

ETSI TS 125 423 V9.9.0 (2012-04)



**Universal Mobile Telecommunications System (UMTS);
UTRAN Iur interface Radio Network Subsystem
Application Part (RNSAP) signalling
(3GPP TS 25.423 version 9.9.0 Release 9)**



Reference

RTS/TSGR-0325423v990

Keywords

UMTS

ETSI

650 Route des Lucioles
F-06921 Sophia Antipolis Cedex - FRANCE

Tel.: +33 4 92 94 42 00 Fax: +33 4 93 65 47 16

Siret N° 348 623 562 00017 - NAF 742 C
Association à but non lucratif enregistrée à la
Sous-Préfecture de Grasse (06) N° 7803/88

Important notice

Individual copies of the present document can be downloaded from:

<http://www.etsi.org>

The present document may be made available in more than one electronic version or in print. In any case of existing or perceived difference in contents between such versions, the reference version is the Portable Document Format (PDF). In case of dispute, the reference shall be the printing on ETSI printers of the PDF version kept on a specific network drive within ETSI Secretariat.

Users of the present document should be aware that the document may be subject to revision or change of status. Information on the current status of this and other ETSI documents is available at

<http://portal.etsi.org/tb/status/status.asp>

If you find errors in the present document, please send your comment to one of the following services:

http://portal.etsi.org/chaicor/ETSI_support.asp

Copyright Notification

No part may be reproduced except as authorized by written permission.
The copyright and the foregoing restriction extend to reproduction in all media.

© European Telecommunications Standards Institute 2012.
All rights reserved.

DECT™, **PLUGTESTS™**, **UMTS™** and the ETSI logo are Trade Marks of ETSI registered for the benefit of its Members.
3GPP™ and **LTE™** are Trade Marks of ETSI registered for the benefit of its Members and of the 3GPP Organizational Partners.
GSM® and the GSM logo are Trade Marks registered and owned by the GSM Association.

Intellectual Property Rights

IPRs essential or potentially essential to the present document may have been declared to ETSI. The information pertaining to these essential IPRs, if any, is publicly available for **ETSI members and non-members**, and can be found in ETSI SR 000 314: *"Intellectual Property Rights (IPRs); Essential, or potentially Essential, IPRs notified to ETSI in respect of ETSI standards"*, which is available from the ETSI Secretariat. Latest updates are available on the ETSI Web server (<http://ipr.etsi.org>).

Pursuant to the ETSI IPR Policy, no investigation, including IPR searches, has been carried out by ETSI. No guarantee can be given as to the existence of other IPRs not referenced in ETSI SR 000 314 (or the updates on the ETSI Web server) which are, or may be, or may become, essential to the present document.

Foreword

This Technical Specification (TS) has been produced by ETSI 3rd Generation Partnership Project (3GPP).

The present document may refer to technical specifications or reports using their 3GPP identities, UMTS identities or GSM identities. These should be interpreted as being references to the corresponding ETSI deliverables.

The cross reference between GSM, UMTS, 3GPP and ETSI identities can be found under <http://webapp.etsi.org/key/queryform.asp>.

Contents

Intellectual Property Rights	2
Foreword.....	2
Foreword.....	22
1 Scope	23
2 References	23
3 Definitions, Symbols and Abbreviations.....	25
3.1 Definitions	25
3.2 Symbols.....	26
3.3 Abbreviations	26
4 General	29
4.1 Procedure Specification Principles.....	29
4.2 Forwards and Backwards Compatibility	30
4.3 Source Signalling Address Handling.....	30
4.4 Specification Notations	30
5 RNSAP Services	31
5.1 RNSAP Procedure Modules	31
5.2 Parallel Transactions	32
6 Services Expected from Signalling Transport.....	32
7 Functions of RNSAP	32
7.1 RNSAP functions and elementary procedures for Iur-g.....	35
8 RNSAP Procedures	35
8.1 Elementary Procedures.....	35
8.2 Basic Mobility Procedures	37
8.2.1 Uplink Signalling Transfer	37
8.2.1.1 General	37
8.2.1.2 Successful Operation.....	38
8.2.1.3 Abnormal Conditions	39
8.2.1A GERAN Uplink Signalling Transfer.....	40
8.2.1A.1 General	40
8.2.1A.2 Successful Operation.....	40
8.2.1A.3 Abnormal Conditions	40
8.2.2 Downlink Signalling Transfer.....	40
8.2.2.1 General	40
8.2.2.1.1 Downlink Signalling Transfer for Iur-g.....	41
8.2.2.2 Successful Operation.....	41
8.2.2.2.1 Successful Operation for Iur-g	41
8.2.2.3 Abnormal Conditions	42
8.2.2.3.1 Abnormal Conditions for Iur-g.....	42
8.2.3 Relocation Commit	42
8.2.3.1 General	42
8.2.3.2 Successful Operation.....	42
8.2.3.2.1 Successful Operation for Iur-g	43
8.2.3.3 Abnormal Conditions	43
8.2.4 Paging	43
8.2.4.1 General	43
8.2.4.2 Successful Operation.....	43
8.2.4.2.1 Successful Operation for Iur-g	43
8.2.4.3 Abnormal Conditions	44
8.2.4.3.1 Abnormal Conditions for Iur-g.....	44
8.2.5 MBSFN MCCH Information	44
8.2.5.1 General	44

8.2.5.2	Successful Operation.....	44
8.2.5.3	Abnormal Conditions	44
8.3	Dedicated Procedures	45
8.3.1	Radio Link Setup	45
8.3.1.1	General	45
8.3.1.2	Successful Operation.....	45
8.3.1.3	Unsuccessful Operation	72
8.3.1.4	Abnormal Conditions	74
8.3.2	Radio Link Addition	77
8.3.2.1	General	77
8.3.2.2	Successful Operation.....	77
8.3.2.3	Unsuccessful Operation	106
8.3.2.4	Abnormal Conditions	107
8.3.3	Radio Link Deletion.....	110
8.3.3.1	General	110
8.3.3.2	Successful Operation.....	111
8.3.3.3	Unsuccessful Operation	111
8.3.3.4	Abnormal Conditions	111
8.3.4	Synchronised Radio Link Reconfiguration Preparation.....	111
8.3.4.1	General	111
8.3.4.2	Successful Operation.....	112
8.3.4.3	Unsuccessful Operation	153
8.3.4.4	Abnormal Conditions	155
8.3.5	Synchronised Radio Link Reconfiguration Commit.....	159
8.3.5.1	General	159
8.3.5.2	Successful Operation.....	159
8.3.5.3	Abnormal Conditions	160
8.3.6	Synchronised Radio Link Reconfiguration Cancellation.....	160
8.3.6.1	General	160
8.3.6.2	Successful Operation.....	161
8.3.6.3	Abnormal Conditions	161
8.3.7	Unsynchronised Radio Link Reconfiguration.....	161
8.3.7.1	General	161
8.3.7.2	Successful Operation.....	161
8.3.7.3	Unsuccessful Operation	196
8.3.7.4	Abnormal Conditions	197
8.3.8	Physical Channel Reconfiguration.....	201
8.3.8.1	General	201
8.3.8.2	Successful Operation.....	201
8.3.8.3	Unsuccessful Operation	202
8.3.8.4	Abnormal Conditions	202
8.3.9	Radio Link Failure	203
8.3.9.1	General	203
8.3.9.2	Successful Operation.....	203
8.3.9.3	Abnormal Conditions	204
8.3.10	Radio Link Restoration	204
8.3.10.1	General	204
8.3.10.2	Successful Operation.....	204
8.3.10.3	Abnormal Conditions	204
8.3.11	Dedicated Measurement Initiation	205
8.3.11.1	General	205
8.3.11.2	Successful Operation.....	205
8.3.11.3	Unsuccessful Operation	208
8.3.11.4	Abnormal Conditions	208
8.3.12	Dedicated Measurement Reporting.....	209
8.3.12.1	General	209
8.3.12.2	Successful Operation.....	209
8.3.12.3	Abnormal Conditions	210
8.3.13	Dedicated Measurement Termination.....	210
8.3.13.1	General	210
8.3.13.2	Successful Operation.....	210
8.3.13.3	Abnormal Conditions	211

8.3.14	Dedicated Measurement Failure	211
8.3.14.1	General	211
8.3.14.2	Successful Operation.....	211
8.3.14.3	Abnormal Conditions	211
8.3.15	Downlink Power Control [FDD]	211
8.3.15.1	General	211
8.3.15.2	Successful Operation.....	212
8.3.15.3	Abnormal Conditions	212
8.3.16	Compressed Mode Command [FDD]	213
8.3.16.1	General	213
8.3.16.2	Successful Operation.....	213
8.3.16.3	Abnormal Conditions	213
8.3.17	Downlink Power Timeslot Control [TDD]	213
8.3.17.1	General	213
8.3.17.2	Successful Operation.....	214
8.3.17.3	Abnormal Conditions	214
8.3.18	Radio Link Pre-emption.....	214
8.3.18.1	General	214
8.3.18.2	Successful Operation.....	214
8.3.18.3	Abnormal Conditions	215
8.3.19	Radio Link Congestion	215
8.3.19.1	General	215
8.3.19.2	Successful Operation.....	215
8.3.19.3	Abnormal Conditions	216
8.3.20	Radio Link Activation	216
8.3.20.1	General	216
8.3.20.2	Successful Operation.....	216
8.3.20.3	Abnormal Conditions	217
8.3.21	Radio Link Parameter Update.....	217
8.3.21.1	General	217
8.3.21.2	Successful Operation.....	217
8.3.21.3	Abnormal Conditions	219
8.3.22	UE Measurement Initiation [TDD].....	219
8.3.22.1	General	219
8.3.22.2	Successful Operation.....	219
8.3.22.3	Unsuccessful Operation	220
8.3.22.4	Abnormal Conditions	221
8.3.23	UE Measurement Reporting [TDD].....	221
8.3.23.1	General	221
8.3.23.2	Successful Operation.....	221
8.3.23.3	Abnormal Conditions	221
8.3.24	UE Measurement Termination [TDD].....	221
8.3.24.1	General	221
8.3.24.2	Successful Operation.....	222
8.3.24.3	Abnormal Conditions	222
8.3.25	UE Measurement Failure [TDD]	222
8.3.25.1	General	222
8.3.25.2	Successful Operation.....	222
8.3.25.3	Abnormal Conditions	223
8.3.26	Iur Invoke Trace	223
8.3.26.1	General	223
8.3.26.2	Successful Operation.....	223
8.3.26.3	Abnormal Conditions	223
8.3.27	Iur Deactivate Trace.....	223
8.3.27.1	General	223
8.3.27.2	Successful Operation.....	224
8.3.27.3	Abnormal Conditions	224
8.3.28	Enhanced Relocation	224
8.3.28.1	General.....	224
8.3.28.2	Successful Operation.....	224
8.3.28.3	Unsuccessful Operation	225
8.3.28.4	Abnormal Conditions	225

8.3.29	Enhanced Relocation Cancel	225
8.3.29.1	General	225
8.3.29.2	Successful Operation	225
8.3.29.3	Unsuccessful Operation	225
8.3.29.4	Abnormal Conditions	226
8.3.30	Enhanced Relocation Signalling Transfer	226
8.3.30.1	General	226
8.3.30.2	Successful Operation	226
8.3.30.3	Abnormal Conditions	226
8.3.31	Enhanced Relocation Release	226
8.3.31.1	General	226
8.3.31.2	Successful Operation	226
8.3.31.3	Abnormal Conditions	227
8.3.32	Secondary UL Frequency Reporting [FDD]	227
8.3.32.1	General	227
8.3.32.2	Successful Operation	227
8.3.32.3	Abnormal Conditions	227
8.3.33	Secondary UL Frequency Update [FDD]	227
8.3.33.1	General	227
8.3.33.2	Successful Operation	228
8.3.33.3	Abnormal Conditions	228
8.4	Common Transport Channel Procedures	228
8.4.1	Common Transport Channel Resources Initialisation	228
8.4.1.1	General	228
8.4.1.2	Successful Operation	228
8.4.1.3	Unsuccessful Operation	230
8.4.1.4	Abnormal Conditions	230
8.4.2	Common Transport Channel Resources Release	231
8.4.2.1	General	231
8.4.2.2	Successful Operation	231
8.4.2.3	Abnormal Conditions	231
8.5	Global Procedures	231
8.5.1	Error Indication	231
8.5.1.1	General	231
8.5.1.2	Successful Operation	231
8.5.1.2.1	Successful Operation for Iur-g	232
8.5.1.3	Abnormal Conditions	232
8.5.2	Common Measurement Initiation	232
8.5.2.1	General	232
8.5.2.2	Successful Operation	233
8.5.2.2.1	Successful Operation for Iur-g	239
8.5.2.3	Unsuccessful Operation	240
8.5.2.4	Abnormal Conditions	240
8.5.2.4.1	Abnormal Conditions for Iur-g	242
8.5.3	Common Measurement Reporting	242
8.5.3.1	General	242
8.5.3.2	Successful Operation	242
8.5.3.2.1	Successful Operation for Iur-g	243
8.5.3.3	Abnormal Conditions	243
8.5.4	Common Measurement Termination	243
8.5.4.1	General	243
8.5.4.2	Successful Operation	244
8.5.4.2.1	Successful Operation for Iur-g	244
8.5.4.3	Abnormal Conditions	244
8.5.5	Common Measurement Failure	244
8.5.5.1	General	244
8.5.5.2	Successful Operation	244
8.5.5.2.1	Successful Operation for Iur-g	244
8.5.5.3	Abnormal Conditions	244
8.5.6	Information Exchange Initiation	245
8.5.6.1	General	245
8.5.6.2	Successful Operation	245

8.5.6.2.1	Successful Operation for Iur-g	248
8.5.6.3	Unsuccessful Operation	249
8.5.6.4	Abnormal Conditions	249
8.5.6.4.1	Abnormal Conditions for Iur-g	250
8.5.7	Information Reporting	250
8.5.7.1	General	250
8.5.7.2	Successful Operation.....	251
8.5.7.2.1	Successful Operation for Iur-g	251
8.5.7.3	Abnormal Conditions	251
8.5.8	Information Exchange Termination.....	251
8.5.8.1	General	251
8.5.8.2	Successful Operation.....	251
8.5.8.2.1	Successful Operation for Iur-g	251
8.5.8.3	Abnormal Conditions	252
8.5.9	Information Exchange Failure	252
8.5.9.1	General	252
8.5.9.2	Successful Operation.....	252
8.5.9.2.1	Successful Operation for Iur-g	252
8.5.10	Reset	252
8.5.10.1	General	252
8.5.10.2	Successful Operation.....	252
8.5.10.3	Abnormal Conditions	253
8.5.11	Direct Information Transfer	253
8.5.11.1	General	253
8.5.11.2	Successful Operation.....	253
8.6	MBMS Procedures	254
8.6.1	MBMS Attach.....	254
8.6.1.1	General	254
8.6.1.2	Successful Operation.....	254
8.6.1.3	Abnormal Conditions	255
8.6.2	MBMS Detach	255
8.6.2.1	General	255
8.6.2.2	Successful Operation.....	255
8.6.2.3	Abnormal Conditions	255
9	Elements for RNSAP Communication.....	255
9.1	Message Functional Definition and Content	255
9.1.1	General.....	255
9.1.2	Message Contents	256
9.1.2.1	Presence	256
9.1.2.2	Criticality	256
9.1.2.3	Range	256
9.1.2.4	Assigned Criticality.....	256
9.1.3	RADIO LINK SETUP REQUEST	257
9.1.3.1	FDD Message.....	257
9.1.3.2	TDD Message	261
9.1.4	RADIO LINK SETUP RESPONSE	265
9.1.4.1	FDD Message.....	265
9.1.4.2	TDD Message	268
9.1.5	RADIO LINK SETUP FAILURE	274
9.1.5.1	FDD Message.....	274
9.1.5.2	TDD Message	277
9.1.6	RADIO LINK ADDITION REQUEST	278
9.1.6.1	FDD Message.....	278
9.1.6.2	TDD Message	281
9.1.7	RADIO LINK ADDITION RESPONSE	283
9.1.7.1	FDD Message.....	283
9.1.7.2	TDD Message	286
9.1.8	RADIO LINK ADDITION FAILURE	293
9.1.8.1	FDD Message.....	293
9.1.8.2	TDD Message	295
9.1.9	RADIO LINK DELETION REQUEST.....	295

9.1.10	RADIO LINK DELETION RESPONSE.....	296
9.1.11	RADIO LINK RECONFIGURATION PREPARE	297
9.1.11.1	FDD Message.....	297
9.1.11.2	TDD Message	302
9.1.12	RADIO LINK RECONFIGURATION READY	308
9.1.12.1	FDD Message.....	308
9.1.12.2	TDD Message	310
9.1.13	RADIO LINK RECONFIGURATION COMMIT	315
9.1.14	RADIO LINK RECONFIGURATION FAILURE.....	315
9.1.15	RADIO LINK RECONFIGURATION CANCEL.....	316
9.1.16	RADIO LINK RECONFIGURATION REQUEST.....	317
9.1.16.1	FDD Message.....	317
9.1.16.2	TDD Message	321
9.1.17	RADIO LINK RECONFIGURATION RESPONSE.....	324
9.1.17.1	FDD Message.....	324
9.1.17.2	TDD Message	326
9.1.18	RADIO LINK FAILURE INDICATION	328
9.1.19	RADIO LINK RESTORE INDICATION	328
9.1.20	DL POWER CONTROL REQUEST [FDD].....	329
9.1.21	PHYSICAL CHANNEL RECONFIGURATION REQUEST	329
9.1.21.1	FDD Message.....	329
9.1.21.2	TDD Message	330
9.1.22	PHYSICAL CHANNEL RECONFIGURATION COMMAND	332
9.1.23	PHYSICAL CHANNEL RECONFIGURATION FAILURE	332
9.1.24	UPLINK SIGNALLING TRANSFER INDICATION	332
9.1.24.1	FDD Message.....	332
9.1.24.2	TDD Message	334
9.1.24A	GERAN UPLINK SIGNALLING TRANSFER INDICATION	335
9.1.25	DOWNLINK SIGNALLING TRANSFER REQUEST	335
9.1.26	RELOCATION COMMIT	336
9.1.27	PAGING REQUEST	336
9.1.28	DEDICATED MEASUREMENT INITIATION REQUEST	337
9.1.29	DEDICATED MEASUREMENT INITIATION RESPONSE.....	338
9.1.30	DEDICATED MEASUREMENT INITIATION FAILURE	340
9.1.31	DEDICATED MEASUREMENT REPORT	341
9.1.32	DEDICATED MEASUREMENT TERMINATION REQUEST	341
9.1.33	DEDICATED MEASUREMENT FAILURE INDICATION	342
9.1.34	COMMON TRANSPORT CHANNEL RESOURCES RELEASE REQUEST.....	342
9.1.35	COMMON TRANSPORT CHANNEL RESOURCES REQUEST	343
9.1.36	COMMON TRANSPORT CHANNEL RESOURCES RESPONSE.....	345
9.1.36.1	FDD Message.....	345
9.1.36.2	TDD Message	347
9.1.37	COMMON TRANSPORT CHANNEL RESOURCES FAILURE	348
9.1.38	COMPRESSED MODE COMMAND [FDD].....	348
9.1.39	ERROR INDICATION.....	348
9.1.40	DL POWER TIMESLOT CONTROL REQUEST [TDD].....	349
9.1.41	RADIO LINK PREEMPTION REQUIRED INDICATION	349
9.1.42	RADIO LINK CONGESTION INDICATION	350
9.1.43	COMMON MEASUREMENT INITIATION REQUEST	351
9.1.44	COMMON MEASUREMENT INITIATION RESPONSE	353
9.1.45	COMMON MEASUREMENT INITIATION FAILURE	353
9.1.46	COMMON MEASUREMENT REPORT	354
9.1.47	COMMON MEASUREMENT TERMINATION REQUEST	354
9.1.48	COMMON MEASUREMENT FAILURE INDICATION.....	354
9.1.49	INFORMATION EXCHANGE INITIATION REQUEST	355
9.1.50	INFORMATION EXCHANGE INITIATION RESPONSE	356
9.1.51	INFORMATION EXCHANGE INITIATION FAILURE	357
9.1.52	INFORMATION REPORT	357
9.1.53	INFORMATION EXCHANGE TERMINATION REQUEST	358
9.1.54	INFORMATION EXCHANGE FAILURE INDICATION	358
9.1.55	RESET REQUEST	358
9.1.56	RESET RESPONSE	360

9.1.57	RADIO LINK ACTIVATION COMMAND.....	360
9.1.57.1	FDD Message.....	360
9.1.57.2	TDD Message	360
9.1.58	RADIO LINK PARAMETER UPDATE INDICATION	361
9.1.58.1	FDD Message.....	361
9.1.58.2	TDD Message	361
9.1.59	UE MEASUREMENT INITIATION REQUEST [TDD]	362
9.1.60	UE MEASUREMENT INITIATION RESPONSE [TDD]	362
9.1.61	UE MEASUREMENT INITIATION FAILURE [TDD].....	362
9.1.62	UE MEASUREMENT REPORT [TDD].....	362
9.1.63	UE MEASUREMENT TERMINATION REQUEST [TDD]	363
9.1.64	UE MEASUREMENT FAILURE INDICATION [TDD].....	363
9.1.65	IUR INVOKE TRACE	363
9.1.66	IUR DEACTIVATE TRACE	363
9.1.67	MBMS ATTACH COMMAND	364
9.1.68	MBMS DETACH COMMAND	365
9.1.69	DIRECT INFORMATION TRANSFER.....	365
9.1.70	ENHANCED RELOCATION REQUEST	366
9.1.71	ENHANCED RELOCATION RESPONSE	366
9.1.72	ENHANCED RELOCATION FAILURE	366
9.1.73	ENHANCED RELOCATION CANCEL	366
9.1.74	ENHANCED RELOCATION SIGNALLING TRANSFER.....	367
9.1.75	ENHANCED RELOCATION RELEASE.....	367
9.1.76	MBSFN MCCH INFORMATION (FDD).....	367
9.1.77	SECONDARY UL FREQUENCY REPORT	368
9.1.77.1	FDD Message.....	368
9.1.78	SECONDARY UL FREQUENCY UPDATE INDICATION.....	368
9.1.78.1	FDD Message.....	368
9.2	Information Element Functional Definition and Contents	368
9.2.0	General.....	368
9.2.1	Common Parameters.....	368
9.2.1.1	Allocation/Retention Priority	368
9.2.1.2	Allowed Queuing Time.....	369
9.2.1.2A	Allowed Rate Information.....	369
9.2.1.2B	Altitude and Direction.....	369
9.2.1.2C	Antenna Co-location Indicator	370
9.2.1.2D	Alternative Format Reporting Indicator	370
9.2.1.3	Binding ID.....	370
9.2.1.4	BLER	371
9.2.1.4A	Block STTD Indicator.....	371
9.2.1.4B	Burst Mode Parameters	371
9.2.1.5	Cause.....	371
9.2.1.5A	Cell Geographical Area Identity (Cell GAI)	377
9.2.1.5B	Cell Geographical Area Additional Shapes (Cell GAI Additional Shapes)	378
9.2.1.5C	Cell Capacity Class Value.....	378
9.2.1.5D	Cell Global Identifier (CGI).....	379
9.2.1.6	Cell Identifier (C-ID)	379
9.2.1.7	Cell Individual Offset.....	379
9.2.1.8	Cell Parameter ID.....	380
9.2.1.9	CFN.....	380
9.2.1.10	CFN Offset.....	380
9.2.1.11	CN CS Domain Identifier.....	380
9.2.1.11A	CN Domain Type	381
9.2.1.12	CN PS Domain Identifier	381
9.2.1.12A	Common Measurement Accuracy.....	381
9.2.1.12B	Common Measurement Object Type	382
9.2.1.12C	Common Measurement Type	382
9.2.1.12D	Common Measurement Value.....	382
9.2.1.12E	Common Measurement Value Information.....	383
9.2.1.12F	Common Transport Channel Resources Initialisation Not Required	384
9.2.1.12G	Coverage Indicator	384
9.2.1.13	Criticality Diagnostics.....	384

9.2.1.14	C-RNTI	386
9.2.1.14A	CTFC.....	386
9.2.1.15	DCH Combination Indicator	387
9.2.1.16	DCH ID	387
9.2.1.16A	DCH Information Response	387
9.2.1.17	Dedicated Measurement Object Type	387
9.2.1.18	Dedicated Measurement Type.....	387
9.2.1.19	Dedicated Measurement Value	388
9.2.1.19A	Dedicated Measurement Value Information	390
9.2.1.19Aa	Delayed Activation.....	390
9.2.1.19Ab	Delayed Activation Update	391
9.2.1.19B	DGPS Corrections.....	391
9.2.1.19C	Discard Timer	392
9.2.1.20	Diversity Control Field	393
9.2.1.21	Diversity Indication.....	393
9.2.1.21A	DL Power	393
9.2.1.22	Downlink SIR Target	393
9.2.1.23	DPCH Constant Value	393
9.2.1.24	D-RNTI	394
9.2.1.25	D-RNTI Release Indication.....	394
9.2.1.26	DRX Cycle Length Coefficient.....	394
9.2.1.26A	DSCH ID.....	394
9.2.1.26Aa	DSCH Initial Window Size	394
9.2.1.26B	DSCH Flow Control Information.....	394
9.2.1.26Ba	DSCH-RNTI	394
9.2.1.26Bb	Extended GSM Cell Individual Offset	395
9.2.1.26C	FACH Flow Control Information.....	395
9.2.1.27	FACH Initial Window Size	395
9.2.1.28	FACH Priority Indicator	395
9.2.1.28A	FN Reporting Indicator	395
9.2.1.29	Frame Handling Priority	396
9.2.1.30	Frame Offset	396
9.2.1.30A	GA Point with Uncertainty.....	396
9.2.1.30B	GA Ellipsoid Point with Uncertainty Ellipse	396
9.2.1.30C	GA Ellipsoid Point with Altitude	396
9.2.1.30D	GA Ellipsoid Point with Altitude and Uncertainty Ellipsoid	397
9.2.1.30E	GA Ellipsoid Arc	397
9.2.1.30F	Geographical Coordinates.....	397
9.2.1.30Fa	GERAN Cell Capability.....	398
9.2.1.30Fb	GERAN Classmark	398
9.2.1.30Fc	GERAN System Information	398
9.2.1.30G	GPS Almanac	399
9.2.1.30H	GPS Ionospheric Model	400
9.2.1.30I	GPS Navigation Model and Time Recovery	400
9.2.1.30J	GPS Real-Time Integrity.....	401
9.2.1.30K	GPS Receiver Geographical Position (GPS RX Pos).....	402
9.2.1.30L	GPS UTC Model.....	402
9.2.1.30M	Guaranteed Rate Information	402
9.2.1.30N	HCS Prio	402
9.2.1.30NA	HS-DSCH Information To Modify Unsynchronised	403
9.2.1.30Na	HS-DSCH Initial Capacity Allocation	404
9.2.1.30Nb	HS-DSCH Initial Window Size.....	405
9.2.1.30O	HS-DSCH MAC-d Flow ID.....	405
9.2.1.30OA	HS-DSCH MAC-d Flows Information.....	405
9.2.1.30OB	HS-DSCH MAC-d Flows To Delete.....	407
9.2.1.30OC	HS-DSCH MAC-d PDU Size Format	407
9.2.1.30Oa	HS-DSCH Physical Layer Category	407
9.2.1.30P	HS-DSCH-RNTI.....	408
9.2.1.30Q	HS-DSCH Information To Modify	408
9.2.1.30R	HS-SCCH Code Change Indicator	412
9.2.1.30S	HS-SCCH Code Change Grant	412
9.2.1.30T	IMEI.....	412

9.2.1.30U	IMEISV	412
9.2.1.30V	HS-PDSCH Code Change Indicator [FDD]	413
9.2.1.30W	HS-PDSCH Code Change Grant [FDD]	413
9.2.1.31	IMSI	413
9.2.1.31A	Information Exchange ID	413
9.2.1.31B	Information Exchange Object Type	414
9.2.1.31C	Information Report Characteristics	414
9.2.1.31D	Information Threshold	414
9.2.1.31E	Information Type	414
9.2.1.31F	IPDL Parameters	417
9.2.1.31G	Inter-frequency Cell Information	418
9.2.1.32	L3 Information	418
9.2.1.33	Limited Power Increase	418
9.2.1.33A	Load Value	419
9.2.1.34	MAC-c/sh SDU Length	419
9.2.1.34A	MAC-d PDU Size	419
9.2.1.34Aa	MAC-hs Guaranteed Bit Rate	419
9.2.1.34Ab	MAC-hs Reordering Buffer Size for RLC-UM	419
9.2.1.34B	MAC-hs Reset Indicator	420
9.2.1.34C	MAC-hs Window Size	420
9.2.1.34D	MAC PDU Size Extended	420
9.2.1.35	Maximum Allowed UL Tx Power	420
9.2.1.35A	Measurement Availability Indicator	420
9.2.1.35B	Measurement Change Time	421
9.2.1.36	Measurement Filter Coefficient	421
9.2.1.36A	Measurement Hysteresis Time	421
9.2.1.37	Measurement ID	421
9.2.1.38	Measurement Increase/Decrease Threshold	421
9.2.1.38A	Measurement Recovery Behavior	423
9.2.1.38B	Measurement Recovery Reporting Indicator	423
9.2.1.38C	Measurement Recovery Support Indicator	423
9.2.1.39	Measurement Threshold	423
9.2.1.39A	Message Structure	425
9.2.1.40	Message Type	426
9.2.1.41	Multiple URAs Indicator	428
9.2.1.41a	NACC Related Data	428
9.2.1.41A	Neighbouring UMTS Cell Information	428
9.2.1.41B	Neighbouring FDD Cell Information	429
9.2.1.41C	Neighbouring GSM Cell Information	431
9.2.1.41D	Neighbouring TDD Cell Information	433
9.2.1.41Dd	Neighbouring TDD Cell Measurement Information LCR	434
9.2.1.41De	Neighbouring E-UTRA Cell Information	434
9.2.1.41Df	EARFCN	435
9.2.1.41E	Paging Cause	435
9.2.1.41F	Paging Record Type	435
9.2.1.41Fa	Partial Reporting Indicator	436
9.2.1.41G	Neighbouring FDD Cell Measurement Information	436
9.2.1.41H	Neighbouring TDD Cell Measurement Information	436
9.2.1.41I	NRT Load Information Value	436
9.2.1.42	Payload CRC Present Indicator	437
9.2.1.43	PCCPCH Power	437
9.2.1.44	Primary CPICH Power	438
9.2.1.45	Primary Scrambling Code	438
9.2.1.45A	Priority Queue ID	438
9.2.1.45B	Process Memory Size	438
9.2.1.46	Puncture Limit	439
9.2.1.46A	QE-Selector	439
9.2.1.47	RANAP Relocation Information	439
9.2.1.48	Report Characteristics	439
9.2.1.48a	Report Periodicity	441
9.2.1.48A	Requested Data Value	441
9.2.1.48B	Requested Data Value Information	443

9.2.1.48C	Restriction State Indicator	443
9.2.1.48D	RLC Mode.....	443
9.2.1.49	RL ID	443
9.2.1.49A	RL Specific DCH Information	444
9.2.1.50	RNC-ID	444
9.2.1.50a	Extended RNC-ID.....	444
9.2.1.50A	SAT ID.....	444
9.2.1.50B	RT Load Value.....	445
9.2.1.51	SCH Time Slot.....	445
9.2.1.51A	Scheduling Priority Indicator	445
9.2.1.52	Service Area Identifier (SAI)	445
9.2.1.52A	SFN	446
9.2.1.52B	SFN-SFN Measurement Threshold Information	446
9.2.1.52C	SFN-SFN Measurement Value Information.....	446
9.2.1.52Ca	Shared Network Area (SNA) Information	447
9.2.1.52D	SID	448
9.2.1.53	S-RNTI.....	448
9.2.1.53a	S-RNTI Group.....	448
9.2.1.54	Sync Case.....	449
9.2.1.54A	T1	449
9.2.1.55	TFCI Presence.....	449
9.2.1.56	Time Slot.....	449
9.2.1.56A	TNL QoS.....	450
9.2.1.57	ToAWE	450
9.2.1.58	ToAWS	450
9.2.1.58a	Trace Depth.....	450
9.2.1.58b	Trace Recording Session Reference.....	451
9.2.1.58c	Trace Reference	451
9.2.1.58A	Traffic Class	451
9.2.1.59	Transaction ID.....	451
9.2.1.59A	Transmitted Carrier Power.....	452
9.2.1.59B	T _{UTRAN-GPS} Accuracy Class.....	452
9.2.1.59C	T _{UTRAN-GPS} Measurement Threshold Information.....	452
9.2.1.59D	T _{UTRAN-GPS} Measurement Value Information.....	452
9.2.1.60	Transport Bearer ID	453
9.2.1.61	Transport Bearer Request Indicator	453
9.2.1.62	Transport Layer Address.....	454
9.2.1.63	Transport Format Combination Set (TFCS).....	454
9.2.1.64	Transport Format Set.....	455
9.2.1.65	TrCH Source Statistics Descriptor	457
9.2.1.66	UARFCN	457
9.2.1.66A	UE Identity	457
9.2.1.67	UL FP Mode.....	457
9.2.1.68	UL Interference Level.....	458
9.2.1.68A	Uncertainty Ellipse.....	458
9.2.1.68B	Unidirectional DCH Indicator.....	458
9.2.1.69	Uplink SIR	458
9.2.1.70	URA ID	458
9.2.1.70A	UTRAN Access Point Position	458
9.2.1.70B	URA Information	459
9.2.1.70C	User Plane Congestion Fields Inclusion.....	459
9.2.1.71	UTRAN Cell Identifier (UC-ID).....	460
9.2.1.72	Neighbouring TDD Cell Information LCR.....	460
9.2.1.73	Permanent NAS UE Identity	460
9.2.1.74	SFN-SFN Measurement Reference Point Position.....	461
9.2.1.75	UTRAN Access Point Position with Altitude	461
9.2.1.76	SFN-SFN Measurement Time Stamp	461
9.2.1.77	SFN-SFN Value	461
9.2.1.78	SCTD Indicator	461
9.2.1.79	Congestion Cause.....	462
9.2.1.80	TMGI	462
9.2.1.81	Transmission Mode.....	462

9.2.1.82	Access Point Name	463
9.2.1.83	IP Multicast Address	463
9.2.1.84	MBMS Bearer Service Full Address	463
9.2.1.85	Provided Information	463
9.2.1.86	MBMS Channel Type Information	464
9.2.1.87	MBMS Preferred Frequency Layer Information	464
9.2.1.88	E-DCH DDI Value	465
9.2.1.89	E-DCH MAC-d Flow Multiplexing List	465
9.2.1.90	E-DCH MAC-d Flows To Delete	465
9.2.1.91	E-DCH MAC-d Flow ID	465
9.2.1.91A	E-DCH MAC-d PDU Size Format	466
9.2.1.92	E-DCH Logical Channel Information	466
9.2.1.93	E-DCH Logical Channel To Modify	467
9.2.1.94	E-RNTI	468
9.2.1.95	E-DCH Processing Overload Level	468
9.2.1.96	E-DCH Power Offset for Scheduling Info	469
9.2.1.97	Logical channel ID	469
9.2.1.98	MAC-es Guaranteed Bit Rate	469
9.2.1.99	MAC-e Reset Indicator	469
9.2.1.100	Maximum Number of Retransmissions for E-DCH	470
9.2.1.101	Scheduling Information	470
9.2.1.102	DGANSS Corrections	470
9.2.1.103	GANSS Almanac	472
9.2.1.104	GANSS Clock Model	476
9.2.1.104a	GANSS Additional Clock Models	477
9.2.1.105	GANSS Ionospheric Model	480
9.2.1.105a	GANSS Additional Ionospheric Model	480
9.2.1.106	GANSS Navigation Model	480
9.2.1.107	GANSS Orbit Model	481
9.2.1.107a	GANSS Additional Orbit Models	482
9.2.1.108	GANSS Real Time Integrity	486
9.2.1.109	GANSS Receiver Geographical Position (GANSS RX Pos)	487
9.2.1.110	GANSS Time Model	487
9.2.1.110a	GANSS Additional Time Models	487
9.2.1.111	GANSS UTC Model	488
9.2.1.111a	GANSS Additional UTC Models	488
9.2.1.112	T _{UTRAN-GANSS} Accuracy Class	490
9.2.1.113	T _{UTRAN-GANSS} Measurement Threshold Information	490
9.2.1.114	T _{UTRAN-GANSS} Measurement Value Information	491
9.2.1.115	GANSS Reference Time	493
9.2.1.116	HARQ Memory Partitioning	494
9.2.1.117	Multiple PLMN List	495
9.2.1.118	GANSS Data Bit Assistance	495
9.2.1.119	GANSS ID	496
9.2.1.119a	GANSS Time ID	496
9.2.1.120	GANSS Navigation Model And Time Recovery	496
9.2.1.120a	GANSS Additional Navigation Models And Time Recovery	497
9.2.1.121	GANSS Signal ID	498
9.2.1.122	GANSS Transmission Time	498
9.2.1.122a	GANSS Earth Orientation Parameters	498
9.2.1.122b	SBAS ID	499
9.2.1.122c	GANSS Auxiliary Information	499
9.2.1.122d	Additional Ionospheric Model Request	500
9.2.1.122e	Earth Orientation Parameters Request	500
9.2.1.122f	GANSS Additional Navigation Models And Time Recovery Request	500
9.2.1.122g	GANSS Additional UTC Models Request	501
9.2.1.122h	GANSS Auxiliary Information Request	501
9.2.1.123	SixtyfourQAM DL Support Indicator	501
9.2.1.124	RANAP Enhanced Relocation Information Request	501
9.2.1.125	RANAP Enhanced Relocation Information Response	501
9.2.1.126	Released CN Domain	501
9.2.1.127	Secondary CCPC system information MBMS	502

9.2.1.128	MBSFN Cluster Identity	502
9.2.1.129	MBSFN Scheduling Transmission Time Interval	502
9.2.1.130	MAC-e-hs Reset Timer	502
9.2.1.131	Enhanced FACH Support Indicator	502
9.2.1.132	Enhanced PCH <i>Capability</i>	503
9.2.1.133	Priority Queue Information for Enhanced FACH/PCH	503
9.2.1.134	MIMO Activation Indicator	503
9.2.1.135	MIMO Mode Indicator.....	503
9.2.1.136	DL RLC PDU Size Format	503
9.2.1.137	UE Aggregate Maximum Bit Rate	504
9.2.1.138	DGNSS Validity Period	504
9.2.2	FDD Specific Parameters.....	505
9.2.2.a	ACK-NACK Repetition Factor.....	505
9.2.2.b	ACK Power Offset	505
9.2.2.A	Active Pattern Sequence Information.....	505
9.2.2.B	Adjustment Period.....	506
9.2.2.C	Adjustment Ratio	506
9.2.2.Ca	Bundling Mode Indicator	506
9.2.2.D	Cell Capability Container FDD.....	507
9.2.2.E	Cell Portion ID	509
9.2.2.1	Chip Offset.....	509
9.2.2.2	Closed Loop Mode1 Support Indicator	510
9.2.2.3	Closed Loop Mode2 Support Indicator	510
9.2.2.3A	Closed Loop Timing Adjustment Mode.....	510
9.2.2.4	Compressed Mode Method	510
9.2.2.4A	DCH FDD Information	510
9.2.2.4B	E-DCH FDD Information	511
9.2.2.4C	E-DCH FDD Information Response	512
9.2.2.4D	E-DCH FDD DL Control Channel Information.....	513
9.2.2.4E	E-DCH RL Indication	515
9.2.2.4F	E-DCH FDD Information To Modify	515
9.2.2.4G	E-DCH Transport Format Combination Set Information (E-TFCS Information).....	518
9.2.2.4J	E-TTI.....	520
9.2.2.4K	E-DPCCH Power Offset	520
9.2.2.4KA	Void.....	520
9.2.2.4L	E-DCH HARQ Power Offset FDD	520
9.2.2.4M	Void.....	520
9.2.2.4MA	Void.....	520
9.2.2.4MB	Void.....	520
9.2.2.4MC	E-DCH MAC-d Flows Information	520
9.2.2.4MD	Void.....	522
9.2.2.4ME	Void.....	522
9.2.2.4MF	Void.....	522
9.2.2.4MG	E-DCH Maximum Bitrate	522
9.2.2.4MH	Void.....	522
9.2.2.4MI	E-DCH Reference Power Offset	522
9.2.2.4MJ	Void.....	523
9.2.2.4N	Maximum Number of Bits per MAC-e PDU for Non-scheduled Transmission	523
9.2.2.4O	HARQ Process Allocation For 2ms TTI	523
9.2.2.4P	Reference E-TFCI Power Offset	523
9.2.2.4Q	Extended Reference E-TFCI Power Offset	523
9.2.2.4R	Extended Maximum Number of Bits per MAC-e PDU for Non-scheduled Transmission	524
9.2.2.4S	Transport Bearer Not Requested Indicator.....	524
9.2.2.4T	Transport Bearer Not Setup Indicator	524
9.2.2.5	D-Field Length.....	524
9.2.2.6	Diversity Control Field	524
9.2.2.7	Diversity Indication.....	524
9.2.2.8	Diversity Mode	524
9.2.2.9	DL DPCH Slot Format.....	525
9.2.2.9A	DL DPCH Timing Adjustment	525
9.2.2.10	DL Power.....	525
9.2.2.10A	DL Power Balancing Information	525

9.2.2.10B	DL Power Balancing Activation Indicator	526
9.2.2.10C	DL Reference Power Information	526
9.2.2.10D	DL Power Balancing Updated Indicator	527
9.2.2.11	DL Scrambling Code.....	527
9.2.2.12	Downlink Frame Type	527
9.2.2.12A	DPC Mode.....	527
9.2.2.13	DRAC Control	527
9.2.2.13A	DSCH FDD Information	528
9.2.2.13B	DSCH FDD Information Response.....	528
9.2.2.13Bb	DSCH-RNTI	528
9.2.2.13C	FDD DCHs To Modify	528
9.2.2.13D	Enhanced DSCH PC	528
9.2.2.13E	Enhanced DSCH PC Counter.....	528
9.2.2.13F	Enhanced DSCH PC Indicator	528
9.2.2.13G	Enhanced DSCH PC Wnd.....	528
9.2.2.13H	Enhanced DSCH Power Offset	529
9.2.2.13I	Enhanced Primary CPICH Ec/No	529
9.2.2.14	FDD DL Channelisation Code Number	529
9.2.2.14A	FDD DL Code Information	529
9.2.2.15	FDD S-CCPCH Offset	529
9.2.2.16	FDD TPC Downlink Step Size.....	529
9.2.2.16A	First RLS Indicator.....	530
9.2.2.17	Gap Position Mode.....	530
9.2.2.18	Gap Period (TGP)	530
9.2.2.19	Gap Starting Slot Number (SN)	530
9.2.2.19a	HS-DSCH FDD Information.....	530
9.2.2.19aa	HS-DSCH FDD Secondary Serving Information.....	532
9.2.2.19b	HS-DSCH FDD Information Response	532
9.2.2.19ba	HS-DSCH FDD Secondary Serving Information Response	533
9.2.2.19bb	HS-DSCH FDD Secondary Serving Information To Modify	534
9.2.2.19bc	HS-DSCH FDD Secondary Serving Information To Modify Unsynchronised	535
9.2.2.19c	HS-DSCH FDD Update Information	535
9.2.2.19ca	HS-DSCH FDD Secondary Serving Update Information	535
9.2.2.19C	HS-DSCH configured indicator	535
9.2.2.19d	HS-SCCH Power Offset.....	536
9.2.2.19e	E-DCH FDD Update Information	536
9.2.2.19f	HS-DSCH Serving Cell Change Information	536
9.2.2.19g	HS-DSCH Serving Cell Change Information Response	537
9.2.2.19ga	HS-DSCH Secondary Serving Cell Change Information Response.....	537
9.2.2.19G	HS-DSCH TB Size Table Indicator	537
9.2.2.19h	E-DCH Serving Cell Change Information Response	538
9.2.2.20	IB_SG_POS	538
9.2.2.21	IB_SG_REP	538
9.2.2.21a	Inner Loop DL PC Status	538
9.2.2.21b	Initial DL DPCH Timing Adjustment Allowed	538
9.2.2.21A	Limited Power Increase.....	538
9.2.2.21B	IPDL FDD Parameters	539
9.2.2.21C	Length of TFCI2	539
9.2.2.21D	Void.....	539
9.2.2.21E	Void.....	539
9.2.2.21F	Void.....	539
9.2.2.22	Max Adjustment Period	539
9.2.2.23	Max Adjustment Step.....	539
9.2.2.24	Max Number of UL DPDCHs.....	539
9.2.2.24a	CQI Feedback Cycle k	540
9.2.2.24b	CQI Power Offset.....	540
9.2.2.24c	CQI Repetition Factor	540
9.2.2.24d	Measurement Power Offset.....	540
9.2.2.24e	Maximum Set of E-DPDCHs	540
9.2.2.24f	Void.....	541
9.2.2.24A	Void.....	541
9.2.2.25	Min UL Channelisation Code Length	541

9.2.2.26	Multiplexing Position.....	541
9.2.2.26a	NACK Power Offset	541
9.2.2.26A	Number of DL Channelisation Codes	541
9.2.2.27	Pattern Duration (PD)	542
9.2.2.27a	PC Preamble.....	542
9.2.2.27A	PDSCH Code Mapping	542
9.2.2.27B	Phase Reference Update Indicator	542
9.2.2.28	Power Adjustment Type.....	542
9.2.2.29	Power Control Mode (PCM).....	542
9.2.2.30	Power Offset	542
9.2.2.31	Power Resume Mode (PRM)	542
9.2.2.31A	Preamble Signatures.....	543
9.2.2.32	Primary CPICH Ec/No.....	543
9.2.2.32A	Primary CPICH Usage For Channel Estimation	543
9.2.2.33	Propagation Delay (PD).....	543
9.2.2.33a	Extended Propagation Delay.....	543
9.2.2.33A	PRACH Minimum Spreading Factor	543
9.2.2.34	QE-Selector	544
9.2.2.34a	Qth Parameter	544
9.2.2.34A	RACH Sub Channel Numbers.....	544
9.2.2.35	RL Set ID	544
9.2.2.35a	RL Specific E-DCH Information	544
9.2.2.35A	Received Total Wide Band Power	544
9.2.2.36	S-Field Length.....	545
9.2.2.36A	Void.....	545
9.2.2.37	Scrambling Code Change.....	545
9.2.2.37A	Scrambling Code Number.....	545
9.2.2.37B	Secondary CCPCH Info	545
9.2.2.38	Secondary CCPCH Slot Format.....	545
9.2.2.38A	Secondary CPICH Information	545
9.2.2.38B	Secondary CPICH Information Change.....	545
9.2.2.38C	Serving E-DCH RL	545
9.2.2.39	Slot Number (SN)	546
9.2.2.39a	Split Type.....	546
9.2.2.39A	SRB Delay.....	546
9.2.2.40	SSDT Cell Identity.....	546
9.2.2.40A	SSDT Cell Identity for EDSCHPC	546
9.2.2.41	SSDT Cell Identity Length.....	546
9.2.2.42	SSDT Indication.....	546
9.2.2.43	SSDT Support Indicator.....	546
9.2.2.44	STTD Indicator	547
9.2.2.45	STTD Support Indicator.....	547
9.2.2.45A	Synchronisation Indicator	547
9.2.2.46	TFCI Signalling Mode	547
9.2.2.46A	TFCI PC Support Indicator	547
9.2.2.47	Transmission Gap Distance (TGD).....	547
9.2.2.47A	Transmission Gap Pattern Sequence Information	547
9.2.2.47B	Transmission Gap Pattern Sequence Scrambling Code Information	549
9.2.2.48	Transmit Diversity Indicator	549
9.2.2.49	Transmit Gap Length (TGL).....	549
9.2.2.50	Tx Diversity Indicator	549
9.2.2.50A	UE Support Of Dedicated Pilots For Channel Estimation	550
9.2.2.50B	UE Support Of Dedicated Pilots For Channel Estimation Of HS-DSCH	550
9.2.2.51	UL/DL Compressed Mode Selection	550
9.2.2.52	UL DPCCCH Slot Format	550
9.2.2.52A	UL DPDCH Indicator for E-DCH operation.....	550
9.2.2.53	UL Scrambling Code.....	550
9.2.2.54	Uplink Delta SIR.....	551
9.2.2.55	Uplink Delta SIR After	551
9.2.2.56	DPC Mode Change Support Indicator.....	551
9.2.2.57	HARQ Preamble Mode.....	551
9.2.2.58	HARQ Preamble Mode Activation Indicator.....	551

9.2.2.59	Frequency Band Indicator	551
9.2.2.60	E-RGCH Release Indicator	552
9.2.2.61	E-AGCH Power Offset	552
9.2.2.61A	E-AGCH Table Choice	552
9.2.2.62	E-RGCH Power Offset.....	553
9.2.2.63	E-HICH Power Offset.....	553
9.2.2.64	E-RGCH 2-Index-Step Threshold.....	553
9.2.2.65	E-RGCH 3-Index-Step Threshold.....	553
9.2.2.66	HARQ Info for E-DCH.....	553
9.2.2.67	DCH Indicator For E-DCH-HSDPA Operation.....	554
9.2.2.68	E-RGCH and E-HICH Channelisation Code Validity Indicator.....	554
9.2.2.69	E-DCH Minimum Set E-TFCI Validity Indicator.....	554
9.2.2.70	Fast Reconfiguration Mode.....	554
9.2.2.71	Fast Reconfiguration Permission	554
9.2.2.72	Continuous Packet Connectivity DTX-DRX Information	555
9.2.2.73	Continuous Packet Connectivity DTX-DRX Information To Modify.....	556
9.2.2.74	Continuous Packet Connectivity HS-SCCH less Information	557
9.2.2.75	Continuous Packet Connectivity HS-SCCH less Information Response	557
9.2.2.75A	Continuous Packet Connectivity HS-SCCH Less Deactivate Indicator.....	557
9.2.2.76	MIMO Activation Indicator	558
9.2.2.77	MIMO Mode Indicator.....	558
9.2.2.78	MIMO Information Response	558
9.2.2.79	SixtyfourQAM DL Support Indicator	558
9.2.2.79A	Sixtyfour QAM Usage Allowed Indicator	558
9.2.2.79B	SixtyfourQAM DL Usage Indicator.....	558
9.2.2.80	Enhanced FACH <i>Support Indicator</i>	559
9.2.2.81	Enhanced PCH <i>Support Indicator</i>	559
9.2.2.82	Priority Queue Information for Enhanced FACH/PCH	559
9.2.2.83	SixteenQAM UL Information	559
9.2.2.84	SixteenQAM UL Information To Modify	559
9.2.2.85	F-DPCH Slot Format.....	559
9.2.2.86	F-DPCH Slot Format Support Request	559
9.2.2.87	Max UE DTX Cycle.....	559
9.2.2.88	Enhanced PCH <i>Capability</i>	559
9.2.2.89	MAC-ehs Reset Timer	559
9.2.2.90	SixteenQAM UL Operation Indicator.....	560
9.2.2.91	E-TFCI Boost Information.....	560
9.2.2.92	Common E-DCH Support Indicator.....	560
9.2.2.93	Common E-DCH MAC-d Flow Specific Information	560
9.2.2.94	Counting Information.....	561
9.2.2.95	Transmission Mode Information	561
9.2.2.96	MBMS Neighbouring Cell Information.....	562
9.2.2.97	RLC Sequence Number.....	562
9.2.2.98	Time Stamp	562
9.2.2.99	HS-DSCH Preconfiguration Info	562
9.2.2.100	HS-DSCH Preconfiguration Setup.....	564
9.2.2.101	Secondary Serving Cell List.....	566
9.2.2.102	Minimum Reduced E-DPDCH Gain Factor.....	566
9.2.2.103	UE Support Indicator Extension	566
9.2.2.104	Power Offset For S-CPICH for MIMO.....	567
9.2.2.105	Power Offset For S-CPICH for MIMO Request Indicator.....	567
9.2.2.106	Single Stream MIMO Activation Indicator.....	568
9.2.2.107	Single Stream MIMO Mode Indicator	568
9.2.2.108	HS-DSCH MAC-ehs Format	568
9.2.2.109	Activation Information.....	568
9.2.2.110	Additional E-DCH FDD Setup Information	568
9.2.2.111	Additional E-DCH Configuration Change Information	569
9.2.2.112	Additional E-DCH FDD Information.....	569
9.2.2.113	Multicell E-DCH Transport Bearer Mode.....	570
9.2.2.114	Multicell E-DCH Information.....	570
9.2.2.115	Additional E-DCH RL Specific Information To Setup.....	570
9.2.2.116	Additional E-DCH RL Specific Information To Add.....	571

9.2.2.117	Additional E-DCH RL Specific Information To Modify	571
9.2.2.118	Additional E-DCH MAC-d Flow Specific Information	572
9.2.2.119	Multicell E-DCH RL Specific Information	572
9.2.2.120	Additional E-DCH FDD Information Response	572
9.2.2.121	Additional Modified E-DCH FDD Information Response	573
9.2.2.122	Additional E-DCH FDD Update Information	574
9.2.2.123	Cell Capability Container Extension FDD	575
9.2.2.124	Non-Serving RL Preconfiguration Setup	576
9.2.2.125	Non-Serving RL Preconfiguration Info	577
9.2.2.126	Void	579
9.2.2.127	Void	579
9.2.2.128	Void	579
9.2.2.129	Support of Dynamic DTXDRX Related HS-SCCH Order	579
9.2.3	TDD Specific Parameters	579
9.2.3.a	Alpha Value	579
9.2.3.A	Block STTD Indicator	579
9.2.3.1	Burst Type	579
9.2.3.1a	Cell Capability Container TDD	579
9.2.3.1b	Cell Capability Container TDD LCR	580
9.2.3.2	CCTrCH ID	580
9.2.3.2A	DCH TDD Information	581
9.2.3.2B	DCH TDD Information Response	581
9.2.3.2C	DL Timeslot Information	582
9.2.3.2D	DL Time Slot ISCP Info	582
9.2.3.2E	DL Timeslot Information LCR	582
9.2.3.2F	DL Time Slot ISCP Info LCR	583
9.2.3.3	DPCH ID	583
9.2.3.3a	DSCH TDD Information	583
9.2.3.3aa	HS-DSCH TDD Information	584
9.2.3.3ab	HS-DSCH TDD Information Response	586
9.2.3.3ac	HS-DSCH TDD Update Information	590
9.2.3.3ad	HS-SICH ID	590
9.2.3.3ae	DSCH ID	590
9.2.3.3af	DSCH Initial Window Size	590
9.2.3.3ag	DSCH Flow Control Information	591
9.2.3.3ah	DSCH-RNTI	591
9.2.3.3ai	TSN-Length	591
9.2.3.3A	Maximum Number of Timeslots	591
9.2.3.3B	Maximum Number of UL Physical Channels per Timeslot	592
9.2.3.3C	Maximum Number of DL Physical Channels	592
9.2.3.3D	Maximum Number of DL Physical Channels per Timeslot	592
9.2.3.4	Midamble Shift And Burst Type	592
9.2.3.4A	Minimum Spreading Factor	593
9.2.3.4B	IPDL TDD parameters	593
9.2.3.4Bb	IPDL TDD parameters LCR	594
9.2.3.4C	Midamble shift LCR	594
9.2.3.4D	Neighbouring TDD Cell Information LCR	595
9.2.3.5	Primary CCPCH RSCP	595
9.2.3.5a	Primary CCPCH RSCP Delta	595
9.2.3.5A	PRACH Midamble	595
9.2.3.5B	RB Identity	595
9.2.3.6	Repetition Length	595
9.2.3.7	Repetition Period	596
9.2.3.7A	Rx Timing Deviation	596
9.2.3.7B	Secondary CCPCH Info TDD	596
9.2.3.7C	Secondary CCPCH TDD Code Information	597
9.2.3.7D	Special Burst Scheduling	597
9.2.3.7E	Synchronisation Configuration	597
9.2.3.7F	Secondary CCPCH Info TDD LCR	597
9.2.3.7G	Secondary CCPCH TDD Code Information LCR	598
9.2.3.7H	Support of 8PSK	598
9.2.3.7I	TDD ACK NACK Power Offset	599

9.2.3.8	TDD Channelisation Code	599
9.2.3.8a	TDD Channelisation Code LCR	599
9.2.3.8A	TDD DPCH Offset	599
9.2.3.8B	TDD DCHs To Modify	600
9.2.3.8C	TDD DL Code Information	600
9.2.3.8D	TDD DL Code Information LCR	601
9.2.3.8E	TDD DL DPCH Time Slot Format LCR	601
9.2.3.9	TDD Physical Channel Offset	601
9.2.3.10	TDD TPC Downlink Step Size	601
9.2.3.10a	TDD TPC Uplink Step Size	602
9.2.3.10A	TDD UL Code Information	602
9.2.3.10B	TDD UL Code Information LCR	602
9.2.3.10C	TDD UL DPCH Time Slot Format LCR	602
9.2.3.10D	1.28 Mcps TDD uplink physical channel capability	603
9.2.3.11	TFCI Coding	603
9.2.3.12	DL Timeslot ISCP	603
9.2.3.12a	Time Slot LCR	603
9.2.3.12A	Timing Advance Applied	603
9.2.3.13	Transport Format Management	604
9.2.3.13A	UL Timeslot ISCP	604
9.2.3.13B	UL PhysCH SF Variation	604
9.2.3.13C	UL Timeslot Information	604
9.2.3.13D	UL Time Slot ISCP Info	605
9.2.3.13E	TSTD Indicator	605
9.2.3.13F	TSTD Support Indicator	605
9.2.3.13Fa	UE Measurement Hysteresis Time	605
9.2.3.13Fb	UE Measurement Parameter Modification Allowed	605
9.2.3.13Fc	UE Measurement Report Characteristics	606
9.2.3.13Fd	UE Measurement Threshold	607
9.2.3.13Fe	UE Measurement Timeslot Information HCR	607
9.2.3.13Ff	UE Measurement Timeslot Information LCR	607
9.2.3.13Fg	UE Measurement Time to Trigger	607
9.2.3.13Fh	UE Measurement Type	608
9.2.3.13Fi	UE Measurement Value	608
9.2.3.13Fj	UE Measurement Value Information	609
9.2.3.13G	UL Timeslot Information LCR	609
9.2.3.13H	UL Time Slot ISCP Info LCR	610
9.2.3.13I	Uplink Synchronisation Frequency	610
9.2.3.13J	Uplink Synchronisation Step Size	610
9.2.3.13K	Uplink Timing Advance Control LCR	610
9.2.3.13L	USCH ID	611
9.2.3.14	USCH Information	611
9.2.3.16	Support of PLCCCH	612
9.2.3.17	PLCCCH Information	612
9.2.3.18	PLCCCH Sequence Number	613
9.2.3.19	Minimum Spreading Factor 7.68Mcps	613
9.2.3.20	Maximum Number of DL Physical Channels 7.68Mcps	613
9.2.3.21	Maximum Number of DL Physical Channels per Timeslot 7.68Mcps	613
9.2.3.22	Secondary CCPCH Info 7.68Mcps TDD	613
9.2.3.23	Midamble Shift And Burst Type 7.68Mcps	614
9.2.3.24	Secondary CCPCH TDD Code Information 7.68Mcps	615
9.2.3.25	TDD Channelisation Code 7.68Mcps	615
9.2.3.26	UL Timeslot Information 7.68Mcps	616
9.2.3.27	TDD UL Code Information 7.68Mcps	616
9.2.3.28	DL Timeslot Information 7.68Mcps	616
9.2.3.29	TDD DL Code Information 7.68Mcps	617
9.2.3.30	Rx Timing Deviation 7.68Mcps	617
9.2.3.31	Cell Capability Container 7.68 Mcps TDD	617
9.2.3.32	Neighbouring TDD Cell Measurement Information 7.68Mcps	618
9.2.3.33	UE Measurement Timeslot Information 7.68Mcps	618
9.2.3.34	DPCH ID 7.68Mcps	619
9.2.3.35	Rx Timing Deviation 3.84Mcps Extended	619

9.2.3.36	E-PUCH Information	619
9.2.3.36a	E-PUCH Information LCR	619
9.2.3.37	E-TFCS Information TDD	620
9.2.3.38	E-DCH MAC-d Flows Information TDD	621
9.2.3.39	E-DCH Non-scheduled Grant Information TDD	622
9.2.3.39a	E-DCH Non-scheduled Grant Information LCR TDD.....	623
9.2.3.40	E-DCH TDD Information	623
9.2.3.40a	E-DCH TDD Information LCR.....	623
9.2.3.41	E-DCH TDD Information Response	624
9.2.3.41a	E-DCH TDD Information Response 1.28Mcps	625
9.2.3.42	E-DCH TDD Information to Modify	626
9.2.3.43	E-DCH Grant Type	627
9.2.3.44	Timeslot Resource Related Information.....	628
9.2.3.44a	Timeslot Resource Related Information LCR.....	628
9.2.3.45	Power Resource Related Information.....	628
9.2.3.46	E-PUCH Offset	628
9.2.3.47	E-DCH TDD Maximum Bitrate.....	628
9.2.3.48	E-HICH Time Offset.....	628
9.2.3.48a	E-HICH Time Offset LCR	629
9.2.3.49	E-DCH HARQ Power Offset TDD.....	629
9.2.3.49a	E-DCH MAC-d Flow Retransmission Timer.....	629
9.2.3.50	E-DCH Non-scheduled Grant Information 7.68Mcps TDD	629
9.2.3.51	E-DCH TDD Information 7.68Mcps	629
9.2.3.52	E-DCH TDD Information Response 7.68Mcps	630
9.2.3.53	E-DCH TDD Maximum Bitrate 7.68Mcps	630
9.2.3.54	E-DCH Physical Layer Category LCR	631
9.2.3.54A	Extended E-DCH Physical layer Category LCR.....	631
9.2.3.55	UpPCH Information LCR	631
9.2.3.56	UpPCH Position LCR	631
9.2.3.57	Common E-DCH MAC-d Flow ID	631
9.2.3.58	Common E-DCH MAC-d Flow Specific Information LCR	632
9.2.3.59	MAC-es Maximum Bit Rate LCR	632
9.2.3.60	Idle Interval Information	632
9.2.3.61	Continuous Packet Connectivity DRX Information LCR	632
9.2.3.62	Continuous Packet Connectivity DRX Information To Modify LCR.....	633
9.2.3.63	Continuous Packet Connectivity DRX Information Response LCR.....	634
9.2.3.64	HS-DSCH Semi-Persistent scheduling Information LCR.....	635
9.2.3.65	HS-DSCH Semi-Persistent scheduling Information to modify LCR	636
9.2.3.66	E-DCH Semi-Persistent scheduling Information LCR.....	637
9.2.3.67	E-DCH Semi-Persistent scheduling Information to modify LCR	638
9.2.3.68	HS-DSCH Semi-Persistent scheduling Information Response LCR.....	639
9.2.3.69	E-DCH Semi-Persistent scheduling Information Response LCR	640
9.2.3.70	HS-DSCH Semi-Persistent scheduling Deactivate Indicator LCR	641
9.2.3.71	E-DCH Semi-Persistent scheduling Deactivate Indicator LCR	641
9.2.3.72	HS-SICH Reference Signal Information.....	641
9.2.3.73	Cell Portion LCR ID	641
9.2.3.74	TS0 HS-PDSCH Indication LCR.....	642
9.2.3.75	DCH Measurement Occasion Information.....	642
9.2.3.76	DCH Measurement Type Indicator	644
9.3	Message and Information Element Abstract Syntax (with ASN.1).....	645
9.3.0	General.....	645
9.3.1	Usage of Private Message Mechanism for Non-standard Use.....	645
9.3.2	Elementary Procedure Definitions	645
9.3.3	PDU Definitions	660
9.3.4	Information Element Definitions	825
9.3.5	Common Definitions.....	1015
9.3.6	Constant Definitions	1016
9.3.7	Container Definitions.....	1033
9.4	Message Transfer Syntax	1038
9.5	Timers	1038
10	Handling of Unknown, Unforeseen and Erroneous Protocol Data	1038

10.1	General	1038
10.2	Transfer Syntax Error	1038
10.3	Abstract Syntax Error	1039
10.3.1	General	1039
10.3.2	Criticality Information	1039
10.3.3	Presence Information	1040
10.3.4	Not Comprehended IE/IE Group	1040
10.3.4.1	Procedure ID	1040
10.3.4.1A	Type of Message	1040
10.3.4.2	IEs Other Than the Procedure ID and Type of Message	1041
10.3.5	Missing IE or IE Group	1042
10.3.6	IEs or IE Groups Received in Wrong Order or With Too Many Occurrences or Erroneously Present ..	1043
10.4	Logical Error	1043
10.5	Exceptions	1044
Annex A (normative): Allocation and Pre-emption of Radio Links in the DRNS		1045
A.1	Deriving Allocation Information for a Radio Link	1045
A.1.1	Establishment of a New Radio Link	1045
A.1.2	Modification of an Existing Radio Link	1045
A.2	Deriving Retention Information for a Radio Link	1046
A.3	The Allocation/Retention Process	1046
A.4	The Pre-emption Process	1047
Annex B (informative): Measurement Reporting		1048
Annex C (informative): Guidelines for Usage of the Criticality Diagnostics IE		1051
C.1	EXAMPLE MESSAGE Layout	1051
C.2	Example on a Received EXAMPLE MESSAGE	1053
C.3	Content of Criticality Diagnostics	1054
C.3.1	Example 1	1054
C.3.2	Example 2	1055
C.3.3	Example 3	1056
C.3.4	Example 4	1057
C.3.5	Example 5	1058
C.4	ASN.1 of EXAMPLE MESSAGE	1058
Annex D (normative): DRNS Behaviour at SRNC or RNSAP Signalling Bearer Failure		1061
D.1	Detection of SRNC or RNSAP Signalling Bearer/Connection Failure	1061
D.1.1	Termination of all UE Contexts Related to a Specific SRNC	1061
D.1.2	Termination of Specific UE Context	1061
D.2	DRNC Actions at UE Context Termination	1061
Annex E (informative): Change History		1062
History		1063

Foreword

This Technical Specification (TS) has been produced by the 3rd Generation Partnership Project (3GPP).

The contents of the present document are subject to continuing work within the TSG and may change following formal TSG approval. Should the TSG modify the contents of the present document, it will be re-released by the TSG with an identifying change of release date and an increase in version number as follows:

Version x.y.z

where:

- x the first digit:
 - 1 presented to TSG for information;
 - 2 presented to TSG for approval;
 - 3 or greater indicates TSG approved document under change control.
- Y the second digit is incremented for all changes of substance, i.e. technical enhancements, corrections, updates, etc.
- z the third digit is incremented when editorial only changes have been incorporated in the document.

1 Scope

The present document specifies the radio network layer signalling procedures of the control plane between RNCs in UTRAN, between RNC in UTRAN and BSS in GERAN Iu mode and between BSSs in GERAN Iu mode.

2 References

The following documents contain provisions which, through reference in this text, constitute provisions of the present document.

- References are either specific (identified by date of publication, edition number, version number, etc.) or non-specific.
- For a specific reference, subsequent revisions do not apply.
- For a non-specific reference, the latest version applies. In the case of a reference to a 3GPP document (including a GSM document), a non-specific reference implicitly refers to the latest version of that document *in the same Release as the present document*.

- [1] 3GPP TS 23.003: "Numbering, addressing and identification".
- [2] 3GPP TS 25.413: "UTRAN Iu Interface RANAP Signalling".
- [3] 3GPP TS 25.426: "UTRAN Iur and Iub Interface Data Transport & Transport Layer Signalling for DCH Data Streams".
- [4] 3GPP TS 25.427: "UTRAN Iur and Iub Interface User Plane Protocols for DCH Data Streams".
- [5] 3GPP TS 25.435: "UTRAN Iub interface User Plane Protocols for Common Transport Channel Data Streams".
- [6] 3GPP TS 25.104: "UTRA (BS) FDD; Radio transmission and Reception".
- [7] 3GPP TS 25.105: "UTRA (BS) TDD; Radio Transmission and Reception".
- [8] 3GPP TS 25.211: "Physical Channels and Mapping of Transport Channels onto Physical Channels (FDD)".
- [9] 3GPP TS 25.212: "Multiplexing and Channel Coding (FDD)".
- [10] 3GPP TS 25.214: "Physical Layer Procedures (FDD)".
- [11] 3GPP TS 25.215: "Physical Layer – Measurements (FDD)".
- [12] 3GPP TS 25.221: "Physical Channels and Mapping of Transport Channels onto Physical Channels (TDD)".
- [13] 3GPP TS 25.223: "Spreading and Modulation (TDD)".
- [14] 3GPP TS 25.225: "Physical Layer – Measurements (TDD)".
- [15] 3GPP TS 25.304: "UE Procedures in Idle Mode"
- [16] 3GPP TS 25.331: "RRC Protocol Specification".
- [17] 3GPP TS 25.402: "Synchronisation in UTRAN, Stage 2".
- [18] ITU-T Recommendation X.680 (07/2002): "Information technology – Abstract Syntax Notation One (ASN.1): Specification of basic notation".
- [19] ITU-T Recommendation X.681 (07/2002): "Information technology – Abstract Syntax Notation One (ASN.1): Information object specification".

- [20] ITU-T Recommendation X.691 (07/2002): “Information technology – ASN.1 encoding rules – Specification of Packed Encoding Rules (PER)”.
- [21] 3GPP TS 25.213: “Spreading and modulation (FDD)”.
- [22] 3GPP TS 25.224: “Physical Layer Procedures (TDD)”.
- [23] 3GPP TS 25.133: “Requirements for support of Radio Resource management (FDD)”.
- [24] 3GPP TS 25.123: “Requirements for support of Radio Resource management (TDD)”.
- [25] 3GPP TS 23.032: “Universal Graphical Area Description (GAD)”.
- [26] 3GPP TS 25.302: “Services Provided by the Physical Layer”.
- [27] 3GPP TS 25.213: “Spreading and modulation (FDD)”.
- [28] 3GPP TR 25.921: “Guidelines and Principles for Protocol Description and Error Handling”.
- [29] GSM TS 05.05: “Digital cellular telecommunications system (Phase 2+); Radio transmission and reception”.
- [30] ICD-GPS-200: “Navstar GPS Space Segment/Navigation User Interface”.
- [31] RTCM-SC104: “RTCM Recommended Standards for Differential GNSS Service (v.2.2)”.
- [32] 3GPP TS 25.425: “UTRAN Iur and Iub Interface User Plane Protocols for Common Transport Channel data streams “.
- [33] IETF RFC 2460 “Internet Protocol, Version 6 (Ipv6) Specification”.
- [34] IETF RFC 768 “User Datagram Protocol”, (8/1980)
- [35] 3GPP TS 25.424: “ UTRAN Iur Interface Data Transport & Transport Signalling for Common Transport Channel Data Streams “.
- [36] 3GPP TS 44.118: “Mobile radio interface layer 3 specification; Radio Resource Control (RRC) Protocol Iu mode”.
- [37] 3GPP TR 43.930: “Iur-g interface; Stage 2”.
- [38] 3GPP TS 48.008: “Mobile-services Switching Centre – Base Station System (MSC – BSS) interface; Layer 3 specification”.
- [39] 3GPP TS 43.051: “GSM/EGDE Radio Access Network; Overall description – Stage 2”.
- [40] 3GPP TS 25.401: “UTRAN Overall Description”.
- [41] 3GPP TS 25.321: “MAC protocol specification”.
- [42] 3GPP TS 25.306: “UE Radio Access capabilities”.
- [43] 3GPP TS 25.101: “ User Equipment (UE) radio transmission and reception (FDD)”.
- [44] IETF RFC 2474 “Definition of the Differentiated Services Field (DS Field) in the Ipv4 and Ipv6 Headers”.
- [45] IETF RFC 2475 “An Architecture for Differentiated Services”.
- [46] 3GPP TS 25.222: “Multiplexing and Channel Coding (TDD)”.
- [47] 3GPP TS 44.060: “General Packet Radio Service (GPRS); Mobile Station (MS) – Base Station System (BSS) interface; Radio Link Control/Medium Access Control (RLC/MAC) protocol”.
- [48] 3GPP TS 32.421: “Subscriber and equipment trace: Trace concepts and requirements”.
- [49] 3GPP TS 32.422: “Subscriber and equipment trace: Trace control and Configuration Management”.

- [50] 3GPP TS 25.346: "Introduction of the Multimedia Broadcast Multicast Service (MBMS) in the Radio Access Network (Stage-2) ".
- [51] 3GPP TS 23.246: "Multimedia Broadcast Multicast Service; Architecture and Functional Description".
- [52] 3GPP TS 25.319: "Enhanced Uplink; Overall description; Stage 2".
- [53] Galileo OS Signal in Space ICD (OS SIS ICD), Draft 0, Galileo Joint Undertaking, May 23rd, 2006.
- [54] 3GPP TS 23.251: "Network Sharing: Architecture and functional description".
- [55] IS-GPS-200, Revision D, Navstar GPS Space Segment/Navigation User Interfaces, March 7th, 2006.
- [56] IS-GPS-705, Navstar GPS Space Segment/User Segment L5 Interfaces, September 22, 2005.
- [57] IS-GPS-800, Navstar GPS Space Segment/User Segment L1C Interfaces, March 31, 2008.
- [58] Specification for the Wide Area Augmentation System (WAAS), US Department of Transportation, Federal Aviation Administration, DTFA01-96-C-00025, 2001.
- [59] IS-QZSS, Quasi Zenith Satellite System Navigation Service Interface Specifications for QZSS, Ver.1.0, June 17, 2008.
- [60] Global Navigation Satellite System GLONASS Interface Control Document, Version 5, 2002.
- [61] 3GPP TS 36.401: "Evolved Universal Terrestrial Radio Access Network (E-UTRAN); Architecture Description".
- [62] 3GPP TS 36.104: " Base Station (BS) radio transmission and reception ".
- [63] 3GPP TS 25.308: "High Speed Downlink Packet Access (HSDPA); Overall description; Stage 2".
- [64] 3GPP TS 36.133: "Requirements for support of radio resource management".
- [65] 3GPP TS 23.195: "Provision of UE Specific Behaviour Information to Network Entities".

3 Definitions, Symbols and Abbreviations

3.1 Definitions

For the purposes of the present document, the following terms and definitions apply:

Elementary Procedure: RNSAP protocol consists of Elementary Procedures (Eps). An Elementary Procedure is a unit of interaction between two RNCs. An EP consists of an initiating message and possibly a response message. Two kinds of Eps are used:

- **Class 1:** Elementary Procedures with response (success or failure);
- **Class 2:** Elementary Procedures without response.

For Class 1 Eps, the types of responses can be as follows:

Successful

- A signalling message explicitly indicates that the elementary procedure has been successfully completed with the receipt of the response.

Unsuccessful

- A signalling message explicitly indicates that the EP failed.

Class 2 Eps are considered always successful.

Prepared Reconfiguration: A Prepared Reconfiguration exists when the Synchronised Radio Link Reconfiguration Preparation procedure has been completed successfully. The Prepared Reconfiguration does not exist anymore only after either of the procedures Synchronised Radio Link Reconfiguration Commit or Synchronised Radio Link Reconfiguration Cancellation has been completed. In particular, the Prepared Reconfiguration still exists if the object (e.g. Radio Link) concerned by the Synchronised Radio Link Reconfiguration (e.g. in the case of an HS-DSCH Setup) is removed, but the UE Context still exists.

UE Context: The UE Context contains the necessary information for the DRNC/DBSS to communicate with a specific UE. The UE Context is created by the Radio Link Setup procedure or by the Uplink Signalling Transfer procedure when the UE makes its first access in a cell controlled by the DRNS/DBSS or by Enhanced Relocation procedure when the procedure is the first dedicated RNSAP procedure for the UE. The UE Context is deleted by the Radio Link Deletion procedure, by the Common Transport Channel Resources Release procedure, or by the Downlink Signalling Transfer procedure when neither any Radio Links nor any common transport channels are established towards the concerned UE. The UE Context is identified by the SCCP Connection for messages using connection oriented mode of the signalling bearer and the D-RNTI for messages using connectionless mode of the signalling bearer, unless specified otherwise in the procedure text.

Distant RNC Context: The Distant RNC context is created by the first Common Measurement Initiation Procedure or Information Exchange Initiation Procedure initiated by one RNC/BSS and requested from another RNC/BSS. The Distant RNC Context is deleted after the Common Measurement Termination, the Common Measurement Failure, the Information Exchange Termination or the Information Exchange Failure procedure when there is no more Common Measurement and no more Information to be provided by the requested RNC/BSS to the requesting RNC/BSS. The Distant RNC Context is identified by an SCCP connection as, for common measurements and information exchange, only the connection oriented mode of the signalling bearer is used.

Signalling radio bearer 2: The signalling radio bearer 2 is used by the UE to access a GERAN cell in order to perform RRC procedures TS 44.118 [36].

UE Link: see definition in TS 25.346 [50].

URA Link: see definition in TS 25.346 [50].

MBMS Bearer Service: see definition in TS 23.246 [51].

MBMS session: see definition in TS 25.346 [50].

MBMS session start: see definition in TS 25.346 [50].

MBMS session stop: see definition in TS 25.346 [50].

MBMS Selected Services: see definition in TS 25.346 [50].

PUESBINE feature: as defined in TS 23.195 [65].

3.2 Symbols

Void.

3.3 Abbreviations

For the purposes of the present document, the following abbreviations apply:

A-GPS	Assisted-GPS
ALCAP	Access Link Control Application Part
APN	Access Point Name
ASN.1	Abstract Syntax Notation One
BER	Bit Error Rate
BLER	Block Error Rate
BSS	Base Station Subsystem
CBSS	Controlling BSS
CCCH	Common Control Channel

CCPCH	Common Control Physical Channel
CCTrCH	Coded Composite Transport Channel
CFN	Connection Frame Number
C-ID	Cell Identifier
CM	Compressed Mode
CN	Core Network
CPICH	Common Pilot Channel
CRNC	Controlling RNC
DBSS	Drift BSS
C-RNTI	Cell Radio Network Temporary Identifier
CS	Circuit Switched
CTFC	Calculated Transport Format Combination DCH Dedicated Channel
DGANSS	Differential GANSS
DGPS	Differential GPS
DL	Downlink
DPC	Downlink Power Control
DPCCH	Dedicated Physical Control Channel
DPCH	Dedicated Physical Channel
DPDCH	Dedicated Physical Data Channel
DRNC	Drift RNC
DRNS	Drift RNS
D-RNTI	Drift Radio Network Temporary Identifier
DRX	Discontinuous Reception
DSCH	Downlink Shared Channel
Ec	Energy in single Code
E-AGCH	E-DCH Absolute Grant Channel
E-DCH	Enhanced UL DCH
E-HICH	E-DCH HARQ Acknowledgement Indicator Channel
E-PUCH	Enhanced Uplink Physical Channel (TDD only)
E-RNTI	E-DCH RNTI
E-RUCCH	E-DCH Random Access Uplink Control Channel (TDD only)
E-TFCI	E-DCH Transport Format Combination Indicator
E-UCCH	E-DCH Uplink Control Channel (TDD only)
E-UTRA	Evolved UTRA
EDSCHPC	Enhanced Downlink Shared Channel Power Control
EGNOS	European Geostationary Navigation Overlay Service
EP	Elementary Procedure
FACH	Forward Access Channel
FDD	Frequency Division Duplex
F-DPCH	Fractional DPCH
FN	Frame Number
FP	Frame Protocol
GANSS	Galileo and Additional Navigation Satellite Systems
GERAN	GSM EDGE Radio Access Network
GA	Geographical Area
GAGAN	GPS Aided Geo Augmented Navigation
GAI	Geographical Area Identifier
GLONASS	GLObal'naya Navigatsionnaya Sputnikovaya Sistema (Engl.: Global Navigation Satellite System)
GNSS	Global Navigation Satellite System
GPS	Global Positioning System
GRA	GERAN Registration Area
GSM	Global System Mobile
GWCN	Gateway Core Network
HSDPA	High Speed Downlink Packet Access
HW	Hardware
IB	Information Block
ICD	Interface Control Document
ID	Identity or Identifier
IE	Information Element
IMSI	International Mobile Subscriber Identity
IP	Internet Protocol
IPDL	Idle Period DownLink

ISCP	Interference Signal Code Power
LAC	Location Area Code
LCR	Low Chip Rate (1.28 Mcps)
LCS	Location Services
MAC	Medium Access Control
MBMS	Multimedia Broadcast Multicast Service
MOCN	Multi-Operator Core Network
MRNC	MBMS Master RNC
MS	Mobile Station
MSAS	Multi-functional Satellite Augmentation System
NACC	Network Assisted Cell Change
NAS	Non Access Stratum
No	Reference Noise
NRT	Non Real Time
O&M	Operation and Maintenance
P(-)CCPCH	Primary CCPCH
PCH	Paging Channel
OTD	Observed Time Difference
P(-)CPICH	Primary CPICH
PCS	Personal Communication Services
PDSCH	Physical Downlink Shared Channel
PDU	Protocol Data Unit
PhCH	Physical Channel
PICH	Paging Indication Channel
PLCCH	Physical Layer Common Control Channel
Pos	Position or Positioning
PRACH	Physical Random Access Channel
PTP	Point To Point
PTM	Point To Multipoint
PS	Packet Switched
PUESBINE	Provision of UE Specific Behaviour Information to Network Entities
QE	Quality Estimate
QZSS	Quasi-Zenith Satellite System
RAC	Routing Area Code
RACH	Random Access Channel
RAN	Radio Access Network
RANAP	Radio Access Network Application Part
RB	Radio Bearer
RL	Radio Link
RLC	Radio Link Control
RLS	Radio Link Set
RM	Rate Matching
RNC	Radio Network Controller
RNS	Radio Network Subsystem
RNSAP	Radio Network Subsystem Application Part
RNTI	Radio Network Temporary Identifier
RRC	Radio Resource Control
RT	Real Time
RSCP	Received Signal Code Power
SBAS	Satellite Based Augmentation System
SBSS	Serving BSS
Rx	Receive or Reception
Sat	Satellite
SCCP	Signalling Connection Control Part
S(-)CCPCH	Secondary CCPCH
SCH	Synchronisation Channel
SCTD	Space Code Transmit Diversity
SDU	Service Data Unit
SF	System Frame
SFN	System Frame Number
SHCCH	Shared Control Channel
SIR	Signal-to-Interference Ratio

SNA	Shared Network Area
SRB2	Signalling radio bearer 2
SRNC	Serving RNC
SRNS	Serving RNS
S-RNTI	Serving Radio Network Temporary Identifier
STTD	Space Time Transmit Diversity
TDD	Time Division Duplex
TF	Transport Format
TFCI	Transport Format Combination Indicator
TFCS	Transport Format Combination Set
TFS	Transport Format Set
TGCFN	Transmission Gap Connection Frame Number
TMGI	Temporary Mobile Group Identity
ToAWE	Time of Arrival Window Endpoint
ToAWS	Time of Arrival Window Startpoint
TPC	Transmit Power Control
TrCH	Transport Channel
TS	Time Slot
TSG	Technical Specification Group
TSTD	Time Switched Transmit Diversity
TTI	Transmission Time Interval
TX	Transmit or Transmission
UARFCN	UTRA Absolute Radio Frequency Channel Number
UDP	User Datagram Protocol
UC-ID	UTRAN Cell Identifier
UE	User Equipment
UL	Uplink
UMTS	Universal Mobile Telecommunications System
URA	UTRAN Registration Area
U-RNTI	UTRAN Radio Network Temporary Identifier
USCH	Uplink Shared Channel
UTC	Universal Coordinated Time
UTRA	Universal Terrestrial Radio Access
UTRAN	Universal Terrestrial Radio Access Network
WAAS	Wide Area Augmentation System

4 General

4.1 Procedure Specification Principles

The principle for specifying the procedure logic is to specify the functional behaviour of the DRNC/CRNC exactly and completely. The SRNC functional behaviour is left unspecified. The Physical Channel Reconfiguration procedure, [TDD – the UE Measurement Initiation, the UE Measurement Reporting, UE Measurement Termination, UE Measurement Failure,] and the Reset procedure are an exception from this principle.

The following specification principles have been applied for the procedure text in subclause 8:

- The procedure text discriminates between:

1) Functionality which “shall” be executed

The procedure text indicates that the receiving node “shall” perform a certain function Y under a certain condition. If the receiving node supports procedure X but cannot perform functionality Y requested in the REQUEST message of a Class 1 EP, the receiving node shall respond with the message used to report unsuccessful outcome for this procedure, containing an appropriate cause value.

04.□ Functionality which “shall, if supported” be executed

The procedure text indicates that the receiving node “shall, if supported,” perform a certain function Y under a certain condition. If the receiving node supports procedure X, but does not support functionality Y, the

receiving node shall proceed with the execution of the EP, possibly informing the requesting node about the not supported functionality.

Any required inclusion of an optional IE in a response message is explicitly indicated in the procedure text. If the procedure text does not explicitly indicate that an optional IE shall be included in a response message, the optional IE shall not be included. For requirements for including *Criticality Diagnostics* IE, see section 10. For examples on how to use the *Criticality Diagnostics* IE, see Annex C.

4.2 Forwards and Backwards Compatibility

The forwards and backwards compatibility of the protocol is assured by a mechanism in which all current and future messages, and IEs or groups of related IEs, include ID and criticality fields that are coded in a standard format that will not be changed in the future. These parts can always be decoded regardless of the standard version.

4.3 Source Signalling Address Handling

The sender of an RNSAP messages shall include the Source Signalling Address, i.e. the Signalling Address of the sending node.

4.4 Specification Notations

For the purposes of the present document, the following notations apply:

- | | |
|----------------------|---|
| [FDD] | This tagging of a word indicates that the word preceding the tag “[FDD]” applies only to FDD. This tagging of a heading indicates that the heading preceding the tag “[FDD]” and the section following the heading applies only to FDD. |
| [TDD] | This tagging of a word indicates that the word preceding the tag “[TDD]” applies only to TDD, including 3.84Mcps TDD, 7.68Mcps TDD and 1.28Mcps TDD. This tagging of a heading indicates that the heading preceding the tag “[TDD]” and the section following the heading applies only to TDD, including 3.84Mcps TDD, 7.68Mcps TDD and 1.28Mcps TDD. |
| [3.84Mcps TDD] | This tagging of a word indicates that the word preceding the tag “[3.84Mcps TDD]” applies only to 3.84Mcps TDD. This tagging of a heading indicates that the heading preceding the tag “[3.84Mcps TDD]” and the section following the heading applies only to 3.84Mcps TDD. |
| [1.28Mcps TDD] | This tagging of a word indicates that the word preceding the tag “[1.28Mcps TDD]” applies only to 1.28Mcps TDD. This tagging of a heading indicates that the heading preceding the tag “[1.28Mcps TDD]” and the section following the heading applies only to 1.28Mcps TDD. |
| [7.68Mcps TDD] | This tagging of a word indicates that the word preceding the tag “[7.68Mcps TDD]” applies only to 7.68Mcps TDD. This tagging of a heading indicates that the heading preceding the tag “[7.68Mcps TDD]” and the section following the heading applies only to 7.68Mcps TDD. |
| [FDD - ...] | This tagging indicates that the enclosed text following the “[FDD – “ applies only to FDD. Multiple sequential paragraphs applying only to FDD are enclosed separately to enable insertion of TDD specific (or common) paragraphs between the FDD specific paragraphs. |
| [TDD - ...] | This tagging indicates that the enclosed text following the “[TDD – “ applies only to TDD including 3.84Mcps TDD, 7.68Mcps TDD and 1.28Mcps TDD. Multiple sequential paragraphs applying only to TDD are enclosed separately to enable insertion of FDD specific (or common) paragraphs between the TDD specific paragraphs. |
| [3.84Mcps TDD - ...] | This tagging indicates that the enclosed text following the “[3.84Mcps TDD – “ applies only to 3.84Mcps TDD. Multiple sequential paragraphs applying only to 3.84Mcps TDD are enclosed separately to enable insertion of FDD and TDD specific (or common) paragraphs between the 3.84Mcps TDD specific paragraphs. |

[1.28Mcps TDD - ...]	This tagging indicates that the enclosed text following the “[1.28Mcps TDD – “ applies only to 1.28Mcps TDD. Multiple sequential paragraphs applying only to 1.28Mcps TDD are enclosed separately to enable insertion of FDD and TDD specific (or common) paragraphs between the 1.28Mcps TDD specific paragraphs.
[7.68Mcps TDD - ...]	This tagging indicates that the enclosed text following the “[7.68Mcps TDD – “ applies only to 7.68Mcps TDD. Multiple sequential paragraphs applying only to 7.68Mcps TDD are enclosed separately to enable insertion of FDD and TDD specific (or common) paragraphs between the 7.68Mcps TDD specific paragraphs.
Procedure	When referring to an elementary procedure in the specification, the Procedure Name is written with the first letters in each word in upper case characters followed by the word “procedure”, e.g. Radio Link Setup procedure.
Message	When referring to a message in the specification, the MESSAGE NAME is written with all letters in upper case characters followed by the word “message”, e.g. RADIO LINK SETUP REQUEST message.
IE	When referring to an information element (IE) in the specification, the <i>Information Element Name</i> is written with the first letters in each word in upper case characters and all letters in Italic font followed by the abbreviation “IE”, e.g. <i>Transport Format Set</i> IE.
Value of an IE	When referring to the value of an information element (IE) in the specification, the “Value” is written as it is specified in subclause 9.2 enclosed by quotation marks, e.g. “Abstract Syntax Error (Reject)”.

5 RNSAP Services

5.1 RNSAP Procedure Modules

The Iur interface RNSAP procedures are divided into five modules as follows:

1. RNSAP Basic Mobility Procedures;
2. RNSAP Dedicated Procedures;
3. RNSAP Common Transport Channel Procedures;
4. RNSAP Global Procedures;
5. RNSAP MBMS Procedures.

The Basic Mobility Procedures module contains procedures used to handle the mobility within UTRAN, within GERAN and between UTRAN and GERAN.

The Dedicated Procedures module contains procedures that are used to handle DCHs, [FDD – F-DPCH,] [TDD – DSCHs, USCHs], HS-DSCH and E-DCH between two RNSs. If procedures from this module are not used in a specific Iur, then the usage of DCH, [FDD – F-DPCH,] [TDD – DSCH, USCH,] HS-DSCH and E-DCH traffic between corresponding RNSs is not possible.

The Common Transport Channel Procedures module contains procedures that are used to control common transport channel data streams (excluding the DSCH, HS-DSCH and USCH) over Iur interface.

The Global Procedures module contains procedures that are not related to a specific UE. The procedures in this module are in contrast to the above modules involving two peer CRNCs/CBSSs.

The MBMS Procedures module contains procedures that are specific to MBMS and used for cases that cannot be handled by other modules.

5.2 Parallel Transactions

Unless explicitly indicated in the procedure specification, at any instance in time one protocol peer shall have a maximum of one ongoing RNSAP Dedicated procedure related to a certain UE.

6 Services Expected from Signalling Transport

The signalling transport shall provide two different service modes for the RNSAP.

1. Connection oriented data transfer service. This service is supported by a signalling connection between two RNCs. It shall be possible to dynamically establish and release signalling connections based on the need. Each active UE shall have its own signalling connection. The signalling connection shall provide in sequence delivery of RNSAP messages. RNSAP shall be notified if the signalling connection breaks.
2. Connectionless data transfer service. RNSAP shall be notified in case a RNSAP message did not reach the intended peer RNSAP entity.

7 Functions of RNSAP

The RNSAP protocol provides the following functions:

- Radio Link Management. This function allows the SRNC to manage radio links using dedicated resources in a DRNS;
- Physical Channel Reconfiguration. This function allows the DRNC to reallocate the physical channel resources for a Radio Link;
- Radio Link Supervision. This function allows the DRNC to report failures and restorations of a Radio Link;
- Compressed Mode Control [FDD]. This function allows the SRNC to control the usage of compressed mode within a DRNS;
- Measurements on Dedicated Resources. This function allows the SRNC to initiate measurements on dedicated resources in the DRNS. The function also allows the DRNC to report the result of the measurements;
- DL Power Drifting Correction [FDD]. This function allows the SRNC to adjust the DL power level of one or more Radio Links in order to avoid DL power drifting between the Radio Links;
- DCH Rate Control. This function allows the DRNC to limit the rate of each DCH configured for the Radio Link(s) of a UE in order to avoid congestion situations in a cell;
- CCCH Signalling Transfer. This function allows the SRNC and DRNC to pass information between the UE and the SRNC on a CCCH controlled by the DRNS;
- GERAN Signalling Transfer. This function allows the SBSS and DBSS, the SRNC and DBSS or the SBSS and DRNC to pass information between the UE/MS and the SRNC/SBSS on an SRB2/CCCH controlled by the DBSS/DRNC;
- Paging. This function allows the SRNC/SBSS to page a UE in a URA/GRA or a cell in the DRNS;
- Common Transport Channel Resources Management. This function allows the SRNC to utilise Common Transport Channel Resources within the DRNS;
- Relocation Execution. This function allows the SRNC/SBSS to finalise a Relocation previously prepared via other interfaces;
- Reporting of General Error Situations. This function allows reporting of general error situations, for which function specific error messages have not been defined.
- DL Power Timeslot Correction [TDD]. This function enables the DRNS to apply an individual offset to the transmission power in each timeslot according to the downlink interference level at the UE.

- Measurements on Common Resources. This function allows an RNC/BSS to request from another RNC/BSS to initiate measurements on Common Resources. The function also allows the requested RNC/BSS to report the result of the measurements.
- Information Exchange. This function allows an RNC to request from another RNC the transfer of information. The function also allows the requested RNC to report the requested information.
- Resetting the Iur. This function is used to completely or partly reset the Iur interface.
- UE Measurement Forwarding[TDD]. This function allows the DRNC to request and receive UE measurements from the SRNC.
- Tracing. This function allows the SRNC to activate or deactivate trace in a DRNC.
- MBMS UE Linking/De-linking. This function allows the SRNC to provide/update/remove the UE Link to/in/from the DRNC.
- MBMS URA Linking/De-linking. This function allows the SRNC to provide/update/remove the URA Link to/in/from the DRNC.
- MBMS Channel Type Indication. This function allows the DRNC to indicate to the SRNC the selected channel type for an MBMS bearer service within certain cells in the DRNS.
- MBMS Preferred Frequency Layer Indication. This function allows the DRNC to indicate to the SRNC the preferred frequency layer for an MBMS bearer service within certain cells in the DRNS.
- MBMS MCCH Information Control. This function allows an MRNC to distribute the MCCH Information to CRNC within the MBSFN cluster.
- Direct Information Transfer. This function allows an RNC to transfer information to another RNC.
- Relocating serving RNC. This function enables to change the serving RNC functionality as well as the related Iu resources (RAB(s) and Signalling connection) from one RNC to another.
- Exchanging information about the secondary UL frequency. This function allows the SRNC to transfer information about the secondary UL frequency to the DRNS and the DRNS to transfer information about the secondary UL frequency to SRNC in Dual-Cell E-DCH operation.

The mapping between the above functions and RNSAP elementary procedures is shown in the Table 1.

Table 1: Mapping between functions and RNSAP elementary procedures

Function	Elementary Procedure(s)
Radio Link Management	a) Radio Link Setup b) Radio Link Addition c) Radio Link Deletion d) Unsynchronised Radio Link Reconfiguration e) Synchronised Radio Link Reconfiguration Preparation f) Synchronised Radio Link Reconfiguration Commit g) Synchronised Radio Link Reconfiguration Cancellation h) Radio Link Pre-emption i) Radio Link Activation j) Radio Link Parameter Update
Physical Channel Reconfiguration	Physical Channel Reconfiguration
Radio Link Supervision	a) Radio Link Failure b) Radio Link Restoration
Compressed Mode Control [FDD]	a) Radio Link Setup b) Radio Link Addition c) Compressed Mode Command d) Unsynchronised Radio Link Reconfiguration e) Synchronised Radio Link Reconfiguration Preparation f) Synchronised Radio Link Reconfiguration Commit g) Synchronised Radio Link Reconfiguration Cancellation
Measurements on Dedicated Resources	a) Dedicated Measurement Initiation b) Dedicated Measurement Reporting c) Dedicated Measurement Termination d) Dedicated Measurement Failure
DL Power Drifting Correction [FDD]	Downlink Power Control
DCH Rate Control	a) Radio Link Setup b) Radio Link Addition c) Unsynchronised Radio Link Reconfiguration d) Synchronised Radio Link Reconfiguration Preparation e) Radio Link Congestion
CCCH Signalling Transfer	a) Uplink Signalling Transfer b) Downlink Signalling Transfer
GERAN Signalling Transfer	a) GERAN Uplink Signalling Transfer b) Downlink Signalling Transfer
Paging	Paging
Common Transport Channel Resources Management	a) Common Transport Channel Resources Initiation b) Common Transport Channel Resources Release
Relocation Execution	Relocation Commit
Reporting of General Error Situations	Error Indication
Measurements on Common Resources	a) Common Measurement Initiation b) Common Measurement Reporting c) Common Measurement Termination d) Common Measurement Failure
Information Exchange	a) Information Exchange Initiation b) Information Reporting c) Information Exchange Termination d) Information Exchange Failure
DL Power Timeslot Correction [TDD]	Downlink Power Timeslot Control
Reset	Reset
UE Measurement Forwarding[TDD]	a) UE Measurement Initiation b) UE Measurement Reporting c) UE Measurement Termination d) UE Measurement Failure
Trace	a) Iur Invoke Trace b) Iur Deactivate Trace

Function	Elementary Procedure(s)
MBMS UE Linking/De-linking	a) Common Transport Channel Resources Initiation b) Radio Link Setup c) Downlink Signalling Transfer d) MBMS Attach e) MBMS Detach
MBMS Channel Type Indication	a) Direct Information Transfer b) Uplink Signalling Transfer c) Radio Link Setup d) Radio Link Addition e) Common Transport Channel Resources Initiation
MBMS Preferred Frequency Layer Indication	a) Direct Information Transfer b) Radio Link Setup d) Radio Link Addition
MBMS URA Linking/De-linking	a) Downlink Signalling Transfer b) MBMS Attach c) MBMS Detach
MBMS MCCH Information Control	a) MBSFN MCCH Information
Direct Information Transfer	a) Direct Information Transfer
Relocating serving RNC	a) Enhanced Relocation b) Enhanced Relocation Cancel c) Enhanced Relocation Signalling Transfer d) Enhanced Relocation Release
Exchanging information about the secondary UL frequency [FDD]	a) Secondary UL Frequency Reporting b) Secondary UL Frequency Update

7.1 RNSAP functions and elementary procedures for Iur-g.

The functions and RNSAP elementary procedures, which are applicable on the Iur-g interface are shown in the Table 1A.

Table 1A: RNSAP elementary procedures applicable on the Iur-g interface

Function	Elementary Procedure(s)
GERAN Signalling Transfer	a) GERAN Uplink Signalling Transfer b) Downlink Signalling Transfer
Paging	Paging
Relocation Execution	Relocation Commit
Reporting of General Error Situations	Error Indication
Measurements on Common Resources	a) Common Measurement Initiation b) Common Measurement Reporting c) Common Measurement Termination d) Common Measurement Failure
Information Exchange	a) Information Exchange Initiation b) Information Reporting c) Information Exchange Termination d) Information Exchange Failure

NOTE: In the connection with the functions related to the GERAN and UTRAN, the term RNC shall refer to RNC/BSS.

8 RNSAP Procedures

8.1 Elementary Procedures

In the following tables, all Eps are divided into Class 1 and Class 2 Eps.

Table 2: Class 1 Elementary Procedures

Elementary Procedure	Initiating Message	Successful Outcome	Unsuccessful Outcome
		Response message	Response message
Radio Link Setup	RADIO LINK SETUP REQUEST	RADIO LINK SETUP RESPONSE	RADIO LINK SETUP FAILURE
Radio Link Addition	RADIO LINK ADDITION REQUEST	RADIO LINK ADDITION RESPONSE	RADIO LINK ADDITION FAILURE
Radio Link Deletion	RADIO LINK DELETION REQUEST	RADIO LINK DELETION RESPONSE	
Synchronised Radio Link Reconfiguration Preparation	RADIO LINK RECONFIGURATION PREPARE	RADIO LINK RECONFIGURATION READY	RADIO LINK RECONFIGURATION FAILURE
Unsynchronised Radio Link Reconfiguration	RADIO LINK RECONFIGURATION REQUEST	RADIO LINK RECONFIGURATION RESPONSE	RADIO LINK RECONFIGURATION FAILURE
Physical Channel Reconfiguration	PHYSICAL CHANNEL RECONFIGURATION REQUEST	PHYSICAL CHANNEL RECONFIGURATION COMMAND	PHYSICAL CHANNEL RECONFIGURATION FAILURE
Dedicated Measurement Initiation	DEDICATED MEASUREMENT INITIATION REQUEST	DEDICATED MEASUREMENT INITIATION RESPONSE	DEDICATED MEASUREMENT INITIATION FAILURE
Common Transport Channel Resources Initialisation	COMMON TRANSPORT CHANNEL RESOURCES REQUEST	COMMON TRANSPORT CHANNEL RESOURCES RESPONSE	COMMON TRANSPORT CHANNEL RESOURCES FAILURE
Common Measurement Initiation	COMMON MEASUREMENT INITIATION REQUEST	COMMON MEASUREMENT INITIATION RESPONSE	COMMON MEASUREMENT INITIATION FAILURE
Information Exchange Initiation	INFORMATION EXCHANGE INITIATION REQUEST	INFORMATION EXCHANGE INITIATION RESPONSE	INFORMATION EXCHANGE INITIATION FAILURE
Reset	RESET REQUEST	RESET RESPONSE	
UE Measurement Initiation[TDD]	UE MEASUREMENT INITIATION REQUEST	UE MEASUREMENT INITIATION RESPONSE	UE MEASUREMENT INITIATION FAILURE
Enhanced Relocation	ENHANCED RELOCATION REQUEST	ENHANCED RELOCATION RESPONSE	ENHANCED RELOCATION FAILURE

Table 3: Class 2 Elementary Procedures

Elementary Procedure	Initiating Message
Uplink Signalling Transfer	UPLINK SIGNALLING TRANSFER INDICATION
GERAN Uplink Signalling Transfer	GERAN UPLINK SIGNALLING TRANSFER INDICATION
Downlink Signalling Transfer	DOWNLINK SIGNALLING TRANSFER REQUEST
Relocation Commit	RELOCATION COMMIT
Paging	PAGING REQUEST
Synchronised Radio Link Reconfiguration Commit	RADIO LINK RECONFIGURATION COMMIT
Synchronised Radio Link Reconfiguration Cancellation	RADIO LINK RECONFIGURATION CANCEL
Radio Link Failure	RADIO LINK FAILURE INDICATION
Radio Link Restoration	RADIO LINK RESTORE INDICATION
Dedicated Measurement Reporting	DEDICATED MEASUREMENT REPORT
Dedicated Measurement Termination	DEDICATED MEASUREMENT TERMINATION REQUEST
Dedicated Measurement Failure	DEDICATED MEASUREMENT FAILURE INDICATION
Downlink Power Control [FDD]	DL POWER CONTROL REQUEST
Compressed Mode Command [FDD]	COMPRESSED MODE COMMAND
Common Transport Channel Resources Release	COMMON TRANSPORT CHANNEL RESOURCES RELEASE REQUEST
Error Indication	ERROR INDICATION
Downlink Power Timeslot Control [TDD]	DL POWER TIMESLOT CONTROL REQUEST
Radio Link Pre-emption	RADIO LINK PREEMPTION REQUIRED INDICATION
Radio Link Congestion	RADIO LINK CONGESTION INDICATION
Common Measurement Reporting	COMMON MEASUREMENT REPORT
Common Measurement Termination	COMMON MEASUREMENT TERMINATION REQUEST
Common Measurement Failure	COMMON MEASUREMENT FAILURE INDICATION
Information Reporting	INFORMATION REPORT
Information Exchange Termination	INFORMATION EXCHANGE TERMINATION REQUEST
Information Exchange Failure	INFORMATION EXCHANGE FAILURE INDICATION
MBMS Attach	MBMS ATTACH COMMAND
MBMS Detach	MBMS DETACH COMMAND
Radio Link Parameter Update	RADIO LINK PARAMETER UPDATE INDICATION
UE Measurement Reporting [TDD]	UE MEASUREMENT REPORT
UE Measurement Termination [TDD]	UE MEASUREMENT TERMINATION REQUEST
UE Measurement Failure [TDD]	UE MEASUREMENT FAILURE INDICATION
Iur Invoke Trace	IUR INVOKE TRACE
Iur Deactivate Trace	IUR DEACTIVATE TRACE
Direct Information Transfer	DIRECT INFORMATION TRANSFER
Enhanced Relocation Cancel	ENHANCED RELOCATION CANCEL
Enhanced Relocation Signalling Transfer	ENHANCED RELOCATION SIGNALLING TRANSFER
Enhanced Relocation Release	ENHANCED RELOCATION RELEASE
MBSFN MCCH Information	MBSFN MCCH INFORMATION
Secondary UL Frequency Reporting [FDD]	SECONDARY UL FREQUENCY REPORT
Secondary UL Frequency Update [FDD]	SECONDARY UL FREQUENCY UPDATE INDICATION

8.2 Basic Mobility Procedures

8.2.1 Uplink Signalling Transfer

8.2.1.1 General

The procedure is used by the DRNC to forward a Uu message received on the CCCH to the SRNC.

This procedure shall use the connectionless mode of the signalling bearer.

8.2.1.2 Successful Operation

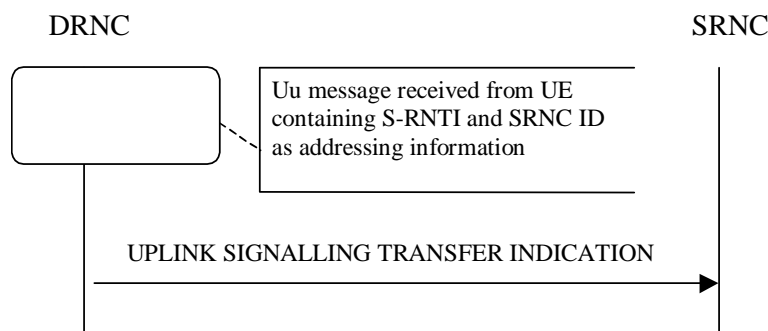

Figure 1: Uplink Signalling Transfer procedure, Successful Operation

When the DRNC receives an Uu message on the CCCH in which the UE addressing information is U-RNTI, i.e. S-RNTI and SRNC-ID, DRNC shall send the UPLINK SIGNALLING TRANSFER INDICATION message to the SRNC identified by the SRNC-ID received from the UE.

If at least one URA Identity is being broadcast in the cell where the Uu message was received (the accessed cell), the DRNC shall include a URA Identity for this cell in the *URA ID IE*, the *Multiple URAs Indicator IE* indicating whether or not multiple URA Identities are being broadcast in the accessed cell, and the RNC Identity of all other RNCs that are having at least one cell within the URA where the Uu message was received in the *URA Information IE* in the UPLINK SIGNALLING TRANSFER INDICATION message.

The DRNC shall include in the message the C-RNTI that it allocates to identify the UE in the radio interface in the accessed cell. If there is no valid C-RNTI for the UE in the accessed cell, the DRNS shall allocate a new C-RNTI for the UE [FDD – and in case Enhanced FACH operation is activated in the accessed cell the DRNC shall allocate the HS-DSCH-RNTI to the UE and shall include the *HS-DSCH-RNTI IE* in the message. And in case Common E-DCH operation is activated in the accessed cell the DRNC shall include the E-RNTI received from Node B and shall include the *E-RNTI IE* in the message]. [1.28Mcps TDD – and in case Enhanced FACH operation is activated in the accessed cell the DRNC shall allocate the HS-DSCH-RNTI to the UE and shall include the *HS-DSCH-RNTI IE* in the message and the DRNC shall include the E-RNTI received from Node B and shall include the *E-RNTI IE* in the message]. If the DRNS allocates a new C-RNTI it shall also release any C-RNTI previously allocated for the UE.

If the DRNS has any RACH and/or FACH resources allocated for the UE identified by the U-RNTI in another cell than the accessed cell in which the Mac SDU sizes, flow control settings (including credits) and/or transport bearer are different from those in the old cell, then the DRNS shall not include the *Common Transport Channel Resources Initialisation Not Required IE* in the UPLINK SIGNALLING TRANSFER INDICATION message. In addition the DRNS shall release these RACH and/or FACH resources in old cell.

If the DRNS has any RACH and/or FACH resources allocated for the UE identified by the U-RNTI in another cell than the accessed cell in which the Mac SDU sizes, flow control settings (including credits) and transport bearer are the same as in the old cell, there is no need for Common Transport Channel Resources Initialisation to be initiated. In that case, DRNC may include the *Common Transport Channel Resources Initialisation Not Required IE* in the UPLINK SIGNALLING TRANSFER INDICATION message. In addition, the DRNS shall move these RACH and/or FACH resources to the new cell. If no Common Transfer Channel Resources Initialisation procedure is executed, the currently applicable Mac SDU sizes, flow control settings (including credits) and transport bearer shall continue to be used while the UE is in the new cell.

If no context exists for this UE in the DRNC, the DRNC shall create a UE Context for this UE, allocate a D-RNTI for the UE Context, and include the *D-RNTI IE* and the identifiers for the CN CS Domain and CN PS Domain that the DRNC is connected to in the UPLINK SIGNALLING TRANSFER INDICATION message. These CN Domain Identifiers shall be based on the LAC and RAC respectively of the cell where the message was received from the UE.

Depending on local configuration in the DRNS, it may include the geographical co-ordinates of the cell, represented either by the *Cell GAI IE* or by the *Cell GA Additional Shapes IE*, in which the Uu message was received in the UPLINK SIGNALLING TRANSFER INDICATION message. If the DRNC includes the *Cell GA Additional Shapes IE* in the UPLINK SIGNALLING TRANSFER INDICATION message, it shall also include the *Cell GAI IE*.

[FDD – The DRNC shall include the *DPC Mode Change Support Indicator IE* in the UPLINK SIGNALLING TRANSFER INDICATION message if the accessed cell supports DPC mode change.]

The DRNC shall include [FDD – the *Cell Capability Container FDD IE*] [3.84Mcps TDD – the *Cell Capability Container TDD IE*] [1.28Mcps TDD – the *Cell Capability Container TDD LCR IE*] [7.68Mcps TDD – the *Cell Capability Container 7.68Mcps TDD IE*] [FDD – and/or the *Cell Capability Container Extension FDD IE*] in the UPLINK SIGNALLING TRANSFER INDICATION message if the accessed cell supports any functionalities listed in [FDD – 9.2.2.D] [3.84Mcps TDD – 9.2.3.1a] [1.28Mcps TDD – 9.2.3.1b] [7.68Mcps TDD – 9.2.3.31] [FDD – 9.2.2.123].

[FDD – If the cell is multicell adjacent carrier operation capable and if the cell can be the serving HS-DSCH then the possible cells to serve multicell adjacent carrier operation (same sector) that can act as secondary serving HS-DSCH shall be listed in the *Secondary Serving Cell List IE*. If the *Secondary Serving Cell List IE* is not present, the multicell (adjacent carrier operation) capable cell can only serve as a secondary serving HS-DSCH cell in single band operation.]

[FDD – If the cell is dual band capable and if the cell can be the serving HS-DSCH then the possible cells to serve dual band carrier operation (same sector) that can act as secondary serving HS-DSCH shall be listed in the *Dual Band Secondary Serving Cell List IE*. If the *Dual Band Secondary Serving Cell List IE* is not present, the dual band capable cell can only serve as a secondary serving HS-DSCH cell in dual band operation.]

If MOCN or GWCN network sharing configuration is used then the DRNC shall include the broadcasted PLMN identities of the concerned cell in the *Multiple PLMN List IE* in the UPLINK SIGNALLING TRANSFER INDICATION message.

If available, the DRNC shall include the *SNA Information IE* for the concerned cell.

When receiving the *SNA Information IE*, the SRNC should use it to restrict cell access based on SNA information. See also TS 25.401 [40] for a broader description of the SNA access control.

[FDD – The DRNC shall include the *Cell Portion ID IE* in the UPLINK SIGNALLING TRANSFER INDICATION message if available.]

[1.28 Mcps TDD – The DRNC shall include the *Cell Portion LCR ID IE* in the UPLINK SIGNALLING TRANSFER INDICATION message if available.]

[FDD – If the propagation delay value exceeds the range of the *Propagation Delay IE* then the DRNC shall if supported include the *Extended Propagation Delay IE* and set the *Propagation Delay IE* to its maximum value.]

If the *D-RNTI IE* is not to be included in the UPLINK SIGNALLING TRANSFER INDICATION message and the UE Link is currently stored in the UE Context in the DRNC, the DRNC shall assume that the UE changes the cell under which it camps in the DRNS (see ref. TS 25.346 [50], section 5.1.6 on intra-DRNC cell change). In this case, if an MBMS session for some MBMS bearer services contained in the UE Link is ongoing in the cell identified by the *UC-ID IE*, the DRNC shall include in the *Active MBMS Bearer Service List IE* the *Transmission Mode IE* for each of these active MBMS bearer services. Or else, if the DRNC receives a Uu message on the CCCH in which the short identities for MBMS Selected Services are included, and the Uu message requests for MBMS PtP radio bearer establishment, the DRNC shall determine which TMGIs correspond with the short identities and shall include in the *Active MBMS Bearer Service List IE* the *TMGI IE* together with the *Transmission Mode IE* for each of these MBMS Selected Services.

If the CCCH message contains *Measurement results for monitored cells on non-used frequencies IE* in *Measured Result on RACH IE*, the DRNC may include in the UPLINK SIGNALLING TRANSFER INDICATION message the *Inter-frequency Cell List IE* for each of the measured inter-frequency cells. The order of cells in *Measurement results for monitored cells on non-used frequencies IE* in the CCCH message shall be preserved in *Inter-frequency Cell List IE*. If the *UL UARFCN IE* in the *Inter-frequency Cell List IE* is not present, the default duplex distance defined for the operating frequency band shall be used in the SRNC (see ref. TS 25.101 [43]).

[3.84 Mcps TDD – the DRNC shall include the *Rx Timing Deviation IE* unless the cell to which the CCCH message was sent is configured to use the extended timing advance in which case *Rx Timing Deviation 3.84Mcps Extended IE* shall be included.]

[7.68 Mcps TDD – the DRNC shall include the *Rx Timing Deviation 7.68Mcps IE*.]

8.2.1.3 Abnormal Conditions

-

8.2.1A GERAN Uplink Signalling Transfer

8.2.1A.1 General

The procedure is used by the DBSS to forward an Um message received on the SRB2 to the SBSS/SRNC. The procedure is also used by the DRNC to forward a Uu message received on the CCCH to the SBSS.

This procedure shall use the connectionless mode of the signalling bearer.

8.2.1A.2 Successful Operation

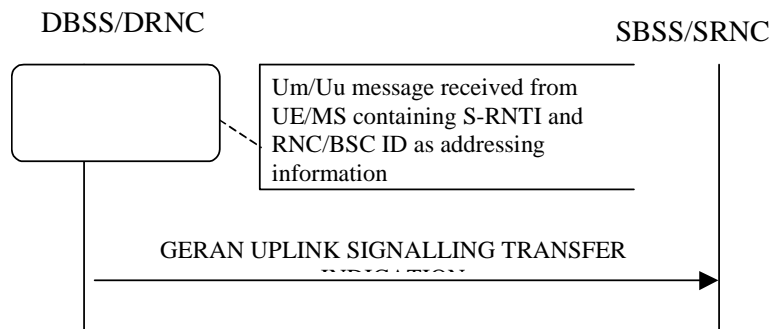

Figure 1A: GERAN Uplink Signalling Transfer procedure, Successful Operation

When the DBSS receives an Um message on the SRB2 in which the MS addressing information is G-RNTI, i.e. S-RNTI and BSC-ID, DBSS shall send the GERAN UPLINK SIGNALLING TRANSFER INDICATION message to the SBSS/SRNC identified by the BSC-ID received from the MS.

Alternatively, when the DRNC receives an Uu message on the CCCH in which the UE addressing information is U-RNTI, i.e. S-RNTI and SRNC-ID, and in which the SRNC-ID points to a GERAN BSS, the DRNC shall send the GERAN UPLINK SIGNALLING TRANSFER INDICATION message to the SBSS identified by SRNC-ID received from the UE.

If at least one GRA/URA Identity is being broadcast in the cell where the Um/Uu message was received (the accessed cell), the DBSS/DRNC shall include a GRA/URA Identity for this cell in the *URA ID IE*, the *Multiple URAs Indicator IE* indicating whether or not multiple GRA/URA Identities are being broadcast in the accessed cell, and the RNC/BSS Identity of all other RNC/BSSs that are having at least one cell within the GRA/URA where the Um/Uu message was received in the *URA Information IE* in the GERAN UPLINK SIGNALLING TRANSFER INDICATION message.

If no context exists for this UE/MS in the DBSS/DRNC, the DBSS/DRNC shall create a UE Context for this UE/MS, allocate a D-RNTI for the UE Context, and include the *D-RNTI IE* and the identifiers for the CN CS Domain and CN PS Domain that the DBSS/DRNC is connected to in the GERAN UPLINK SIGNALLING TRANSFER INDICATION message. These CN Domain Identifiers shall be based on the LAC and RAC respectively of the cell where the message was received from the UE/MS.

8.2.1A.3 Abnormal Conditions

-

8.2.2 Downlink Signalling Transfer

8.2.2.1 General

The procedure is used by the SRNC to request to the DRNC the transfer of a Uu message on the CCCH in a cell. When used, the procedure is in response to a received Uplink Signalling Transfer procedure.

This procedure shall use the connectionless mode of the signalling bearer.

8.2.2.1.1 Downlink Signalling Transfer for lur-g

The procedure is used by the SRNC/SBSS to request to the DBSS the transfer of an Um message on the SRB2 in a cell.

The procedure is used by the SBSS to request to the DRNC the transfer of a Uu message on the CCCH in a cell.

8.2.2.2 Successful Operation



Figure 2: Downlink Signalling Transfer procedure, Successful Operation

The procedure consists of the DOWNLINK SIGNALLING TRANSFER REQUEST message sent by the SRNC to the DRNC.

The message contains the Cell Identifier (C-ID) contained in the received UPLINK SIGNALLING TRANSFER INDICATION message and the D-RNTI.

Upon receipt of the message, the DRNC shall send the L3 Information on the CCCH in the cell indicated by the *C-ID* IE to the UE identified by the *D-RNTI* IE.

If the *D-RNTI Release Indication* IE is set to “Release D-RNTI” and the DRNS has no dedicated resources (DCH, [TDD – USCH and/or DSCH]) allocated for the UE, the DRNS shall release the D-RNTI, the UE Context and any RACH and FACH resources and any C-RNTI allocated to the UE Context upon receipt of the DOWNLINK SIGNALLING TRANSFER REQUEST message. If a UE Link is currently stored in the UE Context, the DRNC shall perform UE De-linking as specified in TS 25.346 [50], section 5.1.6.

If the *D-RNTI Release Indication* IE is set to “Release D-RNTI” and the DRNS has dedicated resources allocated for the UE, the DRNS shall only release any RACH and FACH resources and any C-RNTI allocated to the UE Context upon receipt of the DOWNLINK SIGNALLING TRANSFER REQUEST message.

If the *MBMS Bearer Service List* IE is included and *URA-ID* IE is not included in the DOWNLINK SIGNALLING TRANSFER REQUEST message, the DRNC shall perform the UE Linking as specified in TS 25.346 [50], section 5.1.6.

If the *MBMS Bearer Service List* IE is included and the *URA-ID* IE is included in the DOWNLINK SIGNALLING TRANSFER REQUEST message, the DRNC shall perform the URA Linking as specified in TS 25.346 [50], section 5.1.10.

If the *MBMS Bearer Service List* IE is included and the *Old URA-ID* IE is included in the DOWNLINK SIGNALLING TRANSFER REQUEST message, the DRNC shall perform URA De-linking for the URA identified by the *Old URA-ID* IE as specified in TS 25.346 [50], section 5.1.10.

[FDD – If the *Enhanced PCH Capability* IE is included in the message, the DRNC should store the information. If the *Enhanced PCH Capability* IE is not included in the message, the DRNC shall use the information to release an RRC Connection for the UE in cells supporting Enhanced PCH.]

[1.28Mcps TDD – If the *Enhanced PCH Capability* IE is included in the message, the DRNC should store the information. If the *Enhanced PCH Capability* IE is not included in the message, the DRNC shall use the information to release an RRC Connection for the UE in cells supporting Enhanced PCH.]

8.2.2.2.1 Successful Operation for lur-g

The procedure consists of the DOWNLINK SIGNALLING TRANSFER REQUEST message sent by the SRNC/SBSS to the DBSS or by the SBSS to the DRNC.

The message contains the Cell Identifier (*C-ID*) contained in the received UPLINK SIGNALLING TRANSFER INDICATION message and the *D-RNTI*.

Upon receipt of the message, the DBSS shall send the L3 Information on the SRB2 in the cell indicated by the *C-ID* IE to the UE/MS identified by the *D-RNTI* IE.

Upon receipt of the message, the DRNC shall send the L3 Information on the CCCH in the cell indicated by the *C-ID* IE to the UE/MS identified by the *D-RNTI* IE.

8.2.2.3 Abnormal Conditions

If the user identified by the *D-RNTI* IE has already accessed another cell controlled by the DRNC than the cell identified by the *C-ID* IE in the DOWNLINK SIGNALLING TRANSFER REQUEST message, the message shall be ignored.

8.2.2.3.1 Abnormal Conditions for lur-g

If the user identified by the *D-RNTI* IE has already accessed another cell controlled by the DRNC/DBSS than the cell identified by the *C-ID* IE in the DOWNLINK SIGNALLING TRANSFER REQUEST message, the message shall be ignored.

If the DRNC receives from the SBSS the DOWNLINK SIGNALLING TRANSFER REQUEST message, in which the *D-RNTI Release Indication* IE is set to “not Release D-RNTI”, the DRNC shall ignore this IE and release the *D-RNTI*.

If the DBSS receives from the SBSS/SRNC the DOWNLINK SIGNALLING TRANSFER REQUEST message, in which the *D-RNTI Release Indication* IE is set to “not Release D-RNTI”, the DBSS shall ignore this IE and release the *D-RNTI*.

8.2.3 Relocation Commit

8.2.3.1 General

The Relocation Commit procedure is used by source RNC to execute the Relocation. This procedure supports the Relocation procedures described in TS 25.413 [2].

This procedure shall use the signalling bearer mode specified below.

8.2.3.2 Successful Operation



Figure 3: Relocation Commit procedure, Successful Operation

The source RNC sends the RELOCATION COMMIT message to the target RNC to request the target RNC to proceed with the Relocation. When the UE is utilising one or more radio links in the DRNC the message shall be sent using the connection oriented service of the signalling bearer and no further identification of the UE Context in the DRNC is required. If on the other hand, the UE is not utilising any radio link the message shall be sent using the connectionless service of the signalling bearer and the *D-RNTI* IE shall be included in the message to identify the UE Context in the DRNC.

Upon receipt of the RELOCATION COMMIT message from the source RNC the target RNC finalises the Relocation. If the message contains the transparent *RANAP Relocation Information* IE the target RNC shall use this information when finalising the Relocation.

8.2.3.2.1 Successful Operation for lur-g

The source RNC/BSS sends the RELOCATION COMMIT message to the target RNC/BSS to request the target RNC/BSS to proceed with the Relocation.

The message shall be sent using the connectionless service of the signalling bearer and the *D-RNTI* IE shall be included in the message to identify the UE/MS context in the DBSS.

Upon receipt of the RELOCATION COMMIT message from the source RNC/BSS, the target RNC/BSS finalises the Relocation. If the message contains the transparent *RANAP Relocation Information* IE the target RNC/BSS shall use this information when finalising the Relocation.

8.2.3.3 Abnormal Conditions

-

8.2.4 Paging

8.2.4.1 General

This procedure is used by the SRNC to indicate to a CRNC that a UE shall be paged in a cell or URA that is under the control of the CRNC.

This procedure shall use the connectionless mode of the signalling bearer.

8.2.4.2 Successful Operation



Figure 4: Paging procedure, Successful Operation

The procedure is initiated with a PAGING REQUEST message sent from the SRNC to the CRNC.

If the message contains the *C-ID* IE, the CRNC shall page in the indicated cell. Alternatively, if the message contains the *URA-ID* IE, the CRNC shall page in all cells that it controls in the indicated URA.

If the PAGING REQUEST message includes the *CN Originated Page to Connected Mode UE* IE, the CRNC shall include the information contained in the *CN Originated Page to Connected Mode UE* IE when paging the UE.

The CRNC shall calculate the Paging Occasions from the *IMSI* IE and the *DRX Cycle Length Coefficient* IE according to specification in ref. TS 25.304 [15] and apply transmission on PICH and PCH [FDD – or HS-DSCH] [1.28Mcps TDD – or HS-DSCH] accordingly.

[FDD – If the PAGING REQUEST message includes the *Enhanced PCH Capability* IE, the CRNC shall use the information to page the UE in cells supporting Enhanced PCH.]

[1.28Mcps TDD – If the PAGING REQUEST message includes the *Enhanced PCH Capability* IE, the CRNC shall use the information to page the UE in cells supporting Enhanced PCH.]

8.2.4.2.1 Successful Operation for lur-g

The procedure is initiated with a PAGING REQUEST message sent from the SBSS to the CRNC/CBSS or from the SRNC to the CBSS.

If the message contains the *URA-ID* IE, the CRNC/CBSS shall page in all cells that it controls in the indicated URA/GRA.

If the PAGING REQUEST message includes the *CN Originated Page to Connected Mode UE IE*, the CRNC/CBSS shall include the information contained in the *CN Originated Page to Connected Mode UE IE* when paging the UE.

The CBSS shall calculate the Paging Occasions from the *IMSI IE* and the *GERAN DRX Cycle Length Coefficient IE* according to specification in ref. TS 44.118 [36] and apply transmission on PCCCH or PACCH accordingly.

8.2.4.3 Abnormal Conditions

8.2.4.3.1 Abnormal Conditions for Iur-g

If the DRNC receives a PAGING REQUEST message from the SBSS, which contains the *C-ID IE*, the message shall be ignored.

If the DBSS receives a PAGING REQUEST message from the SBSS/SRNC, which contains the *C-ID IE*, the message shall be ignored.

8.2.5 MBSFN MCCH Information

8.2.5.1 General

The procedure is used by the MRNC to inform the CRNC of the MCCH configuration and scheduling information used in MRNC.

This procedure shall use the connectionless mode of the signalling bearer.

8.2.5.2 Successful Operation

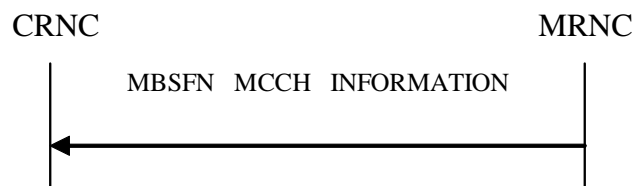

Figure 4A: MBSFN MCCH Information procedure, Successful Operation

The procedure is used for MBSFN operation when a MRNC is used.

The message contains the MCCH message list sent on the MRNC and the MCCH configuration information of the MRNC.

Upon receipt of the message, if the *MCCH Configuration IE* exists, the CRNC shall setup or reconfigure the MCCH of all cells in the MBSFN cluster with the configuration contained in this IE, and update the System Information of these cells.

The CRNC shall decode the *L3 Information IE* contained in the *MCCH Message List IE* and apply the RLC/MAC/PHY configuration specified by relative MCCH Message to setup the RB information of MTCH, and then send the *L3 Information IE* on the MCCH in the receiving sequence at the beginning of the first MCCH modification period following the CFN indicated by the *CFN IE*.

In case MRNC is used and TDM multiplexing is used over air interface, the *MBSFN Scheduling Transmission Time Interval info List IE* shall be contained to show the scheduling transmission time interval for MBMS service which is configured with MBSFN TDM multiplexing. The CRNC shall schedule received data packets in the scheduling transmission time interval following the time point indicated by the timestamp.

8.2.5.3 Abnormal Conditions

-

8.3 Dedicated Procedures

8.3.1 Radio Link Setup

8.3.1.1 General

This procedure is used for establishing the necessary resources in the DRNS for one or more radio links.

The connection-oriented service of the signalling bearer shall be established in conjunction with this procedure.

8.3.1.2 Successful Operation

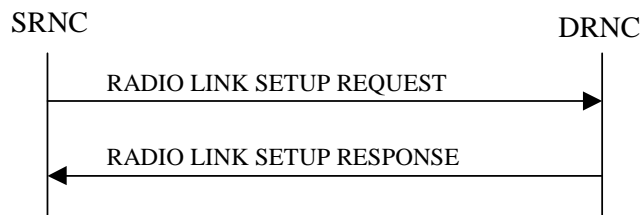

Figure 5: Radio Link Setup procedure: Successful Operation

When the SRNC makes an algorithmic decision to add the first cell or set of cells from a DRNS to the active set of a specific UE-UTRAN connection, the RADIO LINK SETUP REQUEST message is sent to the corresponding DRNC to request establishment of the radio link(s). The Radio Link Setup procedure is initiated with this RADIO LINK SETUP REQUEST message sent from the SRNC to the DRNC.

Upon receipt of the RADIO LINK SETUP REQUEST message, the DRNS shall reserve the necessary resources and configure the new RL(s) according to the parameters given in the message. Unless specified below, the meaning of parameters is specified in other specifications.

The DRNS shall prioritise resource allocation for the RL(s) to be established according to Annex A.

If the RADIO LINK SETUP REQUEST message includes the *Allowed Queuing Time* IE the DRNS may queue the request for a time period not to exceed the value of the *Allowed Queuing Time* IE before starting to execute the request.

If the *UE Aggregate Maximum Bit Rate* IE is contained in the RADIO LINK SETUP REQUEST message, the DRNS shall, if supported, store the received UE Aggregate Maximum Bit Rate parameters to control the aggregate data rate of non GBR traffic for this UE.

Transport Channels Handling:

DCH(s):

[TDD – If the *DCH Information* IE is present in the RADIO LINK SETUP REQUEST message, the DRNS shall configure the new DCHs according to the parameters given in the message.]

If the RADIO LINK SETUP REQUEST message includes a *DCH Information* IE with multiple *DCH Specific Info* IEs, then the DRNS shall treat the DCHs in the *DCH Information* IE as a set of co-ordinated DCHs.

If the *DCH Specific Info* IE includes the *Unidirectional DCH Indicator* IE set to “Uplink DCH only”, the DRNS shall ignore the *Transport Format Set* IE for the downlink for this DCH. As a consequence this DCH is not included as a part of the downlink CCTrCH.

If the *DCH Specific Info* IE includes the *Unidirectional DCH Indicator* IE set to “Downlink DCH only”, the DRNS shall ignore the *Transport Format Set* IE for the uplink for this DCH. As a consequence this DCH is not included as a part of the uplink CCTrCH.

[FDD – For each DCH which do not belong to a set of co-ordinated DCHs, and which includes a *QE-Selector* IE set to “selected”, the DRNS shall use the Transport channel BER from that DCH for the QE in the UL data frames. If no Transport channel BER is available for the selected DCH, the DRNS shall use the Physical

channel BER for the QE, ref. TS 25.427 [4]. If the *QE-Selector* IE is set to “non-selected”, the DRNS shall use the Physical channel BER for the QE in the UL data frames, ref. TS 25.427 [4].]

For a set of co-ordinated DCHs, the DRNS shall use the Transport channel BER from the DCH with the *QE-Selector* IE set to “selected” for the QE in the UL data frames, ref. TS 25.427 [4]. [FDD – If no Transport channel BER is available for the selected DCH, the DRNS shall use the Physical channel BER for the QE, ref. TS 25.427 [4]. If all DCHs have *QE-Selector* IE set to “non-selected”, the DRNS shall use the Physical channel BER for the QE, ref. TS 25.427 [4].] [TDD – If no Transport channel BER is available for the selected DCH, the DRNS shall use 0 for the QE, ref. TS 25.427 [4].]

The DRNS shall use the included *UL DCH FP Mode* IE for a DCH or a set of co-ordinated DCHs as the DCH FP Mode in the Uplink of the user plane for the DCH or the set of co-ordinated DCHs.

The DRNS shall use the included *ToAWS* IE for a DCH or a set of co-ordinated DCHs as the Time of Arrival Window Startpoint in the user plane for the DCH or the set of co-ordinated DCHs.

The DRNS shall use the included *ToAWE* IE for a DCH or a set of co-ordinated DCHs as the Time of Arrival Window Endpoint in the user plane for the DCH or the set of co-ordinated DCHs.

The *Frame Handling Priority* IE defines the priority level that should be used by the DRNS to prioritise between different frames of the data frames of the DCHs in the downlink on the radio interface in congestion situations once the new RL(s) have been activated.

The *Traffic Class* IE may be used to determine the transport bearer characteristics to apply between DRNC and Node B for the related DCH or set of co-ordinated DCHs. The DRNC should ignore the *Traffic Class* IE if the *TrCH Source Statistics Descriptor* IE indicates the value “RRC”.

If the *TNL QoS* IE is included for a DCH or a set of co-ordinated DCHs and if ALCAP is not used, the *TNL QoS* IE may be used by the DRNS to determine the transport bearer characteristics to apply in the uplink for the related DCH or set of co-ordinated DCHs.

If the *DCH Information* IE contains a *DCH Specific Info* IE which includes the *Guaranteed Rate Information* IE, the DRNS shall treat the included IEs according to the following:

- If the *Guaranteed Rate Information* IE includes the *Guaranteed UL Rate* IE, the DRNS shall apply the Guaranteed Rate in the uplink of this DCH. The DRNS may decide to request the SRNC to limit the user rate of the uplink of the DCH at any point in time. The DRNS may request the SRNC to reduce the user rate of the uplink of the DCH below the guaranteed bit rate, however, whenever possible the DRNS should request the SRNC to only reduce the user rate between the maximum bit rate and the guaranteed bit rate. If the *DCH Specific Info* IE in the *DCH Information* IE does not include the *Guaranteed UL Rate* IE, the DRNS shall not limit the user rate of the uplink of the DCH.
- If the *Guaranteed Rate Information* IE includes the *Guaranteed DL Rate* IE, the DRNS shall apply the Guaranteed Rate in the downlink of this DCH. The DRNS may decide to request the SRNC to limit the user rate of the downlink of the DCH at any point in time. The DRNS may request the SRNC to reduce the user rate of the downlink of the DCH below the guaranteed bit rate, however, whenever possible the DRNS should request the SRNC to only reduce the user rate between the maximum bit rate and the guaranteed bit rate. If the *DCH Specific Info* IE in the *DCH Information* IE does not include the *Guaranteed DL Rate* IE, the DRNS shall not limit the user rate of the downlink of the DCH.

[FDD – If the RADIO LINK SETUP REQUEST message includes the *Transport Bearer Not Requested Indicator* IE set to “Transport Bearer shall not be Established” for a DCH, then the DRNC shall not establish a transport bearer for the concerned DCH and shall include the *Transport Bearer Not Setup Indicator* IE for the corresponding DCH in the RADIO LINK SETUP RESPONSE message.]

[FDD – If the RADIO LINK SETUP REQUEST message includes the *Transport Bearer Not Requested Indicator* IE set to “Transport Bearer may not be Established” for a DCH and:]

- [FDD – if the DRNC establishes a transport bearer for the concerned DCH, the DRNC shall include in the RADIO LINK SETUP RESPONSE message the *Binding ID* IE and *Transport Layer Address* IE for establishment of a transport bearer for the DCH being established.]

- [FDD – if the DRNC does not establish a transport bearer for the concerned DCH, the DRNC shall include the *Transport Bearer Not Setup Indicator* IE for the corresponding DCH in the RADIO LINK SETUP RESPONSE message.]

[TDD – DSCH(s):]

[TDD – If the *DSCH Information* IE is included in the RADIO LINK SETUP REQUEST message, the DRNC shall establish the requested DSCHs. If the *Transport Layer Address* IE and *Binding ID* IE are included in the *DSCH Information* IE the DRNC may use the transport layer address and the binding identifier received from the SRNC when establishing a transport bearer for the DSCH. In addition, the DRNC shall send a valid set of *DSCH Scheduling Priority* IE and *MAC-c/sh SDU Length* IE parameters to the SRNC in the RADIO LINK SETUP RESPONSE message. If the *PDSCH RL ID* IE indicates a radio link in the DRNS, then the DRNC shall allocate a DSCH-RNTI to the UE Context and include the *DSCH-RNTI* IE in the RADIO LINK SETUP RESPONSE message.]

[TDD – If the *DSCH Information* IE is included in the RADIO LINK SETUP REQUEST message, the DRNS may use the *Traffic Class* IE to determine the transport bearer characteristics to apply between DRNC and Node B for the related DSCHs.]

[TDD – The DRNC shall include the *DSCH Initial Window Size* IE in the RADIO LINK SETUP RESPONSE message for each DSCH, if the DRNS allows the SRNC to start transmission of MAC-c/sh SDUs before the DRNS has allocated capacity on user plane as described in TS 25.425 [32].]

[TDD – If the RADIO LINK SETUP REQUEST message includes the *TNL QoS* IE in the *DSCH TDD Information* IE and if ALCAP is not used, the DRNS may use the *TNL QoS* IE to determine the transport bearer characteristics to apply in the uplink for the related DSCH.]

[TDD – USCH(s):]

[TDD – The DRNS shall use the list of RB Identities in the *RB Info* IE in the *USCH information* IE to map each *RB Identity* IE to the corresponding USCH. If the *Transport Layer Address* IE and *Binding ID* IE are included in the *USCH Information* IE the DRNC may use the transport layer address and the binding identifier received from the SRNC when establishing a transport bearer for the USCH.]

[TDD – If the *USCH Information* IE is included in the RADIO LINK SETUP REQUEST message, the DRNS may use the *Traffic Class* IE to determine the transport bearer characteristics to apply between DRNC and Node B for the related USCHs.]

[TDD – If the *USCH Information* IE is included in the RADIO LINK SETUP REQUEST message and contains the *TNL QoS* IE, and if ALCAP is not used, the DRNS may use the *TNL QoS* IE to determine the transport bearer characteristics to apply in the uplink for the related USCH.]

[TDD – If the *USCH Information* IE is included in the RADIO LINK SETUP REQUEST message, the DRNS shall establish the requested USCHs, and the DRNC shall provide the [3.84 Mcps TDD – *USCH Information Response* IE] [1.28 Mcps TDD – *USCH Information Response LCR* IE] [7.68 Mcps TDD – *USCH Information Response 7.68 Mcps* IE] in the RADIO LINK SETUP RESPONSE message.]

[TDD – CCTrCH Handling:]

[TDD – If the *UL CCTrCH Information* IE is present in the RADIO LINK SETUP REQUEST message, the DRNS shall configure the new UL CCTrCH(s) according to the parameters given in the message.]

[1.28Mcps TDD – If the *UL CCTrCH Information LCR* IE includes the *TDD TPC Uplink Step Size* IE, the DRNS shall configure the uplink TPC step size according to the parameters given in the message.]

[TDD – If the *DL CCTrCH Information* IE is present in the RADIO LINK SETUP REQUEST message, the DRNS shall configure the new DL CCTrCH(s) according to the parameters given in the message.]

[TDD – If the *TPC CCTrCH List* IE is present in the RADIO LINK SETUP REQUEST message, the DRNS shall configure the identified UL CCTrCHs with TPC according to the parameters given in the message.]

HS-DSCH:

If the *HS-DSCH Information* IE is present in the RADIO LINK SETUP REQUEST message, then:

- The DRNS shall setup the requested HS-PDSCH resources on the Serving HS-DSCH Radio Link indicated by the *HS-PDSCH RL ID IE*.
- The DRNC shall include the *HARQ Memory Partitioning IE* in the [FDD – *HS-DSCH FDD Information Response IE*] [TDD – *HS-DSCH TDD Information Response IE*] in the RADIO LINK SETUP RESPONSE message. [FDD – The *HARQ Memory Partitioning IE* shall either contain the *HARQ Memory Partitioning Information Extension For MIMO IE* or the *Number of Processes IE* set to a value higher than “8”, if the *MIMO Activation Indicator IE* is included in the *HS-DSCH Information IE*.] [1.28Mcps TDD– The *HARQ Memory Partitioning IE* shall either contain the *HARQ Memory Partitioning Information Extension For MIMO IE* or the *Number of Processes IE* set to a value higher than “8”, if the *MIMO Activation Indicator IE* is included in the *HS-DSCH Information IE*.]
- The DRNC shall allocate an HS-DSCH-RNTI to the UE Context and include the *HS-DSCH-RNTI IE* in the RADIO LINK SETUP RESPONSE message.
- The DRNC shall include in the RADIO LINK SETUP RESPONSE message the *Binding ID IE* and *Transport Layer Address IE* for establishment of transport bearer for every HS-DSCH MAC-d flow being established.
- If the RADIO LINK SETUP REQUEST message includes the *Transport Layer Address IE* and *Binding ID IE* in the *HS-DSCH Information IE* for an HS-DSCH MAC-d flow, then the DRNC may use the transport layer address and the binding identifier received from the SRNC when establishing a transport bearer for the concerned HS-DSCH MAC-d flow.
- The DRNS may use the *Traffic Class IE* for a specific HS-DSCH MAC-d flow to determine the transport bearer characteristics to apply between DRNC and Node B. If *TrCH Source Statistics Descriptor IE* is present with the value “RRC” in the *HS-DSCH MAC-d Flows Information IE*, then the DRNC should ignore the *Traffic Class IE*.
- If fields are to be included in the User Plane by the SRNC to handle TNL Congestion Control for HSDPA in the DRNS, then the DRNC shall include the *User Plane Congestion Fields Inclusion IE* in the *HS-DSCH Information Response IE*.
- If the RADIO LINK SETUP REQUEST message includes the *MAC-hs Guaranteed Bit Rate IE* for a Priority Queue in the *HS-DSCH MAC-d Flows Information IE* in the *HS-DSCH Information IE*, then the DRNS shall use this information to optimise MAC-hs scheduling decisions for the related HSDPA Priority Queue.
- If the RADIO LINK SETUP REQUEST message includes the *Discard Timer IE* for a Priority Queue in the *HS-DSCH MAC-d Flows Information IE* in the *HS-DSCH Information IE*, then the DRNS shall use this information to discard out-of-date MAC-hs SDUs from the related HSDPA Priority Queue.
- If the RADIO LINK SETUP REQUEST message includes the *Maximum MAC-d PDU Size Extended IE* for a Priority Queue in the *HS-DSCH MAC-d Flows Information IE* in the *HS-DSCH Information IE*, then the DRNS shall ignore the *SID IE* and *MAC-d PDU Size IE* in the *MAC-d PDU Size Index IE* and use *Maximum MAC-d PDU Size Extended IE* to optimise capacity allocation for the related HSDPA Priority Queue.
- The DRNC shall include the *HS-DSCH Initial Capacity Allocation IE* in the [FDD – *HS-DSCH FDD Information Response IE*] [TDD – *HS-DSCH TDD Information Response IE*] in the RADIO LINK SETUP RESPONSE message for every HS-DSCH MAC-d flow being established, if the DRNS allows the SRNC to start transmission of MAC-d PDUs before the DRNS has allocated capacity on user plane as described in TS 25.425 [32]. If RADIO LINK SETUP REQUEST message includes *HS-DSCH MAC-d PDU Size Format IE* in the *HS-DSCH Information IE* set to the value “Flexible MAC-d PDU Size”, then DRNC shall only set in the *HS-DSCH Initial Capacity Allocation IE* the values for the peer of *Scheduling Priority Indicator IE* and *Maximum MAC-d PDU Size Extended IE* to the values of the corresponding peer I in RADIO LINK SETUP REQUEST in the *HS-DSCH MAC-d Flows Information IE* in the *HS-DSCH Information IE* for a Priority Queue including *Scheduling Priority Indicator IE* and *Maximum MAC-d PDU Size Extended IE*.
- [FDD – If the RADIO LINK SETUP REQUEST message includes the *HS-SCCH Power Offset IE* in the *HS-DSCH Information IE*, then the DRNS may use this value to determine the HS-SCCH power. The HS-SCCH Power Offset should be applied for any HS-SCCH transmission to this UE.]

- [FDD – The DRNC shall include the *Measurement Power Offset* IE in the *HS-DSCH Information Response* IE in the RADIO LINK SETUP RESPONSE message.]
- [FDD – The DRNS shall allocate HS-SCCH codes corresponding to the HS-DSCH and the DRNC shall include the *HS-SCCH Specific Information Response* IE in the *HS-DSCH FDD Information Response* IE in the RADIO LINK SETUP RESPONSE message.]
- [TDD – The DRNS shall allocate HS-SCCH parameters corresponding to the HS-DSCH and the DRNC shall include the [3.84Mcps TDD – *HS-SCCH Specific Information Response* IE] [1.28Mcps TDD – *HS-SCCH Specific Information Response LCR* IE] [7.68 Mcps TDD – *HS-SCCH Specific Information Response 7.68 Mcps* IE] in the *HS-DSCH TDD Information Response* IE in the RADIO LINK SETUP RESPONSE message.]
- [TDD – The DRNC shall include the [3.84 Mcps TDD – *HS-PDSCH Timeslot Specific Information Response* IE] [1.28 Mcps TDD – *HS-PDSCH Timeslot Specific Information Response LCR* IE] [7.68 Mcps TDD – *HS-PDSCH Timeslot Specific Information Response* IE] in the *HS-DSCH Information Response* IE in the RADIO LINK SETUP RESPONSE message.]
- [FDD – The DRNC shall include the *HS-PDSCH And HS-SCCH Scrambling Code* IE in the *HS-DSCH FDD Information Response* IE in the RADIO LINK SETUP RESPONSE message.]
- [FDD – If the RADIO LINK SETUP REQUEST message includes the *HARQ Preamble Mode* IE in the *HS-DSCH Information* IE, then the DRNS shall use the indicated HARQ Preamble Mode as described in TS 25.214 [10], if HS-DPCCH ACK/NACK preamble and postamble is supported. Then, in this case, if the mode 1 is applied, the DRNC shall include the *HARQ Preamble Mode Activation Indicator* IE in the *HS-DSCH Information Response* IE in the RADIO LINK SETUP RESPONSE message. If the *HARQ Preamble Mode* IE is not included or if the mode 0 is applied, then the DRNC shall not include the *HARQ Preamble Mode Activation Indicator* IE in the RADIO LINK SETUP RESPONSE message.]
- If the RADIO LINK SETUP REQUEST message includes the *HS-DSCH MAC-d PDU Size Format* IE in the *HS-DSCH Information* IE, then the DRNS shall use the indicated format in user plane frame structure for HS-DSCH channels TS 25.425 [32] and MAC-hs TS 25.321 [41].
- [FDD – If the *TNL QoS* IE is included for a MAC-d flow and if ALCAP is not used, the *TNL QoS* IE may be used by the DRNS to determine the transport bearer characteristics to apply in the uplink between the DRNS and the SRNC for the related MAC-d flow.]
- [FDD – If the *Serving Cell Change CFN* IE is included in the RADIO LINK SETUP REQUEST message, then the DRNS shall activate the resources that are allocated for the new serving HS-DSCH Radio Link at the next coming CFN with a value equal to the value requested by the SRNC.]
- [FDD – If the *MIMO Activation Indicator* IE is included in the *HS-DSCH FDD Information* IE, then]
 - [FDD – The DRNS shall activate the MIMO mode for the HS-DSCH Radio Link.]
 - [FDD – The DRNS shall decide the pilot configuration and the UE reporting configuration (N/M ratio) according to TS 25.214 [10] for MIMO and include the *MIMO Information Response* IE in the *HS-DSCH FDD Information Response* IE in the RADIO LINK SETUP RESPONSE message.]
 - [FDD – If the *Power Offset For S-CPICH for MIMO Request Indicator* IE is included, the DRNC shall, if supported and MIMO pilot configuration with Primary and Secondary CPICH is set up with a non-zero power offset on the cell where the Serving HS-DSCH Radio Link is established, include the *Power Offset For S-CPICH for MIMO* IE in the *HS-DSCH FDD Information Response* IE in the RADIO LINK SETUP RESPONSE message. If zero power offset the DRNC may include the *Power Offset For S-CPICH for MIMO* IE.]
- [1.28 Mcps TDD – If the *MIMO Activation Indicator* IE is included in the *HS-DSCH TDD Information* IE, then]
 - [1.28 Mcps TDD – The DRNS shall activate the MIMO mode for the HS-DSCH Radio Link.]
 - [1.28 Mcps TDD – The DRNS shall decide the SF mode for HS-PDSCH dual stream and include the *MIMO SF Mode for HS-PDSCH dual stream* IE in the *HS-DSCH TDD Information Response* IE in the RADIO LINK SETUP RESPONSE message.]

- [FDD – If the *Sixtyfour QAM Usage Allowed Indicator* IE is included in the *HS-DSCH FDD Information* IE, then the DRNS may if the value is set to “allowed” use 64 QAM for the HS-DSCH Radio Link, and the DRNS shall include the *SixtyfourQAM DL Usage Indicator* IE in the *HS-DSCH FDD Information Response* IE in the RADIO LINK SETUP RESPONSE message.]
- [FDD – If the *Sixtyfour QAM Usage Allowed Indicator* IE is included in the *HS-DSCH FDD Information* IE with value set to “not allowed”, then the DRNS shall not use 64 QAM for the HS-DSCH Radio Link.]
- [FDD – If the RADIO LINK SETUP REQUEST message includes the *HS-DSCH MAC-d PDU Size Format* IE set to “Flexible MAC-d PDU Size” and if Sixtyfour QAM will not be used, the DRNS shall include the *HS-DSCH TB Size Table Indicator* IE in the RADIO LINK SETUP RESPONSE message if it decides to use the octet aligned table defined in TS 25.321 [41] for HS-DSCH Transport Block Size signalling.]
- [FDD – If the *UE with enhanced HS-SCCH support indicator* IE is included in the *HS-DSCH FDD Information* IE, then the DRNS may use:]
 - [FDD – a different HS-SCCH in consecutive TTIs for this UE]
 - [FDD – HS-SCCH orders for the case of HS-SCCH-less operation to this UE]
- [FDD – If the *UE Support Indicator Extension* IE is included in the *HS-DSCH FDD Information* IE the DRNS may use the supported HSDPA functions for this UE.]
- [FDD - If the *UE Support Indicator Extension* IE is included in the *HS-DSCH FDD Information* IE with the bit *UE DTXDRX related HS-SCCH orders uniform behavior indicator* set to 0, then the DRNS shall, if supported, include the *Support of dynamic DTXDRX related HS-SCCH order* IE in the *HS-DSCH FDD Information Response* IE in the RADIO LINK SETUP RESPONSE message.]
- [FDD – The DRNS shall include the *SixtyfourQAM DL Support Indicator* IE in the RADIO LINK SETUP RESPONSE message. This *SixtyfourQAM DL Support Indicator* IE is related to the HS-DSCH Radio Link.]
- [1.28 Mcps TDD – The DRNS shall include the *SixtyfourQAM DL Support Indicator* IE in the RADIO LINK SETUP RESPONSE message.]
- If the RADIO LINK SETUP REQUEST message includes the *DL RLC PDU Size Format* IE for a Priority Queue in the *HS-DSCH MAC-d Flows Information* IE in the *HS-DSCH Information* IE, the *DL RLC PDU Size Format* IE may be used by the DRNS to determine the allocated capacity on user plane as described in TS 25.425 [32].
- [FDD – If the RADIO LINK SETUP REQUEST message includes the *UE Aggregate Maximum Bit Rate Enforcement Indicator* IE in the *Priority Queue Information* IE in the *HS-DSCH MAC-d Flows Information* IE in the *HS-DSCH Information* IE, the DRNS shall, if supported, consider the data of the related HSDPA Priority Queue for UE Aggregate Maximum Bit Rate Enforcement.]
- [FDD – If the *Single Stream MIMO Activation Indicator* IE is included in the *HS-DSCH FDD Information* IE, then the DRNS shall activate the Single Stream MIMO for the HS-DSCH Radio Link.]
- [1.28 Mcps TDD – If the *UE TS0 Capability LCR* IE is included in the *HS-DSCH TDD Information* IE, then the DRNC may include the *TS0 HS-PDSCH Indication LCR* IE in the RADIO LINK SETUP RESPONSE message if HS-PDSCH resources could be allocated on TS0 for the UE.]

[FDD – Secondary Serving HS-DSCH:]

[FDD – If the *Additional HS Cell Information RL Setup* IE is present in the RADIO LINK SETUP REQUEST message, then:]

- [FDD – The DRNS shall setup the requested HS-PDSCH resources on the Serving HS-DSCH Radio Link indicated by the *HS-PDSCH RL ID* IE. Non cell specific secondary serving Radio Link and non cell specific secondary serving HS-DSCH parameters take the same values as for the serving HS-DSCH cell.]

- [FDD – The DRNC shall allocate an HS-DSCH-RNTI to the UE Context and include the *HS-DSCH-RNTI* IE in the *Additional HS Cell Information Response* IE in the RADIO LINK SETUP RESPONSE message.]
- [FDD – If the RADIO LINK SETUP REQUEST message includes the *HS-SCCH Power Offset* IE in the *HS-DSCH Secondary Serving Information* IE, then the DRNS may use this value to determine the HS-SCCH power. The HS-SCCH Power Offset should be applied for any secondary serving HS-SCCH transmission to this UE.]
- [FDD – The DRNC shall include the *Measurement Power Offset* IE in the *HS-DSCH FDD Secondary Serving Information Response* IE in the *Additional HS Cell Information Response* IE in the RADIO LINK SETUP RESPONSE message.]
- [FDD – The DRNS shall allocate HS-SCCH codes corresponding to the HS-DSCH and the DRNC shall include the *HS-SCCH Specific Secondary Serving Information Response* IE in the *HS-DSCH FDD Secondary Serving Information Response* IE in the *Additional HS Cell Information Response* IE in the RADIO LINK SETUP RESPONSE message.]
- [FDD – The DRNC shall include the *HS-PDSCH And HS-SCCH Scrambling Code* IE in the *HS-DSCH FDD Secondary Serving Information Response* IE in the *Additional HS Cell Information Response* IE in the RADIO LINK SETUP RESPONSE message.]
- [FDD – If the *Serving Cell Change CFN* IE is included in the RADIO LINK SETUP REQUEST message, then the DRNS shall activate the resources that are allocated for the new serving HS-DSCH Radio Link at the next coming CFN with a value equal to the value requested by the SRNC.]
- [FDD – If the *MIMO Activation Indicator* IE is included in the *HS-DSCH FDD Secondary Serving Information* IE, then the DRNS shall activate the MIMO mode for the secondary serving HS-DSCH Radio Link and the DRNS shall decide the pilot configuration and the UE reporting configuration (N/M ratio) according to TS 25.214 [10] for MIMO for the secondary serving HS-DSCH Radio Link and include the *MIMO Information Response* IE in the *HS-DSCH FDD Secondary Serving Information Response* IE in the *Additional HS Cell Information Response* IE in the RADIO LINK SETUP RESPONSE message.]
- [FDD – If the *Power Offset For S-CPICH for MIMO Request Indicator* IE is included, the DRNC shall, if supported and MIMO pilot configuration with Primary and Secondary CPICH is set up with a non-zero power offset on the cell where the Secondary Serving HS-DSCH Radio Link is established, include the *Power Offset For S-CPICH for MIMO* IE in the *HS-DSCH FDD Secondary Serving Information Response* IE in the RADIO LINK SETUP RESPONSE message. If zero power offset the DRNC may include the *Power Offset For S-CPICH for MIMO* IE.]
- [FDD – If the *Single Stream MIMO Activation Indicator* IE is included in the *HS-DSCH FDD Secondary Serving Information* IE, then the DRNS shall activate the Single Stream MIMO mode for the secondary serving HS-DSCH Radio Link.]
- [FDD – If the *Sixtyfour QAM Usage Allowed Indicator* IE is included in the *HS-DSCH FDD Secondary Serving Information* IE, then the DRNS may if the value is set to “allowed” use 64 QAM for the secondary serving HS-DSCH Radio Link, and the DRNS shall include the *SixtyfourQAM DL Usage Indicator* IE in the *HS-DSCH FDD Secondary Serving Information Response* IE in the *Additional HS Cell Information Response* IE in the RADIO LINK SETUP RESPONSE message.]
- [FDD – If the *Sixtyfour QAM Usage Allowed Indicator* IE is included in the *HS-DSCH FDD Secondary Serving Information* IE with value set to “not allowed”, then the DRNS shall not use 64 QAM for the secondary serving HS-DSCH Radio Link.]
- [FDD – If Sixtyfour QAM will not be used for the secondary serving HS-DCSH, the DRNS shall include the *HS-DSCH TB Size Table Indicator* IE in the *HS-DSCH FDD Secondary Serving Information Response* IE in the *Additional HS Cell Information Response* IE in the RADIO LINK SETUP RESPONSE message if it decides to use the octet aligned table defined in TS 25.321 [41] for the secondary serving HS-DSCH Transport Block Size signalling.]
- [FDD – The DRNS shall include the *SixtyfourQAM DL Support Indicator* IE in the *Additional HS Cell Information Response* IE in the RADIO LINK SETUP RESPONSE message.]

[FDD – E-DCH:]

[FDD – If the *E-TFCS Information IE* in the *E-DPCH Information IE* contains the *E-DCH Minimum Set E-TFCI Validity Indicator IE* the DRNS shall ignore the value in *E-DCH Minimum Set E-TFCI IE*. If the *E-DCH Minimum Set E-TFCI validity indicator IE* is absent DRNS shall use the value for the related resource allocation operation.]

[FDD – If the *E-TFCS Information IE* in the *E-DPCH Information IE* contains the *E-DPDCH Power Interpolation IE*, the DRNS shall use the value to determine the applicable E-DPDCH power formula defined in TS 25.214 [10]. If the *E-DPDCH Power Interpolation IE* is not present, the DRNS shall use the E-DPDCH power extrapolation formula defined in TS 25.214 [10].]

[FDD – If the *E-TFCS Information IE* in the *E-DPCH Information IE* contains the *E-TFCI Boost Information IE*, the DRNS shall use the information according to TS 25.214 [10]. If the *E-TFCI Boost Information IE* is not present, the DRNS shall use the value “127” in the algorithm defined in TS 25.214 [10].]

[FDD – If the RADIO LINK SETUP REQUEST message includes the *E-DPCH Information IE*, which contains the *Minimum Reduced E-DPDCH Gain Factor IE*, then the DRNS shall use the value to determine the applicable minimum gain factor ($\beta_{\text{ed,k, reduced, min}}$) defined in TS 25.214 [10]. For the case the *Minimum Reduced E-DPDCH Gain Factor IE* is not available for the UE Context, the DRNS may use the default value defined in TS 25.331 [16].]

[FDD – If the *E-DCH FDD Information IE* is present in the RADIO LINK SETUP REQUEST message then:]

- [FDD – The DRNS shall setup the requested E-DCH resources on the Radio Links indicated by the *E-DCH RL Indication IE*, set to “E-DCH”, in the *RL Information IE*.]
- [FDD – If the RADIO LINK SETUP REQUEST message includes the *HARQ Process Allocation For 2ms Scheduled Transmission Grant IE*, the DRNS shall use this information for the related resource allocation operation.]
- [FDD – If the RADIO LINK SETUP REQUEST message includes the *Transport Layer Address IE* and *Binding ID IE* in the *RL specific E-DCH Information IE* for an E-DCH MAC-d flow, then if the *Transport Bearer Not Requested Indicator IE* is not included for this E-DCH MAC-d flow, the DRNC may use the transport layer address and the binding identifier received from the SRNC when establishing a transport bearer for the concerned E-DCH MAC-d flow. The DRNC shall include in the RADIO LINK SETUP RESPONSE message the *Binding ID IE* and *Transport Layer Address IE* for establishment of a transport bearer for every E-DCH MAC-d flow being established for which the *Transport Bearer Not Requested Indicator IE* was not included.]
- [FDD – If the RADIO LINK SETUP REQUEST message includes the *Transport Bearer Not Requested Indicator IE* set to “Transport Bearer shall not be Established” for an E-DCH MAC-d flow, then the DRNC shall not establish a transport bearer for the concerned E-DCH MAC-d flow and shall include the *Transport Bearer Not Setup Indicator IE* for the corresponding E-DCH MAC-d flow in the RADIO LINK SETUP RESPONSE message.]
- [FDD – If the RADIO LINK SETUP REQUEST message includes the *Transport Bearer Not Requested Indicator IE* set to “Transport Bearer may not be Established” for an E-DCH MAC-d flow and:]
 - [FDD – if the DRNC establishes a transport bearer for the concerned E-DCH MAC-d flow, the DRNC shall include in the RADIO LINK SETUP RESPONSE message the *Binding ID IE* and *Transport Layer Address IE* for establishment of a transport bearer for the E-DCH MAC-d flow being established.]
 - [FDD – if the DRNC does not establish a transport bearer for the concerned E-DCH MAC-d flow, the DRNC shall include the *Transport Bearer Not Setup Indicator IE* for the corresponding E-DCH MAC-d flow in the RADIO LINK SETUP RESPONSE message.]
- [FDD – The DRNS may use the *Traffic Class IE* for a specific E-DCH MAC-d flow to determine the transport bearer characteristics to apply between DRNC and Node B. If *TrCH Source Statistics Descriptor IE* is present with the value “RRC” in the *E-DCH MAC-d Flows Information IE*, then the DRNC should ignore the *Traffic Class IE*.]

- [FDD – If the RADIO LINK SETUP REQUEST message includes the *MAC-es Guaranteed Bit Rate IE* in the *E-DCH Logical Channel Information IE* in the *E-DCH MAC-d Flow Specific Information IE* in the *E-DCH FDD Information IE*, then the DRNS shall use this information to optimise MAC-e scheduling decisions.]
- [FDD – If the RADIO LINK SETUP REQUEST message includes *UE Aggregate Maximum Bit Rate Enforcement Indicator IE* in the *E-DCH Logical Channel Information IE* in the *E-DCH MAC-d Flow Specific Information IE* in the *E-DCH FDD Information IE*, the DRNS shall, if supported, consider the data of the related E-DCH Logical Channel for UE Aggregate Maximum Bit Rate Enforcement.]
- [FDD – If the RADIO LINK SETUP REQUEST message includes the *Maximum MAC-d PDU Size Extended IE* for a E-DCH Logical Channel in the *E-DCH MAC-d Flows Information IE* in the *E-DCH FDD Information IE*, then the DRNS shall ignore the *MAC-d PDU Size IE* in the *MAC-d PDU Size List IE* and use *Maximum MAC-d PDU Size Extended IE* to optimise capacity allocation for the related E-DCH Logical Channel and use the indicated format in user plane frame structure for E-DCH channels TS 25.425 [32] and MAC TS 25.321 [41].]
- [FDD – If the RADIO LINK SETUP REQUEST message includes the *E-DCH MAC-d Flow Multiplexing List IE* for an E-DCH MAC-d flow the DRNS shall use this information for the related resource allocation operation.]
- [FDD – If in the RADIO LINK SETUP REQUEST message the E-DCH Grant Type is indicated as being “E-DCH Non-Scheduled Transmission Grant” for an E-DCH MAC-d flow the DRNS shall assume non-scheduled grants being configured for that E-DCH MAC-d flow and shall use the information within the *HARQ Process Allocation For 2ms Non-Scheduled Transmission Grant IE*, if included, for the related resource allocation operation.]
- [FDD – If in the RADIO LINK SETUP REQUEST message the E-DCH Grant Type is indicated as being “E-DCH Scheduled Transmission Grant” for an E-DCH MAC-d flow the DRNS shall assume scheduled grants being configured for that E-DCH MAC-d flow.]
- [FDD – If the *TNL QoS IE* is included for a E-DCH MAC-d flow and if ALCAP is not used, the *TNL QoS IE* may be used by the DRNS to determine the transport bearer characteristics to apply in the uplink for the related MAC-d flow.]
- [FDD – The DRNC may include the *E-AGCH And E-RGCH/E-HICH FDD Scrambling Code IE* and shall include the *E-RGCH/E-HICH Channelisation Code IE* and the corresponding *E-HICH Signature Sequence IE* and the DRNC may include the corresponding *E-RGCH Signature Sequence IE* in the *E-DCH FDD DL Control Channel Information IE* in the RADIO LINK SETUP RESPONSE message, for every RL indicated by the *E-DCH RL Indication IE*, set to “E-DCH”, in the *RL Information IE*.]
 [FDD – If the RADIO LINK SETUP REQUEST message includes the *E-DCH ReferencePower Offset IE*, then the DRNS may use this value as a default HARQ power offset if it is not able to decode the MAC-e PDU and to determine the value of the actual HARQ power offset.]
- [FDD – If the RADIO LINK SETUP REQUEST message includes the *E-DCH Power Offset for Scheduling Info IE*, then the DRNS shall use this value as a power offset for the transmission of scheduling information without any MAC-d PDUs.]
- [FDD – If the RADIO LINK SETUP REQUEST message contains the *Serving E-DCH RL IE* indicating that the Serving E-DCH RL is in this DRNS:]
 - [FDD – The DRNS shall allocate a primary E-RNTI identifier or a secondary E-RNTI identifier or both and include these E-RNTI identifiers and the Channelisation Code of the corresponding E-AGCH in the *E-DCH FDD DL Control Channel Information IE* in the *RL Information Response IE* for the indicated RL in the RADIO LINK SETUP RESPONSE message.]
 - [FDD – The DRNS may include the *Serving Grant Value IE* and *Primary/Secondary Grant Selector IE* in the RADIO LINK SETUP RESPONSE message for the initial grant for the serving E-DCH RL.]
 - [FDD – If the E-DCH HARQ process allocation for 2ms TTI for scheduled and/or non-scheduled transmission shall be changed, the DRNS shall allocate resources according to the new/changed

configuration and include the new/changed configuration in the *E-DCH FDD Information Response* IE in the RADIO LINK SETUP RESPONSE message.]

- [FDD – If a serving cell change is performed the RADIO LINK SETUP RESPONSE message may contain invalid data (see 9.2.2.4C).]
- [FDD – If the DRNS has no valid data for the *E-RGCH/E-HICH Channelisation Code* IE in the *E-DCH FDD DL Control Channel Information* IE in the RADIO LINK SETUP RESPONSE message, then it shall insert the *E-RGCH and E-HICH Channelisation Code Validity Indicator* IE in the *E-DCH FDD DL Control Channel Information* IE, to indicate that the *E-RGCH/E-HICH Channelisation Code* IE contains invalid data.]
- [FDD – The DRNS may include the *Default Serving Grant in DTX Cycle 2* IE in the RADIO LINK SETUP RESPONSE message for the serving E-DCH RL.]
- [FDD – If the RADIO LINK SETUP REQUEST message includes the *Bundling Mode Indicator* IE for a E-DCH MAC-d flow in the *E-DCH MAC-d Flow Specific Information* IE in the *E-DCH FDD Information* IE and the *Bundling Mode Indicator* IE is set to “Bundling” and the *E-TTI* IE is set to “2ms”, then the DRNS shall use the bundling mode for the E-DCH UL data frames for the related MAC-d flow, otherwise the DRNS shall use the non-bundling mode for the E-DCH UL data frames for the related MAC-d flow.]
- [FDD – If the RADIO LINK SETUP REQUEST message includes the *E-DCH Maximum Bitrate* IE for an E-DCH, the DRNS shall use this information for the related resource allocation operation, and when applicable, for E-DCH scheduling.]
- [FDD – If the RADIO LINK SETUP REQUEST message includes the *E-DCH Processing Overload Level* IE, then if the DRNS could not decode the E-DPCCH/E-DPDCH for the last consecutive number of TTIs, indicated in the *E-DCH Processing Overload Level* IE, because of processing issue, the DRNS shall notify the SRNC by initiating the Radio Link Failure procedure.]
- [FDD – If the RADIO LINK SETUP REQUEST message includes the *E-AGCH Power Offset* IE in the *RL Specific E-DCH Information* IE, then the DRNS may use this value to determine the E-AGCH power. The E-AGCH Power Offset should be applied for any E-AGCH transmission to this UE.]
- [FDD – If the RADIO LINK SETUP REQUEST message includes the *E-RGCH Power Offset* IE in the *RL Specific E-DCH Information* IE, then the DRNS may use this value to determine the E-RGCH power for the RL. The E-RGCH Power Offset should be applied for any E-RGCH transmission to this UE.]
- [FDD – If the RADIO LINK SETUP REQUEST message includes the *E-HICH Power Offset* IE in the *RL Specific E-DCH Information* IE, then the DRNS may use this value to determine the E-HICH power for the RL. The E-HICH Power Offset should be applied for any E-HICH transmission to this UE.]
- [FDD – If the *Serving Cell Change CFN* IE is included in the RADIO LINK SETUP REQUEST message, then the DRNS shall activate the resources that are allocated for the new serving E-DCH Radio Link at the next coming CFN with a value equal to the value requested by the SRNC.]
- [FDD – If the RADIO LINK SETUP REQUEST message includes the *SixteenQAM UL Operation Indicator* IE, the DRNS shall activate/deactivate SixteenQAM UL Operation for the RL in accordance with the *SixteenQAM UL Operation Indicator* IE.]
 - [FDD – If SixteenQAM UL Operation is activated, then the DRNS shall base the handling of the Relative Grant signalling on Scheduling Grant Table 2 according to TS 25.321 [41]. If SixteenQAM UL Operation is deactivated, then the DRNS shall base the handling of the Relative Grant signalling on Scheduling Grant Table 1 according to TS 25.321 [41].]

[FDD – Additional E-DCH Setup:]

[FDD – If the *Additional E-DCH Cell Information RL Setup Req* IE is present in the RADIO LINK SETUP REQUEST message, then the *Additional E-DCH Cell Information Setup* IE defines the new configuration and then:]

- [FDD – The DRNS shall setup the E-DCH on the secondary uplink frequency and setup the requested E-DCH resources on the Radio Links and in the cells indicated by the *E-DCH Additional RL ID IE* and the *C-ID IE* in the *Additional E-DCH RL Specific Information To Setup IE* in the *Additional E-DCH FDD Setup Information IE* in the *Additional E-DCH Cell Information Setup IE*. Non cell specific Radio Link related parameters and non cell specific E-DPCH, UL DPCH, E-DCH and F-DPCH parameters shall take the same values as for the corresponding cell of the Primary uplink frequency.]
- [FDD – If the *UL SIR Target IE* in the *UL DPCH Information IE* in the *Additional E-DCH FDD Setup Information IE* in the *Additional E-DCH Cell Information Setup IE* and/or the *DL Power Balancing Information IE* and/or the *Minimum Reduced E-DPDCH Gain Factor IE* in the *Multicell E-DCH Information IE* in the *Additional E-DCH FDD Setup Information IE* are present, the DRNS shall use the information in the same way as for the information used on Primary uplink frequency.]
- [FDD – If the *Secondary UL Frequency Activation State IE* is present in the *Multicell E-DCH Information IE* in the *Additional E-DCH FDD Setup Information IE*, the DRNS shall use the information as initial activation state of the Radio Links on the secondary uplink frequency.]
- [FDD – If the *Propagation Delay IE*, the *Initial DL Tx Power IE*, *Primary CPICH Ec/No IE*, the *E-AGCH Power Offset IE*, the *E-RGCH Power Offset IE* and/or the *E-HICH Power Offset IE* is included in the *Additional E-DCH RL Specific Information To Setup IE* in the *Additional E-DCH FDD Setup Information IE* in the *Additional E-DCH Cell Information Setup IE*, the DRNS shall use the information in the same way as for the information used on Primary uplink frequency.]
- [FDD – If the *Extended Propagation Delay IE* and/or *Enhanced Primary CPICH Ec/No IE* is included in the *Multicell E-DCH RL Specific Information IE* in the *Additional E-DCH Secondary RL Specific Information To Setup IE* in the *Additional E-DCH FDD Setup Information IE* in the *Additional E-DCH Cell Information Setup IE*, the DRNS shall use the information in the same way as for the information used on Primary uplink frequency.]
- [FDD – If the *F-DPCH Slot Format Support Request IE* in the *F-DPCH Information IE* in the *Additional E-DCH FDD Setup Information IE* in the *Additional E-DCH Cell Information Setup IE* is included, the DRNS shall configure the concerned UE Context for F-DPCH Slot Format operation according to TS 25.211 [8] and include the *F-DPCH Slot Format IE* in the *Additional E-DCH FDD Information Response IE* in the *Additional E-DCH Cell Information Response IE* in the RADIO LINK SETUP RESPONSE message. If the *Multicell E-DCH Information IE* in the *Additional E-DCH FDD Setup Information IE* includes the *F-DPCH Slot Format IE*, the DRNS may use the *F-DPCH Slot Format IE* to determine the F-DPCH slot format.]
- [FDD – If the *HARQ Process Allocation For 2ms Scheduled Transmission Grant IE*, the *E-DCH Maximum Bitrate IE*, the *E-DCH Minimum Set E-TFCI IE* and/or the *E-DCH Processing Overload Level IE* are present in the *Additional E-DCH FDD Information IE* in the *Additional E-DCH FDD Setup Information IE* in the *Additional E-DCH Cell Information Setup IE*, the DRNS shall use the information in same way as for the information used on Primary uplink frequency.]
- [FDD – If the *Multicell E-DCH Transport Bearer Mode IE* for an Additional E-DCH to be Setup is set to “Separate Iur Transport Bearer Mode” the DRNS shall use this mode in the new configuration and apply separate transport bearers for the MAC-d flows.]
- [FDD – if the *Multicell E-DCH Transport Bearer Mode IE* for an Additional E-DCH to be Setup is set to “UL Flow Multiplexing Mode” the DRNS shall use this mode in the new configuration and multiplex MAC-d flows on the transport bearers.]
- [FDD – if Separate Iur Transport Bearer Mode is used in the new configuration, then:]
 - [FDD – The DRNS shall follow the rules defined in this procedure for single carrier mode of operation for establishment of the transport bearer for a MAC-d flow and use the *Transport Bearer Not Requested Indicator IE* in the *RL Specific E-DCH Information IE* in the *RL Information IE* received for the corresponding Radio Link(s) of the Primary Uplink Frequency to determine the transport bearer configuration in the new configuration for the radio links of the Secondary Uplink Frequency.]

- [FDD – If the *Transport Layer Address IE* and *Binding ID IE* is included for an E-DCH MAC-d flow in the *Additional E-DCH MAC-d Flows Specific Information IE* in the *Additional E-DCH RL Specific Information To Setup IE* in the *Additional E-DCH FDD Setup Information IE* in the *Additional E-DCH Cell Information Setup IE*, then the DRNS may use the transport layer address and the binding identifier received from the SRNC when establishing a transport bearer for the concerned E-DCH MAC-d flow. If the DRNS establishes a transport bearer for the concerned E-DCH MAC-d flow the DRNS shall include in the RADIO LINK SETUP RESPONSE message the *Binding ID IE* and *Transport Layer Address IE* in the *Additional E-DCH MAC-d Flow Specific Information Response IE* in the *Additional E-DCH FDD Information Response IE* in the *Additional E-DCH Cell Information Response IE* for establishment of a transport bearer for every E-DCH MAC-d flow being established.]
- [FDD – If activation of power balancing for the Additional E-DCH RL by the RADIO LINK SETUP REQUEST message is supported by the DRNS, the DRNS shall include the *DL Power Balancing Activation Indicator IE* in the *Additional E-DCH FDD Information Response IE* in the *Additional E-DCH Cell Information Response IE* in the RADIO LINK SETUP RESPONSE message.]
- [FDD – For each Additional E-DCH RL not having a common generation of the TPC commands in the DL with another Additional E-DCH RL, the DRNS shall set the *RL Set ID IE* included in the *Additional E-DCH FDD Information Response IE* in the RADIO LINK SETUP RESPONSE message to a value that uniquely identifies the RL as a RL Set within the UE Context. The generation of E-HICH related information for Additional E-DCH RLs in different RL Sets shall not be common.]
- [FDD – For all Additional E-DCH RLs having a common generation of the TPC commands in the DL with another Additional E-DCH RL, the DRNS shall assign to each Additional E-DCH RL the same value for the *RL Set ID IE* included in the *Additional E-DCH FDD Information Response IE* in the RADIO LINK SETUP RESPONSE message. This value shall uniquely identify these Additional E-DCH RLs as members of the same RL Set within the UE Context. The generation of E-HICH information for all Additional E-DCH RLs in a RL Set shall be common.]
- [FDD – For each Additional E-DCH RL which has or can have a common generation of E-RGCH information with another Additional E-DCH RL (current or future) when the DRNS would contain the Additional E-DCH serving RL, the DRNS shall set a same value to the *E-DCH RL Set ID IE* for the Additional E-DCH RL in the *Additional E-DCH FDD Information Response IE* in the *Additional E-DCH Cell Information Response IE* in the RADIO LINK SETUP RESPONSE message]
- [FDD – For every additional E-DCH RL indicated in the *Additional E-DCH RL Specific Information To Setup IE* in the *Additional E-DCH FDD Setup Information IE* the DRNS may include the *E-AGCH And E-RGCH/E-HICH FDD Scrambling Code IE* and shall include the *E-RGCH/E-HICH Channelisation Code IE* and the corresponding *E-HICH Signature Sequence IE* and the DRNS may include the corresponding *E-RGCH Signature Sequence IE* for each Additional E-DCH RL in the *E-DCH FDD DL Control Channel Information IE* in the *Additional E-DCH FDD Information Response IE* in the *Additional E-DCH Cell Information Response IE* in the RADIO LINK SETUP RESPONSE message and if DRNS has no valid data for the *E-RGCH/E-HICH Channelisation Code IE*, then it shall insert the *E-RGCH and E-HICH Channelisation Code Validity Indicator IE* to indicate that the *E-RGCH/E-HICH Channelisation Code IE* contains invalid data.]
- [FDD – If the Additional Serving E-DCH Radio Link is configured in the DRNS, then:]
 - [FDD – The DRNS shall allocate a primary E-RNTI identifier or a secondary E-RNTI identifier or both for the corresponding RL and include these E-RNTI identifiers and the channelisation code of the corresponding E-AGCH in the *E-DCH FDD DL Control Channel Information IE* in the *Additional E-DCH FDD Information Response IE* in the *Additional E-DCH Cell Information Response IE* in the RADIO LINK SETUP RESPONSE message.]
 - [FDD – The DRNS may include in the *E-DCH FDD DL Control Channel Information IE* in the *Additional E-DCH FDD Information Response IE* in the *Additional E-DCH Cell Information Response IE* in the RADIO LINK SETUP RESPONSE message the *Serving Grant Value IE* and *Primary/Secondary Grant Selector IE* for the initial grant for the Additional serving E-DCH RL and may include the *Default Serving Grant in DTX Cycle 2 IE*.]
 - [FDD – If the E-DCH HARQ process allocation for 2ms TTI for scheduled transmission shall be changed, the DRNS shall allocate resources according to the new/changed configuration and include the new/changed configuration in the *HARQ Process Allocation For 2ms Scheduled*

Transmission Grant IE in the Additional E-DCH FDD Information Response IE in the Additional E-DCH Cell Information Response IE in the RADIO LINK SETUP RESPONSE message.]

- [FDD – If the *Serving Cell Change CFN IE* is included in the RADIO LINK SETUP REQUEST message, then the DRNS shall activate the resources that are allocated for the new additional serving E-DCH Radio Link at the next coming CFN with a value equal to the value requested by the SRNC. If the *Serving Cell Change CFN IE* is not included then the DRNS shall activate immediately the resources that are allocated for the new additional serving E-DCH Radio Link]
- [FDD – If the *D-RNTI IE* was included in the RADIO LINK SETUP REQUEST message the DRNS shall include in the RADIO LINK SETUP RESPONSE message the *Primary Scrambling Code IE*, the *UL UARFCN IE* and the *DL UARFCN IE* for the secondary UL frequency in the *Additional E-DCH FDD Information Response IE* in the *Additional E-DCH Cell Information Response IE* in the RADIO LINK SETUP RESPONSE message.]
- [FDD – If Primary CPICH is not to be used as a Phase Reference for this Radio Link on the secondary UL frequency, the DRNS shall include the *Primary CPICH Usage For Channel Estimation IE* set to the value “Primary CPICH shall not be used” in the *Additional E-DCH FDD Information Response IE* in the *Additional E-DCH Cell Information Response IE* RADIO LINK SETUP RESPONSE message.]
- [FDD – If Secondary CPICH may be used as a Phase Reference for this Radio Link on the secondary UL frequency, the DRNS shall include the *Secondary CPICH Information IE* in the *Additional E-DCH FDD Information Response IE* in the *Additional E-DCH Cell Information Response IE* in the RADIO LINK SETUP RESPONSE message. If the DRNS doesn’t include the *Secondary CPICH Information IE*, it shall not include the *Primary CPICH Usage For Channel Estimation IE* set to the value “Primary CPICH shall not be used”.]

[FDD – E-DCH –HS-DSCH:]

[FDD – If the RADIO LINK SETUP REQUEST message includes the *DCH Indicator For E-DCH-HSDPA Operation IE*, then the DRNS shall ignore the *DCH Information IE* in the RADIO LINK SETUP REQUEST message.]

Physical Channels Handling:

[FDD – Compressed Mode:]

[FDD – If the RADIO LINK SETUP REQUEST message includes the *Transmission Gap Pattern Sequence Information IE*, the DRNS shall store the information about the Transmission Gap Pattern Sequences to be used in the Compressed Mode Configuration. This Compressed Mode Configuration shall be valid in the DRNS until the next Compressed Mode Configuration is configured in the DRNS or the last Radio Link is deleted.]

[FDD – If the RADIO LINK SETUP REQUEST message includes the *Transmission Gap Pattern Sequence Information IE* and the *Active Pattern Sequence Information IE*, the DRNS shall use the information to activate the indicated Transmission Gap Pattern Sequence(s) in the new RL. The received *CM Configuration Change CFN IE* refers to latest passed CFN with that value. The DRNS shall treat the received *TGCFN IEs* as follows:]

- [FDD – If any received *TGCFN IE* has the same value as the received *CM Configuration Change CFN IE*, the DRNS shall consider the concerned Transmission Gap Pattern Sequence as activated at that CFN.]
- [FDD – If any received *TGCFN IE* does not have the same value as the received *CM Configuration Change CFN IE* but the first CFN after the *CM Configuration Change CFN IE* with a value equal to the *TGCFN IE* has already passed, the DRNS shall consider the concerned Transmission Gap Pattern Sequence as activated at that CFN.]
- [FDD – For all other Transmission Gap Pattern Sequences included in the *Active Pattern Sequence Information IE*, the DRNS shall activate each Transmission Gap Pattern Sequence at the first CFN after the *CM Configuration Change CFN IE* with a value equal to the *TGCFN IE* for the Transmission Gap Pattern Sequence.]

[FDD – If the *Downlink Compressed Mode Method IE* in one or more Transmission Gap Pattern Sequence is set to “SF/2” in the RADIO LINK SETUP REQUEST message and the UE Context is configured to use DPCH in the downlink, the DRNS shall include the *Transmission Gap Pattern Sequence Scrambling Code*

Information IE in the RADIO LINK SETUP RESPONSE message indicating for each DL Channelisation Code whether the alternative scrambling code shall be used or not.]

[FDD – If the RADIO LINK SETUP REQUEST message includes the *Transmission Gap Pattern Sequence Information* IE and the *Active Pattern Sequence Information* IE and the concerned UE Context is configured to use F-DPCH in the downlink, the DRNS shall ignore, when activating the Transmission Gap Pattern Sequence(s), the information provided by the *Downlink Compressed Mode Method* IE if included for the concerned Transmission Gap Pattern Sequence(s).]

[FDD – DL Code Information:]

[FDD – When more than one DL DPDCH are assigned per RL, the segmented physical channel shall be mapped on to DL DPDCHs according to TS 25.211 [8]. When p number of DL DPDCHs are assigned to each RL, the first pair of DL Scrambling Code and FDD DL Channelisation Code Number corresponds to “*PhCH number 1*”, the second to “*PhCH number 2*”, and so on until the p th to “*PhCH number p*”.]

[FDD – Phase Reference Handling:]

[FDD – If Primary CPICH is not to be used as a Phase Reference for this Radio Link, the DRNC shall include the *Primary CPICH Usage For Channel Estimation* IE set to the value “Primary CPICH shall not be used” in the RADIO LINK SETUP RESPONSE message.]

[FDD – If Secondary CPICH may be used as a Phase Reference for this Radio Link, the DRNC shall include the *Secondary CPICH Information* IE in the RADIO LINK SETUP RESPONSE message.]

[FDD – If the DRNC doesn’t include the *Secondary CPICH Information* IE in the RADIO LINK SETUP RESPONSE message, it shall not include the *Primary CPICH Usage For Channel Estimation* IE set to the value “Primary CPICH shall not be used” in the RADIO LINK SETUP RESPONSE message.]

General:

[FDD – If the *Propagation Delay* IE and optionally the *Extended Propagation Delay* IE are included, the DRNS may use this information to speed up the detection of UL synchronisation on the Uu interface.]

[FDD – If the received *Limited Power Increase* IE is set to “Used”, the DRNS shall, if supported, use Limited Power Increase according to ref. TS 25.214 [10] subclause 5.2.1 for the inner loop DL power control.]

[TDD – If the RADIO LINK SETUP REQUEST message includes the [1.28 Mcps TDD and 3.84 Mcps TDD – *Maximum Number of DL Physical Channels per Timeslot* IE] [7.68 Mcps TDD – *Maximum Number of DL Physical Channels per Timeslot 7.68 Mcps* IE] the DRNC shall take this value into account when allocating physical resources, otherwise the DRNC can assume that this UE capability is consistent with the other signalled UE capabilities.]

[1.28Mcps TDD – If the RADIO LINK SETUP REQUEST message includes the *Support for 8PSK* IE within the *DL Physical Channel Information* IE or *UL Physical Channel Information* IE, the DRNC shall take this into account in the specified direction when allocating physical resources, otherwise the DRNC can assume that this UE does not support 8PSK resource allocation.]

[1.28Mcps TDD – If the RADIO LINK SETUP REQUEST message includes the *Support for PLCCH* IE within the *DL Physical Channel Information* IE, the DRNC shall take this into account when allocating PLCCH sequence numbers, otherwise the DRNC can assume that this UE does not support PLCCH.]

[FDD – If the RADIO LINK SETUP REQUEST message includes the *DL DPCH Information* IE, then the DRNS shall configure the concerned UE Context to use DPCH in the downlink, i.e. with a DL DPCCCH and a DL DPDCH.]

[FDD – If the RADIO LINK SETUP REQUEST message includes the *F-DPCH Information* IE, then:]

- [FDD – The DRNS shall configure the concerned UE Context to use F-DPCH in the downlink, i.e. with transmission of only the TPC field.]
- [FDD – If the *F-DPCH Information* IE includes the *F-DPCH Slot Format Support Request* IE, then the DRNS shall configure the concerned UE Context for F-DPCH Slot Format operation according to TS 25.211 [8] and include the *F-DPCH Slot Format* IE in the RADIO LINK SETUP RESPONSE

message. If the *F-DPCH Information* IE includes the *F-DPCH Slot Format* IE, the DRNC may use the *F-DPCH Slot Format* IE to determine the F-DPCH slot format.]

[FDD – E-DPCH Handling:]

[FDD – If the *UL DPDCH Indicator for E-DCH operation* IE is included in the *UL DPCH Information* IE and set to “UL-DPDCH not present” the *Min UL Channelisation Code Length* IE, the *Puncture Limit* IE and the *TFCS* IE, within the *UL DPCH Information* IE shall be ignored and no UL DPDCH resources shall be allocated.]

[FDD – Continuous Packet Connectivity Handling:]

[FDD – If the RADIO LINK SETUP REQUEST message includes the *Continuous Packet Connectivity DTX-DRX Information* IE, then:]

- [FDD – The DRNS shall configure the concerned UE Context for Continuous Packet Connectivity DTX operation according to TS 25.214 [10].]
- [FDD – If *DRX Information* IE is included in the *Continuous Packet Connectivity DTX-DRX Information* IE, then the DRNS shall configure the concerned UE Context for Continuous Packet Connectivity DRX operation according to TS 25.214 [10].]

[FDD – If the RADIO LINK SETUP REQUEST message includes the *Continuous Packet Connectivity HS-SCCH less Information* IE, then:]

- [FDD – The DRNS shall configure the Serving HS-DSCH Radio Link indicated by the *HS-PDSCH RL ID* IE for Continuous Packet Connectivity HS-SCCH less operation according to TS 25.214 [10].]
- [FDD – The DRNS shall allocate the HS-PDSCH codes needed for HS-SCCH less operation and include the *Continuous Packet Connectivity HS-SCCH less Information Response* IE in the RADIO LINK SETUP RESPONSE message.]
- [FDD – If at least one of *HS-PDSCH Second Code Support* IE is set to “True”, then the DRNC shall include *HS-PDSCH Second Code Index* IE in the RADIO LINK SETUP RESPONSE message.]

[1.28 Mcps TDD – Continuous Packet Connectivity Handling:]

[1.28 Mcps TDD – If the RADIO LINK SETUP REQUEST message includes the *Continuous Packet Connectivity DRX Information LCR* IE, then the DRNS shall take account into these parameters to decide the DRX operation related parameters and configure the concerned UE Context for DRX operation according to TS 25.213 [21] and include the parameter(s) in the *Continuous Packet Connectivity DRX Information Response LCR* IE in the RADIO LINK SETUP RESPONSE message.]

[1.28 Mcps TDD - If the *Inactivity Threshold for UE DRX Cycle Ext* IE is included in the *Continuous Packet Connectivity DRX Information LCR* IE, then the DRNS may use this value to determine the Inactivity Threshold for UE DRX Cycle according to TS 25.224 [22].]

[1.28 Mcps TDD – If the RADIO LINK SETUP REQUEST message includes the *HS-DSCH Semi-Persistent scheduling Information LCR* IE, then:]

- [1.28 Mcps TDD – The DRNS shall configure the Serving HS-DSCH Radio Link indicated by the *HS-PDSCH RL ID* IE for HS-DSCH Semi-Persistent scheduling operation according to TS 25.213 [21].]
- [1.28 Mcps TDD – The DRNS shall allocate the HS-SICH information needed for HS-DSCH Semi-Persistent scheduling operation and include the *HS-DSCH Semi-Persistent scheduling Information Response LCR* IE in the RADIO LINK SETUP RESPONSE message.]
- [1.28 Mcps TDD – If the *HS-DSCH Semi-Persistent Resource Reservation Indicator* IE is included in the *HS-DSCH Semi-Persistent scheduling Information LCR* IE, then the DRNS shall include *Allcoated HS-PDSCH Semi-persistent resource* IE in the RADIO LINK SETUP RESPONSE message.]
- [1.28 Mcps TDD – The DRNS shall include the *Buffer Size for HS-DSCH Semi-Persistent scheduling* IE in the RADIO LINK SETUP RESPONSE message.]
- [1.28 Mcps TDD – The DRNS shall include the *Number of Processes for HS-DSCH Semi-Persistent scheduling* IE in the RADIO LINK SETUP RESPONSE message.]

- [1.28 Mcps TDD – If the *HS-DSCH Semi-Persistent scheduling operation Indicator* IE is included in the *HS-DSCH Semi-Persistent scheduling Information LCR* IE, then the DRNS shall apply this information for HS-DSCH Semi-Persistent scheduling operation.]

[1.28 Mcps TDD – If the RADIO LINK SETUP REQUEST message includes the *E-DCH Semi-Persistent scheduling Information LCR* IE, then:]

- [1.28 Mcps TDD – The DRNS shall configure the Serving E-DCH Radio Link indicated by the *E-DCH Serving RL* IE for E-DCH Semi-Persistent scheduling operation according to TS 25.213 [21].]
- [1.28 Mcps TDD – If the *E-DCH Semi-Persistent Resource Reservation Indicator* IE is included in the *E-DCH Semi-Persistent scheduling Information LCR* IE, then the DRNS shall include *Allocated E-DCH Semi-persistent resource* IE in the RADIO LINK SETUP RESPONSE message.]
- [1.28 Mcps TDD – If the *E-DCH Semi-Persistent scheduling Indicator* IE is included in the *E-DCH Semi-Persistent scheduling Information LCR* IE, then the DRNS shall apply this information for E-DCH Semi-Persistent scheduling operation.]

Radio Link Handling:

Diversity Combination Control:

[FDD – The *Diversity Control Field* IE indicates for each RL except for the first RL whether the DRNS shall combine the RL with any of the other RLs or not.]

- [FDD – If the *Diversity Control Field* IE is set to “May” (be combined with another RL), the DRNS shall decide for any of the alternatives.]
- [FDD – If the *Diversity Control Field* IE is set to “Must”, the DRNS shall combine the RL with one of the other RL.]
- [FDD – If the *Diversity Control Field* IE is set to “Must not”, the DRNS shall not combine the RL with any other existing RL.]

[FDD – When an RL is to be combined, the DRNS shall choose which RL(s) to combine it with.]

[FDD – The *Diversity Control Field* IE is only applicable for DCHs, in case of E-DCH it shall always be assumed to be set to “May”.]

[FDD – In the RADIO LINK SETUP RESPONSE message, the DRNC shall indicate for each RL with the Diversity Indication in the *RL Information Response* IE whether the RL is combined or not.]

- [FDD – In case of not combining with a RL previously listed in the RADIO LINK SETUP RESPONSE message or for the first RL in the RADIO LINK SETUP RESPONSE message, the DRNC shall]
 - [FDD – in case of requested DCHs, include in the *DCH Information Response* IE in the RADIO LINK SETUP RESPONSE message for which the *Transport Bearer Not Requested Indicator* IE was not included the *Binding ID* IE and *Transport Layer Address* IE for the transport bearer to be established for each DCH of this RL.]
 - [FDD – in case of requested DCHs, include in the RADIO LINK SETUP RESPONSE message the *Transport Bearer Not Setup Indicator* IE for every DCH for which establishment of a transport bearer has not taken place as a result of information in the *Transport Bearer Not Requested Indicator* IE in the RADIO LINK SETUP REQUEST message.]
 - [FDD – in case of a requested E-DCH, include in the *E-DCH FDD Information Response* IE in the RADIO LINK SETUP RESPONSE for which the *Transport Bearer Not Requested Indicator* IE was not included message the *Binding ID* IE and the *Transport Layer Address* IE for the establishment of transport bearers for every E-DCH MAC-d flow being established.]
 - [FDD – in case of a requested E-DCH, include in the RADIO LINK SETUP RESPONSE message the *Transport Bearer Not Setup Indicator* IE for every E-DCH MAC-d flow for which establishment of a transport bearer has not taken place as a result of information in the *Transport Bearer Not Requested Indicator* IE in the RADIO LINK SETUP REQUEST message.]

- [FDD – Otherwise in case of combining, the *RL ID IE* indicates (one of) the RL(s) previously listed in this RADIO LINK SETUP RESPONSE message with which the concerned RL is combined and if the ALCAP is not used and the transport bearer for the DCH is already established, the *Transport Layer Address IE* and the *Binding ID IE* in the *RL Specific DCH Information IE* included in the *RL Information IE* for a specific RL in the RADIO LINK SETUP REQUEST message, shall not be used. In case of combining an E-DCH RL, one of the RLs previously listed in this RADIO LINK SETUP RESPONSE message including the *E-DCH FDD Information Response IE* and part of the same Radio Link Set shall be regarded as the RL with which the concerned E-DCH RL is combined and if the ALCAP is not used, the *Transport Layer Address IE* and the *Binding ID IE* in the *RL Specific E-DCH Information IE* included in the *RL Information IE* for a specific RL in the RADIO LINK SETUP REQUEST message, shall not be used.]

[TDD – The DRNC shall always include in the RADIO LINK SETUP RESPONSE message both the *Transport Layer Address IE* and the *Binding ID IE* for the transport bearer to be established for each DCH, DSCH and USCH of the RL.]

In the case of a set of co-ordinated DCHs requiring a new transport bearer the *Binding ID IE* and the *Transport Layer Address IE* shall be included in the RADIO LINK SETUP RESPONSE message for only one of the DCHs in the set of co-ordinated DCHs [FDD – where the *Transport Bearer Not Requested Indicator IE* was not included].

[FDD – Transmit Diversity:]

[FDD – If the cell in which the RL is being set up is capable to provide Close loop Tx diversity, the DRNC shall include the *Closed Loop Timing Adjustment Mode IE* in the RADIO LINK SETUP RESPONSE message indicating the configured Closed loop timing adjustment mode of the cell.]

[FDD – When the *Diversity Mode IE* is set to “STTD”, or “Closed loop mode1”, the DRNC shall activate/deactivate the Transmit Diversity for each Radio Link in accordance with the *Transmit Diversity Indicator IE*.]

[FDD – If the *Diversity Mode IE* is included in the *HS-DSCH FDD Secondary Serving Information IE* in the *Additional HS Cell Information RL Setup IE* in the RADIO LINK SETUP REQUEST message, the DRNS shall apply cell specific transmit diversity configuration and if the *Diversity Mode IE* is not set to “None” the DRNS shall activate/deactivate the Transmit Diversity for the secondary serving HS-DSCH Radio Link in accordance with the *Transmit Diversity Indicator IE* in the *HS-DSCH FDD Secondary Serving Information IE*.]

DL Power Control:

[FDD – If both the *Initial DL TX Power IE* and *Uplink SIR Target IE* are included in the message, the DRNS shall use the indicated DL TX Power and Uplink SIR Target as initial value. If the value of the *Initial DL TX Power IE* is outside the configured DL TX power range, the DRNS shall apply these constraints when setting the initial DL TX power. The DRNS shall also include the configured DL TX power range defined by *Maximum DL TX Power IE* and *Minimum DL TX Power IE* in the RADIO LINK SETUP RESPONSE message. The DRNS shall not transmit with a power higher than indicated by the *Maximum DL TX Power IE* or lower than indicated by the *Minimum DL TX Power IE* on any DL DPCH or on the F-DPCH of the RL except, if the UE Context is configured to use DPCH in the downlink, during compressed mode, when the δP_{curr} , as described in ref. TS 25.214 [10] subclause 5.2.1.3, shall be added to the maximum DL power for the associated compressed frame.]

[FDD – If both the *Initial DL TX Power* and the *Uplink SIR Target* IEs are not included in the RADIO LINK SETUP REQUEST message, then DRNC shall determine the initial Uplink SIR Target and include it in the *Uplink SIR Target IE* in the RADIO LINK SETUP RESPONSE message.]

[TDD – The DRNC shall use the *Uplink SIR Target CCTrCH* IEs in the RADIO LINK SETUP RESPONSE message to indicate for any UL CCTrCH an Uplink SIR Target value in case this is deviating from the value included in the *Uplink SIR Target IE* specified for the Radio Link. If in any [3.84Mcps TDD – *UL CCTrCH Information IE*] [1.28Mcps TDD – *UL CCTrCH Information LCR IE*] [7.68Mcps TDD – *UL CCTrCH Information 7.68 Mcps IE*] the *Uplink SIR Target CCTrCH IE* is not included, the value of the *Uplink SIR Target IE* shall apply to the respective UL CCTrCH.]

[FDD – If the *Primary CPICH Ec/No* IE is present, the DRNC should use the indicated value when deciding the Initial DL TX Power. If the *Enhanced Primary CPICH Ec/No* IE is present, the DRNC should use the indicated value when deciding the Initial DL Tx Power.]

[TDD – If [3.84Mcps TDD and 7.68 Mcps TDD – the *DL Time Slot ISCP Info* IE] [1.28Mcps TDD – the *DL Time Slot ISCP Info LCR* IE] is present, the DRNS should use the indicated value when deciding the Initial DL TX Power for the Radio Link. The DRNS shall use the indicated DL Timeslot ISCP when determining the initial DL power per timeslot as specified in TS 25.224 [22], i.e. it shall reduce the DL TX power in those downlink timeslots of the radio link where the interference is low, and increase the DL TX power in those timeslots where the interference is high, while keeping the total downlink power in the radio link unchanged.]

[TDD – If the *Primary CCPCH RSCP Delta* IE is included, the DRNS should assume that the reported value for Primary CCPCH RSCP is in the negative range as per TS 25.123 [24], and the value is equal to the *Primary CCPCH RSCP Delta* IE. If the *Primary CCPCH RSCP Delta* IE is not included and the *Primary CCPCH RSCP* IE is included, the DRNS should assume that the reported value is in the non-negative range as per TS 25.123 [24], and the value is equal to the *Primary CCPCH RSCP* IE. The DRNS should use the indicated value when deciding the Initial DL TX Power for the Radio Link.]

[3.84 Mcps TDD and 7.68 Mcps TDD – The DL TX power upper and lower limit is configured in the following way:

- The DRNC shall include the *Maximum DL TX Power* IE and *Minimum DL TX Power* IE in the RADIO LINK SETUP RESPONSE message. If the maximum or minimum power needs to be different for particular DCH type CCTrCHs, the DRNC shall include the value(s) for that CCTrCH in the *CCTrCH Maximum DL TX Power* IE and *CCTrCH Minimum DL TX Power* IE. The DRNS shall not transmit with a higher power than indicated by the appropriate *Maximum DL TX Power* IE/*CCTrCH Maximum DL TX Power* IE or lower than indicated by the appropriate *Minimum DL TX Power* IE/*CCTrCH Minimum DL TX Power* IE on any DL DPCH within each CCTrCH of the RL.]

[1.28 Mcps TDD – The DL TX power upper and lower limit is configured in the following way:

- The DRNC shall include the *Maximum DL TX Power* IE and *Minimum DL TX Power* IE in the RADIO LINK SETUP RESPONSE message. If the maximum or minimum power needs to be different for particular timeslots within a DCH type CCTrCH, the DRNC shall include the value(s) for that timeslot in the *Maximum DL TX Power* IE and *Minimum DL TX Power* IE within the *DL Timeslot Information LCR* IE. The DRNS shall not transmit with a higher power than indicated by the appropriate *Maximum DL TX Power* IE or lower than indicated by the appropriate *Minimum DL TX Power* IE on any DL DPCH within each timeslot of the RL.]

[1.28McpsTDD – If the *TSTD Support Indicator* IE is present, the DRNS shall apply this information when configuring the transmit diversity for the new radio link.]

[FDD – The DRNS shall start any DL transmission using the indicated DL TX power level (if received) or the decided DL TX power level on each DL channelisation code or on the F-DPCH of a RL until UL synchronisation is achieved on the Uu interface for the concerned RLS or Power Balancing is activated. No inner loop power control or power balancing shall be performed during this period. The DL power shall then vary according to the inner loop power control (see ref.TS 25.214 [10] subclause 5.2.1.2) and the power control procedure (see 8.3.15).]

[TDD – The DRNS shall start any DL transmission using the decided DL TX power level on each DL channelisation code and on each Time Slot of a RL until UL synchronisation is achieved on the Uu interface for the concerned RL. No inner loop power control shall be performed during this period. Then after UL synchronisation, the DL power shall vary according to the inner loop power control (see ref. TS 25.224 [22] subclause 4.2.3.3).]

[FDD – If the received *Inner Loop DL PC Status* IE is set to “Active”, the DRNS shall activate the inner loop DL power control for all RLS. If *Inner Loop DL PC Status* IE is set to “Inactive”, the DRNS shall deactivate the inner loop DL power control for all RLS according to ref. TS 25.214 [10].]

[FDD – If the *DPC Mode* IE is present in the RADIO LINK SETUP REQUEST message, the DRNC shall apply the DPC mode indicated in the message, and be prepared that the DPC mode may be changed during the lifetime of the RL. If the *DPC Mode* IE is not present in the RADIO LINK SETUP REQUEST message, DPC mode 0 shall be applied (see ref. TS 25.214 [10]).]

[FDD – If the RADIO LINK SETUP REQUEST message includes the *DL Power Balancing Information IE* and the *Power Adjustment Type IE* is set to “Common” or “Individual”, the DRNS shall activate the power balancing, if activation of power balancing by the RADIO LINK SETUP REQUEST message is supported, according to subclause 8.3.15, using the *DL Power Balancing Information IE*. If the DRNS starts the DL transmission and the activation of the power balancing at the same CFN, the initial power of the power balancing i.e. P_{init} shall be set to the power level indicated by the *Initial DL TX Power IE* (if received) or the decided DL TX power level on each DL channelisation code of a RL based on the *Primary CPICH Ec/No IE* or the *Enhanced Primary CPICH Ec/No IE*.]

[FDD – If activation of power balancing by the RADIO LINK SETUP REQUEST message is supported by the DRNS, the DRNC shall include the *DL Power Balancing Activation Indicator IE* in the *RL Information Response IE* in the RADIO LINK SETUP RESPONSE message.]

Neighbouring Cell Handling:

If there are UMTS neighbouring cell(s) to the cell in which a Radio Link was established then:

- The DRNC shall include in the RADIO LINK SETUP RESPONSE message the *Neighbouring FDD Cell Information IE* and/or *Neighbouring TDD Cell Information IE* in the *Neighbouring UMTS Cell Information IE* for each neighbouring FDD cell and/or TDD cell respectively. In addition, if the information is available, the DRNC shall include in the RADIO LINK SETUP RESPONSE message the *Frame Offset IE*, *Primary CPICH Power IE*, *Cell Individual Offset IE*, *STTD Support Indicator IE*, *Closed Loop Mode1 Support Indicator IE*, *Coverage Indicator IE*, *Antenna Co-location Indicator IE* and *HCS Prio IE* in the *Neighbouring FDD Cell Information IE*, and the *Frame Offset IE*, *Cell Individual Offset IE*, *DPCH Constant Value IE*, the *PCCPCH Power IE*, *Coverage Indicator IE*, *Antenna Co-location Indicator IE* and *HCS Prio IE* in the *Neighbouring TDD Cell Information IE* or the *Neighbouring TDD Cell Information LCR IE*. If the *Neighbouring TDD Cell Information IE* includes the *Sync Case IE* for the set to “Case1”, the DRNC shall include the *Time Slot For SCH IE* in the *Neighbouring TDD Cell Information IE*. If the *Neighbouring TDD Cell Information IE* includes *Sync Case IE* set to “Case2”, the DRNC shall include the *SCH Time Slot IE* in the *Neighbouring TDD Cell Information IE*.
- If a UMTS neighbouring cell is not controlled by the same DRNC, the DRNC shall also include in the RADIO LINK SETUP RESPONSE message the *CN PS Domain Identifier IE* and/or *CN CS Domain Identifier IE* which are the identifiers of the CN nodes connected to the RNC controlling the UMTS neighbouring cell.
- If the information is available, the DRNC shall include in the RADIO LINK SETUP RESPONSE message the *DPC Mode Change Support Indicator IE* for each neighbour cell in the *Neighbouring FDD Cell Information IE*
- The DRNC shall include the *Cell Capability Container FDD IE*, the *Cell Capability Container TDD IE*, the *Cell Capability Container TDD LCR IE* and/or the *Cell Capability Container Extension FDD IE* if the DRNC is aware that the neighbouring cell supports any functionality listed in 9.2.2.D, 9.2.3.1a, 9.2.3.1b and/or the *Cell Capability Container Extension FDD IE*.
- [FDD – The DRNC shall, if supported, include the *Cell List Validity Indicator IE* if the neighbouring cell is multi cell capable and/or dual band capable but the cell can not be the serving HS-DSCH in a multicell and/or dual band configuration. Hence the cell can only serve as the secondary serving HS-DSCH cell. When *Cell List Validity Indicator IE* is included the SRNC should ignore the indicated cell list(s).]
- For the UMTS neighbouring cells which are controlled by the DRNC, the DRNC shall report in the RADIO LINK SETUP RESPONSE message the restriction state of those cells, otherwise the *Restriction State Indicator IE* may be absent. The DRNC shall include in the RADIO LINK SETUP RESPONSE message the *Restriction State Indicator IE* for the neighbouring cells which are controlled by the DRNC in the *Neighbouring FDD Cell Information IE*, the *Neighbouring TDD Cell Information IE* and the *Neighbouring TDD Cell Information LCR IE*.
- If MOCN or GWCN network sharing configuration is used then the DRNC shall include the broadcasted PLMN identities of the concerned neighbouring cells in the *Multiple PLMN List IE* in the *Neighbouring FDD Cell Information IE*, the *Neighbouring TDD Cell Information IE* and the *Neighbouring TDD Cell Information LCR IE*.

- If available, the DRNC shall include the *SNA Information* IE for the concerned neighbouring cells in the *Neighbouring FDD Cell Information* IE, the *Neighbouring TDD Cell Information* IE and the *Neighbouring TDD Cell Information LCR* IE.
- If available, the DRNC shall include the *Frequency Band Indicator* IE for the concerned neighbouring cells in the *Neighbouring FDD Cell Information* IE.

If there are GSM neighbouring cells to the cell(s) where a radio link is established, the DRNC shall include in the RADIO LINK SETUP RESPONSE message the *Neighbouring GSM Cell Information* IE for each of the GSM neighbouring cells. If available the DRNC shall include in the RADIO LINK SETUP RESPONSE message the *Cell Individual Offset* IE, and if the *Cell Individual Offset* IE alone cannot represent the value of the offset, the DRNC shall also include the *Extended GSM Cell Individual Offset* IE in the *Neighbouring GSM Cell Information* IE. If available the DRNC shall also include in the RADIO LINK SETUP RESPONSE message the *Coverage Indicator* IE, *Antenna Co-location Indicator* IE and *HCS Prio* IE in the *Neighbouring GSM Cell Information* IE. If available, the DRNC shall also include the *SNA Information* IE for the concerned neighbouring cells in the *Neighbouring GSM Cell Information* IE.

When receiving the *SNA Information* IE in the RADIO LINK SETUP RESPONSE message, the SRNC should use it to restrict cell access based on SNA information. See also TS 25.401 [40] for a broader description of the SNA access control.

If there are GERAN neighbouring cells to the cell(s) where a radio link is established, the DRNC shall include the *GERAN Cell Capability* IE in the *Neighbouring GSM Cell Information* IE that is included in the RADIO LINK SETUP RESPONSE message for each of the GERAN cells.

If there are GERAN Iu-mode neighbouring cells to the cell(s) where a radio link is established, the DRNC shall include, if available, the *GERAN Classmark* IE in the *Neighbouring GSM Cell Information* IE that is included in the RADIO LINK SETUP RESPONSE message for each of the GERAN Iu-mode neighbouring cells. Ref. TS 43.051 [39] defines when the transmission of the *GERAN Classmark* IE will be required at the initiation of the Relocation Preparation procedure.

If there are E-UTRA neighbouring cells to the cell(s) where a radio link is established, the DRNC shall include in the RADIO LINK SETUP RESPONSE message the *Neighbouring E-UTRA Cell Information* IE for each of the E-UTRA neighbouring cells.

[1.28Mcps TDD – Uplink Synchronisation Parameters LCR:]

[1.28Mcps TDD – If the *Uplink Synchronisation Parameters LCR* IE is present, the DRNC shall use the indicated values of *Uplink synchronisation stepsize* IE and *Uplink synchronisation frequency* IE when evaluating the timing of the UL synchronisation.]

[1.28Mcps TDD – Shared physical channels Synchronisation Detection:]

[1.28Mcps TDD – If HS-PDSCH and E-PUCH are configured but no DPCH is configured for the UE, then the DRNS shall also include the *Out-of-sync Detection Window* IE in the *HS-DSCH TDD Information Response* IE in the RADIO LINK SETUP RESPONSE message.]

[1.28Mcps TDD – Uplink Timing Advance Control LCR:]

[1.28Mcps TDD – The DRNC shall include the *Uplink Timing Advance Control LCR* IE in the RADIO LINK SETUP RESPONSE message.]

[1.28Mcps TDD – PowerControl GAP:]

[1.28Mcps TDD – If applied in the DRNS, the DRNC may include the *PowerControl GAP* IE in the RADIO LINK SETUP RESPONSE message.]

[1.28Mcps TDD – E-UTRAN Inter-RAT measurement:]

[1.28Mcps TDD – If the RADIO LINK SETUP REQUEST message includes the *Idle Interval Configuration Indicator* IE, if supported, the DRNC shall include the *Idle Interval Information* IE in the RADIO LINK SETUP RESPONSE message.]

[1.28Mcps TDD – RNTI Allocation Indicator:]

[1.28Mcps TDD – If the RADIO LINK SETUP REQUEST message includes the *RNTI Allocation Indicator* IE, if supported, the DRNS may allocate an E-RNTI and/or an H-RNTI for UE to use in CELL_FACH state.]

[1.28Mcps TDD – Inter-frequency/ Inter-RAT measurement:]

[1.28Mcps TDD – If the RADIO LINK SETUP REQUEST message includes the *DCH Measurement Type indicator* IE, if supported, the DRNS shall include the *Measurement purpose* IE and the *Measurement occasion pattern sequence parameters* IE in the *DCH Measurement Occasion Information* IE in the RADIO LINK SETUP RESPONSE message to configure the measurement occasion pattern(s) indicated by the *DCH Measurement Type indicator* IE.]

MBMS Handling:

If the *MBMS Bearer Service List* IE is included in the RADIO LINK SETUP REQUEST message, the DRNC shall, if supported, perform the UE Linking as specified in TS 25.346 [50], section 5.1.6. If the UE Link is currently stored in the UE Context or the *MBMS Bearer Service List* IE is included in the RADIO LINK SETUP REQUEST message and if an MBMS session for some MBMS bearer services contained in the UE Link is ongoing in some of the cells identified by the *C-ID* IEs in the RADIO LINK SETUP REQUEST message, the DRNC shall include for each of these active MBMS bearer services in the *Active MBMS Bearer Service List* IE the *Transmission Mode* IE in the concerned *RL Information Response* IEs in the RADIO LINK SETUP RESPONSE message.

If the UE Link is currently stored in the UE Context or the *MBMS Bearer Service List* IE is included in the RADIO LINK SETUP REQUEST message and if an MBMS preferred frequency layer for some active MBMS bearer services contained in the UE Link is set in some of the cells identified by the *C-ID* IEs in the RADIO LINK SETUP REQUEST message, the DRNC shall include for each of these active MBMS bearer services in the *Active MBMS Bearer Service List* IE the *Preferred Frequency Layer* IE in the concerned *RL Information Response* IEs in the RADIO LINK SETUP RESPONSE message.

[FDD – HS-DSCH Preconfiguration for Enhanced HS Serving Cell Change]

[FDD – If the RADIO LINK SETUP REQUEST message includes the *HS-DSCH Preconfiguration Setup* IE in the *RL Information* IE for a Radio Link not indicated by the *HS-PDSCH RL ID* IE the DRNS shall if supported preconfigure the indicated cells for Enhanced HS Serving Cell Change according to TS 25.308 [63]:]

- [FDD – The DRNS shall preconfigure sets of HS-SCCH codes on the cells preconfigured for HS-DSCH, primary serving HS-DSCH cell, as well as on the secondary serving HS-DSCH cells. The primary serving HS-DSCH cell is designated through the *C-ID* IE part of the *RL Information* IE in the RADIO LINK SETUP REQUEST message. The list of secondary serving HS-DSCH cells is designated by the list of *Secondary C-ID* IEs in the *HS-DSCH Preconfiguration Setup* IE part of the *RL Information* IE in the RADIO LINK SETUP REQUEST message.]
- [FDD – The number of HS-SCCH codes to preconfigure for each cell may be optionally specified:]
 - [FDD – by the *Num Primary HS-SCCH Codes* IE in the *HS-DSCH Preconfiguration Setup* IE, for the primary serving HS-DSCH cell]
 - [FDD – by the *Num Secondary HS-SCCH Codes* IE in the *Secondary Cells* IE in the *HS-DSCH Preconfiguration Setup* IE for each of the secondary serving HS-DSCH cells]
- [FDD –If *Num Primary HS-SCCH Codes* IE or *Num Secondary HS-SCCH Codes* IE is not included in the message the number and distribution of codes on primary and any secondary cells shall be preconfigured to satisfy any limitations in TS 25.214 [10].]
- [FDD – The DRNS shall return these codes in the *Sets of HS-SCCH Codes* IE along with the corresponding per-cell *HS-DSCH-RNTI* IE in the *HS-DSCH Preconfiguration Info* IE in the *RL Information Response* IE of the RADIO LINK SETUP RESPONSE message or in the *Successful RL Information Response* IE of the RADIO LINK SETUP FAILURE message.]
- [FDD – The DRNS shall use the first in the numbered list of the primary serving HS-DSCH cell's HS-SCCH codes in the *HS-SCCH Preconfigured Codes* IE sent to the SRNC to signal the Target Cell HS-SCCH Order defined in ITU-T Rec. X.680 [18].]

- [FDD – The DRNS shall include, in the *HS-DSCH Preconfiguration Info* IE in the *RL Information Response* IE in the RADIO LINK SETUP RESPONSE message or in the *Successful RL Information Response* IE of the RADIO LINK SETUP FAILURE message, IEs according to the rules defined for HS-DSCH setup and:]
- [FDD – if *HARQ Preamble Mode* IE is included in the *HS-DSCH Preconfiguration Setup* IE the *HARQ Preamble Mode Activation Indicator* IE]
- [FDD – if *MIMO Activation Indicator* IE is included in the *HS-DSCH Preconfiguration Setup* IE or in the *Secondary Cells* IE in the *HS-DSCH Preconfiguration Setup* IE the Pilot Configuration and MIMO N/M Ratio in *MIMO Information Response* IE]
- [FDD – if *HS-DSCH MAC-d PDU Size Format* IE is included in the *HS-DSCH Preconfiguration Setup* IE and set to “Flexible MAC-d PDU Size” and if Sixtyfour QAM will not be used in the preconfiguration, the *HS-DSCH TB Size Table Indicator* IE for each preconfigured cell]
- [FDD – if *Sixtyfour QAM Usage Allowed Indicator* IE is included in the *Secondary Cells* IE in the *HS-DSCH Preconfiguration Setup* IE or in the *HS-DSCH Preconfiguration Setup* IE the *SixtyfourQAM DL Usage Indicator* IE for each preconfigured cell]
- [FDD – if *Continuous Packet Connectivity HS-SCCH less Information* IE is included in the *HS-DSCH Preconfiguration Setup* IE the *Continuous Packet Connectivity HS-SCCH less Information Response* IE]
- [FDD – if the *UE with enhanced HS-SCCH support indicator* IE is included in the *HS-DSCH Preconfiguration Setup* IE, then the DRNS shall store this information in the preconfigured configuration.]
- [FDD - If the *UE Support Indicator Extension* IE is included in the *HS-DSCH Preconfiguration Setup* IE with the bit *UE DTXDRX related HS-SCCH orders uniform behavior indicator* set to 0, then the DRNS shall, if supported, include the *Support of dynamic DTXDRX related HS-SCCH order* IE in the *HS-DSCH Preconfiguration Info* IE in the RADIO LINK SETUP RESPONSE message.]
- [FDD – the *SixtyfourQAM DL Support Indicator* IE shall be included]
- [FDD – if the *UE Support Indicator Extension* IE is included in the *HS-DSCH Preconfiguration Setup* IE, then the DRNS may store this information in the preconfigured configuration.]
- [FDD – the DRNS shall, if supported, include in the *Sets of HS-SCCH Codes* IE the *Measurement Power Offset* IE for each preconfigured cell.]
- [FDD – The DRNS shall include in the *HS-DSCH Preconfiguration Info* IE in the *RL Information Response* IE in the RADIO LINK SETUP RESPONSE message or in the *Successful RL Information Response* IE of the RADIO LINK SETUP FAILURE message the *E-DCH FDD DL Control Channel Information* containing the preconfigured configuration of the E-DCH serving cell according to the rules defined for Serving E-DCH Radio Link Change as follows:]
 - [FDD – The DRNS shall allocate for the preconfigured configuration a primary E-RNTI identifier or a secondary E-RNTI identifier or both for the new Serving E-DCH Radio Link and include these E-RNTI identifiers along with the channelisation code of the corresponding E-AGCH in the *E-DCH FDD DL Control Channel Information* IE.]
 - [FDD – The DRNS may preconfigure the *Serving Grant Value* IE and *Primary/Secondary Grant Selector* IE for the initial grant for the serving E-DCH RL and include these values in the *E-DCH FDD DL Control Channel Information* IE.]
- [FDD –If the *HS-DSCH Preconfiguration Setup* IE includes the *E-DCH Indicator* IE for a secondary cell, the DRNS shall include in the *Additional E-DCH Preconfiguration Information* IE in the *HS-DSCH Preconfiguration Info* IE in the *RL Information Response* IE in the RADIO LINK SETUP RESPONSE message or in the *Successful RL Information Response* IE of the RADIO LINK SETUP FAILURE message the *E-DCH FDD DL Control Channel Information* containing the preconfigured configuration of the Additional E-DCH serving cell, corresponding to the cell indicated with the *E-DCH Indicator* IE, according to the rules defined for Serving Additional E-DCH Radio Link Change as follows:]

- [FDD – The DRNS shall allocate for the preconfigured configuration a primary E-RNTI identifier or a secondary E-RNTI identifier or both for the new Serving Additional E-DCH Radio Link and include these E-RNTI identifiers along with the channelisation code of the corresponding E-AGCH in the *E-DCH FDD DL Control Channel Information IE*.]
- [FDD – The DRNS may preconfigure the *Serving Grant Value IE* and *Primary/Secondary Grant Selector IE* for the initial grant for the serving Additional E-DCH RL and include these values in the *E-DCH FDD DL Control Channel Information IE*.]
- [FDD – If the *Power Offset For S-CPICH for MIMO Request Indicator IE* is included in the *HS-DSCH Preconfiguration Setup IE* or in the *Secondary Cells IE* in the *HS-DSCH Preconfiguration Setup IE*, the DRNC shall, if supported and MIMO pilot configuration with Primary and Secondary CPICH is set up with a non-zero power offset on the cell where HS-DSCH / secondary HS-DSCH is preconfigured, include the *Power Offset For S-CPICH for MIMO IE* in the *HS-DSCH Preconfiguration Info IE* or in the *Sets of HS-SCCH Codes IE* in the *HS-DSCH Preconfiguration Info IE* for each preconfigured cell in the RADIO LINK SETUP RESPONSE message. If zero power offset the DRNC may include the *Power Offset For S-CPICH for MIMO IE*.]

[FDD – If the RADIO LINK SETUP REQUEST message includes the *Non-Serving RL Preconfiguration Setup IE* in the *RL Information IE* and:]

- [FDD – if the choice of *new Serving RL* is "New Serving RL in the DRNS", the DRNC may include the *New non-serving RL E-DCH FDD DL Control Channel Information A IE* and/or *New non-serving RL E-DCH FDD DL Control Channel Information B IE* in the *Non-Serving RL Preconfiguration Info IE* for the RL in the RADIO LINK SETUP RESPONSE message.]
- [FDD – if the choice of *new Serving RL* is "New Serving RL Not in the DRNS", the DRNC may include the *New non-serving RL E-DCH FDD DL Control Channel Information C IE* in the *Non-Serving RL Preconfiguration Info IE* for the RL in the RADIO LINK SETUP RESPONSE message.]
- [FDD – if the choice of *new Serving RL* is "New Serving RL in the DRNS or New Serving RL Not in the DRNS", the DRNC may include the *New non-serving RL E-DCH FDD DL Control Channel Information A IE*, the *New non-serving RL E-DCH FDD DL Control Channel Information B IE* and/or the *New non-serving RL E-DCH FDD DL Control Channel Information C IE* for the RL in the *Non-Serving RL Preconfiguration Info IE* in the RADIO LINK SETUP RESPONSE message.]
- [FDD – if the *Additional E-DCH Non-Serving RL Preconfiguration Setup IE* is included, the DRNC may include the *New non-serving RL E-DCH FDD DL Control Channel Information A IE*, the *New non-serving RL E-DCH FDD DL Control Channel Information B IE* and/or the *New non-serving RL E-DCH FDD DL Control Channel Information C IE* according to the choice of new Serving RL in *Additional E-DCH New non-serving RL E-DCH FDD DL Control Channel Information IE* for the additional non serving E-DCH RL in the *Non-Serving RL Preconfiguration Info IE* in the RADIO LINK SETUP RESPONSE message.]

General:

If the RADIO LINK SETUP REQUEST message includes the *RL Specific DCH Information IE*, the DRNC may use the transport layer address and the binding identifier received from the SRNC when establishing a transport bearer for the DCH or the set of co-ordinated DCHs [FDD – for every DCH being established for which the *Transport Bearer Not Requested Indicator IE* was not included].

If no *D-RNTI IE* was included in the RADIO LINK SETUP REQUEST message, the DRNC shall include in the RADIO LINK SETUP RESPONSE message the *D-RNTI IE*, the *CN PS Domain Identifier IE* and/or the *CN CS Domain Identifier IE* for the CN domains (using LAC and RAC of the current cell) to which the DRNC is connected.

[1.28 Mcps TDD – If no *D-RNTI IE* was included in the RADIO LINK SETUP REQUEST message, the DRNC could include in the RADIO LINK SETUP RESPONSE message the *UARFCN IE*.]

[FDD – If the *D-RNTI IE* was included in the RADIO LINK SETUP REQUEST message the DRNC shall include in the RADIO LINK SETUP RESPONSE message the *Primary Scrambling Code IE*, the *UL UARFCN IE* and the *DL UARFCN IE*.]

[TDD – If the *D-RNTI* IE was included in the RADIO LINK SETUP REQUEST message the DRNC shall include in the RADIO LINK SETUP RESPONSE message the *UARFCN* IE, the *Cell Parameter ID* IE and the *SCTD Indicator* IE.]

[3.84Mcps TDD and 7.68 Mcps TDD – If the *D-RNTI* IE was included in the RADIO LINK SETUP REQUEST message the DRNC shall include in the RADIO LINK SETUP RESPONSE message the *Sync Case* IE and if the *Sync Case* IE is set to “Case 2”, the DRNC shall also include the *SCH Time Slot* IE in the RADIO LINK SETUP RESPONSE message. If the included *Sync Case* IE is set to “Case1”, the DRNC shall also include the *Time Slot For SCH* IE.]

[3.84Mcps TDD – The DRNC shall include the *Secondary CCPCH Info TDD* IE in the RADIO LINK SETUP RESPONSE message if at least one *DSCH Information Response* IE or *USCH Information Response* IE is included in the message and at least one DCH is configured for the radio link. The DRNC shall also include the *Secondary CCPCH Info TDD* IE in the RADIO LINK SETUP RESPONSE message if at least one *DSCH Information Response* IE or *USCH Information Response* IE is included in the message and the SHCCH messages for this radio link will be transmitted over a different secondary CCPCH than selected by the UE from system information.]

[1.28 Mcps TDD – The DRNC shall include the *Secondary CCPCH Info TDD LCR* IE in the RADIO LINK SETUP RESPONSE message if at least one *DSCH Information Response LCR* IE or *USCH Information Response LCR* IE is included in the message and at least one DCH is configured for the radio link. The DRNC shall also include the *Secondary CCPCH Info TDD LCR* IE in the RADIO LINK SETUP RESPONSE message if at least one *DSCH Information Response LCR* IE or *USCH Information Response LCR* IE is included in the message and the SHCCH messages for this radio link will be transmitted over a different secondary CCPCH than selected by the UE from system information.]

[7.68 Mcps TDD – The DRNC shall include the *Secondary CCPCH Info 7.68Mcps TDD* IE in the RADIO LINK SETUP RESPONSE message if at least one *DSCH Information Response 7.68 Mcps* IE or *USCH Information Response 7.68 Mcps* IE is included in the message and at least one DCH is configured for the radio link. The DRNC shall also include the *Secondary CCPCH Info 7.68Mcps TDD* IE in the RADIO LINK SETUP RESPONSE message if at least one *DSCH Information Response 7.68 Mcps* IE or *USCH Information Response 7.68 Mcps* IE is included in the message and the SHCCH messages for this radio link will be transmitted over a different secondary CCPCH than selected by the UE from system information.]

For each Radio Link established in a cell in which at least one URA Identity is being broadcast, the DRNC shall include in the *URA Information* IE within the RADIO LINK SETUP RESPONSE message URA Information for this cell including the *URA ID* IE, the *Multiple URAs Indicator* IE indicating whether or not multiple URA Identities are being broadcast in the cell, and the *RNC-ID* IEs of all other RNCs that have at least one cell within the URA identified by the *URA ID* IE.

Depending on local configuration in the DRNS, the DRNC may include in the RADIO LINK SETUP RESPONSE message the *UTRAN Access Point Position* IE and the geographical co-ordinates of the cell, represented either by the *Cell GAI* IE or by the *Cell GA Additional Shapes* IE. If the DRNC includes the *Cell GA Additional Shapes* IE in the RADIO LINK SETUP RESPONSE message, it shall also include the *Cell GAI* IE.

If the DRNS need to limit the user rate in the uplink of a DCH due to congestion caused by the UL UTRAN Dynamic Resources (see subclause 9.2.1.79) when starting to utilise a new Radio Link, the DRNC shall include in the RADIO LINK SETUP RESPONSE message the *Allowed UL Rate* IE in the *DCH Information Response* IE for this Radio Link.

If the DRNS need to limit the user rate in the downlink of a DCH due to congestion caused by the DL UTRAN Dynamic Resources (see subclause 9.2.1.79) when starting to utilise a new Radio Link, the DRNC shall include in the RADIO LINK SETUP RESPONSE message the *Allowed DL Rate* IE in the *DCH Information Response* IE for this Radio Link.

If the *Permanent NAS UE Identity* IE is included in the RADIO LINK SETUP REQUEST message, the DRNS shall store the information for the considered UE Context for the life-time of the UE Context.

If the RADIO LINK SETUP REQUEST message includes the *Permanent NAS UE Identity* IE and a *C-ID* IE corresponding to a cell reserved for operator use, the DRNS shall use this information to determine whether it can set up a Radio Link on this cell or not for the considered UE Context.

If the HCS priority information is available in the DRNS, it shall include the *HCS Prio* IE for each of the established RLs in the RADIO LINK SETUP RESPONSE message.

The DRNS shall start receiving on the new RL(s) after the RLs are successfully established.

[FDD – If the RADIO LINK SETUP REQUEST message includes the *Cell Portion ID* IE, the DRNS shall use this information when it decides to use beamforming for the new RL.]

[1.28 Mcps TDD – If the RADIO LINK SETUP REQUEST message includes the *Cell Portion LCR ID* IE, the DRNS shall use this information when it decides to allocate physical resource for the new RL.]

[FDD – If the RADIO LINK SETUP REQUEST message includes the *Initial DL DPCH Timing Adjustment Allowed* IE, then the DRNS may perform an initial DL DPCH Timing Adjustment (i.e. perform a timing advance or a timing delay with respect to the SFN timing) on a Radio Link. In this case, the DRNS shall include, for the concerned Radio Link(s), the *Initial DL DPCH Timing Adjustment* IE in the *Radio Link Information Response* IE in the RADIO LINK SETUP RESPONSE message.]

[FDD – If the RADIO LINK SETUP REQUEST message includes the *D-RNTI* IE which already has a RL and *Synchronisation Indicator* IE, the DRNC shall ignore the value in the *Frame Offset* IE and *Chip Offset* IE in the RADIO LINK SETUP REQUEST message and shall include in the *Frame Offset* IE and *Chip Offset* IE the values used for already established RL in the RADIO LINK SETUP RESPONSE message.]

[FDD – Radio Link Set Handling:]

[FDD – The *First RLS Indicator* IE indicates if the concerned RL shall be considered part of the first RLS established towards this UE. The DRNS shall use the *First RLS Indicator* IE to determine the initial TPC pattern in the DL of the concerned RL and all RLs which are part of the same RLS, as described in TS 25.214 [10], section 5.1.2.2.1.2.]

[FDD – For each RL not having a common generation of the TPC commands in the DL with another RL, the DRNS shall assign to the RL a unique value for the *RL Set ID* IE which uniquely identifies the RL as an RL Set within the UE Context. In case of E-DCH, the generation of E-HICH related information for RLs in different RL Set(s) shall not be common.]

[FDD – For all RLs having a common generation of the TPC commands in the DL with another RL, the DRNS shall assign to each RL the same value for the *RL Set ID* IE which uniquely identifies these RLs as members of the same RL Set within the UE Context. In case of E-DCH, the generation of E-HICH information for all RLs in a RL Set shall be common.]

[FDD – The UL out-of-sync algorithm defined in ref. TS 25.214 [10] shall, for each of the established RL Set(s), use the maximum value of the parameters *N_OUTSYNC_IND* and *T_RLFAILURE* that are configured in the cells supporting the radio links of the RL Set. The UL in-sync algorithm defined in TS 25.214 [10] shall, for each of the established RL Set(s), use the minimum value of the parameters *N_INSYNC_IND* that are configured in the cells supporting the radio links of the RL Set.]

[FDD – For each E-DCH RL which has or can have a common generation of E-RGCH information with another RL (current or future) when the DRNS would contain the E-DCH serving RL, the DRNS shall include the *E-DCH RL Set ID* IE in the RADIO LINK SETUP RESPONSE message. The value of the *E-DCH RL Set ID* IE shall allow the SRNC to identify the E-DCH RLs that have or can have a common generation of E-RGCH information.]

[TDD- E-DCH:]

[TDD – If the [3.84Mcps – *E-DCH Information* IE][1.28Mcps – *E-DCH Information 1.28Mcps* IE][7.68Mcps TDD – *E-DCH Information 7.68Mcps* IE] is present in the RADIO LINK SETUP REQUEST message:]

- [TDD – The DRNS shall setup the requested E-DCH resources on the Radio Link indicated by the *E-DCH Serving RL* IE.]
- [TDD – If the *TNL QoS* IE is included in the *E-DCH MAC-d Flows Information TDD* IE for an E-DCH MAC-d flow and if ALCAP is not used, the *TNL QoS* IE may be used by the DRNS to determine the transport bearer characteristics to apply in the uplink for the related MAC-d flow.]
- [TDD – If the RADIO LINK SETUP REQUEST message includes the *Transport Layer Address* IE and *Binding ID* IE in the *E-DCH MAC-d Flows Information TDD* IE for an E-DCH MAC-d flow, then the DRNC may use the transport layer address and the binding identifier received from the SRNC when establishing a transport bearer for the concerned E-DCH MAC-d flow.]

- [TDD – If the RADIO LINK SETUP REQUEST message includes the *E-DCH MAC-d Flow Multiplexing List* IE for an E-DCH MAC-d flow in the *E-DCH MAC-d Flows Information TDD* IE, the DRNS shall use this information for the related resource allocation operation.]
- [TDD – If in the RADIO LINK SETUP REQUEST message the *E-DCH Grant Type* IE in the *E-DCH MAC-d Flows Information TDD* IE is set to “Non-scheduled” for an E-DCH MAC-d flow the DRNS shall assume non-scheduled grants are configured for that E-DCH MAC-d flow.]
- [TDD – If in the RADIO LINK SETUP REQUEST message the *E-DCH Grant Type* IE in the *E-DCH MAC-d Flows Information TDD* IE is set to “Scheduled” the DRNS shall assume that it may issue scheduled grants for the concerned E-DCH MAC-d flow.]
- [TDD – If the RADIO LINK SETUP REQUEST message includes the *MAC-es Guaranteed Bit Rate* IE in the *E-DCH Logical Channel Information* IE in the *E-DCH MAC-d Flows Information TDD* IE, then the DRNS shall use this information to optimise MAC-e scheduling decisions for the related queue.]
- [1.28Mcps TDD – If the RADIO LINK SETUP REQUEST message includes the *MAC-es Maximum Bit Rate LCR* IE in the *E-DCH Logical Channel Information* IE in the *E-DCH MAC-d Flows Information TDD* IE, the DRNS shall use this information for the related resource allocation operation, and when applicable, for E-DCH scheduling.]
- [TDD – If the RADIO LINK SETUP REQUEST message includes the *Maximum MAC-d PDU Size Extended* IE for a E-DCH Logical Channel in the *E-DCH MAC-d Flows Information TDD* IE in the *E-DCH Information* IE, then the DRNS shall ignore the *MAC-d PDU Size* IE in the *MAC-d PDU Size List* IE and use *Maximum MAC-d PDU Size Extended* IE to optimise capacity allocation for the related E-DCH Logical Channel and use the indicated format in user plane frame structure for E-DCH channels TS 25.425 [32] and MAC TS 25.321 [41].]
- [3.84Mcps TDD – If the RADIO LINK SETUP REQUEST message includes the *E-DCH TDD Maximum Bitrate* IE in the *E-DCH TDD Information* IE for an E-DCH, the DRNS shall use this information for the related resource allocation operation, and when applicable, for E-DCH scheduling.]
- [1.28Mcps TDD – If the RADIO LINK SETUP REQUEST message includes the *E-DCH Physical Layer Category LCR* IE or *Extended E-DCH Physical Layer Category LCR* IE in the *E-DCH TDD Information LCR* IE for an E-DCH, the DRNS shall use this information for the related resource allocation operation, and when applicable, for E-DCH scheduling.]
- [7.68Mcps TDD – If the RADIO LINK SETUP REQUEST message includes the *E-DCH TDD Maximum Bitrate 7.68Mcps* IE in the *E-DCH TDD Information 7.68Mcps* IE for an E-DCH, the Node B shall use this information for the related resource allocation operation, and when applicable, for E-DCH scheduling.]
- [3.84Mcps TDD – If the RADIO LINK SETUP REQUEST message includes the *E-DCH Processing Overload Level* IE in the *E-DCH TDD Information* IE, then if the DRNS could not decode the E-PUCH for the last consecutive number of TTIs, indicated in the *E-DCH Processing Overload Level* IE, because of a processing issue, the DRNS shall notify the SRNC by initiating the Radio Link Failure procedure.]
- [7.68Mcps TDD – If the RADIO LINK SETUP REQUEST message includes the *E-DCH Processing Overload Level* IE in the *E-DCH TDD Information 7.68Mcps* IE, then if the DRNS could not decode the E-PUCH for the last consecutive number of TTIs, indicated in the *E-DCH Processing Overload Level* IE, because of a processing issue, the DRNS shall notify the SRNC by initiating the Radio Link Failure procedure.]
- [1.28Mcps TDD – If the RADIO LINK SETUP REQUEST message includes the *E-DCH Processing Overload Level* IE in the *E-DCH TDD Information LCR* IE, then if the DRNS could not decode the E-PUCH for the last consecutive number of TTIs, indicated in the *E-DCH Processing Overload Level* IE, because of a processing issue, the DRNS shall notify the SRNC by initiating the Radio Link Failure procedure.]
- [TDD – The DRNS may use the *Traffic Class* IE for a specific E-DCH MAC-d flow to determine the transport bearer characteristics to apply between DRNC and Node B.]
- [TDD – If the RADIO LINK SETUP REQUEST message includes the [3.84Mcps TDD – *E-DCH TDD Information* IE][1.28Mcps TDD – *E-DCH TDD Information LCR* IE] in the *E-DCH MAC-d Flows Information TDD* IE, then the DRNS shall use this value as a power offset for the transmission of scheduling information without any MAC-d PDUs.]
- [1.28Mcps TDD – If the RADIO LINK SETUP REQUEST message includes the *Maximum Number of Retransmission for Scheduling Info LCR* IE and the *E-DCH Retransmission timer for Scheduling Info LCR* IE in

the *E-DCH TDD Information LCR* IE, then the DRNS shall use these parameters for the transmission of scheduling information without any MAC-d PDUs.]

- [3.84Mcps TDD – The DRNS shall determine any non-scheduled resource to be granted for the radio link, and return this in the *E-DCH Non-scheduled Grant Information TDD* IE in the *E-DCH Information Response* IE in the RADIO LINK SETUP RESPONSE message.]
- [3.84Mcps TDD – The DRNS shall allocate an E-RNTI identifier and include the E-RNTI identifier and the E-AGCH(s) assigned in the *E-DCH Information Response* IE in the RADIO LINK SETUP RESPONSE message.]
- [1.28Mcps TDD – The DRNS shall determine any non-scheduled resource to be granted for the radio link, and return this in the *E-DCH Non-scheduled Grant Information LCR TDD* IE in the *E-DCH Information Response 1.28Mcps* IE in the RADIO LINK ADDITION RESPONSE message.]
- [1.28Mcps TDD – The DRNS shall allocate an E-RNTI identifier and include the E-RNTI identifier, the E-AGCH(s) and E-HICH(s) assigned in the *E-DCH Information Response 1.28Mcps* IE in the RADIO LINK SETUP RESPONSE message.]
- [7.68Mcps TDD – The DRNS shall determine any non-scheduled resource to be granted for the radio link, and return this in the *E-DCH Non-scheduled Grant Information 7.68Mcps TDD* IE in the *E-DCH Information Response 7.68Mcps* IE in the RADIO LINK SETUP RESPONSE message.]
- [7.68Mcps TDD – The DRNS shall allocate an E-RNTI identifier and include the E-RNTI identifier and the E-AGCH(s) assigned in the *E-DCH Information Response 7.68Mcps* IE in the RADIO LINK SETUP RESPONSE message.]

Response Message:

Upon receipt of the RADIO LINK SETUP REQUEST message, the DRNS allocates the requested type of channelisation codes and other physical channel resources for each RL and assigns a binding identifier and a transport layer address for each DCH, for each set of co-ordinated DCHs [TDD – and for each DSCH and USCH]. This information shall be sent to the SRNC in the RADIO LINK SETUP RESPONSE message when all the RLs have been successfully established.

[1.28 Mcps TDD – if the DRNS assigns one or more PLCCCH sequence numbers to the radio link, then the PLCCCH assignment(s) shall be sent to the SRNC in the RADIO LINK SETUP RESPONSE message.]

After sending the RADIO LINK SETUP RESPONSE message the DRNS shall continuously attempt to obtain UL synchronisation on the Uu interface and start reception on the new RL.

For each RL for which the *Delayed Activation* IE is not included in the RADIO LINK SETUP REQUEST message the DRNS shall:

- [FDD – start transmission on the DL DPDCH(s) of the new RL as specified in ref. TS 25.427 [4].]
- [TDD – start transmission on the new RL immediately as specified in ref. TS 25.427 [4].]

For each RL for which the *Delayed Activation* IE is included in the RADIO LINK SETUP REQUEST message, the DRNS shall:

- if the *Delayed Activation* IE indicates “Separate Indication”:
 - not start any DL transmission for the concerned RL on the Uu interface;
- if the *Delayed Activation* IE indicates “CFN”:
 - [FDD – start transmission on the DL DPDCH(s) of the new RL as specified in ref. TS 25.427 [4], however never before the CFN indicated in the *Activation CFN* IE.]
 - [TDD – start transmission on the new RL at the CFN indicated in the *Activation CFN* IE as specified in ref. TS 25.427 [4].]

8.3.1.3 Unsuccessful Operation

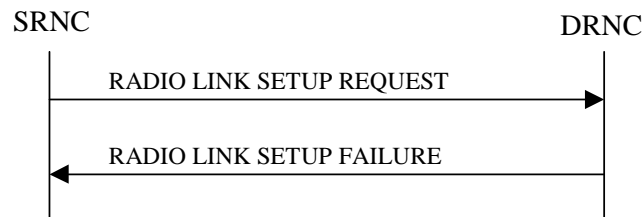

Figure 6: Radio Link Setup procedure: Unsuccessful Operation

If the establishment of at least one radio link is unsuccessful, the DRNC shall respond with a RADIO LINK SETUP FAILURE message. The DRNC shall include in the RADIO LINK SETUP FAILURE message a general *Cause* IE or a *Cause* IE for each failed radio link. The *Cause* IE indicates the reason for failure.

[FDD – If some radio links were established successfully, the DRNC shall indicate this in the RADIO LINK SETUP FAILURE message in the same way as in the RADIO LINK SETUP RESPONSE message.]

If the RADIO LINK SETUP REQUEST message includes a *C-ID* IE corresponding to a cell reserved for operator use and the *Permanent NAS UE Identity* IE is not present, the DRNC shall reject the procedure and send the RADIO LINK SETUP FAILURE message.

[FDD – If the RL identified by the *HS-PDSCH RL ID* IE is a radio link in the DRNS and this RL is successfully established, then the DRNC shall allocate a HS-DSCH-RNTI to the UE Context and include the *HS-DSCH-RNTI* IE, the *HS-DSCH FDD Information Response* IE and the *SixtyfourQAM DL Support Indicator* IE in the RADIO LINK SETUP FAILURE message. This *SixtyfourQAM DL Support Indicator* IE is related to the HS-DSCH Radio Link.]

[FDD – If the RL identified by the *HS-PDSCH RL ID* IE in the *Additional HS Cell Information RL Setup* IE is a radio link in the DRNS and this RL is successfully established, then the DRNC shall allocate a HS-DSCH-RNTI to the UE Context and include the *HS-DSCH-RNTI* IE, the *HS-DSCH FDD Secondary Serving Information Response* IE and the *SixtyfourQAM DL Support Indicator* IE in the *Additional HS Cell Information Response* IE in the RADIO LINK SETUP FAILURE message. If the establishment of the RL identified by the *HS-PDSCH RL ID* IE in the *Additional HS Cell Information RL Setup* IE, i.e. secondary serving HS-DSCH Radio Link is unsuccessful but the establishment of the RL identified by the *HS-PDSCH RL ID* IE for the serving HS-DSCH Radio Link is successful, then the DRNC shall indicate the unsuccessful secondary serving HS-DSCH Radio Link in the *Unsuccessful RL Information Response* IE in the RADIO LINK SETUP FAILURE message by setting the *RL ID* IE to the same value as the unsuccessful *HS-PDSCH RL ID* IE in the *Additional HS Cell Information RL Setup* IE.]

[1.28 Mcps TDD – If the RL identified by the *HS-PDSCH RL ID* IE is a radio link in the DRNS and this RL is successfully established, then the DRNC shall allocate a HS-DSCH-RNTI to the UE Context and include the *HS-DSCH-RNTI* IE, the *HS-DSCH TDD Information Response* IE and the *SixtyfourQAM DL Support Indicator* IE in the RADIO LINK SETUP FAILURE message.]

[FDD – If the *MIMO Activation Indicator* IE is included and the *Power Offset For S-CPICH for MIMO Request Indicator* IE is not included in the *HS-DSCH FDD Information* IE in the RADIO LINK SETUP REQUEST message but MIMO pilot configuration with Primary and Secondary CPICH is set up with a non-zero power offset on the cell where the Serving HS-DSCH Radio Link is established, the setup of the serving HS-DSCH Radio Link shall be reported as failed and the DRNC shall include in the RADIO LINK SETUP FAILURE message the *Cause* IE.]

[FDD – If the RL identified by the *E-DCH Additional RL ID* IE in the *Additional E-DCH RL Specific Information To Setup* IE in the *Additional E-DCH FDD Setup Information* IE is a radio link in the DRNS and this RL is successfully established, then the DRNS shall include the *Additional E-DCH FDD Information Response* IE in the *Additional E-DCH Cell Information Response* IE in the RADIO LINK SETUP FAILURE message in the same way as in the RADIO LINK SETUP RESPONSE message. If the establishment of the RL identified by the *E-DCH Additional RL ID* IE is unsuccessful, then the DRNS shall indicate the unsuccessful setup of the Additional E-DCH Radio Link in the *Unsuccessful RL Information Response* IE in the RADIO LINK SETUP FAILURE message by setting the *RL ID* IE to the same value as the unsuccessful *E-DCH Additional RL ID* IE in the *Additional E-DCH Cell Information Setup* IE.]

Typical cause values are:

Radio Network Layer Causes:

[FDD – UL Scrambling Code Already in Use;]
 DL Radio Resources not Available;
 UL Radio Resources not Available;
 [FDD – Combining Resources not available;]
 Combining not Supported
 Requested Configuration not Supported;
 Cell not Available;
 [FDD – Requested Tx Diversity Mode not Supported;]
 Power Level not Supported;
 Number of DL codes not supported;
 Number of UL codes not supported;
 Dedicated Transport Channel Type not Supported;
 DL Shared Channel Type not Supported;
 [TDD – UL Shared Channel Type not Supported;]
 [FDD – UL Spreading Factor not Supported;]
 [FDD – DL Spreading Factor not Supported;]
 CM not Supported;
 [FDD – DPC mode change not Supported;]
 Cell reserved for operator use;
 Delayed Activation not supported;
 E-DCH not supported;
 [FDD – F-DPCH not supported;]
 [FDD – Continuous Packet Connectivity DTX-DRX operation not Supported;]
 [FDD – Continuous Packet Connectivity HS-SCCH less operation not Supported;]
 [FDD – MIMO not supported;]
 [FDD – E-DCH TTI2ms not supported;]
 [FDD – Continuous Packet Connectivity DTX-DRX operation not available;]
 [FDD – Continuous Packet Connectivity UE DTX Cycle not available;]
 [FDD – MIMO not available;]
 [FDD – SixteenQAM UL not Supported;]
 HS-DSCH MAC-d PDU Size Format not supported;
 [FDD – F-DPCH Slot Format operation not supported;]
 E-DCH MAC-d PDU Size Format not available;
 [FDD – E-DPCCH Power Boosting not supported;]
 [FDD – SixtyfourQAM DL and MIMO Combined not available;]
 [FDD – Multi Cell operation not available;]
 [FDD – Multi Cell operation not supported;]
 [FDD – Multi Cell operation with MIMO not available;]
 [FDD – Multi Cell operation with MIMO not supported;]
 [FDD – Single Stream MIMO not supported;]
 [FDD – Single Stream MIMO not available;]
 [FDD – TX diversity for MIMO UE on DL Control Channels not available;]
 [FDD – Multi Cell E-DCH Operation not supported;]
 [FDD – Multi Cell E-DCH Operation not available;]
 [FDD – Multi Cell operation with Single Stream MIMO not available;]
 [FDD – Multi Cell operation with Single Stream MIMO not supported;]
 [FDD – Cell Specific Tx Diversity Handling For Multi Cell Operation Not Available;]
 [FDD – Cell Specific Tx Diversity Handling For Multi Cell Operation Not Supported.]

Transport Layer Causes:

Transport Resource Unavailable.

Miscellaneous Causes:

Control Processing Overload;
 HW Failure;
 Not enough User Plane Processing Resources.

8.3.1.4 Abnormal Conditions

If the DRNC receives either an S-RNTI or a D-RNTI which already has RL(s) established [FDD – and the *Synchronisation Indicator* IE is not included in the RADIO LINK SETUP message,] the DRNC shall send the RADIO LINK SETUP FAILURE message to the SRNC, indicating the reason for failure.

[FDD – If the RADIO LINK SETUP REQUEST message includes the *Active Pattern Sequence Information* IE, but the *Transmission Gap Pattern Sequence Information* IE is not present, then the DRNC shall reject the procedure using the RADIO LINK SETUP FAILURE message.]

[FDD – If the RADIO LINK SETUP REQUEST message includes both the *Initial DL TX Power* IE and the *Primary CPICH Ec/No* IE or does not include either of these IEs, then the DRNC shall reject the procedure using the RADIO LINK SETUP FAILURE message.]

If more than one DCH of a set of co-ordinated DCHs has the *QE-Selector* IE set to “selected” [TDD – or no DCH of a set of co-ordinated DCHs has the *QE-Selector* IE set to “selected”] the DRNS shall reject the Radio Link Setup procedure and shall respond with a RADIO LINK SETUP FAILURE message.

[FDD – If only the *Initial DL TX Power* IE or the *Uplink SIR Target* IE is included in the RADIO LINK SETUP REQUEST message, then DRNC shall reject the Radio Link Setup procedure and shall respond with the RADIO LINK SETUP FAILURE message.]

If the RADIO LINK SETUP REQUEST message includes a *DCH Information* IE with multiple *DCH Specific Info* IEs, and if the DCHs in the *DCH Information* IE do not have the same *Transmission Time Interval* IE in the *Semi-static Transport Format Information* IE, then the DRNC shall reject the procedure using the RADIO LINK SETUP FAILURE message.

[FDD – If the RADIO LINK SETUP REQUEST message includes the *Enhanced Primary CPICH Ec/No* IE, but not the *Primary CPICH Ec/No* IE, then the DRNC shall reject the procedure using the RADIO LINK SETUP FAILURE message.]

If the RADIO LINK SETUP REQUEST message includes the *Transport Layer Address* IE and the *Binding ID* IE in the *RL Specific DCH Information* IE [FDD – or in the *RL Specific E-DCH Information* IE] included in the *RL Information* IE for a specific RL and the *Diversity Control Field* IE is set to “Must” [FDD- or the RL is combined with an E-DCH RL previously listed in the RADIO LINK SETUP RESPONSE message in the DRNS], the DRNC shall reject the Radio Link Setup procedure and the DRNC shall respond with the RADIO LINK SETUP FAILURE message.

If ALCAP is not used, if the RADIO LINK SETUP REQUEST message does not include the *Transport Layer Address* IE and the *Binding ID* IE in the *RL Specific DCH Information* IE nor *RL Specific E-DCH Information* IE in the *RL Information* IE for a specific RL and the *Diversity Control Field* IE is set to “May”, the DRNC shall reject the Radio Link Setup procedure and respond with the RADIO LINK SETUP FAILURE message.

If ALCAP is not used, if the RADIO LINK SETUP REQUEST message does not include the *Transport Layer Address* IE and the *Binding ID* IE in the *RL Specific DCH Information* IE in the *RL Information* IE for a specific RL and the *Diversity Control Field* IE is set to “Must Not”, the DRNC shall reject the Radio Link Setup procedure and respond with the RADIO LINK SETUP FAILURE message.

If ALCAP is not used, if the RADIO LINK SETUP REQUEST message does not include the *Transport Layer Address* IE and the *Binding ID* IE in the *RL Specific DCH Information* IE in the *RL Information* IE for the first RL and/or [FDD – in the *RL Specific E-DCH Information* IE in the *RL Information* IE for the first E-DCH RL][TDD – in the *E-DCH MAC-d Flows Information TDD* IE], the DRNC shall reject the Radio Link Setup procedure and respond with the RADIO LINK SETUP FAILURE message.

If ALCAP is not used, if the RADIO LINK SETUP REQUEST message does not include the *Transport Layer Address* IE and the *Binding ID* IE for an HS-DSCH MAC-d Flow in the *HS-DSCH MAC-d Flows Information* IE, the DRNC shall reject the Radio Link Setup procedure and respond with the RADIO LINK SETUP FAILURE message.

[TDD – If ALCAP is not used, if the RADIO LINK SETUP REQUEST message does not include the *Transport Layer Address* IE and the *Binding ID* IE for a DSCH in the *DSCH TDD Information* IE and/or for an USCH in the *USCH Information* IE, the DRNC shall reject the Radio Link Setup procedure and respond with the RADIO LINK SETUP FAILURE message.]

If the RADIO LINK SETUP REQUEST message includes the *Transport Layer Address IE* or the *Binding ID IE*, and not both are present for a transport bearer intended to be established, the DRNC shall reject the Radio Link Setup procedure and the DRNC shall respond with the RADIO LINK SETUP FAILURE message.

If the RADIO LINK SETUP REQUEST message includes an *HS-PDSCH RL-ID IE* not referring to one of the radio links to be established, the DRNC shall reject the procedure using the RADIO LINK SETUP FAILURE message.

If the RADIO LINK SETUP REQUEST message contains the *HS-DSCH Information IE* and if the Priority Queues associated with the same *HS-DSCH MAC-d Flow ID IE* have the same *Scheduling Priority Indicator IE* value, the DRNC shall reject the procedure using the RADIO LINK SETUP FAILURE message.

If the RADIO LINK SETUP REQUEST message includes the *Maximum MAC-d PDU Size Extended IE* for a Priority Queue in the *HS-DSCH MAC-d Flows Information IE* in the *HS-DSCH Information IE*, and the *HS-DSCH MAC-d PDU Size Format IE* in the *HS-DSCH Information IE* has the value "Indexed MAC-d PDU Size", the DRNC shall reject the procedure using the RADIO LINK SETUP FAILURE message.

If the RADIO LINK SETUP REQUEST message does not include the *Maximum MAC-d PDU Size Extended IE* for a Priority Queue in the *HS-DSCH MAC-d Flows Information IE* in the *HS-DSCH Information IE*, and the *HS-DSCH MAC-d PDU Size Format IE* in the *HS-DSCH Information IE* has the value "Flexible MAC-d PDU Size", the DRNC shall reject the procedure using the RADIO LINK SETUP FAILURE message.

[FDD – If the RADIO LINK SETUP REQUEST message contains, for at least one logical channel, the *Maximum MAC-d PDU Size Extended IE* in the *E-DCH MAC-d Flows Information IE* in the *E-DCH FDD Information IE* and there exist a logical channel for which the *Maximum MAC-d PDU Size Extended IE* in the *E-DCH MAC-d Flows Information IE* in the *E-DCH FDD Information IE* is not present, the DRNC shall reject the procedure using the RADIO LINK SETUP FAILURE message.]

[TDD – If the RADIO LINK SETUP REQUEST message contains, for at least one logical channel, the *Maximum MAC-d PDU Size Extended IE* in the *E-DCH MAC-d Flows Information TDD IE* in the *E-DCH Information IE*, and there exist a logical channel for which the *Maximum MAC-d PDU Size Extended IE* in the *E-DCH MAC-d Flows Information TDD IE* in the *E-DCH Information IE* is not present, the DRNC shall reject the procedure using the RADIO LINK SETUP FAILURE message.]

[FDD – If the RADIO LINK SETUP REQUEST message includes the *F-DPCH Information IE* and the *DL DPCH Information IE*, then the DRNS shall reject the procedure using the RADIO LINK SETUP FAILURE message.]

[FDD – If the RADIO LINK SETUP REQUEST message contains the *E-DCH RL Indication IE* set to "E-DCH", but does not contain the *E-DCH FDD Information IE*, or if the message contains the *E-DCH FDD Information IE*, but does not contain the *E-DCH RL Indication IE* set to "E-DCH", then the DRNC shall reject the procedure using the RADIO LINK SETUP FAILURE message.]

If the RADIO LINK SETUP REQUEST message contains the *HS-PDSCH RL ID IE* and the *Serving E-DCH RL IE* but the Serving HS-DSCH Radio Link and the Serving E-DCH Radio Link are not configured to be in the same cell then the DRNC shall reject the procedure using the RADIO LINK SETUP FAILURE message.

[FDD – If the RADIO LINK SETUP REQUEST message contains the *HS-PDSCH RL ID IE* and the *E-DPCH Information IE* which includes the *HS-DSCH Configured Indicator IE* set as "HS-DSCH not configured" then the DRNC shall reject the procedure using the RADIO LINK SETUP FAILURE message.]

[FDD – If the RADIO LINK SETUP REQUEST message contains the *E-DPCH Information IE* but does not contain the *UL DPDCH Indicator for E-DCH operation IE*, then the DRNC shall reject the procedure using the RADIO LINK SETUP FAILURE message.]

[FDD – If the RADIO LINK SETUP REQUEST message contains the *Serving Cell Change CFN IE*, but neither the *Serving E-DCH RL IE* nor *HS-DSCH Information IE* is included, then the DRNS shall reject the procedure using the RADIO LINK SETUP FAILURE message.]

[FDD – If the RADIO LINK SETUP REQUEST message contains the *Transport Bearer Not Requested Indicator IE* for a DCH, but does not contain the *Unidirectional DCH indicator IE* set to "Uplink DCH only" in the *DCH Specific Info IE* for the DCH, the DRNC shall reject the procedure using the RADIO LINK SETUP FAILURE message.]

[FDD – If the RADIO LINK SETUP REQUEST message contains the *Synchronisation Indicator IE* for a RL, but does not contain the *D-RNTI IE* which already has the RL, the DRNC shall reject the procedure using the RADIO LINK SETUP FAILURE message.]

[FDD – If the *UL DPCH Information* IE in the RADIO LINK SETUP REQUEST message contains the *UL DPCCCH Slot Format* set to “4” but does not contain the *F-DPCH Information* IE, then the DRNC shall reject the procedure using the RADIO LINK SETUP FAILURE message.]

[FDD – If the *UL DPCH Information* IE in the RADIO LINK SETUP REQUEST message contains the *UL DPCCCH Slot Format* set to “0” or “2” and the *Continuous Packet Connectivity DTX-DRX Information* IE, then the DRNC shall reject the procedure using the RADIO LINK SETUP FAILURE message.]

[FDD – If the *UL DPCH Information* IE in the RADIO LINK SETUP REQUEST message contains *Diversity Mode* IE set to “Closed loop mode 1” and *UL DPCCCH Slot Format* not set to “2” or “3”, then the DRNC shall reject the procedure using the RADIO LINK SETUP FAILURE message.]

[FDD – If the RADIO LINK SETUP REQUEST message contains the *MIMO Activation Indicator* IE, *Sixtyfour QAM Usage Allowed Indicator* IE set to “Allowed”, the *Additional HS Cell Information RL Setup* IE and/or the *Single Stream MIMO Activation Indicator* IE, but does not contain the *HS-DSCH MAC-d PDU Size Format* IE set to “Flexible MAC-d PDU Size”, then the DRNC shall reject the procedure using the RADIO LINK SETUP FAILURE message.]

[FDD – If the RADIO LINK SETUP REQUEST message contains the *Continuous Packet Connectivity DTX-DRX Information* IE but does not contain the *F-DPCH Information* IE, then the DRNC shall reject the procedure using the RADIO LINK SETUP FAILURE message.]

[FDD – If the RADIO LINK SETUP REQUEST message contains the *Serving E-DCH RL ID* IE but contains the *Transport Bearer Not Requested Indicator* IE in the RL Specific E-DCH Information for the new Serving E-DCH RL, the DRNC shall reject the procedure using the RADIO LINK FAILURE message.]

[FDD – If the RADIO LINK SETUP REQUEST message includes the *Transport Bearer Not Requested Indicator* IE for a DCH or an E-DCH MAC-d Flow for a specific RL and the specific RL is combined with RL which the transport bearer is configured to be established for the DCH or the E-DCH MAC-d Flow, previously listed in the RADIO LINK SETUP RESPONSE message in the DRNS, the DRNC shall reject the procedure using the RADIO LINK SETUP FAILURE message.]

[FDD – If the RADIO LINK SETUP REQUEST message contains the *Additional HS Cell Information RL Setup* IE indicating a secondary serving cell that is not in the same Node B as the new serving HS-DSCH cell, then the DRNC shall reject the procedure using the RADIO LINK SETUP FAILURE message.]

[FDD – If the RADIO LINK SETUP REQUEST message contains the *Additional HS Cell Information RL Setup* IE and if the *HS-DSCH Information* IE is not present, then the DRNC shall reject the procedure using the RADIO LINK SETUP FAILURE message.]

If the RADIO LINK SETUP REQUEST message includes the *DL RLC PDU Size Format* IE for a Priority Queue in the *HS-DSCH MAC-d Flows Information* IE in the *HS-DSCH Information* IE set to “Flexible RLC PDU Size”, and the *HS-DSCH MAC-d PDU Size Format* IE in the *HS-DSCH Information* IE has the value “Indexed MAC-d PDU Size”, the DRNC shall reject the procedure using the RADIO LINK SETUP FAILURE message.

If the RADIO LINK SETUP REQUEST message does not include the *Maximum MAC-d PDU Size Extended* IE for a Priority Queue in the *HS-DSCH MAC-d Flows Information* IE in the *HS-DSCH Information* IE, and the *DL RLC PDU Size Format* IE in the *HS-DSCH Information* IE has the value “Flexible RLC PDU Size”, the DRNC shall reject the procedure using the RADIO LINK SETUP FAILURE message.

[FDD – If the RADIO LINK SETUP REQUEST message contains a *MIMO Activation Indicator* IE and a *Single Stream MIMO Activation Indicator* IE in the *HS-DSCH FDD Information* IE or in the *HS-DSCH FDD Secondary Serving Information* IE in the *Additional HS Cell Information RL Setup* IE, then the DRNC shall reject the procedure using the RADIO LINK SETUP FAILURE message.]

[FDD – If the RADIO LINK SETUP REQUEST message contains the *Additional E-DCH Cell Information RL Setup Req* IE and if the *E-DPCH Information* IE is not present, then the DRNS shall reject the procedure using the RADIO LINK SETUP FAILURE message.]

[FDD – If the RADIO LINK SETUP REQUEST message contains the *Additional E-DCH Cell Information RL Setup Req* IE and there exist a logical channel for which the *Maximum MAC-d PDU Size Extended* IE in the *E-DCH MAC-d Flows Information* IE in the *E-DCH FDD Information* IE is not present, the DRNS shall reject the procedure using the RADIO LINK SETUP FAILURE message.]

[FDD – If the RADIO LINK SETUP REQUEST message contains the *Additional E-DCH Cell Information RL Setup Req* IE and the *C-ID* IE is not included in the *Additional E-DCH RL Specific Information To Setup* IE in the *Additional*

E-DCH FDD Setup Information IE in the *Additional E-DCH Cell Information Setup IE*, the DRNS shall reject the procedure using the RADIO LINK SETUP FAILURE message.]

[FDD – If the RADIO LINK SETUP REQUEST message contains in the *HS-DSCH FDD Secondary Serving Information IE* in the *Additional HS Cell Information RL Setup IE* the *Diversity Mode IE* not set to “None” but not the *Transmit Diversity Indicator* or contains the *Transmit Diversity Indicator* but not the *Diversity Mode IE* not set to “None”, then the DRNS shall reject the procedure using the RADIO LINK SETUP FAILURE message.]

8.3.2 Radio Link Addition

8.3.2.1 General

This procedure is used for establishing the necessary resources in the DRNS for one [FDD – or more] additional RLs towards a UE when there is already at least one RL established to the concerned UE via this DRNS.

This procedure shall use the signalling bearer connection for the relevant UE Context.

The Radio Link Addition procedure shall not be initiated if a Prepared Reconfiguration exists, as defined in subclause 3.1.

[TDD – The Radio Link Addition procedure serves to establish a new Radio Link with the DSCH and USCH included, if they existed before.]

8.3.2.2 Successful Operation

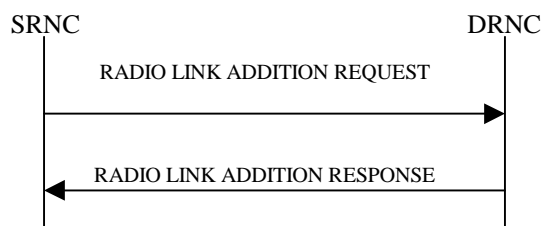

Figure 7: Radio Link Addition procedure: Successful Operation

The procedure is initiated with a RADIO LINK ADDITION REQUEST message sent from the SRNC to the DRNC.

Upon receipt, the DRNS shall reserve the necessary resources and configure the new RL(s) according to the parameters given in the message. Unless specified below, the meaning of parameters is specified in other specifications.

The DRNS shall prioritise resource allocation for the RL(s) to be established according to Annex A.

If the *UE Aggregate Maximum Bit Rate IE* is contained in the RADIO LINK ADDITION REQUEST message, the DRNS shall, if supported, store the received UE Aggregate Maximum Bit Rate parameters to control the aggregate data rate of non GBR traffic for this UE.

Transport Channel Handling:

[3.84 Mcps TDD – The DRNC shall include the *UL/DL DPCH Information IE* within the *UL/DL CTrCH Information IE* for each CTrCH that requires DPCHs.]

[1.28 Mcps TDD – The DRNC shall include the *UL/DL DPCH Information LCR IE* within the *UL/DL CTrCH Information LCR IE* for each CTrCH that requires DPCHs.]

[7.68 Mcps TDD – The DRNC shall include the *UL/DL DPCH Information 7.68 Mcps IE* within the *UL/DL CTrCH Information 7.68 Mcps IE* for each CTrCH that requires DPCHs.]

[TDD – DSCH:]

[3.84 Mcps TDD – If the radio link to be added includes a DSCH, the DRNC shall include in the RADIO LINK ADDITION RESPONSE message a *DSCH Information Response IE* for each DSCH.]

[1.28 Mcps TDD – If the radio link to be added includes a DSCH, the DRNC shall include in the RADIO LINK ADDITION RESPONSE message a *DSCH Information Response LCR* IE for each DSCH.]

[7.68 Mcps TDD – If the radio link to be added includes a DSCH, the DRNC shall include in the RADIO LINK ADDITION RESPONSE message a *DSCH Information Response 7.68 Mcps* IE for each DSCH.]

[TDD – USCH:]

[3.84 Mcps TDD – If the radio link to be added includes any USCHs, the DRNC shall include in the RADIO LINK ADDITION RESPONSE message a *USCH Information Response* IE for each USCH.]

[1.28 Mcps TDD – If the radio link to be added includes any USCHs, the DRNC shall include in the RADIO LINK ADDITION RESPONSE message a *USCH Information Response LCR* IE for each USCH.]

[7.68 Mcps TDD – If the radio link to be added includes any USCHs, the DRNC shall include in the RADIO LINK ADDITION RESPONSE message a *USCH Information Response 7.68 Mcps* IE for each USCH.]

Physical Channels Handling:

[FDD – Compressed Mode:]

[FDD – If the RADIO LINK ADDITION REQUEST message includes the *Active Pattern Sequence Information* IE, the DRNS shall use the information to activate the indicated (all ongoing) Transmission Gap Pattern Sequence(s) in the new RL. The received *CM Configuration Change CFN* IE refers to the latest passed CFN with that value. The DRNS shall treat the received *TGCFN* IEs as follows:]

- [FDD – If any received *TGCFN* IE has the same value as the received *CM Configuration Change CFN* IE, the DRNS shall consider the concerned Transmission Gap Pattern Sequence as activated at that CFN.]
- [FDD – If any received *TGCFN* IE does not have the same value as the received *CM Configuration Change CFN* IE but the first CFN after the *CM Configuration Change CFN* with a value equal to the *TGCFN* IE has already passed, the DRNS shall consider the concerned Transmission Gap Pattern Sequence as activated at that CFN.]
- [FDD – For all other Transmission Gap Pattern Sequences included in the *Active Pattern Sequence Information* IE, the DRNS shall activate each Transmission Gap Pattern Sequence at the first CFN after the *CM Configuration Change CFN* with a value equal to the *TGCFN* IE for the Transmission Gap Pattern Sequence.]

[FDD – If the RADIO LINK ADDITION REQUEST message includes the *Active Pattern Sequence Information* IE and the concerned UE Context is configured to use F-DPCH in the downlink, the DRNS shall ignore, when activating the Transmission Gap Pattern Sequence(s), the downlink compressed mode method information, if existing, for the concerned Transmission Gap Pattern Sequence(s) in the Compressed Mode Configuration.]

[FDD – If the *Active Pattern Sequence Information* IE is not included, the DRNS shall not activate the ongoing compressed mode pattern in the new RLs, but the ongoing pattern in the existing RL shall be maintained.]

[FDD – If some Transmission Gap Pattern sequences using SF/2 method are initialised in the DRNS and the UE Context is configured to use DPCH in the downlink, the DRNC shall include the *Transmission Gap Pattern Sequence Scrambling Code Information* IE in the *DL Code Information* IE in the RADIO LINK ADDITION RESPONSE message to indicate the Scrambling code change method that it selects for each channelisation code.]

[FDD – DL Code Information:]

[FDD – When more than one DL DPDCH are assigned per RL, the segmented physical channel shall be mapped on to DL DPDCHs according to TS 25.211 [8]. When p number of DL DPDCHs are assigned to each RL, the first pair of DL Scrambling Code and FDD DL Channelisation Code Number corresponds to “*PhCH number 1*”, the second to “*PhCH number 2*”, and so on until the p th to “*PhCH number p*”.]

[TDD – CCTrCH Handling:]

[TDD – If the *UL CCTrCH Information* IE is present, the DRNS shall configure the new UL CCTrCH(s) according to the parameters given in the message.]

[1.28Mcps TDD – If the *UL CCTrCH Information* IE includes the *TDD TPC Uplink Step Size* IE, the DRNS shall configure the uplink TPC step size according to the parameters given in the message, otherwise it shall use the step size configured in other radio link.]

[TDD – If the *DL CCTrCH Information* IE is present, the DRNS shall configure the new DL CCTrCH(s) according to the parameters given in the message.]

[TDD – If the *DL CCTrCH Information* IE includes the *TDD TPC Downlink Step Size* IE, the DRNS shall configure the downlink TPC step size according to the parameters given in the message, otherwise it shall use the step size configured in other radio link.]

General:

[FDD – The DRNS shall use the provided Uplink SIR Target value as the current target for the inner-loop power control.]

Radio Link Handling:

Diversity Combination Control:

The *Diversity Control Field* IE indicates for each RL whether the DRNS shall combine the new RL with existing RL(s) or not on the Iur.

- If the *Diversity Control Field* IE is set to “May” (be combined with another RL), the DRNS shall decide for any of the alternatives.
- If the *Diversity Control Field* IE is set to “Must”, the DRNS shall combine the RL with one of the other RL. When a new RL is to be combined the DRNS shall choose which RL(s) to combine it with.
- If the *Diversity Control Field* IE is set to “Must not”, the DRNS shall not combine the RL with any other existing RL.

[FDD – The *Diversity Control Field* IE is only applicable for DCHs, in case of E-DCH it shall always be assumed to be set to “May”.]

In the case of not combining a RL with a RL established with a previous Radio Link Setup or Radio Link Addition Procedure or a RL previously listed in the RADIO LINK ADDITION RESPONSE message, the DRNC shall indicate with the Diversity Indication in the *RL Information Response* IE in the RADIO LINK ADDITION RESPONSE message that no combining is done. In this case the DRNC shall:

- include in the *DCH Information Response* IE both the *Transport Layer Address* IE and the *Binding ID* IE for the transport bearer to be established for each DCH of the RL in the RADIO LINK ADDITION RESPONSE message [FDD – for which the *Transport Bearer Not Requested Indicator* IE was not included].
- [FDD – include in the RADIO LINK ADDITION RESPONSE the *Transport Bearer Not Setup Indicator* IE for every DCH or set of co-ordinated DCHs for which establishment of a transport bearer has not taken place as a result of information in the *Transport Bearer Not Requested Indicator* IE in the RADIO LINK ADDITION REQUEST message.]

[FDD – In case of not combining E-DCH, the *E-DCH FDD Information Response* IE shall be included in the RADIO LINK ADDITION RESPONSE message containing the *Binding ID* IE and the *Transport Layer Address* IE for the establishment of transport bearers for every E-DCH MAC-d flow being established for which the *Transport Bearer Not Requested Indicator* IE was not included.]

[FDD – In case of not combining E-DCH, the DRNC shall include in the RADIO LINK ADDITION RESPONSE the *Transport Bearer Not Setup Indicator* IE for every E-DCH MAC-d flow for which establishment of a transport bearer has not taken place as a result of information in the *Transport Bearer Not Requested Indicator* IE in the RADIO LINK ADDITION REQUEST message.]

In the case of combining with a RL established with a previous Radio Link Setup or Radio Link Addition Procedure or with a RL previously listed in this RADIO LINK ADDITION RESPONSE message, the DRNC shall indicate with the Diversity Indication in the *RL Information Response* IE in the RADIO LINK ADDITION RESPONSE message that the RL is combined. In this case, the *RL ID* IE indicates (one of) the previously established RL(s) or a RL previously listed in this RADIO LINK ADDITION RESPONSE

message with which the new RL is combined and if the ALCAP is not used [FDD – and the transport bearer for this DCH is already established], the *Transport Layer Address IE* and the *Binding ID IE* in the *RL Specific DCH Information IE* included in the *RL Information IE* for a specific RL in the RADIO LINK ADDITION REQUEST message, shall not be used.

[FDD – In the case of combining with an E-DCH RL established with a previous Radio Link Setup or Radio Link Addition Procedure or with a RL previously listed in this RADIO LINK ADDITION RESPONSE message, one of the previously established RLs or a RL previously listed in this RADIO LINK ADDITION RESPONSE message including the *E-DCH FDD Information Response IE* and part of the same Radio Link Set shall be regarded as the RL with which the concerned E-DCH RL is combined and if the ALCAP is not used, the *Transport Layer Address IE* and the *Binding ID IE* in the *RL Specific E-DCH Information IE* included in the *RL Information IE* for a specific RL in the RADIO LINK ADDITION REQUEST message, shall not be used. In case E-DCH RL is established for the first time, the DRNC shall include *E-DCH FDD Information Response IE* instead of using the Diversity Indication of DCH RL in the *RL Information Response IE* in the RADIO LINK ADDITION RESPONSE message. It shall include in the *E-DCH FDD Information Response IE* the *Binding ID IE* and *Transport Layer Address IE* for the transport bearers to be established for each E-DCH MAC-d flow of this E-DCH RL for which the *Transport Bearer Not Requested Indicator IE* was not included.]

[FDD – If the RADIO LINK ADDITION REQUEST message includes the *Additional E-DCH Cell Information RL Add Req IE*, then:]

- [FDD – if the *Multicell E-DCH Transport Bearer Mode IE* for an Additional E-DCH to be Setup is set to “Separate Iur Transport Bearer Mode” the DRNS shall use this mode in the new configuration and apply separate transport bearers for the MAC-d flows.]
- [FDD – if the *Multicell E-DCH Transport Bearer Mode IE* for an Additional E-DCH to be Setup is set to “UL Flow Multiplexing Mode” the DRNS shall use this mode in the new configuration and multiplex MAC-d flows on the transport bearers.]
- [FDD – if Separate Iur Transport Bearer Mode is used in the new configuration, then:]
 - [FDD – the DRNS shall follow the rules defined in this procedure for single carrier mode of operation for establishment of the transport bearer for a MAC-d flow and use the *Transport Bearer Not Requested Indicator IE* in the *RL Specific E-DCH Information IE* in the *RL Information IE* received for the corresponding Radio Link(s) of the Primary Uplink Frequency to determine the transport bearer configuration in the new configuration for the radio links of the Secondary Uplink Frequency.]
 - [FDD – If the *Transport Layer Address IE* and *Binding ID IE* is included for an E-DCH MAC-d flow in the *Additional E-DCH MAC-d Flows Specific Information IE* in the *Additional E-DCH RL Specific Information To Setup IE* in the *Additional E-DCH FDD Setup Information IE* in the *Additional E-DCH Cell Information Setup IE* or in the *Additional E-DCH RL Specific Information To Add IE* in the *Additional E-DCH Cell Information Addition IE*, then the DRNS may use the transport layer address and the binding identifier received from the SRNC when establishing a transport bearer for the concerned E-DCH MAC-d flow. If the DRNS establishes a transport bearer for the concerned E-DCH MAC-d flow the DRNS shall, for establishment of the transport bearer, include in the RADIO LINK ADDITION RESPONSE message the *Binding ID IE* and *Transport Layer Address IE* in the *Additional E-DCH MAC-d Flow Specific Information Response IE* in the *Additional E-DCH FDD Information Response IE* in the *Additional E-DCH Cell Information Response RL Add IE* for establishment of the transport bearer.]

[TDD – The DRNC shall always include in the RADIO LINK ADDITION RESPONSE message both the *Transport Layer Address IE* and the *Binding ID IE* for the transport bearer to be established for each DSCH and USCH of the RL.]

In the case of a set of co-ordinated DCHs, the DRNC shall include in the RADIO LINK ADDITION RESPONSE message the *Binding ID IE* and the *Transport Layer Address IE* for only one of the DCHs in the set of co-ordinated DCHs [FDD – for which the *Transport Bearer Not Requested Indicator IE* was not included].

If the DRNS needs to limit the user rate in the uplink of a DCH due to congestion caused by the UL UTRAN Dynamic Resources (see subclause 9.2.1.79) when starting to utilise a new Radio Link, the DRNC shall include in the RADIO LINK ADDITION RESPONSE message the *Allowed UL Rate IE* in the *DCH Information Response IE* for this Radio Link.

If the DRNS needs to limit the user rate in the downlink of a DCH due to congestion caused by the DL UTRAN Dynamic Resources (see subclause 9.2.1.79) when starting to utilise a new Radio Link, the DRNC shall include in the RADIO LINK ADDITION RESPONSE message the *Allowed DL Rate* IE in the *DCH Information Response* IE for this Radio Link.

[FDD – Transmit Diversity:]

[FDD – The DRNS shall activate any feedback mode diversity according to the received settings.]

[FDD – If the cell in which the RL is being added is capable to provide Close loop Tx diversity, the DRNC shall indicate the Closed loop timing adjustment mode of the cell by including the *Closed Loop Timing Adjustment Mode* IE in the RADIO LINK ADDITION RESPONSE message.]

[FDD – When the *Transmit Diversity Indicator* IE and/or *Transmit Diversity Indicator* IE in the *HS-DSCH FDD Secondary Serving Information* IE in the *Additional HS Cell Information RL Addition* IE is present the DRNS shall activate/deactivate the Transmit Diversity for each new Radio Link and/or secondary serving HS-DSCH Radio Link in accordance with the *Transmit Diversity Indicator* IE and/or *Transmit Diversity Indicator* IE in the *HS-DSCH FDD Secondary Serving Information* IE using the diversity mode of the existing Radio Link(s) and/or existing secondary serving HS-DSCH Radio Link.]

DL Power Control:

[FDD – If the *Primary CPICH Ec/No* IE or the *Primary CPICH Ec/No* IE and the *Enhanced Primary CPICH Ec/No* IE measured by the UE are included for an RL in the RADIO LINK ADDITION REQUEST message, the DRNS shall use this in the calculation of the Initial DL TX Power for this RL. If the *Primary CPICH Ec/No* IE is not present, the DRNS shall set the Initial DL TX Power based on the power relative to the Primary CPICH power used by the existing RLs.]

[TDD – If [3.84Mcps TDD and 7.68 Mcps TDD – the *DL Time Slot ISCP Info* IE] [1.28Mcps TDD – the *DL Time Slot ISCP Info LCR* IE] is included in the RADIO LINK ADDITION REQUEST message, the DRNS shall use it in the calculation of the Initial DL TX Power.]

[TDD – If the *Primary CCPCH RSCP Delta* IE is included, the DRNS shall assume that the reported value for Primary CCPCH RSCP is in the negative range as per TS 25.123 [24], and the value is equal to the *Primary CCPCH RSCP Delta* IE. If the *Primary CCPCH RSCP Delta* IE is not included and the *Primary CCPCH RSCP* IE is included, the DRNS shall assume that the reported value is in the non-negative range as per TS 25.123 [24], and the value is equal to the *Primary CCPCH RSCP* IE. The DRNS shall use it in the calculation of the Initial DL TX Power.]

[TDD – If the *Primary CCPCH RSCP* IE, *Primary CCPCH RSCP Delta* IE, [3.84Mcps TDD and 7.68 Mcps TDD – and the *DL Time Slot ISCP Info* IE] [1.28Mcps TDD – and the *DL Time Slot ISCP Info LCR* IE] are not present, the DRNS shall set the Initial DL TX Power based on the power relative to the Primary CCPCH power used by the existing RL.]

[FDD – The Initial DL TX Power shall be applied until UL synchronisation is achieved on the Uu interface for that RLS or Power Balancing is activated. No inner loop power control or power balancing shall be performed during this period. The DL power shall then vary according to the inner loop power control (see ref. TS 25.214 [10] subclause 5.2.1.2) and the power control procedure (see 8.3.7).]

[TDD – The Initial DL TX Power shall be applied until UL synchronisation is achieved on the Uu interface for that RL. No inner loop power control shall be performed during this period. The DL power shall then vary according to the inner loop power control (see ref. TS 25.224 [22] subclause 4.2.3.3).]

[3.84 Mcps TDD and 7.68 Mcps TDD – The DL TX power upper and lower limit is configured in the following way: The DRNC shall include the *Maximum DL TX Power* IE and *Minimum DL TX Power* IE in the RADIO LINK ADDITION RESPONSE message. If the maximum or minimum power needs to be different for particular DCH type CCTrCHs, the DRNC shall include the value(s) for that CCTrCH in the *CCTrCH Maximum DL TX Power* IE and *CCTrCH Minimum DL TX Power*. The DRNS shall not transmit with a higher power than indicated by the appropriate *Maximum DL TX Power* IE/*CCTrCH Maximum DL TX Power* IE or lower than indicated by the appropriate *Minimum DL TX Power* IE/*CCTrCH Minimum DL TX Power* IE on any DL DPCH within each CCTrCH of the RL.]

[1.28 Mcps TDD – The DL TX power upper and lower limit is configured in the following way: The DRNC shall include the *Maximum DL TX Power* IE and *Minimum DL TX Power* IE in the RADIO LINK

ADDITION RESPONSE message. If the maximum or minimum power needs to be different for particular timeslots within a DCH type CCTrCH, the DRNC shall include the value(s) for that timeslot in the *Maximum DL TX Power* IE and *Minimum DL TX Power* within the *DL Timeslot Information LCR* IE. The DRNS shall not transmit with a higher power than indicated by the appropriate *Maximum DL TX Power* IE or lower than indicated by the appropriate *Minimum DL TX Power* IE on any DL DPCH within each timeslot of the RL.]

[FDD – If the *DPC Mode* IE is present in the RADIO LINK ADDITION REQUEST message, the DRNC shall apply the DPC mode indicated in the message, and be prepared that the DPC mode may be changed during the lifetime of the RL. If the *DPC Mode* IE is not present in the RADIO LINK ADDITION REQUEST message, DPC mode 0 shall be applied (see ref. TS 25.214 [10]).]

The DRNC shall provide the configured *Maximum DL TX Power* IE and *Minimum DL TX Power* IE for every new RL to the SRNC in the RADIO LINK ADDITION RESPONSE message. The DRNS shall not transmit with a power higher than indicated by the *Maximum DL TX Power* IE or lower than indicated by the *Minimum DL TX Power* IE on any DL DPCH [FDD – or on the F-DPCH] of the RL [FDD – except, if the UE Context is configured to use DPCH in the downlink, during compressed mode, when the δP_{curr} , as described in ref. TS 25.214 [10] subclause 5.2.1.3, shall be added to the maximum DL power for the associated compressed frame.]

[FDD – If the power balancing is active with the Power Balancing Adjustment Type of the UE Context set to “Individual” in the existing RL(s) and the RADIO LINK ADDITION REQUEST message includes the *DL Reference Power* IE, the DRNS shall activate the power balancing and use the *DL Reference Power* IE for the power balancing procedure in the new RL(s), if activation of power balancing by the RADIO LINK ADDITION REQUEST message is supported by the DRNS, according to subclause 8.3.15. In this case, the DRNC shall include the *DL Power Balancing Activation Indicator* IE in the *RL Information Response* IE in the RADIO LINK ADDITION RESPONSE message. If the DRNS starts the DL transmission and the activation of the power balancing at the same CFN, the initial power of the power balancing, i.e. P_{init} shall be set to the power level which is calculated based on the *Primary CPICH Ec/No* IE or the *Enhanced Primary CPICH Ec/No* IE (if received), or to the power level which is calculated based on the power relative to the Primary CPICH power used by the existing RLs.]

UL Power Control:

The DRNC shall also provide the configured UL Maximum SIR and UL Minimum SIR for every new RL to the SRNC in the RADIO LINK ADDITION RESPONSE message. These values are taken into consideration by DRNS admission control and shall be used by the SRNC as limits for the UL inner-loop power control target.

Neighbouring Cell Handling:

If there are UMTS neighbouring cell(s) to the cell in which a Radio Link was established then:

- The DRNC shall include in the RADIO LINK ADDITION RESPONSE message the *Neighbouring FDD Cell Information* IE and/or *Neighbouring TDD Cell Information* IE in the *Neighbouring UMTS Cell Information* IE for each neighbouring FDD cell and/or TDD cell respectively. In addition, if the information is available, the DRNC shall include in the RADIO LINK ADDITION RESPONSE message the *Frame Offset* IE, *Primary CPICH Power* IE, *Cell Individual Offset* IE, *STTD Support Indicator* IE, *Closed Loop Mode1 Support Indicator* IE, *Coverage Indicator* IE, *Antenna Co-location Indicator* IE and *HCS Prio* IE in the *Neighbouring FDD Cell Information* IE, and the *Frame Offset* IE, *Cell Individual Offset* IE, *DPCH Constant Value* IE and the *PCCPCH Power* IE, *Coverage Indicator* IE, *Antenna Co-location Indicator* IE and *HCS Prio* IE in the *Neighbouring TDD Cell Information* IE or the *Neighbouring TDD Cell Information LCR* IE. If the *Neighbouring TDD Cell Information* IE includes the *Sync Case* IE set to “Case1”, the DRNC shall include the *Time SlotFor SCH* IE in the *Neighbouring TDD Cell Information* IE. If the *Neighbouring TDD Cell Information* IE includes the *Sync Case* IE set to “Case2”, the DRNC shall include the *SCH Time Slot* IE in the *Neighbouring TDD Cell Information* IE.
- If a UMTS neighbouring cell is not controlled by the same DRNC, the DRNC shall also include in the RADIO LINK ADDITION RESPONSE message the *CN PS Domain Identifier* IE and/or *CN CS Domain Identifier* IE which are the identifiers of the CN nodes connected to the RNC controlling the UMTS neighbouring cell.
- [FDD – The DRNC shall include in the RADIO LINK ADDITION RESPONSE message the *DPC Mode Change Support Indicator* IE for each neighbour cell in the *Neighbouring FDD Cell Information* IE if this information is available.]

- The DRNC shall include the *Cell Capability Container FDD IE*, the *Cell Capability Container TDD IE*, the *Cell Capability Container 7.68Mcps TDD IE*, the *Cell Capability Container TDD LCR IE* and/or the *Cell Capability Container Extension FDD IE* if the DRNC is aware that the neighbouring cell supports any functionality listed in 9.2.2.D, 9.2.3.1a, 9.2.3.1b and 9.2.2.123.
- [FDD – The DRNC shall, if supported, include the *Cell List Validity Indicator IE* if the neighbouring cell is multi cell capable and/or dual band capable but the cell can not be the serving HS-DSCH in a multicell and/or dual band configuration. Hence the cell can only serve as the secondary serving HS-DSCH cell. When *Cell List Validity Indicator IE* is included the SRNC should ignore the indicated cell list(s).]
- For the UMTS neighbouring cells which are controlled by the DRNC, the DRNC shall report in the RADIO LINK ADDITION RESPONSE message the restriction state of those cells, otherwise *Restriction State Indicator IE* may be absent. The DRNC shall include the *Restriction State Indicator IE* for the neighbouring cells which are controlled by the DRNC in the *Neighbouring FDD Cell Information IE*, the *Neighbouring TDD Cell Information IE* and the *Neighbouring TDD Cell Information LCR IE*.
- If available, the DRNC shall include the *SNA Information IE* for the concerned neighbouring cells in the *Neighbouring FDD Cell Information IE*, the *Neighbouring TDD Cell Information IE* and the *Neighbouring TDD Cell Information LCR IE*.
- If MOCN or GWCN network sharing configuration is used then the DRNC shall include the broadcasted PLMN identities of concerned neighbouring cells in the *Multiple PLMN List IE* in the *Neighbouring FDD Cell Information IE*, the *Neighbouring TDD Cell Information IE* and the *Neighbouring TDD Cell Information LCR IE*.
- If available, the DRNC shall include the *Frequency Band Indicator IE* for the concerned neighbouring cells in the *Neighbouring FDD Cell Information IE*.

If there are GSM neighbouring cells to the cell(s) in which a radio link is established, the DRNC shall include the *Neighbouring GSM Cell Information IE* in the RADIO LINK ADDITION RESPONSE message for each of the GSM neighbouring cells. If available the DRNC shall include the *Cell Individual Offset IE*, and if the *Cell Individual Offset IE* alone cannot represent the value of the offset, the DRNC shall also include the *Extended GSM Cell Individual Offset IE* in the *Neighbouring GSM Cell Information IE*. If available the DRNC shall also include the *Coverage Indicator IE*, *Antenna Co-location Indicator IE* and *HCS Prio IE* in the *Neighbouring GSM Cell Information IE*. If available, the DRNC shall also include the *SNA Information IE* for the concerned neighbouring cells in the *Neighbouring GSM Cell Information IE*.

When receiving the *SNA Information IE* in the RADIO LINK ADDITION RESPONSE message, the SRNC should use it to restrict cell access based on SNA information. See also TS 25.401 [40] for a broader description of the SNA access control.

If there are GERAN neighbouring cells to the cell(s) where a radio link is established, the DRNC shall include the *GERAN Cell Capability IE* in the *Neighbouring GSM Cell Information IE* that is included in the RADIO LINK ADDITION RESPONSE message for each of the GERAN cells.

If there are GERAN Iu-mode neighbouring cells to the cell(s) where a radio link is established, the DRNC shall include, if available, the *GERAN Classmark IE* in the *Neighbouring GSM Cell Information IE* that is included in the RADIO LINK ADDITION RESPONSE message for each of the GERAN Iu-mode neighbouring cells. Ref. TS 43.051 [39] defines when the transmission of the *GERAN Classmark IE* will be required at the initiation of the Relocation Preparation procedure.

If there are E-UTRA neighbouring cells to the cell(s) in which a radio link is established, the DRNC shall include the *Neighbouring E-UTRA Cell Information IE* in the RADIO LINK ADDITION RESPONSE message for each of the E-UTRA neighbouring cells.

[1.28Mcps TDD – Uplink Synchronisation Parameters LCR:]

[1.28Mcps TDD – If the *Uplink Synchronisation Parameters LCR IE* is present, the DRNC shall use the indicated values of *Uplink synchronisation stepsize IE* and *Uplink synchronisation frequency IE* when evaluating the timing of the UL synchronisation.]

[1.28Mcps TDD – Shared physical channels Synchronisation Detection:]

[1.28Mcps TDD – If HS-PDSCH and E-PUCH are configured but no DPCH is configured for the UE, then the DRNS shall include the *Out-of-sync Detection Window* IE in the *HS-DSCH TDD Information Response* IE in the RADIO LINK ADDITION RESPONSE message.]

[1.28Mcps TDD – Uplink Timing Advance Control LCR:]

[1.28Mcps TDD – The DRNC shall include the *Uplink Timing Advance Control LCR* IE in the RADIO LINK ADDITION RESPONSE message.]

[1.28Mcps TDD – PowerControl GAP:]

[1.28Mcps TDD – If applied in the DRNS, the DRNC may include the *PowerControl GAP* IE in the RADIO LINK ADDITION RESPONSE message.]

[1.28Mcps TDD – E-UTRAN Inter-RAT measurement:]

[1.28Mcps TDD – If the RADIO LINK ADDITION REQUEST message includes the *Idle Interval Configuration Indicator* IE, if supported, the DRNC shall include the *Idle Interval Information* IE in the RADIO LINK ADDITION RESPONSE message.]

[1.28Mcps TDD – Inter-frequency/ Inter-RAT measurement:]

[1.28Mcps TDD – If the RADIO LINK ADDITION REQUEST message includes the *DCH Measurement Type indicator* IE, if supported, the DRNS shall include the *Measurement purpose* IE and the *Measurement occasion pattern sequence parameters* IE in the *DCH Measurement Occasion Information* IE in the RADIO LINK ADDITION RESPONSE message to configure the measurement occasion pattern(s) indicated by the *DCH Measurement Type indicator* IE.]

MBMS Handling:

If the UE Link is currently stored in the UE Context and an MBMS session for some MBMS bearer services contained in the UE Link is ongoing in some of the cells identified by the *C-ID* IEs in the RADIO LINK ADDITION REQUEST message, the DRNC shall include for each of these active MBMS bearer services in the *Active MBMS Bearer Service List* IE the *Transmission Mode* IE in the concerned *RL Information Response* IEs in the RADIO LINK ADDITION RESPONSE message.

If the UE Link is currently stored in the UE Context and an MBMS preferred frequency layer for some active MBMS bearer services contained in the UE Link is set in some of the cells identified by the *C-ID* IEs in the RADIO LINK ADDITION REQUEST message, the DRNC shall include for each of these active MBMS bearer services in the *Active MBMS Bearer Service List* IE the *Preferred Frequency Layer* IE in the concerned *RL Information Response* IEs in the RADIO LINK ADDITION RESPONSE message.

[FDD – HS-DSCH Preconfiguration for Enhanced HS Serving Cell Change]

[FDD – If the RADIO LINK ADDITION REQUEST message includes the *HS-DSCH Preconfiguration Setup* IE in the *RL Information* IE for a Radio Link not indicated by the *HS-PDSCH RL ID* IE in the *HS-DSCH Serving Cell Change Information* IE the DRNS shall, if supported, preconfigure the indicated cells for Enhanced HS Serving Cell Change according to TS 25.308 [63]:]

- [FDD – The DRNS shall preconfigure sets of HS-SCCH codes on the cells preconfigured for HS-DSCH, primary serving HS-DSCH cell, as well as on the secondary serving HS-DSCH cells. The primary serving HS-DSCH cell is designated through the *C-ID* IE part of the *RL Information* IE in the RADIO LINK ADDITION REQUEST message. The list of secondary serving HS-DSCH cells is designated by the list of *Secondary C-ID* IEs in the *HS-DSCH Preconfiguration Setup* IE part of the *RL Information* IE in the RADIO LINK ADDITION REQUEST message.]
- [FDD – The number of HS-SCCH codes to preconfigure for each cell may be optionally specified:]
 - [FDD – by the *Num Primary HS-SCCH Codes* IE in the *HS-DSCH Preconfiguration Setup* IE, for the primary serving HS-DSCH cell]
 - [FDD – by the *Num Secondary HS-SCCH Codes* IE in the *Secondary Cells* IE in the *HS-DSCH Preconfiguration Setup* IE for each of the secondary serving HS-DSCH cells]

- [FDD – If *Num Primary HS-SCCH Codes IE* or *Num Secondary HS-SCCH Codes IE* is not included in the message the number and distribution of codes on primary and any secondary cells shall be preconfigured to satisfy any limitations in TS 25.214 [10].]
- [FDD – The DRNS shall return these codes in the *Sets of HS-SCCH Codes IE* along with the corresponding per- cell *HS-DSCH-RNTI IE* in the *HS-DSCH Preconfiguration Info IE* in the *RL Information Response IE* of the RADIO LINK ADDITION RESPONSE message or in the *Successful RL Information Response IE* of the RADIO LINK ADDITION FAILURE message.]
- [FDD – The DRNS shall use the first in the numbered list the primary serving HS-DSCH cell’s of HS-SCCH codes in the *HS-SCCH Preconfigured Codes IE* sent to the SRNC to signal the Target Cell HS-SCCH Order defined in ITU-T Rec. X.680 [18]].
- [FDD – The DRNS shall include, in the *HS-DSCH Preconfiguration Info IE* in the *RL Information Response IE* in the RADIO LINK ADDITION RESPONSE message or in the *Successful RL Information Response IE* of the RADIO LINK ADDITION FAILURE message, IEs according to the rules defined for HS-DSCH Setup at Serving HS-DSCH Radio Link Change and:]
 - [FDD – if *HARQ Preamble Mode IE* is included in the *HS-DSCH Preconfiguration Setup IE* the *HARQ Preamble Mode Activation Indicator IE*]
 - [FDD – if *MIMO Activation Indicator IE* is included in the *HS-DSCH Preconfiguration Setup IE* or in the *Secondary Cells IE* in the *HS-DSCH Preconfiguration Setup IE* the Pilot Configuration and MIMO N/M Ratio in *MIMO Information Response IE*]
 - [FDD – if *HS-DSCH MAC-d PDU Size Format IE* is included in the *HS-DSCH Preconfiguration Setup IE* and set to “Flexible MAC-d PDU Size” and if Sixtyfour QAM will not be used for the cell in the preconfiguration the *HS-DSCH TB Size Table Indicator IE* for each preconfigured cell.]
 - [FDD – if *Sixtyfour QAM Usage Allowed Indicator IE* is included in the *Secondary Cells IE* in the *HS-DSCH Preconfiguration Setup IE* or in the *HS-DSCH Preconfiguration Setup IE* the *SixtyfourQAM DL Usage Indicator IE* for each preconfigured cell]
 - [FDD – if *Continuous Packet Connectivity HS-SCCH less Information IE* is included in the *HS-DSCH Preconfiguration Setup IE* the *Continuous Packet Connectivity HS-SCCH less Information Response IE*]
 - [FDD – if the *UE with enhanced HS-SCCH support indicator IE* is included in the *HS-DSCH Preconfiguration Setup IE*, then the DRNS shall store this information in the preconfigured configuration.]
 - [FDD - If the *UE Support Indicator Extension IE* is included in the *HS-DSCH Preconfiguration Setup IE* with the bit *UE DTXDRX related HS-SCCH orders uniform behavior indicator* set to 0, then the DRNS shall, if supported, include the *Support of dynamic DTXDRX related HS-SCCH order IE* in the *HS-DSCH Preconfiguration Info IE* in the RADIO LINK ADDITION RESPONSE message.]
 - [FDD – the *SixtyfourQAM DL Support Indicator IE* may be included]
 - [FDD – If the *UE Support Indicator Extension IE* is included in the *HS-DSCH Preconfiguration Setup IE*, then the DRNS may store this information in the preconfigured configuration.]
 - [FDD – the DRNS shall, if supported, include in the *Sets of HS-SCCH Codes IE* the *Measurement Power Offset IE* for each preconfigured cell.]
- [FDD – If the *Power Offset For S-CPICH for MIMO Request Indicator IE* is included in the *HS-DSCH Preconfiguration Setup IE* or in the *Secondary Cells IE* in the *HS-DSCH Preconfiguration Setup IE*, the DRNC shall, if supported and MIMO pilot configuration with Primary and Secondary CPICH is set up with a non-zero power offset on the cell where HS-DSCH / secondary HS-DSCH is preconfigured, include the *Power Offset For S-CPICH for MIMO IE* in the *HS-DSCH Preconfiguration Info IE* or in the *Sets of HS-SCCH Codes IE* in the *HS-DSCH Preconfiguration Info IE* for each preconfigured cell in the RADIO LINK ADDITION RESPONSE message. If zero power offset the DRNC may include the *Power Offset For S-CPICH for MIMO IE*.]

[FDD – The DRNS shall include in the *HS-DSCH Preconfiguration Info IE* in the *RL Information Response IE* in the RADIO LINK ADDITION RESPONSE message or in the *Successful RL Information Response IE*

of the RADIO LINK ADDITION FAILURE message the *E-DCH FDD DL Control Channel Information* containing the preconfigured configuration of the E-DCH serving cell according to the rules defined for Serving E-DCH Radio Link Change as follows:]

- [FDD – The DRNS shall allocate for the preconfigured configuration a primary E-RNTI identifier or a secondary E-RNTI identifier or both for the new Serving E-DCH Radio Link and include these E-RNTI identifiers along with the channelisation code of the corresponding E-AGCH in the *E-DCH FDD DL Control Channel Information IE*.]
- [FDD – The DRNS may preconfigure the *Serving Grant Value IE* and *Primary/Secondary Grant Selector IE* for the initial grant for the serving E-DCH RL and include these values in the *E-DCH FDD DL Control Channel Information IE*.]

[FDD – If the *HS-DSCH Preconfiguration Setup IE* includes the *E-DCH Indicator IE* for a secondary cell, the DRNS shall include in the *Additional E-DCH Preconfiguration Information IE* in the *HS-DSCH Preconfiguration Info IE* in the *RL Information Response IE* in the RADIO LINK ADDITION RESPONSE message or in the *Successful RL Information Response IE* of the RADIO LINK ADDITION FAILURE message the *E-DCH FDD DL Control Channel Information IE* containing the preconfigured configuration of the Additional E-DCH serving cell, corresponding to the cell indicated with the *E-DCH Indicator IE*, according to the rules defined for Serving Additional E-DCH Radio Link Change as follows:]

- [FDD – The DRNS shall allocate for the preconfigured configuration a primary E-RNTI identifier or a secondary E-RNTI identifier or both for the new Serving Additional E-DCH Radio Link and include these E-RNTI identifiers along with the channelisation code of the corresponding *E-AGCH in the E-DCH FDD DL Control Channel Information IE*.]
- [FDD – The DRNS may preconfigure the *Serving Grant Value IE* and *Primary/Secondary Grant Selector IE* for the initial grant for the serving Additional E-DCH RL and include these values in the *E-DCH FDD DL Control Channel Information IE*.]

[FDD – If the RADIO LINK ADDITION REQUEST message includes the *Non-Serving RL Preconfiguration Setup IE* in the *RL Information IE* and:]

- [FDD – if the choice of *new Serving RL* is "New Serving RL in the DRNS", the DRNC may include the *New non-serving RL E-DCH FDD DL Control Channel Information A IE* and/or *New non-serving RL E-DCH FDD DL Control Channel Information B IE* in the *Non-Serving RL Preconfiguration Info IE* for the RL in the RADIO LINK ADDITION RESPONSE message.]
- [FDD – if the choice of *new Serving RL* is "New Serving RL Not in the DRNS", the DRNC may include the *New non-serving RL E-DCH FDD DL Control Channel Information C IE* in the *Non-Serving RL Preconfiguration Info IE* for the RL in the RADIO LINK ADDITION RESPONSE message.]
- [FDD – if the choice of *new Serving RL* is "New Serving RL in the DRNS or New Serving RL Not in the DRNS", the DRNC may include the *New non-serving RL E-DCH FDD DL Control Channel Information A IE*, the *New non-serving E-DCH FDD DL Control Channel Information B IE* and/or the *New non-serving E-DCH FDD DL Control Channel Information C* for the RL in the *Non-Serving RL Preconfiguration Info IE* in the RADIO LINK ADDITION RESPONSE message.]
- [FDD – if the *Additional E-DCH Non-Serving RL Preconfiguration Setup IE* is included, the DRNC may include the *New non-serving RL E-DCH FDD DL Control Channel Information A IE*, the *New non-serving RL E-DCH FDD DL Control Channel Information B IE* and/or the *New non-serving RL E-DCH FDD DL Control Channel Information C IE* according to the choice of new Serving RL in *Additional E-DCH New non-serving RL E-DCH FDD DL Control Channel Information IE* for the additional non serving E-DCH RL in the *Non-Serving RL Preconfiguration Info IE* in the RADIO LINK ADDITION RESPONSE message.]

General:

If the RADIO LINK ADDITION REQUEST message includes the *RL Specific DCH Information IE*, the DRNC may use the transport layer address and the binding identifier received from the SRNC when establishing a transport bearer for the DCH or the set of co-ordinated DCHs [FDD – for which the *Transport Bearer Not Requested Indicator IE* was not included].

[FDD – If the RADIO LINK ADDITION REQUEST message includes the *Transport Bearer Not Requested Indicator* IE set to “Transport Bearer shall not be Established” for a DCH, then the DRNC shall not establish a transport bearer for the concerned DCH and shall include the *Transport Bearer Not Setup Indicator* IE for the corresponding DCH in the RADIO LINK ADDITION RESPONSE message.]

[FDD – If the RADIO LINK ADDITION REQUEST message includes the *Transport Bearer Not Requested Indicator* IE set to “Transport Bearer may not be Established” for a DCH and:]

- [FDD – if the DRNC establishes a transport bearer for the concerned DCH, the DRNC shall include in the RADIO LINK ADDITION RESPONSE message the *Binding ID* IE and *Transport Layer Address* IE for establishment of a transport bearer for the DCH being established.]
- [FDD – if the DRNC does not establish a transport bearer for the concerned DCH, the DRNC shall include the *Transport Bearer Not Setup Indicator* IE for the corresponding DCH in the RADIO LINK ADDITION RESPONSE message.]

Depending on local configuration in the DRNS, the DRNC may include in the RADIO LINK ADDITION RESPONSE message the *UTRAN Access Point Position* IE and the geographical co-ordinates of the cell, represented either by the *Cell GAI* IE or by the *Cell GA Additional Shapes* IE. If the DRNC includes the *Cell GA Additional Shapes* IE in the RADIO LINK ADDITION RESPONSE message, it shall also include the *Cell GAI* IE.

For each Radio Link established in a cell in which at least one URA Identity is being broadcast, the DRNC shall include in the RADIO LINK ADDITION RESPONSE message a URA Information for this cell including the *URA ID* IE, the *Multiple URAs Indicator* IE indicating whether or not multiple URA Identities are being broadcast in the cell, and the *RNC-ID* IEs of all other RNCs that have at least one cell within the URA identified by the *URA ID* IE.

[3.84Mcps TDD – The DRNC shall include the *Secondary CCPCH Info TDD* IE in the RADIO LINK ADDITION RESPONSE message if at least one *DSCH Information Response* IE or *USCH Information Response* IE is included in the message and at least one DCH is configured for the radio link. The DRNC shall also include the *Secondary CCPCH Info TDD* IE in the RADIO LINK ADDITION RESPONSE message if at least one *DSCH Information Response* IE or *USCH Information Response* IE is included in the message and the SHCCH messages for this radio link will be transmitted over a different secondary CCPCH than selected by the UE from system information.]

[1.28 Mcps TDD – The DRNC shall include the *Secondary CCPCH Info TDD LCR* IE in the RADIO LINK ADDITION RESPONSE message if at least one *DSCH Information Response LCR* IE or *USCH Information Response LCR* IE is included in the message and at least one DCH is configured for the radio link. The DRNC shall also include the *Secondary CCPCH Info TDD LCR* IE in the RADIO LINK ADDITION RESPONSE message if at least one *DSCH Information Response LCR* IE or *USCH Information Response LCR* IE is included in the message and the SHCCH messages for this radio link will be transmitted over a different secondary CCPCH than selected by the UE from system information.]

[7.68 Mcps TDD – The DRNC shall include the *Secondary CCPCH Info 7.68 Mcps TDD* IE in the RADIO LINK ADDITION RESPONSE message if at least one *DSCH Information Response 7.68 Mcps* IE or *USCH Information Response 7.68 Mcps* IE is included in the message and at least one DCH is configured for the radio link. The DRNC shall also include the *Secondary CCPCH Info 7.68 Mcps TDD* IE in the RADIO LINK ADDITION RESPONSE message if at least one *DSCH Information Response 7.68 Mcps* IE or *USCH Information Response 7.68 Mcps* IE is included in the message and the SHCCH messages for this radio link will be transmitted over a different secondary CCPCH than selected by the UE from system information.]

If the *Permanent NAS UE Identity* IE is present in the RADIO LINK ADDITION REQUEST message, the DRNS shall store the information for the considered UE Context for the lifetime of the UE Context.

If the RADIO LINK ADDITION REQUEST message includes a *C-ID* IE corresponding to a cell reserved for operator use and the Permanent NAS UE Identity is available in the DRNC for the considered UE Context, the DRNC shall use this information to determine whether it can add the Radio Link on this cell or not.

If the HCS priority information is available in the DRNS, it shall include the *HCS Prio* IE for each of the established RLs in the RADIO LINK ADDITION RESPONSE message.

The DRNS shall start receiving on the new RL(s) after the RLs are successfully established.

[FDD – If the RADIO LINK ADDITION REQUEST message includes the *Initial DL DPCH Timing Adjustment Allowed* IE, then the DRNS may perform an initial DL DPCH Timing Adjustment (i.e. perform a timing advance or a timing delay with respect to the SFN timing) on a Radio Link. In this case, the DRNS shall include, for the concerned Radio Link(s), the *Initial DL DPCH Timing Adjustment* IE in the *Radio Link Information Response* IE in the RADIO LINK ADDITION RESPONSE message.]

[FDD – If the RADIO LINK ADDITION REQUEST message includes the *Synchronisation Indicator* IE, set to “Timing Maintained Synchronisation”, the DRNS shall use synchronisation procedure B according to subclause 4.3.2.4 in TS 25.214 [10]. The DRNS shall select the TPC pattern as if “first RLS indicator” is set to “first RLS” according to subclause 5.1.2.2.1.2 in TS 25.214 [10].]

[FDD – If the UE Context is configured for F-DPCH Slot Format operation, then the DRNS shall include the *F-DPCH Slot Format* IE in the RADIO LINK ADDITION RESPONSE message.]

[FDD – Radio Link Set Handling:]

[FDD – For each RL not having a common generation of the TPC commands in the DL with another RL, the DRNS shall assign to the RL a unique value for the *RL Set ID* IE which uniquely identifies the RL as an RL Set within the UE Context. In case of E-DCH, the generation of E-HICH information for RLs in different RL Sets shall not be common.]

[FDD – For all RLs having a common generation of the TPC commands in the DL with another new or existing RL, the DRNS shall assign to each RL the same value for the *RL Set ID* IE which uniquely identifies these RLs as members of the same RL Set within the UE Context. In case of E-DCH, the generation of E-HICH related information for all RLs in a RL Set shall be common.]

[FDD – After addition of the new RL(s), the UL out-of-sync algorithm defined in ref. TS 25.214 [10] shall, for each of the previously existing and newly established RL Set(s), use the maximum value of the parameters *N_OUTSYNC_IND* and *T_RLFAILURE* that are configured in the cells supporting the radio links of the RL Set. The UL in-sync algorithm defined in TS 25.214 [10] shall, for each of the established RL Set(s), use the minimum value of the parameters *N_INSYNC_IND* that are configured in the cells supporting the radio links of the RL Set.]

[FDD – For each E-DCH RL which has or can have a common generation of E-RGCH information with another RL (current or future) when the DRNS would contain the E-DCH serving RL, the DRNS shall include the *E-DCH RL Set ID* IE in the RADIO LINK ADDITION RESPONSE message. The value of the *E-DCH RL Set ID* IE shall allow the SRNC to identify the E-DCH RLs that have or can have a common generation of E-RGCH information.]

[FDD – Serving HS-DSCH Radio Link Change:]

[FDD – If the RADIO LINK ADDITION REQUEST message includes the *HS-DSCH Serving Cell Change Information* IE, then the *HS-PDSCH RL ID* IE indicates the new Serving HS-DSCH Radio Link:]

- [FDD – In the new configuration the DRNS shall allocate the HS-PDSCH resources for the new Serving HS-PDSCH Radio Link.]
- [FDD – The DRNS may include the *HARQ Memory Partitioning* IE in the *HS-DSCH FDD Information Response* IE in the RADIO LINK ADDITION RESPONSE message. The *HARQ Memory Partitioning* IE may contain the *HARQ Memory Partitioning Information Extension For MIMO* IE.]
- [FDD – If fields are to be included in the User Plane by the SRNC to handle TNL Congestion Control for HSDPA in the DRNS, then the DRNC shall include the *User Plane Congestion Fields Inclusion* IE in the *HS-DSCH Information Response* IE.]
- [FDD – The DRNC shall allocate a new HS-DSCH-RNTI to the UE Context and include the *HS-DSCH-RNTI* IE in the RADIO LINK ADDITION RESPONSE message.]
- [FDD – If a reset of the MAC-hs is not required the DRNS shall include the *MAC-hs Reset Indicator* IE in the RADIO LINK ADDITION RESPONSE message.]
- [FDD – The DRNC shall include the *Measurement Power Offset* IE in the *HS-DSCH Information Response* IE in the RADIO LINK ADDITION RESPONSE message.]

- [FDD – The DRNS shall allocate HS-SCCH codes corresponding to the HS-DSCH and include the *HS-SCCH Specific Information Response IE* in the *HS-DSCH FDD Information Response IE* in the RADIO LINK ADDITION RESPONSE message.]
- [FDD – The DRNC shall include the *HS-PDSCH And HS-SCCH Scrambling Code IE* in the *HS-DSCH FDD Information Response IE* in the RADIO LINK ADDITION RESPONSE message.]
- If the *TNL QoS IE* is included for a MAC-d flow and if ALCAP is not used, the *TNL QoS IE* may be used by the DRNS to determine the transport bearer characteristics to apply in the uplink between the DRNS and the SRNC for the related MAC-d flow.
- [FDD – If the *HS-DSCH Serving Cell Change Information IE* includes the *Continuous Packet Connectivity HS-SCCH less Information IE*, then:]
 - [FDD – The DRNS shall configure the Serving HS-DSCH Radio Link indicated by the *HS-PDSCH RL ID IE* for Continuous Packet Connectivity HS-SCCH less operation according to TS 25.214 [10].]
 - [FDD – The DRNS shall allocate the HS-PDSCH codes needed for HS-SCCH less operation and include the *Continuous Packet Connectivity HS-SCCH less Information Response IE* in the RADIO LINK ADDITION RESPONSE message.]
 - [FDD – If at least one of *HS-PDSCH Second Code Support IE* is set to “True”, then the DRNC shall include *HS-PDSCH Second Code Index IE* in the RADIO LINK ADDITION RESPONSE message.]
- [FDD – If the *HS-DSCH Serving Cell Change Information IE* includes the *Continuous Packet Connectivity DTX-DRX Information IE*, then:]
 - [FDD – The DRNS shall configure the concerned UE Context for Continuous Packet Connectivity DTX operation according to TS 25.214 [10].]
 - [FDD – If *DRX Information IE* is included in the *Continuous Packet Connectivity DTX-DRX Information IE*, then the DRNS shall configure the concerned UE Context for Continuous Packet Connectivity DRX operation according to TS 25.214 [10].]
- [FDD - If the UE Context is configured with Sixtyfour QAM allowed for the serving HS-DSCH Radio Link and not used in the current configuration and then if the DRNS decides to use 64 QAM in the new configuration, then it shall include the *SixtyfourQAM DL Usage Indicator IE* in the *HS-DSCH FDD Information Response IE* in the RADIO LINK ADDITION RESPONSE message.]
- [FDD – If MAC-ehs is applied in the new configuration, and if Sixtyfour QAM will not be used, the DRNS shall include the *HS-DSCH TB Size Table Indicator IE* in the *HS-DSCH FDD Information Response IE* in the *HS-DSCH Serving Cell Change Information Response IE* in the RADIO LINK ADDITION RESPONSE message if it decides to use the octet aligned table defined in TS 25.321 [41] for HS-DSCH Transport Block Size signalling.]

[FDD – HS-DSCH Setup on a New Radio Link at Serving HS-DSCH Radio Link Change:]

[FDD – If the *HS-DSCH Information IE* is present in the *HS-DSCH Serving Cell Change Information IE*, then:]

- [FDD – The DRNS shall setup the requested HS-PDSCH resources on the *Serving HS-DSCH Radio Link indicated by the HS-PDSCH RL ID IE*.]
- [FDD – the *HS-DSCH Information IE* defines the new HS-DSCH configuration in the DRNS to be used on the new HS-DSCH Radio Link.]
- [FDD – The DRNC shall include the *HARQ Memory Partitioning IE* in the *HS-DSCH FDD Information Response IE* in the RADIO LINK ADDITION RESPONSE message. The *HARQ Memory Partitioning IE* shall either contain the *HARQ Memory Partitioning Information Extension For MIMO IE* or the *Number of Processes IE* set to a value higher than “8”, if the *MIMO Activation Indicator IE* is included in the *HS-DSCH Information IE*.]
- [FDD – The DRNS may use the *Traffic Class IE* for a specific HS-DSCH MAC-d flow to determine the transport bearer characteristics to apply between DRNC and Node B. If *TrCH Source Statistics Descriptor IE* is present with the value “RRC” in the *HS-DSCH MAC-d Flows Information IE*, then the

DRNC should ignore the *Traffic Class* IE. If the *TNL QoS* IE is included for a MAC-d flow and if ALCAP is not used, the *TNL QoS* IE may be used by the DRNS to determine the transport bearer characteristics to apply in the uplink between the DRNS and the SRNC for the related MAC-d flow.]

- [FDD – If the RADIO LINK ADDITION REQUEST message includes the *MAC-hs Guaranteed Bit Rate* IE for a Priority Queue in the *HS-DSCH MAC-d Flows Information* IE in the *HS-DSCH Information* IE, then the DRNS shall use this information to optimise MAC-hs scheduling decisions for the related HSDPA Priority Queue.]
- [FDD – If the RADIO LINK ADDITION REQUEST message includes the *Discard Timer* IE for a Priority Queue in the *HS-DSCH MAC-d Flows Information* IE in the *HS-DSCH Information* IE, then the DRNS shall use this information to discard out-of-date MAC-hs SDUs from the related HSDPA Priority Queue.]
- [FDD – If the RADIO LINK ADDITION REQUEST message includes the *Maximum MAC-d PDU Size Extended* IE for a Priority Queue in the *HS-DSCH MAC-d Flows Information* IE in the *HS-DSCH Information* IE, then the DRNS shall ignore the *SID* IE and *MAC-d PDU Size* IE in the *MAC-d PDU Size Index* IE and use *Maximum MAC-d PDU Size Extended* IE to optimise capacity allocation for the related HSDPA Priority Queue.]
- [FDD – The DRNC shall include the *HS-DSCH Initial Capacity Allocation* IE in the *HS-DSCH FDD Information Response* IE in the RADIO LINK ADDITION RESPONSE message for every HS-DSCH MAC-d flow being established, if the DRNS allows the SRNC to start transmission of MAC-d PDUs before the DRNS has allocated capacity on user plane as described in TS 25.425 [32]. If RADIO LINK ADDITION REQUEST message includes *HS-DSCH MAC-d PDU Size Format* IE in the *HS-DSCH Information* IE set to “Flexible MAC-d PDU Size”, then DRNC shall only set in the *HS-DSCH Initial Capacity Allocation* IE the values for the peer of *Scheduling Priority Indicator* IE and *Maximum MAC-d PDU Size Extended* IE to the values of the corresponding peer I in RADIO LINK ADDITION REQUEST in the *HS-DSCH MAC-d Flows Information* IE in the *HS-DSCH Information* IE for a Priority Queue including *Scheduling Priority Indicator* IE and *Maximum MAC-d PDU Size Extended* IE.]
- [FDD – If the RADIO LINK ADDITION REQUEST message includes the *HS-SCCH Power Offset* IE in the *HS-DSCH Information* IE, then the DRNS may use this value to determine the HS-SCCH power. The HS-SCCH Power Offset should be applied for any HS-SCCH transmission to this UE.]
- [FDD – If the RADIO LINK ADDITION REQUEST message includes the *HARQ Preamble Mode* IE in the *HS-DSCH Information* IE, then the DRNS shall use the indicated HARQ Preamble Mode as described in TS 25.214 [10], if HS-DPCCH ACK/NACK preamble and postamble is supported. Then, in this case, if the mode 1 is applied, the DRNC shall include the *HARQ Preamble Mode Activation Indicator* IE in the *HS-DSCH Information Response* IE in the RADIO LINK ADDITION RESPONSE message. If the *HARQ Preamble Mode* IE is not included or if the mode 0 is applied, then the DRNC shall not include the *HARQ Preamble Mode Activation Indicator* IE in the *HS-DSCH Information Response* IE in the RADIO LINK ADDITION RESPONSE message.]
- [FDD – If the RADIO LINK ADDITION REQUEST message includes the *HS-DSCH MAC-d PDU Size Format* IE in the *HS-DSCH Information* IE, then the DRNS shall use the indicated format in user plane frame structure for HS-DSCH channels TS 25.425 [32] and MAC-hs TS 25.321 [41].]
- [FDD – If the *MIMO Activation Indicator* IE is included in the *HS-DSCH FDD Information* IE, then]
 - [FDD – The DRNS shall activate the MIMO mode for the HS-DSCH Radio Link.]
 - [FDD – The DRNS shall decide the pilot configuration and the UE reporting configuration (N/M ratio) according to TS 25.214 [10] for MIMO and include the *MIMO Information Response* IE in the *HS-DSCH FDD Information Response* IE in the RADIO LINK ADDITION RESPONSE message.]
 - [FDD – If the *Power Offset For S-CPICH for MIMO Request Indicator* IE is included, the DRNC shall, if supported and MIMO pilot configuration with Primary and Secondary CPICH is set up with a non-zero power offset on the cell where the Serving HS-DSCH Radio Link is established, include the *Power Offset For S-CPICH for MIMO* IE in the *HS-DSCH FDD Information Response* IE. If zero power offset the DRNC may include the *Power Offset For S-CPICH for MIMO* IE.]
- [FDD – If the *Sixtyfour QAM Usage Allowed Indicator* IE is included in the *HS-DSCH FDD Information* IE, then the DRNS may if the value is set to “allowed” use 64 QAM for the HS-DSCH Radio Link, and

the DRNS shall include the *SixtyfourQAM DL Usage Indicator* IE in the *HS-DSCH FDD Information Response* IE in the RADIO LINK ADDITION RESPONSE message.]

- [FDD – If the *Sixtyfour QAM Usage Allowed Indicator* IE is included in the *HS-DSCH FDD Information* IE with value set to “not allowed”, then the DRNS shall not use 64 QAM for the HS-DSCH Radio Link.]
- [FDD – If the RADIO LINK ADDITION REQUEST message includes the *HS-DSCH MAC-d PDU Size Format* IE set to “Flexible MAC-d PDU Size” and if Sixtyfour QAM will not be used, the DRNS shall include the *HS-DSCH TB Size Table Indicator* IE in the *HS-DSCH FDD Information Response* IE in the *HS-DSCH Serving Cell Change Information Response* IE in the RADIO LINK ADDITION RESPONSE message if it decides to use the octet aligned table defined in TS 25.321 [41] for HS-DSCH Transport Block Size signalling.]
- [FDD – If the *UE with enhanced HS-SCCH support indicator* IE is included in the *HS-DSCH FDD Information* IE, then the DRNS may use:]
 - [FDD – a different HS-SCCH in consecutive TTIs for this UE]
 - [FDD – HS-SCCH orders for the case of HS-SCCH-less operation to this UE]
- [FDD – If the *UE Support Indicator Extension* IE is included in the *HS-DSCH FDD Information* IE the DRNS may use the supported HSDPA functions for this UE.]
- [FDD - If the *UE Support Indicator Extension* IE is included in the *HS-DSCH FDD Information* IE with the bit *UE DTXDRX related HS-SCCH orders uniform behavior indicator* set to 0, then the DRNS shall, if supported, include the *Support of dynamic DTXDRX related HS-SCCH order* IE in the *HS-DSCH FDD Information Response* IE in the RADIO LINK ADDITION RESPONSE message.]
- [FDD – If the RADIO LINK ADDITION REQUEST message includes *DL RLC PDU Size Format* IE for a Priority Queue in the *HS-DSCH MAC-d Flows Information* IE in the *HS-DSCH Information* IE, the *DL RLC PDU Size Format* IE may be used by the DRNS to determine the allocated capacity on user plane as described in TS 25.425 [32].]
- [FDD – If the RADIO LINK ADDITION REQUEST message includes the *UE Aggregate Maximum Bit Rate Enforcement Indicator* IE in the *Priority Queue Information* IE in the *HS-DSCH MAC-d Flows Information* IE in the *HS-DSCH Information* IE, then the DRNS shall, if supported, consider the data of the HSDPA Priority Queue for UE Aggregate Maximum Bit Rate Enforcement.]
- [FDD – If the *Single Stream MIMO Activation Indicator* IE is included in the *HS-DSCH FDD Information* IE in the *HS-DSCH Serving Cell Change Information* IE, then the DRNS shall activate the Single Stream MIMO for the HS-DSCH Radio Link.]
- [FDD – The DRNC may include the *Transport Layer Address* IE and the *Binding ID* IE for HS-DSCH MAC-d flow in the *HS-DSCH FDD Information Response* IE in the RADIO LINK ADDITION RESPONSE message.]
- [FDD – If the *Serving Cell Change CFN* IE is included in the RADIO LINK ADDITION REQUEST message, then the DRNS shall activate the resources that are allocated for the new serving HS-DSCH Radio Link at the next coming CFN with a value equal to the value requested by the SRNC, or earlier. In this case, in the new configuration the DRNS shall, if applicable, de-allocate the HS-PDSCH resources of the old Serving HS-PDSCH Radio Link. The DRNS shall deactivate those resources at the next coming CFN with a value equal to the value requested by the SRNC.]
- [FDD – If the *Serving Cell Change CFN* IE is not included then the DRNS shall activate immediately the resources that are allocated for the new serving HS-PDSCH Radio Link, and shall keep active the resources that are allocated for the previous serving HS-PDSCH Radio Link.]
- [FDD – If the requested Serving HS-DSCH Radio Link Change was successful or unsuccessful, the DRNS shall indicate this in the *HS-DSCH Serving Cell Change Information Response* IE in the RADIO LINK ADDITION RESPONSE message.]

[FDD – Secondary Serving HS-DSCH Radio Link Change:]

[FDD – If the RADIO LINK ADDITION REQUEST message includes the *Additional HS Cell Information RL Addition* IE, then the *HS-PDSCH RL ID* IE indicates the new Serving HS-DSCH Radio Link:]

- [FDD – In the new configuration the DRNS shall allocate the HS-PDSCH resources for the new secondary serving HS-PDSCH Radio Link. Non cell specific secondary serving Radio Link and non cell specific secondary serving HS-DSCH parameters take the same values as for the serving HS-DSCH cell.]
- [FDD – The DRNC shall allocate a new HS-DSCH-RNTI to the UE Context and include the *HS-DSCH-RNTI* IE in the *HS-DSCH Secondary Serving Cell Change Information Response* IE in the *Additional HS Cell Change Information Response* IE in the RADIO LINK ADDITION RESPONSE message.]
- [FDD – The DRNC shall include the *Measurement Power Offset* IE in the *HS-DSCH FDD Secondary Serving Information Response* IE in the *Additional HS Cell Change Information Response* IE in the RADIO LINK ADDITION RESPONSE message.]
- [FDD – The DRNS shall allocate HS-SCCH codes corresponding to the secondary serving HS-DSCH and include the *HS-SCCH Specific Secondary Serving Information Response* IE in the *HS-DSCH FDD Secondary Serving Information Response* IE in the *HS-DSCH Secondary Serving Cell Change Information Response* IE in the *Additional HS Cell Change Information Response* IE in the RADIO LINK ADDITION RESPONSE message.]
- [FDD – The DRNC shall include the *HS-PDSCH And HS-SCCH Scrambling Code* IE in the *HS-DSCH FDD Secondary Serving Information Response* IE in the *HS-DSCH Secondary Serving Cell Change Information Response* IE in the *Additional HS Cell Change Information Response* IE in the RADIO LINK ADDITION RESPONSE message.]
- [FDD - If the UE Context is configured with Sixtyfour QAM allowed for the secondary serving HS-DSCH Radio Link and not used in the current configuration and then if the DRNS decides to use 64 QAM in the new secondary serving HS-DSCH Radio Link, then it shall include the *SixtyfourQAM DL Usage Indicator* IE in the *HS-DSCH FDD Secondary Serving Information Response* IE in the *Additional HS Cell Information Response* IE in the RADIO LINK ADDITION RESPONSE message.]
- [FDD – If, in the new configuration, the UE context is configured not to use Sixtyfour QAM for the secondary serving HS-DSCH, the DRNS shall include the *HS-DSCH TB Size Table Indicator* IE in the *HS-DSCH FDD Secondary Serving Information Response* IE in the *Additional HS Cell Change Information Response* IE in the RADIO LINK ADDITION RESPONSE message if it decides to use the octet aligned table defined in TS 25.321 [41] for the secondary serving HS-DSCH Transport Block Size signalling.]

[FDD – Secondary Serving HS-DSCH Setup on a New Radio Link at Serving HS-DSCH Radio Link Change:]

- [FDD – The DRNS shall setup the requested HS-PDSCH resources on the Secondary Serving HS-DSCH Radio Link indicated by the *HS-PDSCH RL ID* IE.]
- [FDD – The *HS-DSCH FDD Secondary Serving Information* IE defines the new secondary serving HS-DSCH configuration in the DRNS to be used on the new secondary serving HS-DSCH Radio Link. Non cell specific secondary serving Radio Link and non cell specific secondary serving HS-DSCH parameters take the same values as for the serving HS-DSCH cell.]
- [FDD – If the RADIO LINK ADDITION REQUEST message includes the *HS-SCCH Power Offset* IE in the *HS-DSCH FDD Secondary Serving Information* IE in the *Additional HS Cell Information RL Addition* IE, then the DRNS may use this value to determine the HS-SCCH power. The HS-SCCH Power Offset should be applied for any secondary serving HS-SCCH transmission to this UE.]
- [FDD – If the *MIMO Activation Indicator* IE is included in the *HS-DSCH FDD Secondary Serving Information* IE, then the DRNS shall activate the MIMO mode for the secondary serving HS-DSCH Radio Link and the Node B shall decide the pilot configuration and the UE reporting configuration (N/M ratio) according to TS 25.214 [10] for MIMO and include the *MIMO Information Response* IE in the *HS-DSCH FDD Secondary Serving Information Response* IE in the *HS-DSCH Secondary Serving Cell Change Information Response* IE in the *Additional HS Cell Change Information Response* IE in the RADIO LINK ADDITION RESPONSE message.]
- [FDD – If the *Power Offset For S-CPICH for MIMO Request Indicator* IE is included, the DRNC shall, if supported and MIMO pilot configuration with Primary and Secondary CPICH is set up with a non-zero power offset on the cell where the Secondary Serving HS-DSCH Radio Link is established, include the *Power Offset For S-CPICH for MIMO* IE in the *HS-DSCH FDD Information Response* IE. If zero power offset the DRNC may include the *Power Offset For S-CPICH for MIMO* IE.]

- [FDD – If the *Single Stream MIMO Activation Indicator* IE is included in the *HS-DSCH FDD Secondary Serving Information* IE, then the DRNS shall activate the Single Stream MIMO mode for the secondary serving HS-DSCH Radio Link.]
- [FDD – If the *Sixtyfour QAM Usage Allowed Indicator* IE is included in the *HS-DSCH FDD Secondary Serving Information* IE, then the DRNS may if the value is set to “allowed” use 64 QAM for the secondary serving HS-DSCH Radio Link, and the DRNS shall include the *Sixtyfour QAM DL Usage Indicator* IE in the *HS-DSCH FDD Secondary Serving Information Response* IE in the *HS-DSCH Secondary Serving Cell Change Information Response* IE in the *RADIO LINK ADDITION RESPONSE* message.]
- [FDD – If the *Sixtyfour QAM Usage Allowed Indicator* IE is included in the *HS-DSCH FDD Secondary Serving Information* IE with value set to “not allowed”, then the DRNS shall not use 64 QAM for the secondary serving HS-DSCH Radio Link.]
- [FDD – If Sixtyfour QAM will not be used for the secondary serving cell, the DRNS shall include the *HS-DSCH TB Size Table Indicator* IE in the *HS-DSCH FDD Secondary Serving Information Response* IE in the *HS-DSCH Secondary Serving Cell Change Information Response* IE in the *RADIO LINK ADDITION RESPONSE* message if it decides to use the octet aligned table defined in TS 25.321 [41] for secondary serving HS-DSCH Transport Block Size signalling.]
- [FDD – If the *Diversity Mode* IE is included in the *HS-DSCH FDD Secondary Serving Information* IE in the *Additional HS Cell Information RL Addition* IE in the *RADIO LINK ADDITION REQUEST* message the DRNS shall apply cell specific transmit diversity configuration and if the *Diversity Mode* IE is not set to “None” the DRNS shall activate/deactivate the Transmit Diversity for the secondary serving HS-DSCH Radio Link in accordance with the *Transmit Diversity Indicator* IE in the *HS-DSCH FDD Secondary Serving Information* IE.]
- [FDD – If the *Serving Cell Change CFN* IE is included in the *RADIO LINK ADDITION REQUEST* message, then the DRNS shall activate the resources that are allocated for the new secondary serving HS-DSCH Radio Link at the next coming CFN with a value equal to the value requested by the SRNC, or earlier. In this case, in the new configuration the DRNS shall, if applicable, de-allocate the HS-PDSCH resources of the old secondary serving HS-PDSCH Radio Link. The DRNS shall deactivate those resources at the next coming CFN with a value equal to the value requested by the SRNC.]
- [FDD – If the *Serving Cell Change CFN* IE is not included then the DRNS shall activate immediately the resources that are allocated for the new secondary serving HS-PDSCH Radio Link, and shall keep active the resources that are allocated for the previous secondary serving HS-PDSCH Radio Link.]
- [FDD – If the requested secondary serving HS-DSCH Radio Link Change was successful or unsuccessful, the DRNS shall indicate this in the *HS-DSCH Secondary Serving Cell Change Information Response* IE in the *Additional HS Cell Change Information Response* IE in the *RADIO LINK ADDITION RESPONSE* message.]

[FDD – Additional Serving E-DCH Radio Link Change:]

[FDD – If the *RADIO LINK ADDITION REQUEST* message includes the *Additional E-DCH Cell Information Addition* IE in the *Additional E-DCH Cell Information RL Add Req* IE and the *HS-PDSCH RL ID* IE in the *Additional HS Cell Information RL Addition* IE, the *HS-PDSCH RL ID* IE indicates the new Additional Serving E-DCH Radio Link:]

- [FDD – In the new configuration the DRNS shall allocate the E-DCH resources for the new additional serving E-DCH Radio Link on the secondary UL frequency. Non cell specific E-DCH parameters shall take the same values as for the corresponding cell of the Primary uplink frequency.]
- [FDD – If the old Additional Serving E-DCH RL is within this DRNS, the DRNS shall de-allocate the E-AGCH resources of the old Additional Serving E-DCH Radio Link at the activation of the new configuration.]
- [FDD – The DRNS shall allocate a primary E-RNTI identifier or a secondary E-RNTI identifier or both for the new Additional Serving E-DCH Radio Link and include these E-RNTI identifiers along with the channelisation code of the corresponding E-AGCH in the *E-DCH FDD DL Control Channel Information* IE in the *Additional E-DCH Serving Cell Change Information Response* IE in the *RADIO LINK ADDITION RESPONSE* message.]

- [FDD – The DRNS may include in the *E-DCH FDD DL Control Channel Information IE* in the *Additional E-DCH Serving Cell Change Information Response IE* in the RADIO LINK ADDITION RESPONSE message the *Serving Grant Value IE* and *Primary/Secondary Grant Selector IE* for the initial grant for the additional serving E-DCH RL and may include the *Default Serving Grant in DTX Cycle 2 IE*]
- [FDD – If the E-DCH HARQ process allocation for 2ms TTI for scheduled transmission shall be changed, the DRNS shall allocate resources according to the new/changed configuration and include the new/changed configuration in the *HARQ Process Allocation For 2ms Scheduled Transmission Grant IE* in the *Additional E-DCH FDD Information Response IE* in the RADIO LINK ADDITION RESPONSE message.]
- [FDD – The DRNS may include the *E-RGCH/E-HICH Channelisation Code IE* and/or the *E-HICH Signature Sequence IE* and/or the *E-RGCH Signature Sequence IE* or may alternatively include the *E-RGCH Release Indicator IE* in the *E-DCH FDD DL Control Channel Information IE* in the *Additional E-DCH Serving Cell Change Information Response IE* in the RADIO LINK ADDITION RESPONSE message for any of the other E-DCH Radio Links in the DRNS Communication Context that have not been included in the *E-DCH FDD DL Control Channel Information IE* in the *Additional E-DCH FDD Information Response IE*.]
- [FDD – If the *Serving Cell Change CFN IE* is included in the RADIO LINK ADDITION REQUEST message, then the DRNS shall activate the resources that are allocated for the new additional serving E-DCH Radio Link at the next coming CFN with a value equal to the value requested by the SRNC, or earlier. In this case, in the new configuration the DRNS shall, if applicable, de-allocate the E-AGCH resources of the old Additional Serving E-DCH Radio Link. The DRNS shall deactivate those resources at the next coming CFN with a value equal to the value requested by the SRNC.]
- [FDD- If the *Serving Cell Change CFN IE* is not included then the DRNS shall activate immediately the resources that are allocated for the new additional serving E-DCH Radio Link, and shall keep active the resources that are allocated for the previous additional serving E-DCH Radio Link.]
- [FDD – If the addition of the requested Additional Serving E-DCH Radio Link was successful but the Additional Serving E-DCH Radio Link change was unsuccessful, the DRNS shall indicate this in the *Additional E-DCH Serving Cell Change Information Response IE* in the RADIO LINK ADDITION RESPONSE message.]

[FDD – E-DCH:]

[FDD – If the RADIO LINK ADDITION REQUEST message contains the *E-DCH RL Indication IE*, set to “E-DCH”, in the *RL Information IE*, then for every such RL.]

- [FDD – The DRNS shall setup the E-DCH resources as configured in the UE context.]
- [FDD – If the RADIO LINK ADDITION REQUEST message includes the *Transport Layer Address IE* and *Binding ID IE* in the *RL specific E-DCH Information IE* for an E-DCH MAC-d flow, then if the *Transport Bearer Not Requested Indicator IE* is not included for this E-DCH MAC-d flow, the DRNC may use the transport layer address and the binding identifier received from the SRNC when establishing a transport bearer for the concerned E-DCH MAC-d flow.]
- [FDD – The DRNC shall include in the RADIO LINK ADDITION RESPONSE message the *Binding ID IE* and *Transport Layer Address IE* for establishment of a transport bearer for every E-DCH MAC-d flow being established for which the *Transport Bearer Not Requested Indicator IE* was not included.]
- [FDD – If the RADIO LINK ADDITION REQUEST message includes the *Transport Bearer Not Requested Indicator IE* set to “Transport Bearer Shall not be Established” for an E-DCH MAC-d flow, then the DRNC shall not establish a transport bearer for the concerned E-DCH MAC-d flow and shall include the *Transport Bearer Not Setup Indicator IE* for the corresponding E-DCH MAC-d flow in the RADIO LINK ADDITION RESPONSE message.]
- [FDD – If the RADIO LINK ADDITION REQUEST message includes the *Transport Bearer Not Requested Indicator IE* set to “Transport Bearer may not be Established” for an E-DCH MAC-d flow and:]
 - [FDD – if the DRNC establishes a transport bearer for the concerned E-DCH MAC-d flow, the DRNC shall include in the RADIO LINK ADDITION RESPONSE message the *Binding ID IE* and *Transport Layer Address IE* for establishment of a transport bearer for the E-DCH MAC-d flow being established.]
 - [FDD – if the DRNC does not establish a transport bearer for the concerned E-DCH MAC-d flow, the DRNC shall include the *Transport Bearer Not Setup Indicator IE* for the corresponding E-DCH MAC-d flow in the RADIO LINK ADDITION RESPONSE message.]

- [FDD – The DRNC may include the *E-AGCH And E-RGCH/E-HICH FDD Scrambling Code* IE and shall include the *E-RGCH/E-HICH Channelisation Code* IE and the corresponding *E-HICH Signature Sequence* IE and the DRNC may include the corresponding *E-RGCH Signature Sequence* IE in the *E-DCH FDD DL Control Channel Information* IE in the RADIO LINK ADDITION RESPONSE message, for every RL indicated by the *E-DCH RL Indication* IE, set to “E-DCH”, in the *RL Information* IE.]
- [FDD – If the RADIO LINK ADDITION REQUEST message includes the *E-RGCH Power Offset* IE in the *RL Specific E-DCH Information* IE, then the DRNS may use this value to determine the E-RGCH power for the RL. The E-RGCH Power Offset should be applied for any E-RGCH transmission to this UE.]
- [FDD – If the RADIO LINK ADDITION REQUEST message includes the *E-HICH Power Offset* IE in the *RL Specific E-DCH Information* IE, then the DRNS may use this value to determine the E-HICH power for the RL. The E-HICH Power Offset should be applied for any E-HICH transmission to this UE.]
- [FDD – If the DRNS has no valid data for the *E-RGCH/E-HICH Channelisation Code* IE in the *E-DCH FDD DL Control Channel Information* IE in the RADIO LINK ADDITION RESPONSE message, then it shall insert the *E-RGCH and E-HICH Channelisation Code Validity Indicator* IE in the *E-DCH FDD DL Control Channel Information* IE, to indicate that the *E-RGCH/E-HICH Channelisation Code* IE contains invalid data.]

[FDD – Serving E-DCH Radio Link Change:]

[FDD – If the RADIO LINK ADDITION REQUEST message contains the *Serving E-DCH RL* IE, this indicates the new Serving E-DCH Radio Link:]

- [FDD – If the new Serving E-DCH RL is in this DRNS:]
 - [FDD – The DRNS shall allocate a primary E-RNTI identifier or a secondary E-RNTI identifier or both and include these E-RNTI identifiers and the Channelisation Code of the corresponding E-AGCH in the *E-DCH FDD DL Control Channel Information* IE in the *E-DCH Serving Cell Change Information Response* IE for the indicated RL in the RADIO LINK ADDITION RESPONSE message.]
 - [FDD – The DRNS may include the *Serving Grant Value* IE and *Primary/Secondary Grant Selector* IE in the *E-DCH Serving Cell Change Information Response* IE in the RADIO LINK ADDITION RESPONSE message for the initial grant for the new serving E-DCH RL.]
 - [FDD – If the E-DCH HARQ process allocation for 2ms TTI for scheduled and/or non-scheduled transmission shall be changed, the DRNS shall allocate resources according to the new/changed configuration and include the new/changed configuration in the *E-DCH FDD Information Response* IE in the RADIO LINK ADDITION RESPONSE message.]
 - [FDD – If a serving cell change is performed the RADIO LINK ADDITION RESPONSE message may contain invalid data (see 9.2.2.4C).]
 - [FDD – The DRNS may include the *Default Serving Grant in DTX Cycle 2* IE in the RADIO LINK ADDITION RESPONSE message for the new serving E-DCH RL.]
- [FDD – The DRNS may include the *E-RGCH/E-HICH Channelisation Code* IE and/or the *E-HICH Signature Sequence* IE and/or the *E-RGCH Signature Sequence* IE or may alternatively include the *E-RGCH Release Indicator* IE in the *E-DCH FDD DL Control Channel Information* IE in the *E-DCH Serving Cell Change Information Response* IE in the RADIO LINK ADDITION RESPONSE message for any of the other E-DCH Radio Link in the DRNS Communication Context that have not been included in the *E-DCH FDD DL Control Channel Information* IE in *RL Information Response* IE.]
- [FDD – If the *Serving Cell Change CFN* IE is included in the RADIO LINK ADDITION REQUEST message, then the DRNS shall activate the resources that are allocated for the new serving E-DCH Radio Link at the next coming CFN with a value equal to the value requested by the SRNC, or earlier. In this case, in the new configuration the DRNS shall, if applicable, de-allocate the E-AGCH resources of the old Serving E-DCH Radio Link. The DRNS shall deactivate those resources at the next coming CFN with a value equal to the value requested by the SRNC.]
- [FDD- If the *Serving Cell Change CFN* IE is not included then the DRNS shall activate immediately the resources that are allocated for the new serving E-DCH Radio Link, and shall keep active the resources that are allocated for the previous serving E-DCH Radio Link.]

- [FDD – If the addition of the requested Serving E-DCH Radio Link was successful but the Serving E-DCH Radio Link change was unsuccessful, the DRNS shall indicate this in the *E-DCH Serving Cell Change Information Response* IE in the RADIO LINK ADDITION RESPONSE message.]

[FDD – E-DPCH Handling:]

[FDD – If the RADIO LINK ADDITION REQUEST message includes an *E-DPCH Information* IE it defines the new E-DPCH configuration in the DRNS to be used on the new E-DCH Radio Link and the DRNS shall use the new parameters for the related resource allocation operations.]

[FDD – If the *E-TFCS Information* IE in the *E-DPCH Information* IE contains the *E-TFCSI Boost Information* IE, the DRNS shall use the information according to TS 25.214 [10]. If the *E-TFCSI Boost Information* IE is not present, the DRNS shall use the value “127” in the algorithm defined in TS 25.214 [10].]

[FDD – If the *E-DPCH Information* IE includes the *E-TFCS Information* IE, the DRNS shall use the *E-TFCS Information* IE for the E-DCH when reserving resources for the uplink of the new configuration. The DRNS shall apply the new TFCS in the uplink of the new configuration. If the *E-TFCS Information* IE contains the *E-DCH Minimum Set E-TFCSI Validity Indicator* IE the DRNS shall ignore the value in *E-DCH Minimum Set E-TFCSI* IE. If the *E-DCH Minimum Set E-TFCSI validity indicator* IE is absent DRNS shall use the value for the related resource allocation operation.]

[FDD – If the *E-TFCS Information* IE in the *E-DPCH Information* IE contains the *E-DPDCH Power Interpolation* IE, the DRNS shall use the value to determine the applicable E-DPDCH power formula defined in TS 25.214 [10]. If the *E-DPDCH Power Interpolation* IE is not present, the DRNS shall use the E-DPDCH power extrapolation formula defined in TS 25.214 [10].]

[FDD – If the RADIO LINK ADDITION REQUEST message includes an *E-DPCH Information* IE, which contains the *Minimum Reduced E-DPDCH Gain Factor* IE, then the DRNS shall use the value to determine the applicable minimum gain factor ($\beta_{ed,k, reduced, min}$) defined in TS 25.214 [10]. For the case the *Minimum Reduced E-DPDCH Gain Factor* IE is not available for the UE Context, the DRNS may use the default value defined in TS 25.331 [16].]

[FDD – E-DCH Setup on a new Radio Link:]

[FDD – If the *E-DCH FDD Information* IE is present in the RADIO LINK ADDITION REQUEST message then:]

- [FDD – the *E-DCH FDD Information* IE defines the new E-DCH FDD configuration in the DRNS to be used on the new E-DCH Radio Link.]
- [FDD – If the RADIO LINK ADDITION REQUEST message includes the *MAC-es Guaranteed Bit Rate* IE in the *E-DCH Logical Channel Information* IE in the *E-DCH FDD Information* IE, then the DRNS shall use this information to optimise MAC-e scheduling decisions.]
- [FDD – If the RADIO LINK ADDITION REQUEST message includes *UE Aggregate Maximum Bit Rate Enforcement Indicator* IE in the *E-DCH Logical Channel Information* IE in the *E-DCH MAC-d Flow Specific Information* IE in the *E-DCH FDD Information* IE, then the DRNS shall, if supported, consider the data of the related E-DCH Logical Channel for UE Aggregate Maximum Bit Rate Enforcement.]
- [FDD – If the RADIO LINK ADDITION REQUEST message includes the *Maximum MAC-d PDU Size Extended* IE for a E-DCH Logical Channel in the *E-DCH MAC-d Flows Information* IE in the *E-DCH FDD Information* IE, then the DRNS shall ignore the *MAC-d PDU Size* IE in the *MAC-d PDU Size List* IE and use *Maximum MAC-d PDU Size Extended* IE to optimise capacity allocation for the related E-DCH Logical Channel and use the indicated format in user plane frame structure for E-DCH channels TS 25.425 [32] and MAC TS 25.321 [41].]
- [FDD – If the RADIO LINK ADDITION REQUEST message includes the *E-DCH MAC-d Flow Multiplexing List* IE for an E-DCH MAC-d flow the DRNS shall use this information for the related resource allocation operation.]
- [FDD – If the RADIO LINK ADDITION REQUEST message includes the *HARQ Process Allocation For 2ms Scheduled Transmission Grant* IE, the DRNS shall use this information for the related resource allocation operation.]
- [FDD – If in the RADIO LINK ADDITION REQUEST message the E-DCH Grant Type is indicated as being “E-DCH Non-Scheduled Transmission Grant” for an E-DCH MAC-d flow the DRNS shall assume non-scheduled grants being configured for that E-DCH MAC-d flow and shall use the information within the HARQ

Process Allocation For 2ms Non-Scheduled Transmission Grant IE, if included, for the related resource allocation operation.]

- [FDD – If in the RADIO LINK ADDITION REQUEST message the E-DCH Grant Type is indicated as being “E-DCH Scheduled Transmission Grant” for an E-DCH MAC-d flow the DRNS shall assume scheduled grants being configured for that E-DCH MAC-d flow.]
- [FDD – The DRNS may use the *Traffic Class* IE for a specific E-DCH MAC-d flow to determine the transport bearer characteristics to apply between DRNC and Node B. If *TrCH Source Statistics Descriptor* IE is present with the value “RRC” in the *E-DCH MAC-d Flows Information* IE, then the DRNC should ignore the *Traffic Class* IE.]
- [FDD – If the *TNL QoS* IE is included for an E-DCH MAC-d flow and if ALCAP is not used, the *TNL QoS* IE may be used by the DRNS to determine the transport bearer characteristics to apply in the uplink for the related MAC-d flow.]
- [FDD – If the RADIO LINK ADDITION REQUEST message includes the *Bundling Mode Indicator* IE for a E-DCH MAC-d flow in the *E-DCH MAC-d Flow Specific Information* IE in the *E-DCH FDD Information* IE and the *Bundling Mode Indicator* IE is set to “Bundling” and the *E-TTI* IE is set to “2ms”, then the DRNS shall use the bundling mode for the E-DCH UL data frames for the related MAC-d flow, otherwise the DRNS shall use the non-bundling mode for the E-DCH UL data frames for the related MAC-d flow.]
- [FDD – If the RADIO LINK ADDITION REQUEST message includes the *E-DCH Maximum Bitrate* IE for an E-DCH, the DRNS shall use this information for the related resource allocation operation, and when applicable, for E-DCH scheduling.]
- [FDD – If the RADIO LINK ADDITION REQUEST message includes the *E-DCH Processing Overload Level* IE, then if the DRNS could not decode the E-DPCCH/E-DPDCH for the last consecutive number of TTIs, indicated in the *E-DCH Processing Overload Level* IE, because of processing issue, the DRNS shall notify the SRNC by initiating the Radio Link Failure procedure.]
- [FDD – If the RADIO LINK ADDITION REQUEST message includes the *E-DCH Reference Power Offset* IE, then the DRNS may use this value as a default HARQ power offset if it is not able to decode the MAC-e PDU and to determine the value of the actual HARQ power offset.]
- [FDD – If the RADIO LINK ADDITION REQUEST message includes the *E-AGCH Power Offset* IE in the *RL Specific E-DCH Information* IE, then the DRNS may use this value to determine the E-AGCH power. The E-AGCH Power Offset should be applied for any E-AGCH transmission to this UE.]
- [FDD – If the RADIO LINK ADDITION REQUEST message includes the *E-RGCH Power Offset* IE in the *RL Specific E-DCH Information* IE, then the DRNS may use this value to determine the E-RGCH power for the RL. The E-RGCH Power Offset should be applied for any E-RGCH transmission to this UE.]
- [FDD – If the RADIO LINK ADDITION REQUEST message includes the *E-HICH Power Offset* IE in the *RL Specific E-DCH Information* IE, then the DRNS may use this value to determine the E-HICH power for the RL. The E-HICH Power Offset should be applied for any E-HICH transmission to this UE.]
- [FDD – If the RADIO LINK ADDITION REQUEST message includes the *E-DCH Power Offset for Scheduling Info* IE, then the DRNS shall use this value as a power offset for the transmission of scheduling information without any MAC-d PDUs.]
- [FDD – If the RADIO LINK ADDITION REQUEST message includes the *SixteenQAM UL Operation Indicator* IE, the DRNS shall activate/deactivate SixteenQAM UL Operation for the RL in accordance with the *SixteenQAM UL Operation Indicator* IE.]
 - [FDD – If SixteenQAM UL Operation is activated, then the DRNS shall base the handling of the Relative Grant signalling on Scheduling Grant Table 2 according to TS 25.321 [41]. If SixteenQAM UL Operation is deactivated, then the DRNS shall base the handling of the Relative Grant signalling on Scheduling Grant Table 1 according to TS 25.321 [41].]

[FDD – Additional E-DCH Setup:]

[FDD – If the *Additional E-DCH Cell Information RL Add Req* IE is present in the RADIO LINK ADDITION REQUEST message and the choice of *Setup Or Addition Of E-DCH On Secondary UL Frequency* is “Setup”, then the *Additional E-DCH Cell Information Setup* IE defines the new configuration and then:]

- [FDD – If the *C-ID* IE is included in the *Additional E-DCH RL Specific Information To Setup* IE in the *Additional E-DCH FDD Setup Information* IE the *C-ID* IE indicates the cell in which the additional E-DCH shall be setup]
- [FDD – The DRNS shall setup the Additional E-DCH on the secondary uplink frequency and setup the requested Additional E-DCH resources on the Radio Links and in the cells indicated by the *E-DCH Additional RL ID* IE and the *C-ID* IE in the *Additional E-DCH RL Specific Information To Setup* IE in the *Additional E-DCH FDD Setup Information* IE.]
- [FDD – If the *C-ID* IE is not included in the *Additional E-DCH RL Specific Information To Setup* IE in the *Additional E-DCH FDD Setup Information* IE the *E-DCH Additional RL ID* IE indicates the existing RL on which the Additional E-DCH shall be setup.]
- [FDD – The DRNS shall setup the Additional E-DCH on the Radio Links indicated by the *E-DCH Additional RL ID* IE in the *Additional E-DCH RL Specific Information To Setup* IE in the *Additional E-DCH FDD Setup Information* IE]
- [FDD – The DRNS shall use for the non cell specific Radio Link related parameters and non cell specific E-DPCH, UL DPCH, E-DCH and F-DPCH parameters the same values as for the corresponding cell of the Primary uplink frequency.]
- [FDD – If the *UL SIR Target* IE in the *UL DPCH Information* IE in the *Additional E-DCH FDD Setup Information* IE in the *Additional E-DCH Cell Information Setup* IE and/or the *DL Power Balancing Information* IE and/or the *Minimum Reduced E-DPCH Gain Factor* IE in the *Multicell E-DCH Information* IE in the *Additional E-DCH FDD Setup Information* IE are present, the DRNS shall use the information in the same way as for the information used on Primary uplink frequency.]
- [FDD – If the *Secondary UL Frequency Activation State* IE is present in the *Multicell E-DCH Information* IE in the *Additional E-DCH FDD Setup Information* IE, the DRNS shall use the information as initial activation state of the Radio Links on the secondary uplink frequency.]
- [FDD – If the *Initial DL Tx Power* IE, the *Primary CPICH Ec/No* IE, the *E-AGCH Power Offset* IE, the *E-RGCH Power Offset* IE and/or the *E-HICH Power Offset* IE, is included in the *Additional E-DCH RL Specific Information To Setup* IE in the *Additional E-DCH FDD Setup Information* IE in the *Additional E-DCH Cell Information Setup* IE, the DRNS shall use the information in the same way as for the information used on Primary uplink frequency.]
- [FDD – If the *Enhanced Primary CPICH Ec/No* IE is included in the *Multicell E-DCH RL Specific Information* IE in the *Additional E-DCH Secondary RL Specific Information To Setup* IE in the *Additional E-DCH FDD Setup Information* IE in the *Additional E-DCH Cell Information Setup* IE, the DRNS shall use the information in the same way as for the information used on Primary uplink frequency.]
- If the *F-DPCH Slot Format Support Request* IE in the *F-DPCH Information* IE in the *Additional E-DCH FDD Setup Information* IE in the *Additional E-DCH Cell Information Setup* IE is included, the DRNS shall configure the concerned UE Context for F-DPCH Slot Format operation according to TS 25.211 [8] and include the *F-DPCH Slot Format* IE in the *Additional E-DCH FDD Information Response* IE in the *Additional E-DCH Cell Information Response RL Add* IE in the RADIO LINK ADDITION RESPONSE message. If the *Multicell E-DCH Information* IE in the *Additional E-DCH FDD Setup Information* IE includes the *F-DPCH Slot Format* IE, the DRNS may use the *F-DPCH Slot Format* IE to determine the F-DPCH slot format.]
- [FDD – If the *HARQ Process Allocation For 2ms Scheduled Transmission Grant* IE, the *E-DCH Maximum Bitrate* IE, the *E-DCH Minimum Set E-TFCI* IE and/or the *E-DCH Processing Overload Level* IE are present in the *Additional E-DCH FDD Information* IE in the *Additional E-DCH FDD Setup Information* IE in the *Additional E-DCH Cell Information Setup* IE, the DRNS shall use the information in the same way as for the information used on Primary uplink frequency.]
- [FDD – If activation of power balancing for the Additional E-DCH RL by the RADIO LINK ADDITION REQUEST message is supported by the DRNS, the DRNS shall include the *DL Power Balancing Activation Indicator* IE in the *Additional E-DCH FDD Information Response* IE in the *Additional E-DCH Cell Information Response RL Add* IE in the RADIO LINK ADDITION RESPONSE message.]
- [FDD – For each Additional E-DCH RL not having a common generation of the TPC commands in the DL with another Additional E-DCH RL, the DRNS shall set the *RL Set ID* IE included in the *Additional E-DCH FDD Information Response* IE in the RADIO LINK ADDITION RESPONSE message to a value that uniquely

identifies the RL as a RL Set within the UE Context. The generation of E-HICH related information for Additional E-DCH RLs in different RL Sets shall not be common.]

- [FDD – For all Additional E-DCH RLs having a common generation of the TPC commands in the DL with another Additional E-DCH RL, the DRNS shall assign to each Additional E-DCH RL the same value for the *RL Set ID* IE included in the *Additional E-DCH FDD Information Response* IE in the RADIO LINK ADDITION RESPONSE message. This value shall uniquely identify these Additional E-DCH RLs as members of the same RL Set within the UE Context. The generation of E-HICH information for all Additional E-DCH RLs in a RL Set shall be common.]
- [FDD – For each Additional E-DCH RL which has or can have a common generation of E-RGCH information with another Additional E-DCH RL (current or future) when the DRNS would contain the Additional E-DCH serving RL, the DRNS shall set a same value to the *E-DCH RL Set ID* IE for the Additional E-DCH RL in the *Additional E-DCH FDD Information Response* IE in the *Additional E-DCH Cell Information Response RL Add* IE in the RADIO LINK ADDITION RESPONSE message.]
- [FDD – For every additional E-DCH RL indicated in the *Additional E-DCH RL Specific Information To Setup* IE in the *Additional E-DCH FDD Setup Information* IE the DRNS may include the *E-AGCH And E-RGCH/E-HICH FDD Scrambling Code* IE and shall include the *E-RGCH/E-HICH Channelisation Code* IE and the corresponding *E-HICH Signature Sequence* IE and the DRNS may include the corresponding *E-RGCH Signature Sequence* IE in the *E-DCH FDD DL Control Channel Information* IE in the *Additional E-DCH FDD Information Response* IE in the *Additional E-DCH Cell Information Response RL Add* IE in the RADIO LINK ADDITION RESPONSE message and if DRNS has no valid data for the *E-RGCH/E-HICH Channelisation Code* IE, then it shall insert the *E-RGCH and E-HICH Channelisation Code Validity Indicator* IE to indicate that the *E-RGCH/E-HICH Channelisation Code* IE contains invalid data.]
- [FDD – If the Additional Serving E-DCH Radio Link is configured in the DRNS, then:]
 - [FDD – The DRNS shall allocate a primary E-RNTI identifier or a secondary E-RNTI identifier or both for the corresponding RL and include these E-RNTI identifiers and the channelisation code of the corresponding E-AGCH in the *E-DCH FDD DL Control Channel Information* IE in the *Additional E-DCH FDD Information Response* IE in the *Additional E-DCH Cell Information Response RL Add* IE in the RADIO LINK ADDITION RESPONSE message.]
 - [FDD – The DRNS may include in the *E-DCH FDD DL Control Channel Information* IE in the *Additional E-DCH FDD Information Response* IE in the *Additional E-DCH Cell Information Response RL Add* IE in the RADIO LINK ADDITION RESPONSE message the the *Serving Grant Value* IE and *Primary/Secondary Grant Selector* IE for the initial grant for the Additional serving E-DCH RL and may include the *Default Serving Grant in DTX Cycle 2* IE.]
 - [FDD – If the E-DCH HARQ process allocation for 2ms TTI for scheduled transmission shall be changed, the DRNS shall allocate resources according to the new/changed configuration and include the new/changed configuration in the *HARQ Process Allocation For 2ms Scheduled Transmission Grant E-DCH FDD Information Response* IE in the *Additional E-DCH FDD Information Response* IE in the *Additional E-DCH Cell Information Response* IE in the RADIO LINK ADDITION RESPONSE message.]
 - [FDD – If the *Serving Cell Change CFN* IE is included in the RADIO LINK ADDITION REQUEST message, then the DRNS shall activate the resources that are allocated for the new additional serving E-DCH Radio Link at the next coming CFN with a value equal to the value requested by the SRNC. If the *Serving Cell Change CFN* IE is not included then the DRNS shall activate immediately the resources that are allocated for the new additional serving E-DCH Radio Link]
- [FDD – If Primary CPICH is not to be used as a Phase Reference for this Radio Link on the secondary UL frequency, the DRNS shall include the *Primary CPICH Usage For Channel Estimation* IE set to the value “Primary CPICH shall not be used” in the *Additional E-DCH FDD Information Response* IE in the *Additional E-DCH Cell Information Response RL Add* IE RADIO LINK ADDITION RESPONSE message.]
- [FDD – If Secondary CPICH may be used as a Phase Reference for this Radio Link on the secondary UL frequency, the DRNS shall include the *Secondary CPICH Information* IE in the *Additional E-DCH FDD Information Response* IE in the *Additional E-DCH Cell Information Response RL Add* IE in the RADIO LINK ADDITION RESPONSE message. If the DRNS doesn’t include the *Secondary CPICH Information* IE, it shall not include the *Primary CPICH Usage For Channel Estimation* IE set to the value “Primary CPICH shall not be used”.]

[FDD – Additional E-DCH RL Addition:]

[FDD – If the *Additional E-DCH Cell Information RL Add Req* IE is present in the RADIO LINK ADDITION REQUEST message and the choice of *Setup Or Addition Of E-DCH On Secondary UL Frequency* is “Addition”, then the *Additional E-DCH Cell Information Addition* IE defines the new configuration and then:]

- [FDD – The DRNS shall setup the requested E-DCH resources as requested, or as configured in the UE context , on the Radio Links indicated by the *E-DCH Additional RL ID* IE in the *Additional E-DCH RL Specific Information To Add* IE. Non cell specific Radio Link related parameters and non cell specific E-DPCH, UL DPCH, E-DCH and F-DPCH parameters shall take the same values as for the corresponding cell of the Primary uplink frequency.]
- [FDD – if the *Multicell E-DCH Information* IE is included and contains the *Minimum Reduced E-DPDCH Gain Factor* IE, the DRNS shall use the information in the same way as for the information used on the Primary uplink frequency.]
- [FDD – if the *Additional E-DCH FDD Information* IE is included and contains the *HARQ Process Allocation For 2ms Scheduled Transmission Grant* IE, the *E-DCH Maximum Bitrate* IE, the *E-DCH Minimum Set E-TFCI* IE and/or the *E-DCH Processing Overload Level* IE, the DRNS shall use the information in the same way as for the information used on the Primary uplink frequency.]
- [FDD – If the *E-AGCH Power Offset* IE, the *E-RGCH Power Offset* IE and/or the *E-HICH Power Offset* IE is included in the *Additional E-DCH RL Specific Information To Add* IE, the DRNS shall use the information in the same way as for the information used on Primary uplink frequency.]
- [FDD – If the power balancing is active with the Power Balancing Adjustment Type of the UE Context set to “Individual” in the existing Additional E-DCH RL(s) and the RADIO LINK ADDITION REQUEST message includes the *DL Reference Power* IE in the *Multicell E-DCH RL Specific Information* IE in the *Additional E-DCH RL Specific Information To Add* IE, the DRNS shall activate the power balancing and use the *DL Reference Power* IE for the power balancing procedure in the new Additional RL(s), if activation of power balancing by the RADIO LINK ADDITION REQUEST message is supported, according to subclause 8.3.15. In this case, the DRNS shall include the *DL Power Balancing Activation Indicator* IE in the *Additional E-DCH FDD Information Response* IE in the *Additional E-DCH Cell Information Response RL Add* IE in the RADIO LINK ADDITION RESPONSE message. If the DRNS starts the DL transmission and the activation of the power balancing at the same CFN, the initial power of the power balancing, i.e. P_{init} shall be set to the power level which is calculated based on the following IEs in the *Additional E-DCH RL Specific Information To Add* IE (if received): *Primary CPICH Ec/No* IE or the *Enhanced Primary CPICH Ec/No* IE in the *Multicell E-DCH RL Specific Information* IE or to the power level which is calculated based on the power relative to the Primary CPICH power used by the existing Additional RLs.]
- [FDD – For each Additional E-DCH RL not having a common generation of the TPC commands in the DL with another Additional E-DCH RL, the DRNS shall set the *RL Set ID* IE included in the *Additional E-DCH FDD Information Response* IE in the RADIO LINK ADDITION RESPONSE message to a value that uniquely identifies the RL as a RL Set within the UE Context. The generation of E-HICH related information for Additional E-DCH RLs in different RL Sets shall not be common.]
- [FDD – For all Additional E-DCH RLs having a common generation of the TPC commands in the DL with another Additional E-DCH RL, the DRNS shall assign to each Additional E-DCH RL the same value for the *RL Set ID* IE included in the *Additional E-DCH FDD Information Response* IE in the RADIO LINK ADDITION RESPONSE message. This value shall uniquely identify these Additional E-DCH RLs as members of the same RL Set within the UE Context. The generation of E-HICH information for all Additional E-DCH RLs in a RL Set shall be common.]
- [FDD – For each Additional E-DCH RL which has or can have a common generation of E-RGCH information with another Additional E-DCH RL (current or future) when the DRNS would contain the Additional E-DCH serving RL, the DRNS shall set the same value for the *E-DCH RL Set ID* IE for the Additional E-DCH RL in the *Additional E-DCH FDD Information Response* IE in the *Additional E-DCH Cell Information Response RL Add* IE in the RADIO LINK ADDITION RESPONSE message.]

[FDD – For every additional E-DCH RL indicated in the *Additional E-DCH RL Specific Information To Add* IE the DRNS may include the *E-AGCH And E-RGCH/E-HICH FDD Scrambling Code* IE and shall include the *E-RGCH/E-HICH Channelisation Code* IE and the corresponding *E-HICH Signature Sequence* IE and the DRNS may include the corresponding *E-RGCH Signature Sequence* IE in the *E-DCH FDD DL Control Channel Information* IE in the *Additional E-DCH FDD Information Response* IE in the *Additional E-DCH Cell*

Information Response RL Add IE in the RADIO LINK ADDITION RESPONSE message and if DRNS has no valid data for the *E-RGCH/E-HICH Channelisation Code IE*, then it shall insert the *E-RGCH and E-HICH Channelisation Code Validity Indicator IE* to indicate that the *E-RGCH/E-HICH Channelisation Code IE* contains invalid data.]

- [FDD – If in the *Additional E-DCH RL Specific Information To Add IE* the *Primary CPICH Ec/No IE* or the *Primary CPICH Ec/No IE* and the *Enhanced Primary CPICH Ec/No IE* in the *Multicell E-DCH RL Specific Information IE* measured by the UE are included for an RL in the RADIO LINK ADDITION REQUEST message, the DRNS shall use this in the calculation of the Initial DL TX Power for this additional RL. If the *Primary CPICH Ec/No IE* is not present, the DRNS shall set the Initial DL TX Power based on the power relative to the Primary CPICH power used by the existing RLs.]

[TDD – HS-DSCH Setup:]

[TDD – If the *HS-DSCH Information IE* is present in the RADIO LINK ADDITION REQUEST message, then:]

- [TDD – The DRNS shall setup the requested HS-PDSCH resources on the Serving HS-DSCH Radio Link indicated by the *HS-PDSCH RL ID IE*.]
- [TDD – The DRNC shall include the *HARQ Memory Partitioning IE* in the *HS-DSCH TDD Information Response IE* in the RADIO LINK ADDITION RESPONSE message.]
- [TDD – If the RADIO LINK ADDITION REQUEST message includes the *HS-DSCH MAC-d PDU Size Format IE* in the *HS-DSCH Information IE*, then the DRNS shall use the indicated format in user plane frame structure for HS-DSCH channels TS 25.425 [32] and MAC-hs TS 25.321 [41].]
- [TDD – The DRNS may use the *Traffic Class IE* for a specific HS-DSCH MAC-d flow to determine the transport bearer characteristics to apply between DRNC and Node B. If *TrCH Source Statistics Descriptor IE* is present with the value “RRC” in the *HS-DSCH MAC-d Flows Information IE*, then the DRNC should ignore the *Traffic Class IE*.]
- [TDD – The DRNC shall allocate an HS-DSCH-RNTI to the UE Context and include the *HS-DSCH-RNTI IE* in the RADIO LINK ADDITION RESPONSE message.]
- [TDD – The DRNC shall include in the RADIO LINK ADDITION RESPONSE message the *Binding ID IE* and *Transport Layer Address IE* for establishment of transport bearer for every HS-DSCH MAC-d flow being established.]
- [TDD – If the RADIO LINK ADDITION REQUEST message includes the *Transport Layer Address IE* and *Binding ID IE* in the *HS-DSCH Information IE* for an HS-DSCH MAC-d flow, then the DRNC may use the transport layer address and the binding identifier received from the SRNC when establishing a transport bearer for the concerned HS-DSCH MAC-d flow. If the *TNL QoS IE* is included for a MAC-d flow and if ALCAP is not used, the *TNL QoS IE* may be used by the DRNS to determine the transport bearer characteristics to apply in the uplink between the DRNS and the SRNC for the related MAC-d flow.]
- [TDD – If the RADIO LINK ADDITION REQUEST message includes the *MAC-hs Guaranteed Bit Rate IE* for a Priority Queue in the *HS-DSCH MAC-d Flows Information IE* in the *HS-DSCH Information IE*, then the DRNS shall use this information to optimise MAC-hs scheduling decisions for the related HSDPA Priority Queue.]
- [TDD – If the RADIO LINK ADDITION REQUEST message includes the *Discard Timer IE* for a Priority Queue in the *HS-DSCH MAC-d Flows Information IE* in the *HS-DSCH Information IE*, then the DRNS shall use this information to discard out-of-date MAC-hs SDUs from the related HSDPA Priority Queue.]
- [TDD – If the RADIO LINK ADDITION REQUEST message includes the *Maximum MAC-d PDU Size Extended IE* for a Priority Queue in the *HS-DSCH MAC-d Flows Information IE* in the *HS-DSCH Information IE*, then the DRNC shall ignore the *SID IE* and *MAC-d PDU Size IE* in the *MAC-d PDU Size Index IE* and use *Maximum MAC-d PDU Size Extended IE* to optimise capacity allocation for the related HSDPA Priority Queue.]
- [TDD – If the RADIO LINK ADDITION REQUEST message includes *DL RLC PDU Size Format IE* for a Priority Queue in the *HS-DSCH MAC-d Flows Information IE* in the *HS-DSCH Information IE*, the *DL RLC PDU Size Format IE* may be used by the DRNS to determine the allocated capacity on user plane as described in TS 25.425 [32].]

- [TDD – The DRNC shall include the *HS-DSCH Initial Capacity Allocation IE* in the *HS-DSCH TDD Information Response IE* in the RADIO LINK ADDITION RESPONSE message for every HS-DSCH MAC-d flow being established, if the DRNS allows the SRNC to start transmission of MAC-d PDUs before the DRNS has allocated capacity on user plane as described in TS 25.425 [32]. If RADIO LINK ADDITION REQUEST message includes *HS-DSCH MAC-d PDU Size Format IE* in the *HS-DSCH Information IE* set to “Flexible MAC-d PDU Size”, then DRNC shall only set in the *HS-DSCH Initial Capacity Allocation IE* the values for the peer of *Scheduling Priority Indicator IE* and *Maximum MAC-d PDU Size Extended IE* to the values of the corresponding peer I in RADIO LINK ADDITION REQUEST in the *HS-DSCH MAC-d Flows Information IE* in the *HS-DSCH Information IE* for a Priority Queue including *Scheduling Priority Indicator IE* and *Maximum MAC-d PDU Size Extended IE*.]
- [TDD – The DRNS shall allocate HS-SCCH parameters corresponding to the HS-DSCH and the DRNC shall include the [3.84Mcps TDD – *HS-SCCH Specific Information Response IE*] [1.28Mcps TDD – *HS-SCCH Specific Information Response LCR IE*] in the *HS-DSCH TDD Information Response IE* in the RADIO LINK ADDITION RESPONSE message.]

[1.28 Mcps TDD – If the *MIMO Activation Indicator IE* is included in the *HS-DSCH TDD Information IE*, then, The DRNS shall activate the MIMO mode for the HS-DSCH Radio Link. The DRNS shall decide the SF mode for HS-PDSCH dual stream and include the *MIMO SF Mode for HS-PDSCH dual stream IE* in the *HS-DSCH TDD Information Response IE* in the RADIO LINK ADDITION RESPONSE message.]
- [1.28 Mcps TDD – If the *UE TS0 Capability LCR IE* is included in the *HS-DSCH TDD Information IE*, then the DRNC may include the *TS0 HS-PDSCH Indication LCR IE* in the RADIO LINK ADDITION RESPONSE message if HS-PDSCH resources could be allocated on TS0 for the UE.]

[TDD – Intra-Node B Serving HS-DSCH Radio Link Change:]

[TDD – If the RADIO LINK ADDITION REQUEST message includes the *HS-PDSCH RL ID IE*, this indicates the new Serving HS-DSCH Radio Link:]

- [TDD – The DRNC shall include the *HARQ Memory Partitioning IE* in the *HS-DSCH TDD Information Response IE* in the RADIO LINK ADDITION RESPONSE message.]
- [TDD – The DRNS shall allocate HS-SCCH parameters corresponding to the HS-DSCH and the DRNC shall include the [3.84Mcps TDD – *HS-SCCH Specific Information Response IE*] [1.28Mcps TDD – *HS-SCCH Specific Information Response LCR IE*] [7.68Mcps TDD – *HS-SCCH Specific Information Response 7.68Mcps IE*] in the *HS-DSCH TDD Information Response IE* in the RADIO LINK ADDITION RESPONSE message.]

[TDD – E-DCH:]

[3.84Mcps TDD, 1.28Mcps TDD and 7.68Mcps TDD – If the [3.84Mcps TDD – *E-DCH Information IE*][1.28Mcps TDD – *E-DCH Information 1.28Mcps IE*] [7.68Mcps TDD – *E-DCH Information 7.68Mcps IE*] is present in the RADIO LINK ADDITION REQUEST message:]

- [TDD – The DRNS shall setup the requested E-DCH resources on the Radio Link indicated by the *E-DCH Serving RL IE*.]
- [TDD – If the *TNL QoS IE* is included in the *E-DCH MAC-d Flows Information TDD IE* for an E-DCH MAC-d flow and if ALCAP is not used, the *TNL QoS IE* may be used by the DRNS to determine the transport bearer characteristics to apply in the uplink for the related MAC-d flow.]
- [TDD – If the RADIO LINK ADDITION REQUEST message includes the *Transport Layer Address IE* and *Binding ID IE* in the *E-DCH MAC-d Flows Information TDD IE* for an E-DCH MAC-d flow, then the DRNC may use the transport layer address and the binding identifier received from the SRNC when establishing a transport bearer for the concerned E-DCH MAC-d flow.]
- [TDD – If the RADIO LINK ADDITION REQUEST message includes the *E-DCH MAC-d Flow Multiplexing List IE* for an E-DCH MAC-d flow in the *E-DCH MAC-d Flows Information TDD IE*, the DRNS shall use this information for the related resource allocation operation.]
- [TDD – If in the RADIO LINK ADDITION REQUEST message the *E-DCH Grant Type IE* in the *E-DCH MAC-d Flows Information TDD IE* is set to “Non-scheduled” for an E-DCH MAC-d flow the DRNS shall assume non-scheduled grants are configured for that E-DCH MAC-d flow.]

- [TDD – If in the RADIO LINK ADDITION REQUEST message the *E-DCH Grant Type* IE in the *E-DCH MAC-d Flows Information TDD* IE is set to “Scheduled” the DRNS shall assume that it may issue scheduled grants for the concerned E-DCH MAC-d flow.]
- [TDD – If the RADIO LINK ADDITION REQUEST message includes the *MAC-es Guaranteed Bit Rate* IE in the *E-DCH Logical Channel Information* IE in the *E-DCH MAC-d Flows Information TDD* IE, then the DRNS shall use this information to optimise MAC-e scheduling decisions for the related queue.]
- [1.28Mcps TDD – If the RADIO LINK ADDITION REQUEST message includes the *MAC-es Maximum Bit Rate LCR* IE in the *E-DCH Logical Channel Information* IE in the *E-DCH MAC-d Flows Information TDD* IE, the DRNS shall use this information for the related resource allocation operation, and when applicable, for E-DCH scheduling.]
- [TDD – If the RADIO LINK ADDITION REQUEST message includes the *Maximum MAC-d PDU Size Extended* IE for a E-DCH Logical Channel in the *E-DCH MAC-d Flows Information TDD* IE in the *E-DCH Information* IE, then the DRNS shall ignore the *MAC-d PDU Size* IE in the *MAC-d PDU Size List* IE and use *Maximum MAC-d PDU Size Extended* IE to optimise capacity allocation for the related E-DCH Logical Channel and use the indicated format in user plane frame structure for E-DCH channels TS 25.425 [32] and MAC TS 25.321 [41].]
- [3.84Mcps TDD – If the RADIO LINK ADDITION REQUEST message includes the *E-DCH TDD Maximum Bitrate* IE in the *E-DCH TDD Information* IE for an E-DCH, the DRNS shall use this information for the related resource allocation operation, and when applicable, for E-DCH scheduling.]
- [1.28Mcps TDD – If the RADIO LINK ADDITION REQUEST message includes the *E-DCH Physical Layer Category LCR* IE or *Extended E-DCH Physical Layer Category LCR* IE in the *E-DCH TDD Information LCR* IE for an E-DCH, the DRNS shall use this information for the related resource allocation operation, and when applicable, for E-DCH scheduling.]
- [7.68Mcps TDD – If the RADIO LINK ADDITION REQUEST message includes the *E-DCH TDD Maximum Bitrate 7.68Mcps* IE in the *E-DCH TDD Information 7.68Mcps* IE for an E-DCH, the DRNS shall use this information for the related resource allocation operation, and when applicable, for E-DCH scheduling.]
- [3.84Mcps TDD – If the RADIO LINK ADDITION REQUEST message includes the *E-DCH Processing Overload Level* IE in the *E-DCH TDD Information* IE, then if the DRNS could not decode the E-PUCH for the last consecutive number of TTIs, indicated in the *E-DCH Processing Overload Level* IE, because of a processing issue, the DRNS shall notify the SRNC by initiating the Radio Link Failure procedure.]
- [7.68Mcps TDD – If the RADIO LINK ADDITION REQUEST message includes the *E-DCH Processing Overload Level* IE in the *E-DCH TDD Information 7.68Mcps* IE, then if the DRNS could not decode the E-PUCH for the last consecutive number of TTIs, indicated in the *E-DCH Processing Overload Level* IE, because of a processing issue, the DRNS shall notify the SRNC by initiating the Radio Link Failure procedure.]
- [1.28Mcps TDD – If the RADIO LINK ADDITION REQUEST message includes the *E-DCH Processing Overload Level* IE in the *E-DCH TDD Information LCR* IE, then if the DRNS could not decode the E-PUCH for the last consecutive number of TTIs, indicated in the *E-DCH Processing Overload Level* IE, because of a processing issue, the DRNS shall notify the SRNC by initiating the Radio Link Failure procedure.]
- [TDD – The DRNS may use the *Traffic Class* IE for a specific E-DCH MAC-d flow to determine the transport bearer characteristics to apply between DRNC and Node B.]
- [TDD – If the RADIO LINK ADDITION REQUEST message includes the [3.84Mcps TDD – *E-DCH TDD Information* IE][1.28Mcps TDD – *E-DCH TDD Information LCR* IE] in the *E-DCH MAC-d Flows Information TDD* IE, then the DRNS shall use this value as a power offset for the transmission of scheduling information without any MAC-d PDUs.]
- [1.28Mcps TDD – If the RADIO LINK ADDITION REQUEST message includes the *Maximum Number of Retransmission for Scheduling Info LCR* IE and the *E-DCH Retransmission timer for Scheduling Info LCR* IE in the *E-DCH TDD Information LCR* IE, then the DRNS shall use these parameters for the transmission of scheduling information without any MAC-d PDUs.]
- [3.84Mcps TDD – The DRNS shall determine any non-scheduled resource to be granted for the radio link, and return this in the *E-DCH Non-scheduled Grant Information TDD* IE in the *E-DCH Information Response* IE in the RADIO LINK ADDITION RESPONSE message.]

- [3.84Mcps TDD – The DRNS shall allocate an E-RNTI identifier and include the E-RNTI identifier and the E-AGCH(s) assigned in the *E-DCH Information Response* IE in the RADIO LINK ADDITION RESPONSE message.]
- [1.28Mcps TDD – The DRNS shall determine any non-scheduled resource to be granted for the radio link, and return this in the *E-DCH Non-scheduled Grant Information LCR TDD* IE in the *E-DCH Information Response 1.28Mcps* IE in the RADIO LINK ADDITION RESPONSE message.]
- [1.28Mcps TDD – The DRNS shall allocate an E-RNTI identifier and include the E-RNTI identifier, the E-AGCH(s) and E-HICH(s) assigned in the *E-DCH Information Response 1.28Mcps* IE in the RADIO LINK ADDITION RESPONSE message.]
- [7.684Mcps TDD – The DRNS shall determine any non-scheduled resource to be granted for the radio link, and return this in the *E-DCH Non-scheduled Grant Information 7.68Mcps TDD* IE in the *E-DCH Information Response 7.68Mcps* IE in the RADIO LINK ADDITION RESPONSE message.]
- [7.68Mcps TDD – The DRNS shall allocate an E-RNTI identifier and include the E-RNTI identifier and the E-AGCH(s) assigned in the *E-DCH Information Response 7.68Mcps* IE in the RADIO LINK ADDITION RESPONSE message.]

[3.84Mcps TDD – Intra-Node B Serving E-DCH Radio Link Change:]

[3.84Mcps TDD – If the RADIO LINK ADDITION REQUEST message includes the *E-DCH Serving RL* IE, this indicates the new Serving E-DCH Radio Link:]

- [3.84Mcps TDD – The DRNS shall allocate E-AGCH parameters corresponding to the E-DCH and include the *E-AGCH Specific Information Response* IE in the *E-DCH Information Response* IE in the RADIO LINK ADDITION RESPONSE message.]

[1.28Mcps TDD – Intra-Node B Serving E-DCH Radio Link Change:]

[1.28Mcps TDD – If the RADIO LINK ADDITION REQUEST message includes the *E-DCH Serving RL* IE, this indicates the new Serving E-DCH Radio Link:]

- [1.28Mcps TDD – The DRNS shall allocate E-AGCH parameters and E-HICH parameters corresponding to the E-DCH and include the *E-AGCH Specific Information Response* IE and the *E-HICH Specific Information Response* IE in the *E-DCH Information Response 1.28Mcps* IE in the RADIO LINK ADDITION RESPONSE message.]

[7.68Mcps TDD – Intra-Node B Serving E-DCH Radio Link Change:]

[7.68Mcps TDD – If the RADIO LINK ADDITION REQUEST message includes the *E-DCH Serving RL* IE, this indicates the new Serving E-DCH Radio Link:]

- [7.68Mcps TDD – The DRNS shall allocate E-AGCH parameters corresponding to the E-DCH and include the *E-AGCH Specific Information Response 7.68Mcps TDD* IE in the *E-DCH Information Response 7.68Mcps* IE in the RADIO LINK ADDITION RESPONSE message.]

[1.28 Mcps TDD – Continuous Packet Connectivity Handling:]

[1.28 Mcps TDD – If the RADIO LINK ADDITION REQUEST message includes the *Continuous Packet Connectivity DRX Information LCR* IE, then the DRNS shall take account into these parameters to decide the DRX operation related parameters and configure the concerned UE Context for DRX operation according to TS 25.213 [21] and include the parameter(s) in the *Continuous Packet Connectivity DRX Information Response LCR* IE in the RADIO LINK ADDITION RESPONSE message.]

[1.28 Mcps TDD - If the *Inactivity Threshold for UE DRX Cycle Ext* IE is included in the *Continuous Packet Connectivity DRX Information LCR* IE, then the DRNS may use this value to determine the Inactivity Threshold for UE DRX Cycle according to TS 25.224 [22].]

[1.28 Mcps TDD – If the RADIO LINK ADDITION REQUEST message includes the *HS-DSCH Semi-Persistent scheduling Information LCR* IE, then:]

- [1.28 Mcps TDD – The DRNS shall configure the Serving HS-DSCH Radio Link indicated by the *HS-PDSCH RL ID* IE for HS-DSCH Semi-Persistent scheduling operation according to TS 25.213 [21].]

- [1.28 Mcps TDD – The DRNS shall allocate the HS-SICH information needed for HS-DSCH Semi-Persistent scheduling operation and include the *HS-DSCH Semi-Persistent scheduling Information Response LCR* IE in the RADIO LINK ADDITION RESPONSE message.]
- [1.28 Mcps TDD – If the *HS-DSCH Semi-Persistent Resource Reservation Indicator* IE is included in the *HS-DSCH Semi-Persistent scheduling Information LCR* IE, then the DRNS shall include *Allcoated HS-PDSCH Semi-persistent resource* IE in the RADIO LINK ADDITION RESPONSE message.]
- [1.28 Mcps TDD – The DRNS shall include the *Buffer Size for HS-DSCH Semi-Persistent scheduling* IE in the RADIO LINK ADDITION RESPONSE message.]
- [1.28 Mcps TDD – The DRNS shall include the *Number of Processes for HS-DSCH Semi-Persistent scheduling* IE in the RADIO LINK ADDITION RESPONSE message.]
- [1.28 Mcps TDD – If the *HS-DSCH Semi-Persistent scheduling operation Indicator* IE is included in the *HS-DSCH Semi-Persistent scheduling Information LCR* IE, then the DRNS shall apply this information for HS-DSCH Semi-Persistent scheduling operation.]

[1.28 Mcps TDD – If the RADIO LINK ADDITION REQUEST message includes the *E-DCH Semi-Persistent scheduling Information LCR* IE, then:]

- [1.28 Mcps TDD – The DRNS shall configure the Serving E-DCH Radio Link indicated by the *E-DCH Serving RL* IE for E-DCH Semi-Persistent scheduling operation according to TS 25.213 [21].]
- [1.28 Mcps TDD – If the *E-DCH Semi-Persistent Resource Reservation Indicator* IE is included in the *E-DCH Semi-Persistent scheduling Information LCR* IE, then the DRNS shall include *Allcoated E-DCH Semi-persistent resource* IE in the RADIO LINK ADDITION RESPONSE message.]
- [1.28 Mcps TDD – If the *E-DCH Semi-Persistent scheduling Indicator* IE is included in the *E-DCH Semi-Persistent scheduling Information LCR* IE, then the DRNS shall apply this information for E-DCH Semi-Persistent scheduling operation.]

Response message:

If all requested RLs are successfully added, the DRNS shall respond with a RADIO LINK ADDITION RESPONSE message.

After sending the RADIO LINK ADDITION RESPONSE message the DRNS shall continuously attempt to obtain UL synchronisation on the Uu interface.

For each RL for which the *Delayed Activation* IE is not included in the RADIO LINK ADDITION REQUEST message the DRNS shall:

- [FDD – start transmission on the DL DPDCH(s) of the new RL as specified in ref. TS 25.427 [4].]
- [TDD – start transmission on the new RL immediately as specified in ref. TS 25.427 [4].]

For each RL for which the *Delayed Activation* IE is included in the RADIO LINK ADDITION REQUEST message, the DRNS shall:

- if the *Delayed Activation* IE indicates “Separate Indication”:
 - not start any DL transmission for the concerning RL on the Uu interface;
- if the *Delayed Activation* IE indicates “CFN”:
 - [FDD – start transmission on the DL DPDCH(s) of the new RL as specified in ref. TS 25.427 [4], however never before the CFN indicated in the *Activation CFN* IE.]
 - [TDD – start transmission on the new RL at the CFN indicated in the *Activation CFN* IE as specified in ref. TS 25.427 [4].]

[1.28 Mcps TDD – if the DRNS assigns one or more PLCCCH sequence numbers to the radio link, then the PLCCCH assignment(s) shall be sent to the SRNC in the RADIO LINK ADDITION RESPONSE message.]

8.3.2.3 Unsuccessful Operation

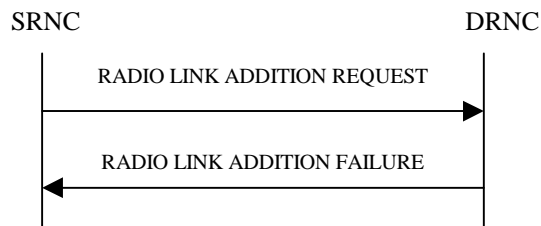

Figure 8: Radio Link Addition procedure: Unsuccessful Operation

If the establishment of at least one RL is unsuccessful, the DRNC shall respond with a RADIO LINK ADDITION FAILURE message. DRNC shall include in the RADIO LINK ADDITION FAILURE message a general *Cause* IE or a *Cause* IE for each failed radio link. The *Cause* IE indicates the reason for failure.

[FDD – If some RL(s) were established successfully, the DRNC shall indicate this in the RADIO LINK ADDITION FAILURE message in the same way as in the RADIO LINK ADDITION RESPONSE message.]

[FDD – If the requested Serving HS-DSCH Radio Link Change was successful, or if the addition of the requested serving HS-DSCH Radio Link was successful or existed already but the Serving HS-DSCH Radio Link change was unsuccessful, the DRNS shall indicate this in the *HS-DSCH Serving Cell Change Information Response* IE in the RADIO LINK ADDITION FAILURE message]

[FDD – If the requested secondary serving HS-DSCH Radio Link Change was successful, or if the addition of the requested secondary serving HS-DSCH Radio Link was successful or existed already but the secondary serving HS-DSCH Radio Link change was unsuccessful, the DRNS shall indicate this in the *HS-DSCH Secondary Serving Cell Change Information Response* IE in the *Additional HS Cell Information Response* IE in the RADIO LINK ADDITION FAILURE message.]

[FDD – If the requested Serving E-DCH Radio Link Change was successful, or if the addition of the requested serving E-DCH Radio Link was successful or existed already but the Serving E-DCH Radio Link change was unsuccessful, the DRNS shall indicate this in the *E-DCH Serving Cell Change Information Response* IE in the RADIO LINK ADDITION FAILURE message.]

[FDD – If the *MIMO Activation Indicator* IE is included and the *Power Offset For S-CPICH for MIMO Request Indicator* IE is not included in the *HS-DSCH FDD Information* IE in the *HS-DSCH Serving Cell Change Information* IE in the RADIO LINK ADDITION REQUEST message or the power offset for S-CPICH for MIMO Request indicator has not been configured in the UE Context but MIMO pilot configuration with Primary and Secondary CPICH is set up with a non-zero power offset on the cell where the Serving HS-DSCH Radio Link is established, the setup of the serving HS-DSCH Radio Link shall be reported as failed and the DRNC shall include in the RADIO LINK ADDITION FAILURE message the *Cause* IE.]

[FDD – If the requested additional serving E-DCH Radio Link Change was successful, or if the addition of the requested additional serving E-DCH Radio Link was successful or existed already but the additional serving E-DCH Radio Link change was unsuccessful, the DRNS shall indicate this in the *Additional E-DCH Secondary Serving Cell Change Information Response* IE in the *Additional E-DCH Cell Change Information Response* IE in the RADIO LINK ADDITION FAILURE message.]

Typical cause values are:

Radio Network Layer Causes:

- DL Radio Resources not Available;
- UL Radio Resources not Available;
- Combining Resources not Available;
- Combining not Supported
- Cell not Available;
- [FDD – Requested Tx Diversity Mode not Supported;]
- Power Level not Supported;
- CM not Supported;
- Reconfiguration CFN not Elapsed;
- Number of DL Codes not Supported;

Number of UL codes not Supported;
 [FDD – DPC mode change not Supported;]
 Cell reserved for operator use;
 Delayed Activation not supported;
 [FDD – F-DPCH not supported;]
 E-DCH not supported;
 [FDD – MIMO not supported;]
 [FDD – E-DCH TTI2ms not supported;]
 [FDD – Continuous Packet Connectivity DTX-DRX operation not available;]
 [FDD – Continuous Packet Connectivity UE DTX Cycle not available;]
 [FDD – MIMO not available;]
 [FDD – F-DPCH Slot Format operation not supported;]
 [FDD – E-DPCCH Power Boosting not supported;]
 [FDD – SixtyfourQAM DL and MIMO Combined not available;]
 [FDD – Multi Cell operation not available;]
 [FDD – Multi Cell operation not supported;]
 [1.28Mcps TDD – MIMO not supported;]
 [1.28Mcps TDD – MIMO not available;]
 [1.28Mcps TDD – SixtyfourQAM DL and MIMO Combined not available;]
 [FDD – TX diversity for MIMO UE on DL Control Channels not available;]
 [FDD – Single Stream MIMO not available;]
 [FDD – Multi Cell operation with MIMO not available;]
 [FDD – Multi Cell operation with MIMO not supported;]
 [FDD – Multi Cell E-DCH Operation not supported;]
 [FDD – Multi Cell E-DCH Operation not available;]
 [FDD – Multi Cell operation with Single Stream MIMO not available;]
 [FDD – Multi Cell operation with Single Stream MIMO not supported;]
 [FDD – Cell Specific Tx Diversity Handling For Multi Cell Operation Not Available;]
 [FDD – Cell Specific Tx Diversity Handling For Multi Cell Operation Not Supported.]

Transport Layer Causes:

Transport Resource Unavailable.

Miscellaneous Causes:

Control Processing Overload;
 HW Failure;
 Not enough User Plane Processing Resources.

8.3.2.4 Abnormal Conditions

If the RADIO LINK ADDITION REQUEST message includes a *C-ID* IE corresponding to a cell reserved for operator use and the Permanent NAS UE Identity is not available in the DRNC for the considered UE Context, the DRNC shall reject the procedure for this particular Radio Link and send the RADIO LINK ADDITION FAILURE message.

[FDD – If the RADIO LINK ADDITION REQUEST message includes the *Transmission Gap Pattern Sequence Status* IEs in the *Active Pattern Sequence Information* IE and it does not address exactly all ongoing compressed mode patterns the DRNS shall reject the Radio Link Addition procedure and shall respond with a RADIO LINK ADDITION FAILURE message with the *Cause* IE value “Invalid CM settings”.]

[FDD – If the RADIO LINK ADDITION REQUEST message is used to establish a new RL without compressed mode when compressed mode is active for the existing RL(s) (as specified in subclause 8.3.2.2), and if at least one of the new RLs is to be established in a cell that has the same UARFCN (both UL and DL) as at least one cell with an already existing RL, the DRNS shall reject the Radio Link Addition procedure and shall respond with a RADIO LINK ADDITION FAILURE message with the cause value “Invalid CM settings”.]

[FDD – If the power balancing is active with the Power Balancing Adjustment Type of the UE Context set to “Individual” in the existing RL(s) and if the *DL Reference Power* IEs are included in the *RL Information* IE but the *DL Reference Power* IE is not present for each RL in the *RL Information* IE, the DRNC shall reject the Radio Link Addition procedure and shall respond with a RADIO LINK ADDITION FAILURE message.]

[FDD – If the RADIO LINK ADDITION REQUEST message includes the *DL Reference Power* IEs in the *RL Information* IE but the power balancing is not active in the existing RL(s) or the power balancing is active with the Power Balancing Adjustment Type of the UE Context set to “Common” in the existing RL(s), the DRNC shall reject the Radio Link Addition procedure and shall respond with a RADIO LINK ADDITION FAILURE message with the cause value “Power Balancing status not compatible”.]

[FDD – If the RADIO LINK ADDITION REQUEST message includes the *Enhanced Primary CPICH Ec/No* IE, but not the *Primary CPICH Ec/No* IE, then the DRNC shall reject the procedure using the RADIO LINK ADDITION FAILURE message.]

If the RADIO LINK ADDITION REQUEST message includes the *Transport Layer Address* IE and the *Binding ID* IE in the *RL Specific DCH Information* IE [FDD – or for an E-DCH MAC-d flow in *RL Specific E-DCH Information* IE] included in the *RL Information* IE for a specific RL and the *Diversity Control Field* IE is set to “Must” [FDD – or the RL is combined with existing E-DCH RL which transport bearer is not established in the DRNS], the DRNC shall reject the Radio Link Addition procedure and respond with the RADIO LINK ADDITION FAILURE message.

If ALCAP is not used, if the RADIO LINK ADDITION REQUEST message does not include the *Transport Layer Address* IE and the *Binding ID* IE in the *RL Specific DCH Information* IE nor *RL Specific E-DCH Information* IE in the *RL Information* IE for a specific RL and the *Diversity Control Field* IE is set to “May”, the DRNC shall reject the Radio Link Addition procedure and respond with the RADIO LINK ADDITION FAILURE message.

If ALCAP is not used, if the RADIO LINK ADDITION REQUEST message does not include the *Transport Layer Address* IE and the *Binding ID* IE in the *RL Specific DCH Information* IE in the *RL Information* IE for a specific RL and the *Diversity Control Field* IE is set to “Must Not”, the DRNC shall reject the Radio Link Addition procedure and respond with the RADIO LINK ADDITION FAILURE message.

If ALCAP is not used, if the RADIO LINK ADDITION REQUEST message does not include the *Transport Layer Address* IE and the *Binding ID* IE in [FDD – the *RL Specific E-DCH Information* IE in the *RL Information* IE for the first E-DCH RL][TDD – the *E-DCH MAC-d Flows Information TDD* IE], the DRNC shall reject the Radio Link Addition procedure and respond with the RADIO LINK ADDITION FAILURE message.

If ALCAP is not used, if the RADIO LINK ADDITION REQUEST message does not include the *Transport Layer Address* IE and the *Binding ID* IE for an HS-DSCH MAC-d Flow in the *HS-DSCH MAC-d Flows Information* IE, the DRNC shall reject the Radio Link Addition procedure and respond with the RADIO LINK ADDITION FAILURE message.

If the RADIO LINK ADDITION REQUEST message includes the *Transport Layer Address* IE or the *Binding ID* IE, and not both are present for a transport bearer intended to be established, the DRNC shall reject the Radio Link Addition procedure and respond with the RADIO LINK ADDITION FAILURE message.

[FDD – If the RADIO LINK ADDITION REQUEST message includes the *HS-DSCH Serving Cell Change Information* IE but not the *HS-DSCH FDD Information* IE and the UE Context is not configured for HS-DSCH, then the DRNS shall reject the procedure using the RADIO LINK ADDITION FAILURE message.]

[FDD – If the RADIO LINK ADDITION REQUEST message includes the *Serving Cell Change CFN* IE but neither the *Serving E-DCH RL* IE nor the *HS-DSCH Serving Cell Change Information* IE, then the DRNS shall reject the procedure using the RADIO LINK ADDITION FAILURE message.]

[FDD – If the RADIO LINK ADDITION REQUEST message includes the *Serving E-DCH RL* IE but the UE Context is not configured for E-DCH, then the DRNS shall reject the procedure using the RADIO LINK ADDITION FAILURE message.]

[FDD – If the *E-DCH FDD Information* IE is present in the RADIO LINK ADDITION REQUEST message, but the *E-DPCH Information* IE is not present, then the DRNS shall reject the procedure using the RADIO LINK ADDITION FAILURE message.]

[FDD – If the RADIO LINK ADDITION REQUEST message includes the *E-DCH RL Indication* IE set to “E-DCH”, but no *E-DCH FDD Information* IE, and the UE Context is not configured for E-DCH, then the DRNC shall reject the procedure using the RADIO LINK ADDITION FAILURE message.]

[FDD – If the RADIO LINK ADDITION REQUEST message includes the *E-DCH FDD Information* IE but no *E-DCH RL Indication* IE set to “E-DCH”, then the DRNC shall reject the procedure using the RADIO LINK ADDITION FAILURE message.]

[TDD – If the RADIO LINK ADDITION REQUEST message includes the *HS-PDSCH RL-ID* IE not equal to the *RL ID* IE, the DRNC shall reject the procedure using the RADIO LINK ADDITION FAILURE message.]

[TDD – If the RADIO LINK ADDITION REQUEST message includes the *E-DCH Serving RL* IE not equal to the *RL ID* IE, the DRNS shall reject the procedure using the RADIO LINK ADDITION FAILURE message.]

If the RADIO LINK ADDITION REQUEST message contains the *HS-PDSCH RL ID* IE [FDD – in the *HS-DSCH Serving Cell Change Information* IE] and/or *Serving E-DCH RL* IE and if both HS-DSCH and E-DCH are configured in the DRNS but the Serving HS-DSCH Radio Link and the Serving E-DCH Radio Link are not in the same cell then the DRNC shall reject the procedure using the RADIO LINK ADDITION FAILURE message.

[FDD – If the RADIO LINK ADDITION REQUEST message contains the *HS-DSCH Serving Cell Change Information* IE and the *E-DPCH Information* IE which includes the *HS-DSCH Configured Indicator* IE set as “HS-DSCH not configured” then the DRNC shall reject the procedure using the RADIO LINK ADDITION FAILURE message.]

If the RADIO LINK ADDITION REQUEST message includes the *Maximum MAC-d PDU Size Extended* IE for a Priority Queue in the *HS-DSCH MAC-d Flows Information* IE in the *HS-DSCH Information* IE [FDD – in the *HS-DSCH Serving Cell Change Information*] and the *HS-DSCH MAC-d PDU Size Format* IE in the *HS-DSCH Information* IE [FDD – in the *HS-DSCH Serving Cell Change Information*] has the value “Indexed MAC-d PDU Size”, the DRNC shall reject the procedure using the RADIO LINK ADDITION FAILURE message.

If the RADIO LINK ADDITION REQUEST message does not include the *Maximum MAC-d PDU Size Extended* IE for a Priority Queue in the *HS-DSCH MAC-d Flows Information* IE in the *HS-DSCH Information* IE [FDD – in the *HS-DSCH Serving Cell Change Information*] and the *HS-DSCH MAC-d PDU Size Format* IE in the *HS-DSCH Information* IE [FDD – in the *HS-DSCH Serving Cell Change Information*] has the value “Flexible MAC-d PDU Size”, the DRNC shall reject the procedure using the RADIO LINK ADDITION FAILURE message.

[FDD – If the RADIO LINK ADDITION REQUEST message contains, for at least one logical channel, the *Maximum MAC-d PDU Size Extended* IE in the *E-DCH MAC-d Flows Information* IE in the *E-DCH FDD Information* IE and there exist a logical channel for which the *Maximum MAC-d PDU Size Extended* IE in the *E-DCH MAC-d Flows Information* IE in the *E-DCH FDD Information* IE is not present, the DRNC shall reject the procedure using the RADIO LINK ADDITION FAILURE message.]

[TDD – If the RADIO LINK ADDITION REQUEST message contains, for at least one logical channel, the *Maximum MAC-d PDU Size Extended* IE in the *E-DCH MAC-d Flows Information TDD* IE in the *E-DCH Information* IE, and there exist a logical channel for which the *Maximum MAC-d PDU Size Extended* IE in the *E-DCH MAC-d Flows Information TDD* IE in the *E-DCH Information* IE is not present, the DRNC shall reject the procedure using the RADIO LINK ADDITION FAILURE message.]

[FDD – If the RADIO LINK ADDITION REQUEST message contains the *Transport Bearer Not Requested Indicator* IE for a DCH but the DCH is configured to be included as a part of the downlink CCTrCH, the DRNC shall reject the procedure using the RADIO LINK ADDITION FAILURE message.]

[FDD – If the RADIO LINK ADDITION REQUEST message contains the *MIMO Activation Indicator* IE, *Sixtyfour QAM Usage Allowed Indicator* IE set to “Allowed”, the *Additional HS Cell Information RL Addition* IE and/or the *Single Stream MIMO Activation Indicator* IE, but does not contain the *HS-DSCH MAC-d PDU Size Format* IE set to “Flexible MAC-d PDU Size”, then the DRNC shall reject the procedure using the RADIO LINK ADDITION FAILURE message.]

[FDD – If the RADIO LINK ADDITION REQUEST message contains the *Serving E-DCH RL ID* IE but contains the *Transport Bearer Not Requested Indicator* IE in the RL Specific E-DCH Information for the new Serving E-DCH RL or there is at least one E-DCH MAC-d flow which transport bearer was not configured in the existing E-DCH RL to be combined with the Serving E-DCH RL, the DRNC shall reject the procedure using the RADIO LINK ADDITION FAILURE message.]

[FDD – If the RADIO LINK ADDITION REQUEST message includes the *Transport Bearer Not Requested Indicator* IE for a DCH or an E-DCH MAC-d Flow for a specific RL and the specific RL is combined with the existing RL which the transport bearer is established for the DCH or the E-DCH MAC-d Flow in DRNS, the DRNC shall reject the procedure using the RADIO LINK ADDITION FAILURE message.]

[FDD – If the RADIO LINK ADDITION REQUEST message contains the *Additional HS Cell Information RL Addition* IE indicating a secondary serving cell that is not in the same Node B as the new serving HS-DSCH cell, then the DRNC shall reject the procedure using the RADIO LINK ADDITION FAILURE message.]

[FDD – If the RADIO LINK ADDITION REQUEST message contains the *Additional HS Cell Information RL Addition* IE and if the HS-DSCH is not configured in the DRNS Communication Context and the *HS-DSCH Information* IE is not present, then the DRNS shall reject the procedure using the RADIO LINK SETUP FAILURE message.]

If the RADIO LINK ADDITION REQUEST message includes *DL RLC PDU Size Format* IE for a Priority Queue in the *HS-DSCH MAC-d Flows Information* IE in the *HS-DSCH Information* IE [FDD – in the *HS-DSCH Serving Cell Change Information* IE] set to “Flexible RLC PDU Size”, *HS-DSCH MAC-d PDU Size Format* IE in the *HS-DSCH Information* IE [FDD – in the *HS-DSCH Serving Cell Change Information* IE] has the value “Indexed MAC-d PDU Size”, the DRNC shall reject the procedure using the RADIO LINK ADDITION FAILURE message.

If the RADIO LINK ADDITION REQUEST message does not include the *Maximum MAC-d PDU Size Extended* IE for a Priority Queue in the *HS-DSCH MAC-d Flows Information* IE in the *HS-DSCH Information* IE [FDD – in the *HS-DSCH Serving Cell Change Information* IE] and the *DL RLC PDU Size Format* IE in the *HS-DSCH Information* IE [FDD – in the *HS-DSCH Serving Cell Change Information* IE] has the value “Flexible RLC PDU Size”, the DRNC shall reject the procedure using the RADIO LINK ADDITION FAILURE message.

[FDD – If the RADIO LINK ADDITION REQUEST message contains a *MIMO Activation Indicator* IE and a *Single Stream MIMO Activation Indicator* IE in the *HS-DSCH FDD Information* IE in the *HS-DSCH Serving Cell Change Information* IE or in the *HS-DSCH FDD Secondary Serving Information* IE in the *Additional HS Cell Information RL Addition* IE, then the DRNC shall reject the procedure using the RADIO LINK ADDITION FAILURE message.]

[FDD – If the RADIO LINK ADDITION REQUEST message contains the *Additional E-DCH Cell Information RL Setup Req* IE and if the *E-DPCH Information* IE is not present or the E-DPCH Information was not configured in the UE Context, then the DRNS shall reject the procedure using the RADIO LINK ADDITION FAILURE message.]

[FDD – If the RADIO LINK ADDITION REQUEST message contains the *Additional E-DCH Cell Information RL Add Req* IE and there exist a logical channel for which the *Maximum MAC-d PDU Size Extended* IE in the *E-DCH MAC-d Flows Information* IE in the *E-DCH FDD Information* IE is not present, the DRNS shall reject the procedure using the RADIO LINK ADDITION FAILURE message.]

[FDD – If the RADIO LINK ADDITION REQUEST message contains the *Additional E-DCH Cell Information RL Add Req* IE and the *C-ID* IE is not included in the *Additional E-DCH RL Specific Information To Setup* IE in the *Additional E-DCH FDD Setup Information* IE in the *Additional E-DCH Cell Information Setup* IE, but the Radio Link indicated by the *E-DCH Additional RL ID* IE is not configured in the current UE context as a Secondary Serving HS-DSCH radio link without any configured Additional E-DCH, the DRNS shall reject the procedure using the RADIO LINK ADDITION FAILURE message.]

[FDD – If the RADIO LINK ADDITION REQUEST message contains the *Diversity Mode* IE in the *HS-DSCH FDD Secondary Serving Information* IE in the *Additional HS Cell Information RL Addition* IE and the secondary serving HS-DSCH is already configured in the UE Context, then the DRNS shall reject the procedure using the RADIO LINK ADDITION FAILURE message.]

[FDD – If the secondary serving HS-DSCH is not configured in the UE Context and if the RADIO LINK ADDITION REQUEST message contains in the *HS-DSCH FDD Secondary Serving Information* IE in the *Additional HS Cell Information RL Addition* IE the *Diversity Mode* IE not set to “None” but not the *Transmit Diversity Indicator* or contains the *Transmit Diversity Indicator* but not the *Diversity Mode* IE not set to “None”, then the DRNS shall reject the procedure using the RADIO LINK SETUP FAILURE message.]

8.3.3 Radio Link Deletion

8.3.3.1 General

The Radio Link Deletion procedure is used to release the resources in a DRNS for one or more established radio links towards a UE.

This procedure shall use the signalling bearer connection for the relevant UE Context.

The Radio Link Deletion procedure may be initiated by the SRNC at any time after establishing a Radio Link.

8.3.3.2 Successful Operation

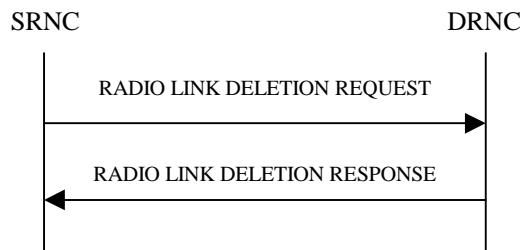

Figure 9: Radio Link Deletion procedure, Successful Operation

The procedure is initiated with a RADIO LINK DELETION REQUEST message sent from the SRNC to the DRNC.

Upon receipt of this message, the DRNS shall delete the radio link(s) identified by the *RL ID* IE(s) in the message, shall release all associated resources and shall respond to the SRNC with a RADIO LINK DELETION RESPONSE message.

If the radio link(s) to be deleted represent the last radio link(s) for the UE in the DRNS and if the UE is not using any common resources in the DRNS, then the DRNC shall release the UE Context.

[FDD – After deletion of the RL(s), the UL out-of-sync algorithm defined in ref. TS 25.214 [10] shall for each of the remaining RL Set(s) use the maximum value of the parameters *N_OUTSYNC_IND* and *T_RLFAILURE* that are configured in the cells supporting the radio links of the RL Set. The UL in-sync algorithm defined in ref. TS 25.214 [10] shall for each of the remaining RL Set(s) use the minimum value of the parameters *N_INSYNC_IND* that are configured in the cells supporting the radio links of the RL Set.]

[FDD – If the RL indicated by the *RL ID* IE in the RADIO LINK DELETION REQUEST message is the serving HS-DSCH Radio link and a related secondary serving HS-DSCH Radio Link exists in the DRNS, the DRNC shall delete the secondary serving HS-DSCH Radio Link.]

[FDD – If the RL indicated by the *RL ID* IE in the RADIO LINK DELETION REQUEST message is the secondary serving HS-DSCH Radio link, the DRNC shall delete the secondary serving HS-DSCH Radio Link.]

8.3.3.3 Unsuccessful Operation

-

8.3.3.4 Abnormal Conditions

If the RL indicated by the *RL ID* IE does not exist, the DRNC shall respond with the RADIO LINK DELETION RESPONSE message.

8.3.4 Synchronised Radio Link Reconfiguration Preparation

8.3.4.1 General

The Synchronised Radio Link Reconfiguration Preparation procedure is used to prepare a new configuration of Radio Link(s) related to one UE-UTRAN connection within a DRNS.

This procedure shall use the signalling bearer connection for the relevant UE Context.

The Synchronised Radio Link Reconfiguration Preparation procedure shall not be initiated if a Prepared Reconfiguration exists, as defined in subclause 3.1.

8.3.4.2 Successful Operation

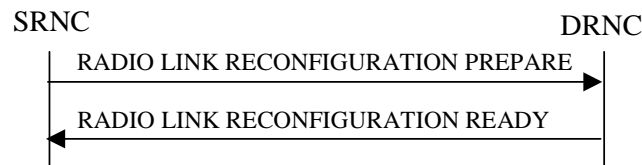

Figure 10: Synchronised Radio Link Reconfiguration Preparation procedure, Successful Operation

The Synchronised Radio Link Reconfiguration Preparation procedure is initiated by the SRNC by sending the RADIO LINK RECONFIGURATION PREPARE message to the DRNC.

Upon receipt, the DRNS shall reserve necessary resources for the new configuration of the Radio Link(s) according to the parameters given in the message. Unless specified below, the meaning of parameters is specified in other specifications.

If the RADIO LINK RECONFIGURATION PREPARE message includes the *Allowed Queuing Time* IE the DRNS may queue the request the time corresponding to the value of the *Allowed Queuing Time* IE before starting to execute the request.

The DRNS shall prioritise resource allocation for the RL(s) to be modified according to Annex A.

If the *UE Aggregate Maximum Bit Rate* IE is contained in the RADIO LINK RECONFIGURATION PREPARE message, the DRNS shall, if supported, store the received UE Aggregate Maximum Bit Rate parameters to control the aggregate data rate of non GBR traffic for this UE.

DCH Modification:

If the RADIO LINK RECONFIGURATION PREPARE message includes any *DCHs To Modify* IEs, the DRNS shall treat them each as follows:

- If the *DCHs To Modify* IE includes multiple *DCH Specific Info* IEs then the DRNS shall treat the DCHs in the *DCHs To Modify* IE as a set of co-ordinated DCHs. The DRNS shall include these DCHs in the new configuration only if it can include all of them in the new configuration.
- If the *DCHs To Modify* IE includes the *UL FP Mode* IE for a DCH or a set of co-ordinated DCHs to be modified, the DRNS shall apply the new FP Mode in the Uplink of the user plane for the DCH or the set of co-ordinated DCHs in the new configuration.
- If the *DCHs To Modify* IE includes the *ToAWS* IE for a DCH or a set of co-ordinated DCHs to be modified, the DRNS shall apply the new ToAWS in the user plane for the DCH or the set of co-ordinated DCHs in the new configuration.
- If the *DCHs To Modify* IE includes the *ToAWE* IE for a DCH or a set of co-ordinated DCHs to be modified, the DRNS shall apply the new ToAWE in the user plane for the DCH or the set of co-ordinated DCHs in the new configuration.
- If the *DCHs To Modify* IE contains a *DCH Specific Info* IE which includes the *Frame Handling Priority* IE for a DCH to be modified, the DRNS should store this information for this DCH in the new configuration. The received Frame Handling Priority should be used when prioritising between different frames in the downlink on the radio interface in congestion situations within the DRNS once the new configuration has been activated.
- If the *DCHs To Modify* IE contains a *DCH Specific Info* IE which includes the *Traffic Class* IE for a DCH to be modified, the DRNS should store this information for this DCH in the new configuration. The *Traffic Class* IE may be used to determine the transport bearer characteristics to apply between DRNC and Node B for the related DCH or set of co-ordinated DCHs. The DRNC should ignore the *Traffic Class* IE if the *TrCH Source Statistics Descriptor* IE for this DCH indicates the value "RRC".
- [FDD – If the *DCHs to Modify* IE contains a *DCH Specific Info* IE which includes the *Unidirectional DCH indicator* IE set to "Uplink DCH only", the DRNS shall ignore the *Transport Format Set* IE for the downlink for this DCH. As a consequence this DCH is not included as a part of the downlink CCTrCH.]

- [FDD – If the *DCHs to Modify* IE contains a *DCH Specific Info* IE which includes the *Unidirectional DCH indicator* IE set to “Downlink DCH only”, the DRNS shall ignore the *Transport Format Set* IE for the uplink for this DCH. As a consequence this DCH is not included as a part of the uplink CCTrCH.]
- If the *DCHs To Modify* IE contains a *DCH Specific Info* IE which includes the *Transport Format Set* IE for the UL of a DCH to be modified, the DRNS shall apply the new Transport Format Set in the Uplink of this DCH in the new configuration.
- If the *DCHs to Modify* IE includes the *TNL QoS* IE for a DCH or a set of co-ordinated DCHs to be modified and if ALCAP is not used, the DRNS may store this information for this DCH in the new configuration. The *TNL QoS* IE may be used to determine the transport bearer characteristics to apply in the uplink for the related DCH or set of co-ordinated DCHs.
- If the *DCHs To Modify* IE contains a *DCH Specific Info* IE which includes the *Transport Format Set* IE for the DL of a DCH to be modified, the DRNS shall apply the new Transport Format Set in the Downlink of this DCH in the new configuration.
- If the *DCHs To Modify* IE contains a *DCH Specific Info* IE which includes the *Allocation/Retention Priority* IE, the DRNS shall apply the new Allocation/Retention Priority to this DCH in the new configuration according to Annex A.
- [TDD – If the *DCHs To Modify* IE includes the *CCTrCH ID* IE for the UL, the DRNS shall map the DCH onto the referenced UL CCTrCH in the new configuration.]
- [TDD – If the *DCHs To Modify* IE includes the *CCTrCH ID* IE for the DL, the DRNS shall map the DCH onto the referenced DL CCTrCH in the new configuration.]
- If the *DCHs To Modify* IE contains a *DCH Specific Info* IE which includes the *Guaranteed Rate Information* IE, the DRNS shall treat the included IEs according to the following:
 - If the *Guaranteed Rate Information* IE includes the *Guaranteed UL Rate* IE, the DRNS shall apply the new Guaranteed Rate in the uplink of this DCH in the new configuration. The DRNS may decide to request the SRNC to limit the user rate in the uplink of the DCH at any point in time after activating the new configuration. The DRNS may request the SRNC to reduce the user rate of the uplink of the DCH below the guaranteed bit rate, however, whenever possible the DRNS should request the SRNC to reduce the user rate between the maximum bit rate and the guaranteed bit rate.
 - If the *Guaranteed Rate Information* IE includes the *Guaranteed DL Rate* IE, the DRNS shall apply the new Guaranteed Rate in the downlink of this DCH in the new configuration. The DRNS may decide to request the SRNC to limit the user rate in the downlink of the DCH at any point in time after activating the new configuration. The DRNS may request the SRNC to reduce the user rate of the downlink of the DCH below the guaranteed bit rate, however, whenever possible the DRNS should request the SRNC to reduce the user rate between the maximum bit rate and the guaranteed bit rate.

DCH Addition:

If the RADIO LINK RECONFIGURATION PREPARE message includes any *DCHs To Add* IEs, the DRNS shall treat them each as follows:

- The DRNS shall reserve necessary resources for the new configuration of the Radio Link(s) according to the parameters given in the message and include these DCH in the new configuration.
- If the *DCH Information* IE includes a *DCHs To Add* IE with multiple *DCH Specific Info* IEs, the DRNS shall treat the DCHs in the *DCHs To Add* IE as a set of co-ordinated DCHs. The DRNS shall include these DCHs in the new configuration only if it can include all of them in the new configuration.
- If the *DCH Specific Info* IE includes the *Unidirectional DCH Indicator* IE set to “Uplink DCH only”, the DRNS shall ignore the *Transport Format Set* IE for the downlink for this DCH. As a consequence this DCH is not included as a part of the downlink CCTrCH.
- If the *DCH Specific Info* IE includes the *Unidirectional DCH Indicator* IE set to “Downlink DCH only”, the DRNS shall ignore the *Transport Format Set* IE for the uplink for this DCH. As a consequence this DCH is not included as a part of the uplink CCTrCH.

- [FDD – For each DCH which do not belong to a set of co-ordinated DCHs and which includes a *QE-Selector* IE set to “selected”, the DRNS shall use the Transport channel BER from that DCH for the QE in the UL data frames. If no Transport channel BER is available for the selected DCH, the DRNS shall use the Physical channel BER for the QE, ref. TS 25.427 [4]. If the *QE-Selector* IE is set to “non-selected”, the DRNS shall use the Physical channel BER for the QE in the UL data frames, ref. TS 25.427 [4].]
- For a set of co-ordinated DCHs, the DRNS shall use the Transport channel BER from the DCH with the *QE-Selector* IE set to “selected” for the QE in the UL data frames, ref. TS 25.427 [4]. [FDD – If no Transport channel BER is available for the selected DCH, the DRNS shall use the Physical channel BER for the QE, ref. TS 25.427 [4]. If all DCHs have the *QE-Selector* IE set to “non-selected”, the DRNS shall use the Physical channel BER for the QE, ref. TS 25.427 [4].] [TDD – If no Transport channel BER is available for the selected DCH, the DRNS shall use 0 for the QE, ref. TS 25.427 [4].]
- The DRNS should store the *Frame Handling Priority* IE received for a DCH to be added in the new configuration. The received Frame Handling Priority should be used when prioritising between different frames in the downlink on the Uu interface in congestion situations within the DRNS once the new configuration has been activated.
- If the *TNL QoS* IE is included for a DCH or a set of co-ordinated DCHs and if ALCAP is not used, the DRNS may use this information to determine the transport bearer characteristics to apply for the uplink for the related DCH or set of co-ordinated DCHs.
- The DRNS should store the *Traffic Class* IE received for a DCH to be added in the new configuration. The *Traffic Class* IE may be used to determine the transport bearer characteristics to apply between DRNC and Node B for the related DCH or set of co-ordinated DCHs. The DRNC should ignore the *Traffic Class* IE if the *TrCH Source Statistics Descriptor* IE indicates the value “RRC”.
- The DRNS shall use the included *UL FP Mode* IE for a DCH or a set of co-ordinated DCHs to be added as the new FP Mode in the Uplink of the user plane for the DCH or the set of co-ordinated DCHs in the new configuration.
- The DRNS shall use the included *ToAWS* IE for a DCH or a set of co-ordinated DCHs to be added as the new Time of Arrival Window Startpoint in the user plane for the DCH or the set of co-ordinated DCHs in the new configuration.
- The DRNS shall use the included *ToAWE* IE for a DCH or a set of co-ordinated DCHs to be added as the new Time of Arrival Window Endpoint in the user plane for the DCH or the set of co-ordinated DCHs in the new configuration.
- [3.84Mcps TDD – The DRNC shall include the *Secondary CCPCH Info TDD* IE in the RADIO LINK RECONFIGURATION READY message if at least one DSCH or USCH exists in the new configuration.]
- [1.28Mcps TDD – The DRNC shall include the *Secondary CCPCH Info TDD LCR* IE in the RADIO LINK RECONFIGURATION READY message if at least one DSCH or USCH exists in the new configuration.]
- [7.68Mcps TDD – The DRNC shall include the *Secondary CCPCH Info TDD 7.68Mcps* IE in the RADIO LINK RECONFIGURATION READY message if at least one DSCH or USCH exists in the new configuration.]
- If the *DCHs To Add* IE contains a *DCH Specific Info* IE which includes the *Guaranteed Rate Information* IE, the DRNS shall treat the included IEs according to the following:
 - If the *Guaranteed Rate Information* IE includes the *Guaranteed UL Rate* IE, the DRNS shall apply the new Guaranteed Rate in the uplink of this DCH in the new configuration. The DRNS may decide to request the SRNC to limit the user rate of the uplink of the DCH at any point in time after activating the new configuration. The DRNS may request the SRNC to reduce the user rate of the uplink of the DCH below the guaranteed bit rate, however, whenever possible the DRNS should request the SRNC to reduce the user rate between the maximum bit rate and the guaranteed bit rate. If the *DCH Specific Info* IE in the *DCHs To Add* IE does not include the *Guaranteed UL Rate* IE, the DRNS shall not limit the user rate of the uplink of the DCH.
 - If the *Guaranteed Rate Information* IE includes the *Guaranteed DL Rate* IE, the DRNS shall apply the new Guaranteed Rate in the downlink of this DCH in the new configuration. The DRNS may decide to request the SRNC to limit the user rate of the downlink of the DCH at any point in time after activating the new configuration. The DRNS may request the SRNC to reduce the user rate of the downlink of the DCH below

the guaranteed bit rate, however, whenever possible the DRNS should request the SRNC to reduce the user rate between the maximum bit rate and the guaranteed bit rate. If the *DCH Specific Info* IE in the *DCHs To Add* IE does not include the *Guaranteed DL Rate* IE, the DRNS shall not limit the user rate of the downlink of the DCH.

- [TDD – The DRNS shall apply the *CCTrCH ID* IE (for the DL) in the Downlink of this DCH in the new configuration.]
- [TDD – The DRNS shall apply the *CCTrCH ID* IE (for the UL) in the Uplink of this DCH in the new configuration.]

DCH Deletion:

If the RADIO LINK RECONFIGURATION PREPARE message includes any *DCH To Delete*, the DRNS shall not include the referenced DCHs in the new configuration.

If all of the DCHs belonging to a set of co-ordinated DCHs are requested to be deleted, the DRNS shall not include this set of co-ordinated DCHs in the new configuration.

Physical Channel Modification:

[FDD – If the RADIO LINK RECONFIGURATION PREPARE message includes an *UL DPCH Information* IE, the DRNS shall apply the parameters to the new configuration as follows:]

- [FDD – If the *UL DPCH Information* IE includes the *Uplink Scrambling Code* IE, the DRNS shall apply this Uplink Scrambling Code to the new configuration.]
- [FDD – If the *UL DPCH Information* IE includes the *Min UL Channelisation Code Length* IE, the DRNS shall apply the new Min UL Channelisation Code Length in the new configuration. The DRNS shall apply the contents of the *Max Number of UL DPDCHs* IE (if it is included) in the new configuration.]
- [FDD – If the *UL DPCH Information* IE includes the *TFCS* IE, the DRNS shall use the *TFCS* IE for the UL when reserving resources for the uplink of the new configuration. The DRNS shall apply the new *TFCS* in the uplink of the new configuration.]
- [FDD – If the *UL DPCH Information* IE includes the *UL DPCCCH Slot Format* IE, the DRNS shall apply the new Uplink DPCCCH Slot Format to the new configuration.]
- [FDD – If the *UL DPCH Information* IE includes the *UL SIR Target* IE, the DRNS shall use the value for the UL inner loop power control when the new configuration is being used.]
- [FDD – If the *UL DPCH Information* IE includes the *Puncture Limit* IE, the DRNS shall apply the value in the uplink of the new configuration.]
- [FDD – If the *UL DPCH Information* IE includes the *Diversity Mode* IE, the DRNS shall apply diversity according to the given value.]
- [FDD – If the *UL DPCH Information* IE includes the *UL DPDCH Indicator For E-DCH Operation* IE and it is set to “UL DPDCH not present”, the UL DPDCH resources shall be removed from the configuration.]

[FDD – If the RADIO LINK RECONFIGURATION PREPARE message includes a *DL DPCH Information* IE and the concerned UE Context is configured to use F-DPCH in the downlink in the old configuration, the DRNS shall configure the concerned UE Context to use DPCH in the downlink in the new configuration. In this case, if at least one Transmission Gap Pattern Sequence is configured with an SF/2 downlink compressed mode method in the new configuration, the DRNC shall include the *Transmission Gap Pattern Sequence Scrambling Code Information* IE in the RADIO LINK RECONFIGURATION READY message indicating for each Channelisation Code whether the alternative scrambling code shall be used or not.]

- [FDD – If the RADIO LINK RECONFIGURATION PREPARE message includes the *DL DPCH Power Information* IE, the DRNS shall use the information contained in it for the power settings of the DL DPCH. In particular, if the received *Inner Loop DL PC Status* IE is set to “Active”, the DRNS shall activate the inner loop DL power control for all RLs. If *Inner Loop DL PC Status* IE is set to “Inactive”, the DRNS shall deactivate the inner loop DL power control for all RLs according to ref. TS 25.214 [10]. Furthermore, the DRNC shall include the *DL Code Information* IE in the RADIO LINK RECONFIGURATION READY.]

[FDD – If the RADIO LINK RECONFIGURATION PREPARE message includes a *DL DPCH Information IE*, the DRNS shall apply the parameters to the new configuration as follows:]

- [FDD – If the *DL DPCH Information IE* includes the *Number of DL Channelisation Codes IE*, the DRNS shall allocate given number of Downlink Channelisation Codes per Radio Link and apply the new Downlink Channelisation Code(s) to the new configuration. Each Downlink Channelisation Code allocated for the new configuration shall be included in the RADIO LINK RECONFIGURATION READY message within the *DL Code Information IE* as a *FDD DL Channelisation Code Number IE* when sent to the SRNC. If some Transmission Gap Pattern sequences using “SF/2” method are already initialised in the DRNS, DRNC shall include the *Transmission Gap Pattern Sequence Scrambling Code Information IE* in the RADIO LINK RECONFIGURATION READY message in case the DRNS selects to change the Scrambling code change method for one or more DL Channelisation Code.]
- [FDD – When more than one DL DPDCH are assigned per RL, the segmented physical channel shall be mapped on to DL DPDCHs according to TS 25.211 [8]. When p number of DL DPDCHs are assigned to each RL, the first pair of DL Scrambling Code and FDD DL Channelisation Code Number corresponds to “*PhCH number 1*”, the second to “*PhCH number 2*”, and so on until the p th to “*PhCH number p*”.]
- [FDD – If the *DL DPCH Information IE* includes the *TFCS IE*, the DRNS shall use the *TFCS IE* for the DL when reserving resources for the downlink of the new configuration. The DRNS shall apply the new TFCS in the Downlink of the new configuration.]
- [FDD – If the *DL DPCH Information IE* includes the *DL DPCH Slot Format IE*, the DRNS shall apply the new slot format used in DPCH in DL.]
- [FDD – If the *DL DPCH Information IE* includes the *TFCI Signalling Mode IE*, the DRNS shall apply the new signalling mode of the TFCI.]
- [FDD – If the *DL DPCH Information IE* includes the *Multiplexing Position IE*, the DRNS shall apply the new parameter to define whether fixed or flexible positions of transport channels shall be used in the physical channel.]
- [FDD – If the *DL DPCH Information IE* includes the *Limited Power Increase IE* set to “Used”, the DRNS shall, if supported, use Limited Power Increase according to ref. TS 25.214 [10] subclause 5.2.1 for the inner loop DL power control in the new configuration.]
- [FDD – If the *DL DPCH Information IE* includes the *Limited Power Increase IE* set to “Not Used”, the DRNS shall not use Limited Power Increase for the inner loop DL power control in the new configuration.]

[FDD – If the RADIO LINK RECONFIGURATION PREPARE message includes the *F-DPCH Information IE*, then:]

- [FDD – The DRNS shall configure the concerned UE Context to use F-DPCH in the downlink in the new configuration.]
- [FDD – If the *F-DPCH Information IE* includes the *F-DPCH Slot Format Support Request IE*, then the DRNS shall configure the concerned UE Context for F-DPCH Slot Format operation according to TS 25.211 [8] and include the *F-DPCH Slot Format IE* in the RADIO LINK RECONFIGURATION READY message. If the *F-DPCH Information IE* includes the *F-DPCH Slot Format IE*, the DRNC may use the *F-DPCH Slot Format IE* to determine the F-DPCH slot format.]

[FDD – If the RADIO LINK RECONFIGURATION PREPARE message includes the *Transmission Gap Pattern Sequence Information IE*, the DRNS shall store the new information about the Transmission Gap Pattern Sequences to be used in the new Compressed Mode Configuration. Any Transmission Gap Pattern Sequences already existing in the previous Compressed Mode Configuration are replaced by the new sequences once the new Compressed Mode Configuration has been activated or once the previous Compressed Mode Configuration has been deactivated. This new Compressed Mode Configuration shall be valid in the DRNS until the next Compressed Mode Configuration is configured in the DRNS or until the last Radio Link is deleted.]

[FDD – If the RADIO LINK RECONFIGURATION PREPARE message includes the *Transmission Gap Pattern Sequence Information IE* and the *Downlink Compressed Mode Method IE* in one or more Transmission Gap Pattern Sequence within the *Transmission Gap Pattern Sequence Information IE* is set to “SF/2” and the UE Context is configured to use DPCH in the downlink in the new configuration, the DRNC shall include the *Transmission Gap Pattern Sequence Scrambling Code Information IE* in the RADIO LINK RECONFIGURATION READY message indicating for each Channelisation Code whether the alternative scrambling code shall be used or not.]

[FDD – If the RADIO LINK RECONFIGURATION PREPARE message includes an *E-DPCH Information* IE, the DRNS shall apply the parameters to the new configuration as follows:]

- [FDD – If the *E-DPCH Information* IE includes the *Maximum Set of E-DPDCHs* IE, the DRNS shall apply the contents of the Maximum Set in the new configuration.]
- [FDD – If the *E-DPCH Information* IE includes the *Puncture Limit* IE, the DRNS shall apply the value in the uplink of the new configuration]
- [FDD – If the *E-DPCH Information* IE includes the *E-TFCS Information* IE, the DRNS shall use the *E-TFCS Information* IE for the E-DCH when reserving resources for the uplink of the new configuration. The DRNS shall apply the new TFCS in the uplink of the new configuration. If the *E-TFCS Information* IE contains the *E-DCH Minimum Set E-TFCI Validity Indicator* IE the DRNS shall ignore the value in *E-DCH Minimum Set E-TFCI* IE. If the *E-DCH Minimum Set E-TFCI validity indicator* IE is absent DRNS shall use the value for the related resource allocation operation.]
- [FDD – If the *E-TFCS Information* IE in the *E-DPCH Information* IE contains the *E-DPDCH Power Interpolation* IE, the DRNS shall use the value to determine the applicable E-DPDCH power formula defined in TS 25.214 [10]. If the *E-DPDCH Power Interpolation* IE is not present, the DRNS shall use the E-DPDCH power extrapolation formula defined in TS 25.214 [10] if the *E-DCH FDD Information* IE is included in the RADIO LINK RECONFIGURATION PREPARE message.]
- [FDD – If the *E-TFCS Information* IE in the *E-DPCH Information* IE contains the *E-TFCI Boost Information* IE, the DRNS shall use the information according to TS 25.214 [10]. If the *E-TFCI Boost Information* IE is not present, the DRNS shall use the value “127” in the algorithm defined in TS 25.214 [10] if the *E-DCH FDD Information* IE is included in the RADIO LINK RECONFIGURATION PREPARE message.]
- [FDD – If the *E-DPCH Information* IE includes the *E-TTI* IE, the DRNS shall use the value when the new configuration is being used.]
- [FDD – If the *E-DPCH Information* IE includes the *E-DPCCH Power Offset* IE, the DRNS shall use the value when the new configuration is being used.]
- [FDD – If the *E-DPCH Information* IE includes the *E-RGCH 2-Index-Step* IE, the DRNS shall use the value when the new configuration is being used.]
- [FDD – If the *E-DPCH Information* IE includes the *E-RGCH 3-Index-Step* IE, the DRNS shall use the value when the new configuration is being used.]
- [FDD – If the *E-DPCH Information* IE includes the *E-DCH HARQ Info* IE, the DRNS shall use the value when the new configuration is being used.]
- [FDD – If the *E-DPCH Information* IE includes the *HS-DSCH Configured Indicator* IE, the DRNS shall use the value when the new configuration is being used.]
- [FDD – If the *E-DPCH Information* IE includes the *Minimum Reduced E-DPDCH Gain Factor* IE, then the DRNS shall use the value to determine the applicable minimum gain factor ($\beta_{ed,k, reduced, min}$) defined in TS 25.214 [10]. For the case the *Minimum Reduced E-DPDCH Gain Factor* IE is not available for the UE Context, the DRNS may use the default value defined in TS 25.331 [16].]

[FDD – If the RADIO LINK RECONFIGURATION PREPAR message includes the *Continuous Packet Connectivity DTX-DRX Information* IE, then:]

- [FDD – The DRNS shall configure the concerned UE Context for Continuous Packet Connectivity DTX operation according to TS 25.214 [10].]
- [FDD – If *DRX Information* IE is included in the *Continuous Packet Connectivity DTX-DRX Information* IE, then the DRNS shall configure the concerned UE Context for Continuous Packet Connectivity DRX operation according to TS 25.214 [10].]

[FDD – If the RADIO LINK RECONFIGURATION PREPARE message includes the *Continuous Packet Connectivity DTX-DRX Information To Modify* IE, then:]

- [FDD – If the *UE DTX DRX Offset* IE is included in the *Continuous Packet Connectivity DTX-DRX Information To Modify* IE, then the DRNS shall apply the indicated Offset in *UE DTX DRX Cycle* IE in the new configuration.]
- [FDD – If the *Enabling Delay* IE is included in the *Continuous Packet Connectivity DTX-DRX Information To Modify* IE, then the DRNS shall use this value to determine the beginning of uplink transmission in the new configuration according to TS 25.214 [10].]
- [FDD – If the *DTX Information To Modify* IE is included in the *Continuous Packet Connectivity DTX-DRX Information To Modify* IE, then the DRNS shall use this information to modify the indicated DTX Information parameter in the new configuration. If the choice of *DTX Information To Modify* IE is “Deactivate”, then DRX should be deactivated together with DTX.]
- [FDD – If the *DRX Information To Modify* IE is included in the *Continuous Packet Connectivity DTX-DRX Information To Modify* IE, then the DRNS shall use this information to modify the indicated DRX Information in the new configuration.]

[FDD – If the RADIO LINK RECONFIGURATION PREPARE message includes the *Continuous Packet Connectivity HS-SCCH less Information* IE, then:]

- [FDD – The DRNS shall configure the Serving HS-DSCH Radio Link indicated by the *HS-PDSCH RL ID* IE for Continuous Packet Connectivity HS-SCCH less operation according to TS 25.214 [10].]
- [FDD – The DRNS shall allocate the HS-PDSCH codes needed for HS-SCCH less operation and include the *Continuous Packet Connectivity HS-SCCH less Information Response* IE in the RADIO LINK RECONFIGURATION READY message.]
- [FDD – If at least one of *HS-PDSCH Second Code Support* IE is set to “True”, then the DRNC shall include *HS-PDSCH Second Code Index* IE in the RADIO LINK RECONFIGURATION READY message.]

[FDD- If the RADIO LINK RECONFIGURATION PREPARE message includes the *Continuous Packet Connectivity HS-SCCH less Deactivate Indicator* IE, then the DRNS shall deactivate the Continuous Packet Connectivity HS-SCCH less operation for the HS-DSCH Radio Link.]

[1.28 Mcps TDD – If the RADIO LINK RECONFIGURATION PREPARE message includes the *Continuous Packet Connectivity DRX Information LCR* IE, then the DRNS shall take account into these parameters to decide the DRX operation related parameters and configure the concerned UE Context for DRX operation according to TS 25.213 [21] and include the parameter(s) in the *Continuous Packet Connectivity DRX Information Response LCR* IE in the RADIO LINK RECONFIGURATION READY message.]

[1.28 Mcps TDD - If the *Inactivity Threshold for UE DRX Cycle Ext* IE is included in the *Continuous Packet Connectivity DRX Information LCR* IE, then the DRNS may use this value to determine the Inactivity Threshold for UE DRX Cycle according to TS 25.224 [22].]

[1.28 Mcps TDD – If the RADIO LINK RECONFIGURATION PREPARE message includes the *Continuous Packet Connectivity DRX Information To Modify LCR* IE, then:]

- [1.28 Mcps TDD – If the *UE DTX DRX Offset* IE is included in the *Continuous Packet Connectivity DRX Information To Modify LCR* IE, then the DRNS shall apply the indicated Offset in *UE DTX DRX Cycle* IE in the new configuration.]
- [1.28 Mcps TDD – If the *Enabling Delay* IE is included in the *Continuous Packet Connectivity DRX Information To Modify LCR* IE, then the DRNS shall use this value to determine the beginning of uplink transmission in the new configuration according to TS 25.213 [21].]
- [1.28 Mcps TDD – If the *DRX Information To Modify* IE is included in the *Continuous Packet Connectivity DRX Information To Modify LCR* IE, then the DRNS shall use this information to modify the indicated DRX Information in the new configuration.]

[1.28 Mcps TDD – If the RADIO LINK RECONFIGURATION PREPARE message includes the *HS-DSCH Semi-Persistent scheduling Information LCR* IE, then:]

- [1.28 Mcps TDD – The DRNS shall configure the Serving HS-DSCH Radio Link indicated by the *HS-PDSCH RL ID* IE for HS-DSCH Semi-Persistent scheduling operation according to TS 25.213 [21].]

- [1.28 Mcps TDD – The DRNS shall allocate the HS-SICH information needed for HS-DSCH Semi-Persistent scheduling operation and include the *HS-DSCH Semi-Persistent scheduling Information Response LCR IE* in the RADIO LINK RECONFIGURATION READY message.]
- [1.28 Mcps TDD – If the *HS-DSCH Semi-Persistent Resource Reservation Indicator IE* is included in the *HS-DSCH Semi-Persistent scheduling Information LCR IE*, then the DRNS shall include *Allcoated HS-PDSCH Semi-persistent resource IE* in the RADIO LINK RECONFIGURATION READY message.]

[1.28 Mcps TDD – If the RADIO LINK RECONFIGURATION PREPARE message includes the *E-DCH Semi-Persistent scheduling Information LCR IE*, then:]

- [1.28 Mcps TDD – The DRNS shall configure the Serving E-DCH Radio Link indicated by the *E-DCH Serving RL IE* for E-DCH Semi-Persistent scheduling operation according to TS 25.213 [21].]
- [1.28 Mcps TDD - If the *E-DCH Semi-Persistent Resource Reservation Indicator IE* is included in the *E-DCH Semi-Persistent scheduling Information LCR IE*, then the DRNS shall include *Allocated E-DCH Semi-persistent resource IE* in the RADIO LINK RECONFIGURATION READY message.]

[1.28 Mcps TDD – If the RADIO LINK RECONFIGURATION PREPARE message includes the *HS-DSCH Semi-Persistent scheduling Information to modify LCR IE*, then:]

- [1.28 Mcps TDD – If the *Transport Block Size List IE* or/and *Repetition Period list IE* is/are included in the *HS-DSCH Semi-Persistent scheduling Information to modify LCR IE*, the DRNS shall modify the configuration of Serving HS-DSCH Radio Link indicated by the *HS-PDSCH RL ID IE* for HS-DSCH Semi-Persistent scheduling operation according to TS 25.213 [21].]
- [1.28 Mcps TDD – The DRNS shall allocate the HS-SICH information needed for HS-DSCH Semi-Persistent scheduling operation and include the *HS-DSCH Semi-Persistent scheduling Information Response LCR IE* in the RADIO LINK RECONFIGURATION READY message.]
- [1.28 Mcps TDD – If the *HS-DSCH Semi-Persistent Resource Reservation Indicator IE* is included in the *HS-DSCH Semi-Persistent scheduling Information to modify LCR IE*, then the DRNS shall include *Allcoated HS-PDSCH Semi-persistent resource IE* in the RADIO LINK RECONFIGURATION READY message.]
- [1.28 Mcps TDD – If the *HS-DSCH Semi-Persistent scheduling operation Indicator IE* is included in the *HS-DSCH Semi-Persistent scheduling Information to modify LCR IE*, then the DRNS shall apply this information for HS-DSCH Semi-Persistent scheduling operation.]
- [1.28 Mcps TDD – If the buffer size for HS-DSCH Semi-Persistent scheduling needs to be modified, then the DRNS shall include the *Buffer Size for HS-DSCH Semi-Persistent scheduling IE* in the RADIO LINK RECONFIGURATION READY message.]
- [1.28 Mcps TDD – If the number of processes for HS-DSCH Semi-Persistent scheduling needs to be modified, then the DRNS shall include the *Number of Processes for HS-DSCH Semi-Persistent scheduling IE* in the RADIO LINK RECONFIGURATION READY message.]

[1.28 Mcps TDD – If the RADIO LINK RECONFIGURATION PREPARE message includes the *E-DCH Semi-Persistent scheduling Information to modify LCR IE*, then:]

- [1.28 Mcps TDD – If the *Repetition Period list IE* is included in the *E-DCH Semi-Persistent scheduling Information to modify LCR IE*, the DRNS shall modify the configuration of Serving E-DCH Radio Link indicated by the *E-DCH Serving RL IE* for E-DCH Semi-Persistent scheduling operation according to TS 25.213 [21].]
- [1.28 Mcps TDD – If the *E-DCH Semi-Persistent scheduling Indicator IE* is included in the *E-DCH Semi-Persistent scheduling Information to modify LCR IE*, then the DRNS shall apply this information for E-DCH Semi-Persistent scheduling operation.]
- [1.28 Mcps TDD - If the *E-DCH Semi-Persistent Resource Reservation Indicator IE* is included in the *E-DCH Semi-Persistent scheduling Information to modify LCR IE*, then the DRNS shall include *Allocated E-DCH Semi-persistent resource IE* in the RADIO LINK RECONFIGURATION READY message.]

[1.28 Mcps TDD – If the RADIO LINK RECONFIGURATION PREPARE message includes the *HS-DSCH Semi-Persistent scheduling Deactivate Indicator LCR IE*, then the DRNS shall deactivate the HS-DSCH Semi-Persistent scheduling operation for the HS-DSCH Radio Link.]

[1.28 Mcps TDD – If the RADIO LINK RECONFIGURATION PREPARE message includes the *E-DCH Semi-Persistent scheduling Deactivate Indicator LCR IE*, then the DRNS shall deactivate the E-DCH Semi-Persistent scheduling operation for the E-DCH Radio Link.]

[TDD – UL/DL CCTrCH Modification]

[TDD – If the RADIO LINK RECONFIGURATION PREPARE message includes any *UL CCTrCH To Modify* IEs or *DL CCTrCH To Modify* IEs, then the DRNS shall treat them each as follows:]

- [TDD – If any of the *UL CCTrCH To Modify* IEs or *DL CCTrCH To Modify* IEs includes any of the *TFCS IE*, *TFCI coding IE*, *Puncture limit IE*, or *TPC CCTrCH ID* IEs the DRNS shall apply these as the new values, otherwise the previous values specified for this CCTrCH are still applicable.]
- [TDD – If any of the following listed DPCH information IEs are modified in the new prepared configuration, the DRNC shall include in the RADIO LINK RECONFIGURATION READY message the IEs indicating the new values: *Repetition Period IE*, *Repetition Length IE*, *TDD DPCH Offset IE*, [3.84Mcps TDD – *UL Timeslot Information IE*,] [1.28Mcps TDD – *UL Timeslot Information LCR IE*,] [7.68 Mcps TDD – *UL Timeslot Information 7.68 Mcps IE*,] [3.84Mcps TDD – *DL Timeslot Information IE*,] [1.28Mcps TDD – *DL Timeslot Information LCR IE*,] [7.68 Mcps TDD – *DL Timeslot Information 7.68 Mcps IE*,] [3.84Mcps TDD – *Midamble Shift And Burst Type IE*,] [1.28Mcps TDD – *Midamble Shift LCR IE*,] [7.68 Mcps TDD – *Midamble Shift And Burst Type 7.68 Mcps IE*,] *TFCI Presence IE*, [3.84Mcps TDD – *TDD Channelisation Code IE*,] [1.28Mcps TDD – and/or *TDD Channelisation Code LCR IE*,] [7.68 Mcps TDD – *TDD Channelisation Code 7.68 Mcps IE*,] [1.28Mcps TDD – *TDD UL DPCH Time Slot Format LCR IE* or *TDD DL DPCH Time Slot Format LCR IE*.]
- [1.28Mcps TDD – If the *UL CCTrCH To Modify* IE includes the *UL SIR Target IE*, the DRNS shall use the value for the UL inner loop power control according TS 25.221 [12] and TS 25.224 [22] in the new configuration.]
- [TDD – If any of the *DL CCTrCH To Modify* IEs includes any *TPC CCTrCH ID* IEs, the DRNS shall apply these as the new values, otherwise the previous values specified for this CCTrCH are still applicable.]
- [1.28Mcps TDD – If the *UL CCTrCH to Modify* IE includes the *TDD TPC Uplink Step Size IE*, the DRNS shall apply this value to the uplink TPC step size in the new configuration.]
- [TDD – If the *DL CCTrCH to Modify* IE includes the *TDD TPC Downlink Step Size IE*, the DRNS shall apply this value to the downlink TPC step size in the new configuration.]
- [1.28 Mcps TDD – if the DRNS modifies, deletes or grants a new PLCCCH assignment(s) to the UL CCTrCH, then the resulting PLCCCH assignment(s) shall be sent to the SRNC in the RADIO LINK RECONFIGURATION READY message.]

[TDD – UL/DL CCTrCH Addition]

[TDD – If the RADIO LINK RECONFIGURATION PREPARE message includes any *UL CCTrCH To Add* IEs or *DL CCTrCH To Add* IEs, the DRNS shall include this CCTrCH in the new configuration.]

[TDD – If the RADIO LINK RECONFIGURATION PREPARE message includes any *DCHs to Add* IEs, the DRNC shall include in the RADIO LINK RECONFIGURATION READY message the DPCH information in [3.84Mcps TDD – *UL DPCH to be Added IE/DL DPCH to be Added IEs*] [1.28Mcps TDD – *UL DPCH to be Added LCR IE/DL DPCH to be Added LCR IEs*] [7.68 Mcps TDD – *UL DPCH to be Added 7.68 Mcps IE/DL DPCH to be Added 7.68 Mcps IEs*]. [3.84Mcps TDD – If no UL DPCH is active before a reconfiguration which adds an UL DPCH, and if a valid Rx Timing Deviation measurement is known in DRNC, then the DRNC shall include the *Rx Timing Deviation IE* (or the *Rx Timing Deviation 3.84 Mcps Extended IE* if the cell containing the radio link is configured for extended timing advance) in the RADIO LINK RECONFIGURATION READY message]. [7.68 Mcps TDD – If no UL DPCH is active before a reconfiguration which adds an UL DPCH, and if a valid Rx Timing Deviation measurement is known in DRNC, then the DRNC shall include the *Rx Timing Deviation 7.68 Mcps IE* in the RADIO LINK RECONFIGURATION READY message].]

[TDD – If the RADIO LINK RECONFIGURATION PREPARE message includes the *TDD TPC Downlink Step Size IE* within a *DL CCTrCH To Add* IE, the DRNS shall set the TPC step size of that CCTrCH to that value, otherwise the DRNS shall use the same value as the lowest numbered DL CCTrCH in the current configuration.]

[1.28Mcps TDD – The DRNS shall use the *UL SIR Target IE* in the *UL CCTrCH To Add* IE as the UL SIR value for the inner loop power control for this CCTrCH according TS 25.221 [12] and TS 25.224 [22] in the new configuration.]

[TDD – If any of the *DL CCH To Add* IEs includes any *TPC CCH ID* IEs, the DRNS shall configure the identified UL CCHs with TPC according to the parameters given in the message.]

[1.28Mcps TDD – If the *UL CCH To Add* IE includes *TDD TPC Uplink Step Size* IE, the DRNS shall apply the uplink TPC step size in the new configuration.]

[1.28 Mcps TDD – if the DRNS grants a PLCCCH assignment(s) to the UL CCH, then the resulting PLCCCH assignment(s) shall be sent to the SRNC in the RADIO LINK RECONFIGURATION READY message.]

[TDD – UL/DL CCH Deletion]

[TDD – If the RADIO LINK RECONFIGURATION PREPARE message includes any *UL CCH To Delete* IEs or *DL CCH To Delete* IEs, the DRNS shall remove this CCH in the new configuration, and the DRNC shall include in the RADIO LINK RECONFIGURATION READY message corresponding *UL DPCH to be Deleted* IEs and *DL DPCH to be Deleted* IEs.]

DL Power Control:

[FDD – If the *RL Information* IE includes the *DL Reference Power* IEs and power balancing is active, DRNS shall update the reference power of the power balancing in the indicated RL(s), if updating of power balancing parameters by the RADIO LINK RECONFIGURATION PREPARE message is supported, when the new configuration has been activated, according to subclause 8.3.15, using the *DL Reference Power* IE. If the CFN modulo the value of the *Adjustment Period* IE is not equal to 0, the power balancing continues with the old reference power until the end of the current adjustment period, and the updated reference power shall be used from the next adjustment period.]

[FDD – If updating of power balancing parameters by the RADIO LINK RECONFIGURATION PREPARE message is supported by the DRNS, the DRNC shall include the *DL Power Balancing Updated Indicator* IE in the *RL Information Response* IE for each affected RL in the RADIO LINK RECONFIGURATION READY message.]

[TDD – DSCH Addition/Modification/Deletion:]

[TDD – If the RADIO LINK RECONFIGURATION PREPARE message includes any *DSCH To Add*, *DSCH To Modify* or *DSCH To Delete* IEs, then the DRNS shall use this information to add/modify/delete the indicated DSCH channels to/from the radio link, in the same way as the DCH info is used to add/modify/release DCHs.]

[TDD – If the RADIO LINK RECONFIGURATION PREPARE message includes any *DSCH To Add* IE, then the DRNS shall use the *Allocation/Retention Priority* IE, *Scheduling Priority Indicator* IE and *TrCH Source Statistics Descriptor* IE to define a set of DSCH Priority classes each of which is associated with a set of supported MAC-c/sh SDU lengths.]

[TDD – The DRNC shall include in the RADIO LINK RECONFIGURATION READY message both the *Transport Layer Address* IE and the *Binding ID* IE for the transport bearer to be established for each added DSCH.]

[TDD – If the RADIO LINK RECONFIGURATION PREPARE message includes any *DSCH To Add* IE, then the DRNS may use the *Traffic Class* IE to determine the transport bearer characteristics to apply between DRNC and Node B for the related DSCHs.]

[TDD – If the RADIO LINK RECONFIGURATION PREPARE message includes the *TNL QoS* IE in the *DSCH TDD Information* IE and if ALCAP is not used, the DRNS may use the *TNL QoS* IE to determine the transport bearer characteristics to apply in the uplink for the related DSCH.]

[TDD – If the RADIO LINK RECONFIGURATION PREPARE message includes any *DSCH To Modify* IE, then the DRNS shall treat them each as follows:]

- [TDD – The DRNC shall include in the RADIO LINK RECONFIGURATION READY message both the *Transport Layer Address* IE and the *Binding ID* IE for any new transport bearer to be established for each modified DSCH.]
- [TDD – If the *DSCHs To Modify* IE includes the *CCH ID* IE, then the DRNS shall map the DSCH onto the referenced DL CCH.]
- [TDD – If the *DSCHs To Modify* IE includes any of the *Allocation/Retention Priority* IE, *Scheduling Priority Indicator* IE or *TrCH Source Statistics Descriptor* IE, the DRNS shall use them to update the set of DSCH Priority classes each of which is associated with a set of supported MAC-c/sh SDU lengths.]

- [TDD – If the *DSCHs To Modify* IE includes any of the *Transport Format Set* IE or *BLER* IE, the DRNS shall apply the parameters to the new configuration.]
- [TDD – If the *DSCHs To Modify* IE includes the *Traffic Class* IE, the DRNS may use this information to determine the transport bearer characteristics to apply between DRNC and Node B for the related DSCHs.]
- [TDD – If the *DSCHs To Modify* IE includes the *TNL QoS* IE and if ALCAP is not used, the DRNS may use the *TNL QoS* IE to determine the transport bearer characteristics to apply in the uplink for the related DSCH.]

[3.84 Mcps TDD – The DRNC shall include the *Secondary CCPCH Info TDD* IE in the RADIO LINK RECONFIGURATION READY message if a DSCH is added and at least one DCH exists in the new configuration. The DRNC shall also include the *Secondary CCPCH Info TDD* IE in the RADIO LINK RECONFIGURATION READY message if the SHCCH messages for this radio link will be transmitted over a different secondary CCPCH than selected by the UE from system information.]

[1.28 Mcps TDD – The DRNC shall include the *Secondary CCPCH Info TDD LCR* IE in the RADIO LINK RECONFIGURATION READY message if a DSCH is added and at least one DCH exists in the new configuration. The DRNC shall also include the *Secondary CCPCH Info TDD LCR* IE in the RADIO LINK RECONFIGURATION READY message if the SHCCH messages for this radio link will be transmitted over a different secondary CCPCH than selected by the UE from system information.]

[7.68 Mcps TDD – The DRNC shall include the *Secondary CCPCH Info 7.68 Mcps TDD* IE in the RADIO LINK RECONFIGURATION READY message if a DSCH is added and at least one DCH exists in the new configuration. The DRNC shall also include the *Secondary CCPCH Info 7.68 Mcps TDD* IE in the RADIO LINK RECONFIGURATION READY message if the SHCCH messages for this radio link will be transmitted over a different secondary CCPCH than selected by the UE from system information.]

[TDD – The DRNC shall include the *DSCH Initial Window Size* IE in the RADIO LINK RECONFIGURATION READY message for each DSCH, if the DRNS allows the SRNC to start transmission of MAC-c/sh SDUs before the DRNS has allocated capacity on user plane as described in TS 25.425 [32].]

[TDD USCH Addition/Modification/Deletion]

[TDD – If the RADIO LINK RECONFIGURATION PREPARE message includes any *USCH To Modify*, *USCH To Add* or *USCH To Delete* IEs, then the DRNS shall use this information to add/modify/delete the indicated USCH channels to/from the radio link, in the same way as the DCH info is used to add/modify/release DCHs.]

[TDD – If the RADIO LINK RECONFIGURATION PREPARE message includes any *USCH To Add* IE, then, the DRNS shall use the *Allocation/Retention Priority* IE, *Scheduling Priority Indicator* IE and *TrCH Source Statistics Descriptor* IE to define a set of USCH Priority classes each of which is associated with a set of supported MAC-c/sh SDU lengths.]

[TDD – If the RADIO LINK RECONFIGURATION PREPARE message includes any *USCH To Add* IE, then the DRNS may use the *Traffic Class* IE to determine the transport bearer characteristics to apply between DRNC and Node B for the related USCHs.]

[TDD – If the RADIO LINK RECONFIGURATION PREPARE message includes any *USCH To Add* IE, if the *TNL QoS* IE is included and if ALCAP is not used, the DRNS may use the *TNL QoS* IE to determine the transport bearer characteristics to apply for the related USCHs.]

[TDD – The DRNC shall include in the RADIO LINK RECONFIGURATION READY message both the *Transport Layer Address* IE and the *Binding ID* IE for the transport bearer to be established for each added USCH.]

[TDD – If the RADIO LINK RECONFIGURATION PREPARE message includes any *USCH To Modify* IE, then the DRNS shall treat them each as follows:]

- [TDD – If the *USCH To Modify* IE includes any of the *Allocation/Retention Priority* IE, *Scheduling Priority Indicator* IE or *TrCH Source Statistics Descriptor* IE, the DRNS shall use them to update the set of USCH Priority classes.]
- [TDD – If the *USCH To Modify* IE includes any of the *CCTrCH ID* IE, *Transport Format Set* IE, *BLER* IE or *RB Info* IE, the DRNS shall apply the parameters to the new configuration.]
- [TDD – If the *USCHs To Modify* IE includes the *Traffic Class* IE, the DRNS may use this information to determine the transport bearer characteristics to apply between DRNC and Node B for the related USCHs.]

- [3.84Mcps TDD – The DRNC shall include the *Secondary CCPCH Info TDD* IE in the RADIO LINK RECONFIGURATION READY message if a USCH is added and at least one DCH exists in the new configuration. The DRNC shall also include the *Secondary CCPCH Info TDD* IE in the RADIO LINK RECONFIGURATION READY message if the SHCCH messages for this radio link will be transmitted over a different secondary CCPCH than selected by the UE from system information.]
- [1.28Mcps TDD – The DRNC shall include the *Secondary CCPCH Info TDD LCR* IE in the RADIO LINK RECONFIGURATION READY message if a USCH is added and at least one DCH exists in the new configuration. The DRNC shall also include the *Secondary CCPCH Info TDD LCR* IE in the RADIO LINK RECONFIGURATION READY message if the SHCCH messages for this radio link will be transmitted over a different secondary CCPCH than selected by the UE from system information.]
- [7.68Mcps TDD – The DRNC shall include the *Secondary CCPCH Info 7.68Mcps TDD* IE in the RADIO LINK RECONFIGURATION READY message if a USCH is added and at least one DCH exists in the new configuration. The DRNC shall also include the *Secondary CCPCH Info 7.68Mcps TDD* IE in the RADIO LINK RECONFIGURATION READY message if the SHCCH messages for this radio link will be transmitted over a different secondary CCPCH than selected by the UE from system information.]
- [TDD – if the *TNL QoS* IE is included and if ALCAP is not used, the DRNS may use the *TNL QoS* IE to determine the transport bearer characteristics to apply for the related USCHs.]
- [TDD – The DRNC shall include in the RADIO LINK RECONFIGURATION READY message both the *Transport Layer Address* IE and the *Binding ID* IE for any new transport bearer to be established for each modified USCH.]

RL Information:

[FDD – If the *RL Information* IE includes the *DL DPCH Timing Adjustment* IE, the DRNS shall adjust the timing of the radio link accordingly in the new configuration. If the UE Context is configured to use F-DPCH in the downlink in the new configuration, the DRNC may include the *DL Code Information* IE in the RADIO LINK RECONFIGURATION READY message.]

HS-DSCH Setup:

If the *HS-DSCH Information* IE is present in the RADIO LINK RECONFIGURATION PREPARE message, then:

- The DRNS shall setup the requested HS-PDSCH resources on the Serving HS-DSCH Radio Link indicated by the *HS-PDSCH RL ID* IE.
- The DRNC shall include the *HARQ Memory Partitioning* IE in the [FDD – *HS-DSCH FDD Information Response* IE] [TDD – *HS-DSCH TDD Information Response* IE] in the RADIO LINK RECONFIGURATION READY message. [FDD – The *HARQ Memory Partitioning* IE shall either contain the *HARQ Memory Partitioning Information Extension For MIMO* IE or the *Number of Processes* IE set to a value higher than “8”, if the *MIMO Activation Indicator* IE is included in the *HS-DSCH Information* IE.] [1.28Mcps TDD– The *HARQ Memory Partitioning* IE shall either contain the *HARQ Memory Partitioning Information Extension For MIMO* IE or the *Number of Processes* IE set to a value higher than “8”, if the *MIMO Activation Indicator* IE is included in the *HS-DSCH Information* IE.]
- The DRNC shall allocate an HS-DSCH-RNTI to the UE Context and include the *HS-DSCH-RNTI* IE in the RADIO LINK RECONFIGURATION READY message.
- The DRNS may use the *Traffic Class* IE for a specific HS-DSCH MAC-d flow to determine the transport bearer characteristics to apply between DRNC and Node B. If *TrCH Source Statistics Descriptor* IE is present with the value “RRC” in the *HS-DSCH MAC-d Flows Information* IE, then the DRNC should ignore the *Traffic Class* IE.
- If the *TNL QoS* IE is included for a MAC-d flow and if ALCAP is not used, the *TNL QoS* IE may be used by the DRNS to determine the transport bearer characteristics to apply in the uplink between the DRNS and the SRNC for the related MAC-d flow.
- If fields are to be included in the User Plane by the SRNC to handle TNL Congestion Control for HSDPA in the DRNS, then the DRNC shall include the *User Plane Congestion Fields Inclusion* IE in the *HS-DSCH Information Response* IE.

- If the RADIO LINK RECONFIGURATION PREPARE message includes the *MAC-hs Guaranteed Bit Rate IE* for a Priority Queue in the *HS-DSCH MAC-d Flows Information IE* in the *HS-DSCH Information IE*, then the DRNS shall use this information to optimise MAC-hs scheduling decisions for the related HSDPA Priority Queue.
- If the RADIO LINK RECONFIGURATION PREPARE message includes the *Discard Timer IE* for a Priority Queue in the *HS-DSCH MAC-d Flows Information IE* in the *HS-DSCH Information IE*, then the DRNS shall use this information to discard out-of-date MAC-hs SDUs from the related HSDPA Priority Queue.
- If the RADIO LINK RECONFIGURATION PREPARE message includes the *Maximum MAC-d PDU Size Extended IE* for a Priority Queue in the *HS-DSCH MAC-d Flows Information IE* in the *HS-DSCH Information IE*, then the DRNS shall ignore the *SID IE* and *MAC-d PDU Size IE* in the *MAC-d PDU Size Index IE* and use *Maximum MAC-d PDU Size Extended IE* to optimise capacity allocation for the related HSDPA Priority Queue.
- The DRNC shall include the *HS-DSCH Initial Capacity Allocation IE* in the [FDD – *HS-DSCH FDD Information Response IE*] [TDD – *HS-DSCH TDD Information Response IE*] in the RADIO LINK RECONFIGURATION READY message for every HS-DSCH MAC-d flow being established, if the DRNS allows the SRNC to start transmission of MAC-d PDUs before the DRNS has allocated capacity on user plane as described in TS 25.425 [32] If RADIO LINK RECONFIGURATION PREPARE message includes *HS-DSCH MAC-d PDU Size Format IE* in the *HS-DSCH Information IE* set to “Flexible MAC-d PDU Size”, then DRNC shall only set in the *HS-DSCH Initial Capacity Allocation IE* the values for the peer of *Scheduling Priority Indicator IE* and *Maximum MAC-d PDU Size Extended IE* to the values of the corresponding peer I in RADIO LINK RECONFIGURATION PREPARE in the *HS-DSCH MAC-d Flows Information IE* in the *HS-DSCH Information IE* for a Priority Queue including *Scheduling Priority Indicator IE* and *Maximum MAC-d PDU Size Extended IE*.
- [FDD – If the RADIO LINK RECONFIGURATION PREPARE message includes the *HS-SCCH Power Offset IE* in the *HS-DSCH Information IE*, then the DRNS may use this value to determine the HS-SCCH power. The HS-SCCH Power Offset should be applied for any HS-SCCH transmission to this UE.]
- [FDD – The DRNC shall include the *Measurement Power Offset IE* in the *HS-DSCH Information Response IE* in the RADIO LINK RECONFIGURATION READY message.]
- [FDD – The DRNS shall allocate HS-SCCH codes corresponding to the HS-DSCH and the DRNC shall include the *HS-SCCH Specific Information Response IE* in the *HS-DSCH FDD Information Response IE* in the RADIO LINK RECONFIGURATION READY message.]
- [TDD – The DRNS shall allocate HS-SCCH parameters corresponding to the HS-DSCH and the DRNC shall include the [3.84Mcps TDD – *HS-SCCH Specific Information Response IE*] [1.28Mcps TDD – *HS-SCCH Specific Information Response LCR IE*] [7.68 Mcps TDD – *HS-SCCH Specific Information Response 7.68 Mcps IE*] in the *HS-DSCH TDD Information Response IE* in the RADIO LINK RECONFIGURATION READY message.]
- [FDD – The DRNC shall include the *HS-PDSCH And HS-SCCH Scrambling Code IE* in the *HS-DSCH FDD Information Response IE* in the RADIO LINK RECONFIGURATION READY message.]
- [FDD – If the RADIO LINK RECONFIGURATION PREPARE message includes the *HARQ Preamble Mode IE* in the *HS-DSCH Information IE*, then the DRNS shall use the indicated HARQ Preamble Mode as described in TS 25.214 [10], if HS-DPCCH ACK/NACK preamble and postamble is supported. Then, in this case, if the mode 1 is applied, the DRNC shall include the *HARQ Preamble Mode Activation Indicator IE* in the *HS-DSCH Information Response IE* in the RADIO LINK RECONFIGURATION READY message. If the *HARQ Preamble Mode IE* is not included or if the mode 0 is applied, then the DRNC shall not include the *HARQ Preamble Mode Activation Indicator IE* in the *HS-DSCH Information Response IE* in the RADIO LINK RECONFIGURATION READY message.]
- If the RADIO LINK RECONFIGURATION PREPARE message includes the *HS-DSCH MAC-d PDU Size Format IE* in the *HS-DSCH Information IE*, then the DRNS shall use the indicated format in user plane frame structure for HS-DSCH channels TS 25.425 [32] and MAC-hs TS 25.321 [41].
- [FDD – If the *MIMO Activation Indicator IE* is included in the *HS-DSCH FDD Information IE*, then:]
 - [FDD – The DRNS shall activate the MIMO mode for the HS-DSCH Radio Link.]

- [FDD – The DRNS shall decide the pilot configuration and the UE reporting configuration (N/M ratio) according to TS 25.214 [10] for MIMO and include the *MIMO Information Response* IE in the *HS-DSCH FDD Information Response* IE in the RADIO LINK RECONFIGURATION READY message.]
- [FDD – If the *Power Offset For S-CPICH for MIMO Request Indicator* IE is included, the DRNC shall, if supported and MIMO pilot configuration with Primary and Secondary CPICH is set up on the cell with a non-zero power offset where the Serving HS-DSCH Radio Link is established, include the *Power Offset For S-CPICH for MIMO* IE in the *HS-DSCH FDD Information Response* IE in the RADIO LINK RECONFIGURATION READY message. If zero power offset the DRNC may include the *Power Offset For S-CPICH for MIMO* IE.]
- [1.28 Mcps TDD – If the *MIMO Activation Indicator* IE is included in the *HS-DSCH TDD Information* IE, then:]
 - [1.28 Mcps TDD – The DRNS shall activate the MIMO mode for the HS-DSCH Radio Link.]
 - [1.28 Mcps TDD – The DRNS shall decide the SF mode for HS-PDSCH dual stream and include the *MIMO SF Mode for HS-PDSCH dual stream* IE in the *HS-DSCH TDD Information Response* IE in the RADIO LINK RECONFIGURATION READY message.]
- [FDD – If the *Sixtyfour QAM Usage Allowed Indicator* IE is included in the *HS-DSCH FDD Information* IE, then the DRNS may if the value is set to “allowed” use 64 QAM for the HS-DSCH Radio Link, and the DRNS shall include the *Sixtyfour QAM DL Usage Indicator* IE in the *HS-DSCH FDD Information Response* IE in the RADIO LINK RECONFIGURATION READY message.]
- [FDD – If the *Sixtyfour QAM Usage Allowed Indicator* IE is included in the *HS-DSCH FDD Information* IE with value set to “not allowed”, then the DRNS shall not use 64 QAM for the HS-DSCH Radio Link.]
- [FDD – If the RADIO LINK RECONFIGURATION PREPARE message includes the *HS-DSCH MAC-d PDU Size Format* IE set to “Flexible MAC-d PDU Size” and if Sixtyfour QAM will not be used, the DRNS shall include the *HS-DSCH TB Size Table Indicator* IE in the *HS-DSCH FDD Information Response* IE in the RADIO LINK RECONFIGURATION READY message if it decides to use the octet aligned table defined in TS 25.321 [41] for HS-DSCH Transport Block Size signalling.]
- [FDD – If the *UE with enhanced HS-SCCH support indicator* IE is included in the *HS-DSCH FDD Information* IE, then the DRNS may use:]
 - [FDD – a different HS-SCCH in consecutive TTIs for this UE]
 - [FDD – HS-SCCH orders for the case of HS-SCCH-less operation to this UE]
- [FDD – If the *UE Support Indicator Extension* IE is included in the *HS-DSCH FDD Information* IE the DRNS may use the supported HSDPA functions for this UE.]
- [FDD - If the *UE Support Indicator Extension* IE is included in the *HS-DSCH FDD Information* IE with the bit *UE DTXDRX related HS-SCCH orders uniform behavior indicator* set to 0, then the DRNS shall, if supported, include the *Support of dynamic DTXDRX related HS-SCCH order* IE in the *HS-DSCH FDD Information Response* IE in the RADIO LINK RECONFIGURATION READY message.]
- [FDD – If secondary serving HS-DSCH is applied also in the new configuration, then any changes related to parameters that are common for both the serving and the secondary serving HS-DSCH should be applied also for the secondary serving HS-DSCH.]
- If the RADIO LINK RECONFIGURATION PREPARE message includes *DL RLC PDU Size Format* IE for a Priority Queue in the *HS-DSCH MAC-d Flows Information* IE in the *HS-DSCH Information* IE, the *DL RLC PDU Size Format* IE may be used by the DRNS to determine the allocated capacity on user plane as described in TS 25.425 [32].
- [FDD – If the RADIO LINK RECONFIGURATION PREPARE message includes the *UE Aggregate Maximum Bit Rate Enforcement Indicator* IE in the *Priority Queue Information* IE in the *HS-DSCH MAC-d Flows Information* IE in the *HS-DSCH Information* IE, the DRNS shall, if supported, consider the data of the related HSDPA Priority Queue for UE Aggregate Maximum Bit Rate Enforcement.]
- [FDD – If the *Single Stream MIMO Activation Indicator* IE is included in the *HS-DSCH FDD Information* IE, then the DRNS shall activate the Single Stream MIMO for the HS-DSCH Radio Link.]

- [1.28 Mcps TDD – If the *UE TS0 Capability LCR* IE is included in the *HS-DSCH TDD Information* IE, then the DRNC may include the *TS0 HS-PDSCH Indication LCR* IE in the RADIO LINK RECONFIGURATION READY message if HS-PDSCH resources could be allocated on TS0 for the UE]

[FDD – Secondary Serving HS-DSCH Setup:]

[FDD – If the *C-ID* IE is present in the *Additional HS Cell Information RL Reconf Prep* IE in the RADIO LINK RECONFIGURATION PREPARE message, then:]

- [FDD – The DRNS shall setup the requested HS-PDSCH resources on the secondary serving HS-DSCH Radio Link indicated by the *HS-PDSCH RL ID* IE. Non cell specific secondary serving Radio Link and non cell specific secondary serving HS-DSCH parameters take the same values as for the serving HS-DSCH cell.]
- [FDD – The DRNC shall allocate an HS-DSCH-RNTI to the UE Context and include the *HS-DSCH-RNTI* IE in the *Additional HS Cell Information Response* IE in the RADIO LINK RECONFIGURATION READY message.]
- [FDD – If the RADIO LINK RECONFIGURATION PREPARE message includes the *HS-SCCH Power Offset* IE in the *HS-DSCH FDD Secondary Serving Information* IE, then the DRNS may use this value to determine the HS-SCCH power. The HS-SCCH Power Offset should be applied for any secondary serving HS-SCCH transmission to this UE.]
- [FDD – The DRNC shall include the *Measurement Power Offset* IE in the *HS-DSCH FDD Secondary Serving Information Response* IE in the *Additional HS Cell Information Response* IE in the RADIO LINK RECONFIGURATION READY message.]
- [FDD – The DRNS shall allocate HS-SCCH codes corresponding to the secondary serving HS-DSCH and the DRNC shall include the *HS-SCCH Specific Secondary Serving Information Response* IE in the *HS-DSCH FDD Secondary Serving Information Response* IE in the *Additional HS Cell Information Response* IE in the RADIO LINK RECONFIGURATION READY message.]
- [FDD – If the *MIMO Activation Indicator* IE is included in the *HS-DSCH FDD Secondary Serving Information* IE, then the DRNS shall activate the MIMO mode for the secondary serving HS-DSCH Radio Link and the DRNS shall decide the pilot configuration and the UE reporting configuration (N/M ratio) according to TS 25.214 [10] for MIMO and include the *MIMO Information Response* IE in the *HS-DSCH FDD Secondary Serving Information Response* IE in the *Additional HS Cell Information Response* IE in the RADIO LINK RECONFIGURATION READY message.]
- [FDD – If the *Power Offset For S-CPICH for MIMO Request Indicator* IE is included, the DRNC shall, if supported and MIMO pilot configuration with Primary and Secondary CPICH is set up on the cell with a non-zero power offset where the Secondary Serving HS-DSCH Radio Link is established, include the *Power Offset For S-CPICH for MIMO* IE in the *HS-DSCH FDD Secondary Serving Information Response* IE in the RADIO LINK RECONFIGURATION READY message. If zero power offset the DRNC may include the *Power Offset For S-CPICH for MIMO* IE.]
- [FDD – If the *Single Stream MIMO Activation Indicator* IE is included in the *HS-DSCH FDD Secondary Serving Information* IE, then the DRNS shall activate the Single Stream MIMO mode for the secondary serving HS-DSCH Radio Link.]
- [FDD – The DRNC shall include the *HS-PDSCH And HS-SCCH Scrambling Code* IE in the *HS-DSCH FDD Secondary Serving Information Response* IE in the *Additional HS Cell Information Response* IE in the RADIO LINK RECONFIGURATION READY message.]
- [FDD – If the *Sixtyfour QAM Usage Allowed Indicator* IE is included in the *HS-DSCH FDD Secondary Serving Information* IE, then the DRNS may if the value is set to “allowed” use 64 QAM for the secondary serving HS-DSCH Radio Link, and the DRNS shall include the *SixtyfourQAM DL Usage Indicator* IE in the *HS-DSCH FDD Secondary Serving Information Response* IE in the *Additional HS Cell Information Response* IE in the RADIO LINK RECONFIGURATION READY message.]
- [FDD – If the *Sixtyfour QAM Usage Allowed Indicator* IE is included in the *HS-DSCH FDD Secondary Serving Information* IE with value set to “not allowed”, then the DRNS shall not use 64 QAM for the secondary serving HS-DSCH Radio Link.]
- [FDD – If, in the new configuration, the UE context is configured not to use Sixtyfour QAM for the secondary serving HS-DSCH, then the DRNC shall include the *HS-DSCH TB Size Table Indicator* IE in the *HS-DSCH*

FDD Secondary Serving Information Response IE in the *Additional HS Cell Information Response* IE in the RADIO LINK RECONFIGURATION READY message if it decides to use the octet aligned table defined in TS 25.321 [41] for secondary serving HS-DSCH Transport Block Size signalling.]

- [FDD – If the *Diversity Mode* IE is included in the *HS-DSCH FDD Secondary Serving Information* IE, the DRNS shall apply cell specific transmit diversity configuration and if the *Diversity Mode* IE is not set to “None” the DRNS shall activate/deactivate the Transmit Diversity for the secondary serving HS-DSCH Radio Link in accordance with the *Transmit Diversity Indicator* IE in the *HS-DSCH FDD Secondary Serving Information* IE.]

Intra-DRNS Serving HS-DSCH Radio Link Change:

If the RADIO LINK RECONFIGURATION PREPARE message includes the *HS-PDSCH RL ID* IE, this indicates the new Serving HS-DSCH Radio Link:

The DRNS shall release the HS-PDSCH resources on the old Serving HS-DSCH Radio Link and setup the HS-PDSCH resources on the new Serving HS-DSCH Radio Link.

The DRNC may include the *HARQ Memory Partitioning* IE in the [FDD – *HS-DSCH FDD Information Response* IE] [TDD – *HS-DSCH TDD Information Response* IE] in the RADIO LINK RECONFIGURATION READY message. [FDD – The *HARQ Memory Partitioning* IE may contain the *HARQ Memory Partitioning Information Extension For MIMO* IE.] [1.28Mcps TDD – The *HARQ Memory Partitioning* IE may contain the *HARQ Memory Partitioning Information Extension For MIMO* IE.]

- If fields are to be included in the User Plane by the SRNC to handle TNL Congestion Control for HSDPA in the DRNS, then the DRNC shall include the *User Plane Congestion Fields Inclusion* IE in the *HS-DSCH Information Response* IE.

The DRNC shall allocate a new HS-DSCH-RNTI to the UE Context and include the *HS-DSCH-RNTI* IE in the RADIO LINK RECONFIGURATION READY message.

If a reset of the MAC-hs is not required the DRNS shall include the *MAC-hs Reset Indicator* IE in the RADIO LINK RECONFIGURATION READY message.

[FDD – The DRNC shall include the *Measurement Power Offset* IE in the *HS-DSCH Information Response* IE in the RADIO LINK RECONFIGURATION READY message.]

[FDD – The DRNS shall allocate HS-SCCH codes corresponding to the HS-DSCH and the DRNC shall include the *HS-SCCH Specific Information Response* IE in the *HS-DSCH FDD Information Response* IE in the RADIO LINK RECONFIGURATION READY message.]

[TDD – The DRNS shall allocate HS-SCCH parameters corresponding to the HS-DSCH and the DRNC shall include the [3.84Mcps TDD – *HS-SCCH Specific Information Response* IE] [1.28Mcps TDD – *HS-SCCH Specific Information Response LCR* IE] [7.68 Mcps TDD – *HS-SCCH Specific Information Response 7.68 Mcps* IE] in the *HS-DSCH TDD Information Response* IE in the RADIO LINK RECONFIGURATION READY message.]

[TDD – The DRNC shall include the [3.84 Mcps TDD – *HS-PDSCH Timeslot Specific Information* IE] [1.28 Mcps TDD – *HS-PDSCH Timeslot Specific Information LCR* IE] [7.68 Mcps TDD – *HS-PDSCH Timeslot Specific Information 7.68 Mcps* IE] in the *HS-DSCH Information Response* IE in the RADIO LINK RECONFIGURATION READY message.]

[FDD – The DRNC shall include the *HS-PDSCH And HS-SCCH Scrambling Code* IE in the *HS-DSCH FDD Information Response* IE in the RADIO LINK RECONFIGURATION READY message.]

- The DRNC may include the *Transport Layer Address* IE and the *Binding ID* IE for HS-DSCH MAC-d flow in the [FDD – *HS-DSCH FDD Information Response* IE] [TDD – *HS-DSCH TDD Information Response* IE] in the RADIO LINK RECONFIGURATION READY message.
- If the *TNL QoS* IE is included for a MAC-d flow and if ALCAP is not used, the *TNL QoS* IE may be used by the DRNS to determine the transport bearer characteristics to apply in the uplink between the DRNS and the SRNC for the related MAC-d flow.
- [FDD - If the *Sixtyfour QAM Usage Allowed Indicator* IE is included in the *HS-DSCH Information To Modify* IE and the value is set to "allowed" or if *HS-DSCH Information To Modify* IE is not included and the UE Context is configured with Sixtyfour QAM allowed for the serving HS-DSCH Radio Link and not used in the current

configuration and then if the DRNS decides to use 64 QAM in the new configuration, then it shall include the *SixtyfourQAM DL Usage Indicator* IE in the *HS-DSCH FDD Information Response* IE in the RADIO LINK RECONFIGURATION READY message.]

- [FDD – If MAC-ehs is applied in the new configuration, and if Sixtyfour QAM will not be used, the DRNS shall include the *HS-DSCH TB Size Table Indicator* IE in the *HS-DSCH FDD Information Response* IE in the RADIO LINK RECONFIGURATION READY message if it decides to use the octet aligned table defined in TS 25.321 [41] for HS-DSCH Transport Block Size signalling.]
- [FDD – If the power offset for S-CPICH for MIMO Request indicator and MIMO activation indicator have been configured in the new configuration and MIMO pilot configuration with Primary and Secondary CPICH is set up with a non-zero power offset on the cell where the Serving HS-DSCH Radio Link is established, the DRNC shall include the *Power Offset For S-CPICH for MIMO* IE in the *HS-DSCH FDD Information Response* IE in the RADIO LINK RECONFIGURATION READY message. If zero power offset the DRNC may include the *Power Offset For S-CPICH for MIMO* IE.]

[FDD – Intra-DRNS Secondary Serving HS-DSCH Radio Link Change:]

[FDD – If the RADIO LINK RECONFIGURATION PREPARE message includes the *C-ID* IE in the *Additional HS Cell Information RL Reconf Prep* IE and the secondary serving HS-DSCH Radio Link has been configured in the DRNS, the *HS-PDSCH RL ID* IE indicates the new Serving HS-DSCH Radio Link:]

- [FDD – The DRNS shall release the HS-PDSCH resources on the old secondary serving HS-DSCH Radio Link and setup the HS-PDSCH resources on the new secondary serving HS-DSCH Radio Link. The DRNS shall remove the old secondary serving HS-PDSCH Radio Link if no E-DCH resources are allocated to the RL. Non cell specific secondary serving Radio Link and non cell specific secondary serving HS-DSCH parameters take the same values as for the serving HS-DSCH cell.]
- [FDD – The DRNC shall allocate an HS-DSCH-RNTI to the UE Context and include the *HS-DSCH-RNTI* IE in the *Additional HS Cell Information Response* IE in the RADIO LINK RECONFIGURATION READY message.]
- [FDD – The DRNC shall include the *Measurement Power Offset* IE in the *HS-DSCH FDD Secondary Serving Information Response* IE in the *Additional HS Cell Information Response* IE in the RADIO LINK RECONFIGURATION READY message.]
- [FDD – The DRNS shall allocate HS-SCCH codes corresponding to the secondary serving HS-DSCH and the DRNC shall include the *HS-SCCH Specific Secondary Serving Information Response* IE in the *HS-DSCH FDD Secondary Serving Information Response* IE in the *Additional HS Cell Information Response* IE in the RADIO LINK RECONFIGURATION READY message.]
- [FDD – The DRNC shall include the *HS-PDSCH And HS-SCCH Scrambling Code* IE in the *HS-DSCH FDD Secondary Serving Information Response* IE in the *Additional HS Cell Information Response* IE in the RADIO LINK RECONFIGURATION READY message.]
- [FDD - If the *Sixtyfour QAM Usage Allowed Indicator* IE is included in the *HS-DSCH FDD Secondary Serving Information To Modify* IE and the value is set to "allowed" or if *HS-DSCH FDD Secondary Serving Information To Modify* IE is not included and the UE Context is configured with Sixtyfour QAM allowed for the secondary serving HS-DSCH Radio Link and not used in the current configuration and then if the DRNS decides to use 64 QAM for the new secondary serving HS-DSCH Radio Link, then it shall include the *SixtyfourQAM DL Usage Indicator* IE in the *Additional HS Cell Information Response* IE in the RADIO LINK RECONFIGURATION READY message.]
- [FDD – If, in the new configuration, the UE context is configured not to use Sixtyfour QAM for the secondary serving HS-DSCH, the DRNS shall include the *HS-DSCH TB Size Table Indicator* IE in the *HS-DSCH FDD Secondary Serving Information Response* IE in the *Additional HS Cell Information Response* IE in the RADIO LINK RECONFIGURATION READY message if it decides to use the octet aligned table defined in TS 25.321 [41] for secondary serving HS-DSCH Transport Block Size signalling.]
- [FDD - If the power offset for S-CPICH for MIMO Request indicator and MIMO activation indicator have been configured for the secondary serving HS-DSCH radio link in the new configuration and MIMO pilot configuration with Primary and Secondary CPICH is set up with a non zero power offset on the cell where the Secondary Serving HS-DSCH Radio Link is established, the DRNC shall include the *Power Offset For S-CPICH for MIMO* IE in the *HS-DSCH FDD Secondary Serving Information Response* IE in the *Additional HS*

Cell Information Response IE in the RADIO LINK RECONFIGURATION READY message. If zero power offset the DRNC may include the *Power Offset For S-CPICH for MIMO* IE.]

[FDD – Additional Serving E-DCH Radio Link Change to an existing additional non serving E-DCH RL:]

[FDD – If the RADIO LINK RECONFIGURATION PREPARE message includes the *C-ID* IE in the *Additional HS Cell Information RL Reconf Prep* IE and an additional non serving E-DCH RL exists in the cell indicated by the *C-ID* IE, the *HS-PDSCH RL ID* IE in the *Additional HS Cell Information RL Reconf Prep* IE indicates the new Additional Serving E-DCH Radio Link.]

- [FDD – If the old Additional Serving E-DCH RL is within this DRNS, the DRNS shall de-allocate the E-AGCH resources of the old Serving Additional E-DCH Radio Link at the activation of the new configuration.]
- [FDD – The DRNS shall allocate a primary E-RNTI identifier or a secondary E-RNTI identifier or both for the new Additional Serving E-DCH Radio Link and include these E-RNTI identifiers along with the channelisation code of the corresponding E-AGCH in the *E-DCH FDD DL Control Channel Information* IE in the *Additional Modified E-DCH FDD Information Response* IE in the *Additional E-DCH Cell Information Response RLReconf* IE in the RADIO LINK RECONFIGURATION READY message]
- [FDD – The DRNS may include the *Serving Grant Value* IE and *Primary/Secondary Grant Selector* IE in the *E-DCH FDD DL Control Channel Information* IE in the *Additional Modified E-DCH FDD Information Response* IE in the *Additional E-DCH Cell Information Response RLReconf* IE in the RADIO LINK RECONFIGURATION READY message for the initial grant for the Additional serving E-DCH RL and may include the *Default Serving Grant in DTX Cycle 2* IE.]
- [FDD – If the E-DCH HARQ process allocation for 2ms TTI for scheduled transmission shall be changed, the DRNS shall allocate resources according to the new/changed configuration and include the new/changed configuration in the *HARQ Process Allocation For 2ms Scheduled Transmission Grant* IE in the *Additional Modified E-DCH FDD Information Response* IE in the *Additional E-DCH Cell Information Response RLReconf* IE in the RADIO LINK RECONFIGURATION READY message.]
- [FDD – The DRNS may include the *E-RGCH/E-HICH Channelisation Code* IE and/or the *E-HICH Signature Sequence* IE and/or the *E-RGCH Signature Sequence* IE or may alternatively include the *E-RGCH Release Indicator* IE in the *E-DCH FDD DL Control Channel Information* IE in the *Additional Modified E-DCH FDD Information Response* IE in the *Additional E-DCH Cell Information Response RLReconf* IE in the RADIO LINK RECONFIGURATION READY message for every E-DCH Radio Link on secondary UL frequency in the DRNS. If the DRNS has no valid data for the *E-RGCH/E-HICH Channelisation Code* IE in the *E-DCH FDD DL Control Channel Information* IE then it shall insert the *E-RGCH and E-HICH Channelisation Code Validity Indicator* IE in the *E-DCH FDD DL Control Channel Information* IE, to indicate that the *E-RGCH/E-HICH Channelisation Code* IE contains invalid data.]

[FDD – Additional Serving E-DCH Radio Link Change to a new RL:]

[FDD – If the RADIO LINK RECONFIGURATION PREPARE message includes the *Additional E-DCH RL Specific Information To Add* IE in the *Additional E-DCH Configuration Change Information* IE in the *Additional E-DCH Cell Information RL Reconf Prep* IE and the *C-ID* IE in the *Additional HS Cell Information RL Reconf Prep* IE and there is no radio links in the cell indicated by the *C-ID* IE for the UE context, the *HS-PDSCH RL ID* IE indicates the new Additional Serving E-DCH Radio Link on secondary UL frequency.]

- [FDD – If the old Additional Serving E-DCH RL is within this DRNS, the DRNS shall de-allocate the E-AGCH resources of the old Additional Serving E-DCH Radio Link at the activation of the new configuration.]
- [FDD – In the new configuration the DRNS shall allocate the E-DCH resources for the new additional serving E-DCH Radio Link on the secondary UL frequency. Non cell specific E-DCH parameters shall take the same values as for the corresponding cell of the Primary uplink frequency.]
- [FDD – The DRNS shall allocate a primary E-RNTI identifier or a secondary E-RNTI identifier or both for the new Additional Serving E-DCH Radio Link and include these E-RNTI identifiers along with the channelisation code of the corresponding E-AGCH in the *E-DCH FDD DL Control Channel Information* IE in the *Additional E-DCH FDD Information Response* IE in the *Additional E-DCH Cell Information Response RLReconf* IE in the RADIO LINK RECONFIGURATION READY message.]

- [FDD – The DRNS may include in the *E-DCH FDD DL Control Channel Information* IE in the *Additional E-DCH FDD Information Response* IE in the *Additional E-DCH Cell Information Response RReconf* IE in the RADIO LINK RECONFIGURATION READY message the *Serving Grant Value* IE and *Primary/Secondary Grant Selector* IE for the initial grant for the additional serving E-DCH RL and may include the *Default Serving Grant in DTX Cycle 2* IE]
- [FDD – If the E-DCH HARQ process allocation for 2ms TTI for scheduled transmission shall be changed, the DRNS shall allocate resources according to the new/changed configuration and include the new/changed configuration in the *HARQ Process Allocation For 2ms Scheduled Transmission Grant* IE in the *Additional E-DCH FDD Information Response* IE in the *Additional E-DCH Cell Information Response RReconf* IE in the RADIO LINK RECONFIGURATION READY message.]

HS-DSCH Modification:

If the RADIO LINK RECONFIGURATION PREPARE message includes the *HS-DSCH Information To Modify* IE, then:

- The DRNC shall include the *HS-DSCH Initial Capacity Allocation* IE for each HS-DSCH MAC-d flow being modified for which the establishment of one or several new Priority Queues was requested, if the DRNS allows the SRNC to start the transmission of MAC-d PDUs for the Priority Queue(s) being established before the DRNS has allocated capacity on user plane as described in TS 25.425 [32]. If RADIO LINK RECONFIGURATION PREPARE message includes *HS-DSCH MAC-d PDU Size Format* IE in the *HS-DSCH Information To Modify* IE set to “Flexible MAC-d PDU Size”, then DRNC shall only set in the *HS-DSCH Initial Capacity Allocation* IE the values for the peer of *Scheduling Priority Indicator* IE and *Maximum MAC-d PDU Size Extended* IE to the values of the corresponding peer I in RADIO LINK RECONFIGURATION PREPARE in the *HS-DSCH Information To Modify* IE for a Priority Queue including *Scheduling Priority Indicator* IE and *Maximum MAC-d PDU Size Extended* IE.
- If the RADIO LINK RECONFIGURATION PREPARE message includes the *Traffic Class* IE in the *HS-DSCH Information To Modify* IE for a specific HS-DSCH MAC-d flow, the DRNS may use this information to determine the transport bearer characteristics to apply between DRNC and Node B. The DRNC should ignore the *Traffic Class* IE if the *TrCH Source Statistics Descriptor* IE for this specific HS-DSCH MAC-d flow indicates the value “RRC”.
- If the *TNL QoS* IE is included for a MAC-d flow and if ALCAP is not used, the *TNL QoS* IE may be used by the DRNS to determine the transport bearer characteristics to apply in the uplink between the DRNS and the SRNC for the related MAC-d flow.
- If the RADIO LINK RECONFIGURATION PREPARE message includes the *MAC-hs Guaranteed Bit Rate* IE in the *HS-DSCH Information To Modify* IE, the DRNS shall use this information to optimise MAC-hs scheduling decisions for the related HSDPA Priority Queue.
- If the RADIO LINK RECONFIGURATION PREPARE message includes the *Discard Timer* IE for a Priority Queue in the *HS-DSCH Information To Modify* IE, then the DRNS shall use this information to discard out-of-date MAC-hs SDUs from the related HSDPA Priority Queue.
- If the RADIO LINK RECONFIGURATION PREPARE message includes the *Maximum MAC-d PDU Size Extended* IE in the *HS-DSCH Information To Modify* IE, then the DRNS shall ignore the *SID* IE and *MAC-d PDU Size* IE in the *MAC-d PDU Size Index* IE and use *Maximum MAC-d PDU Size Extended* IE to optimise capacity allocation for the related HSDPA Priority Queue.
- If the RADIO LINK RECONFIGURATION PREPARE message includes the *MAC-hs Window Size* IE or *TI* IE in the *HS-DSCH Information To Modify* IE, then the DRNS shall use the indicated values in the new configuration for the related HSDPA Priority Queue.
- If the RADIO LINK RECONFIGURATION PREPARE message includes the *MAC-d PDU Size Index* IE in the *Modify Priority Queue* choice, the DRNS shall delete the previous list of MAC-d PDU Size Index values for the related HSDPA Priority Queue and use the MAC-d PDU Size Index values indicated in the *MAC-d PDU Size Index* IE in the new configuration.
- [FDD – If the RADIO LINK RECONFIGURATION PREPARE message includes the *CQI Feedback Cycle k* IE, the *CQI Repetition Factor* IE, the *ACK-NACK Repetition Factor* IE, the *ACK Power Offset* IE, the *NACK Power Offset* IE or the *CQI Power Offset* IE in the *HS-DSCH Information To Modify* IE, then the DRNS shall

use the indicated CQI Feedback Cycle k value, the CQI Repetition Factor or the ACK-NACK Repetition Factor, ACK Power Offset, the NACK Power Offset or the CQI Power Offset in the new configuration.]

- [FDD – If the *HS-SCCH Power Offset* IE is included in the *HS-DSCH Information To Modify* IE, the DRNS may use this value to determine the HS-SCCH power. The HS-SCCH Power Offset should be applied for any HS-SCCH transmission to this UE.]
- [TDD – If the RADIO LINK RECONFIGURATION PREPARE message includes the *TDD ACK NACK Power Offset* IE in the *HS-DSCH Information To Modify* IE, the DRNS shall use the indicated power offset in the new configuration.]
- [FDD – If the *HS-DSCH Information To Modify* IE includes the *HS-SCCH Code Change Grant* IE, then the DRNS may modify the HS-SCCH codes corresponding to the HS-DSCH. The DRNC shall then report the codes which are used in the new configuration specified in the *HS-SCCH Specific Information Response* IE in the RADIO LINK RECONFIGURATION READY message.]
- [FDD – If the *HS-DSCH Information To Modify* IE includes the *HS-PDSCH Code Change Grant* IE, then the DRNS may modify the HS-PDSCH codes corresponding to the HS-DSCH. The DRNC shall then report the codes which are used in the new configuration specified in the *Continuous Packet Connectivity HS-SCCH less Information Response* IE in the RADIO LINK RECONFIGURATION READY message. If the concerned DRNS is not in Continuous Packet Connectivity HS-SCCH less mode, the SRNC shall not include the *HS-PDSCH Code Change Grant* IE in the *HS-DSCH Information To Modify* IE.]
- [TDD – If the *HS-DSCH Information To Modify* IE includes the *HS-SCCH Code Change Grant* IE, then the DRNS may modify the HS-SCCH parameters corresponding to the HS-DSCH. The DRNC shall then report the values for the parameters which are used in the new configuration specified in the [3.84Mcps TDD – *HS-SCCH Specific Information Response* IE] [1.28Mcps TDD – *HS-SCCH Specific Information Response LCR* IE] [7.68 Mcps TDD – *HS-SCCH Specific Information Response 7.68 Mcps* IE] in the RADIO LINK RECONFIGURATION READY message.]
- [FDD – If the RADIO LINK RECONFIGURATION PREPARE message includes the *HARQ Preamble Mode* IE in the *HS-DSCH Information To Modify* IE, then the DRNS shall use the indicated HARQ Preamble Mode in the new configuration as described in TS 25.214 [10], if HS-DPCCH ACK/NACK preamble and postamble is supported. Then, in this case, if the mode 1 is applied, the DRNC shall include the *HARQ Preamble Mode Activation Indicator* IE in the *HS-DSCH Information Response* IE in the RADIO LINK RECONFIGURATION READY message. If the *HARQ Preamble Mode* IE is not included or if the mode 0 is applied, then the DRNC shall not include the *HARQ Preamble Mode Activation Indicator* IE in the *HS-DSCH Information Response* IE in the RADIO LINK RECONFIGURATION READY message.]
- If the RADIO LINK RECONFIGURATION PREPARE message includes the *HS-DSCH MAC-d PDU Size Format* IE in the *HS-DSCH Information To Modify* IE, then the DRNS shall use, in the new configuration, the indicated format in user plane frame structure for HS-DSCH channels TS 25.425 [32] and MAC-hs TS 25.321 [41].
- [FDD – If the RADIO LINK RECONFIGURATION PREPARE message includes the *HS-DSCH Physical Layer Category* IE in the *HS-DSCH Information To Modify* IE, the DRNS shall use this information in the new configuration.]
- [FDD – If the *MIMO Mode Indicator* IE is included in the *HS-DSCH Information To Modify* IE, then:]
 - [FDD – The DRNS shall activate/deactivate the MIMO mode for the HS-DSCH Radio Link in the new configuration in accordance with the *MIMO Mode Indicator* IE.]
 - [FDD – If the *MIMO Mode Indicator* IE is set to “Activate”, then the DRNS shall decide the pilot configuration and the UE reporting configuration (N/M ratio) according to TS 25.214 [10] for MIMO and include the *MIMO Information Response* IE in the *HS-DSCH FDD Information Response* IE in the RADIO LINK RECONFIGURATION READY message.]
 - [FDD – If the *MIMO Mode Indicator* IE is set to “Activate” and *Power Offset For S-CPICH for MIMO Request Indicator* IE is included, the DRNC shall, if supported and MIMO pilot configuration with Primary and Secondary CPICH is set up with a non-zero power offset on the cell where the Serving HS-DSCH Radio Link is established, include the *Power Offset For S-CPICH for MIMO* IE in the *HS-DSCH FDD Information Response* IE. If zero power offset the DRNC may include the *Power Offset For S-CPICH for MIMO* IE.]

- [FDD – The DRNC may include the *HARQ Memory Partitioning* IE in the RADIO LINK RECONFIGURATION READY message. The *HARQ Memory Partitioning* IE may contain the *HARQ Memory Partitioning Information Extension For MIMO* IE.]
- [FDD – If the *Sixtyfour QAM Usage Allowed Indicator* IE is included in the *HS-DSCH Information To Modify* IE, then the DRNS may if the value is set to “allowed” use 64 QAM for the HS-DSCH Radio Link, and the DRNS shall include the *SixtyfourQAM DL Usage Indicator* IE in the *HS-DSCH FDD Information Response* IE in the RADIO LINK RECONFIGURATION READY message.]
- [FDD – If the *Sixtyfour QAM Usage Allowed Indicator* IE is included in the *HS-DSCH Information To Modify* IE with value set to “not allowed”, then the DRNS shall not use 64 QAM for the HS-DSCH Radio Link.]
- [FDD – If MAC-e-hs is applied in the new configuration, and if Sixtyfour QAM will not be used, the DRNS shall include the *HS-DSCH TB Size Table Indicator* IE in the *HS-DSCH FDD Information Response* IE in the RADIO LINK RECONFIGURATION READY message if it decides to use the octet aligned table defined in TS 25.321 [41] for HS-DSCH Transport Block Size signalling.]
- [1.28Mcps TDD – If the *MIMO Mode Indicator* IE is included in the *HS-DSCH Information To Modify* IE, then:]
 - [1.28Mcps TDD – The DRNS shall activate/deactivate the MIMO mode for the HS-DSCH Radio Link in the new configuration in accordance with the *MIMO Mode Indicator* IE.]
 - [1.28 Mcps TDD – If the *MIMO Mode Indicator* IE is set to “Activate”, then the DRNS shall decide the SF mode for HS-PDSCH dual stream and include the *MIMO SF Mode for HS-PDSCH dual stream* IE in the *HS-DSCH TDD Information Response* IE in the RADIO LINK RECONFIGURATION READY message.]
- [1.28Mcps TDD – The DRNC may include the *HARQ Memory Partitioning* IE in the RADIO LINK RECONFIGURATION READY message. The *HARQ Memory Partitioning* IE may contain the *HARQ Memory Partitioning Information Extension For MIMO* IE.]
- [FDD – Any secondary serving HS-DSCH that was applied in the old configuration shall remain in the new configuration unless it is explicitly removed.]
- [FDD – If secondary serving HS-DSCH is applied also in the new configuration, then any changes related to parameters that are common for both the serving and the secondary serving HS-DSCH should be applied also for the secondary serving HS-DSCH.]
- If the RADIO LINK RECONFIGURATION PREPARE message includes *DL RLC PDU Size Format* IE for a Priority Queue in the *HS-DSCH Information To Modify* IE, the *DL RLC PDU Size Format* IE may be used by the DRNS to determine the allocated capacity on user plane as described in TS 25.425 [32].
- [FDD – If the *UE Support Indicator Extension* IE is included in the *HS-DSCH Information To Modify* IE the DRNS may use the supported HSDPA functions for this UE.]
- [FDD - If the *UE Support Indicator Extension* IE is included in the *HS-DSCH Information To Modify* IE with the bit *UE DTXDRX related HS-SCCH orders uniform behavior indicator* set to 0, then the DRNS shall, if supported, include the *Support of dynamic DTXDRX related HS-SCCH order* IE in the *HS-DSCH FDD Information Response* IE in the RADIO LINK RECONFIGURATION READY message.]
- [FDD – If the *Single Stream MIMO Mode Indicator* IE is included in the *HS-DSCH Information To Modify* IE, then the DRNS shall activate/deactivate the Single Stream MIMO for the HS-DSCH Radio Link in accordance with the *Single Stream MIMO Mode Indicator* IE.]

[FDD – Secondary Serving HS-DSCH Modification:]

[FDD – If the RADIO LINK RECONFIGURATION PREPARE message includes the *HS-DSCH FDD Secondary Serving Information To Modify* IE, then:]

- [FDD – If the *HS-SCCH Power Offset* IE is included in the *HS-DSCH FDD Secondary Serving Information To Modify* IE, the DRNS may use this value to determine the HS-SCCH power. The HS-SCCH Power Offset should be applied for any secondary serving HS-SCCH transmission to this UE.]

- [FDD – If the *HS-DSCH FDD Secondary Serving Information To Modify* IE includes the *HS-SCCH Code Change Grant* IE, then the DRNS may modify the HS-SCCH codes corresponding to the secondary serving HS-DSCH. The DRNC shall then report the codes which are used in the new configuration specified in the *HS-SCCH Specific Secondary Serving Information Response* IE in the *HS-DSCH FDD Secondary Serving Information Response* IE in the *Additional HS Cell Information Response* IE in the RADIO LINK RECONFIGURATION READY message.]
- [FDD – If the *MIMO Mode Indicator* IE is included in the *HS-DSCH FDD Secondary Serving Information To Modify* IE, then the DRNS shall activate/deactivate the MIMO mode for the secondary serving HS-DSCH Radio Link in accordance with the *MIMO Mode Indicator* IE.]
- [FDD – If the *MIMO Mode Indicator* IE is set to “Activate”, then the DRNS shall decide the pilot configuration and the UE reporting configuration (N/M ratio) according to TS 25.214 [10] for MIMO and include the *MIMO Information Response* IE in the *HS-DSCH FDD Secondary Serving Information Response* IE in the *Additional HS Cell Information Response* IE in the RADIO LINK RECONFIGURATION READY message.]
- [FDD – If the *MIMO Mode Indicator* IE is set to “Activate” and *Power Offset For S-CPICH for MIMO Request Indicator* IE is included, the DRNC shall, if supported and MIMO pilot configuration with Primary and Secondary CPICH is set up with a non-zero power offset to the cell where the Secondary Serving HS-DSCH Radio Link is established, include the *Power Offset For S-CPICH for MIMO* IE in the *HS-DSCH FDD Secondary Serving Information Response* IE in the *Additional HS Cell Information Response* IE in the RADIO LINK RECONFIGURATION READY message. If zero power offset the DRNC may include the *Power Offset For S-CPICH for MIMO* IE.]
- [FDD – If the *Single Stream MIMO Mode Indicator* IE is included in the *HS-DSCH FDD Secondary Serving Information To Modify* IE, then the DRNS shall activate/deactivate the Single Stream MIMO mode for the secondary serving HS-DSCH Radio Link in accordance with the *Single Stream MIMO Mode Indicator* IE.]
- [FDD – If the *Sixtyfour QAM Usage Allowed Indicator* IE is included in the *HS-DSCH FDD Secondary Serving Information To Modify* IE, then the DRNS may if the value is set to “allowed” use 64 QAM for the secondary serving HS-DSCH Radio Link, and the DRNS shall include the *SixtyfourQAM DL Usage Indicator* IE in the *HS-DSCH FDD Secondary Serving Information Response* IE in the *Additional HS Cell Information Response* IE in the RADIO LINK RECONFIGURATION READY message.]
- [FDD – If the *Sixtyfour QAM Usage Allowed Indicator* IE is included in the *HS-DSCH FDD Secondary Serving Information To Modify* IE with value set to “not allowed”, then the DRNS shall not use 64 QAM for the secondary serving HS-DSCH Radio Link.]
- [FDD – If, in the new configuration, the UE context is configured not to use Sixtyfour QAM for the secondary serving HS-DSCH, then the DRNC shall include the *HS-DSCH TB Size Table Indicator* IE in the *HS-DSCH FDD Secondary Serving Information Response* IE in the *Additional HS Cell Information Response* IE in the RADIO LINK RECONFIGURATION READY message if it decides to use the octet aligned table defined in TS 25.321 [41] for secondary serving HS-DSCH Transport Block Size signalling.]
- [FDD – If the *Diversity Mode* IE is included, then:]
 - [FDD- the DRNS shall apply cell specific transmit diversity configuration for the secondary serving HS-DSCH radio link according to *Diversity Mode* IE and *Transmit Diversity Indicator* IE in the *HS-DSCH FDD Secondary Serving Information To Modify* IE,]
 - [FDD – If the *Diversity Mode* IE is not set to “None”, the DRNS shall apply diversity for the secondary serving HS-DSCH radio link according to the value given in the *Transmit Diversity Indicator* IE in the *HS-DSCH FDD Secondary Serving Information To Modify* IE.]
- [FDD – If the *Non Cell Specific Tx Diversity* IE equals “Tx Diversity” is included, the DRNS shall apply non cell specific transmit diversity configuration and reconfigure the transmit diversity setting for the secondary serving HS-DSCH radio link to the same value as defined for the serving HS-DSCH radio link in the new configuration.]

[FDD – Secondary Serving HS-DSCH Removal:]

[FDD – If the RADIO LINK RECONFIGURATION PREPARE message includes the *HS-DSCH Secondary Serving Remove IE* in the *Additional HS Cell Information RL Reconf Prep IE*, then the indicated secondary serving HS-DSCH Radio Link shall be removed.]

HS-DSCH MAC-d Flow Addition/Deletion:

If the RADIO LINK RECONFIGURATION PREPARE message includes any *HS-DSCH MAC-d Flows To Add* or *HS-DSCH MAC-d Flows To Delete* IEs, then the DRNS shall use this information to add/delete the indicated HS-DSCH MAC-d flows on the Serving HS-DSCH Radio Link. When an HS-DSCH MAC-d flow is deleted, all its associated Priority Queues shall also be removed.

If the RADIO LINK RECONFIGURATION PREPARE message includes an *HS-DSCH MAC-d Flows To Delete IE* requesting the deletion of all remaining HS-DSCH MAC-d flows for the UE Context, then the DRNC shall delete the HS-DSCH configuration from the UE Context and release the HS-PDSCH resources.

If the RADIO LINK RECONFIGURATION PREPARE message includes the *HS-DSCH MAC-d Flows To Add IE*, then:

- The DRNS may use the Traffic Class IE for a specific HS-DSCH MAC-d flow to determine the transport bearer characteristics to apply between DRNC and Node B. If TrCH Source Statistics Descriptor IE is present with the value “RRC” in the HS-DSCH MAC-d Flows Information IE, then the DRNC should ignore the Traffic Class IE.
- If the TNL QoS IE is included for a MAC-d flow and if ALCAP is not used, the TNL QoS IE may be used by the DRNS to determine the transport bearer characteristics to apply in the uplink between the DRNS and the SRNC for the related MAC-d flow.
- The DRNC shall include the HS-DSH Initial Capacity Allocation IE in the RADIO LINK RECONFIGURATION READY message for every HS-DSCH MAC-d flow being added, if the DRNS allows the SRNC to start transmission of MAC-d PDUs before the DRNS has allocated capacity on user plane as described in TS 25.425 [32]. If the UE context is configured to use the “Flexible MAC-d PDU Size” format for the HS-DSCH, then DRNC shall only set in the HS-DSCH Initial Capacity Allocation IE the values for the peer of Scheduling Priority Indicator IE and Maximum MAC-d PDU Size Extended IE to the values of the corresponding peer I in RADIO LINK RECONFIGURATION PREPARE message in the HS-DSCH MAC-d Flows To Add IE for a Priority Queue including Scheduling Priority Indicator IE and Maximum MAC-d PDU Size Extended IE.
- If the RADIO LINK RECONFIGURATION PREPARE message includes the MAC-hs Guaranteed Bit Rate IE in the HS-DSCH MAC-d Flows To Add IE, the DRNS shall use this information to optimise MAC-hs scheduling decisions for the related HSDPA Priority Queue.
- If the RADIO LINK RECONFIGURATION PREPARE message includes the Discard Timer IE for a Priority Queue in the HS-DSCH MAC-d Flows To Add IE, then the DRNS shall use this information to discard out-of-date MAC-hs SDUs from the related HSDPA Priority Queue.
- If the RADIO LINK RECONFIGURATION PREPARE message includes the Maximum MAC-d PDU Size Extended IE for a Priority Queue in the HS-DSCH MAC-d Flows To Add IE, then the DRNC shall ignore the SID IE and MAC-d PDU Size IE in the MAC-d PDU Size Index IE and use Maximum MAC-d PDU Size Extended IE to optimise capacity allocation for the related HSDPA Priority Queue.
- The DRNC may include the HARQ Memory Partitioning IE in the RADIO LINK RECONFIGURATION READY message. [FDD – The HARQ Memory Partitioning IE may contain the HARQ Memory Partitioning Information Extension For MIMO IE.]
- If the RADIO LINK RECONFIGURATION PREPARE message includes DL RLC PDU Size Format IE for a Priority Queue in the HS-DSCH MAC-d Flows To Add IE, the DL RLC PDU Size Format IE may be used by the DRNS to determine the allocated capacity on user plane as described in TS 25.425 [32].
- [FDD – If the RADIO LINK RECONFIGURATION PREPARE message includes the *UE Aggregate Maximum Bit Rate Enforcement Indicator IE* for a Priority Queue in the *HS-DSCH MAC-d Flows To Add IE*, the DRNS shall, if supported, consider the data of the related HSDPA Priority Queue for UE Aggregate Maximum Bit Rate Enforcement.]

[FDD – HS-DSCH Preconfiguration for Enhanced HS Serving Cell Change]

[FDD – If the RADIO LINK RECONFIGURATION PREPARE message includes the *HS-DSCH Preconfiguration Setup* IE in the *RL Information* IE the DRNS shall, if supported, preconfigure the indicated cells for Enhanced HS Serving Cell Change according to TS 25.308 [63]:]

- [FDD – The DRNS shall preconfigure sets of HS-SCCH codes on the cells preconfigured for HS-DSCH, primary serving HS-DSCH cell, as well as on the secondary serving HS-DSCH cells. The primary serving HS-DSCH cell is designated through the *C-ID* IE part of the *RL Information* IE in the RADIO LINK RECONFIGURATION PREPARE message. The list of secondary serving HS-DSCH cells is designated by the list of *Secondary C-ID* IEs in the *HS-DSCH Preconfiguration Setup* IE part of the *RL Information* IE in the RADIO LINK RECONFIGURATION PREPARE message.]
- [FDD – The number of HS-SCCH codes to preconfigure for each cell may be optionally specified:]
 - [FDD – by the *Num Primary HS-SCCH Codes* IE in the *HS-DSCH Preconfiguration Setup* IE, for the primary serving HS-DSCH cell.]
 - [FDD – by the *Num Secondary HS-SCCH Codes* IE in the *Secondary Cells* IE in the *HS-DSCH Preconfiguration Setup* IE for each of the secondary serving HS-DSCH cells.]
- [FDD – If *Num Primary HS-SCCH Codes* IE or *Num Secondary HS-SCCH Codes* IE is not included in the message the number and distribution of codes on primary and any secondary cells shall be preconfigured to satisfy any limitations in TS 25.214 [10].]
- [FDD – The DRNS shall return these codes in the *Sets of HS-SCCH Codes* IE along with the corresponding per-cell *HS-DSCH-RNTI* IE in the *HS-DSCH Preconfiguration Info* IE in the *RL Information Response* IE of the RADIO LINK RECONFIGURATION READY.]
- [FDD – The DRNS shall use the first in the numbered list the primary serving HS-DSCH cell's of HS-SCCH codes in the *HS-SCCH Preconfigured Codes* IE sent to the SRNC to signal the Target Cell HS-SCCH Order defined in ITU-T Rec. X.680 [18].]
- [FDD – The DRNS shall include, in the *HS-DSCH Preconfiguration Info* IE in the *RL Information Response* IE in the RADIO LINK RECONFIGURATION READY message, IEs according to the rules defined for HS-DSCH Setup at Serving HS-DSCH Radio Link Change and:
 - [FDD – if *HARQ Preamble Mode* IE is included in the *HS-DSCH Preconfiguration Setup* IE the HARQ Preamble Mode Activation Indicator IE.]
 - [FDD – if *MIMO Activation Indicator* IE is included in the *HS-DSCH Preconfiguration Setup* IE the *MIMO N/M Ratio* IE.]
 - [FDD – if *HS-DSCH MAC-d PDU Size Format* IE is included in the *HS-DSCH Preconfiguration Setup* IE and set to "Flexible MAC-d PDU Size" and if Sixtyfour QAM will not be used for the cell in the preconfiguration the *HS-DSCH TB Size Table Indicator* IE for each preconfigured cell.]
 - [FDD – if *Sixtyfour QAM Usage Allowed Indicator* IE is included in the *Secondary Cells* IE in the *HS-DSCH Preconfiguration Setup* IE or in the *HS-DSCH Preconfiguration Setup* IE the *Sixtyfour QAM DL Usage Indicator* IE for each preconfigured cell.]
 - [FDD – if *Continuous Packet Connectivity HS-SCCH less Information* IE is included in the *HS-DSCH Preconfiguration Setup* IE the *Continuous Packet Connectivity HS-SCCH less Information Response* IE.]
 - [FDD – if the *UE with enhanced HS-SCCH support indicator* IE is included in the *HS-DSCH Preconfiguration Setup* IE, then the DRNS shall store this information in the preconfigured configuration.]
 - [FDD – the *Sixtyfour QAM DL Support Indicator* IE may be included.]
 - [FDD – If the *UE Support Indicator Extension* IE is included in the *HS-DSCH Preconfiguration Setup* IE, then the DRNS may store this information in the preconfigured configuration.]
 - [FDD - If the *UE Support Indicator Extension* IE is included in the *HS-DSCH Preconfiguration Setup* IE with the bit *UE DTXDRX related HS-SCCH orders uniform behavior indicator* set to 0, then the DRNS shall, if supported, include the *Support of dynamic DTXDRX related HS-SCCH order* IE in the *HS-DSCH Preconfiguration Info* IE in the RADIO LINK RECONFIGURATION READY message.]

- [FDD – the DRNS shall, if supported, include in the *Sets of HS-SCCH Codes IE* the *Measurement Power Offset IE* for each preconfigured cell.]
- [FDD – The DRNS shall include in the *HS-DSCH Preconfiguration Info IE* in the *RL Information Response IE* in the RADIO LINK RECONFIGURATION READY message the *E-DCH FDD DL Control Channel Information* containing the preconfigured configuration of the E-DCH serving cell according to the rules defined for Serving E-DCH Radio Link Change as follows:]
 - [FDD – The DRNS shall allocate for the preconfigured configuration a primary E-RNTI identifier or a secondary E-RNTI identifier or both for the new Serving E-DCH Radio Link and include these E-RNTI identifiers along with the channelisation code of the corresponding E-AGCH in the *E-DCH FDD DL Control Channel Information IE*.]
 - [FDD – The DRNS may preconfigure the *Serving Grant Value IE* and *Primary/Secondary Grant Selector IE* for the initial grant for the serving E-DCH RL and include these values in the *E-DCH FDD DL Control Channel Information IE*.]
 - [FDD – If the *Power Offset For S-CPICH for MIMO Request Indicator IE* is included in the *HS-DSCH Preconfiguration Setup IE* or in the *Secondary Cells IE* in the *HS-DSCH Preconfiguration Setup IE*, the DRNC shall, if supported and MIMO pilot configuration with Primary and Secondary CPICH is set up on the cell with a non-zero power offset where HS-DSCH / secondary HS-DSCH is preconfigured, include the *Power Offset For S-CPICH for MIMO IE* in the *HS-DSCH Preconfiguration Info IE* or in the *Sets of HS-SCCH Codes IE* in the *HS-DSCH Preconfiguration Info IE* for each preconfigured cell in the RADIO LINK RECONFIGURATION READY message. If zero power offset the DRNC may include the *Power Offset For S-CPICH for MIMO IE*.]

[FDD – If the RADIO LINK RECONFIGURATION PREPARE message includes the *Non-Serving RL Preconfiguration Setup IE* in the *RL Information IE* and:]

- [FDD – if the choice of *new Serving RL* is "New Serving RL in the DRNS", the DRNC may include the *New non-serving RL E-DCH FDD DL Control Channel Information A IE* and/or *New non-serving RL E-DCH FDD DL Control Channel Information B IE* in the *Non-Serving RL Preconfiguration Info IE* for the RL in the RADIO LINK RECONFIGURATION READY message.]
- [FDD – if the choice of *new Serving RL* is "New Serving RL Not in the DRNS", the DRNC may include the *New non-serving RL E-DCH FDD DL Control Channel Information C IE* in the *Non-Serving RL Preconfiguration Info IE* for the RL in the RADIO LINK RECONFIGURATION READY message.]
- [FDD – if the choice of *new Serving RL* is "New Serving RL in the DRNS or New Serving RL Not in the DRNS", the DRNC may include the *New non-serving RL E-DCH FDD DL Control Channel Information A IE*, the *New non-serving RL E-DCH FDD DL Control Channel Information B IE* and/or the *New non-serving RL E-DCH FDD DL Control Channel Information C* for the RL in the *Non-Serving RL Preconfiguration Info IE* in the RADIO LINK RECONFIGURATION READY message.]
- [FDD – if the *Additional E-DCH Non-Serving RL Preconfiguration Setup IE* is included, the DRNC may include the *New non-serving RL E-DCH FDD DL Control Channel Information A IE*, the *New non-serving RL E-DCH FDD DL Control Channel Information B IE* and/or the *New non-serving RL E-DCH FDD DL Control Channel Information C IE* according to the choice of new Serving RL in *Additional E-DCH New non-serving RL E-DCH FDD DL Control Channel Information IE* for the additional non serving E-DCH RL in the *Non-Serving RL Preconfiguration Info IE* in the RADIO LINK RECONFIGURATION READY message.]

[FDD – Enhanced HS Serving Cell Change:]

[FDD – Upon receipt of the RADIO LINK RECONFIGURATION PREPARE message, if the Enhanced HS Serving Cell Change is preconfigured in the DRNS for the UE context, the DRNS may execute the Enhanced HS Serving Cell Change procedure according to [63.]

[FDD – If the RADIO LINK RECONFIGURATION PREPARE message includes the *Enhanced HS Serving CC Abort IE* in the *HS-DSCH Information To Modify IE* or the *HS-DSCH FDD Information IE* then the DRNS shall not execute the synchronized Enhanced HS Serving Cell Change procedure when performing the Serving HS-DSCH Radio Link Change or the HS-DSCH Setup.]

[FDD - If the RADIO LINK RECONFIGURATION PREPARE message includes the *Non-Serving RL Preconfiguration Removal IE*, the DRNS shall remove the corresponding preconfigured E-DCH DL Control Channel Information according to the information.]

[FDD – E-DCH Setup:]

[FDD – If the *E-DCH FDD Information* IE is present in the RADIO LINK RECONFIGURATION PREPARE message then:]

- [FDD – If the RADIO LINK RECONFIGURATION PREPARE message includes the *MAC-es Guaranteed Bit Rate* IE in the *E-DCH Logical Channel Information* IE in the *E-DCH FDD Information* IE, then the DRNS shall use this information to optimise MAC-e scheduling decisions.]
- [FDD – If the RADIO LINK RECONFIGURATION PREPARE message includes *UE Aggregate Maximum Bit Rate Enforcement Indicator* IE in the *E-DCH Logical Channel Information* IE in the *E-DCH FDD Information* IE, then the DRNS shall, if supported, consider the data of the related E-DCH Logical Channel for UE Aggregate Maximum Bit Rate Enforcement.]
- [FDD – If the RADIO LINK RECONFIGURATION PREPARE message includes the *Maximum MAC-d PDU Size Extended* IE for a E-DCH Logical Channel in the *E-DCH MAC-d Flows Information* IE in the *E-DCH FDD Information* IE, then the DRNS shall ignore the *MAC-d PDU Size* IE in the *MAC-d PDU Size List* IE and use *Maximum MAC-d PDU Size Extended* IE to optimise capacity allocation for the related E-DCH Logical Channel and use the indicated format in user plane frame structure for E-DCH channels TS 25.425 [32] and MAC TS 25.321 [41].]
- [FDD – If the RADIO LINK RECONFIGURATION PREPARE message includes the *E-DCH MAC-d Flow Multiplexing List* IE for an E-DCH MAC-d flow the DRNS shall use this information for the related resource allocation operation.]
- [FDD – If the RADIO LINK RECONFIGURATION PREPARE message includes the *HARQ Process Allocation For 2ms Scheduled Transmission Grant* IE, the DRNS shall use this information for the related resource allocation operation.]
- [FDD – If in the RADIO LINK RECONFIGURATION PREPARE message the E-DCH Grant Type is indicated as being “E-DCH Non-Scheduled Transmission Grant” for an E-DCH MAC-d flow the DRNS shall assume non-scheduled grants being configured for that E-DCH MAC-d flow and shall use the information within the *HARQ Process Allocation For 2ms Non-Scheduled Transmission Grant* IE, if included, for the related resource allocation operation.]
- [FDD – If in the RADIO LINK RECONFIGURATION PREPARE message the E-DCH Grant Type is indicated as being “E-DCH Scheduled Transmission Grant” for an E-DCH MAC-d flow the DRNS shall assume scheduled grants being configured for that E-DCH MAC-d flow.]
- [FDD – The DRNS may use the *Traffic Class* IE for a specific E-DCH MAC-d flow to determine the transport bearer characteristics to apply between DRNC and Node B. If *TrCH Source Statistics Descriptor* IE is present with the value “RRC” in the *E-DCH MAC-d Flows Information* IE, then the DRNC should ignore the *Traffic Class* IE.]
- [FDD – If the *TNL QoS* IE is included for an E-DCH MAC-d flow and if ALCAP is not used, the *TNL QoS* IE may be used by the DRNS to determine the transport bearer characteristics to apply in the uplink for the related MAC-d flow.]
- [FDD – If the RADIO LINK RECONFIGURATION PREPARE message includes the *Bundling Mode Indicator* IE for a E-DCH MAC-d flow in the *E-DCH MAC-d Flow Specific Information* IE in the *E-DCH FDD Information* IE and the *Bundling Mode Indicator* IE is set to “Bundling” and the *E-TTI* IE is set to “2ms”, then the DRNS shall use the bundling mode for the E-DCH UL data frames for the related MAC-d flow, otherwise the DRNS shall use the non-bundling mode for the E-DCH UL data frames for the related MAC-d flow.]
- [FDD – If the RADIO LINK RECONFIGURATION PREPARE message includes the *E-DCH Maximum Bitrate* IE for an E-DCH, the DRNS shall use this information for the related resource allocation operation, and when applicable, for E-DCH scheduling.]
- [FDD – If the RADIO LINK RECONFIGURATION PREPARE message includes the *E-DCH Processing Overload Level* IE, then if the DRNS could not decode the E-DPCCH/E-DPDCH for the last consecutive number of TTIs, indicated in the *E-DCH Processing Overload Level* IE, because of processing issue, the DRNS shall notify the SRNC by initiating the Radio Link Failure procedure.]

- [FDD – If the RADIO LINK RECONFIGURATION PREPARE message includes the *E-DCH ReferencePower Offset* IE, then the DRNS may use this value as a default HARQ power offset if it is not able to decode the MAC-e PDU and to determine the value of the actual HARQ power offset.]
- [FDD – If the RADIO LINK RECONFIGURATION PREPARE message includes the *E-DCH Power Offset for Scheduling Info* IE, then the DRNS shall use this value as a power offset for the transmission of scheduling information without any MAC-d PDUs.]
- [FDD – If the RADIO LINK RECONFIGURATION PREPARE message includes the *E-AGCH Power Offset* IE in the *RL Specific E-DCH Information* IE, then the DRNS may use this value to determine the E-AGCH power. The E-AGCH Power Offset should be applied for any E-AGCH transmission to this UE.]
- [FDD – If the RADIO LINK RECONFIGURATION PREPARE message includes the *E-RGCH Power Offset* IE in the *RL Specific E-DCH Information* IE, then the DRNS may use this value to determine the E-RGCH power for the RL. The E-RGCH Power Offset should be applied for any E-RGCH transmission to this UE.]
- [FDD – If the RADIO LINK RECONFIGURATION PREPARE message includes the *E-HICH Power Offset* IE in the *RL Specific E-DCH Information* IE, then the DRNS may use this value to determine the E-HICH power for the RL. The E-HICH Power Offset should be applied for any E-HICH transmission to this UE.]
- [FDD – If the RADIO LINK RECONFIGURATION PREPARE message includes the *SixteenQAM UL Operation Indicator* IE, the DRNS shall activate/deactivate SixteenQAM UL Operation for the RL in accordance with the *SixteenQAM UL Operation Indicator* IE.]
 - [FDD – If SixteenQAM UL Operation is activated, then the DRNS shall base the handling of the Relative Grant signalling on Scheduling Grant Table 2 according to TS 25.321 [41]. If SixteenQAM UL Operation is deactivated, then the DRNS shall base the handling of the Relative Grant signalling on Scheduling Grant Table 1 according to TS 25.321 [41].]

[FDD – E-DCH Radio Link Handling:]

[FDD – If the RADIO LINK RECONFIGURATION PREPARE message includes the *E-DCH RL Indication* IE in the *RL Information* IE:]

- [FDD – The DRNC shall setup the E-DCH resources, as requested or as configured in the UE context, on the Radio Links indicated by the *E-DCH RL Indication* IE, set to “E-DCH”, in the *RL Information* IE.]
- [FDD – The DRNC may include the *E-AGCH And E-RGCH/E-HICH FDD Scrambling Code* IE and shall include the *E-RGCH/E-HICH Channelisation Code* IE and the corresponding *E-HICH Signature Sequence* IE and the DRNC may include the corresponding *E-RGCH Signature Sequence* IE in the *E-DCH FDD DL Control Channel Information* IE in the RADIO LINK RECONFIGURATION READY message for every RL indicated by the *E-DCH RL Indication* IE, set to “E-DCH”, in the *RL Information* IE.]
- [FDD – The DRNC shall remove the E-DCH resources, if any, on the Radio Links, that are indicated by the *E-DCH RL Indication* IE set to “Non E-DCH”, in the *RL Information* IE.]
- [FDD – For each RL for which the *E-DCH RL Indication* IE is set to “E-DCH”, and which has or can have a common generation of E-RGCH information with another RL (current or future) when the DRNS would contain the E-DCH serving RL, the DRNS shall include the *E-DCH RL Set ID* IE in the RADIO LINK RECONFIGURATION READY message. The value of the *E-DCH RL Set ID* IE shall allow the SRNC to identify the E-DCH RLs that have or can have a common generation of E-RGCH information.]

[FDD – Serving E-DCH Radio Link Change:]

[FDD – If the RADIO LINK RECONFIGURATION PREPARE message includes the *Serving E-DCH RL ID* IE, this indicates the new Serving E-DCH Radio Link:]

- [FDD – If the old Serving E-DCH RL is within this DRNS, the DRNS shall de-allocate the E-AGCH resources of the old Serving E-DCH Radio Link at the activation of the new configuration.]
- [FDD – If the new Serving E-DCH RL is within this DRNS:]
 - [FDD – the DRNS shall allocate a primary E-RNTI identifier or a secondary E-RNTI identifier or both for the new Serving E-DCH Radio Link and include these E-RNTI identifiers along with the channelisation code of the corresponding E-AGCH in the *E-DCH FDD DL Control Channel Information* IE in the *RL*

Information Response IE for the indicated RL in the RADIO LINK RECONFIGURATION READY message.]

- [FDD – The DRNS may include the *Serving Grant Value* IE and *Primary/Secondary Grant Selector* IE in the RADIO LINK RECONFIGURATION READY message for the initial grant for the new serving E-DCH RL.]
- [FDD – If the E-DCH HARQ process allocation for 2ms TTI for scheduled and/or non-scheduled transmission shall be changed, the DRNS shall allocate resources according to the new/changed configuration and include the new/changed configuration in the *E-DCH FDD Information Response* IE in the RADIO LINK RECONFIGURATION READY message.]
- [FDD – If a serving cell change is performed the RADIO LINK RECONFIGURATION READY message may contain invalid data (see 9.2.2.4C).]
- [FDD – The DRNS may include the *Default Serving Grant in DTX Cycle 2* IE in the RADIO LINK RECONFIGURATION READY message for the new serving E-DCH RL.]
- [FDD – The DRNS may include the *E-RGCH/E-HICH Channelisation Code* IE and/or the *E-HICH Signature Sequence* IE and/or the *E-RGCH Signature Sequence* IE or may alternatively include the *E-RGCH Release Indicator* IE in the *E-DCH FDD DL Control Channel Information* IE in the RADIO LINK RECONFIGURATION READY message for every E-DCH Radio Links in the DRNS.]
- [FDD – If the DRNS has no valid data for the *E-RGCH/E-HICH Channelisation Code* IE in the *E-DCH FDD DL Control Channel Information* IE in the RADIO LINK RECONFIGURATION READY message, then it shall insert the *E-RGCH and E-HICH Channelisation Code Validity Indicator* IE in the *E-DCH FDD DL Control Channel Information* IE, to indicate that the *E-RGCH/E-HICH Channelisation Code* IE contains invalid data.]

[FDD – E-DCH Modification:]

[FDD – If the RADIO LINK RECONFIGURATION PREPARE message includes the *E-DCH FDD Information To Modify* IE, then:]

- [FDD – If the *E-DCH FDD Information To Modify* IE contains a *E-DCH MAC-d Flow Specific Information* IE which includes the *Allocation/Retention Priority* IE, the DRNS shall apply the new Allocation/Retention Priority to this E-DCH in the new configuration according to Annex A.]
- [FDD – If the RADIO LINK RECONFIGURATION PREPARE message includes the *E-DCH MAC-d PDU Size Format* IE in the *E-DCH FDD Information To Modify* IE, then the DRNS shall use the indicated format in user plane frame structure for E-DCH channels TS 25.425 [32] and MAC TS 25.321 [41].]
- [FDD – If the *TNL QoS* IE is included for an E-DCH MAC-d flow and if ALCAP is not used, the *TNL QoS* IE may be used by the DRNS to determine the transport bearer characteristics to apply in the uplink for the related MAC-d flow.]
- [FDD – If the *Traffic Class* IE is included for an E-DCH MAC-d flow then the DRNS may use the *Traffic Class* IE for a specific E-DCH MAC-d flow to determine the transport bearer characteristics to apply between DRNC and Node B. The DRNC should ignore the *Traffic Class* IE if the *TrCH Source Statistics Descriptor* IE for this specific E-DCH MAC-d flow indicates the value “RRC”.]
- [FDD – If the RADIO LINK RECONFIGURATION PREPARE message includes the *Data Description Indicator* IE, the DRNC shall use the DDI values indicated in the *Data Description Indicator* IE in the new configuration.]
- [FDD – If the RADIO LINK RECONFIGURATION PREPARE message includes the *MAC-es Guaranteed Bit Rate* IE in the *E-DCH FDD Information To Modify* IE, the DRNS shall use this information to optimise MAC-e scheduling decisions.]
- [FDD – If the RADIO LINK RECONFIGURATION PREPARE message includes the *Maximum MAC-d PDU Size Extended* IE for a E-DCH Logical Channel in the *E-DCH MAC-d Flows Information* IE in the *E-DCH FDD Information To Modify* IE, then the DRNS shall ignore the *MAC-d PDU Size* IE in the *MAC-d PDU Size List* IE and use *Maximum MAC-d PDU Size Extended* IE to optimise capacity allocation for the related E-DCH Logical Channel.]

- [FDD – If the RADIO LINK RECONFIGURATION PREPARE message includes the *Maximum Number of Retransmissions for E-DCH* IE for an E-DCH MAC-d flow in the *E-DCH FDD Information To Modify* IE, then the DRNS shall use this information to report if the maximum number of retransmissions has been exceeded.]
- [FDD – If the RADIO LINK RECONFIGURATION PREPARE message includes the *E-DCH HARQ Power Offset FDD* IE in the *E-DCH FDD Information To Modify* IE for an E-DCH MAC-d flow the DRNS shall use this information for calculating the unquantised gain factor for an E-TFC ($\beta_{ed,j,uq}$) as defined in TS 25.214 [10].]
- [FDD – If the RADIO LINK RECONFIGURATION PREPARE message includes the *E-DCH MAC-d Flow Multiplexing List* IE for an E-DCH MAC-d flow the DRNS shall use this information for the related resource allocation operation.]
- [FDD – If the RADIO LINK RECONFIGURATION PREPARE message includes the E-DCH Grant Type and it is indicated as being “E-DCH Non-Scheduled Transmission Grant” for an E-DCH MAC-d flow the DRNS shall assume non-scheduled grants being configured for that E-DCH MAC-d flow and shall use the information within the *HARQ Process Allocation For 2ms Non-Scheduled Transmission Grant* IE, if included, for the related resource allocation operation.]
- [FDD – If the RADIO LINK RECONFIGURATION PREPARE message includes the E-DCH Grant Type and it is indicated as being “E-DCH Scheduled Transmission Grant” for an E-DCH MAC-d flow the DRNS shall assume scheduled grants being configured for that E-DCH MAC-d flow.]
- [FDD – If the RADIO LINK RECONFIGURATION PREPARE message includes the *E-DCH Logical Channel To Add* or *E-DCH Logical Channel To Delete* IEs, the DRNS shall use this information to add/delete the indicated logical channels. When an logical channel is deleted, all its associated configuration data shall also be removed.]
- [FDD – If the RADIO LINK RECONFIGURATION PREPARE message includes the *E-DCH Logical Channel To Modify* IE, the DRNS shall use this information to modify the indicated logical channels:]
 - [FDD – If the *E-DCH Logical Channel To Modify* IE includes *Scheduling Priority Indicator* IE, the DRNS shall apply the values in the new configuration.]
 - [FDD – If the *E-DCH Logical Channel To Modify* IE includes *Scheduling Information* IE, the DRNS shall apply the values in the new configuration.]
 - [FDD – If the *E-DCH Logical Channel To Modify* IE includes the *Maximum MAC-d PDU Size Extended* IE, the DRNS shall apply the value in the new configuration.]
- [FDD – If the RADIO LINK RECONFIGURATION PREPARE message includes the *Bundling Mode Indicator* IE for an E-DCH MAC-d flow in the *E-DCH MAC-d Flow Specific Information* IE in the *E-DCH FDD Information To Modify* IE and the *Bundling Mode Indicator* IE is set to “Bundling” and the *E-TTI* IE is set to “2ms”, then the DRNS shall use the bundling mode for the E-DCH UL data frames for the related MAC-d flow, otherwise the DRNS shall use the non-bundling mode for the E-DCH UL data frames for the related MAC-d flow.]
- [FDD – If the RADIO LINK RECONFIGURATION PREPARE message includes the *HARQ Process Allocation For 2ms Scheduled Transmission Grant* IE, the DRNS shall use this information for the related resource allocation operation.]
- [FDD – If the E-DCH serving RL is in this DRNS, the DRNS may choose to change the E-DCH HARQ process allocation for 2ms TTI for scheduled and/or non-scheduled transmission. In this case the DRNS shall allocate resources according to the new/changed configuration and include the new/changed configuration in the *E-DCH FDD Information Response* IE in the RADIO LINK RECONFIGURATION READY message.]
- [FDD – If the RADIO LINK RECONFIGURATION PREPARE message includes the *E-DCH Maximum Bitrate* IE for an E-DCH, the DRNS shall use this information for the related resource allocation operation, and when applicable, for E-DCH scheduling.]
- [FDD – If the RADIO LINK RECONFIGURATION PREPARE message includes the *E-DCH Processing Overload Level* IE, then if the DRNS could not decode the E-DPCCH/E-DPDCH for the last consecutive number of TTIs, indicated in the *E-DCH Processing Overload Level* IE, because of processing issue, the DRNS shall notify the SRNC by initiating the Radio Link Failure procedure.]

- [FDD – If the RADIO LINK RECONFIGURATION PREPARE message includes the *E-DCH ReferencePower Offset* IE, then the DRNS may use this value as a default HARQ power offset if it is not able to decode the MAC-e PDU and to determine the value of the actual HARQ power offset.]
- [FDD – If the RADIO LINK RECONFIGURATION PREPARE message includes the *E-DCH Power Offset for Scheduling Info* IE, then the DRNS shall use this value as a power offset for the transmission of scheduling information without any MAC-d PDUs.]
- [FDD – If the RADIO LINK RECONFIGURATION PREPARE message includes the *E-AGCH Power Offset* IE in the *RL Specific E-DCH Information* IE, then the DRNS may use this value to determine the E-AGCH power. The E-AGCH Power Offset should be applied for any E-AGCH transmission to this UE.]
- [FDD – If the RADIO LINK RECONFIGURATION PREPARE message includes the *E-RGCH Power Offset* IE in the *RL Specific E-DCH Information* IE, then the DRNS may use this value to determine the E-RGCH power for the RL. The E-RGCH Power Offset should be applied for any E-RGCH transmission to this UE.]
- [FDD – If the RADIO LINK RECONFIGURATION PREPARE message includes the *E-HICH Power Offset* IE in the *RL Specific E-DCH Information* IE, then the DRNS may use this value to determine the E-HICH power for the RL. The E-HICH Power Offset should be applied for any E-HICH transmission to this UE.]
- [FDD – If the RADIO LINK RECONFIGURATION PREPARE message includes the *MAC-e Reset Indicator* IE in the *E-DCH FDD Information To Modify* IE, then the DRNS shall use this value to determine whether MAC-e (or MAC-i) Reset is performed in the UE for sending the HARQ Failure Indication.]
- [FDD – If the RADIO LINK RECONFIGURATION PREPARE message includes the *SixteenQAM UL Operation Indicator* IE in the *E-DCH FDD Information To Modify* IE, the DRNS shall activate/deactivate SixteenQAM UL Operation for the RL in accordance with the *SixteenQAM UL Operation Indicator* IE]
 - [FDD – If SixteenQAM UL Operation is activated, then the DRNS shall base the handling of the Relative Grant signalling on Scheduling Grant Table 2 according to TS 25.321 [41]. If SixteenQAM UL Operation is deactivated, then the DRNS shall base the handling of the Relative Grant signalling on Scheduling Grant Table 1 according to TS 25.321 [41].]
- [FDD – If the RADIO LINK RECONFIGURATION PREPARE message includes the *E-DCH DL Control Channel Grant Information* IE in the *E-DCH FDD Information To Modify* IE, the DRNS may modify E-AGCH Channelisation Code, E-RGCH/E-HICH Channelisation Code, E-RGCH Signature Sequence and/or E-HICH Signature Sequence for the E-DCH RL indicated by the *E-DCH RL ID* IE. The DRNS shall then report the modified configuration which is used in the new configuration specified in the *E-DCH FDD DL Control Channel Information* IE for each E-DCH RL in the RADIO LINK RECONFIGURATION READY message.]

[FDD – E-DCH MAC-d Flow Addition:]

[FDD – If the RADIO LINK RECONFIGURATION PREPARE message includes an *E-DCH MAC-d Flows To Add* IE, then the DRNS shall use this information to add the indicated E-DCH MAC-d flows.]

[FDD – If the RADIO LINK RECONFIGURATION PREPARE message includes the *Maximum MAC-d PDU Size Extended* IE for a E-DCH Logical Channel in the *E-DCH MAC-d Flows Information* IE in the *E-DCH MAC-d Flows To Add* IE, then the DRNS shall ignore the *MAC-d PDU Size* IE in the *MAC-d PDU Size List* IE and use *Maximum MAC-d PDU Size Extended* IE to optimise capacity allocation for the related E-DCH Logical Channel.]

[FDD – If the RADIO LINK RECONFIGURATION PREPARE message includes the *E-DCH MAC-d Flows To Add* IE, then:]

- [FDD – The DRNS may use the *Traffic Class* IE for a specific E-DCH MAC-d flow to determine the transport bearer characteristics to apply between DRNS and Node B. If *TrCH Source Statistics Descriptor* IE is present with the value “RRC” in the *E-DCH MAC-d Flows Information* IE, then the DRNS should ignore the *Traffic Class* IE.]
- [FDD – If the RADIO LINK RECONFIGURATION PREPARE message includes the *MAC-es Guaranteed Bit Rate* IE in the *E-DCH Logical Channel Information* IE in the *E-DCH MAC-d Flows To Add* IE, the DRNS shall use this information to optimise MAC-e scheduling decisions.]
- [FDD – If the RADIO LINK RECONFIGURATION PREPARE message includes the *UE Aggregate Maximum Bit Rate Enforcement Indicator* IE in the *E-DCH Logical Channel Information* IE in the *E-DCH MAC-d Flows*

To Add IE, the DRNS shall, if supported, consider the data of the related E-DCH Logical Channel for UE Aggregate Maximum Bit Rate Enforcement.]

[FDD – E-DCH MAC-d Flow Deletion:]

[FDD – If the RADIO LINK RECONFIGURATION PREPARE message includes an E-DCH MAC-d Flows To Delete IEs, then the DRNS shall use this information to delete the indicated E-DCH MAC-d flows. When an E-DCH MAC-d flow is deleted, all its associated configuration shall also be removed.]

[FDD – If the RADIO LINK RECONFIGURATION PREPARE message includes an E-DCH MAC-d Flows To Delete IE requesting the deletion of all remaining E-DCH MAC-d flows for the UE Context, then the DRNC shall delete the E-DCH configuration from the UE Context and release the E-DCH resources.]

[FDD – Additional E-DCH Setup:]

[FDD – If the Additional E-DCH Cell Information RL Reconf Prep IE is present in the RADIO LINK RECONFIGURATION PREPARE message and the choice of Setup, Configuration Change or Removal of E-DCH On Secondary UL Frequency is “Setup”, then the Additional E-DCH Cell Information Setup IE defines the new configuration and then:]

- [FDD – If the C-ID IE is included in the Additional E-DCH RL Specific Information To Setup IE in the Additional E-DCH FDD Setup Information IE the C-ID IE indicates the cell in which the additional E-DCH shall be setup]
- [FDD – The DRNS shall setup the Additional E-DCH on the secondary uplink frequency and setup the requested Additional E-DCH resources on the Radio Links and in the cells indicated by the E-DCH Additional RL ID IE and the C-ID IE in the Additional E-DCH RL Specific Information To Setup IE in the Additional E-DCH FDD Setup Information IE.]
- [FDD – If the C-ID IE is not included in the Additional E-DCH RL Specific Information To Setup IE in the Additional E-DCH FDD Setup Information IE the E-DCH Additional RL ID IE indicates the existing RL on which the Additional E-DCH shall be setup.]
- [FDD – The DRNS shall setup the additional E-DCH on the Radio Links indicated by the E-DCH Additional RL ID IE in the Additional E-DCH RL Specific Information To Setup IE in the Additional E-DCH FDD Setup Information IE]
- [FDD – The DRNS shall use for the non cell specific Radio Link related parameters and non cell specific E-DPCH, UL DPCH, E-DCH and F-DPCH parameters the same values as for the corresponding cell of the Primary uplink frequency.]
- [FDD – If the UL SIR Target IE in the UL DPCH Information IE in the Additional E-DCH FDD Setup Information IE in the Additional E-DCH Cell Information Setup IE and/or the DL Power Balancing Information IE and/or the Minimum Reduced E-DPDCH Gain Factor IE in the Multicell E-DCH Information IE in the Additional E-DCH FDD Setup Information IE are present, the DRNS shall use the information in the same way as for the information used on Primary uplink frequency.]
- [FDD – If the Secondary UL Frequency Activation State IE is present in the Multicell E-DCH Information IE in the Additional E-DCH FDD Setup Information IE, the DRNS shall use the information as initial activation state of the Radio Links on the secondary uplink frequency.]
- [FDD – If the Initial DL Tx Power IE, the Primary CPICH Ec/No IE, the E-AGCH Power Offset IE, the E-RGCH Power Offset IE and/or the E-HICH Power Offset IE is included in the Additional E-DCH RL Specific Information To Setup IE in the Additional E-DCH FDD Setup Information IE in the Additional E-DCH Cell Information Setup IE, the DRNS shall use the information in the same way as for the information used on Primary uplink frequency.]
- [FDD – If the Enhanced Primary CPICH Ec/No IE is included in the Multicell E-DCH RL Specific Information IE in the Additional E-DCH Secondary RL Specific Information To Setup IE in the Additional E-DCH FDD Setup Information IE in the Additional E-DCH Cell Information Setup IE, the DRNS shall use the information in the same way as for the information used on Primary uplink frequency.]
- [FDD – If the F-DPCH Slot Format Support Request IE in the F-DPCH Information IE in the Additional E-DCH FDD Setup Information IE in the Additional E-DCH Cell Information Setup IE is included, the DRNS shall configure the concerned UE Context for F-DPCH Slot Format operation according to TS 25.211 [8] and

include the *F-DPCH Slot Format IE* in the *Additional E-DCH FDD Information Response IE* in the *Additional E-DCH Cell Information Response RL Reconf IE* in the RADIO RECONFIGURATION READY message. If the *Multicell E-DCH Information IE* in the *Additional E-DCH FDD Setup Information IE* includes the *F-DPCH Slot Format IE*, the DRNS may use the *F-DPCH Slot Format IE* to determine the F-DPCH slot format.]

- [FDD – If the *HARQ Process Allocation For 2ms Scheduled Transmission Grant IE*, the *E-DCH Maximum Bitrate IE*, the *E-DCH Minimum Set E-TFCI IE* and/or the *E-DCH Processing Overload Level IE* are present in the *Additional E-DCH FDD Information IE* in the *Additional E-DCH FDD Setup Information IE* in the *Additional E-DCH Cell Information Setup IE*, the DRNS shall use the information in the same way as for the information used on Primary uplink frequency.]
- [FDD – If activation of power balancing for the Additional E-DCH RL by the RADIO LINK RECONFIGURATION PREPARE message is supported by the DRNS, the DRNS shall include the *DL Power Balancing Activation Indicator IE* in the *Additional E-DCH FDD Information Response IE* in the *Additional E-DCH Cell Information Response RLReconf IE* in the RADIO LINK RECONFIGURATION READY message.]
- [FDD – For each Additional E-DCH RL not having a common generation of the TPC commands in the DL with another Additional E-DCH RL, the DRNS shall set the *RL Set ID IE* included in the *Additional E-DCH FDD Information Response IE* in the RADIO LINK RECONFIGURATION READY message to a value that uniquely identifies the RL as a RL Set within the UE Context. The generation of E-HICH related information for Additional E-DCH RLs in different RL Sets shall not be common.]
- [FDD – For all Additional E-DCH RLs having a common generation of the TPC commands in the DL with another Additional E-DCH RL, the DRNS shall assign to each Additional E-DCH RL the same value for the *RL Set ID IE* included in the *Additional E-DCH FDD Information Response IE* in the RADIO LINK RECONFIGURATION READY message. This value shall uniquely identify these Additional E-DCH RLs as members of the same RL Set within the UE Context. The generation of E-HICH information for all Additional E-DCH RLs in a RL Set shall be common.]
- [FDD – For each Additional E-DCH RL which has or can have a common generation of E-RGCH information with another Additional E-DCH RL (current or future) when the DRNS would contain the Additional E-DCH serving RL, the DRNS shall set a same value to the *E-DCH RL Set ID IE* for the Additional E-DCH RL in the *Additional E-DCH FDD Information Response IE* in the *Additional E-DCH Cell Information Response RLReconf IE* in the RADIO LINK RECONFIGURATION READY message]
- [FDD – For every additional E-DCH RL indicated in the *Additional E-DCH RL Specific Information To Setup IE* in the *Additional E-DCH FDD Setup Information IE* the DRNS may include the *E-AGCH And E-RGCH/E-HICH FDD Scrambling Code IE* and shall include the *E-RGCH/E-HICH Channelisation Code IE* and the corresponding *E-HICH Signature Sequence IE* and the DRNS may include the corresponding *E-RGCH Signature Sequence IE* for each Additional E-DCH RL in the *E-DCH FDD DL Control Channel Information IE* in the *Additional E-DCH FDD Information Response IE* in the *Additional E-DCH Cell Information Response RLReconf IE* in the RADIO LINK RECONFIGURATION READY message and if DRNS has no valid data for the *E-RGCH/E-HICH Channelisation Code IE*, then it shall insert the *E-RGCH and E-HICH Channelisation Code Validity Indicator IE* to indicate that the *E-RGCH/E-HICH Channelisation Code IE* contains invalid data.]
- [FDD – If the Additional Serving E-DCH Radio Link is configured in the DRNS, then:]
 - [FDD – The DRNS shall allocate a primary E-RNTI identifier or a secondary E-RNTI identifier or both for the corresponding RL and include these E-RNTI identifiers and the channelisation code of the corresponding E-AGCH in the *E-DCH FDD DL Control Channel Information IE* in the *Additional E-DCH FDD Information Response IE* in the *Additional E-DCH Cell Information Response RLReconf IE* in the RADIO LINK RECONFIGURATION READY message.]
 - [FDD – The DRNS may include in the *E-DCH FDD DL Control Channel Information IE* in the *Additional E-DCH FDD Information Response IE* in the *Additional E-DCH Cell Information Response RLReconf IE* in the RADIO LINK RECONFIGURATION READY message the *Serving Grant Value IE* and *Primary/Secondary Grant Selector IE* for the initial grant for the Additional serving E-DCH RL and may include the *Default Serving Grant in DTX Cycle 2 IE*.]
 - [FDD – If the E-DCH HARQ process allocation for 2ms TTI for scheduled transmission shall be changed, the DRNS shall allocate resources according to the new/changed configuration and include the new/changed configuration in the *HARQ Process Allocation For 2ms Scheduled Transmission Grant IE* in the *Additional E-DCH FDD Information Response IE* in the *Additional E-DCH Cell Information Response IE* in the RADIO LINK RECONFIGURATION READY message.]

- [FDD – If Primary CPICH is not to be used as a Phase Reference for this Radio Link on the secondary UL frequency, the DRNS shall include the *Primary CPICH Usage For Channel Estimation* IE set to the value “Primary CPICH shall not be used” in the *Additional E-DCH FDD Information Response* IE in the *Additional E-DCH Cell Information Response RReconf* IE RADIO LINK RECONFIGURATION READY message.]
- [FDD – If Secondary CPICH may be used as a Phase Reference for this Radio Link on the secondary UL frequency, the DRNS shall include the *Secondary CPICH Information* IE in the *Additional E-DCH FDD Information Response* IE in the *Additional E-DCH Cell Information Response RReconf* IE in the RADIO LINK RECONFIGURATION READY message. If the DRNS doesn’t include the *Secondary CPICH Information* IE, it shall not include the *Primary CPICH Usage For Channel Estimation* IE set to the value “Primary CPICH shall not be used”.]

[FDD – Additional E-DCH Configuration Change]

[FDD – If the *Additional E-DCH Cell Information RReconf Prep* IE is present in the RADIO LINK RECONFIGURATION PREPARE message and the choice of *Setup, Configuration Change or Removal of E-DCH On Secondary UL Frequency* is “Configuration Change”, then the *Additional E-DCH Cell Information Configuration Change* IE defines the new configuration and then:]

- [FDD – If the *UL Scrambling Code* IE and/or the *UL SIR Target* IE are present in the *UL DPCH Information* IE in the *Additional E-DCH Configuration Change Information* IE and/or if the *Minimum Reduced E-DPDCH Gain Factor* IE is present in the *Multicell E-DCH Information* IE in the *Additional E-DCH Configuration Change Information* IE, the DRNS shall use the information in the same way as for the information that is used on the Primary uplink frequency.]
- [FDD – If the RADIO LINK RECONFIGURATION PREPARE message includes the *F-DPCH Information* IE in the *Additional E-DCH Configuration Change Information* IE, then:]
 - [FDD – The DRNS shall configure the concerned UE Context to use F-DPCH in the downlink in the new configuration.]
 - [FDD – If the *F-DPCH Information* IE includes the *F-DPCH Slot Format Support Request* IE, then the DRNS shall configure the concerned UE Context for F-DPCH Slot Format operation according to TS 25.211 [8] and include the *F-DPCH Slot Format* IE in the *Additional E-DCH FDD Information Response* IE for new RLs on the secondary UL frequency or in the *Additional Modified E-DCH FDD Information Response* IE for modified RLs in the RADIO LINK RECONFIGURATION READY message. If the *Multicell E-DCH Information* IE in the *Additional E-DCH Configuration Change Information* IE includes the *F-DPCH Slot Format* IE, the DRNS may use the *F-DPCH Slot Format* IE to determine the F-DPCH slot format.]

[FDD – Additional E-DCH RL Addition:]

[FDD – If the *Additional E-DCH RL Specific Information To Add* IE is present in the *Additional E-DCH Configuration Change Information* IE, then:]

- [FDD – The DRNS shall setup the E-DCH resources, as requested or as configured in the UE context, on the Radio Links indicated by the *E-DCH Additional RL ID* IE. Non cell specific Radio Link related parameters and non cell specific E-DPCH, UL DPCH, E-DCH and F-DPCH parameters shall take the same values as for the corresponding cell of the Primary uplink frequency.]
- [FDD – If the *E-AGCH Power Offset* IE, the *E-RGCH Power Offset* IE, the *E-HICH Power Offset* IE is included, the DRNS shall use the information in the same way as for information is used on the Primary uplink frequency.]
- [FDD – If the power balancing is active with the Power Balancing Adjustment Type of the UE Context set to “Individual” in the existing Additional E-DCH RL(s) and the RADIO LINK RECONFIGURATION PREPARE message includes the *DL Reference Power* IE in the *Multicell E-DCH RL Specific Information* IE, the DRNS shall activate the power balancing and use the *DL Reference Power* IE for the power balancing procedure in the new Additional RL(s), if activation of power balancing by the RADIO LINK RECONFIGURATION PREPARE message at RL addition on secondary UL frequency is supported, according to subclause 8.3.15. In this case, the DRNS shall include the *DL Power Balancing Activation Indicator* IE in the *Additional E-DCH FDD Information Response* IE in the *Additional E-DCH Cell Information Response RReconf* IE in the RADIO LINK RECONFIGURATION READY message. If the DRNS starts the DL transmission and the activation of the power balancing at the same CFN, the initial power of the power balancing, i.e. P_{init} shall be set

to the power level which is calculated based on the following IEs (if received): *Primary CPICH Ec/No* IE or the *Enhanced Primary CPICH Ec/No* IE in the *Multicell E-DCH RL Specific Information* IE or to the power level which is calculated based on the power relative to the Primary CPICH power used by the existing Additional RLs.]

- [FDD – For each Additional E-DCH RL not having a common generation of the TPC commands in the DL with another Additional E-DCH RL, the DRNS shall set the *RL Set ID* IE included in the *Additional E-DCH FDD Information Response* IE in the RADIO LINK RECONFIGURATION READY message to a value that uniquely identifies the RL as a RL Set within the UE Context. The generation of E-HICH related information for Additional E-DCH RLs in different RL Sets shall not be common.]
- [FDD – For all Additional E-DCH RLs having a common generation of the TPC commands in the DL with another Additional E-DCH RL, the DRNS shall assign to each Additional E-DCH RL the same value for the *RL Set ID* IE included in the *Additional E-DCH FDD Information Response* IE in the RADIO LINK RECONFIGURATION READY message. This value shall uniquely identify these Additional E-DCH RLs as members of the same RL Set within the UE Context. The generation of E-HICH information for all Additional E-DCH RLs in a RL Set shall be common.]
- [FDD – For each Additional E-DCH RL which has or can have a common generation of E-RGCH information with another Additional E-DCH RL (current or future) when the DRNS would contain the Additional E-DCH serving RL, the DRNS shall set a same value to the *E-DCH RL Set ID* IE for the Additional E-DCH RL in the *Additional E-DCH FDD Information Response* IE in the *Additional E-DCH Cell Information Response RReconf* IE in the RADIO LINK RECONFIGURATION READY message]
- [FDD – For every additional E-DCH RL indicated in the *Additional E-DCH RL Specific Information To Add* IE, the DRNS may include the *E-AGCH And E-RGCH/E-HICH FDD Scrambling Code* IE and shall include the *E-RGCH/E-HICH Channelisation Code* IE and the corresponding *E-HICH Signature Sequence* IE and the DRNS may include the corresponding *E-RGCH Signature Sequence* IE in the *E-DCH FDD DL Control Channel Information* IE in the *Additional E-DCH FDD Information Response* IE in the *Additional E-DCH Cell Information Response RReconf* IE in the RADIO LINK RECONFIGURATION READY message and if DRNS has no valid data for the *E-RGCH/ E-HICH Channelisation Code* IE, then it shall insert the *E-RGCH/ E-HICH Channelisation Code Validity Indicator* IE to indicate that the *E-RGCH/ E-HICH Channelisation Code* IE contains invalid data.]
- [FDD – If the *Primary CPICH Ec/No* IE or the *Primary CPICH Ec/No* IE and the *Enhanced Primary CPICH Ec/No* IE in the *Multicell E-DCH RL Specific Information* IE measured by the UE are included for a RL in the RADIO LINK RECONFIGURATION PREPARE message, the DRNS shall use this in the calculation of the Initial DL TX Power for this additional RL. If the *Primary CPICH Ec/No* IE is not present, the DRNS shall set the Initial DL TX Power based on the power relative to the Primary CPICH power used by the existing RLs.]

[FDD – Additional E-DCH RL Modification:]

[FDD – If the *Additional E-DCH RL Specific Information To Modify* IE is present in the *Additional E-DCH Configuration Change Information* IE, then the RL indicated by the *E-DCH Additional RL ID* IE indicates the RL on which E-DCH resources shall be modified:]

- [FDD – If the *E-AGCH Power Offset* IE, the *E-RGCH Power Offset* IE, the *E-HICH Power Offset* IE, and/or the *E-DCH DL Control Channel Grant* IE in the *Multicell E-DCH RL Specific Information* IE is included, the DRNS shall use the information in the same way as for the information used on the Primary uplink frequency.]
- [FDD – If the *DL Reference Power* IEs is included in the *Multicell E-DCH RL Specific Information* IE and power balancing is active, DRNS shall apply DL power Control in the same way as defined for the Primary uplink frequency.]
- [FDD – If updating of power balancing parameters by the RADIO LINK RECONFIGURATION PREPARE message is supported by the DRNS, the DRNS shall include the *DL Power Balancing Updated Indicator* IE in the *Additional Modified E-DCH FDD Information Response* IE in the *Additional E-DCH Cell Information Response RReconf* IE for each affected RL in the RADIO LINK RECONFIGURATION READY message.]

- [FDD – If the *Phase Reference Update Indicator* IE is included in the *Multicell E-DCH RL Specific Information* IE, DRNS shall modify the channel estimation information according to TS 25.214 [10] subclause 4.3.2.1 and set the value(s) in *Primary CPICH Usage For Channel Estimation* IE and/or *Secondary CPICH Information Change* IE in the *Additional Modified E-DCH FDD Information Response* IE in the *Additional E-DCH Cell Information Response RReconf* IE in the RADIO LINK RECONFIGURATION READY message accordingly.]
- [FDD – If the RADIO LINK RECONFIGURATION READY message includes the *Primary CPICH Usage For Channel Estimation* IE and/or the *Secondary CPICH Information Change* IE in the *Additional Modified E-DCH FDD Information Response* IE in the *Additional E-DCH Cell Information Response RReconf* IE, the DRNS shall avoid the new configuration in which neither the Primary CPICH nor the Secondary CPICH is used as a Phase Reference for this Radio Link.]

[FDD – Additional E-DCH Modification:]

[FDD – If the *Additional E-DCH FDD Information To Modify* IE is present in the *Additional E-DCH Configuration Change Information* IE, then:]

- [FDD – If the *HARQ Process Allocation For 2ms Scheduled Transmission Grant* IE, the *E-DCH Minimum Set E-TFCI* IE and/or the *E-DCH Maximum Bitrate* IE is included, the DRNS shall use this information for the related resource allocation operation.]
- [FDD – If the *E-DCH Processing Overload Level* IE is included, then if the DRNS could not decode the E-DPCCH/E-DPDCH for the last consecutive number of TTIs, indicated in the *E-DCH Processing Overload Level* IE, because of processing issue, the DRNS shall notify the RNC by initiating the Radio Link Failure procedure.]
- [FDD – If the DL TX power upper or lower limit has been re-configured for the secondary UL frequency, the DRNS shall include the new value(s) in the *Maximum DL TX Power* IE and *Minimum DL TX Power* IE in the *Additional Modified E-DCH FDD Information Response* IE in the *Additional E-DCH Cell Information Response RReconf* IE in the RADIO LINK RECONFIGURATION READY message.]
- [FDD – The DRNS decides the maximum and minimum SIR for the uplink of the Radio Link(s), and the DRNS shall include in the RADIO LINK RECONFIGURATION READY message the *Maximum Uplink SIR* IE and *Minimum Uplink SIR* IE in the *Additional Modified E-DCH FDD Information Response* IE in the *Additional E-DCH Cell Information Response RReconf* IE for each Radio Link when these values are changed.]
- [FDD – If the Additional E-DCH serving RL is in this DRNS, the DRNS may choose to change the E-DCH HARQ process allocation for 2ms TTI for scheduled transmission. In this case the DRNS shall allocate resources according to the new/changed configuration and include the new/changed configuration in the *HARQ Process Allocation For 2ms Scheduled Transmission Grant* IE in the *Additional Modified E-DCH FDD Information Response* IE in the RADIO LINK RECONFIGURATION READY message.]

[FDD – Additional E-DCH Removal]

[FDD – If the *Additional E-DCH Cell Information RL Reconf Prep* IE is present in the RADIO LINK RECONFIGURATION PREPARE message and the choice of *Setup, Configuration Change or Removal of E-DCH On Secondary UL Frequency* is “Removal”, then the additional E-DCH on the secondary uplink frequency shall be removed.]

[1.28Mcps TDD – Uplink Synchronisation Parameters LCR:]

[1.28Mcps TDD –If the *Uplink Synchronisation Parameters LCR* IE is present, the DRNC shall use the indicated values of *Uplink synchronisation stepsize* IE and *Uplink synchronisation frequency* IE when evaluating the timing of the UL synchronisation.]

[1.28Mcps TDD – Shared physical channels Synchronisation Detection:]

[1.28Mcps TDD – If HS-PDSCH and E-PUCH are configured but no DPCH is configured for the UE, then the DRNS shall include the *Out-of-sync Detection Window* IE in the *HS-DSCH TDD Information Response* IE in the RADIO LINK RECONFIGURATION READY message.]

[1.28Mcps TDD – Uplink Timing Advance Control LCR:]

[1.28Mcps TDD – The DRNC shall include the *Uplink Timing Advance Control LCR* IE in the RADIO LINK RECONFIGURATION READY message, if the Uplink Timing Advance Control parameters have been changed.]

[1.28Mcps TDD – PowerControl GAP:]

[1.28Mcps TDD – If applied in the DRNS, the DRNC may include the *PowerControl GAP* IE in the RADIO LINK RECONFIGURATION READY message.]

[1.28Mcps TDD – E-UTRAN Inter-RAT measurement:]

[1.28Mcps TDD – If the RADIO LINK RECONFIGURATION PREPARE message includes the *Need for Idle Interval* IE set to “TRUE”, if supported, the DRNC shall include the *Idle Interval Information* IE in the RADIO LINK RECONFIGURATION READY message. If the *Need for Idle Interval* IE is set to “FALSE”, the DRNC shall delete the configuration related to E-UTRAN Inter-RAT measurement]

[1.28Mcps TDD – RNTI Allocation Indicator:]

[1.28Mcps TDD – If the RADIO LINK RECONFIGURATION PREPARE message includes the *RNTI Allocation Indicator* IE, if supported, the DRNS may allocate an E-RNTI and/or an H-RNTI for UE to use in CELL_FACH state.]

[1.28Mcps TDD – Inter-frequency/ Inter-RAT measurement:]

[1.28Mcps TDD – If the RADIO LINK RECONFIGURATION PREPARE message includes the *DCH Measurement Type indicator* IE, if supported, the DRNS shall include the *Measurement purpose* IE and the *Measurement occasion pattern sequence parameters* IE in the *DCH Measurement Occasion Information* IE in the RADIO LINK RECONFIGURATION READY message to configure the measurement occasion pattern(s) indicated by the *DCH Measurement Type indicator* IE.]

[TDD – DSCH RNTI Addition/Deletion:]

[TDD – If the RADIO LINK RECONFIGURATION PREPARE message includes the *PDSCH RL ID* IE, then the DRNS shall use it as the new RL identifier for PDSCH and PUSCH.]

- [TDD – If the indicated PDSCH RL ID is in the DRNS and there was no DSCH-RNTI allocated to the UE Context, the DRNC shall allocate a DSCH-RNTI to the UE Context and include the *DSCH-RNTI* IE in the RADIO LINK RECONFIGURATION READY message.]
- [TDD – If the indicated PDSCH RL ID is in the DRNS and there was a DSCH-RNTI allocated to the UE Context, the DRNC shall allocate a new DSCH-RNTI to the UE Context, release the old DSCH-RNTI and include the *DSCH-RNTI* IE in the RADIO LINK RECONFIGURATION READY message.]
- [TDD – If the indicated PDSCH RL ID is not in the DRNS and there was a DSCH-RNTI allocated to the UE Context, the DRNC shall release this DSCH-RNTI.]

[TDD – If the RADIO LINK RECONFIGURATION PREPARE message includes a *DSCHs To Delete* IE and/or a *USCHs To Delete* IE which results in the deletion of all DSCH and USCH resources for the UE Context, then the DRNC shall release the DSCH-RNTI allocated to the UE Context, if there was one.]

[FDD – Phase Reference Handling:]

[FDD – If Primary CPICH usage for channel estimation information has been reconfigured, the DRNC shall include the *Primary CPICH Usage For Channel Estimation* IE in the RADIO LINK RECONFIGURATION READY message.]

[FDD – If Secondary CPICH information for channel estimation has been reconfigured, the DRNC shall include the *Secondary CPICH Information Change* IE in the RADIO LINK RECONFIGURATION READY message.]

[FDD – If the RADIO LINK RECONFIGURATION PREPARE message includes *Phase Reference Update Indicator* IE, DRNC shall modify the channel estimation information according to TS 25.214 [10] subclause 4.3.2.1 and set the value(s) in *Primary CPICH Usage For Channel Estimation* IE and/or *Secondary CPICH Information Change* IE in the RADIO LINK RECONFIGURATION READY message accordingly.]

[FDD – If the RADIO LINK RECONFIGURATION READY message includes the *Primary CPICH Usage For Channel Estimation* IE and/or the *Secondary CPICH Information Change* IE, the DRNC shall avoid the new

configuration in which neither the Primary CPICH nor the Secondary CPICH is used as a Phase Reference for this Radio Link.]

[FDD – Fast Reconfiguration:]

[FDD – If the RADIO LINK RECONFIGURATION PREPARE message includes the *Fast Reconfiguration Mode IE*, the DRNS shall, if supported, and if it is possible to base the synchronization of the reconfiguration on the detection of the change in the uplink scrambling code for this reconfiguration, include the *Fast Reconfiguration Permission IE* in the RADIO LINK RECONFIGURATION READY message.]

[TDD – Intra- DRNS Serving E-DCH Radio Link Change:]

TDD- If the RADIO LINK RECONFIGURATION PREPARE message includes the *E-DCH Serving RL IE*, this indicates the new Serving E-DCH Radio Link:]

- [TDD – In the new configuration the DRNS shall de-allocate the E-DCH resources of the old Serving E-DCH Radio Link and allocate the E-DCH resources for the new Serving E-DCH Radio Link.]
- [3.84Mcps TDD – The DRNS shall allocate E-AGCH parameters corresponding to the E-DCH and include the *E-AGCH Specific Information Response IE* in the *E-DCH TDD Information Response IE* in the RADIO LINK RECONFIGURATION READY message.]
- [1.28Mcps TDD – The DRNS shall allocate E-AGCH parameters and E-HICH parameters corresponding to the E-DCH and include the *E-AGCH Specific Information Response IE* and the *E-HICH Specific Information Response IE* in the *E-DCH Information Response 1.28Mcps IE* in the RADIO LINK RECONFIGURATION READY message.]
- [7.68Mcps TDD – The DRNS shall allocate E-AGCH parameters corresponding to the E-DCH and include the *E-AGCH Specific Information Response 7.68Mcps IE* in the *E-DCH TDD Information Response 7.68Mcps IE* in the RADIO LINK RECONFIGURATION READY message.]
- [TDD – If the *TNL QoS IE* is included for a MAC-d flow and if ALCAP is not used, the *TNL QoS IE* may be used by the DRNS to determine the transport bearer characteristics to apply in the uplink for the related MAC-d flow.]

[TDD – E-PUCH Handling:]

[3.84Mcps TDD and 7.68Mcps TDD – If the RADIO LINK RECONFIGURATION PREPARE message includes an *E-PUCH Information IE*, the DRNS shall apply the parameters to the new configuration.]

[1.28Mcps TDD – If the RADIO LINK RECONFIGURATION PREPARE message includes an *E-PUCH Information LCR IE*, the DRNS shall apply the parameters to the new configuration]

[TDD – If the RADIO LINK RECONFIGURATION PREPARE message includes an *E-TFCS Information IE*, the DRNS shall apply the beta parameters to the new configuration.]

[3.84Mcps TDD – E-DCH Setup:]

[3.84Mcps TDD – the radio link may be reconfigured to support E-DCH by including the appropriate E-DCH information elements: *E-DCH Serving RL IE*, *E-PUCH Information IE*, *E-TFCS Information TDD IE*, *E-DCH MAC-d Flows to Add IE* and *E-DCH TDD Information IE*.]

[1.28Mcps TDD – E-DCH Setup:]

[1.28cps TDD – the radio link may be reconfigured to support E-DCH by including the appropriate E-DCH information elements: *E-DCH Serving RL IE*, *E-PUCH Information LCR IE*, *E-TFCS Information TDD IE*, *E-DCH MAC-d Flows to Add IE* and *E-DCH TDD Information LCR IE*.]

[7.68Mcps TDD – E-DCH Setup:]

[7.68Mcps TDD – the radio link may be reconfigured to support E-DCH by including the appropriate E-DCH information elements: *E-DCH Serving RL IE*, *E-PUCH Information IE*, *E-TFCS Information TDD IE*, *E-DCH MAC-d Flows to Add IE* and *E-DCH TDD Information 7.68Mcps IE*.]

[TDD- E-DCH MAC-d Flow Addition/Deletion:]

[TDD- If the RADIO LINK RECONFIGURATION PREPARE message includes any *E-DCH MAC-d Flows To Add* or *E-DCH MAC-d Flows To Delete* IEs, then the DRNS shall use this information to add/delete the indicated E-DCH MAC-d flows. When an E-DCH MAC-d flow is deleted, all its associated configuration data shall also be removed.]

[TDD – If the RADIO LINK RECONFIGURATION PREPARE message includes the *Maximum MAC-d PDU Size Extended* IE for a E-DCH Logical Channel in the *E-DCH MAC-d Flows Information TDD* IE in the *E-DCH MAC-d Flows To Add* IE, then the DRNS shall ignore the *MAC-d PDU Size* IE in the *MAC-d PDU Size List* IE and use *Maximum MAC-d PDU Size Extended* IE to optimise capacity allocation for the related E-DCH Logical Channel.]

[TDD- If the RADIO LINK RECONFIGURATION PREPARE message includes an *E-DCH MAC-d Flows To Delete* IE requesting the deletion of all remaining E-DCH MAC-d flows for the UE Context, then the DRNS shall delete the E-DCH configuration from the UE Context and release the E-DCH resources.]

[TDD- If the RADIO LINK RECONFIGURATION PREPARE message includes the *E-DCH MAC-d Flows To Add* IE, then:]

- [TDD- If the RADIO LINK RECONFIGURATION PREPARE message includes the *MAC-es Guaranteed Bit Rate* IE in the *E-DCH MAC-d Flows To Add* IE, the DRNS shall use this information to optimise MAC-e scheduling decisions.]
- [1.28Mcps TDD – If the RADIO LINK RECONFIGURATION PREPARE message includes the *MAC-es Maximum Bit Rate LCR* IE in the *E-DCH Logical Channel Information* IE in the *E-DCH MAC-d Flows To Add* IE, the DRNS shall use this information for the related resource allocation operation, and when applicable, for E-DCH scheduling.]

[3.84Mcps TDD – E-DCH Non-scheduled allocations:]

[3.84Mcps TDD – The DRNS shall determine any non-scheduled resource to be granted for the radio link, and return this in the *E-DCH Non-scheduled Grant Information TDD* IE in the *E-DCH Information Response* IE in the RADIO LINK RECONFIGURATION READY message.]

[1.28Mcps TDD – E-DCH Non-scheduled allocations:]

[1.28Mcps – The DRNS shall determine any non-scheduled resource to be granted for the radio link, and return this in the *E-DCH Non-scheduled Grant Information LCR TDD* IE in the *E-DCH Information Response 1.28Mcps* IE in the RADIO LINK RECONFIGURATION READY message.]

[7.68Mcps TDD – E-DCH Non-scheduled allocations:]

[7.68Mcps TDD – The DRNS shall determine any non-scheduled resource to be granted for the radio link, and return this in the *E-DCH Non-scheduled Grant Information 7.68Mcps TDD* IE in the *E-DCH Information Response 7.68Mcps* IE in the RADIO LINK RECONFIGURATION READY message.]

[TDD – E-DCH Modification:]

[TDD – If the RADIO LINK RECONFIGURATION PREPARE message includes the *Maximum MAC-d PDU Size Extended* IE for a E-DCH Logical Channel in the *E-DCH MAC-d Flows Information* IE in the *E-DCH TDD Information To Modify* IE, then the DRNS shall ignore the *MAC-d PDU Size* IE in the *MAC-d PDU Size List* IE and use *Maximum MAC-d PDU Size Extended* IE to optimise capacity allocation for the related E-DCH Logical Channel.]

[TDD – If the RADIO LINK RECONFIGURATION PREPARE message includes the *E-DCH MAC-d PDU Size Format* IE in the *E-DCH TDD Information To Modify* IE, then the DRNS shall use the indicated format in user plane frame structure for E-DCH channels TS 25.425 [32] and MAC TS 25.321 [41].]

[3.84Mcps TDD – E-DCH Modification:]

[3.84Mcps TDD – If the RADIO LINK RECONFIGURATION PREPARE message includes the *E-DCH TDD Information* IE, then:]

- [3.84Mcps TDD – If the *E-DCH TDD Information* IE includes the *E-DCH TDD Maximum Bitrate* IE for an E-DCH, the DRNS shall use this information for the related resource allocation operation, and when applicable, for E-DCH scheduling.]
- [3.84Mcps TDD – If the *E-DCH TDD Information* IE includes the *E-DCH Processing Overload Level* IE, then if the DRNS could not decode the E-PUCH for the last consecutive number of TTIs, indicated in the *E-DCH*

Processing Overload Level IE, because of a processing issue, the DRNS shall notify the SRNC by initiating the Radio Link Failure procedure.]

- [3.84Mcps TDD – If the *E-DCH TDD Information IE* includes the *E-DCH Power Offset for Scheduling Info IE*, then the DRNS shall use this value as a power offset for the transmission of scheduling information without any MAC-d PDUs.]

[1.28Mcps TDD – E-DCH Modification:]

[1.28Mcps TDD – If the RADIO LINK RECONFIGURATION PREPARE message includes the *E-DCH TDD Information LCR IE*, then:]

- [1.28Mcps TDD – If the *E-DCH TDD Information LCR IE* includes the *E-DCH Physical Layer Category LCR IE* or *Extended E-DCH Physical Layer Category LCR IE* for an E-DCH, the DRNS shall use this information for the related resource allocation operation, and when applicable, for E-DCH scheduling.]
- [1.28Mcps TDD – If the *E-DCH TDD Information LCR IE* includes the *E-DCH Processing Overload Level IE* for an E-DCH, then if the DRNS could not decode the E-PUCH for the last consecutive number of TTIs, indicated in the *E-DCH Processing Overload Level IE*, because of a processing issue, the DRNS shall notify the SRNC by initiating the Radio Link Failure procedure.]
- [1.28Mcps TDD – If the *E-DCH TDD Information LCR IE* includes the *E-DCH Power Offset for Scheduling Info IE*, then the DRNS shall use this value as a power offset for the transmission of scheduling information without any MAC-d PDUs.]
- [1.28Mcps TDD – If the *E-DCH TDD Information LCR IE* includes the *Maximum Number of Retransmission for Scheduling Info LCR IE* and the *E-DCH Retransmission timer for Scheduling Info LCR IE*, then the DRNS shall use these parameters for the transmission of scheduling information without any MAC-d PDUs.]

[7.68Mcps TDD – E-DCH Modification:]

[7.68Mcps TDD – If the RADIO LINK RECONFIGURATION PREPARE message includes the *E-DCH TDD Information 7.68Mcps IE*, then:]

- [7.68Mcps TDD – If the *E-DCH TDD Information 7.68Mcps IE* includes the *E-DCH TDD Maximum Bitrate 7.68Mcps IE* for an E-DCH, the DRNS shall use this information for the related resource allocation operation, and when applicable, for E-DCH scheduling.]
- [7.68Mcps TDD – If the *E-DCH TDD Information 7.68Mcps IE* includes the *E-DCH Processing Overload Level IE*, then if the DRNS could not decode the E-PUCH for the last consecutive number of TTIs, indicated in the *E-DCH Processing Overload Level IE*, because of a processing issue, the DRNS shall notify the SRNC by initiating the Radio Link Failure procedure.]
- [7.68Mcps TDD – If the *E-DCH TDD Information 7.68Mcps IE* includes the *E-DCH Power Offset for Scheduling Info IE*, then the DRNS shall use this value as a power offset for the transmission of scheduling information without any MAC-d PDUs.]

[TDD- If the RADIO LINK RECONFIGURATION PREPARE message includes the *E-DCH TDD Information To Modify IE*, then:]

- [TDD- If the *E-DCH TDD Information To Modify IE* contains a *E-DCH MAC-d Flow Specific Information IE* which includes the *Allocation/Retention Priority IE*, the DRNS shall apply the new Allocation/Retention Priority to this E-DCH in the new configuration according to Annex A.]

[TDD- If the *E-DCH TDD Information To Modify IE* contains a *TNL QoS IE* for an E-DCH MAC-d flow and if ALCAP is not used, the *TNL QoS IE* may be used by the DRNS to determine the transport bearer characteristics to apply in the uplink for the related MAC-d flow.]

- [TDD- If the *E-DCH TDD Information To Modify IE* includes the *Maximum Number of Retransmissions for E-DCH IE* for an E-DCH MAC-d flow then the DRNS shall use this information to report if the maximum number of retransmissions has been exceeded.]
- [1.28Mcps TDD – If the *E-DCH TDD Information To Modify IE* includes the *E-DCH MAC-d Flow Retransmission Timer IE* for an E-DCH MAC-d flow then the DRNS shall use this information to set the retransmission timer.]

- [TDD- If the *TNL QoS* IE is included in the *E-DCH TDD Information to Modify* IE for an E-DCH MAC-d flow and if ALCAP is not used, the *TNL QoS* IE may be used by the DRNS to determine the transport bearer characteristics to apply in the uplink for the related MAC-d flow.]
- [TDD- If the *E-DCH TDD Information To Modify* IE includes the *E-DCH HARQ Power Offset TDD* IE for an E-DCH MAC-d flow the DRNS shall use this new power offset value.]
- [TDD- If the *E-DCH TDD Information To Modify* IE includes the *E-DCH MAC-d Flow Multiplexing List* IE for an E-DCH MAC-d flow the DRNS shall use this information for the related resource allocation operation.]
- [TDD- If the *E-DCH TDD Information To Modify* IE contains the *E-DCH Grant Type* IE, the DRNS shall treat the E-DCH MAC-d flow as Scheduled or Non-scheduled accordingly.]
- [TDD- If the *E-DCH TDD Information To Modify* IE includes the *E-DCH Logical Channel To Add* or *E-DCH Logical Channel To Delete* IEs, the DRNS shall use this information to add/delete the indicated logical channels. When a logical channel is deleted, all its associated configuration data shall also removed.]
- [TDD- If the *E-DCH TDD Information To Modify* IE includes the *E-DCH Logical Channel To Modify* IE, the DRNS shall use this information to modify the indicated logical channels:]
 - [TDD – If the *E-DCH Logical Channel To Modify* IE includes *Scheduling Priority Indicator* IE, the DRNS shall apply the values in the new configuration.]
 - [TDD – If the *E-DCH Logical Channel To Modify* IE includes *Scheduling Information* IE, the DRNS shall apply the values in the new configuration.]
 - [TDD – If the *E-DCH Logical Channel To Modify* IE includes *MAC-es Guaranteed Bit Rate* IE, the DRNS shall apply the values in the new configuration.]
 - [TDD – If the *E-DCH Logical Channel To Modify* IE includes *E-DCH DDI Value* IE, the DRNS shall apply the values in the new configuration.]
 - [1.28Mcps TDD – If the *E-DCH Logical Channel To Modify* IE includes *MAC-es Maximum Bit Rate LCR* IE, the DRNS shall use this information for the related resource allocation operation, and when applicable, for E-DCH scheduling.]
 - [TDD – If the *E-DCH Logical Channel To Modify* IE includes the *Maximum MAC-d PDU Size Extended* IE, the DRNS shall apply the value in the new configuration.]
- [TDD- If the *E-DCH TDD Information To Modify* IE includes the *MAC-e Reset Indicator* IE, then the DRNS shall use this value to determine whether MAC-e (or MAC-i) Reset is performed in the UE for sending the HARQ Failure Indication.]

General

If the requested modifications are allowed by the DRNC and the DRNC has successfully reserved the required resources for the new configuration of the Radio Link(s), it shall respond to the SRNC with the RADIO LINK RECONFIGURATION READY message. When this procedure has been completed successfully there exists a Prepared Reconfiguration, as defined in subclause 3.1.

If the RADIO LINK RECONFIGURATION PREPARE message includes the *Transport Layer Address* IE and *Binding ID* IE in the [TDD – *DSCHs To Modify* IE, *DSCHs To Add* IE, *USCHs To Modify* IE, *USCHs To Add* IE], *HS-DSCH Information* IE, *HS-DSCH Information To Modify* IE, *HS-DSCH MAC-d Flows To Add* IE, [FDD – *RL Specific E-DCH Information* IE,] [TDD – *E-DCH MAC-d Flows to Add* IE,] [TDD – *E-DCH TDD Information to Modify* IE,] or in the *RL Specific DCH Information* IEs, the DRNC may use the transport layer address and the binding identifier received from the SRNC when establishing a transport bearer for any Transport Channel [FDD – for which the *Transport Bearer Not Requested Indicator* IE is not included], HS-DSCH MAC-d flow being added or E-DCH MAC-d flow [FDD – for which the *Transport Bearer Not Requested Indicator* IE is not included] being added, or any Transport Channel, HS-DSCH MAC-d flow or E-DCH MAC-d flow being modified for which a new transport bearer was requested with the *Transport Bearer Request Indicator* IE.

The DRNC shall include in the RADIO LINK RECONFIGURATION READY message the *Transport Layer Address* IE and the *Binding ID* IE for any Transport Channel [FDD – for which the *Transport Bearer Not Requested Indicator* IE is not included], HS-DSCH MAC-d flow being added or E-DCH MAC-d flow [FDD – for which the *Transport Bearer Not Requested Indicator* IE is not included] being added, or any Transport Channel [FDD – for which the

Transport Bearer Not Requested Indicator IE was not included], HS-DSCH MAC-d flow or E-DCH MAC-d flow [FDD – for which the *Transport Bearer Not Requested Indicator* IE was not included] being modified for which a new transport bearer was requested with the *Transport Bearer Request Indicator* IE. In the case of a set of co-ordinated DCHs requiring a new transport bearer on the Iur interface, the *Transport Layer Address* IE and the *Binding ID* IE in the *DCH Information Response* IE shall be included [FDD – if the *Transport Bearer Not Requested Indicator* IE is not included for the corresponding DCH,] for only one of the DCHs in the set of co-ordinated DCHs.

[FDD – If the RADIO LINK RECONFIGURATION PREPARE message includes the *Transport Bearer Not Requested Indicator* IE set to “Transport Bearer Shall not be Established” for a DCH or an E-DCH MAC-d flow, then the DRNC shall not establish a transport bearer for the concerned DCH or E-DCH MAC-d flow and shall include the *Transport Bearer Not Setup Indicator* IE for the corresponding DCH or E-DCH MAC-d flow in the RADIO LINK RECONFIGURATION READY message.]

[FDD – If the RADIO LINK RECONFIGURATION PREPARE message includes the *Transport Bearer Not Requested Indicator* IE set to “Transport Bearer may not be Established” for a DCH or an E-DCH MAC-d flow and:]

- [FDD – if the DRNC establishes a transport bearer for the concerned DCH or E-DCH MAC-d flow, the DRNC shall include in the RADIO LINK RECONFIGURATION READY message the *Binding ID* IE and *Transport Layer Address* IE for establishment of a transport bearer for the DCH or E-DCH MAC-d flow being established.]
- [FDD – if the DRNC does not establish a transport bearer for the concerned DCH or E-DCH MAC-d flow, the DRNC shall include the *Transport Bearer Not Setup Indicator* IE for the corresponding DCH or E-DCH MAC-d flow in the RADIO LINK RECONFIGURATION READY message.]

In the case of a Radio Link being combined with another Radio Link within the DRNS, the *Transport Layer Address* IE and the *Binding ID* IE in the *DCH Information Response* IE shall be included for only one of the combined Radio Links [FDD – if the *Transport Bearer Not Requested Indicator* IE is not included for this DCH of the Radio Link].

[FDD – In the case of an E-DCH RL being combined with another E-DCH RL within the DRNS, the *E-DCH FDD Information Response* IE shall be included only for one of the combined E-DCH RLs.]

[FDD – If the RADIO LINK RECONFIGURATION PREPARE message includes the *Additional E-DCH Cell Information RL Reconf Prep* IE, then:]

- [FDD – if the *Multicell E-DCH Transport Bearer Mode* IE for an Additional E-DCH to be Setup is set to “Separate Iur Transport Bearer Mode” the DRNS shall use this mode in the new configuration and apply separate transport bearers for the MAC-d flows.]
- [FDD – if the *Multicell E-DCH Transport Bearer Mode* IE for an Additional E-DCH to be Setup is set to “UL Flow Multiplexing Mode” the DRNS shall use this mode in the new configuration and multiplex MAC-d flows on the transport bearers.]
- [FDD – if Separate Iur Transport Bearer Mode is used in the new configuration, then:]
 - [FDD – the DRNS shall follow the rules defined in this procedure for single carrier mode of operation for establishment of the transport bearer for a MAC-d flow, use the *Transport Bearer Not Requested Indicator* IE in the *RL Specific E-DCH Information* IE in the *RL Information* IE and/or the *Transport Bearer Request Indicator* IE in the *E-DCH FDD Information To Modify* IE received for the corresponding Radio Link(s) of the Primary Uplink Frequency to determine the transport bearer configuration in the new configuration for the radio links of the Secondary Uplink Frequency.]
 - [FDD – If the *Transport Layer Address* IE and *Binding ID* IE is included for an E-DCH MAC-d flow in the *Additional E-DCH MAC-d Flows Specific Information* IE in the *Additional E-DCH RL Specific Information To Setup* IE in the *Additional E-DCH FDD Setup Information* IE in the *Additional E-DCH Cell Information Setup* IE or in the *Additional E-DCH RL Specific Information To Add* IE and/or the *Additional E-DCH RL Specific Information To Modify* IE in the *Additional E-DCH Configuration Change Information* IE in the *Additional E-DCH Cell Information Configuration Change* IE, then the DRNS may use the transport layer address and the binding identifier received from the SRNC when establishing a transport bearer for the concerned E-DCH MAC-d flow. If the DRNS establishes a transport bearer for the concerned E-DCH MAC-d flow the DRNS shall, for establishment of the transport bearer, include in the RADIO LINK RECONFIGURATION READY message in the *Additional E-DCH Cell Information Response RLReconf* IE the *Binding ID* IE and *Transport Layer Address* IE in the *Additional E-DCH MAC-d Flow Specific Information Response* IE in the *Additional E-DCH FDD Information Response* IE for new E-DCH radio links on the Secondary UL frequency and/or include the *Binding ID* IE and *Transport Layer Address* IE in

the *Additional E-DCH MAC-d Flow Specific Information Response IE* in the *Additional Modified E-DCH FDD Information Response IE* for radio links on the Secondary UL frequency that has been modified.]

Any allowed rate for the uplink of a modified DCH provided for the old configuration will not be valid for the new configuration. If the DRNS needs to limit the user rate in the uplink of a DCH due to congestion caused by the UL UTRAN Dynamic Resources (see subclause 9.2.1.79) in the new configuration for a Radio Link, the DRNC shall include in the RADIO LINK RECONFIGURATION READY message the *Allowed UL Rate IE* in the *DCH Information Response IE* for this Radio Link.

Any allowed rate for the downlink of a modified DCH provided for the old configuration will not be valid for the new configuration. If the DRNS needs to limit the user rate in the downlink of a DCH due to congestion caused by the DL UTRAN Dynamic Resources (see subclause 9.2.1.79) in the new configuration for a Radio Link, the DRNC shall include in the RADIO LINK RECONFIGURATION READY message the *Allowed DL Rate IE* in the *DCH Information Response IE* for this Radio Link.

The DRNS decides the maximum and minimum SIR for the uplink of the Radio Link(s) and the DRNC shall include in the RADIO LINK RECONFIGURATION READY message the *Maximum Uplink SIR IE* and *Minimum Uplink SIR IE* for each Radio Link when these values are changed.

[FDD – If the DL TX power upper or lower limit has been re-configured, the DRNC shall include in the RADIO LINK RECONFIGURATION READY message the *Maximum DL TX Power IE* and *Minimum DL TX Power IE* respectively. The DRNS shall not transmit with a higher power than indicated by the *Maximum DL TX Power IE* or lower than indicated by the *Minimum DL TX Power IE* on any DL DPCH or on the F-DPCH of the RL –except, if the UE Context is configured to use DPCH in the downlink, during compressed mode, when the δP_{curr} , as described in ref.TS 25.214 [10] subclause 5.2.1.3, shall be added to the maximum DL power for the associated compressed frame.]

[3.84 Mcps TDD and 7.68 Mcps TDD – If the DL TX power upper or lower limit has been re-configured, the DRNC shall include the new value(s) in the *Maximum DL TX Power IE* and *Minimum DL TX Power IE* in the RADIO LINK RECONFIGURATION READY message. If the maximum or minimum power needs to be different for particular DCH type CCTrCHs, the DRNC shall include the new value(s) for that CCTrCH in the *CCTrCH Maximum DL TX Power IE* and *CCTrCH Minimum DL TX Power IE*. The DRNS shall not transmit with a higher power than indicated by the appropriate *Maximum DL TX Power IE/CCTrCH Maximum DL TX Power IE* or lower than indicated by the appropriate *Minimum DL TX Power IE/CCTrCH Minimum DL TX Power IE* on any DL DPCH within each CCTrCH of the RL.]

[1.28 Mcps TDD – If the DL TX power upper or lower limit has been re-configured, the DRNC shall include the new value(s) in the *Maximum DL TX Power IE* and *Minimum DL TX Power IE* in the RADIO LINK RECONFIGURATION READY message. If the maximum or minimum power needs to be different for particular timeslots within a DCH type CCTrCH, the DRNC shall include the new value(s) for that timeslot in the *Maximum DL TX Power IE* and *Minimum DL TX Power IE* within the *DL Timeslot Information LCR IE*. The DRNS shall not transmit with a higher power than indicated by the appropriate *Maximum DL TX Power IE* or lower than indicated by the appropriate *Minimum DL TX Power IE* on any DL DPCH within each timeslot of the RL.]

[TDD – If the [3.84Mcps TDD and 7.68 Mcps TDD – *DL Time Slot ISCP Info IE*][1.28Mcps TDD – *DL Time Slot ISCP Info LCR IE*] is present, the DRNS should use the indicated values when deciding the Initial DL TX Power.]

[TDD – If the *Primary CCPCH RSCP Delta IE* is included, the DRNS shall assume that the reported value for Primary CCPCH RSCP is in the negative range as per TS 25.123 [24], and the value is equal to the *Primary CCPCH RSCP Delta IE*. If the *Primary CCPCH RSCP Delta IE* is not included and the *Primary CCPCH RSCP IE* is included, the DRNS shall assume that the reported value is in the non-negative range as per TS 25.123 [24], and the value is equal to the *Primary CCPCH RSCP IE*. The DRNS shall use the indicated values when deciding the Initial DL TX Power.]

8.3.4.3 Unsuccessful Operation

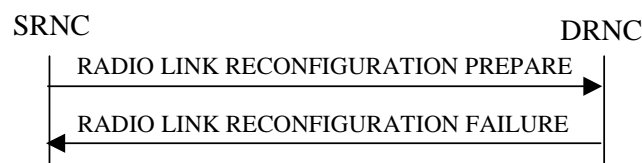

Figure 11: Synchronised Radio Link Reconfiguration Preparation procedure, Unsuccessful Operation

If the DRNS cannot reserve the necessary resources for all the new DCHs of a set of co-ordinated DCHs requested to be added, it shall reject the Synchronised Radio Link Reconfiguration Preparation procedure as having failed.

If the requested Synchronised Radio Link Reconfiguration Preparation procedure fails for one or more RLs, the DRNC shall send the RADIO LINK RECONFIGURATION FAILURE message to the SRNC, indicating the reason for failure for each failed radio link in a *Cause IE*.

[FDD – If the *MIMO Activation Indicator IE* is included and the *Power Offset For S-CPICH for MIMO Request Indicator IE* is not included in the HS-DSCH FDD Information IE in the *HS-DSCH FDD Information IE* in the RADIO LINK RECONFIGURATION PREPARE message or MIMO is activated and the power offset for S-CPICH for MIMO Request indicator has not been configured in the new configuration but MIMO pilot configuration with Primary and Secondary CPICH is set up with a non-zero power offset on the cell where the Serving HS-DSCH Radio Link is established, the setup of the serving HS-DSCH Radio Link, and/or activation of MIMO, shall be reported as failed and the DRNC shall include in the RADIO LINK RECONFIGURATION FAILURE message the *Cause IE*.]

Typical cause values are:

Radio Network Layer Causes:

- UL Scrambling Code Already in Use;
- DL Radio Resources not Available;
- UL Radio Resources not Available;
- Requested Configuration not Supported;
- Number of DL Codes not Supported;
- Number of UL Codes not Supported;
- Dedicated Transport Channel Type not Supported;
- DL Shared Channel Type not Supported;
- [TDD – UL Shared Channel Type not Supported;]
- [FDD – UL Spreading Factor not Supported;]
- [FDD – DL Spreading Factor not Supported;]
- CM not supported;
- RL Timing Adjustment not Supported;
- E-DCH not supported;
- [FDD – F-DPCH not supported;]
- [FDD – Continuous Packet Connectivity DTX-DRX operation not Supported;]
- [FDD – Continuous Packet Connectivity HS-SCCH less operation not Supported;]
- [FDD – MIMO not supported;]
- [FDD – E-DCH TTI2ms not supported;]
- [FDD – Continuous Packet Connectivity DTX-DRX operation not available;]
- [FDD – Continuous Packet Connectivity UE DTX Cycle not available;]
- [FDD – MIMO not available;]
- [FDD – SixteenQAM UL not Supported;]
- HS-DSCH MAC-d PDU Size Format not supported;
- [FDD – F-DPCH Slot Format operation not supported;]
- E-DCH MAC-d PDU Size Format not available;
- [FDD – E-DPCCH Power Boosting not supported;]
- [FDD – SixtyfourQAM DL and MIMO Combined not available;]
- [FDD – Multi Cell operation not available;]
- [FDD – Multi Cell operation not supported;]
- [FDD – SixtyfourQAM DL and MIMO Combined not supported;]
- [1.28Mcps TDD- MIMO not supported;]
- [1.28Mcps TDD – MIMO not available;]
- [1.28Mcps TDD – SixtyfourQAM DL and MIMO Combined not available;]
- [FDD – TX diversity for MIMO UE on DL Control Channels not available;]
- [FDD – Single Stream MIMO not supported;]
- [FDD – Single Stream MIMO not available;]
- [FDD – Multi Cell operation with MIMO not available;]
- [FDD – Multi Cell operation with MIMO not supported;]
- [FDD – Multi Cell E-DCH Operation not supported;]
- [FDD – Multi Cell E-DCH Operation not available;]
- [FDD – Multi Cell operation with Single Stream MIMO not available;]
- [FDD – Multi Cell operation with Single Stream MIMO not supported;]
- [FDD – Cell Specific Tx Diversity Handling For Multi Cell Operation Not Available;]

[FDD – Cell Specific Tx Diversity Handling For Multi Cell Operation Not Supported.]

Miscellaneous Causes:

Control Processing Overload;
Not enough User Plane Processing Resources.

8.3.4.4 Abnormal Conditions

If only a subset of all the DCHs belonging to a set of co-ordinated DCHs is requested to be deleted, the DRNS shall reject the Synchronised Radio Link Reconfiguration Preparation procedure as having failed and shall send the RADIO LINK RECONFIGURATION FAILURE message to the SRNC.

If more than one DCH of a set of co-ordinated DCHs has the *QE-Selector* IE set to “selected” [TDD – or no DCH of a set of co-ordinated DCHs has the *QE-Selector* IE set to “selected”] the DRNS shall reject the Synchronised Radio Link Reconfiguration Preparation procedure and the DRNC shall respond with a RADIO LINK RECONFIGURATION FAILURE message.

If the RADIO LINK RECONFIGURATION PREPARE message includes a *DCHs To Modify* IE or *DCHs To Add* IE with multiple *DCH Specific Info* IEs, and if the DCHs in the *DCHs To Modify* IE or *DCHs To Add* IE do not have the same *Transmission Time Interval* IE in the *Semi-static Transport Format Information* IE, then the DRNC shall reject the procedure using the RADIO LINK RECONFIGURATION FAILURE message.

[FDD – If the *RL Information* IE includes the *DL Reference Power* IE, but the power balancing is not active in the indicated RL(s), the DRNS shall reject the Synchronised Radio Link Reconfiguration Preparation procedure as having failed and the DRNC shall respond with the RADIO LINK RECONFIGURATION FAILURE message with the cause value “Power Balancing status not compatible”.]

[FDD – If the power balancing is active with the Power Balancing Adjustment Type of the UE Context set to “Common” in the existing RL(s) but the RADIO LINK RECONFIGURATION PREPARE message includes more than one *DL Reference Power* IE, the DRNS shall reject the Synchronised Radio Link Reconfiguration Preparation procedure as having failed and the DRNC shall respond with the RADIO LINK RECONFIGURATION FAILURE message with the cause value “Power Balancing status not compatible”.]

If the RADIO LINK RECONFIGURATION PREPARE message contains the *Transport Layer Address* IE or the *Binding ID* IE when establishing a transport bearer for any Transport Channel or HS-DSCH MAC-d flow being added, or any Transport Channel or HS-DSCH MAC-d flow being modified for which a new transport bearer was requested with the *Transport Bearer Request Indicator* IE., and not both are present for a transport bearer intended to be established, the DRNC shall reject the Synchronised Radio Link Reconfiguration Preparation procedure and the DRNC shall respond with a RADIO LINK RECONFIGURATION FAILURE message.

If the RADIO LINK RECONFIGURATION PREPARE message contains any of the *HS-DSCH Information To Modify* IE, *HS-DSCH MAC-d Flows To Add* IE or *HS-DSCH MAC-d Flows To Delete* IE in addition to the *HS-DSCH Information* IE, the DRNC shall reject the procedure using the RADIO LINK RECONFIGURATION FAILURE message.

If the RADIO LINK RECONFIGURATION PREPARE message contains any of the *HS-DSCH Information To Modify* IE, *HS-DSCH MAC-d Flows To Add* IE, *HS-DSCH MAC-d Flows To Delete* IE or *HS-PDSCH RL ID* IE and the Serving HS-DSCH Radio Link is not in the DRNS, the DRNC shall reject the procedure using the RADIO LINK RECONFIGURATION FAILURE message.

If the RADIO LINK RECONFIGURATION PREPARE message includes the *HS-DSCH Information* IE and does not include the *HS-PDSCH RL-ID* IE, the DRNC shall reject the procedure using the RADIO LINK RECONFIGURATION FAILURE message.

If the RADIO LINK RECONFIGURATION PREPARE message includes the *HS-DSCH Information To Modify* IE deleting the last remaining Priority Queue of an HS-DSCH MAC-d Flow, the DRNC shall reject the procedure using the RADIO LINK RECONFIGURATION FAILURE message.

If the RADIO LINK RECONFIGURATION PREPARE message includes the *HS-PDSCH RL-ID* IE indicating a Radio Link not existing in the UE Context, the DRNC shall reject the procedure using the RADIO LINK RECONFIGURATION FAILURE message.

If the RADIO LINK RECONFIGURATION PREPARE message contains any of the *HS-DSCH Information IE*, *HS-DSCH Information To Modify IE*, or *HS-DSCH MAC-d Flows To Add IE* and if in the new configuration the Priority Queues associated with the same *HS-DSCH MAC-d Flow ID IE* have the same *Scheduling Priority Indicator IE* value, the DRNC shall reject the procedure using the RADIO LINK RECONFIGURATION FAILURE message.

If, in the new configuration, the concerned UE Context is configured to use “Indexed MAC-d PDU Size” for an HS-DSCH but there exist a priority queue of the MAC-d flows of the HS-DSCH that is configured to use Maximum MAC-d PDU Size Extended, the DRNC shall reject the procedure using the RADIO LINK RECONFIGURATION FAILURE message.

If, in the new configuration, the concerned UE Context is configured to use “Flexible MAC-d PDU Size” for an HS-DSCH but there exist a priority queue of the MAC-d flows of the HS-DSCH that is configured to use MAC-d PDU Size Index, the DRNC shall reject the procedure using the RADIO LINK RECONFIGURATION FAILURE message.

If, in the new configuration, the concerned UE Context is configured to use “Fixed MAC-d PDU Size” for an E-DCH and there exist a Logical Channel of the MAC-d flows of the E-DCH that is configured to use Maximum MAC-d PDU Size Extended, the DRNC shall reject the procedure using the RADIO LINK RECONFIGURATION FAILURE message.

If, in the new configuration, the concerned UE Context is configured to use “Flexible MAC-d PDU Size” for an E-DCH and there exist a Logical Channel of the MAC-d flows of the E-DCH that is configured to use *MAC-d PDU Size List*, the DRNC shall reject the procedure using the RADIO LINK RECONFIGURATION FAILURE message.

[FDD – If the RADIO LINK RECONFIGURATION PREPARE message includes the *F-DPCH Information IE* and the *DL DPCH Information IE*, then the DRNS shall reject the procedure using the RADIO LINK RECONFIGURATION FAILURE message.]

If the RADIO LINK RECONFIGURATION PREPARE message includes *HS-DSCH Information IE* and the HS-DSCH is already configured in the UE Context, the DRNC shall reject the procedure using the RADIO LINK RECONFIGURATION FAILURE message.

[FDD – If the concerned UE Context is configured to use DPCH in the downlink in the old configuration and if the RADIO LINK RECONFIGURATION PREPARE message includes the *DL DPCH Power Information IE*, then the DRNS shall reject the procedure using the RADIO LINK RECONFIGURATION FAILURE message.]

[FDD – If the concerned UE Context is configured to use F-DPCH in the downlink in the old configuration and the RADIO LINK RECONFIGURATION PREPARE message includes at least one but not all of the *TFCS IE*, *DL DPCH Slot Format IE*, *TFCI Signalling Mode IE*, *Multiplexing Position IE*, *Limited Power Increase IE* and *DL DPCH Power Information IE* in the *DL DPCH Information IE*, then the DRNS shall reject the procedure using the RADIO LINK RECONFIGURATION FAILURE message.]

[FDD – If the *E-DCH FDD Information IE* is present in the RADIO LINK RECONFIGURATION PREPARE message, but the *E-DPCH Information IE* is not present or if any of the *Maximum Set of E-DPDCHs IE*, *Puncture Limit IE*, *E-TFCS Information IE*, *E-TTI IE*, *E-DPCCH Power Offset IE*, *E-RGCH 2-Index-Step Threshold IE*, *E-RGCH 3-Index-Step Threshold IE*, *HARQ Info for E-DCH IE* or *HS-DSCH Configured Indicator IE* are not present in the *E-DPCH Information IE*, then the DRNS shall reject the procedure using the RADIO LINK RECONFIGURATION FAILURE message.]

[FDD – If the RADIO LINK RECONFIGURATION PREPARE message includes the *E-DCH RL Indication IE* set to “E-DCH”, but no *E-DCH FDD Information IE*, and the UE Context is not configured for E-DCH, then the DRNC shall reject the procedure using the RADIO LINK RECONFIGURATION FAILURE message.]

[FDD – If the RADIO LINK RECONFIGURATION PREPARE message includes the *E-DCH FDD Information IE* but no *E-DCH RL Indication IE* set to “E-DCH”, then the DRNC shall reject the procedure using the RADIO LINK RECONFIGURATION FAILURE message.]

If the RADIO LINK RECONFIGURATION PREPARE message contains the *HS-PDSCH RL ID IE* and/or the *Serving E-DCH RL IE* and if both HS-DSCH and E-DCH are configured in the new configuration but the Serving HS-DSCH Radio Link and the Serving E-DCH Radio Link are not in the same cell then the DRNC shall reject the procedure using the RADIO LINK RECONFIGURATION FAILURE message.

[FDD – If the RADIO LINK RECONFIGURATION PREPARE message contains the *HS-PDSCH RL ID IE* and the *E-DPCH Information IE* which includes the *HS-DSCH Configured Indicator IE* set as “HS-DSCH not configured” then the DRNC shall reject the procedure using the RADIO LINK RECONFIGURATION FAILURE message.]

[FDD – If the RADIO LINK RECONFIGURATION PREPARE message contains any of the *E-DCH FDD Information To Modify* IE, *E-DCH MAC-d Flows To Add* IE or *E-DCH MAC-d Flows To Delete* IE in addition to the *E-DCH FDD Information* IE, the DRNC shall reject the procedure using the RADIO LINK RECONFIGURATION FAILURE message.]

[FDD – If the RADIO LINK RECONFIGURATION PREPARE message contains any of the *E-DCH FDD Information To Modify* IE, *E-DCH MAC-d Flows To Add* IE, *E-DCH MAC-d Flows To Delete* IE and the UE Context is not configured for E-DCH, the DRNC shall reject the procedure using the RADIO LINK RECONFIGURATION FAILURE message.]

[FDD – If the RADIO LINK RECONFIGURATION PREPARE message includes the *E-DCH FDD Information To Modify* IE deleting the last remaining E-DCH Logical Channel of an E-DCH MAC-d Flow, the DRNC shall reject the procedure using the RADIO LINK RECONFIGURATION FAILURE message.]

[FDD – If the RADIO LINK RECONFIGURATION PREPARE message includes *E-DCH FDD Information* IE and the E-DCH is already configured in the UE Context, the DRNC shall reject the procedure using the RADIO LINK RECONFIGURATION FAILURE message.]

[FDD – If the *Fast Reconfiguration* IE is included in the RADIO LINK RECONFIGURATION PREPARE message and the *UL Scrambling Code* IE does not indicate an uplink scrambling code different from the currently used uplink scrambling code the DRNC shall reject the procedure using the RADIO LINK RECONFIGURATION FAILURE message.]

[FDD – If the RADIO LINK RECONFIGURATION PREPARE message includes the *Continuous Packet Connectivity DTX-DRX Information To Modify* IE in addition to the *Continuous Packet Connectivity DTX-DRX Information* IE, then the DRNC shall reject the procedure using the RADIO LINK RECONFIGURATION FAILURE message.]

[FDD – If the RADIO LINK RECONFIGURATION PREPARE message includes the *Continuous Packet Connectivity HS-SCCH less Deactivate Indicator* IE in addition to the *Continuous Packet Connectivity HS-SCCH less Information* IE, the DRNC shall reject the procedure using the RADIO LINK RECONFIGURATION FAILURE message.]

[FDD – If the RADIO LINK RECONFIGURATION PREPARE message includes the *Continuous Packet Connectivity HS-SCCH less Deactivate Indicator* IE while the Continuous Packet Connectivity HS-SCCH less configuration isn't configured in the DRNC, the DRNC shall reject the procedure using the RADIO LINK RECONFIGURATION FAILURE message.]

[FDD – If the RADIO LINK RECONFIGURATION PREPARE message includes the *Continuous Packet Connectivity DTX-DRX Information To Modify* IE while the Continuous Packet Connectivity *DTX-DRX* configuration isn't configured in the DRNC, the DRNC shall reject the procedure using the RADIO LINK RECONFIGURATION FAILURE message.]

[FDD – If the RADIO LINK RECONFIGURATION PREPARE message includes the *DRX Information To Modify* IE in *Continuous Packet Connectivity DTX-DRX Information To Modify* IE while the Continuous Packet Connectivity DRX configuration is not configured in the DRNC, the DRNC shall reject the procedure using the RADIO LINK RECONFIGURATION FAILURE message.]

If the *DCHs to Modify* IE contains a *DCH Specific Info* IE which includes the *Unidirectional DCH Indicator* IE set to “Uplink DCH only” but no *Transport Format Set* IE for the uplink for this DCH and the DRNC had ignored the configuration of Transport Format Set for uplink, the DRNC shall reject the procedure using the RADIO LINK RECONFIGURATION FAILURE message.

If the *DCHs to Modify* IE contains a *DCH Specific Info* IE which includes the *Unidirectional DCH Indicator* IE set to “Downlink DCH only” but no *Transport Format Set* IE for the downlink for this DCH and the DRNC had ignored the configuration of Transport Format Set for downlink, the DRNC shall reject the procedure using the RADIO LINK RECONFIGURATION FAILURE message.

[FDD – If the RADIO LINK RECONFIGURATION PREPARE message contains the *Transport Bearer Not Requested Indicator* IE for a DCH or an E-DCH MAC-d flow but does not contain the corresponding *DCH ID* IE and the *Unidirectional DCH indicator* IE set to “Uplink DCH only” for the DCH in *DCH Information To Add* IE or does not contain the corresponding *E-DCH MAC-d Flow ID* IE in *E-DCH MAC-d Flows Information* IE, the DRNC shall reject the procedure using the RADIO LINK RECONFIGURATION FAILURE message.]

[FDD – If the concerned UE Context is configured to apply UL DPCCCH Slot Format 4 but is not configured to use F-DPCH, then the DRNC shall reject the procedure using the RADIO LINK RECONFIGURATION FAILURE message.]

[FDD – If the concerned UE Context is configured to apply UL DPCCH Slot Format 0 or 2 and execute Continuous Packet Connectivity DTX-DRX operation, then the DRNC shall reject the procedure using the RADIO LINK RECONFIGURATION FAILURE message.]

[FDD – If the concerned UE Context is configured to apply the “Closed loop mode 1” and if the concerned UE Context is not configured to apply UL DPCCH Slot Format 2 or 3, then the DRNC shall reject the procedure using the RADIO LINK RECONFIGURATION FAILURE message.]

[FDD – If the concerned UE Context is configured to apply MIMO, allowed to apply 64QAM, establish the secondary serving HS-DSCH Radio Link or apply Single Stream MIMO in the new configuration but is not configured to use flexible MAC-d PDU Size, then the DRNC shall reject the procedure using the RADIO LINK RECONFIGURATION FAILURE message.]

[FDD – If the RADIO LINK RECONFIGURATION PREPARE message includes the *Transport Bearer Not Requested Indicator* IE for a DCH in the *RL Specific DCH Information* IE but does not include the *DCH ID* IE for the DCH in the *DCHs to Add* IE, the DRNC shall reject the procedure using the RADIO LINK RECONFIGURATION FAILURE message.]

[FDD – If the RADIO LINK RECONFIGURATION PREPARE message includes the *Transport Bearer Not Requested Indicator* IE for an E-DCH MAC-d flow in the *RL Specific E-DCH Information* IE but does not include the *E-DCH MAC-d flow ID* IE for the E-DCH MAC-d flow in the *E-DCH MAC-d flows Information* IE, the DRNC shall reject the procedure using the RADIO LINK RECONFIGURATION FAILURE message.]

[FDD – If the RADIO LINK RECONFIGURATION PREPARE message contains the *Continuous Packet Connectivity DTX-DRX Information* IE but does not contain the *F-DPCH Information* IE and the concerned UE Context is not previously configured to use F-DPCH, then the DRNC shall reject the procedure using the RADIO LINK RECONFIGURATION FAILURE message.]

[FDD – If the concerned UE Context is configured to have the Serving E-DCH Radio Link but there is at least one E-DCH MAC-d flow which the transport bearer is not configured for the Serving E-DCH Radio Link in DRNS, the DRNC shall reject the procedure using the RADIO LINK RECONFIGURATION FAILURE message.]

[FDD – If the RADIO LINK RECONFIGURATION PREPARE message includes the *Transport Bearer Not Requested Indicator* IE for a DCH or an E-DCH MAC-d Flow for a specific RL and the specific RL is combined with existing RL which the transport bearer is established for the DCH or the E-DCH MAC-d Flow in the DRNS, the DRNC shall reject the procedure using the RADIO LINK RECONFIGURATION FAILURE message.]

[FDD – If the RADIO LINK RECONFIGURATION PREPARE message contains the *Additional HS Cell Information RL Reconf Prep* IE indicating a new secondary serving cell that is not in the same Node B as the serving HS-DSCH cell (or new serving in case of simultaneous serving HS-DSCH cell change), then the DRNC shall reject the procedure using the RADIO LINK RECONFIGURATION FAILURE message.]

If ALCAP is not used, if the concerned UE Context is configured to establish a DCH, an E-DCH MAC-d flow and/or an HS-DSCH MAC-d flow but the RADIO LINK RECONFIGURATION PREPARE message does not include the *Transport Layer Address* IE and the *Binding ID* IE for the DCH, the E-DCH MAC-d flow and/or the HS-DSCH MAC-d flow, the DRNC shall reject the procedure using the RADIO LINK RECONFIGURATION FAILURE message.

[TDD – If ALCAP is not used, if the concerned UE Context is configured to establish a DSCH and/or a USCH but the RADIO LINK RECONFIGURATION PREPARE message does not include the *Transport Layer Address* IE and the *Binding ID* IE for the DSCH and/or the USCH, the DRNC shall reject the procedure using the RADIO LINK RECONFIGURATION FAILURE message.]

If, in the new configuration, there exist a priority queue of the MAC-d flows of the HS-DSCH that is configured to use “Flexible RLC PDU Size” for an HS-DSCH but is not configured to use Maximum MAC-d PDU Size Extended, the DRNC shall reject the procedure using the RADIO LINK RECONFIGURATION FAILURE message.

If, in the new configuration, the concerned UE Context is configured to use MAC-d PDU Size Index for an HS-DSCH but there exist a priority queue of the MAC-d flows of the HS-DSCH that is configured to use “Flexible RLC PDU Size”, the DRNC shall reject the procedure using the RADIO LINK RECONFIGURATION FAILURE message.

[FDD – If the RADIO LINK RECONFIGURATION PREPARE message contains a *MIMO Activation Indicator* IE and a *Single Stream MIMO Activation Indicator* IE in the *HS-DSCH FDD Information* IE or in the *HS-DSCH FDD Secondary Serving Information* IE in the *Additional HS Cell Information RL Reconf Prep* IE, then the DRNC shall reject the procedure using the RADIO LINK RECONFIGURATION FAILURE message.]

[FDD – If the concerned UE Context is configured to apply MIMO and Single Stream MIMO for the HS-DSCH Radio Link or the Secondary Serving Radio link, the DRNC shall reject the procedure using the RADIO LINK RECONFIGURATION FAILURE message.]

[FDD – If the RADIO LINK RECONFIGURATION PREPARE message contains the *Additional E-DCH Cell Information RL Reconf Prep* IE and if the *E-DPCH Information* IE is not present or the E-DPCH Information was not configured in the UE Context, then the DRNS shall reject the procedure using the RADIO LINK RECONFIGURATION FAILURE message.]

[FDD – If the RADIO LINK RECONFIGURATION PREPARE message contains the *Additional E-DCH Cell Information RL Reconf Prep* IE and there exist a logical channel for which the *Maximum MAC-d PDU Size Extended* IE in the *E-DCH MAC-d Flows Information* IE in the *E-DCH FDD Information* IE is not present, the DRNS shall reject the procedure using the RADIO LINK RECONFIGURATION FAILURE message.]

[FDD – If the RADIO LINK RECONFIGURATION PREPARE message contains the *Additional E-DCH RL Specific Information To Setup* IE in the *Additional E-DCH FDD Setup Information* IE in the *Additional E-DCH Cell Information Setup* IE in the *Additional E-DCH Cell Information RL Reconf Prep* IE and the *C-ID* IE is not included but the RL indicated by the *E-DCH Additional RL ID* IE is not configured in the current UE context as a Secondary Serving HS-DSCH radio link without any configured Additional E-DCH, the DRNS shall reject the procedure using the RADIO LINK RECONFIGURATION FAILURE message.]

[FDD – If the RADIO LINK RECONFIGURATION PREPARE message contains the *Diversity Mode* IE in the *HS-DSCH FDD Secondary Serving Information* IE in the *Additional HS Cell Information RL Reconf Prep* IE and the secondary serving HS-DSCH is already configured in the UE Context, then the DRNS shall reject the procedure using the RADIO LINK RECONFIGURATION FAILURE message.]

[FDD – If the secondary serving HS-DSCH is not configured in the UE Context and if the RADIO LINK RECONFIGURATION PREPARE message contains in the *HS-DSCH FDD Secondary Serving Information* IE in the *Additional HS Cell Information RL Reconf Prep* IE the *Diversity Mode* IE not set to “None” but not the *Transmit Diversity Indicator* or contains the *Transmit Diversity Indicator* but not the *Diversity Mode* IE not set to “None”, then the DRNS shall reject the procedure using the RADIO LINK RECONFIGURATION FAILURE message.]

[FDD – If the RADIO LINK RECONFIGURATION PREPARE message contains the *Diversity Mode* IE in the *Secondary Serving Information To Modify* IE in the *Additional HS Cell Information RL Reconf Prep* IE and the *Non Cell Specific Tx Diversity* IE, the DRNS shall reject the procedure using the RADIO LINK RECONFIGURATION FAILURE message.]

8.3.5 Synchronised Radio Link Reconfiguration Commit

8.3.5.1 General

This procedure is used to order the DRNS to switch to the new configuration for the Radio Link(s) within the DRNS, previously prepared by the Synchronised Radio Link Reconfiguration Preparation procedure.

This procedure shall use the signalling bearer connection for the relevant UE Context.

8.3.5.2 Successful Operation



Figure 12: Synchronised Radio Link Reconfiguration Commit procedure, Successful Operation

The DRNS shall switch to the new configuration previously prepared by the Synchronised Radio Link Reconfiguration Preparation procedure at the “configuration switching point” occurring:

- [TDD – at the next coming CFN with a value equal to the value requested by the SRNC in the *CFN* IE (see ref. TS 25.402 [17] subclause 9.4) when receiving the RADIO LINK RECONFIGURATION COMMIT message from the SRNC.]

- [FDD – if the *Fast Reconfiguration* IE is not included in the RADIO LINK RECONFIGURATION COMMIT message at the next coming CFN with a value equal to the value requested by the SRNC in the *CFN* IE (see ref.TS 25.402 [17] subclause 9.4) when receiving the RADIO LINK RECONFIGURATION COMMIT message from the SRNC.]
- [FDD – if the *Fast Reconfiguration* IE is included in the RADIO LINK RECONFIGURATION COMMIT message as soon as the DRNS detects that the UE uses the new configuration in the uplink (e.g. the NodeB indicates that the UE uses the new scrambling code used for the uplink by sending the RADIO LINK RESTORATION message). In order to limit the period for the detection in the DRNS the CFN in the RADIO LINK RECONFIGURATION COMMIT message indicates the earliest possible time instant at which the UE might use the new configuration.]

[FDD – If the *Active Pattern Sequence Information* IE is included in the RADIO LINK RECONFIGURATION COMMIT message, the *CM Configuration Change CFN* IE in the *Active Pattern Sequence Information* IE shall be ignored by the DRNS.]

[FDD – If the *Active Pattern Sequence Information* IE is not included in the RADIO LINK RECONFIGURATION COMMIT message and a new Compressed Mode Configuration exists in the prepared configuration, the DRNS shall behave as if an *Active Pattern Sequence Information* IE with an empty *Transmission Gap Pattern Sequence Status* IE was included.]

When this procedure has been completed the Prepared Reconfiguration does not exist any more, see subclause 3.1.

In the case of a Transport Channel or MAC-d flow modification for which a new transport bearer was requested and established, the switch to the new transport bearer shall also take place at the configuration switching point (defined above) indicated CFN.

The detailed frame protocol handling during transport bearer replacement is described in TS 25.427 [4], subclause 5.10.1, and in TS 25.425 [32], subclauses 5.3.1 and 5.3.2.

[FDD – If the RADIO LINK RECONFIGURATION COMMIT includes the *Active Pattern Sequence Information* IE, the DRNS shall deactivate all the ongoing Transmission Gap Pattern Sequences at the configuration switching point (defined above). From that moment on all Transmission Gap Pattern Sequences included in *Transmission Gap Pattern Sequence Status* IE repetitions shall be started when the indicated *TGCFN* IE elapses. The *CFN* IE and *TGCFN* IE for each sequence refer to the next coming CFN with that value. If the values of the *CFN* IE and the *TGCFN* IE are equal, the concerned Transmission Gap Pattern Sequence shall be started immediately at the CFN with a value equal to the value received in the *CFN* IE.]

[FDD – If the RADIO LINK RECONFIGURATION COMMIT message includes the *Active Pattern Sequence Information* IE and the concerned UE Context is configured to use F-DPCH in the downlink, the DRNS shall ignore, when activating the Transmission Gap Pattern Sequence(s), the downlink compressed mode method information, if existing, for the concerned Transmission Gap Pattern Sequence(s) in the Compressed Mode Configuration]

8.3.5.3 Abnormal Conditions

If a new transport bearer is required for the new configuration and it is not available at the requested configuration switching point (defined in sub-clause 8.3.3.2), the DRNS shall initiate the Radio Link Failure procedure.

[FDD – If the *Fast Reconfiguration* IE is included in the RADIO LINK RECONFIGURATION COMMIT message and the DRNC did not include the *Fast ReconfigurationPermission* IE in the RADIO LINK RECONFIGURATION READY message, the DRNC shall initiate the Radio Link Failure procedure.]

8.3.6 Synchronised Radio Link Reconfiguration Cancellation

8.3.6.1 General

This procedure is used to order the DRNS to release the new configuration for the Radio Link(s) within the DRNS, previously prepared by the Synchronised Radio Link Reconfiguration Preparation procedure.

This procedure shall use the signalling bearer connection for the relevant UE Context.

8.3.6.2 Successful Operation



Figure 13: Synchronised Radio Link Reconfiguration Cancellation procedure, Successful Operation

Upon receipt of the RADIO LINK RECONFIGURATION CANCEL message from the SRNC, the DRNS shall release the new configuration ([FDD – including the new Transmission Gap Pattern Sequence parameters (if existing)]) previously prepared by the Synchronised RL Reconfiguration Preparation procedure and continue using the old configuration. When this procedure has been completed the Prepared Reconfiguration does not exist any more, see subclause 3.1.

8.3.6.3 Abnormal Conditions

-

8.3.7 Unsynchronised Radio Link Reconfiguration

8.3.7.1 General

The Unsynchronised Radio Link Reconfiguration procedure is used to reconfigure Radio Link(s) related to one UE-UTRAN connection within a DRNS.

The procedure is used when there is no need to synchronise the time of the switching from the old to the new radio link configuration in the cells used by the UE-UTRAN connection within the DRNS.

This procedure shall use the signalling bearer connection for the relevant UE Context.

The Unsynchronised Radio Link Reconfiguration procedure shall not be initiated if a Prepared Reconfiguration exists, as defined in subclause 3.1.

8.3.7.2 Successful Operation

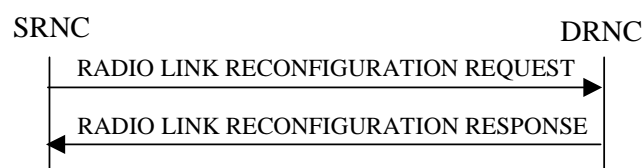

Figure 14: Unsynchronised Radio Link Reconfiguration procedure, Successful Operation

The Unsynchronised Radio Link Reconfiguration procedure is initiated by the SRNC by sending the RADIO LINK RECONFIGURATION REQUEST message to the DRNC.

Upon receipt, the DRNS shall modify the configuration of the Radio Link(s) according to the parameters given in the message. Unless specified below, the meaning of parameters is specified in other specifications.

If the RADIO LINK RECONFIGURATION REQUEST message includes the *Allowed Queuing Time* IE the DRNS may queue the request the time corresponding to the value of the *Allowed Queuing Time* IE before starting to execute the request.

The DRNS shall prioritise resource allocation for the RL to be modified according to Annex A.

If the *UE Aggregate Maximum Bit Rate* IE is contained in the RADIO LINK RECONFIGURATION REQUEST message, the DRNS shall, if supported, store the received UE Aggregate Maximum Bit Rate parameters to control the aggregate data rate of non GBR traffic for this UE.

DCH Modification:

If the RADIO LINK RECONFIGURATION REQUEST message includes any *DCHs To Modify* IEs, then the DRNS shall treat them as follows:

- If the *DCHs To Modify* IE includes multiple *DCH Specific Info* IEs, then the DRNS shall treat the DCHs as a set of co-ordinated DCHs. The DRNS shall include these DCHs in the new configuration only if it can include all of them in the new configuration.
- If the *DCHs To Modify* IE includes the *UL FP Mode* IE for a DCH or a set of co-ordinated DCHs to be modified, the DRNS shall apply the new FP Mode in the Uplink of the user plane for the DCH or the set of co-ordinated DCHs in the new configuration.
- If the *DCHs To Modify* IE includes the *ToAWS* IE for a DCH or a set of co-ordinated DCHs to be modified, the DRNS shall apply the new ToAWS in the user plane for the DCH or the set of co-ordinated DCHs in the new configuration.
- If the *DCHs To Modify* IE includes the *ToAWE* IE for a DCH or a set of co-ordinated DCHs to be modified, the DRNS shall apply the new ToAWE in the user plane for the DCH or the set of co-ordinated DCHs in the new configuration.
- If the *DCHs To Modify* IE contains a *DCH Specific Info* IE which includes a *Transport Format Set* IE for the UL of a DCH to be modified, the DRNS shall apply the new Transport Format Set in the Uplink of this DCH in the new configuration.
- If the *DCHs To Modify* IE contains a *DCH Specific Info* IE which includes a *Transport Format Set* IE for the DL of a DCH to be modified, the DRNS shall apply the new Transport Format Set in the Downlink of this DCH in the new configuration.
- If the *DCHs To Modify* IE contains a *DCH Specific Info* IE which includes the *Frame Handling Priority* IE, the DRNS should store this information for this DCH in the new configuration. The received Frame Handling Priority should be used when prioritising between different frames in the downlink on the radio interface in congestion situations within the DRNS once the new configuration has been activated.
- If the *DCH Specific Info* IE includes the *Traffic Class* IE, the DRNC may use this information to determine the transport bearer characteristics to apply between DRNC and Node B for the related DCH or set of co-ordinated DCHs. The DRNC should ignore the *Traffic Class* IE if the *TrCH Source Statistics Descriptor* IE for this DCH indicates the value "RRC".
- [FDD – If the *DCHs to Modify* IE contains a *DCH Specific Info* IE which includes the *Unidirectional DCH indicator* IE set to "Uplink DCH only", the DRNS shall ignore the *Transport Format Set* IE for the downlink for this DCH. As a consequence this DCH is not included as a part of the downlink CCTrCH.]
- [FDD – If the *DCHs to Modify* IE contains a *DCH Specific Info* IE which includes the *Unidirectional DCH indicator* IE set to "Downlink DCH only", the DRNS shall ignore the *Transport Format Set* IE for the uplink for this DCH. As a consequence this DCH is not included as a part of the uplink CCTrCH.]
- If the *TNL QoS* IE is included for a DCH or a set of co-ordinated DCHs and if ALCAP is not used, the DRNS may use this information to determine the transport bearer characteristics to apply for the uplink for the related DCH or set of co-ordinated DCHs.
- If the *DCHs To Modify* IE contains a *DCH Specific Info* IE which includes the *Allocation/Retention Priority* IE, the DRNS shall apply the new Allocation/Retention Priority to this DCH in the new configuration according to Annex A.
- [TDD – If the *DCHs To Modify* IE contains a *DCH Specific Info* IE which includes the *CCTrCH ID* IE for the UL, the DRNS shall map the DCH onto the referenced UL CCTrCH in the new configuration.]
- [TDD – If the *DCHs To Modify* IE contains a *DCH Specific Info* IE which includes the *CCTrCH ID* IE for the DL, the DRNS shall map the DCH onto the referenced DL CCTrCH in the new configuration.]
- If the *DCHs To Modify* IE contains a *DCH Specific Info* IE which includes the *Guaranteed Rate Information* IE, the DRNS shall treat the included IEs according to the following:

- If the *Guaranteed Rate Information* IE includes the *Guaranteed UL Rate* IE, the DRNS shall apply the new Guaranteed Rate in the uplink of this DCH in the new configuration. The DRNS may decide to request the SRNC to limit the user rate in the uplink of the DCH at any point in time after activating the new configuration. The DRNS may request the SRNC to reduce the user rate of the uplink of the DCH below the guaranteed bit rate, however, whenever possible the DRNS should request the SRNC to reduce the user rate between the maximum bit rate and the guaranteed bit rate.
- If the *Guaranteed Rate Information* IE includes the *Guaranteed DL Rate* IE, the DRNS shall apply the new Guaranteed Rate in the downlink of this DCH in the new configuration. The DRNS may decide to request the SRNC to limit the user in the downlink of the DCH at any point in time after activating the new configuration. The DRNS may request the SRNC to reduce the user rate of the downlink of the DCH below the guaranteed bit rate, however, whenever possible the DRNS should request the SRNC to reduce the user rate between the maximum bit rate and the guaranteed bit rate.

DCH Addition:

If the RADIO LINK RECONFIGURATION REQUEST message includes any *DCHs To Add* IEs, then the DRNS shall treat them each as follows:

- The DRNS shall reserve necessary resources for the new configuration of the Radio Link(s) according to the parameters given in the message and include these DCH in the new configuration.
- If the *DCHs To Add* IE includes multiple *DCH Specific Info* IEs then the DRNS shall treat the DCHs in the *DCHs To Add* IE as a set of co-ordinated DCHs. The DRNS shall include these DCHs in the new configuration only if all of them can be in the new configuration.
- If the *DCH Specific Info* IE includes the *Unidirectional DCH Indicator* IE set to “Uplink DCH only”, the DRNS shall ignore the *Transport Format Set* IE for the downlink for this DCH. As a consequence this DCH is not included as a part of the downlink CCTrCH.
- If the *DCH Specific Info* IE includes the *Unidirectional DCH Indicator* IE set to “Downlink DCH only”, the DRNS shall ignore the *Transport Format Set* IE for the uplink for this DCH. As a consequence this DCH is not included as a part of the uplink CCTrCH.
- [FDD – For each DCH which does not belong to a set of co-ordinated DCHs, and which includes a *QE-Selector* IE set to “selected”, the DRNS shall use the Transport channel BER from that DCH for the QE in the UL data frames. If no Transport channel BER is available for the selected DCH, the DRNS shall use the Physical channel BER for the QE, ref. TS 25.427 [4]. If the *QE-Selector* IE is set to “non-selected”, the DRNS shall use the Physical channel BER for the QE in the UL data frames, ref. TS 25.427 [4].]
- For a set of co-ordinated DCHs, the DRNS shall use the Transport channel BER from the DCH with the *QE-Selector* IE set to “selected” for the QE in the UL data frames, ref. TS 25.427 [4]. [FDD – If no Transport channel BER is available for the selected DCH, the DRNS shall use the Physical channel BER for the QE, ref. TS 25.427 [4]. If all DCHs have the *QE-Selector* IE set to “non-selected”, the DRNS shall use the Physical channel BER for the QE, ref. TS 25.427 [4].] [TDD – If no Transport channel BER is available for the selected DCH, the DRNS shall use 0 for the QE, ref. TS 25.427 [4].]
- The DRNS should store the *Frame Handling Priority* IE received for a DCH to be added in the new configuration. The received Frame Handling Priority should be used when prioritising between different frames in the downlink on the Uu interface in congestion situations within the DRNS once the new configuration has been activated.
- The *Traffic Class* IE may be used to determine the transport bearer characteristics to apply between DRNC and Node B for the related DCH or set of co-ordinated DCHs. The DRNC should ignore the *Traffic Class* IE if the *TrCH Source Statistics Descriptor* IE indicates the value “RRC”.
- If the *TNL QoS* IE is included for a DCH or a set of co-ordinated DCHs and if ALCAP is not used, the DRNS may use this information to determine the transport bearer characteristics to apply for the uplink for the related DCH or set of co-ordinated DCHs.
- The DRNS shall use the included *UL FP Mode* IE for a DCH or a set of co-ordinated DCHs to be added as the new FP Mode in the Uplink of the user plane for the DCH or the set of co-ordinated DCHs in the new configuration.

- The DRNS shall use the included *ToAWS* IE for a DCH or a set of co-ordinated DCHs to be added as the new Time of Arrival Window Startpoint in the user plane for the DCH or the set of co-ordinated DCHs in the new configuration.
- The DRNS shall use the included *ToAWE* IE for a DCH or a set of co-ordinated DCHs to be added as the new Time of Arrival Window Endpoint in the user plane for the DCH or the set of co-ordinated DCHs in the new configuration.
- If the *DCH Specific Info* IE includes the *Guaranteed Rate Information* IE, the DRNS shall treat the included IEs according to the following:
 - If the *Guaranteed Rate Information* IE includes the *Guaranteed UL Rate* IE, the DRNS shall apply the new Guaranteed Rate in the uplink of this DCH in the new configuration. The DRNS may decide to request the SRNC to limit the user rate of the uplink of the DCH at any point in time after activating the new configuration. The DRNS may request the SRNC to reduce the user rate of the uplink of the DCH below the guaranteed bit rate, however, whenever possible the DRNS should request the SRNC to reduce the user rate between the maximum bit rate and the guaranteed bit rate. If the *DCH Specific Info* IE in the *DCH Information* IE does not include the *Guaranteed UL Rate* IE, the DRNS shall not limit the user rate of the uplink of the DCH.
 - If the *Guaranteed Rate Information* IE includes the *Guaranteed DL Rate* IE, the DRNS shall apply the new Guaranteed Rate in the downlink of this DCH in the new configuration. The DRNS may decide to request the SRNC to limit the user rate of the downlink of the DCH at any point in time after activating the new configuration. The DRNS may request the SRNC to reduce the user rate of the downlink of the DCH below the guaranteed bit rate, however, whenever possible the DRNS should request the SRNC to reduce the user rate between the maximum bit rate and the guaranteed bit rate. If the *DCH Specific Info* IE in the *DCH Information* IE does not include the *Guaranteed DL Rate* IE, the DRNS shall not limit the user rate of the uplink of the DCH.

DCH Deletion:

If the RADIO LINK RECONFIGURATION REQUEST message includes any *DCHs To Delete* IEs, the DRNS shall not include the referenced DCHs in the new configuration.

If all of the DCHs belonging to a set of co-ordinated DCHs are requested to be deleted, the DRNS shall not include this set of co-ordinated DCHs in the new configuration.

[FDD – Physical Channel Modification:]

[FDD – If the RADIO LINK RECONFIGURATION REQUEST message includes an *UL DPCH Information* IE, then the DRNS shall apply the parameters to the new configuration as follows:]

- [FDD – If the *UL DPCH Information* IE includes the *TFCS* IE for the UL, the DRNS shall apply the new TFCS in the Uplink of the new configuration.]
- [FDD – If the *UL DPCH Information* IE includes the *UL DPDCH Indicator For E-DCH Operation* IE set to “UL DPDCH not present”, the UL DPDCH resources shall be removed from the configuration.]

[FDD – If the RADIO LINK RECONFIGURATION REQUEST message includes a *DL DPCH Information* IE, then the DRNS shall apply the parameters to the new configuration as follows:]

- [FDD – If the *DL DPCH Information* IE includes the *TFCS* IE for the DL, the DRNS shall apply the new TFCS in the Downlink of the new configuration.]
- [FDD – If the *DL DPCH Information* IE includes the *TFCI Signalling Mode* IE for the DL, the DRNS shall apply the new TFCI Signalling Mode in the Downlink of the new configuration.]
- [FDD – If the *DL DPCH Information* IE includes the *Limited Power Increase* IE and the IE is set to “Used”, the DRNS shall, if supported, use Limited Power Increase according to ref. TS 25.214 [10] subclause 5.2.1 for the inner loop DL power control in the new configuration.]
- [FDD – If the *DL DPCH Information* IE includes the *Limited Power Increase* IE and the IE is set to “Not Used”, the DRNS shall not use Limited Power Increase for the inner loop DL power control in the new configuration.]

[FDD – If the RADIO LINK RECONFIGURATION REQUEST message includes the *Transmission Gap Pattern Sequence Information IE*, the DRNS shall store the new information about the Transmission Gap Pattern Sequences to be used in the new Compressed Mode configuration. Any Transmission Gap Pattern Sequences already existing in the previous Compressed Mode Configuration are replaced by the new sequences once the new Compressed Mode Configuration has been activated. This new Compressed Mode Configuration shall be valid in the DRNS until the next Compressed Mode Configuration is configured in the DRNS or last Radio Link is deleted.]

[FDD – If the RADIO LINK RECONFIGURATION REQUEST message includes the *Transmission Gap Pattern Sequence Information IE*, and if the *Downlink Compressed Mode Method* in one or more Transmission Gap Pattern Sequence within the *Transmission Gap Pattern Sequence Information IE* is set to “SF/2”, the DRNC shall include the *DL Code Information IE* in the RADIO LINK RECONFIGURATION RESPONSE message, without changing any of the DL Channelisation Codes or DL Scrambling Codes, indicating for each DL Channelisation Code whether the alternative scrambling code shall be used or not.]

[FDD – If the RADIO LINK RECONFIGURATION REQUEST message includes an *E-DPCH Information IE* which contains the *E-TFCS Information IE*, the DRNS shall use the *E-TFCS Information IE* for the E-DCH when reserving resources for the uplink of the new configuration. The DRNS shall apply the new TFCS in the uplink of the new configuration. If the *E-TFCS Information IE* contains the *E-DCH Minimum Set E-TFCI Validity Indicator IE* the DRNS shall ignore the value in *E-DCH Minimum Set E-TFCI IE*. If the *E-DCH Minimum Set E-TFCI validity indicator IE* is absent DRNS shall use the value for the related resource allocation operation.]

[FDD – If the *E-TFCS Information IE* in the *E-DPCH Information IE* contains the *E-DPDCH Power Interpolation IE*, the DRNS shall use the value to determine the applicable E-DPDCH power formula defined in TS 25.214 [10]. If the *E-DPDCH Power Interpolation IE* is not present, the DRNS shall use the E-DPDCH power extrapolation formula defined in TS 25.214 [10] if the *E-DCH FDD Information IE* is included in the RADIO LINK RECONFIGURATION REQUEST message.]

FDD – If the *E-TFCS Information IE* in the *E-DPCH Information IE* contains the *E-TFCI Boost Information IE*, the DRNS shall use the information according to TS 25.214 [10]. If the *E-TFCI Boost Information IE* is not present, the DRNS shall use the value “127” in the algorithm defined in TS 25.214 [10] if the *E-DCH FDD Information IE* is included in the RADIO LINK RECONFIGURATION REQUEST message.]

[FDD – If the RADIO LINK RECONFIGURATION REQUEST includes an *E-DPCH Information IE* which contains the *E-DPCCH Power Offset IE*, the DRNS shall use the value when the new configuration is being used.]

[FDD – If the RADIO LINK RECONFIGURATION REQUEST includes an *E-DPCH Information IE* which contains the *E-RGCH 2-Index-Step IE*, the DRNS shall use the value when the new configuration is being used.]

[FDD – If the RADIO LINK RECONFIGURATION REQUEST includes an *E-DPCH Information IE* which contains the *E-RGCH 3-Index-Step IE*, the DRNS shall use the value when the new configuration is being used.]

[FDD – If the RADIO LINK RECONFIGURATION REQUEST includes an *E-DPCH Information IE* which contains the *HARQ Info for E-DCH IE*, the DRNS shall use the value when the new configuration is being used.]

[FDD – If the RADIO LINK RECONFIGURATION REQUEST includes an *E-DPCH Information IE* which contains the *Minimum Reduced E-DPDCH Gain Factor IE*, then the DRNS shall use the value to determine the applicable minimum gain factor ($\beta_{ed,k, reduced, min}$) defined in TS 25.214 [10]. For the case the *Minimum Reduced E-DPDCH Gain Factor IE* is not available for the UE Context, the DRNS may use the default value defined in TS 25.331 [16].]

[FDD – If the RADIO LINK RECONFIGURATION REQUEST message includes the *Continuous Packet Connectivity DTX-DRX Information IE*, then:]

- [FDD – The DRNS shall configure the concerned UE Context for Continuous Packet Connectivity DTX operation according to TS 25.214 [10].]
- [FDD – If *DRX Information IE* is included in the *Continuous Packet Connectivity DTX-DRX Information IE*, then the DRNS shall configure the concerned UE Context for Continuous Packet Connectivity DRX operation according to TS 25.214 [10].]

[FDD – If the RADIO LINK RECONFIGURATION REQUEST message includes the *Continuous Packet Connectivity DTX-DRX Information To Modify IE*, then:]

- [FDD – If the *UE DTX DRX Offset IE* is included in the *Continuous Packet Connectivity DTX-DRX Information To Modify IE*, then the DRNS shall apply the indicated Offset in *UE DTX DRX Cycle IE* in the new configuration.]

- [FDD – If the *Enabling Delay* IE is included in the *Continuous Packet Connectivity DTX-DRX Information To Modify* IE, then the DRNS shall use this value to determine the beginning of uplink transmission in the new configuration according to TS 25.214 [10].]
- [FDD – If the *DTX Information To Modify* IE is included in the *Continuous Packet Connectivity DTX-DRX Information To Modify* IE, then the DRNS shall use this information to modify the indicated DTX Information parameter in the new configuration. If the choice of *DTX Information To Modify* IE is “Deactivate”, then DRX should be deactivated together with DTX.]
- [FDD – If the *DRX Information To Modify* IE is included in the *Continuous Packet Connectivity DTX-DRX Information To Modify* IE, then the DRNS shall use this information to modify the indicated DRX Information in the new configuration.]

[FDD – If the RADIO LINK RECONFIGURATION REQUEST message includes the *Continuous Packet Connectivity HS-SCCH less Information* IE, then:]

- [FDD – The DRNS shall configure the Serving HS-DSCH Radio Link indicated by the *HS-PDSCH RL ID* IE for Continuous Packet Connectivity HS-SCCH less operation according to TS 25.214 [10].]
- [FDD – The DRNS shall allocate the HS-PDSCH codes needed for HS-SCCH less operation and include the *Continuous Packet Connectivity HS-SCCH less Information Response* IE in the RADIO LINK RECONFIGURATION RESPONSE message.]
- [FDD – If at least one of *HS-PDSCH Second Code Support* IE is set to “True”, then the DRNC shall include *HS-PDSCH Second Code Index* IE in the RADIO LINK RECONFIGURATION RESPONSE message.]

[FDD- If the RADIO LINK RECONFIGURATION REQUEST message includes the *Continuous Packet Connectivity HS-SCCH less Deactivate Indicator* IE, then the DRNS shall deactivate the Continuous Packet Connectivity HS-SCCH less operation for the HS-DSCH Radio Link.]

[1.28 Mcps TDD – If the RADIO LINK RECONFIGURATION REQUEST message includes the *Continuous Packet Connectivity DRX Information LCR* IE, then the DRNS shall take account into these parameters to decide the DRX operation related parameters and configure the concerned UE Context for DRX operation according to TS 25.213 [21] and include the parameter(s) in the *Continuous Packet Connectivity DRX Information Response LCR* IE in the RADIO LINK RECONFIGURATION RESPONSE message.]

[1.28 Mcps TDD - If the *Inactivity Threshold for UE DRX Cycle Ext* IE is included in the *Continuous Packet Connectivity DRX Information LCR* IE, then the DRNS may use this value to determine the Inactivity Threshold for UE DRX Cycle according to TS 25.224 [22].]

[1.28 Mcps TDD – If the RADIO LINK RECONFIGURATION REQUEST message includes the *Continuous Packet Connectivity DRX Information To Modify LCR* IE, then:]

- [1.28 Mcps TDD – If the *UE DTX DRX Offset* IE is included in the *Continuous Packet Connectivity DRX Information To Modify LCR* IE, then the DRNS shall apply the indicated Offset in *UE DTX DRX Cycle* IE in the new configuration.]
- [1.28 Mcps TDD – If the *Enabling Delay* IE is included in the *Continuous Packet Connectivity DRX Information To Modify LCR* IE, then the DRNS shall use this value to determine the beginning of uplink transmission in the new configuration according to TS 25.213 [21].]
- [1.28 Mcps TDD – If the *DRX Information To Modify* IE is included in the *Continuous Packet Connectivity DRX Information To Modify LCR* IE, then the DRNS shall use this information to modify the indicated DRX Information in the new configuration.]

[1.28 Mcps TDD – If the RADIO LINK RECONFIGURATION REQUEST message includes the *HS-DSCH Semi-Persistent scheduling Information LCR* IE, then:]

- [1.28 Mcps TDD – The DRNS shall configure the Serving HS-DSCH Radio Link indicated by the *HS-PDSCH RL ID* IE for HS-DSCH Semi-Persistent scheduling operation according to TS 25.213 [21].]
- [1.28 Mcps TDD – The DRNS shall allocate the HS-SICH information needed for HS-DSCH Semi-Persistent scheduling operation and include the *HS-DSCH Semi-Persistent scheduling Information Response LCR* IE in the RADIO LINK RECONFIGURATION RESPONSE message.]

- [1.28 Mcps TDD – If the *HS-DSCH Semi-Persistent Resource Reservation Indicator* IE is included in the *HS-DSCH Semi-Persistent scheduling Information LCR* IE, then the DRNS shall include *Allcoated HS-PDSCH Semi-persistent resource IE* in the RADIO LINK RECONFIGURATION RESPONSE message.]

[1.28 Mcps TDD – If the RADIO LINK RECONFIGURATION REQUEST message includes the *E-DCH Semi-Persistent scheduling Information LCR* IE, then:]

- [1.28 Mcps TDD – The DRNS shall configure the Serving E-DCH Radio Link indicated by the *E-DCH Serving RL* IE for E-DCH Semi-Persistent scheduling operation according to TS 25.213 [21].]
- [1.28 Mcps TDD - If the *E-DCH Semi-Persistent Resource Reservation Indicator* IE is included in the *E-DCH Semi-Persistent scheduling Information LCR* IE, then the DRNS shall include *Allocated E-DCH Semi-persistent resource IE* in the RADIO LINK RECONFIGURATION RESPONSE message.]

[1.28 Mcps TDD – If the RADIO LINK RECONFIGURATION REQUEST message includes the *HS-DSCH Semi-Persistent scheduling Information to modify LCR* IE, then:]

- [1.28 Mcps TDD – If the *Transport Block Size List* IE or/and *Repetition Period list* IE is/are included in the *HS-DSCH Semi-Persistent scheduling Information to modify LCR* IE, the DRNS shall modify the configuration of Serving HS-DSCH Radio Link indicated by the *HS-PDSCH RL ID* IE for HS-DSCH Semi-Persistent scheduling operation according to TS 25.213 [21].]
- [1.28 Mcps TDD – The DRNS shall allocate the HS-SICH information needed for HS-DSCH Semi-Persistent scheduling operation and include the *HS-DSCH Semi-Persistent scheduling Information Response LCR* IE in the RADIO LINK RECONFIGURATION RESPONSE message.]
- [1.28 Mcps TDD – If the *HS-DSCH Semi-Persistent Resource Reservation Indicator* IE is included in the *HS-DSCH Semi-Persistent scheduling Information to modify LCR* IE, then the DRNS shall include *Allcoated HS-PDSCH Semi-persistent resource IE* in the RADIO LINK RECONFIGURATION RESPONSE message.]
- [1.28 Mcps TDD – If the *HS-DSCH Semi-Persistent scheduling operation Indicator* IE is included in the *HS-DSCH Semi-Persistent scheduling Information to modify LCR* IE, then the DRNS shall apply this information for HS-DSCH Semi-Persistent scheduling operation.]
- [1.28 Mcps TDD – If the buffer size for HS-DSCH Semi-Persistent scheduling needs to be modified, then the DRNS shall include the *Buffer Size for HS-DSCH Semi-Persistent scheduling* IE in the RADIO LINK RECONFIGURATION RESPONSE message.]
- [1.28 Mcps TDD – If the number of processes for HS-DSCH Semi-Persistent scheduling needs to be modified, then the DRNS shall include the *Number of Processes for HS-DSCH Semi-Persistent scheduling* IE in the RADIO LINK RECONFIGURATION RESPONSE message.]

[1.28 Mcps TDD – If the RADIO LINK RECONFIGURATION REQUEST message includes the *E-DCH Semi-Persistent scheduling Information to modify LCR* IE, then:]

- [1.28 Mcps TDD – If the *Repetition Period list* IE is included in the *E-DCH Semi-Persistent scheduling Information to modify LCR* IE, the DRNS shall modify the configuration of Serving HS-DSCH Radio Link indicated by the *E-DCH Serving RL* IE for E-DCH Semi-Persistent scheduling operation according to TS 25.213 [21].]
- [1.28 Mcps TDD – If the *E-DCH Semi-Persistent scheduling Indicator* IE is included in the *E-DCH Semi-Persistent scheduling Information to modify LCR* IE, then the DRNS shall apply this information for E-DCH Semi-Persistent scheduling operation.]
- [1.28 Mcps TDD - If the *E-DCH Semi-Persistent Resource Reservation Indicator* IE is included in the *E-DCH Semi-Persistent scheduling Information to modify LCR* IE, then the DRNS shall include *Allocated E-DCH Semi-persistent resource IE* in the RADIO LINK RECONFIGURATION RESPONSE message.]

[1.28 Mcps TDD – If the RADIO LINK RECONFIGURATION REQUEST message includes the *HS-DSCH Semi-Persistent scheduling Deactivate Indicator LCR* IE, then the DRNS shall deactivate the HS-DSCH Semi-Persistent scheduling operation for the HS-DSCH Radio Link.]

[1.28 Mcps TDD – If the RADIO LINK RECONFIGURATION REQUEST message includes the *E-DCH Semi-Persistent scheduling Deactivate Indicator LCR* IE, then the DRNS shall deactivate the E-DCH Semi-Persistent scheduling operation for the E-DCH Radio Link.]

[TDD – UL/DL CCTrCH Modification]

[TDD – If the RADIO LINK RECONFIGURATION REQUEST message includes any *UL CCTrCH To Modify* IE or *DL CCTrCH To Modify* IE, the DRNS shall reserve necessary resources for the new configuration of the Radio Link(s) according to the parameters given in the message.]

[TDD – If the RADIO LINK RECONFIGURATION REQUEST message includes any *UL CCTrCH Information To Modify* IEs or *DL CCTrCH Information To Modify* IEs which contain a *TFCS* IE, the DRNS shall apply the included *TFCS* IE as the new value(s) to the referenced CCTrCH. Otherwise the DRNS shall continue to apply the previous value(s) specified for this CCTrCH.]

[1.28Mcps TDD – If the *UL CCTrCH To Modify* IE includes *UL SIR Target* IE, the DRNS shall apply this value as the new configuration and use it for the UL inner loop power control according TS 25.221 [12] and TS 25.224 [22].]

[TDD – UL/DL CCTrCH Deletion]

[TDD – If the RADIO LINK RECONFIGURATION REQUEST message includes any *UL CCTrCH Information To Delete* IEs or *DL CCTrCH Information To Delete* IEs, the DRNS shall not include the referenced CCTrCH in the new configuration.]

DL Power Control:

[FDD – If the RADIO LINK RECONFIGURATION REQUEST message includes the *DL Reference Power Information* IE and the power balancing is active, the DRNS shall update the reference power of the power balancing in the indicated RL(s), if updating of power balancing parameters by the RADIO LINK RECONFIGURATION REQUEST message is supported, using the *DL Reference Power Information* IE in the RADIO LINK RECONFIGURATION REQUEST message. The updated reference power shall be used from the next adjustment period.]

[FDD – If updating of power balancing parameters by the RADIO LINK RECONFIGURATION REQUEST message is supported by the DRNS, the DRNC shall include the *DL Power Balancing Updated Indicator* IE in the *RL Information Response* IE for each affected RL in the RADIO LINK RECONFIGURATION RESPONSE message.]

[1.28Mcps TDD – Uplink Synchronisation Parameters LCR:]

[1.28Mcps TDD – If the *Uplink Synchronisation Parameters LCR* IE is present, the DRNC shall use the indicated values of *Uplink synchronisation stepsize* IE and *Uplink synchronisation frequency* IE when evaluating the timing of the UL synchronisation.]

[1.28Mcps TDD – Shared physical channels Synchronisation Detection:]

[1.28Mcps TDD – If HS-PDSCH and E-PUSCH are configured but no DPCH is configured for the UE, then the DRNS shall include the *Out-of-sync Detection Window* IE in the *HS-DSCH TDD Information Response* IE in the RADIO LINK RECONFIGURATION RESPONSE message.]

[1.28Mcps TDD – Uplink Timing Advance Control LCR:]

[1.28Mcps TDD – The DRNC shall include the *Uplink Timing Advance Control LCR* IE in the RADIO LINK RECONFIGURATION RESPONSE message, if the Uplink Timing Advance Control parameters have been changed.]

[1.28Mcps TDD – PowerControl GAP:]

[1.28Mcps TDD – If applied in the DRNS, the DRNC may include the *PowerControl GAP* IE in the RADIO LINK RECONFIGURATION RESPONSE message.]

[1.28Mcps TDD – E-UTRAN Inter-RAT measurement:]

[1.28Mcps TDD – If the RADIO LINK RECONFIGURATION REQUEST message includes the *Need for Idle Interval* IE set to “TRUE”, if supported, the DRNC shall include the *Idle Interval Information* IE in the RADIO LINK RECONFIGURATION RESPONSE message. If the *Need for Idle Interval* IE is set to “FALSE”, the DRNC shall delete the configuration related to E-UTRAN Inter-RAT measurement]

[1.28Mcps TDD – Inter-frequency/ Inter-RAT measurement:]

[1.28Mcps TDD – If the RADIO LINK RECONFIGURATION REQUEST message includes the *DCH Measurement Type indicator* IE, if supported, the DRNS shall include the *Measurement purpose* IE and the *Measurement occasion*

pattern sequence parameters IE in the *DCH Measurement Occasion Information* IE in the RADIO LINK RECONFIGURATION RESPONSE message to configure the measurement occasion pattern(s) indicated by the *DCH Measurement Type indicator* IE.]

[1.28Mcps TDD – RNTI Allocation Indicator:]

[1.28Mcps TDD – If the RADIO LINK RECONFIGURATION REQUEST message includes the *RNTI Allocation Indicator* IE, if supported, the DRNS may allocate an E-RNTI and/or an H-RNTI for UE to use in CELL_FACH state.]

RL Information:

[FDD. If the UE Context is configured for F-DPCH Slot Format operation, the DRNS shall include the *F-DPCH Slot Format* IE in the RADIO LINK RECONFIGURATION RESPONSE message.]

HS-DSCH Setup:

If the *HS-DSCH Information* IE is present in the RADIO LINK RECONFIGURATION REQUEST message, then:

- The DRNS shall setup the requested HS-PDSCH resources on the Serving HS-DSCH Radio Link indicated by the *HS-PDSCH RL ID* IE.
- The DRNC shall include the *HARQ Memory Partitioning* IE in the [FDD – *HS-DSCH FDD Information Response* IE] [TDD – *HS-DSCH TDD Information Response* IE] in the RADIO LINK RECONFIGURATION RESPONSE message. [FDD – The *HARQ Memory Partitioning* IE shall either contain the *HARQ Memory Partitioning Information Extension For MIMO* IE or the *Number of Processes* IE set to a value higher than “8”, if the *MIMO Activation Indicator* IE is included in the *HS-DSCH Information* IE.] [1.28Mcps TDD– The *HARQ Memory Partitioning* IE shall either contain the *HARQ Memory Partitioning Information Extension For MIMO* IE or the *Number of Processes* IE set to a value higher than “8”, if the *MIMO Activation Indicator* IE is included in the *HS-DSCH Information* IE.]
- The DRNC shall allocate an HS-DSCH-RNTI to the UE Context and include the *HS-DSCH-RNTI* IE in the RADIO LINK RECONFIGURATION RESPONSE message.
- The DRNS may use the *Traffic Class* IE for a specific HS-DSCH MAC-d flow to determine the transport bearer characteristics to apply between DRNC and Node B. If *TrCH Source Statistics Descriptor* IE is present with the value “RRC” in the *HS-DSCH MAC-d Flows Information* IE, then the DRNC should ignore the *Traffic Class* IE.
- If the *TNL QoS* IE is included for a MAC-d flow and if ALCAP is not used, the *TNL QoS* IE may be used by the DRNS to determine the transport bearer characteristics to apply in the uplink between the DRNS and the SRNC for the related MAC-d flow.
- If fields are to be included in the User Plane by the SRNC to handle TNL Congestion Control for HSDPA in the DRNS, then the DRNC shall include the *User Plane Congestion Fields Inclusion* IE in the *HS-DSCH Information Response* IE.
- If the RADIO LINK RECONFIGURATION REQUEST message includes the *MAC-hs Guaranteed Bit Rate* IE for a Priority Queue in the *HS-DSCH MAC-d Flows Information* IE in the *HS-DSCH Information* IE, then the DRNS shall use this information to optimise MAC-hs scheduling decisions for the related HSDPA Priority Queue.
- If the RADIO LINK RECONFIGURATION REQUEST message includes the *Discard Timer* IE for a Priority Queue in the *HS-DSCH MAC-d Flows Information* IE in the *HS-DSCH Information* IE, then the DRNS shall use this information to discard out-of-date MAC-hs SDUs from the related HSDPA Priority Queue.
- If the RADIO LINK RECONFIGURATION REQUEST message includes the *Maximum MAC-d PDU Size Extended* IE for a Priority Queue in the *HS-DSCH MAC-d Flows Information* IE in the *HS-DSCH Information* IE, then the DRNS shall ignore the *SID* IE and *MAC-d PDU Size* IE in the *MAC-d PDU Size Index* IE and use *Maximum MAC-d PDU Size Extended* IE to optimise capacity allocation for the related HSDPA Priority Queue.
- The DRNC shall include the *HS-DSCH Initial Capacity Allocation* IE in the [FDD – *HS-DSCH FDD Information Response* IE] [TDD – *HS-DSCH TDD Information Response* IE] in the RADIO LINK RECONFIGURATION RESPONSE message for every HS-DSCH MAC-d flow being established, if the DRNS allows the SRNC to start transmission of MAC-d PDUs before the DRNS has allocated capacity on user plane as described in TS 25.425 [32]. If RADIO LINK RECONFIGURATION REQUEST message includes *HS-*

DSCH MAC-d PDU Size Format IE in the *HS-DSCH Information* IE set to “Flexible MAC-d PDU Size”, then DRNC shall only set in the *HS-DSCH Initial Capacity Allocation* IE the values for the peer of *Scheduling Priority Indicator* IE and *Maximum MAC-d PDU Size Extended* IE to the values of the corresponding peer I in RADIO LINK RECONFIGURATION REQUEST in the *HS-DSCH MAC-d Flows Information* IE in the *HS-DSCH Information* IE for a Priority Queue including *Scheduling Priority Indicator* IE and *Maximum MAC-d PDU Size Extended* IE.

- [FDD – If the RADIO LINK RECONFIGURATION REQUEST message includes the *HS-SCCH Power Offset* IE in the *HS-DSCH Information* IE, then the DRNS may use this value to determine the HS-SCCH power. The HS-SCCH Power Offset should be applied for any HS-SCCH transmission to this UE.]
- [FDD – The DRNS shall allocate HS-SCCH codes corresponding to the HS-DSCH and the DRNC shall include the *HS-SCCH Specific Information Response* IE in the *HS-DSCH FDD Information Response* IE in the RADIO LINK RECONFIGURATION RESPONSE message.]
- [TDD – The DRNS shall allocate HS-SCCH parameters corresponding to the HS-DSCH and the DRNC shall include the [3.84Mcps TDD – *HS-SCCH Specific Information Response* IE] [1.28Mcps TDD – *HS-SCCH Specific Information Response LCR* IE] [7.68Mcps TDD – *HS-SCCH Specific Information Response 7.68Mcps* IE] in the *HS-DSCH TDD Information Response* IE in the RADIO LINK RECONFIGURATION RESPONSE message.]
- [FDD – The DRNC shall include the *HS-PDSCH And HS-SCCH Scrambling Code* IE in the *HS-DSCH FDD Information Response* IE in the RADIO LINK RECONFIGURATION RESPONSE message.]
- [FDD – If the RADIO LINK RECONFIGURATION REQUEST message includes the *HARQ Preamble Mode* IE in the *HS-DSCH Information* IE, then the DRNS shall use the indicated HARQ Preamble Mode as described in TS 25.214 [10], if HS-DPCCH ACK/NACK preamble and postamble is supported. Then, in this case, if the mode 1 is applied, the DRNC shall include the *HARQ Preamble Mode Activation Indicator* IE in the *HS-DSCH Information Response* IE in the RADIO LINK RECONFIGURATION RESPONSE message. If the *HARQ Preamble Mode* IE is not included or if the mode 0 is applied, then the DRNC shall not include the *HARQ Preamble Mode Activation Indicator* IE in the *HS-DSCH Information Response* IE in the RADIO LINK RECONFIGURATION RESPONSE message.]
- If the RADIO LINK RECONFIGURATION REQUEST message includes the *HS-DSCH MAC-d PDU Size Format* IE in the *HS-DSCH Information* IE, then the DRNS shall use the indicated format in user plane frame structure for HS-DSCH channels TS 25.425 [32] and MAC-hs TS 25.321 [41].
- [FDD – The DRNC shall include the *Measurement Power Offset* IE in the *HS-DSCH Information Response* IE in the RADIO LINK RECONFIGURATION RESPONSE message.]
- [FDD – If the *MIMO Activation Indicator* IE is included in the *HS-DSCH FDD Information* IE, then]
 - [FDD – The DRNS shall activate the MIMO mode for the HS-DSCH Radio Link.]
 - [FDD – The DRNS shall decide the pilot configuration and the UE reporting configuration (N/M ratio) according to TS 25.214 [10] for MIMO and include the *MIMO Information Response* IE in the *HS-DSCH FDD Information Response* IE in the RADIO LINK RECONFIGURATION RESPONSE message.]
 - [FDD – If the *Power Offset For S-CPICH for MIMO Request Indicator* IE is included, the DRNC shall, if supported and MIMO pilot configuration with Primary and Secondary CPICH is set up with a non-zero power offset on the cell where the Serving HS-DSCH Radio Link is established, include the *Power Offset For S-CPICH for MIMO* IE in the *HS-DSCH FDD Information Response* IE in the RADIO LINK RECONFIGURATION RESPONSE message. If zero power offset the DRNC may include the *Power Offset For S-CPICH for MIMO* IE.]
- [1.28 Mcps TDD – If the *MIMO Activation Indicator* IE is included in the *HS-DSCH TDD Information* IE, then]
 - [1.28 Mcps TDD – The DRNS shall activate the MIMO mode for the HS-DSCH Radio Link.]
 - [1.28 Mcps TDD – The DRNS shall decide the SF mode for HS-PDSCH dual stream and include the *MIMO SF Mode for HS-PDSCH dual stream* IE in the *HS-DSCH TDD Information Response* IE in the RADIO LINK RECONFIGURATION RESPONSE message.]
- [FDD – If the *Sixtyfour QAM Usage Allowed Indicator* IE is included in the *HS-DSCH FDD Information* IE, then the DRNS may if the value is set to “allowed” use 64 QAM for the HS-DSCH Radio Link, and the DRNS

shall include the *SixtyfourQAM DL Usage Indicator* IE in the *HS-DSCH FDD Information Response* IE in the RADIO LINK RECONFIGURATION RESPONSE message.]

- [FDD – If the *Sixtyfour QAM Usage Allowed Indicator* IE is included in the *HS-DSCH FDD Information* IE with value set to “not allowed”, then the DRNS shall not use 64 QAM for the HS-DSCH Radio Link.]
- [FDD – If the RADIO LINK RECONFIGURATION REQUEST message includes the *HS-DSCH MAC-d PDU Size Format* IE set to “Flexible MAC-d PDU Size” and if Sixtyfour QAM will not be used, the DRNS shall include the *HS-DSCH TB Size Table Indicator* IE in the *HS-DSCH FDD Information Response* IE in the RADIO LINK RECONFIGURATION RESPONSE message if it decides to use the octet aligned table defined in TS 25.321 [41] for HS-DSCH Transport Block Size signalling.]
- [FDD – If the *UE with enhanced HS-SCCH support indicator* IE is included in the *HS-DSCH FDD Information* IE, then the DRNS may use:]
 - [FDD – a different HS-SCCH in consecutive TTIs for this UE]
 - [FDD – HS-SCCH orders for the case of HS-SCCH-less operation to this UE]
- [FDD – If the *UE Support Indicator Extension* IE is included in the *HS-DSCH FDD Information* IE the DRNS may use the supported HSDPA functions for this UE.]
- [FDD - If the *UE Support Indicator Extension* IE is included in the *HS-DSCH FDD Information* IE with the bit *UE DTXDRX related HS-SCCH orders uniform behavior indicator* set to 0, then the DRNS shall, if supported, include the *Support of dynamic DTXDRX related HS-SCCH order* IE in the *HS-DSCH FDD Information Response* IE in the RADIO LINK RECONFIGURATION RESPONSE message.]
- [FDD – If secondary serving HS-DSCH is applied also in the new configuration, then any changes related to parameters that are common for both the serving and the secondary serving HS-DSCH should be applied also for the secondary serving HS-DSCH.]
- If the RADIO LINK RECONFIGURATION REQUEST message includes *DL RLC PDU Size Format* IE for a Priority Queue in the *HS-DSCH MAC-d Flows Information* IE in the *HS-DSCH Information* IE, the *DL RLC PDU Size Format* IE may be used by the DRNS to determine the allocated capacity on user plane as described in TS 25.425 [32].
- [FDD – If the RADIO LINK RECONFIGURATION REQUEST message includes the *UE Aggregate Maximum Bit Rate Enforcement Indicator* IE in the *Priority Queue Information* IE in the *HS-DSCH MAC-d Flows Information* IE in the *HS-DSCH Information* IE, the DRNS shall, if supported, consider the data of the related HSDPA Priority Queue for UE Aggregate Maximum Bit Rate Enforcement.]
- [FDD – If the *Single Stream MIMO Activation Indicator* IE is included in the *HS-DSCH FDD Information* IE, then the DRNS shall activate the Single Stream MIMO for the HS-DSCH Radio Link.]
- [1.28 Mcps TDD – If the *UE TS0 Capability LCR* IE is included in the *HS-DSCH TDD Information* IE, then the DRNC may include the *TS0 HS-PDSCH Indication LCR* IE in the RADIO LINK RECONFIGURATION RESPONSE message if HS-PDSCH resources could be allocated on TS0 for the UE.]

[FDD – Secondary Serving HS-DSCH Setup:]

[FDD – If the *C-ID* IE is present in the RADIO LINK RECONFIGURATION REQUEST message, then:]

- [FDD – The DRNS shall setup the requested HS-PDSCH resources on the secondary serving HS-DSCH Radio Link indicated by the *HS-PDSCH RL ID* IE. Non cell specific secondary serving Radio Link and non cell specific secondary serving HS-DSCH parameters take the same values as for the serving HS-DSCH cell.]
- [FDD – The DRNC shall allocate an HS-DSCH-RNTI to the UE Context and include the *HS-DSCH-RNTI* IE in the *Additional HS Cell Information Response* IE in the RADIO LINK RECONFIGURATION RESPONSE message.]
- [FDD – If the RADIO LINK RECONFIGURATION REQUEST message includes the *HS-SCCH Power Offset* IE in the *HS-DSCH FDD Secondary Serving Information* IE, then the DRNS may use this value to determine the HS-SCCH power. The HS-SCCH Power Offset should be applied for any secondary serving HS-SCCH transmission to this UE.]

- [FDD – The DRNS shall allocate HS-SCCH codes corresponding to the secondary serving HS-DSCH and the DRNC shall include the *HS-SCCH Specific Secondary Serving Information Response* IE in the *HS-DSCH FDD Secondary Serving Information Response* IE in the *Additional HS Cell Information Response* IE in the RADIO LINK RECONFIGURATION RESPONSE message.]
- [FDD – The DRNC shall include the *HS-PDSCH And HS-SCCH Scrambling Code* IE in the *HS-DSCH FDD Secondary Serving Information Response* IE in the *Additional HS Cell Information Response* IE in the RADIO LINK RECONFIGURATION RESPONSE message.]
- [FDD – The DRNC shall include the *Measurement Power Offset* IE in the *HS-DSCH FDD Secondary Serving Information Response* IE in the *Additional HS Cell Information Response* IE in the RADIO LINK RECONFIGURATION RESPONSE message.]
- [FDD – If the *MIMO Activation Indicator* IE is included in the *HS-DSCH FDD Secondary Serving Information* IE, then the DRNS shall activate the MIMO mode for the secondary serving HS-DSCH Radio Link and the DRNS shall decide the pilot configuration and the UE reporting configuration (N/M ratio) according to TS 25.214 [10] for MIMO and include the *MIMO Information Response* IE in the *HS-DSCH FDD Secondary Serving Information Response* IE in the *Additional HS Cell Information Response* IE in the RADIO LINK RECONFIGURATION RESPONSE message.]
- [FDD – If the *Power Offset For S-CPICH for MIMO Request Indicator* IE is included, the DRNC shall, if supported and MIMO pilot configuration with Primary and Secondary CPICH is set up with a non-zero power offset on the cell where the Secondary Serving HS-DSCH Radio Link is established, include the *Power Offset For S-CPICH for MIMO* IE in the *HS-DSCH FDD Secondary Serving Information Response* IE in the RADIO LINK RECONFIGURATION RESPONSE message. If zero power offset the DRNC may include the *Power Offset For S-CPICH for MIMO* IE.]
- [FDD – If the *Single Stream MIMO Activation Indicator* IE is included in the *HS-DSCH FDD Secondary Serving Information* IE, then the DRNS shall activate the Single Stream MIMO mode for the secondary serving HS-DSCH Radio Link.]
- [FDD – If the *Sixtyfour QAM Usage Allowed Indicator* IE is included in the *HS-DSCH FDD Secondary Serving Information* IE, then the DRNS may if the value is set to “allowed” use 64 QAM for the secondary serving HS-DSCH Radio Link, and the DRNS shall include the *SixtyfourQAM DL Usage Indicator* IE in the *HS-DSCH FDD Secondary Serving Information Response* IE in the *Additional HS Cell Information Response* IE in the RADIO LINK RECONFIGURATION RESPONSE message.]
- [FDD – If the *Sixtyfour QAM Usage Allowed Indicator* IE is included in the *HS-DSCH FDD Secondary Serving Information* IE with value set to “not allowed”, then the DRNS shall not use 64 QAM for the secondary serving HS-DSCH Radio Link.]
- [FDD – If, in the new configuration, the UE context is configured not to use Sixtyfour QAM for the secondary serving HS-DSCH, the DRNS shall include the *HS-DSCH TB Size Table Indicator* IE in the *HS-DSCH FDD Secondary Serving Information Response* IE in the *Additional HS Cell Information Response* IE in the RADIO LINK RECONFIGURATION RESPONSE message if it decides to use the octet aligned table defined in TS 25.321 [41] for secondary serving HS-DSCH Transport Block Size signalling.]

Intra-DRNS Serving HS-DSCH Radio Link Change:

If the RADIO LINK RECONFIGURATION REQUEST message includes the *HS-PDSCH RL ID* IE, this indicates the new Serving HS-DSCH Radio Link:

- The DRNS shall release the HS-PDSCH resources on the old Serving HS-DSCH Radio Link and setup the HS-PDSCH resources on the new Serving HS-DSCH Radio Link.
- If fields are to be included in the User Plane by the SRNC to handle TNL Congestion Control for HSDPA in the DRNS, then the DRNC shall include the *User Plane Congestion Fields Inclusion* IE in the *HS-DSCH Information Response* IE.
- The DRNC may include the *HARQ Memory Partitioning* IE in the [FDD – *HS-DSCH FDD Information Response* IE] [TDD – *HS-DSCH TDD Information Response* IE] in the RADIO LINK RECONFIGURATION RESPONSE message. [FDD – The *HARQ Memory Partitioning* IE may contain the *HARQ Memory Partitioning Information Extension For MIMO* IE.] [1.28Mcps TDD– The *HARQ Memory Partitioning* IE may contain the *HARQ Memory Partitioning Information Extension For MIMO* IE.]

- The DRNC shall allocate a new HS-DSCH-RNTI to the UE Context and include the *HS-DSCH-RNTI* IE in the RADIO LINK RECONFIGURATION RESPONSE message.
- If a reset of the MAC-hs is not required the DRNS shall include the *MAC-hs Reset Indicator* IE in the RADIO LINK RECONFIGURATION RESPONSE message.
- [FDD – The DRNC shall include the *Measurement Power Offset* IE in the *HS-DSCH Information Response* IE in the RADIO LINK RECONFIGURATION RESPONSE message.]
- [FDD – The DRNS shall allocate HS-SCCH codes corresponding to the HS-DSCH and the DRNC shall include the *HS-SCCH Specific Information Response* IE in the *HS-DSCH FDD Information Response* IE in the RADIO LINK RECONFIGURATION RESPONSE message.]
- [TDD – The DRNS shall allocate HS-SCCH parameters corresponding to the HS-DSCH and the DRNC shall include the [3.84Mcps TDD – *HS-SCCH Specific Information Response* IE] [1.28Mcps TDD – *HS-SCCH Specific Information Response LCR* IE] [7.68 Mcps TDD – *HS-SCCH Specific Information Response 7.68 Mcps* IE] in the *HS-DSCH TDD Information Response* IE in the RADIO LINK RECONFIGURATION RESPONSE message.]
- [TDD – The DRNC shall include the [3.84 Mcps TDD – *HS-PDSCH Timeslot Specific Information* IE] [1.28 Mcps TDD – *HS-PDSCH Timeslot Specific Information LCR* IE] [7.68 Mcps TDD – *HS-PDSCH Timeslot Specific Information 7.68 Mcps* IE] in the *HS-DSCH Information Response* IE in the RADIO LINK RECONFIGURATION RESPONSE message.]
- [FDD – The DRNC shall include the *HS-PDSCH And HS-SCCH Scrambling Code* IE in the *HS-DSCH FDD Information Response* IE in the RADIO LINK RECONFIGURATION RESPONSE message.]
- The DRNC may include the *Transport Layer Address* IE and the *Binding ID* IE for HS-DSCH MAC-d flow in the [FDD – *HS-DSCH FDD Information Response* IE] [TDD – *HS-DSCH TDD Information Response* IE] in the RADIO LINK RECONFIGURATION RESPONSE message.
- If the *TNL QoS* IE is included for a MAC-d flow and if ALCAP is not used, the *TNL QoS* IE may be used by the DRNS to determine the transport bearer characteristics to apply in the uplink between the DRNS and the SRNC for the related MAC-d flow.
- [FDD - If the *Sixtyfour QAM Usage Allowed Indicator* IE is included in the *HS-DSCH Information To Modify Unsynchronised* IE and the value is set to "allowed" or if *HS-DSCH Information To Modify Unsynchronised* IE is not included and the UE Context is configured with Sixtyfour QAM allowed for the serving HS-DSCH Radio Link and not used in the current configuration and then if the DRNS decides to use 64 QAM in the new configuration, then it shall include the *SixtyfourQAM DL Usage Indicator* IE in the *HS-DSCH FDD Information Response* IE in the RADIO LINK RECONFIGURATION RESPONSE message.]
- [FDD – If MAC-ehs is applied in the new configuration, and if Sixtyfour QAM will not be used, the DRNS shall include the *HS-DSCH TB Size Table Indicator* IE in the *HS-DSCH FDD Information Response* IE in the RADIO LINK RECONFIGURATION RESPONSE message if it decides to use the octet aligned table defined in TS 25.321 [41] for HS-DSCH Transport Block Size signalling.]
- [FDD – If the power offset for S-CPICH for MIMO Request indicator and MIMO activation indicator have been configured in the new configuration and MIMO pilot configuration with Primary and Secondary CPICH is set up with a non-zero power offset on the cell where the Serving HS-DSCH Radio Link is established, the DRNC shall include the *Power Offset For S-CPICH for MIMO* IE in the *HS-DSCH FDD Information Response* IE in the RADIO LINK RECONFIGURATION RESPONSE message. If zero power offset the DRNC may include the *Power Offset For S-CPICH for MIMO* IE.]

[FDD – Intra-DRNS Secondary Serving HS-DSCH Radio Link Change:]

[FDD – If the RADIO LINK RECONFIGURATION REQUEST message includes the *C-ID* IE in the *Additional HS Cell Information RL Reconf Req* IE and the secondary serving HS-DSCH Radio Link has been configured in the DRNS, the *HS-PDSCH RL ID* IE indicates the new Serving HS-DSCH Radio Link:]

- [FDD – The DRNS shall release the HS-PDSCH resources on the old secondary serving HS-DSCH Radio Link and setup the HS-PDSCH resources on the new secondary serving HS-DSCH Radio Link. The DRNS shall remove the old secondary serving HS-PDSCH Radio Link if no E-DCH resources are allocated to the RL. Non cell specific secondary serving Radio Link and non cell specific secondary serving HS-DSCH parameters take the same values as for the serving HS-DSCH cell.]

- [FDD – The DRNC shall allocate a new HS-DSCH-RNTI to the UE Context and include the *HS-DSCH-RNTI* IE in the *Additional HS Cell Information Response* IE in the RADIO LINK RECONFIGURATION RESPONSE message.]
- [FDD – The DRNC shall include the *Measurement Power Offset* IE in the *HS-DSCH FDD Secondary Serving Information Response* IE in the *Additional HS Cell Information Response* IE in the RADIO LINK RECONFIGURATION RESPONSE message.]
- [FDD – The DRNS shall allocate HS-SCCH codes corresponding to the secondary serving HS-DSCH and the DRNC shall include the *HS-SCCH Specific Secondary Serving Information Response* IE in the *HS-DSCH FDD Secondary Serving Information Response* IE in the *Additional HS Cell Information Response* IE in the RADIO LINK RECONFIGURATION RESPONSE message.]
- [FDD – The DRNC shall include the *HS-PDSCH And HS-SCCH Scrambling Code* IE in the *HS-DSCH FDD Secondary Serving Information Response* IE in the *Additional HS Cell Information Response* IE in the RADIO LINK RECONFIGURATION RESPONSE message.]
- [FDD - If the *Sixtyfour QAM Usage Allowed Indicator* IE is included in the *HS-DSCH FDD Secondary Serving Information To Modify Unsynchronised* IE and the value is set to "allowed" or if *HS-DSCH FDD Secondary Serving Information To Modify Unsynchronised* IE is not included and the UE context is configured with Sixtyfour QAM allowed for the secondary serving HS-DSCH Radio Link and not used in the current configuration and then if the DRNS decides to use 64 QAM for the new secondary serving HS-DSCH Radio Link, then it shall include the *SixtyfourQAM DL Usage Indicator* IE in the *Additional HS Cell Information Response* IE in the RADIO LINK RECONFIGURATION RESPONSE message.]
- [FDD – If, in the new configuration, the UE context is configured not to use Sixtyfour QAM for the secondary serving HS-DSCH, the DRNS shall include the *HS-DSCH TB Size Table Indicator* IE in the *HS-DSCH FDD Secondary Serving Information Response* IE in the *Additional HS Cell Information Response* IE in the RADIO LINK RECONFIGURATION RESPONSE message if it decides to use the octet aligned table defined in TS 25.321 [41] for secondary serving HS-DSCH Transport Block Size signalling.]
- [FDD – If the power offset for S-CPICH for MIMO Request indicator and MIMO activation indicator have been configured in the new configuration and MIMO pilot configuration with Primary and Secondary CPICH is set up with a non-zero power offset on the cell where the Secondary Serving HS-DSCH Radio Link is established, the DRNC shall include the *Power Offset For S-CPICH for MIMO* IE in the *HS-DSCH FDD Secondary Serving Information Response* IE in the RADIO LINK RECONFIGURATION RESPONSE message. If zero power offset the DRNC may include the *Power Offset For S-CPICH for MIMO* IE.]

[FDD – Additional Serving E-DCH Radio Link Change to an existing additional non serving E-DCH RL:]

[FDD – If the RADIO LINK RECONFIGURATION REQUEST message includes the *C-ID* IE in the *Additional HS Cell Information RL Reconf Req* IE and an additional non serving E-DCH RL exists in the cell indicated by the *C-ID* IE, the *HS-PDSCH RL ID* IE in the *HS Cell Information RL Reconf Req* IE indicates the new Additional Serving E-DCH Radio Link.]

- [FDD – If the old Additional Serving E-DCH RL is within this DRNS, the DRNS shall de-allocate the E-AGCH resources of the old Additional Serving E-DCH Radio Link at the activation of the new configuration.]
- [FDD – The DRNS shall allocate a primary E-RNTI identifier or a secondary E-RNTI identifier or both for the new Additional Serving E-DCH Radio Link and include these E-RNTI identifiers along with the channelisation code of the corresponding E-AGCH in the *E-DCH FDD DL Control Channel Information* IE in the *Additional Modified E-DCH FDD Information Response* IE in the *Additional E-DCH Cell Information Response RLReconf* IE in the RADIO LINK RECONFIGURATION RESPONSE message]
- [FDD – The DRNS may include the *Serving Grant Value* IE and *Primary/Secondary Grant Selector* IE in the *E-DCH FDD DL Control Channel Information* IE in the *Additional Modified E-DCH FDD Information Response* IE in the *Additional E-DCH Cell Information Response RLReconf* IE in the RADIO LINK RECONFIGURATION READY message for the initial grant for the Additional serving E-DCH RL and may include the *Default Serving Grant in DTX Cycle 2* IE.]
- [FDD – If the E-DCH HARQ process allocation for 2ms TTI for scheduled transmission shall be changed, the DRNS shall allocate resources according to the new/changed configuration and include the new/changed configuration in the *HARQ Process Allocation For 2ms Scheduled Transmission Grant* IE in the *Additional*

Modified E-DCH FDD Information Response IE in the *Additional E-DCH Cell Information Response RLReconf IE* in the RADIO LINK RECONFIGURATION READY message.]

- [FDD – The DRNS may include the *E-RGCH/E-HICH Channelisation Code IE* and/or the *E-HICH Signature Sequence IE* and/or the *E-RGCH Signature Sequence IE* or may alternatively include the *E-RGCH Release Indicator IE* in the *E-DCH FDD DL Control Channel Information IE* in the *Additional Modified E-DCH FDD Information Response IE* in the *Additional E-DCH Cell Information Response RLReconf IE* in the RADIO LINK RECONFIGURATION RESPONSE message for every E-DCH Radio Link on secondary UL frequency in the DRNS. If the DRNS has no valid data for the *E-RGCH/E-HICH Channelisation Code IE* in the *E-DCH FDD DL Control Channel Information IE* then it shall insert the *E-RGCH and E-HICH Channelisation Code Validity Indicator IE* in the *E-DCH FDD DL Control Channel Information IE*, to indicate that the *E-RGCH/E-HICH Channelisation Code IE* contains invalid data.]

[FDD – Additional Serving E-DCH Radio Link Change to a new RL:]

[FDD – If the RADIO LINK RECONFIGURATION REQUEST message includes the *Additional E-DCH RL Specific Information To Add IE* in the *Additional E-DCH Configuration Change Information IE* in the *Additional E-DCH Cell Information RL Reconf Req IE* and the *C-ID IE* in the *Additional HS Cell Information RL Reconf Req IE* and there is no radio links in the cell indicated by the *C-ID IE* for the UE context, the *HS-PDSCH RL ID IE* indicates the new Additional Serving E-DCH Radio Link on secondary UL frequency.]

- [FDD – If the old Additional Serving E-DCH RL is within this DRNS, the DRNS shall de-allocate the E-AGCH resources of the old Additional Serving E-DCH Radio Link at the activation of the new configuration.]
- [FDD – In the new configuration the DRNS shall allocate the E-DCH resources for the new additional serving E-DCH Radio Link on the secondary UL frequency. Non cell specific E-DCH parameters shall take the same values as for the corresponding cell of the Primary uplink frequency.]
- [FDD – The DRNS shall allocate a primary E-RNTI identifier or a secondary E-RNTI identifier or both for the new Additional Serving E-DCH Radio Link and include these E-RNTI identifiers along with the channelisation code of the corresponding E-AGCH in the *E-DCH FDD DL Control Channel Information IE* in the *Additional E-DCH FDD Information Response IE* in the *Additional E-DCH Cell Information Response RLReconf IE* in the RADIO LINK RECONFIGURATION RESPONSE message.]
- [FDD – The DRNS may include in the *E-DCH FDD DL Control Channel Information IE* in the *Additional E-DCH FDD Information Response IE* in the *Additional E-DCH Cell Information Response RLReconf IE* in the RADIO LINK RECONFIGURATION RESPONSE message the *Serving Grant Value IE* and *Primary/Secondary Grant Selector IE* for the initial grant for the additional serving E-DCH RL and may include the *Default Serving Grant in DTX Cycle 2 IE*]
- [FDD – If the E-DCH HARQ process allocation for 2ms TTI for scheduled transmission shall be changed, the DRNS shall allocate resources according to the new/changed configuration and include the new/changed configuration in the *HARQ Process Allocation For 2ms Scheduled Transmission Grant IE* in the *Additional E-DCH FDD Information Response IE* in the *Additional E-DCH Cell Information Response RLReconf IE* in the RADIO LINK RECONFIGURATION RESPONSE message.]

HS-DSCH Modification:

If the RADIO LINK RECONFIGURATION REQUEST message includes the *HS-DSCH Information To Modify Unsynchronised IE*, then:

- The DRNC shall include the *HS-DSCH Initial Capacity Allocation IE* for each HS-DSCH MAC-d flow being modified for which the establishment of one or several new Priority Queues was requested, if the DRNS allows the SRNC to start the transmission of MAC-d PDUs for the Priority Queue(s) being established before the DRNS has allocated capacity on user plane as described in TS 25.425 [32]. If UE context is configured to use “Flexible MAC-d PDU Size”, then DRNC shall only set in the *HS-DSCH Initial Capacity Allocation IE* the values for the peer of *Scheduling Priority Indicator IE* and *Maximum MAC-d PDU Size Extended IE* to the values of the corresponding peer for the Priority Queue of UE context.
- If the RADIO LINK RECONFIGURATION REQUEST message includes the *Traffic Class IE* in the *HS-DSCH Information To Modify Unsynchronised IE* for a specific HS-DSCH MAC-d flow, the DRNS may use this information to determine the transport bearer characteristics to apply between DRNC and Node B. The DRNC

should ignore the *Traffic Class* IE if the *TrCH Source Statistics Descriptor* IE for this specific HS-DSCH MAC-d flow indicates the value “RRC”.

- If the *TNL QoS* IE is included for a MAC-d flow and if ALCAP is not used, the *TNL QoS* IE may be used by the DRNS to determine the transport bearer characteristics to apply in the uplink between the DRNS and the SRNC for the related MAC-d flow.
- If the RADIO LINK RECONFIGURATION REQUEST message includes the *MAC-hs Guaranteed Bit Rate* IE in the *HS-DSCH Information To Modify Unsynchronised* IE, the DRNS shall use this information to optimise MAC-hs scheduling decisions for the related HSDPA Priority Queue.
- If the RADIO LINK RECONFIGURATION REQUEST message includes the *Discard Timer* IE for a Priority Queue in the *HS-DSCH Information To Modify Unsynchronised* IE, then the DRNS shall use this information to discard out-of-date MAC-hs SDUs from the related HSDPA Priority Queue.
- [FDD – If the RADIO LINK RECONFIGURATION REQUEST message includes the *ACK Power Offset* IE, the *NACK Power Offset* IE or the *CQI Power Offset* IE in the *HS-DSCH Information To Modify Unsynchronised* IE, then the DRNS shall use the indicated ACK Power Offset, the NACK Power Offset or the CQI Power Offset in the new configuration.]
- [FDD – If the *HS-SCCH Power Offset* IE is included in the *HS-DSCH Information To Modify Unsynchronised* IE, the DRNS may use this value to determine the HS-SCCH power. The HS-SCCH Power Offset should be applied for any HS-SCCH transmission to this UE.]
- [TDD – If the RADIO LINK RECONFIGURATION REQUEST message includes the *TDD ACK NACK Power Offset* IE in the *HS-DSCH Information To Modify Unsynchronised* IE, the DRNS shall use the indicated power offset in the new configuration.]
- [FDD – If the RADIO LINK RECONFIGURATION REQUEST message includes the *HARQ Preamble Mode* IE in the *HS-DSCH Information To Modify Unsynchronised* IE, then the DRNS shall use the indicated HARQ Preamble Mode in the new configuration as described in TS 25.214 [10], if HS-DPCCH ACK/NACK preamble and postamble is supported. Then, in this case, if the mode 1 is applied, the DRNC shall include the *HARQ Preamble Mode Activation Indicator* IE in the *HS-DSCH Information Response* IE in the RADIO LINK RECONFIGURATION RESPONSE message. If the *HARQ Preamble Mode* IE is not included or if the mode 0 is applied, then the DRNC shall not include the *HARQ Preamble Mode Activation Indicator* IE in the *HS-DSCH Information Response* IE in the RADIO LINK RECONFIGURATION RESPONSE message.]
- [FDD – If the *MIMO Mode Indicator To Modify* IE is included in the *HS-DSCH Information To Modify Unsynchronised* IE, then]
 - [FDD – The DRNS shall activate/deactivate the MIMO mode for the HS-DSCH Radio Link in the new configuration in accordance with the *MIMO Mode Indicator* IE.]
 - [FDD – If the *MIMO Mode Indicator* IE is set to “Activate”, then the DRNS shall decide the pilot configuration and the UE reporting configuration (N/M ratio) according to TS 25.214 [10] for MIMO and include the *MIMO Information Response* IE in the *HS-DSCH FDD Information Response* IE in the RADIO LINK RECONFIGURATION RESPONSE message.]
 - [FDD – If the *MIMO Mode Indicator* IE is set to “Activate” and *Power Offset For S-CPICH for MIMO Request Indicator* IE is included, the DRNC shall, if supported and MIMO pilot configuration with Primary and Secondary CPICH is set up with a non-zero power offset on the cell where the Serving HS-DSCH Radio Link is established, include the *Power Offset For S-CPICH for MIMO* IE in the *HS-DSCH FDD Information Response* IE. If zero power offset the DRNC may include the *Power Offset For S-CPICH for MIMO* IE.]
- [FDD – The DRNC may include the *HARQ Memory Partitioning* IE in the RADIO LINK RECONFIGURATION RESPONSE message. The *HARQ Memory Partitioning* IE may contain the *HARQ Memory Partitioning Information Extension For MIMO* IE.]
- [FDD – If the *Sixtyfour QAM Usage Allowed Indicator* IE is included in the *HS-DSCH Information To Modify Unsynchronised* IE, then the DRNS may if the value is set to “allowed” use 64 QAM for the HS-DSCH Radio Link, and the DRNS shall include the *Sixtyfour QAM DL Usage Indicator* IE in the *HS-DSCH FDD Information Response* IE in the RADIO LINK RECONFIGURATION RESPONSE message.]

- [FDD – If the *Sixtyfour QAM Usage Allowed Indicator* IE is included in the *HS-DSCH Information To Modify Unsynchronised* IE with value set to “not allowed”, then the DRNS shall not use 64 QAM for the HS-DSCH Radio Link.]
- [FDD – If MAC-ehs is applied in the new configuration, and if Sixtyfour QAM will not be used, the DRNS shall include the *HS-DSCH TB Size Table Indicator* IE in the *HS-DSCH FDD Information Response* IE in the RADIO LINK RECONFIGURATION RESPONSE message if it decides to use the octet aligned table defined in TS 25.321 [41] for HS-DSCH Transport Block Size signalling.]
- [1.28Mcps TDD- If the *MIMO Mode Indicator To Modify* IE is included in the *HS-DSCH Information To Modify Unsynchronised* IE, then]
 - [1.28Mcps TDD- The DRNS shall activate/deactivate the MIMO mode for the HS-DSCH Radio Link in the new configuration in accordance with the *MIMO Mode Indicator* IE.]
 - [1.28 Mcps TDD – If the *MIMO Mode Indicator* IE is set to “Activate”, then the DRNS shall decide the SF mode for HS-PDSCH dual stream and include the *MIMO SF Mode for HS-PDSCH dual stream* IE in the *HS-DSCH TDD Information Response* IE in the RADIO LINK RECONFIGURATION RESPONSE message.]
- [FDD – Any secondary serving HS-DSCH that was applied in the old configuration shall remain in the new configuration unless it is explicitly removed.]
- [FDD – If secondary serving HS-DSCH is applied also in the new configuration, then any changes related to parameters that are common for both the serving and the secondary serving HS-DSCH should be applied also for the secondary serving HS-DSCH.]
- [FDD – If the *UE Support Indicator Extension* IE is included in the *HS-DSCH Information To Modify Unsynchronised* IE the DRNS may use the supported HSDPA functions for this UE.]
- [FDD - If the *UE Support Indicator Extension* IE is included in the *HS-DSCH Information To Modify* IE with the bit *UE DTXDRX related HS-SCCH orders uniform behavior indicator* set to 0, then the DRNS shall, if supported, include the *Support of dynamic DTXDRX related HS-SCCH order* IE in the *HS-DSCH FDD Response* IE in the RADIO LINK RECONFIGURATION RESPONSE message.]
- [FDD – If the *Single Stream MIMO Mode Indicator* IE is included in the *HS-DSCH Information To Modify Unsynchronised* IE, then the DRNS shall activate/deactivate the Single Stream MIMO for the HS-DSCH Radio Link in accordance with the *Single Stream MIMO Mode Indicator* IE.]

[FDD – Secondary Serving HS-DSCH Modification:]

[FDD – If the RADIO LINK RECONFIGURATION REQUEST message includes the *HS-DSCH FDD Secondary Serving Information To Modify Unsynchronised* IE in the *Additional HS Cell Information RL Reconf Req* IE, then:]

- [FDD – If the *HS-SCCH Power Offset* IE is included in the *HS-DSCH FDD Secondary Serving Information To Modify Unsynchronised* IE, the DRNS may use this value to determine the HS-SCCH power. The HS-SCCH Power Offset should be applied for any secondary serving HS-SCCH transmission to this UE.]
- [FDD – If the *MIMO Mode Indicator* IE is included in the *HS-DSCH FDD Secondary Serving Information To Modify Unsynchronised* IE, then the DRNS shall activate/deactivate the MIMO mode for the secondary serving HS-DSCH Radio Link in accordance with the *MIMO Mode Indicator* IE.]
- [FDD – If the *MIMO Mode Indicator* IE is set to “Activate”, then the DRNS shall decide the pilot configuration and the UE reporting configuration (N/M ratio) according to TS 25.214 [10] for MIMO and include the *MIMO Information Response* IE in the *HS-DSCH FDD Secondary Serving Information Response* IE in the *Additional HS Cell Information Response* IE in the RADIO LINK RECONFIGURATION RESPONSE message.]
- [FDD – If the *MIMO Mode Indicator* IE is set to “Activate” and *Power Offset For S-CPICH for MIMO Request Indicator* IE is included, the DRNC shall, if supported and MIMO pilot configuration with Primary and Secondary CPICH is set up with a non-zero power offset on the cell where the Secondary Serving HS-DSCH Radio Link is established, include the *Power Offset For S-CPICH for MIMO* IE in the *HS-DSCH FDD Secondary Serving Information Response* IE in the RADIO LINK RECONFIGURATION RESPONSE message. If zero power offset the DRNC may include the *Power Offset For S-CPICH for MIMO* IE.]
- [FDD – If the *Single Stream MIMO Mode Indicator* IE is included in the *HS-DSCH FDD Secondary Serving Information To Modify Unsynchronised* IE, then the Node B shall activate/deactivate the Single Stream MIMO

mode for the secondary serving HS-DSCH Radio Link in accordance with the *Single Stream MIMO Mode Indicator* IE.]

- [FDD – If the *Sixtyfour QAM Usage Allowed Indicator* IE is included in the *HS-DSCH FDD Secondary Serving Information To Modify Unsynchronised* IE, then the DRNS may if the value is set to “allowed” use 64 QAM for the secondary serving HS-DSCH Radio Link, and the DRNS shall include the *SixtyfourQAM DL Usage Indicator* IE in the *HS-DSCH FDD Secondary Serving Information Response* IE in the *Additional HS Cell Information Response* IE in the RADIO LINK RECONFIGURATION RESPONSE message.]
- [FDD – If the *Sixtyfour QAM Usage Allowed Indicator* IE is included in the *HS-DSCH FDD Secondary Serving Information To Modify Unsynchronised* IE with value set to “not allowed”, then the DRNS shall not use 64 QAM for the secondary serving HS-DSCH Radio Link.]
- [FDD – If, in the new configuration, the UE context is configured to use the “Flexible MAC-d PDU Size” format and if Sixtyfour QAM will not be used for the secondary serving HS-DSCH, then the DRNS shall include the *HS-DSCH TB Size Table Indicator* IE in the *HS-DSCH FDD Secondary Serving Information Response* IE in the *Additional HS Cell Information Response* IE in the RADIO LINK RECONFIGURATION RESPONSE message if it decides to use the octet aligned table defined in TS 25.321 [41] for secondary serving HS-DSCH Transport Block Size signalling.]

[FDD – Secondary Serving HS-DSCH Removal:]

[FDD – If the RADIO LINK RECONFIGURATION REQUEST message includes the *HS-DSCH Secondary Serving Remove* IE in the *Additional HS Cell Information RL Reconf Req* IE, then the indicated secondary serving HS-DSCH Radio Link shall be removed.]

HS-DSCH MAC-d Flow Addition/Deletion:

If the RADIO LINK RECONFIGURATION REQUEST message includes any *HS-DSCH MAC-d Flows To Add* or *HS-DSCH MAC-d Flows To Delete* IEs, then the DRNS shall use this information to add/delete the indicated HS-DSCH MAC-d flows on the Serving HS-DSCH Radio Link. When an HS-DSCH MAC-d flow is deleted, all its associated Priority Queues shall also be removed.

If the RADIO LINK RECONFIGURATION REQUEST message includes an *HS-DSCH MAC-d Flows To Delete* IE requesting the deletion of all remaining HS-DSCH MAC-d flows for the UE Context, then the DRNC shall delete the HS-DSCH configuration from the UE Context and release the HS-PDSCH resources.

If the RADIO LINK RECONFIGURATION REQUEST message includes the *HS-DSCH MAC-d Flows To Add* IE, then:

- The DRNS may use the Traffic Class IE for a specific HS-DSCH MAC-d flow to determine the transport bearer characteristics to apply between DRNC and Node B. If TrCH Source Statistics Descriptor IE is present with the value “RRC” in the HS-DSCH MAC-d Flows Information IE, then the DRNC should ignore the Traffic Class IE.
- If the TNL QoS IE is included for a MAC-d flow and if ALCAP is not used, the TNL QoS IE may be used by the DRNS to determine the transport bearer characteristics to apply in the uplink between the DRNS and the SRNC for the related MAC-d flow.
- The DRNC shall include the HS-DSCH Initial Capacity Allocation IE in the RADIO LINK RECONFIGURATION RESPONSE message for every HS-DSCH MAC-d flow being added, if the DRNS allows the SRNC to start transmission of MAC-d PDUs before the DRNS has allocated capacity on user plane as described in TS 25.425 [32]. If the UE context is configured to use the “Flexible MAC-d PDU Size” format for the HS-DSCH, then DRNC shall only set in the HS-DSCH Initial Capacity Allocation IE the values for the peer of Scheduling Priority Indicator IE and Maximum MAC-d PDU Size Extended IE to the values of the corresponding peer I in RADIO LINK RECONFIGURATION REQUEST message in the HS-DSCH MAC-d Flows To Add IE for a Priority Queue including Scheduling Priority Indicator IE and Maximum MAC-d PDU Size Extended IE
- If the RADIO LINK RECONFIGURATION REQUEST message includes the MAC-hs Guaranteed Bit Rate IE in the HS-DSCH MAC-d Flows To Add IE, the DRNS shall use this information to optimise MAC-hs scheduling decisions for the related HSDPA Priority Queue.
- If the RADIO LINK RECONFIGURATION REQUEST message includes the Maximum MAC-d PDU Size Extended IE for a Priority Queue in the HS-DSCH MAC-d Flows To Add IE, then the DRNC shall ignore the

SID IE and MAC-d PDU Size IE in the MAC-d PDU Size Index IE and use Maximum MAC-d PDU Size Extended IE to optimise capacity allocation for the related HSDPA Priority Queue.

- If the RADIO LINK RECONFIGURATION REQUEST message includes DL RLC PDU Size Format IE for a Priority Queue in the HS-DSCH MAC-d Flows To Add IE, the DL RLC PDU Size Format IE may be used by the DRNS to determine the allocated capacity on user plane as described in TS 25.425 [32].
- [FDD – FDD – If the RADIO LINK RECONFIGURATION REQUEST message includes the *UE Aggregate Maximum Bit Rate Enforcement Indicator* IE for a Priority Queue in the *HS-DSCH MAC-d Flows To Add* IE, the DRNS shall, if supported, consider the data of the related HSDPA Priority Queue for UE Aggregate Maximum Bit Rate Enforcement.]

If the RADIO LINK RECONFIGURATION REQUEST message includes the *Discard Timer* IE for a Priority Queue in the *HS-DSCH MAC-d Flows To Add* IE, then the DRNS shall use this information to discard out-of-date MAC-hs SDUs from the related HSDPA Priority Queue.

[FDD – HS-DSCH Preconfiguration for Enhanced HS Serving Cell Change]

[FDD – If the RADIO LINK RECONFIGURATION REQUEST message includes the *HS-DSCH Preconfiguration Setup* IE in the *RL Information* IE the DRNS shall, if supported, preconfigure the indicated cells for Enhanced HS Serving Cell Change according to TS 25.308 [63]:]

- [FDD – The DRNS shall preconfigure sets of HS-SCCH codes on the cells preconfigured for HS-DSCH, primary serving HS-DSCH cell, as well as on the secondary serving HS-DSCH cells. The primary serving HS-DSCH cell is designated through the *C-ID* IE part of the *RL Information* IE in the RADIO LINK RECONFIGURATION REQUEST message. The list of secondary serving HS-DSCH cells is designated by the list of *Secondary C-ID* IEs in the *HS-DSCH Preconfiguration Setup* IE part of the *RL Information* IE in the RADIO LINK RECONFIGURATION REQUEST message.]
- [FDD – The number of HS-SCCH codes to preconfigure for each cell may be optionally specified:]
 - [FDD – by the *Num Primary HS-SCCH Codes* IE in the *HS-DSCH Preconfiguration Setup* IE, for the primary serving HS-DSCH cell.]
 - [FDD – by the *Num Secondary HS-SCCH Codes* IE in the *Secondary Cells* IE in the *HS-DSCH Preconfiguration Setup* IE for each of the secondary serving HS-DSCH cells.]
- [FDD – If *Num Primary HS-SCCH Codes* IE or *Num Secondary HS-SCCH Codes* IE is not included in the message the number and distribution of codes on primary and any secondary cells shall be preconfigured to satisfy any limitations in TS 25.214 [10].]
- [FDD – The DRNS shall return these codes in the *Sets of HS-SCCH Codes* IE along with the corresponding per-cell *HS-DSCH-RNTI* IE in the *HS-DSCH Preconfiguration Info* IE in the *RL Information Response* IE of the RADIO LINK RECONFIGURATION RESPONSE.]
- [FDD – The DRNS shall use the first in the numbered list the primary serving HS-DSCH cell's of HS-SCCH codes in the *HS-SCCH Preconfigured Codes* IE sent to the SRNC to signal the Target Cell HS-SCCH Order defined in ITU-T Rec. X.680 [18].]
- [FDD – The DRNS shall include, in the *HS-DSCH Preconfiguration Info* IE in the *RL Information Response* IE in the RADIO LINK RECONFIGURATION RESPONSE message, IEs according to the rules defined for HS-DSCH Setup at Serving HS-DSCH Radio Link Change and:]
 - [FDD – if *HARQ Preamble Mode* IE is included in the *HS-DSCH Preconfiguration Setup* IE the HARQ Preamble Mode Activation Indicator IE.]
 - [FDD – if *MIMO Activation Indicator* IE is included in the *HS-DSCH Preconfiguration Setup* IE the *MIMO N/M Ratio* IE.]
 - [FDD – if *HS-DSCH MAC-d PDU Size Format* IE is included in the *HS-DSCH Preconfiguration Setup* IE and set to "Flexible MAC-d PDU Size" and if Sixtyfour QAM will not be used for the cell in the preconfiguration the *HS-DSCH TB Size Table Indicator* IE for each preconfigured cell.]

- [FDD – if *Sixtyfour QAM Usage Allowed Indicator* IE is included in the *Secondary Cells* IE in the *HS-DSCH Preconfiguration Setup* IE or in the *HS-DSCH Preconfiguration Setup* IE the *SixtyfourQAM DL Usage Indicator* IE for each preconfigured cell.]
- [FDD – if *Continuous Packet Connectivity HS-SCCH less Information* IE is included in the *HS-DSCH Preconfiguration Setup* IE the *Continuous Packet Connectivity HS-SCCH less Information Response* IE.]
- [FDD – if the *UE with enhanced HS-SCCH support indicator* IE is included in the *HS-DSCH Preconfiguration Setup* IE, then the DRNS shall store this information in the preconfigured configuration.]
- [FDD – the *SixtyfourQAM DL Support Indicator* IE may be included.]
- [FDD – If the *UE Support Indicator Extension* IE is included in the *HS-DSCH Preconfiguration Setup* IE, then the DRNS may store this information in the preconfigured configuration.]
- [FDD - If the *UE Support Indicator Extension* IE is included in the *HS-DSCH Preconfiguration Setup* IE with the bit *UE DTXDRX related HS-SCCH orders uniform behavior indicator* set to 0, then the DRNS shall, if supported, include the *Support of dynamic DTXDRX related HS-SCCH order* IE in the *Preconfiguration Info* IE in the RADIO LINK RECONFIGURATION RESPONSE message.]
- [FDD – the DRNS shall, if supported, include in the *Sets of HS-SCCH Codes* IE the *Measurement Power Offset* IE for each preconfigured cell.]
- [FDD – The DRNS shall include in the *HS-DSCH Preconfiguration Info* IE in the *RL Information Response* IE in the RADIO LINK RECONFIGURATION RESPONSE message the *E-DCH FDD DL Control Channel Information* containing the preconfigured configuration of the E-DCH serving cell according to the rules defined for Serving E-DCH Radio Link Change as follows:
 - [FDD – The DRNS shall allocate for the preconfigured configuration a primary E-RNTI identifier or a secondary E-RNTI identifier or both for the new Serving E-DCH Radio Link and include these E-RNTI identifiers along with the channelisation code of the corresponding E-AGCH in the *E-DCH FDD DL Control Channel Information* IE.]
 - [FDD – The DRNS may preconfigure the *Serving Grant Value* IE and *Primary/Secondary Grant Selector* IE for the initial grant for the serving E-DCH RL and include these values in the *E-DCH FDD DL Control Channel Information* IE.]
- [FDD – If the *Power Offset For S-CPICH for MIMO Request Indicator* IE is included in the *HS-DSCH Preconfiguration Setup* IE or in the *Secondary Cells* IE in the *HS-DSCH Preconfiguration Setup* IE, the DRNC shall, if supported and MIMO pilot configuration with Primary and Secondary CPICH is set up on the cell with a non-zero power offset where HS-DSCH / secondary HS-DSCH is preconfigured, include the *Power Offset For S-CPICH for MIMO* IE in the *HS-DSCH Preconfiguration Info* IE or in the *Sets of HS-SCCH Codes* IE in the *HS-DSCH Preconfiguration Info* IE for each preconfigured cell in the RADIO LINK RECONFIGURATION RESPONSE message. If zero power offset the DRNC may include the *Power Offset For S-CPICH for MIMO* IE.]

[FDD – If the RADIO LINK RECONFIGURATION REQUEST message includes the *Non-Serving RL Preconfiguration Setup* IE in the *RL Information* IE and:]

- [FDD – if the choice of *new Serving RL* is "New Serving RL in the DRNS", the DRNC may include the *New non-serving RL E-DCH FDD DL Control Channel Information A* IE and/or *New non-serving RL E-DCH FDD DL Control Channel Information B* IE in the *Non-Serving RL Preconfiguration Info* IE for the RL in the RADIO LINK RECONFIGURATION RESPONSE message.]
- [FDD – if the choice of *new Serving RL* is "New Serving RL Not in the DRNS", the DRNC may include the *New non-serving RL E-DCH FDD DL Control Channel Information C* IE in the *Non-Serving RL Preconfiguration Info* IE for the RL in the RADIO LINK RECONFIGURATION RESPONSE message.]
- [FDD – if the choice of *new Serving RL* is "New Serving RL in the DRNS or New Serving RL Not in the DRNS", the DRNC may include the *New non-serving RL E-DCH FDD DL Control Channel Information A* IE, the *New non-serving RL E-DCH FDD DL Control Channel Information B* IE and/or the *New non-serving RL E-DCH FDD DL Control Channel Information C* for the RL in the *Non-Serving RL Preconfiguration Info* IE in the RADIO LINK RECONFIGURATION RESPONSE message.]

- [FDD – if the *Additional E-DCH Non-Serving RL Preconfiguration Setup* IE is included, the DRNC may include the *New non-serving RL E-DCH FDD DL Control Channel Information A* IE, the *New non-serving RL E-DCH FDD DL Control Channel Information B* IE and/or the *New non-serving RL E-DCH FDD DL Control Channel Information C* IE according to the choice of new Serving RL in *Additional E-DCH New non-serving RL E-DCH FDD DL Control Channel Information* IE for the additional non serving E-DCH RL in the *Non-Serving RL Preconfiguration Info* IE in the RADIO LINK RECONFIGURATION RESPONSE message.]

[FDD – Enhanced HS Serving Cell Change:]

[FDD – Upon receipt of the RADIO LINK RECONFIGURATION REQUEST message, if the Enhanced HS Serving Cell Change is preconfigured in the DRNS for the UE context, the DRNS may execute the Enhanced HS Serving Cell Change procedure according to TS 25.308 [63]

[FDD – If the RADIO LINK RECONFIGURATION REQUEST message includes the *Enhanced HS Serving CC Abort* IE in the *HS-DSCH Information To Modify Unsynchronised* IE or the *HS-DSCH FDD Information* IE then the DRNS shall not execute the unsynchronized Enhanced HS Serving Cell Change procedure when performing the Serving HS-DSCH Radio Link Change or the HS-DSCH Setup.]

[FDD – If the RADIO LINK RECONFIGURATION REQUEST message includes the *No of Target Cell HS-SCCH Order* IE then the DRNS shall repeat the Target Cell HS-SCCH Order on the HS-SCCH the number of times defined in the IE.]

[FDD - If the RADIO LINK RECONFIGURATION REQUEST message includes the *Non-Serving RL Preconfiguration Removal* IE, the DRNC shall remove the corresponding preconfigured E-DCH DL Control Channel Information according to the information.]

[FDD – E-DCH Setup:]

[FDD – If the *E-DCH FDD Information* IE is present in the RADIO LINK RECONFIGURATION REQUEST message then:]

- [FDD – If the RADIO LINK RECONFIGURATION REQUEST message includes the *MAC-es Guaranteed Bit Rate* IE in the *E-DCH Logical Channel information* IE in the *E-DCH FDD Information* IE, then the DRNS shall use this information to optimise MAC-e scheduling decisions.]
- [FDD – If the RADIO LINK RECONFIGURATION REQUEST message includes *UE Aggregate Maximum Bit Rate Enforcement Indicator* IE in the *E-DCH Logical Channel Information* IE in the *E-DCH FDD Information* IE, the DRNS shall, if supported, consider the data of the related E-DCH Logical Channel for UE Aggregate Maximum Bit Rate Enforcement.]
- [FDD – If the RADIO LINK RECONFIGURATION REQUEST message includes the *Maximum MAC-d PDU Size Extended* IE for a E-DCH Logical Channel in the *E-DCH MAC-d Flows Information* IE in the *E-DCH Information* IE, then the DRNS shall ignore the *MAC-d PDU Size* IE in the *MAC-d PDU Size List* IE and use *Maximum MAC-d PDU Size Extended* IE to optimise capacity allocation for the related E-DCH Logical Channel and use the indicated format in user plane frame structure for E-DCH channels TS 25.425 [32] and MAC TS 25.321 [41].]
- [FDD – If the RADIO LINK RECONFIGURATION REQUEST message includes the *E-DCH MAC-d Flow Multiplexing List* IE for an E-DCH MAC-d flow the DRNS shall use this information for the related resource allocation operation.]
- [FDD – If the RADIO LINK RECONFIGURATION REQUEST message includes the *HARQ Process Allocation For 2ms Scheduled Transmission Grant* IE, the DRNS shall use this information for the related resource allocation operation.]
- [FDD – If in the RADIO LINK RECONFIGURATION REQUEST message the E-DCH Grant Type is indicated as being “E-DCH Non-Scheduled Transmission Grant” for an E-DCH MAC-d flow the DRNS shall assume non-scheduled grants being configured for that E-DCH MAC-d flow and shall use the information within the *HARQ Process Allocation For 2ms Non-Scheduled Transmission Grant* IE, if included, for the related resource allocation operation.]
- [FDD – If in the RADIO LINK RECONFIGURATION REQUEST message the E-DCH Grant Type is indicated as being “E-DCH Scheduled Transmission Grant” for an E-DCH MAC-d flow the DRNS shall assume scheduled grants being configured for that E-DCH MAC-d flow.]

- [FDD – The DRNS may use the *Traffic Class* IE for a specific E-DCH MAC-d flow to determine the transport bearer characteristics to apply between DRNC and Node B. If *TrCH Source Statistics Descriptor* IE is present with the value “RRC” in the *E-DCH MAC-d Flows Information* IE, then the DRNC should ignore the *Traffic Class* IE.]
- [FDD – If the *TNL QoS* IE is included for an E-DCH MAC-d flow and if ALCAP is not used, the *TNL QoS* IE may be used by the DRNS to determine the transport bearer characteristics to apply in the uplink for the related MAC-d flow.]
- [FDD – If the RADIO LINK RECONFIGURATION REQUEST message includes the *Bundling Mode Indicator* IE for a E-DCH MAC-d flow in the *E-DCH MAC-d Flow Specific Information* IE in the *E-DCH FDD Information* IE and the *Bundling Mode Indicator* IE is set to “Bundling” and the *E-TTI* IE is set to “2ms”, then the DRNS shall use the bundling mode for the E-DCH UL data frames for the related Mac-d flow, otherwise the DRNS shall use the non-bundling mode for the E-DCH UL data frames for the related Mac-d flow.]
- [FDD – If the RADIO LINK RECONFIGURATION REQUEST message includes the *E-DCH Maximum Bitrate* IE for an E-DCH, the DRNS shall use this information for the related resource allocation operation, and when applicable, for E-DCH scheduling.]
- [FDD – If the RADIO LINK RECONFIGURATION REQUEST message includes the *E-DCH Processing Overload Level* IE, then if the DRNS could not decode the E-DPCCH/E-DPDCH for the last consecutive number of TTIs, indicated in the *E-DCH Processing Overload Level* IE, because of processing issue, the DRNS shall notify the SRNC by initiating the Radio Link Failure procedure.]
- [FDD – If the RADIO LINK RECONFIGURATION REQUEST message includes the *E-DCH ReferencePower Offset* IE, then the DRNS may use this value as a default HARQ power offset if it is not able to decode the MAC-e PDU and to determine the value of the actual HARQ power offset.]
- [FDD – If the RADIO LINK RECONFIGURATION REQUEST message includes the *E-DCH Power Offset for Scheduling Info* IE, then the DRNS shall use this value as a power offset for the transmission of scheduling information without any MAC-d PDUs.]
- [FDD – If the RADIO LINK RECONFIGURATION REQUEST message includes the *E-AGCH Power Offset* IE in the *RL Specific E-DCH Information* IE, then the DRNS may use this value to determine the E-AGCH power. The E-AGCH Power Offset should be applied for any E-AGCH transmission to this UE.]
- [FDD – If the RADIO LINK RECONFIGURATION REQUEST message includes the *E-RGCH Power Offset* IE in the *RL Specific E-DCH Information* IE, then the DRNS may use this value to determine the E-RGCH power for the RL. The E-RGCH Power Offset should be applied for any E-RGCH transmission to this UE.]
- [FDD – If the RADIO LINK RECONFIGURATION REQUEST message includes the *E-HICH Power Offset* IE in the *RL Specific E-DCH Information* IE, then the DRNS may use this value to determine the E-HICH power for the RL. The E-HICH Power Offset should be applied for any E-HICH transmission to this UE.]
- [FDD – If the RADIO LINK RECONFIGURATION REQUEST message includes an *E-DPCH Information* IE which contains the *HS-DSCH Configured Indicator* IE and/or the *Maximum Set of E-DPDCHs* IE, and/or the *Puncture Limit* IE and/or the *E-TTI* IE, the DRNS shall use and apply the value(s) in the new configuration.]
- [FDD – If the RADIO LINK RECONFIGURATION REQUEST message includes the *SixteenQAM UL Operation Indicator* IE, the DRNS shall activate/deactivate SixteenQAM UL Operation for the RL in accordance with the *SixteenQAM UL Operation Indicator* IE.]
 - [FDD – If SixteenQAM UL Operation is activated, then the DRNS shall base the handling of the Relative Grant signalling on Scheduling Grant Table 2 according to TS 25.321 [41]. If SixteenQAM UL Operation is deactivated, then the DRNS shall base the handling of the Relative Grant signalling on Scheduling Grant Table 1 according to TS 25.321 [41].]

[FDD – E-DCH Radio Link Handling:]

[FDD – If the RADIO LINK RECONFIGURATION REQUEST message includes the *E-DCH RL Indication* IE in the *RL Information* IE:]

- [FDD – The DRNC shall setup the E-DCH resources, as requested or as configured in the UE context, on the Radio Links indicated by the *E-DCH RL Indication* IE, set to “E-DCH”, in the *RL Information* IE.]

- [FDD – The DRNC may include the *E-AGCH And E-RGCH/E-HICH FDD Scrambling Code* IE and shall include the *E-RGCH/E-HICH Channelisation Code* IE and the corresponding *E-HICH Signature Sequence* IE and the DRNC may include the corresponding *E-RGCH Signature Sequence* IE in the *E-DCH FDD DL Control Channel Information* IE in the RADIO LINK RECONFIGURATION RESPONSE message for every RL indicated by the *E-DCH RL Indication* IE, set to “E-DCH”, in the *RL Information* IE.]
- [FDD – The DRNC shall remove the E-DCH resources, if any, on the Radio Links, that are indicated by the *E-DCH RL Indication* set to “Non E-DCH”.]
- [FDD – For each RL for which the *E-DCH RL Indication* IE is set to “E-DCH”, and which has or can have a common generation of E-RGCH information with another RL (current or future) when the DRNS would contain the E-DCH serving RL, the DRNS shall include the *E-DCH RL Set ID* IE in the RADIO LINK RECONFIGURATION RESPONSE message. The value of the *E-DCH RL Set ID* IE shall allow the SRNC to identify the E-DCH RLs that have or can have a common generation of E-RGCH information.]

[FDD – Serving E-DCH Radio Link Change:]

[FDD – If the RADIO LINK RECONFIGURATION REQUEST message includes the *Serving E-DCH RL* IE, this indicates the new Serving E-DCH Radio Link:]

- [FDD – If the old Serving E-DCH RL is within this DRNS, the DRNS shall de-allocate the E-AGCH resources of the old Serving E-DCH Radio Link.]
- [FDD – If the new Serving E-DCH RL is within this DRNS:]
 - [FDD – The DRNS shall allocate a primary E-RNTI identifier or a secondary E-RNTI identifier or both for the new Serving E-DCH Radio Link and include these E-RNTI identifiers along with the channelisation code of the corresponding E-AGCH in the *E-DCH FDD DL Control Channel Information* IE in the *RL Information Response* IE for the indicated RL in the RADIO LINK RECONFIGURATION RESPONSE message.]
 - [FDD – The DRNS may include the *Serving Grant Value* IE and *Primary/Secondary Grant Selector* IE in the RADIO LINK RECONFIGURATION RESPONSE message for the initial grant for the new serving E-DCH RL.]
 - [FDD – If the E-DCH HARQ process allocation for 2ms TTI for scheduled and/or non-scheduled transmission shall be changed, the DRNS shall allocate resources according to the new/changed configuration and include the new/changed configuration in the *E-DCH FDD Information Response* IE in the RADIO LINK RECONFIGURATION RESPONSE message.]
 - [FDD – If a serving cell change is performed the RADIO LINK RECONFIGURATION RESPONSE message may contain invalid data (see 9.2.2.4C).]
 - [FDD – The DRNS may include the *Default Serving Grant in DTX Cycle 2* IE in the RADIO LINK RECONFIGURATION RESPONSE message for the new serving E-DCH RL.]
- [FDD – The DRNS may include the *E-RGCH/E-HICH Channelisation Code* IE and/or the *E-HICH Signature Sequence* IE and/or the *E-RGCH Signature Sequence* IE or may alternatively include the *E-RGCH Release Indicator* IE in the *E-DCH FDD DL Control Channel Information* IE in the RADIO LINK RECONFIGURATION RESPONSE message for every E-DCH Radio Links in the DRNS.]
- [FDD – If the DRNS has no valid data for the *E-RGCH/E-HICH Channelisation Code* IE in the *E-DCH FDD DL Control Channel Information* IE in the RADIO LINK RECONFIGURATION RESPONSE message, then it shall insert the *E-RGCH and E-HICH Channelisation Code Validity Indicator* IE in the *E-DCH FDD DL Control Channel Information* IE, to indicate that the *E-RGCH/E-HICH Channelisation Code* IE contains invalid data.]

[FDD – E-DCH Modification:]

[FDD – If the RADIO LINK RECONFIGURATION REQUEST message includes the *E-DCH FDD Information To Modify* IE, then:]

- [FDD – If the *E-DCH FDD Information To Modify* IE contains a *E-DCH MAC-d Flow Specific Information* IE which includes the *Allocation/Retention Priority* IE, the DRNS shall apply the new Allocation/Retention Priority to this E-DCH in the new configuration according to Annex A.]

- [FDD – If the *TNL QoS* IE is included for an E-DCH MAC-d flow and if ALCAP is not used, the *TNL QoS* IE may be used by the DRNS to determine the transport bearer characteristics to apply in the uplink for the related MAC-d flow.]
- [FDD – If *Traffic Class* IE is included for an E-DCH MAC-d flow the DRNS may use the *Traffic Class* IE for a specific E-DCH MAC-d flow to determine the transport bearer characteristics to apply between DRNC and Node B. The DRNC should ignore the *Traffic Class* IE if the *TrCH Source Statistics Descriptor* IE for this specific E-DCH MAC-d flow indicates the value “RRC”.]
- [FDD – If the RADIO LINK RECONFIGURATION REQUEST message includes the *Data Description Indicator* IE, the DRNC shall use the DDI values indicated in the *Data Description Indicator* IE in the new configuration.]
- [FDD – If the RADIO LINK RECONFIGURATION REQUEST message includes the *MAC-es Guaranteed Bit Rate* IE in the *E-DCH FDD Information To Modify* IE, the DRNS shall use this information to optimise MAC-e scheduling decisions.]
- [FDD – If the RADIO LINK RECONFIGURATION REQUEST message includes the *Maximum Number of Retransmissions for E-DCH* IE for an E-DCH MAC-d flow in the *E-DCH FDD Information To Modify* IE, then the DRNS shall use this information to report if the maximum number of retransmissions has been exceeded.]
- [FDD – If the RADIO LINK RECONFIGURATION REQUEST message includes the *E-DCH HARQ Power Offset FDD* IE in the *E-DCH FDD Information To Modify* IE for an E-DCH MAC-d flow the DRNS shall use this information for calculating the unquantised gain factor for an E-TFC ($\beta_{ed,j,uq}$) as defined in TS 25.214 [10].]
- [FDD – If the RADIO LINK RECONFIGURATION REQUEST message includes the *E-DCH MAC-d Flow Multiplexing List* IE for an E-DCH MAC-d flow the DRNS shall use this information for the related resource allocation operation.]
- [FDD – If the RADIO LINK RECONFIGURATION REQUEST message includes the E-DCH Grant Type and it is indicated as being “E-DCH Non-Scheduled Transmission Grant” for an E-DCH MAC-d flow the DRNS shall assume non-scheduled grants being configured for that E-DCH MAC-d flow and shall use the information within the *HARQ Process Allocation For 2ms Non-Scheduled Transmission Grant* IE, if included, for the related resource allocation operation.]
- [FDD – If the RADIO LINK RECONFIGURATION REQUEST message includes the E-DCH Grant Type and it is indicated as being “E-DCH Scheduled Transmission Grant” for an E-DCH MAC-d flow the DRNS shall assume scheduled grants being configured for that E-DCH MAC-d flow.]
- [FDD – If the RADIO LINK RECONFIGURATION REQUEST message includes the *E-DCH Logical Channel To Add* or *E-DCH Logical Channel To Delete* IEs, the DRNS shall use this information to add/delete the indicated logical channels. When an logical channel is deleted, all its associated configuration data shall also be removed.]
- [FDD – If the RADIO LINK RECONFIGURATION REQUEST message includes the *E-DCH Logical Channel To Modify* IE, the DRNS shall use this information to modify the indicated logical channels.]
 - [FDD – If the *E-DCH Logical Channel To Modify* IE includes *Scheduling Priority Indicator* IE, the DRNS shall apply the values in the new configuration.]
 - [FDD – If the *E-DCH Logical Channel To Modify* IE includes *Scheduling Information* IE, the DRNS shall apply the values in the new configuration.]
 - [FDD – If the *E-DCH Logical Channel To Modify* IE includes the *Maximum MAC-d PDU Size Extended* IE, the DRNC shall apply the value in the new configuration.]
- [FDD – If the RADIO LINK RECONFIGURATION REQUEST message includes the *Bundling Mode Indicator* IE for an E-DCH MAC-d flow in the *E-DCH MAC-d Flow Specific Information* IE in the *E-DCH FDD Information To Modify* IE and the *Bundling Mode Indicator* IE is set to “Bundling” and the *E-TTI* IE is set to “2ms”, then the DRNS shall use the bundling mode for the E-DCH UL data frames for the related MAC-d flow, otherwise the DRNS shall use the non-bundling mode for the E-DCH UL data frames for the related MAC-d flow.]

- [FDD – If the RADIO LINK RECONFIGURATION REQUEST message includes the *HARQ Process Allocation For 2ms Scheduled Transmission Grant IE*, the DRNS shall use this information for the related resource allocation operation.]
- [FDD – If the E-DCH serving RL is in this DRNS, the DRNS may choose to change the E-DCH HARQ process allocation for 2ms TTI for scheduled and/or non-scheduled transmission. In this case the DRNS shall allocate resources according to the new/changed configuration and include the new/changed configuration in the *E-DCH FDD Information Response IE* in the RADIO LINK RECONFIGURATION RESPONSE message.]
- [FDD – If the RADIO LINK RECONFIGURATION REQUEST message includes the *E-DCH Maximum Bitrate IE* for an E-DCH, the DRNS shall use this information for the related resource allocation operation, and when applicable, for E-DCH scheduling.]
- [FDD – If the RADIO LINK RECONFIGURATION REQUEST message includes the *E-DCH Processing Overload Level IE*, then if the DRNS could not decode the E-DPCCH/E-DPDCH for the last consecutive number of TTIs, indicated in the *E-DCH Processing Overload Level IE*, because of processing issue, the DRNS shall notify the SRNC by initiating the Radio Link Failure procedure.]
- [FDD – If the RADIO LINK RECONFIGURATION REQUEST message includes the *E-DCH ReferencePower Offset IE*, then the DRNS may use this value as a default HARQ power offset if it is not able to decode the MAC-e PDU and to determine the value of the actual HARQ power offset.]
- [FDD – If the RADIO LINK RECONFIGURATION REQUEST message includes the *E-AGCH Power Offset IE* in the *RL Specific E-DCH Information IE*, then the DRNS may use this value to determine the E-AGCH power. The E-AGCH Power Offset should be applied for any E-AGCH transmission to this UE.]
- [FDD – If the RADIO LINK RECONFIGURATION REQUEST message includes the *E-RGCH Power Offset IE* in the *RL Specific E-DCH Information IE*, then the DRNS may use this value to determine the E-RGCH power for the RL. The E-RGCH Power Offset should be applied for any E-RGCH transmission to this UE.]
- [FDD – If the RADIO LINK RECONFIGURATION REQUEST message includes the *E-HICH Power Offset IE* in the *RL Specific E-DCH Information IE*, then the DRNS may use this value to determine the E-HICH power for the RL. The E-HICH Power Offset should be applied for any E-HICH transmission to this UE.]
- [FDD – If the RADIO LINK RECONFIGURATION REQUEST message includes the *E-DCH Power Offset for Scheduling Info IE*, then the DRNS shall use this value as a power offset for the transmission of scheduling information without any MAC-d PDUs.]
- [FDD – If the RADIO LINK RECONFIGURATION REQUEST message includes the *SixteenQAM UL Operation Indicator IE* in the *E-DCH FDD Information To Modify IE*, the DRNS shall activate/deactivate SixteenQAM UL Operation for the RL in accordance with the *SixteenQAM UL Operation Indicator IE*.]
 - [FDD – If SixteenQAM UL Operation is activated, then the DRNS shall base the handling of the Relative Grant signalling on Scheduling Grant Table 2 according to TS 25.321 [41]. If SixteenQAM UL Operation is deactivated, then the DRNS shall base the handling of the Relative Grant signalling on Scheduling Grant Table 1 according to TS 25.321 [41].]
- [FDD – If the RADIO LINK RECONFIGURATION REQUEST message includes the *E-DCH DL Control Channel Grant Information IE* in the *E-DCH FDD Information To Modify IE*, the DRNS may modify E-AGCH Channelisation Code, E-RGCH/E-HICH Channelisation Code, E-RGCH Signature Sequence and/or E-HICH Signature Sequence for the E-DCH RL indicated by the *E-DCH RL ID IE*. The DRNS shall then report the modified configuration which is used in the new configuration specified in the *E-DCH FDD DL Control Channel Information IE* for each E-DCH RL in the RADIO LINK RECONFIGURATION RESPONSE message.]

[FDD – E-DCH MAC-d Flow Addition:]

[FDD – If the RADIO LINK RECONFIGURATION REQUEST message includes an *E-DCH MAC-d Flows To Add IE*, then the DRNS shall use this information to add the indicated E-DCH MAC-d flows.]

[FDD – If the RADIO LINK RECONFIGURATION REQUEST message includes the *Maximum MAC-d PDU Size Extended IE* for a E-DCH Logical Channel in the *E-DCH MAC-d Flows Information IE* in the *E-DCH MAC-d Flows To Add IE*, then the DRNS shall ignore the *MAC-d PDU Size IE* in the *MAC-d PDU Size List IE* and use *Maximum MAC-d PDU Size Extended IE* to optimise capacity allocation for the related E-DCH Logical Channel.]

[FDD – If the RADIO LINK RECONFIGURATION REQUEST message includes the *E-DCH MAC-d Flows To Add* IE, then:]

- [FDD – The DRNS may use the *Traffic Class* IE for a specific E-DCH MAC-d flow to determine the transport bearer characteristics to apply between DRNC and Node B. If *TrCH Source Statistics Descriptor* IE is present with the value “RRC” in the *E-DCH MAC-d Flows Information* IE, then the DRNC should ignore the *Traffic Class* IE.]
- [FDD – If the RADIO LINK RECONFIGURATION REQUEST message includes the *MAC-es Guaranteed Bit Rate* IE in the *E-DCH Logical Channel Information* IE in the *E-DCH MAC-d Flows To Add* IE, the DRNS shall use this information to optimise MAC-e scheduling decisions.]
- [FDD – If the RADIO LINK RECONFIGURATION REQUEST message includes the *UE Aggregate Maximum Bit Rate Enforcement Indicator* IE in the *E-DCH Logical Channel Information* IE in the *E-DCH MAC-d Flows To Add* IE, the DRNS shall, if supported, consider the data of the related E-DCH Logical Channel for UE Aggregate Maximum Bit Rate Enforcement.]

[FDD – E-DCH MAC-d Flow Deletion:]

[FDD – If the RADIO LINK RECONFIGURATION REQUEST message includes an *E-DCH MAC-d Flows To Delete* IEs, then the DRNS shall use this information to delete the indicated E-DCH MAC-d flows. When an E-DCH MAC-d flow is deleted, all its associated configuration shall also be removed.]

[FDD – If the RADIO LINK RECONFIGURATION REQUEST message includes an *E-DCH MAC-d Flows To Delete* IE requesting the deletion of all remaining E-DCH MAC-d flows for the UE Context, then the DRNC shall delete the E-DCH configuration from the UE Context and release the E-DCH resources.]

[FDD – Additional E-DCH Setup:]

[FDD – If the *Additional E-DCH Cell Information RL Reconf Req* IE is present in the RADIO LINK RECONFIGURATION REQUEST message and the choice of *Setup, Configuration Change or Removal of E-DCH On Secondary UL Frequency* is “Setup”, then the *Additional E-DCH Cell Information Setup* IE defines the new configuration and then:]

- [FDD – If the *C-ID* IE is included in the *Additional E-DCH RL Specific Information To Setup* IE in the *Additional E-DCH FDD Setup Information* IE the *C-ID* IE indicates the cell in which the additional E-DCH shall be setup]
- [FDD – The DRNS shall setup the E-DCH on the secondary uplink frequency and setup the requested E-DCH resources on the Radio Links and in the cells indicated by the *E-DCH Additional RL ID* IE and the *C-ID* IE in the *Additional E-DCH RL Specific Information To Setup* IE in the *Additional E-DCH FDD Setup Information* IE.]
- [FDD – If the *C-ID* IE is not included in the *Additional E-DCH RL Specific Information To Setup* IE in the *Additional E-DCH FDD Setup Information* IE the *E-DCH Additional RL ID* IE indicates the existing RL on which the additional E-DCH shall be setup.]
- [FDD – The DRNS shall setup the additional E-DCH on the Radio Links indicated by the *E-DCH Additional RL ID* IE in the *Additional E-DCH RL Specific Information To Setup* IE in the *Additional E-DCH FDD Setup Information* IE]
- [FDD – The DRNS shall use for the non cell specific Radio Link related parameters and non cell specific E-DPCH, UL DPCH, E-DCH and F-DPCH parameters the same values as for the corresponding cell of the Primary uplink frequency.]
- [FDD – If the *UL SIR Target* IE in the *UL DPCH Information* IE in the *Additional E-DCH FDD Setup Information* IE in the *Additional E-DCH Cell Information Setup* IE and/or the *DL Power Balancing Information* IE and/or the *Minimum Reduced E-DPDCH Gain Factor* IE in the *Multicell E-DCH Information* IE in the *Additional E-DCH FDD Setup Information* IE are present, the DRNS shall use the information in the same way as for the information used on Primary uplink frequency.]
- [FDD – If the *Secondary UL Frequency Activation State* IE is present in the *Multicell E-DCH Information* IE in the *Additional E-DCH FDD Setup Information* IE, the DRNS shall use the information as initial activation state of the Radio Links on the secondary uplink frequency.]

- [FDD – If the *Initial DL Tx Power IE*, the *Primary CPICH Ec/No IE*, the *E-AGCH Power Offset IE*, the *E-RGCH Power Offset IE* and/or the *E-HICH Power Offset IE* is included in the *Additional E-DCH RL Specific Information To Setup IE* in the *Additional E-DCH FDD Setup Information IE* in the *Additional E-DCH Cell Information Setup IE*, the DRNS shall use the information in the same way as for the information used on Primary uplink frequency.]
- [FDD – If the *Enhanced Primary CPICH Ec/No IE* is included in the *Multicell E-DCH RL Specific Information IE* in the *Additional E-DCH Secondary RL Specific Information To Setup IE* in the *Additional E-DCH FDD Setup Information IE* in the *Additional E-DCH Cell Information Setup IE*, the DRNS shall use the information in the same way as for the information used on Primary uplink frequency.]
- [FDD – If the *F-DPCH Slot Format Support Request IE* in the *F-DPCH Information IE* in the *Additional E-DCH FDD Setup Information IE* in the *Additional E-DCH Cell Information Setup IE* is included, the DRNS shall configure the concerned UE Context for F-DPCH Slot Format operation according to TS 25.211 [8] and include the *F-DPCH Slot Format IE* in the *Additional E-DCH FDD Information Response IE* in the *Additional E-DCH Cell Information Response RReconf IE* in the RADIO LINK RECONFIGURATION RESPONSE message. If the *Multicell E-DCH Information IE* in the *Additional E-DCH FDD Setup Information IE* includes the *F-DPCH Slot Format IE*, the DRNS may use the *F-DPCH Slot Format IE* to determine the F-DPCH slot format.]
- [FDD – If the *HARQ Process Allocation For 2ms Scheduled Transmission Grant IE*, the *E-DCH Maximum Bitrate IE*, the *E-DCH Minimum Set E-TFCI IE* and/or the *E-DCH Processing Overload Level IE* are present in the *Additional E-DCH FDD Information IE* in the *Additional E-DCH FDD Setup Information IE* in the *Additional E-DCH Cell Information Setup IE*, the DRNS shall use the information in the same way as for the information used on Primary uplink frequency.]
- [FDD – If activation of power balancing for the Additional E-DCH RL by the RADIO LINK RECONFIGURATION REQUEST message is supported by the DRNS, the DRNS shall include the *DL Power Balancing Activation Indicator IE* in the *Additional E-DCH FDD Information Response IE* in the *Additional E-DCH Cell Information Response RReconf IE* in the RADIO LINK RECONFIGURATION RESPONSE message.]
- [FDD – For each Additional E-DCH RL not having a common generation of the TPC commands in the DL with another Additional E-DCH RL, the DRNS shall set the *RL Set ID IE* included in the *Additional E-DCH FDD Information Response IE* in the RADIO LINK RECONFIGURATION RESPONSE message to a value that uniquely identifies the RL as a RL Set within the UE Context. The generation of E-HICH related information for Additional E-DCH RLs in different RL Sets shall not be common.]
- [FDD – For all Additional E-DCH RLs having a common generation of the TPC commands in the DL with another Additional E-DCH RL, the DRNS shall assign to each Additional E-DCH RL the same value for the *RL Set ID IE* included in the *Additional E-DCH FDD Information Response IE* in the RADIO LINK RECONFIGURATION RESPONSE message. This value shall uniquely identify these Additional E-DCH RLs as members of the same RL Set within the UE Context. The generation of E-HICH information for all Additional E-DCH RLs in a RL Set shall be common.]
- [FDD – For each Additional E-DCH RL which has or can have a common generation of E-RGCH information with another Additional E-DCH RL (current or future) when the DRNS would contain the Additional E-DCH serving RL, the DRNS shall set a same value to the *E-DCH RL Set ID IE* for the Additional E-DCH RL in the *Additional E-DCH FDD Information Response IE* in the *Additional E-DCH Cell Information Response RReconf IE* in the RADIO LINK RECONFIGURATION RESPONSE message]
- [FDD – For every additional E-DCH RL indicated in the *Additional E-DCH RL Specific Information To Setup IE* in the *Additional E-DCH FDD Setup Information IE* the DRNS may include the *E-AGCH And E-RGCH/E-HICH FDD Scrambling Code IE* and shall include the *E-RGCH/E-HICH Channelisation Code IE* and the corresponding *E-HICH Signature Sequence IE* and the DRNS may include the corresponding *E-RGCH Signature Sequence IE* for each Additional E-DCH RL in the *E-DCH FDD DL Control Channel Information IE* in the *Additional E-DCH FDD Information Response IE* in the *Additional E-DCH Cell Information Response RReconf IE* in the RADIO LINK RECONFIGURATION RESPONSE message and if DRNS has no valid data for the *E-RGCH/E-HICH Channelisation Code IE*, then it shall insert the *E-RGCH and E-HICH Channelisation Code Validity Indicator IE* to indicate that the *E-RGCH/E-HICH Channelisation Code IE* contains invalid data.]
- [FDD – If the Additional Serving E-DCH Radio Link is configured in the DRNS, then:]

- [FDD – The DRNS shall allocate a primary E-RNTI identifier or a secondary E-RNTI identifier or both for the corresponding RL and include these E-RNTI identifiers and the channelisation code of the corresponding E-AGCH in the *E-DCH FDD DL Control Channel Information IE* in the *Additional E-DCH FDD Information Response IE* in the *Additional E-DCH Cell Information Response RLReconf IE* in the RADIO LINK RECONFIGURATION RESPONSE message.]
- [FDD – The DRNS may include in the *E-DCH FDD DL Control Channel Information IE* in the *Additional E-DCH FDD Information Response IE* in the *Additional E-DCH Cell Information Response RLReconf IE* in the RADIO LINK RECONFIGURATION RESPONSE message the *Serving Grant Value IE* and *Primary/Secondary Grant Selector IE* for the initial grant for the Additional serving E-DCH RL and may include the *Default Serving Grant in DTX Cycle 2 IE*.]
- [FDD – If the E-DCH HARQ process allocation for 2ms TTI for scheduled transmission shall be changed, the DRNS shall allocate resources according to the new/changed configuration and include the new/changed configuration in the *HARQ Process Allocation For 2ms Scheduled Transmission Grant IE* in the *Additional E-DCH FDD Information Response IE* in the *Additional E-DCH Cell Information Response IE* in the RADIO LINK RECONFIGURATION RESPONSE message.]
- [FDD – If Primary CPICH is not to be used as a Phase Reference for this Radio Link on the secondary UL frequency, the DRNS shall include the *Primary CPICH Usage For Channel Estimation IE* set to the value “Primary CPICH shall not be used” in the *Additional E-DCH FDD Information Response IE* in the *Additional E-DCH Cell Information Response RLReconf IE* RADIO LINK RECONFIGURATION RESPONSE message.]
- [FDD – If Secondary CPICH may be used as a Phase Reference for this Radio Link on the secondary UL frequency, the DRNS shall include the *Secondary CPICH Information IE* in the *Additional E-DCH FDD Information Response IE* in the *Additional E-DCH Cell Information Response RLReconf IE* in the RADIO LINK RECONFIGURATION RESPONSE message. If the DRNS doesn’t include the *Secondary CPICH Information IE*, it shall not include the *Primary CPICH Usage For Channel Estimation IE* set to the value “Primary CPICH shall not be used”.]

[FDD – Additional E-DCH Configuration Change]

[FDD – If the *Additional E-DCH Cell Information RL Reconf Req IE* is present in the RADIO LINK RECONFIGURATION REQUEST message and the choice of *Setup, Configuration Change or Removal of E-DCH On Secondary UL Frequency* is “Configuration Change”, then the *Additional E-DCH Cell Information Configuration Change IE* defines the new configuration and then:]

- [FDD – If the *Minimum Reduced E-DPDCH Gain Factor IE* and/or the *Common DL Reference Power IE* is present in the *Multicell E-DCH Information IE* in the *Additional E-DCH Configuration Change Information IE* IE the DRNS shall use the information in the same way as for the information that is used on the Primary uplink frequency.]
- [FDD. If the UE Context is configured for F-DPCH Slot Format operation, the DRNS shall include the *F-DPCH Slot Format IE* in the *Additional E-DCH FDD Information Response IE* for new RLs on the secondary UL frequency or in the *Additional Modified E-DCH FDD Information Response IE* for modified RLs in the RADIO LINK RECONFIGURATION RESPONSE message.]

[FDD – Additional E-DCH RL Addition:]

[FDD – If the *Additional E-DCH RL Specific Information To Add IE* is present in the *Additional E-DCH Configuration Change Information IE* in the *Additional E-DCH Configuration Change Information IE*, then:]

- [FDD – The DRNS shall setup the E-DCH resources, as requested or as configured in the UE context, on the Radio Links indicated by the *E-DCH Additional RL ID IE*. Non cell specific Radio Link related parameters and non cell specific E-DPCH, UL DPCH, E-DCH and F-DPCH parameters shall take the same values as for the corresponding cell of the Primary uplink frequency.]
- [FDD – If the *E-AGCH Power Offset IE*, the *E-RGCH Power Offset IE*, the *E-HICH Power Offset IE* is included, the DRNS shall use the information in the same way as for the information used on the Primary uplink frequency.]
- [FDD – If the power balancing is active with the Power Balancing Adjustment Type of the UE Context set to “Individual” in the existing Additional E-DCH RL(s) and the RADIO LINK

RECONFIGURATION REQUEST message includes the *DL Reference Power* IE in the *Multicell E-DCH RL Specific Information* IE, the DRNS shall activate the power balancing and use the *DL Reference Power* IE for the power balancing procedure in the new Additional RL(s), if activation of power balancing by the RADIO LINK RECONFIGURATION REQUEST message at RL addition on secondary UL frequency is supported, according to subclause 8.3.15. In this case, the DRNS shall include the *DL Power Balancing Activation Indicator* IE in the *Additional E-DCH FDD Information Response* IE in the *Additional E-DCH Cell Information Response RReconf* IE in the RADIO LINK RECONFIGURATION RESPONSE message. If the DRNS starts the DL transmission and the activation of the power balancing at the same CFN, the initial power of the power balancing, i.e. P_{init} shall be set to the power level which is calculated based on the following IEs (if received): *Primary CPICH Ec/No* IE or the *Enhanced Primary CPICH Ec/No* IE in the *Multicell E-DCH RL Specific Information* IE or to the power level which is calculated based on the power relative to the Primary CPICH power used by the existing Additional RLs.]

- [FDD – For each Additional E-DCH RL not having a common generation of the TPC commands in the DL with another Additional E-DCH RL, the DRNS shall set the *RL Set ID* IE included in the *Additional E-DCH FDD Information Response* IE in the RADIO LINK RECONFIGURATION RESPONSE message to a value that uniquely identifies the RL as a RL Set within the UE Context. The generation of E-HICH related information for Additional E-DCH RLs in different RL Sets shall not be common.]
- [FDD – For all Additional E-DCH RLs having a common generation of the TPC commands in the DL with another Additional E-DCH RL, the DRNS shall assign to each Additional E-DCH RL the same value for the *RL Set ID* IE included in the *Additional E-DCH FDD Information Response* IE in the RADIO LINK RECONFIGURATION RESPONSE message. This value shall uniquely identify these Additional E-DCH RLs as members of the same RL Set within the UE Context. The generation of E-HICH information for all Additional E-DCH RLs in a RL Set shall be common.]
- [FDD – For each Additional E-DCH RL which has or can have a common generation of E-RGCH information with another Additional E-DCH RL (current or future) when the DRNS would contain the Additional E-DCH serving RL, the DRNS shall set a same value to the *E-DCH RL Set ID* IE for the Additional E-DCH RL in the *Additional E-DCH FDD Information Response* IE in the *Additional E-DCH Cell Information Response RReconf* IE in the RADIO LINK RECONFIGURATION RESPONSE message]
- [FDD – For every additional E-DCH RL indicated in the *Additional E-DCH RL Specific Information To Add* IE, the DRNS may include the *E-AGCH And E-RGCH/E-HICH FDD Scrambling Code* IE and shall include the *E-RGCH/E-HICH Channelisation Code* IE and the corresponding *E-HICH Signature Sequence* IE and the DRNS may include the corresponding *E-RGCH Signature Sequence* IE in the *E-DCH FDD DL Control Channel Information* IE in the *Additional E-DCH FDD Information Response* IE in the *Additional E-DCH Cell Information Response RReconf* IE in the RADIO LINK RECONFIGURATION RESPONSE message and if DRNS has no valid data for the *E-RGCH/ E-HICH Channelisation Code* IE, then it shall insert the *E-RGCH/ E-HICH Channelisation Code Validity Indicator* IE to indicate that the *E-RGCH/ E-HICH Channelisation Code* IE contains invalid data.]
- [FDD – If the *Primary CPICH Ec/No* IE or the *Primary CPICH Ec/No* IE and the *Enhanced Primary CPICH Ec/No* IE in the *Multicell E-DCH RL Specific Information* IE measured by the UE are included for a RL in the RADIO LINK RECONFIGURATION REQUEST message, the DRNS shall use this in the calculation of the Initial DL TX Power for this additional RL. If the *Primary CPICH Ec/No* IE is not present, the DRNS shall set the Initial DL TX Power based on the power relative to the Primary CPICH power used by the existing RLs.]

[FDD – Additional E-DCH RL Modification:]

[FDD – If the *Additional E-DCH RL Specific Information To Modify* IE is present in the *Additional E-DCH Configuration Change Information* IE, then the additional E-DCH RL indicated by the *E-DCH Additional RL ID* IE indicates the RL on which E-DCH resources shall be modified:]

- [FDD – If the *E-AGCH Power Offset* IE, the *E-RGCH Power Offset* IE, the *E-HICH Power Offset* IE, and/or the *E-DCH DL Control Channel Grant* IE in the *Multicell E-DCH RL Specific Information* IE is included, the DRNS shall use the information in the same way as for the information used on the Primary uplink frequency.]

- [FDD – If the *DL Reference Power* IEs is included in the *Multicell E-DCH RL Specific Information* IE and power balancing is active, DRNS shall apply DL power Control in the same way as defined for the Primary uplink frequency.]
- [FDD – If updating of power balancing parameters by the RADIO LINK RECONFIGURATION REQUEST message is supported by the DRNS, the DRNS shall include the *DL Power Balancing Updated Indicator* IE in the *Additional Modified E-DCH FDD Information Response* IE in the *Additional E-DCH Cell Information Response RLReconf* IE for each affected RL in the RADIO LINK RECONFIGURATION RESPONSE message.]
- [FDD – If the RADIO LINK RECONFIGURATION RESPONSE message includes the *Primary CPICH Usage For Channel Estimation* IE and/or the *Secondary CPICH Information Change* IE in the *Additional Modified E-DCH FDD Information Response* IE in the *Additional E-DCH Cell Information Response RLReconf* IE, the DRNS shall avoid the new configuration in which neither the Primary CPICH nor the Secondary CPICH is used as a Phase Reference for this Radio Link.]

[FDD – Additional E-DCH Modification:]

[FDD – If the *Additional E-DCH FDD Information To Modify* IE is present in the *Additional E-DCH Configuration Change Information* IE, then:]

- [FDD – If the *HARQ Process Allocation For 2ms Scheduled Transmission Grant* IE, the *E-DCH Minimum Set E-TFCI* IE and/or the *E-DCH Maximum Bitrate* IE is included, the DRNS shall use this information for the related resource allocation operation.]
- [FDD – If the *E-DCH Processing Overload Level* IE is included, then if the DRNS could not decode the E-DPCCH/E-DPDCH for the last consecutive number of TTIs, indicated in the *E-DCH Processing Overload Level* IE, because of processing issue, the DRNS shall notify the RNC by initiating the Radio Link Failure procedure.]
- [FDD – If the DL TX power upper or lower limit has been re-configured for the secondary UL frequency, the DRNS shall include the new value(s) in the *Maximum DL TX Power* IE and *Minimum DL TX Power* IE in the *Additional Modified E-DCH FDD Information Response* IE in the *Additional E-DCH Cell Information Response RLReconf* IE in the RADIO LINK RECONFIGURATION RESPONSE message.
- [FDD – The DRNS decides the maximum and minimum SIR for the uplink of the Radio Link(s), and the DRNS shall include in the RADIO LINK RECONFIGURATION RESPONSE message the *Maximum Uplink SIR* IE and *Minimum Uplink SIR* IE in the *Additional Modified E-DCH FDD Information Response* IE in the *Additional E-DCH Cell Information Response RLReconf* IE for each Radio Link when these values are changed.]
- [FDD – If the Additional E-DCH serving RL is in this DRNS, the DRNS may choose to change the E-DCH HARQ process allocation for 2ms TTI for scheduled transmission. In this case the DRNS shall allocate resources according to the new/changed configuration and include the new/changed configuration in the *HARQ Process Allocation For 2ms Scheduled Transmission Grant* IE in the *Additional Modified E-DCH FDD Information Response* IE in the RADIO LINK RECONFIGURATION RESPONSE message.]

[FDD – Additional E-DCH Removal]

[FDD – If the *Additional E-DCH Cell Information RL Reconf Req* IE is present in the RADIO LINK RECONFIGURATION REQUEST message and the choice of *Setup, Configuration Change or Removal of E-DCH On Secondary UL Frequency* is “Removal”, then the additional E-DCH on the secondary uplink frequency shall be removed.]

[TDD – Intra- DRNS Serving E-DCH Radio Link Change:]

[TDD- If the RADIO LINK RECONFIGURATION REQUEST message includes the *E-DCH Serving RL* IE, this indicates the new Serving E-DCH Radio Link:]

- [TDD – In the new configuration the DRNS shall de-allocate the E-DCH resources of the old Serving E-DCH Radio Link and allocate the E-DCH resources for the new Serving E-DCH Radio Link.]

- [3.84Mcps TDD – The DRNS shall allocate E-AGCH parameters corresponding to the E-DCH and include the *E-AGCH Specific Information Response* IE in the *E-DCH TDD Information Response* IE in the RADIO LINK RECONFIGURATION RESPONSE message.]
- [1.28Mcps TDD – The DRNS shall allocate E-AGCH parameters and E-HICH parameters corresponding to the E-DCH and include the *E-AGCH Specific Information Response* IE and the *E-HICH Specific Information Response* IE in the *E-DCH Information Response 1.28Mcps* IE in the RADIO LINK RECONFIGURATION RESPONSE message.]
- [7.68Mcps TDD – The DRNS shall allocate E-AGCH parameters corresponding to the E-DCH and include the *E-AGCH Specific Information Response 7.68Mcps* IE in the *E-DCH TDD Information Response 7.68Mcps* IE in the RADIO LINK RECONFIGURATION READY message.]
- [TDD – If the *TNL QoS* IE is included for a MAC-d flow and if ALCAP is not used, the *TNL QoS* IE may be used by the DRNS to determine the transport bearer characteristics to apply in the uplink for the related MAC-d flow.]

[TDD – E-PUCH Handling:]

[3.84Mcps TDD and 7.68Mcps TDD – If the RADIO LINK RECONFIGURATION REQUEST message includes an *E-PUCH Information* IE, the DRNS shall apply the parameters to the new configuration.]

[1.28Mcps TDD – If the RADIO LINK RECONFIGURATION REQUEST message includes an *E-PUCH Information LCR* IE, the DRNS shall apply the parameters to the new configuration]

[TDD – If the RADIO LINK RECONFIGURATION REQUEST message includes an *E-TFCS Information* IE, the DRNS shall apply the beta parameters to the new configuration.]

[3.84Mcps TDD – E-DCH Setup:]

[3.84Mcps TDD – the radio link may be reconfigured to support E-DCH by including the appropriate E-DCH information elements: *E-DCH Serving RL* IE, *E-PUCH Information* IE, *E-TFCS Information TDD* IE, *E-DCH MAC-d Flows to Add* IE and *E-DCH TDD Information* IE.]

[1.28Mcps TDD – E-DCH Setup:]

[1.28cps TDD – the radio link may be reconfigured to support E-DCH by including the appropriate E-DCH information elements: *E-DCH Serving RL* IE, *E-PUCH Information LCR* IE, *E-TFCS Information TDD* IE, *E-DCH MAC-d Flows to Add* IE and *E-DCH TDD Information LCR* IE.]

[7.68Mcps TDD – E-DCH Setup:]

[7.68Mcps TDD – the radio link may be reconfigured to support E-DCH by including the appropriate E-DCH information elements: *E-DCH Serving RL* IE, *E-PUCH Information* IE, *E-TFCS Information TDD* IE, *E-DCH MAC-d Flows to Add* IE and *E-DCH TDD Information 7.68Mcps* IE.]

[TDD- E-DCH MAC-d Flow Addition/Deletion:]

[TDD- If the RADIO LINK RECONFIGURATION REQUEST message includes any *E-DCH MAC-d Flows To Add* or *E-DCH MAC-d Flows To Delete* IEs, then the DRNS shall use this information to add/delete the indicated E-DCH MAC-d flows. When an E-DCH MAC-d flow is deleted, all its associated configuration data shall also be removed.]

[TDD – If the RADIO LINK RECONFIGURATION REQUEST message includes the *Maximum MAC-d PDU Size Extended* IE for a E-DCH Logical Channel in the *E-DCH MAC-d Flows Information* IE in the *E-DCH TDD Information To Add* IE, then the DRNS shall ignore the *MAC-d PDU Size* IE in the *MAC-d PDU Size List* IE and use *Maximum MAC-d PDU Size Extended* IE to optimise capacity allocation for the related E-DCH Logical Channel.]

[TDD- If the RADIO LINK RECONFIGURATION REQUEST message includes an *E-DCH MAC-d Flows To Delete* IE requesting the deletion of all remaining E-DCH MAC-d flows for the UE Context, then the DRNS shall delete the E-DCH configuration from the UE Context and release the E-DCH resources.]

[TDD- If the RADIO LINK RECONFIGURATION REQUEST message includes the *E-DCH MAC-d Flows To Add* IE, then:]

- [TDD- If the RADIO LINK RECONFIGURATION REQUEST message includes the *MAC-es Guaranteed Bit Rate* IE in the *E-DCH MAC-d Flows To Add* IE, the DRNS shall use this information to optimise MAC-e scheduling decisions.]
- [1.28Mcps TDD – If the RADIO LINK RECONFIGURATION REQUEST message includes the *MAC-es Maximum Bit Rate LCR* IE in the *E-DCH Logical Channel Information* IE in the *E-DCH MAC-d Flows To Add* IE, the DRNS shall use this information for the related resource allocation operation, and when applicable, for E-DCH scheduling.]

[3.84Mcps TDD – E-DCH Non-scheduled allocations:]

[3.84Mcps TDD – The DRNS shall determine any non-scheduled resource to be granted for the radio link, and return this in the *E-DCH Non-scheduled Grant Information TDD* IE in the *E-DCH Information Response* IE in the RADIO LINK RECONFIGURATION RESPONSE message.]

[1.28Mcps TDD – E-DCH Non-scheduled allocations:]

[1.28Mcps – The DRNS shall determine any non-scheduled resource to be granted for the radio link, and return this in the *E-DCH Non-scheduled Grant Information LCR TDD* IE in the *E-DCH Information Response 1.28Mcps* IE in the RADIO LINK RECONFIGURATION RESPONSE message.]

[7.68Mcps TDD – E-DCH Non-scheduled allocations:]

[7.68Mcps TDD – The DRNS shall determine any non-scheduled resource to be granted for the radio link, and return this in the *E-DCH Non-scheduled Grant Information 7.68Mcps TDD* IE in the *E-DCH Information Response 7.68Mcps* IE in the RADIO LINK RECONFIGURATION RESPONSE message.]

[3.84Mcps TDD – E-DCH Modification:]

[3.84Mcps TDD – If the RADIO LINK RECONFIGURATION REQUEST message includes the *E-DCH TDD Information* IE, then:]

- [3.84Mcps TDD – If the *E-DCH TDD Information* IE includes the *E-DCH TDD Maximum Bitrate* IE for an E-DCH, the DRNS shall use this information for the related resource allocation operation, and when applicable, for E-DCH scheduling.]
- [3.84Mcps TDD – If the *E-DCH TDD Information* IE includes the *E-DCH Processing Overload Level* IE, then if the DRNS could not decode the E-PUCH for the last consecutive number of TTIs, indicated in the *E-DCH Processing Overload Level* IE, because of a processing issue, the DRNS shall notify the SRNC by initiating the Radio Link Failure procedure.]
- [3.84Mcps TDD – If the *E-DCH TDD Information* IE includes the *E-DCH Power Offset for Scheduling Info* IE, then the DRNS shall use this value as a power offset for the transmission of scheduling information without any MAC-d PDUs.]

[1.28Mcps TDD – E-DCH Modification:]

[1.28Mcps TDD – If the RADIO LINK RECONFIGURATION REQUEST message includes the *E-DCH TDD Information LCR* IE, then:]

- [1.28Mcps TDD – If the *E-DCH TDD Information LCR* IE includes the *E-DCH Physical Layer Category LCR* IE or *Extended E-DCH Physical Layer Category LCR* IE for an E-DCH, the DRNS shall use this information for the related resource allocation operation, and when applicable, for E-DCH scheduling.]
- [1.28Mcps TDD – If the *E-DCH TDD Information LCR* IE includes the *E-DCH Processing Overload Level* IE, then if the DRNS could not decode the E-PUCH for the last consecutive number of TTIs, indicated in the *E-DCH Processing Overload Level* IE, because of a processing issue, the DRNS shall notify the SRNC by initiating the Radio Link Failure procedure.]
- [1.28Mcps TDD – If the *E-DCH TDD Information LCR* IE includes the *E-DCH Power Offset for Scheduling Info* IE, then the DRNS shall use this value as a power offset for the transmission of scheduling information without any MAC-d PDUs.]
- [1.28Mcps TDD – If the *E-DCH TDD Information LCR* IE includes the *Maximum Number of Retransmission for Scheduling Info LCR* IE and the *E-DCH Retransmission timer for Scheduling Info LCR* IE, then the DRNS shall use these parameters for the transmission of scheduling information without any MAC-d PDUs.]

[7.68Mcps TDD – E-DCH Modification:]

[7.68Mcps TDD – If the RADIO LINK RECONFIGURATION REQUEST message includes the *E-DCH TDD Information 7.68Mcps* IE, then:]

- [7.68Mcps TDD – If the *E-DCH TDD Information 7.68Mcps* IE includes the *E-DCH TDD Maximum Bitrate 7.68Mcps* IE for an E-DCH, the DRNS shall use this information for the related resource allocation operation, and when applicable, for E-DCH scheduling.]
- [7.68Mcps TDD – If the *E-DCH TDD Information 7.68Mcps* IE includes the *E-DCH Processing Overload Level* IE, then if the DRNS could not decode the E-PUCH for the last consecutive number of TTIs, indicated in the *E-DCH Processing Overload Level* IE, because of a processing issue, the DRNS shall notify the SRNC by initiating the Radio Link Failure procedure.]
- [7.68Mcps TDD – If the *E-DCH TDD Information 7.68Mcps* IE includes the *E-DCH Power Offset for Scheduling Info* IE, then the DRNS shall use this value as a power offset for the transmission of scheduling information without any MAC-d PDUs.]

[TDD- If the RADIO LINK RECONFIGURATION REQUEST message includes the *E-DCH TDD Information To Modify* IE, then:]

- [TDD- If the *E-DCH TDD Information To Modify* IE contains a *E-DCH MAC-d Flow Specific Information* IE which includes the *Allocation/Retention Priority* IE, the DRNS shall apply the new Allocation/Retention Priority to this E-DCH in the new configuration according to Annex A.]
- [TDD- If the *E-DCH TDD Information To Modify* IE contains a *TNL QoS* IE for an E-DCH MAC-d flow and if ALCAP is not used, the *TNL QoS* IE may be used by the DRNS to determine the transport bearer characteristics to apply in the uplink for the related MAC-d flow.]
- [TDD- If the *E-DCH TDD Information To Modify* IE includes the *Maximum Number of Retransmissions for E-DCH* IE for an E-DCH MAC-d flow then the DRNS shall use this information to report if the maximum number of retransmissions has been exceeded.]
- [1.28Mcps TDD – If the *E-DCH TDD Information To Modify* IE includes the *E-DCH MAC-d Flow Retransmission Timer* IE for an E-DCH MAC-d flow then the DRNS shall use this information to set the retransmission timer.]
- [TDD– If the *TNL QoS* IE is included in the *E-DCH TDD Information to Modify* IE for an E-DCH MAC-d flow and if ALCAP is not used, the *TNL QoS* IE may be used by the DRNS to determine the transport bearer characteristics to apply in the uplink for the related MAC-d flow.]
- [TDD- If the *E-DCH TDD Information To Modify* IE includes the *E-DCH HARQ Power Offset TDD* IE for an E-DCH MAC-d flow the DRNS shall use this new power offset value.]
- [TDD- If the *E-DCH TDD Information To Modify* IE includes the *E-DCH MAC-d Flow Multiplexing List* IE for an E-DCH MAC-d flow the DRNS shall use this information for the related resource allocation operation.]
- [TDD- If the *E-DCH TDD Information To Modify* IE contains the *E-DCH Grant Type* IE, the DRNS shall treat the E-DCH MAC-d flow as Scheduled or Non-scheduled accordingly.]
- [TDD- If the *E-DCH TDD Information To Modify* IE includes the *E-DCH Logical Channel To Add* or *E-DCH Logical Channel To Delete* IEs, the DRNS shall use this information to add/delete the indicated logical channels. When a logical channel is deleted, all its associated configuration data shall also removed.]
- [TDD- If the *E-DCH TDD Information To Modify* IE includes the *E-DCH Logical Channel To Modify* IE, the DRNS shall use this information to modify the indicated logical channels:]
 - [TDD – If the *E-DCH Logical Channel To Modify* IE includes *Scheduling Priority Indicator* IE, the DRNS shall apply the values in the new configuration.]
 - [TDD – If the *E-DCH Logical Channel To Modify* IE includes *Scheduling Information* IE, the DRNS shall apply the values in the new configuration.]
 - [TDD – If the *E-DCH Logical Channel To Modify* IE includes *MAC-es Guaranteed Bit Rate* IE, the DRNS shall apply the values in the new configuration.]

- [TDD – If the *E-DCH Logical Channel To Modify* IE includes *E-DCH DDI Value* IE, the DRNS shall apply the values in the new configuration.]
- [1.28Mcps TDD – If the *E-DCH Logical Channel To Modify* IE includes *MAC-es Maximum Bit Rate LCR* IE, the DRNS shall use this information for the related resource allocation operation, and when applicable, for E-DCH scheduling.]
- [TDD – If the *E-DCH Logical Channel To Modify* IE includes the *Maximum MAC-d PDU Size Extended* IE, the DRNC shall apply the value in the new configuration.]
- [TDD– If the *E-DCH TDD Information To Modify* IE includes the *MAC-e Reset Indicator* IE, then the DRNS shall use this value to determine whether MAC-e (or MAC-i) Reset is performed in the UE for sending the HARQ Failure Indication.]

General:

If the requested modifications are allowed by the DRNS, and if the DRNS has successfully allocated the required resources and changed to the new configuration, the DRNC shall respond to the SRNC with the RADIO LINK RECONFIGURATION RESPONSE message.

If the RADIO LINK RECONFIGURATION REQUEST message includes the *RL Specific DCH Information* IE, *HS-DSCH Information* IE, *HS-DSCH Information To Modify Unsynchronised* IE, *HS-DSCH MAC-d Flows To Add* IE, [FDD – *RL Specific E-DCH Information* IE] [TDD – *E-DCH MAC-d Flows to Add* IE], the DRNC may use the transport layer address and the binding identifier received from the SRNC when establishing a transport bearer for any Transport Channel [FDD – for which the *Transport Bearer Not Requested Indicator* IE is not included], HS-DSCH MAC-d flow being added or E-DCH MAC-d flow [FDD – for which the *Transport Bearer Not Requested Indicator* IE is not included] being added, or any Transport Channel [FDD – for which the *Transport Bearer Not Requested Indicator* IE was not included] or HS-DSCH MAC-d flow being modified for which a new transport bearer was requested with the *Transport Bearer Request Indicator* IE.

The DRNC shall include the *Transport Layer Address* IE and the *Binding ID* IE in the RADIO LINK RECONFIGURATION RESPONSE message for any Transport Channel [FDD – for which the *Transport Bearer Not Requested Indicator* IE is not included], HS-DSCH MAC-d flow being added or E-DCH MAC-d flow [FDD – for which the *Transport Bearer Not Requested Indicator* IE is not included] being added, or any Transport Channel [FDD – for which the *Transport Bearer Not Requested Indicator* IE was not included], HS-DSCH MAC-d flow or E-DCH MAC-d flow [FDD – for which the *Transport Bearer Not Requested Indicator* IE was not included] being modified for which a new transport bearer was requested with the *Transport Bearer Request Indicator* IE. The detailed frame protocol handling during transport bearer replacement is described in TS 25.427 [4], subclause 5.10.1, and in TS 25.425 [32], subclause 5.3.2.

- [FDD – If the RADIO LINK RECONFIGURATION REQUEST message includes the *Transport Bearer Not Requested Indicator* IE set to “Transport Bearer Shall not be Established” for a DCH or an E-DCH MAC-d flow being added, then the DRNC shall not establish a transport bearer for the concerned DCH or E-DCH MAC-d flow and shall include the *Transport Bearer Not Setup Indicator* IE for the corresponding DCH or E-DCH MAC-d flow in the RADIO LINK RECONFIGURATION RESPONSE message.]
- [FDD – If the RADIO LINK RECONFIGURATION REQUEST message includes the *Transport Bearer Not Requested Indicator* IE set to “Transport Bearer may not be Established” for a DCH or an E-DCH MAC-d flow being added and:]
 - [FDD – if the DRNC establishes a transport bearer for the concerned DCH or E-DCH MAC-d flow, the DRNC shall include in the RADIO LINK RECONFIGURATION RESPONSE message the *Binding ID* IE and *Transport Layer Address* IE for establishment of a transport bearer for the DCH or E-DCH MAC-d flow being established.]
 - [FDD – if the DRNC does not establish a transport bearer for the concerned DCH or E-DCH MAC-d flow, the DRNC shall include the *Transport Bearer Not Setup Indicator* IE for the corresponding DCH or E-DCH MAC-d flow in the RADIO LINK RECONFIGURATION RESPONSE message.]

In the case of a set of co-ordinated DCHs requiring a new transport bearer on the Iur interface, the DRNC shall include the *Transport Layer Address* IE and the *Binding ID* IE in the *DCH Information Response* IE only for one of the DCHs [FDD – for which the *Transport Bearer Not Requested Indicator* IE is not included] in the set of co-ordinated DCHs.

In the case of a Radio Link being combined with another Radio Link within the DRNS, the DRNC shall include the *Transport Layer Address IE* and the *Binding ID IE* [FDD for the concerned DCH for which the *Transport Bearer Not Requested Indicator IE* is not included] in the *DCH Information Response IE* in the RADIO LINK RECONFIGURATION RESPONSE message for only one of the combined Radio Links.

[FDD – In the case of an E-DCH RL being combined with another E-DCH RL within the DRNS, the *E-DCH FDD Information Response IE* shall be included only for one of the combined E-DCH RLs.]

[FDD – If the RADIO LINK RECONFIGURATION REQUEST message includes the *Additional E-DCH Cell Information RL Reconf Req IE*, then:]

- [FDD – if the *Multicell E-DCH Transport Bearer Mode IE* for an Additional E-DCH to be Setup is set to “Separate Iur Transport Bearer Mode” the DRNS shall use this mode in the new configuration and apply separate transport bearers for the MAC-d flows.]
- [FDD – if the *Multicell E-DCH Transport Bearer Mode IE* for an Additional E-DCH to be Setup is set to “UL Flow Multiplexing Mode” the DRNS shall use this mode in the new configuration and multiplex MAC-d flows on the transport bearers.]
- [FDD – if Separate Iur Transport Bearer Mode is used in the new configuration, then:]
 - [FDD – the DRNS shall follow the rules defined in this procedure for single carrier mode of operation for establishment of the transport bearer for a MAC-d flow, use the *Transport Bearer Not Requested Indicator IE* in the *RL Specific E-DCH Information IE* in the *RL Information IE* and/or the *Transport Bearer Request Indicator IE* in the *E-DCH FDD Information To Modify IE* received for the corresponding Radio Link(s) of the Primary Uplink Frequency to determine the transport bearer configuration in the new configuration for the radio links of the Secondary Uplink Frequency.]
 - [FDD – If the *Transport Layer Address IE* and *Binding ID IE* is included for an E-DCH MAC-d flow in the *Additional E-DCH MAC-d Flows Specific Information IE* in the *Additional E-DCH RL Specific Information To Setup IE* in the *Additional E-DCH FDD Setup Information IE* in the *Additional E-DCH Cell Information Setup IE* or in the *Additional E-DCH RL Specific Information To Add IE* and/or the *Additional E-DCH RL Specific Information To Modify IE* in the *Additional E-DCH Configuration Change Information IE* in the *Additional E-DCH Cell Information Configuration Change IE*, then the DRNS may use the transport layer address and the binding identifier received from the SRNC when establishing a transport bearer for the concerned E-DCH MAC-d flow. If the DRNS establishes a transport bearer for the concerned E-DCH MAC-d flow the DRNS shall, for establishment of the transport bearer, include in the RADIO LINK RECONFIGURATION RESPONSE message in the *Additional E-DCH Cell Information Response RL Reconf IE* the *Binding ID IE* and *Transport Layer Address IE* in the *Additional E-DCH MAC-d Flow Specific Information Response IE* in the *Additional E-DCH FDD Information Response IE* for new E-DCH radio links on the Secondary UL frequency and/or include the *Binding ID IE* and *Transport Layer Address IE* in the *Additional E-DCH MAC-d Flow Specific Information Response IE* in the *Additional Modified E-DCH FDD Information Response IE* for radio links on the Secondary UL frequency that has been modified.]

Any allowed rate for the uplink of a modified DCH provided for the old configuration will not be valid for the new configuration. If the DRNS needs to limit the user rate in the uplink of a DCH due to congestion caused by the UL UTRAN Dynamic Resources (see subclause 9.2.1.79) in the new configuration for a Radio Link, the DRNC shall include in the RADIO LINK RECONFIGURATION RESPONSE message the *Allowed UL Rate IE* in the *DCH Information Response IE* for this Radio Link.

Any allowed rate for the downlink of a modified DCH provided for the old configuration will not be valid for the new configuration. If the DRNS needs to limit the user rate in the downlink of a DCH due to congestion caused by the DL UTRAN Dynamic Resources (see subclause 9.2.1.79) in the new configuration for a Radio Link, the DRNC shall include in the RADIO LINK RECONFIGURATION RESPONSE message the *Allowed DL Rate IE* in the *DCH Information Response IE* for this Radio Link.

The DRNS decides the maximum and minimum SIR for the uplink of the Radio Link(s), and the DRNC shall include in the RADIO LINK RECONFIGURATION RESPONSE message the *Maximum Uplink SIR IE* and *Minimum Uplink SIR IE* for each Radio Link when these values are changed.

[FDD – If the DL TX power upper or lower limit has been re-configured, the DRNC shall include the new value(s) in the *Maximum DL TX Power IE* and *Minimum DL TX Power IE* in the RADIO LINK RECONFIGURATION RESPONSE message. The DRNS shall not transmit with a higher power than indicated by the *Maximum DL TX Power IE* or lower than indicated by the *Minimum DL TX Power IE* on any DL DPCH or on the F-DPCH of the RL except, if

the UE Context is configured to use DPCH in the downlink, during compressed mode, when the δP_{curr} , as described in ref.TS 25.214 [10] subclause 5.2.1.3, shall be added to the maximum DL power for the associated compressed frame.]

[3.84 Mcps TDD and 7.68 Mcps TDD – If the DL TX power upper or lower limit has been re-configured, the DRNC shall include the new value(s) in the *Maximum DL TX Power* IE and *Minimum DL TX Power* IE in the RADIO LINK RECONFIGURATION RESPONSE message. If the maximum or minimum power needs to be different for particular DCH type CCTrCHs, the DRNC shall include the new value(s) for that CCTrCH in the *CCTrCH Maximum DL TX Power* IE and *CCTrCH Minimum DL TX Power*. The DRNS shall not transmit with a higher power than indicated by the appropriate *Maximum DL TX Power* IE/*CCTrCH Maximum DL TX Power* IE or lower than indicated by the appropriate *Minimum DL TX Power* IE/*CCTrCH Minimum DL TX Power* IE on any DL DPCH within each CCTrCH of the RL.]

[1.28 Mcps TDD – If the DL TX power upper or lower limit has been re-configured, the DRNC shall include the new value(s) in the *Maximum DL TX Power* IE and *Minimum DL TX Power* IE in the RADIO LINK RECONFIGURATION RESPONSE message. If the maximum or minimum power needs to be different for particular timeslots within a DCH type CCTrCH, the DRNC shall include the new value(s) for that timeslot in the *Maximum DL TX Power* IE and *Minimum DL TX Power* within the *DL Timeslot Information LCR* IE. The DRNS shall not transmit with a higher power than indicated by the appropriate *Maximum DL TX Power* IE or lower than indicated by the appropriate *Minimum DL TX Power* IE on any DL DPCH within each timeslot of the RL.]

8.3.7.3 Unsuccessful Operation

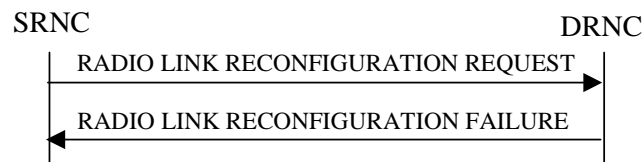

Figure 15: Unsynchronised Radio Link Reconfiguration procedure, Unsuccessful Operation

If the DRNS cannot allocate the necessary resources for all the new DCHs in a set of co-ordinated DCHs requested to be added, it shall reject the Unsynchronised Radio Link Reconfiguration procedure as having failed.

If the requested Unsynchronised Radio Link Reconfiguration procedure fails for one or more Radio Link(s), the DRNC shall send the RADIO LINK RECONFIGURATION FAILURE message to the SRNC, indicating the reason for failure.

[FDD – If the *MIMO Activation Indicator* IE is included and the *Power Offset For S-CPICH for MIMO Request Indicator* IE is not included in the *HS-DSCH FDD Information* IE in the *HS-DSCH Serving Cell Change Information* IE in the RADIO LINK RECONFIGURATION REQUEST message or MIMO is activated and the power offset for S-CPICH for MIMO Request indicator has not been configured in the UE Context but MIMO pilot configuration with Primary and Secondary CPICH is set up with a non-zero power offset on the cell where the Serving HS-DSCH Radio Link is established, the setup of the serving HS-DSCH Radio Link, and/or activation of MIMO, shall be reported as failed and the DRNC shall include in the RADIO LINK RECONFIGURATION FAILURE message the *Cause* IE.]

Typical cause values are:

Radio Network Layer Causes:

- UL Scrambling Code Already in Use;
- DL Radio Resources not Available;
- UL Radio Resources not Available;
- Requested Configuration not Supported;
- CM not Supported;
- E-DCH not supported;
- [FDD – Continuous Packet Connectivity DTX-DRX operation not Supported;]
- [FDD – Continuous Packet Connectivity HS-SCCH less operation not Supported;]
- [FDD – MIMO not supported;]
- [FDD – E-DCH TTI2ms not supported;]
- [FDD – Continuous Packet Connectivity DTX-DRX operation not available;]
- [FDD – Continuous Packet Connectivity UE DTX Cycle not available;]
- [FDD – MIMO not available;]
- [FDD – SixteenQAM UL not Supported;]

HS-DSCH MAC-d PDU Size Format not supported;
 E-DCH MAC-d PDU Size Format not available;
 [FDD – E-DPCCH Power Boosting not supported;]
 [FDD – SixtyfourQAM DL and MIMO Combined not available;]
 [FDD – Multi Cell operation not available;]
 [FDD – Multi Cell operation not supported;]
 [FDD – SixtyfourQAM DL and MIMO Combined not supported;]
 [1.28Mcps TDD – MIMO not available;]
 [1.28Mcps TDD- SixteenQAM UL not Supported;]
 [1.28Mcps TDD – SixtyfourQAM DL and MIMO Combined not available;]
 [FDD – Single Stream MIMO not supported;]
 [FDD – Single Stream MIMO not available;]
 [FDD – Multi Cell operation with MIMO not available;]
 [FDD – Multi Cell operation with MIMO not supported;]
 [FDD – Multi Cell E-DCH Operation not supported;]
 [FDD – Multi Cell E-DCH Operation not available;]
 [FDD – Multi Cell operation with Single Stream MIMO not available;]
 [FDD – Multi Cell operation with Single Stream MIMO not supported.]

Miscellaneous Causes:

Control Processing Overload;
 Not enough User Plane Processing Resources.

8.3.7.4 Abnormal Conditions

If only a subset of all the DCHs belonging to a set of co-ordinated DCHs is requested to be deleted, the DRNS shall reject the Unsynchronised Radio Link Reconfiguration procedure as having failed, and the DRNC shall send the RADIO LINK RECONFIGURATION FAILURE message to the SRNC.

If more than one DCH of a set of co-ordinated DCHs has the *QE-Selector* IE set to “selected” [TDD – or no DCH of a set of co-ordinated DCHs has the *QE-Selector* IE set to “selected”], the DRNS shall reject the Unsynchronised Radio Link Reconfiguration procedure, and the DRNC shall respond with a RADIO LINK RECONFIGURATION FAILURE message.

If the RADIO LINK RECONFIGURATION REQUEST message includes a *DCHs To Modify* IE or *DCHs To Add* IE with multiple *DCH Specific Info* IEs, and if the DCHs in the *DCHs To Modify* IE or *DCHs To Add* IE do not have the same *Transmission Time Interval* IE in the *Semi-static Transport Format Information* IE, then the DRNC shall reject the procedure using the RADIO LINK RECONFIGURATION FAILURE message.

[FDD – If the RADIO LINK RECONFIGURATION REQUEST message includes the *DL Reference Power Information* IE, but the power balancing is not active in the indicated RL(s), the DRNS shall reject the Unsynchronised Radio Link Reconfiguration procedure as having failed and the DRNC shall respond the RADIO LINK RECONFIGURATION FAILURE message with the cause value “Power Balancing status not compatible”.]

[FDD – If the power balancing is active with the Power Balancing Adjustment Type of the UE Context set to “Common” in the existing RL(s) but the *DL Reference Power Information* IE includes the *Individual DL Reference Power Information* IE, the DRNS shall reject the Unsynchronised Radio Link Reconfiguration procedure as having failed and the DRNC shall respond with the RADIO LINK RECONFIGURATION FAILURE message with the cause value “Power Balancing status not compatible”.]

[FDD – If the power balancing is active with the Power Balancing Adjustment Type of the UE Context set to “Individual” in the existing RL(s) but the *DL Reference Power Information* IE includes the *Common DL Reference Power* IE, the DRNS shall reject the Unsynchronised Radio Link Reconfiguration procedure as having failed and the DRNC shall respond with the RADIO LINK RECONFIGURATION FAILURE message with the cause value “Power Balancing status not compatible”.]

If the RADIO LINK RECONFIGURATION REQUEST message contains the *Transport Layer Address* IE or the *Binding ID* IE when establishing a transport bearer for any Transport Channel or HS-DSCH MAC-d flow being added, or any Transport Channel or HS-DSCH MAC-d flow being modified for which a new transport bearer was requested with the *Transport Bearer Request Indicator* IE., and not both are present for a transport bearer intended to be established, the DRNC shall reject the Unsynchronised Radio Link Reconfiguration procedure, and the DRNC shall respond with a RADIO LINK RECONFIGURATION FAILURE message.

If the RADIO LINK RECONFIGURATION REQUEST message contains any of the *HS-DSCH Information To Modify* IE, *HS-DSCH MAC-d Flows To Add* IE or *HS-DSCH MAC-d Flows To Delete* IE in addition to the *HS-DSCH Information* IE, the DRNC shall reject the procedure using the RADIO LINK RECONFIGURATION FAILURE message.

If the RADIO LINK RECONFIGURATION REQUEST message contains any of the *HS-DSCH Information To Modify* IE, *HS-DSCH MAC-d Flows To Add* IE, *HS-DSCH MAC-d Flows To Delete* IE or *HS-PDSCH RL ID* IE and the Serving HS-DSCH Radio Link is not in the DRNS, the DRNC shall reject the procedure using the RADIO LINK RECONFIGURATION FAILURE message.

If the RADIO LINK RECONFIGURATION REQUEST message includes the *HS-DSCH Information* IE and does not include the *HS-PDSCH RL-ID* IE, the DRNC shall reject the procedure using the RADIO LINK RECONFIGURATION FAILURE message.

If the RADIO LINK RECONFIGURATION REQUEST message includes the *HS-PDSCH RL-ID* IE indicating a Radio Link not existing in the UE Context, the DRNS shall reject the procedure using the RADIO LINK RECONFIGURATION FAILURE message.

If the RADIO LINK RECONFIGURATION REQUEST message contains any of the *HS-DSCH Information* IE, *HS-DSCH Information To Modify* IE, or *HS-DSCH MAC-d Flows To Add* IE and if in the new configuration the Priority Queues associated with the same *HS-DSCH MAC-d Flow ID* IE have the same *Scheduling Priority Indicator* IE value, the DRNC shall reject the procedure using the RADIO LINK RECONFIGURATION FAILURE message.

If, in the new configuration, the concerned UE Context is configured to use “Indexed MAC-d PDU Size” for an HS-DSCH but there exist a priority queue of the MAC-d flows of the HS-DSCH that is configured to use Maximum MAC-d PDU Size Extended, the DRNC shall reject the procedure using the RADIO LINK RECONFIGURATION FAILURE message.

If, in the new configuration, the concerned UE Context is configured to use “Flexible MAC-d PDU Size” for an HS-DSCH but there exist a priority queue of the MAC-d flows of the HS-DSCH that is configured to use MAC-d PDU Size Index, the DRNC shall reject the procedure using the RADIO LINK RECONFIGURATION FAILURE message.

If, in the new configuration, the UE Context is configured to use “Fixed MAC-d PDU Size” for an E-DCH and there exist a Logical Channel of the MAC-d flows of the E-DCH that is configured to use Maximum MAC-d PDU Size Extended, the DRNC shall reject the procedure using the RADIO LINK RECONFIGURATION FAILURE message.

If, in the new configuration, the concerned UE Context is configured to use “Flexible MAC-d PDU Size” for an E-DCH and there exist a Logical Channel of the MAC-d flows of the E-DCH that is configured to use MAC-d PDU Size List, the DRNC shall reject the procedure using the RADIO LINK RECONFIGURATION FAILURE message.

If the RADIO LINK RECONFIGURATION REQUEST message includes *HS-DSCH Information* IE and the HS-DSCH is already configured in the UE Context, the DRNC shall reject the procedure using the RADIO LINK RECONFIGURATION FAILURE message.

[FDD – If the *E-DCH FDD Information* IE is present in the RADIO LINK RECONFIGURATION REQUEST message, but the *E-DPCH Information* IE is not present or if any of the *Maximum Set of E-DPDCHs* IE, *Puncture Limit* IE, *E-TFCS Information* IE, *E-TTI* IE, *E-DPCCH Power Offset* IE, *E-RGCH 2-Index-Step Threshold* IE, *E-RGCH 3-Index-Step Threshold* IE, *HARQ Info for E-DCH* IE or *HS-DSCH Configured Indicator* IE are not present in the *E-DPCH Information* IE, then the DRNS shall reject the procedure using the RADIO LINK RECONFIGURATION FAILURE message.]

[FDD – If any of the *HS-DSCH Configured Indicator* IE, *Maximum Set of E-DPDCHs* IE, *Puncture Limit* IE or *E-TTI* IE are present in the *E-DPCH Information* IE and the *E-DCH FDD Information* IE is not present in the RADIO LINK RECONFIGURATION REQUEST message, then the DRNS shall reject the procedure using the RADIO LINK RECONFIGURATION FAILURE message.]

[FDD – If the RADIO LINK RECONFIGURATION REQUEST message includes the *E-DCH RL Indication* IE set to “E-DCH”, but no *E-DCH FDD Information* IE, and the UE Context is not configured for E-DCH, then the DRNC shall reject the procedure using the RADIO LINK RECONFIGURATION FAILURE message.]

[FDD – If the RADIO LINK RECONFIGURATION REQUEST message includes the *E-DCH FDD Information* IE but no *E-DCH RL Indication* IE set to “E-DCH”, then the DRNC shall reject the procedure using the RADIO LINK RECONFIGURATION FAILURE message.]

If the RADIO LINK RECONFIGURATION REQUEST message contains the *HS-PDSCH RL ID* IE and/or the *Serving E-DCH RL* IE and if both HS-DSCH and E-DCH are configured in the new configuration but the Serving HS-DSCH Radio Link and the Serving E-DCH Radio Link are not in the same cell then the DRNC shall reject the procedure using the RADIO LINK RECONFIGURATION FAILURE message.

[FDD – If the RADIO LINK RECONFIGURATION REQUEST message contains the *HS-PDSCH RL ID* IE and the *E-DPCH Information* IE which includes the *HS-DSCH Configured Indicator* IE set as “HS-DSCH not configured” then the DRNC shall reject the procedure using the RADIO LINK RECONFIGURATION FAILURE message.]

[FDD – If the RADIO LINK RECONFIGURATION REQUEST message contains any of the *E-DCH FDD Information To Modify* IE, *E-DCH MAC-d Flows To Add* IE or *E-DCH MAC-d Flows To Delete* IE in addition to the *E-DCH FDD Information* IE, the DRNC shall reject the procedure using the RADIO LINK RECONFIGURATION FAILURE message.]

[FDD – If the RADIO LINK RECONFIGURATION REQUEST message contains any of the *E-DCH FDD Information To Modify* IE, *E-DCH MAC-d Flows To Add* IE, *E-DCH MAC-d Flows To Delete* IE and the UE Context is not configured for E-DCH, the DRNC shall reject the procedure using the RADIO LINK RECONFIGURATION FAILURE message.]

[FDD – If the RADIO LINK RECONFIGURATION REQUEST message includes the *E-DCH FDD Information To Modify* IE deleting the last remaining E-DCH Logical Channel of an E-DCH MAC-d Flow, the DRNC shall reject the procedure using the RADIO LINK RECONFIGURATION FAILURE message.]

[FDD – If the RADIO LINK RECONFIGURATION REQUEST message includes *E-DCH FDD Information* IE and the E-DCH is already configured in the UE Context, the DRNC shall reject the procedure using the RADIO LINK RECONFIGURATION FAILURE message.]

[FDD – If the RADIO LINK RECONFIGURATION REQUEST message includes the *Continuous Packet Connectivity DTX-DRX Information To Modify* IE in addition to the *Continuous Packet Connectivity DTX-DRX Information* IE, then the DRNC shall reject the procedure using the RADIO LINK RECONFIGURATION FAILURE message.]

[FDD – If the RADIO LINK RECONFIGURATION REQUEST message includes the *Continuous Packet Connectivity HS-SCCH less Deactivate Indicator* IE in addition to the *Continuous Packet Connectivity HS-SCCH less Information* IE, the DRNC shall reject the procedure using the RADIO LINK RECONFIGURATION FAILURE message.]

[FDD – If the RADIO LINK RECONFIGURATION REQUEST message includes the *Continuous Packet Connectivity HS-SCCH less Deactivate Indicator* IE while the Continuous Packet Connectivity HS-SCCH less configuration isn't configured in the DRNC, the DRNC shall reject the procedure using the RADIO LINK RECONFIGURATION FAILURE message.]

[FDD – If the RADIO LINK RECONFIGURATION REQUEST message includes the *Continuous Packet Connectivity DTX-DRX Information To Modify* IE while the Continuous Packet Connectivity *DTX-DRX* configuration isn't configured in the DRNC, the DRNC shall reject the procedure using the RADIO LINK RECONFIGURATION FAILURE message.]

[FDD – If the RADIO LINK RECONFIGURATION REQUEST message includes the *DRX Information To Modify* IE in *Continuous Packet Connectivity DTX-DRX Information To Modify* IE while the Continuous Packet Connectivity DRX configuration is not configured in the DRNC, the DRNC shall reject the procedure using the RADIO LINK RECONFIGURATION FAILURE message.]

If the *DCHs to Modify* IE contains a *DCH Specific Info* IE which includes the *Unidirectional DCH Indicator* IE set to “Uplink DCH only” but no *Transport Format Set* IE for the uplink for this DCH and the DRNC had ignored the configuration of Transport Format Set for uplink, the DRNC shall reject the procedure using the RADIO LINK RECONFIGURATION FAILURE message.

If the *DCHs to Modify* IE contains a *DCH Specific Info* IE which includes the *Unidirectional DCH Indicator* IE set to “Downlink DCH only” but no *Transport Format Set* IE for the downlink for this DCH and the DRNC had ignored the configuration of Transport Format Set for downlink, the DRNC shall reject the procedure using the RADIO LINK RECONFIGURATION FAILURE message.

[FDD – If the RADIO LINK RECONFIGURATION REQUEST message contains the *Transport Bearer Not Requested Indicator* IE for a DCH or an E-DCH MAC-d flow but does not contain the corresponding *DCH ID* IE and the *Unidirectional DCH indicator* IE set to “Uplink DCH only” for the DCH in *DCH Information To Add* IE or does not

contain the corresponding *E-DCH MAC-d Flow ID* IE in *E-DCH MAC-d Flows Information* IE, the DRNC shall reject the procedure using the RADIO LINK RECONFIGURATION FAILURE message.]

[FDD – If the concerned UE Context is configured to apply UL DPCCH Slot Format 0 or 2 and execute Continuous Packet Connectivity DTX-DRX operation, then the DRNC shall reject the procedure using the RADIO LINK RECONFIGURATION FAILURE message.]

[FDD – If the concerned UE Context is configured to apply MIMO, allowed to apply 64QAM, establish the secondary serving HS-DSCH Radio Link or apply Single Stream MIMO in the new configuration but is not configured to use flexible MAC-d PDU Size, then the DRNC shall reject the procedure using the RADIO LINK RECONFIGURATION FAILURE message.]

[FDD – If the RADIO LINK RECONFIGURATION REQUEST message contains the *Additional HS Cell Information RL Reconf Req* IE indicating a new secondary serving cell that is not in the same Node B as the serving HS-DSCH cell (or new serving in case of simultaneous serving HS-DSCH cell change), then the DRNC shall reject the procedure using the RADIO LINK RECONFIGURATION FAILURE message.]

[FDD – If the RADIO LINK RECONFIGURATION REQUEST message includes the *Transport Bearer Not Requested Indicator* IE for a DCH in the *RL Specific DCH Information* IE but does not include the *DCH ID* IE for the DCH in the *DCHs to Add* IE, the DRNC shall reject the procedure using the RADIO LINK RECONFIGURATION FAILURE message.]

[FDD – If the RADIO LINK RECONFIGURATION REQUEST message includes the *Transport Bearer Not Requested Indicator* IE for an E-DCH MAC-d flow in the *RL Specific E-DCH Information* IE but does not include the *E-DCH MAC-d flow ID* IE for the E-DCH MAC-d flow in the *E-DCH MAC-d flows Information* IE, the DRNC shall reject the procedure using the RADIO LINK RECONFIGURATION FAILURE message.]

[FDD – If the RADIO LINK RECONFIGURATION REQUEST message contains the *Continuous Packet Connectivity DTX-DRX Information* IE but the concerned UE Context is not previously configured to use F-DPCH, then the DRNC shall reject the procedure using the RADIO LINK RECONFIGURATION FAILURE message.]

[FDD – If the concerned UE Context is configured to have the Serving E-DCH Radio Link but there is at least one E-DCH MAC-d flow which the transport bearer is not configured for the Serving E-DCH Radio Link in DRNS, the DRNC shall reject the procedure using the RADIO LINK RECONFIGURATION FAILURE message.]

[FDD – If the RADIO LINK RECONFIGURATION REQUEST message includes the *Transport Bearer Not Requested Indicator* IE for a DCH or an E-DCH MAC-d Flow for a specific RL and the specific RL is combined with existing RL which the transport bearer is established for the DCH or the E-DCH MAC-d Flow in the DRNS, the DRNC shall reject the procedure using the RADIO LINK RECONFIGURATION FAILURE message.]

If ALCAP is not used, if the concerned UE Context is configured to establish a DCH, an E-DCH MAC-d flow and/or an HS-DSCH MAC-d flow but the RADIO LINK RECONFIGURATION REQUEST message does not include the *Transport Layer Address* IE and the *Binding ID* IE for the DCH, the E-DCH MAC-d flow and/or HS-DSCH MAC-d flow, the DRNC shall reject the procedure using the RADIO LINK RECONFIGURATION FAILURE message.

If, in the new configuration, there exist a priority queue of the MAC-d flows of the HS-DSCH that is configured to use “Flexible RLC PDU Size” for an HS-DSCH but is not configured to use Maximum MAC-d PDU Size Extended, the DRNC shall reject the procedure using the RADIO LINK RECONFIGURATION FAILURE message.

If, in the new configuration, the concerned UE Context is configured to use MAC-d PDU Size Index for an HS-DSCH but there exist a priority queue of the MAC-d flows of the HS-DSCH that is configured to use “Flexible RLC PDU Size”, the DRNC shall reject the procedure using the RADIO LINK RECONFIGURATION FAILURE message.

[FDD – If the RADIO LINK RECONFIGURATION REQUEST message contains a *MIMO Activation Indicator* IE and a *Single Stream MIMO Activation Indicator* IE in the *HS-DSCH FDD Information* IE or in the *HS-DSCH FDD Secondary Serving Information* IE in the *Additional HS Cell Information RL Reconf Req* IE, then the DRNC shall reject the procedure using the RADIO LINK RECONFIGURATION FAILURE message.]

[FDD – If the concerned UE Context is configured to apply MIMO and Single Stream MIMO for the HS-DSCH Radio Link or the Secondary Serving Radio link, the DRNC shall reject the procedure using the RADIO LINK RECONFIGURATION FAILURE message.]

[FDD – If the RADIO LINK RECONFIGURATION REQUEST message contains the *Additional E-DCH Cell Information RL Reconf Req* IE and if the *E-DPCH Information* IE is not present or the E-DPCH Information was not

configured in the UE Context, then the DRNS shall reject the procedure using the RADIO LINK RECONFIGURATION FAILURE message.]

[FDD – If the RADIO LINK RECONFIGURATION REQUEST message contains the *Additional E-DCH Cell Information RL Reconf Req* IE and there exist a logical channel for which the *Maximum MAC-d PDU Size Extended* IE in the *E-DCH MAC-d Flows Information* IE in the *E-DCH FDD Information* IE is not present, the DRNS shall reject the procedure using the RADIO LINK RECONFIGURATION FAILURE message.]

[FDD – If the RADIO LINK RECONFIGURATION REQUEST message contains the *Additional E-DCH RL Specific Information To Setup* IE in the *Additional E-DCH FDD Setup Information* IE in the *Additional E-DCH Cell Information Setup* IE in the *Additional E-DCH Cell Information RL Reconf Req* IE and the *C-ID* IE is not included but the RL indicated by the *E-DCH Additional RL ID* IE is not configured in the current UE context as a Secondary Serving HS-DSCH radio link without any configured Additional E-DCH, the DRNS shall reject the procedure using the RADIO LINK RECONFIGURATION FAILURE message.]

8.3.8 Physical Channel Reconfiguration

8.3.8.1 General

The Physical Channel Reconfiguration procedure is used by the DRNS to request the SRNC to reconfigure one of the configured physical channels.

This procedure shall use the signalling bearer connection for the relevant UE Context.

The DRNS shall not initiate the Physical Channel Reconfiguration procedure if a Prepared Reconfiguration exists as defined in subclause 3.1, or if a Synchronised Radio Link Reconfiguration Preparation procedure, Unsynchronised Radio Link Reconfiguration procedure or Radio Link Deletion procedure is ongoing for the relevant UE context.

8.3.8.2 Successful Operation

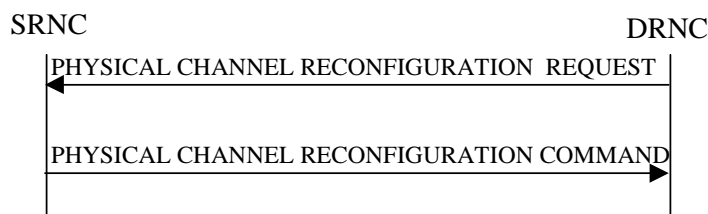

Figure 16: Physical Channel Reconfiguration procedure, Successful Operation

When the DRNC detects the need to modify one of its physical channels, it shall send a PHYSICAL CHANNEL RECONFIGURATION REQUEST to the SRNC.

The PHYSICAL CHANNEL RECONFIGURATION REQUEST message contains the new value(s) of the physical channel parameter(s) of the radio link for which the DRNC is requesting the reconfiguration.

[FDD – If compressed mode is prepared or active and at least one of the downlink compressed mode methods is “SF/2”, the DRNC shall include the *Transmission Gap Pattern Sequence Scrambling Code Information* IE in the *DL Code Information* IE in the PHYSICAL CHANNEL RECONFIGURATION REQUEST message indicating for each DL Channelisation Code whether the alternative scrambling code will be used or not if the downlink compressed mode methods “SF/2” is activated.]

[TDD – The SRNC shall apply the new values for any of [3.84Mcps TDD – *UL Code Information* IE, *Midamble Shift And Burst Type* IE,] [1.28Mcps TDD – *UL Code Information LCR* IE, *Midamble Shift LCR* IE,] [7.68 Mcps TDD – *UL Code Information 7.68 Mcps* IE, *Midamble Shift And Burst Type 7.68 Mcps* IE,] *TDD DPCH Offset* IE, *Repetition Period* IE, *Repetition Length* IE, or *TFCI presence* IE included in the *UL DPCH Information* IE within the PHYSICAL CHANNEL RECONFIGURATION REQUEST message, otherwise the previous values specified for this DPCH shall still apply.]

[TDD – The SRNC shall apply the new values for any of [3.84Mcps TDD – *DL Code Information* IE, *Midamble Shift And Burst Type* IE,] [1.28Mcps TDD – *DL Code Information LCR* IE, *Midamble Shift LCR* IE,] [7.68 Mcps TDD – *DL Code Information 7.68 Mcps* IE, *Midamble Shift And Burst Type 7.68 Mcps* IE,] *TDD DPCH Offset* IE *Repetition*

Period IE, *Repetition Length IE*, or *TFCI presence IE* included in the *DL DPCH Information IE* within the *PHYSICAL CHANNEL RECONFIGURATION REQUEST* message, otherwise the previous values specified for this DPCH shall still apply.]

[3.84 Mcps TDD – If the *PHYSICAL CHANNEL RECONFIGURATION REQUEST* includes *HS-PDSCH Timeslot Specific Information IE* the SRNC shall apply the values of the *Midamble Shift And Burst Type IE* for each HS-PDSCH timeslot.]

[1.28 Mcps TDD – If the *PHYSICAL CHANNEL RECONFIGURATION REQUEST* includes *HS-PDSCH Timeslot Specific Information LCR IE* the SRNC shall apply the values of the *Midamble Shift LCR IE* for each HS-PDSCH timeslot.]

[1.28 Mcps TDD – if the *PHYSICAL CHANNEL RECONFIGURATION REQUEST* includes the *PLCCH Information IE* the SRNC shall modify, delete or grant a new PLCCH assignment to the indicated timeslot of the indicated UL DCH-type CCTrCH according to its content.]

[7.68 Mcps TDD – If the *PHYSICAL CHANNEL RECONFIGURATION REQUEST* includes *HS-PDSCH Timeslot Specific Information 7.68 Mcps IE* the SRNC shall apply the values of the *Midamble Shift And Burst Type 7.68 Mcps IE* for each HS-PDSCH timeslot.]

[FDD – If the *PHYSICAL CHANNEL RECONFIGURATION REQUEST* includes *F-DPCH Slot Format IE* the SRNC shall apply the values of the *F-DPCH Slot Formats IE* for F-DPCH Slot Format operation.]

Upon receipt of the *PHYSICAL CHANNEL RECONFIGURATION REQUEST*, the SRNC shall decide an appropriate execution time for the change. The SRNC shall respond with a *PHYSICAL CHANNEL RECONFIGURATION COMMAND* message to the DRNC that includes the *CFN IE* indicating the execution time.

At the CFN, the DRNS shall switch to the new configuration that has been requested, and release the resources related to the old physical channel configuration.

8.3.8.3 Unsuccessful Operation

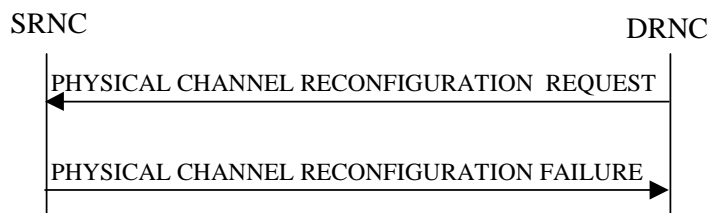

Figure 17: Physical Channel Reconfiguration procedure, Unsuccessful Operation

If the SRNC cannot accept the reconfiguration request it shall send the *PHYSICAL CHANNEL RECONFIGURATION FAILURE* message to the DRNC, including the reason for the failure in the *Cause IE*.

Typical cause values are:

Radio Network Layer Causes:

- Reconfiguration not Allowed.

8.3.8.4 Abnormal Conditions

While waiting for the *PHYSICAL CHANNEL RECONFIGURATION COMMAND* message, if the DRNC receives any of the *RADIO LINK RECONFIGURATION PREPARE*, *RADIO LINK RECONFIGURATION REQUEST*, or *RADIO LINK DELETION REQUEST* messages, the DRNC shall abort the Physical Channel Reconfiguration procedure. These messages thus override the DRNC request for physical channel reconfiguration.

When the SRNC receives a *PHYSICAL CHANNEL RECONFIGURATION REQUEST* message while a Synchronised Radio Link Reconfiguration procedure, Unsynchronised Radio Link Reconfiguration procedure or Radio Link Deletion procedure is ongoing, the SRNC shall ignore the request message and assume that receipt of any of the messages *RADIO LINK RECONFIGURATION PREPARE*, *RADIO LINK RECONFIGURATION REQUEST* or *RADIO LINK*

DELETION REQUEST by the DRNC has terminated the Physical Channel Reconfiguration procedure. In this case the SRNC shall not send a PHYSICAL CHANNEL RECONFIGURATION FAILURE message to the DRNC.

8.3.9 Radio Link Failure

8.3.9.1 General

This procedure is started by the DRNS when one or more Radio Links [FDD – or Radio Link Sets][TDD – or CCTrCHs within a Radio Link] are no longer available.

This procedure shall use the signalling bearer connection for the relevant UE Context.

The DRNS may initiate the Radio Link Failure procedure at any time after establishing a Radio Link.

8.3.9.2 Successful Operation

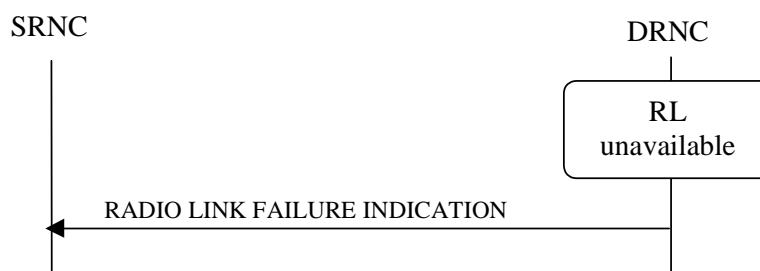

Figure 18: Radio Link Failure procedure, Successful Operation

When the DRNC detects that one or more Radio Link(s) [FDD – or Radio Link Set(s)] [TDD – or CCTrCHs within a Radio Link] are no longer available, it shall send the RADIO LINK FAILURE INDICATION message to the SRNC. The message indicates the failed Radio Link(s) [FDD – or Radio Link Set(s)] [TDD – or CCTrCHs] with the most appropriate cause values defined in the *Cause* IE. If the failure concerns one or more individual Radio Links the DRNC shall include the affected Radio Link(s) using the *RL Information* IE. [FDD – If the failure concerns one or more Radio Link Set(s) the DRNC shall include the affected Radio Link Set(s) using the *RL Set Information* IE.] [TDD – If the failure concerns only the failure of one or more CCTrCHs within a radio link the DRNC shall include the affected CCTrCHs using the *CCTrCH ID* IE.]

When the RL Failure procedure is used to notify loss of UL synchronisation of a [FDD – Radio Link Set] [TDD – Radio Link or CCTrCHs within a Radio Link] on the Uu interface, the RADIO LINK FAILURE INDICATION message shall be sent with the *Cause* IE set to “Synchronisation Failure” when indicated by the UL synchronisation detection algorithm defined in ref. TS 25.214 [10] subclause 4.3 and TS 25.224 [22] subclause 4.4.2.

[FDD – When the Radio Link Failure procedure is used to indicate permanent failure in one or more Radio Link(s)/Radio Link Set(s) due to the occurrence of an UL or DL frame with more than one transmission gap caused by one or more compressed mode pattern sequences, the DL transmission shall be stopped and the RADIO LINK FAILURE INDICATION message shall be sent with the *Cause Value* IE set to “Invalid CM Settings”. After sending the RADIO LINK FAILURE INDICATION message to notify the permanent failure, the DRNS shall not remove the Radio Link(s)/Radio Link Set(s) from the UE Context, or remove the UE Context itself.]

[FDD – When the Radio Link Failure Procedure is used to indicate E-DCH non serving cell processing issue, the RADIO LINK FAILURE INDICATION shall be sent, with the *Cause* IE set to “Not enough user plane processing resources”.]

In the other cases the Radio Link Failure procedure is used to indicate that one or more Radio Link(s) [FDD – or Radio Link Set(s)] are permanently unavailable and cannot be restored. After sending the RADIO LINK FAILURE INDICATION message to notify the permanent failure, the DRNS shall not remove the Radio Link from the UE Context, or remove the UE Context itself. When applicable, the allocation retention priorities associated with the transport channels shall be used by the DRNS to prioritise which Radio Links to indicate as unavailable to the SRNC.

Typical cause values are:

Radio Network Layer Causes:

Synchronisation Failure;
Invalid CM Settings.

Transport Layer Causes:

Transport Resources Unavailable.

Miscellaneous Causes:

Control Processing Overload;
HW Failure;
O&M Intervention;
Not enough user plane processing resources.

8.3.9.3 Abnormal Conditions

-

8.3.10 Radio Link Restoration

8.3.10.1 General

This procedure is used to notify establishment and re-establishment of UL synchronisation of one or more [FDD – RL Set(s)] [TDD – Radio Links or CCTrCH(s) in a Radio Link] on the Uu interface.

This procedure shall use the signalling bearer connection for the relevant UE Context.

The DRNC may initiate the Radio Link Restoration procedure at any time after establishing a Radio Link.

8.3.10.2 Successful Operation



Figure 19: Radio Link Restoration procedure, Successful Operation

The DRNC shall send the RADIO LINK RESTORE INDICATION message to the SRNC when and as specified by the UL Uu synchronisation detection algorithm defined in ref. TS 25.214 [10] subclause 4.3 and TS 25.224 [22] subclause 4.4.2 [FDD -, or when the *Fast Reconfiguration Mode* IE has been included in the RADIO LINK RECONFIGURATION COMMIT message and the DRNS has detected that the UE has changed to the new configuration. The algorithm in ref. TS 25.214 [10] shall use the minimum value of the parameters N_INSYNC_IND that are configured in the cells supporting the radio links of the RL Set.]

[TDD – If the re-established UL Uu synchronisation concerns one or more individual Radio Links the DRNC shall include in the RADIO LINK RESTORE INDICATION message the *RL Information* IE to indicate the affected Radio Link(s). If the re-established synchronisation concerns one or more individual CCTrCHs within a radio link the DRNS shall include in the RADIO LINK RESTORE INDICATION message the *RL Information* IE to indicate the affected CCTrCHs.] [FDD – If the re-established UL Uu synchronisation concerns one or more Radio Link Sets the DRNC shall include in the RADIO LINK RESTORE INDICATION message the *RL Set Information* IE to indicate the affected Radio Link Set(s).]

[FDD – The DRNC shall send the RADIO LINK RESTORE INDICATION message when the E-DCH processing issue condition has ceased.]

8.3.10.3 Abnormal Conditions

-

8.3.11 Dedicated Measurement Initiation

8.3.11.1 General

This procedure is used by an SRNS to request the initiation of dedicated measurements in a DRNS.

This procedure shall use the signalling bearer connection for the relevant UE Context.

The Dedicated Measurement Initiation procedure shall not be initiated if a Prepared Reconfiguration exists, as defined in subclause 3.1.

8.3.11.2 Successful Operation

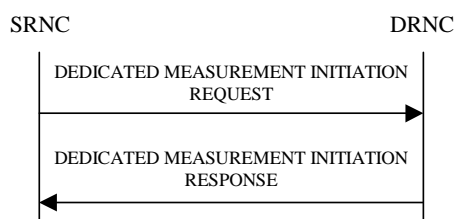

Figure 20: Dedicated Measurement Initiation procedure, Successful Operation

The procedure is initiated with a DEDICATED MEASUREMENT INITIATION REQUEST message sent from the SRNC to the DRNC.

Upon receipt, the DRNC shall initiate the requested dedicated measurement according to the parameters given in the DEDICATED MEASUREMENT INITIATION REQUEST message.

If the Dedicated Measurement Object Type is indicated as being “RL” in the DEDICATED MEASUREMENT INITIATION REQUEST message, measurement results shall be reported for all the indicated Radio Links.

[FDD – If the Dedicated Measurement Object Type is indicated as being “RLS” in the DEDICATED MEASUREMENT INITIATION REQUEST message, measurement results shall be reported for all the indicated Radio Link Sets.]

[FDD – If the Dedicated Measurement Object Type is indicated as being “ALL RL” in the DEDICATED MEASUREMENT INITIATION REQUEST message, measurement results shall be reported for all current and future Radio Links within the UE Context.]

[TDD – If the Dedicated Measurement Object Type is indicated as being “ALL RL” in the DEDICATED MEASUREMENT INITIATION REQUEST message, measurement results shall be reported for one existing DPCH per CCTrCH in each used time slot of current and future Radio Links within the UE Context, provided the measurement type is applicable to the respective DPCH.]

[FDD – If the Dedicated Measurement Object Type is indicated as being “ALL RLS” in the DEDICATED MEASUREMENT INITIATION REQUEST message, measurement results shall be reported for all the existing and future Radio Link Sets within the UE Context.]

[TDD – If the *DPCH ID* IE or *DPCH ID 7.68Mcps* IE is provided within the RL Information, the measurement request shall apply for the requested physical channel individually. If no *DPCH ID* IE, *DPCH ID 7.68Mcps* IE or *HS-SICH ID* IE is provided within the RL Information the measurement request shall apply for one existing DPCH per CCTrCH in each used time slot of the Radio Link, provided the measurement type is applicable to this DPCH.]

[TDD – If the *HS-SICH Information* IE is provided within the RL Information, the measurement request shall apply for the requested physical channel individually.]

[TDD – If the *Dedicated Measurement Type* IE is set to “HS-SICH reception quality “, the DRNS shall initiate measurements of the failed, missed and total HS-SICH transmissions on all of the HS-SICH assigned to this UE Context. If either the failed or missed HS-SICH transmission satisfies the requested report characteristics, the DRNS

shall report the result of both failed and missed transmission measurements along with the total number of transmissions.]

Report characteristics

The *Report Characteristics* IE indicates how the reporting of the dedicated measurement shall be performed. See also Annex B.

If the *Report Characteristics* IE is set to “On Demand” and if the *CFN* IE is not provided, the DRNS shall report the measurement result immediately in the DEDICATED MEASUREMENT INITIATION RESPONSE message. If the *CFN* IE is provided, it indicates the frame for which the measurement value shall be provided. The provided measurement value shall be the one reported by the layer 3 filter, referred to as point C in the measurement model in TS 25.302 [26].

If the *Report Characteristics* IE is set to “Periodic” and if the *CFN* IE is not provided, the DRNS shall immediately and periodically initiate the Dedicated Measurement Reporting procedure for this measurement, with a frequency as specified by the *Report Periodicity* IE. If the *CFN* IE is provided, the DRNS shall initiate a Dedicated Measurement Reporting procedure for this measurement at the CFN indicated in the *CFN* IE, and shall repeat this initiation periodically thereafter with a frequency as specified by the *Report Periodicity* IE. The provided measurement value shall be the one reported by the layer 3 filter, referred to as point C in the measurement model in TS 25.302 [26].

If the *Report Characteristics* IE is set to “Event A”, the DRNS shall initiate the Dedicated Measurement Reporting procedure when the measured entity rises above the requested threshold, as specified by the *Measurement Threshold* IE, and then stays above the threshold for the requested hysteresis time, as specified by the *Measurement Hysteresis Time* IE. If the *Measurement Hysteresis Time* IE is not included, the DRNC shall use the value zero for the hysteresis time.

If the *Report Characteristics* IE is set to “Event B”, the DRNS shall initiate the Dedicated Measurement Reporting procedure when the measured entity falls below the requested threshold, as specified by the *Measurement Threshold* IE, and then stays below the threshold for the requested hysteresis time, as specified by the *Measurement Hysteresis Time* IE. If the *Measurement Hysteresis Time* IE is not included, the DRNC shall use the value zero for the hysteresis time.

If the *Report Characteristics* IE is set to “Event C”, the DRNS shall initiate the Dedicated Measurement Reporting procedure when the measured entity rises more than the requested threshold specified by the *Measurement Increase/Decrease Threshold* IE, and only when this rise occurs within the requested rising time specified by the *Measurement Change Time* IE. After reporting this type of event, DRNS shall not initiate the next C event reporting for the same measurement during the subsequent time specified by the *Measurement Change Time* IE.

If the *Report Characteristics* IE is set to “Event D”, the DRNS shall initiate the Dedicated Measurement Reporting procedure when the measured entity falls more than the requested threshold specified by the *Measurement Increase/Decrease Threshold* IE, and only when this falls occurs within the requested falling time specified by the *Measurement Change Time* IE. After reporting this type of event, the DRNS shall not initiate the next D event reporting for the same measurement during the subsequent time specified by the *Measurement Change Time* IE.

If the *Report Characteristics* IE is set to “Event E”, the DRNS shall initiate the Dedicated Measurement Reporting procedure when the measured entity rises above the *Measurement Threshold 1* IE and stays above the threshold for the *Measurement Hysteresis Time* IE (Report A). When the conditions for Report A are met and if the *Report Periodicity* IE is provided, the DRNS shall initiate the Dedicated Measurement Reporting procedure periodically with the requested report frequency specified by the *Report Periodicity* IE. If the conditions for Report A have been met and the measured entity falls below the *Measurement Threshold 2* IE and stays below the threshold for the *Measurement Hysteresis Time* IE, the DRNS shall initiate the Dedicated Measurement Reporting procedure (Report B) and shall terminate any corresponding periodic reporting. If the *Measurement Threshold 2* IE is not present, the DRNS shall use the value of the *Measurement Threshold 1* IE instead. If the *Measurement Hysteresis Time* IE is not included, the DRNC shall use the value zero as hysteresis times for both Report A and Report B.

If the *Report Characteristics* IE is set to “Event F”, the DRNS shall initiate the Dedicated Measurement Reporting procedure when the measured entity falls below the *Measurement Threshold 1* IE and stays below the threshold for the *Measurement Hysteresis Time* IE (Report A). When the conditions for Report A are met and if the *Report Periodicity* IE is provided, the DRNS shall initiate the Dedicated Measurement Reporting procedure periodically with the requested report frequency specified by the *Report Periodicity* IE. If the conditions for Report A have been met and the measured entity rises above the *Measurement Threshold 2* IE and stays above the threshold for the *Measurement Hysteresis Time* IE, the DRNS shall initiate the Dedicated Measurement Reporting procedure (Report B) and shall terminate any corresponding periodic reporting. If the *Measurement Threshold 2* IE is not present, the DRNS shall use the value of the *Measurement Threshold 1* IE instead. If the *Measurement Hysteresis Time* IE is not included, the DRNC shall use the value zero as hysteresis times for both Report A and Report B.

If the *Report Characteristics* IE is not set to “On –Demand”, the DRNS is required to perform reporting for a dedicated measurement object, in accordance with the conditions provided in the DEDICATED MEASUREMENT INITIATION REQUEST message, as long as the object exists. If no dedicated measurement object(s) for which a measurement is defined exists any more, the DRNS shall terminate the measurement locally without reporting this to the SRNC.

If at the start of the measurement, the reporting criteria are fulfilled for any of Event A, Event B, Event E or Event F, the DRNS shall initiate the Dedicated Measurement Reporting procedure immediately, and then continue with the measurements as specified in the DEDICATED MEASUREMENT INITIATION REQUEST message.

Higher layer filtering

The *Measurement Filter Coefficient* IE indicates how filtering of the dedicated measurement values shall be performed before measurement event evaluation and reporting.

The averaging shall be performed according to the following formula.

$$F_n = (1 - a) \cdot F_{n-1} + a \cdot M_n$$

The variables in the formula are defined as follows:

F_n is the updated filtered measurement result

F_{n-1} is the old filtered measurement result

M_n is the latest received measurement result from physical layer measurements, the unit used for M_n is the same unit as the reported unit in the DEDICATED MEASUREMENT INITIATION RESPONSE, DEDICATED MEASUREMENT REPORT messages or the unit used in the event evaluation (i.e. same unit as for F_n).

$A = 1/2^{(k/2)}$, where k is the parameter received in the *Measurement Filter Coefficient* IE. If the *Measurement Filter Coefficient* IE is not present, a shall be set to 1 (no filtering)

In order to initialise the averaging filter, F_0 is set to M_1 when the first measurement result from the physical layer measurement is received.

Measurement Recovery Behavior:

If the *Measurement Recovery Behavior* IE is included in the DEDICATED MEASUREMENT INITIATION REQUEST message, the DRNS shall, if Measurement Recovery Behavior is supported, include the *Measurement Recovery Support Indicator* IE in the DEDICATED MEASUREMENT INITIATION RESPONSE message and perform the Measurement Recovery Behavior as described in subclause 8.3.12.2.

Response message

If the DRNS was able to initiate the measurement requested by the SRNS it shall respond with the DEDICATED MEASUREMENT INITIATION RESPONSE message. The message shall include the same Measurement ID that was used in the DEDICATED MEASUREMENT INITIATION REQUEST message.

In the case in which the *Report Characteristics* IE is set to “On Demand”:

- The DRNC shall include the measurement result in the *Dedicated Measurement Value* IE within the DEDICATED MEASUREMENT INITIATION RESPONSE message.
- If the *CFN Reporting Indicator* IE is set to “FN Reporting Required”, the *CFN* IE shall be included in the DEDICATED MEASUREMENT INITIATION RESPONSE message. The reported CFN shall be the CFN at the time when the dedicated measurement value was reported by the layer 3 filter, referred to as point C in the measurement model in TS 25.302 [26].
- [TDD – If the measurement was made on a particular DPCH, the DEDICATED MEASUREMENT INITIATION RESPONSE message shall include the DPCH ID of that DPCH in the [1.28Mcps TDD and 3.84Mcps TDD – *DPCH ID* IE] [7.68Mcps TDD – *DPCH ID 7.68Mcps* IE].]
- [TDD – If the measurement was made on a particular HS-SICH, the DEDICATED MEASUREMENT INITIATION RESPONSE message shall include the ID of that HS-SICH in the *HS-SICH ID* IE.]

[FDD – If the *Alternative Format Reporting Indicator* IE is set to “Alternative format is allowed” in the DEDICATED MEASUREMENT INITIATION REQUEST message, the DRNC may include the *Extended Round Trip Time* IE in the DEDICATED MEASUREMENT INITIATION RESPONSE message.]

8.3.11.3 Unsuccessful Operation

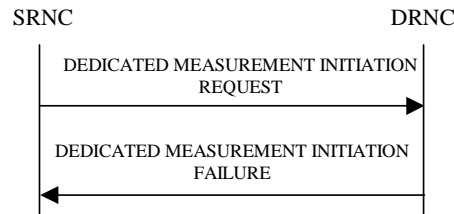

Figure 21: Dedicated Measurement Initiation procedure, Unsuccessful Operation

If the requested measurement cannot be initiated for one of the RL/RLS, the DRNC shall send a DEDICATED MEASUREMENT INITIATION FAILURE message. The message shall include the same *Measurement ID* IE that was used in the DEDICATED MEASUREMENT INITIATION REQUEST message and shall include the *Cause* IE set to an appropriate value.

If the DEDICATED MEASUREMENT INITIATION REQUEST message includes the *Partial Reporting Indicator* IE, the DRNS shall, if partial reporting is supported, separate the unsuccessful measurement initiations from the successful measurement initiations. For the successful measurement initiations on a RL or an RLS, the DRNS shall include the *Successful RL Information* IE or the *Successful RL Set Information* IE for the concerned RL or RLS if the *Report Characteristics* IE in the DEDICATED MEASUREMENT INITIATION REQUEST message was set to “On Demand”. For the unsuccessful measurement initiations, the DRNS shall include the *Individual Cause* IE set to an appropriate value if it differs from the value of the *Cause* IE.

Typical cause values are:

Radio Network Layer Causes:

- Measurement not Supported For The Object
- Measurement Temporarily not Available

Miscellaneous Causes:

- Control Processing Overload
- HW Failure

8.3.11.4 Abnormal Conditions

The allowed combinations of the Dedicated Measurement Type and Report Characteristics Type are shown in the table below marked with “X”. For not allowed combinations, the DRNS shall reject the Dedicated Measurement Initiation procedure using the DEDICATED MEASUREMENT INITIATION FAILURE message.

Table 4: Allowed Dedicated Measurement Type and Report Characteristics Type combinations

Dedicated Measurement Type	Report Characteristics Type								On Modification
	On Demand	Periodic	Event A	Event B	Event C	Event D	Event E	Event F	
SIR	X	X	X	X	X	X	X	X	
SIR Error	X	X	X	X	X	X	X	X	
Transmitted Code Power	X	X	X	X	X	X	X	X	
RSCP	X	X	X	X	X	X	X	X	
Rx Timing Deviation	X	X	X	X			X	X	
Round Trip Time	X	X	X	X	X	X	X	X	
Rx Timing Deviation LCR	X	X	X	X			X	X	
HS-SICH Reception Quality	X	X	X	X			X	X	
Angle Of Arrival LCR	X	X							
Rx Timing Deviation 7.68Mcps	X	X	X	X			X	X	
Rx Timing Deviation 3.84Mcps Extended	X	X	X	X			X	X	

If the Dedicated Measurement Type received in the *Dedicated Measurement Type* IE is not defined in ref. TS 25.215 [11] or TS 25.225 [14] to be measured on the Dedicated Measurement Object Type received in the DEDICATED MEASUREMENT INITIATION REQUEST message, the DRNS shall reject the Dedicated Measurement Initiation procedure.

If the *CFN* IE is included in the DEDICATED MEASUREMENT INITIATION REQUEST message and the *Report Characteristics* IE is other than “Periodic” or “On Demand”, the DRNS shall reject the Dedicated Measurement Initiation procedure, and the DRNC shall send a DEDICATED MEASUREMENT INITIATION FAILURE message.

8.3.12 Dedicated Measurement Reporting

8.3.12.1 General

This procedure is used by the DRNS to report the results of the successfully initiated measurements requested by the SRNS with the Dedicated Measurement Initiation procedure.

This procedure shall use the signalling bearer connection for the relevant UE Context.

The DRNC may initiate the Dedicated Measurement Reporting procedure at any time after establishing a Radio Link.

8.3.12.2 Successful Operation

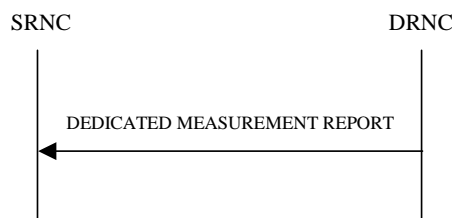

Figure 22: Dedicated Measurement Reporting procedure, Successful Operation

If the requested measurement reporting criteria are met, the DRNS shall initiate the Dedicated Measurement Reporting procedure. If the measurement was initiated (by the Dedicated Measurement Initiation procedure) for multiple dedicated measurement objects, the DRNC may include dedicated measurement values in the *Dedicated Measurement Value Information* IE for multiple objects in the DEDICATED MEASUREMENT REPORT message.

The *Measurement ID* IE shall be set to the Measurement ID provided by the SRNC when initiating the measurement with the Dedicated Measurement Initiation procedure.

If the achieved measurement accuracy does not fulfil the given accuracy requirement specified in ref. TS 25.133 [23] and TS 25.123 [24] or the measurement is temporarily not available in case Measurement Recovery Behavior is supported, the Measurement not available shall be reported in the *Dedicated Measurement Value Information* IE in the DEDICATED MEASUREMENT REPORT message, otherwise the DRNC shall include the *Dedicated Measurement Value* IE within the *Dedicated Measurement Value Information* IE. If the DRNC was configured to perform the Measurement Recovery Behavior, the DRNC shall indicate Measurement Available to the SRNC when the achieved measurement accuracy again fulfils the given accuracy requirement (see ref. TS 25.133 [23] and TS 25.123 [24]) and include the *Measurement Recovery Report Indicator* IE in the DEDICATED MEASUREMENT REPORT message if the requested measurement reporting criteria are not met.

If the CFN Reporting Indicator when initiating the measurement with the Dedicated Measurement Initiation procedure was set to “FN Reporting Required”, the DRNC shall include the *CFN* IE in the DEDICATED MEASUREMENT REPORT message. The reported CFN shall be the CFN at the time when the dedicated measurement value was reported by the layer 3 filter, referred to as point C in the measurement model in TS 25.302 [26].

[TDD – If the measurement was made on a particular DPCH, the DEDICATED MEASUREMENT REPORT message shall include the DPCH ID of that DPCH in the [1.28Mcps TDD and 3.84Mcps TDD – *DPCH ID* IE] [7.68Mcps TDD – *DPCH ID 7.68Mcps* IE].]

[TDD – If the measurement was made on a particular HS-SICH, the DEDICATED MEASUREMENT INITIATION RESPONSE message shall include the ID of that HS-SICH in the *HS-SICH ID* IE.]

[FDD – If the *Alternative Format Reporting Indicator* IE was set to “Alternative format is allowed” in the DEDICATED MEASUREMENT INITIATION REQUEST message setting up the measurement to be reported, the DRNC may include the *Extended Round Trip Time* IE in the DEDICATED MEASUREMENT REPORT message.]

8.3.12.3 Abnormal Conditions

-

8.3.13 Dedicated Measurement Termination

8.3.13.1 General

This procedure is used by the SRNS to terminate a measurement previously requested by the Dedicated Measurement Initiation procedure.

This procedure shall use the signalling bearer connection for the relevant UE Context.

The Dedicated Measurement Termination procedure shall not be initiated if a Prepared Reconfiguration exists, as defined in subclause 3.1.

8.3.13.2 Successful Operation

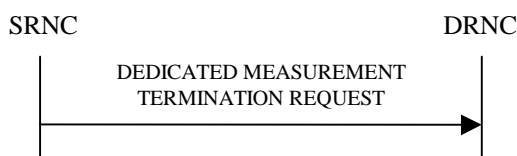

Figure 23: Dedicated Measurement Termination procedure, Successful Operation

This procedure is initiated with a DEDICATED MEASUREMENT TERMINATION REQUEST message, sent from the SRNC to the DRNC.

Upon receipt, the DRNS shall terminate reporting of dedicated measurements corresponding to the received *Measurement ID* IE.

8.3.13.3 Abnormal Conditions

-

8.3.14 Dedicated Measurement Failure

8.3.14.1 General

This procedure is used by the DRNS to notify the SRNS that a measurement previously requested by the Dedicated Measurement Initiation procedure can no longer be reported. When partial reporting is allowed and supported, this procedure shall be used to report that measurement for one or more RL/RLS can no longer be reported.

This procedure shall use the signalling bearer connection for the relevant UE Context.

The DRNC may initiate the Dedicated Measurement Failure procedure at any time after establishing a Radio Link.

8.3.14.2 Successful Operation

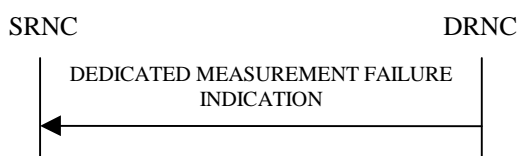

Figure 24: Dedicated Measurement Failure procedure, Successful Operation

This procedure is initiated with a DEDICATED MEASUREMENT FAILURE INDICATION message, sent from the DRNC to the SRNC, to inform the SRNC that a previously requested dedicated measurement can no longer be reported. The DRNC has locally terminated the indicated measurement. The DRNC shall include in the DEDICATED MEASUREMENT FAILURE INDICATION message the reason for the failure in the *Cause IE*.

The DRNS shall include *Unsuccessful RL Information IE* or the *Unsuccessful RL Set Information IE* for the concerned RL or RLS if partial reporting is allowed and it is supported. The DRNS shall include the *Individual Cause IE* set to an appropriate value if it differs from the value of the *Cause IE*.

Typical cause values are:

Miscellaneous Causes:

- Control Processing Overload
- HW Failure
- O&M Intervention

8.3.14.3 Abnormal Conditions

-

8.3.15 Downlink Power Control [FDD]

8.3.15.1 General

The purpose of this procedure is to balance the DL transmission powers of one or more radio links for one UE.

This procedure shall use the signalling bearer connection for the relevant UE Context.

The Downlink Power Control procedure may be initiated by the SRNC at any time after establishing a Radio Link. If the SRNC has initiated in this DRNS the deletion of the last Radio Link for this UE context, the Downlink Power Control procedure shall not be initiated.

8.3.15.2 Successful Operation



Figure 25: Downlink Power Control procedure, Successful Operation

The Downlink Power Control procedure is initiated by the SRNC sending a DL POWER CONTROL REQUEST message to the DRNC.

The *Power Adjustment Type* IE defines the characteristic of the power adjustment.

If the value of the *Power Adjustment Type* IE is “Common”, the DRNS shall set the Power Balancing Adjustment Type of the UE Context set to “Common”. As long as the Power Balancing Adjustment Type of the UE Context is set to “Common”, the DRNS shall perform the power adjustment (see below) for all existing and future radio links for the UE Context and use a common DL reference power level.

If the value of the *Power Adjustment Type* IE is “Individual”, the DRNS shall set the Power Balancing Adjustment Type of the UE Context set to “Individual”. The DRNS shall perform the power adjustment (see below) for all radio links addressed in the message using the given DL Reference Power per RL. If the Power Balancing Adjustment Type of the UE Context was set to “Common” before this message was received, power balancing on all radio links not addressed by the DL POWER CONTROL REQUEST message shall remain to be executed in accordance with the existing power balancing parameters which are now considered RL individual parameters. Power balancing will not be started on future radio links without a specific request.

If the value of the *Power Adjustment Type* IE is “None”, the DRNS shall set the Power Balancing Adjustment Type of the UE Context set to “None” and the DRNS shall suspend on going power adjustments for all radio links for the UE Context.

If the *Inner Loop DL PC Status* IE is present and set to “Active”, the DRNS shall activate inner loop DL power control for all radio links for the UE Context. If the *Inner Loop DL PC Status* IE is present and set to “Inactive”, the DRNS shall deactivate inner loop DL power control for all radio links for the UE Context according to ref. TS 25.214 [10].

Power Adjustment

The power balancing adjustment shall be superimposed on the inner loop power control adjustment (see ref. TS 25.214 [10]) if activated. The power balancing adjustment shall be such that:

$$\sum P_{bal} = (1 - r)(P_{ref} + P_{P-CPICH} - P_{init}) \text{ with an accuracy of } \pm 0.5 \text{ dB}$$

where the sum is performed over an adjustment period corresponding to a number of frames equal to the value of the *Adjustment Period* IE, P_{ref} is the value of the *DL Reference Power* IE, $P_{P-CPICH}$ is the power used on the primary CPICH, P_{init} is the code power of the last slot of the previous adjustment period and r is given by the *Adjustment Ratio* IE. If the last slot of the previous adjustment period is within a transmission gap due to compressed mode, P_{init} shall be set to the same value as the code power of the slot just before the transmission gap.

The adjustment within one adjustment period shall in any case be performed with the constraints given by the *Max Adjustment Step* IE and the DL TX power range set by the DRNC.

The power adjustments shall be started at the first slot of a frame with CFN modulo the value of *Adjustment Period* IE equal to 0 and shall be repeated for every adjustment period and shall be restarted at the first slot of a frame with CFN=0, until a new DL POWER CONTROL REQUEST message is received or the RL is deleted.

8.3.15.3 Abnormal Conditions

-

8.3.16 Compressed Mode Command [FDD]

8.3.16.1 General

The Compressed Mode Command procedure is used to activate or deactivate the compressed mode in the DRNS for one UE-UTRAN connection. This procedure shall use the signalling bearer connection for the relevant UE Context.

The Compressed Mode Command procedure shall not be initiated if a Prepared Reconfiguration exists, as defined in subclause 3.1.

8.3.16.2 Successful Operation



Figure 26: Compressed Mode Command procedure, Successful Operation

The procedure is initiated by the SRNC sending a COMPRESSED MODE COMMAND message to the DRNC.

Upon receipt of the COMPRESSED MODE COMMAND message from the SRNC and at the CFN indicated in the *CM Configuration Change CFN* IE, the DRNS shall deactivate all the ongoing Transmission Gap Pattern Sequences. From that moment on all Transmission Gap Pattern Sequences included in *Transmission Gap Pattern Sequence Status* IE repetitions (if present) shall be started when the indicated *TGCFN* IE elapses. The *CM Configuration Change CFN* IE in the *Active Pattern Sequence Information* IE and *TGCFN* IE for each sequence refer to the next coming CFN with that value.

If the values of the *CM Configuration Change CFN* IE and the *TGCFN* IE are equal, the concerned Transmission Gap Pattern Sequence shall be started immediately at the CFN with a value equal to the value received in the *CM Configuration Change CFN* IE.

If the concerned UE Context is configured to use F-DPCH in the downlink, the DRNS shall ignore, when activating the Transmission Gap Pattern Sequence(s), the downlink compressed mode method information, if existing, for the concerned Transmission Gap Pattern Sequence(s) in the Compressed Mode Configuration.

8.3.16.3 Abnormal Conditions

-

8.3.17 Downlink Power Timeslot Control [TDD]

8.3.17.1 General

The purpose of this procedure is to provide the DRNS with updated DL Timeslot ISCP values to use when deciding the DL TX Power for each timeslot.

This procedure shall use the signalling bearer connection for the relevant UE Context.

The Downlink Power Timeslot Control procedure can be initiated by the SRNC at any time after establishing a Radio Link. If the SRNC has initiated deletion of the last Radio Link in this DRNS, the Downlink Power Timeslot Control procedure shall not be initiated.

8.3.17.2 Successful Operation



Figure 26A: Downlink Power Timeslot Control procedure, Successful Operation

The Downlink Power Timeslot Control procedure is initiated by the SRNC sending a DL POWER TIMESLOT CONTROL REQUEST message to the DRNC.

Upon receipt of the DL POWER TIMESLOT CONTROL REQUEST message, the DRNS shall use the included [3.84Mcps TDD and 7.68 Mcps TDD – *DL Timeslot ISCP Info IE*] [1.28Mcps TDD – *DL Timeslot ISCP Info LCR IE*] value when deciding the DL TX Power for each timeslot as specified in TS 25.224 [22], i.e. it shall reduce the DL TX power in those downlink timeslots of the radio link in which the interference is low, and increase the DL TX power in those timeslots in which the interference is high, while keeping the total downlink power in the radio link unchanged.

If the *Primary CCPCH RSCP Delta IE* is included, the DRNS shall assume that the reported value for Primary CCPCH RSCP is in the negative range as per TS 25.123 [24], and the value is equal to the *Primary CCPCH RSCP Delta IE*. If the *Primary CCPCH RSCP Delta IE* is not included and the *Primary CCPCH RSCP IE* is included, the DRNS shall assume that the reported value is in the non-negative range as per TS 25.123 [24], and the value is equal to the *Primary CCPCH RSCP IE*. The DRNS should use the indicated value for HS-DSCH scheduling and transmit power adjustment.

8.3.17.3 Abnormal Conditions

-

8.3.18 Radio Link Pre-emption

8.3.18.1 General

This procedure is started by the DRNS when resources need to be freed.

This procedure shall use the signalling bearer connection for the UE Context associated with the RL to be pre-empted.

The DRNS may initiate the Radio Link Pre-emption procedure at any time after establishing a Radio Link.

8.3.18.2 Successful Operation

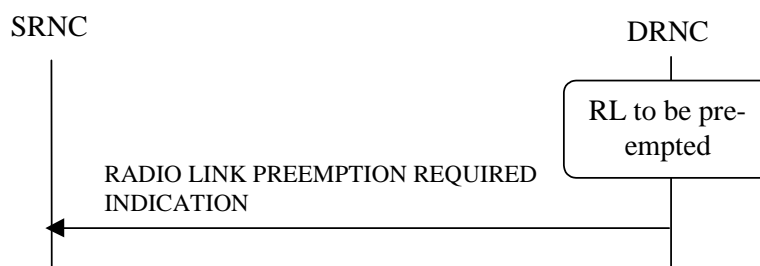

Figure 26B: Radio Link Pre-emption procedure, Successful Operation

When DRNC detects that one or more Radio Link(s) should be pre-empted (see Annex A), it shall send the RADIO LINK PREEMPTION REQUIRED INDICATION message to the SRNC. If all Radio Links for a UE Context should be pre-empted, the *RL Information IE* shall not be included in the message. If one or several but not all Radio Link(s) should be pre-empted for an UE Context, the Radio Link(s) that should be pre-empted shall be indicated in the *RL Information IE*. The Radio Link(s) that should be pre-empted, should be deleted by the SRNC.

[FDD – If only the E-DCH traffic on a Radio Link should be pre-empted, the DRNC shall indicate the EDCH MAC-d flows that should be pre-empted by including the *E-DCH MAC-d Flow Specific Information* IE in the RADIO LINK PREEMPTION REQUIRED INDICATION message.]

When only the HS-DSCH traffic on a Radio Link should be pre-empted, the DRNC shall indicate the HS-DSCH MAC-d flow(s) that should be pre-empted by including the *HS-DSCH MAC-d Flow Specific Information* IE in the RADIO LINK PREEMPTION REQUIRED INDICATION message.

8.3.18.3 Abnormal Conditions

-

8.3.19 Radio Link Congestion

8.3.19.1 General

This procedure is started by the DRNS when resource congestion is detected and the rate of one or more DCHs, corresponding to one or more radio links, is preferred to be limited in the UL and/or DL. This procedure is also used by the DRNC to indicate to the SRNC any change of the UL/DL resource congestion situation, affecting these radio links. This procedure shall use the signalling bearer connection for the relevant UE Context.

The Radio Link Congestion procedure shall not be initiated if a Prepared Reconfiguration exists, as defined in subclause 3.1.

8.3.19.2 Successful Operation



Figure 26C: Radio Link Congestion procedure, Successful Operation

Start of an UL/DL Resource Congestion Situation

When the DRNC detects the start of a UL/DL resource congestion situation and prefers the rate of one or more DCHs for one or more Radio Link(s) to be limited below the maximum rate currently configured in the UL/DL TFS, it shall send the RADIO LINK CONGESTION INDICATION message to the SRNC. The DRNC shall indicate the cause of the congestion in the *Congestion Cause* IE and shall indicate all the Radio Links for which the rate of a DCH needs to be reduced. For each DCH within the RL with UL congestion, the DRNC shall indicate the desired maximum UL data rate with the *Allowed UL Rate* IE in the *Allowed Rate Information* IE. For each DCH within the RL with DL congestion, the DRNC shall indicate the desired maximum DL data rate with the *Allowed DL Rate* IE in the *Allowed Rate Information* IE.

[FDD – For each E-DCH MAC-d flow within the RL with UL congestion, the DRNC shall indicate all the MAC-d flows for which the rate cannot be fulfilled.]

When receiving the RADIO LINK CONGESTION INDICATION message the SRNC should reduce the rate in accordance with the *Congestion Cause* IE and the indicated *Allowed DL Rate* IE and/or *Allowed UL Rate* IE for a DCH.

[FDD – If the RADIO LINK CONGESTION INDICATION message includes the *DCH Indicator For E-DCH-HSDPA Operation* IE, then the SRNS shall ignore the *DCH Rate Information* IE in the RADIO LINK CONGESTION INDICATION message.]

Change of UL/DL Resource Congestion Situation

The DRNC shall indicate any change of the UL/DL resource congestion situation by sending the RADIO LINK CONGESTION INDICATION message in which the new allowed rate(s) of the DCHs are indicated by the *Allowed Rate Information* IE. In the case that for at least one DCH the new allowed rate is lower than the previously indicated allowed rate for that DCH, the *Congestion Cause* IE, indicating the cause of the congestion, shall also be included.

When receiving a RADIO LINK CONGESTION INDICATION message indicating a further rate decrease on any DCH(s) on any RL, the SRNC should reduce the rate in accordance with the indicated congestion cause and the indicated allowed rate(s) for the DCH(s).

End of UL/DL Resource Congestion Situation

The end of an UL resource congestion situation, affecting a specific RL, shall be indicated by including the TF corresponding to the highest data rate in the *Allowed UL Rate* IE in the *Allowed Rate Information* IE for the concerned RL. The end of a DL resource congestion situation, affecting a specific RL, shall be indicated by including the TF with the highest data rate in the *Allowed DL Rate* IE in the *Allowed Rate Information* IE for the concerned RL.

8.3.19.3 Abnormal Conditions

-

8.3.20 Radio Link Activation

8.3.20.1 General

This procedure is used to activate or de-activate the DL transmission on the Uu interface regarding selected RLs.

8.3.20.2 Successful Operation



Figure 26D: Radio Link Activation procedure

This procedure is initiated by sending the RADIO LINK ACTIVATION COMMAND message from the SRNC to the DRNC. This procedure shall use the signalling bearer connection for the relevant UE Context.

Upon receipt, the DRNS shall for each concerned RL:

- if the *Delayed Activation Update* IE indicates “Activate”:
- if the *Activation Type* IE equals “Unsynchronised”:
- [FDD – start transmission on the new RL after synchronisation is achieved in the DL user plane as specified in TS 25.427 [4].]
- [TDD – start transmission on the new RL immediately as specified in TS 25.427 [4].]
- if the *Activation Type* IE equals “Synchronised”:
- [FDD – start transmission on the new RL after synchronisation is achieved in the DL user plane as specified in TS 25.427 [4], however never before the CFN indicated in the *Activation CFN* IE.]
- [TDD – start transmission on the new RL at the CFN indicated in the *Activation CFN* IE as specified in TS 25.427 [4].]
- [FDD – the DRNS shall apply the power level indicated in the *Initial DL Tx Power* IE to the transmission on each DL DPCH or on the F-DPCH of the RL when starting transmission until either UL synchronisation on the Uu interface is achieved for the RLS or power balancing is activated. During this period no inner loop power control shall be performed and, unless activated by the DL POWER CONTROL REQUEST message, no power balancing shall be performed. The DL power shall then vary according to the inner loop power control (see ref. TS 25.214 [10], subclause 5.2.1.2) and downlink power balancing adjustments (see 8.3.7).]

- [TDD – the DRNS shall apply the power level indicated in the *Initial DL Tx Power* IE to the transmission on each DL DPCH and on each Time Slot of the RL when starting transmission until the UL synchronisation on the Uu interface is achieved for the RL. No inner loop power control shall be performed during this period. The DL power shall then vary according to the inner loop power control (see ref.TS 25.224 [22], subclause 4.2.3.3).]
- [FDD – if the *Propagation Delay* IE and optionally the *Extended Propagation Delay* IE are included, the DRNS may use this information to speed up the detection of UL synchronisation on the Uu interface.]
- [FDD – if the *First RLS Indicator* IE is included, it indicates if the concerned RL shall be considered part of the first RLS established towards this UE. The *First RLS Indicator* IE shall be used by the DRNS to determine the initial TPC pattern in the DL of the concerned RL and all RLs which are part of the same RLS, as described in TS 25.214 [10], section 5.1.2.2.1.2.]
- if the *Delayed Activation Update* IE indicates “Deactivate”:
 - stop DL transmission immediately if the *Deactivation Type* IE equals “Unsynchronised”, or at the CFN indicated by the *Deactivation CFN* IE if the *Deactivation Type* IE equals “Synchronised”.

8.3.20.3 Abnormal Conditions

[FDD – If the *Delayed Activation Update* IE is included in the RADIO LINK ACTIVATION COMMAND message, it indicates “Activate” and the *First RLS Indicator* IE is not included, the DRNC shall initiate the ERROR INDICATION procedure.]

8.3.21 Radio Link Parameter Update

8.3.21.1 General

The Radio Link Parameter Update procedure is executed by the DRNS to update parameters related to HS-DSCH on a radio link for a UE-UTRAN connection or to update phase reference on a list of the radio links.

This procedure shall use the signalling bearer connection for the relevant UE context.

The Radio Link Parameter Update procedure shall not be initiated if a Prepared Reconfiguration exists, as defined in subclause 3.1.

8.3.21.2 Successful Operation



Figure 26E: Radio Link Parameter Update Indication, Successful Operation

The Radio Link Parameter Update procedure is initiated by the DRNS by sending the RADIO LINK PARAMETER UPDATE INDICATION message to the SRNC.

HS-DSCH related Parameter(s) Updating:

If RADIO LINK PARAMETER UPDATE INDICATION message is used to update the parameters related to HS-DSCH, it contains suggested value(s) of the HS-DSCH related parameter(s) that should be reconfigured on the radio link.

If the DRNS needs to update HS-DSCH related parameters, the DRNS shall initiate RADIO LINK PARAMETER UPDATE INDICATION message including [FDD – *HS-DSCH FDD Update Information* IE] [TDD – *HS-DSCH TDD Update Information* IE].

If the DRNS needs to allocate new HS-SCCH Codes, the DRNS shall initiate RADIO LINK PARAMETER UPDATE INDICATION message including *HS-SCCH Code Change Indicator IE*.

[FDD – If the DRNS needs to allocate new HS-PDSCH Codes, the DRNS shall initiate RADIO LINK PARAMETER UPDATE INDICATION message including *HS-PDSCH Code Change Indicator IE*.]

[FDD – If the DRNS needs to update the CQI Feedback Cycle k , CQI Repetition Factor, ACK-NACK Repetition Factor, CQI Power Offset, ACK Power Offset and/or NACK Power Offset, the DRNS shall initiate RADIO LINK PARAMETER UPDATE INDICATION message including *CQI Feedback Cycle k IE*, *CQI Repetition Factor IE*, *ACK-NACK Repetition Factor IE*, *CQI Power Offset IE*, *ACK Power Offset IE* and/or *NACK Power Offset IE*.]

[TDD – If the DRNS needs to update the TDD ACK-NACK Power Offset the DRNS shall initiate RADIO LINK PARAMETER UPDATE INDICATION message including *TDD ACK-NACK Power Offset IE*.]

[FDD – Secondary Serving HS-DSCH related Parameter(s) Updating:]

[FDD – If RADIO LINK PARAMETER UPDATE INDICATION message is used to update the parameters related to secondary serving HS-DSCH, it contains suggested value(s) of the secondary serving HS-DSCH related parameter(s) that should be reconfigured on the radio link.]

[FDD – If the DRNS needs to update secondary serving HS-DSCH related parameters, the DRNS shall initiate RADIO LINK PARAMETER UPDATE INDICATION message and include the *Additional HS Cell Information RL Param Upd IE*.]

- [FDD – If the DRNS needs to allocate new secondary serving HS-SCCH Codes, the DRNS shall include the *HS-SCCH Code Change Indicator IE* in the *HS-DSCH FDD Secondary Serving Update Information IE*.]

[FDD – Phase Reference Handling:]

[FDD – If DRNS needs to update phase reference for the channel estimation for one or several Radio Links, the DRNC shall initiate RADIO LINK PARAMETER UPDATE INDICATION message including *Phase Reference Update Information IE* for the concerned RL(s).]

[FDD – E-DCH:]

[FDD – If DRNS needs to update E-DCH related parameters, the DRNC shall initiate RADIO LINK PARAMETER UPDATE INDICATION message including *E-DCH FDD Update Information IE*.]

[FDD – If the DRNS needs to update the HARQ process allocation for non-scheduled transmission and/or HARQ process allocation for scheduled Transmission, the DRNS shall initiate RADIO LINK PARAMETER UPDATE INDICATION message including the *HARQ Process Allocation For 2ms Non-Scheduled Transmission Grant IE* for the concerned MAC-d Flows and/or *HARQ Process Allocation For 2ms Scheduled Transmission Grant IE*.]

[FDD – If the DRNS needs to allocate new E-AGCH Channelisation Code, new E-RGCH/E-HICH Channelisation Code, new E-RGCH Signature Sequence and/or new E-HICH Signature Sequence, the DRNC shall initiate RADIO LINK PARAMETER UPDATE INDICATION message including *E-DCH DL Control Channel Change Information IE*.]

[FDD – If the DRNS needs to update Additional E-DCH related parameters, the DRNS shall initiate RADIO LINK PARAMETER UPDATE INDICATION message including *Additional E-DCH Cell Information RL Param Upd IE*.]

- [FDD – If the DRNS needs to update the HARQ process allocation for scheduled Transmission, the DRNS shall initiate RADIO LINK PARAMETER UPDATE INDICATION message including the *HARQ Process Allocation For 2ms Scheduled Transmission Grant* .]
- [FDD – If the DRNS needs to allocate new E-AGCH Channelisation Code, new E-RGCH/E-HICH Channelisation Code, new E-RGCH Signature Sequence and/or new E-HICH Signature Sequence, the DRNS shall initiate RADIO LINK PARAMETER UPDATE INDICATION message including *Additional E-DCH DL Control Channel Change Information IE*.]

[FDD – CPC Recovery:]

[FDD – If the DRNS needs to indicate that the CPC Recovery has been initiated, the DRNC shall initiate RADIO LINK PARAMETER UPDATE INDICATION message including *CPC Recovery Report IE*.]

8.3.21.3 Abnormal Conditions

-

8.3.22 UE Measurement Initiation [TDD]

8.3.22.1 General

This procedure is used by a DRNC to request the initiation of UE measurements by the SRNC.

This procedure shall use the signalling bearer connection for the relevant UE Context.

The UE Measurement Initiation procedure shall not be initiated if a Prepared Reconfiguration exists, as defined in subclause 3.1.

8.3.22.2 Successful Operation

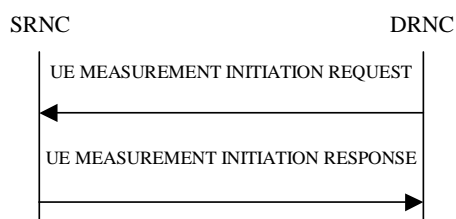

Figure 26F: UE Measurement Initiation procedure, Successful Operation

The procedure is initiated with a UE MEASUREMENT INITIATION REQUEST message sent from the DRNC to the SRNC.

Upon receipt the SRNC shall, provided that it determines that the measurement can be performed by the UE, initiate and forward the requested UE measurement according to the parameters given in the UE MEASUREMENT INITIATION REQUEST message. If the UE MEASUREMENT INITIATION REQUEST message includes the *UE Measurement Parameter Modification Allowed* IE with a value of “Parameter Modification Allowed” the *UE Measurement Report Characteristics* IE and the *Measurement Filter Coefficient* IE, if it is included, are suggested values, otherwise the values of these parameters must be fulfilled.

[3.84 Mcps TDD – If the *UE Measurement Timeslot Information HCR* IE is provided, the measurement request shall apply for the requested timeslot(s) individually. If the *UE Measurement Timeslot Information HCR* IE are not provided the SRNC may choose the timeslots for measurements that apply to individual timeslots.]

[1.28 Mcps TDD – If the *UE Measurement Timeslot Information LCR* IE is provided, the measurement request shall apply for the requested timeslot(s) individually. If the *UE Measurement Timeslot Information LCR* IE are not provided the SRNC may choose the timeslots for measurements that apply to individual timeslots.]

[7.68 Mcps TDD – If the *UE Measurement Timeslot Information 7.68 Mcps* IE is provided, the measurement request shall apply for the requested timeslot(s) individually. If the *UE Measurement Timeslot Information 7.68 Mcps* IE are not provided the SRNC may choose the timeslots for measurements that apply to individual timeslots.]

If the UE MEASUREMENT INITIATION REQUEST message includes the *Allowed Queuing Time* IE the SRNC may queue the request for a time period not to exceed the value of the *Allowed Queuing Time* IE before starting to execute the request.

The SRNC is required to perform reporting for a UE measurement object, in accordance with the conditions provided in the UE MEASUREMENT INITIATION REQUEST message, as long as the object exists. If no UE measurement object(s) for which a measurement is defined exists any more, the SRNC shall terminate the measurement locally without reporting this to the DRNC.

If at the start of the measurement, the reporting criteria are fulfilled for any of Event 1h, Event 1i, Event 6a, Event 6b, Event 6c, or Event 6d, the SRNC shall initiate the UE Measurement Reporting procedure immediately, and then continue with the measurements as specified in the UE MEASUREMENT INITIATION REQUEST message

At the start of a periodic measurement, the SRNC shall not initiate UE Measurement Reporting procedure until the next measurement is received from the UE, even if measurement data is available.

Report characteristics

The *UE Measurement Report Characteristics* IE indicates how the reporting of the dedicated measurement shall be performed. See TS 25.331 [16].

Higher layer filtering

The *Measurement Filter Coefficient* IE indicates how filtering of the dedicated measurement values shall be performed before measurement event evaluation and reporting. If the *Measurement Filter Coefficient* IE is not present, *a* shall be set to 1 (no filtering). The use of the *Measurement Filter Coefficient* IE is shown in TS 25.331 [16].

Response message

If the SRNC was able to initiate the measurement requested by the DRNC it shall respond with the UE MEASUREMENT INITIATION RESPONSE message. The message shall include the same Measurement ID that was used in the UE MEASUREMENT INITIATION REQUEST message.

If the DRNC allowed parameter modification and the SRNC modified the *Measurement Filter Coefficient* IE the SRNC shall include the modified value in the UE MEASUREMENT INITIATION RESPONSE message.

If the DRNC allowed parameter modification and the SRNC modified the *UE Measurement Report Characteristics* IE the SRNC shall include the modified value in the UE MEASUREMENT INITIATION RESPONSE message.

8.3.22.3 Unsuccessful Operation

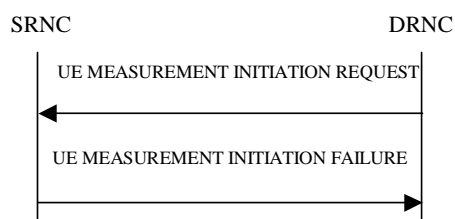

Figure 26G: UE Measurement Initiation procedure, Unsuccessful Operation

If the requested measurement cannot be initiated, the SRNC shall send a UE MEASUREMENT INITIATION FAILURE message. The message shall include the same *Measurement ID* IE that was used in the UE MEASUREMENT INITIATION REQUEST message and shall include the *Cause* IE set to an appropriate value.

Typical cause values are:

Radio Network Layer Causes:

- Measurement not Supported For The Object
- Measurement Temporarily not Available
- Measurement Repetition Rate not Compatible with Current Measurements
- UE not Capable to Implement Measurement

Miscellaneous Causes:

- Control Processing Overload
- HW Failure

8.3.22.4 Abnormal Conditions

-

8.3.23 UE Measurement Reporting [TDD]

8.3.23.1 General

This procedure is used by the SRNC to report the results of the successfully initiated measurements requested by the DRNC with the UE Measurement Initiation procedure.

This procedure shall use the signalling bearer connection for the relevant UE Context.

The SRNC may initiate the UE Measurement Reporting procedure at any time after establishing a Radio Link.

8.3.23.2 Successful Operation

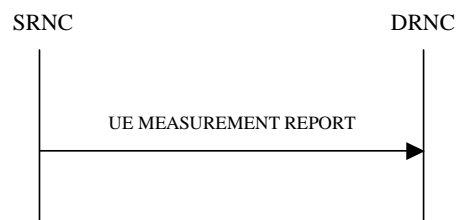

Figure 26H: UE Measurement Reporting procedure, Successful Operation

If the requested measurement reporting criteria was met in the UE and reported to the SRNC, the SRNC shall initiate the UE Measurement Reporting procedure. The *Measurement ID* IE shall be set to the Measurement ID provided by the DRNC when initiating the measurement with the UE Measurement Initiation procedure.

If Primary CCPCH RSCP is being reported:

- If the *Primary CCPCH RSCP Delta* IE is included, the DRNC shall assume that the reported value for Primary CCPCH RSCP is in the negative range as per TS 25.123 [24], and the value is equal to the *Primary CCPCH RSCP Delta* IE.
- If the *Primary CCPCH RSCP Delta* IE is not included the DRNC shall assume that the reported value is in the non negative range as per TS 25.123 [24], and the value is equal to the *Primary CCPCH RSCP* IE

If the achieved measurement accuracy does not fulfil the given accuracy requirement specified in ref. TS 25.123 [24], the Measurement not available shall be reported in the *UE Measurement Value Information* IE in the UE MEASUREMENT REPORT message, otherwise the SRNC shall include the *UE Measurement Value* IE within the *UE Measurement Value Information* IE.

8.3.23.3 Abnormal Conditions

-

8.3.24 UE Measurement Termination [TDD]

8.3.24.1 General

This procedure is used by the DRNC to terminate a measurement previously requested by the UE Measurement Initiation procedure.

This procedure shall use the signalling bearer connection for the relevant UE Context.

The UE Measurement Termination procedure shall not be initiated if a Prepared Reconfiguration exists, as defined in subclause 3.1.

8.3.24.2 Successful Operation



Figure 26I: UE Measurement Termination procedure, Successful Operation

This procedure is initiated with a UE MEASUREMENT TERMINATION REQUEST message, sent from the DRNC to the SRNC.

Upon receipt, the SRNC shall terminate forwarding of UE measurements corresponding to the received *Measurement ID* IE.

8.3.24.3 Abnormal Conditions

-

8.3.25 UE Measurement Failure [TDD]

8.3.25.1 General

This procedure is used by the SRNC to notify the DRNC that a measurement previously requested by the UE Measurement Initiation procedure can no longer be reported.

This procedure shall use the signalling bearer connection for the relevant UE Context.

The SRNC may initiate the UE Measurement Failure procedure at any time after establishing a Radio Link.

8.3.25.2 Successful Operation

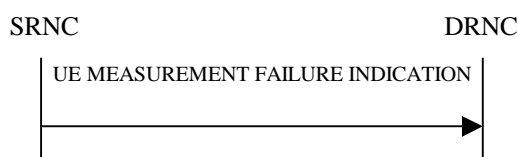

Figure 26J: UE Measurement Failure procedure, Successful Operation

This procedure is initiated with a UE MEASUREMENT FAILURE INDICATION message, sent from the SRNC to the DRNC, to inform the DRNC that a previously requested UE measurement can no longer be reported. The SRNC has locally terminated the forwarding of the indicated measurement. The SRNC shall include in the UE MEASUREMENT FAILURE INDICATION message the reason for the failure in the *Cause* IE.

Typical cause values are:

Miscellaneous Causes:

- Control Processing Overload
- HW Failure
- O&M Intervention

8.3.25.3 Abnormal Conditions

-

8.3.26 Iur Invoke Trace

8.3.26.1 General

The purpose of the Iur Invoke Trace procedure is to inform the DRNC that it should begin a Trace Session for a given UE Context according to the Trace Parameters indicated by the SRNC. This procedure is used for Trace Parameter Propagation in the Signalling Based Activation mechanism as defined in TS 32.421 [48] and TS 32.422 [49].

This procedure shall use the signalling bearer mode specified below.

8.3.26.2 Successful Operation



Figure 26K: Iur Invoke Trace procedure, Successful Operation

The Iur Invoke Trace procedure is invoked by the SRNC by sending an IUR INVOKE TRACE message to the DRNC.

When the concerned UE is utilising one or more radio links in the DRNC the message shall be sent using the connection oriented service of the signalling bearer and no further identification of the UE Context in the DRNC is required. If on the other hand, the UE is not utilising any radio link the message shall be sent using the connectionless service of the signalling bearer and the *D-RNTI* IE shall be included in the message to identify the UE Context in the DRNC.

Upon receiving the IUR INVOKE TRACE message, the DRNC should begin a Trace Recording Session according to the parameters indicated in the IUR INVOKE TRACE message.

If the *List Of Interfaces To Trace* IE is included in the IUR INVOKE TRACE message, the DRNC shall trace, for the concerned UE Context, the interfaces indicated by the *List Of Interfaces To Trace* IE. Otherwise, the DRNC shall trace, for the concerned UE Context, the Iur and Iub interfaces.

The values of the *UE Identity* IE, *Trace Reference* IE and *Trace Recording Session Reference* IE are used to tag the Trace Record to allow simpler construction of the total record by the entity which combines Trace Records.

If the DRNC does not support the requested value “Minimum” or “Medium” of the *Trace Depth* IE, the DRNC should begin a Trace Recording Session with maximum Trace Depth.

The DRNC may not start a Trace Recording Session if there are insufficient resources available within the DRNC.

8.3.26.3 Abnormal Conditions

-

8.3.27 Iur Deactivate Trace

8.3.27.1 General

The purpose of the Iur Deactivate Trace procedure is to inform the DRNC that it should stop a Trace Session for the concerned UE Context and the indicated Trace Reference. This procedure is used for the Signalling Based Deactivation mechanism as defined in TS 32.421 [48] and TS 32.422 [49].

This procedure shall use the signalling bearer mode specified below.

8.3.27.2 Successful Operation



Figure 26L: Iur Invoke Trace procedure, Successful Operation

The Iur Deactivate Trace procedure is invoked by the SRNC by sending an IUR DEACTIVATE TRACE message to the DRNC.

When the concerned UE is utilising one or more radio links in the DRNC the message shall be sent using the connection oriented service of the signalling bearer and no further identification of the UE Context in the DRNC is required. If on the other hand, the UE is not utilising any radio link the message shall be sent using the connectionless service of the signalling bearer and the *D-RNTI* IE shall be included in the message to identify the UE Context in the DRNC.

Upon receiving the IUR DEACTIVATE TRACE message, the DRNC shall stop for the concerned UE Context any ongoing Trace Recording Session for the Trace Session identified by the *Trace Reference* IE.

8.3.27.3 Abnormal Conditions

-

8.3.28 Enhanced Relocation

8.3.28.1 General

This procedure is used for relocation of SRNS in case the SRNC and DRNC connect to same CN node.

The connection-oriented service of the signalling bearer shall be established in conjunction with this procedure in case the relevant UE Context does not exist for the UE.

This procedure shall use the signalling bearer connection for the relevant UE Context in the UE Context exists. The Enhanced Relocation procedure shall not be initiated if a Prepared Reconfiguration exists, as defined in subclause 3.1.

8.3.28.2 Successful Operation

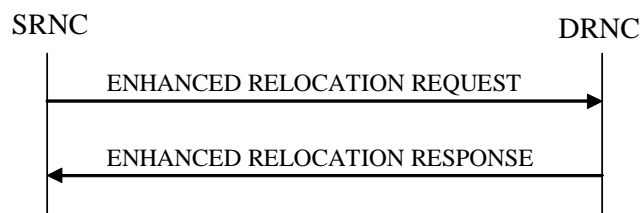

Figure 26M: Enhanced Relocation procedure: Successful Operation

The SRNC initiates the procedure by sending an ENHANCED RELOCATION REQUEST message. When the SRNC sends the ENHANCED RELOCATION REQUEST message, it shall start the timer $T_{RELOC_{prep}}$. The ENHANCED RELOCATION REQUEST message shall contain the *Cause* IE with an appropriate value e.g.: “Time critical Relocation”, “Resource optimisation relocation”, “Relocation desirable for radio reasons”, “Directed Retry”, “Reduce Load in Serving Cell”, “No Iu CS UP relocation”.

If the ENHANCED RELOCATION REQUEST message includes SRNC-ID, the DRNC shall create a UE Context for this UE, allocate a D-RNTI for the UE Context.

8.3.28.3 Unsuccessful Operation

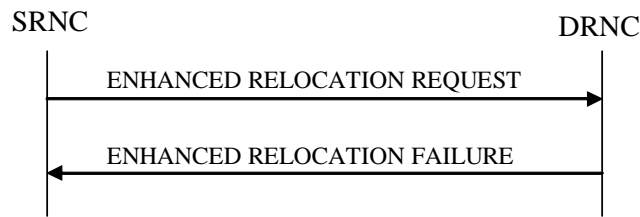

Figure 26N: Enhanced Relocation procedure: Unsuccessful Operation

If the DRNC is not able to accept any of the RABs or a failure occurs during the procedure, the DRNC shall send the ENHANCED RELOCATION FAILURE message to the SRNC. The message shall contain the *Cause* IE with an appropriate value.

Interactions with Enhanced Relocation Cancel procedure:

If there is no response from the DRNC to the ENHANCED RELOCATION REQUEST message before timer $T_{RELOC_{prep}}$ expires in the DRNC, the SRNC should cancel the Enhanced Relocation procedure towards the DRNC by initiating the Enhanced Relocation Cancel procedure with the appropriate value for the *Cause* IE, e.g. “ $T_{RELOC_{prep}}$ expiry”. The SRNC shall ignore any ENHANCED RELOCATION RESPONSE or ENHANCED RELOCATION FAILURE message received after the initiation of the Enhanced Relocation Cancel procedure and remove any reference and release any resources related to the concerned UE Context.

8.3.28.4 Abnormal Conditions

-

8.3.29 Enhanced Relocation Cancel

8.3.29.1 General

This procedure is used to cancel an ongoing enhanced relocation or an already prepared relocation.

This procedure shall use the signalling bearer connection for the relevant UE Context.

8.3.29.2 Successful Operation



Figure 26O: Enhanced Relocation Cancel procedure: Successful Operation

The SRNC initiates the procedure by sending the ENHANCED RELOCATION CANCEL message to the DRNC. The SRNC shall indicate the reason for cancelling the relocation by means of an appropriate cause value. Typical cause values are “ $T_{RELOC_{prep}}$ Expiry”, “Relocation Cancelled”, “Traffic Load In The Target Cell Higher Than In The Source Cell”.

At the reception of the ENHANCED RELOCATION CANCEL message, the DRNC shall remove any reference to, and release any resources previously reserved to the concerned UE context.

8.3.29.3 Unsuccessful Operation

Not applicable.

8.3.29.4 Abnormal Conditions

-

8.3.30 Enhanced Relocation Signalling Transfer

8.3.30.1 General

The procedure is used by the SRNC to transfer DL L3 information to DRNC during enhanced relocation.

This procedure shall use the signalling bearer connection for the relevant UE Context.

8.3.30.2 Successful Operation



Figure 26P: Enhanced Relocation Signalling Transfer procedure, Successful Operation

The procedure consists of the ENHANCED RELOCATION SIGNALLING TRANSFER message sent by the SRNC to the DRNC.

The ENHANCED RELOCATION SIGNALLING TRANSFER message contains the L3 Information and after the receipt of the message, the DRNC shall send the L3 Information on the DCCH.

8.3.30.3 Abnormal Conditions

-

8.3.31 Enhanced Relocation Release

8.3.31.1 General

The procedure is used by the DRNC to signal to the SRNC that resource for CN domain is released due to failure of the enhanced relocation.

This procedure shall use the signalling bearer connection for the relevant UE Context.

8.3.31.2 Successful Operation

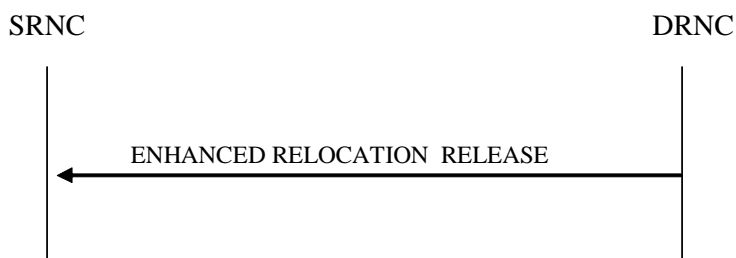

Figure 26Q: Enhanced Relocation Signalling Transfer procedure, Successful Operation

The procedure consists of the ENHANCED RELOCATION RELEASE message sent by the DRNC to the SRNC.

Upon reception of the ENHANCED RELOCATION RELEASE message, the SRNC shall release related resources associated to indicated CN domain(s) by the *Released CN Domain* IE in the message for the UE context.

8.3.31.3 Abnormal Conditions

-

8.3.32 Secondary UL Frequency Reporting [FDD]

8.3.32.1 General

The purpose of this procedure is to inform the DRNS about the activation state of the secondary UL frequency of the UE in Dual Cell E-DCH operation.

This procedure shall use the signalling bearer connection for the relevant UE Context.

8.3.32.2 Successful Operation

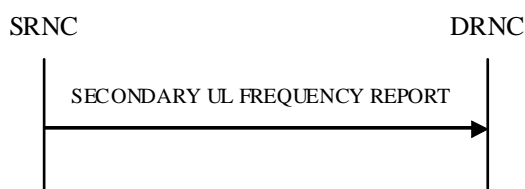

Figure 26R: Secondary UL Frequency Reporting procedure

The Secondary UL Frequency Reporting procedure is initiated by sending the SECONDARY UL FREQUENCY REPORT message from the SRNC to the DRNC.

The *Activation Information* IE defines the local activation state of the Secondary uplink frequency of the UE in Dual Cell E-DCH operation.

- If the value of *Uu Activation State* IE is “Activated”: the DRNS shall if supported use this information for resource allocation operation of the secondary E-DCH radio link(s), F-DPCH transmission and DPCH detection.
- If the value of *Uu Activation State* IE is “De-Activated”: the DRNS shall if supported use this information for release of the related resources for the secondary E-DCH radio link(s), cease of F-DPCH transmission and DPCH detection.

8.3.32.3 Abnormal Conditions

-

8.3.33 Secondary UL Frequency Update [FDD]

8.3.33.1 General

The purpose of this procedure is to inform the SRNC about updates to activation state of the secondary UL frequency of the UE in Dual Cell E-DCH operation .

This procedure shall use the signalling bearer connection for the relevant UE context.

8.3.33.2 Successful Operation

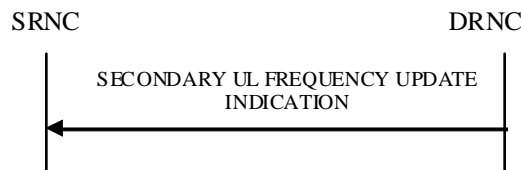

Figure 26S: Secondary UL Frequency Update procedure

The Secondary UL Frequency Update procedure is initiated by the DRNS by sending the SECONDARY UL FREQUENCY UPDATE INDICATION message to the SRNC.

If the DRNS needs to update the local activation state of the Secondary uplink frequency of the UE in Dual Cell E-DCH operation, the DRNS shall send SECONDARY UL FREQUENCY UPDATE INDICATION message and include the *Activation Information IE*.

8.3.33.3 Abnormal Conditions

-

8.4 Common Transport Channel Procedures

8.4.1 Common Transport Channel Resources Initialisation

8.4.1.1 General

The Common Transport Channel Resources Initialisation procedure is used by the SRNC for the initialisation of the Common Transport Channel user plane towards the DRNC and/or for the initialisation of the Common Transport Channel resources in the DRNC to be used by a UE.

This procedure shall use the connectionless mode of the signalling bearer.

8.4.1.2 Successful Operation

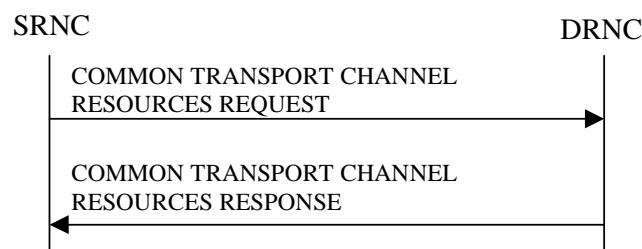

Figure 27: Common Transport Channel Resources Initialisation procedure, Successful Operation

The SRNC initiates the procedure by sending the message COMMON TRANSPORT CHANNEL RESOURCES REQUEST message to the DRNC.

If the value of the *Transport Bearer Request Indicator IE* is set to “Bearer Requested”, the DRNC shall store the received *Transport Bearer ID IE*. The DRNC may use the *Transport Layer Address* and *Binding ID IEs* included in the COMMON TRANSPORT CHANNEL RESOURCES REQUEST message received from the SRNC when establishing a transport bearer for the common transport channel. In addition, the DRNC shall include its own *Binding ID IE* and *Transport Layer Address IE* in the COMMON TRANSPORT CHANNEL RESOURCES RESPONSE message.

If the *TNL QoS* IE is included and if ALCAP is not used, the *TNL QoS* IE may be used by the DRNC to determine the transport bearer characteristics to apply in the uplink between the DRNS and the SRNC for the related common transport channels.

If the value of the *Transport Bearer Request Indicator* IE is set to "Bearer not Requested", the DRNC shall use the transport bearer indicated by the *Transport Bearer ID* IE.

If the *C-ID* IE is included in the COMMON TRANSPORT CHANNEL RESOURCES REQUEST message, the DRNC shall allocate a C-RNTI for the indicated cell and include the *C-RNTI* IE in the COMMON TRANSPORT CHANNEL RESOURCES RESPONSE message.

If the *C-ID* IE is included in the COMMON TRANSPORT CHANNEL RESOURCES REQUEST message, the DRNC shall include the *FACH Info for UE Selected S-CCPCH* IE valid for the cell indicated by the *C-ID* IE and the corresponding *C-ID* IE in the COMMON TRANSPORT CHANNEL RESOURCES RESPONSE message. If the *C-ID* IE is not included in the COMMON TRANSPORT CHANNEL RESOURCES REQUEST message, the DRNC shall include the *FACH Info for UE Selected S-CCPCH* IE valid for the cell where the UE is located and the corresponding *C-ID* IE. The DRNC shall include the *FACH Scheduling Priority* IE and *FACH Initial Window Size* IE in the *FACH Flow Control Information* IE of the *FACH Info for UE Selected S-CCPCH* IE for each priority class that the DRNC has determined shall be used. The DRNC may include several *MAC-c/sh SDU Length* IEs for each priority class.

If the DRNS has any RACH and/or FACH [FDD – and/or HS-DSCH] [1.28Mcps TDD – and/or HS-DSCH] resources previously allocated for the UE in another cell than the cell in which resources are currently being allocated, the DRNS shall release the previously allocated RACH and/or FACH resources [FDD – and/or HS-DSCH] [1.28Mcps TDD – and/or HS-DSCH].

If the DRNS has successfully reserved the required resources, the DRNC shall respond to the SRNC with the COMMON TRANSPORT CHANNEL RESOURCES RESPONSE message.

If the *Permanent NAS UE Identity* IE is present in the COMMON TRANSPORT CHANNEL RESOURCES REQUEST message, the DRNS shall store the information for the considered UE Context for the lifetime of the UE Context.

If the COMMON TRANSPORT CHANNEL RESOURCES REQUEST message includes a *C-ID* IE corresponding to a cell reserved for operator use and the Permanent NAS UE Identity is available in the DRNC for the considered UE Context, the DRNC shall use this information to determine whether it can reserve resources on a common transport channel in this cell or not.

If the *MBMS Bearer Service List* IE is included in the COMMON TRANSPORT CHANNEL RESOURCES REQUEST message, the DRNC shall, if supported, perform the UE Linking as specified in TS 25.346 [50], section 5.1.6. If an MBMS session for some MBMS bearer services contained in the UE Link is ongoing in the cell identified by the *C-ID* IE, the DRNC shall include in the *Active MBMS Bearer Service List* IE the *Transmission Mode* IE for each of these active MBMS bearer services in the COMMON TRANSPORT CHANNEL RESOURCES RESPONSE message.

[FDD – If the COMMON TRANSPORT CHANNEL RESOURCES REQUEST message includes an *Enhanced FACH Support Indicator* IE, the DRNC may include the *Enhanced FACH Information Response* IE in the COMMON TRANSPORT CHANNEL RESOURCES RESPONSE message. If a HS-DSCH RNTI was not previously allocated to the UE or a new HS-DSCH RNTI is allocated to the UE, the DRNC shall include the *HS-DSCH-RNTI* IE in the *Enhanced FACH Information Response* IE. And if Enhanced PCH operation is activated in the cell indicated by the *C-ID* IE, the DRNC shall include the *Priority Queue Information for Enhanced PCH* IE in the *Enhanced FACH Information Response* IE.]

[1.28Mcps TDD – If the COMMON TRANSPORT CHANNEL RESOURCES REQUEST message includes an *Enhanced FACH Support Indicator* IE, the DRNC may include the *Enhanced FACH Information Response* IE in the COMMON TRANSPORT CHANNEL RESOURCES RESPONSE message. If a HS-DSCH RNTI was not previously allocated to the UE or a new HS-DSCH RNTI is allocated to the UE, the DRNC shall include the *HS-DSCH-RNTI* IE in the *Enhanced FACH Information Response* IE. And if Enhanced PCH operation is activated in the cell indicated by the *C-ID* IE, the DRNC shall include the *Priority Queue Information for Enhanced PCH* IE in the *Enhanced FACH Information Response* IE.]

[FDD – If the COMMON TRANSPORT CHANNEL RESOURCES REQUEST message includes an *Common E-DCH Support Indicator* IE, the DRNC may include the *Common E-DCH MAC-d Flow Specific Information* IE in the COMMON TRANSPORT CHANNEL RESOURCES RESPONSE message. If the E-DCH MAC-d Flow Multiplexing List for a Common E-DCH MAC-d Flow is configured in DRNC, the DRNC shall include the *E-DCH MAC-d Flow Multiplexing List* IE in the COMMON TRANSPORT CHANNEL RESOURCES RESPONSE message. If the COMMON TRANSPORT CHANNEL RESOURCES REQUEST message includes the *C-ID* IE and the *Common E-*

DCH Support Indicator IE, the DRNC may include the *E-RNTI* IE in the COMMON TRANSPORT CHANNEL RESOURCES RESPONSE message.]

[1.28Mcps TDD – If the COMMON TRANSPORT CHANNEL RESOURCES REQUEST message includes a *Enhanced FACH Support Indicator* IE, the DRNC may include the *Common E-DCH MAC-d Flow Specific Information LCR* IE in the COMMON TRANSPORT CHANNEL RESOURCES RESPONSE message.]

If the COMMON TRANSPORT CHANNEL RESOURCES REQUEST message includes an *HS-DSCH physical layer category* IE, the DRNC may store the information for the considered UE Context for the lifetime of the UE Context.

[FDD – If the COMMON TRANSPORT CHANNEL RESOURCES REQUEST message includes an *UE with enhanced HS-SCCH support indicator* IE, the DRNC may store the information for the considered UE Context for the lifetime of the UE context.]

8.4.1.3 Unsuccessful Operation

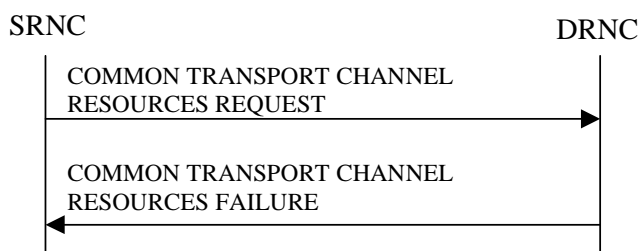

Figure 28: Common Transport Channel Resources Initialisation procedure, Unsuccessful Operation

If the *Transport Bearer Request Indicator* IE is set to “Bearer Requested” and the DRNC is not able to provide a Transport Bearer, the DRNC shall reject the procedure and respond to the SRNC with the COMMON TRANSPORT CHANNEL RESOURCES FAILURE message, including the reason for the failure in the *Cause* IE.

If the COMMON TRANSPORT CHANNEL RESOURCES REQUEST message contains a *C-ID* IE corresponding to a cell reserved for operator use and the Permanent NAS UE Identity is not available for the considered UE Context, the DRNC shall reject the procedure and send the COMMON TRANSPORT CHANNEL RESOURCES FAILURE message, including the reason for the failure in the *Cause* IE.

Typical cause values are:

Radio Network Layer Causes:

- Common Transport Channel Type not Supported;
- Cell reserved for operator use.

Transport Layer Causes:

- Transport Resource Unavailable.

8.4.1.4 Abnormal Conditions

If the COMMON TRANSPORT CHANNEL RESOURCES REQUEST message contains the *Transport Layer Address* IE or the *Binding ID* IE, and not both are present for a transport channel intended to be established, the DRNC shall reject the procedure using the COMMON TRANSPORT CHANNEL RESOURCES FAILURE message.

If ALCAP is not used, if the COMMON TRANSPORT CHANNEL RESOURCES REQUEST message contains the *Transport Bearer Request Indicator* IE set to “Bearer Requested” but does not contain the *Transport Layer Address* IE and the *Binding ID* IE, the DRNC shall reject the procedure using the COMMON TRANSPORT CHANNEL RESOURCES FAILURE message.

8.4.2 Common Transport Channel Resources Release

8.4.2.1 General

This procedure is used by the SRNC to request release of Common Transport Channel Resources for a given UE in the DRNS. The SRNC uses this procedure either to release the UE Context from the DRNC (and thus both the D-RNTI and the C-RNTI) or to release only the C-RNTI.

This procedure shall use the connectionless mode of the signalling bearer.

8.4.2.2 Successful Operation



Figure 29: Common Transport Channel Resources Release procedure, Successful Operation

The SRNC initiates the Common Transport Channel Resources Release procedure by sending the COMMON TRANSPORT CHANNEL RESOURCES RELEASE REQUEST message to the DRNC. Upon receipt of the message the DRNC shall release the UE Context identified by the D-RNTI and all its related RACH and/or FACH resources, unless the UE is using dedicated resources (DCH, [TDD – USCH and/or DSCH]) in the DRNS in which case the DRNC shall release only the C-RNTI and all its related RACH and/or FACH [FDD – and/or HS-DSCH] [1.28Mcps TDD – and/or HS-DSCH] resources allocated for the UE.

8.4.2.3 Abnormal Conditions

-

8.5 Global Procedures

8.5.1 Error Indication

8.5.1.1 General

The Error Indication procedure is initiated by a node to report detected errors in a received message, provided they cannot be reported by an appropriate response message.

This procedure shall use the signalling bearer mode specified below.

8.5.1.2 Successful Operation

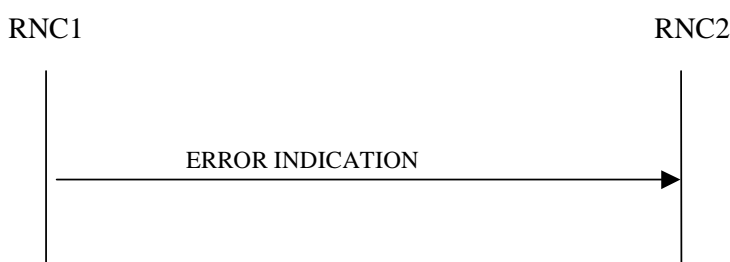

Figure 30: Error Indication procedure, Successful Operation

When the conditions defined in clause 10 are fulfilled, the Error Indication procedure is initiated by an ERROR INDICATION message sent from the receiving node. This message shall use the same mode of the signalling bearer and the same signalling bearer connection (if connection oriented) as the message that triggers the procedure.

When the ERROR INDICATION message is sent from a DRNC to an SRNC using connectionless mode of the signalling bearer, the *S-RNTI* IE shall be included in the message if the UE Context addressed by the *D-RNTI* IE which was received in the message triggering the Error Indication procedure exists. When the ERROR INDICATION message is sent from an SRNC to a DRNC using connectionless mode of the signalling bearer, the *D-RNTI* IE shall be included in the message if available.

When a message using connectionless mode of the signalling bearer is received in the DRNC and there is no UE Context in the DRNC as indicated by the *D-RNTI* IE, the DRNC shall include the D-RNTI from the received message in the *D-RNTI* IE and set the *Cause* IE to "Unknown RNTI" in the ERROR INDICATION message, unless another handling is specified in the procedure text for the affected procedure.

When a message using connectionless mode of the signalling bearer is received in the SRNC and there is no UE in the SRNC as indicated by the *S-RNTI* IE, the SRNC shall include the S-RNTI from the received message in the *S-RNTI* IE and set the *Cause* IE to "Unknown RNTI" in the ERROR INDICATION message, unless another handling is specified in the procedure text for the affected procedure.

The ERROR INDICATION message shall include either the *Cause* IE, or the *Criticality Diagnostics* IE, or both the *Cause* IE and the *Criticality Diagnostics* IE to indicate the reason for the error indication.

Typical cause values for the ERROR INDICATION message are:

Protocol Causes:

- Transfer Syntax Error
- Abstract Syntax Error (Reject)
- Abstract Syntax Error (Ignore and Notify)
- Message not Compatible with Receiver State
- Unspecified

8.5.1.2.1 Successful Operation for lur-g

The RNC₁/BSS₁ and RNC₂/BSS₂ shall use the error indication procedure as specified in section 8.5.1.2.

8.5.1.3 Abnormal Conditions

-

8.5.2 Common Measurement Initiation

8.5.2.1 General

This procedure is used by an RNC to request the initiation of measurements of common resources to another RNC. The requesting RNC is referred to as RNC₁ and the RNC to which the request is sent is referred to as RNC₂.

This procedure uses the signalling bearer connection for the relevant Distant RNC Context.

8.5.2.2 Successful Operation

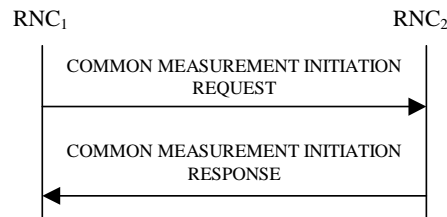

Figure 30A: Common Measurement Initiation procedure, Successful Operation

The procedure is initiated with a COMMON MEASUREMENT INITIATION REQUEST message sent from the RNC₁ to the RNC₂.

Upon receipt, the RNC₂ shall initiate the requested measurement according to the parameters given in the request.

Unless specified below, the meaning of the parameters are given in other specifications.

[TDD – If the [3.84 Mcps TDD and 7.68 Mcps TDD – *Time Slot IE*] [1.28 Mcps – *Time Slot LCR IE*] is present in the COMMON MEASUREMENT INITIATION REQUEST message, the measurement request shall apply to the requested time slot individually.]

Common measurement type

If the *Common Measurement Type IE* is set to “SFN-SFN Observed Time Difference”, then:

- The RNC₂ shall initiate the SFN-SFN Observed Time Difference measurements between the reference cell identified by the *Reference Cell Identifier IE* and the neighbouring cells identified by the *UTRAN Cell Identifier IE (UC-ID)* in the *Neighbouring Cell Measurement Information IE*.
- [3.84 Mcps TDD – The RNC₂ shall perform the measurement using the time slot specified in the *Time Slot IE* in the *Neighbouring TDD Cell Measurement Information IE* and using the midamble shift and burst type specified in the *Midamble Shift And Burst Type IE* in the *Neighbouring TDD Cell Measurement Information IE*. If *Time Slot IE* and *Midamble Shift And Burst Type IE* are not available in the *Neighbouring TDD Cell Measurement Information IE*, the RNC₂ may use any appropriate time slots, midamble shifts and burst types to make the measurement.]
- [7.68 Mcps TDD – The RNC₂ shall perform the measurement using the time slot specified in the *Time Slot IE* in the *Neighbouring TDD Cell Measurement Information 7.68 Mcps IE* and using the midamble shift and burst type specified in the *Midamble Shift And Burst Type 7.68 Mcps IE* in the *Neighbouring TDD Cell Measurement Information 7.68 Mcps IE*. If *Time Slot IE* and *Midamble Shift And Burst Type 7.68 Mcps IE* are not available in the *Neighbouring TDD Cell Measurement Information 7.68 Mcps IE*, the RNC₂ may use any appropriate time slots, midamble shifts and burst types to make the measurement.]

If the *Common Measurement Type IE* is set to “load”, the RNC₂ shall initiate measurements of uplink and downlink load on the measured object identified by the *Reference Cell Identifier IE*. If either uplink or downlink load satisfies the requested report characteristics, the RNC₂ shall report the result of both uplink and downlink measurements.

If the *Common Measurement Type IE* is set to “UTRAN GPS Timing of Cell Frames for UE Positioning”, “UTRAN GANSS Timing of Cell Frames for UE Positioning”, “transmitted carrier power”, “received total wide band power”, or “UL timeslot ISCP” the RNC₂ shall initiate measurements on the measured object identified by the *Reference Cell Identifier IE*.

If the *Common Measurement Type IE* is set to “UTRAN GANSS Timing of Cell Frames for UE Positioning”, then the RNC₂ shall initiate the UTRAN GANSS Timing of Cell Frames measurements using the GNSS system time identified by *GANSS Time ID IE* included in the COMMON MEASUREMENT INITIATION REQUEST message.

- If the *Common Measurement Type IE* is set to “UTRAN GANSS Timing of Cell Frames for UE Positioning” and the *GANSS Time ID IE* is not included in the COMMON MEASUREMENT INITIATION REQUEST message, the RNC₂ shall assume that the corresponding GANSS time is “Galileo” system time.

If the *Common Measurement Type* IE is set to “RT load”, the RNC₂ shall initiate measurements of uplink and downlink estimated share of RT (Real Time) traffic of the load of the measured object. If either uplink or downlink RT load satisfies the requested report characteristics, the RNC₂ shall report the result of both uplink and downlink measurements.

If the *Common Measurement Type* IE is set to “NRT load Information”, the RNC₂ shall initiate measurements of uplink and downlink NRT (Non Real Time) load situation on the measured object. If either uplink or downlink NRT load satisfies the requested report characteristics, the RNC₂ shall report the result of both uplink and downlink measurements.

Report characteristics

The *Report Characteristics* IE indicates how the reporting of the measurement shall be performed. See also Annex B.

If the *Report Characteristics* IE is set to “On Demand” and if the *SFN* IE is not provided, the RNC₂ shall report the result of the requested measurement immediately in the COMMON MEASUREMENT INITIATION RESPONSE message. If the *SFN* IE is provided, it indicates the frame for which the measurement value shall be provided. The provided measurement value shall be the one reported by the layer 3 filter, referred to as point C in the measurement model in TS 25.302 [26]. Furthermore, if the *SFN* IE is present and if the *Common Measurement Type* IE is set to “SFN-SFN Observed Time Difference”, then the *SFN* IE relates to the Radio Frames of the Reference Cell identified by the *Reference Cell Identifier* IE.

If the *Report Characteristics* IE is set to “Periodic” and if the *SFN* IE is not provided, the RNC₂ shall immediately and periodically initiate a Common Measurement Reporting procedure for this measurement, with a frequency as specified by the *Report Periodicity* IE. If the *SFN* IE is provided, the RNC₂ shall initiate a Common Measurement Reporting procedure for this measurement at the SFN indicated in the *SFN* IE, and shall repeat this initiation periodically thereafter with a frequency as specified by the *Report Periodicity* IE. The provided measurement value shall be the one reported by the layer 3 filter, referred to as point C in the measurement model in TS 25.302 [26]. Furthermore, if the *SFN* IE is present and if the *Common Measurement Type* IE is set to “SFN-SFN Observed Time Difference”, then the *SFN* IE relates to the Radio Frames of the Reference Cell identified by the *Reference Cell Identifier* IE.

If the *Report Characteristics* IE is set to “Event A”, the RNC₂ shall initiate the Common Measurement Reporting procedure when the measured entity rises above the requested threshold, as specified by the *Measurement Threshold* IE, and then stays above the threshold for the requested hysteresis time, as specified by the *Measurement Hysteresis Time* IE. If the *Measurement Hysteresis Time* IE is not included, the RNC₂ shall use the value zero for the hysteresis time.

If the *Report Characteristics* IE is set to “Event B”, the RNC₂ shall initiate the Common Measurement Reporting procedure when the measured entity falls below the requested threshold, as specified by the *Measurement Threshold* IE, and then stays below the threshold for the requested hysteresis time, as specified by the *Measurement Hysteresis Time* IE. If the *Measurement Hysteresis Time* IE is not included, the RNC₂ shall use the value zero for the hysteresis time.

If the *Report Characteristics* IE is set to “Event C”, the RNC₂ shall initiate the Common Measurement Reporting procedure when the measured entity rises more than the requested threshold specified by the *Measurement Increase/Decrease Threshold* IE, and only when this rise occurs within the requested rising time specified by the *Measurement Change Time* IE. After reporting this type of event, the RNC₂ shall not initiate the next C event reporting for the same measurement during the subsequent time specified by the *Measurement Change Time* IE.

If the *Report Characteristics* IE is set to “Event D”, the RNC₂ shall initiate the Common Measurement Reporting procedure when the measured entity falls more than the requested threshold specified by the *Measurement Increase/Decrease Threshold* IE, and only when this fall occurs within the requested falling time specified by the *Measurement Change Time* IE. After reporting this type of event,, the RNC₂ shall not initiate the next D event reporting for the same measurement during the subsequent time specified by the *Measurement Change Time* IE.

If the *Report Characteristics* IE is set to “Event E”, the RNC₂ shall initiate the Common Measurement Reporting procedure when the measured entity rises above the *Measurement Threshold 1* IE and stays above the threshold for the *Measurement Hysteresis Time* IE (Report A). When the conditions for Report A are met and if the *Report Periodicity* IE is provided, the RNC₂ shall initiate the Common Measurement Reporting procedure periodically with the requested report frequency specified by the *Report Periodicity* IE. If the conditions for Report A have been met and the measured entity falls below the *Measurement Threshold 2* IE and stays below the threshold for the *Measurement Hysteresis Time* IE, the RNC₂ shall initiate the Common Measurement Reporting procedure (Report B) and shall terminate any corresponding periodic reporting. If the *Measurement Threshold 2* IE is not present, the RNC₂ shall use the value of the *Measurement Threshold 1* IE instead. If the *Measurement Hysteresis Time* IE is not included, the RNC₂ shall use the value zero as hysteresis times for both Report A and Report B.

If the *Report Characteristics* IE is set to “Event F”, the RNC₂ shall initiate the Common Measurement Reporting procedure when the measured entity falls below the *Measurement Threshold 1* IE and stays below the threshold for the *Measurement Hysteresis Time* IE (Report A). When the conditions for Report A are met and if the *Report Periodicity* IE is provided, the RNC₂ shall initiate the Measurement Reporting procedure periodically with the requested report frequency specified by the *Report Periodicity* IE. If the conditions for Report A have been met and the measured entity rises above the *Measurement Threshold 2* IE and stays above the threshold for the *Measurement Hysteresis Time* IE, the RNC₂ shall initiate the Common Measurement Reporting procedure (Report B) and shall terminate any corresponding periodic reporting. If the *Measurement Threshold 2* IE is not present, the RNC₂ shall use the value of the *Measurement Threshold 1* IE instead. If the *Measurement Hysteresis Time* IE is not included, the RNC₂ shall use the value zero as hysteresis times for both Report A and Report B.

If the *Report Characteristics* IE is set to “On Modification” and if the *SFN* IE is not provided, the RNC₂ shall report the result of the requested measurement immediately. If the *SFN* IE is provided, it indicates the frame for which the first measurement value shall be provided. The provided measurement value shall be the one reported by the layer 3 filter, referred to as point C in the measurement model in TS 25.302 [26]. Furthermore, if the *SFN* IE is present and if the *Common Measurement Type* IE is set to “SFN-SFN Observed Time Difference”, then the *SFN* IE relates to the Radio Frames of the Reference Cell identified by the *Reference Cell Identifier* IE. Following the first measurement report, the RNC₂ shall initiate the Common Measurement Reporting procedure in accordance to the following conditions:

1. If the *Common Measurement Type* IE is set to “UTRAN GPS Timing of Cell Frames for UE Positioning”:

- If the *T_{UTRAN-GPS} Change Limit* IE is included in the *T_{UTRAN-GPS} Measurement Threshold Information* IE, the RNC₂ shall calculate the change of T_{UTRAN-GPS} value (F_n) each time a new measurement result is received after point C in the measurement model in TS 25.302 [26]. The RNC₂ shall initiate the Common Measurement Reporting procedure and set n equal to zero when the absolute value of F_n rises above the threshold indicated by the *T_{UTRAN-GPS} Change Limit* IE. The change of T_{UTRAN-GPS} value (F_n) is calculated according to the following:

$$F_n = 0 \text{ for } n=0$$

$$F_n = (M_n - M_{n-1}) \bmod 37158912000000 - ((SFN_n - SFN_{n-1}) \bmod 4096) * 10 * 3.84 * 10^3 * 16 + F_{n-1} \quad \text{for } n > 0$$

F_n is the change of the T_{UTRAN-GPS} value expressed in unit [1/16 chip] when n measurement results have been received after the first Common Measurement Reporting at initiation or after the last event was triggered.

M_n is the latest measurement result received after point C in the measurement model in TS 25.302 [26], measured at SFN_n.

M_{n-1} is the previous measurement result received after point C in the measurement model in TS 25.302 [26], measured at SFN_{n-1}.

M₁ is the first measurement result received after point C in the measurement model in TS 25.302 [26], after first Common Measurement Reporting at initiation or after the last event was triggered.

M₀ is equal to the value reported in the first Common Measurement Reporting at initiation or in the Common Measurement Reporting when the event was triggered.

- If the *Predicted T_{UTRAN-GPS} Deviation Limit* IE is included in the *T_{UTRAN-GPS} Measurement Threshold Information* IE, the RNC₂ shall update the P_n and F each time a new measurement result is received after point C in the measurement model in TS 25.302 [26]. The RNC₂ shall initiate the Common Measurement Reporting procedure and set n equal to zero when F_n rises above the threshold indicated by the *Predicted T_{UTRAN-GPS} Deviation Limit* IE. The P_n and F_n are calculated according to the following:

$$P_n = b \text{ for } n=0$$

$$P_n = ((a/16) * ((SFN_n - SFN_{n-1}) \bmod 4096) / 100 + ((SFN_n - SFN_{n-1}) \bmod 4096) * 10 * 3.84 * 10^3 * 16 + P_{n-1}) \bmod 37158912000000 \text{ for } n > 0$$

$$F_n = \min((M_n - P_n) \bmod 37158912000000, (P_n - M_n) \bmod 37158912000000) \quad \text{for } n > 0$$

P_n is the predicted T_{UTRAN-GPS} value when n measurement results have been received after the first Common Measurement Reporting at initiation or after the last event was triggered.

A is the last reported T_{UTRAN-GPS} Drift Rate value.

B is the last reported $T_{\text{UTRAN-GPS}}$ value.

F_n is the deviation of the last measurement result from the predicted $T_{\text{UTRAN-GPS}}$ value (P_n) when n measurements have been received after the first Common Measurement Reporting at initiation or after the last event was triggered.

M_n is the latest measurement result received after point C in the measurement model in TS 25.302 [26], measured at SFN_n .

M_1 is the first measurement result received after point C in the measurement model in TS 25.302 [26], after first Common Measurement Reporting at initiation or after the last event was triggered.

The $T_{\text{UTRAN-GPS}}$ Drift Rate is determined by the RNS_2 in an implementation-dependent way after point B (see model of physical layer measurements in TS 25.302 [26]).

2. If the *Common Measurement Type* IE is set to “SFN-SFN Observed Time Difference”:

- If the *SFN-SFN Change Limit* IE is included in the *SFN-SFN Measurement Threshold Information* IE, the RNC_2 shall calculate the change of SFN-SFN value (F_n) each time a new measurement result is received after point C in the measurement model in TS 25.302 [26]. The RNC_2 shall initiate the Common Measurement Reporting procedure in order to report the particular SFN-SFN measurement which has triggered the event and set n equal to zero when the absolute value of F_n rises above the threshold indicated by the *SFN-SFN Change Limit* IE. The change of the SFN-SFN value is calculated according to the following:

$F_n=0$ for $n=0$

$[\text{FDD} - F_n = (M_n - a) \bmod 614400 \quad \text{for } n>0]$

$[\text{TDD} - F_n = (M_n - a) \bmod 40960 \quad \text{for } n>0]$

F_n is the change of the SFN-SFN value expressed in unit [1/16 chip] when n measurement results have been received after the first Common Measurement Reporting at initiation or after the last event was triggered.

A is the last reported SFN-SFN.

M_n is the latest measurement result received after point C in the measurement model in TS 25.302 [26], measured at SFN_n .

M_1 is the first measurement result received after point C in the measurement model in TS 25.302 [26], after the first Common Measurement Reporting at initiation or after the last event was triggered.

- If the *Predicted SFN-SFN Deviation Limit* IE is included in the *SFN-SFN Measurement Threshold Information* IE, the RNC_2 shall each time a new measurement result is received after point C in the measurement model in TS 25.302 [26], update the P_n and F_n . The RNC_2 shall initiate the Common Measurement Reporting procedure in order to report the particular SFN-SFN measurement which has triggered the event and set n equal to zero when F_n rises above the threshold indicated by the *Predicted SFN-SFN Deviation Limit* IE. The P_n and F_n are calculated according to the following:

$P_n=b$ for $n=0$

$[\text{FDD} - P_n = ((a/16) * ((\text{SFN}_n - \text{SFN}_{n-1}) \bmod 4096)/100 + P_{n-1}) \bmod 614400 \quad \text{for } n>0]$

$[\text{FDD} - F_n = \min((M_n - P_n) \bmod 614400, (P_n - M_n) \bmod 614400) \quad \text{for } n>0]$

$[\text{TDD} - P_n = ((a/16) * (15 * (\text{SFN}_n - \text{SFN}_{n-1}) \bmod 4096 + (\text{TS}_n - \text{TS}_{n-1}))/1500 + P_{n-1}) \bmod 40960 \quad \text{for } n>0]$

$[\text{TDD} - F_n = \min((M_n - P_n) \bmod 40960, (P_n - M_n) \bmod 40960) \quad \text{for } n>0]$

P_n is the predicted SFN-SFN value when n measurement results have been received after the first Common Measurement Reporting at initiation or after the last event was triggered.

A is the last reported SFN-SFN Drift Rate value.

B is the last reported SFN-SFN value.

F_n is the deviation of the last measurement result from the predicted SFN-SFN value (P_n) when n measurements have been received after first Common Measurement Reporting at initiation or after the last event was triggered.

M_n is the latest measurement result received after point C in the measurement model in TS 25.302 [26], measured at the [TDD – the Time Slot TS_n of] the Frame SFN_n .

M_1 is the first measurement result received after point C in the measurement model in TS 25.302 [26], after first Common Measurement Reporting at initiation or after the last event was triggered.

The SFN-SFN Drift Rate is determined by the RNS_2 in an implementation-dependent way after point B (see model of physical layer measurements in TS 25.302 [26]).

3. If the *Common Measurement Type* IE is set to “UTRAN GANSS Timing of Cell Frames for UE Positioning”:

- If the *$T_{UTRAN-GANSS}$ Change Limit* IE is included in the *$T_{UTRAN-GANSS}$ Measurement Threshold Information* IE, the RNC_2 shall calculate the change of $T_{UTRAN-GANSS}$ value (F_n) each time a new measurement result is received after point C in the measurement model in TS 25.302 [26]. The RNC_2 shall initiate the Common Measurement Reporting procedure and set n equal to zero when the absolute value of F_n rises above the threshold indicated by the *$T_{UTRAN-GANSS}$ Change Limit* IE. The change of $T_{UTRAN-GANSS}$ value (F_n) is calculated according to the following:

$F_n=0$ for $n=0$

$F_n = (GAM_n - GAM_{n-1}) \bmod 5308416000000 - ((SFN_n - SFN_{n-1}) \bmod 4096) * 10 * 3.84 * 10^3 * 16 + F_{n-1}$
for $n > 0$

F_n is the change of the $T_{UTRAN-GANSS}$ value expressed in unit [1/16 chip] when n measurement results have been received after the first Common Measurement Reporting at initiation or after the last event was triggered.

GAM_n is the latest GANSS measurement result received after point C in the GANSS measurement model, measured at SFN_n .

GAM_{n-1} is the previous GANSS measurement result received after point C in the GANSS measurement model, measured at SFN_{n-1} .

GAM_1 is the first GANSS measurement result received after point C in the GANSS measurement model, after the first Common Measurement Reporting at initiation or after the last event was triggered.

GAM_0 is equal to the value reported in the first Common Measurement Reporting at initiation or in the Common Measurement Reporting when the event was triggered.

GANSS measurement model is the timing between cell j and GANSS Time Of Day. $T_{UE-GANSS_j}$ is defined as the time of occurrence of a specified UTRAN event according to GANSS time. The specified UTRAN event is the beginning of a particular frame (identified through its SFN) in the first detected path (in time) of the cell j CPICH, where cell j is a cell chosen by the UE. The reference point for $T_{UE-GANSS_j}$ shall be the antenna connector of the UE.

- If the *Predicted $T_{UTRAN-GANSS}$ Deviation Limit* IE is included in the *$T_{UTRAN-GANSS}$ Measurement Threshold Information* IE, the RNC_2 shall update the P_n and F each time a new measurement result is received after point C in the measurement model in TS 25.302 [26]. The RNC_2 shall initiate the Common Measurement Reporting procedure and set n equal to zero when F_n rises above the threshold indicated by the *Predicted $T_{UTRAN-GANSS}$ Deviation Limit* IE. The P_n and F_n are calculated according to the following:

$P_n=b$ for $n=0$

$P_n = ((a/16) * ((SFN_n - SFN_{n-1}) \bmod 4096) / 100 + ((SFN_n - SFN_{n-1}) \bmod 4096) * 10 * 3.84 * 10^3 * 16 + P_{n-1}) \bmod 5308416000000$
for $n > 0$

$F_n = \min((GAM_n - P_n) \bmod 5308416000000, (P_n - GAM_n) \bmod 5308416000000)$ for $n > 0$

P_n is the predicted $T_{UTRAN-GANSS}$ value when n measurement results have been received after the first Common Measurement Reporting at initiation or after the last event was triggered.

A is the last reported $T_{\text{UTRAN-GANSS}}$ Drift Rate value.

B is the last reported $T_{\text{UTRAN-GANSS}}$ value.

F_n is the deviation of the last measurement result from the predicted $T_{\text{UTRAN-GANSS}}$ value (P_n) when n measurements have been received after the first Common Measurement Reporting at initiation or after the last event was triggered.

GAM_n is the latest GANSS measurement result received after point C in the GANSS measurement model, measured at SFN_n .

GAM_1 is the first GANSS measurement result received after point C in the GANSS measurement model, after the first Common Measurement Reporting at initiation or after the last event was triggered.

The $T_{\text{UTRAN-GANSS}}$ Drift Rate is determined by the RNS_2 in an implementation-dependent way after point B (see model of physical layer measurements in TS 25.302 [26]).

If the *Report Characteristics* IE is not set to “On Demand”, the RNC_2 is required to perform reporting for a common measurement object, in accordance with the conditions provided in the COMMON MEASUREMENT INITIATION REQUEST message, as long as the object exists. If no common measurement object(s) for which a measurement is defined exists any more, the RNC_2 shall terminate the measurement locally without reporting this to RNC_1 .

If at the start of the measurement, the reporting criteria are fulfilled for any of Event A, Event B, Event E or Event F, the RNC_2 shall initiate a Measurement Reporting procedure immediately, and then continue with the measurements as specified in the COMMON MEASUREMENT INITIATION REQUEST message.

Common measurement accuracy

If the *Common Measurement Type* IE is set to “UTRAN GPS Timing of Cell Frames for UE Positioning”, then the RNC_2 shall use the $T_{\text{UTRAN-GPS}}$ *Measurement Accuracy Class* IE included in the *Common Measurement Accuracy* IE according to the following:

- If the $T_{\text{UTRAN-GPS}}$ *Measurement Accuracy Class* IE indicates “Class A”, then the concerned RNC_2 shall perform the measurement with the highest supported accuracy within the accuracy classes A, B or C.
- If the $T_{\text{UTRAN-GPS}}$ *Measurement Accuracy Class* IE indicates the “Class B”, then the concerned RNC_2 shall perform the measurements with the highest supported accuracy within the accuracy classes B and C.
- If the $T_{\text{UTRAN-GPS}}$ *Measurement Accuracy Class* IE indicates “Class C”, then the concerned RNC_2 shall perform the measurements with the highest supported accuracy according to class C.

If the *Common Measurement Type* IE is set to “SFN-SFN Observed Time Difference”, then the concerned RNC_2 shall initiate the SFN-SFN observed Time Difference measurements between the reference cell identified by *UC-ID* IE and the neighbouring cells identified by their UC-ID. The *Report Characteristics* IE applies to each of these measurements.

If the *Common Measurement Type* IE is set to “UTRAN GANSS Timing of Cell Frames for UE positioning”, then the RNC_2 shall use the $T_{\text{UTRAN-GANSS}}$ *Measurement Accuracy Class* IE included in the *Common Measurement Accuracy* IE according to the following:

- If the $T_{\text{UTRAN-GANSS}}$ *Measurement Accuracy Class* IE indicates “Class A”, then the concerned RNC_2 shall perform the measurement with the highest supported accuracy within the accuracy classes A, B or C.
- If the $T_{\text{UTRAN-GANSS}}$ *Measurement Accuracy Class* IE indicates the “Class B”, then the concerned RNC_2 shall perform the measurements with the highest supported accuracy within the accuracy classes B and C.
- If the $T_{\text{UTRAN-GANSS}}$ *Measurement Accuracy Class* IE indicates “Class C”, then the concerned RNC_2 shall perform the measurements with the highest supported accuracy according to class C.

Higher layer filtering

The *Measurement Filter Coefficient* IE indicates how filtering of the measurement values shall be performed before measurement event evaluation and reporting.

The averaging shall be performed according to the following formula.

$$F_n = (1 - a) \cdot F_{n-1} + a \cdot M_n$$

The variables in the formula are defined as follows

F_n is the updated filtered measurement result

F_{n-1} is the old filtered measurement result

M_n is the latest received measurement result from physical layer measurements, the unit used for M_n is the same unit as the reported unit in the COMMON MEASUREMENT INITIATION RESPONSE, COMMON MEASUREMENT REPORT messages or the unit used in the event evaluation (i.e. same unit as for F_n).

$A = 1/2^{(k/2)}$, where k is the parameter received in the *Measurement Filter Coefficient* IE. If the *Measurement Filter Coefficient* IE is not present, a shall be set to 1 (no filtering).

In order to initialise the averaging filter, F_0 is set to M_1 when the first measurement result from the physical layer measurement is received.

Measurement Recovery Behavior:

If the *Measurement Recovery Behavior* IE is included in the COMMON MEASUREMENT INITIATION REQUEST message, the RNC₂ shall, if Measurement Recovery Behavior is supported, include the *Measurement Recovery Support Indicator* IE in the COMMON MEASUREMENT INITIATION RESPONSE message and perform the Measurement Recovery Behavior as described in subclause 8.5.3.2.

Response message

If the RNC₂ was able to initiate the measurement requested by RNC, it shall respond with the COMMON MEASUREMENT INITIATION RESPONSE message. The message shall include the same Measurement ID that was used in the COMMON MEASUREMENT INITIATION REQUEST message.

In the case in which the *Report Characteristics* IE is set to “On Demand” or “On Modification”:

- The COMMON MEASUREMENT INITIATION RESPONSE message shall include the *Common Measurement Object Type* IE containing the measurement result. It shall also include the *Common Measurement Achieved Accuracy* IE if the *Common Measurement Type* IE is set to “UTRAN GPS Timing of Cell Frames for UE positioning” or “UTRAN GANSS Timing of Cell Frames for UE positioning”.
- If the *Common Measurement Type* IE is not set to “SFN-SFN Observed Time Difference” and if the *SFN Reporting Indicator* IE is set to “FN Reporting Required”, then the RNC₂ shall include the *SFN* IE in the COMMON MEASUREMENT INITIATION RESPONSE message. The reported SFN shall be the SFN at the time when the measurement value was reported by the layer 3 filter, referred to as point C in the measurement model in TS 25.302 [26]. If the *Common Measurement Type* IE is set to “SFN-SFN Observed Time Difference”, then the *SFN Reporting Indicator* IE is ignored.
- If the *Common Measurement Type* IE is set to “SFN-SFN Observed Time Difference”, then the RNC₂ shall report all the available measurements in the *Successful Neighbouring cell SFN-SFN Observed Time Difference Measurement Information* IE, and the RNC₂ shall report the neighbouring cells with no measurement result available in the *Unsuccessful Neighbouring cell SFN-SFN Observed Time Difference Measurement Information* IE. For all available measurement results, the RNC₂ shall include in the *Successful Neighbouring Cell SFN-SFN Observed Time Difference Measurement Information* IE the *SFN-SFN Quality* IE and the *SFN-SFN Drift Rate Quality* IE, if available.

If the *Common Measurement Type* IE is set to “UTRAN GPS Timing of Cell Frames for UE Positioning” and the *Report Characteristics* IE is set to “On Demand” or “On Modification”, the RNC₂ shall include in the *T_{UTRAN-GPS} Measurement Value Information* IE the *T_{UTRAN-GPS} Quality* IE and the *T_{UTRAN-GPS} Drift Rate Quality* IE, if available.

If the *Common Measurement Type* IE is set to “UTRAN GANSS Timing of Cell Frames for UE Positioning” and the *Report Characteristics* IE is set to “On Demand” or “On Modification”, the RNC₂ shall include in the *T_{UTRAN-GANSS} Measurement Value Information* IE, the *T_{UTRAN-GANSS} Quality* IE and the *T_{UTRAN-GANSS} Drift Rate Quality* IE, if available.

8.5.2.2.1 Successful Operation for lur-g

The procedure is initiated with a COMMON MEASUREMENT INITIATION REQUEST message sent from the RNC₁ to the BSS₂ or from the BSS₁ to the RNC₂/BSS₂.

Upon receipt, the RNC₂ /BSS₂ shall initiate the requested measurement according to the parameters given in the request.

Common measurement type on Iur-g

If the *Common Measurement Type* IE is set to “load”, the RNC₂/BSS₂ shall initiate measurements and report results as described in section 8.5.2.2.

If the *Common Measurement Type* IE is set to “RT load”, the RNC₂/BSS₂ shall initiate measurements and report results as described in section 8.5.2.2.

If the *Common Measurement Type* IE is set to “NRT load Information”, the RNC₂/BSS₂ shall initiate measurements and report results as described in section 8.5.2.2.

Report characteristics on Iur-g

The *Report Characteristics* IE indicates how the reporting of the measurement shall be performed. This IE is used as described in section 8.5.2.2.

Response message for Iur-g

If the RNC₂/BSS₂ was able to initiate the measurement requested by RNC₁/BSS₁ it shall respond with the COMMON MEASUREMENT INITIATION RESPONSE message sent. The message shall include the same Measurement ID that was used in the measurement request. Only in the case when the *Report Characteristics* IE is set to “On Demand”, the COMMON MEASUREMENT INITIATION RESPONSE message shall contain the measurement result.

8.5.2.3 Unsuccessful Operation

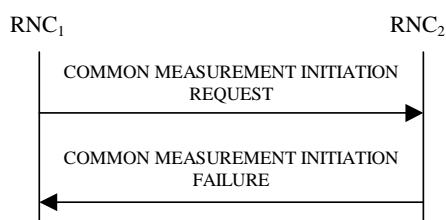

Figure 30B: Common Measurement Initiation procedure, Unsuccessful Operation

If the requested measurement cannot be initiated, the RNC₂ shall send a COMMON MEASUREMENT INITIATION FAILURE message. The message shall include the same *Measurement ID* IE that was used in the COMMON MEASUREMENT INITIATION REQUEST message and shall include the *Cause* IE set to an appropriate value.

Typical cause values are as follows:

Radio Network Layer Cause

- Measurement not supported for the object.
- Measurement Temporarily not Available

8.5.2.4 Abnormal Conditions

If the COMMON MEASUREMENT INITIATION REQUEST message contains the *SFN-SFN Measurement Threshold Information* IE (in the *Measurement Threshold* IE contained in the *Report Characteristics* IE) and it does not contain at least one IE, the RNC₂ shall reject the procedure using the COMMON MEASUREMENT INITIATION FAILURE message.

If the COMMON MEASUREMENT INITIATION REQUEST message contains the *T_{UTRAN-GPS} Measurement Threshold Information* IE (in the *Measurement Threshold* IE contained in the *Report Characteristics* IE) and it does not contain at least one IE, the RNC₂ shall reject the procedure using the COMMON MEASUREMENT INITIATION FAILURE message.

If the COMMON MEASUREMENT INITIATION REQUEST message contains the *T_{UTRAN-GANSS} Measurement Threshold Information* IE (in the *Measurement Threshold* IE contained in the *Report Characteristics* IE) and it does not

contain at least one IE, the RNC₂ shall reject the procedure using the COMMON MEASUREMENT INITIATION FAILURE message.

If the *Common Measurement Type* IE is set to “UTRAN GPS Timing of Cell Frames for UE positioning”, but the *T_{UTRAN-GPS} Measurement Accuracy Class* IE in the *Common Measurement Accuracy* IE is not included in the COMMON MEASUREMENT INITIATION REQUEST message, the RNC₂ shall reject the Common Measurement Initiation procedure using the COMMON MEASUREMENT INITIATION FAILURE message.

If the *Common Measurement Type* IE is set to “UTRAN GANSS Timing of Cell Frames for UE positioning”, but the *T_{UTRAN-GANSS} Measurement Accuracy Class* IE in the *Common Measurement Accuracy* IE is not included in the COMMON MEASUREMENT INITIATION REQUEST message, the RNC₂ shall reject the Common Measurement Initiation procedure using the COMMON MEASUREMENT INITIATION FAILURE message.

If the Common Measurement Type received in the *Common Measurement Type* IE is not “load”, “RT load” or “NRT load Information”, and if the Common Measurement Type received in the *Common Measurement Type* IE is not defined in ref. TS 25.215 [11] or TS 25.304 [15] to be measured on the Common Measurement Object Type indicated in the COMMON MEASUREMENT INITIATION REQUEST message the RNC₂ shall reject the Common Measurement Initiation procedure using the COMMON MEASUREMENT INITIATION FAILURE message.

If the *Common Measurement Type* IE is set to “SFN-SFN Observed Time Difference”, but the *Neighbouring Cell Measurement Information* IE is not received in the COMMON MEASUREMENT INITIATION REQUEST message, the RNC₂ shall reject the Common Measurement Initiation procedure using the COMMON MEASUREMENT INITIATION FAILURE message.

The allowed combinations of the Common Measurement Type and Report Characteristics Type are shown in the table below marked with “X”. For not allowed combinations, the RNC₂ shall reject the Common Measurement Initiation procedure using the COMMON MEASUREMENT INITIATION FAILURE message.

Table 5: Allowed Common Measurement Type and Report Characteristics Type Combinations

Common measurement type	Report characteristics type								
	On Demand	Periodic	Event A	Event B	Event C	Event D	Event E	Event F	On Modification
Received total wide band power	X	X	X	X	X	X	X	X	
Transmitted Carrier Power	X	X	X	X	X	X	X	X	
UL Timeslot ISCP	X	X	X	X	X	X	X	X	
Load	X	X	X	X	X	X	X	X	
UTRAN GPS Timing of Cell Frames for UE Positioning	X	X							X
SFN-SFN Observed Time Difference	X	X							X
RT load	X	X	X	X	X	X	X	X	
NRT load Information	X	X	X	X	X	X	X	X	
UpPTS interference	X	X	X	X	X	X	X	X	
UTRAN GANSS Timing of Cell Frames for UE Positioning	X	X							X

[TDD – If the Common Measurement Type requires the Time Slot Information but the [3.84Mcps TDD and 7.68 Mcps TDD – *Time Slot* IE] [1.28Mcps TDD – *Time Slot LCR* IE] is not provided in the COMMON MEASUREMENT INITIATION REQUEST message the RNS₂ shall reject the Common Measurement Initiation procedure using the COMMON MEASUREMENT INITIATION FAILURE message.]

If the *SFN* IE is included in the COMMON MEASUREMENT INITIATION REQUEST message and the *Report Characteristics* IE is other than “Periodic”, “On Demand” or “On Modification”, the RNS₂ shall reject the Common Measurement Initiation procedure using the COMMON MEASUREMENT INITIATION FAILURE message.

8.5.2.4.1 Abnormal Conditions for Iur-g

The measurements which can be requested on the Iur and Iur-g interfaces are shown in the table below marked with “X”.

Table 6: Allowed Common measurement type on Iur and Iur-g interfaces

Common Measurement Type	Interface	
	Iur	Iur-g
Received total wide band power	X	
Transmitted Carrier Power	X	
UL Timeslot ISCP	X	
Load	X	X
UTRAN GPS Timing of Cell Frames for LCS	X	
SFN-SFN Observed Time Difference	X	
RT load	X	X
NRT load Information	X	X
UTRAN GANSS Timing of Cell Frames for UE Positioning	X	

If the RNC₂ receives from the BSS₁ a COMMON MEASUREMENT INITIATION REQUEST message in which a measurement, which is not applicable on the Iur-g interface, is requested, the RNC₂ shall reject the Common Measurement Initiation procedure.

If the BSS₂ receives from the BSS₁ / RNC₁ a COMMON MEASUREMENT INITIATION REQUEST message in which a measurement, which is not applicable on the Iur-g interface, is requested, the BSS₂ shall reject the Common Measurement Initiation procedure.

If the RNC₂ receives from the BSS₁ a COMMON MEASUREMENT INITIATION REQUEST message in which the SFN reporting indicator IE is set to “FN Reporting Required”, the RNC₂ shall ignore that IE.

If the BSS₂ receives from the BSS₁ / RNC₁ a COMMON MEASUREMENT INITIATION REQUEST message in which the SFN reporting indicator IE is set to “FN Reporting Required”, the BSS₂ shall ignore that IE.

The allowed combinations of the Common measurement type and Report characteristics type are shown in the table in section 8.5.2.4 marked with “X”. For not allowed combinations, the RNC₂/BSS₂ shall reject the Common Measurement Initiation procedure.

8.5.3 Common Measurement Reporting

8.5.3.1 General

This procedure is used by an RNC to report the result of measurements requested by another RNC using the Common Measurement Initiation.

This procedure uses the signalling bearer connection for the relevant Distant RNC Context.

8.5.3.2 Successful Operation

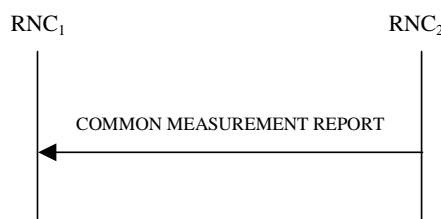

Figure 30C: Common Measurement Reporting procedure, Successful Operation

If the requested measurement reporting criteria are met, the RNC₂ shall initiate the Common Measurement Reporting procedure. Unless specified below, the meaning of the parameters are given in other specifications.

The *Measurement ID* IE shall be set to the Measurement ID provided by RNC₁ when initiating the measurement with the Common Measurement Initiation procedure.

If the achieved measurement accuracy does not fulfil the given accuracy requirement (see ref. TS 25.133 [23] and TS 25.123 [24]) or the measurement is temporarily not available in case Measurement Recovery Behavior is supported, the *Common Measurement Value Information* IE shall indicate Measurement not Available. If the RNC₂ was configured to perform the Measurement Recovery Behavior, the RNC₂ shall indicate Measurement Available to the RNC₁ when the achieved measurement accuracy again fulfils the given accuracy requirement (see ref. TS 25.133 [23] and TS 25.123 [24]) and include the *Measurement Recovery Report Indicator* IE in the COMMON MEASUREMENT REPORT message if the requested measurement reporting criteria are not met.

For measurements included in the *Successful Neighbouring Cell SFN-SFN Observed Time Difference Measurement Information* IE, the RNC₂ shall include the *SFN-SFN Quality* IE and the *SFN-SFN Drift Rate Quality* IE if available.

If the Common Measurement Type provided by RNC₁ when initiating the measurement with the Common Measurement Initiation procedure was “UTRAN GPS Timing of Cell Frames for UE Positioning”, then the RNC₂ shall include in the *T_{UTRAN-GPS} Measurement Value Information* IE the *T_{UTRAN-GPS} Quality* IE and the *T_{UTRAN-GPS} Drift Rate Quality* IE, if available.

If the Common Measurement Type provided by RNC₁ when initiating the measurement with the Common Measurement Initiation procedure was “UTRAN GANSS Timing of Cell Frames for UE Positioning”, then the RNC₂ shall include in the *T_{UTRAN-GANSS} Measurement Value Information* IE the *T_{UTRAN-GANSS} Quality* IE and the *T_{UTRAN-GANSS} Drift Rate Quality* IE, if available.

8.5.3.2.1 Successful Operation for Iur-g

If the requested measurement reporting criteria are met, the RNC₂/BSS₂ shall initiate a Measurement Reporting procedure. Unless specified below, the meaning of the parameters are given in other specifications.

The *Common Measurement ID* IE shall be set to the Common Measurement ID provided by RNC₁/BSS₁ when initiating the measurement with the Common Measurement Initiation procedure.

If the Common measurement type provided by RNC₁ when initiating the measurement with the Common Measurement Initiation procedure was “SFN-SFN Observed Time Difference”, then RNC₂ shall include in the COMMON MEASUREMENT REPORT all the available measurements in the *Successful Neighbouring cell SFN-SFN Observed Time Difference Measurement Information* IE and shall include the neighbouring cells with no measurement result available in the *Unsuccessful Neighbouring cell SFN-SFN Observed Time Difference Measurement Information* IE.

If the Common measurement type provided by RNC₁ when initiating the measurement with the Common Measurement Initiation procedure was not set to “SFN-SFN Observed Time Difference” and the SFN Reporting Indicator when initiating the measurement was set to “FN Reporting Required”, the RNC₂ shall include the *SFN* IE in the COMMON MEASUREMENT REPORT message. The reported SFN shall be the SFN at the time when the measurement value was reported by the layer 3 filter, referred to as point C in the measurement model in TS 25.302 [26]. If the *Common Measurement Type* IE is set to “SFN-SFN Observed Time Difference”, then the *SFN Reporting Indicator* IE is ignored.

8.5.3.3 Abnormal Conditions

-

8.5.4 Common Measurement Termination

8.5.4.1 General

This procedure is used by an RNC to terminate a measurement previously requested by the Common Measurement Initiation procedure.

This procedure uses the signalling bearer connection for the relevant Distant RNC Context.

8.5.4.2 Successful Operation



Figure 30D: Common Measurement Termination procedure, Successful Operation

This procedure is initiated with a COMMON MEASUREMENT TERMINATION REQUEST message.

Upon receipt, RNC₂ shall terminate reporting of common measurements corresponding to the received *Measurement ID* IE.

8.5.4.2.1 Successful Operation for lur-g

The RNC₁/BSS₁ and RNC₂/BSS₂ shall use the Common Measurement Termination procedure as specified in section 8.5.4.2.

8.5.4.3 Abnormal Conditions

-

8.5.5 Common Measurement Failure

8.5.5.1 General

This procedure is used by an RNC to notify another RNC that a measurement previously requested by the Common Measurement Initiation procedure can no longer be reported.

This procedure uses the signalling bearer connection for the relevant Distant RNC Context.

8.5.5.2 Successful Operation



Figure 30E: Common Measurement Failure procedure, Successful Operation

This procedure is initiated with a COMMON MEASUREMENT FAILURE INDICATION message, sent from RNC₂ to RNC₁ to inform the RNC₁ that a previously requested measurement can no longer be reported. RNC₂ has locally terminated the indicated measurement. The RNC₂ shall include in the COMMON MEASUREMENT FAILURE INDICATION message the reason for the failure in the *Cause* IE.

8.5.5.2.1 Successful Operation for lur-g

The RNC₁/BSS₁ and RNC₂/BSS₂ shall use the Common Measurement Failure procedure as specified in section 8.5.5.2.

8.5.5.3 Abnormal Conditions

-

8.5.6 Information Exchange Initiation

8.5.6.1 General

This procedure is used by an RNC to request the initiation of an information exchange with another RNC.

This procedure uses the signalling bearer connection for the relevant Distant RNC Context.

8.5.6.2 Successful Operation

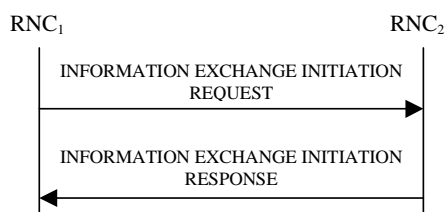

Figure 30F: Information Exchange Initiation procedure, Successful Operation

The procedure is initiated with an INFORMATION EXCHANGE INITIATION REQUEST message sent from RNC₁ to RNC₂.

Upon receipt, the RNC₂ shall provide the requested information according to the parameters given in the request. Unless specified below, the meaning of the parameters are given in other specifications.

If the *Information Exchange Object Type* is set to “MBMS Bearer Service” and the *Information Type Item IE* is set to “MBMS Bearer Service Full Address”, the RNC₂ shall report for each TMGI included in the received *MBMS Bearer Service Identifiers List IE*, the Access Point Name and the IP Multicast Address corresponding to this TMGI in the *MBMS Bearer Service Identifiers List IE* in the INFORMATION EXCHANGE INITIATION RESPONSE message.

[FDD – If the *Information Exchange Object Type* is set to “MBMS Bearer Service in MBMS Cell” and the *Information Type Item IE* is set to “MBMS Counting Information”, the RNC₂ shall perform counting in cells as defined in TS 25.346 [50] and report in the *Counting Result IE* for each TMGI included in the received *MBMS Bearer Service Identifiers List IE* for each cell included in the received *MBMS Cell List IE* either the counting information or, if relevant counting information is not available in RNC₂ TS 25.346 [50], the value “0” in the INFORMATION EXCHANGE INITIATION RESPONSE message.]

[FDD – If the *Information Exchange Object Type* is set to “MBMS Bearer Service in MBMS Cell” and the *Information Type Item IE* is set to “MBMS Transmission Mode”, the RNC₂ shall report for each TMGI included in the received *MBMS Bearer Service Identifiers List IE* for each cell included in the received *MBMS Cell List IE*, the transmission mode for each TMGI in the cells of RNC₂ that have a neighbour relation to the cells received in *MBMS Cell List IE* as defined in TS 25.346 [50] in the INFORMATION EXCHANGE INITIATION RESPONSE message. If no cells of RNC₂ have a neighbour relation to a cell received in *MBMS Cell List IE* for a TMGI the value “Not Provided” shall be used]

[FDD – If the *Information Exchange Object Type* is set to “MBMS Cell” and the *Information Type Item IE* is set to “MBMS Neighbouring Cell Information”, the RNC₂ shall report for each cell included in the received *MBMS Cell List IE*, the MBMS radio bearer information for each cells in the INFORMATION EXCHANGE INITIATION RESPONSE message.]

[FDD – If the *Information Exchange Object Type* is set to “MBMS Bearer Service in MBMS Cell” and the *Information Type Item IE* is set to “MBMS RLC Sequence Number”, the RNC₂ shall report for each TMGI included in the received *MBMS Bearer Service Identifiers List IE* for each cell included in the received *MBMS Cell List IE*, the RLC sequence number for each TMGI for the indicated cells in the INFORMATION EXCHANGE INITIATION RESPONSE message.]

If the *Information Type IE* contains a *GANSS Generic Data IE*, at least one of the *GANSS Navigation Model And Time Recovery*, *GANSS Time Model GNSS-GNSS*, *GANSS UTC Model*, *GANSS Almanac*, *GANSS Real Time Integrity*,

GANSS Data Bit Assistance, *GANSS Additional Navigation Models And Time Recovery*, *GANSS Additional UTC Models*, *GANSS Auxiliary Information IEs* shall be present in the *GANSS Generic Data IE*.

- If the *GANSS Generic Data IE* does not contain the *GANSS ID IE*, the RNC₂ shall assume that the corresponding GANSS is “Galileo”.

Information Report Characteristics:

The *Information Report Characteristics IE* indicates how the reporting of the information shall be performed.

If the *Information Report Characteristics IE* is set to “On Demand”, the RNC₂ shall report the requested information immediately.

If the *Information Report Characteristics IE* is set to “Periodic”, the RNC₂ shall report the requested information immediately and then shall periodically initiate the Information Reporting procedure for all the requested information, with the report frequency indicated by the *Information Report Periodicity IE*.

If the *Information Report Characteristics IE* is set to “On Modification”, the RNC₂ shall report the requested information immediately if available. If the requested information is not available at the moment of receiving the INFORMATION EXCHANGE INITIATION REQUEST message, but expected to become available after some acquisition time, the RNC₂ shall initiate the Information Reporting procedure when the requested information becomes available. The RNC₂ shall then initiate the Information Reporting procedure in accordance to the following conditions:

- If the *Information Type Item IE* is set to “IPDL Parameters”, the RNC₂ shall initiate the Information Reporting procedure when any change in the parameters occurs.
- If the *Information Type Item IE* is set to “DGPS Corrections”, the RNC₂ shall initiate the Information Reporting procedure for this specific Information Type when either the PRC has drifted from the previously reported value more than the threshold indicated in the *PRC Deviation IE* in the *Information Threshold IE* or a change has occurred in the IODE.
- If the *Information Type Item IE* is set to “GPS Information” and the *GPS Information Item IE* includes “GPS Navigation Model & Recovery Assistance”, the RNC₂ shall initiate the Information Reporting procedure for this specific GPS Information Item when a change has occurred regarding either the IODC or the list of visible satellites, identified by the *Sat ID IEs*.
- If the *Information Type Item IE* is set to “GPS Information” and the *GPS Information Item IE* includes “GPS Ionospheric Model”, the RNC₂ shall initiate the Information Reporting procedure for this specific GPS Information Item when any change has occurred.
- If the *Information Type Item IE* is set to “GPS Information” and the *GPS Information Item IE* includes “GPS UTC Model”, the RNC₂ shall initiate the Information Reporting procedure for this specific GPS Information Item when a change has occurred in the t_{ot} or WN_t parameter.
- If the *Information Type Item IE* is set to “GPS Information” and the *GPS Information Item IE* includes “GPS Almanac”, the RNC₂ shall initiate the Information Reporting procedure for this specific GPS Information Item when a change in the t_{oa} or WN_a parameter has occurred.
- If the *Information Type Item IE* is set to “GPS Information” and the *GPS Information Item IE* includes “GPS Real-Time Integrity”, the RNC₂ shall initiate the Information Reporting procedure for this specific GPS Information Item when any change has occurred.
- If the *Information Type IE* is set to “Cell Capacity Class”, the RNC₂ shall initiate the Information Reporting procedure for uplink and downlink cell capacity class when any change has occurred. If either uplink or downlink cell capacity class satisfies the requested report characteristics, the RNC₂ shall report the result of both uplink and downlink cell capacity information.
- If any of the above *Information Type IEs* becomes temporarily unavailable, the RNC₂ shall initiate the Information Reporting procedure for this specific Information Item by indicating “Information Not Available” in the *Requested Data Value Information IE*. If the Information becomes available again, the RNC₂ shall initiate the Information Reporting procedure for this specific Information.
- If the *Information Type IE* is set to “NACC related data”, the RNC₂ shall initiate the Information Reporting procedure for NACC related data if any change has occurred.

- If the *Information Type* IE is set to “Inter-frequency Cell Information”, the RNC₂ shall initiate the Information Reporting procedure for this specific Information Item when any change has occurred to the inter-frequency cell information broadcasted in the SIB11 or SIB12.
- If the *Information Type Item* IE is set to “DGANSS Corrections”, the RNC₂ shall initiate the Information Reporting procedure for this specific Information Type when either the PRC has drifted from the previously reported value more than the threshold indicated in the *PRC Deviation* IE in the *Information Threshold* IE or a change has occurred in the IODE.
- If the *Information Type Item* IE is set to “GANSS Information” and the *GANSS Information* IE includes the *GANSS Navigation Model And Time Recovery* IE, the RNC₂ shall initiate the Information Reporting procedure for this specific GANSS Information Item when a change has occurred regarding either the IOD or the list of visible satellites, identified by the *Sat ID* IEs.
- If the *Information Type Item* IE is set to “GANSS Information” and the *GANSS Information* IE includes the *GANSS Ionospheric Model* IE, the RNC₂ shall initiate the Information Reporting procedure for this specific GANSS Information Item when any change has occurred.
- If the *Information Type Item* IE is set to “GANSS Information” and the *GANSS Information* IE includes the *GANSS UTC Model* IE, the RNC₂ shall initiate the Information Reporting procedure for this specific GANSS Information Item when a change has occurred in the t_{ot} or WN_t parameter.
- If the *Information Type Item* IE is set to “GANSS Information” and the *GANSS Information* IE includes the *GANSS Almanac* IE, the RNC₂ shall initiate the Information Reporting procedure for this specific GANSS Information Item when a change in the T_{oa} , IOD_a , or Week Number parameter has occurred.
- If the *Information Type Item* IE is set to “GANSS Information” and the *GANSS Information* IE includes the *GANSS Real Time Integrity* IE, the RNC₂ shall initiate the Information Reporting procedure for this specific GANSS Information Item when any change has occurred.
- If the *Information Type Item* IE is set to “GANSS Information” and the *GANSS Information* IE includes the *GANSS Data Bit Assistance* IE, the RNC₂ shall initiate the Information Reporting procedure for this specific GANSS Information Item when any change has occurred.
- If the *Information Type Item* IE is set to “MBMS Transmission Mode”, the RNC₂ shall initiate the Information Reporting procedure when any change in the parameter occurs.
- If the *Information Type Item* IE is set to “MBMS Neighbouring Cell Information”, the RNC₂ shall initiate the Information Reporting procedure when any change in the parameters occurs.
- If the *Information Type Item* IE is set to “GANSS Information” and the *GANSS Information* IE includes the *GANSS Additional Navigation Models And Time Recovery* IE, the RNC₂ shall initiate the Information Reporting procedure for this specific GANSS Information item when a change has occurred regarding either the IOD or the list of visible satellites, identified by the *Sat ID* IEs.
- If the *Information Type Item* IE is set to “GANSS Information” and the *GANSS Information* IE includes the *GANSS Additional Ionospheric Model* IE, the RNC₂ shall initiate the Information Reporting procedure for this specific GANSS Information item when any change has occurred.
- If the *Information Type Item* IE is set to “GANSS Information” and the *GANSS Information* IE includes the *GANSS Additional UTC Models* IE, the RNC₂ shall initiate the Information Reporting procedure for this specific GANSS Information item when a change has occurred in the t_{ot} , WN_{ot} , WN_t , or N^A parameter.
- If the *Information Type Item* IE is set to “GANSS Information” and the *GANSS Information* IE includes the *GANSS Earth Orientation Parameters* IE, the RNC₂ shall initiate the Information Reporting procedure for this specific GANSS Information item when a change has occurred in the t_{EOP} parameter.
- If the *Information Type Item* IE is set to “GANSS Information” and the *GANSS Information* IE includes the *GANSS Auxiliary Information* IE, the RNC₂ shall initiate the Information Reporting procedure for this specific GANSS Information item when a change has occurred in the *Signals Available* or *Channel Number* IE parameter.

Response message:

If the RNC₂ is able to determine the information requested by the RNC₁, it shall respond with the INFORMATION EXCHANGE INITIATION RESPONSE message. The message shall include the *Information Exchange ID* IE set to the same value that was included in the INFORMATION EXCHANGE INITIATION REQUEST message. When the *Report Characteristics* IE is set to or “On Modification” or “Periodic”, the INFORMATION EXCHANGE INITIATION RESPONSE message shall contain the *Requested Data Value* IE if the data are available. When the *Report Characteristics* IE is set to “On Demand”, the INFORMATION EXCHANGE INITIATION RESPONSE message shall contain the *Requested Data Value* IE.

If the *Requested Data Value* IE contains the *GANSS Common Data* IE, at least one of the *GANSS Ionospheric Model*, *GANSS RX Pos*, *GANSS Additional Ionospheric Model*, or *GANSS Earth Orientation Parameters* IEs shall be present.

Any *GANSS Generic Data* IE associated with a given GANSS included in the *Requested Data Value* IE shall contain at least one of the *DGANSS Corrections*, *GANSS Navigation Model And Time Recovery*, *GANSS Time Model*, *GANSS UTC Model*, *GANSS Almanac*, *GANSS Real Time Integrity*, *GANSS Data Bit Assistance*, *GANSS Additional Time Models*, *GANSS Additional Navigation Models And Time Recovery*, *GANSS Additional UTC Models*, or *GANSS Auxiliary Information* IEs.

- If the *GANSS Generic Data* IE does not contain the *GANSS ID* IE, the corresponding GANSS is “Galileo”.
- The *DGANSS Corrections* IE contains one or several *DGANSS Information* IE(s), each of them associated with a GANSS Signal. A *DGANSS Information* IE for a particular GANSS that does not contain the *GANSS Signal ID* IE is by default associated with the default signal defined in TS 25.331 [16], clause 10.3.3.45a.
- The *GANSS Real Time Integrity* IE contains one or several *Satellite Information* IEs, each of them associated with a satellite and a GANSS Signal. A *Satellite Information* IE for a particular GANSS that does not contain the *Bad GANSS Signal ID* IE is by default associated with all the signals of the corresponding satellite (see OS SIS ICD [53], IS-GPS-200 [55], 56, 57, 58, 59, 60]).

If the *Information Type Item* IE is set to “GANSS Information” and the *GANSS Information* IE includes the *GANSS Time Model GNSS-GNSS* IE with exactly one bit set to value “1”, the RNC₂ shall include the *GANSS Time Model* IE in the *Requested Data Value* IE with the requested time information.

If the *Information Type Item* IE is set to “GANSS Information” and the *GANSS Information* IE includes the *GANSS Time Model GNSS-GNSS* IE with more than one bit set to value “1”, the RNC₂ shall include the *GANSS Additional Time Models* IE in *Requested Data Value* IE with the requested time information for each GANSS.

If the *Information Type Item* IE is set to “DGPS Corrections”, the RNC₂ shall include the *DGPS Corrections* IE in *Requested Data Value* IE with the *DGNSS Validity Period* IE included, if available.

If the *Information Type Item* IE is set to “DGANSS Corrections”, the Node B shall include the *DGANSS Corrections* IE in *Requested Data Value* IE with the *DGNSS Validity Period* IE included, if available.

8.5.6.2.1 Successful Operation for Iur-g

The procedure is initiated with an INFORMATION EXCHANGE INITIATION REQUEST message sent from BSS₁ to BSS₂/RNC₂ or by RNC₁ to BSS₂.

Upon receipt, the BSS₂/RNC₂ shall provide the requested information according to the parameters given in the request. Unless specified below, the meaning of the parameters are given in other specifications.

Information Report Characteristics on Iur-g:

If the *Information Type Item* IE is set to “Cell Capacity Class”, the RNC₂/BSS₂ shall initiate measurements and report results as described in section 8.5.6.2.

The *Information Report Characteristics* IE indicates how the reporting of the information shall be performed. This IE is used as described in section 8.5.6.2.

8.5.6.3 Unsuccessful Operation

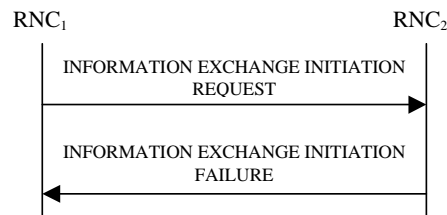

Figure 30G: Information Exchange Initiation procedure, Unsuccessful Operation

If the requested Information Type received in the *Information Type* IE indicates a type of information that RNC₂ cannot provide, the RNC₂ shall reject the Information Exchange Initiation procedure.

If the requested information provision cannot be accessed, the RNC₂ shall reject the procedure and shall send the INFORMATION EXCHANGE INITIATION FAILURE message.

The message shall include the *Information Exchange ID* IE set to the same value that was used in the INFORMATION EXCHANGE INITIATION REQUEST message and the *Cause* IE set to an appropriate value.

Typical cause values are as follows:

Radio Network Layer Cause:

- Information temporarily not available.
- Information Provision not supported for the object.

8.5.6.4 Abnormal Conditions

If the *Information Report Characteristics* IE is set to “On Modification”, and the *Information Type Item* IE is set to “DGPS Corrections”, but the *Information Threshold* IE is not received in the INFORMATION EXCHANGE INITIATION REQUEST message, the RNC₂ shall reject the Information Exchange Initiation procedure and shall send the INFORMATION EXCHANGE INITIATION FAILURE message.

If the *Information Exchange Object Type* IE is set to a value other than “GSM Cell” and the *Information Type Item* IE set to “NACC related data” the RNC₂ shall reject the Information Exchange Initiation procedure and shall send the INFORMATION EXCHANGE INITIATION FAILURE message.

If the *Information Type Item* IE is set to the value “MBMS Bearer Service Full Address” and the *Information Exchange Object Type* IE is not set to “MBMS Bearer Service”, the RNC₂ shall reject the Information Exchange Initiation procedure and shall send the INFORMATION EXCHANGE INITIATION FAILURE message.

The allowed combinations of the Information type and Information Report Characteristics type are shown in the table below marked with “X”. For not allowed combinations, the RNC₂ shall reject the Information Exchange Initiation procedure using the INFORMATION EXCHANGE INITIATION FAILURE message.

Table 6a: Allowed Information Type and Information Report Characteristics type combinations

Type	Information Report Characteristics Type		
	On Demand	Periodic	On Modification
UTRAN Access Point Position with Altitude Information	X		
UTRAN Access Point Position	X		
IPDL Parameters	X	X	X
GPS Information	X	X	X
DGPS Corrections	X	X	X
GPS RX Pos	X		
SFN-SFN Measurement Reference Point Position	X		
Cell Capacity Class	X		X
NACC related data	X		X
MBMS Bearer Service Full Address	X		
Inter-frequency Cell Information	X		X
GANSS Information	X	X	X
DGANSS Corrections	X	X	X
GANSS RX Pos	X		
MBMS Counting Information [FDD only]	X		
MBMS Transmission Mode [FDD only]			X
MBMS Neighbouring Cell Information [FDD only]	X		X
MBMS RLC Sequence Number [FDD only]	X		

8.5.6.4.1 Abnormal Conditions for Iur-g

The information types that can be requested on the Iur and Iur-g interfaces are shown in the table below marked with "X". For information types that are not applicable on the Iur-g interface, the BSS shall reject the Information Exchange Initiation procedure.

Table 7: Allowed Information types on Iur and Iur-g interfaces

Information Type	Interface	
	Iur	Iur-g
UTRAN Access Point Position with Altitude Information	X	
UTRAN Access Point Position	X	
IPDL Parameters	X	
DGPS Corrections	X	
GPS Information	X	
GPS RX Pos	X	
SFN-SFN Measurement Reference Point Position	X	
Cell Capacity Class	X	X
NACC related data	X	
MBMS Bearer Service Full Address	X	
Inter-frequency Cell Information	X	
DGANSS Corrections	X	
GANSS Information	X	
GANSS RX Pos	X	
MBMS Counting Information [FDD only]	X	
MBMS Transmission Mode [FDD only]	X	
MBMS Neighbouring Cell Information [FDD only]	X	
MBMS RLC Sequence Number [FDD only]	X	

8.5.7 Information Reporting

8.5.7.1 General

This procedure is used by a RNC to report the result of information requested by another RNC using the Information Exchange Initiation.

This procedure uses the signalling bearer connection for the relevant Distant RNC Context.

8.5.7.2 Successful Operation

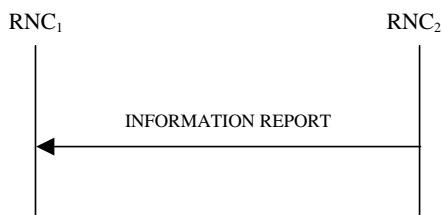

Figure 30H: Information Reporting procedure, Successful Operation

If the requested information reporting criteria are met, the RNC₂ shall initiate an Information Reporting procedure. Unless specified below, the meaning of the parameters are given in other specifications.

The *Information Exchange ID* IE shall be set to the Information Exchange ID provided by the RNC₁ when initiating the information exchange with the Information Exchange Initiation procedure.

The *Requested Data Value* IE shall include at least one IE containing the data to be reported.

8.5.7.2.1 Successful Operation for lur-g

The RNC₁/BSS₁ and RNC₂/BSS₂ shall use the Information Reporting procedure as specified in section 8.5.7.2.

8.5.7.3 Abnormal Conditions

-

8.5.8 Information Exchange Termination

8.5.8.1 General

This procedure is used by a RNC to terminate the information exchange requested using the Information Exchange Initiation.

This procedure uses the signalling bearer connection for the relevant Distant RNC Context.

8.5.8.2 Successful Operation



Figure 30I: Information Exchange Termination procedure, Successful Operation

This procedure is initiated with a INFORMATION EXCHANGE TERMINATION REQUEST message.

Upon receipt, the RNC₂ shall terminate the information exchange corresponding to the *Information Exchange ID* IE provided by the RNC₁ when initiating the information exchange with the Information Exchange Initiation procedure.

8.5.8.2.1 Successful Operation for lur-g

The RNC₁/BSS₁ and RNC₂/BSS₂ shall use the Information Exchange Termination procedure as specified in section 8.5.8.2.

8.5.8.3 Abnormal Conditions

-

8.5.9 Information Exchange Failure

8.5.9.1 General

This procedure is used by a RNC to notify another that the information exchange it previously requested using the Information Exchange Initiation can no longer be reported.

This procedure uses the signalling bearer connection for the relevant Distant RNC Context.

8.5.9.2 Successful Operation

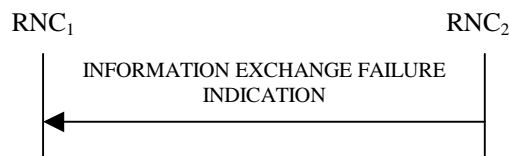

Figure 30J: Information Exchange Failure procedure, Successful Operation

This procedure is initiated with a INFORMATION EXCHANGE FAILURE INDICATION message, sent from the RNC₂ to the RNC₁, to inform the RNC₁ that information previously requested by the Information Exchange Initiation procedure can no longer be reported. The RNC₂ shall include in the INFORMATION EXCHANGE FAILURE INDICATION message the *Information Exchange ID* IE set to the same value provided by the RNC₁ when initiating the information exchange with the Information Exchange Initiation procedure, and the RNC₂ shall include the *Cause* IE set to an appropriate value.

Typical cause values are as follows:

Radio Network Layer Cause:

Information temporarily not available.

8.5.9.2.1 Successful Operation for lur-g

The RNC₁/BSS₁ and RNC₂/BSS₂ shall use the Information Exchange Failure procedure as specified in section 8.5.9.2.

8.5.10 Reset

8.5.10.1 General

The purpose of the reset procedure is to align the resources in RNC₁ and RNC₂ in the event of an abnormal failure.

The procedure uses connectionless signalling.

8.5.10.2 Successful Operation

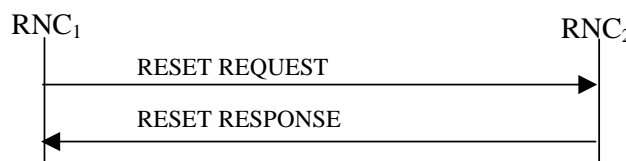

Figure 30K: Reset procedure, Successful Operation

The procedure is initiated with a RESET REQUEST message sent from the RNC₁ to the RNC₂.

If the *Reset Indicator* IE is set to “Context”, then:

- For all indicated UE Contexts identified by the *S-RNTI* IE, the RNC₂ in the role of DRNC, shall remove all the indicated UE Contexts and all the radio resources allocated for these UE Contexts. In addition, the RNC₂ shall take actions according to Annex D.2.
- For all indicated UE Contexts identified by the *D-RNTI* IE, the RNC₂ in the role of SRNC, shall remove the information related to the RNC₁ for all indicated UE Contexts and the radio resources allocated for these UE Contexts.

If the *Reset Indicator* IE is set to “Context Group”, then:

- For all indicated UE Context Groups identified by the *S-RNTI Group* IE, the RNC₂ in the role of DRNC, shall remove all the indicated UE Contexts and all the radio resources allocated for these UE Contexts. In addition, the RNC₂ shall take actions according to Annex D.2.

If the *Reset Indicator* IE is set to “All Contexts”, then the RNC₂ shall:

- In the role of DRNC, remove all the UE Contexts for which the RNC₁ is the SRNC and all the radio resources allocated for these UE Contexts. In addition, the RNC₂ shall take actions according to Annex D.2.
- In the role of SRNC, remove the information related to the RNC₁ for all the UE Contexts and all the radio resources allocated for these UE Contexts.

For all the removed UE Contexts and for all the UE Contexts for which the RNC₂ has removed information related to the RNC₁, the RNC₂ shall also initiate release of the dedicated or common user plane resources that were involved in these UE Contexts. After clearing all related resources, the RNC₂ shall return the RESET RESPONSE message to the RNC₁.

8.5.10.3 Abnormal Conditions

If the RESET message is received, any other ongoing procedure (except another Reset procedure) on same Iur interface related to a context indicated explicitly or implicitly in the message shall be aborted.

8.5.11 Direct Information Transfer

8.5.11.1 General

This procedure is used by an RNC to transfer information to another RNC spontaneously.

This procedure shall use the connectionless mode of signalling bearer.

8.5.11.2 Successful Operation

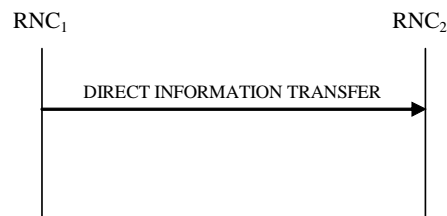

Figure 30L: Direct Information Transfer procedure, Successful Operation

The procedure is initiated with an DIRECT INFORMATION TRANSFER message sent from RNC₁ to RNC₂.

If the initiating RNC of this procedure is RNC₁, RNC₁ shall provide appropriate information in the *Provided Information* IE.

MBMS Channel Type Indication:

At the start time of a session for an MBMS bearer service, if the RNC₁ is in the DRNC role for some Ues whose UE Link contains the concerned MBMS bearer service and whose SRNC is RNC₂ and if the channel type is determined by the RNC₁ for certain cells in the DRNS, the procedure shall be initiated by the RNC₁ to the RNC₂. In this case, the RNC₁ shall include in the *Provided Information IE* the *Channel Type Information IE* in the DIRECT INFORMATION TRANSFER message.

During a session of an MBMS bearer service, if the RNC₁ is in the DRNC role for some Ues whose UE Link contains the concerned MBMS bearer service and whose SRNC is RNC₂, then the RNC₁ may initiate this procedure to indicate channel type change for the MBMS bearer service in certain cells. In this case, the RNC₁ shall include in the *Provided Information IE* the *Channel Type Information IE* in the DIRECT INFORMATION TRANSFER message.

The RNC₁ shall include the available information within the *PTM Cell List IE*, the *PTP Cell List IE* and/or the *Not Provided Cell List IE* in the *Channel Type Information IE*.

MBMS Preferred Frequency Layer Indication:

At the start time of a session for an MBMS bearer service, if the RNC₁ is in the DRNC role for at least one CELL_DCH UE whose UE Link contains the concerned MBMS bearer service and whose SRNC is RNC₂ and if the preferred frequency layer is determined by the RNC₁ for certain cells that host at least one of these CELL_DCH Ues whose SRNC is RNC₂, the procedure shall be initiated by the RNC₁ to the RNC₂. In this case, the RNC₁ shall include in the *Provided Information IE* the *Preferred Frequency Layer Information IE* in the DIRECT INFORMATION TRANSFER message.

If some of the cells controlled by RNC₁ that host at least one of these CELL_DCH Ues whose SRNC is RNC₂ are configured with different preferred frequencies, the *Additional Preferred Frequency IE* as well as *Default Preferred Frequency IE* shall be included in the *Preferred Frequency Layer Information IE*. In this case, for each preferred frequency different from the *Default Preferred Frequency IE*, one *Additional Preferred Frequency IE* shall be included containing at least one *Corresponding Cells IE*.

8.6 MBMS Procedures

8.6.1 MBMS Attach

8.6.1.1 General

The MBMS Attach procedure is used by the SRNC to either create a UE Link/URA Link in the DRNC or inform the DRNC about any addition of one or several MBMS bearer services in an already stored UE Link or URA Link.

This procedure shall use the signalling bearer mode specified below.

8.6.1.2 Successful Operation

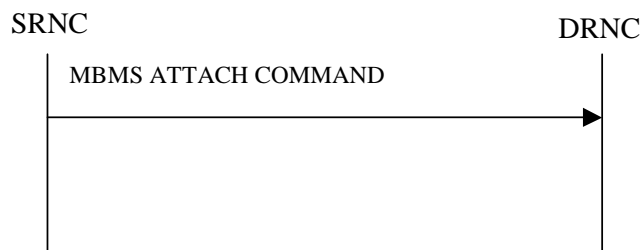

Figure 31: MBMS Attach procedure, Successful Operation

The SRNC initiates the procedure by sending the message MBMS ATTACH COMMAND message to the DRNC.

When the UE is utilising one or more radio links in the DRNC, the message shall be sent using the connection oriented service of the signalling bearer and no further identification of the UE Context in the DRNC is required. If the UE is not utilising any radio link, the message shall be sent using the connectionless service of the signalling bearer.

If no *UE State* IE is included in the message or the *UE State* IE is set to “CELL_FACH/CELL_PCH”, the DRNC shall perform the UE Linking as specified in TS 25.346 [50], section 5.1.6.

If the *UE State* IE is set to “URA_PCH”, the DRNC shall perform the URA Linking as specified in TS 25.346 [50], section 5.1.10.

8.6.1.3 Abnormal Conditions

-

8.6.2 MBMS Detach

8.6.2.1 General

The MBMS Detach procedure is used by the SRNC to either delete a UE Link/URA Link in the DRNC or to inform DRNC about any removal of one or several MBMS bearer services in an already stored UE link or URA Link.

This procedure shall use the signalling bearer mode specified below.

8.6.2.2 Successful Operation

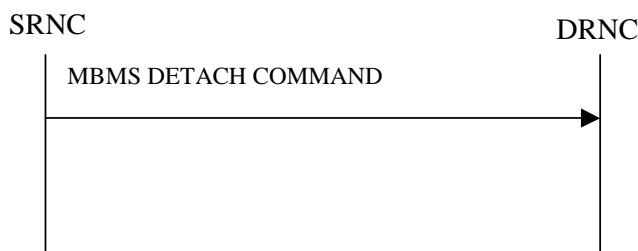

Figure 32: MBMS Detach procedure, Successful Operation

The SRNC initiates the procedure by sending the message MBMS DETACH COMMAND message to the DRNC.

When the UE is utilising one or more radio links in the DRNC, the message shall be sent using the connection oriented service of the signalling bearer and no further identification of the UE Context in the DRNC is required. If the UE is not utilising any radio link, the message shall be sent using the connectionless service of the signalling bearer.

If no *UE State* IE is included in the message or the *UE State* IE is set to “CELL_FACH/CELL_PCH”, the DRNC shall perform the UE De-linking as specified in TS 25.346 [50], section 5.1.6.

If the *UE State* IE is set to “URA_PCH”, the DRNC shall perform the URA De-linking as specified in TS 25.346 [50], section 5.1.10.

8.6.2.3 Abnormal Conditions

-

9 Elements for RNSAP Communication

9.1 Message Functional Definition and Content

9.1.1 General

This subclause defines the structure of the messages required for the RNSAP protocol in tabular format. The corresponding ASN.1 definition is presented in subclause 9.3. In case there is contradiction between the tabular format

in subclause 9.1 and the ASN.1 definition, the ASN.1 shall take precedence, except for the definition of conditions for the presence of conditional IEs, in which the tabular format shall take precedence.

NOTE: The messages have been defined in accordance to the guidelines specified in TR 25.921 [28].

9.1.2 Message Contents

9.1.2.1 Presence

An information element can be of the following types:

M	IEs marked as Mandatory (M) shall always be included in the message.
O	IEs marked as Optional (O) may or may not be included in the message.
C	IEs marked as Conditional I shall be included in a message only if the condition is satisfied. Otherwise the IE shall not be included.

In the case of an Information Element group, the group is preceded by a name for the info group (in bold). It is also indicated how many times a group may be repeated in the message and whether the group is conditional. Each group may be also repeated within one message. The presence field of the Information Elements inside one group defines if the Information Element is mandatory, optional or conditional if the group is present.

9.1.2.2 Criticality

Each information element or Group of information elements may have criticality information applied to it. Following cases are possible:

-	No criticality information is applied explicitly.
YES	Criticality information is applied. 'YES' is usable only for non-repeatable information elements.
GLOBAL	The information element and all its repetitions together have one common criticality information. 'GLOBAL' is usable only for repeatable information elements.
EACH	Each repetition of the information element has its own criticality information. It is not allowed to assign different criticality values to the repetitions. 'EACH' is usable only for repeatable information elements.

9.1.2.3 Range

The Range column indicates the allowed number of copies of repetitive IEs/IE groups.

9.1.2.4 Assigned Criticality

This column provides the actual criticality information as defined in subclause 10.3.2, if applicable.

9.1.3 RADIO LINK SETUP REQUEST

9.1.3.1 FDD Message

IE/Group Name	Presence	Range	IE Type and Reference	Semantics Description	Criticality	Assigned Criticality
Message Type	M		9.2.1.40		YES	reject
Transaction ID	M		9.2.1.59		–	
SRNC-ID	M		RNC-ID 9.2.1.50	If the <i>Extended SRNC-ID</i> IE is included in the message, the <i>SRNC-ID</i> IE shall be ignored.	YES	reject
S-RNTI	M		9.2.1.53		YES	reject
D-RNTI	O		9.2.1.24		YES	reject
Allowed Queuing Time	O		9.2.1.2		YES	reject
UL DPCH Information		1			YES	reject
>UL Scrambling Code	M		9.2.2.53		–	
>Min UL Channelisation Code Length	M		9.2.2.25		–	
>Max Number of UL DPDCHs	C – CodeLen		9.2.2.24		–	
>Puncture Limit	M		9.2.1.46	For the UL.	–	
>TFCS	M		9.2.1.63		–	
>UL DPCCH Slot Format	M		9.2.2.52		–	
>Uplink SIR Target	O		Uplink SIR 9.2.1.69		–	
>Diversity mode	M		9.2.2.8		–	
>Not Used	O		NULL		–	
>Not Used	O		NULL		–	
>DPC Mode	O		9.2.2.12A		YES	reject
>UL DPDCH Indicator for E-DCH operation	O		9.2.2.52A	This IE may be present without the presence of the <i>E-DPCH Information</i> IE	YES	reject
DL DPCH Information		0..1			YES	reject
>TFCS	M		9.2.1.63		–	
>DL DPCH Slot Format	M		9.2.2.9		–	
>Number of DL Channelisation Codes	M		9.2.2.26A		–	
>TFCI Signalling Mode	M		9.2.2.46		–	
>TFCI Presence	C- SlotFormat		9.2.1.55		–	
>Multiplexing Position	M		9.2.2.26		–	
>Power Offset Information		1			–	
>>PO1	M		Power Offset 9.2.2.30	Power offset for the TFCI bits.	–	
>>PO2	M		Power Offset 9.2.2.30	Power offset for the TPC bits.	–	
>>PO3	M		Power Offset 9.2.2.30	Power offset for the pilot bits.	–	
>FDD TPC Downlink Step Size	M		9.2.2.16		–	

IE/Group Name	Presence	Range	IE Type and Reference	Semantics Description	Criticality	Assigned Criticality
>Limited Power Increase	M		9.2.2.21A		–	
>Inner Loop DL PC Status	M		9.2.2.21a		–	
DCH Information	M		DCH FDD Information 9.2.2.4A		YES	reject
RL Information		<i>1..<maxno ofRLs></i>			EACH	notify
>RL ID	M		9.2.1.49		–	
>C-ID	M		9.2.1.6		–	
>First RLS Indicator	M		9.2.2.16A		–	
>Frame Offset	M		9.2.1.30		–	
>Chip Offset	M		9.2.2.1		–	
>Propagation Delay	O		9.2.2.33		–	
>Diversity Control Field	C – NotFirstRL		9.2.1.20		–	
>Initial DL TX Power	O		DL Power 9.2.1.21A		–	
>Primary CPICH Ec/No	O		9.2.2.32		–	
>Not Used	O		NULL		–	
>Transmit Diversity Indicator	C – Diversity mode		9.2.2.48		–	
>Enhanced Primary CPICH Ec/No	O		9.2.2.13l		YES	ignore
>RL Specific DCH Information	O		9.2.1.49A		YES	ignore
>Delayed Activation	O		9.2.1.19Aa		YES	reject
>Cell Portion ID	O		9.2.2.E		YES	ignore
>RL specific E-DCH Information	O		9.2.2.35a		YES	reject
>E-DCH RL Indication	O		9.2.2.4E		YES	reject
>Extended Propagation Delay	O		9.2.2.33a		YES	ignore
>Synchronisation Indicator	O		9.2.2.45A		YES	reject
>HS-DSCH Preconfiguration Setup	O		9.2.2.100		YES	ignore
>Non-Serving RL Preconfiguration Setup	O		9.2.2.124		YES	ignore
Transmission Gap Pattern Sequence Information	O		9.2.2.47A		YES	reject
Active Pattern Sequence Information	O		9.2.2.A		YES	reject
Permanent NAS UE Identity	O		9.2.1.73		YES	ignore
DL Power Balancing Information	O		9.2.2.10A		YES	ignore
HS-DSCH Information	O		HS-DSCH FDD Information 9.2.2.19a		YES	reject
HS-PDSCH RL ID	C – InfoHSDSCH		RL ID 9.2.1.49		YES	reject
MBMS Bearer Service List		<i>0..<maxno ofMBMS></i>			GLOBAL	notify
>TMGI	M		9.2.1.80		–	
E-DPCH Information		<i>0..1</i>			YES	reject
>Maximum Set of E-DPDCHs	M		9.2.2.24e		–	
>Puncture Limit	M		9.2.1.46		–	
>E-TFCS Information	M		9.2.2.4G		–	
>E-TTI	M		9.2.2.4J		–	
>E-DPCCH Power Offset	M		9.2.2.4K		–	
>E-RGCH 2-Index-Step Threshold	M		9.2.2.64		–	

IE/Group Name	Presence	Range	IE Type and Reference	Semantics Description	Criticality	Assigned Criticality
>E-RGCH 3-Index-Step Threshold	M		9.2.2.65		–	
>HARQ Info for E-DCH	M		9.2.2.66		–	
>HS-DSCH Configured Indicator	M		9.2.2.19C		–	
> Minimum Reduced E-DPDCH Gain Factor	O		9.2.2.102		YES	ignore
E-DCH FDD Information	C-EDCHInfo		9.2.2.4B		YES	reject
Serving E-DCH RL	O		9.2.2.38C		YES	reject
F-DPCH Information		0..1			YES	reject
>Power Offset Information		1			–	
>>PO2	M		Power Offset 9.2.2.30	This IE shall be ignored by DRNS.	–	
>FDD TPC Downlink Step Size	M		9.2.2.16		–	
>Limited Power Increase	M		9.2.2.21A		–	
>Inner Loop DL PC Status	M		9.2.2.21a		–	
>F-DPCH Slot Format Support Request	O		9.2.2.86		YES	reject
>F-DPCH Slot Format	O		9.2.2.85		YES	ignore
Initial DL DPCH Timing Adjustment Allowed	O		9.2.2.21b		YES	ignore
DCH Indicator For E-DCH-HSDPA Operation	O		9.2.2.67		YES	reject
Serving Cell Change CFN	O		CFN 9.2.1.9		YES	reject
Continuous Packet Connectivity DTX-DRX Information	O		9.2.2.72		YES	reject
Continuous Packet Connectivity HS-SCCH less Information	O		9.2.2.74		YES	reject
Extended SRNC-ID	O		Extended RNC-ID 9.2.1.50a	The <i>Extended SRNC-ID</i> IE shall be used if the RNC identity has a value larger than 4095.	YES	reject
Additional HS Cell Information RL Setup		0..<maxno ofHSDSC H-1>		For secondary serving HS-DSCH cell. Max 1 in this 3GPP release.	EACH	reject
>HS-PDSCH RL ID	M		RL ID 9.2.1.49		–	
>C-ID	M		9.2.1.6		–	
>HS-DSCH Secondary Serving Information	M		9.2.2.19aa		–	
UE Aggregate Maximum Bit Rate	O		9.2.1.137		YES	ignore
Additional E-DCH Cell Information RL Setup Req		0..1		For E-DCH on multiple frequencies in this DRNS.	YES	reject
>Multicell E-DCH Transport Bearer Mode	M		9.2.2.113		–	

IE/Group Name	Presence	Range	IE Type and Reference	Semantics Description	Criticality	Assigned Criticality
>Additional E-DCH Cell Information Setup		1..<maxno ofEDCH-1>		E-DCH on Secondary uplink frequency – max 1 in this 3GPP release.	–	
>> Additional E-DCH FDD Setup Information	M		9.2.2.110		-	

Condition	Explanation
CodeLen	The IE shall be present if <i>Min UL Channelisation Code length</i> IE equals to 4
SlotFormat	The IE shall be present if the <i>DL DPCH Slot Format</i> IE is equal to any of the values from 12 to 16.
NotFirstRL	The IE shall be present if the RL is not the first one in the <i>RL Information</i> IE.
Diversity mode	The IE shall be present if <i>Diversity Mode</i> IE in <i>UL DPCH Information</i> IE is not equal to “none”.
InfoHSDSCH	This IE shall be present if <i>HS-DSCH Information</i> IE is present.
EDCHInfo	This IE shall be present if <i>E-DPCH Information</i> IE is present.

Range bound	Explanation
<i>maxnoofRLs</i>	Maximum number of RLs for one UE.
<i>maxnoofMBMS</i>	Maximum number of MBMS bearer services that a UE can join.
<i>maxnoofHSDSCH-1</i>	Maximum number of Secondary Serving HS-DSCH cells for one UE.
<i>maxnoofEDCH-1</i>	Maximum number of uplink frequencies -1 for E-DCH for one UE

9.1.3.2 TDD Message

IE/Group Name	Presence	Range	IE Type and Reference	Semantics Description	Criticality	Assigned Criticality
Message Type	M		9.2.1.40		YES	reject
Transaction ID	M		9.2.1.59		–	
SRNC-ID	M		RNC-ID 9.2.1.50	If the <i>Extended SRNC-ID</i> IE is included in the message, the <i>SRNC-ID</i> IE shall be ignored.	YES	reject
S-RNTI	M		9.2.1.53		YES	reject
D-RNTI	O		9.2.1.24		YES	reject
UL Physical Channel Information		1			YES	reject
>Maximum Number of Timeslots	M		9.2.3.3A	For the UL	–	
>Minimum Spreading Factor	M		9.2.3.4A	For the UL	–	
>Maximum Number of UL Physical Channels per Timeslot	M		9.2.3.3B		–	
>Support of 8PSK	O		9.2.3.7H	Applicable to 1.28Mcps TDD only	YES	ignore
>Minimum Spreading Factor 7.68Mcps	O		9.2.3.19	Applicable to 7.68Mcps TDD only	YES	ignore
DL Physical Channel Information		1			YES	reject
>Maximum Number of Timeslots	M		9.2.3.3A	For the DL	–	
>Minimum Spreading Factor	M		9.2.3.4A	For the DL	–	
>Maximum Number of DL Physical Channels	M		9.2.3.3C		–	
>Maximum Number of DL Physical Channels per Timeslot	O		9.2.3.3D		YES	ignore
>Support of 8PSK	O		9.2.3.7H	Applicable to 1.28Mcps TDD only	YES	ignore
>Support of PLCCH	O		9.2.3.16	Applicable to 1.28Mcps TDD only	YES	ignore

>Minimum Spreading Factor 7.68Mcps	O		9.2.3.19	Applicable to 7.68Mcps TDD only	YES	ignore
>Maximum Number of DL Physical Channels 7.68Mcps	O		9.2.3.20	Applicable to 7.68Mcps TDD only	YES	ignore
>Maximum Number of DL Physical Channels per Timeslot 7.68Mcps	O		9.2.3.21	Applicable to 7.68Mcps TDD only	YES	ignore
Allowed Queuing Time	O		9.2.1.2		YES	reject
UL CCTrCH Information		<i>0..<maxn oofCCTr CHs></i>		For DCH and USCH	EACH	notify
>CCTrCH ID	M		9.2.3.2		–	
>TFCS	M		9.2.1.63	For the UL.	–	
>TFCI Coding	M		9.2.3.11		–	
>Puncture Limit	M		9.2.1.46		–	
>TDD TPC Uplink Step Size	O		9.2.3.10a	Mandatory for 1.28Mcps TDD, not applicable to 3.84Mcps TDD or 7.68Mcps TDD	YES	reject
DL CCTrCH Information		<i>0..<maxn oofCCTr CHs></i>		For DCH and DSCH	EACH	notify
>CCTrCH ID	M		9.2.3.2		–	
>TFCS	M		9.2.1.63	For the DL.	–	
>TFCI Coding	M		9.2.3.11		–	
>Puncture Limit	M		9.2.1.46		–	
>TDD TPC Downlink Step Size	M		9.2.3.10		–	
>TPC CCTrCH List		<i>0..<maxn oCCTrC Hs></i>		List of uplink CCTrCH which provide TPC	–	
>>TPC CCTrCH ID	M		CCTrCH ID 9.2.3.2		–	
DCH Information	O		DCH TDD Information 9.2.3.2A		YES	reject
DSCH Information	O		DSCH TDD Information 9.2.3.3a		YES	reject
USCH Information	O		9.2.3.15		YES	reject
RL Information		1			YES	reject
>RL ID	M		9.2.1.49		–	
>C-ID	M		9.2.1.6		–	
>Frame Offset	M		9.2.1.30		–	
>Special Burst Scheduling	M		9.2.3.7D		–	
>Primary CCPCH RSCP	O		9.2.3.5		–	
>DL Time Slot ISCP Info	O		9.2.3.2D	Applicable to 3.84Mcps TDD and 7.68Mcps TDD only	–	
>DL Time Slot ISCP Info LCR	O		9.2.3.2F	Applicable to 1.28Mcps TDD only	YES	reject
>TSTD Support Indicator	O		9.2.3.13F	Applicable to 1.28Mcps TDD only	YES	ignore
>RL Specific DCH Information	O		9.2.1.49A		YES	ignore
>Delayed Activation	O		9.2.1.19Aa		YES	reject

>UL Synchronisation Parameters LCR		0..1		Mandatory for 1.28Mcps TDD. Not Applicable to 3.84Mcps TDD or 7.68Mcps TDD.	YES	reject
>>Uplink Synchronisation Step Size	M		9.2.3.13J		–	
>>Uplink Synchronisation Frequency	M		9.2.3.13I		–	
>Primary CCPCH RSCP Delta	O		9.2.3.5a		YES	ignore
>Idle Interval Configuration Indicator	O		NULL	TDD only	YES	ignore
>Cell Portion LCR ID	O		9.2.3.73	Applicable to 1.28Mcps TDD only	YES	ignore
Permanent NAS UE Identity	O		9.2.1.73		YES	ignore
HS-DSCH Information	O		HS-DSCH TDD Information 9.2.3.3aa		YES	reject
HS-PDSCH RL ID	C – InfoHSDSCH		RL ID 9.2.1.49		YES	reject
PDSCH-RL-ID	O		RL ID 9.2.1.49		YES	ignore
MBMS Bearer Service List		0..<maxNumberOfMBMS>			GLOBAL	notify
>TMGI	M		9.2.1.80		–	
E-DCH Information		0..1		3.84Mcps TDD only	YES	reject
>E-PUCH Information	M		9.2.3.36		–	
>E-TFCS Information TDD	M		9.2.3.37		–	
>E-DCH MAC-d Flows Information TDD	M		9.2.3.38		–	
>E-DCH TDD Information	M		9.2.3.40		–	
E-DCH Serving RL	O		9.2.1.49	TDD only	YES	reject
E-DCH Information 7.68Mcps		0..1		7.68Mcps TDD only	YES	reject
>E-PUCH Information	M		9.2.3.36		–	
>E-TFCS Information TDD	M		9.2.3.37		–	
>E-DCH MAC-d Flows Information TDD	M		9.2.3.38		–	
>E-DCH TDD Information 7.68Mcps	M		9.2.3.51		–	
E-DCH Information 1.28Mcps		0..1		1.28Mcps TDD only	YES	reject
>E-PUCH Information LCR	M		9.2.3.36a		–	
>E-TFCS Information TDD	M		9.2.3.37		–	
>E-DCH MAC-d Flows Information TDD	M		9.2.3.38		–	
>E-DCH TDD Information LCR	M		9.2.3.40a		–	
Extended SRNC-ID	O		Extended RNC-ID 9.2.1.50a	The <i>Extended SRNC-ID</i> IE shall be used if the RNC identity has a value larger than 4095.	YES	reject
Continuous Packet Connectivity DRX Information LCR	O		9.2.3.61	1.28 Mcps TDD only	YES	reject

HS-DSCH Semi-Persistent scheduling Information LCR	O		9.2.3.64	1.28 Mcps TDD only	YES	reject
E-DCH Semi-Persistent scheduling Information LCR	O		9.2.3.66	1.28 Mcps TDD only	YES	reject
RNTI Allocation Indicator	O		ENUMERA TED (True)	1.28 Mcps TDD only	YES	ignore
DCH Measurement Type indicator	O		9.2.3.76	1.28 Mcps TDD only	YES	reject

Condition	Explanation
InfoHSDSCH	This IE shall be present if <i>HS-DSCH Information</i> IE is present.

Range bound	Explanation
<i>maxnoofCCTrCHs</i>	Maximum number of CCTrCH for one UE.
<i>maxnoofMBMS</i>	Maximum number of MBMS bearer services that a UE can join.

9.1.4 RADIO LINK SETUP RESPONSE

9.1.4.1 FDD Message

IE/Group Name	Presence	Range	IE Type and Reference	Semantics Description	Criticality	Assigned Criticality
Message Type	M		9.2.1.40		YES	reject
Transaction ID	M		9.2.1.59		–	
D-RNTI	O		9.2.1.24		YES	ignore
CN PS Domain Identifier	O		9.2.1.12		YES	ignore
CN CS Domain Identifier	O		9.2.1.11		YES	ignore
RL Information Response		<i>1..<maxno of RLS></i>			EACH	ignore
>RL ID	M		9.2.1.49		–	
>RL Set ID	M		9.2.2.35		–	
>URA Information	O		9.2.1.70B		–	
>SAI	M		9.2.1.52		–	
>Cell GAI	O		9.2.1.5A		–	
>UTRAN Access Point Position	O		9.2.1.70A		–	
>Received Total Wide Band Power	M		9.2.2.35A		–	
>Not Used	O		NULL		–	
>DL Code Information	M		FDD DL Code Information 9.2.2.14A		–	
>CHOICE <i>Diversity Indication</i>	M				–	
>> <i>Combining</i>					–	
>>>RL ID	M		9.2.1.49	Reference RL ID for the combining	–	
>>>DCH Information Response	O		9.2.1.16A		YES	ignore
>>>E-DCH FDD Information Response	O		9.2.2.4C		YES	ignore
>> <i>Non Combining or First RL</i>					–	
>>>DCH Information Response	M		9.2.1.16A		–	
>>>E-DCH FDD Information Response	O		9.2.2.4C		YES	ignore
>SSDT Support Indicator	M		9.2.2.43		–	
>Maximum Uplink SIR	M		Uplink SIR 9.2.1.69		–	
>Minimum Uplink SIR	M		Uplink SIR 9.2.1.69		–	
>Closed Loop Timing Adjustment Mode	O		9.2.2.3A		–	
>Maximum Allowed UL Tx Power	M		9.2.1.35		–	
>Maximum DL TX Power	M		DL Power 9.2.1.21A		–	
>Minimum DL TX Power	M		DL Power 9.2.1.21A		–	
>Primary Scrambling Code	O		9.2.1.45		–	
>UL UARFCN	O		UARFCN 9.2.1.66	Corresponds to Nu in ref. TS 25.104 [6]	–	
>DL UARFCN	O		UARFCN 9.2.1.66	Corresponds to Nd in ref. TS 25.104 [6]	–	

IE/Group Name	Presence	Range	IE Type and Reference	Semantics Description	Criticality	Assigned Criticality
>Primary CPICH Power	M		9.2.1.44		–	
>Not Used	O		NULL		–	
>Neighbouring UMTS Cell Information	O		9.2.1.41A		–	
>Neighbouring GSM Cell Information	O		9.2.1.41C		–	
>PC Preamble	M		9.2.2.27a		–	
>SRB Delay	M		9.2.2.39A		–	
>Cell GA Additional Shapes	O		9.2.1.5B		YES	ignore
>DL Power Balancing Activation Indicator	O		9.2.2.10B		YES	ignore
>HCS Prio	O		9.2.1.30N		YES	ignore
>Primary CPICH Usage For Channel Estimation	O		9.2.2.32A		YES	ignore
>Secondary CPICH Information	O		9.2.2.38A		YES	ignore
>Active MBMS Bearer Service List		<i>0..<maxno ofActiveM BMS></i>			GLOBAL	ignore
>>TMGI	M		9.2.1.80		–	
>>Transmission Mode	O		9.2.1.81		–	
>>Preferred Frequency Layer	O		UARFCN 9.2.1.66		–	
>E-DCH RL Set ID	O		RL Set ID 9.2.2.35		YES	ignore
>E-DCH FDD DL Control Channel Information	O		9.2.2.4D		YES	ignore
>Initial DL DPCH Timing Adjustment	O		DL DPCH Timing Adjustment 9.2.2.9A		YES	ignore
>F-DPCH Slot Format	O		9.2.2.85		YES	ignore
>Frame Offset	O		9.2.1.30		YES	ignore
>Chip Offset	O		9.2.2.1		YES	ignore
>Neighbouring E-UTRA Cell Information	O		9.2.1.41De		YES	ignore
>HS-DSCH Preconfiguration Info	O		9.2.2.99		YES	ignore
>Non-Serving RL Preconfiguration Info	O		9.2.2.125		YES	ignore
Uplink SIR Target	O		Uplink SIR 9.2.1.69		YES	ignore
Criticality Diagnostics	O		9.2.1.13		YES	ignore
HS-DSCH-RNTI	O		9.2.1.30P		YES	ignore
HS-DSCH Information Response	O		HS-DSCH FDD Information Response 9.2.2.19b		YES	ignore
Continuous Packet Connectivity HS-SCCH less Information Response	O		9.2.2.75		YES	ignore
SixtyfourQAM DL Support Indicator	O		9.2.1.123		YES	ignore
Additional HS Cell Information Response		<i>0..<maxno ofHSDSC H-1></i>		For secondary serving HS-DSCH cell. Max 1 in this 3GPP release.	EACH	ignore
>HS-PDSCH RL ID	M		RL ID 9.2.1.49		–	
>HS-DSCH-RNTI	M		9.2.1.30P		–	

IE/Group Name	Presence	Range	IE Type and Reference	Semantics Description	Criticality	Assigned Criticality
>HS-DSCH FDD Secondary Serving Information Response	M		9.2.2.19ba		–	
>SixtyfourQAM DL Support Indicator	O		9.2.1.123		–	
Additional E-DCH Cell Information Response		<i>0..<maxno ofEDCH-1></i>		E-DCH on Secondary uplink frequency – max 1 in this 3GPP release.	EACH	ignore
>Additional E-DCH FDD Information Response	M		9.2.2.120		–	

Range bound	Explanation
<i>maxnoofRLs</i>	Maximum number of RLs for one UE.
<i>maxnoofActiveMBMS</i>	Maximum number of MBMS bearer services that are active in parallel.
<i>maxnoofHSDSCH-1</i>	Maximum number of Secondary Serving HS-DSCH cells for one UE.
<i>maxnoofEDCH-1</i>	Maximum number of uplink frequencies -1 for E-DCH for one UE

9.1.4.2 TDD Message

IE/Group Name	Presence	Range	IE Type and Reference	Semantics Description	Criticality	Assigned Criticality
Message Type	M		9.2.1.40		YES	reject
Transaction ID	M		9.2.1.59		–	
D-RNTI	O		9.2.1.24		YES	ignore
CN PS Domain Identifier	O		9.2.1.12		YES	ignore
CN CS Domain Identifier	O		9.2.1.11		YES	ignore
RL Information Response		0..1		Mandatory for 3.84Mcps TDD , not applicable to 1.28Mcps TDD or 7.68Mcps TDD	YES	ignore
>RL ID	M		9.2.1.49		–	
>URA Information	O		9.2.1.70B		–	
>SAI	M		9.2.1.52		–	
>Cell GAI	O		9.2.1.5A		–	
>UTRAN Access Point Position	O		9.2.1.70A		–	
>UL Time Slot ISCP Info	M		9.2.3.13D		–	
>Maximum Uplink SIR	M		Uplink SIR 9.2.1.69		–	
>Minimum Uplink SIR	M		Uplink SIR 9.2.1.69		–	
>Maximum Allowed UL Tx Power	M		9.2.1.35		–	
>Maximum DL TX Power	M		DL Power 9.2.1.21A		–	
>Minimum DL TX Power	M		DL Power 9.2.1.21A		–	
>UARFCN	O		9.2.1.66	Corresponds to Nt in ref. TS 25.105 [7]	–	
>Cell Parameter ID	O		9.2.1.8		–	
>Sync Case	O		9.2.1.54		–	
>SCH Time Slot	C-Case2		9.2.1.51		–	
>SCTD Indicator	O		9.2.1.78		–	
>PCCPCH Power	M		9.2.1.43		–	
>Timing Advance Applied	M		9.2.3.12A		–	
>Alpha Value	M		9.2.3.a		–	
>UL PhysCH SF Variation	M		9.2.3.13B		–	
>Synchronisation Configuration	M		9.2.3.7E		–	
>Secondary CCPCH Info TDD	O		9.2.3.7B		–	
>UL CCTrCH Information		0..<maxno of CCTrCHs>		For DCH	GLOBAL	ignore
>>CCTrCH ID	M		9.2.3.2		–	
>>UL DPCH Information		0..1			YES	ignore
>>>Repetition Period	M		9.2.3.7		–	
>>>Repetition Length	M		9.2.3.6		–	
>>>TDD DPCH Offset	M		9.2.3.8A		–	
>>>UL Timeslot Information	M		9.2.3.13C		–	
>>Uplink SIR Target CCTrCH	O		Uplink SIR 9.2.1.69		YES	ignore
>DL CCTrCH Information		0..<maxno of CCTrCHs>		For DCH	GLOBAL	ignore
>>CCTrCH ID	M		9.2.3.2		–	

IE/Group Name	Presence	Range	IE Type and Reference	Semantics Description	Criticality	Assigned Criticality
>>DL DPCH Information		0..1			YES	ignore
>>>Repetition Period	M		9.2.3.7		–	
>>>Repetition Length	M		9.2.3.6		–	
>>>TDD DPCH Offset	M		9.2.3.8A		–	
>>>DL Timeslot Information	M		9.2.3.2C			
>>CCTrCH Maximum DL TX Power	O		DL Power 9.2.1.21A	Maximum allowed power on DPCH	YES	ignore
>>CCTrCH Minimum DL TX Power	O		DL Power 9.2.1.21A	Minimum allowed power on DPCH	YES	ignore
>DCH Information Response	O		9.2.1.16A		YES	ignore
>DSCH Information Response		0 .. <maxnoof DSCHs>			GLOBAL	ignore
>>DSCH ID	M		9.2.3.3ae		–	
>>DSCH Flow Control Information	M		9.2.3.3ag		–	
>>Binding ID	O		9.2.1.3		–	
>>Transport Layer Address	O		9.2.1.62		–	
>>Transport Format Management	M		9.2.3.13		–	
>USCH Information Response		0 .. <maxnoof USCHs>			GLOBAL	ignore
>>USCH ID	M		9.2.3.14		–	
>>Binding ID	O		9.2.1.3		–	
>>Transport Layer Address	O		9.2.1.62		–	
>>Transport Format Management	M		9.2.3.13		–	
>Neighbouring UMTS Cell Information	O		9.2.1.41A		–	
>Neighbouring GSM Cell Information	O		9.2.1.41C		–	
>Cell GA Additional Shapes	O		9.2.1.5B		YES	ignore
>HCS Prio	O		9.2.1.30N		YES	ignore
>Time Slot for SCH	C-Case1		Time Slot 9.2.1.56		YES	ignore
>Neighbouring E-UTRA Cell Information	O		9.2.1.41De		YES	ignore
Uplink SIR Target	M		Uplink SIR 9.2.1.69		YES	ignore
Criticality Diagnostics	O		9.2.1.13		YES	ignore
RL Information Response LCR		0..1		Mandatory for 1.28Mcps TDD, not applicable to 3.84Mcps TDD or 7.68Mcps TDD	YES	ignore
>RL ID	M		9.2.1.49		–	
>URA Information	M		9.2.1.70B		–	
>SAI	M		9.2.1.52		–	
>Cell GAI	O		9.2.1.5A		–	
>UTRAN Access Point Position	O		9.2.1.70A		–	
>UL Time Slot ISCP Info LCR	M		9.2.3.13H		–	
>Maximum Uplink SIR	M		Uplink SIR		–	

IE/Group Name	Presence	Range	IE Type and Reference	Semantics Description	Criticality	Assigned Criticality
>Minimum Uplink SIR	M		9.2.1.69 Uplink SIR 9.2.1.69		–	
>Maximum Allowed UL Tx Power	M		9.2.1.35		–	
>Maximum DL TX Power	M		DL Power 9.2.1.21A		–	
>Minimum DL TX Power	M		DL Power 9.2.1.21A		–	
>UARFCN	O		9.2.1.66	Corresponds to Nt in ref. TS 25.105 [7]	–	
>Cell Parameter ID	O		9.2.1.8		–	
>SCTD Indicator	O		9.2.1.78		–	
>PCCPCH Power	M		9.2.1.43		–	
>Alpha Value	M		9.2.3.a		–	
>UL PhysCH SF Variation	M		9.2.3.13B		–	
>Synchronisation Configuration	M		9.2.3.7E		–	
>Secondary CCPCH Info TDD LCR	O		9.2.3.7F		–	
>UL CCTrCH Information LCR		<i>0..<maxno of CCTrCH sLCR></i>		For DCH	GLOBAL	ignore
>>CCTrCH ID	M		9.2.3.2		–	
>>UL DPCH Information LCR		<i>0..1</i>			YES	ignore
>>>Repetition Period	M		9.2.3.7		–	
>>>Repetition Length	M		9.2.3.6		–	
>>>TDD DPCH Offset	M		9.2.3.8A		–	
>>>UL Timeslot Information LCR	M		9.2.3.13G		–	
>>Uplink SIR Target CCTrCH	O		Uplink SIR 9.2.1.69		YES	ignore
>DL CCTrCH Information LCR		<i>0..<maxno of CCTrCH sLCR></i>		For DCH	GLOBAL	ignore
>>CCTrCH ID	M		9.2.3.2		–	
>>DL DPCH Information LCR		<i>0..1</i>			YES	ignore
>>>Repetition Period	M		9.2.3.7		–	
>>>Repetition Length	M		9.2.3.6		–	
>>>TDD DPCH Offset	M		9.2.3.8A		–	
>>>DL Timeslot Information LCR	M		9.2.3.2E		–	
>>>TSTD Indicator	M		9.2.3.13E		–	
>DCH Information Response	O		9.2.1.16A		YES	ignore
>DSCH Information Response LCR		<i>0 .. <maxno of DSCHsLC R></i>			GLOBAL	ignore
>>DSCH ID	M		9.2.3.3ae		–	
>>DSCH Flow Control Information	M		9.2.3.3ag		–	
>>Binding ID	O		9.2.1.3		–	
>>Transport Layer Address	O		9.2.1.62		–	
>>Transport Format Management	M		9.2.3.13		–	
>USCH Information Response LCR		<i>0 .. <maxno of USCHsLC R></i>			GLOBAL	ignore

IE/Group Name	Presence	Range	IE Type and Reference	Semantics Description	Criticality	Assigned Criticality
>>USCH ID	M		9.2.3.14		–	
>>Binding ID	O		9.2.1.3		–	
>>Transport Layer Address	O		9.2.1.62		–	
>>Transport Format Management	M		9.2.3.13		–	
>Neighbouring UMTS Cell Information	O		9.2.1.41A		–	
>Neighbouring GSM Cell Information	O		9.2.1.41C		–	
>HCS Prio	O		9.2.1.30N		YES	ignore
>Cell GA Additional Shapes	O		9.2.1.5B		YES	ignore
>Uplink Timing Advance Control LCR	M		9.2.3.13K		YES	ignore
>PowerControl GAP	O		INTEGER (1..255)	Unit: umber of subframes Applicable to 1.28Mcps TDD only	YES	ignore
>SixtyfourQAM DL Support Indicator	O		9.2.1.123	Applicable to 1.28Mcps TDD only	YES	ignore
>Neighbouring E-UTRA Cell Information	O		9.2.1.41De		YES	ignore
>Idle Interval Information	O		9.2.3.60	TDD only	YES	ignore
HS-DSCH-RNTI	O		9.2.1.30P		YES	ignore
HS-DSCH Information Response	O		HS-DSCH TDD Information Response 9.2.3.3ab		YES	ignore
DSCH-RNTI	O		9.2.3.3ah		YES	ignore
Active MBMS Bearer Service List		<i>0..<maxno ofActiveM BMS></i>			GLOBAL	ignore
>TMGI	M		9.2.1.80		–	
>Transmission Mode	O		9.2.1.81		–	
>Preferred Frequency Layer	O		UARFCN 9.2.1.66		–	
RL Information Response 7.68Mcps		<i>0..1</i>		Mandatory for 7.68Mcps TDD , not applicable to 1.28Mcps TDD or 3.84Mcps TDD	YES	ignore
>RL ID	M		9.2.1.49		–	
>URA Information	O		9.2.1.70B		–	
>SAI	M		9.2.1.52		–	
>Cell GAI	O		9.2.1.5A		–	
>UTRAN Access Point Position	O		9.2.1.70A		–	
>UL Time Slot ISCP Info	M		9.2.3.13D		–	
>Maximum Uplink SIR	M		Uplink SIR 9.2.1.69		–	
>Minimum Uplink SIR	M		Uplink SIR 9.2.1.69		–	
>Maximum Allowed UL Tx Power	M		9.2.1.35		–	
>Maximum DL TX Power	M		DL Power 9.2.1.21A		–	
>Minimum DL TX Power	M		DL Power 9.2.1.21A		–	

IE/Group Name	Presence	Range	IE Type and Reference	Semantics Description	Criticality	Assigned Criticality
>UARFCN	O		UARFCN 9.2.1.66	Corresponds to Nt in ref. TS 25.105 [7]	–	
>Cell Parameter ID	O		9.2.1.8		–	
>Sync Case	O		9.2.1.54		–	
>SCH Time Slot	C-Case2		9.2.1.51		–	
>SCTD Indicator	O		9.2.1.78		–	
>PCCPCH Power	M		9.2.1.43		–	
>Timing Advance Applied	M		9.2.3.12A		–	
>Alpha Value	M		9.2.3.a		–	
>UL PhysCH SF Variation	M		9.2.3.13B		–	
>Synchronisation Configuration	M		9.2.3.7E		–	
>Secondary CCPCH Info 7.68Mcps TDD	O		9.2.3.22		–	
>UL CCTrCH Information 7.68 Mcps		<i>0..<maxno ofCCTrCH s></i>		For DCH	GLOBAL	ignore
>>CCTrCH ID	M		9.2.3.2		–	
>>UL DPCH Information		<i>0..1</i>			YES	ignore
>>>Repetition Period	M		9.2.3.7		–	
>>>Repetition Length	M		9.2.3.6		–	
>>>TDD DPCH Offset	M		9.2.3.8A		–	
>>>UL Timeslot Information 7.68Mcps	M		9.2.3.26		–	
>>Uplink SIR Target CCTrCH	O		Uplink SIR 9.2.1.69		–	
>DL CCTrCH Information 7.68 Mcps		<i>0..<maxno ofCCTrCH s></i>		For DCH	GLOBAL	ignore
>>CCTrCH ID	M		9.2.3.2		–	
>>DL DPCH Information		<i>0..1</i>			YES	ignore
>>>Repetition Period	M		9.2.3.7		–	
>>>Repetition Length	M		9.2.3.6		–	
>>>TDD DPCH Offset	M		9.2.3.8A		–	
>>>DL Timeslot Information 7.68Mcps	M		9.2.3.28		–	
>>CCTrCH Maximum DL TX Power	O		DL Power 9.2.1.21A	Maximum allowed power on DPCH	–	
>>CCTrCH Minimum DL TX Power	O		DL Power 9.2.1.21A	Minimum allowed power on DPCH	–	
>DCH Information Response	O		9.2.1.16A		YES	ignore
>DSCH Information Response 7.68 Mcps		<i>0.. <maxnoof DSCHs></i>			GLOBAL	ignore
>>DSCH ID	M		9.2.3.3ae		–	
>>DSCH Flow Control Information	M		9.2.3.3ag		–	
>>Binding ID	O		9.2.1.3		–	
>>Transport Layer Address	O		9.2.1.62		–	
>>Transport Format Management	M		9.2.3.13		–	
>USCH Information Response 7.68 Mcps		<i>0.. <maxnoof USCHs></i>			GLOBAL	ignore
>>USCH ID	M		9.2.3.14		–	
>>Binding ID	O		9.2.1.3		–	
>>Transport Layer Address	O		9.2.1.62		–	
>>Transport Format	M		9.2.3.13		–	

IE/Group Name	Presence	Range	IE Type and Reference	Semantics Description	Criticality	Assigned Criticality
Management						
>Neighbouring UMTS Cell Information	O		9.2.1.41A		–	
>Neighbouring GSM Cell Information	O		9.2.1.41C		–	
>Cell GA Additional Shapes	O		9.2.1.5B		–	
>HCS Prio	O		9.2.1.30N		–	
>Time Slot for SCH	C-Case1		Time Slot 9.2.1.56		–	
>Neighbouring E-UTRA Cell Information	O		9.2.1.41De		YES	ignore
E-DCH Information Response	O		E-DCH TDD Information Response 9.2.3.41	3.84Mcps TDD only	YES	ignore
E-DCH Information Response 7.68Mcps	O		E-DCH TDD Information Response 7.68Mcps 9.2.3.52	7.68Mcps TDD only	YES	ignore
E-DCH Information Response 1.28Mcps	O		E-DCH TDD Information Response 1.28Mcps 9.2.3.41a	1.28Mcps TDD only	YES	ignore
Continuous Packet Connectivity DRX Information Response LCR	O		9.2.3.63	1.28 Mcps TDD only	YES	ignore
HS-DSCH Semi-Persistent scheduling Information Response LCR	O		9.2.3.68	1.28 Mcps TDD only	YES	ignore
E-DCH Semi-Persistent scheduling Information Response LCR	O		9.2.3.69	1.28 Mcps TDD only	YES	ignore
E-RNTI for FACH	O		E-RNTI 9.2.1.94	1.28 Mcps TDD only	YES	ignore
H-RNTI for FACH	O		HS-DSCH- RNTI 9.2.1.30P	1.28 Mcps TDD only	YES	ignore
DCH Measurement Occasion Information	O		9.2.3.75	1.28 Mcps TDD only	YES	reject

Condition	Explanation
Case2	The IE shall be present if <i>Sync Case</i> IE is equal to "Case2".
Case1	This IE shall be present if <i>Sync Case</i> IE is equal to "Case1".

Range bound	Explanation
<i>maxnoofDSCHs</i>	Maximum number of DSCHs for one UE for 3.84Mcps TDD or 7.68Mcps TDD.
<i>maxnoofUSCHs</i>	Maximum number of USCHs for one UE for 3.84Mcps TDD or 7.68Mcps TDD.
<i>maxnoofCCTrCHs</i>	Maximum number of CCTrCH for one UE for 3.84Mcps TDD or 7.68Mcps TDD.
<i>maxnoofDSCHsLCR</i>	Maximum number of DSCHs for one UE for 1.28Mcps TDD.
<i>maxnoofUSCHsLCR</i>	Maximum number of USCHs for one UE for 1.28Mcps TDD.
<i>maxnoofCCTrCHsLCR</i>	Maximum number of CCTrCH for one UE for 1.28Mcps TDD.
<i>maxnoofActiveMBMS</i>	Maximum number of MBMS bearer services that are active in parallel.

9.1.5 RADIO LINK SETUP FAILURE

9.1.5.1 FDD Message

IE/Group Name	Presence	Range	IE Type and Reference	Semantics Description	Criticality	Assigned Criticality
Message Type	M		9.2.1.40		YES	reject
Transaction ID	M		9.2.1.59		–	
D-RNTI	O		9.2.1.24		YES	ignore
CN PS Domain Identifier	O		9.2.1.12		YES	ignore
CN CS Domain Identifier	O		9.2.1.11		YES	ignore
CHOICE Cause Level	M				YES	ignore
>General					–	
>>Cause	M		9.2.1.5		–	
>RL Specific					–	
>>Unsuccessful RL Information Response		1..<maxno ofRLs>			EACH	ignore
>>>RL ID	M		9.2.1.49		–	
>>>Cause	M		9.2.1.5		–	
>>>Max UE DTX Cycle	C-DTX-CycleNotA available		9.2.2.87		YES	ignore
>>Successful RL Information Response		0..<maxno ofRLs-1>			EACH	ignore
>>>RL ID	M		9.2.1.49		–	
>>>RL Set ID	M		9.2.2.35		–	
>>>URA Information	O		9.2.1.70B		–	
>>>SAI	M		9.2.1.52		–	
>>>Cell GAI	O		9.2.1.5A		–	
>>>UTRAN Access Point Position	O		9.2.1.70A		–	
>>>Received Total Wide Band Power	M		9.2.2.35A		–	
>>>Not Used	O		NULL		–	
>>>DL Code Information	M		FDD DL Code Information 9.2.2.14A		–	
>>>CHOICE Diversity Indication	M				–	
>>>>Combining					–	
>>>>>RL ID	M		9.2.1.49	Reference RL ID for the combining	–	
>>>>>DCH Information Response	O		9.2.1.16A		YES	ignore
>>>>>E-DCH FDD Information Response	O		9.2.2.4C		YES	ignore
>>>>Non Combining or First RL					–	
>>>>>DCH Information Response	M		9.2.1.16A		–	
>>>>>E-DCH FDD Information Response	O		9.2.2.4C		YES	ignore
>>>SSDT Support Indicator	M		9.2.2.43		–	
>>>Maximum Uplink SIR	M		Uplink SIR 9.2.1.69		–	
>>>Minimum Uplink SIR	M		Uplink SIR 9.2.1.69		–	
>>>Closed Loop Timing Adjustment Mode	O		9.2.2.3A		–	
>>>Maximum Allowed UL Tx Power	M		9.2.1.35		–	

IE/Group Name	Presence	Range	IE Type and Reference	Semantics Description	Criticality	Assigned Criticality
>>>Maximum DL TX Power	M		DL Power 9.2.1.21A		–	
>>>Minimum DL TX Power	M		DL Power 9.2.1.21A		–	
>>>Primary CPICH Power	M		9.2.1.44		–	
>>>Primary Scrambling Code	O		9.2.1.45		–	
>>>UL UARFCN	O		UARFCN 9.2.1.66	Corresponds to Nu in ref. TS 25.104 [6]	–	
>>>DL UARFCN	O		UARFCN 9.2.1.66	Corresponds to Nd in ref. TS 25.104 [6]	–	
>>>Not Used	O		NULL		–	
>>>Neighbouring UMTS Cell Information	O		9.2.1.41A		–	
>>>Neighbouring GSM Cell Information	O		9.2.1.41C		–	
>>>PC Preamble	M		9.2.2.27a		–	
>>>SRB Delay	M		9.2.2.39A		–	
>>>Cell GA Additional Shapes	O		9.2.1.5B		YES	ignore
>>>DL Power Balancing Activation Indicator	O		9.2.2.10B		YES	ignore
>>>HCS Prio	O		9.2.1.30N		YES	ignore
>>>Primary CPICH Usage For Channel Estimation	O		9.2.2.32A		YES	ignore
>>>Secondary CPICH Information	O		9.2.2.38A		YES	ignore
>>>Active MBMS Bearer Service List		<i>0..<maxno ofActiveM BMS></i>			GLOBAL	ignore
>>>>TMGI	M		9.2.1.80		–	
>>>>Transmission Mode	O		9.2.1.81		–	
>>>>Preferred Frequency Layer	O		UARFCN 9.2.1.66		–	
>>>E-DCH RL Set ID	O		RL Set ID 9.2.2.35		YES	ignore
>>>E-DCH FDD DL Control Channel Information	O		9.2.2.4D		YES	ignore
>>>Initial DL DPCH Timing Adjustment	O		DL DPCH Timing Adjustment 9.2.2.9A		YES	ignore
>>>Neighbouring E-UTRA Cell Information	O		9.2.1.41De		YES	ignore
>>> HS-DSCH Preconfiguration Info	O		9.2.2.99		YES	ignore
>>>F-DPCH Slot Format	O		9.2.2.85		YES	ignore
>>>Non-Serving RL Preconfiguration Info	O		9.2.2.125		YES	ignore
>>HS-DSCH-RNTI	O		9.2.1.30P		YES	ignore
>>HS-DSCH Information Response	O		HS-DSCH FDD Information Response 9.2.2.19b		YES	ignore

IE/Group Name	Presence	Range	IE Type and Reference	Semantics Description	Criticality	Assigned Criticality
>>Continuous Packet Connectivity HS-SCCH less Information Response	O		9.2.2.75		YES	ignore
>>SixtyfourQAM DL Support Indicator	O		9.2.1.123		YES	ignore
>>>Additional HS Cell Information Response	O	0..<maxno ofHSDSCH-1>		For secondary serving HS-DSCH cell. Max 1 in this 3GPP release.	EACH	ignore
>>>HS-PDSCH RL ID	M		RL ID 9.2.1.49		–	
>>>HS-DSCH-RNTI	M		9.2.1.30P		–	
>>>HS-DSCH FDD Secondary Serving Information Response	M		9.2.2.19ba		–	
>>>SixtyfourQAM DL Support Indicator	O		9.2.1.123		–	
>>>Additional E-DCH Cell Information Response		0..<maxno ofEDCH-1>		E-DCH on Secondary uplink frequency – max 1 in this 3GPP release.	EACH	ignore
>>>Additional E-DCH FDD Information Response	M		9.2.2.120		–	
Uplink SIR Target	O		Uplink SIR 9.2.1.69		YES	ignore
Criticality Diagnostics	O		9.2.1.13		YES	ignore

Condition	Explanation
DTX-CycleNotAvailable	The IE shall be present if the Cause IE is set to Continuous Packet Connectivity UE DTX Cycle not Available “.

Range bound	Explanation
<i>maxnoofRLs</i>	Maximum number of RLs for one UE.
<i>maxnoofActiveMBMS</i>	Maximum number of MBMS bearer services that are active in parallel.
<i>maxnoofHSDSCH-1</i>	Maximum number of Secondary Serving HS-DSCH cells for one UE.
<i>maxnoofEDCH-1</i>	Maximum number of uplink frequencies -1 for E-DCH for one UE

9.1.5.2 TDD Message

IE/Group Name	Presence	Range	IE Type and Reference	Semantics Description	Criticality	Assigned Criticality
Message Type	M		9.2.1.40		YES	reject
Transaction ID	M		9.2.1.59		–	
CHOICE Cause Level	M				YES	ignore
>General					–	
>>Cause	M		9.2.1.5		–	
>RL Specific					–	
>>Unsuccessful RL Information Response		1			YES	ignore
>>>RL ID	M		9.2.1.49		–	
>>>Cause	M		9.2.1.5		–	
>>SixtyfourQAM DL Support Indicator	O		9.2.1.123		YES	ignore
Criticality Diagnostics	O		9.2.1.13		YES	ignore

9.1.6 RADIO LINK ADDITION REQUEST

9.1.6.1 FDD Message

IE/Group Name	Presence	Range	IE Type and Reference	Semantics Description	Criticality	Assigned Criticality
Message Type	M		9.2.1.40		YES	reject
Transaction ID	M		9.2.1.59		–	
Uplink SIR Target	M		Uplink SIR 9.2.1.69		YES	reject
RL Information		<i>1..<maxn oofRLs- 1></i>			EACH	notify
>RL ID	M		9.2.1.49		–	
>C-ID	M		9.2.1.6		–	
>Frame Offset	M		9.2.1.30		–	
>Chip Offset	M		9.2.2.1		–	
>Diversity Control Field	M		9.2.1.20		–	
>Primary CPICH Ec/No	O		9.2.2.32		–	
>Not Used	O		NULL		–	
>Transmit Diversity Indicator	O		9.2.2.48		–	
>DL Reference Power	O		DL Power 9.2.1.21A	Power on DPCH or on F-DPCH	YES	ignore
>Enhanced Primary CPICH Ec/No	O		9.2.2.13l		YES	ignore
>RL Specific DCH Information	O		9.2.1.49A		YES	ignore
>Delayed Activation	O		9.2.1.19Aa		YES	reject
>RL specific E-DCH Information	O		9.2.2.35a		YES	reject
>E-DCH RL Indication	O		9.2.2.4E		YES	reject
>Synchronisation Indicator	O		9.2.2.45A		YES	ignore
>HS-DSCH Preconfiguration Setup	O		9.2.2.100		YES	Ignore
>Non-Serving RL Preconfiguration Setup	O		9.2.2.124		YES	Ignore
Active Pattern Sequence Information	O		9.2.2A	Either all the already active Transmissio n Gap Sequence(s) are addressed (Transmissio n Gap Pattern sequence shall overlap with the existing one) or none of the transmission gap sequences is activated.	YES	reject
DPC Mode	O		9.2.2.12A		YES	reject
Permanent NAS UE Identity	O		9.2.1.73		YES	ignore
Serving E-DCH RL	O		9.2.2.38C		YES	reject
Initial DL DPCH Timing Adjustment Allowed	O		9.2.2.21b		YES	ignore
HS-DSCH Serving Cell Change Information	O		9.2.2.19f		YES	reject

Serving Cell Change CFN	O		CFN 9.2.1.9		YES	reject
E-DPCH Information		0..1			YES	reject
>Maximum Set of E-DPCHs	M		9.2.2.24e		–	
>Puncture Limit	M		9.2.1.46		–	
>E-TFCS Information	M		9.2.2.4G		–	
>E-TTI	M		9.2.2.4J		–	
>E-DPCCH Power Offset	M		9.2.2.4K		–	
>E-RGCH 2-Index-Step Threshold	M		9.2.2.64		–	
>E-RGCH 3-Index-Step Threshold	M		9.2.2.65		–	
>HARQ Info for E-DCH	M		9.2.2.66		–	
>HS-DSCH Configured Indicator	M		9.2.2.19C		YES	reject
> Minimum Reduced E-DPCH Gain Factor	O		9.2.2.102		YES	ignore
E-DCH FDD Information	C-EDCHInfo		9.2.2.4B		YES	reject
Additional HS Cell Information RL Addition		0..<maxn oofHS DSC H-1>		For secondary serving HS-DSCH cell. Max 1 in this 3GPP release.	EACH	reject
>HS-PDSCH RL ID	M		RL ID 9.2.1.49		–	
>C-ID	M		9.2.1.6		–	
>HS-DSCH FDD Secondary Serving Information	M		9.2.2.19aa		–	
UE Aggregate Maximum Bit Rate	O		9.2.1.137		YES	ignore
Additional E-DCH Cell Information RL Add Req		0..1		For E-DCH on multiple frequencies in this DRNS.	YES	reject
>CHOICE Setup Or Addition Of E-DCH On Secondary UL Frequency	M				YES	reject
>> Setup				Used when the secondary UL frequency does not exist or is not configured with E-DCH in the current UE context	–	
>>>Multicell E-DCH Transport Bearer Mode	M		9.2.2.113		–	
>>>>Additional E-DCH Cell Information Setup		1..<maxn oofEDCH -1>		E-DCH on Secondary uplink frequency – max 1 in this 3GPP release.	–	
>>>>>Additional E-DCH FDD Setup Information	M		9.2.2.110		–	
>>>>>Addition				Used when	–	

				there exist additional E-DCH RLs in the current UE context		
>>>Additional E-DCH Cell Information Addition		$1..<max\ noofEDCH-1>$		E-DCH on Secondary uplink frequency – max 1 in this 3GPP release.	–	
>>>>UL DPCH Information		1			–	
>>>>>Uplink SIR Target	M		Uplink SIR 9.2.1.69		–	
>>>>Additional E-DCH RL Specific Information To Add	M		9.2.2.116		–	
>>>>Additional E-DCH FDD Information	O		9.2.2.112		–	
>>>>Multicell E-DCH Information	O		9.2.2.114		YES	ignore

Condition	Explanation
EDCHInfo	This IE shall be present if <i>E-DPCH Information</i> IE is present.

Range bound	Explanation
<i>maxnoofRLs</i>	Maximum number of radio links for one UE.
<i>maxnoofHSDSCH-1</i>	Maximum number of Secondary Serving HS-DSCH cells for one UE.
<i>maxnoofEDCH-1</i>	Maximum number of uplink frequencies -1 for E-DCH for one UE

9.1.6.2 TDD Message

IE/Group Name	Presence	Range	IE Type and Reference	Semantics Description	Criticality	Assigned Criticality
Message Type	M		9.2.1.40		YES	reject
Transaction ID	M		9.2.1.59		–	
RL Information		1			YES	reject
>RL ID	M		9.2.1.49		–	
>C-ID	M		9.2.1.6		–	
>Frame Offset	M		9.2.1.30		–	
>Diversity Control Field	M		9.2.1.20		–	
>Primary CCPCH RSCP	O		9.2.3.5		–	
>DL Time Slot ISCP Info	O		9.2.3.2D	Applicable to 3.84Mcps TDD and 7.68Mcps TDD only	–	
>DL Time Slot ISCP Info LCR	O		9.2.3.2F	Applicable to 1.28Mcps TDD only	YES	reject
>RL Specific DCH Information	O		9.2.1.49A		YES	ignore
>Delayed Activation	O		9.2.1.19Aa		YES	reject
>UL Synchronisation Parameters LCR		0..1		Mandatory for 1.28Mcps TDD. Not Applicable to 3.84Mcps TDD or 7.68Mcps TDD.	YES	reject
>>Uplink Synchronisation Step Size	M		9.2.3.13J		–	
>>Uplink Synchronisation Frequency	M		9.2.3.13I		–	
> Primary CCPCH RSCP Delta	O		9.2.3.5a		YES	ignore
>Idle Interval Configuration Indicator	O		NULL	TDD only	YES	ignore
Permanent NAS UE Identity	O		9.2.1.73		YES	ignore
UL CCTrCH Information		0..<maxno of CCTr CHs >			EACH	notify
>CCTrCH ID	M		9.2.3.2		–	
>TDD TPC Uplink Step Size	O		9.2.3.10a	Applicable to 1.28Mcps TDD only	–	
DL CCTrCH Information		0..<maxno of CCTr CHs >			EACH	notify
>CCTrCH ID	M		9.2.3.2		–	
>TDD TPC Downlink Step Size	O		9.2.3.10		–	
HS-DSCH Information	O		HS-DSCH TDD Information 9.2.3.3aa		YES	reject
HS-PDSCH RL ID	O		RL ID 9.2.1.49		YES	reject
E-DCH Information		0..1		3.84Mcps TDD only	YES	reject
>E-PUCH Information	M		9.2.3.36		–	

>E-TFCS Information TDD	M		9.2.3.37		–	
>E-DCH MAC-d Flows Information TDD	M		9.2.3.38		–	
>E-DCH TDD Information	M		9.2.3.40		–	
E-DCH Serving RL	O		9.2.1.49	3.84Mcps TDD only	YES	reject
E-DCH Information 7.68Mcps		0..1		7.68Mcps TDD only	YES	reject
>E-PUCH Information	M		9.2.3.36		–	
>E-TFCS Information TDD	M		9.2.3.37		–	
>E-DCH MAC-d Flows Information TDD	M		9.2.3.38		–	
>E-DCH TDD Information 7.68Mcps	M		9.2.3.51		–	
E-DCH Information 1.28Mcps		0..1		1.28Mcps TDD only	YES	reject
>E-PUCH Information LCR	M		9.2.3.36a		–	
>E-TFCS Information TDD	M		9.2.3.37		–	
>E-DCH MAC-d Flows Information TDD	M		9.2.3.38		–	
>E-DCH TDD Information LCR	M		9.2.3.40a		–	
Continuous Packet Connectivity DRX Information LCR	O		9.2.3.61	1.28 Mcps TDD only	YES	reject
HS-DSCH Semi-Persistent scheduling Information LCR	O		9.2.3.64	1.28 Mcps TDD only	YES	reject
E-DCH Semi-Persistent scheduling Information LCR	O		9.2.3.66	1.28 Mcps TDD only	YES	reject
DCH Measurement Type indicator	O		9.2.3.76	1.28 Mcps TDD only	YES	reject

Range bound	Explanation
<i>maxnoofCCTrCHs</i>	Maximum number of CCTrCH for one UE.

9.1.7 RADIO LINK ADDITION RESPONSE

9.1.7.1 FDD Message

IE/Group Name	Presence	Range	IE Type and Reference	Semantics Description	Criticality	Assigned Criticality
Message Type	M		9.2.1.40		YES	reject
Transaction ID	M		9.2.1.59		–	
RL Information Response		1..<maxnoof RLS-1>			EACH	ignore
>RL ID	M		9.2.1.49		–	
>RL Set ID	M		9.2.2.35		–	
>URA Information	O		9.2.1.70B		–	
>SAI	M		9.2.1.52		–	
>Cell GAI	O		9.2.1.5A		–	
>UTRAN Access Point Position	O		9.2.1.70A		–	
>Received Total Wide Band Power	M		9.2.2.35A		–	
>Not Used	O		NULL		–	
>DL Code Information	M		FDD DL Code Information 9.2.2.14A		YES	ignore
>CHOICE <i>Diversity Indication</i>	M				–	
>> <i>Combining</i>					–	
>>>RL ID	M		9.2.1.49	Reference RL ID	–	
>>>DCH Information Response	O		9.2.1.16A		YES	ignore
>>>E-DCH FDD Information Response	O		9.2.2.4C		YES	ignore
>> <i>Non Combining</i>					–	
>>>DCH Information Response	M		9.2.1.16A		–	
>>>E-DCH FDD Information Response	O		9.2.2.4C		YES	ignore
>SSDT Support Indicator	M		9.2.2.43		–	
>Minimum Uplink SIR	M		Uplink SIR 9.2.1.69		–	
>Maximum Uplink SIR	M		Uplink SIR 9.2.1.69		–	
>Closed Loop Timing Adjustment Mode	O		9.2.2.3A		–	
>Maximum Allowed UL Tx Power	M		9.2.1.35		–	
>Maximum DL TX Power	M		DL Power 9.2.1.21A		–	
>Minimum DL TX Power	M		DL Power 9.2.1.21A		–	
>Neighbouring UMTS Cell Information	O		9.2.1.41A		–	
>Neighbouring GSM Cell Information	O		9.2.1.41C		–	
>PC Preamble	M		9.2.2.27a		–	
>SRB Delay	M		9.2.2.39A		–	
>Primary CPICH Power	M		9.2.1.44		–	
>Cell GA Additional Shapes	O		9.2.1.5B		YES	ignore
>DL Power Balancing Activation Indicator	O		9.2.2.10B		YES	ignore
>HCS Prio	O		9.2.1.30N		YES	ignore
>Active MBMS Bearer		0..<maxnoof			GLOBAL	ignore

IE/Group Name	Presence	Range	IE Type and Reference	Semantics Description	Criticality	Assigned Criticality
Service List		<i>ActiveMBM S></i>				
>>TMGI	M		9.2.1.80		–	
>>Transmission Mode	O		9.2.1.81		–	
>>Preferred Frequency Layer	O		UARFCN 9.2.1.66		–	
>E-DCH RL Set ID	O		RL Set ID 9.2.2.35		YES	ignore
>E-DCH FDD DL Control Channel Information	O		9.2.2.4D		YES	ignore
>Initial DL DPCH Timing Adjustment	O		DL DPCH Timing Adjustment 9.2.2.9.A		YES	ignore
>F-DPCH Slot Format	O		9.2.2.85		YES	ignore
>Neighbouring E-UTRA Cell Information	O		9.2.1.41De		YES	ignore
>HS-DSCH Preconfiguration Info	O		9.2.2.99		YES	ignore
>Non-Serving RL Preconfiguration Info	O		9.2.2.125		YES	ignore
Criticality Diagnostics	O		9.2.1.13		YES	ignore
HS-DSCH Serving Cell Change Information Response	O		9.2.2.19g		YES	ignore
E-DCH Serving Cell Change Information Response	O		9.2.2.19h		YES	ignore
MAC-hs Reset Indicator	O		9.2.1.34B		YES	ignore
Additional HS Cell Change Information Response		<i>0..<maxnoof HSDSCH-1></i>		For secondary serving HS-DSCH cell. Max 1 in this 3GPP release.	EACH	ignore
>HS-PDSCH RL ID	M		RL ID 9.2.1.49		–	
>HS-DSCH Secondary Serving Cell Change Information Response	M		9.2.2.19ga		–	
Additional E-DCH Cell Information Response RL Add		<i>0..<maxnoof EDCH-1></i>		E-DCH on Secondary uplink frequency – max 1 in this 3GPP release.	EACH	ignore
>Additional E-DCH FDD Information Response	O		9.2.2.120		–	
>Additional E-DCH Serving Cell Change Information response	O		E-DCH Serving Cell Change Information Response 9.2.2.19h		–	

Range bound	Explanation
<i>maxnoofRLs</i>	Maximum number of radio links for one UE.
<i>maxnoofActiveMBMS</i>	Maximum number of MBMS bearer services that are active in parallel.
<i>maxnoofHSDSCH-1</i>	Maximum number of Secondary Serving HS-DSCH cells for one UE.
<i>maxnoofEDCH-1</i>	Maximum number of uplink frequencies -1 for E-DCH for one UE

9.1.7.2 TDD Message

IE/Group Name	Presence	Range	IE Type and Reference	Semantics Description	Criticality	Assigned Criticality
Message Type	M		9.2.1.40		YES	reject
Transaction ID	M		9.2.1.59		–	
RL Information Response		0..1		Mandatory for 3.84Mcps TDD, not applicable to 1.28Mcps TDD or 7.68Mcps TDD	YES	ignore
>RL ID	M		9.2.1.49		–	
>URA Information	O		9.2.1.70B		–	
>SAI	M		9.2.1.52		–	
>Cell GAI	O		9.2.1.5A		–	
>UTRAN Access Point Position	O		9.2.1.70A		–	
>UL Time Slot ISCP Info	M		9.2.3.13D		–	
>Minimum Uplink SIR	M		Uplink SIR 9.2.1.69		–	
>Maximum Uplink SIR	M		Uplink SIR 9.2.1.69		–	
>Maximum Allowed UL Tx Power	M		9.2.1.35		–	
>Maximum DL TX Power	M		DL Power 9.2.1.21A		–	
>Minimum DL TX Power	M		DL Power 9.2.1.21A		–	
>PCCPCH Power	M		9.2.1.43		–	
>Timing Advance Applied	M		9.2.3.12A		–	
>Alpha Value	M		9.2.3.a		–	
>UL PhysCH SF Variation	M		9.2.3.13B		–	
>Synchronisation Configuration	M		9.2.3.7E		–	
>Secondary CCPCH Info TDD	O		9.2.3.7B		–	
>UL CCTrCH Information		0..<maxnoof CCTrCHs>		For DCH	GLOBAL	ignore
>>CCTrCH ID	M		9.2.3.2		–	
>>UL DPCH Information		0..1			YES	ignore
>>>Repetition Period	M		9.2.3.7		–	
>>>Repetition Length	M		9.2.3.6		–	
>>>TDD DPCH Offset	M		9.2.3.8A		–	
>>>UL Timeslot Information	M		9.2.3.13C		–	
>DL CCTrCH Information		0..<maxnoof CCTrCHs>		For DCH	GLOBAL	ignore
>>CCTrCH ID	M		9.2.3.2		–	
>>DL DPCH Information		0..1			YES	ignore
>>>Repetition Period	M		9.2.3.7		–	
>>>Repetition Length	M		9.2.3.6		–	
>>>TDD DPCH Offset	M		9.2.3.8A		–	
>>>DL Timeslot Information	M		9.2.3.2C		–	
>>CCTrCH Maximum DL TX Power	O		DL Power 9.2.1.21A	Maximum allowed power on DPCH	YES	ignore
>>CCTrCH Minimum DL TX Power	O		DL Power 9.2.1.21A	Minimum allowed	YES	ignore

IE/Group Name	Presence	Range	IE Type and Reference	Semantics Description	Criticality	Assigned Criticality
				power on DPCH		
>DCH Information		0..1			–	
>>CHOICE Diversity Indication	M				–	
>>>Combining					–	
>>>>RL ID	M		9.2.1.49	Reference RL	–	
>>>>DCH Information Response	O		9.2.1.16A		YES	ignore
>>>Non Combining					–	
>>>>DCH Information Response	M		9.2.1.16A		–	
>DSCH Information Response		0 .. <maxnoof DSCHs>			GLOBAL	ignore
>>DSCH ID	M		9.2.3.3ae		–	
>>Transport Format Management	M		9.2.3.13		–	
>>DSCH Flow Control Information	M		9.2.3.3ag		–	
>>CHOICE Diversity Indication	O				–	
>>>Non Combining					–	
>>>>Binding ID	O		9.2.1.3		–	
>>>>Transport Layer Address	O		9.2.1.62		–	
>USCH Information Response		0 .. <maxnoof USCHs>			GLOBAL	ignore
>>USCH ID	M		9.2.3.14		–	
>>Transport Format Management	M		9.2.3.13		–	
>>CHOICE Diversity Indication	O				–	
>>>Non Combining					–	
>>>>Binding ID	O		9.2.1.3		–	
>>>>Transport Layer Address	O		9.2.1.62		–	
>Neighbouring UMTS Cell Information	O		9.2.1.41A		–	
>Neighbouring GSM Cell Information	O		9.2.1.41C		–	
>Cell GA Additional Shapes	O		9.2.1.5B		YES	ignore
>HCS Prio	O		9.2.1.30N		YES	ignore
>Neighbouring E-UTRA Cell Information	O		9.2.1.41De		YES	ignore
Criticality Diagnostics	O		9.2.1.13		YES	ignore
RL Information Response LCR		0..1		Mandatory for 1.28Mcps TDD, not applicable to 3.84Mcps TDD or 7.68Mcps TDD	YES	ignore
>RL ID	M		9.2.1.49		–	
>URA Information	M		9.2.1.70B		–	
>SAI	M		9.2.1.52		–	
>Cell GAI	O		9.2.1.5A		–	
>UTRAN Access Point	O		9.2.1.70A		–	

IE/Group Name	Presence	Range	IE Type and Reference	Semantics Description	Criticality	Assigned Criticality
Position						
>UL Time Slot ISCP Info LCR	M		9.2.3.13H		–	
>Maximum Uplink SIR	M		Uplink SIR 9.2.1.69		–	
>Minimum Uplink SIR	M		Uplink SIR 9.2.1.69		–	
>PCCPCH Power	M		9.2.1.43		–	
>Maximum Allowed UL Tx Power	M		9.2.1.35		–	
>Maximum DL TX Power	M		DL Power 9.2.1.21A		–	
>Minimum DL TX Power	M		DL Power 9.2.1.21A		–	
>Alpha Value	M		9.2.3.a		–	
>UL PhysCH SF Variation	M		9.2.3.13B		–	
>Synchronisation Configuration	M		9.2.3.7E		–	
>Secondary CCPCH Info TDD LCR	O		9.2.3.7F		–	
>UL CCTrCH Information LCR		<i>0..<maxnoof CCTrCHsLCR></i>		For DCH	GLOBAL	ignore
>>CCTrCH ID	M		9.2.3.2		–	
>>UL DPCH Information LCR		<i>0..1</i>			YES	ignore
>>>Repetition Period	M		9.2.3.7		–	
>>>Repetition Length	M		9.2.3.6		–	
>>>TDD DPCH Offset	M		9.2.3.8A		–	
>>>UL Timeslot Information LCR	M		9.2.3.13G		–	
>DL CCTrCH Information LCR		<i>0..<maxnoof CCTrCHsLCR></i>		For DCH	GLOBAL	ignore
>>CCTrCH ID	M		9.2.3.2		–	
>>DL DPCH Information LCR		<i>0..1</i>			YES	ignore
>>>Repetition Period	M		9.2.3.7		–	
>>>Repetition Length	M		9.2.3.6		–	
>>>TDD DPCH Offset	M		9.2.3.8A		–	
>>>DL Timeslot Information LCR	M		9.2.3.2E		–	
>>>TSTD Indicator	M		9.2.3.13E		–	
>DCH Information Response	M		9.2.1.16A		–	
>DSCH Information Response LCR		<i>0 .. <maxnoof DSCHsLCR></i>			GLOBAL	ignore
>>DSCH ID	M		9.2.3.3ae		–	
>>DSCH Flow Control Information	M		9.2.3.3ag		–	
>>Binding ID	O		9.2.1.3		–	
>>Transport Layer Address	O		9.2.1.62		–	
>>Transport Format Management	M		9.2.3.13		–	
>USCH Information Response LCR		<i>0 .. <maxnoof USCHsLCR></i>			GLOBAL	ignore
>>USCH ID	M		9.2.3.14		–	
>>Transport Format Management	M		9.2.3.13		–	

IE/Group Name	Presence	Range	IE Type and Reference	Semantics Description	Criticality	Assigned Criticality
>>CHOICE Diversity Indication	O				–	
>>>Non Combining					–	
>>>>Binding ID	O		9.2.1.3		–	
>>>>Transport Layer Address	O		9.2.1.62		–	
>Neighbouring UMTS Cell Information	O		9.2.1.41A		–	
>Neighbouring GSM Cell Information	O		9.2.1.41C		–	
>Cell GA Additional Shapes	O		9.2.1.5B		YES	ignore
>HCS Prio	O		9.2.1.30N		YES	ignore
>Uplink Timing Advance Control LCR	M		9.2.3.13K		YES	ignore
>PowerControl GAP	O		INTEGER (1..255)	Unit: number of subframes. Applicable to 1.28Mcps TDD only	YES	
>UARFCN	O		9.2.1.66	Applicable to 1.28Mcps TDD only. Mandatory for 1.28Mcps TDD when using multiple frequencies. Corresponds to Nt 3GPP TS 25.105.	YES	ignore
>Neighbouring E-UTRA Cell Information	O		9.2.1.41De		YES	ignore
>Idle Interval Information	O		9.2.3.60	TDD only	YES	ignore
RL Information Response 7.68Mcps		0..1		Mandatory for 7.68Mcps TDD, not applicable to 1.28Mcps TDD or 3.84Mcps TDD	YES	ignore
>RL ID	M		9.2.1.49		–	
>URA Information	O		9.2.1.70B		–	
>SAI	M		9.2.1.52		–	
>Cell GAI	O		9.2.1.5A		–	
>UTRAN Access Point Position	O		9.2.1.70A		–	
>UL Time Slot ISCP Info	M		9.2.3.13D		–	
>Minimum Uplink SIR	M		Uplink SIR 9.2.1.69		–	
>Maximum Uplink SIR	M		Uplink SIR 9.2.1.69		–	
>Maximum Allowed UL Tx Power	M		9.2.1.35		–	
>Maximum DL TX Power	M		DL Power 9.2.1.21A		–	
>Minimum DL TX Power	M		DL Power 9.2.1.21A		–	
>PCCPCH Power	M		9.2.1.43		–	
>Timing Advance Applied	M		9.2.3.12A		–	
>Alpha Value	M		9.2.3.a		–	

IE/Group Name	Presence	Range	IE Type and Reference	Semantics Description	Criticality	Assigned Criticality
>UL PhysCH SF Variation	M		9.2.3.13B		–	
>Synchronisation Configuration	M		9.2.3.7E		–	
>Secondary CCPCH Info 7.68Mcps TDD	O		9.2.3.22		–	
>UL CCTrCH Information 7.68 Mcps		0..<maxnoof CCTrCHs>		For DCH	GLOBAL	ignore
>>CCTrCH ID	M		9.2.3.2		–	
>>UL DPCH Information 7.68 Mcps		0..1			YES	ignore
>>>Repetition Period	M		9.2.3.7		–	
>>>Repetition Length	M		9.2.3.6		–	
>>>TDD DPCH Offset	M		9.2.3.8A		–	
>>>UL Timeslot Information 7.68Mcps	M		9.2.3.26		–	
>DL CCTrCH Information 7.68 Mcps		0..<maxnoof CCTrCHs>		For DCH	GLOBAL	ignore
>>CCTrCH ID	M		9.2.3.2		–	
>>DL DPCH Information 7.68 Mcps		0..1			YES	ignore
>>>Repetition Period	M		9.2.3.7		–	
>>>Repetition Length	M		9.2.3.6		–	
>>>TDD DPCH Offset	M		9.2.3.8A		–	
>>>DL Timeslot Information 7.68Mcps	M		9.2.3.28		–	
>>CCTrCH Maximum DL TX Power	O		DL Power 9.2.1.21A	Maximum allowed power on DPCH	–	
>>CCTrCH Minimum DL TX Power	O		DL Power 9.2.1.21A	Minimum allowed power on DPCH	–	
>DCH Information		0..1			–	
>>CHOICE Diversity Indication	M				–	
>>>Combining					–	
>>>>RL ID	M		9.2.1.49	Reference RL	–	
>>>>DCH Information Response	O		9.2.1.16A		YES	ignore
>>>>Non Combining					–	
>>>>DCH Information Response	M		9.2.1.16A		–	
>DSCH Information Response 7.68 Mcps		0 .. <maxnoof DSCHs>			GLOBAL	ignore
>>DSCH ID	M		9.2.3.3ae		–	
>>Transport Format Management	M		9.2.3.13		–	
>>DSCH Flow Control Information	M		9.2.3.3ag		–	
>>CHOICE Diversity Indication	O				–	
>>>Non Combining					–	
>>>>Binding ID	O		9.2.1.3		–	
>>>>Transport Layer Address	O		9.2.1.62		–	
>USCH Information Response 7.68 Mcps		0 .. <maxnoof USCHs>			GLOBAL	ignore
>>USCH ID	M		9.2.3.14		–	

IE/Group Name	Presence	Range	IE Type and Reference	Semantics Description	Criticality	Assigned Criticality
>>Transport Format Management	M		9.2.3.13		–	
>>CHOICE <i>Diversity Indication</i>	O				–	
>>> <i>Non Combining</i>					–	
>>>>Binding ID	O		9.2.1.3		–	
>>>>Transport Layer Address	O		9.2.1.62		–	
>Neighbouring UMTS Cell Information	O		9.2.1.41A		–	
>Neighbouring GSM Cell Information	O		9.2.1.41C		–	
>Cell GA Additional Shapes	O		9.2.1.5B		–	
>HCS Prio	O		9.2.1.30N		–	
>Neighbouring E-UTRA Cell Information	O		9.2.1.41De		YES	ignore
Active MBMS Bearer Service List		<i>0..<maxroof ActiveMBMS></i>			GLOBAL	ignore
>TMGI	M		9.2.1.80		–	
>Transmission Mode	O		9.2.1.81		–	
>Preferred Frequency Layer	O		UARFCN 9.2.1.66		–	
HS-DSCH Information Response	O		HS-DSCH TDD Information Response 9.2.3.3ab		YES	ignore
HS-DSCH-RNTI	O		9.2.1.30P		YES	ignore
E-DCH Information Response	O		E-DCH TDD Information Response 9.2.3.41	3.84Mcps TDD only	YES	ignore
E-DCH Information Response 7.68Mcps	O		E-DCH TDD Information Response 7.68Mcps 9.2.3.52	7.68Mcps TDD only	YES	ignore
E-DCH Information Response 1.28Mcps	O		E-DCH TDD Information Response 1.28Mcps 9.2.3.41a	1.28Mcps TDD only	YES	ignore
Continuous Packet Connectivity DRX Information Response LCR	O		9.2.3.63	1.28 Mcps TDD only	YES	ignore
HS-DSCH Semi-Persistent scheduling Information Response LCR	O		9.2.3.68	1.28 Mcps TDD only	YES	ignore
E-DCH Semi-Persistent scheduling Information Response LCR	O		9.2.3.69	1.28 Mcps TDD only	YES	ignore
DCH Measurement Occasion Information	O		9.2.3.75	1.28 Mcps TDD only	YES	reject

Range Bound	Explanation
<i>maxnoofDSCHs</i>	Maximum number of DSCHs for one UE for 3.84Mcps TDD.
<i>maxnoofUSCHs</i>	Maximum number of USCHs for one UE for 3.84Mcps TDD.
<i>maxnoofCCTrCHs</i>	Maximum number of CCTrCHs for one UE for 3.84Mcps TDD.
<i>maxnoofDSCHsLCR</i>	Maximum number of DSCHs for one UE for 1.28Mcps TDD.
<i>maxnoofUSCHsLCR</i>	Maximum number of USCHs for one UE for 1.28Mcps TDD.
<i>maxnoofCCTrCHsLCR</i>	Maximum number of CCTrCH for one UE for 1.28Mcps TDD.
<i>maxnoofActiveMBMS</i>	Maximum number of MBMS bearer services that are active in parallel.

9.1.8 RADIO LINK ADDITION FAILURE

9.1.8.1 FDD Message

IE/Group Name	Presence	Range	IE Type and Reference	Semantics Description	Criticality	Assigned Criticality
Message Type	M		9.2.1.40		YES	reject
Transaction ID	M		9.2.1.59		–	
CHOICE <i>Cause Level</i>	M				YES	ignore
> <i>General</i>					–	
>> <i>Cause</i>	M		9.2.1.5		–	
> <i>RL Specific</i>					–	
>> Unsuccessful RL Information Response		1.. <i>maxnoof RLS-1</i> >			EACH	ignore
>>>RL ID	M		9.2.1.49		–	
>>>Cause	M		9.2.1.5		–	
>> Successful RL Information Response		0.. <i>maxnoof RLS-2</i> >			EACH	ignore
>>>RL ID	M		9.2.1.49		–	
>>>RL Set ID	M		9.2.2.35		–	
>>>URA Information	O		9.2.1.70B		–	
>>>SAI	M		9.2.1.52		–	
>>>Cell GAI	O		9.2.1.5A		–	
>>>UTRAN Access Point Position	O		9.2.1.70A		–	
>>>Received Total Wide Band Power	M		9.2.2.35A		–	
>>>Not Used	O		NULL		–	
>>>DL Code Information	M		FDD DL Code Information 9.2.2.14A		YES	ignore
>>>CHOICE <i>Diversity Indication</i>	M				–	
>>>> <i>Combining</i>					–	
>>>>>RL ID	M		9.2.1.49	Reference RL ID	–	
>>>>>DCH Information Response	O		9.2.1.16A		YES	ignore
>>>>>E-DCH FDD Information Response	O		9.2.2.4C		YES	ignore
>>>>> <i>Non Combining</i>					–	
>>>>>DCH Information Response	M		9.2.1.16A		–	
>>>>>E-DCH FDD Information Response	O		9.2.2.4C		YES	ignore
>>>SSDT Support Indicator	M		9.2.2.43		–	
>>>Minimum Uplink SIR	M		Uplink SIR 9.2.1.69		–	
>>>Maximum Uplink SIR	M		Uplink SIR 9.2.1.69		–	
>>>Closed Loop Timing Adjustment Mode	O		9.2.2.3A		–	
>>>Maximum Allowed UL Tx Power	M		9.2.1.35		–	
>>>Maximum DL TX Power	M		DL Power 9.2.1.21A		–	
>>>Minimum DL TX Power	M		DL Power 9.2.1.21A		–	

IE/Group Name	Presence	Range	IE Type and Reference	Semantics Description	Criticality	Assigned Criticality
>>>Neighbouring UMTS Cell Information	O		9.2.1.41A		–	
>>>Neighbouring GSM Cell Information	O		9.2.1.41C		–	
>>>Primary CPICH Power	M		9.2.1.44		–	
>>>PC Preamble	M		9.2.2.27a		–	
>>>SRB Delay	M		9.2.2.39A		–	
>>>Cell GA Additional Shapes	O		9.2.1.5B		YES	ignore
>>>DL Power Balancing Activation Indicator	O		9.2.2.10B		YES	ignore
>>>HCS Prio	O		9.2.1.30N		YES	ignore
>>>Active MBMS Bearer Service List		<i>0..<maxnoof ActiveMBMS></i>			GLOBAL	ignore
>>>>TMGI	M		9.2.1.80		–	
>>>>Transmission Mode	O		9.2.1.81		–	
>>>>Preferred Frequency Layer	O		UARFCN 9.2.1.66		–	
>>>E-DCH RL Set ID	O		RL Set ID 9.2.2.35		YES	ignore
>>>E-DCH FDD DL Control Channel Information	O		9.2.2.4D		YES	ignore
>>>Initial DL DPCH Timing Adjustment	O		DL DPCH Timing Adjustment 9.2.2.9.A		YES	ignore
>>>Neighbouring E-UTRA Cell Information	O		9.2.1.41De		YES	ignore
>>>HS-DSCH Preconfiguration Info	O		9.2.2.99		YES	ignore
>>>F-DPCH Slot Format	O		9.2.2.85		YES	ignore
>>>Non-Serving RL Preconfiguration Info	O		9.2.2.125		YES	ignore
Criticality Diagnostics	O		9.2.1.13		YES	ignore
HS-DSCH Serving Cell Change Information Response	O		9.2.2.19g		YES	Ignore
E-DCH Serving Cell Change Information Response	O		9.2.2.19h		YES	Ignore
Additional HS Cell Change Information Response		<i>0..<maxnoof HSDSCH-1></i>		For secondary serving HS-DSCH cell. Max 1 in this 3GPP release.	EACH	Ignore
>HS-PDSCH RL ID	M		RL ID 9.2.1.49		–	
>HS-DSCH Secondary Serving Cell Change Information Response	M		9.2.2.19ga		–	
MAC-hs Reset Indicator	O		9.2.1.34B		YES	ignore
Additional E-DCH Cell Information Response RL Add		<i>0..<maxnoof EDCH-1></i>		E-DCH on Secondary uplink frequency – max 1 in this 3GPP	EACH	ignore

IE/Group Name	Presence	Range	IE Type and Reference	Semantics Description	Criticality	Assigned Criticality
				release.		
>Additional E-DCH FDD Information Response	O		9.2.2.120		–	
>Additional E-DCH Serving Cell Change Information response	O		E-DCH Serving Cell Change Information Response 9.2.2.19h		–	

Range bound	Explanation
<i>maxnoofRLs</i>	Maximum number of radio links for one UE.
<i>maxnoofActiveMBMS</i>	Maximum number of MBMS bearer services that are active in parallel.
<i>maxnoofHSDSCH-1</i>	Maximum number of Secondary Serving HS-DSCH cells for one UE.
<i>maxnoofEDCH-1</i>	Maximum number of uplink frequencies -1 for E-DCH for one UE

9.1.8.2 TDD Message

IE/Group Name	Presence	Range	IE Type and Reference	Semantics Description	Criticality	Assigned Criticality
Message Type	M		9.2.1.40		YES	reject
Transaction ID	M		9.2.1.59		–	
CHOICE <i>Cause Level</i>	M				YES	ignore
> <i>General</i>					–	
>> <i>Cause</i>	M		9.2.1.5		–	
> <i>RL Specific</i>					–	
>> Unsuccessful RL Information Response		1			YES	ignore
>>>RL ID	M		9.2.1.49		–	
>>> <i>Cause</i>	M		9.2.1.5		–	
Criticality Diagnostics	O		9.2.1.13		YES	ignore

9.1.9 RADIO LINK DELETION REQUEST

IE/Group Name	Presence	Range	IE Type and Reference	Semantics Description	Criticality	Assigned Criticality
Message Type	M		9.2.1.40		YES	reject
Transaction ID	M		9.2.1.59		–	
RL Information		1..< <i>maxno ofRLs</i> >			EACH	notify
>RL ID	M		9.2.1.49		–	

Range bound	Explanation
<i>maxnoofRLs</i>	Maximum number of radio links for one UE

9.1.10 RADIO LINK DELETION RESPONSE

IE/Group Name	Presence	Range	IE Type and Reference	Semantics Description	Criticality	Assigned Criticality
Message Type	M		9.2.1.40		YES	reject
Transaction ID	M		9.2.1.59		–	
Criticality Diagnostics	O		9.2.1.13		YES	ignore

9.1.11 RADIO LINK RECONFIGURATION PREPARE

9.1.11.1 FDD Message

IE/Group Name	Presence	Range	IE Type and Reference	Semantics Description	Criticality	Assigned Criticality
Message Type	M		9.2.1.40		YES	reject
Transaction ID	M		9.2.1.59		–	
Allowed Queuing Time	O		9.2.1.2		YES	reject
UL DPCH Information		0..1			YES	reject
>UL Scrambling Code	O		9.2.2.53		–	
>UL SIR Target	O		Uplink SIR 9.2.1.69		–	
>Min UL Channelisation Code Length	O		9.2.2.25		–	
>Max Number of UL DPDCHs	C – CodeLen		9.2.2.24		–	
>Puncture Limit	O		9.2.1.46	For the UL.	–	
>TFCS	O		9.2.1.63	TFCS for the UL.	–	
>UL DPCCH Slot Format	O		9.2.2.52		–	
>Diversity Mode	O		9.2.2.8		–	
>Not Used	O		NULL		–	
>Not Used	O		NULL		–	
>UL DPDCH Indicator For E-DCH Operation	O		9.2.2.52A		YES	reject
DL DPCH Information		0..1			YES	reject
>TFCS	O		9.2.1.63	TFCS for the DL.	–	
>DL DPCH Slot Format	O		9.2.2.9		–	
>Number of DL Channelisation Codes	O		9.2.2.26A		–	
>TFCI Signalling Mode	O		9.2.2.46		–	
>TFCI Presence	C- SlotFormat		9.2.1.55		–	
>Multiplexing Position	O		9.2.2.26		–	
>Limited Power Increase	O		9.2.2.21A		–	
>DL DPCH Power Information		0..1			YES	reject
>>Power Offset Information		1			–	
>>>PO1	M		Power Offset 9.2.2.30	Power offset for the TFCI bits	–	
>>>PO2	M		Power Offset 9.2.2.30	Power offset for the TPC bits	–	
>>>PO3	M		Power Offset 9.2.2.30	Power offset for the pilot bits	–	
>>FDD TPC Downlink Step Size	M		9.2.2.16		–	
>>Inner Loop DL PC Status	M		9.2.2.21a		–	
DCHs To Modify	O		FDD DCHs To Modify 9.2.2.13C		YES	reject
DCHs To Add	O		DCH FDD Information 9.2.2.4A		YES	reject
DCHs To Delete		0..<maxnoof DCHs>			GLOBAL	reject

IE/Group Name	Presence	Range	IE Type and Reference	Semantics Description	Criticality	Assigned Criticality
>DCH ID	M		9.2.1.16		–	
RL Information		0..<maxnoof RLs>			EACH	reject
>RL ID	M		9.2.1.49		–	
>Not Used	O		NULL		–	
>Not Used	O		NULL		–	
>Transmit Diversity Indicator	C – Diversity mode		9.2.2.48		–	
>DL Reference Power	O		DL Power 9.2.1.21A	Power on DPCH	YES	ignore
>RL Specific DCH Information	O		9.2.1.49A		YES	ignore
>DL DPCH Timing Adjustment	O		9.2.2.9A	Required RL Timing Adjustment	YES	reject
>Phase Reference Update Indicator	O		9.2.2.27B		YES	ignore
>RL specific E-DCH Information	O		9.2.2.35a		YES	reject
>E-DCH RL Indication	O		9.2.2.4E		YES	reject
>HS-DSCH Preconfiguration Setup	O		9.2.2.100		YES	ignore
>Non-Serving RL Preconfiguration Setup	O		9.2.2.124		YES	ignore
>Non-Serving RL Preconfiguration Removal	O		Non-Serving RL Preconfiguration Setup 9.2.2.124		YES	ignore
Transmission Gap Pattern Sequence Information	O		9.2.2.47A		YES	reject
HS-DSCH Information	O		HS-DSCH FDD Information 9.2.2.19a		YES	reject
HS-DSCH Information To Modify	O		9.2.1.30Q		YES	reject
HS-DSCH MAC-d Flows To Add	O		HS-DSCH MAC-d Flows Information 9.2.1.30OA		YES	reject
HS-DSCH MAC-d Flows To Delete	O		9.2.1.30OB		YES	reject
HS-PDSCH RL ID	O		RL ID 9.2.1.49		YES	reject
E-DPCH Information		0..1			YES	reject
>Maximum Set of E-DPDCHs	O		9.2.2.24e		–	
>Puncture Limit	O		9.2.1.46		–	
>E-TFCS Information	O		9.2.2.4G		–	
>E-TTI	O		9.2.2.4J		–	
>E-DPCCH Power Offset	O		9.2.2.4K		–	
>E-RGCH 2-Index-Step Threshold	O		9.2.2.64		–	
>E-RGCH 3-Index-Step Threshold	O		9.2.2.65		–	
>HARQ Info for E-DCH	O		9.2.2.66		–	
>HS-DSCH Configured Indicator	O		9.2.2.19C		–	
> Minimum Reduced E-	O		9.2.2.102		YES	ignore

IE/Group Name	Presence	Range	IE Type and Reference	Semantics Description	Criticality	Assigned Criticality
DPDCH Gain Factor						
E-DCH FDD Information	O		9.2.2.4B		YES	reject
E-DCH FDD Information to Modify	O		9.2.2.4F		YES	reject
E-DCH MAC-d Flows to Add	O		E-DCH MAC-d flows Information 9.2.2.4MC		YES	reject
E-DCH MAC-d Flows to Delete	O		9.2.1.90		YES	reject
Serving E-DCH RL	O		9.2.2.38C		YES	reject
F-DPCH Information		0..1			YES	reject
>Power Offset Information		1			-	
>>PO2	M		Power Offset 9.2.2.30	This IE shall be ignored by DRNS.	-	
>FDD TPC Downlink Step Size	M		9.2.2.16		-	
>Limited Power Increase	M		9.2.2.21A		-	
>Inner Loop DL PC Status	M		9.2.2.21a		-	
>F-DPCH Slot Format Support Request	O		9.2.2.86		YES	reject
>F-DPCH Slot Format	O		9.2.2.85		YES	ignore
Fast Reconfiguration Mode	O		9.2.2.70		YES	ignore
CPC Information		0..1			YES	reject
>Continuous Packet Connectivity DTX-DRX Information	O		9.2.2.72		-	
>Continuous Packet Connectivity DTX-DRX Information To Modify	O		9.2.2.73		-	
>Continuous Packet Connectivity HS-SCCH less Information	O		9.2.2.74		-	
>Continuous Packet Connectivity HS-SCCH less Deactivate Indicator	O		9.2.2.75A		YES	reject
Additional HS Cell Information RL Reconf Prep		0..<maxnof HSDSCH-1>		For secondary serving HS-DSCH cell. Max 1 in this 3GPP release.	EACH	reject
>HS-PDSCH RL ID	M		RL ID 9.2.1.49		-	
>C-ID	O		9.2.1.6		-	
>HS-DSCH FDD Secondary Serving Information	O		9.2.2.19aa		-	
>HS-DSCH FDD Secondary Serving Information To Modify	O		9.2.2.19bb		-	
>HS-DSCH Secondary Serving Remove	O		NULL		-	
UE Aggregate Maximum Bit Rate	O		9.2.1.137		YES	ignore
Additional E-DCH Cell Information RL Reconf Prep		0..1		For E-DCH on multiple frequencies in this	YES	reject

IE/Group Name	Presence	Range	IE Type and Reference	Semantics Description	Criticality	Assigned Criticality
				DRNS.		
>CHOICE Setup, Configuration Change or Removal of E-DCH On Secondary UL Frequency	M				YES	reject
>>Setup				Used when RLs on the secondary UL frequency does not exist or is not configured with E-DCH in the current UE context	–	
>>>Multicell E-DCH Transport Bearer Mode	M		9.2.2.113		–	
>>>>Additional E-DCH Cell Information Setup		1..<maxnoof EDCH-1>		E-DCH on Secondary uplink frequency – max 1 in this 3GPP release.	–	
>>>>Additional E-DCH FDD Setup Information	M		9.2.2.110		–	
>>Configuration Change				Used when RLs with additional E-DCH on the secondary UL frequency exist in the current UE context and the configuration is modified (adding new RLs or modification of existing RLs)	–	
>>>>Additional E-DCH Cell Information Configuration Change		1..<maxnoof EDCH-1>		E-DCH on Secondary uplink frequency – max 1 in this 3GPP release.	–	
>>>>>Additional E-DCH Configuration Change Information	M		9.2.2.111		–	
>>Removal				Used when all RLs on the indicated secondary UL	–	

IE/Group Name	Presence	Range	IE Type and Reference	Semantics Description	Criticality	Assigned Criticality
				frequency is removed.		
>>>Additional E-DCH Cell Information Removal		1..<maxnoof EDCH-1>		E-DCH on Secondary uplink frequency – max 1 in this 3GPP release.	–	
>>>>RL on Secondary UL Frequency	M		ENUMERATED (Remove, ...)	Removal of all RL on secondary UL frequency	–	

Condition	Explanation
CodeLen	The IE shall be present only if the <i>Min UL Channelisation Code length</i> IE equals to 4.
SlotFormat	The IE shall only be present if the <i>DL DPCH Slot Format</i> IE is equal to any of the values from 12 to 16.
Diversity mode	The IE shall be present if <i>Diversity Mode</i> IE is present in the <i>UL DPCH Information</i> IE and is not equal to "none".

Range bound	Explanation
<i>maxnoofDCHs</i>	Maximum number of DCHs for a UE.
<i>maxnoofRLs</i>	Maximum number of RLs for a UE.
<i>maxnoofHSDSCH-1</i>	Maximum number of Secondary Serving HS-DSCH cells for one UE.
<i>maxnoofEDCH-1</i>	Maximum number of uplink frequencies -1 for E-DCH for one UE

9.1.11.2 TDD Message

IE/Group Name	Presence	Range	IE Type and Reference	Semantics Description	Criticality	Assigned Criticality
Message Type	M		9.2.1.40		YES	reject
Transaction ID	M		9.2.1.59		–	
Allowed Queuing Time	O		9.2.1.2		YES	reject
UL CCTrCH To Add		<i>0..<maxn oofCCTr CHs></i>		For DCH and USCH	EACH	notify
>CCTrCH ID	M		9.2.3.2		–	
>TFCS	M		9.2.1.63	For the UL.	–	
>TFCI Coding	M		9.2.3.11		–	
>Puncture Limit	M		9.2.1.46		–	
>UL SIR Target	O		Uplink SIR 9.2.1.69	Mandatory for 1.28Mcps TDD; not applicable to 3.84Mcps TDD or 7.68Mcps TDD	YES	reject
>TDD TPC Uplink Step Size	O		9.2.3.10a	Mandatory for 1.28Mcps TDD, not applicable to 3.84Mcps TDD or 7.68Mcps TDD	YES	reject
UL CCTrCH To Modify		<i>0..<maxn oofCCTr CHs></i>			EACH	notify
>CCTrCH ID	M		9.2.3.2		–	
>TFCS	O		9.2.1.63	For the UL.	–	
>TFCI Coding	O		9.2.3.11		–	
>Puncture Limit	O		9.2.1.46		–	
>UL SIR Target	O		Uplink SIR 9.2.1.69	Applicable to 1.28Mcps TDD only	YES	reject
>TDD TPC Uplink Step Size	O		9.2.3.10a	Applicable to 1.28Mcps TDD only	YES	reject
UL CCTrCH to Delete		<i>0..<maxn oofCCTr CHs></i>			EACH	notify
>CCTrCH ID	M		9.2.3.2		–	
DL CCTrCH To Add		<i>0..<maxn oofCCTr CHs></i>		For DCH and DSCH	EACH	notify
>CCTrCH ID	M		9.2.3.2		–	
>TFCS	M		9.2.1.63	For the DL.	–	
>TFCI Coding	M		9.2.3.11		–	
>Puncture Limit	M		9.2.1.46		–	
>TPC CCTrCH List		<i>0..<maxn oCCTrCHs></i>		List of uplink CCTrCH which provide TPC	–	
>>TPC CCTrCH ID	M		CCTrCH ID 9.2.3.2		–	
>TDD TPC Downlink Step Size	O		9.2.3.10		YES	reject
DL CCTrCH To Modify		<i>0..<maxn oofCCTr CHs></i>			EACH	notify

IE/Group Name	Presence	Range	IE Type and Reference	Semantics Description	Criticality	Assigned Criticality
>CCTrCH ID	M		9.2.3.2		–	
>TFCS	O		9.2.1.63	For the DL.	–	
>TFCI Coding	O		9.2.3.11		–	
>Puncture Limit	O		9.2.1.46		–	
>TPC CCTrCH List		<i>0..<maxn oCCTrCHs></i>		List of uplink CCTrCH which provide TPC	–	
>>TPC CCTrCH ID	M		CCTrCH ID 9.2.3.2		–	
>TDD TPC Downlink Step Size	O		9.2.3.10		YES	reject
DL CCTrCH to Delete		<i>0..<maxn oofCCTrCHs></i>			EACH	notify
>CCTrCH ID	M		9.2.3.2		–	
DCHs To Modify	O		TDD DCHs To Modify 9.2.3.8B		YES	reject
DCHs To Add	O		DCH TDD Information 9.2.3.2A		YES	reject
DCHs to Delete		<i>0..<maxn oofDCHs></i>			GLOBAL	reject
>DCH ID	M		9.2.1.16		–	
DSCHs To Modify		<i>0..<maxn oofDSCHs></i>			GLOBAL	reject
>DSCH ID	M		9.2.3.3ae		–	
>CCTrCH ID	O		9.2.3.2	DL CCTrCH in which the DSCH is mapped.	–	
>TrCH Source Statistics Descriptor	O		9.2.1.65		–	
>Transport Format Set	O		9.2.1.64		–	
>Allocation/Retention Priority	O		9.2.1.1		–	
>Scheduling Priority Indicator	O		9.2.1.51A		–	
>BLER	O		9.2.1.4		–	
>Transport Bearer Request Indicator	M		9.2.1.61		–	
>Traffic Class	O		9.2.1.58A		YES	ignore
>Binding ID	O		9.2.1.3	Shall be ignored if bearer establishment with ALCAP.	YES	ignore
>Transport Layer Address	O		9.2.1.62	Shall be ignored if bearer establishment with ALCAP.	YES	ignore
>TNL QoS	O		9.2.1.56A	Shall be ignored if bearer establishment with ALCAP.	YES	ignore
DSCHs To Add	O		DSCH TDD Information 9.2.3.3a		YES	reject

IE/Group Name	Presence	Range	IE Type and Reference	Semantics Description	Criticality	Assigned Criticality
DSCHs to Delete		$0..<maxn\ of\ DSCH\ s>$			GLOBAL	reject
>DSCH ID	M		9.2.3.3ae		–	
USCHs To Modify		$0..<maxn\ of\ USCH\ s>$			GLOBAL	reject
>USCH ID	M		9.2.3.14		–	
>CCTrCH ID	O		9.2.3.2	UL CCTrCH in which the USCH is mapped.	–	
>TrCH Source Statistics Descriptor	O		9.2.1.65		–	
>Transport Format Set	O		9.2.1.64		–	
>Allocation/Retention Priority	O		9.2.1.1		–	
>Scheduling Priority Indicator	O		9.2.1.51A		–	
>BLER	O		9.2.1.4		–	
>Transport Bearer Request Indicator	M		9.2.1.61		–	
>RB Info		$0..<maxn\ of\ RB>$		All Radio Bearers using this USCH	–	
>>RB Identity	M		9.2.3.5B		–	
>Traffic class	O		9.2.1.58A		YES	ignore
>Binding ID	O		9.2.1.3	Shall be ignored if bearer establishment with ALCAP.	YES	ignore
>Transport Layer Address	O		9.2.1.62	Shall be ignored if bearer establishment with ALCAP.	YES	ignore
>TNL QoS	O		9.2.1.56A		YES	ignore

IE/Group Name	Presence	Range	IE Type and Reference	Semantics Description	Criticality	Assigned Criticality
USCHs To Add	O		USCH Information 9.2.3.15		YES	reject
USCHs to Delete		$0..<maxn\ oofUSCH\ s>$			GLOBAL	reject
>USCH ID	M		9.2.3.14		–	
Primary CCPCH RSCP	O		9.2.3.5		YES	ignore
DL Time Slot ISCP Info	O		9.2.3.2D	Applicable to 3.84Mcps TDD and 7.68Mcps TDD only	YES	ignore
DL Time Slot ISCP Info LCR	O		9.2.3.2F	Applicable to 1.28Mcps TDD only	YES	ignore
HS-DSCH Information	O		HS-DSCH TDD Information 9.2.3.3aa		YES	reject
HS-DSCH Information To Modify	O		9.2.1.30Q		YES	reject
HS-DSCH MAC-d Flows To Add	O		HS-DSCH MAC-d Flows Information 9.2.1.30OA		YES	reject
HS-DSCH MAC-d Flows To Delete	O		9.2.1.30OB		YES	reject
HS-PDSCH RL ID	O		RL ID 9.2.1.49		YES	reject
PDSCH-RL-ID	O		RL ID 9.2.1.49		YES	ignore
UL Synchronisation Parameters LCR		$0..1$		Mandatory for 1.28Mcps TDD. Not Applicable to 3.84Mcps TDD or 7.68Mcps TDD.	YES	ignore
>Uplink Synchronisation Step Size	M		9.2.3.13J		–	
>Uplink Synchronisation Frequency	M		9.2.3.13I		–	
RL Information		$0..<maxn\ oofRLs.$			YES	ignore
>RL ID	M		9.2.1.49		–	
>RL Specific DCH Information	O		9.2.1.49A		–	
Primary CCPCH RSCP Delta	O		9.2.3.5a		YES	ignore
E-DCH Information		$0..1$		3.84Mcps TDD only	YES	reject
>E-PUCH Information	O		9.2.3.36		–	
>E-TFCS Information TDD	O		9.2.3.37		–	
>E-DCH MAC-d Flows to Add	O		9.2.3.38		–	
>E-DCH MAC-d Flows to Delete	O		9.2.1.90		–	
>E-DCH TDD Information	O		9.2.3.40		–	
>E-DCH TDD Information to Modify	O		9.2.3.42		–	

IE/Group Name	Presence	Range	IE Type and Reference	Semantics Description	Criticality	Assigned Criticality
E-DCH Serving RL	O		9.2.1.49	3.84Mcps TDD only	YES	reject
E-DCH Information 7.68Mcps		0..1		7.68Mcps TDD only	YES	reject
>E-PUCH Information	O		9.2.3.36		–	
>E-TFCS Information TDD	O		9.2.3.37		–	
>E-DCH MAC-d Flows to Add	O		9.2.3.38		–	
>E-DCH MAC-d Flows to Delete	O		9.2.1.90		–	
>E-DCH TDD Information 7.68Mcps	O		9.2.3.51		–	
>E-DCH TDD Information to Modify	O		9.2.3.42		–	
E-DCH Information 1.28Mcps		0..1		1.28Mcps TDD only	YES	reject
>E-PUCH Information LCR	O		9.2.3.36a		–	
>E-TFCS Information TDD	O		9.2.3.37		–	
>E-DCH MAC-d Flows to Add	O		9.2.3.38		–	
>E-DCH MAC-d Flows to Delete	O		9.2.1.90		–	
>E-DCH TDD Information LCR	O		9.2.3.40a		–	
>E-DCH TDD Information to Modify	O		9.2.3.42		–	
Need for Idle Interval	O		ENUMERATED (True, False)	TDD only	YES	ignore
CPC Information		0..1		1.28Mcps TDD only	YES	reject
>Continuous Packet Connectivity DRX Information LCR	O		9.2.3.61		–	
>Continuous Packet Connectivity DRX Information To Modify LCR	O		9.2.3.62		–	
>HS-DSCH Semi-Persistent scheduling Information LCR	O		9.2.3.64		–	
>HS-DSCH Semi-Persistent scheduling Information to modify LCR	O		9.2.3.65		–	
>HS-DSCH Semi-Persistent scheduling Deactivate Indicator LCR	O		9.2.3.70		–	
>E-DCH Semi-Persistent scheduling Information LCR	O		9.2.3.66		–	
>E-DCH Semi-Persistent scheduling Information to modify LCR	O		9.2.3.67		–	
>E-DCH Semi-Persistent scheduling Deactivate Indicator LCR	O		9.2.3.71		–	
RNTI Allocation Indicator	O		ENUMERATED (True)	1.28 Mcps TDD only	YES	ignore
DCH Measurement Type indicator	O		9.2.3.76	1.28 Mcps TDD only	YES	reject

Range bound	Explanation
<i>maxnoofDCHs</i>	Maximum number of DCHs for a UE.
<i>maxnoofCCTrCHs</i>	Maximum number of CCTrCHs for a UE.
<i>maxnoofDSCHs</i>	Maximum number of DSCHs for one UE.
<i>maxnoofUSCHs</i>	Maximum number of USCHs for one UE.
<i>maxnoofRLs</i>	Maximum number of RLs for one UE

9.1.12 RADIO LINK RECONFIGURATION READY

9.1.12.1 FDD Message

IE/Group Name	Presence	Range	IE Type and Reference	Semantics Description	Criticality	Assigned Criticality
Message Type	M		9.2.1.40		YES	reject
Transaction ID	M		9.2.1.59		–	
RL Information Response		<i>0..<maxno ofRLs></i>			EACH	ignore
>RL ID	M		9.2.1.49		–	
>Maximum Uplink SIR	O		Uplink SIR 9.2.1.69		–	
>Minimum Uplink SIR	O		Uplink SIR 9.2.1.69		–	
>Maximum DL TX Power	O		DL Power 9.2.1.21A		–	
>Minimum DL TX Power	O		DL Power 9.2.1.21A		–	
>Not Used	O		NULL		–	
>DL Code Information	O		FDD DL Code Information 9.2.2.14A		YES	ignore
>DCH Information Response	O		9.2.1.16A		YES	ignore
>Not Used	O		NULL		–	
>DL Power Balancing Updated Indicator	O		9.2.2.10D		YES	ignore
>Primary CPICH Usage For Channel Estimation	O		9.2.2.32A		YES	ignore
>Secondary CPICH Information Change	O		9.2.2.38B		YES	ignore
>E-DCH FDD Information Response	O		9.2.2.4C		YES	ignore
>E-DCH RL Set ID	O		RL Set ID 9.2.2.35		YES	ignore
>E-DCH FDD DL Control Channel Information	O		9.2.2.4D		YES	ignore
>F-DPCH Slot Format	O		9.2.2.85		YES	ignore
>HS-DSCH Preconfiguration Info	O		9.2.2.99		YES	ignore
>Non-Serving RL Preconfiguration Info	O		9.2.2.125		YES	ignore
Criticality Diagnostics	O		9.2.1.13		YES	ignore
HS-DSCH-RNTI	O		9.2.1.30P		YES	ignore
HS-DSCH Information Response	O		HS-DSCH FDD Information Response 9.2.2.19b		YES	ignore
MAC-hs Reset Indicator	O		9.2.1.34B		YES	ignore
Fast Reconfiguration Permission	O		9.2.2.71	FDD only	YES	ignore
Continuous Packet Connectivity HS-SCCH less Information Response	O		9.2.2.75		YES	ignore
Additional HS Cell Information Response		<i>0..<maxno ofHSDSC H-1></i>		For secondary serving HS-DSCH cell. Max 1 in this 3GPP release.	EACH	ignore

IE/Group Name	Presence	Range	IE Type and Reference	Semantics Description	Criticality	Assigned Criticality
>HS-PDSCH RL ID	M		RL ID 9.2.1.49		–	
>HS-DSCH-RNTI	M		9.2.1.30P		–	
>HS-DSCH FDD Secondary Serving Information Response	M		9.2.2.19ba		–	
Additional E-DCH Cell Information Response RLReconf		<i>0..<maxno ofEDCH- 1></i>		E-DCH on Secondary uplink frequency – max 1 in this 3GPP release.	EACH	ignore
>Additional E-DCH FDD Information Response	O		9.2.2.120	For new E- DCH Radio Links on secondary carrier	–	
>Additional Modified E- DCH FDD Information Response	O		9.2.2.121		–	

Range bound	Explanation
<i>maxnoofRLs</i>	Maximum number of RLs for a UE.
<i>maxnoofHSDSCH-1</i>	Maximum number of Secondary Serving HS-DSCH cells for one UE.
<i>maxnoofEDCH-1</i>	Maximum number of uplink frequencies -1 for E-DCH for one UE

9.1.12.2 TDD Message

IE/Group Name	Presence	Range	IE Type and Reference	Semantics Description	Criticality	Assigned Criticality
Message Type	M		9.2.1.40		YES	reject
Transaction ID	M		9.2.1.59		–	
RL Information Response		<i>0..<maxn oofRLs></i>		See Note 1 below	YES	ignore
>RL ID	M		9.2.1.49		–	
>Maximum Uplink SIR	O		Uplink SIR 9.2.1.69		–	
>Minimum Uplink SIR	O		Uplink SIR 9.2.1.69		–	
>Maximum DL TX Power	O		DL Power 9.2.1.21A		–	
>Minimum DL TX Power	O		DL Power 9.2.1.21A		–	
>Secondary CCPCH Info TDD	O		9.2.3.7B	Applicable to 3.84Mcps TDD only	–	
>UL CCTrCH Information		<i>0..<maxn oofCCTr CHs></i>		For DCH	GLOBAL	ignore
>>CCTrCH ID	M		9.2.3.2		–	
>>UL DPCH to be Added		<i>0..1</i>		Applicable to 3.84Mcps TDD only	YES	ignore
>>>Repetition Period	M		9.2.3.7		–	
>>>Repetition Length	M		9.2.3.6		–	
>>>TDD DPCH Offset	M		9.2.3.8A		–	
>>> Rx Timing Deviation	O		9.2.3.7A		–	
>>>UL Timeslot Information	M		9.2.3.13C		–	
>>> Rx Timing Deviation 3.84 Mcps Extended	O		9.2.3.35		YES	Ignore
>>UL DPCH to be Modified		<i>0..1</i>			YES	ignore
>>>Repetition Period	O		9.2.3.7		–	
>>>Repetition Length	O		9.2.3.6		–	
>>>TDD DPCH Offset	O		9.2.3.8A		–	
>>>UL Timeslot Information		<i>0..<maxn oOfTTS></i>		Applicable to 3.84Mcps TDD only	–	
>>>>Time Slot	M		9.2.1.56		–	
>>>>Midamble Shift And Burst Type	O		9.2.3.4		–	
>>>>TFCI Presence	O		9.2.1.55		–	
>>>>UL Code Information		<i>0..<maxn oOfDPC Hs></i>			–	
>>>>>DPCH ID	M		9.2.3.3		–	
>>>>>TDD Channelisation Code	O		9.2.3.8		–	
>>>>UL Timeslot Information LCR		<i>0..<maxn oOfTSLC R></i>		Applicable to 1.28Mcps TDD only	GLOBAL	ignore
>>>>>Time Slot LCR	M		9.2.3.12a		–	
>>>>>Midamble	O		9.2.3.4C		–	

IE/Group Name	Presence	Range	IE Type and Reference	Semantics Description	Criticality	Assigned Criticality
Shift LCR						
>>>>TFCI Presence	O		9.2.1.55		–	
>>>>UL Code Information LCR		<i>0..<maxn oOfDPC HLCR></i>			GLOBAL	ignore
>>>>>DPCH ID	M		9.2.3.3		–	
>>>>>TDD Channelisation Code LCR	O		9.2.3.8a		–	
>>>>> TDD UL DPCH Time Slot Format LCR	O		9.2.3.10C		YES	reject
>>>UL Timeslot Information 7.68Mcps		<i>0..<maxn oOfTS></i>		Applicable to 7.68Mcps TDD only	GLOBAL	ignore
>>>>Time Slot	M		9.2.1.56		–	
>>>>Midamble Shift And Burst Type 7.68Mcps	O		9.2.3.23		–	
>>>>TFCI Presence	O		9.2.1.55		–	
>>>>UL Code Information 7.68Mcps		<i>0..<maxn oOfDPC Hs768></i>			GLOBAL	ignore
>>>>>DPCH ID	M		9.2.3.3		–	
>>>>>TDD Channelisation Code 7.68Mcps	O		9.2.3.25		–	
>>UL DPCH to be Deleted		<i>0..<maxn oofDPCHs></i>			GLOBAL	ignore
>>>>DPCH ID	M		9.2.3.3		–	
>>UL DPCH to be Added LCR		<i>0..1</i>		Applicable to 1.28Mcps TDD only	YES	ignore
>>>>Repetition Period	M		9.2.3.7		–	
>>>>Repetition Length	M		9.2.3.6		–	
>>>>TDD DPCH Offset	M		9.2.3.8A		–	
>>>>UL Timeslot Information LCR	M		9.2.3.13G		–	
>>UL DPCH to be Added 7.68Mcps		<i>0..1</i>		Applicable to 7.68Mcps TDD only	YES	ignore
>>>>Repetition Period	M		9.2.3.7		–	
>>>>Repetition Length	M		9.2.3.6		–	
>>>>TDD DPCH Offset	M		9.2.3.8A		–	
>>> Rx Timing Deviation 7.68Mcps	O		9.2.3.30		–	
>>>>UL Timeslot Information 7.68Mcps	M		9.2.3.26		–	
>DL CCTrCH Information		<i>0..<maxn oofCCTr CHs></i>		For DCH	GLOBAL	ignore
>>>>CCTrCH ID	M		9.2.3.2		–	
>>DL DPCH to be Added		<i>0..1</i>		Applicable to 3.84Mcps TDD only	YES	ignore
>>>>Repetition Period	M		9.2.3.7		–	

IE/Group Name	Presence	Range	IE Type and Reference	Semantics Description	Criticality	Assigned Criticality
>>>Repetition Length	M		9.2.3.6		–	
>>>TDD DPCH Offset	M		9.2.3.8A		–	
>>>DL Timeslot Information	M		9.2.3.2C		–	
>>DL DPCH to be Modified		0..1			YES	ignore
>>>Repetition Period	O		9.2.3.7		–	
>>>Repetition Length	O		9.2.3.6		–	
>>>TDD DPCH Offset	O		9.2.3.8A		–	
>>>DL Timeslot Information		0..<maxn oOfTS>		Applicable to 3.84Mcps TDD only	–	
>>>>Time Slot	M		9.2.1.56		–	
>>>>Midamble Shift And Burst Type	O		9.2.3.4		–	
>>>>TFCI Presence	O		9.2.1.55		–	
>>>>DL Code Information		0..<maxn oOfDPC Hs>			–	
>>>>>DPCH ID	M		9.2.3.3		–	
>>>>>TDD Channelisation Code	O		9.2.3.8		–	
>>>>DL Timeslot Information LCR		0..<maxn oOfTSLC R>		Applicable to 1.28Mcps TDD only	GLOBAL	ignore
>>>>>Time Slot LCR	M		9.2.3.12a		–	
>>>>>Midamble Shift LCR	O		9.2.3.4C		–	
>>>>>TFCI Presence	O		9.2.1.55		–	
>>>>>DL Code Information LCR		0..<maxn oOfDPC HLCR>			GLOBAL	ignore
>>>>>>DPCH ID	M		9.2.3.3		–	
>>>>>>TDD Channelisation Code LCR	O		9.2.3.8a		–	
>>>>>>TDD DL DPCH Time Slot Format LCR	O		9.2.3.8E		YES	reject
>>>>>>Maximum DL TX Power	O		DL Power 9.2.1.21A	Maximum allowed power on DPCH	YES	ignore
>>>>>>Minimum DL TX Power	O		DL Power 9.2.1.21A	Minimum allowed power on DPCH	YES	ignore
>>>>DL Timeslot Information 7.68Mcps		0..<maxn oOfTS>		Applicable to 7.68Mcps TDD only	GLOBAL	ignore
>>>>>Time Slot	M		9.2.1.56		–	
>>>>>Midamble Shift And Burst Type 7.68Mcps	O		9.2.3.23		–	
>>>>>TFCI Presence	O		9.2.1.55		–	
>>>>>>DL Code Information		0..<maxn oOfDPC Hs768>			–	
>>>>>>>DPCH ID 7.68Mcps	M		9.2.3.34		–	
>>>>>>>TDD Channelisation Code 7.68Mcps	O		9.2.3.25		–	
>>DL DPCH to be		0..<maxn			GLOBAL	ignore

IE/Group Name	Presence	Range	IE Type and Reference	Semantics Description	Criticality	Assigned Criticality
Deleted		<i>oofDPCHs</i>				
>>>DPCH ID	M		9.2.3.3		–	
>>DL DPCH to be Deleted 7.68Mcps TDD		<i>0..<maxnofDPCHs768></i>			GLOBAL	ignore
>>>DPCH ID 7.68Mcps	M		9.2.3.34		–	
>>DL DPCH to be Added LCR		<i>0..1</i>		Applicable to 1.28Mcps TDD only	YES	ignore
>>>Repetition Period	M		9.2.3.7		–	
>>>Repetition Length	M		9.2.3.6		–	
>>>TDD DPCH Offset	M		9.2.3.8A		–	
>>>DL Timeslot Information LCR	M		9.2.3.2E		–	
>>DL DPCH to be Added 7.68Mcps		<i>0..1</i>		Applicable to 7.68Mcps TDD only	YES	ignore
>>>Repetition Period	M		9.2.3.7		–	
>>>Repetition Length	M		9.2.3.6		–	
>>>TDD DPCH Offset	M		9.2.3.8A		–	
>>>DL Timeslot Information 7.68Mcps	M		9.2.3.28		–	
>>CCTrCH Maximum DL TX Power	O		DL Power 9.2.1.21A	Maximum allowed power on DPCH Applicable to 3.84Mcps TDD and 7.68Mcps TDD only	YES	ignore
>>CCTrCH Minimum DL TX Power	O		DL Power 9.2.1.21A	Minimum allowed power on DPCH Applicable to 3.84Mcps TDD and 7.68Mcps TDD only	YES	ignore
>DCH Information Response	O		9.2.1.16A		YES	ignore
>DSCH to be Added or Modified		<i>0..<maxnofDSCHs></i>			GLOBAL	ignore
>>DSCH ID	M		9.2.3.3ae		–	
>>Transport Format Management	M		9.2.3.13		–	
>>DSCH Flow Control Information	M		9.2.3.3ag		–	
>>Binding ID	O		9.2.1.3		–	
>>Transport Layer Address	O		9.2.1.62		–	
>USCH to be Added or Modified		<i>0..<maxnofUSCHs></i>			GLOBAL	ignore
>>USCH ID	M		9.2.3.14		–	
>>Transport Format Management	M		9.2.3.13		–	
>>Binding ID	O		9.2.1.3		–	
>>Transport Layer Address	O		9.2.1.62		–	
>Uplink Timing Advance Control LCR	O		9.2.3.13K	Applicable to 1.28Mcps TDD	YES	ignore

IE/Group Name	Presence	Range	IE Type and Reference	Semantics Description	Criticality	Assigned Criticality
				only		
>Secondary CCPCH Info TDD LCR	O		9.2.3.7F	Applicable to 1.28Mcps TDD only	YES	ignore
>Secondary CCPCH Info 7.68Mcps TDD	O		9.2.3.22	Applicable to 7.68Mcps TDD only	YES	ignore
>UARFCN	O		9.2.1.66	Applicable to 1.28Mcps TDD only. Mandatory for 1.28Mcps TDD when using multiple frequencies. Corresponds to Nt (3GPP TS 25.105)	YES	ignore
Criticality Diagnostics	O		9.2.1.13		YES	ignore
HS-DSCH-RNTI	O		9.2.1.30P		YES	ignore
HS-DSCH Information Response	O		HS-DSCH TDD Information Response 9.2.3.3ab		YES	ignore
DSCH-RNTI	O		9.2.3.3ah		YES	ignore
MAC-hs Reset Indicator	O		9.2.1.34B		YES	ignore
E-DCH Information Response	O		E-DCH TDD Information Response 9.2.3.41	3.84Mcps TDD only	YES	ignore
E-DCH Information Response 7.68Mcps	O		E-DCH TDD Information Response 7.68Mcps 9.2.3.52	7.68Mcps TDD only	YES	ignore
E-DCH Information Response 1.28Mcps	O		E-DCH TDD Information Response 1.28Mcps 9.2.3.41a	1.28Mcps TDD only	YES	ignore
PowerControl GAP	O		INTEGER (1..255)	1.28Mcps TDD only	YES	ignore
Idle Interval Information	O		9.2.3.60	TDD only	YES	ignore
Continuous Packet Connectivity DRX Information Response LCR	O		9.2.3.63	1.28 Mcps TDD only	YES	ignore
HS-DSCH Semi-Persistent scheduling Information Response LCR	O		9.2.3.68	1.28 Mcps TDD only	YES	ignore
E-DCH Semi-Persistent scheduling Information Response LCR	O		9.2.3.69	1.28 Mcps TDD only	YES	ignore
E-RNTI for FACH	O		E-RNTI 9.2.1.94	1.28 Mcps TDD only	YES	ignore
H-RNTI for FACH	O		HS-DSCH-RNTI 9.2.1.30P	1.28 Mcps TDD only	YES	ignore
DCH Measurement Occasion Information	O		9.2.3.75	1.28 Mcps TDD only	YES	reject
Note 1: This information element is a simplified representation of the ASN.1. Repetition 1 and repetition 2 through maxnoofRLs are represented by separate ASN.1 structures with different criticalities.						

Range bound	Explanation
<i>maxnoofDSCHs</i>	Maximum number of DSCHs for one UE.
<i>maxnoofUSCHs</i>	Maximum number of USCHs for one UE.
<i>maxnoofCCTrCHs</i>	Maximum number of CCTrCHs for a UE.
<i>maxnoofTS</i>	Maximum number of Timeslots for a UE for 3.84Mcps TDD or 7.68Mcps TDD.
<i>maxnoofDPCHs</i>	Maximum number of DPCH for a UE for 3.84Mcps TDD.
<i>maxnoofTSLCRs</i>	Maximum number of Timeslots for a UE for 1.28Mcps TDD.
<i>maxnoofDPCHLCRs</i>	Maximum number of DPCH for a UE for 1.28Mcps TDD.
<i>maxnoofRLs</i>	Maximum number of RLs for one UE
<i>maxnoofDPCHs768</i>	Maximum number of DPCH for a UE for 7.68Mcps TDD.

9.1.13 RADIO LINK RECONFIGURATION COMMIT

IE/Group Name	Presence	Range	IE Type and Reference	Semantics Description	Criticality	Assigned Criticality
Message Type	M		9.2.1.40		YES	ignore
Transaction ID	M		9.2.1.59		–	
CFN	M		9.2.1.9		YES	ignore
Active Pattern Sequence Information	O		9.2.2.A	FDD only	YES	ignore
Fast Reconfiguration Mode	O		9.2.2.70	FDD only	YES	reject

9.1.14 RADIO LINK RECONFIGURATION FAILURE

IE/Group Name	Presence	Range	IE Type and Reference	Semantics Description	Criticality	Assigned Criticality
Message Type	M		9.2.1.40		YES	reject
Transaction ID	M		9.2.1.59		–	
CHOICE Cause Level	M				YES	ignore
>General					–	
>>Cause	M		9.2.1.5		–	
>RL Specific					–	
>>RLs Causing Reconfiguration Failure		0..<maxnoof RLs>			EACH	ignore
>>>RL ID	M		9.2.1.49		–	
>>>Cause	M		9.2.1.5		–	
>>>Max UE DTX Cycle	C-DTX-CycleNotA vailable		9.2.2.87		YES	ignore
Criticality Diagnostics	O		9.2.1.13		YES	ignore

Condition	Explanation
DTX-CycleNotAvailable	The IE shall be present if the Cause IE is set to "Continuous Packet Connectivity UE DTX Cycle not Available".

Range bound	Explanation
<i>maxnoofRLs</i>	Maximum number of RLs for a UE.

9.1.15 RADIO LINK RECONFIGURATION CANCEL

IE/Group Name	Presence	Range	IE Type and Reference	Semantics Description	Criticality	Assigned Criticality
Message Type	M		9.2.1.40		YES	ignore
Transaction ID	M		9.2.1.59		–	

9.1.16 RADIO LINK RECONFIGURATION REQUEST

9.1.16.1 FDD Message

IE/Group Name	Presence	Range	IE Type and Reference	Semantics Description	Criticality	Assigned Criticality
Message Type	M		9.2.1.40		YES	reject
Transaction ID	M		9.2.1.59		–	
Allowed Queuing Time	O		9.2.1.2		YES	reject
UL DPCH Information		0..1			YES	reject
>TFCS	O		9.2.1.63	TFCS for the UL.	–	
>UL DPDCH Indicator For E-DCH Operation	O		9.2.2.52A		YES	reject
DL DPCH Information		0..1			YES	reject
>TFCS	O		9.2.1.63	TFCS for the DL.	–	
>TFCI Signalling Mode	O		9.2.2.46		–	
>Limited Power Increase	O		9.2.2.21A		–	
DCHs To Modify	O		FDD DCHs To Modify 9.2.2.13C		YES	reject
DCHs To Add	O		DCH FDD Information 9.2.2.4A		YES	reject
DCHs To Delete		0..<maxno ofDCHs>			GLOBAL	reject
>DCH ID	M		9.2.1.16		–	
Transmission Gap Pattern Sequence Information	O		9.2.2.47A		YES	reject
RL Information		0..<maxno ofRLs>			EACH	ignore
>RL ID	M		9.2.1.49		–	
>RL Specific DCH Information	O		9.2.1.49A		–	
>RL specific E-DCH Information	O		9.2.2.35a		YES	reject
>E-DCH RL Indication	O		9.2.2.4E		YES	reject
>HS-DSCH Preconfiguration Setup	O		9.2.2.100		YES	ignore
>Non-Serving RL Preconfiguration Setup	O		9.2.2.124		YES	ignore
>Non-Serving RL Preconfiguration Removal	O		Non-Serving RL Preconfiguration Setup 9.2.2.124		YES	ignore
DL Reference Power Information	O		9.2.2.10C		YES	ignore
HS-DSCH Information	O		HS-DSCH FDD Information 9.2.2.19a		YES	reject
HS-DSCH Information To Modify Unsynchronised	O		9.2.1.30NA		YES	reject
HS-DSCH MAC-d Flows To Add	O		HS-DSCH MAC-d Flows Information 9.2.1.30OA		YES	reject
HS-DSCH MAC-d Flows To Delete	O		9.2.1.30OB		YES	reject

HS-PDSCH RL ID	O		RL ID 9.2.1.49		YES	reject
E-DPCH Information		<i>0..1</i>			YES	reject
>Maximum Set of E-DPDCHs	O		9.2.2.24e		–	
>Puncture Limit	O		9.2.1.46		–	
>E-TFCS Information	O		9.2.2.4G		–	
>E-TTI	O		9.2.2.4J		–	
>E-DPCCH Power Offset	O		9.2.2.4K		–	
>E-RGCH 2-Index-Step Threshold	O		9.2.2.64		–	
>E-RGCH 3-Index-Step Threshold	O		9.2.2.65		–	
>HARQ Info for E-DCH	O		9.2.2.66		–	
> Minimum Reduced E-DPDCH Gain Factor	O		9.2.2.102		YES	ignore
>HS-DSCH Configured Indicator	O		9.2.2.19C		–	
E-DCH FDD Information	O		9.2.2.4B		YES	reject
E-DCH FDD Information to Modify	O		9.2.2.4F		YES	reject
E-DCH MAC-d Flows to Add	O		E-DCH MAC-d flows Information 9.2.2.4MC		YES	reject
E-DCH MAC-d Flows to Delete	O		9.2.1.90		YES	reject
Serving E-DCH RL	O		9.2.2.38C		YES	reject
CPC Information		<i>0..1</i>			YES	reject
>Continuous Packet Connectivity DTX-DRX Information	O		9.2.2.72		–	
>Continuous Packet Connectivity DTX-DRX Information To Modify	O		9.2.2.73		–	
>Continuous Packet Connectivity HS-SCCH less Information	O		9.2.2.74		–	
>Continuous Packet Connectivity HS-SCCH less Deactivate Indicator	O		9.2.2.75A		YES	reject
No of Target Cell HS-SCCH Order	O		INTEGER (1..30)		YES	ignore
Additional HS Cell Information RL Reconf Req		<i>0..<maxno ofHSDSC H-1></i>		For secondary serving HS-DSCH cell. Max 1 in this 3GPP release.	EACH	reject
>HS-PDSCH RL ID	M		RL ID 9.2.1.49		–	
>C-ID	O		9.2.1.6		–	
>HS-DSCH FDD Secondary Serving Information	O		9.2.2.19aa		–	
>HS-DSCH FDD Secondary Serving Information To Modify Unsynchronised	O		9.2.2.19bc		–	

>HS-DSCH Secondary Serving Remove	O		NULL		–	
UE Aggregate Maximum Bit Rate	O		9.2.1.137		YES	ignore
Additional E-DCH Cell Information RL Reconf Req		0..1		For E-DCH on multiple frequencies in this DRNS.	YES	reject
>CHOICE Setup, Configuration Change or Removal of E-DCH On Secondary UL Frequency	M				YES	reject
>>Setup				Used when RLs on the secondary UL frequency does not exist or is not configured with E-DCH in the current UE context	–	
>>>Multicell E-DCH Transport Bearer Mode	M		9.2.2.113		–	
>>>Additional E-DCH Cell Information Setup		1..<maxno ofEDCH-1>		E-DCH on Secondary uplink frequency – max 1 in this 3GPP release.	–	
>>>>Additional E-DCH FDD Setup Information	M		9.2.2.110		–	
>>>>Configuration Change				Used when RLs with additional E-DCH on the secondary UL frequency exist in the current UE context and the configuration is modified (adding new RLs or modification of existing RLs)	–	
>>>>Additional E-DCH Cell Information Configuration Change		1..<maxno ofEDCH-1>		E-DCH on Secondary uplink frequency – max 1 in this 3GPP release.	–	
>>>> Additional E-DCH Configuration Change Information	M		9.2.2.111		–	
>>>>Removal				Used when all RLs on the indicated	–	

				secondary UL frequency is removed.		
>>>Additional E-DCH Cell Information Removal		1..<maxno ofEDCH-1>		E-DCH on Secondary uplink frequency – max 1 in this 3GPP release.	–	
>>>>RL on Secondary UL Frequency	M		ENUMERATED (Remove, ...)	Removal of all RL on secondary UL frequency	–	

Range Bound	Explanation
<i>maxnoofDCHs</i>	Maximum number of DCHs for one UE.
<i>maxnoofRLs</i>	Maximum number of RLs for a UE.
<i>maxnoofHSDSCH-1</i>	Maximum number of Secondary Serving HS-DSCH cells for one UE.
<i>maxnoofEDCH-1</i>	Maximum number of uplink frequencies -1 for E-DCH for one UE

9.1.16.2 TDD Message

IE/Group Name	Presence	Range	IE Type and Reference	Semantics Description	Criticality	Assigned Criticality
Message Type	M		9.2.1.40		YES	reject
Transaction ID	M		9.2.1.59		–	
Allowed Queuing Time	O		9.2.1.2		YES	reject
UL CCTrCH Information To Modify		<i>0..<maxn oofCCTr CHs></i>			EACH	notify
>CCTrCH ID	M		9.2.3.2		–	
>TFCS	O		9.2.1.63		–	
>UL SIR Target	O		Uplink SIR 9.2.1.69	Applicable to 1.28Mcps TDD only	YES	reject
UL CCTrCH Information to Delete		<i>0..<maxn oofCCTr CHs></i>			EACH	notify
>CCTrCH ID	M		9.2.3.2		–	
DL CCTrCH Information To Modify		<i>0..<maxn oofCCTr CHs></i>			EACH	notify
>CCTrCH ID	M		9.2.3.2		–	
>TFCS	O		9.2.1.63		–	
DL CCTrCH Information to Delete		<i>0..<maxn oofCCTr CHs></i>			EACH	notify
>CCTrCH ID	M		9.2.3.2		–	
DCHs To Modify	O		TDD DCHs To Modify 9.2.3.8B		YES	reject
DCHs To Add	O		DCH TDD Information 9.2.3.2A		YES	reject
DCHs to Delete		<i>0..<maxn oofDCHs ></i>			GLOBAL	reject
>DCH ID	M		9.2.1.16		–	
RL Information		<i>0..<maxn oofRLs></i>			YES	ignore
>RL ID	M		9.2.1.49		–	
>RL Specific DCH Information	O		9.2.1.49A		–	
UL Synchronisation Parameters LCR		<i>0..1</i>		Mandatory for 1.28Mcps TDD. Not Applicable to 3.84Mcps TDD.	YES	ignore
>Uplink Synchronisation Step Size	M		9.2.3.13J		–	
>Uplink Synchronisation Frequency	M		9.2.3.13I		–	
HS-DSCH Information	O		HS-DSCH TDD Information9. 2.3.3aa		YES	reject
HS-DSCH Information To Modify Unsynchronised	O		9.2.1.30NA		YES	reject
HS-DSCH MAC-d Flows To Add	O		HS-DSCH MAC-d Flows Information 9.2.1.30OA		YES	reject
HS-DSCH MAC-d Flows To Delete	O		9.2.1.30OB		YES	reject
HS-PDSCH RL ID	O		RL ID		YES	reject

IE/Group Name	Presence	Range	IE Type and Reference	Semantics Description	Criticality	Assigned Criticality
			9.2.1.49			
E-DCH Information		0..1		3.84Mcps TDD only	YES	reject
>E-PUCH Information	O		9.2.3.36		–	
>E-TFCS Information TDD	O		9.2.3.37		–	
>E-DCH MAC-d Flows to Add	O		9.2.3.38		–	
>E-DCH MAC-d Flows to Delete	O		9.2.1.90		–	
>E-DCH TDD Information	O		9.2.3.40		–	
>E-DCH TDD Information to Modify	O		9.2.3.42		–	
E-DCH Serving RL	O		9.2.1.49	3.84Mcps TDD only	YES	reject
E-DCH Information 7.68Mcps		0..1		7.68Mcps TDD only	YES	reject
>E-PUCH Information	O		9.2.3.36		–	
>E-TFCS Information TDD	O		9.2.3.37		–	
>E-DCH MAC-d Flows to Add	O		9.2.3.38		–	
>E-DCH MAC-d Flows to Delete	O		9.2.1.90		–	
>E-DCH TDD Information 7.68Mcps	O		9.2.3.51		–	
>E-DCH TDD Information to Modify	O		9.2.3.42		–	
E-DCH Information 1.28Mcps		0..1		1.28Mcps TDD only	YES	reject
>E-PUCH Information LCR	O		9.2.3.36a		–	
>E-TFCS Information TDD	O		9.2.3.37		–	
>E-DCH MAC-d Flows to Add	O		9.2.3.38		–	
>E-DCH MAC-d Flows to Delete	O		9.2.1.90		–	
>E-DCH TDD Information LCR	O		9.2.3.40a		–	
>E-DCH TDD Information to Modify	O		9.2.3.42		–	
Need for Idle Interval	O		ENUMERATED (True, False)	TDD only	YES	ignore
CPC Information		0..1			YES	reject
>Continuous Packet Connectivity DRX Information LCR	O		9.2.3.61		–	
>Continuous Packet Connectivity DRX Information To Modify LCR	O		9.2.3.62		–	
>HS-DSCH Semi-Persistent scheduling Information LCR	O		9.2.3.64		–	
>HS-DSCH Semi-Persistent scheduling Information to modify LCR	O		9.2.3.65		–	
>HS-DSCH Semi-Persistent scheduling Deactivate Indicator LCR	O		9.2.3.70		–	
>E-DCH Semi-Persistent scheduling Information LCR	O		9.2.3.66		–	
>E-DCH Semi-Persistent scheduling Information to modify LCR	O		9.2.3.67		–	
>E-DCH Semi-Persistent scheduling Deactivate Indicator LCR	O		9.2.3.71		–	

IE/Group Name	Presence	Range	IE Type and Reference	Semantics Description	Criticality	Assigned Criticality
RNTI Allocation Indicator	O		ENUMERATED (True)	1.28 Mcps TDD only	YES	ignore
DCH Measurement Type indicator	O		9.2.3.76	1.28 Mcps TDD only	YES	reject

Range Bound	Explanation
<i>maxnoofCCTrCHs</i>	Maximum number of CCTrCHs for a UE.
<i>maxnoofDCHs</i>	Maximum number of DCHs for one UE.
<i>maxnoofRLs</i>	Maximum number of RLs for one UE

9.1.17 RADIO LINK RECONFIGURATION RESPONSE

9.1.17.1 FDD Message

IE/Group Name	Presence	Range	IE Type and Reference	Semantics Description	Criticality	Assigned Criticality
Message Type	M		9.2.1.40		YES	reject
Transaction ID	M		9.2.1.59		–	
RL Information Response		<i>0..<maxno ofRLs></i>			EACH	ignore
>RL ID	M		9.2.1.49		–	
>Maximum Uplink SIR	O		Uplink SIR 9.2.1.69		–	
>Minimum Uplink SIR	O		Uplink SIR 9.2.1.69		–	
>Maximum DL TX Power	O		DL Power 9.2.1.21A		–	
>Minimum DL TX Power	O		DL Power 9.2.1.21A		–	
>Not Used	O		NULL		–	
>DCH Information Response	O		9.2.1.16A		YES	ignore
>DL Code Information	O		FDD DL Code Information 9.2.2.14A		YES	ignore
>DL Power Balancing Updated Indicator	O		9.2.2.10D		YES	ignore
>E-DCH FDD Information Response	O		9.2.2.4C		YES	ignore
>E-DCH RL Set ID	O		RL Set ID 9.2.2.35		YES	ignore
>E-DCH FDD DL Control Channel Information	O		9.2.2.4D		YES	ignore
>F-DPCH Slot Format	O		9.2.2.85		YES	ignore
>HS-DSCH Preconfiguration Info	O		9.2.2.99		YES	ignore
>Non-Serving RL Preconfiguration Info	O		9.2.2.125		YES	ignore
Criticality Diagnostics	O		9.2.1.13		YES	ignore
HS-DSCH-RNTI	O		9.2.1.30P		YES	ignore
HS-DSCH Information Response	O		HS-DSCH FDD Information Response 9.2.2.19b		YES	ignore
MAC-hs Reset Indicator	O		9.2.1.34B		YES	ignore
Continuous Packet Connectivity HS-SCCH less Information Response	O		9.2.2.75		YES	ignore
Additional HS Cell Information Response		<i>0..<maxno ofHSDSC H-1></i>		For secondary serving HS-DSCH cell. Max 1 in this 3GPP release.	EACH	ignore
>HS-PDSCH RL ID	M		RL ID 9.2.1.49		–	
>HS-DSCH-RNTI	M		9.2.1.30P		–	
>HS-DSCH FDD Secondary Serving Information Response	M		9.2.2.19ba		–	
Additional E-DCH Cell		<i>0..<maxno</i>		E-DCH on	EACH	ignore

IE/Group Name	Presence	Range	IE Type and Reference	Semantics Description	Criticality	Assigned Criticality
Information Response RLReconf		<i>ofEDCH-1</i> >		Secondary uplink frequency – max 1 in this 3GPP release.		
>Additional E-DCH FDD Information Response	O		9.2.2.120	For new E-DCH Radio Links on secondary carrier	–	
>Additional Modified E-DCH FDD Information Response	O		9.2.2.121		–	

Range Bound	Explanation
<i>maxnoofRLs</i>	Maximum number of RLs for a UE.
<i>maxnoofHSDSCH-1</i>	Maximum number of Secondary Serving HS-DSCH cells for one UE.
<i>maxnoofEDCH-1</i>	Maximum number of uplink frequencies -1 for E-DCH for one UE

9.1.17.2 TDD Message

IE/Group Name	Presence	Range	IE Type and Reference	Semantics Description	Criticality	Assigned Criticality
Message Type	M		9.2.1.40		YES	reject
Transaction ID	M		9.2.1.59		–	
RL Information Response		<i>0..<max noofRLs ></i>		See note 1 below	YES	ignore
>RL ID	M		9.2.1.49		–	
>Maximum Uplink SIR	O		Uplink SIR 9.2.1.69		–	
>Minimum Uplink SIR	O		Uplink SIR 9.2.1.69		–	
>Maximum DL TX Power	O		DL Power 9.2.1.21A		–	
>Minimum DL TX Power	O		DL Power 9.2.1.21A		–	
>DCH Information Response	O		9.2.1.16A		YES	ignore
>DL CCTrCH Information		<i>0..<max noofCC TrCHs></i>		For DCH	GLOBAL	ignore
>>CCTrCH ID	M		9.2.3.2		–	
>>DL DPCH To Modify LCR		<i>0..1</i>		Applicable to 1.28Mcps TDD only	YES	ignore
>>>DL Timeslot Information LCR		<i>0..<max noOfTS LCR></i>			–	
>>>>Time Slot LCR	M		9.2.3.12a		–	
>>>>Maximum DL TX Power	O		DL Power 9.2.1.21A	Maximum allowed power on DPCH	–	
>>>>Minimum DL TX Power	O		DL Power 9.2.1.21A	Minimum allowed power on DPCH	–	
>>CCTrCH Maximum DL TX Power	O		DL Power 9.2.1.21A	Maximum allowed power on DPCH Applicable to 3.84Mcps TDD and 7.68Mcps TDD only	YES	ignore
>>CCTrCH Minimum DL TX Power	O		DL Power 9.2.1.21A	Minimum allowed power on DPCH Applicable to 3.84Mcps TDD and 7.68Mcps TDD only	YES	ignore
>Uplink Timing Advance Control LCR	O		9.2.3.13K	Applicable to 1.28Mcps TDD only	YES	ignore
Criticality Diagnostics	O		9.2.1.13		YES	ignore
HS-DSCH-RNTI	O		9.2.1.30P		YES	ignore
HS-DSCH Information Response	O		HS-DSCH TDD Information Response 9.2.3.3ab		YES	ignore
MAC-hs Reset Indicator	O		9.2.1.34B		YES	ignore
E-DCH Information Response	O		E-DCH TDD Information	3.84Mcps TDD only	YES	ignore

IE/Group Name	Presence	Range	IE Type and Reference	Semantics Description	Criticality	Assigned Criticality
			Response 9.2.3.41			
E-DCH Information Response 7.68Mcps	O		E-DCH TDD Information Response 7.68Mcps 9.2.3.52	7.68Mcps TDD only	YES	ignore
E-DCH Information Response 1.28Mcps	O		E-DCH TDD Information Response 1.28Mcps 9.2.3.41a	1.28Mcps TDD only	YES	ignore
PowerControl GAP	O		INTEGER (1..255)	1.28Mcps TDD only	YES	ignore
Idle Interval Information	O		9.2.3.60	TDD only	YES	ignore
Continuous Packet Connectivity DRX Information Response LCR	O		9.2.3.63	1.28 Mcps TDD only	YES	ignore
HS-DSCH Semi-Persistent scheduling Information Response LCR	O		9.2.3.68	1.28 Mcps TDD only	YES	ignore
E-DCH Semi-Persistent scheduling Information Response LCR	O		9.2.3.69	1.28 Mcps TDD only	YES	ignore
E-RNTI for FACH	O		E-RNTI 9.2.1.94	1.28 Mcps TDD only	YES	ignore
H-RNTI for FACH	O		HS-DSCH-RNTI 9.2.1.30P	1.28 Mcps TDD only	YES	ignore
DCH Measurement Occasion Information	O		9.2.3.75	1.28 Mcps TDD only	YES	reject
Note 1: This information element is a simplified representation of the ASN.1. Repetition 1 and repetition 2 through maxnoofRLs are represented by separate ASN.1 structures with different criticalities.						

Range bound	Explanation
<i>maxnoofCCTrCHs</i>	Maximum number of CCTrCHs for a UE.
<i>maxnoofTSLCRs</i>	Maximum number of Timeslots for a UE for 1.28Mcps TDD.
<i>maxnoofRLs</i>	Maximum number of RLs for one UE

9.1.18 RADIO LINK FAILURE INDICATION

IE/Group Name	Presence	Range	IE Type and Reference	Semantics Description	Criticality	Assigned Criticality
Message Type	M		9.2.1.40		YES	ignore
Transaction ID	M		9.2.1.59		–	
CHOICE <i>Reporting Object</i>	M			Object for which the Failure shall be reported.	YES	ignore
>RL					–	
>>RL Information		1..<maxnoofRLs>			EACH	ignore
>>>RL ID	M		9.2.1.49		–	
>>>Cause	M		9.2.1.5		–	
>RLS				FDD only	–	
>>RL Set Information		1..<maxnoofRLSets>			EACH	ignore
>>>RL Set ID	M		9.2.2.35		–	
>>>Cause	M		9.2.1.5		–	
>CCTrCH				TDD only	–	
>>RL ID	M		9.2.1.49		–	
>>CCTrCH List		1..<maxnoCCTrCHs>			EACH	ignore
>>>CCTrCH ID	M		9.2.3.2		–	
>>>Cause	M		9.2.1.5		–	

Range bound	Explanation
<i>maxnoofRLs</i>	Maximum number of RLs for one UE.
<i>maxnoofRLSets</i>	Maximum number of RL Sets for one UE.
<i>maxnoofCCTrCHs</i>	Maximum number of CCTrCHs for a UE.

9.1.19 RADIO LINK RESTORE INDICATION

IE/Group Name	Presence	Range	IE Type and Reference	Semantics Description	Criticality	Assigned Criticality
Message Type	M		9.2.1.40		YES	ignore
Transaction ID	M		9.2.1.59		–	
CHOICE <i>Reporting Object</i>	M			Object for which the Restoration shall be reported.	YES	ignore
>RL				TDD only	–	
>>RL Information		1..<maxnoofRLs>			EACH	ignore
>>>RL ID	M		9.2.1.49		–	
>RLS				FDD only	–	
>>RL Set Information		1..<maxnoofRLSets>			EACH	ignore
>>>RL Set ID	M		9.2.2.35		–	
>CCTrCH				TDD only	–	
>>RL ID	M		9.2.1.49		–	
>>CCTrCH List		1..<maxnoCCTrCHs>			EACH	ignore
>>>CCTrCH ID	M		9.2.3.2		–	

Range bound	Explanation
<i>maxnoofRLs</i>	Maximum number of RLs for one UE.
<i>maxnoofRLSets</i>	Maximum number of RL Sets for one UE.
<i>maxnoofCCTrCHs</i>	Maximum number of CCTrCHs for a UE.

9.1.20 DL POWER CONTROL REQUEST [FDD]

IE/Group Name	Presence	Range	IE Type and Reference	Semantics Description	Criticality	Assigned Criticality
Message Type	M		9.2.1.40		YES	ignore
Transaction ID	M		9.2.1.59		–	
Power Adjustment Type	M		9.2.2.28		YES	ignore
DL Reference Power	C-Common		DL Power 9.2.1.21A		YES	ignore
Inner Loop DL PC Status	O		9.2.2.21a		YES	ignore
DL Reference Power Information	C-Individual	1..<maxnoofRLs>			EACH	ignore
>RL ID	M		9.2.1.49		–	
>DL Reference Power	M		DL Power 9.2.1.21A		–	
Max Adjustment Step	C-Common Or Individual		9.2.2.23		YES	ignore
Adjustment Period	C-Common Or Individual		9.2.2.B		YES	ignore
Adjustment Ratio	C-Common Or Individual		9.2.2.C		YES	ignore

Condition	Explanation
Common	The IE shall be present if the <i>Power Adjustment Type</i> IE is set to "Common".
Individual	The IE shall be present if the <i>Power Adjustment Type</i> IE is set to "Individual".
CommonOrIndividual	The IE shall be present if the <i>Power Adjustment Type</i> IE is set to "Common" or "Individual".

Range Bound	Explanation
<i>maxnoofRLs</i>	Maximum number of RLs for one UE.

9.1.21 PHYSICAL CHANNEL RECONFIGURATION REQUEST

9.1.21.1 FDD Message

IE/Group Name	Presence	Range	IE Type and Reference	Semantics Description	Criticality	Assigned Criticality
Message Type	M		9.2.1.40		YES	reject
Transaction ID	M		9.2.1.59		–	
RL Information		1			YES	reject
>RL ID	M		9.2.1.49		–	
>DL Code Information	M		FDD DL Code Information 9.2.2.14A		YES	notify
>F-DPCH Slot Format	O		9.2.2.85		YES	Ignore

9.1.21.2 TDD Message

IE/Group Name	Presence	Range	IE Type and Reference	Semantics Description	Criticality	Assigned Criticality
Message Type	M		9.2.1.40		YES	reject
Transaction ID	M		9.2.1.59		–	
RL Information		1			YES	reject
>RL ID	M		9.2.1.49		–	
>UL CCTrCH Information		0.. <maxnoof CCTrCHs>			GLOBAL	reject
>>CCTrCH ID	M		9.2.3.2		–	
>>UL DPCH Information		1			YES	notify
>>>Repetition Period	O		9.2.3.7		–	
>>>Repetition Length	O		9.2.3.6		–	
>>>TDD DPCH Offset	O		9.2.3.8A		–	
>>>UL Timeslot Information		0..<maxno OFTS>		Applicable to 3.84Mcps TDD only	–	
>>>>Time Slot	M		9.2.1.56		–	
>>>>Midamble Shift And Burst Type	O		9.2.3.4		–	
>>>>TFCI Presence	O		9.2.1.55		–	
>>>>UL Code Information	O		TDD UL Code Information 9.2.3.10A		–	
>>>UL Timeslot Information LCR		0..<maxno OFTSLCR >		Applicable to 1.28Mcps TDD only	GLOBAL	reject
>>>>Time Slot LCR	M		9.2.3.12a		–	
>>>>Midamble Shift LCR	O		9.2.3.4C		–	
>>>>TFCI Presence	O		9.2.1.55		–	
>>>>UL Code Information LCR	O		TDD UL Code Information LCR 9.2.3.10B		–	
>>>>PLCCH Information	O		9.2.3.17		YES	Reject
>>>UL Timeslot Information 7.68Mcps		0..<maxno OFTS>		Applicable to 7.68Mcps TDD only	GLOBAL	reject
>>>>Time Slot	M		9.2.1.56		–	
>>>>Midamble Shift And Burst Type 7.68Mcps	O		9.2.3.23		–	
>>>>TFCI Presence	O		9.2.1.55		–	
>>>>UL Code Information 7.68Mcps	O		TDD UL Code Information 9.2.3.27		–	
>DL CCTrCH Information		0..<maxno ofCCTrCH s>			GLOBAL	reject
>>CCTrCH ID	M		9.2.3.2		–	
>>DL DPCH Information		1			YES	notify
>>>Repetition Period	O		9.2.3.7		–	
>>>Repetition Length	O		9.2.3.6		–	
>>>TDD DPCH Offset	O		9.2.3.8A		–	
>>>DL Timeslot Information		0..<maxno OFTS>		Applicable to 3.84Mcps TDD only	–	
>>>>Time Slot	M		9.2.1.56		–	
>>>>Midamble Shift	O		9.2.3.4		–	

And Burst Type						
>>>>TFCI Presence	O		9.2.1.55		–	
>>>>DL Code Information	O		TDD DL Code Information 9.2.3.8C		–	
>>>>DL Timeslot Information LCR		$0..<maxno\ ofTSLCR>$		Applicable to 1.28Mcps TDD only	GLOBAL	reject
>>>>Time Slot LCR	M		9.2.3.12a		–	
>>>>Midamble Shift LCR	O		9.2.3.4C		–	
>>>>TFCI Presence	O		9.2.1.55		–	
>>>>DL Code Information LCR	O		TDD DL Code Information LCR 9.2.3.8D		–	
>>>>DL Timeslot Information 7.68Mcps		$0..<maxno\ ofTS>$		Applicable to 7.68Mcps TDD only	GLOBAL	reject
>>>>Time Slot	M		9.2.1.56		–	
>>>>Midamble Shift And Burst Type 7.68Mcps	O		9.2.3.23		–	
>>>>TFCI Presence	O		9.2.1.55		–	
>>>>DL Code Information 7.68Mcps	O		TDD DL Code Information 7.68Mcps 9.2.3.29		–	
>HS-PDSCH Timeslot Specific Information		$0..<maxno\ ofDLts>$		Applicable to 3.84Mcps TDD only.	GLOBAL	reject
>>Time Slot	M		9.2.1.56		–	
>>Midamble Shift And Burst Type	M		9.2.3.4		–	
>HS-PDSCH Timeslot Specific Information LCR		$0..<maxno\ ofDLtsLCR>$		Applicable to 1.28Mcps TDD only	GLOBAL	reject
>>Time Slot LCR	M		9.2.3.12a		–	
>>Midamble Shift LCR	M		9.2.3.4C		–	
>HS-PDSCH Timeslot Specific Information 7.68Mcps		$0..<maxno\ ofDLts>$		Applicable to 7.68Mcps TDD only.	GLOBAL	reject
>>Time Slot	M		9.2.1.56		–	
>>Midamble Shift And Burst Type 7.68Mcps	M		9.2.3.23		–	
>UARFCN	O		9.2.1.66	Applicable to 1.28Mcps TDD only.	YES	ignore

Range bound	Explanation
$maxnoofCCTrCHs$	Maximum number of CCTrCHs for a UE.
$maxnoofTS$	Maximum number of Timeslots for a UE for 3.84Mcps TDD or 7.68Mcps TDD.
$maxnoofTSLCR$	Maximum number of Timeslots for a UE for 1.28Mcps TDD.
$maxnoofDLts$	Maximum number of downlink time slots per Radio Link for 3.84Mcps TDD or 7.68Mcps TDD.
$maxnoofDLtsLCR$	Maximum number of Downlink time slots per Radio Link for 1.28Mcps TDD.

9.1.22 PHYSICAL CHANNEL RECONFIGURATION COMMAND

IE/Group Name	Presence	Range	IE Type and Reference	Semantics Description	Criticality	Assigned Criticality
Message Type	M		9.2.1.40		YES	reject
Transaction ID	M		9.2.1.59		–	
CFN	M		9.2.1.9		YES	ignore
Criticality Diagnostics	O		9.2.1.13		YES	ignore

9.1.23 PHYSICAL CHANNEL RECONFIGURATION FAILURE

IE/Group Name	Presence	Range	IE Type and Reference	Semantics Description	Criticality	Assigned Criticality
Message Type	M		9.2.1.40		YES	reject
Transaction ID	M		9.2.1.59		–	
Cause	M		9.2.1.5		YES	ignore
Criticality Diagnostics	O		9.2.1.13		YES	ignore

9.1.24 UPLINK SIGNALLING TRANSFER INDICATION

9.1.24.1 FDD Message

IE/Group Name	Presence	Range	IE Type and Reference	Semantics Description	Criticality	Assigned Criticality
Message Type	M		9.2.1.40		YES	ignore
Transaction ID	M		9.2.1.59		–	
UC-ID	M		9.2.1.71		YES	ignore
SAI	M		9.2.1.52		YES	ignore
Cell GAI	O		9.2.1.5A		YES	ignore
C-RNTI	M		9.2.1.14		YES	ignore
S-RNTI	M		9.2.1.53		YES	ignore
D-RNTI	O		9.2.1.24		YES	ignore
Propagation Delay	M		9.2.2.33		YES	ignore
STTD Support Indicator	M		9.2.2.45		YES	ignore
Closed Loop Mode1 Support Indicator	M		9.2.2.2		YES	ignore
L3 Information	M		9.2.1.32		YES	ignore
CN PS Domain Identifier	O		9.2.1.12		YES	ignore
CN CS Domain Identifier	O		9.2.1.11		YES	ignore
URA Information	O		9.2.1.70B		YES	ignore
Cell GA Additional Shapes	O		9.2.1.5B		YES	ignore
DPC Mode Change Support Indicator	O		9.2.2.56		YES	ignore
Common Transport Channel Resources Initialisation Not Required	O		9.2.1.12F		YES	Ignore

Cell Capability Container FDD	O		9.2.2.D		YES	ignore
SNA Information	O		9.2.1.52Ca		YES	ignore
Cell Portion ID	O		9.2.2.E		YES	ignore
Active MBMS Bearer Service List		$0..<maxnoofActiveMBMS>$			GLOBAL	ignore
>TMGI	M		9.2.1.80		–	
>Transmission Mode	M		9.2.1.81		–	
Inter-frequency Cell List		$0..<maxCellsMeasured>$			GLOBAL	ignore
>DL UARFCN	M		UARFCN 9.2.1.66		–	
>UL UARFCN	O		UARFCN 9.2.1.66		–	
>Primary Scrambling Code	M		9.2.1.45		–	
Extended Propagation Delay	O		9.2.2.33a		YES	ignore
HS-DSCH-RNTI	O		9.2.1.30P		YES	ignore
Multiple PLMN List	O		9.2.1.117		YES	ignore
E-RNTI	O		9.2.1.94		YES	ignore
Max UE DTX Cycle		C-DTX-DRXCapability	9.2.2.87		YES	ignore
Cell Capability Container FDD Extension	O		9.2.2.123		YES	ignore
Secondary Serving Cell List	O		9.2.2.101		YES	ignore
Dual Band Secondary Serving Cell List	O		Secondary Serving Cell List 9.2.2.101		YES	ignore

Condition	Explanation
DTX-DRXCapability	The IE shall be present if the <i>Continuous Packet Connectivity DTX-DRX Support Indicator</i> IE in <i>Cell Capability Container FDD</i> IE is set to 1.

Range bound	Explanation
<i>maxnoofActiveMBMS</i>	Maximum number of MBMS bearer services that are active in parallel.
<i>maxCellsMeas</i>	Maximum number of inter-frequency cells measured by a UE.

9.1.24.2 TDD Message

IE/Group Name	Presence	Range	IE Type and Reference	Semantics Description	Criticality	Assigned Criticality
Message Type	M		9.2.1.40		YES	ignore
Transaction ID	M		9.2.1.59		–	
UC-ID	M		9.2.1.71		YES	ignore
SAI	M		9.2.1.52		YES	ignore
Cell GAI	O		9.2.1.5A		YES	ignore
C-RNTI	M		9.2.1.14		YES	ignore
S-RNTI	M		9.2.1.53		YES	ignore
D-RNTI	O		9.2.1.24		YES	ignore
Rx Timing Deviation	M		9.2.3.7A		YES	ignore
L3 Information	M		9.2.1.32		YES	ignore
CN PS Domain Identifier	O		9.2.1.12		YES	ignore
CN CS Domain Identifier	O		9.2.1.11		YES	ignore
URA Information	O		9.2.1.70B		YES	ignore
Cell GA Additional Shapes	O		9.2.1.5B		YES	ignore
Common Transport Channel Resources Initialisation Not Required	O		9.2.1.12F		YES	ignore
Cell Capability Container TDD	O		9.2.3.1a	Applicable to 3.84Mcps TDD only	YES	ignore
Cell Capability Container TDD LCR	O		9.2.3.1b	Applicable to 1.28Mcps TDD only	YES	ignore
SNA Information	O		9.2.1.52Ca		YES	ignore
Active MBMS Bearer Service List		<i>0..<maxnoofActiveMBMS></i>			GLOBAL	ignore
>TMGI	M		9.2.1.80		–	
>Transmission Mode	M		9.2.1.81		–	
Cell Capability Container 7.68Mcps TDD	O		9.2.3.31	Applicable to 7.68Mcps TDD only	YES	ignore
Rx Timing Deviation 7.68Mcps	O		9.2.3.30	Applicable to 7.68Mcps TDD only	YES	ignore
Rx Timing Deviation 3.84Mcps Extended	O		9.2.3.35	Applicable to 3.84Mcps TDD only	YES	ignore
Multiple PLMN List	O		9.2.1.117		YES	ignore
HS-DSCH-RNTI	O		9.2.1.30P		YES	ignore
E-RNTI	O		9.2.1.94		YES	ignore
Cell Portion LCR ID	O		9.2.3.73	Applicable to 1.28Mcps TDD only	YES	ignore

Range bound	Explanation
<i>maxnoofActiveMBMS</i>	Maximum number of MBMS bearer services that are active in parallel.

9.1.24A GERAN UPLINK SIGNALLING TRANSFER INDICATION

IE/Group Name	Presence	Range	IE type and reference	Semantics description	Criticality	Assigned Criticality
Message Type	M		9.2.1.40		YES	ignore
Transaction ID	M		9.2.1.59		–	
UC-ID	M		9.2.1.71	UC-ID may be a GERAN cell identifier.	YES	ignore
SAI	M		9.2.1.52		YES	ignore
S-RNTI	M		9.2.1.53		YES	ignore
D-RNTI	O		9.2.1.24		YES	ignore
L3 Information	M		9.2.1.32		YES	ignore
CN PS Domain Identifier	O		9.2.1.12		YES	ignore
CN CS Domain Identifier	O		9.2.1.11		YES	ignore
URA Information	O		9.2.1.70B	URA information may be GRA information	YES	ignore

9.1.25 DOWNLINK SIGNALLING TRANSFER REQUEST

IE/Group Name	Presence	Range	IE Type and Reference	Semantics Description	Criticality	Assigned Criticality
Message Type	M		9.2.1.40		YES	ignore
Transaction ID	M		9.2.1.59		–	
C-ID	M		9.2.1.6	May be a GERAN cell identifier	YES	ignore
D-RNTI	M		9.2.1.24		YES	ignore
L3 Information	M		9.2.1.32		YES	ignore
D-RNTI Release Indication	M		9.2.1.25		YES	ignore
URA-ID	O		9.2.1.70		YES	ignore
MBMS Bearer Service List		<i>0..<maxno ofMBMS></i>			GLOBAL	ignore
>TMGI	M		9.2.1.80		–	
Old URA-ID	O		URA-ID 9.2.1.70		YES	ignore
SRNC-ID	C-URA		RNC-ID 9.2.1.50	If the <i>Extended SRNC-ID</i> IE is included in the message, the <i>SRNC-ID</i> IE shall be ignored.	YES	ignore
Extended SRNC-ID	O		Extended RNC-ID 9.2.1.50a	The <i>Extended SRNC-ID</i> IE shall be used if the RNC identity has a value larger than 4095.	YES	reject
Enhanced PCH Capability	O		9.2.1.132	FDD and 1.28Mcps TDD only	YES	Ignore

Condition	Explanation
URA	The IE shall be present if the <i>URA-ID</i> IE or <i>Old URA-ID</i> IE is present.

Range bound	Explanation
<i>maxnoofMBMS</i>	Maximum number of MBMS bearer services that a UE can join.

9.1.26 RELOCATION COMMIT

IE/Group Name	Presence	Range	IE Type and Reference	Semantics Description	Criticality	Assigned Criticality
Message Type	M		9.2.1.40		YES	ignore
Transaction ID	M		9.2.1.59		–	
D-RNTI	O		9.2.1.24		YES	ignore
RANAP Relocation Information	O		9.2.1.47		YES	ignore

9.1.27 PAGING REQUEST

IE/Group Name	Presence	Range	IE Type and Reference	Semantics Description	Criticality	Assigned Criticality
Message Type	M		9.2.1.40		YES	ignore
Transaction ID	M		9.2.1.59		–	
CHOICE <i>Paging Area</i>	M				YES	ignore
> <i>URA</i>					–	
>> <i>URA-ID</i>	M		9.2.1.70	May be a <i>GRA-ID</i> .	–	
> <i>Cell</i>				UTRAN only	–	
>> <i>C-ID</i>	M		9.2.1.6		–	
SRNC-ID	M		RNC-ID 9.2.1.50	May be a <i>BSC-ID</i> . If the <i>Extended SRNC-ID</i> IE is included in the message, the <i>SRNC-ID</i> IE shall be ignored.	YES	ignore
S-RNTI	M		9.2.1.53		YES	ignore
IMSI	M		9.2.1.31		YES	ignore
DRX Cycle Length Coefficient	M		9.2.1.26		YES	ignore
CN Originated Page to Connected Mode UE		<i>0..1</i>			YES	ignore
> <i>Paging Cause</i>	M		9.2.1.41E		–	
> <i>CN Domain Type</i>	M		9.2.1.11A		–	
> <i>Paging Record Type</i>	M		9.2.1.41F		–	
Extended SRNC-ID	O		Extended RNC-ID 9.2.1.50a	The <i>Extended SRNC-ID</i> IE shall be used if the RNC identity has a value larger than 4095.	YES	reject
Enhanced PCH Capability	O		9.2.1.132	FDD and 1.28Mcps TDD only	YES	ignore

9.1.28 DEDICATED MEASUREMENT INITIATION REQUEST

IE/Group Name	Presence	Range	IE Type and Reference	Semantics Description	Criticality	Assigned Criticality
Message Type	M		9.2.1.40		YES	reject
Transaction ID	M		9.2.1.59		–	
Measurement ID	M		9.2.1.37		YES	reject
CHOICE <i>Dedicated Measurement Object Type</i>	M				YES	reject
>RL					–	
>>RL Information		1..<maxn oofRLs>			EACH	reject
>>>RL-ID	M		9.2.1.49		–	
>>>DPCH ID	O		9.2.3.3	TDD only	–	
>>>DPCH ID 7.68Mcps	O		9.2.3.34	7.68Mcps TDD only	–	
>>>HS-SICH Information		0..<maxn oofHSSI CHs>		TDD only	GLOBAL	reject
>>>>HS-SICH ID	M		9.2.3.3ad		–	
>RLS				FDD only	–	
>>RL Set Information		1..<maxn oofRLSets>			EACH	reject
>>>RL-Set-ID	M		9.2.2.35		–	
>ALL RL			NULL		–	
>ALL RLS			NULL	FDD only	–	
Dedicated Measurement Type	M		9.2.1.18		YES	reject
Measurement Filter Coefficient	O		9.2.1.36		YES	reject
Report Characteristics	M		9.2.1.48		YES	reject
CFN reporting indicator	M		FN reporting indicator 9.2.1.28A		YES	reject
CFN	O		9.2.1.9		YES	reject
Partial Reporting Indicator	O		9.2.1.41Fa		YES	ignore
Measurement Recovery Behavior	O		9.2.1.38A		YES	ignore
Alternative Format Reporting Indicator	O		9.2.1.2D		YES	ignore

Range bound	Explanation
<i>maxnoofRLs</i>	Maximum number of individual RLs a measurement can be started on.
<i>maxnoofRLSets</i>	Maximum number of individual RL Sets a measurement can be started on.

9.1.29 DEDICATED MEASUREMENT INITIATION RESPONSE

IE/Group Name	Presence	Range	IE Type and Reference	Semantics Description	Criticality	Assigned Criticality
Message Type	M		9.2.1.40		YES	reject
Transaction ID	M		9.2.1.59		–	
Measurement ID	M		9.2.1.37		YES	ignore
CHOICE <i>Dedicated Measurement Object Type</i>	O			Dedicated Measurement Object Type the measurement was initiated with	YES	ignore
>RL or ALL RL				See Note 1	–	
>>RL Information		1..<maxno ofRLs>			EACH	ignore
>>>RL ID	M		9.2.1.49		–	
>>>DPCH ID	O		9.2.3.3	TDD only	–	
>>>DPCH ID 7.68Mcps	O		9.2.3.34	7.68Mcps TDD only	–	
>>>Dedicated Measurement Value	M		9.2.1.19		–	
>>>CFN	O		9.2.1.9	Dedicated Measurement Time Reference	–	
>>>HS-SICH ID	O		9.2.3.3ad	TDD only	YES	reject
>>>Multiple Dedicated Measurement Value Information		0..<maxno ofDPCHsPerRL-1>		Applicable to 3.84Mcps TDD only	GLOBAL	ignore
>>>>DPCH ID	M		9.2.3.3		–	
>>>>Dedicated Measurement Value	M		9.2.1.19		–	
>>>>Multiple Dedicated Measurement Value Information LCR		0..<maxno ofDPCHsLCRPerRL-1>		Applicable to 1.28McpsTDD only	GLOBAL	ignore
>>>>DPCH ID	M		9.2.3.3		–	
>>>>Dedicated Measurement Value	M		9.2.1.19		–	
>>>>Multiple HS-SICH Measurement Value Information		0..<maxno ofHSSICHs-1>		TDD only	GLOBAL	ignore
>>>>HS-SICH ID	M		9.2.3.3ad		–	
>>>>Dedicated Measurement Value	M		9.2.1.19		–	
>>>>Multiple Dedicated Measurement Value Information 7.68Mcps		0..<maxno ofDPCHs768PerRL-1>		Applicable to 7.68Mcps TDD only	GLOBAL	ignore
>>>>DPCH ID 7.68Mcps	M		9.2.3.34		–	
>>>>Dedicated Measurement Value	M		9.2.1.19		–	
>RLS or ALL RLS				FDD only See Note 2	–	
>>RL Set Information		1..<maxno ofRLSets>			EACH	ignore
>>>RL Set ID	M		9.2.2.35		–	
>>>Dedicated	M		9.2.1.19		–	

Measurement Value						
>>>CFN	O		9.2.1.9	Dedicated Measurement Time Reference	–	
Criticality Diagnostics	O		9.2.1.13		YES	Ignore
Measurement Recovery Support Indicator	O		9.2.1.38C		YES	ignore
<p>Note 1: This is a simplified representation of the ASN.1: there are two different choice tags “RL” and “ALL RL” in the ASN.1, each having exactly the same structure.</p> <p>Note 2: This is a simplified representation of the ASN.1: there are two different choice tags “RLS” and “ALL RLS” in the ASN.1, each having exactly the same structure.</p>						

Range bound	Explanation
<i>maxnoofRLs</i>	Maximum number of individual RLs the measurement can be started on.
<i>maxnoofRLSets</i>	Maximum number of individual RL Sets the measurement can be started on.
<i>maxnoofDPCHsPerRL</i>	Maximum number of DPCHs per RL a measurement can be started on for 3.84Mcps TDD
<i>maxnoofDPCHsLCRPerRL</i>	Maximum number of DPCHs per RL a measurement can be started on for 1.28Mcps TDD
<i>maxnoofHSSICHs</i>	Maximum number of HSSICHs per RL a measurement can be started on
<i>maxnoofDPCHs768PerRL</i>	Maximum number of DPCHs per RL a measurement can be started on for 7.68Mcps TDD

9.1.30 DEDICATED MEASUREMENT INITIATION FAILURE

IE/Group Name	Presence	Range	IE Type and Reference	Semantics Description	Criticality	Assigned Criticality
Message Type	M		9.2.1.40		YES	reject
Transaction ID	M		9.2.1.59		–	
Measurement ID	M		9.2.1.37		YES	ignore
Cause	M		9.2.1.5		YES	ignore
Criticality Diagnostics	O		9.2.1.13		YES	ignore
CHOICE <i>Dedicated Measurement Object Type</i>	O			Dedicated Measurement Object Type the measurement was initiated with	YES	ignore
>RL or ALL RL					–	
>>Unsuccessful RL Information		1..<maxno ofRLs>			EACH	ignore
>>>RL ID	M		9.2.1.49		–	
>>>Individual Cause	O		Cause 9.2.1.5		–	
>>Successful RL Information		0..<maxno ofRLs-1>			EACH	ignore
>>>RL ID	M		9.2.1.49		–	
>>>DPCH ID	O		9.2.3.3	TDD only	–	
>>>Dedicated Measurement Value	M		9.2.1.19		–	
>>>CFN	O		9.2.1.9	Dedicated Measurement Time Reference	–	
>>>HS-SICH ID	O		9.2.3.3ad	TDD only	YES	reject
>RLS or ALL RLS				FDD only	–	
>>Unsuccessful RL Set Information		1..<maxno ofRLSets>			EACH	ignore
>>>RL Set ID	M		9.2.2.35		–	
>>>Individual Cause	O		Cause 9.2.1.5		–	
>>Successful RL Set Information		0..<maxno ofRLSets-1>			EACH	ignore
>>>RL Set ID	M		9.2.2.35		–	
>>>Dedicated Measurement Value	M		9.2.1.19		–	
>>>CFN	O		9.2.1.9	Dedicated Measurement Time Reference	–	

Range bound	Explanation
<i>maxnoofRLs</i>	Maximum number of individual RLs the measurement can be started on.
<i>maxnoofRLSets</i>	Maximum number of individual RL Sets the measurement can be started on.

9.1.31 DEDICATED MEASUREMENT REPORT

IE/Group Name	Presence	Range	IE Type and Reference	Semantics Description	Criticality	Assigned Criticality
Message Type	M		9.2.1.40		YES	ignore
Transaction ID	M		9.2.1.59		–	
Measurement ID	M		9.2.1.37		YES	ignore
CHOICE <i>Dedicated Measurement Object Type</i>	M			Dedicated Measurement Object Type the measurement was initiated with	YES	ignore
>RL or ALL RL				See Note 1	–	
>>RL Information		1..<maxnoofRLs>			EACH	ignore
>>>RL-ID	M		9.2.1.49		–	
>>>DPCH ID	O		9.2.3.3	TDD only	–	
>>>DPCH ID 7.68Mcps	O		9.2.3.34	7.68Mcps TDD only	–	
>>>Dedicated Measurement Value Information	M		9.2.1.19A		–	
>>>HS-SICH ID	O		9.2.3.3ad	TDD only	YES	ignore
>RLS or ALL RLS				FDD only See Note 2	–	
>>RL Set Information		1..<maxnoofRLSets>			EACH	ignore
>>>RL Set ID	M		9.2.2.35		–	
>>>Dedicated Measurement Value Information	M		9.2.1.19A		–	
Measurement Recovery Reporting Indicator	O		9.2.1.38B		YES	ignore
Note 1: This is a simplified representation of the ASN.1: there are two different choice tags “RL” and “ALL RL” in the ASN.1, each having exactly the same structure.						
Note 2: This is a simplified representation of the ASN.1: there are two different choice tags “RLS” and “ALL RLS” in the ASN.1, each having exactly the same structure.						

Range bound	Explanation
<i>maxnoofRLs</i>	Maximum number of individual RLs the measurement can be started on.
<i>maxnoofRLSets</i>	Maximum number of individual RL Sets the measurement can be started on.

9.1.32 DEDICATED MEASUREMENT TERMINATION REQUEST

IE/Group Name	Presence	Range	IE Type and Reference	Semantics Description	Criticality	Assigned Criticality
Message Type	M		9.2.1.40		YES	ignore
Transaction ID	M		9.2.1.59		–	
Measurement ID	M		9.2.1.37		YES	ignore

9.1.33 DEDICATED MEASUREMENT FAILURE INDICATION

IE/Group Name	Presence	Range	IE Type and Reference	Semantics Description	Criticality	Assigned Criticality
Message Type	M		9.2.1.40		YES	ignore
Transaction ID	M		9.2.1.59		–	
Measurement ID	M		9.2.1.37		YES	ignore
Cause	M		9.2.1.5		YES	ignore
CHOICE <i>Dedicated Measurement Object Type</i>	O			Dedicated Measurement Object Type the measurement was initiated with	YES	ignore
>RL or ALL RL					–	
>>Unsuccessful RL Information		1..<maxnoof RLs>			EACH	ignore
>>>RL ID	M		9.2.1.49		–	
>>>Individual Cause	O		Cause 9.2.1.5		–	
>RLS or ALL RLS				FDD only	–	
>>Unsuccessful RL Set Information		1..<maxnoof RLSets>			EACH	ignore
>>>RL Set ID	M		9.2.2.35		–	
>>>Individual Cause	O		Cause 9.2.1.5		–	

Range bound	Explanation
<i>maxnoofRLs</i>	Maximum number of individual RLs the measurement can be started on.
<i>maxnoofRLSets</i>	Maximum number of individual RL Sets the measurement can be started on.

9.1.34 COMMON TRANSPORT CHANNEL RESOURCES RELEASE REQUEST

IE/Group Name	Presence	Range	IE Type and Reference	Semantics Description	Criticality	Assigned Criticality
Message Type	M		9.2.1.40		YES	ignore
Transaction ID	M		9.2.1.59		–	
D-RNTI	M		9.2.1.24		YES	ignore

9.1.35 COMMON TRANSPORT CHANNEL RESOURCES REQUEST

IE/Group Name	Presence	Range	IE Type and Reference	Semantics Description	Criticality	Assigned Criticality
Message Type	M		9.2.1.40		YES	reject
Transaction ID	M		9.2.1.59		–	
D-RNTI	M		9.2.1.24		YES	reject
C-ID	O		9.2.1.6		YES	reject
Transport Bearer Request Indicator	M		9.2.1.61	Request a new transport bearer or to use an existing bearer for the user plane.	YES	reject
Transport Bearer ID	M		9.2.1.60	Indicates the lur transport bearer to be used for the user plane.	YES	reject
Permanent NAS UE Identity Binding ID	O		9.2.1.73		YES	ignore
	O		9.2.1.3	Shall be ignored if bearer establishment with ALCAP.	YES	ignore
Transport Layer Address	O		9.2.1.62	Shall be ignored if bearer establishment with ALCAP.	YES	ignore
MBMS Bearer Service List		<i>0..<max noofMB MS></i>			GLOBAL	notify
>TMGI	M		9.2.1. 80		–	
TNL QoS	O		9.2.1.56A	Shall be ignored if bearer establishment with ALCAP.	YES	ignore
Enhanced FACH Support Indicator	O		9.2.1.131	FDD and 1.28Mcps TDD only	YES	Ignore
Common E-DCH Support Indicator	O		9.2.2.92	FDD only	YES	Ignore
HS-DSCH Physical Layer Category	O		9.2.1.300a		Yes	Ignore
UE with enhanced HS-SCCH support indicator	O		NULL	UE supports enhanced HS-SCCH functionality: - UE supports different HS-SCCH in consecutive TTIs	YES	ignore

Range bound	Explanation
<i>maxnoofMBMS</i>	Maximum number of MBMS bearer services that a UE can join.

9.1.36 COMMON TRANSPORT CHANNEL RESOURCES RESPONSE

9.1.36.1 FDD Message

IE/Group Name	Presence	Range	IE Type and Reference	Semantics Description	Criticality	Assigned Criticality
Message Type	M		9.2.1.40		YES	reject
Transaction ID	M		9.2.1.59		–	
S-RNTI	M		9.2.1.53		YES	ignore
C-RNTI	O		9.2.1.14		YES	ignore
FACH Info for UE Selected S-CCPCH		1			YES	ignore
>FACH Flow Control Information	M		9.2.1.26C	If the <i>Enhanced FACH Information Response</i> IE is included in the message, the <i>FACH Flow Control Information</i> IE shall be ignored.	YES	ignore
Transport Layer Address	O		9.2.1.62		YES	ignore
Binding Identity	O		9.2.1.3		YES	ignore
Criticality Diagnostics	O		9.2.1.13		YES	ignore
C-ID	M		9.2.1.6		YES	ignore
Active MBMS Bearer Service List		0..<maxnoo fActiveMB MS>			GLOBAL	ignore
>TMGI	M		9.2.1.80		–	
>Transmission Mode	M		9.2.1.81		–	
Enhanced FACH Information Response		0..1			YES	ignore
>Common HS-DSCH-RNTI Priority Queue Information for Enhanced FACH	M		Priority Queue Information for Enhanced FACH/PC H 9.2.1.133		–	
>Dedicated HS-DSCH-RNTI Priority Queue Information for Enhanced FACH	M		Priority Queue Information for Enhanced FACH/PC H 9.2.1.133		–	
>Priority Queue Information for Enhanced PCH	O		Priority Queue Information for Enhanced FACH/PC H 9.2.1.133		–	
>HS-DSCH Initial Capacity Allocation	M		9.2.1.30Na		–	
>HS-DSCH-RNTI	O		9.2.1.30P		–	
Common E-DCH MAC-d Flow Specific Information	O		9.2.2.93		–	

E-RNTI	O		9.2.1.94		YES	ignore
--------	---	--	----------	--	-----	--------

Range bound	Explanation
<i>maxnoofActiveMBMS</i>	Maximum number of MBMS bearer services that are active in parallel.

9.1.36.2 TDD Message

IE/Group Name	Presence	Range	IE Type and Reference	Semantics Description	Criticality	Assigned Criticality
Message Type	M		9.2.1.40		YES	reject
Transaction ID	M		9.2.1.59		–	
S-RNTI	M		9.2.1.53		YES	ignore
C-RNTI	O		9.2.1.14		YES	ignore
FACH Info for UE Selected S-CCPCHs		1			YES	ignore
>FACH Flow Control Information	M		9.2.1.26C	If the <i>Enhanced FACH Information Response</i> IE is included in the message, the <i>FACH Flow Control Information</i> IE shall be ignored.	YES	ignore
Transport Layer Address	O		9.2.1.62		YES	ignore
Binding Identity	O		9.2.1.3		YES	ignore
Criticality Diagnostics	O		9.2.1.13		YES	ignore
C-ID	M		9.2.1.6		YES	ignore
Active MBMS Bearer Service List		0..<maxno ofActiveMBMS>			GLOBAL	ignore
>TMGI	M		9.2.1.80		–	
>Transmission Mode	M		9.2.1.81		–	
Enhanced FACH Information Response		0.. 1			YES	ignore
>Common HS-DSCH-RNTI Priority Queue Information for Enhanced FACH	M		Priority Queue Information for Enhanced FACH/PC H 9.2.1.133		–	
>Dedicated HS-DSCH-RNTI Priority Queue Information for Enhanced FACH	M		Priority Queue Information for Enhanced FACH/PC H 9.2.1.133		–	
>Priority Queue Information for Enhanced PCH	O		Priority Queue Information for Enhanced FACH/PC H 9.2.1.133		–	
>HS-DSCH Initial Capacity Allocation	M		9.2.1.30Na		–	
>HS-DSCH-RNTI	O		9.2.1.30P		–	
Common E-DCH MAC-d Flow Specific Information LCR	O		9.2.3.58		YES	ignore

Range bound	Explanation
<i>maxnoofActiveMBMS</i>	Maximum number of MBMS bearer services that are active in parallel.

9.1.37 COMMON TRANSPORT CHANNEL RESOURCES FAILURE

IE/Group Name	Presence	Range	IE Type and Reference	Semantics Description	Criticality	Assigned Criticality
Message Type	M		9.2.1.40		YES	reject
Transaction ID	M		9.2.1.59		–	
S-RNTI	M		9.2.1.53		YES	ignore
Cause	M		9.2.1.5		YES	ignore
Criticality Diagnostics	O		9.2.1.13		YES	ignore

9.1.38 COMPRESSED MODE COMMAND [FDD]

IE/Group Name	Presence	Range	IE Type and Reference	Semantics Description	Criticality	Assigned Criticality
Message Type	M		9.2.1.40		YES	ignore
Transaction ID	M		9.2.1.59		–	
Active Pattern Sequence Information	M		9.2.2.A		YES	ignore

9.1.39 ERROR INDICATION

IE/Group Name	Presence	Range	IE Type and Reference	Semantics Description	Criticality	Assigned Criticality
Message Type	M		9.2.1.40		YES	ignore
Transaction ID	M		9.2.1.59		–	
Cause	O		9.2.1.5		YES	ignore
Criticality Diagnostics	O		9.2.1.13		YES	ignore
S-RNTI	O		9.2.1.53		YES	ignore
D-RNTI	O		9.2.1.24		YES	ignore

9.1.40 DL POWER TIMESLOT CONTROL REQUEST [TDD]

IE/Group Name	Presence	Range	IE Type and Reference	Semantics Description	Criticality	Assigned Criticality
Message Type	M		9.2.1.40		YES	ignore
Transaction ID	M		9.2.1.59		–	
DL Time Slot ISCP Info	O		9.2.3.2D	Mandatory for 3.84Mcps TDD and 7.68Mcps TDD, not applicable to 1.28Mcps TDD	YES	ignore
DL Time Slot ISCP Info LCR	O		9.2.3.2F	Mandatory for 1.28Mcps TDD, not applicable to 3.84Mcps TDD or 7.68Mcps TDD	YES	ignore
Primary CCPCH RSCP	O		9.2.3.5		YES	ignore
Primary CCPCH RSCP Delta	O		9.2.3.5a		YES	ignore

9.1.41 RADIO LINK PREEMPTION REQUIRED INDICATION

IE/Group Name	Presence	Range	IE Type and Reference	Semantics Description	Criticality	Assigned Criticality
Message Type	M		9.2.1.40		YES	ignore
Transaction ID	M		9.2.1.59		–	
RL Information		<i>0..<maxno ofRLs></i>			EACH	ignore
>RL ID	M		9.2.1.49		–	
>E-DCH MAC-d Flow Specific Information		<i>0..<maxno ofEDCHMACdFlows></i>			EACH	ignore
>>E-DCH MAC-d Flow ID	M		9.2.1.91		–	
HS-DSCH MAC-d Flow Specific Information		<i>0..<maxno ofMACdFlows></i>			EACH	ignore
>HS-DSCH MAC-d Flow ID	M		9.2.1.300		–	

Range bound	Explanation
<i>maxnoofRLs</i>	Maximum number of radio links for one UE
<i>maxnoofMACdFlows</i>	Maximum number of HS-DSCH MAC-d flows
<i>maxnoofEDCHMACdFlows</i>	Maximum number of E-DCH MAC-d flows

9.1.42 RADIO LINK CONGESTION INDICATION

IE/Group Name	Presence	Range	IE Type and Reference	Semantics Description	Criticality	Assigned Criticality
Message Type	M		9.2.1.40		YES	ignore
Transaction ID	M		9.2.1.59		–	
Congestion Cause	O		9.2.1.79		YES	ignore
RL Information		1..<maxno ofRLs>			EACH	ignore
>RL ID	M		9.2.1.49		–	
>DCH Rate Information		1..<maxno ofDCHs>			EACH	ignore
>>DCH ID	M		9.2.1.16		–	
>>Allowed Rate Information	O		9.2.1.2A		–	
>E-DCH MAC-d Flow Specific Information		0..<maxno ofEDCHMACdFlows >			EACH	ignore
>>E-DCH MAC-d Flow ID	M		9.2.1.91		–	
>DCH Indicator For E-DCH-HSDPA Operation	O		9.2.2.67		YES	ignore

Range bound	Explanation
<i>maxnoofRLs</i>	Maximum number of Radio Links for one UE
<i>maxnoofDCHs</i>	Maximum number of DCHs for one UE.
<i>maxnoofEDCHMACdFlows</i>	Maximum number of E-DCH MAC-d flows

9.1.43 COMMON MEASUREMENT INITIATION REQUEST

IE/Group Name	Presence	Range	IE Type and Reference	Semantics Description	Criticality	Assigned Criticality
Message Type	M		9.2.1.40		YES	reject
Transaction ID	M		9.2.1.59		–	
Measurement ID	M		9.2.1.37		YES	reject
CHOICE <i>Common Measurement Object Type</i>	M				YES	reject
>Cell					–	
>>Reference Cell Identifier	M		UTRAN Cell Identifier 9.2.1.71	May be a GERAN Cell Identifier	–	
>>Time Slot	O		9.2.1.56	3.84Mcps TDD and 7.68 Mcps TDD only	–	
>>Time Slot LCR	O		9.2.3.12a	1.28Mcps TDD only	–	
>>>Neighbouring Cell Measurement Information		0..<maxn oofMeas NCells>		UTRAN only	–	
>>>>CHOICE <i>Neighbouring Cell Measurement Information</i>					–	
>>>>>Neighbouring FDD Cell Measurement Information				FDD only	–	
>>>>>>Neighbouring FDD Cell Measurement Information	M		9.2.1.41G		–	
>>>>>>Neighbouring TDD Cell Measurement Information				3.84Mcps TDD only	–	
>>>>>>>Neighbouring TDD Cell Measurement Information	M		9.2.1.41H		–	
>>>>>>>>Additional Neighbouring Cell Measurement Information					–	
>>>>>>>>Neighbouring TDD Cell Measurement InformationLCR				1.28Mcps TDD only	–	
>>>>>>>>>Neighbouring TDD Cell Measurement InformationLCR	M		9.2.1.41Dd		YES	reject
>>>>>>>>>>Additional Neighbouring Cell Measurement Information 7.68Mcps					–	
>>>>>>>>>>>Neighbouring TDD Cell Measurement Information 7.68 Mcps				7.68Mcps TDD only	–	
>>>>>>>>>>>>Neighbouring TDD Cell Measurement	M		9.2.3.32		YES	reject

Information 7.68 Mcps						
>>UARFCN	O		9.2.1.66	Applicable to 1.28Mcps TDD only.	YES	ignore
>>UpPCH Position LCR	O		9.2.3.56	Applicable to 1.28Mcps TDD only.	YES	ignore
Common Measurement Type	M		9.2.1.12C		YES	reject
Measurement Filter Coefficient	O		9.2.1.36	UTRAN only	YES	reject
Report Characteristics	M		9.2.1.48		YES	reject
SFN reporting indicator	M		FN reporting indicator 9.2.1.28A		YES	reject
SFN	O		9.2.1.52A	UTRAN only	YES	reject
Common Measurement Accuracy	O		9.2.1.12A	UTRAN only	YES	reject
Measurement Recovery Behavior	O		9.2.1.38A	UTRAN only	YES	ignore
GANSS Time ID	O		9.2.1.119a	This IE may only be present if the <i>Common Measurement Type</i> IE is set to "UTRAN GANSS Timing of Cell Frames for UE Positioning". If the <i>Common Measurement Type</i> IE is set to "UTRAN GANSS Timing of Cell Frames for UE Positioning" and this IE is absent, the GANSS time is Galileo system time.	YES	ignore

Range bound	Explanation
<i>maxnoofMeasNCell</i>	Maximum number of neighbouring cells on which measurements can be performed.

9.1.44 COMMON MEASUREMENT INITIATION RESPONSE

IE/Group Name	Presence	Range	IE Type and Reference	Semantics Description	Criticality	Assigned Criticality
Message Type	M		9.2.1.40		YES	reject
Transaction ID	M		9.2.1.59		–	
Measurement ID	M		9.2.1.37		YES	ignore
CHOICE <i>Common Measurement Object Type</i>	O			Common Measurement Object Type that the measurement was initiated with.	YES	ignore
>Cell					–	
>>Common Measurement value	M		9.2.1.12D		–	
SFN	O		9.2.1.52A	Common Measurement Time Reference, UTRAN only.	YES	ignore
Criticality Diagnostics	O		9.2.1.13		YES	ignore
Common Measurement Achieved Accuracy	O		Common Measurement Accuracy 9.2.1.12A	UTRAN only	YES	ignore
Measurement Recovery Support Indicator	O		9.2.1.38C	UTRAN only	YES	ignore

9.1.45 COMMON MEASUREMENT INITIATION FAILURE

IE/Group Name	Presence	Range	IE Type and Reference	Semantics Description	Criticality	Assigned Criticality
Message Type	M		9.2.1.40		YES	reject
Transaction ID	M		9.2.1.59		–	
Measurement ID	M		9.2.1.37		YES	ignore
Cause	M		9.2.1.5		YES	ignore
Criticality Diagnostics	O		9.2.1.13		YES	ignore

9.1.46 COMMON MEASUREMENT REPORT

IE/Group Name	Presence	Range	IE Type and Reference	Semantics Description	Criticality	Assigned Criticality
Message Type	M		9.2.1.40		YES	ignore
Transaction ID	M		9.2.1.59		–	
Measurement ID	M		9.2.1.37		YES	ignore
CHOICE <i>Common Measurement Object Type</i>	M			Common Measurement Object Type that the measurement was initiated with.	YES	ignore
> <i>Cell</i>					–	
>>Common Measurement Value Information	M		9.2.1.12E		–	
SFN	O		9.2.1.52A	Common Measurement Time Reference, UTRAN only.	YES	ignore
<i>Measurement Recovery Reporting Indicator</i>	O		9.2.1.38B	UTRAN only	YES	ignore

9.1.47 COMMON MEASUREMENT TERMINATION REQUEST

IE/Group Name	Presence	Range	IE Type and Reference	Semantics Description	Criticality	Assigned Criticality
Message Type	M		9.2.1.40		YES	ignore
Transaction ID	M		9.2.1.59		–	
Measurement ID	M		9.2.1.37		YES	ignore

9.1.48 COMMON MEASUREMENT FAILURE INDICATION

IE/Group Name	Presence	Range	IE Type and Reference	Semantics Description	Criticality	Assigned Criticality
Message Type	M		9.2.1.40		YES	ignore
Transaction ID	M		9.2.1.59		–	
Measurement ID	M		9.2.1.37		YES	ignore
Cause	M		9.2.1.5		YES	ignore

9.1.49 INFORMATION EXCHANGE INITIATION REQUEST

IE/Group Name	Presence	Range	IE Type and Reference	Semantics Description	Criticality	Assigned Criticality
Message Type	M		9.2.1.40		YES	reject
Transaction ID	M		9.2.1.59		–	
Information Exchange ID	M		9.2.1.31A		YES	reject
CHOICE <i>Information Exchange Object Type</i>	M				YES	reject
>Cell					–	
>>C-ID	M		9.2.1.6	May be a GERAN cell identifier	–	
>Additional Information Exchange Object Types					–	
>>GSM Cell					–	
>>>CGI	M		9.2.1.5D		–	
>>MBMS Bearer Service					–	
>>>MBMS Bearer Service List		1..<maxno ofMBMS>			GLOBAL	reject
>>>>TMGI	M		9.2.1.80		–	
>>MBMS Bearer Service in MBMS Cell				FDD only	GLOBAL	reject
>>>MBMS Cell List		1..<maxno ofcell>			–	
>>>>C-ID	M		9.2.1.6	Cell identifier of cell in RNC initiating Information Exchange Initiation procedure	–	
>>>>MBMS Bearer Service List		1..<maxno ofMBMS>			–	
>>>>>TMGI	M		9.2.1.80		–	
>>MBMS Cell				FDD only	GLOBAL	reject
>>>MBMS Cell List		1..<maxno ofcell>			–	
>>>>C-ID	M		9.2.1.6	Cell identifier of cell in receiving RNC not initiating Information Exchange Initiation procedure	–	
Information Type	M		9.2.1.31E		YES	reject
Information Report Characteristics	M		9.2.1.31C		YES	reject

Range bound	Explanation
<i>maxnoofMBMS</i>	Maximum number of MBMS bearer services that a UE can join.
<i>Maxnoofcell</i>	Maximum number of cells that can be indicated in the corresponding IE.

9.1.50 INFORMATION EXCHANGE INITIATION RESPONSE

IE/Group Name	Presence	Range	IE Type and Reference	Semantics Description	Criticality	Assigned Criticality
Message Type	M		9.2.1.40		YES	reject
Transaction ID	M		9.2.1.59		–	
Information Exchange ID	M		9.2.1.31A		YES	ignore
CHOICE <i>Information Exchange Object Type</i>	O				YES	ignore
>Cell					–	
>>Requested Data Value	M		9.2.1.48A		–	
>Additional Information Exchange Object Types					–	
>>MBMS Bearer Service					–	
>>>MBMS Bearer Service List		1..<maxno ofMBMS>			GLOBAL	ignore
>>>>TMGI	M		9.2.1.80		–	
>>>>Requested Data Value	M		9.2.1.48A		–	
>>MBMS Bearer Service in MBMS Cell				FDD only	GLOBAL	ignore
>>>MBMS Cell List		1..<maxno ofcell>			–	
>>>>C-ID	M		9.2.1.6	Cell identifier of cell in RNC initiating Information Exchange Initiation procedure	–	
>>>>MBMS Bearer Service List		1..<maxno ofMBMS>			–	
>>>>>TMGI	M		9.2.1.80		–	
>>>>>Requested Data Value	M		9.2.1.48A		–	
>>MBMS Cell				FDD only	GLOBAL	ignore
>>>MBMS Cell List		1..<maxno ofcell>			–	
>>>>C-ID	M		9.2.1.6	Cell identifier of cell in sending RNC not initiating Information Exchange Initiation procedure	–	
>>>>>Requested Data Value	M		9.2.1.48A		–	
Criticality Diagnostics	O		9.2.1.13		YES	ignore

Range bound	Explanation
<i>maxnoofMBMS</i>	Maximum number of MBMS bearer services that a UE can join.
<i>Maxnoofcell</i>	Maximum number of cells that can be indicated in the corresponding IE.

9.1.51 INFORMATION EXCHANGE INITIATION FAILURE

IE/Group Name	Presence	Range	IE Type and Reference	Semantics Description	Criticality	Assigned Criticality
Message Type	M		9.2.1.40		YES	reject
Transaction ID	M		9.2.1.59		–	
Information Exchange ID	M		9.2.1.31A		YES	ignore
Cause	M		9.2.1.5		YES	ignore
Criticality Diagnostics	O		9.2.1.13		YES	ignore

9.1.52 INFORMATION REPORT

IE/Group Name	Presence	Range	IE Type and Reference	Semantics Description	Criticality	Assigned Criticality
Message Type	M		9.2.1.40		YES	ignore
Transaction ID	M		9.2.1.59		–	
Information Exchange ID	M		9.2.1.31A		YES	ignore
CHOICE <i>Information Exchange Object Type</i>	M				YES	ignore
>Cell					–	
>>Requested Data Value Information	M		9.2.1.48B		–	
>Additional Information Exchange Object Types					–	
>>MBMS Bearer Service in MBMS Cell				FDD only	GLOBAL	ignore
>>>MBMS Cell List		1..<maxno ofcell>			–	
>>>>C-ID	M		9.2.1.6	Cell identifier of cell in receiving RNC initiating Information Exchange Initiation procedure	–	
>>>>MBMS Bearer Service List		1..<maxno ofMBMS>			–	
>>>>>TMGI	M		9.2.1.80		–	
>>>>>Requested Data Value Information	M		9.2.1.48B		–	
>>MBMS Cell				FDD only	GLOBAL	ignore
>>>MBMS Cell List		1..<maxno ofcell>			–	
>>>>C-ID	M		9.2.1.6	Cell identifier of cell in sending RNC not initiating Information Exchange Initiation procedure	–	
>>>>>Requested Data Value Information	M		9.2.1.48B		–	

Range bound	Explanation
<i>maxnoofMBMS</i>	Maximum number of MBMS bearer services that a UE can join.
<i>Maxnoofcell</i>	Maximum number of cells that can be indicated in the corresponding IE.

9.1.53 INFORMATION EXCHANGE TERMINATION REQUEST

IE/Group Name	Presence	Range	IE Type and Reference	Semantics Description	Criticality	Assigned Criticality
Message Type	M		9.2.1.40		YES	ignore
Transaction ID	M		9.2.1.59		–	
Information Exchange ID	M		9.2.1.31A		YES	ignore

9.1.54 INFORMATION EXCHANGE FAILURE INDICATION

IE/Group Name	Presence	Range	IE Type and Reference	Semantics Description	Criticality	Assigned Criticality
Message Type	M		9.2.1.40		YES	ignore
Transaction ID	M		9.2.1.59		–	
Information Exchange ID	M		9.2.1.31A		YES	ignore
Cause	M		9.2.1.5		YES	ignore

9.1.55 RESET REQUEST

IE/Group Name	Presence	Range	IE Type and Reference	Semantics Description	Criticality	Assigned Criticality
Message Type	M		9.2.1.40		YES	reject
Transaction ID	M		9.2.1.59		–	

RNC-ID	M		9.2.1.50	Identity of the sending RNC. If the <i>Extended RNC-ID</i> IE is included in the message, the <i>RNC-ID</i> IE shall be ignored.	YES	reject
CHOICE <i>Reset Indicator</i>	M				YES	reject
> <i>Context</i>					–	
>> Context Information		1..< <i>maxResetContext</i> >			EACH	reject
>>>CHOICE <i>Context Type</i>	M				–	
>>>> <i>SRNTI</i>					–	
>>>>>S-RNTI	M		9.2.1.53		–	
>>>>> <i>DRNTI</i>					–	
>>>>>D-RNTI	M		9.2.1.24		–	
> <i>All Contexts</i>			NULL		–	
> <i>Context Group</i>					–	
>> Context Group Information		1..< <i>maxResetContext Groups</i> >			EACH	reject
>>>S-RNTI Group	M		9.2.1.53a		–	
Extended RNC-ID	O		9.2.1.50a	Identity of the sending RNC. The <i>Extended RNC-ID</i> IE shall be used if the RNC identity has a value larger than 4095.	YES	reject

Range bound	Explanation
<i>maxResetContext</i>	Maximum number of contexts that can be reset by one RESET message.
<i>maxResetContextGroups</i>	Maximum number of context groups that can be reset by one RESET message.

9.1.56 RESET RESPONSE

IE/Group Name	Presence	Range	IE Type and Reference	Semantics Description	Criticality	Assigned Criticality
Message Type	M		9.2.1.40		YES	reject
Transaction ID	M		9.2.1.59		–	
RNC-ID	M		9.2.1.50	Identity of the sending RNC. If the <i>Extended RNC-ID</i> IE is included in the message, the <i>RNC-ID</i> IE shall be ignored.	YES	ignore
Criticality Diagnostics	O		9.2.1.13		YES	ignore
Extended RNC-ID	O		9.2.1.50a	Identity of the sending RNC. The <i>Extended RNC-ID</i> IE shall be used if the RNC identity has a value larger than 4095.	YES	reject

9.1.57 RADIO LINK ACTIVATION COMMAND

9.1.57.1 FDD Message

IE/Group Name	Presence	Range	IE Type and Reference	Semantics Description	Criticality	Assigned Criticality
Message Type	M		9.2.1.46		YES	ignore
Transaction ID	M		9.2.1.62		–	
Delayed activation Information		<i>1..<maxnoofRLs></i>			EACH	ignore
>RL ID	M		9.2.1.49		–	
>Delayed Activation Update	M		9.2.1.19Ab		–	

9.1.57.2 TDD Message

IE/Group Name	Presence	Range	IE Type and Reference	Semantics Description	Criticality	Assigned Criticality
Message Type	M		9.2.1.46		YES	ignore
Transaction ID	M		9.2.1.62		–	
Delayed activation Information		<i>1..<maxnoofRLs></i>			EACH	ignore
>RL ID	M		9.2.1.49		–	
>Delayed Activation Update	M		9.2.1.19Ab		–	

9.1.58 RADIO LINK PARAMETER UPDATE INDICATION

9.1.58.1 FDD Message

IE/Group name	Presence	Range	IE Type and Reference	Semantic Description	Criticality	Assigned Criticality
Message type	M		9.2.1.40		YES	ignore
Transaction ID	M		9.2.1.59		–	
HS-DSCH FDD Update Information	O		9.2.2.19c		YES	ignore
RL Information		<i>0..<max noofRLs ></i>			EACH	ignore
>RL Id	M		9.2.1.49		–	
>Phase Reference Update Indicator	O		9.2.2.27B		–	
E-DCH FDD Update Information	O		9.2.2.19e		YES	ignore
Additional HS Cell Information RL Param Upd		<i>0..<max noofHS DSCH-1></i>		For secondary serving HS-DSCH cell. Max 1 in this 3GPP release.	EACH	ignore
>HS-PDSCH RL ID	M		RL ID 9.2.1.49		–	
>HS-DSCH FDD Secondary Serving Update Information	O		9.2.2.19ca		–	
Additional E-DCH Cell Information RL Param Upd		<i>0..<max noofED CH-1></i>		For E-DCH on multiple frequencies in this DRNS. E-DCH on Secondary uplink frequency – max 1 in this 3GPP release.	EACH	ignore
>Additional E-DCH FDD Update Information	M		9.2.2.122		–	
CPC Recovery Report	O		ENUMERATED(Initiated, ...)		YES	ignore

Range bound	Explanation
<i>maxnoofHSDSCH-1</i>	Maximum number of Secondary Serving HS-DSCH cells for one UE.
<i>maxnoofEDCH-1</i>	Maximum number of uplink frequencies -1 for E-DCH for one UE

9.1.58.2 TDD Message

IE/Group name	Presence	Range	IE Type and Reference	Semantic Description	Criticality	Assigned Criticality
Message type	M		9.2.1.40		YES	ignore
Transaction ID	M		9.2.1.59		–	
HS-DSCH TDD Update Information	O		9.2.3.3ac		YES	ignore

9.1.59 UE MEASUREMENT INITIATION REQUEST [TDD]

IE/Group Name	Presence	Range	IE Type and Reference	Semantics Description	Criticality	Assigned Criticality
Message Type	M		9.2.1.40		YES	reject
Transaction ID	M		9.2.1.59		–	
Allowed Queuing Time	O		9.2.1.2		YES	reject
Measurement ID	M		9.2.1.37		YES	reject
UE Measurement Type	M		9.2.3.13Fh		YES	reject
UE Measurement Timeslot information HCR	O		9.2.3.13Fe	3.84 Mcps TDD only	YES	reject
UE Measurement Timeslot information LCR	O		9.2.3.13Ff	1.28 Mcps TDD only	YES	reject
UE Measurement Timeslot information 7.68Mcps	O		9.2.3.33	7.68 Mcps TDD only	YES	reject
Measurement Filter Coefficient	O		9.2.1.36		YES	reject
UE Measurement Report Characteristics	M		9.2.3.13Fc		YES	reject
UE Measurement Parameter Modification Allowed	O		9.2.3.13Fb		YES	reject

9.1.60 UE MEASUREMENT INITIATION RESPONSE [TDD]

IE/Group Name	Presence	Range	IE Type and Reference	Semantics Description	Criticality	Assigned Criticality
Message Type	M		9.2.1.40		YES	reject
Transaction ID	M		9.2.1.59		–	
Measurement ID	M		9.2.1.37		YES	ignore
Measurement Filter Coefficient	O		9.2.1.36		YES	reject
UE Measurement Report Characteristics	O		9.2.3.13Fc		YES	reject
Criticality Diagnostics	O		9.2.1.13		YES	ignore

9.1.61 UE MEASUREMENT INITIATION FAILURE [TDD]

IE/Group Name	Presence	Range	IE Type and Reference	Semantics Description	Criticality	Assigned Criticality
Message Type	M		9.2.1.40		YES	reject
Transaction ID	M		9.2.1.59		–	
Measurement ID	M		9.2.1.37		YES	ignore
Cause	M		9.2.1.5		YES	ignore
Criticality Diagnostics	O		9.2.1.13		YES	ignore

9.1.62 UE MEASUREMENT REPORT [TDD]

IE/Group Name	Presence	Range	IE Type and Reference	Semantics Description	Criticality	Assigned Criticality
Message Type	M		9.2.1.40		YES	ignore
Transaction ID	M		9.2.1.59		–	
Measurement ID	M		9.2.1.37		YES	ignore
UE Measurement Value Information	M		9.2.3.13Fj		YES	ignore

9.1.63 UE MEASUREMENT TERMINATION REQUEST [TDD]

IE/Group Name	Presence	Range	IE Type and Reference	Semantics Description	Criticality	Assigned Criticality
Message Type	M		9.2.1.40		YES	ignore
Transaction ID	M		9.2.1.59		–	
Measurement ID	M		9.2.1.37		YES	ignore

9.1.64 UE MEASUREMENT FAILURE INDICATION [TDD]

IE/Group Name	Presence	Range	IE Type and Reference	Semantics Description	Criticality	Assigned Criticality
Message Type	M		9.2.1.40		YES	ignore
Transaction ID	M		9.2.1.59		–	
Measurement ID	M		9.2.1.37		YES	ignore
Cause	M		9.2.1.5		YES	ignore

9.1.65 IUR INVOKE TRACE

IE/Group Name	Presence	Range	IE Type and Reference	Semantics Description	Criticality	Assigned Criticality
Message Type	M		9.2.1.40		YES	ignore
Transaction ID	M		9.2.1.59		–	
D-RNTI	O		9.2.1.24		YES	ignore
Trace Reference	M		9.2.1.58c		YES	ignore
UE Identity	M		9.2.1.66A		YES	ignore
Trace Recording Session Reference	M		9.2.1.58b		YES	ignore
List Of Interfaces To Trace		<i>0..maxnoofInterfaces</i>			EACH	ignore
>Interface	M		ENUMERATED (Iub, Iur,...)		–	
Trace Depth	M		9.2.1.58a		YES	ignore

Range bound	Explanation
<i>maxnoofInterfaces</i>	Maximum of Interfaces to be traced.

9.1.66 IUR DEACTIVATE TRACE

IE/Group Name	Presence	Range	IE Type and Reference	Semantics Description	Criticality	Assigned Criticality
Message Type	M		9.2.1.40		YES	ignore
Transaction ID	M		9.2.1.59		–	
D-RNTI	O		9.2.1.24		YES	ignore
Trace Reference	M		9.2.1.58c		YES	ignore

9.1.67 MBMS ATTACH COMMAND

IE/Group Name	Presence	Range	IE Type and Reference	Semantics Description	Criticality	Assigned Criticality
Message Type	M		9.2.1.40		YES	ignore
Transaction ID	M		9.2.1.59		–	
MBMS Bearer Service List		1..<maxno ofMBMS>			GLOBAL	ignore
>TMGI	M		9.2.1.80		–	
CHOICE UE State	O				YES	ignore
>CELL_FACH/CELL_PCH					–	
>>D-RNTI	M		9.2.1.24		–	
>URA_PCH					–	
>>SRNC-ID	M		RNC-ID 9.2.1.50	If the <i>Extended SRNC-ID</i> IE is included in the message, the <i>SRNC-ID</i> IE shall be ignored.	–	
>>URA-ID	M		9.2.1.70		–	
>>Extended SRNC-ID	O		Extended RNC-ID 9.2.1.50a	The <i>Extended SRNC-ID</i> IE shall be used if the RNC identity has a value larger than 4095.	YES	reject

Range bound	Explanation
<i>maxnoofMBMS</i>	Maximum number of MBMS bearer services that a UE can join.

9.1.68 MBMS DETACH COMMAND

IE/Group Name	Presence	Range	IE Type and Reference	Semantics Description	Criticality	Assigned Criticality
Message Type	M		9.2.1.40		YES	ignore
Transaction ID	M		9.2.1.59		–	
MBMS Bearer Service List		1..<maxno ofMBMS>			GLOBAL	ignore
>TMGI	M		9.2.1.80		–	
CHOICE UE State	O				YES	ignore
>CELL_FACH/CELL_PCH					–	
>>D-RNTI	M		9.2.1.24		–	
>URA_PCH					–	
>>SRNC-ID	M		RNC-ID 9.2.1.50	If the <i>Extended SRNC-ID</i> IE is included in the message, the <i>SRNC-ID</i> IE shall be ignored.	–	
>>URA-ID	M		9.2.1.70		–	
>>Extended SRNC-ID	O		Extended RNC-ID 9.2.1.50a	The <i>Extended SRNC-ID</i> IE shall be used if the RNC identity has a value larger than 4095.	YES	reject

Range bound	Explanation
<i>maxnoofMBMS</i>	Maximum number of MBMS bearer services that a UE can join.

9.1.69 DIRECT INFORMATION TRANSFER

IE/Group Name	Presence	Range	IE Type and Reference	Semantics Description	Criticality	Assigned Criticality
Message Type	M		9.2.1.40		YES	ignore
Transaction ID	M		9.2.1.59		–	
RNC-ID	M		9.2.1.50	ID of an RNC which initiates the procedure. If the <i>Extended RNC-ID</i> IE is included in the message, the <i>RNC-ID</i> IE shall be ignored.	YES	ignore
Provided Information	M		9.2.1.85		YES	ignore
Extended RNC-ID	O		9.2.1.50a	The <i>Extended RNC-ID</i> IE shall be used if the RNC identity has a value larger than 4095.	YES	reject

9.1.70 ENHANCED RELOCATION REQUEST

IE/Group Name	Presence	Range	IE Type and Reference	Semantics Description	Criticality	Assigned Criticality
Message Type	M		9.2.1.40		YES	reject
Transaction ID	M		9.2.1.59		–	
Cause	M		9.2.1.5		YES	reject
Permanent NAS UE Identity	M		9.2.1.73		YES	reject
SRNC-ID	O		RNC-ID 9.2.1.50	If the <i>Extended SRNC-ID</i> IE is included in the message, the <i>SRNC-ID</i> IE shall be ignored.	YES	reject
Extended SRNC-ID	O		Extended RNC-ID 9.2.1.50a	The <i>Extended SRNC-ID</i> IE shall be used if the RNC identity has a value larger than 4095.	YES	reject
S-RNTI	M		9.2.1.53		YES	reject
RANAP Enhanced Relocation Information Request	M		9.2.1.124		YES	reject

9.1.71 ENHANCED RELOCATION RESPONSE

IE/Group Name	Presence	Range	IE Type and Reference	Semantics Description	Criticality	Assigned Criticality
Message Type	M		9.2.1.40		YES	reject
Transaction ID	M		9.2.1.59		–	
RANAP Enhanced Relocation Information Response	M		9.2.1.125		YES	ignore

9.1.72 ENHANCED RELOCATION FAILURE

IE/Group Name	Presence	Range	IE Type and Reference	Semantics Description	Criticality	Assigned Criticality
Message Type	M		9.2.1.40		YES	reject
Transaction ID	M		9.2.1.59		–	
Cause	M		9.2.1.5		YES	ignore
Criticality Diagnostics	O		9.2.1.13		YES	ignore

9.1.73 ENHANCED RELOCATION CANCEL

IE/Group Name	Presence	Range	IE Type and Reference	Semantics Description	Criticality	Assigned Criticality
Message Type	M		9.2.1.40		YES	ignore
Transaction ID	M		9.2.1.59		–	
Cause	M		9.2.1.5		YES	ignore

9.1.74 ENHANCED RELOCATION SIGNALLING TRANSFER

IE/Group Name	Presence	Range	IE Type and Reference	Semantics Description	Criticality	Assigned Criticality
Message Type	M		9.2.1.40		YES	ignore
Transaction ID	M		9.2.1.59		–	
L3 Information	M		9.2.1.32		YES	ignore

9.1.75 ENHANCED RELOCATION RELEASE

IE/Group Name	Presence	Range	IE Type and Reference	Semantics Description	Criticality	Assigned Criticality
Message Type	M		9.2.1.40		YES	ignore
Transaction ID	M		9.2.1.59		–	
Released CN Domain	M		9.2.1.126		YES	ignore

9.1.76 MBSFN MCCH INFORMATION (FDD)

IE/Group Name	Presence	Range	IE Type and Reference	Semantics Description	Criticality	Assigned Criticality
Message Type	M		9.2.1.40		YES	reject
Transaction ID	M		9.2.1.59		–	
MBSFN Cluster Identity	M		9.2.1.128		YES	ignore
MCCH Message List		<i>1..<maxno of MCCH Messages></i>			YES	reject
>L3 Information	M		9.2.1.32	See Note1 below.	–	
CFN	M		9.2.1.9		YES	reject
MCCH Configuration Info		0..1			YES	ignore
>Secondary CCPCH system information MBMS	M		9.2.1.127		–	
MBSFN Scheduling Transmission Time Interval info List		<i>0..<maxNrOf MBMSL3></i>			YES	ignore
>TMGI	M		9.2.1.80		–	
>MBSFN Scheduling Transmission Time Interval	M		9.2.1.129		–	
Note 1: The IE Contains one of the following messages defined in ref. TS 25.331 [16]: MBMS MODIFIED SERVICES INFORMATION, MBMS UNMODIFIED SERVICES INFORMATION, MBMS GENERAL INFORMATION, MBMS COMMON P-T-M RB INFORMATION, MBMS CURRENT Cell PTM RB INFORMATION.						

Range bound	Explanation
<i>maxnoofMCCHMessages</i>	Maximum number of MCCH Messages simultaneous sent on MCCH
<i>maxNrOfMBMSL3</i>	Maximum number of MBMS service in L3 information

9.1.77 SECONDARY UL FREQUENCY REPORT

9.1.77.1 FDD Message

IE/Group Name	Presence	Range	IE Type and Reference	Semantics Description	Criticality	Assigned Criticality
Message Type	M		9.2.1.40		YES	ignore
Transaction ID	M		9.2.1.59		–	
Activation Information	M		9.2.2.109		YES	ignore

9.1.78 SECONDARY UL FREQUENCY UPDATE INDICATION

9.1.78.1 FDD Message

IE/Group Name	Presence	Range	IE Type and Reference	Semantics Description	Criticality	Assigned Criticality
Message Type	M		9.2.1.40		YES	ignore
Transaction ID	M		9.2.1.59		–	
Activation Information	M		9.2.2.109		YES	ignore

9.2 Information Element Functional Definition and Contents

9.2.0 General

Subclause 9.2 presents the RNSAP IE definitions in tabular format. The corresponding ASN.1 definition is presented in subclause 9.3. In case there is a contradiction between the tabular format in subclause 9.2 and the ASN.1 definition, the ASN.1 shall take precedence, except for the definition of conditions for the presence of conditional elements, in which the tabular format shall take precedence.

When specifying information elements which are to be represented by bitstrings, if not otherwise specifically stated in the semantics description of the concerned IE or elsewhere, the following principle applies with regards to the ordering of bits:

- The first bit (leftmost bit) contains the most significant bit (MSB);
- The last bit (rightmost bit) contains the least significant bit (LSB);
- When importing bitstrings from other specifications, the first bit of the bitstring contains the first bit of the concerned information;

9.2.1 Common Parameters

This subclause contains parameters that are common to FDD and TDD.

9.2.1.1 Allocation/Retention Priority

This parameter indicates the priority level in the allocation and retention of transport channel resources in DRNS. DRNS may use the Allocation/Retention priority information of the transport channels composing the RL to prioritise requests for RL Setup/addition and reconfiguration. In similar way, DRNS may use the allocation/Retention priority information of the transport channels composing the RL to prioritise which RL shall be set to failure, in case prioritisation is possible. See Annex A.

IE/Group Name	Presence	Range	IE Type and Reference	Semantics Description
Priority Level	M		INTEGER(0..15)	This IE indicates the priority of the request. Usage: Value "0" means "Spare"; It shall be treated as a logical error if received. Values between 1 and 14 are ordered in decreasing order of priority, "1" being the highest and "14" the lowest. Value "15" means "No Priority".
Pre-emption Capability	M		ENUMERATED(shall not trigger pre-emption, may trigger pre-emption)	
Pre-emption Vulnerability	M		ENUMERATED(not pre-emptable, pre-emptable)	

9.2.1.2 Allowed Queuing Time

This parameter specifies the maximum queuing time that is allowed in the DRNS until the DRNS must start to execute the request.

IE/Group Name	Presence	Range	IE Type and Reference	Semantics Description
Allowed Queuing Time			INTEGER(1..60)	Unit: Seconds

9.2.1.2A Allowed Rate Information

The *Allowed Rate Information* IE indicates the TFI corresponding to the highest allowed bit rate for the uplink and/or the downlink of a DCH. The SRNC is allowed to use any rate being lower than or equal to the rate corresponding to the indicated TFI.

IE/Group Name	Presence	Range	IE Type and Reference	Semantics Description
Allowed UL Rate	O		INTEGER(1..maxTFcount)	"1": TFI 0, "2": TFI 1, "3": TFI 2, ...
Allowed DL Rate	O		INTEGER(1..maxTFcount)	"1": TFI 0, "2": TFI 1, "3": TFI 2, ...

9.2.1.2B Altitude and Direction

This IE contains a description of Altitude and Direction.

IE/Group Name	Presence	Range	IE Type and Reference	Semantics Description
Direction of Altitude	M		ENUMERATED(Height, Depth)	
Altitude	M		INTEGER($0..2^{15}-1$)	The relation between the value (N) and the altitude (a) in meters it describes is $N \leq a < N+1$, except for $N=2^{15}-1$ for which the range is extended to include all greater values of (a).

9.2.1.2C Antenna Co-location Indicator

The Antenna Co-location Indicator indicates whether the antenna of the serving and neighbouring cells are approximately co-located.

IE/Group Name	Presence	Range	IE Type and Reference	Semantics Description
Antenna Co-location Indicator			ENUMERATED(co-located,...)	

9.2.1.2D Alternative Format Reporting Indicator

This IE indicates if DRNS may report a measurement using an alternative format.

IE/Group Name	Presence	Range	IE Type and Reference	Semantics Description
Alternative Format Reporting Indicator			ENUMERATED(Alternative format is allowed, ...)	

9.2.1.3 Binding ID

The Binding ID is the identifier of a user data stream.

In case of transport bearer establishment with ALCAP (TS 25.426 [3]) and (TS 25.424 [35]), this IE contains the identifier that is allocated at the DRNS and that is unique for each transport bearer under establishment to/from the DRNS.

If the Transport Layer Address contains an IP address (IETF RFC 2460 [33]), this IE contains the UDP port (IETF RFC 768 [34]) intended to be used for the user plane transport.

IE/Group Name	Presence	Range	IE Type and Reference	Semantics Description
Binding ID			OCTET STRING (1..4,...)	If the Binding ID includes an UDP port, the UDP port is included in octet 1 and 2. The first octet of the UDP port field shall be included in the first octet of the Binding ID.

9.2.1.4 BLER

This Block Error Rate defines the target radio interface Transport Block Error Rate of the transport channel . BLER is used by the DRNS to determine the needed SIR targets, for admission control and power management reasons.

IE/Group Name	Presence	Range	IE Type and Reference	Semantics Description
BLER			INTEGER(-63..0)	Step 0.1. (Range -6.3...0). It is the Log10 of the BLER

9.2.1.4A Block STTD Indicator

Void.

9.2.1.4B Burst Mode Parameters

The *Burst Mode Parameters* IE provides all the relevant information in order to able IPDL in the Burst mode.

IE/Group name	Presence	Range	IE Type and Reference	Semantics Description
Burst Start	M		INTEGER(0..15)	See TS 25.214 [10] and TS 25.224 [22]
Burst Length	M		INTEGER(10..25)	See TS 25.214 [10] and TS 25.224 [22]
Burst freq	M		INTEGER(1..16)	See TS 25.214 [10] and TS 25.224 [22]

9.2.1.5 Cause

The purpose of the cause information element is to indicate the reason for a particular event for the whole protocol.

IE/Group Name	Presence	Range	IE Type and Reference	Semantics Description
CHOICE Cause Group	M			
>Radio Network Layer				
>>Radio Network Layer Cause	M		<p>ENUMERATED (Unknown C-ID, Cell not Available, Power Level not Supported, UL Scrambling Code Already in Use, DL Radio Resources not Available, UL Radio Resources not Available, Measurement not Supported For The Object, Combining Resources Not Available, Combining not Supported, Reconfiguration not Allowed, Requested Configuration not Supported, Synchronisation Failure, Requested Tx Diversity Mode not Supported, Measurement Temporarily not Available, Unspecified, Invalid CM Settings, Reconfiguration CFN not Elapsed, Number of DL Codes Not Supported, Dedicated Transport Channel Type not Supported, DL Shared Channel Type not Supported, UL Shared Channel Type not Supported, Common Transport Channel Type not Supported, UL Spreading Factor not Supported, DL Spreading Factor not Supported, CM not Supported, Transaction not Supported by Destination Node B, RL Already Activated/Allocated, ..., Number of UL Codes Not Supported, Cell reserved for operator use, DPC Mode Change not Supported, Information temporarily not available, Information Provision not supported for the object, Power Balancing status not compatible, Delayed Activation not Supported, RL Timing Adjustment Not Supported, Unknown RNTI, Measurement Repetition Rate not Compatible with Current Measurements, UE not Capable to Implement Measurement, F-DPCH not supported, E-DCH not supported, Continuous Packet Connectivity DTX-DRX operation not supported, Continuous Packet Connectivity HS-SCCH less operation not supported, MIMO not supported, E-DCH TTI2ms not supported, Continuous Packet Connectivity DTX-DRX operation not available, Continuous Packet Connectivity UE DTX Cycle not available, MIMO not available, SixteenQAM UL not supported, HS-DSCH MAC-d PDU Size Format not supported, F-DPCH Slot Format operation not supported,</p>	

			<p>E-DCH MAC-d PDU Size Format not available, E-DPCCH Power Boosting not supported, Trelocprep Expiry, Relocation Cancelled, Traffic Load In The Target Cell Higher Than In The Source Cell, Time critical Relocation, Resource optimisation relocation, Relocation desirable for radio reasons</p> <p>, Directed Retry, Reduce Load in Serving Cell, No lu CS UP relocation, SixtyfourQAM DL and MIMO Combined not available, Multi Cell operation not available, Multi Cell operation not supported, Semi-Persistent scheduling not supported, Continuous Packet Connectivity DRX not supported, Continuous Packet Connectivity DRX not available, Enhanced Relocation not Supported, Relocation Not Supported Due To PUESBINE Feature, Relocation Failure In Target RNC, Relocation Target not allowed, Requested Ciphering and/or Integrity Protection Algorithms not Supported, SixtyfourQAM DL and MIMO Combined not supported, TX diversity for MIMO UE on DL Control Channels not available, Single Stream MIMO not supported, Single Stream MIMO not available, Multi Cell operation with MIMO not available, Multi Cell operation with MIMO not supported, Multi Cell E-DCH operation not available, Multi Cell E-DCH operation not supported, Multi Cell operation with Single Stream MIMO not available, Multi Cell operation with Single Stream MIMO not supported, Cell Specific Tx Diversity Handling For Multi Cell Operation Not Available, Cell Specific Tx Diversity Handling For Multi Cell Operation Not Supported)</p>	
>Transport Layer				
>>Transport Layer Cause	M		<p>ENUMERATED (Transport Resource Unavailable, Unspecified, ...)</p>	
>Protocol				
>>Protocol Cause	M		<p>ENUMERATED (Transfer Syntax Error, Abstract Syntax Error (Reject), Abstract Syntax Error (Ignore and Notify), Message not Compatible with Receiver State, Semantic Error, Unspecified, Abstract Syntax Error (Falsely Constructed Message),...)</p>	
>Misc				
>>Miscellaneous Cause	M		<p>ENUMERATED (Control Processing Overload, Hardware Failure, O&M Intervention,</p>	

			Not enough User Plane Processing Resources, Unspecified,...)	
--	--	--	--	--

The meaning of the different cause values is described in the following table. In general, “not supported” cause values indicate that the concerned capability is missing. On the other hand, “not available” cause values indicate that the concerned capability is present, but insufficient resources were available to perform the requested action.

Radio Network Layer cause	Meaning
----------------------------------	----------------

Cell not Available	The concerned cell is not available
Cell reserved for operator use	The concerned cell is reserved for operator use
Cell Specific Tx Diversity Handling For Multi Cell Operation Not Available	Cell specific tx diversity handling for multi cell operation not available in the concerned cell(s)
Cell Specific Tx Diversity Handling For Multi Cell Operation Not Supported	The concerned cell(s) do not support the cell specific tx diversity handling for multi cell operation
CM not Supported	The concerned cell(s) do not support Compressed Mode
Combining not Supported	The DRNS does not support the RL combining for the concerned cells
Combining Resources Not Available	The value of the received <i>Diversity Control Field</i> IE was set to "Must", but the DRNS cannot perform the requested combining
Common Transport Channel Type not Supported	The concerned cell(s) do not support the RACH and/or FACH Common Transport Channel Type
Continuous Packet Connectivity DTX-DRX operation not available	CPC resources for DTX-DRX operation not available in the concerned cell(s).
Continuous Packet Connectivity DRX not available	HSPA resources for DRX operation not available in the concerned cell(s). (for 1.28Mcps TDD only)
Continuous Packet Connectivity DRX not supported	The concerned cell(s) do not support the Continuous Packet Connectivity DRX operation (for 1.28Mcps TDD only)
Continuous Packet Connectivity DTX-DRX operation not Supported	The concerned cell(s) do not support the Continuous Packet Connectivity DTX-DRX operation
Continuous Packet Connectivity HS-SCCH less operation not Supported	The concerned cell(s) do not support the Continuous Packet Connectivity HS-SCCH less operation
Continuous Packet Connectivity UE DTX Cycle not available	CPC resources for the UE DTX Cycle not available in the concerned cell(s).
Dedicated Transport Channel Type not Supported	The concerned cell(s) do not support the Dedicated Transport Channel Type
Delayed Activation not Supported	The concerned cell(s) do not support delayed activation of RLs
Directed Retry	The reason for action is Directed Retry
DL Radio Resources not Available	The DRNS does not have sufficient DL radio resources available
DL SF not Supported	The concerned cell(s) do not support the requested DL SF
DL Shared Channel Type not Supported	The concerned cell(s) do not support the Downlink Shared Channel Type
DPC Mode Change not Supported	The concerned cells do not support the DPC mode changes
E-DCH MAC-d PDU Size Format not available	The selected E-DCH MAC-d PDU Size Format is not available in the concerned cell(s).
E-DCH not supported	The concerned cell(s) do not support E-DCH
E-DCH TTI2ms not supported	The concerned cell(s) do not support the E-DCH 2ms TTI operation
E-DPCCH Power Boosting not supported	The concerned cell(s) do not support the E-DPCCH Power Boosting.
Enhanced Relocation not Supported	The DRNS does not support the Enhanced Relocation.
F-DPCH not supported	The concerned cell(s) do not support the Fractional DPCH
F-DPCH Slot Format operation not supported	The concerned cell(s) do not support the F-DPCH Slot Format operation
HS-DSCH MAC-d PDU Size Format not supported	The concerned cell(s) do not support the selected HS-DSCH MAC-d PDU Size Format
Information Provision not supported for the object	The RNS doesn't support provision of the requested information for the concerned object types
Information temporarily not available	The RNS can temporarily not provide the requested information
Invalid CM Settings	The concerned cell(s) consider the requested Compressed Mode settings invalid
Measurement not Supported For The Object	At least one of the concerned cell(s) does not support the requested measurement on the concerned object type
Measurement Repetition Rate not Compatible with Current Measurements	The requested parameters for a forwarded UE measurement are not compatible with the current measurement schedule in the SRNC.
Measurement Temporarily not Available	The DRNS can temporarily not provide the requested measurement value
MIMO not available	MIMO resources not available in the concerned cell(s).
MIMO not supported	The concerned cell(s) do not support the MIMO operation
Multi Cell E-DCH operation not available	Multi cell E-DCH operation is not available in the concerned cell(s).
Multi Cell E-DCH operation not	The concerned cell(s) do not support Multi cell E-DCH operation

supported	
Multi Cell operation not available	Multi Cell operation resources not available in the concerned cell(s).
Multi Cell operation not supported	The concerned cell(s) do not support Multi Cell operation
Multi Cell operation with MIMO not available	Multi Cell operation with MIMO resources not available in the concerned cell(s).
Multi Cell operation with MIMO not supported	The concerned cell(s) do not support Multi Cell operation with MIMO
Multi Cell operation with Single Stream MIMO not available	Multi Cell operation with Single Stream MIMO resources not available in the concerned cell(s).
Multi Cell operation with Single Stream MIMO not supported	The concerned cell(s) do not support Multi Cell operation with Single Stream MIMO
No lu CS UP relocation	The relocation is triggered by CS call and the source RNC has no lu CS user plane.
Number of DL Codes not Supported	The concerned cell(s) do not support the requested number of DL codes
Number of UL Codes not Supported	The concerned cell(s) do not support the requested number of UL codes
Power Balancing status not compatible	The power balancing status in the SRNC is not compatible with that of the DRNC.
Power Level not Supported	A DL power level was requested which the concerned cell(s) do not support
Reconfiguration CFN not Elapsed	The requested action cannot be performed due to that a COMMIT message was received previously, but the concerned CFN has not yet elapsed
Reconfiguration not Allowed	The SRNC does currently not allow the requested reconfiguration
Reduce Load in Serving Cell	Load on serving cell needs to be reduced.
Relocation Cancelled	The reason for the action is relocation cancellation.
Relocation Desirable For Radio Reasons	The reason for requesting relocation is radio related.
Relocation Failure In Target RNC	Relocation failed due to a failure in target RNC.
Relocation Not Supported Due To PUESBINE Feature	The DRNS can not support the relocation due to the PUESBINE Feature.
Relocation Target not allowed	Relocation to the indicated target cell is not allowed for the UE in question.
Requested Ciphering And/Or Integrity Protection Algorithms Not Supported	The DRNS does not support the requested ciphering and/or integrity protection algorithms.
Requested Configuration not Supported	The concerned cell(s) do not support the requested configuration i.e. power levels, Transport Formats, physical channel parameters,.....
Requested Tx Diversity mode not Supported	The concerned cell(s) do not support the requested transmit diversity mode
Resource Optimisation Relocation	The reason for requesting relocation is resource optimisation.
RL Already Activated/ Allocated	The DRNS has already allocated an RL with the requested RL ID for this UE Context
RL Timing Adjustment not Supported	The concerned cell(s) do not support adjustments of the RL timing
Semi-Persistent scheduling not supported	The concerned cell(s) do not support the Semi-Persistent scheduling operation (for 1.28Mcps TDD only)
SixteenQAM UL not Supported	The concerned cell(s) do not support the 16 QAM UL
SixtyfourQAM DL and MIMO Combined not available	SixtyfourQAM DL and MIMO Combined not available in the concerned cell(s)
SixtyfourQAM DL and MIMO Combined not supported	The DRNS does not support SixtyfourQAM DL and MIMO Combined for the concerned cells.
Synchronisation Failure	Loss of UL Uu synchronisation
Time Critical Relocation	Relocation is requested for time critical reason i.e. this cause value is reserved to represent all critical cases where the connection is likely to be dropped if relocation is not performed.
Traffic Load In The Target Cell Higher Than In The Source Cell	Relocation to reduce load in the source cell is rejected, as the target cell's traffic load is higher than that in the source cell.
Transaction not Supported by Destination Node B	The requested action cannot be performed due to lack of support of the corresponding action in the destination Node B
T _{RELOCprep} Expiry	Relocation Preparation procedure is cancelled when timer T _{RELOCprep} expires.
Single Stream MIMO not supported	The concerned cell(s) do not support the Single Stream MIMO.
Single Stream MIMO not available	Single Stream MIMO resources not available in the concerned cell(s).
TX diversity for MIMO UE on DL Control Channels not available	The DRNS does not have sufficient radio resources available to support transmit diversity on downlink control channels when the UE is configured

	in MIMO mode with P-CPICH & S-CPICH as phase references TS 25.211 [8]
UE not Capable to Implement Measurement	The UE is not capable to initiate/report a requested measurement due to its current state or capabilities.
UL Radio Resources not Available	The DRNS does not have sufficient UL radio resources available
UL Scrambling Code Already in Use	The concerned UL scrambling code is already in use for another UE
UL SF not Supported	The concerned cell(s) do not support the requested minimum UL SF
UL Shared Channel Type not Supported	The concerned cell(s) do not support the Uplink Shared Channel Type
Unknown C-ID	The DRNS is not aware of a cell with the provided C-ID
Unknown RNTI	The SRNC or DRNC is not aware of a UE indicated with the provided RNTI
Unspecified	Sent when none of the above cause values applies but still the cause is Radio Network Layer related

Transport Network Layer cause	Meaning
Transport resource unavailable	The required transport resources are not available
Unspecified	Sent when none of the above cause values applies but still the cause is Transport Network Layer related

Protocol cause	Meaning
Abstract Syntax Error (Reject)	The received message included an abstract syntax error and the concerned criticality indicated "reject" (see subclause 10.3)
Abstract Syntax Error (Ignore and Notify)	The received message included an abstract syntax error and the concerned criticality indicated "ignore and notify" (see subclause 10.3)
Abstract syntax error (falsely constructed message)	The received message contained IEs or IE groups in wrong order or with too many occurrences (see subclause 10.3)
Message not Compatible with Receiver State	The received message was not compatible with the receiver state (see subclause 10.4)
Semantic Error	The received message included a semantic error (see subclause 10.4)
Transfer Syntax Error	The received message included a transfer syntax error (see subclause 10.2)
Unspecified	Sent when none of the above cause values applies but still the cause is Protocol related

Miscellaneous cause	Meaning
Control Processing Overload	DRNS control processing overload
Hardware Failure	DRNS hardware failure
Not enough User Plane Processing Resources	DRNS has insufficient user plane processing resources available
O&M Intervention	Operation and Maintenance intervention related to DRNS equipment
Unspecified	Sent when none of the above cause values applies and the cause is not related to any of the categories Radio Network Layer, Transport Network Layer or Protocol.

9.2.1.5A Cell Geographical Area Identity (Cell GAI)

The Cell Geographical Area is used to identify the geographical area of a cell. The area is represented as a polygon. See ref. TS 23.032 [25].

IE/Group Name	Presence	Range	IE Type and Reference	Semantics Description
Cell GAI Geographical Co-ordinates		1 .. <maxnoofPoints>		
>Latitude Sign	M		ENUMERATED(North, South)	
>Degrees of Latitude	M		INTEGER(0..2 ²³ -1)	The IE value (N) is derived by this formula: N ≤ 2 ²³ X / 90 < N+1 X being the latitude in degree (0°.. 90°)
>Degrees of Longitude	M		INTEGER(-2 ²³ ..2 ²³ -1)	The IE value (N) is derived by this formula: N ≤ 2 ²⁴ X / 360 < N+1 X being the longitude in degree (-180°..+180°)

Range bound	Explanation
maxnoofPoints	Maximum no. of points in polygon.

9.2.1.5B Cell Geographical Area Additional Shapes (Cell GAI Additional Shapes)

This IE is used to provide several descriptions of the geographical area of a cell.

IE/Group Name	Presence	Range	IE Type and Reference	Semantics Description
<i>CHOICE Cell GAI Additional Shapes</i>				
>GA Point With Uncertainty				
>>GA Point With Uncertainty	M		9.2.1.30A	Ellipsoid point with uncertainty circle
>GA Ellipsoid point with uncertainty Ellipse				
>>GA Ellipsoid point with uncertainty Ellipse	M		9.2.1.30B	Ellipsoid point with uncertainty Ellipse
>GA Ellipsoid point with altitude				
>>GA Ellipsoid point with altitude	M		9.2.1.30C	Ellipsoid point with altitude
>GA Ellipsoid point with altitude and uncertainty Ellipsoid				
>>GA Ellipsoid point with altitude and uncertainty Ellipsoid	M		9.2.1.30D	Ellipsoid point with altitude and uncertainty Ellipsoid
>GA Ellipsoid Arc				
>>GA Ellipsoid Arc	M		9.2.1.30E	Ellipsoid Arc

9.2.1.5C Cell Capacity Class Value

The *Cell Capacity Class Value* IE contains the capacity class for both the uplink and downlink. *Cell Capacity Class Value* IE is the value that classifies the cell capacity with regards to the other cells. *Cell Capacity Class Value* IE only indicates resources that are configured for traffic purposes.

IE/Group Name	Presence	Range	IE Type and Reference	Semantics Description
Uplink Cell Capacity Class Value	M		INTEGER(1..100,...)	Value 1 shall indicate the minimum uplink cell capacity, and 100 shall indicate the maximum uplink cell capacity. There should be linear relation between uplink cell capacity and Uplink Cell Capacity Class Value.
Downlink Cell Capacity Class Value	M		INTEGER(1..100,...)	Value 1 shall indicate the minimum downlink cell capacity, and 100 shall indicate the maximum downlink cell capacity. There should be linear relation between downlink cell capacity and Downlink Cell Capacity Class Value.

9.2.1.5D Cell Global Identifier (CGI)

The *Cell Global Identifier* IE contains the Cell Global Identity as defined in ref. TS 23.003 [1].

IE/Group Name	Presence	Range	IE Type and Reference	Semantics Description
LAI		1		
>PLMN Identity	M		OCTET STRING (3)	<ul style="list-style-type: none"> - digits 0 to 9, two digits per octet, - each digit encoded 0000 to 1001, - 1111 used as filler - bit 4 to 1 of octet n encoding digit 2n-1 - bit 8 to 5 of octet n encoding digit 2n -The PLMN Identity consists of 3 digits from MCC followed by either -a filler plus 2 digits from MNC (in case of 2 digit MNC) or -3 digits from MNC (in case of a 3 digit MNC).
>LAC	M		OCTET STRING (2)	0000 and FFFE not allowed
CI	M		OCTET STRING (2)	

9.2.1.6 Cell Identifier (C-ID)

The C-ID (Cell Identifier) is the identifier of a cell in one RNS.

IE/Group Name	Presence	Range	IE Type and Reference	Semantics Description
C-ID			INTEGER (0..65535)	

9.2.1.7 Cell Individual Offset

Cell individual offset is an offset that will be applied by UE to the measurement results for a Primary-CPICH[FDD]/Primary-CCPCH[TDD] or for GSM Carrier RSSI according to TS 25.331 [16].

IE/Group Name	Presence	Range	IE Type and Reference	Semantics Description
Cell Individual Offset			INTEGER(-20..+20)	-20 -> -10dB -19 -> -9.5dB ... +20 -> +10dB

9.2.1.8 Cell Parameter ID

The Cell Parameter ID identifies unambiguously the [3.84 Mcps TDD and 7.68Mcps TDD – Code Groups, Scrambling Codes, Midambles and Toffset] [1.28 Mcps TDD – SYNC-DL and SYNC-UL sequences, the scrambling codes and the midamble codes] (see ref. ITU-T Rec. X.691 [20]).

IE/Group Name	Presence	Range	IE Type and Reference	Semantics Description
Cell Parameter ID			INTEGER(0..127,...)	

9.2.1.9 CFN

Connection Frame Number for the radio connection, see ref. TS 25.402 [17].

IE/Group Name	Presence	Range	IE Type and Reference	Semantics Description
CFN			INTEGER(0..255)	

9.2.1.10 CFN Offset

Void

9.2.1.11 CN CS Domain Identifier

Identification of the CN node in the CS Domain.

IE/Group Name	Presence	Range	IE Type and Reference	Semantics Description
PLMN Identity	M		OCTET STRING (3)	- digits 0 to 9, two digits per octet, - each digit encoded 0000 to 1001, - 1111 used as filler - bit 4 to 1 of octet n encoding digit 2n-1 - bit 8 to 5 of octet n encoding digit 2n -The PLMN Identity consists of 3 digits from MCC followed by either -a filler plus 2 digits from MNC (in case of 2 digit MNC) or -3 digits from MNC (in case of a 3 digit MNC).
LAC	M		OCTET STRING (2)	0000 and FFFE not allowed

9.2.1.11A CN Domain Type

Identifies the type of core network domain.

IE/Group Name	Presence	Range	IE Type and Reference	Semantics Description
CN Domain Type			ENUMERATED(CS domain, PS domain, Don't care,...)	See in TS 25.331 [16]

9.2.1.12 CN PS Domain Identifier

Identification of the CN Node in the PS Domain.

IE/Group Name	Presence	Range	IE Type and Reference	Semantics Description
PLMN Identity	M		OCTET STRING (3)	- digits 0 to 9, two digits per octet, - each digit encoded 0000 to 1001, - 1111 used as filler - bit 4 to 1 of octet n encoding digit 2n-1 - bit 8 to 5 of octet n encoding digit 2n -The PLMN Identity consists of 3 digits from MCC followed by either -a filler plus 2 digits from MNC (in case of 2 digit MNC) or -3 digits from MNC (in case of a 3 digit MNC).
LAC	M		OCTET STRING (2)	0000 and FFFE not allowed
RAC	M		OCTET STRING (1)	

9.2.1.12A Common Measurement Accuracy

The *Common Measurement Accuracy* IE indicates the accuracy of the common measurement.

IE/Group Name	Presence	Range	IE Type and Reference	Semantics Description
CHOICE <i>Common Measurement Accuracy</i>	M			
> $T_{UTRAN-GPS}$ <i>Measurement Accuracy Class</i>				
>> $T_{UTRAN-GPS}$ <i>Measurement Accuracy Class</i>	M		$T_{UTRAN-GPS}$ Accuracy Class 9.2.1.59B	
> $T_{UTRAN-GANSS}$ <i>Measurement Accuracy Class</i>				
>> $T_{UTRAN-GANSS}$ <i>Measurement Accuracy Class</i>	M		$T_{UTRAN-GANSS}$ Accuracy Class 9.2.1.112	

9.2.1.12B Common Measurement Object Type

Void.

9.2.1.12C Common Measurement Type

The Common Measurement Type identifies which measurement that shall be performed.

IE/Group Name	Presence	Range	IE Type and Reference	Semantics Description
Common Measurement Type			ENUMERATED (UTRAN GPS Timing of Cell Frames for UE Positioning , SFN-SFN Observed Time Difference, load, transmitted carrier power, received total wide band power, UL timeslot ISCP, ..., RT Load, NRT Load Information, UpPTS interference, UTRAN GANSS Timing of Cell Frames for UE Positioning)	UL timeslot ISCP shall only be used by TDD. For measurements, which are requested on the Iur-g interface, only load, RT Load and NRT Load information are used. "UpPTS interference" is used by 1.28Mcps TDD only "UpPTS interference" means "UpPCH interference" in the whole 25.423, refer to TS 25.225 [14] and TS 25.224 [22].

9.2.1.12D Common Measurement Value

The Common Measurement Value shall be the most recent value for this measurement, for which the reporting criteria were met.

IE/Group Name	Presence	Range	IE Type and Reference	Semantics Description	Criticality	Assigned Criticality
CHOICE <i>Common Measurement Value</i>	M				–	
> <i>T_{UTRAN-GPS} Measurement Value Information</i>				UTRAN only	–	
>> <i>T_{UTRAN-GPS} Measurement Value Information</i>	M		9.2.1.59D		–	
> <i>SFN-SFN Measurement Value Information</i>				UTRAN only	–	
>> <i>SFN-SFN Measurement Value Information</i>	M		9.2.1.52C		–	
> <i>Load Value</i>					–	
>> <i>Load Value</i>	M		9.2.1.33A		–	
> <i>Transmitted Carrier Power Value</i>				UTRAN only	–	
>> <i>Transmitted Carrier Power Value</i>	M		Transmitted Carrier Power 9.2.1.59A		–	
> <i>Received Total Wide Band Power Value</i>				UTRAN only	–	
>> <i>Received Total Wide Band Power Value</i>	M		Received Total Wide Band Power 9.2.2.35A		–	
> <i>UL Timeslot ISCP Value</i>				TDD Only	–	
>> <i>UL Timeslot ISCP Value</i>	M		UL Timeslot ISCP 9.2.3.13A		–	
> <i>Additional Common Measurement Values</i>					–	
>> <i>RT Load Value</i>					–	
>>> <i>RT Load Value</i>	M		9.2.1.50B		YES	ignore
>> <i>NRT Load Information Value</i>					–	
>>> <i>NRT Load Information Value</i>	M		9.2.1.41I		YES	ignore
>> <i>UpPTS interference</i>				1.28Mcps TDD Only	–	
>>> <i>UpPTS interference Value</i>	M		INTEGER (0..127,...)	According to mapping in TS 25.123 [24]	YES	reject
>> <i>T_{UTRAN-GANSS} Measurement Value Information</i>				UTRAN only	–	
>>> <i>T_{UTRAN-GANSS} Measurement Value Information</i>	M		9.2.1.114		YES	reject

9.2.1.12E Common Measurement Value Information

The *Common Measurement Value Information* IE provides information both on whether the Common Measurement Value is provided in the message or not and if provided also the Common Measurement Value itself.

IE/Group Name	Presence	Range	IE Type and Reference	Semantics Description
CHOICE <i>Measurement Availability</i>	M			
> <i>Measurement Available</i>				
>>Common Measurement Value	M		9.2.1.12D	
> <i>Measurement not Available</i>			NULL	

9.2.1.12F Common Transport Channel Resources Initialisation Not Required

If present, this IE indicates that as far as the DRNC is concerned, there is no need to initiate a Common Transport Channel Resources Initialisation procedure if the SRNC wants to allocate common transport channel resources in the new cell.

IE/Group Name	Presence	Range	IE Type and Reference	Semantics Description
Common Transport Channel Resources Initialisation Not Required			ENUMERATED(Not Required)	

9.2.1.12G Coverage Indicator

The Coverage Indicator indicates whether the serving and the neighbouring cell are overlapped, i.e. the cells have approximately same coverage area or whether the neighbouring cell covers or contained in the serving cell.

IE/Group Name	Presence	Range	IE Type and Reference	Semantics Description
Coverage Indicator			ENUMERATED(Overlap, Covers, Contained in,...)	

9.2.1.13 Criticality Diagnostics

The *Criticality Diagnostics* IE is sent by an RNC when parts of a received message have not been comprehended or were missing, or if the message contained logical errors. When applicable, it contains information about which IEs that were not comprehended or were missing.

For further details on how to use the *Criticality Diagnostics* IE, see Annex C.

IE/Group Name	Presence	Range	IE Type and Reference	Semantics Description	Criticality	Assigned Criticality
Procedure ID		0..1		Procedure ID is to be used if Criticality Diagnostics is part of Error Indication procedure, and not within the response message of the same procedure that caused the error	–	
>Procedure Code	M		INTEGER(0..255)		–	
>Ddmode	M		ENUMERATED(FDD, TDD, Common)	Common = common to FDD and TDD. Common Ddmode is also applicable for luring procedures listed in section 7.	–	
Triggering Message	O		ENUMERATED(initiating message, successful outcome, unsuccessful outcome, outcome)	The Triggering Message is used only if the Criticality Diagnostics is part of Error Indication.	–	
Procedure Criticality	O		ENUMERATED(reject, ignore, notify)	This Procedure Criticality is used for reporting the Criticality of the Triggering message (Procedure).	–	
Transaction ID	O		Transaction ID		–	
Information Element Criticality Diagnostics		<i>0..<max noof errors></i>			–	
>IE Criticality	M		ENUMERATED(reject, ignore, notify)	The IE Criticality is used for reporting the criticality of the triggering IE. The value "Ignore" shall never be used.	–	
>IE ID	M		INTEGER(0..65535)	The IE ID of the not understood or missing IE as defined in the ASN.1 part of the specification.	–	
>Repetition Number	O		INTEGER(0..255)	The <i>Repetition Number</i> IE gives <ul style="list-style-type: none"> in case of a not understood IE: The number of occurrences of the reported IE up to and including the not understood occurrence in case of a missing IE: The number of occurrences up to but not including the missing occurrence. Note: All the counted	–	

				occurrences of the reported IE must have the same topdown hierarchical message structure of IEs with assigned criticality above them.		
>Message Structure	O		9.2.1.39A	The <i>Message Structure</i> IE describes the structure in which the not understood or missing IE was detected. This IE is included if the not understood IE is not the top level of the message.	YES	ignore
>Type of Error	M		ENUMERATED(not understood, missing, ...)		YES	ignore

Range bound	Explanation
<i>maxnooferrors</i>	Maximum number of IE errors allowed to be reported with a single message.

9.2.1.14 C-RNTI

C-RNTI (Cell RNTI) is the UE identifier allocated by the DRNS to be used over the radio interface. It is unique in the cell. One UE Context has one unique C-RNTI value allocated in the DRNS.

IE/Group Name	Presence	Range	IE Type and Reference	Semantics Description
C-RNTI			INTEGER(0..65535)	

9.2.1.14A CTFC

The CTFC is an integer number calculated in accordance with TS 25.331 [16], subclause 14.10. Regarding the channel ordering, for all transport channels, 'TrCH1' corresponds to the transport channel having the lowest transport channel identity among all configured transport channels on this CCTrCH. 'TrCH2' corresponds to the transport channel having the next lowest transport channel identity, and so on.

IE/Group Name	Presence	Range	IE Type and Reference	Semantics Description
CHOICE <i>CTFC Format</i>				
>2 bits long				
>>CTFC value	M		INTEGER (0..3)	
>4 bits long				
>>CTFC value	M		INTEGER (0..15)	
>6 bits long				
>>CTFC value	M		INTEGER (0..63)	
>8 bits long				
>>CTFC value	M		INTEGER (0..255)	
>12 bits long				
>>CTFC value	M		INTEGER (0..4095)	
>16 bits long				
>>CTFC value	M		INTEGER (0..65535)	
>max nb bits long				
>>CTFC value	M		INTEGER (0..maxCTFC)	

Range Bound	Explanation
MaxCTFC	Maximum number of the CTFC value is calculated according to the following: $\sum_{i=1}^I (L_i - 1)P_i$ with the notation according to ref. TS 25.331 [16]

9.2.1.15 DCH Combination Indicator

Void

9.2.1.16 DCH ID

The DCH ID is the identifier of an active dedicated transport channel. It is unique for each active DCH among the active DCHs simultaneously allocated for the same UE.

IE/Group Name	Presence	Range	IE Type and Reference	Semantics Description
DCH ID			INTEGER (0..255)	

9.2.1.16A DCH Information Response

The *DCH Information* IE provides information for DCHs that have been established or modified.

IE/Group Name	Presence	Range	IE Type and Reference	Semantics Description	Criticality	Assigned Criticality
DCH Information Response		1..<maxno ofDCHs>		Several DCHs belonging to the same set of coordinated DCHs may be included.	–	
>DCH ID	M		9.2.1.16		–	
>Binding ID	O		9.2.1.3		–	
>Transport Layer Address	O		9.2.1.62		–	
>Allowed Rate Information	O		9.2.1.2A		YES	ignore
>Transport Bearer Not Setup Indicator	O		9.2.2.4T	FDD Only	YES	Ignore

Range bound	Explanation
<i>maxnoofDCHs</i>	Maximum number of DCHs for one UE.

9.2.1.17 Dedicated Measurement Object Type

Void.

9.2.1.18 Dedicated Measurement Type

The Dedicated Measurement Type identifies the type of measurement that shall be performed.

IE/Group Name	Presence	Range	IE Type and Reference	Semantics Description
Dedicated Measurement Type			ENUMERATED(SIR, SIR Error, Transmitted Code Power, RSCP, Rx Timing Deviation, Round Trip Time, ..., Rx Timing Deviation LCR, Angle Of Arrival LCR, HS-SICH Reception Quality, Rx Timing Deviation 768, Rx Timing Deviation 384 Extended)	RSCP and HS-SICH Receptions Quality are used by TDD only, Rx Timing Deviation and Rx Timing Deviation 384 Extended are used by 3.84 Mcps TDD only, Rx Timing Deviation LCR is used by 1.28 TDD only, Round Trip Time, SIR Error are used by FDD only. Angle Of Arrival LCR is used by 1.28Mcps TDD only. Rx Timing Deviation 768 is used by 7.68Mcps TDD only.

NOTE: For definitions of the measurement types refer to ref. TS 25.215 [11] and TS 25.225 [14].

9.2.1.19 Dedicated Measurement Value

The Dedicated Measurement Value shall be the most recent value for this measurement, for which the reporting criteria were met.

IE/Group Name	Presence	Range	IE Type and Reference	Semantics Description	Criticality	Assigned Criticality
CHOICE <i>Dedicated Measurement Value</i>	M				–	
> <i>SIR Value</i>					–	
>> <i>SIR Value</i>	M		INTEGER(0..63)	According to mapping in ref. TS 25.133 [23] and TS 25.123 [24]	–	
> <i>SIR Error Value</i>				FDD Only	–	
>> <i>SIR Error Value</i>	M		INTEGER(0..125)	According to mapping in TS 25.133 [23]	–	
> <i>Transmitted Code Power Value</i>					–	
>> <i>Transmitted Code Power Value</i>	M		INTEGER(0..127)	According to mapping in ref. TS 25.133 [23] and TS 25.123 [24] Values 0 to 9 and 123 to 127 shall not be used.	–	
> <i>RSCP</i>				TDD Only	–	
>> <i>RSCP</i>	M		INTEGER(0..127)	According to mapping in ref. TS 25.123 [24]	–	
> <i>Rx Timing Deviation Value</i>				3.84Mcps TDD Only	–	
>> <i>Rx Timing Deviation</i>	M		INTEGER(0..8191)	According to mapping in TS 25.123 [24]	–	
> <i>Round Trip Time</i>				FDD Only	–	
>> <i>Round Trip Time</i>	M		INTEGER(0..32767)	According to mapping in TS 25.133 [23]	–	
> <i>Additional Dedicated Measurement Values</i>					–	
>> <i>Rx Timing Deviation Value LCR</i>				1.28Mcps TDD Only	YES	reject
>>> <i>Rx Timing Deviation LCR</i>	M		INTEGER(0..511)	According to mapping in TS 25.123 [24]	–	
>> <i>Angle of Arrival Value LCR</i>				1.28Mcps TDD only	YES	reject
>>> <i>AOA LCR</i>	M		INTEGER(0..719)	According to mapping in TS 25.123 [24]	–	
>>> <i>AOA LCR Accuracy Class</i>	M		ENUMERATED(A, B, C, D, E, F, G, H,...)	According to mapping in TS 25.123 [24]	–	
>> <i>HS-SICH reception quality</i>				Applicable to TDD only	–	
>>> <i>HS-SICH reception quality Value</i>		1			YES	reject

>>>>Failed HS-SICH	M		INTEGER (0..20)	According to mapping in TS 25.123 [24]	–	
>>>Missed HS-SICH	M		INTEGER (0..20)	According to mapping in TS 25.123 [24]	–	
>>>Total HS-SICH	M		INTEGER (0..20)	According to mapping in TS 25.123 [24]	–	
>>Rx Timing Deviation Value 7.68Mcps				7.68Mcps TDD Only	YES	reject
>>>Rx Timing Deviation 7.68Mcps	M		INTEGER(0..65535)	According to mapping in TS 25.123 [24]	–	
>>Rx Timing Deviation Value 3.84Mcps Extended				3.84 Mcps TDD Only	YES	reject
>>>Rx Timing Deviation 3.84Mcps Extended	M		INTEGER(0..32767)	According to mapping in TS 25.123 [24]	–	
>>Extended Round Trip Time				FDD Only	YES	ignore
>>>Extended Round Trip Time Value	M		INTEGER (32767..103041)	Continuation of intervals with step size as defined in TS 25.133 [23].	–	

9.2.1.19A Dedicated Measurement Value Information

The *Dedicated Measurement Value Information* IE provides information both on whether or not the Dedicated Measurement Value is provided in the message and if provided also the Dedicated Measurement Value itself.

IE/Group Name	Presence	Range	IE Type and Reference	Semantics Description	Criticality	Assigned Criticality
CHOICE <i>Measurement Availability Indicator</i>	M				–	
> <i>Measurement Available</i>					–	
>>Dedicated Measurement Value	M		9.2.1.19		–	
>>CFN	O		9.2.1.9	Dedicated Measurement Time Reference	–	
> <i>Measurement not Available</i>			NULL		–	

9.2.1.19Aa Delayed Activation

The *Delayed Activation* IE indicates that the activation of the DL power shall be delayed until an indicated CFN or until a separate activation indication is received.

IE/Group Name	Presence	Range	IE Type and Reference	Semantics Description
CHOICE <i>Delayed Activation</i>	M			
> <i>CFN</i>				
>> <i>Activation CFN</i>	M		CFN 9.2.1.7	
> <i>Separate Indication</i>			NULL	

9.2.1.19Ab Delayed Activation Update

The *Delayed Activation Update* IE indicates a change of the activation of the DL power for a specific RL.

IE/Group Name	Presence	Range	IE Type and Reference	Semantics Description
CHOICE <i>Delayed Activation Update</i>	M			
> <i>Activate</i>				
>>CHOICE <i>Activation Type</i>	M			
>>> <i>Synchronised</i>				
>>>>Activation CFN	M		CFN 9.2.1.7	
>>>> <i>Unsynchronised</i>			NULL	
>>Initial DL TX Power	M		DL Power 9.2.1.21	
>>First RLS Indicator	O		9.2.2.16A	FDD Only
>>Propagation Delay	O		9.2.2.35	FDD Only
>>Extended Propagation Delay	O		9.2.2.33a	FDD Only
> <i>Deactivate</i>				
>>CHOICE <i>Deactivation type</i>	M			
>>> <i>Synchronised</i>				
>>>>Deactivation CFN	M		CFN 9.2.1.7	
>>>> <i>Unsynchronised</i>			NULL	

9.2.1.19B DGPS Corrections

The *DGPS Corrections* IE contains DGPS information used by the UE Positioning A-GPS method. For further details on the meaning of parameters, see RTCM-SC104 [31].

IE/Group Name	Presence	Range	IE Type and Reference	Semantics Description	Criticality	Assigned Criticality
GPS TOW	M		INTEGER(0..604799)	Time in seconds. This field indicates the baseline time for which the corrections are valid	-	
Status/Health	M		ENUMERATED (UDRE scale 1.0, UDRE scale 0.75, UDRE scale 0.5, UDRE scale 0.3, UDRE scale 0.1, no data, invalid data)	This field indicates the status of the differential corrections	-	
Satellite DGPS Corrections Information		<i>1..<maxNoSat></i>			-	
>SatID	M		SAT ID 9.2.1.50A		-	
>IODE	M		BIT STRING(8)	This IE is the sequence number for the ephemeris for the particular satellite. It can be used to determine if new ephemeris is used for calculating the corrections that are provided. This eight-bit IE is incremented for each new set of ephemeris for the satellite and may occupy the numerical range of [0, 239] during normal operations.	-	
>UDRE	M		ENUMERATED (UDRE ≤1.0m, 1.0m < UDRE ≤ 4.0m, 4.0m < UDRE ≤ 8.0m, 8.0m < UDRE,...)	User Differential Range Error. This field provides an estimate of the uncertainty (1-σ) in the corrections for the particular satellite. The value in this field shall be multiplied by the UDRE Scale Factor in the common Corrections Status/Health field to determine the final UDRE estimate for the particular satellite	-	
>PRC	M		INTEGER(-2047..2047)	Scaling factor 0.32 meters	-	
>Range Correction Rate	M		INTEGER(-127..127)	Scaling factor 0.032 m/s	-	
>DGNSS Validity Period	O		9.2.1.138		YES	ignore

Range Bound	Explanation
<i>maxNoSat</i>	Maximum number of satellites for which information can be provided

9.2.1.19C Discard Timer

The *Discard Timer* IE defines the time to live for a MAC-hs SDU starting from the instant of its arrival into an HSDPA Priority Queue. The DRNS shall use this information to discard out-of-date MAC-hs SDUs from the HSDPA Priority Queues.

IE/Group Name	Presence	Range	IE type and reference	Semantics description
Discard Timer			ENUMERATED (20, 40, 60, 80, 100, 120, 140, 160, 180, 200, 250, 300, 400, 500, 750, 1000, 1250, 1500, 1750, 2000, 2500, 3000, 3500, 4000, 4500, 5000, 7500, ...)	Unit: ms

9.2.1.20 Diversity Control Field

The Diversity Control Field indicates if the current RL may, must or must not be combined with the already existing RLs.

IE/Group Name	Presence	Range	IE Type and Reference	Semantics Description
Diversity Control Field			ENUMERATED (May, Must, Must not, ...)	

9.2.1.21 Diversity Indication

Void.

9.2.1.21A DL Power

The *DL Power* IE indicates a power level relative to the [FDD – primary CPICH power] [TDD – PCCPCH power] configured in a cell. [FDD – If referred to a DPCH, it indicates the power of the transmitted DPDCH symbols. If referred to an F-DPCH, it indicates the Reference F-DPCH TX Power.] If Transmit Diversity is applied to a downlink physical channel, the *DL Power* IE indicates the power offset between the linear sum of the power for this downlink physical channel on all branches and the [FDD – primary CPICH power] [TDD – PCCPCH power] configured in a cell.

[TDD – If referred to a DPCH, it indicates the power of a spreading factor 16 code, the power for a spreading factor 1 code would be 12 dB higher.]

IE/Group Name	Presence	Range	IE Type and Reference	Semantics Description
DL Power			INTEGER (-350..150)	Value = DL Power /10 Unit dB Range -35.0 .. +15.0 Step 0.1dB

9.2.1.22 Downlink SIR Target

Void

9.2.1.23 DPCH Constant Value

DPCH Constant Value is the power margin used by a UE to set the proper uplink power.

IE/Group Name	Presence	Range	IE Type and Reference	Semantics Description
DPCH Constant Value			INTEGER (-10..10)	Unit dB Granularity 1 dB.

9.2.1.24 D-RNTI

The D-RNTI identifies the UE Context in the DRNC.

IE/Group Name	Presence	Range	IE Type and Reference	Semantics Description
D-RNTI			INTEGER(0..20-1)	

9.2.1.25 D-RNTI Release Indication

The D-RNTI Release Indication indicates whether or not a DRNC shall release the D-RNTI allocated for a particular UE.

IE/Group Name	Presence	Range	IE Type and Reference	Semantics Description
D-RNTI Release Indication			ENUMERATED(Release D-RNTI, not Release D-RNTI)	

9.2.1.26 DRX Cycle Length Coefficient

The DRX Cycle Length Coefficient is used as input for the formula to establish the paging occasions to be used in DRX.

IE/Group Name	Presence	Range	IE Type and Reference	Semantics Description
DRX Cycle Length Coefficient			INTEGER (3..9)	Refers to 'k' in the formula as specified in ref. TS 25.304 [15], Discontinuous Reception.

9.2.1.26A DSCH ID

Void.

9.2.1.26Aa DSCH Initial Window Size

Void.

9.2.1.26B DSCH Flow Control Information

Void.

9.2.1.26Ba DSCH-RNTI

Void.

9.2.1.26Bb Extended GSM Cell Individual Offset

Extended GSM Cell individual offset is an offset that will be applied by UE to the measurement results for GSM carrier RSSI according to TS 25.331 [16]. It shall be used when the offset exceeds the range of values that can be indicated using the *Cell Individual Offset* IE (Subclause 9.2.1.7).

IE/Group Name	Presence	Range	IE Type and Reference	Semantics Description
Extended GSM Cell Individual Offset			INTEGER (-50..-11 11..50)	Unit in dB. Step size is 1 dB.

9.2.1.26C FACH Flow Control Information

The *FACH Flow Control Information* IE provides flow control information for each scheduling priority class for the FACH FP over Iur.

IE/Group Name	Presence	Range	IE Type and Reference	Semantics Description	Criticality	Assigned Criticality
FACH Flow Control Information		1..16			–	
>FACH Scheduling Priority	M		Scheduling Priority Indicator 9.2.1.51A		–	
>MAC-c/sh SDU Length		1..<maxNb MAC-c/shSDULength>			–	
>>MAC-c/sh SDU Length	M		9.2.1.34		–	
>FACH Initial Window Size	M		9.2.1.27		–	

Range bound	Explanation
maxNbMAC-c/shSDULength	Maximum number of different MAC-c/sh SDU lengths.

9.2.1.27 FACH Initial Window Size

Indicates the initial number of MAC-c/sh SDUs that may be transmitted before an acknowledgement is received from the DRNC.

IE/Group Name	Presence	Range	IE Type and Reference	Semantics Description
FACH Initial Window Size			INTEGER(0..255)	Number of frames (MAC-c/sh SDUs.) 255 = Unlimited number of FACH data frames.

9.2.1.28 FACH Priority Indicator

Void

9.2.1.28A FN Reporting Indicator

Frame Number reporting indicator.

Indicates if the SFN or CFN shall be included together with the reported measurement value.

IE/Group Name	Presence	Range	IE Type and Reference	Semantics Description
FN reporting indicator			ENUMERATED(FN reporting required, FN reporting not required)	

9.2.1.29 Frame Handling Priority

This parameter indicates the priority level to be used during the lifetime of the DCH, [TDD – DSCH] for temporary restriction of the allocated resources due overload reason.

IE/Group Name	Presence	Range	IE Type and Reference	Semantics Description
Frame Handling Priority			INTEGER (0..15)	0=Lowest Priority, ... 15=Highest Priority

9.2.1.30 Frame Offset

Frame Offset is the required offset between the dedicated channel downlink transmission frames (CFN, Connection Frame Number) and the broadcast channel frame offset (Cell Frame Number). The Frame Offset is used in the translation between Connection Frame Number (CFN) on Iub/Iur and least significant 8 bits of SFN (System Frame Number) on Uu. The Frame Offset is UE and cell specific.

IE/Group Name	Presence	Range	IE Type and Reference	Semantics Description
Frame Offset			INTEGER (0..255)	Frames

9.2.1.30A GA Point with Uncertainty

This IE contains one of the possible descriptions of a Cell Geographical Area.

IE/Group Name	Presence	Range	IE Type and Reference	Semantics Description
Geographical Coordinates	M		9.2.1.30F	
Uncertainty Code	M		INTEGER(0..127)	The uncertainty "r" is derived from the "uncertainty code" k by $r = 10 \times (1.1^k - 1)$

9.2.1.30B GA Ellipsoid Point with Uncertainty Ellipse

This IE contains one of the possible descriptions of a Cell Geographical Area.

IE/Group Name	Presence	Range	IE Type and Reference	Semantics Description
Geographical Coordinates	M		9.2.1.30F	
Uncertainty Ellipse	M		9.2.1.68A	
Confidence	M		INTEGER(0..127)	

9.2.1.30C GA Ellipsoid Point with Altitude

This IE contains one of the possible descriptions of a Cell Geographical Area.

IE/Group Name	Presence	Range	IE Type and Reference	Semantics Description
Geographical Coordinates	M		9.2.1.30F	
Altitude and direction	M		9.2.1.2B	

9.2.1.30D GA Ellipsoid Point with Altitude and Uncertainty Ellipsoid

This IE contains one of the possible descriptions of a Cell Geographical Area.

IE/Group Name	Presence	Range	IE Type and Reference	Semantics Description
Geographical Coordinates	M		9.2.1.30F	
Altitude and direction	M		9.2.1.2B	
Uncertainty Ellipse	M		9.2.1.68A	
Uncertainty Altitude	M		INTEGER(0..127)	
Confidence	M		INTEGER(0..127)	

9.2.1.30E GA Ellipsoid Arc

This IE contains one of the possible descriptions of a Cell Geographical Area.

IE/Group Name	Presence	Range	IE Type and Reference	Semantics Description
Geographical Coordinates	M		9.2.1.30F	
Inner radius	M		INTEGER(0..2 ¹⁶ -1)	The relation between the value (N) and the radius l in meters it describes is $5N \leq r < 5(N+1)$, except for $N=2^{16}-1$ for which the range is extended to include all greater values of l.
Uncertainty radius	M		INTEGER(0..127)	The uncertainty "r" is derived from the "uncertainty code" k by $r = 10 \times (1.1^k - 1)$
Offset angle	M		INTEGER(0..179)	The relation between the value (N) and the angle (a) in degrees it describes is $2N \leq a < 2(N+1)$
Included angle	M		INTEGER(0..179)	The relation between the value (N) and the angle (a) in degrees it describes is $2N < a \leq 2(N+1)$
Confidence	M		INTEGER(0..127)	

9.2.1.30F Geographical Coordinates

This IE contains the description of geographical coordinates.

IE/Group Name	Presence	Range	IE Type and Reference	Semantics Description
Latitude Sign	M		ENUMERATED(North, South)	
Degrees Of Latitude	M		INTEGER(0..2 ²³ -1)	The IE value (N) is derived by this formula: $N \leq 2^{23} \times X / 90 < N+1$ X being the latitude in degree (0°.. 90°)
Degrees Of Longitude	M		INTEGER(-2 ²³ ..2 ²³ -1)	The IE value (N) is derived by this formula: $N \leq 2^{24} \times X / 360 < N+1$ X being the longitude in degree (-180°..+180°)

9.2.1.30Fa GERAN Cell Capability

The *GERAN Cell Capability* IE is used to transfer the capabilities of a certain GERAN cell via the Iur interface.

IE/Group Name	Presence	Range	IE type and reference	Semantics description
GERAN Cell Capability	M		BIT STRING (16)	Each bit indicates whether a cell supports a particular functionality or not. The value 1 of a bit indicates that the corresponding functionality is supported in a cell and value 0 indicates that the corresponding functionality is not supported in a cell. Each bit is defined as follows. The first bit: A/Gb mode. The second bit: Iu mode. Note that undefined bits are considered as a spare bit and spare bits shall be set to 0 by the transmitter and shall be ignored by the receiver.

9.2.1.30Fb GERAN Classmark

The *GERAN Classmark* IE is used to transfer the capabilities of a certain GERAN Iu-mode capable cell via the Iur interface.

IE/Group Name	Presence	Range	IE type and reference	Semantics description
GERAN Classmark	M		OCTET STRING	Contents defined in TS 48.008 [38]

9.2.1.30Fc GERAN System Information

The *GERAN System Information* IE provides GERAN specific information.

IE/Group Name	Presence	Range	IE Type and Reference	Semantics Description
GERAN System Info		<i>1..<maxNrOfGERANSI></i>		
>GERAN System Info Block	M		OCTET STRING (1..23)	The first octet contains octet 1 of the GERAN system information block, the second octet contains octet 2 of the GERAN system information block and so on.

Range bound	Explanation
<i>maxNrOfGERANSI</i>	Maximum number of GERAN SI blocks that can be provided as part of NACC information

9.2.1.30G GPS Almanac

This IE provides the information regarding the GPS Almanac. For further details on the meaning of parameters, see ICD-GPS-200 [30].

IE/Group name	Presence	Range	IE Type and Reference	Semantics Description
WN _a	M		BIT STRING(8)	
Satellite Almanac Information	M	<i>1..<maxNoOfSatAlmanac></i>		See Note 1.
>DataID	M		INTEGER (0..3)	
>SatID	M		SAT ID 9.2.1.50A	
>e	M		BIT STRING(16)	
>t _{oa}	M		BIT STRING(8)	
>δi	M		BIT STRING(16)	
>OMEGADOT	M		BIT STRING(16)	
>SV Health	M		BIT STRING(8)	
>A ^{1/2}	M		BIT STRING(24)	
>OMEGA ₀	M		BIT STRING(24)	
>M ₀	M		BIT STRING(24)	
>ω	M		BIT STRING(24)	
>af ₀	M		BIT STRING(11)	
>af ₁	M		BIT STRING(11)	
SV Global Health	O		BIT STRING(364)	
Note 1: This information element is a simplified representation of the ASN.1 description. Repetitions 1 through maxNoSat and repetitions maxNoSat+1 through maxNoOfSatAlmanac are represented by separate ASN.1 structures with different criticality.				

Range Bound	Explanation
<i>maxNoOfSatAlmanac</i>	Maximum number of satellite almanacs for which information can be provided

9.2.1.30H GPS Ionospheric Model

This IE provides the information regarding the GPS Ionospheric Model. For further details on the meaning of parameters, see ICD-GPS-200 [30].

IE/Group Name	Presence	Range	IE Type and Reference	Semantics Description
α_0	M		BIT STRING(8)	
α_1	M		BIT STRING(8)	
α_2	M		BIT STRING(8)	
α_3	M		BIT STRING(8)	
β_0	M		BIT STRING(8)	
β_1	M		BIT STRING(8)	
β_2	M		BIT STRING(8)	
β_3	M		BIT STRING(8)	

9.2.1.30I GPS Navigation Model and Time Recovery

This IE contains subframes 1 to 3 of the GPS navigation message. For further details on the meaning of parameters, see ICD-GPS-200 [30].

IE/Group Name	Presence	Range	IE Type and Reference	Semantics Description
Navigation Message 1to3		<i>1..<maxNoSat></i>		
>Transmission TOW	M		INTEGER0..1048575)	Time of the Week when the message is broadcast.
>SatID	M		SAT ID 9.2.1.50A	
>TLM Message	M		BIT STRING(14)	
>TIm Revd I	M		BIT STRING(2)	
>HO-Word	M		BIT STRING(22)	
>WN	M		BIT STRING(10)	
>C/A or P on L2	M		BIT STRING(2)	
>User Range Accuracy Index	M		BIT STRING(4)	
>SV Health	M		BIT STRING(6)	
>IODC	M		BIT STRING(10)	
>L2 P Data Flag	M		BIT STRING(1)	
>SF 1 Reserved	M		BIT STRING(87)	
>T _{GD}	M		BIT STRING(8)	
>t _{OC}	M		BIT STRING(16)	
>af ₂	M		BIT STRING(8)	
>af ₁	M		BIT STRING(16)	
>af ₀	M		BIT STRING(22)	
>C _{rs}	M		BIT STRING(16)	
>Δn	M		BIT STRING(16)	
>M ₀	M		BIT STRING(32)	
>C _{uc}	M		BIT STRING(16)	
>e	M		BIT STRING(32)	
>C _{us}	M		BIT STRING(16)	
>(A) ^{1/2}	M		BIT STRING(32)	
>t _{oe}	M		BIT STRING(16)	
>Fit Interval Flag	M		BIT STRING(1)	
>AODO	M		BIT STRING(5)	
>C _{ic}	M		BIT STRING(16)	
>OMEGA ₀	M		BIT STRING(32)	
>C _{is}	M		BIT STRING(16)	
>i ₀	M		BIT STRING(32)	
>C _{rc}	M		BIT STRING(16)	
>ω	M		BIT STRING(32)	
>OMEGA _{dot}	M		BIT STRING(24)	
>Idot	M		BIT STRING(14)	
>Spare/zero fill	M		BIT STRING(20)	

Range Bound	Explanation
<i>maxNoSat</i>	Maximum number of satellites for which information can be provided

9.2.1.30J GPS Real-Time Integrity

This IE provides the information regarding the status of the GPS constellation. For further details on the meaning of parameters, see ICD-GPS-200 [30].

IE/Group name	Presence	Range	IE Type and Reference	Semantics Description
<i>CHOICE Bad Satellites Presence</i>	M			
> <i>Bad Satellites</i>				
>> Satellite Information		<i>1..<maxNoSat></i>		
>>>BadSatID	M		SAT ID 9.2.1.50A	
> <i>No Bad Satellites</i>			NULL	

Range Bound	Explanation
<i>MaxNoSat</i>	Maximum number of satellites for which information can be provided

9.2.1.30K GPS Receiver Geographical Position (GPS RX Pos)

The GPS Receiver Geographical Position is used to identify the geographical coordinates of a GPS receiver relevant for a certain Information Exchange Object.

IE/Group Name	Presence	Range	IE Type and Reference	Semantics Description
Geographical Coordinates	M		9.2.1.30F	
Altitude and direction	M		9.2.1.2B	

9.2.1.30L GPS UTC Model

This IE provides the information regarding the GPS UTC Model. For further details on the meaning of parameters, see ICD-GPS-200 [30].

IE/Group name	Presence	Range	IE Type and Reference	Semantics Description
A_1	M		BIT STRING(24)	
A_0	M		BIT STRING(32)	
t_{tot}	M		BIT STRING(8)	
Δt_{LS}	M		BIT STRING(8)	
WN_t	M		BIT STRING(8)	
WN_{LSF}	M		BIT STRING(8)	
DN	M		BIT STRING(8)	
Δt_{LSF}	M		BIT STRING(8)	

9.2.1.30M Guaranteed Rate Information

The *Guaranteed Rate Information* IE indicates the TFI corresponding to the guaranteed bit rate for the uplink and/or the downlink of a DCH.

IE/Group Name	Presence	Range	IE Type and Reference	Semantics Description
Guaranteed UL Rate	O		INTEGER(1. .maxTFcount)	"1": TFI 0, "2": TFI 1, "3": TFI 2, ...
Guaranteed DL Rate	O		INTEGER(1. .maxTFcount)	"1": TFI 0, "2": TFI 1, "3": TFI 2, ...

9.2.1.30N HCS Prio

The HCS Prio is the characteristics of the cell as defined in TS 25.304 [15].

IE/Group Name	Presence	Range	IE Type and Reference	Semantics Description
HCS Prio			INTEGER (0..7)	0=Lowest Priority, ... 7=Highest Priority

9.2.1.30NA HS-DSCH Information To Modify Unsynchronised

The *HS-DSCH Information To Modify Unsynchronised* IE is used for modification of HS-DSCH information in a UE Context with the Unsynchronised Radio Link Reconfiguration procedure.

IE/Group Name	Presence	Range	IE Type and Reference	Semantics Description	Criticality	Assigned Criticality
HS-DSCH MAC-d Flow Specific Information		<i>0..<maxn oofMACd Flows></i>			–	
>HS-DSCH MAC-d Flow ID	M		9.2.1.300		–	
>Allocation/Retention Priority	O		9.2.1.1		–	
>Transport Bearer Request Indicator	M		9.2.1.61		–	
>Traffic Class	O		9.2.1.58A		–	
>Binding ID	O		9.2.1.3	Shall be ignored if bearer establishment with ALCAP.	–	
>Transport Layer Address	O		9.2.1.62	Shall be ignored if bearer establishment with ALCAP.	–	
>TNL QoS	O		9.2.1.56A	Shall be ignored if bearer establishment with ALCAP.	YES	ignore
Priority Queue Information		<i>0..<maxn oofPrioQ ueues></i>			–	
>Priority Queue ID	M		9.2.1.45A		–	
>Scheduling Priority Indicator	O		9.2.1.51A		–	
>Discard Timer	O		9.2.1.19C		–	
>MAC-hs Guaranteed Bit Rate	O		9.2.1.34Aa		–	
CQI Power Offset	O		9.2.2.24b	For FDD only	–	
ACK Power Offset	O		9.2.2.b	For FDD only	–	
NACK Power Offset	O		9.2.2.26a	For FDD only	–	
HS-SCCH Power Offset	O		9.2.2.19d	For FDD only	–	
TDD ACK NACK Power Offset	O		9.2.3.7l	For TDD only	–	
HARQ Preamble Mode	O		9.2.2.57	For FDD only	YES	ignore
MIMO Mode Indicator	O		9.2.1.135	For FDD and 1.28Mcps TDD only	YES	reject
Sixtyfour QAM Usage Allowed Indicator	O		9.2.2.79A	For FDD only	YES	ignore
Enhanced HS Serving CC Abort	O		ENUMERATED (Abort Enhanced HS Serving CC, ...)	For FDD only	YES	reject
UE Support Indicator Extension	O		9.2.2.103		YES	ignore
Power Offset For S-CPICH for MIMO Request Indicator	O		9.2.2.105	For FDD only	YES	ignore
Single Stream MIMO Mode Indicator	O		9.2.2.107	For FDD only	YES	reject

9.2.1.30Na HS-DSCH Initial Capacity Allocation

The *HS-DSCH Initial Capacity Allocation* IE provides flow control information for each scheduling priority class for the HS-DSCH FP over Iur.

IE/Group Name	Presence	Range	IE Type and Reference	Semantics Description	Criticality	Assigned Criticality
HS-DSCH Initial Capacity Allocation		1..< <i>maxnoofPrioQueues</i> >			–	
>Scheduling Priority Indicator	M		9.2.1.51A		–	
>Maximum MAC-d PDU Size	M		MAC-d PDU Size 9.2.1.34A	Shall be ignored if <i>Maximum MAC-d PDU Size Extended</i> IE is present.	–	
>HS-DSCH Initial Window Size	M		9.2.1.30Nb		–	
>Maximum MAC-d PDU Size Extended	O		MAC PDU Size Extended 9.2.1.34D		YES	ignore

Range Bound	Explanation
<i>maxnoofPrioQueues</i>	Maximum number of Priority Queues

9.2.1.30Nb HS-DSCH Initial Window Size

Indicates the initial number of MAC-d PDUs (or octets in case *HS-DSCH MAC-d PDU Size Format* = “Flexible MAC-d PDU Size”) that may be transmitted before new credits are received from the DRNC.

IE/Group Name	Presence	Range	IE type and reference	Semantics description
HS-DSCH Initial Window Size			INTEGER (1..255)	Number of MAC-d PDUs If <i>HS-DSCH MAC-d PDU Size Format</i> = “Flexible MAC-d PDU Size” the credit shall be determined in octets: credit (in octets) = <i>Maximum MAC-d PDU Size extended</i> * <i>HS-DSCH Initial Window Size</i>

9.2.1.30O HS-DSCH MAC-d Flow ID

HS-DSCH MAC-d Flow ID is the unique identifier for one MAC-d flow.

IE/Group Name	Presence	Range	IE Type and Reference	Semantics Description
HS-DSCH MAC-d Flow ID			INTEGER (0..7)	

9.2.1.30OA HS-DSCH MAC-d Flows Information

The *HS-DSCH MAC-d Flows Information* IE is used for the establishment of HS-DSCH MAC-d flows for a UE Context.

IE/Group Name	Presence	Range	IE Type and Reference	Semantics Description	Criticality	Assigned Criticality
HS-DSCH MAC-d Flow Specific Information		<i>1..<maxn oofMACd Flows></i>			–	
>HS-DSCH MAC-d Flow ID	M		9.2.1.300		–	
>Allocation/Retention Priority	M		9.2.1.1		–	
>Traffic Class	M		9.2.1.58A		–	
>Binding ID	O		9.2.1.3	Shall be ignored if bearer establishment with ALCAP.	–	
>Transport Layer Address	O		9.2.1.62	Shall be ignored if bearer establishment with ALCAP.	–	
>TNL QoS	O		9.2.1.56A	Shall be ignored if bearer establishment with ALCAP.	YES	ignore
>TrCH Source Statistics Descriptor	O		9.2.1.65		YES	ignore
Priority Queue Information		<i>1..<maxn oofPrioQueues></i>			–	
>Priority Queue ID	M		9.2.1.45A		–	
>Associated HS-DSCH MAC-d Flow	M		HS-DSCH MAC-d Flow ID 9.2.1.300	The HS-DSCH MAC-d Flow ID shall be one of the flow IDs defined in the HS-DSCH MAC-d Flow Specific Information of this IE. Multiple Priority Queues can be associated with the same HS-DSCH MAC-d Flow ID.	–	
>Scheduling Priority Indicator	M		9.2.1.51A		–	
>T1	M		9.2.1.54A		–	
>Discard Timer	O		9.2.1.19C		–	
>MAC-hs Window Size	M		9.2.1.34C		–	
>MAC-hs Guaranteed Bit Rate	O		9.2.1.34Aa		–	
>MAC-d PDU Size Index		<i>1..<maxn oofMACd PDUindexes></i>			–	
>>SID	M		9.2.1.52D	Shall be ignored if <i>Maximum MAC-d PDU Size extended</i> IE is present.	–	
>>MAC-d PDU Size	M		9.2.1.34A	Shall be ignored if <i>Maximum MAC-d PDU</i>	–	

				Size extended IE is present.		
>RLC Mode	M		9.2.1.48D		–	
>Maximum MAC-d PDU Size extended	O		MAC PDU Size Extended 9.2.1.34D		YES	reject
>DL RLC PDU Size Format	O		9.2.1.136		YES	ignore
>UE Aggregate Maximum Bit Rate Enforcement Indicator	O		NULL		YES	ignore

Range Bound	Explanation
<i>maxnoofMACdFlows</i>	Maximum number of HS-DSCH MAC-d flows
<i>maxnoofPrioQueues</i>	Maximum number of Priority Queues
<i>maxnoofMACdPDUindexes</i>	Maximum number of different MAC-d PDU SIDs

9.2.1.300B HS-DSCH MAC-d Flows To Delete

The *HS-DSCH MAC-d Flows To Delete* IE is used for the removal of HS-DSCH MAC-d flows from a UE Context.

IE/Group Name	Presence	Range	IE Type and Reference	Semantics Description
HS-DSCH MAC-d Flows To Delete		1..<maxnoofMACdFlows>		
>HS-DSCH MAC-d Flow ID	M		9.2.1.300	

Range Bound	Explanation
<i>maxnoofMACdFlows</i>	Maximum number of HS-DSCH MAC-d flows

9.2.1.300C HS-DSCH MAC-d PDU Size Format

The *HS-DSCH MAC-d PDU Size Format* IE provides information about the type of MAC-d PDU Size Format used for HS-DSCH. “Indexed MAC-d PDU Size” uses MAC-d PDU sizes based on *SID* IE and *MAC-d PDU Size* IE of *MAC-d PDU Size Index* IE. “Flexible MAC-d PDU Size” uses a flexible MAC-d PDU size with a maximum PDU size as defined by *Maximum MAC-d PDU Size extended* IE of *Priority Queue Information* IE. The actual MAC-d PDU size is determined as specified in TS 25.425 [32] and TS 25.321 [41].

IE/Group Name	Presence	Range	IE Type and Reference	Semantics Description
HS-DSCH MAC-d PDU Size Format			ENUMERATED (Indexed MAC-d PDU Size, Flexible MAC-d PDU Size)	

9.2.1.300a HS-DSCH Physical Layer Category

The *HS-DSCH Physical Layer Category* IE defines a set of UE radio access capabilities related to HSDPA, as defined in 25.306 [42].

IE/Group Name	Presence	Range	IE Type and Reference	Semantics Description
HS-DSCH Physical Layer Category			INTEGER (1..64,...)	

9.2.1.30P HS-DSCH-RNTI

The HS-DSCH-RNTI is needed for the UE-specific CRC in HS-SCCH and HS-DSCH.

IE/Group Name	Presence	Range	IE Type and Reference	Semantics Description
HS-DSCH-RNTI			INTEGER (0..65535)	

9.2.1.30Q HS-DSCH Information To Modify

The *HS-DSCH Information To Modify* IE is used for modification of HS-DSCH information in a UE Context.

IE/Group Name	Presence	Range	IE Type and Reference	Semantics Description	Criticality	Assigned Criticality
HS-DSCH MAC-d Flow Specific Information		<i>0..<maxn oofMACd Flows></i>			–	
>HS-DSCH MAC-d Flow ID	M		9.2.1.30O		–	
>Allocation/Retention Priority	O		9.2.1.1		–	
>Transport Bearer Request Indicator	M		9.2.1.61		–	
>Traffic Class	O		9.2.1.58A		–	
>Binding ID	O		9.2.1.3	Shall be ignored if bearer establishment with ALCAP.	–	
>Transport Layer Address	O		9.2.1.62	Shall be ignored if bearer establishment with ALCAP.	–	
>TNL QoS	O		9.2.1.56A	Shall be ignored if bearer establishment with ALCAP.	YES	ignore
Priority Queue Information		<i>0..<maxn oofPrioQueues></i>			–	
>CHOICE <i>Priority Queue</i>	M				–	
>>Add <i>Priority Queue</i>					–	
>>>Priority Queue ID	M		9.2.1.45A		–	
>>>Associated HS-DSCH MAC-d Flow	M		HS-DSCH MAC-d Flow ID 9.2.1.30O	Shall only refer to a HS-DSCH MAC-d flow already existing in the old configuration. Multiple Priority Queues can be associated with the same HS-DSCH MAC-d Flow ID.	–	
>>>Scheduling Priority Indicator	M		9.2.1.51A		–	
>>>T1	M		9.2.1.54A		–	
>>>Discard Timer	O		9.2.1.19C		–	
>>>MAC-hs Window Size	M		9.2.1.34C		–	
>>>MAC-hs Guaranteed Bit Rate	O		9.2.1.34Aa		–	
>>>MAC-d PDU Size Index		<i>1..<maxn oofMACd PDUIndexes></i>			–	
>>>>SID	M		9.2.1.52D	Shall be ignored if <i>Maximum MAC-d PDU Size extended</i> IE is present.	–	
>>>>MAC-d PDU Size	M		9.2.1.34A	Shall be ignored if	–	

IE/Group Name	Presence	Range	IE Type and Reference	Semantics Description	Criticality	Assigned Criticality
				<i>Maximum MAC-d PDU Size extended</i> IE is present.		
>>>RLC Mode	M		9.2.1.48D		–	
>>>Maximum MAC-d PDU Size extended	O		MAC PDU Size Extended 9.2.1.34D		YES	reject
>>>DL RLC PDU Size Format	O		9.2.1.136		Yes	ignore
>>Modify Priority Queue					–	
>>>Priority Queue ID	M		9.2.1.45A	Shall only refer to a Priority Queue already existing in the old configuration.	–	
>>>Scheduling Priority Indicator	O		9.2.1.51A		–	
>>>T1	O		9.2.1.54A		–	
>>>Discard Timer	O		9.2.1.19C		–	
>>>MAC-hs Window Size	O		9.2.1.34C		–	
>>>MAC-hs Guaranteed Bit Rate	O		9.2.1.34Aa		–	
>>>MAC-d PDU Size Index		<i>0..<maximum MAC-d PDU indexes></i>			–	
>>>>SID	M		9.2.1.52D	Shall be ignored if <i>Maximum MAC-d PDU Size extended</i> IE is present.	–	
>>>>MAC-d PDU Size	M		9.2.1.34A	Shall be ignored if <i>Maximum MAC-d PDU Size extended</i> IE is present.	–	
>>>Maximum MAC-d PDU Size extended	O		MAC PDU Size Extended 9.2.1.34D		YES	reject
>>>DL RLC PDU Size Format	O		9.2.1.136		Yes	ignore
>>Delete Priority Queue					–	
>>>Priority Queue ID	M		9.2.1.45A	Shall only refer to a Priority Queue already existing in the old configuration.	–	
MAC-hs Reordering Buffer Size for RLC-UM	O		9.2.1.34Ab		–	
CQI Feedback Cycle k	O		9.2.2.24a	For FDD only	–	
CQI Repetition Factor	O		9.2.2.24c	For FDD only	–	
ACK-NACK Repetition Factor	O		9.2.2.a	For FDD only	–	
CQI Power Offset	O		9.2.2.24b	For FDD only	–	
ACK Power Offset	O		9.2.2.b	For FDD only	–	
NACK Power Offset	O		9.2.2.26a	For FDD only	–	

IE/Group Name	Presence	Range	IE Type and Reference	Semantics Description	Criticality	Assigned Criticality
HS-SCCH Power Offset	O		9.2.2.19d	For FDD only	–	
HS-SCCH Code Change Grant	O		9.2.1.30S		–	
TDD ACK NACK Power Offset	O		9.2.3.7I	For TDD only	–	
HARQ Preamble Mode	O		9.2.2.57	For FDD only	YES	ignore
HS-PDSCH Code Change Grant	O		9.2.1.30W	For FDD only	YES	ignore
MIMO Mode Indicator	O		9.2.1.135	For FDD and 1.28Mcps TDD only	YES	reject
HS-DSCH MAC-d PDU Size Format	O		9.2.1.30O C		YES	reject
Sixtyfour QAM Usage Allowed Indicator	O		9.2.2.79A	For FDD only	YES	ignore
UE Capabilities Information	O				YES	ignore
>HS-DSCH Physical Layer Category	M		9.2.1.30O a		–	
>1.28 Mcps TDD uplink physical channel capability	O		9.2.3.10D	Applicable to 1.28Mcps TDD only	YES	ignore
>Number of Supported Carriers	O		ENUMERATED (One-one carrier, One-three carrier, Three-three carrier, One-six carrier, Tree-six carrier, Six-six carrier, ...)	Applicable to 1.28Mcps TDD only This IE indicates the number of carrier that UE can support at the same time, where “ One-three carrier” means the number of supported carrier is one for the uplink, and three for the downlink.	YES	reject
>Multi-carrier HS-DSCH Physical Layer Category	O		9.2.1.30O a	Applicable to 1.28Mcps TDD only	YES	ignore
>MIMO SF Mode Supported For HS-PDSCH dual stream	O		ENUMERATED (SF1, SF1/SF16)	Applicable to 1.28Mcps TDD only	YES	ignore
>UE TS0 Capability LCR	O		ENUMERATED (TS0 Capable, TS0 Non-Capable)	Applicable to 1.28Mcps TDD only	YES	ignore
Enhanced HS Serving CC Abort	O		ENUMERATED (Abort Enhanced HS Serving CC, ...)	For FDD only	YES	reject
UE Support Indicator Extension	O		9.2.2.103		YES	ignore
Power Offset For S-CPICH for MIMO Request Indicator	O		9.2.2.105	For FDD only	YES	ignore
Single Stream MIMO Mode Indicator	O		9.2.2.107	For FDD only	YES	reject

Range bound	Explanation
<i>maxnoofMACdFlows</i>	Maximum number of MAC-d flows.
<i>maxnoofPrioQueues</i>	Maximum number of Priority Queues.
<i>maxnoofMACdPDUIndexes</i>	Maximum number of MAC-d PDU Size Indexes (SIDs).

9.2.1.30R HS-SCCH Code Change Indicator

The HS-SCCH Code Change Indicator indicates whether the HS-SCCH Code change is needed or not.

IE/Group Name	Presence	Range	IE type and reference	Semantics description
HS-SCCH Code Change Indicator			ENUMERATED (HS-SCCH Code Change needed)	

9.2.1.30S HS-SCCH Code Change Grant

The *HS-SCCH Code Change Grant* IE indicates that modification of HS-SCCH Codes is granted.

IE/Group Name	Presence	Range	IE Type and Reference	Semantics Description
HS-SCCH Code Change Grant			ENUMERATED (Change Granted)	

9.2.1.30T IMEI

The IMEI is a permanent UE Equipment Identity, see ref. TS 23.003 [1].

IE/Group Name	Presence	Range	IE Type and Reference	Semantics Description
IMEI			OCTET STRING (SIZE (8))	<ul style="list-style-type: none"> - hexadecimal digits 0 to F, two hexadecimal digits per octet, - each hexadecimal digit encoded 0000 to 1111, - 1111 used as filler for bits 8 to 5 of last octet - bit 4 to 1 of octet n encoding digit 2n-1 - bit 8 to 5 of octet n encoding digit 2n <p>Number of hexadecimal digits shall be 15.</p>

9.2.1.30U IMEISV

The IMEISV is a permanent UE Equipment Identity, see ref. TS 23.003 [1].

IE/Group Name	Presence	Range	IE Type and Reference	Semantics Description
IMEISV			OCTET STRING (SIZE (8))	<ul style="list-style-type: none"> - hexadecimal digits 0 to F, two hexadecimal digits per octet, - each hexadecimal digit encoded 0000 to 1111, - 1111 used as filler for bits 8 to 5 of last octet - bit 4 to 1 of octet n encoding digit 2n-1 - bit 8 to 5 of octet n encoding digit 2n <p>Number of hexadecimal digits shall be 16.</p>

9.2.1.30V HS-PDSCH Code Change Indicator [FDD]

The HS-PDSCH Code Change Indicator indicates whether the HS-PDSCH Code change is needed or not.

IE/Group Name	Presence	Range	IE Type and Reference	Semantics Description
HS-PDSCH Code Change Indicator			ENUMERATED (HS-PDSCH Code Change needed)	

9.2.1.30W HS-PDSCH Code Change Grant [FDD]

The *HS-PDSCH Code Change Grant* IE indicates that modification of HS-PDSCH Codes is granted.

IE/Group Name	Presence	Range	IE Type and Reference	Semantics Description
HS-PDSCH Code Change Grant			ENUMERATED(Chan ge Granted)	

9.2.1.31 IMSI

The IMSI is the permanent UE user Identity, see ref. TS 23.003 [1].

IE/Group Name	Presence	Range	IE Type and Reference	Semantics Description
IMSI			OCTET STRING (SIZE(3..8))	<ul style="list-style-type: none"> -Decimal digits coded in BCD -“1111” used as filler -bit 4 to 1 of octet n is encoding digit 2n-1 -bit 8 to 5 of octet n is encoding digit 2n

9.2.1.31A Information Exchange ID

The Information Exchange ID uniquely identifies any requested information per RNS.

IE/Group Name	Presence	Range	IE Type and Reference	Semantics Description
Information Exchange ID	M		INTEGER(0 .. 2 ²⁰ -1)	

9.2.1.31B Information Exchange Object Type

Void.

9.2.1.31C Information Report Characteristics

The information report characteristics define how the reporting shall be performed.

IE/Group Name	Presence	Range	IE Type and Reference	Semantics Description
CHOICE <i>Information Report Characteristics Type</i>	M			
> <i>On Demand</i>			NULL	
> <i>Periodic</i>				
>>CHOICE <i>Information Report Periodicity Scale</i>	M			The frequency with which the Node B shall send information reports.
>>> <i>minute</i>				
>>>>Report Periodicity Value	M		INTEGER (1..60,...)	
>>> <i>hour</i>				
>>>>Report Periodicity Value	M		INTEGER (1..24,...)	
> <i>On Modification</i>				
>>Information Threshold	O		9.2.1.31D	

9.2.1.31D Information Threshold

The Information Threshold indicates which kind of information shall trigger the Information Reporting procedure.

IE/Group Name	Presence	Range	IE Type and Reference	Semantics Description	Criticality	Assigned Criticality
CHOICE <i>Information Type Item</i>	M				–	
> <i>DGPS Corrections</i>						
>>PRC Deviation	M		ENUMERATED(1, 2, 5, 10, ...)	PRC deviation in meters from the previously reported value, which shall trigger a report	–	
> <i>DGANSS</i>						
>>PRC Deviation	M		ENUMERATED(1, 2, 5, 10, ...)	PRC deviation in meters from the previously reported value, which shall trigger a report	–	

9.2.1.31E Information Type

The Information Type indicates which kind of information the RNS shall provide.

IE/Group Name	Presence	Range	IE Type and Reference	Semantics Description	Criticality	Assigned Criticality
Information Type Item	M		ENUMERATED (UTRAN Access Point Position with Altitude, UTRAN Access Point Position, IPDL Parameters, GPS Information, DGPS Corrections, GPS RX Pos, SFN-SFN Measurement Reference Point Position,..., Cell Capacity Class, NACC Related Data, MBMS Bearer Service Full Address, Inter-frequency Cell Information, GANSS Information, DGANSS Corrections, GANSS RX Pos, MBMS Counting Information, MBMS Transmission Mode, MBMS Neighbouring Cell Information, MBMS RLC Sequence Number)	For information exchange on the Iur-g interface, only the Cell Capacity Class is used. MBMS Counting Information, MBMS Transmission Mode, MBMS Neighbouring Cell Information and MBMS RLC Sequence Number shall only be used by FDD.	–	
GPS Information	C-GPS	1..<maximum of GPSTypes>			–	
>GPS Information Item			ENUMERATED (GPS Navigation Model and Time Recovery, GPS Ionospheric Model, GPS UTC Model, GPS Almanac, GPS Real-Time Integrity, ...)		–	
GANSS Information	C-GANSS				YES	Ignore
>GANSS Common Data		0..1			–	
>>Ionospheric Model	O		BOOLEAN	True means requested	–	
>>Additional Ionospheric Model	O		Additional Ionospheric Model Request 9.2.1.122d	Presence means requested.	YES	Ignore
>>Earth Orientation Parameters	O		Earth Orientation Parameters Request 9.2.1.122e		YES	Ignore

>GANSS Generic Data		<i>0..<maxn oofGANS S></i>			–	
>>GANSS ID	O		9.2.1.119		–	
>>GANSS Navigation Model And Time Recovery	O		BOOLEAN	True means requested	–	
>>GANSS Time Model GNSS-GNSS	O		BIT STRING(9)	Defines the time model required. Bit 1 is the MSB and bit 9 is the LSB (see section 9.2.0). Bit 1:GPS, Bit 2:Galileo, Bit 3:QZSS, Bit 4:GLONASS. Other bits are reserved.	–	
>>GANSS UTC Model	O		BOOLEAN	True means requested	–	
>>GANSS Almanac	O		BOOLEAN	True means requested	–	
>>GANSS Real Time Integrity	O		BOOLEAN	True means requested	–	
>>GANSS Data Bit Assistance		<i>0..1</i>			–	
>>>GANSS TOD	M		INTEGER (0..86399)	The GANSS Time Of Day for which the data bits are requested	–	
>>>Data Bit Assistance		<i>1</i>			–	
>>>>DGANSS Signal ID	M		BIT STRING(8)	Defined in TS 25.331 [16]	–	
>>>>GANSS Data Bit Interval	M		INTEGER (0..15)	Defined in TS 25.331 [16]	–	
>>>>Satellite Information		<i>0..<max GANSS Sat></i>			–	
>>>>Sat ID	M		INTEGER(0..63)	Identifies the satellite and is equal to (SV ID No – 1)	–	
>>GANSS Additional Navigation Models And Time Recovery	O		GANSS Additional Navigation Models And Time Recovery Request 9.2.1.122f		YES	Ignore
>>GANSS Additional UTC Models	O		GANSS Additional UTC Models Request 9.2.1.122g		YES	Ignore
>>GANSS Auxiliary Information	O		GANSS Auxiliary Information Request 9.2.1.122h		YES	Ignore
>>SBAS ID	C-GANSS-ID		9.2.1.122b		YES	Ignore
DGANSS Corrections Req	C-DGANSS Corrections	<i>1</i>			YES	ignore

>DGANSS Signal ID	M		BIT STRING(8)	Defined in TS 25.331 [16]	–	
>GANSS ID	O		9.2.1.119		YES	Ignore
MBMS RLC Sequence Number Information	C-MBMSRLCSequenceNumber			FDD only	YES	Ignore
> MBMS Cell List		1..<maxnoofcell>			–	
>>C-ID	M		9.2.1.6		–	
>> MBMS Bearer Service List		1..<maxnoofMBMS>			–	
>>>TMGI	M		9.2.1.80		–	
>>>Time Stamp	M		9.2.2.98		–	

Condition	Explanation
<i>DGANSSCorrections</i>	The IE shall be present if the <i>Information Type Item</i> IE indicates “DGANSS Corrections”.
<i>GPS</i>	This IE shall be present if the <i>Information Type Item</i> IE indicates “GPS Information”.
<i>GANSS</i>	This IE shall be present if the <i>Information Type Item</i> IE indicates “GANSS Information”.
<i>GANSS-ID</i>	This IE shall be present if the <i>GANSS ID</i> IE indicates “SBAS”.
<i>MBMSRLCSequenceNumber</i>	This IE shall be present if the <i>Information Type Item</i> IE indicates “MBMS RLC Sequence Number”.

Range Bound	Explanation
<i>maxGANSSSat</i>	Maximum number of satellites for which data is included in the IE
<i>maxnoofGPSTypes</i>	Maximum number of GPS Information Types supported in one Information Exchange.
<i>maxnoofGANSS</i>	Maximum number of GANSS Systems.
<i>maxnoofMBMS</i>	Maximum number of MBMS bearer services that a UE can join.
<i>Maxnoofcell</i>	Maximum number of cells that can be indicated in the corresponding IE.

9.2.1.31F IPDL Parameters

IE/Group Name	Presence	Range	IE Type and Reference	Semantics Description	Criticality	Assigned Criticality
CHOICE <i>IPDL Parameters</i>					-	
> <i>IPDL FDD Parameters</i>						
>>IPDL FDD parameters	M		9.2.2.21B		–	
> <i>IPDL TDD Parameters</i>				Applicable to 3.84Mcps TDD and 7.68Mcps TDD only		
>>IPDL TDD parameters	M		9.2.3.4B		–	
> <i>Additional IPDL Parameters</i>						
>>IPDL TDD Parameters LCR				Applicable to 1.28Mcps TDD only	–	
>>>IPDL TDD parameters LCR	M		9.2.3.4Bb		YES	reject

9.2.1.31G Inter-frequency Cell Information

This IE contains the inter-frequency cell information of a cell in the DRNS broadcasted in SIB11 or SIB12.

IE/Group Name	Presence	Range	IE Type and Reference	Semantics Description
SIB11		0..2		
>Inter-frequency Cell Indication- SIB11	M		Integer(0..1)	Value tag in 10.3.7.45 in TS 25.331 [16] with the same IE name.
>Inter-frequency Cell List in SIB11		0..<maxCellSIB11 OrSIB12>		
>>Inter-frequency Cell Id	M		Integer(0..31)	The order of the inter-frequency cell in SIB11.
>>DL UARFCN	M		UARFCN 9.2.1.66	
>>UL UARFCN	O		UARFCN 9.2.1.66	If this IE is not present, the default duplex distance defined for the operating frequency band shall be used , see TS 25.101 [43]
>>Primary Scrambling Code	M		9.2.1.45	
SIB12		0..2		
>Inter-frequency Cell Indication- SIB12	M			Value tag in 10.3.7.45 in TS 25.331 [16] with the same IE name.
>Inter-frequency Cell List in SIB12		0..<maxCellSIB11 OrSIB12>		
>>Inter-frequency Cell Id			Integer(0..31)	The order of the inter-frequency cell in SIB12.
>>DL UARFCN	M		UARFCN 9.2.1.66	
>>UL UARFCN	O		UARFCN 9.2.1.66	If this IE is not present, the default duplex distance defined for the operating frequency band shall be used, see TS 25.101 [43]
>>Primary Scrambling Code	M		9.2.1.45	

Range bound	Explanation
<i>maxCellSIB11OrSIB12</i>	Maximum number of inter-frequency cells broadcasted in SIB11 or SIB12.

9.2.1.32 L3 Information

This parameter contains the Layer 3 Information from a Uu message as received from the UE over the Uu interface or the Layer 3 Information for a Uu message to be sent to a UE by the DRNC, as defined in ref. TS 25.331 [16].

IE/Group Name	Presence	Range	IE Type and Reference	Semantics Description
L3 Information			BIT STRING	The content is defined in ref. TS 25.331 [16]

9.2.1.33 Limited Power Increase

Void.

9.2.1.33A Load Value

The *Load Value* IE contains the total load on the measured object relative to the maximum planned load for both the uplink and downlink. It is defined as the load percentage of the Cell Capacity Class.

IE/Group Name	Presence	Range	IE Type and Reference	Semantics Description
Uplink Load Value	M		INTEGER(0..100)	Value 0 shall indicate the minimum load, and 100 shall indicate the maximum load. Load should be measured on a linear scale.
Downlink Load Value	M		INTEGER(0..100)	Value 0 shall indicate the minimum load, and 100 shall indicate the maximum load. Load should be measured on a linear scale.

9.2.1.34 MAC-c/sh SDU Length

Indicates the MAC-c/sh SDU Length. Which is used for FACH, [TDD – DSCH and USCH]. There may be multiple MAC-c/sh SDU Lengths per priority class.

IE/Group Name	Presence	Range	IE Type and Reference	Semantics Description
MAC-c/sh SDU Length			INTEGER(1..5000)	Size of the MAC-c/sh SDU in number of bits.

9.2.1.34A MAC-d PDU Size

The *MAC-d PDU Size* IE provides the size in bits of the MAC-d PDU.

IE/Group Name	Presence	Range	IE Type and Reference	Semantics Description
MAC-d PDU Size			INTEGER (1..5000,...)	In case of E-DCH, value 8 and values not multiple of 8 shall not be used.

9.2.1.34Aa MAC-hs Guaranteed Bit Rate

The *MAC-hs Guaranteed Bit Rate* IE indicates the guaranteed number of bits per second that Node B should deliver over the air interface under normal operating conditions (provided there is data to deliver). If the *MAC-hs Guaranteed Bit Rate* IE is received with the value set to 0 during RL set up or modification, no guarantee is applied.

IE/Group Name	Presence	Range	IE type and reference	Semantics description
MAC-hs Guaranteed Bit Rate			INTEGER (0..2 ²⁴ -1, ..., 2 ²⁴ ..256,000,000)	Unit: bit/s

9.2.1.34Ab MAC-hs Reordering Buffer Size for RLC-UM

The *MAC-hs Reordering Buffer Size for RLC-UM* IE indicates the portion of the buffer in the UE that can be used for RLC-UM traffic (i.e. for Priority Queues whose *RLC Mode* IE is set to “RLC-UM”).

IE/Group Name	Presence	Range	IE Type and Reference	Semantics Description
MAC-hs Reordering Buffer Size for RLC-UM			INTEGER (0..300,...)	Unit: kBytes And N kBytes = N*1024 Bytes. The D R N S shall use this value to avoid the overflow of the UE buffer.

9.2.1.34B MAC-hs Reset Indicator

The *MAC-hs Reset Indicator* IE indicates that a reset of the MAC-hs is not required.

IE/Group Name	Presence	Range	IE Type and Reference	Semantics Description
MAC-hs Reset Indicator			ENUMERATED (MAC-hs Not Reset)	

9.2.1.34C MAC-hs Window Size

The *MAC-hs Window Size* IE is used for MAC-hs/MAC-ehs PDU retransmission as defined in TS 25.321 [41]. [FDD – the values 64 and 128 is only allowed when the MAC header type is MAC-ehs and under conditions defined in TS 25.425 [32]].

IE/Group Name	Presence	Range	IE type and reference	Semantics description
MAC-hs Window Size			ENUMERATED (4, 6, 8, 12, 16, 24, 32,...)	

9.2.1.34D MAC PDU Size Extended

The *MAC PDU Size Extended* IE provides the size in octets of the MAC level PDU when an extended MAC level PDU size is required.

IE/Group Name	Presence	Range	IE Type and Reference	Semantics Description
MAC PDU Size Extended			INTEGER (1..1504,...,1505)	In case of E-DCH, value 1 shall not be used

9.2.1.35 Maximum Allowed UL Tx Power

Maximum Allowed UL Tx Power is the maximum power that a UE in a particular cell is allowed to transmit.

IE/Group Name	Presence	Range	IE Type and Reference	Semantics Description
Maximum Allowed UL Tx Power			INTEGER(-50..+33)	dBm

9.2.1.35A Measurement Availability Indicator

Void

9.2.1.35B Measurement Change Time

IE/Group Name	Presence	Range	IE Type and Reference	Semantics Description
Measurement Change Time	M		INTEGER (1..6000,...)	Unit: ms Range: 10..60000 ms Step: 10 ms

9.2.1.36 Measurement Filter Coefficient

The Measurement Filter Coefficient determines the amount of filtering to be applied for measurements.

IE/Group Name	Presence	Range	IE Type and Reference	Semantics Description
Measurement Filter Coefficient			ENUMERATED(0, 1, 2, 3, 4, 5, 6, 7, 8, 9, 11, 13, 15, 17, 19,...)	

9.2.1.36A Measurement Hysteresis Time

The Measurement Hysteresis Time provides the duration during which a reporting criterion has to be fulfilled for the Measurement Reporting procedure to be triggered.

IE/Group Name	Presence	Range	IE Type and Reference	Semantics Description
Measurement Hysteresis Time			INTEGER (1..6000,...)	Unit: ms Range: 10..60000 ms Step: 10 ms

9.2.1.37 Measurement ID

The Measurement ID uniquely identifies a dedicated measurement within a UE Context or a common measurement within a Distant RNC Context [TDD – or a UE measurement within a UE Context].

IE/Group Name	Presence	Range	IE Type and Reference	Semantics Description
Measurement ID			INTEGER(0 .. 2 ²⁰ -1)	

9.2.1.38 Measurement Increase/Decrease Threshold

The Measurement Increase/Decrease Threshold defines the threshold that shall trigger Event C or D.

IE/Group Name	Presence	Range	IE Type and Reference	Semantics Description	Criticality	Assigned Criticality
CHOICE <i>Measurement Increase/Decrease Threshold</i>	M				–	
> <i>SIR</i>						
>> <i>SIR</i>	M		INTEGER(0..62)	0: 0 dB 1: 0.5 dB 2: 1 dB ... 62: 31dB	–	
> <i>SIR Error</i>				FDD Only		
>> <i>SIR Error</i>	M		INTEGER(0..124)	0: 0 dB 1: 0.5 dB 2: 1 dB ... 124: 62 dB	–	
> <i>Transmitted Code Power</i>						
>> <i>Transmitted Code Power</i>	M		INTEGER(0..112 ,...)	0: 0 dB 1: 0.5 dB 2: 1 dB ... 112: 56 dB	–	
> <i>RSCP</i>				TDD Only		
>> <i>RSCP</i>	M		INTEGER(0..126)	0: 0 dB 1: 0.5 dB 2: 1 dB ... 126: 63 dB	–	
> <i>Round Trip Time</i>				FDD Only		
>> <i>Round Trip Time</i>	M		INTEGER(0..327 66)	0: 0 chips 1: 0.0625 chips 2: 0.1250 chips ... 32766: 2047.875 chips	–	
> <i>Additional Measurement Thresholds</i>						
>> <i>Load</i>						
>>> <i>Load</i>	M		INTEGER(0..100)	Units are the same as for the Uplink <i>Load Value</i> IE and <i>Downlink Load Value</i> IE.	–	
>> <i>Transmitted Carrier Power</i>						
>>> <i>Transmitted Carrier Power</i>	M		INTEGER(0..100)	According to mapping in TS 25.133 [23] and TS 25.123 [24].	YES	reject
>> <i>Received Total Wide Band Power</i>						
>>> <i>Received Total Wide Band Power</i>	M		INTEGER(0..620)	0: 0dB 1: 0.1dB 2: 0.2dB ... 620: 62dB	YES	reject
>> <i>UL Timeslot ISCP</i>				TDD Only		
>>> <i>UL Timeslot ISCP</i>	M		INTEGER(0..126)	0: 0dB 1: 0.5dB 2: 1dB ... 126: 63dB	YES	reject

>>RT Load						
>>>RT Load	M		INTEGER(0..100)	Units are the same as for the <i>Uplink RT Load Value</i> IE and <i>Downlink RT Load Value</i> IE.	YES	reject
>>NRT Load Information						
>>>NRT Load Information	M		INTEGER(0..3)		YES	reject
>>UpPTS interference				1.28Mcps TDD Only		
>>>UpPTS interference Value	M		INTEGER (0..127,...)	According to mapping in TS 25.123 [24]	YES	reject

9.2.1.38A Measurement Recovery Behavior

This IE controls the Measurement Recovery Behavior.

IE/Group Name	Presence	Range	IE Type and Reference	Semantics Description
Measurement Recovery Behavior			NULL	

9.2.1.38B Measurement Recovery Reporting Indicator

This IE indicates the Measurement Recovery Reporting.

IE/Group Name	Presence	Range	IE Type and Reference	Semantics Description
Measurement Recovery Reporting Indicator			NULL	

9.2.1.38C Measurement Recovery Support Indicator

This IE indicates the Measurement Recovery Support.

IE/Group Name	Presence	Range	IE Type and Reference	Semantics Description
Measurement Recovery Support Indicator			NULL	

9.2.1.39 Measurement Threshold

The Measurement Threshold defines which threshold that shall trigger Event A, B, E, F or On Modification.

IE/Group Name	Presence	Range	IE Type and Reference	Semantics Description	Criticality	Assigned Criticality
CHOICE <i>Measurement Threshold</i>					-	
> <i>SIR</i>						
>> <i>SIR</i>	M		INTEGER(0..63)	According to mapping in ref. TS 25.133 [23] and TS 25.123 [24].	-	
> <i>SIR Error</i>				FDD Only		
>> <i>SIR Error</i>	M		INTEGER(0..125)	According to mapping in TS 25.133 [23]	-	
> <i>Transmitted Carrier Power</i>						
>> <i>Transmitted Code Power</i>	M		INTEGER(0..127)	According to mapping in ref. TS 25.133 [23] and TS 25.123 [24].	-	
> <i>RSCP</i>				TDD Only		
>> <i>RSCP</i>	M		INTEGER(0..127)	According to mapping in ref. TS 25.123 [24]	-	
> <i>Rx Timing Deviation</i>				Applicable to 3.84Mcps TDD Only		
>> <i>Rx Timing Deviation</i>	M		INTEGER(0..8191)	According to mapping in TS 25.123 [24]	-	
> <i>Round Trip Time</i>				FDD Only		
>> <i>Round Trip Time</i>	M		INTEGER(0..32767)	According to mapping in TS 25.133 [23]	-	
> <i>Additional Measurement Thresholds</i>						
>> <i>T_{UTRAN-GPS} Measurement Threshold Information</i>						
>>> <i>T_{UTRAN-GPS} Measurement Threshold Information</i>	M		9.2.1.59C		YES	reject
>> <i>SFN-SFN Measurement Threshold Information</i>						
>>> <i>SFN-SFN Measurement Threshold Information</i>	M		9.2.1.52B		YES	reject
>> <i>Load</i>						
>>> <i>Load</i>	M		INTEGER(0..100)	0 is the minimum indicated load, and 100 is the maximum indicated load.	YES	reject
>> <i>Transmitted Carrier Power</i>						
>>> <i>Transmitted Carrier Power</i>	M		INTEGER(0..100)	According to mapping in TS 25.133 [23] and TS 25.123 [24].	YES	reject
>> <i>Received Total Wide Band Power</i>						
>>> <i>Received Total Wide Band Power</i>	M		INTEGER(0..621)	According to mapping in TS 25.133 [23] and TS 25.123 [24].	YES	reject
>> <i>UL Timeslot ISCP</i>				TDD Only		
>>> <i>UL Timeslot ISCP</i>	M		INTEGER(0..127)	According to mapping in TS 25.123 [24]	YES	reject
>> <i>RT Load</i>						

>>>RT Load	M		INTEGER(0..100)		YES	reject
>>NRT Load Information						
>>>NRT Load Information	M		INTEGER(0..3)		YES	reject
>>Rx Timing Deviation LCR				Applicable to 1.28Mcps TDD Only		
>>>Rx Timing Deviation LCR	M		INTEGER(0..511)	According to mapping in TS 25.123 [24]	YES	reject
>>HS-SICH reception quality				Applicable to TDD Only		
>>>HS-SICH reception quality	M		INTEGER (0..20)	According to mapping in TS 25.123 [24]	YES	reject
>>UpPTS interference				1.28Mcps TDD Only		
>>>UpPTS interference Value	M		INTEGER (0..127,...)	According to mapping in TS 25.123 [24]	YES	reject
>>Rx Timing Deviation 768				Applicable to 7.68Mcps TDD Only		
>>>Rx Timing Deviation 768	M		INTEGER(0..65535)	According to mapping in TS 25.123 [24]	YES	reject
>>Rx Timing Deviation 384 Extended				Applicable to 3.84Mcps TDD Only		
>>>Rx Timing Deviation 384 Extended	M		INTEGER(0..32767)	According to mapping in TS 25.123 [24]	YES	reject
>>Extended Round Trip Time				FDD Only		
>>>Extended Round Trip Time Value	M		INTEGER (32767..103041)	Continuation of intervals with step size as defined in TS 25.133 [23].	YES	reject
>>T _{UTRAN-GANSS} Measurement Threshold Information						
>>>T _{UTRAN-GANSS} Measurement Threshold Information	M		9.2.1.113		YES	reject

9.2.1.39A Message Structure

The *Message Structure* IE gives information for each level with assigned criticality in an hierarchical message structure from top level down to the lowest level above the reported level for the occurred error (reported in the *Information Element Criticality Diagnostics* IE).

IE/Group Name	Presence	Range	IE Type and Reference	Semantics Description	Criticality	Assigned Criticality
Message structure		<i>1..<maxnooflevels></i>		The first repetition of the <i>Message Structure</i> IE corresponds to the top level of the message. The last repetition of the <i>Message Structure</i> IE corresponds to the level above the reported level for the occurred error of the message.	–	
>IE ID	M		INTEGER(0..65535)	The IE ID of this level's IE containing the not understood or missing IE.	–	
>Repetition Number	O		INTEGER(1..256)	The <i>Repetition Number</i> IE gives, if applicable, the number of occurrences of this level's reported IE up to and including the occurrence containing the not understood or missing IE. Note: All the counted occurrences of the reported IE must have the same topdown hierarchical message structure of IEs with assigned criticality above them.	–	

Range bound	Explanation
maxnooflevels	Maximum no. of message levels to report. The value for maxnooflevels is 256.

9.2.1.40 Message Type

The Message Type uniquely identifies the message being sent.

IE/Group Name	Presence	Range	IE Type and Reference	Semantics Description
Procedure ID		1		
>Procedure Code	M		INTEGER (0..255)	<p>“0” = Common Transport Channel Resources Initialisation</p> <p>“1” = Common Transport Channel Resources Release</p> <p>“2” = Compressed Mode Command</p> <p>“3” = Downlink Power Control</p> <p>“4” = Downlink Power Timeslot Control</p> <p>“5” = Downlink Signalling Transfer</p> <p>“6” = Error Indication</p> <p>“7” = Dedicated Measurement Failure</p> <p>“8” = Dedicated Measurement Initiation</p> <p>“9” = Dedicated Measurement Reporting</p> <p>“10” = Dedicated Measurement Termination</p> <p>“11” = Paging</p> <p>“12” = Physical Channel Reconfiguration</p> <p>“14” = Radio Link Addition</p> <p>“15” = Radio Link Deletion</p> <p>“16” = Radio Link Failure</p> <p>“17” = Radio Link Preemption</p> <p>“18” = Radio Link Restoration</p> <p>“19” = Radio Link Setup</p> <p>“20” = Relocation Commit</p> <p>“21” = Synchronised Radio Link Reconfiguration Cancellation</p> <p>“22” = Synchronised Radio Link Reconfiguration Commit</p> <p>“23” = Synchronised Radio Link Reconfiguration Preparation</p> <p>“24” = UnSynchronised Radio Link Reconfiguration</p> <p>“25” = Uplink Signalling Transfer</p> <p>“26” = Common Measurement Failure</p> <p>“27” = Common Measurement Initiation</p> <p>“28” = Common Measurement Reporting</p> <p>“29” = Common Measurement Termination</p> <p>“30” = Information Exchange Failure</p> <p>“31” = Information Exchange Initiation</p> <p>“32” = Information Reporting</p> <p>“33” = Information Exchange Termination</p> <p>“34” = Radio Link Congestion</p> <p>“35” = Reset</p> <p>“36” = Radio Link Activation</p> <p>“37” = GERAN Uplink Signalling Transfer</p> <p>“38” = Radio Link Parameter Update</p> <p>“39” = UE Measurement Failure</p> <p>“40” = UE Measurement Initiation</p> <p>“41” = UE Measurement Reporting</p> <p>“42” = UE Measurement Termination</p> <p>“43” = Iur Deactivate Trace</p> <p>“44” = Iur Invoke Trace</p> <p>“45” = MBMS Attach</p> <p>“46” = MBMS Detach</p> <p>“48” = Direct Information Transfer</p> <p>“49” = Enhanced Relocation</p> <p>“50” = Enhanced Relocation Cancel</p> <p>“51” = Enhanced Relocation Signalling Transfer</p>

				"52" = Enhanced Relocation Release "53" = MBSFN MCCH Information "54" = Secondary UL Frequency Reporting "55" = Secondary UL Frequency Update
>Ddmode	M		ENUMERATED(FDD, TDD, Common, ...)	Common = common to FDD and TDD.
Type of Message	M		ENUMERATED(Initiating Message, Successful Outcome, Unsuccessful Outcome, Outcome)	

9.2.1.41 Multiple URAs Indicator

The Multiple URAs Indicator indicates whether the accessed cell has multiple URAs.

IE/Group Name	Presence	Range	IE Type and Reference	Semantics Description
Multiple URAs Indicator			ENUMERATED(Multiple URAs exist, Single URA Exists)	

9.2.1.41a NACC Related Data

The *NACC related data* IE provides NACC related information for the indicated GSM cell.

IE/Group Name	Presence	Range	IE Type and Reference	Semantics Description
CHOICE GERAN System Info Type	M			
>SI				
>>SI	M		9.2.1.30Fc	GERAN system information SI3, SI13, SI1 TS 44.060 [47]
>PSI				
>>PSI	M		9.2.1.30Fc	GERAN system information PSI1, PSI2, PSI4 TS 44.060 [47]

9.2.1.41A Neighbouring UMTS Cell Information

The *Neighbouring UMTS Cell Information* IE provides information for UMTS Cells that are neighbouring cells to a cell in the DRNC. The neighbouring cell information is provided for each RNC (including the DRNC) that has cells that are neighbouring cells to the cell in the DRNC.

IE/Group Name	Presence	Range	IE Type and Reference	Semantics Description	Criticality	Assigned Criticality
Neighbouring UMTS Cell Information		<i>1..<maxnoof neighbouringRNCs></i>			EACH	ignore
>RNC-ID	M		9.2.1.50	If the <i>Extended RNC-ID</i> IE is included in the <i>Neighbouring UMTS Cell Information</i> IE, the <i>RNC-ID</i> IE shall be ignored.	–	
>CN PS Domain Identifier	O		9.2.1.12		–	
>CN CS Domain Identifier	O		9.2.1.11		–	
>Neighbouring FDD Cell Information	O		9.2.1.41B		–	
>Neighbouring TDD Cell Information	O		9.2.1.41D		–	
>Neighbouring TDD Cell Information LCR	O		9.2.1.72		YES	ignore
>Extended RNC-ID	O		9.2.1.50a	The <i>Extended RNC-ID</i> IE shall be used if the RNC identity has a value larger than 4095.	YES	reject

Range bound	Explanation
<i>maxnoofneighbouringRNCs</i>	Maximum number of neighbouring RNCs.

9.2.1.41B Neighbouring FDD Cell Information

The *Neighbouring FDD Cell Information* IE provides information for FDD cells that are neighbouring cells to a cell in the DRNC.

IE/Group Name	Presence	Range	IE Type and Reference	Semantics Description	Criticality	Assigned Criticality
Neighbouring FDD Cell Information		<i>1..<max noofFDD neighbours></i>			–	
>C-ID	M		9.2.1.6		–	
>UL UARFCN	M		UARFCN 9.2.1.66	Corresponds to Nu in ref. TS 25.104 [6]	–	
>DL UARFCN	M		UARFCN 9.2.1.66	Corresponds to Nd in ref. TS 25.104 [6]	–	
>Frame Offset	O		9.2.1.30		–	
>Primary Scrambling Code	M		9.2.1.45		–	
>Primary CPICH Power	O		9.2.1.44		–	
>Cell Individual Offset	O		9.2.1.7		–	
>Tx Diversity Indicator	M		9.2.2.50		–	
>STTD Support Indicator	O		9.2.2.45		–	
>Closed Loop Mode1 Support Indicator	O		9.2.2.2		–	
>Not Used	O		NULL		–	
>Restriction State Indicator	O		9.2.1.48C		YES	ignore
>DPC Mode Change Support Indicator	O		9.2.2.56		YES	ignore
>Coverage Indicator	O		9.2.1.12G		YES	ignore
>Antenna Co-location Indicator	O		9.2.1.2C		YES	ignore
>HCS Prio	O		9.2.1.30N		YES	ignore
>Cell Capability Container FDD	O		9.2.2.D		YES	ignore
>SNA Information	O		9.2.1.52Ca		YES	ignore
>Frequency Band Indicator	O		9.2.2.59		YES	ignore
>Max UE DTX Cycle	C-CPC-DTX-DRXCapable		9.2.2.87		YES	ignore
>Multiple PLMN List	O		9.2.1.117		YES	ignore
>Secondary Serving Cell List	C-MC-Capable		9.2.2.101		YES	ignore
>Dual Band Secondary Serving Cell List	C-DB-Capable		Secondary Serving Cell List 9.2.2.101		YES	ignore
>Cell Capability Container Extension FDD	O		9.2.2.123		YES	ignore
>Cell List Validity Indicator	O		ENUMERATED (Ignore Secondary Serving Cell List, Ignore Dual Band Secondary Serving Cell List, Ignore Both)		YES	ignore

Range bound	Explanation
<i>maxnoofFDDneighbours</i>	Maximum number of neighbouring FDD cell for one cell.

Condition	Explanation
CPC-DTX-DRXCapable	The IE shall be present if the the fifteenth bit Continuous Packet Connectivity DTX-DRX Support Indicator in the <i>Cell Capability Container FDD</i> IE is set to the value "1".
MC-Capable	The IE shall be present if the the Multi Cell Support Indicator in the <i>Cell Capability Container FDD</i> IE is set to the value "1".
DB-Capable	The IE shall be present if the the Dual Band Support Indicator in the <i>Cell Capability Container FDD</i> IE is set to the value "1".

9.2.1.41C Neighbouring GSM Cell Information

The *Neighbouring GSM Cell Information* IE provides information for all GSM Cells that are a neighbouring cell to a cell in the DRNC.

IE/Group Name	Presence	Range	IE Type and Reference	Semantics Description	Criticality	Assigned Criticality
Neighbouring GSM Cell Information		<i>1..<max noofGS Mneighb ours></i>			GLOBAL	ignore
>CGI		1		Cell Global Identity as defined in ref. TS 23.003 [1].	–	
>>LAI		1			–	
>>>PLMN Identity	M		OCTET STRING (3)	- digits 0 to 9, two digits per octet, - each digit encoded 0000 to 1001, - 1111 used as filler - bit 4 to 1 of octet n encoding digit 2n-1 - bit 8 to 5 of octet n encoding digit 2n -The PLMN Identity consists of 3 digits from MCC followed by either -a filler plus 2 digits from MNC (in case of 2 digit MNC) or -3 digits from MNC (in case of a 3 digit MNC).	–	
>>>LAC	M		OCTET STRING (2)	0000 and FFFE not allowed	–	
>>CI	M		OCTET STRING (2)		–	
>Cell Individual Offset	O		9.2.1.7	The Cell Individual Offset to be used for Ues using DCHs. If the <i>Extended GSM Cell Individual Offset</i> IE is present, the <i>Cell Individual Offset</i> IE shall be set to a) –10dB if the <i>Extended GSM Cell Individual Offset</i> IE is < -10dB and b) 10dB if the <i>Extended GSM Cell Individual Offset</i> IE is > 10dB.	–	
>BSIC		1		Base Station Identity Code as defined in ref. TS 23.003 [1].	–	
>>NCC	M		BIT STRING(3)	Network Colour Code.	–	
>>BCC	M		BIT STRING(3)	Base Station Colour Code.	–	
>Band Indicator	M		ENUMERATED(DCS 1800 band, PCS 1900 band, ...)	Indicates whether or not the BCCH ARFCN belongs to the 1800 band or 1900 band of GSM frequencies.	–	
>BCCH ARFCN	M		INTEGER(0..1023)	BCCH Frequency as defined in ref. TS 05.05 [29].	–	
>Coverage Indicator	O		9.2.1.12G		YES	ignore
>Antenna Co-location	O		9.2.1.2C		YES	ignore

Indicator						
>HCS Prio	O		9.2.1.30N		YES	ignore
> SNA Information	O		9.2.1.52Ca		YES	ignore
>GERAN Cell Capability	O		9.2.1.30Fa		YES	ignore
>GERAN Classmark	O		9.2.1.30Fb		YES	ignore
>Extended GSM Cell Individual Offset	O		9.2.1.26Bb	The Extended GSM Cell Individual Offset to be used for Ues using DCHs, for values that exceed the range of the Cell Individual Offset IE.	YES	ignore

Range bound	Explanation
<i>maxnoofGSMneighbours</i>	Maximum number of neighbouring GSM cells for one cell.

9.2.1.41D Neighbouring TDD Cell Information

The *Neighbouring TDD Cell Information* IE provides information for 3.84Mcps TDD or 7.68Mcps TDD cells that are neighbouring cells to a cell in the DRNC.

IE/Group Name	Presence	Range	IE Type and Reference	Semantics Description	Criticality	Assigned Criticality
Neighbouring TDD Cell Information		<i>1..<maxnoofTDDneighbours></i>			–	
>C-ID	M		9.2.1.6		–	
>UARFCN	M		9.2.1.66	Corresponds to Nt in ref. TS 25.105 [7]	–	
>Frame Offset	O		9.2.1.30		–	
>Cell Parameter ID	M		9.2.1.8		–	
>Sync Case	M		9.2.1.54		–	
>Time Slot For SCH	C-Case1		Time Slot 9.2.1.56		–	
>SCH Time Slot	C-Case2		9.2.1.51		–	
>SCTD Indicator	M		9.2.1.78		–	
>Cell Individual Offset	O		9.2.1.7		–	
>DPCH Constant Value	O		9.2.1.23		–	
>PCCPCH Power	O		9.2.1.43		–	
>Restriction State Indicator	O		9.2.1.48C		YES	ignore
>Coverage Indicator	O		9.2.1.12G		YES	ignore
>Antenna Co-location Indicator	O		9.2.1.2C		YES	ignore
>HCS Prio	O		9.2.1.30N		YES	ignore
>Cell Capability Container TDD	O		9.2.3.1a		YES	ignore
>Cell Capability Container 7.68Mcps TDD	O		9.2.3.31		YES	ignore
> SNA Information	O		9.2.1.52Ca		YES	ignore
>Multiple PLMN List	O		9.2.1.117		YES	ignore

Condition	Explanation
Case1	The IE shall be present if the <i>Sync Case</i> IE is set to “Case1”.
Case2	The IE shall be present if the <i>Sync Case</i> IE is set to “Case2”.

Range bound	Explanation
<i>maxnoofTDDneighbours</i>	Maximum number of neighbouring 3.84Mcps TDD or 7.68Mcps TDD cell for one cell.

9.2.1.41Dd Neighbouring TDD Cell Measurement Information LCR

This IE provides information on the 1.28Mcps TDD neighbouring cells used for the purpose of Measurements. Since the measurement can be performed on every time slot and midamble shift, the *Time slot LCR* IE and *Midamble shift LCR* IE shall be included if available.

IE/Group Name	Presence	Range	IE Type and Reference	Semantics Description
UTRAN Cell Identifier	M		9.2.1.71	
UARFCN	M		9.2.1.66	Corresponds to Nt TS 25.304 [15]
Cell Parameter ID	M		9.2.1.8	
Time Slot LCR	O		9.2.3.12a	
Midamble shift LCR	O		9.2.3.4C	

9.2.1.41De Neighbouring E-UTRA Cell Information

The *Neighbouring E-UTRA Cell Information* IE provides information for all E-UTRA Cells that are a neighbouring cell to a cell in the DRNC.

IE/Group Name	Presence	Range	IE Type and Reference	Semantics Description	Criticality	Assigned Criticality
Neighbouring E-UTRA Cell Information		<i>1..<max noofEUTRAneighbours></i>			–	
>ECGI		1		EUTRAN Cell Global Identity as defined in ref. TS 36.401 [61].	–	
>>PLMN Identity	M		OCTET STRING (3)	- digits 0 to 9, two digits per octet, - each digit encoded 0000 to 1001, - 1111 used as filler - bit 4 to 1 of octet n encoding digit 2n-1 - bit 8 to 5 of octet n encoding digit 2n -The PLMN Identity consists of 3 digits from MCC followed by either -a filler plus 2 digits from MNC (in case of 2 digit MNC) or -3 digits from MNC (in case of a 3 digit MNC).	–	
>>E-UTRAN Cell Identifier	M		BIT STRING (28)	The leftmost bits of the <i>E-UTRAN Cell Identifier</i> IE value correspond to the value of the eNB ID.	–	
>CHOICE EARFCN Information	M				–	
>>FDD						
>>>EARFCN-FDD		1				
>>>UL EARFCN	M		9.2.1.41Df EARFCN	Corresponds to NuL in TS 36.104 [62]	–	
>>>DL EARFCN	M		9.2.1.41Df EARFCN	Corresponds to NdL in TS 36.104 [62]	–	
>>TDD						
>>> EARFCN	M		9.2.1.41Df EARFCN	Corresponds to NdL in TS 36.104 [62]	–	

Range bound	Explanation
<i>maxnoofLTEneighbours</i>	Maximum number of neighbouring LTE cells for one cell.

9.2.1.41Df EARFCN

The EARFCN (E-UTRA Absolute Radio Frequency Channel Number) defines the carrier.

IE/Group Name	Presence	Range	IE Type and Reference	Semantics Description
EARFCN			INTEGER (0..maxEARFCN)	Defined in TS 36.104 [62].

9.2.1.41E Paging Cause

Cause for a CN originated page.

IE/Group Name	Presence	Range	IE Type and Reference	Semantics Description
Paging Cause			ENUMERATED (Terminating Conversational Call, Terminating Streaming Call, Terminating Interactive Call, Terminating Background Call, Terminating Low Priority Signalling, ... , Terminating High Priority Signalling, Terminating – cause unknown)	See in TS 25.331 [16]

9.2.1.41F Paging Record Type

IE/Group Name	Presence	Range	IE Type and Reference	Semantics Description
Paging Record Type			ENUMERATED (IMSI (GSM-MAP), TMSI (GSM-MAP), P-TMSI (GSM-MAP), IMSI (DS-41), TMSI (DS-41),...)	See ref. TS 25.331 [16]

9.2.1.41Fa Partial Reporting Indicator

This IE indicates if DRNS may report partially successful measurements.

IE/Group Name	Presence	Range	IE type and reference	Semantics description
Partial Reporting Indicator			ENUMERATED (partial reporting allowed)	

9.2.1.41G Neighbouring FDD Cell Measurement Information

This IE provides information on the FDD neighbouring cells used for the purpose of Measurements.

IE/Group Name	Presence	Range	IE Type and Reference	Semantics Description
UTRAN Cell Identifier	M		9.2.1.71	
UARFCN	M		9.2.1.66	Corresponds to Nd TS 25.104 [6]
Primary Scrambling Code	M		9.2.1.45	

9.2.1.41H Neighbouring TDD Cell Measurement Information

This IE provides information on the 3.84Mcps TDD neighbouring cells used for the purpose of Measurements. Since the measurement can be performed on every time slot and midamble shift, the *Time slot* IE and *Midamble shift and burst type* IE shall be included if available.

IE/Group Name	Presence	Range	IE Type and Reference	Semantics Description
UTRAN Cell Identifier	M		9.2.1.71	
UARFCN	M		9.2.1.66	Corresponds to Nt TS 25.304 [15]
Cell Parameter ID	M		9.2.1.8	
Time slot	O		9.2.1.56	
Midamble Shift And Burst Type	O		9.2.3.4	

9.2.1.41I NRT Load Information Value

The *NRT Load Information* IE indicates the load situation on the cell for the Non Real-Time traffic. Non Real Time traffic corresponds to the Interactive and Background traffic classes.

IE/Group Name	Presence	Range	IE Type and Reference	Semantics Description
Uplink NRT Load Information Value	M		INTEGER(0..3)	Mapping of the status: 0: low: The Uplink NRT load is low. 1: medium: The Uplink NRT load is medium. 2: high: Uplink NRT load is high. Probability to admit a new user is low. 3: overloaded: Uplink NRT overload. The probability to admit a new user is low, packets are discarded and the source is recommended to reduce the data flow.
Downlink NRT Load Information Value	M		INTEGER(0..3)	Mapping of the status: 0: low: The Downlink NRT load is low. 1: medium: The Downlink NRT load is medium. 2: high: Downlink NRT load is high. Probability to admit a new user is low. 3: overloaded: Downlink NRT overload. The probability to admit a new user is low, packets are discarded and the source is recommended to reduce the data flow.

9.2.1.42 Payload CRC Present Indicator

This parameter indicates whether FP payload 16 bit CRC is used or not.

IE/Group Name	Presence	Range	IE Type and Reference	Semantics Description
Payload CRC Presence Indicator			ENUMERATED(CRC Included, CRC not included)	

9.2.1.43 PCCPCH Power

Primary CCPCH power is the power that shall be used for reference power value in a TDD cell. The reference point is the antenna connector. If Transmit Diversity is applied to the Primary CCPCH, the PCCPCH Power is the linear sum of the power that is used for transmitting the PCCPCH on all branches.

IE/Group Name	Presence	Range	IE Type and Reference	Semantics Description
PCCPCH Power			INTEGER (-150..400,...)	Unit dBm Range -15.0 to 40.0 dBm, Step size 0.1 dB. -15.0 shall indicate $P_{\leq} -15\text{dBm}$ +40.0 shall indicate $P_{\geq} 40\text{dBm}$.

9.2.1.44 Primary CPICH Power

Primary CPICH power is the power that is used for transmitting the Primary CPICH in a cell. The reference point is the antenna connector. If Transmit Diversity is applied to the Primary CPICH, the Primary CPICH Power is the linear sum of the power that is used for transmitting the Primary CPICH on all branches.

IE/Group Name	Presence	Range	IE Type and Reference	Semantics Description
Primary CPICH Power			INTEGER (-100..500)	Value = Primary CPICH Power/10 Unit dBm Range -10.0..+50.0 Step 0.1 dB

9.2.1.45 Primary Scrambling Code

The Primary scrambling code to be used in the cell.

IE/Group Name	Presence	Range	IE Type and Reference	Semantics Description
Primary Scrambling Code			INTEGER(0..511)	

9.2.1.45A Priority Queue ID

The *Priority Queue ID* IE provides the identity of the Priority Queue. The Priority Queue ID is unique across all MAC-d flows that are currently allocated for one UE Context or across all Common MAC flows within a cell.

IE/Group Name	Presence	Range	IE Type and Reference	Semantics Description
Priority Queue ID			INTEGER (0..7)	

9.2.1.45B Process Memory Size

The *Process Memory Size* IE is the size of an HARQ process in the DRNS expressed in bits. It provides the maximum number of soft channel bits in the virtual IR buffer TS 25.212 [9] or TS 25.222 [46].

IE/Group Name	Presence	Range	IE Type and Reference	Semantics Description
Process Memory Size			ENUMERATED (800, 1600, 2400, 3200, 4000, 4800, 5600, 6400, 7200, 8000, 8800, 9600, 10400, 11200, 12000, 12800, 13600, 14400, 15200, 16000, 17600, 19200, 20800, 22400, 24000, 25600, 27200, 28800, 30400, 32000, 36000, 40000, 44000, 48000, 52000, 56000, 60000, 64000, 68000, 72000, 76000, 80000, 88000, 96000, 104000, 112000, 120000, 128000, 136000, 144000, 152000, 160000, 176000, 192000, 208000, 224000, 240000, 256000, 272000, 288000, 304000,...)	

9.2.1.46 Puncture Limit

The maximum amount of puncturing for a transport channel in rate matching.

IE/Group Name	Presence	Range	IE Type and Reference	Semantics Description
Puncture Limit			INTEGER (0..15)	0: 40% 1: 44 % ... 14: 96% 15: 100% (no puncturing) [FDD – Value 0 is not applicable for E-DPCH.]

9.2.1.46A QE-Selector

The QE-Selector indicates from which source the value for the quality estimate (QE) shall be taken.

IE/Group Name	Presence	Range	IE Type and Reference	Semantics Description
QE-Selector			ENUMERATED(selected, non-selected)	

9.2.1.47 RANAP Relocation Information

This parameter is transparent to the RNSAP. The parameter contains information for the Relocation procedure as defined in TS 25.413 [2].

IE/Group Name	Presence	Range	IE Type and Reference	Semantics Description
RANAP Relocation Information			BIT STRING	The content is defined in ref. TS 25.413 [2].

9.2.1.48 Report Characteristics

The Report Characteristics, defines how the reporting shall be performed.

IE/Group Name	Presence	Range	IE Type and Reference	Semantics Description	Criticality	Assigned Criticality
CHOICE <i>Report Characteristics</i>	M				–	
> <i>On Demand</i>			NULL		–	
> <i>Periodic</i>						
>>Report Periodicity	M		9.2.1.48a	The periodicity with which the DRNS shall send measurement reports.	–	
> <i>Event A</i>						
>>Measurement Threshold	M		9.2.1.39	The threshold for which the DRNS shall trigger a measurement report.	–	
>>Measurement Hysteresis Time	O		9.2.1.36A		–	
> <i>Event B</i>						
>>Measurement Threshold	M		9.2.1.39	The threshold for which the DRNS shall trigger a measurement report.	–	
>>Measurement Hysteresis Time	O		9.2.1.36A		–	
> <i>Event C</i>						
>>Measurement Increase/Decrease Threshold	M		9.2.1.38		–	
>>Measurement Change Time	M		9.2.1.35B	The time within which the measurement entity shall rise, in order to trigger a measurement report.	–	
> <i>Event D</i>						
>>Measurement Increase/Decrease Threshold	M		9.2.1.38		–	
>>Measurement Change Time	M		9.2.1.35B	The time within which the measurement entity shall fall, in order to trigger a measurement report.	–	
> <i>Event E</i>						
>>Measurement Threshold 1	M		Measurement Threshold 9.2.1.39		–	
>>Measurement Threshold 2	O		Measurement Threshold		–	

IE/Group Name	Presence	Range	IE Type and Reference	Semantics Description	Criticality	Assigned Criticality
			9.2.1.39			
>>Measurement Hysteresis Time	O		9.2.1.36A	The hysteresis time in ms	–	
>>Report Periodicity	O		9.2.1.48a	The periodicity with which the DRNS shall send measurement reports.	–	
> <i>Event F</i>						
>>Measurement Threshold 1	M		Measurement Threshold 9.2.1.39		–	
>>Measurement Threshold 2	O		Measurement Threshold 9.2.1.39		–	
>>Measurement Hysteresis Time	O		9.2.1.36A	The hysteresis time in ms	–	
>>Report Periodicity	O		9.2.1.48a	The periodicity with which the DRNS shall send measurement reports.	–	
> <i>Additional Report Characteristics</i>						
>> <i>On Modification</i>						
>>> On Modification		1			YES	reject
>>>>Measurement Threshold	M		9.2.1.39			

9.2.1.48a Report Periodicity

The Report Periodicity defines the frequency at which the Node B shall send measurement reports.

IE/Group Name	Presence	Range	IE Type and Reference	Semantics Description
CHOICE <i>Report Periodicity Scale</i>	M			
> <i>millisecond</i>				
>>Report Periodicity Value	M		INTEGER (1..6000,...)	Unit: ms Range: 10..60000 ms Step: 10 ms
> <i>minute</i>				
>>Report Periodicity Value	M		INTEGER (1..60,...)	Unit: min Range: 1..60 min Step: 1 min

9.2.1.48A Requested Data Value

The Requested Data Value contains the relevant data concerned the ongoing information exchange. *Requested Data Value* IE shall include at least one of the following IE.

IE/Group Name	Presence	Range	IE Type and Reference	Semantics Description	Criticality	Assigned Criticality
UTRAN Access Point Position with Altitude	O		9.2.1.75		–	
IPDL Parameters	O		9.2.1.31F		–	
DGPS Corrections	O		9.2.1.19B		–	
GPS Navigation Model and Time Recovery	O		9.2.1.30I		–	
GPS Ionospheric Model	O		9.2.1.30H		–	
GPS UTC Model	O		9.2.1.30L		–	
GPS Almanac	O		9.2.1.30G		–	
GPS Real-Time Integrity	O		9.2.1.30J		–	
GPS RX Pos	O		9.2.1.30K		–	
SFN-SFN Measurement Reference Point Position	O		9.2.1.74		–	
Cell Capacity Class Value	O		9.2.1.5C		YES	ignore
NACC Related Data	O		9.2.1.41a		YES	ignore
MBMS Bearer Service Full Address	O		9.2.1.84		YES	ignore
Inter-frequency Cell Information	O		9.2.1.31G		YES	ignore
GANSS Common Data		0..1			YES	ignore
>GANSS Ionospheric Model	O		9.2.1.105		–	
>GANSS RX Pos	O		9.2.1.109		–	
>GANSS Additional Ionospheric Model	O		9.2.1.105a		YES	Ignore
>GANSS Earth Orientation Parameters	O		9.2.1.122a		YES	Ignore
GANSS Generic Data		0..<maxno of GANSS >			GLOBAL	ignore
>GANSS ID	O		9.2.1.119		–	
>DGANSS Corrections	O		9.2.1.102		–	
>GANSS Navigation Model And Time Recovery	O		9.2.1.120		–	
>GANSS Time Model	O		9.2.1.110		–	
>GANSS UTC Model	O		9.2.1.111		–	
>GANSS Almanac	O		9.2.1.103		–	
>GANSS Real Time Integrity	O		9.2.1.108		–	
>GANSS Data Bit Assistance	O		9.2.1.118		–	
>GANSS Additional Time Models	O		9.2.1.110a		YES	Ignore
>GANSS Additional Navigation Models And Time Recovery	O		9.2.1.120a		YES	Ignore
>GANSS Additional UTC Models	O		9.2.1.111a		YES	Ignore
>GANSS Auxiliary Information	O		9.2.1.122c		YES	Ignore
>SBAS ID	C-GANSS-ID		9.2.1.122b		YES	Ignore
Counting Information	O		9.2.2.94	FDD only	YES	ignore
Transmission Mode Information	O		9.2.2.95	FDD only	YES	ignore
MBMS Neighbouring Cell Information	O		9.2.2.96	FDD only	YES	ignore
RLC Sequene Number	O		9.2.2.97	FDD only	YES	ignore

Condition	Explanation
GANSS-ID	This IE shall be present if the GANSS ID IE indicates "SBAS".

Range Bound	Explanation
<i>maxnoofGANSS</i>	Maximum number of GANSS Systems

9.2.1.48B Requested Data Value Information

The *Requested Data Value Information* IE provides information on whether or not the Requested Data Value is available in the message and also the Requested Data Value itself if available. In case of “Periodic” and “On Modification” reporting, “Information Not Available” shall be used when at least one part of the requested information was not available at the moment of initiating the Information Reporting procedure.

IE/Group Name	Presence	Range	IE Type and Reference	Semantics Description	Criticality	Assigned Criticality
CHOICE <i>Information Availability Indicator</i>	M				–	
> <i>Information Available</i>					–	
>>Requested Data Value	M		9.2.1.48A		–	
> <i>Information not Available</i>			NULL		–	

9.2.1.48C Restriction State Indicator

The Restriction state indicator is the identifier indicates whether the cell is “Cell Reserved for Operator Use” or not. It is provided by DRNS and reported to SRNC.

IE/Group Name	Presence	Range	IE Type and Reference	Semantics Description
Restriction state indicator			ENUMERATED (Cell Not Reserved for Operator Use, Cell Reserved for Operator Use, ...)	

9.2.1.48D RLC Mode

The *RLC Mode* IE indicates the RLC Mode used for a Priority Queue.

IE/Group Name	Presence	Range	IE Type and Reference	Semantics Description
RLC Mode			ENUMERATED (RLC-AM, RLC-UM,...)	

9.2.1.49 RL ID

The RL ID is the unique identifier for one RL associated with a UE.

IE/Group Name	Presence	Range	IE Type and Reference	Semantics Description
RL ID			INTEGER (0..31)	

9.2.1.49A RL Specific DCH Information

The *RL Specific DCH Information* IE provides RL Specific DCH Information for DCHs. In case of a set of co-ordinated DCHs requiring a new transport bearer on Iur, the *Transport Layer Address* IE and the *Binding ID* IE in the *RL Specific DCH Information* IE shall be included only for one of the DCHs in the set of co-ordinated DCHs.

IE/Group Name	Presence	Range	IE Type and Reference	Semantics Description	Criticality	Assigned Criticality
RL Specific DCH Information		1..<maxno ofDCHs>			–	
>DCH ID	M		9.2.1.16		–	
>Binding ID	O		9.2.1.3	Shall be ignored if bearer establishment with ALCAP.	–	
>Transport Layer Address	O		9.2.1.62	Shall be ignored if bearer establishment with ALCAP.	–	
>Transport Bearer Not Requested Indicator	O		9.2.2.4S	FDD Only	YES	Ignore

Range bound	Explanation
<i>maxnoofDCHs</i>	Maximum number of DCHs for one UE.

9.2.1.50 RNC-ID

This is the identifier of one RNC in UTRAN.

IE/Group Name	Presence	Range	IE Type and Reference	Semantics Description
RNC-ID			INTEGER(0..4095)	

9.2.1.50a Extended RNC-ID

This is the identifier of one RNC in UTRAN.

IE/Group Name	Presence	Range	IE Type and Reference	Semantics Description
Extended RNC-ID			INTEGER(4096..65535)	Note: Application of the <i>Extended RNC-ID</i> IE to very large networks is FFS.

9.2.1.50A SAT ID

The SAT ID indicates the identity of the satellite.

IE/Group Name	Presence	Range	IE Type and Reference	Semantics Description
SAT ID			INTEGER(0..63)	Identifies the satellite and is equal to (SV ID No – 1) where SV ID No is defined in ICD-GPS-200 [30].

9.2.1.50B RT Load Value

The *RT Load Value* IE indicates in percents the ratio of the load generated by Real Time traffic, relative to the measured Load Value. Real Time traffic corresponds to the Conversational and Streaming traffic classes.

IE/Group Name	Presence	Range	IE Type and Reference	Semantics Description
Uplink RT Load Value	M		INTEGER(0..100)	
Downlink RT Load Value	M		INTEGER(0..100)	

9.2.1.51 SCH Time Slot

The *SCH Time Slot* IE represents the first time slot (k) of a pair of time slots inside a Radio Frame that is assigned to the Physical Channel SCH. The *SCH Time Slot* IE is only applicable if the value of *Sync Case* IE is Case 2 since in this case the SCH is allocated in TS#k and TS#k+8.

IE/Group Name	Presence	Range	IE Type and Reference	Semantics Description
SCH Time Slot			INTEGER(0..6)	

9.2.1.51A Scheduling Priority Indicator

Indicates the relative priority of the FACH, [TDD – DSCH, USCH,] HS-DSCH [FDD – or E-DCH] data frame. Used by the DRNC when scheduling FACH, [TDD – DSCH, USCH,] HS-DSCH [FDD – or E-DCH] traffic.

IE/Group Name	Presence	Range	IE Type and Reference	Semantics Description
Scheduling Priority Indicator			INTEGER(0..15)	Relative priority of the FACH, [TDD – DSCH, USCH,] HS-DSCH [FDD – or E-DCH] data frame: 0=Lowest Priority ... 15=Highest Priority

9.2.1.52 Service Area Identifier (SAI)

This information element is used to identify an area consisting of one or more cells belonging to the same Location Area. Such an area is called a Service Area and can be used for indicating the location of a UE to the CN. For this protocol, only a Service Area that is defined to be applicable to the PS and CS domains shall be used.

IE/Group Name	Presence	Range	IE Type and Reference	Semantics Description
PLMN Identity	M		OCTET STRING (3)	- digits 0 to 9, two digits per octet, - each digit encoded 0000 to 1001, - 1111 used as filler - bit 4 to 1 of octet n encoding digit 2n-1 - bit 8 to 5 of octet n encoding digit 2n -The PLMN Identity consists of 3 digits from MCC followed by either -a filler plus 2 digits from MNC (in case of 2 digit MNC) or -3 digits from MNC (in case of a 3 digit MNC).
LAC	M		OCTET STRING (2)	0000 and FFFE not allowed
SAC	M		OCTET STRING (2)	

9.2.1.52A SFN

System Frame Number of the cell, see ref. TS 25.402 [17].

IE/Group Name	Presence	Range	IE Type and Reference	Semantics Description
SFN			INTEGER(0..4095)	

9.2.1.52B SFN-SFN Measurement Threshold Information

The SFN-SFN Measurement Threshold Information defines the related thresholds SFN-SFN Observed Time Difference measurements which shall trigger the Event On Modification.

IE/Group Name	Presence	Range	IE Type and Reference	Semantics Description
SFN-SFN Change Limit	O		INTEGER(1..256)	Change of SFN-SFN value compared to previously reported value, which shall trigger a new report. Unit in 1/16 chip.
Predicted SFN-SFN Deviation Limit	O		INTEGER(1..256)	Deviation the Predicted SFN-SFN from the latest measurement result, which shall trigger a new report. Unit in 1/16 chip.

9.2.1.52C SFN-SFN Measurement Value Information

The *SFN-SFN Measurement Value Information* IE indicates the measurement result related to SFN-SFN Observed Time Difference measurements as well as other related information.

IE/Group Name	Presence	Range	IE Type and Reference	Semantics Description
Successful Neighbouring cell SFN-SFN Observed Time Difference Measurement Information		<i>1..<maxnoofMeasN Cell></i>		
>UTRAN Cell Identifier	M		9.2.1.71	
>SFN-SFN Value	M		9.2.1.77	
>SFN-SFN Quality	O		INTEGER(0..255)	Indicates the standard deviation (std) of the SFN-SFN otd (observed time difference) measurements in 1/16 chip. SFN-SFN Quality = $\sqrt{E[(x-\mu)^2]}$ = std of reported SFN-SFN Value, where x is the reported SFN-SFN Value and $\mu = E[x]$ is the expectation value of x.
>SFN-SFN Drift Rate	M		INTEGER(-100..100)	Indicates the SFN-SFN drift rate in 1/256 chip per second. A positive value indicates that the Reference cell clock is running at a greater frequency than the measured neighbouring cell.
>SFN-SFN Drift Rate Quality	O		INTEGER(0..100)	Indicates the standard deviation (std) of the SFN-SFN drift rate measurements in 1/256 chip per second. SFN-SFN Drift Rate Quality = $\sqrt{E[(x-\mu)^2]}$ = std of reported SFN-SFN Drift Rate, where x is the reported SFN-SFN Drift Rate and $\mu = E[x]$ is the expectation value of x.
>SFN-SFN Measurement Time Stamp	M		9.2.1.76	
Unsuccessful Neighbouring cell SFN-SFN Observed Time Difference Measurement Information		<i>0..<maxnoofMeasN Cell-1></i>		
>UTRAN Cell Identifier	M		9.2.1.71	

Range bound	Explanation
<i>maxnoofMeasNCell</i>	Maximum number of neighbouring cells on which measurements can be performed.

9.2.1.52Ca Shared Network Area (SNA) Information

This information element contains a list of Shared Network Areas, identified by the Shared Network Area Code (SNAC, see TS 23.003 [1]) which a certain cell belongs to. For a broader description of the SNA access control see TS 25.401 [40].

IE/Group Name	Presence	Range	IE type and reference	Semantics description
PLMN Identity	M		OCTET STRING (3)	- digits 0 to 9, two digits per octet, - each digit encoded 0000 to 1001, - 1111 used as filler - bit 4 to 1 of octet n encoding digit 2n-1 - bit 8 to 5 of octet n encoding digit 2n -The PLMN Identity consists of 3 digits from MCC followed by either -a filler plus 2 digits from MNC (in case of 2 digit MNC) or -3 digits from MNC (in case of a 3 digit MNC).
List of SNAs		0..<maxnoofSNAs >		
> SNAC	M		INTEGER (0.. 65535)	

Range bound	Explanation
maxnoofSNAs	Maximum number of SNAs one cell can be part of.

9.2.1.52D SID

The *SID* IE provides the identity of the Size Index.

IE/Group Name	Presence	Range	IE Type and Reference	Semantics Description
SID			INTEGER (0..7)	

9.2.1.53 S-RNTI

The S-RNTI identifies the UE in the SRNC.

IE/Group Name	Presence	Range	IE Type and Reference	Semantics Description
S-RNTI			INTEGER(0..2 ²⁰ -1)	

9.2.1.53a S-RNTI Group

The S-RNTI Group identifies a group of Ues in the SRNC.

IE/Group Name	Presence	Range	IE Type and Reference	Semantics Description
S-RNTI	M		9.2.1.53	
S-RNTI bit mask index	M		Enumerated(b1, b2,..b19,...)	

The S-RNTI group is identified by all S-RNTI values whose bits starting from the most significant bit down to, and including, the bit indicated by S-RNTI bit mask index, are equal to the corresponding bits of the S-RNTI in this IE.

The bits of the S-RNTI in this IE that are less significant than the bit position indicated by the S-RNTI bit mask index shall be ignored.

9.2.1.54 Sync Case

The SCH and PCCPCH in a TDD cell are mapped on one or two downlink slots per frame. There are two cases of Sync Case as follows:

- Case 1) SCH and PCCPCH allocated in a single TS#k
- Case 2) SCH allocated in two TS: TS#k and TS#k+8
PCCPCH allocated in TS#k

[1.28Mcps TDD – There is no Sync Case indication needed for 1.28Mcps TDD. If the *Sync Case* IE must be included in a message from DRNC to SRNC used for 1.28Mcps TDD, the DRNC shall indicate Sync Case 1 and the SRNC shall ignore it.]

IE/Group Name	Presence	Range	IE Type and Reference	Semantics Description
Sync Case			INTEGER (1..2,...)	

9.2.1.54A T1

The *T1* IE is used as described in ref TS 25.321 [41] subclause 11.6.2.3.

IE/Group Name	Presence	Range	IE type and reference	Semantics description
T1			ENUMERATED (10, 20, 30, 40, 50, 60, 70, 80, 90, 100, 120, 140, 160, 200, 300, 400, ...)	Unit: ms Node B may use this value to stop the re-transmission of the corresponding MAC-hs PDU.

9.2.1.55 TFCI Presence

The TFCI Presence parameter indicates whether the TFCI shall be included. [TDD – If it is present in the timeslot, it will be mapped to the channelisation code defined by TS 25.221 [12].]

IE/Group Name	Presence	Range	IE Type and Reference	Semantics Description
TFCI Presence			ENUMERATED (Present, not present)	

9.2.1.56 Time Slot

The Time Slot represents the time interval assigned to a Physical Channel referred to the start of a Radio Frame.

IE/Group Name	Presence	Range	IE Type and Reference	Semantics Description
Time Slot			INTEGER (0..14)	

9.2.1.56A TNL QoS

This IE indicates the TNL QoS characteristics of the transport bearer for the uplink data traffic.

When the *DS field* IE is used, the value of this IE is configurable by the operator.

When the *Generic Traffic Category* IE is used, generic traffic categories are implementation-specific (e.g. they may be determined by the sender from the application parameters). The value assigned to each of these categories and sent in the *Generic Traffic Category* IE is configurable by the operator, as well as the mapping of this value to DS field (IETF RFC 2474 [44]) at the DRNS side.

IE/Group Name	Presence	Range	IE Type and Reference	Semantics Description
CHOICE <i>TNL QoS type</i>	M			
> <i>DS Field</i>				
>>DS field	M		BIT STRING (8)	DS field as defined in IETF RFC 2474 [44]. Typically used when the DRNS and its SRNC are in the same DS domain as defined in IETF RFC 2475 [45].
> <i>Generic Traffic Category</i>				
>>Generic Traffic Category	M		BIT STRING (8)	

9.2.1.57 ToAWE

ToAWE is the window endpoint. DL data frames are expected to be received before this window endpoint. ToAWE is defined with a positive value relative Latest Time of Arrival (LtoA). A data frame arriving after ToAWE gives a Timing Adjustment Control frame response.

IE/Group Name	Presence	Range	IE Type and Reference	Semantics Description
ToAWE			INTEGER (0..2559)	Unit: msec.

9.2.1.58 ToAWS

ToAWS is the window startpoint. DL data frames are expected to be received after this window startpoint. ToAWS is defined with a positive value relative Time of Arrival Window Endpoint (ToAWE). A data frame arriving before ToAWS gives a Timing Adjustment Control frame response.

IE/Group Name	Presence	Range	IE Type and Reference	Semantics Description
ToAWS			INTEGER (0..1279)	Unit: msec.

9.2.1.58a Trace Depth

The *Trace Depth* IE is Trace Configuration Parameter what should be traced by the DRNC on the indicated interfaces.

IE/Group Name	Presence	Range	IE Type and Reference	Semantics Description
Trace Depth			ENUMERATED (Minimum, Medium, Maximum,...)	Meaning of this parameter is described in TS 32.422 [49]

9.2.1.58b Trace Recording Session Reference

The *Trace Recording Session Reference* IE provides a Trace Recording Session Reference allocated by the triggering entity.

IE/Group Name	Presence	Range	IE Type and Reference	Semantics Description
Trace Recording Session Reference			INTEGER (0..65535)	

9.2.1.58c Trace Reference

The *Trace Reference* IE provides a Trace Reference allocated by the triggering entity.

IE/Group Name	Presence	Range	IE Type and Reference	Semantics Description
Trace Reference			OCTET STRING (SIZE(2..3))	

9.2.1.58A Traffic Class

This IE indicates the type of application the Radio Bearer is optimised for.

IE/Group Name	Presence	Range	IE Type and Reference	Semantics Description
Traffic Class			ENUMERATED (conversational, streaming, interactive, background, ...)	

9.2.1.59 Transaction ID

The Transaction ID is used to associate all the messages belonging to the same procedure. Messages belonging to the same procedure shall use the same Transaction ID.

The Transaction ID is determined by the initiating peer of a procedure.

For procedures addressed to a specific UE Context, the Transaction ID shall uniquely identify a procedure among all ongoing parallel procedures for the same UE using the same procedure code, and initiated by the same protocol peer.

For procedures not addressed to a specific UE Context, the Transaction ID shall uniquely identify a procedure among all ongoing parallel procedures using the same procedure code, and initiated by the same protocol peer.

IE/Group Name	Presence	Range	IE Type and Reference	Semantics Description
CHOICE <i>Transaction ID Length</i>				The Transaction ID shall be interpreted for its integer value, not for the type of encoding ("short" or "long").
> <i>Short</i>				
>>Transaction ID Value	M		INTEGER (0..127)	
> <i>Long</i>				
>>Transaction ID Value	M		INTEGER (0..32767)	

9.2.1.59A Transmitted Carrier Power

The *Transmitted Carrier Power* IE contains the Transmitted Carrier Power in a cell, as defined in TS 25.215 [11] & TS 25.225 [14].

IE/Group Name	Presence	Range	IE Type and Reference	Semantics Description
Transmitted Carrier Power			INTEGER(0..100)	According to mapping in TS 25.133 [23] and TS 25.123 [24].

9.2.1.59B T_{UTRAN-GPS} Accuracy Class

IE/Group Name	Presence	Range	IE Type and Reference	Semantics Description
T _{UTRAN-GPS} Accuracy Class			ENUMERATED(Accuracy Class A, Accuracy Class B, Accuracy Class C,...)	More information about Measurement Accuracy Class is included in TS 25.133 [23].

9.2.1.59C T_{UTRAN-GPS} Measurement Threshold Information

The T_{UTRAN-GPS} Measurement Threshold Information defines the related thresholds for UTRAN GPS Timing of Cell Frames for UE Positioning measurements shall trigger the Event On Modification.

IE/Group Name	Presence	Range	IE Type and Reference	Semantics Description
T _{UTRAN-GPS} Change Limit	O		INTEGER(1..256)	Change of T _{UTRAN-GPS} value compared to previously reported value, which shall trigger a new report. Unit in 1/16 chip.
Predicted T _{UTRAN-GPS} Deviation Limit	O		INTEGER(1..256)	Deviation of the Predicted T _{UTRAN-GPS} from the latest measurement result, which shall trigger a new report. Unit in 1/16 chip.

9.2.1.59D T_{UTRAN-GPS} Measurement Value Information

The T_{UTRAN-GPS} *Measurement Value Information* IE indicates the measurement results related to the UTRAN GPS Timing of Cell Frames for UE Positioning measurements.

IE/Group Name	Presence	Range	IE Type and Reference	Semantics Description
T _{UTRAN-GPS}		1		Indicates the UTRAN GPS Timing of Cell Frames for UE Positioning. According to mapping in TS 25.133 [23] and TS 25.123 [24]; significant values range from 0 to 37158911999999.
>MS	M		INTEGER (0..16383)	Most Significant Part
>LS	M		INTEGER (0..4294967295)	Least Significant Part
T _{UTRAN-GPS} Quality	O		INTEGER(0..255)	Indicates the standard deviation (std) of the T _{UTRAN-GPS} measurements in 1/16 chip. $T_{UTRAN-GPS} \text{ Quality} = \sqrt{E[(x-\mu)^2]}$ = std of reported T _{UTRAN-GPS} Value, where x is the reported T _{UTRAN-GPS} Value and $\mu = E[x]$ is the expectation value of x.
T _{UTRAN-GPS} Drift Rate	M		INTEGER(-50..50)	Indicates the T _{UTRAN-GPS} drift rate in 1/256 chip per second. A positive value indicates that the UTRAN clock is running at a lower frequency than GPS clock.
T _{UTRAN-GPS} Drift Rate Quality	O		INTEGER(0..50)	Indicates the standard deviation (std) of the T _{UTRAN-GPS} drift rate measurements in 1/256 chip per second. $T_{UTRAN-GPS} \text{ Drift Rate Quality} = \sqrt{E[(x-\mu)^2]}$ = std of reported T _{UTRAN-GPS} Drift Rate, where x is the reported T _{UTRAN-GPS} Drift Rate and $\mu = E[x]$ is the expectation value of x.

9.2.1.60 Transport Bearer ID

The Transport Bearer ID uniquely identifies an Iur transport bearer.

IE/Group Name	Presence	Range	IE Type and Reference	Semantics Description
Transport Bearer ID			INTEGER(0..4095)	

9.2.1.61 Transport Bearer Request Indicator

Indicates whether a new Iur transport bearer needs to be established for carrying the corresponding data stream(s), or whether an existing transport bearer will be used.

IE/Group Name	Presence	Range	IE Type and Reference	Semantics Description
Transport Bearer Request Indicator			ENUMERATED(Bearer Requested, Bearer not Requested, ...)	

9.2.1.62 Transport Layer Address

In case of transport bearer establishment with ALCAP (TS 25.426 [3]) and (TS 25.424 [35]), this IE contains the address to be used for Transport Network Control Plane signalling to establish the transport bearer according to TS 25.426 [3] and TS 25.424 [35].

In order to allow transport bearer establishment without ALCAP, this IE contains the address of the transport bearer to be used for the user plane transport.

For details on the Transport Address used see TS 25.426 [3].

IE/Group Name	Presence	Range	IE Type and Reference	Semantics Description
Transport Layer Address			BIT STRING(1..1 60, ...)	

9.2.1.63 Transport Format Combination Set (TFCS)

The Transport Format Combination Set is defined as a set of Transport Format Combinations on a Coded Composite Transport Channel. It is the allowed Transport Format Combinations of the corresponding Transport Channels. The DL Transport Format Combination Set is applicable to DL Transport Channels.

IE/Group Name	Presence	Range	IE Type and Reference	Semantics Description
CHOICE TFCS Values	M			
>Always Used				This choice is always made.
>>TFCS		1.. <i>maxnoofTFCS</i> >		The first instance of the parameter corresponds to TFCI zero, the second to 1 and so on. [TDD – The first entry (for TFCI 0) should be ignored by the receiver.]
>>>CTFC	M		9.2.1.14A	
>>>CHOICE Gain Factors	C- PhysChan			
>>>>Signalled Gain Factors				
>>>>Gain Factor β_c	M		INTEGER(0 ..15)	[FDD – For UL DPCH or control part of PRACH ref. TS 25.213 [21].] [TDD - β for UL DPCH mapping in accordance to TS 25.223 [13].]
>>>>Gain Factor β_d	M		INTEGER(0 ..15)	[FDD – For UL DPCH or data part of PRACH ref. TS 25.213 [21].] [TDD – Should be set to 0 by the sender, and shall be ignored by the receiver.]
>>>>Reference TFC nr	O		INTEGER(0 ..15)	If this TFC is a reference TFC, this IE indicates the reference number
>>>>Computed Gain Factors				
>>>>Reference TFC nr	M		INTEGER(0 ..15)	Indicates the reference TFC to be used to calculate the gain factors for this TFC
>Not Used			NULL	This choice shall never be made by the SRNC and the DRNC shall consider the procedure as failed if it is received.

Condition	Explanation
PhysChan	The choice shall be present if the TFCS concerns a UL DPCH [FDD – or PRACH channel].

Range bound	Explanation
<i>maxnoofTFCS</i>	The maximum number of Transport Format Combinations.

9.2.1.64 Transport Format Set

The Transport Format Set is defined as the set of Transport Formats associated to a Transport Channel, e.g. DCH.

[TDD – The Transport Format Set for each transport channel within the same CCTrCH shall have the same value for the 2nd *Interleaving Mode* IE.]

IE/Group Name	Presence	Range	IE Type and Reference	Semantics Description
Dynamic Transport Format Information		$1..<maxTFcount>$		The first instance of the parameter corresponds to TFI zero, the second to 1 and so on.
>Number of Transport Blocks	M		INTEGER (0..512)	
>Transport Block Size	C – Blocks		INTEGER (0..5000)	Unit: Bits
>CHOICE Mode	M			
>>TDD				
>>>Transmission Time Interval Information	C-TTIdynamic	$1..<maxTTIcount>$		
>>>>Transmission Time Interval	M		ENUMERATED(10, 20, 40, 80,...)	Unit: msec
Semi-static Transport Format Information		1		
>Transmission Time Interval	M		ENUMERATED (10, 20, 40, 80, dynamic, ...)	Unit: msec Value “dynamic” for TDD only. For FDD DCH, the value “80” is applicable only when <i>DL DPCH Slot Format</i> IE indicates a slot format with SF=512.
>Type of Channel Coding	M		ENUMERATED (No codingTDD, Convolutional, Turbo,...)	[FDD – The value “No codingTDD” shall be treated as logical error if received]
>Coding Rate	C – Coding		ENUMERATED (1/2, 1/3,...)	
>Rate Matching Attribute	M		INTEGER (1..maxRM)	
>CRC size	M		ENUMERATED (0, 8, 12, 16, 24,...)	
>CHOICE Mode	M			
>>TDD				
>>>2 nd Interleaving Mode	M		ENUMERATED(Frame related, Timeslot related,...)	

Condition	Explanation
Blocks	The IE shall be present if the <i>Number of Transport Blocks</i> IE is set to a value greater than 0.
Coding	The IE shall be present if <i>Type of Channel Coding</i> IE is set to “Convolutional” or “Turbo”.
TTIdynamic	The IE shall be present if the <i>Transmission Time Interval</i> IE in the <i>Semi-static Transport Format Information</i> IE is set to “dynamic”.

Range bound	Explanation
<i>maxTFcount</i>	The maximum number of different transport formats that can be included in the Transport format set for one transport channel.
<i>maxRM</i>	The maximum number that could be set as rate matching attribute for a transport channel.
<i>maxTTIcount</i>	The amount of different TTI that are possible for that transport format is.

9.2.1.65 TrCH Source Statistics Descriptor

Defines the statistics of the data transmitted in the transport channel. This information may be used in reserving resources in the DRNS.

IE/Group Name	Presence	Range	IE Type and Reference	Semantics Description
TrCH Source Statistics Descriptor			ENUMERATED(Speech, RRC, Unknown, ...)	“Speech” = Statistics of the data corresponds to speech. “RRC” = Statistics of the data corresponds to RRC signalling “Unknown” = The statistics of the data is unknown

9.2.1.66 UARFCN

The UTRA Absolute Radio Frequency Channel Number defines the carrier.

IE/Group Name	Presence	Range	IE Type and Reference	Semantics Description
UARFCN			INTEGER(0..16383, ...)	Corresponds to: 0.0Hz..3276.6MHz see ref. TS 25.104 [6] and ref. TS 25.105 [7].

9.2.1.66A UE Identity

The *UE Identity* IE identifies the UE by one of its Permanent NAS Identifier.

IE/Group Name	Presence	Range	IE Type and Reference	Semantics Description
CHOICE <i>UE Identity</i>	M			
> <i>IMSI</i>				
>> <i>IMSI</i>	M		9.2.1.31	
> <i>IMEI</i>				
>> <i>IMEI</i>	M		9.2.1.30T	
> <i>IMEISV</i>				
>> <i>IMEISV</i>	M		9.2.1.30U	

9.2.1.67 UL FP Mode

This parameter defines if normal or silent mode of the Frame Protocol shall be used for the UL.

IE/Group Name	Presence	Range	IE Type and Reference	Semantics Description
UL FP Mode			ENUMERATED(Normal, Silent,...)	

9.2.1.68 UL Interference Level

Void

9.2.1.68A Uncertainty Ellipse

This IE contains the uncertainty ellipse used to describe a possible shape of the geographical area of a cell.

IE/Group Name	Presence	Range	IE Type and Reference	Semantics Description
Uncertainty semi-major	M		INTEGER(0..127)	The uncertainty "r" is derived from the "uncertainty code" k by $r = 10 \times (1.1^k - 1)$
Uncertainty semi-minor	M		INTEGER(0..127)	The uncertainty "r" is derived from the "uncertainty code" k by $r = 10 \times (1.1^k - 1)$
Orientation of major axis	M		INTEGER(0..179)	The relation between the IE value (N) and the angle (a) in degrees it describes is $2N \leq a < 2(N+1)$. The values 90..179 shall not be used.

9.2.1.68B Unidirectional DCH Indicator

The *Unidirectional DCH Indicator* IE indicates that the DCH is unidirectional.

IE/Group Name	Presence	Range	IE Type and Reference	Semantics Description
Unidirectional DCH Indicator			ENUMERATED (Downlink DCH only, Uplink DCH only)	

9.2.1.69 Uplink SIR

The UL SIR indicates a received UL SIR.

IE/Group Name	Presence	Range	IE Type and Reference	Semantics Description
Uplink SIR			INTEGER (-82..173)	Value = Uplink SIR/10 Unit dB Range -8.2..+17.3 Step 0.1 dB

9.2.1.70 URA ID

IE/Group Name	Presence	Range	IE Type and Reference	Semantics Description
URA ID			INTEGER(0..65 535)	

9.2.1.70A UTRAN Access Point Position

The UTRAN Access Point Position indicates the exact geographical position of the base station antenna.

IE/Group Name	Presence	Range	IE Type and Reference	Semantics Description
Latitude Sign	M		ENUMERATED(North, South)	
Degrees of Latitude	M		INTEGER(0..2 ²³ -1)	The IE value (N) is derived by this formula: $N \leq 2^{23} X / 90 < N+1$ X being the latitude in degree (0°.. 90°)
Degrees of Longitude	M		INTEGER(-2 ²³ ..2 ²³ -1)	The IE value (N) is derived by this formula: $N \leq 2^{24} X / 360 < N+1$ X being the longitude in degree (-180°..+180°)

9.2.1.70B URA Information

The *URA Information* IE contains URA Information for one cell.

IE/Group Name	Presence	Range	IE Type and Reference	Semantics Description	Criticality	Assigned Criticality
URA ID	M		9.2.1.70		–	
Multiple URAs Indicator	M		9.2.1.41		–	
RNCs with Cells in the Accessed URA		0 .. <maxRNCin URA-1>		Other RNCs having at least one cell in the URA identified by the <i>URA ID</i> IE.	–	
>RNC-ID	M		9.2.1.50	If the <i>Extended RNC-ID</i> IE is included in the <i>URA Information</i> IE, the <i>RNC-ID</i> IE shall be ignored.	–	
>Extended RNC-ID	O		9.2.1.50a	The <i>Extended RNC-ID</i> IE shall be used if the RNC identity has a value larger than 4095.	YES	reject

Range Bound	Explanation
maxRNCinURA	Maximum number of RNC in one URA.

9.2.1.70C User Plane Congestion Fields Inclusion

The *User Plane Congestion Fields Inclusion* IE is used by the DRNC to indicate to the SRNC to include in the HS-DSCH Data Frames the User Plane fields related to TNL Congestion Control for HSDPA (namely the Frame Sequence Number and the DRT, see TS 25.425 [32]).

IE/Group Name	Presence	Range	IE Type and Reference	Semantics Description
User Plane Congestion Fields Inclusion			ENUMERATED (Shall be included)	

9.2.1.71 UTRAN Cell Identifier (UC-ID)

The UC-ID (UTRAN Cell identifier) is the identifier of a cell in one UTRAN.

IE/Group Name	Presence	Range	IE Type and Reference	Semantics Description
RNC-ID	M		9.2.1.50	If the <i>Extended RNC-ID</i> IE is included in the <i>UC-ID</i> IE, the <i>RNC-ID</i> IE shall be ignored.
C-ID	M		9.2.1.6	
Extended RNC-ID	O		9.2.1.50a	The <i>Extended RNC-ID</i> IE shall be used if the RNC identity has a value larger than 4095.

9.2.1.72 Neighbouring TDD Cell Information LCR

The *Neighbouring TDD Cell Information LCR* IE provides information for 1.28Mcps TDD cells that are neighbouring cells to a cell in the DRNC.

IE/Group Name	Presence	Range	IE Type and Reference	Semantics Description	Criticality	Assigned Criticality
Neighbouring TDD Cell Information LCR		<i>1..<maxno of LCRTDD neighbour s></i>			–	
>C-ID	M		9.2.1.6		–	
>UARFCN	M		9.2.1.66	Corresponds to Nt in ref. TS 25.105 [7]	–	
>Frame Offset	O		9.2.1.30		–	
>Cell Parameter ID	M		9.2.1.8		–	
>SCTD Indicator	M		9.2.1.78		–	
>Cell Individual Offset	O		9.2.1.7		–	
>DPCH Constant Value	O		9.2.1.23		–	
>PCCPCH Power	O		9.2.1.43		–	
>Restriction State Indicator	O		9.2.1.48C		–	
>Coverage Indicator	O		9.2.1.12G		YES	ignore
>Antenna Co-location Indicator	O		9.2.1.2C		YES	ignore
>HCS Prio	O		9.2.1.30N		YES	ignore
>Cell Capability Container TDD LCR	O		9.2.3.1b		YES	ignore
> SNA Information	O		9.2.1.52Ca		YES	ignore
>Multiple PLMN List	O		9.2.1.117		YES	ignore

Range bound	Explanation
<i>maxnoofLCRTDDneighbours</i>	Maximum number of neighbouring 1.28Mcps TDD cell for one cell.

9.2.1.73 Permanent NAS UE Identity

This element is used to identify the UE in UTRAN.

IE/Group Name	Presence	Range	IE Type and Reference	Semantics Description
Choice <i>Permanent NAS UE Identity</i>				
> <i>IMSI</i>				
>> <i>IMSI</i>	M		9.2.1.31	

9.2.1.74 SFN-SFN Measurement Reference Point Position

The SFN-SFN Measurement Reference Point Position indicates the exact geographical position of the SFN-SFN measurement reference point. The altitude shall be included when available.

IE/Group Name	Presence	Range	IE Type and Reference	Semantics Description
Geographical Coordinates	M		9.2.1.30F	
Altitude and direction	O		9.2.1.2B	

9.2.1.75 UTRAN Access Point Position with Altitude

The UTRAN Access Point Position with Altitude indicates the exact geographical position of the base station antenna. The altitude shall be included when available.

IE/Group Name	Presence	Range	IE Type and Reference	Semantics Description
Geographical Coordinates	M		9.2.1.30F	
Altitude and direction	O		9.2.1.2B	

9.2.1.76 SFN-SFN Measurement Time Stamp

IE/Group Name	Presence	Range	IE Type and Reference	Semantics Description
CHOICE Mode	M			
>FDD				
>>SFN	M		9.2.1.52A	Indicates the SFN of the reference cell at which the measurement has been performed.
>TDD				
>>SFN	M		9.2.1.52A	Indicates the SFN of the reference cell at which the measurement has been performed.
>>Time Slot	M		9.2.1.56	Indicates the Time Slot of the reference cell at which this measurement has been performed.

9.2.1.77 SFN-SFN Value

IE/Group Name	Presence	Range	IE Type and Reference	Semantics Description
CHOICE Mode	M			
>FDD				
>>SFN-SFN	M		INTEGER(0..614399)	According to mapping in TS 25.133 [23].
>TDD				1.28Mcps or 3.84Mcps TDD
>>SFN-SFN	M		INTEGER(0..40961)	According to mapping in TS 25.123 [24].
>TDD 7.68Mcps				
>>SFN-SFN	M		INTEGER(0..81923)	According to mapping in TS 25.123 [24].

9.2.1.78 SCTD Indicator

Indicates if SCTD antenna diversity is applied or not to the PCCPCH and PICH [3.84Mcps TDD].

IE/Group Name	Presence	Range	IE Type and Reference	Semantics Description
SCTD Indicator			ENUMERATED (active, inactive)	

9.2.1.79 Congestion Cause

The *Congestion Cause* IE indicates the cause of a congestion situation:

IE/Group Name	Presence	Range	IE Type and Reference	Semantics Description
Congestion Cause			ENUMERATED (UTRAN Dynamic Resources, UTRAN Semistatic Resources, ...)	

The meaning of the different congestion cause values is described in the following table:

Congestion cause	Meaning
UTRAN Dynamic Resources	UL and/or DL resource congestion situation mainly caused by the UL and/or DL UTRAN Dynamic Resources. This type of congestion situation is, e.g. related to the limitation of the DL transmitted carrier power of the cell(s), or the UL Interference situation in the concerned cell(s).
UTRAN Semistatic Resources	UL and/or DL resource congestion situation mainly related to UTRAN Semistatic Resources (e.g. channelisation codes, Node-B resources, ..).

9.2.1.80 TMGI

The TMGI is the unique identifier for an MBMS bearer service, see ref.TS 23.003 [1].

IE/Group Name	Presence	Range	IE Type and Reference	Semantics Description
PLMN Identity	M		OCTET STRING (3)	<ul style="list-style-type: none"> - digits 0 to 9, two digits per octet, - each digit encoded 0000 to 1001, - 1111 used as filler - bit 4 to 1 of octet n encoding digit 2n-1 - bit 8 to 5 of octet n encoding digit 2n -The PLMN Identity consists of 3 digits from MCC followed by either -a filler plus 2 digits from MNC (in case of 2 digit MNC) or -3 digits from MNC (in case of a 3 digit MNC).
Service ID	M		OCTET STRING (3)	

9.2.1.81 Transmission Mode

The *Transmission Mode* IE indicates the transmission mode used for MBMS data transmission in one cell.

IE/Group Name	Presence	Range	IE Type and Reference	Semantics Description
Transmission Mode			ENUMERATED(PTP, PTM, Not Provided).	PTP: The MBMS data is transmitted through point to point channel. PTM: The MBMS data is transmitted through point to multipoint channel. Not Provided: The MBMS data is not transmitted in the DRNC.

9.2.1.82 Access Point Name

The APN and IP Multicast Address uniquely identify an MBMS bearer service.

IE/Group Name	Presence	Range	IE Type and Reference	Semantics Description
APN	M		OCTET STRING (1..255)	

9.2.1.83 IP Multicast Address

The APN and IP Multicast Address uniquely identify an MBMS bearer service.

IE/Group Name	Presence	Range	IE Type and Reference	Semantics Description
IP Multicast Address	M		OCTET STRING (4..16)	

9.2.1.84 MBMS Bearer Service Full Address

This IE provides the full address of an MBMS Bearer Service otherwise identified by its TMGI.

IE/Group Name	Presence	Range	IE Type and Reference	Semantics Description
Access Point Name	M		9.2.1.82	
IP Multicast Address	M		9.2.1.83	

9.2.1.85 Provided Information

This IE contains the relevant data concerned the direct information transfer procedure. *Provided Information* IE shall include at least one of the following IEs.

IE/Group Name	Presence	Range	IE Type and Reference	Semantics Description	Criticality	Assigned Criticality
MBMS Channel Type Information	O		9.2.1.86			
MBMS Preferred Frequency Layer Information	O		9.2.1.87			
UpPCH Information LCR	O		9.2.3.55	Applicable to 1.28Mcps TDD only .	YES	ignore

9.2.1.86 MBMS Channel Type Information

This IE contains the channel types of a MBMS Bearer Service indicated by *TMGI* IE in one or more cells. *MBMS Channel Type Information* IE shall include at least one *C-ID* IE and *Affected UE Information for MBMS* IE in the *PTM Cell List* IE, the *PTP Cell List* IE and/or *Not Provided Cell List* IE.

IE/Group Name	Presence	Range	IE Type and Reference	Semantics Description
TMGI	M		9.2.1.80	
PTM Cell List		0..<maxnoofCells>		
>C-ID	M		9.2.1.6	
>Affected UE Information for MBMS		0..<maxnoofUEs>		
>>S-RNTI	M		9.2.1.53	
PTP Cell List		0.. <maxnoofCells>		
>C-ID	M		9.2.1.6	
>Affected UE Information for MBMS		0..<maxnoofUEs>		
>>S-RNTI	M		9.2.1.53	
Not Provided Cell List		0.. <maxnoofCells>		
>C-ID	M		9.2.1.6	
>Affected UE Information for MBMS		0..<maxnoofUEs>		
>>S-RNTI	M		9.2.1.53	

Range Bound	Explanation
<i>maxnoofCells</i>	Maximum number of cells that can be indicated in the corresponding IE.
<i>maxnoofUEs</i>	Maximum number of S-RNTIs that can be indicated per cell in the respective IEs.

9.2.1.87 MBMS Preferred Frequency Layer Information

This IE contains the preferred frequency layer of a MBMS Bearer Service indicated by *TMGI* IE in one or more cells that host at least one *CELL_DCH* UE whose *UE Link* contains the concerned MBMS Bearer Service and whose *SRNC* is different from the *CRNC*.

IE/Group Name	Presence	Range	IE Type and Reference	Semantics Description
TMGI	M		9.2.1.80	
Preferred Frequency Layer Information				
>Default Preferred Frequency	M		UARFCN 9.2.1.66	
>Additional Preferred Frequency		0..<maxnoofAddFreq>		Preferred frequencies different from default preferred frequency
>>DL UARFCN	M		UARFCN 9.2.1.66	
>>Corresponding Cells		1..<maxnoofCellsPerFreq>		
>>>C-ID	M		9.2.1.6	

Range Bound	Explanation
<i>maxnoofAddFreq</i>	Maximum number of additional preferred frequencies different from default preferred frequency in an RNC.
<i>maxnoofCellsPerFreq</i>	Maximum number of cells whose preferred frequency is the same.

9.2.1.88 E-DCH DDI Value

The *E-DCH DDI Value* IE is the Data Description Indicator value identifying a unique combination of E-DCH MAC-d Flow ID and MAC-d PDU Size.

IE/Group Name	Presence	Range	IE Type and Reference	Semantics Description
E-DCH DDI Value			INTEGER (0..62)	

9.2.1.89 E-DCH MAC-d Flow Multiplexing List

The E-DCH MAC-d Flow Multiplexing List indicates which E-DCH MAC-d flows are allowed to be multiplexed within a MAC-e PDU with the MAC-d flow it is associated to. If the E-DCH MAC-d Flow Multiplexing List is signalled for an E-DCH MAC-d flow it indicates that E-DCH MAC-d PDUs of this E-DCH MAC-d flow are the first E-DCH MAC-d PDU in the MAC-e PDU. If an E-DCH MAC-d Flow Multiplexing List was already received within a previous Radio Link related procedure and no E-DCH MAC-d Flow Multiplexing List is signalled for a E-DCH MAC-d flow, the DRNS shall continue to use the previously received one. If no E-DCH MAC-d Flow Multiplexing List was ever received for an E-DCH MAC-d flow no restrictions shall be assumed for the related E-DCH MAC-d flow for multiplexing E-DCH MAC-d flows.

IE/Group Name	Presence	Range	IE Type and Reference	Semantics Description
E-DCH MAC-d Flow Multiplexing List			BIT STRING (8)	The first Bit corresponds to E-DCH MAC-d flow 0, the second bit corresponds to E-DCH MAC-d flow 1, etc. For 1.28Mcps TDD, if the IE is included in the IE Common E-DCH MAC-d Flow Specific Information LCR, the first Bit corresponds to E-DCH MAC-d with the lowest E-DCH MAC-d Flow ID within the same frequency, the second bit corresponds to E-DCH MAC-d flow with the second lowest E-DCH MAC-d Flow ID within the same frequency, etc.

9.2.1.90 E-DCH MAC-d Flows To Delete

The *E-DCH MAC-d Flows To Delete* IE is used for the removal of E-DCH MAC-d flows.

IE/Group Name	Presence	Range	IE Type and Reference	Semantics Description
E-DCH MAC-d Flows To Delete		<i>1..<maxnoofEDCH MACdFlows></i>		
>E-DCH MAC-d Flow ID	M		9.2.1.91	

Range Bound	Explanation
<i>maxnoofEDCHMACdFlows</i>	Maximum number of E-DCH MAC-d flows

9.2.1.91 E-DCH MAC-d Flow ID

The *E-DCH MAC-d Flow ID* IE is the unique identifier for one MAC-d flow on E-DCH.

IE/Group Name	Presence	Range	IE Type and Reference	Semantics Description
E-DCH MAC-d Flow ID			INTEGER (0.. maxnoofEDC HMACdFlow s-1)	

Range Bound	Explanation
maxnoofEDCHMACdFlows	Maximum number of E-DCH MAC-d flows

9.2.1.91A E-DCH MAC-d PDU Size Format

The *E-DCH MAC-d PDU Size Format* IE provides information about the type of MAC-d PDU Size Format that shall be used for the E-DCH in the new configuration. “Fixed MAC-d PDU Size” uses MAC-d PDU sizes defined in *MAC-d PDU Size List* IE of the *E-DCH Logical Channel Information* IE. “Flexible MAC-d PDU Size” uses a flexible MAC-d PDU size with a maximum PDU size as defined by *Maximum MAC-d PDU Size Extended* IE of *E-DCH Logical Channel Information* IE. The actual MAC-d PDU size is determined as specified in TS 25.123 [24] and TS 25.425 [32].

IE/Group Name	Presence	Range	IE Type and Reference	Semantics Description
E-DCH MAC-d PDU Size Format			ENUMERATED (Fixed MAC-d PDU Size, Flexible MAC-d PDU Size)	

9.2.1.92 E-DCH Logical Channel Information

The *E-DCH Logical Channel Information* IE is used for the establishment of E-DCH Logical Channels.

IE/Group Name	Presence	Range	IE Type and Reference	Semantics Description	Criticality	Assigned Criticality
E-DCH Logical Channel Information		$1..<maxnooflogicalchannels>$			–	
>Logical Channel ID	M		9.2.1.97		–	
>Scheduling Priority Indicator	M		9.2.1.51A		–	
>Scheduling Information	M		9.2.1.101		–	
>MAC-es Guaranteed Bit Rate	O		9.2.1.98		–	
>E-DCH DDI Value	M		9.2.1.88	If more than 1 MAC-d PDU size is configured for this Logical Channel, the different sizes will use subsequent DDI values starting from this DDI value. Value "0x3F" is reserved. Shall be ignored if <i>Maximum MAC-d PDU Size Extended IE</i> is present.	–	
>MAC-d PDU Size List		$1..<maxnoofMACdPDUSize>$			–	
>>MAC-d PDU Size	M		9.2.1.34A	Shall be ignored if <i>Maximum MAC-d PDU Size Extended IE</i> is present.	–	
>Maximum MAC-d PDU Size Extended	O		MAC PDU Size Extended 9.2.1.34D		YES	reject
>MAC-es Maximum Bit Rate LCR	O		9.2.3.59	1.28Mcps TDD only	YES	ignore
>UE Aggregate Maximum Bit Rate Enforcement Indicator	O		NULL		YES	ignore

Range Bound	Explanation
$maxnooflogicalchannels$	Maximum number of logical channels
$maxnoofMACdPDUSize$	Maximum number of MAC-d PDU size per Logical Channels

9.2.1.93 E-DCH Logical Channel To Modify

The *E-DCH Logical Channel To Modify* IE is used for the reconfiguration of E-DCH Logical Channels.

IE/Group Name	Presence	Range	IE Type and Reference	Semantics Description	Criticality	Assigned Criticality
E-DCH Logical Channel Information		$1..<maxnooflogicalchannels>$			–	
>Logical Channel ID	M		9.2.1.97		–	
>Scheduling Priority Indicator	O		9.2.1.51A		–	
>Scheduling Information	O		9.2.1.101		–	
>MAC-es Guaranteed Bit Rate	O		9.2.1.98		–	
>E-DCH DDI Value	O		9.2.1.88	If more than 1 MAC-d PDU size is configured for this Logical Channel, the different sizes will use subsequent DDI values starting from this DDI value. Value "0x3F" is reserved. Shall be ignored if <i>Maximum MAC-d PDU Size Extended</i> IE is present.	–	
>MAC-d PDU Size List		$0..<maxnoofMACdPDUSize>$			–	
>>MAC-d PDU Size	M		9.2.1.34A		–	
>Maximum MAC-d PDU Size Extended	O		MAC PDU Size Extended 9.2.1.34D		YES	reject
>MAC-es Maximum Bit Rate LCR	O		9.2.3.59	1.28Mcps TDD only	YES	ignore

Range Bound	Explanation
<i>maxnooflogicalchannels</i>	Maximum number of logical channels
<i>maxnoofMACdPDUSize</i>	Maximum number of MAC-d PDU size per Logical Channels

9.2.1.94 E-RNTI

The *E-RNTI* IE is needed for the UE (or UE group) specific CRC in E-AGCH, see ref. TS 25.319 [52].

IE/Group Name	Presence	Range	IE Type and Reference	Semantics Description
E-RNTI			INTEGER (0..65535)	

9.2.1.95 E-DCH Processing Overload Level

The *E-DCH Processing Overload Level* IE defines the threshold that determines when DRNS shall indicate processing issue problems to the SRNC.

IE/Group Name	Presence	Range	IE type and reference	Semantics description
E-DCH Processing Overload Level			INTEGER (0..10,...)	Number of consecutive TTIs. The value "0" is a special value, that means infinity, i.e. when this value is used, the DRNS shall never indicate processing issue to the RNC.

9.2.1.96 E-DCH Power Offset for Scheduling Info

The E-DCH Power Offset for Scheduling Info is used to calculate the [FDD – E-DPDCH][TDD – E-PUCH] power for transmission of scheduling information without any MAC-d PDUs.

IE/Group Name	Presence	Range	IE Type and Reference	Semantics Description
E-DCH Power Offset for Scheduling Info			INTEGER (0..6)	Unit: dB Step: 1 dB

9.2.1.97 Logical channel ID

The *Logical Channel ID* IE is used to identify a E-DCH logical channel in Scheduling Information that is sent over U_u .

IE/Group Name	Presence	Range	IE Type and Reference	Semantics Description
Logical Channel ID		INTEGER (1..15)		

9.2.1.98 MAC-es Guaranteed Bit Rate

The *MAC-es Guaranteed Bit Rate* IE indicates the guaranteed number of bits per second to be delivered over the air interface under normal operating conditions (provided there is data to deliver) for which the Node B shall provide sufficient UL resources. If the *MAC-es Guaranteed Bit Rate* IE is received with the value set to 0 during RL set up or modification, no guarantee is applied.

IE/Group Name	Presence	Range	IE type and reference	Semantics description
MAC-es Guaranteed Bit Rate			INTEGER (0..2 ²⁴ -1, ..., 2 ²⁴ ..256,000,000)	Unit: bit/s

9.2.1.99 MAC-e Reset Indicator

Indicates the MAC-e (or MAC-i) Reset is performed in UE.

IE/Group Name	Presence	Range	IE Type and Reference	Semantics Description
MAC-e Reset Indicator			ENUMERATED (MAC-e Reset)	Means MAC-I Reset in case Maximum MAC-d PDU Size Extended is configured for an E-DCH Logical Channel.

9.2.1.100 Maximum Number of Retransmissions for E-DCH

The *Maximum Number of Retransmissions for E-DCH* IE specifies the upper boundary for retransmissions for a single MAC-d flow.

IE/Group Name	Presence	Range	IE Type and Reference	Semantics Description
Maximum Number of Retransmissions for E-DCH			INTEGER (0..15)	

9.2.1.101 Scheduling Information

The *Scheduling Information* IE indicates whether the scheduling information is included for the E-DCH logical channel or not.

IE/Group Name	Presence	Range	IE Type and Reference	Semantics Description
Scheduling Information			ENUMERATED (Included, Not Included)	

9.2.1.102 DGANSS Corrections

This IE contains DGANSS corrections.

IE/Group name	Presence	Range	IE Type and Reference	Semantics description	Criticality	Assigned Criticality
DGANSS Reference Time	M		INTEGER(0..3570 by step of 30)	Seconds. Time in GNSS system time (modulo 3600 s) when the DGANSS corrections were calculated	-	
DGANSS Information		<i>1 to <maxSgnType></i>			-	
>GANSS Signal ID	O		9.2.1.121		-	
>Status/Health	M		ENUMERATED (UDRE scale 1.0, UDRE scale 0.75, UDRE scale 0.5, UDRE scale 0.3, UDRE scale 0.2, UDRE scale 0.1, no data, invalid data)		-	
>DGANSS Signal Information	C- <i>Status/Health</i>	<i>1 to <maxGANSSat></i>		If the Cipher information is included these fields are ciphered	-	
>>Sat ID	M		INTEGER(0..63)	Defined in TS 25.331 [16].	-	
>>IOD	M		BIT STRING(10)		-	

IE/Group name	Presence	Range	IE Type and Reference	Semantics description	Criticality	Assigned Criticality
>>UDRE	M		ENUMERATED (UDRE ≤ 1.0 m, 1.0m < UDRE ≤ 4.0m, 4.0m < UDRE ≤ 8.0m, 8.0m < UDRE)	The value in this field shall be multiplied by the UDRE Scale Factor in the IE Status/Health to determine the final UDRE estimate for the particular satellite.	-	
>>PRC	M		INTEGER(-2047..2047)	Scaling factor 0.32 meters	-	
>>RRC	M		INTEGER(-127..127)	Scaling factor 0.032 meters/sec	-	
>>DGNSS Validity Period	O		9.2.1.138		YES	ignore

Condition	Explanation
<i>Status/Health</i>	This IE shall be present if the <i>Status/Health</i> IE value is not equal to "no data" or "invalid data".

Range Bound	Explanation
<i>maxGANSSSat</i>	Maximum number of satellites for which data is included in the IE
<i>maxSgnType</i>	Maximum number of signals for which data is included in the IE

9.2.1.103 GANSS Almanac

This IE contains a reduced-precision subset of the ephemeris and clock correction parameters.

IE/Group name	Presence	Range	IE Type and Reference	Semantics description	Criticality	Assigned Criticality
Week Number	M		INTEGER(0..255)	Almanac reference week , number of weeks since the beginning of GANSS specific system time (mod 256)	–	
CHOICE <i>Almanac Model</i>	M				–	
> <i>Keplerian Parameters</i>				Model 1		
>>T _{oa}	M		INTEGER(0..255)	Scaling factor 2 ¹² s Reference time of almanac within week in GANSS TOD time base	–	
>>IOD _a	M		INTEGER(0..3)	Issue-Of –Data, common to all satellites	–	
>>>Satellite Information KP		1 to <maxGANSSSatAlmanac>		Almanacs are in the order of the SV IDs, the smallest ID first.	–	
>>>>Sat ID	M		INTEGER(0..63)	Defined in TS 25.331 [16].	–	
>>>>e	M		BIT STRING(11)	Eccentricity, dimensionless, see Galileo OS Signal in Space ICD (OS SIS ICD) [53]	–	
>>>>δi	M		BIT STRING(11)	semi-circles , see Galileo OS Signal in Space ICD (OS SIS ICD) [53]	–	
>>>>OMEGADOT	M		BIT STRING(11)	Longitude of Ascending Node of Orbit Plane at Weekly Epoch (semi-circles/sec) , see Galileo OS Signal in Space ICD (OS SIS ICD) [53]	–	
>>>>SV Health KP	M		BIT STRING(4)	dimensionless	–	
>>>>delta A ^{1/2}	M		BIT STRING(17)	Semi-Major Axis delta (meters) ^{1/2} , see Galileo OS Signal in Space ICD (OS SIS ICD) [53]	–	
>>>>OMEGA ₀	M		BIT STRING(16)	Longitude of Ascending Node of Orbit Plane at Weekly Epoch (semi-circles) , see Galileo OS Signal in Space ICD (OS SIS ICD) [53]	–	
>>>>M ₀	M		BIT STRING(16)	Mean Anomaly at Reference Time (semi-circles) , see Galileo OS Signal in Space ICD (OS SIS ICD) [53]	–	
>>>>ω	M		BIT STRING(16)	Argument of Perigee (semi-circles) , see	–	

				Galileo OS Signal in Space ICD (OS SIS ICD) [53]		
>>>af ₀	M		BIT STRING(14)	Seconds , see Galileo OS Signal in Space ICD (OS SIS ICD) [53]	–	
>>>af ₁	M		BIT STRING(11)	sec/sec , see Galileo OS Signal in Space ICD (OS SIS ICD) [53]	–	
>NAV Keplerian Parameters				Model 2		
>>Keplerian NAV Almanac	M				YES	ignore
>>>T _{oa}	M		INTEGER(0..255)	Scaling factor 2 ¹² s Reference time of almanac within week in GANSS TOD time base	–	
>>>Satellite information NAV-KP		1..<maxGANSSSatAlmanac>			–	
>>>>Sat ID	M		INTEGER (0..63)	Defined in TS 25.331 [16].	–	
>>>>e	M		BIT STRING(16)	Eccentricity, dimensionless (IS-QZSS [59])	–	
>>>>δi	M		BIT STRING (16)	Correction to inclination, semi-circles (IS-QZSS [59])	–	
>>>>OMEGADOT	M		BIT STRING (16)	Rate of right ascension, semi-circles/sec (IS-QZSS [59])	–	
>>>>SV Health	M		BIT STRING (8)	Satellite health (IS-QZSS [59])	–	
>>>>A ^{1/2}	M		BIT STRING (24)	Square root of the semi-major axis, meters ^{1/2} (IS-QZSS [59])	–	
>>>>OMEGA ₀	M		BIT STRING (24)	Longitude of ascending node of orbit plane at weekly epoch, semi-circles (IS-QZSS [59])	–	
>>>>ω	M		BIT STRING (24)	Argument of perigee semi-circles (IS-QZSS [59])	–	
>>>>M ₀	M		BIT STRING (24)	Mean anomaly at reference time semi-circles (IS-QZSS [59])	–	
>>>>af ₀	M		BIT STRING (11)	Apparent satellite clock correction seconds (IS-QZSS [59])	–	
>>>>af ₁	M		BIT STRING (11)	Apparent satellite clock correction sec/sec (IS-QZSS [59])	–	
>Reduced Keplerian Parameters				Model 3		
>>Keplerian Reduced Almanac	M				YES	ignore

>>>T _{oa}	M		INTEGER(0..255)	Scaling factor 2 ¹² s Reference time of almanac within week in GANSS TOD time base	–	
>>>Satellite information RED-KP		1..<maxGANSSSatAlmanac>			–	
>>>>Sat ID	M		INTEGER(0..63)	Defined in TS 25.331 [16].	–	
>>>>δ _A	M		BIT STRING(8)	meters (IS-GPS-200 [55], IS-GPS-705 [56], IS-GPS-800 [57], IS-QZSS [59])	–	
>>>>Ω ₀	M		BIT STRING(7)	semi-circles (IS-GPS-200 [55], IS-GPS-705 [56], IS-GPS-800 [57], IS-QZSS [59])	–	
>>>>Φ ₀	M		BIT STRING(7)	semi-circles (IS-GPS-200 [55], IS-GPS-705 [56], IS-GPS-800 [57], IS-QZSS [59])	–	
>>>>L1 Health	M		BIT STRING(1)	dimensionless (IS-GPS-200 [55], IS-GPS-705 [56], IS-GPS-800 [57], IS-QZSS [59])	–	
>>>>L2 Health	M		BIT STRING(1)	dimensionless (IS-GPS-200 [55], IS-GPS-705 [56], IS-GPS-800 [57], IS-QZSS [59])	–	
>>>>L5 Health	M		BIT STRING(1)	dimensionless (IS-GPS-200 [55], IS-GPS-705 [56], IS-GPS-800 [57], IS-QZSS [59])	–	
>Midi Keplerian Parameters				Model 4		
>> Keplerian Midi Almanac	M				YES	ignore
>>>T _{oa}	M		INTEGER(0..255)	Scaling factor 2 ¹² s Reference time of almanac within week in GANSS TOD time base	–	
>>>Satellite information MIDI-KP		1..<maxGANSSSatAlmanac>			–	
>>>>Sat ID	M		INTEGER(0..63)	Defined in TS 25.331 [16].	–	
>>>>e	M		BIT STRING(11)	dimensionless (IS-GPS-200 [55], IS-GPS-705 [56], IS-GPS-800 [57], IS-QZSS [59])	–	
>>>>δ _i	M		BIT STRING(11)	semi-circles (IS-GPS-200 [55], IS-GPS-705 [56], IS-GPS-800 [57], IS-QZSS [59])	–	
>>>>Ω _{dot}	M		BIT STRING(11)	semi-circles/sec (IS-GPS-200 [55], IS-GPS-705 [56], IS-GPS-800 [57], IS-QZSS [59])	–	
>>>>sqrtA	M		BIT STRING	meters ^{1/2} (IS-GPS-200	–	

			(17)	[55], IS-GPS-705 [56], IS-GPS-800 [57], IS-QZSS [59])		
>>>> Ω_0	M		BIT STRING (16)	semi-circles (IS-GPS-200 [55], IS-GPS-705 [56], IS-GPS-800 [57], IS-QZSS [59])	–	
>>>> ω	M		BIT STRING (16)	semi-circles (IS-GPS-200 [55], IS-GPS-705 [56], IS-GPS-800 [57], IS-QZSS [59])	–	
>>>> M_0	M		BIT STRING (16)	semi-circles (IS-GPS-200 [55], IS-GPS-705 [56], IS-GPS-800 [57], IS-QZSS [59])	–	
>>>> a_{f_0}	M		BIT STRING (11)	seconds (IS-GPS-200 [55], IS-GPS-705 [56], IS-GPS-800 [57], IS-QZSS [59])	–	
>>>> a_{f_1}	M		BIT STRING (10)	sec/sec (IS-GPS-200 [55], IS-GPS-705 [56], IS-GPS-800 [57], IS-QZSS [59])	–	
>>>>L1 Health	M		BIT STRING (1)	Dimensionless (IS-GPS-200 [55], IS-GPS-705 [56], IS-GPS-800 [57], IS-QZSS [59])	–	
>>>>L2 Health	M		BIT STRING (1)	dimensionless (IS-GPS-200 [55], IS-GPS-705 [56], IS-GPS-800 [57], IS-QZSS [59])	–	
>>>>L5 Health	M		BIT STRING (1)	dimensionless (IS-GPS-200 [55], IS-GPS-705 [56], IS-GPS-800 [57], IS-QZSS [59])	–	
>GLONASS Keplerian Parameters				Model 5		
>> Keplerian GLONASS	M				YES	ignore
>>>Satellite information GLO-KP		1.. <maxGANSSSatAImanac>			–	
>>>> N^A	M		BIT STRING(11)	days [60]	–	
>>>> n^A	M		BIT STRING (5)	dimensionless [60]	–	
>>>> H_n^A	M		BIT STRING (5)	dimensionless [60]	–	
>>>> λ_n^A	M		BIT STRING (21)	semi-circles [60]	–	
>>>> $t_{\lambda_n}^A$	M		BIT STRING (21)	seconds [60]	–	
>>>> Δi_n^A	M		BIT STRING (18)	semi-circles [60]	–	
>>>> ΔT_n^A	M		BIT STRING (22)	sec/orbit period [60]	–	
>>>> $\Delta T_DOT_n^A$	M		BIT STRING (7)	sec/orbit period ² [60]	–	
>>>> ϵ_n^A	M		BIT STRING (15)	dimensionless [60]	–	
>>>> ω_n^A	M		BIT STRING (16)	semi-circles [60]	–	
>>>> τ_n^A	M		BIT STRING (10)	seconds [60]	–	

>>>>I	M		BIT STRING (1)	dimensionless [60]	–	
>>>>M _n ^A	O		BIT STRING (2)	dimensionless [60]	–	
>SBAS ECEF Parameters				Model 6		
>> ECEF SBAS Almanac	M				YES	ignore
>>>>Satellite information SBAS-ECEF		1.. <maxGANSSSatAlmanac>			–	
>>>>Data ID	M		BIT STRING(2)	Dimensionless (DTFA01-96-C-00025 [58])	–	
>>>>SV ID	M		INTEGER (0..63)	Defined in TS 25.331 [16].	–	
>>>>Health	M		BIT STRING (8)	Dimensionless (DTFA01-96-C-00025 [58])	–	
>>>>X _G	M		BIT STRING (15)	meters (DTFA01-96-C-00025 [58])	–	
>>>>Y _G	M		BIT STRING (15)	meters (DTFA01-96-C-00025 [58])	–	
>>>>Z _G	M		BIT STRING (9)	meters (DTFA01-96-C-00025 [58])	–	
>>>>X _G Rate-of-Change	M		BIT STRING (3)	meters/sec (DTFA01-96-C-00025 [58])	–	
>>>>Y _G Rate-of-Change	M		BIT STRING (3)	meters/sec (DTFA01-96-C-00025 [58])	–	
>>>>Z _G Rate-of-Change	M		BIT STRING (4)	meters/sec (DTFA01-96-C-00025 [58])	–	
>>>>t ₀	M		BIT STRING (11)	seconds (DTFA01-96-C-00025 [58])	–	

Range Bound	Explanation
maxGANSSSatAlmanac	Maximum number of satellites for which data is included in the IE

9.2.1.104 GANSS Clock Model

The IE contains fields needed to model the GANSS clock parameters.

IE/Group name	Presence	Range	IE Type and Reference	Semantics description
Satellite Clock Model		1 to <maxGANSSClockModel>		Model -1 There may be more than one clock model included if defined in SIS ICD (e.g. two for Galileo)
>t _{oc}	M		BIT STRING(14)	defined in Galileo OS Signal in Space ICD (OS SIS ICD) [53]
>a _{i2}	M		BIT STRING(12)	defined in Galileo OS Signal in Space ICD (OS SIS ICD) [53]
>a _{i1}	M		BIT STRING(18)	defined in Galileo OS Signal in Space ICD (OS SIS ICD) [53]
>a _{i0}	M		BIT STRING(28)	defined in Galileo OS Signal in Space ICD (OS SIS ICD) [53]
>T _{GD}	O		BIT STRING(10)	defined in Galileo OS Signal in Space ICD (OS SIS ICD) [53]
>Model ID	O		INTEGER(0..1)	Coded as defined in TS 25.331 [16].

Range bound	Explanation
<i>maxGANSSClockMod</i>	Maximum number of satellite clock models for which data is included in the IE.

9.2.1.104a GANSS Additional Clock Models

The IE contains fields needed to model the GANSS clock parameters.

IE/Group name	Presence	Range	IE Type and Reference	Semantics description
----------------------	-----------------	--------------	------------------------------	------------------------------

IE/Group name	Presence	Range	IE Type and Reference	Semantics description
CHOICE <i>Additional Clock Models</i>				
>NAV-Clock Model				Model-2
>>t _{oc}	M		BIT STRING(16)	Time of clock (seconds) (IS-QZSS [59])
>>af ₂	M		BIT STRING (8)	Clock correction polynomial coefficient (sec/sec ²) (IS-QZSS [59])
>>af ₁	M		BIT STRING (16)	Clock correction polynomial coefficient (sec/sec) (IS-QZSS [59])
>>af ₀	M		BIT STRING (22)	Clock correction polynomial coefficient (seconds) (IS-QZSS [59])
>>T _{GD}	M		BIT STRING (8)	Group delay (seconds) (IS-QZSS [59])
>CNAV/CNAV-2 Clock Model				Model-3
>>t _{oc}	M		BIT STRING (11)	Clock data reference time of week (seconds) (IS-GPS-200 [55], IS-GPS-705 [56], IS-GPS-800 [57], IS-QZSS [59])
>>t _{op}	M		BIT STRING (11)	Clock data predict time of week (seconds) (IS-GPS-200 [55], IS-GPS-705 [56], IS-GPS-800 [57], IS-QZSS [59])
>>URA _{oc} Index	M		BIT STRING (5)	SV clock accuracy index (dimensionless) (IS-GPS-200 [55], IS-GPS-705 [56], IS-GPS-800 [57], IS-QZSS [59])
>>URA _{oc1} Index	M		BIT STRING (3)	SV clock accuracy change index (dimensionless) (IS-GPS-200 [55], IS-GPS-705 [56], IS-GPS-800 [57], IS-QZSS [59])
>>URA _{oc2} Index	M		BIT STRING (3)	SV clock accuracy change rate index (dimensionless) (IS-GPS-200 [55], IS-GPS-705 [56], IS-GPS-800 [57], IS-QZSS [59])
>>a _{f2-n}	M		BIT STRING (10)	SV clock drift rate correction coefficient (sec/sec ²) (IS-GPS-200 [55], IS-GPS-705 [56], IS-GPS-800 [57], IS-QZSS [59])
>>a _{f1-n}	M		BIT STRING (20)	SV clock drift correction coefficient (sec/sec) (IS-GPS-200 [55], IS-GPS-705 [56], IS-GPS-800 [57], IS-QZSS [59])
>>a _{f0-n}	M		BIT STRING (26)	SV clock bias correction coefficient (seconds) (IS-GPS-200 [55], IS-GPS-705 [56], IS-GPS-800 [57], IS-QZSS [59])
>>T _{GD}	M		BIT STRING (13)	Group delay correction (seconds) (IS-GPS-200 [55], IS-GPS-705 [56], IS-GPS-800 [57], IS-QZSS [59])
>>ISC _{L1CP}	O		BIT STRING (13)	Inter signal group delay correction (seconds) (IS-GPS-800 [57], IS-QZSS [59])
>>ISC _{L1CD}	O		BIT STRING (13)	Inter signal group delay correction

IE/Group name	Presence	Range	IE Type and Reference	Semantics description
				(seconds) (IS-GPS-800 [57], IS-QZSS [59])
>>ISC _{L1C/A}	O		BIT STRING (13)	Inter signal group delay correction (seconds) (IS-GPS-200 [55], IS-GPS-705 [56], IS-QZSS [59])
>>ISC _{L2C}	O		BIT STRING (13)	Inter signal group delay correction (seconds) (IS-GPS-200 [55], IS-GPS-705 [56], IS-QZSS [59])
>>ISC _{L5I5}	O		BIT STRING (13)	Inter signal group delay correction (seconds) (IS-GPS-705 [56], IS-QZSS [59])
>>ISC _{L5Q5}	O		BIT STRING (13)	Inter signal group delay correction (seconds) (IS-GPS-705 [56], IS-QZSS [59])
>GLONASS Satellite Clock Model				Model-4
> $\tau_n(t_b)$	M		BIT STRING (22)	Satellite clock offset (seconds) [60]
> $\gamma_n(t_b)$	M		BIT STRING (11)	Relative frequency offset from nominal value (dimensionless) [60]
> $\Delta\tau_n$	O		BIT STRING (5)	Time difference between transmission in G2 and G1 (seconds) [60]
>SBAS Satellite Clock Model				Model-5
> t_0	M		BIT STRING (13)	(seconds) (DTFA01-96-C-00025 [58])
> a_{Gf0}	M		BIT STRING (12)	(seconds) (DTFA01-96-C-00025 [58])
> a_{Gr1}	M		BIT STRING (8)	(sec/sec) (DTFA01-96-C-00025 [58])

9.2.1.105 GANSS Ionospheric Model

The IE contains fields needed to model the propagation delays of the GANSS signals through the ionosphere.

IE/Group name	Presence	Range	IE Type and Reference	Semantics description
a_{i0}	M		BIT STRING(12)	This parameter is used as defined in Galileo OS Signal in Space ICD (OS SIS ICD) [53]
a_{i1}	M		BIT STRING(12)	This parameter is used as defined in Galileo OS Signal in Space ICD (OS SIS ICD) [53]
a_{i2}	M		BIT STRING(12)	This parameter is used as defined in Galileo OS Signal in Space ICD (OS SIS ICD) [53]
GANSS Ionosphere Regional Storm Flags		0..1		
>Storm Flag 1	M		BOOLEAN	This parameter is used as defined in Galileo OS Signal in Space ICD (OS SIS ICD) [53]
>Storm Flag 2	M		BOOLEAN	This parameter is used as defined in Galileo OS Signal in Space ICD (OS SIS ICD) [53]
>Storm Flag 3	M		BOOLEAN	This parameter is used as defined in Galileo OS Signal in Space ICD (OS SIS ICD) [53]
>Storm Flag 4	M		BOOLEAN	This parameter is used as defined in Galileo OS Signal in Space ICD (OS SIS ICD) [53]
>Storm Flag 5	M		BOOLEAN	This parameter is used as defined in Galileo OS Signal in Space ICD (OS SIS ICD) [53]

9.2.1.105a GANSS Additional Ionospheric Model

The IE contains fields needed to model the propagation delays of the GANSS signals through the ionosphere.

IE/Group name	Presence	Range	IE Type and Reference	Semantics description
Data ID	M		BIT STRING(2)	Coded as defined in TS 25.331 [16]
α_0	M		BIT STRING (8)	seconds (IS-QZSS [59])
α_1	M		BIT STRING (8)	sec/semi-circle (IS-QZSS [59])
α_2	M		BIT STRING (8)	sec/(semi-circle) ² (IS-QZSS [59])
α_3	M		BIT STRING (8)	sec/(semi-circle) ³ (IS-QZSS [59])
β_0	M		BIT STRING (8)	seconds (IS-QZSS [59])
β_1	M		BIT STRING (8)	sec/semi-circle (IS-QZSS [59])
β_2	M		BIT STRING (8)	sec/(semi-circle) ² (IS-QZSS [59])
β_3	M		BIT STRING (8)	sec/(semi-circle) ³ (IS-QZSS [59])

9.2.1.106 GANSS Navigation Model

Void.

9.2.1.107 GANSS Orbit Model

This IE contains information for GANSS orbit model parameters.

IE/Group name	Presence	Range	IE Type and Reference	Semantics description
CHOICE <i>Orbit Model</i>	M			
> <i>Keplerian Parameters</i>				Model-1
>> <i>t_{oe}</i>	M		BIT STRING(14)	Time-of-Ephemeris in seconds, scale factor 60 , see Galileo OS Signal in Space ICD (OS SIS ICD) [53]
>> <i>ω</i>	M		BIT STRING(32)	Argument of Perigee (semi-circles) , see Galileo OS Signal in Space ICD (OS SIS ICD) [53]
>> <i>Δn</i>	M		BIT STRING(16)	Mean Motion Difference From Computed Value (semi-circles/sec) , see Galileo OS Signal in Space ICD (OS SIS ICD) [53]
>> <i>M₀</i>	M		BIT STRING(32)	Mean Anomaly at Reference Time (semi-circles) , see Galileo OS Signal in Space ICD (OS SIS ICD) [53]
>> <i>OMEGA_{dot}</i>	M		BIT STRING(24)	Longitude of Ascending Node of Orbit Plane at Weekly Epoch (semi-circles/sec) , see Galileo OS Signal in Space ICD (OS SIS ICD) [53]
>> <i>e</i>	M		BIT STRING(32)	Eccentricity, scale factor 2^{-33} , see Galileo OS Signal in Space ICD (OS SIS ICD) [53]
>> <i>l_{dot}</i>	M		BIT STRING(14)	Rate of Inclination Angle (semi-circles/sec) , see Galileo OS Signal in Space ICD (OS SIS ICD) [53]
>> <i>sqrtA</i>	M		BIT STRING(32)	Least significant bits of Semi-Major Axis in (meters) ^{1/2} , scale factor 2^{-19} , see Galileo OS Signal in Space ICD (OS SIS ICD) [53]
>> <i>i₀</i>	M		BIT STRING(32)	Inclination Angle at Reference Time (semi-circles) , see Galileo OS Signal in Space ICD (OS SIS ICD) [53]
>> <i>OMEGA₀</i>	M		BIT STRING(32)	Longitude of Ascending Node of Orbit Plane at Weekly Epoch (semi-circles) , see Galileo OS Signal in Space ICD (OS SIS ICD) [53]
>> <i>C_{rs}</i>	M		BIT STRING(16)	Amplitude of the Sine Harmonic Correction Term to the Orbit Radius (meters) , see Galileo OS Signal in Space ICD (OS SIS ICD) [53]
>> <i>C_{is}</i>	M		BIT STRING(16)	Amplitude of the Sine Harmonic Correction Term To The Angle Of Inclination (radians) , see Galileo OS Signal in Space ICD (OS SIS ICD) [53]

IE/Group name	Presence	Range	IE Type and Reference	Semantics description
>>C _{US}	M		BIT STRING(16)	Amplitude of the Sine Harmonic Correction Term To The Argument Of Latitude (radians) , see Galileo OS Signal in Space ICD (OS SIS ICD) [53]
>>C _{rc}	M		BIT STRING(16)	Amplitude of the Cosine Harmonic Correction Term to the Orbit Radius (meters) , see Galileo OS Signal in Space ICD (OS SIS ICD) [53]
>>C _{ic}	M		BIT STRING(16)	Amplitude of the Cosine Harmonic Correction Term To The Angle Of Inclination (radians) , see Galileo OS Signal in Space ICD (OS SIS ICD) [53]
>>C _{uc}	M		BIT STRING(16)	Amplitude of the Cosine Harmonic Correction Term To The Argument Of Latitude (radians) , see Galileo OS Signal in Space ICD (OS SIS ICD) [53]

9.2.1.107a GANSS Additional Orbit Models

This IE contains information for GANSS orbit model parameters.

IE/Group name	Presence	Range	IE Type and Reference	Semantics description
<i>CHOICE Additional Orbit Models</i>				
<i>>NAV-Keplerian Parameters</i>				Model-2
>>URA Index	M		BIT STRING(4)	SV accuracy (dimensionless) (IS-QZSS [59])
>>Fit Interval Flag	M		BIT STRING (1)	Fit interval indication (dimensionless) (IS-QZSS [59])
>>t _{oe}	M		BIT STRING(16)	Time of ephemeris (seconds) (IS-QZSS [59])
>> ω	M		BIT STRING (32)	Argument of perigee (semi-circles) (IS-QZSS [59])
>> Δn	M		BIT STRING (16)	Mean motion difference from computed value (semi-circles/sec) (IS-QZSS [59])
>>M ₀	M		BIT STRING (32)	Mean anomaly at reference time (semi-circles) (IS-QZSS [59])
>>OMEGA _{dot}	M		BIT STRING (24)	Rate of right ascension (semi-circles/sec) (IS-QZSS [59])
>>e	M		BIT STRING (32)	Eccentricity (dimensionless) (IS-QZSS [59])
>>I _{dot}	M		BIT STRING (14)	Rate of inclination angle (semi-circles/sec) (IS-QZSS [59])
>>sqrtA	M		BIT STRING (32)	Square root of semi-major axis (meters ^{1/2}) (IS-QZSS [59])
>>i ₀	M		BIT STRING (32)	Inclination angle at reference time (semi-circles) (IS-QZSS [59])

IE/Group name	Presence	Range	IE Type and Reference	Semantics description
>>OMEGA ₀	M		BIT STRING (32)	Longitude of ascending node of orbit plane at weekly epoch (semi-circles) (IS-QZSS [59])
>>C _{rs}	M		BIT STRING (16)	Amplitude of sine harmonic correction term to the orbit radius (meters) (IS-QZSS [59])
>>C _{is}	M		BIT STRING (16)	Amplitude of sine harmonic correction term to the angle of inclination (radians) (IS-QZSS [59])
>>C _{us}	M		BIT STRING (16)	Amplitude of sine harmonic correction term to the argument of latitude (radians) (IS-QZSS [59])
>>C _{rc}	M		BIT STRING (16)	Amplitude of cosine harmonic correction term to the orbit radius (meters) (IS-QZSS [59])
>>C _{ic}	M		BIT STRING (16)	Amplitude of cosine harmonic correction term to the angle of inclination (radians) (IS-QZSS [59])
>>C _{uc}	M		BIT STRING (16)	Amplitude of cosine harmonic correction term to the argument of latitude (radians) (IS-QZSS [59])

IE/Group name	Presence	Range	IE Type and Reference	Semantics description
>CNAV/CNAV-2 Keplerian Parameters				Model-3
>>t _{op}	M		BIT STRING (11)	Data predict time of week (seconds) (IS-GPS-200 [55], IS-GPS-705 [56], IS-GPS-800 [57], IS-QZSS [59])
>>URA _{oe} Index	M		BIT STRING (5)	SV accuracy (dimensionless) (IS-GPS-200 [55], IS-GPS-705 [56], IS-GPS-800 [57], IS-QZSS [59])
>>ΔA	M		BIT STRING (26)	Semi-major axis difference at reference time (meters) (IS-GPS-200 [55], IS-GPS-705 [56], IS-GPS-800 [57], IS-QZSS [59])
>>A _{dot}	M		BIT STRING (25)	Change rate in semi-major axis (meters/sec) (IS-GPS-200 [55], IS-GPS-705 [56], IS-GPS-800 [57], IS-QZSS [59])
>>Δn ₀	M		BIT STRING (17)	Mean motion difference from computed value at reference time (semi-circles/sec) (IS-GPS-200 [55], IS-GPS-705 [56], IS-GPS-800 [57], IS-QZSS [59])
>>Δn _{0_dot}	M		BIT STRING (23)	Rate of mean motion difference from computed value (semi-circles/sec ²) (IS-GPS-200 [55], IS-GPS-705 [56], IS-GPS-800 [57], IS-QZSS [59])
>>M _{0-n}	M		Bit String(33)	Mean anomaly at reference time (semi-circles) (IS-GPS-200 [55], IS-GPS-705 [56], IS-GPS-800 [57], IS-QZSS [59])
>>e _n	M		BIT STRING (33)	Eccentricity (dimensionless) (IS-GPS-200 [55], IS-GPS-705 [56], IS-GPS-800 [57], IS-QZSS [59])
>>ω _n	M		Bit String(33)	Argument of perigee (semi-circles) (IS-GPS-200 [55], IS-GPS-705 [56], IS-GPS-800 [57], IS-QZSS [59])
>>Ω _{0-n}	M		BIT STRING (33)	Reference right ascension angle (semi-circles) (IS-GPS-200 [55], IS-GPS-705 [56], IS-GPS-800 [57], IS-QZSS [59])
>>ΔΩ _{dot}	M		BIT STRING (17)	Rate of right ascension difference (semi-circles/sec) (IS-GPS-200 [55], IS-GPS-705 [56], IS-GPS-800 [57], IS-QZSS [59])
>>i _{0-n}	M		BIT STRING (33)	Inclination angle at reference time (semi-circles) (IS-GPS-200 [55], IS-GPS-705 [56], IS-GPS-800 [57], IS-QZSS [59])
>>i _{0-n_dot}	M		BIT STRING (15)	Rate of inclination angle (semi-circles/sec) (IS-GPS-200 [55], IS-GPS-705 [56], IS-GPS-800 [57], IS-QZSS [59])

IE/Group name	Presence	Range	IE Type and Reference	Semantics description
>>C _{is-n}	M		BIT STRING (16)	Amplitude of sine harmonic correction term to the angle of inclination (radians) (IS-GPS-200 [55], IS-GPS-705 [56], IS-GPS-800 [57], IS-QZSS [59])
>>C _{ic-n}	M		BIT STRING (16)	Amplitude of cosine harmonic correction term to the angle of inclination (radians) (IS-GPS-200 [55], IS-GPS-705 [56], IS-GPS-800 [57], IS-QZSS [59])
>>C _{rs-n}	M		BIT STRING (24)	Amplitude of sine harmonic correction term to the orbit radius (meters) (IS-GPS-200 [55], IS-GPS-705 [56], IS-GPS-800 [57], IS-QZSS [59])
>>C _{rc-n}	M		BIT STRING (24)	Amplitude of cosine harmonic correction term to the orbit radius (meters) (IS-GPS-200 [55], IS-GPS-705 [56], IS-GPS-800 [57], IS-QZSS [59])
>>C _{us-n}	M		BIT STRING (21)	Amplitude of sine harmonic correction term to the argument of latitude (radians) (IS-GPS-200 [55], IS-GPS-705 [56], IS-GPS-800 [57], IS-QZSS [59])
>>C _{uc-n}	M		BIT STRING (21)	Amplitude of cosine harmonic correction term to the argument of latitude (radians) (IS-GPS-200 [55], IS-GPS-705 [56], IS-GPS-800 [57], IS-QZSS [59])
>GLONASS Earth-Centered, Earth-fixed Parameters				Model-4
>>E _n	M		BIT STRING (5)	Age of data (days) [60]
>>P1	M		BIT STRING (2)	Time interval between two adjacent values of t _b (minutes) [60]
>>P2	M		BIT STRING (1)	Change of t _b flag (dimensionless) [60]
>>M	O		BIT STRING (2)	Type of satellite (dimensionless) [60]
>> x _n (t _b)	M		BIT STRING (27)	x-coordinate of satellite at time t _b (kilometers) [60]
>> $\dot{x}_n(t_b)$	M		BIT STRING (24)	x-coordinate of satellite velocity at time t _b (kilometers/sec) [60]
>> $\ddot{x}_n(t_b)$	M		BIT STRING (5)	x-coordinate of satellite acceleration at time t _b (kilometers/sec ²) [60]
>> y _n (t _b)	M		BIT STRING (27)	y-coordinate of satellite at time t _b (kilometers) [60]
>> $\dot{y}_n(t_b)$	M		BIT STRING (24)	y-coordinate of satellite velocity at time t _b (kilometers/sec) [60]
>> $\ddot{y}_n(t_b)$	M		BIT STRING (5)	y-coordinate of satellite acceleration at time t _b (kilometers/sec ²) [60]

IE/Group name	Presence	Range	IE Type and Reference	Semantics description
$\gg z_n(t_b)$	M		BIT STRING (27)	z-coordinate of satellite at time t_b (kilometers) [60]
$\gg \dot{z}_n(t_b)$	M		BIT STRING (24)	z-coordinate of satellite velocity at time t_b (kilometers/sec) [60]
$\gg \ddot{z}_n(t_b)$	M		BIT STRING (5)	z-coordinate of satellite acceleration at time t_b (kilometers/sec ²) [60]
>SBAS Earth-Centered, Earth-fixed Parameters				Model-5
$\gg t_0$	<i>C-ClockModel</i>		BIT STRING (13)	Time of applicability (seconds) (DTFA01-96-C-00025 [58])
\gg Accuracy	M		BIT STRING (4)	(dimensionless) (DTFA01-96-C-00025 [58])
$\gg X_G$	M		BIT STRING (30)	(meters) (DTFA01-96-C-00025 [58])
$\gg Y_G$	M		BIT STRING (30)	(meters) (DTFA01-96-C-00025 [58])
$\gg Z_G$	M		BIT STRING (25)	(meters) (DTFA01-96-C-00025 [58])
$\gg X_G$ Rate-of-Change	M		BIT STRING (17)	(meters/sec) (DTFA01-96-C-00025 [58])
$\gg Y_G$ Rate-of-Change	M		BIT STRING (17)	(meters/sec) (DTFA01-96-C-00025 [58])
$\gg Z_G$ Rate-of-Change	M		BIT STRING (18)	(meters/sec) (DTFA01-96-C-00025 [58])
$\gg X_G$ Acceleration	M		BIT STRING (10)	(meters/sec ²) (DTFA01-96-C-00025 [58])
$\gg Y_G$ Acceleration	M		BIT STRING (10)	(meters/sec ²) (DTFA01-96-C-00025 [58])
$\gg Z_G$ Acceleration	M		BIT STRING (10)	(meters/sec ²) (DTFA01-96-C-00025 [58])

Condition	Explanation
<i>ClockModel</i>	This IE shall be present if "SBAS Earth-Centered, Earth-fixed Parameters" (Model-5) in IE <i>GANSS Additional Clock Models</i> is not included in <i>GANSS Additional Navigation Models</i> IE.

9.2.1.108 GANSS Real Time Integrity

This IE contains parameters that describe the real-time status of the GANSS constellation.

IE/Group name	Presence	Range	IE Type and Reference	Semantics description
Satellite Information				
>Bad GANSS Sat ID	M	1 to $\langle \text{maxGANSSSat} \rangle$	INTEGER(0..63)	Defined in TS 25.331 [16].
>Bad GANSS Signal ID	O		BIT STRING(8)	Coded as defined in TS 25.331 [16].

Range Bound	Explanation
<i>maxGANSSSat</i>	Maximum number of satellites for which data is included in the IE

9.2.1.109 GANSS Receiver Geographical Position (GANSS RX Pos)

The *GANSS Receiver Geographical Position* IE is used to identify the geographical coordinates of a GANSS receiver relevant for a certain Information Exchange Object.

IE/Group Name	Presence	Range	IE Type and Reference	Semantics Description
Latitude Sign	M		ENUMERATED (North, South)	
Degrees of Latitude	M		INTEGER (0..2 ³¹ -1)	The IE value (N) is derived by this formula: N ≤ 2 ³¹ X / 90 < N+1 X being the latitude in degree (0°.. 90°)
Degrees of Longitude	M		INTEGER (-2 ³¹ ..2 ³¹ -1)	The IE value (N) is derived by this formula: N ≤ 2 ³² X / 360 < N+1 X being the longitude in degree (-180°..+180°)
Direction of Altitude	M		ENUMERATED (Height, Depth)	
Altitude	M		INTEGER (0..2 ¹⁵ -1)	The relation between the value (N) and the altitude (a) in meters it describes is N ≤ a < N+1, except for N=2 ¹⁵ -1 for which the range is extended to include all greater values of (a).

9.2.1.110 GANSS Time Model

The *GANSS Time Model* IE contains a set of parameters needed to relate GANSS time to selected time reference indicated by GNSS_TO_ID.

IE/Group name	Presence	Range	IE Type and Reference	Semantics description
GANSS Time Model Reference Time	M		INTEGER(0..37799)	GANSS reference time (modulo 1 week) in seconds. The scale factor is 2 ⁴
T _{A0}	M		INTEGER(-2147483648..2147483647)	Seconds, scale factor 2 ⁻³⁵
T _{A1}	O		INTEGER (-8388608..8388607)	sec/sec, scale factor 2 ⁻⁵¹
T _{A2}	O		INTEGER (-64..63)	sec/sec ² , scale factor 2 ⁻⁶⁸
GNSS_TO_ID	M		ENUMERATED(GPS,..., Galileo, QZSS, GLONASS)	
Week Number	O		INTEGER(0..8191)	Reference week of GANSS Time Model

9.2.1.110a GANSS Additional Time Models

The *GANSS Additional Time Models* IE contains a set of parameters needed to relate GANSS time to selected time references.

IE/Group name	Presence	Range	IE Type and Reference	Semantics description
GNSS-GNSS Time Model		1..<maxGANSS-1>		
>GANSS Time Model			9.2.1.110	

Range Bound	Explanation
maxGANSS-1	Maximum number of GANSS systems for which data is included in this IE.

9.2.1.111 GANSS UTC Model

The *GANSS UTC Model* IE contains a set of parameters needed to relate GANSS time to Universal Time Coordinate (UTC).

IE/Group name	Presence	Range	IE Type and Reference	Semantics description
A_1	M		BIT STRING(24)	sec/sec , see Galileo OS Signal in Space ICD (OS SIS ICD) [53]
A_0	M		BIT STRING(32)	seconds , see Galileo OS Signal in Space ICD (OS SIS ICD) [53]
t_{tot}	M		BIT STRING(8)	seconds , see Galileo OS Signal in Space ICD (OS SIS ICD) [53]
WN_t	M		BIT STRING(8)	weeks , see Galileo OS Signal in Space ICD (OS SIS ICD) [53]
Δt_{LS}	M		BIT STRING(8)	seconds , see Galileo OS Signal in Space ICD (OS SIS ICD) [53]
WN_{LSF}	M		BIT STRING(8)	weeks , see Galileo OS Signal in Space ICD (OS SIS ICD) [53]
DN	M		BIT STRING(8)	days , see Galileo OS Signal in Space ICD (OS SIS ICD) [53]
Δt_{LSF}	M		BIT STRING(8)	seconds , see Galileo OS Signal in Space ICD (OS SIS ICD) [53]

9.2.1.111a GANSS Additional UTC Models

The *GANSS Additional UTC Models* IE contains several sets of parameters needed to relate GANSS time to Universal Time Coordinate (UTC), as defined in IS-GPS-200 [55], IS-GPS-705 [56], IS-GPS-800 [57], DTFA01-96-C-00025 [58], IS-QZSS [59], [60].

IE/Group name	Presence	Range	IE Type and Reference	Semantics description
---------------	----------	-------	-----------------------	-----------------------

IE/Group name	Presence	Range	IE Type and Reference	Semantics description
<i>CHOICE Additional UTC Models</i>				
<i>>Model Set 1</i>				
>A _{0-n}	M		BIT STRING(16)	Bias coefficient of GNSS time scale relative to UTC time scale (seconds) (IS-GPS-200 [55], IS-GPS-705 [56], IS-GPS-800 [57], IS-QZSS [59])
>A _{1-n}	M		BIT STRING (13)	Drift coefficient of GNSS time scale relative to UTC time scale (sec/sec) (IS-GPS-200 [55], IS-GPS-705 [56], IS-GPS-800 [57], IS-QZSS [59])
>A _{2-n}	M		BIT STRING (7)	Drift rate correction coefficient of GNSS time scale relative to UTC time scale (sec/sec ²) (IS-GPS-200 [55], IS-GPS-705 [56], IS-GPS-800 [57], IS-QZSS [59])
>Δt _{LS}	M		BIT STRING (8)	Current or past leap second count (seconds) (IS-GPS-200 [55], IS-GPS-705 [56], IS-GPS-800 [57], IS-QZSS [59])
>t _{ot}	M		BIT STRING (16)	Time data reference time of week (seconds) (IS-GPS-200 [55], IS-GPS-705 [56], IS-GPS-800 [57], IS-QZSS [59])
>WN _{ot}	M		BIT STRING (13)	Time data reference week number (weeks) (IS-GPS-200 [55], IS-GPS-705 [56], IS-GPS-800 [57], IS-QZSS [59])
>WN _{LSF}	M		BIT STRING (8)	Leap second reference week number (weeks) (IS-GPS-200 [55], IS-GPS-705 [56], IS-GPS-800 [57], IS-QZSS [59])
>DN	M		BIT STRING (4)	Leap second reference day number (days) (IS-GPS-200 [55], IS-GPS-705 [56], IS-GPS-800 [57], IS-QZSS [59])
>Δt _{LSF}	M		BIT STRING (8)	Current or future leap second count (seconds) (IS-GPS-200 [55], IS-GPS-705 [56], IS-GPS-800 [57], IS-QZSS [59])
<i>>Model Set 2</i>				
>N ^A	M		BIT STRING (11)	Calendar day number within four-year period beginning since the leap year (days) [60]
>τ _c	M		BIT STRING (32)	GLONASS time scale correction to UTC(SU) (seconds) [60]
>Delta UT1	O			
>>B1	M		BIT STRING (11)	Coefficient to determine ΔUT1 (seconds) [60]
>>B2	M		BIT STRING (10)	Coefficient to determine ΔUT1 (seconds/msd) [60]
>KP	O		BIT STRING (2)	Notification of expected leap second correction

IE/Group name	Presence	Range	IE Type and Reference	Semantics description
				(dimensionless) [60]
<i>>Model Set 3</i>				
>A _{1WNT}	M		BIT STRING (24)	sec/sec (DTFA01-96-C-00025 [58], Message Type 12)
>A _{0WNT}	M		BIT STRING (32)	seconds (DTFA01-96-C-00025 [58], Message Type 12)
>t _{ot}	M		BIT STRING (8)	seconds (DTFA01-96-C-00025 [58], Message Type 12)
>WN _t	M		BIT STRING (8)	weeks (DTFA01-96-C-00025 [58], Message Type 12)
>Δt _{LS}	M		BIT STRING (8)	seconds (DTFA01-96-C-00025 [58], Message Type 12)
>WN _{LSF}	M		BIT STRING (8)	weeks (DTFA01-96-C-00025 [58], Message Type 12)
>DN	M		BIT STRING (8)	days (DTFA01-96-C-00025 [58], Message Type 12)
>Δt _{LSF}	M		BIT STRING (8)	seconds (DTFA01-96-C-00025 [58], Message Type 12)
>UTC Standard ID	M		BIT STRING (3)	dimensionless Coded as defined in TS 25.331 [16]

9.2.1.112 T_{UTRAN-GANSS} Accuracy Class

The *T_{UTRAN-GANSS} Accuracy Class* IE indicates the accuracy class of the UTRAN GANSS Timing of Cell Frames for UE Positioning measurement.

IE/Group Name	Presence	Range	IE Type and Reference	Semantics Description
T _{UTRAN-GANSS} Accuracy Class			ENUMERATED (Accuracy Class A, Accuracy Class B, Accuracy Class C,...)	More information about Measurement Accuracy Class is included in TS 25.133 [23].

9.2.1.113 T_{UTRAN-GANSS} Measurement Threshold Information

The *T_{UTRAN-GANSS} Measurement Threshold Information* IE defines the related thresholds for UTRAN GANSS Timing of Cell Frames for UE Positioning measurements shall trigger the Event On Modification.

IE/Group Name	Presence	Range	IE Type and Reference	Semantics Description
T _{UTRAN-GANSS} Change Limit	O		INTEGER(1. .256)	Change of T _{UTRAN-GANSS} value compared to previously reported value, which shall trigger a new report. Unit in 1/16 chip.
Predicted T _{UTRAN-GANSS} Deviation Limit	O		INTEGER(1. .256)	Deviation of the Predicted T _{UTRAN-GANSS} from the latest measurement result, which shall trigger a new report. Unit in 1/16 chip.

9.2.1.114 T_{UTRAN-GANSS} Measurement Value Information

The T_{UTRAN-GANSS} *Measurement Value Information* IE indicates the measurement results related to the UTRAN GANSS Timing of Cell Frames for UE Positioning measurements.

IE/Group Name	Presence	Range	IE Type and Reference	Semantics Description	Criticality	Assigned Criticality
T _{UTRAN-GANSS}	M			Indicates the UTRAN GANSS Timing of Cell Frames for UE Positioning. According to mapping in TS 25.133 [23] and TS 25.123 [24]; significant values range from 0 to 371589119999.99.	–	
>MS	M		INTEGER(0..16383)	Most Significant Part	–	
>LS	M		INTEGER(0..4294967295)	Least Significant Part	–	
T _{UTRAN-GANSS} Quality	O		INTEGER(0..255)	Indicates the standard deviation (std) of the T _{UTRAN-GANSS} measurements in 1/16 chip. $T_{UTRAN-GANSS} \text{ Quality} = \sqrt{E[(x-\mu)^2]}$ = std of reported T _{UTRAN-GANSS} Value, where x is the reported T _{UTRAN-GANSS} Value and $\mu = E[x]$ is the expectation value of x.	–	
T _{UTRAN-GANSS} Drift Rate	M		INTEGER(-50..50)	Indicates the T _{UTRAN-GANSS} drift rate in 1/256 chip per second. A positive value indicates that the UTRAN clock is running at a lower frequency than GANSS clock.	–	
T _{UTRAN-GANSS} Drift Rate Quality	O		INTEGER(0..50)	Indicates the standard deviation (std) of the T _{UTRAN-GANSS} drift rate measurements in 1/256 chip per second. $T_{UTRAN-GANSS} \text{ Drift Rate Quality} = \sqrt{E[(x-\mu)^2]}$ = std of reported T _{UTRAN-GANSS} Drift Rate, where x is the	–	

				reported $T_{\text{UTRAN-GANSS}}$ Drift Rate and $\mu = E[x]$ is the expectation value of x .		
GANSS Time ID	O		9.2.1.119a	Absence of this IE means Galileo system time.	YES	ignore

9.2.1.115 GANSS Reference Time

Void.

9.2.1.116 HARQ Memory Partitioning

IE/Group Name	Presence	Range	IE Type and Reference	Semantics Description	Criticality	Assigned Criticality
CHOICE <i>HARQ Memory Partitioning</i>		1			–	
> <i>Implicit</i>					–	
>>Number of Processes	M		INTEGER (1..8,...12,14,16)	For HARQ process IDs going from 0 to “Number of Processes” – 1 the Total number of soft channel bits 25.306 [42] is partitioned equally between all HARQ processes according to the rules in TS 25.331 [16].	–	
> <i>Explicit</i>					–	
>>HARQ Memory Partitioning I		1..<maxnoofHARQprocesses>		The first instance of the parameter corresponds to HARQ process with identifier 0, the second instance to HARQ process with identifier 1, and so on.	–	
>>>Process Memory Size	M		9.2.1.49D	See TS 25.331 [16]	–	
>>HARQ Memory Partitioning Information Extension For MIMO		0, 4, 6 or 8		FDD and 1.28Mcps TDD only The 1 st instance corresponds to HARQ process with identifier set to “maxnoofHARQprocesses”, the 2 nd instance to HARQ process with identifier set to “maxnoofHARQprocesses+1”, and so on.	GLOBAL	ignore
>>>Process Memory Size	M		9.2.1.49D	See TS 25.331 [16]	–	

Range Bound	Explanation
<i>MaxnoofHARQprocesses</i>	Maximum number of HARQ processes for one UE [FDD – per stream (the maximum number of HARQ processes per UE is 2 * <i>MaxnoofHARQprocesses</i> in dual stream transmission mode)]

9.2.1.117 Multiple PLMN List

This information element contains a list of PLMN identities, which identifies the broadcasted PLMN Identities in MOCN and GWCN shared network configurations. The mandatory PLMN Identity in the MIB (called common PLMN in TS 23.251 [54]) is the first PLMN.

IE/Group Name	Presence	Range	IE type and reference	Semantics description
PLMN Identity	M		OCTET STRING (SIZE (3))	- digits 0 to 9, two digits per octet, - each digit encoded 0000 to 1001, - 1111 used as filler - bit 4 to 1 of octet n encoding digit 2n-1 - bit 8 to 5 of octet n encoding digit 2n -The PLMN identity consists of 3 digits from MCC followed by either -a filler plus 2 digits from MNC (in case of 2 digit MNC) or -3 digits from MNC (in case of a 3 digit MNC).
List of PLMNs		0 .. <maxNrOfBroadcastPLMNs>		
>PLMN Identity	M		OCTET STRING (SIZE (3))	- digits 0 to 9, two digits per octet, - each digit encoded 0000 to 1001, - 1111 used as filler - bit 4 to 1 of octet n encoding digit 2n-1 - bit 8 to 5 of octet n encoding digit 2n -The PLMN identity consists of 3 digits from MCC followed by either -a filler plus 2 digits from MNC (in case of 2 digit MNC) or -3 digits from MNC (in case of a 3 digit MNC).

Range bound	Explanation
maxNrOfBroadcastPLMNs	Maximum number of additional PLMN identities that can be broadcasted in a cell involved in a MOCN or GWCN Shared Network configuration. The value for maxNrOfBroadcastPLMNs is 5.

9.2.1.118 GANSS Data Bit Assistance

IE/Group Name	Presence	Range	IE Type and Reference	Semantics Description
GANSS TOD	M		INTEGER(0..59,...)	Reference time (modulo 1 minute) of the first bit of the data in <i>Data Bits</i> IE, in seconds.
Data Bit Assistance List		1..<maxGANS SSat>		
>Sat ID	M		INTEGER(0..63)	Defined in TS 25.331 [16].
>Data Bit Assistance Sgn List		1..<maxSgnTy pe>		
>>GANSS Signal ID	M		9.2.1.121	
>>Data Bits	M		BIT STRING(1..1024)	Raw data bits as transmitted from a specific satellite at the time indicated by GANSS_TOD. See TS 25.331 [16].

Range Bound	Explanation
<i>maxGANSSSat</i>	Maximum number of satellites for which data is included in the IE
<i>maxSgnType</i>	Maximum number of GANSS signals included in the IE

9.2.1.119 GANSS ID

This IE defines a particular GANSS.

IE/Group Name	Presence	Range	IE Type and Reference	Semantics Description
GANSS ID	M		INTEGER(0..7 ,...)	Defines the GANSS and is coded as defined in TS 25.331 [16].

9.2.1.119a GANSS Time ID

This IE defines a particular GANSS system time.

IE/Group Name	Presence	Range	IE Type and Reference	Semantics Description
GANSS Time ID	M		INTEGER(0..7 ,...)	Defines the GANSS system time for the UTRAN GANSS Timing of Cell Frames for UE Positioning. Coded as defined in TS 25.331 [16], subclause 10.3.7.93a.

9.2.1.120 GANSS Navigation Model And Time Recovery

This IE contain information required to manage the transfer of precise navigation data to the GANSS-capable UE.

IE/Group name	Presence	Range	IE Type and Reference	Semantics description
GANSS Transmission Time	M		9.2.1.122	GANSS Time when the Navigation model has been retrieved
Non-Broadcast Indication	O		ENUMERATED(true)	If this IE is present, GANSS navigation model is not derived from satellite broadcast. See NOTE 1
Satellite Information		1 to <maxGANSSSat>		
>Sat ID	M		INTEGER(0..63)	Defined in TS 25.331 [16].
>SV Health	M		BIT STRING(5)	Coded as defined in Galileo OS Signal in Space ICD (OS SIS ICD) [53]
>IOD	M		BIT STRING(10)	
>GANSS Clock Model	M		9.2.1.104	
>GANSS Orbit Model	M		9.2.1.107	
NOTE 1: The Non-Broadcast Indication allows to inform that the navigation model is not bit-to-bit the one broadcast by the satellite. If it is set to 1, the UE is informed that techniques such as data wiping off applied to the navigation model may not work for instance.				

Condition	Explanation
<i>Orbit model</i>	The IE shall be present if the <i>GANSS Orbit Model</i> IE indicates "Keplerian Parameters".

Range bound	Explanation
<i>maxGANSSSat</i>	Maximum number of satellites for which data is included in the IE.

9.2.1.120a GANSS Additional Navigation Models And Time Recovery

This IE contain information required to manage the transfer of precise navigation data to the GANSS-capable UE.

IE/Group name	Presence	Range	IE Type and Reference	Semantics description
GANSS Transmission Time	M		9.2.1.122	GANSS Time when the Navigation model has been retrieved
Non-Broadcast Indication	O		ENUMERATED(true)	If this IE is present, GANSS navigation model is not derived from satellite broadcast. See NOTE 1 in 9.2.1.120.
Satellite Information		1..<maxGANSSSat>		
>Sat ID	M		INTEGER(0..63)	Defined in TS 25.331 [16].
>SV Health	M		BIT STRING(6)	Coded as defined in TS 25.331 [16].
>IOD	M		BIT STRING(11)	Coded as defined in TS 25.331 [16].
>GANSS Additional Clock Models	M		GANSS I Clock Models 9.2.1.104a	
>GANSS Additional Orbit Models	M		GANSS Additional Orbit Models 9.2.1.107a	

Range bound	Explanation
maxGANSSSat	Maximum number of satellites for which data is included in this IE. The value of maxGANSSSat is 64

9.2.1.121 GANSS Signal ID

This IE defines a specific signal within a particular GANSS.

IE/Group Name	Presence	Range	IE Type and Reference	Semantics Description
GANSS Signal ID	M		INTEGER(0..7,...)	Coded as defined in TS 25.331 [16].

9.2.1.122 GANSS Transmission Time

This IE indicates the GANSS Transmission Time.

IE/Group name	Presence	Range	IE Type and Reference	Semantics description
GANSS Day	O		INTEGER(0..8191)	The sequential number of days from the origin of the GNSS system time (indicated by the GANSS_ID given in the <i>Requested Data Value</i> IE) modulo 8192 days (about 22 years).
GANSS TOD	M		INTEGER(0..86399)	GANSS Time of Day in seconds

9.2.1.122a GANSS Earth Orientation Parameters

IE/Group Name	Presence	Range	IE Type and Reference	Semantics Description
t_{EOP}	M		BIT STRING(16)	EOP data reference time (seconds), see IS-GPS-200 [55]
PM_X	M		BIT STRING (21)	X-axis polar motion value at reference time (arc-seconds), see IS-GPS-200 [55]
PM_X_dot	M		BIT STRING (15)	X-axis polar motion drift at reference time (arc-seconds/day), see IS-GPS-200 [55]
PM_Y	M		BIT STRING (21)	Y-axis polar motion value at reference time (arc-seconds), see IS-GPS-200 [55]
PM_Y_dot	M		BIT STRING (15)	Y-axis polar motion drift at reference time (arc-seconds/day), see IS-GPS-200 [55]
$\Delta UT1$	M		BIT STRING (31)	UT1-UTC difference at reference time (seconds), see IS-GPS-200 [55]
$\Delta UT1_dot$	M		BIT STRING (19)	Rate of UT1-UTC difference at reference time (seconds/day), see IS-GPS-200 [55]

9.2.1.122b SBAS ID

This IE defines a specific SBAS.

IE/Group Name	Presence	Range	IE Type and Reference	Semantics Description
SBAS ID	M		ENUMERATED(WAAS, EGNOS, MSAS, GAGAN, ...)	

9.2.1.122c GANSS Auxiliary Information

IE/Group name	Presence	Range	IE Type and Reference	Semantics description
---------------	----------	-------	-----------------------	-----------------------

IE/Group name	Presence	Range	IE Type and Reference	Semantics description
CHOICE <i>GANSS-ID</i>				
> <i>GANSS-ID-1</i>				This choice may only be present if GANSS ID indicated "Modernized GPS"
>>Aux Info List		1 .. <maxGAN SSSat>		
>>>Sat ID	M		INTEGER(0..63)	Defined in TS 25.331 [16].
>>>Signals Available	M		BIT STRING(8)	Coded as defined in TS 25.331 [16].
> <i>GANSS-ID-3</i>				This choice may be present if GANSS ID indicated "GLONASS"
>>Aux Info List		1 .. <maxGAN SSSat>		
>>>Sat ID	M		INTEGER(0..63)	Defined in TS 25.331 [16].
>>>Signals Available	M		BIT STRING(8)	Coded as defined in TS 25.331 [16].
>>>Channel Number	M		INTEGER (-7..13)	This field indicates the GLONASS carrier frequency number of the satellite identified by <i>Sat ID</i> , as defined in [60].

Range Bound	Explanation
maxGANSSSat	Maximum number of GANSS satellites for which data is included in this IE.

9.2.1.122d Additional Ionospheric Model Request

IE/Group Name	Presence	Range	IE Type and Reference	Semantics Description
Additional Ionospheric Model Request	M		BIT STRING(2)	Data ID for GANSS Additional Ionospheric Model as defined in TS 25.331 [16], subclause 10.3.7.92b.

9.2.1.122e Earth Orientation Parameters Request

IE/Group Name	Presence	Range	IE Type and Reference	Semantics Description
Earth Orientation Parameters Request	M		BOOLEAN	True means requested.

9.2.1.122f GANSS Additional Navigation Models And Time Recovery Request

IE/Group Name	Presence	Range	IE Type and Reference	Semantics Description
GANSS Additional Navigation Models And Time Recovery Request	M		BOOLEAN	True means requested.

9.2.1.122g GANSS Additional UTC Models Request

IE/Group Name	Presence	Range	IE Type and Reference	Semantics Description
GANSS Additional UTC Models Request	M		BOOLEAN	True means requested.

9.2.1.122h GANSS Auxiliary Information Request

IE/Group Name	Presence	Range	IE Type and Reference	Semantics Description
GANSS Auxiliary Information Request	M		BOOLEAN	True means requested.

9.2.1.123 SixtyfourQAM DL Support Indicator

The *SixtyfourQAM DL Support Indicator* indicates whether the particular cell is capable to support Sixtyfour QAM in DL or not.

IE/Group Name	Presence	Range	IE Type and Reference	Semantics Description
SixtyfourQAM DL Support Indicator			ENUMERATED (SixtyfourQAM DL Supported, SixtyfourQAM DL Not Supported)	

9.2.1.124 RANAP Enhanced Relocation Information Request

This parameter is transparent to the RNSAP. The parameter contains information for the Enhanced Relocation procedure as defined in TS 25.413 [2].

IE/Group Name	Presence	Range	IE Type and Reference	Semantics Description
RANAP Enhanced Relocation Information Request			BIT STRING	The content is defined in ref. TS 25.413 [2].

9.2.1.125 RANAP Enhanced Relocation Information Response

This parameter is transparent to the RNSAP. The parameter contains information for the Enhanced Relocation procedure as defined in TS 25.413 [2].

IE/Group Name	Presence	Range	IE Type and Reference	Semantics Description
RANAP Enhanced Relocation Information Response			BIT STRING	The content is defined in ref. TS 25.413 [2].

9.2.1.126 Released CN Domain

The parameter indicates the CD Domain(s) which the RNC shall release the related resource for.

IE/Group Name	Presence	Range	IE Type and Reference	Semantics Description
CHOICE <i>Released CN Domain</i>	M			
> <i>PS Domain</i>			NULL	
> <i>CS Domain</i>			NULL	
> <i>PS and CS Domain</i>			NULL	

9.2.1.127 Secondary CCPCH system information MBMS

The parameter contains information for the Secondary CCPCH system information MBMS as defined in TS 25.331 [16].

IE/Group Name	Presence	Range	IE Type and Reference	Semantics Description
Secondary CCPCH system information MBMS			BIT STRING	The content is defined in ref. TS 25.331 [16].

9.2.1.128 MBSFN Cluster Identity

The parameter is the identifier of a MBSFN cluster in one PLMN.

IE/Group Name	Presence	Range	IE Type and Reference	Semantics Description
MBSFN Cluster Identity			INTEGER (0..65535)	the identifier of a MBSFN cluster in one PLMN

9.2.1.129 MBSFN Scheduling Transmission Time Interval

The parameter is the identifier of an MBSFN Scheduling Transmission Time Interval.

IE/Group Name	Presence	Range	IE Type and Reference	Semantics Description
MBSFN Scheduling Transmission Time Interval			INTEGER (4,8,16,32,64,128,256)	Number of TTIs

9.2.1.130 MAC-ehs Reset Timer

The *MAC-ehs Reset Timer* IE is used as Reset Timer(*Treset*) described in ref TS 25.321 [41] subclause 11.6.4.5.

IE/Group Name	Presence	Range	IE type and reference	Semantics description
MAC-ehs Reset Timer			ENUMERATED (1, 2, 3, 4, ...)	Timer in multiples of T1 values (milliseconds). Used when MAC-ehs reordering queue is reset in CELL_FACH and CELL_PCH

9.2.1.131 Enhanced FACH Support Indicator

This IE indicates the Enhanced FACH Support. [1.28Mcps TDD – This IE indicates the Enhanced FACH Support in both downlink and uplink.]

IE/Group Name	Presence	Range	IE Type and Reference	Semantics Description
Enhanced FACH Support Indicator			NULL	

9.2.1.132 Enhanced PCH Capability

This IE indicates the UE is capable of Enhanced PCH or not.

IE/Group Name	Presence	Range	IE Type and Reference	Semantics Description
Enhanced PCH Capability			ENUMERATED (Enhanced PCH Capable, Enhanced PCH Not Capable)	

9.2.1.133 Priority Queue Information for Enhanced FACH/PCH

The *Priority Queue Information for Enhanced FACH/PCH* IE provides information associated to HSDPA Priority Queue used for Enhanced FACH and/or Enhanced PCH.

IE/Group Name	Presence	Range	IE Type and Reference	Semantics Description
Priority Queue Information		<i>1..<maxnoofPrioQueues></i>		
>Priority Queue ID	M		9.2.1.45A	
>Scheduling Priority Indicator	M		9.2.1.51A	
>T1	M		9.2.1.54A	
>MAC-ehs Reset Timer	M		9.2.1.130	
>Discard Timer	O		9.2.1.19C	
>MAC-hs Window Size	M		9.2.1.34C	
>Maximum MAC-d PDU Size	M		MAC PDU Size Extended 9.2.1.34D	

Range Bound	Explanation
<i>maxnoofPrioQueues</i>	Maximum number of Priority Queues

9.2.1.134 MIMO Activation Indicator

IE/Group Name	Presence	Range	IE Type and Reference	Semantics Description
MIMO Activation Indicator	M		NULL	

9.2.1.135 MIMO Mode Indicator

IE/Group Name	Presence	Range	IE Type and Reference	Semantics Description
MIMO Mode Indicator			ENUMERATED (Activate, Deactivate)	

9.2.1.136 DL RLC PDU Size Format

The *DL RLC PDU Size Format* IE indicates the downlink RLC PDU size format used for a Priority Queue.

IE/Group Name	Presence	Range	IE Type and Reference	Semantics Description
DL RLC PDU Size Format			ENUMERATED (Fixed RLC PDU size, Flexible RLC PDU size ,...)	

9.2.1.137 UE Aggregate Maximum Bit Rate

The *UE Aggregate Maximum Bitrate* IE is applicable for all Non-GBR bearers per UE which is defined for the Downlink and the Uplink direction and provided by the CN to the RNC. At least one of the *UE Aggregate Maximum Bit Rate Downlink* IE and *UE Aggregate Maximum Bit Rate Uplink* IE shall be included in the *UE Aggregate Maximum Bit Rate* IE.

IE/Group Name	Presence	Range	IE type and reference	Semantics description
UE Aggregate Maximum Bit Rate				Desc: Applicable for non-GBR bearers
>UE Aggregate Maximum Bit Rate Downlink	O		INTEGER (1..1,000,000,000)	Desc.: This IE indicates the aggregated maximum number of bits delivered by UTRAN and to UTRAN in DL within a period of time, divided by the duration of the period for all non-GBR bearers in one UE. The MBR of non-GBR bearers shall be ignored if this IE present.
>UE Aggregate Maximum Bit Rate Uplink	O		INTEGER (1..1,000,000,000)	Desc.: This IE indicates the aggregated maximum number of bits delivered by UTRAN and to UTRAN in UL within a period of time, divided by the duration of the period for all non-GBR bearers in one UE. The MBR of non-GBR bearers shall be ignored if this IE present.

9.2.1.138 DGNSS Validity Period

This IE defines the validity period of the GNSS differential corrections provided in *DGPS corrections* and *DGNSS corrections* IEs.

IE/Group Name	Presence	Range	IE Type and Reference	Semantics Description
UDRE Growth Rate	M		Enumerated(UDRE growth 1.5, UDRE growth 2, UDRE growth 4, UDRE growth 6, UDRE growth 8, UDRE growth 10, UDRE growth 12, UDRE growth 16)	This field provides an estimate of the growth rate of uncertainty ($1-\sigma$) in the corrections. The UDRE at time value specified in the <i>Time of Validity for UDRE Growth Rate field</i> is the value of this field times the value of UDRE provided in <i>DGPS Corrections</i> or <i>DGANSS corrections</i> IE TS 25.427 [4].
Time of Validity for UDRE Growth Rate	M		Enumerated(val20sec, val40sec, val80sec, val160sec, val320sec, val640sec, val1280sec, val2560sec)	This field specifies the time when the <i>UDRE Growth Rate field</i> applies TS 25.427 [4].

9.2.2 FDD Specific Parameters

This subclause contains parameters that are specific to FDD.

9.2.2.a ACK-NACK Repetition Factor

The *ACK-NACK Repetition Factor* IE indicates the consecutive repetition of the ACK and NACK.

IE/Group Name	Presence	Range	IE type and reference	Semantics description
ACK-NACK Repetition Factor			INTEGER (1..4,...)	Step: 1

9.2.2.b ACK Power Offset

The *ACK Power Offset* IE indicates Power offset used in the UL between the HS-DPCCH slot carrying HARQ ACK information and the associated DPCCH.

IE/Group Name	Presence	Range	IE type and reference	Semantics description
ACK Power Offset			INTEGER (0.8,...)	According to mapping in ref. TS 25.213 [21] subclause 4.2.1.

9.2.2.A Active Pattern Sequence Information

Defines the parameters for the compressed mode gap pattern sequence activation. For details see ref. TS 25.331 [16].

IE/Group Name	Presence	Range	IE Type and Reference	Semantics Description
CM Configuration Change CFN	M		CFN 9.2.1.9	
Transmission Gap Pattern Sequence Status		0.. <maxTGPS>		If the group is not present, none of the pattern sequences are activated.
>TGPSI Identifier	M		INTEGER(1..<MaxTGPS>)	Establish a reference to the compressed mode pattern sequence. Up to <MaxTGPS> simultaneous compressed mode pattern sequences can be activated.
>TGPRC	M		INTEGER(0..511)	The number of transmission gap patterns within the Transmission Gap Pattern Sequence. 0=Infinity.
>TGCFN	M		CFN 9.2.1.9	Connection Frame Number of the first frame of the first pattern 1 within the Transmission Gap Pattern Sequence.

Range bound	Explanation
maxTGPS	Maximum number of active pattern sequences. Value 6.

9.2.2.B Adjustment Period

Adjustment Period IE defines the period to be used for power balancing.

IE/Group Name	Presence	Range	IE Type and Reference	Semantics Description
Adjustment Period			INTEGER (1 .. 256)	Unit: Frames

9.2.2.C Adjustment Ratio

Adjustment Ratio IE (*Radj*) defines the convergence rate used for the associated Adjustment Period.

IE/Group Name	Presence	Range	IE Type and Reference	Semantics Description
Adjustment Ratio			INTEGER (0 .. 100)	The Adjustment Ratio is given with a granularity of 0.01 0 -> 0.00 1 -> 0.01 ... 100 -> 1.00

9.2.2.Ca Bundling Mode Indicator

The Bundling Mode Indicator indicates whether the bundling shall be done or shall not be done for Iur.

IE/Group Name	Presence	Range	IE Type and Reference	Semantics Description
Bundling Mode Indicator			ENUMERATED (Bundling, No bundling)	The value "Bundling" is applicable only when E-TTI indicates "2ms".

9.2.2.D Cell Capability Container FDD

The Cell Capability Container FDD indicates which functionalities a cell supports.

IE/Group Name	Presence	Range	IE Type and Reference	Semantics Description
Cell Capability Container FDD			BIT STRING (32)	<p>Each bit indicates whether a cell supports a particular functionality or not. The value 1 of a bit indicates that the corresponding functionality is supported in a cell and value 0 indicates that the corresponding functionality is not supported in a cell. Each bit is defined as follows.</p> <p>The first bit: Reserved.</p> <p>The second bit: Delayed Activation Support Indicator.</p> <p>The third bit: HS-DSCH Support Indicator.</p> <p>The fourth bit: Reserved.</p> <p>The fifth bit: F-DPCH Support Indicator.</p> <p>The sixth bit: E-DCH Support Indicator.</p> <p>The seventh bit: E-DCH TTI2ms Support Indicator.</p> <p>The eighth bit: E-DCH 2sf2and2sf4 and all inferior SFs Support Indicator.</p> <p>The ninth bit: E-DCH 2sf2 and all inferior SFs Support Indicator.</p> <p>The tenth bit: E-DCH 2sf4 and all inferior SFs Support Indicator.</p> <p>The eleventh bit: E-DCH sf4 and all inferior SFs Support Indicator.</p> <p>The twelveth bit: E-DCH sf8 and all inferior SFs Support Indicator.</p> <p>The thirteenth bit: E-DCH HARQ IR Combining Support Indicator.</p> <p>The fourteenth bit: E-DCH HARQ Chase Combining Support Indicator.</p> <p>The fifteenth bit: Continuous Packet Connectivity DTX-DRX Support Indicator.</p> <p>The sixteenth bit: Continuous Packet Connectivity HS-SCCH less Support Indicator.</p> <p>The seventeenth bit: MIMO Support Indicator.</p> <p>The eighteenth bit: SixteenQAM UL Support Indicator.</p> <p>The nineteenth bit: Flexible MAC-d PDU Size Support Indicator.</p> <p>The twentieth bit: F-DPCH Slot Format Support Indicator.</p> <p>The twentyfirst bit: SixtyfourQAM DL Support Indicator.</p> <p>The twentysecond bit:</p>

				<p>Flexible E-DCH MAC-d PDU Size Support Indicator. The twentythird bit: E-DPCCH Power Boosting Support Indicator. The twentyfourth bit: SixtyfourQAM DL and MIMO Combined Support Indicator. This bit shall not be set to 1 if SixtyfourQAM DL Support Indicator is set to 0 or MIMO Support Indicator is set to 0. The twentyfifth bit: Multi Cell Support Indicator The twentysixth bit: MBMS Support Indicator. The twentyseventh bit: TX Diversity on DL Control Channels by MIMO Capable UE when MIMO operation is Active Support Indicator. The twentyeighth bit: Dual Band Support Indicator The twenty ninth bit: Single Stream MIMO Support Indicator. The thirtieth bit: Preferred Precoding Weight Set Restriction Support Indicator. (See TS 25.331 [16], the value 1 indicates preferred)</p> <p>Note that undefined bits are considered as a spare bit and spare bits shall be set to 0 by the transmitter and shall be ignored by the receiver. Note that Reserved bits are not considered as a spare bit. They shall however be set to 0 by the transmitter and shall be ignored by the receiver.</p>
--	--	--	--	--

9.2.2.E Cell Portion ID

Cell Portion ID is the unique identifier for a cell portion within a cell. See TS 25.215 [11].

IE/Group Name	Presence	Range	IE Type and Reference	Semantics Description
Cell Portion ID			INTEGER (0..63,...)	

9.2.2.1 Chip Offset

The Chip Offset is defined as the radio timing offset inside a radio frame. The Chip Offset is used as offset for the DL DPCH relative to the Primary CPICH timing for the DL DPCH or for the F-DPCH.

IE/Group Name	Presence	Range	IE Type and Reference	Semantics Description
Chip Offset			INTEGER (0..38399)	Unit: Chips

9.2.2.2 Closed Loop Mode1 Support Indicator

The Closed Loop Mode1 Support Indicator indicates whether the particular cell is capable to support Closed loop mode1 or not

IE/Group Name	Presence	Range	IE Type and Reference	Semantics Description
Closed Loop Mode1 Support Indicator			ENUMERATED(Closed loop mode1 Supported, Closed loop mode1 not supported).	

9.2.2.3 Closed Loop Mode2 Support Indicator

Void.

9.2.2.3A Closed Loop Timing Adjustment Mode

Indicates when the phase/amplitude adjustment is performed in the DL in relation to the receipt of the UL feedback command in case of closed loop mode transmit diversity on DPCH.

IE/Group Name	Presence	Range	IE Type and Reference	Semantics Description
Closed Loop Timing Adjustment Mode			ENUMERATED(Offset1, Offset2,...)	According to TS 25.214 [10] subclause 7.1: Offset1 = slot(j+1)mod15 Offset2 = slot(j+2)mod15

9.2.2.4 Compressed Mode Method

Void

9.2.2.4A DCH FDD Information

The *DCH FDD Information* IE provides information for DCHs to be established.

IE/Group Name	Presence	Range	IE Type and Reference	Semantics Description	Criticality	Assigned Criticality
DCH FDD Information		<i>1..<maxno ofDCHs></i>			–	
>Payload CRC Presence Indicator	M		9.2.1.42		–	
>UL FP Mode	M		9.2.1.67		–	
>ToAWS	M		9.2.1.58		–	
>ToAWE	M		9.2.1.57		–	
>DCH Specific Info		<i>1..<maxno ofDCHs></i>			–	
>>DCH ID	M		9.2.1.16		–	
>>TrCH Source Statistics Descriptor	M		9.2.1.65		–	
>>Transport Format Set	M		9.2.1.64	For the UL.	–	
>>Transport Format Set	M		9.2.1.64	For the DL.	–	
>>BLER	M		9.2.1.4	For the UL.	–	
>>BLER	M		9.2.1.4	For the DL.	–	
>>Allocation/Retention Priority	M		9.2.1.1		–	
>>Frame Handling Priority	M		9.2.1.29		–	
>>QE-Selector	M		9.2.1.46A		–	
>>DRAC control	M		9.2.2.13		–	
>>Guaranteed Rate Information	O		9.2.1.30M		YES	ignore
>>Traffic Class	M		9.2.1.58A		YES	ignore
>>Unidirectional DCH Indicator	O		9.2.1.68B		YES	reject
>TNL QoS	O		9.2.1.56A		YES	ignore

Range bound	Explanation
<i>maxnoofDCHs</i>	Maximum number of DCHs for one UE.

9.2.2.4B E-DCH FDD Information

The E-DCH *FDD Information* IE provides information for an E-DCH to be established.

IE/Group Name	Presence	Range	IE Type and Reference	Semantics Description	Criticality	Assigned Criticality
E-DCH MAC-d Flows Information	M		9.2.2.4MC		–	
HARQ Process Allocation For 2ms Scheduled Transmission Grant	O		HARQ Process Allocation for 2ms TTI 9.2.2.4O	If this IE is not included, scheduled transmission in all HARQ processes is allowed.	–	
E-DCH Maximum Bitrate	O		9.2.2.4MG		–	
E-DCH Processing Overload Level	O		9.2.1.95		–	
E-DCH Reference Power Offset	O		9.2.2.4MI		–	
E-DCH Power Offset for Scheduling Info	O		9.2.1.96		YES	ignore
SixteenQAM UL Operation Indicator	O		9.2.2.90		YES	reject
E-AGCH Table Choice	C- SixteenQAM UL Operation		9.2.2.61A	If the SixteenQAM UL operation is not configured for this UE, Table 16B for E-AGCH in TS 25.212 [9] shall be used.	YES	ignore

Condition	Explanation
SixteenQAM UL Operation	The IE shall be present if the <i>SixteenQAM UL Operation Indicator</i> IE is set to "Activate".

9.2.2.4C E-DCH FDD Information Response

The *E-DCH FDD Information Response* IE provides information for E-DCH MAC-d flows that have been established or modified. It also provides additional E-DCH information determined within the DRNS.

IE/Group Name	Presence	Range	IE Type and Reference	Semantics Description	Criticality	Assigned Criticality
E-DCH MAC-d Flow Specific Information Response		$1..<maxno\ of\ EDCHM\ ACdFlows\ >$			–	
>E-DCH MAC-d Flow ID	M		9.2.1.91	If only <i>HARQ Process Allocation For 2ms Scheduled Transmission Grant</i> IE and this IE (<i>E-DCH MAC-d Flow ID</i>) are present in the <i>E-DCH FDD Information Response</i> IE, the content of this IE shall be considered invalid	–	
>Binding ID	O		9.2.1.3		–	
>Transport Layer Address	O		9.2.1.62		–	
>HARQ Process Allocation For 2ms Non-Scheduled Transmission Grant	O		HARQ Process Allocation for 2ms TTI 9.2.2.4O		–	
>Transport Bearer Not Setup Indicator	O		9.2.2.4T		YES	ignore
HARQ Process Allocation For 2ms Scheduled Transmission Grant	O		HARQ Process Allocation for 2ms TTI 9.2.2.4O		–	

Range bound	Explanation
$maxnoofEDCHMACdFlows$	Maximum number of E-DCH MAC-d flows.

9.2.2.4D E-DCH FDD DL Control Channel Information

The *E-DCH FDD DL Control Channel Information* IE provides information for E-DCH specific DL Control Channels to be provided to UE via RRC signalling.

IE/Group Name	Presence	Range	IE Type and Reference	Semantics Description	Criticality	Assigned Criticality
E-AGCH And E-RGCH/E-HICH FDD Scrambling Code	O		DL Scrambling Code 9.2.2.11	Scrambling code on which E-AGCH, E-RGCH and E-HICH are transmitted. 0= Primary scrambling code of the cell 1...15 = Secondary scrambling code	–	
E-AGCH Channelisation Code	O		FDD DL Channelisation Code Number 9.2.2.14		–	
Primary E-RNTI	O		E-RNTI 9.2.1.94		–	
Secondary E-RNTI	O		E-RNTI 9.2.1.94		–	
E-RGCH/E-HICH Channelisation Code	M		FDD DL Channelisation Code Number 9.2.2.14		–	
E-RGCH Signature Sequence	O		INTEGER (0..maxnoof SigSeqERG HICH-1)		–	
E-HICH Signature Sequence	O		INTEGER (0..maxnoof SigSeqERG HICH-1)		–	
Serving Grant Value	O		INTEGER (0..37,38)	(0..37) indicates E-DCH serving grant index as defined in TS 25.321 [41]; index 38 means zero grant	–	
Primary/Secondary Grant Selector	O		ENUMERATED (Primary, Secondary)	Indicates whether the Serving Grant Value is granted with a primary E-RNTI or a secondary E-RNTI	–	
E-RGCH Release Indicator	O		9.2.2.60		–	
E-RGCH and E-HICH Channelisation Code Validity Indicator	O		9.2.2.68	Indicates whether the value of E-RGCH and E-HICH Channelisation Code is invalid	YES	ignore
Default Serving Grant in	O		INTEGER	Serving Grant	YES	ignore

DTX Cycle 2			(0..37,38)	value to be used in DTX-Cycle-2. (0..37) indicates E-DCH serving grant index as defined in TS 25.425 [32]; index 38 means zero grant		
-------------	--	--	------------	--	--	--

Range bound	Explanation
maxnoofSigSeqERGHICH	Maximum number Signature Sequences for E-RGCH / E-HICH

9.2.2.4E E-DCH RL Indication

Indicates whether a RL is an E-DCH RL.

IE/Group Name	Presence	Range	IE Type and Reference	Semantics Description
E-DCH RL Indication			ENUMERATED (E-DCH, non E-DCH)	

9.2.2.4F E-DCH FDD Information To Modify

The E-DCH *FDD Information* IE provides information for an E-DCH to be modified.

IE/Group Name	Presence	Range	IE Type and Reference	Semantics Description	Criticality	Assigned Criticality
E-DCH MAC-d Flow Specific Information		<i>1..<maxno of EDCHM ACdFlows ></i>		See Note1 below.	–	
>E-DCH MAC-d Flow ID	M		9.2.1.91		–	
>Allocation/Retention Priority	O		9.2.1.1		–	
>Transport Bearer Request Indicator	M		9.2.1.61		–	
>TNL QoS	O		9.2.1.56A		–	
>Maximum Number of Retransmissions for E-DCH	O		9.2.1.100		–	
>Traffic Class	O		9.2.1.58A		–	
>E-DCH HARQ Power Offset FDD	O		9.2.2.4L		–	
>E-DCH MAC-d Flow Multiplexing List	O		9.2.1.89		–	
> CHOICE <i>E-DCH grant type</i>	O					
>> <i>E-DCH Non-Scheduled Transmission Grant</i>						
>>>Maximum Number of Bits per MAC-e PDU for Non-scheduled Transmission	M		9.2.2.4N	If the <i>Extended Maximum Number of Bits per MAC-e PDU for Non-scheduled Transmission</i> IE is present, this IE shall be ignored. When <i>Maximum MAC-d PDU Size Extended</i> IE is configured for an E-DCH Logical Channel this IE indicates the maximum number of bits per MAC-I PDU.	–	
>>>HARQ Process Allocation For 2ms Non-Scheduled Transmission Grant	O		HARQ Process Allocation for 2ms TTI 9.2.2.4O		–	

>>>Extended Maximum Number of Bits per MAC-e PDU for Non-scheduled Transmission	O		9.2.2.4R	When <i>Maximum MAC-d PDU Size Extended</i> IE is configured for an E-DCH Logical Channel this IE indicates the extended maximum number of bits per MAC-I PDU.	YES	reject
>>E-DCH Scheduled Transmission Grant			NULL			
>Bundling Mode Indicator	O		9.2.2.Ca		–	
>E-DCH Logical Channel To Add	O		E-DCH Logical Channel Information 9.2.1.92		–	
>E-DCH Logical Channel To Modify			9.2.1.93		–	
>E-DCH Logical Channel To Delete		0..<maxnoflogicalchannels>			–	
>>Logical Channel ID	M		9.2.1.97		–	
HARQ Process Allocation For 2ms Scheduled Transmission Grant	O		HARQ Process Allocation for 2ms TTI 9.2.2.4O		–	
E-DCH Maximum Bitrate	O		9.2.2.4MG		–	
E-DCH Processing Overload Level	O		9.2.1.95		–	
E-DCH Reference Power Offset	O		9.2.2.4MI		–	
MAC-e Reset Indicator	O		9.2.1.99		–	
E-DCH Power Offset for Scheduling Info	O		9.2.1.96		YES	ignore
SixteenQAM UL Operation Indicator	O		9.2.2.90		YES	reject
E-DCH MAC-d PDU Size Format	O		9.2.1.91A		YES	reject
E-DCH DL Control Channel Grant Information		0..<maxnofEDCHRLs>			GLOBAL	ignore
>E-DCH RL ID	M		RL ID 9.2.1.49		–	
E-AGCH Table Choice	C-SixteenQAM UL Operation		9.2.2.61A	If sixteenQAM UL operation is not used in the new configuration for this UE, Table 16B for E-AGCH in TS 25.212 [9] shall be used in the new configuration.	YES	ignore
Note 1: Even if no E-DCH MAC-d Flow Specific Information needs to be modified, one E-DCH MAC-d Flow Information shall be included, which only contains the <i>E-DCH MAC-d Flow ID</i> IE and the <i>Transport BearerRequest Indicator</i> IE set to "Bearer not Requested".						

Condition	Explanation
SixteenQAM UL Operation	The IE shall be present if the <i>SixteenQAM UL Operation Indicator</i> IE is set to "Activate".

Range bound	Explanation
<i>maxnoofEDCHMACdFlows</i>	Maximum number of E-DCH MAC-d flows.
<i>Maxnooflogicalchannels</i>	Maximum number of Logical Channels
<i>maxnoofEDCHRLs</i>	Maximum number of E-DCH RLs for one UE

9.2.2.4G E-DCH Transport Format Combination Set Information (E-TFCS Information)

Whereas the related Transport Block sizes are standardised in TS 25.321 [41] this IE gives details on the referenced Transport Block Size Table, the E-DCH Minimum Set E-TFCS, the Reference E-TFCSs and configuration parameters used for the calculation of the gain factors β_{ec} and β_{ed} defined in TS 25.214 [10].

IE/Group Name	Presence	Range	IE Type and Reference	Semantics Description	Criticality	Assigned Criticality
E-TFCI Table Index	M		INTEGER (0..1, ..., 2..7)	Indicates which standardised E-TFCS Transport Block Size Table shall be used. The related tables are specified in TS 25.321 [41].	–	
E-DCH Minimum Set E-TFCI	M		INTEGER (0..127)	For the concept of “E-DCH Minimum Set of TFCs” see TS 25.321 [41] and TS 25.331 [16].	–	
Reference E-TFCI Information		<i>1..<maxno ofRefETF CIs></i>			–	
>Reference E-TFCI	M		INTEGER (0..127)		–	
>Reference E-TFCI Power Offset	M		9.2.2.4P	If the <i>Extended Reference E-TFCI Power Offset</i> IE is present, this IE shall be ignored	–	
>Extended Reference E-TFCI Power Offset	O		9.2.2.4Q		YES	reject
E-DCH Minimum Set E-TFCI Validity Indicator	O		9.2.2.69	Indicates whether the value of E-DCH Minimum Set E-TFCI is invalid	YES	reject
E-TFCI Boost Information	O		9.2.2.91		YES	reject
E-DPDCH Power Interpolation	O		BOOLEAN	True means that the E-DPDCH power interpolation formula shall be applied, False means that the E-DPDCH power extrapolation formula shall be applied for the computation of the gain factor β_{ed} according to TS 25.214 [10]	YES	reject

Range Bound	Explanation
<i>maxnoofRefETF CIs</i>	Maximum number of signalled reference E-TFCIs

9.2.2.4J E-TTI

The E-TTI parameter indicates the Transmission Time Interval for E-DPCH operation.

IE/Group Name	Presence	Range	IE Type and Reference	Semantics Description
E-TTI			ENUMERATED (2ms, 10ms)	

9.2.2.4K E-DPCCH Power Offset

The E-DPCCH Power Offset is used to calculate the E-DPCCH gain factor β_{ec} as defined in TS 25.214 [10], whereas β_{ec} is related to the power difference between DPCCH and E-DPCCH.

IE/Group Name	Presence	Range	IE Type and Reference	Semantics Description
E-DPCCH Power Offset			INTEGER (0..8)	According to mapping in ref. TS 25.213 [21] subclause 4.2.1.3

9.2.2.4KA Void

9.2.2.4L E-DCH HARQ Power Offset FDD

The E-DCH HARQ Power Offset FDD is used to calculate the unquantised gain factor for an E-TFC ($\beta_{ed,j,uq}$) as defined in TS 25.214 [10].

IE/Group Name	Presence	Range	IE Type and Reference	Semantics Description
E-DCH HARQ Power Offset FDD			INTEGER (0..6)	According to mapping in ref. TS 25.213 [21] subclause 4.2.1.3.

9.2.2.4M Void

9.2.2.4MA Void

9.2.2.4MB Void

9.2.2.4MC E-DCH MAC-d Flows Information

The *E-DCH MAC-d Flows Information* IE is used for the establishment of E-DCH MAC-d flows.

IE/Group Name	Presence	Range	IE Type and Reference	Semantics Description	Criticality	Assigned Criticality
E-DCH MAC-d Flow Specific Information		<i>1..<maxno ofEDCHM ACdFlows ></i>			–	
>E-DCH MAC-d Flow ID	M		9.2.1.91		–	
>Allocation/Retention Priority	O		9.2.1.1		–	
>TNL QoS	O		9.2.1.56A		–	
>Payload CRC Presence Indicator	M		9.2.1.42		–	
>Maximum Number of Retransmissions for E-DCH	M		9.2.1.100		–	
>Traffic Class	M		9.2.1.58A		–	
>E-DCH HARQ Power Offset FDD	M		9.2.2.4L		–	
>E-DCH MAC-d Flow Multiplexing List	O		9.2.1.89		–	
>CHOICE <i>E-DCH grant type</i>	M				–	
>> <i>E-DCH Non-Scheduled Transmission Grant</i>						
>>>Maximum Number of Bits per MAC-e PDU for Non-scheduled Transmission	M		9.2.2.4N	If the <i>Extended Maximum Number of Bits per MAC-e PDU for Non-scheduled Transmission</i> IE is present, this IE shall be ignored. When <i>Maximum MAC-d PDU Size Extended</i> IE is configured for an E-DCH Logical Channel this IE indicates the maximum number of bits per MAC-I PDU.	–	
>>>HARQ Process Allocation For 2ms Non-Scheduled Transmission Grant	O		HARQ Process Allocation for 2ms TTI 9.2.2.4O	If this IE is not included, transmission in all HARQ processes is allowed.	–	

>>>Extended Maximum Number of Bits per MAC-e PDU for Non-scheduled Transmission	O		9.2.2.4R	When <i>Maximum MAC-d PDU Size Extended</i> IE is configured for an E-DCH Logical Channel this IE indicates the extended maximum number of bits per MAC-I PDU.	YES	reject
>>E-DCH Scheduled Transmission Grant			NULL			
>Bundling Mode Indicator	O		9.2.2.Ca		–	
>E-DCH Logical Channel Information	M		9.2.1.92		–	
>TrCH Source Statistics Descriptor	O		9.2.1.65		YES	ignore

Range bound	Explanation
<i>maxnoofEDCHMACdFlows</i>	Maximum number of E-DCH MAC-d flows.

9.2.2.4MD Void

9.2.2.4ME Void

9.2.2.4MF Void

9.2.2.4MG E-DCH Maximum Bitrate

The E-DCH Maximum Bitrate parameter indicates the Maximum Bitrate for an E-DCH.

IE/Group Name	Presence	Range	IE Type and Reference	Semantics Description
E-DCH Maximum Bitrate			INTEGER (0..5742,...., 5743..11498)	Bitrate on transport block level. Unit is kbits per second.

9.2.2.4MH Void

9.2.2.4MI E-DCH Reference Power Offset

The E-DCH Reference Power Offset is used to estimate the E-DPDCH power from E-TFCI without decoding MAC-e PDUs.

IE/Group Name	Presence	Range	IE Type and Reference	Semantics Description
E-DCH Reference Power Offset			INTEGER (0..6)	According to mapping in ref. TS 25.213 [21] subclause 4.2.1.3.

9.2.2.4MJ Void

9.2.2.4N Maximum Number of Bits per MAC-e PDU for Non-scheduled Transmission

The Maximum Number of Bits per MAC-e PDU for Non-scheduled Transmission indicates the maximum numbers of bits allowed to be included in a MAC-e (or MAC-i) PDU per E-DCH MAC-d flow configured for non-scheduled transmissions. If the range of the *Maximum Number of Bits per MAC-e PDU for Non-scheduled Transmission* IE is insufficient to represent the value to be sent to the DRNS, the *Extended Maximum Number of Bits per MAC-e PDU for Non-scheduled Transmission* IE shall be used to represent the value to be sent to the DRNS, see section 9.2.2.4R.

IE/Group Name	Presence	Range	IE Type and Reference	Semantics Description
Maximum Number of Bits per MAC-e PDU for Non-Scheduled Transmission			INTEGER (1..19982)	

9.2.2.4O HARQ Process Allocation For 2ms TTI

The HARQ Process Allocation for 2ms TTI indicates those HARQ processes that are allowed. MAC-d PDU's for a MAC-d flow are only allowed to be transmitted in those processes for which the bit is set to "1".

IE/Group Name	Presence	Range	IE Type and Reference	Semantics Description
HARQ Process Allocation For 2ms TTI			BIT STRING (8)	The first Bit corresponds to HARQ process ID = 0, the second bit corresponds to HARQ process ID = 1, etc. The HARQ process ID for 2ms TTI is defined in TS 25.321 [41], chapter 11.8.1.3.

9.2.2.4P Reference E-TFCI Power Offset

The Reference E-TFCI Power Offset is used to calculate the reference E-TFC gain factor $\beta_{ed,ref}$ as defined in TS 25.214 [10]. If the range of the *Reference E-TFCI Power Offset* IE is insufficient to represent the value to be sent to the DRNS, the *Extended Reference E-TFCI Power Offset* IE shall be used to represent the value to be sent to the DRNS, see section 9.2.2.4Q.

IE/Group Name	Presence	Range	IE Type and Reference	Semantics Description
Reference E-TFCI Power Offset			INTEGER (0..29)	According to mapping in ref. TS 25.213 [21] subclause 4.2.1.3

9.2.2.4Q Extended Reference E-TFCI Power Offset

The *Extended Reference E-TFCI Power Offset* IE shall be used if the range of the *Reference E-TFCI Power Offset* IE (see section 9.2.2.4P) is insufficient to represent the value of the Reference E-TFCI Power Offset to be sent to the DRNS.

IE/Group Name	Presence	Range	IE Type and Reference	Semantics Description
Extended Reference E-TFCI Power Offset			INTEGER (30..31,...)	According to mapping in ref. TS 25.213 [21] subclause 4.2.1.3

9.2.2.4R Extended Maximum Number of Bits per MAC-e PDU for Non-scheduled Transmission

The *Extended Maximum Number of Bits per MAC-e PDU for Non-scheduled Transmission* IE shall be used if the range of the *Maximum Number of Bits per MAC-e PDU for Non-scheduled Transmission* IE (see section 9.2.2.4N) is insufficient to represent the value of the Maximum Number of Bits per MAC-e (or MAC-i) PDU for Non-scheduled Transmission to be sent to the DRNS.

IE/Group Name	Presence	Range	IE Type and Reference	Semantics Description
Extended Maximum Number of Bits per MAC-e PDU for Non-scheduled Transmission			INTEGER (19983..22978,...)	

9.2.2.4S Transport Bearer Not Requested Indicator

The Transport Bearer Not Requested Indicator parameter indicates that a transport bearer shall not be established or may not to be established for DCH or an E-DCH MAC-d flow.

IE/Group Name	Presence	Range	IE Type and Reference	Semantics Description
Transport Bearer Not Requested Indicator			ENUMERATED (Transport Bearer shall not be Established, Transport Bearer may not be Established)	

9.2.2.4T Transport Bearer Not Setup Indicator

The Transport Bearer Not Setup Indicator parameter indicates that a transport bearer will not be established for a DCH or an E-DCH MAC-d flow.

IE/Group Name	Presence	Range	IE Type and Reference	Semantics Description
Transport Bearer Not Setup Indicator			ENUMERATED (Transport Bearer Not Setup)	

9.2.2.5 D-Field Length

Void

9.2.2.6 Diversity Control Field

Void.

9.2.2.7 Diversity Indication

Void.

9.2.2.8 Diversity Mode

Define the diversity mode to be applied.

IE/Group Name	Presence	Range	IE Type and Reference	Semantics Description
Diversity Mode			ENUMERATED(None, STTD, Closed loop mode 1, Not Used,...)	The <i>Diversity Mode</i> IE shall never be set to "Not Used". If received it shall be rejected.

9.2.2.9 DL DPCH Slot Format

Indicates the slot format used in DPCH in DL, according to ref. TS 25.211 [8].

IE/Group Name	Presence	Range	IE Type and Reference	Semantics Description
DL DPCH Slot Format			INTEGER (0..16,...)	

9.2.2.9A DL DPCH Timing Adjustment

The DL DPCH Timing Adjustment indicates that a timing adjustment of the related radio link is required or that an Initial DL DPCH Timing Adjustment has been performed by the DRNS. It also indicates whether the timing adjustment consists of a timing advance or a timing delay with respect to the SFN timing. The adjustment always consists of 256 chips.

IE/Group Name	Presence	Range	IE Type and Reference	Semantics Description
DL DPCH Timing Adjustment			ENUMERATED(timing advance, timing delay)	The size of the timing adjustment is 256 chips.

9.2.2.10 DL Power

Void

9.2.2.10A DL Power Balancing Information

The *DL Power Balancing Information* IE provides information for power balancing to be activated in the relevant RL(s).

IE/Group Name	Presence	Range	IE Type and Reference	Semantics Description	Criticality	Assigned Criticality
Power Adjustment Type	M		9.2.2.28		–	
DL Reference Power	C-Common		DL power 9.2.1.21A	Power on DPCH or on F-DPCH	–	
DL Reference Power Information	C-Individual	<i>1..<maxnoof RLS></i>			–	
>RL ID	M		9.2.1.49		–	
>DL Reference Power	M		DL power 9.2.1.21A	Power on DPCH or on F-DPCH	–	
Max Adjustment Step	C-CommonOrIndividual		9.2.2.23		–	
Adjustment Period	C-CommonOrIndividual		9.2.2.B		–	
Adjustment Ratio	C-CommonOrIndividual		9.2.2.C		–	

Condition	Explanation
Common	The IE shall be present if the <i>Power Adjustment Type</i> IE is set to "Common".
Individual	The IE shall be present if the <i>Power Adjustment Type</i> IE is set to "Individual".
CommonOrIndividual	The IE shall be present if the <i>Power Adjustment Type</i> IE is set to "Common" or "Individual".

Range Bound	Explanation
<i>maxnoofRLs</i>	Maximum number of Radio Links for a UE.

9.2.2.10B DL Power Balancing Activation Indicator

The *DL Power Balancing Activation Indicator* IE indicates that the power balancing is activated in the RL.

IE/Group Name	Presence	Range	IE Type and Reference	Semantics Description
DL Power Balancing Activation Indicator			ENUMERATED(DL Power Balancing Activated).	

9.2.2.10C DL Reference Power Information

The *DL Reference Power Information* IE provides reference power of the power balancing to be used in the relevant RL(s).

IE/Group Name	Presence	Range	IE Type and Reference	Semantics Description	Criticality	Assigned Criticality
Common DL Reference Power	O		DL power 9.2.1.21A	Power on DPCH or on F-DPCH	–	
Individual DL Reference Power Information		<i>0..<maxnoof RLS></i>			–	
>RL ID	M		9.2.1.49		–	
>DL Reference Power	M		DL power 9.2.1.21A	Power on DPCH or on F-DPCH	–	

Range bound	Explanation
<i>maxnoofRLs</i>	Maximum number of RLs for a UE.

9.2.2.10D DL Power Balancing Updated Indicator

The *DL Power Balancing Updated Indicator* IE indicates that the power balancing related parameters is updated in the RL.

IE/Group Name	Presence	Range	IE Type and Reference	Semantics Description
DL Power Balancing Updated Indicator			ENUMERATED(DL Power Balancing Updated).	

9.2.2.11 DL Scrambling Code

DL Scrambling code to be used by the RL. One cell may have multiple DL Scrambling codes available.

IE/Group Name	Presence	Range	IE Type and Reference	Semantics Description
DL Scrambling Code			INTEGER (0..15)	0= Primary scrambling code of the cell 1...15= Secondary scrambling code

9.2.2.12 Downlink Frame Type

Void

9.2.2.12A DPC Mode

The *DPC Mode* IE indicates the DPC mode to be applied TS 25.214 [10].

IE/Group Name	Presence	Range	IE Type and Reference	Semantics Description
DPC Mode			ENUMERATED (Mode0, Mode1, ...)	Mode0: The DRNS shall estimate the UE transmitted TPC command and update the DL power in every slot Mode1: The DRNS shall estimate the UE transmitted TPC command over three slots and shall update the DL power in every three slots

9.2.2.13 DRAC Control

The possibility to use DRAC control has been removed.

IE/Group Name	Presence	Range	IE Type and Reference	Semantics Description
DRAC Control			ENUMERATED (Not Used, Not-Requested)	The <i>DRAC Control</i> IE shall never be set to "Not Used".

9.2.2.13A DSCH FDD Information

Void.

9.2.2.13B DSCH FDD Information Response

Void.

9.2.2.13Bb DSCH-RNTI

Void.

9.2.2.13C FDD DCHs To Modify

The *FDD DCHs To Modify* IE provides information for DCHs to be modified.

IE/Group Name	Presence	Range	IE Type and Reference	Semantics Description	Criticality	Assigned Criticality
FDD DCHs To Modify		<i>1..<maxno ofDCHs></i>			–	
>UL FP Mode	O		9.2.1.67		–	
>ToAWS	O		9.2.1.58		–	
>ToAWE	O		9.2.1.57		–	
>Transport Bearer Request Indicator	M		9.2.1.61		–	
>DCH Specific Info		<i>1..<maxno ofDCHs></i>			–	
>>DCH ID	M		9.2.1.16		–	
>>Transport Format Set	O		9.2.1.64	For the UL.	–	
>>Transport Format Set	O		9.2.1.64	For the DL.	–	
>>Allocation/Retention Priority	O		9.2.1.1		–	
>>Frame Handling Priority	O		9.2.1.29		–	
>>Not Used	O		NULL		–	
>>Guaranteed Rate Information	O		9.2.1.30M		YES	ignore
>>Traffic Class	O		9.2.1.58A		YES	ignore
>>Unidirectional DCH Indicator	O		9.2.1.68B		YES	reject
>TNL QoS	O		9.2.1.56A		YES	ignore

Range bound	Explanation
<i>maxnoofDCHs</i>	Maximum number of DCHs for one UE.

9.2.2.13D Enhanced DSCH PC

Void.

9.2.2.13E Enhanced DSCH PC Counter

Void.

9.2.2.13F Enhanced DSCH PC Indicator

Void.

9.2.2.13G Enhanced DSCH PC Wnd

Void.

9.2.2.13H Enhanced DSCH Power Offset

Void.

9.2.2.13I Enhanced Primary CPICH Ec/No

Energy per PN chip divided by the total received power spectral density measured on the Primary CPICH by the UE.

IE/Group Name	Presence	Range	IE Type and Reference	Semantics Description
Enhanced Primary CPICH Ec/No			INTEGER(0..49)	According to the mapping of the Primary CPICH Ec/No UE measurement defined in ref. TS 25.133 [23] and TS 25.123 [24]

9.2.2.14 FDD DL Channelisation Code Number

The DL Channelisation Code Number indicates the DL Channelisation Code number for a specific DL physical channel.

IE/Group Name	Presence	Range	IE Type and Reference	Semantics Description
FDD DL Channelisation Code Number			INTEGER(0..511)	According to the mapping in TS 25.213 [27]. The maximum value is equal to the DL spreading factor –1

9.2.2.14A FDD DL Code Information

The *FDD DL Code Information* IE provides FDD DL Code information for all DPCHs or for the F-DPCH of one Radio Link.

IE/Group Name	Presence	Range	IE Type and Reference	Semantics Description	Criticality	Assigned Criticality
FDD DL Code Information		1.. <maxnoof DLCodes			–	
>DL Scrambling Code	M		9.2.2.11		–	
>FDD DL Channelisation Code Number	M		9.2.2.14		–	
>Transmission Gap Pattern Sequence Scrambling Code Information	O		9.2.2.47B		–	

Range bound	Explanation
maxnoofDLCodes	Maximum number of DL Channelisation Codes for one UE.

9.2.2.15 FDD S-CCPCH Offset

Void.

9.2.2.16 FDD TPC Downlink Step Size

This parameter indicates step size for the DL power adjustment.

IE/Group Name	Presence	Range	IE Type and Reference	Semantics Description
FDD TPC Downlink Step Size			ENUMERATED(0.5, 1, 1.5, 2,...)	

9.2.2.16A First RLS Indicator

The First *RLS Indicator* IE indicates if a specific Radio Link and all Radio Links which are part of the same Radio Link Set, shall be considered as the first radio links established towards the UE or not.

IE/Group Name	Presence	Range	IE Type and Reference	Semantics Description
First RLS Indicator			ENUMERATED(first RLS, not first RLS)	

9.2.2.17 Gap Position Mode

Void.

9.2.2.18 Gap Period (TGP)

Void.

9.2.2.19 Gap Starting Slot Number (SN)

Void

9.2.2.19a HS-DSCH FDD Information

The *HS-DSCH FDD Information* IE is used for initial addition of HS-DSCH information to UE Context.

IE/Group Name	Presence	Range	IE Type and Reference	Semantics Description	Criticality	Assigned Criticality
HS-DSCH MAC-d Flows Information	M		9.2.1.300A		–	
UE Capabilities Information		1			–	
>HS-DSCH Physical Layer Category	M		9.2.1.300a		–	
>1.28 Mcps TDD uplink physical channel capability	O		9.2.3.10D	Not to be used.	YES	ignore
>Number of Supported Carriers	O		ENUMERATE D (One-one carrier, One-three carrier, Three-three carrier, One-six carrier, Tree-six carrier, Six-six carrier, ...)	Not to be used.	YES	reject
>Multi-carrier HS-DSCH Physical Layer Category	O		9.2.1.300a	Not to be used.	YES	ignore
MAC-hs Reordering Buffer Size for RLC-UM	M		9.2.1.34Ab		–	
CQI Feedback Cycle k	M		9.2.2.24a		–	
CQI Repetition Factor	C-CQICyclek		9.2.2.24c		–	
ACK-NACK Repetition Factor	M		9.2.2.a		–	
CQI Power Offset	M		9.2.2.24b		–	
ACK Power Offset	M		9.2.2.b		–	
NACK Power Offset	M		9.2.2.26a		–	
HS-SCCH Power Offset	O		9.2.2.19d		–	
HARQ Preamble Mode	O		9.2.2.57		YES	ignore
MIMO Activation Indicator	O		9.2.1.134		YES	reject
HS-DSCH MAC-d PDU Size Format	O		9.2.1.300C	If not present, "Indexed MAC-d PDU Size" shall be used.	YES	reject
Sixtyfour QAM Usage Allowed Indicator	O		9.2.2.79A		YES	ignore
UE with enhanced HS-SCCH support indicator	O		NULL	UE supports enhanced HS-SCCH functionality: - UE supports different HS-SCCH in consecutive TTIs and, - in HS-SCCH-less operation mode the UE supports HS-SCCH orders	YES	ignore
Enhanced HS Serving CC Abort	O		ENUMERATE D (Abort Enhanced HS Serving CC, ...)	Shall be ignored in Radio Link Setup and Radio Link Addition procedures.	YES	reject
UE Support Indicator Extension	O		9.2.2.103		YES	ignore

Power Offset For S-CPICH for MIMO Request Indicator	O		9.2.2.105		YES	ignore
Single Stream MIMO Activation Indicator	O		9.2.2.106		YES	reject

Condition	Explanation
CQICyclek	The IE shall be present if the <i>CQI Feedback Cycle k</i> IE is set to a value greater than 0.

9.2.2.19aa HS-DSCH FDD Secondary Serving Information

The *HS-DSCH FDD Secondary Serving Information* IE is used for initial addition of Secondary Serving HS-DSCH information to UE Context and defines the cell specific parameters for the secondary serving HS-DSCH Radio Link.

IE/Group Name	Presence	Range	IE Type and Reference	Semantics Description	Criticality	Assigned Criticality
HS-SCCH Power Offset	O		9.2.2.19d		–	
Sixtyfour QAM Usage Allowed Indicator	O		9.2.2.79A		–	
MIMO Activation Indicator	O		9.2.1.119		YES	reject
Single Stream MIMO Activation Indicator	O		9.2.2.106		YES	reject
Diversity Mode	O		9.2.2.8	If Diversity mode = "Closed loop mode 1" the procedure shall be rejected.	YES	reject
Transmit Diversity Indicator	O		9.2.2.48		YES	reject
Power Offset For S-CPICH for MIMO Request Indicator	O		9.2.2.105		YES	ignore

9.2.2.19b HS-DSCH FDD Information Response

The *HS-DSCH FDD Information Response* IE provides information for HS-DSCH MAC-d flows that have been established or modified. It also provides additional HS-DSCH information determined within the DRNS.

IE/Group Name	Presence	Range	IE Type and Reference	Semantics Description	Criticality	Assigned Criticality
HS-DSCH MAC-d Flow Specific Information Response		<i>0..<maxnoofMACdFlows></i>			–	
>HS-DSCH MAC-d Flow ID	M		9.2.1.30O		–	
>Binding ID	O		9.2.1.3		–	
>Transport Layer Address	O		9.2.1.62		–	
>HS-DSCH Initial Capacity Allocation	O		9.2.1.30Na		–	
HS-SCCH Specific Information Response		<i>0..<maxnoofHSSCCHcodes></i>			–	
>Code Number	M		INTEGER (0..127)		–	
HS-PDSCH And HS-SCCH Scrambling Code	O		DL Scrambling Code 9.2.2.11		–	
Measurement Power Offset	O		9.2.2.24d		–	
HARQ Memory Partitioning	O		9.2.1.116		–	
User Plane Congestion Fields Inclusion	O		9.2.1.70C		YES	ignore
HARQ Preamble Mode Activation Indicator	O		9.2.2.58		YES	ignore
MIMO Information Response	O		9.2.2.78		YES	ignore
SixtyfourQAM DL Usage Indicator	O		9.2.2.79B		YES	ignore
HS-DSCH TB Size Table Indicator	O		9.2.2.19G		YES	ignore
Power Offset For S-CPICH for MIMO	O		9.2.2.104		YES	ignore
Support of dynamic DTXDRX related HS-SCCH order	O		9.2.2.126		YES	ignore

Range bound	Explanation
<i>maxnoofMACdFlows</i>	Maximum number of MAC-d flows.
<i>maxnoofHSSCCHcodes</i>	Maximum number of HS-SCCH codes.

9.2.2.19ba HS-DSCH FDD Secondary Serving Information Response

The *HS-DSCH FDD Secondary Serving Information Response* IE provides Secondary Serving HS-DSCH information determined within the DRNS.

IE/Group Name	Presence	Range	IE Type and Reference	Semantics Description	Criticality	Assigned Criticality
HS-SCCH Specific Secondary Serving Information Response		$0..<maxnoofHSSCCHcodes>$			–	
>Code Number	M		INTEGER (0..127)		–	
HS-PDSCH And HS-SCCH Scrambling Code	O		DL Scrambling Code 9.2.2.11		–	
Measurement Power Offset	O		9.2.2.24d		–	
SixtyfourQAM DL Usage Indicator	O		9.2.2.79B		–	
HS-DSCH TB Size Table Indicator	O		9.2.2.19G		–	
MIMO Information Response	O		9.2.2.78		YES	ignore
Power Offset For S-CPICH for MIMO	O		9.2.2.104		YES	ignore

Range bound	Explanation
$maxnoofHSSCCHcodes$	Maximum number of HS-SCCH codes.

9.2.2.19bb HS-DSCH FDD Secondary Serving Information To Modify

The *HS-DSCH FDD Secondary Serving Information To Modify* IE is used for modification of cell specific Secondary Serving HS-DSCH information in a UE Context.

IE/Group Name	Presence	Range	IE Type and Reference	Semantics Description	Criticality	Assigned Criticality
HS-SCCH Power Offset	O		9.2.2.19d		–	
HS-SCCH Code Change Grant	O		9.2.1.30S		–	
Sixtyfour QAM Usage Allowed Indicator	O		9.2.2.79A		–	
MIMO Mode Indicator	O		9.2.1.135		YES	reject
Single Stream MIMO Mode Indicator	O		9.2.2.107		YES	reject
Diversity Mode	O		9.2.2.8	If Diversity mode = "Closed loop mode 1" the procedure shall be rejected.	YES	reject
Transmit Diversity Indicator	C-DiversityMode		9.2.2.48		YES	reject
Non Cell Specific Tx Diversity	O		ENUMERATED (Tx Diversity, ...)	Value = "Tx Diversity": Diversity Mode and Transmit Diversity Indicator shall be non cell specific.	YES	reject
Power Offset For S-CPICH for MIMO Request Indicator	O		9.2.2.105		YES	ignore

Condition	Explanation
DiversityMode	The IE shall be present if <i>Diversity Mode</i> IE is present and not set to "None".

9.2.2.19bc HS-DSCH FDD Secondary Serving Information To Modify Unsynchronised

The *HS-DSCH FDD Secondary Serving Information To Modify Unsynchronised* IE is used for modification of Secondary Serving HS-DSCH information in a UE Context with the Unsynchronised Radio Link Reconfiguration procedure.

IE/Group Name	Presence	Range	IE Type and Reference	Semantics Description	Criticality	Assigned Criticality
HS-SCCH Power Offset	O		9.2.2.19d		–	
Sixtyfour QAM Usage Allowed Indicator	O		9.2.2.79A		–	
MIMO Mode Indicator	O		9.2.1.135		YES	reject
Single Stream MIMO Mode Indicator	O		9.2.2.107		YES	reject
Power Offset For S-CPICH for MIMO Request Indicator	O		9.2.2.105		YES	ignore

9.2.2.19c HS-DSCH FDD Update Information

The *HS-DSCH FDD Update Information* IE provides information for HS-DSCH to be updated. At least one IE shall be presented.

IE/Group name	Presence	Range	IE Type and Reference	Semantic Description	Criticality	Assigned Criticality
HS-SCCH Code Change Indicator	O		9.2.1.30R		–	
CQI Feedback Cycle k	O		9.2.2.24a		–	
CQI Repetition Factor	O		9.2.2.24c		–	
ACK-NACK Repetition Factor	O		9.2.2.a		–	
CQI Power Offset	O		9.2.2.24b		–	
ACK Power Offset	O		9.2.2.b		–	
NACK Power Offset	O		9.2.2.26a		–	
HS-PDSCH Code Change Indicator	O		9.2.1.30V		YES	ignore

9.2.2.19ca HS-DSCH FDD Secondary Serving Update Information

The *HS-DSCH FDD Secondary Serving Update Information* IE provides information for HS-DSCH to be updated. At least one IE shall be presented.

IE/Group name	Presence	Range	IE Type and Reference	Semantic Description
HS-SCCH Code Change Indicator	O		9.2.1.30R	
HS-PDSCH Code Change Indicator	O		9.2.1.30V	This IE shall never be included. If received it shall be ignored.

9.2.2.19C HS-DSCH configured indicator

The *HS-DSCH Configured Indicator* IE indicates the configuration of HS-DSCH for the UE. The *HS-DSCH Configured Indicator* IE shall be used for the configuration of the E-DPDCH IQ branch mapping TS 25.213 [21].

IE/Group Name	Presence	Range	IE type and reference	Semantics description
HS-DSCH Configured Indicator			ENUMERATED (HS-DSCH configured, HS-DSCH not configured)	Indicator of the HS-DSCH configuration for configuration of the E-DPDCHs IQ branch mapping TS 25.213 [21].

9.2.2.19d HS-SCCH Power Offset

The *HS-SCCH Power Offset* IE indicates the Power offset relative to the pilot bits on the DL DPCCH except when FDPCH is configured. When F-DPCH is configured, the *HS-SCCH Power Offset* IE indicates the Power offset relative to the power of transmitted TPC bits on the F-DPCH.

IE/Group Name	Presence	Range	IE type and reference	Semantics description
HS-SCCH Power Offset			INTEGER (0..255)	Step 0.25 dB, range -32-+31.75 dB

9.2.2.19e E-DCH FDD Update Information

The *E-DCH FDD Update Information* IE provides information for E-DCH to be updated. At least one IE shall be present.

IE/Group Name	Presence	Range	IE Type and Reference	Semantics Description	Criticality	Assigned Criticality
E-DCH MAC-d Flow Specific Update Information		<i>0..<maxnoofEDCHMACdFlows></i>			–	
>E-DCH MAC-d Flow ID	M		9.2.1.91		–	
>HARQ Process Allocation For 2ms Non-Scheduled Transmission Grant	O		HARQ Process Allocation for 2ms TTI 9.2.2.40		–	
HARQ Process Allocation For 2ms Scheduled Transmission Grant	O		HARQ Process Allocation for 2ms TTI 9.2.2.40		–	
E-DCH DL Control Channel Change Information		<i>0..<maxnoofEDCHRLs></i>			GLOBAL	ignore
>E-DCH RL ID	M		RL ID 9.2.1.49		–	

Range bound	Explanation
<i>maxnoofEDCHMACdFlows</i>	Maximum number of E-DCH MAC-d flows.
<i>maxnoofEDCHRLs</i>	Maximum number of E-DCH RLs for one UE

9.2.2.19f HS-DSCH Serving Cell Change Information

The *HS-DSCH Serving Cell Change Information* IE contains information which is used in HS-DSCH Serving Cell change.

IE/Group Name	Presence	Range	IE Type and Reference	Semantics Description	Criticality	Assigned Criticality
HS-PDSCH RL ID	M		RL ID 9.2.1.49		–	
HS-DSCH Information	O		HS-DSCH FDD Information 9.2.2.19a		–	
Continuous Packet Connectivity HS-SCCH less Information	O		9.2.2.74		YES	reject
Continuous Packet Connectivity DTX-DRX Information	O		9.2.2.72		YES	reject

9.2.2.19g HS-DSCH Serving Cell Change Information Response

The *HS-DSCH Serving Cell Change Information Response* IE contains information which is used in HS-DSCH Serving Cell change.

IE/Group Name	Presence	Range	IE Type and Reference	Semantics Description	Criticality	Assigned Criticality
CHOICE Serving Cell Change					–	
> <i>Successful</i>					–	
>>HS-DSCH FDD Information Response	M		9.2.2.19b		–	
>>HS-DSCH-RNTI	M		9.2.1.30P		–	
>>Continuous Packet Connectivity HS-SCCH less Information Response	O		9.2.2.75		YES	Ignore
> <i>Unsuccessful</i>					–	
>>Cause	M		9.2.1.5		–	

9.2.2.19ga HS-DSCH Secondary Serving Cell Change Information Response

The *HS-DSCH Secondary Serving Cell Change Information Response* IE contains information which is used in HS-DSCH Secondary Serving Cell change.

IE/Group Name	Presence	Range	IE Type and Reference	Semantics Description
CHOICE Secondary Serving Cell Change				
> <i>Successful</i>				
>>HS-DSCH FDD Secondary Serving Information Response	M		9.2.2.19ba	
>>HS-DSCH-RNTI	M		9.2.1.30P	
> <i>Unsuccessful</i>				
>>Cause	M		9.2.1.5	

9.2.2.19G HS-DSCH TB Size Table Indicator

The *HS-DSCH TB Size Table Indicator* IE is used to indicate that octet aligned table TS 25.321 [41] shall be used.

IE/Group Name	Presence	Range	IE Type and Reference	Semantics Description
HS-DSCH TB Size Table Indicator			ENUMERATED (octet aligned)	

9.2.2.19h E-DCH Serving Cell Change Information Response

The *E-DCH Serving Cell Change Information Response* IE contains information which is used in E-DCH Serving Cell change.

IE/Group Name	Presence	Range	IE Type and Reference	Semantics Description
CHOICE <i>Serving Cell Change</i>				
> <i>Successful</i>				
>>RL Information Response		0..<maxno ofRLs>		
>>>RL ID	M		9.2.1.49	
>>>E-DCH FDD DL Control Channel Information	M		9.2.2.4D	
> <i>Unsuccessful</i>				
>>Cause	M		9.2.1.5	

Range bound	Explanation
<i>maxnoofRLs</i>	Maximum number of RLs for one UE

9.2.2.20 IB_SG_POS

Void.

9.2.2.21 IB_SG_REP

Void.

9.2.2.21a Inner Loop DL PC Status

The *Inner Loop DL PC Status* IE indicates whether inner loop DL control shall be active or inactive for all radio links for the UE Context.

IE/Group Name	Presence	Range	IE Type and Reference	Semantics Description
Inner Loop DL PC Status			ENUMERATED (Active, Inactive)	

9.2.2.21b Initial DL DPCH Timing Adjustment Allowed

The *Initial DL DPCH Timing Adjustment Allowed* IE indicates that the DRNS is allowed to perform a timing adjustment (either a timing advance or a timing delay with respect to the SFN timing) when establishing a radio link.

IE/Group Name	Presence	Range	IE Type and Reference	Semantics Description
Initial DL DPCH Timing Adjustment Allowed			ENUMERATED (initial DL DPCH Timing Adjustment Allowed)	

9.2.2.21A Limited Power Increase

The parameter is used for a more efficient use of the inner loop DL power control for non real time data.

If the limited power increase is used, DRNS shall use the limited power increase algorithm as specified in TS 25.214 [10], subclause 5.2.

IE/Group Name	Presence	Range	IE Type and Reference	Semantics Description
Limited Power Increase			ENUMERATED(Used, Not used ,)	

9.2.2.21B IPDL FDD Parameters

The *IPDL FDD Parameters* IE provides the information for the IPDL Configuration applied in FDD mode.

IE/Group name	Presence	Range	IE Type and Reference	Semantics Description
IP spacing FDD	M		ENUMERATED(5,7,10,15,20,30,40,50,...)	See TS 25.214 [10]
IP length	M		ENUMERATED(5,10,...)	See TS 25.214 [10]
IP offset	M		INTEGER(0..9)	See TS 25.214 [10]
Seed	M		INTEGER(0..63)	See TS 25.214 [10]
Burst mode parameters	O		9.2.1.4B	

9.2.2.21C Length of TFCI2

Void.

9.2.2.21D Void

9.2.2.21E Void

9.2.2.21F Void

9.2.2.22 Max Adjustment Period

Void.

9.2.2.23 Max Adjustment Step

Defines the maximum allowed value for the change of DL power level during a certain number of slots that can be utilised by the downlink power balancing algorithm. *Max Adjustment Step* IE defines a time period, in terms of number of slots, in which the accumulated power adjustments shall be maximum 1 dB. This value does not include the DL inner loop PC adjustment.

IE/Group Name	Presence	Range	IE Type and Reference	Semantics Description
Max Adjustment Step			INTEGER(1..10)	Slots

9.2.2.24 Max Number of UL DPDCHs

Maximum number of uplink DPDCHs during the connection. Needed by the rate matching algorithm.

IE/Group Name	Presence	Range	IE Type and Reference	Semantics Description
Max Number of UL DPDCHs			INTEGER (1..6)	

9.2.2.24a CQI Feedback Cycle k

The *CQI Feedback Cycle k* IE provides the duration of the CQI feedback cycle.

IE/Group Name	Presence	Range	IE Type and Reference	Semantics Description
CQI Feedback Cycle k			ENUMERATED (0, 2, 4, 8, 10, 20, 40, 80, 160,..., 16, 32, 64)	Unit ms The allowed values for this IE depend on the configured CQI Repetition Factor and the HS-DSCH configuration as defined in TS 25.214 [10].

9.2.2.24b CQI Power Offset

The *CQI Power Offset* IE indicates Power offset used in the UL between the HS-DPCCH slots carrying CQI information and the associated DPCCH.

IE/Group Name	Presence	Range	IE type and reference	Semantics description
CQI Power Offset			INTEGER (0..8,...)	According to mapping in ref. TS 25.213 [21] subclause 4.2.1.

9.2.2.24c CQI Repetition Factor

The *CQI Repetition Factor* IE indicates the consecutive repetition of the CQI.

IE/Group Name	Presence	Range	IE type and reference	Semantics description
CQI Repetition Factor			INTEGER (1..4,...)	Step: 1

9.2.2.24d Measurement Power Offset

The *Measurement Power Offset* IE is used as defined in TS 25.214 [10] subclause 6A.2.

IE/Group Name	Presence	Range	IE Type and Reference	Semantics Description
Measurement Power Offset			INTEGER (-12..26)	Unit: dB Range: -6..13dB Step: 0.5dB

9.2.2.24e Maximum Set of E-DPDCHs

The Maximum Set of E-DPDCHs as defined in TS 25.212 [9]. Needed by rate matching algorithm.

IE/Group Name	Presence	Range	IE Type and Reference	Semantics Description
Maximum Set of E-DPDCHs			ENUMERATED (vN256, vN128, vN64, vN32, vN16, vN8, vN4, v2xN4, v2xN2, v2xN2plus2xN4,..., v2xM2plus2xM4)	

9.2.2.24f Void

9.2.2.24A Void

9.2.2.25 Min UL Channelisation Code Length

Minimum UL channelisation code length (spreading factor) of a DPDCH during the connection. Needed by rate matching algorithm.

IE/Group Name	Presence	Range	IE Type and Reference	Semantics Description
Min UL Channelisation Code Length			ENUMERATED(4,8,16, 32,64,128, 256)	

9.2.2.26 Multiplexing Position

Multiplexing Position specifies whether fixed or flexible positions of transport channels shall be used in the physical channel.

IE/Group Name	Presence	Range	IE Type and Reference	Semantics Description
Multiplexing Position			ENUMERATED(Fixed, Flexible)	

9.2.2.26a NACK Power Offset

The *NACK Power Offset* IE indicates Power offset used in the UL between the HS-DPCCH slot carrying HARQ NACK information and the associated DPCCH.

IE/Group Name	Presence	Range	IE type and reference	Semantics description
NACK Power Offset			INTEGER (0..8,...)	According to mapping in ref. TS 25.213 [21] subclause 4.2.1.

9.2.2.26A Number of DL Channelisation Codes

This parameter notifies DRNS of the number of DL channelisation codes required for the Radio Link(s).

IE/Group Name	Presence	Range	IE Type and Reference	Semantics Description
Number of DL Channelisation Codes			INTEGER (1..8)	

9.2.2.27 Pattern Duration (PD)

Void

9.2.2.27a PC Preamble

Indicates DPDCH power control preamble length see ref. TS 25.105 [7].

IE/Group Name	Presence	Range	IE Type and Reference	Semantics Description
PCP Preamble			INTEGER (0..7,...)	In number of frames.

9.2.2.27A PDSCH Code Mapping

Void.

9.2.2.27B Phase Reference Update Indicator

The *Phase Reference Update Indicator* IE indicates that the phase reference for the radio link needs to be changed.

IE/Group Name	Presence	Range	IE Type and Reference	Semantics Description
Phase Reference Update indicator			ENUMERATED (Phase Reference needs to be changed)	

9.2.2.28 Power Adjustment Type

Defines the characteristic of the power adjustment.

IE/Group Name	Presence	Range	IE Type and Reference	Semantics Description
Power Adjustment Type			ENUMERATED (None, Common, Individual)	

9.2.2.29 Power Control Mode (PCM)

Void.

9.2.2.30 Power Offset

This IE defines a power offset relative to the Downlink transmission power of a DPCH in case the UE Context is configured to use DPCH in the downlink.

IE/Group Name	Presence	Range	IE Type and Reference	Semantics Description
Power Offset			INTEGER (0..24)	Unit dB, Step 0.25 dB, Range 0..6 dB

9.2.2.31 Power Resume Mode (PRM)

Void.

9.2.2.31A Preamble Signatures

Void.

9.2.2.32 Primary CPICH Ec/No

Energy per chip divided by the power density per band measured on the Primary CPICH by the terminal.

IE/Group Name	Presence	Range	IE Type and Reference	Semantics Description
Primary CPICH Ec/No			INTEGER (-30..+30)	Unit dB, step 1 dB The value range is typically within the range of -24 dB to 0 dB according to the CPICH Ec/Io UE measurement defined in ref. TS 25.133 [23].

9.2.2.32A Primary CPICH Usage For Channel Estimation

The *Primary CPICH Usage For Channel Estimation* IE indicates whether the Primary CPICH may be used for channel estimation or not.

IE/Group Name	Presence	Range	IE Type and Reference	Semantics Description
Primary CPICH Usage For Channel Estimation			ENUMERATED (Primary CPICH may be used, Primary CPICH shall not be used)	

9.2.2.33 Propagation Delay (PD)

Propagation delay is the one-way propagation delay of the radio signal from the UE to the Node B. If the range of the *Propagation Delay* IE is insufficient to represent the measured value, it shall be set to its maximum value, and the *Extended Propagation Delay* IE (see 9.2.2.33a) shall be used to represent the propagation delay value.

IE/Group Name	Presence	Range	IE Type and Reference	Semantics Description
Propagation Delay			INTEGER (0..255)	Unit: Chips. Step: 3 chips. 0=0 chips, 1=3 chips, ...

9.2.2.33a Extended Propagation Delay

The Extended Propagation delay is the one-way propagation delay of the radio signal from the MS to the Node B. It shall be used if the *Propagation Delay* IE (see 9.2.2.33) cannot represent the measured value, due to range limitation.

IE/Group Name	Presence	Range	IE Type and Reference	Semantics Description
Extended Propagation Delay			INTEGER (255..1023)	Continuation of intervals as defined in TS 25.133 [23]. Unit: chip Range: 765..3069 chips Step: 3 chips

9.2.2.33A PRACH Minimum Spreading Factor

Void.

9.2.2.34 QE-Selector

Void.

9.2.2.34a Qth Parameter

Void.

9.2.2.34A RACH Sub Channel Numbers

Void.

9.2.2.35 RL Set ID

The RL Set ID uniquely identifies one RL Set within a UE Context.

IE/Group Name	Presence	Range	IE Type and Reference	Semantics Description
RL Set ID			INTEGER (0..31)	

9.2.2.35a RL Specific E-DCH Information

The *RL Specific E-DCH Information* IE provides RL specific E-DCH Information.

IE/Group Name	Presence	Range	IE Type and Reference	Semantics Description	Criticality	Assigned Criticality
RL Specific E-DCH Information		<i>1..<maxnoofEDCHMACdFlows></i>			–	
>E-DCH MAC-d Flow ID	M		9.2.1.91		–	
>Binding ID	O		9.2.1.3	Shall be ignored if bearer establishment with ALCAP.	–	
>Transport Layer Address	O		9.2.1.62	Shall be ignored if bearer establishment with ALCAP.	–	
>Transport Bearer Not Requested Indicator	O		9.2.2.4S		YES	ignore
E-AGCH Power Offset	O		9.2.2.61		–	
E-RGCH Power Offset	O		9.2.2.62		–	
E-HICH Power Offset	O		9.2.2.63		–	

Range Bound	Explanation
<i>maxnoofEDCHMACdFlows</i>	Maximum number of E-DCH MAC-d flows

9.2.2.35A Received Total Wide Band Power

The parameter indicates the Received total wide band power in a cell, see ref. TS 25.215 [11].

IE/Group Name	Presence	Range	IE Type and Reference	Semantics Description
Received Total Wide Band Power			INTEGER(0..621)	According to mapping in TS 25.133 [23].

9.2.2.36 S-Field Length

Void.

9.2.2.36A Void

9.2.2.37 Scrambling Code Change

Void.

9.2.2.37A Scrambling Code Number

Void.

9.2.2.37B Secondary CCPCH Info

Void.

9.2.2.38 Secondary CCPCH Slot Format

Void.

9.2.2.38A Secondary CPICH Information

The *Secondary CPICH Information* IE provides the information on the Secondary CPICH when it can be used for channel estimation.

IE/Group Name	Presence	Range	IE Type and Reference	Semantics Description
DL Scrambling Code	M		9.2.2.11	
FDD DL Channelisation Code Number	M		9.2.2.14	

9.2.2.38B Secondary CPICH Information Change

The *Secondary CPICH Information Change* IE indicates modification of information of the Secondary CPICH for channel estimation.

IE/Group Name	Presence	Range	IE Type and Reference	Semantics Description
CHOICE <i>Secondary CPICH Information Change</i>	M			
> <i>New Secondary CPICH</i>				
>>Secondary CPICH Information	M		9.2.2.38A	
> <i>Secondary CPICH Shall Not Be Used</i>			NULL	

9.2.2.38C Serving E-DCH RL

The *Serving E-DCH RL* IE indicates whether the Serving E-DCH RL is in the DRNS.

IE/Group Name	Presence	Range	IE Type and Reference	Semantics Description
CHOICE <i>Serving E-DCH RL</i>	M			
> <i>Serving E-DCH RL in this DRNS</i>				
>>Serving E-DCH RL ID	M		RL ID 9.2.1.49	
> <i>Serving E-DCH RL not in this DRNS</i>			NULL	

9.2.2.39 Slot Number (SN)

Void

9.2.2.39a Split Type

Void.

9.2.2.39A SRB Delay

Indicates the number of frames after the PC Preamble period during which transmission of data on some RRC Signalling Bearers shall be prohibited by UE in accordance with ref. TS 25.331 [16].

IE/Group Name	Presence	Range	IE Type and Reference	Semantics Description
SRB Delay			INTEGER(0..7,...)	In number of frames.

9.2.2.40 SSDT Cell Identity

Void.

9.2.2.40A SSDT Cell Identity for EDSCHPC

Void.

9.2.2.41 SSDT Cell Identity Length

Void.

9.2.2.42 SSDT Indication

Void.

9.2.2.43 SSDT Support Indicator

The possibility to use SSDT Support Indicator has been removed.

IE/Group Name	Presence	Range	IE Type and Reference	Semantics Description
SSDT Support Indicator			ENUMERATED(Not Used, SSDT not supported).	The <i>SSDT Support Indicator</i> IE shall never be set to "Not Used".

9.2.2.44 STTD Indicator

Void.

9.2.2.45 STTD Support Indicator

The STTD Support Indicator indicates whether the STTD can be applied to DL DPCH and F-DPCH in the cell or not.

IE/Group Name	Presence	Range	IE Type and Reference	Semantics Description
STTD Support Indicator			ENUMERATED(STTD Supported, STTD not Supported).	

9.2.2.45A Synchronisation Indicator

The *Synchronisation Indicator* IE indicates that Timing Maintained Synchronisation shall be used at start of Radio Link, see also TS 25.214 [10].

IE/Group Name	Presence	Range	IE Type and Reference	Semantics Description
Synchronisation Indicator			ENUMERATED (Timing Maintained Synchronisation,...)	

9.2.2.46 TFCI Signalling Mode

This parameter indicates has only one value with any meaning.

IE/Group Name	Presence	Range	IE Type and Reference	Semantics Description
TFCI Signalling Mode			ENUMERATED(Normal, Not Used)	The value "Not Used" shall not be used by the SRNC. The procedure shall be rejected by the DRNC if the value "Not Used" is received.

9.2.2.46A TFCI PC Support Indicator

Void.

9.2.2.47 Transmission Gap Distance (TGD)

Void.

9.2.2.47A Transmission Gap Pattern Sequence Information

Defines the parameters for the compressed mode gap pattern sequence. For details see TS 25.331 [16].

IE/Group Name	Presence	Range	IE Type and Reference	Semantics Description
Transmission Gap Pattern Sequence Information		1..<maxTGPS>		
>TGPSI Identifier	M		INTEGER(1..<MaxTGPS>)	Transmission Gap Pattern Sequence Identifier Establish a reference to the compressed mode pattern sequence. Up to <MaxTGPS> simultaneous compressed mode pattern sequences can be used.
>TGSN	M		INTEGER(0..14)	Transmission Gap Starting Slot Number The slot number of the first transmission gap slot within the TGCFN.
>TGL1	M		INTEGER(1..14)	The length of the first Transmission Gap within the transmission gap pattern expressed in number of slots.
>TGL2	O		INTEGER(1..14)	The length of the second Transmission Gap within the transmission gap pattern. If omitted, then TGL2=TGL1.
>TGD	M		INTEGER (0, 15.. 269)	Transmission gap distance indicates the number of slots between the starting slots of two consecutive transmission gaps within a transmission gap pattern. If there is only one transmission gap in the transmission gap pattern, this parameter shall be set to 0 (0 =undefined).
>TGPL1	M		INTEGER(1..144,...)	The duration of transmission gap pattern 1 in frames.
>Not-to-be-used-1	O		INTEGER(1..144,...)	This IE shall never be included in the IE group. If received it shall be ignored.
>UL/DL mode	M		ENUMERATE D(UL only, DL only, UL/DL)	Defines whether only DL, only UL, or combined UL/DL compressed mode is used.
>Downlink Compressed Mode Method	C-DL		ENUMERATE D(not Used, SF/2, higher layer scheduling,...)	Method for generating downlink compressed mode gap The <i>Downlink Compressed Mode Method</i> IE shall never be set to "not Used".
>Uplink Compressed Mode Method	C-UL		ENUMERATE D(SF/2, higher layer scheduling,...)	Method for generating uplink compressed mode gap.
>Downlink Frame Type	M		ENUMERATE D(A, B,...)	Defines if frame type "A" or "B" shall be used in downlink compressed mode.
>DeltaSIR1	M		INTEGER(0..30)	Delta in SIR target value to be set in the DRNS during the frame containing the start of the first transmission gap in the transmission gap pattern (without including the effect of the bit-rate increase) Step 0.1 dB, Range 0-3dB
>DeltaSIRafter1	M		INTEGER (0..30)	Delta in SIR target value to be set in the DRNS one frame after the frame containing the start of the first transmission gap in the

				transmission gap pattern,. Step 0.1 dB, Range 0-3dB
>DeltaSIR2	O		INTEGER (0..30)	Delta in SIR target value to be set in the DRNS during the frame containing the start of the second transmission gap in the transmission gap pattern (without including the effect of the bit-rate increase) When omitted, DeltaSIR2 = DeltaSIR1. Step 0.1 dB, Range 0-3dB
>DeltaSIRafter2	O		INTEGER (0..30)	Delta in SIR target value to be set in the DRNS one frame after the frame containing the start of the second transmission gap in the transmission gap pattern. When omitted, DeltaSIRafter2 = DeltaSIRafter1. Step 0.1 dB, Range 0-3dB

Condition	Explanation
UL	The IE shall be present if the <i>UL/DL mode</i> IE is set to "UL only" or "UL/DL".
DL	The IE shall be present if the <i>UL/DL mode</i> IE is set to "DL only" or "UL/DL".

Range bound	Explanation
<i>maxTGPS</i>	Maximum number of transmission gap pattern sequences.

9.2.2.47B Transmission Gap Pattern Sequence Scrambling Code Information

This IE indicates whether or not the alternative scrambling code will be used in the DRNS for the Downlink compressed mode method "SF/2" in the Transmission Gap Pattern Sequence. For details see ref. TS 25.331 [16].

IE/Group Name	Presence	Range	IE Type and Reference	Semantics Description
Transmission Gap Pattern Sequence Scrambling Code Information			ENUMERATED (code change, no code change)	Code change = alternative scrambling code will be used.

9.2.2.48 Transmit Diversity Indicator

The Transmit Diversity Indicator indicates whether Transmit Diversity shall be active or not.

IE/Group Name	Presence	Range	IE Type and Reference	Semantics Description
Transmit Diversity Indicator			ENUMERATED (active, inactive)	

9.2.2.49 Transmit Gap Length (TGL)

Void

9.2.2.50 Tx Diversity Indicator

The Tx Diversity Indicator indicates if the following conditions are satisfied:

- Primary CPICH is broadcast from two antennas
- STTD is applied to Primary CCPCH
- TSTD is applied to Primary SCH and Secondary SCH

IE/Group Name	Presence	Range	IE Type and Reference	Semantics Description
Tx Diversity Indicator			ENUMERATED(true, false).	

9.2.2.50A UE Support Of Dedicated Pilots For Channel Estimation

Void.

9.2.2.50B UE Support Of Dedicated Pilots For Channel Estimation Of HS-DSCH

Void.

9.2.2.51 UL/DL Compressed Mode Selection

Void

9.2.2.52 UL DPCCH Slot Format

Indicates the slot format used in DPCCH in UL, according to ref. TS 25.211 [8].

IE/Group Name	Presence	Range	IE Type and Reference	Semantics Description
UL DPCCH Slot Format			INTEGER (0..5,...)	Value 5 shall not be used. If value 5 is received, the procedure shall be rejected.

9.2.2.52A UL DPDCH Indicator for E-DCH operation

This IE indicated whether the requested configuration actually contain an UL DPDCH.

IE/Group Name	Presence	Range	IE Type and Reference	Semantics Description
UL DPDCH Indicator for E-DCH operation			ENUMERATED (UL-DPDCH present, UL-DPDCH not present)	

9.2.2.53 UL Scrambling Code

The UL Scrambling Code is the scrambling code used by UE. Every UE has its specific UL Scrambling Code.

IE/Group Name	Presence	Range	IE Type and Reference	Semantics Description
UL Scrambling Code Number	M		INTEGER (0.. $2^{24}-1$)	
UL Scrambling Code Length	M		ENUMERATED (Short, Long)	

9.2.2.54 Uplink Delta SIR

Void

9.2.2.55 Uplink Delta SIR After

Void

9.2.2.56 DPC Mode Change Support Indicator

The *DPC Mode Change Support Indicator* IE indicates that the particular cell is capable to support DPC mode change.

IE/Group Name	Presence	Range	IE Type and Reference	Semantics Description
DPC Mode Change Support Indicator			ENUMERATED (DPC Mode Change Supported)	

9.2.2.57 HARQ Preamble Mode

The *HARQ Preamble Mode* IE is used as described as described in ref TS 25.214 [10].

IE/Group Name	Presence	Range	IE Type and Reference	Semantics Description
HARQ Preamble Mode			ENUMERATED(mode0, mode1)	"mode0" means HARQ Preamble Mode =0 "mode1" means HARQ Preamble Mode =1

9.2.2.58 HARQ Preamble Mode Activation Indicator

The HARQ Preamble Activation Indicator indicates if the configured HARQ Preamble Mode has been activated in the DRNS.

IE/Group Name	Presence	Range	IE Type and Reference	Semantics Description
HARQ Preamble Mode Activation Indicator			ENUMERATED(HARQ Preamble Mode Activated).	

9.2.2.59 Frequency Band Indicator

The *Frequency Band Indicator* IE indicates frequency band as defined in TS 25.104 [6].

IE/Group Name	Presence	Range	IE type and reference	Semantics description
Frequency Band Indicator			ENUMERATED (Band I, Band II, Band III, Band IV, Band V, Band VI, Band VII, Band VIII, Band IX, Band X, Band XI, Band XII, Band XIII, Band XIV, Band XV, Band XVI, Band XVII, Band XVIII, Band XIX, Band XX, Band XXI, Band XXII,...)	

9.2.2.60 E-RGCH Release Indicator

Indicates that the E-RGCH is released..

IE/Group Name	Presence	Range	IE Type and Reference	Semantics Description
E-RGCH Release Indicator			ENUMERATED (E-RGCH released)	

9.2.2.61 E-AGCH Power Offset

The *E-AGCH Power Offset* IE indicates the Power offset relative to the pilot bits on the DL DPCCCH except when F-DPCH is configured. When F-DPCH is configured, the *E-AGCH Power Offset* IE indicates the Power offset relative to the power of transmitted TPC bits on the F-DPCH.

IE/Group Name	Presence	Range	IE Type and Reference	Semantics Description
E-AGCH Power Offset			INTEGER (0..255,...)	Unit: dB Range: -32 .. +31.75 dB Step: 0.25 dB

9.2.2.61A E-AGCH Table Choice

The *E-AGCH Table Choice* IE indicates the choice of the E-AGCH table in TS 25.212 [9].

IE/Group Name	Presence	Range	IE Type and Reference	Semantics Description
E-AGCH Table Choice	M		ENUMERATED (Table 16B, Table 16B-1, ...)	Table 16B indicates the Table 16B: Mapping of Absolute Grant Value in TS 25.212 [9] and Table 16B-1 indicates the Table 16B.1: Alternative Mapping of Absolute Grant Value in TS 25.212 [9].

9.2.2.62 E-RGCH Power Offset

The *E-RGCH Power Offset* IE indicates the Power offset relative to the pilot bits on the DL DPCCCH except when F-DPCH is configured. When F-DPCH is configured, the *E-RGCH Power Offset* IE indicates the Power offset relative to the power of transmitted TPC bits on the F-DPCH.

IE/Group Name	Presence	Range	IE Type and Reference	Semantics Description
E-RGCH Power Offset			INTEGER (0..255,...)	Unit: dB Range: -32 .. +31.75 dB Step: 0.25 dB

9.2.2.63 E-HICH Power Offset

The *E-HICH Power Offset* IE indicates the Power offset relative to the pilot bits on the DL DPCCCH except when F-DPCH is configured. When F-DPCH is configured, the *E-HICH Power Offset* IE indicates the Power offset relative to the power of transmitted TPC bits on the F-DPCH.

IE/Group Name	Presence	Range	IE Type and Reference	Semantics Description
E-HICH Power Offset			INTEGER (0..255,...)	Unit: dB Range: -32 .. +31.75 dB Step: 0.25 dB

9.2.2.64 E-RGCH 2-Index-Step Threshold

The *E-RGCH 2-index-step-threshold* IE is used to determine the Serving Grant.

IE/Group Name	Presence	Range	IE Type and Reference	Semantics Description
E-RGCH 2-Index-Step Threshold			INTEGER (0..37)	Refers to an index in the "SG-Table" (see TS 25.321 [41]).

9.2.2.65 E-RGCH 3-Index-Step Threshold

The *E-RGCH 3-index-step-threshold* IE is used to determine the Serving Grant.

IE/Group Name	Presence	Range	IE Type and Reference	Semantics Description
E-RGCH 3-Index-Step Threshold			INTEGER (0..37)	Refers to an index in the "SG-Table" (see TS 25.321 [41]).

9.2.2.66 HARQ Info for E-DCH

The HARQ Info for E-DCH is used to indicate the use of redundancy version (RV) for the EDCH HARQ transmissions.

IE/Group name	Presence	Range	IE Type and Reference	Semantics description
HARQ Info for E-DCH			ENUMERATED (rv0, rvtable)	"rv0" indicates that the UE will only use E_DCH RV index 0. "rvtable" indicates that the UE will use an RSN based RV index as specified in TS 25.212 [9]

9.2.2.67 DCH Indicator For E-DCH-HSDPA Operation

The *DCH Indicator For E-DCH-HSDPA Operation* parameter indicates whether *DCH Information* IE should be ignored in the message in which the *DCH Indicator For E-DCH-HSDPA Operation* IE is included.

IE/Group Name	Presence	Range	IE Type and Reference	Semantics Description
DCH Indicator For E-DCH-HSDPA Operation			ENUMERATED (DCH not present)	

9.2.2.68 E-RGCH and E-HICH Channelisation Code Validity Indicator

The *E-RGCH and E-HICH Channelisation Code Validity Indicator* parameter indicates if the *E-RGCH/E-HICH Channelisation Code* IE shall be ignored in the *E-DCH FDD DL Control Channel Information* IE in which the *E-RGCH and E-HICH Channelisation Code Validity Indicator* IE was included.

IE/Group Name	Presence	Range	IE Type and Reference	Semantics Description
E-RGCH and E-HICH Channelisation Code Validity Indicator			ENUMERATED (E-RGCH and E-HICH Channelisation Code not valid)	

9.2.2.69 E-DCH Minimum Set E-TFCI Validity Indicator

The *E-DCH Minimum Set E-TFCI Validity Indicator* parameter indicates if the *E-DCH Minimum Set E-TFCI* IE shall be ignored in the *E-DCH Transport Format Combination Set Information* IE in which the *E-DCH Minimum Set E-TFCI Validity Indicator* IE was included.

IE/Group Name	Presence	Range	IE Type and Reference	Semantics Description
E-DCH Minimum Set E-TFCI Validity Indicator			ENUMERATED (E-DCH Minimum Set E-TFCI not valid)	

9.2.2.70 Fast Reconfiguration Mode

The *Fast Reconfiguration Mode* IE is used to notify the DRNS that the SRNC would like to use the activation time “when the UE is detected on the new configuration” as the timing for the reconfiguration.

IE/Group Name	Presence	Range	IE Type and Reference	Semantics Description
Fast Reconfiguration Mode			ENUMERATED (Fast)	

9.2.2.71 Fast Reconfiguration Permission

The *Fast Reconfiguration Permission* IE is used to indicate to the SRNC that the DRNS can apply the activation time “when the UE is detected on the new configuration” for this reconfiguration.

IE/Group Name	Presence	Range	IE Type and Reference	Semantics Description
Fast Reconfiguration Permission			ENUMERATED (Allowed)	

9.2.2.72 Continuous Packet Connectivity DTX-DRX Information

The *Continuous Packet Connectivity DTX-DRX Information* IE defines the parameters used for Continuous Packet Connectivity DTX-DRX operation (see ref. TS 25.214 [10]).

IE/Group Name	Presence	Range	IE Type and Reference	Semantics Description
UE DTX DRX Offset	M		INTEGER (0..159)	Units of subframes. Offset of the UE DTX and DRX cycles at the given TTI
Enabling Delay	M		ENUMERATED (0, 1, 2, 4, 8, 16, 32, 64, 128)	Units of radio frames
DTX Information		<i>1</i>		
>CHOICE E-DCH TTI Length	M			
>>2ms				
>>>UE DTX Cycle 1	M		ENUMERATED (1, 4, 5, 8, 10, 16, 20)	Units of subframes
>>>UE DTX Cycle 2	M		ENUMERATED (4, 5, 8, 10, 16, 20, 32, 40, 64, 80, 128, 160)	Units of subframes
>>>MAC DTX Cycle	M		ENUMERATED (1, 4, 5, 8, 10, 16, 20)	Units of subframes
>>10ms				
>>>UE DTX Cycle 1	M		ENUMERATED (1, 5, 10, 20)	Units of subframes
>>>UE DTX Cycle 2	M		ENUMERATED (5, 10, 20, 40, 80, 160)	Units of subframes
>>>MAC DTX Cycle	M		ENUMERATED (5, 10, 20)	Units of subframes
>Inactivity Threshold for UE DTX Cycle 2	M		ENUMERATED (1, 4, 8, 16, 32, 64, 128, 256)	Units of E-DCH TTIs
>UE DTX Long Preamble	M		ENUMERATED (2,4,15)	Units of slots
>MAC Inactivity Threshold	M		ENUMERATED (1, 2, 4, 8, 16, 32, 64, 128, 256, 512, Infinity)	Units of E-DCH TTIs
>CQI DTX Timer	M		ENUMERATED (0, 1, 2, 4, 8, 16, 32, 64, 128, 256, 512, Infinity)	Units of subframes
>UE DPCCH burst1	M		ENUMERATED (1, 2, 5)	Units of subframes
>UE DPCCH burst2	M		ENUMERATED (1, 2, 5)	Units of subframes
DRX Information		<i>0..1</i>		
>UE DRX Cycle	M		ENUMERATED (4, 5, 8, 10, 16, 20)	Units of subframes
>Inactivity Threshold for UE DRX Cycle	M		ENUMERATED (0, 1, 2, 4, 8, 16, 32, 64, 128, 256, 512)	Units of subframes
>Inactivity Threshold for UE Grant Monitoring	M		ENUMERATED (0, 1, 2, 4, 8, 16, 32, 64, 128, 256)	Units of E-DCH TTIs
>UE DRX Grant Monitoring	M		BOOLEAN	True: DRX Grant Monitoring shall be applied. False: DRX Grant Monitoring shall not be applied.

9.2.2.73 Continuous Packet Connectivity DTX-DRX Information To Modify

The *Continuous Packet Connectivity DTX-DRX Information To Modify* IE is used for modification of Continuous Packet Connectivity DTX-DRX information in a UE Context. The *Continuous Packet Connectivity DTX-DRX Information To Modify* IE shall include at least one of the following IE.

IE/Group Name	Presence	Range	IE Type and Reference	Semantics Description
UE DTX DRX Offset	O		INTEGER (0..159)	Units of subframes. Offset of the UE DTX and DRX cycles at the given TTI
Enabling Delay	O		ENUMERATED (0, 1, 2, 4, 8, 16, 32, 64, 128)	Units of radio frames
CHOICE <i>DTX Information To Modify</i>	O			
> <i>Modify</i>				
>>CHOICE E-DCH TTI Length	O			
>>>2ms				
>>>>UE DTX Cycle 1	O		ENUMERATED (1, 4, 5, 8, 10, 16, 20)	Units of subframes
>>>>UE DTX Cycle 2	O		ENUMERATED (4, 5, 8, 10, 16, 20, 32, 40, 64, 80, 128, 160)	Units of subframes
>>>>MAC DTX Cycle	O		ENUMERATED (1, 4, 5, 8, 10, 16, 20)	Units of subframes
>>>10ms				
>>>>UE DTX Cycle 1	O		ENUMERATED (1, 5, 10, 20)	Units of subframes
>>>>UE DTX Cycle 2	O		ENUMERATED (5, 10, 20, 40, 80, 160)	Units of subframes
>>>>MAC DTX Cycle	O		ENUMERATED (5, 10, 20)	Units of subframes
>>Inactivity Threshold for UE DTX Cycle 2	O		ENUMERATED (1, 4, 8, 16, 32, 64, 128, 256)	Units of E-DCH TTIs
>>UE DTX Long Preamble	O		ENUMERATED (2,4,15)	Units of slots
>>MAC Inactivity Threshold	O		ENUMERATED (1, 2, 4, 8, 16, 32, 64, 128, 256, 512, Infinity)	Units of E-DCH TTIs
>>CQI DTX Timer	O		ENUMERATED (0, 1, 2, 4, 8, 16, 32, 64, 128, 256, 512, Infinity)	Units of subframes
>>UE DPCCH burst1	O		ENUMERATED (1, 2, 5)	Units of subframes
>>UE DPCCH burst2	O		ENUMERATED (1, 2, 5)	Units of subframes
> <i>Deactivate</i>				
CHOICE <i>DRX Information To Modify</i>	O			
> <i>Modify</i>				
>>UE DRX Cycle	O		ENUMERATED (4, 5, 8, 10, 16, 20)	Units of subframes
>>Inactivity Threshold for UE DRX Cycle	O		ENUMERATED (0, 1, 2, 4, 8, 16, 32, 64, 128, 256, 512)	Units of subframes
>>Inactivity Threshold for UE Grant Monitoring	O		ENUMERATED (0, 1, 2, 4, 8, 16, 32, 64, 128, 256)	Units of E-DCH TTIs
>>UE DRX Grant Monitoring	O		BOOLEAN	True = DRX Grant Monitoring shall be applied. False = DRX Grant Monitoring shall not be applied.

>Deactivate			NULL	
-------------	--	--	------	--

9.2.2.74 Continuous Packet Connectivity HS-SCCH less Information

The *Continuous Packet Connectivity HS-SCCH less Information* IE defines the parameters used for Continuous Packet Connectivity HS-SCCH less operation (see ref. TS 25.214 [10]).

IE/Group Name	Presence	Range	IE Type and Reference	Semantics Description
Transport Block Size List		1..<maxno ofHS-DSCHTBSsHS-SCCHless>		
>Transport Block Size Index	M		INTEGER (1..maxnoofHS-DSCHTBSs)	
>HS-PDSCH Second Code Support	M		BOOLEAN	True = The second HS-PDSCH code shall also be used False = The second HS-PDSCH code shall not be used

Range Bound	Explanation
maxnoofHS-DSCHTBSsHS-SCCHless	Maximum number of HS-DSCH Transport Block Sizes used for HS-SCCH-less operation
maxnoofHS-DSCHTBSs	Maximum number of HS-DSCH Transport Block Sizes

9.2.2.75 Continuous Packet Connectivity HS-SCCH less Information Response

The *Continuous Packet Connectivity HS-SCCH less Information Response* IE provides information for HS-SCCH less operation determined within the Node B (see ref. TS 25.214 [10]).

IE/Group Name	Presence	Range	IE Type and Reference	Semantics Description
HS-PDSCH First Code Index	M		INTEGER (1..maxHS-PDSCHCodeNrComp-1)	Index of first HS-PDSCH code
HS-PDSCH Second Code Index	O		INTEGER (1..maxHS-PDSCHCodeNrComp-1)	Index of second HS-PDSCH code. See Note 1.
NOTE 1: The "HS-PDSCH second code index" value is the value of IE "HS-PDSCH First Code Index" incremented by 1.				

Range Bound	Explanation
maxHS-PDSCHCodeNrComp	Maximum number of codes at the defined spreading factor, within the complete code tree

9.2.2.75A Continuous Packet Connectivity HS-SCCH Less Deactivate Indicator

The *Continuous Packet Connectivity HS-SCCH Less Deactivate Indicator* IE is used to deactivate HS-SCCH less operation.

IE/Group Name	Presence	Range	IE Type and Reference	Semantics Description
Continuous Packet Connectivity HS-SCCH Less Deactivate Indicator	M		NULL	

9.2.2.76 MIMO Activation Indicator

Void

9.2.2.77 MIMO Mode Indicator

Void

9.2.2.78 MIMO Information Response

IE/Group Name	Presence	Range	IE Type and Reference	Semantics Description
CHOICE Pilot Configuration	M			
>Primary and Secondary CPICH				
>>MIMO S-CPICH Channelisation Code	M		INTEGER (0..255)	
>Normal and Diversity Primary CPICH			NULL	
MIMO N/M Ratio	M		ENUMERATED (1/2, 2/3, 3/4, 4/5, 5/6, 6/7, 7/8, 8/9, 9/10, 1/1,...)	

9.2.2.79 SixtyfourQAM DL Support Indicator

Void.

9.2.2.79A Sixtyfour QAM Usage Allowed Indicator

The *Sixtyfour QAM Usage Allowed Indicator* IE indicates whether the Node B is allowed to use 64 QAM modulation for HS-DSCH transmission or not.

IE/Group Name	Presence	Range	IE Type and Reference	Semantics Description
Sixtyfour QAM Usage Allowed Indicator	M		ENUMERATED (Allowed, Not-Allowed)	

9.2.2.79B SixtyfourQAM DL Usage Indicator

The *SixtyfourQAM DL Usage Indicator* IE indicates if the Node B is using 64 QAM modulation for the HS-DSCH transmission, or if the Node B is not using 64 QAM modulation.

IE/Group Name	Presence	Range	IE Type and Reference	Semantics Description
SixtyfourQAM DL Usage Indicator			ENUMERATED (SixtyfourQAM DL Used, SixtyfourQAM DL Not Used)	

9.2.2.80 Enhanced FACH *Support Indicator*

Void.

9.2.2.81 Enhanced PCH *Support Indicator*

Void.

9.2.2.82 Priority Queue Information for Enhanced FACH/PCH

Void.

9.2.2.83 SixteenQAM UL Information

Void.

9.2.2.84 SixteenQAM UL Information To Modify

Void.

9.2.2.85 F-DPCH Slot Format

The *F-DPCH Slot Format* IE defines the F-DPCH slot format for the TPC bits, as defined in TS 25.211 [8].

IE/Group Name	Presence	Range	IE Type and Reference	Semantics Description
F-DPCH Slot Format			INTEGER (0..9)	

9.2.2.86 F-DPCH Slot Format Support Request

IE/Group Name	Presence	Range	IE Type and Reference	Semantics Description
F-DPCH Slot Format Support Request			NULL	

9.2.2.87 Max UE DTX Cycle

The *Max UE DTX Cycle* IE defines the maximum UE DTX cycle supported by the Node B for Continuous Packet Connectivity DTX-DRX operation.

IE/Group Name	Presence	Range	IE Type and Reference	Semantics Description
Max UE DTX Cycle	M		ENUMERATED (v5, v10, v20, v40, v64, v80, v128, v160,...)	Units of subframes

9.2.2.88 Enhanced PCH *Capability*

Void.

9.2.2.89 MAC-ehs Reset Timer

Void.

9.2.2.90 SixteenQAM UL Operation Indicator

IE/Group Name	Presence	Range	IE Type and Reference	Semantics Description
SixteenQAM UL Operation Indicator	O		ENUMERATED (Activate, Deactivate)	

9.2.2.91 E-TFCI Boost Information

IE/Group Name	Presence	Range	IE Type and Reference	Semantics Description
E-TFCI BetaEC Boost	M		INTEGER (0..127,...)	E-TFCI threshold beyond which boosting of E-DPCCH is enabled
UL Delta T2TP	<i>C-E-TFCIboost 127</i>		INTEGER (0..6,...)	Total E-DPDCH power across all codes to the combined power of DPCCH and E-DPCCH

Condition	Explanation
E-TFCIboost127	The IE shall be present if the E-TFCI BetaEC Boost IE value is not set o 127.

9.2.2.92 Common E-DCH Support Indicator

This IE indicates the Common E-DCH Support.

IE/Group Name	Presence	Range	IE Type and Reference	Semantics Description
Common E-DCH Support Indicator			NULL	

9.2.2.93 Common E-DCH MAC-d Flow Specific Information

The *Common E-DCH MAC-d Flow Specific Information* IE provides information associated to Common E-DCH MAC-d Flow used for Common E-DCH.

IE/Group Name	Presence	Range	IE Type and Reference	Semantics Description
Common E-DCH MAC-d Flow Specific Information		<i>1..<maxno ofEDCHMACdFlows></i>		
>Common E-DCH MAC-d Flow ID	M		E-DCH MAC-d flow 9.2.1.91	
>Maximum Number Of Retransmissions For E-DCH	M		9.2.1.100	
>E-DCH HARQ Power Offset FDD	M		9.2.2.4L	
>E-DCH MAC-d Flow Multiplexing List	O		9.2.1.89	
>Common E-DCH Logical Channel information	M	<i>1..<maxno oflogicalchannels></i>		
>>Logical Channel ID	M		9.2.1.97	
>>Maximum MAC-d PDU Size Extended	M		MAC PDU Size Extended 9.2.1.34D	

Range bound	Explanation
<i>maxnoofEDCHMACdFlows</i>	Maximum number of E-DCH MAC-d Flows
<i>maxnooflogicalchannels</i>	Maximum number of logical channels

9.2.2.94 Counting Information

The *Counting Information* IE provides counting result for MBMS service for each cell.

IE/Group Name	Presence	Range	IE Type and Reference	Semantics Description
Counting Information		<i>1..<maxno ofFDDneighbours></i>		
>C-ID	M		9.2.1.6	
>Counting Result	M		INTEGER (0..63)	The number of Ues listen to the MBMS Service. If the number of the UE is more than 63, this IE set to 63.

Range bound	Explanation
<i>maxnoofFDDneighbours</i>	Maximum number of neighbouring FDD cell for one cell.

9.2.2.95 Transmission Mode Information

The *Transmission Mode Information* IE provides transmission mode for MBMS service for each cell.

IE/Group Name	Presence	Range	IE Type and Reference	Semantics Description
Counting Information		<i>1..<maxno ofFDDneighbours></i>		
>C-ID	M		9.2.1.6	
>Transmission Mode	M		9.2.1.81	

Range bound	Explanation
<i>maxnoofFDDneighbours</i>	Maximum number of neighbouring FDD cell for one cell.

9.2.2.96 MBMS Neighbouring Cell Information

The parameter contains information for the MBMS p-t-m radio bearer configuration procedure as defined in TS 25.331 [16].

IE/Group Name	Presence	Range	IE Type and Reference	Semantics Description
MBMS Neighbouring Cell Information				
>MBMS Concatenated Service List		$1..<maxlengthMBMSConcatServiceLists >$		TMGI shall be uniquely defined by a reference to this index from the <i>MBMS short transmission identity</i> IE TS 25.331 [16] in the <i>L3 Information</i> IE.
>>TMGI	M		9.2.1.80	
>L3 Information	O		9.2.1.32	The IE Contains MBMS COMMON P-T-M RB INFORMATION defined in ref. TS 25.331 [16].
>L3 Information	O		9.2.1.32	The IE Contains MBMS CURRENT CELL P-T-M RB INFORMATION defined in ref. TS 25.331 [16].

Range bound	Explanation
$maxlengthMBMSConcatServiceLists$	Maximum length of the concatenated service lists contained in MBMS MODIFIED SERVICES INFORMATION and the MBMS UNMODIFIED SERVICES INFORMATION messages defined in ref. TS 25.331 [16]

9.2.2.97 RLC Sequence Number

This parameter indicates the RLC Sequence Number.

IE/Group Name	Presence	Range	IE Type and Reference	Semantics Description
RLC Sequence Number			INTEGER (0..127)	

9.2.2.98 Time Stamp

This parameter indicates the Time Stamp used for Inter-RNC MBMS synchronisation.

IE/Group Name	Presence	Range	IE Type and Reference	Semantics Description
Time Stamp			INTEGER (0..9999)	Units: 10ms

9.2.2.99 HS-DSCH Preconfiguration Info

The *HS-DSCH Preconfiguration Info* IE provides information of the target cell preconfiguration in the DRNS as defined in ITU-T Rec. X.680 [18].

IE/Group Name	Presence	Range	IE Type and Reference	Semantics Description	Criticality	Assigned Criticality
Sets of HS-SCCH Codes		1...<maxnoofHSDSCH>		Index 1 refers to the serving HS-DSCH cell Index 2...<maxnoofHSDSCH> refer to secondary serving HS-DSCH cells in the order as listed in 9.2.2.100 HS-DSCH Preconfiguration Setup. Max index is 2 in this 3GPP release.	–	
>HS-SCCH Preconfigured Codes		1..<maxnoofHSDSCHcodes>			–	
>>Code Number	M		INTEGER (0..127)		–	
> HS-DSCH-RNTI	M		9.2.1.31J		–	
>HS-PDSCH And HS-SCCH Scrambling Code	M		DL Scrambling Code 9.2.2.11		–	
>SixtyfourQAM DL Support Indicator	O		9.2.1.123		–	
>SixtyfourQAM DL Usage Indicator	O		9.2.2.79B		–	
>HS-DSCH TB Size Table Indicator	O		9.2.2.19G		–	
>MIMO Information Response	O		9.2.2.78	Applicable for multicarrier mode of operation.	YES	ignore
>Power Offset For S-CPICH for MIMO	O		9.2.2.104	Applicable for multicarrier mode of operation. The "Power Offset For S-CPICH for MIMO" in the index 1 of "Sets of HS-SCCH Codes" shall be ignored.	YES	ignore
>Measurement Power Offset	O		9.2.2.24d		YES	ignore
HARQ Memory Partitioning	M		9.2.1.116		–	
E-DCH FDD DL Control Channel Information	O		9.2.2.4D	For the primary UL frequency in Dual-cell E-DCH mode of operation.	–	
HARQ Preamble Mode Activation Indicator	O		9.2.2.58		–	
MIMO Information Response	O		9.2.2.78	Only applicable for MIMO in single carrier mode of operation. Shall be ignored in multicarrier mode of operation.	–	
Continuous Packet Connectivity HS-SCCH less Information Response	O		9.2.2.75		–	
Power Offset For S-CPICH for MIMO	O		9.2.2.104	For the serving HS-DSCH cell in both the single carrier mode and	YES	ignore

				multicarrier mode of operation.		
Additional E-DCH Preconfiguration Information		<i>0..<maxnoofEDCH-1></i>		For E-DCH on multiple frequencies in this DRNS. E-DCH on Secondary uplink frequency – max 1 in this 3GPP release. Index 1 correspond to the secondary serving HS-DSCH cells with index 2 in the IE <i>Sets of HS-SCCH Codes</i> . The list is in the order as listed in 9.2.2.100 HS-DSCH Preconfiguration Setup.	EACH	ignore
>E-DCH FDD DL Control Channel Information	M		9.2.2.4D	For the secondary UL frequency In Dual-cell E-DCH mode of operation.	–	
Support of dynamic DTXDRX related HS-SCCH order	O		9.2.2.126		YES	ignore

Range bound	Explanation
<i>maxnoofHSSCCHcodes</i>	Maximum number of HS-SCCH codes
<i>maxnoofHSDSCH</i>	Maximum number of Primary Serving plus Secondary Serving HS-DSCH cells for one UE
<i>maxnoofEDCH-1</i>	Maximum number of uplink frequencies -1 for E-DCH for one UE

9.2.2.100 HS-DSCH Preconfiguration Setup

The *HS-DSCH Preconfiguration Setup* IE indicates that the DRNS shall preconfigure set(s) of HS-SCCH codes and may contain a list of secondary serving HS-DSCH cells to be preconfigured for Enhanced Service Cell Change. The Cell Change procedure for Dual Cell operation is described in TS 25.308 [63]

IE/Group Name	Presence	Range	IE Type and Reference	Semantics Description	Criticality	Assigned Criticality
MAC-hs/ehs reset scheme	M		ENUMERATED (Always, Inter NodeB Change)	MAC-hs/ehs reset handling at enhanced HS serving cell change: "Always" means always reset "Inter NodeB Change" means Only reset at inter Node B cell change	–	
HS-DSCH Physical Layer Category	M		9.2.1.30Oa		–	
MAC-hs Reordering Buffer Size for RLC-UM	M		9.2.1.34Ab		–	
Secondary Cells		0..<maxnoofHSDSCH-1>		Preconfigured secondary serving HS-DSCH cell. <i>maxnoofHSDSCH-1</i> is max 1 in this 3GPP release.	–	
>Secondary C-ID	M		9.2.1.9	C-ID of the preconfigured secondary serving HS-DSCH cell	–	
>Num Secondary HS-SCCH Codes	O		INTEGER (1..<maxnoofHSSCCHcodes>)	For the secondary serving HS-DSCH cell	–	
>Sixtyfour QAM Usage Allowed Indicator	O		9.2.2.79A	For the secondary serving HS-DSCH cell	–	
>MIMO Activation Indicator	O		9.2.1.134	For the secondary serving HS-DSCH cell	YES	ignore
>E-DCH Indicator	O		NULL	The secondary serving HS-DSCH cell shall be pre-configured with E-DCH.	YES	ignore
>Power Offset For S-CPICH for MIMO Request Indicator	O		9.2.2.105	For the secondary serving HS-DSCH cell	YES	ignore
Num Primary HS-SCCH Codes	O		INTEGER (1..<maxnoofHSSCCHcodes>)	For the primary serving HS-DSCH cell	–	
HARQ Preamble Mode	O		9.2.1.134		–	
MIMO Activation Indicator	O		9.2.1.134	In multicarrier mode of operation the IE is for the serving HS-DSCH cell	–	
HS-DSCH MAC-d PDU Size Format	O		9.2.1.30OC	If not present, "Indexed MAC-d PDU Size" shall be assumed.	–	
Sixtyfour QAM Usage Allowed Indicator	O		9.2.2.79A	For the serving HS-DSCH cell	–	
UE with enhanced HS-SCCH support indicator	O		NULL	UE supports enhanced HS-SCCH functionality: - UE supports different HS-SCCH in consecutive TTIs and, - in HS-SCCH-less operation mode the UE supports HS-SCCH orders	–	
Continuous Packet	O		9.2.2.74		–	

Connectivity HS-SCCH less Information						
UE Support Indicator Extension	O		9.2.2.103		YES	ignore
Power Offset For S-CPICH for MIMO Request Indicator	O		9.2.2.105	For the serving HS-DSCH cell in both the single carrier mode and multicarrier mode of operation.	YES	ignore

Range bound	Explanation
<i>maxnoofHSDSCH-1</i>	Maximum number of Secondary Serving HS-DSCH cells for one UE
<i>maxnoofHSSCCHcodes</i>	Maximum number of HS-SCCH codes

9.2.2.101 Secondary Serving Cell List

This *Secondary Serving Cell List* IE identifies the possible secondary serving HS-DSCH cells for a Multi Cell/Dual-Band capable cell that is able to serve as a serving HS-DSCH cell.

IE/Group Name	Presence	Range	IE Type and Reference	Semantics Description
Possible Secondary Serving Cell List		<i>1..<maxno ofHSDSCH-1></i>		For secondary serving HS-DSCH cell.
>Possible Secondary Serving Cell	M		C-ID 9.2.1.9	

Range bound	Explanation
<i>maxnoofHSDSCH-1</i>	Maximum number of Secondary Serving HS-DSCH cells for one UE.

9.2.2.102 Minimum Reduced E-DPDCH Gain Factor

The minimum gain factor ($\beta_{ed,k, reduced, min}$) defined in TS 25.214 [10].

IE/Group Name	Presence	Range	IE Type and Reference	Semantics Description
Minimum Reduced E-DPDCH Gain Factor			ENUMERATED (8/15, 11/15, 15/15, 21/15, 30/15, 42/15, 60/15, 84/15, ...)	

9.2.2.103 UE Support Indicator Extension

The *UE Support Indicator Extension* IE is used to indicate the support level in the UE for optional HSDPA functions to the DRNS.

IE/Group Name	Presence	Range	IE Type and Reference	Semantics Description
UE support indicator extension			BIT STRING (32)	<p>Each bit indicates whether the UE supports a particular HSDPA function or not. The value 1 of a bit indicates that the corresponding functionality is supported in the UE and value 0 indicates that the corresponding functionality is not supported in the UE. Each bit is defined as follows:</p> <p>the first bit: Different HS-SCCH In Consecutive TTIs Support Indicator,</p> <p>the second bit: HS-SCCH orders in HS-SCCH-less Operation Support Indicator,</p> <p>the third bit: RRC Rel-9 (onwards) handling of DL secondary HS-DSCH (de)activation state Support Indicator,</p> <p>the fourth bit: UE DTXDRX related HS-SCCH orders uniform behavior indicator.</p> <p>Note that undefined bits are considered as a spare bit and spare bits shall be set to 0 by the transmitter and shall be ignored by the receiver.</p>

9.2.2.104 Power Offset For S-CPICH for MIMO

The *Power Offset For S-CPICH for MIMO* IE indicates the the relative transmit power of the S-CPICH compared to the primary CPICH transmit power, when S-CPICH is used as a phase reference for a second transmit antenna in MIMO mode TS 25.214 [10].

IE/Group Name	Presence	Range	IE Type and Reference	Semantics Description
Power Offset For S-CPICH for MIMO			INTEGER(-6 .. 0)	Offset in dB

9.2.2.105 Power Offset For S-CPICH for MIMO Request Indicator

The *Power Offset For S-CPICH for MIMO Request Indicator* IE is present when the SRNC needs the DRNS to supply, if possible, the *Power Offset For S-CPICH for MIMO* IE when S-CPICH is used as a phase reference for a second transmit antenna in MIMO mode TS 25.214 [10].

IE/Group Name	Presence	Range	IE Type and Reference	Semantics Description
Power Offset For S-CPICH for MIMO Request Indicator			NULL	

9.2.2.106 Single Stream MIMO Activation Indicator

IE/Group Name	Presence	Range	IE Type and Reference	Semantics Description
Single Stream MIMO Activation Indicator	M		NULL	

9.2.2.107 Single Stream MIMO Mode Indicator

IE/Group Name	Presence	Range	IE Type and Reference	Semantics Description
Single Stream MIMO Mode Indicator			ENUMERATED (Activate, Deactivate)	

9.2.2.108 HS-DSCH MAC-ehs Format

Void.

9.2.2.109 Activation Information

The *Activation Information* IE defines the local activation state of the secondary uplink frequency of the UE in Dual Cell E-DCH operation.

IE/Group Name	Presence	Range	IE Type and Reference	Semantics Description
Activation Information		$1..<maxnoo_{EDCH-1}>$	For secondary E-DCH. Max 1 in this 3GPP release.	
>Uu Activation State	M		ENUMERATED (Activated, De-activated, ...)	The activation state of the secondary UL frequency

Range Bound	Explanation
$maxnoo_{EDCH-1}$	Maximum number of uplink frequencies -1 for E-DCH for one UE

9.2.2.110 Additional E-DCH FDD Setup Information

IE/Group Name	Presence	Range	IE Type and Reference	Semantics Description	Criticality	Assigned Criticality
UL DPCH Information		1			–	
>UL Scrambling Code	M		9.2.2.53		–	
>UL SIR Target	O		UL SIR 9.2.1.69		–	
Additional E-DCH RL Specific Information To Setup	M		9.2.2.115		–	
Additional E-DCH FDD Information	O		9.2.2.112		–	
F-DPCH Information		1			–	
>FDD TPC DL Step Size	M		9.2.2.16		–	
>Limited Power Increase	M		9.2.2.21A		–	
>Inner Loop DL PC Status	M		9.2.2.21a		–	
>F-DPCH Slot Format Support Request	O		9.2.2.86		–	
Multicell E-DCH Information	O		9.2.2.114		YES	ignore

9.2.2.111 Additional E-DCH Configuration Change Information

IE/Group Name	Presence	Range	IE Type and Reference	Semantics Description	Criticality	Assigned Criticality
UL DPCH Information		0..1			–	
>UL Scrambling Code	O		9.2.2.53		–	
>UL SIR Target	O		UL SIR 9.2.1.69		–	
Additional E-DCH RL Specific Information To Add	O		9.2.2.116	Used when the E-DCH RL to add does not exist in the current UE context on the secondary UL frequency.	–	
Additional E-DCH RL Specific Information To Modify	O		9.2.2.117	Used when an existing E-DCH RL on the secondary UL frequency is modified.	–	
Additional E-DCH FDD Information To Modify	O		Additional E-DCH FDD Information 9.2.2.112	Used to modify the current additional E-DCH configuration with or without a new RL added in this procedure	–	
F-DPCH Information		0..1			–	
>FDD TPC DL Step Size	M		9.2.2.16		–	
>Limited Power Increase	M		9.2.2.21A		–	
>Inner Loop DL PC Status	M		9.2.2.21a		–	
>F-DPCH Slot Format Support Request	O		9.2.2.86		–	
Multicell E-DCH Information	O		9.2.2.114		YES	ignore

9.2.2.112 Additional E-DCH FDD Information

IE/Group Name	Presence	Range	IE Type and Reference	Semantics Description
Additional E-DCH FDD Information				
>HARQ Process Allocation For 2ms Scheduled Transmission Grant	O		HARQ Process Allocation for 2ms TTI 9.2.2.40	
>E-DCH Maximum Bitrate	O		9.2.2.4MG	
>E-DCH Processing Overload Level	O		9.2.1.95	
>E-DCH Minimum Set E-TFCI	O		INTEGER (0..127)	For the concept of “E-DCH Minimum Set of TFCs” see TS 25.321 [41] and TS 25.331 [16].

9.2.2.113 Multicell E-DCH Transport Bearer Mode

This parameter indicates the Multicell E-DCH Transport Bearer Mode. For *Multicell E-DCH Transport Bearer Mode* = "Separate Iur Transport Bearer Mode" the Mac-d flows from each carrier uses different Iur transport bearers, for *Multicell E-DCH Transport Bearer Mode* = "UL Flow Multiplexing Mode" the Mac-d flows received on the different carriers in the DRNS is multiplexed on one Iur transport bearer (per Mac-d flow). The SRNC should apply the stored cell capabilities for the cell on primary UL frequency for the capabilities related to Multicell E-DCH Transport Bearer Mode.

IE/Group Name	Presence	Range	IE Type and Reference	Semantics Description
Multicell E-DCH Transport Bearer Mode			ENUMERATED (Separate Iur Transport Bearer Mode, UL Flow Multiplexing Mode)	

9.2.2.114 Multicell E-DCH Information

IE/Group Name	Presence	Range	IE Type and Reference	Semantics Description
DL Power Balancing Information	O		9.2.2.10A	
Minimum Reduced E-DPDCH Gain Factor	O		9.2.2.102	
Secondary UL Frequency Activation State	O		ENUMERATED (Activated, Deactivated,...)	
F-DPCH Slot Format	O		9.2.2.85	
Common DL Reference Power	O		DL power 9.2.1.21A	Power on F-DPCH

9.2.2.115 Additional E-DCH RL Specific Information To Setup

IE/Group Name	Presence	Range	IE Type and Reference	Semantics Description	Criticality	Assigned Criticality
E-DCH Additional RL Specific Information		<i>1..<maxnoofEDCHRLs></i>			–	
>E-DCH Additional RL ID	M		RL ID 9.2.1.49		–	
>C-ID	O		9.2.1.6		–	
>First RLS Indicator	M		9.2.2.16A		–	
>Propagation Delay	O		9.2.2.33		–	
>Initial DL Tx Power	O		DL Power 9.2.1.21A			
>Primary CPICH Ec/No	O		9.2.2.32		–	
>E-AGCH Power Offset	O		9.2.2.61		–	
>E-RGCH Power Offset	O		9.2.2.62		–	
>E-HICH Power Offset	O		9.2.2.63		–	
>Additional E-DCH MAC-d Flow Specific Information	O		9.2.2.118		–	
>Multicell E-DCH RL Specific Information	O		9.2.2.119		YES	ignore

Range bound	Explanation
<i>maxnoofEDCHRLs</i>	Maximum number of E-DCH RLs for one UE

9.2.2.116 Additional E-DCH RL Specific Information To Add

IE/Group Name	Presence	Range	IE Type and Reference	Semantics Description	Criticality	Assigned Criticality
E-DCH Additional RL Specific Information To Add		<i>1..<maxno ofEDCHRLs></i>			–	
>E-DCH Additional RL ID	M		RL ID 9.2.1.49		–	
>C-ID	M		9.2.1.6		–	
>Primary CPICH Ec/No	O		9.2.2.32		–	
>E-AGCH Power Offset	O		9.2.2.61		–	
>E-RGCH Power Offset	O		9.2.2.62		–	
>E-HICH Power Offset	O		9.2.2.63		–	
>Additional E-DCH MAC-d Flow Specific Information	O		9.2.2.118		–	
>Multicell E-DCH RL Specific Information	O		9.2.2.119		YES	ignore

Range bound	Explanation
<i>maxnoofEDCHRLs</i>	Maximum number of E-DCH RLs for one UE

9.2.2.117 Additional E-DCH RL Specific Information To Modify

IE/Group Name	Presence	Range	IE Type and Reference	Semantics Description	Criticality	Assigned Criticality
E-DCH Additional RL Specific Information to Modify		<i>1..<maxno ofEDCHRLs></i>			–	
>E-DCH Additional RL ID	M		RL ID 9.2.1.49		–	
>E-AGCH Power Offset	O		9.2.2.61		–	
>E-RGCH Power Offset	O		9.2.2.62		–	
>E-HICH Power Offset	O		9.2.2.63		–	
>Additional E-DCH MAC-d Flow Specific Information	O		9.2.2.118		–	
>Multicell E-DCH RL Specific Information	O		9.2.2.119		YES	ignore

Range bound	Explanation
<i>maxnoofEDCHRLs</i>	Maximum number of E-DCH RLs for one UE

9.2.2.118 Additional E-DCH MAC-d Flow Specific Information

IE/Group Name	Presence	Range	IE Type and Reference	Semantics Description
Additional E-DCH MAC-d Flow Specific Information		$1..<maxno\ of\ EDCHM\ ACdFlows>$		
>E-DCH MAC-d Flow ID	M		9.2.1.91	
>Binding ID	O		9.2.1.3	
>Transport Layer Address	O		9.2.1.62	

Range Bound	Explanation
$maxnoofEDCHMACdFlows$	Maximum number of E-DCH MAC-d flows

9.2.2.119 Multicell E-DCH RL Specific Information

IE/Group Name	Presence	Range	IE Type and Reference	Semantics Description
Extended Propagation Delay	O		9.2.2.33a	
Enhanced Primary CPICH Ec/No	O		9.2.2.13l	
DL Reference Power	O		DL power 9.2.1.21A	
Phase Reference Update Indicator	O		9.2.2.27B	
E-DCH DL Control Channel Grant	O		NULL	

9.2.2.120 Additional E-DCH FDD Information Response

The *Additional E-DCH FDD Information Response* IE provides information for new E-DCH radio links on the secondary UL frequency.

IE/Group Name	Presence	Range	IE Type and Reference	Semantics Description
Additional E-DCH RL Information Response		<i>1..<maxno ofEDCHRLs></i>		
>E-DCH Additional RL ID	M		RL ID 9.2.1.49	
>Received Total Wide Band Power	M		9.2.2.35A	
>DL Power Balancing Activation Indicator	O		9.2.2.10B	
>RL Set ID	M		9.2.2.35	
>E-DCH RL Set ID	M		RL Set ID 9.2.2.35	
>E-DCH FDD DL Control Channel Information	M		9.2.2.4D	
>DL Code Information	M		FDD DL Code Information 9.2.2.14A	
>Additional E-DCH MAC-d Flow Specific Information Response		<i>0..<maxno ofEDCHMACdFlows></i>		
>>E-DCH MAC-d Flow ID	M		9.2.1.91	
>>Binding ID	O		9.2.1.3	
>>Transport Layer Address	O		9.2.1.62	
>HARQ Process Allocation For 2ms Scheduled Transmission Grant	O		HARQ Process Allocation for 2ms TTI 9.2.2.4O	
>Maximum Uplink SIR	M		Uplink SIR 9.2.1.69	
>Minimum Uplink SIR	M		Uplink SIR 9.2.1.69	
>Maximum Allowed UL Tx Power	M		9.2.1.35	
>Maximum DL TX Power	M		DL Power 9.2.1.21A	
>Minimum DL TX Power	M		DL Power 9.2.1.21A	
>Primary Scrambling Code	O		9.2.1.45	
>UL UARFCN	O		UARFCN 9.2.1.66	Corresponds to Nu in ref. TS 25.104 [6]
>DL UARFCN	O		UARFCN 9.2.1.66	Corresponds to Nd in ref. TS 25.104 [6]
>Primary CPICH Power	M		9.2.1.44	
>PC Preamble	M		9.2.2.27a	
>Primary CPICH Usage For Channel Estimation	O		9.2.2.32A	
>Secondary CPICH Information	O		9.2.2.38A	
>F-DPCH Slot Format	O		9.2.2.85	

Range bound	Explanation
<i>maxnoofEDCHRLs</i>	Maximum number of E-DCH RLs for one UE

9.2.2.121 Additional Modified E-DCH FDD Information Response

The *Additional Modified E-DCH RL Information Response* IE provides information for RLs on the secondary UL frequency that has been modified and existed in the UE Context configuration before the reconfiguration procedure.

IE/Group Name	Presence	Range	IE Type and Reference	Semantics Description
Additional Modified E-DCH RL Information Response		<i>1..<maxno ofEDCHRLs>></i>		
>E-DCH Additional RL ID	M		RL ID 9.2.1.49	
>DL Power Balancing Updated Indicator	O		9.2.2.10D	
>E-DCH FDD DL Control Channel Information	O		9.2.2.4D	
>Additional E-DCH MAC-d Flow Specific Information Response		<i>0..<maxno ofEDCHMACdFlows></i>		
>>E-DCH MAC-d Flow ID	M		9.2.1.91	
>>Binding ID	O		9.2.1.3	
>>Transport Layer Address	O		9.2.1.62	
>HARQ Process Allocation For 2ms Scheduled Transmission Grant	O		HARQ Process Allocation for 2ms TTI 9.2.2.4O	
>Maximum Uplink SIR	O		Uplink SIR 9.2.1.69	
>Minimum Uplink SIR	O		Uplink SIR 9.2.1.69	
>Maximum DL TX Power	O		DL Power 9.2.1.21A	
>Minimum DL TX Power	O		DL Power 9.2.1.21A	
>Primary CPICH Usage For Channel Estimation	O		9.2.2.32A	
>Secondary CPICH Information Change	O		9.2.2.38B	
>F-DPCH Slot Format	O		9.2.2.85	

Range bound	Explanation
<i>maxnoofEDCHRLs</i>	Maximum number of E-DCH RLs for one UE

9.2.2.122 Additional E-DCH FDD Update Information

IE/Group Name	Presence	Range	IE Type and Reference	Semantics Description
HARQ Process Allocation For 2ms Scheduled Transmission Grant	O		HARQ Process Allocation for 2ms TTI 9.2.2.4O	
Additional E-DCH DL Control Channel Change Information		<i>0..<maxnoofEDCHRLs></i>		
> E-DCH Additional RL ID	M		RL ID 9.2.1.49	

Range bound	Explanation
<i>maxnoofEDCHRLs</i>	Maximum number of E-DCH RLs for one UE

9.2.2.123 Cell Capability Container Extension FDD

The *Cell Capability Container Extension FDD* IE is an extension to the *Cell Capability Container FDD* IE and indicates the cell capability in the same way as *Cell Capability Container Extension FDD* IE.

The cell capability of multi-cell related functions may depend on that the cell also is multi-cell capable (adjacent carrier). These capability indicators shall be ignored if the Multi Cell Support Indicator in the *Cell Capability Container FDD* IE is set to 0. These support indicators are indicated in the table below with /Multi-cell/. Support indicators marked /Multi-cell/ indicates the support regardless of the supported multi-cell type in a multicell configuration: supported multi-cell type is - both serving HS-DSCH and secondary serving HS-DSCH, - secondary serving HS-DSCH or - serving HS-DSCH.

IE/Group Name	Presence	Range	IE Type and Reference	Semantics Description
Cell Capability Container Extension FDD			BIT STRING (128)	<p>Each bit indicates whether a cell supports a particular functionality or not. The value 1 of a bit indicates that the corresponding functionality is supported in a cell and value 0 indicates that the corresponding functionality is not supported in a cell. Each bit is defined as follows.</p> <p>The first bit: Cell Specific Tx Diversity Handling For Multi Cell Operation Support Indicator, /Multi-cell/.</p> <p>The second bit: Multi Cell and MIMO Support Indicator, /Multi-cell/.</p> <p>The third bit: Multi Cell and Single Stream MIMO Support Indicator, /Multi-cell/.</p> <p>The fourth bit: Multi Cell E-DCH Support Indicator, /Multi-cell/.</p> <p>This bit shall be ignored by the SRNC if the fifth bit: Separate Iur Transport Bearer Support Indicator = "0" and the sixth bit: E-DCH UL Flow Multiplexing Support Indicator = "0"</p> <p>The fifth bit: Separate Iur Transport Bearer Support Indicator, /Multi-cell/.</p> <p>This bit shall be ignored by the SRNC if the fourth bit: Multi Cell E-DCH Support Indicator = "0"</p> <p>The sixth bit: E-DCH UL Flow Multiplexing Support Indicator, /Multi-cell/.</p> <p>This bit shall be ignored by the SRNC if the fourth bit: Multi Cell E-DCH Support Indicator = "0"</p> <p>Note that undefined bits are considered as a spare bit and spare bits shall be set to 0 by the transmitter and shall be ignored by the receiver. Note that Reserved bits are not considered as a spare bit. They shall however be set to 0 by the transmitter and shall be ignored by the receiver.</p>

9.2.2.124 Non-Serving RL Preconfiguration Setup

The *Non-Serving RL Preconfiguration Setup* IE indicates that the DRNS may preconfigure E-DCH DL Code Information configured for new non-serving RL for Enhanced Service Cell Change and contains the information for the location of new serving RL after the Enhanced Serving Cell Change.

IE/Group Name	Presence	Range	IE Type and Reference	Semantics Description	Criticality	Assigned Criticality
CHOICE <i>new Serving RL</i>	M				–	
> <i>New Serving RL in the DRNS</i>			NULL		–	
> <i>New Serving RL Not in the DRNS</i>			NULL		–	
> <i>New Serving RL in the DRNS or New Serving RL Not in the DRNS</i>			NULL		–	
Additional E-DCH Non-Serving RL Preconfiguration Setup	O		NULL		YES	ignore

9.2.2.125 Non-Serving RL Preconfiguration Info

The *Non-Serving RL Preconfiguration Info* IE provides information for the new non-serving RL after Enhanced Serving Cell Change.

IE/Group Name	Presence	Range	IE Type and Reference	Semantics Description	Criticality	Assigned Criticality
New non-serving RL E-DCH FDD DL Control Channel Information A	O		9.2.2.4D E-DCH FDD DL Control Channel Information	E-DCH FDD DL Control Channel Information for non- serving RL in Serving E- DCH RLS	–	
New non-serving RL E-DCH FDD DL Control Channel Information B	O		9.2.2.4D E-DCH FDD DL Control Channel Information	E-DCH FDD DL Control Channel Information for non- serving RL in non serving E-DCH RLS in in case serving RL is in the DRNS	–	
New non-serving RL E-DCH FDD DL Control Channel Information C	O		9.2.2.4D E-DCH FDD DL Control Channel Information	E-DCH FDD DL Control Channel Information for non- serving RL in case serving RL is not in the DRNS	–	
Additional E-DCH New non-serving RL E-DCH FDD DL Control Channel Information		<i>0..<maxno ofEDCH-1></i>		E-DCH on Secondary uplink frequency - max 1 in this 3GPP release.	EACH	ignore
>New non-serving RL E-DCH FDD DL Control Channel Information A	O		9.2.2.13Dc E-DCH FDD DL Control Channel Information	E-DCH FDD DL Control Channel Information for Additional non-serving RL in Serving E- DCH RLS	–	
>New non-serving RL E-DCH FDD DL Control Channel Information B	O		9.2.2.13Dc E-DCH FDD DL Control Channel Information	E-DCH FDD DL Control Channel Information for Additional non-serving RL in non serving E- DCH RLS in case Additional serving RL is in the DRNS	–	
>New non-serving RL E-DCH FDD DL Control Channel Information C	O		9.2.2.13Dc E-DCH FDD DL Control Channel Information	E-DCH FDD DL Control Channel Information for Additional non-serving RL in case Additional	–	

				serving RL is not in the DRNS		
--	--	--	--	-------------------------------	--	--

9.2.2.126 Void

9.2.2.127 Void

9.2.2.128 Void

9.2.2.129 Support of Dynamic DTXDRX Related HS-SCCH Order

The *Support of dynamic DTXDRX related HS-SCCH order* IE is to indicate if DRNS supports the DRX/DTX related HS-SCCH order for CPC non-uniform UE.

IE/Group Name	Presence	Range	IE Type and Reference	Semantics Description
Support of dynamic DTXDRX related HS-SCCH order			ENUMERATED (Supported, Not Supported)	

9.2.3 TDD Specific Parameters

This subclause contains parameters that are specific to TDD.

9.2.3.a Alpha Value

Used to support signalling of cell specific Alpha Value to SRNS.

IE/Group Name	Presence	Range	IE Type and Reference	Semantics Description
Alpha Value			ENUMERATED(0, 1/8, 2/8, 3/8, 4/8, 5/8, 6/8, 7/8, 1)	

9.2.3.A Block STTD Indicator

Void.

9.2.3.1 Burst Type

Void.

9.2.3.1a Cell Capability Container TDD

The Cell Capability Container TDD indicates which functionalities a 3.84Mcps TDD cell supports.

IE/Group Name	Presence	Range	IE Type and Reference	Semantics Description
Cell Capability Container TDD			BIT STRING (32)	<p>Each bit indicates whether a cell supports a particular functionality or not. The value 1 of a bit indicates that the corresponding functionality is supported in a cell and value 0 indicates that the corresponding functionality is not supported in a cell. Each bit is defined as follows.</p> <p>The first bit: Delayed Activation Support Indicator.</p> <p>The second bit: HS-DSCH Support Indicator.</p> <p>The third bit: DSCH Support Indicator.</p> <p>The fourth bit: Flexible MAC-d PDU Size Support Indicator.</p> <p>The fifth: MBMS Support Indicator.</p> <p>Note that undefined bits are considered as a spare bit and spare bits shall be set to 0 by the transmitter and shall be ignored by the receiver.</p>

9.2.3.1b Cell Capability Container TDD LCR

The Cell Capability Container TDD LCR indicates which functionalities a cell supports.

IE/Group Name	Presence	Range	IE Type and Reference	Semantics Description
Cell Capability Container TDD LCR			BIT STRING (32)	<p>Each bit indicates whether a cell supports a particular functionality or not. The value 1 of a bit indicates that the corresponding functionality is supported in a cell and value 0 indicates that the corresponding functionality is not supported in a cell. Each bit is defined as follows.</p> <p>The first bit: Delayed Activation Support Indicator.</p> <p>The second bit: HS-DSCH Support Indicator.</p> <p>The third bit: DSCH Support Indicator.</p> <p>The fourth bit: Flexible MAC-d PDU Size Support Indicator.</p> <p>Note that undefined bits are considered as a spare bit and spare bits shall be set to 0 by the transmitter and shall be ignored by the receiver.</p>

9.2.3.2 CCTrCH ID

The CCTrCH ID identifies unambiguously a CCTrCH inside a Radio Link.

IE/Group Name	Presence	Range	IE Type and Reference	Semantics Description
CCTrCH ID			INTEGER (0..15)	

9.2.3.2A DCH TDD Information

The *DCH TDD Information* IE provides information for DCHs to be established.

IE/Group Name	Presence	Range	IE Type and Reference	Semantics Description	Criticality	Assigned Criticality
DCH Information		<i>1..<maxno ofDCHs></i>			–	
>Payload CRC Presence Indicator	M		9.2.1.42		–	
>UL FP Mode	M		9.2.1.67		–	
>ToAWS	M		9.2.1.58		–	
>ToAWE	M		9.2.1.57		–	
>DCH Specific Info		<i>1..<maxno ofDCHs></i>			–	
>>DCH ID	M		9.2.1.16		–	
>>CCTrCH ID	M		9.2.3.2	UL CCTrCH in which the DCH is mapped	–	
>>CCTrCH ID	M		9.2.3.2	DL CCTrCH in which the DCH is mapped	–	
>>TrCH Source Statistics Descriptor	M		9.2.1.65		–	
>>Transport Format Set	M		9.2.1.64	For the UL.	–	
>>Transport Format Set	M		9.2.1.64	For the DL.	–	
>>BLER	M		9.2.1.4	For the UL.	–	
>>BLER	M		9.2.1.4	For the DL.	–	
>>Allocation/Retention Priority	M		9.2.1.1		–	
>>Frame Handling Priority	M		9.2.1.29		–	
>>QE-Selector	C-CoordDCH		9.2.1.46A		–	
>>Guaranteed Rate Information	O		9.2.1.30M		YES	ignore
>>Traffic Class	M		9.2.1.58A		YES	ignore
>>Unidirectional DCH Indicator	O		9.2.1.68B		YES	reject
>TNL QoS	O		9.2.1.56A		YES	ignore

Condition	Explanation
CoordDCH	The IE shall be present if this DCH is part of a set of coordinated DCHs (number of instances of the <i>DCH Specific Info</i> IE is greater than 1).

Range bound	Explanation
<i>maxnoofDCHs</i>	Maximum number of DCHs for one UE.

9.2.3.2B DCH TDD Information Response

Void

9.2.3.2C DL Timeslot Information

The *DL Timeslot Information* IE provides information on the time slot allocation for a DL DPCH at 3.84Mcps.

IE/Group Name	Presence	Range	IE Type and Reference	Semantics Description	Criticality	Assigned Criticality
DL Timeslot Information		1..<maxno OFTS>			–	
>Time Slot	M		9.2.1.56		–	
>Midamble Shift And Burst Type	M		9.2.3.4		–	
>TFCI Presence	M		9.2.1.55		–	
>DL Code Information	M		TDD DL Code Information 9.2.3.8C		–	

Range bound	Explanation
maxnoofTSSs	Maximum number of Timeslots for a UE.

9.2.3.2D DL Time Slot ISCP Info

The *DL Time Slot ISCP Info* IE gives interference level for each DL time slot within the Radio Link.

IE/Group Name	Presence	Range	IE Type and Reference	Semantics Description	Criticality	Assigned Criticality
DL Time Slot ISCP Info		1..<maxno ofDLts>			–	
>Time Slot	M		9.2.1.56		–	
>DL Timeslot ISCP	M		9.2.3.12		–	

Range bound	Explanation
maxnoofDLts	Maximum number of downlink time slots per Radio Link for 3.84Mcps TDD.

9.2.3.2E DL Timeslot Information LCR

The *DL Timeslot Information LCR* IE provides information for DL Timeslot to be established for 1.28Mcps TDD.

IE/Group Name	Presence	Range	IE Type and Reference	Semantics Description	Criticality	Assigned Criticality
DL Timeslot Information LCR		1 .. <maxnoof DLtsLCR>			–	
>Time Slot LCR	M		9.2.3.12a		–	
>Midamble Shift LCR	M		9.2.3.4C		–	
>TFCI Presence	M		9.2.1.57		–	
>DL Code Information LCR	M		TDD DL Code Information LCR 9.2.3.8D		–	
>Maximum DL TX Power	O		DL Power 9.2.1.21A	Maximum allowed power on DPCH	YES	ignore
>Minimum DL TX Power	O		DL Power 9.2.1.21A	Minimum allowed power on DPCH	YES	ignore

Range bound	Explanation
<i>maxnoofDLtsLCR</i>	Maximum number of Downlink time slots per Radio Link for 1.28Mcps TDD.

9.2.3.2F DL Time Slot ISCP Info LCR

The *DL Time Slot ISCP Info LCR* IE provides information for DL Interference level for each time slot within the Radio Link for 1.28Mcps TDD.

IE/Group Name	Presence	Range	IE Type and Reference	Semantics Description	Criticality	Assigned Criticality
DL Time Slot ISCP Info LCR		1 .. <maxnoofUL tsLCR>			–	
>Time Slot LCR	M		9.2.3.12a		–	
>DL Timeslot ISCP	M		9.2.3.12		–	

Range bound	Explanation
<i>maxnoofULtsLCR</i>	Maximum number of Uplink time slots per Radio Link for 1.28Mcps TDD

9.2.3.3 DPCH ID

The DPCH ID identifies unambiguously a DPCH inside a Radio Link.

IE/Group Name	Presence	Range	IE Type and Reference	Semantics Description
DPCH ID			INTEGER (0..239)	

9.2.3.3a DSCH TDD Information

The *DSCH TDD Information* IE provides information for DSCHs to be established.

IE/Group Name	Presence	Range	IE Type and Reference	Semantics Description	Criticality	Assigned Criticality
DSCH TDD Information		<i>1..<maxno ofDSCHs></i>			–	
>DSCH ID	M		9.2.3.3ae		–	
>CCTrCH ID	M		9.2.3.2	DL CCTrCH in which the DSCH is mapped.	–	
>TrCH Source Statistics Descriptor	M		9.2.1.65		–	
>Transport Format Set	M		9.2.1.64		–	
>Allocation/Retention Priority	M		9.2.1.1		–	
>Scheduling Priority Indicator	M		9.2.1.51A		–	
>BLER	M		9.2.1.4		–	
>Traffic Class	M		9.2.1.58A		YES	ignore
>Binding ID	O		9.2.1.3	Shall be ignored if bearer establishment with ALCAP.	YES	ignore
>Transport Layer Address	O		9.2.1.62	Shall be ignored if bearer establishment with ALCAP.	YES	ignore
>TNL QoS	O		9.2.1.56A	Shall be ignored if bearer establishment with ALCAP.	YES	ignore

Range bound	Explanation
<i>maxnoofDSCHs</i>	Maximum number of DSCHs for one UE.

9.2.3.3aa HS-DSCH TDD Information

The *HS-DSCH TDD Information* IE is used for initial addition of HS-DSCH information to a UE Context.

IE/Group Name	Presence	Range	IE Type and Reference	Semantics Description	Criticality	Assigned Criticality
HS-DSCH MAC-d Flows Information	M		9.2.1.300A		–	
UE Capabilities Information		1			–	
>HS-DSCH Physical Layer Category	M		9.2.1.300a		–	
>1.28 Mcps TDD uplink physical channel capability	O		9.2.3.10D	Applicable to 1.28Mcps TDD only	YES	ignore
>Number of Supported Carriers	O		ENUMERATE D (One-one carrier, One-three carrier, Three-three carrier, One-six carrier, Tree-six carrier, Six-six carrier, ...)	Applicable to 1.28Mcps TDD only This IE indicates the number of carrier that UE can support at the same time, where “ One-three carrier” means the number of supported carrier is one for the uplink, and three for the downlink.	YES	reject
>Multi-carrier HS-DSCH Physical Layer Category	O		9.2.1.300a	Applicable to 1.28Mcps TDD only	YES	ignore
>MIMO SF Mode Supported For HS-PDSCH dual stream	O		Enumerated (SF1, SF1/SF16)	Applicable to 1.28Mcps TDD only	YES	ignore
>UE TS0 Capability LCR	O		ENUMERATE D (TS0 Capable, TS0 Non-Capable)	Applicable to 1.28Mcps TDD only	YES	ignore
MAC-hs Reordering Buffer Size for RLC-UM	M		9.2.1.34Ab		–	
TDD ACK NACK Power Offset	M		9.2.3.7I		–	
HS-DSCH MAC-d PDU Size Format	O		9.2.1.300C	If not present, “Indexed MAC-d PDU Size” shall be used.	YES	reject
HS-SICH SIR Target	O		UL SIR 9.2.1.69	Applicable to 1.28Mcps TDD only	YES	ignore
HS-SICH TPC step size	O		9.2.3.10a	Applicable to 1.28Mcps TDD only	YES	ignore
TSN-Length	O		9.2.3.3ai	Applicable for 1.28Mcps TDD when using multiple frequencies	YES	reject
MIMO Activation Indicator	O		9.2.1.134		YES	reject

9.2.3.3ab HS-DSCH TDD Information Response

The *HS-DSCH TDD Information Response* IE provides information for HS-DSCH that have been established or modified. It also provides additional HS-DSCH information determined within the DRNS.

IE/Group Name	Presence	Range	IE Type and Reference	Semantics Description	Criticality	Assigned Criticality
HS-DSCH MAC-d Flow Specific Information Response		<i>0..<maxno ofMACdFlows></i>			–	
>HS-DSCH MAC-d Flow ID	M		9.2.1.30O		–	
>Binding ID	O		9.2.1.3		–	
>Transport Layer Address	O		9.2.1.62		–	
>HS-DSCH Initial Capacity Allocation	O		9.2.1.30Na		–	
HS-SCCH Specific Information Response		<i>0..<maxno ofHSSCC Hcodes></i>		Not applicable to 1.28 Mcps TDD or 7.68Mcps TDD	GLOBAL	reject
>Time Slot	M		9.2.1.56		–	
>Midamble Shift And Burst Type	M		9.2.3.4		–	
>TDD Channelisation Code	M		9.2.3.8		–	
>HS-SICH Information		<i>1</i>			–	
>>HS SICH ID	M		9.2.3.3ad		–	
>>Time Slot	M		9.2.1.56		–	
>>Midamble Shift And Burst Type	M		9.2.3.4		–	
>>TDD Channelisation Code	M		9.2.3.8		–	
HS-SCCH Specific Information Response LCR		<i>0..<maxno ofHSSCC Hcodes></i>		Not applicable to 3.84 Mcps TDD or 7.68Mcps TDD	GLOBAL	reject
>Time Slot LCR	M		9.2.3.12a		–	
>Midamble shift LCR	M		9.2.3.4C		–	
>First TDD Channelisation Code	M		TDD Channelisation Code 9.2.3.8		–	
>Second TDD Channelisation Code	M		TDD Channelisation Code 9.2.3.8		–	
>HS-SICH Information LCR		<i>1</i>			–	
>>HS SICH ID	M		9.2.3.3ad		–	
>>Time Slot LCR	M		9.2.3.12a		–	
>>Midamble shift LCR	M		9.2.3.4C		–	
>>TDD Channelisation Code	M		9.2.3.8		–	
>Used Frequency	O		UARFCN 9.2.1.66	Applicable for 1.28Mcps TDD when using multiple frequencies. This IE indicates the frequency which is actually used by the HS-SCCH.	YES	reject
>UARFCN	O		9.2.1.66	Corresponds to Nt (3GPP TS 25.105) Applicable	YES	ignore

IE/Group Name	Presence	Range	IE Type and Reference	Semantics Description	Criticality	Assigned Criticality
				for 1.28Mcps TDD when using multiple frequencies. See note1 below		
HS-SCCH Specific Information Response 7.68 Mcps		<i>0..<maxno ofHSSCC Hcodes></i>		Applicable to 7.68 Mcps TDD only	YES	ignore
>Time Slot	M		9.2.1.56		–	
>Midamble Shift And Burst Type 7.68Mcps	M		9.2.3.23		–	
>TDD Channelisation Code 7.68Mcps	M		9.2.3.25		–	
>HS-SICH Information		1			–	
>>HS SICH ID	M		9.2.3.3ad		–	
>>Time Slot	M		9.2.1.56		–	
>>Midamble Shift And Burst Type 7.68Mcps	M		9.2.3.23		–	
>>TDD Channelisation Code 7.68Mcps	M		9.2.3.25		–	
HS-PDSCH Timeslot Specific Information Response		<i>0..<maxno ofDLts></i>		Not Applicable to 1.28Mcps TDD or 7.68Mcps TDD.	GLOBAL	reject
>Time Slot	M		9.2.1.56		–	
>Midamble Shift And Burst Type	M		9.2.3.4		–	
HS-PDSCH Timeslot Specific Information Response LCR		<i>0..<maxno ofDLtsLCR ></i>		Not Applicable to 3.84Mcps TDD or 7.68Mcps TDD.	GLOBAL	reject
>Time Slot LCR	M		9.2.3.12a		–	
>Midamble Shift LCR	M		9.2.3.4C		–	
HS-PDSCH Timeslot Specific Information Response 7.68Mcps		<i>0..<maxno ofDLts></i>		Applicable to 7.68Mcps TDD only.	YES	Ignore
>Time Slot	M		9.2.1.56		–	
>Midamble Shift And Burst Type 7.68Mcps	M		9.2.3.23		–	
HARQ Memory Partitioning	O		9.2.1.116		–	
User Plane Congestion Fields Inclusion	O		9.2.1.70C		YES	ignore
HS-SCCH Specific Information Response LCR per UARFCN		<i>0..<maxH SDPAFreq uency-1></i>		Applicable for 1.28Mcps TDD	GLOBAL	reject
>HS-SCCH Specific Information Response LCR		<i>1..<maxNo OfHSSCC Hcodes></i>			–	
>>Time Slot LCR	M		9.2.3.12a		–	
>>Midamble Shift LCR	M		9.2.3.4C		–	
>>First TDD Channelisation Code	M		TDD Channelisation Code 9.2.3.8		–	
>>Second TDD Channelisation Code	M		TDD Channelisation Code 9.2.3.8		–	

IE/Group Name	Presence	Range	IE Type and Reference	Semantics Description	Criticality	Assigned Criticality
>>HS-SICH Information LCR		1			–	
>>>HS SICH ID	M		9.2.3.3ad			
>>>Time Slot LCR	M		9.2.3.12a		–	
>>>Midamble Shift LCR	M		9.2.3.4C		–	
>>>TDD Channelisation Code	M		9.2.3.8		–	
>>Used Frequency	O		UARFCN 9.2.1.66	Applicable for 1.28Mcps TDD when using multiple frequencies. This IE indicates the frequency which is actually used by the HS-SCCH.	YES	reject
>UARFCN	O		9.2.1.66	Corresponds to Nt 3GPP TS 25.105 Applicable for 1.28Mcps TDD when using multiple frequencies. See note 1 below	YES	ignore
>HARQ Memory Partitioning per UARFCN		<i>0..<maxHSDPAFrequency-1></i>				
>>HARQ Memory Partitioning	O		9.2.1.116		–	
>UARFCN	O		9.2.1.66	Corresponds to Nt 3GPP TS 25.105 Applicable for 1.28Mcps TDD when using multiple frequencies. See note 1 below	YES	ignore
>TS0 HS-PDSCH Indication LCR	O		9.2.3.74	1.28Mcps TDD only	YES	ignore
Multi-Carrier number	O		Integer(1.. <i>maxHSDPAFrequency</i>)	Applicable for 1.28Mcps TDD when using multiple frequencies.	YES	ignore
MIMO SF Mode for HS-PDSCH dual stream	O		Enumerated (SF1, SF1/SF16)	Applicable for 1.28Mcps TDD when MIMO is configured	YES	reject
MIMO Reference Signal Information	O	<i>0..<maxNumberOfHSCCHcodes></i>		Applicable for 1.28Mcps TDD when MIMO is configured	YES	reject

IE/Group Name	Presence	Range	IE Type and Reference	Semantics Description	Criticality	Assigned Criticality
>HS-SICH Reference Signal Information	M		9.2.3.72		YES	
Out-of-sync Detection Window	O		ENUMERATED (40, 80, 160, 320, 640, ...)	Unit: ms Applicable to 1.28Mcps TDD.	YES	reject

Note 1: This information element is a simplified representation of the ASN.1 description.

Range bound	Explanation
<i>maxnoofMACdFlows</i>	Maximum number of MAC-d flows.
<i>maxnoofHSSCCHcodes</i>	Maximum number of HS-SCCH codes.
<i>maxnoofDLts</i>	Maximum number of downlink time slots per Radio Link for 3.84Mcps TDD.
<i>maxnoofDLtsLCR</i>	Maximum number of Downlink time slots per Radio Link for 1.28Mcps TDD.
<i>maxHSDPAFrequency</i>	Maximum number of Frequency that UE can support HSDPA

9.2.3.3ac HS-DSCH TDD Update Information

The *HS-DSCH TDD Update Information* IE provides information for HS-DSCH to be updated. At least one IE shall be presented.

IE/Group name	Presence	Range	IE Type and Reference	Semantic Description	Criticality	Assigned Criticality
HS-SCCH Code Change Indicator	O		9.2.1.30R		–	
TDD ACK NACK Power Offset	O		9.2.3.71		–	

9.2.3.3ad HS-SICH ID

The HS-SICH ID identifies unambiguously a HS-SICH.

IE/Group Name	Presence	Range	IE Type and Reference	Semantics Description
HS SICH ID			INTEGER (0..31)	For 1.28Mcps TDD, the IE is INTEGER (0..255). In ASN.1, it is presented by another IE for the value beyond the 31.

9.2.3.3ae DSCH ID

The DSCH ID is the identifier of an active downlink shared channel. It is unique for each active DSCH among the active DSCHs simultaneously allocated for the same UE.

IE/Group Name	Presence	Range	IE Type and Reference	Semantics Description
DSCH ID			INTEGER (0..255)	

9.2.3.3af DSCH Initial Window Size

Indicates the initial number of MAC-c/sh SDUs that may be transmitted before new credits are received from the DRNC.

IE/Group Name	Presence	Range	IE type and reference	Semantics description
DSCH Initial Window Size			INTEGER (1..255)	Number of MAC-c/sh SDUs: 255 = Unlimited number of MAC-c/sh SDUs.

9.2.3.3ag DSCH Flow Control Information

The *DSCH Flow Control Information* IE provides flow control information for each scheduling priority class for the DSCH FP over Iur.

IE/Group Name	Presence	Range	IE Type and Reference	Semantics Description	Criticality	Assigned Criticality
DSCH Flow Control Information		1..16			–	
>DSCH Scheduling Priority	M		Scheduling Priority Indicator 9.2.1.51A		–	
>MAC-c/sh SDU Length		1..<maxNb MAC-c/shSDULength>			–	
>>MAC-c/sh SDU Length	M		9.2.1.34		–	
>DSCH Initial Window Size	O		9.2.3.3af		YES	ignore

Range bound	Explanation
<i>maxNbMAC-c/shSDULength</i>	Maximum number of different MAC-c/sh SDU lengths.

9.2.3.3ah DSCH-RNTI

DSCH-RNTI is the UE identifier allocated by DRNS to be used over the radio interface by Ues having one or several DSCHs and/or USCHs. It is unique within a cell.

IE/Group Name	Presence	Range	IE type and reference	Semantics description
DSCH-RNTI			INTEGER(0..65535)	

9.2.3.3ai TSN-Length

The IE indicates the TSN length.

IE/Group Name	Presence	Range	IE Type and Reference	Semantics Description
TSN-Length			ENUMERATED (tsn-6bits, tsn-9bits)	

9.2.3.3A Maximum Number of Timeslots

Defines the maximum number of timeslots the UE has the capability of receiving or transmitting. [3.84Mcps TDD and 7.68Mcps TDD – in a frame] [1.28Mcps TDD – in a subframe]

IE/Group Name	Presence	Range	IE Type and Reference	Semantics Description
Maximum Number of Timeslots			INTEGER (1..14)	For 1.28Mcps TDD the values 7 through 14 are not used.

9.2.3.3B Maximum Number of UL Physical Channels per Timeslot

Defines the maximum number of physical channels [3.84Mcps TDD and 7.68Mcps TDD – per frame] [1.28Mcps TDD – per subframe] that the UE is capable to transmit.

IE/Group Name	Presence	Range	IE Type and Reference	Semantics Description
Maximum Number of UL Physical Channels per Timeslot			INTEGER (1..2)	

9.2.3.3C Maximum Number of DL Physical Channels

Defines the maximum number of physical channels [3.84Mcps TDD – per frame] [1.28Mcps TDD – per subframe] that the UE is capable to receive.

IE/Group Name	Presence	Range	IE Type and Reference	Semantics Description
Maximum Number of DL Physical Channels			INTEGER (1..224)	For 1.28Mcps TDD the values 97 through 224 are not used.

9.2.3.3D Maximum Number of DL Physical Channels per Timeslot

Defines the maximum number of physical channels per timeslot that the UE is capable to receive.

IE/Group Name	Presence	Range	IE Type and Reference	Semantics Description
Maximum Number of DL Physical Channels per Timeslot			INTEGER (1..16)	

9.2.3.4 Midamble Shift And Burst Type

This information element indicates burst type and midamble allocation.

Three different midamble allocation schemes exist:

- Default midamble: the midamble is allocated by layer 1 depending on the associated channelisation code (DL and UL);
- Common midamble: the midamble is allocated by layer 1 depending on the number of channelisation codes (possible in DL only);
- UE specific midamble: a UE specific midamble is explicitly assigned (DL and UL).

IE/Group Name	Presence	Range	IE Type and Reference	Semantics Description
CHOICE <i>Burst Type</i>				
> <i>Type 1</i>				
>> Midamble Configuration Burst Type 1 And 3	M		ENUMERATED(4, 8, 16)	As defined in TS 25.221 [12]
>>Midamble Allocation Mode	M		ENUMERATED(Default midamble, Common midamble, UE specific midamble)	
>>Midamble Shift Long	C-UE		INTEGER(0..15)	
> <i>Type 2</i>				
>> Midamble Configuration Burst Type 2	M		ENUMERATED (3, 6)	As defined in TS 25.221 [12]
>>Midamble Allocation Mode	M		ENUMERATED(Default midamble, Common midamble, UE specific midamble)	
>>Midamble Shift Short	C-UE		INTEGER (0..15)	
> <i>Type 3</i>				UL only
>> Midamble Configuration Burst Type 1 And 3	M		ENUMERATED (4, 8, 16)	As defined in TS 25.221 [12]
>>Midamble Allocation Mode	M		ENUMERATED(Default midamble, UE specific midamble)	
>>Midamble Shift Long	C-UE		INTEGER(0..15)	

Condition	Explanation
UE	The IE shall be present if the <i>Midamble Allocation Mode</i> IE is set to "UE-specific midamble".

9.2.3.4A Minimum Spreading Factor

Defines the minimum spreading factor the UE has the capability of receiving or transmitting.

IE/Group Name	Presence	Range	IE Type and Reference	Semantics Description
Minimum Spreading Factor			INTEGER (1..16)	

9.2.3.4B IPDL TDD parameters

The *IPDL TDD Parameters* IE provides the information for the IPDL Configuration applied in 3.84Mcps TDD mode.

IE/Group name	Presence	Range	IE Type and Reference	Semantics Description
IP Spacing TDD	M		ENUMERATED(30,40,50,70,100,...)	See TS 25.224 [22]
IP Start	M		INTEGER(0..4095)	See TS 25.224 [22]
IP Slot	M		INTEGER(0..14)	See TS 25.224 [22]
IP P-CCPCH	M		ENUMERATED(Switch off 1 frame, Switch off 2 frames)	See TS 25.224 [22]
Burst mode parameters	O		9.2.1.4B	

9.2.3.4Bb IPDL TDD parameters LCR

The *IPDL TDD Parameters LCR* IE provides the information for the IPDL Configuration applied in 1.28Mcps TDD mode.

IE/Group name	Presence	Range	IE Type and Reference	Semantics Description
IP Spacing TDD	M		ENUMERATED(30,40,50,70,100,...)	See TS 25.224 [22]
IP Start	M		INTEGER(0..4095)	See TS 25.224 [22]
IP_Sub	M		ENUMERATED(First,Second,Both)	See TS 25.224 [22]
Burst mode parameters	O		9.2.1.4B	

9.2.3.4C Midamble shift LCR

This information element indicates midamble allocation in 1.28Mcps TDD.

Three different midamble allocation schemes exist:

- Default midamble: the midamble is allocated by layer 1 depending on the associated channelisation code (DL and UL);
- Common midamble: the midamble is allocated by layer 1 depending on the number of channelisation codes (possible in DL only);
- UE specific midamble: a UE specific midamble is explicitly assigned (DL and UL).

IE/Group name	Presence	Range	IE Type and Reference	Semantics Description
Midamble Allocation Mode	M		ENUMERATED(Default midamble, Common midamble, UE specific midamble,...)	
Midamble Shift Long	C-UE		INTEGER(0..15)	
Midamble Configuration LCR	M		ENUMERATED(2, 4, 6, 8, 10, 12, 14, 16, ...)	As defined in TS 25.221 [12]

Condition	Explanation
UE	The IE shall be present if the <i>Midamble Allocation Mode</i> IE is set to "UE-specific midamble".

9.2.3.4D Neighbouring TDD Cell Information LCR

Void

9.2.3.5 Primary CCPCH RSCP

Received Signal Code Power is the received power on PCCPCH of the target cell after despreading. The reference point for the RSCP is the antenna connector at the UE, see ref. TS 25.225 [14].

IE/Group Name	Presence	Range	IE Type and Reference	Semantics Description
Primary CCPCH RSCP			INTEGER(0..91)	According to mapping of the non-negative values in ref. TS 25.123 [24].

9.2.3.5a Primary CCPCH RSCP Delta

Primary CCPCH RSCP Delta is the offset used to report the negative reporting range of P-CCPCH RSCP as per TS 25.123 [24].

IE/Group Name	Presence	Range	IE Type and Reference	Semantics Description
Primary CCPCH RSCP Delta			INTEGER(-5..-1,...)	If present, the actual value of Primary CCPCH RSCP = Primary CCPCH RSCP Delta

9.2.3.5A PRACH Midamble

Void.

9.2.3.5B RB Identity

The RB Identity is the identifier of a radio bearer. It is unique for each active Radio bearer among the active radio bearers simultaneously allocated for the same UE.

IE/Group Name	Presence	Range	IE Type and Reference	Semantics Description
RB Identity			INTEGER(0..31)	In line with TS 25.331 [16], ch. 10.3.4.11

9.2.3.6 Repetition Length

The Repetition Length represents the number of consecutive Radio Frames inside a Repetition Period in which the same Time Slot is assigned to the same Physical Channel see ref. TS 25.331 [16].

[1.28Mcps TDD- When applied to configure the E-DCH Non-scheduled Grant Information, the Repetition Length represents the number of consecutive Subframes, i.e. 5ms inside a Repetition Period in which the same Time Slot is assigned to the same Physical Channel see ref. TS 25.331 [16].]

IE/Group Name	Presence	Range	IE Type and Reference	Semantics Description
Repetition Length			INTEGER(1..63)	

9.2.3.7 Repetition Period

The Repetition Period represents the number of consecutive Radio Frames after which the same assignment scheme of Time Slots to a Physical Channel is repeated. This means that if the Time Slot K is assigned to a physical channel in the Radio Frame J , it is assigned to the same physical channel also in all the Radio Frames $J+n*Repetition\ Period$ (where n is an integer) see ref. TS 25.331 [16].

[1.28Mcps TDD- When applied to configure the E-DCH Non-scheduled Grant Information, the Repetition Period represents the number of consecutiveSubframes, i.e. 5ms after which the same assignment scheme of Time Slots to a Physical Channel is repeated see ref. TS 25.331 [16].]

IE/Group Name	Presence	Range	IE Type and Reference	Semantics Description
Repetition Period			ENUMERATED (1,2,4,8,16,32,64)	

9.2.3.7A Rx Timing Deviation

Measured Rx Timing Deviation as a basis for timing advance, either measured directly from a RACH burst, or calculated from the Rx Timing Deviation measurement on the USCH by adding the current Timing Advance value. For 1.28Mcps TDD this IE must be set to 0.

IE/Group Name	Presence	Range	IE Type and Reference	Semantics Description
Rx Timing Deviation			INTEGER (0..127)	As specified in TS 25.435 [5], ch. 6.2.7.6

9.2.3.7B Secondary CCPCH Info TDD

The *Secondary CCPCH Info TDD* IE provides information on the Secondary CCPCH that carries the logical channel SHCCH for the UE.

IE/Group Name	Presence	Range	IE Type and Reference	Semantics Description	Criticality	Assigned Criticality
TFCS	M		9.2.1.63	For the DL.	–	
TFCI Coding	M		9.2.3.11		–	
Secondary CCPCH		$0..<maxno\ of\ SCCPC\ Hs>$			–	
>Time Slot	M		9.2.1.56		–	
>Midamble Shift And Burst Type	M		9.2.3.4		–	
>TFCI Presence	M		9.2.1.55		–	
>Secondary CCPCH TDD Code Information	M		9.2.3.7C		–	
>TDD Physical Channel Offset	M		9.2.3.9		–	
>Repetition Length	M		9.2.3.6		–	
>Repetition Period	M		9.2.3.7		–	
FACH		$0..maxno\ of\ FACHs$			–	
>TFS	M		9.2.1.64	For the DL.	–	
PCH		$0..1$			–	
>TFS	M		9.2.1.64	For the DL.	–	

Range bound	Explanation
$maxno\ of\ SCCPCs$	Maximum number of Secondary CCPCHs per CCTrCH.
$maxno\ of\ FACHs$	Maximum number of FACHs mapped onto a Secondary CCPCH.

9.2.3.7C Secondary CCPCH TDD Code Information

The *Secondary CCPCH TDD Code Information* IE provides TDD Channelisation Code information for all SCCPCHs of one Time Slot.

IE/Group Name	Presence	Range	IE Type and Reference	Semantics Description	Criticality	Assigned Criticality
Secondary CCPCH TDD Code Information		<i>1..<maxno OfSCCPC Hs></i>			–	
>TDD Channelisation Code	M		9.2.3.8		–	

Range bound	Explanation
<i>maxnoofSCCPCs</i>	Maximum number of SCCPCHs for one CCTrCH.

9.2.3.7D Special Burst Scheduling

The number of frames between special burst transmissions during DTX.

IE/Group Name	Presence	Range	IE Type and Reference	Semantics Description
Special Burst Scheduling			<i>INTEGER(1, 2, ..., 256)</i>	Number of frames between special burst transmissions during DTX

9.2.3.7E Synchronisation Configuration

The Synchronisation Configuration parameters that are used by the DRNS in the Radio Link Failure/Restore procedure.

IE/Group Name	Presence	Range	IE Type and Reference	Semantics Description
N_INSYNC_IND	M		<i>INTEGER(1, 2, ..., 256)</i>	
N_OUTSYNC_IND	M		<i>INTEGER(1, 2, ..., 256)</i>	
T_RLFAILURE	M		<i>ENUMERATED(0, 0.1, 0.2, ..., 25.5)</i>	Unit: seconds

9.2.3.7F Secondary CCPCH Info TDD LCR

The *Secondary CCPCH Info TDD LCR* IE provides information on the Secondary CCPCH that carries the logical channel SHCCH for the UE.

IE/Group Name	Presence	Range	IE Type and Reference	Semantics Description	Criticality	Assigned Criticality
TFCS	M		9.2.1.63	For the DL.	–	
TFCI Coding	M		9.2.3.11		–	
Secondary CCPCH		<i>0..<maxno ofSCCPCHs></i>			–	
>Time Slot LCR	M		9.2.3.12a		–	
>Midamble Shift LCR	M		9.2.3.4C		–	
>TFCI Presence	M		9.2.1.55		–	
>Secondary CCPCH TDD Code Information LCR	M		9.2.3.7G		–	
>TDD Physical Channel Offset	M		9.2.3.9		–	
>Repetition Length	M		9.2.3.6		–	
>Repetition Period	M		9.2.3.7		–	
FACH		<i>0..<maxno ofFACHs></i>			–	
>TFS	M		9.2.1.64	For the DL.	–	
PCH		<i>0..1</i>			–	
>TFS	M		9.2.1.64	For the DL.	–	

Range bound	Explanation
<i>maxnoofSCCPCHs</i>	Maximum number of Secondary CCPCHs per CCTrCH.
<i>maxnoofFACHs</i>	Maximum number of FACHs mapped onto a Secondary CCPCH.

9.2.3.7G Secondary CCPCH TDD Code Information LCR

The *Secondary CCPCH TDD Code Information LCR* IE provides LCR TDD Channelisation Code information for all SCCPCHs of one Time Slot.

IE/Group Name	Presence	Range	IE Type and Reference	Semantics Description	Criticality	Assigned Criticality
Secondary CCPCH TDD Code Information		<i>1..<maxno ofSCCPCHs></i>			–	
>TDD Channelisation Code LCR	M		9.2.3.8a		–	
>SCCPCH Time Slot Format LCR	M		TDD DL DPCH Time Slot Format LCR 9.2.3.8E		–	

Range bound	Explanation
<i>maxnoofSCCPCHs</i>	Maximum number of SCCPCHs for one CCTrCH.

9.2.3.7H Support of 8PSK

The *Support of 8PSK* IE indicates whether 8PSK is supported or not.

IE/Group Name	Presence	Range	IE Type and Reference	Semantics Description
Support of 8PSK			ENUMERATED(supported)	

9.2.3.71 TDD ACK NACK Power Offset

The *TDD ACK NACK Power Offset* IE indicates Power offset used in the UL in the HS-SICH between transmissions carrying positive and negative acknowledgements as per TS 25.331 [16].

IE/Group Name	Presence	Range	IE type and reference	Semantics description
TDD ACK NACK Power Offset			INTEGER (-7..8,...)	Unit: dB Range: -7..+8 dB Step: 1 dB

9.2.3.8 TDD Channelisation Code

The Channelisation Code Number indicates which Channelisation Code is used for a given Physical Channel. In TDD the Channelisation Code is an Orthogonal Variable Spreading Factor code that can have a spreading factor of 1, 2, 4, 8 or 16.

IE/Group Name	Presence	Range	IE Type and Reference	Semantics Description
TDD Channelisation Code			ENUMERATED (1/1), (2/1), (2/2), (4/1), .. (4/4), (8/1), .. (8/8), (16/1), .. (16/16),...)	

9.2.3.8a TDD Channelisation Code LCR

The Channelisation Code Number indicates which Channelisation Code is used for a given Physical Channel. In 1.28Mcps TDD the Channelisation Code is an Orthogonal Variable Spreading Factor code, that can have a spreading factor of 1, 2, 4, 8 or 16 and there is a choice between QPSK and 8PSK modulation.

IE/Group Name	Presence	Range	IE Type and Reference	Semantics Description
TDD Channelisation Code	M		ENUMERATED (1/1), (2/1), (2/2), (4/1),...(4/4), (8/1), .. (8/8), (16/1).. (16/16) ,...)	
Modulation	M		ENUMERATED (QPSK, 8PSK, ...)	Modulation options for 1.28Mcps TDD in contrast to 3.84Mcps TDD

9.2.3.8A TDD DPCH Offset

The Offset represents the phase information for the allocation of a group of dedicated physical channels. The *Offset Type* IE = "No Initial Offset" is used when a starting offset is not required and the TDD Physical channel offset for each DPCH in the CCTrCH shall be directly determined from the TDD DPCH Offset. The *Offset Type* IE = "Initial Offset" is used when a starting offset is required. The TDD DPCH Offset shall map to the CFN and the TDD Physical Channel Offset for each DPCH in this CCTrCH shall be calculated by TDD DPCH Offset *mod* Repetition period, see ref. TS 25.331 [16].

IE/Group Name	Presence	Range	IE Type and Reference	Semantics Description
CHOICE <i>Offset Type</i>				
> <i>Initial Offset</i>				
>>TDD DPCH Offset Value	M		INTEGER (0..255)	
> <i>No Initial Offset</i>				
>>TDD DPCH Offset Value	M		INTEGER (0..63)	

9.2.3.8B TDD DCHs To Modify

The *TDD DCHs To Modify* IE provides information for DCHs to be modified.

IE/Group Name	Presence	Range	IE Type and Reference	Semantics Description	Criticality	Assigned Criticality
TDD DCHs To Modify		<i>1..<maxno ofDCHs></i>			–	
>UL FP Mode	O		9.2.1.67		–	
>ToAWS	O		9.2.1.58		–	
>ToAWE	O		9.2.1.57		–	
>Transport Bearer Request Indicator	M		9.2.1.61		–	
>DCH Specific Info		<i>1..<maxno ofDCHs></i>			–	
>>DCH ID	M		9.2.1.16		–	
>>CCTrCH ID	O		9.2.3.2	UL CCTrCH in which the DCH is mapped.	–	
>>CCTrCH ID	O		9.2.3.2	DL CCTrCH in which the DCH is mapped	–	
>>Transport Format Set	O		9.2.1.64	For the UL.	–	
>>Transport Format Set	O		9.2.1.64	For the DL.	–	
>>Allocation/Retention Priority	O		9.2.1.1		–	
>>Frame Handling Priority	O		9.2.1.29		–	
>>Guaranteed Rate Information	O		9.2.1.30M		YES	ignore
>>Traffic Class	O		9.2.1.58A		YES	ignore
>TNL QoS	O		9.2.1.56A		YES	ignore

Range bound	Explanation
<i>maxnoofDCHs</i>	Maximum number of DCHs for one UE.

9.2.3.8C TDD DL Code Information

The *TDD DL Code Information* IE provides TDD DL Code information for all DPCHs of one DL Time Slot.

IE/Group Name	Presence	Range	IE Type and Reference	Semantics Description	Criticality	Assigned Criticality
TDD DL Code Information		<i>1..<maxno OfDPCHs ></i>			–	
>DPCH ID	M		9.2.3.3		–	
>TDD Channelisation Code	M		9.2.3.8		–	

Range bound	Explanation
<i>maxnoofDPCHs</i>	Maximum number of DPCHs for one CCTrCH.

9.2.3.8D TDD DL Code Information LCR

The *TDD DL Code Information LCR* IE provides DL Code information for the RL for 1.28Mcps TDD.

IE/Group Name	Presence	Range	IE Type and Reference	Semantics Description	Criticality	Assigned Criticality
TDD DL Code Information LCR		1 .. < <i>maxnoOfDPCHLCR</i> >			–	
>DPCH ID	M		9.2.3.5		–	
>TDD Channelisation Code LCR	M		9.2.3.8a		–	
> TDD DL DPCH Time Slot Format LCR	M		9.2.3.8E		–	

Range bound	Explanation
<i>maxnoOfDPCHLCR</i>	Maximum number of DPCH in one CCTrCH for 1.28Mcps TDD

9.2.3.8E TDD DL DPCH Time Slot Format LCR

TDD DL DPCH Time Slot Format LCR indicates the time slot formats used in DL DPCH for 1.28Mcps TDD (see ref. TS 25.221 [12]).

IE/Group Name	Presence	Range	IE type and reference	Semantics description
<i>CHOICE Modulation</i>				
> <i>QPSK</i>				
>>QPSK TDD DL DPCH TimeSlot Format LCR	M		INTEGER (0..24,...)	
> <i>8PSK</i>				
>>8PSK TDD DL DPCH TimeSlot Format LCR	M		INTEGER (0..24,...)	

9.2.3.9 TDD Physical Channel Offset

The TDD Physical Channel Offset represents the phase information for the allocation of a non DPCH physical channel. (CFN mod Repetition Period = TDD Physical Channel Offset) see ref. TS 25.331 [16].

IE/Group Name	Presence	Range	IE Type and Reference	Semantics Description
TDD Physical Channel Offset			INTEGER (0..63)	

9.2.3.10 TDD TPC Downlink Step Size

This parameter indicates step size for the DL power adjustment (see ref TS 25.224 [22]).

IE/Group Name	Presence	Range	IE Type and Reference	Semantics Description
TDD TPC Downlink Step Size			ENUMERATED(1, 2, 3,...)	Unit: dB

9.2.3.10a TDD TPC Uplink Step Size

This parameter indicates step size for the UL power adjustment (see ref TS 25.224 [22]).

IE/Group Name	Presence	Range	IE Type and Reference	Semantics Description
TDD TPC Uplink Step Size			ENUMERATED (1, 2, 3,...)	Unit: dB

9.2.3.10A TDD UL Code Information

The *TDD UL Code Information* IE provides TDD UL Code information for all DPCHs of one UL Time Slot.

IE/Group Name	Presence	Range	IE Type and Reference	Semantics Description	Criticality	Assigned Criticality
TDD UL Code Information		1..<maxno OfDPCHs >			–	
>DPCH ID	M		9.2.3.3		–	
>TDD Channelisation Code	M		9.2.3.8		–	

Range bound	Explanation
<i>maxnoOfDPCHs</i>	Maximum number of DPCHs for one CCTrCH.

9.2.3.10B TDD UL Code Information LCR

The *TDD UL Code Information LCR* IE provides information for UL Code to be established for 1.28Mcps TDD.

IE/Group Name	Presence	Range	IE Type and Reference	Semantics Description	Criticality	Assigned Criticality
TDD UL Code Information LCR		1 .. <maxno OfDPCH LCR>			–	
>DPCH ID	M		9.2.3.5		–	
>TDD Channelisation Code LCR	M		9.2.3.8a		–	
> TDD UL DPCH Time Slot Format LCR	M		9.2.3.10C		–	

Range bound	Explanation
<i>maxnoOfDPCHLCR</i>	Maximum number of DPCH in one CCTrCH for 1.28Mcps TDD.

9.2.3.10C TDD UL DPCH Time Slot Format LCR

TDD UL DPCH Time Slot Format LCR indicates the time slot formats used in UL DPCH for 1.28Mcps TDD (see ref. TS 25.221 [12]).

IE/Group Name	Presence	Range	IE type and reference	Semantics description
CHOICE <i>Modulation</i>				
> <i>QPSK</i>				
>>QPSK TDD UL DPCH Time Slot Format LCR	M		INTEGER (0..69,...)	
> <i>8PSK</i>				
>>8PSK TDD UL DPCH Time Slot Format LCR	M		INTEGER (0..24,...)	

9.2.3.10D 1.28 Mcps TDD uplink physical channel capability

1.28 Mcps TDD uplink physical channel capability IE defines the UE uplink physical channel capability for 1.28 Mcps TDD.

IE/Group Name	Presence	Range	IE Type and Reference	Semantics Description
Maximum Number of timeslots per subframe	M		INTEGER (1..6)	
Maximum number of physical channels per timeslot	M		ENUMERATED (1,2,3,4...)	

9.2.3.11 TFCI Coding

The TFCI Coding describes how the TFCI bits are coded. By default 1 TFCI bit is coded with 4 bits, 2 TFCI bits are coded with 8 bits, 3-5 TFCI bits are coded with 16 bits and 6-10 TFCI bits are coded with 32 bits.

IE/Group Name	Presence	Range	IE Type and Reference	Semantics Description
TFCI Coding			ENUMERATED (4, 8, 16, 32,...)	

9.2.3.12 DL Timeslot ISCP

DL Timeslot ISCP is the measured interference in a downlink timeslot at the UE, see ref. TS 25.225 [14].

IE/Group Name	Presence	Range	IE Type and Reference	Semantics Description
DL Timeslot ISCP			INTEGER(0..91)	According to mapping in TS 25.123 [24].

9.2.3.12a Time Slot LCR

The Time Slot LCR is the number of the traffic time slot within a 5 ms subframe of LCR TDD.

IE/Group Name	Presence	Range	IE Type and Reference	Semantics Description
Time Slot LCR			INTEGER (0..6)	

9.2.3.12A Timing Advance Applied

Defines the need for Timing Advance functions such as Rx Timing Deviation measurement in a particular cell.

IE/Group Name	Presence	Range	IE Type and Reference	Semantics Description
Timing Advance Applied			ENUMERATED(Yes, No)	

9.2.3.13 Transport Format Management

Defines whether the cell transmits the transport format information via broadcast or whether the transport format information is transmitted to the UE using dedicated RRC procedures

IE/Group Name	Presence	Range	IE Type and Reference	Semantics Description
Transport Format Management			ENUMERATED(Cell Based, UE Based,...)	

9.2.3.13A UL Timeslot ISCP

UL Timeslot ISCP is the measured interference in a uplink timeslot at the DRNS, see ref. TS 25.225 [14].

IE/Group Name	Presence	Range	IE Type and Reference	Semantics Description
UL Timeslot ISCP			INTEGER(0..127)	According to mapping in TS 25.123 [24].

9.2.3.13B UL PhysCH SF Variation

Indicates whether variation of SF in UL is supported by Radio Link or not.

IE/Group Name	Presence	Range	IE Type and Reference	Semantics Description
UL PhysCH SF Variation			ENUMERATED(SF_Variation_supported, SF_Variation_NOT_supported)	

9.2.3.13C UL Timeslot Information

The *UL Timeslot Information* IE provides information on the time slot allocation for a UL DPCH.

IE/Group Name	Presence	Range	IE Type and Reference	Semantics Description	Criticality	Assigned Criticality
UL Timeslot Information		<i>1..<maxno OFTS></i>			–	
>Time Slot	M		9.2.1.56		–	
>Midamble Shift And Burst Type	M		9.2.3.4		–	
>TFCI Presence	M		9.2.1.55		–	
>UL Code Information	M		TDD UL Code Information 9.2.3.10A		–	

Range bound	Explanation
<i>maxnoofTs</i>	Maximum number of Timeslots for a UE.

9.2.3.13D UL Time Slot ISCP Info

The *UL Time Slot ISCP Info* IE gives interference level for each UL time slot within the Radio Link.

IE/Group Name	Presence	Range	IE Type and Reference	Semantics Description	Criticality	Assigned Criticality
UL Time Slot ISCP Info		1 .. < <i>maxnoof ULts</i> >			–	
>Time Slot	M		9.2.1.56		–	
>UL Timeslot ISCP	M		9.2.3.13A		–	

Range bound	Explanation
<i>maxnoofULts</i>	Maximum number of uplink time slots per Radio Link.

9.2.3.13E TSTD Indicator

Indicates if TSTD shall be active or not for the DL DPCH.

IE/Group Name	Presence	Range	IE Type and Reference	Semantics Description
TSTD Indicator			ENUMERATED(active, inactive)	

9.2.3.13F TSTD Support Indicator

Indicates if UE support TSTD or not for DL DPCH.

IE/Group Name	Presence	Range	IE Type and Reference	Semantics Description
TSTD Support Indicator			ENUMERATED(TSTD supported, TSTD not supported)	

9.2.3.13Fa UE Measurement Hysteresis Time

The UE Measurement Hysteresis Time provides the duration during which a reporting criterion has to be fulfilled for the UE Measurement Reporting procedure to be triggered, see TS 25.331 [16].

IE/Group Name	Presence	Range	IE Type and Reference	Semantics Description
UE Measurement Hysteresis Time			INTEGER(0..15)	Unit: dB Range: 0..7.5 dB Step: 0.5 dB

9.2.3.13Fb UE Measurement Parameter Modification Allowed

Indicates if the SRNC may modify the UE measurement parameters based on its existing measurement schedule.

IE/Group Name	Presence	Range	IE Type and Reference	Semantics Description
UE Measurement Parameter Modification Allowed			ENUMERATED (Parameter Modification Allowed, ...)	

9.2.3.13Fc UE Measurement Report Characteristics

The UE Measurement Report Characteristics, defines how the reporting shall be performed. For definition of the event criteria see TS 25.331 [16].

IE/Group Name	Presence	Range	IE Type and Reference	Semantics Description
<i>CHOICE UE Report Characteristics</i>				
<i>>Periodic</i>				
<i>>>Amount of Reporting</i>	M		ENUMERATED(1, 2, 4, 8, 16, 32, 64, infinity)	
<i>>>Reporting Interval</i>	M		ENUMERATED (250, 500, 1000, 2000, 3000, 4000, 6000, 8000, 12000, 16000, 20000, 24000, 28000, 32000, 64000)	Indicates the interval of periodical report interval in milliseconds
<i>>Event 1h</i>				
<i>>>UE Measurement Threshold</i>	M		9.2.3.13Fd	The threshold for which the DRNS shall trigger a measurement report.
<i>>>UE Measurement Time to Trigger</i>	M		9.2.3.13Fg	
<i>>>Hysteresis</i>	M		9.2.3.13Fa	
<i>>Event 1i</i>				
<i>>>UE Measurement Threshold</i>	M		9.2.3.13Fd	The threshold for which the DRNS shall trigger a measurement report.
<i>>>UE Measurement Time to Trigger</i>	M		9.2.3.13Fg	
<i>>>Hysteresis</i>	M		9.2.3.13Fa	
<i>>Event 6a</i>				
<i>>>UE Measurement Threshold</i>	M		9.2.3.13Fd	
<i>>>UE Measurement Time to Trigger</i>	M		9.2.3.13Fg	
<i>>Event 6b</i>				
<i>>>UE Measurement Threshold</i>	M		9.2.3.13Fd	
<i>>>UE Measurement Time to Trigger</i>	M		9.2.3.13Fg	
<i>>Event 6c</i>				
<i>>>UE Measurement Time to Trigger</i>	M		9.2.3.13Fg	
<i>>Event 6d</i>				
<i>>>UE Measurement Time to Trigger</i>	M		9.2.3.13Fg	

9.2.3.13Fd UE Measurement Threshold

The Measurement Threshold defines which threshold that shall trigger Event 1h, 1i, 6a or 6b, see TS 25.331 [16].

IE/Group Name	Presence	Range	IE Type and Reference	Semantics Description
CHOICE <i>UE Measurement Threshold</i>				
> <i>Timeslot ISCP</i>				
>>Timeslot ISCP	M		INTEGER (-115..-25)	In dBm
> <i>UE Tx Power</i>				
>>UE Transmitted Power	M		INTEGER(-50..33)	In dBm

9.2.3.13Fe UE Measurement Timeslot Information HCR

The *UE Measurement Time Slot Information* IE provides information for DL timeslots for the UE to measure, see TS 25.331 [16].

IE/Group Name	Presence	Range	IE Type and Reference	Semantics Description
UE Measurement Timeslot Information		1..<maxnoOfTS>		
>Time Slot	M		9.2.1.56	
>Burst Type	M		ENUMERATED(Type1, Type 2, Type 3,...)	

Range bound	Explanation
maxnoOfTSs	Maximum number of Timeslots for a UE for 3.84Mcps TDD.

9.2.3.13Ff UE Measurement Timeslot Information LCR

The *UE Measurement Time Slot Information LCR* IE provides information for DL timeslots for the UE to measure, see TS 25.331 [16].

IE/Group Name	Presence	Range	IE Type and Reference	Semantics Description
UE Measurement Time Slot Information LCR		1 .. <maxnoOfTSLCR >		
>Time Slot LCR	M		9.2.3.12a	

Range bound	Explanation
maxnoOfTSLCR	Maximum number of Timeslots for a UE for 1.28Mcps TDD

9.2.3.13Fg UE Measurement Time to Trigger

The UE time to trigger indicates the period of time between the timing of event detection and the timing of sending Measurement Report, see TS 25.331 [16].

IE/Group Name	Presence	Range	IE Type and Reference	Semantics Description
UE Measurement Time to trigger	M		ENUMERATED(0, 10, 20, 40, 60, 80, 100, 120,	Time in ms.

			160, 200, 240, 320, 640, 1280, 2560, 5000)	
--	--	--	---	--

9.2.3.13Fh UE Measurement Type

The UE Measurement Type identifies the type of measurement that shall be performed see TS 25.331 [16].

IE/Group Name	Presence	Range	IE Type and Reference	Semantics Description
UE Measurement Type	M		ENUMERATED(Primary CCPCH RSCP, DL Timeslot ISCP, UE Transmitted Power,...)	

9.2.3.13Fi UE Measurement Value

The UE Measurement Value shall be the most recent value for this measurement, for which the reporting criteria were met.

IE/Group Name	Presence	Range	IE Type and Reference	Semantics Description
CHOICE UE Measurement Value	M			
>UE Transmitted Power				
>>UE Transmitted Power list HCR		0..<maxnoOfTS>		Mandatory for 3.84Mcps TDD, not applicable to 1.28Mcps TDD or 7.68Mcps TDD
>>>Time Slot	M		9.2.1.56	
>>>UE Transmitted Power	M		INTEGER (0..104)	According to mapping in TS 25.123 [24] Values 0..20 are not used
>>UE Transmitted Power list LCR		0..<maxnoOfTSLCR>		Mandatory for 1.28Mcps TDD, not applicable to 3.84Mcps TDD or 7.68Mcps TDD
>>>Time Slot LCR	M		9.2.3.12a	
>>>UE Transmitted Power	M		INTEGER (0..104)	According to mapping in TS 25.123 [24] Values 0..20 are not used
>>UE Transmitted Power list 768		0..<maxnoOfTS>		Mandatory for 7.68Mcps TDD, not applicable to 1.28Mcps TDD or 3.84Mcps TDD
>>>Time Slot	M		9.2.1.56	
>>>UE Transmitted Power	M		INTEGER (0..104)	According to mapping in TS 25.123 [24] Values 0..20 are not used
>P-CCPCH RSCP				
>>Primary CCPCH RSCP	O		9.2.3.5	According to mapping in TS 25.123 [24]
>>Primary CCPCH RSCP Delta	O		9.2.3.5a	According to mapping in TS 25.123 [24]
>DL Timeslot ISCP				
>>Timeslot list HCR		0..<maxnoOfTS>		Mandatory for 3.84Mcps TDD, not applicable to 1.28Mcps TDD or 7.68Mcps TDD
>>>Time Slot	M		9.2.1.56	
>>>Timeslot	M		9.2.3.12	

ISCP				
>>Timeslot list LCR		<i>0..<maxnoOfTSLCR></i>		Mandatory for 1.28Mcps TDD, not applicable to 3.84Mcps TDD or 7.68Mcps TDD
>>>Time Slot LCR	M		9.2.3.12a	
>>>Timeslot ISCP	M		9.2.3.12	
>>Timeslot list 768		<i>0..<maxnoOfTS></i>		Mandatory for 7.68Mcps TDD, not applicable to 1.28Mcps TDD or 3.84Mcps TDD
>>>Time Slot	M		9.2.1.56	
>>>Timeslot ISCP	M		9.2.3.12	

Range bound	Explanation
<i>maxnoOfTS</i>	Maximum number of Timeslots for a UE for 3.84Mcps TDD or 7.68Mcps TDD.
<i>maxnoofTSLCR</i>	Maximum number of Timeslots for a UE for 1.28Mcps TDD.

9.2.3.13Fj UE Measurement Value Information

The *UE Measurement Value Information* IE provides information both on whether or not the UE Measurement Value is provided in the message and if provided also the UE Measurement Value itself.

IE/Group Name	Presence	Range	IE Type and Reference	Semantics Description
CHOICE <i>Measurement Availability Indicator</i>	M			
> <i>Measurement Available</i>				
>>UE Measurement Value	M		9.2.3.13Fi	
> <i>Measurement not Available</i>			NULL	

9.2.3.13G UL Timeslot Information LCR

The *UL Timeslot Information LCR* IE provides information on the timeslot allocation for an UL DPCH.

IE/Group Name	Presence	Range	IE Type and Reference	Semantics Description	Criticality	Assigned Criticality
UL Timeslot Information LCR		<i>1 .. <maxnoofULtsLCR></i>			–	
>Time Slot LCR	M		9.2.3.12a		–	
>Midamble Shift LCR	M		9.2.3.4C		–	
>TFCI Presence	M		9.2.1.57		–	
>UL Code Information LCR	M		TDD UL Code Information LCR 9.2.3.10B			
>PLCCH Information	O		9.2.3.17		YES	ignore

Range bound	Explanation
<i>maxnoofULtsLCR</i>	Maximum number of Uplink time slots per Radio Link for 1.28Mcps TDD.

9.2.3.13H UL Time Slot ISCP Info LCR

The *UL Time Slot ISCP Info LCR* IE provides information for UL Interference level for each time slot within the Radio Link for 1.28Mcps TDD.

IE/Group Name	Presence	Range	IE Type and Reference	Semantics Description	Criticality	Assigned Criticality
UL Time Slot ISCP Info		1 .. <maxnoofUL tsLCR>			–	
>Time Slot LCR	M		9.2.3.12a		–	
>UL Timeslot ISCP	M		9.2.3.26A		–	

Range bound	Explanation
<i>maxnoofULtsLCR</i>	Maximum number of Uplink time slots per Radio Link for 1.28Mcps TDD

9.2.3.13I Uplink Synchronisation Frequency

The *UL Synchronisation Frequency* IE specifies the frequency of the adjustment of the uplink transmission timing.

IE/Group Name	Presence	Range	IE Type and Reference	Semantics Description
Uplink synchronisation frequency			INTEGER (1..8)	Unit: subframe, step: 1

9.2.3.13J Uplink Synchronisation Step Size

The *UL Synchronisation Step Size* IE specifies the step size to be used for the adjustment of the uplink transmission timing.

IE/Group Name	Presence	Range	IE Type and Reference	Semantics Description
Uplink synchronisation step size			INTEGER (1..8)	Unit: 1/8 chip, step: 1.

9.2.3.13K Uplink Timing Advance Control LCR

The Uplink Timing Advance Control LCR indicates the parameters which are used to support Uplink Synchronisation for the UE in 1.28Mcps TDD.

IE/Group Name	Presence	Range	IE Type and Reference	Semantics Description
SYNC UL codes bitmap	M		BITSTRING (8)	Each bit indicates the availability of a SYNC_UL code.
FPACH info		1		
>Time Slot LCR	M		9.2.3.12a	
>TDD Channelisation Code LCR	M		9.2.3.8a	
>Midamble Shift LCR	M		9.2.3.4C	
>WT	M		INTEGER (1..4)	Maximum number of subframes to wait for transmission of FPACH.
PRXupPCHdes	M		INTEGER (-120 .. -58, ...)	Desired UpPCH receive power. Unit: dBm Step size: 1
SYNC UL procedure parameters		1		
>Maximum Sync UL transmissions	M		ENUMERATED (1,2,4,8,...)	
>Power Ramp Step	M		INTEGER (0..3, ...)	
Mmax	M		INTEGER (1..32)	Maximum number of synchronisation attempts

9.2.3.13L USCH ID

The USCH ID is the identifier of an uplink shared channel. It is unique among the USCHs simultaneously allocated for the same UE.

IE/Group Name	Presence	Range	IE Type and Reference	Semantics Description
USCH ID			INTEGER (0..255)	

9.2.3.14 USCH Information

The *USCH Information* IE provides information for USCHs to be established.

IE/Group Name	Presence	Range	IE Type and Reference	Semantics Description	Criticality	Assigned Criticality
USCH Information		1 to <maxnoofUSCHs>			–	
>USCH ID	M		9.2.3.14		–	
>CCTrCH ID	M		9.2.3.2	UL CCTrCH in which the USCH is mapped	–	
>TrCH Source Statistics Descriptor	M		9.2.1.65		–	
>Transport Format Set	M		9.2.1.64	For USCH	–	
>Allocation/Retention Priority	M		9.2.1.1		–	
>Scheduling Priority Indicator	M		9.2.1.51A		–	
>RB Info		1..<maxnoofRB>		All Radio Bearers using this USCH	–	
>>RB Identity	M		9.2.3.5B		–	
>Traffic class	M		9.2.1.58A		YES	ignore
>Binding ID	O		9.2.1.3	Shall be ignored if bearer establishment with ALCAP.	YES	ignore
>Transport Layer Address	O		9.2.1.62	Shall be ignored if bearer establishment with ALCAP.	YES	ignore
>TNL QoS	O		9.2.1.56A		YES	ignore

Range bound	Explanation
<i>maxnoofUSCHs</i>	Maximum number of USCHs for one UE.
<i>maxnoofRBs</i>	Maximum number of Radio Bearers for one UE.

9.2.3.16 Support of PLCCH

The *Support of PLCCH* IE indicates whether PLCCH is supported or not.

IE/Group Name	Presence	Range	IE Type and Reference	Semantics Description
Support of PLCCH			ENUMERATED(supported)	

9.2.3.17 PLCCH Information

The *PLCCH Information* IE carries a PLCCH assignment for a timeslot of an UL DCH-type CCTrCH.

IE/Group Name	Presence	Range	IE Type and Reference	Semantics Description
TDD Channelisation Code	M		9.2.3.8	Only QPSK modulation is used with PLCCH
Time Slot LCR	M		9.2.3.12a	
Midamble Shift LCR	M		9.2.3.4C	
PLCCH Sequence Number	M		9.2.3.18	

9.2.3.18 PLCCCH Sequence Number

This sequence number represents a portion of a PLCCCH used to signal TPC / SS bits to a single UE. A value of zero indicates that the PLCCCH assignment has been deleted.

IE/Group Name	Presence	Range	IE Type and Reference	Semantics Description
PLCCCH Sequence Number			INTEGER (0..14)	

9.2.3.19 Minimum Spreading Factor 7.68Mcps

Defines the minimum spreading factor the UE has the capability of receiving or transmitting for 7.68Mcps TDD.

IE/Group Name	Presence	Range	IE Type and Reference	Semantics Description
Minimum Spreading Factor 768			INTEGER (1..32)	

9.2.3.20 Maximum Number of DL Physical Channels 7.68Mcps

Defines the maximum number of physical channels for 7.68Mcps TDD – per frame that the UE is capable to receive.

IE/Group Name	Presence	Range	IE Type and Reference	Semantics Description
Maximum Number of DL Physical Channels 768			INTEGER (1..448)	

9.2.3.21 Maximum Number of DL Physical Channels per Timeslot 7.68Mcps

Defines the maximum number of physical channels per timeslot that the UE is capable to receive for 7.68 Mcps TDD.

IE/Group Name	Presence	Range	IE Type and Reference	Semantics Description
Maximum Number of DL Physical Channels per Timeslot 768			INTEGER (1..32)	

9.2.3.22 Secondary CCPCH Info 7.68Mcps TDD

The *Secondary CCPCH Info 7.68Mcps TDD* IE provides information on the Secondary CCPCH that carries the logical channel SHCCH for the UE for 7.68Mcps TDD.

IE/Group Name	Presence	Range	IE Type and Reference	Semantics Description	Criticality	Assigned Criticality
TFCs	M		9.2.1.63	For the DL.	–	
TFCI Coding	M		9.2.3.11		–	
Secondary CCPCH		<i>0..<maxno ofSCCPCHs768></i>			–	
>Time Slot	M		9.2.1.56		–	
>Midamble Shift And Burst Type 7.68Mcps	M		9.2.3.23		–	
>TFCI Presence	M		9.2.1.55		–	
>Secondary CCPCH TDD Code Information 7.68Mcps	M		9.2.3.24		–	
>TDD Physical Channel Offset	M		9.2.3.9		–	
>Repetition Length	M		9.2.3.6		–	
>Repetition Period	M		9.2.3.7		–	
FACH		0..maxno ofFACHs			–	
>TFS	M		9.2.1.64	For the DL.	–	
PCH		0..1			–	
>TFS	M		9.2.1.64	For the DL.	–	

Range bound	Explanation
<i>maxnoofSCCPCHs768</i>	Maximum number of Secondary CCPCHs per CCTrCH.
<i>maxnoofFACHs</i>	Maximum number of FACHs mapped onto a Secondary CCPCH.

9.2.3.23 Midamble Shift And Burst Type 7.68Mcps

This information element indicates burst type and midamble allocation for 7.68Mcps TDD.

Three different midamble allocation schemes exist:

- Default midamble: the midamble is allocated by layer 1 depending on the associated channelisation code (DL and UL);
- Common midamble: the midamble is allocated by layer 1 depending on the number of channelisation codes (possible in DL only);
- UE specific midamble: a UE specific midamble is explicitly assigned (DL and UL).

IE/Group Name	Presence	Range	IE Type and Reference	Semantics Description
CHOICE <i>Burst Type</i>				
> <i>Type 1</i>				
>> Midamble Configuration Burst Type 1 And 3	M		ENUMERATED(4, 8, 16)	As defined in TS 25.221 [12]
>>Midamble Allocation Mode	M		ENUMERATED(Default midamble, Common midamble, UE specific midamble)	
>>Midamble Shift Long	C-UE		INTEGER(0..15)	
> <i>Type 2</i>				
>> Midamble Configuration Burst Type 2	M		ENUMERATED (4, 8)	As defined in TS 25.221 [12]
>>Midamble Allocation Mode	M		ENUMERATED(Default midamble, Common midamble, UE specific midamble)	
>>Midamble Shift Short	C-UE		INTEGER (0..7)	
> <i>Type 3</i>				
>> Midamble Configuration Burst Type 1 And 3	M		ENUMERATED (4, 8, 16)	As defined in TS 25.221 [12]
>>Midamble Allocation Mode	M		ENUMERATED(Default midamble, UE specific midamble)	
>>Midamble Shift Long	C-UE		INTEGER(0..15)	

Condition	Explanation
UE	The IE shall be present if the <i>Midamble Allocation Mode</i> IE is set to "UE-specific midamble".

9.2.3.24 Secondary CCPCH TDD Code Information 7.68Mcps

The *Secondary CCPCH TDD Code Information 7.68Mcps* IE provides TDD Channelisation Code information for all SCCPCHs of one Time Slot for 7.68Mcps TDD.

IE/Group Name	Presence	Range	IE Type and Reference	Semantics Description	Criticality	Assigned Criticality
Secondary CCPCH TDD Code Information 7.68Mcps		<i>1..<maxno OfSCCPC Hs768></i>			-	
>TDD Channelisation Code 7.68Mcps	M		9.2.3.25		-	

Range bound	Explanation
<i>maxnoofSCCPCs768</i>	Maximum number of SCCPCHs for one CCTrCH.

9.2.3.25 TDD Channelisation Code 7.68Mcps

The Channelisation Code Number indicates which Channelisation Code is used for a given Physical Channel. In 7.68Mcps TDD the Channelisation Code is an Orthogonal Variable Spreading Factor code that can have a spreading factor of 1, 2, 4, 8, 16 or 32.

IE/Group Name	Presence	Range	IE Type and Reference	Semantics Description
TDD Channelisation Code			ENUMERATED((1/1), (2/1), (2/2), (4/1), .. (4/4), (8/1), .. (8/8), (16/1), .. (16/16), (32/1), .. (32,32),...)	

9.2.3.26 UL Timeslot Information 7.68Mcps

The *UL Timeslot Information* IE provides information on the time slot allocation for a UL DPCH for 7.68Mcps TDD.

IE/Group Name	Presence	Range	IE Type and Reference	Semantics Description	Criticality	Assigned Criticality
UL Timeslot Information		<i>1..<maxno OFTS></i>			–	
>Time Slot	M		9.2.1.56		–	
>Midamble Shift And Burst Type 7.68Mcps	M		9.2.3.23		–	
>TFCI Presence	M		9.2.1.55		–	
>UL Code Information 7.68Mcps	M		TDD UL Code Information 7.68Mcps 9.2.3.27		–	

Range bound	Explanation
<i>maxnoofTSs</i>	Maximum number of Timeslots for a UE.

9.2.3.27 TDD UL Code Information 7.68Mcps

The *TDD UL Code Information 7.68Mcps* IE provides TDD UL Code information for all DPCHs of one UL Time Slot for 7.68Mcps TDD.

IE/Group Name	Presence	Range	IE Type and Reference	Semantics Description	Criticality	Assigned Criticality
TDD UL Code Information		<i>1..<maxno OfDPCHs 768></i>			–	
>DPCH ID	M		9.2.3.3		–	
>TDD Channelisation Code 7.68Mcps	M		9.2.3.25		–	

Range bound	Explanation
<i>maxnoofDPCHs768</i>	Maximum number of DPCHs for one CCTrCH.

9.2.3.28 DL Timeslot Information 7.68Mcps

The *DL Timeslot Information 7.68Mcps* IE provides information on the time slot allocation for a DL DPCH for 7.68Mcps TDD.

IE/Group Name	Presence	Range	IE Type and Reference	Semantics Description	Criticality	Assigned Criticality
DL Timeslot Information		<i>1..<maxno OfTS></i>			–	
>Time Slot	M		9.2.1.56		–	
>Midamble Shift And Burst Type 7.68Mcps	M		9.2.3.23		–	
>TFCI Presence	M		9.2.1.55		–	
>DL Code Information 7.68Mcps	M		TDD DL Code Information 7.68Mcps 9.2.3.29		–	

Range bound	Explanation
<i>maxnoofTSs</i>	Maximum number of Timeslots for a UE.

9.2.3.29 TDD DL Code Information 7.68Mcps

The *TDD DL Code Information* IE provides TDD DL Code information for all DPCHs of one DL Time Slot for 7.68Mpc TDD.

IE/Group Name	Presence	Range	IE Type and Reference	Semantics Description	Criticality	Assigned Criticality
TDD DL Code Information		<i>1..<maxno OfDPCHs 768></i>			–	
>DPCH ID	M		9.2.3.3		–	
>TDD Channelisation Code 7.68Mcps	M		9.2.3.25		–	

Range bound	Explanation
<i>maxnoofDPCHs768</i>	Maximum number of DPCHs for one CCTrCH.

9.2.3.30 Rx Timing Deviation 7.68Mcps

Measured Rx Timing Deviation as a basis for timing advance, either measured directly from a RACH burst, or calculated from the Rx Timing Deviation measurement on the USCH by adding the current Timing Advance value..

IE/Group Name	Presence	Range	IE Type and Reference	Semantics Description
Rx Timing Deviation			INTEGER (0..1023)	As specified in TS 25.435 [5]

9.2.3.31 Cell Capability Container 7.68 Mcps TDD

The Cell Capability Container 7.68 McpsTDD indicates which functionalities a cell supports.

IE/Group Name	Presence	Range	IE Type and Reference	Semantics Description
Cell Capability Container TDD			BIT STRING (32)	Each bit indicates whether a cell supports a particular functionality or not. The value 1 of a bit indicates that the corresponding functionality is supported in a cell and value 0 indicates that the corresponding functionality is not supported in a cell. Each bit is defined as follows. The first bit: Delayed Activation Support Indicator. The second bit: HS-DSCH Support Indicator. The third bit: DSCH Support Indicator. The fourth bit: Flexible MAC-d PDU Size Support Indicator. Note that undefined bits are considered as a spare bit and spare bits shall be set to 0 by the transmitter and shall be ignored by the receiver.

9.2.3.32 Neighbouring TDD Cell Measurement Information 7.68Mcps

This IE provides information on the 7.68Mcps TDD neighbouring cells used for the purpose of Measurements. Since the measurement can be performed on every time slot and midamble shift, the *Time slot* IE and *Midamble shift and burst type* IE shall be included if available.

IE/Group Name	Presence	Range	IE Type and Reference	Semantics Description
UTRAN Cell Identifier	M		9.2.1.71	
UARFCN	M		9.2.1.66	Corresponds to Nt TS 25.304 [15]
Cell Parameter ID	M		9.2.1.8	
Time slot	O		9.2.1.56	
Midamble Shift And Burst Type 7.68Mcps	O		9.2.3.23	

9.2.3.33 UE Measurement Timeslot Information 7.68Mcps

The *UE Measurement Time Slot Information* IE provides information for DL timeslots for the UE to measure, see TS 25.331 [16].

IE/Group Name	Presence	Range	IE Type and Reference	Semantics Description
UE Measurement Timeslot Information		1..<maxnoOfTS>		
>Time Slot	M		9.2.1.56	
>Burst Type	M		ENUMERATED (Type1, Type 2, Type 3,...)	

Range bound	Explanation
maxnoOfTSs	Maximum number of Timeslots for a UE for 7.68Mcps TDD.

9.2.3.34 DPCH ID 7.68Mcps

The *DPCH ID 7.68Mcps* identifies unambiguously a DPCH inside a downlink Radio Link for 7.68Mcps TDD.

IE/Group Name	Presence	Range	IE Type and Reference	Semantics Description
DPCH ID			INTEGER (0..479)	

9.2.3.35 Rx Timing Deviation 3.84Mcps Extended

Measured Rx Timing Deviation as a basis for timing advance, either measured directly from a RACH burst, or calculated from the Rx Timing Deviation measurement on the USCH by adding the current Timing Advance value. This is used when the extended timing advance is in use at 3.84 Mcps.

IE/Group Name	Presence	Range	IE Type and Reference	Semantics Description
Rx Timing Deviation			INTEGER (0..511)	As specified in TS 25.435 [5]

9.2.3.36 E-PUCH Information

The *E-PUCH Information* IE provides parameters to configure the E-PUCH physical channel for 3.84Mcps TDD and 7.68 Mcps TDD.

IE/Group Name	Presence	Range	IE Type and Reference	Semantics Description
Minimum code rate	M		INTEGER (0..63)	Unit: - Range: 0.055 ..1 Step: 0.015
Maximum code rate	M		INTEGER (0..63)	Unit: - Range: 0.055 ..1 Step: 0.015
HARQ Info for E-DCH	M		ENUMERATED (rv0, rvtable)	"rv0" indicates that the UE will only use E_DCH RV index 0. "rvtable" indicates that the UE will use an RSN based RV index as specified in TS 25.211 [8]
N _{E-UCCH}	M		INTEGER (1..12)	Number of slots that are required to carry TPC and TFCI (consecutively allocated slots beginning with the first).

9.2.3.36a E-PUCH Information LCR

The *E-PUCH Information LCR* IE provides parameters to configure the E-PUCH physical channel for 1.28Mcps TDD.

IE/Group Name	Presence	Range	IE Type and Reference	Semantics Description	Criticality	Assigned Criticality
Minimum code rate	M		INTEGER (0..63)	Unit: - Range: 0.055..1 Step: 0.015	–	
Maximum code rate	M		INTEGER (0..63)	Unit: - Range: 0.055..1 Step: 0.015	–	
HARQ Info for E-DCH	M		ENUMERATED (rv0, rvtable)	“rv0” indicates that the UE will only use E_DCH RV index 0. “rvtable” indicates that the UE will use an RSN based RV index as specified in TS 25.211 [8]	–	
PRXdes_base	M		INTEGER (-112..-50)	dBm. Reference Desired RX power level for E-PUCH	–	
E-PUCH TPC Step Size	M		9.2.3.10a		–	
N _{E-UCCH}	M		INTEGER (1..8)	Number of E-UCCH and TPC instances within an E-DCH TTI. Details are described in TS 25.221 [12].	–	
E-PUCH Power Control GAP	O		INTEGER (1..255)	Unit: Number of subframes. Reference to E-PUCH Power Control for 1.28Mcps TDD in TS 25.224 [22]. If it is not present, UE shall deem it to be infinite in which case closed loop power control shall always be used.	YES	ignore

9.2.3.37 E-TFCS Information TDD

Whereas the related E-DCH Transport Block sizes are standardised in TS 25.425 [32] this IE gives details on the Reference Betas.

IE/Group Name	Presence	Range	IE Type and Reference	Semantics Description
Reference Beta Information QPSK		1..<maxnoofRefbetas>		
>Reference Code Rate	M		INTEGER (0..10)	Unit: - Range: 0..1 Step: 0.1
>Reference Beta	M		INTEGER(-15..16)	Unit: - Range: -15..+16 Step: 1 dB
Reference Beta Information 16QAM		1..<maxnoofRefbetas>		
>Reference Code Rate	M		INTEGER (0..10)	Unit: - Range: 0..1 Step: 0.1
>Reference Beta	M		INTEGER(-15..16)	Unit: - Range: -15..+16 Step: 1 dB

Range Bound	Explanation
<i>maxnoofRefbetas</i>	Maximum number of signalled reference betas

9.2.3.38 E-DCH MAC-d Flows Information TDD

The *E-DCH MAC-d Flows Information TDD* IE is used for the establishment of E-DCH MAC-d flows for TDD.

IE/Group Name	Presence	Range	IE Type and Reference	Semantics Description	Criticality	Assigned Criticality
E-DCH MAC-d Flow Specific Information		<i>1..<maxnofEDCHMACdFlows></i>			–	
>E-DCH MAC-d Flow ID	M		9.2.1.91		–	
>Allocation/Retention Priority	M		9.2.1.1		–	
>TNL QoS	O		9.2.1.56A		–	
>Binding ID	O		9.2.1.3	Shall be ignored if bearer establishment with ALCAP.	–	
>Transport Layer Address	O		9.2.1.62	Shall be ignored if bearer establishment with ALCAP.	–	
>Payload CRC Presence Indicator	M		9.2.1.42		–	
>Maximum Number Of Retransmissions For E-DCH	M		9.2.1.100		–	
>E-DCH HARQ Power Offset TDD	M		9.2.3.49		–	
>E-DCH MAC-d Flow Multiplexing List	O		9.2.1.89		–	
>E-DCH Grant Type	M		9.2.3.43		–	
>E-DCH Logical Channel Information	M		9.2.1.92		–	
>E-DCH MAC-d Flow Retransmission Timer	O		9.2.3.49a	Mandatory for LCR TDD. Not applicable for 3.84Mcps TDD and 7.68Mcps TDD.	YES	YES
>Traffic Class	M		9.2.1.58A		YES	ignore

Range Bound	Explanation
<i>maxnofEDCHMACdFlows</i>	Maximum number of E-DCH MAC-d flows

9.2.3.39 E-DCH Non-scheduled Grant Information TDD

The *E-DCH Non-scheduled Grant Information TDD* IE is used to specify the details of a non-scheduled grant for 3.84Mcps and 7.68Mcps TDD.

IE/Group Name	Presence	Range	IE Type and Reference	Semantics Description
Timeslot Resource Related Information	M		9.2.3.44	
Power Resource Related Information	M		9.2.3.45	
Repetition Period	M		9.2.3.6	
Repetition Length	M		9.2.3.7	
TDD E-PUCH Offset	M		9.2.3.46	
TDD Channelisation Code	M		9.2.3.8	

9.2.3.39a E-DCH Non-scheduled Grant Information LCR TDD

The *E-DCH Non-scheduled Grant Information LCR TDD* IE is used to specify the details of an non-scheduled grant for 1.28Mcps TDD.

IE/Group Name	Presence	Range	IE Type and Reference	Semantics Description
Timeslot Resource Related Information LCR	M		9.2.3.44a	
Power Resource Related Information	M		9.2.3.45	
Repetition Period	M		9.2.3.6	
Repetition Length	M		9.2.3.7	
Subframe Number	M		ENUMERATED (0,1)	Used to indicate from which subframe of the Radio Frame indicated by <i>TDD E-PUCH Offset</i> IE the physical resources are assigned to the E-DCH Non-scheduled Grant.
TDD E-PUCH Offset	M		9.2.3.46	
TDD Channelisation Code	M		9.2.3.8	

9.2.3.40 E-DCH TDD Information

The *E-DCH TDD Information* specifies the details of the maximum bit rate and processing overload level.

IE/Group Name	Presence	Range	IE Type and Reference	Semantics Description
E-DCH TDD Maximum Bitrate	O		9.2.3.47	
E-DCH Processing Overload Level	O		9.2.1.95	
E-DCH Power Offset for Scheduling Info	O		9.2.1.96	

9.2.3.40a E-DCH TDD Information LCR

The *E-DCH TDD Information LCR* IE specifies the details of UE physical layer category, NodeB processing overload level and power offset, Maximum Number of Retransmission and E-DCH Retransmission timer for scheduling info. The *E-AGCH Inactivity Monitor Threshold* IE is used for E-AGCH channel monitoring control for scheduled transmission.

IE/Group Name	Presence	Range	IE Type and Reference	Semantics Description	Criticality	Assigned Criticality
E-DCH Physical Layer Category LCR	O		9.2.3.54	If the <i>Extended E-DCH Physical Layer Category LCR</i> IE is included in the <i>E-DCH TDD Information LCR</i> IE, the <i>E-DCH Physical Layer Category LCR</i> IE shall be ignored.	–	
E-DCH Processing Overload Level	O		9.2.1.95		–	
E-DCH Power Offset for Scheduling Info	O		9.2.1.96		–	
Extended E-DCH Physical Layer Category LCR	O		9.2.3.54A	The <i>Extended E-DCH Physical Layer Category LCR</i> IE shall be used if the <i>E-DCH Physical Layer Category</i> has a value larger than 5.	YES	reject
Maximum Number of Retransmission for Scheduling Info LCR	O		9.2.1.100		YES	ignore
E-DCH Retransmission timer for Scheduling Info LCR	O		9.2.3.49a		YES	ignore
E-AGCH Inactivity Monitor Threshold	O		Enumerated (0, 1, 2, 4, 8, 16, 32, 64, 128, 256, 512, spare5, ..., infinity)	Units of subframes.	YES	ignore

9.2.3.41 E-DCH TDD Information Response

The *E-DCH TDD Information Response* IE provides information for E-DCH MAC-d flows that have been established or modified. It also provides additional E-DCH information determined within the Node B.

IE/Group Name	Presence	Range	IE Type and Reference	Semantics Description
E-DCH MAC-d Flow Specific Information Response		$0..<maxnoofEDCHMACdFlows>$		
>E-DCH MAC-d Flow ID	M		9.2.1.91	
>Binding ID	O		9.2.1.3	
>Transport Layer Address	O		9.2.1.62	
E-AGCH Specific Information Response		$0..<maxNoOfEAGCHcodes>$		
>Time Slot	M		9.2.1.56	
>Midamble Shift And Burst Type	M		9.2.3.4	
>TDD Channelisation Code	M		9.2.3.8	
E-HICH Information Response		$0..1$		
>Time Slot	M		9.2.1.56	
>Midamble Shift And Burst Type	M		9.2.3.4	
>TDD Channelisation Code	M		9.2.3.8	
>E-HICH Time Offset	M		9.2.3.48	
E-DCH Non-scheduled Grant Information TDD	O		9.2.3.39	
E-RNTI	O		9.2.1.94	

Range bound	Explanation
$maxnoofEDCHMACdFlows$	Maximum number of MAC-d flows
$maxnoofEAGCHcodes$	Maximum number of E-AGCHs assigned to one UE

9.2.3.41a E-DCH TDD Information Response 1.28Mcps

Only for 1.28Mcps TDD. The *E-DCH TDD Information Response 1.28Mcps* IE provides information for E-DCH MAC-d flows that have been established or modified. It also provides additional E-DCH information determined within the Node B.

IE/Group Name	Presence	Range	IE Type and Reference	Semantics Description
E-DCH MAC-d Flow Specific Information Response		<i>0..<maxnoofEDCHMACdFlows></i>		
>E-DCH MAC-d Flow ID	M		9.2.1.91	
>Binding ID	O		9.2.1.3	
>Transport Layer Address	O		9.2.1.62	
E-AGCH Specific Information Response		<i>0..<maxNoOfEAGCHcodes></i>		
>Time Slot LCR	M		9.2.3.12a	
>Midamble Shift LCR	M		9.2.3.4C	
>TDD Channelisation Code	M		9.2.3.8	
E-HICH Scheduled specific Information Response		<i>0..1</i>		
> Scheduled		<i>0..<maxNoOfEHICHcodes></i>		
>>EI	M		INTEGER (0..3)	E-HICH indication which is used to indicate UE on which E-HICH the feedback info is carried.
>>Time Slot LCR	M		9.2.3.12a	
>>Midamble Shift LCR	M		9.2.3.4C	
>>TDD Channelisation Code	M		9.2.3.8	
> Non-Scheduled		<i>0..1</i>		
>>Time Slot LCR	M		9.2.3.12a	
>>Midamble Shift LCR	M		9.2.3.4C	
>>TDD Channelisation Code	M		9.2.3.8	
>>Signature Sequence Group Index	M		INTEGER (0..19)	
>E-HICH time offset LCR	M		9.2.3.48a	
E-DCH Non-scheduled Grant Information LCR TDD	O		9.2.3.39a	
E-RNTI	O		9.2.1.94	

Range bound	Explanation
<i>maxnoofEDCHMACdFlows</i>	Maximum number of MAC-d flows
<i>maxnoofEAGCHcodes</i>	Maximum number of E-AGCHs assigned to one UE
<i>maxnoofEHICHcodes</i>	Maximum number of E-HICHs assigned to one UE

9.2.3.42 E-DCH TDD Information to Modify

The *E-DCH MAC-d Flows Information TDD* IE is used for the establishment of E-DCH MAC-d flows for TDD.

IE/Group Name	Presence	Range	IE Type and Reference	Semantics Description	Criticality	Assigned Criticality
E-DCH MAC-d Flow Specific Information		1..<maxno ofEDCHMACdFlows>			–	
>E-DCH MAC-d Flow ID	M		9.2.1.91		–	
>Allocation/Retention Priority	O		9.2.1.1		–	
>Transport Bearer Request Indicator	M		9.2.1.61		–	
>Binding ID	O		9.2.1.3	Shall be ignored if bearer establishment with ALCAP.	–	
>Transport Layer Address	O		9.2.1.62	Shall be ignored if bearer establishment with ALCAP.	–	
>TNL QoS	O		9.2.1.56A		–	
>Maximum Number Of Retransmissions For E-DCH	O		9.2.1.100		–	
>E-DCH HARQ Power Offset TDD	O		9.2.3.49		–	
>E-DCH MAC-d Flow Multiplexing List	O		9.2.1.89		–	
>E-DCH Grant Type	O		9.2.3.43		–	
>E-DCH Logical Channel To Add	O		E-DCH Logical Channel Information 9.2.1.92		–	
>E-DCH Logical Channel To Modify	O		9.2.1.93		–	
>E-DCH Logical Channel To Delete		0..<maxnooflogicalchannels>			–	
>>Logical Channel ID	M		9.2.1.97		–	
>E-DCH MAC-d Flow Retransmission Timer	O		9.2.3.49a	Applicable for 1.28Mcps TDD only	YES	ignore
>Traffic Class	O		9.2.1.58A		YES	ignore
MAC-e Reset Indicator	O		9.2.1.99		–	
E-DCH MAC-d PDU Size Format	O		9.2.1.91A		YES	reject

Range Bound	Explanation
<i>maxnoofEDCHMACdFlows</i>	Maximum number of E-DCH MAC-d flows
<i>maxnooflogicalchannels</i>	Maximum number of logical channels

9.2.3.43 E-DCH Grant Type

The *E-DCH Grant Type* identifies whether a MAC-d flow is scheduled or non-scheduled.

IE/Group Name	Presence	Range	IE Type and Reference	Semantics Description
E-DCH Grant Type			ENUMERATED (Scheduled, Non-scheduled)	

9.2.3.44 Timeslot Resource Related Information

The *Timeslot Resource Related Information* is a bitmap indicating which of the timeslots configured for E-DCH are allocated for non-scheduled transmissions.

IE/Group Name	Presence	Range	IE Type and Reference	Semantics Description
Timeslot Resource Related Information			BIT STRING (13)	

9.2.3.44a Timeslot Resource Related Information LCR

The *Timeslot Resource Related Information LCR* IE is a bitmap indicating which of the timeslots configured for E-DCH are allocated for non-scheduled transmissions.

IE/Group Name	Presence	Range	IE Type and Reference	Semantics Description
Timeslot Resource Related Information LCR			BIT STRING (5)	

9.2.3.45 Power Resource Related Information

The *Power Resource Related Information* specifies the maximum allowed E-PUCH power resource (dB relative to $P_{e,base}$) that the UE may use for non-scheduled transmissions.

IE/Group Name	Presence	Range	IE Type and Reference	Semantics Description
Power Resource Related Information			INTEGER (1..32)	

9.2.3.46 E-PUCH Offset

The *E-PUCH Offset* represents the CFN offset at which a non-scheduled E-DCH grant begins.

IE/Group Name	Presence	Range	IE Type and Reference	Semantics Description
E-PUCH Offset			INTEGER (0..255)	

9.2.3.47 E-DCH TDD Maximum Bitrate

The *E-DCH TDD Maximum Bitrate* parameter indicates the Maximum Bitrate for an E-DCH in TDD mode.

IE/Group Name	Presence	Range	IE Type and Reference	Semantics Description
E-DCH TDD Maximum Bitrate			INTEGER (0..9201,...)	Bitrate on transport block level. Unit is kbits per second.

9.2.3.48 E-HICH Time Offset

The E-HICH Time Offset (aka n_{E-HICH} in ITU-T Rec. X.681 [19]) is determined by the Node B.

IE/Group Name	Presence	Range	IE Type and Reference	Semantics Description
E-HICH Time Offset			INTEGER (4..44)	

9.2.3.48a E-HICH Time Offset LCR

The *E-HICH Time Offset LCR* IE (aka n_{E-HICH} in ITU-T Rec. X.681 [19]) is determined by the Node B.

IE/Group Name	Presence	Range	IE Type and Reference	Semantics Description
E-HICH Time Offset LCR			INTEGER (4..15)	

9.2.3.49 E-DCH HARQ Power Offset TDD

The *E-DCH HARQ Power Offset TDD* is the power offset measured in dB.

IE/Group Name	Presence	Range	IE Type and Reference	Semantics Description
E-DCH HARQ Power Offset TDD			INTEGER (0..6)	

9.2.3.49a E-DCH MAC-d Flow Retransmission Timer

The *E-DCH MAC-d Flow Retransmission Timer* IE is used in the E-DCH retransmission control as defined in ref. TS 25.425 [32].

IE/Group Name	Presence	Range	IE Type and Reference	Semantics Description
E-DCH MAC-d Flow Retransmission Timer			ENUMERATED (10, 15, 20, 25, 30, 35, 40, 45, 50, 55, 60, 65, 70, 75, 80, 85, 90, 95, 100, 110, 120, 140, 160, 200, 240, 280, 320, 400, 480, 560,...)	Unit: ms Node B may use this value to stop the re-transmission of the corresponding MAC-e PDU.

9.2.3.50 E-DCH Non-scheduled Grant Information 7.68Mcps TDD

The *E-DCH Non-scheduled Grant Information 7.68Mcps TDD* IE is used to specify the details of a non-scheduled grant for TDD.

IE/Group Name	Presence	Range	IE Type and Reference	Semantics Description
Timeslot Resource Related Information	M		9.2.3.44	
Power Resource Related Information	M		9.2.3.45	
Repetition Period	M		9.2.3.6	
Repetition Length	M		9.2.3.7	
TDD E-PUCH Offset	M		9.2.3.46	
TDD Channelisation Code 7.68Mcps	M		9.2.3.25	

9.2.3.51 E-DCH TDD Information 7.68Mcps

The *E-DCH TDD Information 7.68Mcps* specifies the details of the maximum bit rate and processing overload level for 7.68Mcps TDD.

IE/Group Name	Presence	Range	IE Type and Reference	Semantics Description
E-DCH TDD Maximum Bitrate 7.68Mcps	O		9.2.3.53	
E-DCH Processing Overload Level	O		9.2.1.95	
E-DCH Power Offset for Scheduling Info	O		9.2.1.96	

9.2.3.52 E-DCH TDD Information Response 7.68Mcps

The *E-DCH TDD Information Response 7.68Mcps* IE provides information for E-DCH MAC-d flows that have been established or modified for 7.68Mcps TDD. It also provides additional E-DCH information determined within the Node B.

IE/Group Name	Presence	Range	IE Type and Reference	Semantics Description
E-DCH MAC-d Flow Specific Information Response		<i>0..<maxnoofEDCHMACdFlows></i>		
>E-DCH MAC-d Flow ID	M		9.2.1.91	
>Binding ID	O		9.2.1.3	
>Transport Layer Address	O		9.2.1.62	
E-AGCH Specific Information Response 7.68Mcps		<i>0..<maxNoOfEAGCHcodes></i>		
>Time Slot	M		9.2.1.56	
>Midamble Shift And Burst Type 7.68Mcps	M		9.2.3.23	
>TDD Channelisation Code 7.68Mcps	M		9.2.3.25	
E-HICH Information Response 7.68Mcps		<i>0..1</i>		
>Time Slot	M		9.2.1.56	
>Midamble Shift And Burst Type 7.68Mcps	M		9.2.3.23	
>TDD Channelisation Code 7.68Mcps	M		9.2.3.25	
>E-HICH Time Offset	M		9.2.3.48	
E-DCH Non-scheduled Grant Information 7.68Mcps TDD	O		9.2.3.50	
E-RNTI	O		9.2.1.94	

Range Bound	Explanation
maxnoofEDCHMACdFlows	Maximum number of E-DCH MAC-d flows
maxnoofEAGCHcodes	Maximum number of E-AGCHs assigned to one UE

9.2.3.53 E-DCH TDD Maximum Bitrate 7.68Mcps

The *E-DCH TDD Maximum Bitrate 7.68Mcps* parameter indicates the Maximum Bitrate for an E-DCH in 7.68Mcps TDD mode.

IE/Group Name	Presence	Range	IE Type and Reference	Semantics Description
E-DCH TDD Maximum Bitrate 7.68Mcps			INTEGER (0..17713,...)	Bitrate on transport block level. Unit is kbits per second.

9.2.3.54 E-DCH Physical Layer Category LCR

Only for 1.28Mcps TDD. The *E-DCH Physical Layer Category LCR* IE parameter indicates the E-DCH physical layer capability of UE in LCR TDD mode.

IE/Group Name	Presence	Range	IE Type and Reference	Semantics Description
E-DCH Physical Layer Category LCR			INTEGER (1..5)	As defined in 25.306 [42]

9.2.3.54A Extended E-DCH Physical layer Category LCR

Only for 1.28Mcps TDD. The *Extended E-DCH Physical Layer Category LCR* IE parameter indicates the E-DCH physical layer capability of UE in LCR TDD mode.

IE/Group Name	Presence	Range	IE Type and Reference	Semantics Description
Extended E-DCH Physical Layer Category LCR			INTEGER(6,...)	As defined in 25.306 [42]

9.2.3.55 UpPCH Information LCR

Only for 1.28Mcps TDD.

IE/Group Name	Presence	Range	IE Type and Reference	Semantics Description	Criticality	Assigned Criticality
UpPCH Information LCR		$1..<maxFrequencyinCell>$			EACH	ignore
>UARFCN	O		9.2.1.66		–	
>UpPCH Position LCR	O		9.2.3.56		–	

Range Bound	Explanation
maxFrequencyinCell	Maximum number of Frequency that can be defined in a Cell

9.2.3.56 UpPCH Position LCR

Only for 1.28Mcps TDD.

IE/Group Name	Presence	Range	IE Type and Reference	Semantics Description
UpPCH Position LCR			INTEGER (1..127)	

9.2.3.57 Common E-DCH MAC-d Flow ID

The *Common E-DCH MAC-d Flow ID* IE is the unique identifier for one MAC-d flow on E-DCH.

IE/Group Name	Presence	Range	IE Type and Reference	Semantics Description
Common E-DCH MAC-d Flow ID			INTEGER (0..255)	

9.2.3.58 Common E-DCH MAC-d Flow Specific Information LCR

The *Common E-DCH MAC-d Flow Specific Information LCR* IE provides information associated to Common E-DCH MAC-d Flow used for Common E-DCH.

IE/Group Name	Presence	Range	IE Type and Reference	Semantics Description
Common E-DCH MAC-d Flow Specific Information LCR		<i>1..<maxnoofEDCHMACdFlowsLCR></i>		
>Common E-DCH MAC-d Flow ID	M		9.2.3.57	
>Maximum Number Of Retransmissions For E-DCH	M		9.2.1.100	
>E-DCH HARQ Power Offset TDD	M		9.2.3.49	
>E-DCH MAC-d Flow Multiplexing List	O		9.2.1.89	
>Common E-DCH Logical Channel information	M	<i>1..<maxnooflogicalchannelsLCR></i>		
>>Logical Channel ID	M		9.2.1.97	
>>Maximum MAC-d PDU Size Extended	M		MAC PDU Size Extended 9.2.1.34D	

Range bound	Explanation
<i>maxnoofEDCHMACdFlowsLCR</i>	Maximum number of E-DCH MAC-d Flows for 1.28Mcps TDD
<i>maxnooflogicalchannelsLCR</i>	Maximum number of logical channels

9.2.3.59 MAC-es Maximum Bit Rate LCR

The *MAC-es Maximum Bit Rate LCR* IE indicates the maximum number of bits per second to be delivered over the air interface.

IE/Group Name	Presence	Range	IE Type and Reference	Semantics Description
MAC-es Maximum Bit Rate LCR			INTEGER (0..256,000,000,...)	Unit: bit/s

9.2.3.60 Idle Interval Information

The *Idle Interval Information* IE indicates the idle interval used for E-UTRAN measurements by a multi-RAT UE in CELL_DCH state. Ref TS 36.133 [64].

IE/Group Name	Presence	Range	IE Type and Reference	Semantics Description
K	M		INTEGER (2..3)	The actual idle interval period = 2 ^K .
Offset	M		INTEGER (0..7)	The idle interval position in the period.

9.2.3.61 Continuous Packet Connectivity DRX Information LCR

The *Continuous Packet Connectivity DRX Information LCR* IE defines the parameters used for Continuous Packet Connectivity DRX operation for 1.28 Mcps TDD (see ref. TS 25.213 [21]).

IE/Group Name	Presence	Range	IE Type and Reference	Semantics Description	Criticality	Assignment Criticality
Enabling Delay	M		ENUMERATED (0, 1, 2, 4, 8, 16, 32, 64, 128)	Units of radio frames	-	
HS-SCCH DRX Information		1			-	
>UE DRX Cycle	M		ENUMERATED(1,2,4,8,16,32,64,...)	Units of subframes	-	
>Inactivity Threshold for UE DRX Cycle	O		ENUMERATED(1,2,4,8,16,32,64,...)	Units of subframes	-	
>UE DRX Offset	M		INTEGER (0..63)	Units of subframes. Offset of the UE DRX cycles at the given TTI	-	
>Inactivity Threshold for UE DRX Cycle Ext	O		ENUMERATED(128, 256,512,...)	Units of subframes	YES	ignore
E-AGCH DRX Information		0..1			-	
CHOICE <i>E-AGCH DRX information type</i>	M				-	
>Same as HS-SCCH			NULL	Indicate the E-AGCH DRX Cycle and Offset are the same as the HS-SCCH DRX Cycle and Offset, and the E-AGCH Inactivity Monitor Threshold is absent	-	
> <i>E-AGCH DRX parameters</i>					-	
>>E-AGCH DRX cycle	M		ENUMERATED (1,2,4,8,16,32,64,...)	Units of subframes.	-	
>>E-AGCH Inactivity Monitor Threshold	O		ENUMERATED (0, 1, 2, 4, 8, 16, 32, 64, 128, 256, 512, infinity,...)	Units of subframes.	-	
>>E-AGCH DRX Offset	M		INTEGER (0.. 63)	Units of subframes. Offset of the E-AGCH DRX cycles.	-	

9.2.3.62 Continuous Packet Connectivity DRX Information To Modify LCR

The *Continuous Packet Connectivity DRX Information To Modify LCR* IE is used for modification of Continuous Packet Connectivity DRX information in a Node B Communication Context. The *Continuous Packet Connectivity DRX Information To Modify LCR* IE shall include at least one of the following IE.

IE/Group Name	Presence	Range	IE Type and Reference	Semantics Description	Criticality	Assign Criticality
Enabling Delay	O		ENUMERATED (0, 1, 2, 4, 8, 16, 32, 64, 128)	Units of radio frames	-	
CHOICE <i>DRX Information To Modify</i>	O				-	
> <i>Modify</i>					-	
>> HS-SCCH DRX Information		0..1			-	
>>>UE DRX Cycle	M		ENUMERATED(1,2,4,8,16,32,64,...)	Units of subframes	-	
>>>Inactivity Threshold for UE DRX Cycle	O		ENUMERATED(1,2,4,8,16,32,64,...)	Units of subframes	-	
>>>UE DRX Offset	M		INTEGER (0..63)	Units of subframes. Offset of the UE DRX cycles at the given TTI	-	
>>>Inactivity Threshold for UE DRX Cycle Ext	O		ENUMERATED(128, 256,512,...)	Units of subframes	YES	ignore
>> E-AGCH DRX Information		0..1			-	
>>>CHOICE E-AGCH DRX information type	M				-	
>>>> <i>Same as HS-SCCH</i>			NULL	Indicate the E-AGCH DRX Cycle and Offset are the same as the HS-SCCH DRX Cycle and Offset, and the E-AGCH Inactivity Monitor Threshold is absent	-	
>>>> <i>E-AGCH DRX parameters</i>					-	
>>>>>E-AGCH DRX cycle	M		Enumerated (1,2,4,8,16,32,64,...)	Units of subframes.	-	
>>>>>E-AGCH Inactivity Monitor Threshold	O		Enumerated (0, 1, 2, 4, 8, 16, 32, 64, 128, 256, 512, infinity,...)	Units of subframes.	-	
>>>>>E-AGCH DRX Offset	M		Integer (0.. 63)	Units of subframes. Offset of the E-AGCH DRX cycles.	-	
> <i>Deactivate</i>			NULL		-	

9.2.3.63 Continuous Packet Connectivity DRX Information Response LCR

DRNS uses the *Continuous Packet Connectivity DRX Information Response LCR* IE to inform the SRNS the parameters used for Continuous Packet Connectivity DRX operation for 1.28 Mcps TDD (see ref. TS 25.213 [21]). Continuous Packet Connectivity DRX related parameters shall be configured by SRNS. For the parameters which can be accepted by DRNS, the DRNS shall not included the related IEs in the *Continuous Packet Connectivity DRX Information Response LCR* IE. For the parameters which can be not accepted by DRNS, the DRNS shall included the related IEs in the *Continuous Packet Connectivity DRX Information Response LCR* IE.

IE/Group Name	Presence	Range	IE Type and Reference	Semantics Description	Criticality	Assignment Criticality
Enabling Delay	O		ENUMERATED (0, 1, 2, 4, 8, 16, 32, 64, 128)	Units of radio frames	-	
HS-SCCH DRX Information		0..1			-	
>UE DRX Cycle	O		ENUMERATED(1,2,4,8,16,32,64,...)	Units of subframes	-	
>Inactivity Threshold for UE DRX Cycle	O		ENUMERATED(1,2,4,8,16,32,64,...)	Units of subframes	-	
>UE DRX Offset	O		INTEGER (0..63)	Units of subframes. Offset of the UE DRX cycles at the given TTI	-	
>Inactivity Threshold for UE DRX Cycle Ext	O		ENUMERATED(128, 256,512,...)	Units of subframes. This IE can only be used when the Inactivity Threshold for UE DRX Cycle Ext is included in the request message, otherwise, the IE shall not be used	YES	ignore
E-AGCH DRX Information		0..1			-	
CHOICE E-AGCH DRX information type	M				-	
>Same as HS-SCCH			NULL	Indicate the E-AGCH DRX Cycle and Offset are the same as the HS-SCCH DRX Cycle and Offset, and the E-AGCH Inactivity Monitor Threshold is absent	-	
>E-AGCH DRX parameters					-	
>>E-AGCH DRX cycle	O		Enumerated (1,2,4,8,16,32,64,...)	Units of subframes.	-	
>>E-AGCH Inactivity Monitor Threshold	O		Enumerated (0, 1, 2, 4, 8, 16, 32, 64, 128, 256, 512, infinity,...)	Units of subframes.	-	
>>E-AGCH DRX Offset	O		Integer (0.. 63)	Units of subframes. Offset of the E-AGCH DRX cycles.	-	

9.2.3.64 HS-DSCH Semi-Persistent scheduling Information LCR

The *HS-DSCH Semi-Persistent scheduling Information LCR* IE defines the parameters used for HS-DSCH semi-Persistent scheduling for 1.28 Mcps TDD (see ref. TS 25.213 [21]).

IE/Group Name	Presence	Range	IE Type and Reference	Semantics Description
Transport Block Size List		1..<maxnoofTBSsMapping>		
>Transport Block Size mapping Index	M		INTEGER (0..maxnoofTBSsMapping-1)	Corresponds to the <i>Transport-block size information</i> field carried on HS-SCCH (see ref IETF RFC 768 [34]).
>Transport Block Size Index	M		INTEGER (1..maxnoofHS-DSCHTBSsLCR)	Corresponds to the <i>TB index</i> in the related Transport Block Size table (see ref TS 25.425 [32]).
Repetition Period list		1..<maxnoofRepetitionPeriodLCR>		
>Repetition Period Index	M		INTEGER (0..maxnoofRepetitionP)	Corresponds to the <i>Resource repetition period index</i> field

			eriodLCR-1)	carried on HS-SCCH (see ref IETF RFC 768 [34]).
>Repetition Period	M		ENUMERATED (1, 2, 4, 8, 16, 32, 64,...)	Units of subframes
>Repetition Length	O		INTEGER (1..63)	Absence means Repetition Length equal to 1.
HS-DSCH Semi-Persistent Resource Reservation Indicator	O		ENUMERATED(Reserve)	Reserve means the HS-DSCH Semi-Persistent Resource is required to be reserved and be informed via response message.
HS-DSCH Semi-Persistent scheduling operation Indicator		1		
>CHOICE configuration				
>>Logical Channel level			BIT STRING (16)	Available when MAC-e-hs is configured. Indicates the logical channels for which the HS-DSCH Semi-Persistent operation is intended to be used. Bit 0 is for logical channel 0, Bit 1 is for logical channel 1, ... Value '1' for a bit means that the HS-DSCH Semi-Persistent operation is allowed. Bit 0 is the first/leftmost bit of the bit string.
>>Priority Queue level			BIT STRING (8)	Indicates the Priority Queues for which the HS-DSCH Semi-Persistent operation is intended to be used. Bit 0 is for priority queue 0, Bit 1 is for priority queue 1, ... Value '1' for a bit means that the HS-DSCH Semi-Persistent operation is allowed. Bit 0 is the first/leftmost bit of the bit string.

Range Bound	Explanation
<i>maxnoofHS-DSCHTBSsLCR</i>	Maximum number of HS-DSCH Transport Block Sizes
<i>maxnoofRepetitionPeriodLCR</i>	Maximum number of Repetition Period for 1.28Mcps TDD
<i>maxnoofTBSsMapping</i>	Maximum number of Transport Block Size mapping index on HS-SCCH.

9.2.3.65 HS-DSCH Semi-Persistent scheduling Information to modify LCR

The *HS-PSCH Semi-Persistent scheduling Information to modify LCR* IE is used for the modification of HS-DSCH Semi-Persistent scheduling information for 1.28 Mcps TDD (see ref. TS 25.213 [21]).

IE/Group Name	Presence	Range	IE Type and Reference	Semantics Description
Transport Block Size List		<i>0..< maxnoofTBSsMapping ></i>		
> Transport Block Size mapping Index	M		INTEGER (0..maxnoofTBSsMapping-1)	Corresponds to the <i>Transport-block size information</i> field carried on HS-SCCH (see ref IETF RFC 768 [34]).
>Transport Block Size Index	M		INTEGER (1..maxnoofHS-DSCHTBSsLCR)	Corresponds to the <i>TB index</i> in the related Transport Block Size table (see ref TS 25.425

				[32]).
Repetition Period list		<i>0..<maxno ofRepetitionPeriodLCR></i>		
>Repetition Period Index	M		INTEGER (0..maxnoofRepetitionPeriodLCR)	Corresponds to the <i>Resource repetition period index</i> field carried on HS-SCCH (see ref IETF RFC 768 [34]).
>Repetition Period	M		ENUMERATED (1, 2, 4, 8, 16, 32, 64,...)	Units of subframes
>Repetition Length	O		INTEGER (1..63)	Absence means Repetition Length equal to 1.
HS-DSCH Semi-Persistent Resource Reservation Indicator	O		ENUMERATED(Reserve)	Reserve means the Semi-Persistent HS-DSCH Resource is required to be reserved and be informed via response message.
HS-DSCH Semi-Persistent scheduling operation Indicator		<i>0..1</i>		
>CHOICE configuration				
>>Logical Channel level			BIT STRING (16)	Available when MAC-e-hs is configured. Indicates the logical channels for which the HS-DSCH Semi-Persistent operation is intended to be used. Bit 0 is for logical channel 0, Bit1 is for logical channel 1, ... Value '1' for a bit means that the HS-DSCH Semi-Persistent operation is allowed. Bit 0 is the first/leftmost bit of the bit string.
>> Priority Queue level			BIT STRING (8)	Indicates the Priority Queues for which the HS-DSCH Semi-Persistent operation is intended to be used. Bit 0 is for priority queue 0, Bit1 is for priority queue 1, ... Value '1' for a bit means that the HS-DSCH Semi-Persistent operation is allowed. Bit 0 is the first/leftmost bit of the bit string.

Range Bound	Explanation
<i>maxnoofHS-DSCHTBSSLCR</i>	Maximum number of HS-DSCH Transport Block Sizes
<i>maxnoofRepetitionPeriodLCR</i>	Maximum number of Repetition Period for 1.28Mcps TDD
<i>maxnoofTBSSMapping</i>	Maximum number of Transport Block Size mapping index on HS-SCCH.

9.2.3.66 E-DCH Semi-Persistent scheduling Information LCR

The *E-DCH Semi-Persistent scheduling Information LCR* IE defines the parameters used for E-DCH semi-Persistent scheduling for 1.28 Mcps TDD (see ref. TS 25.213 [21]).

IE/Group Name	Presence	Range	IE Type and Reference	Semantics Description
Repetition Period list		<i>1..<maxno ofRepetitionPeriodL</i>		

		<i>CR</i> >		
>Repetition Period Index	M		INTEGER (0.. <i>maxnoofRepetitionP eriodLCR-1</i>)	
>Repetition Period	M		ENUMERATED (1, 2, 4, 8, 16, 32, 64,...)	Units of subframes
>Repetition Length	O		INTEGER (1..63))	Absence means Repetition Length equal to 1.
E-DCH Semi-Persistent scheduling Indicator	M		BIT STRING (16)	Indicates the logical channels for which the E-DCH Semi- Persistent operation is intended to be used. Bit 0 is for logical channel 0, Bit1 is for logical channel 1, ... Value '1' for a bit means that the HS-DSCH Semi-Persistent operation is allowed. Bit 0 is the first/leftmost bit of the bit string.
E-DCH Semi-Persistent Resource Reservation Indicator	O		ENUMERATED(Res erve)	Reserve means the E-DCH Semi-Persistent Resource is required to be reserved and be informed via response message.

Range Bound	Explanation
<i>maxnoofRepetitionPeriodLCR</i>	Maximum number of Repetition Period for 1.28Mcps TDD

9.2.3.67 E-DCH Semi-Persistent scheduling Information to modify LCR

The *E-DCH Semi-Persistent scheduling Information to modify LCR* IE is used for the modification of E-DCH Semi-Persistent scheduling information for 1.28 Mcps TDD (see ref. TS 25.213 [21]).

IE/Group Name	Presence	Range	IE Type and Reference	Semantics Description
Repetition Period list		<i>0..<maxno ofRepetitio nPeriodL CR</i> >		
>Repetition Period Index	M		INTEGER (0.. <i>maxnoofRepetitionP eriodLCR-1</i>)	
>Repetition Period	M		ENUMERATED (1, 2, 4, 8, 16, 32, 64,...)	Units of subframes
>Repetition Length	O		INTEGER (1..63))	Absence means Repetition Length equal to 1.
E-DCH Semi-Persistent scheduling Indicator	O		BIT STRING (16)	Indicates the logical channels for which the E-DCH Semi- Persistent operation is intended to be used. Bit 0 is for logical channel 0, Bit1 is for logical channel 1, ... Value '1' for a bit means that the HS-DSCH Semi-Persistent operation is allowed. Bit 0 is the first/leftmost bit of the bit string.
E-DCH Semi-Persistent Resource Reservation Indicator	O		ENUMERATED(Res erve)	Reserve means the E-DCH Semi-Persistent Resource is required to be reserved and be informed via response message.

Range Bound	Explanation
<i>maxnoofRepetitionPeriodLCR</i>	Maximum number of Repetition Period for 1.28Mcps TDD

9.2.3.68 HS-DSCH Semi-Persistent scheduling Information Response LCR

The *HS-DSCH Semi-Persistent scheduling Information Response LCR* IE provides information for HS-DSCH Semi-Persistent scheduling determined within the Node B (see ref. TS 25.213 [21]).

IE/Group Name	Presence	Range	IE Type and Reference	Semantics Description
HS-SICH information for HS-DSCH Semi-Persistent Scheduling operation		$1..<maxnoofHS-SICHforSPS>$		
>HS-SICH mapping index	M		INTEGER (0.. maxnoofHS-SICHforSPS-1)	
>CHIOCE <i>HS-SICH type</i>				
>> <i>HS-SCCH associated HS-SICH</i>				
>>>HS-SICH ID	M		HS SICH ID 9.2.3.3ad	
>> <i>Non-HS-SCCH associated HS-SICH</i>				
>>>Time Slot LCR	M		9.2.3.12a	
>>>Midamble shift LCR	M		9.2.3.4C	
>>>TDD Channelisation Code	M		9.2.3.8	
Allcoated HS-PDSCH Semi-persistent resource		$0..1$		
>Repetition Period Index	M		INTEGER (0.. maxnoofRepetitionPeriodLCR-1)	
>Repetition Length for HS-PDSCH Semi-persistent Resource	O		INTEGER (1..63)	Absence means Repetition Length equal to 1.
>HS-PDSCH offset	M		INTEGER (0..63)	Units of subframes
>HS-PDSCH Midamble Configuration	M		Midamble Shift LCR 9.2.3.7A	
>Timeslot Resource Related Information	M		BIT STRING(5)	Each bit indicates availability of a timeslot, where the bit 0 corresponds to TS2, the bit 1 is TS3, the bit 3 is TS4... bit 5 corresponds to TS6. The value 1 of a bit indicates that the corresponding timeslot is available. Bit 0 is the first/leftmost bit of the bit string.
>Start Code	M		TDD Channelisation Code 9.2.3.19	
>End Code	M		TDD Channelisation Code 9.2.3.19	
>Transport Block Size Index	M		INTEGER (0.. maxnoofTBSsMapping-1)	
>Modulation type	M		ENUMERATED (QPSK, 16QAM)	
>HS-SICH mapping index	M		INTEGER (0.. maxnoofHS-SICHforSPS-1)	

Buffer Size for HS-DSCH Semi-Persistent scheduling	O		ENUMERATED (800..304000,...)	Indicats the buffer size that shall be reserved for HS-DSCH semi-persistent scheduling operation. 800 .. 16000 by step of 800, 17600 .. 32000 by step of 1600, 36000 .. 80000 by step of 4000, 88000 .. 160000 by step of 8000, 176000 .. 304000 by step of 16000
Number of Processes for HS-DSCH Semi-Persistent scheduling	O		INTEGER (1..16)	

Range Bound	Explanation
<i>maxnoofHS-SICHforSPS</i>	Maximum number of HS-SICH for HS-DSCH Semi-Persistent scheduling operation
<i>maxnoofTBSsMapping</i>	Maximum number of Transport Block Size mapping index on HS-SCCH.

9.2.3.69 E-DCH Semi-Persistent scheduling Information Response LCR

The *E-DCH Semi-Persistent scheduling Information Response LCR* IE provides information for E-DCH Semi-Persistent scheduling information determined within the Node B (see ref. TS 25.213 [21]).

IE/Group Name	Presence	Range	IE Type and Reference	Semantics Description
Allcoated E-DCH Semi-persistent resource		<i>0..1</i>		
>Timeslot Resource Related Information LCR	M		9.2.3.54a	
>Power Resource Related Information	M		9.2.3.55	
>Repetition Period Index	M		INTEGER (0..maxnoofRepetitionPeriodLCR-1)	
>Repetition Length	M		INTEGER (1..63)	Absence means Repetition Length equal to 1.
>Subframe Number	M		ENUMERATED (0,1)	Used to indicate from which subframe of the Radio Frame indicated by TDD E-PUCH Offset IE the physical resources are assigned to the E-DCH Non-scheduled Grant.
>TDD E-PUCH Offset	M		9.2.3.56	
>TDD Channelisation Code	M		9.2.3.19	
>NE-UCCH	M		INTEGER (1..8)	Number of E-UCCH and TPC instances within an E-DCH TTI. Details are described in ITU-T Rec. X.681 [19].
E-DCH SPS E-HICH information		<i>0..1</i>		

>CHOICE <i>E-HICH configuration</i>	M			
>>same as scheduled <i>E-HICH</i>				
>>> EI			INTEGER (0..3)	
>>explicit				
>>>Time Slot LCR	M		9.2.3.12a	
>>>Midamble Shift LCR	M		9.2.3.4C	
>>>TDD Channelisation Code	M		9.2.3.8	
>Signature Sequence Group Index	M		INTEGER (0..19)	

9.2.3.70 HS-DSCH Semi-Persistent scheduling Deactivate Indicator LCR

The *HS-DSCH Semi-Persistent scheduling Deactivate Indicator LCR* IE is used to deactivate HS-DSCH Semi-Persistent scheduling operation for 1.28 Mcps TDD.

IE/Group Name	Presence	Range	IE Type and Reference	Semantics Description
HS-DSCH Semi-Persistent scheduling Deactivate Indicator	M		NULL	

9.2.3.71 E-DCH Semi-Persistent scheduling Deactivate Indicator LCR

The *E-DCH Semi-Persistent scheduling Deactivate Indicator LCR* IE is used to deactivate E-DCH Semi-Persistent scheduling operation for 1.28 Mcps TDD.

IE/Group Name	Presence	Range	IE Type and Reference	Semantics Description
E-DCH Semi-Persistent scheduling Deactivate Indicator	M		NULL	

9.2.3.72 HS-SICH Reference Signal Information

IE/Group Name	Presence	Range	IE Type and Reference	Semantics Description	Criticality	Assigned Criticality
Midamble Configuration LCR	M		ENUMERATE D (2, 4, 6, 8, 10, 12, 14, 16, ...)	As defined in ITU-T Rec. X.681 [19]		
Midamble Shift	M		INTEGER (0..15)			
Time Slot LCR	M		9.2.3.12a			

9.2.3.73 Cell Portion LCR ID

Cell Portion LCR ID is the unique identifier for a cell portion within a cell for 1.28 Mcps TDD. See TS 25.225 [14].

IE/Group Name	Presence	Range	IE Type and Reference	Semantics Description
Cell Portion LCR ID			INTEGER (0..255,...)	

9.2.3.74 TS0 HS-PDSCH Indication LCR

Only for 1.28Mcps TDD. The *TS0 HS-PDSCH Indication LCR* IE indicates the first bit of timeslot information included in the HS-SCCH can be used to allocate the HS-PDSCH resources on TS0.

IE/Group Name	Presence	Range	IE Type and Reference	Semantics Description
TS0 HS-PDSCH Indication LCR			NULL	

9.2.3.75 DCH Measurement Occasion Information

The *DCH Measurement Occasion Information* IE indicates Measurement Occasion Information used for inter-frequency/ inter-RAT measurements in CELL_DCH state for 1.28Mcps TDD.

IE/Group Name	Presence	Range	IE Type and Reference	Semantics Description
---------------	----------	-------	-----------------------	-----------------------

IE/Group Name	Presence	Range	IE Type and Reference	Semantics Description
CELL_DCH measurement occasion pattern sequence		1 to <maxDCHMeasurementOccasionPatternSequence>		
>Pattern sequence identifier	M		Integer(1..maxDCHMeasurementOccasionPatternSequence)	
>Status Flag	M		Enumerated(activate, deactivate)	This flag indicates whether the measurement occasion pattern sequence shall be activated or deactivated.
>Measurement purpose	O		BIT STRING (5)	Measurement Purpose. Bit 0 is for Inter-frequency measurement. Bit 1 is for GSM carrier RSSI measurement. Bit 2 is for Initial BSIC identification. Bit 3 is for BSIC re-confirmation. Bit 4 is for E-UTRA measurement. The value 1 of a bit means that the measurement occasion pattern sequence is applicable for the corresponding type of measurement. Bit 0 is the first/leftmost bit of the bit string.
>Measurement occasion pattern sequence parameters	O			
>>k	M		Integer(1..9)	CELL_DCH measurement occasion cycle length coefficient. The actual measurement occasion period equal to 2^k radio frames. Value 0 indicates continuous allocation.
>>Offset	M		Integer(0..511)	In frames. The measurement occasion position in the measurement period.
>>M_Length	M		Integer(1..512)	The measurement occasion length in frames starting from the Offset.
>>Timeslot Bitmap	M		Bit string (7)	Bitmap indicating which of the timeslot(s) is/are allocated for measurement. Bit 0 is for timeslot 0. Bit 1 is for timeslot 1. Bit 2 is for timeslot 2. Bit 3 is for timeslot 3. Bit 4 is for timeslot 4. Bit 5 is for

IE/Group Name	Presence	Range	IE Type and Reference	Semantics Description
				timeslot 5. Bit 6 is for timeslot 6. The value 0 of a bit means the corresponding timeslot is not used for measurement. The value 1 of a bit means the corresponding timeslot is used for measurement. Bit 0 is the first/leftmost bit of the bit string.

Condition	Explanation
Measurementoccasionpatternsequence parameters	The IE shall be present if <i>Measurement occasion pattern sequence parameters</i> IE is present.

Range Bound	Explanation
maxDCHMeasurementOccasionPatternSequence	Maximum number of measurement occasion pattern sequence

9.2.3.76 DCH Measurement Type Indicator

The *DCH Measurement Type Indicator* IE indicates the measurement type(s) which the DRNS shall configured for the UE with TSO enhancement capability in CELL_DCH state for 1.28Mcps TDD.

IE/Group Name	Presence	Range	IE Type and Reference	Semantics Description
Measurement type	M		BIT STRING (5)	Measurement type. Bit 0 is for Inter-frequency measurement. Bit 1 is for GSM carrier RSSI measurement. Bit 2 is for Initial BSIC identification. Bit 3 is for BSIC re-confirmation. Bit 4 is for E-UTRA measurement. The value 1 of a bit means that the measurement occasion pattern sequence should be configured for the corresponding type of measurement. Bit 0 is the first/leftmost bit of the bit string.

9.3 Message and Information Element Abstract Syntax (with ASN.1)

9.3.0 General

Subclause 9.3 presents the Abstract Syntax of RNSAP protocol with ASN.1. In case there is contradiction between the ASN.1 definition in this subclause and the tabular format in subclause 9.1 and 9.2, the ASN.1 shall take precedence, except for the definition of conditions for the presence of conditional elements, in which the tabular format shall take precedence.

The ASN.1 definition specifies the structure and content of RNSAP messages. RNSAP messages can contain any IEs specified in the object set definitions for that message without the order or number of occurrence being restricted by ASN.1. However, for this version of the standard, a sending entity shall construct a RNSAP message according to the PDU definitions module and with the following additional rules (Note that in the following IE means an IE in the object set with an explicit id. If one IE needed to appear more than once in one object set, then the different occurrences have different IE ids):

- IEs shall be ordered (in an IE container) in the order they appear in object set definitions.
- Object set definitions specify how many times IEs may appear. An IE shall appear exactly once if the presence field in an object has value “mandatory”. An IE may appear at most once if the presence field in an object has value “optional” or “conditional”. If in a tabular format there is multiplicity specified for an IE (i.e. an IE list) then in the corresponding ASN.1 definition the list definition is separated into two parts. The first part defines an IE container list in which the list elements reside. The second part defines list elements. The IE container list appears as an IE of its own. For this version of the standard an IE container list may contain only one kind of list elements.

If a RNSAP message that is not constructed as defined above is received, this shall be considered as Abstract Syntax Error, and the message shall be handled as defined for Abstract Syntax Error in subclause 10.3.6.

9.3.1 Usage of Private Message Mechanism for Non-standard Use

The private message mechanism for non-standard use may be used:

- for special operator (and/or vendor) specific features considered not to be part of the basic functionality, i.e. the functionality required for a complete and high-quality specification in order to guarantee multivendor inter-operability.
- by vendors for research purposes, e.g. to implement and evaluate new algorithms/features before such features are proposed for standardisation.

The private message mechanism shall not be used for basic functionality. Such functionality shall be standardised.

9.3.2 Elementary Procedure Definitions

```
-- *****
--
-- Elementary Procedure definitions
--
-- *****
```

```
RNSAP-PDU-Descriptions {
itu-t (0) identified-organization (4) etsi (0) mobileDomain (0)
umts-Access (20) modules (3) rnsap (1) version1 (1) rnsap-PDU-Descriptions (0) }
```

```
DEFINITIONS AUTOMATIC TAGS ::=
```

```
BEGIN
```

```
-- *****
--
-- IE parameter types from other modules.
--
-- *****
```

```
IMPORTS
```

```
    Criticality,
    ProcedureID,
    TransactionID
```

```
FROM RNSAP-CommonDataTypes
```

```
    CommonMeasurementFailureIndication,
    CommonMeasurementInitiationFailure,
    CommonMeasurementInitiationRequest,
    CommonMeasurementInitiationResponse,
    CommonMeasurementReport,
    CommonMeasurementTerminationRequest,
    CommonTransportChannelResourcesFailure,
    CommonTransportChannelResourcesRequest,
    CommonTransportChannelResourcesReleaseRequest,
    CommonTransportChannelResourcesResponseFDD,
    CommonTransportChannelResourcesResponseTDD,
    CompressedModeCommand,
    DedicatedMeasurementFailureIndication,
    DedicatedMeasurementInitiationFailure,
    DedicatedMeasurementInitiationRequest,
    DedicatedMeasurementInitiationResponse,
    DedicatedMeasurementReport,
    DedicatedMeasurementTerminationRequest,
    DirectInformationTransfer,
    DL-PowerControlRequest,
    DL-PowerTimeslotControlRequest,
    DownlinkSignallingTransferRequest,
    ErrorIndication,
    EnhancedRelocationCancel,
    EnhancedRelocationFailure,
    EnhancedRelocationRequest,
    EnhancedRelocationResponse,
    EnhancedRelocationSignallingTransfer,
    EnhancedRelocationRelease,
    InformationExchangeFailureIndication,
    InformationExchangeInitiationFailure,
    InformationExchangeInitiationRequest,
    InformationExchangeInitiationResponse,
    InformationExchangeTerminationRequest,
```

InformationReport,
IurDeactivateTrace,
IurInvokeTrace,
MBMSAttachCommand,
MBMSDetachCommand,
MBSFNMCCHInformation,
PagingRequest,
PhysicalChannelReconfigurationCommand,
PhysicalChannelReconfigurationFailure,
PhysicalChannelReconfigurationRequestFDD,
PhysicalChannelReconfigurationRequestTDD,
PrivateMessage,
RadioLinkActivationCommandFDD,
RadioLinkActivationCommandTDD,
RadioLinkAdditionFailureFDD,
RadioLinkAdditionFailureTDD,
RadioLinkAdditionRequestFDD,
RadioLinkAdditionRequestTDD,
RadioLinkAdditionResponseFDD,
RadioLinkAdditionResponseTDD,
RadioLinkCongestionIndication,
RadioLinkDeletionRequest,
RadioLinkDeletionResponse,
RadioLinkFailureIndication,
RadioLinkParameterUpdateIndicationFDD,
RadioLinkParameterUpdateIndicationTDD,
RadioLinkPreemptionRequiredIndication,
RadioLinkReconfigurationCancel,
RadioLinkReconfigurationCommit,
RadioLinkReconfigurationFailure,
RadioLinkReconfigurationPrepareFDD,
RadioLinkReconfigurationPrepareTDD,
RadioLinkReconfigurationReadyFDD,
RadioLinkReconfigurationReadyTDD,
RadioLinkReconfigurationRequestFDD,
RadioLinkReconfigurationRequestTDD,
RadioLinkReconfigurationResponseFDD,
RadioLinkReconfigurationResponseTDD,
RadioLinkRestoreIndication,
RadioLinkSetupFailureFDD,
RadioLinkSetupFailureTDD,
RadioLinkSetupRequestFDD,
RadioLinkSetupRequestTDD,
RadioLinkSetupResponseFDD,
RadioLinkSetupResponseTDD,
RelocationCommit,
ResetRequest,
ResetResponse,
UEMeasurementFailureIndication,
UEMeasurementInitiationFailure,
UEMeasurementInitiationRequest,
UEMeasurementInitiationResponse,
UEMeasurementReport,
UEMeasurementTerminationRequest,

SecondaryULFrequencyReport,
SecondaryULFrequencyUpdateIndication,
UplinkSignallingTransferIndicationFDD,
UplinkSignallingTransferIndicationTDD,
GERANUplinkSignallingTransferIndication
FROM RNSAP-PDU-Contents

id-commonMeasurementFailure,
id-commonMeasurementInitiation,
id-commonMeasurementReporting,
id-commonMeasurementTermination,
id-commonTransportChannelResourcesInitialisation,
id-commonTransportChannelResourcesRelease,
id-compressedModeCommand,
id-downlinkPowerControl,
id-downlinkSignallingTransfer,
id-downlinkPowerTimeslotControl,
id-enhancedRelocation,
id-enhancedRelocationCancel,
id-enhancedRelocationSignallingTransfer,
id-enhancedRelocationRelease,
id-errorIndication,
id-informationExchangeFailure,
id-informationExchangeInitiation,
id-informationReporting,
id-informationExchangeTermination,
id-iurDeactivateTrace,
id-iurInvokeTrace,
id-dedicatedMeasurementFailure,
id-dedicatedMeasurementInitiation,
id-dedicatedMeasurementReporting,
id-dedicatedMeasurementTermination,
id-directInformationTransfer,
id-mBMSAttach,
id-mBMSDetach,
id-mBSFNMCCHInformation,
id-paging,
id-physicalChannelReconfiguration,
id-privateMessage,
id-radioLinkActivation,
id-radioLinkAddition,
id-radioLinkCongestion,
id-radioLinkDeletion,
id-radioLinkFailure,
id-radioLinkParameterUpdate,
id-radioLinkPreemption,
id-radioLinkRestoration,
id-radioLinkSetup,
id-relocationCommit,
id-reset,
id-synchronisedRadioLinkReconfigurationCancellation,
id-synchronisedRadioLinkReconfigurationCommit,
id-synchronisedRadioLinkReconfigurationPreparation,
id-uEMeasurementFailure,

```

    id-uEMeasurementInitiation,
    id-uEMeasurementReporting,
    id-uEMeasurementTermination,
    id-secondaryULFrequencyReporting,
    id-secondaryULFrequencyUpdate,
    id-unSynchronisedRadioLinkReconfiguration,
    id-uplinkSignallingTransfer,
    id-gERANuplinkSignallingTransfer
FROM RNSAP-Constants;

-- *****
--
-- Interface Elementary Procedure Class
--
-- *****

RNSAP-ELEMENTARY-PROCEDURE ::= CLASS {
    &InitiatingMessage          ,
    &SuccessfulOutcome          OPTIONAL,
    &UnsuccessfulOutcome        OPTIONAL,
    &Outcome                    OPTIONAL,
    &procedureID                ProcedureID    UNIQUE,
    &criticality                 Criticality    DEFAULT ignore
}
WITH SYNTAX {
    INITIATING MESSAGE          &InitiatingMessage
    [SUCCESSFUL OUTCOME         &SuccessfulOutcome]
    [UNSUCCESSFUL OUTCOME       &UnsuccessfulOutcome]
    [OUTCOME                    &Outcome]
    PROCEDURE ID                &procedureID
    [CRITICALITY                &criticality]
}

-- *****
--
-- Interface PDU Definition
--
-- *****

RNSAP-PDU ::= CHOICE {
    initiatingMessage    InitiatingMessage,
    successfulOutcome    SuccessfulOutcome,
    unsuccessfulOutcome  UnsuccessfulOutcome,
    outcome              Outcome,
    ...
}

InitiatingMessage ::= SEQUENCE {
    procedureID RNSAP-ELEMENTARY-PROCEDURE.&procedureID    ({RNSAP-ELEMENTARY-PROCEDURES}),
    criticality RNSAP-ELEMENTARY-PROCEDURE.&criticality      ({RNSAP-ELEMENTARY-PROCEDURES}{@procedureID}),
    transactionID TransactionID,
    value        RNSAP-ELEMENTARY-PROCEDURE.&InitiatingMessage    ({RNSAP-ELEMENTARY-PROCEDURES}{@procedureID})
}

```

```

SuccessfulOutcome ::= SEQUENCE {
  procedureID RNSAP-ELEMENTARY-PROCEDURE.&procedureID      ({RNSAP-ELEMENTARY-PROCEDURES}),
  criticality RNSAP-ELEMENTARY-PROCEDURE.&criticality      ({RNSAP-ELEMENTARY-PROCEDURES}@procedureID),
  transactionID TransactionID,
  value       RNSAP-ELEMENTARY-PROCEDURE.&SuccessfulOutcome ({RNSAP-ELEMENTARY-PROCEDURES}@procedureID)
}

UnsuccessfulOutcome ::= SEQUENCE {
  procedureID RNSAP-ELEMENTARY-PROCEDURE.&procedureID      ({RNSAP-ELEMENTARY-PROCEDURES}),
  criticality RNSAP-ELEMENTARY-PROCEDURE.&criticality      ({RNSAP-ELEMENTARY-PROCEDURES}@procedureID),
  transactionID TransactionID,
  value       RNSAP-ELEMENTARY-PROCEDURE.&UnsuccessfulOutcome ({RNSAP-ELEMENTARY-PROCEDURES}@procedureID)
}

Outcome ::= SEQUENCE {
  procedureID RNSAP-ELEMENTARY-PROCEDURE.&procedureID      ({RNSAP-ELEMENTARY-PROCEDURES}),
  criticality RNSAP-ELEMENTARY-PROCEDURE.&criticality      ({RNSAP-ELEMENTARY-PROCEDURES}@procedureID),
  transactionID TransactionID,
  value       RNSAP-ELEMENTARY-PROCEDURE.&Outcome          ({RNSAP-ELEMENTARY-PROCEDURES}@procedureID)
}

-- *****
--
-- Interface Elementary Procedure List
--
-- *****

RNSAP-ELEMENTARY-PROCEDURES RNSAP-ELEMENTARY-PROCEDURE ::= {
  RNSAP-ELEMENTARY-PROCEDURES-CLASS-1 |
  RNSAP-ELEMENTARY-PROCEDURES-CLASS-2 |
  RNSAP-ELEMENTARY-PROCEDURES-CLASS-3 ,
  ...
}

RNSAP-ELEMENTARY-PROCEDURES-CLASS-1 RNSAP-ELEMENTARY-PROCEDURE ::= {
  radioLinkSetupFDD |
  radioLinkSetupTDD |
  radioLinkAdditionFDD |
  radioLinkAdditionTDD |
  radioLinkDeletion |
  synchronisedRadioLinkReconfigurationPreparationFDD |
  synchronisedRadioLinkReconfigurationPreparationTDD |
  unSynchronisedRadioLinkReconfigurationFDD |
  unSynchronisedRadioLinkReconfigurationTDD |
  physicalChannelReconfigurationFDD |
  physicalChannelReconfigurationTDD |
  dedicatedMeasurementInitiation |
  commonTransportChannelResourcesInitialisationFDD |
  commonTransportChannelResourcesInitialisationTDD |
  ...,
  commonMeasurementInitiation |
  informationExchangeInitiation |
  reset |
  uEMeasurementInitiation
}

```

```

    enhancedRelocation
}
RNSAP-ELEMENTARY-PROCEDURES-CLASS-2 RNSAP-ELEMENTARY-PROCEDURE ::= {
    uplinkSignallingTransferFDD
    uplinkSignallingTransferTDD
    downlinkSignallingTransfer
    relocationCommit
    paging
    synchronisedRadioLinkReconfigurationCommit
    synchronisedRadioLinkReconfigurationCancellation
    radioLinkFailure
    radioLinkPreemption
    radioLinkRestoration
    dedicatedMeasurementReporting
    dedicatedMeasurementTermination
    dedicatedMeasurementFailure
    downlinkPowerControlFDD
    downlinkPowerTimeslotControl
    compressedModeCommandFDD
    commonTransportChannelResourcesRelease
    errorIndication
    privateMessage
    ...,
    radioLinkCongestion
    commonMeasurementFailure
    commonMeasurementReporting
    commonMeasurementTermination
    informationExchangeFailure
    informationExchangeTermination
    informationReporting
    radioLinkActivationFDD
    radioLinkActivationTDD
    gERANuplinkSignallingTransfer
    radioLinkParameterUpdateFDD
    radioLinkParameterUpdateTDD
    uEMeasurementReporting
    uEMeasurementTermination
    uEMeasurementFailure
    iurInvokeTrace
    iurDeactivateTrace
    mBMSAttach
    mBMSDetach
    directInformationTransfer
    enhancedRelocationCancel
    enhancedRelocationSignallingTransfer
    enhancedRelocationRelease
    mBSFNCCHInformation
    secondaryULFrequencyReportingFDD
    secondaryULFrequencyUpdateFDD

```

```

}
RNSAP-ELEMENTARY-PROCEDURES-CLASS-3 RNSAP-ELEMENTARY-PROCEDURE ::= {
  ...
}
-- *****
--
-- Interface Elementary Procedures
--
-- *****

radioLinkSetupFDD RNSAP-ELEMENTARY-PROCEDURE ::= {
  INITIATING MESSAGE  RadioLinkSetupRequestFDD
  SUCCESSFUL OUTCOME  RadioLinkSetupResponseFDD
  UNSUCCESSFUL OUTCOME  RadioLinkSetupFailureFDD
  PROCEDURE ID        { procedureCode id-radioLinkSetup, ddMode fdd }
  CRITICALITY         reject
}

radioLinkSetupTDD RNSAP-ELEMENTARY-PROCEDURE ::= {
  INITIATING MESSAGE  RadioLinkSetupRequestTDD
  SUCCESSFUL OUTCOME  RadioLinkSetupResponseTDD
  UNSUCCESSFUL OUTCOME  RadioLinkSetupFailureTDD
  PROCEDURE ID        { procedureCode id-radioLinkSetup, ddMode tdd }
  CRITICALITY         reject
}

radioLinkAdditionFDD RNSAP-ELEMENTARY-PROCEDURE ::= {
  INITIATING MESSAGE  RadioLinkAdditionRequestFDD
  SUCCESSFUL OUTCOME  RadioLinkAdditionResponseFDD
  UNSUCCESSFUL OUTCOME  RadioLinkAdditionFailureFDD
  PROCEDURE ID        { procedureCode id-radioLinkAddition , ddMode fdd }
  CRITICALITY         reject
}

radioLinkAdditionTDD RNSAP-ELEMENTARY-PROCEDURE ::= {
  INITIATING MESSAGE  RadioLinkAdditionRequestTDD
  SUCCESSFUL OUTCOME  RadioLinkAdditionResponseTDD
  UNSUCCESSFUL OUTCOME  RadioLinkAdditionFailureTDD
  PROCEDURE ID        { procedureCode id-radioLinkAddition , ddMode tdd }
  CRITICALITY         reject
}

radioLinkDeletion RNSAP-ELEMENTARY-PROCEDURE ::= {
  INITIATING MESSAGE  RadioLinkDeletionRequest
  SUCCESSFUL OUTCOME  RadioLinkDeletionResponse
  PROCEDURE ID        { procedureCode id-radioLinkDeletion, ddMode common }
  CRITICALITY         reject
}

synchronisedRadioLinkReconfigurationPreparationFDD RNSAP-ELEMENTARY-PROCEDURE ::= {
  INITIATING MESSAGE  RadioLinkReconfigurationPrepareFDD
  SUCCESSFUL OUTCOME  RadioLinkReconfigurationReadyFDD
}

```

```

    UNSUCCESSFUL OUTCOME    RadioLinkReconfigurationFailure
    PROCEDURE ID            { procedureCode id-synchronisedRadioLinkReconfigurationPreparation, ddMode fdd }
    CRITICALITY             reject
}

synchronisedRadioLinkReconfigurationPreparationTDD RNSAP-ELEMENTARY-PROCEDURE ::= {
    INITIATING MESSAGE      RadioLinkReconfigurationPrepareTDD
    SUCCESSFUL OUTCOME       RadioLinkReconfigurationReadyTDD
    UNSUCCESSFUL OUTCOME    RadioLinkReconfigurationFailure
    PROCEDURE ID            { procedureCode id-synchronisedRadioLinkReconfigurationPreparation, ddMode tdd }
    CRITICALITY             reject
}

unSynchronisedRadioLinkReconfigurationFDD RNSAP-ELEMENTARY-PROCEDURE ::= {
    INITIATING MESSAGE      RadioLinkReconfigurationRequestFDD
    SUCCESSFUL OUTCOME       RadioLinkReconfigurationResponseFDD
    UNSUCCESSFUL OUTCOME    RadioLinkReconfigurationFailure
    PROCEDURE ID            { procedureCode id-unSynchronisedRadioLinkReconfiguration, ddMode fdd }
    CRITICALITY             reject
}

unSynchronisedRadioLinkReconfigurationTDD RNSAP-ELEMENTARY-PROCEDURE ::= {
    INITIATING MESSAGE      RadioLinkReconfigurationRequestTDD
    SUCCESSFUL OUTCOME       RadioLinkReconfigurationResponseTDD
    UNSUCCESSFUL OUTCOME    RadioLinkReconfigurationFailure
    PROCEDURE ID            { procedureCode id-unSynchronisedRadioLinkReconfiguration, ddMode tdd }
    CRITICALITY             reject
}

physicalChannelReconfigurationFDD RNSAP-ELEMENTARY-PROCEDURE ::= {
    INITIATING MESSAGE      PhysicalChannelReconfigurationRequestFDD
    SUCCESSFUL OUTCOME       PhysicalChannelReconfigurationCommand
    UNSUCCESSFUL OUTCOME    PhysicalChannelReconfigurationFailure
    PROCEDURE ID            { procedureCode id-physicalChannelReconfiguration, ddMode fdd }
    CRITICALITY             reject
}

physicalChannelReconfigurationTDD RNSAP-ELEMENTARY-PROCEDURE ::= {
    INITIATING MESSAGE      PhysicalChannelReconfigurationRequestTDD
    SUCCESSFUL OUTCOME       PhysicalChannelReconfigurationCommand
    UNSUCCESSFUL OUTCOME    PhysicalChannelReconfigurationFailure
    PROCEDURE ID            { procedureCode id-physicalChannelReconfiguration, ddMode tdd }
    CRITICALITY             reject
}

dedicatedMeasurementInitiation RNSAP-ELEMENTARY-PROCEDURE ::= {
    INITIATING MESSAGE      DedicatedMeasurementInitiationRequest
    SUCCESSFUL OUTCOME       DedicatedMeasurementInitiationResponse
    UNSUCCESSFUL OUTCOME    DedicatedMeasurementInitiationFailure
    PROCEDURE ID            { procedureCode id-dedicatedMeasurementInitiation, ddMode common }
    CRITICALITY             reject
}

commonTransportChannelResourcesInitialisationFDD RNSAP-ELEMENTARY-PROCEDURE ::= {

```

```
INITIATING MESSAGE CommonTransportChannelResourcesRequest
SUCCESSFUL OUTCOME CommonTransportChannelResourcesResponseFDD
UNSUCCESSFUL OUTCOME CommonTransportChannelResourcesFailure
PROCEDURE ID { procedureCode id-commonTransportChannelResourcesInitialisation, ddMode fdd }
CRITICALITY reject
}

commonTransportChannelResourcesInitialisationTDD RNSAP-ELEMENTARY-PROCEDURE ::= {
  INITIATING MESSAGE CommonTransportChannelResourcesRequest
  SUCCESSFUL OUTCOME CommonTransportChannelResourcesResponseTDD
  UNSUCCESSFUL OUTCOME CommonTransportChannelResourcesFailure
  PROCEDURE ID { procedureCode id-commonTransportChannelResourcesInitialisation, ddMode tdd }
  CRITICALITY reject
}

uplinkSignallingTransferFDD RNSAP-ELEMENTARY-PROCEDURE ::= {
  INITIATING MESSAGE UplinkSignallingTransferIndicationFDD
  PROCEDURE ID { procedureCode id-uplinkSignallingTransfer, ddMode fdd }
  CRITICALITY ignore
}

uplinkSignallingTransferTDD RNSAP-ELEMENTARY-PROCEDURE ::= {
  INITIATING MESSAGE UplinkSignallingTransferIndicationTDD
  PROCEDURE ID { procedureCode id-uplinkSignallingTransfer, ddMode tdd }
  CRITICALITY ignore
}

downlinkSignallingTransfer RNSAP-ELEMENTARY-PROCEDURE ::= {
  INITIATING MESSAGE DownlinkSignallingTransferRequest
  PROCEDURE ID { procedureCode id-downlinkSignallingTransfer, ddMode common }
  CRITICALITY ignore
}

relocationCommit RNSAP-ELEMENTARY-PROCEDURE ::= {
  INITIATING MESSAGE RelocationCommit
  PROCEDURE ID { procedureCode id-relocationCommit, ddMode common }
  CRITICALITY ignore
}

paging RNSAP-ELEMENTARY-PROCEDURE ::= {
  INITIATING MESSAGE PagingRequest
  PROCEDURE ID { procedureCode id-paging, ddMode common }
  CRITICALITY ignore
}

synchronisedRadioLinkReconfigurationCommit RNSAP-ELEMENTARY-PROCEDURE ::= {
  INITIATING MESSAGE RadioLinkReconfigurationCommit
  PROCEDURE ID { procedureCode id-synchronisedRadioLinkReconfigurationCommit, ddMode common }
  CRITICALITY ignore
}

synchronisedRadioLinkReconfigurationCancellation RNSAP-ELEMENTARY-PROCEDURE ::= {
  INITIATING MESSAGE RadioLinkReconfigurationCancel
  PROCEDURE ID { procedureCode id-synchronisedRadioLinkReconfigurationCancellation, ddMode common }
```

```
    CRITICALITY    ignore
}

radioLinkFailure RNSAP-ELEMENTARY-PROCEDURE ::= {
    INITIATING MESSAGE    RadioLinkFailureIndication
    PROCEDURE ID          { procedureCode id-radioLinkFailure, ddMode common }
    CRITICALITY           ignore
}

radioLinkPreemption RNSAP-ELEMENTARY-PROCEDURE ::= {
    INITIATING MESSAGE    RadioLinkPreemptionRequiredIndication
    PROCEDURE ID          { procedureCode id-radioLinkPreemption, ddMode common }
    CRITICALITY           ignore
}

radioLinkRestoration RNSAP-ELEMENTARY-PROCEDURE ::= {
    INITIATING MESSAGE    RadioLinkRestoreIndication
    PROCEDURE ID          { procedureCode id-radioLinkRestoration, ddMode common }
    CRITICALITY           ignore
}

dedicatedMeasurementReporting RNSAP-ELEMENTARY-PROCEDURE ::= {
    INITIATING MESSAGE    DedicatedMeasurementReport
    PROCEDURE ID          { procedureCode id-dedicatedMeasurementReporting, ddMode common }
    CRITICALITY           ignore
}

dedicatedMeasurementTermination RNSAP-ELEMENTARY-PROCEDURE ::= {
    INITIATING MESSAGE    DedicatedMeasurementTerminationRequest
    PROCEDURE ID          { procedureCode id-dedicatedMeasurementTermination, ddMode common }
    CRITICALITY           ignore
}

dedicatedMeasurementFailure RNSAP-ELEMENTARY-PROCEDURE ::= {
    INITIATING MESSAGE    DedicatedMeasurementFailureIndication
    PROCEDURE ID          { procedureCode id-dedicatedMeasurementFailure, ddMode common }
    CRITICALITY           ignore
}

radioLinkCongestion RNSAP-ELEMENTARY-PROCEDURE ::= {
    INITIATING MESSAGE    RadioLinkCongestionIndication
    PROCEDURE ID          { procedureCode id-radioLinkCongestion, ddMode common }
    CRITICALITY           ignore
}

downlinkPowerControlFDD RNSAP-ELEMENTARY-PROCEDURE ::= {
    INITIATING MESSAGE    DL-PowerControlRequest
    PROCEDURE ID          { procedureCode id-downlinkPowerControl, ddMode fdd }
    CRITICALITY           ignore
}

downlinkPowerTimeslotControl RNSAP-ELEMENTARY-PROCEDURE ::= {
    INITIATING MESSAGE    DL-PowerTimeslotControlRequest
    PROCEDURE ID          { procedureCode id-downlinkPowerTimeslotControl, ddMode tdd }
}
```



```
    CRITICALITY    ignore
  }

compressedModeCommandFDD RNSAP-ELEMENTARY-PROCEDURE ::= {
  INITIATING MESSAGE  CompressedModeCommand
  PROCEDURE ID       { procedureCode id-compressedModeCommand, ddMode fdd }
  CRITICALITY        ignore
}

commonTransportChannelResourcesRelease RNSAP-ELEMENTARY-PROCEDURE ::= {
  INITIATING MESSAGE  CommonTransportChannelResourcesReleaseRequest
  PROCEDURE ID       { procedureCode id-commonTransportChannelResourcesRelease, ddMode common }
  CRITICALITY        ignore
}

errorIndication RNSAP-ELEMENTARY-PROCEDURE ::= {
  INITIATING MESSAGE  ErrorIndication
  PROCEDURE ID       { procedureCode id-errorIndication, ddMode common }
  CRITICALITY        ignore
}

commonMeasurementInitiation RNSAP-ELEMENTARY-PROCEDURE ::= {
  INITIATING MESSAGE  CommonMeasurementInitiationRequest
  SUCCESSFUL OUTCOME  CommonMeasurementInitiationResponse
  UNSUCCESSFUL OUTCOME  CommonMeasurementInitiationFailure
  PROCEDURE ID       { procedureCode id-commonMeasurementInitiation, ddMode common }
  CRITICALITY        reject
}

commonMeasurementReporting RNSAP-ELEMENTARY-PROCEDURE ::= {
  INITIATING MESSAGE  CommonMeasurementReport
  PROCEDURE ID       { procedureCode id-commonMeasurementReporting, ddMode common }
  CRITICALITY        ignore
}

commonMeasurementTermination RNSAP-ELEMENTARY-PROCEDURE ::= {
  INITIATING MESSAGE  CommonMeasurementTerminationRequest
  PROCEDURE ID       { procedureCode id-commonMeasurementTermination, ddMode common }
  CRITICALITY        ignore
}

commonMeasurementFailure RNSAP-ELEMENTARY-PROCEDURE ::= {
  INITIATING MESSAGE  CommonMeasurementFailureIndication
  PROCEDURE ID       { procedureCode id-commonMeasurementFailure, ddMode common }
  CRITICALITY        ignore
}

informationExchangeInitiation RNSAP-ELEMENTARY-PROCEDURE ::= {
  INITIATING MESSAGE  InformationExchangeInitiationRequest
  SUCCESSFUL OUTCOME  InformationExchangeInitiationResponse
  UNSUCCESSFUL OUTCOME  InformationExchangeInitiationFailure
  PROCEDURE ID       { procedureCode id-informationExchangeInitiation, ddMode common }
  CRITICALITY        reject
}
```

```
informationReporting RNSAP-ELEMENTARY-PROCEDURE ::= {
  INITIATING MESSAGE      InformationReport
  PROCEDURE ID            { procedureCode id-informationReporting, ddMode common }
  CRITICALITY             ignore
}

informationExchangeTermination RNSAP-ELEMENTARY-PROCEDURE ::= {
  INITIATING MESSAGE      InformationExchangeTerminationRequest
  PROCEDURE ID            { procedureCode id-informationExchangeTermination, ddMode common }
  CRITICALITY             ignore
}

informationExchangeFailure RNSAP-ELEMENTARY-PROCEDURE ::= {
  INITIATING MESSAGE      InformationExchangeFailureIndication
  PROCEDURE ID            { procedureCode id-informationExchangeFailure, ddMode common }
  CRITICALITY             ignore
}

privateMessage RNSAP-ELEMENTARY-PROCEDURE ::= {
  INITIATING MESSAGE      PrivateMessage
  PROCEDURE ID            { procedureCode id-privateMessage, ddMode common }
  CRITICALITY             ignore
}

reset RNSAP-ELEMENTARY-PROCEDURE ::= {
  INITIATING MESSAGE      ResetRequest
  SUCCESSFUL OUTCOME      ResetResponse
  PROCEDURE ID            { procedureCode id-reset, ddMode common }
  CRITICALITY             reject
}

radioLinkActivationFDD RNSAP-ELEMENTARY-PROCEDURE ::= {
  INITIATING MESSAGE      RadioLinkActivationCommandFDD
  PROCEDURE ID            { procedureCode id-radioLinkActivation, ddMode fdd }
  CRITICALITY             ignore
}

radioLinkActivationTDD RNSAP-ELEMENTARY-PROCEDURE ::= {
  INITIATING MESSAGE      RadioLinkActivationCommandTDD
  PROCEDURE ID            { procedureCode id-radioLinkActivation, ddMode tdd }
  CRITICALITY             ignore
}

geranUplinkSignallingTransfer RNSAP-ELEMENTARY-PROCEDURE ::= {
  INITIATING MESSAGE      GERANUplinkSignallingTransferIndication
  PROCEDURE ID            { procedureCode id-geranUplinkSignallingTransfer, ddMode common }
  CRITICALITY             ignore
}

radioLinkParameterUpdateFDD RNSAP-ELEMENTARY-PROCEDURE ::= {
  INITIATING MESSAGE      RadioLinkParameterUpdateIndicationFDD
  PROCEDURE ID            { procedureCode id-radioLinkParameterUpdate, ddMode fdd }
}
```

```
    CRITICALITY          ignore
  }

radioLinkParameterUpdateTDD RNSAP-ELEMENTARY-PROCEDURE ::= {
  INITIATING MESSAGE    RadioLinkParameterUpdateIndicationTDD
  PROCEDURE ID          { procedureCode id-radioLinkParameterUpdate, ddMode tdd }
  CRITICALITY          ignore
}

uEMeasurementInitiation RNSAP-ELEMENTARY-PROCEDURE ::= {
  INITIATING MESSAGE    UEMeasurementInitiationRequest
  SUCCESSFUL OUTCOME    UEMeasurementInitiationResponse
  UNSUCCESSFUL OUTCOME UEMeasurementInitiationFailure
  PROCEDURE ID          { procedureCode id-uEMeasurementInitiation, ddMode tdd }
  CRITICALITY          reject
}

uEMeasurementReporting RNSAP-ELEMENTARY-PROCEDURE ::= {
  INITIATING MESSAGE    UEMeasurementReport
  PROCEDURE ID          { procedureCode id-uEMeasurementReporting, ddMode tdd }
  CRITICALITY          ignore
}

uEMeasurementTermination RNSAP-ELEMENTARY-PROCEDURE ::= {
  INITIATING MESSAGE    UEMeasurementTerminationRequest
  PROCEDURE ID          { procedureCode id-uEMeasurementTermination, ddMode tdd }
  CRITICALITY          ignore
}

uEMeasurementFailure RNSAP-ELEMENTARY-PROCEDURE ::= {
  INITIATING MESSAGE    UEMeasurementFailureIndication
  PROCEDURE ID          { procedureCode id-uEMeasurementFailure, ddMode tdd }
  CRITICALITY          ignore
}

iurInvokeTrace RNSAP-ELEMENTARY-PROCEDURE ::= {
  INITIATING MESSAGE    IurInvokeTrace
  PROCEDURE ID          { procedureCode id-iurInvokeTrace, ddMode common }
  CRITICALITY          ignore
}

iurDeactivateTrace RNSAP-ELEMENTARY-PROCEDURE ::= {
  INITIATING MESSAGE    IurDeactivateTrace
  PROCEDURE ID          { procedureCode id-iurDeactivateTrace, ddMode common }
  CRITICALITY          ignore
}

mBMSAttach RNSAP-ELEMENTARY-PROCEDURE ::= {
  INITIATING MESSAGE    MBMSAttachCommand
  PROCEDURE ID          { procedureCode id-mBMSAttach, ddMode common }
  CRITICALITY          ignore
}

mBMSDetach RNSAP-ELEMENTARY-PROCEDURE ::= {
```

```
INITIATING MESSAGE      MBMSDetachCommand
PROCEDURE ID            { procedureCode id-mBMSDetach, ddMode common }
CRITICALITY            ignore
}

directInformationTransfer RNSAP-ELEMENTARY-PROCEDURE ::= {
  INITIATING MESSAGE      DirectInformationTransfer
  PROCEDURE ID            { procedureCode id-directInformationTransfer, ddMode common }
  CRITICALITY            ignore
}

enhancedRelocation RNSAP-ELEMENTARY-PROCEDURE ::= {
  INITIATING MESSAGE      EnhancedRelocationRequest
  SUCCESSFUL OUTCOME      EnhancedRelocationResponse
  UNSUCCESSFUL OUTCOME    EnhancedRelocationFailure
  PROCEDURE ID            { procedureCode id-enhancedRelocation, ddMode common }
  CRITICALITY            reject
}

enhancedRelocationCancel RNSAP-ELEMENTARY-PROCEDURE ::= {
  INITIATING MESSAGE      EnhancedRelocationCancel
  PROCEDURE ID            { procedureCode id-enhancedRelocationCancel, ddMode common }
  CRITICALITY            ignore
}

enhancedRelocationSignallingTransfer RNSAP-ELEMENTARY-PROCEDURE ::= {
  INITIATING MESSAGE      EnhancedRelocationSignallingTransfer
  PROCEDURE ID            { procedureCode id-enhancedRelocationSignallingTransfer, ddMode common }
  CRITICALITY            ignore
}

enhancedRelocationRelease RNSAP-ELEMENTARY-PROCEDURE ::= {
  INITIATING MESSAGE      EnhancedRelocationRelease
  PROCEDURE ID            { procedureCode id-enhancedRelocationRelease, ddMode common }
  CRITICALITY            ignore
}

mBSFNCCHInformation RNSAP-ELEMENTARY-PROCEDURE ::= {
  INITIATING MESSAGE      MBSFNCCHInformation
  PROCEDURE ID            { procedureCode id-mBSFNCCHInformation, ddMode common }
  CRITICALITY            reject
}

secondaryULFrequencyReportingFDD RNSAP-ELEMENTARY-PROCEDURE ::= {
  INITIATING MESSAGE      SecondaryULFrequencyReport
  PROCEDURE ID            { procedureCode id-secondaryULFrequencyReporting, ddMode fdd }
  CRITICALITY            ignore
}

secondaryULFrequencyUpdateFDD RNSAP-ELEMENTARY-PROCEDURE ::= {
  INITIATING MESSAGE      SecondaryULFrequencyUpdateIndication
  PROCEDURE ID            { procedureCode id-secondaryULFrequencyUpdate, ddMode fdd }
  CRITICALITY            ignore
}
```

END

9.3.3 PDU Definitions

```
-- *****
--
-- PDU definitions for RNSAP.
--
-- *****

RNSAP-PDU-Contents {
itu-t (0) identified-organization (4) etsi (0) mobileDomain (0)
umts-Access (20) modules (3) rnsap (1) version1 (1) rnsap-PDU-Contents (1) }

DEFINITIONS AUTOMATIC TAGS ::=

BEGIN

-- *****
--
-- IE parameter types from other modules.
--
-- *****

IMPORTS
    Active-Pattern-Sequence-Information,
    Active-MBMS-Bearer-Service-ListFDD,
    Active-MBMS-Bearer-Service-ListFDD-PFL,
    Active-MBMS-Bearer-Service-ListTDD,
    Active-MBMS-Bearer-Service-ListTDD-PFL,
    AllocationRetentionPriority,
    AllowedQueuingTime,
    Allowed-Rate-Information,
    AlphaValue,
    AlternativeFormatReportingIndicator,
    AntennaColocationIndicator,
    BLER,
    SCTD-Indicator,
    BindingID,
    C-ID,
    C-RNTI,
    CCTrCH-ID,
    CFN,
    CGI,
    ClosedLoopModel-SupportIndicator,
    Closedlooptimingadjustmentmode,
    CN-CS-DomainIdentifier,
    CN-PS-DomainIdentifier,
    CNDomainType,
    Cause,
    CellCapabilityContainer-FDD,
    CellCapabilityContainerExtension-FDD,
```

CellCapabilityContainer-TDD,
CellCapabilityContainer-TDD-LCR,
CellCapabilityContainer-TDD768,
CellParameterID,
CellPortionID,
ChipOffset,
CommonMeasurementAccuracy,
CommonMeasurementType,
CommonMeasurementValue,
CommonMeasurementValueInformation,
CommonTransportChannelResourcesInitialisationNotRequired,
Common-EDCH-MAC-d-Flow-Specific-InformationFDD,
Common-EDCH-Support-Indicator,
CongestionCause,
Continuous-Packet-Connectivity-DTX-DRX-Information,
Continuous-Packet-Connectivity-HS-SCCH-Less-Information,
Continuous-Packet-Connectivity-HS-SCCH-Less-Information-Response,
CPC-Information,
CoverageIndicator,
CriticalityDiagnostics,
CellPortionLCRID,
D-RNTI,
D-RNTI-ReleaseIndication,
DCH-FDD-Information,
DCH-ID,
DCH-Indicator-For-E-DCH-HSDPA-Operation,
DPCH-ID768,
DCH-InformationResponse,
DCH-TDD-Information,
DL-DPCH-SlotFormat,
DL-TimeslotISCP,
DL-Power,
DL-PowerBalancing-Information,
DL-PowerBalancing-ActivationIndicator,
DL-PowerBalancing-UpdatedIndicator,
DL-ReferencePowerInformation,
DL-ScramblingCode,
DL-Timeslot-Information,
DL-Timeslot-Information768,
DL-TimeslotLCR-Information,
DL-TimeSlot-ISCP-Info,
DL-TimeSlot-ISCP-LCR-Information,
DPC-Mode,
DPC-Mode-Change-SupportIndicator,
DPCH-ID,
DL-DPCH-TimingAdjustment,
DRXCycleLengthCoefficient,
DedicatedMeasurementType,
DedicatedMeasurementValue,
DedicatedMeasurementValueInformation,
DelayedActivation,
DelayedActivationUpdate,
DiversityControlField,
DiversityMode,

DSCH-FlowControlInformation,
DSCH-FlowControlItem,
DSCH-TDD-Information,
DSCH-ID,
DSCH-RNTI,
EDCH-FDD-Information,
EDCH-FDD-InformationResponse,
EDCH-FDD-Information-To-Modify,
EDCH-FDD-DL-ControlChannelInformation,
EDCH-DDI-Value,
EDCH-MACdFlow-ID,
EDCH-MACdFlow-Specific-InfoList,
EDCH-MACdFlows-To-Delete,
EDCH-MACdFlows-Information,
EDCH-RL-Indication,
EDCH-Serving-RL,
E-DCH-Serving-cell-change-informationResponse,
EDPCH-Information-FDD,
EDPCH-Information-RLReconfPrepare-FDD,
EDPCH-Information-RLReconfRequest-FDD,
E-DCH-FDD-Update-Information,
E-DPCCH-PO,
E-RGCH-2-IndexStepThreshold,
E-RGCH-3-IndexStepThreshold,
E-RNTI,
E-TFCS-Information,
E-TTI,
Enhanced-FACH-Support-Indicator,
Enhanced-FACH-Information-ResponseFDD,
Enhanced-PCH-Capability,
ExtendedPropagationDelay,
Extended-RNC-ID,
SchedulingPriorityIndicator,
Enhanced-PrimaryCPICH-EcNo,
F-DPCH-SlotFormat,
F-DPCH-SlotFormatSupportRequest,
FACH-FlowControlInformation,
Fast-Reconfiguration-Mode,
Fast-Reconfiguration-Permission,
FDD-DCHs-to-Modify,
FDD-DL-ChannelisationCodeNumber,
FDD-DL-CodeInformation,
FDD-TPC-DownlinkStepSize,
FirstRLS-Indicator,
FNReportingIndicator,
FrameHandlingPriority,
FrameOffset,
GA-AccessPointPosition,
GA-Cell,
GA-CellAdditionalShapes,
HARQ-Info-for-E-DCH,
HCS-Prio,
HSDSCH-Configured-Indicator,
HSDSCH-FDD-Information,

HSDSCH-FDD-Information-Response,
HSDSCH-FDD-Update-Information,
HSDSCH-TDD-Update-Information,
HSDSCH-Information-to-Modify,
HSDSCH-Information-to-Modify-Unsynchronised,
HSDSCH-MACdFlow-ID,
HSDSCH-MACdFlows-Information,
HSDSCH-MACdFlows-to-Delete,
HSDSCH-Physical-Layer-Category,
HSDSCH-RNTI,
HS-DSCH-serving-cell-change-information,
HS-DSCH-serving-cell-change-informationResponse,
HSDSCH-TDD-Information,
HSDSCH-TDD-Information-Response,
HS-SICH-ID,
IMSI,
InformationExchangeID,
InformationReportCharacteristics,
InformationType,
Initial-DL-DPCH-TimingAdjustment-Allowed,
InnerLoopDLPCStatus,
Inter-Frequency-Cell-List,
L3-Information,
LimitedPowerIncrease,
MaximumAllowedULTxPower,
MaxNrDLPhysicalchannels,
MaxNrDLPhysicalchannelsTS,
MaxNrDLPhysicalchannels768,
MaxNrDLPhysicalchannelsTS768,
MaxNrOfUL-DPCHs,
MaxNrTimeslots,
MaxNrULPhysicalchannels,
MACes-Guaranteed-Bitrate,
MaxNr-Retransmissions-EDCH,
Max-Set-E-DPCHs,
Max-UE-DTX-Cycle,
MeasurementFilterCoefficient,
MeasurementID,
MeasurementRecoveryBehavior,
MeasurementRecoveryReportingIndicator,
MeasurementRecoverySupportIndicator,
MBMS-Bearer-Service-List,
MBSFN-Cluster-Identity,
MCCH-Configuration-Info,
MCCH-Message-List,
MBSFN-Scheduling-Transmission-Time-Interval-Info-List,
MidambleAllocationMode,
MidambleShiftAndBurstType,
MidambleShiftAndBurstType768,
MidambleShiftLCR,
MinimumSpreadingFactor,
MinimumSpreadingFactor768,
MinUL-ChannelisationCodeLength,
Multiple-PLMN-List,

MultiplexingPosition,
NeighbouringFDDCellMeasurementInformation,
NeighbouringTDDCellMeasurementInformation,
NeighbouringTDDCellMeasurementInformation768,
Neighbouring-GSM-CellInformation,
Neighbouring-UMTS-CellInformation,
NeighbouringTDDCellMeasurementInformationLCR,
Neighbouring-E-UTRA-CellInformation,
NrOfDLchannelisationcodes,
PagingCause,
PagingRecordType,
PartialReportingIndicator,
PayloadCRC-PresenceIndicator,
PCCPCH-Power,
PC-Preamble,
Permanent-NAS-UE-Identity,
Phase-Reference-Update-Indicator,
PowerAdjustmentType,
PowerOffset,
PrimaryCCPCH-RSCP,
PrimaryCPICH-EcNo,
PrimaryCPICH-Power,
Primary-CPICH-Usage-For-Channel-Estimation,
PrimaryScramblingCode,
PropagationDelay,
ProvidedInformation,
PunctureLimit,
QE-Selector,
RANAP-EnhancedRelocationInformationRequest,
RANAP-EnhancedRelocationInformationResponse,
RANAP-RelocationInformation,
RB-Info,
Released-CN-Domain,
RL-ID,
RL-Set-ID,
RL-Specific-EDCH-Information,
RNC-ID,
RepetitionLength,
RepetitionPeriod,
ReportCharacteristics,
Received-total-wide-band-power,
RequestedDataValue,
RequestedDataValueInformation,
RL-Specific-DCH-Info,
RxTimingDeviationForTA,
RxTimingDeviationForTA768,
S-RNTI,
S-RNTI-Group,
SCH-TimeSlot,
SAI,
SFN,
Secondary-CCPCH-Info-TDD,
Secondary-CCPCH-Info-TDD768,
Secondary-CCPCH-System-Information-MBMS,

Secondary-CPICH-Information,
Secondary-CPICH-Information-Change,
Secondary-LCR-CCPCH-Info-TDD,
Secondary-Serving-Cell-List,
SNA-Information,
SpecialBurstScheduling,
SSDT-SupportIndicator,
STTD-SupportIndicator,
AdjustmentPeriod,
ScaledAdjustmentRatio,
MaxAdjustmentStep,
SRB-Delay,
Support-8PSK,
SyncCase,
SynchronisationConfiguration,
SixtyfourQAM-DL-SupportIndicator,
TDD-ChannelisationCode,
TDD-ChannelisationCode768,
TDD-DCHs-to-Modify,
TDD-DL-Code-Information,
TDD-DPCHOffset,
TDD-PhysicalChannelOffset,
TDD-TPC-DownlinkStepSize,
TDD-ChannelisationCodeLCR,
TDD-DL-Code-LCR-Information,
TDD-DL-Code-Information768,
TDD-UL-Code-Information,
TDD-UL-Code-LCR-Information,
TDD-UL-Code-Information768,
TFCI-Coding,
TFCI-Presence,
TFCI-SignallingMode,
TimeSlot,
TimeSlotLCR,
TimingAdvanceApplied,
TMGI,
TnlQos,
ToAWE,
ToAWS,
TraceDepth,
TraceRecordingSessionReference,
TraceReference,
TrafficClass,
TransmitDiversityIndicator,
TransportBearerID,
TransportBearerRequestIndicator,
TFCS,
Transmission-Gap-Pattern-Sequence-Information,
TransportFormatManagement,
TransportFormatSet,
TransportLayerAddress,
TrCH-SrcStatisticsDescr,
TSTD-Indicator,
TSTD-Support-Indicator,

UARFCN,
UC-ID,
UE-AggregateMaximumBitRate,
UEIdentity,
UEMeasurementType,
UEMeasurementTimeslotInfoHCR,
UEMeasurementTimeslotInfoLCR,
UEMeasurementTimeslotInfo768,
UEMeasurementReportCharacteristics,
UEMeasurementParameterModAllow,
UEMeasurementValueInformation,
UE-State,
UL-DPCCH-SlotFormat,
UL-DPDCHIndicatorEDCH,
UL-SIR,
UL-FP-Mode,
UL-PhysCH-SF-Variation,
UL-ScramblingCode,
UL-Timeslot-Information,
UL-Timeslot-Information768,
UL-TimeslotLCR-Information,
UL-TimeSlot-ISCP-Info,
UL-TimeSlot-ISCP-LCR-Info,
URA-ID,
URA-Information,
USCH-ID,
USCH-Information,
UL-Synchronisation-Parameters-LCR,
TDD-DL-DPCH-TimeSlotFormat-LCR,
TDD-UL-DPCH-TimeSlotFormat-LCR,
MACHs-ResetIndicator,
UL-TimingAdvanceCtrl-LCR,
TDD-TPC-UplinkStepSize-LCR,
PrimaryCCPCH-RSCP-Delta,
SynchronisationIndicator,
Support-PLCCH,
PLCCHinformation,
RxTimingDeviationForTAext,
E-DCH-Information,
E-DCH-Information-Reconfig,
E-DCH-Information-Response,
E-DCH-768-Information,
E-DCH-768-Information-Reconfig,
E-DCH-768-Information-Response,
E-DCH-LCR-Information,
E-DCH-LCR-Information-Reconfig,
E-DCH-LCR-Information-Response,
ControlGAP,
IdleIntervalInformation,
NeedforIdleInterval,
HS-SICH-ID-Extension,
TSN-Length,
UPPCHPositionLCR,
Common-EDCH-MAC-d-Flow-Specific-InformationLCR,

Enhanced-FACH-Information-ResponseLCR,
HSDSCH-PreconfigurationSetup,
HSDSCH-PreconfigurationInfo,
NoOfTargetCellHS-SCCH-Order,
EnhancedHSServingCC-Abort,
GANSS-Time-ID,
HS-DSCH-FDD-Secondary-Serving-Update-Information,
HS-DSCH-Secondary-Serving-Remove,
HS-DSCH-FDD-Secondary-Serving-Information-To-Modify-Unsynchronised,
HS-DSCH-Secondary-Serving-Information-To-Modify,
HS-DSCH-Secondary-Serving-Cell-Change-Information-Response,
HS-DSCH-FDD-Secondary-Serving-Information-Response,
HS-DSCH-FDD-Secondary-Serving-Information,
MinimumReducedE-DPDCH-GainFactor,
ContinuousPacketConnectivity-DRX-InformationLCR,
ContinuousPacketConnectivity-DRX-Information-ResponseLCR,
CPC-InformationLCR,
E-DCH-Semi-PersistentScheduling-Information-LCR,
HS-DSCH-Semi-PersistentScheduling-Information-LCR,
HS-DSCH-Semi-PersistentScheduling-Information-ResponseLCR,
E-DCH-Semi-PersistentScheduling-Information-ResponseLCR,
RNTI-Allocation-Indicator,
ActivationInformation,
Additional-EDCH-Setup-Info,
Additional-EDCH-Cell-Information-Response-List,
Additional-EDCH-FDD-Update-Information,
Additional-EDCH-Cell-Information-To-Add-List,
Additional-EDCH-Cell-Information-Response-RLReconf-List,
DCH-MeasurementOccasion-Information,
DCH-MeasurementType-Indicator,
Setup-Or-ConfigurationChange-Or-Removal-Of-EDCH-On-secondary-UL-Frequency,
Additional-EDCH-Cell-Information-Response-RLAddList,
Non-Serving-RL-Preconfig-Setup,
Non-Serving-RL-Preconfig-Info,
CPC-RecoveryReport

FROM RNSAP-IES

PrivateIE-Container{},
ProtocolExtensionContainer{},
ProtocolIE-ContainerList{},
ProtocolIE-ContainerPair{},
ProtocolIE-ContainerPairList{},
ProtocolIE-Container{},
ProtocolIE-Single-Container{},
RNSAP-PRIVATE-IES,
RNSAP-PROTOCOL-EXTENSION,
RNSAP-PROTOCOL-IES,
RNSAP-PROTOCOL-IES-PAIR

FROM RNSAP-Containers

maxCellsMeas,
maxNoOfDSCHs,
maxNoOfUSCHs,
maxNrOfCCTrCHs,
maxNrOfDCHs,
maxNrOfTS,
maxNrOfDPCHs,
maxNrOfDPCHs768,
maxNrOfDPCHsPerRL-1,
maxNrOfDPCHs768PerRL-1,
maxNrOfInterfaces,
maxNrOfRLs,
maxNrOfRLSets,
maxNrOfRLSets-1,
maxNrOfRLs-1,
maxNrOfRLs-2,
maxNrOfULTs,
maxNrOfDLTs,
maxResetContext,
maxResetContextGroup,
maxNoOfDSCHsLCR,
maxNoOfUSCHsLCR,
maxNrOfCCTrCHsLCR,
maxNrOfTsLCR,
maxNrOfDLTsLCR,
maxNrOfULTsLCR,
maxNrOfDPCHsLCR,
maxNrOfDPCHsLCRPerRL-1,
maxNrOfLCRTDDNeighboursPerRNC,
maxNrOfMeasNCell,
maxNrOfMACdFlows,
maxNrOfMACdPDUSize,
maxNrOfMCCHMessages,
maxNrOfMBMSL3,
maxNrOfEDCHMACdFlows,
maxNrOfHSSICHs,
maxNrOfHSSICHs-1,
maxNrOfActiveMBMSServices,
maxNrOfMBMSServices,
maxNrOfSigSeqERGHICH-1,
maxNrOfCells,
maxNrOfHSDSCH-1,
maxNrOfEDCH-1,

id-Active-MBMS-Bearer-ServiceFDD,
id-Active-MBMS-Bearer-ServiceFDD-PFL,
id-Active-MBMS-Bearer-ServiceTDD,
id-Active-MBMS-Bearer-ServiceTDD-PFL,
id-Active-Pattern-Sequence-Information,
id-AdjustmentRatio,
id-AllowedQueuingTime,
id-AlternativeFormatReportingIndicator,
id-AntennaColocationIndicator,
id-BindingID,
id-C-ID,

id-C-RNTI,
id-CFN,
id-CFNReportingIndicator,
id-CN-CS-DomainIdentifier,
id-CN-PS-DomainIdentifier,
id-Cause,
id-CauseLevel-RL-AdditionFailureFDD,
id-CauseLevel-RL-AdditionFailureTDD,
id-CauseLevel-RL-ReconfFailure,
id-CauseLevel-RL-SetupFailureFDD,
id-CauseLevel-RL-SetupFailureTDD,
id-CCTrCH-InformationItem-RL-FailureInd,
id-CCTrCH-InformationItem-RL-RestoreInd,
id-CellCapabilityContainer-FDD,
id-CellCapabilityContainerExtension-FDD,
id-CellCapabilityContainer-TDD,
id-CellCapabilityContainer-TDD-LCR,
id-CellPortionID,
id-ChipOffset,
id-ClosedLoopModel-SupportIndicator,
id-CNOriginatedPage-PagingRqst,
id-CommonMeasurementAccuracy,
id-CommonMeasurementObjectType-CM-Rprt,
id-CommonMeasurementObjectType-CM-Rqst,
id-CommonMeasurementObjectType-CM-Rsp,
id-CommonMeasurementType,
id-CommonTransportChannelResourcesInitialisationNotRequired,
id-Common-EDCH-MAC-d-Flow-Specific-InformationFDD,
id-Common-EDCH-Support-Indicator,
id-CongestionCause,
id-Continuous-Packet-Connectivity-DTX-DRX-Information,
id-Continuous-Packet-Connectivity-HS-SCCH-Less-Information,
id-Continuous-Packet-Connectivity-HS-SCCH-Less-Information-Response,
id-CPC-Information,
id-CoverageIndicator,
id-CriticalityDiagnostics,
id-CellPortionLCRID,
id-D-RNTI,
id-D-RNTI-ReleaseIndication,
id-DCHs-to-Add-FDD,
id-DCHs-to-Add-TDD,
id-DCH-DeleteList-RL-ReconfPrepFDD,
id-DCH-DeleteList-RL-ReconfPrepTDD,
id-DCH-DeleteList-RL-ReconfRqstFDD,
id-DCH-DeleteList-RL-ReconfRqstTDD,
id-DCH-FDD-Information,
id-DCH-TDD-Information,
id-DCH-Indicator-For-E-DCH-HSDPA-Operation,
id-FDD-DCHs-to-Modify,
id-TDD-DCHs-to-Modify,
id-DCH-InformationResponse,
id-DCH-Rate-InformationItem-RL-CongestInd,
id-DL-CCTrCH-InformationAddItem-RL-ReconfPrepTDD,
id-DL-CCTrCH-InformationDeleteItem-RL-ReconfPrepTDD,

id-DL-CCTrCH-InformationModifyItem-RL-ReconfPrepTDD,
id-DL-CCTrCH-InformationListIE-RL-ReconfReadyTDD,
id-DL-CCTrCH-InformationModifyItem-RL-ReconfRqstTDD,
id-DL-CCTrCH-InformationDeleteItem-RL-ReconfRqstTDD,
id-DL-CCTrCH-InformationItem-RL-SetupRqstTDD,
id-DL-CCTrCH-InformationListIE-PhyChReconfRqstTDD,
id-DL-CCTrCH-InformationListIE-RL-AdditionRspTDD,
id-DL-CCTrCH-InformationListIE-RL-SetupRspTDD,
id-DL-CCTrCH-InformationAddList-RL-ReconfPrepTDD,
id-DL-CCTrCH-InformationDeleteList-RL-ReconfPrepTDD,
id-DL-CCTrCH-InformationModifyList-RL-ReconfPrepTDD,
id-DL-CCTrCH-InformationDeleteList-RL-ReconfRqstTDD,
id-DL-CCTrCH-InformationModifyList-RL-ReconfRqstTDD,
id-DL-CCTrCH-InformationList-RL-SetupRqstTDD,
id-FDD-DL-CodeInformation,
id-DL-DPCH-Information-RL-ReconfPrepFDD,
id-DL-DPCH-Information-RL-SetupRqstFDD,
id-DL-DPCH-Information-RL-ReconfRqstFDD,
id-DL-DPCH-InformationItem-PhyChReconfRqstTDD,
id-DL-DPCH-InformationItem-RL-AdditionRspTDD,
id-DL-DPCH-InformationItem-RL-SetupRspTDD,
id-DL-DPCH-InformationAddListIE-RL-ReconfReadyTDD,
id-DL-DPCH-InformationDeleteListIE-RL-ReconfReadyTDD,
id-DL-DPCH-InformationModifyListIE-RL-ReconfReadyTDD,
id-DL-DPCH-TimingAdjustment,
id-DL-DPCH-Power-Information-RL-ReconfPrepFDD,
id-DL-Physical-Channel-Information-RL-SetupRqstTDD,
id-DL-PowerBalancing-Information,
id-DL-PowerBalancing-ActivationIndicator,
id-DL-PowerBalancing-UpdatedIndicator,
id-DL-ReferencePowerInformation,
id-DLReferencePower,
id-DLReferencePowerList-DL-PC-Rqst,
id-DL-ReferencePowerInformation-DL-PC-Rqst,
id-DRXCycleLengthCoefficient,
id-DedicatedMeasurementObjectType-DM-Fail,
id-DedicatedMeasurementObjectType-DM-Fail-Ind,
id-DedicatedMeasurementObjectType-DM-Rprt,
id-DedicatedMeasurementObjectType-DM-Rqst,
id-DedicatedMeasurementObjectType-DM-Rsp,
id-DedicatedMeasurementType,
id-DelayedActivation,
id-DelayedActivationList-RL-ActivationCmdFDD,
id-DelayedActivationList-RL-ActivationCmdTDD,
id-DelayedActivationInformation-RL-ActivationCmdFDD,
id-DelayedActivationInformation-RL-ActivationCmdTDD,
id-DPC-Mode,
id-DPC-Mode-Change-SupportIndicator,
id-DSCHs-to-Add-TDD,
id-DSCH-DeleteList-RL-ReconfPrepTDD,
id-DSCH-InformationListIE-RL-AdditionRspTDD,
id-DSCH-InformationListIEs-RL-SetupRspTDD,
id-DSCH-TDD-Information,
id-DSCH-ModifyList-RL-ReconfPrepTDD,

id-DSCH-RNTI,
id-DSCHToBeAddedOrModifiedList-RL-ReconfReadyTDD,
id-Dual-Band-Secondary-Serving-Cell-List,
id-EDPCH-Information,
id-EDCH-RL-Indication,
id-EDCH-FDD-Information,
id-Serving-EDCHRL-Id,
id-EDCH-FDD-DL-ControlChannelInformation,
id-EDCH-FDD-InformationResponse,
id-E-DCH-FDD-Update-Information,
id-EDCH-MACdFlows-To-Add,
id-EDCH-FDD-Information-To-Modify,
id-EDCH-MACdFlows-To-Delete,
id-EDPCH-Information-RLReconfRequest-FDD,
id-EDPCH-Information-RLAdditionReq-FDD,
id-EDCH-MacFlowSpecificInformationList-RL-PreemptRequiredInd,
id-EDCH-MacFlowSpecificInformationItem-RL-PreemptRequiredInd,
id-EDCH-MacFlowSpecificInformationList-RL-CongestInd,
id-EDCH-MacFlowSpecificInformationItem-RL-CongestInd,
id-Enhanced-FACH-Support-Indicator,
id-Enhanced-FACH-Information-ResponseFDD,
id-Enhanced-PCH-Capability,
id-ExtendedPropagationDelay,
id-Extended-SRNC-ID,
id-Extended-RNC-ID,
id-Serving-cell-change-CFN,
id-E-DCH-Serving-cell-change-informationResponse,
id-E-RNTI-For-FACH,
id-H-RNTI-For-FACH,
id-RNTI-Allocation-Indicator,
id-Enhanced-PrimaryCPICH-EcNo,
id-E-RNTI,
id-F-DPCH-SlotFormat,
id-F-DPCH-SlotFormatSupportRequest,
id-FACH-InfoForUESelectedS-CCPCH-CTCH-ResourceRspFDD,
id-FACH-InfoForUESelectedS-CCPCH-CTCH-ResourceRspTDD,
id-Fast-Reconfiguration-Mode,
id-Fast-Reconfiguration-Permission,
id-FrameOffset,
id-F-DPCH-Information-RL-ReconfPrepFDD,
id-F-DPCH-Information-RL-SetupRqstFDD,
id-GA-Cell,
id-GA-CellAdditionalShapes,
id-GSM-Cell-InfEx-Rqst,
id-HCS-Prio,
id-HSDSCH-Configured-Indicator,
id-HSDSCH-FDD-Information,
id-HSDSCH-FDD-Information-Response,
id-HSDSCH-FDD-Update-Information,
id-HSDSCH-TDD-Update-Information,
id-HSDSCH-Information-to-Modify,
id-HSDSCH-Information-to-Modify-Unsynchronised,
id-HSDSCH-MACdFlows-to-Add,
id-HSDSCH-MACdFlows-to-Delete,

id-HSDSCHMacdFlowSpecificInformationList-RL-PreemptRequiredInd,
id-HSDSCHMacdFlowSpecificInformationItem-RL-PreemptRequiredInd,
id-HSDSCH-Physical-Layer-Category,
id-HSDSCH-RNTI,
id-HS-DSCH-serving-cell-change-information,
id-HS-DSCH-serving-cell-change-informationResponse,
id-HSDSCH-TDD-Information,
id-HSDSCH-TDD-Information-Response,
id-HSPDSCH-RL-ID,
id-HSPDSCH-Timeslot-InformationList-PhyChReconfRqstTDD,
id-HSPDSCH-Timeslot-InformationListLCR-PhyChReconfRqstTDD,
id-HSSICH-Info-DM-Rprt,
id-HSSICH-Info-DM-Rqst,
id-HSSICH-Info-DM,
id-IMSI,
id-InformationExchangeID,
id-InformationExchangeObjectType-InfEx-Rprt,
id-InformationExchangeObjectType-InfEx-Rqst,
id-InformationExchangeObjectType-InfEx-Rsp,
id-InformationReportCharacteristics,
id-InformationType,
id-Initial-DL-DPCH-TimingAdjustment,
id-Initial-DL-DPCH-TimingAdjustment-Allowed,
id-InnerLoopDLPCStatus,
id-InterfacesToTraceItem,
id-Inter-Frequency-Cell-List,
id-L3-Information,
id-AdjustmentPeriod,
id-ListOfInterfacesToTrace,
id-MaxAdjustmentStep,
id-Max-UE-DTX-Cycle,
id-MBMS-Bearer-Service-List,
id-MBMS-Bearer-Service-List-InfEx-Rsp,
id-MBMS-Bearer-Service-in-MBMS-Cell-InfEx-Rqst,
id-MBMS-Bearer-Service-in-MBMS-Cell-InfEx-Rsp,
id-MBMS-Bearer-Service-in-MBMS-Cell-InfEx-Rprt,
id-MBMS-Cell-InfEx-Rqst,
id-MBMS-Cell-InfEx-Rsp,
id-MBMS-Cell-InfEx-Rprt,
id-MBSFN-Cluster-Identity,
id-MBSFN-Scheduling-Transmission-Time-Interval-Info-List,
id-MCCH-Configuration-Info,
id-MCCH-Message-List,
id-MeasurementFilterCoefficient,
id-MeasurementID,
id-MeasurementRecoveryBehavior,
id-MeasurementRecoveryReportingIndicator,
id-MeasurementRecoverySupportIndicator,
id-Multiple-PLMN-List,
id-Multiple-RL-InformationResponse-RL-ReconfReadyTDD,
id-NACC-Related-Data,
id-Neighbouring-E-UTRA-CellInformation,
id-Old-URA-ID,
id-PagingArea-PagingRqst,

id-PartialReportingIndicator,
id-PDSCH-RL-ID,
id-Permanent-NAS-UE-Identity,
id-Phase-Reference-Update-Indicator,
id-FACH-FlowControlInformation,
id-PLCCH-Information-PhyChReconfRqstTDD,
id-PowerAdjustmentType,
id-PrimCCPCH-RSCP-DL-PC-RqstTDD,
id-Primary-CPICH-Usage-For-Channel-Estimation,
id-PropagationDelay,
id-ProvidedInformation,
id-RANAP-EnhancedRelocationInformationRequest,
id-RANAP-EnhancedRelocationInformationResponse,
id-RANAP-RelocationInformation,
id-ResetIndicator,
id-Released-CN-Domain,
id-EDCH-RLSet-ID,
id-RL-Information-PhyChReconfRqstFDD,
id-RL-Information-PhyChReconfRqstTDD,
id-RL-Information-RL-AdditionRqstFDD,
id-RL-Information-RL-AdditionRqstTDD,
id-RL-Information-RL-DeletionRqst,
id-RL-Information-RL-FailureInd,
id-RL-Information-RL-ReconfPrepFDD,
id-RL-Information-RL-ReconfPrepTDD,
id-RL-Information-RL-RestoreInd,
id-RL-Information-RL-SetupRqstFDD,
id-RL-Information-RL-SetupRqstTDD,
id-RL-InformationItem-RL-CongestInd,
id-RL-InformationItem-DM-Rprt,
id-RL-InformationItem-DM-Rqst,
id-RL-InformationItem-DM-Rsp,
id-RL-InformationItem-RL-PreemptRequiredInd,
id-RL-InformationItem-RL-SetupRqstFDD,
id-RL-InformationList-RL-CongestInd,
id-RL-InformationList-RL-AdditionRqstFDD,
id-RL-InformationList-RL-DeletionRqst,
id-RL-InformationList-RL-PreemptRequiredInd,
id-RL-InformationList-RL-ReconfPrepFDD,
id-RL-InformationResponse-RL-AdditionRspTDD,
id-RL-InformationResponse-RL-ReconfReadyTDD,
id-RL-InformationResponse-RL-ReconfRspTDD,
id-RL-InformationResponse-RL-SetupRspTDD,
id-RL-InformationResponseItem-RL-AdditionRspFDD,
id-RL-InformationResponseItem-RL-ReconfReadyFDD,
id-RL-InformationResponseItem-RL-ReconfRspFDD,
id-RL-InformationResponseItem-RL-SetupRspFDD,
id-RL-InformationResponseList-RL-AdditionRspFDD,
id-RL-InformationResponseList-RL-ReconfReadyFDD,
id-RL-InformationResponseList-RL-ReconfRspFDD,
id-RL-InformationResponseList-RL-SetupRspFDD,
id-RL-ParameterUpdateIndicationFDD-RL-Information-Item,
id-RL-ParameterUpdateIndicationFDD-RL-InformationList,
id-RL-ReconfigurationFailure-RL-ReconfFail,

id-RL-ReconfigurationRequestFDD-RL-InformationList,
id-RL-ReconfigurationRequestFDD-RL-Information-IEs,
id-RL-ReconfigurationRequestTDD-RL-Information,
id-RL-ReconfigurationResponseTDD-RL-Information,
id-RL-Specific-DCH-Info,
id-RL-Specific-EDCH-Information,
id-RL-Set-InformationItem-DM-Rprt,
id-RL-Set-InformationItem-DM-Rqst,
id-RL-Set-InformationItem-DM-Rsp,
id-RL-Set-Information-RL-FailureInd,
id-RL-Set-Information-RL-RestoreInd,
id-RL-Set-Successful-InformationItem-DM-Fail,
id-RL-Set-Unsuccessful-InformationItem-DM-Fail,
id-RL-Set-Unsuccessful-InformationItem-DM-Fail-Ind,
id-RL-Successful-InformationItem-DM-Fail,
id-RL-Unsuccessful-InformationItem-DM-Fail,
id-RL-Unsuccessful-InformationItem-DM-Fail-Ind,
id-ReportCharacteristics,
id-Reporting-Object-RL-FailureInd,
id-Reporting-Object-RL-RestoreInd,
id-RNC-ID,
id-RxTimingDeviationForTA,
id-S-RNTI,
id-SAI,
id-Secondary-CPICH-Information,
id-Secondary-CPICH-Information-Change,
id-Secondary-Serving-Cell-List,
id-Dual-Band-Secondary-Serving-Cell-List,
id-SixtyfourQAM-DL-SupportIndicator,
id-SFN,
id-SFNReportingIndicator,
id-SNA-Information,
id-SRNC-ID,
id-STTD-SupportIndicator,
id-SuccessfulRL-InformationResponse-RL-AdditionFailureFDD,
id-SuccessfulRL-InformationResponse-RL-SetupFailureFDD,
id-TDD-maxNrDLPhysicalchannels,
id-TDD-Support-8PSK,
id-TDD-Support-PLCCH,
id-timeSlot-ISCP,
id-TimeSlot-RL-SetupRspTDD,
id-TnlQos,
id-TraceDepth,
id-TraceRecordingSessionReference,
id-TraceReference,
id-TransportBearerID,
id-TransportBearerRequestIndicator,
id-TransportLayerAddress,
id-UC-ID,
id-ContextInfoItem-Reset,
id-ContextGroupInfoItem-Reset,
id-Transmission-Gap-Pattern-Sequence-Information,
id-UE-AggregateMaximumBitRate,
id-UEIdentity,

id-UEMeasurementType,
id-UEMeasurementTimeslotInfoHCR,
id-UEMeasurementTimeslotInfoLCR,
id-UEMeasurementReportCharacteristics,
id-UEMeasurementParameterModAllow,
id-UEMeasurementValueInformation,
id-UE-State,
id-UE-with-enhanced-HS-SCCH-support-indicator,
id-UL-CCTrCH-AddInformation-RL-ReconfPrepTDD,
id-UL-CCTrCH-DeleteInformation-RL-ReconfPrepTDD,
id-UL-CCTrCH-ModifyInformation-RL-ReconfPrepTDD,
id-UL-CCTrCH-InformationDeleteItem-RL-ReconfRqstTDD,
id-UL-CCTrCH-InformationModifyItem-RL-ReconfRqstTDD,
id-UL-CCTrCH-InformationAddList-RL-ReconfPrepTDD,
id-UL-CCTrCH-InformationDeleteList-RL-ReconfPrepTDD,
id-UL-CCTrCH-InformationModifyList-RL-ReconfPrepTDD,
id-UL-CCTrCH-InformationDeleteList-RL-ReconfRqstTDD,
id-UL-CCTrCH-InformationModifyList-RL-ReconfRqstTDD,
id-UL-CCTrCH-InformationItem-RL-SetupRqstTDD,
id-UL-CCTrCH-InformationList-RL-SetupRqstTDD,
id-UL-CCTrCH-InformationListIE-PhyChReconfRqstTDD,
id-UL-CCTrCH-InformationListIE-RL-AdditionRspTDD,
id-UL-CCTrCH-InformationListIE-RL-ReconfReadyTDD,
id-UL-CCTrCH-InformationListIE-RL-SetupRspTDD,
id-UL-DPCH-Information-RL-ReconfPrepFDD,
id-UL-DPCH-Information-RL-ReconfRqstFDD,
id-UL-DPCH-Information-RL-SetupRqstFDD,
id-UL-DPDCHIndicatorEDCH,
id-UL-DPCH-InformationItem-PhyChReconfRqstTDD,
id-UL-DPCH-InformationItem-RL-AdditionRspTDD,
id-UL-DPCH-InformationItem-RL-SetupRspTDD,
id-UL-DPCH-InformationAddListIE-RL-ReconfReadyTDD,
id-UL-DPCH-InformationDeleteListIE-RL-ReconfReadyTDD,
id-UL-DPCH-InformationModifyListIE-RL-ReconfReadyTDD,
id-UL-Physical-Channel-Information-RL-SetupRqstTDD,
id-UL-SIRTarget,
id-URA-ID,
id-URA-Information,
id-UnsuccessfulRL-InformationResponse-RL-AdditionFailureFDD,
id-UnsuccessfulRL-InformationResponse-RL-AdditionFailureTDD,
id-UnsuccessfulRL-InformationResponse-RL-SetupFailureFDD,
id-UnsuccessfulRL-InformationResponse-RL-SetupFailureTDD,
id-USCHs-to-Add,
id-USCH-DeleteList-RL-ReconfPrepTDD,
id-USCH-InformationListIE-RL-AdditionRspTDD,
id-USCH-InformationListIEs-RL-SetupRspTDD,
id-USCH-Information,
id-USCH-ModifyList-RL-ReconfPrepTDD,
id-USCHToBeAddedOrModifiedList-RL-ReconfReadyTDD,
id-DL-Timeslot-ISCP-LCR-Information-RL-SetupRqstTDD,
id-RL-LCR-InformationResponse-RL-SetupRspTDD,
id-UL-CCTrCH-LCR-InformationListIE-RL-SetupRspTDD,
id-UL-DPCH-LCR-InformationItem-RL-SetupRspTDD,
id-DL-CCTrCH-LCR-InformationListIE-RL-SetupRspTDD,

id-DL-DPCH-LCR-InformationItem-RL-SetupRspTDD,
id-DSCH-LCR-InformationListIEs-RL-SetupRspTDD,
id-USCH-LCR-InformationListIEs-RL-SetupRspTDD,
id-DL-Timeslot-ISCP-LCR-Information-RL-AdditionRqstTDD,
id-RL-LCR-InformationResponse-RL-AdditionRspTDD,
id-UL-CCTrCH-LCR-InformationListIE-RL-AdditionRspTDD,
id-UL-DPCH-LCR-InformationItem-RL-AdditionRspTDD,
id-DL-CCTrCH-LCR-InformationListIE-RL-AdditionRspTDD,
id-DL-DPCH-LCR-InformationItem-RL-AdditionRspTDD,
id-DSCH-LCR-InformationListIEs-RL-AdditionRspTDD,
id-USCH-LCR-InformationListIEs-RL-AdditionRspTDD,
id-UL-DPCH-LCR-InformationAddListIE-RL-ReconfReadyTDD,
id-UL-Timeslot-LCR-InformationModifyList-RL-ReconfReadyTDD,
id-DL-DPCH-LCR-InformationAddListIE-RL-ReconfReadyTDD,
id-DL-Timeslot-LCR-InformationModifyList-RL-ReconfReadyTDD,
id-UL-Timeslot-LCR-InformationList-PhyChReconfRqstTDD,
id-DL-Timeslot-LCR-InformationList-PhyChReconfRqstTDD,
id-timeSlot-ISCP-LCR-List-DL-PC-Rqst-TDD,
id-TSTD-Support-Indicator-RL-SetupRqstTDD,
id-PrimaryCCPCH-RSCP-RL-ReconfPrepTDD,
id-DL-TimeSlot-ISCP-Info-RL-ReconfPrepTDD,
id-DL-TimeSlot-ISCP-LCR-Information-RL-ReconfPrepTDD,
id-neighbouringTDDCellMeasurementInformationLCR,
id-UL-SIR-Target-CCTrCH-InformationItem-RL-SetupRspTDD,
id-UL-SIR-Target-CCTrCH-LCR-InformationItem-RL-SetupRspTDD,
id-TrafficClass,
id-UL-Synchronisation-Parameters-LCR,
id-TDD-DL-DPCH-TimeSlotFormatModifyItem-LCR-RL-ReconfReadyTDD,
id-TDD-UL-DPCH-TimeSlotFormatModifyItem-LCR-RL-ReconfReadyTDD,
id-MACHs-ResetIndicator,
id-UL-TimingAdvanceCtrl-LCR,
id-CCTrCH-Maximum-DL-Power-RL-SetupRspTDD,
id-CCTrCH-Minimum-DL-Power-RL-SetupRspTDD,
id-CCTrCH-Maximum-DL-Power-RL-AdditionRspTDD,
id-CCTrCH-Minimum-DL-Power-RL-AdditionRspTDD,
id-CCTrCH-Maximum-DL-Power-RL-ReconfReadyTDD,
id-CCTrCH-Minimum-DL-Power-RL-ReconfReadyTDD,
id-Maximum-DL-Power-TimeSlotLCR-InformationModifyItem-RL-ReconfReadyTDD,
id-Minimum-DL-Power-TimeSlotLCR-InformationModifyItem-RL-ReconfReadyTDD,
id-DL-CCTrCH-InformationList-RL-ReconfRspTDD,
id-DL-DPCH-InformationModifyItem-LCR-RL-ReconfRspTDD,
id-TDD-TPC-UplinkStepSize-LCR-RL-SetupRqstTDD,
id-UL-CCTrCH-InformationList-RL-AdditionRqstTDD,
id-UL-CCTrCH-InformationItem-RL-AdditionRqstTDD,
id-DL-CCTrCH-InformationList-RL-AdditionRqstTDD,
id-DL-CCTrCH-InformationItem-RL-AdditionRqstTDD,
id-TDD-TPC-UplinkStepSize-InformationAdd-LCR-RL-ReconfPrepTDD,
id-TDD-TPC-UplinkStepSize-InformationModify-LCR-RL-ReconfPrepTDD,
id-TDD-TPC-DownlinkStepSize-InformationAdd-RL-ReconfPrepTDD,
id-TDD-TPC-DownlinkStepSize-InformationModify-RL-ReconfPrepTDD,
id-PrimaryCCPCH-RSCP-Delta,
id-multiple-DedicatedMeasurementValueList-TDD-DM-Rsp,
id-multiple-DedicatedMeasurementValueList-LCR-TDD-DM-Rsp,
id-SynchronisationIndicator,

id-secondary-LCR-CCPCH-Info-TDD,
id-multiple-HSSICHMeasurementValueList-TDD-DM-Rsp,
id-CellCapabilityContainer-TDD768,
id-neighbouringTDDCellMeasurementInformation768,
id-RL-InformationResponse-RL-SetupRspTDD768,
id-UL-CCTrCH-InformationListIE-RL-SetupRspTDD768,
id-DL-CCTrCH-InformationListIE-RL-SetupRspTDD768,
id-UL-DPCH-InformationItem-RL-SetupRspTDD768,
id-DL-DPCH-InformationItem-RL-SetupRspTDD768,
id-TDD768-minimumSpreadingFactor-UL,
id-TDD768-minimumSpreadingFactor-DL,
id-TDD768-maxNrDLPhysicalchannels,
id-TDD768-maxNrDLPhysicalchannelsTS,
id-RL-InformationResponse-RL-AdditionRspTDD768,
id-UL-CCTrCH-InformationListIE-RL-AdditionRspTDD768,
id-DL-CCTrCH-InformationListIE-RL-AdditionRspTDD768,
id-UL-DPCH-InformationItem-RL-AdditionRspTDD768,
id-DL-DPCH-InformationItem-RL-AdditionRspTDD768,
id-UL-DPCH-InformationAddListIE-RL-ReconfReadyTDD768,
id-UL-Timeslot-InformationModifyList-RL-ReconfReadyTDD768,
id-DL-DPCH-InformationAddListIE-RL-ReconfReadyTDD768,
id-DL-Timeslot-InformationModifyList-RL-ReconfReadyTDD768,
id-secondary-CCPCH-Info-RL-ReconfReadyTDD768,
id-HSPDSCH-Timeslot-InformationList-PhyChReconfRqstTDD768,
id-UL-Timeslot-InformationList-PhyChReconfRqstTDD768,
id-DL-Timeslot-InformationList-PhyChReconfRqstTDD768,
id-multiple-DedicatedMeasurementValueList-TDD768-DM-Rsp,
id-UEMeasurementTimeslotInfo768,
id-DL-DPCH-InformationDeleteList768-RL-ReconfReadyTDD,
id-DPCH-ID768-DM-Rsp,
id-DPCH-ID768-DM-Rqst,
id-DPCH-ID768-DM-Rprt,
id-RxTimingDeviationForTAext,
id-RxTimingDeviationForTA768,
id-E-DCH-Information,
id-E-DCH-Information-Reconfig,
id-E-DCH-Serving-RL-ID,
id-E-DCH-Information-Response,
id-E-DCH-768-Information,
id-E-DCH-768-Information-Reconfig,
id-E-DCH-768-Information-Response,
id-E-DCH-LCR-Information,
id-E-DCH-LCR-Information-Reconfig,
id-E-DCH-LCR-Information-Response,
id-PowerControlGAP,
id-IdleIntervalInformation,
id-NeedforIdleInterval,
id-IdleIntervalConfigurationIndicator,
id-UARFCNforNt,
id-HS-SICH-ID-Extension,
id-HSSICH-Info-DM-Rqst-Extension,
id-UPPCHPositionLCR,
id-Common-EDCH-MAC-d-Flow-Specific-InformationLCR,
id-Enhanced-FACH-Information-ResponseLCR,

```

id-HSDSCH-PreconfigurationSetup,
id-HSDSCH-PreconfigurationInfo,
id-NoOfTargetCellHS-SCCH-Order,
id-EnhancedHSServingCC-Abort,
id-GANSS-Time-ID,
id-Additional-HS-Cell-Information-RL-Setup,
id-Additional-HS-Cell-Information-Response,
id-Additional-HS-Cell-Information-RL-Addition,
id-Additional-HS-Cell-Change-Information-Response,
id-Additional-HS-Cell-Information-RL-Reconf-Prep,
id-Additional-HS-Cell-Information-RL-Reconf-Req,
id-Additional-HS-Cell-RL-Reconf-Response,
id-Additional-HS-Cell-Information-RL-Param-Upd,
id-MinimumReducedE-DPDCH-GainFactor,
id-ContinuousPacketConnectivity-DRX-InformationLCR,
id-ContinuousPacketConnectivity-DRX-Information-ResponseLCR,
id-CPC-InformationLCR,
id-E-DCH-Semi-PersistentScheduling-Information-LCR,
id-HS-DSCH-Semi-PersistentScheduling-Information-LCR,
id-HS-DSCH-Semi-PersistentScheduling-Information-ResponseLCR,
id-E-DCH-Semi-PersistentScheduling-Information-ResponseLCR,
id-ActivationInformation,
id-Additional-EDCH-Cell-Information-RL-Setup-Req,
id-Additional-EDCH-Cell-Information-Response,
id-Additional-EDCH-Cell-Information-RL-Add-Req,
id-Additional-EDCH-Cell-Information-Response-RLAdd,
id-Additional-EDCH-Cell-Information-RL-Reconf-Prep,
id-Additional-EDCH-Cell-Information-RL-Reconf-Req,
id-Additional-EDCH-Cell-Information-RL-Param-Upd,
id-Additional-EDCH-Cell-Information-ResponseRLReconf,
id-DCH-MeasurementOccasion-Information,
id-DCH-MeasurementType-Indicator,
id-Non-Serving-RL-Preconfig-Info,
id-Non-Serving-RL-Preconfig-Setup,
id-Non-Serving-RL-Preconfig-Removal,
id-CPC-RecoveryReport

```

```
FROM RNSAP-Constants;
```

```

-- *****
--
-- RADIO LINK SETUP REQUEST FDD
--
-- *****

```

```

RadioLinkSetupRequestFDD ::= SEQUENCE {
    protocolIEs          ProtocolIE-Container          {{RadioLinkSetupRequestFDD-IEs}},
    protocolExtensions   ProtocolExtensionContainer    {{RadioLinkSetupRequestFDD-Extensions}}
    ...
}

```

OPTIONAL,

```

RadioLinkSetupRequestFDD-IEs RNSAP-PROTOCOL-IES ::= {
  { ID id-SRNC-ID          CRITICALITY reject  TYPE RNC-ID          PRESENCE mandatory} |
  { ID id-S-RNTI          CRITICALITY reject  TYPE S-RNTI          PRESENCE mandatory  } |
  { ID id-D-RNTI          CRITICALITY reject  TYPE D-RNTI          PRESENCE optional   } |
  { ID id-AllowedQueuingTime CRITICALITY reject  TYPE AllowedQueuingTime PRESENCE optional   } |
  { ID id-UL-DPCH-Information-RL-SetupRqstFDD CRITICALITY reject  TYPE UL-DPCH-Information-RL-SetupRqstFDD PRESENCE mandatory  } |
  { ID id-DL-DPCH-Information-RL-SetupRqstFDD CRITICALITY reject  TYPE DL-DPCH-Information-RL-SetupRqstFDD PRESENCE optional   } |
  { ID id-DCH-FDD-Information CRITICALITY reject  TYPE DCH-FDD-Information PRESENCE mandatory  } |
  { ID id-RL-Information-RL-SetupRqstFDD CRITICALITY notify  TYPE RL-InformationList-RL-SetupRqstFDD PRESENCE mandatory  } |
  { ID id-Transmission-Gap-Pattern-Sequence-Information CRITICALITY reject  TYPE Transmission-Gap-Pattern-Sequence-Information PRESENCE optional } |
  { ID id-Active-Pattern-Sequence-Information CRITICALITY reject  TYPE Active-Pattern-Sequence-Information PRESENCE optional },
  ...
}

UL-DPCH-Information-RL-SetupRqstFDD ::= SEQUENCE {
  ul-ScramblingCode          UL-ScramblingCode,
  minUL-ChannelisationCodeLength MinUL-ChannelisationCodeLength,
  maxNrOfUL-DPCHs           MaxNrOfUL-DPCHs          OPTIONAL
  -- This IE shall be present if minUL-ChannelisationCodeLength equals to 4 -- ,
  ul-PunctureLimit          PunctureLimit,
  ul-TFCS                   TFCS,
  ul-DPCCCH-SlotFormat      UL-DPCCCH-SlotFormat,
  ul-SIRTarget              UL-SIR          OPTIONAL,
  diversityMode             DiversityMode,
  not-Used-sSDT-CellIdLength NULL          OPTIONAL,
  not-Used-s-FieldLength    NULL          OPTIONAL,
  iE-Extensions             ProtocolExtensionContainer { {UL-DPCH-Information-RL-SetupRqstFDD-ExtIEs} } OPTIONAL,
  ...
}

UL-DPCH-Information-RL-SetupRqstFDD-ExtIEs RNSAP-PROTOCOL-EXTENSION ::= {
  { ID id-DPC-Mode          CRITICALITY reject  EXTENSION DPC-Mode          PRESENCE optional } |
  { ID id-UL-DPDCHIndicatorEDCH CRITICALITY reject  EXTENSION UL-DPDCHIndicatorEDCH PRESENCE optional },
  ...
}

DL-DPCH-Information-RL-SetupRqstFDD ::= SEQUENCE {
  tFCS                      TFCS,
  dl-DPCH-SlotFormat        DL-DPCH-SlotFormat,
  nrOfDLchannelisationcodes NrOfDLchannelisationcodes,
  tFCI-SignallingMode       TFCI-SignallingMode,
  tFCI-Presence             TFCI-Presence          OPTIONAL
  -- This IE shall be present if DL DPCH Slot Format IE is equal to any of the values from 12 to 16 -- ,
  multiplexingPosition      MultiplexingPosition,
  powerOffsetInformation    PowerOffsetInformation-RL-SetupRqstFDD,
  fdd-dl-TPC-DownlinkStepSize FDD-TPC-DownlinkStepSize,
  limitedPowerIncrease      LimitedPowerIncrease,
  innerLoopDLPCStatus       InnerLoopDLPCStatus,
  iE-Extensions             ProtocolExtensionContainer { {DL-DPCH-Information-RL-SetupRqstFDD-ExtIEs} } OPTIONAL,
  ...
}

DL-DPCH-Information-RL-SetupRqstFDD-ExtIEs RNSAP-PROTOCOL-EXTENSION ::= {

```



```

}
...
PowerOffsetInformation-RL-SetupRqstFDD ::= SEQUENCE {
    po1-ForTFCI-Bits      PowerOffset,
    po2-ForTPC-Bits      PowerOffset,
    po3-ForPilotBits     PowerOffset,
    iE-Extensions        ProtocolExtensionContainer { { PowerOffsetInformation-RL-SetupRqstFDD-ExtIEs } } OPTIONAL,
    ...
}

PowerOffsetInformation-RL-SetupRqstFDD-ExtIEs RNSAP-PROTOCOL-EXTENSION ::= {
    ...
}

RL-InformationList-RL-SetupRqstFDD ::= SEQUENCE (SIZE (1..maxNrOfRLs)) OF ProtocolIE-Single-Container { {RL-InformationItemIEs-RL-SetupRqstFDD} }

RL-InformationItemIEs-RL-SetupRqstFDD RNSAP-PROTOCOL-IES ::= {
    { ID id-RL-InformationItem-RL-SetupRqstFDD CRITICALITY notify TYPE RL-InformationItem-RL-SetupRqstFDD PRESENCE mandatory }
}

RL-InformationItem-RL-SetupRqstFDD ::= SEQUENCE {
    rL-ID                RL-ID,
    c-ID                 C-ID,
    firstRLS-indicator  FirstRLS-Indicator,
    frameOffset         FrameOffset,
    chipOffset          ChipOffset,
    propagationDelay    PropagationDelay OPTIONAL,
    diversityControlField DiversityControlField OPTIONAL
    -- This IE shall be present if the RL is not the first one in the RL-InformationList-RL-SetupRqstFDD --,
    dl-InitialTX-Power  DL-Power OPTIONAL,
    primaryCPICH-EcNo   PrimaryCPICH-EcNo OPTIONAL,
    not-Used-sSDT-CellID NULL OPTIONAL,
    transmitDiversityIndicator TransmitDiversityIndicator OPTIONAL,
    -- This IE shall be present unless Diversity Mode IE in UL DPCH Information group is "none"
    iE-Extensions      ProtocolExtensionContainer { {RL-InformationItem-RL-SetupRqstFDD-ExtIEs} } OPTIONAL,
    ...
}

RL-InformationItem-RL-SetupRqstFDD-ExtIEs RNSAP-PROTOCOL-EXTENSION ::= {
    { ID id-Enhanced-PrimaryCPICH-EcNo CRITICALITY ignore EXTENSION Enhanced-PrimaryCPICH-EcNo PRESENCE optional } |
    { ID id-RL-Specific-DCH-Info CRITICALITY ignore EXTENSION RL-Specific-DCH-Info PRESENCE optional } |
    { ID id-DelayedActivation CRITICALITY reject EXTENSION DelayedActivation PRESENCE optional } |
    { ID id-CellPortionID CRITICALITY ignore EXTENSION CellPortionID PRESENCE optional } |
    { ID id-RL-Specific-EDCH-Information CRITICALITY reject EXTENSION RL-Specific-EDCH-Information PRESENCE optional } |
    { ID id-EDCH-RL-Indication CRITICALITY reject EXTENSION EDCH-RL-Indication PRESENCE optional } |
    { ID id-ExtendedPropagationDelay CRITICALITY ignore EXTENSION ExtendedPropagationDelay PRESENCE optional } |
    { ID id-SynchronisationIndicator CRITICALITY reject EXTENSION SynchronisationIndicator PRESENCE optional } |
    { ID id-HSDSCH-PreconfigurationSetup CRITICALITY ignore EXTENSION HSDSCH-PreconfigurationSetup PRESENCE optional } |
    { ID id-Non-Serving-RL-Preconfig-Setup CRITICALITY ignore EXTENSION Non-Serving-RL-Preconfig-Setup PRESENCE optional } |
    ...
}

```

```

RadioLinkSetupRequestFDD-Extensions RNSAP-PROTOCOL-EXTENSION ::= {
  { ID id-Permanent-NAS-UE-Identity          CRITICALITY ignore  EXTENSION Permanent-NAS-UE-Identity          PRESENCE optional
  }|
  { ID id-DL-PowerBalancing-Information      CRITICALITY ignore  EXTENSION DL-PowerBalancing-Information      PRESENCE optional}|
  { ID id-HSDSCH-FDD-Information             CRITICALITY reject  EXTENSION HSDSCH-FDD-Information             PRESENCE optional
  }|
  { ID id-HSPDSCH-RL-ID                     CRITICALITY reject  EXTENSION RL-ID                             PRESENCE
conditional }|
  -- This IE shall be present if HS-DSCH Information IE is present.
  { ID id-MBMS-Bearer-Service-List          CRITICALITY notify  EXTENSION MBMS-Bearer-Service-List          PRESENCE
optional }|
  { ID id-EDPCH-Information                  CRITICALITY reject  EXTENSION EDPCH-Information-FDD             PRESENCE
optional }|
  { ID id-EDCH-FDD-Information               CRITICALITY reject  EXTENSION EDCH-FDD-Information              PRESENCE
conditional }|
  -- This IE is present if E-DPCH Information IE is present.
  { ID id-Serving-EDCHRL-Id                 CRITICALITY reject  EXTENSION EDCH-Serving-RL                  PRESENCE
optional }|
  -- This IE is present if E-DCHInformation IE is present.
  { ID id-F-DPCH-Information-RL-SetupRqstFDD CRITICALITY reject  EXTENSION F-DPCH-Information-RL-SetupRqstFDD PRESENCE optional
  }|
  { ID id-Initial-DL-DPCH-TimingAdjustment-Allowed CRITICALITY ignore  EXTENSION Initial-DL-DPCH-TimingAdjustment-Allowed PRESENCE optional
  }|
  { ID id-DCH-Indicator-For-E-DCH-HSDPA-Operation CRITICALITY reject  EXTENSION DCH-Indicator-For-E-DCH-HSDPA-Operation PRESENCE optional
  }|
  { ID id-Serving-cell-change-CFN           CRITICALITY reject  EXTENSION CFN                             PRESENCE optional
  }|
  { ID id-Continuous-Packet-Connectivity-DTX-DRX-Information CRITICALITY reject  EXTENSION Continuous-Packet-Connectivity-DTX-DRX-
Information PRESENCE optional }|
  { ID id-Continuous-Packet-Connectivity-HS-SCCH-Less-Information CRITICALITY reject  EXTENSION Continuous-Packet-Connectivity-HS-SCCH-Less-
Information PRESENCE optional
  }|
  { ID id-Extended-SRNC-ID                   CRITICALITY reject  EXTENSION Extended-RNC-ID                  PRESENCE optional
  }|
  { ID id-Additional-HS-Cell-Information-RL-Setup CRITICALITY reject  EXTENSION Additional-HS-Cell-Information-RL-Setup-List
PRESENCE optional }|
  { ID id-UE-AggregateMaximumBitRate        CRITICALITY ignore  EXTENSION UE-AggregateMaximumBitRate        PRESENCE optional
  }|
  { ID id-Additional-EDCH-Cell-Information-RL-Setup-Req CRITICALITY reject  EXTENSION Additional-EDCH-Setup-Info
PRESENCE optional },
  ...
}

```

Additional-HS-Cell-Information-RL-Setup-List ::= SEQUENCE (SIZE (1..maxNrOfHSDSCH-1)) OF Additional-HS-Cell-Information-RL-Setup-ItemIEs

```

Additional-HS-Cell-Information-RL-Setup-ItemIEs ::=SEQUENCE{
  hSPDSCH-RL-ID          RL-ID,
  c-ID                   C-ID,
  hS-DSCH-FDD-Secondary-Serving-Information  HS-DSCH-FDD-Secondary-Serving-Information,
  iE-Extensions          ProtocolExtensionContainer { { Additional-HS-Cell-Information-RL-Setup-ItemIEs-ExtIEs } } OPTIONAL,
}

```

```

}
...
Additional-HS-Cell-Information-RL-Setup-ItemIEs-ExtIEs RNSAP-PROTOCOL-EXTENSION ::= {
}
...
F-DPCH-Information-RL-SetupRqstFDD ::= SEQUENCE {
  powerOffsetInformation      PowerOffsetInformation-F-DPCH-RL-SetupRqstFDD,
  fdd-dl-TPC-DownlinkStepSize FDD-TPC-DownlinkStepSize,
  limitedPowerIncrease        LimitedPowerIncrease,
  innerLoopDLPCStatus         InnerLoopDLPCStatus,
  iE-Extensions               ProtocolExtensionContainer { { F-DPCH-Information-RL-SetupRqstFDD-ExtIEs } }
  OPTIONAL,
  ...
}

F-DPCH-Information-RL-SetupRqstFDD-ExtIEs RNSAP-PROTOCOL-EXTENSION ::= {
  { ID id-F-DPCH-SlotFormatSupportRequest CRITICALITY reject EXTENSION F-DPCH-SlotFormatSupportRequest PRESENCE optional
  } |
  { ID id-F-DPCH-SlotFormat CRITICALITY ignore EXTENSION F-DPCH-SlotFormat PRESENCE optional },
  ...
}

PowerOffsetInformation-F-DPCH-RL-SetupRqstFDD ::= SEQUENCE {
  pc2-ForTPC-Bits            PowerOffset,
  --This IE shall be ignored by DRNS
  iE-Extensions              ProtocolExtensionContainer { { PowerOffsetInformation-F-DPCH-RL-SetupRqstFDD-ExtIEs } }
  OPTIONAL,
  ...
}

PowerOffsetInformation-F-DPCH-RL-SetupRqstFDD-ExtIEs RNSAP-PROTOCOL-EXTENSION ::= {
}
...
-- *****
--
-- RADIO LINK SETUP REQUEST TDD
--
-- *****

RadioLinkSetupRequestTDD ::= SEQUENCE {
  protocolIEs                ProtocolIE-Container {{RadioLinkSetupRequestTDD-IEs}},
  protocolExtensions          ProtocolExtensionContainer {{RadioLinkSetupRequestTDD-Extensions}}
  OPTIONAL,
  ...
}

RadioLinkSetupRequestTDD-IEs RNSAP-PROTOCOL-IES ::= {
  { ID id-SRNC-ID CRITICALITY reject TYPE RNC-ID PRESENCE mandatory } |
  { ID id-S-RNTI CRITICALITY reject TYPE S-RNTI PRESENCE mandatory } |
  { ID id-D-RNTI CRITICALITY reject TYPE D-RNTI PRESENCE optional } |
  { ID id-UL-Physical-Channel-Information-RL-SetupRqstTDD CRITICALITY reject TYPE UL-Physical-Channel-Information-RL-SetupRqstTDD PRESENCE mand
  { ID id-DL-Physical-Channel-Information-RL-SetupRqstTDD CRITICALITY reject TYPE DL-Physical-Channel-Information-RL-SetupRqstTDD PRESENCE mand
  { ID id-AllowedQueuingTime CRITICALITY reject TYPE AllowedQueuingTime PRESENCE optional } |

```

```

    { ID id-UL-CCTrCH-InformationList-RL-SetupRqstTDD          CRITICALITY notify   TYPE UL-CCTrCH-InformationList-RL-SetupRqstTDD  PRESENCE optional
  } |
    { ID id-DL-CCTrCH-InformationList-RL-SetupRqstTDD          CRITICALITY notify   TYPE DL-CCTrCH-InformationList-RL-SetupRqstTDD  PRESENCE optional
  } |
    { ID id-DCH-TDD-Information                                CRITICALITY reject   TYPE DCH-TDD-Information                        PRESENCE optional } |
    { ID id-DSCH-TDD-Information                               CRITICALITY reject   TYPE DSCH-TDD-Information                       PRESENCE optional } |
    { ID id-USCH-Information                                   CRITICALITY reject   TYPE USCH-Information                           PRESENCE optional } |
    { ID id-RL-Information-RL-SetupRqstTDD                    CRITICALITY reject   TYPE RL-Information-RL-SetupRqstTDD            PRESENCE mandatory
  },
  ...
}

UL-Physical-Channel-Information-RL-SetupRqstTDD ::= SEQUENCE {
  maxNrTimeslots-UL          MaxNrTimeslots,
  minimumSpreadingFactor-UL  MinimumSpreadingFactor,
  maxNrULPhysicalchannels    MaxNrULPhysicalchannels,
  iE-Extensions              ProtocolExtensionContainer { {UL-Physical-Channel-InformationItem-RL-SetupRqstTDD-ExtIEs} } OPTIONAL,
  ...
}

UL-Physical-Channel-InformationItem-RL-SetupRqstTDD-ExtIEs RNSAP-PROTOCOL-EXTENSION ::= {
  { ID id-TDD-Support-8PSK          CRITICALITY ignore      EXTENSION Support-8PSK          PRESENCE optional      }|
  -- Applicable to 1.28Mcps TDD only
  { ID id-TDD768-minimumSpreadingFactor-UL          CRITICALITY ignore      EXTENSION MinimumSpreadingFactor768          PRESENCE optional
  },
  ...
}

DL-Physical-Channel-Information-RL-SetupRqstTDD ::= SEQUENCE {
  maxNrTimeslots-DL          MaxNrTimeslots,
  minimumSpreadingFactor-DL  MinimumSpreadingFactor,
  maxNrDLPhysicalchannels    MaxNrDLPhysicalchannels,
  iE-Extensions              ProtocolExtensionContainer { {DL-Physical-Channel-InformationItem-RL-SetupRqstTDD-ExtIEs} } OPTIONAL,
  ...
}

DL-Physical-Channel-InformationItem-RL-SetupRqstTDD-ExtIEs RNSAP-PROTOCOL-EXTENSION ::= {
  optional { ID id-TDD-maxNrDLPhysicalchannels          CRITICALITY ignore      EXTENSION MaxNrDLPhysicalchannelsTS          PRESENCE
  }|
  { ID id-TDD-Support-8PSK          CRITICALITY ignore      EXTENSION Support-8PSK
  PRESENCE optional }|
  -- Applicable to 1.28Mcps TDD only
  { ID id-TDD-Support-PLCCH          CRITICALITY ignore      EXTENSION Support-PLCCH
  PRESENCE optional }|
  { ID id-TDD768-minimumSpreadingFactor-DL          CRITICALITY ignore      EXTENSION MinimumSpreadingFactor768          PRESENCE
  optional }|
  { ID id-TDD768-maxNrDLPhysicalchannels          CRITICALITY ignore      EXTENSION MaxNrDLPhysicalchannels768          PRESENCE optional
  }|
  { ID id-TDD768-maxNrDLPhysicalchannelsTS          CRITICALITY ignore      EXTENSION MaxNrDLPhysicalchannelsTS768          PRESENCE optional
  },
  ...
}

```

```

UL-CCTrCH-InformationList-RL-SetupRqstTDD ::= SEQUENCE (SIZE (1..maxNrOfCCTrCHs)) OF ProtocolIE-Single-Container { {UL-CCTrCH-
InformationItemIEs-RL-SetupRqstTDD} }

UL-CCTrCH-InformationItemIEs-RL-SetupRqstTDD RNSAP-PROTOCOL-IES ::= {
  { ID id-UL-CCTrCH-InformationItem-RL-SetupRqstTDD CRITICALITY notify TYPE UL-CCTrCH-InformationItem-RL-SetupRqstTDD PRESENCE mandatory
  }
}

UL-CCTrCH-InformationItem-RL-SetupRqstTDD ::= SEQUENCE {
  cCTrCH-ID CCTrCH-ID,
  ul-TFCS TFCS,
  tFCI-Coding TFCI-Coding,
  ul-PunctureLimit PunctureLimit,
  iE-Extensions ProtocolExtensionContainer { {UL-CCTrCH-InformationItem-RL-SetupRqstTDD-ExtIEs} } OPTIONAL,
  ...
}

UL-CCTrCH-InformationItem-RL-SetupRqstTDD-ExtIEs RNSAP-PROTOCOL-EXTENSION ::= {
  optional { ID id-TDD-TPC-UplinkStepSize-LCR-RL-SetupRqstTDD CRITICALITY reject EXTENSION TDD-TPC-UplinkStepSize-LCR PRESENCE
  },
  -- Mandatory for 1.28Mcps TDD, not applicable to 3.84Mcps TDD or 7.68Mcps TDD
  ...
}

DL-CCTrCH-InformationList-RL-SetupRqstTDD ::= SEQUENCE (SIZE (1..maxNrOfCCTrCHs)) OF ProtocolIE-Single-Container { {DL-CCTrCH-
InformationItemIEs-RL-SetupRqstTDD} }

DL-CCTrCH-InformationItemIEs-RL-SetupRqstTDD RNSAP-PROTOCOL-IES ::= {
  { ID id-DL-CCTrCH-InformationItem-RL-SetupRqstTDD CRITICALITY notify TYPE DL-CCTrCH-InformationItem-RL-SetupRqstTDD PRESENCE mandatory
  }
}

DL-CCTrCH-InformationItem-RL-SetupRqstTDD ::= SEQUENCE {
  cCTrCH-ID CCTrCH-ID,
  dl-TFCS TFCS,
  tFCI-Coding TFCI-Coding,
  dl-PunctureLimit PunctureLimit,
  tdd-TPC-DownlinkStepSize TDD-TPC-DownlinkStepSize,
  cCTrCH-TPCList CCTrCH-TPCList-RL-SetupRqstTDD OPTIONAL,
  iE-Extensions ProtocolExtensionContainer { {DL-CCTrCH-InformationItem-RL-SetupRqstTDD-ExtIEs} } OPTIONAL,
  ...
}

DL-CCTrCH-InformationItem-RL-SetupRqstTDD-ExtIEs RNSAP-PROTOCOL-EXTENSION ::= {
  ...
}

CCTrCH-TPCList-RL-SetupRqstTDD ::= SEQUENCE (SIZE (1..maxNrOfCCTrCHs)) OF CCTrCH-TPCItem-RL-SetupRqstTDD

CCTrCH-TPCItem-RL-SetupRqstTDD ::= SEQUENCE {
  cCTrCH-ID CCTrCH-ID,
  iE-Extensions ProtocolExtensionContainer { { CCTrCH-TPCItem-RL-SetupRqstTDD-ExtIEs } } OPTIONAL,
  ...
}

```

```
CCTrCH-TPCItem-RL-SetupRqstTDD-ExtIEs RNSAP-PROTOCOL-EXTENSION ::= {
  ...
}
```

```
RL-Information-RL-SetupRqstTDD ::= SEQUENCE {
  rL-ID                RL-ID,
  c-ID                 C-ID,
  frameOffset          FrameOffset,
  specialBurstScheduling SpecialBurstScheduling,
  primaryCCPCH-RSCP    PrimaryCCPCH-RSCP OPTIONAL,
  dL-TimeSlot-ISCP     DL-TimeSlot-ISCP-Info OPTIONAL,
  --for 3.84Mcps TDD and 7.68Mcps TDD only
  iE-Extensions        ProtocolExtensionContainer { {RL-Information-RL-SetupRqstTDD-ExtIEs} } OPTIONAL,
  ...
}
```

```
RL-Information-RL-SetupRqstTDD-ExtIEs RNSAP-PROTOCOL-EXTENSION ::= {
  { ID id-DL-TimeSlot-ISCP-LCR-Information-RL-SetupRqstTDD CRITICALITY reject EXTENSION DL-TimeSlot-ISCP-LCR-Information
  PRESENCE optional }|
  { ID id-TSTD-Support-Indicator-RL-SetupRqstTDD CRITICALITY ignore EXTENSION TSTD-Support-Indicator
  PRESENCE optional }|
  --for 1.28Mcps TDD only
  { ID id-RL-Specific-DCH-Info CRITICALITY ignore EXTENSION RL-Specific-DCH-Info PRESENCE optional }|
  { ID id-DelayedActivation CRITICALITY reject EXTENSION DelayedActivation PRESENCE optional }|
  { ID id-UL-Synchronisation-Parameters-LCR CRITICALITY reject EXTENSION UL-Synchronisation-Parameters-LCR PRESENCE
  optional }| -- Mandatory for 1.28Mcps TDD, Not Applicable to 3.84Mcps TDD or 7.68Mcps TDD
  { ID id-PrimaryCCPCH-RSCP-Delta CRITICALITY ignore EXTENSION PrimaryCCPCH-RSCP-Delta PRESENCE optional }|
  { ID id-IdleIntervalConfigurationIndicator CRITICALITY ignore EXTENSION NULL PRESENCE
  optional }|
  { ID id-CellPortionLCRID CRITICALITY ignore EXTENSION CellPortionLCRID PRESENCE optional },
  ...
}
```

```
RadioLinkSetupRequestTDD-Extensions RNSAP-PROTOCOL-EXTENSION ::= {
  { ID id-Permanent-NAS-UE-Identity CRITICALITY ignore EXTENSION Permanent-NAS-UE-Identity PRESENCE optional
  }|
  { ID id-HSDSCH-TDD-Information CRITICALITY reject EXTENSION HSDSCH-TDD-Information PRESENCE optional
  }|
  { ID id-HSPDSCH-RL-ID CRITICALITY reject EXTENSION RL-ID PRESENCE conditional
  }|
  -- This IE shall be present if HS-DSCH Information IE is present.
  { ID id-PDSCH-RL-ID CRITICALITY ignore EXTENSION RL-ID PRESENCE optional }|
  { ID id-MBMS-Bearer-Service-List CRITICALITY notify EXTENSION MBMS-Bearer-Service-List PRESENCE optional }|
  { ID id-E-DCH-Information CRITICALITY reject EXTENSION E-DCH-Information PRESENCE optional }|
  { ID id-E-DCH-Serving-RL-ID CRITICALITY reject EXTENSION RL-ID PRESENCE optional
  }|
  { ID id-E-DCH-768-Information CRITICALITY reject EXTENSION E-DCH-768-Information PRESENCE optional
  }|
  { ID id-E-DCH-LCR-Information CRITICALITY reject EXTENSION E-DCH-LCR-Information PRESENCE optional
  }|
  { ID id-Extended-SRNC-ID CRITICALITY reject EXTENSION Extended-RNC-ID PRESENCE optional }|
  { ID id-ContinuousPacketConnectivity-DRX-InformationLCR CRITICALITY reject EXTENSION ContinuousPacketConnectivity-DRX-InformationLCR
  PRESENCE optional }|
}
```

```

    { ID id-HS-DSCH-Semi-PersistentScheduling-Information-LCR CRITICALITY reject EXTENSION HS-DSCH-Semi-PersistentScheduling-Information-LCR
      PRESENCE optional }|
    { ID id-E-DCH-Semi-PersistentScheduling-Information-LCR CRITICALITY reject EXTENSION E-DCH-Semi-PersistentScheduling-Information-LCR
      PRESENCE optional }|
    { ID id-RNTI-Allocation-Indicator CRITICALITY ignore EXTENSION RNTI-Allocation-Indicator PRESENCE
optional }|
    { ID id-DCH-MeasurementType-Indicator CRITICALITY reject EXTENSION DCH-MeasurementType-Indicator PRESENCE optional },
    ...
}

-- *****
--
-- RADIO LINK SETUP RESPONSE FDD
--
-- *****

RadioLinkSetupResponseFDD ::= SEQUENCE {
    protocolIEs ProtocolIE-Container {{RadioLinkSetupResponseFDD-IEs}},
    protocolExtensions ProtocolExtensionContainer {{RadioLinkSetupResponseFDD-Extensions}} OPTIONAL,
    ...
}

RadioLinkSetupResponseFDD-IEs RNSAP-PROTOCOL-IES ::= {
    { ID id-D-RNTI CRITICALITY ignore TYPE D-RNTI PRESENCE optional } |
    { ID id-CN-PS-DomainIdentifier CRITICALITY ignore TYPE CN-PS-DomainIdentifier PRESENCE optional } |
    { ID id-CN-CS-DomainIdentifier CRITICALITY ignore TYPE CN-CS-DomainIdentifier PRESENCE optional } |
    { ID id-RL-InformationResponseList-RL-SetupRspFDD CRITICALITY ignore TYPE RL-InformationResponseList-RL-SetupRspFDD PRESENCE mandatory } |
    } |
    { ID id-UL-SIRTarget CRITICALITY ignore TYPE UL-SIR PRESENCE optional } |
    { ID id-CriticalityDiagnostics CRITICALITY ignore TYPE CriticalityDiagnostics PRESENCE optional },
    ...
}

RL-InformationResponseList-RL-SetupRspFDD ::= SEQUENCE (SIZE (1..maxNrOfRLs)) OF ProtocolIE-Single-Container { {RL-
InformationResponseItemIEs-RL-SetupRspFDD} }

RL-InformationResponseItemIEs-RL-SetupRspFDD RNSAP-PROTOCOL-IES ::= {
    { ID id-RL-InformationResponseItem-RL-SetupRspFDD CRITICALITY ignore TYPE RL-InformationResponseItem-RL-SetupRspFDD PRESENCE mandatory }
}

RL-InformationResponseItem-RL-SetupRspFDD ::= SEQUENCE {
    rL-ID RL-ID,
    rL-Set-ID RL-Set-ID,
    uRA-Information URA-Information OPTIONAL,
    sAI SAI,
    gA-Cell GA-Cell OPTIONAL,
    gA-AccessPointPosition GA-AccessPointPosition OPTIONAL,
    received-total-wide-band-power Received-total-wide-band-power,
    not-Used-secondary-CCPCH-Info NULL OPTIONAL,
    dl-CodeInformation FDD-DL-CodeInformation,
    diversityIndication DiversityIndication-RL-SetupRspFDD,
    sSDT-SupportIndicator SSdT-SupportIndicator,
    maxUL-SIR UL-SIR,

```

```

minUL-SIR                UL-SIR,
closedloopTimingAdjustmentmode ClosedloopTimingAdjustmentmode  OPTIONAL,
maximumAllowedULTxPower  MaximumAllowedULTxPower,
maximumDLTxPower         DL-Power,
minimumDLTxPower         DL-Power,
primaryScramblingCode    PrimaryScramblingCode                OPTIONAL,
uL-UARFCN                UARFCN                        OPTIONAL,
dL-UARFCN                UARFCN                        OPTIONAL,
primaryCPICH-Power       PrimaryCPICH-Power,
not-Used-dSCHInformationResponse NULL                    OPTIONAL,
neighbouring-UMTS-CellInformation Neighbouring-UMTS-CellInformation OPTIONAL,
neighbouring-GSM-CellInformation Neighbouring-GSM-CellInformation OPTIONAL,
pC-Preamble              PC-Preamble,
sRB-Delay                SRB-Delay,
iE-Extensions            ProtocolExtensionContainer { {RL-InformationResponseItem-RL-SetupRspFDD-ExtIEs} } OPTIONAL,
...
}

RL-InformationResponseItem-RL-SetupRspFDD-ExtIEs RNSAP-PROTOCOL-EXTENSION ::= {
  { ID id-GA-CellAdditionalShapes                CRITICALITY ignore EXTENSION GA-CellAdditionalShapes
    PRESENCE optional }|
  { ID id-DL-PowerBalancing-ActivationIndicator  CRITICALITY ignore EXTENSION DL-PowerBalancing-ActivationIndicator
    PRESENCE optional }|
  { ID id-HCS-Prio                               CRITICALITY ignore EXTENSION HCS-Prio
    PRESENCE optional }|
  { ID id-Primary-CPICH-Usage-For-Channel-Estimation CRITICALITY ignore EXTENSION Primary-CPICH-Usage-For-Channel-Estimation
    PRESENCE optional }|
  { ID id-Secondary-CPICH-Information            CRITICALITY ignore EXTENSION Secondary-CPICH-Information
    PRESENCE optional }|
  { ID id-Active-MBMS-Bearer-ServiceFDD-PFL     CRITICALITY ignore EXTENSION Active-MBMS-Bearer-Service-ListFDD-PFL
    PRESENCE optional }|
  { ID id-EDCH-RLSet-Id                         CRITICALITY ignore EXTENSION RL-Set-ID
    PRESENCE optional }|
  { ID id-EDCH-FDD-DL-ControlChannelInformation CRITICALITY ignore EXTENSION EDCH-FDD-DL-ControlChannelInformation
    PRESENCE optional }|
  { ID id-Initial-DL-DPCH-TimingAdjustment      CRITICALITY ignore EXTENSION DL-DPCH-TimingAdjustment
    PRESENCE optional }|
  { ID id-F-DPCH-SlotFormat                     CRITICALITY ignore EXTENSION F-DPCH-SlotFormat
    PRESENCE optional }|
  { ID id-FrameOffset                           CRITICALITY ignore EXTENSION FrameOffset
    PRESENCE optional }|
  { ID id-ChipOffset                             CRITICALITY ignore EXTENSION ChipOffset
    PRESENCE optional }|
  { ID id-Neighbouring-E-UTRA-CellInformation    CRITICALITY ignore EXTENSION Neighbouring-E-UTRA-CellInformation
    PRESENCE optional }|
  { ID id-HSDSCH-PreconfigurationInfo           CRITICALITY ignore EXTENSION HSDSCH-PreconfigurationInfo
    PRESENCE optional }|
  { ID id-Non-Serving-RL-Preconfig-Info        CRITICALITY ignore EXTENSION Non-Serving-RL-Preconfig-Info
    PRESENCE optional },
  ...
}

DiversityIndication-RL-SetupRspFDD ::= CHOICE {
  combining                Combining-RL-SetupRspFDD,

```



```

    nonCombiningOrFirstRL          NonCombiningOrFirstRL-RL-SetupRspFDD
}

Combining-RL-SetupRspFDD ::= SEQUENCE {
    rL-ID          RL-ID,
    iE-Extensions ProtocolExtensionContainer { { CombiningItem-RL-SetupRspFDD-ExtIEs} } OPTIONAL,
    ...
}

CombiningItem-RL-SetupRspFDD-ExtIEs RNSAP-PROTOCOL-EXTENSION ::= {
    { ID id-DCH-InformationResponse          CRITICALITY ignore EXTENSION DCH-InformationResponse          PRESENCE optional
    }|
    { ID id-EDCH-FDD-InformationResponse     CRITICALITY ignore EXTENSION EDCH-FDD-InformationResponse     PRESENCE optional
    },
    ...
}

NonCombiningOrFirstRL-RL-SetupRspFDD ::= SEQUENCE {
    dCH-InformationResponse DCH-InformationResponse,
    iE-Extensions          ProtocolExtensionContainer { { NonCombiningOrFirstRLItem-RL-SetupRspFDD-ExtIEs} } OPTIONAL,
    ...
}

NonCombiningOrFirstRLItem-RL-SetupRspFDD-ExtIEs RNSAP-PROTOCOL-EXTENSION ::= {
    {ID id-EDCH-FDD-InformationResponse     CRITICALITY ignore EXTENSION EDCH-FDD-InformationResponse     PRESENCE optional},
    ...
}

RadioLinkSetupResponseFDD-Extensions RNSAP-PROTOCOL-EXTENSION ::= {
    { ID id-HSDSCH-RNTI          CRITICALITY ignore EXTENSION HSDSCH-RNTI
    PRESENCE optional }|
    { ID id-HSDSCH-FDD-Information-Response CRITICALITY ignore EXTENSION HSDSCH-FDD-Information-Response PRESENCE optional }|
    { ID id-Continuous-Packet-Connectivity-HS-SCCH-Less-Information-Response CRITICALITY ignore EXTENSION Continuous-Packet-
Connectivity-HS-SCCH-Less-Information-Response PRESENCE optional }|
    { ID id-SixtyfourQAM-DL-SupportIndicator CRITICALITY ignore EXTENSION SixtyfourQAM-DL-SupportIndicator PRESENCE optional }|
    { ID id-Additional-HS-Cell-Information-Response CRITICALITY ignore EXTENSION Additional-HS-Cell-Information-Response-List
    PRESENCE optional }|
    { ID id-Additional-EDCH-Cell-Information-Response CRITICALITY ignore EXTENSION Additional-EDCH-Cell-Information-Response-List
    PRESENCE optional },
    ...
}

Additional-HS-Cell-Information-Response-List ::= SEQUENCE (SIZE (1..maxNrOfHSDSCH-1)) OF Additional-HS-Cell-Information-Response-ItemIEs

Additional-HS-Cell-Information-Response-ItemIEs ::=SEQUENCE{
    hSPDSCH-RL-ID          RL-ID,
    hSDSCH-RNTI            HSDSCH-RNTI,
    hS-DSCH-FDD-Secondary-Serving-Information-Response HS-DSCH-FDD-Secondary-Serving-Information-Response,
    sixtyfourQAM-DL-SupportIndicator SixtyfourQAM-DL-SupportIndicator OPTIONAL,
    iE-Extensions          ProtocolExtensionContainer { { Additional-HS-Cell-Information-Response-ItemIEs-ExtIEs} } OPTIONAL,
    ...
}

```

```

Additional-HS-Cell-Information-Response-ItemIEs-ExtIEs  RNSAP-PROTOCOL-EXTENSION ::= {
  ...
}

-- *****
--
-- RADIO LINK SETUP RESPONSE TDD
--
-- *****

RadioLinkSetupResponseTDD ::= SEQUENCE {
  protocolIEs          ProtocolIE-Container    {{RadioLinkSetupResponseTDD-IEs}},
  protocolExtensions  ProtocolExtensionContainer {{RadioLinkSetupResponseTDD-Extensions}}      OPTIONAL,
  ...
}

RadioLinkSetupResponseTDD-IEs RNSAP-PROTOCOL-IES ::= {
  { ID id-D-RNTI          CRITICALITY ignore  TYPE D-RNTI          PRESENCE optional } |
  { ID id-CN-PS-DomainIdentifier CRITICALITY ignore  TYPE CN-PS-DomainIdentifier PRESENCE optional } |
  { ID id-CN-CS-DomainIdentifier CRITICALITY ignore  TYPE CN-CS-DomainIdentifier PRESENCE optional } |
  { ID id-RL-InformationResponse-RL-SetupRspTDD CRITICALITY ignore  TYPE RL-InformationResponse-RL-SetupRspTDD PRESENCE optional } |
  --Mandatory for 3.84Mcps TDD only
  { ID id-UL-SIRTarget    CRITICALITY ignore  TYPE UL-SIR          PRESENCE mandatory } |
  { ID id-CriticalityDiagnostics CRITICALITY ignore  TYPE CriticalityDiagnostics PRESENCE optional },
  ...
}

RL-InformationResponse-RL-SetupRspTDD ::= SEQUENCE {
  rL-ID          RL-ID,
  uRA-Information  URA-Information  OPTIONAL,
  sAI            SAI,
  gA-Cell        GA-Cell  OPTIONAL,
  gA-AccessPointPosition  GA-AccessPointPosition  OPTIONAL,
  ul-TimeSlot-ISCP-Info  UL-TimeSlot-ISCP-Info,
  maxUL-SIR        UL-SIR,
  minUL-SIR        UL-SIR,
  maximumAllowedULTxPower  MaximumAllowedULTxPower,
  maximumDLTxPower  DL-Power,
  minimumDLTxPower  DL-Power,
  uARFCNforNt      UARFCN  OPTIONAL,
  cellParameterID  CellParameterID  OPTIONAL,
  syncCase         SyncCase  OPTIONAL,
  sCH-TimeSlot     SCH-TimeSlot  OPTIONAL,
  -- This IE shall be present if Sync Case IE is equal to "Case2". --
  sCTD-Indicator   SCTD-Indicator  OPTIONAL,
  pCCPCH-Power     PCCPCH-Power,
  timingAdvanceApplied  TimingAdvanceApplied,
  alphaValue       AlphaValue,
  ul-PhysCH-SF-Variation  UL-PhysCH-SF-Variation,
  synchronisationConfiguration  SynchronisationConfiguration,
  secondary-CCPCH-Info-TDD  Secondary-CCPCH-Info-TDD  OPTIONAL,
  ul-CCTrCHInformation  UL-CCTrCHInformationList-RL-SetupRspTDD  OPTIONAL,
  dl-CCTrCHInformation  DL-CCTrCHInformationList-RL-SetupRspTDD  OPTIONAL,
  dCH-InformationResponse  DCH-InformationResponseList-RL-SetupRspTDD  OPTIONAL,

```

```

dsch-InformationResponse          DSCH-InformationResponse-RL-SetupRspTDD OPTIONAL,
usch-InformationResponse          USCH-InformationResponse-RL-SetupRspTDD OPTIONAL,
neighbouring-UMTS-CellInformation Neighbouring-UMTS-CellInformation OPTIONAL,
neighbouring-GSM-CellInformation  Neighbouring-GSM-CellInformation OPTIONAL,
iE-Extensions                    ProtocolExtensionContainer { {RL-InformationResponse-RL-SetupRspTDD-ExtIEs} } OPTIONAL,
...
}

RL-InformationResponse-RL-SetupRspTDD-ExtIEs RNSAP-PROTOCOL-EXTENSION ::= {
  { ID id-GA-CellAdditionalShapes          CRITICALITY ignore EXTENSION GA-CellAdditionalShapes
  PRESENCE optional }|
  { ID id-HCS-Prio                        CRITICALITY ignore EXTENSION HCS-Prio
  PRESENCE optional }|
  { ID id-TimeSlot-RL-SetupRspTDD         CRITICALITY ignore EXTENSION TimeSlot
  PRESENCE conditional }|
  -- This IE shall be present if Sync Case IE is Case1. --
  { ID id-Neighbouring-E-UTRA-CellInformation CRITICALITY ignore EXTENSION Neighbouring-E-UTRA-CellInformation
  PRESENCE optional },
  ...
}

UL-CCTrCHInformationList-RL-SetupRspTDD ::= ProtocolIE-Single-Container {{UL-CCTrCHInformationListIEs-RL-SetupRspTDD}}

UL-CCTrCHInformationListIEs-RL-SetupRspTDD RNSAP-PROTOCOL-IES ::= {
  { ID id-UL-CCTrCH-InformationListIE-RL-SetupRspTDD CRITICALITY ignore TYPE UL-CCTrCHInformationListIE-RL-SetupRspTDD
  PRESENCE mandatory }
}

UL-CCTrCHInformationListIE-RL-SetupRspTDD ::= SEQUENCE (SIZE (1..maxNrOfCCTrCHs)) OF UL-CCTrCHInformationItem-RL-SetupRspTDD

UL-CCTrCHInformationItem-RL-SetupRspTDD ::= SEQUENCE {
  cCTrCH-ID          CCTrCH-ID,
  ul-DPCH-Information UL-DPCH-InformationList-RL-SetupRspTDD OPTIONAL,
  iE-Extensions      ProtocolExtensionContainer { {UL-CCTrCHInformationItem-RL-SetupRspTDD-ExtIEs} } OPTIONAL,
  ...
}

UL-CCTrCHInformationItem-RL-SetupRspTDD-ExtIEs RNSAP-PROTOCOL-EXTENSION ::= {
  {ID id-UL-SIR-Target-CCTrCH-InformationItem-RL-SetupRspTDD CRITICALITY ignore EXTENSION UL-SIR PRESENCE optional},
  ...
}

UL-DPCH-InformationList-RL-SetupRspTDD ::= ProtocolIE-Single-Container { {UL-DPCH-InformationListIEs-RL-SetupRspTDD} }

UL-DPCH-InformationListIEs-RL-SetupRspTDD RNSAP-PROTOCOL-IES ::= {
  { ID id-UL-DPCH-InformationItem-RL-SetupRspTDD CRITICALITY ignore TYPE UL-DPCH-InformationItem-RL-SetupRspTDD PRESENCE mandatory }
}

UL-DPCH-InformationItem-RL-SetupRspTDD ::= SEQUENCE {
  repetitionPeriod      RepetitionPeriod,
  repetitionLength      RepetitionLength,
  tDD-DPCHOffset        TDD-DPCHOffset,
  uL-Timeslot-Information UL-Timeslot-Information,
  iE-Extensions         ProtocolExtensionContainer { {UL-DPCH-InformationItem-RL-SetupRspTDD-ExtIEs} } OPTIONAL,
}

```

```

}
...
}
UL-DPCH-InformationItem-RL-SetupRspTDD-ExtIEs RNSAP-PROTOCOL-EXTENSION ::= {
...
}
DL-CCTrCHInformationList-RL-SetupRspTDD ::= ProtocolIE-Single-Container {{DL-CCTrCHInformationListIEs-RL-SetupRspTDD}}
DL-CCTrCHInformationListIEs-RL-SetupRspTDD RNSAP-PROTOCOL-IES ::= {
{ ID id-DL-CCTrCH-InformationListIE-RL-SetupRspTDD CRITICALITY ignore TYPE DL-CCTrCHInformationListIE-RL-SetupRspTDD PRESENCE mandatory }
}
DL-CCTrCHInformationListIE-RL-SetupRspTDD ::= SEQUENCE (SIZE (1..maxNrOfCCTrCHs)) OF DL-CCTrCHInformationItem-RL-SetupRspTDD
DL-CCTrCHInformationItem-RL-SetupRspTDD ::= SEQUENCE {
cCTrCH-ID CCTrCH-ID,
dl-DPCH-Information DL-DPCH-InformationList-RL-SetupRspTDD OPTIONAL,
iE-Extensions ProtocolExtensionContainer { {DL-CCTrCHInformationItem-RL-SetupRspTDD-ExtIEs} } OPTIONAL,
...
}
DL-CCTrCHInformationItem-RL-SetupRspTDD-ExtIEs RNSAP-PROTOCOL-EXTENSION ::= {
{ ID id-CCTrCH-Maximum-DL-Power-RL-SetupRspTDD CRITICALITY ignore EXTENSION DL-Power PRESENCE optional } | -- this is a DCH type CCTrCH power
{ ID id-CCTrCH-Minimum-DL-Power-RL-SetupRspTDD CRITICALITY ignore EXTENSION DL-Power PRESENCE optional }, -- this is a DCH type CCTrCH power
...
}
DL-DPCH-InformationList-RL-SetupRspTDD ::= ProtocolIE-Single-Container { {DL-DPCH-InformationListIEs-RL-SetupRspTDD} }
DL-DPCH-InformationListIEs-RL-SetupRspTDD RNSAP-PROTOCOL-IES ::= {
{ ID id-DL-DPCH-InformationItem-RL-SetupRspTDD CRITICALITY ignore TYPE DL-DPCH-InformationItem-RL-SetupRspTDD PRESENCE mandatory }
}
DL-DPCH-InformationItem-RL-SetupRspTDD ::= SEQUENCE {
repetitionPeriod RepetitionPeriod,
repetitionLength RepetitionLength,
tDD-DPCHOffset TDD-DPCHOffset,
dL-Timeslot-Information DL-Timeslot-Information,
iE-Extensions ProtocolExtensionContainer { {DL-DPCH-InformationItem-RL-SetupRspTDD-ExtIEs} } OPTIONAL,
...
}
DL-DPCH-InformationItem-RL-SetupRspTDD-ExtIEs RNSAP-PROTOCOL-EXTENSION ::= {
...
}
DCH-InformationResponseList-RL-SetupRspTDD ::= ProtocolIE-Single-Container {{DCH-InformationResponseListIEs-RL-SetupRspTDD}}
DCH-InformationResponseListIEs-RL-SetupRspTDD RNSAP-PROTOCOL-IES ::= {
{ ID id-DCH-InformationResponse CRITICALITY ignore TYPE DCH-InformationResponse PRESENCE mandatory }
}
DSCH-InformationResponse-RL-SetupRspTDD ::= ProtocolIE-Single-Container {{DSCH-InformationList-RL-SetupRspTDD}}

```

```
DSCH-InformationList-RL-SetupRspTDD RNSAP-PROTOCOL-IES ::= {
  { ID id-DSCH-InformationListIES-RL-SetupRspTDD      CRITICALITY ignore  TYPE DSCH-InformationListIES-RL-SetupRspTDD PRESENCE mandatory }
}
```

```
DSCH-InformationListIES-RL-SetupRspTDD ::= SEQUENCE (SIZE(0..maxNoOfDSCHs)) OF DSCHInformationItem-RL-SetupRspTDD
```

```
DSCHInformationItem-RL-SetupRspTDD ::= SEQUENCE {
  dsch-ID                DSCH-ID,
  dsch-FlowControlInformation DSCH-FlowControlInformation,
  bindingID              BindingID OPTIONAL,
  transportLayerAddress  TransportLayerAddress OPTIONAL,
  transportFormatManagement TransportFormatManagement,
  iE-Extensions         ProtocolExtensionContainer { {DSCHInformationItem-RL-SetupRspTDD-ExtIES} } OPTIONAL,
  ...
}
```

```
DSCHInformationItem-RL-SetupRspTDD-ExtIES RNSAP-PROTOCOL-EXTENSION ::= {
  ...
}
```

```
USCH-InformationResponse-RL-SetupRspTDD ::= ProtocolIE-Single-Container {{USCH-InformationList-RL-SetupRspTDD}}
```

```
USCH-InformationList-RL-SetupRspTDD RNSAP-PROTOCOL-IES ::= {
  { ID id-USCH-InformationListIES-RL-SetupRspTDD      CRITICALITY ignore  TYPE USCH-InformationListIES-RL-SetupRspTDD PRESENCE mandatory }
}
```

```
USCH-InformationListIES-RL-SetupRspTDD ::= SEQUENCE (SIZE(0..maxNoOfUSCHs)) OF USCHInformationItem-RL-SetupRspTDD
```

```
USCHInformationItem-RL-SetupRspTDD ::= SEQUENCE {
  usch-ID                USCH-ID,
  bindingID              BindingID OPTIONAL,
  transportLayerAddress  TransportLayerAddress OPTIONAL,
  transportFormatManagement TransportFormatManagement,
  iE-Extensions         ProtocolExtensionContainer { {USCHInformationItem-RL-SetupRspTDD-ExtIES} } OPTIONAL,
  ...
}
```

```
USCHInformationItem-RL-SetupRspTDD-ExtIES RNSAP-PROTOCOL-EXTENSION ::= {
  ...
}
```

```
RadioLinkSetupResponseTDD-Extensions RNSAP-PROTOCOL-EXTENSION ::= {
  { ID id-RL-LCR-InformationResponse-RL-SetupRspTDD  CRITICALITY ignore  EXTENSION  RL-LCR-InformationResponse-RL-SetupRspTDD
  PRESENCE optional}|
  --Mandatory for 1.28Mcps TDD only
  { ID id-HSDSCH-RNTI                                CRITICALITY ignore  EXTENSION  HSDSCH-RNTI
  PRESENCE optional }|
  { ID id-HSDSCH-TDD-Information-Response           CRITICALITY ignore  EXTENSION  HSDSCH-TDD-Information-Response
  PRESENCE optional }|
  { ID id-DSCH-RNTI                                  CRITICALITY ignore  EXTENSION  DSCH-RNTI
  PRESENCE optional }|
  { ID id-Active-MBMS-Bearer-ServiceTDD-PFL        CRITICALITY ignore  EXTENSION  Active-MBMS-Bearer-Service-ListTDD-PFL
  PRESENCE optional }|
}
```

```

    { ID id-RL-InformationResponse-RL-SetupRspTDD768      CRITICALITY ignore  EXTENSION RL-InformationResponse-RL-SetupRspTDD768      PRESENCE
optional }|
    { ID id-E-DCH-Information-Response                    CRITICALITY ignore  EXTENSION E-DCH-Information-Response
  PRESENCE optional }|
    { ID id-E-DCH-768-Information-Response                CRITICALITY ignore  EXTENSION E-DCH-768-Information-Response
  PRESENCE optional }|
    { ID id-E-DCH-LCR-Information-Response                CRITICALITY ignore  EXTENSION E-DCH-LCR-Information-Response
  PRESENCE optional }|
    { ID id-ContinuousPacketConnectivity-DRX-Information-ResponseLCR      CRITICALITY ignore  EXTENSION ContinuousPacketConnectivity-DRX-Information-
ResponseLCR      PRESENCE optional }|
    { ID id-HS-DSCH-Semi-PersistentScheduling-Information-ResponseLCR      CRITICALITY ignore  EXTENSION HS-DSCH-Semi-PersistentScheduling-
Information-ResponseLCR      PRESENCE optional }|
    { ID id-E-DCH-Semi-PersistentScheduling-Information-ResponseLCR      CRITICALITY ignore  EXTENSION E-DCH-Semi-PersistentScheduling-Information-
ResponseLCR      PRESENCE optional }|
    { ID id-E-RNTI-For-FACH                                CRITICALITY ignore  EXTENSION E-RNTI
  PRESENCE optional }|
    { ID id-H-RNTI-For-FACH                                CRITICALITY ignore  EXTENSION HSDSCH-RNTI
  PRESENCE optional }|
    { ID id-DCH-MeasurementOccasion-Information            CRITICALITY reject  EXTENSION DCH-MeasurementOccasion-Information
  PRESENCE optional},
    ...
}

RL-LCR-InformationResponse-RL-SetupRspTDD ::= SEQUENCE {
  rL-ID                RL-ID,
  uRA-Information      URA-Information,
  sAI                  SAI,
  gA-Cell              GA-Cell      OPTIONAL,
  gA-AccessPointPosition  GA-AccessPointPosition  OPTIONAL,
  ul-TimeSlot-ISCP-LCR-Info  UL-TimeSlot-ISCP-LCR-Info,
  maxUL-SIR            UL-SIR,
  minUL-SIR            UL-SIR,
  maximumAllowedULTxPower  MaximumAllowedULTxPower,
  maximumDLTxPower      DL-Power,
  minimumDLTxPower      DL-Power,
  uARFCNforNt          UARFCN      OPTIONAL,
  cellParameterID      CellParameterID      OPTIONAL,
  sCTD-Indicator       SCTD-Indicator  OPTIONAL,
  pCCPCH-Power         PCCPCH-Power,
  alphaValue           AlphaValue,
  ul-PhysCH-SF-Variation  UL-PhysCH-SF-Variation,
  synchronisationConfiguration  SynchronisationConfiguration,
  secondary-LCR-CCPCH-Info-TDD  Secondary-LCR-CCPCH-Info-TDD      OPTIONAL,
  ul-LCR-CCTrCHInformationList-RL-SetupRspTDD  UL-LCR-CCTrCHInformationList-RL-SetupRspTDD      OPTIONAL,
  dl-LCR-CCTrCHInformationList-RL-SetupRspTDD  DL-LCR-CCTrCHInformationList-RL-SetupRspTDD      OPTIONAL,
  dCH-InformationResponseList-RL-SetupRspTDD  DCH-InformationResponseList-RL-SetupRspTDD      OPTIONAL,
  dsch-LCR-InformationResponseList-RL-SetupRspTDD  DSCH-LCR-InformationResponseList-RL-SetupRspTDD      OPTIONAL,
  usch-LCR-InformationResponseList-RL-SetupRspTDD  USCH-LCR-InformationResponseList-RL-SetupRspTDD      OPTIONAL,
  neighbouring-UMTS-CellInformationList-RL-SetupRspTDD  Neighbouring-UMTS-CellInformationList-RL-SetupRspTDD      OPTIONAL,
  neighbouring-GSM-CellInformationList-RL-SetupRspTDD  Neighbouring-GSM-CellInformationList-RL-SetupRspTDD      OPTIONAL,
  IE-Extensions        ProtocolExtensionContainer { { RL-LCR-InformationResponseList-RL-SetupRspTDD-ExtIEs } }
  OPTIONAL,
  ...
}

```

```

RL-LCR-InformationResponseList-RL-SetupRspTDD-ExtIEs RNSAP-PROTOCOL-EXTENSION ::= {
  optional { ID id-GA-CellAdditionalShapes CRITICALITY ignore EXTENSION GA-CellAdditionalShapes PRESENCE optional }|
  optional { ID id-HCS-Prio CRITICALITY ignore EXTENSION HCS-Prio PRESENCE optional }|
  optional { ID id-UL-TimingAdvanceCtrl-LCR CRITICALITY ignore EXTENSION UL-TimingAdvanceCtrl-LCR PRESENCE optional }|
  --Mandatory for 1.28Mcps TDD only
  { ID id-PowerControlGAP CRITICALITY ignore EXTENSION ControlGAP PRESENCE optional }|
  -- Applicable to 1.28Mcps TDD only
  { ID id-SixtyfourQAM-DL-SupportIndicator CRITICALITY ignore EXTENSION SixtyfourQAM-DL-SupportIndicator PRESENCE optional }|
  -- Applicable to 1.28Mcps TDD only
  { ID id-Neighbouring-E-UTRA-CellInformation CRITICALITY ignore EXTENSION Neighbouring-E-UTRA-CellInformation PRESENCE optional }|
  { ID id-IdleIntervalInformation CRITICALITY ignore EXTENSION IdleIntervalInformation PRESENCE optional },
  ...
}

UL-LCR-CCTrCHInformationList-RL-SetupRspTDD ::= ProtocolIE-Single-Container {{UL-LCR-CCTrCHInformationListIEs-RL-SetupRspTDD}}

UL-LCR-CCTrCHInformationListIEs-RL-SetupRspTDD RNSAP-PROTOCOL-IES ::= {
  { ID id-UL-CCTrCH-LCR-InformationListIE-RL-SetupRspTDD CRITICALITY ignore TYPE UL-LCR-CCTrCHInformationListIE-RL-SetupRspTDD PRESENCE mandatory }
}

UL-LCR-CCTrCHInformationListIE-RL-SetupRspTDD ::= SEQUENCE (SIZE (1..maxNrOfCCTrCHsLCR)) OF UL-LCR-CCTrCHInformationItem-RL-SetupRspTDD

UL-LCR-CCTrCHInformationItem-RL-SetupRspTDD ::= SEQUENCE {
  cCTrCH-ID CCTrCH-ID,
  ul-DPCH-LCR-Information UL-DPCH-LCR-InformationList-RL-SetupRspTDD OPTIONAL,
  iE-Extensions ProtocolExtensionContainer { {UL-LCR-CCTrCHInformationItem-RL-SetupRspTDD-ExtIEs} } OPTIONAL,
  ...
}

UL-LCR-CCTrCHInformationItem-RL-SetupRspTDD-ExtIEs RNSAP-PROTOCOL-EXTENSION ::= {
  {ID id-UL-SIR-Target-CCTrCH-LCR-InformationItem-RL-SetupRspTDD CRITICALITY ignore EXTENSION UL-SIR PRESENCE optional},
  ...
}

UL-DPCH-LCR-InformationList-RL-SetupRspTDD ::= ProtocolIE-Single-Container { {UL-DPCH-LCR-InformationListIEs-RL-SetupRspTDD} }

UL-DPCH-LCR-InformationListIEs-RL-SetupRspTDD RNSAP-PROTOCOL-IES ::= {
  { ID id-UL-DPCH-LCR-InformationItem-RL-SetupRspTDD CRITICALITY ignore TYPE UL-DPCH-LCR-InformationItem-RL-SetupRspTDD PRESENCE mandatory }
}

UL-DPCH-LCR-InformationItem-RL-SetupRspTDD ::= SEQUENCE {
  repetitionPeriod RepetitionPeriod,
  repetitionLength RepetitionLength,
  tDD-DPCHOffset TDD-DPCHOffset,
  uL-TimeslotLCR-Information UL-TimeslotLCR-Information,
  iE-Extensions ProtocolExtensionContainer { {UL-DPCH-LCR-InformationItem-RL-SetupRspTDD-ExtIEs} } OPTIONAL,
  ...
}

```

```

UL-DPCH-LCR-InformationItem-RL-SetupRspTDD-ExtIEs RNSAP-PROTOCOL-EXTENSION ::= {
  ...
}
DL-LCR-CCTrCHInformationList-RL-SetupRspTDD ::= ProtocolIE-Single-Container { {DL-LCR-CCTrCHInformationListIEs-RL-SetupRspTDD} }

DL-LCR-CCTrCHInformationListIEs-RL-SetupRspTDD RNSAP-PROTOCOL-IES ::= {
  { ID id-DL-CCTrCH-LCR-InformationListIE-RL-SetupRspTDD   CRITICALITY ignore TYPE DL-CCTrCH-LCR-InformationListIE-RL-SetupRspTDD   PRESENCE
mandatory }
}

DL-CCTrCH-LCR-InformationListIE-RL-SetupRspTDD ::= SEQUENCE (SIZE (1..maxNrOfCCTrCHsLCR)) OF DL-CCTrCH-LCR-InformationItem-RL-SetupRspTDD

DL-CCTrCH-LCR-InformationItem-RL-SetupRspTDD ::= SEQUENCE {
  cCTrCH-ID           CCTrCH-ID,
  dl-DPCH-LCR-Information   DL-DPCH-LCR-InformationList-RL-SetupRspTDD   OPTIONAL,
  iE-Extensions         ProtocolExtensionContainer { {DL-CCTrCH-LCR-InformationItem-RL-SetupRspTDD-ExtIEs} } OPTIONAL,
  ...
}

DL-CCTrCH-LCR-InformationItem-RL-SetupRspTDD-ExtIEs RNSAP-PROTOCOL-EXTENSION ::= {
  ...
}

DL-DPCH-LCR-InformationList-RL-SetupRspTDD ::= ProtocolIE-Single-Container { {DL-DPCH-LCR-InformationListIEs-RL-SetupRspTDD} }

DL-DPCH-LCR-InformationListIEs-RL-SetupRspTDD RNSAP-PROTOCOL-IES ::= {
  { ID id-DL-DPCH-LCR-InformationItem-RL-SetupRspTDD   CRITICALITY ignore TYPE DL-DPCH-LCR-InformationItem-RL-SetupRspTDD   PRESENCE mandatory
}
}

DL-DPCH-LCR-InformationItem-RL-SetupRspTDD ::= SEQUENCE {
  repetitionPeriod           RepetitionPeriod,
  repetitionLength           RepetitionLength,
  tDD-DPCHOffset            TDD-DPCHOffset,
  dL-Timeslot-LCR-Information   DL-TimeslotLCR-Information,
  tSTD-Indicator             TSTD-Indicator,
  iE-Extensions             ProtocolExtensionContainer { {DL-DPCH-LCR-InformationItem-RL-SetupRspTDD-ExtIEs} } OPTIONAL,
  ...
}

DL-DPCH-LCR-InformationItem-RL-SetupRspTDD-ExtIEs RNSAP-PROTOCOL-EXTENSION ::= {
  ...
}

DSCH-LCR-InformationResponse-RL-SetupRspTDD ::= ProtocolIE-Single-Container { {DSCH-LCR-InformationList-RL-SetupRspTDD} }

DSCH-LCR-InformationList-RL-SetupRspTDD RNSAP-PROTOCOL-IES ::= {
  { ID id-DSCH-LCR-InformationListIEs-RL-SetupRspTDD   CRITICALITY ignore TYPE DSCH-LCR-InformationListIEs-RL-SetupRspTDD   PRESENCE mandatory
}
}

DSCH-LCR-InformationListIEs-RL-SetupRspTDD ::= SEQUENCE (SIZE(0..maxNoOfDSCHsLCR)) OF DSCH-LCR-InformationItem-RL-SetupRspTDD

```



```

DSCH-LCR-InformationItem-RL-SetupRspTDD ::= SEQUENCE {
    dsch-ID                DSCH-ID,
    dsch-FlowControlInformation DSCH-FlowControlInformation,
    bindingID              BindingID OPTIONAL,
    transportLayerAddress  TransportLayerAddress OPTIONAL,
    transportFormatManagement TransportFormatManagement,
    iE-Extensions         ProtocolExtensionContainer { {DSCH-LCR-InformationItem-RL-SetupRspTDD-ExtIEs} } OPTIONAL,
    ...
}

DSCH-LCR-InformationItem-RL-SetupRspTDD-ExtIEs RNSAP-PROTOCOL-EXTENSION ::= {
    ...
}

USCH-LCR-InformationResponse-RL-SetupRspTDD ::= ProtocolIE-Single-Container {{USCH-LCR-InformationList-RL-SetupRspTDD}}

USCH-LCR-InformationList-RL-SetupRspTDD RNSAP-PROTOCOL-IES ::= {
    { ID id-USCH-LCR-InformationListIEs-RL-SetupRspTDD CRITICALITY ignore TYPE USCH-LCR-InformationListIEs-RL-SetupRspTDD PRESENCE mandatory
    }
}

USCH-LCR-InformationListIEs-RL-SetupRspTDD ::= SEQUENCE (SIZE(0..maxNoOfUSCHsLCR)) OF USCH-LCR-InformationItem-RL-SetupRspTDD

USCH-LCR-InformationItem-RL-SetupRspTDD ::= SEQUENCE {
    usch-ID                USCH-ID,
    bindingID              BindingID OPTIONAL,
    transportLayerAddress  TransportLayerAddress OPTIONAL,
    transportFormatManagement TransportFormatManagement,
    iE-Extensions         ProtocolExtensionContainer { {USCH-LCR-InformationItem-RL-SetupRspTDD-ExtIEs} } OPTIONAL,
    ...
}

USCH-LCR-InformationItem-RL-SetupRspTDD-ExtIEs RNSAP-PROTOCOL-EXTENSION ::= {
    ...
}

RL-InformationResponse-RL-SetupRspTDD768 ::= SEQUENCE {
    rL-ID                RL-ID,
    uRA-Information      URA-Information OPTIONAL,
    sAI                  SAI,
    gA-Cell              GA-Cell OPTIONAL,
    gA-AccessPointPosition GA-AccessPointPosition OPTIONAL,
    ul-TimeSlot-ISCP-Info UL-TimeSlot-ISCP-Info,
    maxUL-SIR            UL-SIR,
    minUL-SIR            UL-SIR,
    maximumAllowedULTxPower MaximumAllowedULTxPower,
    maximumDLTxPower    DL-Power,
    minimumDLTxPower    DL-Power,
    uARFCNforNt          UARFCN OPTIONAL,
    cellParameterID      CellParameterID OPTIONAL,
    syncCase              SyncCase OPTIONAL,
    sCH-TimeSlot          SCH-TimeSlot OPTIONAL,
    -- This IE shall be present if Sync Case IE is equal to "Case2". --
    sCTD-Indicator        SCTD-Indicator OPTIONAL,
}

```

```

pCCPCH-Power                PCCPCH-Power,
timingAdvanceApplied         TimingAdvanceApplied,
alphaValue                  AlphaValue,
ul-PhysCH-SF-Variation      UL-PhysCH-SF-Variation,
synchronisationConfiguration SynchronisationConfiguration,
secondary-CCPCH-Info-TDD768 Secondary-CCPCH-Info-TDD768    OPTIONAL,
ul-CCTrCHInformation768     UL-CCTrCHInformationList-RL-SetupRspTDD768    OPTIONAL,
dl-CCTrCHInformation768     DL-CCTrCHInformationList-RL-SetupRspTDD768    OPTIONAL,
dCH-InformationResponse     DCH-InformationResponseList-RL-SetupRspTDD    OPTIONAL,
dsch-InformationResponse    DSCH-InformationResponse-RL-SetupRspTDD    OPTIONAL,
usch-InformationResponse    USCH-InformationResponse-RL-SetupRspTDD    OPTIONAL,
neighbouring-UMTS-CellInformation Neighbouring-UMTS-CellInformation    OPTIONAL,
neighbouring-GSM-CellInformation Neighbouring-GSM-CellInformation    OPTIONAL,
gA-CellAdditionalShapes     GA-CellAdditionalShapes    OPTIONAL,
hCS-Prio                    HCS-Prio    OPTIONAL,
timeSlot-RL-SetupRspTDD     TimeSlot    OPTIONAL,
-- This IE shall be present if Sync Case IE is Case1. --

iE-Extensions                ProtocolExtensionContainer { {RL-InformationResponse-RL-SetupRspTDD768-ExtIEs} } OPTIONAL,
...
}

RL-InformationResponse-RL-SetupRspTDD768-ExtIEs RNSAP-PROTOCOL-EXTENSION ::= {
  { ID id-Neighbouring-E-UTRA-CellInformation          CRITICALITY ignore  EXTENSION Neighbouring-E-UTRA-CellInformation
  PRESENCE optional },
  ...
}

UL-CCTrCHInformationList-RL-SetupRspTDD768 ::= ProtocolIE-Single-Container { {UL-CCTrCHInformationListIEs-RL-SetupRspTDD768} }

UL-CCTrCHInformationListIEs-RL-SetupRspTDD768 RNSAP-PROTOCOL-IES ::= {
  { ID id-UL-CCTrCH-InformationListIE-RL-SetupRspTDD768  CRITICALITY ignore  TYPE UL-CCTrCHInformationListIE-RL-SetupRspTDD768
  PRESENCE mandatory }
}

UL-CCTrCHInformationListIE-RL-SetupRspTDD768 ::= SEQUENCE (SIZE (1..maxNrOfCCTrCHs)) OF UL-CCTrCHInformationItem-RL-SetupRspTDD768

UL-CCTrCHInformationItem-RL-SetupRspTDD768 ::= SEQUENCE {
  cCTrCH-ID                CCTrCH-ID,
  ul-DPCH-Information768    UL-DPCH-InformationList-RL-SetupRspTDD768    OPTIONAL,
  uL-SIR-Target-CCTrCH-InformationItem-RL-SetupRspTDD768    UL-SIR    OPTIONAL,
  iE-Extensions            ProtocolExtensionContainer { {UL-CCTrCHInformationItem-RL-SetupRspTDD768-ExtIEs} } OPTIONAL,
  ...
}

UL-CCTrCHInformationItem-RL-SetupRspTDD768-ExtIEs RNSAP-PROTOCOL-EXTENSION ::= {
  ...
}

UL-DPCH-InformationList-RL-SetupRspTDD768 ::= ProtocolIE-Single-Container { {UL-DPCH-InformationListIEs-RL-SetupRspTDD768} }

UL-DPCH-InformationListIEs-RL-SetupRspTDD768 RNSAP-PROTOCOL-IES ::= {
  { ID id-UL-DPCH-InformationItem-RL-SetupRspTDD768    CRITICALITY ignore  TYPE UL-DPCH-InformationItem-RL-SetupRspTDD768  PRESENCE mandatory
  }
}

```

```

}

UL-DPCH-InformationItem-RL-SetupRspTDD768 ::= SEQUENCE {
    repetitionPeriod      RepetitionPeriod,
    repetitionLength      RepetitionLength,
    tDD-DPCHOffset        TDD-DPCHOffset,
    uL-Timeslot-Information768    UL-Timeslot-Information768,
    iE-Extensions          ProtocolExtensionContainer { {UL-DPCH-InformationItem-RL-SetupRspTDD768-ExtIEs} } OPTIONAL,
    ...
}

UL-DPCH-InformationItem-RL-SetupRspTDD768-ExtIEs RNSAP-PROTOCOL-EXTENSION ::= {
    ...
}

DL-CCTrCHInformationList-RL-SetupRspTDD768 ::= ProtocolIE-Single-Container {{DL-CCTrCHInformationListIEs-RL-SetupRspTDD768}}

DL-CCTrCHInformationListIEs-RL-SetupRspTDD768 RNSAP-PROTOCOL-IES ::= {
    { ID id-DL-CCTrCH-InformationListIE-RL-SetupRspTDD768    CRITICALITY ignore    TYPE DL-CCTrCHInformationListIE-RL-SetupRspTDD768    PRESENCE
mandatory }
}

DL-CCTrCHInformationListIE-RL-SetupRspTDD768 ::= SEQUENCE (SIZE (1..maxNrOfCCTrCHs)) OF DL-CCTrCHInformationItem-RL-SetupRspTDD768

DL-CCTrCHInformationItem-RL-SetupRspTDD768 ::= SEQUENCE {
    cCTrCH-ID                CCTrCH-ID,
    dl-DPCH-Information768    DL-DPCH-InformationList-RL-SetupRspTDD768    OPTIONAL,
    cCTrCH-Maximum-DL-Power    DL-Power    OPTIONAL, -- this is a DCH type CCTrCH power
    cCTrCH-Minimum-DL-Power    DL-Power    OPTIONAL, -- this is a DCH type CCTrCH power
    iE-Extensions            ProtocolExtensionContainer { {DL-CCTrCHInformationItem-RL-SetupRspTDD768-ExtIEs} } OPTIONAL,
    ...
}

DL-CCTrCHInformationItem-RL-SetupRspTDD768-ExtIEs RNSAP-PROTOCOL-EXTENSION ::= {
    ...
}

DL-DPCH-InformationList-RL-SetupRspTDD768 ::= ProtocolIE-Single-Container { {DL-DPCH-InformationListIEs-RL-SetupRspTDD768} }

DL-DPCH-InformationListIEs-RL-SetupRspTDD768 RNSAP-PROTOCOL-IES ::= {
    { ID id-DL-DPCH-InformationItem-RL-SetupRspTDD768    CRITICALITY ignore    TYPE DL-DPCH-InformationItem-RL-SetupRspTDD768    PRESENCE mandatory
}
}

DL-DPCH-InformationItem-RL-SetupRspTDD768 ::= SEQUENCE {
    repetitionPeriod      RepetitionPeriod,
    repetitionLength      RepetitionLength,
    tDD-DPCHOffset        TDD-DPCHOffset,
    dL-Timeslot-Information768    DL-Timeslot-Information768,
    iE-Extensions          ProtocolExtensionContainer { {DL-DPCH-InformationItem-RL-SetupRspTDD768-ExtIEs} } OPTIONAL,
    ...
}

DL-DPCH-InformationItem-RL-SetupRspTDD768-ExtIEs RNSAP-PROTOCOL-EXTENSION ::= {

```

```

}
...
}
-- *****
--
-- RADIO LINK SETUP FAILURE FDD
--
-- *****

RadioLinkSetupFailureFDD ::= SEQUENCE {
    protocolIEs                ProtocolIE-Container    {{RadioLinkSetupFailureFDD-IEs}},
    protocolExtensions          ProtocolExtensionContainer {{RadioLinkSetupFailureFDD-Extensions}}
    ...
}

RadioLinkSetupFailureFDD-IEs RNSAP-PROTOCOL-IES ::= {
    { ID id-D-RNTI                CRITICALITY ignore TYPE D-RNTI                PRESENCE optional } |
    { ID id-CN-PS-DomainIdentifier CRITICALITY ignore TYPE CN-PS-DomainIdentifier PRESENCE optional } |
    { ID id-CN-CS-DomainIdentifier CRITICALITY ignore TYPE CN-CS-DomainIdentifier PRESENCE optional } |
    { ID id-CauseLevel-RL-SetupFailureFDD CRITICALITY ignore TYPE CauseLevel-RL-SetupFailureFDD PRESENCE mandatory } |
    { ID id-UL-SIRTarget           CRITICALITY ignore TYPE UL-SIR                PRESENCE optional } |
    { ID id-CriticalityDiagnostics CRITICALITY ignore TYPE CriticalityDiagnostics PRESENCE optional } ,
    ...
}

CauseLevel-RL-SetupFailureFDD ::= CHOICE {
    generalCause          GeneralCauseList-RL-SetupFailureFDD,
    rLSpecificCause      RLSpecificCauseList-RL-SetupFailureFDD,
    ...
}

GeneralCauseList-RL-SetupFailureFDD ::= SEQUENCE {
    cause                Cause,
    iE-Extensions        ProtocolExtensionContainer { { GeneralCauseItem-RL-SetupFailureFDD-ExtIEs} }
    ...
}

GeneralCauseItem-RL-SetupFailureFDD-ExtIEs RNSAP-PROTOCOL-EXTENSION ::= {
    ...
}

RLSpecificCauseList-RL-SetupFailureFDD ::= SEQUENCE {
    unsuccessful-RL-InformationRespList-RL-SetupFailureFDD UnsuccessfulRL-InformationResponseList-RL-SetupFailureFDD,
    successful-RL-InformationRespList-RL-SetupFailureFDD    SuccessfulRL-InformationResponseList-RL-SetupFailureFDD OPTIONAL,
    iE-Extensions        ProtocolExtensionContainer { { RLSpecificCauseItem-RL-SetupFailureFDD-ExtIEs} }
    ...
}

RLSpecificCauseItem-RL-SetupFailureFDD-ExtIEs RNSAP-PROTOCOL-EXTENSION ::= {
    { ID id-HSDSCH-RNTI                CRITICALITY ignore     EXTENSION HSDSCH-RNTI
    PRESENCE optional } |
    { ID id-HSDSCH-FDD-Information-Response CRITICALITY ignore     EXTENSION HSDSCH-FDD-Information-Response PRESENCE optional } |
    { ID id-Continuous-Packet-Connectivity-HS-SCCH-Less-Information-Response CRITICALITY ignore     EXTENSION Continuous-Packet-
Connectivity-HS-SCCH-Less-Information-Response PRESENCE optional } |

```

```

    { ID id-SixtyfourQAM-DL-SupportIndicator      CRITICALITY ignore      EXTENSION SixtyfourQAM-DL-SupportIndicator      PRESENCE optional } |
    { ID id-Additional-HS-Cell-Information-Response CRITICALITY ignore      EXTENSION Additional-HS-Cell-Information-Response-List
    PRESENCE optional } |
    { ID id-Additional-EDCH-Cell-Information-Response      CRITICALITY ignore      EXTENSION      Additional-EDCH-Cell-Information-Response-List
      PRESENCE optional },
    ...
}

UnsuccessfulRL-InformationResponseList-RL-SetupFailureFDD ::= SEQUENCE (SIZE (1..maxNrOfRLs)) OF ProtocolIE-Single-Container { {UnsuccessfulRL-
InformationResponse-RL-SetupFailureFDD-IEs} }

UnsuccessfulRL-InformationResponse-RL-SetupFailureFDD-IEs RNSAP-PROTOCOL-IES ::= {
  { ID id-UnsuccessfulRL-InformationResponse-RL-SetupFailureFDD      CRITICALITY ignore      TYPE UnsuccessfulRL-InformationResponse-RL-
  SetupFailureFDD      PRESENCE mandatory }
}

UnsuccessfulRL-InformationResponse-RL-SetupFailureFDD ::= SEQUENCE {
  rL-ID          RL-ID,
  cause          Cause,
  iE-Extensions ProtocolExtensionContainer { {UnsuccessfulRL-InformationResponse-RL-SetupFailureFDD-ExtIEs} } OPTIONAL,
  ...
}

UnsuccessfulRL-InformationResponse-RL-SetupFailureFDD-ExtIEs RNSAP-PROTOCOL-EXTENSION ::= {
  { ID id-Max-UE-DTX-Cycle      CRITICALITY ignore      EXTENSION Max-UE-DTX-Cycle      PRESENCE conditional },
  -- This IE shall be present if the Cause IE is set to "Continuous Packet Connectivity UE DTX Cycle not Available".
  ...
}

SuccessfulRL-InformationResponseList-RL-SetupFailureFDD ::= SEQUENCE (SIZE (0..maxNrOfRLs-1)) OF ProtocolIE-Single-Container { {SuccessfulRL-
InformationResponse-RL-SetupFailureFDD-IEs} }

SuccessfulRL-InformationResponse-RL-SetupFailureFDD-IEs RNSAP-PROTOCOL-IES ::= {
  { ID id-SuccessfulRL-InformationResponse-RL-SetupFailureFDD      CRITICALITY ignore      TYPE SuccessfulRL-InformationResponse-RL-SetupFailureFDD
    PRESENCE mandatory }
}

SuccessfulRL-InformationResponse-RL-SetupFailureFDD ::= SEQUENCE {
  rL-ID          RL-ID,
  rL-Set-ID      RL-Set-ID,
  uRA-Information URA-Information      OPTIONAL,
  sAI           SAI,
  gA-Cell       GA-Cell      OPTIONAL,
  gA-AccessPointPosition GA-AccessPointPosition      OPTIONAL,
  received-total-wide-band-power Received-total-wide-band-power,
  not-Used-secondary-CCPCH-Info      NULL      OPTIONAL,
  dl-CodeInformation FDD-DL-CodeInformation,
  diversityIndication DiversityIndication-RL-SetupFailureFDD,
  sSDT-SupportIndicator sSDT-SupportIndicator,
  maxUL-SIR          UL-SIR,
  minUL-SIR          UL-SIR,
  closedloopoptimingadjustmentmode Closedloopoptimingadjustmentmode      OPTIONAL,
  maximumAllowedULTxPower MaximumAllowedULTxPower,
  maximumDLTxPower  DL-Power,

```

```

    minimumDLTxPower          DL-Power,
    primaryCPICH-Power        PrimaryCPICH-Power,
    primaryScramblingCode     PrimaryScramblingCode          OPTIONAL,
    uL-UARFCN                 UARFCN                      OPTIONAL,
    dL-UARFCN                 UARFCN                      OPTIONAL,
    not-Used-dSCH-InformationResponse-RL-SetupFailureFDD  NULL          OPTIONAL,
    neighbouring-UMTS-CellInformation Neighbouring-UMTS-CellInformation OPTIONAL,
    neighbouring-GSM-CellInformation Neighbouring-GSM-CellInformation OPTIONAL,
    pC-Preamble               PC-Preamble,
    sRB-Delay                 SRB-Delay,
    iE-Extensions             ProtocolExtensionContainer { {SuccessfulRL-InformationResponse-RL-SetupFailureFDD-ExtIEs} } OPTIONAL,
    ...
}

SuccessfulRL-InformationResponse-RL-SetupFailureFDD-ExtIEs RNSAP-PROTOCOL-EXTENSION ::= {
    { ID id-GA-CellAdditionalShapes          CRITICALITY ignore  EXTENSION GA-CellAdditionalShapes
      PRESENCE optional }|
    { ID id-DL-PowerBalancing-ActivationIndicator CRITICALITY ignore  EXTENSION DL-PowerBalancing-ActivationIndicator
      PRESENCE optional }|
    { ID id-HCS-Prio                        CRITICALITY ignore  EXTENSION HCS-Prio
      PRESENCE optional }|
    { ID id-Primary-CPICH-Usage-For-Channel-Estimation CRITICALITY ignore  EXTENSION Primary-CPICH-Usage-For-Channel-Estimation
      PRESENCE optional }|
    { ID id-Secondary-CPICH-Information      CRITICALITY ignore  EXTENSION Secondary-CPICH-Information
      PRESENCE optional }|
    { ID id-Active-MBMS-Bearer-ServiceFDD-PFL CRITICALITY ignore  EXTENSION Active-MBMS-Bearer-Service-ListFDD-PFL
      PRESENCE optional }|
    { ID id-EDCH-RLSet-Id                   CRITICALITY ignore  EXTENSION RL-Set-ID
      PRESENCE optional }|
    { ID id-EDCH-FDD-DL-ControlChannelInformation CRITICALITY ignore  EXTENSION EDCH-FDD-DL-ControlChannelInformation
      PRESENCE optional }|
    { ID id-Initial-DL-DPCH-TimingAdjustment CRITICALITY ignore  EXTENSION DL-DPCH-TimingAdjustment
      PRESENCE optional }|
    { ID id-Neighbouring-E-UTRA-CellInformation CRITICALITY ignore  EXTENSION Neighbouring-E-UTRA-CellInformation
      PRESENCE optional }|
    { ID id-HSDSCH-PreconfigurationInfo     CRITICALITY ignore  EXTENSION HSDSCH-PreconfigurationInfo
      PRESENCE optional }|
    { ID id-F-DPCH-SlotFormat               CRITICALITY ignore  EXTENSION F-DPCH-SlotFormat
      PRESENCE optional }|
    { ID id-Non-Serving-RL-Preconfig-Info  CRITICALITY ignore  EXTENSION Non-Serving-RL-Preconfig-Info
      PRESENCE optional },
    ...
}

DiversityIndication-RL-SetupFailureFDD ::= CHOICE {
    combining          Combining-RL-SetupFailureFDD,
    nonCombiningOrFirstRL NonCombiningOrFirstRL-RL-SetupFailureFDD
}

Combining-RL-SetupFailureFDD ::= SEQUENCE {
    rL-ID              RL-ID,
    iE-Extensions     ProtocolExtensionContainer { { CombiningItem-RL-SetupFailureFDD-ExtIEs} } OPTIONAL,
    ...
}

```

```

CombiningItem-RL-SetupFailureFDD-ExtIEs RNSAP-PROTOCOL-EXTENSION ::= {
  { ID id-DCH-InformationResponse          CRITICALITY ignore  EXTENSION DCH-InformationResponse          PRESENCE optional  }|
  { ID id-EDCH-FDD-InformationResponse     CRITICALITY ignore  EXTENSION EDCH-FDD-InformationResponse     PRESENCE optional  },
  ...
}

NonCombiningOrFirstRL-RL-SetupFailureFDD ::= SEQUENCE {
  dCH-InformationResponse          DCH-InformationResponse,
  iE-Extensions                    ProtocolExtensionContainer { { NonCombiningOrFirstRLItem-RL-SetupFailureFDD-ExtIEs } } OPTIONAL,
  ...
}

NonCombiningOrFirstRLItem-RL-SetupFailureFDD-ExtIEs RNSAP-PROTOCOL-EXTENSION ::= {
  { ID id-EDCH-FDD-InformationResponse     CRITICALITY ignore  EXTENSION EDCH-FDD-InformationResponse     PRESENCE optional  },
  ...
}

RadioLinkSetupFailureFDD-Extensions RNSAP-PROTOCOL-EXTENSION ::= {
  ...
}

-- *****
--
-- RADIO LINK SETUP FAILURE TDD
--
-- *****

RadioLinkSetupFailureTDD ::= SEQUENCE {
  protocolIEs                      ProtocolIE-Container      {{RadioLinkSetupFailureTDD-IEs}},
  protocolExtensions                ProtocolExtensionContainer {{RadioLinkSetupFailureTDD-Extensions}}
  ...
}

RadioLinkSetupFailureTDD-IEs RNSAP-PROTOCOL-IES ::= {
  { ID id-CauseLevel-RL-SetupFailureTDD    CRITICALITY ignore  TYPE CauseLevel-RL-SetupFailureTDD        PRESENCE mandatory }|
  { ID id-CriticalityDiagnostics           CRITICALITY ignore  TYPE CriticalityDiagnostics                PRESENCE optional  },
  ...
}

CauseLevel-RL-SetupFailureTDD ::= CHOICE {
  generalCause                      GeneralCauseList-RL-SetupFailureTDD,
  rLSpecificCause                    RLSpecificCauseList-RL-SetupFailureTDD,
  ...
}

GeneralCauseList-RL-SetupFailureTDD ::= SEQUENCE {
  cause                              Cause,
  iE-Extensions                      ProtocolExtensionContainer { { GeneralCauseItem-RL-SetupFailureTDD-ExtIEs } }
  ...
}

GeneralCauseItem-RL-SetupFailureTDD-ExtIEs RNSAP-PROTOCOL-EXTENSION ::= {
  ...
}

```

```

}

RLSpecificCauseList-RL-SetupFailureTDD ::= SEQUENCE {
    unsuccessful-RL-InformationRespItem-RL-SetupFailureTDD Unsuccessful-RL-InformationRespItem-RL-SetupFailureTDD,
    iE-Extensions                                         ProtocolExtensionContainer { { RLSpecificCauseItem-RL-SetupFailureTDD-ExtIEs } }
    OPTIONAL,
    ...
}

RLSpecificCauseItem-RL-SetupFailureTDD-ExtIEs RNSAP-PROTOCOL-EXTENSION ::= {
    { ID id-SixtyfourQAM-DL-SupportIndicator    CRITICALITY ignore      EXTENSION SixtyfourQAM-DL-SupportIndicator          PRESENCE optional },
    ...
}

Unsuccessful-RL-InformationRespItem-RL-SetupFailureTDD ::= ProtocolIE-Single-Container { {Unsuccessful-RL-InformationRespItemIE-RL-SetupFailureTDD}
}

Unsuccessful-RL-InformationRespItemIE-RL-SetupFailureTDD RNSAP-PROTOCOL-IES ::= {
    { ID id-UnsuccessfulRL-InformationResponse-RL-SetupFailureTDD    CRITICALITY ignore      TYPE UnsuccessfulRL-InformationResponse-RL-
SetupFailureTDD      PRESENCE mandatory }
}

UnsuccessfulRL-InformationResponse-RL-SetupFailureTDD ::= SEQUENCE {
    rL-ID                RL-ID,
    cause                Cause,
    iE-Extensions        ProtocolExtensionContainer { {UnsuccessfulRL-InformationResponse-RL-SetupFailureTDD-ExtIEs} } OPTIONAL,
    ...
}

UnsuccessfulRL-InformationResponse-RL-SetupFailureTDD-ExtIEs RNSAP-PROTOCOL-EXTENSION ::= {
    ...
}

RadioLinkSetupFailureTDD-Extensions RNSAP-PROTOCOL-EXTENSION ::= {
    ...
}

-- *****
--
-- RADIO LINK ADDITION REQUEST FDD
--
-- *****

RadioLinkAdditionRequestFDD ::= SEQUENCE {
    protocolIEs                ProtocolIE-Container    {{RadioLinkAdditionRequestFDD-IEs}},
    protocolExtensions          ProtocolExtensionContainer {{RadioLinkAdditionRequestFDD-Extensions}}          OPTIONAL,
    ...
}

RadioLinkAdditionRequestFDD-IEs RNSAP-PROTOCOL-IES ::= {
    { ID id-UL-SIRTarget        CRITICALITY reject    TYPE UL-SIR          PRESENCE mandatory } |
    { ID id-RL-InformationList-RL-AdditionRqstFDD    CRITICALITY notify    TYPE RL-InformationList-RL-AdditionRqstFDD    PRESENCE mandatory } |
    { ID id-Active-Pattern-Sequence-Information    CRITICALITY reject    TYPE Active-Pattern-Sequence-Information    PRESENCE optional },
    ...
}

```



```

}

RL-InformationList-RL-AdditionRqstFDD ::= SEQUENCE (SIZE (1..maxNrOfRLs-1)) OF ProtocolIE-Single-Container { {RL-Information-RL-AdditionRqstFDD-IEs} }

RL-Information-RL-AdditionRqstFDD-IEs RNSAP-PROTOCOL-IES ::= {
  { ID id-RL-Information-RL-AdditionRqstFDD CRITICALITY notify TYPE RL-Information-RL-AdditionRqstFDD PRESENCE mandatory }
}

RL-Information-RL-AdditionRqstFDD ::= SEQUENCE {
  rL-ID RL-ID,
  c-ID C-ID,
  frameOffset FrameOffset,
  chipOffset ChipOffset,
  diversityControlField DiversityControlField,
  primaryCPICH-EcNo PrimaryCPICH-EcNo OPTIONAL,
  not-Used-sSDT-CellID NULL OPTIONAL,
  transmitDiversityIndicator TransmitDiversityIndicator OPTIONAL,
  iE-Extensions ProtocolExtensionContainer { {RL-Information-RL-AdditionRqstFDD-ExtIEs} } OPTIONAL,
  ...
}

RL-Information-RL-AdditionRqstFDD-ExtIEs RNSAP-PROTOCOL-EXTENSION ::= {
  { ID id-DLReferencePower CRITICALITY ignore EXTENSION DL-Power PRESENCE optional }|
  { ID id-Enhanced-PrimaryCPICH-EcNo CRITICALITY ignore EXTENSION Enhanced-PrimaryCPICH-EcNo PRESENCE optional }|
  { ID id-RL-Specific-DCH-Info CRITICALITY ignore EXTENSION RL-Specific-DCH-Info PRESENCE optional }|
  { ID id-DelayedActivation CRITICALITY reject EXTENSION DelayedActivation PRESENCE optional }|
  { ID id-RL-Specific-EDCH-Information CRITICALITY reject EXTENSION RL-Specific-EDCH-Information PRESENCE optional }|
  { ID id-EDCH-RL-Indication CRITICALITY reject EXTENSION EDCH-RL-Indication PRESENCE optional }|
  { ID id-SynchronisationIndicator CRITICALITY ignore EXTENSION SynchronisationIndicator PRESENCE optional }|
  { ID id-HSDSCH-PreconfigurationSetup CRITICALITY ignore EXTENSION HSDSCH-PreconfigurationSetup PRESENCE optional }|
  { ID id-Non-Serving-RL-Preconfig-Setup CRITICALITY ignore EXTENSION Non-Serving-RL-Preconfig-Setup PRESENCE optional },
  ...
}

RadioLinkAdditionRequestFDD-Extensions RNSAP-PROTOCOL-EXTENSION ::= {
  { ID id-DPC-Mode CRITICALITY reject EXTENSION DPC-Mode PRESENCE optional }|
  { ID id-Permanent-NAS-UE-Identity CRITICALITY ignore EXTENSION Permanent-NAS-UE-Identity PRESENCE optional }|
  { ID id-Serving-EDCH-RL-Id CRITICALITY reject EXTENSION EDCH-Serving-RL PRESENCE optional }|
  { ID id-Initial-DL-DPCH-TimingAdjustment-Allowed CRITICALITY ignore EXTENSION Initial-DL-DPCH-TimingAdjustment-Allowed PRESENCE optional }|
  { ID id-HS-DSCH-serving-cell-change-information CRITICALITY reject EXTENSION HS-DSCH-serving-cell-change-information PRESENCE optional }|
  { ID id-Serving-cell-change-CFN CRITICALITY reject EXTENSION CFN PRESENCE optional }|
}

```

```

    { ID id-EDPCH-Information                CRITICALITY reject  EXTENSION EDPCH-Information-RLAdditionReq-FDD
      PRESENCE optional }|
    { ID id-EDCH-FDD-Information              CRITICALITY reject  EXTENSION EDCH-FDD-Information
      PRESENCE optional }|
    { ID id-Additional-HS-Cell-Information-RL-Addition CRITICALITY reject  EXTENSION Additional-HS-Cell-Information-RL-Addition-List PRESENCE
optional }|
    -- This IE shall be present if E-DPCH Information is present
    { ID id-UE-AggregateMaximumBitRate        CRITICALITY ignore  EXTENSION UE-AggregateMaximumBitRate
      PRESENCE optional }|
    { ID id-Additional-EDCH-Cell-Information-RL-Add-Req CRITICALITY reject  EXTENSION Additional-EDCH-Cell-Information-RL-Add-Req
      PRESENCE optional },
    ...
}

```

Additional-HS-Cell-Information-RL-Addition-List ::= SEQUENCE (SIZE (1..maxNrOfHSDSCH-1)) OF Additional-HS-Cell-Information-RL-Addition-ItemIEs

```

Additional-HS-Cell-Information-RL-Addition-ItemIEs ::=SEQUENCE{
    hSPDSCH-RL-ID                RL-ID,
    c-ID                          C-ID,
    HS-DSCH-FDD-Secondary-Serving-Information HS-DSCH-FDD-Secondary-Serving-Information,
    IE-Extensions                 ProtocolExtensionContainer { { Additional-HS-Cell-Information-RL-Addition-ItemIEs-ExtIEs} } OPTIONAL,
    ...
}

```

```

Additional-HS-Cell-Information-RL-Addition-ItemIEs-ExtIEs RNSAP-PROTOCOL-EXTENSION ::= {
    ...
}

```

```

Additional-EDCH-Cell-Information-RL-Add-Req ::=SEQUENCE{
    setup-Or-Addition-Of-EDCH-On-secondary-UL-Frequency Setup-Or-Addition-Of-EDCH-On-secondary-UL-Frequency,
    IE-Extensions                 ProtocolExtensionContainer { { Additional-EDCH-Cell-Information-RL-Add-Req-ExtIEs} } OPTIONAL,
    ...
}

```

```

Additional-EDCH-Cell-Information-RL-Add-Req-ExtIEs RNSAP-PROTOCOL-EXTENSION ::= {
    ...
}

```

```

Setup-Or-Addition-Of-EDCH-On-secondary-UL-Frequency ::= CHOICE {
    setup          Additional-EDCH-Setup-Info,
    addition       Additional-EDCH-Cell-Information-To-Add-List,
    ...
}

```

```

EDPCH-Information-RLAdditionReq-FDD ::= SEQUENCE {
    maxSet-E-DPDCHs          Max-Set-E-DPDCHs,
    ul-PunctureLimit         PunctureLimit,
    e-TFCS-Information        E-TFCS-Information,
    e-TTI                    E-TTI,
    e-DPCCH-PO               E-DPCCH-PO,
    e-RGCH-2-IndexStepThreshold E-RGCH-2-IndexStepThreshold,
    e-RGCH-3-IndexStepThreshold E-RGCH-3-IndexStepThreshold,
}

```

```

    HARQ-Info-for-E-DCH
    iE-Extensions
    ...
}

EDPCH-Information-RLAdditionReq-FDD-ExtIEs RNSAP-PROTOCOL-EXTENSION ::= {
{ ID id-HSDSCH-Configured-Indicator      CRITICALITY reject  EXTENSION  HSDSCH-Configured-Indicator      PRESENCE mandatory }|
-- This shall be present for EDPCH configuration with HSDCH
{ ID id-MinimumReducedE-DPDCH-GainFactor  CRITICALITY ignore  EXTENSION  MinimumReducedE-DPDCH-GainFactor  PRESENCE optional },
...
}

-- *****
--
-- RADIO LINK ADDITION REQUEST TDD
--
-- *****

RadioLinkAdditionRequestTDD ::= SEQUENCE {
    protocolIEs          ProtocolIE-Container      {{RadioLinkAdditionRequestTDD-IEs}},
    protocolExtensions   ProtocolExtensionContainer {{RadioLinkAdditionRequestTDD-Extensions}}
    ...
}

RadioLinkAdditionRequestTDD-IEs RNSAP-PROTOCOL-IES ::= {
    { ID id-RL-Information-RL-AdditionRqstTDD  CRITICALITY reject  TYPE  RL-Information-RL-AdditionRqstTDD  PRESENCE mandatory  },
    ...
}

RL-Information-RL-AdditionRqstTDD ::= SEQUENCE {
    rL-ID                RL-ID,
    c-ID                 C-ID,
    frameOffset          FrameOffset,
    diversityControlField DiversityControlField,
    primaryCCPCH-RSCP    PrimaryCCPCH-RSCP    OPTIONAL,
    dL-TimeSlot-ISCP-Info DL-TimeSlot-ISCP-Info  OPTIONAL,
    --for 3.84Mcps TDD only
    iE-Extensions        ProtocolExtensionContainer { {RL-Information-RL-AdditionRqstTDD-ExtIEs} } OPTIONAL,
    ...
}

RL-Information-RL-AdditionRqstTDD-ExtIEs RNSAP-PROTOCOL-EXTENSION ::= {
    { ID id-DL-Timeslot-ISCP-LCR-Information-RL-AdditionRqstTDD  CRITICALITY reject  EXTENSION  DL-TimeSlot-ISCP-LCR-Information
    PRESENCE optional }|
    --for 1.28Mcps TDD only
    { ID id-RL-Specific-DCH-Info          CRITICALITY ignore  EXTENSION  RL-Specific-DCH-Info          PRESENCE optional }|
    { ID id-DelayedActivation             CRITICALITY reject  EXTENSION  DelayedActivation             PRESENCE optional }|
    { ID id-UL-Synchronisation-Parameters-LCR  CRITICALITY reject  EXTENSION  UL-Synchronisation-Parameters-LCR  PRESENCE optional }|
    -- Mandatory for 1.28Mcps TDD, Not Applicable to 3.84Mcps TDD or 7.68Mcps TDD
    { ID id-PrimaryCCPCH-RSCP-Delta       CRITICALITY ignore  EXTENSION  PrimaryCCPCH-RSCP-Delta         PRESENCE optional }|
    { ID id-IdleIntervalConfigurationIndicator  CRITICALITY ignore  EXTENSION  NULL                             PRESENCE optional },
    ...
}

```

```

RadioLinkAdditionRequestTDD-Extensions RNSAP-PROTOCOL-EXTENSION ::= {
  { ID id-Permanent-NAS-UE-Identity          CRITICALITY ignore      EXTENSION Permanent-NAS-UE-Identity          PRESENCE optional
  } |
  { ID id-UL-CCTrCH-InformationList-RL-AdditionRqstTDD  CRITICALITY notify  EXTENSION UL-CCTrCH-InformationList-RL-AdditionRqstTDD  PRESENCE
optional } |
  { ID id-DL-CCTrCH-InformationList-RL-AdditionRqstTDD  CRITICALITY notify  EXTENSION DL-CCTrCH-InformationList-RL-AdditionRqstTDD
PRESENCE optional } |
  { ID id-HSDSCH-TDD-Information          CRITICALITY reject      EXTENSION HSDSCH-TDD-Information          PRESENCE
optional } |
  { ID id-HSPDSCH-RL-ID          CRITICALITY reject      EXTENSION RL-ID
PRESENCE optional } |
  { ID id-E-DCH-Information          CRITICALITY reject      EXTENSION E-DCH-Information          PRESENCE
optional } |
  { ID id-E-DCH-Serving-RL-ID          CRITICALITY reject      EXTENSION RL-ID          PRESENCE
optional } |
  { ID id-E-DCH-768-Information          CRITICALITY reject      EXTENSION E-DCH-768-Information
PRESENCE optional } |
  { ID id-E-DCH-LCR-Information          CRITICALITY reject      EXTENSION E-DCH-LCR-Information
PRESENCE optional } |
  { ID id-ContinuousPacketConnectivity-DRX-InformationLCR  CRITICALITY reject      EXTENSION ContinuousPacketConnectivity-DRX-InformationLCR
PRESENCE optional } |
  { ID id-HS-DSCH-Semi-PersistentScheduling-Information-LCR  CRITICALITY reject      EXTENSION HS-DSCH-Semi-PersistentScheduling-Information-LCR
PRESENCE optional } |
  { ID id-E-DCH-Semi-PersistentScheduling-Information-LCR  CRITICALITY reject      EXTENSION E-DCH-Semi-PersistentScheduling-Information-LCR
PRESENCE optional } |
  { ID id-DCH-MeasurementType-Indicator          CRITICALITY reject      EXTENSION DCH-MeasurementType-Indicator          PRESENCE optional},
  ...
}

UL-CCTrCH-InformationList-RL-AdditionRqstTDD ::= SEQUENCE (SIZE (1..maxNrOfCCTrCHs)) OF ProtocolIE-Single-Container { {UL-CCTrCH-
InformationItemIEs-RL-AdditionRqstTDD} }

UL-CCTrCH-InformationItemIEs-RL-AdditionRqstTDD RNSAP-PROTOCOL-IES ::= {
  { ID id-UL-CCTrCH-InformationItem-RL-AdditionRqstTDD  CRITICALITY notify  TYPE UL-CCTrCH-InformationItem-RL-AdditionRqstTDD  PRESENCE
optional},
  ...
}

UL-CCTrCH-InformationItem-RL-AdditionRqstTDD ::= SEQUENCE {
  cCTrCH-ID          CCTrCH-ID,
  uplinkStepSizeLCR          TDD-TPC-UplinkStepSize-LCR  OPTIONAL,
  -- Applicable to 1.28Mcps TDD only
  iE-Extensions          ProtocolExtensionContainer { {UL-CCTrCH-InformationItem-RL-AdditionRqstTDD-ExtIEs} } OPTIONAL,
  ...
}

UL-CCTrCH-InformationItem-RL-AdditionRqstTDD-ExtIEs RNSAP-PROTOCOL-EXTENSION ::= {
  ...
}

DL-CCTrCH-InformationList-RL-AdditionRqstTDD ::= SEQUENCE (SIZE (1..maxNrOfCCTrCHs)) OF ProtocolIE-Single-Container { {DL-CCTrCH-
InformationItemIEs-RL-AdditionRqstTDD} }

DL-CCTrCH-InformationItemIEs-RL-AdditionRqstTDD RNSAP-PROTOCOL-IES ::= {

```

```

    { ID id-DL-CCTrCH-InformationItem-RL-AdditionRqstTDD    CRITICALITY notify    TYPE DL-CCTrCH-InformationItem-RL-AdditionRqstTDD    PRESENCE
optional},
    ...
}

DL-CCTrCH-InformationItem-RL-AdditionRqstTDD ::= SEQUENCE {
    cCTrCH-ID                CCTrCH-ID,
    downlinkStepSize        TDD-TPC-DownlinkStepSize    OPTIONAL,
    iE-Extensions           ProtocolExtensionContainer { {DL-CCTrCH-InformationItem-RL-AdditionRqstTDD-ExtIEs} } OPTIONAL,
    ...
}

DL-CCTrCH-InformationItem-RL-AdditionRqstTDD-ExtIEs RNSAP-PROTOCOL-EXTENSION ::= {
    ...
}

-- *****
--
-- RADIO LINK ADDITION RESPONSE FDD
--
-- *****

RadioLinkAdditionResponseFDD ::= SEQUENCE {
    protocolIEs                ProtocolIE-Container    {{RadioLinkAdditionResponseFDD-IEs}},
    protocolExtensions         ProtocolExtensionContainer {{RadioLinkAdditionResponseFDD-Extensions}}    OPTIONAL,
    ...
}

RadioLinkAdditionResponseFDD-IEs RNSAP-PROTOCOL-IES ::= {
    { ID id-RL-InformationResponseList-RL-AdditionRspFDD    CRITICALITY ignore    TYPE RL-InformationResponseList-RL-AdditionRspFDD
    PRESENCE mandatory } |
    { ID id-CriticalityDiagnostics                CRITICALITY ignore    TYPE CriticalityDiagnostics                PRESENCE optional    },
    ...
}

RL-InformationResponseList-RL-AdditionRspFDD ::= SEQUENCE (SIZE (1..maxNrOfRLs-1)) OF ProtocolIE-Single-Container { {RL-
InformationResponseItemIEs-RL-AdditionRspFDD} }

RL-InformationResponseItemIEs-RL-AdditionRspFDD RNSAP-PROTOCOL-IES ::= {
    { ID id-RL-InformationResponseItem-RL-AdditionRspFDD    CRITICALITY ignore    TYPE RL-InformationResponseItem-RL-AdditionRspFDD    PRESENCE
mandatory }
}

RL-InformationResponseItem-RL-AdditionRspFDD ::= SEQUENCE {
    rL-ID                    RL-ID,
    rL-Set-ID                RL-Set-ID,
    uRA-Information          URA-Information    OPTIONAL,
    sAI                      SAI,
    gA-Cell                  GA-Cell    OPTIONAL,
    gA-AccessPointPosition   GA-AccessPointPosition    OPTIONAL,
    received-total-wide-band-power    Received-total-wide-band-power,
    not-Used-secondary-CCPCH-Info     NULL    OPTIONAL,
    dl-CodeInformation        DL-CodeInformationList-RL-AdditionRspFDD,
    diversityIndication       DiversityIndication-RL-AdditionRspFDD,
}

```

```

sSDT-SupportIndicator          SSdT-SupportIndicator,
minUL-SIR                      UL-SIR,
maxUL-SIR                      UL-SIR,
closedloopTimingAdjustmentMode ClosedloopTimingAdjustmentMode OPTIONAL,
maximumAllowedULTxPower       MaximumAllowedULTxPower,
maximumDLTxPower              DL-Power,
minimumDLTxPower              DL-Power,
neighbouring-UMTS-CellInformation Neighbouring-UMTS-CellInformation OPTIONAL,
neighbouring-GSM-CellInformation Neighbouring-GSM-CellInformation OPTIONAL,
pC-Preamble                    PC-Preamble,
sRB-Delay                      SRB-Delay,
primaryCPICH-Power             PrimaryCPICH-Power,
iE-Extensions                  ProtocolExtensionContainer { {RL-InformationResponseItem-RL-AdditionRspFDD-ExtIEs} } OPTIONAL,
...
}

RL-InformationResponseItem-RL-AdditionRspFDD-ExtIEs RNSAP-PROTOCOL-EXTENSION ::= {
  { ID id-GA-CellAdditionalShapes          CRITICALITY ignore EXTENSION GA-CellAdditionalShapes
    PRESENCE optional }|
  { ID id-DL-PowerBalancing-ActivationIndicator CRITICALITY ignore EXTENSION DL-PowerBalancing-ActivationIndicator PRESENCE optional }|
  { ID id-HCS-Prio                        CRITICALITY ignore EXTENSION HCS-Prio
    PRESENCE optional }|
  optional { ID id-Active-MBMS-Bearer-ServiceFDD-PFL CRITICALITY ignore EXTENSION Active-MBMS-Bearer-Service-ListFDD-PFL PRESENCE
    optional }|
  { ID id-EDCH-RLSet-Id                  CRITICALITY ignore EXTENSION RL-Set-ID
    PRESENCE optional }|
  { ID id-EDCH-FDD-DL-ControlChannelInformation CRITICALITY ignore EXTENSION EDCH-FDD-DL-ControlChannelInformation PRESENCE optional }|
  { ID id-Initial-DL-DPCH-TimingAdjustment CRITICALITY ignore EXTENSION DL-DPCH-TimingAdjustment
    PRESENCE optional }|
  { ID id-F-DPCH-SlotFormat              CRITICALITY ignore EXTENSION F-DPCH-SlotFormat
    PRESENCE optional }|
  optional { ID id-Neighbouring-E-UTRA-CellInformation CRITICALITY ignore EXTENSION Neighbouring-E-UTRA-CellInformation PRESENCE
    optional }|
  { ID id-HSDSCH-PreconfigurationInfo     CRITICALITY ignore EXTENSION HSDSCH-PreconfigurationInfo
    PRESENCE optional }|
  { ID id-Non-Serving-RL-Preconfig-Info   CRITICALITY ignore EXTENSION Non-Serving-RL-Preconfig-Info
    PRESENCE optional },
  ...
}

DL-CodeInformationList-RL-AdditionRspFDD ::= ProtocolIE-Single-Container {{ DL-CodeInformationListIEs-RL-AdditionRspFDD }}

DL-CodeInformationListIEs-RL-AdditionRspFDD RNSAP-PROTOCOL-IES ::= {
  { ID id-FDD-DL-CodeInformation CRITICALITY ignore TYPE FDD-DL-CodeInformation PRESENCE mandatory }
}

DiversityIndication-RL-AdditionRspFDD ::= CHOICE {
  combining          Combining-RL-AdditionRspFDD,
  nonCombining      NonCombining-RL-AdditionRspFDD
}

Combining-RL-AdditionRspFDD ::= SEQUENCE {
  rL-ID              RL-ID,

```

```

    iE-Extensions          ProtocolExtensionContainer { { CombiningItem-RL-AdditionRspFDD-ExtIEs } } OPTIONAL,
    ...
}

CombiningItem-RL-AdditionRspFDD-ExtIEs RNSAP-PROTOCOL-EXTENSION ::= {
    { ID id-DCH-InformationResponse          CRITICALITY ignore EXTENSION DCH-InformationResponse          PRESENCE optional }|
    { ID id-EDCH-FDD-InformationResponse     CRITICALITY ignore EXTENSION EDCH-FDD-InformationResponse     PRESENCE optional },
    ...
}

NonCombining-RL-AdditionRspFDD ::= SEQUENCE {
    dCH-InformationResponse          DCH-InformationResponse,
    iE-Extensions                    ProtocolExtensionContainer { { NonCombiningItem-RL-AdditionRspFDD-ExtIEs } } OPTIONAL,
    ...
}

NonCombiningItem-RL-AdditionRspFDD-ExtIEs RNSAP-PROTOCOL-EXTENSION ::= {
    { ID id-EDCH-FDD-InformationResponse     CRITICALITY ignore EXTENSION EDCH-FDD-InformationResponse     PRESENCE optional },
    ...
}

RadioLinkAdditionResponseFDD-Extensions RNSAP-PROTOCOL-EXTENSION ::= {
    { ID id-HS-DSCH-serving-cell-change-informationResponse CRITICALITY ignore EXTENSION HS-DSCH-serving-cell-change-informationResponse
      PRESENCE optional }|
    { ID id-E-DCH-Serving-cell-change-informationResponse CRITICALITY ignore EXTENSION E-DCH-Serving-cell-change-informationResponse
      PRESENCE optional }|
    { ID id-MACHs-ResetIndicator              CRITICALITY ignore EXTENSION MACHs-ResetIndicator
      PRESENCE optional }|
    { ID id-Additional-HS-Cell-Change-Information-Response CRITICALITY ignore EXTENSION Additional-HS-Cell-Change-Information-Response-List
      PRESENCE optional }|
    { ID id-Additional-EDCH-Cell-Information-Response-RLAdd CRITICALITY ignore EXTENSION Additional-EDCH-Cell-Information-Response-RLAddList
      PRESENCE optional },
    ...
}

Additional-HS-Cell-Change-Information-Response-List ::= SEQUENCE (SIZE (1..maxNrOfHSDSCH-1)) OF Additional-HS-Cell-Change-Information-Response-
ItemIEs

Additional-HS-Cell-Change-Information-Response-ItemIEs ::=SEQUENCE{
    hSPDSCH-RL-ID          RL-ID,
    hSDSCH-RNTI            HSDSCH-RNTI,
    hS-DSCH-Secondary-Serving-Cell-Change-Information-Response HS-DSCH-Secondary-Serving-Cell-Change-Information-Response,
    iE-Extensions          ProtocolExtensionContainer { { Additional-HS-Cell-Change-Information-Response-ItemIEs-ExtIEs } } OPTIONAL,
    ...
}

Additional-HS-Cell-Change-Information-Response-ItemIEs-ExtIEs RNSAP-PROTOCOL-EXTENSION ::= {
    ...
}

-- *****

```

```

--
-- RADIO LINK ADDITION RESPONSE TDD
--
-- *****

RadioLinkAdditionResponseTDD ::= SEQUENCE {
    protocolIEs                ProtocolIE-Container    {{RadioLinkAdditionResponseTDD-IEs}},
    protocolExtensions         ProtocolExtensionContainer {{RadioLinkAdditionResponseTDD-Extensions}}    OPTIONAL,
    ...
}

RadioLinkAdditionResponseTDD-IEs RNSAP-PROTOCOL-IES ::= {
    { ID id-RL-InformationResponse-RL-AdditionRspTDD          CRITICALITY ignore TYPE RL-InformationResponse-RL-AdditionRspTDD PRESENCE optional
    } |
    --Mandatory for 3.84Mcps TDD only
    { ID id-CriticalityDiagnostics          CRITICALITY ignore TYPE CriticalityDiagnostics PRESENCE optional },
    ...
}

RL-InformationResponse-RL-AdditionRspTDD ::= SEQUENCE {
    rL-ID                    RL-ID,
    uRA-Information          URA-Information    OPTIONAL,
    sAI                      SAI,
    gA-Cell                  GA-Cell    OPTIONAL,
    gA-AccessPointPosition  GA-AccessPointPosition  OPTIONAL,
    ul-TimeSlot-ISCP-Info   UL-TimeSlot-ISCP-Info,
    minUL-SIR               UL-SIR,
    maxUL-SIR               UL-SIR,
    maximumAllowedULTxPower MaximumAllowedULTxPower,
    maximumDLTxPower        DL-Power,
    minimumDLTxPower        DL-Power,
    pCCPCH-Power            PCCPCH-Power,
    timingAdvanceApplied    TimingAdvanceApplied,
    alphaValue              AlphaValue,
    ul-PhysCH-SF-Variation  UL-PhysCH-SF-Variation,
    synchronisationConfiguration SynchronisationConfiguration,
    secondary-CCPCH-Info-TDD Secondary-CCPCH-Info-TDD                OPTIONAL,
    ul-CCTrCHInformation    UL-CCTrCHInformationList-RL-AdditionRspTDD  OPTIONAL,
    dl-CCTrCHInformation    DL-CCTrCHInformationList-RL-AdditionRspTDD  OPTIONAL,
    dCH-Information        DCH-Information-RL-AdditionRspTDD  OPTIONAL,
    dSCH-InformationResponse DSCH-InformationResponse-RL-AdditionRspTDD  OPTIONAL,
    uSCH-InformationResponse USCH-InformationResponse-RL-AdditionRspTDD  OPTIONAL,
    neighbouring-UMTS-CellInformation Neighbouring-UMTS-CellInformation  OPTIONAL,
    neighbouring-GSM-CellInformation Neighbouring-GSM-CellInformation  OPTIONAL,
    IE-Extensions          ProtocolExtensionContainer { {RL-InformationResponse-RL-AdditionRspTDD-ExtIEs} } OPTIONAL,
    ...
}

RL-InformationResponse-RL-AdditionRspTDD-ExtIEs RNSAP-PROTOCOL-EXTENSION ::= {
    { ID id-GA-CellAdditionalShapes          CRITICALITY ignore EXTENSION GA-CellAdditionalShapes
    PRESENCE optional } |
    { ID id-HCS-Prio          CRITICALITY ignore EXTENSION HCS-Prio
    PRESENCE optional } |
}

```



```

    { ID id-Neighbouring-E-UTRA-CellInformation      CRITICALITY ignore  EXTENSION Neighbouring-E-UTRA-CellInformation
optional },
    ...
}

UL-CCTrCHInformationList-RL-AdditionRspTDD ::= ProtocolIE-Single-Container {{UL-CCTrCHInformationListIEs-RL-AdditionRspTDD}}

UL-CCTrCHInformationListIEs-RL-AdditionRspTDD RNSAP-PROTOCOL-IES ::= {
    { ID id-UL-CCTrCH-InformationListIE-RL-AdditionRspTDD      CRITICALITY ignore  TYPE UL-CCTrCHInformationListIE-RL-AdditionRspTDD
    PRESENCE mandatory }
}

UL-CCTrCHInformationListIE-RL-AdditionRspTDD ::= SEQUENCE (SIZE (1..maxNrOfCCTrCHs)) OF UL-CCTrCHInformationItem-RL-AdditionRspTDD

UL-CCTrCHInformationItem-RL-AdditionRspTDD ::= SEQUENCE {
    cCtRch-ID                CCTrCH-ID,
    ul-DPCH-Information      UL-DPCH-InformationList-RL-AdditionRspTDD      OPTIONAL,
    iE-Extensions            ProtocolExtensionContainer { {UL-CCTrCHInformationItem-RL-AdditionRspTDD-ExtIEs} } OPTIONAL,
    ...
}

UL-CCTrCHInformationItem-RL-AdditionRspTDD-ExtIEs RNSAP-PROTOCOL-EXTENSION ::= {
    ...
}

UL-DPCH-InformationList-RL-AdditionRspTDD ::= ProtocolIE-Single-Container { {UL-DPCH-InformationListIEs-RL-AdditionRspTDD} }

UL-DPCH-InformationListIEs-RL-AdditionRspTDD RNSAP-PROTOCOL-IES ::= {
    { ID id-UL-DPCH-InformationItem-RL-AdditionRspTDD          CRITICALITY ignore  TYPE UL-DPCH-InformationItem-RL-AdditionRspTDD  PRESENCE mandatory
    }
}

UL-DPCH-InformationItem-RL-AdditionRspTDD ::= SEQUENCE {
    repetitionPeriod        RepetitionPeriod,
    repetitionLength        RepetitionLength,
    tDD-DPCHOffset          TDD-DPCHOffset,
    uL-Timeslot-Information  UL-Timeslot-Information,
    iE-Extensions            ProtocolExtensionContainer { {UL-DPCH-InformationItem-RL-AdditionRspTDD-ExtIEs} } OPTIONAL,
    ...
}

UL-DPCH-InformationItem-RL-AdditionRspTDD-ExtIEs RNSAP-PROTOCOL-EXTENSION ::= {
    ...
}

DL-CCTrCHInformationList-RL-AdditionRspTDD ::= ProtocolIE-Single-Container {{DL-CCTrCHInformationListIEs-RL-AdditionRspTDD}}

DL-CCTrCHInformationListIEs-RL-AdditionRspTDD RNSAP-PROTOCOL-IES ::= {
    { ID id-DL-CCTrCH-InformationListIE-RL-AdditionRspTDD      CRITICALITY ignore  TYPE DL-CCTrCHInformationListIE-RL-AdditionRspTDD
    PRESENCE mandatory }
}

DL-CCTrCHInformationListIE-RL-AdditionRspTDD ::= SEQUENCE (SIZE (1..maxNrOfCCTrCHs)) OF DL-CCTrCHInformationItem-RL-AdditionRspTDD

```

```

DL-CCTrCHInformationItem-RL-AdditionRspTDD ::= SEQUENCE {
    cCTrCH-ID                CCTrCH-ID,
    dl-DPCH-Information      DL-DPCH-InformationList-RL-AdditionRspTDD    OPTIONAL,
    iE-Extensions            ProtocolExtensionContainer { {DL-CCTrCHInformationItem-RL-AdditionRspTDD-ExtIEs} } OPTIONAL,
    ...
}

DL-CCTrCHInformationItem-RL-AdditionRspTDD-ExtIEs RNSAP-PROTOCOL-EXTENSION ::= {
    { ID id-CCTrCH-Maximum-DL-Power-RL-AdditionRspTDD    CRITICALITY ignore    EXTENSION DL-Power    PRESENCE optional    } | -- this is a DCH
type CCTrCH power
    { ID id-CCTrCH-Minimum-DL-Power-RL-AdditionRspTDD    CRITICALITY ignore    EXTENSION DL-Power    PRESENCE optional    }, -- this is a DCH
type CCTrCH power
    ...
}

DL-DPCH-InformationList-RL-AdditionRspTDD ::= ProtocolIE-Single-Container { {DL-DPCH-InformationListIEs-RL-AdditionRspTDD} }

DL-DPCH-InformationListIEs-RL-AdditionRspTDD RNSAP-PROTOCOL-IES ::= {
    { ID id-DL-DPCH-InformationItem-RL-AdditionRspTDD    CRITICALITY ignore    TYPE DL-DPCH-InformationItem-RL-AdditionRspTDD    PRESENCE mandatory
    }
}

DL-DPCH-InformationItem-RL-AdditionRspTDD ::= SEQUENCE {
    repetitionPeriod        RepetitionPeriod,
    repetitionLength        RepetitionLength,
    tDD-DPCHOffset          TDD-DPCHOffset,
    dL-Timeslot-Information DL-Timeslot-Information,
    iE-Extensions            ProtocolExtensionContainer { {DL-DPCH-InformationItem-RL-AdditionRspTDD-ExtIEs} } OPTIONAL,
    ...
}

DL-DPCH-InformationItem-RL-AdditionRspTDD-ExtIEs RNSAP-PROTOCOL-EXTENSION ::= {
    ...
}

DCH-Information-RL-AdditionRspTDD ::= SEQUENCE {
    diversityIndication      DiversityIndication-RL-AdditionRspTDD,

    iE-Extensions            ProtocolExtensionContainer { { DCH-Information-RL-AdditionRspTDD-ExtIEs} } OPTIONAL,
    ...
}

DCH-Information-RL-AdditionRspTDD-ExtIEs RNSAP-PROTOCOL-EXTENSION ::= {
    ...
}

DiversityIndication-RL-AdditionRspTDD ::= CHOICE {
    combining                Combining-RL-AdditionRspTDD,
    nonCombining            NonCombining-RL-AdditionRspTDD
}

Combining-RL-AdditionRspTDD ::= SEQUENCE {
    rL-ID                    RL-ID,
    iE-Extensions            ProtocolExtensionContainer { { CombiningItem-RL-AdditionRspTDD-ExtIEs} } OPTIONAL,

```

```

}
...
}
CombiningItem-RL-AdditionRspTDD-ExtIEs RNSAP-PROTOCOL-EXTENSION ::= {
  { ID id-DCH-InformationResponse      CRITICALITY ignore  EXTENSION DCH-InformationResponse      PRESENCE optional  },
  ...
}
NonCombining-RL-AdditionRspTDD ::= SEQUENCE {
  dCH-InformationResponse      DCH-InformationResponse,
  iE-Extensions                ProtocolExtensionContainer { { NonCombiningItem-RL-AdditionRspTDD-ExtIEs } } OPTIONAL,
  ...
}
NonCombiningItem-RL-AdditionRspTDD-ExtIEs RNSAP-PROTOCOL-EXTENSION ::= {
  ...
}
DSCH-InformationResponse-RL-AdditionRspTDD ::= ProtocolIE-Single-Container {{DSCH-InformationListIEs-RL-AdditionRspTDD}}
DSCH-InformationListIEs-RL-AdditionRspTDD RNSAP-PROTOCOL-IES ::= {
  { ID id-DSCH-InformationListIE-RL-AdditionRspTDD      CRITICALITY ignore  TYPE DSCH-InformationListIE-RL-AdditionRspTDD      PRESENCE
  mandatory }
}
DSCH-InformationListIE-RL-AdditionRspTDD ::= SEQUENCE (SIZE(0..maxNoOfDSCHs)) OF DSCHInformationItem-RL-AdditionRspTDD
DSCHInformationItem-RL-AdditionRspTDD ::= SEQUENCE {
  dsch-ID                DSCH-ID,
  transportFormatManagement      TransportFormatManagement,
  dSCH-FlowControlInformation      DSCH-FlowControlInformation,
  diversityIndication      DiversityIndication-RL-AdditionRspTDD2 OPTIONAL,
  -- diversityIndication present, if CHOICE = nonCombining
  iE-Extensions                ProtocolExtensionContainer { {DSCHInformationItem-RL-AdditionRspTDD-ExtIEs} } OPTIONAL,
  ...
}
DSCHInformationItem-RL-AdditionRspTDD-ExtIEs RNSAP-PROTOCOL-EXTENSION ::= {
  ...
}
DiversityIndication-RL-AdditionRspTDD2 ::= SEQUENCE {
  bindingID                BindingID OPTIONAL,
  transportLayerAddress      TransportLayerAddress OPTIONAL,
  iE-Extensions                ProtocolExtensionContainer { {DiversityIndication-RL-AdditionRspTDD2-ExtIEs} } OPTIONAL,
  ...
}
DiversityIndication-RL-AdditionRspTDD2-ExtIEs RNSAP-PROTOCOL-EXTENSION ::= {
  ...
}
USCH-InformationResponse-RL-AdditionRspTDD ::= ProtocolIE-Single-Container {{USCH-InformationListIEs-RL-AdditionRspTDD}}
USCH-InformationListIEs-RL-AdditionRspTDD RNSAP-PROTOCOL-IES ::= {

```

```

    { ID id-USCH-InformationListIE-RL-AdditionRspTDD      CRITICALITY ignore  TYPE USCH-InformationListIE-RL-AdditionRspTDD      PRESENCE
mandatory }
}

USCH-InformationListIE-RL-AdditionRspTDD ::= SEQUENCE (SIZE(0..maxNoOfUSCHs)) OF USCHInformationItem-RL-AdditionRspTDD

USCHInformationItem-RL-AdditionRspTDD ::= SEQUENCE {
    uSCH-ID          USCH-ID,
    transportFormatManagement TransportFormatManagement,
    diversityIndication DiversityIndication-RL-AdditionRspTDD2 OPTIONAL,
    -- diversityIndication present, if CHOICE = nonCombining
    iE-Extensions    ProtocolExtensionContainer { {USCHInformationItem-RL-AdditionRspTDD-ExtIEs} } OPTIONAL,
    ...
}

USCHInformationItem-RL-AdditionRspTDD-ExtIEs RNSAP-PROTOCOL-EXTENSION ::= {
    ...
}

RadioLinkAdditionResponseTDD-Extensions RNSAP-PROTOCOL-EXTENSION ::= {
    { ID id-RL-LCR-InformationResponse-RL-AdditionRspTDD      CRITICALITY ignore      EXTENSION RL-LCR-InformationResponse-RL-AdditionRspTDD
PRESENCE optional }|
    --Mandatory for 1.28Mcps TDD only
    { ID id-Active-MBMS-Bearer-ServiceTDD-PFL                CRITICALITY ignore      EXTENSION Active-MBMS-Bearer-Service-ListTDD-PFL
PRESENCE optional }|
    { ID id-HSDSCH-TDD-Information-Response                  CRITICALITY ignore      EXTENSION HSDSCH-TDD-Information-Response
PRESENCE optional }|
    { ID id-DSCH-RNTI                                        CRITICALITY ignore      EXTENSION DSCH-RNTI
PRESENCE optional }|
    { ID id-RL-InformationResponse-RL-AdditionRspTDD768     CRITICALITY ignore      EXTENSION RL-InformationResponse-RL-AdditionRspTDD768
PRESENCE optional }|
    { ID id-E-DCH-Information-Response                       CRITICALITY ignore      EXTENSION E-DCH-Information-Response
PRESENCE optional }|
    { ID id-E-DCH-768-Information-Response                  CRITICALITY ignore      EXTENSION E-DCH-768-Information-Response
PRESENCE optional }|
    { ID id-E-DCH-LCR-Information-Response                   CRITICALITY ignore      EXTENSION E-DCH-LCR-Information-Response
PRESENCE optional }|
    { ID id-ContinuousPacketConnectivity-DRX-Information-ResponseLCR
ContinuousPacketConnectivity-DRX-Information-ResponseLCR      CRITICALITY ignore      EXTENSION
PRESENCE optional }|
    { ID id-HS-DSCH-Semi-PersistentScheduling-Information-ResponseLCR
PersistentScheduling-Information-ResponseLCR                    CRITICALITY ignore      EXTENSION HS-DSCH-Semi-
PRESENCE optional }|
    { ID id-E-DCH-Semi-PersistentScheduling-Information-ResponseLCR
Information-ResponseLCR                                         CRITICALITY ignore      EXTENSION E-DCH-Semi-PersistentScheduling-
PRESENCE optional }|
    { ID id-DCH-MeasurementOccasion-Information              CRITICALITY reject      EXTENSION DCH-MeasurementOccasion-Information
PRESENCE optional},
    ...
}

RL-LCR-InformationResponse-RL-AdditionRspTDD ::= SEQUENCE {
    rL-ID          RL-ID,
    uRA-Information URA-Information,
    sAI            SAI,
    gA-Cell        GA-Cell      OPTIONAL,
    gA-AccessPointPosition GA-AccessPointPosition OPTIONAL,

```

```

    ul-TimeSlot-ISCP-LCR-Info    UL-TimeSlot-ISCP-LCR-Info,
    maxUL-SIR                   UL-SIR,
    minUL-SIR                   UL-SIR,
    pCCPCH-Power                PCCPCH-Power,
    maximumAllowedULTxPower     MaximumAllowedULTxPower,
    maximumDLTxPower            DL-Power,
    minimumDLTxPower            DL-Power,
    alphaValue                  AlphaValue,
    ul-PhysCH-SF-Variation      UL-PhysCH-SF-Variation,
    synchronisationConfiguration SynchronisationConfiguration,
    secondary-LCR-CCPCH-Info-TDD Secondary-LCR-CCPCH-Info-TDD                OPTIONAL,
    ul-CCTrCH-LCR-InformationList-RL-AdditionRspTDD UL-CCTrCH-LCR-InformationList-RL-AdditionRspTDD OPTIONAL,
    dl-CCTrCH-LCR-InformationList-RL-AdditionRspTDD DL-CCTrCH-LCR-InformationList-RL-AdditionRspTDD OPTIONAL,
    dCH-InformationResponseList-RL-AdditionRspTDD DCH-InformationResponseList-RL-AdditionRspTDD OPTIONAL,
    dsch-LCR-InformationResponseList-RL-AdditionRspTDD DSCH-LCR-InformationResponseList-RL-AdditionRspTDD OPTIONAL,
    usch-LCR-InformationResponseList-RL-AdditionRspTDD USCH-LCR-InformationResponseList-RL-AdditionRspTDD OPTIONAL,
    neighbouring-UMTS-CellInformation Neighbouring-UMTS-CellInformation OPTIONAL,
    neighbouring-GSM-CellInformation Neighbouring-GSM-CellInformation OPTIONAL,
    iE-Extensions                ProtocolExtensionContainer { { RL-LCR-InformationResponseList-RL-AdditionRspTDD-ExtIEs } }
    OPTIONAL,
    ...
}

RL-LCR-InformationResponseList-RL-AdditionRspTDD-ExtIEs RNSAP-PROTOCOL-EXTENSION ::= {
  { ID id-GA-CellAdditionalShapes          CRITICALITY ignore EXTENSION GA-CellAdditionalShapes
  PRESENCE optional }|
  { ID id-HCS-Prio                         CRITICALITY ignore EXTENSION HCS-Prio
  PRESENCE optional }|
  { ID id-UL-TimingAdvanceCtrl-LCR         CRITICALITY ignore EXTENSION UL-TimingAdvanceCtrl-LCR
  PRESENCE optional }|
  --Mandatory for 1.28Mcps TDD only
  { ID id-PowerControlGAP                  CRITICALITY ignore EXTENSION ControlGAP
  PRESENCE optional }|
  -- Applicable to 1.28Mcps TDD only
  { ID id-UARFCNforNt                       CRITICALITY ignore EXTENSION UARFCN
  PRESENCE optional }|
  -- Applicable to 1.28Mcps TDD only
  { ID id-Neighbouring-E-UTRA-CellInformation CRITICALITY ignore EXTENSION Neighbouring-E-UTRA-CellInformation
  optional }|
  { ID id-IdleIntervalInformation          CRITICALITY ignore EXTENSION IdleIntervalInformation
  optional },
  ...
}

UL-CCTrCH-LCR-InformationList-RL-AdditionRspTDD ::= ProtocolIE-Single-Container {{UL-CCTrCH-LCR-InformationListIEs-RL-AdditionRspTDD }}

UL-CCTrCH-LCR-InformationListIEs-RL-AdditionRspTDD RNSAP-PROTOCOL-IES ::= {
  { ID id-UL-CCTrCH-LCR-InformationListIE-RL-AdditionRspTDD CRITICALITY ignore TYPE UL-CCTrCH-LCR-InformationListIE-RL-AdditionRspTDD
  PRESENCE mandatory }
}

UL-CCTrCH-LCR-InformationListIE-RL-AdditionRspTDD ::= SEQUENCE (SIZE (1..maxNrOfCCTrCHsLCR)) OF UL-CCTrCH-LCR-InformationItem-RL-AdditionRspTDD

UL-CCTrCH-LCR-InformationItem-RL-AdditionRspTDD ::= SEQUENCE {

```

```

    cTrCH-ID          CTrCH-ID,
    ul-DPCH-LCR-InformationList-RL-AdditionRspTDD OPTIONAL,
    iE-Extensions    ProtocolExtensionContainer { {UL-CTrCH-LCR-InformationItem-RL-AdditionRspTDD-ExtIEs} } OPTIONAL,
    ...
}

UL-CTrCH-LCR-InformationItem-RL-AdditionRspTDD-ExtIEs RNSAP-PROTOCOL-EXTENSION ::= {
    ...
}

UL-DPCH-LCR-InformationList-RL-AdditionRspTDD ::= ProtocolIE-Single-Container { {UL-DPCH-LCR-InformationListIEs-RL-AdditionRspTDD} }

UL-DPCH-LCR-InformationListIEs-RL-AdditionRspTDD RNSAP-PROTOCOL-IES ::= {
    { ID id-UL-DPCH-LCR-InformationItem-RL-AdditionRspTDD CRITICALITY ignore TYPE UL-DPCH-LCR-InformationItem-RL-AdditionRspTDD PRESENCE
    mandatory }
}

UL-DPCH-LCR-InformationItem-RL-AdditionRspTDD ::= SEQUENCE {
    repetitionPeriod      RepetitionPeriod,
    repetitionLength      RepetitionLength,
    tDD-DPCHOffset        TDD-DPCHOffset,
    uL-TimeslotLCR-InformationList-RL-AdditionRspTDD-ExtIEs OPTIONAL,
    iE-Extensions
    ...
}

UL-DPCH-LCR-InformationItem-RL-AdditionRspTDD-ExtIEs RNSAP-PROTOCOL-EXTENSION ::= {
    ...
}

DL-CTrCH-LCR-InformationList-RL-AdditionRspTDD ::= ProtocolIE-Single-Container { {DL-CTrCH-LCR-InformationListIEs-RL-AdditionRspTDD} }

DL-CTrCH-LCR-InformationListIEs-RL-AdditionRspTDD RNSAP-PROTOCOL-IES ::= {
    { ID id-DL-CTrCH-LCR-InformationListIE-RL-AdditionRspTDD CRITICALITY ignore TYPE DL-CTrCH-LCR-InformationListIE-RL-AdditionRspTDD
    PRESENCE mandatory }
}

DL-CTrCH-LCR-InformationListIE-RL-AdditionRspTDD ::= SEQUENCE (SIZE (1..maxNrOfCTrCHsLCR)) OF DL-CTrCH-LCR-InformationItem-RL-AdditionRspTDD

DL-CTrCH-LCR-InformationItem-RL-AdditionRspTDD ::= SEQUENCE {
    cTrCH-ID          CTrCH-ID,
    dl-DPCH-LCR-InformationList-RL-AdditionRspTDD OPTIONAL,
    iE-Extensions    ProtocolExtensionContainer { {DL-CTrCH-LCR-InformationItem-RL-AdditionRspTDD-ExtIEs} } OPTIONAL,
    ...
}

DL-CTrCH-LCR-InformationItem-RL-AdditionRspTDD-ExtIEs RNSAP-PROTOCOL-EXTENSION ::= {
    ...
}

DL-DPCH-LCR-InformationList-RL-AdditionRspTDD ::= ProtocolIE-Single-Container { {DL-DPCH-LCR-InformationListIEs-RL-AdditionRspTDD} }

DL-DPCH-LCR-InformationListIEs-RL-AdditionRspTDD RNSAP-PROTOCOL-IES ::= {

```

```

    { ID id-DL-DPCH-LCR-InformationItem-RL-AdditionRspTDD      CRITICALITY ignore  TYPE DL-DPCH-LCR-InformationItem-RL-AdditionRspTDD  PRESENCE
mandatory }
}

DL-DPCH-LCR-InformationItem-RL-AdditionRspTDD ::= SEQUENCE {
    repetitionPeriod      RepetitionPeriod,
    repetitionLength      RepetitionLength,
    tDD-DPCHOffset        TDD-DPCHOffset,
    dL-TimeslotLCR-Information  DL-TimeslotLCR-Information,
    tSTD-Indicator        TSTD-Indicator,
    iE-Extensions        ProtocolExtensionContainer { {DL-DPCH-LCR-InformationItem-RL-AdditionRspTDD-ExtIEs} } OPTIONAL,
    ...
}

DL-DPCH-LCR-InformationItem-RL-AdditionRspTDD-ExtIEs RNSAP-PROTOCOL-EXTENSION ::= {
    ...
}

DCH-InformationResponseList-RL-AdditionRspTDD ::= ProtocolIE-Single-Container {{DCH-InformationResponseListIEs-RL-AdditionRspTDD}}

DCH-InformationResponseListIEs-RL-AdditionRspTDD RNSAP-PROTOCOL-IES ::= {
    { ID id-DCH-InformationResponse  CRITICALITY ignore  TYPE DCH-InformationResponse  PRESENCE mandatory }
}

DSCH-LCR-InformationResponse-RL-AdditionRspTDD ::= ProtocolIE-Single-Container {{DSCH-LCR-InformationList-RL-AdditionRspTDD}}

DSCH-LCR-InformationList-RL-AdditionRspTDD RNSAP-PROTOCOL-IES ::= {
    { ID id-DSCH-LCR-InformationListIEs-RL-AdditionRspTDD      CRITICALITY ignore  TYPE DSCH-LCR-InformationListIEs-RL-AdditionRspTDD  PRESENCE
mandatory }
}

DSCH-LCR-InformationListIEs-RL-AdditionRspTDD ::= SEQUENCE (SIZE(0..maxNoOfDSCHsLCR)) OF DSCH-LCR-InformationItem-RL-AdditionRspTDD

DSCH-LCR-InformationItem-RL-AdditionRspTDD ::= SEQUENCE {
    dsch-ID      DSCH-ID,
    dSCH-FlowControlInformation  DSCH-FlowControlInformation,
    bindingID      BindingID  OPTIONAL,
    transportLayerAddress  TransportLayerAddress  OPTIONAL,
    transportFormatManagement  TransportFormatManagement,
    iE-Extensions        ProtocolExtensionContainer { {DSCH-LCR-InformationItem-RL-AdditionRspTDD-ExtIEs} } OPTIONAL,
    ...
}

DSCH-LCR-InformationItem-RL-AdditionRspTDD-ExtIEs RNSAP-PROTOCOL-EXTENSION ::= {
    ...
}

USCH-LCR-InformationResponse-RL-AdditionRspTDD ::= ProtocolIE-Single-Container {{USCH-LCR-InformationList-RL-AdditionRspTDD}}

USCH-LCR-InformationList-RL-AdditionRspTDD RNSAP-PROTOCOL-IES ::= {
    { ID id-USCH-LCR-InformationListIEs-RL-AdditionRspTDD      CRITICALITY ignore  TYPE USCH-LCR-InformationListIEs-RL-AdditionRspTDD  PRESENCE
mandatory }
}

```

USCH-LCR-InformationListIEs-RL-AdditionRspTDD ::= SEQUENCE (SIZE(0..maxNoOfUSCHsLCR)) OF USCH-LCR-InformationItem-RL-AdditionRspTDD

```
USCH-LCR-InformationItem-RL-AdditionRspTDD ::= SEQUENCE {
    usch-ID                USCH-ID,
    transportFormatManagement TransportFormatManagement,
    diversityIndication    DiversityIndication-RL-AdditionRspTDD2    OPTIONAL,
    iE-Extensions          ProtocolExtensionContainer { {USCH-LCR-InformationItem-RL-AdditionRspTDD-ExtIEs} } OPTIONAL,
    ...
}
```

```
USCH-LCR-InformationItem-RL-AdditionRspTDD-ExtIEs RNSAP-PROTOCOL-EXTENSION ::= {
    ...
}
```

```
RL-InformationResponse-RL-AdditionRspTDD768 ::= SEQUENCE {
    rL-ID                RL-ID,
    uRA-Information      URA-Information    OPTIONAL,
    sAI                  SAI,
    gA-Cell              GA-Cell    OPTIONAL,
    gA-AccessPointPosition GA-AccessPointPosition    OPTIONAL,
    ul-TimeSlot-ISCP-Info UL-TimeSlot-ISCP-Info,
    minUL-SIR            UL-SIR,
    maxUL-SIR            UL-SIR,
    maximumAllowedULTxPower MaximumAllowedULTxPower,
    maximumDLTxPower    DL-Power,
    minimumDLTxPower    DL-Power,
    pCCPCH-Power        PCCPCH-Power,
    timingAdvanceApplied TimingAdvanceApplied,
    alphaValue          AlphaValue,
    ul-PhysCH-SF-Variation UL-PhysCH-SF-Variation,
    synchronisationConfiguration SynchronisationConfiguration,
    secondary-CCPCH-Info-TDD768 Secondary-CCPCH-Info-TDD768    OPTIONAL,
    ul-CCTrCHInformationList768 UL-CCTrCHInformationList-RL-AdditionRspTDD768    OPTIONAL,
    dl-CCTrCHInformationList768 DL-CCTrCHInformationList-RL-AdditionRspTDD768    OPTIONAL,
    dCH-Information     DCH-Information-RL-AdditionRspTDD    OPTIONAL,
    dSCH-InformationResponse DSCH-InformationResponse-RL-AdditionRspTDD    OPTIONAL,
    uSCH-InformationResponse USCH-InformationResponse-RL-AdditionRspTDD    OPTIONAL,
    neighbouring-UMTS-CellInformation Neighbouring-UMTS-CellInformation    OPTIONAL,
    neighbouring-GSM-CellInformation Neighbouring-GSM-CellInformation    OPTIONAL,
    gA-CellAdditionalShapes GA-CellAdditionalShapes    OPTIONAL,
    hCS-Prio             HCS-Prio    OPTIONAL,
    iE-Extensions        ProtocolExtensionContainer { {RL-InformationResponse-RL-AdditionRspTDD768-ExtIEs} } OPTIONAL,
    ...
}
```

```
RL-InformationResponse-RL-AdditionRspTDD768-ExtIEs RNSAP-PROTOCOL-EXTENSION ::= {
    { ID id-Neighbouring-E-UTRA-CellInformation    CRITICALITY ignore    EXTENSION Neighbouring-E-UTRA-CellInformation
    PRESENCE optional },
    ...
}
```

UL-CCTrCHInformationList-RL-AdditionRspTDD768 ::= ProtocolIE-Single-Container {{UL-CCTrCHInformationListIEs-RL-AdditionRspTDD768}}

UL-CCTrCHInformationListIEs-RL-AdditionRspTDD768 RNSAP-PROTOCOL-IES ::= {

```

    { ID id-UL-CCTrCH-InformationListIE-RL-AdditionRspTDD768 CRITICALITY ignore TYPE UL-CCTrCHInformationListIE-RL-AdditionRspTDD768
      PRESENCE mandatory }
  }

UL-CCTrCHInformationListIE-RL-AdditionRspTDD768 ::= SEQUENCE (SIZE (1..maxNrOfCCTrCHs)) OF UL-CCTrCHInformationItem-RL-AdditionRspTDD768

UL-CCTrCHInformationItem-RL-AdditionRspTDD768 ::= SEQUENCE {
  cCTrCH-ID CCTrCH-ID,
  ul-DPCH-Information768 UL-DPCH-InformationList-RL-AdditionRspTDD768 OPTIONAL,
  iE-Extensions ProtocolExtensionContainer { {UL-CCTrCHInformationItem-RL-AdditionRspTDD768-ExtIEs} } OPTIONAL,
  ...
}

UL-CCTrCHInformationItem-RL-AdditionRspTDD768-ExtIEs RNSAP-PROTOCOL-EXTENSION ::= {
  ...
}

UL-DPCH-InformationList-RL-AdditionRspTDD768 ::= ProtocolIE-Single-Container { {UL-DPCH-InformationListIEs-RL-AdditionRspTDD768} }

UL-DPCH-InformationListIEs-RL-AdditionRspTDD768 RNSAP-PROTOCOL-IES ::= {
  { ID id-UL-DPCH-InformationItem-RL-AdditionRspTDD CRITICALITY ignore TYPE UL-DPCH-InformationItem-RL-AdditionRspTDD768 PRESENCE
    mandatory }
}

UL-DPCH-InformationItem-RL-AdditionRspTDD768 ::= SEQUENCE {
  repetitionPeriod RepetitionPeriod,
  repetitionLength RepetitionLength,
  tDD-DPCHOffset TDD-DPCHOffset,
  uL-Timeslot-Information768 UL-Timeslot-Information768,
  iE-Extensions ProtocolExtensionContainer { {UL-DPCH-InformationItem-RL-AdditionRspTDD768-ExtIEs} } OPTIONAL,
  ...
}

UL-DPCH-InformationItem-RL-AdditionRspTDD768-ExtIEs RNSAP-PROTOCOL-EXTENSION ::= {
  ...
}

DL-CCTrCHInformationList-RL-AdditionRspTDD768 ::= ProtocolIE-Single-Container {{DL-CCTrCHInformationListIEs-RL-AdditionRspTDD768}}

DL-CCTrCHInformationListIEs-RL-AdditionRspTDD768 RNSAP-PROTOCOL-IES ::= {
  { ID id-DL-CCTrCH-InformationListIE-RL-AdditionRspTDD768 CRITICALITY ignore TYPE DL-CCTrCHInformationListIE-RL-AdditionRspTDD768
    PRESENCE mandatory }
}

DL-CCTrCHInformationListIE-RL-AdditionRspTDD768 ::= SEQUENCE (SIZE (1..maxNrOfCCTrCHs)) OF DL-CCTrCHInformationItem-RL-AdditionRspTDD768

DL-CCTrCHInformationItem-RL-AdditionRspTDD768 ::= SEQUENCE {
  cCTrCH-ID CCTrCH-ID,
  dl-DPCH-Information768 DL-DPCH-InformationList-RL-AdditionRspTDD768 OPTIONAL,
  cCTrCH-Maximum-DL-Power DL-Power OPTIONAL, -- this is a DCH type CCTrCH power
  cCTrCH-Minimum-DL-Power DL-Power OPTIONAL, -- this is a DCH type CCTrCH power
  iE-Extensions ProtocolExtensionContainer { {DL-CCTrCHInformationItem-RL-AdditionRspTDD768-ExtIEs} } OPTIONAL,
  ...
}

```

```

DL-CCTrCHInformationItem-RL-AdditionRspTDD768-ExtIEs RNSAP-PROTOCOL-EXTENSION ::= {
  ...
}

DL-DPCH-InformationList-RL-AdditionRspTDD768 ::= ProtocolIE-Single-Container { {DL-DPCH-InformationListIEs-RL-AdditionRspTDD768} }

DL-DPCH-InformationListIEs-RL-AdditionRspTDD768 RNSAP-PROTOCOL-IES ::= {
  { ID id-DL-DPCH-InformationItem-RL-AdditionRspTDD768          CRITICALITY ignore   TYPE DL-DPCH-InformationItem-RL-AdditionRspTDD768  PRESENCE
mandatory }
}

DL-DPCH-InformationItem-RL-AdditionRspTDD768 ::= SEQUENCE {
  repetitionPeriod          RepetitionPeriod,
  repetitionLength          RepetitionLength,
  tDD-DPCHOffset            TDD-DPCHOffset,
  dL-Timeslot-Information768 DL-Timeslot-Information768,
  iE-Extensions             ProtocolExtensionContainer { {DL-DPCH-InformationItem-RL-AdditionRspTDD768-ExtIEs} } OPTIONAL,
  ...
}

DL-DPCH-InformationItem-RL-AdditionRspTDD768-ExtIEs RNSAP-PROTOCOL-EXTENSION ::= {
  ...
}

-- *****
--
-- RADIO LINK ADDITION FAILURE FDD
--
-- *****

RadioLinkAdditionFailureFDD ::= SEQUENCE {
  protocolIEs          ProtocolIE-Container   {{RadioLinkAdditionFailureFDD-IEs}},
  protocolExtensions   ProtocolExtensionContainer {{RadioLinkAdditionFailureFDD-Extensions}}          OPTIONAL,
  ...
}

RadioLinkAdditionFailureFDD-IEs RNSAP-PROTOCOL-IES ::= {
  { ID id-CauseLevel-RL-AdditionFailureFDD          CRITICALITY   ignore          TYPE CauseLevel-RL-AdditionFailureFDD
  PRESENCE mandatory }|
  { ID id-CriticalityDiagnostics          CRITICALITY ignore   TYPE CriticalityDiagnostics          PRESENCE optional   },
  ...
}

CauseLevel-RL-AdditionFailureFDD ::= CHOICE {
  generalCause          GeneralCauseList-RL-AdditionFailureFDD,
  rLSpecificCause       RLSpecificCauseList-RL-AdditionFailureFDD,
  ...
}

GeneralCauseList-RL-AdditionFailureFDD ::= SEQUENCE {
  cause          Cause,
  iE-Extensions ProtocolExtensionContainer { { GeneralCauseItem-RL-AdditionFailureFDD-ExtIEs} }
OPTIONAL,
}

```

```

}
...
}
GeneralCauseItem-RL-AdditionFailureFDD-ExtIEs  RNSAP-PROTOCOL-EXTENSION ::= {
}
...
}
RLSpecificCauseList-RL-AdditionFailureFDD ::= SEQUENCE {
  unsuccessful-RL-InformationRespList-RL-AdditionFailureFDD      UnsuccessfulRL-InformationResponseList-RL-AdditionFailureFDD,
  successful-RL-InformationRespList-RL-AdditionFailureFDD        SuccessfulRL-InformationResponseList-RL-AdditionFailureFDD OPTIONAL,
  iE-Extensions                                                  ProtocolExtensionContainer { { RLSpecificCauseItem-RL-AdditionFailureFDD-ExtIEs } }
  OPTIONAL,
  ...
}
}
RLSpecificCauseItem-RL-AdditionFailureFDD-ExtIEs  RNSAP-PROTOCOL-EXTENSION ::= {
}
...
}
UnsuccessfulRL-InformationResponseList-RL-AdditionFailureFDD ::= SEQUENCE (SIZE (1..maxNrOfRLs-1)) OF ProtocolIE-Single-Container {
{UnsuccessfulRL-InformationResponse-RL-AdditionFailureFDD-IEs} }
}
UnsuccessfulRL-InformationResponse-RL-AdditionFailureFDD-IEs RNSAP-PROTOCOL-IES ::= {
  { ID id-UnsuccessfulRL-InformationResponse-RL-AdditionFailureFDD      CRITICALITY ignore  TYPE UnsuccessfulRL-InformationResponse-RL-
  AdditionFailureFDD          PRESENCE mandatory }
}
}
UnsuccessfulRL-InformationResponse-RL-AdditionFailureFDD ::= SEQUENCE {
  rL-ID                RL-ID,
  cause                Cause,
  iE-Extensions        ProtocolExtensionContainer { {UnsuccessfulRL-InformationResponse-RL-AdditionFailureFDD-ExtIEs} } OPTIONAL,
  ...
}
}
UnsuccessfulRL-InformationResponse-RL-AdditionFailureFDD-ExtIEs RNSAP-PROTOCOL-EXTENSION ::= {
}
...
}
SuccessfulRL-InformationResponseList-RL-AdditionFailureFDD ::= SEQUENCE (SIZE (0..maxNrOfRLs-2)) OF ProtocolIE-Single-Container { {SuccessfulRL-
InformationResponse-RL-AdditionFailureFDD-IEs} }
}
SuccessfulRL-InformationResponse-RL-AdditionFailureFDD-IEs RNSAP-PROTOCOL-IES ::= {
  { ID id-SuccessfulRL-InformationResponse-RL-AdditionFailureFDD      CRITICALITY ignore  TYPE SuccessfulRL-InformationResponse-RL-
  AdditionFailureFDD          PRESENCE mandatory }
}
}
SuccessfulRL-InformationResponse-RL-AdditionFailureFDD ::= SEQUENCE {
  rL-ID                RL-ID,
  rL-Set-ID            RL-Set-ID,
  uRA-Information      URA-Information      OPTIONAL,
  sAI                  SAI,
  gA-Cell              GA-Cell      OPTIONAL,
  gA-AccessPointPosition  GA-AccessPointPosition      OPTIONAL,
  received-total-wide-band-power  Received-total-wide-band-power,
}

```

```

not-Used-secondary-CCPCH-Info          NULL          OPTIONAL,
dl-CodeInformationList-RL-AdditionFailureFDD,
diversityIndication-RL-AdditionFailureFDD,
-- This IE represents both the Diversity Indication IE and the choice based on the diversity indication as described in
-- the tabular message format in subclause 9.1.
sSDT-SupportIndicator                  SSDT-SupportIndicator,
minUL-SIR                              UL-SIR,
maxUL-SIR                              UL-SIR,
closedloopTimingAdjustmentmode         ClosedloopTimingAdjustmentmode OPTIONAL,
maximumAllowedULTxPower                MaximumAllowedULTxPower,
maximumDLTxPower                       DL-Power,
minimumDLTxPower                       DL-Power,
neighbouring-UMTS-CellInformation       Neighbouring-UMTS-CellInformation OPTIONAL,
neighbouring-GSM-CellInformation        Neighbouring-GSM-CellInformation OPTIONAL,
primaryCPICH-Power                     PrimaryCPICH-Power,
pC-Preamble                            PC-Preamble,
sRB-Delay                              SRB-Delay,
iE-Extensions                          ProtocolExtensionContainer { {SuccessfulRL-InformationResponse-RL-AdditionFailureFDD-ExtIEs} } OPTIONAL,
...
}

SuccessfulRL-InformationResponse-RL-AdditionFailureFDD-ExtIEs RNSAP-PROTOCOL-EXTENSION ::= {
  { ID id-GA-CellAdditionalShapes          CRITICALITY ignore EXTENSION GA-CellAdditionalShapes
    PRESENCE optional }|
  { ID id-DL-PowerBalancing-ActivationIndicator CRITICALITY ignore EXTENSION DL-PowerBalancing-ActivationIndicator
    PRESENCE optional }|
  { ID id-HCS-Prio                        CRITICALITY ignore EXTENSION HCS-Prio
    PRESENCE optional }|
  { ID id-Active-MBMS-Bearer-ServiceFDD-PFL CRITICALITY ignore EXTENSION Active-MBMS-Bearer-Service-ListFDD-PFL
    PRESENCE optional }|
  { ID id-EDCH-RLSet-Id                   CRITICALITY ignore EXTENSION RL-Set-ID
    PRESENCE optional }|
  { ID id-EDCH-FDD-DL-ControlChannelInformation CRITICALITY ignore EXTENSION EDCH-FDD-DL-ControlChannelInformation
    PRESENCE optional }|
  { ID id-Initial-DL-DPCH-TimingAdjustment CRITICALITY ignore EXTENSION DL-DPCH-TimingAdjustment
    PRESENCE optional }|
  { ID id-Neighbouring-E-UTRA-CellInformation CRITICALITY ignore EXTENSION Neighbouring-E-UTRA-CellInformation
    PRESENCE optional }|
  { ID id-HSDSCH-PreconfigurationInfo      CRITICALITY ignore EXTENSION HSDSCH-PreconfigurationInfo
    PRESENCE optional }|
  { ID id-F-DPCH-SlotFormat                CRITICALITY ignore EXTENSION F-DPCH-SlotFormat
    PRESENCE optional }|
  { ID id-Non-Serving-RL-Preconfig-Info    CRITICALITY ignore EXTENSION Non-Serving-RL-Preconfig-Info
    PRESENCE optional },
  ...
}

DL-CodeInformationList-RL-AdditionFailureFDD ::= ProtocolIE-Single-Container { { DL-CodeInformationListIEs-RL-AdditionFailureFDD } }

DL-CodeInformationListIEs-RL-AdditionFailureFDD RNSAP-PROTOCOL-IES ::= {
  { ID id-FDD-DL-CodeInformation          CRITICALITY ignore TYPE FDD-DL-CodeInformation
    PRESENCE mandatory }
}

DiversityIndication-RL-AdditionFailureFDD ::= CHOICE {

```

```

    combining                Combining-RL-AdditionFailureFDD,
    nonCombining             NonCombining-RL-AdditionFailureFDD
}

Combining-RL-AdditionFailureFDD ::= SEQUENCE {
    rL-ID                    RL-ID,
    iE-Extensions            ProtocolExtensionContainer { { CombiningItem-RL-AdditionFailureFDD-ExtIEs} } OPTIONAL,
    ...
}

CombiningItem-RL-AdditionFailureFDD-ExtIEs RNSAP-PROTOCOL-EXTENSION ::= {
    { ID id-DCH-InformationResponse          CRITICALITY ignore EXTENSION DCH-InformationResponse          PRESENCE optional }|
    { ID id-EDCH-FDD-InformationResponse     CRITICALITY ignore EXTENSION EDCH-FDD-InformationResponse     PRESENCE optional }|
    ...
}

NonCombining-RL-AdditionFailureFDD ::= SEQUENCE {
    dCH-InformationResponse    DCH-InformationResponse,
    iE-Extensions              ProtocolExtensionContainer { { NonCombiningItem-RL-AdditionFailureFDD-ExtIEs} } OPTIONAL,
    ...
}

NonCombiningItem-RL-AdditionFailureFDD-ExtIEs RNSAP-PROTOCOL-EXTENSION ::= {
    { ID id-EDCH-FDD-InformationResponse     CRITICALITY ignore EXTENSION EDCH-FDD-InformationResponse     PRESENCE optional }|
    ...
}

RadioLinkAdditionFailureFDD-Extensions RNSAP-PROTOCOL-EXTENSION ::= {
    { ID id-HS-DSCH-serving-cell-change-informationResponse CRITICALITY ignore EXTENSION HS-DSCH-serving-cell-change-informationResponse PRESENCE optional}|
    { ID id-E-DCH-Serving-cell-change-informationResponse CRITICALITY ignore EXTENSION E-DCH-Serving-cell-change-informationResponse PRESENCE optional}|
    { ID id-Additional-HS-Cell-Change-Information-Response CRITICALITY ignore EXTENSION Additional-HS-Cell-Change-Information-Response-List PRESENCE optional}|
    { ID id-MACHs-ResetIndicator              CRITICALITY ignore EXTENSION MACHs-ResetIndicator              PRESENCE optional}|
    { ID id-Additional-EDCH-Cell-Information-Response-RLAdd CRITICALITY ignore EXTENSION Additional-EDCH-Cell-Information-Response-RLAddList PRESENCE optional }|
    ...
}

-- *****
--
-- RADIO LINK ADDITION FAILURE TDD
--
-- *****

RadioLinkAdditionFailureTDD ::= SEQUENCE {
    protocolIEs                ProtocolIE-Container    {{RadioLinkAdditionFailureTDD-IEs}},
    protocolExtensions          ProtocolExtensionContainer {{RadioLinkAdditionFailureTDD-Extensions}}
    ...
}

RadioLinkAdditionFailureTDD-IEs RNSAP-PROTOCOL-IES ::= {

```

```

    { ID id-CauseLevel-RL-AdditionFailureTDD    CRITICALITY ignore    TYPE CauseLevel-RL-AdditionFailureTDD    PRESENCE mandatory }|
    { ID id-CriticalityDiagnostics              CRITICALITY ignore    TYPE CriticalityDiagnostics    PRESENCE optional    },
    ...
}

CauseLevel-RL-AdditionFailureTDD ::= CHOICE {
    generalCause          GeneralCauseList-RL-AdditionFailureTDD,
    rLSpecificCause      RLSpecificCauseList-RL-AdditionFailureTDD,
    ...
}

GeneralCauseList-RL-AdditionFailureTDD ::= SEQUENCE {
    cause                Cause,
    iE-Extensions        ProtocolExtensionContainer { { GeneralCauseItem-RL-AdditionFailureTDD-ExtIEs } }    OPTIONAL,
    ...
}

GeneralCauseItem-RL-AdditionFailureTDD-ExtIEs RNSAP-PROTOCOL-EXTENSION ::= {
    ...
}

RLSpecificCauseList-RL-AdditionFailureTDD ::= SEQUENCE {
    unsuccessful-RL-InformationRespItem-RL-AdditionFailureTDD    Unsuccessful-RL-InformationRespItem-RL-AdditionFailureTDD,
    iE-Extensions        ProtocolExtensionContainer { { RLSpecificCauseItem-RL-AdditionFailureTDD-ExtIEs } }    OPTIONAL,
    ...
}

RLSpecificCauseItem-RL-AdditionFailureTDD-ExtIEs RNSAP-PROTOCOL-EXTENSION ::= {
    ...
}

Unsuccessful-RL-InformationRespItem-RL-AdditionFailureTDD ::= ProtocolIE-Single-Container { {Unsuccessful-RL-InformationRespItemIE-RL-AdditionFailureTDD} }

Unsuccessful-RL-InformationRespItemIE-RL-AdditionFailureTDD RNSAP-PROTOCOL-IES ::= {
    { ID id-UnsuccessfulRL-InformationResponse-RL-AdditionFailureTDD    CRITICALITY ignore    TYPE    UnsuccessfulRL-InformationResponse-RL-AdditionFailureTDD    PRESENCE mandatory}
}

UnsuccessfulRL-InformationResponse-RL-AdditionFailureTDD ::= SEQUENCE {
    rL-ID                RL-ID,
    cause                Cause,
    iE-Extensions        ProtocolExtensionContainer { {UnsuccessfulRL-InformationResponse-RL-AdditionFailureTDD-ExtIEs} }    OPTIONAL,
    ...
}

UnsuccessfulRL-InformationResponse-RL-AdditionFailureTDD-ExtIEs RNSAP-PROTOCOL-EXTENSION ::= {
    ...
}

RadioLinkAdditionFailureTDD-Extensions RNSAP-PROTOCOL-EXTENSION ::= {
    ...
}

```

```

-- *****
--
-- RADIO LINK DELETION REQUEST
--
-- *****

RadioLinkDeletionRequest ::= SEQUENCE {
    protocolIEs          ProtocolIE-Container    {{RadioLinkDeletionRequest-IEs}},
    protocolExtensions   ProtocolExtensionContainer {{RadioLinkDeletionRequest-Extensions}}    OPTIONAL,
    ...
}

RadioLinkDeletionRequest-IEs RNSAP-PROTOCOL-IES ::= {
    { ID id-RL-InformationList-RL-DeletionRqst  CRITICALITY notify  TYPE RL-InformationList-RL-DeletionRqst          PRESENCE mandatory    },
    ...
}

RL-InformationList-RL-DeletionRqst          ::= SEQUENCE (SIZE (1..maxNrOfRLs)) OF ProtocolIE-Single-Container { {RL-Information-RL-DeletionRqst-IEs} }

RL-Information-RL-DeletionRqst-IEs RNSAP-PROTOCOL-IES ::= {
    { ID id-RL-Information-RL-DeletionRqst      CRITICALITY notify  TYPE RL-Information-RL-DeletionRqst          PRESENCE mandatory    }
}

RL-Information-RL-DeletionRqst ::= SEQUENCE {
    rL-ID          RL-ID,
    iE-Extensions ProtocolExtensionContainer { {RL-Information-RL-DeletionRqst-ExtIEs} } OPTIONAL,
    ...
}

RL-Information-RL-DeletionRqst-ExtIEs RNSAP-PROTOCOL-EXTENSION ::= {
    ...
}

RadioLinkDeletionRequest-Extensions RNSAP-PROTOCOL-EXTENSION ::= {
    ...
}

-- *****
--
-- RADIO LINK DELETION RESPONSE
--
-- *****

RadioLinkDeletionResponse ::= SEQUENCE {
    protocolIEs          ProtocolIE-Container    {{RadioLinkDeletionResponse-IEs}},
    protocolExtensions   ProtocolExtensionContainer {{RadioLinkDeletionResponse-Extensions}}    OPTIONAL,
    ...
}

RadioLinkDeletionResponse-IEs RNSAP-PROTOCOL-IES ::= {
    { ID id-CriticalityDiagnostics              CRITICALITY ignore  TYPE CriticalityDiagnostics          PRESENCE optional    },
    ...
}

```

```

}

RadioLinkDeletionResponse-Extensions RNSAP-PROTOCOL-EXTENSION ::= {
  ...
}

-- *****
--
-- RADIO LINK RECONFIGURATION PREPARE FDD
--
-- *****

RadioLinkReconfigurationPrepareFDD ::= SEQUENCE {
  protocolIEs          ProtocolIE-Container  {{{RadioLinkReconfigurationPrepareFDD-IEs}}},
  protocolExtensions  ProtocolExtensionContainer {{{RadioLinkReconfigurationPrepareFDD-Extensions}}} OPTIONAL,
  ...
}

RadioLinkReconfigurationPrepareFDD-IEs RNSAP-PROTOCOL-IES ::= {
  { ID id-AllowedQueuingTime          CRITICALITY reject  TYPE AllowedQueuingTime          PRESENCE optional          } |
  { ID id-UL-DPCH-Information-RL-ReconfPrepFDD          CRITICALITY reject  TYPE UL-DPCH-Information-RL-ReconfPrepFDD          PRESENCE optional          } |
  { ID id-DL-DPCH-Information-RL-ReconfPrepFDD          CRITICALITY reject  TYPE DL-DPCH-Information-RL-ReconfPrepFDD          PRESENCE optional          } |
  { ID id-FDD-DCHs-to-Modify          CRITICALITY reject  TYPE FDD-DCHs-to-Modify          PRESENCE optional          } |
  { ID id-DCHs-to-Add-FDD             CRITICALITY reject  TYPE DCH-FDD-Information          PRESENCE optional          } |
  { ID id-DCH-DeleteList-RL-ReconfPrepFDD              CRITICALITY reject  TYPE DCH-DeleteList-RL-ReconfPrepFDD              PRESENCE optional          } |
  { ID id-RL-InformationList-RL-ReconfPrepFDD          CRITICALITY reject  TYPE RL-InformationList-RL-ReconfPrepFDD          PRESENCE optional          } |
  { ID id-Transmission-Gap-Pattern-Sequence-Information CRITICALITY reject  TYPE Transmission-Gap-Pattern-Sequence-Information PRESENCE optional          } |
  optional },
  ...
}

UL-DPCH-Information-RL-ReconfPrepFDD ::= SEQUENCE {
  ul-ScramblingCode          UL-ScramblingCode          OPTIONAL,
  ul-SIRTarget               UL-SIR                   OPTIONAL,
  minUL-ChannelisationCodeLength MinUL-ChannelisationCodeLength OPTIONAL,
  maxNrOfUL-DPDCHs          MaxNrOfUL-DPDCHs          OPTIONAL
  -- This IE shall be present if minUL-ChannelisationCodeLength equals to 4 --,
  ul-PunctureLimit          PunctureLimit           OPTIONAL,
  tFCS                       TFCS                 OPTIONAL,
  ul-DPCCH-SlotFormat        UL-DPCCH-SlotFormat        OPTIONAL,
  diversityMode              DiversityMode             OPTIONAL,
  not-Used-sSDT-CellIDLength NULL                 OPTIONAL,
  not-Used-s-FieldLength     NULL                 OPTIONAL,
  iE-Extensions              ProtocolExtensionContainer { {UL-DPCH-Information-RL-ReconfPrepFDD-ExtIEs} } OPTIONAL,
  ...
}

UL-DPCH-Information-RL-ReconfPrepFDD-ExtIEs RNSAP-PROTOCOL-EXTENSION ::= {
  { ID id-UL-DPDCHIndicatorEDCH      CRITICALITY reject      EXTENSION UL-DPDCHIndicatorEDCH PRESENCE optional  },
  ...
}

```



```

DL-DPCH-Information-RL-ReconfPrepFDD ::= SEQUENCE {
    tFCS                                TFCS            OPTIONAL,
    dl-DPCH-SlotFormat                  DL-DPCH-SlotFormat    OPTIONAL,
    nrOfDLchannelisationcodes           NrOfDLchannelisationcodes  OPTIONAL,
    tFCI-SignallingMode                 TFCI-SignallingMode    OPTIONAL,
    tFCI-Presence                       TFCI-Presence         OPTIONAL
    -- This IE shall be present if DL DPCH Slot Format IE is from 12 to 16 --,
    multiplexingPosition                MultiplexingPosition    OPTIONAL,
    limitedPowerIncrease                LimitedPowerIncrease    OPTIONAL,
    iE-Extensions                       ProtocolExtensionContainer { {DL-DPCH-Information-RL-ReconfPrepFDD-ExtIEs} } OPTIONAL,
    ...
}

DL-DPCH-Information-RL-ReconfPrepFDD-ExtIEs RNSAP-PROTOCOL-EXTENSION ::= {
    { ID id-DL-DPCH-Power-Information-RL-ReconfPrepFDD CRITICALITY reject EXTENSION DL-DPCH-Power-Information-RL-ReconfPrepFDD PRESENCE
optional },
    ...
}

DL-DPCH-Power-Information-RL-ReconfPrepFDD ::= SEQUENCE {
    powerOffsetInformation              PowerOffsetInformation-RL-ReconfPrepFDD,
    fdd-TPC-DownlinkStepSize           FDD-TPC-DownlinkStepSize,
    innerLoopDLPCStatus                InnerLoopDLPCStatus,
    iE-Extensions                      ProtocolExtensionContainer { { DL-DPCH-Power-Information-RL-ReconfPrepFDD-ExtIEs } } OPTIONAL,
    ...
}

DL-DPCH-Power-Information-RL-ReconfPrepFDD-ExtIEs RNSAP-PROTOCOL-EXTENSION ::= {
    ...
}

PowerOffsetInformation-RL-ReconfPrepFDD ::= SEQUENCE {
    p01-ForTFCI-Bits                  PowerOffset,
    p02-ForTPC-Bits                   PowerOffset,
    p03-ForPilotBits                  PowerOffset,
    iE-Extensions                     ProtocolExtensionContainer { { PowerOffsetInformation-RL-ReconfPrepFDD-ExtIEs } } OPTIONAL,
    ...
}

PowerOffsetInformation-RL-ReconfPrepFDD-ExtIEs RNSAP-PROTOCOL-EXTENSION ::= {
    ...
}

DCH-DeleteList-RL-ReconfPrepFDD      ::= SEQUENCE (SIZE (0..maxNrOfDCHs)) OF DCH-DeleteItem-RL-ReconfPrepFDD

DCH-DeleteItem-RL-ReconfPrepFDD ::= SEQUENCE {
    dCH-ID                             DCH-ID,
    iE-Extensions                      ProtocolExtensionContainer { {DCH-DeleteItem-RL-ReconfPrepFDD-ExtIEs} } OPTIONAL,
    ...
}

DCH-DeleteItem-RL-ReconfPrepFDD-ExtIEs RNSAP-PROTOCOL-EXTENSION ::= {
    ...
}

```

```

RL-InformationList-RL-ReconfPrepFDD ::= SEQUENCE (SIZE (0..maxNrOfRLs)) OF ProtocolIE-Single-Container { {RL-Information-RL-ReconfPrepFDD-
IEs} }

RL-Information-RL-ReconfPrepFDD-IEs RNSAP-PROTOCOL-IES ::= {
  { ID id-RL-Information-RL-ReconfPrepFDD      CRITICALITY reject  TYPE RL-Information-RL-ReconfPrepFDD      PRESENCE mandatory      }
}

RL-Information-RL-ReconfPrepFDD ::= SEQUENCE {
  rL-ID                               RL-ID,
  not-Used-sSDT-Indication             NULL          OPTIONAL,
  not-Used-sSDT-CellIdentity           NULL          OPTIONAL,
  transmitDiversityIndicator           TransmitDiversityIndicator  OPTIONAL,
  -- This IE shall be present if Diversity Mode IE is present in UL DPCH Information IE and is not equal to "none"
  iE-Extensions                        ProtocolExtensionContainer { {RL-Information-RL-ReconfPrepFDD-ExtIEs} } OPTIONAL,
  ...
}

RL-Information-RL-ReconfPrepFDD-ExtIEs RNSAP-PROTOCOL-EXTENSION ::= {
  optional { ID id-DLReferencePower          CRITICALITY ignore  EXTENSION DL-Power          PRESENCE
  optional }|
  optional { ID id-RL-Specific-DCH-Info      CRITICALITY ignore  EXTENSION RL-Specific-DCH-Info          PRESENCE
  optional }|
  { ID id-DL-DPCH-TimingAdjustment         CRITICALITY reject  EXTENSION DL-DPCH-TimingAdjustment          PRESENCE optional }|
  { ID id-Phase-Reference-Update-Indicator CRITICALITY ignore  EXTENSION Phase-Reference-Update-Indicator PRESENCE optional }|
  { ID id-RL-Specific-EDCH-Information      CRITICALITY reject  EXTENSION RL-Specific-EDCH-Information          PRESENCE optional }|
  optional { ID id-EDCH-RL-Indication        CRITICALITY reject  EXTENSION EDCH-RL-Indication          PRESENCE
  optional }|
  { ID id-HSDSCH-PreconfigurationSetup      CRITICALITY ignore  EXTENSION HSDSCH-PreconfigurationSetup          PRESENCE optional }|
  { ID id-Non-Serving-RL-Preconfig-Setup    CRITICALITY ignore  EXTENSION Non-Serving-RL-Preconfig-Setup          PRESENCE optional }|
  { ID id-Non-Serving-RL-Preconfig-Removal  CRITICALITY ignore  EXTENSION Non-Serving-RL-Preconfig-Setup          PRESENCE optional },
  ...
}

RadioLinkReconfigurationPrepareFDD-Extensions RNSAP-PROTOCOL-EXTENSION ::= {
  { ID id-HSDSCH-FDD-Information            CRITICALITY reject  EXTENSION HSDSCH-FDD-Information
  PRESENCE optional}|
  { ID id-HSDSCH-Information-to-Modify      CRITICALITY reject  EXTENSION HSDSCH-Information-to-Modify
  PRESENCE optional}|
  { ID id-HSDSCH-MACdFlows-to-Add           CRITICALITY reject  EXTENSION HSDSCH-MACdFlows-Information
  PRESENCE optional}|
  { ID id-HSDSCH-MACdFlows-to-Delete        CRITICALITY reject  EXTENSION HSDSCH-MACdFlows-to-Delete
  PRESENCE optional}|
  { ID id-HSPDSCH-RL-ID                    CRITICALITY reject  EXTENSION RL-ID
  PRESENCE optional}|
  { ID id-EDPCH-Information                 CRITICALITY reject  EXTENSION EDPCH-Information-RLReconfPrepare-FDD
  PRESENCE optional}|
  { ID id-EDCH-FDD-Information              CRITICALITY reject  EXTENSION EDCH-FDD-Information
  PRESENCE optional}|
  { ID id-EDCH-FDD-Information-To-Modify    CRITICALITY reject  EXTENSION EDCH-FDD-Information-To-Modify
  PRESENCE optional}|
  { ID id-EDCH-MACdFlows-To-Add            CRITICALITY reject  EXTENSION EDCH-MACdFlows-Information
  PRESENCE optional}|
}

```

```

{ ID id-EDCH-MACdFlows-To-Delete          CRITICALITY reject EXTENSION EDCH-MACdFlows-To-Delete
  PRESENCE optional }|
{ ID id-Serving-EDCHRL-Id                CRITICALITY reject EXTENSION EDCH-Serving-RL
  PRESENCE optional }|
{ ID id-F-DPCH-Information-RL-ReconfPrepFDD CRITICALITY reject EXTENSION F-DPCH-Information-RL-ReconfPrepFDD PRESENCE optional }|
{ ID id-Fast-Reconfiguration-Mode        CRITICALITY ignore  EXTENSION Fast-Reconfiguration-Mode
  PRESENCE optional }|
{ ID id-CPC-Information                   CRITICALITY reject  EXTENSION CPC-Information
  PRESENCE optional }|
{ ID id-Additional-HS-Cell-Information-RL-Reconf-Prep CRITICALITY reject EXTENSION Additional-HS-Cell-Information-RL-Reconf-Prep
  PRESENCE optional }|
{ ID id-UE-AggregateMaximumBitRate       CRITICALITY ignore  EXTENSION UE-AggregateMaximumBitRate
  PRESENCE optional }|
{ ID id-Additional-EDCH-Cell-Information-RL-Reconf-Prep CRITICALITY reject EXTENSION Additional-EDCH-Cell-Information-RL-Reconf-Prep
  PRESENCE optional },
...
}

Additional-HS-Cell-Information-RL-Reconf-Prep ::= SEQUENCE (SIZE (1..maxNrOfHSDSCH-1)) OF Additional-HS-Cell-Information-RL-Reconf-Prep-ItemIEs

Additional-HS-Cell-Information-RL-Reconf-Prep-ItemIEs ::=SEQUENCE{
  hSPDSCH-RL-ID          RL-ID,
  c-ID                   C-ID           OPTIONAL,
  hS-DSCH-FDD-Secondary-Serving-Information HS-DSCH-FDD-Secondary-Serving-Information OPTIONAL,
  hS-DSCH-Secondary-Serving-Information-To-Modify HS-DSCH-Secondary-Serving-Information-To-Modify OPTIONAL,
  hS-HS-DSCH-Secondary-Serving-Remove HS-DSCH-Secondary-Serving-Remove OPTIONAL,
  iE-Extensions          ProtocolExtensionContainer { { Additional-HS-Cell-Information-RL-Reconf-Prep-ItemIEs-ExtIEs } } OPTIONAL,
  ...
}

Additional-HS-Cell-Information-RL-Reconf-Prep-ItemIEs-ExtIEs RNSAP-PROTOCOL-EXTENSION ::= {
  ...
}

Additional-EDCH-Cell-Information-RL-Reconf-Prep ::=SEQUENCE{
  setup-Or-ConfigurationChange-Or-Removal-Of-EDCH-On-secondary-UL-Frequency Setup-Or-ConfigurationChange-Or-Removal-Of-EDCH-On-secondary-UL-Frequency,
  iE-Extensions          ProtocolExtensionContainer { { Additional-EDCH-Cell-Information-RL-Reconf-Prep-ExtIEs } } OPTIONAL,
  ...
}

Additional-EDCH-Cell-Information-RL-Reconf-Prep-ExtIEs RNSAP-PROTOCOL-EXTENSION ::= {
  ...
}

F-DPCH-Information-RL-ReconfPrepFDD ::= SEQUENCE {
  powerOffsetInformation PowerOffsetInformation-F-DPCH-RL-ReconfPrepFDD,
  fdd-dl-TPC-DownlinkStepSize FDD-TPC-DownlinkStepSize,
  limitedPowerIncrease LimitedPowerIncrease,
  innerLoopDLPCStatus InnerLoopDLPCStatus,
  iE-Extensions          ProtocolExtensionContainer { { F-DPCH-Information-RL-ReconfPrepFDD-ExtIEs } }
  OPTIONAL,
  ...
}

```

```

F-DPCH-Information-RL-ReconfPrepFDD-ExtIEs RNSAP-PROTOCOL-EXTENSION ::= {
  { ID id-F-DPCH-SlotFormatSupportRequest    CRITICALITY reject    EXTENSION F-DPCH-SlotFormatSupportRequest    PRESENCE optional
  } |
  { ID id-F-DPCH-SlotFormat                  CRITICALITY ignore    EXTENSION F-DPCH-SlotFormat    PRESENCE optional },
  ...
}

PowerOffsetInformation-F-DPCH-RL-ReconfPrepFDD ::= SEQUENCE {
  po2-ForTPC-Bits          PowerOffset,
  --This IE shall be ignored by DRNS
  iE-Extensions            ProtocolExtensionContainer { { PowerOffsetInformation-F-DPCH-RL-ReconfPrepFDD-ExtIEs } }    OPTIONAL,
  ...
}

PowerOffsetInformation-F-DPCH-RL-ReconfPrepFDD-ExtIEs RNSAP-PROTOCOL-EXTENSION ::= {
  ...
}

-- *****
--
-- RADIO LINK RECONFIGURATION PREPARE TDD
--
-- *****

RadioLinkReconfigurationPrepareTDD ::= SEQUENCE {
  protocolIEs              ProtocolIE-Container    {{RadioLinkReconfigurationPrepareTDD-IEs}},
  protocolExtensions       ProtocolExtensionContainer {{RadioLinkReconfigurationPrepareTDD-Extensions}}    OPTIONAL,
  ...
}

RadioLinkReconfigurationPrepareTDD-IEs RNSAP-PROTOCOL-IES ::= {
  { ID id-AllowedQueuingTime          CRITICALITY reject    TYPE AllowedQueuingTime          PRESENCE optional    } |
  { ID id-UL-CCTrCH-InformationAddList-RL-ReconfPrepTDD    CRITICALITY notify    TYPE UL-CCTrCH-InformationAddList-RL-ReconfPrepTDD    PRESENCE optional    } |
  { ID id-UL-CCTrCH-InformationModifyList-RL-ReconfPrepTDD    CRITICALITY notify    TYPE UL-CCTrCH-InformationModifyList-RL-ReconfPrepTDD    PRESENCE optional    } |
  { ID id-UL-CCTrCH-InformationDeleteList-RL-ReconfPrepTDD    CRITICALITY notify    TYPE UL-CCTrCH-InformationDeleteList-RL-ReconfPrepTDD    PRESENCE optional    } |
  { ID id-DL-CCTrCH-InformationAddList-RL-ReconfPrepTDD    CRITICALITY notify    TYPE DL-CCTrCH-InformationAddList-RL-ReconfPrepTDD    PRESENCE optional    } |
  { ID id-DL-CCTrCH-InformationModifyList-RL-ReconfPrepTDD    CRITICALITY notify    TYPE DL-CCTrCH-InformationModifyList-RL-ReconfPrepTDD    PRESENCE optional    } |
  { ID id-DL-CCTrCH-InformationDeleteList-RL-ReconfPrepTDD    CRITICALITY notify    TYPE DL-CCTrCH-InformationDeleteList-RL-ReconfPrepTDD    PRESENCE optional    } |
  { ID id-TDD-DCHs-to-Modify          CRITICALITY reject    TYPE TDD-DCHs-to-Modify          PRESENCE optional    } |
  { ID id-DCHs-to-Add-TDD              CRITICALITY reject    TYPE DCH-TDD-Information          PRESENCE optional    } |
  { ID id-DCH-DeleteList-RL-ReconfPrepTDD    CRITICALITY reject    TYPE DCH-DeleteList-RL-ReconfPrepTDD    PRESENCE optional    } |
  { ID id-DSCH-ModifyList-RL-ReconfPrepTDD    CRITICALITY reject    TYPE DSCH-ModifyList-RL-ReconfPrepTDD    PRESENCE optional    } |
  { ID id-DSCHs-to-Add-TDD            CRITICALITY reject    TYPE DSCH-TDD-Information          PRESENCE optional    } |
  { ID id-DSCH-DeleteList-RL-ReconfPrepTDD    CRITICALITY reject    TYPE DSCH-DeleteList-RL-ReconfPrepTDD    PRESENCE optional    } |
  { ID id-USCH-ModifyList-RL-ReconfPrepTDD    CRITICALITY reject    TYPE USCH-ModifyList-RL-ReconfPrepTDD    PRESENCE optional    } |
  { ID id-USCHs-to-Add                CRITICALITY reject    TYPE USCH-Information              PRESENCE optional    } |
}

```

```

    { ID id-USCH-DeleteList-RL-ReconfPrepTDD    CRITICALITY reject    TYPE USCH-DeleteList-RL-ReconfPrepTDD    PRESENCE optional    },
    ...
}

UL-CCTrCH-InformationAddList-RL-ReconfPrepTDD ::= SEQUENCE (SIZE (0..maxNrOfCCTrCHs)) OF ProtocolIE-Single-Container { {UL-CCTrCH-
AddInformation-RL-ReconfPrepTDD-IEs} }

UL-CCTrCH-AddInformation-RL-ReconfPrepTDD-IEs RNSAP-PROTOCOL-IES ::= {
    { ID id-UL-CCTrCH-AddInformation-RL-ReconfPrepTDD    CRITICALITY notify    TYPE UL-CCTrCH-AddInformation-RL-ReconfPrepTDD    PRESENCE mandatory
    }
}

UL-CCTrCH-AddInformation-RL-ReconfPrepTDD ::= SEQUENCE {
    cCTrCH-ID                CCTrCH-ID,
    tFCS                      TFCS,
    tFCI-Coding               TFCI-Coding,
    punctureLimit             PunctureLimit,
    iE-Extensions             ProtocolExtensionContainer { {UL-CCTrCH-AddInformation-RL-ReconfPrepTDD-ExtIEs} } OPTIONAL,
    ...
}

UL-CCTrCH-AddInformation-RL-ReconfPrepTDD-ExtIEs RNSAP-PROTOCOL-EXTENSION ::= {
    { ID id-UL-SIRTarget      CRITICALITY reject      EXTENSION      UL-SIR      PRESENCE optional}|
    -- This IE shall be mandatory for 1.28Mcps TDD, not applicable for 3.84Mcps TDD or 7.68Mcps TDD.
    { ID id-TDD-TPC-UplinkStepSize-InformationAdd-LCR-RL-ReconfPrepTDD CRITICALITY reject      EXTENSION TDD-TPC-UplinkStepSize-LCR      PRESENCE
    optional    },
    -- Mandatory for 1.28Mcps TDD, not applicable to 3.84Mcps TDD or 7.68Mcps TDD
    ...
}

UL-CCTrCH-InformationModifyList-RL-ReconfPrepTDD ::= SEQUENCE (SIZE (0..maxNrOfCCTrCHs)) OF ProtocolIE-Single-Container { {UL-CCTrCH-
ModifyInformation-RL-ReconfPrepTDD-IEs} }

UL-CCTrCH-ModifyInformation-RL-ReconfPrepTDD-IEs RNSAP-PROTOCOL-IES ::= {
    { ID id-UL-CCTrCH-ModifyInformation-RL-ReconfPrepTDD    CRITICALITY notify    TYPE UL-CCTrCH-ModifyInformation-RL-ReconfPrepTDD    PRESENCE
    mandatory    }
}

UL-CCTrCH-ModifyInformation-RL-ReconfPrepTDD ::= SEQUENCE {
    cCTrCH-ID                CCTrCH-ID,
    tFCS                      TFCS      OPTIONAL,
    tFCI-Coding               TFCI-Coding      OPTIONAL,
    punctureLimit             PunctureLimit      OPTIONAL,
    iE-Extensions             ProtocolExtensionContainer { {UL-CCTrCH-ModifyInformation-RL-ReconfPrepTDD-ExtIEs} } OPTIONAL,
    ...
}

UL-CCTrCH-ModifyInformation-RL-ReconfPrepTDD-ExtIEs RNSAP-PROTOCOL-EXTENSION ::= {
    { ID id-UL-SIRTarget      CRITICALITY reject      EXTENSION      UL-SIR      PRESENCE optional}|
    -- This IE shall be applicable for 1.28Mcps TDD only.
    { ID id-TDD-TPC-UplinkStepSize-InformationModify-LCR-RL-ReconfPrepTDD CRITICALITY reject      EXTENSION      TDD-TPC-UplinkStepSize-LCR
    PRESENCE optional    },
    -- Applicable to 1.28Mcps TDD only
    ...
}

```

```

}

UL-CCTrCH-InformationDeleteList-RL-ReconfPrepTDD ::= SEQUENCE (SIZE (0..maxNrOfCCTrCHs)) OF ProtocolIE-Single-Container { {UL-CCTrCH-
DeleteInformation-RL-ReconfPrepTDD-IEs} }

UL-CCTrCH-DeleteInformation-RL-ReconfPrepTDD-IEs RNSAP-PROTOCOL-IES ::= {
  { ID id-UL-CCTrCH-DeleteInformation-RL-ReconfPrepTDD   CRITICALITY notify   TYPE UL-CCTrCH-DeleteInformation-RL-ReconfPrepTDD   PRESENCE
mandatory }
}

UL-CCTrCH-DeleteInformation-RL-ReconfPrepTDD ::= SEQUENCE {
  cCTrCH-ID          CCTrCH-ID,
  iE-Extensions     ProtocolExtensionContainer { {UL-CCTrCH-DeleteInformation-RL-ReconfPrepTDD-ExtIEs} } OPTIONAL,
  ...
}

UL-CCTrCH-DeleteInformation-RL-ReconfPrepTDD-ExtIEs RNSAP-PROTOCOL-EXTENSION ::= {
  ...
}

DL-CCTrCH-InformationAddList-RL-ReconfPrepTDD ::= SEQUENCE (SIZE (0..maxNrOfCCTrCHs)) OF ProtocolIE-Single-Container { {DL-CCTrCH-
AddInformation-RL-ReconfPrepTDD-IEs} }

DL-CCTrCH-AddInformation-RL-ReconfPrepTDD-IEs RNSAP-PROTOCOL-IES ::= {
  { ID id-DL-CCTrCH-InformationAddItem-RL-ReconfPrepTDD   CRITICALITY notify   TYPE DL-CCTrCH-InformationAddItem-RL-ReconfPrepTDD   PRESENCE
mandatory }
}

DL-CCTrCH-InformationAddItem-RL-ReconfPrepTDD ::= SEQUENCE {
  cCTrCH-ID          CCTrCH-ID,
  tFCS               TFCS,
  tFCI-Coding       TFCI-Coding,
  punctureLimit     PunctureLimit,
  cCTrCH-TPCList    CCTrCH-TPCAddList-RL-ReconfPrepTDD OPTIONAL,
  iE-Extensions     ProtocolExtensionContainer { {DL-CCTrCH-InformationAddItem-RL-ReconfPrepTDD-ExtIEs} } OPTIONAL,
  ...
}

DL-CCTrCH-InformationAddItem-RL-ReconfPrepTDD-ExtIEs RNSAP-PROTOCOL-EXTENSION ::= {
  { ID id-TDD-TPC-DownlinkStepSize-InformationAdd-RL-ReconfPrepTDD   CRITICALITY reject   EXTENSION   TDD-TPC-DownlinkStepSize   PRESENCE
optional },
  ...
}

CCTrCH-TPCAddList-RL-ReconfPrepTDD ::= SEQUENCE (SIZE (1..maxNrOfCCTrCHs)) OF CCTrCH-TPCAddItem-RL-ReconfPrepTDD

CCTrCH-TPCAddItem-RL-ReconfPrepTDD ::= SEQUENCE {
  cCTrCH-ID          CCTrCH-ID,
  iE-Extensions     ProtocolExtensionContainer { { CCTrCH-TPCAddItem-RL-ReconfPrepTDD-ExtIEs} } OPTIONAL,
  ...
}

CCTrCH-TPCAddItem-RL-ReconfPrepTDD-ExtIEs RNSAP-PROTOCOL-EXTENSION ::= {
  ...
}

```

```

}

DL-CCTrCH-InformationModifyList-RL-ReconfPrepTDD ::= SEQUENCE (SIZE (0..maxNrOfCCTrCHs)) OF ProtocolIE-Single-Container { {DL-CCTrCH-
ModifyInformation-RL-ReconfPrepTDD-IEs} }

DL-CCTrCH-ModifyInformation-RL-ReconfPrepTDD-IEs RNSAP-PROTOCOL-IES ::= {
  { ID id-DL-CCTrCH-InformationModifyItem-RL-ReconfPrepTDD CRITICALITY notify TYPE DL-CCTrCH-InformationModifyItem-RL-ReconfPrepTDD
  PRESENCE mandatory }
}

DL-CCTrCH-InformationModifyItem-RL-ReconfPrepTDD ::= SEQUENCE {
  cCTrCH-ID CCTrCH-ID,
  tFCS TFCS OPTIONAL,
  tFCI-Coding TFCI-Coding OPTIONAL,
  punctureLimit PunctureLimit OPTIONAL,
  cCTrCH-TPCList CCTrCH-TPCModifyList-RL-ReconfPrepTDD OPTIONAL,
  iE-Extensions ProtocolExtensionContainer { {DL-CCTrCH-InformationModifyItem-RL-ReconfPrepTDD-ExtIEs} } OPTIONAL,
  ...
}

DL-CCTrCH-InformationModifyItem-RL-ReconfPrepTDD-ExtIEs RNSAP-PROTOCOL-EXTENSION ::= {
  { ID id-TDD-TPC-DownlinkStepSize-InformationModify-RL-ReconfPrepTDD CRITICALITY reject EXTENSION TDD-TPC-DownlinkStepSize
  PRESENCE optional},
  ...
}

CCTrCH-TPCModifyList-RL-ReconfPrepTDD ::= SEQUENCE (SIZE (1..maxNrOfCCTrCHs)) OF CCTrCH-TPCModifyItem-RL-ReconfPrepTDD

CCTrCH-TPCModifyItem-RL-ReconfPrepTDD ::= SEQUENCE {
  cCTrCH-ID CCTrCH-ID,
  iE-Extensions ProtocolExtensionContainer { { CCTrCH-TPCModifyItem-RL-ReconfPrepTDD-ExtIEs} } OPTIONAL,
  ...
}

CCTrCH-TPCModifyItem-RL-ReconfPrepTDD-ExtIEs RNSAP-PROTOCOL-EXTENSION ::= {
  ...
}

DL-CCTrCH-InformationDeleteList-RL-ReconfPrepTDD ::= SEQUENCE (SIZE (0..maxNrOfCCTrCHs)) OF ProtocolIE-Single-Container { {DL-CCTrCH-
DeleteInformation-RL-ReconfPrepTDD-IEs} }

DL-CCTrCH-DeleteInformation-RL-ReconfPrepTDD-IEs RNSAP-PROTOCOL-IES ::= {
  { ID id-DL-CCTrCH-InformationDeleteItem-RL-ReconfPrepTDD CRITICALITY notify TYPE DL-CCTrCH-InformationDeleteItem-RL-ReconfPrepTDD
  PRESENCE mandatory }
}

DL-CCTrCH-InformationDeleteItem-RL-ReconfPrepTDD ::= SEQUENCE {
  cCTrCH-ID CCTrCH-ID,
  iE-Extensions ProtocolExtensionContainer { {DL-CCTrCH-InformationDeleteItem-RL-ReconfPrepTDD-ExtIEs} } OPTIONAL,
  ...
}

DL-CCTrCH-InformationDeleteItem-RL-ReconfPrepTDD-ExtIEs RNSAP-PROTOCOL-EXTENSION ::= {
  ...
}

```

```

}

DCH-DeleteList-RL-ReconfPrepTDD ::= SEQUENCE (SIZE (0..maxNrOfDCHs)) OF DCH-DeleteItem-RL-ReconfPrepTDD

DCH-DeleteItem-RL-ReconfPrepTDD ::= SEQUENCE {
    dCH-ID                DCH-ID,
    iE-Extensions         ProtocolExtensionContainer { {DCH-DeleteItem-RL-ReconfPrepTDD-ExtIEs} } OPTIONAL,
    ...
}

DCH-DeleteItem-RL-ReconfPrepTDD-ExtIEs RNSAP-PROTOCOL-EXTENSION ::= {
    ...
}

DSCH-ModifyList-RL-ReconfPrepTDD ::= SEQUENCE (SIZE(0..maxNoOfDSCHs)) OF DSCH-ModifyItem-RL-ReconfPrepTDD

DSCH-ModifyItem-RL-ReconfPrepTDD ::= SEQUENCE {
    dSCH-ID                DSCH-ID,
    dl-ccTrCHID            CCH-TRCH-ID                OPTIONAL,
    trChSourceStatisticsDescriptor TrCh-SrcStatisticsDescr OPTIONAL,
    transportFormatSet     TransportFormatSet          OPTIONAL,
    allocationRetentionPriority AllocationRetentionPriority OPTIONAL,
    schedulingPriorityIndicator SchedulingPriorityIndicator OPTIONAL,
    bLER                   BLER                        OPTIONAL,
    transportBearerRequestIndicator TransportBearerRequestIndicator,
    iE-Extensions         ProtocolExtensionContainer { {DSCH-ModifyItem-RL-ReconfPrepTDD-ExtIEs} } OPTIONAL,
    ...
}

DSCH-ModifyItem-RL-ReconfPrepTDD-ExtIEs RNSAP-PROTOCOL-EXTENSION ::= {
    { ID id-TrafficClass          CRITICALITY ignore EXTENSION TrafficClass          PRESENCE optional }|
    { ID id-BindingID            CRITICALITY ignore EXTENSION BindingID            PRESENCE optional }|
    -- Shall be ignored if bearer establishment with ALCAP.
    { ID id-TransportLayerAddress CRITICALITY ignore EXTENSION TransportLayerAddress PRESENCE optional }|
    -- Shall be ignored if bearer establishment with ALCAP.
    { ID id-TnlQos                CRITICALITY ignore EXTENSION TnlQos                PRESENCE optional },
    ...
}

DSCH-DeleteList-RL-ReconfPrepTDD ::= SEQUENCE (SIZE(0..maxNoOfDSCHs)) OF DSCH-DeleteItem-RL-ReconfPrepTDD

DSCH-DeleteItem-RL-ReconfPrepTDD ::= SEQUENCE {
    dSCH-ID                DSCH-ID,
    iE-Extensions         ProtocolExtensionContainer { {DSCH-DeleteItem-RL-ReconfPrepTDD-ExtIEs} } OPTIONAL,
    ...
}

DSCH-DeleteItem-RL-ReconfPrepTDD-ExtIEs RNSAP-PROTOCOL-EXTENSION ::= {
    ...
}

USCH-ModifyList-RL-ReconfPrepTDD ::= SEQUENCE (SIZE(0..maxNoOfUSCHs)) OF USCH-ModifyItem-RL-ReconfPrepTDD

```



```

USCH-ModifyItem-RL-ReconfPrepTDD ::= SEQUENCE {
    uSCH-ID                USCH-ID,
    ul-ccTrCHID           CCTrCH-ID                OPTIONAL,
    trChSourceStatisticsDescriptor TrCh-SrcStatisticsDescr OPTIONAL,
    transportFormatSet    TransportFormatSet        OPTIONAL,
    allocationRetentionPriority AllocationRetentionPriority OPTIONAL,
    schedulingPriorityIndicator SchedulingPriorityIndicator OPTIONAL,
    bLER                  BLER                    OPTIONAL,
    transportBearerRequestIndicator TransportBearerRequestIndicator,
    rb-Info               RB-Info                  OPTIONAL,
    iE-Extensions         ProtocolExtensionContainer { {USCH-ModifyItem-RL-ReconfPrepTDD-ExtIEs} } OPTIONAL,
    ...
}

USCH-ModifyItem-RL-ReconfPrepTDD-ExtIEs RNSAP-PROTOCOL-EXTENSION ::= {
    { ID id-TrafficClass          CRITICALITY ignore EXTENSION TrafficClass          PRESENCE optional }|
    { ID id-BindingID            CRITICALITY ignore EXTENSION BindingID            PRESENCE optional }|
    -- Shall be ignored if bearer establishment with ALCAP.
    { ID id-TransportLayerAddress CRITICALITY ignore EXTENSION TransportLayerAddress PRESENCE optional }|
    -- Shall be ignored if bearer establishment with ALCAP.
    { ID id-TnlQos               CRITICALITY ignore EXTENSION TnlQos               PRESENCE optional },
    ...
}

USCH-DeleteList-RL-ReconfPrepTDD ::= SEQUENCE (SIZE(0..maxNoOfUSCHs)) OF USCH-DeleteItem-RL-ReconfPrepTDD

USCH-DeleteItem-RL-ReconfPrepTDD ::= SEQUENCE {
    uSCH-ID                USCH-ID,
    iE-Extensions         ProtocolExtensionContainer { {USCH-DeleteItem-RL-ReconfPrepTDD-ExtIEs} } OPTIONAL,
    ...
}

USCH-DeleteItem-RL-ReconfPrepTDD-ExtIEs RNSAP-PROTOCOL-EXTENSION ::= {
    ...
}

RadioLinkReconfigurationPrepareTDD-Extensions RNSAP-PROTOCOL-EXTENSION ::= {
    { ID id-PrimaryCCPCH-RSCP-RL-ReconfPrepTDD          CRITICALITY ignore EXTENSION PrimaryCCPCH-RSCP          PRESENCE optional }|
    { ID id-DL-TimeSlot-ISCP-Info-RL-ReconfPrepTDD      CRITICALITY ignore EXTENSION DL-TimeSlot-ISCP-Info          PRESENCE optional }|
    { ID id-DL-Timeslot-ISCP-LCR-Information-RL-ReconfPrepTDD CRITICALITY ignore EXTENSION DL-TimeSlot-ISCP-LCR-Information PRESENCE optional }|
    { ID id-HSDSCH-TDD-Information                      CRITICALITY reject EXTENSION HSDSCH-TDD-Information PRESENCE optional}|
    { ID id-HSDSCH-Information-to-Modify                CRITICALITY reject EXTENSION HSDSCH-Information-to-Modify PRESENCE optional}|
    { ID id-HSDSCH-MACdFlows-to-Add                    CRITICALITY reject EXTENSION HSDSCH-MACdFlows-Information PRESENCE optional}|
    { ID id-HSDSCH-MACdFlows-to-Delete                 CRITICALITY reject EXTENSION HSDSCH-MACdFlows-to-Delete PRESENCE optional}|
    { ID id-HSPDSCH-RL-ID                              CRITICALITY reject EXTENSION RL-ID PRESENCE optional}|
    { ID id-PDSCH-RL-ID                                CRITICALITY ignore EXTENSION RL-ID PRESENCE optional }|
    { ID id-UL-Synchronisation-Parameters-LCR          CRITICALITY ignore EXTENSION UL-Synchronisation-Parameters-LCR PRESENCE optional }|
}

```

```

-- Mandatory for 1.28Mcps TDD, Not Applicable to 3.84Mcps TDD or 7.68Mcps TDD
  { ID id-RL-Information-RL-ReconfPrepTDD      CRITICALITY ignore      EXTENSION RL-Information-RL-ReconfPrepTDD      PRESENCE optional
  } |
  { ID id-PrimaryCCPCH-RSCP-Delta              CRITICALITY ignore      EXTENSION PrimaryCCPCH-RSCP-Delta
  PRESENCE optional } |
  { ID id-E-DCH-Information-Reconfig           CRITICALITY reject      EXTENSION E-DCH-Information-Reconfig           PRESENCE optional } |
  { ID id-E-DCH-Serving-RL-ID                  CRITICALITY reject      EXTENSION RL-ID                                 PRESENCE optional } |
  { ID id-E-DCH-768-Information-Reconfig       CRITICALITY reject      EXTENSION E-DCH-768-Information-Reconfig       PRESENCE optional } |
  { ID id-E-DCH-LCR-Information-Reconfig       CRITICALITY reject      EXTENSION E-DCH-LCR-Information-Reconfig       PRESENCE optional
  } |
  { ID id-NeedforIdleInterval                  CRITICALITY ignore      EXTENSION NeedforIdleInterval
  PRESENCE optional } |
  { ID id-CPC-InformationLCR                   CRITICALITY reject      EXTENSION CPC-InformationLCR
  PRESENCE optional } |
  { ID id-RNTI-Allocation-Indicator            CRITICALITY ignore      EXTENSION RNTI-Allocation-Indicator            PRESENCE
optional } |
  { ID id-DCH-MeasurementType-Indicator        CRITICALITY reject      EXTENSION DCH-MeasurementType-Indicator        PRESENCE optional},
  ...
}

RL-Information-RL-ReconfPrepTDD ::= SEQUENCE (SIZE (1..maxNrOfRLs)) OF RL-InformationIE-RL-ReconfPrepTDD

RL-InformationIE-RL-ReconfPrepTDD ::= SEQUENCE {
  rL-ID                      RL-ID,
  rL-Specific-DCH-Info       RL-Specific-DCH-Info      OPTIONAL,
  iE-Extensions              ProtocolExtensionContainer { { RL-InformationIE-RL-ReconfPrepTDD-ExtIEs } }  OPTIONAL,
  ...
}

RL-InformationIE-RL-ReconfPrepTDD-ExtIEs RNSAP-PROTOCOL-EXTENSION ::= {
  ...
}

-- *****
--
-- RADIO LINK RECONFIGURATION READY FDD
--
-- *****

RadioLinkReconfigurationReadyFDD ::= SEQUENCE {
  protocolIEs                ProtocolIE-Container    {{RadioLinkReconfigurationReadyFDD-IEs}},
  protocolExtensions         ProtocolExtensionContainer {{RadioLinkReconfigurationReadyFDD-Extensions}}  OPTIONAL,
  ...
}

RadioLinkReconfigurationReadyFDD-IEs RNSAP-PROTOCOL-IES ::= {
  { ID id-RL-InformationResponseList-RL-ReconfReadyFDD  CRITICALITY ignore  TYPE RL-InformationResponseList-RL-ReconfReadyFDD
  PRESENCE optional } |
  { ID id-CriticalityDiagnostics                        CRITICALITY ignore  TYPE CriticalityDiagnostics      PRESENCE optional },
  ...
}

```

```

RL-InformationResponseList-RL-ReconfReadyFDD ::= SEQUENCE (SIZE (0..maxNrOfRLs)) OF ProtocolIE-Single-Container { {RL-InformationResponse-
RL-ReconfReadyFDD-IEs} }

RL-InformationResponse-RL-ReconfReadyFDD-IEs RNSAP-PROTOCOL-IES ::= {
  { ID id-RL-InformationResponseItem-RL-ReconfReadyFDD CRITICALITY ignore TYPE RL-InformationResponseItem-RL-ReconfReadyFDD
  PRESENCE mandatory }
}

RL-InformationResponseItem-RL-ReconfReadyFDD ::= SEQUENCE {
  rL-ID RL-ID,
  max-UL-SIR UL-SIR OPTIONAL,
  min-UL-SIR UL-SIR OPTIONAL,
  maximumDLTxPower DL-Power OPTIONAL,
  minimumDLTxPower DL-Power OPTIONAL,
  not-Used-secondary-CCPCH-Info NULL OPTIONAL,
  dl-CodeInformationList DL-CodeInformationList-RL-ReconfReadyFDD OPTIONAL,
  dCHInformationResponse DCH-InformationResponseList-RL-ReconfReadyFDD OPTIONAL,
  not-Used-dSCHsToBeAddedOrModified NULL OPTIONAL,
  iE-Extensions ProtocolExtensionContainer { {RL-InformationResponseItem-RL-ReconfReadyFDD-ExtIEs} } OPTIONAL,
  ...
}

RL-InformationResponseItem-RL-ReconfReadyFDD-ExtIEs RNSAP-PROTOCOL-EXTENSION ::= {
  { ID id-DL-PowerBalancing-UpdatedIndicator CRITICALITY ignore EXTENSION DL-PowerBalancing-UpdatedIndicator
  PRESENCE optional }|
  { ID id-Primary-CPICH-Usage-For-Channel-Estimation CRITICALITY ignore EXTENSION Primary-CPICH-Usage-For-Channel-Estimation PRESENCE
  optional }|
  { ID id-Secondary-CPICH-Information-Change CRITICALITY ignore EXTENSION Secondary-CPICH-Information-Change
  PRESENCE optional }|
  { ID id-EDCH-FDD-InformationResponse CRITICALITY ignore EXTENSION EDCH-FDD-InformationResponse
  PRESENCE optional }|
  { ID id-EDCH-RLSet-Id CRITICALITY ignore EXTENSION RL-Set-ID
  PRESENCE optional }|
  { ID id-EDCH-FDD-DL-ControlChannelInformation CRITICALITY ignore EXTENSION EDCH-FDD-DL-ControlChannelInformation
  PRESENCE optional }|
  { ID id-F-DPCH-SlotFormat CRITICALITY ignore EXTENSION F-DPCH-SlotFormat
  PRESENCE optional }|
  { ID id-HSDSCH-PreconfigurationInfo CRITICALITY ignore EXTENSION HSDSCH-PreconfigurationInfo
  PRESENCE optional }|
  { ID id-Non-Serving-RL-Preconfig-Info CRITICALITY ignore EXTENSION Non-Serving-RL-Preconfig-Info
  PRESENCE optional },
  ...
}

DL-CodeInformationList-RL-ReconfReadyFDD ::= ProtocolIE-Single-Container { { DL-CodeInformationListIEs-RL-ReconfReadyFDD } }

DL-CodeInformationListIEs-RL-ReconfReadyFDD RNSAP-PROTOCOL-IES ::= {
  { ID id-FDD-DL-CodeInformation CRITICALITY ignore TYPE FDD-DL-CodeInformation PRESENCE mandatory }
}

DCH-InformationResponseList-RL-ReconfReadyFDD ::= ProtocolIE-Single-Container { {DCH-InformationResponseListIEs-RL-ReconfReadyFDD} }

DCH-InformationResponseListIEs-RL-ReconfReadyFDD RNSAP-PROTOCOL-IES ::= {
  { ID id-DCH-InformationResponse CRITICALITY ignore TYPE DCH-InformationResponse PRESENCE mandatory }
}

```

```

}
RadioLinkReconfigurationReadyFDD-Extensions RNSAP-PROTOCOL-EXTENSION ::= {
  { ID id-HSDSCH-RNTI                CRITICALITY ignore      EXTENSION HSDSCH-RNTI
  PRESENCE optional }|
  { ID id-HSDSCH-FDD-Information-Response  CRITICALITY ignore      EXTENSION HSDSCH-FDD-Information-Response      PRESENCE optional }|
  { ID id-MACHs-ResetIndicator          CRITICALITY ignore      EXTENSION MACHs-ResetIndicator
  PRESENCE optional }|
  { ID id-Fast-Reconfiguration-Permission  CRITICALITY ignore      EXTENSION Fast-Reconfiguration-Permission      PRESENCE optional }|
  { ID id-Continuous-Packet-Connectivity-HS-SCCH-Less-Information-Response  CRITICALITY ignore      EXTENSION Continuous-Packet-
Connectivity-HS-SCCH-Less-Information-Response  PRESENCE optional }|
  { ID id-Additional-HS-Cell-RL-Reconf-Response  CRITICALITY ignore      EXTENSION Additional-HS-Cell-RL-Reconf-Response      PRESENCE
optional }|
  { ID id-Additional-EDCH-Cell-Information-ResponseRLReconf  CRITICALITY ignore      EXTENSION Additional-EDCH-Cell-Information-Response-
RLReconf-List          PRESENCE optional },
  ...
}

```

Additional-HS-Cell-RL-Reconf-Response ::= SEQUENCE (SIZE (1..maxNrOfHSDSCH-1)) OF Additional-HS-Cell-RL-Reconf-Response-ItemIEs

```

Additional-HS-Cell-RL-Reconf-Response-ItemIEs ::=SEQUENCE{
  hSPDSCH-RL-ID                RL-ID,
  hSDSCH-RNTI                  HSDSCH-RNTI,
  HS-DSCH-FDD-Secondary-Serving-Information-Response  HS-DSCH-FDD-Secondary-Serving-Information-Response,
  IE-Extensions                ProtocolExtensionContainer { { Additional-HS-Cell-RL-Reconf-Response-ItemIEs-ExtIEs} } OPTIONAL,
  ...
}

```

```

Additional-HS-Cell-RL-Reconf-Response-ItemIEs-ExtIEs RNSAP-PROTOCOL-EXTENSION ::= {
  ...
}

```

```

-- *****
--
-- RADIO LINK RECONFIGURATION READY TDD
--
-- *****

```

```

RadioLinkReconfigurationReadyTDD ::= SEQUENCE {
  protocolIEs                ProtocolIE-Container    {{RadioLinkReconfigurationReadyTDD-IEs}},
  protocolExtensions        ProtocolExtensionContainer {{RadioLinkReconfigurationReadyTDD-Extensions}}      OPTIONAL,
  ...
}

```

```

RadioLinkReconfigurationReadyTDD-IEs RNSAP-PROTOCOL-IES ::= {
  { ID id-RL-InformationResponse-RL-ReconfReadyTDD  CRITICALITY ignore  TYPE RL-InformationResponse-RL-ReconfReadyTDD  PRESENCE optional  } |
  --This RL-InformationResponse-RL-ReconfReadyTDD is for the first RL repetition in the list.
  --Repetitions 2 and on are defined in Multiple-RL-InformationResponse-RL-ReconfReadyTDD.
  { ID id-CriticalityDiagnostics  CRITICALITY ignore  TYPE CriticalityDiagnostics  PRESENCE optional  },
  ...
}

```

```

RL-InformationResponse-RL-ReconfReadyTDD ::= SEQUENCE {
    rL-ID                RL-ID,
    max-UL-SIR           UL-SIR           OPTIONAL,
    min-UL-SIR           UL-SIR           OPTIONAL,
    maximumDLTxPower     DL-Power       OPTIONAL,
    minimumDLTxPower     DL-Power       OPTIONAL,
    secondary-CCPCH-Info-TDD Secondary-CCPCH-Info-TDD OPTIONAL,
    ul-CCTrCH-Information UL-CCTrCH-InformationList-RL-ReconfReadyTDD OPTIONAL,
    dl-CCTrCH-Information DL-CCTrCH-InformationList-RL-ReconfReadyTDD OPTIONAL,
    dCHInformationResponse DCH-InformationResponseList-RL-ReconfReadyTDD OPTIONAL,
    dSCHsToBeAddedOrModified DSCHToBeAddedOrModified-RL-ReconfReadyTDD OPTIONAL,
    uSCHsToBeAddedOrModified USCHToBeAddedOrModified-RL-ReconfReadyTDD OPTIONAL,
    iE-Extensions        ProtocolExtensionContainer { {RL-InformationResponse-RL-ReconfReadyTDD-ExtIEs} } OPTIONAL,
    ...
}

RL-InformationResponse-RL-ReconfReadyTDD-ExtIEs RNSAP-PROTOCOL-EXTENSION ::= {
    { ID id-UL-TimingAdvanceCtrl-LCR                CRITICALITY ignore EXTENSION UL-TimingAdvanceCtrl-LCR
      PRESENCE optional }|
    --For 1.28Mcps TDD only
    { ID id-secondary-LCR-CCPCH-Info-TDD            CRITICALITY ignore EXTENSION Secondary-LCR-CCPCH-Info-TDD
      PRESENCE optional }|
    --For 1.28Mcps TDD only
    { ID id-secondary-CCPCH-Info-RL-ReconfReadyTDD768 CRITICALITY ignore EXTENSION Secondary-CCPCH-Info-TDD768
      PRESENCE optional }|
    { ID id-UARFCNforNt                             CRITICALITY ignore EXTENSION UARFCN
      PRESENCE optional },
    -- Applicable to 1.28Mcps TDD only
    ...
}

UL-CCTrCH-InformationList-RL-ReconfReadyTDD ::= ProtocolIE-Single-Container {{UL-CCTrCHInformationListIEs-RL-ReconfReadyTDD}}

UL-CCTrCHInformationListIEs-RL-ReconfReadyTDD RNSAP-PROTOCOL-IES ::= {
    { ID id-UL-CCTrCH-InformationListIE-RL-ReconfReadyTDD CRITICALITY ignore TYPE UL-CCTrCHInformationListIE-RL-ReconfReadyTDD
      PRESENCE mandatory }
}

UL-CCTrCHInformationListIE-RL-ReconfReadyTDD ::= SEQUENCE (SIZE (0..maxNrOfCCTrCHs)) OF UL-CCTrCH-InformationItem-RL-ReconfReadyTDD

UL-CCTrCH-InformationItem-RL-ReconfReadyTDD ::= SEQUENCE {
    cCTrCH-ID                CCTrCH-ID,
    ul-DPCH-AddInformation    UL-DPCH-InformationAddList-RL-ReconfReadyTDD OPTIONAL,
    --For 3.84Mcps TDD only
    ul-DPCH-ModifyInformation UL-DPCH-InformationModifyList-RL-ReconfReadyTDD OPTIONAL,
    ul-DPCH-DeleteInformation UL-DPCH-InformationDeleteList-RL-ReconfReadyTDD OPTIONAL,
    iE-Extensions            ProtocolExtensionContainer { {UL-CCTrCH-InformationItem-RL-ReconfReadyTDD-ExtIEs} } OPTIONAL,
    ...
}

UL-CCTrCH-InformationItem-RL-ReconfReadyTDD-ExtIEs RNSAP-PROTOCOL-EXTENSION ::= {
    { ID id-UL-DPCH-LCR-InformationAddListIE-RL-ReconfReadyTDD CRITICALITY ignore EXTENSION UL-DPCH-LCR-InformationAddList-RL-
      ReconfReadyTDD PRESENCE optional }|
    --For 1.28Mcps TDD only
}

```

```

    { ID id-UL-DPCH-InformationAddListIE-RL-ReconfReadyTDD768
      ReconfReadyTDD768      PRESENCE optional },
      --For 7.68Mcps TDD only
      ...
    }

UL-DPCH-LCR-InformationAddList-RL-ReconfReadyTDD ::= SEQUENCE {
  repetitionPeriod      RepetitionPeriod,
  repetitionLength      RepetitionLength,
  tDD-DPCHOffset        TDD-DPCHOffset,
  uL-TimeslotLCR-Info    UL-TimeslotLCR-Information,
  iE-Extensions          ProtocolExtensionContainer { {UL-DPCH-LCR-InformationAddItem-RL-ReconfReadyTDD-ExtIEs} } OPTIONAL,
  ...
}

UL-DPCH-LCR-InformationAddItem-RL-ReconfReadyTDD-ExtIEs RNSAP-PROTOCOL-EXTENSION ::= {
  ...
}

UL-DPCH-InformationAddList-RL-ReconfReadyTDD ::= ProtocolIE-Single-Container {{UL-DPCH-InformationAddListIEs-RL-ReconfReadyTDD}}

UL-DPCH-InformationAddListIEs-RL-ReconfReadyTDD RNSAP-PROTOCOL-IES ::= {
  { ID id-UL-DPCH-InformationAddListIE-RL-ReconfReadyTDD
    PRESENCE optional }
}

UL-DPCH-InformationAddListIE-RL-ReconfReadyTDD ::= SEQUENCE {
  repetitionPeriod      RepetitionPeriod,
  repetitionLength      RepetitionLength,
  tDD-DPCHOffset        TDD-DPCHOffset,
  rxTimingDeviationForTA  RxTimingDeviationForTA      OPTIONAL,
  uL-Timeslot-Information  UL-Timeslot-Information,
  iE-Extensions          ProtocolExtensionContainer { {UL-DPCH-InformationAddItem-RL-ReconfReadyTDD-ExtIEs} } OPTIONAL,
  ...
}

UL-DPCH-InformationAddItem-RL-ReconfReadyTDD-ExtIEs RNSAP-PROTOCOL-EXTENSION ::= {
  { ID id-RxTimingDeviationForTAext
    CRITICALITY ignore
    EXTENSION RxTimingDeviationForTAext
    PRESENCE optional },
  ...
}

UL-DPCH-InformationAddList-RL-ReconfReadyTDD768 ::= SEQUENCE {
  repetitionPeriod      RepetitionPeriod,
  repetitionLength      RepetitionLength,
  tDD-DPCHOffset        TDD-DPCHOffset,
  rxTimingDeviationForTA768  RxTimingDeviationForTA768      OPTIONAL,
  uL-Timeslot-Information768  UL-Timeslot-Information768,
  iE-Extensions          ProtocolExtensionContainer { {UL-DPCH-InformationAddItem-RL-ReconfReadyTDD768-ExtIEs} } OPTIONAL,
  ...
}

UL-DPCH-InformationAddItem-RL-ReconfReadyTDD768-ExtIEs RNSAP-PROTOCOL-EXTENSION ::= {
  ...
}

```

```
UL-DPCH-InformationModifyList-RL-ReconfReadyTDD ::= ProtocolIE-Single-Container {{UL-DPCH-InformationModifyListIEs-RL-ReconfReadyTDD}}
```

```
UL-DPCH-InformationModifyListIEs-RL-ReconfReadyTDD RNSAP-PROTOCOL-IES ::= {
  { ID id-UL-DPCH-InformationModifyListIE-RL-ReconfReadyTDD  CRITICALITY ignore  TYPE UL-DPCH-InformationModifyListIE-RL-ReconfReadyTDD
  PRESENCE mandatory }
}
```

```
UL-DPCH-InformationModifyListIE-RL-ReconfReadyTDD ::= SEQUENCE {
  repetitionPeriod          RepetitionPeriod          OPTIONAL,
  repetitionLength          RepetitionLength          OPTIONAL,
  tDD-DPCHOffset           TDD-DPCHOffset           OPTIONAL,
  uL-Timeslot-InformationModifyList-RL-ReconfReadyTDD  UL-Timeslot-InformationModifyList-RL-ReconfReadyTDD  OPTIONAL,
  --For 3.84Mcps TDD only
  iE-Extensions            ProtocolExtensionContainer { {UL-DPCH-InformationModifyItem-RL-ReconfReadyTDD-ExtIEs} } OPTIONAL,
  ...
}
```

```
UL-DPCH-InformationModifyItem-RL-ReconfReadyTDD-ExtIEs RNSAP-PROTOCOL-EXTENSION ::= {
  { ID id-UL-Timeslot-LCR-InformationModifyList-RL-ReconfReadyTDD  CRITICALITY ignore  EXTENSION  UL-TimeslotLCR-InformationModifyList-RL-
  ReconfReadyTDD  PRESENCE optional }|
  --For 1.28Mcps TDD only
  { ID id-UL-Timeslot-InformationModifyList-RL-ReconfReadyTDD768  CRITICALITY ignore  EXTENSION  UL-Timeslot-InformationModifyList-RL-
  ReconfReadyTDD768  PRESENCE optional },
  --For 7.68Mcps TDD only
  ...
}
```

```
UL-TimeslotLCR-InformationModifyList-RL-ReconfReadyTDD ::= SEQUENCE ( SIZE (1..maxNrOfTsLCR)) OF UL-TimeslotLCR-InformationModifyItem-RL-
ReconfReadyTDD
```

```
UL-TimeslotLCR-InformationModifyItem-RL-ReconfReadyTDD ::= SEQUENCE {
  timeSlotLCR          TimeSlotLCR,
  midambleShiftLCR    MidambleShiftLCR          OPTIONAL,
  tFCI-Presence        TFCI-Presence          OPTIONAL,
  tDD-uL-Code-LCR-Information  TDD-UL-Code-LCR-InformationModifyList-RL-ReconfReadyTDD  OPTIONAL,
  iE-Extensions        ProtocolExtensionContainer { {UL-TimeslotLCR-InformationModifyItem-RL-ReconfReadyTDD-ExtIEs} } OPTIONAL,
  ...
}
```

```
TDD-UL-Code-LCR-InformationModifyList-RL-ReconfReadyTDD ::= SEQUENCE ( SIZE (1..maxNrOfDPCHsLCR)) OF TDD-UL-Code-LCR-InformationModifyItem-RL-
ReconfReadyTDD
```

```
TDD-UL-Code-LCR-InformationModifyItem-RL-ReconfReadyTDD ::= SEQUENCE {
  dPCH-ID              DPCH-ID,
  tDD-ChannelisationCodeLCR  TDD-ChannelisationCodeLCR  OPTIONAL,
  iE-Extensions        ProtocolExtensionContainer { {TDD-UL-Code-LCR-InformationModifyItem-RL-ReconfReadyTDD-ExtIEs} } OPTIONAL,
  ...
}
```

```
TDD-UL-Code-LCR-InformationModifyItem-RL-ReconfReadyTDD-ExtIEs RNSAP-PROTOCOL-EXTENSION ::= {
  { ID id-TDD-UL-DPCH-TimeSlotFormatModifyItem-LCR-RL-ReconfReadyTDD  CRITICALITY  reject  EXTENSION  TDD-UL-DPCH-TimeSlotFormat-LCR
  PRESENCE optional},
  ...
}
```

```

}
UL-TimeslotLCR-InformationModifyItem-RL-ReconfReadyTDD-ExtIEs RNSAP-PROTOCOL-EXTENSION ::= {
    ...
}
UL-Timeslot-InformationModifyList-RL-ReconfReadyTDD ::= SEQUENCE ( SIZE (1..maxNrOfTS)) OF UL-Timeslot-InformationModifyItem-RL-ReconfReadyTDD
UL-Timeslot-InformationModifyItem-RL-ReconfReadyTDD ::= SEQUENCE {
    timeSlot                TimeSlot,
    midambleShiftAndBurstType          MidambleShiftAndBurstType          OPTIONAL,
    tFCI-Presence                TFCI-Presence                OPTIONAL,
    uL-Code-Information                TDD-UL-Code-InformationModifyList-RL-ReconfReadyTDD                OPTIONAL,
    iE-Extensions                ProtocolExtensionContainer { {UL-Timeslot-InformationModifyItem-RL-ReconfReadyTDD-ExtIEs} } OPTIONAL,
    ...
}
UL-Timeslot-InformationModifyItem-RL-ReconfReadyTDD-ExtIEs RNSAP-PROTOCOL-EXTENSION ::= {
    ...
}
TDD-UL-Code-InformationModifyList-RL-ReconfReadyTDD ::= SEQUENCE ( SIZE (1..maxNrOfDPCHs)) OF TDD-UL-Code-InformationModifyItem-RL-ReconfReadyTDD
TDD-UL-Code-InformationModifyItem-RL-ReconfReadyTDD ::= SEQUENCE {
    dPCH-ID                DPCH-ID,
    tDD-ChannelisationCode                TDD-ChannelisationCode                OPTIONAL,
    iE-Extensions                ProtocolExtensionContainer { {TDD-UL-Code-InformationModifyItem-RL-ReconfReadyTDD-ExtIEs} } OPTIONAL,
    ...
}
TDD-UL-Code-InformationModifyItem-RL-ReconfReadyTDD-ExtIEs RNSAP-PROTOCOL-EXTENSION ::= {
    ...
}
UL-Timeslot-InformationModifyList-RL-ReconfReadyTDD768 ::= SEQUENCE ( SIZE (1..maxNrOfTS)) OF UL-Timeslot-InformationModifyItem-RL-ReconfReadyTDD768
UL-Timeslot-InformationModifyItem-RL-ReconfReadyTDD768 ::= SEQUENCE {
    timeSlot                TimeSlot,
    midambleShiftAndBurstType768          MidambleShiftAndBurstType768          OPTIONAL,
    tFCI-Presence                TFCI-Presence                OPTIONAL,
    uL-Code-Information768                TDD-UL-Code-InformationModifyList-RL-ReconfReadyTDD768                OPTIONAL,
    iE-Extensions                ProtocolExtensionContainer { {UL-Timeslot-InformationModifyItem-RL-ReconfReadyTDD768-ExtIEs} } OPTIONAL,
    ...
}
UL-Timeslot-InformationModifyItem-RL-ReconfReadyTDD768-ExtIEs RNSAP-PROTOCOL-EXTENSION ::= {
    ...
}
TDD-UL-Code-InformationModifyList-RL-ReconfReadyTDD768 ::= SEQUENCE ( SIZE (1..maxNrOfDPCHs768)) OF TDD-UL-Code-InformationModifyItem-RL-ReconfReadyTDD768
TDD-UL-Code-InformationModifyItem-RL-ReconfReadyTDD768 ::= SEQUENCE {
    dPCH-ID                DPCH-ID,

```



```

tDD-ChannelisationCode768      TDD-ChannelisationCode768      OPTIONAL,
iE-Extensions                  ProtocolExtensionContainer { {TDD-UL-Code-InformationModifyItem-RL-ReconfReadyTDD768-ExtIEs} } OPTIONAL,
...
}

TDD-UL-Code-InformationModifyItem-RL-ReconfReadyTDD768-ExtIEs RNSAP-PROTOCOL-EXTENSION ::= {
...
}

UL-DPCH-InformationDeleteList-RL-ReconfReadyTDD ::= ProtocolIE-Single-Container {{UL-DPCH-InformationDeleteListIEs-RL-ReconfReadyTDD}}

UL-DPCH-InformationDeleteListIEs-RL-ReconfReadyTDD RNSAP-PROTOCOL-IES ::= {
{ ID id-UL-DPCH-InformationDeleteListIE-RL-ReconfReadyTDD  CRITICALITY ignore  TYPE UL-DPCH-InformationDeleteListIE-RL-ReconfReadyTDD
  PRESENCE mandatory }
}

UL-DPCH-InformationDeleteListIE-RL-ReconfReadyTDD ::= SEQUENCE (SIZE (0..maxNrOfDPCHs)) OF UL-DPCH-InformationDeleteItem-RL-ReconfReadyTDD

UL-DPCH-InformationDeleteItem-RL-ReconfReadyTDD ::= SEQUENCE {
  dPCH-ID          DPCH-ID,
  iE-Extensions    ProtocolExtensionContainer { {UL-DPCH-InformationDeleteList-RL-ReconfReadyTDD-ExtIEs} } OPTIONAL,
  ...
}

UL-DPCH-InformationDeleteList-RL-ReconfReadyTDD-ExtIEs RNSAP-PROTOCOL-EXTENSION ::= {
...
}

DL-CCTrCH-InformationList-RL-ReconfReadyTDD          ::= ProtocolIE-Single-Container {{DL-CCTrCHInformationListIEs-RL-ReconfReadyTDD}}

DL-CCTrCHInformationListIEs-RL-ReconfReadyTDD RNSAP-PROTOCOL-IES ::= {
{ ID id-DL-CCTrCH-InformationListIE-RL-ReconfReadyTDD  CRITICALITY ignore  TYPE DL-CCTrCHInformationListIE-RL-ReconfReadyTDD
  PRESENCE mandatory }
}

DL-CCTrCHInformationListIE-RL-ReconfReadyTDD ::= SEQUENCE (SIZE (0..maxNrOfCCTrCHs)) OF DL-CCTrCH-InformationItem-RL-ReconfReadyTDD

DL-CCTrCH-InformationItem-RL-ReconfReadyTDD ::= SEQUENCE {
  cCTrCH-ID          CCTrCH-ID,
  dl-DPCH-AddInformation    DL-DPCH-InformationAddList-RL-ReconfReadyTDD          OPTIONAL,
  --For 3.84Mcps TDD only
  dl-DPCH-ModifyInformation    DL-DPCH-InformationModifyList-RL-ReconfReadyTDD    OPTIONAL,
  dl-DPCH-DeleteInformation    DL-DPCH-InformationDeleteList-RL-ReconfReadyTDD    OPTIONAL,
  iE-Extensions            ProtocolExtensionContainer { {DL-CCTrCH-InformationItem-RL-ReconfReadyTDD-ExtIEs} } OPTIONAL,
  ...
}

DL-CCTrCH-InformationItem-RL-ReconfReadyTDD-ExtIEs RNSAP-PROTOCOL-EXTENSION ::= {
{ ID id-DL-DPCH-LCR-InformationAddListIE-RL-ReconfReadyTDD  CRITICALITY ignore          EXTENSION    DL-DPCH-LCR-InformationAddList-RL-
ReconfReadyTDD          PRESENCE optional}}
  --For 1.28Mcps TDD only
{ ID id-CCTrCH-Maximum-DL-Power-RL-ReconfReadyTDD          CRITICALITY ignore          EXTENSION DL-Power
  PRESENCE optional }|
}

```

```

-- Applicable to 3.84Mcps TDD and 7.68Mcps TDD only, this is a DCH type CCH power
{ ID id-CCH-Minimum-DL-Power-RL-ReconfReadyTDD          CRITICALITY ignore      EXTENSION DL-Power
  PRESENCE optional }|
-- Applicable to 3.84Mcps TDD and 7.68Mcps TDD only, this is a DCH type CCH power
{ ID id-DL-DPCH-InformationAddListIE-RL-ReconfReadyTDD768  CRITICALITY ignore      EXTENSION DL-DPCH-InformationAddList-RL-
ReconfReadyTDD768          PRESENCE optional}|
--For 7.68Mcps TDD only
{ ID id-DL-DPCH-InformationDeleteList768-RL-ReconfReadyTDD  CRITICALITY ignore      EXTENSION DL-DPCH-InformationDeleteList768-RL-
ReconfReadyTDD          PRESENCE optional},
...
}

DL-DPCH-LCR-InformationAddList-RL-ReconfReadyTDD ::= SEQUENCE {
  repetitionPeriod          RepetitionPeriod,
  repetitionLength          RepetitionLength,
  tDD-DPCHOffset           TDD-DPCHOffset,
  dL-TimeslotLCR-Info      DL-TimeslotLCR-Information,
  iE-Extensions            ProtocolExtensionContainer { {DL-DPCH-LCR-InformationAddItem-RL-ReconfReadyTDD-ExtIEs} } OPTIONAL,
  ...
}

DL-DPCH-LCR-InformationAddItem-RL-ReconfReadyTDD-ExtIEs RNSAP-PROTOCOL-EXTENSION ::= {
  ...
}

DL-DPCH-InformationAddList-RL-ReconfReadyTDD ::= ProtocolIE-Single-Container { {DL-DPCH-InformationAddListIEs-RL-ReconfReadyTDD} }

DL-DPCH-InformationAddListIEs-RL-ReconfReadyTDD RNSAP-PROTOCOL-IES ::= {
  { ID id-DL-DPCH-InformationAddListIE-RL-ReconfReadyTDD  CRITICALITY ignore TYPE DL-DPCH-InformationAddListIE-RL-ReconfReadyTDD
  PRESENCE mandatory }
}

DL-DPCH-InformationAddListIE-RL-ReconfReadyTDD ::= SEQUENCE {
  repetitionPeriod          RepetitionPeriod,
  repetitionLength          RepetitionLength,
  tDD-DPCHOffset           TDD-DPCHOffset,
  dL-Timeslot-Information  DL-Timeslot-Information,
  iE-Extensions            ProtocolExtensionContainer { {DL-DPCH-InformationAddItem-RL-ReconfReadyTDD-ExtIEs} } OPTIONAL,
  ...
}

DL-DPCH-InformationAddItem-RL-ReconfReadyTDD-ExtIEs RNSAP-PROTOCOL-EXTENSION ::= {
  ...
}

DL-DPCH-InformationAddList-RL-ReconfReadyTDD768 ::= SEQUENCE {
  repetitionPeriod          RepetitionPeriod,
  repetitionLength          RepetitionLength,
  tDD-DPCHOffset           TDD-DPCHOffset,
  dL-Timeslot-Information768 DL-Timeslot-Information768,
  iE-Extensions            ProtocolExtensionContainer { {DL-DPCH-InformationAddItem-RL-ReconfReadyTDD768-ExtIEs} } OPTIONAL,
  ...
}

```

```

DL-DPCH-InformationAddItem-RL-ReconfReadyTDD768-ExtIEs RNSAP-PROTOCOL-EXTENSION ::= {
  ...
}

DL-DPCH-InformationModifyList-RL-ReconfReadyTDD ::= ProtocolIE-Single-Container {{DL-DPCH-InformationModifyListIEs-RL-ReconfReadyTDD}}

DL-DPCH-InformationModifyListIEs-RL-ReconfReadyTDD RNSAP-PROTOCOL-IES ::= {
  { ID id-DL-DPCH-InformationModifyListIE-RL-ReconfReadyTDD CRITICALITY ignore TYPE DL-DPCH-InformationModifyListIE-RL-ReconfReadyTDD
  PRESENCE mandatory }
}

DL-DPCH-InformationModifyListIE-RL-ReconfReadyTDD ::= SEQUENCE {
  repetitionPeriod RepetitionPeriod OPTIONAL,
  repetitionLength RepetitionLength OPTIONAL,
  tDD-DPCHOffset TDD-DPCHOffset OPTIONAL,
  dL-Timeslot-InformationModifyList-RL-ReconfReadyTDD DL-Timeslot-InformationModifyList-RL-ReconfReadyTDD OPTIONAL,
  --For 3.84Mcps TDD only
  iE-Extensions ProtocolExtensionContainer { {DL-DPCH-InformationModifyItem-RL-ReconfReadyTDD-ExtIEs} } OPTIONAL,
  ...
}

DL-DPCH-InformationModifyItem-RL-ReconfReadyTDD-ExtIEs RNSAP-PROTOCOL-EXTENSION ::= {
  { ID id-DL-Timeslot-LCR-InformationModifyList-RL-ReconfReadyTDD CRITICALITY ignore EXTENSION DL-TimeslotLCR-InformationModifyList-RL-
  ReconfReadyTDD PRESENCE optional }
  --For 1.28Mcps TDD only
  { ID id-DL-Timeslot-InformationModifyList-RL-ReconfReadyTDD768 CRITICALITY ignore EXTENSION DL-Timeslot-InformationModifyList-RL-
  ReconfReadyTDD768 PRESENCE optional },
  --For 7.68Mcps TDD only
  ...
}

DL-TimeslotLCR-InformationModifyList-RL-ReconfReadyTDD ::= SEQUENCE ( SIZE (1..maxNrOfTsLCR)) OF DL-TimeslotLCR-InformationModifyItem-RL-
ReconfReadyTDD

DL-TimeslotLCR-InformationModifyItem-RL-ReconfReadyTDD ::= SEQUENCE {
  timeSlotLCR TimeSlotLCR,
  midambleShiftLCR MidambleShiftLCR OPTIONAL,
  tFCI-Presence TFCI-Presence OPTIONAL,
  tDD-dL-Code-LCR-Information TDD-DL-Code-LCR-InformationModifyList-RL-ReconfReadyTDD OPTIONAL,
  iE-Extensions ProtocolExtensionContainer { {DL-TimeslotLCR-InformationModifyItem-RL-ReconfReadyTDD-ExtIEs} } OPTIONAL,
  ...
}

TDD-DL-Code-LCR-InformationModifyList-RL-ReconfReadyTDD ::= SEQUENCE ( SIZE (1..maxNrOfDPCHsLCR)) OF TDD-DL-Code-LCR-InformationModifyItem-RL-
ReconfReadyTDD

TDD-DL-Code-LCR-InformationModifyItem-RL-ReconfReadyTDD ::= SEQUENCE {
  dPCH-ID DPCH-ID,
  tDD-ChannelisationCodeLCR TDD-ChannelisationCodeLCR OPTIONAL,
  iE-Extensions ProtocolExtensionContainer { {TDD-DL-Code-LCR-InformationModifyItem-RL-ReconfReadyTDD-ExtIEs} } OPTIONAL,
  ...
}

TDD-DL-Code-LCR-InformationModifyItem-RL-ReconfReadyTDD-ExtIEs RNSAP-PROTOCOL-EXTENSION ::= {

```

```

    { ID id-TDD-DL-DPCH-TimeSlotFormatModifyItem-LCR-RL-ReconfReadyTDD      CRITICALITY reject      EXTENSION TDD-DL-DPCH-TimeSlotFormat-LCR
      PRESENCE optional},
    ...
}

DL-TimeslotLCR-InformationModifyItem-RL-ReconfReadyTDD-ExtIEs RNSAP-PROTOCOL-EXTENSION ::= {
  { ID id-Maximum-DL-Power-TimeSlotLCR-InformationModifyItem-RL-ReconfReadyTDD  CRITICALITY ignore      EXTENSION DL-Power      PRESENCE
optional }}|
  { ID id-Minimum-DL-Power-TimeSlotLCR-InformationModifyItem-RL-ReconfReadyTDD  CRITICALITY ignore      EXTENSION DL-Power      PRESENCE
optional },
  ...
}

DL-Timeslot-InformationModifyList-RL-ReconfReadyTDD ::= SEQUENCE ( SIZE (1..maxNrOfTS)) OF DL-Timeslot-InformationModifyItem-RL-ReconfReadyTDD

DL-Timeslot-InformationModifyItem-RL-ReconfReadyTDD ::= SEQUENCE {
  timeSlot                TimeSlot,
  midambleShiftAndBurstType  MidambleShiftAndBurstType      OPTIONAL,
  tFCI-Presence            TFCI-Presence      OPTIONAL,
  dL-Code-Information      TDD-DL-Code-InformationModifyList-RL-ReconfReadyTDD      OPTIONAL,
  iE-Extensions            ProtocolExtensionContainer { {DL-Timeslot-InformationModifyItem-RL-ReconfReadyTDD-ExtIEs} } OPTIONAL,
  ...
}

DL-Timeslot-InformationModifyItem-RL-ReconfReadyTDD-ExtIEs RNSAP-PROTOCOL-EXTENSION ::= {
  ...
}

TDD-DL-Code-InformationModifyList-RL-ReconfReadyTDD ::= SEQUENCE ( SIZE (1..maxNrOfDPCHs)) OF TDD-DL-Code-InformationModifyItem-RL-ReconfReadyTDD

TDD-DL-Code-InformationModifyItem-RL-ReconfReadyTDD ::= SEQUENCE {
  dPCH-ID                DPCH-ID,
  tDD-ChannelisationCode  TDD-ChannelisationCode      OPTIONAL,
  iE-Extensions            ProtocolExtensionContainer { {TDD-DL-Code-InformationModifyItem-RL-ReconfReadyTDD-ExtIEs} } OPTIONAL,
  ...
}

TDD-DL-Code-InformationModifyItem-RL-ReconfReadyTDD-ExtIEs RNSAP-PROTOCOL-EXTENSION ::= {
  { ID id-TDD-DL-DPCH-TimeSlotFormatModifyItem-LCR-RL-ReconfReadyTDD  CRITICALITY reject      EXTENSION TDD-DL-DPCH-TimeSlotFormat-LCR
PRESENCE optional},
  -- This IE shall not be used
  ...
}

DL-Timeslot-InformationModifyList-RL-ReconfReadyTDD768 ::= SEQUENCE ( SIZE (1..maxNrOfTS)) OF DL-Timeslot-InformationModifyItem-RL-ReconfReadyTDD768

DL-Timeslot-InformationModifyItem-RL-ReconfReadyTDD768 ::= SEQUENCE {
  timeSlot                TimeSlot,
  midambleShiftAndBurstType768  MidambleShiftAndBurstType768      OPTIONAL,
  tFCI-Presence            TFCI-Presence      OPTIONAL,
  dL-Code-Information768    TDD-DL-Code-InformationModifyList-RL-ReconfReadyTDD768      OPTIONAL,
  iE-Extensions            ProtocolExtensionContainer { {DL-Timeslot-InformationModifyItem-RL-ReconfReadyTDD768-ExtIEs} } OPTIONAL,
  ...
}

```

```

DL-Timeslot-InformationModifyItem-RL-ReconfReadyTDD768-ExtIEs RNSAP-PROTOCOL-EXTENSION ::= {
    ...
}

TDD-DL-Code-InformationModifyList-RL-ReconfReadyTDD768 ::= SEQUENCE ( SIZE (1..maxNrOfDPCHs768)) OF TDD-DL-Code-InformationModifyItem-RL-
ReconfReadyTDD768

TDD-DL-Code-InformationModifyItem-RL-ReconfReadyTDD768 ::= SEQUENCE {
    dPCH-ID768                DPCH-ID768,
    tDD-ChannelisationCode768 TDD-ChannelisationCode768 OPTIONAL,
    iE-Extensions             ProtocolExtensionContainer { {TDD-DL-Code-InformationModifyItem-RL-ReconfReadyTDD768-ExtIEs} } OPTIONAL,
    ...
}

TDD-DL-Code-InformationModifyItem-RL-ReconfReadyTDD768-ExtIEs RNSAP-PROTOCOL-EXTENSION ::= {
    ...
}

DL-DPCH-InformationDeleteList-RL-ReconfReadyTDD ::= ProtocolIE-Single-Container { {DL-DPCH-InformationDeleteListIEs-RL-ReconfReadyTDD} }

DL-DPCH-InformationDeleteListIEs-RL-ReconfReadyTDD RNSAP-PROTOCOL-IES ::= {
    { ID id-DL-DPCH-InformationDeleteListIE-RL-ReconfReadyTDD CRITICALITY ignore TYPE DL-DPCH-InformationDeleteListIE-RL-ReconfReadyTDD
    PRESENCE mandatory }
}

DL-DPCH-InformationDeleteListIE-RL-ReconfReadyTDD ::= SEQUENCE (SIZE (0..maxNrOfDPCHs)) OF DL-DPCH-InformationDeleteItem-RL-ReconfReadyTDD

DL-DPCH-InformationDeleteItem-RL-ReconfReadyTDD ::= SEQUENCE {
    dPCH-ID                DPCH-ID,
    iE-Extensions          ProtocolExtensionContainer { {DL-DPCH-InformationDeleteList-RL-ReconfReadyTDD-ExtIEs} } OPTIONAL,
    ...
}

DL-DPCH-InformationDeleteList-RL-ReconfReadyTDD-ExtIEs RNSAP-PROTOCOL-EXTENSION ::= {
    ...
}

DL-DPCH-InformationDeleteList768-RL-ReconfReadyTDD ::= SEQUENCE (SIZE (0..maxNrOfDPCHs768)) OF DL-DPCH-InformationDeleteItem768-RL-ReconfReadyTDD

DL-DPCH-InformationDeleteItem768-RL-ReconfReadyTDD ::= SEQUENCE {
    dPCH-ID768                DPCH-ID768,
    iE-Extensions             ProtocolExtensionContainer { {DL-DPCH-InformationDeleteList768-RL-ReconfReadyTDD-ExtIEs} } OPTIONAL,
    ...
}

DL-DPCH-InformationDeleteList768-RL-ReconfReadyTDD-ExtIEs RNSAP-PROTOCOL-EXTENSION ::= {
    ...
}

DCH-InformationResponseList-RL-ReconfReadyTDD ::= ProtocolIE-Single-Container { {DCH-InformationResponseListIEs-RL-ReconfReadyTDD} }

DCH-InformationResponseListIEs-RL-ReconfReadyTDD RNSAP-PROTOCOL-IES ::= {
    { ID id-DCH-InformationResponse CRITICALITY ignore TYPE DCH-InformationResponse PRESENCE mandatory }
}

```

```

}

DSCHToBeAddedOrModified-RL-ReconfReadyTDD ::= ProtocolIE-Single-Container { {DSCHToBeAddedOrModifiedIEs-RL-ReconfReadyTDD} }

DSCHToBeAddedOrModifiedIEs-RL-ReconfReadyTDD RNSAP-PROTOCOL-IES ::= {
  { ID id-DSCHToBeAddedOrModifiedList-RL-ReconfReadyTDD CRITICALITY ignore TYPE DSCHToBeAddedOrModifiedList-RL-ReconfReadyTDD
  PRESENCE mandatory }
}

DSCHToBeAddedOrModifiedList-RL-ReconfReadyTDD ::= SEQUENCE (SIZE (0..maxNoOfDSCHs)) OF DSCHToBeAddedOrModifiedItem-RL-ReconfReadyTDD

DSCHToBeAddedOrModifiedItem-RL-ReconfReadyTDD ::= SEQUENCE {
  dsch-ID DSCH-ID,
  transportFormatManagement TransportFormatManagement,
  dsch-FlowControlInformation DSCH-FlowControlInformation,
  bindingID BindingID OPTIONAL,
  transportLayerAddress TransportLayerAddress OPTIONAL,
  iE-Extensions ProtocolExtensionContainer { {DSCHToBeAddedOrModifiedItem-RL-ReconfReadyTDD-ExtIEs} } OPTIONAL,
  ...
}

DSCHToBeAddedOrModifiedItem-RL-ReconfReadyTDD-ExtIEs RNSAP-PROTOCOL-EXTENSION ::= {
  ...
}

USCHToBeAddedOrModified-RL-ReconfReadyTDD ::= ProtocolIE-Single-Container { {USCHToBeAddedOrModifiedIEs-RL-ReconfReadyTDD} }
}USCHToBeAddedOrModifiedIEs-RL-ReconfReadyTDD RNSAP-PROTOCOL-IES ::= {
  { ID id-USCHToBeAddedOrModifiedList-RL-ReconfReadyTDD CRITICALITY ignore TYPE USCHToBeAddedOrModifiedList-RL-ReconfReadyTDD
  PRESENCE mandatory }
}

USCHToBeAddedOrModifiedList-RL-ReconfReadyTDD ::= SEQUENCE (SIZE (0..maxNoOfUSCHs)) OF USCHToBeAddedOrModifiedItem-RL-ReconfReadyTDD

USCHToBeAddedOrModifiedItem-RL-ReconfReadyTDD ::= SEQUENCE {
  uSCH-ID USCH-ID,
  transportFormatManagement TransportFormatManagement,
  bindingID BindingID OPTIONAL,
  transportLayerAddress TransportLayerAddress OPTIONAL,
  iE-Extensions ProtocolExtensionContainer { {USCHToBeAddedOrModifiedItem-RL-ReconfReadyTDD-ExtIEs} } OPTIONAL,
  ...
}

USCHToBeAddedOrModifiedItem-RL-ReconfReadyTDD-ExtIEs RNSAP-PROTOCOL-EXTENSION ::= {
  ...
}

RadioLinkReconfigurationReadyTDD-Extensions RNSAP-PROTOCOL-EXTENSION ::= {
  { ID id-HSDSCH-RNTI CRITICALITY ignore EXTENSION HSDSCH-RNTI
  PRESENCE optional }|
  { ID id-DSCH-RNTI CRITICALITY ignore EXTENSION DSCH-RNTI
  PRESENCE optional }|
  { ID id-HSDSCH-TDD-Information-Response CRITICALITY ignore EXTENSION HSDSCH-TDD-Information-Response PRESENCE optional }|
  { ID id-MACHs-ResetIndicator CRITICALITY ignore EXTENSION MACHs-ResetIndicator
  PRESENCE optional }|
}

```

```

    { ID id-Multiple-RL-InformationResponse-RL-ReconfReadyTDD CRITICALITY ignore EXTENSION Multiple-RL-InformationResponse-RL-
ReconfReadyTDD PRESENCE optional }|
-- This is for RL repetitions 2 and on in RL list.
    { ID id-E-DCH-Information-Response CRITICALITY ignore EXTENSION E-DCH-Information-Response PRESENCE optional }|
    { ID id-E-DCH-768-Information-Response CRITICALITY ignore EXTENSION E-DCH-768-Information-Response PRESENCE optional }|
    { ID id-E-DCH-LCR-Information-Response CRITICALITY ignore EXTENSION E-DCH-LCR-Information-Response PRESENCE optional }|
    { ID id-PowerControlGAP CRITICALITY ignore EXTENSION ControlGAP PRESENCE optional }|
-- Applicable to 1.28Mcps TDD only
    { ID id-IdleIntervalInformation CRITICALITY ignore EXTENSION IdleIntervalInformation PRESENCE optional }|
    { ID id-ContinuousPacketConnectivity-DRX-Information-ResponseLCR CRITICALITY ignore EXTENSION ContinuousPacketConnectivity-DRX-Information-
ResponseLCR PRESENCE optional }|
    { ID id-HS-DSCH-Semi-PersistentScheduling-Information-ResponseLCR CRITICALITY ignore EXTENSION HS-DSCH-Semi-PersistentScheduling-
Information-ResponseLCR PRESENCE optional }|
    { ID id-E-DCH-Semi-PersistentScheduling-Information-ResponseLCR CRITICALITY ignore EXTENSION E-DCH-Semi-PersistentScheduling-Information-
ResponseLCR PRESENCE optional }|
    { ID id-E-RNTI-For-FACH CRITICALITY ignore EXTENSION E-RNTI PRESENCE optional }|
    { ID id-H-RNTI-For-FACH CRITICALITY ignore EXTENSION HSDSCH-RNTI PRESENCE optional }|
    { ID id-DCH-MeasurementOccasion-Information CRITICALITY reject EXTENSION DCH-MeasurementOccasion-Information PRESENCE optional },
    ...
}

Multiple-RL-InformationResponse-RL-ReconfReadyTDD ::= SEQUENCE (SIZE (1..maxNrOfRLs-1)) OF RL-InformationResponse-RL-ReconfReadyTDD

-- *****
--
-- RADIO LINK RECONFIGURATION COMMIT
--
-- *****

RadioLinkReconfigurationCommit ::= SEQUENCE {
    protocolIEs ProtocolIE-Container {{RadioLinkReconfigurationCommit-IEs}},
    protocolExtensions ProtocolExtensionContainer {{RadioLinkReconfigurationCommit-Extensions}} OPTIONAL,
    ...
}

RadioLinkReconfigurationCommit-IEs RNSAP-PROTOCOL-IES ::= {
    { ID id-CFN CRITICALITY ignore TYPE CFN PRESENCE mandatory }|
    { ID id-Active-Pattern-Sequence-Information CRITICALITY ignore TYPE Active-Pattern-Sequence-Information PRESENCE optional },--FDD
only
    ...
}

RadioLinkReconfigurationCommit-Extensions RNSAP-PROTOCOL-EXTENSION ::= {
    { ID id-Fast-Reconfiguration-Mode CRITICALITY reject EXTENSION Fast-Reconfiguration-Mode PRESENCE optional },--FDD only
    ...
}

-- *****
--
-- RADIO LINK RECONFIGURATION FAILURE
--

```

```

-- *****
RadioLinkReconfigurationFailure ::= SEQUENCE {
    protocolIEs          ProtocolIE-Container    {{RadioLinkReconfigurationFailure-IEs}},
    protocolExtensions   ProtocolExtensionContainer {{RadioLinkReconfigurationFailure-Extensions}}
    ...
}

RadioLinkReconfigurationFailure-IEs RNSAP-PROTOCOL-IES ::= {
    { ID id-CauseLevel-RL-ReconfFailure    CRITICALITY ignore TYPE CauseLevel-RL-ReconfFailure PRESENCE mandatory } |
    { ID id-CriticalityDiagnostics         CRITICALITY ignore TYPE CriticalityDiagnostics PRESENCE optional },
    ...
}

CauseLevel-RL-ReconfFailure ::= CHOICE {
    generalCause          GeneralCauseList-RL-ReconfFailure,
    rLSpecificCause      RLSpecificCauseList-RL-ReconfFailure,
    ...
}

GeneralCauseList-RL-ReconfFailure ::= SEQUENCE {
    cause                 Cause,
    iE-Extensions         ProtocolExtensionContainer { { GeneralCauseItem-RL-ReconfFailure-ExtIEs } }
    OPTIONAL,
    ...
}

GeneralCauseItem-RL-ReconfFailure-ExtIEs RNSAP-PROTOCOL-EXTENSION ::= {
    ...
}

RLSpecificCauseList-RL-ReconfFailure ::= SEQUENCE {
    rL-ReconfigurationFailureList-RL-ReconfFailure    RL-ReconfigurationFailureList-RL-ReconfFailure    OPTIONAL,
    iE-Extensions                                     ProtocolExtensionContainer { { RLSpecificCauseItem-RL-ReconfFailure-ExtIEs } }
    OPTIONAL,
    ...
}

RLSpecificCauseItem-RL-ReconfFailure-ExtIEs RNSAP-PROTOCOL-EXTENSION ::= {
    ...
}

RL-ReconfigurationFailureList-RL-ReconfFailure ::= SEQUENCE (SIZE (0..maxNrOfRLs)) OF ProtocolIE-Single-Container { {RL-ReconfigurationFailure-RL-ReconfFailure-IEs} }

RL-ReconfigurationFailure-RL-ReconfFailure-IEs RNSAP-PROTOCOL-IES ::= {
    { ID id-RL-ReconfigurationFailure-RL-ReconfFail CRITICALITY ignore TYPE RL-ReconfigurationFailure-RL-ReconfFail PRESENCE mandatory }
}

RL-ReconfigurationFailure-RL-ReconfFail ::= SEQUENCE {
    rL-ID          RL-ID,
    cause          Cause,
    iE-Extensions ProtocolExtensionContainer { {RL-ReconfigurationFailure-RL-ReconfFailure-ExtIEs} } OPTIONAL,
    ...
}

```



```

}
RL-ReconfigurationFailure-RL-ReconfFailure-ExtIEs RNSAP-PROTOCOL-EXTENSION ::= {
  { ID id-Max-UE-DTX-Cycle          CRITICALITY ignore          EXTENSION Max-UE-DTX-Cycle          PRESENCE conditional },
  -- This IE shall be present if the Cause IE is set to "Continuous Packet Connectivity UE DTX Cycle not Available".
  ...
}

RadioLinkReconfigurationFailure-Extensions RNSAP-PROTOCOL-EXTENSION ::= {
  ...
}

-- *****
--
-- RADIO LINK RECONFIGURATION CANCEL
--
-- *****

RadioLinkReconfigurationCancel ::= SEQUENCE {
  protocolIEs          ProtocolIE-Container          {{RadioLinkReconfigurationCancel-IEs}},
  protocolExtensions   ProtocolExtensionContainer    {{RadioLinkReconfigurationCancel-Extensions}}          OPTIONAL,
  ...
}

RadioLinkReconfigurationCancel-IEs RNSAP-PROTOCOL-IES ::= {
  ...
}

RadioLinkReconfigurationCancel-Extensions RNSAP-PROTOCOL-EXTENSION ::= {
  ...
}

-- *****
--
-- RADIO LINK RECONFIGURATION REQUEST FDD
--
-- *****

RadioLinkReconfigurationRequestFDD ::= SEQUENCE {
  protocolIEs          ProtocolIE-Container          {{RadioLinkReconfigurationRequestFDD-IEs}},
  protocolExtensions   ProtocolExtensionContainer    {{RadioLinkReconfigurationRequestFDD-Extensions}}          OPTIONAL,
  ...
}

RadioLinkReconfigurationRequestFDD-IEs RNSAP-PROTOCOL-IES ::= {
  { ID id-AllowedQueuingTime          CRITICALITY reject   TYPE AllowedQueuingTime          PRESENCE optional
  } |
  { ID id-UL-DPCH-Information-RL-ReconfRqstFDD          CRITICALITY reject   TYPE UL-DPCH-Information-RL-ReconfRqstFDD          PRESENCE optional
  } |
  { ID id-DL-DPCH-Information-RL-ReconfRqstFDD          CRITICALITY reject   TYPE DL-DPCH-Information-RL-ReconfRqstFDD          PRESENCE optional
  } |
  { ID id-FDD-DCHs-to-Modify          CRITICALITY reject   TYPE FDD-DCHs-to-Modify          PRESENCE optional
  } |

```

```

    { ID id-DCHs-to-Add-FDD                                CRITICALITY reject TYPE DCH-FDD-Information PRESENCE optional
    } |
    { ID id-DCH-DeleteList-RL-ReconfRqstFDD                CRITICALITY reject TYPE DCH-DeleteList-RL-ReconfRqstFDD PRESENCE optional
    } |
    { ID id-Transmission-Gap-Pattern-Sequence-Information CRITICALITY reject TYPE Transmission-Gap-Pattern-Sequence-Information PRESENCE optional
    },
    ...
}

UL-DPCH-Information-RL-ReconfRqstFDD ::= SEQUENCE {
    tFCS                TFCS OPTIONAL,
    iE-Extensions       ProtocolExtensionContainer { {UL-DPCH-Information-RL-ReconfRqstFDD-ExtIEs} } OPTIONAL,
    ...
}

UL-DPCH-Information-RL-ReconfRqstFDD-ExtIEs RNSAP-PROTOCOL-EXTENSION ::= {
    { ID id-UL-DPDCHIndicatorEDCH CRITICALITY reject EXTENSION UL-DPDCHIndicatorEDCH PRESENCE optional },
    ...
}

DL-DPCH-Information-RL-ReconfRqstFDD ::= SEQUENCE {
    tFCS                TFCS OPTIONAL,
    tFCI-SignallingMode TFCS-SignallingMode OPTIONAL,
    limitedPowerIncrease LimitedPowerIncrease OPTIONAL,
    iE-Extensions       ProtocolExtensionContainer { {DL-DPCH-Information-RL-ReconfRqstFDD-ExtIEs} } OPTIONAL,
    ...
}

DL-DPCH-Information-RL-ReconfRqstFDD-ExtIEs RNSAP-PROTOCOL-EXTENSION ::= {
    ...
}

DCH-DeleteList-RL-ReconfRqstFDD ::= SEQUENCE (SIZE (0..maxNrOfDCHs)) OF DCH-DeleteItem-RL-ReconfRqstFDD

DCH-DeleteItem-RL-ReconfRqstFDD ::= SEQUENCE {
    dCH-ID                DCH-ID,
    iE-Extensions         ProtocolExtensionContainer { {DCH-DeleteItem-RL-ReconfRqstFDD-ExtIEs} } OPTIONAL,
    ...
}

DCH-DeleteItem-RL-ReconfRqstFDD-ExtIEs RNSAP-PROTOCOL-EXTENSION ::= {
    ...
}

RadioLinkReconfigurationRequestFDD-Extensions RNSAP-PROTOCOL-EXTENSION ::= {
    { ID id-RL-ReconfigurationRequestFDD-RL-InformationList CRITICALITY ignore EXTENSION RL-ReconfigurationRequestFDD-RL-InformationList PRESENCE optional } |
    { ID id-DL-ReferencePowerInformation CRITICALITY ignore EXTENSION DL-ReferencePowerInformation PRESENCE optional } |
    { ID id-HSDSCH-FDD-Information CRITICALITY reject EXTENSION HSDSCH-FDD-Information PRESENCE optional } |
    { ID id-HSDSCH-Information-to-Modify-Unsynchronised CRITICALITY reject EXTENSION HSDSCH-Information-to-Modify-Unsynchronised PRESENCE optional } |
    { ID id-HSDSCH-MACdFlows-to-Add CRITICALITY reject EXTENSION HSDSCH-MACdFlows-Information PRESENCE optional } |
    { ID id-HSDSCH-MACdFlows-to-Delete CRITICALITY reject EXTENSION HSDSCH-MACdFlows-to-Delete PRESENCE optional }
}

```

```

    { ID id-HSPDSCH-RL-ID                CRITICALITY reject    EXTENSION RL-ID
      PRESENCE optional}|
  { ID id-EDPCH-Information-RLReconfRequest-FDD  CRITICALITY reject    EXTENSION EDPCH-Information-RLReconfRequest-FDD      PRESENCE
optional}|
  { ID id-EDCH-FDD-Information            CRITICALITY reject    EXTENSION EDCH-FDD-Information
  PRESENCE optional}|
  { ID id-EDCH-FDD-Information-To-Modify    CRITICALITY reject    EXTENSION EDCH-FDD-Information-To-Modify      PRESENCE optional}|
  { ID id-EDCH-MACdFlows-To-Add           CRITICALITY reject    EXTENSION EDCH-MACdFlows-Information          PRESENCE
optional}|
  { ID id-EDCH-MACdFlows-To-Delete        CRITICALITY reject    EXTENSION EDCH-MACdFlows-To-Delete            PRESENCE
optional}|
  { ID id-Serving-EDCHRL-Id              CRITICALITY reject    EXTENSION EDCH-Serving-RL
  PRESENCE optional}|
  { ID id-CPC-Information                 CRITICALITY reject    EXTENSION CPC-Information
  PRESENCE optional}|
  { ID id-NoOfTargetCellHS-SCCH-Order     CRITICALITY ignore    EXTENSION NoOfTargetCellHS-SCCH-Order        PRESENCE
optional}|
  { ID id-Additional-HS-Cell-Information-RL-Reconf-Req  CRITICALITY reject    EXTENSION Additional-HS-Cell-Information-RL-Reconf-Req
  PRESENCE optional}|
  { ID id-UE-AggregateMaximumBitRate      CRITICALITY ignore    EXTENSION UE-AggregateMaximumBitRate        PRESENCE
optional }|
  { ID id-Additional-EDCH-Cell-Information-RL-Reconf-Req  CRITICALITY reject    EXTENSION Additional-EDCH-Cell-Information-RL-Reconf-Req
  PRESENCE optional },
  ...
}

```

Additional-HS-Cell-Information-RL-Reconf-Req ::= SEQUENCE (SIZE (1..maxNrOfHSDSCH-1)) OF Additional-HS-Cell-Information-RL-Reconf-Req-ItemIEs

```

Additional-HS-Cell-Information-RL-Reconf-Req-ItemIEs ::=SEQUENCE{
  hSPDSCH-RL-ID                RL-ID,
  c-ID                          C-ID                                OPTIONAL,
  hS-DSCH-FDD-Secondary-Serving-Information  HS-DSCH-FDD-Secondary-Serving-Information  OPTIONAL,
  hS-DSCH-FDD-Secondary-Serving-Information-To-Modify-Unsynchronised  HS-DSCH-FDD-Secondary-Serving-Information-To-Modify-Unsynchronised
  OPTIONAL,
  hS-DSCH-Secondary-Serving-Remove          HS-DSCH-Secondary-Serving-Remove          OPTIONAL,
  iE-Extensions                          ProtocolExtensionContainer { { Additional-HS-Cell-Information-RL-Reconf-Req-ExtIEs } } OPTIONAL,
  ...
}

```

Additional-HS-Cell-Information-RL-Reconf-Req-ExtIEs RNSAP-PROTOCOL-EXTENSION ::= {
 ...
}

```

Additional-EDCH-Cell-Information-RL-Reconf-Req ::=SEQUENCE{
  setup-Or-ConfigurationChange-Or-Removal-Of-EDCH-On-secondary-UL-Frequency  Setup-Or-ConfigurationChange-Or-Removal-Of-EDCH-On-secondary-
  UL-Frequency,
  iE-Extensions                          ProtocolExtensionContainer { { Additional-EDCH-Cell-Information-RL-Reconf-Req-ExtIEs } } OPTIONAL,
  ...
}

```

Additional-EDCH-Cell-Information-RL-Reconf-Req-ExtIEs RNSAP-PROTOCOL-EXTENSION ::= {
 ...
}

```

RL-ReconfigurationRequestFDD-RL-InformationList ::= SEQUENCE (SIZE (0..maxNrOfRLs)) OF ProtocolIE-Single-Container {
    {RL-ReconfigurationRequestFDD-RL-Information-ListItem} }

RL-ReconfigurationRequestFDD-RL-Information-ListItem RNSAP-PROTOCOL-IES ::= {
    { ID id-RL-ReconfigurationRequestFDD-RL-Information-IES CRITICALITY ignore TYPE RL-ReconfigurationRequestFDD-RL-Information-IES PRESENCE
optional } }

RL-ReconfigurationRequestFDD-RL-Information-IES ::= SEQUENCE {
    rL-ID RL-ID,
    rL-Specific-DCH-Info RL-Specific-DCH-Info OPTIONAL,
    iE-Extensions ProtocolExtensionContainer { { RL-ReconfigurationRequestFDD-RL-Information-ExtIES} } OPTIONAL,
    ...
}

RL-ReconfigurationRequestFDD-RL-Information-ExtIES RNSAP-PROTOCOL-EXTENSION ::= {
    { ID id-RL-Specific-EDCH-Information CRITICALITY reject EXTENSION RL-Specific-EDCH-Information PRESENCE optional } |
    { ID id-EDCH-RL-Indication CRITICALITY reject EXTENSION EDCH-RL-Indication PRESENCE
optional } |
    { ID id-HSDSCH-PreconfigurationSetup CRITICALITY ignore EXTENSION HSDSCH-PreconfigurationSetup PRESENCE optional } |
    { ID id-Non-Serving-RL-Preconfig-Setup CRITICALITY ignore EXTENSION Non-Serving-RL-Preconfig-Setup PRESENCE optional } |
    { ID id-Non-Serving-RL-Preconfig-Removal CRITICALITY ignore EXTENSION Non-Serving-RL-Preconfig-Setup PRESENCE optional },
    ...
}

-- *****
--
-- RADIO LINK RECONFIGURATION REQUEST TDD
--
-- *****

RadioLinkReconfigurationRequestTDD ::= SEQUENCE {
    protocolIES ProtocolIE-Container {{RadioLinkReconfigurationRequestTDD-IES}},
    protocolExtensions ProtocolExtensionContainer {{RadioLinkReconfigurationRequestTDD-Extensions}} OPTIONAL,
    ...
}

RadioLinkReconfigurationRequestTDD-IES RNSAP-PROTOCOL-IES ::= {
    { ID id-AllowedQueuingTime CRITICALITY reject TYPE AllowedQueuingTime PRESENCE optional } |
    { ID id-UL-CCTrCH-InformationModifyList-RL-ReconfRqstTDD CRITICALITY notify TYPE UL-CCTrCH-InformationModifyList-RL-ReconfRqstTDD
PRESENCE optional } |
    { ID id-UL-CCTrCH-InformationDeleteList-RL-ReconfRqstTDD CRITICALITY notify TYPE UL-CCTrCH-InformationDeleteList-RL-ReconfRqstTDD
PRESENCE optional } |
    { ID id-DL-CCTrCH-InformationModifyList-RL-ReconfRqstTDD CRITICALITY notify TYPE DL-CCTrCH-InformationModifyList-RL-ReconfRqstTDD
PRESENCE optional } |
    { ID id-DL-CCTrCH-InformationDeleteList-RL-ReconfRqstTDD CRITICALITY notify TYPE DL-CCTrCH-InformationDeleteList-RL-ReconfRqstTDD
PRESENCE optional } |
    { ID id-TDD-DCHs-to-Modify CRITICALITY reject TYPE TDD-DCHs-to-Modify PRESENCE optional } |
    { ID id-DCHs-to-Add-TDD CRITICALITY reject TYPE DCH-TDD-Information PRESENCE optional } |
    { ID id-DCH-DeleteList-RL-ReconfRqstTDD CRITICALITY reject TYPE DCH-DeleteList-RL-ReconfRqstTDD PRESENCE optional },
    ...
}

```

```

UL-CCTrCH-InformationModifyList-RL-ReconfRqstTDD ::= SEQUENCE (SIZE (0..maxNrOfCCTrCHs)) OF ProtocolIE-Single-Container { {UL-CCTrCH-
InformationModifyList-RL-ReconfRqstTDD-IEs} }

UL-CCTrCH-InformationModifyList-RL-ReconfRqstTDD-IEs RNSAP-PROTOCOL-IES ::= {
  { ID id-UL-CCTrCH-InformationModifyItem-RL-ReconfRqstTDD    CRITICALITY notify  TYPE UL-CCTrCH-InformationModifyItem-RL-ReconfRqstTDD
  PRESENCE mandatory }
}

UL-CCTrCH-InformationModifyItem-RL-ReconfRqstTDD ::= SEQUENCE {
  cCCTrCH-ID          CCTrCH-ID,
  tFCS                TFCS      OPTIONAL,
  iE-Extensions      ProtocolExtensionContainer { {UL-CCTrCH-InformationModifyItem-RL-ReconfRqstTDD-ExtIEs} } OPTIONAL,
  ...
}

UL-CCTrCH-InformationModifyItem-RL-ReconfRqstTDD-ExtIEs RNSAP-PROTOCOL-EXTENSION ::= {
  { ID id-UL-SIRTarget    CRITICALITY reject    EXTENSION    UL-SIR    PRESENCE    optional    },
  -- Applicable to 1.28Mcps TDD only
  ...
}

UL-CCTrCH-InformationDeleteList-RL-ReconfRqstTDD ::= SEQUENCE (SIZE (0..maxNrOfCCTrCHs)) OF ProtocolIE-Single-Container { {UL-CCTrCH-
InformationDeleteList-RL-ReconfRqstTDD-IEs} }

UL-CCTrCH-InformationDeleteList-RL-ReconfRqstTDD-IEs RNSAP-PROTOCOL-IES ::= {
  { ID id-UL-CCTrCH-InformationDeleteItem-RL-ReconfRqstTDD    CRITICALITY notify  TYPE UL-CCTrCH-InformationDeleteItem-RL-ReconfRqstTDD
  PRESENCE mandatory }
}

UL-CCTrCH-InformationDeleteItem-RL-ReconfRqstTDD ::= SEQUENCE {
  cCCTrCH-ID          CCTrCH-ID,
  iE-Extensions      ProtocolExtensionContainer { {UL-CCTrCH-InformationDeleteItem-RL-ReconfRqstTDD-ExtIEs} } OPTIONAL,
  ...
}

UL-CCTrCH-InformationDeleteItem-RL-ReconfRqstTDD-ExtIEs RNSAP-PROTOCOL-EXTENSION ::= {
  ...
}

DL-CCTrCH-InformationModifyList-RL-ReconfRqstTDD ::= SEQUENCE (SIZE (0..maxNrOfCCTrCHs)) OF ProtocolIE-Single-Container { {DL-CCTrCH-
InformationModifyList-RL-ReconfRqstTDD-IEs} }

DL-CCTrCH-InformationModifyList-RL-ReconfRqstTDD-IEs RNSAP-PROTOCOL-IES ::= {
  { ID id-DL-CCTrCH-InformationModifyItem-RL-ReconfRqstTDD    CRITICALITY notify  TYPE DL-CCTrCH-InformationModifyItem-RL-ReconfRqstTDD
  PRESENCE mandatory }
}

DL-CCTrCH-InformationModifyItem-RL-ReconfRqstTDD ::= SEQUENCE {
  cCCTrCH-ID          CCTrCH-ID,
  tFCS                TFCS      OPTIONAL,
  iE-Extensions      ProtocolExtensionContainer { {DL-CCTrCH-InformationModifyItem-RL-ReconfRqstTDD-ExtIEs} } OPTIONAL,
  ...
}

```

```

DL-CCTrCH-InformationModifyItem-RL-ReconfRqstTDD-ExtIEs RNSAP-PROTOCOL-EXTENSION ::= {
    ...
}

DL-CCTrCH-InformationDeleteList-RL-ReconfRqstTDD ::= SEQUENCE (SIZE (0..maxNrOfCCTrCHs)) OF ProtocolIE-Single-Container { {DL-CCTrCH-
InformationDeleteList-RL-ReconfRqstTDD-IEs} }

DL-CCTrCH-InformationDeleteList-RL-ReconfRqstTDD-IEs RNSAP-PROTOCOL-IES ::= {
    { ID id-DL-CCTrCH-InformationDeleteItem-RL-ReconfRqstTDD CRITICALITY notify TYPE DL-CCTrCH-InformationDeleteItem-RL-ReconfRqstTDD
    PRESENCE mandatory }
}

DL-CCTrCH-InformationDeleteItem-RL-ReconfRqstTDD ::= SEQUENCE {
    cCTrCH-ID CCTrCH-ID,
    iE-Extensions ProtocolExtensionContainer { {DL-CCTrCH-InformationDeleteItem-RL-ReconfRqstTDD-ExtIEs} } OPTIONAL,
    ...
}

DL-CCTrCH-InformationDeleteItem-RL-ReconfRqstTDD-ExtIEs RNSAP-PROTOCOL-EXTENSION ::= {
    ...
}

DCH-DeleteList-RL-ReconfRqstTDD ::= SEQUENCE (SIZE(0..maxNrOfDCHs)) OF DCH-DeleteItem-RL-ReconfRqstTDD

DCH-DeleteItem-RL-ReconfRqstTDD ::= SEQUENCE {
    dCH-ID DCH-ID,
    iE-Extensions ProtocolExtensionContainer { {DCH-DeleteItem-RL-ReconfRqstTDD-ExtIEs} } OPTIONAL,
    ...
}

DCH-DeleteItem-RL-ReconfRqstTDD-ExtIEs RNSAP-PROTOCOL-EXTENSION ::= {
    ...
}

RadioLinkReconfigurationRequestTDD-Extensions RNSAP-PROTOCOL-EXTENSION ::= {
    { ID id-RL-ReconfigurationRequestTDD-RL-Information CRITICALITY ignore EXTENSION Multiple-RL-ReconfigurationRequestTDD-RL-Information
    PRESENCE optional} |
    { ID id-HSDSCH-TDD-Information CRITICALITY reject EXTENSION HSDSCH-TDD-Information PRESENCE optional} |
    { ID id-HSDSCH-Information-to-Modify-Unsynchronised CRITICALITY reject EXTENSION HSDSCH-Information-to-Modify-Unsynchronised PRESENCE
optional} |
    { ID id-HSDSCH-MACdFlows-to-Add CRITICALITY reject EXTENSION HSDSCH-MACdFlows-Information PRESENCE optional} |
    { ID id-HSDSCH-MACdFlows-to-Delete CRITICALITY reject EXTENSION HSDSCH-MACdFlows-to-Delete PRESENCE optional} |
    { ID id-HSPDSCH-RL-ID CRITICALITY reject EXTENSION RL-ID
    PRESENCE optional} |
    { ID id-E-DCH-Information-Reconfig CRITICALITY reject EXTENSION E-DCH-Information-Reconfig PRESENCE optional } |
    { ID id-E-DCH-Serving-RL-ID CRITICALITY reject EXTENSION RL-ID PRESENCE optional } |
    { ID id-E-DCH-768-Information-Reconfig CRITICALITY reject EXTENSION E-DCH-768-Information-Reconfig PRESENCE optional } |
    { ID id-E-DCH-LCR-Information-Reconfig CRITICALITY reject EXTENSION E-DCH-LCR-Information-Reconfig PRESENCE optional
    } |
    { ID id-CPC-InformationLCR CRITICALITY reject EXTENSION CPC-InformationLCR
    PRESENCE optional } |
    { ID id-RNTI-Allocation-Indicator CRITICALITY ignore EXTENSION RNTI-Allocation-Indicator PRESENCE
optional } |
    { ID id-DCH-MeasurementType-Indicator CRITICALITY reject EXTENSION DCH-MeasurementType-Indicator PRESENCE optional},
}

```

```

}
...
}
Multiple-RL-ReconfigurationRequestTDD-RL-Information ::= SEQUENCE (SIZE (1..maxNrOfRLs)) OF RL-ReconfigurationRequestTDD-RL-Information

RL-ReconfigurationRequestTDD-RL-Information ::= SEQUENCE {
    rL-ID                RL-ID,
    rL-Specific-DCH-Info  RL-Specific-DCH-Info OPTIONAL,
    iE-Extensions         ProtocolExtensionContainer { { RL-ReconfigurationRequestTDD-RL-Information-ExtIEs} } OPTIONAL,
    ...
}

RL-ReconfigurationRequestTDD-RL-Information-ExtIEs RNSAP-PROTOCOL-EXTENSION ::= {
    { ID id-UL-Synchronisation-Parameters-LCR          CRITICALITY ignore  EXTENSION  UL-Synchronisation-Parameters-LCR
    PRESENCE optional  } | -- Mandatory for 1.28Mcps TDD, Not Applicable to 3.84Mcps TDD or 7.68Mcps TDD
    { ID id-NeedforIdleInterval                        CRITICALITY ignore  EXTENSION  NeedforIdleInterval          PRESENCE
optional  },
    ...
}

-- *****
--
-- RADIO LINK RECONFIGURATION RESPONSE FDD
--
-- *****

RadioLinkReconfigurationResponseFDD ::= SEQUENCE {
    protocolIEs                ProtocolIE-Container    {{RadioLinkReconfigurationResponseFDD-IEs}},
    protocolExtensions         ProtocolExtensionContainer {{RadioLinkReconfigurationResponseFDD-Extensions}}
    ...
}

RadioLinkReconfigurationResponseFDD-IEs RNSAP-PROTOCOL-IES ::= {
    { ID id-RL-InformationResponseList-RL-ReconfRspFDD  CRITICALITY ignore  TYPE RL-InformationResponseList-RL-ReconfRspFDD
    PRESENCE optional  } |
    { ID id-CriticalityDiagnostics                      CRITICALITY ignore  TYPE CriticalityDiagnostics      PRESENCE optional  },
    ...
}

RL-InformationResponseList-RL-ReconfRspFDD ::= SEQUENCE (SIZE (0..maxNrOfRLs)) OF ProtocolIE-Single-Container { {RL-InformationResponse-RL-ReconfRspFDD-IEs} }

RL-InformationResponse-RL-ReconfRspFDD-IEs RNSAP-PROTOCOL-IES ::= {
    { ID id-RL-InformationResponseItem-RL-ReconfRspFDD  CRITICALITY ignore  TYPE RL-InformationResponseItem-RL-ReconfRspFDD      PRESENCE
mandatory  }
}

RL-InformationResponseItem-RL-ReconfRspFDD ::= SEQUENCE {
    rL-ID                RL-ID,
    max-UL-SIR           UL-SIR          OPTIONAL,
    min-UL-SIR           UL-SIR          OPTIONAL,
    maximumDLTxPower     DL-Power       OPTIONAL,
    minimumDLTxPower     DL-Power       OPTIONAL,
    not-Used-secondary-CCPCH-Info  NULL          OPTIONAL,
}

```

```

dCHsInformationResponseList    DCH-InformationResponseList-RL-ReconfRspFDD OPTIONAL,
dL-CodeInformationList-RL-ReconfResp    DL-CodeInformationList-RL-ReconfRspFDD OPTIONAL,
IE-Extensions                    ProtocolExtensionContainer { {RL-InformationResponseItem-RL-ReconfRspFDD-ExtIEs} } OPTIONAL,
...
}

RL-InformationResponseItem-RL-ReconfRspFDD-ExtIEs RNSAP-PROTOCOL-EXTENSION ::= {
  { ID id-DL-PowerBalancing-UpdatedIndicator    CRITICALITY ignore    EXTENSION DL-PowerBalancing-UpdatedIndicator    PRESENCE
optional }|
  { ID id-EDCH-FDD-InformationResponse          CRITICALITY ignore    EXTENSION EDCH-FDD-InformationResponse
PRESENCE optional }|
  { ID id-EDCH-RLSet-Id                          CRITICALITY ignore    EXTENSION RL-Set-ID
PRESENCE optional }|
  { ID id-EDCH-FDD-DL-ControlChannelInformation  CRITICALITY ignore    EXTENSION EDCH-FDD-DL-ControlChannelInformation    PRESENCE optional }|
  { ID id-F-DPCH-SlotFormat                      CRITICALITY ignore    EXTENSION F-DPCH-SlotFormat
PRESENCE optional }|
  { ID id-HSDSCH-PreconfigurationInfo            CRITICALITY ignore    EXTENSION HSDSCH-PreconfigurationInfo
PRESENCE optional }|
  { ID id-Non-Serving-RL-Preconfig-Info         CRITICALITY ignore    EXTENSION Non-Serving-RL-Preconfig-Info
PRESENCE optional },
  ...
}

DCH-InformationResponseList-RL-ReconfRspFDD ::= ProtocolIE-Single-Container { {DCH-InformationResponseListIEs-RL-ReconfRspFDD} }

DCH-InformationResponseListIEs-RL-ReconfRspFDD RNSAP-PROTOCOL-IES ::= {
  { ID id-DCH-InformationResponse    CRITICALITY ignore    TYPE DCH-InformationResponse    PRESENCE mandatory    }
}

DL-CodeInformationList-RL-ReconfRspFDD ::= ProtocolIE-Single-Container { { DL-CodeInformationListIEs-RL-ReconfRspFDD } }

DL-CodeInformationListIEs-RL-ReconfRspFDD RNSAP-PROTOCOL-IES ::= {
  { ID id-FDD-DL-CodeInformation    CRITICALITY ignore    TYPE FDD-DL-CodeInformation    PRESENCE optional }
}

RadioLinkReconfigurationResponseFDD-Extensions RNSAP-PROTOCOL-EXTENSION ::= {
  { ID id-HSDSCH-RNTI                CRITICALITY ignore    EXTENSION HSDSCH-RNTI
PRESENCE optional }|
  { ID id-HSDSCH-FDD-Information-Response    CRITICALITY ignore    EXTENSION HSDSCH-FDD-Information-Response    PRESENCE optional }|
  { ID id-MACHs-ResetIndicator              CRITICALITY ignore    EXTENSION MACHs-ResetIndicator
PRESENCE optional }|
  { ID id-Continuous-Packet-Connectivity-HS-SCCH-Less-Information-Response    CRITICALITY ignore    EXTENSION Continuous-
Packet-Connectivity-HS-SCCH-Less-Information-Response    PRESENCE optional }|
  { ID id-Additional-HS-Cell-Information-Response    CRITICALITY ignore    EXTENSION Additional-HS-Cell-Information-Response-List
PRESENCE optional }|
  { ID id-Additional-EDCH-Cell-Information-ResponseRLReconf    CRITICALITY ignore    EXTENSION Additional-EDCH-Cell-Information-Response-
RLReconf-List    PRESENCE optional },
  ...
}

-- *****
--
-- RADIO LINK RECONFIGURATION RESPONSE TDD
--

```



```

-- *****
RadioLinkReconfigurationResponseTDD ::= SEQUENCE {
    protocolIEs                ProtocolIE-Container    {{RadioLinkReconfigurationResponseTDD-IEs}},
    protocolExtensions         ProtocolExtensionContainer {{RadioLinkReconfigurationResponseTDD-Extensions}}
    OPTIONAL,
    ...
}

RadioLinkReconfigurationResponseTDD-IEs RNSAP-PROTOCOL-IES ::= {
    { ID id-RL-InformationResponse-RL-ReconfRspTDD    CRITICALITY ignore    TYPE RL-InformationResponse-RL-ReconfRspTDD    PRESENCE
optional } |
    --This RL-InformationResponse-RL-ReconfRspTDD is for the first RL repetition in the list.
    --Repetitions 2 and on are defined in Multiple-RL-InformationResponse-RL-ReconfRspTDD.
    { ID id-CriticalityDiagnostics    CRITICALITY ignore    TYPE CriticalityDiagnostics    PRESENCE optional    },
    ...
}

RL-InformationResponse-RL-ReconfRspTDD ::= SEQUENCE {
    rL-ID                RL-ID,
    max-UL-SIR           UL-SIR            OPTIONAL,
    min-UL-SIR           UL-SIR            OPTIONAL,
    maximumDLTxPower     DL-Power        OPTIONAL,
    minimumDLTxPower     DL-Power        OPTIONAL,
    dChsInformationResponseList    DCH-InformationResponseList-RL-ReconfRspTDD    OPTIONAL,
    iE-Extensions        ProtocolExtensionContainer { {RL-InformationResponse-RL-ReconfRspTDD-ExtIEs} } OPTIONAL,
    ...
}

RL-InformationResponse-RL-ReconfRspTDD-ExtIEs RNSAP-PROTOCOL-EXTENSION ::= {
    { ID id-DL-CCTrCH-InformationList-RL-ReconfRspTDD    CRITICALITY ignore    EXTENSION DL-CCTrCH-InformationList-RL-ReconfRspTDD    PRESENCE
optional } |
    { ID id-UL-TimingAdvanceCtrl-LCR                    CRITICALITY ignore    EXTENSION UL-TimingAdvanceCtrl-LCR                    PRESENCE optional },
    --For 1.28Mcps TDD only
    ...
}

DL-CCTrCH-InformationList-RL-ReconfRspTDD ::= SEQUENCE (SIZE (1..maxNrOfCCTrCHs)) OF DL-CCTrCH-InformationItem-RL-ReconfRspTDD

DL-CCTrCH-InformationItem-RL-ReconfRspTDD ::= SEQUENCE {
    cCtRCH-ID                CCTrCH-ID,
    dl-DPCH-ModifyInformation-LCR    DL-DPCH-InformationModifyList-LCR-RL-ReconfRspTDD    OPTIONAL,
    --For 1.28Mcps TDD only
    cCtRCH-Maximum-DL-Power        DL-Power            OPTIONAL,
    --For 3.84Mcps TDD and 7.68Mcps TDD only, this is a DCH type CCTrCH power
    cCtRCH-Minimum-DL-Power        DL-Power            OPTIONAL,
    --For 3.84Mcps TDD and 7.68Mcps TDD only, this is a DCH type CCTrCH power
    iE-Extensions                ProtocolExtensionContainer { { DL-CCTrCH-InformationItem-RL-ReconfRspTDD-ExtIEs} }
OPTIONAL,
    ...
}

DL-CCTrCH-InformationItem-RL-ReconfRspTDD-ExtIEs RNSAP-PROTOCOL-EXTENSION ::= {
    ...
}

```

```

DL-DPCH-InformationModifyList-LCR-RL-ReconfRspTDD ::= ProtocolIE-Single-Container { { DL-DPCH-InformationModifyListIEs-LCR-RL-ReconfRspTDD } }

DL-DPCH-InformationModifyListIEs-LCR-RL-ReconfRspTDD RNSAP-PROTOCOL-IES ::= {
  { ID id-DL-DPCH-InformationModifyItem-LCR-RL-ReconfRspTDD CRITICALITY ignore TYPE DL-DPCH-InformationModifyItem-LCR-RL-ReconfRspTDD
  PRESENCE optional },
  ...
}

DL-DPCH-InformationModifyItem-LCR-RL-ReconfRspTDD ::= SEQUENCE {
  dL-Timeslot-LCR-InformationModifyList-RL-ReconfRgstTDD DL-Timeslot-LCR-InformationModifyList-RL-ReconfRspTDD OPTIONAL,
  iE-ExtensionsProtocolExtensionContainer { { DL-DPCH-InformationModifyItem-LCR-RL-ReconfRspTDD-ExtIEs } } OPTIONAL,
  ...
}

DL-DPCH-InformationModifyItem-LCR-RL-ReconfRspTDD-ExtIEs RNSAP-PROTOCOL-EXTENSION ::= {
  ...
}

DL-Timeslot-LCR-InformationModifyList-RL-ReconfRspTDD ::= SEQUENCE (SIZE (1..maxNrOfDLTsLCR)) OF DL-Timeslot-LCR-InformationModifyItem-RL-
ReconfRspTDD

DL-Timeslot-LCR-InformationModifyItem-RL-ReconfRspTDD ::= SEQUENCE {
  timeSlotLCR TimeSlotLCR,
  maxPowerLCR DL-Power OPTIONAL,
  minPowerLCR DL-Power OPTIONAL,
  iE-Extensions ProtocolExtensionContainer { { DL-Timeslot-LCR-InformationModifyItem-RL-ReconfRspTDD-ExtIEs } }
  OPTIONAL,
  ...
}

DL-Timeslot-LCR-InformationModifyItem-RL-ReconfRspTDD-ExtIEs RNSAP-PROTOCOL-EXTENSION ::= {
  ...
}

DCH-InformationResponseList-RL-ReconfRspTDD ::= ProtocolIE-Single-Container { { DCH-InformationResponseListIEs-RL-ReconfRspTDD } }

DCH-InformationResponseListIEs-RL-ReconfRspTDD RNSAP-PROTOCOL-IES ::= {
  { ID id-DCH-InformationResponse CRITICALITY ignore TYPE DCH-InformationResponse PRESENCE optional }
}

RadioLinkReconfigurationResponseTDD-Extensions RNSAP-PROTOCOL-EXTENSION ::= {
  { ID id-HSDSCH-RNTI CRITICALITY ignore EXTENSION HSDSCH-RNTI
  PRESENCE optional }|
  { ID id-HSDSCH-TDD-Information-Response CRITICALITY ignore EXTENSION HSDSCH-TDD-Information-Response PRESENCE optional }|
  { ID id-MACHs-ResetIndicator CRITICALITY ignore EXTENSION MACHs-ResetIndicator
  PRESENCE optional }|
  { ID id-RL-ReconfigurationResponseTDD-RL-Information CRITICALITY ignore EXTENSION Multiple-RL-InformationResponse-RL-ReconfRspTDD
  PRESENCE optional }|
  { ID id-E-DCH-Information-Response CRITICALITY ignore EXTENSION E-DCH-Information-Response PRESENCE optional }|
  { ID id-E-DCH-768-Information-Response CRITICALITY ignore EXTENSION E-DCH-768-Information-Response PRESENCE optional }|
  { ID id-E-DCH-LCR-Information-Response CRITICALITY ignore EXTENSION E-DCH-LCR-Information-Response PRESENCE optional }|
  { ID id-PowerControlGAP CRITICALITY ignore EXTENSION ControlGAP PRESENCE optional }|
  -- Applicable to 1.28Mcps TDD only
}

```

```

    { ID id-IdleIntervalInformation          CRITICALITY ignore      EXTENSION IdleIntervalInformation          PRESENCE
optional }|
    { ID id-ContinuousPacketConnectivity-DRX-Information-ResponseLCR
ResponseLCR          PRESENCE optional }|
    { ID id-HS-DSCH-Semi-PersistentScheduling-Information-ResponseLCR
Information-ResponseLCR          PRESENCE optional }|
    { ID id-E-DCH-Semi-PersistentScheduling-Information-ResponseLCR
Information-ResponseLCR          PRESENCE optional }|
    { ID id-E-RNTI-For-FACH                  CRITICALITY ignore      EXTENSION E-RNTI
PRESENCE optional }|
    { ID id-H-RNTI-For-FACH                  CRITICALITY ignore      EXTENSION HSDSCH-RNTI
PRESENCE optional }|
    { ID id-DCH-MeasurementOccasion-Information
CRITICALITY reject      EXTENSION DCH-MeasurementOccasion-Information          PRESENCE optional },
    ...
}

Multiple-RL-InformationResponse-RL-ReconfRspTDD ::= SEQUENCE (SIZE (1..maxNrOfRLs-1)) OF RL-InformationResponse-RL-ReconfRspTDD
--Includes the 2nd through the max number of radio link information repetitions.

-- *****
--
-- RADIO LINK FAILURE INDICATION
--
-- *****

RadioLinkFailureIndication ::= SEQUENCE {
    protocolIEs          ProtocolIE-Container          {{RadioLinkFailureIndication-IEs}},
    protocolExtensions   ProtocolExtensionContainer    {{RadioLinkFailureIndication-Extensions}}          OPTIONAL,
    ...
}

RadioLinkFailureIndication-IEs RNSAP-PROTOCOL-IES ::= {
    { ID id-Reporting-Object-RL-FailureInd CRITICALITY ignore TYPE Reporting-Object-RL-FailureInd          PRESENCE mandatory },
    ...
}

Reporting-Object-RL-FailureInd ::= CHOICE {
    rL          RL-RL-FailureInd,
    rL-Set      RL-Set-RL-FailureInd, --FDD only
    ...,
    cCTrCH      CCTrCH-RL-FailureInd --TDD only
}

RL-RL-FailureInd ::= SEQUENCE {
    rL-InformationList-RL-FailureInd          RL-InformationList-RL-FailureInd,
    iE-Extensions          ProtocolExtensionContainer { { RLItem-RL-FailureInd-ExtIEs} } OPTIONAL,
    ...
}

RLItem-RL-FailureInd-ExtIEs RNSAP-PROTOCOL-EXTENSION ::= {
    ...
}

```

```

RL-InformationList-RL-FailureInd ::= SEQUENCE (SIZE (1..maxNrOfRLs)) OF ProtocolIE-Single-Container { {RL-Information-RL-FailureInd-IEs}
}

RL-Information-RL-FailureInd-IEs RNSAP-PROTOCOL-IES ::= {
  { ID id-RL-Information-RL-FailureInd          CRITICALITY ignore  TYPE RL-Information-RL-FailureInd          PRESENCE mandatory    }
}

RL-Information-RL-FailureInd ::= SEQUENCE {
  rL-ID          RL-ID,
  cause          Cause,
  iE-Extensions ProtocolExtensionContainer { {RL-Information-RL-FailureInd-ExtIEs} } OPTIONAL,
  ...
}

RL-Information-RL-FailureInd-ExtIEs RNSAP-PROTOCOL-EXTENSION ::= {
  ...
}

RL-Set-RL-FailureInd ::= SEQUENCE {
  rL-Set-InformationList-RL-FailureInd  RL-Set-InformationList-RL-FailureInd,
  iE-Extensions                        ProtocolExtensionContainer { { RL-SetItem-RL-FailureInd-ExtIEs} } OPTIONAL,
  ...
}

RL-SetItem-RL-FailureInd-ExtIEs RNSAP-PROTOCOL-EXTENSION ::= {
  ...
}

RL-Set-InformationList-RL-FailureInd ::= SEQUENCE (SIZE (1..maxNrOfRLSets)) OF ProtocolIE-Single-Container { {RL-Set-Information-RL-
FailureInd-IEs} }

RL-Set-Information-RL-FailureInd-IEs RNSAP-PROTOCOL-IES ::= {
  { ID id-RL-Set-Information-RL-FailureInd          CRITICALITY ignore  TYPE RL-Set-Information-RL-FailureInd          PRESENCE mandatory    }
}

RL-Set-Information-RL-FailureInd ::= SEQUENCE {
  rL-Set-ID          RL-Set-ID,
  cause              Cause,
  iE-Extensions      ProtocolExtensionContainer { {RL-Set-Information-RL-FailureInd-ExtIEs} } OPTIONAL,
  ...
}

RL-Set-Information-RL-FailureInd-ExtIEs RNSAP-PROTOCOL-EXTENSION ::= {
  ...
}

RadioLinkFailureIndication-Extensions RNSAP-PROTOCOL-EXTENSION ::= {
  ...
}

CCTrCH-RL-FailureInd ::= SEQUENCE {
  rL-ID          RL-ID,
  CCTrCH-InformationList-RL-FailureInd  CCTrCH-InformationList-RL-FailureInd,
  iE-Extensions ProtocolExtensionContainer { { CCTrCHItem-RL-FailureInd-ExtIEs } }          OPTIONAL,
}

```

```

    ...
  }
CCTrCHItem-RL-FailureInd-ExtIEs RNSAP-PROTOCOL-EXTENSION ::= {
  ...
}
CCTrCH-InformationList-RL-FailureInd ::= SEQUENCE (SIZE (1..maxNrOfCCTrCHs)) OF ProtocolIE-Single-Container {{ CCTrCH-InformationItemIE-RL-
FailureInd}}
CCTrCH-InformationItemIE-RL-FailureInd RNSAP-PROTOCOL-IES ::= {
  { ID id-CCTrCH-InformationItem-RL-FailureInd CRITICALITY ignore TYPE CCTrCH-InformationItem-RL-FailureInd
  PRESENCE mandatory}
}
CCTrCH-InformationItem-RL-FailureInd ::= SEQUENCE {
  cCTrCH-ID CCTrCH-ID,
  cause Cause,
  iE-Extensions ProtocolExtensionContainer { { CCTrCH-InformationItem-RL-FailureInd-ExtIEs } } OPTIONAL,
  ...
}
CCTrCH-InformationItem-RL-FailureInd-ExtIEs RNSAP-PROTOCOL-EXTENSION ::= {
  ...
}
-- *****
--
-- RADIO LINK PREEMPTION REQUIRED INDICATION
--
-- *****

RadioLinkPreemptionRequiredIndication ::= SEQUENCE {
  protocolIEs ProtocolIE-Container {{RadioLinkPreemptionRequiredIndication-IEs}},
  protocolExtensions ProtocolExtensionContainer {{RadioLinkPreemptionRequiredIndication-Extensions}} OPTIONAL,
  ...
}
RadioLinkPreemptionRequiredIndication-IEs RNSAP-PROTOCOL-IES ::= {
  { ID id-RL-InformationList-RL-PreemptRequiredInd CRITICALITY ignore TYPE RL-InformationList-RL-PreemptRequiredInd PRESENCE
optional },
  ...
}
RL-InformationList-RL-PreemptRequiredInd ::= SEQUENCE (SIZE (1..maxNrOfRLs)) OF ProtocolIE-Single-Container { {RL-InformationItemIEs-RL-
PreemptRequiredInd} }
RL-InformationItemIEs-RL-PreemptRequiredInd RNSAP-PROTOCOL-IES ::= {
  { ID id-RL-InformationItem-RL-PreemptRequiredInd CRITICALITY ignore TYPE RL-InformationItem-RL-PreemptRequiredInd PRESENCE
mandatory }
}
RL-InformationItem-RL-PreemptRequiredInd ::= SEQUENCE {
  rL-ID RL-ID,

```

```

    iE-Extensions          ProtocolExtensionContainer { {RL-Information-RL-PreemptRequiredInd-ExtIEs} } OPTIONAL,
  }
  ...
}

RL-Information-RL-PreemptRequiredInd-ExtIEs RNSAP-PROTOCOL-EXTENSION ::= {
  { ID id-EDCH-MacFlowSpecificInformationList-RL-PreemptRequiredInd CRITICALITY ignore EXTENSION EDCH-MacFlowSpecificInformationList-RL-
  PreemptRequiredInd PRESENCE optional },
  ...
}

RadioLinkPreemptionRequiredIndication-Extensions RNSAP-PROTOCOL-EXTENSION ::= {
  { ID id-HSDSCHMacFlowSpecificInformationList-RL-PreemptRequiredInd CRITICALITY ignore EXTENSION HSDSCHMacFlowSpecificInformationList-RL-
  PreemptRequiredInd PRESENCE optional },
  ...
}

HSDSCHMacFlowSpecificInformationList-RL-PreemptRequiredInd ::= SEQUENCE (SIZE (1.. maxNrOfMACdFlows)) OF ProtocolIE-Single-Container {
  {HSDSCHMacFlowSpecificInformationItemIEs-RL-PreemptRequiredInd} }

HSDSCHMacFlowSpecificInformationItemIEs-RL-PreemptRequiredInd RNSAP-PROTOCOL-IES ::= {
  { ID id-HSDSCHMacFlowSpecificInformationItem-RL-PreemptRequiredInd CRITICALITY ignore TYPE HSDSCHMacFlowSpecificInformationItem-RL-
  PreemptRequiredInd PRESENCE mandatory }
}

HSDSCHMacFlowSpecificInformationItem-RL-PreemptRequiredInd ::= SEQUENCE {
  hSDSCH-MACdFlow-ID          HSDSCH-MACdFlow-ID,
  iE-Extensions          ProtocolExtensionContainer { { HSDSCHMacFlowSpecificInformation-RL-PreemptRequiredInd-ExtIEs} } OPTIONAL,
  ...
}

HSDSCHMacFlowSpecificInformation-RL-PreemptRequiredInd-ExtIEs RNSAP-PROTOCOL-EXTENSION ::= {
  ...
}

EDCH-MacFlowSpecificInformationList-RL-PreemptRequiredInd ::= SEQUENCE (SIZE (1.. maxNrOfEDCHMACdFlows)) OF ProtocolIE-Single-Container { {EDCH-
MacFlowSpecificInformationItemIEs-RL-PreemptRequiredInd} }

EDCH-MacFlowSpecificInformationItemIEs-RL-PreemptRequiredInd RNSAP-PROTOCOL-IES ::= {
  { ID id-EDCH-MacFlowSpecificInformationItem-RL-PreemptRequiredInd CRITICALITY ignore TYPE EDCH-MacFlowSpecificInformationItem-RL-
  PreemptRequiredInd PRESENCE mandatory }
}

EDCH-MacFlowSpecificInformationItem-RL-PreemptRequiredInd ::= SEQUENCE {
  eDCH-MACdFlow-ID          EDCH-MACdFlow-ID,
  iE-Extensions          ProtocolExtensionContainer { { EDCH-MacFlowSpecificInformation-RL-PreemptRequiredInd-ExtIEs} } OPTIONAL,
  ...
}

EDCH-MacFlowSpecificInformation-RL-PreemptRequiredInd-ExtIEs RNSAP-PROTOCOL-EXTENSION ::= {
  ...
}

-- *****

```

```

--
-- RADIO LINK RESTORE INDICATION
--
-- *****

RadioLinkRestoreIndication ::= SEQUENCE {
    protocolIEs                ProtocolIE-Container    {{RadioLinkRestoreIndication-IEs}},
    protocolExtensions         ProtocolExtensionContainer {{RadioLinkRestoreIndication-Extensions}}      OPTIONAL,
    ...
}

RadioLinkRestoreIndication-IEs RNSAP-PROTOCOL-IES ::= {
    { ID id-Reporting-Object-RL-RestoreInd    CRITICALITY ignore    TYPE Reporting-Object-RL-RestoreInd          PRESENCE mandatory    },
    ...
}

Reporting-Object-RL-RestoreInd ::= CHOICE {
    rL                        RL-RL-RestoreInd, --TDD only
    rL-Set                    RL-Set-RL-RestoreInd, --FDD only
    ...,
    cCTrCH                    CCTrCH-RL-RestoreInd --TDD only
}

RL-RL-RestoreInd ::= SEQUENCE {
    rL-InformationList-RL-RestoreInd    RL-InformationList-RL-RestoreInd,
    iE-Extensions                      ProtocolExtensionContainer { { RLItem-RL-RestoreInd-ExtIEs } } OPTIONAL,
    ...
}

RLItem-RL-RestoreInd-ExtIEs RNSAP-PROTOCOL-EXTENSION ::= {
    ...
}

RL-InformationList-RL-RestoreInd ::= SEQUENCE (SIZE (1..maxNrOfRLs)) OF ProtocolIE-Single-Container { {RL-Information-RL-RestoreInd-IEs} }

RL-Information-RL-RestoreInd-IEs RNSAP-PROTOCOL-IES ::= {
    { ID id-RL-Information-RL-RestoreInd    CRITICALITY ignore    TYPE RL-Information-RL-RestoreInd          PRESENCE mandatory    }
}

RL-Information-RL-RestoreInd ::= SEQUENCE {
    rL-ID                        RL-ID,
    iE-Extensions                ProtocolExtensionContainer { {RL-Information-RL-RestoreInd-ExtIEs} } OPTIONAL,
    ...
}

RL-Information-RL-RestoreInd-ExtIEs RNSAP-PROTOCOL-EXTENSION ::= {
    ...
}

RL-Set-RL-RestoreInd ::= SEQUENCE {
    rL-Set-InformationList-RL-RestoreInd    RL-Set-InformationList-RL-RestoreInd,
    iE-Extensions                          ProtocolExtensionContainer { { RL-SetItem-RL-RestoreInd-ExtIEs } } OPTIONAL,
    ...
}

```

```

}

RL-SetItem-RL-RestoreInd-ExtIEs RNSAP-PROTOCOL-EXTENSION ::= {
    ...
}

RL-Set-InformationList-RL-RestoreInd ::= SEQUENCE (SIZE (1..maxNrOfRLSets)) OF ProtocolIE-Single-Container { {RL-Set-Information-RL-
RestoreInd-IEs} }

RL-Set-Information-RL-RestoreInd-IEs RNSAP-PROTOCOL-IES ::= {
    { ID id-RL-Set-Information-RL-RestoreInd          CRITICALITY ignore   TYPE RL-Set-Information-RL-RestoreInd          PRESENCE mandatory    }
}

RL-Set-Information-RL-RestoreInd ::= SEQUENCE {
    rL-Set-ID          RL-Set-ID,
    iE-Extensions      ProtocolExtensionContainer { {RL-Set-Information-RL-RestoreInd-ExtIEs} } OPTIONAL,
    ...
}

RL-Set-Information-RL-RestoreInd-ExtIEs RNSAP-PROTOCOL-EXTENSION ::= {
    ...
}

RadioLinkRestoreIndication-Extensions RNSAP-PROTOCOL-EXTENSION ::= {
    ...
}

CCTrCH-RL-RestoreInd ::= SEQUENCE {
    rL-ID          RL-ID,
    cCTrCH-InformationList-RL-RestoreInd          CCTrCH-InformationList-RL-RestoreInd,
    iE-Extensions      ProtocolExtensionContainer { { CCTrCHItem-RL-RestoreInd-ExtIEs } }          OPTIONAL,
    ...
}

CCTrCHItem-RL-RestoreInd-ExtIEs RNSAP-PROTOCOL-EXTENSION ::= {
    ...
}

CCTrCH-InformationList-RL-RestoreInd ::= SEQUENCE (SIZE (1..maxNrOfCCTrCHs)) OF ProtocolIE-Single-Container {{ CCTrCH-InformationItemIE-RL-
RestoreInd}}

CCTrCH-InformationItemIE-RL-RestoreInd RNSAP-PROTOCOL-IES ::= {
    { ID          id-CCTrCH-InformationItem-RL-RestoreInd          CRITICALITY          ignore          TYPE CCTrCH-InformationItem-RL-RestoreInd
PRESENCE          mandatory}
}

CCTrCH-InformationItem-RL-RestoreInd ::= SEQUENCE {
    cCTrCH-ID          CCTrCH-ID,
    iE-Extensions      ProtocolExtensionContainer { { CCTrCH-InformationItem-RL-RestoreInd-ExtIEs } }          OPTIONAL,
    ...
}

CCTrCH-InformationItem-RL-RestoreInd-ExtIEs RNSAP-PROTOCOL-EXTENSION ::= {
    ...
}

```



```

}
-- *****
--
-- DOWNLINK POWER CONTROL REQUEST
--
-- *****

DL-PowerControlRequest ::= SEQUENCE {
    protocolIEs          ProtocolIE-Container    {{DL-PowerControlRequest-IEs}},
    protocolExtensions   ProtocolExtensionContainer {{DL-PowerControlRequest-Extensions}}    OPTIONAL,
    ...
}

DL-PowerControlRequest-IEs RNSAP-PROTOCOL-IES ::= {
    { ID id-PowerAdjustmentType          CRITICALITY ignore          TYPE PowerAdjustmentType          PRESENCE mandatory } |
    { ID id-DLReferencePower              CRITICALITY ignore          TYPE DL-Power                      PRESENCE conditional }
    |
    -- This IE shall be present if Power Adjustment Type IE equals to 'Common'
    { ID id-InnerLoopDLPCStatus           CRITICALITY ignore          TYPE InnerLoopDLPCStatus           PRESENCE optional } |
    { ID id-DLReferencePowerList-DL-PC-Rqst CRITICALITY ignore          TYPE DL-ReferencePowerInformationList-DL-PC-Rqst PRESENCE conditional }
    |
    -- This IE shall be present if Power Adjustment Type IE equals to 'Individual'
    { ID id-MaxAdjustmentStep             CRITICALITY ignore          TYPE MaxAdjustmentStep             PRESENCE conditional }
    |
    -- This IE shall be present if Power Adjustment Type IE equals to 'Common' or 'Individual'
    { ID id-AdjustmentPeriod              CRITICALITY ignore          TYPE AdjustmentPeriod              PRESENCE conditional }
} |
-- This IE shall be present if Power Adjustment Type IE equals to 'Common' or 'Individual'
{ ID id-AdjustmentRatio                  CRITICALITY ignore          TYPE ScaledAdjustmentRatio         PRESENCE conditional }
},
-- This IE shall be present if Power Adjustment Type IE equals to 'Common' or 'Individual'
...
}

DL-ReferencePowerInformationList-DL-PC-Rqst ::= SEQUENCE (SIZE (1..maxNrOfRLs)) OF ProtocolIE-Single-Container { {DL-ReferencePowerInformation-DL-PC-Rqst-IEs} }

DL-ReferencePowerInformation-DL-PC-Rqst-IEs RNSAP-PROTOCOL-IES ::= {
    { ID id-DL-ReferencePowerInformation-DL-PC-Rqst CRITICALITY ignore TYPE DL-ReferencePowerInformation-DL-PC-Rqst PRESENCE mandatory }
}

DL-ReferencePowerInformation-DL-PC-Rqst ::= SEQUENCE {
    rL-ID          RL-ID,
    dl-Reference-Power DL-Power,
    iE-Extensions  ProtocolExtensionContainer { {DL-ReferencePowerInformation-DL-PC-Rqst-ExtIEs} } OPTIONAL,
    ...
}

DL-ReferencePowerInformation-DL-PC-Rqst-ExtIEs RNSAP-PROTOCOL-EXTENSION ::= {
    ...
}

DL-PowerControlRequest-Extensions RNSAP-PROTOCOL-EXTENSION ::= {

```

```

}
...
}
-- *****
--
-- DOWNLINK POWER TIMESLOT CONTROL REQUEST TDD
--
-- *****

DL-PowerTimeslotControlRequest ::= SEQUENCE {
    protocolIEs                ProtocolIE-Container    {{DL-PowerTimeslotControlRequest-IEs}},
    protocolExtensions         ProtocolExtensionContainer {{DL-PowerTimeslotControlRequest-Extensions}}      OPTIONAL,
    ...
}

DL-PowerTimeslotControlRequest-IEs RNSAP-PROTOCOL-IES ::= {
    { ID id-timeSlot-ISCP    CRITICALITY ignore  TYPE DL-TimeSlot-ISCP-Info  PRESENCE optional},
    --Mandatory for 3.84Mcps TDD and 7.68 Mcps TDD only
    ...
}

DL-PowerTimeslotControlRequest-Extensions RNSAP-PROTOCOL-EXTENSION ::= {
    { ID id-timeSlot-ISCP-LCR-List-DL-PC-Rqst-TDD    CRITICALITY ignore      EXTENSION DL-TimeSlot-ISCP-LCR-Information PRESENCE optional}|
    --Mandatory for 1.28Mcps TDD only
    { ID id-PrimCCPCH-RSCP-DL-PC-RqstTDD            CRITICALITY ignore      EXTENSION PrimaryCCPCH-RSCP
    PRESENCE optional }|
    { ID id-PrimaryCCPCH-RSCP-Delta                 CRITICALITY ignore      EXTENSION PrimaryCCPCH-RSCP-Delta
    PRESENCE optional },
    ...
}

-- *****
--
-- PHYSICAL CHANNEL RECONFIGURATION REQUEST FDD
--
-- *****

PhysicalChannelReconfigurationRequestFDD ::= SEQUENCE {
    protocolIEs                ProtocolIE-Container    {{PhysicalChannelReconfigurationRequestFDD-IEs}},
    protocolExtensions         ProtocolExtensionContainer {{PhysicalChannelReconfigurationRequestFDD-Extensions}}      OPTIONAL,
    ...
}

PhysicalChannelReconfigurationRequestFDD-IEs RNSAP-PROTOCOL-IES ::= {
    { ID id-RL-Information-PhyChReconfRqstFDD    CRITICALITY reject  TYPE RL-Information-PhyChReconfRqstFDD      PRESENCE mandatory    },
    ...
}

RL-Information-PhyChReconfRqstFDD ::= SEQUENCE {
    rL-ID                        RL-ID,
    dl-CodeInformation           DL-CodeInformationList-PhyChReconfRqstFDD,
    iE-Extensions               ProtocolExtensionContainer { {RL-Information-PhyChReconfRqstFDD-ExtIEs} } OPTIONAL,
    ...
}

```

```

RL-Information-PhyChReconfRqstFDD-ExtIEs RNSAP-PROTOCOL-EXTENSION ::= {
  { ID id-F-DPCH-SlotFormat          CRITICALITY ignore  EXTENSION F-DPCH-SlotFormat    PRESENCE optional },
  ...
}

DL-CodeInformationList-PhyChReconfRqstFDD ::= ProtocolIE-Single-Container { {DL-CodeInformationListIEs-PhyChReconfRqstFDD} }

DL-CodeInformationListIEs-PhyChReconfRqstFDD RNSAP-PROTOCOL-IES ::= {
  { ID id-FDD-DL-CodeInformation  CRITICALITY notify  TYPE FDD-DL-CodeInformation PRESENCE mandatory }
}

PhysicalChannelReconfigurationRequestFDD-Extensions RNSAP-PROTOCOL-EXTENSION ::= {
  ...
}

-- *****
--
-- PHYSICAL CHANNEL RECONFIGURATION REQUEST TDD
--
-- *****

PhysicalChannelReconfigurationRequestTDD ::= SEQUENCE {
  protocolIEs          ProtocolIE-Container    {{PhysicalChannelReconfigurationRequestTDD-IEs}},
  protocolExtensions   ProtocolExtensionContainer {{PhysicalChannelReconfigurationRequestTDD-Extensions}}      OPTIONAL,
  ...
}

PhysicalChannelReconfigurationRequestTDD-IEs RNSAP-PROTOCOL-IES ::= {
  { ID id-RL-Information-PhyChReconfRqstTDD  CRITICALITY reject  TYPE RL-Information-PhyChReconfRqstTDD    PRESENCE mandatory },
  ...
}

RL-Information-PhyChReconfRqstTDD ::= SEQUENCE {
  rL-ID                RL-ID,
  ul-CCTrCH-Information  UL-CCTrCH-InformationList-PhyChReconfRqstTDD  OPTIONAL,
  dl-CCTrCH-Information  DL-CCTrCH-InformationList-PhyChReconfRqstTDD  OPTIONAL,
  iE-Extensions         ProtocolExtensionContainer { {RL-Information-PhyChReconfRqstTDD-ExtIEs} } OPTIONAL,
  ...
}

RL-Information-PhyChReconfRqstTDD-ExtIEs RNSAP-PROTOCOL-EXTENSION ::= {
  { ID id-HSPDSCH-Timeslot-InformationList-PhyChReconfRqstTDD  CRITICALITY reject  EXTENSION HSPDSCH-Timeslot-InformationList-
PhyChReconfRqstTDD  PRESENCE optional } |
  --For 3.84Mcps TDD only
  { ID id-HSPDSCH-Timeslot-InformationListLCR-PhyChReconfRqstTDD  CRITICALITY reject  EXTENSION HSPDSCH-Timeslot-InformationListLCR-
PhyChReconfRqstTDD  PRESENCE optional } |
  --For 1.28Mcps TDD only
  { ID id-HSPDSCH-Timeslot-InformationList-PhyChReconfRqstTDD768  CRITICALITY reject  EXTENSION HSPDSCH-Timeslot-InformationList-
PhyChReconfRqstTDD768  PRESENCE optional } |
  --For 7.68Mcps TDD only
  { ID id-UARFCNforNt          CRITICALITY ignore  EXTENSION UARFCN          PRESENCE optional },
  -- Applicable to 1.28Mcps TDD only
  ...
}

```

```

}
UL-CCTrCH-InformationList-PhyChReconfRqstTDD ::= ProtocolIE-Single-Container { {UL-CCTrCH-InformationListIEs-PhyChReconfRqstTDD} }
UL-CCTrCH-InformationListIEs-PhyChReconfRqstTDD RNSAP-PROTOCOL-IES ::= {
  { ID id-UL-CCTrCH-InformationListIE-PhyChReconfRqstTDD CRITICALITY reject TYPE UL-CCTrCH-InformationListIE-PhyChReconfRqstTDD
  PRESENCE mandatory }
}
UL-CCTrCH-InformationListIE-PhyChReconfRqstTDD ::= SEQUENCE (SIZE (1..maxNrOfCCTrCHs)) OF UL-CCTrCH-InformationItem-PhyChReconfRqstTDD
UL-CCTrCH-InformationItem-PhyChReconfRqstTDD ::= SEQUENCE {
  cCTrCH-ID CCTrCH-ID,
  ul-DPCH-Information UL-DPCH-InformationList-PhyChReconfRqstTDD,
  iE-Extensions ProtocolExtensionContainer { {UL-CCTrCH-InformationItem-PhyChReconfRqstTDD-ExtIEs} } OPTIONAL,
  ...
}
UL-CCTrCH-InformationItem-PhyChReconfRqstTDD-ExtIEs RNSAP-PROTOCOL-EXTENSION ::= {
  ...
}
UL-DPCH-InformationList-PhyChReconfRqstTDD ::= ProtocolIE-Single-Container {{UL-DPCH-InformationListIEs-PhyChReconfRqstTDD}}
UL-DPCH-InformationListIEs-PhyChReconfRqstTDD RNSAP-PROTOCOL-IES ::= {
  { ID id-UL-DPCH-InformationItem-PhyChReconfRqstTDD CRITICALITY notify TYPE UL-DPCH-InformationItem-PhyChReconfRqstTDD PRESENCE
  mandatory }
}
UL-DPCH-InformationItem-PhyChReconfRqstTDD ::= SEQUENCE {
  repetitionPeriod RepetitionPeriod OPTIONAL,
  repetitionLength RepetitionLength OPTIONAL,
  tDD-DPCHOffset TDD-DPCHOffset OPTIONAL,
  uL-Timeslot-InformationList-PhyChReconfRqstTDD UL-Timeslot-InformationList-PhyChReconfRqstTDD OPTIONAL,
  --For 3.84Mcps TDD only
  iE-Extensions ProtocolExtensionContainer { {UL-DPCH-InformationItem-PhyChReconfRqstTDD-ExtIEs} } OPTIONAL,
  ...
}
UL-DPCH-InformationItem-PhyChReconfRqstTDD-ExtIEs RNSAP-PROTOCOL-EXTENSION ::= {
  { ID id-UL-Timeslot-LCR-InformationList-PhyChReconfRqstTDD CRITICALITY reject EXTENSION UL-TimeslotLCR-InformationList-
  PhyChReconfRqstTDD PRESENCE optional }|
  --For 1.28Mcps TDD only
  { ID id-UL-Timeslot-InformationList-PhyChReconfRqstTDD768 CRITICALITY reject EXTENSION UL-Timeslot-InformationList-
  PhyChReconfRqstTDD768 PRESENCE optional },
  --For 7.68Mcps TDD only
  ...
}
UL-TimeslotLCR-InformationList-PhyChReconfRqstTDD ::= SEQUENCE ( SIZE (1..maxNrOfTsLCR)) OF UL-TimeslotLCR-InformationItem-PhyChReconfRqstTDD
UL-TimeslotLCR-InformationItem-PhyChReconfRqstTDD ::= SEQUENCE {
  timeSlotLCR TimeSlotLCR,
  midambleShiftLCR MidambleShiftLCR OPTIONAL,

```

```

tFCI-Presence                TFCI-Presence                OPTIONAL,
uL-Code-LCR-Information       TDD-UL-Code-LCR-Information  OPTIONAL,
iE-Extensions                 ProtocolExtensionContainer { {UL-TimeslotLCR-InformationItem-PhyChReconfRqstTDD-ExtIEs} } OPTIONAL,
...
}

UL-TimeslotLCR-InformationItem-PhyChReconfRqstTDD-ExtIEs RNSAP-PROTOCOL-EXTENSION ::= {
  { ID id-PLCCH-Information-PhyChReconfRqstTDD          CRITICALITY reject          EXTENSION PLCCHinformation          PRESENCE optional },
  ...
}

UL-Timeslot-InformationList-PhyChReconfRqstTDD ::= SEQUENCE ( SIZE (1..maxNrOfTS)) OF UL-Timeslot-InformationItem-PhyChReconfRqstTDD

UL-Timeslot-InformationItem-PhyChReconfRqstTDD ::= SEQUENCE {
  timeSlot                TimeSlot,
  midambleShiftAndBurstType MidambleShiftAndBurstType          OPTIONAL,
  tFCI-Presence           TFCI-Presence                OPTIONAL,
  uL-Code-Information     TDD-UL-Code-Information  OPTIONAL,
  iE-Extensions          ProtocolExtensionContainer { {UL-Timeslot-InformationItem-PhyChReconfRqstTDD-ExtIEs} } OPTIONAL,
  ...
}

UL-Timeslot-InformationItem-PhyChReconfRqstTDD-ExtIEs RNSAP-PROTOCOL-EXTENSION ::= {
  ...
}

UL-Timeslot-InformationList-PhyChReconfRqstTDD768 ::= SEQUENCE ( SIZE (1..maxNrOfTS)) OF UL-Timeslot-InformationItem-PhyChReconfRqstTDD768

UL-Timeslot-InformationItem-PhyChReconfRqstTDD768 ::= SEQUENCE {
  timeSlot                TimeSlot,
  midambleShiftAndBurstType768 MidambleShiftAndBurstType768          OPTIONAL,
  tFCI-Presence           TFCI-Presence                OPTIONAL,
  uL-Code-Information768  TDD-UL-Code-Information768          OPTIONAL,
  iE-Extensions          ProtocolExtensionContainer { {UL-Timeslot-InformationItem-PhyChReconfRqstTDD768-ExtIEs} } OPTIONAL,
  ...
}

UL-Timeslot-InformationItem-PhyChReconfRqstTDD768-ExtIEs RNSAP-PROTOCOL-EXTENSION ::= {
  ...
}

DL-CCTrCH-InformationList-PhyChReconfRqstTDD ::= ProtocolIE-Single-Container { {DL-CCTrCH-InformationListIEs-PhyChReconfRqstTDD} }

DL-CCTrCH-InformationListIEs-PhyChReconfRqstTDD RNSAP-PROTOCOL-IES ::= {
  { ID id-DL-CCTrCH-InformationListIE-PhyChReconfRqstTDD          CRITICALITY reject          TYPE DL-CCTrCH-InformationListIE-PhyChReconfRqstTDD
  PRESENCE mandatory }
}

DL-CCTrCH-InformationListIE-PhyChReconfRqstTDD ::= SEQUENCE (SIZE (1..maxNrOfCCTrCHs)) OF DL-CCTrCH-InformationItem-PhyChReconfRqstTDD

DL-CCTrCH-InformationItem-PhyChReconfRqstTDD ::= SEQUENCE {
  cCCTrCH-ID              CCTrCH-ID,
  dl-DPCH-Information     DL-DPCH-InformationList-PhyChReconfRqstTDD,
  iE-Extensions          ProtocolExtensionContainer { {DL-CCTrCH-InformationItem-PhyChReconfRqstTDD-ExtIEs} } OPTIONAL,
}

```

```

}
...
DL-CCTrCH-InformationItem-PhyChReconfRqstTDD-ExtIEs RNSAP-PROTOCOL-EXTENSION ::= {
}
...
DL-DPCH-InformationList-PhyChReconfRqstTDD ::= ProtocolIE-Single-Container {{DL-DPCH-InformationListIEs-PhyChReconfRqstTDD}}

DL-DPCH-InformationListIEs-PhyChReconfRqstTDD RNSAP-PROTOCOL-IES ::= {
  { ID id-DL-DPCH-InformationItem-PhyChReconfRqstTDD    CRITICALITY notify TYPE DL-DPCH-InformationItem-PhyChReconfRqstTDD          PRESENCE
mandatory }
}

DL-DPCH-InformationItem-PhyChReconfRqstTDD ::= SEQUENCE {
  repetitionPeriod          RepetitionPeriod          OPTIONAL,
  repetitionLength          RepetitionLength          OPTIONAL,
  tDD-DPCHOffset           TDD-DPCHOffset           OPTIONAL,
  dL-Timeslot-InformationList-PhyChReconfRqstTDD      DL-Timeslot-InformationList-PhyChReconfRqstTDD  OPTIONAL,
  iE-Extensions            ProtocolExtensionContainer { {DL-DPCH-InformationItem-PhyChReconfRqstTDD-ExtIEs} } OPTIONAL,
  ...
}

DL-DPCH-InformationItem-PhyChReconfRqstTDD-ExtIEs RNSAP-PROTOCOL-EXTENSION ::= {
  { ID id-DL-Timeslot-LCR-InformationList-PhyChReconfRqstTDD    CRITICALITY reject      EXTENSION DL-TimeslotLCR-InformationList-
PhyChReconfRqstTDD      PRESENCE optional }|
  --For 1.28Mcps TDD only
  { ID id-DL-Timeslot-InformationList-PhyChReconfRqstTDD768    CRITICALITY reject      EXTENSION DL-Timeslot-InformationList-
PhyChReconfRqstTDD768  PRESENCE optional },
  --For 7.68Mcps TDD only
  ...
}

DL-TimeslotLCR-InformationList-PhyChReconfRqstTDD ::= SEQUENCE ( SIZE (1..maxNrOfTsLCR)) OF DL-TimeslotLCR-InformationItem-PhyChReconfRqstTDD

DL-TimeslotLCR-InformationItem-PhyChReconfRqstTDD ::= SEQUENCE {
  timeSlotLCR              TimeSlotLCR,
  midambleShiftLCR        MidambleShiftLCR          OPTIONAL,
  tFCI-Presence           TFCI-Presence            OPTIONAL,
  dL-Code-LCR-Information TDD-DL-Code-LCR-Information  OPTIONAL,
  iE-Extensions           ProtocolExtensionContainer { {DL-TimeslotLCR-InformationItem-PhyChReconfRqstTDD-ExtIEs} } OPTIONAL,
  ...
}

DL-TimeslotLCR-InformationItem-PhyChReconfRqstTDD-ExtIEs RNSAP-PROTOCOL-EXTENSION ::= {
}
...

DL-Timeslot-InformationList-PhyChReconfRqstTDD ::= SEQUENCE ( SIZE (1..maxNrOfTs)) OF DL-Timeslot-InformationItem-PhyChReconfRqstTDD

DL-Timeslot-InformationItem-PhyChReconfRqstTDD ::= SEQUENCE {
  timeSlot                TimeSlot,
  midambleShiftAndBurstType MidambleShiftAndBurstType  OPTIONAL,
  tFCI-Presence           TFCI-Presence            OPTIONAL,

```

```

    dL-Code-Information          TDD-DL-Code-Information  OPTIONAL,
    iE-Extensions                ProtocolExtensionContainer { {DL-Timeslot-InformationItem-PhyChReconfRqstTDD-ExtIEs} } OPTIONAL,
    ...
}

DL-Timeslot-InformationItem-PhyChReconfRqstTDD-ExtIEs RNSAP-PROTOCOL-EXTENSION ::= {
    ...
}

DL-Timeslot-InformationList-PhyChReconfRqstTDD768 ::= SEQUENCE ( SIZE (1..maxNrOfTS) ) OF DL-Timeslot-InformationItem-PhyChReconfRqstTDD768

DL-Timeslot-InformationItem-PhyChReconfRqstTDD768 ::= SEQUENCE {
    timeSlot                    TimeSlot,
    midambleShiftAndBurstType768 MidambleShiftAndBurstType768          OPTIONAL,
    tFCI-Presence                TFCI-Presence                        OPTIONAL,
    dL-Code-Information768       TDD-DL-Code-Information768    OPTIONAL,
    iE-Extensions                ProtocolExtensionContainer { {DL-Timeslot-InformationItem-PhyChReconfRqstTDD768-ExtIEs} } OPTIONAL,
    ...
}

DL-Timeslot-InformationItem-PhyChReconfRqstTDD768-ExtIEs RNSAP-PROTOCOL-EXTENSION ::= {
    ...
}

HSPDSCH-Timeslot-InformationList-PhyChReconfRqstTDD ::= SEQUENCE (SIZE (1..maxNrOfDLTs)) OF HSPDSCH-Timeslot-InformationItem-PhyChReconfRqstTDD

HSPDSCH-Timeslot-InformationItem-PhyChReconfRqstTDD ::= SEQUENCE {
    timeslot                    TimeSlot,
    midambleShiftAndBurstType   MidambleShiftAndBurstType,
    iE-Extensions                ProtocolExtensionContainer { { HSPDSCH-Timeslot-InformationItem-PhyChReconfRqstTDD-ExtIEs } }
    OPTIONAL,
    ...
}

HSPDSCH-Timeslot-InformationItem-PhyChReconfRqstTDD-ExtIEs RNSAP-PROTOCOL-EXTENSION ::= {
    ...
}

HSPDSCH-Timeslot-InformationListLCR-PhyChReconfRqstTDD ::= SEQUENCE (SIZE (1..maxNrOfDLTsLCR)) OF HSPDSCH-Timeslot-InformationItemLCR-PhyChReconfRqstTDD

HSPDSCH-Timeslot-InformationItemLCR-PhyChReconfRqstTDD ::= SEQUENCE {
    timeslotLCR                 TimeSlotLCR,
    midambleShiftLCR            MidambleShiftLCR,
    iE-Extensions                ProtocolExtensionContainer { { HSPDSCH-Timeslot-InformationItemLCR-PhyChReconfRqstTDD-ExtIEs } }
    OPTIONAL,
    ...
}

HSPDSCH-Timeslot-InformationItemLCR-PhyChReconfRqstTDD-ExtIEs RNSAP-PROTOCOL-EXTENSION ::= {
    ...
}

```

```

HSPDSCH-Timeslot-InformationList-PhyChReconfRqstTDD768 ::= SEQUENCE (SIZE (1..maxNrOfDLTs)) OF HSPDSCH-Timeslot-InformationItem-PhyChReconfRqstTDD768

HSPDSCH-Timeslot-InformationItem-PhyChReconfRqstTDD768 ::= SEQUENCE {
    timeslot                               TimeSlot,
    midambleShiftAndBurstType768          MidambleShiftAndBurstType768,
    iE-Extensions                          ProtocolExtensionContainer { { HSPDSCH-Timeslot-InformationItem-PhyChReconfRqstTDD768-ExtIEs } }
}
    OPTIONAL,
    ...
}

HSPDSCH-Timeslot-InformationItem-PhyChReconfRqstTDD768-ExtIEs RNSAP-PROTOCOL-EXTENSION ::= {
    ...
}

PhysicalChannelReconfigurationRequestTDD-Extensions RNSAP-PROTOCOL-EXTENSION ::= {
    ...
}

-- *****
--
-- PHYSICAL CHANNEL RECONFIGURATION COMMAND
--
-- *****

PhysicalChannelReconfigurationCommand ::= SEQUENCE {
    protocolIEs                          ProtocolIE-Container    {{PhysicalChannelReconfigurationCommand-IEs}},
    protocolExtensions                    ProtocolExtensionContainer {{PhysicalChannelReconfigurationCommand-Extensions}}
    ...
}
    OPTIONAL,
    ...
}

PhysicalChannelReconfigurationCommand-IEs RNSAP-PROTOCOL-IES ::= {
    { ID id-CFN          CRITICALITY ignore TYPE CFN          PRESENCE mandatory } |
    { ID id-CriticalityDiagnostics CRITICALITY ignore TYPE CriticalityDiagnostics PRESENCE optional },
    ...
}

PhysicalChannelReconfigurationCommand-Extensions RNSAP-PROTOCOL-EXTENSION ::= {
    ...
}

-- *****
--
-- PHYSICAL CHANNEL RECONFIGURATION FAILURE
--
-- *****

PhysicalChannelReconfigurationFailure ::= SEQUENCE {
    protocolIEs                          ProtocolIE-Container    {{PhysicalChannelReconfigurationFailure-IEs}},
    protocolExtensions                    ProtocolExtensionContainer {{PhysicalChannelReconfigurationFailure-Extensions}}
    ...
}
    OPTIONAL,
    ...
}

PhysicalChannelReconfigurationFailure-IEs RNSAP-PROTOCOL-IES ::= {

```



```

    { ID id-Cause                CRITICALITY ignore  TYPE Cause                PRESENCE mandatory } |
    { ID id-CriticalityDiagnostics CRITICALITY ignore  TYPE CriticalityDiagnostics PRESENCE optional },
    ...
}

PhysicalChannelReconfigurationFailure-Extensions RNSAP-PROTOCOL-EXTENSION ::= {
    ...
}

-- *****
--
-- RADIO LINK CONGESTION INDICATION
--
-- *****

RadioLinkCongestionIndication ::= SEQUENCE {
    protocolIEs                ProtocolIE-Container    {{RadioLinkCongestionIndication-IEs}},
    protocolExtensions          ProtocolExtensionContainer {{RadioLinkCongestionIndication-Extensions}} OPTIONAL,
    ...
}

RadioLinkCongestionIndication-IEs RNSAP-PROTOCOL-IES ::= {
    { ID id-CongestionCause      CRITICALITY ignore  TYPE CongestionCause                PRESENCE optional } |
    { ID id-RL-InformationList-RL-CongestInd CRITICALITY ignore  TYPE RL-InformationList-RL-CongestInd PRESENCE mandatory },
    ...
}

RL-InformationList-RL-CongestInd ::= SEQUENCE (SIZE (1..maxNrOfRLs)) OF ProtocolIE-Single-Container { {RL-InformationItemIEs-RL-CongestInd} }

RL-InformationItemIEs-RL-CongestInd RNSAP-PROTOCOL-IES ::= {
    { ID id-RL-InformationItem-RL-CongestInd CRITICALITY ignore  TYPE RL-InformationItem-RL-CongestInd PRESENCE mandatory }
}

RL-InformationItem-RL-CongestInd ::= SEQUENCE {
    rL-ID                      RL-ID,
    dCH-Rate-Information        DCH-Rate-Information-RL-CongestInd,
    iE-Extensions              ProtocolExtensionContainer { {RL-Information-RL-CongestInd-ExtIEs} } OPTIONAL,
    ...
}

DCH-Rate-Information-RL-CongestInd ::= SEQUENCE (SIZE (1..maxNrOfDCHs)) OF ProtocolIE-Single-Container { {DCH-Rate-InformationItemIEs-RL-CongestInd} }

DCH-Rate-InformationItemIEs-RL-CongestInd RNSAP-PROTOCOL-IES ::= {
    { ID id-DCH-Rate-InformationItem-RL-CongestInd CRITICALITY ignore  TYPE DCH-Rate-InformationItem-RL-CongestInd PRESENCE mandatory }
}

DCH-Rate-InformationItem-RL-CongestInd ::= SEQUENCE {
    dCH-ID                    DCH-ID,
    allowed-Rate-Information  Allowed-Rate-Information OPTIONAL,
    iE-Extensions            ProtocolExtensionContainer { {DCH-Rate-InformationItem-RL-CongestInd-ExtIEs} } OPTIONAL,
    ...
}

```

```

}
DCH-Rate-InformationItem-RL-CongestInd-ExtIEs RNSAP-PROTOCOL-EXTENSION ::= {
  ...
}
RL-Information-RL-CongestInd-ExtIEs RNSAP-PROTOCOL-EXTENSION ::= {
  { ID id-EDCH-MacdFlowSpecificInformationList-RL-CongestInd CRITICALITY ignore EXTENSION EDCH-MacdFlowSpecificInformationList-RL-CongestInd
  PRESENCE optional } |
  { ID id-DCH-Indicator-For-E-DCH-HSDPA-Operation CRITICALITY ignore EXTENSION DCH-Indicator-For-E-DCH-HSDPA-Operation
  PRESENCE optional },
  ...
}
RadioLinkCongestionIndication-Extensions RNSAP-PROTOCOL-EXTENSION ::= {
  ...
}
EDCH-MacdFlowSpecificInformationList-RL-CongestInd ::= SEQUENCE (SIZE (1.. maxNrOfEDCHMACdFlows)) OF ProtocolIE-Single-Container { {EDCH-
MacdFlowSpecificInformationItemIEs-RL-CongestInd} }
EDCH-MacdFlowSpecificInformationItemIEs-RL-CongestInd RNSAP-PROTOCOL-IES ::= {
  { ID id-EDCH-MacdFlowSpecificInformationItem-RL-CongestInd CRITICALITY ignore TYPE EDCH-MacdFlowSpecificInformationItem-RL-CongestInd
  PRESENCE mandatory }
}
EDCH-MacdFlowSpecificInformationItem-RL-CongestInd ::= SEQUENCE {
  eDCH-MACdFlow-ID EDCH-MACdFlow-ID,
  iE-Extensions ProtocolExtensionContainer { { EDCH-MacdFlowSpecificInformation-RL-CongestInd-ExtIEs } } OPTIONAL,
  ...
}
EDCH-MacdFlowSpecificInformation-RL-CongestInd-ExtIEs RNSAP-PROTOCOL-EXTENSION ::= {
  ...
}
-- *****
--
-- UPLINK SIGNALLING TRANSFER INDICATION FDD
--
-- *****
UplinkSignallingTransferIndicationFDD ::= SEQUENCE {
  protocolIEs ProtocolIE-Container {{UplinkSignallingTransferIndicationFDD-IEs}},
  protocolExtensions ProtocolExtensionContainer {{UplinkSignallingTransferIndicationFDD-Extensions}} OPTIONAL,
  ...
}
UplinkSignallingTransferIndicationFDD-IEs RNSAP-PROTOCOL-IES ::= {
  { ID id-UC-ID CRITICALITY ignore TYPE UC-ID PRESENCE mandatory
  } |
  { ID id-SAI CRITICALITY ignore TYPE SAI PRESENCE mandatory
  } |

```

```

    { ID id-GA-Cell                CRITICALITY ignore  TYPE GA-Cell                PRESENCE optional
    } |
    { ID id-C-RNTI                 CRITICALITY ignore  TYPE C-RNTI                 PRESENCE mandatory
    } |
    { ID id-S-RNTI                 CRITICALITY ignore  TYPE S-RNTI                 PRESENCE mandatory
    } |
    { ID id-D-RNTI                 CRITICALITY ignore  TYPE D-RNTI                 PRESENCE optional
    } |
    { ID id-PropagationDelay        CRITICALITY ignore  TYPE PropagationDelay       PRESENCE mandatory
    } |
    { ID id-STTD-SupportIndicator    CRITICALITY ignore  TYPE STTD-SupportIndicator  PRESENCE mandatory }
    |
    { ID id-ClosedLoopModel-SupportIndicator CRITICALITY ignore  TYPE ClosedLoopModel-SupportIndicator PRESENCE mandatory }
    |
    { ID id-L3-Information           CRITICALITY ignore  TYPE L3-Information         PRESENCE mandatory
    } |
    { ID id-CN-PS-DomainIdentifier   CRITICALITY ignore  TYPE CN-PS-DomainIdentifier  PRESENCE optional
    } |
    { ID id-CN-CS-DomainIdentifier   CRITICALITY ignore  TYPE CN-CS-DomainIdentifier  PRESENCE optional
    } |
    { ID id-URA-Information         CRITICALITY ignore  TYPE URA-Information        PRESENCE optional
    },
    ...
}

UplinkSignallingTransferIndicationFDD-Extensions RNSAP-PROTOCOL-EXTENSION ::= {
  { ID id-GA-CellAdditionalShapes    CRITICALITY ignore  EXTENSION GA-CellAdditionalShapes  PRESENCE optional }|
  { ID id-DPC-Mode-Change-SupportIndicator CRITICALITY ignore  EXTENSION DPC-Mode-Change-SupportIndicator PRESENCE optional }|
  { ID id-CommonTransportChannelResourcesInitialisationNotRequired CRITICALITY ignore  EXTENSION
CommonTransportChannelResourcesInitialisationNotRequired PRESENCE optional }|
  { ID id-CellCapabilityContainer-FDD CRITICALITY ignore  EXTENSION CellCapabilityContainer-FDD PRESENCE optional }|
  { ID id-SNA-Information            CRITICALITY ignore  EXTENSION SNA-Information          PRESENCE optional }|
  { ID id-CellPortionID              CRITICALITY ignore  EXTENSION CellPortionID           PRESENCE optional }|
  { ID id-Active-MBMS-Bearer-ServiceFDD CRITICALITY ignore  EXTENSION Active-MBMS-Bearer-Service-ListFDD PRESENCE optional }|
  { ID id-Inter-Frequency-Cell-List CRITICALITY ignore  EXTENSION Inter-Frequency-Cell-List PRESENCE optional }|
  { ID id-ExtendedPropagationDelay    CRITICALITY ignore  EXTENSION ExtendedPropagationDelay PRESENCE optional }|
  { ID id-HSDSCH-RNTI                CRITICALITY ignore  EXTENSION HSDSCH-RNTI             PRESENCE optional }|
  { ID id-Multiple-PLMN-List          CRITICALITY ignore  EXTENSION Multiple-PLMN-List      PRESENCE optional }|
  { ID id-E-RNTI                    CRITICALITY ignore  EXTENSION E-RNTI                  PRESENCE optional }|
  { ID id-Max-UE-DTX-Cycle            CRITICALITY ignore  EXTENSION Max-UE-DTX-Cycle        PRESENCE
conditional }|
  -- This IE shall be present if the Continuous Packet Connectivity DTX-DRX Support Indicator IE in Cell Capability Container FDD IE is set to 1.
  { ID id-CellCapabilityContainerExtension-FDD CRITICALITY ignore  EXTENSION CellCapabilityContainerExtension-FDD PRESENCE optional }|
  { ID id-Secondary-Serving-Cell-List CRITICALITY ignore  EXTENSION Secondary-Serving-Cell-List PRESENCE optional }|
  { ID id-Dual-Band-Secondary-Serving-Cell-List CRITICALITY ignore  EXTENSION Secondary-Serving-Cell-List PRESENCE optional },
  ...
}

-- *****
--
-- UPLINK SIGNALLING TRANSFER INDICATION TDD
--
-- *****

```

```

UplinkSignallingTransferIndicationTDD ::= SEQUENCE {
    protocolIEs                ProtocolIE-Container    {{UplinkSignallingTransferIndicationTDD-IEs}},
    protocolExtensions         ProtocolExtensionContainer {{UplinkSignallingTransferIndicationTDD-Extensions}}
    ...
}

UplinkSignallingTransferIndicationTDD-IEs RNSAP-PROTOCOL-IES ::= {
    { ID id-UC-ID                CRITICALITY ignore    TYPE UC-ID                PRESENCE mandatory }
    |
    { ID id-SAI                  CRITICALITY ignore    TYPE SAI                   PRESENCE mandatory }
    |
    { ID id-GA-Cell              CRITICALITY ignore    TYPE GA-Cell              PRESENCE optional }
    |
    { ID id-C-RNTI               CRITICALITY ignore    TYPE C-RNTI               PRESENCE mandatory }
    |
    { ID id-S-RNTI               CRITICALITY ignore    TYPE S-RNTI               PRESENCE mandatory }
    |
    { ID id-D-RNTI               CRITICALITY ignore    TYPE D-RNTI               PRESENCE optional }
    |
    { ID id-RxTimingDeviationForTA CRITICALITY ignore    TYPE RxTimingDeviationForTA PRESENCE mandatory }
    |
    { ID id-L3-Information        CRITICALITY ignore    TYPE L3-Information        PRESENCE mandatory }
    |
    { ID id-CN-PS-DomainIdentifier CRITICALITY ignore    TYPE CN-PS-DomainIdentifier PRESENCE optional }
    |
    { ID id-CN-CS-DomainIdentifier CRITICALITY ignore    TYPE CN-CS-DomainIdentifier PRESENCE optional }
    |
    { ID id-URA-Information      CRITICALITY ignore    TYPE URA-Information      PRESENCE optional },
    ...
}

UplinkSignallingTransferIndicationTDD-Extensions RNSAP-PROTOCOL-EXTENSION ::= {
    { ID id-GA-CellAdditionalShapes CRITICALITY ignore    EXTENSION GA-CellAdditionalShapes PRESENCE optional }|
    { ID id-CommonTransportChannelResourcesInitialisationNotRequired CRITICALITY ignore
EXTENSION CommonTransportChannelResourcesInitialisationNotRequired PRESENCE optional }|
    { ID id-CellCapabilityContainer-TDD CRITICALITY ignore    EXTENSION CellCapabilityContainer-TDD PRESENCE optional }|
    -- Applicable to 3.84Mcps TDD only
    { ID id-CellCapabilityContainer-TDD-LCR CRITICALITY ignore    EXTENSION CellCapabilityContainer-TDD-LCR PRESENCE optional }|
    -- Applicable to 1.28Mcps TDD only
    { ID id-SNA-Information          CRITICALITY ignore    EXTENSION SNA-Information          PRESENCE optional }|
    { ID id-Active-MBMS-Bearer-ServiceTDD CRITICALITY ignore    EXTENSION Active-MBMS-Bearer-Service-ListTDD PRESENCE optional }|
    { ID id-CellCapabilityContainer-TDD768 CRITICALITY ignore    EXTENSION CellCapabilityContainer-TDD768 PRESENCE optional }|
    -- Applicable to 7.68Mcps TDD only
    { ID id-RxTimingDeviationForTA768 CRITICALITY ignore    EXTENSION RxTimingDeviationForTA768 PRESENCE optional }|
    { ID id-RxTimingDeviationForTAext CRITICALITY ignore    EXTENSION RxTimingDeviationForTAext PRESENCE optional }|
    { ID id-Multiple-PLMN-List        CRITICALITY ignore    EXTENSION Multiple-PLMN-List        PRESENCE optional }|
    { ID id-HSDSCH-RNTI              CRITICALITY ignore    EXTENSION HSDSCH-RNTI              PRESENCE optional }|
    { ID id-E-RNTI                  CRITICALITY ignore    EXTENSION E-RNTI                  PRESENCE optional }|
    { ID id-CellPortionLCRID          CRITICALITY ignore    EXTENSION CellPortionLCRID          PRESENCE optional },
    ...
}

-- *****

```

```

--
-- DOWNLINK SIGNALLING TRANSFER REQUEST
--
-- *****

DownlinkSignallingTransferRequest ::= SEQUENCE {
    protocolIEs          ProtocolIE-Container    {{DownlinkSignallingTransferRequest-IEs}},
    protocolExtensions   ProtocolExtensionContainer {{DownlinkSignallingTransferRequest-Extensions}}      OPTIONAL,
    ...
}

DownlinkSignallingTransferRequest-IEs RNSAP-PROTOCOL-IES ::= {
    { ID id-C-ID          CRITICALITY ignore   TYPE C-ID          PRESENCE mandatory } |
    -- May be a GERAN cell identifier
    { ID id-D-RNTI        CRITICALITY ignore   TYPE D-RNTI          PRESENCE mandatory } |
    { ID id-L3-Information CRITICALITY ignore   TYPE L3-Information  PRESENCE mandatory } |
    { ID id-D-RNTI-ReleaseIndication CRITICALITY ignore   TYPE D-RNTI-ReleaseIndication PRESENCE mandatory },
    ...
}

DownlinkSignallingTransferRequest-Extensions RNSAP-PROTOCOL-EXTENSION ::= {
    { ID id-URA-ID        CRITICALITY ignore   EXTENSION URA-ID          PRESENCE optional} |
    { ID id-MBMS-Bearer-Service-List CRITICALITY ignore   EXTENSION MBMS-Bearer-Service-List PRESENCE optional} |
    { ID id-Old-URA-ID    CRITICALITY ignore   EXTENSION URA-ID          PRESENCE optional} |
    { ID id-SRNC-ID        CRITICALITY ignore   EXTENSION RNC-ID          PRESENCE conditional} |
    -- This IE shall be present if the URA-ID IE or Old URA-ID IE is present.
    { ID id-Extended-SRNC-ID CRITICALITY reject   EXTENSION Extended-RNC-ID PRESENCE optional} |
    { ID id-Enhanced-PCH-Capability CRITICALITY ignore   EXTENSION Enhanced-PCH-Capability PRESENCE optional},
    ...
}

-- *****
--
-- RELOCATION COMMIT
--
-- *****

RelocationCommit ::= SEQUENCE {
    protocolIEs          ProtocolIE-Container    {{RelocationCommit-IEs}},
    protocolExtensions   ProtocolExtensionContainer {{RelocationCommit-Extensions}}      OPTIONAL,
    ...
}

RelocationCommit-IEs RNSAP-PROTOCOL-IES ::= {
    { ID id-D-RNTI        CRITICALITY ignore   TYPE D-RNTI          PRESENCE optional } |
    { ID id-RANAP-RelocationInformation CRITICALITY ignore   TYPE RANAP-RelocationInformation PRESENCE optional },
    ...
}

RelocationCommit-Extensions RNSAP-PROTOCOL-EXTENSION ::= {
    ...
}

```

```

-- *****
--
-- PAGING REQUEST
--
-- *****

PagingRequest ::= SEQUENCE {
    protocolIEs          ProtocolIE-Container    {{PagingRequest-IEs}},
    protocolExtensions   ProtocolExtensionContainer {{PagingRequest-Extensions}}    OPTIONAL,
    ...
}

PagingRequest-IEs RNSAP-PROTOCOL-IES ::= {
    { ID id-PagingArea-PagingRqst    CRITICALITY ignore TYPE PagingArea-PagingRqst    PRESENCE mandatory } |
    { ID id-SRNC-ID                  CRITICALITY ignore TYPE RNC-ID                PRESENCE mandatory } | -- May be a BSC-
    Id.
    { ID id-S-RNTI                   CRITICALITY ignore TYPE S-RNTI                PRESENCE mandatory } |
    { ID id-IMSI                     CRITICALITY ignore TYPE IMSI                PRESENCE mandatory } |
    { ID id-DRXCycleLengthCoefficient CRITICALITY ignore TYPE DRXCycleLengthCoefficient PRESENCE mandatory } |
    { ID id-CNOriginatedPage-PagingRqst CRITICALITY ignore TYPE CNOriginatedPage-PagingRqst PRESENCE optional } |
    ...
}

PagingArea-PagingRqst ::= CHOICE {
    uRA          URA-PagingRqst, -- May be a GRA-ID.
    cell        Cell-PagingRqst, -- UTRAN only
    ...
}

URA-PagingRqst ::= SEQUENCE {
    uRA-ID          URA-ID,
    iE-Extensions   ProtocolExtensionContainer { { URAItem-PagingRqst-ExtIEs } } OPTIONAL,
    ...
}

URAItem-PagingRqst-ExtIEs RNSAP-PROTOCOL-EXTENSION ::= {
    ...
}

Cell-PagingRqst ::= SEQUENCE {
    c-ID          C-ID,
    iE-Extensions ProtocolExtensionContainer { { CellItem-PagingRqst-ExtIEs } } OPTIONAL,
    ...
}

CellItem-PagingRqst-ExtIEs RNSAP-PROTOCOL-EXTENSION ::= {
    ...
}

CNOriginatedPage-PagingRqst ::= SEQUENCE {
    pagingCause          PagingCause,
    cNDomainType         CNDomainType,
    pagingRecordType     PagingRecordType,
}

```

```

    iE-Extensions          ProtocolExtensionContainer { { CNOriginatedPage-PagingRqst-ExtIEs } } OPTIONAL,
  }
  ...
}

CNOriginatedPage-PagingRqst-ExtIEs RNSAP-PROTOCOL-EXTENSION ::= {
  ...
}

PagingRequest-Extensions RNSAP-PROTOCOL-EXTENSION ::= {
  { ID id-Extended-SRNC-ID          CRITICALITY reject      EXTENSION   Extended-RNC-ID          PRESENCE optional } |
  { ID id-Enhanced-PCH-Capability   CRITICALITY ignore   EXTENSION   Enhanced-PCH-Capability   PRESENCE optional },
  -- FDD and 1.28Mcps TDD only
  ...
}

-- *****
--
-- DEDICATED MEASUREMENT INITIATION REQUEST
--
-- *****

DedicatedMeasurementInitiationRequest ::= SEQUENCE {
  protocolIEs          ProtocolIE-Container          {{DedicatedMeasurementInitiationRequest-IEs}},
  protocolExtensions   ProtocolExtensionContainer {{DedicatedMeasurementInitiationRequest-Extensions}}
  ...
}

DedicatedMeasurementInitiationRequest-IEs RNSAP-PROTOCOL-IES ::= {
  { ID id-MeasurementID          CRITICALITY reject  TYPE MeasurementID          PRESENCE mandatory } |
  { ID id-DedicatedMeasurementObjectType-DM-Rqst CRITICALITY reject  TYPE DedicatedMeasurementObjectType-DM-Rqst PRESENCE mandatory } |

  { ID id-DedicatedMeasurementType          CRITICALITY reject  TYPE DedicatedMeasurementType          PRESENCE mandatory } |
  { ID id-MeasurementFilterCoefficient      CRITICALITY reject  TYPE MeasurementFilterCoefficient      PRESENCE optional } |
  { ID id-ReportCharacteristics             CRITICALITY reject  TYPE ReportCharacteristics             PRESENCE mandatory } |
  { ID id-CFNReportingIndicator             CRITICALITY reject  TYPE FNReportingIndicator             PRESENCE mandatory } |
  { ID id-CFN                              CRITICALITY reject  TYPE CFN                              PRESENCE optional },
  ...
}

DedicatedMeasurementObjectType-DM-Rqst ::= CHOICE {
  rL          RL-DM-Rqst,
  rLS         RL-Set-DM-Rqst,
  allRL       All-RL-DM-Rqst,
  allRLS      All-RL-Set-DM-Rqst,
  ...
}

RL-DM-Rqst ::= SEQUENCE {
  rL-InformationList-DM-Rqst  RL-InformationList-DM-Rqst,
  iE-Extensions              ProtocolExtensionContainer { { RLItem-DM-Rqst-ExtIEs } } OPTIONAL,
  ...
}

RLItem-DM-Rqst-ExtIEs RNSAP-PROTOCOL-EXTENSION ::= {

```

```

}
...
RL-InformationList-DM-Rqst ::= SEQUENCE (SIZE (1..maxNrOfRLs)) OF ProtocolIE-Single-Container { {RL-Information-DM-Rqst-IEs} }

RL-Information-DM-Rqst-IEs RNSAP-PROTOCOL-IES ::= {
  { ID id-RL-InformationItem-DM-Rqst      CRITICALITY reject  TYPE RL-InformationItem-DM-Rqst      PRESENCE mandatory  }
}

RL-InformationItem-DM-Rqst ::= SEQUENCE {
  rL-ID                RL-ID,
  dPCH-ID              DPCH-ID      OPTIONAL,
  iE-Extensions        ProtocolExtensionContainer { {RL-InformationItem-DM-Rqst-ExtIEs} } OPTIONAL,
  ...
}

RL-InformationItem-DM-Rqst-ExtIEs RNSAP-PROTOCOL-EXTENSION ::= {
  { ID id-HSSICH-Info-DM-Rqst          CRITICALITY reject          EXTENSION HSSICH-Info-DM-Rqst
    PRESENCE optional}|
  -- TDD only
  { ID id-DPCH-ID768-DM-Rqst          CRITICALITY reject          EXTENSION DPCH-ID768
    PRESENCE optional}|
  { ID id-HSSICH-Info-DM-Rqst-Extension CRITICALITY reject          EXTENSION HSSICH-Info-DM-Rqst-Extension
    PRESENCE optional},
  -- Applicable for 1.28Mcps TDD only when the HS-SICH ID IE is more than 31
  ...
}

HSSICH-Info-DM-Rqst ::= SEQUENCE (SIZE (1..maxNrOfHSSICHs)) OF HS-SICH-ID

HSSICH-Info-DM-Rqst-Extension ::= SEQUENCE (SIZE (1..maxNrOfHSSICHs)) OF HS-SICH-ID-Extension

RL-Set-DM-Rqst ::= SEQUENCE {
  rL-Set-InformationList-DM-Rqst RL-Set-InformationList-DM-Rqst,
  iE-Extensions                  ProtocolExtensionContainer { { RL-SetItem-DM-Rqst-ExtIEs} } OPTIONAL,
  ...
}

RL-SetItem-DM-Rqst-ExtIEs RNSAP-PROTOCOL-EXTENSION ::= {
  ...
}

RL-Set-InformationList-DM-Rqst ::= SEQUENCE (SIZE (1..maxNrOfRLSets)) OF ProtocolIE-Single-Container { {RL-Set-Information-DM-Rqst-IEs} }

RL-Set-Information-DM-Rqst-IEs RNSAP-PROTOCOL-IES ::= {
  { ID id-RL-Set-InformationItem-DM-Rqst CRITICALITY reject  TYPE RL-Set-InformationItem-DM-Rqst      PRESENCE mandatory  }
}

RL-Set-InformationItem-DM-Rqst ::= SEQUENCE {
  rL-Set-ID                RL-Set-ID,
  iE-Extensions            ProtocolExtensionContainer { {RL-Set-InformationItem-DM-Rqst-ExtIEs} } OPTIONAL,
  ...
}

```



```

RL-Set-InformationItem-DM-Rqst-ExtIEs RNSAP-PROTOCOL-EXTENSION ::= {
  ...
}

All-RL-DM-Rqst ::= NULL

All-RL-Set-DM-Rqst ::= NULL

DedicatedMeasurementInitiationRequest-Extensions RNSAP-PROTOCOL-EXTENSION ::= {
  { ID id-PartialReportingIndicator          CRITICALITY ignore EXTENSION PartialReportingIndicator
  PRESENCE optional }|
  { ID id-MeasurementRecoveryBehavior        CRITICALITY ignore EXTENSION MeasurementRecoveryBehavior          PRESENCE
optional }|
  { ID id-AlternativeFormatReportingIndicator CRITICALITY ignore EXTENSION AlternativeFormatReportingIndicator PRESENCE optional },
  ...
}

-- *****
--
-- DEDICATED MEASUREMENT INITIATION RESPONSE
--
-- *****

DedicatedMeasurementInitiationResponse ::= SEQUENCE {
  protocolIEs          ProtocolIE-Container    {{DedicatedMeasurementInitiationResponse-IEs}},
  protocolExtensions   ProtocolExtensionContainer {{DedicatedMeasurementInitiationResponse-Extensions}}
  ...
}

DedicatedMeasurementInitiationResponse-IEs RNSAP-PROTOCOL-IES ::= {
  { ID id-MeasurementID          CRITICALITY ignore TYPE MeasurementID
  PRESENCE mandatory } |
  { ID id-DedicatedMeasurementObjectType-DM-Rsp CRITICALITY ignore TYPE DedicatedMeasurementObjectType-DM-Rsp          PRESENCE optional }
|
  { ID id-CriticalityDiagnostics CRITICALITY ignore TYPE CriticalityDiagnostics
  PRESENCE optional },
  ...
}

DedicatedMeasurementObjectType-DM-Rsp ::= CHOICE {
  rLs          RL-DM-Rsp,
  rLS          RL-Set-DM-Rsp,
  allRL       RL-DM-Rsp,
  allRLS      RL-Set-DM-Rsp,
  ...
}

RL-DM-Rsp ::= SEQUENCE {
  rL-InformationList-DM-Rsp          RL-InformationList-DM-Rsp,
  IE-Extensions                     ProtocolExtensionContainer { { RLItem-DM-Rsp-ExtIEs } } OPTIONAL,
  ...
}

```

```

RLItem-DM-Rsp-ExtIEs RNSAP-PROTOCOL-EXTENSION ::= {
    ...
}

RL-Set-DM-Rsp ::= SEQUENCE {
    rL-Set-InformationList-DM-Rsp    RL-Set-InformationList-DM-Rsp,
    iE-Extensions                    ProtocolExtensionContainer { { RL-SetItem-DM-Rsp-ExtIEs } } OPTIONAL,
    ...
}

RL-SetItem-DM-Rsp-ExtIEs RNSAP-PROTOCOL-EXTENSION ::= {
    ...
}

RL-InformationList-DM-Rsp
    ::= SEQUENCE (SIZE (1..maxNrOfRLs)) OF ProtocolIE-Single-Container { {RL-Information-DM-Rsp-IEs} }

RL-Information-DM-Rsp-IEs RNSAP-PROTOCOL-IES ::= {
    { ID id-RL-InformationItem-DM-Rsp    CRITICALITY ignore    TYPE RL-InformationItem-DM-Rsp    PRESENCE mandatory    }
}

RL-InformationItem-DM-Rsp ::= SEQUENCE {
    rL-ID                RL-ID,
    dPCH-ID              DPCH-ID                OPTIONAL,
    dedicatedMeasurementValue    DedicatedMeasurementValue,
    cFN                  CFN                    OPTIONAL,
    iE-Extensions        ProtocolExtensionContainer { {RL-InformationItem-DM-Rsp-ExtIEs} } OPTIONAL,
    ...
}

RL-InformationItem-DM-Rsp-ExtIEs RNSAP-PROTOCOL-EXTENSION ::= {
    {ID id-HSSICH-Info-DM    CRITICALITY reject    EXTENSION    HS-SICH-ID    PRESENCE optional}|
    -- TDD only
    { ID    id-multiple-DedicatedMeasurementValueList-TDD-DM-Rsp    CRITICALITY ignore    EXTENSION Multiple-DedicatedMeasurementValueList-TDD-DM-Rsp
    PRESENCE optional    }|
    -- Applicable to 3.84Mcps TDD only. This list of dedicated measurement values is used for the 2nd and beyond measurements of a RL when multiple
    dedicated measurement values need to be reported.
    { ID    id-multiple-DedicatedMeasurementValueList-LCR-TDD-DM-Rsp    CRITICALITY ignore    EXTENSION Multiple-DedicatedMeasurementValueList-LCR-
    TDD-DM-Rsp    PRESENCE optional    }|
    -- Applicable to 1.28Mcps TDD only. This list of dedicated measurement values is used for the 2nd and beyond measurements of a RL when multiple
    dedicated measurement values need to be reported.
    { ID    id-multiple-HSSICHMeasurementValueList-TDD-DM-Rsp    CRITICALITY ignore    EXTENSION Multiple-HSSICHMeasurementValueList-TDD-DM-
    Rsp    PRESENCE optional    }|
    -- TDD only. This list of HS-SICH measurement values is used for the 2nd and beyond measurements of a RL when multiple HS-SICH measurement
    values need to be reported.
    { ID    id-multiple-DedicatedMeasurementValueList-TDD768-DM-Rsp    CRITICALITY ignore    EXTENSION Multiple-DedicatedMeasurementValueList-
    TDD768-DM-Rsp    PRESENCE optional    }|
    -- Applicable to 7.68Mcps TDD only. This list of dedicated measurement values is used for the 2nd and beyond measurements of a RL when multiple
    dedicated measurement values need to be reported.
    { ID    id-DPCH-ID768-DM-Rsp    CRITICALITY ignore    EXTENSION DPCH-ID768
    PRESENCE optional}|
    { ID id-HS-SICH-ID-Extension    CRITICALITY ignore    EXTENSION HS-SICH-ID-Extension
    PRESENCE optional},
    -- Applicable for 1.28Mcps TDD only when the HS-SICH ID IE is more than 31
    ...
}

```

```

}
RL-Set-InformationList-DM-Rsp ::= SEQUENCE (SIZE (1..maxNrOfRLSets)) OF ProtocolIE-Single-Container { {RL-Set-Information-DM-Rsp-IEs} }
RL-Set-Information-DM-Rsp-IEs RNSAP-PROTOCOL-IES ::= {
  { ID id-RL-Set-InformationItem-DM-Rsp          CRITICALITY ignore   TYPE RL-Set-InformationItem-DM-Rsp          PRESENCE mandatory   }
}
RL-Set-InformationItem-DM-Rsp ::= SEQUENCE {
  rL-Set-ID                RL-Set-ID,
  dedicatedMeasurementValue DedicatedMeasurementValue,
  cFN                      CFN          OPTIONAL,
  iE-Extensions            ProtocolExtensionContainer { {RL-Set-InformationItem-DM-Rspns-ExtIEs} }  OPTIONAL,
  ...
}
RL-Set-InformationItem-DM-Rspns-ExtIEs RNSAP-PROTOCOL-EXTENSION ::= {
  ...
}
DedicatedMeasurementInitiationResponse-Extensions RNSAP-PROTOCOL-EXTENSION ::= {
  { ID id-MeasurementRecoverySupportIndicator  CRITICALITY ignore   EXTENSION MeasurementRecoverySupportIndicator  PRESENCE optional }
  },
  ...
}
Multiple-DedicatedMeasurementValueList-TDD-DM-Rsp ::= SEQUENCE (SIZE (1.. maxNrOfDPCHsPerRL-1)) OF Multiple-DedicatedMeasurementValueItem-TDD-DM-Rsp
Multiple-DedicatedMeasurementValueItem-TDD-DM-Rsp ::= SEQUENCE {
  dPCH-ID                DPCH-ID,
  dedicatedMeasurementValue DedicatedMeasurementValue,
  iE-Extensions          ProtocolExtensionContainer { { Multiple-DedicatedMeasurementValueItem-TDD-DM-Rsp-ExtIEs} }
  OPTIONAL,
  ...
}
Multiple-DedicatedMeasurementValueItem-TDD-DM-Rsp-ExtIEs RNSAP-PROTOCOL-EXTENSION ::= {
  ...
}
Multiple-DedicatedMeasurementValueList-LCR-TDD-DM-Rsp ::= SEQUENCE (SIZE (1.. maxNrOfDPCHsLCRPerRL-1)) OF Multiple-DedicatedMeasurementValueItem-LCR-TDD-DM-Rsp
Multiple-DedicatedMeasurementValueItem-LCR-TDD-DM-Rsp ::= SEQUENCE {
  dPCH-ID                DPCH-ID,
  dedicatedMeasurementValue DedicatedMeasurementValue,
  iE-Extensions          ProtocolExtensionContainer { { Multiple-DedicatedMeasurementValueItem-LCR-TDD-DM-Rsp-ExtIEs} }
  OPTIONAL,
  ...
}

```

```

Multiple-DedicatedMeasurementValueItem-LCR-TDD-DM-Rsp-ExtIEs RNSAP-PROTOCOL-EXTENSION ::= {
  ...
}

Multiple-HSSICHMeasurementValueList-TDD-DM-Rsp ::= SEQUENCE (SIZE (1.. maxNrOfHSSICHs-1)) OF Multiple-HSSICHMeasurementValueItem-TDD-DM-Rsp

Multiple-HSSICHMeasurementValueItem-TDD-DM-Rsp ::= SEQUENCE {
  hsSICH-ID                HS-SICH-ID,
  dedicatedMeasurementValue DedicatedMeasurementValue,
  iE-Extensions            ProtocolExtensionContainer { { Multiple-HSSICHMeasurementValueItem-TDD-DM-Rsp-ExtIEs} } OPTIONAL,
  ...
}

Multiple-HSSICHMeasurementValueItem-TDD-DM-Rsp-ExtIEs RNSAP-PROTOCOL-EXTENSION ::= {
  { ID id-HS-SICH-ID-Extension          CRITICALITY ignore          EXTENSION HS-SICH-ID-Extension          PRESENCE optional},
  -- Applicable for 1.28Mcps TDD only when the HS-SICH ID IE is more than 31
  ...
}

Multiple-DedicatedMeasurementValueList-TDD768-DM-Rsp ::= SEQUENCE (SIZE (1.. maxNrOfDPCHs768PerRL-1)) OF Multiple-DedicatedMeasurementValueItem-TDD768-DM-Rsp

Multiple-DedicatedMeasurementValueItem-TDD768-DM-Rsp ::= SEQUENCE {
  dPCH-ID768                DPCH-ID768,
  dedicatedMeasurementValue  DedicatedMeasurementValue,
  iE-Extensions            ProtocolExtensionContainer { { Multiple-DedicatedMeasurementValueItem-TDD768-DM-Rsp-ExtIEs} } OPTIONAL,
  ...
}

Multiple-DedicatedMeasurementValueItem-TDD768-DM-Rsp-ExtIEs RNSAP-PROTOCOL-EXTENSION ::= {
  ...
}

-- *****
--
-- DEDICATED MEASUREMENT INITIATION FAILURE
--
-- *****

DedicatedMeasurementInitiationFailure ::= SEQUENCE {
  protocolIEs                ProtocolIE-Container          {{DedicatedMeasurementInitiationFailure-IEs}},
  protocolExtensions         ProtocolExtensionContainer {{DedicatedMeasurementInitiationFailure-Extensions}} OPTIONAL,
  ...
}

DedicatedMeasurementInitiationFailure-IEs RNSAP-PROTOCOL-IES ::= {
  { ID id-MeasurementID          CRITICALITY ignore TYPE MeasurementID          PRESENCE mandatory } |
  { ID id-Cause                  CRITICALITY ignore TYPE Cause                PRESENCE mandatory } |
  { ID id-CriticalityDiagnostics CRITICALITY ignore TYPE CriticalityDiagnostics PRESENCE optional },
  ...
}

```

```

DedicatedMeasurementInitiationFailure-Extensions RNSAP-PROTOCOL-EXTENSION ::= {
  { ID id-DedicatedMeasurementObjectType-DM-Fail CRITICALITY ignore EXTENSION DedicatedMeasurementObjectType-DM-Fail PRESENCE optional
  },
  ...
}

DedicatedMeasurementObjectType-DM-Fail ::= CHOICE {
  rL RL-DM-Fail,
  rLS RL-Set-DM-Fail,
  allRL RL-DM-Fail,
  allRLS RL-Set-DM-Fail,
  ...
}

RL-DM-Fail ::= SEQUENCE {
  rL-unsuccessful-InformationRespList-DM-Fail RL-Unsuccessful-InformationRespList-DM-Fail,
  rL-successful-InformationRespList-DM-Fail RL-Successful-InformationRespList-DM-Fail OPTIONAL,
  iE-Extensions ProtocolExtensionContainer { { RLItem-DM-Fail-ExtIEs } } OPTIONAL,
  ...
}

RLItem-DM-Fail-ExtIEs RNSAP-PROTOCOL-EXTENSION ::= {
  ...
}

RL-Set-DM-Fail ::= SEQUENCE {
  rL-Set-unsuccessful-InformationRespList-DM-Fail RL-Set-Unsuccessful-InformationRespList-DM-Fail,
  rL-Set-successful-InformationRespList-DM-Fail RL-Set-Successful-InformationRespList-DM-Fail OPTIONAL,
  iE-Extensions ProtocolExtensionContainer { { RL-SetItem-DM-Fail-ExtIEs } } OPTIONAL,
  ...
}

RL-SetItem-DM-Fail-ExtIEs RNSAP-PROTOCOL-EXTENSION ::= {
  ...
}

RL-Unsuccessful-InformationRespList-DM-Fail ::= SEQUENCE (SIZE (1..maxNrOfRLs)) OF ProtocolIE-Single-Container { {RL-Unsuccessful-
InformationResp-DM-Fail-IEs} }

RL-Unsuccessful-InformationResp-DM-Fail-IEs RNSAP-PROTOCOL-IES ::= {
  { ID id-RL-Unsuccessful-InformationItem-DM-Fail CRITICALITY ignore TYPE RL-Unsuccessful-InformationItem-DM-Fail PRESENCE
mandatory }
}

RL-Unsuccessful-InformationItem-DM-Fail ::= SEQUENCE {
  rL-ID RL-ID,
  individualCause Cause OPTIONAL,
  iE-Extensions ProtocolExtensionContainer { {RL-Unsuccessful-InformationItem-DM-Fail-ExtIEs} } OPTIONAL,
  ...
}

RL-Unsuccessful-InformationItem-DM-Fail-ExtIEs RNSAP-PROTOCOL-EXTENSION ::= {
  ...
}

```

```

}

RL-Successful-InformationRespList-DM-Fail ::= SEQUENCE (SIZE (1..maxNrOfRLs-1)) OF ProtocolIE-Single-Container { {RL-Successful-
InformationResp-DM-Fail-IEs} }

RL-Successful-InformationResp-DM-Fail-IEs RNSAP-PROTOCOL-IES ::= {
  { ID id-RL-Successful-InformationItem-DM-Fail          CRITICALITY ignore   TYPE RL-Successful-InformationItem-DM-Fail          PRESENCE mandatory
  }
}

RL-Successful-InformationItem-DM-Fail ::= SEQUENCE {
  rL-ID                RL-ID,
  dPCH-ID              DPCH-ID          OPTIONAL,
  dedicatedMeasurementValue DedicatedMeasurementValue,
  cFN                  CFN              OPTIONAL,
  iE-Extensions        ProtocolExtensionContainer { {RL-Successful-InformationItem-DM-Fail-ExtIEs} } OPTIONAL,
  ...
}

RL-Successful-InformationItem-DM-Fail-ExtIEs RNSAP-PROTOCOL-EXTENSION ::= {
  {ID id-HSSICH-Info-DM          CRITICALITY reject          EXTENSION HS-SICH-ID          PRESENCE optional}|
  -- TDD only
  { ID id-HS-SICH-ID-Extension    CRITICALITY ignore          EXTENSION HS-SICH-ID-Extension    PRESENCE optional},
  -- Applicable for 1.28Mcps TDD only when the HS-SICH ID IE is more than 31
  ...
}

RL-Set-Unsuccessful-InformationRespList-DM-Fail ::= SEQUENCE (SIZE (1..maxNrOfRLSets)) OF ProtocolIE-Single-Container { {RL-Set-
Unsuccessful-InformationResp-DM-Fail-IEs} }

RL-Set-Unsuccessful-InformationResp-DM-Fail-IEs RNSAP-PROTOCOL-IES ::= {
  { ID id-RL-Set-Unsuccessful-InformationItem-DM-Fail    CRITICALITY ignore   TYPE RL-Set-Unsuccessful-InformationItem-DM-Fail
  PRESENCE mandatory }
}

RL-Set-Unsuccessful-InformationItem-DM-Fail ::= SEQUENCE {
  rL-Set-ID                RL-Set-ID,
  individualCause          Cause          OPTIONAL,
  iE-Extensions            ProtocolExtensionContainer { {RL-Set-Unsuccessful-InformationItem-DM-Failns-ExtIEs} } OPTIONAL,
  ...
}

RL-Set-Unsuccessful-InformationItem-DM-Failns-ExtIEs RNSAP-PROTOCOL-EXTENSION ::= {
  ...
}

RL-Set-Successful-InformationRespList-DM-Fail ::= SEQUENCE (SIZE (1..maxNrOfRLSets-1)) OF ProtocolIE-Single-Container { {RL-Set-
Successful-InformationResp-DM-Fail-IEs} }

RL-Set-Successful-InformationResp-DM-Fail-IEs RNSAP-PROTOCOL-IES ::= {
  { ID id-RL-Set-Successful-InformationItem-DM-Fail    CRITICALITY ignore   TYPE RL-Set-Successful-InformationItem-DM-Fail    PRESENCE
  mandatory }
}

```

```

RL-Set-Successful-InformationItem-DM-Fail ::= SEQUENCE {
    rL-Set-ID                RL-Set-ID,
    dedicatedMeasurementValue DedicatedMeasurementValue,
    cFN                      CFN                      OPTIONAL,
    iE-Extensions            ProtocolExtensionContainer { {RL-Set-Successful-InformationItem-DM-Failns-ExtIEs} } OPTIONAL,
    ...
}

RL-Set-Successful-InformationItem-DM-Failns-ExtIEs RNSAP-PROTOCOL-EXTENSION ::= {
    ...
}

-- *****
--
-- DEDICATED MEASUREMENT REPORT
--
-- *****

DedicatedMeasurementReport ::= SEQUENCE {
    protocolIEs                ProtocolIE-Container    {{DedicatedMeasurementReport-IEs}},
    protocolExtensions          ProtocolExtensionContainer {{DedicatedMeasurementReport-Extensions}}          OPTIONAL,
    ...
}

DedicatedMeasurementReport-IEs RNSAP-PROTOCOL-IES ::= {
    { ID id-MeasurementID          CRITICALITY ignore TYPE MeasurementID          PRESENCE mandatory } |
    { ID id-DedicatedMeasurementObjectType-DM-Rpmt CRITICALITY ignore TYPE DedicatedMeasurementObjectType-DM-Rpmt PRESENCE mandatory },
    ...
}

DedicatedMeasurementObjectType-DM-Rpmt ::= CHOICE {
    rLs                RL-DM-Rpmt,
    rLS                RL-Set-DM-Rpmt,
    allRL              RL-DM-Rpmt,
    allRLS             RL-Set-DM-Rpmt,
    ...
}

RL-DM-Rpmt ::= SEQUENCE {
    rL-InformationList-DM-Rpmt    RL-InformationList-DM-Rpmt,
    iE-Extensions                ProtocolExtensionContainer { { RLItem-DM-Rpmt-ExtIEs } } OPTIONAL,
    ...
}

RLItem-DM-Rpmt-ExtIEs RNSAP-PROTOCOL-EXTENSION ::= {
    ...
}

RL-Set-DM-Rpmt ::= SEQUENCE {
    rL-Set-InformationList-DM-Rpmt RL-Set-InformationList-DM-Rpmt,
    iE-Extensions                ProtocolExtensionContainer { { RL-SetItem-DM-Rpmt-ExtIEs } } OPTIONAL,
    ...
}

```

```

RL-SetItem-DM-Rprt-ExtIEs RNSAP-PROTOCOL-EXTENSION ::= {
    ...
}

RL-InformationList-DM-Rprt ::= SEQUENCE (SIZE (1..maxNrOfRLs)) OF ProtocolIE-Single-Container { {RL-Information-DM-Rprt-IEs} }

RL-Information-DM-Rprt-IEs RNSAP-PROTOCOL-IES ::= {
    { ID id-RL-InformationItem-DM-Rprt          CRITICALITY ignore  TYPE RL-InformationItem-DM-Rprt          PRESENCE mandatory      }
}

RL-InformationItem-DM-Rprt ::= SEQUENCE {
    rL-ID                RL-ID,
    dPCH-ID              DPCH-ID                OPTIONAL,
    dedicatedMeasurementValueInformation    DedicatedMeasurementValueInformation,
    iE-Extensions        ProtocolExtensionContainer { {RL-InformationItem-DM-Rprt-ExtIEs} } OPTIONAL,
    ...
}

RL-InformationItem-DM-Rprt-ExtIEs RNSAP-PROTOCOL-EXTENSION ::= {
    {ID id-HSSICH-Info-DM-Rprt          CRITICALITY ignore          EXTENSION  HS-SICH-ID          PRESENCE optional}|
    -- TDD only
    { ID id-DPCH-ID768-DM-Rprt          CRITICALITY ignore          EXTENSION  DPCH-ID768          PRESENCE optional}|
    { ID id-HS-SICH-ID-Extension        CRITICALITY ignore          EXTENSION  HS-SICH-ID-Extension        PRESENCE optional},
    optional},
    -- Applicable for 1.28Mcps TDD only when the HS-SICH ID IE is more than 31
    ...
}

RL-Set-InformationList-DM-Rprt ::= SEQUENCE (SIZE (1..maxNrOfRLSets)) OF ProtocolIE-Single-Container { {RL-Set-Information-DM-Rprt-IEs} }

RL-Set-Information-DM-Rprt-IEs RNSAP-PROTOCOL-IES ::= {
    { ID id-RL-Set-InformationItem-DM-Rprt          CRITICALITY ignore  TYPE RL-Set-InformationItem-DM-Rprt          PRESENCE mandatory      }
}

RL-Set-InformationItem-DM-Rprt ::= SEQUENCE {
    rL-Set-ID                RL-Set-ID,
    dedicatedMeasurementValueInformation    DedicatedMeasurementValueInformation,
    iE-Extensions            ProtocolExtensionContainer { {RL-Set-InformationItem-DM-Rprt-ExtIEs} } OPTIONAL,
    ...
}

RL-Set-InformationItem-DM-Rprt-ExtIEs RNSAP-PROTOCOL-EXTENSION ::= {
    ...
}

DedicatedMeasurementReport-Extensions RNSAP-PROTOCOL-EXTENSION ::= {
    { ID id-MeasurementRecoveryReportingIndicator          CRITICALITY ignore          EXTENSION  MeasurementRecoveryReportingIndicator          PRESENCE optional },
    ...
}

-- *****
--

```



```

-- DEDICATED MEASUREMENT TERMINATION REQUEST
--
-- *****
DedicatedMeasurementTerminationRequest ::= SEQUENCE {
    protocolIEs          ProtocolIE-Container    {{DedicatedMeasurementTerminationRequest-IEs}},
    protocolExtensions  ProtocolExtensionContainer {{DedicatedMeasurementTerminationRequest-Extensions}}
    ...
}
DedicatedMeasurementTerminationRequest-IEs RNSAP-PROTOCOL-IES ::= {
    { ID id-MeasurementID          CRITICALITY ignore TYPE MeasurementID          PRESENCE mandatory },
    ...
}
DedicatedMeasurementTerminationRequest-Extensions RNSAP-PROTOCOL-EXTENSION ::= {
    ...
}
-- *****
-- DEDICATED MEASUREMENT FAILURE INDICATION
--
-- *****
DedicatedMeasurementFailureIndication ::= SEQUENCE {
    protocolIEs          ProtocolIE-Container    {{DedicatedMeasurementFailureIndication-IEs}},
    protocolExtensions  ProtocolExtensionContainer {{DedicatedMeasurementFailureIndication-Extensions}}
    ...
}
DedicatedMeasurementFailureIndication-IEs RNSAP-PROTOCOL-IES ::= {
    { ID id-MeasurementID          CRITICALITY ignore TYPE MeasurementID          PRESENCE mandatory } |
    { ID id-Cause                  CRITICALITY ignore TYPE Cause                  PRESENCE mandatory },
    ...
}
DedicatedMeasurementFailureIndication-Extensions RNSAP-PROTOCOL-EXTENSION ::= {
    { ID id-DedicatedMeasurementObjectType-DM-Fail-Ind CRITICALITY ignore EXTENSION DedicatedMeasurementObjectType-DM-Fail-Ind
optional },
    ...
}
DedicatedMeasurementObjectType-DM-Fail-Ind ::= CHOICE {
    rL          RL-DM-Fail-Ind,
    rLS         RL-Set-DM-Fail-Ind,
    allRL       RL-DM-Fail-Ind,
    allRLS      RL-Set-DM-Fail-Ind,
    ...
}
RL-DM-Fail-Ind ::= SEQUENCE {
    rL-unsuccessful-InformationRespList-DM-Fail-Ind  RL-Unsuccessful-InformationRespList-DM-Fail-Ind,
    iE-Extensions                                     ProtocolExtensionContainer { { RLItem-DM-Fail-Ind-ExtIEs } } OPTIONAL,
}

```

```

}
...
}
RLItem-DM-Fail-Ind-ExtIEs RNSAP-PROTOCOL-EXTENSION ::= {
    ...
}
RL-Set-DM-Fail-Ind ::= SEQUENCE {
    rL-Set-unsuccessful-InformationRespList-DM-Fail-Ind    RL-Set-Unsuccessful-InformationRespList-DM-Fail-Ind,
    iE-Extensions                                          ProtocolExtensionContainer { { RL-SetItem-DM-Fail-Ind-ExtIEs} } OPTIONAL,
    ...
}
RL-SetItem-DM-Fail-Ind-ExtIEs RNSAP-PROTOCOL-EXTENSION ::= {
    ...
}
RL-Unsuccessful-InformationRespList-DM-Fail-Ind          ::= SEQUENCE (SIZE (1..maxNrOfRLs)) OF ProtocolIE-Single-Container { {RL-Unsuccessful-
InformationResp-DM-Fail-Ind-IEs} }
RL-Unsuccessful-InformationResp-DM-Fail-Ind-IEs RNSAP-PROTOCOL-IES ::= {
    { ID id-RL-Unsuccessful-InformationItem-DM-Fail-Ind    CRITICALITY ignore TYPE RL-Unsuccessful-InformationItem-DM-Fail-Ind
    PRESENCE mandatory }
}
RL-Unsuccessful-InformationItem-DM-Fail-Ind ::= SEQUENCE {
    rL-ID                    RL-ID,
    individualcause          Cause          OPTIONAL,
    iE-Extensions            ProtocolExtensionContainer { {RL-Unsuccessful-InformationItem-DM-Fail-Ind-ExtIEs} } OPTIONAL,
    ...
}
RL-Unsuccessful-InformationItem-DM-Fail-Ind-ExtIEs RNSAP-PROTOCOL-EXTENSION ::= {
    ...
}
RL-Set-Unsuccessful-InformationRespList-DM-Fail-Ind          ::= SEQUENCE (SIZE (1..maxNrOfRLSets)) OF ProtocolIE-Single-Container { {RL-Set-
Unsuccessful-InformationResp-DM-Fail-Ind-IEs} }
RL-Set-Unsuccessful-InformationResp-DM-Fail-Ind-IEs RNSAP-PROTOCOL-IES ::= {
    { ID id-RL-Set-Unsuccessful-InformationItem-DM-Fail-Ind    CRITICALITY ignore TYPE RL-Set-Unsuccessful-InformationItem-DM-Fail-Ind
    PRESENCE mandatory }
}
RL-Set-Unsuccessful-InformationItem-DM-Fail-Ind ::= SEQUENCE {
    rL-Set-ID                    RL-Set-ID,
    individualcause          Cause          OPTIONAL,
    iE-Extensions            ProtocolExtensionContainer { {RL-Set-Unsuccessful-InformationItem-DM-Fail-Indns-ExtIEs} } OPTIONAL,
    ...
}
RL-Set-Unsuccessful-InformationItem-DM-Fail-Indns-ExtIEs RNSAP-PROTOCOL-EXTENSION ::= {
    ...
}

```

```

-- *****
--
-- COMMON TRANSPORT CHANNEL RESOURCES RELEASE REQUEST
--
-- *****

CommonTransportChannelResourcesReleaseRequest ::= SEQUENCE {
    protocolIEs                ProtocolIE-Container    {{CommonTransportChannelResourcesReleaseRequest-IEs}},
    protocolExtensions         ProtocolExtensionContainer {{CommonTransportChannelResourcesReleaseRequest-Extensions}}
OPTIONAL,
    ...
}

CommonTransportChannelResourcesReleaseRequest-IEs RNSAP-PROTOCOL-IES ::= {
    { ID id-D-RNTI                CRITICALITY ignore  TYPE D-RNTI                PRESENCE mandatory },
    ...
}

CommonTransportChannelResourcesReleaseRequest-Extensions RNSAP-PROTOCOL-EXTENSION ::= {
    ...
}

-- *****
--
-- COMMON TRANSPORT CHANNEL RESOURCES REQUEST
--
-- *****

CommonTransportChannelResourcesRequest ::= SEQUENCE {
    protocolIEs                ProtocolIE-Container    {{CommonTransportChannelResourcesRequest-IEs}},
    protocolExtensions         ProtocolExtensionContainer {{CommonTransportChannelResourcesRequest-Extensions}}
OPTIONAL,
    ...
}

CommonTransportChannelResourcesRequest-IEs RNSAP-PROTOCOL-IES ::= {
    { ID id-D-RNTI                CRITICALITY reject  TYPE D-RNTI                PRESENCE mandatory } |
    { ID id-C-ID                  CRITICALITY reject  TYPE C-ID                  PRESENCE optional } |
    { ID id-TransportBearerRequestIndicator CRITICALITY reject  TYPE TransportBearerRequestIndicator PRESENCE mandatory } |
    { ID id-TransportBearerID      CRITICALITY reject  TYPE TransportBearerID     PRESENCE mandatory },
    ...
}

CommonTransportChannelResourcesRequest-Extensions RNSAP-PROTOCOL-EXTENSION ::= {
    { ID id-Permanent-NAS-UE-Identity CRITICALITY ignore  EXTENSION Permanent-NAS-UE-Identity PRESENCE optional } |
    { ID id-BindingID                CRITICALITY ignore  EXTENSION BindingID           PRESENCE optional } |
    -- Shall be ignored if bearer establishment with ALCAP.
    { ID id-TransportLayerAddress      CRITICALITY ignore  EXTENSION TransportLayerAddress PRESENCE optional } |
    -- Shall be ignored if bearer establishment with ALCAP.
    { ID id-MBMS-Bearer-Service-List CRITICALITY notify  EXTENSION MBMS-Bearer-Service-List PRESENCE optional } |
    { ID id-TnIqos                    CRITICALITY ignore  EXTENSION TnIqos              PRESENCE optional } |
    { ID id-Enhanced-FACH-Support-Indicator CRITICALITY ignore  EXTENSION Enhanced-FACH-Support-Indicator PRESENCE optional } |
    -- FDD and 1.28Mcps TDD only
    { ID id-Common-EDCH-Support-Indicator CRITICALITY ignore  EXTENSION Common-EDCH-Support-Indicator PRESENCE optional } |
}

```

```

-- FDD only
{ ID id-HSDSCH-Physical-Layer-Category      CRITICALITY ignore  EXTENSION HSDSCH-Physical-Layer-Category  PRESENCE optional }|
{ ID id-UE-with-enhanced-HS-SCCH-support-indicator CRITICALITY ignore  EXTENSION NULL      PRESENCE optional },
...
}

-- *****
--
-- COMMON TRANSPORT CHANNEL RESOURCES RESPONSE FDD
--
-- *****

CommonTransportChannelResourcesResponseFDD ::= SEQUENCE {
    protocolIEs                ProtocolIE-Container    {{CommonTransportChannelResourcesResponseFDD-IEs}},
    protocolExtensions         ProtocolExtensionContainer {{CommonTransportChannelResourcesResponseFDD-Extensions}}
    OPTIONAL,
    ...
}

CommonTransportChannelResourcesResponseFDD-IEs RNSAP-PROTOCOL-IES ::= {
    { ID id-S-RNTI                CRITICALITY ignore  TYPE S-RNTI                PRESENCE mandatory } |
    { ID id-C-RNTI                CRITICALITY ignore  TYPE C-RNTI                PRESENCE optional   } |
    { ID id-FACH-InfoForUESelectedS-CCPCH-CTCH-ResourceRspFDD  CRITICALITY ignore  TYPE FACH-InfoForUESelectedS-CCPCH-CTCH-ResourceRspFDD  PRESENCE mandatory } |
    { ID id-TransportLayerAddress  CRITICALITY ignore  TYPE TransportLayerAddress  PRESENCE optional   } |
    { ID id-BindingID              CRITICALITY ignore  TYPE BindingID              PRESENCE optional   } |
    { ID id-CriticalityDiagnostics  CRITICALITY ignore  TYPE CriticalityDiagnostics  PRESENCE optional   },
    ...
}

FACH-InfoForUESelectedS-CCPCH-CTCH-ResourceRspFDD ::= SEQUENCE {
    fACH-FlowControlInformation  FACH-FlowControlInformation-CTCH-ResourceRspFDD,
    -- If the Enhanced FACH Information Response IE is included in the message, the FACH Flow Control Information IE shall be ignored.
    iE-Extensions                ProtocolExtensionContainer { {FACH-InfoForUESelectedS-CCPCH-CTCH-ResourceRspFDD-ExtIEs} } OPTIONAL,
    ...
}

FACH-InfoForUESelectedS-CCPCH-CTCH-ResourceRspFDD-ExtIEs RNSAP-PROTOCOL-EXTENSION ::= {
    ...
}

FACH-FlowControlInformation-CTCH-ResourceRspFDD ::= ProtocolIE-Single-Container {{ FACH-FlowControlInformationIEs-CTCH-ResourceRspFDD }}

FACH-FlowControlInformationIEs-CTCH-ResourceRspFDD RNSAP-PROTOCOL-IES ::= {
    { ID id-FACH-FlowControlInformation CRITICALITY ignore  TYPE FACH-FlowControlInformation PRESENCE mandatory }
}

CommonTransportChannelResourcesResponseFDD-Extensions RNSAP-PROTOCOL-EXTENSION ::= {
    { ID id-C-ID                                CRITICALITY ignore  EXTENSION C-ID
      PRESENCE mandatory }|
    { ID id-Active-MBMS-Bearer-ServiceFDD      CRITICALITY ignore  EXTENSION Active-MBMS-Bearer-Service-ListFDD
      PRESENCE optional}|
    { ID id-Enhanced-FACH-Information-ResponseFDD  CRITICALITY ignore  EXTENSION Enhanced-FACH-Information-ResponseFDD
      PRESENCE optional}|
}

```

```

    { ID id-Common-EDCH-MAC-d-Flow-Specific-InformationFDD      CRITICALITY ignore      EXTENSION Common-EDCH-MAC-d-Flow-Specific-InformationFDD
      PRESENCE optional}|
    { ID id-E-RNTI      CRITICALITY ignore      EXTENSION E-RNTI      PRESENCE optional },
    ...
}

-- *****
--
-- COMMON TRANSPORT CHANNEL RESOURCES RESPONSE TDD
--
-- *****

CommonTransportChannelResourcesResponseTDD ::= SEQUENCE {
    protocolIES                ProtocolIE-Container      {{CommonTransportChannelResourcesResponseTDD-IEs}},
    protocolExtensions         ProtocolExtensionContainer {{CommonTransportChannelResourcesResponseTDD-Extensions}}
    OPTIONAL,
    ...
}

CommonTransportChannelResourcesResponseTDD-IEs RNSAP-PROTOCOL-IES ::= {
    { ID id-S-RNTI                CRITICALITY ignore      TYPE S-RNTI                PRESENCE mandatory } |
    { ID id-C-RNTI                CRITICALITY ignore      TYPE C-RNTI                PRESENCE optional   } |
    { ID id-FACH-InfoForUESelectedS-CCPCH-CTCH-ResourceRspTDD  CRITICALITY ignore      TYPE FACH-InfoForUESelectedS-CCPCH-CTCH-ResourceRspTDD
    PRESENCE mandatory } |
    { ID id-TransportLayerAddress  CRITICALITY ignore      TYPE TransportLayerAddress  PRESENCE optional   } |
    { ID id-BindingID              CRITICALITY ignore      TYPE BindingID              PRESENCE optional   } |
    { ID id-CriticalityDiagnostics  CRITICALITY ignore      TYPE CriticalityDiagnostics  PRESENCE optional   },
    ...
}

FACH-InfoForUESelectedS-CCPCH-CTCH-ResourceRspTDD ::= SEQUENCE {
    fACH-FlowControlInformation  FACH-FlowControlInformation-CTCH-ResourceRspTDD,
    iE-Extensions                ProtocolExtensionContainer { {FACH-InfoForUESelectedS-CCPCH-CTCH-ResourceRspTDD-ExtIEs} } OPTIONAL,
    ...
}

FACH-InfoForUESelectedS-CCPCH-CTCH-ResourceRspTDD-ExtIEs RNSAP-PROTOCOL-EXTENSION ::= {
    ...
}

FACH-FlowControlInformation-CTCH-ResourceRspTDD ::= ProtocolIE-Single-Container {{ FACH-FlowControlInformationIEs-CTCH-ResourceRspTDD }}

FACH-FlowControlInformationIEs-CTCH-ResourceRspTDD RNSAP-PROTOCOL-IES ::= {
    { ID id-FACH-FlowControlInformation CRITICALITY ignore      TYPE      FACH-FlowControlInformation PRESENCE mandatory }
}

CommonTransportChannelResourcesResponseTDD-Extensions RNSAP-PROTOCOL-EXTENSION ::= {
    { ID id-C-ID                CRITICALITY ignore      EXTENSION      C-ID
      PRESENCE mandatory } |
    { ID id-Active-MBMS-Bearer-ServiceTDD  CRITICALITY ignore      EXTENSION Active-MBMS-Bearer-Service-ListTDD
      PRESENCE optional}|
    { ID id-Enhanced-FACH-Information-ResponseLCR  CRITICALITY ignore      EXTENSION Enhanced-FACH-Information-ResponseLCR
      PRESENCE optional}|
}

```

```

    { ID id-Common-EDCH-MAC-d-Flow-Specific-InformationLCR      CRITICALITY ignore      EXTENSION Common-EDCH-MAC-d-Flow-Specific-InformationLCR
      PRESENCE optional},
    ...
  }
}

-- *****
--
-- COMMON TRANSPORT CHANNEL RESOURCES FAILURE
--
-- *****

CommonTransportChannelResourcesFailure ::= SEQUENCE {
  protocolIEs          ProtocolIE-Container    {{CommonTransportChannelResourcesFailure-IEs}},
  protocolExtensions   ProtocolExtensionContainer {{CommonTransportChannelResourcesFailure-Extensions}}
  ...
}

CommonTransportChannelResourcesFailure-IEs RNSAP-PROTOCOL-IES ::= {
  { ID id-S-RNTI          CRITICALITY ignore  TYPE S-RNTI          PRESENCE mandatory } |
  { ID id-Cause           CRITICALITY ignore  TYPE Cause           PRESENCE mandatory } |
  { ID id-CriticalityDiagnostics CRITICALITY ignore  TYPE CriticalityDiagnostics PRESENCE optional },
  ...
}

CommonTransportChannelResourcesFailure-Extensions RNSAP-PROTOCOL-EXTENSION ::= {
  ...
}

-- *****
--
-- COMPRESSED MODE COMMAND
--
-- *****

CompressedModeCommand ::= SEQUENCE {
  protocolIEs          ProtocolIE-Container    {{CompressedModeCommand-IEs}},
  protocolExtensions   ProtocolExtensionContainer {{CompressedModeCommand-Extensions}}
  ...
}

CompressedModeCommand-IEs RNSAP-PROTOCOL-IES ::= {
  { ID id-Active-Pattern-Sequence-Information CRITICALITY ignore  TYPE Active-Pattern-Sequence-Information PRESENCE mandatory },
  ...
}

CompressedModeCommand-Extensions RNSAP-PROTOCOL-EXTENSION ::= {
  ...
}

-- *****
--
-- ERROR INDICATION
--
-- *****

```

```

ErrorIndication ::= SEQUENCE {
    protocolIEs          ProtocolIE-Container    {{ErrorIndication-IEs}},
    protocolExtensions  ProtocolExtensionContainer {{ErrorIndication-Extensions}}
    ...
}

ErrorIndication-IEs RNSAP-PROTOCOL-IES ::= {
    { ID id-Cause          CRITICALITY ignore TYPE Cause          PRESENCE optional } |
    { ID id-CriticalityDiagnostics CRITICALITY ignore TYPE CriticalityDiagnostics PRESENCE optional },
    ...
}

ErrorIndication-Extensions RNSAP-PROTOCOL-EXTENSION ::= {
    { ID id-S-RNTI          CRITICALITY ignore EXTENSION S-RNTI          PRESENCE optional } |
    { ID id-D-RNTI          CRITICALITY ignore EXTENSION D-RNTI          PRESENCE optional },
    ...
}

-- *****
--
-- COMMON MEASUREMENT INITIATION REQUEST
--
-- *****

CommonMeasurementInitiationRequest ::= SEQUENCE {
    protocolIEs          ProtocolIE-Container    {{CommonMeasurementInitiationRequest-IEs}},
    protocolExtensions  ProtocolExtensionContainer {{CommonMeasurementInitiationRequest-Extensions}}
    ...
}

CommonMeasurementInitiationRequest-IEs RNSAP-PROTOCOL-IES ::= {
    { ID id-MeasurementID          CRITICALITY reject TYPE MeasurementID          PRESENCE mandatory } |
    { ID id-CommonMeasurementObjectType-CM-Rqst CRITICALITY reject TYPE CommonMeasurementObjectType-CM-Rqst PRESENCE mandatory } |
    { ID id-CommonMeasurementType          CRITICALITY reject TYPE CommonMeasurementType          PRESENCE mandatory } |
    { ID id-MeasurementFilterCoefficient CRITICALITY reject TYPE MeasurementFilterCoefficient PRESENCE optional } |
    -- UTRAN only
    { ID id-ReportCharacteristics          CRITICALITY reject TYPE ReportCharacteristics          PRESENCE mandatory } |
    { ID id-SFNReportingIndicator          CRITICALITY reject TYPE FNReportingIndicator          PRESENCE mandatory } |
    { ID id-SFN                          CRITICALITY reject TYPE SFN                          PRESENCE optional } |
    -- UTRAN only
    { ID id-CommonMeasurementAccuracy      CRITICALITY reject TYPE CommonMeasurementAccuracy      PRESENCE optional },
    -- UTRAN only
    ...
}

CommonMeasurementInitiationRequest-Extensions RNSAP-PROTOCOL-EXTENSION ::= {

```

```

    { ID id-MeasurementRecoveryBehavior          CRITICALITY ignore          EXTENSION MeasurementRecoveryBehavior          PRESENCE
      optional
    }|
    -- UTRAN only
    { ID id-GANSS-Time-ID                        CRITICALITY ignore          EXTENSION GANSS-Time-ID
      PRESENCE optional},
    ...
  }

CommonMeasurementObjectType-CM-Rqst ::= CHOICE {
  cell Cell-CM-Rqst,
  ...
}

Cell-CM-Rqst ::= SEQUENCE {
  uC-ID UC-ID,
  -- May be a GERAN cell identifier
  timeSlot TimeSlot OPTIONAL, --3.84Mcps TDD and 7.68Mcps TDD only
  timeSlotLCR TimeSlotLCR OPTIONAL, --1.28Mcps TDD only
  neighbouringCellMeasurementInformation NeighbouringCellMeasurementInfo OPTIONAL,
  -- UTRAN only
  iE-Extensions ProtocolExtensionContainer { { CellItem-CM-Rqst-ExtIEs } } OPTIONAL,
  ...
}

NeighbouringCellMeasurementInfo ::= SEQUENCE (SIZE (1..maxNrOfMeasNCell)) OF
  CHOICE {
    neighbouringFDDCellMeasurementInformation NeighbouringFDDCellMeasurementInformation,
    neighbouringTDDCellMeasurementInformation NeighbouringTDDCellMeasurementInformation,
    ...,
    extension-neighbouringCellMeasurementInformation Extension-neighbouringCellMeasurementInformation,
    extension-neighbouringCellMeasurementInformation768 Extension-neighbouringCellMeasurementInformation768
  }

Extension-neighbouringCellMeasurementInformation ::= ProtocolIE-Single-Container {{ Extension-neighbouringCellMeasurementInformationIE }}

Extension-neighbouringCellMeasurementInformationIE RNSAP-PROTOCOL-IES ::= {
  { ID id-neighbouringTDDCellMeasurementInformationLCR CRITICALITY reject TYPE NeighbouringTDDCellMeasurementInformationLCR PRESENCE
  mandatory },
  ...
}

Extension-neighbouringCellMeasurementInformation768 ::= ProtocolIE-Single-Container {{ Extension-neighbouringCellMeasurementInformation768IE }}

Extension-neighbouringCellMeasurementInformation768IE RNSAP-PROTOCOL-IES ::= {
  { ID id-neighbouringTDDCellMeasurementInformation768 CRITICALITY reject TYPE NeighbouringTDDCellMeasurementInformation768 PRESENCE
  mandatory },
  ...
}

CellItem-CM-Rqst-ExtIEs RNSAP-PROTOCOL-EXTENSION ::= {
  { ID id-UARFCNforNt CRITICALITY ignore EXTENSION UARFCN PRESENCE optional }|
  -- Applicable to 1.28Mcps TDD only
}

```



```

    { ID id-UPPCHPositionLCR          CRITICALITY reject  EXTENSION UPPCHPositionLCR      PRESENCE optional},
    -- Applicable to 1.28Mcps TDD only
    ...
}

-- *****
--
-- COMMON MEASUREMENT INITIATION RESPONSE
--
-- *****

CommonMeasurementInitiationResponse ::= SEQUENCE {
    protocolIEs          ProtocolIE-Container    {{CommonMeasurementInitiationResponse-IEs}},
    protocolExtensions   ProtocolExtensionContainer  {{CommonMeasurementInitiationResponse-Extensions}}      OPTIONAL,
    ...
}

CommonMeasurementInitiationResponse-IEs RNSAP-PROTOCOL-IES ::= {
    { ID      id-MeasurementID          CRITICALITY ignore  TYPE      MeasurementID
      PRESENCE mandatory }|
    { ID      id-CommonMeasurementObjectType-CM-Rsp  CRITICALITY ignore  TYPE      CommonMeasurementObjectType-CM-Rsp
      optional }|
    { ID      id-SFN                    CRITICALITY ignore  TYPE      SFN
      PRESENCE optional }|
    -- UTRAN only
    { ID      id-CriticalityDiagnostics  CRITICALITY ignore  TYPE      CriticalityDiagnostics
      PRESENCE optional }|
    { ID      id-CommonMeasurementAccuracy  CRITICALITY reject  TYPE      CommonMeasurementAccuracy
      PRESENCE optional },
    -- UTRAN only
    ...
}

CommonMeasurementInitiationResponse-Extensions RNSAP-PROTOCOL-EXTENSION ::= {
    optional
    { ID      id-MeasurementRecoverySupportIndicator  CRITICALITY ignore  EXTENSION  MeasurementRecoverySupportIndicator  PRESENCE
    },
    -- UTRAN only
    ...
}

CommonMeasurementObjectType-CM-Rsp ::= CHOICE {
    cell          Cell-CM-Rsp,
    ...
}

Cell-CM-Rsp ::= SEQUENCE {
    commonMeasurementValue          CommonMeasurementValue,
    IE-Extensions                   ProtocolExtensionContainer  { { CellItem-CM-Rsp-ExtIEs } }      OPTIONAL,
    ...
}

CellItem-CM-Rsp-ExtIEs RNSAP-PROTOCOL-EXTENSION ::= {
    ...
}

```

```

}

-- *****
--
-- COMMON MEASUREMENT INITIATION FAILURE
--
-- *****

CommonMeasurementInitiationFailure ::= SEQUENCE {
    protocolIEs          ProtocolIE-Container    {{CommonMeasurementInitiationFailure-IEs}},
    protocolExtensions   ProtocolExtensionContainer {{CommonMeasurementInitiationFailure-Extensions}}    OPTIONAL,
    ...
}

CommonMeasurementInitiationFailure-IEs RNSAP-PROTOCOL-IES ::= {
    { ID      id-MeasurementID          CRITICALITY ignore      TYPE      MeasurementID          PRESENCE
      mandatory }|
    { ID      id-Cause                  CRITICALITY ignore      TYPE      Cause                  PRESENCE
      mandatory }|
    { ID      id-CriticalityDiagnostics CRITICALITY ignore      TYPE      CriticalityDiagnostics PRESENCE      optional },
    ...
}

CommonMeasurementInitiationFailure-Extensions RNSAP-PROTOCOL-EXTENSION ::= {
    ...
}

-- *****
--
-- COMMON MEASUREMENT REPORT
--
-- *****

CommonMeasurementReport ::= SEQUENCE {
    protocolIEs          ProtocolIE-Container    {{CommonMeasurementReport-IEs}},
    protocolExtensions   ProtocolExtensionContainer {{CommonMeasurementReport-Extensions}}    OPTIONAL,
    ...
}

CommonMeasurementReport-IEs RNSAP-PROTOCOL-IES ::= {
    { ID      id-MeasurementID          CRITICALITY ignore      TYPE      MeasurementID          PRESENCE
      mandatory }|
    { ID      id-CommonMeasurementObjectType-CM-Rprt CRITICALITY ignore      TYPE      CommonMeasurementObjectType-CM-Rprt PRESENCE
      mandatory }|
    { ID      id-SFN                    CRITICALITY ignore      TYPE      SFN                    PRESENCE
      optional },
    -- UTRAN only
    ...
}

CommonMeasurementReport-Extensions RNSAP-PROTOCOL-EXTENSION ::= {
    { ID      id-MeasurementRecoveryReportingIndicator CRITICALITY ignore      EXTENSION MeasurementRecoveryReportingIndicator
      PRESENCE optional },
    -- UTRAN only
}

```

```

}
...
}
CommonMeasurementObjectType-CM-Rprt ::= CHOICE {
    cell                Cell-CM-Rprt,
    ...
}

Cell-CM-Rprt ::= SEQUENCE {
    commonMeasurementValueInformation    CommonMeasurementValueInformation,
    iE-Extensions                        ProtocolExtensionContainer {{ CellItem-CM-Rprt-ExtIEs }}    OPTIONAL,
    ...
}

CellItem-CM-Rprt-ExtIEs RNSAP-PROTOCOL-EXTENSION ::= {
    ...
}

-- *****
--
-- COMMON MEASUREMENT TERMINATION REQUEST
--
-- *****

CommonMeasurementTerminationRequest ::= SEQUENCE {
    protocolIEs                ProtocolIE-Container    {{CommonMeasurementTerminationRequest-IEs}},
    protocolExtensions          ProtocolExtensionContainer {{CommonMeasurementTerminationRequest-Extensions}}    OPTIONAL,
    ...
}

CommonMeasurementTerminationRequest-IEs RNSAP-PROTOCOL-IES ::= {
    { ID      id-MeasurementID          CRITICALITY    ignore                TYPE      MeasurementID          PRESENCE    mandatory},
    ...
}

CommonMeasurementTerminationRequest-Extensions RNSAP-PROTOCOL-EXTENSION ::= {
    ...
}

-- *****
--
-- COMMON MEASUREMENT FAILURE INDICATION
--
-- *****

CommonMeasurementFailureIndication ::= SEQUENCE {
    protocolIEs                ProtocolIE-Container    {{CommonMeasurementFailureIndication-IEs}},
    protocolExtensions          ProtocolExtensionContainer {{CommonMeasurementFailureIndication-Extensions}}    OPTIONAL,
    ...
}

CommonMeasurementFailureIndication-IEs RNSAP-PROTOCOL-IES ::= {
    { ID      id-MeasurementID          CRITICALITY ignore                TYPE      MeasurementID          PRESENCE    mandatory    }|

```

```

    { ID      id-Cause
      ...
    }
}

CommonMeasurementFailureIndication-Extensions RNSAP-PROTOCOL-EXTENSION ::= {
  ...
}

-- *****
--
-- INFORMATION EXCHANGE INITIATION REQUEST
--
-- *****

InformationExchangeInitiationRequest ::= SEQUENCE {
  protocolIEs          ProtocolIE-Container    {{InformationExchangeInitiationRequest-IEs}},
  protocolExtensions   ProtocolExtensionContainer {{InformationExchangeInitiationRequest-Extensions}}      OPTIONAL,
  ...
}

InformationExchangeInitiationRequest-IEs RNSAP-PROTOCOL-IES ::= {
  { ID      id-InformationExchangeID          CRITICALITY reject      TYPE      InformationExchangeID
    PRESENCE mandatory }|
  { ID      id-InformationExchangeObjectType-InfEx-Rqst  CRITICALITY reject      TYPE      InformationExchangeObjectType-InfEx-Rqst
    PRESENCE mandatory }|

  { ID      id-InformationType                CRITICALITY reject      TYPE      InformationType
    PRESENCE mandatory }|
  { ID      id-InformationReportCharacteristics  CRITICALITY reject      TYPE      InformationReportCharacteristics      PRESENCE
    mandatory },
  ...
}

InformationExchangeInitiationRequest-Extensions RNSAP-PROTOCOL-EXTENSION ::= {
  ...
}

InformationExchangeObjectType-InfEx-Rqst ::= CHOICE {
  cell
  ...,
  extension-InformationExchangeObjectType-InfEx-Rqst      Extension-InformationExchangeObjectType-InfEx-Rqst
}

Cell-InfEx-Rqst ::= SEQUENCE {
  c-ID              C-ID, --May be a GERAN cell identifier
  iE-Extensions     ProtocolExtensionContainer { { CellItem-InfEx-Rqst-ExtIEs} }      OPTIONAL,
  ...
}

CellItem-InfEx-Rqst-ExtIEs RNSAP-PROTOCOL-EXTENSION ::= {
  ...
}

```

```

Extension-InformationExchangeObjectType-InfEx-Rqst ::= ProtocolIE-Single-Container {{ Extension-InformationExchangeObjectType-InfEx-RqstIE }}

Extension-InformationExchangeObjectType-InfEx-RqstIE RNSAP-PROTOCOL-IES ::= {
  { ID id-GSM-Cell-InfEx-Rqst          CRITICALITY reject          TYPE GSM-Cell-InfEx-Rqst
    PRESENCE mandatory }|
  { ID id-MBMS-Bearer-Service-List     CRITICALITY  reject        TYPE  MBMS-Bearer-Service-List
    PRESENCE mandatory }|
  { ID id-MBMS-Bearer-Service-in-MBMS-Cell-InfEx-Rqst CRITICALITY  reject        TYPE  MBMS-Bearer-Service-in-MBMS-Cell-InfEx-Rqst
    PRESENCE mandatory }|
  { ID id-MBMS-Cell-InfEx-Rqst        CRITICALITY  reject        TYPE  MBMS-Cell-InfEx-Rqst
    PRESENCE mandatory }
}

GSM-Cell-InfEx-Rqst ::= SEQUENCE {
  CGI,
  iE-Extensions          ProtocolExtensionContainer  { { GSMCellItem-InfEx-Rqst-ExtIEs } }          OPTIONAL,
  ...
}

GSMCellItem-InfEx-Rqst-ExtIEs RNSAP-PROTOCOL-EXTENSION ::= {
  ...
}

MBMS-Bearer-Service-in-MBMS-Cell-InfEx-Rqst ::= SEQUENCE (SIZE (1..maxNrOfCells)) OF MBMS-Bearer-Service-in-MBMS-Cell-Item-InfEx-Rqst

MBMS-Bearer-Service-in-MBMS-Cell-Item-InfEx-Rqst ::= SEQUENCE {
  c-ID          C-ID,
  mBMS-Bearer-Service-List-InfEx-Rqst          MBMS-Bearer-Service-List-InfEx-Rqst,
  iE-Extensions          ProtocolExtensionContainer  { { MBMS-Bearer-Service-in-MBMS-Cell-Item-InfEx-Rqst-ExtIEs } }          OPTIONAL,
  ...
}

MBMS-Bearer-Service-in-MBMS-Cell-Item-InfEx-Rqst-ExtIEs RNSAP-PROTOCOL-EXTENSION ::= {
  ...
}

MBMS-Bearer-Service-List-InfEx-Rqst ::= SEQUENCE (SIZE (1..maxNrOfMBMSServices)) OF TMGI

MBMS-Cell-InfEx-Rqst ::= SEQUENCE (SIZE (1..maxNrOfCells)) OF C-ID

-- *****
--
-- INFORMATION EXCHANGE INITIATION RESPONSE
--
-- *****

InformationExchangeInitiationResponse ::= SEQUENCE {
  protocolIEs          ProtocolIE-Container  {{InformationExchangeInitiationResponse-IEs}},
  protocolExtensions          ProtocolExtensionContainer  {{InformationExchangeInitiationResponse-Extensions}}          OPTIONAL,
  ...
}

```

```

InformationExchangeInitiationResponse-IEs RNSAP-PROTOCOL-IES ::= {
  { ID id-InformationExchangeID CRITICALITY ignore TYPE InformationExchangeID
  PRESENCE mandatory }|
  { ID id-InformationExchangeObjectType-InfEx-Rsp CRITICALITY ignore TYPE InformationExchangeObjectType-InfEx-Rsp PRESENCE
  optional }|
  { ID id-CriticalityDiagnostics CRITICALITY ignore TYPE CriticalityDiagnostics
  PRESENCE optional },
  ...
}

InformationExchangeInitiationResponse-Extensions RNSAP-PROTOCOL-EXTENSION ::= {
  ...
}

InformationExchangeObjectType-InfEx-Rsp ::= CHOICE {
  cell Cell-InfEx-Rsp,
  ...,
  extension-InformationExchangeObjectType-InfEx-Rsp Extension-InformationExchangeObjectType-InfEx-Rsp
}

Cell-InfEx-Rsp ::= SEQUENCE {
  requestedDataValue RequestedDataValue,
  iE-Extensions ProtocolExtensionContainer { { CellItem-InfEx-Rsp-ExtIEs } } OPTIONAL,
  ...
}

CellItem-InfEx-Rsp-ExtIEs RNSAP-PROTOCOL-EXTENSION ::= {
  ...
}

Extension-InformationExchangeObjectType-InfEx-Rsp ::= ProtocolIE-Single-Container {{ Extension-InformationExchangeObjectType-InfEx-RspIE }}

Extension-InformationExchangeObjectType-InfEx-RspIE RNSAP-PROTOCOL-IES ::= {
  { ID id-MBMS-Bearer-Service-List-InfEx-Rsp CRITICALITY ignore TYPE MBMS-Bearer-Service-List-InfEx-Rsp
  PRESENCE mandatory}|
  { ID id-MBMS-Bearer-Service-in-MBMS-Cell-InfEx-Rsp CRITICALITY ignore TYPE MBMS-Bearer-Service-in-MBMS-Cell-InfEx-Rsp
  PRESENCE mandatory}|
  { ID id-MBMS-Cell-InfEx-Rsp CRITICALITY ignore TYPE MBMS-Cell-InfEx-Rsp
  PRESENCE mandatory}
}

MBMS-Bearer-Service-List-InfEx-Rsp ::= SEQUENCE (SIZE (1..maxNrOfMBMSServices)) OF MBMS-Bearer-ServiceItemIEs-InfEx-Rsp

MBMS-Bearer-ServiceItemIEs-InfEx-Rsp ::=SEQUENCE{
  tmgi TMGI,
  requestedDataValue RequestedDataValue,
  iE-Extensions ProtocolExtensionContainer { { MBMS-Bearer-ServiceItem-InfEx-Rsp-ExtIEs } } OPTIONAL,
  ...
}

```

```

MBMS-Bearer-ServiceItem-InfEx-Rsp-ExtIEs    RNSAP-PROTOCOL-EXTENSION ::= {
  ...
}

MBMS-Bearer-Service-in-MBMS-Cell-InfEx-Rsp ::= SEQUENCE (SIZE (1..maxNrOfCells)) OF MBMS-Bearer-Service-in-MBMS-Cell-Item-InfEx-Rsp

MBMS-Bearer-Service-in-MBMS-Cell-Item-InfEx-Rsp ::= SEQUENCE {
  c-ID                               C-ID,
  mBMS-Bearer-Service-List-InfEx-Rsp MBMS-Bearer-Service-List-InfEx-Rsp,
  iE-Extensions                       ProtocolExtensionContainer { { MBMS-Bearer-Service-in-MBMS-Cell-Item-InfEx-Rsp-ExtIEs } } OPTIONAL,
  ...
}

MBMS-Bearer-Service-in-MBMS-Cell-Item-InfEx-Rsp-ExtIEs RNSAP-PROTOCOL-EXTENSION ::= {
  ...
}

MBMS-Cell-InfEx-Rsp ::= SEQUENCE (SIZE (1..maxNrOfCells)) OF MBMS-Cell-Item-InfEx-Rsp

MBMS-Cell-Item-InfEx-Rsp ::= SEQUENCE {
  c-ID                               C-ID,
  requestedDataValue                 RequestedDataValue,
  iE-Extensions                       ProtocolExtensionContainer { { MBMS-Cell-Item-InfEx-Rsp-ExtIEs } } OPTIONAL,
  ...
}

MBMS-Cell-Item-InfEx-Rsp-ExtIEs RNSAP-PROTOCOL-EXTENSION ::= {
  ...
}

-- *****
--
-- INFORMATION EXCHANGE INITIATION FAILURE
--
-- *****

InformationExchangeInitiationFailure ::= SEQUENCE {
  protocolIEs           ProtocolIE-Container   {{InformationExchangeInitiationFailure-IEs}},
  protocolExtensions    ProtocolExtensionContainer {{InformationExchangeInitiationFailure-Extensions}} OPTIONAL,
  ...
}

InformationExchangeInitiationFailure-IEs RNSAP-PROTOCOL-IES ::= {
  { ID      id-InformationExchangeID      CRITICALITY  ignore      TYPE      InformationExchangeID
  PRESENCE  mandatory    }|
  { ID      id-Cause                       CRITICALITY  ignore      TYPE      Cause
  PRESENCE  mandatory    }|
  { ID      id-CriticalityDiagnostics      CRITICALITY  ignore      TYPE      CriticalityDiagnostics
  PRESENCE  optional      },
  ...
}

InformationExchangeInitiationFailure-Extensions RNSAP-PROTOCOL-EXTENSION ::= {

```

```

}
...
}
-- *****
--
-- INFORMATION REPORT
--
-- *****

InformationReport ::= SEQUENCE {
    protocolIEs          ProtocolIE-Container    {{InformationReport-IEs}},
    protocolExtensions   ProtocolExtensionContainer {{InformationReport-Extensions}}    OPTIONAL,
    ...
}

InformationReport-IEs RNSAP-PROTOCOL-IES ::= {
    { ID id-InformationExchangeID          CRITICALITY ignore          TYPE InformationExchangeID
      PRESENCE mandatory }|
    { ID id-InformationExchangeObjectType-InfEx-Rprt CRITICALITY ignore          TYPE InformationExchangeObjectType-InfEx-Rprt
      PRESENCE mandatory },
    ...
}

InformationReport-Extensions RNSAP-PROTOCOL-EXTENSION ::= {
    ...
}

InformationExchangeObjectType-InfEx-Rprt ::= CHOICE {
    cell                      Cell-InfEx-Rprt,
    ...,
    extension-InformationExchangeObjectType-InfEx-Rprt Extension-InformationExchangeObjectType-InfEx-Rprt
}

Extension-InformationExchangeObjectType-InfEx-Rprt ::= ProtocolIE-Single-Container {{ Extension-InformationExchangeObjectType-InfEx-RprtIE }}

Extension-InformationExchangeObjectType-InfEx-RprtIE RNSAP-PROTOCOL-IES ::= {
    { ID id-MBMS-Bearer-Service-in-MBMS-Cell-InfEx-Rprt CRITICALITY ignore          TYPE MBMS-Bearer-Service-in-MBMS-Cell-InfEx-Rprt
      PRESENCE mandatory }|
    { ID id-MBMS-Cell-InfEx-Rprt CRITICALITY ignore          TYPE MBMS-Cell-InfEx-Rprt
      PRESENCE mandatory }
}

Cell-InfEx-Rprt ::= SEQUENCE {
    requestedDataValueInformation RequestedDataValueInformation,
    iE-Extensions                 ProtocolExtensionContainer {{ CellItem-InfEx-Rprt-ExtIEs }}    OPTIONAL,
    ...
}

CellItem-InfEx-Rprt-ExtIEs RNSAP-PROTOCOL-EXTENSION ::= {
    ...
}

```



```

}

MBMS-Bearer-Service-in-MBMS-Cell-InfEx-Rprt ::= SEQUENCE (SIZE (1..maxNrOfCells)) OF MBMS-Bearer-Service-in-MBMS-Cell-Item-InfEx-Rprt

MBMS-Bearer-Service-in-MBMS-Cell-Item-InfEx-Rprt ::= SEQUENCE {
  c-ID                C-ID,
  mBMS-Bearer-Service-List-InfEx-Rprt  MBMS-Bearer-Service-List-InfEx-Rprt,
  iE-Extensions      ProtocolExtensionContainer  { { MBMS-Bearer-Service-in-MBMS-Cell-Item-InfEx-Rprt-ExtIEs } }      OPTIONAL,
  ...
}

MBMS-Bearer-Service-in-MBMS-Cell-Item-InfEx-Rprt-ExtIEs RNSAP-PROTOCOL-EXTENSION ::= {
  ...
}

MBMS-Bearer-Service-List-InfEx-Rprt ::= SEQUENCE (SIZE (1..maxNrOfMBMSServices)) OF MBMS-Bearer-Service-List-Item-InfEx-Rprt

MBMS-Bearer-Service-List-Item-InfEx-Rprt ::= SEQUENCE {
  tmgi                TMGI,
  requestedDataValueInformation  RequestedDataValueInformation,
  iE-Extensions      ProtocolExtensionContainer  { { MBMS-Bearer-Service-List-Item-InfEx-Rprt-ExtIEs } }      OPTIONAL,
  ...
}

MBMS-Bearer-Service-List-Item-InfEx-Rprt-ExtIEs RNSAP-PROTOCOL-EXTENSION ::= {
  ...
}

MBMS-Cell-InfEx-Rprt ::= SEQUENCE (SIZE (1..maxNrOfCells)) OF MBMS-Cell-Item-InfEx-Rprt

MBMS-Cell-Item-InfEx-Rprt ::= SEQUENCE {
  c-ID                C-ID,
  requestedDataValueInformation  RequestedDataValueInformation,
  iE-Extensions      ProtocolExtensionContainer  { { MBMS-Cell-Item-InfEx-Rprt-ExtIEs } }      OPTIONAL,
  ...
}

MBMS-Cell-Item-InfEx-Rprt-ExtIEs RNSAP-PROTOCOL-EXTENSION ::= {
  ...
}

-- *****
--
-- INFORMATION EXCHANGE TERMINATION REQUEST
--
-- *****

InformationExchangeTerminationRequest ::= SEQUENCE {
  protocolIEs        ProtocolIE-Container  {{InformationExchangeTerminationRequest-IEs}},
  protocolExtensions  ProtocolExtensionContainer  {{InformationExchangeTerminationRequest-Extensions}}      OPTIONAL,
  ...
}

```

```

InformationExchangeTerminationRequest-IEs RNSAP-PROTOCOL-IES ::= {
  { ID id-InformationExchangeID          CRITICALITY ignore          TYPE InformationExchangeID          PRESENCE
    mandatory},
  ...
}

InformationExchangeTerminationRequest-Extensions RNSAP-PROTOCOL-EXTENSION ::= {
  ...
}

-- *****
--
-- INFORMATION EXCHANGE FAILURE INDICATION
--
-- *****

InformationExchangeFailureIndication ::= SEQUENCE {
  protocolIEs          ProtocolIE-Container  {{InformationExchangeFailureIndication-IEs}},
  protocolExtensions   ProtocolExtensionContainer  {{InformationExchangeFailureIndication-Extensions}}          OPTIONAL,
  ...
}

InformationExchangeFailureIndication-IEs RNSAP-PROTOCOL-IES ::= {
  { ID id-InformationExchangeID          CRITICALITY ignore          TYPE InformationExchangeID          PRESENCE
    mandatory }|
  { ID id-Cause                          CRITICALITY ignore          TYPE Cause                          PRESENCE
    mandatory },
  ...
}

InformationExchangeFailureIndication-Extensions RNSAP-PROTOCOL-EXTENSION ::= {
  ...
}

-- *****
--
-- RESET REQUEST
--
-- *****

ResetRequest ::= SEQUENCE {
  protocolIEs          ProtocolIE-Container  {{ResetRequest-IEs}},
  protocolExtensions   ProtocolExtensionContainer  {{ResetRequest-Extensions}}          OPTIONAL,
  ...
}

ResetRequest-IEs RNSAP-PROTOCOL-IES ::= {
  { ID id-RNC-ID          CRITICALITY reject  TYPE RNC-ID          PRESENCE mandatory } |
  { ID id-ResetIndicator  CRITICALITY reject  TYPE ResetIndicator  PRESENCE mandatory },
  ...
}

ResetRequest-Extensions RNSAP-PROTOCOL-EXTENSION ::= {

```

```

    { ID id-Extended-RNC-ID          CRITICALITY reject  EXTENSION Extended-RNC-ID          PRESENCE optional},
    ...
}

ResetIndicator ::= CHOICE {
    context          ContextList-Reset,
    all-contexts     NULL,
    ...,
    contextGroup     ContextGroupList-Reset
}

ContextList-Reset ::= SEQUENCE {
    contextInfoList-Reset          ContextInfoList-Reset,
    iE-Extensions                  ProtocolExtensionContainer { {ContextItem-Reset-ExtIEs} }          OPTIONAL,
    ...
}

ContextItem-Reset-ExtIEs RNSAP-PROTOCOL-EXTENSION ::= {
    ...
}

ContextInfoList-Reset ::= SEQUENCE (SIZE (1.. maxResetContext)) OF ProtocolIE-Single-Container {{ ContextInfoItemIE-Reset }}

ContextInfoItemIE-Reset RNSAP-PROTOCOL-IES ::= {
    {ID id-ContextInfoItem-Reset          CRITICALITY reject          TYPE ContextInfoItem-Reset          PRESENCE mandatory}
}

ContextInfoItem-Reset ::= SEQUENCE {
    contextType-Reset          ContextType-Reset,
    iE-Extensions              ProtocolExtensionContainer { { ContextInfoItem-Reset-ExtIEs} }          OPTIONAL,
    ...
}

ContextInfoItem-Reset-ExtIEs RNSAP-PROTOCOL-EXTENSION ::= {
    ...
}

ContextType-Reset ::= CHOICE {
    sRNTI          S-RNTI,
    dRNTI          D-RNTI,
    ...
}

ContextGroupList-Reset ::= SEQUENCE {
    contextGroupInfoList-Reset          ContextGroupInfoList-Reset,
    iE-Extensions                      ProtocolExtensionContainer { {ContextGroupItem-Reset-ExtIEs} }          OPTIONAL,
    ...
}

ContextGroupItem-Reset-ExtIEs RNSAP-PROTOCOL-EXTENSION ::= {
    ...
}

ContextGroupInfoList-Reset ::= SEQUENCE (SIZE (1.. maxResetContextGroup)) OF ProtocolIE-Single-Container {{ ContextGroupInfoItemIE-Reset }}

```

```

ContextGroupInfoItemIE-Reset RNSAP-PROTOCOL-IES ::= {
  { ID id-ContextGroupInfoItem-Reset          CRITICALITY reject          TYPE ContextGroupInfoItem-Reset          PRESENCE mandatory}
}

ContextGroupInfoItem-Reset ::= SEQUENCE {
  s-RNTI-Group          S-RNTI-Group,
  iE-Extensions          ProtocolExtensionContainer  { { ContextGroupInfoItem-Reset-ExtIEs} }          OPTIONAL,
  ...
}

ContextGroupInfoItem-Reset-ExtIEs RNSAP-PROTOCOL-EXTENSION ::= {
  ...
}

-- *****
--
-- RESET RESPONSE
--
-- *****

ResetResponse ::= SEQUENCE {
  protocolIEs          ProtocolIE-Container  {{ResetResponse-IEs}},
  protocolExtensions  ProtocolExtensionContainer  {{ResetResponse-Extensions}}          OPTIONAL,
  ...
}

ResetResponse-IEs RNSAP-PROTOCOL-IES ::= {
  { ID id-RNC-ID          CRITICALITY ignore  TYPE RNC-ID          PRESENCE mandatory} |
  { ID id-CriticalityDiagnostics          CRITICALITY          ignore          TYPE          CriticalityDiagnostics          PRESENCE          optional},
  ...
}

ResetResponse-Extensions RNSAP-PROTOCOL-EXTENSION ::= {
  { ID id-Extended-RNC-ID          CRITICALITY reject  EXTENSION Extended-RNC-ID          PRESENCE optional},
  ...
}

-- *****
--
-- RADIO LINK ACTIVATION COMMAND FDD
--
-- *****

RadioLinkActivationCommandFDD ::= SEQUENCE {
  protocolIEs          ProtocolIE-Container  {{RadioLinkActivationCommandFDD-IEs}},
  protocolExtensions  ProtocolExtensionContainer  {{RadioLinkActivationCommandFDD-Extensions}}          OPTIONAL,
  ...
}

RadioLinkActivationCommandFDD-IEs RNSAP-PROTOCOL-IES ::= {
  { ID id-DelayedActivationList-RL-ActivationCmdFDD          CRITICALITY ignore  TYPE          DelayedActivationInformationList-RL-ActivationCmdFDD          PRESENCE          mandatory },
  ...
}

```

```

}

RadioLinkActivationCommandFDD-Extensions RNSAP-PROTOCOL-EXTENSION ::= {
  ...
}

DelayedActivationInformationList-RL-ActivationCmdFDD ::= SEQUENCE (SIZE (1..maxNrOfRLs)) OF ProtocolIE-Single-Container {
  { DelayedActivationInformation-RL-ActivationCmdFDD-IEs } }

DelayedActivationInformation-RL-ActivationCmdFDD-IEs RNSAP-PROTOCOL-IES ::= {
  { ID id-DelayedActivationInformation-RL-ActivationCmdFDD      CRITICALITY ignore  TYPE DelayedActivationInformation-RL-ActivationCmdFDD
    PRESENCE optional    }
}

DelayedActivationInformation-RL-ActivationCmdFDD ::= SEQUENCE {
  rL-ID                RL-ID,
  delayed-activation-update  DelayedActivationUpdate,
  iE-Extensions         ProtocolExtensionContainer { { DelayedActivationInformation-RL-ActivationCmdFDD-ExtIEs } } OPTIONAL,
  ...
}

DelayedActivationInformation-RL-ActivationCmdFDD-ExtIEs RNSAP-PROTOCOL-EXTENSION ::= {
  ...
}

-- *****
--
-- RADIO LINK ACTIVATION COMMAND TDD
--
-- *****

RadioLinkActivationCommandTDD ::= SEQUENCE {
  protocolIEs          ProtocolIE-Container   {{RadioLinkActivationCommandTDD-IEs}},
  protocolExtensions  ProtocolExtensionContainer {{RadioLinkActivationCommandTDD-Extensions}}          OPTIONAL,
  ...
}

RadioLinkActivationCommandTDD-IEs RNSAP-PROTOCOL-IES ::= {
  { ID id-DelayedActivationList-RL-ActivationCmdTDD      CRITICALITY ignore  TYPE    DelayedActivationInformationList-RL-ActivationCmdTDD
    PRESENCE mandatory  },
  ...
}

RadioLinkActivationCommandTDD-Extensions RNSAP-PROTOCOL-EXTENSION ::= {
  ...
}

DelayedActivationInformationList-RL-ActivationCmdTDD ::= SEQUENCE (SIZE (1..maxNrOfRLs)) OF ProtocolIE-Single-Container {
  { DelayedActivationInformation-RL-ActivationCmdTDD-IEs } }

DelayedActivationInformation-RL-ActivationCmdTDD-IEs RNSAP-PROTOCOL-IES ::= {
  { ID id-DelayedActivationInformation-RL-ActivationCmdTDD      CRITICALITY ignore  TYPE DelayedActivationInformation-RL-ActivationCmdTDD
    PRESENCE optional    }
}

```

```

DelayedActivationInformation-RL-ActivationCmdTDD ::= SEQUENCE {
    rL-ID                RL-ID,
    delayed-activation-update DelayedActivationUpdate,
    iE-Extensions        ProtocolExtensionContainer { { DelayedActivationInformation-RL-ActivationCmdTDD-ExtIEs } } OPTIONAL,
    ...
}

DelayedActivationInformation-RL-ActivationCmdTDD-ExtIEs RNSAP-PROTOCOL-EXTENSION ::= {
    ...
}

-- *****
--
-- GERAN UPLINK SIGNALLING TRANSFER INDICATION
--
-- *****

GERANUplinkSignallingTransferIndication ::= SEQUENCE {
    protocolIEs                ProtocolIE-Container    {{GERANUplinkSignallingTransferIndication-IEs}},
    protocolExtensions          ProtocolExtensionContainer {{GERANUplinkSignallingTransferIndication-Extensions}} OPTIONAL,
    ...
}

GERANUplinkSignallingTransferIndication-IEs RNSAP-PROTOCOL-IES ::= {
    { ID id-UC-ID                CRITICALITY ignore TYPE UC-ID                PRESENCE mandatory } |
    -- UC-Id may be GERAN cell identifier.
    { ID id-SAI                  CRITICALITY ignore TYPE SAI                  PRESENCE mandatory } |
    { ID id-S-RNTI               CRITICALITY ignore TYPE S-RNTI             PRESENCE mandatory } |
    { ID id-D-RNTI               CRITICALITY ignore TYPE D-RNTI             PRESENCE optional   } |
    { ID id-L3-Information        CRITICALITY ignore TYPE L3-Information        PRESENCE mandatory } |
    { ID id-CN-PS-DomainIdentifier CRITICALITY ignore TYPE CN-PS-DomainIdentifier PRESENCE optional   } |
    { ID id-CN-CS-DomainIdentifier CRITICALITY ignore TYPE CN-CS-DomainIdentifier PRESENCE optional   } |
    { ID id-URA-Information       CRITICALITY ignore TYPE URA-Information       PRESENCE optional   },
    -- URA information may be GRA information
    ...
}

GERANUplinkSignallingTransferIndication-Extensions RNSAP-PROTOCOL-EXTENSION ::= {
    ...
}

-- *****
--
-- RADIO LINK PARAMETER UPDATE INDICATION FDD
--
-- *****

RadioLinkParameterUpdateIndicationFDD ::= SEQUENCE {
    protocolIEs                ProtocolIE-Container    {{RadioLinkParameterUpdateIndicationFDD-IEs}},
    protocolExtensions          ProtocolExtensionContainer {{RadioLinkParameterUpdateIndicationFDD-Extensions}} OPTIONAL,
    ...
}

```

```

RadioLinkParameterUpdateIndicationFDD-IEs RNSAP-PROTOCOL-IES ::= {
  { ID id-HSDSCH-FDD-Update-Information          CRITICALITY ignore  TYPE    HSDSCH-FDD-Update-Information
    PRESENCE optional } |
  { ID id-RL-ParameterUpdateIndicationFDD-RL-InformationList  CRITICALITY ignore  TYPE    RL-ParameterUpdateIndicationFDD-RL-InformationList
    PRESENCE optional  },
  ...
}

RL-ParameterUpdateIndicationFDD-RL-InformationList ::= SEQUENCE (SIZE (1..maxNrOfRLs)) OF ProtocolIE-Single-Container { { RL-
ParameterUpdateIndicationFDD-RL-InformationList-IEs } }

RL-ParameterUpdateIndicationFDD-RL-InformationList-IEs RNSAP-PROTOCOL-IES ::= {
  { ID id-RL-ParameterUpdateIndicationFDD-RL-Information-Item  CRITICALITY ignore  TYPE  RL-ParameterUpdateIndicationFDD-RL-Information-Item
    PRESENCE mandatory  }
}

RL-ParameterUpdateIndicationFDD-RL-Information-Item ::= SEQUENCE {
  rL-ID                RL-ID,
  phase-Reference-Update-Indicator  Phase-Reference-Update-Indicator  OPTIONAL,
  iE-Extensions        ProtocolExtensionContainer { { RL-ParameterUpdateIndicationFDD-RL-Information-ExtIEs } } OPTIONAL,
  ...
}

RL-ParameterUpdateIndicationFDD-RL-Information-ExtIEs RNSAP-PROTOCOL-EXTENSION ::= {
  ...
}

RadioLinkParameterUpdateIndicationFDD-Extensions RNSAP-PROTOCOL-EXTENSION ::= {
  { ID id-E-DCH-FDD-Update-Information          CRITICALITY ignore  EXTENSION E-DCH-FDD-Update-Information          PRESENCE optional } |
  { ID id-Additional-HS-Cell-Information-RL-Param-Upd  CRITICALITY ignore  EXTENSION Additional-HS-Cell-Information-RL-Param-Upd  PRESENCE
optional } |
  { ID id-Additional-EDCH-Cell-Information-RL-Param-Upd  CRITICALITY ignore  EXTENSION Additional-EDCH-Cell-Information-RL-Param-Upd
    PRESENCE optional } |
  { ID id-CPC-RecoveryReport                    CRITICALITY ignore  EXTENSION CPC-RecoveryReport                    PRESENCE optional },
  ...
}

Additional-HS-Cell-Information-RL-Param-Upd ::= SEQUENCE (SIZE (1..maxNrOfHSDSCH-1)) OF Additional-HS-Cell-Information-RL-Param-Upd-ItemIEs

Additional-HS-Cell-Information-RL-Param-Upd-ItemIEs ::= SEQUENCE {
  hSPDSCH-RL-ID                RL-ID,
  hS-DSCH-FDD-Secondary-Serving-Update-Information  HS-DSCH-FDD-Secondary-Serving-Update-Information,
  iE-Extensions                ProtocolExtensionContainer { { Additional-HS-Cell-Information-RL-Setup-ExtIEs } } OPTIONAL,
  ...
}

Additional-HS-Cell-Information-RL-Setup-ExtIEs RNSAP-PROTOCOL-EXTENSION ::= {
  ...
}

Additional-EDCH-Cell-Information-RL-Param-Upd ::= SEQUENCE (SIZE (1..maxNrOfEDCH-1)) OF Additional-EDCH-Cell-Information-RL-Param-Upd-ItemIEs

```

```

Additional-EDCH-Cell-Information-RL-Param-Upd-ItemIEs ::=SEQUENCE{
  additional-EDCH-FDD-Update-Information          Additional-EDCH-FDD-Update-Information,
  IE-Extensions                                  ProtocolExtensionContainer { { Additional-EDCH-FDD-Update-Information-ExtIEs} } OPTIONAL,
  ...
}

Additional-EDCH-FDD-Update-Information-ExtIEs  RNSAP-PROTOCOL-EXTENSION ::= {
  ...
}

-- *****
--
-- RADIO LINK PARAMETER UPDATE INDICATION TDD
--
-- *****

RadioLinkParameterUpdateIndicationTDD ::= SEQUENCE {
  protocolIEs          ProtocolIE-Container   {{RadioLinkParameterUpdateIndicationTDD-IEs}},
  protocolExtensions   ProtocolExtensionContainer {{RadioLinkParameterUpdateIndicationTDD-Extensions}}          OPTIONAL,
  ...
}

RadioLinkParameterUpdateIndicationTDD-IEs RNSAP-PROTOCOL-IES ::= {
  { ID id-HSDSCH-TDD-Update-Information          CRITICALITY ignore      TYPE HSDSCH-TDD-Update-Information          PRESENCE optional},
  ...
}

RadioLinkParameterUpdateIndicationTDD-Extensions RNSAP-PROTOCOL-EXTENSION ::= {
  ...
}

-- *****
--
-- UE MEASUREMENT INITIATION REQUEST
--
-- *****

UEMeasurementInitiationRequest ::= SEQUENCE {
  protocolIEs          ProtocolIE-Container   {{UEMeasurementInitiationRequest-IEs}},
  protocolExtensions   ProtocolExtensionContainer {{UEMeasurementInitiationRequest-Extensions}}          OPTIONAL,
  ...
}

UEMeasurementInitiationRequest-IEs RNSAP-PROTOCOL-IES ::= {
  { ID id-AllowedQueuingTime          CRITICALITY reject  TYPE AllowedQueuingTime          PRESENCE optional
  } |
  { ID id-MeasurementID              CRITICALITY reject  TYPE MeasurementID              PRESENCE mandatory
  } |
  { ID id-UEMeasurementType          CRITICALITY reject  TYPE UEMeasurementType          PRESENCE mandatory
  } |
  { ID id-UEMeasurementTimeslotInfoHCR CRITICALITY reject  TYPE UEMeasurementTimeslotInfoHCR PRESENCE optional
  } |
}

```



```

    { ID id-UEMeasurementTimeslotInfoLCR          CRITICALITY reject TYPE UEMeasurementTimeslotInfoLCR          PRESENCE optional
    } |
    { ID id-MeasurementFilterCoefficient          CRITICALITY reject TYPE MeasurementFilterCoefficient          PRESENCE optional
    } |
    { ID id-UEMeasurementReportCharacteristics    CRITICALITY reject TYPE UEMeasurementReportCharacteristics    PRESENCE mandatory } |
    { ID id-UEMeasurementParameterModAllow       CRITICALITY reject TYPE UEMeasurementParameterModAllow       PRESENCE mandatory },
    ...
}

UEMeasurementInitiationRequest-Extensions RNSAP-PROTOCOL-EXTENSION ::= {
  { ID id-UEMeasurementTimeslotInfo768          CRITICALITY reject EXTENSION UEMeasurementTimeslotInfo768    PRESENCE optional},
  ...
}

-- *****
--
-- UE MEASUREMENT INITIATION RESPONSE
--
-- *****

UEMeasurementInitiationResponse ::= SEQUENCE {
  protocolIEs          ProtocolIE-Container    {{UEMeasurementInitiationResponse-IEs}},
  protocolExtensions   ProtocolExtensionContainer {{UEMeasurementInitiationResponse-Extensions}}
  ...
}

UEMeasurementInitiationResponse-IEs RNSAP-PROTOCOL-IES ::= {
  { ID id-MeasurementID          CRITICALITY ignore TYPE MeasurementID          PRESENCE mandatory
  } |
  { ID id-MeasurementFilterCoefficient          CRITICALITY reject TYPE MeasurementFilterCoefficient          PRESENCE optional
  } |
  { ID id-UEMeasurementReportCharacteristics    CRITICALITY reject TYPE UEMeasurementReportCharacteristics    PRESENCE optional } |
  { ID id-CriticalityDiagnostics          CRITICALITY ignore TYPE CriticalityDiagnostics          PRESENCE optional
  },
  ...
}

UEMeasurementInitiationResponse-Extensions RNSAP-PROTOCOL-EXTENSION ::= {
  ...
}

-- *****
--
-- UE MEASUREMENT INITIATION FAILURE
--
-- *****

UEMeasurementInitiationFailure ::= SEQUENCE {
  protocolIEs          ProtocolIE-Container    {{UEMeasurementInitiationFailure-IEs}},
  protocolExtensions   ProtocolExtensionContainer {{UEMeasurementInitiationFailure-Extensions}}
  ...
}

UEMeasurementInitiationFailure-IEs RNSAP-PROTOCOL-IES ::= {

```

```

    { ID id-MeasurementID           CRITICALITY ignore TYPE MeasurementID           PRESENCE mandatory } |
    { ID id-Cause                   CRITICALITY ignore TYPE Cause                 PRESENCE mandatory } |
    { ID id-CriticalityDiagnostics   CRITICALITY ignore TYPE CriticalityDiagnostics PRESENCE optional   },
    ...
}

UEMeasurementInitiationFailure-Extensions RNSAP-PROTOCOL-EXTENSION ::= {
    ...
}

-- *****
--
-- UE MEASUREMENT REPORT
--
-- *****

UEMeasurementReport ::= SEQUENCE {
    protocolIEs           ProtocolIE-Container  {{UEMeasurementReport-IEs}},
    protocolExtensions    ProtocolExtensionContainer {{UEMeasurementReport-Extensions}}           OPTIONAL,
    ...
}

UEMeasurementReport-IEs RNSAP-PROTOCOL-IES ::= {
    { ID id-MeasurementID           CRITICALITY ignore TYPE MeasurementID           PRESENCE mandatory } |
    { ID id-UEMeasurementValueInformation CRITICALITY ignore TYPE UEMeasurementValueInformation PRESENCE mandatory } |
    ...
}

UEMeasurementReport-Extensions RNSAP-PROTOCOL-EXTENSION ::= {
    ...
}

-- *****
--
-- UE MEASUREMENT TERMINATION REQUEST
--
-- *****

UEMeasurementTerminationRequest ::= SEQUENCE {
    protocolIEs           ProtocolIE-Container  {{UEMeasurementTerminationRequest-IEs}},
    protocolExtensions    ProtocolExtensionContainer {{UEMeasurementTerminationRequest-Extensions}}           OPTIONAL,
    ...
}

UEMeasurementTerminationRequest-IEs RNSAP-PROTOCOL-IES ::= {
    { ID id-MeasurementID           CRITICALITY ignore TYPE MeasurementID           PRESENCE mandatory },
    ...
}

UEMeasurementTerminationRequest-Extensions RNSAP-PROTOCOL-EXTENSION ::= {
    ...
}

-- *****

```

```

--
-- UE MEASUREMENT FAILURE INDICATION
--
-- *****

UEMeasurementFailureIndication ::= SEQUENCE {
    protocolIEs                ProtocolIE-Container    {{UEMeasurementFailureIndication-IEs}},
    protocolExtensions          ProtocolExtensionContainer {{UEMeasurementFailureIndication-Extensions}}      OPTIONAL,
    ...
}

UEMeasurementFailureIndication-IEs RNSAP-PROTOCOL-IES ::= {
    { ID id-MeasurementID          CRITICALITY ignore TYPE MeasurementID          PRESENCE mandatory } |
    { ID id-Cause                  CRITICALITY ignore TYPE Cause                  PRESENCE mandatory } |
    ...
}

UEMeasurementFailureIndication-Extensions RNSAP-PROTOCOL-EXTENSION ::= {
    ...
}

-- *****
--
-- IUR INVOKE TRACE
--
-- *****

IurInvokeTrace ::= SEQUENCE {
    protocolIEs                ProtocolIE-Container    {{IurInvokeTrace-IEs}},
    protocolExtensions          ProtocolExtensionContainer {{IurInvokeTrace-Extensions}}      OPTIONAL,
    ...
}

IurInvokeTrace-IEs RNSAP-PROTOCOL-IES ::= {
    { ID id-D-RNTI                CRITICALITY ignore TYPE D-RNTI                PRESENCE optional
    } |
    { ID id-TraceReference         CRITICALITY ignore TYPE TraceReference         PRESENCE mandatory
    } |
    { ID id-UEIdentity             CRITICALITY ignore TYPE UEIdentity             PRESENCE mandatory
    } |
    { ID id-TraceRecordingSessionReference CRITICALITY ignore TYPE TraceRecordingSessionReference PRESENCE mandatory } |
    { ID id-ListOfInterfacesToTrace CRITICALITY ignore TYPE ListOfInterfacesToTrace PRESENCE optional
    } |
    { ID id-TraceDepth            CRITICALITY ignore TYPE TraceDepth            PRESENCE mandatory
    },
    ...
}

ListOfInterfacesToTrace ::= SEQUENCE (SIZE (1..maxNrOfInterfaces)) OF ProtocolIE-Single-Container {{ InterfacesToBeTracedItemIE }}

InterfacesToBeTracedItemIE RNSAP-PROTOCOL-IES ::= {
    { ID id-InterfacesToTraceItem  CRITICALITY ignore TYPE InterfacesToTraceItem  PRESENCE mandatory
    }
}

```

```

InterfacesToTraceItem ::= SEQUENCE {
    interface          ENUMERATED {iub,iur,...},
    iE-Extensions      ProtocolExtensionContainer { {InterfacesToTraceItem-ExtIEs} } OPTIONAL,
    ...
}

InterfacesToTraceItem-ExtIEs RNSAP-PROTOCOL-EXTENSION ::= {
    ...
}

IurInvokeTrace-Extensions RNSAP-PROTOCOL-EXTENSION ::= {
    ...
}

-- *****
--
-- IUR DEACTIVATE TRACE
--
-- *****

IurDeactivateTrace ::= SEQUENCE {
    protocolIEs          ProtocolIE-Container    {{IurDeactivateTrace-IEs}},
    protocolExtensions   ProtocolExtensionContainer {{IurDeactivateTrace-Extensions}} OPTIONAL,
    ...
}

IurDeactivateTrace-IEs RNSAP-PROTOCOL-IES ::= {
    { ID id-D-RNTI          CRITICALITY ignore  TYPE D-RNTI          PRESENCE optional
    } |
    { ID id-TraceReference  CRITICALITY ignore  TYPE TraceReference PRESENCE mandatory
    },
    ...
}

IurDeactivateTrace-Extensions RNSAP-PROTOCOL-EXTENSION ::= {
    ...
}

-- *****
--
-- MBMS ATTACH COMMAND
--
-- *****

MBMSAttachCommand ::= SEQUENCE {
    protocolIEs          ProtocolIE-Container    {{MBMSAttachCommand-IEs}},
    protocolExtensions   ProtocolExtensionContainer {{MBMSAttachCommand-Extensions}} OPTIONAL,
    ...
}

MBMSAttachCommand-IEs RNSAP-PROTOCOL-IES ::= {
    { ID id-MBMS-Bearer-Service-List  CRITICALITY ignore  TYPE MBMS-Bearer-Service-List PRESENCE mandatory } |

```

```

    { ID id-UE-State          CRITICALITY ignore TYPE UE-State          PRESENCE optional},
    ...
}

MBMSAttachCommand-Extensions RNSAP-PROTOCOL-EXTENSION ::= {
    ...
}

-- *****
--
-- MBMS DETACH COMMAND
--
-- *****

MBMSDetachCommand ::= SEQUENCE {
    protocolIEs          ProtocolIE-Container    {{MBMSDetachCommand-IEs}},
    protocolExtensions   ProtocolExtensionContainer {{MBMSDetachCommand-Extensions}}    OPTIONAL,
    ...
}

MBMSDetachCommand-IEs RNSAP-PROTOCOL-IES ::= {
    { ID id-MBMS-Bearer-Service-List CRITICALITY ignore TYPE MBMS-Bearer-Service-List PRESENCE mandatory} |
    { ID id-UE-State          CRITICALITY ignore TYPE UE-State          PRESENCE optional},
    ...
}

MBMSDetachCommand-Extensions RNSAP-PROTOCOL-EXTENSION ::= {
    ...
}

-- *****
--
-- DIRECT INFORMATION TRANSFER
--
-- *****

DirectInformationTransfer ::= SEQUENCE {
    protocolIEs          ProtocolIE-Container    {{DirectInformationTransfer-IEs}},
    protocolExtensions   ProtocolExtensionContainer {{DirectInformationTransfer-Extensions}}    OPTIONAL,
    ...
}

DirectInformationTransfer-IEs RNSAP-PROTOCOL-IES ::= {
    { ID id-RNC-ID          CRITICALITY ignore TYPE RNC-ID          PRESENCE mandatory} |
    { ID id-ProvidedInformation CRITICALITY ignore TYPE ProvidedInformation PRESENCE mandatory} ,
    ...
}

DirectInformationTransfer-Extensions RNSAP-PROTOCOL-EXTENSION ::= {
    { ID id-Extended-RNC-ID          CRITICALITY reject EXTENSION Extended-RNC-ID PRESENCE optional },
    ...
}

-- *****

```

```

--
-- ENHANCED RELOCATION REQUEST
--
-- *****

EnhancedRelocationRequest ::= SEQUENCE {
    protocolIEs          ProtocolIE-Container    {{EnhancedRelocationRequest-IEs}},
    protocolExtensions   ProtocolExtensionContainer {{EnhancedRelocationRequest-Extensions}}    OPTIONAL,
    ...
}

EnhancedRelocationRequest-IEs RNSAP-PROTOCOL-IES ::= {
    { ID id-Cause          CRITICALITY reject TYPE Cause          PRESENCE mandatory } |
    { ID id-Permanent-NAS-UE-Identity CRITICALITY reject TYPE Permanent-NAS-UE-Identity PRESENCE mandatory } |
    { ID id-SRNC-ID        CRITICALITY reject TYPE RNC-ID PRESENCE optional } |
    -- This IE shall be present if the Relocation type IE is set to "UE involved in relocation of SRNS" --
    { ID id-Extended-SRNC-ID CRITICALITY reject TYPE Extended-RNC-ID PRESENCE optional } |
    { ID id-S-RNTI          CRITICALITY reject TYPE S-RNTI PRESENCE mandatory } |
    { ID id-RANAP-EnhancedRelocationInformationRequest CRITICALITY reject TYPE RANAP-EnhancedRelocationInformationRequest PRESENCE
mandatory },
    ...
}

EnhancedRelocationRequest-Extensions RNSAP-PROTOCOL-EXTENSION ::= {
    ...
}

-- *****
--
-- ENHANCED RELOCATION RESPONSE
--
-- *****

EnhancedRelocationResponse ::= SEQUENCE {
    protocolIEs          ProtocolIE-Container    {{EnhancedRelocationResponse-IEs}},
    protocolExtensions   ProtocolExtensionContainer {{EnhancedRelocationResponse-Extensions}}    OPTIONAL,
    ...
}

EnhancedRelocationResponse-IEs RNSAP-PROTOCOL-IES ::= {
    { ID id-RANAP-EnhancedRelocationInformationResponse CRITICALITY ignore TYPE RANAP-EnhancedRelocationInformationResponse
PRESENCE mandatory },
    ...
}

EnhancedRelocationResponse-Extensions RNSAP-PROTOCOL-EXTENSION ::= {
    ...
}

-- *****
--
-- ENHANCED RELOCATION FAILURE
--
-- *****

```

```

EnhancedRelocationFailure ::= SEQUENCE {
    protocolIEs                ProtocolIE-Container    {{EnhancedRelocationFailure-IEs}},
    protocolExtensions          ProtocolExtensionContainer {{EnhancedRelocationFailure-Extensions}}
    ...
}

EnhancedRelocationFailure-IEs RNSAP-PROTOCOL-IES ::= {
    { ID id-Cause                CRITICALITY ignore TYPE Cause                PRESENCE mandatory }|
    { ID id-CriticalityDiagnostics CRITICALITY ignore TYPE CriticalityDiagnostics PRESENCE optional },
    ...
}

EnhancedRelocationFailure-Extensions RNSAP-PROTOCOL-EXTENSION ::= {
    ...
}

-- *****
--
-- ENHANCED RELOCATION CANCEL
--
-- *****

EnhancedRelocationCancel ::= SEQUENCE {
    protocolIEs                ProtocolIE-Container    {{EnhancedRelocationCancel-IEs}},
    protocolExtensions          ProtocolExtensionContainer {{EnhancedRelocationCancel-Extensions}}
    ...
}

EnhancedRelocationCancel-IEs RNSAP-PROTOCOL-IES ::= {
    { ID id-Cause                CRITICALITY ignore TYPE Cause                PRESENCE mandatory },
    ...
}

EnhancedRelocationCancel-Extensions RNSAP-PROTOCOL-EXTENSION ::= {
    ...
}

-- *****
--
-- ENHANCED RELOCATION SIGNALLING TRANSFER
--
-- *****

EnhancedRelocationSignallingTransfer ::= SEQUENCE {
    protocolIEs                ProtocolIE-Container    {{EnhancedRelocationSignallingTransfer-IEs}},
    protocolExtensions          ProtocolExtensionContainer {{EnhancedRelocationSignallingTransfer-Extensions}}
    ...
}

EnhancedRelocationSignallingTransfer-IEs RNSAP-PROTOCOL-IES ::= {
    { ID id-L3-Information        CRITICALITY ignore TYPE L3-Information        PRESENCE mandatory },
    ...
}

```

```

EnhancedRelocationSignallingTransfer-Extensions RNSAP-PROTOCOL-EXTENSION ::= {
  ...
}

-- *****
--
-- ENHANCED RELOCATION RELEASE
--
-- *****

EnhancedRelocationRelease ::= SEQUENCE {
  protocolIEs          ProtocolIE-Container    {{EnhancedRelocationRelease-IEs}},
  protocolExtensions   ProtocolExtensionContainer {{EnhancedRelocationRelease-Extensions}}   OPTIONAL,
  ...
}

EnhancedRelocationRelease-IEs RNSAP-PROTOCOL-IES ::= {
  { ID id-Released-CN-Domain    CRITICALITY ignore  TYPE Released-CN-Domain    PRESENCE mandatory  },
  ...
}

EnhancedRelocationRelease-Extensions RNSAP-PROTOCOL-EXTENSION ::= {
  ...
}

-- *****
--
-- MBSFN MCCH INFORMATION
--
-- *****

MBSFNMCCInformation ::= SEQUENCE {
  protocolIEs          ProtocolIE-Container    {{MBSFNMCCInformation-IEs}},
  protocolExtensions   ProtocolExtensionContainer {{MBSFNMCCInformation-Extensions}}   OPTIONAL,
  ...
}

MBSFNMCCInformation-IEs RNSAP-PROTOCOL-IES ::= {
  { ID id-MBSFN-Cluster-Identity CRITICALITY ignore    TYPE MBSFN-Cluster-Identity PRESENCE mandatory } |
  { ID id-MCCH-Message-List      CRITICALITY reject   TYPE MCCH-Message-List PRESENCE mandatory } |
  { ID id-CFN                    CRITICALITY reject   TYPE CFN PRESENCE mandatory } |
  { ID id-MCCH-Configuration-Info CRITICALITY ignore    TYPE MCCH-Configuration-Info PRESENCE optional } |
  { ID id-MBSFN-Scheduling-Transmission-Time-Interval-Info-List CRITICALITY ignore    TYPE MBSFN-Scheduling-Transmission-Time-Interval-Info-List PRESENCE optional },
  ...
}

MBSFNMCCInformation-Extensions RNSAP-PROTOCOL-EXTENSION ::= {
  ...
}

-- *****

```



```

--
-- SECONDARY UL FREQUENCY REPORT
--
-- *****

SecondaryULFrequencyReport ::= SEQUENCE {
    protocolIEs          ProtocolIE-Container    {{SecondaryULFrequencyReport-IEs}},
    protocolExtensions   ProtocolExtensionContainer {{SecondaryULFrequencyReport-Extensions}}    OPTIONAL,
    ...
}

SecondaryULFrequencyReport-IEs RNSAP-PROTOCOL-IES ::= {
    { ID id-ActivationInformation    CRITICALITY    ignore    TYPE ActivationInformation    PRESENCE mandatory },
    ...
}

SecondaryULFrequencyReport-Extensions RNSAP-PROTOCOL-EXTENSION ::= {
    ...
}

-- *****
--
-- SECONDARY UL FREQUENCY UPDATE INDICATION
--
-- *****

SecondaryULFrequencyUpdateIndication ::= SEQUENCE {
    protocolIEs          ProtocolIE-Container    {{SecondaryULFrequencyUpdateIndication-IEs}},
    protocolExtensions   ProtocolExtensionContainer {{SecondaryULFrequencyUpdateIndication-Extensions}}    OPTIONAL,
    ...
}

SecondaryULFrequencyUpdateIndication-IEs RNSAP-PROTOCOL-IES ::= {
    { ID id-ActivationInformation    CRITICALITY    ignore    TYPE ActivationInformation    PRESENCE mandatory },
    ...
}

SecondaryULFrequencyUpdateIndication-Extensions RNSAP-PROTOCOL-EXTENSION ::= {
    ...
}

-- *****
--
-- PRIVATE MESSAGE
--
-- *****

PrivateMessage ::= SEQUENCE {
    privateIEs          PrivateIE-Container    {{PrivateMessage-IEs}},
    ...
}

```

```

PrivateMessage-IEs RNSAP-PRIVATE-IES ::= {
    ...
}
END

```

9.3.4 Information Element Definitions

```

-- *****
--
-- Information Element Definitions
--
-- *****

RNSAP-IEs {
itu-t (0) identified-organization (4) etsi (0) mobileDomain (0)
umts-Access (20) modules (3) rnsap (1) version1 (1) rnsap-IEs (2) }

DEFINITIONS AUTOMATIC TAGS ::=

BEGIN

IMPORTS
    maxCellsSIB11OrSIB12,
    maxNrOfFACHs,
    maxIBSEG,
    maxCellsMeas,
    maxNoOfDSCHs,
    maxNoOfUSCHs,
    maxNrOfDCHs,
    maxNrOfDL-Codes,
    maxNrOfDLTs,
    maxNrOfDLTsLCR,
    maxNrOfDPCHs,
    maxNrOfDPCHs768,
    maxNrOfDPCHsLCR,
    maxNrOfEDCH-HARQ-PO-QUANTSTEPS,
    maxNrOfEDCHHARQProcesses2msEDCH,
    maxNrOfBits-MACe-PDU-non-scheduled,
    maxNrOfEDPCCH-PO-QUANTSTEPS,
    maxNrOfRefETFCI-PO-QUANTSTEPS,
    maxNrOfRefETFCIs,
    maxNrOfErrors,
    maxNrOfFDDNeighboursPerRNC,
    maxNrOfMACcshSDU-Length,
    maxNrOfNeighbouringRNCs,
    maxNrOfTDDNeighboursPerRNC,
    maxNrOfLCRTDDNeighboursPerRNC,
    maxNrOfTS,
    maxNrOfTsLCR,
    maxNrOfULTs,
    maxNrOfULTsLCR,
    maxNrOfGSMNeighboursPerRNC,

```

maxRateMatching,
maxNrOfPoints,
maxNoOfRB,
maxNrOfRLs,
maxNrOfTFCS,
maxNrOfTFs,
maxCTFC,
maxRNCinURA-1,
maxNrOfSCCPCHs,
maxNrOfSCCPCHs768,
maxTGPS,
maxTTI-Count,
maxNoGPSTypes,
maxNoSat,
maxNrOfActiveMBMSServices,
maxNrOfCells,
maxNrOfSNAs,
maxNrOfHARQProc,
maxNrOfHSSCCHCodes,
maxNrOfMACdFlows,
maxNrOfMACdFlows-1,
maxNrOfMACdPDUSize,
maxNrOfMBMSL3,
maxNrOfMCCHMessages,
maxNrOfEDCHMACdFlows,
maxNrOfEDCHMACdFlows-1,
maxNrOfEDCHMACdFlowsLCR,
maxNrOfEDCHMACdFlowsLCR-1,
maxNrOfMBMSServices,
maxNrOfPDUIndexes,
maxNrOfPDUIndexes-1,
maxNrOfPrioQueues,
maxNrOfPrioQueues-1,
maxNrOfSatAlmanac-maxNoSat,
maxNrOfGERANSI,
maxNrOfSigSeqERGHICH-1,
maxNrOfUEs,
maxNrOfAddFreq,
maxNrOfCellsPerFreq,
maxNoOfLogicalChannels,
maxNrOfRefBetas,
maxNrOfEAGCHCodes,
maxNrOfHS-DSCHTBSs,
maxNrOfHS-DSCHTBSs-HS-SCCHless,
maxHS-PDSCHCodeNrComp-1,
maxNrOfEHICHCodes,
maxGANSSSat,
maxNoGANSS,
maxSgnType,
maxNrOfBroadcastPLMNs,
maxHSDPAFrequency,
maxHSDPAFrequency-1,
maxFrequencyinCell,
maxFrequencyinCell-1,

maxGANSSSatAlmanac,
maxGANSSClockMod,
maxNrOfEDCHRLs,
maxNrOfEUTRANeighboursPerRNC,
maxEARFCN,
maxNrOfPreconfiguredNeighbours,
maxNrOfHSDSCH-1,
maxNrOfHSDSCH,
maxGANSS-1,
maxLengthMBMSConcatServingLists,
maxNoOfTBSS-Mapping-HS-DSCH-SPS,
maxNoOfTBSS-Mapping-HS-DSCH-SPS-1,
maxNoOfHS-DSCH-TBSSLCR,
maxNoOfRepetition-Period-LCR,
maxNoOfRepetitionPeriod-SPS-LCR-1,
maxNoOf-HS-SICH-SPS,
maxNoOf-HS-SICH-SPS-1,
maxNoOfNon-HS-SCCH-Associated-HS-SICH,
maxNrOfEDCH-1,
maxNrOfDCHMeasurementOccasionPatternSequence,

id-Allowed-Rate-Information,
id-AntennaColocationIndicator,
id-BindingID,
id-Cell-Capacity-Class-Value,
id-CellCapabilityContainer-FDD,
id-CellCapabilityContainer-TDD,
id-CellCapabilityContainer-TDD-LCR,
id-Continuous-Packet-Connectivity-HS-SCCH-Less-Information,
id-Continuous-Packet-Connectivity-HS-SCCH-Less-Information-Response,
id-Counting-Information,
id-CoverageIndicator,
id-DPC-Mode-Change-SupportIndicator,
id-E-DCH-Minimum-Set-E-TFCIValidityIndicator,
id-E-RGCH-E-HICH-ChannelisationCodeValidityIndicator,
id-Extended-Round-Trip-Time-Value,
id-ExtendedPropagationDelay,
id-Extended-SRNC-ID,
id-Extended-RNC-ID,
id-GERAN-Cell-Capability,
id-GERAN-Classmark,
id-Guaranteed-Rate-Information,
id-HARQ-Preamble-Mode-Activation-Indicator,
id-HCS-Prio,
id-Inter-Frequency-Cell-Information,
id-Load-Value,
id-Load-Value-IncrDecrThres,
id-Neighbouring-GSM-CellInformation,
id-Neighbouring-UMTS-CellInformationItem,
id-neighbouring-LCR-TDD-CellInformation,
id-NRT-Load-Information-Value,
id-NRT-Load-Information-Value-IncrDecrThres,
id-OnModification,

id-Received-Total-Wideband-Power-Value,
id-Received-Total-Wideband-Power-Value-IncrDecrThres,
id-RT-Load-Value,
id-RT-Load-Value-IncrDecrThres,
id-SFNMeasurementThresholdInformation,
id-SNA-Information,
id-TrafficClass,
id-Transmitted-Carrier-Power-Value,
id-Transmitted-Carrier-Power-Value-IncrDecrThres,
id-TUTRANGPSMeasurementThresholdInformation,
id-UL-Timeslot-ISCP-Value,
id-UL-Timeslot-ISCP-Value-IncrDecrThres,
maxNrOfLevels,
maxNrOfMeasNCell,
maxNrOfMeasNCell-1,
id-MessageStructure,
id-RestrictionStateIndicator,
id-Rx-Timing-Deviation-Value-LCR,
id-TransportLayerAddress,
id-Transmission-Mode-Information,
id-TypeOfError,
id-Angle-Of-Arrival-Value-LCR,
id-IPDL-TDD-ParametersLCR,
id-DSCH-InitialWindowSize,
id-Maximum-DL-Power-TimeslotLCR-InformationItem,
id-MBMS-Bearer-Service-Full-Address,
id-MBMS-Neighbouring-Cell-Information,
id-MBMS-RLC-Sequence-Number-Information,
id-MBSFN-Cluster-Identity,
id-MBSFN-Scheduling-Transmission-Time-Interval-Info-List,
id-MCCH-Configuration-Info,
id-MCCH-Message-List,
id-Minimum-DL-Power-TimeslotLCR-InformationItem,
id-HS-SICH-Reception-Quality,
id-HS-SICH-Reception-Quality-Measurement-Value,
id-HS-PDSCH-Code-Change-Grant,
id-HS-PDSCH-Code-Change-Indicator,
id-ExtendedGSMCellIndividualOffset,
id-Unidirectional-DCH-Indicator,
id-RTLloadValue,
id-RLC-Sequence-Number,
id-NRTLloadInformationValue,
id-Satellite-Almanac-Information-ExtItem,
id-TnlQos,
id-UpPTSInterferenceValue,
id-NACC-Related-Data,
id-HARQ-Preamble-Mode,
id-User-Plane-Congestion-Fields-Inclusion,
id-FrequencyBandIndicator,
id-PLCCH-Information-UL-TimeslotLCR-Info,
id-CellCapabilityContainer-TDD768,
id-hSSCCH-TDD-Specific-InfoList-Response768,
id-hSPDSCH-TDD-Specific-InfoList-Response768,
id-Rx-Timing-Deviation-Value-768,

id-UEMeasurementValueTransmittedPowerList768,
id-UEMeasurementValueTimeslotISCPList768,
id-E-DCH-PowerOffset-for-SchedulingInfo,
id-Rx-Timing-Deviation-Value-ext,
id-TrCH-SrcStatisticsDescr,
id-eDCH-MACdFlow-Retransmission-Timer-LCR,
id-MIMO-ActivationIndicator,
id-MIMO-InformationResponse,
id-MIMO-Mode-Indicator,
id-MIMO-N-M-Ratio,
id-SixteenQAM-UL-Operation-Indicator,
id-E-AGCH-Table-Choice,
id-E-TFCI-Boost-Information,
id-E-DPDCH-PowerInterpolation,
id-HSDSCH-MACdPDUSizeFormat,
id-MaximumMACdPDU-SizeExtended,
id-GANSS-Common-Data,
id-GANSS-Information,
id-GANSS-Generic-Data,
id-TUTRANGANSSMeasurementThresholdInformation,
id-TUTRANGANSSMeasurementValueInformation,
id-HARQ-MemoryPartitioningInfoExtForMIMO,
id-Ext-Reference-E-TFCI-PO,
id-Ext-Max-Bits-MACe-PDU-non-scheduled,
id-Multiple-PLMN-List,
id-TransportBearerNotSetupIndicator,
id-TransportBearerNotRequestedIndicator,
id-UARFCNforNt,
id-LCRTDD-uplink-Physical-Channel-Capability,
id-number-Of-Supported-Carriers,
id-HSSICH-SIRTarget,
id-HSSICH-TPC-StepSize,
id-tSN-Length,
id-HS-SICH-ID-Extension,
id-multipleFreq-HSPDSCH-InformationList-ResponseTDDLRCR,
id-multicarrier-number,
id-UpPCH-InformationList-LCRTDD,
id-UpPCH-InformationItem-LCRTDD,
id-Max-UE-DTX-Cycle,
id-Default-Serving-Grant-in-DTX-Cycle2,
id-SixtyfourQAM-UsageAllowedIndicator,
id-SixtyfourQAM-DL-UsageIndicator,
id-UE-Capabilities-Info,
id-Extended-E-DCH-LCRTDD-PhysicalLayerCategory,
id-Continuous-Packet-Connectivity-HS-SCCH-Less-Deactivate-Indicator,
id-E-DCH-MACdPDUSizeFormat,
id-E-PUCH-PowerControlGAP,
id-MaximumNumber-Of-Retransmission-For-SchedulingInfo-LCRTDD,
id-E-DCH-RetransmissionTimer-For-SchedulingInfo-LCRTDD,
id-HSDSCH-TBSizeTableIndicator,
id-E-DCH-DL-Control-Channel-Change-Information,
id-E-DCH-DL-Control-Channel-Grant-Information,
id-DGANSS-Corrections-Req,
id-UE-with-enhanced-HS-SCCH-support-indicator,

id-EnhancedHSServingCC-Abort,
id-GANSS-Time-ID,
id-GANSS-AddIonoModelReq,
id-GANSS-EarthOrientParaReq,
id-GANSS-AddNavigationModelsReq,
id-GANSS-AddUTCModelsReq,
id-GANSS-AuxInfoReq,
id-GANSS-SBAS-ID,
id-GANSS-ID,
id-GANSS-Additional-Ionospheric-Model,
id-GANSS-Earth-Orientation-Parameters,
id-GANSS-Additional-Time-Models,
id-GANSS-Additional-Navigation-Models,
id-GANSS-Additional-UTC-Models,
id-GANSS-Auxiliary-Information,
id-GANSS-alm-keplerianNAValmanac,
id-GANSS-alm-keplerianReducedAlmanac,
id-GANSS-alm-keplerianMidiAlmanac,
id-GANSS-alm-keplerianGLONASS,
id-GANSS-alm-ecefsSBASAlmanac,
id-Secondary-Serving-Cell-List,
id-MinimumReducedE-DPDCH-GainFactor,
id-E-AGCH-UE-Inactivity-Monitor-Threshold,
id-MACes-Maximum-Bitrate-LCR,
id-MultiCarrier-HSDSCH-Physical-Layer-Category,
id-MIMO-SFMode-For-HSPDSCHDualStream,
id-MIMO-SFMode-Supported-For-HSPDSCHDualStream,
id-MIMO-ReferenceSignal-InformationListLCR,
id-DL-RLC-PDU-Size-Format,
id-UE-SupportIndicatorExtension,
id-power-offset-for-S-CPICH-for-MIMO,
id-power-offset-for-S-CPICH-for-MIMO-Request-Indicator,
id-Dual-Band-Secondary-Serving-Cell-List,
id-Single-Stream-MIMO-ActivationIndicator,
id-Single-Stream-MIMO-Mode-Indicator,
id-Additional-EDCH-Preconfiguration-Information,
id-MulticellEDCH-Information,
id-EDCH-Indicator,
id-DiversityMode,
id-TransmitDiversityIndicator,
id-NonCellSpecificTxDiversity,
id-CellCapabilityContainerExtension-FDD,
id-HSDSCH-Physical-Layer-Category,
id-TS0-HS-PDSCH-Indication-LCR,
id-UE-TS0-CapabilityLCR,
id-DGNSS-ValidityPeriod,
id-UE-AggregateMaximumBitRate-Enforcement-Indicator,
id-Out-of-Synchronization-Window,
id-MulticellEDCH-RL-SpecificInformation,
id-Continuous-Packet-Connectivity-DTX-DRX-Information,
id-Additional-E-DCH-Non-Serving-RL-Preconfiguration-Setup,
id-Additional-E-DCH-New-non-serving-RL-E-DCH-FDD-DL-Control-Channel-InfoList,
id-CellListValidityIndicator,

```

id-HS-SCCH-Inactivity-Threshold-for-UE-DRX-Cycle-LCR-Ext,
id-Measurement-Power-Offset,
id-Support-of-Dynamic-DTXDRX-Related-HS-SCCH-Order

```

```
FROM RNSAP-Constants
```

```

Criticality,
ProcedureID,
ProtocolIE-ID,
TransactionID,
TriggeringMessage

```

```
FROM RNSAP-CommonDataTypes
```

```

ProtocolIE-Single-Container{},
ProtocolExtensionContainer{},
RNSAP-PROTOCOL-IES,
RNSAP-PROTOCOL-EXTENSION

```

```
FROM RNSAP-Containers;
```

```
-- A
```

```
AccessPointName ::= OCTET STRING (SIZE (1..255))
```

```
AckNack-RepetitionFactor ::= INTEGER (1..4,...)
```

```
-- Step: 1
```

```
Ack-Power-Offset ::= INTEGER (0..8,...)
```

```
-- According to mapping in ref. TS 25.213 [21] subclause 4.2.1
```

```
ActivationInformation ::= SEQUENCE (SIZE (1..maxNrOfEDCH-1)) OF ActivationInformationItem
```

```

ActivationInformationItem ::= SEQUENCE {
  uU-ActivationState Uu-ActivationState,
  iE-Extensions                                     ProtocolExtensionContainer { { ActivationInformationItem-ExtIEs } }
  OPTIONAL,
  ...
}

```

```

ActivationInformationItem-ExtIEs RNSAP-PROTOCOL-EXTENSION ::= {
  ...
}

```

```
Active-MBMS-Bearer-Service-ListFDD ::= SEQUENCE (SIZE (1..maxNrOfActiveMBMSServices)) OF MBMS-Bearer-ServiceItemFDD
```

```
Active-MBMS-Bearer-Service-ListFDD-PFL ::= SEQUENCE (SIZE (1..maxNrOfActiveMBMSServices)) OF MBMS-Bearer-ServiceItemFDD-PFL
```

```
Active-MBMS-Bearer-Service-ListTDD ::= SEQUENCE (SIZE (1..maxNrOfActiveMBMSServices)) OF MBMS-Bearer-ServiceItemTDD
```

```
Active-MBMS-Bearer-Service-ListTDD-PFL ::= SEQUENCE (SIZE (1..maxNrOfActiveMBMSServices)) OF MBMS-Bearer-ServiceItemTDD-PFL
```

```

Active-Pattern-Sequence-Information ::= SEQUENCE {
  cmConfigurationChangeCFN      CFN,

```



```

    transmission-Gap-Pattern-Sequence-Status      Transmission-Gap-Pattern-Sequence-Status-List      OPTIONAL,
    iE-Extensions      ProtocolExtensionContainer { {Active-Pattern-Sequence-Information-ExtIEs} } OPTIONAL,
    ...
}

Active-Pattern-Sequence-Information-ExtIEs RNSAP-PROTOCOL-EXTENSION ::= {
    ...
}

Additional-EDCH-Cell-Information-Response-RLAddList ::= SEQUENCE (SIZE (1..maxNrOfEDCH-1)) OF Additional-EDCH-Cell-Information-Response-RLAdd-ItemIEs

Additional-EDCH-Cell-Information-Response-RLAdd-ItemIEs ::=SEQUENCE{
    additional-EDCH-FDD-Information-Response      Additional-EDCH-FDD-Information-Response-ItemIEs      OPTIONAL,
    additional-EDCH-Serving-Cell-Change-Information-Response-RLAdd      E-DCH-Serving-cell-change-informationResponse      OPTIONAL,
    iE-Extensions      ProtocolExtensionContainer { { Additional-EDCH-Cell-Information-Response-RLAdd-ItemIEs-ExtIEs} } OPTIONAL,
    ...
}

Additional-EDCH-Cell-Information-Response-RLAdd-ItemIEs-ExtIEs RNSAP-PROTOCOL-EXTENSION ::= {
    ...
}

Additional-EDCH-Setup-Info ::=SEQUENCE{
    multicell-EDCH-Transport-Bearer-Mode      Multicell-EDCH-Transport-Bearer-Mode,
    additional-EDCH-Cell-Information-Setup      Additional-EDCH-Cell-Information-Setup,
    iE-Extensions      ProtocolExtensionContainer { { Additional-EDCH-Setup-Info-ExtIEs} } OPTIONAL,
    ...
}

Additional-EDCH-Setup-Info-ExtIEs RNSAP-PROTOCOL-EXTENSION ::= {
    ...
}

Multicell-EDCH-Transport-Bearer-Mode ::= ENUMERATED {
    separate-Iur-Transport-Bearer-Mode,
    uL-Flow-Multiplexing-Mode
}

Additional-EDCH-Cell-Information-Setup ::= SEQUENCE (SIZE (1..maxNrOfEDCH-1)) OF Additional-EDCH-FDD-Setup-Cell-Information

Additional-EDCH-FDD-Setup-Cell-Information ::=SEQUENCE{
    additional-EDCH-UL-DPCH-Information-Setup      Additional-EDCH-UL-DPCH-Information-Setup,
    additional-EDCH-RL-Specific-Information-To-Setup      Additional-EDCH-RL-Specific-Information-To-Setup-List,
    additional-EDCH-FDD-Information      Additional-EDCH-FDD-Information      OPTIONAL,
    additional-EDCH-F-DPCH-Information-Setup      Additional-EDCH-F-DPCH-Information,
    multicellEDCH-Information      MulticellEDCH-Information      OPTIONAL,
    iE-Extensions      ProtocolExtensionContainer { { Additional-EDCH-FDD-Setup-Cell-Information-ExtIEs} } OPTIONAL,
    ...
}

Additional-EDCH-FDD-Setup-Cell-Information-ExtIEs RNSAP-PROTOCOL-EXTENSION ::= {
    ...
}

```

```

Additional-EDCH-UL-DPCH-Information-Setup ::=SEQUENCE{
  ul-ScramblingCode          UL-ScramblingCode,
  ul-SIR-Target              UL-SIR          OPTIONAL,
  iE-Extensions              ProtocolExtensionContainer { { Additional-EDCH-UL-DPCH-Information-Setup-ExtIEs} } OPTIONAL,
  ...
}

Additional-EDCH-UL-DPCH-Information-Setup-ExtIEs RNSAP-PROTOCOL-EXTENSION ::= {
  ...
}

Additional-EDCH-F-DPCH-Information ::=SEQUENCE{
  fdd-TPC-DownlinkStepSize    FDD-TPC-DownlinkStepSize,
  limitedPowerIncrease        LimitedPowerIncrease,
  innerLoopDLPCStatus         InnerLoopDLPCStatus,
  f-DPCH-SlotFormatSupportRequest F-DPCH-SlotFormatSupportRequest OPTIONAL,
  iE-Extensions              ProtocolExtensionContainer { { Additional-EDCH-F-DPCH-Information-ExtIEs} } OPTIONAL,
  ...
}

Additional-EDCH-F-DPCH-Information-ExtIEs RNSAP-PROTOCOL-EXTENSION ::= {
  ...
}

Additional-EDCH-RL-Specific-Information-To-Setup-List ::= SEQUENCE (SIZE (1.. maxNrOfEDCHRLs)) OF Additional-EDCH-RL-Specific-Information-To-Setup-ItemIEs

Additional-EDCH-RL-Specific-Information-To-Setup-ItemIEs ::=SEQUENCE{
  eDCH-Additional-RL-ID        RL-ID,
  c-ID                        C-ID          OPTIONAL,
  firstRLS-indicator          FirstRLS-Indicator,
  propagationDelay            PropagationDelay          OPTIONAL,
  initialDL-transmissionPower DL-Power          OPTIONAL,
  primaryCPICH-EcNo           PrimaryCPICH-EcNo          OPTIONAL,
  e-AGCH-PowerOffset          E-AGCH-PowerOffset          OPTIONAL,
  e-RGCH-PowerOffset          E-RGCH-PowerOffset          OPTIONAL,
  e-HICH-PowerOffset          E-HICH-PowerOffset          OPTIONAL,
  additional-EDCH-MAC-d-Flows-Specific-Info-List Additional-EDCH-MAC-d-Flows-Specific-Info-List OPTIONAL,
  multicelledEDCH-RL-SpecificInformation MulticelledEDCH-RL-SpecificInformation OPTIONAL,
  iE-Extensions              ProtocolExtensionContainer { { Additional-EDCH-RL-Specific-Information-To-Setup-ItemIEs-ExtIEs} } OPTIONAL,
  ...
}

Additional-EDCH-RL-Specific-Information-To-Setup-ItemIEs-ExtIEs RNSAP-PROTOCOL-EXTENSION ::= {
  ...
}

Additional-EDCH-Cell-Information-To-Add-List ::= SEQUENCE (SIZE (1.. maxNrOfEDCH-1)) OF Additional-EDCH-Cell-Information-To-Add-ItemIEs

Additional-EDCH-Cell-Information-To-Add-ItemIEs ::=SEQUENCE{
  additional-EDCH-UL-DPCH-Information-Setup Additional-EDCH-UL-DPCH-Information-Addition,
  additional-EDCH-RL-Specific-Information-To-Add-List Additional-EDCH-RL-Specific-Information-To-Add-List,
  additional-EDCH-FDD-Information Additional-EDCH-FDD-Information OPTIONAL,
}

```

```

    multicelledCH-Information          MulticelledCH-Information          OPTIONAL,
    iE-Extensions                      ProtocolExtensionContainer { { Additional-EDCH-Cell-Information-To-Add-ItemIEs-ExtIEs } } OPTIONAL,
    ...
}

Additional-EDCH-Cell-Information-To-Add-ItemIEs-ExtIEs  RNSAP-PROTOCOL-EXTENSION ::= {
    ...
}

Additional-EDCH-UL-DPCH-Information-Addition ::=SEQUENCE{
    ul-SIR-Target                      UL-SIR,
    iE-Extensions                      ProtocolExtensionContainer { { Additional-EDCH-UL-DPCH-Information-Addition-ExtIEs } } OPTIONAL,
    ...
}

Additional-EDCH-UL-DPCH-Information-Addition-ExtIEs  RNSAP-PROTOCOL-EXTENSION ::= {
    ...
}

Additional-EDCH-RL-Specific-Information-To-Add-List ::= SEQUENCE (SIZE (1.. maxNrOfEDCHRLs)) OF Additional-EDCH-RL-Specific-Information-To-Add-ItemIEs

Additional-EDCH-RL-Specific-Information-To-Add-ItemIEs ::=SEQUENCE{
    eDCH-Additional-RL-ID              RL-ID,
    c-ID                              C-ID,
    primaryCPICH-EcNo                 PrimaryCPICH-EcNo          OPTIONAL,
    e-AGCH-PowerOffset                E-AGCH-PowerOffset      OPTIONAL,
    e-RGCH-PowerOffset                E-RGCH-PowerOffset      OPTIONAL,
    e-HICH-PowerOffset                E-HICH-PowerOffset      OPTIONAL,
    additional-EDCH-MAC-d-Flows-Specific-Info-List Additional-EDCH-MAC-d-Flows-Specific-Info-List OPTIONAL,
    multicelledCH-RL-SpecificInformation MulticelledCH-RL-SpecificInformation OPTIONAL,
    iE-Extensions                      ProtocolExtensionContainer { { Additional-EDCH-RL-Specific-Information-To-Add-ItemIEs-ExtIEs } } OPTIONAL,
    ...
}

Additional-EDCH-RL-Specific-Information-To-Add-ItemIEs-ExtIEs  RNSAP-PROTOCOL-EXTENSION ::= {
    ...
}

Additional-EDCH-RL-Specific-Information-To-Modify-List ::= SEQUENCE (SIZE (1..maxNrOfEDCHRLs)) OF Additional-EDCH-RL-Specific-Information-To-Modify-ItemIEs

Additional-EDCH-RL-Specific-Information-To-Modify-ItemIEs ::=SEQUENCE{
    eDCH-Additional-RL-ID              RL-ID,
    e-AGCH-PowerOffset                E-AGCH-PowerOffset      OPTIONAL,
    e-RGCH-PowerOffset                E-RGCH-PowerOffset      OPTIONAL,
    e-HICH-PowerOffset                E-HICH-PowerOffset      OPTIONAL,
    additional-EDCH-MAC-d-Flows-Specific-Info-List Additional-EDCH-MAC-d-Flows-Specific-Info-List OPTIONAL,
    multicelledCH-RL-SpecificInformation MulticelledCH-RL-SpecificInformation OPTIONAL,
    iE-Extensions                      ProtocolExtensionContainer { { Additional-EDCH-RL-Specific-Information-To-Modify-ItemIEs-ExtIEs } }
OPTIONAL,
    ...
}

```

```

Additional-EDCH-RL-Specific-Information-To-Modify-ItemIEs-ExtIEs  RNSAP-PROTOCOL-EXTENSION ::= {
  ...
}

Additional-EDCH-FDD-Information ::=SEQUENCE{
  HARQ-Process-Allocation-Scheduled-2ms-EDCH      HARQ-Process-Allocation-2ms-EDCH
  OPTIONAL,
  e-DCH-Maximum-Bitrate                          E-DCH-Maximum-Bitrate
  OPTIONAL,
  e-DCH-Processing-Overload-Level                 E-DCH-Processing-Overload-Level
  OPTIONAL,
  e-DCH-Min-Set-E-TFCI                           E-TFCI
  OPTIONAL,
  iE-Extensions                                  ProtocolExtensionContainer { { Additional-EDCH-FDD-Information-ExtIEs } } OPTIONAL,
  ...
}

Additional-EDCH-FDD-Information-ExtIEs  RNSAP-PROTOCOL-EXTENSION ::= {
  ...
}

Additional-EDCH-MAC-d-Flows-Specific-Info-List ::= SEQUENCE (SIZE (1..maxNrOfEDCHMACdFlows)) OF Additional-EDCH-MAC-d-Flows-Specific-Info

Additional-EDCH-MAC-d-Flows-Specific-Info ::= SEQUENCE {
  e-DCH-MACdFlow-ID          EDCH-MACdFlow-ID,
  bindingID                  BindingID
  OPTIONAL,
  transportLayerAddress      TransportLayerAddress
  OPTIONAL,
  iE-Extensions              ProtocolExtensionContainer { { Additional-EDCH-MAC-d-Flows-Specific-Info-ExtIEs } }
  OPTIONAL,
  ...
}

Additional-EDCH-MAC-d-Flows-Specific-Info-ExtIEs  RNSAP-PROTOCOL-EXTENSION ::= {
  ...
}

Additional-EDCH-MAC-d-Flow-Specific-Information-Response-List ::= SEQUENCE (SIZE (1..maxNrOfEDCHMACdFlows)) OF Additional-EDCH-MAC-d-Flows-Specific-Info-Response

Additional-EDCH-MAC-d-Flows-Specific-Info-Response ::= SEQUENCE {
  e-DCH-MACdFlow-ID          EDCH-MACdFlow-ID,
  bindingID                  BindingID
  transportLayerAddress      TransportLayerAddress
  iE-Extensions              ProtocolExtensionContainer { { Additional-EDCH-MAC-d-Flows-Specific-Info-Response-ExtIEs } }
  OPTIONAL,
  OPTIONAL,
  ...
}

Additional-EDCH-MAC-d-Flows-Specific-Info-Response-ExtIEs  RNSAP-PROTOCOL-EXTENSION ::= {
  ...
}

```

Additional-EDCH-Cell-Information-Response-List ::= SEQUENCE (SIZE (1..maxNrOfEDCH-1)) OF Additional-EDCH-FDD-Information-Response-ItemIEs

```
Additional-EDCH-FDD-Information-Response-ItemIEs ::=SEQUENCE{
  eDCH-Additional-RL-Specific-Information-Response          EDCH-Additional-RL-Specific-Information-Response-List,
  iE-Extensions          ProtocolExtensionContainer { { Additional-EDCH-FDD-Information-Response-ItemIEs-ExtIEs} } OPTIONAL,
  ...
}
```

```
Additional-EDCH-FDD-Information-Response-ItemIEs-ExtIEs RNSAP-PROTOCOL-EXTENSION ::= {
  ...
}
```

EDCH-Additional-RL-Specific-Information-Response-List ::= SEQUENCE (SIZE (1..maxNrOfEDCHRLs)) OF EDCH-Additional-RL-Specific-Information-Response-ItemIEs

```
EDCH-Additional-RL-Specific-Information-Response-ItemIEs ::=SEQUENCE{
  eDCH-Additional-RL-ID          RL-ID,
  received-total-wide-band-power          Received-total-wide-band-power,
  dL-PowerBalancing-ActivationIndicator          DL-PowerBalancing-ActivationIndicator  OPTIONAL,
  rL-Set-ID          RL-Set-ID,
  e-DCH-RL-Set-ID          RL-Set-ID,
  eDCH-FDD-DL-ControlChannelInformation          EDCH-FDD-DL-ControlChannelInformation,
  dl-CodeInformation          FDD-DL-CodeInformation,

  additional-EDCH-MAC-d-Flow-Specific-Information-Response-List          Additional-EDCH-MAC-d-Flow-Specific-Information-Response-List
  OPTIONAL,
  HARQ-Process-Allocation-Scheduled-2ms-EDCH          HARQ-Process-Allocation-2ms-EDCH          OPTIONAL,          maxUL-SIR
  UL-SIR,
  minUL-SIR          UL-SIR,
  maximumAllowedULTxPower          MaximumAllowedULTxPower,
  maximumDL-power          DL-Power,
  minimumDL-power          DL-Power,
  primaryScramblingCode          PrimaryScramblingCode          OPTIONAL,
  uL-UARFCN          UARFCN          OPTIONAL,
  dL-UARFCN          UARFCN          OPTIONAL,
  primaryCPICH-Power          PrimaryCPICH-Power,
  pC-Preamble          PC-Preamble,
  primary-CPICH-Usage-For-Channel-Estimation          Primary-CPICH-Usage-For-Channel-Estimation          OPTIONAL,
  secondary-CPICH-Information          Secondary-CPICH-Information          OPTIONAL,
  f-DPCH-SlotFormat          F-DPCH-SlotFormat          OPTIONAL,
  iE-Extensions          ProtocolExtensionContainer { { EDCH-Additional-RL-Specific-Information-Response-ItemIEs-ExtIEs} } OPTIONAL,
  ...
}
```

```
EDCH-Additional-RL-Specific-Information-Response-ItemIEs-ExtIEs RNSAP-PROTOCOL-EXTENSION ::= {
  ...
}
```

Additional-EDCH-Cell-Information-Response-RLReconf-List ::= SEQUENCE (SIZE (1..maxNrOfEDCH-1)) OF Additional-EDCH-FDD-Information-Response-RLReconf-Items

```
Additional-EDCH-FDD-Information-Response-RLReconf-Items ::=SEQUENCE{
  eDCH-Additional-RL-Specific-Information-Response          EDCH-Additional-RL-Specific-Information-Response-List
  OPTIONAL,
```

```

    eDCH-Additional-RL-Specific-Modified-Information-Response      EDCH-Additional-RL-Specific-Modified-Information-Response-List
    OPTIONAL,
    iE-Extensions          ProtocolExtensionContainer { { Additional-EDCH-FDD-Information-Response-RLReconf-Items-ExtIEs} } OPTIONAL,
    ...
}

Additional-EDCH-FDD-Information-Response-RLReconf-Items-ExtIEs  RNSAP-PROTOCOL-EXTENSION ::= {
    ...
}

EDCH-Additional-RL-Specific-Modified-Information-Response-List ::= SEQUENCE (SIZE (1..maxNrOfEDCHRLs)) OF EDCH-Additional-RL-Specific-Modified-
Information-Response-ItemIEs

EDCH-Additional-RL-Specific-Modified-Information-Response-ItemIEs ::=SEQUENCE{
    eDCH-Additional-RL-ID          RL-ID,
    dL-PowerBalancing-UpdatedIndicator      DL-PowerBalancing-UpdatedIndicator      OPTIONAL,
    eDCH-FDD-DL-ControlChannelInformation    EDCH-FDD-DL-ControlChannelInformation    OPTIONAL,
    additional-EDCH-MAC-d-Flow-Specific-Information-Response-List      Additional-EDCH-MAC-d-Flow-Specific-Information-Response-List
    OPTIONAL,
    hARQ-Process-Allocation-Scheduled-2ms-EDCH      HARQ-Process-Allocation-2ms-EDCH      OPTIONAL,
    maxUL-SIR          UL-SIR      OPTIONAL,
    minUL-SIR          UL-SIR      OPTIONAL,
    maximumDL-power      DL-Power      OPTIONAL,
    minimumDL-power      DL-Power      OPTIONAL,
    primary-CPICH-Usage-For-Channel-Estimation      Primary-CPICH-Usage-For-Channel-Estimation      OPTIONAL,
    secondary-CPICH-Information-Change      Secondary-CPICH-Information-Change      OPTIONAL,
    f-DPCH-SlotFormat      F-DPCH-SlotFormat      OPTIONAL,
    iE-Extensions          ProtocolExtensionContainer { { EDCH-Additional-RL-Specific-Modified-Information-Response-ItemIEs-ExtIEs} }
    OPTIONAL,
    ...
}

EDCH-Additional-RL-Specific-Modified-Information-Response-ItemIEs-ExtIEs  RNSAP-PROTOCOL-EXTENSION ::= {
    ...
}

Additional-EDCH-Cell-Information-ConfigurationChange-List ::= SEQUENCE (SIZE (1..maxNrOfEDCH-1)) OF Additional-EDCH-ConfigurationChange-Info-
ItemIEs
Additional-EDCH-ConfigurationChange-Info-ItemIEs ::=SEQUENCE{
    additional-EDCH-UL-DPCH-Information-Modify      Additional-EDCH-UL-DPCH-Information-Modify      OPTIONAL,
    additional-EDCH-RL-Specific-Information-To-Add      Additional-EDCH-RL-Specific-Information-To-Add-List      OPTIONAL,
    additional-EDCH-RL-Specific-Information-To-Modify      Additional-EDCH-RL-Specific-Information-To-Modify-List      OPTIONAL,
    additional-EDCH-FDD-Information-To-Modify      Additional-EDCH-FDD-Information      OPTIONAL,
    additional-EDCH-F-DPCH-Information-Modify      Additional-EDCH-F-DPCH-Information      OPTIONAL,
    multicelledCH-Information      MulticelledCH-Information      OPTIONAL,
    iE-Extensions          ProtocolExtensionContainer { { Additional-EDCH-ConfigurationChange-Info-ItemIEs-ExtIEs} } OPTIONAL,
    ...
}

Additional-EDCH-ConfigurationChange-Info-ItemIEs-ExtIEs  RNSAP-PROTOCOL-EXTENSION ::= {
    ...
}

Additional-EDCH-UL-DPCH-Information-Modify      ::=SEQUENCE{

```

```

    ul-ScramblingCode          UL-ScramblingCode    OPTIONAL,
    ul-SIR-Target              UL-SIR              OPTIONAL,
    iE-Extensions              ProtocolExtensionContainer { { Additional-EDCH-UL-DPCH-Information-Modify-ExtIEs} } OPTIONAL,
    ...
}

Additional-EDCH-UL-DPCH-Information-Modify-ExtIEs  RNSAP-PROTOCOL-EXTENSION ::= {
    ...
}

Additional-EDCH-Cell-Information-Removal-List      ::= SEQUENCE (SIZE (1..maxNrOfEDCH-1)) OF Additional-EDCH-Cell-Information-Removal-Info-ItemIEs

Additional-EDCH-Cell-Information-Removal-Info-ItemIEs ::=SEQUENCE{
    rL-on-Secondary-UL-Frequency                    RL-on-Secondary-UL-Frequency,
    iE-Extensions                                  ProtocolExtensionContainer { { Additional-EDCH-Cell-Information-Removal-Info-ItemIEs-ExtIEs} } OPTIONAL,
    ...
}

Additional-EDCH-Cell-Information-Removal-Info-ItemIEs-ExtIEs  RNSAP-PROTOCOL-EXTENSION ::= {
    ...
}

RL-on-Secondary-UL-Frequency ::= ENUMERATED {
    remove,
    ...
}

Additional-EDCH-FDD-Update-Information ::=SEQUENCE{
    HARQ-Process-Allocation-Scheduled-2ms-EDCH          HARQ-Process-Allocation-2ms-EDCH          OPTIONAL,
    additional-EDCH-DL-Control-Channel-Change-Information  Additional-EDCH-DL-Control-Channel-Change-Information-List
    OPTIONAL,
    iE-Extensions                                          ProtocolExtensionContainer { { Additional-EDCH-FDD-Update-Information-ExtIEs} } OPTIONAL,
    ...
}

Additional-EDCH-FDD-Update-Information-ExtIEs  RNSAP-PROTOCOL-EXTENSION ::= {
    ...
}

Additional-EDCH-DL-Control-Channel-Change-Information-List ::= SEQUENCE (SIZE (1..maxNrOfEDCHRLs)) OF Additional-EDCH-DL-Control-Channel-Change-Info-ItemIEs

Additional-EDCH-DL-Control-Channel-Change-Info-ItemIEs ::=SEQUENCE{
    eDCH-Additional-RL-ID                                RL-ID,
    iE-Extensions                                        ProtocolExtensionContainer { { Additional-EDCH-DL-Control-Channel-Change-Info-ItemIEs-ExtIEs} } OPTIONAL,
    ...
}

Additional-EDCH-DL-Control-Channel-Change-Info-ItemIEs-ExtIEs  RNSAP-PROTOCOL-EXTENSION ::= {
    ...
}

```

```

AdditionalPreferredFrequency ::= SEQUENCE (SIZE (1..maxNrOfAddFreq)) OF AdditionalPreferredFrequencyItem

AdditionalPreferredFrequencyItem ::= SEQUENCE {
    dL-UARFCN                UARFCN,
    correspondingCells       CorrespondingCells,
    iE-Extensions            ProtocolExtensionContainer { { AdditionalPreferredFrequencyItem-ExtIEs} } OPTIONAL,
    ...
}

AdditionalPreferredFrequencyItem-ExtIEs RNSAP-PROTOCOL-EXTENSION ::= {
    ...
}

AdjustmentPeriod            ::= INTEGER(1..256)
-- Unit Frame

AffectedUEInformationForMBMS ::= SEQUENCE (SIZE (1..maxNrOfUEs)) OF S-RNTI

AllocationRetentionPriority ::= SEQUENCE {
    priorityLevel            PriorityLevel,
    pre-emptionCapability    Pre-emptionCapability,
    pre-emptionVulnerability Pre-emptionVulnerability,
    iE-Extensions           ProtocolExtensionContainer { {AllocationRetentionPriority-ExtIEs} } OPTIONAL,
    ...
}

AllocationRetentionPriority-ExtIEs RNSAP-PROTOCOL-EXTENSION ::= {
    ...
}

Allowed-Rate-Information ::= SEQUENCE {
    allowed-UL-Rate          Allowed-Rate OPTIONAL,
    allowed-DL-Rate          Allowed-Rate OPTIONAL,
    iE-Extensions           ProtocolExtensionContainer { {Allowed-Rate-Information-ExtIEs} } OPTIONAL,
    ...
}

Allowed-Rate-Information-ExtIEs RNSAP-PROTOCOL-EXTENSION ::= {
    ...
}

Allowed-Rate                ::= INTEGER (1..maxNrOfTFs)
-- "1": TFI 0, "2": TFI 1, "3": TFI 2, ...

AllowedQueuingTime          ::= INTEGER (1..60)
-- seconds

AlphaValue                  ::= INTEGER (0..8)
-- Actual value = Alpha / 8

AlternativeFormatReportingIndicator ::= ENUMERATED {
    alternativeFormatAllowed, ...
}

```



```

Angle-Of-Arrival-Value-LCR ::= SEQUENCE {
    aOA-LCR                AOA-LCR,
    aOA-LCR-Accuracy-Class AOA-LCR-Accuracy-Class,
    iE-Extensions          ProtocolExtensionContainer { {Angle-Of-Arrival-Value-LCR-ExtIEs} } OPTIONAL,
    ...
}

Angle-Of-Arrival-Value-LCR-ExtIEs RNSAP-PROTOCOL-EXTENSION ::= {
    ...
}

AOA-LCR ::= INTEGER (0..719)
-- Angle Of Arrival for 1.28Mcps TDD

AOA-LCR-Accuracy-Class ::= ENUMERATED {a,b,c,d,e,f,g,h,...}

AntennaColocationIndicator ::= ENUMERATED {
    co-located,
    ...
}

-- B

BadSatellites ::= SEQUENCE {
    badSatelliteInformation SEQUENCE (SIZE (1..maxNoSat)) OF
        SEQUENCE {
            badSAT-ID          SAT-ID,
            iE-Extensions      ProtocolExtensionContainer { { BadSatelliteInformation-ExtIEs} } OPTIONAL,
            ...
        },
    iE-Extensions          ProtocolExtensionContainer { { BadSatellites-ExtIEs} } OPTIONAL,
    ...
}

BadSatelliteInformation-ExtIEs RNSAP-PROTOCOL-EXTENSION ::= {
    ...
}

BadSatellites-ExtIEs RNSAP-PROTOCOL-EXTENSION ::= {
    ...
}

Band-Indicator ::= ENUMERATED {
    dcs1800Band,
    pcs1900Band,
    ...
}

BCC ::= BIT STRING (SIZE (3))

BCCH-ARFCN ::= INTEGER (0..1023)

BetaCD ::= INTEGER (0..15)

```

```

BindingID ::= OCTET STRING (SIZE (1..4,...))
-- If the Binding ID includes an UDP port, the UDP port is included in octet 1 and 2.

BLER ::= INTEGER (-63..0)
-- Step 0.1 (Range -6.3..0). It is the Log10 of the BLER

SCTD-Indicator ::= ENUMERATED {
    active,
    inactive
}

BSIC ::= SEQUENCE {
    nCC NCC,
    bCC BCC
}

BundlingModeIndicator ::= ENUMERATED {
    bundling,
    no-bundling
}

BurstModeParameters ::= SEQUENCE {
    burstStart INTEGER (0..15),
    burstLength INTEGER (10..25),
    burstFreq INTEGER (1..16),
    iE-Extensions ProtocolExtensionContainer { { BurstModeParameters-ExtIEs } } OPTIONAL,
    ...
}

BurstModeParameters-ExtIEs RNSAP-PROTOCOL-EXTENSION ::= {
    ...
}

-- C

Cause ::= CHOICE {
    radioNetwork CauseRadioNetwork,
    transport CauseTransport,
    protocol CauseProtocol,
    misc CauseMisc,
    ...
}

CauseMisc ::= ENUMERATED {
    control-processing-overload,
    hardware-failure,
    om-intervention,
    not-enough-user-plane-processing-resources,
    unspecified,
    ...
}

CauseProtocol ::= ENUMERATED {

```

```
transfer-syntax-error,  
abstract-syntax-error-reject,  
abstract-syntax-error-ignore-and-notify,  
message-not-compatible-with-receiver-state,  
semantic-error,  
unspecified,  
abstract-syntax-error-falsely-constructed-message,  
...  
}  
  
CauseRadioNetwork ::= ENUMERATED {  
  unknown-C-ID,  
  cell-not-available,  
  power-level-not-supported,  
  ul-scrambling-code-already-in-use,  
  dl-radio-resources-not-available,  
  ul-radio-resources-not-available,  
  measurement-not-supported-for-the-object,  
  combining-resources-not-available,  
  combining-not-supported,  
  reconfiguration-not-allowed,  
  requested-configuration-not-supported,  
  synchronisation-failure,  
  requested-tx-diversity-mode-not-supported,  
  measurement-temporarily-not-available,  
  unspecified,  
  invalid-CM-settings,  
  reconfiguration-CFN-not-elapsed,  
  number-of-DL-codes-not-supported,  
  dedicated-transport-channel-type-not-supported,  
  dl-shared-channel-type-not-supported,  
  ul-shared-channel-type-not-supported,  
  common-transport-channel-type-not-supported,  
  ul-spreading-factor-not-supported,  
  dl-spreading-factor-not-supported,  
  cm-not-supported,  
  transaction-not-supported-by-destination-node-b,  
  rl-already-activated-or-allocated,  
  ...,  
  number-of-UL-codes-not-supported,  
  cell-reserved-for-operator-use,  
  dpc-mode-change-not-supported,  
  information-temporarily-not-available,  
  information-provision-not-supported-for-the-object,  
  power-balancing-status-not-compatible,  
  delayed-activation-not-supported,  
  rl-timing-adjustment-not-supported,  
  unknown-RNTI,  
  measurement-repetition-rate-not-compatible,  
  ue-not-capable-of-support,  
  f-dpch-not-supported,  
  e-dch-not-supported,  
  continuous-packet-connectivity-dtx-drx-operation-not-supported,  
  continuous-packet-connectivity-hs-scch-less-operation-not-supported,  
}
```

```

mimo-not-supported,
e-dch-tti2ms-not-supported,
continuous-packet-connectivity-DTX-DRX-operation-not-available,
continuous-packet-connectivity-UE-DTX-Cycle-not-available,
mimo-not-available,
sixteenQAM-UL-not-Supported,
hSDSCH-MACdPDU-SizeFormatNotSupported,
f-dpch-slot-format-operation-not-supported,
e-DCH-MACdPDU-SizeFormat-not-available,
e-DPCCH-Power-Boosting-not-supported,
trelocprep-expiry,
directed-retry,
no-Iu-CS-UP-relocation,
reduce-load-in-serving-cell,
relocation-cancelled,
relocation-desirable-for-radio-reasons,
resource-optimisation-relocation,
time-critical-relocation,
traffic-load-in-the-target-cell-higher-than-in-the-source-cell,
sixtyfourQAM-DL-and-MIMO-Combined-not-available,
multi-Cell-operation-not-available,
multi-Cell-operation-not-supported,
semi-Persistent-scheduling-not-supported,
continuous-Packet-Connectivity-DRX-not-supported,
continuous-Packet-Connectivity-DRX-not-available,
enhanced-relocation-not-supported,
relocation-not-supported-due-to-PUESBINE-feature,
relocation-failure-in-target-RNC,
relocation-target-not-allowed,
requested-ciphering-and-or-integrity-protection-algorithms-not-supported,
sixtyfourQAM-DL-and-MIMO-Combined-not-supported,
tx-diversity-for-mimo-on-DL-control-channels-not-available,
single-Stream-MIMO-not-supported,
single-Stream-MIMO-not-available,
multi-Cell-operation-with-MIMO-not-supported,
multi-Cell-operation-with-MIMO-not-available,
multi-Cell-EDCH-operation-not-supported,
multi-Cell-EDCH-operation-not-available,
multi-Cell-operation-with-Single-Stream-MIMO-not-supported,
multi-Cell-operation-with-Single-Stream-MIMO-not-available,
cellSpecificTxDiversityHandlingForMultiCellOperationNotAvailable,
cellSpecificTxDiversityHandlingForMultiCellOperationNotSupported
}

CauseTransport ::= ENUMERATED {
    transport-resource-unavailable,
    unspecified,
    ...
}

CellCapabilityContainer-FDD ::= BIT STRING (SIZE (32))
-- First bit: Flexible Hard Split Support Indicator
-- Second bit: Delayed Activation Support Indicator

```

```
-- Third bit: HS-DSCH Support Indicator
-- Fourth bit: DSCH Support Indicator
-- Fifth bit: F-DPCH Support Indicator
-- Sixth bit: E-DCH Support Indicator
-- Seventh bit: E-DCH TTI2ms Support Indicator
-- Eighth bit: E-DCH 2sf2and2sf4 and all inferior SFs Support Indicator
-- Ninth bit: E-DCH 2sf2 and all inferior SFs Support Indicator
-- Tenth bit: E-DCH 2sf4 and all inferior SFs Support Indicator
-- Eleventh bit: E-DCH sf4 and all inferior SFs Support Indicator
-- Twelveth bit: E-DCH sf8 and all inferior SFs Support Indicator
-- Thirteenth bit: E-DCH HARQ IR Combining Support Indicator
-- Fourteenth bit: E-DCH HARQ Chase Combining Support Indicator
-- Fifteenth bit: Continuous Packet Connectivity DTX-DRX Support Indicator
-- Sixteenth bit: Continuous Packet Connectivity HS-SCCH less Support Indicator
-- Seventeenth bit: MIMO Support Indicator
-- Eighteenth bit: SixteenQAM UL Support Indicator
-- Nineteenth bit: Flexible MAC-d PDU Size Support Indicator
-- Twentieth bit: F-DPCH Slot Format Support Indicator
-- Twentyfirst bit: SixtyfourQAM DL Support Indicator
-- Twentysecond bit: Flexible E-DCH MAC-d PDU Size Support Indicator
-- Twentythird bit: E-DPCCH Power Boosting Support Indicator
-- Twentyfourth bit: SixtyfourQAM DL and MIMO Combined Support Indicator
-- Twentyfifth bit: Multi Cell Support Indicator Support Indicator
-- Twentysixth bit: MBMS Support Indicator
-- Twentyseventh bit: DRNS Support STTD on DL ctrl ch when the RL is in MIMO P-CPICH + S-CPICH cell
-- Twentyeighth bit: Dual Band Support Indicator
-- Twentyninth bit: Single Stream MIMO Support Indicator
-- Thirtieth bit: Preferred Precoding Weight Set Restriction Support Indicator
-- Note that undefined bits are considered as a spare bit and spare bits shall be set to 0 by the transmitter and shall be ignored by the receiver.
```

CellCapabilityContainerExtension-FDD ::= BIT STRING (SIZE (128))

```
-- First bit: Cell Specific Tx Diversity Handling For Multi Cell Operation Support Indicator
-- Second bit: Multi Cell and MIMO Support Indicator
-- Third bit: Multi Cell and Single Stream MIMO Support Indicator
-- Fourth bit: Multi Cell E-DCH Support Indicator
-- Fifth bit: Separate Iub Transport Bearer Support Indicator
-- Sixth bit: E-DCH UL Flow Multiplexing Support Indicator
-- Note that undefined bits are considered as a spare bit and spare bits shall be set to 0 by the transmitter and shall be ignored by the receiver.
```

CellCapabilityContainer-TDD ::= BIT STRING (SIZE (32))

```
-- First bit: Delayed Activation Support Indicator
-- Second bit: HS-DSCH Support Indicator
-- Third bit: DSCH Support Indicator
-- The fourth bit: Flexible MAC-d PDU Size Support Indicator
-- Fifth bit: MBMS Support Indicator
-- Note that undefined bits are considered as a spare bit and spare bits shall be set to 0 by the transmitter and shall be ignored by the receiver.
```

CellCapabilityContainer-TDD-LCR ::= BIT STRING (SIZE (32))

```
-- First bit: Delayed Activation Support Indicator
-- Second bit: HS-DSCH Support Indicator
-- Third bit: DSCH Support Indicator
-- The fourth bit: Flexible MAC-d PDU Size Support Indicator
-- Note that undefined bits are considered as a spare bit and spare bits shall be set to 0 by the transmitter and shall be ignored by the receiver.
```

```

CellCapabilityContainer-TDD768 ::= BIT STRING (SIZE (32))
-- First bit: Delayed Activation Support Indicator
-- Second bit: HS-DSCH Support Indicator
-- Third bit: DSCH Support Indicator
-- The fourth bit: Flexible MAC-d PDU Size Support Indicator
-- Note that undefined bits are considered as a spare bit and spare bits shall be set to 0 by the transmitter and shall be ignored by the receiver.

C-ID ::= INTEGER (0..65535)

CCTrCH-ID ::= INTEGER (0..15)

Cell-Capacity-Class-Value ::= SEQUENCE {
    uplinkCellCapacityClassValue    INTEGER(1..100,...),
    downlinkCellCapacityClassValue  INTEGER(1..100,...)
}

CellIndividualOffset ::= INTEGER (-20..20)

CellListValidityIndicator ::= ENUMERATED {
    ignoreSecondaryServingCellList,
    ignoreDualBandSecondaryServingCellList,
    ignoreBoth
}

CellParameterID ::= INTEGER (0..127,...)

CellPortionID ::= INTEGER (0..63,...)

CellPortionLCRID ::= INTEGER (0..255,...)

CFN ::= INTEGER (0..255)

CGI ::= SEQUENCE {
    LAI SEQUENCE {
        pLMN-Identity PLMN-Identity,
        lAC LAC,
        iE-Extensions ProtocolExtensionContainer { {LAI-ExtIEs} } OPTIONAL,
        ...
    },
    cI CI,
    iE-Extensions ProtocolExtensionContainer { {CGI-ExtIEs} } OPTIONAL
}

LAI-ExtIEs RNSAP-PROTOCOL-EXTENSION ::= {
    ...
}

CGI-ExtIEs RNSAP-PROTOCOL-EXTENSION ::= {
    ...
}

ChannelCodingType ::= ENUMERATED {

```

```

    no-codingTDD,
    convolutional-coding,
    turbo-coding,
    ...
}

ChipOffset ::= INTEGER (0..38399)

CI ::= OCTET STRING (SIZE (2))

ClosedLoopModel-SupportIndicator ::= ENUMERATED {
    closedLoop-Model-Supported,
    closedLoop-Model-not-Supported
}

Closedlooptimingadjustmentmode ::= ENUMERATED {
    adj-1-slot,
    adj-2-slot,
    ...
}

CodingRate ::= ENUMERATED {
    half,
    third,
    ...
}

CommonMeasurementAccuracy ::= CHOICE {
    tUTRANGPSMeasurementAccuracyClass    TUTRANGPSAccuracyClass,
    ...,
    tUTRANGANSSMeasurementAccuracyClass  TUTRANGANSSAccuracyClass
}

CommonMeasurementType ::= ENUMERATED {
    uTRAN-GPS-timing-of-cell-frames-for-UE-Positioning,
    sFN-SFN-observerd-time-difference,
    load,
    transmitted-carrier-power,
    received-total-wide-band-power,
    uplink-timeslot-iscp,
    ...,
    rT-load,
    nRT-load-Information,
    upPTSInterference,
    uTRAN-GANSS-timing-of-cell-frames-for-UE-Positioning
}
-- For measurements on the Iur-g interface, only load, RT Load and NRT Load information are requested.

CommonMeasurementValue ::= CHOICE {
    tUTRANGPSMeasurementValueInformation    TUTRANGPSMeasurementValueInformation,
    sFNSFNMeasurementValueInformation      SFNSFNMeasurementValueInformation,
    loadValue                               LoadValue,
    transmittedCarrierPowerValue           INTEGER(0..100),

```

```

    receivedTotalWideBandPowerValue      INTEGER(0..621),
    uplinkTimeslotISCPValue              UL-TimeslotISCP,
    ...,
    extension-CommonMeasurementValue      Extension-CommonMeasurementValue
}

Extension-CommonMeasurementValue ::= ProtocolIE-Single-Container {{ Extension-CommonMeasurementValueIE }}

Extension-CommonMeasurementValueIE RNSAP-PROTOCOL-IES ::= {
  { ID id-RTLoadValue                CRITICALITY ignore  TYPE RTLoadValue
    PRESENCE mandatory }|
  { ID id-NRTLInformationValue        CRITICALITY ignore  TYPE NRTLInformationValue
    PRESENCE mandatory }|
  { ID id-UpPTSInterferenceValue      CRITICALITY reject  TYPE UpPTSInterferenceValue
    PRESENCE mandatory }|
  { ID id-TUTRANGANSSMeasurementValueInformation  CRITICALITY reject  TYPE TUTRANGANSSMeasurementValueInformation PRESENCE mandatory }
}

-- For measurements on the Iur-g interface, only load, RT Load and NRT Load values are reported.

CommonMeasurementValueInformation ::= CHOICE {
  measurementAvailable      CommonMeasurementAvailable,
  measurementnotAvailable   NULL
}

CommonMeasurementAvailable ::= SEQUENCE {
  commonMeasurementValue      CommonMeasurementValue,
  IE-Extensions               ProtocolExtensionContainer { { CommonMeasurementAvailableItem-ExtIEs} }           OPTIONAL,
  ...
}

CommonMeasurementAvailableItem-ExtIEs RNSAP-PROTOCOL-EXTENSION ::= {
  ...
}

CongestionCause ::= ENUMERATED {
  uTRAN-dynamic-resources,
  uTRAN-semistatic-resources,
  ...
}

CommonTransportChannelResourcesInitialisationNotRequired ::= ENUMERATED {
  not-Required
}

Common-EDCH-MAC-d-Flow-Specific-InformationFDD ::= SEQUENCE (SIZE (1..maxNrOfEDCHMACdFlows)) OF Common-EDCH-MAC-d-Flow-Specific-InformationFDDItem

Common-EDCH-MAC-d-Flow-Specific-InformationFDDItem ::= SEQUENCE {
  common-EDCH-MACdFlow-ID      EDCH-MACdFlow-ID,
  maximum-Number-of-Retransmissions-For-E-DCH      MaxNr-Retransmissions-EDCH,
  eDCH-HARQ-PO-FDD            E-DCH-HARQ-PO-FDD,
  eDCH-MACdFlow-Multiplexing-List      E-DCH-MACdFlow-Multiplexing-List           OPTIONAL,
  common-E-DCHLogicalChannelInformation      Common-E-DCH-LogicalChannelInformation,
}

```



```

    iE-Extensions                               ProtocolExtensionContainer { { Common-EDCH-MAC-d-Flow-Specific-InformationFDDItem-ExtIEs } }
        OPTIONAL,
    ...
}

Common-EDCH-MAC-d-Flow-Specific-InformationFDDItem-ExtIEs RNSAP-PROTOCOL-EXTENSION ::= {
    ...
}

Common-EDCH-MAC-d-Flow-Specific-InformationLCR ::= SEQUENCE (SIZE (1..maxNrOfEDCHMACdFlowsLCR)) OF Common-EDCH-MAC-d-Flow-Specific-
InformationItemLCR

Common-EDCH-MAC-d-Flow-Specific-InformationItemLCR ::= SEQUENCE {
    common-EDCH-MACdFlow-ID-LCR                EDCH-MACdFlow-ID-LCR,
    maximum-Number-of-Retransmissions-For-E-DCH MaxNr-Retransmissions-EDCH,
    eDCH-HARQ-PO-TDD                           E-DCH-HARQ-PO-TDD,
    eDCH-MACdFlow-Multiplexing-List            E-DCH-MACdFlow-Multiplexing-List                               OPTIONAL,
    common-E-DCHLogicalChannelInformation       Common-E-DCH-LogicalChannelInformation,
    iE-Extensions                               ProtocolExtensionContainer { { Common-EDCH-MAC-d-Flow-Specific-InformationItemLCR-ExtIEs } }
        OPTIONAL,
    ...
}

Common-EDCH-MAC-d-Flow-Specific-InformationItemLCR-ExtIEs RNSAP-PROTOCOL-EXTENSION ::= {
    ...
}

Common-E-DCH-LogicalChannelInformation ::= SEQUENCE (SIZE (1..maxNoOfLogicalChannels)) OF Common-E-DCH-LogicalChannelInformationItem

Common-E-DCH-LogicalChannelInformationItem ::= SEQUENCE {
    logicalChannelId                LogicalChannelID,
    maximumMACdPDU-SizeExtended     MAC-PDU-SizeExtended,
    iE-Extensions                   ProtocolExtensionContainer { { Common-E-DCH-LogicalChannelInformationItem-ExtIEs } }
    OPTIONAL,
    ...
}

Common-E-DCH-LogicalChannelInformationItem-ExtIEs RNSAP-PROTOCOL-EXTENSION ::= {
    ...
}

Common-EDCH-Support-Indicator ::= NULL

Continuous-Packet-Connectivity-DTX-DRX-Information ::= SEQUENCE {
    uE-DTX-DRX-Offset              UE-DTX-DRX-Offset,
    enabling-Delay                 Enabling-Delay,
    dTX-Information                DTX-Information,
    dRX-Information                DRX-Information                               OPTIONAL,
    iE-Extensions                  ProtocolExtensionContainer { { Continuous-Packet-Connectivity-DTX-DRX-Information-ExtIEs } }
        OPTIONAL,
    ...
}

```

```

Continuous-Packet-Connectivity-DTX-DRX-Information-ExtIEs RNSAP-PROTOCOL-EXTENSION ::= {
  ...
}

Continuous-Packet-Connectivity-DTX-DRX-Information-to-Modify ::= SEQUENCE {
  uE-DTX-DRX-Offset          UE-DTX-DRX-Offset          OPTIONAL,
  enabling-Delay             Enabling-Delay             OPTIONAL,
  dTX-Information-to-Modify  DTX-Information-to-Modify  OPTIONAL,
  dRX-Information-to-Modify  DRX-Information-to-Modify  OPTIONAL,
  iE-Extensions              ProtocolExtensionContainer { { Continuous-Packet-Connectivity-DTX-DRX-Information-to-Modify-ExtIEs
} } OPTIONAL,
  ...
}

Continuous-Packet-Connectivity-DTX-DRX-Information-to-Modify-ExtIEs RNSAP-PROTOCOL-EXTENSION ::= {
  ...
}

Continuous-Packet-Connectivity-HS-SCCH-Less-Information ::= SEQUENCE (SIZE (1..maxNrOfHS-DSCHTBSs-HS-SCCHless)) OF Continuous-Packet-Connectivity-
HS-SCCH-Less-InformationItem

Continuous-Packet-Connectivity-HS-SCCH-Less-InformationItem ::= SEQUENCE {
  transport-Block-Size-Index  Transport-Block-Size-Index,
  hSPDSCH-Second-Code-Support HSPDSCH-Second-Code-Support,
  iE-Extensions               ProtocolExtensionContainer { { Continuous-Packet-Connectivity-HS-SCCH-Less-InformationItem-ExtIEs } }
  OPTIONAL,
  ...
}

Continuous-Packet-Connectivity-HS-SCCH-Less-InformationItem-ExtIEs RNSAP-PROTOCOL-EXTENSION ::= {
  ...
}

Continuous-Packet-Connectivity-HS-SCCH-Less-Information-Response ::= SEQUENCE {
  hSPDSCH-First-Code-Index  HSPDSCH-First-Code-Index,
  hSPDSCH-Second-Code-Index HSPDSCH-Second-Code-Index          OPTIONAL,
  iE-Extensions             ProtocolExtensionContainer { { Continuous-Packet-Connectivity-HS-SCCH-Less-Information-Response-ExtIEs
} } OPTIONAL,
  ...
}

Continuous-Packet-Connectivity-HS-SCCH-Less-Information-Response-ExtIEs RNSAP-PROTOCOL-EXTENSION ::= {
  ...
}

CorrespondingCells ::= SEQUENCE (SIZE (1..maxNrOfCellsPerFreq)) OF C-ID

CoverageIndicator ::= ENUMERATED {
  overlap,
  covers,
  containedIn,
  ...
}

```

```

}

CPC-Information ::= SEQUENCE {
    continuous-Packet-Connectivity-DTX-DRX-Information          Continuous-Packet-Connectivity-DTX-DRX-Information
        OPTIONAL,
    continuous-Packet-Connectivity-DTX-DRX-Information-to-Modify Continuous-Packet-Connectivity-DTX-DRX-Information-to-Modify
        OPTIONAL,
    continuous-Packet-Connectivity-HS-SCCH-Less-Information     Continuous-Packet-Connectivity-HS-SCCH-Less-Information
        OPTIONAL,
    iE-Extensions                                               ProtocolExtensionContainer { { CPC-Information-ExtIEs} }
        OPTIONAL,
    ...
}

CPC-Information-ExtIEs RNSAP-PROTOCOL-EXTENSION ::= {
    {ID id-Continuous-Packet-Connectivity-HS-SCCH-Less-Deactivate-Indicator          CRITICALITY reject          EXTENSION
    Continuous-Packet-Connectivity-HS-SCCH-less-Deactivate-Indicator          PRESENCE optional},
    ...
}

CPC-RecoveryReport ::= ENUMERATED {
    initiated,
    ...
}

Continuous-Packet-Connectivity-HS-SCCH-less-Deactivate-Indicator ::= NULL

Counting-Information ::= SEQUENCE ( SIZE (1..maxNrOfFDDNeighboursPerRNC,...)) OF Counting-Information-List

Counting-Information-List ::= SEQUENCE {
    c-ID                C-ID,
    counting-Result     Counting-Result,
    iE-Extensions       ProtocolExtensionContainer { { Counting-Information-List-ExtIEs} } OPTIONAL,
    ...
}

Counting-Information-List-ExtIEs RNSAP-PROTOCOL-EXTENSION ::= {
    ...
}

Counting-Result ::= INTEGER (0..63)

CRC-Size ::= ENUMERATED {
    v0,
    v8,
    v12,
    v16,
    v24,
    ...
}

```

```

CriticalityDiagnostics ::= SEQUENCE {
    procedureID                ProcedureID                OPTIONAL,
    triggeringMessage           TriggeringMessage         OPTIONAL,
    procedureCriticality        Criticality                OPTIONAL,
    transactionID              TransactionID            OPTIONAL,
    iEsCriticalityDiagnostics   CriticalityDiagnostics-IE-List OPTIONAL,
    iE-Extensions              ProtocolExtensionContainer { {CriticalityDiagnostics-ExtIEs} } OPTIONAL,
    ...
}

CriticalityDiagnostics-ExtIEs RNSAP-PROTOCOL-EXTENSION ::= {
    ...
}

CriticalityDiagnostics-IE-List ::= SEQUENCE (SIZE (1..maxNrOfErrors)) OF
SEQUENCE {
    iECriticality              Criticality,
    iE-ID                      ProtocolIE-ID,
    repetitionNumber           RepetitionNumber0    OPTIONAL,
    iE-Extensions              ProtocolExtensionContainer { {CriticalityDiagnostics-IE-List-ExtIEs} } OPTIONAL,
    ...
}

CriticalityDiagnostics-IE-List-ExtIEs RNSAP-PROTOCOL-EXTENSION ::= {
{ ID id-MessageStructure      CRITICALITY ignore      EXTENSION MessageStructure      PRESENCE optional      }|
{ ID id-TypeOfError           CRITICALITY ignore      EXTENSION TypeOfError           PRESENCE mandatory     },
    ...
}

MessageStructure ::= SEQUENCE (SIZE (1..maxNrOfLevels)) OF
SEQUENCE {
    iE-ID                      ProtocolIE-ID,
    repetitionNumber           RepetitionNumber1    OPTIONAL,
    iE-Extensions              ProtocolExtensionContainer { {MessageStructure-ExtIEs} } OPTIONAL,
    ...
}

MessageStructure-ExtIEs RNSAP-PROTOCOL-EXTENSION ::= {
    ...
}

CN-CS-DomainIdentifier ::= SEQUENCE {
    pLMN-Identity              PLMN-Identity,
    LAC                        LAC,
    iE-Extensions              ProtocolExtensionContainer { {CN-CS-DomainIdentifier-ExtIEs} } OPTIONAL
}

CN-CS-DomainIdentifier-ExtIEs RNSAP-PROTOCOL-EXTENSION ::= {
    ...
}

CN-PS-DomainIdentifier ::= SEQUENCE {
    pLMN-Identity              PLMN-Identity,

```

```

    LAC                LAC,
    rAC                RAC,
    iE-Extensions     ProtocolExtensionContainer { {CN-PS-DomainIdentifier-ExtIEs} } OPTIONAL
}

CN-PS-DomainIdentifier-ExtIEs RNSAP-PROTOCOL-EXTENSION ::= {
    ...
}

CNDomainType ::= ENUMERATED {
    cs-domain,
    ps-domain,
    i-care,
    ...
}
-- See in TS 25.331 [16]

CQI-DTX-Timer ::= ENUMERATED {v0, v1, v2, v4, v8, v16, v32, v64, v128, v256, v512, infinity}
-- Unit subframe

ControlGAP ::= INTEGER (1..255)

CQI-Feedback-Cycle ::= ENUMERATED {v0, v2, v4, v8, v10, v20, v40, v80, v160,..., v16, v32, v64}

CQI-Power-Offset ::= INTEGER (0..8,...)
-- According to mapping in ref. TS 25.213 [21] subclause 4.2.1

CQI-RepetitionFactor ::= INTEGER (1..4,...)
-- Step: 1

C-RNTI                ::= INTEGER (0..65535)

CodeRate ::= INTEGER (0..63)

CodeRate-short ::= INTEGER (0..10)

CPC-InformationLCR ::= SEQUENCE {
    continuousPacketConnectivity-DRX-InformationLCR                ContinuousPacketConnectivity-DRX-InformationLCR
    OPTIONAL,
    continuousPacketConnectivity-DRX-Information-to-Modify-LCR      ContinuousPacketConnectivity-DRX-Information-to-Modify-LCR      OPTIONAL,
    hS-DSCH-Semi-PersistentScheduling-Information-LCR              HS-DSCH-Semi-PersistentScheduling-Information-LCR
    OPTIONAL,
    hS-DSCH-Semi-PersistentScheduling-Information-to-Modify-LCR    HS-DSCH-Semi-PersistentScheduling-Information-to-Modify-LCR    OPTIONAL,
    hS-DSCH-SPS-Deactivate-Indicator-LCR                          NULL OPTIONAL,
    e-DCH-Semi-PersistentScheduling-Information-LCR                E-DCH-Semi-PersistentScheduling-Information-LCR
    OPTIONAL,
    e-DCH-Semi-PersistentScheduling-Information-to-Modify-LCR      E-DCH-Semi-PersistentScheduling-Information-to-Modify-LCR      OPTIONAL,
    e-DCH-SPS-Deactivate-Indicator-LCR                            NULL OPTIONAL,
    iE-Extensions         ProtocolExtensionContainer { { CPC-InformationLCR-ExtIEs } } OPTIONAL,
    ...
}

CPC-InformationLCR-ExtIEs RNSAP-PROTOCOL-EXTENSION ::= {
    ...
}

```

```

}

ContinuousPacketConnectivity-DRX-InformationLCR ::= SEQUENCE {
    enabling-Delay          Enabling-Delay,
    hS-SCCH-DRX-Information-LCR  HS-SCCH-DRX-Information-LCR,
    e-AGCH-DRX-Information-LCR  E-AGCH-DRX-Information-LCR OPTIONAL,
    iE-Extensions           ProtocolExtensionContainer { { ContinuousPacketConnectivity-DRX-InformationLCR-ExtIEs } }
    OPTIONAL,
    ...
}

ContinuousPacketConnectivity-DRX-InformationLCR-ExtIEs RNSAP-PROTOCOL-EXTENSION ::= {
    ...
}

HS-SCCH-DRX-Information-LCR ::= SEQUENCE {
    hS-SCCH-UE-DRX-Cycle-LCR          UE-DRX-Cycle-LCR,
    hS-SCCH-Inactivity-Threshold-for-UE-DRX-Cycle-LCR  Inactivity-Threshold-for-UE-DRX-Cycle-LCR OPTIONAL,
    hS-SCCH-UE-DRX-Offset-LCR        UE-DRX-Offset-LCR,
    iE-Extensions           ProtocolExtensionContainer { { HS-SCCH-DRX-Information-LCR-ExtIEs } } OPTIONAL,
    ...
}

HS-SCCH-DRX-Information-LCR-ExtIEs RNSAP-PROTOCOL-EXTENSION ::= {
    { ID id-HS-SCCH-Inactivity-Threshold-for-UE-DRX-Cycle-LCR-Ext  CRITICALITY ignore  EXTENSION Inactivity-Threshold-for-UE-DRX-Cycle-LCR-Ext
    PRESENCE optional },
    ...
}

E-AGCH-DRX-Information-LCR ::= CHOICE {
    sameAsHS-SCCH          NULL,
    e-AGCH-DRX-Parameters  E-AGCH-DRX-Parameters,
    ...
}

E-AGCH-DRX-Parameters ::= SEQUENCE {
    e-AGCH-UE-DRX-Cycle-LCR          UE-DRX-Cycle-LCR,
    e-AGCH-UE-Inactivity-Monitor-Threshold  E-AGCH-UE-Inactivity-Monitor-Threshold OPTIONAL,
    e-AGCH-UE-DRX-Offset-LCR        UE-DRX-Offset-LCR,
    iE-Extensions           ProtocolExtensionContainer { { E-AGCH-DRX-Parameters-ExtIEs } } OPTIONAL,
    ...
}

E-AGCH-DRX-Parameters-ExtIEs RNSAP-PROTOCOL-EXTENSION ::= {
    ...
}

UE-DRX-Cycle-LCR ::= ENUMERATED {v1, v2, v4, v8, v16, v32, v64,...}
-- Unit subframe

UE-DRX-Offset-LCR ::= INTEGER (0..63)
-- Unit subframe

Inactivity-Threshold-for-UE-DRX-Cycle-LCR ::= ENUMERATED {v1, v2, v4, v8, v16, v32, v64,...}

```

```

-- Unit subframe

Inactivity-Threshold-for-UE-DRX-Cycle-LCR-Ext ::= ENUMERATED {v128, v256, v512,...}
-- Unit subframe

E-AGCH-UE-Inactivity-Monitor-Threshold ::= ENUMERATED {v0, v1, v2, v4, v8, v16, v32, v64, v128, v256, v512, infinity,...}
-- Unit subframe

ContinuousPacketConnectivity-DRX-Information-to-Modify-LCR ::= SEQUENCE {
    enabling-Delay          Enabling-Delay          OPTIONAL,
    dRX-Information-to-Modify-LCR DRX-Information-to-Modify-LCR OPTIONAL,
    iE-Extensions          ProtocolExtensionContainer { { ContinuousPacketConnectivity-DRX-Information-to-Modify-LCR-ExtIEs }
}
    OPTIONAL,
    ...
}

ContinuousPacketConnectivity-DRX-Information-to-Modify-LCR-ExtIEs RNSAP-PROTOCOL-EXTENSION ::= {
    ...
}

DRX-Information-to-Modify-LCR ::= CHOICE {
    modify          DRX-Information-to-Modify-Items-LCR,
    deactivate      NULL,
    ...
}

DRX-Information-to-Modify-Items-LCR ::= SEQUENCE {
    hS-SCCH-DRX-Information-LCR          HS-SCCH-DRX-Information-LCR          OPTIONAL,
    e-AGCH-DRX-Information-LCR          E-AGCH-DRX-Information-LCR          OPTIONAL,
    iE-Extensions          ProtocolExtensionContainer { { DRX-Information-to-Modify-Items-LCR-ExtIEs } } OPTIONAL,
    ...
}

DRX-Information-to-Modify-Items-LCR-ExtIEs RNSAP-PROTOCOL-EXTENSION ::= {
    ...
}

ContinuousPacketConnectivity-DRX-Information-ResponseLCR ::= SEQUENCE {
    enabling-Delay          Enabling-Delay          OPTIONAL,
    hS-SCCH-DRX-Information-ResponseLCR HS-SCCH-DRX-Information-ResponseLCR OPTIONAL,
    e-AGCH-DRX-Information-ResponseLCR E-AGCH-DRX-Information-ResponseLCR OPTIONAL,
    iE-Extensions          ProtocolExtensionContainer { { ContinuousPacketConnectivity-DRX-Information-ResponseLCR-ExtIEs } }
    OPTIONAL,
    ...
}

ContinuousPacketConnectivity-DRX-Information-ResponseLCR-ExtIEs RNSAP-PROTOCOL-EXTENSION ::= {
    ...
}

HS-SCCH-DRX-Information-ResponseLCR ::= SEQUENCE {
    hS-SCCH-UE-DRX-Cycle-LCR          UE-DRX-Cycle-LCR          OPTIONAL,
    hS-SCCH-Inactivity-Threshold-for-UE-DRX-Cycle-LCR Inactivity-Threshold-for-UE-DRX-Cycle-LCR OPTIONAL,
    hS-SCCH-UE-DRX-Offset-LCR          UE-DRX-Offset-LCR          OPTIONAL,

```

```

    iE-Extensions          ProtocolExtensionContainer { { HS-SCCH-DRX-Information-ResponseLCR-ExtIEs } } OPTIONAL,
    ...
}

HS-SCCH-DRX-Information-ResponseLCR-ExtIEs RNSAP-PROTOCOL-EXTENSION ::= {
    { ID id-HS-SCCH-Inactivity-Threshold-for-UE-DRX-Cycle-LCR-Ext    CRITICALITY ignore    EXTENSION Inactivity-Threshold-for-UE-DRX-Cycle-LCR-Ext
    PRESENCE optional },
    ...
}

E-AGCH-DRX-Information-ResponseLCR ::= CHOICE {
    sameAsHS-SCCH          NULL,
    e-AGCH-DRX-Parameters-Response    E-AGCH-DRX-Parameters-Response,
    ...
}

E-AGCH-DRX-Parameters-Response ::= SEQUENCE {
    e-AGCH-UE-DRX-Cycle-LCR          UE-DRX-Cycle-LCR          OPTIONAL,
    e-AGCH-UE-Inactivity-Monitor-Threshold    E-AGCH-UE-Inactivity-Monitor-Threshold    OPTIONAL,
    e-AGCH-UE-DRX-Offset-LCR          UE-DRX-Offset-LCR          OPTIONAL,
    iE-Extensions          ProtocolExtensionContainer { { E-AGCH-DRX-Parameters-Response-ExtIEs } } OPTIONAL,
    ...
}

E-AGCH-DRX-Parameters-Response-ExtIEs RNSAP-PROTOCOL-EXTENSION ::= {
    ...
}

-- D

DATA-ID ::= INTEGER (0..3)

DCH-FDD-Information ::= SEQUENCE (SIZE (1..maxNrOfDCHs)) OF DCH-FDD-InformationItem

DCH-FDD-InformationItem ::= SEQUENCE {
    payloadCRC-PresenceIndicator    PayloadCRC-PresenceIndicator,
    ul-FP-Mode          UL-FP-Mode,
    toAWS          ToAWS,
    toAWE          ToAWE,
    dCH-SpecificInformationList    DCH-Specific-FDD-InformationList,
    iE-Extensions          ProtocolExtensionContainer { { DCH-FDD-InformationItem-ExtIEs } } OPTIONAL,
    ...
}

DCH-FDD-InformationItem-ExtIEs RNSAP-PROTOCOL-EXTENSION ::= {
    { ID id-TnIQos          CRITICALITY    ignore    EXTENSION    TnIQos    PRESENCE    optional    },
    ...
}

DCH-MeasurementOccasion-Information ::= SEQUENCE (SIZE (1.. maxNrOfDCHMeasurementOccasionPatternSequence)) OF DchMeasurementOccasionInformation-Item

DchMeasurementOccasionInformation-Item ::= SEQUENCE {

```



```

    pattern-Sequence-Identifier          Pattern-Sequence-Identifier,
    status-Flag                          Status-Flag,
    measurement-Occasion-Pattern-Sequence-parameters      Measurement-Occasion-Pattern-Sequence-parameters
    iE-Extensions                        ProtocolExtensionContainer { { DCH-MeasurementOccasion-Information-ExtIEs } }
    OPTIONAL,
    ...
}

DCH-MeasurementOccasion-Information-ExtIEs RNSAP-PROTOCOL-EXTENSION ::= {
    ...
}

Measurement-Occasion-Pattern-Sequence-parameters ::= SEQUENCE {
    measurement-Occasion-Pattern-Sequence-parameters-k      INTEGER (1..9),
    measurement-Occasion-Pattern-Sequence-parameters-offset  INTEGER (0..511),
    measurement-Occasion-Pattern-Sequence-parameters-M-Length  INTEGER (1..512),
    measurement-Occasion-Pattern-Sequence-parameters-Timeslot-Bitmap  BIT STRING (SIZE (7)),
    iE-Extensions      ProtocolExtensionContainer { { Measurement-Occasion-Pattern-Sequence-parameters-ExtIEs } } OPTIONAL,
    ...
}

Measurement-Occasion-Pattern-Sequence-parameters-ExtIEs RNSAP-PROTOCOL-EXTENSION ::= {
    ...
}

DCH-MeasurementType-Indicator ::= BIT STRING (SIZE (5))

DCH-Specific-FDD-InformationList ::= SEQUENCE (SIZE (1..maxNrOfDCHs)) OF DCH-Specific-FDD-Item

DCH-Specific-FDD-Item ::= SEQUENCE {
    dCH-ID          DCH-ID,
    trCH-SrcStatisticsDescr      TrCH-SrcStatisticsDescr,
    ul-transportFormatSet        TransportFormatSet,
    dl-transportFormatSet        TransportFormatSet,
    ul-BLER          BLER,
    dl-BLER          BLER,
    allocationRetentionPriority  AllocationRetentionPriority,
    frameHandlingPriority        FrameHandlingPriority,
    qE-Selector          QE-Selector,
    dRACControl          DRACControl,
    iE-Extensions      ProtocolExtensionContainer { {DCH-FDD-SpecificItem-ExtIEs} } OPTIONAL,
    ...
}

DCH-FDD-SpecificItem-ExtIEs RNSAP-PROTOCOL-EXTENSION ::= {
    { ID id-Guaranteed-Rate-Information      CRITICALITY ignore EXTENSION Guaranteed-Rate-Information      PRESENCE optional      }|
    { ID id-TrafficClass                    CRITICALITY ignore EXTENSION TrafficClass PRESENCE mandatory}|
    { ID id-Unidirectional-DCH-Indicator    CRITICALITY reject  EXTENSION Unidirectional-DCH-Indicator    PRESENCE optional      },
    ...
}

DCH-Indicator-For-E-DCH-HSDPA-Operation ::= ENUMERATED {
    dch-not-present
}

```

```

}

DCH-ID ::= INTEGER (0..255)

DCH-InformationResponse ::= SEQUENCE (SIZE (1..maxNrOfDCHs)) OF DCH-InformationResponseItem

DCH-InformationResponseItem ::= SEQUENCE {
    dCH-ID DCH-ID,
    bindingID BindingID OPTIONAL,
    transportLayerAddress TransportLayerAddress OPTIONAL,
    iE-Extensions ProtocolExtensionContainer { {DCH-InformationResponseItem-ExtIEs} } OPTIONAL,
    ...
}

DCH-InformationResponseItem-ExtIEs RNSAP-PROTOCOL-EXTENSION ::= {
    optional { ID id-Allowed-Rate-Information CRITICALITY ignore EXTENSION Allowed-Rate-Information PRESENCE
    { ID id-TransportBearerNotSetupIndicator CRITICALITY ignore EXTENSION TransportBearerNotSetupIndicator PRESENCE optional }, --
    FDD only
    ...
}

DCH-TDD-Information ::= SEQUENCE (SIZE (1..maxNrOfDCHs)) OF DCH-TDD-InformationItem

DCH-TDD-InformationItem ::= SEQUENCE {
    payloadCRC-PresenceIndicator PayloadCRC-PresenceIndicator,
    ul-FP-Mode UL-FP-Mode,
    toAWS ToAWS,
    toAWE ToAWE,
    dCH-SpecificInformationList DCH-Specific-TDD-InformationList,
    iE-Extensions ProtocolExtensionContainer { {DCH-TDD-InformationItem-ExtIEs} } OPTIONAL,
    ...
}

DCH-TDD-InformationItem-ExtIEs RNSAP-PROTOCOL-EXTENSION ::= {
    { ID id-TnlQos CRITICALITY ignore EXTENSION TnlQos PRESENCE optional },
    ...
}

DCH-Specific-TDD-InformationList ::= SEQUENCE (SIZE (1..maxNrOfDCHs)) OF DCH-Specific-TDD-Item

DCH-Specific-TDD-Item ::= SEQUENCE {
    dCH-ID DCH-ID,
    ul-cCTrCH-ID CCTrCH-ID, -- UL CCTrCH in which the DCH is mapped
    dl-cCTrCH-ID CCTrCH-ID, -- DL CCTrCH in which the DCH is mapped
    trCH-SrcStatisticsDescr TrCH-SrcStatisticsDescr,
    ul-transportFormatSet TransportFormatSet,
    dl-transportFormatSet TransportFormatSet,
    ul-BLER BLER,
    dl-BLER BLER,
    allocationRetentionPriority AllocationRetentionPriority,
    frameHandlingPriority FrameHandlingPriority,
    qE-Selector QE-Selector OPTIONAL,
    -- This IE shall be present if DCH is part of set of Co-ordinated DCHs
}

```

```

    iE-Extensions          ProtocolExtensionContainer { {DCH-Specific-TDD-Item-ExtIEs} } OPTIONAL,
    ...
}

DCH-Specific-TDD-Item-ExtIEs RNSAP-PROTOCOL-EXTENSION ::= {
    { ID id-Guaranteed-Rate-Information      CRITICALITY ignore  EXTENSION Guaranteed-Rate-Information      PRESENCE optional      }|
    { ID id-TrafficClass                    CRITICALITY ignore  EXTENSION TrafficClass      PRESENCE mandatory    }|
    { ID id-Unidirectional-DCH-Indicator    CRITICALITY reject  EXTENSION Unidirectional-DCH-Indicator    PRESENCE optional     },
    ...
}

DedicatedMeasurementType ::= ENUMERATED {
    sir,
    sir-error,
    transmitted-code-power,
    rSCP,
    rx-timing-deviation,
    round-trip-time,
    ...,
    rx-timing-deviation-LCR,
    angle-Of-Arrival-LCR,
    hs-sich-quality,
    rx-timing-deviation-768,
    rx-timing-deviation-ext
}

DedicatedMeasurementValue ::= CHOICE {
    sIR-Value          SIR-Value,
    sIR-ErrorValue    SIR-Error-Value,
    transmittedCodePowerValue  Transmitted-Code-Power-Value,
    rSCP              RSCP-Value, -- TDD only
    rxTimingDeviationValue  Rx-Timing-Deviation-Value, -- 3.84Mcps TDD only
    roundTripTime     Round-Trip-Time-Value, -- FDD only
    ...,
    extension-DedicatedMeasurementValue  Extension-DedicatedMeasurementValue
}

Extension-DedicatedMeasurementValue ::= ProtocolIE-Single-Container {{ Extension-DedicatedMeasurementValueIE }}

Extension-DedicatedMeasurementValueIE RNSAP-PROTOCOL-IES ::= {
    { ID id-Rx-Timing-Deviation-Value-LCR      CRITICALITY reject  TYPE Rx-Timing-Deviation-Value-LCR      PRESENCE mandatory }|
    { ID id-Angle-Of-Arrival-Value-LCR        CRITICALITY reject  TYPE Angle-Of-Arrival-Value-LCR        PRESENCE mandatory }|
    { ID id-HS-SICH-Reception-Quality         CRITICALITY reject  TYPE HS-SICH-Reception-Quality-Value  PRESENCE mandatory }|
    { ID id-Rx-Timing-Deviation-Value-768    CRITICALITY reject  TYPE Rx-Timing-Deviation-Value-768    PRESENCE mandatory }|
    { ID id-Rx-Timing-Deviation-Value-ext    CRITICALITY reject  TYPE Rx-Timing-Deviation-Value-ext    PRESENCE mandatory }|
    { ID id-Extended-Round-Trip-Time-Value   CRITICALITY reject  TYPE Extended-Round-Trip-Time-Value   PRESENCE mandatory },
    ...
}

DedicatedMeasurementValueInformation ::= CHOICE {
    measurementAvailable      DedicatedMeasurementAvailable,
    measurementnotAvailable   DedicatedMeasurementnotAvailable
}

```

```

DedicatedMeasurementAvailable ::= SEQUENCE {
    dedicatedmeasurementValue    DedicatedMeasurementValue,
    cfn                           CFN                               OPTIONAL,
    ie-Extensions                 ProtocolExtensionContainer { { DedicatedMeasurementAvailableItem-ExtIEs} }    OPTIONAL,
    ...
}

DedicatedMeasurementAvailableItem-ExtIEs RNSAP-PROTOCOL-EXTENSION ::= {
    ...
}

DedicatedMeasurementnotAvailable ::= NULL

DelayedActivation ::= CHOICE {
    cfn                           CFN,
    separate-indication          NULL
}

DelayedActivationUpdate ::= CHOICE {
    activate      Activate-Info,
    deactivate    Deactivate-Info
}

Activate-Info ::= SEQUENCE {
    activation-type      Execution-Type,
    initial-dl-tx-power  DL-Power,
    firstRLS-Indicator   FirstRLS-Indicator           OPTIONAL, --FDD Only
    propagation-delay    PropagationDelay             OPTIONAL, --FDD Only
    iE-Extensions        ProtocolExtensionContainer { { Activate-Info-ExtIEs} }    OPTIONAL,
    ...
}

Activate-Info-ExtIEs RNSAP-PROTOCOL-EXTENSION ::= {
    { ID id-ExtendedPropagationDelay    CRITICALITY ignore    EXTENSION ExtendedPropagationDelay    PRESENCE optional    },
    ...
}

Deactivate-Info ::= SEQUENCE {
    deactivation-type      Execution-Type,
    iE-Extensions         ProtocolExtensionContainer { { Deactivate-Info-ExtIEs} }    OPTIONAL,
    ...
}

Deactivate-Info-ExtIEs RNSAP-PROTOCOL-EXTENSION ::= {
    ...
}

Execution-Type ::= CHOICE {
    synchronised    CFN,
    unsynchronised NULL
}

```

```

DeltaSIR ::= INTEGER (0..30)
-- Step 0.1 dB, Range 0..3 dB.

DGANSSCorrections ::= SEQUENCE {
  dGANSS-ReferenceTime      INTEGER(0..119),
  dGANSS-Information        SEQUENCE (SIZE (1..maxSgnType)) OF SEQUENCE {
    gANSS-SignalId          GANSS-Signal-ID                                OPTIONAL,
    gANSS-StatusHealth      GANSS-StatusHealth,
    -- The following IE shall be present if the StatusHealth IE value is not equal to "no data" or "invalid data"
    dGANSS-SignalInformation SEQUENCE (SIZE (1..maxGANSSSat)) OF SEQUENCE {
      satId                  INTEGER(0..63),
      gANSS-iod              BIT STRING (SIZE (10)),
      udre                    UDRE,
      ganss-prc               INTEGER(-2047..2047),
      ganss-rrc               INTEGER(-127..127),
      ie-Extensions          ProtocolExtensionContainer { { DGANSS-SignalInformationItem-ExtIEs } } OPTIONAL,
      ...
    }
    ie-Extensions           ProtocolExtensionContainer { { DGANSS-InformationItem-ExtIEs } } OPTIONAL,
    ...
  },
  ie-Extensions             ProtocolExtensionContainer { { DGANSSCorrections-ExtIEs } } OPTIONAL,
  ...
}

DGANSSCorrections-ExtIEs RNSAP-PROTOCOL-EXTENSION ::= {
  ...
}

DGANSS-Corrections-Req ::= SEQUENCE {
  dGANSS-Signal-ID          BIT STRING (SIZE (8)),
  ie-Extensions             ProtocolExtensionContainer { { DGANSS-Corrections-Req-ExtIEs } } OPTIONAL,
  ...
}

DGANSS-Corrections-Req-ExtIEs RNSAP-PROTOCOL-EXTENSION ::= {
  {ID id-GANSS-ID          CRITICALITY ignore EXTENSION GANSS-ID          PRESENCE optional},
  ...
}

DGANSS-InformationItem-ExtIEs RNSAP-PROTOCOL-EXTENSION ::= {
  ...
}

```

```

DGANSS-SignalInformationItem-ExtIEs RNSAP-PROTOCOL-EXTENSION ::= {
  {ID id-DGNSS-ValidityPeriod CRITICALITY ignore EXTENSION DGNSS-ValidityPeriod PRESENCE optional},
  ...
}

DGANSSThreshold ::= SEQUENCE {
  pRCDeviation PRCDeviation,
  ...
}

DGNSS-ValidityPeriod ::= SEQUENCE {
  udreGrowthRate UDREGrowthRate,
  udreValidityTime UDREValidityTime,
  iE-Extensions ProtocolExtensionContainer { { DGNSS-ValidityPeriod-ExtIEs } } OPTIONAL,
  ...
}

DGNSS-ValidityPeriod-ExtIEs RNSAP-PROTOCOL-EXTENSION ::= {
  ...
}

DGPSCorrections ::= SEQUENCE {
  gPSTOW GPSTOW,
  gPS-Status-Health GPS-Status-Health,
  satellite-DGPSCorrections-Information SEQUENCE (SIZE (1..maxNoSat)) OF
    SEQUENCE {
      sAT-ID SAT-ID,
      iode-dgps BIT STRING (SIZE (8)),
      uDRE UDRE,
      pRC PRC,
      range-Correction-Rate Range-Correction-Rate,
      iE-Extensions ProtocolExtensionContainer { { Satellite-DGPSCorrections-Information-ExtIEs } } OPTIONAL,
      ...
    },
  iE-Extensions ProtocolExtensionContainer { { DGPSCorrections-ExtIEs } } OPTIONAL,
  ...
}

Satellite-DGPSCorrections-Information-ExtIEs RNSAP-PROTOCOL-EXTENSION ::= {
  {ID id-DGNSS-ValidityPeriod CRITICALITY ignore EXTENSION DGNSS-ValidityPeriod PRESENCE optional},
  ...
}

DGPSCorrections-ExtIEs RNSAP-PROTOCOL-EXTENSION ::= {
  ...
}

DGPSThreshold ::= SEQUENCE {
  pRCDeviation PRCDeviation,
  iE-Extensions ProtocolExtensionContainer { { DGPSThreshold-ExtIEs } } OPTIONAL,
}

```

```

    ...
}

DGPSThreshold-ExtIEs RNSAP-PROTOCOL-EXTENSION ::= {
    ...
}

DiscardTimer ::= ENUMERATED
{v20,v40,v60,v80,v100,v120,v140,v160,v180,v200,v250,v300,v400,v500,v750,v1000,v1250,v1500,v1750,v2000,v2500,v3000,v3500,v4000,v4500,v5000,v7500,
...
}

DiversityControlField ::= ENUMERATED {
    may,
    must,
    must-not
}

DiversityMode ::= ENUMERATED {
    none,
    sTTD,
    closedLoopModel,
    not-used-closedLoopMode2,
    ...
}

DL-DPCH-SlotFormat ::= INTEGER (0..16,...)

DL-DPCH-TimingAdjustment ::= ENUMERATED {
    timing-advance,
    timing-delay
}

DL-Power ::= INTEGER (-350..150)
-- Value = DL-Power / 10
-- Unit dB, Range -35dB .. +15dB, Step 0.1dB

DL-PowerBalancing-Information ::= SEQUENCE {
    powerAdjustmentType PowerAdjustmentType,
    dlReferencePower DL-Power OPTIONAL,
    -- This IE shall be present if Power Adjustment Type IE equals to 'Common'
    dlReferencePowerList DL-ReferencePowerInformationList OPTIONAL,
    -- This IE shall be present if Power Adjustment Type IE equals to 'Individual'
    maxAdjustmentStep MaxAdjustmentStep OPTIONAL,
    -- This IE shall be present if Power Adjustment Type IE equals to 'Common' or 'Individual'
    adjustmentPeriod AdjustmentPeriod OPTIONAL,
    -- This IE shall be present if Power Adjustment Type IE equals to 'Common' or 'Individual'
    adjustmentRatio ScaledAdjustmentRatio OPTIONAL,
    -- This IE shall be present if Power Adjustment Type IE equals to 'Common' or 'Individual'
    iE-Extensions ProtocolExtensionContainer { { DL-PowerBalancing-Information-ExtIEs } } OPTIONAL,
    ...
}

DL-PowerBalancing-Information-ExtIEs RNSAP-PROTOCOL-EXTENSION ::= {

```

```

}
...
}
DL-ReferencePowerInformationList ::= SEQUENCE (SIZE (1..maxNrOfRLs)) OF DL-ReferencePowerInformationItem
DL-ReferencePowerInformationItem ::= SEQUENCE {
    rL-ID                RL-ID,
    dl-Reference-Power   DL-Power,
    iE-Extensions       ProtocolExtensionContainer { {DL-ReferencePowerInformationItem-ExtIEs} } OPTIONAL,
    ...
}
DL-ReferencePowerInformationItem-ExtIEs RNSAP-PROTOCOL-EXTENSION ::= {
    ...
}
DL-PowerBalancing-ActivationIndicator ::= ENUMERATED {
    dL-PowerBalancing-Activated
}
DL-PowerBalancing-UpdatedIndicator ::= ENUMERATED {
    dL-PowerBalancing-Updated
}
DL-ReferencePowerInformation ::= SEQUENCE {
    common-DL-ReferencePowerInformation    DL-Power        OPTIONAL,
    individual-DL-ReferencePowerInformation DL-ReferencePowerInformationList    OPTIONAL,
    iE-Extensions                          ProtocolExtensionContainer { { DL-ReferencePowerInformation-ExtIEs } } OPTIONAL,
    ...
}
DL-ReferencePowerInformation-ExtIEs RNSAP-PROTOCOL-EXTENSION ::= {
    ...
}
D-RNTI ::= INTEGER (0..1048575)
D-RNTI-ReleaseIndication ::= ENUMERATED {
    release-D-RNTI,
    not-release-D-RNTI
}
DL-ScramblingCode ::= INTEGER (0..15)
DL-FrameType ::= ENUMERATED {
    typeA,
    typeB,
    ...
}
DL-Timeslot-Information ::= SEQUENCE ( SIZE (1..maxNrOfTS)) OF DL-Timeslot-InformationItem
DL-Timeslot-InformationItem ::= SEQUENCE {
    timeSlot                TimeSlot,

```



```

midambleShiftAndBurstType      MidambleShiftAndBurstType,
tFCI-Presence                   TFCI-Presence,
dL-Code-Information             TDD-DL-Code-Information,
iE-Extensions                   ProtocolExtensionContainer { {DL-Timeslot-InformationItem-ExtIEs} } OPTIONAL,
...
}

DL-Timeslot-InformationItem-ExtIEs RNSAP-PROTOCOL-EXTENSION ::= {
...
}

DL-TimeslotLCR-Information ::= SEQUENCE (SIZE (1.. maxNrOfDLTsLCR)) OF DL-TimeslotLCR-InformationItem

DL-TimeslotLCR-InformationItem ::= SEQUENCE {
timeSlotLCR                     TimeSlotLCR,
midambleShiftLCR                MidambleShiftLCR,
tFCI-Presence                   TFCI-Presence,
dL-Code-LCR-Information         TDD-DL-Code-LCR-Information,
iE-Extensions                   ProtocolExtensionContainer { { DL-TimeslotLCR-InformationItem-ExtIEs} } OPTIONAL,
...
}

DL-TimeslotLCR-InformationItem-ExtIEs RNSAP-PROTOCOL-EXTENSION ::= {
  { ID id-Maximum-DL-Power-TimeslotLCR-InformationItem  CRITICALITY ignore  EXTENSION DL-Power          PRESENCE optional  }|
  -- Applicable to 1.28Mcps TDD only
  { ID id-Minimum-DL-Power-TimeslotLCR-InformationItem  CRITICALITY ignore  EXTENSION DL-Power          PRESENCE optional  }|
  -- Applicable to 1.28Mcps TDD only
  ...
}

DL-Timeslot-Information768 ::= SEQUENCE ( SIZE (1..maxNrOfTS)) OF DL-Timeslot-InformationItem768

DL-Timeslot-InformationItem768 ::= SEQUENCE {
timeSlot                         TimeSlot,
midambleShiftAndBurstType768    MidambleShiftAndBurstType768,
tFCI-Presence                   TFCI-Presence,
dL-Code-Information768          TDD-DL-Code-Information768,
iE-Extensions                   ProtocolExtensionContainer { {DL-Timeslot-InformationItem768-ExtIEs} } OPTIONAL,
...
}

DL-Timeslot-InformationItem768-ExtIEs RNSAP-PROTOCOL-EXTENSION ::= {
...
}

DL-TimeSlot-ISCP-Info ::= SEQUENCE (SIZE (1..maxNrOfDLTs)) OF DL-TimeSlot-ISCP-InfoItem

DL-TimeSlot-ISCP-InfoItem ::= SEQUENCE {
timeSlot                         TimeSlot,
dL-TimeSlotISCP                 DL-TimeSlotISCP,
iE-Extensions                   ProtocolExtensionContainer { { DL-TimeSlot-ISCP-InfoItem-ExtIEs} } OPTIONAL,
...
}

```

```
DL-TimeSlot-ISCP-InfoItem-ExtIEs RNSAP-PROTOCOL-EXTENSION ::= {
    ...
}

DL-TimeSlot-ISCP-LCR-Information ::= SEQUENCE (SIZE (1..maxNrOfDLTsLCR)) OF DL-TimeSlot-ISCP-LCR-InfoItem

DL-TimeSlot-ISCP-LCR-InfoItem ::= SEQUENCE {
    timeSlotLCR                TimeSlotLCR,
    dL-TimeslotISCP            DL-TimeslotISCP,
    iE-Extensions              ProtocolExtensionContainer { { DL-TimeSlot-ISCP-LCR-InfoItem-ExtIEs } } OPTIONAL,
    ...
}

DL-TimeSlot-ISCP-LCR-InfoItem-ExtIEs RNSAP-PROTOCOL-EXTENSION ::= {
    ...
}

DL-TimeslotISCP                ::= INTEGER (0..91)
-- According to mapping in TS 25.123 [24]

Downlink-Compressed-Mode-Method ::= ENUMERATED {
    not-Used-puncturing,
    sFdiv2,
    higher-layer-scheduling,
    ...
}

DPC-Mode ::= ENUMERATED {
    mode0,
    mode1,
    ...
}

DPC-Mode-Change-SupportIndicator ::= ENUMERATED {
    dPC-ModeChangeSupported
}

DPCH-ID                        ::= INTEGER (0..239)

DPCH-ID768 ::= INTEGER (0..479)

DPCHConstantValue ::= INTEGER (-10..10)
-- Unit dB, Step 1dB

DRACControl ::= ENUMERATED {
    not-Used-requested,
    not-requested
}

DRXCycleLengthCoefficient      ::= INTEGER (3..9)
-- See in TS 25.331 [16]

DRX-Information ::= SEQUENCE {
```

```

    uE-DRX-Cycle                UE-DRX-Cycle,
    inactivity-Threshold-for-UE-DRX-Cycle  Inactivity-Threshold-for-UE-DRX-Cycle,
    inactivity-Threshold-for-UE-Grant-Monitoring  Inactivity-Threshold-for-UE-Grant-Monitoring,
    uE-DRX-Grant-Monitoring    UE-DRX-Grant-Monitoring,
    iE-Extensions              ProtocolExtensionContainer { {DRX-Information-ExtIEs} } OPTIONAL,
    ...
}

DRX-Information-ExtIEs RNSAP-PROTOCOL-EXTENSION ::= {
    ...
}

DRX-Information-to-Modify ::= CHOICE {
    modify          DRX-Information-to-Modify-Items,
    deactivate      NULL,
    ...
}

DRX-Information-to-Modify-Items ::= SEQUENCE {
    uE-DRX-Cycle                UE-DRX-Cycle                OPTIONAL,
    inactivity-Threshold-for-UE-DRX-Cycle  Inactivity-Threshold-for-UE-DRX-Cycle                OPTIONAL,
    inactivity-Threshold-for-UE-Grant-Monitoring  Inactivity-Threshold-for-UE-Grant-Monitoring                OPTIONAL,
    uE-DRX-Grant-Monitoring    UE-DRX-Grant-Monitoring                OPTIONAL,
    iE-Extensions              ProtocolExtensionContainer { {DRX-Information-to-Modify-Items-ExtIEs} } OPTIONAL,
    ...
}

DRX-Information-to-Modify-Items-ExtIEs RNSAP-PROTOCOL-EXTENSION ::= {
    ...
}

DSCH-RNTI ::= INTEGER (0..65535)

DSCH-FlowControlInformation ::= SEQUENCE (SIZE(1..16)) OF DSCH-FlowControlItem

DSCH-FlowControlItem ::= SEQUENCE {
    dSCH-SchedulingPriority      SchedulingPriorityIndicator,
    MAC-c-sh-SDU-Lengths        MAC-c-sh-SDU-LengthList,
    iE-Extensions              ProtocolExtensionContainer { {DSCH-FlowControlItem-ExtIEs} } OPTIONAL,
    ...
}

DSCH-FlowControlItem-ExtIEs RNSAP-PROTOCOL-EXTENSION ::= {
    { ID id-DSCH-InitialWindowSize CRITICALITY ignore EXTENSION DSCH-InitialWindowSize PRESENCE optional },
    ...
}

DSCH-ID ::= INTEGER (0..255)

DSCH-InitialWindowSize ::= INTEGER (1..255)
-- Number of MAC-c/sh SDUs.
-- 255 = Unlimited number of MAC-c/sh SDUs

```

DSCH-TDD-Information ::= SEQUENCE (SIZE (1..maxNoOfDSCHs)) OF DSCH-TDD-InformationItem

```
DSCH-TDD-InformationItem ::= SEQUENCE {
    dSCH-ID                DSCH-ID,
    dl-ccTrCHID           CCTrCH-ID, -- DL CCTrCH in which the DSCH is mapped
    trChSourceStatisticsDescriptor TrCH-SrcStatisticsDescr,
    transportFormatSet    TransportFormatSet,
    allocationRetentionPriority AllocationRetentionPriority,
    schedulingPriorityIndicator SchedulingPriorityIndicator,
    bLER                  BLER,
    iE-Extensions        ProtocolExtensionContainer { {DSCH-TDD-InformationItem-ExtIEs} } OPTIONAL,
    ...
}
```

```
DSCH-TDD-InformationItem-ExtIEs RNSAP-PROTOCOL-EXTENSION ::= {
    { ID id-TrafficClass          CRITICALITY ignore EXTENSION TrafficClass          PRESENCE mandatory }|
    { ID id-BindingID            CRITICALITY ignore EXTENSION BindingID            PRESENCE optional }|
    -- Shall be ignored if bearer establishment with ALCAP.
    { ID id-TransportLayerAddress CRITICALITY ignore EXTENSION TransportLayerAddress PRESENCE optional }|
    -- Shall be ignored if bearer establishment with ALCAP.
    { ID id-TnlQos               CRITICALITY ignore EXTENSION TnlQos               PRESENCE optional },
    ...
}
```

DsField ::= BIT STRING (SIZE (8))

```
DTX-Cycle-2ms-Items ::= SEQUENCE {
    uE-DTX-Cycle1-2ms        UE-DTX-Cycle1-2ms,
    uE-DTX-Cycle2-2ms        UE-DTX-Cycle2-2ms,
    mAC-DTX-Cycle-2ms        MAC-DTX-Cycle-2ms,
    iE-Extensions            ProtocolExtensionContainer { { DTX-Cycle-2ms-Items-ExtIEs} } OPTIONAL,
    ...
}
```

```
DTX-Cycle-2ms-Items-ExtIEs RNSAP-PROTOCOL-EXTENSION ::= {
    ...
}
```

```
DTX-Cycle-2ms-to-Modify-Items ::= SEQUENCE {
    uE-DTX-Cycle1-2ms        UE-DTX-Cycle1-2ms        OPTIONAL,
    uE-DTX-Cycle2-2ms        UE-DTX-Cycle2-2ms        OPTIONAL,
    mAC-DTX-Cycle-2ms        MAC-DTX-Cycle-2ms        OPTIONAL,
    iE-Extensions            ProtocolExtensionContainer { { DTX-Cycle-2ms-to-Modify-Items-ExtIEs} } OPTIONAL,
    ...
}
```

```
DTX-Cycle-2ms-to-Modify-Items-ExtIEs RNSAP-PROTOCOL-EXTENSION ::= {
    ...
}
```

```
DTX-Cycle-10ms-Items ::= SEQUENCE {
    uE-DTX-Cycle1-10ms      UE-DTX-Cycle1-10ms,
```

```

    uE-DTX-Cycle2-10ms          UE-DTX-Cycle2-10ms,
    mAC-DTX-Cycle-10ms         MAC-DTX-Cycle-10ms,
    iE-Extensions              ProtocolExtensionContainer { { DTX-Cycle-10ms-Items-ExtIEs } }
    ...
}
DTX-Cycle-10ms-Items-ExtIEs RNSAP-PROTOCOL-EXTENSION ::= {
    ...
}
DTX-Cycle-10ms-to-Modify-Items ::= SEQUENCE {
    uE-DTX-Cycle1-10ms          UE-DTX-Cycle1-10ms          OPTIONAL,
    uE-DTX-Cycle2-10ms          UE-DTX-Cycle2-10ms          OPTIONAL,
    mAC-DTX-Cycle-10ms         MAC-DTX-Cycle-10ms
    iE-Extensions              ProtocolExtensionContainer { { DTX-Cycle-10ms-to-Modify-Items-ExtIEs } }
    ...
}
DTX-Cycle-10ms-to-Modify-Items-ExtIEs RNSAP-PROTOCOL-EXTENSION ::= {
    ...
}
DTX-Information ::= SEQUENCE {
    e-DCH-TTI-Length           E-DCH-TTI-Length,
    inactivity-Threshold-for-UE-DTX-Cycle2 Inactivity-Threshold-for-UE-DTX-Cycle2,
    uE-DTX-Long-Preamble       UE-DTX-Long-Preamble,
    mAC-Inactivity-Threshold   MAC-Inactivity-Threshold ,
    cqi-DTX-Timer              CQI-DTX-Timer,
    uE-DPCCH-burst1            UE-DPCCH-burst1,
    uE-DPCCH-burst2            UE-DPCCH-burst2,
    iE-Extensions              ProtocolExtensionContainer { {DTX-Information-ExtIEs} } OPTIONAL,
    ...
}
DTX-Information-ExtIEs RNSAP-PROTOCOL-EXTENSION ::= {
    ...
}
DTX-Information-to-Modify ::= CHOICE {
    modify                      DTX-Information-to-Modify-Items,
    deactivate                  NULL,
    ...
}
DTX-Information-to-Modify-Items ::= SEQUENCE {
    e-DCH-TTI-Length-to-Modify E-DCH-TTI-Length-to-Modify          OPTIONAL,
    inactivity-Threshold-for-UE-DTX-Cycle2 Inactivity-Threshold-for-UE-DTX-Cycle2          OPTIONAL,
    uE-DTX-Long-Preamble       UE-DTX-Long-Preamble          OPTIONAL,
    mAC-Inactivity-Threshold   MAC-Inactivity-Threshold          OPTIONAL,
    cqi-DTX-Timer              CQI-DTX-Timer          OPTIONAL,
    uE-DPCCH-burst1            UE-DPCCH-burst1          OPTIONAL,
    uE-DPCCH-burst2            UE-DPCCH-burst2          OPTIONAL,
    iE-Extensions              ProtocolExtensionContainer { {DTX-Information-to-Modify-Items-ExtIEs} } OPTIONAL,

```

```

    ...
}
DTX-Information-to-Modify-Items-ExtIEs RNSAP-PROTOCOL-EXTENSION ::= {
    ...
}
-- E

EARFCN ::= INTEGER (0..maxEARFCN)

EARFCN-Information ::= CHOICE {
    fDD    EARFCN-FDD,
    tDD    EARFCN,
    ...
}

EARFCN-FDD ::= SEQUENCE {
    uL-EARFCN    EARFCN,
    dL-EARFCN    EARFCN
}

E-AGCH-Table-Choice ::= ENUMERATED{table16B, table16B-1, ...}

ECGI ::= SEQUENCE {
    pLMN-Identity          PLMN-Identity,
    e-UTRAN-Cell-ID       BIT STRING (SIZE (28)),
    iE-Extensions         ProtocolExtensionContainer { {ECGI-ExtIEs} } OPTIONAL,
    ...
}

ECGI-ExtIEs RNSAP-PROTOCOL-EXTENSION ::= {
    ...
}

EDCH-DDI-Value ::= INTEGER (0..62)

EDCH-FDD-DL-ControlChannelInformation ::= SEQUENCE {
    eAGCH-ERGCH-EHICH-FDD-ScramblingCode    DL-ScramblingCode                OPTIONAL,
    eAGCH-ChannelisationCode                FDD-DL-ChannelisationCodeNumber    OPTIONAL,
    primary-e-RNTI                          E-RNTI                            OPTIONAL,
    secondary-e-RNTI                        E-RNTI                            OPTIONAL,
    eRGCH-EHICH-ChannelisationCode          FDD-DL-ChannelisationCodeNumber,
    eRGCH-SignatureSequence                ERGCH-SignatureSequence            OPTIONAL,
    eHICH-SignatureSequence                EHICH-SignatureSequence            OPTIONAL,
    serving-Grant-Value                    E-Serving-Grant-Value              OPTIONAL,
    primary-Secondary-Grant-Selector        E-Primary-Secondary-Grant-Selector OPTIONAL,
    e-RGCH-Release-Indicator                E-RGCH-Release-Indicator           OPTIONAL,
    iE-Extensions                          ProtocolExtensionContainer { { EDCH-FDD-DL-ControlChannelInformation-ExtIEs } }
        OPTIONAL,
    ...
}

```

```

EDCH-FDD-DL-ControlChannelInformation-ExtIEs RNSAP-PROTOCOL-EXTENSION ::= {
  { ID id-E-RGCH-E-HICH-ChannelisationCodeValidityIndicator CRITICALITY ignore EXTENSION E-RGCH-E-HICH-ChannelisationCodeValidityIndicator
    PRESENCE optional }|
  { ID id-Default-Serving-Grant-in-DTX-Cycle2 CRITICALITY ignore EXTENSION E-Serving-Grant-Value
    PRESENCE optional },
  ...
}
E-RGCH-E-HICH-ChannelisationCodeValidityIndicator ::= ENUMERATED {
  e-RGCH-E-HICH-Channelisation-Code-response-not-valid
}

EDCH-FDD-Information ::= SEQUENCE {
  eDCH-MACdFlows-Information EDCH-MACdFlows-Information,
  hARQ-Process-Allocation-Scheduled-2ms-EDCH HARQ-Process-Allocation-2ms-EDCH
    OPTIONAL,
  e-DCH-Maximum-Bitrate E-DCH-Maximum-Bitrate OPTIONAL,
  e-DCH-Processing-Overload-Level E-DCH-Processing-Overload-Level OPTIONAL,
  e-DCH-Reference-Power-Offset E-DCH-Reference-Power-Offset OPTIONAL,
  iE-Extensions ProtocolExtensionContainer { { EDCH-FDD-Information-ExtIEs } }
  ...
}

EDCH-FDD-Information-ExtIEs RNSAP-PROTOCOL-EXTENSION ::= {
  { ID id-E-DCH-PowerOffset-for-SchedulingInfo CRITICALITY ignore EXTENSION E-DCH-PowerOffset-for-SchedulingInfo PRESENCE optional}|
  { ID id-SixteenQAM-UL-Operation-Indicator CRITICALITY reject EXTENSION SixteenQAM-UL-Operation-Indicator PRESENCE
optional}|
  { ID id-E-AGCH-Table-Choice CRITICALITY ignore EXTENSION E-AGCH-Table-Choice PRESENCE conditional},
  -- The IE shall be present if the SixteenQAM UL Operation Indicator IE is set to "Activate"--
  ...
}

EDCH-FDD-InformationResponse ::= SEQUENCE {
  eDCH-MACdFlow-Specific-InformationResponse EDCH-MACdFlow-Specific-InformationResponse,
  hARQ-Process-Allocation-Scheduled-2ms-EDCH HARQ-Process-Allocation-2ms-EDCH
    OPTIONAL,
  iE-Extensions ProtocolExtensionContainer { { EDCH-FDD-InformationResponse-ExtIEs } }
  OPTIONAL,
  ...
}

EDCH-FDD-InformationResponse-ExtIEs RNSAP-PROTOCOL-EXTENSION ::= {
  ...
}

EDCH-MACdFlow-Specific-InformationResponse ::= SEQUENCE (SIZE (1..maxNrOfEDCHMACdFlows)) OF EDCH-MACdFlow-Specific-InformationResponseItem

EDCH-MACdFlow-Specific-InformationResponseItem ::= SEQUENCE {
  eDCH-MACdFlow-ID EDCH-MACdFlow-ID,
  bindingID BindingID
    OPTIONAL,
  transportLayerAddress TransportLayerAddress
    OPTIONAL,
}

```

```

    hARQ-Process-Allocation-NonSched-2ms-EDCH          HARQ-Process-Allocation-2ms-EDCH
        OPTIONAL,
    iE-Extensions          ProtocolExtensionContainer { {EDCH-MACdFlow-Specific-InformationResponseItem-ExtIEs} } OPTIONAL,
    ...
}

EDCH-MACdFlow-Specific-InformationResponseItem-ExtIEs RNSAP-PROTOCOL-EXTENSION ::= {
    { ID id-TransportBearerNotSetupIndicator          CRITICALITY ignore  EXTENSION TransportBearerNotSetupIndicator          PRESENCE optional          }, --
FDD only
    ...
}

EDCH-FDD-Information-To-Modify ::= SEQUENCE {
    eDCH-MACdFlow-Specific-Information          EDCH-MACdFlow-Specific-InfoToModifyList,
    hARQ-Process-Allocation-Scheduled-2ms-EDCH          HARQ-Process-Allocation-2ms-EDCH
        OPTIONAL,
    e-DCH-Maximum-Bitrate          E-DCH-Maximum-Bitrate
    OPTIONAL,
    e-DCH-Processing-Overload-Level          E-DCH-Processing-Overload-Level
    OPTIONAL,
    e-DCH-Reference-Power-Offset          E-DCH-Reference-Power-Offset
    OPTIONAL,
    mACeReset-Indicator          MACeReset-Indicator
    OPTIONAL,
    iE-Extensions          ProtocolExtensionContainer { { EDCH-FDD-Information-To-Modify-ExtIEs } }
    OPTIONAL,
    ...
}

EDCH-FDD-Information-To-Modify-ExtIEs RNSAP-PROTOCOL-EXTENSION ::= {
{ ID id-E-DCH-PowerOffset-for-SchedulingInfo          CRITICALITY ignore  EXTENSION  E-DCH-PowerOffset-for-SchedulingInfo
    PRESENCE optional}|
{ ID id-SixteenQAM-UL-Operation-Indicator          CRITICALITY reject  EXTENSION  SixteenQAM-UL-Operation-Indicator
    PRESENCE optional}|
{ ID id-E-DCH-MACdPDUSizeFormat          CRITICALITY reject  EXTENSION  E-DCH-MACdPDUSizeFormat
    PRESENCE optional}|
{ ID id-E-DCH-DL-Control-Channel-Grant-Information          CRITICALITY ignore  EXTENSION  E-DCH-DL-Control-Channel-Grant-Information PRESENCE optional}|
{ ID id-E-AGCH-Table-Choice          CRITICALITY ignore  EXTENSION  E-AGCH-Table-Choice
    PRESENCE conditional},
-- The IE shall be present if the SixteenQAM UL Operation Indicator IE is set to "Activate"--
    ...
}

E-DCH-FDD-Update-Information ::= SEQUENCE {
    e-DCH-MACdFlow-Specific-UpdateInformation          E-DCH-MACdFlow-Specific-UpdateInformation
        OPTIONAL,
    hARQ-Process-Allocation-Scheduled-2ms-EDCH          HARQ-Process-Allocation-2ms-EDCH
        OPTIONAL,
    iE-Extensions          ProtocolExtensionContainer { { E-DCH-FDD-Update-Information-ExtIEs } }
        OPTIONAL,
    ...
}

E-DCH-FDD-Update-Information-ExtIEs RNSAP-PROTOCOL-EXTENSION ::= {

```



```

    { ID id-E-DCH-DL-Control-Channel-Change-Information      CRITICALITY ignore EXTENSION E-DCH-DL-Control-Channel-Change-Information
      PRESENCE optional},
    ...
}

E-DCH-MACdFlow-Specific-UpdateInformation ::= SEQUENCE (SIZE (1..maxNrOfEDCHMACdFlows)) OF E-DCH-MACdFlow-Specific-UpdateInformation-Item

E-DCH-MACdFlow-Specific-UpdateInformation-Item ::= SEQUENCE {
  e-DCH-MACdFlow-ID          EDCH-MACdFlow-ID,
  hARQ-Process-Allocation-NonSched-2ms-EDCH HARQ-Process-Allocation-2ms-EDCH
                                OPTIONAL,
  iE-Extensions              ProtocolExtensionContainer { { E-DCH-MACdFlow-Specific-UpdateInformation-Item-ExtIEs } }
  OPTIONAL,
  ...
}

E-DCH-MACdFlow-Specific-UpdateInformation-Item-ExtIEs RNSAP-PROTOCOL-EXTENSION ::= {
  ...
}

E-DCH-DL-Control-Channel-Change-Information ::= SEQUENCE (SIZE (1..maxNrOfEDCHRLs)) OF E-DCH-DL-Control-Channel-Change-Information-Item

E-DCH-DL-Control-Channel-Change-Information-Item ::= SEQUENCE {
  e-DCH-RL-ID          RL-ID,
  iE-Extensions        ProtocolExtensionContainer { { E-DCH-DL-Control-Channel-Change-Information-Item-ExtIEs } } OPTIONAL,
  ...
}

E-DCH-DL-Control-Channel-Change-Information-Item-ExtIEs RNSAP-PROTOCOL-EXTENSION ::= {
  ...
}

E-DCH-DL-Control-Channel-Grant-Information ::= SEQUENCE (SIZE (1..maxNrOfEDCHRLs)) OF E-DCH-DL-Control-Channel-Grant-Information-Item

E-DCH-DL-Control-Channel-Grant-Information-Item ::= SEQUENCE {
  e-DCH-RL-ID          RL-ID,
  iE-Extensions        ProtocolExtensionContainer { { E-DCH-DL-Control-Channel-Grant-Information-Item-ExtIEs } } OPTIONAL,
  ...
}

E-DCH-DL-Control-Channel-Grant-Information-Item-ExtIEs RNSAP-PROTOCOL-EXTENSION ::= {
  ...
}

E-DCH-Grant-Type-Information ::= CHOICE {
  e-DCH-Non-Scheduled-Transmission-Grant E-DCH-Non-Scheduled-Transmission-Grant-Items,
  e-DCH-Scheduled-Transmission-Grant     NULL,
  ...
}

E-DCH-HARQ-PO-FDD ::= INTEGER (0.. maxNrOfEDCH-HARQ-PO-QUANTSTEPS)

```

```

E-DCH-LogicalChannelInformation ::= SEQUENCE (SIZE (1..maxNoOfLogicalChannels)) OF E-DCH-LogicalChannelInformationItem

E-DCH-LogicalChannelInformationItem ::= SEQUENCE {
    logicalChannelId          LogicalChannelID,
    schedulingPriorityIndicator SchedulingPriorityIndicator,
    schedulingInformation     SchedulingInformation,
    mACes-GuaranteedBitRate   MACes-Guaranteed-Bitrate          OPTIONAL,
    eDCH-DDI-Value           EDCH-DDI-Value,
    mACd-PDU-Size-List       E-DCH-MACdPDU-SizeList,
    iE-Extensions            ProtocolExtensionContainer { { E-DCH-LogicalChannelInformationItem-ExtIEs } }          OPTIONAL,
    ...
}

E-DCH-LogicalChannelInformationItem-ExtIEs RNSAP-PROTOCOL-EXTENSION ::= {
    { ID id-MaximumMACdPDU-SizeExtended      CRITICALITY reject      EXTENSION  MAC-PDU-SizeExtended      PRESENCE optional} |
    { ID id-MACes-Maximum-Bitrate-LCR        CRITICALITY ignore        EXTENSION  MACes-Maximum-Bitrate-LCR  PRESENCE optional} | --
    1.28Mcps TDD only
    { ID id-UE-AggregateMaximumBitRate-Enforcement-Indicator CRITICALITY ignore EXTENSION UE-AggregateMaximumBitRate-Enforcement-Indicator PRESENCE optional},
    ...
}

E-DCH-Maximum-Bitrate ::= INTEGER (0..5742,...,5743..11498)

E-DCH-PowerOffset-for-SchedulingInfo ::= INTEGER (0.. maxNrOfEDCH-HARQ-PO-QUANTSTEPS)

E-DCH-Processing-Overload-Level ::= INTEGER (0..10,...)

E-DCH-Reference-Power-Offset ::= INTEGER (0.. maxNrOfEDCH-HARQ-PO-QUANTSTEPS)

E-DCH-MACdPDU-SizeList ::= SEQUENCE (SIZE (1..maxNrOfMACdPDUSize)) OF E-DCH-MACdPDU-SizeListItem

E-DCH-MACdPDU-SizeListItem ::= SEQUENCE {
    mACdPDU-Size          MACdPDU-Size,
    iE-Extensions         ProtocolExtensionContainer { { E-DCH-MACdPDU-SizeListItem-ExtIEs } }          OPTIONAL,
    ...
}

E-DCH-MACdPDU-SizeListItem-ExtIEs RNSAP-PROTOCOL-EXTENSION ::= {
    ...
}

E-DCH-MACdPDUSizeFormat ::= ENUMERATED {
    fixedMACdPDU-Size,
    flexibleMACdPDU-Size
}

E-DCH-LogicalChannelToModify ::= SEQUENCE (SIZE (1..maxNoOfLogicalChannels)) OF E-DCH-LogicalChannelToModifyItem

E-DCH-LogicalChannelToModifyItem ::= SEQUENCE {

```

```

    logicalChannelId          LogicalChannelID,
    schedulingPriorityIndicator SchedulingPriorityIndicator  OPTIONAL,
    schedulingInformation      SchedulingInformation        OPTIONAL,
    mACes-GuaranteedBitRate    MACes-Guaranteed-Bitrate     OPTIONAL,
    eDCH-DDI-Value            EDCH-DDI-Value              OPTIONAL,
    mACd-PDU-Size-List        E-DCH-MACdPDU-SizeToModifyList,
    iE-Extensions              ProtocolExtensionContainer { { E-DCH-LogicalChannelToModifyItem-ExtIEs } }      OPTIONAL,
    ...
}

E-DCH-LogicalChannelToModifyItem-ExtIEs RNSAP-PROTOCOL-EXTENSION ::= {
    { ID id-MaximumMACdPDU-SizeExtended    CRITICALITY reject    EXTENSION    MAC-PDU-SizeExtended    PRESENCE optional} |
    { ID id-MACes-Maximum-Bitrate-LCR      CRITICALITY ignore     EXTENSION    MACes-Maximum-Bitrate-LCR    PRESENCE optional}, --
    1.28Mcps TDD only
    ...
}

E-DCH-MACdPDU-SizeToModifyList ::= SEQUENCE (SIZE (0..maxNrOfMACdPDUSize)) OF E-DCH-MACdPDU-SizeListItem

E-DCH-LogicalChannelToDelete ::= SEQUENCE (SIZE (1..maxNoOfLogicalChannels)) OF E-DCH-LogicalChannelToDeleteItem

E-DCH-LogicalChannelToDeleteItem ::= SEQUENCE {
    logicalChannelId          LogicalChannelID,
    iE-Extensions              ProtocolExtensionContainer { { E-DCH-LogicalChannelToDeleteItem-ExtIEs } }      OPTIONAL,
    ...
}

E-DCH-LogicalChannelToDeleteItem-ExtIEs RNSAP-PROTOCOL-EXTENSION ::= {
    ...
}

LogicalChannelID ::= INTEGER (1..15)

EDCH-MACdFlow-ID ::= INTEGER (0..maxNrOfEDCHMACdFlows-1)
EDCH-MACdFlow-ID-LCR ::= INTEGER (0..maxNrOfEDCHMACdFlowsLCR-1)

EDCH-MACdFlows-Information ::= SEQUENCE {
    eDCH-MACdFlow-Specific-Information      EDCH-MACdFlow-Specific-InfoList,
    iE-Extensions                            ProtocolExtensionContainer { { EDCH-MACdFlow-Information-ExtIEs } }      OPTIONAL,
    ...
}

E-DCH-MACdFlow-Multiplexing-List ::= BIT STRING ( SIZE(maxNrOfEDCHMACdFlows) )

EDCH-MACdFlow-Information-ExtIEs RNSAP-PROTOCOL-EXTENSION ::= {
    ...
}

EDCH-MACdFlow-Specific-InfoList ::= SEQUENCE (SIZE (1..maxNrOfEDCHMACdFlows)) OF EDCH-MACdFlow-Specific-InfoItem

```

```

EDCH-MACdFlow-Specific-InfoItem ::= SEQUENCE {
    eDCH-MACdFlow-ID                EDCH-MACdFlow-ID,
    allocationRetentionPriority      AllocationRetentionPriority    OPTIONAL,
    tnlQoS                           TnlQoS                          OPTIONAL,
    payloadCRC-PresenceIndicator     PayloadCRC-PresenceIndicator,
    maxNr-Retransmissions-EDCH      MaxNr-Retransmissions-EDCH,
    trafficClass                     TrafficClass,
    eDCH-HARQ-PO-FDD                E-DCH-HARQ-PO-FDD,
    eDCH-MACdFlow-Multiplexing-List E-DCH-MACdFlow-Multiplexing-List OPTIONAL,
    eDCH-Grant-Type-Information      E-DCH-Grant-Type-Information  OPTIONAL,
    bundlingModeIndicator            BundlingModeIndicator          OPTIONAL,
    eDCHLogicalChannelInformation     E-DCH-LogicalChannelInformation,
    iE-Extensions                    ProtocolExtensionContainer { { EDCH-MACdFlow-Specific-InfoItem-ExtIEs } } OPTIONAL,
    ...
}

EDCH-MACdFlow-Specific-InfoItem-ExtIEs RNSAP-PROTOCOL-EXTENSION ::= {
    {ID id-TrCH-SrcStatisticsDescr CRITICALITY ignore EXTENSION TrCH-SrcStatisticsDescr PRESENCE optional },
    ...
}

EDCH-MACdFlow-Specific-InfoToModifyList ::= SEQUENCE (SIZE (1..maxNrOfEDCHMACdFlows)) OF EDCH-MACdFlow-Specific-InfoToModifyItem

EDCH-MACdFlow-Specific-InfoToModifyItem ::= SEQUENCE {
    eDCH-MACdFlow-ID                EDCH-MACdFlow-ID,
    allocationRetentionPriority      AllocationRetentionPriority    OPTIONAL,
    transportBearerRequestIndicator TransportBearerRequestIndicator,
    tnlQoS                           TnlQoS                          OPTIONAL,
    maxNr-Retransmissions-EDCH      MaxNr-Retransmissions-EDCH    OPTIONAL,
    trafficClass                     TrafficClass                     OPTIONAL,
    eDCH-HARQ-PO-FDD                E-DCH-HARQ-PO-FDD            OPTIONAL,
    eDCH-MACdFlow-Multiplexing-List E-DCH-MACdFlow-Multiplexing-List OPTIONAL,
    eDCH-Grant-Type-Information      E-DCH-Grant-Type-Information  OPTIONAL,
    bundlingModeIndicator            BundlingModeIndicator          OPTIONAL,
    eDCH-LogicalChannelToAdd         E-DCH-LogicalChannelInformation OPTIONAL,
    eDCH-LogicalChannelToModify      E-DCH-LogicalChannelToModify  OPTIONAL,
    eDCH-LogicalChannelToDelete      E-DCH-LogicalChannelToDelete  OPTIONAL,
    iE-Extensions                    ProtocolExtensionContainer { { EDCH-MACdFlow-Specific-InfoToModifyItem-ExtIEs } } OPTIONAL,
    ...
}

EDCH-MACdFlow-Specific-InfoToModifyItem-ExtIEs RNSAP-PROTOCOL-EXTENSION ::= {
    ...
}

EDCH-MACdFlows-To-Delete ::= SEQUENCE (SIZE (1..maxNrOfEDCHMACdFlows)) OF EDCH-MACdFlows-To-Delete-Item

EDCH-MACdFlows-To-Delete-Item ::= SEQUENCE {
    eDCH-MACdFlow-ID                EDCH-MACdFlow-ID,
    iE-Extensions                    ProtocolExtensionContainer { { EDCH-MACdFlows-To-Delete-Item-ExtIEs } } OPTIONAL,
    ...
}

```

```

EDCH-MACdFlows-To-Delete-Item-ExtIEs RNSAP-PROTOCOL-EXTENSION ::= {
    ...
}

EDCH-RL-Indication ::= ENUMERATED {
    eDCH,
    non-EDCH
}

E-DCH-Non-Scheduled-Transmission-Grant-Items ::= SEQUENCE {
    -- The following IE shall be ignored if id-Ext-Max-Bits-MACe-PDU-non-scheduled is present in E-DCH-Non-Scheduled-Transmission-Grant-Items-
    ExtIEs
    maxBits-MACe-PDU-non-scheduled          Max-Bits-MACe-PDU-non-scheduled,
    hARQ-Process-Allocation-NonSched-2ms    HARQ-Process-Allocation-2ms-EDCH
    OPTIONAL,
    iE-Extensions                          ProtocolExtensionContainer { { E-DCH-Non-Scheduled-Transmission-Grant-Items-ExtIEs } }
    OPTIONAL,
    ...
}

E-DCH-Non-Scheduled-Transmission-Grant-Items-ExtIEs RNSAP-PROTOCOL-EXTENSION ::= {
    -- The following IE shall be present if the maximum number of bits to be signalled exceeds maxNrOfBits-MACe-PDU-non-scheduled
    { ID id-Ext-Max-Bits-MACe-PDU-non-scheduled    CRITICALITY reject    EXTENSION    Ext-Max-Bits-MACe-PDU-non-scheduled    PRESENCE
optional},
    ...
}

E-DCH-TFCI-Table-Index ::= INTEGER (0..1,...,2..7)

E-DCH-Serving-cell-change-informationResponse ::= SEQUENCE {
    e-DCH-serving-cell-outcome-choice        E-DCH-serving-cell-change-choice,
    iE-Extensions                          ProtocolExtensionContainer { { E-DCH-serving-cell-change-informationResponse-ExtIEs } } OPTIONAL,
    ...
}

E-DCH-serving-cell-change-informationResponse-ExtIEs RNSAP-PROTOCOL-EXTENSION ::= {
    ...
}

E-DCH-serving-cell-change-choice ::= CHOICE {
    e-DCH-serving-cell-change-successful    E-DCH-serving-cell-change-successful,
    e-DCH-serving-cell-change-unsuccessful  E-DCH-serving-cell-change-unsuccessful,
    ...
}

E-DCH-serving-cell-change-successful ::= SEQUENCE {
    e-DCH-RL-InformationList-Rsp           E-DCH-RL-InformationList-Rsp,
    iE-Extensions                          ProtocolExtensionContainer { { E-DCH-serving-cell-change-successful-ExtIEs } } OPTIONAL,
    ...
}

E-DCH-serving-cell-change-successful-ExtIEs RNSAP-PROTOCOL-EXTENSION ::= {
    ...
}

```

E-DCH-RL-InformationList-Rsp ::= SEQUENCE (SIZE (0..maxNrOfRLs)) OF E-DCH-RL-InformationList-Rsp-Item

```
E-DCH-RL-InformationList-Rsp-Item ::= SEQUENCE {
    e-DCH-reconfigured-RL-Id          RL-ID,
    e-DCH-FDD-DL-Control-Channel-Info EDCH-FDD-DL-ControlChannelInformation,
    iE-Extensions                     ProtocolExtensionContainer { { E-DCH-RL-InformationList-Rsp-Item-ExtIEs } } OPTIONAL,
    ...
}
```

```
E-DCH-RL-InformationList-Rsp-Item-ExtIEs RNSAP-PROTOCOL-EXTENSION ::= {
    ...
}
```

```
E-DCH-serving-cell-change-unsuccessful ::= SEQUENCE {
    cause          Cause,
    iE-Extensions ProtocolExtensionContainer { { E-DCH-serving-cell-change-unsuccessful-ExtIEs } } OPTIONAL,
    ...
}
```

```
E-DCH-serving-cell-change-unsuccessful-ExtIEs RNSAP-PROTOCOL-EXTENSION ::= {
    ...
}
```

```
E-DCH-TTI-Length ::= CHOICE {
    two-ms      DTX-Cycle-2ms-Items,
    ten-ms     DTX-Cycle-10ms-Items,
    ...
}
```

```
E-DCH-TTI-Length-to-Modify ::= CHOICE {
    two-ms      DTX-Cycle-2ms-to-Modify-Items,
    ten-ms     DTX-Cycle-10ms-to-Modify-Items,
    ...
}
```

```
EDPCH-Information-FDD ::= SEQUENCE {
    maxSet-E-DPDCHs          Max-Set-E-DPDCHs,
    punctureLimit           PunctureLimit,
    e-TFCS-Information       E-TFCS-Information,
    e-TTI                   E-TTI,
    e-DPCCH-PO              E-DPCCH-PO,
    e-RGCH-2-IndexStepThreshold E-RGCH-2-IndexStepThreshold,
    e-RGCH-3-IndexStepThreshold E-RGCH-3-IndexStepThreshold,
    hARQ-Info-for-E-DCH     HARQ-Info-for-E-DCH,
    hSDSCH-Configured-Indicator HSDSCH-Configured-Indicator,
    iE-Extensions           ProtocolExtensionContainer { { EDPCH-Information-FDD-ExtIEs } } OPTIONAL,
    ...
}
```

```
EDPCH-Information-FDD-ExtIEs RNSAP-PROTOCOL-EXTENSION ::= {
    { ID id-MinimumReducedE-DPDCH-GainFactor CRITICALITY ignore EXTENSION MinimumReducedE-DPDCH-GainFactor PRESENCE optional },

```

```

}
...
}
EDPCH-Information-RLReconfPrepare-FDD ::= SEQUENCE {
    maxSet-E-DPDCHs                Max-Set-E-DPDCHs                OPTIONAL,
    punctureLimit                   PunctureLimit                   OPTIONAL,
    e-TFCS-Information               E-TFCS-Information           OPTIONAL,
    e-TTI                             E-TTI                         OPTIONAL,
    e-DPCCH-PO                       E-DPCCH-PO                   OPTIONAL,
    e-RGCH-2-IndexStepThreshold      E-RGCH-2-IndexStepThreshold  OPTIONAL,
    e-RGCH-3-IndexStepThreshold      E-RGCH-3-IndexStepThreshold  OPTIONAL,
    hARQ-Info-for-E-DCH              HARQ-Info-for-E-DCH          OPTIONAL,
    hSDSCH-Configured-Indicator      HSDSCH-Configured-Indicator  OPTIONAL,
    iE-Extensions                    ProtocolExtensionContainer { { EDPCH-Information-RLReconfPrepare-FDD-ExtIEs } } OPTIONAL,
    ...
}

EDPCH-Information-RLReconfPrepare-FDD-ExtIEs RNSAP-PROTOCOL-EXTENSION ::= {
    { ID id-MinimumReducedE-DPDCH-GainFactor          CRITICALITY ignore EXTENSION MinimumReducedE-DPDCH-GainFactor          PRESENCE optional },
    ...
}

EDPCH-Information-RLReconfRequest-FDD ::= SEQUENCE {
    maxSet-E-DPDCHs                Max-Set-E-DPDCHs
    OPTIONAL,
    punctureLimit                   PunctureLimit
    OPTIONAL,
    e-TFCS-Information               E-TFCS-Information
    OPTIONAL,
    e-TTI                             E-TTI
    OPTIONAL,
    e-DPCCH-PO                       E-DPCCH-PO
    OPTIONAL,
    e-RGCH-2-IndexStepThreshold      E-RGCH-2-IndexStepThreshold
    OPTIONAL,
    e-RGCH-3-IndexStepThreshold      E-RGCH-3-IndexStepThreshold
    OPTIONAL,
    hARQ-Info-for-E-DCH              HARQ-Info-for-E-DCH
    OPTIONAL,
    hSDSCH-Configured-Indicator      HSDSCH-Configured-Indicator
    OPTIONAL,
    iE-Extensions                    ProtocolExtensionContainer { { EDPCH-Information-RLReconfRequest-FDD-ExtIEs } } OPTIONAL,
    ...
}

EDPCH-Information-RLReconfRequest-FDD-ExtIEs RNSAP-PROTOCOL-EXTENSION ::= {
    { ID id-MinimumReducedE-DPDCH-GainFactor          CRITICALITY ignore EXTENSION MinimumReducedE-DPDCH-GainFactor          PRESENCE optional },
    ...
}

E-DPCCH-PO ::= INTEGER (0..maxNrOfEDPCCH-PO-QUANTSTEPS)

E-DPDCH-PowerInterpolation ::= BOOLEAN

```

```

E-Primary-Secondary-Grant-Selector ::= ENUMERATED {
    primary,
    secondary
}

EHICH-SignatureSequence ::= INTEGER (0..maxNrofSigSeqERGHICH-1)

E-RGCH-Release-Indicator ::= ENUMERATED {e-RGCHreleased}

ERGCH-SignatureSequence ::= INTEGER (0..maxNrofSigSeqERGHICH-1)

E-Serving-Grant-Value ::= INTEGER (0..38)

E-RGCH-2-IndexStepThreshold ::= INTEGER (0..37)

E-RGCH-3-IndexStepThreshold ::= INTEGER (0..37)

EDCH-Serving-RL ::= CHOICE {
    e-DCH-Serving-RL-in-this-DRNS          EDCH-Serving-RL-in-this-DRNS,
    e-DCH-Serving-RL-not-in-this-DRNS     NULL,
    ...
}

EDCH-Serving-RL-in-this-DRNS ::= SEQUENCE {
    e-DCH-Serving-RL-Id          RL-ID,
    iE-Extensions                ProtocolExtensionContainer { { EDCH-Serving-RL-in-this-DRNS-ExtIEs } } OPTIONAL,
    ...
}

EDCH-Serving-RL-in-this-DRNS-ExtIEs RNSAP-PROTOCOL-EXTENSION ::= {
    ...
}

Enhanced-FACH-Information-ResponseFDD ::= SEQUENCE {
    common-HS-DSCH-RNTI-priorityQueueInfo-EnhancedFACH          PriorityQueue-InfoList-EnhancedFACH-PCH,
    dedicated-HS-DSCH-RNTI-priorityQueueInfo-EnhancedFACH      PriorityQueue-InfoList-EnhancedFACH-PCH,
    priorityQueueInfo-EnhancedPCH                               PriorityQueue-InfoList-EnhancedFACH-PCH OPTIONAL,
    hSDSCH-Initial-Capacity-Allocation                        HSDSCH-Initial-Capacity-Allocation,
    hSDSCH-RNTI                                                HSDSCH-RNTI
    OPTIONAL,
    iE-Extensions                ProtocolExtensionContainer { { Enhanced-FACH-Information-ResponseFDD-ExtIEs } } OPTIONAL,
    ...
}

Enhanced-FACH-Information-ResponseFDD-ExtIEs RNSAP-PROTOCOL-EXTENSION ::= {
    ...
}

Enhanced-FACH-Information-ResponseLCR ::= SEQUENCE {
    common-HS-DSCH-RNTI-priorityQueueInfo-EnhancedFACH          PriorityQueue-InfoList-EnhancedFACH-PCH,
    dedicated-HS-DSCH-RNTI-priorityQueueInfo-EnhancedFACH      PriorityQueue-InfoList-EnhancedFACH-PCH,
    priorityQueueInfo-EnhancedPCH                               PriorityQueue-InfoList-EnhancedFACH-PCH OPTIONAL,

```



```

hSDSCH-Initial-Capacity-Allocation      HSDSCH-Initial-Capacity-Allocation,
hSDSCH-RNTI                              HSDSCH-RNTI
OPTIONAL,
iE-Extensions                            ProtocolExtensionContainer { { Enhanced-FACH-Information-ResponseLCR-ExtIEs } }
...
}
Enhanced-FACH-Information-ResponseLCR-ExtIEs RNSAP-PROTOCOL-EXTENSION ::= {
...
}
Enhanced-FACH-Support-Indicator ::= NULL
EnhancedHSServingCC-Abort ::= ENUMERATED {abortEnhancedHSServingCC,...}

Enhanced-PCH-Capability ::= ENUMERATED {
enhanced-pch-capable,
enhanced-pch-not-capable
}

E-RNTI ::= INTEGER (0..65535)
E-TFCI ::= INTEGER (0..127)
E-TFCI-BetaEC-Boost ::= INTEGER (0..127,...)

E-TFCI-Boost-Information ::= SEQUENCE {
e-TFCI-BetaEC-Boost          E-TFCI-BetaEC-Boost,
uL-Delta-T2TP              UL-Delta-T2TP          OPTIONAL,
-- This IE shall be present if the E-TFCI BetaEC Boost IE value is not set to 127.
iE-Extensions              ProtocolExtensionContainer { { E-TFCI-Boost-Information-ExtIEs } }
...
}
E-TFCI-Boost-Information-ExtIEs RNSAP-PROTOCOL-EXTENSION ::= {
...
}

E-TFCS-Information ::= SEQUENCE {
e-DCH-TFCI-Table-Index      E-DCH-TFCI-Table-Index,
e-DCH-Min-Set-E-TFCI       E-TFCI,
reference-E-TFCI-Information Reference-E-TFCI-Information,
iE-Extensions              ProtocolExtensionContainer { { E-TFCS-Information-ExtIEs } }
...
}
E-TFCS-Information-ExtIEs RNSAP-PROTOCOL-EXTENSION ::= {
{ ID id-E-DCH-Minimum-Set-E-TFCIValidityIndicator CRITICALITY reject EXTENSION E-DCH-Minimum-Set-E-TFCIValidityIndicator
optional }|
}

```

```

    { ID id-E-TFCI-Boost-Information
      PRESENCE optional }|
    { ID id-E-DPDCH-PowerInterpolation
      PRESENCE optional },
    ...
  }

E-DCH-Minimum-Set-E-TFCIValidityIndicator ::= ENUMERATED {
  e-DCH-Minimum-Set-E-TFCI-response-not-valid
}

E-TTI ::= ENUMERATED {
  tti10,
  tti2
-- 10ms TTI, 2ms TTI
}

E-AGCH-PowerOffset ::= INTEGER (0..255,...)
-- PowerOffset = -32 + offset * 0.25
-- Unit dB, Range -32dB .. +31.75dB, Step +0.25dB

E-RGCH-PowerOffset ::= INTEGER (0..255,...)
-- PowerOffset = -32 + offset * 0.25
-- Unit dB, Range -32dB .. +31.75dB, Step +0.25dB

E-HICH-PowerOffset ::= INTEGER (0..255,...)
-- PowerOffset = -32 + offset * 0.25
-- Unit dB, Range -32dB .. +31.75dB, Step +0.25dB

Enhanced-PrimaryCPICH-EcNo          ::= INTEGER (0..49)

EventA ::= SEQUENCE {
  measurementThreshold      MeasurementThreshold,
  measurementHysteresisTime MeasurementHysteresisTime OPTIONAL,
  iE-Extensions             ProtocolExtensionContainer { {EventA-ExtIEs} } OPTIONAL,
  ...
}

EventA-ExtIEs RNSAP-PROTOCOL-EXTENSION ::= {
  ...
}

EventB ::= SEQUENCE {
  measurementThreshold      MeasurementThreshold,
  measurementHysteresisTime MeasurementHysteresisTime OPTIONAL,
  iE-Extensions             ProtocolExtensionContainer { {EventB-ExtIEs} } OPTIONAL,
  ...
}

EventB-ExtIEs RNSAP-PROTOCOL-EXTENSION ::= {
  ...
}

```

```

EventC ::= SEQUENCE {
    measurementIncreaseDecreaseThreshold    MeasurementIncreaseDecreaseThreshold,
    measurementChangeTime                  MeasurementChangeTime,
    iE-Extensions                          ProtocolExtensionContainer { {EventC-ExtIEs} } OPTIONAL,
    ...
}

EventC-ExtIEs RNSAP-PROTOCOL-EXTENSION ::= {
    ...
}

EventD ::= SEQUENCE {
    measurementIncreaseDecreaseThreshold    MeasurementIncreaseDecreaseThreshold,
    measurementChangeTime                  MeasurementChangeTime,
    iE-Extensions                          ProtocolExtensionContainer { {EventD-ExtIEs} } OPTIONAL,
    ...
}

EventD-ExtIEs RNSAP-PROTOCOL-EXTENSION ::= {
    ...
}

EventE ::= SEQUENCE {
    measurementThreshold1                  MeasurementThreshold,
    measurementThreshold2                  MeasurementThreshold                OPTIONAL,
    measurementHysteresisTime              MeasurementHysteresisTime            OPTIONAL,
    reportPeriodicity                      ReportPeriodicity                  OPTIONAL,
    iE-Extensions                          ProtocolExtensionContainer { {EventE-ExtIEs} } OPTIONAL,
    ...
}

EventE-ExtIEs RNSAP-PROTOCOL-EXTENSION ::= {
    ...
}

EventF ::= SEQUENCE {
    measurementThreshold1                  MeasurementThreshold,
    measurementThreshold2                  MeasurementThreshold                OPTIONAL,
    measurementHysteresisTime              MeasurementHysteresisTime            OPTIONAL,
    reportPeriodicity                      ReportPeriodicity                  OPTIONAL,
    iE-Extensions                          ProtocolExtensionContainer { {EventF-ExtIEs} } OPTIONAL,
    ...
}

EventF-ExtIEs RNSAP-PROTOCOL-EXTENSION ::= {
    ...
}

ExtendedGSMCellIndividualOffset ::= INTEGER (-50..-11|11..50)

E-DCH-Information ::= SEQUENCE {
    e-PUCH-Information                    E-PUCH-Information,
    e-TFCS-Information-TDD                E-TFCS-Information-TDD,
    e-DCH-MACdFlows-Information-TDD      E-DCH-MACdFlows-Information-TDD,
}

```

```

    e-DCH-TDD-Information          E-DCH-TDD-Information,
    iE-Extensions                  ProtocolExtensionContainer { { E-DCH-Information-ExtIEs } }
    ...
}
E-DCH-Information-ExtIEs RNSAP-PROTOCOL-EXTENSION ::= {
    ...
}
E-PUCH-Information ::= SEQUENCE {
    minCR                          CodeRate,
    maxCR                          CodeRate,
    harqInfo                       HARQ-Info-for-E-DCH,
    n-E-UCCH                       N-E-UCCH,
    iE-Extensions                  ProtocolExtensionContainer { { E-PUCH-Information-ExtIEs } }
    ...
}
E-PUCH-Information-ExtIEs RNSAP-PROTOCOL-EXTENSION ::= {
    ...
}
E-TFCS-Information-TDD ::= SEQUENCE {
    e-DCH-QPSK-RefBetaInfo         E-DCH-QPSK-RefBetaInfo,
    e-DCH-sixteenQAM-RefBetaInfo   E-DCH-sixteenQAM-RefBetaInfo,
    iE-Extensions                  ProtocolExtensionContainer { { E-TFCS-Information-TDD-ExtIEs } }
    ...
}
E-TFCS-Information-TDD-ExtIEs RNSAP-PROTOCOL-EXTENSION ::= {
    ...
}
E-DCH-QPSK-RefBetaInfo ::= SEQUENCE (SIZE (1..maxNrOfRefBetas)) OF E-DCH-RefBeta-Item
E-DCH-sixteenQAM-RefBetaInfo ::= SEQUENCE (SIZE (1..maxNrOfRefBetas)) OF E-DCH-RefBeta-Item
E-DCH-RefBeta-Item ::= SEQUENCE {
    refCodeRate                    CodeRate-short,
    refBeta                        RefBeta
}
E-DCH-MACdFlows-Information-TDD ::= SEQUENCE (SIZE (1..maxNrOfEDCHMACdFlows)) OF E-DCH-MACdFlow-InfoTDDItem
E-DCH-MACdFlow-InfoTDDItem ::= SEQUENCE {
    e-DCH-MACdFlow-ID              EDCH-MACdFlow-ID,
    allocationRetentionPriority     AllocationRetentionPriority,
    tnlQos                          OPTIONAL,
    bindingID                       OPTIONAL,
    transportLayerAddress           OPTIONAL,
    payloadCRC-PresenceIndicator    PayloadCRC-PresenceIndicator,
    maximum-Number-of-Retransmissions-For-E-DCH MaxNr-Retransmissions-EDCH,
    eDCH-HARQ-PO-TDD               E-DCH-HARQ-PO-TDD,
    eDCH-MACdFlow-Multiplexing-List E-DCH-MACdFlow-Multiplexing-List
}

```

```

eDCH-Grant-TypeTDD
eDCHLogicalChannelInformation
iE-Extensions
OPTIONAL,
...
}

E-DCH-MACdFlow-InfoTDDItem-ExtIEs RNSAP-PROTOCOL-EXTENSION ::= {
  { ID id-eDCH-MACdFlow-Retransmission-Timer-LCR CRITICALITY ignore EXTENSION E-DCH-MACdFlow-Retransmission-Timer-LCR PRESENCE
optional }|
  { ID id-TrafficClass CRITICALITY ignore EXTENSION TrafficClass
  PRESENCE mandatory},
  ...
}

E-DCH-MACdFlow-Retransmission-Timer-LCR ::= ENUMERATED {
ms10, ms15, ms20, ms25, ms30, ms35, ms40, ms45, ms50, ms55, ms60, ms65, ms70, ms75, ms80, ms85, ms90,
ms95, ms100, ms110, ms120, ms140, ms160, ms200, ms240, ms280, ms320, ms400, ms480, ms560, ...
}

E-DCH-HARQ-PO-TDD ::= INTEGER (0..6)

E-DCH-Grant-TypeTDD ::= ENUMERATED {
  scheduled,
  non-scheduled
}

E-DCH-TimeslotResource ::= BIT STRING (SIZE (13))

E-DCH-PowerResource ::= INTEGER(1..32)

Tdde-PUCH-Offset ::= INTEGER(0..255)

E-DCH-TDD-Information ::= SEQUENCE {
  e-DCH-TDD-Maximum-Bitrate E-DCH-TDD-Maximum-Bitrate OPTIONAL,
  e-DCH-Processing-Overload-Level E-DCH-Processing-Overload-Level OPTIONAL,
  e-DCH-PowerOffset-for-SchedulingInfo E-DCH-PowerOffset-for-SchedulingInfo OPTIONAL,
  iE-Extensions ProtocolExtensionContainer { { E-DCH-TDD-Information-ExtIEs } } OPTIONAL,
  ...
}

E-DCH-TDD-Information-ExtIEs RNSAP-PROTOCOL-EXTENSION ::= {
  ...
}

E-DCH-TDD-Maximum-Bitrate ::= INTEGER (0..9201,...)

E-DCH-Information-Reconfig ::= SEQUENCE {
  e-PUCH-Information E-PUCH-Information OPTIONAL,
  e-TFCS-Information-TDD E-TFCS-Information-TDD OPTIONAL,
  e-DCH-MACdFlows-to-Add E-DCH-MACdFlows-Information-TDD OPTIONAL,
  e-DCH-MACdFlows-to-Delete EDCH-MACdFlows-To-Delete OPTIONAL,
  e-DCH-Non-Scheduled-Grant-Info E-DCH-Non-Scheduled-Grant-Info OPTIONAL,

```

```

    e-DCH-TDD-Information                E-DCH-TDD-Information                OPTIONAL,
    e-DCH-TDD-Information-to-Modify      E-DCH-TDD-Information-to-Modify      OPTIONAL,
    iE-Extensions                        ProtocolExtensionContainer { { E-DCH-Information-Reconfig-ExtIEs } }    OPTIONAL,
    ...
}

E-DCH-Information-Reconfig-ExtIEs RNSAP-PROTOCOL-EXTENSION ::= {
    ...
}

E-DCH-TDD-Information-to-Modify ::= SEQUENCE {
    e-DCH-TDD-Information-to-Modify-List E-DCH-TDD-Information-to-Modify-List OPTIONAL,
    mACeReset-Indicator                 MACeReset-Indicator                 OPTIONAL,
    iE-Extensions                        ProtocolExtensionContainer { { E-DCH-TDD-Information-to-Modify-ExtIEs } }    OPTIONAL,
    ...
}

E-DCH-TDD-Information-to-Modify-ExtIEs RNSAP-PROTOCOL-EXTENSION ::= {
    { ID id-E-DCH-MACdPDUSizeFormat      CRITICALITY reject EXTENSION E-DCH-MACdPDUSizeFormat
    PRESENCE optional},
    ...
}

E-DCH-TDD-Information-to-Modify-List ::= SEQUENCE (SIZE (1..maxNrOfEDCHMACdFlows)) OF E-DCH-MACdFlow-ModifyTDDItem

E-DCH-MACdFlow-ModifyTDDItem ::= SEQUENCE {
    e-DCH-MACdFlow-ID                    EDCH-MACdFlow-ID,
    allocationRetentionPriority           AllocationRetentionPriority          OPTIONAL,
    transportBearerRequestIndicator      TransportBearerRequestIndicator,
    bindingID                             BindingID                            OPTIONAL,
    transportLayerAddress                TransportLayerAddress               OPTIONAL,
    tnlQos                                TnlQos                              OPTIONAL,
    maximum-Number-of-Retransmissions-For-E-DCH MaxNr-Retransmissions-EDCH          OPTIONAL,
    eDCH-HARQ-PO-TDD                     E-DCH-HARQ-PO-TDD                  OPTIONAL,
    eDCH-MACdFlow-Multiplexing-List      E-DCH-MACdFlow-Multiplexing-List   OPTIONAL,
    eDCH-Grant-TypeTDD                   E-DCH-Grant-TypeTDD                OPTIONAL,
    e-DCH-LogicalChannelToAdd            E-DCH-LogicalChannelInformation     OPTIONAL,
    e-DCH-LogicalChannelToModify         E-DCH-LogicalChannelToModify       OPTIONAL,
    e-DCH-LogicalChannelToDelete        E-DCH-LogicalChannelToDelete       OPTIONAL,
    iE-Extensions                        ProtocolExtensionContainer { {E-DCH-MACdFlow-ModifyTDDItem-ExtIEs } }    OPTIONAL,
    ...
}

E-DCH-MACdFlow-ModifyTDDItem-ExtIEs RNSAP-PROTOCOL-EXTENSION ::= {
    { ID id-eDCH-MACdFlow-Retransmission-Timer-LCR CRITICALITY ignore EXTENSION E-DCH-MACdFlow-Retransmission-Timer-LCR
    PRESENCE optional }|
    { ID id-TrafficClass                    CRITICALITY ignore EXTENSION TrafficClass
    PRESENCE optional},
    ...
}

E-DCH-Information-Response ::= SEQUENCE {
    e-DCH-TDD-MACdFlow-Specific-InformationResp E-DCH-TDD-MACdFlow-Specific-InformationResp OPTIONAL,
    e-AGCH-Specific-Information-ResponseTDD    E-AGCH-Specific-InformationRespListTDD OPTIONAL,
    e-HICH-Information-Response                E-HICH-InformationResp              OPTIONAL,
}

```

```

    e-DCH-Non-Scheduled-Grant-Info      E-DCH-Non-Scheduled-Grant-Info  OPTIONAL,
    e-RNTI                                E-RNTI,
    iE-Extensions                          ProtocolExtensionContainer { { E-DCH-Information-Response-ExtIEs } }      OPTIONAL,
    ...
}

E-DCH-Information-Response-ExtIEs RNSAP-PROTOCOL-EXTENSION ::= {
    ...
}

E-DCH-TDD-MACdFlow-Specific-InformationResp ::= SEQUENCE (SIZE (1..maxNrOfEDCHMACdFlows)) OF E-DCH-TDD-MACdFlow-Specific-InformationResp-Item

E-DCH-TDD-MACdFlow-Specific-InformationResp-Item ::= SEQUENCE {
    e-DCH-MacdFlow-Id                    EDCH-MACdFlow-ID,
    bindingID                             BindingID                                OPTIONAL,
    transportLayerAddress                  TransportLayerAddress                    OPTIONAL,
    iE-Extensions                          ProtocolExtensionContainer { { E-DCH-TDD-MACdFlow-Specific-InformationRespItem-ExtIEs } }
    OPTIONAL,
    ...
}

E-DCH-TDD-MACdFlow-Specific-InformationRespItem-ExtIEs RNSAP-PROTOCOL-EXTENSION ::= {
    ...
}

E-AGCH-Specific-InformationRespListTDD ::= SEQUENCE (SIZE (1..maxNrOfEAGCHCodes)) OF E-AGCH-Specific-InformationResp-ItemTDD

E-AGCH-Specific-InformationResp-ItemTDD ::= SEQUENCE {
    timeslot                               TimeSlot,
    midambleShiftAndBurstType              MidambleShiftAndBurstType,
    tDD-ChannelisationCode                 TDD-ChannelisationCode,
    iE-Extensions                          ProtocolExtensionContainer { { E-AGCH-Specific-InformationResp-ItemTDD-ExtIEs } }
    OPTIONAL,
    ...
}

E-AGCH-Specific-InformationResp-ItemTDD-ExtIEs RNSAP-PROTOCOL-EXTENSION ::= {
    ...
}

E-HICH-InformationResp ::= SEQUENCE {
    timeslot                               TimeSlot,
    midambleShiftAndBurstType              MidambleShiftAndBurstType,
    tDD-ChannelisationCode                 TDD-ChannelisationCode,
    e-HICH-TimeOffset                       E-HICH-TimeOffset,
    iE-Extensions                          ProtocolExtensionContainer { { E-HICH-InformationResp-ExtIEs } }      OPTIONAL,
    ...
}

E-HICH-InformationResp-ExtIEs RNSAP-PROTOCOL-EXTENSION ::= {
    ...
}

E-HICH-TimeOffset ::= INTEGER (4..44)

```

```

E-DCH-Non-Scheduled-Grant-Info ::= SEQUENCE {
    timeslotResource          E-DCH-TimeslotResource,
    powerResource            E-DCH-PowerResource,
    repetitionPeriod        RepetitionPeriod,
    repetitionLength        RepetitionLength,
    tddE-PUCH-Offset        TddE-PUCH-Offset,
    tdd-ChannelisationCode  TDD-ChannelisationCode,
    iE-Extensions           ProtocolExtensionContainer { { E-DCH-Non-Scheduled-Grant-Info-ExtIEs } }      OPTIONAL,
    ...
}

E-DCH-Non-Scheduled-Grant-Info-ExtIEs RNSAP-PROTOCOL-EXTENSION ::= {
    ...
}

E-DCH-768-Information ::= SEQUENCE {
    e-PUCH-Information        E-PUCH-Information,
    e-TFCS-Information-TDD    E-TFCS-Information-TDD,
    e-DCH-MACdFlows-Information-TDD E-DCH-MACdFlows-Information-TDD,
    e-DCH-TDD-Information768  E-DCH-TDD-Information768,
    iE-Extensions           ProtocolExtensionContainer { { E-DCH-768-Information-ExtIEs } }      OPTIONAL,
    ...
}

E-DCH-768-Information-ExtIEs RNSAP-PROTOCOL-EXTENSION ::= {
    ...
}

E-DCH-TDD-Information768 ::= SEQUENCE {
    e-DCH-TDD-Maximum-Bitrate768 E-DCH-TDD-Maximum-Bitrate768      OPTIONAL,
    e-DCH-Processing-Overload-Level E-DCH-Processing-Overload-Level    OPTIONAL,
    e-DCH-PowerOffset-for-SchedulingInfo E-DCH-PowerOffset-for-SchedulingInfo OPTIONAL,
    iE-Extensions           ProtocolExtensionContainer { { E-DCH-TDD-Information768-ExtIEs } }      OPTIONAL,
    ...
}

E-DCH-TDD-Information768-ExtIEs RNSAP-PROTOCOL-EXTENSION ::= {
    ...
}

E-DCH-TDD-Maximum-Bitrate768 ::= INTEGER (0..17713,...)

E-DCH-768-Information-Reconfig ::= SEQUENCE {
    e-PUCH-Information        E-PUCH-Information      OPTIONAL,
    e-TFCS-Information-TDD    E-TFCS-Information-TDD  OPTIONAL,
    e-DCH-MACdFlows-to-Add    E-DCH-MACdFlows-Information-TDD  OPTIONAL,
    e-DCH-MACdFlows-to-Delete EDCH-MACdFlows-To-Delete    OPTIONAL,
    e-DCH-Non-Scheduled-Grant-Info768 E-DCH-Non-Scheduled-Grant-Info768  OPTIONAL,
    e-DCH-TDD-Information768  E-DCH-TDD-Information768    OPTIONAL,
    e-DCH-TDD-Information-to-Modify E-DCH-TDD-Information-to-Modify    OPTIONAL,
    iE-Extensions           ProtocolExtensionContainer { { E-DCH-768-Information-Reconfig-ExtIEs } }      OPTIONAL,
    ...
}

```



```

}
E-DCH-768-Information-Reconfig-ExtIEs RNSAP-PROTOCOL-EXTENSION ::= {
  ...
}
E-DCH-768-Information-Response ::= SEQUENCE {
  e-DCH-TDD-MACdFlow-Specific-InformationResp          E-DCH-TDD-MACdFlow-Specific-InformationResp OPTIONAL,
  e-AGCH-Specific-Information-Response768TDD          E-AGCH-Specific-InformationRespList768TDD  OPTIONAL,
  e-HICH-Information-Response768                      E-HICH-InformationResp768  OPTIONAL,
  e-DCH-Non-Scheduled-Grant-Info768                  E-DCH-Non-Scheduled-Grant-Info768  OPTIONAL,
  e-RNTI                                                E-RNTI,
  iE-Extensions                                         ProtocolExtensionContainer { { E-DCH-768-Information-Response-ExtIEs } }      OPTIONAL,
  ...
}
E-DCH-768-Information-Response-ExtIEs RNSAP-PROTOCOL-EXTENSION ::= {
  ...
}
E-AGCH-Specific-InformationRespList768TDD ::= SEQUENCE (SIZE (1..maxNrOfEAGCHCodes)) OF E-AGCH-Specific-InformationResp-Item768TDD
E-AGCH-Specific-InformationResp-Item768TDD ::= SEQUENCE {
  timeslot                TimeSlot,
  midambleShiftAndBurstType768  MidambleShiftAndBurstType768,
  tDD-ChannelisationCode768    TDD-ChannelisationCode768,
  iE-Extensions              ProtocolExtensionContainer { { E-AGCH-Specific-InformationResp-Item768TDD-ExtIEs } }
  OPTIONAL,
  ...
}
E-AGCH-Specific-InformationResp-Item768TDD-ExtIEs RNSAP-PROTOCOL-EXTENSION ::= {
  ...
}
E-HICH-InformationResp768 ::= SEQUENCE {
  timeslot                TimeSlot,
  midambleShiftAndBurstType768  MidambleShiftAndBurstType768,
  tDD-ChannelisationCode768    TDD-ChannelisationCode768,
  e-HICH-TimeOffset          E-HICH-TimeOffset,
  iE-Extensions              ProtocolExtensionContainer { { E-HICH-InformationResp768-ExtIEs } }      OPTIONAL,
  ...
}
E-HICH-InformationResp768-ExtIEs RNSAP-PROTOCOL-EXTENSION ::= {
  ...
}
E-DCH-Non-Scheduled-Grant-Info768 ::= SEQUENCE {
  timeslotResource        E-DCH-TimeslotResource,
  powerResource           E-DCH-PowerResource,
  repetitionPeriod        RepetitionPeriod,
  repetitionLength        RepetitionLength,
  tddE-PUCH-Offset        TddE-PUCH-Offset,
  tdd-ChannelisationCode768  TDD-ChannelisationCode768,

```

```

    iE-Extensions          ProtocolExtensionContainer { { E-DCH-Non-Scheduled-Grant-Info768-ExtIEs } }          OPTIONAL,
    ...
}

E-DCH-Non-Scheduled-Grant-Info768-ExtIEs RNSAP-PROTOCOL-EXTENSION ::= {
    ...
}

E-DCH-LCR-Information ::= SEQUENCE {
    e-PUCH-LCR-Information          E-PUCH-LCR-Information,
    e-TFCS-Information-TDD          E-TFCS-Information-TDD,
    e-DCH-MACdFlows-Information-TDD E-DCH-MACdFlows-Information-TDD,
    e-DCH-LCR-TDD-Information       E-DCH-LCR-TDD-Information,
    iE-Extensions                  ProtocolExtensionContainer { { E-DCH-Information-LCR-ExtIEs } }          OPTIONAL,
    ...
}

E-DCH-Information-LCR-ExtIEs RNSAP-PROTOCOL-EXTENSION ::= {
    ...
}

E-PUCH-LCR-Information ::= SEQUENCE {
    minCR                          CodeRate,
    maxCR                          CodeRate,
    harqInfo                       HARQ-Info-for-E-DCH,
    pRxdesBase                     E-PUCH-PRXdesBase,
    e-PUCH-TPC-Step-Size           TDD-TPC-UplinkStepSize-LCR,
    n-E-UCCH-LCR                   N-E-UCCH-LCR,
    iE-Extensions                  ProtocolExtensionContainer { { E-PUCH-Information-LCR-ExtIEs } }          OPTIONAL,
    ...
}

E-PUCH-Information-LCR-ExtIEs RNSAP-PROTOCOL-EXTENSION ::= {
    { ID id-E-PUCH-PowerControlGAP   CRITICALITY ignore      EXTENSION ControlGAP      PRESENCE optional      },
    ...
}

E-PUCH-PRXdesBase ::= INTEGER(-112..-50)
--SETP=1

E-DCH-LCR-TDD-Information ::= SEQUENCE {
    e-DCH-Physical-Layer-Category-LCR E-DCH-Physical-Layer-Category-LCR          OPTIONAL,
    e-DCH-Processing-Overload-Level    E-DCH-Processing-Overload-Level          OPTIONAL,
    e-DCH-PowerOffset-for-SchedulingInfo E-DCH-PowerOffset-for-SchedulingInfo      OPTIONAL,
    iE-Extensions                    ProtocolExtensionContainer { { E-DCH-LCR-TDD-Information-ExtIEs } }          OPTIONAL,
    ...
}

E-DCH-LCR-TDD-Information-ExtIEs RNSAP-PROTOCOL-EXTENSION ::= {
    { ID id-Extended-E-DCH-LCRTDD-PhysicalLayerCategory          CRITICALITY reject          EXTENSION Extended-E-DCH-LCRTDD-PhysicalLayerCategory          PRESENCE optional }|
    -- This IE shall be used if the E-DCH Physical Layer Category has a value larger than 5.
    { ID id-MaximumNumber-Of-Retransmission-For-SchedulingInfo-LCRTDD          CRITICALITY ignore          EXTENSION MaxNr-Retransmissions-EDCH          PRESENCE optional }|
}

```

```

    { ID id-E-DCH-RetransmissionTimer-For-SchedulingInfo-LCRTDD
Retransmission-Timer-LCR    PRESENCE optional }|
    { ID id-E-AGCH-UE-Inactivity-Monitor-Threshold
Monitor-Threshold    PRESENCE optional },
    ...
}

E-DCH-Physical-Layer-Category-LCR ::= INTEGER (1..5)

Extended-E-DCH-LCRTDD-PhysicalLayerCategory ::= INTEGER (6,...)

E-DCH-LCR-Information-Reconfig ::= SEQUENCE {
    e-PUCH-LCR-Information          E-PUCH-LCR-Information          OPTIONAL,
    e-TFCS-Information-TDD          E-TFCS-Information-TDD          OPTIONAL,
    e-DCH-MACdFlows-to-Add          E-DCH-MACdFlows-Information-TDD OPTIONAL,
    e-DCH-MACdFlows-to-Delete       EDCH-MACdFlows-To-Delete       OPTIONAL,
    e-DCH-LCR-TDD-Information        E-DCH-LCR-TDD-Information        OPTIONAL,
    e-DCH-TDD-Information-to-Modify E-DCH-TDD-Information-to-Modify OPTIONAL,
    iE-Extensions                    ProtocolExtensionContainer { { E-DCH-Information-Reconfig-LCR-ExtIEs } } OPTIONAL,
    ...
}

E-DCH-Information-Reconfig-LCR-ExtIEs RNSAP-PROTOCOL-EXTENSION ::= {
    ...
}

E-DCH-LCR-Information-Response ::= SEQUENCE {
    e-DCH-TDD-MACdFlow-Specific-InformationResp    E-DCH-TDD-MACdFlow-Specific-InformationResp OPTIONAL,
    e-AGCH-Specific-Information-Response-LCR-TDD   E-AGCH-Specific-InformationRespList-LCR-TDD OPTIONAL,
    e-HICH-Specific-Information-Response-LCR        E-HICH-Specific-InformationResp-LCR OPTIONAL,
    e-DCH-Non-Scheduled-Grant-Info-LCR             E-DCH-Non-Scheduled-Grant-Info-LCR OPTIONAL,
    e-RNTI                                           E-RNTI OPTIONAL,
    iE-Extensions                                    ProtocolExtensionContainer { { E-DCH-Information-Response-LCR-ExtIEs } } OPTIONAL,
    ...
}

E-DCH-Information-Response-LCR-ExtIEs RNSAP-PROTOCOL-EXTENSION ::= {
    ...
}

E-AGCH-Specific-InformationRespList-LCR-TDD ::= SEQUENCE (SIZE (1..maxNrOfEAGCHCodes)) OF E-AGCH-Specific-InformationResp-Item-LCR-TDD

E-AGCH-Specific-InformationResp-Item-LCR-TDD ::= SEQUENCE {
    timeSlotLCR          TimeSlotLCR,
    midambleShiftLCR     MidambleShiftLCR,
    tDD-ChannelisationCode TDD-ChannelisationCode,
    iE-Extensions        ProtocolExtensionContainer { { E-AGCH-Specific-InformationResp-ItemTDD-LCR-ExtIEs } }
    OPTIONAL,
    ...
}

E-AGCH-Specific-InformationResp-ItemTDD-LCR-ExtIEs RNSAP-PROTOCOL-EXTENSION ::= {
    ...
}

```

```

E-HICH-Specific-InformationResp-LCR ::= SEQUENCE {
    e-HICH-Scheduled-InformationResp-LCR          E-HICH-Scheduled-InformationRespList-LCR-TDD          OPTIONAL,
    e-HICH-non-Scheduled-InformationResp-LCR      E-HICH-InformationResp-LCR                              OPTIONAL,
    e-HICH-TimeOffset-lcr                        E-HICH-TimeOffset-LCR,
    iE-Extensions                                ProtocolExtensionContainer { { E-HICH-Specific-InformationResp-LCR-ExtIEs } }
    OPTIONAL,
    ...
}

E-HICH-Specific-InformationResp-LCR-ExtIEs RNSAP-PROTOCOL-EXTENSION ::= {
    ...
}

E-HICH-Scheduled-InformationRespList-LCR-TDD ::= SEQUENCE (SIZE (1..maxNrOfEHICHCodes)) OF E-HICH-Scheduled-InformationResp-Item-LCR-TDD

E-HICH-Scheduled-InformationResp-Item-LCR-TDD ::= SEQUENCE {
    e-HICH-EI                                     E-HICH-EI,
    e-HICH-Scheduled-InformationResp-LCR         E-HICH-InformationResp-LCR,
    iE-Extensions                                ProtocolExtensionContainer { { E-HICH-Scheduled-InformationResp-LCR-ExtIEs } }          OPTIONAL,
    ...
}

E-HICH-Scheduled-InformationResp-LCR-ExtIEs RNSAP-PROTOCOL-EXTENSION ::= {
    ...
}

E-HICH-EI ::= INTEGER (0..3)

E-HICH-InformationResp-LCR ::= SEQUENCE {
    timeSlotLCR                                  TimeSlotLCR,
    midambleShiftLCR                             MidambleShiftLCR,
    tDD-ChannelisationCode                       TDD-ChannelisationCode,
    signatureSequenceGroupIndex                  SignatureSequenceGroupIndex,
    iE-Extensions                                ProtocolExtensionContainer { { E-HICH-InformationResp-LCR-ExtIEs } }          OPTIONAL,
    ...
}

E-HICH-InformationResp-LCR-ExtIEs RNSAP-PROTOCOL-EXTENSION ::= {
    ...
}

E-HICH-TimeOffset-LCR ::= INTEGER (4..15)

E-DCH-SubframeNumber-LCR ::= ENUMERATED{s0,s1}

E-DCH-TimeslotResource-LCR ::= BIT STRING (SIZE (5))

E-DCH-Non-Scheduled-Grant-Info-LCR ::= SEQUENCE {
    timeslotResource-LCR                         E-DCH-TimeslotResource-LCR,

```

```

    powerResource                E-DCH-PowerResource,
    repetitionPeriod             RepetitionPeriod,
    repetitionLength             RepetitionLength,
    subframenumbers             E-DCH-SubframeNumber-LCR,
    tddE-PUCH-Offset            TddE-PUCH-Offset,
    tdd-ChannelisationCode      TDD-ChannelisationCode,
    iE-Extensions               ProtocolExtensionContainer { { E-DCH-Non-Scheduled-Grant-Info-LCR-ExtIEs } } OPTIONAL,
    ...
}

E-DCH-Non-Scheduled-Grant-Info-LCR-ExtIEs RNSAP-PROTOCOL-EXTENSION ::= {
    ...
}

Enabling-Delay ::= ENUMERATED {v0, v1, v2, v4, v8, v16, v32, v64, v128}
-- Unit radio frame

Ext-Reference-E-TFCI-PO ::= INTEGER(30..31,...)

ExtendedPropagationDelay ::= INTEGER(255..1023)

Extended-RNC-ID                ::= INTEGER (4096..65535)

Extended-Round-Trip-Time-Value ::= INTEGER(32767..103041)
-- See also mapping in TS 25.133 [23]

Ext-Max-Bits-MACe-PDU-non-scheduled ::= INTEGER(19983..22978,...)

E-DCH-Semi-PersistentScheduling-Information-LCR ::= SEQUENCE {
    repetition-Period-List-LCR      Repetition-Period-List-LCR,
    e-DCH-SPS-Indicator             E-DCH-SPS-Indicator,
    e-DCH-SPS-Reservation-Indicator SPS-Reservation-Indicator OPTIONAL,
    iE-Extensions                   ProtocolExtensionContainer { { E-DCH-Semi-PersistentScheduling-Information-LCR-ExtIEs } }
    OPTIONAL,
    ...
}

E-DCH-Semi-PersistentScheduling-Information-LCR-ExtIEs RNSAP-PROTOCOL-EXTENSION ::= {
    ...
}

E-DCH-SPS-Indicator ::= BIT STRING (SIZE (16))

E-DCH-Semi-PersistentScheduling-Information-to-Modify-LCR ::= SEQUENCE {
    repetition-Period-List-LCR      Repetition-Period-List-LCR OPTIONAL,
    e-DCH-SPS-Indicator             E-DCH-SPS-Indicator OPTIONAL,
    e-DCH-SPS-Reservation-Indicator SPS-Reservation-Indicator OPTIONAL,
    iE-Extensions                   ProtocolExtensionContainer { { E-DCH-Semi-PersistentScheduling-Information-to-Modify-LCR-ExtIEs } }
    OPTIONAL,
    ...
}

```

```

E-DCH-Semi-PersistentScheduling-Information-to-Modify-LCR-ExtIEs RNSAP-PROTOCOL-EXTENSION ::= {
  ...
}

E-DCH-Semi-PersistentScheduling-Information-ResponseLCR ::= SEQUENCE {
  initial-E-DCH-SPS-resource          Initial-E-DCH-SPS-resource          OPTIONAL,
  e-DCH-SPS-HICH-Information          E-DCH-SPS-HICH-Information          OPTIONAL,
  iE-Extensions                       ProtocolExtensionContainer { { E-DCH-Semi-PersistentScheduling-Information-ResponseLCR-ExtIEs } }
  OPTIONAL,
  ...
}

E-DCH-Semi-PersistentScheduling-Information-ResponseLCR-ExtIEs RNSAP-PROTOCOL-EXTENSION ::= {
  ...
}

Initial-E-DCH-SPS-resource ::= SEQUENCE {
  timeslot-Resource-Related-Information  E-DCH-TimeslotResource-LCR,
  powerResource                         E-DCH-PowerResource,
  repetitionPeriodIndex                  RepetitionPeriodIndex,
  repetitionLength                       RepetitionLength,
  subframeNumber                        ENUMERATED {v0, v1},
  tddE-PUCH-Offset                       TddE-PUCH-Offset,
  tdd-ChannelisationCode                 TDD-ChannelisationCode,
  n-E-UCCHLCR                            N-E-UCCH-LCR,
  iE-Extensions                          ProtocolExtensionContainer { { Initial-E-DCH-SPS-resource-ExtIEs } }
  OPTIONAL,
  ...
}

Initial-E-DCH-SPS-resource-ExtIEs RNSAP-PROTOCOL-EXTENSION ::= {
  ...
}

E-DCH-SPS-HICH-Information ::= SEQUENCE {
  e-HICH-Configuration                  E-HICH-Configuration,
  signatureSequenceGroupIndex           SignatureSequenceGroupIndex,
  iE-Extensions                          ProtocolExtensionContainer { { E-DCH-SPS-HICH-Information-ExtIEs } }
  OPTIONAL,
  ...
}

E-DCH-SPS-HICH-Information-ExtIEs RNSAP-PROTOCOL-EXTENSION ::= {
  ...
}

E-HICH-Configuration ::= CHOICE {
  same-As-Scheduled-E-HICH              Same-As-Scheduled-E-HICH,
  explicit                               E-HICH-InformationResp-ExplicitConfiguration-LCR,
  ...
}

```

```

Same-As-Scheduled-E-HICH ::= SEQUENCE {
    e-HICH-EI                E-HICH-EI,
    ...
}

E-HICH-InformationResp-ExplicitConfiguration-LCR ::= SEQUENCE {
    timeSlotLCR                TimeSlotLCR,
    midambleShiftLCR           MidambleShiftLCR,
    tDD-ChannelisationCode     TDD-ChannelisationCode,
    iE-Extensions              ProtocolExtensionContainer { { E-HICH-InformationResp-ExplicitConfiguration-LCR-ExtIEs } }
    OPTIONAL,
    ...
}

E-HICH-InformationResp-ExplicitConfiguration-LCR-ExtIEs RNSAP-PROTOCOL-EXTENSION ::= {
    ...
}

-- F

FACH-FlowControlInformation ::= SEQUENCE (SIZE (1..16)) OF FACH-FlowControlInformationItem

FACH-FlowControlInformationItem ::= SEQUENCE {
    fACH-SchedulingPriority     SchedulingPriorityIndicator,
    mAC-c-sh-SDU-Lengths       MAC-c-sh-SDU-LengthList,
    fACH-InitialWindowSize     FACH-InitialWindowSize,
    iE-Extensions              ProtocolExtensionContainer { {FACH-FlowControlInformationItem-ExtIEs} } OPTIONAL,
    ...
}

FACH-FlowControlInformationItem-ExtIEs RNSAP-PROTOCOL-EXTENSION ::= {
    ...
}

FACH-InitialWindowSize        ::= INTEGER { unlimited(255) } (0..255)
-- Number of frames MAC-c-sh SDUs.
-- 255 = Unlimited number of FACH data frames

FACH-InformationList ::= SEQUENCE (SIZE(0.. maxNrOfFACHs)) OF FACH-InformationItem

FACH-InformationItem ::= SEQUENCE {
    transportFormatSet         TransportFormatSet,
    iE-Extensions              ProtocolExtensionContainer { { FACH-InformationItem-ExtIEs} } OPTIONAL,
    ...
}

FACH-InformationItem-ExtIEs RNSAP-PROTOCOL-EXTENSION ::= {
    ...
}

Fast-Reconfiguration-Mode ::= ENUMERATED {fast,...}
Fast-Reconfiguration-Permission ::= ENUMERATED {allowed,...}

```

```

FDD-DCHs-to-Modify ::= SEQUENCE (SIZE (1..maxNrOfDCHs)) OF FDD-DCHs-to-ModifyItem

FDD-DCHs-to-ModifyItem ::= SEQUENCE {
    ul-FP-Mode          UL-FP-Mode          OPTIONAL,
    toAWS              ToAWS              OPTIONAL,
    toAWE              ToAWE              OPTIONAL,
    transportBearerRequestIndicator TransportBearerRequestIndicator,
    dCH-SpecificInformationList FDD-DCHs-to-ModifySpecificInformationList,
    iE-Extensions      ProtocolExtensionContainer { {FDD-DCHs-to-ModifyItem-ExtIEs} } OPTIONAL,
    ...
}

FDD-DCHs-to-ModifyItem-ExtIEs RNSAP-PROTOCOL-EXTENSION ::= {
    { ID id-TnIQos          CRITICALITY ignore      EXTENSION TnIQos PRESENCE optional },
    ...
}

FDD-DCHs-to-ModifySpecificInformationList ::= SEQUENCE (SIZE (1..maxNrOfDCHs)) OF FDD-DCHs-to-ModifySpecificItem

FDD-DCHs-to-ModifySpecificItem ::= SEQUENCE {
    dCH-ID              DCH-ID,
    ul-TransportformatSet TransportFormatSet OPTIONAL,
    dl-TransportformatSet TransportFormatSet OPTIONAL,
    allocationRetentionPriority AllocationRetentionPriority OPTIONAL,
    frameHandlingPriority FrameHandlingPriority OPTIONAL,
    not-Used-dRACControl NULL OPTIONAL,
    iE-Extensions      ProtocolExtensionContainer { {FDD-DCHs-to-ModifySpecificItem-ExtIEs} } OPTIONAL,
    ...
}

FDD-DCHs-to-ModifySpecificItem-ExtIEs RNSAP-PROTOCOL-EXTENSION ::= {
    { ID id-Guaranteed-Rate-Information CRITICALITY ignore EXTENSION Guaranteed-Rate-Information PRESENCE optional }|
    { ID id-TrafficClass CRITICALITY ignore EXTENSION TrafficClass PRESENCE optional }|
    { ID id-Unidirectional-DCH-Indicator CRITICALITY reject EXTENSION Unidirectional-DCH-Indicator PRESENCE optional},
    ...
}

FDD-DL-ChannelisationCodeNumber ::= INTEGER (0..511)
-- According to the mapping in TS 25.213 [27]. The maximum value is equal to the DL spreading factor -1--

FDD-DL-CodeInformation ::= SEQUENCE (SIZE (1..maxNrOfDL-Codes)) OF FDD-DL-CodeInformationItem

FDD-DL-CodeInformationItem ::= SEQUENCE {
    dl-ScramblingCode          DL-ScramblingCode,
    fDD-DL-ChannelisationCodeNumber FDD-DL-ChannelisationCodeNumber,
    transmission-Gap-Pattern-Sequence-ScramblingCode-Information Transmission-Gap-Pattern-Sequence-ScramblingCode-Information OPTIONAL,
    iE-Extensions              ProtocolExtensionContainer { {FDD-DL-CodeInformationItem-ExtIEs} } OPTIONAL,
    ...
}

FDD-DL-CodeInformationItem-ExtIEs RNSAP-PROTOCOL-EXTENSION ::= {
    ...
}

```



```
FDD-TPC-DownlinkStepSize ::= ENUMERATED {
    step-size0-5,
    step-size1,
    step-size1-5,
    step-size2,
    ...
}

SchedulingPriorityIndicator          ::= INTEGER { lowest(0), highest(15) } (0..15)

F-DPCH-SlotFormat ::= INTEGER (0..9)

F-DPCH-SlotFormatSupportRequest ::= NULL

FirstRLS-Indicator ::= ENUMERATED {
    first-RLS,
    not-first-RLS
}

FNReportingIndicator ::= ENUMERATED {
    fN-reporting-required,
    fN-reporting-not-required
}

FPACH-Information ::= SEQUENCE {
    timeSlotLCR           TimeSlotLCR,
    tDD-ChannelisationCodeLCR TDD-ChannelisationCodeLCR,
    midambleShiftLCR      MidambleShiftLCR,
    wT                     INTEGER (1..4),
    ...
}

FrameHandlingPriority          ::= INTEGER { lowest(0), highest(15) } (0..15)

FrameOffset                   ::= INTEGER (0..255)
-- Frames

FrequencyBandIndicator        ::= ENUMERATED {
    bandI,
    bandII,
    bandIII,
    bandIV,
    bandV,
    bandVI,
    bandVII,
    bandVIII,
    bandIX,
    bandX,
    bandXI,
    bandXII,
    bandXIII,
    bandXIV,
    bandXV,
}
```

```

    bandXVI,
    bandXVII,
    bandXVIII,
    bandXIX,
    bandXX,
    bandXXI,
    bandXXII,
    ...
}

-- G

GapLength                ::= INTEGER (1..14)
-- Unit Slot

GapDuration              ::= INTEGER (1..144,...)
-- Unit Frame

GA-Cell ::= SEQUENCE (SIZE (1..maxNrOfPoints)) OF
    SEQUENCE {
        cell-GAIgeographicalCoordinate    GeographicalCoordinate,
        iE-Extensions                      ProtocolExtensionContainer { {GA-Cell-ExtIEs} } OPTIONAL,
        ...
    }

GA-Cell-ExtIEs RNSAP-PROTOCOL-EXTENSION ::= {
    ...
}

GA-CellAdditionalShapes ::= CHOICE {
    pointWithUncertainty                GA-PointWithUnCertainty,
    pointWithUncertaintyEllipse         GA-PointWithUnCertaintyEllipse,
    pointWithAltitude                   GA-PointWithAltitude,
    pointWithAltitudeAndUncertaintyEllipsoid GA-PointWithAltitudeAndUncertaintyEllipsoid,
    ellipsoidArc                         GA-EllipsoidArc,
    ...
}

GA-AltitudeAndDirection ::= SEQUENCE {
    directionOfAltitude    ENUMERATED {height, depth},
    altitude                INTEGER (0..32767),
    ...
}

GA-EllipsoidArc ::= SEQUENCE {
    geographicalCoordinates    GeographicalCoordinate,
    innerRadius                INTEGER (0..65535),
    uncertaintyRadius          INTEGER (0..127),
    offsetAngle                INTEGER (0..179),
    includedAngle              INTEGER (0..179),
    confidence                  INTEGER (0..127),
    iE-Extensions              ProtocolExtensionContainer { { GA-EllipsoidArc-ExtIEs} } OPTIONAL,
    ...
}

```

```

}

GA-EllipsoidArc-ExtIEs RNSAP-PROTOCOL-EXTENSION ::= {
  ...
}

GANSS-AddClockModels ::= CHOICE {
  navClockModel          GANSS-NAVclockModel,
  cnavClockModel         GANSS-CNAVclockModel,
  glonassClockModel      GANSS-GLONASSclockModel,
  sbasClockModel         GANSS-SBASclockModel,
  ...
}

GANSS-AddIonoModelReq ::= BIT STRING (SIZE(2))

GANSS-AddNavigationModelsReq ::= BOOLEAN

GANSS-AddOrbitModels ::= CHOICE {
  navKeplerianSet        GANSS-NavModel-NAVKeplerianSet,
  cnavKeplerianSet       GANSS-NavModel-CNAVKeplerianSet,
  glonassECEF            GANSS-NavModel-GLONASSecef,
  sbasECEF               GANSS-NavModel-SBAssecef,
  ...
}

GANSS-AddUTCModelsReq ::= BOOLEAN

GANSS-Additional-Ionospheric-Model ::= SEQUENCE {
  dataID                  BIT STRING (SIZE(2)),
  alpha-beta-parameters  GPS-Ionospheric-Model,
  ie-Extensions           ProtocolExtensionContainer { { GANSS-Additional-Ionospheric-Model-ExtIEs } } OPTIONAL,
  ...
}

GANSS-Additional-Ionospheric-Model-ExtIEs RNSAP-PROTOCOL-EXTENSION ::= {
  ...
}

GANSS-Additional-Navigation-Models ::= SEQUENCE {
  ganss-Transmission-Time GANSS-Transmission-Time,
  non-broadcastIndication ENUMERATED { true } OPTIONAL,
  ganssSatInfoNavList     Ganss-Sat-Info-AddNavList,
  ie-Extensions           ProtocolExtensionContainer { { GANSS-Additional-Navigation-Models-ExtIEs } } OPTIONAL,
  ...
}

GANSS-Additional-Navigation-Models-ExtIEs RNSAP-PROTOCOL-EXTENSION ::= {
  ...
}

```

```

GANSS-Additional-Time-Models ::= SEQUENCE (SIZE (1..maxGANSS-1)) OF GANSS-Time-Model

GANSS-Additional-UTC-Models ::= CHOICE {
    utcModel1      GANSS-UTCmodelSet1,
    utcModel2      GANSS-UTCmodelSet2,
    utcModel3      GANSS-UTCmodelSet3,
    ...
}

GANSS-Almanac ::= SEQUENCE{
    ganss-wk-number      INTEGER(0..255),
    gANSS-AlmanacModel   CHOICE {
        gANSS-keplerianParameters      SEQUENCE {
            t-oa      INTEGER(0..255),
            iod-a     INTEGER(0..3),
            gANSS-SatelliteInformationKP GANSS-SatelliteInformationKP,
            ie-Extensions      ProtocolExtensionContainer { { GANSS-KeplerianParametersAlm-ExtIEs } } OPTIONAL,
            ...
        },
        ...,
        extension-GANSS-AlmanacModel     Extension-GANSS-AlmanacModel
    },
    ie-Extensions      ProtocolExtensionContainer { { GANSS-Almanac-ExtIEs } } OPTIONAL,
    ...
}

GANSS-KeplerianParametersAlm-ExtIEs RNSAP-PROTOCOL-EXTENSION ::= {
    ...
}

Extension-GANSS-AlmanacModel ::= ProtocolIE-Single-Container {{ Extension-GANSS-AlmanacModel-IE }}

Extension-GANSS-AlmanacModel-IE RNSAP-PROTOCOL-IES ::= {
    { ID id-GANSS-alm-keplerianNAVALmanac      CRITICALITY   ignore     TYPE     GANSS-alm-keplerianNAVALmanac
    PRESENCE mandatory}|
    { ID id-GANSS-alm-keplerianReducedAlmanac  CRITICALITY   ignore     TYPE     GANSS-alm-keplerianReducedAlmanac
    PRESENCE mandatory}|
    { ID id-GANSS-alm-keplerianMidiAlmanac     CRITICALITY   ignore     TYPE     GANSS-alm-keplerianMidiAlmanac
    PRESENCE mandatory}|
    { ID id-GANSS-alm-keplerianGLONASS        CRITICALITY   ignore     TYPE     GANSS-alm-keplerianGLONASS
    PRESENCE mandatory}|
    { ID id-GANSS-alm-ecefSBASAlmanac         CRITICALITY   ignore     TYPE     GANSS-alm-ecefSBASAlmanac
    PRESENCE mandatory}
}

GANSS-alm-keplerianNAVALmanac ::= SEQUENCE {
    t-oa      INTEGER (0..255),
    sat-info-NAVkpList      GANSS-SAT-Info-Almanac-NAVkpList,

```

```

    ie-Extensions          ProtocolExtensionContainer { { GANSS-ALM-NAVKeplerianSet-ExtIEs } }
    ...
}

GANSS-ALM-NAVKeplerianSet-ExtIEs RNSAP-PROTOCOL-EXTENSION ::= {
    ...
}

GANSS-alm-keplerianReducedAlmanac ::= SEQUENCE {
    t-oa                    INTEGER (0..255),
    sat-info-REDkpList      GANSS-SAT-Info-Almanac-REDkpList,
    ie-Extensions          ProtocolExtensionContainer { { GANSS-ALM-ReducedKeplerianSet-ExtIEs } }
    ...
}

GANSS-ALM-ReducedKeplerianSet-ExtIEs RNSAP-PROTOCOL-EXTENSION ::= {
    ...
}

GANSS-alm-keplerianMidiAlmanac ::= SEQUENCE {
    t-oa                    INTEGER (0..255),
    sat-info-MIDIkpList     GANSS-SAT-Info-Almanac-MIDIkpList,
    ie-Extensions          ProtocolExtensionContainer { { GANSS-ALM-MidiAlmanacSet-ExtIEs } }
    ...
}

GANSS-ALM-MidiAlmanacSet-ExtIEs RNSAP-PROTOCOL-EXTENSION ::= {
    ...
}

GANSS-alm-keplerianGLONASS ::= SEQUENCE {
    sat-info-GLOkpList      GANSS-SAT-Info-Almanac-GLOkpList,
    ie-Extensions          ProtocolExtensionContainer { { GANSS-ALM-GlonassAlmanacSet-ExtIEs } }
    ...
}

GANSS-ALM-GlonassAlmanacSet-ExtIEs RNSAP-PROTOCOL-EXTENSION ::= {
    ...
}

GANSS-alm-ecefSBASAlmanac ::= SEQUENCE {
    sat-info-SBAscefList    GANSS-SAT-Info-Almanac-SBAscefList,

```

```

    ie-Extensions          ProtocolExtensionContainer { { GANSS-ALM-ECEFSbasAlmanacSet-ExtIEs } }          OPTIONAL,
    ...
}

GANSS-ALM-ECEFSbasAlmanacSet-ExtIEs RNSAP-PROTOCOL-EXTENSION ::= {
    ...
}

GANSS-Almanac-ExtIEs RNSAP-PROTOCOL-EXTENSION ::= {
    ...
}

GANSS-Auxiliary-Information ::= CHOICE {
    ganssID1      GANSS-AuxInfoGANSS-ID1,      -- This choice may only be present if GANSS ID indicates Modernized GPS
    ganssID3      GANSS-AuxInfoGANSS-ID3,      -- This choice may only be present if GANSS ID indicates GLONASS
    ...
}

GANSS-AuxInfoGANSS-ID1 ::= SEQUENCE (SIZE(1.. maxGANSSSat)) OF SEQUENCE {
    svID          INTEGER(0..63),
    signalsAvailable BIT STRING (SIZE(8)),
    ie-Extensions ProtocolExtensionContainer { { GANSS-AuxInfoGANSS-ID1-element-ExtIEs } } OPTIONAL,
    ...
}

GANSS-AuxInfoGANSS-ID1-element-ExtIEs RNSAP-PROTOCOL-EXTENSION ::= {
    ...
}

GANSS-AuxInfoGANSS-ID3 ::= SEQUENCE (SIZE(1.. maxGANSSSat)) OF SEQUENCE {
    svID          INTEGER(0..63),
    signalsAvailable BIT STRING (SIZE(8)),
    channelNumber INTEGER (-7..13),
    ie-Extensions ProtocolExtensionContainer { { GANSS-AuxInfoGANSS-ID3-element-ExtIEs } } OPTIONAL,
    ...
}

GANSS-AuxInfoGANSS-ID3-element-ExtIEs RNSAP-PROTOCOL-EXTENSION ::= {
    ...
}

GANSS-AuxInfoReq ::= BOOLEAN

GANSS-Clock-Model ::= SEQUENCE (SIZE (1..maxGANSSClockMod)) OF SEQUENCE {
    t-oc          BIT STRING (SIZE (14)),
    a-i2          BIT STRING (SIZE (12)),
    a-i1          BIT STRING (SIZE (18)),
    a-i0          BIT STRING (SIZE (28)),
    t-gd          BIT STRING (SIZE (10))
} OPTIONAL,

```

```

    model-id                INTEGER(0..1,...)                OPTIONAL,
    ie-Extensions            ProtocolExtensionContainer { { GANSS-ClockModelItem-ExtIEs } }  OPTIONAL,
    ...
}

GANSS-ClockModelItem-ExtIEs RNSAP-PROTOCOL-EXTENSION ::= {
    ...
}

GANSS-CNAVclockModel ::= SEQUENCE {
    cnavToc                BIT STRING (SIZE (11)),
    cnavTop                BIT STRING (SIZE (11)),
    cnavURA0              BIT STRING (SIZE (5)),
    cnavURA1              BIT STRING (SIZE (3)),
    cnavURA2              BIT STRING (SIZE (3)),
    cnavAf2                BIT STRING (SIZE (10)),
    cnavAf1                BIT STRING (SIZE (20)),
    cnavAf0                BIT STRING (SIZE (26)),
    cnavTgd                BIT STRING (SIZE (13)),
    cnavISCl1cp            BIT STRING (SIZE (13))                OPTIONAL,
    cnavISCl1cd            BIT STRING (SIZE (13))                OPTIONAL,
    cnavISCl1ca            BIT STRING (SIZE (13))                OPTIONAL,
    cnavISCl2c            BIT STRING (SIZE (13))                OPTIONAL,
    cnavISCl5i5            BIT STRING (SIZE (13))                OPTIONAL,
    cnavISCl5q5            BIT STRING (SIZE (13))                OPTIONAL,
    ie-Extensions          ProtocolExtensionContainer { { GANSS-CNAVclockModel-ExtIEs } }  OPTIONAL,
    ...
}

GANSS-CNAVclockModel-ExtIEs RNSAP-PROTOCOL-EXTENSION ::= {
    ...
}

GANSS-Common-Data ::= SEQUENCE {
    ganss-Ionospheric-Model GANSS-Ionospheric-Model
    OPTIONAL,
    ganss-Rx-Pos             GANSS-RX-Pos
    OPTIONAL,
    ie-Extensions            ProtocolExtensionContainer { { GANSS-Common-Data-ExtIEs } }  OPTIONAL,
    ...
}

GANSS-Common-Data-ExtIEs RNSAP-PROTOCOL-EXTENSION ::= {
    { ID id-GANSS-Additional-Ionospheric-Model CRITICALITY ignore EXTENSION GANSS-Additional-Ionospheric-Model PRESENCE optional }|
    { ID id-GANSS-Earth-Orientation-Parameters CRITICALITY ignore EXTENSION GANSS-Earth-Orientation-Parameters PRESENCE optional },
    ...
}

GANSS-CommonDataInfoReq ::= SEQUENCE {
    ionospheric-Model        BOOLEAN
    OPTIONAL,

```

```

    ie-Extensions          ProtocolExtensionContainer { { GANSS-CommonDataInfoReq-ExtIEs } }      OPTIONAL,
    ...
}

GANSS-CommonDataInfoReq-ExtIEs RNSAP-PROTOCOL-EXTENSION ::= {
    {ID id-GANSS-AddIonoModelReq          CRITICALITY ignore EXTENSION GANSS-AddIonoModelReq
    PRESENCE optional} |
    {ID id-GANSS-EarthOrientParaReq      CRITICALITY ignore EXTENSION GANSS-EarthOrientParaReq      PRESENCE optional} ,
    ...
}

GANSS-Data-Bit-Assistance ::= SEQUENCE {
    ganssTod                INTEGER (0..59,...),
    dataBitAssistancelist   GANSS-DataBitAssistanceList,
    ie-Extensions          ProtocolExtensionContainer { { GANSS-Data-Bit-Assistance-ExtIEs } }      OPTIONAL,
    ...
}

GANSS-Data-Bit-Assistance-ExtIEs RNSAP-PROTOCOL-EXTENSION ::= {
    ...
}

GANSS-DataBitAssistanceList ::= SEQUENCE (SIZE (1..maxGANSSSat)) OF GANSS-DataBitAssistanceItem

GANSS-DataBitAssistanceItem ::= SEQUENCE {
    satId                   INTEGER(0..63),
    dataBitAssistanceSgnList GANSS-DataBitAssistanceSgnList,
    ie-Extensions          ProtocolExtensionContainer { { GANSS-DataBitAssistanceItem-ExtIEs } }      OPTIONAL,
    ...
}

GANSS-DataBitAssistanceItem-ExtIEs RNSAP-PROTOCOL-EXTENSION ::= {
    ...
}

GANSS-DataBitAssistanceSgnList ::= SEQUENCE (SIZE (1..maxSgnType)) OF GANSS-DataBitAssistanceSgnItem

GANSS-DataBitAssistanceSgnItem ::= SEQUENCE {
    ganss-SignalId          GANSS-Signal-ID,
    ganssDataBits           BIT STRING (SIZE (1..1024)),
    ie-Extensions          ProtocolExtensionContainer { { GANSS-DataBitAssistanceSgnItem-ExtIEs } }      OPTIONAL,
    ...
}

GANSS-DataBitAssistanceSgnItem-ExtIEs RNSAP-PROTOCOL-EXTENSION ::= {
    ...
}

GANSS-Data-Bit-Assistance-ReqItem ::= SEQUENCE {
    ganssTod                INTEGER (0..86399),

```



```

    ganss-Data-Bit-Assistance-ReqList      GANSS-Data-Bit-Assistance-ReqList,
    iE-Extensions                          ProtocolExtensionContainer { { GANSS-Data-Bit-Assistance-ReqItem-ExtIEs } } OPTIONAL,
    ...
}

GANSS-Data-Bit-Assistance-ReqItem-ExtIEs RNSAP-PROTOCOL-EXTENSION ::= {
    ...
}

GANSS-Data-Bit-Assistance-ReqList ::= SEQUENCE {
    dGANSS-Signal-ID                      BIT STRING (SIZE (8)),
    ganss-DataBitInterval                  INTEGER(0..15),
    ganss-SatelliteInfo                    SEQUENCE (SIZE (1..maxGANSSSat)) OF INTEGER(0..63)
    OPTIONAL,
    iE-Extensions                          ProtocolExtensionContainer { { GANSS-Data-Bit-Assistance-ReqList-ExtIEs } } OPTIONAL,
    ...
}

GANSS-Data-Bit-Assistance-ReqList-ExtIEs RNSAP-PROTOCOL-EXTENSION ::= {
    ...
}

GANSS-DeltaUT1 ::= SEQUENCE {
    b1                                     BIT STRING (SIZE(11)),
    b2                                     BIT STRING (SIZE(10)),
    ie-Extensions                          ProtocolExtensionContainer { { GANSS-DeltaUT1-ExtIEs } } OPTIONAL,
    ...
}

GANSS-DeltaUT1-ExtIEs RNSAP-PROTOCOL-EXTENSION ::= {
    ...
}

GANSS-Earth-Orientation-Parameters ::= SEQUENCE {
    teop                                   BIT STRING (SIZE (16)),
    pmX                                    BIT STRING (SIZE (21)),
    pmXdot                                 BIT STRING (SIZE (15)),
    pmY                                    BIT STRING (SIZE (21)),
    pmYdot                                 BIT STRING (SIZE (15)),
    deltaUT1                               BIT STRING (SIZE (31)),
    deltaUT1dot                             BIT STRING (SIZE (19)),
    ie-Extensions                          ProtocolExtensionContainer { { GANSS-Earth-Orientation-Parameters-ExtIEs } } OPTIONAL,
    ...
}

GANSS-Earth-Orientation-Parameters-ExtIEs RNSAP-PROTOCOL-EXTENSION ::= {
    ...
}

GANSS-EarthOrientParaReq ::= BOOLEAN

GANSS-GenericDataInfoReqList ::= SEQUENCE (SIZE(1..maxNoGANSS)) OF GANSS-GenericDataInfoReqItem

GANSS-GenericDataInfoReqItem ::= SEQUENCE {

```

```

ganss-Id GANSS-ID
OPTIONAL,
ganss-Navigation-Model-And-Time-Recovery BOOLEAN OPTIONAL,
ganss-Time-Model-GNSS-GNSS BIT STRING (SIZE (9)) OPTIONAL,
ganss-UTC-Model BOOLEAN OPTIONAL,
ganss-Almanac BOOLEAN OPTIONAL,
ganss-Real-Time-Integrity BOOLEAN OPTIONAL,
ganss-Data-Bit-Assistance-Req GANSS-Data-Bit-Assistance-ReqItem OPTIONAL,
ie-Extensions ProtocolExtensionContainer { { GANSS-GenericDataInfoReqItem-ExtIEs } } OPTIONAL,
...
}

GANSS-GenericDataInfoReqItem-ExtIEs RNSAP-PROTOCOL-EXTENSION ::= {
  { ID id-GANSS-AddNavigationModelsReq CRITICALITY ignore EXTENSION GANSS-AddNavigationModelsReq PRESENCE optional } |
  { ID id-GANSS-AddUTCModelsReq CRITICALITY ignore EXTENSION GANSS-AddUTCModelsReq PRESENCE optional } |
  { ID id-GANSS-AuxInfoReq CRITICALITY ignore EXTENSION GANSS-AuxInfoReq PRESENCE optional } |
  -- The following IE shall be present if 'GANSS-ID' in 'GANSS-GenericDataInfoReqItem' is '0' (SBAS)
  { ID id-GANSS-SBAS-ID CRITICALITY ignore EXTENSION GANSS-SBAS-ID PRESENCE optional } ,
  ...
}

GANSS-Generic-Data ::= SEQUENCE (SIZE(1..maxNoGANSS)) OF GANSS-Generic-DataItem

GANSS-Generic-DataItem ::= SEQUENCE {
  ganss-Id GANSS-ID
  OPTIONAL,
  dganss-Correction DGANSSCorrections
  OPTIONAL,
  ganss-Navigation-Model-And-Time-Recovery GANSS-Navigation-Model-And-Time-Recovery
  OPTIONAL,
  ganss-Time-Model GANSS-Time-Model
  OPTIONAL,
  ganss-UTC-TIME GANSS-UTC-Model
  OPTIONAL,
  ganss-Almanac GANSS-Almanac
  OPTIONAL,
  ganss-Real-Time-Integrity GANSS-Real-Time-Integrity
  OPTIONAL,
  ganss-Data-Bit-Assistance GANSS-Data-Bit-Assistance
  OPTIONAL,
  ie-Extensions ProtocolExtensionContainer { { GANSS-Generic-DataItem-ExtIEs } } OPTIONAL,
  ...
}

GANSS-Generic-DataItem-ExtIEs RNSAP-PROTOCOL-EXTENSION ::= {
  { ID id-GANSS-Additional-Time-Models CRITICALITY ignore EXTENSION GANSS-Additional-Time-Models PRESENCE optional } |
  { ID id-GANSS-Additional-Navigation-Models CRITICALITY ignore EXTENSION GANSS-Additional-Navigation-Models PRESENCE optional } |
  { ID id-GANSS-Additional-UTC-Models CRITICALITY ignore EXTENSION GANSS-Additional-UTC-Models PRESENCE optional } |
  optional } |
}

```

```

    { ID id-GANSS-Auxiliary-Information          CRITICALITY ignore EXTENSION GANSS-Auxiliary-Information          PRESENCE
optional }|
-- The following element shall be present if 'GANSS-ID' in 'GANSS-Generic-DataItem' is '0' ('SBAS')
    { ID id-GANSS-SBAS-ID                      CRITICALITY ignore EXTENSION GANSS-SBAS-ID                      PRESENCE optional },
    ...
}

GANSS-GLONASSclockModel ::= SEQUENCE {
    gloTau          BIT STRING (SIZE (22)),
    gloGamma       BIT STRING (SIZE (11)),
    gloDeltaTau    BIT STRING (SIZE (5))          OPTIONAL,
    ie-Extensions  ProtocolExtensionContainer { { GANSS-GLONASSclockModel-ExtIEs } } OPTIONAL,
    ...
}

GANSS-GLONASSclockModel-ExtIEs RNSAP-PROTOCOL-EXTENSION ::= {
    ...
}

GANSS-ID ::= INTEGER(0..7,...)

GANSS-Information ::= SEQUENCE {
    gANSS-CommonDataInfoReq          GANSS-CommonDataInfoReq          OPTIONAL,
    gANSS-GenericDataInfoReqList     GANSS-GenericDataInfoReqList     OPTIONAL,
    ie-Extensions                    ProtocolExtensionContainer { { GANSS-Information-ExtIEs } } OPTIONAL,
    ...
}

GANSS-Information-ExtIEs RNSAP-PROTOCOL-EXTENSION ::= {
    ...
}

GANSS-Ionospheric-Model ::= SEQUENCE {
    alpha-zero-ionos          BIT STRING (SIZE (12)),
    alpha-one-ionos          BIT STRING (SIZE (12)),
    alpha-two-ionos          BIT STRING (SIZE (12)),
    gANSS-IonosphereRegionalStormFlags GANSS-IonosphereRegionalStormFlags          OPTIONAL,
    ie-Extensions            ProtocolExtensionContainer { { GANSS-Ionospheric-Model-ExtIEs } } OPTIONAL,
    ...
}

GANSS-Ionospheric-Model-ExtIEs RNSAP-PROTOCOL-EXTENSION ::= {
    ...
}

GANSS-IonosphereRegionalStormFlags ::= SEQUENCE {
    storm-flag-one          BOOLEAN,
    storm-flag-two         BOOLEAN,
    storm-flag-three       BOOLEAN,
    storm-flag-four        BOOLEAN,
}

```

```

    storm-flag-five          BOOLEAN,
    ie-Extensions            ProtocolExtensionContainer { { GANSS-IonosphereRegionalStormFlags-ExtIEs } } OPTIONAL,
    ...
}

GANSS-IonosphereRegionalStormFlags-ExtIEs RNSAP-PROTOCOL-EXTENSION ::= {
    ...
}

GANSS-NAVclockModel ::= SEQUENCE {
    navToc                   BIT STRING (SIZE (16)),
    navaf2                   BIT STRING (SIZE (8)),
    navaf1                   BIT STRING (SIZE (16)),
    navaf0                   BIT STRING (SIZE (22)),
    navTgd                   BIT STRING (SIZE (8)),
    ie-Extensions            ProtocolExtensionContainer { { GANSS-NAVclockModel-ExtIEs } } OPTIONAL,
    ...
}

GANSS-NAVclockModel-ExtIEs RNSAP-PROTOCOL-EXTENSION ::= {
    ...
}

GANSS-Navigation-Model-And-Time-Recovery ::= SEQUENCE {
    ganss-Transmission-Time GANSS-Transmission-Time,
    non-broadcastIndication ENUMERATED{true} OPTIONAL,
    ganssSatInfoNav         GANSS-Sat-Info-Nav,
    ie-Extensions            ProtocolExtensionContainer { { GANSS-Navigation-Model-And-Time-Recovery-ExtIEs } } OPTIONAL,
    ...
}

GANSS-Navigation-Model-And-Time-Recovery-ExtIEs RNSAP-PROTOCOL-EXTENSION ::= {
    ...
}

GANSS-NavModel-CNAVKeplerianSet ::= SEQUENCE {
    cnavTop                  BIT STRING (SIZE (11)),
    cnavURAindex            BIT STRING (SIZE (5)),
    cnavDeltaA              BIT STRING (SIZE (26)),
    cnavAdot                BIT STRING (SIZE (25)),
    cnavDeltaNo             BIT STRING (SIZE (17)),
    cnavDeltaNoDot          BIT STRING (SIZE (23)),
    cnavMo                  BIT STRING (SIZE (33)),
    cnavE                   BIT STRING (SIZE (33)),
    cnavOmega               BIT STRING (SIZE (33)),
    cnavOMEGA0              BIT STRING (SIZE (33)),
    cnavDeltaOmegaDot       BIT STRING (SIZE (17)),
    cnavIo                  BIT STRING (SIZE (33)),
    cnavIoDot               BIT STRING (SIZE (15)),
    cnavCis                  BIT STRING (SIZE (16)),
    cnavCic                  BIT STRING (SIZE (16)),

```

```

    cnavCrs          BIT STRING (SIZE (24)),
    cnavCrc          BIT STRING (SIZE (24)),
    cnavCus          BIT STRING (SIZE (21)),
    cnavCuc          BIT STRING (SIZE (21)),
    ie-Extensions   ProtocolExtensionContainer { { GANSS-NavModel-CNAVKeplerianSet-ExtIEs } } OPTIONAL,
    ...
}

GANSS-NavModel-CNAVKeplerianSet-ExtIEs RNSAP-PROTOCOL-EXTENSION ::= {
    ...
}

GANSS-NavModel-GLONASsecef ::= SEQUENCE {
    gloEn           BIT STRING (SIZE (5)),
    gloP1           BIT STRING (SIZE (2)),
    gloP2           BIT STRING (SIZE (1)),
    gloM            BIT STRING (SIZE (2))
    OPTIONAL,
    gloX            BIT STRING (SIZE (27)),
    gloXdot         BIT STRING (SIZE (24)),
    gloXdotdot     BIT STRING (SIZE (5)),
    gloY            BIT STRING (SIZE (27)),
    gloYdot        BIT STRING (SIZE (24)),
    gloYdotdot     BIT STRING (SIZE (5)),
    gloZ            BIT STRING (SIZE (27)),
    gloZdot        BIT STRING (SIZE (24)),
    gloZdotdot     BIT STRING (SIZE (5)),
    ie-Extensions   ProtocolExtensionContainer { { GANSS-NavModel-GLONASsecef-ExtIEs } } OPTIONAL,
    ...
}

GANSS-NavModel-GLONASsecef-ExtIEs RNSAP-PROTOCOL-EXTENSION ::= {
    ...
}

GANSS-NavModel-NAVKeplerianSet ::= SEQUENCE {
    navURA         BIT STRING (SIZE (4)),
    navFitFlag      BIT STRING (SIZE (1)),
    navToe          BIT STRING (SIZE (16)),
    navOmega        BIT STRING (SIZE (32)),
    navDeltaN       BIT STRING (SIZE (16)),
    navM0           BIT STRING (SIZE (32)),
    navOmegaADot    BIT STRING (SIZE (24)),
    navE            BIT STRING (SIZE (32)),
    navIDot         BIT STRING (SIZE (14)),
    navAPowerHalf   BIT STRING (SIZE (32)),
    navI0           BIT STRING (SIZE (32)),
    navOmegaA0      BIT STRING (SIZE (32)),
    navCrs          BIT STRING (SIZE (16)),
    navCis          BIT STRING (SIZE (16)),
    navCus          BIT STRING (SIZE (16)),
    navCrc          BIT STRING (SIZE (16)),

```

```

    navCic                BIT STRING (SIZE (16)),
    navCuc                BIT STRING (SIZE (16)),
    ie-Extensions        ProtocolExtensionContainer { { GANSS-NavModel-NAVKeplerianSet-ExtIEs } }           OPTIONAL,
    ...
}

GANSS-NavModel-NAVKeplerianSet-ExtIEs RNSAP-PROTOCOL-EXTENSION ::= {
    ...
}

GANSS-NavModel-SBAscefc ::= SEQUENCE {
    -- the following IE shall be present if 'GANSS-SBASclockModel' in 'GANSS-AddClockModels' is not included in 'Ganss-Sat-Info-AddNavList'
    sbasTo                BIT STRING (SIZE (13))                               OPTIONAL,
    sbasAccuracy          BIT STRING (SIZE (4)),
    sbasXg                BIT STRING (SIZE (30)),
    sbasYg                BIT STRING (SIZE (30)),
    sbasZg                BIT STRING (SIZE (25)),
    sbasXgDot             BIT STRING (SIZE (17)),
    sbasYgDot             BIT STRING (SIZE (17)),
    sbasZgDot             BIT STRING (SIZE (18)),
    sbasXgDotDot          BIT STRING (SIZE (10)),
    sbasYgDotDot          BIT STRING (SIZE (10)),
    sbasZgDotDot          BIT STRING (SIZE (10)),
    ie-Extensions        ProtocolExtensionContainer { { GANSS-NavModel-SBAscefc-ExtIEs } }           OPTIONAL,
    ...
}

GANSS-NavModel-SBAscefc-ExtIEs RNSAP-PROTOCOL-EXTENSION ::= {
    ...
}

GANSS-Orbit-Model ::= CHOICE {
    gANSS-keplerianParameters SEQUENCE {
        toe-nav                BIT STRING (SIZE (14)),
        ganss-omega-nav        BIT STRING (SIZE (32)),
        delta-n-nav            BIT STRING (SIZE (16)),
        m-zero-nav             BIT STRING (SIZE (32)),
        omegadot-nav           BIT STRING (SIZE (24)),
        ganss-e-nav            BIT STRING (SIZE (32)),
        idot-nav                BIT STRING (SIZE (14)),
        a-sqrt-nav             BIT STRING (SIZE (32)),
        i-zero-nav             BIT STRING (SIZE (32)),
        omega-zero-nav         BIT STRING (SIZE (32)),
        c-rs-nav                BIT STRING (SIZE (16)),
        c-is-nav                BIT STRING (SIZE (16)),
        c-us-nav                BIT STRING (SIZE (16)),
        c-rc-nav                BIT STRING (SIZE (16)),
        c-ic-nav                BIT STRING (SIZE (16)),
        c-uc-nav                BIT STRING (SIZE (16)),
        ie-Extensions          ProtocolExtensionContainer { { GANSS-KeplerianParametersOrb-ExtIEs } }           OPTIONAL,
    }
}

```

```

    ...
  },
  ...
}

GANSS-KeplerianParametersOrb-ExtIEs RNSAP-PROTOCOL-EXTENSION ::= {
  ...
}

GANSS-Real-Time-Integrity ::= SEQUENCE (SIZE (1..maxGANSSSat)) OF SEQUENCE {
  bad-ganss-satId          INTEGER(0..63),
  bad-ganss-signalId      BIT STRING(SIZE(8))                                OPTIONAL,
  ie-Extensions           ProtocolExtensionContainer { { GANSS-RealTimeInformationItem-ExtIEs } }  OPTIONAL,
  ...
}

GANSS-RealTimeInformationItem-ExtIEs RNSAP-PROTOCOL-EXTENSION ::= {
  ...
}

GANSS-RX-Pos ::= SEQUENCE {
  latitudeSign             ENUMERATED{north,south},
  degreesOfLatitude       INTEGER(0..2147483647),
  degreesOfLongitude      INTEGER(-2147483648..2147483647),
  directionOfAltitude     ENUMERATED{height,depth},
  altitude                INTEGER(0..32767),
  ie-Extensions           ProtocolExtensionContainer { { GANSS-RX-Pos-ExtIEs } }  OPTIONAL,
  ...
}

GANSS-RX-Pos-ExtIEs RNSAP-PROTOCOL-EXTENSION ::= {
  ...
}

GANSS-SatelliteInformationKP ::= SEQUENCE (SIZE (1..maxGANSSSatAlmanac)) OF SEQUENCE {
  satId                   INTEGER(0..63),
  ganss-e-alm             BIT STRING (SIZE (11)),
  ganss-delta-I-alm       BIT STRING (SIZE (11)),
  ganss-omegadot-alm     BIT STRING (SIZE (11)),
  ganss-svhealth-alm     BIT STRING (SIZE (4)),
  ganss-delta-a-sqrt-alm  BIT STRING (SIZE (17)),
  ganss-omegazero-alm     BIT STRING (SIZE (16)),
  ganss-m-zero-alm        BIT STRING (SIZE (16)),
  ganss-omega-alm         BIT STRING (SIZE (16)),
  ganss-af-zero-alm       BIT STRING (SIZE (14)),
  ganss-af-one-alm        BIT STRING (SIZE (11)),
  ie-Extensions           ProtocolExtensionContainer { { GANSS-SatelliteInformationKPItem-ExtIEs } }  OPTIONAL,

```

```

}
...
}

GANSS-SatelliteInformationKPIItem-ExtIEs RNSAP-PROTOCOL-EXTENSION ::= {
...
}

Ganss-Sat-Info-AddNavList ::= SEQUENCE (SIZE (1..maxGANSSSat)) OF SEQUENCE {
  satId                INTEGER (0..63),
  svHealth             BIT STRING (SIZE (6)),
  iod                 BIT STRING (SIZE (11)),
  ganssAddClockModels GANSS-AddClockModels,
  ganssAddOrbitModels GANSS-AddOrbitModels,
  ie-Extensions       ProtocolExtensionContainer { { Ganss-Sat-Info-AddNavList-ExtIEs } } OPTIONAL,
  ...
}

Ganss-Sat-Info-AddNavList-ExtIEs RNSAP-PROTOCOL-EXTENSION ::= {
...
}

GANSS-SAT-Info-Almanac-GLOkpList ::= SEQUENCE (SIZE (1.. maxGANSSSatAlmanac)) OF SEQUENCE {
  gloAlmNA             BIT STRING (SIZE(11)),
  gloAlmNA             BIT STRING (SIZE(5)),
  gloAlmHA             BIT STRING (SIZE(5)),
  gloAlmLambdaA       BIT STRING (SIZE(21)),
  gloAlmTlambdAA      BIT STRING (SIZE(21)),
  gloAlmDeltaIA       BIT STRING (SIZE(18)),
  gloAlmDeltaTA       BIT STRING (SIZE(22)),
  gloAlmDeltaTdotA    BIT STRING (SIZE(7)),
  gloAlmEpsilonA      BIT STRING (SIZE(15)),
  gloAlmOmegaA        BIT STRING (SIZE(16)),
  gloAlmTauA          BIT STRING (SIZE(10)),
  gloAlmCA            BIT STRING (SIZE(1)),
  gloAlmMA            BIT STRING (SIZE(2))
  OPTIONAL,
  ie-Extensions       ProtocolExtensionContainer { { GANSS-SAT-Info-Almanac-GLOkp-ExtIEs } } OPTIONAL,
  ...
}

GANSS-SAT-Info-Almanac-GLOkp-ExtIEs RNSAP-PROTOCOL-EXTENSION ::= {
...
}

GANSS-SAT-Info-Almanac-MIDIkpList ::= SEQUENCE (SIZE (1.. maxGANSSSatAlmanac)) OF SEQUENCE {
  svID                INTEGER(0..63),
  midiAlmE            BIT STRING (SIZE (11)),
  midiAlmDeltaI       BIT STRING (SIZE (11)),
  midiAlmOmegaDot     BIT STRING (SIZE (11)),

```



```

    midiAlmSqrtA          BIT STRING (SIZE (17)),
    midiAlmOmega0         BIT STRING (SIZE (16)),
    midiAlmOmega          BIT STRING (SIZE (16)),
    midiAlmMo             BIT STRING (SIZE (16)),
    midiAlmaf0            BIT STRING (SIZE (11)),
    midiAlmaf1            BIT STRING (SIZE (10)),
    midiAlmL1Health       BIT STRING (SIZE (1)),
    midiAlmL2Health       BIT STRING (SIZE (1)),
    midiAlmL5Health       BIT STRING (SIZE (1)),
    ie-Extensions         ProtocolExtensionContainer { { GANSS-SAT-Info-Almanac-MIDIkp-ExtIEs } } OPTIONAL,
    ...
}

GANSS-SAT-Info-Almanac-MIDIkp-ExtIEs RNSAP-PROTOCOL-EXTENSION ::= {
    ...
}

GANSS-SAT-Info-Almanac-NAVkpList ::= SEQUENCE (SIZE (1.. maxGANSSSatAlmanac)) OF SEQUENCE {
    svID                  INTEGER(0..63),
    navAlmE               BIT STRING (SIZE (16)),
    navAlmDeltaI          BIT STRING (SIZE (16)),
    navAlmOMEGADOT        BIT STRING (SIZE (16)),
    navAlmSVHealth        BIT STRING (SIZE (8)),
    navAlmSqrtA           BIT STRING (SIZE (24)),
    navAlmOMEGAO           BIT STRING (SIZE (24)),
    navAlmOmega            BIT STRING (SIZE (24)),
    navAlmMo              BIT STRING (SIZE (24)),
    navAlmaf0             BIT STRING (SIZE (11)),
    navAlmaf1             BIT STRING (SIZE (11)),
    ie-Extensions         ProtocolExtensionContainer { { GANSS-SAT-Info-Almanac-NAVkp-ExtIEs } } OPTIONAL,
    ...
}

GANSS-SAT-Info-Almanac-NAVkp-ExtIEs RNSAP-PROTOCOL-EXTENSION ::= {
    ...
}

GANSS-SAT-Info-Almanac-REDkpList ::= SEQUENCE (SIZE (1.. maxGANSSSatAlmanac)) OF SEQUENCE {
    svID                  INTEGER(0..63),
    redAlmDeltaA          BIT STRING (SIZE (8)),
    redAlmOmega0          BIT STRING (SIZE (7)),
    redAlmPhi0            BIT STRING (SIZE (7)),
    redAlmL1Health        BIT STRING (SIZE (1)),
    redAlmL2Health        BIT STRING (SIZE (1)),
    redAlmL5Health        BIT STRING (SIZE (1)),
    ie-Extensions         ProtocolExtensionContainer { { GANSS-SAT-Info-Almanac-REDkp-ExtIEs } } OPTIONAL,
    ...
}

```

```

GANSS-SAT-Info-Almanac-REDkp-ExtIEs RNSAP-PROTOCOL-EXTENSION ::= {
    ...
}

GANSS-SAT-Info-Almanac-SBAscefcList ::= SEQUENCE (SIZE (1.. maxGANSSSatAlmanac)) OF SEQUENCE {
    sbasAlmDataID      BIT STRING (SIZE(2)),
    svID               INTEGER(0..63),
    sbasAlmHealth     BIT STRING (SIZE(8)),
    sbasAlmXg         BIT STRING (SIZE(15)),
    sbasAlmYg         BIT STRING (SIZE(15)),
    sbasAlmZg         BIT STRING (SIZE(9)),
    sbasAlmXgdot      BIT STRING (SIZE(3)),
    sbasAlmYgdot      BIT STRING (SIZE(3)),
    sbasAlmZgdot      BIT STRING (SIZE(4)),
    sbasAlmTo         BIT STRING (SIZE(11)),
    ie-Extensions     ProtocolExtensionContainer { { GANSS-SAT-Info-Almanac-SBAscefc-ExtIEs } } OPTIONAL,
    ...
}

GANSS-SAT-Info-Almanac-SBAscefc-ExtIEs RNSAP-PROTOCOL-EXTENSION ::= {
    ...
}

GANSS-Sat-Info-Nav ::= SEQUENCE (SIZE(1..maxGANSSSat)) OF SEQUENCE {
    satId              INTEGER(0..63),
    svHealth           BIT STRING (SIZE(5)),
    iod                BIT STRING (SIZE(10)),
    ganssClockModel    GANSS-Clock-Model,
    ganssOrbitModel     GANSS-Orbit-Model,
    ie-Extensions     ProtocolExtensionContainer { { GANSS-Sat-Info-Nav-ExtIEs } } OPTIONAL,
    ...
}

GANSS-Sat-Info-Nav-ExtIEs RNSAP-PROTOCOL-EXTENSION ::= {
    ...
}

GANSS-SBAS-ID ::= ENUMERATED {
    waas,
    egnos,
    msas,
    gagan,
    ...
}

GANSS-SBASclockModel ::= SEQUENCE {
    sbasTo             BIT STRING (SIZE (13)),
    sbasAgfo           BIT STRING (SIZE (12)),
}

```

```

    sbasAgf1                BIT STRING (SIZE (8)),
    ie-Extensions           ProtocolExtensionContainer { { GANSS-SBASclockModel-ExtIEs } } OPTIONAL,
    ...
}

GANSS-SBASclockModel-ExtIEs RNSAP-PROTOCOL-EXTENSION ::= {
    ...
}

GANSS-Signal-ID ::= INTEGER(0..7,...)

GANSS-StatusHealth ::= ENUMERATED {
    udre-scale-1dot0,
    udre-scale-0dot75,
    udre-scale-0dot5,
    udre-scale-0dot3,
    udre-scale-0dot2,
    udre-scale-0dot1,
    no-data,
    invalid-data
}

GANSS-Time-ID ::= INTEGER(0..7,...)

GANSS-Time-Model ::= SEQUENCE {
    ganss-time-model-Ref-Time    INTEGER(0..37799),
    ganss-t-a0                   INTEGER(-2147483648..2147483647),
    ganss-t-a1                   INTEGER(-8388608..8388607)                OPTIONAL,
    ganss-t-a2                   INTEGER(-64..63)                        OPTIONAL,
    gnss-to-id                   ENUMERATED{gps,...,galileo,qzss,glonass},
    ganss-wk-number              INTEGER(0..8191)                        OPTIONAL,
    ie-Extensions                ProtocolExtensionContainer { { GANSS-Time-Model-ExtIEs } } OPTIONAL,
    ...
}

GANSS-Time-Model-ExtIEs RNSAP-PROTOCOL-EXTENSION ::= {
    ...
}

GANSS-Transmission-Time ::= SEQUENCE {
    ganssDay                     INTEGER(0..8191)
    OPTIONAL,
    ganssTod                     INTEGER(0..86399),
    ie-Extensions                ProtocolExtensionContainer { { GANSS-Transmission-Time-ExtIEs } }
    OPTIONAL,
    ...
}

GANSS-Transmission-Time-ExtIEs RNSAP-PROTOCOL-EXTENSION ::= {
    ...
}

```

```

}

GANSS-UTC-Model ::= SEQUENCE {
    a-one-utc          BIT STRING (SIZE (24)),
    a-zero-utc         BIT STRING (SIZE (32)),
    t-ot-utc           BIT STRING (SIZE (8)),
    w-n-t-utc          BIT STRING (SIZE (8)),
    delta-t-ls-utc     BIT STRING (SIZE (8)),
    w-n-lsf-utc        BIT STRING (SIZE (8)),
    dn-utc              BIT STRING (SIZE (8)),
    delta-t-lsf-utc    BIT STRING (SIZE (8)),
    ie-Extensions      ProtocolExtensionContainer { { GANSS-UTC-Model-ExtIEs } } OPTIONAL,
    ...
}

GANSS-UTC-Model-ExtIEs RNSAP-PROTOCOL-EXTENSION ::= {
    ...
}

GANSS-UTCmodelSet1 ::= SEQUENCE {
    utcA0              BIT STRING (SIZE(16)),
    utcA1              BIT STRING (SIZE(13)),
    utcA2              BIT STRING (SIZE(7)),
    utcDeltaTls        BIT STRING (SIZE(8)),
    utcTot             BIT STRING (SIZE(16)),
    utcWNot            BIT STRING (SIZE(13)),
    utcWNlsf           BIT STRING (SIZE(8)),
    utcDN              BIT STRING (SIZE(4)),
    utcDeltaTlsf       BIT STRING (SIZE(8)),
    ie-Extensions      ProtocolExtensionContainer { { GANSS-UTCmodelSet1-ExtIEs } } OPTIONAL,
    ...
}

GANSS-UTCmodelSet1-ExtIEs RNSAP-PROTOCOL-EXTENSION ::= {
    ...
}

GANSS-UTCmodelSet2 ::= SEQUENCE {
    nA                 BIT STRING (SIZE(11)),
    tauC               BIT STRING (SIZE(32)),
    deltaUT1           GANSS-DeltaUT1 OPTIONAL,
    kp                 BIT STRING (SIZE(2)) OPTIONAL,
    ie-Extensions      ProtocolExtensionContainer { { GANSS-UTCmodelSet2-ExtIEs } } OPTIONAL,
    ...
}

GANSS-UTCmodelSet2-ExtIEs RNSAP-PROTOCOL-EXTENSION ::= {
    ...
}

GANSS-UTCmodelSet3 ::= SEQUENCE {

```

```

    utcAlwnt          BIT STRING (SIZE(24)),
    utcA0wnt          BIT STRING (SIZE(32)),
    utcTot            BIT STRING (SIZE(8)),
    utcWnt           BIT STRING (SIZE(8)),
    utcDeltaTls      BIT STRING (SIZE(8)),
    utcWNlsf         BIT STRING (SIZE(8)),
    utcDN            BIT STRING (SIZE(8)),
    utcDeltaTlsf     BIT STRING (SIZE(8)),
    utcStandardID    BIT STRING (SIZE(3)),
    ie-Extensions    ProtocolExtensionContainer { { GANSS-UTCmodelSet3-ExtIEs } } OPTIONAL,
    ...
}

GANSS-UTCmodelSet3-ExtIEs RNSAP-PROTOCOL-EXTENSION ::= {
    ...
}

GA-PointWithAltitude ::= SEQUENCE {
    geographicalCoordinates    GeographicalCoordinate,
    altitudeAndDirection      GA-AltitudeAndDirection,
    iE-Extensions             ProtocolExtensionContainer { { GA-PointWithAltitude-ExtIEs } } OPTIONAL,
    ...
}

GA-PointWithAltitude-ExtIEs RNSAP-PROTOCOL-EXTENSION ::= {
    ...
}

GA-PointWithAltitudeAndUncertaintyEllipsoid ::= SEQUENCE {
    geographicalCoordinates    GeographicalCoordinate,
    altitudeAndDirection      GA-AltitudeAndDirection,
    uncertaintyEllipse         GA-UncertaintyEllipse,
    uncertaintyAltitude       INTEGER (0..127),
    confidence                 INTEGER (0..127),
    iE-Extensions             ProtocolExtensionContainer { { GA-PointWithAltitudeAndUncertaintyEllipsoid-ExtIEs } } OPTIONAL,
    ...
}

GA-PointWithAltitudeAndUncertaintyEllipsoid-ExtIEs RNSAP-PROTOCOL-EXTENSION ::= {
    ...
}

GA-PointWithUnCertaintyEllipse ::= SEQUENCE {
    geographicalCoordinates    GeographicalCoordinate,
    uncertaintyEllipse         GA-UncertaintyEllipse,
    confidence                 INTEGER (0..127),
    iE-Extensions             ProtocolExtensionContainer { { GA-PointWithUnCertaintyEllipse-ExtIEs } } OPTIONAL,
    ...
}

GA-PointWithUnCertaintyEllipse-ExtIEs RNSAP-PROTOCOL-EXTENSION ::= {
    ...
}

```

```

GA-UncertaintyEllipse ::= SEQUENCE {
    uncertaintySemi-major      INTEGER (0..127),
    uncertaintySemi-minor      INTEGER (0..127),
    orientationOfMajorAxis     INTEGER (0..179),    -- The values 90..179 shall not be used.
    ...
}

GA-PointWithUnCertainty ::=SEQUENCE {
    geographicalCoordinates     GeographicalCoordinate,
    uncertaintyCode             INTEGER (0..127),
    iE-Extensions              ProtocolExtensionContainer { {GA-PointWithUnCertainty-ExtIEs} } OPTIONAL,
    ...
}

GA-PointWithUnCertainty-ExtIEs RNSAP-PROTOCOL-EXTENSION ::= {
    ...
}

GA-AccessPointPosition ::= SEQUENCE {
    geographicalCoordinate      GeographicalCoordinate,
    iE-Extensions              ProtocolExtensionContainer { {GA-AccessPoint-ExtIEs} } OPTIONAL,
    ...
}

GA-AccessPoint-ExtIEs RNSAP-PROTOCOL-EXTENSION ::= {
    ...
}

GeographicalCoordinate ::= SEQUENCE {
    latitudeSign                ENUMERATED { north, south },
    latitude                    INTEGER (0..8388607),
    longitude                   INTEGER (-8388608..8388607),
    iE-Extensions              ProtocolExtensionContainer { {GeographicalCoordinate-ExtIEs} } OPTIONAL,
    ...
}

GeographicalCoordinate-ExtIEs RNSAP-PROTOCOL-EXTENSION ::= {
    ...
}

GERAN-Cell-Capability ::=  BIT STRING (SIZE (16))
-- First bit:  A/Gb mode --
-- Second bit:  Iu mode  --
-- Note: undefined bits are considered as a spare bit and spare bits shall be set to 0 by the transmitter and shall be ignored by the receiver. --

GERAN-Classmark ::=          OCTET STRING
-- GERAN Classmark as defined in (38) --

GERAN-SI-Type ::= CHOICE {
    sI                        GERAN-SystemInfo,
    pSI                       GERAN-SystemInfo,
    ...
}

```

```

GERAN-SystemInfo ::= SEQUENCE (SIZE (1..maxNrOfGERANSI)) OF
    SEQUENCE {
        gERAN-SI-block      OCTET STRING (SIZE (1..23)),
        iE-Extensions       ProtocolExtensionContainer { { GERAN-SystemInfo-ExtIEs } }      OPTIONAL,
        ...
    }

GERAN-SystemInfo-ExtIEs RNSAP-PROTOCOL-EXTENSION ::= {
    ...
}

GenericTrafficCategory ::= BIT STRING (SIZE (8))

GPS-Almanac ::= SEQUENCE {
    wna-alm          BIT STRING (SIZE (8)),
    satellite-Almanac-Information SEQUENCE (SIZE (1..maxNoSat)) OF
        SEQUENCE {
            dATA-ID          DATA-ID,
            sAT-ID           SAT-ID,
            gps-e-alm        BIT STRING (SIZE (16)),
            gps-toa-alm      BIT STRING (SIZE (8)),
            gps-delta-I-alm  BIT STRING (SIZE (16)),
            omegadot-alm     BIT STRING (SIZE (16)),
            svhealth-alm     BIT STRING (SIZE (8)),
            gps-a-sqrt-alm   BIT STRING (SIZE (24)),
            omegazero-alm    BIT STRING (SIZE (24)),
            m-zero-alm       BIT STRING (SIZE (24)),
            gps-omega-alm    BIT STRING (SIZE (24)),
            gps-af-zero-alm  BIT STRING (SIZE (11)),
            gps-af-one-alm   BIT STRING (SIZE (11)),
            iE-Extensions    ProtocolExtensionContainer { { Satellite-Almanac-Information-ExtIEs } }      OPTIONAL,
            ...
        },
    -- This GPS-Almanac-Information is for the 1st 16 satellites
    sVGlobalHealth-alm     BIT STRING (SIZE (364))      OPTIONAL,
    iE-Extensions          ProtocolExtensionContainer { { GPS-Almanac-ExtIEs } }      OPTIONAL,
    ...
}

Satellite-Almanac-Information-ExtIEs RNSAP-PROTOCOL-EXTENSION ::= {
    ...
}

GPS-Almanac-ExtIEs RNSAP-PROTOCOL-EXTENSION ::= {
    { ID id-Satellite-Almanac-Information-ExtItem CRITICALITY ignore      EXTENSION  Satellite-Almanac-Information-ExtItem
    PRESENCE optional},
    ...
}

Satellite-Almanac-Information-ExtItem ::= SEQUENCE (SIZE (1..maxNrOfSatAlmanac-maxNoSat)) OF
    SEQUENCE {
        dATA-ID          DATA-ID,
        sAT-ID           SAT-ID,
    }

```

```

    gps-e-alm          BIT STRING (SIZE (16)),
    gps-toa-alm       BIT STRING (SIZE (8)),
    gps-delta-I-alm   BIT STRING (SIZE (16)),
    omegadot-alm      BIT STRING (SIZE (16)),
    svhealth-alm      BIT STRING (SIZE (8)),
    gps-a-sqrt-alm    BIT STRING (SIZE (24)),
    omegazero-alm     BIT STRING (SIZE (24)),
    m-zero-alm        BIT STRING (SIZE (24)),
    gps-omega-alm     BIT STRING (SIZE (24)),
    gps-af-zero-alm   BIT STRING (SIZE (11)),
    gps-af-one-alm    BIT STRING (SIZE (11)),
    iE-Extensions     ProtocolExtensionContainer { { Satellite-Almanac-Information-ExtItemIEs } } OPTIONAL,
    ...
}
-- Includes the GPS-Almanac-Information for the 17th through 32nd satellites.

Satellite-Almanac-Information-ExtItemIEs RNSAP-PROTOCOL-EXTENSION ::= {
    ...
}

GPSInformation ::= SEQUENCE (SIZE (1..maxNoGPSTypes)) OF
    SEQUENCE {
        gpsInformationItem      ENUMERATED {
            gps-NavigationModel-and-TimeRecovery,
            gps-Ionospheric-Model,
            gps-UTC-Model,
            gps-Almanac,
            gps-RealTime-Integrity,
            ...
        },
        iE-Extensions           ProtocolExtensionContainer { { GPSInformation-ExtIEs } } OPTIONAL,
        ...
    }
-- This IE shall be present if the Information Type IE indicates 'GPS Information'

GPSInformation-ExtIEs RNSAP-PROTOCOL-EXTENSION ::= {
    ...
}

GPS-Ionospheric-Model ::= SEQUENCE {
    alpha-zero-ionos          BIT STRING (SIZE (8)),
    alpha-one-ionos           BIT STRING (SIZE (8)),
    alpha-two-ionos           BIT STRING (SIZE (8)),
    alpha-three-ionos         BIT STRING (SIZE (8)),
    beta-zero-ionos           BIT STRING (SIZE (8)),
    beta-one-ionos            BIT STRING (SIZE (8)),
    beta-two-ionos            BIT STRING (SIZE (8)),
    beta-three-ionos          BIT STRING (SIZE (8)),
    iE-Extensions             ProtocolExtensionContainer { { GPS-Ionospheric-Model-ExtIEs } } OPTIONAL,
    ...
}

GPS-Ionospheric-Model-ExtIEs RNSAP-PROTOCOL-EXTENSION ::= {
    ...
}

```



```

}

GPS-NavigationModel-and-TimeRecovery ::= SEQUENCE (SIZE (1..maxNoSat)) OF
  SEQUENCE {
    tx-tow-nav                INTEGER (0..1048575),
    sAT-ID                    SAT-ID,
    tlm-message-nav          BIT STRING (SIZE (14)),
    tlm-revd-c-nav           BIT STRING (SIZE (2)),
    ho-word-nav               BIT STRING (SIZE (22)),
    w-n-nav                   BIT STRING (SIZE (10)),
    ca-or-p-on-l2-nav        BIT STRING (SIZE (2)),
    user-range-accuracy-index-nav BIT STRING (SIZE (4)),
    sv-health-nav            BIT STRING (SIZE (6)),
    iodc-nav                  BIT STRING (SIZE (10)),
    l2-p-dataflag-nav        BIT STRING (SIZE (1)),
    sfl-reserved-nav         BIT STRING (SIZE (87)),
    t-gd-nav                  BIT STRING (SIZE (8)),
    t-oc-nav                  BIT STRING (SIZE (16)),
    a-f-2-nav                 BIT STRING (SIZE (8)),
    a-f-1-nav                 BIT STRING (SIZE (16)),
    a-f-zero-nav              BIT STRING (SIZE (22)),
    c-rs-nav                  BIT STRING (SIZE (16)),
    delta-n-nav               BIT STRING (SIZE (16)),
    m-zero-nav                BIT STRING (SIZE (32)),
    c-uc-nav                  BIT STRING (SIZE (16)),
    gps-e-nav                 BIT STRING (SIZE (32)),
    c-us-nav                  BIT STRING (SIZE (16)),
    a-sqrt-nav                BIT STRING (SIZE (32)),
    t-oe-nav                  BIT STRING (SIZE (16)),
    fit-interval-flag-nav     BIT STRING (SIZE (1)),
    aodo-nav                  BIT STRING (SIZE (5)),
    c-ic-nav                  BIT STRING (SIZE (16)),
    omega-zero-nav            BIT STRING (SIZE (32)),
    c-is-nav                  BIT STRING (SIZE (16)),
    i-zero-nav                BIT STRING (SIZE (32)),
    c-rc-nav                  BIT STRING (SIZE (16)),
    gps-omega-nav             BIT STRING (SIZE (32)),
    omegadot-nav              BIT STRING (SIZE (24)),
    idot-nav                  BIT STRING (SIZE (14)),
    spare-zero-fill           BIT STRING (SIZE (20)),
    iE-Extensions             ProtocolExtensionContainer { { GPS-NavigationModel-and-TimeRecoveryItem-ExtIEs } }
    ...
  }

GPS-NavigationModel-and-TimeRecoveryItem-ExtIEs RNSAP-PROTOCOL-EXTENSION ::= {
  ...
}

GPS-RealTime-Integrity ::= CHOICE {
  badSatellites              BadSatellites,
  noBadSatellite             NULL
}

GPS-RX-POS ::= SEQUENCE {

```

```

    geographicalCoordinate      GeographicalCoordinate,
    altitudeAndDirection        GA-AltitudeAndDirection,
    iE-Extensions                ProtocolExtensionContainer { { GPS-RX-POS-ExtIEs } } OPTIONAL,
    ...
}

GPS-RX-POS-ExtIEs RNSAP-PROTOCOL-EXTENSION ::= {
    ...
}

GPS-Status-Health ::= ENUMERATED {
    udre-1-0,
    udre-0-75,
    udre-0-5,
    udre-0-3,
    udre-0-1,
    no-data,
    invalid-data
}

GPSTOW ::= INTEGER (0..604799)

GPS-UTC-Model ::= SEQUENCE {
    a-one-utc          BIT STRING (SIZE (24)),
    a-zero-utc         BIT STRING (SIZE (32)),
    t-ot-utc           BIT STRING (SIZE (8)),
    delta-t-ls-utc     BIT STRING (SIZE (8)),
    w-n-t-utc          BIT STRING (SIZE (8)),
    w-n-lsf-utc        BIT STRING (SIZE (8)),
    dn-utc             BIT STRING (SIZE (8)),
    delta-t-lsf-utc    BIT STRING (SIZE (8)),
    iE-Extensions      ProtocolExtensionContainer { { GPS-UTC-Model-ExtIEs } } OPTIONAL,
    ...
}

GPS-UTC-Model-ExtIEs RNSAP-PROTOCOL-EXTENSION ::= {
    ...
}

Guaranteed-Rate-Information ::= SEQUENCE {
    guaranteed-UL-Rate    Guaranteed-Rate OPTIONAL,
    guaranteed-DL-Rate    Guaranteed-Rate OPTIONAL,
    iE-Extensions         ProtocolExtensionContainer { { Guaranteed-Rate-Information-ExtIEs } } OPTIONAL,
    ...
}

Guaranteed-Rate-Information-ExtIEs RNSAP-PROTOCOL-EXTENSION ::= {
    ...
}

Guaranteed-Rate ::= INTEGER (1..maxNrOfTFs)
-- "1": TFI 0, "2": TFI 1, "3": TFI 2, ...

-- H

```

```

HARQ-Info-for-E-DCH ::= ENUMERATED {
    rv0,
    rvtable
}

HARQ-MemoryPartitioning ::= CHOICE {
    implicit      HARQ-MemoryPartitioning-Implicit,
    explicit      HARQ-MemoryPartitioning-Explicit,
    ...
}

HARQ-MemoryPartitioning-Implicit ::= SEQUENCE {
    number-of-Processes      INTEGER (1..8,...,12|14|16),
    iE-Extensions            ProtocolExtensionContainer { { HARQ-MemoryPartitioning-Implicit-ExtIEs } }      OPTIONAL,
    ...
}

HARQ-MemoryPartitioning-Implicit-ExtIEs RNSAP-PROTOCOL-EXTENSION ::= {
    ...
}

HARQ-MemoryPartitioning-Explicit ::= SEQUENCE {
    HARQ-MemoryPartitioningList      HARQ-MemoryPartitioningList,
    iE-Extensions                    ProtocolExtensionContainer { { HARQ-MemoryPartitioning-Explicit-ExtIEs } }      OPTIONAL,
    ...
}

HARQ-MemoryPartitioning-Explicit-ExtIEs RNSAP-PROTOCOL-EXTENSION ::= {
    {ID id-HARQ-MemoryPartitioningInfoExtForMIMO      CRITICALITY ignore      EXTENSION HARQ-MemoryPartitioningInfoExtForMIMO PRESENCE optional},
    ...
}

HARQ-MemoryPartitioningList ::= SEQUENCE (SIZE (1..maxNrOfHARQProc)) OF HARQ-MemoryPartitioningItem

HARQ-MemoryPartitioningInfoExtForMIMO ::= SEQUENCE (SIZE (4|6|8)) OF HARQ-MemoryPartitioningItem

HARQ-MemoryPartitioningItem ::= SEQUENCE {
    process-Memory-Size      ENUMERATED {
        hms800, hms1600, hms2400, hms3200, hms4000,
        hms4800, hms5600, hms6400, hms7200, hms8000,
        hms8800, hms9600, hms10400, hms11200, hms12000,
        hms12800, hms13600, hms14400, hms15200, hms16000,
        hms17600, hms19200, hms20800, hms22400, hms24000,
        hms25600, hms27200, hms28800, hms30400, hms32000,
        hms36000, hms40000, hms44000, hms48000, hms52000,
        hms56000, hms60000, hms64000, hms68000, hms72000,
        hms76000, hms80000, hms88000, hms96000, hms104000,
        hms112000, hms120000, hms128000, hms136000, hms144000,
        hms152000, hms160000, hms176000, hms192000, hms208000,
        hms224000, hms240000, hms256000, hms272000, hms288000,
        hms304000,...},
    iE-Extensions            ProtocolExtensionContainer { { HARQ-MemoryPartitioningItem-ExtIEs } }      OPTIONAL,
    ...
}

```

```

}

HARQ-MemoryPartitioningItem-ExtIEs RNSAP-PROTOCOL-EXTENSION ::= {
  ...
}

HARQ-Preamble-Mode ::= ENUMERATED {
  mode0,
  mode1
}

HARQ-Process-Allocation-2ms-EDCH ::= BIT STRING ( SIZE(maxNrOfEDCHHARQProcesses2msEDCH) )

HARQ-Preamble-Mode-Activation-Indicator ::=ENUMERATED {
  harqPreambleModeSupported
}

HCS-Prio ::= INTEGER (0..7)
-- 0 = lowest priority, ...7 = highest priority

HSDSCH-Configured-Indicator ::= ENUMERATED {
  configured-HS-DSCH,
  no-configured-HS-DSCH
}

HSDSCH-FDD-Information ::= SEQUENCE {
  hSDSCH-MACdFlows-Information          HSDSCH-MACdFlows-Information,
  uE-Capabilities-Info                 UE-Capabilities-Info,
  mACHs-Reordering-Buffer-Size-for-RLC-UM MACHsReorderingBufferSize-for-RLC-UM,
  cqiFeedback-CycleK                  CQI-Feedback-Cycle,
  cqiRepetitionFactor                 CQI-RepetitionFactor          OPTIONAL,
  -- This IE shall be present if the CQI Feedback Cycle k IE is set to a value greater than 0.
  ackNackRepetitionFactor             AckNack-RepetitionFactor,
  cqiPowerOffset                      CQI-Power-Offset,
  ackPowerOffset                      Ack-Power-Offset,
  nackPowerOffset                     Nack-Power-Offset,
  hsscch-PowerOffset                  HSSCCH-PowerOffset          OPTIONAL,
  iE-Extensions                       ProtocolExtensionContainer { { HSDSCH-FDD-Information-ExtIEs } } OPTIONAL,
  ...
}

HSDSCH-FDD-Information-ExtIEs RNSAP-PROTOCOL-EXTENSION ::= {
{ ID id-HARQ-Preamble-Mode              CRITICALITY ignore EXTENSION HARQ-Preamble-Mode
  PRESENCE optional}|
{ ID id-MIMO-ActivationIndicator        CRITICALITY reject EXTENSION MIMO-ActivationIndicator
  PRESENCE optional}|
{ ID id-HSDSCH-MACdPDUSizeFormat       CRITICALITY reject EXTENSION HSDSCH-MACdPDUSizeFormat
  PRESENCE optional}|
{ ID id-SixtyfourQAM-UsageAllowedIndicator CRITICALITY ignore EXTENSION SixtyfourQAM-UsageAllowedIndicator
  optional}|
{ ID id-UE-with-enhanced-HS-SCCH-support-indicator CRITICALITY ignore EXTENSION NULL
  PRESENCE optional}|
{ ID id-EnhancedHSServingCC-Abort      CRITICALITY reject EXTENSION EnhancedHSServingCC-Abort
  PRESENCE optional}|

```

```

{ ID id-UE-SupportIndicatorExtension          CRITICALITY ignore EXTENSION UE-SupportIndicatorExtension
  PRESENCE optional}|
{ ID id-power-offset-for-S-CPICH-for-MIMO-Request-Indicator    CRITICALITY ignore EXTENSION PowerOffsetForSecondaryCPICHforMIMORequestIndicator
  PRESENCE optional}|
{ ID id-Single-Stream-MIMO-ActivationIndicator    CRITICALITY reject EXTENSION Single-Stream-MIMO-ActivationIndicator          PRESENCE
optional},
  ...
}

HSDSCH-FDD-Information-Response ::= SEQUENCE {
  hSDSCH-MACdFlow-Specific-InfoList-Response    HSDSCH-MACdFlow-Specific-InfoList-Response
    OPTIONAL,
  hSSCCH-Specific-InfoList-Response            HSSCCH-FDD-Specific-InfoList-Response
    OPTIONAL,
  hSPDSCH-and-HSSCCH-ScramblingCode           DL-ScramblingCode
    OPTIONAL,
  measurement-Power-Offset                    Measurement-Power-Offset
    OPTIONAL,
  hARQ-MemoryPartitioning                     HARQ-MemoryPartitioning
    OPTIONAL,
  iE-Extensions                               ProtocolExtensionContainer { { HSDSCH-FDD-Information-Response-ExtIEs } }
    ...
}

HSDSCH-FDD-Information-Response-ExtIEs RNSAP-PROTOCOL-EXTENSION ::= {
{ ID id-User-Plane-Congestion-Fields-Inclusion    CRITICALITY ignore EXTENSION User-Plane-Congestion-Fields-Inclusion          PRESENCE
optional}|
{ ID id-HARQ-Preamble-Mode-Activation-Indicator    CRITICALITY ignore EXTENSION HARQ-Preamble-Mode-Activation-Indicator          PRESENCE
optional}|
{ ID id-MIMO-InformationResponse                CRITICALITY ignore EXTENSION MIMO-InformationResponse          PRESENCE
optional}|
{ ID id-SixtyfourQAM-DL-UsageIndicator           CRITICALITY ignore EXTENSION SixtyfourQAM-DL-UsageIndicator          PRESENCE
optional}|
{ ID id-HSDSCH-TBSizeTableIndicator             CRITICALITY ignore EXTENSION HSDSCH-TBSizeTableIndicator          PRESENCE
optional}|
{ ID id-power-offset-for-S-CPICH-for-MIMO        CRITICALITY ignore EXTENSION PowerOffsetForSecondaryCPICHforMIMO          PRESENCE
optional}|
{ ID id-Support-of-Dynamic-DTXDRX-Related-HS-SCCH-Order CRITICALITY ignore EXTENSION Support-of-Dynamic-DTXDRX-Related-HS-SCCH-Order PRESENCE
optional},
  ...
}

HS-DSCH-FDD-Secondary-Serving-Information ::= SEQUENCE {
  hsscch-PowerOffset                            HSSCCH-PowerOffset                                OPTIONAL,
  sixtyfourQAM-UsageAllowedIndicator            SixtyfourQAM-UsageAllowedIndicator                OPTIONAL,
  iE-Extensions                               ProtocolExtensionContainer { { HS-DSCH-FDD-Secondary-Serving-Information-ExtIEs } }
    OPTIONAL,
  ...
}

HS-DSCH-FDD-Secondary-Serving-Information-ExtIEs RNSAP-PROTOCOL-EXTENSION ::= {
{ID id-MIMO-ActivationIndicator                CRITICALITY reject EXTENSION MIMO-ActivationIndicator          PRESENCE optional}|
{ID id-Single-Stream-MIMO-ActivationIndicator    CRITICALITY reject EXTENSION Single-Stream-MIMO-ActivationIndicator PRESENCE optional}|
{ID id-DiversityMode                           CRITICALITY reject EXTENSION DiversityMode                    PRESENCE optional}|
}

```

```

{ID id-TransmitDiversityIndicator          CRITICALITY reject  EXTENSION TransmitDiversityIndicator          PRESENCE optional}|
{ID id-power-offset-for-S-CPICH-for-MIMO-Request-Indicator  CRITICALITY ignore  EXTENSION PowerOffsetForSecondaryCPICHforMIMORequestIndicator
  PRESENCE optional},
...
}

HS-DSCH-FDD-Secondary-Serving-Information-Response ::= SEQUENCE {
  hSSCCH-Specific-InfoList-Response      HSSCCH-FDD-Specific-InfoList-Response      OPTIONAL,
  hSPDSCH-and-HSSCCH-ScramblingCode      DL-ScramblingCode                          OPTIONAL,
  measurement-Power-Offset               Measurement-Power-Offset                    OPTIONAL,
  sixtyfourQAM-DL-UsageIndicator         SixtyfourQAM-DL-UsageIndicator             OPTIONAL,
  hSDSCH-TBSizeTableIndicator            HSDSCH-TBSizeTableIndicator               OPTIONAL,
  IE-Extensions                          ProtocolExtensionContainer { { HS-DSCH-FDD-Secondary-Serving-Information-Respons-ExtIEs } }
  OPTIONAL,
  ...
}

HS-DSCH-FDD-Secondary-Serving-Information-Respons-ExtIEs RNSAP-PROTOCOL-EXTENSION ::= {
{ID id-MIMO-InformationResponse          CRITICALITY ignore  EXTENSION MIMO-InformationResponse          PRESENCE optional}|
{ID id-power-offset-for-S-CPICH-for-MIMO  CRITICALITY ignore  EXTENSION PowerOffsetForSecondaryCPICHforMIMO  PRESENCE optional},
...
}

HS-DSCH-Secondary-Serving-Information-To-Modify ::= SEQUENCE {
  hsscch-PowerOffset                    HSSCCH-PowerOffset                    OPTIONAL,
  hSSCCH-CodeChangeGrant                HSSCCH-Code-Change-Grant                OPTIONAL,
  sixtyfourQAM-UsageAllowedIndicator    SixtyfourQAM-UsageAllowedIndicator      OPTIONAL,
  IE-Extensions                          ProtocolExtensionContainer { { HS-DSCH-Secondary-Serving-Information-To-Modify-ExtIEs } }
  OPTIONAL,
  ...
}

HS-DSCH-Secondary-Serving-Information-To-Modify-ExtIEs RNSAP-PROTOCOL-EXTENSION ::= {
{ID id-MIMO-Mode-Indicator              CRITICALITY reject  EXTENSION MIMO-Mode-Indicator              PRESENCE optional}|
{ID id-Single-Stream-MIMO-Mode-Indicator  CRITICALITY reject  EXTENSION Single-Stream-MIMO-Mode-Indicator  PRESENCE optional}|
{ID id-DiversityMode                    CRITICALITY reject  EXTENSION DiversityMode                    PRESENCE optional}|
{ID id-TransmitDiversityIndicator        CRITICALITY reject  EXTENSION TransmitDiversityIndicator        PRESENCE optional}|
-- This IE shall be present if Diversity Mode IE is present and is not set to "none"
{ID id-NonCellSpecificTxDiversity        CRITICALITY reject  EXTENSION NonCellSpecificTxDiversity        PRESENCE optional}|
{ID id-power-offset-for-S-CPICH-for-MIMO-Request-Indicator  CRITICALITY ignore  EXTENSION PowerOffsetForSecondaryCPICHforMIMORequestIndicator
  PRESENCE optional},
...
}

HS-DSCH-FDD-Secondary-Serving-Information-To-Modify-Unsynchronised ::= SEQUENCE {
  hsscch-PowerOffset                    HSSCCH-PowerOffset                    OPTIONAL,
  sixtyfourQAM-UsageAllowedIndicator    SixtyfourQAM-UsageAllowedIndicator      OPTIONAL,
  IE-Extensions                          ProtocolExtensionContainer { { HS-DSCH-FDD-Secondary-Serving-Information-To-Modify-Unsynchronised-ExtIEs } }
  OPTIONAL,
  ...
}

HS-DSCH-FDD-Secondary-Serving-Information-To-Modify-Unsynchronised-ExtIEs RNSAP-PROTOCOL-EXTENSION ::= {
{ID id-MIMO-Mode-Indicator              CRITICALITY reject  EXTENSION MIMO-Mode-Indicator              PRESENCE optional}|

```

```

{ID id-Single-Stream-MIMO-Mode-Indicator CRITICALITY reject EXTENSION Single-Stream-MIMO-Mode-Indicator PRESENCE optional}|
{ID id-power-offset-for-S-CPICH-for-MIMO-Request-Indicator CRITICALITY ignore EXTENSION PowerOffsetForSecondaryCPICHforMIMORequestIndicator
  PRESENCE optional},
...
}

HS-DSCH-FDD-Secondary-Serving-Update-Information ::= SEQUENCE {
  hsSCCHCodeChangeIndicator          HSSCCH-CodeChangeIndicator          OPTIONAL,
  hS-PDSCH-Code-Change-Indicator     HS-PDSCH-Code-Change-Indicator     OPTIONAL,
  -- This IE shall never be included. If received it shall be ignored.
  iE-Extensions                      ProtocolExtensionContainer { { HS-DSCH-FDD-Secondary-Serving-Update-Information-ExtIEs } }
  OPTIONAL,
  ...
}

HS-DSCH-FDD-Secondary-Serving-Update-Information-ExtIEs RNSAP-PROTOCOL-EXTENSION ::= {
  ...
}

HS-DSCH-Secondary-Serving-Cell-Change-Information-Response ::= SEQUENCE {
  hS-DSCH-Secondary-Serving-cell-choice HS-DSCH-Secondary-Serving-cell-change-choice,
  iE-Extensions                      ProtocolExtensionContainer { { HS-DSCH-Secondary-Serving-Cell-Change-Information-Response-ExtIEs } }
  OPTIONAL,
  ...
}

HS-DSCH-Secondary-Serving-Cell-Change-Information-Response-ExtIEs RNSAP-PROTOCOL-EXTENSION ::= {
  ...
}

HS-DSCH-Secondary-Serving-cell-change-choice ::= CHOICE {
  hS-Secondary-Serving-cell-change-successful HS-Secondary-Serving-cell-change-successful,
  hS-Secondary-Serving-cell-change-unsuccessful HS-Secondary-Serving-cell-change-unsuccessful,
  ...
}

HS-Secondary-Serving-cell-change-successful ::= SEQUENCE {
  hS-DSCH-FDD-Secondary-Serving-Information-Response HS-DSCH-FDD-Secondary-Serving-Information-Response,
  hSDSCH-RNTI HSDSCH-RNTI,
  iE-Extensions ProtocolExtensionContainer { { HS-Secondary-Serving-cell-change-successful-ExtIEs } } OPTIONAL,
  ...
}

HS-Secondary-Serving-cell-change-successful-ExtIEs RNSAP-PROTOCOL-EXTENSION ::= {
  ...
}

HS-Secondary-Serving-cell-change-unsuccessful ::= SEQUENCE {
  cause Cause,
  iE-Extensions ProtocolExtensionContainer { { HS-Secondary-Serving-cell-change-unsuccessful-ExtIEs } } OPTIONAL,
  ...
}

HS-Secondary-Serving-cell-change-unsuccessful-ExtIEs RNSAP-PROTOCOL-EXTENSION ::= {

```

```

    ...
}
HS-DSCH-Secondary-Serving-Remove ::= NULL

HSDSCH-Information-to-Modify ::= SEQUENCE {
    hSDSCH-MACdFlow-Specific-InfoList-to-Modify HSDSCH-MACdFlow-Specific-InfoList-to-Modify OPTIONAL,
    priorityQueue-Info-to-Modify PriorityQueue-InfoList-to-Modify OPTIONAL,
    mACHs-Reordering-Buffer-Size-for-RLC-UM MAChsReorderingBufferSize-for-RLC-UM OPTIONAL,
    cqiFeedback-CycleK CQI-Feedback-Cycle OPTIONAL, -- For FDD only
    cqiRepetitionFactor CQI-RepetitionFactor OPTIONAL, -- For FDD only
    ackNackRepetitionFactor AckNack-RepetitionFactor OPTIONAL, -- For FDD only
    cqiPowerOffset CQI-Power-Offset OPTIONAL, -- For FDD only
    ackPowerOffset Ack-Power-Offset OPTIONAL, -- For FDD only
    nackPowerOffset Nack-Power-Offset OPTIONAL, -- For FDD only
    hsscch-PowerOffset HSSCCH-PowerOffset OPTIONAL, -- For FDD only
    hSSCCH-CodeChangeGrant HSSCCH-Code-Change-Grant OPTIONAL,
    tDDAckNackPowerOffset TDD-AckNack-Power-Offset OPTIONAL, -- For TDD only
    iE-Extensions ProtocolExtensionContainer { { HSDSCH-Information-to-Modify-ExtIEs } }
    OPTIONAL,
    ...
}

HSDSCH-Information-to-Modify-ExtIEs RNSAP-PROTOCOL-EXTENSION ::= {
    { ID id-HARQ-Preamble-Mode CRITICALITY ignore EXTENSION HARQ-Preamble-Mode PRESENCE optional} |
    { ID id-HS-PDSCH-Code-Change-Grant CRITICALITY ignore EXTENSION HS-PDSCH-Code-Change-Grant PRESENCE optional} |
    -- Applicable to FDD only
    { ID id-MIMO-Mode-Indicator CRITICALITY reject EXTENSION MIMO-Mode-Indicator PRESENCE optional} |
    { ID id-HSDSCH-MACdPDUSizeFormat CRITICALITY reject EXTENSION HSDSCH-MACdPDUSizeFormat PRESENCE optional} |
    { ID id-SixtyfourQAM-UsageAllowedIndicator CRITICALITY ignore EXTENSION SixtyfourQAM-UsageAllowedIndicator PRESENCE optional} |
    { ID id-UE-Capabilities-Info CRITICALITY ignore EXTENSION UE-Capabilities-Info PRESENCE optional} |
    { ID id-EnhancedHSServingCC-Abort CRITICALITY reject EXTENSION EnhancedHSServingCC-Abort PRESENCE optional} |
    { ID id-UE-SupportIndicatorExtension CRITICALITY ignore EXTENSION UE-SupportIndicatorExtension PRESENCE optional} |
    { ID id-power-offset-for-S-CPICH-for-MIMO-Request-Indicator CRITICALITY ignore EXTENSION PowerOffsetForSecondaryCPICHforMIMORequestIndicator PRESENCE optional} |
    { ID id-Single-Stream-MIMO-Mode-Indicator CRITICALITY reject EXTENSION Single-Stream-MIMO-Mode-Indicator PRESENCE optional},
    ...
}

HSDSCH-Information-to-Modify-Unsynchronised ::= SEQUENCE {
    hSDSCH-MACdFlow-Specific-InfoList-to-Modify HSDSCH-MACdFlow-Specific-InfoList-to-Modify OPTIONAL,
    priorityQueueInfoToModifyUnsynchronised PriorityQueue-InfoList-to-Modify-Unsynchronised OPTIONAL,
    cqiPowerOffset CQI-Power-Offset OPTIONAL, -- For FDD only
    ackPowerOffset Ack-Power-Offset OPTIONAL, -- For FDD only
    nackPowerOffset Nack-Power-Offset OPTIONAL, -- For FDD only
    hsscch-PowerOffset HSSCCH-PowerOffset OPTIONAL, -- Only for FDD
    tDDAckNackPowerOffset TDD-AckNack-Power-Offset OPTIONAL, -- For TDD only
    iE-Extensions ProtocolExtensionContainer { { HSDSCH-Information-to-Modify-Unsynchronised-ExtIEs } }
    OPTIONAL,

```



```

}
...
}
HSDSCH-Information-to-Modify-Unsynchronised-ExtIEs RNSAP-PROTOCOL-EXTENSION ::= {
{ ID id-HARQ-Preamble-Mode CRITICALITY ignore EXTENSION HARQ-Preamble-Mode PRESENCE optional}|
{ ID id-MIMO-Mode-Indicator CRITICALITY reject EXTENSION MIMO-Mode-Indicator
PRESENCE optional}|
{ ID id-SixtyfourQAM-UsageAllowedIndicator CRITICALITY ignore EXTENSION SixtyfourQAM-UsageAllowedIndicator PRESENCE optional}|
{ ID id-EnhancedHSServingCC-Abort CRITICALITY reject EXTENSION EnhancedHSServingCC-Abort PRESENCE
optional}|
{ ID id-UE-SupportIndicatorExtension CRITICALITY ignore EXTENSION UE-SupportIndicatorExtension PRESENCE optional}|
{ ID id-power-offset-for-S-CPICH-for-MIMO-Request-Indicator CRITICALITY ignore EXTENSION PowerOffsetForSecondaryCPICHforMIMORequestIndicator
PRESENCE optional}|
{ ID id-Single-Stream-MIMO-Mode-Indicator CRITICALITY reject EXTENSION Single-Stream-MIMO-Mode-Indicator PRESENCE optional},
...
}
HSDSCH-MACdFlow-ID ::= INTEGER (0..maxNrOfMACdFlows-1)
HSDSCH-MACdFlow-Specific-InfoList ::= SEQUENCE (SIZE (1..maxNrOfMACdFlows)) OF HSDSCH-MACdFlow-Specific-InfoItem
HSDSCH-MACdPDUSizeFormat ::= ENUMERATED {
indexedMACdPDU-Size,
flexibleMACdPDU-Size
}
HSDSCH-MACdFlow-Specific-InfoItem ::= SEQUENCE {
hSDSCH-MACdFlow-ID HSDSCH-MACdFlow-ID,
allocationRetentionPriority AllocationRetentionPriority,
trafficClass TrafficClass,
bindingID BindingID OPTIONAL,
transportLayerAddress TransportLayerAddress OPTIONAL,
iE-Extensions ProtocolExtensionContainer { { HSDSCH-MACdFlow-Specific-InfoItem-ExtIEs } } OPTIONAL,
...
}
HSDSCH-MACdFlow-Specific-InfoItem-ExtIEs RNSAP-PROTOCOL-EXTENSION ::= {
{ID id-TnlQos CRITICALITY ignore EXTENSION TnlQos PRESENCE optional }|
{ID id-TrCH-SrcStatisticsDescr CRITICALITY ignore EXTENSION TrCH-SrcStatisticsDescr PRESENCE optional },
...
}
HSDSCH-MACdFlow-Specific-InfoList-Response ::= SEQUENCE (SIZE (0..maxNrOfMACdFlows)) OF HSDSCH-MACdFlow-Specific-InfoItem-Response
HSDSCH-MACdFlow-Specific-InfoItem-Response ::= SEQUENCE {
hSDSCH-MACdFlow-ID HSDSCH-MACdFlow-ID,
bindingID BindingID OPTIONAL,
transportLayerAddress TransportLayerAddress OPTIONAL,
hSDSCH-Initial-Capacity-Allocation HSDSCH-Initial-Capacity-Allocation OPTIONAL,
iE-Extensions ProtocolExtensionContainer { { HSDSCH-MACdFlow-Specific-InfoItem-Response-ExtIEs } }
OPTIONAL,
...
}

```

```

HSDSCH-MACdFlow-Specific-InfoItem-Response-ExtIEs RNSAP-PROTOCOL-EXTENSION ::= {
    ...
}

HSDSCH-MACdFlow-Specific-InfoList-to-Modify ::= SEQUENCE (SIZE (1..maxNrOfMACdFlows)) OF HSDSCH-MACdFlow-Specific-InfoItem-to-Modify

HSDSCH-MACdFlow-Specific-InfoItem-to-Modify ::= SEQUENCE {
    hSDSCH-MACdFlow-ID                HSDSCH-MACdFlow-ID,
    allocationRetentionPriority        AllocationRetentionPriority           OPTIONAL,
    transportBearerRequestIndicator    TransportBearerRequestIndicator,
    trafficClass                       TrafficClass                       OPTIONAL,
    bindingID                          BindingID                          OPTIONAL,
    transportLayerAddress              TransportLayerAddress           OPTIONAL,
    iE-Extensions                      ProtocolExtensionContainer { { HSDSCH-MACdFlow-Specific-InfoItem-to-Modify-ExtIEs } }
    OPTIONAL,
    ...
}

HSDSCH-MACdFlow-Specific-InfoItem-to-Modify-ExtIEs RNSAP-PROTOCOL-EXTENSION ::= {
    {ID id-TnlQos          CRITICALITY ignore      EXTENSION TnlQos PRESENCE optional },
    ...
}

HSDSCH-MACdFlows-Information ::= SEQUENCE {
    hSDSCH-MACdFlow-Specific-Info        HSDSCH-MACdFlow-Specific-InfoList,
    priorityQueue-Info                  PriorityQueue-InfoList,
    iE-Extensions                      ProtocolExtensionContainer { { HSDSCH-MACdFlows-Information-ExtIEs } }
    OPTIONAL,
    ...
}

HSDSCH-MACdFlows-Information-ExtIEs RNSAP-PROTOCOL-EXTENSION ::= {
    ...
}

HSDSCH-MACdFlows-to-Delete ::= SEQUENCE (SIZE (1..maxNrOfMACdFlows)) OF HSDSCH-MACdFlows-to-Delete-Item

HSDSCH-MACdFlows-to-Delete-Item ::= SEQUENCE {
    hsDSCH-MACdFlow-ID                HSDSCH-MACdFlow-ID,
    iE-Extensions                      ProtocolExtensionContainer { { HSDSCH-MACdFlows-to-Delete-Item-ExtIEs } }           OPTIONAL,
    ...
}

HSDSCH-MACdFlows-to-Delete-Item-ExtIEs RNSAP-PROTOCOL-EXTENSION ::= {
    ...
}

HSDSCH-Initial-Capacity-Allocation ::= SEQUENCE (SIZE (1..maxNrOfPrioQueues)) OF HSDSCH-Initial-Capacity-AllocationItem

HSDSCH-Initial-Capacity-AllocationItem ::= SEQUENCE {
    schedulingPriorityIndicator        SchedulingPriorityIndicator,
    maximum-MACdPDU-Size              MACdPDU-Size,
    hSDSCH-InitialWindowSize          HSDSCH-InitialWindowSize,
}

```

```

    iE-Extensions          ProtocolExtensionContainer { {HSDSCH-Initial-Capacity-AllocationItem-ExtIEs} } OPTIONAL,
    ...
}

HSDSCH-InitialCapacityAllocationItem-ExtIEs RNSAP-PROTOCOL-EXTENSION ::= {
{ ID id-MaximumMACdPDU-SizeExtended          CRITICALITY ignore          EXTENSION  MAC-PDU-SizeExtended  PRESENCE optional},
    ...
}

HSDSCH-InitialWindowSize          ::= INTEGER (1..255)
-- Number of MAC-d PDUs.

HSDSCH-PreconfigurationInfo ::= SEQUENCE {
    setsOfHS-SCCH-Codes          SetsOfHS-SCCH-Codes,
    hARQ-MemoryPartitioning      HARQ-MemoryPartitioning,
    eDCH-FDD-DL-ControlChannelInformation      EDCH-FDD-DL-ControlChannelInformation      OPTIONAL,
    hARQ-Preamble-Mode-Activation-Indicator      HARQ-Preamble-Mode-Activation-Indicator      OPTIONAL,
    mIMO-N-M-Ratio              MIMO-InformationResponse          OPTIONAL,
    continuous-Packet-Connectivity-HS-SCCH-Less-Information-Response      Continuous-Packet-Connectivity-HS-SCCH-Less-Information-Response      OPTIONAL,
    iE-Extensions              ProtocolExtensionContainer { { HSDSCH-PreconfigurationInfo-ExtIEs} }          OPTIONAL,
    ...
}

HSDSCH-PreconfigurationInfo-ExtIEs RNSAP-PROTOCOL-EXTENSION ::= {
{ ID id-power-offset-for-S-CPICH-for-MIMO          CRITICALITY ignore          EXTENSION  PowerOffsetForSecondaryCPICHforMIMO          PRESENCE optional}|
{ ID id-Additional-EDCH-Preconfiguration-Information      CRITICALITY ignore          EXTENSION  Additional-EDCH-Preconfiguration-Information      PRESENCE optional}|
{ ID id-Support-of-Dynamic-DTXDRX-Related-HS-SCCH-Order      CRITICALITY ignore          EXTENSION  Support-of-Dynamic-DTXDRX-Related-HS-SCCH-Order      PRESENCE optional},
    ...
}

Additional-EDCH-Preconfiguration-Information      ::= SEQUENCE (SIZE (1..maxNrOfEDCH-1)) OF Additional-EDCH-Preconfiguration-Information-ItemIEs

Additional-EDCH-Preconfiguration-Information-ItemIEs      ::= SEQUENCE {
    eDCH-FDD-DL-ControlChannelInformation      EDCH-FDD-DL-ControlChannelInformation,
    iE-Extensions          ProtocolExtensionContainer { { Additional-EDCH-Preconfiguration-Information-ItemIEs-ExtIEs} } OPTIONAL,
    ...
}

Additional-EDCH-Preconfiguration-Information-ItemIEs-ExtIEs RNSAP-PROTOCOL-EXTENSION ::= {
    ...
}

HSDSCH-PreconfigurationSetup ::= SEQUENCE {
    mACHsResetScheme          MACHsResetScheme,
    hSDSCH-Physical-Layer-Category          INTEGER (1..64,...),
    mACHs-Reordering-Buffer-Size-for-RLC-UM          MACHsReorderingBufferSize-for-RLC-UM,
    secondaryServingCells          SecondaryServingCells          OPTIONAL,
}

```

```

numPrimaryHS-SCCH-Codes      NumHS-SCCH-Codes      OPTIONAL,
hARQ-Preamble-Mode          HARQ-Preamble-Mode          OPTIONAL,
mIMO-ActivationIndicator     MIMO-ActivationIndicator     OPTIONAL,
hSDSCH-MACdPDUSizeFormat    HSDSCH-MACdPDUSizeFormat    OPTIONAL,
sixtyfourQAM-UsageAllowedIndicator SixtyfourQAM-UsageAllowedIndicator OPTIONAL,
uE-with-enhanced-HS-SCCH-support-indicator NULL          OPTIONAL,
continuous-Packet-Connectivity-HS-SCCH-Less-Information Continuous-Packet-Connectivity-HS-SCCH-Less-Information OPTIONAL,
iE-Extensions                ProtocolExtensionContainer { { HSDSCHPreconfigurationSetup-ExtIEs } } OPTIONAL,
...
}

HSDSCHPreconfigurationSetup-ExtIEs RNSAP-PROTOCOL-EXTENSION ::= {
{ ID id-UE-SupportIndicatorExtension CRITICALITY ignore EXTENSION UE-SupportIndicatorExtension PRESENCE optional} |
{ ID id-power-offset-for-S-CPICH-for-MIMO-Request-Indicator CRITICALITY ignore EXTENSION PowerOffsetForSecondaryCPICHforMIMOREquestIndicator PRESENCE optional},
...
}

HS-SCCH-PreconfiguredCodes ::= SEQUENCE (SIZE (1..maxNrOfHSSCCHCodes)) OF HS-SCCH-PreconfiguredCodesItem

HS-SCCH-PreconfiguredCodesItem ::= SEQUENCE {
  hS-SCCH-CodeNumber HS-SCCH-CodeNumber,
  iE-Extensions ProtocolExtensionContainer { { HS-SCCH-PreconfiguredCodesItem-ExtIEs } } OPTIONAL,
  ...
}

HS-SCCH-PreconfiguredCodesItem-ExtIEs RNSAP-PROTOCOL-EXTENSION ::= {
  ...
}

HS-SCCH-CodeNumber ::= INTEGER (0..127)

HSDSCH-RNTI ::= INTEGER (0..65535)

HS-DSCH-serving-cell-change-information ::= SEQUENCE {
  hS-PDSCH-RLID RL-ID,
  hSDSCH-FDD-Information HSDSCH-FDD-Information
  OPTIONAL,
  iE-Extensions ProtocolExtensionContainer { { HS-DSCH-serving-cell-change-information-ExtIEs } } OPTIONAL,
  ...
}

HS-DSCH-serving-cell-change-information-ExtIEs RNSAP-PROTOCOL-EXTENSION ::= {
{ ID id-Continuous-Packet-Connectivity-HS-SCCH-Less-Information CRITICALITY reject EXTENSION Continuous-Packet-Connectivity-HS-SCCH-Less-Information PRESENCE optional} |
{ ID id-Continuous-Packet-Connectivity-DTX-DRX-Information CRITICALITY reject EXTENSION Continuous-Packet-Connectivity-DTX-DRX-Information PRESENCE optional},
...
}

```

```

HS-DSCH-serving-cell-change-informationResponse ::= SEQUENCE {
    hS-DSCH-serving-cell-choice      HS-DSCH-serving-cell-change-choice,
    iE-Extensions                    ProtocolExtensionContainer { { HS-DSCH-serving-cell-change-informationResponse-ExtIEs } } OPTIONAL,
    ...
}

HS-DSCH-serving-cell-change-informationResponse-ExtIEs RNSAP-PROTOCOL-EXTENSION ::= {
    ...
}

HS-DSCH-serving-cell-change-choice ::= CHOICE {
    hS-serving-cell-change-successful      HS-serving-cell-change-successful,
    hS-serving-cell-change-unsuccessful    HS-serving-cell-change-unsuccessful,
    ...
}

HSDSCH-TBSizeTableIndicator ::= ENUMERATED {
    octet-aligned
}

HS-serving-cell-change-successful ::= SEQUENCE {
    hSDSCH-FDD-Information-Response      HSDSCH-FDD-Information-Response,
    hSDSCH-RNTI                          HSDSCH-RNTI,
    iE-Extensions                        ProtocolExtensionContainer { { HS-serving-cell-change-successful-ExtIEs } } OPTIONAL,
    ...
}

HS-serving-cell-change-successful-ExtIEs RNSAP-PROTOCOL-EXTENSION ::= {
    { ID id-Continuous-Packet-Connectivity-HS-SCCH-Less-Information-Response      CRITICALITY ignore EXTENSION Continuous-Packet-Connectivity-HS-SCCH-
    Less-Information-Response          PRESENCE optional},
    ...
}

HS-serving-cell-change-unsuccessful ::= SEQUENCE {
    cause                                Cause,
    iE-Extensions                        ProtocolExtensionContainer { { HS-serving-cell-change-unsuccessful-ExtIEs } } OPTIONAL,
    ...
}

HS-serving-cell-change-unsuccessful-ExtIEs RNSAP-PROTOCOL-EXTENSION ::= {
    ...
}

HSPDSCH-First-Code-Index ::= INTEGER (1..maxHS-PDSCHCodeNrComp-1)
    -- index of first HS-PDSCH code

HSPDSCH-Second-Code-Index ::= INTEGER (1..maxHS-PDSCHCodeNrComp-1)
    -- index of second HS-PDSCH code

HSPDSCH-Second-Code-Support ::= BOOLEAN
    -- true: applied, false: not applied

HSDSCH-TDD-Information ::= SEQUENCE {

```

```

hSDSCH-MACdFlows-Information      HSDSCH-MACdFlows-Information,
uE-Capabilities-Info              UE-Capabilities-Info,
mAChs-Reordering-Buffer-Size-for-RLC-UM  MAChsReorderingBufferSize-for-RLC-UM,
tDD-AckNack-Power-Offset          TDD-AckNack-Power-Offset,
iE-Extensions                      ProtocolExtensionContainer { { HSDSCH-TDD-Information-ExtIEs } }
...
}

HSDSCH-TDD-Information-ExtIEs RNSAP-PROTOCOL-EXTENSION ::= {
{ ID id-HSDSCH-MACdPDUSizeFormat      CRITICALITY reject      EXTENSION  HSDSCH-MACdPDUSizeFormat  PRESENCE optional}|
{ ID id-HSSICH-SIRTarget              CRITICALITY ignore      EXTENSION  UL-SIR
  PRESENCE optional}|
-- Applicable to 1.28Mcps TDD only
{ ID id-HSSICH-TPC-StepSize            CRITICALITY ignore      EXTENSION  TDD-TPC-UplinkStepSize-LCR      PRESENCE optional}|
-- Mandatory for 1.28Mcps TDD only
{ ID id-tSN-Length                    CRITICALITY reject      EXTENSION  TSN-Length                            PRESENCE optional }|
-- Applicable for 1.28Mcps TDD when using multiple frequencies
{ ID id-MIMO-ActivationIndicator       CRITICALITY reject      EXTENSION  MIMO-ActivationIndicator              PRESENCE optional},
...
}

HSDSCH-TDD-Information-Response ::= SEQUENCE {
  hSDSCH-MACdFlow-Specific-InfoList-Response      HSDSCH-MACdFlow-Specific-InfoList-Response      OPTIONAL,
  hSSCCH-TDD-Specific-InfoList-Response           HSSCCH-TDD-Specific-InfoList-Response           OPTIONAL,
  -- Not Applicable to 1.28Mcps TDD
  hSSCCH-TDD-Specific-InfoList-Response-LCR       HSSCCH-TDD-Specific-InfoList-Response-LCR       OPTIONAL,
  -- Not Applicable to 3.84Mcps TDD or 7.68Mcps TDD. This HSSCCH Specific Information is for the first Frequency repetition, HSSCCH Specific
Information for Frequency repetitions 2 and on, should be defined in MultipleFreq-HSPDSCH-InformationList-ResponseTDDLRCR
  hSPDSCH-TDD-Specific-InfoList-Response          HSPDSCH-TDD-Specific-InfoList-Response          OPTIONAL,
  hSPDSCH-TDD-Specific-InfoList-Response-LCR     HSPDSCH-TDD-Specific-InfoList-Response-LCR     OPTIONAL,
  hARQ-MemoryPartitioning                        HARQ-MemoryPartitioning                        OPTIONAL,
  -- For 1.28Mcps TDD, this HARQ Memory Partitioning Information is for the first Frequency repetition, HARQ Memory Partitioning Information for
Frequency repetitions 2 and on, should be defined in MultipleFreq-HSPDSCH-InformationList-ResponseTDDLRCR
  iE-Extensions                                  ProtocolExtensionContainer { { HSDSCH-TDD-Information-Response-ExtIEs } }
  OPTIONAL,
  ...
}

HSDSCH-TDD-Information-Response-ExtIEs RNSAP-PROTOCOL-EXTENSION ::= {
{ ID id-User-Plane-Congestion-Fields-Inclusion      CRITICALITY ignore      EXTENSION  User-Plane-Congestion-Fields-Inclusion
  PRESENCE optional}|
{ ID id-hSSCCH-TDD-Specific-InfoList-Response768  CRITICALITY ignore      EXTENSION  HSSCCH-TDD-Specific-InfoList-Response768
  PRESENCE optional}|
{ ID id-hSPDSCH-TDD-Specific-InfoList-Response768 CRITICALITY ignore      EXTENSION  HSPDSCH-TDD-Specific-InfoList-Response768
  PRESENCE optional}|
{ ID id-UARFCNforNt                              CRITICALITY ignore      EXTENSION  UARFCN
  PRESENCE optional}|
-- Applicable to 1.28Mcps TDD when using multiple frequencies ,This is the UARFCN for the first Frequency repetition
{ ID id-multipleFreq-HSPDSCH-InformationList-ResponseTDDLRCR CRITICALITY ignore      EXTENSION  MultipleFreq-HSPDSCH-InformationList-ResponseTDDLRCR
PRESENCE optional }|
-- Applicable to 1.28Mcps TDD when using multiple frequencies ,This MultipleFreq-HSPDSCH-InformationList-ResponseTDDLRCR is the HS-SCCH and HARQ
Memory Partitioning information for the 2nd and beyond HS-PDSCH frequencies
{ ID id-multicarrier-number                      CRITICALITY ignore      EXTENSION  Multicarrier-Number
  PRESENCE optional }|

```

```

-- Applicable for 1.28Mcps TDD when using multiple frequencies
{ID id-MIMO-SFMode-For-HSPDSCHDualStream          CRITICALITY reject      EXTENSION MIMO-SFMode-For-HSPDSCHDualStream
  PRESENCE optional}|
{ID id-MIMO-ReferenceSignal-InformationListLCR      CRITICALITY reject      EXTENSION MIMO-ReferenceSignal-InformationListLCR          PRESENCE
optional}|
{ ID id-TS0-HS-PDSCH-Indication-LCR CRITICALITY ignore          EXTENSION TS0-HS-PDSCH-Indication-LCR          PRESENCE optional }|
{ ID id-Out-of-Synchronization-Window              CRITICALITY reject          EXTENSION Out-of-Synchronization-Window
  PRESENCE optional},
  ...
}

Multicarrier-Number ::= INTEGER (1..maxHSDPAFrequency)

HSPDSCH-TDD-Specific-InfoList-Response ::= SEQUENCE (SIZE (0..maxNrOfDLTs)) OF HSPDSCH-TDD-Specific-InfoItem-Response

HSPDSCH-TDD-Specific-InfoItem-Response ::= SEQUENCE {
  timeslot                TimeSlot,
  midambleShiftAndBurstType MidambleShiftAndBurstType,
  iE-Extensions           ProtocolExtensionContainer { { HSPDSCH-TDD-Specific-InfoItem-Response-ExtIEs } }
  OPTIONAL,
  ...
}

HSPDSCH-TDD-Specific-InfoItem-Response-ExtIEs RNSAP-PROTOCOL-EXTENSION ::= {
  ...
}

HSPDSCH-TDD-Specific-InfoList-Response-LCR ::= SEQUENCE (SIZE (1.. maxNrOfDLTsLCR)) OF HSPDSCH-TDD-Specific-InfoItem-Response-LCR

HSPDSCH-TDD-Specific-InfoItem-Response-LCR ::= SEQUENCE {
  timeslotLCR                TimeSlotLCR,
  midambleShiftLCR           MidambleShiftLCR,
  iE-Extensions              ProtocolExtensionContainer { { HSPDSCH-TDD-Specific-InfoItem-Response-LCR-ExtIEs } }
  OPTIONAL,
  ...
}

HSPDSCH-TDD-Specific-InfoItem-Response-LCR-ExtIEs RNSAP-PROTOCOL-EXTENSION ::= {
  ...
}

HSPDSCH-TDD-Specific-InfoList-Response768 ::= SEQUENCE (SIZE (0..maxNrOfDLTs)) OF HSPDSCH-TDD-Specific-InfoItem-Response768

HSPDSCH-TDD-Specific-InfoItem-Response768 ::= SEQUENCE {
  timeslot                TimeSlot,
  midambleShiftAndBurstType768 MidambleShiftAndBurstType768,
  iE-Extensions           ProtocolExtensionContainer { { HSPDSCH-TDD-Specific-InfoItem-Response-768-ExtIEs } }
  OPTIONAL,
  ...
}

HSPDSCH-TDD-Specific-InfoItem-Response-768-ExtIEs RNSAP-PROTOCOL-EXTENSION ::= {
  ...
}

```

```

HSSCCH-FDD-Specific-InfoList-Response ::= SEQUENCE (SIZE (0..maxNrOfHSSCCHCodes)) OF HSSCCH-FDD-Specific-InfoItem-Response

HSSCCH-FDD-Specific-InfoItem-Response ::= SEQUENCE {
    code-Number                INTEGER (0..127),
    iE-Extensions              ProtocolExtensionContainer { { HSSCCH-FDD-Specific-InfoItem-Response-ExtIEs } }
    OPTIONAL,
    ...
}

HSSCCH-FDD-Specific-InfoItem-Response-ExtIEs RNSAP-PROTOCOL-EXTENSION ::= {
    ...
}

HSSCCH-PowerOffset ::= INTEGER (0..255)
-- PowerOffset = -32 + offset * 0.25
-- Unit dB, Range -32dB .. +31.75dB, Step +0.25dB

HSSCCH-TDD-Specific-InfoList-Response ::= SEQUENCE (SIZE (0..maxNrOfHSSCCHCodes)) OF HSSCCH-TDD-Specific-InfoItem-Response

HSSCCH-TDD-Specific-InfoItem-Response ::= SEQUENCE {
    timeslot                    TimeSlot,
    midambleShiftAndBurstType   MidambleShiftAndBurstType,
    tDD-ChannelisationCode      TDD-ChannelisationCode,
    hSSICH-Info                 HSSICH-Info,
    iE-Extensions              ProtocolExtensionContainer { { HSSCCH-TDD-Specific-InfoItem-Response-ExtIEs } }
    OPTIONAL,
    ...
}

HSSCCH-TDD-Specific-InfoItem-Response-ExtIEs RNSAP-PROTOCOL-EXTENSION ::= {
    ...
}

HSSCCH-TDD-Specific-InfoList-Response-LCR ::= SEQUENCE (SIZE (0..maxNrOfHSSCCHCodes)) OF HSSCCH-TDD-Specific-InfoItem-Response-LCR

HSSCCH-TDD-Specific-InfoItem-Response-LCR ::= SEQUENCE {
    timeslotLCR                TimeSlotLCR,
    midambleShiftLCR           MidambleShiftLCR,
    first-TDD-ChannelisationCode TDD-ChannelisationCode,
    second-TDD-ChannelisationCode TDD-ChannelisationCode,
    hSSICH-InfoLCR             HSSICH-InfoLCR,
    iE-Extensions              ProtocolExtensionContainer { { HSSCCH-TDD-Specific-InfoItem-Response-LCR-ExtIEs } }
    OPTIONAL,
    ...
}

HSSCCH-TDD-Specific-InfoItem-Response-LCR-ExtIEs RNSAP-PROTOCOL-EXTENSION ::= {
    ...
}

HSSCCH-TDD-Specific-InfoList-Response768 ::= SEQUENCE (SIZE (0..maxNrOfHSSCCHCodes)) OF HSSCCH-TDD-Specific-InfoItem-Response768

HSSCCH-TDD-Specific-InfoItem-Response768 ::= SEQUENCE {

```



```

timeslot                               TimeSlot,
midambleShiftAndBurstType768          MidambleShiftAndBurstType768,
tDD-ChannelisationCode768             TDD-ChannelisationCode768,
hSSICH-Info768                        HSSICH-Info768,
iE-Extensions                          ProtocolExtensionContainer { { HSSCCH-TDD-Specific-InfoItem-Response768-ExtIEs } }
OPTIONAL,
...
}

HSSCCH-TDD-Specific-InfoItem-Response768-ExtIEs RNSAP-PROTOCOL-EXTENSION ::= {
...
}

HSSICH-Info ::= SEQUENCE {
hsSICH-ID                               HS-SICH-ID,
timeslot                               TimeSlot,
midambleShiftAndBurstType              MidambleShiftAndBurstType,
tDD-ChannelisationCode                 TDD-ChannelisationCode,
iE-Extensions                          ProtocolExtensionContainer { { HSSICH-Info-ExtIEs } }
...
}
OPTIONAL,

HSSICH-Info-ExtIEs RNSAP-PROTOCOL-EXTENSION ::= {
...
}

HSSICH-InfoLCR ::= SEQUENCE {
hsSICH-ID                               HS-SICH-ID,
timeslotLCR                             TimeSlotLCR,
midambleShiftLCR                        MidambleShiftLCR,
tDD-ChannelisationCode                 TDD-ChannelisationCode,
iE-Extensions                          ProtocolExtensionContainer { { HSSICH-Info-LCR-ExtIEs } }
...
}
OPTIONAL,

HSSICH-Info-LCR-ExtIEs RNSAP-PROTOCOL-EXTENSION ::= {
{ ID id-HS-SICH-ID-Extension             CRITICALITY ignore      EXTENSION HS-SICH-ID-Extension      PRESENCE optional},
-- Applicable for 1.28Mcps TDD only when the HS-SICH ID IE is more than 31
...
}

HSSICH-Info768 ::= SEQUENCE {
hsSICH-ID                               HS-SICH-ID,
timeslot                               TimeSlot,
midambleShiftAndBurstType768          MidambleShiftAndBurstType768,
tDD-ChannelisationCode768             TDD-ChannelisationCode768,
iE-Extensions                          ProtocolExtensionContainer { { HSSICH-Info-768-ExtIEs } }
...
}
OPTIONAL,

HSSICH-Info-768-ExtIEs RNSAP-PROTOCOL-EXTENSION ::= {
...
}

```

```

HS-SICH-Reception-Quality-Value ::= SEQUENCE {
    failed-HS-SICH           HS-SICH-failed,
    missed-HS-SICH          HS-SICH-missed,
    total-HS-SICH           HS-SICH-total,
    iE-Extensions           ProtocolExtensionContainer { { HS-SICH-Reception-Quality-Value-ExtIEs } } OPTIONAL,
    ...
}

HS-SICH-Reception-Quality-Value-ExtIEs RNSAP-PROTOCOL-EXTENSION ::= {
    ...
}

HS-SICH-failed ::= INTEGER (0..20)

HS-SICH-missed ::= INTEGER (0..20)

HS-SICH-total ::= INTEGER (0..20)

HS-SICH-Reception-Quality-Measurement-Value ::= INTEGER (0..20)
-- According to mapping in TS 25.133 [23]

HS-SICH-ID ::= INTEGER (0..31)

HS-SICH-ID-Extension ::= INTEGER (32..255,...)

HSSCCH-CodeChangeIndicator ::= ENUMERATED {
    hsSCCHCodeChangeNeeded
}

HSSCCH-Code-Change-Grant ::= ENUMERATED {
    changeGranted
}

HS-PDSCH-Code-Change-Indicator ::= ENUMERATED {
    hsPDSCHCodeChangeNeeded
}

HS-PDSCH-Code-Change-Grant ::= ENUMERATED {
    changeGranted
}

HSDSCH-FDD-Update-Information ::= SEQUENCE {
    hsSCCHCodeChangeIndicator           HSSCCH-CodeChangeIndicator           OPTIONAL,
    cqiFeedback-CycleK                  CQI-Feedback-Cycle                  OPTIONAL,
    cqiRepetitionFactor                  CQI-RepetitionFactor                OPTIONAL,
    ackNackRepetitionFactor              AckNack-RepetitionFactor            OPTIONAL,
    cqiPowerOffset                       CQI-Power-Offset                    OPTIONAL,
    ackPowerOffset                       Ack-Power-Offset                    OPTIONAL,
    nackPowerOffset                       Nack-Power-Offset                    OPTIONAL,
    iE-Extensions                       ProtocolExtensionContainer { { HSDSCH-FDD-Update-Information-ExtIEs } } OPTIONAL,
    ...
}

HSDSCH-FDD-Update-Information-ExtIEs RNSAP-PROTOCOL-EXTENSION ::= {

```

```

{ID id-HS-PDSCH-Code-Change-Indicator      CRITICALITY ignore      EXTENSION  HS-PDSCH-Code-Change-Indicator  PRESENCE optional },
  ...
}

HSDSCH-TDD-Update-Information ::= SEQUENCE {
  hsSCCHCodeChangeIndicator      HSSCCH-CodeChangeIndicator      OPTIONAL,
  tDDAckNackPowerOffset          TDD-AckNack-Power-Offset        OPTIONAL,
  iE-Extensions                  ProtocolExtensionContainer { { HSDSCH-TDD-Update-Information-ExtIEs } }      OPTIONAL,
  ...
}

HSDSCH-TDD-Update-Information-ExtIEs RNSAP-PROTOCOL-EXTENSION ::= {
  ...
}

MIMO-ReferenceSignal-InformationListLCR ::= SEQUENCE (SIZE (1..maxNrOfHSSCCHCodes)) OF HSSICH-ReferenceSignal-InformationLCR

HSSICH-ReferenceSignal-InformationLCR ::= SEQUENCE {
  midambleConfigurationLCR      MidambleConfigurationLCR,
  midambleShift                 INTEGER (0..15),
  timeSlotLCR                  TimeSlotLCR,
  iE-Extensions                 ProtocolExtensionContainer { { HSSICH-ReferenceSignal-InformationLCR-ExtIEs } }      OPTIONAL,
  ...
}

HSSICH-ReferenceSignal-InformationLCR-ExtIEs RNSAP-PROTOCOL-EXTENSION ::= {
  ...
}

HS-DSCH-Semi-PersistentScheduling-Information-LCR ::= SEQUENCE {
  transport-Block-Size-List      Transport-Block-Size-List-LCR,
  repetition-Period-List-LCR     Repetition-Period-List-LCR,
  hS-DSCH-SPS-Reservation-Indicator  SPS-Reservation-Indicator      OPTIONAL,
  hS-DSCH-SPS-Operation-Indicator    HS-DSCH-SPS-Operation-Indicator,
  iE-Extensions                  ProtocolExtensionContainer { { HS-DSCH-Semi-PersistentScheduling-Information-LCR-ExtIEs } }      OPTIONAL,
  ...
}

HS-DSCH-Semi-PersistentScheduling-Information-LCR-ExtIEs RNSAP-PROTOCOL-EXTENSION ::= {
  ...
}

HSDSCH-Physical-Layer-Category ::= INTEGER (1..64)

Transport-Block-Size-List-LCR ::= SEQUENCE (SIZE (1..maxNoOfTBSs-Mapping-HS-DSCH-SPS)) OF Transport-Block-Size-Item-LCR

Transport-Block-Size-Item-LCR ::= SEQUENCE {
  transport-Block-Size-mapping-Index-LCR  Transport-Block-Size-mapping-Index-LCR,
  transport-Block-Size-Index-LCR          Transport-Block-Size-Index-LCR,
  iE-Extensions                          ProtocolExtensionContainer { { Transport-Block-Size-Item-LCR-ExtIEs } }      OPTIONAL,
  ...
}

```

```

Transport-Block-Size-Item-LCR-ExtIEs RNSAP-PROTOCOL-EXTENSION ::= {
  ...
}

Transport-Block-Size-mapping-Index-LCR ::= INTEGER (0..maxNoOfTBSs-Mapping-HS-DSCH-SPS-1)

Transport-Block-Size-Index-LCR ::= INTEGER (1..maxNoOfHS-DSCH-TBSsLCR)

TS0-HS-PDSCH-Indication-LCR ::= NULL

Repetition-Period-List-LCR ::= SEQUENCE (SIZE (1..maxNoOfRepetition-Period-LCR)) OF Repetition-Period-Item-LCR

Repetition-Period-Item-LCR ::= SEQUENCE {
  repetitionPeriodIndex      RepetitionPeriodIndex,
  repetitionPeriod           RepetitionPeriod,
  repetitionLength           RepetitionLength           OPTIONAL,
  iE-Extensions              ProtocolExtensionContainer { { Repetition-Period-Item-LCR-ExtIEs } } OPTIONAL,
  ...
}

Repetition-Period-Item-LCR-ExtIEs RNSAP-PROTOCOL-EXTENSION ::= {
  ...
}

RepetitionPeriodIndex ::= INTEGER (0..maxNoOfRepetitionPeriod-SPS-LCR-1)

SPS-Reservation-Indicator ::= ENUMERATED {
  reserve
}

HS-DSCH-SPS-Operation-Indicator ::= CHOICE {
  logicalChannellevel      LogicalChannellevel,
  priorityQueuelevel       PriorityQueuelevel,
  ...
}

LogicalChannellevel ::= BIT STRING (SIZE (16))

PriorityQueuelevel ::= BIT STRING (SIZE (8))

HS-DSCH-Semi-PersistentScheduling-Information-to-Modify-LCR ::= SEQUENCE {
  transport-Block-Size-List      Transport-Block-Size-List-LCR           OPTIONAL,
  repetition-Period-List-LCR     Repetition-Period-List-LCR           OPTIONAL,
  hS-DSCH-SPS-Reservation-Indicator SPS-Reservation-Indicator         OPTIONAL,
  hS-DSCH-SPS-Operation-Indicator HS-DSCH-SPS-Operation-Indicator     OPTIONAL,
  iE-Extensions                  ProtocolExtensionContainer { { HS-DSCH-Semi-PersistentScheduling-Information-to-Modify-LCR-ExtIEs } } OPTIONAL,
  ...
}

HS-DSCH-Semi-PersistentScheduling-Information-to-Modify-LCR-ExtIEs RNSAP-PROTOCOL-EXTENSION ::= {
  ...
}

```

```

HS-DSCH-Semi-PersistentScheduling-Information-ResponseLCR ::= SEQUENCE {
    hS-SICH-InformationList-for-HS-DSCH-SPS    HS-SICH-InformationList-for-HS-DSCH-SPS,
    initial-HS-PDSCH-SPS-Resource              Initial-HS-PDSCH-SPS-Resource              OPTIONAL,
    buffer-Size-for-HS-DSCH-SPS                Process-Memory-Size                      OPTIONAL,
    number-of-Processes-for-HS-DSCH-SPS        Number-of-Processes-for-HS-DSCH-SPS      OPTIONAL,
    iE-Extensions                              ProtocolExtensionContainer { { HS-DSCH-Semi-PersistentScheduling-Information-ResponseLCR-ExtIEs } }
    OPTIONAL,
    ...
}

HS-DSCH-Semi-PersistentScheduling-Information-ResponseLCR-ExtIEs RNSAP-PROTOCOL-EXTENSION ::= {
    ...
}

HS-SICH-InformationList-for-HS-DSCH-SPS ::= SEQUENCE (SIZE (1..maxNoOf-HS-SICH-SPS)) OF HS-SICH-InformationItem-for-HS-DSCH-SPS

HS-SICH-InformationItem-for-HS-DSCH-SPS ::= SEQUENCE {
    hS-SICH-Mapping-Index                      HS-SICH-Mapping-Index                      OPTIONAL,
    hS-SICH-Type                               HS-SICH-Type,
    iE-Extensions                              ProtocolExtensionContainer { { HS-SICH-InformationItem-for-HS-DSCH-SPS-ExtIEs } }
    ...
    OPTIONAL,
}

HS-SICH-InformationItem-for-HS-DSCH-SPS-ExtIEs RNSAP-PROTOCOL-EXTENSION ::= {
    ...
}

HS-SICH-Mapping-Index ::= INTEGER (0..maxNoOf-HS-SICH-SPS-1)

HS-SICH-Type ::= CHOICE {
    hS-SCCH-Associated-HS-SICH                  HS-SCCH-Associated-HS-SICH,
    non-HS-SCCH-Associated-HS-SICH              Non-HS-SCCH-Associated-HS-SICH,
    ...
}

HS-SCCH-Associated-HS-SICH ::= SEQUENCE {
    hsSICH-ID                                  HS-SICH-ID,
    extended-HS-SICH-ID                        HS-SICH-ID-Extension                      OPTIONAL,
    ...
}

Non-HS-SCCH-Associated-HS-SICH ::= SEQUENCE {
    non-HS-SCCH-Aassociated-HS-SICH-ID          Non-HS-SCCH-Aassociated-HS-SICH-ID,
    ...
}

Non-HS-SCCH-Aassociated-HS-SICH-ID ::= INTEGER (0..255)

Initial-HS-PDSCH-SPS-Resource ::= SEQUENCE {
    repetitionPeriodIndex                      RepetitionPeriodIndex,
    repetitionLength                            RepetitionLength                          OPTIONAL,
    hS-PDSCH-Offset                            TDD-PhysicalChannelOffset,
}

```

```

    hS-PDSCH-Midamble-Configuration      MidambleShiftLCR,
    timeslot-Resource-Related-Information HS-DSCH-TimeslotResourceLCR,
    startCode                            TDD-ChannelisationCode,
    endCode                               TDD-ChannelisationCode,
    transport-Block-Size-Index           Transport-Block-Size-Index-LCR,
    modulationType                       ModulationSPS-LCR,
    hS-SICH-Mapping-Index                HS-SICH-Mapping-Index,
    iE-Extensions                        ProtocolExtensionContainer { { Initial-HS-PDSCH-SPS-Resource-ExtIEs } }
    ...
}
}
Initial-HS-PDSCH-SPS-Resource-ExtIEs RNSAP-PROTOCOL-EXTENSION ::= {
    ...
}
HS-DSCH-TimeslotResourceLCR ::= BIT STRING (SIZE (5))
ModulationSPS-LCR ::= ENUMERATED {
    qPSK,
    sixteenQAM,
    ...
}
Number-of-Processes-for-HS-DSCH-SPS ::= INTEGER (1..16)
-- I
IMEI      ::= OCTET STRING (SIZE(8))
IMEISV    ::= OCTET STRING (SIZE(8))
IMSI      ::= OCTET STRING (SIZE(3..8))
Inactivity-Threshold-for-UE-DTX-Cycle2 ::= ENUMERATED {v1, v4, v8, v16, v32, v64, v128, v256}
-- Unit E-DCH TTI
Inactivity-Threshold-for-UE-DRX-Cycle ::= ENUMERATED {v0, v1, v2, v4, v8, v16, v32, v64, v128, v256, v512}
-- Unit subframe
Inactivity-Threshold-for-UE-Grant-Monitoring ::= ENUMERATED {v0, v1, v2, v4, v8, v16, v32, v64, v128, v256}
-- Unit E-DCH TTI

InformationAvailable ::= SEQUENCE {
    requestedDataValue      RequestedDataValue,
    iE-Extensions           ProtocolExtensionContainer { { InformationAvailable-ExtIEs } }
    ...
}
InformationAvailable-ExtIEs RNSAP-PROTOCOL-EXTENSION ::= {
    ...
}

```

```

InformationExchangeID ::= INTEGER (0..1048575)

InformationNotAvailable ::= NULL

InformationReportCharacteristics ::= CHOICE {
    onDemand          NULL,
    periodic          PeriodicInformation,
    onModification   OnModificationInformation,
    ...
}

InformationReportPeriodicity ::= CHOICE {
    min              INTEGER (1..60,...),
    -- Unit min, Step 1min
    hour            INTEGER (1..24,...),
    -- Unit hour, Step 1hour
    ...
}

InformationThreshold ::= CHOICE {
    dGPSThreshold   DGPSThreshold,
    ...,
    dGANSSThreshold DGANSSThreshold
}

InformationType ::= SEQUENCE {
    informationTypeItem    ENUMERATED {
        gA-AccessPointPositionwithAltitude,
        gA-AccessPointPosition,
        iPDLParameters,
        gPSInformation,
        dGPSCorrections,
        gPS-RX-POS,
        sFNSFN-GA-AccessPointPosition,
        ...,
        cell-Capacity-Class,
        nACC-Related-Data,
        mBMSBearerServiceFullAddress,
        interFrequencyCellInformation,
        gANSSThreshold,
        dGANSSThreshold,
        gANSSThreshold-Pos,
        mBMS-Counting-Information,
        mBMS-Transmission-Mode,
        mBMS-Neighbouring-Cell-Information,
        mBMS-RLC-Sequence-Number
    },
    gPSInformation          GPSInformation          OPTIONAL,
    iE-Extensions          ProtocolExtensionContainer { { InformationType-ExtIEs } }    OPTIONAL,
    ...
}

-- The GPS Information IE shall be present if the Information Exchange Type IE indicates 'GPS Information'

```

```

-- For information exchange on the Iur-g interface, only the Cell Capacity Class is used.

InformationType-ExtIEs RNSAP-PROTOCOL-EXTENSION ::= {
-- The following IE shall be present if the Information Type Item IE indicates 'GANSS Information'
  { ID id-GANSS-Information          CRITICALITY ignore  EXTENSION GANSS-Information          PRESENCE conditional } |
-- The following IE shall be present if the Information Type Item IE indicates 'DGANSS Corrections'
  { ID id-DGANSS-Corrections-Req    CRITICALITY ignore  EXTENSION DGANSS-Corrections-Req    PRESENCE conditional } |
-- The following IE shall be present if the Information Type Item IE indicates 'MBMS RLC Sequence Number'
  { ID id-MBMS-RLC-Sequence-Number-Information  CRITICALITY ignore  EXTENSION MBMS-RLC-Sequence-Number-Information  PRESENCE conditional
},
  ...
}

Initial-DL-DPCH-TimingAdjustment-Allowed ::= ENUMERATED {
  initial-DL-DPCH-TimingAdjustment-Allowed
}

InnerLoopDLPCStatus      ::= ENUMERATED {active, inactive}

IPDLParameters ::= CHOICE {
  iPDL-FDD-Parameters      IPDL-FDD-Parameters,
  iPDL-TDD-Parameters      IPDL-TDD-Parameters,    --3.84Mcps TDD and 7.68Mcps TDD only
  ...,
  extension-IPDLParameters  Extension-IPDLParameters
}

Extension-IPDLParameters ::= ProtocolIE-Single-Container {{ Extension-IPDLParametersIE }}

Extension-IPDLParametersIE RNSAP-PROTOCOL-IES ::= {
  { ID id-IPDL-TDD-ParametersLCR  CRITICALITY reject  TYPE IPDL-TDD-ParametersLCR  PRESENCE mandatory },
  ...
}

Inter-Frequency-Cell-List ::= SEQUENCE (SIZE (0..maxCellsMeas)) OF Inter-Frequency-Cell

Inter-Frequency-Cell ::= SEQUENCE {
  dL-UARFCN          UARFCN,
  uL-UARFCN          UARFCN      OPTIONAL,
  primaryScramblingCode  PrimaryScramblingCode,
  iE-Extensions       ProtocolExtensionContainer { {Inter-Frequency-Cell-ExtIEs} }      OPTIONAL,
  ...
}

Inter-Frequency-Cell-ExtIEs RNSAP-PROTOCOL-EXTENSION ::= {
  ...
}

Inter-Frequency-Cell-Information ::= SEQUENCE {
  inter-Frequency-Cell-Information-SIB11  Inter-Frequency-Cell-Information-SIB11,
  inter-Frequency-Cell-Information-SIB12  Inter-Frequency-Cell-Information-SIB12,
  iE-Extensions       ProtocolExtensionContainer { {Inter-Frequency-Cell-Information-ExtIEs} }      OPTIONAL,
  ...
}

```



```

Inter-Frequency-Cell-Information-ExtIEs RNSAP-PROTOCOL-EXTENSION ::= {
  ...
}

Inter-Frequency-Cell-Information-SIB11 ::= SEQUENCE (SIZE (0..2)) OF Inter-Frequency-Cells-Information-SIB11-Per-Indication

Inter-Frequency-Cell-Information-SIB12 ::= SEQUENCE (SIZE (0..2)) OF Inter-Frequency-Cells-Information-SIB12-Per-Indication

Inter-Frequency-Cells-Information-SIB11-Per-Indication ::= SEQUENCE {
  inter-Frequency-Cell-Indication-SIB11      Inter-Frequency-Cell-Indication,
  inter-Frequency-Cell-List-SIB11           Inter-Frequency-Cell-SIB11-or-SIB12-List,
  iE-Extensions                             ProtocolExtensionContainer { { Inter-Frequency-Cells-Information-SIB11-Per-Indication-ExtIEs } }      OPTIONAL,
  ...
}

Inter-Frequency-Cells-Information-SIB11-Per-Indication-ExtIEs RNSAP-PROTOCOL-EXTENSION ::= {
  ...
}

Inter-Frequency-Cells-Information-SIB12-Per-Indication ::= SEQUENCE {
  inter-Frequency-Cell-Indication-SIB12      Inter-Frequency-Cell-Indication,
  inter-Frequency-Cell-List-SIB12           Inter-Frequency-Cell-SIB11-or-SIB12-List,
  iE-Extensions                             ProtocolExtensionContainer { { Inter-Frequency-Cells-Information-SIB12-Per-Indication-ExtIEs } }      OPTIONAL,
  ...
}

Inter-Frequency-Cells-Information-SIB12-Per-Indication-ExtIEs RNSAP-PROTOCOL-EXTENSION ::= {
  ...
}

Inter-Frequency-Cell-Indication ::= INTEGER (0..1)
Inter-Frequency-Cell-SIB11-or-SIB12-List ::= SEQUENCE (SIZE (0..maxCellSIB11OrSIB12)) OF Inter-Frequency-Cell-SIB11-or-SIB12

Inter-Frequency-Cell-SIB11-or-SIB12 ::= SEQUENCE {
  interFrequencyCellID      InterFrequencyCellID,
  dL-UARFCN                 UARFCN,
  uL-UARFCN                 UARFCN      OPTIONAL,
  primaryScramblingCode     PrimaryScramblingCode,
  iE-Extensions             ProtocolExtensionContainer { {Inter-Frequency-Cell-ExtIEs} }      OPTIONAL,
  ...
}

InterFrequencyCellID ::= INTEGER (0..31)

IPDL-FDD-Parameters ::= SEQUENCE {
  iPSpacingFDD              IPSpacingFDD,
  iPLength                  IPLength,
  iPOffset                  IPOffset,
  seed                      Seed,
  burstModeParameters       BurstModeParameters      OPTIONAL,
  iE-Extensions             ProtocolExtensionContainer { { IPDL-FDD-Parameters-ExtIEs } }      OPTIONAL,
  ...
}

```

```

}

IPDL-FDD-Parameters-ExtIEs RNSAP-PROTOCOL-EXTENSION ::= {
  ...
}

IPDL-TDD-Parameters ::= SEQUENCE {
  iPSpacingTDD          IPSpacingTDD,
  IPStart               IPStart,
  IPSlot               IPSlot,
  IP-P-CCPCH           IP-P-CCPCH,
  burstModeParameters  BurstModeParameters OPTIONAL,
  IE-Extensions        ProtocolExtensionContainer { { IPDL-TDD-Parameters-ExtIEs } } OPTIONAL,
  ...
}

-- The BurstModeParameters IE shall be included if the Idle Periods are arranged in Burst Mode.

IPDL-TDD-Parameters-ExtIEs RNSAP-PROTOCOL-EXTENSION ::= {
  ...
}

IPDL-TDD-ParametersLCR ::= SEQUENCE {
  iPSpacingTDD          IPSpacingTDD,
  IPStart               IPStart,
  IPSub                 IPSub,
  burstModeParameters  BurstModeParameters OPTIONAL,
  IE-Extensions        ProtocolExtensionContainer { { IPDL-TDD-ParametersLCR-ExtIEs } } OPTIONAL,
  ...
}

-- The BurstModeParameters IE shall be included if the Idle Periods are arranged in Burst Mode.

IPDL-TDD-ParametersLCR-ExtIEs RNSAP-PROTOCOL-EXTENSION ::= {
  ...
}

IPLength ::= ENUMERATED {
  ip15,
  ip110,
  ...
}

IPMulticastAddress ::= OCTET STRING (SIZE (4..16))

IPOffset ::= INTEGER (0..9)

IP-P-CCPCH ::= ENUMERATED {
  switchOff-1-Frame,
  switchOff-2-Frames
}

IPSlot ::= INTEGER (0..14)

```

```
IPSpacingFDD ::= ENUMERATED {
    ipsF5,
    ipsF7,
    ipsF10,
    ipsF15,
    ipsF20,
    ipsF30,
    ipsF40,
    ipsF50,
    ...
}

IPSpacingTDD ::= ENUMERATED {
    ipsT30,
    ipsT40,
    ipsT50,
    ipsT70,
    ipsT100,
    ...
}

IPStart ::= INTEGER (0..4095)

IPSub ::= ENUMERATED {
    first,
    second,
    both
}

IdleIntervalInformation ::= SEQUENCE {
    idleIntervalInfo-k          INTEGER(2..3),
    idleIntervalInfo-offset    INTEGER(0..7),
    ...
}

-- J
-- K
-- L

LAC          ::= OCTET STRING (SIZE (2)) --(EXCEPT ('0000'H|'FFFE'H))

LimitedPowerIncrease ::= ENUMERATED {
    used,
    not-used
}

List-Of-PLMNs ::= SEQUENCE (SIZE (1..maxNrOfBroadcastPLMNs)) OF PLMN-Identity

L3-Information          ::= BIT STRING

Load-Value-IncrDecrThres ::= INTEGER(0..100)

Load-Value ::= INTEGER(0..100)
```

```

LoadValue ::= SEQUENCE {
    uplinkLoadValue    INTEGER(0..100),
    downlinkLoadValue  INTEGER(0..100)
}

LCRTDD-Uplink-Physical-Channel-Capability ::= SEQUENCE {
    maxTimeslotsPerSubFrame    INTEGER(1..6),
    maxPhysChPerTimeslot       ENUMERATED{ts1, ts2, ts3, ts4,...},
    iE-Extensions               ProtocolExtensionContainer { { LCRTDD-Uplink-Physical-Channel-Capability-ExtIEs } } OPTIONAL,
    ...
}

LCRTDD-Uplink-Physical-Channel-Capability-ExtIEs RNSAP-PROTOCOL-EXTENSION ::= {
    ...
}

-- M

MaxNrOfUL-DPCHs                ::= INTEGER (1..6)

MAC-c-sh-SDU-Length            ::= INTEGER (1..5000)

MAC-c-sh-SDU-LengthList ::= SEQUENCE(SIZE(1..maxNrOfMACcshSDU-Length)) OF MAC-c-sh-SDU-Length

MAC-DTX-Cycle-2ms ::= ENUMERATED {v1, v4, v5, v8, v10, v16, v20}

MAC-DTX-Cycle-10ms ::= ENUMERATED {v5, v10, v20}

MAC-ehs-Reset-Timer ::= ENUMERATED {v1, v2, v3, v4,...}

MAC-Inactivity-Threshold ::= ENUMERATED {v1, v2, v4, v8, v16, v32, v64, v128, v256, v512, infinity}
-- Unit subframe

MACdPDU-Size ::= INTEGER (1..5000,...)
-- In case of E-DCH value 8 and values not multiple of 8 shall not be used

MAC-PDU-SizeExtended ::= INTEGER (1..1504,...,1505)
-- In case of E-DCH value 1 shall not be used

MACdPDU-Size-IndexList ::= SEQUENCE (SIZE (1..maxNrOfPDUIndexes)) OF MACdPDU-Size-IndexItem

MACdPDU-Size-IndexItem ::= SEQUENCE {
    sID                SID,
    mACdPDU-Size       MACdPDU-Size,
    iE-Extensions      ProtocolExtensionContainer { { MACdPDU-Size-IndexItem-ExtIEs } } OPTIONAL,
    ...
}

MACdPDU-Size-IndexItem-ExtIEs RNSAP-PROTOCOL-EXTENSION ::= {
    ...
}

MACdPDU-Size-IndexList-to-Modify ::= SEQUENCE (SIZE (1..maxNrOfPDUIndexes)) OF MACdPDU-Size-IndexItem-to-Modify

```

```
MACdPDU-Size-IndexItem-to-Modify ::= SEQUENCE {
    sID                               SID,
    mACdPDU-Size                       MACdPDU-Size,
    iE-Extensions                       ProtocolExtensionContainer { { MACdPDU-Size-IndexItem-to-Modify-ExtIEs } }
    ...
}
MACdPDU-Size-IndexItem-to-Modify-ExtIEs RNSAP-PROTOCOL-EXTENSION ::= {
    ...
}
MACes-Guaranteed-Bitrate ::= INTEGER (0..16777215,...,16777216..256000000)
MACes-Maximum-Bitrate-LCR ::= INTEGER (0..256000000,...)
MACeReset-Indicator ::= ENUMERATED {mACeReset}
MACHsGuaranteedBitRate ::= INTEGER (0..16777215,...,16777216..256000000)
MACHsReorderingBufferSize-for-RLC-UM ::= INTEGER (0..300,...)
-- Unit kBytes
MAC-hsWindowSize ::= ENUMERATED {v4, v6, v8, v12, v16, v24, v32,... , v64, v128}
MACHsResetScheme ::= ENUMERATED {
    always,
    interNodeB-change
}
MaximumAllowedULTxPower ::= INTEGER (-50..33)
Max-Bits-MACe-PDU-non-scheduled ::= INTEGER(1..maxNrOfBits-MACe-PDU-non-scheduled)
MaxNrDLPhysicalchannels ::= INTEGER (1..224)
-- 1.28Mcps TDD 97 - 224 are unused
MaxNrDLPhysicalchannels768 ::= INTEGER (1..448)
MaxNrDLPhysicalchannelsTS ::= INTEGER (1..16)
MaxNrDLPhysicalchannelsTS768 ::= INTEGER (1..32)
MaxNr-Retransmissions-EDCH ::= INTEGER (0..15)
MaxNrTimeslots ::= INTEGER (1..14)
-- 1.28Mcps values 7-14 are unused
MaxNrULPhysicalchannels ::= INTEGER (1..2)
Max-Set-E-DPDCHs ::= ENUMERATED {
    vN256, vN128, vN64, vN32, vN16, vN8, vN4, v2xN4, v2xN2, v2xN2plus2xN4,
    ...
}
```

```

    v2xM2plus2xM4
  }
-- Values releated to TS 25.212 [9]

Max-UE-DTX-Cycle ::= ENUMERATED {
  v5, v10, v20, v40, v64, v80, v128, v160,
  ...
}

MBMS-Bearer-Service-Full-Address ::= SEQUENCE {
  accessPointName           AccessPointName,
  iPMulticastAddress        IPMulticastAddress,
  iE-Extensions             ProtocolExtensionContainer { { MBMS-Bearer-Service-Full-Address-ExtIEs } } OPTIONAL,
  ...
}

MBMS-Bearer-Service-Full-Address-ExtIEs RNSAP-PROTOCOL-EXTENSION ::= {
  ...
}

MBMS-Bearer-Service-List ::= SEQUENCE (SIZE (1..maxNrOfMBMSServices)) OF TMGI

MBMS-Bearer-ServiceItemFDD ::=SEQUENCE{
  tmgi      TMGI,
  transmissionMode      TransmissionMode,
  iE-Extensions             ProtocolExtensionContainer { { MBMS-Bearer-ServiceItemFDD-ExtIEs} } OPTIONAL,
  ...
}

MBMS-Bearer-ServiceItemFDD-ExtIEs RNSAP-PROTOCOL-EXTENSION ::= {
  ...
}

MBMS-Bearer-ServiceItemFDD-PFL ::=SEQUENCE{
  tmgi      TMGI,
  transmissionMode      TransmissionMode      OPTIONAL,
  preferredFrequencyLayer      UARFCN          OPTIONAL,
  iE-Extensions             ProtocolExtensionContainer { { MBMS-Bearer-ServiceItemFDD-PFL-ExtIEs} } OPTIONAL,
  ...
}

MBMS-Bearer-ServiceItemFDD-PFL-ExtIEs RNSAP-PROTOCOL-EXTENSION ::= {
  ...
}

MBMS-Bearer-ServiceItemTDD ::=SEQUENCE{
  tmgi      TMGI,
  transmissionMode      TransmissionMode,
  iE-Extensions             ProtocolExtensionContainer { { MBMS-Bearer-ServiceItemTDD-ExtIEs} } OPTIONAL,
  ...
}

```

```

MBMS-Bearer-ServiceItemTDD-ExtIEs RNSAP-PROTOCOL-EXTENSION ::= {
    ...
}

MBMS-Bearer-ServiceItemTDD-PFL ::=SEQUENCE{
    tmgi TMGI,
    transmissionMode TransmissionMode OPTIONAL,
    preferredFrequencyLayer UARFCN OPTIONAL,
    iE-Extensions ProtocolExtensionContainer { { MBMS-Bearer-ServiceItemTDD-PFL-ExtIEs} } OPTIONAL,
    ...
}
MBMS-Bearer-ServiceItemTDD-PFL-ExtIEs RNSAP-PROTOCOL-EXTENSION ::= {
    ...
}

MBMSChannelTypeInfo ::= SEQUENCE {
    tmgi TMGI,
    pTM-Cell-List PTMCellList OPTIONAL,
    pTP-Cell-List PTPCellList OPTIONAL,
    not-Provided-Cell-List NotProvidedCellList OPTIONAL,
    iE-Extensions ProtocolExtensionContainer { { MBMSChannelTypeInfo-ExtIEs} } OPTIONAL,
    ...
}

MBMSChannelTypeInfo-ExtIEs RNSAP-PROTOCOL-EXTENSION ::= {
    ...
}

MBMSChannelTypeCellList ::= SEQUENCE {
    c-ID C-ID,
    affectedUEInformationForMBMS AffectedUEInformationForMBMS OPTIONAL,
    iE-Extensions ProtocolExtensionContainer { { MBMSChannelTypeCellList-ExtIEs} } OPTIONAL,
    ...
}

MBMSChannelTypeCellList-ExtIEs RNSAP-PROTOCOL-EXTENSION ::= {
    ...
}

MBMSPreferredFreqLayerInfo ::= SEQUENCE {
    tmgi TMGI,
    preferredFrequencyLayerInfo PreferredFrequencyLayerInfo,
    iE-Extensions ProtocolExtensionContainer { { MBMSPreferredFreqLayerInfo-ExtIEs} } OPTIONAL,
    ...
}

MBMSPreferredFreqLayerInfo-ExtIEs RNSAP-PROTOCOL-EXTENSION ::= {
    ...
}

MBMS-Neighbouring-Cell-Information ::= SEQUENCE {
    mBMS-ConcatenatedServiceList MBMS-ConcatenatedServiceList,
    l3-Information-1 L3-Information OPTIONAL,
    -- This IE contains MBMS COMMON P-T-M RB INFORMATION defined in TS 25.331 [16]
    l3-Information-2 L3-Information OPTIONAL,

```

```

-- This IE contains MBMS CURRENT CELL P-T-M RB INFORMATION defined in TS 25.331 [16]
  iE-Extensions          ProtocolExtensionContainer { { MBMS-Neighbouring-Cell-Information-ExtIEs } } OPTIONAL,
  ...
}

MBMS-Neighbouring-Cell-Information-ExtIEs RNSAP-PROTOCOL-EXTENSION ::= {
  ...
}

MBMS-ConcatenatedServiceList ::= SEQUENCE (SIZE (1..maxLengthMBMSConcatServlists)) OF TMGI

MBMS-RLC-Sequence-Number-Information ::= SEQUENCE (SIZE (1..maxNrOfCells)) OF MBMS-RLC-Sequence-Number-Information-List

MBMS-RLC-Sequence-Number-Information-List ::= SEQUENCE {
  c-ID                    C-ID,
  mBMS-Bearer-Service-List-RLC          MBMS-Bearer-Service-List-RLC,
  iE-Extensions          ProtocolExtensionContainer { { MBMS-RLC-Sequence-Number-Information-List-ExtIEs } } OPTIONAL,
  ...
}

MBMS-RLC-Sequence-Number-Information-List-ExtIEs RNSAP-PROTOCOL-EXTENSION ::= {
  ...
}

MBMS-Bearer-Service-List-RLC ::= SEQUENCE (SIZE (1..maxNrOfMBMSServices)) OF MBMS-Bearer-Service-List-RLCinfo

MBMS-Bearer-Service-List-RLCinfo ::= SEQUENCE {
  tmgi                    TMGI,
  time-Stamp             Time-Stamp,
  iE-Extensions          ProtocolExtensionContainer { { MBMS-Bearer-Service-List-RLCinfo-ExtIEs } } OPTIONAL,
  ...
}

MBMS-Bearer-Service-List-RLCinfo-ExtIEs RNSAP-PROTOCOL-EXTENSION ::= {
  ...
}

MBSFN-Cluster-Identity ::= INTEGER (0..65535)

MCCH-Message-List ::= SEQUENCE (SIZE (1.. maxNrOfMCCHMessages)) OF L3-Information

MCCH-Configuration-Info ::= SEQUENCE {
  secondaryCCPCHSystemInformationMBMS          Secondary-CCPCH-System-Information-MBMS,
  ie-Extensions          ProtocolExtensionContainer { { MCCH-Configuration-Info-ExtIEs } } OPTIONAL,
  ...
}

MCCH-Configuration-Info-ExtIEs RNSAP-PROTOCOL-EXTENSION ::= {
  ...
}

Secondary-CCPCH-System-Information-MBMS ::= BIT STRING

```



```

MBSFN-Scheduling-Transmission-Time-Interval-Info-List ::= SEQUENCE (SIZE (1.. maxNrOfMBMSL3)) OF MBSFN-Scheduling-Transmission-Time-Interval-Item

MBSFN-Scheduling-Transmission-Time-Interval-Item ::= SEQUENCE {
    tMGI                TMGI,
    mbsfnSchedulingTransmissionTimeInterval  MbsfnSchedulingTransmissionTimeInterval,
    ie-Extensions       ProtocolExtensionContainer { { MBSFN-Scheduling-Transmission-Time-Interval-Item-ExtIEs } }
    OPTIONAL,
    ...
}

MBSFN-Scheduling-Transmission-Time-Interval-Item-ExtIEs RNSAP-PROTOCOL-EXTENSION ::= {
    ...
}

MbsfnSchedulingTransmissionTimeInterval ::= ENUMERATED {tti4, tti8, tti16, tti32, tti64, tti128, tti256}

MeasurementFilterCoefficient ::= ENUMERATED{k0, k1, k2, k3, k4, k5, k6, k7, k8, k9, k11, k13, k15, k17, k19,...}
-- Measurement Filter Coefficient to be used for measurement

MeasurementID ::= INTEGER (0..1048575)

Measurement-Power-Offset ::= INTEGER(-12 .. 26)
-- Actual value = IE value * 0.5

MinimumSpreadingFactor ::= INTEGER (1..16)

MinimumSpreadingFactor768 ::= INTEGER (1..32)

MultipleURAsIndicator ::= ENUMERATED {
    multiple-URAs-exist,
    single-URA-exists
}

MaxAdjustmentStep ::= INTEGER(1..10)
-- Unit Slot

MeasurementChangeTime ::= INTEGER (1..6000,...)
-- The MeasurementChangeTime gives the MeasurementChangeTime
-- in number of 10 ms periods.
-- E.g. Value 6000 means 60000ms(1min)
-- Unit is ms, Step is 10 ms

MeasurementHysteresisTime ::= INTEGER (1..6000,...)
-- The MeasurementHysteresisTime gives the
-- MeasurementHysteresisTime in number of 10 ms periods.
-- E.g. Value 6000 means 60000ms(1min)
-- Unit is ms, Step is 10ms

MeasurementIncreaseDecreaseThreshold ::= CHOICE {

```

```

sir                SIR-Value-IncrDecrThres,
sir-error          SIR-Error-Value-IncrDecrThres,
transmitted-code-power  Transmitted-Code-Power-Value-IncrDecrThres,
rscp              RSCP-Value-IncrDecrThres,
round-trip-time   Round-Trip-Time-IncrDecrThres,
...,
extension-MeasurementIncreaseDecreaseThreshold  Extension-MeasurementIncreaseDecreaseThreshold
}

```

```
Extension-MeasurementIncreaseDecreaseThreshold ::= ProtocolIE-Single-Container {{ Extension-MeasurementIncreaseDecreaseThresholdIE }}
```

```

Extension-MeasurementIncreaseDecreaseThresholdIE RNSAP-PROTOCOL-IES ::= {
  { ID id-Load-Value-IncrDecrThres    CRITICALITY reject  TYPE Load-Value-IncrDecrThres    PRESENCE mandatory }|
  { ID id-Transmitted-Carrier-Power-Value-IncrDecrThres  CRITICALITY reject  TYPE Transmitted-Carrier-Power-Value-IncrDecrThres
  PRESENCE mandatory }|
  { ID id-Received-Total-Wideband-Power-Value-IncrDecrThres  CRITICALITY reject  TYPE Received-Total-Wideband-Power-Value-IncrDecrThres
  PRESENCE mandatory }|
  { ID id-UL-Timeslot-ISCP-Value-IncrDecrThres  CRITICALITY reject  TYPE UL-Timeslot-ISCP-Value-IncrDecrThres          PRESENCE mandatory }|
  { ID id-RT-Load-Value-IncrDecrThres  CRITICALITY reject  TYPE RT-Load-Value-IncrDecrThres    PRESENCE mandatory }|
  { ID id-NRT-Load-Information-Value-IncrDecrThres  CRITICALITY reject  TYPE NRT-Load-Information-Value-IncrDecrThres          PRESENCE mandatory
}|
  { ID id-UpPTSInterferenceValue      CRITICALITY reject  TYPE UpPTSInterferenceValue        PRESENCE mandatory }
}

```

```
MeasurementRecoveryBehavior ::= NULL
```

```
MeasurementRecoveryReportingIndicator ::= NULL
```

```
MeasurementRecoverySupportIndicator ::= NULL
```

```

MeasurementThreshold ::= CHOICE {
  sir                SIR-Value,
  sir-error          SIR-Error-Value,
  transmitted-code-power  Transmitted-Code-Power-Value,
  rscp              RSCP-Value,
  rx-timing-deviation  Rx-Timing-Deviation-Value,
  round-trip-time   Round-Trip-Time-Value,
  ...,
  extension-MeasurementThreshold  Extension-MeasurementThreshold
}

```

```
Extension-MeasurementThreshold ::= ProtocolIE-Single-Container {{ Extension-MeasurementThresholdIE }}
```

```

Extension-MeasurementThresholdIE RNSAP-PROTOCOL-IES ::= {
  { ID id-TUTRANGPSMeasurementThresholdInformation  CRITICALITY reject  TYPE TUTRANGPSMeasurementThresholdInformation          PRESENCE
mandatory }|
  { ID id-SFNFSNMeasurementThresholdInformation    CRITICALITY reject  TYPE SFNFSNMeasurementThresholdInformation          PRESENCE
mandatory }|
  { ID id-Load-Value                              CRITICALITY reject  TYPE Load-Value
  PRESENCE mandatory }|
  { ID id-Transmitted-Carrier-Power-Value          CRITICALITY reject  TYPE Transmitted-Carrier-Power-Value
  PRESENCE mandatory }|
  { ID id-Received-Total-Wideband-Power-Value     CRITICALITY reject  TYPE Received-Total-Wideband-Power-Value          PRESENCE
mandatory }|
}

```

```

{ ID id-UL-Timeslot-ISCP-Value          CRITICALITY reject TYPE UL-Timeslot-ISCP-Value
  PRESENCE mandatory }|
{ ID id-RT-Load-Value                   CRITICALITY reject TYPE RT-Load-Value
  PRESENCE mandatory }|
{ ID id-NRT-Load-Information-Value      CRITICALITY reject TYPE NRT-Load-Information-Value
  PRESENCE mandatory }|
{ ID id-Rx-Timing-Deviation-Value-LCR   CRITICALITY reject TYPE Rx-Timing-Deviation-Value-LCR
  PRESENCE mandatory }|
{ ID id-HS-SICH-Reception-Quality-Measurement-Value CRITICALITY reject TYPE HS-SICH-Reception-Quality-Measurement-Value PRESENCE mandatory }|
{ ID id-UpPTSInterferenceValue          CRITICALITY reject TYPE UpPTSInterferenceValue
  PRESENCE mandatory }|
{ ID id-Rx-Timing-Deviation-Value-768   CRITICALITY reject TYPE Rx-Timing-Deviation-Value-768
  PRESENCE mandatory }|
{ ID id-Rx-Timing-Deviation-Value-ext   CRITICALITY reject TYPE Rx-Timing-Deviation-Value-ext
  PRESENCE mandatory }|
{ ID id-Extended-Round-Trip-Time-Value  CRITICALITY reject TYPE Extended-Round-Trip-Time-Value
  PRESENCE mandatory }|
{ ID id-TUTRANGANSSMeasurementThresholdInformation CRITICALITY reject TYPE TUTRANGANSSMeasurementThresholdInformation PRESENCE mandatory }
}

MidambleConfigurationBurstType1And3 ::= ENUMERATED {v4, v8, v16}

MidambleConfigurationBurstType2 ::= ENUMERATED {v3, v6}

MidambleConfigurationLCR ::= ENUMERATED {v2, v4, v6, v8, v10, v12, v14, v16, ...}

MidambleShiftAndBurstType ::= CHOICE {
  type1 SEQUENCE {
    midambleConfigurationBurstType1And3 MidambleConfigurationBurstType1And3,
    midambleAllocationMode CHOICE {
      defaultMidamble NULL,
      commonMidamble NULL,
      ueSpecificMidamble MidambleShiftLong,
      ...
    },
    ...
  },
  type2 SEQUENCE {
    midambleConfigurationBurstType2 MidambleConfigurationBurstType2,
    midambleAllocationMode CHOICE {
      defaultMidamble NULL,
      commonMidamble NULL,
      ueSpecificMidamble MidambleShiftShort,
      ...
    },
    ...
  },
  type3 SEQUENCE {
    midambleConfigurationBurstType1And3 MidambleConfigurationBurstType1And3,
    midambleAllocationMode CHOICE {
      defaultMidamble NULL,
      ueSpecificMidamble MidambleShiftLong,
      ...
    },
    ...
  },
}

```

```

    },
    ...
}

MidambleShiftLong ::= INTEGER (0..15)

MidambleShiftShort ::= INTEGER (0..5)

MidambleShiftLCR ::= SEQUENCE {
    midambleAllocationMode MidambleAllocationMode,
    midambleShift MidambleShiftLong OPTIONAL,
    -- The IE shall be present if the Midamble Allocation Mode IE is set to "UE specific midamble".
    midambleConfigurationLCR MidambleConfigurationLCR,
    iE-Extensions ProtocolExtensionContainer { {MidambleShiftLCR-ExtIEs} } OPTIONAL,
    ...
}

MidambleAllocationMode ::= ENUMERATED {
    defaultMidamble,
    commonMidamble,
    ueSpecificMidamble,
    ...
}

MidambleShiftLCR-ExtIEs RNSAP-PROTOCOL-EXTENSION ::= {
    ...
}

MidambleShiftAndBurstType768 ::= CHOICE {
    type1 SEQUENCE {
        midambleConfigurationBurstType1And3 MidambleConfigurationBurstType1And3,
        midambleAllocationMode CHOICE {
            defaultMidamble NULL,
            commonMidamble NULL,
            ueSpecificMidamble MidambleShiftLong,
            ...
        },
        ...
    },
    type2 SEQUENCE {
        midambleConfigurationBurstType2-768 MidambleConfigurationBurstType2-768,
        midambleAllocationMode CHOICE {
            defaultMidamble NULL,
            commonMidamble NULL,
            ueSpecificMidamble MidambleShiftShort768,
            ...
        },
        ...
    },
    type3 SEQUENCE {
        midambleConfigurationBurstType1And3 MidambleConfigurationBurstType1And3,
        midambleAllocationMode CHOICE {
            defaultMidamble NULL,

```

```

        ueSpecificMidamble          MidambleShiftLong,
        ...
    },
    ...
}

MidambleConfigurationBurstType2-768 ::= ENUMERATED {v4, v8}

MidambleShiftShort768 ::= INTEGER (0..7)

MIMO-ActivationIndicator ::= NULL

MIMO-InformationResponse ::= SEQUENCE {
    mIMO-PilotConfiguration          MIMO-PilotConfiguration,
    mIMO-N-M-Ratio                   MIMO-N-M-Ratio,
    iE-Extensions                    ProtocolExtensionContainer { { MIMO-InformationResponse-ExtIEs } }
    ...
}
OPTIONAL,

MIMO-InformationResponse-ExtIEs RNSAP-PROTOCOL-EXTENSION ::= {
    ...
}

MIMO-Mode-Indicator ::= ENUMERATED {
    activate,
    deactivate
}

MIMO-N-M-Ratio ::= ENUMERATED {v1-2, v2-3, v3-4, v4-5, v5-6, v6-7, v7-8, v8-9, v9-10, v1-1,...}

MIMO-PilotConfiguration ::= CHOICE {
    primary-and-secondary-CPICH      MIMO-S-CPICH-Channelisation-Code,
    normal-and-diversity-primary-CPICH NULL,
    ...
}

MIMO-S-CPICH-Channelisation-Code ::= INTEGER (0..255)

MinUL-ChannelisationCodeLength ::= ENUMERATED {
    v4,
    v8,
    v16,
    v32,
    v64,
    v128,
    v256
}

MinimumReducedE-DPDCH-GainFactor ::= ENUMERATED {m8-15, m11-15, m15-15, m21-15, m30-15, m42-15, m60-15, m84-15,...}

```

```

ModifyPriorityQueue ::= CHOICE {
    addPriorityQueue          PriorityQueue-InfoItem-to-Add,
    modifyPriorityQueue       PriorityQueue-InfoItem-to-Modify,
    deletePriorityQueue      PriorityQueue-Id,
    ...
}

Modulation ::= ENUMERATED {
    qPSK,
    eightPSK,
    ...
}

MulticelledCH-Information ::= ProtocolIE-Single-Container { {MulticelledCH-InformationItem} }

MulticelledCH-InformationItem RNSAP-PROTOCOL-IES ::= {
    { ID id-MulticelledCH-Information    CRITICALITY ignore    TYPE MulticelledCH-InformationItemIES    PRESENCE mandatory }
}

MulticelledCH-InformationItemIES ::= SEQUENCE {
    dl-PowerBalancing-Information          DL-PowerBalancing-Information          OPTIONAL,
    minimumReducedE-DPDCH-GainFactor      MinimumReducedE-DPDCH-GainFactor      OPTIONAL,
    secondary-UL-Frequency-Activation-State Secondary-UL-Frequency-Activation-State OPTIONAL,
    f-DPCH-SlotFormat                     F-DPCH-SlotFormat                     OPTIONAL,
    common-DL-ReferencePowerInformation    DL-Power                               OPTIONAL,
    iE-Extensions                          ProtocolExtensionContainer { { MulticelledCH-InformationItemIES-ExtIES } } OPTIONAL,
    ...
}

MulticelledCH-InformationItemIES-ExtIES RNSAP-PROTOCOL-EXTENSION ::= {
    ...
}

MulticelledCH-RL-SpecificInformation ::= ProtocolIE-Single-Container { {MulticelledCH-RL-SpecificInformationItem} }

MulticelledCH-RL-SpecificInformationItem RNSAP-PROTOCOL-IES ::= {
    { ID id-MulticelledCH-RL-SpecificInformation    CRITICALITY ignore    TYPE MulticelledCH-RL-SpecificInformationItemIES    PRESENCE
    mandatory }
}

MulticelledCH-RL-SpecificInformationItemIES ::= SEQUENCE {
    extendedPropagationDelay          ExtendedPropagationDelay          OPTIONAL,
    enhanced-PrimaryCPICH-EcNo        Enhanced-PrimaryCPICH-EcNo        OPTIONAL,
    dl-Reference-Power                DL-Power                          OPTIONAL,
    phase-Reference-Update-Indicator   Phase-Reference-Update-Indicator   OPTIONAL,
    additional-e-DCH-DL-Control-Channel-Grant NULL                               OPTIONAL,
    iE-Extensions                      ProtocolExtensionContainer { { MulticelledCH-RL-SpecificInformationItemIES-ExtIES } } OPTIONAL,
    ...
}

MulticelledCH-RL-SpecificInformationItemIES-ExtIES RNSAP-PROTOCOL-EXTENSION ::= {
    ...
}

```

```

}

Multiple-PLMN-List ::= SEQUENCE {
    pLMN-Identity      PLMN-Identity,
    list-Of-PLMNs     List-Of-PLMNs
    iE-Extensions     ProtocolExtensionContainer { { Multiple-PLMN-List-ExtIEs } } OPTIONAL,
    ...
}

Multiple-PLMN-List-ExtIEs RNSAP-PROTOCOL-EXTENSION ::= {
    ...
}

MultiplexingPosition ::= ENUMERATED {
    fixed,
    flexible
}

MACHs-ResetIndicator ::= ENUMERATED{
    mACHs-NotReset
}

MultipleFreq-HSPDSCH-InformationList-ResponseTDDLCR ::= SEQUENCE (SIZE (1.. maxHSDPAFrequency-1)) OF MultipleFreq-HSPDSCH-InformationItem-ResponseTDDLCR
--Includes the 2nd through the max number of frequency repetitions

MultipleFreq-HSPDSCH-InformationItem-ResponseTDDLCR ::= SEQUENCE{
    hSSCCH-TDD-Specific-InfoList-Response-LCR      HSSCCH-TDD-Specific-InfoList-Response-LCR    OPTIONAL,
    HARQ-MemoryPartitioning                        HARQ-MemoryPartitioning                        OPTIONAL,
    uARFCN                                          UARFCN,
    -- This is the UARFCN for the second and beyond Frequency repetition.
    iE-Extensions                                  ProtocolExtensionContainer { { MultipleFreq-HSPDSCH-InformationItem-ResponseTDDLCR-ExtIEs } }
    OPTIONAL,
    ...
}

MultipleFreq-HSPDSCH-InformationItem-ResponseTDDLCR-ExtIEs RNSAP-PROTOCOL-EXTENSION ::= {
    ...
}

MIMO-SFMode-For-HSPDSCHDualStream ::= ENUMERATED {
    sF1,
    sF1SF16
}

-- N

NACC-Related-Data ::= SEQUENCE {
    gERAN-SI-Type      GERAN-SI-Type,
    iE-Extensions     ProtocolExtensionContainer { {NACC-Related-Data-ExtIEs} }        OPTIONAL,
    ...
}

```

```
NACC-Related-Data-ExtIEs RNSAP-PROTOCOL-EXTENSION ::= {
  ...
}
```

```
Nack-Power-Offset ::= INTEGER (0..8,...)
-- According to mapping in ref. TS 25.213 [21] subclause 4.2.1
```

```
NCC ::= BIT STRING (SIZE (3))
```

```
Neighbouring-UMTS-CellInformation ::= SEQUENCE (SIZE (1..maxNrOfNeighbouringRNCs)) OF ProtocolIE-Single-Container {{ Neighbouring-UMTS-CellInformationItemIE }}
```

```
Neighbouring-UMTS-CellInformationItemIE RNSAP-PROTOCOL-IES ::= {
  { ID id-Neighbouring-UMTS-CellInformationItem CRITICALITY ignore TYPE Neighbouring-UMTS-CellInformationItem PRESENCE mandatory }
}
```

```
Neighbouring-UMTS-CellInformationItem ::= SEQUENCE {
  rNC-ID RNC-ID,
  cN-PS-DomainIdentifier CN-PS-DomainIdentifier OPTIONAL,
  cN-CS-DomainIdentifier CN-CS-DomainIdentifier OPTIONAL,
  neighbouring-FDD-CellInformation Neighbouring-FDD-CellInformation OPTIONAL,
  neighbouring-TDD-CellInformation Neighbouring-TDD-CellInformation OPTIONAL,
  iE-Extensions ProtocolExtensionContainer { {Neighbouring-UMTS-CellInformationItem-ExtIEs} } OPTIONAL,
  ...
}
```

```
Neighbouring-UMTS-CellInformationItem-ExtIEs RNSAP-PROTOCOL-EXTENSION ::= {
  { ID id-neighbouring-LCR-TDD-CellInformation CRITICALITY ignore EXTENSION Neighbouring-LCR-TDD-CellInformation PRESENCE optional } |
  { ID id-Extended-RNC-ID CRITICALITY reject EXTENSION Extended-RNC-ID PRESENCE optional },
  ...
}
```

```
Neighbouring-FDD-CellInformation ::= SEQUENCE ( SIZE (1..maxNrOfFDDNeighboursPerRNC,...)) OF Neighbouring-FDD-CellInformationItem
```

```
Neighbouring-FDD-CellInformationItem ::= SEQUENCE {
  c-ID C-ID,
  uARFCNforNu UARFCN,
  uARFCNforNd UARFCN,
  frameOffset FrameOffset OPTIONAL,
  primaryScramblingCode PrimaryScramblingCode,
  primaryCPICH-Power PrimaryCPICH-Power OPTIONAL,
  cellIndividualOffset CellIndividualOffset OPTIONAL,
  txDiversityIndicator TxDiversityIndicator,
  sTTD-SupportIndicator STTD-SupportIndicator OPTIONAL,
  closedLoopModel1-SupportIndicator ClosedLoopModel1-SupportIndicator OPTIONAL,
  not-used-closedLoopMode2-SupportIndicator NULL OPTIONAL,
  iE-Extensions ProtocolExtensionContainer { { Neighbouring-FDD-CellInformationItem-ExtIEs} } OPTIONAL,
  ...
}
```

```
Neighbouring-FDD-CellInformationItem-ExtIEs RNSAP-PROTOCOL-EXTENSION ::= {
```



```

    { ID id-RestrictionStateIndicator          CRITICALITY ignore          EXTENSION RestrictionStateIndicator          PRESENCE optional
    }|
    { ID id-DPC-Mode-Change-SupportIndicator   CRITICALITY ignore          EXTENSION DPC-Mode-Change-SupportIndicator   PRESENCE optional }|
    { ID id-CoverageIndicator                 CRITICALITY ignore          EXTENSION CoverageIndicator                 PRESENCE
optional   }|
    { ID id-AntennaColocationIndicator         CRITICALITY ignore          EXTENSION AntennaColocationIndicator         PRESENCE optional }|
    { ID id-HCS-Prio                          CRITICALITY ignore          EXTENSION HCS-Prio                          PRESENCE
optional   }|
    { ID id-CellCapabilityContainer-FDD        CRITICALITY ignore          EXTENSION CellCapabilityContainer-FDD        PRESENCE
optional   }|
    { ID id-SNA-Information                   CRITICALITY ignore          EXTENSION SNA-Information                   PRESENCE optional }|
    { ID id-FrequencyBandIndicator            CRITICALITY ignore          EXTENSION FrequencyBandIndicator            PRESENCE optional }|
    { ID id-Max-UE-DTX-Cycle                  CRITICALITY ignore          EXTENSION Max-UE-DTX-Cycle                  PRESENCE
conditional }|
    -- This IE shall be present if the the fifteenth bit Continuous Packet Connectivity DTX-DRX Support Indicator in the Cell Capability Container FDD IE is set to the value "1".
    { ID id-Multiple-PLMN-List                CRITICALITY ignore          EXTENSION Multiple-PLMN-List                PRESENCE
optional   }|
    { ID id-Secondary-Serving-Cell-List       CRITICALITY ignore          EXTENSION Secondary-Serving-Cell-List       PRESENCE optional }|
    { ID id-Dual-Band-Secondary-Serving-Cell-List CRITICALITY ignore          EXTENSION Dual-Band-Secondary-Serving-Cell-List PRESENCE optional }|
    -- This IE shall be present if the twenty-eighth bit Dual Band Support Indicator in the Cell Capability Container FDD IE is set to the value "1".
    { ID id-CellCapabilityContainerExtension-FDD CRITICALITY ignore          EXTENSION CellCapabilityContainerExtension-FDD PRESENCE optional }|
    { ID id-CellListValidityIndicator         CRITICALITY ignore          EXTENSION CellListValidityIndicator         PRESENCE optional },
    ...
}

NeighbouringFDDCellMeasurementInformation ::= SEQUENCE {
    uC-ID                UC-ID,
    uARFCN                UARFCN,
    primaryScramblingCode PrimaryScramblingCode,
    iE-Extensions        ProtocolExtensionContainer { { NeighbouringFDDCellMeasurementInformationItem-ExtIEs } } OPTIONAL,
    ...
}

NeighbouringFDDCellMeasurementInformationItem-ExtIEs RNSAP-PROTOCOL-EXTENSION ::= {
    ...
}

Neighbouring-GSM-CellInformation ::= ProtocolIE-Single-Container {{ Neighbouring-GSM-CellInformationIE }}

Neighbouring-GSM-CellInformationIE RNSAP-PROTOCOL-IES ::= {
    { ID id-Neighbouring-GSM-CellInformation CRITICALITY ignore TYPE Neighbouring-GSM-CellInformationIEs PRESENCE mandatory }
}

Neighbouring-GSM-CellInformationIEs ::= SEQUENCE ( SIZE (1..maxNrOfGSMNeighboursPerRNC,...)) OF Neighbouring-GSM-CellInformationItem

Neighbouring-GSM-CellInformationItem ::= SEQUENCE {
    CGI                CGI,
    cellIndividualOffset CellIndividualOffset OPTIONAL,
    bSIC                BSIC,
    band-Indicator      Band-Indicator,
    bCCH-ARFCN          BCCH-ARFCN,
    iE-Extensions        ProtocolExtensionContainer { { Neighbouring-GSM-CellInformationItem-ExtIEs } } OPTIONAL,
    ...
}

```

```

}

Neighbouring-GSM-CellInformationItem-ExtIEs RNSAP-PROTOCOL-EXTENSION ::= {
  { ID id-CoverageIndicator          CRITICALITY ignore          EXTENSION CoverageIndicator          PRESENCE optional
  PRESENCE optional } |
  { ID id-AntennaColocationIndicator CRITICALITY ignore          EXTENSION AntennaColocationIndicator PRESENCE optional
  } |
  { ID id-HCS-Prio                   CRITICALITY ignore          EXTENSION HCS-Prio                   PRESENCE
  PRESENCE optional } |
  { ID id-SNA-Information             CRITICALITY ignore          EXTENSION SNA-Information            PRESENCE
  PRESENCE optional } |
  { ID id-GERAN-Cell-Capability       CRITICALITY ignore          EXTENSION GERAN-Cell-Capability      PRESENCE
optional } |
  { ID id-GERAN-Classmark             CRITICALITY ignore          EXTENSION GERAN-Classmark            PRESENCE
  PRESENCE optional } |
  { ID id-ExtendedGSMCellIndividualOffset CRITICALITY ignore          EXTENSION ExtendedGSMCellIndividualOffset PRESENCE optional },
  ...
}

Neighbouring-TDD-CellInformation ::= SEQUENCE ( SIZE (1..maxNrOfTDDNeighboursPerRNC,...)) OF Neighbouring-TDD-CellInformationItem

Neighbouring-TDD-CellInformationItem ::= SEQUENCE {
  c-ID                               C-ID,
  uARFCNforNt                        UARFCN,
  frameOffset                         FrameOffset          OPTIONAL,
  cellParameterID                    CellParameterID,
  syncCase                            SyncCase,
  timeSlot                            TimeSlot             OPTIONAL
  -- This IE shall be present if Sync Case = Case1 -- ,
  sCH-TimeSlot                        SCH-TimeSlot         OPTIONAL
  -- This IE shall be present if Sync Case = Case2 -- ,
  sCTD-Indicator                      SCTD-Indicator,
  cellIndividualOffset                CellIndividualOffset OPTIONAL,
  dPCHConstantValue                  DPCHConstantValue  OPTIONAL,
  pCCPCH-Power                       PCCPCH-Power       OPTIONAL,
  iE-Extensions                      ProtocolExtensionContainer { { Neighbouring-TDD-CellInformationItem-ExtIEs } } OPTIONAL,
  ...
}

Neighbouring-TDD-CellInformationItem-ExtIEs RNSAP-PROTOCOL-EXTENSION ::= {
  { ID id-RestrictionStateIndicator   CRITICALITY ignore          EXTENSION RestrictionStateIndicator   PRESENCE optional
  } |
  { ID id-CoverageIndicator            CRITICALITY ignore          EXTENSION CoverageIndicator            PRESENCE
optional } |
  { ID id-AntennaColocationIndicator   CRITICALITY ignore          EXTENSION AntennaColocationIndicator   PRESENCE optional } |
  { ID id-HCS-Prio                    CRITICALITY ignore          EXTENSION HCS-Prio                    PRESENCE
optional } |
  { ID id-CellCapabilityContainer-TDD   CRITICALITY ignore          EXTENSION CellCapabilityContainer-TDD   PRESENCE optional } |
  { ID id-SNA-Information              CRITICALITY ignore          EXTENSION SNA-Information              PRESENCE
optional } |
  { ID id-CellCapabilityContainer-TDD768 CRITICALITY ignore          EXTENSION CellCapabilityContainer-TDD768 PRESENCE
optional } |
  { ID id-Multiple-PLMN-List           CRITICALITY ignore          EXTENSION Multiple-PLMN-List           PRESENCE
optional },
}

```

```

}
...
}
NeighbouringTDDCellMeasurementInformation ::= SEQUENCE {
    uC-ID                UC-ID,
    uARFCN                UARFCN,
    cellParameterID      CellParameterID,
    timeSlot              TimeSlot                OPTIONAL,
    midambleShiftAndBurstType MidambleShiftAndBurstType  OPTIONAL,
    iE-Extensions         ProtocolExtensionContainer { { NeighbouringTDDCellMeasurementInformationItem-ExtIEs } } OPTIONAL,
    ...
}

NeighbouringTDDCellMeasurementInformationItem-ExtIEs RNSAP-PROTOCOL-EXTENSION ::= {
    ...
}

NeighbouringTDDCellMeasurementInformationLCR ::= SEQUENCE {
    uC-ID                UC-ID,
    uARFCN                UARFCN,
    cellParameterID      CellParameterID,
    timeSlotLCR          TimeSlotLCR                OPTIONAL,
    midambleShiftLCR     MidambleShiftLCR            OPTIONAL,
    iE-Extensions         ProtocolExtensionContainer { { NeighbouringTDDCellMeasurementInformationLCRItem-ExtIEs } } OPTIONAL,
    ...
}

NeighbouringTDDCellMeasurementInformationLCRItem-ExtIEs RNSAP-PROTOCOL-EXTENSION ::= {
    ...
}

NeighbouringTDDCellMeasurementInformation768 ::= SEQUENCE {
    uC-ID                UC-ID,
    uARFCN                UARFCN,
    cellParameterID      CellParameterID,
    timeSlot              TimeSlot                OPTIONAL,
    midambleShiftAndBurstType768 MidambleShiftAndBurstType768  OPTIONAL,
    iE-Extensions         ProtocolExtensionContainer { { NeighbouringTDDCellMeasurementInformationItem768-ExtIEs } } OPTIONAL,
    ...
}

NeighbouringTDDCellMeasurementInformationItem768-ExtIEs RNSAP-PROTOCOL-EXTENSION ::= {
    ...
}

Neighbouring-LCR-TDD-CellInformation ::= SEQUENCE (SIZE (1.. maxNrOfLCRTDDNeighboursPerRNC,...)) OF Neighbouring-LCR-TDD-CellInformationItem

Neighbouring-LCR-TDD-CellInformationItem ::= SEQUENCE {
    c-ID                C-ID,
    uARFCNforNt         UARFCN,
    frameOffset         FrameOffset                OPTIONAL,
    cellParameterID     CellParameterID,
}

```

```

sCTD-Indicator          SCTD-Indicator,
cellIndividualOffset    CellIndividualOffset  OPTIONAL,
dPCHConstantValue      DPCHConstantValue  OPTIONAL,
pCCPCH-Power           PCCPCH-Power      OPTIONAL,
restrictionStateIndicator RestrictionStateIndicator  OPTIONAL,
iE-Extensions          ProtocolExtensionContainer { { Neighbouring-LCR-TDD-CellInformationItem-ExtIEs } } OPTIONAL,
...
}

Neighbouring-LCR-TDD-CellInformationItem-ExtIEs RNSAP-PROTOCOL-EXTENSION ::= {
  { ID id-CoverageIndicator          CRITICALITY ignore      EXTENSION  CoverageIndicator
  PRESENCE optional }|
  { ID id-AntennaColocationIndicator CRITICALITY ignore      EXTENSION  AntennaColocationIndicator          PRESENCE
optional }|
  { ID id-HCS-Prio                   CRITICALITY ignore      EXTENSION  HCS-Prio
  PRESENCE optional }|
  { ID id-CellCapabilityContainer-TDD-LCR CRITICALITY ignore      EXTENSION  CellCapabilityContainer-TDD-LCR      PRESENCE optional }|
  { ID id-SNA-Information             CRITICALITY ignore      EXTENSION  SNA-Information
  PRESENCE optional }|
  { ID id-Multiple-PLMN-List          CRITICALITY ignore      EXTENSION  Multiple-PLMN-List
  PRESENCE optional },
  ...
}

Neighbouring-E-UTRA-CellInformation ::= SEQUENCE ( SIZE (1..maxNrOfEUTRANeighboursPerRNC,...)) OF Neighbouring-E-UTRA-CellInformationItem

Neighbouring-E-UTRA-CellInformationItem ::= SEQUENCE {
  eCGI                ECGI,
  eARFCN-Information  EARFCN-Information,
  iE-Extensions       ProtocolExtensionContainer { { Neighbouring-E-UTRA-CellInformationItem-ExtIEs } } OPTIONAL,
  ...
}

Neighbouring-E-UTRA-CellInformationItem-ExtIEs RNSAP-PROTOCOL-EXTENSION ::= {
  ...
}

NonCellSpecificTxDiversity ::= ENUMERATED {
  txDiversity,
  ...
}

NotProvidedCellList ::= SEQUENCE (SIZE (1..maxNrOfCells)) OF MBMSChannelTypeCellList

NrOfDLchannelisationcodes ::= INTEGER (1..8)

NrOfTransportBlocks ::= INTEGER (0..512)

NRT-Load-Information-Value-IncrDecrThres ::= INTEGER(0..3)

NRT-Load-Information-Value ::= INTEGER(0..3)

NRTLInformationValue ::= SEQUENCE {

```

```

        uplinkNRTLoadInformationValue    INTEGER(0..3),
        downlinkNRTLoadInformationValue  INTEGER(0..3)
    }

N-E-UCCH ::= INTEGER (1..12)

N-E-UCCH-LCR ::= INTEGER (1..8)

Number-Of-Supported-Carriers ::= ENUMERATED {
    one-one-carrier,
    one-three-carrier,
    three-three-carrier,
    one-six-carrier,
    three-six-carrier,
    six-six-carrier,
    ...
}

NumHS-SCCH-Codes ::= INTEGER (1..maxNrOfHSSCCHCodes)

NoOfTargetCellHS-SCCH-Order ::= INTEGER (1..30)

Non-Serving-RL-Preconfig-Setup ::= SEQUENCE {
    new-non-serving-RL-selection    New-non-serving-RL-setup-selection,
    iE-Extensions                    ProtocolExtensionContainer { {Non-Serving-RL-Preconfig-Setup-ExtIEs} } OPTIONAL,
    ...
}

Non-Serving-RL-Preconfig-Setup-ExtIEs    RNSAP-PROTOCOL-EXTENSION ::= {
    {ID id-Additional-E-DCH-Non-Serving-RL-Preconfiguration-Setup    CRITICALITY ignore    EXTENSION Additional-E-DCH-Non-Serving-RL-Preconfiguration-Setup PRESENCE optional },
    ...
}

Additional-E-DCH-Non-Serving-RL-Preconfiguration-Setup ::= NULL

New-non-serving-RL-setup-selection ::= CHOICE {
    new-Serving-RL-in-DRNS                NULL,
    new-Serving-RL-Not-in-DRNS            NULL,
    new-Serving-RL-in-or-Not-in-DRNS      NULL,
    ...
}

Non-Serving-RL-Preconfig-Info ::= SEQUENCE {
    new-non-serving-RL-E-DCH-FDD-DL-ControlChannelInformation-A    EDCH-FDD-DL-ControlChannelInformation OPTIONAL,
    new-non-serving-RL-E-DCH-FDD-DL-ControlChannelInformation-B    EDCH-FDD-DL-ControlChannelInformation OPTIONAL,
    new-non-serving-RL-E-DCH-FDD-DL-ControlChannelInformation-C    EDCH-FDD-DL-ControlChannelInformation OPTIONAL,
    iE-Extensions                    ProtocolExtensionContainer { {Non-Serving-RL-Preconfig-Info-ExtIEs} } OPTIONAL,
    ...
}

Non-Serving-RL-Preconfig-Info-ExtIEs    RNSAP-PROTOCOL-EXTENSION ::= {

```

```

    {ID id-Additional-E-DCH-New-non-serving-RL-E-DCH-FDD-DL-Control-Channel-InfoList    CRITICALITY ignore    EXTENSION Additional-E-DCH-New-non-
serving-RL-E-DCH-FDD-DL-Control-Channel-InfoList PRESENCE optional},
    ...
}

Additional-E-DCH-New-non-serving-RL-E-DCH-FDD-DL-Control-Channel-InfoList ::= SEQUENCE(SIZE(1.. maxNrOfEDCH-1)) OF SEQUENCE {
    new-non-serving-RL-E-DCH-FDD-DL-Control-Channel-Information-A    EDCH-FDD-DL-ControlChannelInformation OPTIONAL,
    new-non-serving-RL-E-DCH-FDD-DL-Control-Channel-Information-B    EDCH-FDD-DL-ControlChannelInformation OPTIONAL,
    new-non-serving-RL-E-DCH-FDD-DL-Control-Channel-Information-C    EDCH-FDD-DL-ControlChannelInformation OPTIONAL,
    iE-Extensions            ProtocolExtensionContainer { { Additional-E-DCH-New-non-serving-RL-E-DCH-FDD-DL-Control-Channel-InfoList-ExtIEs} }
OPTIONAL,
    ...
}

Additional-E-DCH-New-non-serving-RL-E-DCH-FDD-DL-Control-Channel-InfoList-ExtIEs    RNSAP-PROTOCOL-EXTENSION ::= {
    ...
}

NeedforIdleInterval ::= ENUMERATED {
    true,
    false
}

-- O

OnModification ::= SEQUENCE {
    measurementThreshold    MeasurementThreshold,
    iE-Extensions            ProtocolExtensionContainer { {OnModification-ExtIEs} } OPTIONAL,
    ...
}

OnModification-ExtIEs RNSAP-PROTOCOL-EXTENSION ::= {
    ...
}

OnModificationInformation ::= SEQUENCE {
    informationThreshold    InformationThreshold    OPTIONAL,
    iE-Extensions            ProtocolExtensionContainer { {OnModificationInformation-ExtIEs} } OPTIONAL,
    ...
}

OnModificationInformation-ExtIEs RNSAP-PROTOCOL-EXTENSION ::= {
    ...
}

Out-of-Synchronization-Window ::= ENUMERATED {
    ms40,
    ms80,
    ms160,
    ms320,
    ms640,
    ...
}

```

```
}
-- P
PagingCause ::= ENUMERATED {
    terminating-conversational-call,
    terminating-streaming-call,
    terminating-interactive-call,
    terminating-background-call,
    terminating-low-priority-signalling,
    ...,
    terminating-high-priority-signalling,
    terminating-cause-unknown
}
-- See in TS 25.331 [16]
PagingRecordType ::= ENUMERATED {
    imsi-gsm-map,
    tmsi-gsm-map,
    p-tmsi-gsm-map,
    imsi-ds-41,
    tmsi-ds-41,
    ...
}
-- See in TS 25.331 [16]
PartialReportingIndicator ::= ENUMERATED {
    partial-reporting-allowed
}
Pattern-Sequence-Identifier ::= INTEGER (1.. maxNrOfDCHMeasurementOccasionPatternSequence)
PayloadCRC-PresenceIndicator ::= ENUMERATED {
    crc-included,
    crc-not-included
}
PCCPCH-Power ::= INTEGER (-150..400,...)
-- PCCPCH-power = power * 10
-- If power <= -15 PCCPCH shall be set to -150
-- If power >= 40 PCCPCH shall be set to 400
-- Unit dBm, Range -15dBm .. +40 dBm, Step 0.1dBm
PCH-InformationList ::= SEQUENCE (SIZE(0..1)) OF PCH-InformationItem
PCH-InformationItem ::= SEQUENCE {
    transportFormatSet          TransportFormatSet,
    iE-Extensions               ProtocolExtensionContainer { { PCH-InformationItem-ExtIEs } } OPTIONAL,
    ...
}
PCH-InformationItem-ExtIEs RNSAP-PROTOCOL-EXTENSION ::= {
    ...
}
```

```
PC-Preamble ::= INTEGER(0..7,...)

Periodic ::= SEQUENCE {
    reportPeriodicity      ReportPeriodicity,
    iE-Extensions          ProtocolExtensionContainer { {Periodic-ExtIEs} } OPTIONAL,
    ...
}

Periodic-ExtIEs RNSAP-PROTOCOL-EXTENSION ::= {
    ...
}

PeriodicInformation ::= SEQUENCE {
    informationReportPeriodicity      InformationReportPeriodicity,
    iE-Extensions                    ProtocolExtensionContainer { {PeriodicInformation-ExtIEs} } OPTIONAL,
    ...
}

PeriodicInformation-ExtIEs RNSAP-PROTOCOL-EXTENSION ::= {
    ...
}

Permanent-NAS-UE-Identity ::= CHOICE {
    imsi      IMSI,
    ...
}

Phase-Reference-Update-Indicator ::= ENUMERATED {
    phase-reference-needs-to-be-changed
}

PLCCHsequenceNumber ::= INTEGER (0..14)

PLMN-Identity ::= OCTET STRING (SIZE(3))

PowerAdjustmentType ::= ENUMERATED {
    none,
    common,
    individual
}

PowerOffset ::= INTEGER (0..24)

PowerOffsetForSecondaryCPICHforMIMO ::= INTEGER (-6..0)
-- Unit dB, Range -10dB .. 5dB, Step +1dB

PowerOffsetForSecondaryCPICHforMIMOREquestIndicator ::= NULL

PRC ::= INTEGER (-2047..2047)
--pseudo range correction; scaling factor 0.32 meters

PRCDeviation ::= ENUMERATED {
    prcd1,
```



```

    prcd2,
    prcd5,
    prcd10,
    ...
}

Pre-emptionCapability ::= ENUMERATED {
    shall-not-trigger-pre-emption,
    may-trigger-pre-emption
}

Pre-emptionVulnerability ::= ENUMERATED {
    not-pre-emptable,
    pre-emptable
}

PredictedSFNSFNDeviationLimit ::= INTEGER (1..256)
-- Unit chip, Step 1/16 chip, Range 1/16..16 chip

PredictedTUTRANGPSDeviationLimit ::= INTEGER (1..256)
-- Unit chip, Step 1/16 chip, Range 1/16..16 chip

PreferredFrequencyLayerInfo ::= SEQUENCE {
    defaultPreferredFrequency    UARFCN,
    additionalPreferredFrequency AdditionalPreferredFrequency OPTIONAL,
    iE-Extensions                ProtocolExtensionContainer { { PreferredFrequencyLayerInfo-ExtIEs } } OPTIONAL,
    ...
}
PreferredFrequencyLayerInfo-ExtIEs RNSAP-PROTOCOL-EXTENSION ::= {
    ...
}

PrimaryCPICH-Power          ::= INTEGER (-100..500)
-- step 0.1 (Range -10.0..50.0) Unit is dBm

PrimaryCPICH-EcNo          ::= INTEGER (-30..30)

Primary-CPICH-Usage-For-Channel-Estimation ::= ENUMERATED {
    primary-CPICH-may-be-used,
    primary-CPICH-shall-not-be-used
}

PrimaryCCPCH-RSCP          ::= INTEGER (0..91)
-- Mapping of Non Negative values according to mapping in TS 25.123 [24]

PrimaryCCPCH-RSCP-Delta    ::= INTEGER (-5..-1,...)
-- Mapping of Negative values according to mapping in TS 25.123 [24]

PrimaryScramblingCode      ::= INTEGER (0..511)

PriorityLevel               ::= INTEGER (0..15)
-- 0 = spare, 1 = highest priority, ..14 = lowest priority and 15 = no priority

```

PriorityQueue-Id ::= INTEGER (0..maxNrOfPrioQueues-1)

PriorityQueue-InfoList ::= SEQUENCE (SIZE (1..maxNrOfPrioQueues)) OF PriorityQueue-InfoItem

```
PriorityQueue-InfoItem ::= SEQUENCE {
  priorityQueue-Id          PriorityQueue-Id,
  associatedHSDSCH-MACdFlow HSDSCH-MACdFlow-ID,
  schedulingPriorityIndicator SchedulingPriorityIndicator,
  t1                        T1,
  discardTimer              DiscardTimer                OPTIONAL,
  mAC-hsWindowSize          MAC-hsWindowSize,
  mAChsGuaranteedBitRate    MACHsGuaranteedBitRate      OPTIONAL,
  mACdPDU-Size-Index        MACdPDU-Size-IndexList,
  rLC-Mode                  RLC-Mode,
  iE-Extensions             ProtocolExtensionContainer { { PriorityQueue-InfoItem-ExtIEs } } OPTIONAL,
  ...
}
```

```
PriorityQueue-InfoItem-ExtIEs RNSAP-PROTOCOL-EXTENSION ::= {
  { ID id-MaximumMACdPDU-SizeExtended CRITICALITY reject EXTENSION MAC-PDU-SizeExtended PRESENCE optional}|
  { ID id-DL-RLC-PDU-Size-Format CRITICALITY ignore EXTENSION DL-RLC-PDU-Size-Format PRESENCE optional}|
  { ID id-UE-AggregateMaximumBitRate-Enforcement-Indicator CRITICALITY ignore EXTENSION UE-AggregateMaximumBitRate-Enforcement-Indicator PRESENCE optional},
  ...
}
```

PriorityQueue-InfoList-EnhancedFACH-PCH ::= SEQUENCE (SIZE (1..maxNrOfPrioQueues)) OF PriorityQueue-InfoItem-EnhancedFACH-PCH

```
PriorityQueue-InfoItem-EnhancedFACH-PCH ::= SEQUENCE {
  priorityQueue-Id          PriorityQueue-Id,
  schedulingPriorityIndicator SchedulingPriorityIndicator,
  t1                        T1,
  mAC-ehs-Reset-Timer       MAC-ehs-Reset-Timer,
  discardTimer              DiscardTimer                OPTIONAL,
  mAC-hsWindowSize          MAC-hsWindowSize,
  maximum-MACdPDU-Size      MAC-PDU-SizeExtended,
  iE-Extensions             ProtocolExtensionContainer { { PriorityQueue-InfoItem-EnhancedFACH-PCH-ExtIEs } }
  OPTIONAL,
  ...
}
```

```
PriorityQueue-InfoItem-EnhancedFACH-PCH-ExtIEs RNSAP-PROTOCOL-EXTENSION ::= {
  ...
}
```

PriorityQueue-InfoList-to-Modify ::= SEQUENCE (SIZE (1..maxNrOfPrioQueues)) OF ModifyPriorityQueue

```
PriorityQueue-InfoItem-to-Add ::= SEQUENCE {
  priorityQueue-Id          PriorityQueue-Id,
  associatedHSDSCH-MACdFlow HSDSCH-MACdFlow-ID,
  schedulingPriorityIndicator SchedulingPriorityIndicator,
  t1                        T1,
  discardTimer              DiscardTimer                OPTIONAL,
  mAC-hsWindowSize          MAC-hsWindowSize,
```

```

mAChsGuaranteedBitRate          MAChsGuaranteedBitRate          OPTIONAL,
mACdPDU-Size-Index              MACdPDU-Size-IndexList,
rLC-Mode                        RLC-Mode,
iE-Extensions                    ProtocolExtensionContainer { { PriorityQueue-InfoItem-to-Add-ExtIEs } } OPTIONAL,
...
}

PriorityQueue-InfoItem-to-Add-ExtIEs RNSAP-PROTOCOL-EXTENSION ::= {
{ ID id-MaximumMACdPDU-SizeExtended CRITICALITY reject EXTENSION MAC-PDU-SizeExtended PRESENCE optional} |
{ ID id-DL-RLC-PDU-Size-Format CRITICALITY ignore EXTENSION DL-RLC-PDU-Size-Format PRESENCE optional},
...
}

PriorityQueue-InfoItem-to-Modify ::= SEQUENCE {
priorityQueue-Id                PriorityQueue-Id,
schedulingPriorityIndicator      SchedulingPriorityIndicator          OPTIONAL,
t1                               T1                                OPTIONAL,
discardTimer                    DiscardTimer                          OPTIONAL,
mAC-hsWindowSize                MAC-hsWindowSize                      OPTIONAL,
mAChsGuaranteedBitRate          MAChsGuaranteedBitRate              OPTIONAL,
mACdPDU-Size-Index-to-Modify    MACdPDU-Size-IndexList-to-Modify    OPTIONAL,
iE-Extensions                    ProtocolExtensionContainer { { PriorityQueue-InfoItem-to-Modify-ExtIEs } } OPTIONAL,
...
}

PriorityQueue-InfoItem-to-Modify-ExtIEs RNSAP-PROTOCOL-EXTENSION ::= {
{ ID id-MaximumMACdPDU-SizeExtended CRITICALITY reject EXTENSION MAC-PDU-SizeExtended PRESENCE optional} |
{ ID id-DL-RLC-PDU-Size-Format CRITICALITY ignore EXTENSION DL-RLC-PDU-Size-Format PRESENCE optional},
...
}

PriorityQueue-InfoList-to-Modify-Unsynchronised ::= SEQUENCE (SIZE (0..maxNrOfPrioQueues)) OF PriorityQueue-InfoItem-to-Modify-Unsynchronised

PriorityQueue-InfoItem-to-Modify-Unsynchronised ::= SEQUENCE {
priorityQueueId                PriorityQueue-Id,
schedulingPriorityIndicator      SchedulingPriorityIndicator          OPTIONAL,
discardTimer                    DiscardTimer                          OPTIONAL,
mAChsGuaranteedBitRate          MAChsGuaranteedBitRate              OPTIONAL,
iE-Extensions                    ProtocolExtensionContainer { { PriorityQueue-InfoItem-to-Modify-Unsynchronised-ExtIEs } } OPTIONAL,
...
}

PriorityQueue-InfoItem-to-Modify-Unsynchronised-ExtIEs RNSAP-PROTOCOL-EXTENSION ::= {
...
}

PropagationDelay                ::= INTEGER (0..255)

ProvidedInformation ::= SEQUENCE {
mBMSChannelTypeInfo            MBMSChannelTypeInfo          OPTIONAL,
mBMSPreferredFreqLayerInfo     MBMSPreferredFreqLayerInfo  OPTIONAL,
iE-Extensions                    ProtocolExtensionContainer { { ProvideInformation-ExtIEs } } OPTIONAL,
...
}

```

```

}
ProvideInformation-ExtIEs RNSAP-PROTOCOL-EXTENSION ::= {
  { ID id-UpPCH-InformationList-LCRTDD CRITICALITY ignore EXTENSION UpPCH-InformationList-LCRTDD PRESENCE optional},
  -- Applicable to 1.28Mcps TDD only
  ...
}

UpPCH-InformationList-LCRTDD ::= SEQUENCE (SIZE (0.. maxFrequencyinCell)) OF ProtocolIE-Single-Container {{ UpPCH-InformationItemIE-LCRTDD }}

UpPCH-InformationItemIE-LCRTDD RNSAP-PROTOCOL-IES ::= {
  { ID id-UpPCH-InformationItem-LCRTDD CRITICALITY ignore TYPE UpPCH-InformationItem-LCRTDD PRESENCE mandatory},
  ...
}

UpPCH-InformationItem-LCRTDD ::= SEQUENCE {
  uARFCNforNt UARFCN OPTIONAL,
  uPPCHPositionLCR UPPCHPositionLCR OPTIONAL,
  iE-Extensions ProtocolExtensionContainer { { UpPCH-InformationItem-LCRTDD-ExtIEs } } OPTIONAL,
  ...
}

UpPCH-InformationItem-LCRTDD-ExtIEs RNSAP-PROTOCOL-EXTENSION ::= {
  ...
}

PunctureLimit ::= INTEGER (0..15)
-- 0: 40%; 1: 44%; ... 14: 96%; 15: 100
-- 0 is not applicable for E-DPCH

PTMCellList ::= SEQUENCE (SIZE (1..maxNrOfCells)) OF MBMSChannelTypeCellList

PTPCellList ::= SEQUENCE (SIZE (1..maxNrOfCells)) OF MBMSChannelTypeCellList

-- Q

QE-Selector ::= ENUMERATED {
  selected,
  non-selected
}

Process-Memory-Size ::= ENUMERATED {
  hms800, hms1600, hms2400, hms3200, hms4000,
  hms4800, hms5600, hms6400, hms7200, hms8000,
  hms8800, hms9600, hms10400, hms11200, hms12000,
  hms12800, hms13600, hms14400, hms15200, hms16000,
  hms17600, hms19200, hms20800, hms22400, hms24000,
  hms25600, hms27200, hms28800, hms30400, hms32000,
  hms36000, hms40000, hms44000, hms48000, hms52000,
  hms56000, hms60000, hms64000, hms68000, hms72000,
  hms76000, hms80000, hms88000, hms96000, hms104000,
  hms112000, hms120000, hms128000, hms136000, hms144000,
  hms152000, hms160000, hms176000, hms192000, hms208000,

```

```

hms224000, hms240000, hms256000, hms272000, hms288000,
hms304000, ...}

-- R

RAC ::= OCTET STRING (SIZE(1))

RANAP-EnhancedRelocationInformationRequest ::= BIT STRING

RANAP-EnhancedRelocationInformationResponse ::= BIT STRING

RANAP-RelocationInformation ::= BIT STRING

Range-Correction-Rate ::= INTEGER (-127..127)
-- scaling factor 0.032 m/s

RateMatchingAttribute ::= INTEGER (1..maxRateMatching)

RB-Identity ::= INTEGER (0..31)

RB-Info ::= SEQUENCE (SIZE(1..maxNoOfRB)) OF RB-Identity

Received-Total-Wideband-Power-Value ::= Received-total-wide-band-power

Received-Total-Wideband-Power-Value-IncrDecrThres ::= INTEGER(0..620)
-- Unit dB Step 0.1dB
-- e.g. value 100 means 10dB

Reference-E-TFCI-Information ::= SEQUENCE (SIZE (1..maxNrOfRefETFCIs)) OF Reference-E-TFCI-Information-Item

Reference-E-TFCI-Information-Item ::= SEQUENCE {
    reference-E-TFCI E-TFCI,
    -- The following IE shall be ignored if id-Ext-Reference-E-TFCI-PO is present in Reference-E-TFCI-Information-Item-ExtIEs
    reference-E-TFCI-PO Reference-E-TFCI-PO,
    iE-Extensions ProtocolExtensionContainer { { Reference-E-TFCI-Information-Item-ExtIEs} } OPTIONAL,
    ...
}

Reference-E-TFCI-Information-Item-ExtIEs RNSAP-PROTOCOL-EXTENSION ::= {
    -- The following IE shall be present if the ref E-TFCI power offset to be signalled exceeds maxNrOfRefETFCI-PO-QUANTSTEPS
    { ID id-Ext-Reference-E-TFCI-PO CRITICALITY reject EXTENSION Ext-Reference-E-TFCI-PO PRESENCE optional},
    ...
}

Reference-E-TFCI-PO ::= INTEGER (0.. maxNrOfRefETFCI-PO-QUANTSTEPS)

RefTFCNumber ::= INTEGER (0..15)

Released-CN-Domain ::= CHOICE {
    pSDomain NULL,
    cSDomain NULL,
    pS-CSDomain NULL,
    ...
}

```

```

RepetitionLength ::= INTEGER (1..63)

RepetitionPeriod ::= ENUMERATED {
    v1,
    v2,
    v4,
    v8,
    v16,
    v32,
    v64
}

RepetitionNumber0 ::= INTEGER (0..255)
RepetitionNumber1 ::= INTEGER (1..256)

ReportCharacteristics ::= CHOICE {
    onDemand          NULL,
    periodic          Periodic,
    eventA            EventA,
    eventB            EventB,
    eventC            EventC,
    eventD            EventD,
    eventE            EventE,
    eventF            EventF,
    ...,
    extension-ReportCharacteristics  Extension-ReportCharacteristics
}

Extension-ReportCharacteristics ::= ProtocolIE-Single-Container {{ Extension-ReportCharacteristicsIE }}

Extension-ReportCharacteristicsIE RNSAP-PROTOCOL-IES ::= {
    { ID id-OnModification CRITICALITY reject TYPE OnModification PRESENCE mandatory }
}

ReportPeriodicity ::= CHOICE {
    ten-msec          INTEGER (1..6000,...),
    -- The Report Periodicity gives the reporting periodicity in number of 10 ms periods.
    -- E.g. value 6000 means 60000ms (i.e. 1min)
    -- Unit ms, Step 10ms
    min               INTEGER (1..60,...),
    -- Unit min, Step 1min
    ...
}

RequestedDataValue ::= SEQUENCE {
    gA-AccessPointPositionwithAltitude      GA-AccessPointPositionwithOptionalAltitude  OPTIONAL,
    iPDLParameters                          IPDLParameters                          OPTIONAL,
    dGPSCorrections                         DGPSCorrections                         OPTIONAL,
    gPS-NavigationModel-and-TimeRecovery    GPS-NavigationModel-and-TimeRecovery    OPTIONAL,
    gPS-Ionospheric-Model                   GPS-Ionospheric-Model                   OPTIONAL,
    gPS-UTC-Model                           GPS-UTC-Model                           OPTIONAL,

```

```

gPS-Almanac                GPS-Almanac                OPTIONAL,
gPS-RealTime-Integrity     GPS-RealTime-Integrity  OPTIONAL,
gPS-RX-POS                 GPS-RX-POS              OPTIONAL,
sFNSFN-GA-AccessPointPosition  GA-AccessPointPositionwithOptionalAltitude  OPTIONAL,
iE-Extensions              ProtocolExtensionContainer { { RequestedDataValue-ExtIEs } }  OPTIONAL,
...
}

RequestedDataValue-ExtIEs RNSAP-PROTOCOL-EXTENSION ::= {
  { ID id-Cell-Capacity-Class-Value          CRITICALITY ignore  EXTENSION Cell-Capacity-Class-Value
  PRESENCE optional }|
  { ID id-NACC-Related-Data                  CRITICALITY ignore  EXTENSION NACC-Related-Data
  PRESENCE optional }|
  { ID id-MBMS-Bearer-Service-Full-Address    CRITICALITY ignore  EXTENSION MBMS-Bearer-Service-Full-Address
  optional }|
  { ID id-Inter-Frequency-Cell-Information    CRITICALITY ignore  EXTENSION Inter-Frequency-Cell-Information
  { ID id-GANSS-Common-Data                  CRITICALITY ignore  EXTENSION GANSS-Common-Data
  { ID id-GANSS-Generic-Data                  CRITICALITY ignore  EXTENSION GANSS-Generic-Data
  PRESENCE optional }|
  { ID id-Counting-Information                CRITICALITY ignore  EXTENSION Counting-Information
  { ID id-Transmission-Mode-Information      CRITICALITY ignore  EXTENSION Transmission-Mode-Information
  optional }|
  { ID id-MBMS-Neighbouring-Cell-Information CRITICALITY ignore  EXTENSION MBMS-Neighbouring-Cell-Information
  { ID id-RLC-Sequence-Number                CRITICALITY ignore  EXTENSION RLC-Sequence-Number
  ...
}

RequestedDataValueInformation ::= CHOICE {
  informationAvailable      InformationAvailable,
  informationNotAvailable   InformationNotAvailable
}

RestrictionStateIndicator ::= ENUMERATED {
  cellNotResevedForOperatorUse,
  cellResevedForOperatorUse,
  ...
}

RL-ID ::= INTEGER (0..31)

RL-Set-ID ::= INTEGER (0..31)

RL-Specific-DCH-Info ::= SEQUENCE (SIZE (1..maxNrOfDCHs)) OF RL-Specific-DCH-Info-Item

RL-Specific-DCH-Info-Item ::= SEQUENCE {
  dCH-id          DCH-ID,
  bindingID       BindingID OPTIONAL,
  -- Shall be ignored if bearer establishment with ALCAP.
  transportLayerAddress TransportLayerAddress OPTIONAL,
  -- Shall be ignored if bearer establishment with ALCAP.
  iE-Extensions   ProtocolExtensionContainer { { RL-Specific-DCH-Info-Item-ExtIEs } } OPTIONAL,
  ...
}

```

```

RL-Specific-DCH-Info-Item-ExtIEs RNSAP-PROTOCOL-EXTENSION ::= {
  { ID id-TransportBearerNotRequestedIndicator    CRITICALITY ignore  EXTENSION TransportBearerNotRequestedIndicator    PRESENCE optional
  }, -- FDD only
  ...
}

RL-Specific-EDCH-Information ::= SEQUENCE {
  rL-Specific-EDCH-Info    RL-Specific-EDCH-Info,
  e-AGCH-PowerOffset       E-AGCH-PowerOffset                OPTIONAL,
  e-RGCH-PowerOffset       E-RGCH-PowerOffset                OPTIONAL,
  e-HICH-PowerOffset       E-HICH-PowerOffset                OPTIONAL,
  iE-Extensions            ProtocolExtensionContainer { { RL-Specific-EDCH-Information-Item-ExtIEs } }  OPTIONAL,
  ...
}

RL-Specific-EDCH-Information-Item-ExtIEs RNSAP-PROTOCOL-EXTENSION ::= {
  ...
}

RL-Specific-EDCH-Info ::= SEQUENCE (SIZE (1..maxNrOfEDCHMACdFlows)) OF RL-Specific-EDCH-InfoItem

RL-Specific-EDCH-InfoItem ::= SEQUENCE {
  eDCH-MACdFlow-ID        EDCH-MACdFlow-ID,
  bindingID               BindingID                OPTIONAL,
  -- Shall be ignored if bearer establishment with ALCAP.
  transportLayerAddress   TransportLayerAddress    OPTIONAL,
  -- Shall be ignored if bearer establishment with ALCAP.
  iE-Extensions          ProtocolExtensionContainer { { RL-Specific-EDCH-Info-Item-ExtIEs } }  OPTIONAL,
  ...
}

RL-Specific-EDCH-Info-Item-ExtIEs RNSAP-PROTOCOL-EXTENSION ::= {
  { ID id-TransportBearerNotRequestedIndicator    CRITICALITY ignore  EXTENSION TransportBearerNotRequestedIndicator    PRESENCE optional
  }, -- FDD only
  ...
}

RLC-Mode ::= ENUMERATED {
  rLC-AM,
  rLC-UM,
  ...
}

DL-RLC-PDU-Size-Format ::= ENUMERATED {
  fixed-RLC-PDU-Size,
  flexible-RLC-PDU-Size,
  ...
}

RLC-Sequence-Number ::= INTEGER (0..127)

RNC-ID ::= INTEGER (0..4095)

```



```
RNTI-Allocation-Indicator ::= ENUMERATED {
    true
}

Round-Trip-Time-IncrDecrThres ::= INTEGER(0..32766)

Round-Trip-Time-Value ::= INTEGER(0..32767)
-- According to mapping in TS 25.133 [23]

RSCP-Value ::= INTEGER (0..127)
-- According to mapping in TS 25.123 [24]

RSCP-Value-IncrDecrThres ::= INTEGER (0..126)

Received-total-wide-band-power          ::= INTEGER (0..621)
-- According to mapping in TS 25.133 [23]

RT-Load-Value-IncrDecrThres ::= INTEGER(0..100)

RT-Load-Value ::= INTEGER(0..100)

RTLoadValue ::= SEQUENCE {
    uplinkRTLoadValue      INTEGER(0..100),
    downlinkRTLoadValue    INTEGER(0..100)
}

RxTimingDeviationForTA          ::= INTEGER (0..127)
-- As specified in TS 25.435 [5], ch. 6.2.7.6
-- For 1.28Mcps TDD this IE must be set to 0.

RxTimingDeviationForTAext       ::= INTEGER (0..511)
-- As specified in TS 25.435 [5] [3.84 Mcps TDD only]

RxTimingDeviationForTA768       ::= INTEGER (0.. 1023)
-- As specified in TS 25.435 [5]

Rx-Timing-Deviation-Value ::= INTEGER (0..8191)
--According to mapping in TS 25.123 [24] [3.84Mcps TDD only]

Rx-Timing-Deviation-Value-ext ::= INTEGER (0..32767)
--According to mapping in TS 25.123 [24] [3.84Mcps TDD only]

Rx-Timing-Deviation-Value-LCR ::= INTEGER (0..511)
--According to mapping in TS 25.123 [24] [1.28Mcps TDD only]

Rx-Timing-Deviation-Value-768 ::= INTEGER (0..65535)
--According to mapping in TS 25.123 [24] [7.68Mcps TDD only]

RefBeta ::= INTEGER (-15..16)

-- S

SAC          ::= OCTET STRING (SIZE (2))
```

```

SAI ::= SEQUENCE {
    pLMN-Identity      PLMN-Identity,
    lAC                LAC,
    sAC                SAC,
    iE-Extensions     ProtocolExtensionContainer { {SAI-ExtIEs} } OPTIONAL
}

SAI-ExtIEs RNSAP-PROTOCOL-EXTENSION ::= {
    ...
}

SAT-ID ::= INTEGER (0..63)

SCH-TimeSlot          ::= INTEGER (0..6)

ScaledAdjustmentRatio ::= INTEGER(0..100)
-- AdjustmentRatio = ScaledAdjustmentRatio / 100

SchedulingInformation ::= ENUMERATED {
    included,
    not-included
}

SecondaryServingCells ::= SEQUENCE (SIZE (1..maxNrOfHSDSCH-1)) OF SecondaryServingCellsItem

SecondaryServingCellsItem ::= SEQUENCE {
    secondaryC-ID          C-ID,
    numSecondaryHS-SCCH-Codes NumHS-SCCH-Codes OPTIONAL,
    sixtyfourQAM-UsageAllowedIndicator SixtyfourQAM-UsageAllowedIndicator OPTIONAL,
    iE-Extensions         ProtocolExtensionContainer { { SecondaryServingCellsItem-ExtIEs} }
    OPTIONAL,
    ...
}

SecondaryServingCellsItem-ExtIEs RNSAP-PROTOCOL-EXTENSION ::= {
    {ID id-MIMO-ActivationIndicator CRITICALITY ignore EXTENSION MIMO-ActivationIndicator PRESENCE optional}}
    {ID id-EDCH-Indicator CRITICALITY ignore EXTENSION NULL PRESENCE optional}}
    {ID id-power-offset-for-S-CPICH-for-MIMO-Request-Indicator CRITICALITY ignore EXTENSION PowerOffsetForSecondaryCPICHforMIMORequestIndicator
    PRESENCE optional}},
    ...
}

Secondary-CCPCH-Info-TDD ::= SEQUENCE {
    dl-TFCS                TFCS,
    tFCI-Coding            TFCI-Coding,
    secondary-CCPCH-TDD-InformationList Secondary-CCPCH-TDD-InformationList,
    fACH-InformationList   FACH-InformationList,
    pCH-InformationList    PCH-InformationList,
    iE-Extensions         ProtocolExtensionContainer { { Secondary-CCPCH-Info-TDD-ExtIEs} } OPTIONAL,
    ...
}

```

```

Secondary-CCPCH-Info-TDD-ExtIEs RNSAP-PROTOCOL-EXTENSION ::= {
    ...
}

Secondary-CPICH-Information ::= SEQUENCE {
    dl-ScramblingCode          DL-ScramblingCode,
    fdd-DL-ChannelisationCodeNumber FDD-DL-ChannelisationCodeNumber,
    iE-Extensions              ProtocolExtensionContainer { { Secondary-CPICH-Information-ExtIEs} } OPTIONAL,
    ...
}

Secondary-CPICH-Information-ExtIEs RNSAP-PROTOCOL-EXTENSION ::= {
    ...
}

Secondary-CPICH-Information-Change ::= CHOICE {
    new-secondary-CPICH          Secondary-CPICH-Information,
    secondary-CPICH-shall-not-be-used NULL,
    ...
}

Secondary-LCR-CCPCH-Info-TDD ::= SEQUENCE {
    dl-TFCS                      TFCS,
    tFCI-Coding                  TFCI-Coding,
    secondary-LCR-CCPCH-TDD-InformationList Secondary-LCR-CCPCH-TDD-InformationList,
    fACH-InformationList         FACH-InformationList,
    pCH-InformationList          PCH-InformationList,
    iE-Extensions                ProtocolExtensionContainer { { Secondary-LCR-CCPCH-Info-TDD-ExtIEs} } OPTIONAL,
    ...
}

Secondary-LCR-CCPCH-Info-TDD-ExtIEs RNSAP-PROTOCOL-EXTENSION ::= {
    ...
}

Secondary-CCPCH-Info-TDD768 ::= SEQUENCE {
    dl-TFCS                      TFCS,
    tFCI-Coding                  TFCI-Coding,
    secondary-CCPCH-TDD-InformationList768 Secondary-CCPCH-TDD-InformationList768,
    fACH-InformationList         FACH-InformationList,
    pCH-InformationList          PCH-InformationList,
    iE-Extensions                ProtocolExtensionContainer { { Secondary-CCPCH-Info-TDD768-ExtIEs} } OPTIONAL,
    ...
}

Secondary-CCPCH-Info-TDD768-ExtIEs RNSAP-PROTOCOL-EXTENSION ::= {
    ...
}

Secondary-CCPCH-TDD-InformationList ::= SEQUENCE (SIZE(0.. maxNrOfSCCPCHs)) OF Secondary-CCPCH-TDD-InformationItem

Secondary-CCPCH-TDD-InformationItem ::= SEQUENCE {
    timeSlot                     TimeSlot,
    midambleShiftAndBurstType    MidambleShiftAndBurstType,

```

```

tFCI-Presence          TFCI-Presence,
secondary-CCPCH-TDD-Code-Information      Secondary-CCPCH-TDD-Code-Information,
tDD-PhysicalChannelOffset      TDD-PhysicalChannelOffset,
repetitionLength      RepetitionLength,
repetitionPeriod      RepetitionPeriod,
iE-Extensions          ProtocolExtensionContainer { { Secondary-CCPCH-TDD-InformationItem-ExtIEs } } OPTIONAL,
...
}

Secondary-CCPCH-TDD-InformationItem-ExtIEs RNSAP-PROTOCOL-EXTENSION ::= {
...
}

Secondary-LCR-CCPCH-TDD-InformationList ::= SEQUENCE (SIZE(0.. maxNrOfSCCPCHs)) OF Secondary-LCR-CCPCH-TDD-InformationItem

Secondary-LCR-CCPCH-TDD-InformationItem ::= SEQUENCE {
timeSlotLCR          TimeSlotLCR,
midambleShiftLCR      MidambleShiftLCR,
tFCI-Presence          TFCI-Presence,
secondary-LCR-CCPCH-TDD-Code-Information      Secondary-LCR-CCPCH-TDD-Code-Information,
tDD-PhysicalChannelOffset      TDD-PhysicalChannelOffset,
repetitionLength      RepetitionLength,
repetitionPeriod      RepetitionPeriod,
iE-Extensions          ProtocolExtensionContainer { { Secondary-LCR-CCPCH-TDD-InformationItem-ExtIEs } } OPTIONAL,
...
}

Secondary-LCR-CCPCH-TDD-InformationItem-ExtIEs RNSAP-PROTOCOL-EXTENSION ::= {
...
}

Secondary-CCPCH-TDD-InformationList768 ::= SEQUENCE (SIZE(0.. maxNrOfSCCPCHs768)) OF Secondary-CCPCH-TDD-InformationItem768

Secondary-CCPCH-TDD-InformationItem768 ::= SEQUENCE {
timeSlot          TimeSlot,
midambleShiftAndBurstType768      MidambleShiftAndBurstType768,
tFCI-Presence          TFCI-Presence,
secondary-CCPCH-TDD-Code-Information768      Secondary-CCPCH-TDD-Code-Information768,
tDD-PhysicalChannelOffset      TDD-PhysicalChannelOffset,
repetitionLength      RepetitionLength,
repetitionPeriod      RepetitionPeriod,
iE-Extensions          ProtocolExtensionContainer { { Secondary-CCPCH-TDD-InformationItem768-ExtIEs } } OPTIONAL,
...
}

Secondary-CCPCH-TDD-InformationItem768-ExtIEs RNSAP-PROTOCOL-EXTENSION ::= {
...
}

Secondary-CCPCH-TDD-Code-Information ::= SEQUENCE ( SIZE (1..maxNrOfSCCPCHs)) OF Secondary-CCPCH-TDD-Code-InformationItem

Secondary-CCPCH-TDD-Code-InformationItem ::= SEQUENCE {
tDD-ChannelisationCode      TDD-ChannelisationCode,
iE-Extensions          ProtocolExtensionContainer { {Secondary-CCPCH-TDD-Code-InformationItem-ExtIEs} } OPTIONAL,

```

```

    ...
}

Secondary-CCPCH-TDD-Code-InformationItem-ExtIEs RNSAP-PROTOCOL-EXTENSION ::= {
    ...
}

Secondary-LCR-CCPCH-TDD-Code-Information ::= SEQUENCE ( SIZE (1..maxNrOfSCCPCHs)) OF Secondary-LCR-CCPCH-TDD-Code-InformationItem

Secondary-LCR-CCPCH-TDD-Code-InformationItem ::= SEQUENCE {
    tDD-ChannelisationCodeLCR          TDD-ChannelisationCodeLCR,
    s-CCPCH-TimeSlotFormat-LCR        TDD-DL-DPCH-TimeSlotFormat-LCR,
    iE-Extensions                      ProtocolExtensionContainer { {Secondary-LCR-CCPCH-TDD-Code-InformationItem-ExtIEs} } OPTIONAL,
    ...
}

Secondary-LCR-CCPCH-TDD-Code-InformationItem-ExtIEs RNSAP-PROTOCOL-EXTENSION ::= {
    ...
}

Secondary-CCPCH-TDD-Code-Information768 ::= SEQUENCE ( SIZE (1..maxNrOfSCCPCHs768)) OF Secondary-CCPCH-TDD-Code-InformationItem768

Secondary-CCPCH-TDD-Code-InformationItem768 ::= SEQUENCE {
    tDD-ChannelisationCode768          TDD-ChannelisationCode768,
    iE-Extensions                      ProtocolExtensionContainer { {Secondary-CCPCH-TDD-Code-InformationItem768-ExtIEs} } OPTIONAL,
    ...
}

Secondary-CCPCH-TDD-Code-InformationItem768-ExtIEs RNSAP-PROTOCOL-EXTENSION ::= {
    ...
}

Secondary-Serving-Cell-List ::= SEQUENCE {
    possible-Secondary-Serving-Cell-List Possible-Secondary-Serving-Cell-List,
    iE-Extensions                      ProtocolExtensionContainer { { Secondary-Serving-Cell-List-ExtIEs } } OPTIONAL,
    ...
}

Secondary-Serving-Cell-List-ExtIEs RNSAP-PROTOCOL-EXTENSION ::= {
    ...
}

Possible-Secondary-Serving-Cell-List ::= SEQUENCE (SIZE (1..maxNrOfHSDSCH-1)) OF Possible-Secondary-Serving-Cell

Possible-Secondary-Serving-Cell ::= SEQUENCE {
    c-ID                               C-ID,
    iE-Extensions                      ProtocolExtensionContainer { { Possible-Secondary-Serving-Cell-ExtIEs } } OPTIONAL,
    ...
}

Possible-Secondary-Serving-Cell-ExtIEs RNSAP-PROTOCOL-EXTENSION ::= {
    ...
}

```

```

SecondInterleavingMode ::= ENUMERATED {
    frame-related,
    timeslot-related,
    ...
}

Secondary-UL-Frequency-Activation-State ::= ENUMERATED {
    activated,
    deactivated,
    ...
}

Seed ::= INTEGER (0..63)

Service-ID ::= OCTET STRING (SIZE (3))

SetsOfHS-SCCH-Codes ::= SEQUENCE (SIZE (1..maxNrOfHSDSCH)) OF SetsOfHS-SCCH-CodesItem

SetsOfHS-SCCH-CodesItem ::= SEQUENCE {
    hS-SCCH-PreconfiguredCodes      HS-SCCH-PreconfiguredCodes,
    hSDSCH-RNTI                     HSDSCH-RNTI,
    hSPDSCH-and-HSSCCH-ScramblingCode  DL-ScramblingCode,
    sixtyfourQAM-DL-SupportIndicator  SixtyfourQAM-DL-SupportIndicator OPTIONAL,
    sixtyfourQAM-DL-UsageIndicator    SixtyfourQAM-DL-UsageIndicator  OPTIONAL,
    hSDSCH-TBSizeTableIndicator      HSDSCH-TBSizeTableIndicator  OPTIONAL,
    iE-Extensions                    ProtocolExtensionContainer { { SetsOfHS-SCCH-CodesItem-ExtIEs } } OPTIONAL,
    ...
}

SetsOfHS-SCCH-CodesItem-ExtIEs RNSAP-PROTOCOL-EXTENSION ::= {
    {ID id-MIMO-InformationResponse      CRITICALITY ignore  EXTENSION MIMO-InformationResponse      PRESENCE optional}|
    {ID id-power-offset-for-S-CPICH-for-MIMO  CRITICALITY ignore  EXTENSION PowerOffsetForSecondaryCPICHforMIMO  PRESENCE optional}|
    {ID id-Measurement-Power-Offset          CRITICALITY ignore  EXTENSION Measurement-Power-Offset          PRESENCE optional},
    ...
}

Setup-Or-ConfigurationChange-Or-Removal-Of-EDCH-On-secondary-UL-Frequency ::= CHOICE {
    setup                Additional-EDCH-Setup-Info,
    configurationChange  Additional-EDCH-Cell-Information-ConfigurationChange-List,
    removal              Additional-EDCH-Cell-Information-Removal-List,
    ...
}

SFN ::= INTEGER (0..4095)

SFNSFN-FDD ::= INTEGER(0..614399)

SFNSFN-TDD ::= INTEGER(0..40961)

SFNSFN-TDD768 ::= INTEGER(0..81923)

GA-AccessPointPositionwithOptionalAltitude ::= SEQUENCE {
    geographicalCoordinate      GeographicalCoordinate,
    altitudeAndDirection        GA-AltitudeAndDirection  OPTIONAL,
}

```

```

    iE-Extensions          ProtocolExtensionContainer { { GA-AccessPointPositionwithOptionalAltitude-ExtIEs } } OPTIONAL,
  }
  ...
}

GA-AccessPointPositionwithOptionalAltitude-ExtIEs RNSAP-PROTOCOL-EXTENSION ::= {
  ...
}

SFNSFNChangeLimit ::= INTEGER (1..256)
-- Unit chip, Step 1/16 chip, Range 1/16..16 chip

SFNSFNDriftRate ::= INTEGER (-100..100)
-- Unit chip/s, Step 1/256 chip/s, Range -100/256..+100/256 chip/s

SFNSFNDriftRateQuality ::= INTEGER (0..100)
-- Unit chip/s, Step 1/256 chip/s, Range 0..100/256 chip/s

SFNSFNMeasurementThresholdInformation ::= SEQUENCE {
  sFNChangeLimit          SFNSFNChangeLimit          OPTIONAL,
  predictedSFNSFNDeviationLimit PredictedSFNSFNDeviationLimit OPTIONAL,
  iE-Extensions          ProtocolExtensionContainer { { SFNSFNMeasurementThresholdInformation-ExtIEs } } OPTIONAL,
  ...
}

SFNSFNMeasurementThresholdInformation-ExtIEs RNSAP-PROTOCOL-EXTENSION ::= {
  ...
}

SFNSFNMeasurementValueInformation ::= SEQUENCE {
  successfulNeighbouringCellSFNSFNObservedTimeDifferenceMeasurementInformation SEQUENCE (SIZE(1..maxNrOfMeasNCell)) OF
    SEQUENCE {
      uC-ID          UC-ID,
      sFNValue       SFNSFNValue,
      sFNQuality     SFNSFNQuality          OPTIONAL,
      sFNDriftRate   SFNSFNDriftRate,
      sFNDriftRateQuality SFNSFNDriftRateQuality OPTIONAL,
      sFNTimeStampInformation SFNSFNTimeStampInformation,
      iE-Extensions ProtocolExtensionContainer { {
        SuccessfulNeighbouringCellSFNSFNObservedTimeDifferenceMeasurementInformationItem-ExtIEs } } OPTIONAL,
      ...
    },
  unsuccessfulNeighbouringCellSFNSFNObservedTimeDifferenceMeasurementInformation SEQUENCE (SIZE(0..maxNrOfMeasNCell-1)) OF
    SEQUENCE {
      uC-ID          UC-ID,
      iE-Extensions ProtocolExtensionContainer { { UnsuccessfulNeighbouringCellSFNSFNObservedTimeDifferenceMeasurementInformationItem-
        ExtIEs } } OPTIONAL,
      ...
    },
  iE-Extensions          ProtocolExtensionContainer { { SFNSFNMeasurementValueInformationItem-ExtIEs } } OPTIONAL,
  ...
}

SFNSFNMeasurementValueInformationItem-ExtIEs RNSAP-PROTOCOL-EXTENSION ::= {

```

```

    ...
}

SuccessfulNeighbouringCellSFNSFNObservedTimeDifferenceMeasurementInformationItem-ExtIEs RNSAP-PROTOCOL-EXTENSION ::= {
    ...
}

UnsuccessfulNeighbouringCellSFNSFNObservedTimeDifferenceMeasurementInformationItem-ExtIEs RNSAP-PROTOCOL-EXTENSION ::= {
    ...
}

SFNSFNQuality ::= INTEGER (0..255)
-- Unit chip, Step 1/16 chip, Range 0.. 255/16 chip

SFNSFNTimeStampInformation ::= CHOICE {
    sFNSFNTimeStamp-FDD      SFN,
    sFNSFNTimeStamp-TDD     SFNSFNTimeStamp-TDD,
    ...
}

SFNSFNTimeStamp-TDD ::= SEQUENCE {
    sFN                      SFN,
    timeSlot                 TimeSlot,
    iE-Extensions            ProtocolExtensionContainer { { SFNSFNTimeStamp-ExtIEs}} OPTIONAL,
    ...
}

SFNSFNTimeStamp-ExtIEs RNSAP-PROTOCOL-EXTENSION ::= {
    ...
}

SFNSFNValue ::= CHOICE {
    sFNSFN-FDD              SFNSFN-FDD,
    sFNSFN-TDD              SFNSFN-TDD,      -- LCR & HCR TDD
    ...,
    sFNSFN-TDD768           SFNSFN-TDD768
}

SID ::= INTEGER (0..maxNrOfPDUIndexes-1)

Single-Stream-MIMO-ActivationIndicator ::= NULL

Single-Stream-MIMO-Mode-Indicator ::= ENUMERATED {
    activate,
    deactivate
}

```



```
SIR-Error-Value ::= INTEGER (0..125)

SIR-Error-Value-IncrDecrThres ::= INTEGER (0..124)

SIR-Value ::= INTEGER (0..63)
-- According to mapping in TS 25.215 [11]/TS 25.225 [14]

SIR-Value-IncrDecrThres ::= INTEGER (0..62)

SixteenQAM-UL-Operation-Indicator ::= ENUMERATED {
    activate,
    deactivate
}

SixtyfourQAM-UsageAllowedIndicator ::= ENUMERATED {
    allowed,
    not-allowed
}

SixtyfourQAM-DL-SupportIndicator ::= ENUMERATED {
    sixtyfourQAM-DL-supported,
    sixtyfourQAM-DL-not-supported
}

SixtyfourQAM-DL-UsageIndicator ::= ENUMERATED {
    sixtyfourQAM-DL-used,
    sixtyfourQAM-DL-not-used
}

SignatureSequenceGroupIndex ::= INTEGER (0..19)

SNA-Information ::= SEQUENCE {
    pLMN-Identity PLMN-Identity,
    listOfSNAs ListOfSNAs OPTIONAL,
    iE-Extensions ProtocolExtensionContainer { { SNA-Information-ExtIEs } } OPTIONAL,
    ...
}

SNA-Information-ExtIEs RNSAP-PROTOCOL-EXTENSION ::= {
    ...
}

ListofSNAs ::= SEQUENCE (SIZE (1.. maxNrOfSNAs)) OF SNACode

SNACode ::= INTEGER (0..65535)

SpecialBurstScheduling ::= INTEGER (1..256)

S-RNTI ::= INTEGER (0..1048575)
-- From 0 to 2^20-1

S-RNTI-Group ::= SEQUENCE {
```

```
sRNTI                S-RNTI,
sRNTI-BitMaskIndex   ENUMERATED {
    b1,
    b2,
    b3,
    b4,
    b5,
    b6,
    b7,
    b8,
    b9,
    b10,
    b11,
    b12,
    b13,
    b14,
    b15,
    b16,
    b17,
    b18,
    b19,...
}
}

SRB-Delay ::= INTEGER(0..7,...)

SSDT-SupportIndicator ::= ENUMERATED {
    not-Used-sSDT-supported,
    sSDT-not-supported
}

Status-Flag ::= ENUMERATED {
    activate,
    deactivate
}

STTD-SupportIndicator ::= ENUMERATED {
    sTTD-Supported,
    sTTD-not-Supported
}

Support-8PSK ::= ENUMERATED {
    v8PSK-Supported
}

Support-PLCCH ::= ENUMERATED {
    vPLCCH-Supported
}

Support-of-Dynamic-DTXDRX-Related-HS-SCCH-Order ::= ENUMERATED {
    supported,
    not-supported
}
```

```
}
SyncCase ::= INTEGER (1..2,...)

SynchronisationConfiguration ::= SEQUENCE {
    n-INSYNC-IND          INTEGER (1..256),
    n-OUTSYNC-IND        INTEGER (1..256),
    t-RLFFAILURE         INTEGER (0..255),
    -- Unit seconds, Range 0s .. 25.5s, Step 0.1s
    iE-Extensions        ProtocolExtensionContainer { { SynchronisationConfiguration-ExtIEs } } OPTIONAL,
    ...
}

SynchronisationConfiguration-ExtIEs RNSAP-PROTOCOL-EXTENSION ::= {
    ...
}

SYNC-UL-ProcParameters ::= SEQUENCE {
    maxSYNC-UL-transmissions    ENUMERATED {v1, v2, v4, v8, ...},
    powerRampStep               INTEGER (0..3, ...),
    ...
}

-- T

T1 ::= ENUMERATED {v10,v20,v30,v40,v50,v60,v70,v80,v90,v100,v120,v140,v160,v200,v300,v400,...}

TDD-AckNack-Power-Offset ::= INTEGER (-7..8,...)
-- Unit dB, Range -7dB .. +8dB, Step 1dB

TDD-ChannelisationCode ::= ENUMERATED {
    chCode1div1,
    chCode2div1,
    chCode2div2,
    chCode4div1,
    chCode4div2,
    chCode4div3,
    chCode4div4,
    chCode8div1,
    chCode8div2,
    chCode8div3,
    chCode8div4,
    chCode8div5,
    chCode8div6,
    chCode8div7,
    chCode8div8,
    chCode16div1,
    chCode16div2,
    chCode16div3,
    chCode16div4,
    chCode16div5,
    chCode16div6,
    chCode16div7,
    chCode16div8,
```

```
    chCode16div9,  
    chCode16div10,  
    chCode16div11,  
    chCode16div12,  
    chCode16div13,  
    chCode16div14,  
    chCode16div15,  
    chCode16div16,  
    ...  
}  
  
TDD-ChannelisationCode768 ::= ENUMERATED {  
    chCode1div1,  
    chCode2div1,  
    chCode2div2,  
    chCode4div1,  
    chCode4div2,  
    chCode4div3,  
    chCode4div4,  
    chCode8div1,  
    chCode8div2,  
    chCode8div3,  
    chCode8div4,  
    chCode8div5,  
    chCode8div6,  
    chCode8div7,  
    chCode8div8,  
    chCode16div1,  
    chCode16div2,  
    chCode16div3,  
    chCode16div4,  
    chCode16div5,  
    chCode16div6,  
    chCode16div7,  
    chCode16div8,  
    chCode16div9,  
    chCode16div10,  
    chCode16div11,  
    chCode16div12,  
    chCode16div13,  
    chCode16div14,  
    chCode16div15,  
    chCode16div16,  
    chCode32div1,  
    chCode32div2,  
    chCode32div3,  
    chCode32div4,  
    chCode32div5,  
    chCode32div6,  
    chCode32div7,  
    chCode32div8,  
    chCode32div9,  
    chCode32div10,  
    chCode32div11,  
}
```

```

    chCode32div12,
    chCode32div13,
    chCode32div14,
    chCode32div15,
    chCode32div16,
    chCode32div17,
    chCode32div18,
    chCode32div19,
    chCode32div20,
    chCode32div21,
    chCode32div22,
    chCode32div23,
    chCode32div24,
    chCode32div25,
    chCode32div26,
    chCode32div27,
    chCode32div28,
    chCode32div29,
    chCode32div30,
    chCode32div31,
    chCode32div32,
    ...
}

TDD-ChannelisationCodeLCR ::= SEQUENCE {
    tDD-ChannelisationCode      TDD-ChannelisationCode,
    modulation                   Modulation, -- Modulation options for 1.28Mcps TDD in contrast to 3.84Mcps TDD or 7.68Mcps TDD
    ...
}

TDD-DCHs-to-Modify ::= SEQUENCE (SIZE (1..maxNrOfDCHs)) OF TDD-DCHs-to-ModifyItem

TDD-DCHs-to-ModifyItem ::= SEQUENCE {
    ul-FP-Mode                   UL-FP-Mode    OPTIONAL,
    toAWS                        ToAWS        OPTIONAL,
    toAWE                         ToAWE      OPTIONAL,
    transportBearerRequestIndicator TransportBearerRequestIndicator,
    dCH-SpecificInformationList  TDD-DCHs-to-ModifySpecificInformationList,
    iE-Extensions                ProtocolExtensionContainer { {TDD-DCHs-to-ModifyItem-ExtIEs} } OPTIONAL,
    ...
}

TDD-DCHs-to-ModifyItem-ExtIEs RNSAP-PROTOCOL-EXTENSION ::= {
    { ID id-TnIQos                CRITICALITY ignore      EXTENSION TnIQos PRESENCE optional },
    ...
}

TDD-DCHs-to-ModifySpecificInformationList ::= SEQUENCE (SIZE (1..maxNrOfDCHs)) OF TDD-DCHs-to-ModifySpecificItem

TDD-DCHs-to-ModifySpecificItem ::= SEQUENCE {
    dCH-ID                       DCH-ID,
    ul-CCTrCH-ID                 CCTrCH-ID    OPTIONAL,
    dl-CCTrCH-ID                 CCTrCH-ID    OPTIONAL,
    ul-TransportformatSet        TransportFormatSet OPTIONAL,

```

```

dl-TransportformatSet      TransportFormatSet OPTIONAL,
allocationRetentionPriority AllocationRetentionPriority OPTIONAL,
frameHandlingPriority      FrameHandlingPriority OPTIONAL,
iE-Extensions              ProtocolExtensionContainer { {TDD-DCHs-to-ModifySpecificItem-ExtIEs} } OPTIONAL,
...
}

TDD-DCHs-to-ModifySpecificItem-ExtIEs RNSAP-PROTOCOL-EXTENSION ::= {
  { ID id-Guaranteed-Rate-Information CRITICALITY ignore EXTENSION Guaranteed-Rate-Information PRESENCE optional }|
  { ID id-TrafficClass CRITICALITY ignore EXTENSION TrafficClass PRESENCE optional},
  ...
}

TDD-DL-Code-Information ::= SEQUENCE ( SIZE (1..maxNrOfDPCHs)) OF TDD-DL-Code-InformationItem

TDD-DL-Code-InformationItem ::= SEQUENCE {
  dPCH-ID DPCH-ID,
  tDD-ChannelisationCode TDD-ChannelisationCode,
  iE-Extensions ProtocolExtensionContainer { {TDD-DL-Code-InformationItem-ExtIEs} } OPTIONAL,
  ...
}

TDD-DL-Code-InformationItem-ExtIEs RNSAP-PROTOCOL-EXTENSION ::= {
  ...
}

TDD-DL-Code-LCR-Information ::= SEQUENCE (SIZE (1..maxNrOfDPCHsLCR)) OF TDD-DL-Code-LCR-InformationItem

TDD-DL-Code-LCR-InformationItem ::= SEQUENCE {
  dPCH-ID DPCH-ID,
  tdd-ChannelisationCodeLCR TDD-ChannelisationCodeLCR,
  tdd-DL-DPCH-TimeSlotFormat-LCR TDD-DL-DPCH-TimeSlotFormat-LCR,
  iE-Extensions ProtocolExtensionContainer { { TDD-DL-Code-LCR-InformationItem-ExtIEs} } OPTIONAL,
  ...
}

TDD-DL-Code-LCR-InformationItem-ExtIEs RNSAP-PROTOCOL-EXTENSION ::= {
  ...
}

TDD-DL-Code-Information768 ::= SEQUENCE ( SIZE (1..maxNrOfDPCHs768)) OF TDD-DL-Code-InformationItem768

TDD-DL-Code-InformationItem768 ::= SEQUENCE {
  dPCH-ID DPCH-ID,
  tDD-ChannelisationCode768 TDD-ChannelisationCode768,
  iE-Extensions ProtocolExtensionContainer { {TDD-DL-Code-InformationItem768-ExtIEs} } OPTIONAL,
  ...
}

TDD-DL-Code-InformationItem768-ExtIEs RNSAP-PROTOCOL-EXTENSION ::= {
  ...
}

TDD-DL-DPCH-TimeSlotFormat-LCR ::= CHOICE {

```

```

    qPSK                QPSK-DL-DPCH-TimeSlotFormatTDD-LCR,
    eightPSK            EightPSK-DL-DPCH-TimeSlotFormatTDD-LCR,
    ...
}

QPSK-DL-DPCH-TimeSlotFormatTDD-LCR ::= INTEGER(0..24,...)

EightPSK-DL-DPCH-TimeSlotFormatTDD-LCR ::= INTEGER(0..24,...)

TDD-DPCHOffset ::= CHOICE {
    initialOffset      INTEGER (0..255),
    noinitialOffset    INTEGER (0..63)
}

TDD-PhysicalChannelOffset      ::= INTEGER (0..63)

TDD-TPC-DownlinkStepSize ::= ENUMERATED {
    step-size1,
    step-size2,
    step-size3,
    ...
}

TDD-TPC-UplinkStepSize-LCR ::= ENUMERATED {
    step-size1,
    step-size2,
    step-size3,
    ...
}

TDD-UL-Code-Information ::= SEQUENCE ( SIZE (1..maxNrOfDPCHs)) OF TDD-UL-Code-InformationItem

TDD-UL-Code-InformationItem ::= SEQUENCE {
    dPCH-ID                DPCH-ID,
    tDD-ChannelisationCode TDD-ChannelisationCode,
    iE-Extensions          ProtocolExtensionContainer { {TDD-UL-Code-InformationItem-ExtIEs} } OPTIONAL,
    ...
}

TDD-UL-Code-InformationItem-ExtIEs RNSAP-PROTOCOL-EXTENSION ::= {
    ...
}

TDD-UL-Code-LCR-Information ::= SEQUENCE (SIZE (1..maxNrOfDPCHsLCR)) OF TDD-UL-Code-LCR-InformationItem

TDD-UL-Code-LCR-InformationItem ::= SEQUENCE {
    dPCH-ID                DPCH-ID,
    tdd-ChannelisationCodeLCR TDD-ChannelisationCodeLCR,
    tdd-UL-DPCH-TimeSlotFormat-LCR TDD-UL-DPCH-TimeSlotFormat-LCR,
    iE-Extensions          ProtocolExtensionContainer { { TDD-UL-Code-LCR-InformationItem-ExtIEs} } OPTIONAL,
    ...
}

TDD-UL-Code-LCR-InformationItem-ExtIEs RNSAP-PROTOCOL-EXTENSION ::= {

```

```

    ...
}

TDD-UL-Code-Information768 ::= SEQUENCE ( SIZE (1..maxNrOfDPCHs768)) OF TDD-UL-Code-InformationItem768

TDD-UL-Code-InformationItem768 ::= SEQUENCE {
    dPCH-ID                DPCH-ID,
    tDD-ChannelisationCode768  TDD-ChannelisationCode768,
    iE-Extensions          ProtocolExtensionContainer { {TDD-UL-Code-InformationItem768-ExtIEs} } OPTIONAL,
    ...
}

TDD-UL-Code-InformationItem768-ExtIEs RNSAP-PROTOCOL-EXTENSION ::= {
    ...
}

TDD-UL-DPCH-TimeSlotFormat-LCR ::= CHOICE {
    qPSK                QPSK-UL-DPCH-TimeSlotFormatTDD-LCR,
    eightPSK            EightPSK-UL-DPCH-TimeSlotFormatTDD-LCR,
    ...
}

QPSK-UL-DPCH-TimeSlotFormatTDD-LCR ::= INTEGER(0..69,...)

EightPSK-UL-DPCH-TimeSlotFormatTDD-LCR ::= INTEGER(0..24,...)

TFCI-Coding ::= ENUMERATED {
    v4,
    v8,
    v16,
    v32,
    ...
}

TFCI-Presence ::= ENUMERATED {
    present,
    not-present
}

TFCI-SignallingMode ::= ENUMERATED {
    normal,
    not-Used-split
}

-- The value "Not Used" shall not be used by the SRNC. The procedure shall be rejected by the DRNC if the value "Not Used" is received.

TGD                ::= INTEGER (0|15..269)
-- 0 = Undefined, only one transmission gap in the transmission gap pattern sequence

TGPRC              ::= INTEGER (0..511)
-- 0 = infinity

TGPSID             ::= INTEGER (1.. maxTGPS)

TGSN               ::= INTEGER (0..14)

```



```
TimeSlot                ::= INTEGER (0..14)

TimeSlotLCR ::= INTEGER (0..6)

Time-Stamp ::= INTEGER (0..9999)
-- Unit: 10ms

TimingAdvanceApplied ::= ENUMERATED {
    yes,
    no
}

SynchronisationIndicator ::= ENUMERATED {
    timingMaintainedSynchronisation,
    ...
}

TMGI ::= SEQUENCE {
    plmn-id      PLMN-Identity,
    service-id  Service-ID,
    iE-Extensions          ProtocolExtensionContainer { { TMGI-ExtIEs } } OPTIONAL,
    ...
}

TMGI-ExtIEs RNSAP-PROTOCOL-EXTENSION ::= {
    ...
}

TnlQos ::= CHOICE {
    dsField          DsField,
    genericTrafficCategory  GenericTrafficCategory,
    ...
}

ToAWE                ::= INTEGER (0..2559)

ToAWS                ::= INTEGER (0..1279)

TraceDepth           ::= ENUMERATED {
    minimum,
    medium,
    maximum,
    ...
}

TraceRecordingSessionReference ::= INTEGER (0..65535)

TraceReference       ::= OCTET STRING (SIZE (2..3))

TrafficClass ::= ENUMERATED {
    conversational,
```

```

    streaming,
    interactive,
    background,
    ...
}

Transmission-Gap-Pattern-Sequence-Information ::= SEQUENCE (SIZE (1..maxTGPS)) OF
SEQUENCE {
    tGPSID          TGPSID,
    tGSN            TGSN,
    tGL1            GapLength,
    tGL2            GapLength OPTIONAL,
    tGD             TGD,
    tGPL1           GapDuration,
    not-to-be-used-1  GapDuration OPTIONAL,
    -- This IE shall never be included in the SEQUENCE. If received it shall be ignored
    uL-DL-mode      UL-DL-mode,
    downlink-Compressed-Mode-Method  Downlink-Compressed-Mode-Method  OPTIONAL,
    -- This IE shall be present if the value of the UL/DL mode IE is "DL only" or "UL/DL"
    uplink-Compressed-Mode-Method    Uplink-Compressed-Mode-Method    OPTIONAL,
    -- This IE shall be present if the value of the UL/DL mode IE is "UL only" or "UL/DL"
    dL-FrameType    DL-FrameType,
    delta-SIR1       DeltaSIR,
    delta-SIR-after1 DeltaSIR,
    delta-SIR2       DeltaSIR OPTIONAL,
    delta-SIR-after2 DeltaSIR OPTIONAL,
    iE-Extensions    ProtocolExtensionContainer { {Transmission-Gap-Pattern-Sequence-Information-ExtIEs} } OPTIONAL,
    ...
}

Transmission-Gap-Pattern-Sequence-Information-ExtIEs RNSAP-PROTOCOL-EXTENSION ::= {
    ...
}

Transmission-Gap-Pattern-Sequence-ScramblingCode-Information ::= ENUMERATED{
    code-change,
    nocode-change
}

Transmission-Gap-Pattern-Sequence-Status-List ::= SEQUENCE (SIZE (0..maxTGPS)) OF
SEQUENCE {
    tGPSID          TGPSID,
    tGPRC           TGPRC,
    tGCFN           CFN,
    iE-Extensions    ProtocolExtensionContainer { { Transmission-Gap-Pattern-Sequence-Status-List-ExtIEs } } OPTIONAL,
    ...
}

Transmission-Gap-Pattern-Sequence-Status-List-ExtIEs RNSAP-PROTOCOL-EXTENSION ::= {
    ...
}

TransmissionMode ::=ENUMERATED {
    p-t-p,

```

```

    p-t-m,
    not-provided,
    ...
}

Transmission-Mode-Information ::= SEQUENCE ( SIZE (1..maxNrOfFDDNeighboursPerRNC,...)) OF Transmission-Mode-Information-List

Transmission-Mode-Information-List ::= SEQUENCE {
    c-ID                C-ID,
    transmissionMode    TransmissionMode,
    iE-Extensions       ProtocolExtensionContainer { { Transmission-Mode-Information-List-ExtIEs } } OPTIONAL,
    ...
}

Transmission-Mode-Information-List-ExtIEs RNSAP-PROTOCOL-EXTENSION ::= {
    ...
}

TransmissionTimeIntervalDynamic ::= ENUMERATED {
    msec-10,
    msec-20,
    msec-40,
    msec-80,
    ...
}

TransmissionTimeIntervalSemiStatic ::= ENUMERATED {
    msec-10,
    msec-20,
    msec-40,
    msec-80,
    dynamic,
    ...
}

TransmitDiversityIndicator ::= ENUMERATED {
    active,
    inactive
}

Transmitted-Carrier-Power-Value ::= INTEGER(0..100)
-- according to mapping in TS 25.133 [23] and TS 25.123 [24]

Transmitted-Carrier-Power-Value-IncrDecrThres ::= INTEGER(0..100)
-- according to mapping in TS 25.133 [23] and TS 25.123 [24]

Transport-Block-Size-Index ::= INTEGER(1..maxNrOfHS-DSCHTBSs)

TUTRANGANSS ::= SEQUENCE {
    mS                INTEGER(0..16383),
    lS                INTEGER(0..4294967295)
}

TUTRANGANSSAccuracyClass ::= ENUMERATED {

```

```

    ganssAccuracy-class-A,
    ganssAccuracy-class-B,
    ganssAccuracy-class-C,
    ...
}

TUTRANGANSSMeasurementThresholdInformation ::= SEQUENCE {
    tUTRANGANSSChangeLimit          INTEGER(1..256)
    OPTIONAL,
    predictedTUTRANGANSSDeviationLimit  INTEGER(1..256)
    OPTIONAL,
    ie-Extensions                    ProtocolExtensionContainer { { TUTRANGANSSMeasurementThresholdInformation-ExtIEs } } OPTIONAL,
    ...
}

TUTRANGANSSMeasurementThresholdInformation-ExtIEs RNSAP-PROTOCOL-EXTENSION ::= {
    ...
}

TUTRANGANSSMeasurementValueInformation ::= SEQUENCE {
    tUTRANGANSS                    TUTRANGANSS,
    tUTRANGANSSQuality              INTEGER(0..255)
    OPTIONAL,
    tUTRANGANSSDriftRate            INTEGER(-50..50),
    tUTRANGANSSDriftRateQuality     INTEGER(0..50)
    OPTIONAL,
    ie-Extensions                    ProtocolExtensionContainer { { TUTRANGANSSMeasurementValueInformation-ExtIEs } } OPTIONAL,
    ...
}

TUTRANGANSSMeasurementValueInformation-ExtIEs RNSAP-PROTOCOL-EXTENSION ::= {
    { ID id-GANSS-Time-ID          CRITICALITY ignore      EXTENSION GANSS-Time-ID      PRESENCE          optional},
    ...
}

TUTRANGPS ::= SEQUENCE {
    ms-part      INTEGER (0..16383),
    ls-part      INTEGER (0..4294967295)
}

TUTRANGPSChangeLimit ::= INTEGER (1..256)
-- Unit chip, Step 1/16 chip, Range 1/16..16 chip

TUTRANGPSDriftRate ::= INTEGER (-50..50)
-- Unit chip/s, Step 1/256 chip/s, Range -50/256..+50/256 chip/s

TUTRANGPSDriftRateQuality ::= INTEGER (0..50)
-- Unit chip/s, Step 1/256 chip/s, Range 0..50/256 chip/s

TUTRANGPSAccuracyClass ::= ENUMERATED {
    accuracy-class-A,

```

```

    accuracy-class-B,
    accuracy-class-C,
    ...
}

TUTRANGPSMeasurementThresholdInformation ::= SEQUENCE {
    tUTRANGPSChangeLimit          TUTRANGPSChangeLimit          OPTIONAL,
    predictedTUTRANGPSDeviationLimit    PredictedTUTRANGPSDeviationLimit    OPTIONAL,
    iE-Extensions                  ProtocolExtensionContainer { { TUTRANGPSMeasurementThresholdInformation-ExtIEs} }    OPTIONAL,
    ...
}

TUTRANGPSMeasurementThresholdInformation-ExtIEs RNSAP-PROTOCOL-EXTENSION ::= {
    ...
}

TUTRANGPSMeasurementValueInformation ::= SEQUENCE {
    tUTRANGPS                      TUTRANGPS,
    tUTRANGPSQuality                TUTRANGPSQuality          OPTIONAL,
    tUTRANGPSDriftRate              TUTRANGPSDriftRate,
    tUTRANGPSDriftRateQuality        TUTRANGPSDriftRateQuality    OPTIONAL,
    iEe-Extensions                  ProtocolExtensionContainer { { TUTRANGPSMeasurementValueInformationItem-ExtIEs} }    OPTIONAL,
    ...
}

TUTRANGPSMeasurementValueInformationItem-ExtIEs RNSAP-PROTOCOL-EXTENSION ::= {
    ...
}

TUTRANGPSQuality ::= INTEGER (0..255)
-- Unit chip, Step 1/16 chip, Range 0.. 255/16 chip

TransportBearerID ::= INTEGER (0..4095)

TransportBearerRequestIndicator ::= ENUMERATED {
    bearer-requested,
    bearer-not-requested,
    ...
}

TransportBearerNotRequestedIndicator ::= ENUMERATED {
    transport-bearer-shall-not-be-established,
    transport-bearer-may-not-be-established
}

TransportBearerNotSetupIndicator ::= ENUMERATED {
    transport-bearer-not-setup
}

TransportBlockSize ::= INTEGER (0..5000)
-- Unit is bits

```

```

TransportFormatCombination-Beta ::= CHOICE {
    signalledGainFactors SEQUENCE {
        betaC          BetaCD,
        betaD          BetaCD,
        refTFCNumber   RefTFCNumber OPTIONAL,
        iE-Extensions  ProtocolExtensionContainer { { SignalledGainFactors-ExtIEs } } OPTIONAL,
        ...
    },
    refTFCNumber       RefTFCNumber,
    ...
}

SignalledGainFactors-ExtIEs RNSAP-PROTOCOL-EXTENSION ::= {
    ...
}

TFCS ::= SEQUENCE {
    tFCSvalues CHOICE {
        no-Split-in-TFCI      TFCs-TFCSList,
        not-Used-split-in-TFCI NULL,
        -- This choice shall never be made by the SRNC and the DRNC shall consider the procedure as failed if it is received.
        ...
    },
    iE-Extensions ProtocolExtensionContainer { { TFCS-ExtIEs } } OPTIONAL,
    ...
}

TFCS-ExtIEs RNSAP-PROTOCOL-EXTENSION ::= {
    ...
}

TFCS-TFCSList ::= SEQUENCE (SIZE (1..maxNrOfTFCS)) OF
    SEQUENCE {
        cTFC          TFCs-CTFC,
        tFC-Beta      TransportFormatCombination-Beta OPTIONAL,
        -- The IE shall be present if the TFCS concerns a UL DPCH [FDD - or PRACH channel in FDD]
        iE-Extensions ProtocolExtensionContainer { { TFCS-TFCSList-ExtIEs } } OPTIONAL,
        ...
    }

TFCS-TFCSList-ExtIEs RNSAP-PROTOCOL-EXTENSION ::= {
    ...
}

TFCS-CTFC ::= CHOICE {
    ctfc2bit          INTEGER (0..3),
    ctfc4bit          INTEGER (0..15),
    ctfc6bit          INTEGER (0..63),
    ctfc8bit          INTEGER (0..255),
    ctfc12bit         INTEGER (0..4095),
    ctfc16bit         INTEGER (0..65535),
    ctfcmaxbit        INTEGER (0..maxCTFC)
}

```

```

TransportFormatSet ::= SEQUENCE {
    dynamicParts          TransportFormatSet-DynamicPartList,
    semi-staticPart      TransportFormatSet-Semi-staticPart,
    iE-Extensions        ProtocolExtensionContainer { {TransportFormatSet-ExtIEs} } OPTIONAL,
    ...
}

TransportFormatSet-ExtIEs RNSAP-PROTOCOL-EXTENSION ::= {
    ...
}

TransportFormatSet-DynamicPartList ::= SEQUENCE (SIZE (1..maxNrOfTFs)) OF
SEQUENCE {
    nrOfTransportBlocks      NrOfTransportBlocks,
    transportBlockSize      TransportBlockSize OPTIONAL
    -- This IE shall be present if nrOfTransportBlocks is greater than 0 --,
    mode                    TransportFormatSet-ModeDP,
    iE-Extensions          ProtocolExtensionContainer { {TransportFormatSet-DynamicPartList-ExtIEs} } OPTIONAL,
    ...
}

TransportFormatSet-DynamicPartList-ExtIEs RNSAP-PROTOCOL-EXTENSION ::= {
    ...
}

TransportFormatSet-ModeDP ::= CHOICE {
    tdd                    TDD-TransportFormatSet-ModeDP,
    notApplicable          NULL,
    ...
}

TDD-TransportFormatSet-ModeDP ::= SEQUENCE {
    transmissionTimeIntervalInformation      TransmissionTimeIntervalInformation OPTIONAL,
    -- This IE shall be present if the "Transmission Time Interval" of the "Semi-static Transport Format Information" is "dynamic". Otherwise it is
    absent.
    iE-Extensions          ProtocolExtensionContainer { {TDD-TransportFormatSet-ModeDP-ExtIEs} } OPTIONAL,
    ...
}

TDD-TransportFormatSet-ModeDP-ExtIEs RNSAP-PROTOCOL-EXTENSION ::= {
    ...
}

TransmissionTimeIntervalInformation ::= SEQUENCE (SIZE (1..maxTTI-Count)) OF
SEQUENCE {
    transmissionTimeInterval      TransmissionTimeIntervalDynamic,
    iE-Extensions          ProtocolExtensionContainer { {TransmissionTimeIntervalInformation-ExtIEs} } OPTIONAL,
    ...
}

TransmissionTimeIntervalInformation-ExtIEs RNSAP-PROTOCOL-EXTENSION ::= {
    ...
}

```

```
Transmitted-Code-Power-Value ::= INTEGER (0..127)
-- According to mapping in TS 25.215 [11]/TS 25.225 [14]

Transmitted-Code-Power-Value-IncrDecrThres ::= INTEGER (0..112,...)

TransportFormatManagement ::= ENUMERATED {
    cell-based,
    ue-based,
    ...
}

TransportFormatSet-Semi-staticPart ::= SEQUENCE {
    transmissionTime      TransmissionTimeIntervalSemiStatic,
    channelCoding         ChannelCodingType,
    codingRate            CodingRate          OPTIONAL
    -- This IE shall be present if channelCoding is 'convolutional' or 'turbo' --,
    rateMatchingAttribute RateMatchingAttribute,
    cRC-Size              CRC-Size,
    mode                  TransportFormatSet-ModeSSP,
    iE-Extensions         ProtocolExtensionContainer { {TransportFormatSet-Semi-staticPart-ExtIEs} } OPTIONAL,
    ...
}

TransportFormatSet-Semi-staticPart-ExtIEs RNSAP-PROTOCOL-EXTENSION ::= {
    ...
}

TransportFormatSet-ModeSSP ::= CHOICE {
    tdd                SecondInterleavingMode,
    notApplicable      NULL,
    ...
}

TransportLayerAddress      ::= BIT STRING (SIZE(1..160, ...))

TrCH-SrcStatisticsDescr   ::= ENUMERATED {
    speech,
    rRC,
    unknown,
    ...
}

TSN-Length ::= ENUMERATED {
    tsn-6bits,
    tsn-9bits
}

TSTD-Indicator ::= ENUMERATED {
    active,
    inactive
}

TSTD-Support-Indicator ::= ENUMERATED {
    tSTD-supported,
```



```

    tSTD-not-supported
}

TxDiversityIndicator ::= ENUMERATED {
    true,
    false
}

TypeOfError ::= ENUMERATED {
    not-understood,
    missing,
    ...
}

-- U

UARFCN ::= INTEGER (0..16383,...)
-- Corresponds to: 0.0Hz..3276.6Mhz. See TS 25.105 [7], TS 25.101 [43]

UDRE ::= ENUMERATED {
    lessThan1,
    between1-and-4,
    between4-and-8,
    over8,
    ...
}

UDREGrowthRate ::= ENUMERATED {
    growth-1-point-5,
    growth-2,
    growth-4,
    growth-6,
    growth-8,
    growth-10,
    growth-12,
    growth-16 }

UDREValidityTime ::= ENUMERATED {
    val-20sec,
    val-40sec,
    val-80sec,
    val-160sec,
    val-320sec,
    val-640sec,
    val-1280sec,
    val-2560sec }

UE-AggregateMaximumBitRate ::= SEQUENCE {
    uE-AggregateMaximumBitRateDownlink UE-AggregateMaximumBitRateDownlink OPTIONAL,
    uE-AggregateMaximumBitRateUplink UE-AggregateMaximumBitRateUplink OPTIONAL,
    ...
}

UE-AggregateMaximumBitRateDownlink ::= INTEGER (1..1000000000)

```

```

-- Unit is bits per sec

UE-AggregateMaximumBitRateUplink          ::= INTEGER (1..1000000000)
-- Unit is bits per sec

UE-AggregateMaximumBitRate-Enforcement-Indicator ::= NULL

UE-Capabilities-Info ::= SEQUENCE {
  hSDSCH-Physical-Layer-Category          INTEGER (1..64,...),
  iE-Extensions                          ProtocolExtensionContainer { { UE-Capabilities-Info-ExtIEs } }           OPTIONAL,
  ...
}

UE-Capabilities-Info-ExtIEs RNSAP-PROTOCOL-EXTENSION ::= {
  {ID id-LCRTDD-uplink-Physical-Channel-Capability          CRITICALITY ignore          EXTENSION LCRTDD-Uplink-Physical-Channel-Capability
    PRESENCE optional}|
  {ID id-number-Of-Supported-Carriers                      CRITICALITY reject          EXTENSION Number-Of-Supported-Carriers
    PRESENCE optional}|
  {ID id-MIMO-SFMode-Supported-For-HSPDSCHDualStream      CRITICALITY ignore          EXTENSION MIMO-SFMode-For-HSPDSCHDualStream
    PRESENCE optional}|
  {ID id-MultiCarrier-HSDSCH-Physical-Layer-Category      CRITICALITY ignore          EXTENSION LCRTDD-HSDSCH-Physical-Layer-Category
    PRESENCE optional}|
  {ID id-UE-TS0-CapabilityLCR          CRITICALITY ignore          EXTENSION UE-TS0-CapabilityLCR          PRESENCE optional},
  ...
}

UE-TS0-CapabilityLCR ::= ENUMERATED {
  tS0-Capable,
  tS0-Not-Capable
}

LCRTDD-HSDSCH-Physical-Layer-Category ::= INTEGER (1..64)

UE-DPCCH-burst1 ::= ENUMERATED {v1, v2, v5}
-- Unit subframe

UE-DPCCH-burst2 ::= ENUMERATED {v1, v2, v5}
-- Unit subframe

UE-DRX-Cycle ::= ENUMERATED {v4, v5, v8, v10, v16, v20}
-- Unit subframe

UE-DRX-Grant-Monitoring ::= BOOLEAN
-- true: applied, false: not applied

UE-DTX-Cycle1-2ms ::= ENUMERATED {v1, v4, v5, v8, v10, v16, v20}
-- Unit subframe

UE-DTX-Cycle1-10ms ::= ENUMERATED {v1, v5, v10, v20}
-- Unit subframe

UE-DTX-Cycle2-2ms ::= ENUMERATED {v4, v5, v8, v10, v16, v20, v32, v40, v64, v80, v128, v160}
-- Unit subframe

```

```

UE-DTX-Cycle2-10ms ::= ENUMERATED {v5, v10, v20, v40, v80, v160}
  -- Unit subframe

UE-DTX-DRX-Offset ::= INTEGER (0..159)
  -- Unit subframe

UE-DTX-Long-Preamble ::= ENUMERATED {v2, v4, v15}
  -- Units of slots

UEIdentity ::= CHOICE {
  imsi      IMSI,
  imei      IMEI,
  imeisv    IMEISV,
  ...
}

UEMeasurementHysteresisTime ::= INTEGER (0..15)
  -- Unit dB
  -- Range 0..7.5 dB
  -- Step 0.5 dB

UEMeasurementParameterModAllow ::= ENUMERATED {
  parameterModificationAllowed,
  ...
}

UEMeasurementReportCharacteristics ::= CHOICE {
  periodic      UEMeasurementReportCharacteristicsPeriodic,
  event1h       UEMeasurementReportCharacteristicsEvent1h,
  event1l       UEMeasurementReportCharacteristicsEvent1l,
  event6a       UEMeasurementReportCharacteristicsEvent6a,
  event6b       UEMeasurementReportCharacteristicsEvent6b,
  event6c       UEMeasurementReportCharacteristicsEvent6c,
  event6d       UEMeasurementReportCharacteristicsEvent6d,
  ...,
  extension-ReportCharacteristics  UEMeasurementReportCharacteristics-Extension
}

UEMeasurementReportCharacteristicsEvent1h ::= SEQUENCE {
  uEMeasurementTreshold      UEMeasurementThreshold,
  uEMeasurementTimeToTrigger UEMeasurementTimeToTrigger,
  uEMeasurementHysteresisTime UEMeasurementHysteresisTime,
  IE-Extensions              ProtocolExtensionContainer { { UEMeasurementReportCharacteristicsEvent1h-ExtIEs } } OPTIONAL,
  ...
}

UEMeasurementReportCharacteristicsEvent1h-ExtIEs RNSAP-PROTOCOL-EXTENSION ::= {
  ...
}

UEMeasurementReportCharacteristicsEvent1l ::= SEQUENCE {
  uEMeasurementTreshold      UEMeasurementThreshold,

```

```

    uEMeasurementTimeToTrigger    UMeasurementTimeToTrigger,
    uEMeasurementHysteresisTime    UMeasurementHysteresisTime,
    iE-Extensions                  ProtocolExtensionContainer { { UMeasurementReportCharacteristicsEvent1i-ExtIEs } } OPTIONAL,
    ...
}

UEMeasurementReportCharacteristicsEvent1i-ExtIEs RNSAP-PROTOCOL-EXTENSION ::= {
    ...
}

UEMeasurementReportCharacteristicsEvent6a ::= SEQUENCE {
    uEMeasurementTreshold          UMeasurementThreshold,
    uEMeasurementTimeToTrigger    UMeasurementTimeToTrigger,
    iE-Extensions                  ProtocolExtensionContainer { { UMeasurementReportCharacteristicsEvent6a-ExtIEs } } OPTIONAL,
    ...
}

UEMeasurementReportCharacteristicsEvent6a-ExtIEs RNSAP-PROTOCOL-EXTENSION ::= {
    ...
}

UEMeasurementReportCharacteristicsEvent6b ::= SEQUENCE {
    uEMeasurementTreshold          UMeasurementThreshold,
    uEMeasurementTimeToTrigger    UMeasurementTimeToTrigger,
    iE-Extensions                  ProtocolExtensionContainer { { UMeasurementReportCharacteristicsEvent6b-ExtIEs } } OPTIONAL,
    ...
}

UEMeasurementReportCharacteristicsEvent6b-ExtIEs RNSAP-PROTOCOL-EXTENSION ::= {
    ...
}

UEMeasurementReportCharacteristicsEvent6c ::= SEQUENCE {
    uEMeasurementTimeToTrigger    UMeasurementTimeToTrigger,
    iE-Extensions                  ProtocolExtensionContainer { { UMeasurementReportCharacteristicsEvent6c-ExtIEs } } OPTIONAL,
    ...
}

UEMeasurementReportCharacteristicsEvent6c-ExtIEs RNSAP-PROTOCOL-EXTENSION ::= {
    ...
}

UEMeasurementReportCharacteristicsEvent6d ::= SEQUENCE {
    uEMeasurementTimeToTrigger    UMeasurementTimeToTrigger,
    iE-Extensions                  ProtocolExtensionContainer { { UMeasurementReportCharacteristicsEvent6d-ExtIEs } } OPTIONAL,
    ...
}

UEMeasurementReportCharacteristicsEvent6d-ExtIEs RNSAP-PROTOCOL-EXTENSION ::= {
    ...
}

UEMeasurementReportCharacteristicsPeriodic ::= SEQUENCE {
    amountofReporting              UMeasurementReportCharacteristicsPeriodicAmountofReporting,

```

```

    reportingInterval      UEMeasurementReportCharacteristicsPeriodicReportingInterval,
    iE-Extensions          ProtocolExtensionContainer { {UEMeasurementReportCharacteristicsPeriodic-ExtIEs} } OPTIONAL,
    ...
}

UEMeasurementReportCharacteristicsPeriodicAmountofReporting ::= ENUMERATED {
    r1,
    r2,
    r4,
    r8,
    r16,
    r32,
    r64,
    rInfinity
}

UEMeasurementReportCharacteristicsPeriodicReportingInterval ::= ENUMERATED {
    r250,
    r500,
    r1000,
    r2000,
    r3000,
    r4000,
    r6000,
    r8000,
    r12000,
    r16000,
    r20000,
    r24000,
    r28000,
    r32000,
    r64000
}

UEMeasurementReportCharacteristicsPeriodic-ExtIEs RNSAP-PROTOCOL-EXTENSION ::= {
    ...
}

UEMeasurementReportCharacteristics-Extension ::= ProtocolIE-Single-Container {{ UEMeasurementReportCharacteristics-ExtensionIE }}

UEMeasurementReportCharacteristics-ExtensionIE RNSAP-PROTOCOL-IES ::= {
    ...
}

UEMeasurementThreshold ::= CHOICE {
    timeslotISCP          UEMeasurementThresholdDLTimeslotISCP,
    uETransmitPower      UEMeasurementThresholdUETransmitPower,
    ...,
    extension-UEMeasurementThreshold  UEMeasurementThreshold-Extension
}

UEMeasurementThresholdDLTimeslotISCP ::= INTEGER(-115..-25)

UEMeasurementThresholdUETransmitPower ::= INTEGER(-50..33)

```

```

UEMeasurementThreshold-Extension ::= ProtocolIE-Single-Container {{ UEMeasurementThreshold-ExtensionIE }}

UEMeasurementThreshold-ExtensionIE RNSAP-PROTOCOL-IES ::= {
    ...
}

UEMeasurementTimeslotInfoHCR ::= SEQUENCE (SIZE (1..maxNrOfTS)) OF UEMeasurementTimeslotInfoHCR-IEs

UEMeasurementTimeslotInfoHCR-IEs ::= SEQUENCE {
    timeSlot          TimeSlot,
    burstType         UEMeasurementTimeslotInfoHCRBurstType,
    iE-Extensions     ProtocolExtensionContainer { { UEMeasurementTimeslotInfoHCR-IEs-ExtIEs} } OPTIONAL,
    ...
}

UEMeasurementTimeslotInfoHCRBurstType ::= ENUMERATED {
    type1,
    type2,
    type3,
    ...
}

UEMeasurementTimeslotInfoHCR-IEs-ExtIEs RNSAP-PROTOCOL-EXTENSION ::= {
    ...
}

UEMeasurementTimeslotInfoLCR ::= SEQUENCE (SIZE (1..maxNrOfTsLCR)) OF UEMeasurementTimeslotInfoLCR-IEs

UEMeasurementTimeslotInfoLCR-IEs ::= SEQUENCE {
    timeSlot          TimeSlotLCR,
    iE-Extensions     ProtocolExtensionContainer { { UEMeasurementTimeslotInfoLCR-IEs-ExtIEs} } OPTIONAL,
    ...
}

UEMeasurementTimeslotInfoLCR-IEs-ExtIEs RNSAP-PROTOCOL-EXTENSION ::= {
    ...
}

UEMeasurementTimeslotInfo768 ::= SEQUENCE (SIZE (1..maxNrOfTS)) OF UEMeasurementTimeslotInfo768-IEs

UEMeasurementTimeslotInfo768-IEs ::= SEQUENCE {
    timeSlot          TimeSlot,
    burstType         UEMeasurementTimeslotInfo768BurstType,
    iE-Extensions     ProtocolExtensionContainer { { UEMeasurementTimeslotInfo768-IEs-ExtIEs} } OPTIONAL,
    ...
}

UEMeasurementTimeslotInfo768BurstType ::= ENUMERATED {
    type1,
    type2,
    type3,
    ...
}

```

```

}

UEMeasurementTimeslotInfo768-IEs-ExtIEs RNSAP-PROTOCOL-EXTENSION ::= {
  ...
}

UEMeasurementTimeToTrigger ::= ENUMERATED {
  r0,
  r10,
  r20,
  r40,
  r60,
  r80,
  r100,
  r120,
  r160,
  r200,
  r240,
  r320,
  r640,
  r1280,
  r2560,
  r5000
}

UEMeasurementType ::= ENUMERATED {
  primary-CCPCH-RSCP,
  dL-Timeslot-ISCP,
  uE-Transmitted-power,
  ...
}

UEMeasurementValue ::= CHOICE {
  uE-Transmitted-Power          UE-MeasurementValue-UE-Transmitted-Power,
  primary-CCPCH-RSCP            UE-MeasurementValue-Primary-CCPCH-RSCP,
  dL-Timeslot-ISCP              UE-MeasurementValue-DL-Timeslot-ISCP,
  ...,
  extension-UEMeasurementValue  UEMeasurementValue-Extension
}

UE-MeasurementValue-UE-Transmitted-Power ::= SEQUENCE {
  uEMeasurementTransmittedPowerListHCR      UEMeasurementValueTransmittedPowerListHCR   OPTIONAL,
  -- Mandatory for 3.84Mcps TDD, Not applicable for 1.28Mcps TDD or 7.68Mcps TDD
  uEMeasurementTransmittedPowerListLCR      UEMeasurementValueTransmittedPowerListLCR   OPTIONAL,
  -- Mandatory for 1.28Mcps TDD, Not applicable for 3.84Mcps TDD or 7.68Mcps TDD
  iE-Extensions                             ProtocolExtensionContainer { { UE-MeasurementValue-UE-Transmitted-Power-ExtIEs} }
  OPTIONAL,
  ...
}

UE-MeasurementValue-UE-Transmitted-Power-ExtIEs RNSAP-PROTOCOL-EXTENSION ::= {
  { ID id-UEMeasurementValueTransmittedPowerList768          CRITICALITY ignore  EXTENSION UEMeasurementValueTransmittedPowerList768
    PRESENCE optional },
  ...
}

```

```

}

UEMeasurementValueTransmittedPowerListHCR ::= SEQUENCE (SIZE (1..maxNrOfTS)) OF UEMeasurementValueTransmittedPowerListHCR-IEs

UEMeasurementValueTransmittedPowerListHCR-IEs ::= SEQUENCE {
    timeSlot                TimeSlot,
    uETransmitPower          INTEGER(0..104),
    -- mapping according to TS 25.123 [24], values 0..20 not used
    iE-Extensions            ProtocolExtensionContainer { { UEMeasurementValueTransmittedPowerListHCR-IEs-ExtIEs} }
    OPTIONAL,
    ...
}

UEMeasurementValueTransmittedPowerListHCR-IEs-ExtIEs RNSAP-PROTOCOL-EXTENSION ::= {
    ...
}

UEMeasurementValueTransmittedPowerListLCR ::= SEQUENCE (SIZE (1..maxNrOfTsLCR)) OF UEMeasurementValueTransmittedPowerListLCR-IEs

UEMeasurementValueTransmittedPowerListLCR-IEs ::= SEQUENCE {
    timeSlotLCR              TimeSlotLCR,
    uETransmitPower          INTEGER(0..104),
    -- mapping according to TS 25.123 [24], values 0..20 not used
    iE-Extensions            ProtocolExtensionContainer { { UEMeasurementValueTransmittedPowerListLCR-IEs-ExtIEs} }
    OPTIONAL,
    ...
}

UEMeasurementValueTransmittedPowerListLCR-IEs-ExtIEs RNSAP-PROTOCOL-EXTENSION ::= {
    ...
}

UEMeasurementValueTransmittedPowerList768 ::= SEQUENCE (SIZE (1..maxNrOfTS)) OF UEMeasurementValueTransmittedPowerList768-IEs

UEMeasurementValueTransmittedPowerList768-IEs ::= SEQUENCE {
    timeSlot                TimeSlot,
    uETransmitPower          INTEGER(0..104),
    -- mapping according to TS 25.123 [24], values 0..20 not used
    iE-Extensions            ProtocolExtensionContainer { { UEMeasurementValueTransmittedPowerList768-IEs-ExtIEs} }
    OPTIONAL,
    ...
}

UEMeasurementValueTransmittedPowerList768-IEs-ExtIEs RNSAP-PROTOCOL-EXTENSION ::= {
    ...
}

UE-MeasurementValue-Primary-CCPCH-RSCP ::= SEQUENCE {
    primaryCCPCH-RSCP        PrimaryCCPCH-RSCP                OPTIONAL,
    primaryCCPCH-RSCP-Delta  PrimaryCCPCH-RSCP-Delta          OPTIONAL,
    iE-Extensions            ProtocolExtensionContainer { { UE-MeasurementValue-Primary-CCPCH-RSCP-ExtIEs} }    OPTIONAL,
    ...
}

```



```

UE-MeasurementValue-Primary-CCPCH-RSCP-ExtIEs RNSAP-PROTOCOL-EXTENSION ::= {
  ...
}

UE-MeasurementValue-DL-Timeslot-ISCP ::= SEQUENCE {
  uEMeasurementTimeslotISCPListHCR      UEMeasurementValueTimeslotISCPListHCR  OPTIONAL,
-- Mandatory for 3.84Mcps TDD, Not applicable for 1.28Mcps TDD or 7.68Mcps TDD
  uEMeasurementTimeslotISCPListLCR      UEMeasurementValueTimeslotISCPListLCR  OPTIONAL,
-- Mandatory for 1.28Mcps TDD, Not applicable for 3.84Mcps TDD or 7.68Mcps TDD
  iE-Extensions                          ProtocolExtensionContainer { { UE-MeasurementValue-DL-Timeslot-ISCP-ExtIEs} }  OPTIONAL,
  ...
}

UE-MeasurementValue-DL-Timeslot-ISCP-ExtIEs RNSAP-PROTOCOL-EXTENSION ::= {
  { ID id-UEMeasurementValueTimeslotISCPList768          CRITICALITY ignore  EXTENSION UEMeasurementValueTimeslotISCPList768
  PRESENCE optional },
  ...
}

UEMeasurementValueTimeslotISCPListHCR ::= SEQUENCE (SIZE (1..maxNrOfTS)) OF UEMeasurementValueTimeslotISCPListHCR-IEs

UEMeasurementValueTimeslotISCPListHCR-IEs ::= SEQUENCE {
  timeSlot          TimeSlot,
  dL-TimeslotISCP  DL-TimeslotISCP,
  iE-Extensions    ProtocolExtensionContainer { { UEMeasurementValueTimeslotISCPListHCR-IEs-ExtIEs} }  OPTIONAL,
  ...
}

UEMeasurementValueTimeslotISCPListHCR-IEs-ExtIEs RNSAP-PROTOCOL-EXTENSION ::= {
  ...
}

UEMeasurementValueTimeslotISCPListLCR ::= SEQUENCE (SIZE (1..maxNrOfTsLCR)) OF UEMeasurementValueTimeslotISCPListLCR-IEs

UEMeasurementValueTimeslotISCPListLCR-IEs ::= SEQUENCE {
  timeSlotLCR          TimeSlotLCR,
  dL-TimeslotISCP     DL-TimeslotISCP,
  iE-Extensions       ProtocolExtensionContainer { { UEMeasurementValueTimeslotISCPListLCR-IEs-ExtIEs} }  OPTIONAL,
  ...
}

UEMeasurementValueTimeslotISCPListLCR-IEs-ExtIEs RNSAP-PROTOCOL-EXTENSION ::= {
  ...
}

UEMeasurementValueTimeslotISCPList768 ::= SEQUENCE (SIZE (1..maxNrOfTS)) OF UEMeasurementValueTimeslotISCPList768-IEs

UEMeasurementValueTimeslotISCPList768-IEs ::= SEQUENCE {
  timeSlot          TimeSlot,
  dL-TimeslotISCP  DL-TimeslotISCP,
  iE-Extensions    ProtocolExtensionContainer { { UEMeasurementValueTimeslotISCPList768-IEs-ExtIEs} }  OPTIONAL,
  ...
}

```

```

UEMeasurementValueTimeslotISCPList768-IEs-ExtIEs RNSAP-PROTOCOL-EXTENSION ::= {
    ...
}

UEMeasurementValue-Extension ::= ProtocolIE-Single-Container {{ UEMeasurementValue-ExtensionIE }}

UEMeasurementValue-ExtensionIE RNSAP-PROTOCOL-IES ::= {
    ...
}

UEMeasurementValueInformation ::= CHOICE {
    measurementAvailable      UEMeasurementValueInformationAvailable,
    measurementnotAvailable    UEMeasurementValueInformationnotAvailable
}

UEMeasurementValueInformationAvailable ::= SEQUENCE {
    ueMeasurementValue      UEMeasurementValue,
    ie-Extensions           ProtocolExtensionContainer { { UEMeasurementValueInformationAvailableItem-ExtIEs} }      OPTIONAL,
    ...
}

UEMeasurementValueInformationAvailableItem-ExtIEs RNSAP-PROTOCOL-EXTENSION ::= {
    ...
}

UEMeasurementValueInformationnotAvailable ::= NULL

UE-SupportIndicatorExtension ::= BIT STRING (SIZE (32))
-- First bit: Different HS-SCCH In Consecutive TTIs Support Indicator
-- Second bit: HS-SCCH orders in HS-SCCH-less Operation Support Indicator
-- Third bit: RRC Rel-9 (onwards) handling of DL secondary HS-DSCH (de)activation state Support Indicator
-- Fourth bit: UE DTX/DRX related HS-SCCH orders uniform behavior indicator
-- Note that undefined bits are considered as a spare bit and spare bits shall be set to 0 by the transmitter and shall be ignored by the receiver.

UE-State ::= CHOICE {
    cell-fach-pch          Cell-Fach-Pch-State,
    ura-pch                Ura-Pch-State,
    ...
}

Cell-Fach-Pch-State ::= SEQUENCE {
    d-RNTI                 D-RNTI,
    ie-Extensions          ProtocolExtensionContainer { { Cell-Fach-Pch-State-ExtIEs} }      OPTIONAL,
    ...
}

Cell-Fach-Pch-State-ExtIEs RNSAP-PROTOCOL-EXTENSION ::= {
    ...
}

Ura-Pch-State ::= SEQUENCE {
    srnc-id                RNC-ID,

```

```

ura-id                URA-ID,
iE-Extensions         ProtocolExtensionContainer { { Ura-Pch-State-ExtIEs } }    OPTIONAL,
...
}

Ura-Pch-State-ExtIEs RNSAP-PROTOCOL-EXTENSION ::= {
  { ID id-Extended-SRNC-ID                CRITICALITY reject  EXTENSION Extended-RNC-ID                PRESENCE optional },
  ...
}

UL-Delta-T2TP ::= INTEGER (0..6,...)

UL-DL-mode ::= ENUMERATED {
  ul-only,
  dl-only,
  both-ul-and-dl
}

UL-DPDCHIndicatorEDCH ::= ENUMERATED {
  uL-DPDCH-present,
  uL-DPDCH-not-present}

UL-Timeslot-Information ::= SEQUENCE ( SIZE (1..maxNrOfTS)) OF UL-Timeslot-InformationItem

UL-Timeslot-InformationItem ::= SEQUENCE {
  timeSlot                TimeSlot,
  midambleShiftAndBurstType  MidambleShiftAndBurstType,
  tFCI-Presence            TFCI-Presence,
  uL-Code-Information       TDD-UL-Code-Information,
  iE-Extensions            ProtocolExtensionContainer { {UL-Timeslot-InformationItem-ExtIEs} } OPTIONAL,
  ...
}

UL-Timeslot-InformationItem-ExtIEs RNSAP-PROTOCOL-EXTENSION ::= {
  ...
}

UL-TimeslotLCR-Information ::= SEQUENCE (SIZE (1..maxNrOfULTsLCR)) OF UL-TimeslotLCR-InformationItem

UL-TimeslotLCR-InformationItem ::= SEQUENCE {
  timeSlotLCR                TimeSlotLCR,
  midambleShiftLCR            MidambleShiftLCR,
  tFCI-Presence                TFCI-Presence,
  uL-Code-InformationList      TDD-UL-Code-Information,
  iE-Extensions                ProtocolExtensionContainer { { UL-TimeslotLCR-InformationItem-ExtIEs } }    OPTIONAL,
  ...
}

UL-TimeslotLCR-InformationItem-ExtIEs RNSAP-PROTOCOL-EXTENSION ::= {
  { ID id-PLCCH-Information-UL-TimeslotLCR-Info  CRITICALITY ignore  EXTENSION  PLCCHinformation  PRESENCE optional },
  ...
}

PLCCHinformation ::= SEQUENCE {
  tDD-ChannelisationCode      TDD-ChannelisationCode,

```

```

    timeSlotLCR                TimeSlotLCR,
    midambleShiftLCR           MidambleShiftLCR,
    sequenceNumber             PLCCHsequenceNumber,
    iE-Extensions              ProtocolExtensionContainer { { PLCCHinformation-ExtIEs } }
    ...
}
OPTIONAL,

PLCCHinformation-ExtIEs RNSAP-PROTOCOL-EXTENSION ::= {
    ...
}

UL-Timeslot-Information768 ::= SEQUENCE ( SIZE (1..maxNrOfTS)) OF UL-Timeslot-InformationItem768

UL-Timeslot-InformationItem768 ::= SEQUENCE {
    timeSlot                    TimeSlot,
    midambleShiftAndBurstType768 MidambleShiftAndBurstType768,
    tFCI-Presence               TFCI-Presence,
    uL-Code-Information768      TDD-UL-Code-Information768,
    iE-Extensions              ProtocolExtensionContainer { {UL-Timeslot-InformationItem768-ExtIEs} } OPTIONAL,
    ...
}

UL-Timeslot-InformationItem768-ExtIEs RNSAP-PROTOCOL-EXTENSION ::= {
    ...
}

UL-TimeSlot-ISCP-Info ::= SEQUENCE (SIZE (1..maxNrOfULTs)) OF UL-TimeSlot-ISCP-InfoItem

UL-TimeSlot-ISCP-InfoItem ::= SEQUENCE {
    timeSlot                    TimeSlot,
    uL-TimeslotISCP             UL-TimeslotISCP,
    iE-Extensions              ProtocolExtensionContainer { { UL-TimeSlot-ISCP-InfoItem-ExtIEs} } OPTIONAL,
    ...
}

UL-TimeSlot-ISCP-InfoItem-ExtIEs RNSAP-PROTOCOL-EXTENSION ::= {
    ...
}

UL-TimeSlot-ISCP-LCR-Info ::= SEQUENCE (SIZE (1..maxNrOfULTsLCR)) OF UL-TimeSlot-ISCP-LCR-InfoItem

UL-TimeSlot-ISCP-LCR-InfoItem ::= SEQUENCE {
    timeSlotLCR                TimeSlotLCR,
    iSCP                        UL-Timeslot-ISCP-Value,
    iE-Extensions              ProtocolExtensionContainer { { UL-TimeSlot-ISCP-LCR-InfoItem-ExtIEs} }
    ...
}
OPTIONAL,

UL-TimeSlot-ISCP-LCR-InfoItem-ExtIEs RNSAP-PROTOCOL-EXTENSION ::= {
    ...
}

UL-Timeslot-ISCP-Value ::= UL-TimeslotISCP

```

```

UL-Timeslot-ISCP-Value-IncrDecrThres ::= INTEGER(0..126)
-- Unit dB. Step 0.5dB
-- e.g. Value 100 means 50dB

UL-TimingAdvanceCtrl-LCR ::= SEQUENCE {
    sync-UL-codes-bitmap          BIT STRING (SIZE(8)),
    fPACH-info                    FPACH-Information,
    prxUpPCHdes                   INTEGER (-120 .. -58, ...),
    syncUL-procParameter          SYNC-UL-ProcParameters,
    mMax                          INTEGER (1..32),
    ...
}

Uplink-Compressed-Mode-Method ::= ENUMERATED {
    sFdiv2,
    higher-layer-scheduling,
    ...
}

UL-SIR ::= INTEGER (-82..173)
-- The UL-SIR gives the UL-SIR in number of 0.1 dB steps.
-- E.g. Value 173 means 17.3 dB
-- Unit dB. Step 0.1 dB.

UC-ID ::= SEQUENCE {
    rNC-ID          RNC-ID,
    c-ID            C-ID,
    iE-Extensions  ProtocolExtensionContainer { {UC-ID-ExtIEs} } OPTIONAL,
    ...
}

UC-ID-ExtIEs RNSAP-PROTOCOL-EXTENSION ::= {
    { ID id-Extended-RNC-ID    CRITICALITY reject    EXTENSION    Extended-RNC-ID PRESENCE optional},
    ...
}

UL-DPCCH-SlotFormat ::= INTEGER (0..5,...)

UL-FP-Mode ::= ENUMERATED {
    normal,
    silent,
    ...
}

UL-PhysCH-SF-Variation ::= ENUMERATED {
    sf-variation-supported,
    sf-variation-not-supported
}

UL-ScramblingCode ::= SEQUENCE {
    ul-ScramblingCodeNumber    UL-ScramblingCodeNumber,
    ul-ScramblingCodeLength    UL-ScramblingCodeLength,
    iE-Extensions              ProtocolExtensionContainer { {UL-ScramblingCode-ExtIEs} } OPTIONAL
}

```

```

UL-ScramblingCode-ExtIEs RNSAP-PROTOCOL-EXTENSION ::= {
  ...
}

UL-ScramblingCodeLength ::= ENUMERATED {
  short,
  long
}

UL-ScramblingCodeNumber ::= INTEGER (0..16777215)

UL-Synchronisation-Parameters-LCR ::= SEQUENCE {
  uL-Synchronisation-StepSize          UL-Synchronisation-StepSize,
  uL-Synchronisation-Frequency         UL-Synchronisation-Frequency,
  iE-Extensions                        ProtocolExtensionContainer { { UL-Synchronisation-Parameters-LCR-ExtIEs } }
  ...
}

UL-Synchronisation-Parameters-LCR-ExtIEs RNSAP-PROTOCOL-EXTENSION ::= {
  ...
}

UL-Synchronisation-StepSize ::= INTEGER (1..8)

UL-Synchronisation-Frequency ::= INTEGER (1..8)

UL-TimeslotISCP ::= INTEGER (0..127)
-- According to mapping in TS 25.225 [14]

UPPCHPositionLCR ::= INTEGER (0..127)

UpPTSInterferenceValue ::= INTEGER (0..127,...)

Unidirectional-DCH-Indicator ::= ENUMERATED {
  downlink-DCH-only,
  uplink-DCH-only
}

URA-ID ::= INTEGER (0..65535)

URA-Information ::= SEQUENCE {
  uRA-ID          URA-ID,
  multipleURAsIndicator MultipleURAsIndicator,
  rNCsWithCellsInTheAccessedURA-List RNCsWithCellsInTheAccessedURA-List OPTIONAL,
  iE-Extensions ProtocolExtensionContainer { { URA-Information-ExtIEs } } OPTIONAL,
  ...
}

URA-Information-ExtIEs RNSAP-PROTOCOL-EXTENSION ::= {
  { ID id-Extended-RNC-ID          CRITICALITY reject EXTENSION Extended-RNC-ID PRESENCE optional },
  ...
}

```

```

RNCsWithCellsInTheAccessedURA-List ::= SEQUENCE (SIZE (1..maxRNCinURA-1)) OF RNCsWithCellsInTheAccessedURA-Item

RNCsWithCellsInTheAccessedURA-Item ::= SEQUENCE {
    rNC-ID                RNC-ID,
    iE-Extensions         ProtocolExtensionContainer { {RNCsWithCellsInTheAccessedURA-Item-ExtIEs} } OPTIONAL,
    ...
}

RNCsWithCellsInTheAccessedURA-Item-ExtIEs RNSAP-PROTOCOL-EXTENSION ::= {
    ...
}

USCH-ID                ::= INTEGER (0..255)

USCH-Information ::= SEQUENCE (SIZE (1..maxNoOfUSCHs)) OF USCH-InformationItem

USCH-InformationItem ::= SEQUENCE {
    uSCH-ID                USCH-ID,
    ul-CCTrCH-ID          CCTrCH-ID,
    trChSourceStatisticsDescriptor TrCH-SrcStatisticsDescr,
    transportFormatSet    TransportFormatSet,
    allocationRetentionPriority AllocationRetentionPriority,
    schedulingPriorityIndicator SchedulingPriorityIndicator,
    rb-Info               RB-Info,
    iE-Extensions         ProtocolExtensionContainer { {USCH-InformationItem-ExtIEs} } OPTIONAL,
    ...
}

USCH-InformationItem-ExtIEs RNSAP-PROTOCOL-EXTENSION ::= {
    { ID id-TrafficClass          CRITICALITY ignore EXTENSION TrafficClass          PRESENCE mandatory          }|
    { ID id-BindingID            CRITICALITY ignore EXTENSION BindingID          PRESENCE optional          }|
    -- Shall be ignored if bearer establishment with ALCAP.
    { ID id-TransportLayerAddress CRITICALITY ignore EXTENSION TransportLayerAddress PRESENCE optional          }|
    -- Shall be ignored if bearer establishment with ALCAP.
    { ID id-TnlQos                CRITICALITY ignore EXTENSION TnlQos                PRESENCE optional          },
    ...
}

User-Plane-Congestion-Fields-Inclusion ::= ENUMERATED { shall-be-included }

Uu-ActivationState ::= ENUMERATED {
    activated,
    de-activated,
    ...
}

-- V
-- W
-- X
-- Y
-- Z

END

```

9.3.5 Common Definitions

```

-- *****
--
-- Common definitions
--
-- *****

RNSAP-CommonDataTypes {
itu-t (0) identified-organization (4) etsi (0) mobileDomain (0)
umts-Access (20) modules (3) rnsap (1) version1 (1) rnsap-CommonDataTypes (3) }

DEFINITIONS AUTOMATIC TAGS ::=

BEGIN

-- *****
--
-- Extension constants
--
-- *****

maxPrivateIEs                INTEGER ::= 65535
maxProtocolExtensions        INTEGER ::= 65535
maxProtocolIEs               INTEGER ::= 65535

-- *****
--
-- Common Data Types
--
-- *****

Criticality      ::= ENUMERATED { reject, ignore, notify }

Presence         ::= ENUMERATED { optional, conditional, mandatory }

PrivateIE-ID     ::= CHOICE {
    local          INTEGER (0.. maxPrivateIEs),
    global         OBJECT IDENTIFIER
}

ProcedureCode    ::= INTEGER (0..255)

ProcedureID ::= SEQUENCE {
    procedureCode    ProcedureCode,
    ddMode          ENUMERATED { tdd, fdd, common, ... }
}

ProtocolIE-ID    ::= INTEGER (0..maxProtocolIEs)

TransactionID    ::= CHOICE {
    shortTransActionId  INTEGER (0..127),

```



```

    longTransActionId  INTEGER (0..32767)
}
TriggeringMessage ::= ENUMERATED { initiating-message, successful-outcome, unsuccessful-outcome, outcome }
END

```

9.3.6 Constant Definitions

```

-- *****
--
-- Constant definitions
--
-- *****

RNSAP-Constants {
itu-t (0) identified-organization (4) etsi (0) mobileDomain (0)
umts-Access (20) modules (3) rnsap (1) version1 (1) rnsap-Constants (4) }

DEFINITIONS AUTOMATIC TAGS ::=

BEGIN

IMPORTS
    ProcedureCode,
    ProtocolIE-ID
FROM RNSAP-CommonDataTypes;

-- *****
--
-- Elementary Procedures
--
-- *****

id-commonTransportChannelResourcesInitialisation      ProcedureCode ::= 0
id-commonTransportChannelResourcesRelease             ProcedureCode ::= 1
id-compressedModeCommand                             ProcedureCode ::= 2
id-downlinkPowerControl                              ProcedureCode ::= 3
id-downlinkPowerTimeslotControl                      ProcedureCode ::= 4
id-downlinkSignallingTransfer                        ProcedureCode ::= 5
id-errorIndication                                   ProcedureCode ::= 6
id-dedicatedMeasurementFailure                       ProcedureCode ::= 7
id-dedicatedMeasurementInitiation                   ProcedureCode ::= 8
id-dedicatedMeasurementReporting                    ProcedureCode ::= 9
id-dedicatedMeasurementTermination                   ProcedureCode ::= 10
id-paging                                             ProcedureCode ::= 11
id-physicalChannelReconfiguration                    ProcedureCode ::= 12
id-privateMessage                                    ProcedureCode ::= 13
id-radioLinkAddition                                 ProcedureCode ::= 14
id-radioLinkCongestion                               ProcedureCode ::= 34
id-radioLinkDeletion                                 ProcedureCode ::= 15
id-radioLinkFailure                                  ProcedureCode ::= 16
id-radioLinkPreemption                               ProcedureCode ::= 17

```

id-radioLinkRestoration	ProcedureCode ::= 18
id-radioLinkSetup	ProcedureCode ::= 19
id-relocationCommit	ProcedureCode ::= 20
id-synchronisedRadioLinkReconfigurationCancellation	ProcedureCode ::= 21
id-synchronisedRadioLinkReconfigurationCommit	ProcedureCode ::= 22
id-synchronisedRadioLinkReconfigurationPreparation	ProcedureCode ::= 23
id-unsynchronisedRadioLinkReconfiguration	ProcedureCode ::= 24
id-uplinkSignallingTransfer	ProcedureCode ::= 25
id-commonMeasurementFailure	ProcedureCode ::= 26
id-commonMeasurementInitiation	ProcedureCode ::= 27
id-commonMeasurementReporting	ProcedureCode ::= 28
id-commonMeasurementTermination	ProcedureCode ::= 29
id-informationExchangeFailure	ProcedureCode ::= 30
id-informationExchangeInitiation	ProcedureCode ::= 31
id-informationReporting	ProcedureCode ::= 32
id-informationExchangeTermination	ProcedureCode ::= 33
id-reset	ProcedureCode ::= 35
id-radioLinkActivation	ProcedureCode ::= 36
id-gERANuplinkSignallingTransfer	ProcedureCode ::= 37
id-radioLinkParameterUpdate	ProcedureCode ::= 38
id-uEMeasurementFailure	ProcedureCode ::= 39
id-uEMeasurementInitiation	ProcedureCode ::= 40
id-uEMeasurementReporting	ProcedureCode ::= 41
id-uEMeasurementTermination	ProcedureCode ::= 42
id-iurDeactivateTrace	ProcedureCode ::= 43
id-iurInvokeTrace	ProcedureCode ::= 44
id-mBMSAttach	ProcedureCode ::= 45
id-mBMSDetach	ProcedureCode ::= 46
id-directInformationTransfer	ProcedureCode ::= 48
id-enhancedRelocation	ProcedureCode ::= 49
id-enhancedRelocationCancel	ProcedureCode ::= 50
id-enhancedRelocationSignallingTransfer	ProcedureCode ::= 51
id-enhancedRelocationRelease	ProcedureCode ::= 52
id-mBSFNMCCHInformation	ProcedureCode ::= 53
id-secondaryULFrequencyReporting	ProcedureCode ::= 54
id-secondaryULFrequencyUpdate	ProcedureCode ::= 55

```
-- *****
--
-- Lists
--
-- *****
```

maxCellsSIB11OrSIB12	INTEGER ::= 32
maxCellsMeas	INTEGER ::= 8
maxRateMatching	INTEGER ::= 256
maxNoOfDSCHs	INTEGER ::= 10
maxNoOfDSCHsLCR	INTEGER ::= 10
maxNoOfRB	INTEGER ::= 32
maxNoOfUSCHs	INTEGER ::= 10
maxNoOfUSCHsLCR	INTEGER ::= 10
maxNrOfTFCs	INTEGER ::= 1024
maxNrOfTFs	INTEGER ::= 32
maxNrOfCCTrCHs	INTEGER ::= 16

maxNrOfCCTrCHsLCR	INTEGER	::= 16
maxNrOfDCHs	INTEGER	::= 128
maxNrOfDL-Codes	INTEGER	::= 8
maxNrOfDPCHs	INTEGER	::= 240
maxNrOfDPCHsPerRL-1	INTEGER	::= 239 -- maxNrOfCCTrCH*maxNrOfULTs-1
maxNrOfDPCHsLCR	INTEGER	::= 240
maxNrOfDPCHsLCRPerRL-1	INTEGER	::= 95 -- maxNrOfCCTrCH*maxNrOfULTsLCR-1
maxNrOfDPCHs768	INTEGER	::= 480
maxNrOfDPCHs768PerRL-1	INTEGER	::= 479
maxNrOfErrors	INTEGER	::= 256
maxNrOfMACcshSDU-Length	INTEGER	::= 16
maxNrOfMBMSServices	INTEGER	::= 128
maxNrOfActiveMBMSServices	INTEGER	::= 256
maxNrOfPoints	INTEGER	::= 15
maxNrOfRLs	INTEGER	::= 16
maxNrOfRLSets	INTEGER	::= maxNrOfRLs
maxNrOfRLSets-1	INTEGER	::= 15 -- maxNrOfRLSets - 1
maxNrOfRLs-1	INTEGER	::= 15 -- maxNrOfRLs - 1
maxNrOfRLs-2	INTEGER	::= 14 -- maxNrOfRLs - 2
maxNrOfUES	INTEGER	::= 4096
maxNrOfULTs	INTEGER	::= 15
maxNrOfULTsLCR	INTEGER	::= 6
maxNrOfDLTs	INTEGER	::= 15
maxNrOfDLTsLCR	INTEGER	::= 6
maxRNCinURA-1	INTEGER	::= 15
maxTTI-Count	INTEGER	::= 4
maxCTFC	INTEGER	::= 16777215
maxNrOfNeighbouringRNCs	INTEGER	::= 10
maxNrOfFDDNeighboursPerRNC	INTEGER	::= 256
maxNrOfGSMNeighboursPerRNC	INTEGER	::= 256
maxNrOfTDDNeighboursPerRNC	INTEGER	::= 256
maxNrOfFACHs	INTEGER	::= 8
maxNrOfLCRTDDNeighboursPerRNC	INTEGER	::= 256
maxIBSEG	INTEGER	::= 16
maxNrOfSCCPCHs	INTEGER	::= 8
maxNrOfSCCPCHs768	INTEGER	::= 16
maxTGPS	INTEGER	::= 6
maxNrOfTS	INTEGER	::= 15
maxNrOfLevels	INTEGER	::= 256
maxNrOfTsLCR	INTEGER	::= 6
maxNoSat	INTEGER	::= 16
maxNoGPSTypes	INTEGER	::= 8
maxNrOfMeasNCell	INTEGER	::= 96
maxNrOfMeasNCell-1	INTEGER	::= 95 -- maxNrOfMeasNCell - 1
maxResetContext	INTEGER	::= 250
maxResetContextGroup	INTEGER	::= 32
maxNrOfHARQProc	INTEGER	::= 8
maxNrOfHSSCCHCodes	INTEGER	::= 4
maxNrOfHSSICHs	INTEGER	::= 4
maxNrOfHSSICHs-1	INTEGER	::= 3
maxNrOfMACdFlows	INTEGER	::= 8
maxNrOfMACdFlows-1	INTEGER	::= 7 -- maxNrOfMACdFlows - 1
maxNrOfMACdPDUSize	INTEGER	::= 32
maxNrOfPDUIndexes	INTEGER	::= 8

```

maxNrOfPDUIndexes-1          INTEGER ::= 7 -- maxNrOfPDUIndexes - 1
maxNrOfPrioQueues            INTEGER ::= 8
maxNrOfPrioQueues-1          INTEGER ::= 7 -- maxNrOfPrioQueues - 1
maxNrOfSNAs                   INTEGER ::= 65536
maxNrOfSatAlmanac-maxNoSat    INTEGER ::= 16
maxNrOfGERANSI                INTEGER ::= 8
maxNrOfInterfaces             INTEGER ::= 16
maxNrofSigSeqERGHICH-1       INTEGER ::= 39
maxNrOfCells                  INTEGER ::= 65536
maxNrOfAddFreq                INTEGER ::= 8
maxNrOfCellsPerFreq           INTEGER ::= 65536
maxNrOfEDCHMACdFlows-1        INTEGER ::= 7
maxNrOfEDCH-HARQ-PO-QUANTSTEPS INTEGER ::= 6
maxNrOfEDPCCH-PO-QUANTSTEPS   INTEGER ::= 8
maxNrOfEDCHHARQProcesses2msEDCH INTEGER ::= 8
maxNrOfBits-MACe-PDU-non-scheduled INTEGER ::= 19982
maxNrOfRefETFICI              INTEGER ::= 8
maxNrOfRefETFICI-PO-QUANTSTEPS INTEGER ::= 29
maxNrOfEDCHMACdFlows          INTEGER ::= 8
maxNoOfLogicalChannels         INTEGER ::= 16 -- only maximum 15 can be used
maxNrOfRefBetas                INTEGER ::= 8
maxNrOfEAGCHCodes              INTEGER ::= 4
maxNrOfHS-DSCHTBSs             INTEGER ::= 90
maxNrOfHS-DSCHTBSs-HS-SCCHless INTEGER ::= 4
maxHS-PDSCHCodeNrComp-1        INTEGER ::= 15
maxNrOfEHICHCodes              INTEGER ::= 4
maxGANSSSat                    INTEGER ::= 64
maxNoGANSs                     INTEGER ::= 8
maxSgnType                      INTEGER ::= 8
maxNrOfBroadcastPLMNs          INTEGER ::= 5
maxHSDPAFrequency              INTEGER ::= 8
maxHSDPAFrequency-1            INTEGER ::= 7
maxFrequencyinCell              INTEGER ::= 12
maxFrequencyinCell-1           INTEGER ::= 11
maxGANSSSatAlmanac             INTEGER ::= 36
maxGANSsClockMod                INTEGER ::= 4
maxNrOfEDCHRLs                 INTEGER ::= 4
maxEARFCN                       INTEGER ::= 65535
maxNrOfEUTRANeighboursPerRNC   INTEGER ::= 256
maxNrOfMCCHMessages            INTEGER ::= 5
maxNrOfMBMSL3                   INTEGER ::= 64
maxNrOfEDCHMACdFlowsLCR         INTEGER ::= 256
maxNrOfEDCHMACdFlowsLCR-1       INTEGER ::= 255
maxNrOfPreconfiguredNeighbours INTEGER ::= 256
maxNrOfHSDSCH-1                 INTEGER ::= 32
maxNrOfHSDSCH                   INTEGER ::= 33
maxGANSs-1                       INTEGER ::= 7
maxLengthMBMSconcatserlists     INTEGER ::= 96
maxNoOfTBSs-Mapping-HS-DSCH-SPS INTEGER ::= 4
maxNoOfTBSs-Mapping-HS-DSCH-SPS-1 INTEGER ::= 3
maxNoOfHS-DSCH-TBSsLCR          INTEGER ::= 64
maxNoOfRepetition-Period-LCR     INTEGER ::= 4
maxNoOfRepetitionPeriod-SPS-LCR-1 INTEGER ::= 3
maxNoOf-HS-SICH-SPS             INTEGER ::= 4

```

```

maxNoOf-HS-SICH-SPS-1                INTEGER ::= 3
maxNoOfNon-HS-SCCH-Associated-HS-SICH  INTEGER ::= 4
maxNrOfEDCH-1                        INTEGER ::= 32
maxNrOfDCHMeasurementOccasionPatternSequence  INTEGER ::= 6

-- *****
--
-- IEs
--
-- *****

id-AllowedQueuingTime                ProtocolIE-ID ::= 4
id-AllowedRate-Information            ProtocolIE-ID ::= 42
id-AntennaColocationIndicator        ProtocolIE-ID ::= 309
id-BindingID                        ProtocolIE-ID ::= 5
id-C-ID                             ProtocolIE-ID ::= 6
id-C-RNTI                           ProtocolIE-ID ::= 7
id-Cell-Capacity-Class-Value         ProtocolIE-ID ::= 303
id-CFN                              ProtocolIE-ID ::= 8
id-CN-CS-DomainIdentifier            ProtocolIE-ID ::= 9
id-CN-PS-DomainIdentifier            ProtocolIE-ID ::= 10
id-Cause                             ProtocolIE-ID ::= 11
id-CoverageIndicator                 ProtocolIE-ID ::= 310
id-CriticalityDiagnostics            ProtocolIE-ID ::= 20
id-ContextInfoItem-Reset             ProtocolIE-ID ::= 211
id-ContextGroupInfoItem-Reset       ProtocolIE-ID ::= 515
id-D-RNTI                           ProtocolIE-ID ::= 21
id-D-RNTI-ReleaseIndication          ProtocolIE-ID ::= 22
id-DCHs-to-Add-FDD                  ProtocolIE-ID ::= 26
id-DCHs-to-Add-TDD                  ProtocolIE-ID ::= 27
id-DCH-DeleteList-RL-ReconfPrepFDD  ProtocolIE-ID ::= 30
id-DCH-DeleteList-RL-ReconfPrepTDD  ProtocolIE-ID ::= 31
id-DCH-DeleteList-RL-ReconfRqstFDD  ProtocolIE-ID ::= 32
id-DCH-DeleteList-RL-ReconfRqstTDD  ProtocolIE-ID ::= 33
id-DCH-FDD-Information               ProtocolIE-ID ::= 34
id-DCH-TDD-Information               ProtocolIE-ID ::= 35
id-FDD-DCHs-to-Modify                ProtocolIE-ID ::= 39
id-TDD-DCHs-to-Modify                ProtocolIE-ID ::= 40
id-DCH-InformationResponse           ProtocolIE-ID ::= 43
id-DCH-Rate-InformationItem-RL-CongestInd  ProtocolIE-ID ::= 38
id-DL-CCTrCH-InformationAddItem-RL-ReconfPrepTDD  ProtocolIE-ID ::= 44
id-DL-CCTrCH-InformationListIE-RL-ReconfReadyTDD  ProtocolIE-ID ::= 45
id-DL-CCTrCH-InformationDeleteItem-RL-ReconfRqstTDD  ProtocolIE-ID ::= 46
id-DL-CCTrCH-InformationItem-RL-SetupRqstTDD  ProtocolIE-ID ::= 47
id-DL-CCTrCH-InformationListIE-PhyChReconfRqstTDD  ProtocolIE-ID ::= 48
id-DL-CCTrCH-InformationListIE-RL-AdditionRspTDD  ProtocolIE-ID ::= 49
id-DL-CCTrCH-InformationListIE-RL-SetupRspTDD  ProtocolIE-ID ::= 50
id-DL-CCTrCH-InformationAddList-RL-ReconfPrepTDD  ProtocolIE-ID ::= 51
id-DL-CCTrCH-InformationDeleteList-RL-ReconfRqstTDD  ProtocolIE-ID ::= 52
id-DL-CCTrCH-InformationList-RL-SetupRqstTDD  ProtocolIE-ID ::= 53
id-FDD-DL-CodeInformation             ProtocolIE-ID ::= 54
id-DL-DPCH-Information-RL-ReconfPrepFDD  ProtocolIE-ID ::= 59

```

id-DL-DPCH-Information-RL-SetupRqstFDD	ProtocolIE-ID ::= 60
id-DL-DPCH-Information-RL-ReconfRqstFDD	ProtocolIE-ID ::= 61
id-DL-DPCH-InformationItem-PhyChReconfRqstTDD	ProtocolIE-ID ::= 62
id-DL-DPCH-InformationItem-RL-AdditionRspTDD	ProtocolIE-ID ::= 63
id-DL-DPCH-InformationItem-RL-SetupRspTDD	ProtocolIE-ID ::= 64
id-DL-DPCH-TimingAdjustment	ProtocolIE-ID ::= 278
id-DLReferencePower	ProtocolIE-ID ::= 67
id-DLReferencePowerList-DL-PC-Rqst	ProtocolIE-ID ::= 68
id-DL-ReferencePowerInformation-DL-PC-Rqst	ProtocolIE-ID ::= 69
id-DPC-Mode	ProtocolIE-ID ::= 12
id-DRXCycleLengthCoefficient	ProtocolIE-ID ::= 70
id-DedicatedMeasurementObjectType-DM-Fail-Ind	ProtocolIE-ID ::= 470
id-DedicatedMeasurementObjectType-DM-Fail	ProtocolIE-ID ::= 471
id-DedicatedMeasurementObjectType-DM-Rprt	ProtocolIE-ID ::= 71
id-DedicatedMeasurementObjectType-DM-Rqst	ProtocolIE-ID ::= 72
id-DedicatedMeasurementObjectType-DM-Rsp	ProtocolIE-ID ::= 73
id-DedicatedMeasurementType	ProtocolIE-ID ::= 74
id-FACH-InfoForUESelectedS-CCPCH-CTCH-ResourceRspFDD	ProtocolIE-ID ::= 82
id-FACH-InfoForUESelectedS-CCPCH-CTCH-ResourceRspTDD	ProtocolIE-ID ::= 83
id-Guaranteed-Rate-Information	ProtocolIE-ID ::= 41
id-IMSI	ProtocolIE-ID ::= 84
id-HCS-Prio	ProtocolIE-ID ::= 311
id-L3-Information	ProtocolIE-ID ::= 85
id-AdjustmentPeriod	ProtocolIE-ID ::= 90
id-MaxAdjustmentStep	ProtocolIE-ID ::= 91
id-MeasurementFilterCoefficient	ProtocolIE-ID ::= 92
id-MessageStructure	ProtocolIE-ID ::= 57
id-MeasurementID	ProtocolIE-ID ::= 93
id-Neighbouring-GSM-CellInformation	ProtocolIE-ID ::= 13
id-Neighbouring-UMTS-CellInformationItem	ProtocolIE-ID ::= 95
id-NRT-Load-Information-Value	ProtocolIE-ID ::= 305
id-NRT-Load-Information-Value-IncrDecrThres	ProtocolIE-ID ::= 306
id-PagingArea-PagingRqst	ProtocolIE-ID ::= 102
id-FACH-FlowControlInformation	ProtocolIE-ID ::= 103
id-PartialReportingIndicator	ProtocolIE-ID ::= 472
id-Permanent-NAS-UE-Identity	ProtocolIE-ID ::= 17
id-PowerAdjustmentType	ProtocolIE-ID ::= 107
id-RANAP-RelocationInformation	ProtocolIE-ID ::= 109
id-RL-Information-PhyChReconfRqstFDD	ProtocolIE-ID ::= 110
id-RL-Information-PhyChReconfRqstTDD	ProtocolIE-ID ::= 111
id-RL-Information-RL-AdditionRqstFDD	ProtocolIE-ID ::= 112
id-RL-Information-RL-AdditionRqstTDD	ProtocolIE-ID ::= 113
id-RL-Information-RL-DeletionRqst	ProtocolIE-ID ::= 114
id-RL-Information-RL-FailureInd	ProtocolIE-ID ::= 115
id-RL-Information-RL-ReconfPrepFDD	ProtocolIE-ID ::= 116
id-RL-Information-RL-RestoreInd	ProtocolIE-ID ::= 117
id-RL-Information-RL-SetupRqstFDD	ProtocolIE-ID ::= 118
id-RL-Information-RL-SetupRqstTDD	ProtocolIE-ID ::= 119
id-RL-InformationItem-RL-CongestInd	ProtocolIE-ID ::= 55
id-RL-InformationItem-DM-Rprt	ProtocolIE-ID ::= 120
id-RL-InformationItem-DM-Rqst	ProtocolIE-ID ::= 121
id-RL-InformationItem-DM-Rsp	ProtocolIE-ID ::= 122
id-RL-InformationItem-RL-PreemptRequiredInd	ProtocolIE-ID ::= 2
id-RL-InformationItem-RL-SetupRqstFDD	ProtocolIE-ID ::= 123

id-RL-InformationList-RL-CongestInd	ProtocolIE-ID ::= 56
id-RL-InformationList-RL-AdditionRqstFDD	ProtocolIE-ID ::= 124
id-RL-InformationList-RL-DeletionRqst	ProtocolIE-ID ::= 125
id-RL-InformationList-RL-PreemptRequiredInd	ProtocolIE-ID ::= 1
id-RL-InformationList-RL-ReconfPrepFDD	ProtocolIE-ID ::= 126
id-RL-InformationResponse-RL-AdditionRspTDD	ProtocolIE-ID ::= 127
id-RL-InformationResponse-RL-ReconfReadyTDD	ProtocolIE-ID ::= 128
id-RL-InformationResponse-RL-SetupRspTDD	ProtocolIE-ID ::= 129
id-RL-InformationResponseItem-RL-AdditionRspFDD	ProtocolIE-ID ::= 130
id-RL-InformationResponseItem-RL-ReconfReadyFDD	ProtocolIE-ID ::= 131
id-RL-InformationResponseItem-RL-ReconfRspFDD	ProtocolIE-ID ::= 132
id-RL-InformationResponseItem-RL-SetupRspFDD	ProtocolIE-ID ::= 133
id-RL-InformationResponseList-RL-AdditionRspFDD	ProtocolIE-ID ::= 134
id-RL-InformationResponseList-RL-ReconfReadyFDD	ProtocolIE-ID ::= 135
id-RL-InformationResponseList-RL-ReconfRspFDD	ProtocolIE-ID ::= 136
id-RL-InformationResponse-RL-ReconfRspTDD	ProtocolIE-ID ::= 28
id-RL-InformationResponseList-RL-SetupRspFDD	ProtocolIE-ID ::= 137
id-RL-ReconfigurationFailure-RL-ReconfFail	ProtocolIE-ID ::= 141
id-RL-Set-InformationItem-DM-Rprt	ProtocolIE-ID ::= 143
id-RL-Set-InformationItem-DM-Rqst	ProtocolIE-ID ::= 144
id-RL-Set-InformationItem-DM-Rsp	ProtocolIE-ID ::= 145
id-RL-Set-Information-RL-FailureInd	ProtocolIE-ID ::= 146
id-RL-Set-Information-RL-RestoreInd	ProtocolIE-ID ::= 147
id-RL-Set-Successful-InformationItem-DM-Fail	ProtocolIE-ID ::= 473
id-RL-Set-Unsuccessful-InformationItem-DM-Fail	ProtocolIE-ID ::= 474
id-RL-Set-Unsuccessful-InformationItem-DM-Fail-Ind	ProtocolIE-ID ::= 475
id-RL-Successful-InformationItem-DM-Fail	ProtocolIE-ID ::= 476
id-RL-Unsuccessful-InformationItem-DM-Fail	ProtocolIE-ID ::= 477
id-RL-Unsuccessful-InformationItem-DM-Fail-Ind	ProtocolIE-ID ::= 478
id-ReportCharacteristics	ProtocolIE-ID ::= 152
id-Reporting-Object-RL-FailureInd	ProtocolIE-ID ::= 153
id-Reporting-Object-RL-RestoreInd	ProtocolIE-ID ::= 154
id-RT-Load-Value	ProtocolIE-ID ::= 307
id-RT-Load-Value-IncrDecrThres	ProtocolIE-ID ::= 308
id-S-RNTI	ProtocolIE-ID ::= 155
id-ResetIndicator	ProtocolIE-ID ::= 244
id-RNC-ID	ProtocolIE-ID ::= 245
id-SAI	ProtocolIE-ID ::= 156
id-SRNC-ID	ProtocolIE-ID ::= 157
id-SuccessfulRL-InformationResponse-RL-AdditionFailureFDD	ProtocolIE-ID ::= 159
id-SuccessfulRL-InformationResponse-RL-SetupFailureFDD	ProtocolIE-ID ::= 160
id-TransportBearerID	ProtocolIE-ID ::= 163
id-TransportBearerRequestIndicator	ProtocolIE-ID ::= 164
id-TransportLayerAddress	ProtocolIE-ID ::= 165
id-TypeOfError	ProtocolIE-ID ::= 140
id-UC-ID	ProtocolIE-ID ::= 166
id-UL-CCTrCH-AddInformation-RL-ReconfPrepTDD	ProtocolIE-ID ::= 167
id-UL-CCTrCH-InformationAddList-RL-ReconfPrepTDD	ProtocolIE-ID ::= 169
id-UL-CCTrCH-InformationItem-RL-SetupRqstTDD	ProtocolIE-ID ::= 171
id-UL-CCTrCH-InformationList-RL-SetupRqstTDD	ProtocolIE-ID ::= 172
id-UL-CCTrCH-InformationListIE-PhyChReconfRqstTDD	ProtocolIE-ID ::= 173
id-UL-CCTrCH-InformationListIE-RL-AdditionRspTDD	ProtocolIE-ID ::= 174
id-UL-CCTrCH-InformationListIE-RL-ReconfReadyTDD	ProtocolIE-ID ::= 175
id-UL-CCTrCH-InformationListIE-RL-SetupRspTDD	ProtocolIE-ID ::= 176

id-UL-DPCH-Information-RL-ReconfPrepFDD	ProtocolIE-ID ::= 177
id-UL-DPCH-Information-RL-ReconfRqstFDD	ProtocolIE-ID ::= 178
id-UL-DPCH-Information-RL-SetupRqstFDD	ProtocolIE-ID ::= 179
id-UL-DPCH-InformationItem-PhyChReconfRqstTDD	ProtocolIE-ID ::= 180
id-UL-DPCH-InformationItem-RL-AdditionRspTDD	ProtocolIE-ID ::= 181
id-UL-DPCH-InformationItem-RL-SetupRspTDD	ProtocolIE-ID ::= 182
id-UL-DPCH-InformationAddListIE-RL-ReconfReadyTDD	ProtocolIE-ID ::= 183
id-UL-SIRTarget	ProtocolIE-ID ::= 184
id-URA-Information	ProtocolIE-ID ::= 185
id-UnsuccessfulRL-InformationResponse-RL-AdditionFailureFDD	ProtocolIE-ID ::= 188
id-UnsuccessfulRL-InformationResponse-RL-SetupFailureFDD	ProtocolIE-ID ::= 189
id-UnsuccessfulRL-InformationResponse-RL-SetupFailureTDD	ProtocolIE-ID ::= 190
id-Active-Pattern-Sequence-Information	ProtocolIE-ID ::= 193
id-AdjustmentRatio	ProtocolIE-ID ::= 194
id-CauseLevel-RL-AdditionFailureFDD	ProtocolIE-ID ::= 197
id-CauseLevel-RL-AdditionFailureTDD	ProtocolIE-ID ::= 198
id-CauseLevel-RL-ReconfFailure	ProtocolIE-ID ::= 199
id-CauseLevel-RL-SetupFailureFDD	ProtocolIE-ID ::= 200
id-CauseLevel-RL-SetupFailureTDD	ProtocolIE-ID ::= 201
id-DL-CCTrCH-InformationDeleteItem-RL-ReconfPrepTDD	ProtocolIE-ID ::= 205
id-DL-CCTrCH-InformationModifyItem-RL-ReconfPrepTDD	ProtocolIE-ID ::= 206
id-DL-CCTrCH-InformationModifyItem-RL-ReconfRqstTDD	ProtocolIE-ID ::= 207
id-DL-CCTrCH-InformationDeleteList-RL-ReconfPrepTDD	ProtocolIE-ID ::= 208
id-DL-CCTrCH-InformationModifyList-RL-ReconfPrepTDD	ProtocolIE-ID ::= 209
id-DL-CCTrCH-InformationModifyList-RL-ReconfRqstTDD	ProtocolIE-ID ::= 210
id-DL-DPCH-InformationAddListIE-RL-ReconfReadyTDD	ProtocolIE-ID ::= 212
id-DL-DPCH-InformationDeleteListIE-RL-ReconfReadyTDD	ProtocolIE-ID ::= 213
id-DL-DPCH-InformationModifyListIE-RL-ReconfReadyTDD	ProtocolIE-ID ::= 214
id-DSCHs-to-Add-TDD	ProtocolIE-ID ::= 215
id-Unused-ProtocolIE-ID-216	ProtocolIE-ID ::= 216
id-DSCH-DeleteList-RL-ReconfPrepTDD	ProtocolIE-ID ::= 217
id-Unused-ProtocolIE-ID-218	ProtocolIE-ID ::= 218
id-Unused-ProtocolIE-ID-219	ProtocolIE-ID ::= 219
id-DSCH-InformationListIE-RL-AdditionRspTDD	ProtocolIE-ID ::= 220
id-DSCH-InformationListIEs-RL-SetupRspTDD	ProtocolIE-ID ::= 221
id-DSCH-TDD-Information	ProtocolIE-ID ::= 222
id-Unused-ProtocolIE-ID-223	ProtocolIE-ID ::= 223
id-Unused-ProtocolIE-ID-226	ProtocolIE-ID ::= 226
id-DSCH-ModifyList-RL-ReconfPrepTDD	ProtocolIE-ID ::= 227
id-Unused-ProtocolIE-ID-228	ProtocolIE-ID ::= 228
id-Unused-ProtocolIE-ID-324	ProtocolIE-ID ::= 324
id-Unused-ProtocolIE-ID-229	ProtocolIE-ID ::= 229
id-DSCHToBeAddedOrModifiedList-RL-ReconfReadyTDD	ProtocolIE-ID ::= 230
id-Unused-ProtocolIE-ID-29	ProtocolIE-ID ::= 29
id-Unused-ProtocolIE-ID-225	ProtocolIE-ID ::= 225
id-GA-Cell	ProtocolIE-ID ::= 232
id-GA-CellAdditionalShapes	ProtocolIE-ID ::= 3
id-Unused-ProtocolIE-ID-246	ProtocolIE-ID ::= 246
id-Transmission-Gap-Pattern-Sequence-Information	ProtocolIE-ID ::= 255
id-UL-CCTrCH-DeleteInformation-RL-ReconfPrepTDD	ProtocolIE-ID ::= 256
id-UL-CCTrCH-ModifyInformation-RL-ReconfPrepTDD	ProtocolIE-ID ::= 257
id-UL-CCTrCH-InformationModifyItem-RL-ReconfRqstTDD	ProtocolIE-ID ::= 258
id-UL-CCTrCH-InformationDeleteList-RL-ReconfPrepTDD	ProtocolIE-ID ::= 259
id-UL-CCTrCH-InformationModifyList-RL-ReconfPrepTDD	ProtocolIE-ID ::= 260

id-UL-CCTrCH-InformationModifyList-RL-ReconfRqstTDD	ProtocolIE-ID ::= 261
id-UL-CCTrCH-InformationDeleteItem-RL-ReconfRqstTDD	ProtocolIE-ID ::= 262
id-UL-CCTrCH-InformationDeleteList-RL-ReconfRqstTDD	ProtocolIE-ID ::= 263
id-UL-DPCH-InformationDeleteListIE-RL-ReconfReadyTDD	ProtocolIE-ID ::= 264
id-UL-DPCH-InformationModifyListIE-RL-ReconfReadyTDD	ProtocolIE-ID ::= 265
id-UnsuccessfulRL-InformationResponse-RL-AdditionFailureTDD	ProtocolIE-ID ::= 266
id-USCHs-to-Add	ProtocolIE-ID ::= 267
id-USCH-DeleteList-RL-ReconfPrepTDD	ProtocolIE-ID ::= 268
id-USCH-InformationListIE-RL-AdditionRspTDD	ProtocolIE-ID ::= 269
id-USCH-InformationListIEs-RL-SetupRspTDD	ProtocolIE-ID ::= 270
id-USCH-Information	ProtocolIE-ID ::= 271
id-USCH-ModifyList-RL-ReconfPrepTDD	ProtocolIE-ID ::= 272
id-USCHToBeAddedOrModifiedList-RL-ReconfReadyTDD	ProtocolIE-ID ::= 273
id-DL-Physical-Channel-Information-RL-SetupRqstTDD	ProtocolIE-ID ::= 274
id-UL-Physical-Channel-Information-RL-SetupRqstTDD	ProtocolIE-ID ::= 275
id-ClosedLoopModel-SupportIndicator	ProtocolIE-ID ::= 276
id-Unused-ProtocolIE-ID-277	ProtocolIE-ID ::= 277
id-STTD-SupportIndicator	ProtocolIE-ID ::= 279
id-CFNReportingIndicator	ProtocolIE-ID ::= 14
id-CNOriginatedPage-PagingRqst	ProtocolIE-ID ::= 23
id-InnerLoopDLPCStatus	ProtocolIE-ID ::= 24
id-PropagationDelay	ProtocolIE-ID ::= 25
id-RxTimingDeviationForTA	ProtocolIE-ID ::= 36
id-timeSlot-ISCP	ProtocolIE-ID ::= 37
id-CCTrCH-InformationItem-RL-FailureInd	ProtocolIE-ID ::= 15
id-CCTrCH-InformationItem-RL-RestoreInd	ProtocolIE-ID ::= 16
id-CommonMeasurementAccuracy	ProtocolIE-ID ::= 280
id-CommonMeasurementObjectType-CM-Rprt	ProtocolIE-ID ::= 281
id-CommonMeasurementObjectType-CM-Rqst	ProtocolIE-ID ::= 282
id-CommonMeasurementObjectType-CM-Rsp	ProtocolIE-ID ::= 283
id-CommonMeasurementType	ProtocolIE-ID ::= 284
id-CongestionCause	ProtocolIE-ID ::= 18
id-SFN	ProtocolIE-ID ::= 285
id-SFNReportingIndicator	ProtocolIE-ID ::= 286
id-InformationExchangeID	ProtocolIE-ID ::= 287
id-InformationExchangeObjectType-InfEx-Rprt	ProtocolIE-ID ::= 288
id-InformationExchangeObjectType-InfEx-Rqst	ProtocolIE-ID ::= 289
id-InformationExchangeObjectType-InfEx-Rsp	ProtocolIE-ID ::= 290
id-InformationReportCharacteristics	ProtocolIE-ID ::= 291
id-InformationType	ProtocolIE-ID ::= 292
id-neighbouring-LCR-TDD-CellInformation	ProtocolIE-ID ::= 58
id-DL-Timeslot-ISCP-LCR-Information-RL-SetupRqstTDD	ProtocolIE-ID ::= 65
id-RL-LCR-InformationResponse-RL-SetupRspTDD	ProtocolIE-ID ::= 66
id-UL-CCTrCH-LCR-InformationListIE-RL-SetupRspTDD	ProtocolIE-ID ::= 75
id-UL-DPCH-LCR-InformationItem-RL-SetupRspTDD	ProtocolIE-ID ::= 76
id-DL-CCTrCH-LCR-InformationListIE-RL-SetupRspTDD	ProtocolIE-ID ::= 77
id-DL-DPCH-LCR-InformationItem-RL-SetupRspTDD	ProtocolIE-ID ::= 78
id-DSCH-LCR-InformationListIEs-RL-SetupRspTDD	ProtocolIE-ID ::= 79
id-USCH-LCR-InformationListIEs-RL-SetupRspTDD	ProtocolIE-ID ::= 80
id-DL-Timeslot-ISCP-LCR-Information-RL-AdditionRqstTDD	ProtocolIE-ID ::= 81
id-RL-LCR-InformationResponse-RL-AdditionRspTDD	ProtocolIE-ID ::= 86
id-UL-CCTrCH-LCR-InformationListIE-RL-AdditionRspTDD	ProtocolIE-ID ::= 87
id-UL-DPCH-LCR-InformationItem-RL-AdditionRspTDD	ProtocolIE-ID ::= 88
id-DL-CCTrCH-LCR-InformationListIE-RL-AdditionRspTDD	ProtocolIE-ID ::= 89

id-DL-DPCH-LCR-InformationItem-RL-AdditionRspTDD	ProtocolIE-ID ::= 94
id-DSCH-LCR-InformationListIEs-RL-AdditionRspTDD	ProtocolIE-ID ::= 96
id-USCH-LCR-InformationListIEs-RL-AdditionRspTDD	ProtocolIE-ID ::= 97
id-UL-DPCH-LCR-InformationAddListIE-RL-ReconfReadyTDD	ProtocolIE-ID ::= 98
id-UL-Timeslot-LCR-InformationModifyList-RL-ReconfReadyTDD	ProtocolIE-ID ::= 100
id-DL-DPCH-LCR-InformationAddListIE-RL-ReconfReadyTDD	ProtocolIE-ID ::= 101
id-DL-Timeslot-LCR-InformationModifyList-RL-ReconfReadyTDD	ProtocolIE-ID ::= 104
id-UL-Timeslot-LCR-InformationList-PhyChReconfRqstTDD	ProtocolIE-ID ::= 105
id-DL-Timeslot-LCR-InformationList-PhyChReconfRqstTDD	ProtocolIE-ID ::= 106
id-timeSlot-ISCP-LCR-List-DL-PC-Rqst-TDD	ProtocolIE-ID ::= 138
id-TSTD-Support-Indicator-RL-SetupRqstTDD	ProtocolIE-ID ::= 139
id-RestrictionStateIndicator	ProtocolIE-ID ::= 142
id-Load-Value	ProtocolIE-ID ::= 233
id-Load-Value-IncrDecrThres	ProtocolIE-ID ::= 234
id-OnModification	ProtocolIE-ID ::= 235
id-Received-Total-Wideband-Power-Value	ProtocolIE-ID ::= 236
id-Received-Total-Wideband-Power-Value-IncrDecrThres	ProtocolIE-ID ::= 237
id-SFNFSNMeasurementThresholdInformation	ProtocolIE-ID ::= 238
id-Transmitted-Carrier-Power-Value	ProtocolIE-ID ::= 239
id-Transmitted-Carrier-Power-Value-IncrDecrThres	ProtocolIE-ID ::= 240
id-TUTRANGPSMeasurementThresholdInformation	ProtocolIE-ID ::= 241
id-UL-Timeslot-ISCP-Value	ProtocolIE-ID ::= 242
id-UL-Timeslot-ISCP-Value-IncrDecrThres	ProtocolIE-ID ::= 243
id-Rx-Timing-Deviation-Value-LCR	ProtocolIE-ID ::= 293
id-DPC-Mode-Change-SupportIndicator	ProtocolIE-ID ::= 19
id-Unused-ProtocolIE-ID-247	ProtocolIE-ID ::= 247
id-Unused-ProtocolIE-ID-295	ProtocolIE-ID ::= 295
id-PrimaryCCPCH-RSCP-RL-ReconfPrepTDD	ProtocolIE-ID ::= 202
id-DL-TimeSlot-ISCP-Info-RL-ReconfPrepTDD	ProtocolIE-ID ::= 203
id-DL-Timeslot-ISCP-LCR-Information-RL-ReconfPrepTDD	ProtocolIE-ID ::= 204
id-DSCH-RNTI	ProtocolIE-ID ::= 249
id-DL-PowerBalancing-Information	ProtocolIE-ID ::= 296
id-DL-PowerBalancing-ActivationIndicator	ProtocolIE-ID ::= 297
id-DL-PowerBalancing-UpdatedIndicator	ProtocolIE-ID ::= 298
id-DL-ReferencePowerInformation	ProtocolIE-ID ::= 299
id-Enhanced-PrimaryCPICH-EcNo	ProtocolIE-ID ::= 224
id-IPDL-TDD-ParametersLCR	ProtocolIE-ID ::= 252
id-CellCapabilityContainer-FDD	ProtocolIE-ID ::= 300
id-CellCapabilityContainer-TDD	ProtocolIE-ID ::= 301
id-CellCapabilityContainer-TDD-LCR	ProtocolIE-ID ::= 302
id-RL-Specific-DCH-Info	ProtocolIE-ID ::= 317
id-RL-ReconfigurationRequestFDD-RL-InformationList	ProtocolIE-ID ::= 318
id-RL-ReconfigurationRequestFDD-RL-Information-IEs	ProtocolIE-ID ::= 319
id-RL-ReconfigurationRequestTDD-RL-Information	ProtocolIE-ID ::= 321
id-CommonTransportChannelResourcesInitialisationNotRequired	ProtocolIE-ID ::= 250
id-DelayedActivation	ProtocolIE-ID ::= 312
id-DelayedActivationList-RL-ActivationCmdFDD	ProtocolIE-ID ::= 313
id-DelayedActivationInformation-RL-ActivationCmdFDD	ProtocolIE-ID ::= 314
id-DelayedActivationList-RL-ActivationCmdTDD	ProtocolIE-ID ::= 315
id-DelayedActivationInformation-RL-ActivationCmdTDD	ProtocolIE-ID ::= 316
id-neighbouringTDDCellMeasurementInformationLCR	ProtocolIE-ID ::= 251
id-UL-SIR-Target-CCTrCH-InformationItem-RL-SetupRspTDD	ProtocolIE-ID ::= 150
id-UL-SIR-Target-CCTrCH-LCR-InformationItem-RL-SetupRspTDD	ProtocolIE-ID ::= 151
id-PrimCCPCH-RSCP-DL-PC-RqstTDD	ProtocolIE-ID ::= 451

id-HSDSCH-FDD-Information	ProtocolIE-ID ::= 452
id-HSDSCH-FDD-Information-Response	ProtocolIE-ID ::= 453
id-HSDSCH-FDD-Update-Information	ProtocolIE-ID ::= 466
id-HSDSCH-Information-to-Modify	ProtocolIE-ID ::= 456
id-HSDSCHMacdFlowSpecificInformationList-RL-PreemptRequiredInd	ProtocolIE-ID ::= 516
id-HSDSCHMacdFlowSpecificInformationItem-RL-PreemptRequiredInd	ProtocolIE-ID ::= 517
id-HSDSCH-RNTI	ProtocolIE-ID ::= 457
id-HSDSCH-TDD-Information	ProtocolIE-ID ::= 458
id-HSDSCH-TDD-Information-Response	ProtocolIE-ID ::= 459
id-HSDSCH-TDD-Update-Information	ProtocolIE-ID ::= 467
id-HSPDSCH-RL-ID	ProtocolIE-ID ::= 463
id-HSDSCH-MACdFlows-to-Add	ProtocolIE-ID ::= 531
id-HSDSCH-MACdFlows-to-Delete	ProtocolIE-ID ::= 532
id-Angle-Of-Arrival-Value-LCR	ProtocolIE-ID ::= 148
id-TrafficClass	ProtocolIE-ID ::= 158
id-Unused-ProtocolIE-ID-248	ProtocolIE-ID ::= 248
id-Unused-ProtocolIE-ID-253	ProtocolIE-ID ::= 253
id-PDSCH-RL-ID	ProtocolIE-ID ::= 323
id-TimeSlot-RL-SetupRspTDD	ProtocolIE-ID ::= 325
id-GERAN-Cell-Capability	ProtocolIE-ID ::= 468
id-GERAN-Classmark	ProtocolIE-ID ::= 469
id-DSCH-InitialWindowSize	ProtocolIE-ID ::= 480
id-UL-Synchronisation-Parameters-LCR	ProtocolIE-ID ::= 464
id-SNA-Information	ProtocolIE-ID ::= 479
id-MACHs-ResetIndicator	ProtocolIE-ID ::= 465
id-TDD-DL-DPCH-TimeSlotFormatModifyItem-LCR-RL-ReconfReadyTDD	ProtocolIE-ID ::= 481
id-TDD-UL-DPCH-TimeSlotFormatModifyItem-LCR-RL-ReconfReadyTDD	ProtocolIE-ID ::= 482
id-TDD-TPC-UplinkStepSize-LCR-RL-SetupRqstTDD	ProtocolIE-ID ::= 483
id-UL-CCTrCH-InformationList-RL-AdditionRqstTDD	ProtocolIE-ID ::= 484
id-UL-CCTrCH-InformationItem-RL-AdditionRqstTDD	ProtocolIE-ID ::= 485
id-DL-CCTrCH-InformationList-RL-AdditionRqstTDD	ProtocolIE-ID ::= 486
id-DL-CCTrCH-InformationItem-RL-AdditionRqstTDD	ProtocolIE-ID ::= 487
id-TDD-TPC-UplinkStepSize-InformationAdd-LCR-RL-ReconfPrepTDD	ProtocolIE-ID ::= 488
id-TDD-TPC-UplinkStepSize-InformationModify-LCR-RL-ReconfPrepTDD	ProtocolIE-ID ::= 489
id-TDD-TPC-DownlinkStepSize-InformationAdd-RL-ReconfPrepTDD	ProtocolIE-ID ::= 490
id-TDD-TPC-DownlinkStepSize-InformationModify-RL-ReconfPrepTDD	ProtocolIE-ID ::= 491
id-UL-TimingAdvanceCtrl-LCR	ProtocolIE-ID ::= 492
id-HSPDSCH-Timeslot-InformationList-PhyChReconfRqstTDD	ProtocolIE-ID ::= 493
id-HSPDSCH-Timeslot-InformationListLCR-PhyChReconfRqstTDD	ProtocolIE-ID ::= 494
id-HS-SICH-Reception-Quality	ProtocolIE-ID ::= 495
id-HS-SICH-Reception-Quality-Measurement-Value	ProtocolIE-ID ::= 496
id-HSSICH-Info-DM-Rprt	ProtocolIE-ID ::= 497
id-HSSICH-Info-DM-Rqst	ProtocolIE-ID ::= 498
id-HSSICH-Info-DM	ProtocolIE-ID ::= 499
id-CCTrCH-Maximum-DL-Power-RL-SetupRspTDD	ProtocolIE-ID ::= 500
id-CCTrCH-Minimum-DL-Power-RL-SetupRspTDD	ProtocolIE-ID ::= 501
id-CCTrCH-Maximum-DL-Power-RL-AdditionRspTDD	ProtocolIE-ID ::= 502
id-CCTrCH-Minimum-DL-Power-RL-AdditionRspTDD	ProtocolIE-ID ::= 503
id-CCTrCH-Maximum-DL-Power-RL-ReconfReadyTDD	ProtocolIE-ID ::= 504
id-CCTrCH-Minimum-DL-Power-RL-ReconfReadyTDD	ProtocolIE-ID ::= 505
id-Maximum-DL-Power-TimeslotLCR-InformationModifyItem-RL-ReconfReadyTDD	ProtocolIE-ID ::= 506
id-Minimum-DL-Power-TimeslotLCR-InformationModifyItem-RL-ReconfReadyTDD	ProtocolIE-ID ::= 507
id-DL-CCTrCH-InformationList-RL-ReconfRspTDD	ProtocolIE-ID ::= 508
id-DL-DPCH-InformationModifyItem-LCR-RL-ReconfRspTDD	ProtocolIE-ID ::= 509

id-Maximum-DL-Power-TimeslotLCR-InformationItem	ProtocolIE-ID ::= 510
id-Minimum-DL-Power-TimeslotLCR-InformationItem	ProtocolIE-ID ::= 511
id-TDD-Support-8PSK	ProtocolIE-ID ::= 512
id-TDD-maxNrDLPhysicalchannels	ProtocolIE-ID ::= 513
id-ExtendedGSMCellIndividualOffset	ProtocolIE-ID ::= 514
id-RL-ParameterUpdateIndicationFDD-RL-InformationList	ProtocolIE-ID ::= 518
id-Primary-CPICH-Usage-For-Channel-Estimation	ProtocolIE-ID ::= 519
id-Secondary-CPICH-Information	ProtocolIE-ID ::= 520
id-Secondary-CPICH-Information-Change	ProtocolIE-ID ::= 521
id-Unused-ProtocolIE-ID-522	ProtocolIE-ID ::= 522
id-Unused-ProtocolIE-ID-523	ProtocolIE-ID ::= 523
id-RL-ParameterUpdateIndicationFDD-RL-Information-Item	ProtocolIE-ID ::= 524
id-Phase-Reference-Update-Indicator	ProtocolIE-ID ::= 525
id-Unidirectional-DCH-Indicator	ProtocolIE-ID ::= 526
id-RL-Information-RL-ReconfPrepTDD	ProtocolIE-ID ::= 527
id-Multiple-RL-InformationResponse-RL-ReconfReadyTDD	ProtocolIE-ID ::= 528
id-RL-ReconfigurationResponseTDD-RL-Information	ProtocolIE-ID ::= 529
id-Satellite-Almanac-Information-ExtItem	ProtocolIE-ID ::= 530
id-HSDSCH-Information-to-Modify-Unsynchronised	ProtocolIE-ID ::= 533
id-TnlQos	ProtocolIE-ID ::= 534
id-RTLloadValue	ProtocolIE-ID ::= 535
id-NRTLloadInformationValue	ProtocolIE-ID ::= 536
id-CellPortionID	ProtocolIE-ID ::= 537
id-UpPTSInterferenceValue	ProtocolIE-ID ::= 538
id-PrimaryCCPCH-RSCP-Delta	ProtocolIE-ID ::= 539
id-UEMeasurementType	ProtocolIE-ID ::= 540
id-UEMeasurementTimeslotInfoHCR	ProtocolIE-ID ::= 541
id-UEMeasurementTimeslotInfoLCR	ProtocolIE-ID ::= 542
id-UEMeasurementReportCharacteristics	ProtocolIE-ID ::= 543
id-UEMeasurementParameterModAllow	ProtocolIE-ID ::= 544
id-UEMeasurementValueInformation	ProtocolIE-ID ::= 545
id-InterfacesToTraceItem	ProtocolIE-ID ::= 546
id-ListOfInterfacesToTrace	ProtocolIE-ID ::= 547
id-TraceDepth	ProtocolIE-ID ::= 548
id-TraceRecordingSessionReference	ProtocolIE-ID ::= 549
id-TraceReference	ProtocolIE-ID ::= 550
id-UEIdentity	ProtocolIE-ID ::= 551
id-NACC-Related-Data	ProtocolIE-ID ::= 552
id-GSM-Cell-InfEx-Rqst	ProtocolIE-ID ::= 553
id-MeasurementRecoveryBehavior	ProtocolIE-ID ::= 554
id-MeasurementRecoveryReportingIndicator	ProtocolIE-ID ::= 555
id-MeasurementRecoverySupportIndicator	ProtocolIE-ID ::= 556
id-DL-DPCH-Power-Information-RL-ReconfPrepFDD	ProtocolIE-ID ::= 557
id-F-DPCH-Information-RL-ReconfPrepFDD	ProtocolIE-ID ::= 558
id-F-DPCH-Information-RL-SetupRqstFDD	ProtocolIE-ID ::= 559
id-MBMS-Bearer-Service-List	ProtocolIE-ID ::= 560
id-MBMS-Bearer-Service-List-InfEx-Rsp	ProtocolIE-ID ::= 561
id-Active-MBMS-Bearer-ServiceFDD	ProtocolIE-ID ::= 562
id-Active-MBMS-Bearer-ServiceTDD	ProtocolIE-ID ::= 563
id-Old-URA-ID	ProtocolIE-ID ::= 564
id-UE-State	ProtocolIE-ID ::= 568
id-URA-ID	ProtocolIE-ID ::= 569
id-HARQ-Preamble-Mode	ProtocolIE-ID ::= 571
id-SynchronisationIndicator	ProtocolIE-ID ::= 572

id-UL-DPDCHIndicatorEDCH	ProtocolIE-ID ::= 573
id-EDPCH-Information	ProtocolIE-ID ::= 574
id-RL-Specific-EDCH-Information	ProtocolIE-ID ::= 575
id-EDCH-RL-Indication	ProtocolIE-ID ::= 576
id-EDCH-FDD-Information	ProtocolIE-ID ::= 577
id-EDCH-RLSet-Id	ProtocolIE-ID ::= 578
id-Serving-EDCHRL-Id	ProtocolIE-ID ::= 579
id-EDCH-FDD-DL-ControlChannelInformation	ProtocolIE-ID ::= 580
id-EDCH-FDD-InformationResponse	ProtocolIE-ID ::= 581
id-EDCH-MACdFlows-To-Add	ProtocolIE-ID ::= 582
id-EDCH-FDD-Information-To-Modify	ProtocolIE-ID ::= 583
id-EDCH-MACdFlows-To-Delete	ProtocolIE-ID ::= 584
id-EDPCH-Information-RLReconfRequest-FDD	ProtocolIE-ID ::= 585
id-EDCH-MacFlowSpecificInformationList-RL-PreemptRequiredInd	ProtocolIE-ID ::= 586
id-EDCH-MacFlowSpecificInformationItem-RL-PreemptRequiredInd	ProtocolIE-ID ::= 587
id-EDCH-MacFlowSpecificInformationList-RL-CongestInd	ProtocolIE-ID ::= 588
id-EDCH-MacFlowSpecificInformationItem-RL-CongestInd	ProtocolIE-ID ::= 589
id-MBMS-Bearer-Service-Full-Address	ProtocolIE-ID ::= 590
id-Initial-DL-DPCH-TimingAdjustment	ProtocolIE-ID ::= 591
id-Initial-DL-DPCH-TimingAdjustment-Allowed	ProtocolIE-ID ::= 592
id-User-Plane-Congestion-Fields-Inclusion	ProtocolIE-ID ::= 593
id-HARQ-Preamble-Mode-Activation-Indicator	ProtocolIE-ID ::= 594
id-multiple-DedicatedMeasurementValueList-TDD-DM-Rsp	ProtocolIE-ID ::= 595
id-multiple-DedicatedMeasurementValueList-LCR-TDD-DM-Rsp	ProtocolIE-ID ::= 596
id-ProvidedInformation	ProtocolIE-ID ::= 597
id-Active-MBMS-Bearer-ServiceFDD-PFL	ProtocolIE-ID ::= 598
id-Active-MBMS-Bearer-ServiceTDD-PFL	ProtocolIE-ID ::= 599
id-FrequencyBandIndicator	ProtocolIE-ID ::= 600
id-Serving-cell-change-CFN	ProtocolIE-ID ::= 601
id-HS-DSCH-serving-cell-change-information	ProtocolIE-ID ::= 602
id-HS-DSCH-serving-cell-change-informationResponse	ProtocolIE-ID ::= 603
id-E-DCH-Serving-cell-change-informationResponse	ProtocolIE-ID ::= 604
id-secondary-LCR-CCPCH-Info-TDD	ProtocolIE-ID ::= 605
id-E-DCH-FDD-Update-Information	ProtocolIE-ID ::= 606
id-Inter-Frequency-Cell-List	ProtocolIE-ID ::= 607
id-Inter-Frequency-Cell-Information	ProtocolIE-ID ::= 608
id-multiple-HSSICHMeasurementValueList-TDD-DM-Rsp	ProtocolIE-ID ::= 609
id-TDD-Support-PLCCH	ProtocolIE-ID ::= 610
id-PLCCH-Information-UL-TimeslotLCR-Info	ProtocolIE-ID ::= 611
id-PLCCH-Information-PhyChReconfRqstTDD	ProtocolIE-ID ::= 612
id-TDD768-maxNrDLPhysicalchannelsTS	ProtocolIE-ID ::= 613
id-RL-InformationResponse-RL-AdditionRspTDD768	ProtocolIE-ID ::= 614
id-UL-CCTrCH-InformationListIE-RL-AdditionRspTDD768	ProtocolIE-ID ::= 615
id-DL-CCTrCH-InformationListIE-RL-AdditionRspTDD768	ProtocolIE-ID ::= 616
id-UL-DPCH-InformationItem-RL-AdditionRspTDD768	ProtocolIE-ID ::= 617
id-DL-DPCH-InformationItem-RL-AdditionRspTDD768	ProtocolIE-ID ::= 618
id-UL-DPCH-InformationAddListIE-RL-ReconfReadyTDD768	ProtocolIE-ID ::= 619
id-UL-Timeslot-InformationModifyList-RL-ReconfReadyTDD768	ProtocolIE-ID ::= 620
id-DL-DPCH-InformationAddListIE-RL-ReconfReadyTDD768	ProtocolIE-ID ::= 621
id-DL-Timeslot-InformationModifyList-RL-ReconfReadyTDD768	ProtocolIE-ID ::= 622
id-secondary-CCPCH-Info-RL-ReconfReadyTDD768	ProtocolIE-ID ::= 623
id-hSSCCH-TDD-Specific-InfoList-Response768	ProtocolIE-ID ::= 624
id-hSPDSCH-TDD-Specific-InfoList-Response768	ProtocolIE-ID ::= 625
id-HSPDSCH-Timeslot-InformationList-PhyChReconfRqstTDD768	ProtocolIE-ID ::= 626

id-UL-Timeslot-InformationList-PhyChReconfRqstTDD768	ProtocolIE-ID ::= 627
id-DL-Timeslot-InformationList-PhyChReconfRqstTDD768	ProtocolIE-ID ::= 628
id-CellCapabilityContainer-TDD768	ProtocolIE-ID ::= 629
id-multiple-DedicatedMeasurementValueList-TDD768-DM-Rsp	ProtocolIE-ID ::= 630
id-neighbouringTDDCellMeasurementInformation768	ProtocolIE-ID ::= 631
id-UEMeasurementTimeslotInfo768	ProtocolIE-ID ::= 632
id-Rx-Timing-Deviation-Value-768	ProtocolIE-ID ::= 633
id-UEMeasurementValueTransmittedPowerList768	ProtocolIE-ID ::= 634
id-UEMeasurementValueTimeslotISCPList768	ProtocolIE-ID ::= 635
id-RL-InformationResponse-RL-SetupRspTDD768	ProtocolIE-ID ::= 636
id-UL-CCTrCH-InformationListIE-RL-SetupRspTDD768	ProtocolIE-ID ::= 637
id-DL-CCTrCH-InformationListIE-RL-SetupRspTDD768	ProtocolIE-ID ::= 638
id-UL-DPCH-InformationItem-RL-SetupRspTDD768	ProtocolIE-ID ::= 639
id-DL-DPCH-InformationItem-RL-SetupRspTDD768	ProtocolIE-ID ::= 640
id-TDD768-minimumSpreadingFactor-UL	ProtocolIE-ID ::= 641
id-TDD768-minimumSpreadingFactor-DL	ProtocolIE-ID ::= 642
id-TDD768-maxNrDLPhysicalchannels	ProtocolIE-ID ::= 643
id-DL-DPCH-InformationDeleteList768-RL-ReconfReadyTDD	ProtocolIE-ID ::= 644
id-DPCH-ID768-DM-Rsp	ProtocolIE-ID ::= 645
id-DPCH-ID768-DM-Rqst	ProtocolIE-ID ::= 646
id-DPCH-ID768-DM-Rprt	ProtocolIE-ID ::= 647
id-EDPCH-Information-RLAdditionReq-FDD	ProtocolIE-ID ::= 648
id-HSDSCH-Configured-Indicator	ProtocolIE-ID ::= 649
id-RxTimingDeviationForTAext	ProtocolIE-ID ::= 650
id-RxTimingDeviationForTA768	ProtocolIE-ID ::= 651
id-Rx-Timing-Deviation-Value-ext	ProtocolIE-ID ::= 652
id-E-DCH-PowerOffset-for-SchedulingInfo	ProtocolIE-ID ::= 653
id-TrCH-SrcStatisticsDescr	ProtocolIE-ID ::= 654
id-E-DCH-Information	ProtocolIE-ID ::= 655
id-E-DCH-Serving-RL-ID	ProtocolIE-ID ::= 656
id-E-DCH-Information-Reconfig	ProtocolIE-ID ::= 657
id-E-DCH-Information-Response	ProtocolIE-ID ::= 658
id-E-DCH-768-Information	ProtocolIE-ID ::= 659
id-E-DCH-768-Information-Reconfig	ProtocolIE-ID ::= 660
id-E-DCH-768-Information-Response	ProtocolIE-ID ::= 661
id-ExtendedPropagationDelay	ProtocolIE-ID ::= 662
id-Extended-Round-Trip-Time-Value	ProtocolIE-ID ::= 663
id-AlternativeFormatReportingIndicator	ProtocolIE-ID ::= 664
id-DCH-Indicator-For-E-DCH-HSDPA-Operation	ProtocolIE-ID ::= 665
id-E-RGCH-E-HICH-ChannelisationCodeValidityIndicator	ProtocolIE-ID ::= 666
id-E-DCH-Minimum-Set-E-TFCIValityIndicator	ProtocolIE-ID ::= 667
id-Fast-Reconfiguration-Mode	ProtocolIE-ID ::= 668
id-Fast-Reconfiguration-Permission	ProtocolIE-ID ::= 669
id-Continuous-Packet-Connectivity-DTX-DRX-Information	ProtocolIE-ID ::= 670
id-Continuous-Packet-Connectivity-HS-SCCH-Less-Information	ProtocolIE-ID ::= 671
id-Continuous-Packet-Connectivity-HS-SCCH-Less-Information-Response	ProtocolIE-ID ::= 672
id-CPC-Information	ProtocolIE-ID ::= 673
id-MIMO-InformationResponse	ProtocolIE-ID ::= 675
id-E-DCH-LCR-Information	ProtocolIE-ID ::= 677
id-E-DCH-LCR-Information-Reconfig	ProtocolIE-ID ::= 678
id-E-DCH-LCR-Information-Response	ProtocolIE-ID ::= 679
id-HS-PDSCH-Code-Change-Grant	ProtocolIE-ID ::= 680
id-HS-PDSCH-Code-Change-Indicator	ProtocolIE-ID ::= 681
id-Extended-SRNC-ID	ProtocolIE-ID ::= 682

id-Extended-RNC-ID	ProtocolIE-ID ::= 683
id-SixtyfourQAM-DL-SupportIndicator	ProtocolIE-ID ::= 684
id-Enhanced-FACH-Support-Indicator	ProtocolIE-ID ::= 685
id-Enhanced-FACH-Information-ResponseFDD	ProtocolIE-ID ::= 686
id-HSDSCH-MACdPDUSizeFormat	ProtocolIE-ID ::= 690
id-MaximumMACdPDU-SizeExtended	ProtocolIE-ID ::= 691
id-F-DPCH-SlotFormat	ProtocolIE-ID ::= 692
id-F-DPCH-SlotFormatSupportRequest	ProtocolIE-ID ::= 693
id-eDCH-MACdFlow-Retransmission-Timer-LCR	ProtocolIE-ID ::= 694
id-Max-UE-DTX-Cycle	ProtocolIE-ID ::= 695
id-GANSS-Common-Data	ProtocolIE-ID ::= 699
id-GANSS-Information	ProtocolIE-ID ::= 700
id-GANSS-Generic-Data	ProtocolIE-ID ::= 701
id-TUTRANGANSSMeasurementThresholdInformation	ProtocolIE-ID ::= 702
id-TUTRANGANSSMeasurementValueInformation	ProtocolIE-ID ::= 703
id-Ext-Reference-E-TFCI-PO	ProtocolIE-ID ::= 705
id-Ext-Max-Bits-MACe-PDU-non-scheduled	ProtocolIE-ID ::= 706
id-HARQ-MemoryPartitioningInfoExtForMIMO	ProtocolIE-ID ::= 707
id-MIMO-ActivationIndicator	ProtocolIE-ID ::= 708
id-MIMO-Mode-Indicator	ProtocolIE-ID ::= 709
id-MIMO-N-M-Ratio	ProtocolIE-ID ::= 710
id-TransportBearerNotSetupIndicator	ProtocolIE-ID ::= 711
id-TransportBearerNotRequestedIndicator	ProtocolIE-ID ::= 712
id-PowerControlGAP	ProtocolIE-ID ::= 713
id-UARFCNforNt	ProtocolIE-ID ::= 714
id-LCRTDD-uplink-Physical-Channel-Capability	ProtocolIE-ID ::= 715
id-number-Of-Supported-Carriers	ProtocolIE-ID ::= 716
id-HSSICH-SIRTarget	ProtocolIE-ID ::= 717
id-HSSICH-TPC-StepSize	ProtocolIE-ID ::= 718
id-tSN-Length	ProtocolIE-ID ::= 719
id-HS-SICH-ID-Extension	ProtocolIE-ID ::= 720
id-HSSICH-Info-DM-Rqst-Extension	ProtocolIE-ID ::= 721
id-multipleFreq-HSPDSCH-InformationList-ResponseTDDLRC	ProtocolIE-ID ::= 722
id-multicarrier-number	ProtocolIE-ID ::= 723
id-UPPCHPositionLCR	ProtocolIE-ID ::= 724
id-UpPCH-InformationList-LCRTDD	ProtocolIE-ID ::= 725
id-UpPCH-InformationItem-LCRTDD	ProtocolIE-ID ::= 726
id-Multiple-PLMN-List	ProtocolIE-ID ::= 727
id-UE-Capabilities-Info	ProtocolIE-ID ::= 728
id-FrameOffset	ProtocolIE-ID ::= 729
id-ChipOffset	ProtocolIE-ID ::= 730
id-Enhanced-PCH-Capability	ProtocolIE-ID ::= 731
id-SixteenQAM-UL-Operation-Indicator	ProtocolIE-ID ::= 732
id-E-TFCI-Boost-Information	ProtocolIE-ID ::= 733
id-SixtyfourQAM-UsageAllowedIndicator	ProtocolIE-ID ::= 734
id-SixtyfourQAM-DL-UsageIndicator	ProtocolIE-ID ::= 735
id-Default-Serving-Grant-in-DTX-Cycle2	ProtocolIE-ID ::= 736
id-E-DPDCCH-PowerInterpolation	ProtocolIE-ID ::= 737
id-Extended-E-DCH-LCRTDD-PhysicalLayerCategory	ProtocolIE-ID ::= 738
id-E-DCH-MACdPDUSizeFormat	ProtocolIE-ID ::= 739
id-Continuous-Packet-Connectivity-HS-SCCH-Less-Deactivate-Indicator	ProtocolIE-ID ::= 740
id-E-DCH-DL-Control-Channel-Change-Information	ProtocolIE-ID ::= 741
id-E-DCH-DL-Control-Channel-Grant-Information	ProtocolIE-ID ::= 742
id-MaximumNumber-Of-Retransmission-For-SchedulingInfo-LCRTDD	ProtocolIE-ID ::= 743

id-E-DCH-RetransmissionTimer-For-SchedulingInfo-LCRTDD	ProtocolIE-ID ::= 744
id-E-PUCH-PowerControlGAP	ProtocolIE-ID ::= 745
id-HSDSCH-TBSizeTableIndicator	ProtocolIE-ID ::= 746
id-UE-with-enhanced-HS-SCCH-support-indicator	ProtocolIE-ID ::= 747
id-DGANSS-Corrections-Req	ProtocolIE-ID ::= 748
id-E-AGCH-Table-Choice	ProtocolIE-ID ::= 749
id-RANAP-EnhancedRelocationInformationRequest	ProtocolIE-ID ::= 750
id-RANAP-EnhancedRelocationInformationResponse	ProtocolIE-ID ::= 751
id-Common-EDCH-MAC-d-Flow-Specific-InformationFDD	ProtocolIE-ID ::= 752
id-Common-EDCH-Support-Indicator	ProtocolIE-ID ::= 753
id-E-RNTI	ProtocolIE-ID ::= 754
id-Released-CN-Domain	ProtocolIE-ID ::= 755
id-MBMS-Bearer-Service-in-MBMS-Cell-InfEx-Rqst	ProtocolIE-ID ::= 756
id-MBMS-Bearer-Service-in-MBMS-Cell-InfEx-Rsp	ProtocolIE-ID ::= 757
id-MBMS-Bearer-Service-in-MBMS-Cell-InfEx-Rprt	ProtocolIE-ID ::= 758
id-MBMS-Cell-InfEx-Rqst	ProtocolIE-ID ::= 759
id-MBMS-Cell-InfEx-Rsp	ProtocolIE-ID ::= 760
id-MBMS-Cell-InfEx-Rprt	ProtocolIE-ID ::= 761
id-Counting-Information	ProtocolIE-ID ::= 762
id-Transmission-Mode-Information	ProtocolIE-ID ::= 763
id-MBMS-Neighbouring-Cell-Information	ProtocolIE-ID ::= 764
id-MBMS-RLC-Sequence-Number-Information	ProtocolIE-ID ::= 765
id-RLC-Sequence-Number	ProtocolIE-ID ::= 766
id-Neighbouring-E-UTRA-CellInformation	ProtocolIE-ID ::= 767
id-MBSFN-Cluster-Identity	ProtocolIE-ID ::= 769
id-MCCH-Configuration-Info	ProtocolIE-ID ::= 770
id-MCCH-Message-List	ProtocolIE-ID ::= 771
id-MBSFN-Scheduling-Transmission-Time-Interval-Info-List	ProtocolIE-ID ::= 772
id-GANSS-Time-ID	ProtocolIE-ID ::= 773
id-GANSS-AddIonoModelReq	ProtocolIE-ID ::= 774
id-GANSS-EarthOrientParaReq	ProtocolIE-ID ::= 775
id-GANSS-AddNavigationModelsReq	ProtocolIE-ID ::= 776
id-GANSS-AddUTCModelsReq	ProtocolIE-ID ::= 777
id-GANSS-AuxInfoReq	ProtocolIE-ID ::= 778
id-GANSS-SBAS-ID	ProtocolIE-ID ::= 779
id-GANSS-ID	ProtocolIE-ID ::= 780
id-GANSS-Additional-Ionospheric-Model	ProtocolIE-ID ::= 781
id-GANSS-Earth-Orientation-Parameters	ProtocolIE-ID ::= 782
id-GANSS-Additional-Time-Models	ProtocolIE-ID ::= 783
id-GANSS-Additional-Navigation-Models	ProtocolIE-ID ::= 784
id-GANSS-Additional-UTC-Models	ProtocolIE-ID ::= 785
id-GANSS-Auxiliary-Information	ProtocolIE-ID ::= 786
id-MinimumReducedE-DPDCH-GainFactor	ProtocolIE-ID ::= 787
id-Enhanced-FACH-Information-ResponseLCR	ProtocolIE-ID ::= 788
id-Common-EDCH-MAC-d-Flow-Specific-InformationLCR	ProtocolIE-ID ::= 789
id-HSDSCH-PreconfigurationSetup	ProtocolIE-ID ::= 790
id-HSDSCH-PreconfigurationInfo	ProtocolIE-ID ::= 791
id-NoOfTargetCellHS-SCCH-Order	ProtocolIE-ID ::= 792
id-EnhancedHSServingCC-Abort	ProtocolIE-ID ::= 793
id-Additional-HS-Cell-Information-RL-Setup	ProtocolIE-ID ::= 794
id-Additional-HS-Cell-Information-Response	ProtocolIE-ID ::= 795
id-Additional-HS-Cell-Information-RL-Addition	ProtocolIE-ID ::= 796
id-Additional-HS-Cell-Change-Information-Response	ProtocolIE-ID ::= 797
id-Additional-HS-Cell-Information-RL-Reconf-Prep	ProtocolIE-ID ::= 798

id-Additional-HS-Cell-Information-RL-Reconf-Req	ProtocolIE-ID ::= 799
id-Additional-HS-Cell-RL-Reconf-Response	ProtocolIE-ID ::= 800
id-Additional-HS-Cell-Information-RL-Param-Upd	ProtocolIE-ID ::= 801
id-Secondary-Serving-Cell-List	ProtocolIE-ID ::= 802
id-MultiCarrier-HSDSCH-Physical-Layer-Category	ProtocolIE-ID ::= 803
id-IdleIntervalInformation	ProtocolIE-ID ::= 804
id-NeedforIdleInterval	ProtocolIE-ID ::= 805
id-IdleIntervalConfigurationIndicator	ProtocolIE-ID ::= 806
id-ContinuousPacketConnectivity-DRX-InformationLCR	ProtocolIE-ID ::= 807
id-ContinuousPacketConnectivity-DRX-Information-ResponseLCR	ProtocolIE-ID ::= 808
id-E-AGCH-UE-Inactivity-Monitor-Threshold	ProtocolIE-ID ::= 809
id-CPC-InformationLCR	ProtocolIE-ID ::= 810
id-E-DCH-Semi-PersistentScheduling-Information-LCR	ProtocolIE-ID ::= 811
id-HS-DSCH-Semi-PersistentScheduling-Information-LCR	ProtocolIE-ID ::= 812
id-HS-DSCH-Semi-PersistentScheduling-Information-ResponseLCR	ProtocolIE-ID ::= 813
id-E-DCH-Semi-PersistentScheduling-Information-ResponseLCR	ProtocolIE-ID ::= 814
id-MIMO-SFMode-For-HSPDSDHDualStream	ProtocolIE-ID ::= 815
id-MIMO-SFMode-Supported-For-HSPDSDHDualStream	ProtocolIE-ID ::= 816
id-MIMO-ReferenceSignal-InformationListLCR	ProtocolIE-ID ::= 817
id-GANSS-alm-keplerianNAValmanac	ProtocolIE-ID ::= 818
id-GANSS-alm-keplerianReducedAlmanac	ProtocolIE-ID ::= 819
id-GANSS-alm-keplerianMidiAlmanac	ProtocolIE-ID ::= 820
id-GANSS-alm-keplerianGLONASS	ProtocolIE-ID ::= 821
id-GANSS-alm-ecefSBASAlmanac	ProtocolIE-ID ::= 822
id-DL-RLC-PDU-Size-Format	ProtocolIE-ID ::= 823
id-MACes-Maximum-Bitrate-LCR	ProtocolIE-ID ::= 824
id-Single-Stream-MIMO-ActivationIndicator	ProtocolIE-ID ::= 825
id-Single-Stream-MIMO-Mode-Indicator	ProtocolIE-ID ::= 826
id-Dual-Band-Secondary-Serving-Cell-List	ProtocolIE-ID ::= 827
id-UE-AggregateMaximumBitRate	ProtocolIE-ID ::= 828
id-power-offset-for-S-CPICH-for-MIMO	ProtocolIE-ID ::= 829
id-power-offset-for-S-CPICH-for-MIMO-Request-Indicator	ProtocolIE-ID ::= 830
id-UE-SupportIndicatorExtension	ProtocolIE-ID ::= 831
id-ActivationInformation	ProtocolIE-ID ::= 835
id-CellPortionLCRID	ProtocolIE-ID ::= 836
id-Additional-EDCH-Cell-Information-RL-Setup-Req	ProtocolIE-ID ::= 837
id-Additional-EDCH-Cell-Information-Response	ProtocolIE-ID ::= 838
id-Additional-EDCH-Cell-Information-RL-Add-Req	ProtocolIE-ID ::= 839
id-Additional-EDCH-Cell-Information-Response-RLAdd	ProtocolIE-ID ::= 840
id-Additional-EDCH-Cell-Information-RL-Reconf-Prep	ProtocolIE-ID ::= 841
id-Additional-EDCH-Cell-Information-RL-Reconf-Req	ProtocolIE-ID ::= 842
id-Additional-EDCH-Cell-Information-RL-Param-Upd	ProtocolIE-ID ::= 843
id-Additional-EDCH-Preconfiguration-Information	ProtocolIE-ID ::= 844
id-MulticelledEDCH-Information	ProtocolIE-ID ::= 845
id-Additional-EDCH-Cell-Information-ResponseRLReconf	ProtocolIE-ID ::= 854
id-EDCH-Indicator	ProtocolIE-ID ::= 855
id-DiversityMode	ProtocolIE-ID ::= 856
id-TransmitDiversityIndicator	ProtocolIE-ID ::= 857
id-NonCellSpecificTxDiversity	ProtocolIE-ID ::= 858
id-CellCapabilityContainerExtension-FDD	ProtocolIE-ID ::= 859
id-HSDSCH-Physical-Layer-Category	ProtocolIE-ID ::= 860
id-E-RNTI-For-FACH	ProtocolIE-ID ::= 861
id-H-RNTI-For-FACH	ProtocolIE-ID ::= 862
id-RNTI-Allocation-Indicator	ProtocolIE-ID ::= 863

id-UE-AggregateMaximumBitRate-Enforcement-Indicator	ProtocolIE-ID ::= 864
id-DCH-MeasurementOccasion-Information	ProtocolIE-ID ::= 865
id-DCH-MeasurementType-Indicator	ProtocolIE-ID ::= 866
id-Out-of-Synchronization-Window	ProtocolIE-ID ::= 867
id-MulticellEDCH-RL-SpecificInformation	ProtocolIE-ID ::= 868
id-DGNSS-ValidityPeriod	ProtocolIE-ID ::= 869
id-TS0-HS-PDSCH-Indication-LCR	ProtocolIE-ID ::= 870
id-UE-TS0-CapabilityLCR	ProtocolIE-ID ::= 871
id-Non-Serving-RL-Preconfig-Info	ProtocolIE-ID ::= 872
id-Non-Serving-RL-Preconfig-Setup	ProtocolIE-ID ::= 873
id-Non-Serving-RL-Preconfig-Removal	ProtocolIE-ID ::= 874
id-Additional-E-DCH-Non-Serving-RL-Preconfiguration-Setup	ProtocolIE-ID ::= 875
id-Additional-E-DCH-New-non-serving-RL-E-DCH-FDD-DL-Control-Channel-InfoList	ProtocolIE-ID ::= 876
id-CellListValidityIndicator	ProtocolIE-ID ::= 877
id-HS-SCCH-Inactivity-Threshold-for-UE-DRX-Cycle-LCR-Ext	ProtocolIE-ID ::= 890
id-Measurement-Power-Offset	ProtocolIE-ID ::= 893
id-Support-of-Dynamic-DTXDRX-Related-HS-SCCH-Order	ProtocolIE-ID ::= 909
id-CPC-RecoveryReport	ProtocolIE-ID ::= 910

END

9.3.7 Container Definitions

```
-- *****
--
-- Container definitions
--
-- *****

RNSAP-Containers {
itu-t (0) identified-organization (4) etsi (0) mobileDomain (0)
umts-Access (20) modules (3) rnsap (1) version1 (1) rnsap-Containers (5) }

DEFINITIONS AUTOMATIC TAGS ::=

BEGIN

-- *****
--
-- IE parameter types from other modules.
--
-- *****

IMPORTS
    maxPrivateIEs,
    maxProtocolExtensions,
    maxProtocolIEs,
    Criticality,
    Presence,
    PrivateIE-ID,
    ProtocolIE-ID
FROM RNSAP-CommonDataTypes;
```

```
-- *****
--
-- Class Definition for Protocol IEs
--
-- *****

RNSAP-PROTOCOL-IES ::= CLASS {
    &id          ProtocolIE-ID          UNIQUE,
    &criticality Criticality,
    &Value,
    &presence    Presence
}
WITH SYNTAX {
    ID          &id
    CRITICALITY &criticality
    TYPE       &Value
    PRESENCE   &presence
}

-- *****
--
-- Class Definition for Protocol IEs
--
-- *****

RNSAP-PROTOCOL-IES-PAIR ::= CLASS {
    &id          ProtocolIE-ID          UNIQUE,
    &firstCriticality Criticality,
    &FirstValue,
    &secondCriticality Criticality,
    &SecondValue,
    &presence    Presence
}
WITH SYNTAX {
    ID          &id
    FIRST CRITICALITY &firstCriticality
    FIRST TYPE      &FirstValue
    SECOND CRITICALITY &secondCriticality
    SECOND TYPE     &SecondValue
    PRESENCE       &presence
}

-- *****
--
-- Class Definition for Protocol Extensions
--
-- *****

RNSAP-PROTOCOL-EXTENSION ::= CLASS {
    &id          ProtocolIE-ID          UNIQUE,
    &criticality Criticality,
    &Extension,
    &presence    Presence
}
```

```

WITH SYNTAX {
  ID                &id
  CRITICALITY       &criticality
  EXTENSION          &Extension
  PRESENCE          &presence
}

-- *****
--
-- Class Definition for Private IEs
--
-- *****

RNSAP-PRIVATE-IES ::= CLASS {
  &id                PrivateIE-ID,
  &criticality       Criticality,
  &Value,
  &presence          Presence
}
WITH SYNTAX {
  ID                &id
  CRITICALITY       &criticality
  TYPE              &Value
  PRESENCE          &presence
}

-- *****
--
-- Container for Protocol IEs
--
-- *****

ProtocolIE-Container {RNSAP-PROTOCOL-IES : IesSetParam} ::=
  SEQUENCE (SIZE (0..maxProtocolIEs)) OF
  ProtocolIE-Field {{IesSetParam}}

ProtocolIE-Single-Container {RNSAP-PROTOCOL-IES : IesSetParam} ::=
  ProtocolIE-Field {{IesSetParam}}

ProtocolIE-Field {RNSAP-PROTOCOL-IES : IesSetParam} ::= SEQUENCE {
  id                RNSAP-PROTOCOL-IES.&id                ({IesSetParam}),
  criticality       RNSAP-PROTOCOL-IES.&criticality        ({IesSetParam}@id}),
  value            RNSAP-PROTOCOL-IES.&Value              ({IesSetParam}@id)}
}

-- *****
--
-- Container for Protocol IE Pairs
--
-- *****

ProtocolIE-ContainerPair {RNSAP-PROTOCOL-IES-PAIR : IesSetParam} ::=
  SEQUENCE (SIZE (0..maxProtocolIEs)) OF
  ProtocolIE-FieldPair {{IesSetParam}}

```

```

ProtocolIE-FieldPair {RNSAP-PROTOCOL-IES-PAIR : IesSetParam} ::= SEQUENCE {
    id                RNSAP-PROTOCOL-IES-PAIR.&id                ({IesSetParam}),
    firstCriticality  RNSAP-PROTOCOL-IES-PAIR.&firstCriticality  ({IesSetParam}{@id}),
    firstValue        RNSAP-PROTOCOL-IES-PAIR.&firstValue        ({IesSetParam}{@id}),
    secondCriticality RNSAP-PROTOCOL-IES-PAIR.&secondCriticality  ({IesSetParam}{@id}),
    secondValue       RNSAP-PROTOCOL-IES-PAIR.&secondValue       ({IesSetParam}{@id})
}

-- *****
--
-- Container Lists for Protocol IE Containers
--
-- *****

ProtocolIE-ContainerList {INTEGER : lowerBound, INTEGER : upperBound, RNSAP-PROTOCOL-IES : IesSetParam} ::=
    SEQUENCE (SIZE (lowerBound..upperBound)) OF
        ProtocolIE-Container {{IesSetParam}}

ProtocolIE-ContainerPairList {INTEGER : lowerBound, INTEGER : upperBound, RNSAP-PROTOCOL-IES-PAIR : IesSetParam} ::=
    SEQUENCE (SIZE (lowerBound..upperBound)) OF
        ProtocolIE-ContainerPair {{IesSetParam}}

-- *****
--
-- Container for Protocol Extensions
--
-- *****

ProtocolExtensionContainer {RNSAP-PROTOCOL-EXTENSION : ExtensionSetParam} ::=
    SEQUENCE (SIZE (1..maxProtocolExtensions)) OF
        ProtocolExtensionField {{ExtensionSetParam}}

ProtocolExtensionField {RNSAP-PROTOCOL-EXTENSION : ExtensionSetParam} ::= SEQUENCE {
    id                RNSAP-PROTOCOL-EXTENSION.&id                ({ExtensionSetParam}),
    criticality        RNSAP-PROTOCOL-EXTENSION.&criticality        ({ExtensionSetParam}{@id}),
    extensionValue     RNSAP-PROTOCOL-EXTENSION.&Extension         ({ExtensionSetParam}{@id})
}

-- *****
--
-- Container for Private IEs
--
-- *****

PrivateIE-Container {RNSAP-PRIVATE-IES : IesSetParam} ::=
    SEQUENCE (SIZE (1..maxPrivateIEs)) OF
        PrivateIE-Field {{IesSetParam}}

PrivateIE-Field {RNSAP-PRIVATE-IES : IesSetParam} ::= SEQUENCE {
    id                RNSAP-PRIVATE-IES.&id                ({IesSetParam}),
    criticality        RNSAP-PRIVATE-IES.&criticality        ({IesSetParam}{@id}),
    value              RNSAP-PRIVATE-IES.&Value              ({IesSetParam}{@id})
}

```

END

9.4 Message Transfer Syntax

RNSAP shall use the ASN.1 Basic Packed Encoding Rules (BASIC-PER) Aligned Variant as transfer syntax as specified in ref. ITU-T Rec. X.691 [20].

9.5 Timers

T_{Preempt}

- Specifies the maximum time that a DRNS may wait for pre-emption of resources for establishment or reconfiguration of Radio Links.

$T_{\text{RELOCprep}}$

- Specifies the maximum time for the Enhanced Relocation procedure in the SRNC.

10 Handling of Unknown, Unforeseen and Erroneous Protocol Data

10.1 General

Protocol Error cases can be divided into three classes:

1. Transfer Syntax Error;
2. Abstract Syntax Error;
3. Logical Error.

Protocol errors can occur in the following functions within a receiving node.

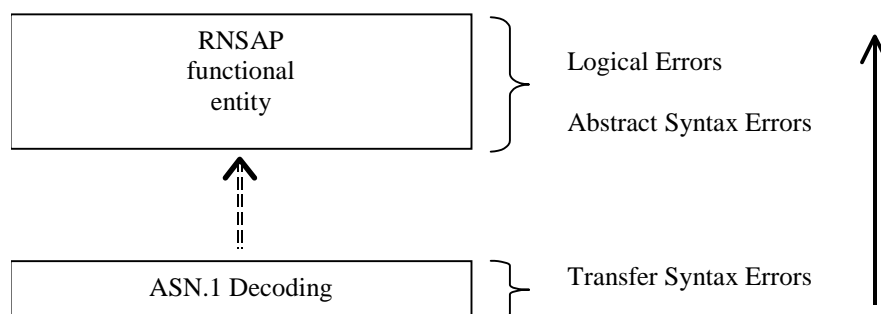

Figure 34: Protocol Errors in RNSAP

The information stated in subclauses 10.2, 10.3 and 10.4, to be included in the message used when reporting an error, is what at minimum shall be included. Other optional information elements within the message may also be included, if available. This is also valid for the case when the reporting is done with a response message. The latter is an exception to what is stated in subclause 4.1.

10.2 Transfer Syntax Error

A Transfer Syntax Error occurs when the receiver is not able to decode the received physical message. Transfer syntax errors are always detected in the process of ASN.1 decoding. If a Transfer Syntax Error occurs, the receiver should initiate Error Indication procedure with appropriate cause value for the Transfer Syntax protocol error.

Examples for Transfer Syntax Errors are:

- Violation of value ranges in ASN.1 definition of messages. E.g.: If an IE has a defined value range of 0 to 10 (ASN.1: INTEGER (0..10)), and 12 will be received, then this will be treated as a transfer syntax error;
- Violation in list element constraints. E.g.: If a list is defined as containing 1 to 10 elements, and 12 elements will be received, then this case will be handled as a transfer syntax error;
- Missing mandatory elements in ASN.1 SEQUENCE definitions (as sent by the originator of the message);
- Wrong order of elements in ASN.1 SEQUENCE definitions (as sent by the originator of the message).

10.3 Abstract Syntax Error

10.3.1 General

An Abstract Syntax Error occurs when the receiving functional RNSAP entity:

1. Receives IEs or IE groups that cannot be understood (unknown IE id);
2. Receives IEs for which the logical range is violated (e.g.: ASN.1 definition: 0 to 15, the logical range is 0 to 10 (values 11 to 15 are undefined), and 12 will be received; this case will be handled as an abstract syntax error using criticality information sent by the originator of the message);
3. Does not receive IEs or IE groups but according to the specified presence of the concerned object, the IEs or IE groups should have been present in the received message;
4. Receives IEs or IE groups that are defined to be part of that message in wrong order or with too many occurrences of the same IE or IE group;
5. receives IEs or IE groups but according to the conditional presence of the concerned object and the specified condition, the IEs or IE groups should not have been present in the received message.

Cases 1 and 2 (not comprehended IE/IE group) are handled based on received Criticality information. Case 3 (missing IE/IE group) is handled based on Criticality information and Presence information for the missing IE/IE group specified in the version of the specification used by the receiver. Case 4 (IEs or IE groups in wrong order or with too many occurrences) and Case 5 (erroneously present conditional IEs or IE groups) result in rejecting the procedure.

If an Abstract Syntax Error occurs, the receiver shall read the remaining message and shall then for each detected Abstract Syntax Error that belong to cases 1-3 act according to the Criticality Information and Presence Information for the IE/IE group due to which Abstract Syntax Error occurred in accordance with subclauses 10.3.4 and 10.3.5. The handling of cases 4 and 5 is specified in subclause 10.3.6.

10.3.2 Criticality Information

In the RNSAP messages there is criticality information set for individual IEs and/or IE groups. This criticality information instructs the receiver how to act when receiving an IE or an IE group that is not comprehended, i.e. the entire item (IE or IE group) which is not (fully or partially) comprehended shall be treated in accordance with its own criticality information as specified in subclause 10.3.4.

In addition, the criticality information is used in case of the missing IE/IE group abstract syntax error (see subclause 10.3.5).

The receiving node shall take different actions depending on the value of the Criticality Information. The three possible values of the Criticality Information for an IE/IE group are:

1. Reject IE;
2. Ignore IE and Notify Sender;
3. Ignore IE.

The following rules restrict when a receiving entity may consider an IE, an IE group or an EP not comprehended (not implemented), and when action based on criticality information is applicable:

1. IE or IE group: When one new or modified IE or IE group is implemented for one EP from a standard version, then other new or modified IEs or IE groups specified for that EP in that standard version shall be considered comprehended by a receiving entity (some may still remain unsupported).
2. EP: The comprehension of different Eps within a standard version or between different standard versions is not mandated. Any EP that is not supported may be considered not comprehended, even if another EP from that standard version is comprehended, and action based on criticality shall be applied.

10.3.3 Presence Information

For many IEs/IE groups which are optional according to the ASN.1 transfer syntax, RNSAP specifies separately if the presence of these IEs/IE groups is optional or mandatory with respect to RNS application by means of the presence field of the concerned object of class RNSAP-PROTOCOL-IES, RNSAP-PROTOCOL-IES-PAIR, RNSAP-PROTOCOL-EXTENSION or RNSAP-PRIVATE-IES.

The presence field of the indicated classes supports three values:

1. Optional;
2. Conditional;
3. Mandatory.

If an IE/IE group is not included in a received message and the presence of the IE/IE group is mandatory or the presence is conditional and the condition is true according to the version of the specification used by the receiver, an abstract syntax error occurs due to a missing IE/IE group.

If an IE/IE group is included in a received message and the presence of the IE/IE group is conditional and the condition is false according to the version of the specification used by the receiver, an abstract syntax error occurs due to this erroneously present conditional IE/IE group.

10.3.4 Not Comprehended IE/IE Group

10.3.4.1 Procedure ID

The receiving node shall treat the different types of received criticality information of the *Procedure ID* according to the following:

Reject IE:

- If a message is received with a *Procedure ID* marked with “*Reject IE*” which the receiving node does not comprehend, the receiving node shall reject the procedure using the Error Indication procedure.

Ignore IE and Notify Sender:

- If a message is received with a *Procedure ID* marked with “*Ignore IE and Notify Sender*” which the receiving node does not comprehend, the receiving node shall ignore the procedure and initiate the Error Indication procedure.

Ignore IE:

- If a message is received with a *Procedure ID* marked with “*Ignore IE*” which the receiving node does not comprehend, the receiving node shall ignore the procedure.

When using the Error Indication procedure to reject a procedure or to report an ignored procedure it shall include the *Procedure ID* IE, the *Triggering Message* IE, and the *Procedure Criticality* IE in the *Criticality Diagnostics* IE.

10.3.4.1A Type of Message

When the receiving node cannot decode the *Type of Message* IE, the Error Indication procedure shall be initiated with an appropriate cause value.

10.3.4.2 IEs Other Than the Procedure ID and Type of Message

The receiving node shall treat the different types of received criticality information of an IE/IE group other than the *Procedure ID IE* and *Type of Message IE* according to the following:

Reject IE:

- If a message *initiating* a procedure is received containing one or more IEs/IE groups marked with “*Reject IE*” which the receiving node does not comprehend; none of the functional requests of the message shall be executed. The receiving node shall reject the procedure and report the rejection of one or more IEs/IE groups using the message normally used to report unsuccessful outcome of the procedure. In case the information received in the initiating message was insufficient to determine a value for all IEs that are required to be present in the message used to report the unsuccessful outcome of the procedure, the receiving node shall instead terminate the procedure and initiate the Error Indication procedure.
- If a message *initiating* a procedure that does not have a message to report unsuccessful outcome is received containing one or more IEs/IE groups marked with “*Reject IE*” which the receiving node does not comprehend, the receiving node shall terminate the procedure and initiate the Error Indication procedure.
- If a *response* message is received containing one or more IEs/IE groups marked with “*Reject IE*”, that the receiving node does not comprehend, the receiving node shall consider the procedure as unsuccessfully terminated and initiate local error handling.

Ignore IE and Notify Sender:

- If a message *initiating* a procedure is received containing one or more IEs/IE groups marked with “*Ignore IE and Notify Sender*” which the receiving node does not comprehend, the receiving node shall ignore the content of the not comprehended IEs/IE groups, continue with the procedure as if the not comprehended IEs/IE groups were not received (except for the reporting) using the understood IEs/IE groups, and report in the response message of the procedure that one or more IEs/IE groups have been ignored. In case the information received in the initiating message was insufficient to determine a value for all IEs that are required to be present in the response message, the receiving node shall instead terminate the procedure and initiate the Error Indication procedure.
- If a message *initiating* a procedure that does not have a message to report the outcome of the procedure is received containing one or more IEs/IE groups marked with “*Ignore IE and Notify Sender*” which the receiving node does not comprehend, the receiving node shall ignore the content of the not comprehended IEs/IE groups, continue with the procedure as if the not comprehended IEs/IE groups were not received (except for the reporting) using the understood IEs/IE groups, and initiate the Error Indication procedure to report that one or more IEs/IE groups have been ignored.
- If a *response* message is received containing one or more IEs/IE groups marked with “*Ignore IE and Notify Sender*” which the receiving node does not comprehend, the receiving node shall ignore the content of the not comprehended IEs/IE groups, continue with the procedure as if the not comprehended IEs/IE groups were not received (except for the reporting) using the understood IEs/IE groups and initiate the Error Indication procedure.

Ignore IE:

- If a message *initiating* a procedure is received containing one or more IEs/IE groups marked with “*Ignore IE*” which the receiving node does not comprehend, the receiving node shall ignore the content of the not comprehended IEs/IE groups and continue with the procedure as if the not comprehended IEs/IE groups were not received using the understood IEs/IE groups.
- If a *response* message is received containing one or more IEs/IE groups marked with “*Ignore IE*” which the receiving node does not comprehend, the receiving node shall ignore the content of the not comprehended IEs/IE groups and continue with the procedure as if the not comprehended IEs/IE groups were not received using the understood IEs/IE groups.

When reporting not comprehended IEs/IE groups marked with “*Reject IE*” or “*Ignore IE and Notify Sender*” using a response message defined for the procedure, the *Information Element Criticality Diagnostics IE* shall be included in the *Criticality Diagnostics IE* for each reported IE/IE group. In the *Information Element Criticality Diagnostics IE* the *Repetition Number IE* shall be included and in addition, if the not comprehended IE/IE group is not at message hierarchy level 1 (top level; see annex C) also the *Message Structure IE* shall be included.

When reporting not comprehended IEs/IE groups marked with “*Reject IE*” or “*Ignore IE and Notify Sender*” using the Error Indication procedure, the *Procedure ID IE*, the *Triggering Message IE*, *Procedure Criticality IE*, the *Transaction ID IE*, and the *Information Element Criticality Diagnostics IE* shall be included in the *Criticality Diagnostics IE* for each reported IE/IE group. In the *Information Element Criticality Diagnostics IE* the *Repetition Number IE* shall be included and in addition, if the not comprehended IE/IE group is not at message hierarchy level 1 (top level; see annex C) also the *Message Structure IE* shall be included.

10.3.5 Missing IE or IE Group

The receiving node shall treat the missing IE/IE group according to the criticality information for the missing IE/IE group in the received message specified in the version of this specification used by the receiver:

Reject IE:

- If a received message *initiating* a procedure is missing one or more IEs/IE groups with specified criticality “*Reject IE*”; none of the functional requests of the message shall be executed. The receiving node shall reject the procedure and report the missing IEs/IE groups using the message normally used to report unsuccessful outcome of the procedure. In case the information received in the initiating message was insufficient to determine a value for all IEs that are required to be present in the message used to report the unsuccessful outcome of the procedure, the receiving node shall instead terminate the procedure and initiate the Error Indication procedure.
- If a received message *initiating* a procedure that does not have a message to report unsuccessful outcome is missing one or more IEs/IE groups with specified criticality “*Reject IE*”, the receiving node shall terminate the procedure and initiate the Error Indication procedure.
- If a received *response* message is missing one or more IEs/IE groups with specified criticality “*Reject IE*”, the receiving node shall consider the procedure as unsuccessfully terminated and initiate local error handling.

Ignore IE and Notify Sender:

- If a received message *initiating* a procedure is missing one or more IEs/IE groups with specified criticality “*Ignore IE and Notify Sender*”, the receiving node shall ignore that those IEs are missing and continue with the procedure based on the other IEs/IE groups present in the message and report in the response message of the procedure that one or more IEs/IE groups were missing. In case the information received in the initiating message was insufficient to determine a value for all IEs that are required to be present in the response message, the receiving node shall instead terminate the procedure and initiate the Error Indication procedure.
- If a received message *initiating* a procedure that does not have a message to report the outcome of the procedure is missing one or more IEs/IE groups with specified criticality “*Ignore IE and Notify Sender*”, the receiving node shall ignore that those IEs are missing and continue with the procedure based on the other IEs/IE groups present in the message and initiate the Error Indication procedure to report that one or more IEs/IE groups were missing.
- If a received *response* message is missing one or more IEs/IE groups with specified criticality “*Ignore IE and Notify Sender*”, the receiving node shall ignore that those IEs are missing and continue with the procedure based on the other IEs/IE groups present in the message and initiate the Error Indication procedure to report that one or more IEs/IE groups were missing.

Ignore IE:

- If a received message *initiating* a procedure is missing one or more IEs/IE groups with specified criticality “*Ignore IE*”, the receiving node shall ignore that those IEs are missing and continue with the procedure based on the other IEs/IE groups present in the message.
- If a received *response* message is missing one or more IEs/IE groups with specified criticality “*Ignore IE*”, the receiving node shall ignore that those IEs/IE groups are missing and continue with the procedure based on the other IEs/IE groups present in the message.

When reporting missing IEs/IE groups with specified criticality “*Reject IE*” or “*Ignore IE and Notify Sender*” using a response message defined for the procedure, the *Information Element Criticality Diagnostics IE* shall be included in the *Criticality Diagnostics IE* for each reported IE/IE group. In the *Information Element Criticality Diagnostics IE* the *Repetition Number IE* shall be included and in addition, if the missing IE/IE group is not at message hierarchy level 1 (top level; see annex C) also the *Message Structure IE* shall be included.

When reporting missing IEs/IE groups with specified criticality “*Reject IE*” or “*Ignore IE and Notify Sender*” using the Error Indication procedure, the *Procedure ID IE*, the *Triggering Message IE*, *Procedure Criticality IE*, the *Transaction ID IE*, and the *Information Element Criticality Diagnostics IE* shall be included in the *Criticality Diagnostics IE* for each reported IE/IE group. In the *Information Element Criticality Diagnostics IE* the *Repetition Number IE* shall be included and in addition, if the missing IE/IE group is not at message hierarchy level 1 (top level; see annex C) also the *Message Structure IE* shall be included.

10.3.6 IEs or IE Groups Received in Wrong Order or With Too Many Occurrences or Erroneously Present

If a message with IEs or IE groups in wrong order or with too many occurrences is received or if IEs or IE groups with a conditional presence are present when the condition is not met (i.e. erroneously present), the receiving node shall behave according to the following:

- If a message *initiating* a procedure is received containing IEs or IE groups in wrong order or with too many occurrences or erroneously present, none of the functional requests of the message shall be executed. The receiving node shall reject the procedure and report the cause value “Abstract Syntax Error (Falsely Constructed Message)” using the message normally used to report unsuccessful outcome of the procedure. In case the information received in the initiating message was insufficient to determine a value for all IEs that are required to be present in the message used to report the unsuccessful outcome of the procedure, the receiving node shall instead terminate the procedure and initiate the Error Indication procedure.
- If a message *initiating* a procedure that does not have a message to report unsuccessful outcome is received containing IEs or IE groups in wrong order or with too many occurrences or erroneously present, the receiving node shall terminate the procedure and initiate the Error Indication procedure, and use cause value “Abstract Syntax Error (Falsely Constructed Message)”.
- If a *response* message is received containing IEs or IE groups in wrong order or with too many occurrences or erroneously present, the receiving node consider the procedure as unsuccessfully terminated and initiate local error handling.

When determining the correct order only the IEs specified in the specification version used by the receiver shall be considered.

10.4 Logical Error

Logical error situations occur when a message is comprehended correctly, but the information contained within the message is not valid (i.e. semantic error), or describes a procedure which is not compatible with the state of the receiver. In these conditions, the following behaviour shall be performed (unless otherwise specified) as defined by the class of the elementary procedure, irrespective of the criticality information of the IEs/IE groups containing the erroneous values.

Class 1:

Where the logical error occurs in a request message of a class 1 procedure, and the procedure has a message to report this unsuccessful outcome, this message shall be sent with an appropriate cause value. Typical cause values are:

Protocol Causes:

1. Semantic Error;
2. Message not Compatible with Receiver State.

Where the logical error is contained in a request message of a class 1 procedure, and the procedure does not have a message to report this unsuccessful outcome, the procedure shall be terminated and the Error Indication procedure shall be initiated with an appropriate cause value. The *Procedure ID IE*, the *Triggering Message IE* and the *Transaction ID IE* within the *Criticality Diagnostics IE* shall then be included in order to identify the message containing the logical error.

Where the logical error exists in a response message of a class 1 procedure, the procedure shall be considered as unsuccessfully terminated and local error handling shall be initiated.

Class 2:

Where the logical error occurs in a message of a class 2 procedure, the procedure shall be terminated and the Error Indication procedure shall be initiated with an appropriate cause value. The *Procedure ID* IE, the *Triggering Message* IE and the *Transaction ID* IE within the *Criticality Diagnostics* IE shall then be included in order to identify the message containing the logical error.

10.5 Exceptions

The error handling for all the cases described hereafter shall take precedence over any other error handling described in the other subclauses of clause 10.

- If any type of error (Transfer Syntax Error, Abstract Syntax Error or Logical Error) is detected in the ERROR INDICATION message, it shall not trigger the Error Indication procedure in the receiving Node but local error handling.
- In case a response message or ERROR INDICATION message needs to be returned, but the information necessary to determine the receiver of that message is missing, the procedure shall be considered as unsuccessfully terminated and local error handling shall be initiated.

If an error that terminates a procedure occurs, the returned cause value shall reflect the error that caused the termination of the procedure even if one or more abstract syntax errors with criticality “ignore and notify” have earlier occurred within the same procedure.

Annex A (normative): Allocation and Pre-emption of Radio Links in the DRNS

A.1 Deriving Allocation Information for a Radio Link

A.1.1 Establishment of a New Radio Link

The Allocation Information for a Radio Link in the case of establishment of a new Radio Link shall be derived as follows:

- The latest received *Allocation/Retention Priority* IE for each transport channel shall be used.

Note: The *Allocation/Retention Priority* IE for a transport channel may have been received in
a) the procedure that establishes the first Radio Link for the UE in the DRNS or
b) a procedure adding or modifying the transport channel.

- If the *Priority Level* IE in the *Allocation/Retention Priority* IE for all transport channels that are intended to use the Radio Link is set to “no priority”, the pre-emption capability of the Radio Link shall be set to “shall not trigger pre-emption”.
- If the *Priority Level* IE in the *Allocation/Retention Priority* IE for one or more of the transport channels that are intended to use the Radio Link is not set to “no priority”, the allocation priority and the pre-emption capability of the Radio Link shall be set according to the following:
 - The transport channels that have the *Priority Level* IE in the *Allocation/Retention Priority* IE set to “no priority” shall be excluded when setting the allocation priority and pre-emption capability of a Radio Link.
 - The allocation priority for a Radio Link shall be set to highest priority level, given by the *Priority Level* IE in the *Allocation/Retention Priority* IE, for all non excluded transport channels that are intended to use the Radio Link.
 - If all non-excluded transport channels that are intended to use a Radio Link to be established have the pre-emption capability, given by the *Pre-emption Capability* IE in the *Allocation/Retention Priority* IE, set to “shall not trigger pre-emption”, the pre-emption capability of the Radio Link shall be set to “shall not trigger pre-emption”.
If one or more non-excluded transport channels that are intended to use the Radio Link to be established have the value of the *Pre-emption Capability* IE in the *Allocation/Retention Priority* IE set to “may trigger pre-emption”, the pre-emption capability of the Radio Link shall be set to “may trigger pre-emption”.

The derived allocation priority and pre-emption capability are only valid during this allocation/retention process.

A.1.2 Modification of an Existing Radio Link

The Allocation Information for a Radio Link in the case of modification of a Radio Link (addition or modification of transport channels using the Radio Link) shall be derived as follows:

- The latest received *Allocation/Retention Priority* IE for each transport channel shall be used.

Note: The *Allocation/Retention Priority* IE for a transport channel may have been received in
a) the procedure that establishes the first Radio Link for the UE in the DRNS,
b) a previous procedure adding or modifying the transport channel, or
c) the current procedure adding or modifying the transport channel.

- If the *Priority Level* IE in the *Allocation/Retention Priority* IE for all transport channels to be added or modified in the Radio Link is set to “no priority”, the pre-emption capability of the Radio Link to be modified shall be set to “shall not trigger pre-emption”.

- If the *Priority Level* IE in the *Allocation/Retention Priority* IE for one or more of the transport channels to be added or modified in the Radio Link is not set to “no priority”, the allocation priority of and the pre-emption capability of the Radio Link to be modified shall be set according to the following:
 - The transport channels to be added or modified that have the *Priority Level* IE in the *Allocation/Retention Priority* IE set to “no priority” shall be excluded when setting the allocation priority and pre-emption capability of a Radio Link to be modified.
 - The allocation priority for a Radio Link to be modified shall be set to highest priority level, given by the *Priority Level* IE in the *Allocation/Retention Priority* IE, for all the non-excluded transport channels that are to be added or modified.
 - If all non-excluded transport channels that are to be added or modified in the Radio Link have the pre-emption capability, given by the *Pre-emption Capability* IE in the *Allocation/Retention Priority* IE, set to “shall not trigger pre-emption”, the pre-emption capability of the Radio Link to be modified shall be set to “shall not trigger pre-emption”.
If one or more of the non-excluded transport channels to be added or modified in the Radio Link have the value of the *Pre-emption Capability* IE in the *Allocation/Retention Priority* IE set to “may trigger pre-emption”, the pre-emption capability of the Radio Link to be modified shall be set to “may trigger pre-emption”.

The derived allocation priority and pre-emption capability are only valid during this allocation/retention process.

A.2 Deriving Retention Information for a Radio Link

The Retention Information for an existing Radio Link shall be derived as follows:

- The latest received *Allocation/Retention Priority* IE for each transport channel shall be used.
- Note: The *Allocation/Retention Priority* IE for a transport channel may have been received in
- a) the procedure that establishes the first Radio Link for the UE in the DRNS or
 - b) a procedure adding or modifying the transport channel.
- If the *Priority Level* IE in the *Allocation/Retention Priority* IE for one or more transport channels using the Radio Link is set to “no priority”, the pre-emption vulnerability of the Radio Link shall be set to “not pre-emptable”.
 - If the *Priority Level* IE in the *Allocation/Retention Priority* IE for all the transport channels using the Radio Link is not set to “no priority”, the retention priority of the Radio Link and the pre-emption vulnerability of the Radio Link shall be set according to the following:
 - The retention priority for a Radio Link shall be set to highest priority level, given by the *Priority Level* IE in the *Allocation/Retention Priority* IE, for all transport channels that uses the Radio Link.
 - If all transport channels that uses the Radio Link have the pre-emption vulnerability, given by the *Pre-emption Vulnerability* IE in the *Allocation/Retention Priority* IE, set to “pre-emptable”, the pre-emption vulnerability of the Radio Link shall be set to “pre-emptable”.
If one or more transport channels that uses the Radio Link have the value of the *Pre-emption Vulnerability* IE in the *Allocation/Retention Priority* IE set to “not pre-emptable”, the pre-emption vulnerability of the Radio Link shall be set to “not pre-emptable”.

The derived retention priority and pre-emption vulnerability are valid until they are changed, or until the Radio Link is deleted. When new transport channels are added to or deleted from the Radio Link or when existing transport channels are modified with regards to the *Allocation/Retention Priority* IE, the retention information shall be derived again according to above.

A.3 The Allocation/Retention Process

The DRNS shall establish or modify the resources for a Radio Link according to:

- The value of the Allocation Information (allocation priority and pre-emption capability) of the Radio to be established or modified. The Allocation Information is derived according to clause A.1.
- The value of the Retention Information (retention priority and pre-emption vulnerability) of existing Radio Links. The Retention Information derived according to clause A.2.
- The resource situation in the DRNS.

Whilst the process and the extent of the pre-emption functionality is operator dependent, the pre-emption indicators (pre-emption capability and pre-emption vulnerability) shall be treated as follows:

- If the pre-emption capability for a Radio Link to be established or modified is set to “may trigger pre-emption” and the resource situation so requires, the DRNS may trigger the pre-emption process in clause A.4 to free resources for this allocation request.
- If the pre-emption capability for a Radio Link to be established or modified is set to “shall not trigger pre-emption”, then this allocation request shall not trigger the pre-emption process in clause A.4.
- If the pre-emption vulnerability for an existing Radio Link is set to “pre-emptable”, then this Radio Link shall be included in the pre-emption process in clause A.4.
- If the pre-emption vulnerability for an existing Radio Link is set to “not pre-emptable”, then this Radio Link shall not be included in the pre-emption process in clause A.4.

A.4 The Pre-emption Process

The pre-emption process shall only pre-empt Radio Links with lower retention priority than the allocation priority of the Radio Link to be established or modified. The Radio Links to be pre-empted shall be selected in ascending order of the retention priority.

When the pre-emption process detects that one or more Radio Links have to be pre-empted to free resources for a Radio Link(s) to be established or modified, the DRNS shall initiate the Radio Link Pre-emption procedure for all the UE Contexts having Radio Links selected for pre-emption and start the T_{Preempt} timer.

When enough resources are freed to establish or modify the Radio Link(s) according to the request, the DRNS shall stop the T_{Preempt} timer and complete the procedure that triggered the pre-emption process in accordance with the “Successful Operation” subclause of the procedure.

If the T_{Preempt} timer expires, the DRNS shall reject the procedure that triggered the pre-emption process and complete the procedure in accordance with the “Unsuccessful Operation” subclause of the procedure.

Annex B (informative): Measurement Reporting

When the *Report Characteristics* IE is set to “Event A” (figure B.1), the Measurement Reporting procedure is initiated when the measured entity rises above the requested threshold and stays there for the requested hysteresis time. If no hysteresis time is given, the value zero shall be used for the hysteresis time.

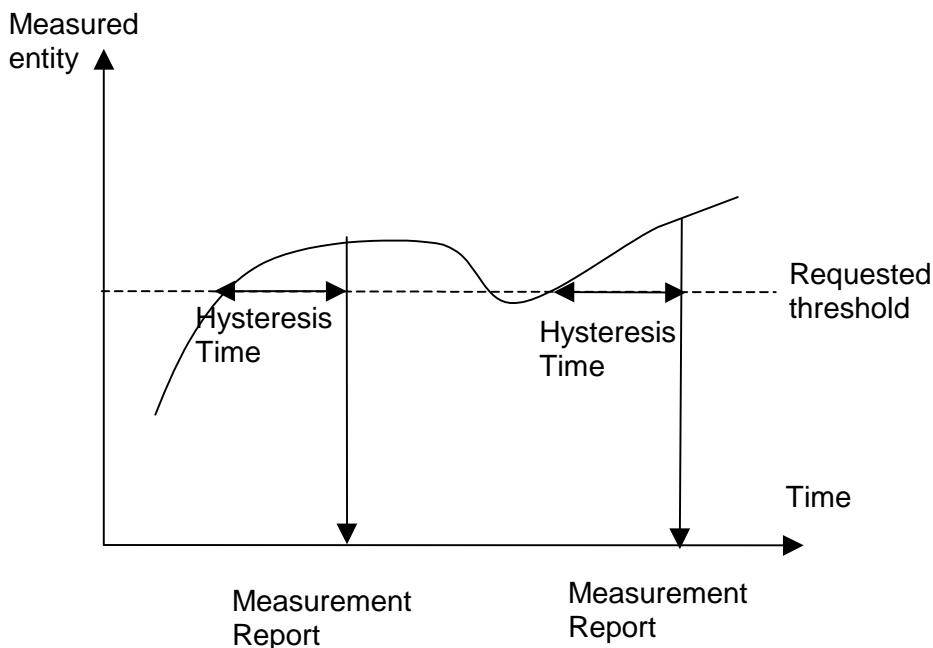

Figure B.1: Event A reporting with Hysteresis Time specified

When the *Report Characteristics* IE is set to “Event B” (figure B.2), the Measurement Reporting procedure is initiated when the measured entity falls below the requested threshold and stays there for the requested hysteresis time. If no hysteresis time is given, the value zero shall be used for the hysteresis time.

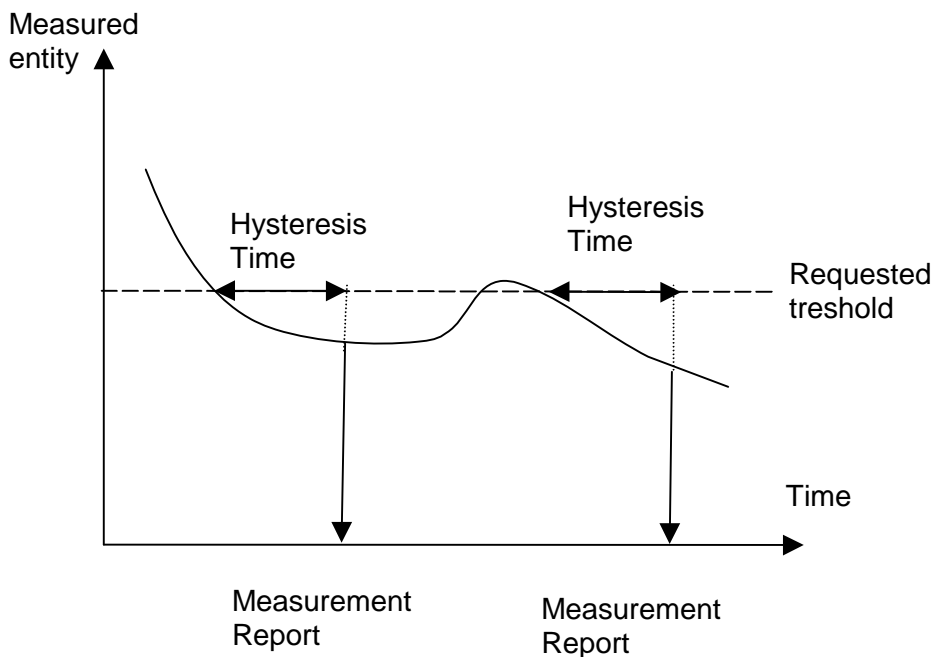

Figure B.2: Event B reporting with Hysteresis Time specified

When the *Report Characteristics* IE is set to “Event C” (figure B.3), the Measurement Reporting procedure is initiated always when the measured entity rises by an amount greater than the requested threshold within the requested time. The reporting in figure B.3 is initiated if the Rising Time T1 is less than the requested time.

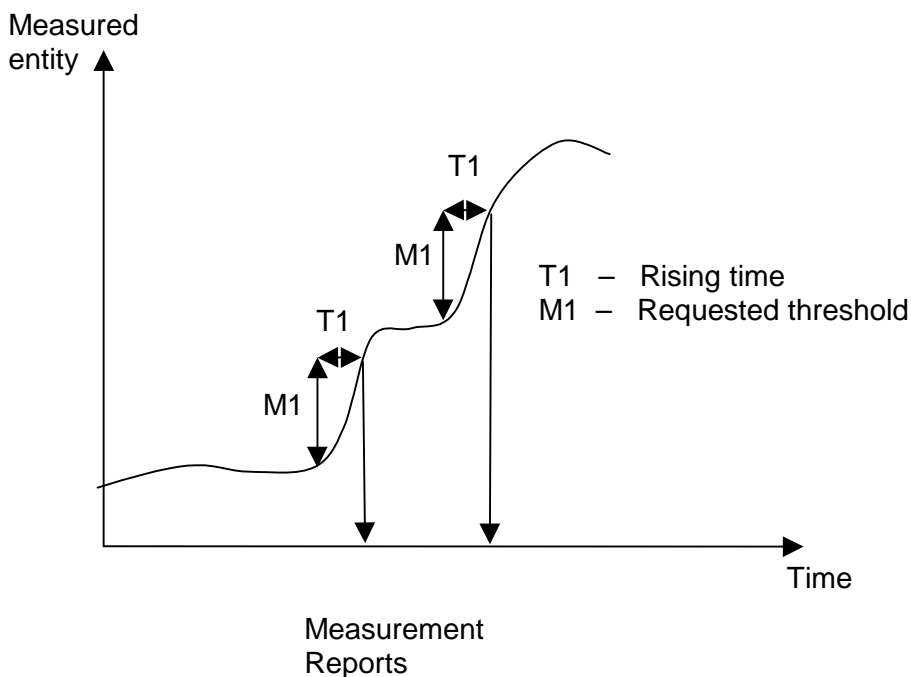

Figure B.3: Event C reporting

When the *Report Characteristics* IE is set to “Event D” (figure B.4), the Measurement Reporting procedure is initiated always when the measured entity falls by an amount greater than the requested threshold within the requested time. The reporting in figure B.4 is initiated if the Falling Time T1 is less than the requested time.

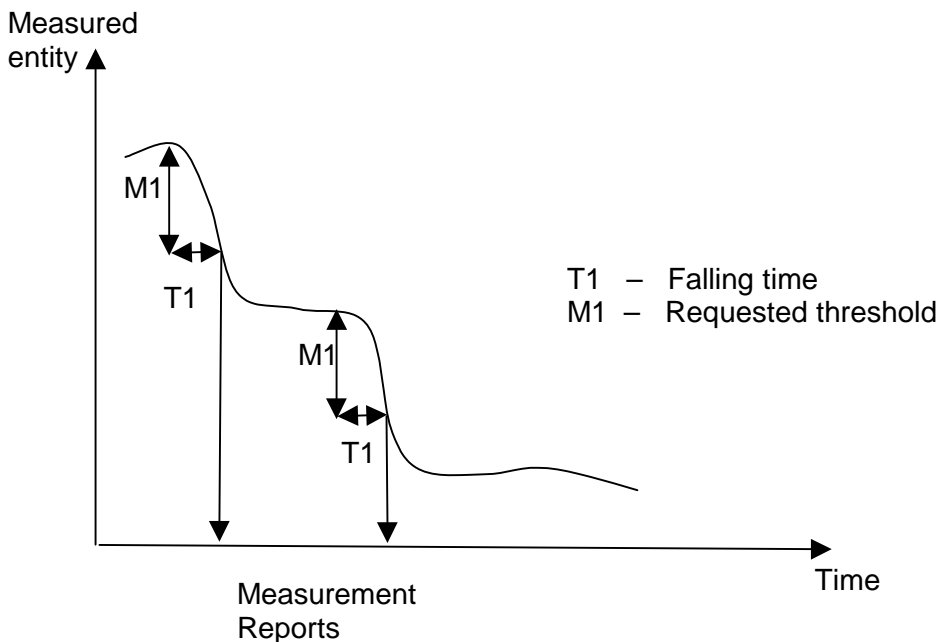

Figure B.4: Event D reporting

When the *Report Characteristics* IE is set to “Event E” (figure B.5), the Measurement Reporting procedure (Report A) is initiated always when the measured entity rises above the “Measurement Threshold 1” and stays there for the “Measurement Hysteresis Time” (T1 in figure B.5). If *Report Periodicity* IE is provided DRNS shall also initiate Measurement Reporting procedure periodically. The periodic reporting continues although the measured entity falls below the “Measurement Threshold 1” and is terminated by the Report B.

When the Report A conditions have been met and the measured entity falls below the “Measurement Threshold 2” and stays there for the “Measurement Hysteresis Time” (T1) the Measurement Reporting procedure (Report B) is initiated and the periodic reporting is terminated.

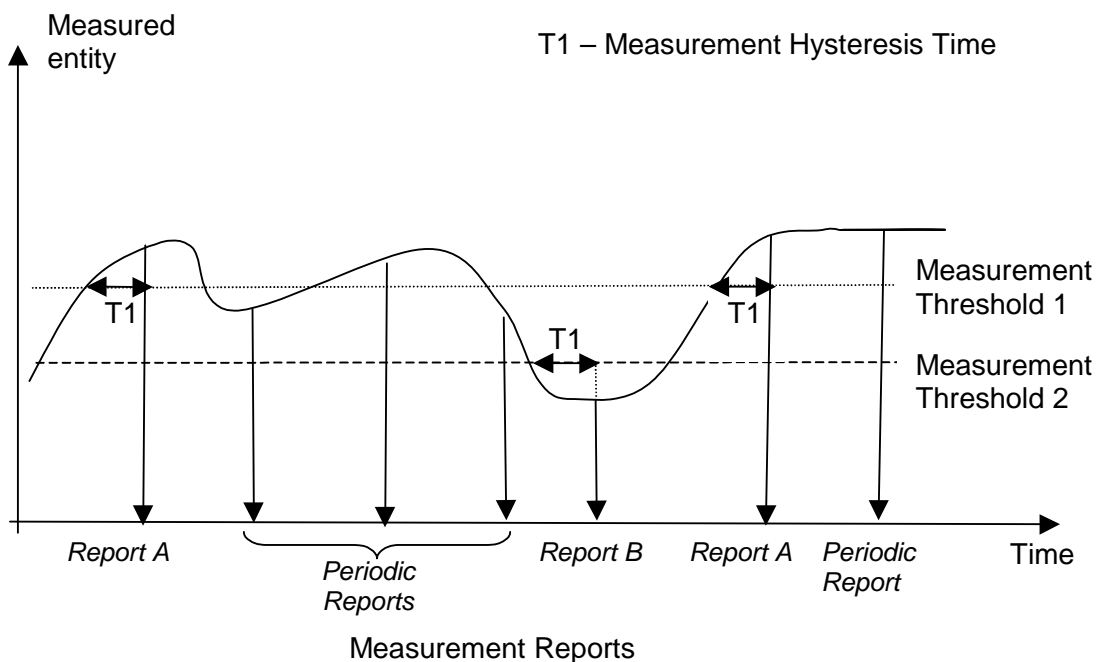

Figure B.5: Event E reporting with Hysteresis Time specified and Periodic Reporting requested

When the *Report Characteristics* IE is set to “Event F” (figure B.6), the Measurement Reporting procedure (Report A) is initiated always when the measured entity falls below the “Measurement Threshold 1” and stays there for the “Measurement Hysteresis Time” (T1 in figure B.6). If *Report Periodicity* IE is provided DRNS shall also initiate Measurement Reporting procedure periodically. The periodic reporting continues although the measured entity rises above the “Measurement Threshold 1” and is terminated by the Report B.

When the Report A conditions have been met and the measured entity rises above the “Measurement Threshold 2” and stays there for the “Measurement Hysteresis Time” (T1) Measurement Reporting procedure (Report B) is initiated and the periodic reporting is terminated.

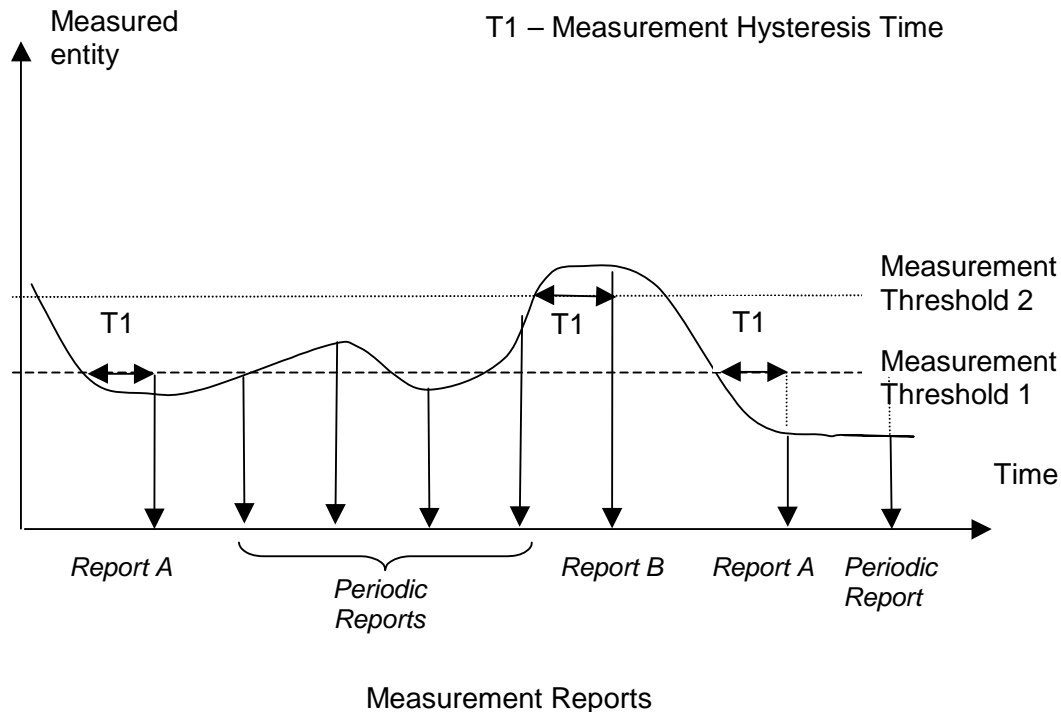

Figure B.6: Event F reporting with Hysteresis Time specified and Periodic Reporting requested

Annex C (informative): Guidelines for Usage of the Criticality Diagnostics IE

C.1 EXAMPLE MESSAGE Layout

Assume the following message format:

IE/Group Name	Presence	Range	IE Type and Reference	Semantics Description	Criticality	Assigned Criticality
Message Type	M				YES	reject
Transaction ID	M				-	
A	M				YES	reject
B	M				YES	reject
>E		1..<maxE>			EACH	ignore
>>F		1..<maxF>			-	
>>>G		0..3, ...			EACH	ignore
>>H		1..<maxH>			EACH	ignore
>>>G		0..3, ...			EACH	ignore and notify
>>G	M				YES	reject
>>J		1..<maxJ>			-	
>>>G		0..3, ...			EACH	reject
C	M				YES	reject
>K		1..<maxK>			EACH	ignore and notify
>>L		1..<maxL>			-	
>>>M	O				-	
D	M				YES	reject

Note 1. The IEs F, J, and L do not have assigned criticality. The IEs F, J, and L are consequently realised as the ASN.1 type SEQUENCE OF of “ordinary” ASN.1 type, e.g. INTEGER. On the other hand, the repeatable IEs with assigned criticality are realised as the ASN.1 type SEQUENCE OF of an IE object, e.g. ProtocolIE-Single-Container.

For the corresponding ASN.1 layout, see subclause C.4.

C.2 Example on a Received EXAMPLE MESSAGE

Assume further more that a received message based on the above tabular format is according to the figure below.

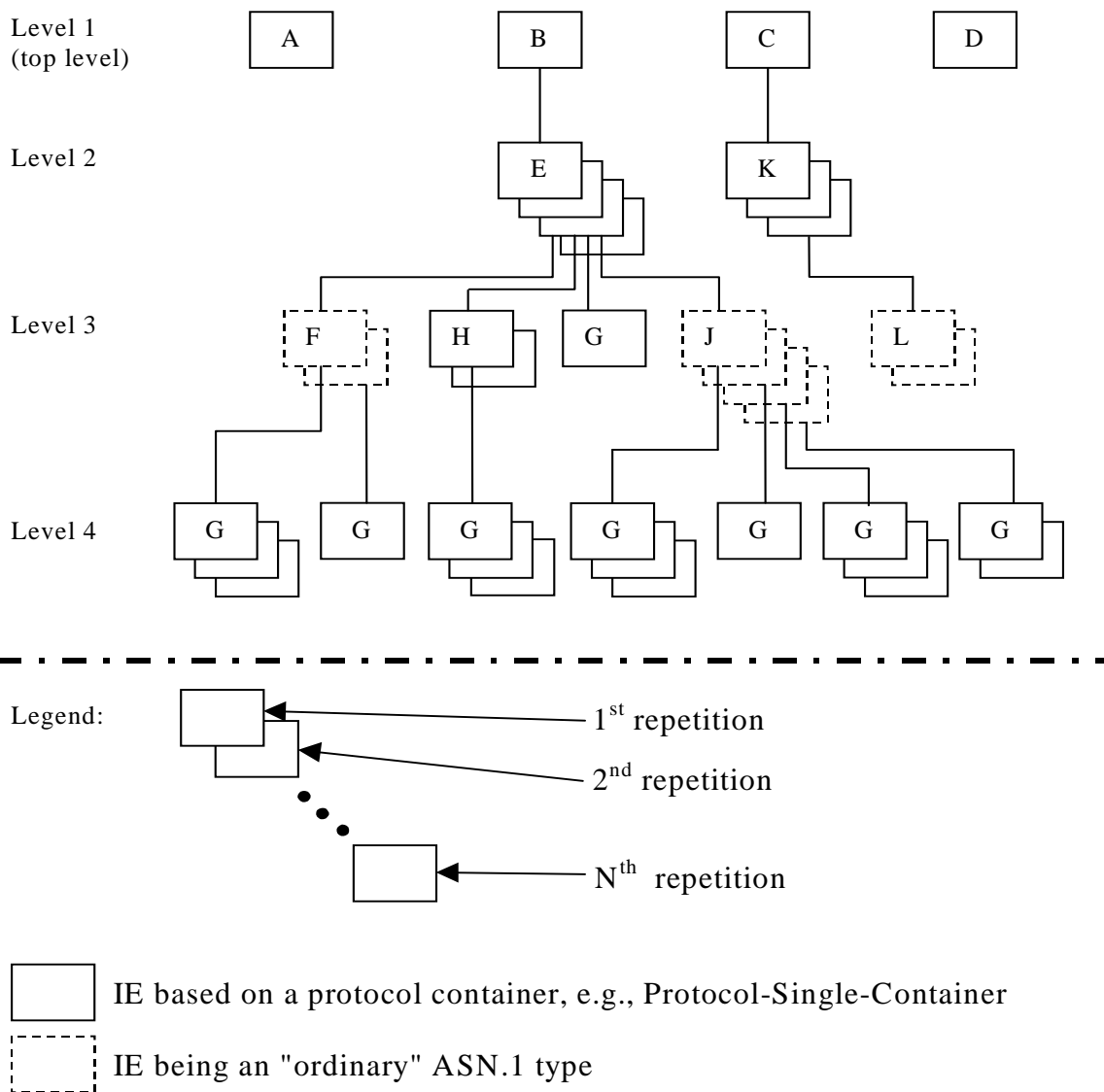
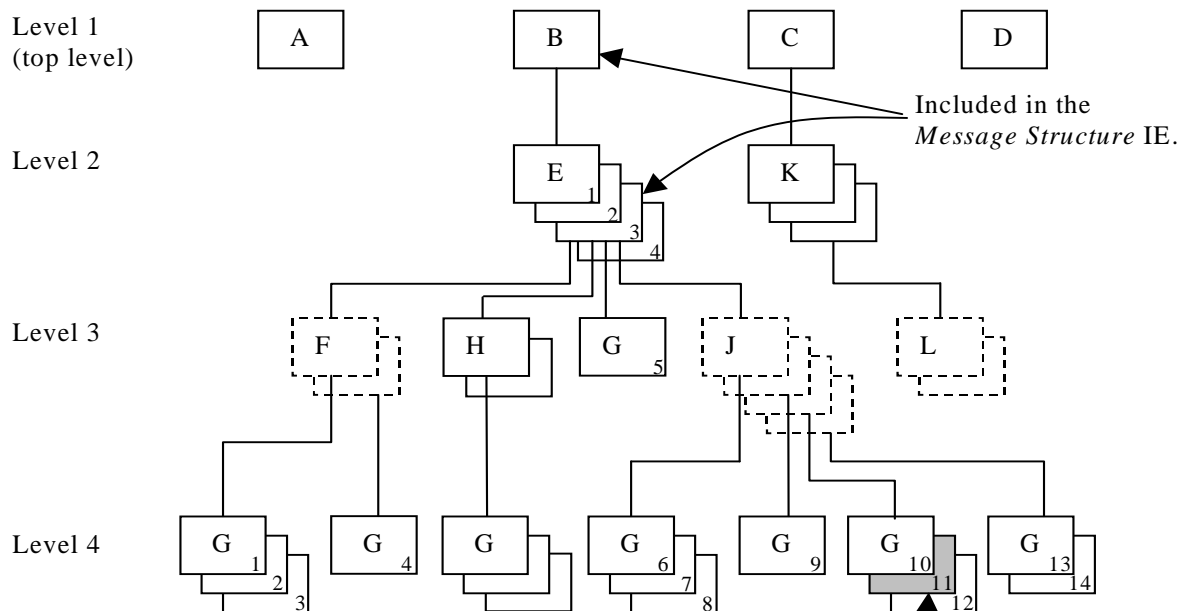

Figure C.1: Example of content of a received RNSAP message based on the EXAMPLE MESSAGE

C.3 Content of Criticality Diagnostics

C.3.1 Example 1



Included in the *Information Element Criticality Diagnostics* IE:

- a) *IE ID* IE
- b) *Repetition Number* IE

Figure C.2: Example of a received RNSAP message containing a not comprehended IE

If there is an error within the instance marked as grey in the IE G in the IE J shown in the figure C.2 above, this will be reported within the *Information Element Criticality Diagnostics* IE within the *Criticality Diagnostics* IE as follows:

IE name	Value	Comment
IE Criticality	reject	Criticality for IE on the reported level, i.e. level 4.
IE ID	id-G	IE ID from the reported level, i.e. level 4.
Repetition Number	11	Repetition number on the reported level, i.e. level 4. (Since the IE E (level 2) is the lowest level included in the <i>Message Structure</i> IE this is the eleventh occurrence of IE G within the IE E (level 2).)
Type of Error	not understood	
<i>Message Structure, first repetition</i>		
>IE ID	id-B	IE ID from level 1.
<i>Message Structure, second repetition</i>		
>IE ID	id-E	IE ID from the lowest level above the reported level, i.e. level 2.
>Repetition Number	3	Repetition number from the lowest level above the reported level, i.e. level 2.

Note 2. The IE J on level 3 cannot be included in the *Message Structure* IE since they have no criticality of their own.

Note 3. The repetition number of the reported IE indicates the number of repetitions of IE G received up to the detected erroneous repetition, counting all occurrences of the IE G below the same instance of the previous level with assigned criticality (instance 3 of IE E on level 2).

C.3.2 Example 2

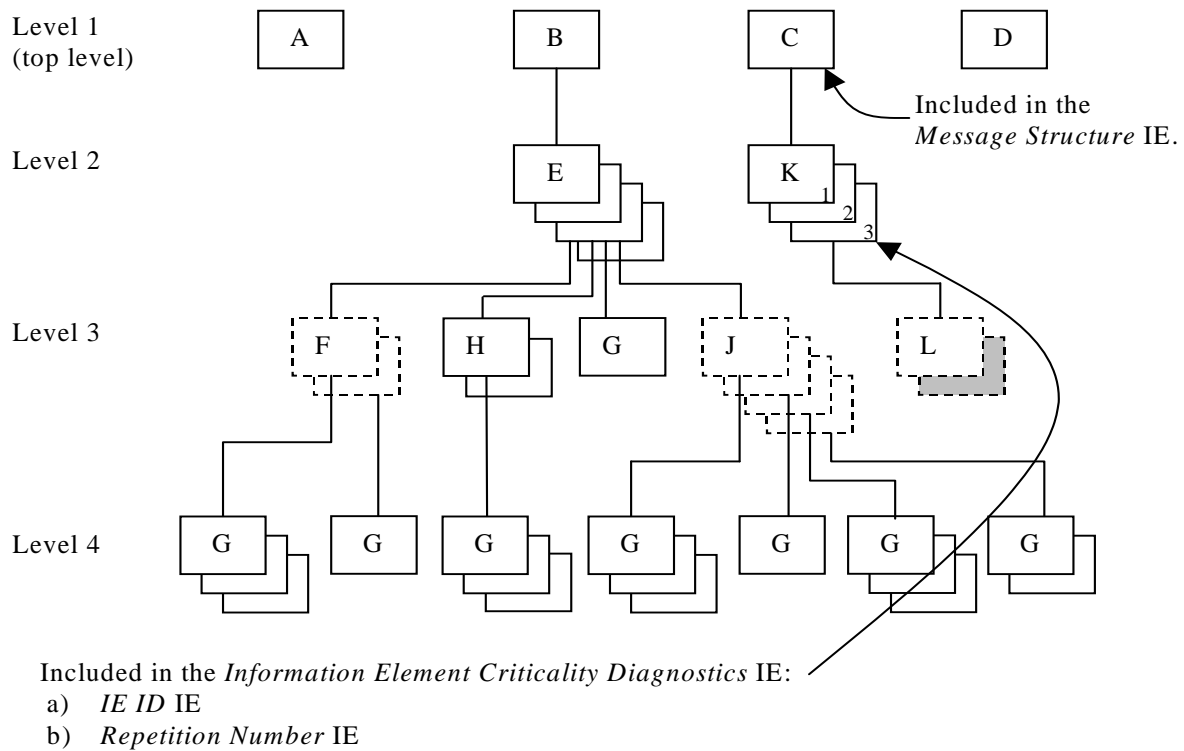

Figure C.3: Example of a received RNSAP message containing a not comprehended IE

If there is an error within the second instance (marked as grey) in the sequence (IE L in the tabular format) on level 3 below IE K in the structure shown in the figure C.3 above, this will be reported within the *Information Element Criticality Diagnostics* IE within the *Criticality Diagnostics* IE as follows:

IE name	Value	Comment
IE Criticality	ignore and notify	Criticality for IE on the reported level, i.e. level 2.
IE ID	id-K	IE ID from the reported level, i.e. level 2.
Repetition Number	3	Repetition number on the reported level, i.e. level 2.
Type of Error	not understood	
<i>Message Structure, first repetition</i>		
>IE ID	id-C	IE ID from the lowest level above the reported level, i.e. level 1.

Note 4. The IE L on level 3 cannot be reported individually included in the *Message Structure* IE since it has no criticality of its own.

C.3.3 Example 3

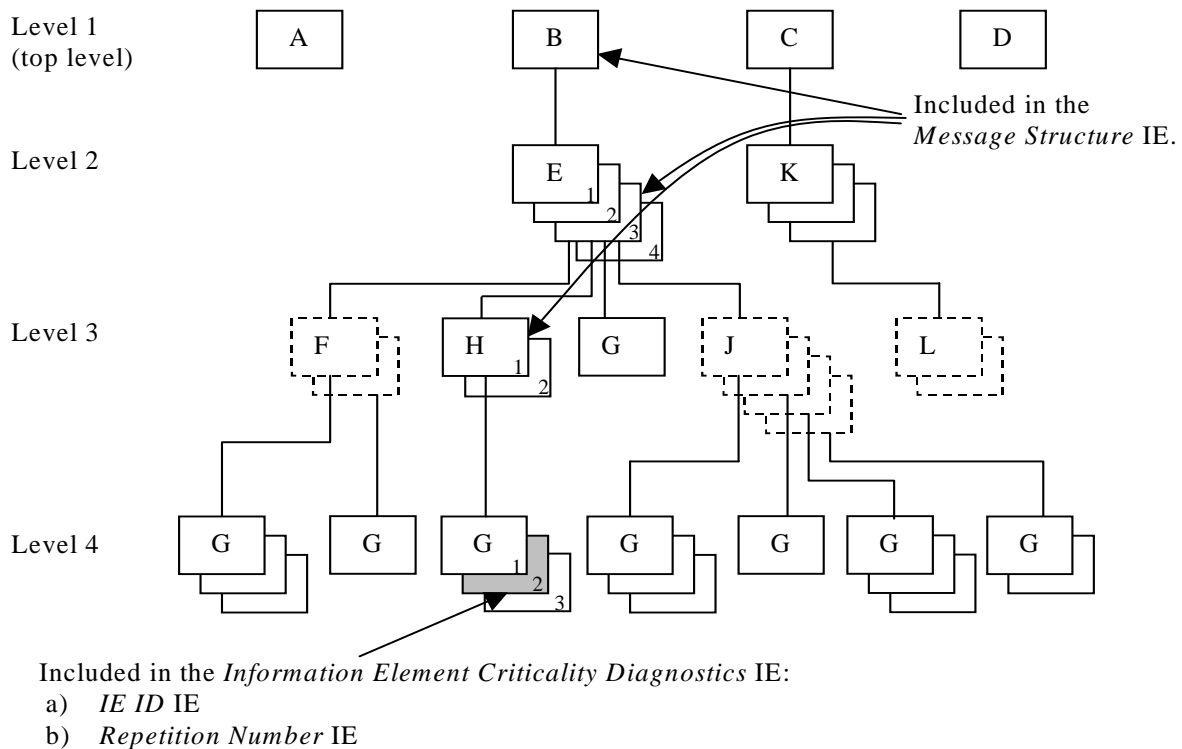

Figure C.4: Example of a received RNSAP message containing a not comprehended IE

If there is an error within the instance marked as grey in the IE G in the IE H shown in the figure C.4 above, this will be reported within the *Information Element Criticality Diagnostics* IE within the *Criticality Diagnostics* IE as follows:

IE name	Value	Comment
IE Criticality	ignore and notify	Criticality for IE on the reported level, i.e. level 4.
IE ID	id-G	IE ID from the reported level, i.e. level 4.
Repetition Number	2	Repetition number on the reported level, i.e. level 4.
Type of Error	not understood	
<i>Message Structure, first repetition</i>		
>IE ID	id-B	IE ID from level 1.
<i>Message Structure, second repetition</i>		
>IE ID	id-E	IE ID from level 2.
>Repetition Number	3	Repetition number from level 2.
<i>Message Structure, third repetition</i>		
>IE ID	id-H	IE ID from the lowest level above the reported level, i.e. level 3.
>Repetition Number	1	Repetition number from the lowest level above the reported level, i.e. level 3.

Note 5. The repetition number of level 4 indicates the number of repetitions of IE G received up to the detected erroneous repetition, counted below the same instance of the previous level with assigned criticality (instance 1 of IE H on level 3).

C.3.4 Example 4

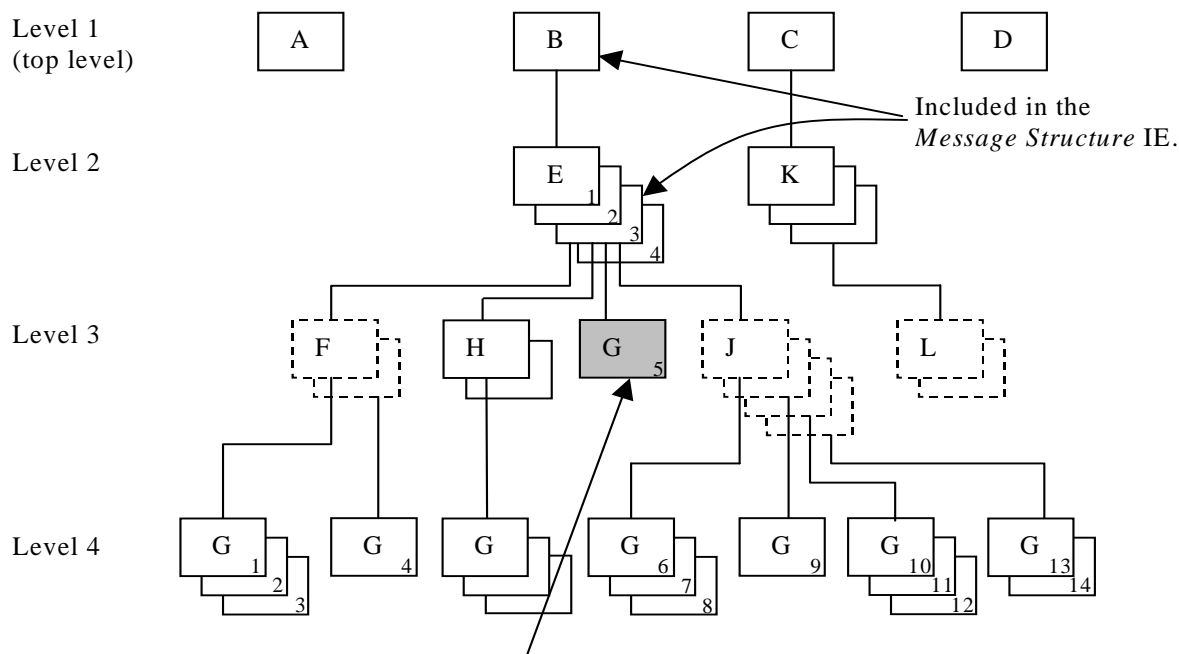

Included in the *Information Element Criticality Diagnostics IE*:

- a) *IE ID IE*
- b) *Repetition Number IE*

Figure C.5: Example of a received RNSAP message containing a not comprehended IE

If there is an error within the instance marked as grey in the IE G in the IE E shown in the figure C.5 above, this will be reported within the *Information Element Criticality Diagnostics IE* within the *Criticality Diagnostics IE* as follows:

IE name	Value	Comment
IE Criticality	reject	Criticality for IE on the reported level, i.e. level 3.
IE ID	id-G	IE ID from the reported level, i.e. level 3.
Repetition Number	5	Repetition number on the reported level, i.e. level 3. (Since the IE E (level 2) is the lowest level included in the <i>Message Structure IE</i> this is the fifth occurrence of IE G within the IE E (level 2).
Type of Error	not understood	
<i>Message Structure, first repetition</i>		
>IE ID	id-B	IE ID from level 1.
<i>Message Structure, second repetition</i>		
>IE ID	id-E	IE ID from the lowest level above the reported level, i.e. level 2.
>Repetition Number	3	Repetition number from the lowest level above the reported level, i.e. level 2.

Note 6. The repetition number of the reported IE indicates the number of repetitions of IE G received up to the detected erroneous repetition, counting all occurrences of the IE G below the same instance of the previous level with assigned criticality (instance 3 of IE E on level 2).

C.3.5 Example 5

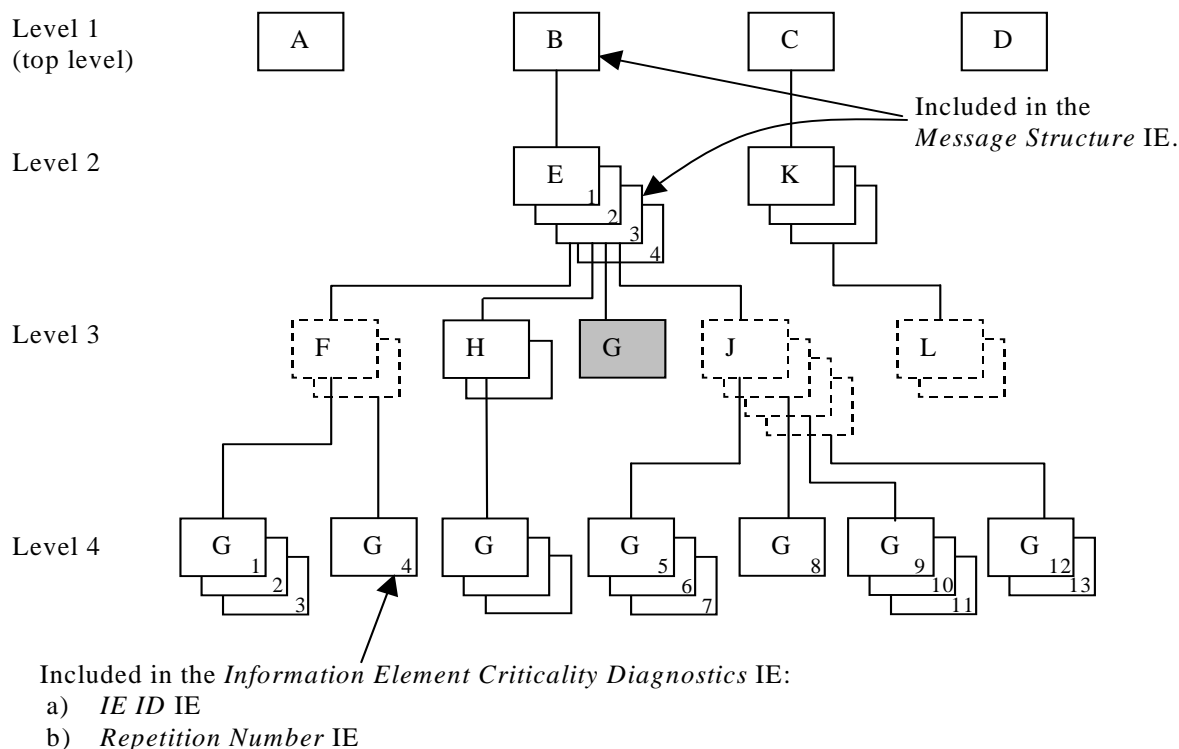

Figure C.6: Example of a received RNSAP message with a missing IE

If the instance marked as grey in the IE G in the IE E shown in the figure C.6 above, is missing this will be reported within the Information Element Criticality Diagnostics IE within the Criticality Diagnostics IE as follows:

IE name	Value	Comment
IE Criticality	reject	Criticality for IE on the reported level, i.e. level 3.
IE ID	id-G	IE ID from the reported level, i.e. level 3.
Repetition Number	4	Repetition number up to the missing IE on the reported level, i.e. level 3. (Since the IE E (level 2) is the lowest level included in the Message Structure IE there have been four occurrences of IE G within the IE E (level 2) up to the missing occurrence.
Type of Error	missing	
Message Structure, first repetition		
>IE ID	id-B	IE ID from level 1.
Message Structure, second repetition		
>IE ID	id-E	IE ID from the lowest level above the reported level, i.e. level 2.
>Repetition Number	3	Repetition number from the lowest level above the reported level, i.e. level 2.

Note 7. The repetition number of the reported IE indicates the number of repetitions of IE G received up to but not including the missing occurrence, counting all occurrences of the IE G below the same instance of the previous level with assigned criticality (instance 3 of IE E on level 2).

C.4 ASN.1 of EXAMPLE MESSAGE

```

ExampleMessage ::= SEQUENCE {
    ProtocolIEs          ProtocolIE-Container          {{ExampleMessage-IEs}},
    ProtocolExtensions  ProtocolExtensionContainer    {{ExampleMessage-Extensions}} OPTIONAL,
    ...
}

ExampleMessage-IEs RNSAP-PROTOCOL-IES ::= {
    { ID id-A CRITICALITY reject TYPE A PRESENCE mandatory} |

```

```

    { ID id-B    CRITICALITY reject  TYPE B  PRESENCE mandatory } |
    { ID id-C    CRITICALITY reject  TYPE C  PRESENCE mandatory } |
    { ID id-D    CRITICALITY reject  TYPE D  PRESENCE mandatory } ,
    ...
}

B ::= SEQUENCE {
    e          E-List,
    iE-Extensions  ProtocolExtensionContainer { {B-ExtIEs} }  OPTIONAL,
    ...
}

B-ExtIEs RNSAP-PROTOCOL-EXTENSION ::= {
    ...
}

E-List ::= SEQUENCE (SIZE (1..maxE)) OF ProtocolIE-Single-Container { {E-IEs} }

E-Ies RNSAP-PROTOCOL-IES ::= {
    { ID id-E    CRITICALITY ignore  TYPE E  PRESENCE mandatory }
}

E ::= SEQUENCE {
    f          F-List,
    h          H-List,
    g          G-List1,
    j          J-List,
    iE-Extensions  ProtocolExtensionContainer { {E-ExtIEs} }  OPTIONAL,
    ...
}

E-ExtIEs RNSAP-PROTOCOL-EXTENSION ::= {
    ...
}

F-List ::= SEQUENCE (SIZE (1..maxF)) OF F

F ::= SEQUENCE {
    g          G-List2 OPTIONAL,
    iE-Extensions  ProtocolExtensionContainer { {F-ExtIEs} }  OPTIONAL,
    ...
}

F-ExtIEs RNSAP-PROTOCOL-EXTENSION ::= {
    ...
}

G-List2 ::= SEQUENCE (SIZE (1..3, ...)) OF ProtocolIE-Single-Container { {G2-IEs} }

G2-IEs RNSAP-PROTOCOL-IES ::= {
    { ID id-G    CRITICALITY ignore  TYPE G  PRESENCE mandatory }
}

H-List ::= SEQUENCE (SIZE (1..maxH)) OF ProtocolIE-Single-Container { {H-IEs} }

H-Ies RNSAP-PROTOCOL-IES ::= {
    { ID id-H    CRITICALITY ignore  TYPE H  PRESENCE mandatory }
}

H ::= SEQUENCE {
    g          G-List3 OPTIONAL,
    iE-Extensions  ProtocolExtensionContainer { {H-ExtIEs} }  OPTIONAL,
    ...
}

H-ExtIEs RNSAP-PROTOCOL-EXTENSION ::= {
    ...
}

G-List3 ::= SEQUENCE (SIZE (1..3, ...)) OF ProtocolIE-Single-Container { {G3-IEs} }

G3-IEs RNSAP-PROTOCOL-IES ::= {
    { ID id-G    CRITICALITY notify  TYPE G  PRESENCE mandatory }
}

G-List1 ::= ProtocolIE-Single-Container { {G1-IEs} }

G1-IEs RNSAP-PROTOCOL-IES ::= {

```

```

    { ID id-G    CRITICALITY reject  TYPE G  PRESENCE mandatory }
  }
J-List ::= SEQUENCE (SIZE (1..maxJ)) OF J
J ::= SEQUENCE {
    g                G-List4 OPTIONAL,
    iE-Extensions   ProtocolExtensionContainer { {J-ExtIEs} } OPTIONAL,
    ...
}
J-ExtIEs  RNSAP-PROTOCOL-EXTENSION ::= {
    ...
}
G-List4 ::= SEQUENCE (SIZE (1..3, ...)) OF ProtocolIE-Single-Container { {G4-IEs} }
G4-IEs  RNSAP-PROTOCOL-IES ::= {
    { ID id-G    CRITICALITY reject  TYPE G  PRESENCE mandatory }
}
C ::= SEQUENCE {
    k                K-List,
    iE-Extensions   ProtocolExtensionContainer { {C-ExtIEs} } OPTIONAL,
    ...
}
C-ExtIEs  RNSAP-PROTOCOL-EXTENSION ::= {
    ...
}
K-List ::= SEQUENCE (SIZE (1..maxK)) OF ProtocolIE-Single-Container { {K-IEs} }
K-IEs  RNSAP-PROTOCOL-IES ::= {
    { ID id-K    CRITICALITY notify  TYPE K  PRESENCE mandatory }
}
K ::= SEQUENCE {
    l                L-List,
    iE-Extensions   ProtocolExtensionContainer { {K-ExtIEs} } OPTIONAL,
    ...
}
K-ExtIEs  RNSAP-PROTOCOL-EXTENSION ::= {
    ...
}
L-List ::= SEQUENCE (SIZE (1..maxL)) OF L
L ::= SEQUENCE {
    m                M OPTIONAL,
    iE-Extensions   ProtocolExtensionContainer { {L-ExtIEs} } OPTIONAL,
    ...
}
L-ExtIEs  RNSAP-PROTOCOL-EXTENSION ::= {
    ...
}
ExampleMessage-Extensions  RNSAP-PROTOCOL-EXTENSION ::= {
    ...
}

```

Annex D (normative): DRNS Behaviour at SRNC or RNSAP Signalling Bearer Failure

This annex describes the DRNC actions in the event of SRNC or RNSAP Signalling Bearer failure when all or some of the UE Contexts related to the SRNC need to be removed in DRNC.

D.1 Detection of SRNC or RNSAP Signalling Bearer/Connection Failure

Termination of all or some of the UE Contexts in DRNC which are related to an SRNC may be triggered due to failure of SRNC, RNSAP Signalling Bearer or the Iur signalling connection of an UE(s).

D.1.1 Termination of all UE Contexts Related to a Specific SRNC

Termination of all UE Contexts in DRNC which are related to a specific SRNC is triggered if the RNSAP Signalling Bearer failure is detected by the RNSAP according to the procedure described in the sub-clause 4.5.1.5.1 of TS 25.420. By "all" UE Contexts, it means all Ues having dedicated and/or common channel resources.

D.1.2 Termination of Specific UE Context

Termination of a specific UE Context in DRNC is triggered for an UE which has dedicated transport channel resources according to the procedure described in the sub-clause 4.5.1.5.2 of TS 25.420.

D.2 DRNC Actions at UE Context Termination

When termination of the UE Context is required, the DRNC shall remove any common and/or dedicated radio resources related to the UE Context. The DRNC shall also initiate release of the dedicated or common user plane resources that were involved in these UE contexts. In addition, if it is possible the DRNC shall release the RRC connection.

Annex E (informative): Change History

TSG #	TSG Doc.	CR	Rev	Subject/Comment	New
09/2009	-	-	-	Release 9 version created based on v8.6.0	9.0.0
45	RP-090777	1521	2	Introduction of UE AMBR concept in UMTS	9.0.0
45	RP-090774	1528	1	Introduction of TxAA extension for non-MIMO Ues	9.0.0
45	RP-090772	1529	2	Introduction of Dual-Band HSDPA	9.0.0
45	RP-090773	1536	1	Introduction of MIMO for DC HSDPA	9.0.0
46	RP-091188	1540	-	Introduction of Cell Portion for 1.28 Mcps TDD	9.1.0
46	RP-091187	1541	1	Single Stream MIMO for DC-HSDPA	9.1.0
46	RP-091186	1542	-	Activation and deactivation of secondary carrier in non serving Node B	9.1.0
46	RP-091182	1544	1	Correction of abnormal conditions for Dual cell HS-DSCH in RL Addition procedure	9.1.0
46	RP-091180	1551	1	Clarification of the meaning of BIT STRING type IEs for SPS operation for 1.28Mcps TDD	9.1.0
46	RP-091181	1558	1	MAC-e Reset Indicator for MAC-I Reset	9.1.0
46	RP-091182	1560	-	Further Corrections for DC-HSDPA	9.1.0
46	RP-091179	1563	1	Wrong ref in tabular	9.1.0
46	RP-091179	1567		STTD is cell specific in Dual-Cell HSDPA	9.1.0
46	RP-091186	1568	2	Introduction of Dual Cell E-DCH mode of operation	9.1.0
46	RP-091187	1571		Removal of MAC-ehs format indicator	9.1.0
46	RP-091179	1573		Correction on IE "E-AGCH Table Choice"	9.1.0
46	RP-091186	1574	1	Introduction of Re9 HSPA Capability into RNSAP	9.1.0
47	RP-100215	1576		Addition of HS-DSCH physical layer category over lur	9.2.0
47	RP-100219	1577	1	E-RNTI Allocation for UE moves to Cell_FACH from Cell_DCH	9.2.0
47	RP-100215	1579		Allow reconfiguration of some Ies in RL Addition procedure	9.2.0
47	RP-100219	1581		Correction of DC-HSDPA Capability in lur	9.2.0
47	RP-100218	1584		Correction for the description of E-DCH serving radio link IE for E-DCH semi-persistent operation	9.2.0
47	RP-100215	1586		Combining E-DCH Radio Links within the RLS	9.2.0
47	RP-100220	1587	1	Correction of Multi-cell Capability Report in lur	9.2.0
47	RP-100230	1588	2	Introduction of HS-PDSCH resources on TS0 for 1.28Mcps TDD	9.2.0
47	RP-100217	1591	3	Correction to state transition of Enhanced CELL_FACH UE for LCR TDD	9.2.0
47	RP-100230	1592	2	Rel-9 Flexible cell combinations in DC-HSDPA	9.2.0
47	RP-100230	1593	1	Addition of DGNSS Validity Period in RNSAP	9.2.0
47	RP-100229	1594	1	Introduction of UE Aggregate Maximum Bit Rate Enforcement Indicator	9.2.0
47	RP-100218	1596	1	Synchronization detection window configuration in CPC for 1.28 Mcps TDD	9.2.0
47	RP-100230	1597	2	Measurement occasion configuration in CELL_DCH for 1.28Mcps TDD	9.2.0
47	RP-100216	1601		Correction for Procedural Text on E-RNTI Allocation at E-DCH Serving Cell Change	9.2.0
47	RP-100199	1604		Indication of Precoding Weight Set Restriction preference	9.2.0
47	RP-100229	1605		Rapporteur's update of RNSAP protocol	9.2.0
47	RP-100224	1606	3	Corrections to DC HSUPA	9.2.0
47	RP-100221	1608		Remove Cell Specific HARQ memory partitioning for DC HSDPA+MIMO and additional corrections for HS-DSCH preconfiguration	9.2.0
04/2010				Corrected a typo in ASN.1 to make it pass the syntax checker	9.2.1
04/2010				ToC updated	9.2.2
04/2010				Corrupted headers fixed	9.2.3
48	RP-100592	1618	1	CPC parameters missing for serving HS-DSCH RL change in RL Addition procedure	9.3.0
48	RP-100593	1622		Correction of procedure text that appears to be duplicated and mis-placed	9.3.0
48	RP-100594	1625	2	CQI Feedback Cycle k for DC-HSDPA and MIMO operation	9.3.0
48	RP-100591	1629		Correction when the power offset for S-CPICH for MIMO is zero	9.3.0
48	RP-100545	1631		Correction for Enhanced Serving Cell Change	9.3.0
49	RP-100904	1633	1	Clarification of 64 QAM usage at intra Node B serving HS-DSCH RL change	9.4.0
49	RP-100909	1634	2	Corrections to HSDPA secondary serving cell list handling	9.4.0
49	RP-100905	1637		Correction of procedure text for E-DCH SPS operation	9.4.0
49	RP-100904	1641		Addition of UE with enhanced HS-SCCH support indicator IE for Cell_FACH	9.4.0
50	RP-101269	1646		Corrections to E-DCH MAC-d Flow Multiplexing for 1.28Mcps TDD	9.5.0
50	RP-101269	1649	1	Correction of Inactivity Threshold for UE DRX Cycle for 1.28Mcps TDD	9.5.0
50	RP-101271	1651	1	Power Offset For S-CPICH for MIMO of secondary cell	9.5.0
SP-49	SP-100629			Clarification on the use of References (TS 21.801 CR#0030)	9.6.0
51	RP-110222	1659	1	Addition of Measurement Power Offset in ESCC procedure over lur	9.6.0
52	RP-110681	1676	1	Misalignment between message tabular and ASN.1 for Idle Interval Information IE	9.7.0
52	RP-110681	1684	2	UE support indicator for DL secondary HS-DSCH activation state according to RRC Rel-9	9.7.0
54	RP-111645	1723	2	Support of dynamic HS-SCCH order for DTXDRX	9.8.0
55	RP-120231	1737	1	The role of RNC in RNSAP Reset procedure	9.9.0

History

Document history		
V9.1.0	February 2010	Publication
V9.2.3	April 2010	Publication
V9.3.0	July 2010	Publication
V9.4.0	October 2010	Publication
V9.5.0	March 2011	Publication
V9.6.0	May 2011	Publication
V9.7.0	July 2011	Publication
V9.8.0	January 2012	Publication
V9.9.0	April 2012	Publication