

# ETSI TS 125 425 V12.1.0 (2014-09)



**Universal Mobile Telecommunications System (UMTS);  
UTRAN Iur interface user plane protocols  
for Common Transport Channel data streams  
(3GPP TS 25.425 version 12.1.0 Release 12)**



---

**Reference**

RTS/TSGR-0325425vc10

---

**Keywords**

UMTS

**ETSI**

---

650 Route des Lucioles  
F-06921 Sophia Antipolis Cedex - FRANCE

Tel.: +33 4 92 94 42 00 Fax: +33 4 93 65 47 16

Siret N° 348 623 562 00017 - NAF 742 C  
Association à but non lucratif enregistrée à la  
Sous-Préfecture de Grasse (06) N° 7803/88

---

**Important notice**

The present document can be downloaded from:

<http://www.etsi.org>

The present document may be made available in electronic versions and/or in print. The content of any electronic and/or print versions of the present document shall not be modified without the prior written authorization of ETSI. In case of any existing or perceived difference in contents between such versions and/or in print, the only prevailing document is the print of the Portable Document Format (PDF) version kept on a specific network drive within ETSI Secretariat.

Users of the present document should be aware that the document may be subject to revision or change of status. Information on the current status of this and other ETSI documents is available at

<http://portal.etsi.org/tb/status/status.asp>

If you find errors in the present document, please send your comment to one of the following services:

[http://portal.etsi.org/chaicor/ETSI\\_support.asp](http://portal.etsi.org/chaicor/ETSI_support.asp)

---

**Copyright Notification**

No part may be reproduced or utilized in any form or by any means, electronic or mechanical, including photocopying and microfilm except as authorized by written permission of ETSI.

The content of the PDF version shall not be modified without the written authorization of ETSI.

The copyright and the foregoing restriction extend to reproduction in all media.

© European Telecommunications Standards Institute 2014.

All rights reserved.

**DECT™**, **PLUGTESTS™**, **UMTS™** and the ETSI logo are Trade Marks of ETSI registered for the benefit of its Members. **3GPP™** and **LTE™** are Trade Marks of ETSI registered for the benefit of its Members and of the 3GPP Organizational Partners.

**GSM®** and the GSM logo are Trade Marks registered and owned by the GSM Association.

---

## Intellectual Property Rights

IPRs essential or potentially essential to the present document may have been declared to ETSI. The information pertaining to these essential IPRs, if any, is publicly available for **ETSI members and non-members**, and can be found in ETSI SR 000 314: *"Intellectual Property Rights (IPRs); Essential, or potentially Essential, IPRs notified to ETSI in respect of ETSI standards"*, which is available from the ETSI Secretariat. Latest updates are available on the ETSI Web server (<http://ipr.etsi.org>).

Pursuant to the ETSI IPR Policy, no investigation, including IPR searches, has been carried out by ETSI. No guarantee can be given as to the existence of other IPRs not referenced in ETSI SR 000 314 (or the updates on the ETSI Web server) which are, or may be, or may become, essential to the present document.

---

## Foreword

This Technical Specification (TS) has been produced by ETSI 3rd Generation Partnership Project (3GPP).

The present document may refer to technical specifications or reports using their 3GPP identities, UMTS identities or GSM identities. These should be interpreted as being references to the corresponding ETSI deliverables.

The cross reference between GSM, UMTS, 3GPP and ETSI identities can be found under <http://webapp.etsi.org/key/queryform.asp>.

---

## Modal verbs terminology

In the present document "**shall**", "**shall not**", "**should**", "**should not**", "**may**", "**may not**", "**need**", "**need not**", "**will**", "**will not**", "**can**" and "**cannot**" are to be interpreted as described in clause 3.2 of the [ETSI Drafting Rules](#) (Verbal forms for the expression of provisions).

"**must**" and "**must not**" are **NOT** allowed in ETSI deliverables except when used in direct citation.

# Contents

Intellectual Property Rights .....	2
Foreword.....	2
Modal verbs terminology.....	2
Foreword.....	7
1 Scope .....	8
2 References .....	8
3 Definitions, symbols and abbreviations .....	8
3.1 Definitions .....	8
3.2 Symbols.....	8
3.3 Abbreviations .....	9
3.4 Specification Notations .....	9
4 General Aspects.....	10
4.1 Common Transport Channel Data Streams User Plane Protocol Services .....	10
4.1.1 RACH Data Streams User Plane Protocol Services.....	10
4.1.2 FACH Data Streams User Plane Protocol Services .....	11
4.1.3 USCH/DSCH Data Streams User Plane Protocol Services [TDD].....	11
4.1.4 HS-DSCH Data Streams User Plane Protocol Services.....	11
4.1.5 E-DCH for CELL_FACH and Idle Data Streams User Plane Protocol Services [FDD and 1.28Mcps TDD].....	11
4.2 Services expected from the Data Transport Network layer.....	11
4.3 Protocol Version.....	11
5 Common Transport Channel Data Streams User Plane Procedures.....	11
5.1 Data Transfer.....	12
5.1.1 RACH Data Transfer .....	12
5.1.2 FACH Data Transfer.....	12
5.1.3 USCH Data Transfer [TDD].....	13
5.1.4 DSCH Data Transfer [TDD].....	13
5.1.5 HS-DSCH Data Transfer .....	14
5.1.6 E-DCH for CELL_FACH and Idle Data Transfer [FDD and 1.28Mcps TDD].....	15
5.1.7 Indication of UE State Transition [1.28Mcps TDD].....	15
5.1.8 HS-DSCH UL Synchronization Establishment Failure [1.28Mcps TDD].....	15
5.2 Flow Control .....	16
5.2.1 FACH Flow Control .....	16
5.2.2 DSCH Capacity Request [TDD] .....	16
5.2.3 DSCH Capacity Allocation [TDD].....	17
5.2.4 FACH Capacity Request.....	17
5.2.5 HS-DSCH Capacity Request .....	18
5.2.6 HS-DSCH Capacity Allocation .....	18
5.2A Node Synchronisation .....	19
5.3 General .....	19
5.3.1 DSCH / USCH transport bearer replacement [TDD].....	19
5.3.2 HS-DSCH Transport Bearer Replacement .....	20
5.4 HS-DSCH PDU DROP INDICATION.....	20
6 Frame Structure and Coding.....	21
6.1 General .....	21
6.2 Data Frame structure .....	22
6.2.1 RACH Channels .....	22
6.2.2 FACH Channels.....	23
6.2.3 USCH Channels [TDD] .....	24
6.2.4 DSCH Channels [TDD] .....	24
6.2.4A HS-DSCH Channels .....	24

6.2.4B	E-DCH for CELL_FACH and Idle Channels [FDD and 1.28Mcps TDD]	27
6.2.5	Coding of Information Elements in DATA FRAMES	29
6.2.5.1	Header CRC	29
6.2.5.2	Frame Type (FT)	29
6.2.5.3	DRNTI	29
6.2.5.4	S-RNTI	29
6.2.5.5	UE-ID Type Indicator (UE-ID Type)	29
6.2.5.6	S-CCPCH Indicator (S-CI)	29
6.2.5.7	Common Transport Channel Priority Indicator (CmCH-PI)	29
6.2.5.8	MAC-c/sh SDU Length	30
6.2.5.9	NumOfSDU	30
6.2.5.10	Propagation delay [FDD]	30
6.2.5.10A	Ext Propagation Delay [FDD]	30
6.2.5.11	Rx Timing Deviation [3.84Mcps TDD]	30
6.2.5.11A	Received SYNC UL Timing Deviation [1.28Mcps TDD]	31
6.2.5.11B	Rx Timing Deviation [7.68Mcps TDD]	31
6.2.5.12	User Buffer Size	31
6.2.5.13	MAC-c/sh SDU	31
6.2.5.14	Payload CRC	31
6.2.5.15	Spare Extension	31
6.2.5.16	MAC-d PDU Length	31
6.2.5.17	NumOfPDU	32
6.2.5.18	MAC-d PDU	32
6.2.5.19	Cell Portion ID [FDD]	32
6.2.5.20	New IE Flags	32
6.2.5.21	Flush	32
6.2.5.22	DRT (Delay Reference Time)	32
6.2.5.23	Frame Sequence Number	33
6.2.5.24	Logical Channel ID in block n	33
6.2.5.25	Total Number of PDU blocks	33
6.2.5.26	MAC-d PDU length in block n	33
6.2.5.27	Number of MAC-d PDUs in block n (#PDUs in block n)	33
6.2.5.28	DRT Indicator	33
6.2.5.29	FACH Indicator (FI) [FDD and 1.28Mcps TDD]	34
6.2.5.30	S-RNTI [FDD and 1.28Mcps TDD]	34
6.2.5.31	UE-ID Type Indicator (UE-ID Type)	34
6.2.5.32	FSN/DRT Reset	34
6.2.5.33	MAC-d Type 2 PDU	34
6.2.5.34	PCH Indicator (PI) [FDD]	34
6.2.5.35	DRX Cycle Length Coefficient [FDD]	34
6.2.5.36	Number of Subframes [FDD and 1.28Mcps TDD]	35
6.2.5.37	Number of MAC-is SDU in frame [FDD and 1.28Mcps TDD]	35
6.2.5.38	Number of MAC-is PDUs [FDD and 1.28Mcps TDD]	35
6.2.5.39	Subframe Number [FDD and 1.28Mcps TDD]	35
6.2.5.40	E-DCH User Buffer Size [FDD and 1.28Mcps TDD]	35
6.2.5.41	MAC-is PDU descriptor [FDD and 1.28Mcps TDD]	36
6.2.5.42	eDRX Indication [FDD]	36
6.2.5.43	Cell Portion LCR ID [1.28Mcps TDD]	36
6.2.5.44	TS0 Indication [1.28Mcps TDD]	36
6.2.5.45	MU-MIMO Indication(MI) [1.28Mcps TDD]	36
6.2.5.46	CPC Recovery (CPC Recov) [FDD]	36
6.2.5.47	FeDRX Indication [FDD]	36
6.2.5.48	NodeB Triggered HS-DPCCH Transmission(NTHT) [FDD]	36
6.2.5.49	TTI length [FDD]	37
6.2.5.50	SN, Frame Number	37
6.2.5.51	S/D, Store/Discard indicator	37
6.2.5.52	Connection Frame Number (CFN)	37
6.2.5.53	CR Ind (Cell Reselection Indication)	37
6.2.5.54	CRR Rec (Cell Reselection Request Received)	37
6.3	Control Frame structure	37
6.3.1	Introduction	37
6.3.2	Header structure of the control frames	38

6.3.2.1	Control frame CRC .....	38
6.3.2.2	Frame type (FT) .....	38
6.3.2.3	Control Frame Type .....	38
6.3.3	Payload structure and information elements .....	39
6.3.3.1	FACH FLOW CONTROL .....	39
6.3.3.1.1	S-RNTI .....	39
6.3.3.1.2	Common Transport Channel Priority Indicator (CmCH-PI) .....	39
6.3.3.1.3	Credits .....	39
6.3.3.1.4	Spare Extension .....	39
6.3.3.2	DSCH CAPACITY REQUEST [TDD] .....	39
6.3.3.2.1	Common Transport Channel Priority Indicator (CmCH-PI) .....	39
6.3.3.2.2	User Buffer Size .....	40
6.3.3.2.3	Spare Extension .....	40
6.3.3.3	DSCH CAPACITY ALLOCATION [TDD] .....	40
6.3.3.3.1	Common Transport Channel Priority Indicator (CmCH-PI) .....	40
6.3.3.3.2	Maximum MAC-c/sh SDU Length .....	40
6.3.3.3.3	Credits .....	40
6.3.3.3.4	Interval .....	40
6.3.3.3.5	Repetition Period .....	41
6.3.3.3.6	Spare Extension .....	41
6.3.3.4	FACH CAPACITY REQUEST .....	41
6.3.3.4.1	D-RNTI .....	41
6.3.3.4.2	Common Transport Channel Priority Indicator (CmCH-PI) .....	41
6.3.3.4.3	User Buffer Size .....	41
6.3.3.4.4	Spare extension .....	41
6.3.3.5	HS-DSCH CAPACITY REQUEST .....	41
6.3.3.5.1	Common Transport Channel Priority Indicator (CmCH-PI) .....	42
6.3.3.5.2	User Buffer Size .....	42
6.3.3.5.3	Spare Extension .....	42
6.3.3.5.4	DRNTI [FDD] .....	42
6.3.3.6	HS-DSCH CAPACITY ALLOCATION .....	42
6.3.3.6.1	Common Transport Channel Priority Indicator (CmCH-PI) .....	43
6.3.3.6.2	Maximum MAC-d PDU Length .....	43
6.3.3.6.3	HS-DSCH Credits .....	43
6.3.3.6.4	HS-DSCH Interval .....	44
6.3.3.6.5	HS-DSCH Repetition Period .....	44
6.3.3.6.8	Spare Extension .....	44
6.3.3.6.9	Congestion Status .....	44
6.3.3.6.10	SRNTI Indicator [FDD and 1.28Mcps TDD] .....	44
6.3.3.6.11	S-RNTI [FDD and 1.28Mcps TDD] .....	44
6.3.3.6.12	Maximum MAC-d PDU Length Type 2 .....	44
6.3.3.7	DL NODE SYNCHRONISATION .....	45
6.3.3.7.1	Payload structure .....	45
6.3.3.7.2	T1 .....	45
6.3.3.7.3	Spare Extension .....	45
6.3.3.8	UL NODE SYNCHRONISATION .....	45
6.3.3.8.1	Payload structure .....	45
6.3.3.8.2	T1 .....	45
6.3.3.8.3	T2 .....	46
6.3.3.8.4	T3 .....	46
6.3.3.8.5	Spare Extension .....	46
6.3.3.9	HS-DSCH UL SYNCHRONIZATION ESTABLISHMENT FAILURE [1.28Mcps TDD] .....	46
6.3.3.9.1	Payload structure .....	46
6.3.3.9.2	S-RNTI .....	46
6.3.3.10	HS-DSCH PDU DROP INDICATION .....	46
6.3.3.10.1	Payload structure .....	46
6.3.3.10.2	Drop Reason .....	47
6.3.3.10.3	PDU Index .....	47
7	Handling of Unknown, Unforeseen and Erroneous Protocol Data .....	47
7.1	General .....	47

**Annex A (informative):**      **Change History** .....48  
History .....49

---

# Foreword

This Technical Specification (TS) has been produced by the 3<sup>rd</sup> Generation Partnership Project (3GPP).

The contents of the present document are subject to continuing work within the TSG and may change following formal TSG approval. Should the TSG modify the contents of the present document, it will be re-released by the TSG with an identifying change of release date and an increase in version number as follows:

Version x.y.z

where:

- x the first digit:
  - 1 presented to TSG for information;
  - 2 presented to TSG for approval;
  - 3 or greater indicates TSG approved document under change control.
- y the second digit is incremented for all changes of substance, i.e. technical enhancements, corrections, updates, etc.
- z the third digit is incremented when editorial only changes have been incorporated in the document.



---

# 1 Scope

The present document shall provide a description of the UTRAN RNS-RNS (Iur) interface user plane protocols for Common Transport Channel data streams as agreed within the TSG-RAN working group 3.

---

## 2 References

The following documents contain provisions which, through reference in this text, constitute provisions of the present document.

- References are either specific (identified by date of publication, edition number, version number, etc.) or non-specific.
- For a specific reference, subsequent revisions do not apply.
- For a non-specific reference, the latest version applies. In the case of a reference to a 3GPP document (including a GSM document), a non-specific reference implicitly refers to the latest version of that document *in the same Release as the present document*.

[1]	Void
[2]	Void
[3]	Void
[4]	Void
[5]	3GPP TS 25.401: "UTRAN overall description".
[6]	Void
[7]	3GPP TS 25.321: "Medium Access Control (MAC) protocol specification".
[8]	3GPP TS 25.423: "UTRAN Iur Interface RNSAP Signalling".
[9]	3GPP TS 25.321: "Medium Access Control (MAC) protocol specification".
[10]	3GPP TS 25.224: "Physical layer procedures (TDD)".

---

## 3 Definitions, symbols and abbreviations

### 3.1 Definitions

For the purposes of the present document, the terms and definitions in TS 25.401 [5] and the following apply:

**Common Transport Channel:** it is defined as a transport channel that is shared by several users i.e. DSCH [TDD], USCH [TDD], RACH, FACH [FDD and 1.28Mcps TDD -], E-DCH for CELL\_FACH and Idle] and HS-DSCH.

**Transport Connection:** service provided by the transport layer and used by Frame Protocol for the delivery of FP PDU

### 3.2 Symbols

No special symbols are defined in the present document.

### 3.3 Abbreviations

For the purposes of the present document, the following abbreviations apply:

CFN	Connection Frame Number
CmCH	Common Transport Channel
C-RNC	Controlling Radio Network Controller
CRC	Cyclic Redundancy Checksum
DCH	Dedicated Transport Channel
DL	Downlink
D-RNTI	Drift RNTI
DRT	Delay Reference Time
DSCH	Downlink Shared Channel
E-DCH	Enhanced Dedicated Transport Channel
FACH	Forward Access Channel
FP	Frame Protocol
FT	Frame Type
FSN	Frame Sequence Number
HSDPA	High Speed Downlink Packet Access
HS-DSCH	High Speed Downlink Shared Channel
RACH	Random Access Channel
RNC	Radio Network Controller
RNTI	Radio Network Temporary Identity
SRNC	Serving Radio Network Controller
S-RNTI	Serving RNTI
SSCS	Service Specific Convergence Sublayer
TB	Transport Block
TBS	Transport Block Set
TFI	Transport Format Indicator
TNL	Transport Network Layer
ToA	Time of Arrival
TTI	Transmission Time Interval
UE	User Equipment
UL	Uplink
U-RNTI	UTRAN RNTI
USCH	Uplink Shared Channel

### 3.4 Specification Notations

For the purposes of the present document, the following notations apply:

[FDD]	This tagging of a word indicates that the word preceding the tag "[FDD]" applies only to FDD. This tagging of a heading indicates that the heading preceding the tag "[FDD]" and the section following the heading applies only to FDD.
[TDD]	This tagging of a word indicates that the word preceding the tag "[TDD]" applies only to TDD, including 7.68Mcps TDD, 3.84Mcps TDD and 1.28Mcps TDD. This tagging of a heading indicates that the heading preceding the tag "[TDD]" and the section following the heading applies only to TDD, including 7.68Mcps TDD, 3.84Mcps TDD and 1.28Mcps TDD.
[7.68Mcps TDD]	This tagging of a word indicates that the word preceding the tag '[7.68Mcps TDD]' applies only to 7.68Mcps TDD. This tagging of a heading indicates that the heading preceding the tag '[7.68Mcps TDD]' and the section following the heading applies only to 7.68Mcps TDD.
[3.84Mcps TDD]	This tagging of a word indicates that the word preceding the tag '[3.84Mcps TDD]' applies only to 3.84Mcps TDD. This tagging of a heading indicates that the heading preceding the tag '[3.84Mcps TDD]' and the section following the heading applies only to 3.84Mcps TDD.

[1.28Mcps TDD]	This tagging of a word indicates that the word preceding the tag "[1.28Mcps TDD]" applies only to 1.28Mcps TDD. This tagging of a heading indicates that the heading preceding the tag "[1.28Mcps TDD]" and the section following the heading applies only to 1.28Mcps TDD.
[FDD - ...]	This tagging indicates that the enclosed text following the "[FDD - " applies only to FDD. Multiple sequential paragraphs applying only to FDD are enclosed separately to enable insertion of TDD specific (or common) paragraphs between the FDD specific paragraphs.
[TDD - ...]	This tagging indicates that the enclosed text following the "[TDD - " applies only to TDD including 7.68Mcps TDD, 3.84Mcps TDD and 1.28Mcps TDD. Multiple sequential paragraphs applying only to TDD are enclosed separately to enable insertion of FDD specific (or common) paragraphs between the TDD specific paragraphs.
[7.68Mcps TDD - ...]	This tagging indicates that the enclosed text following the "[7.68Mcps TDD - " applies only to 7.68Mcps TDD. Multiple sequential paragraphs applying only to 7.68Mcps TDD are enclosed separately to enable insertion of FDD and TDD specific (or common) paragraphs between the 7.68Mcps TDD specific paragraphs.
[3.84Mcps TDD - ...]	This tagging indicates that the enclosed text following the "[3.84Mcps TDD - " applies only to 3.84Mcps TDD. Multiple sequential paragraphs applying only to 3.84Mcps TDD are enclosed separately to enable insertion of FDD and TDD specific (or common) paragraphs between the 3.84Mcps TDD specific paragraphs.
[1.28Mcps TDD - ...]	This tagging indicates that the enclosed text following the "[1.28Mcps TDD - " applies only to 1.28Mcps TDD. Multiple sequential paragraphs applying only to 1.28Mcps TDD are enclosed separately to enable insertion of FDD and TDD specific (or common) paragraphs between the 1.28Mcps TDD specific paragraphs.
Procedure	When referring to a procedure in the specification, the Procedure Name is written with the first letters in each word in upper case characters followed by the word "procedure", e.g. FACH Data Transfer procedure.
Frame	When referring to a control or data frame in the specification, the CONTROL/DATA FRAME NAME is written with all letters in upper case characters followed by the words "control/data frame", e.g. FACH FLOW CONTROL control frame.
IE	When referring to an information element (IE) in the specification, the <i>Information Element Name</i> is written with the first letters in each word in upper case characters and all letters in Italic font followed by the abbreviation "IE", e.g. <i>Credits</i> IE.
Value of an IE	When referring to the value of an information element (IE) in the specification, the "Value" is written as it is specified in subclause 6.2.5 or 6.3.3 enclosed by quotation marks, e.g. "0" or "255".

---

## 4 General Aspects

### 4.1 Common Transport Channel Data Streams User Plane Protocol Services

This subclause describes the services that the User Plane Protocols provide such as data transfer, flow control.

#### 4.1.1 RACH Data Streams User Plane Protocol Services

RACH frame protocol provides the following services:

- Transport of MAC-c/sh SDUs from the DRNC to the SRNC for RACH common transport channels.

### 4.1.2 FACH Data Streams User Plane Protocol Services

FACH frame protocol provides the following services:

- Transport of MAC-c/sh SDUs from the SRNC to the DRNC for FACH common transport channel.
- Flow Control between MAC-d and MAC-c/sh.

### 4.1.3 USCH/DSCH Data Streams User Plane Protocol Services [TDD]

[TDD USCH]/DSCH frame protocol provides the following services:

- Transport of MAC-c/sh SDUs between the SRNC and the DRNC for [TDD USCH] and DSCH common transport channels.
- Flow Control between MAC-d and MAC-c/sh.

### 4.1.4 HS-DSCH Data Streams User Plane Protocol Services

HS-DSCH frame protocol provides the following services:

- Transport of MAC-d flows between the SRNC and the DRNC for HS-DSCH common transport channels.
- Flow Control between MAC-d and CRNC HS-DSCH Flow Control.

### 4.1.5 E-DCH for CELL\_FACH and Idle Data Streams User Plane Protocol Services [FDD and 1.28Mcps TDD]

E-DCH for CELL\_FACH and Idle frame protocol provides the following services:

- Transport of MAC-is PDUs in Cell\_FACH state between the DRNC and the SRNC for E-DCH common transport channels.

## 4.2 Services expected from the Data Transport Network layer

The following services are expected from the transport layer:

- Delivery of Frame Protocol PDUs.

In sequence delivery is not required. However, frequent out-of-sequence delivery may impact the performance and should be avoided.

## 4.3 Protocol Version

This revision of the specification specifies version 1 of the protocols.

---

# 5 Common Transport Channel Data Streams User Plane Procedures

This clause specifies the user plane procedures for Common Transport Channels data streams. Typical related scenarios at Iur interface should be described.

For the user plane of the radio network layer there are five Common Transport Channel frame handling protocols:

1. Random Access Channel/Common Packet Channel [FDD] Frame Protocol (RACH FP) for transport of Iur data streams carried on RACH on the Uu-interface.

2. Forward Access Channel Frame Protocol (FACH FP) for transport of Iur data streams carried on FACH on the Uu-interface.
3. Downlink Shared Channel Frame Protocol ([TDD - DSCH FP]) for transport of Iur data streams carried on DSCH on the Uu-interface.
4. Uplink Shared Channel Frame Protocol ([TDD - USCH] FP) for transport of Iur data streams carried on USCH on the Uu-interface.
5. High Speed Downlink Shared Channel Frame Protocol (HS-DSCH FP) for transport of Iur data streams carried on HS-DSCH on the Uu-interface.
6. [FDD and 1.28Mcps TDD - E-DCH for CELL\_FACH and Idle Frame Protocol (E-DCH for CELL\_FACH and Idle FP) for transport of Iur data streams carried on E-DCH in Cell\_FACH and Idle on Uu-Interface.]

## 5.1 Data Transfer

### 5.1.1 RACH Data Transfer

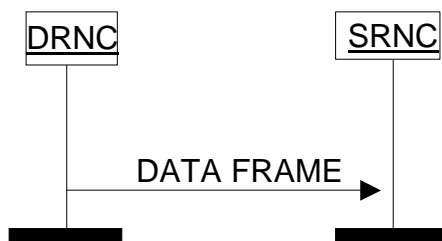

**Figure 1: RACH Data Transfer procedure**

Data received on the RACH transport channel is transmitted from the DRNC to the SRNC using RACH DATA FRAMES. The data is protected by a mandatory payload CRC. Multiple MAC-c/sh SDUs of same length may be transmitted in the same RACH DATA FRAME.

### 5.1.2 FACH Data Transfer

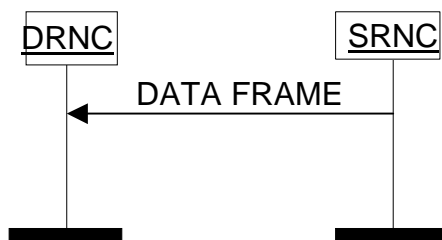
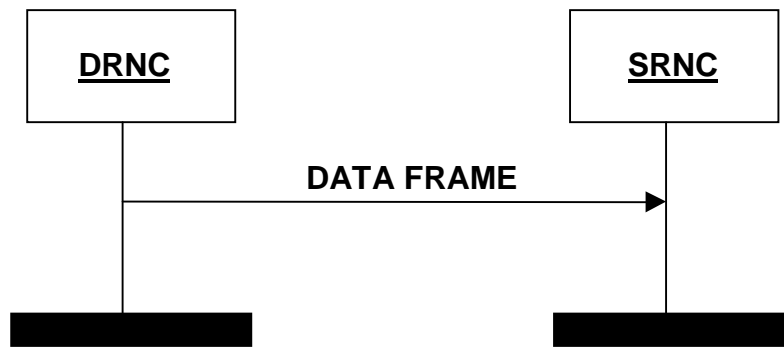

**Figure 2: FACH Data Transfer procedure**

Data to be transmitted on the FACH transport channel is transmitted from the SRNC to the DRNC using FACH DATA FRAMES. Multiple MAC-c/sh SDUs of same length and same priority level (CmCH-PI) may be transmitted in the same FACH DATA FRAME. Within one priority and size the MAC-c/sh SDUs shall be transmitted by the DRNS on the Uu interface in the same order as they were received from the SRNC.

The *UE-ID Type Indicator* IE indicates which UE-ID type MAC-c/sh shall include in the MAC header.

### 5.1.3 USCH Data Transfer [TDD]

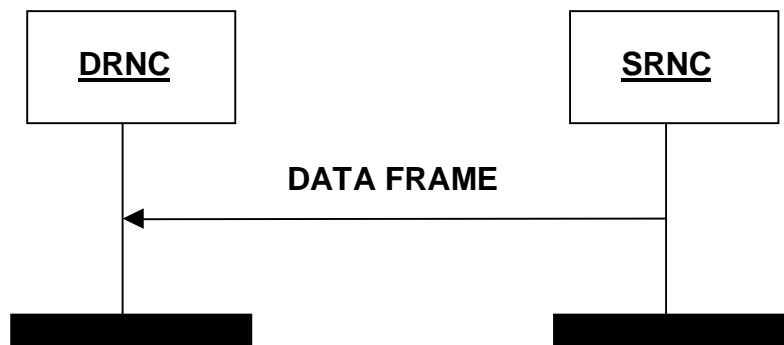

**Figure 3: USCH Data Transfer procedure**

Whenever there is USCH data in the DRNC, transfer is done immediately to the SRNC via the USCH Data Port using USCH DATA FRAMES.

Data received on the USCH transport channel is transmitted from the DRNC to the SRNC using USCH DATA FRAMES. The data is protected by a mandatory payload CRC. Multiple MAC-c/sh SDUs of same length may be transmitted in the same USCH DATA FRAME.

### 5.1.4 DSCH Data Transfer [TDD]



**Figure 4: DSCH Data Transfer procedure**

When the SRNC has been granted capacity by the DRNC via the DSCH CAPACITY ALLOCATION Control Frame or via the DSCH initial capacity allocation as described in TS 25.423 [8] and the SRNC has data waiting to be sent, then the DSCH DATA FRAME is used to transfer the data. If the SRNC has been granted capacity by the DRNC via the DSCH initial capacity allocation as described in TS 25.423 [8], this capacity is valid for only the first DSCH DATA FRAME transmission. When data is waiting to be transferred, and a CAPACITY ALLOCATION is received, a DATA FRAME will be transmitted immediately according to allocation received.

Multiple MAC-c/sh SDUs of same length and same priority level (CmCH-PI) may be transmitted in the same DSCH DATA FRAME.

The DSCH DATA FRAME includes a *User Buffer Size* IE to indicate the amount of data pending for the respective UE for the indicated priority level. Within one priority level and size the MAC-c/sh SDUs shall be transmitted by the DRNS on the Uu interface in the same order as they were received from the SRNC.

### 5.1.5 HS-DSCH Data Transfer

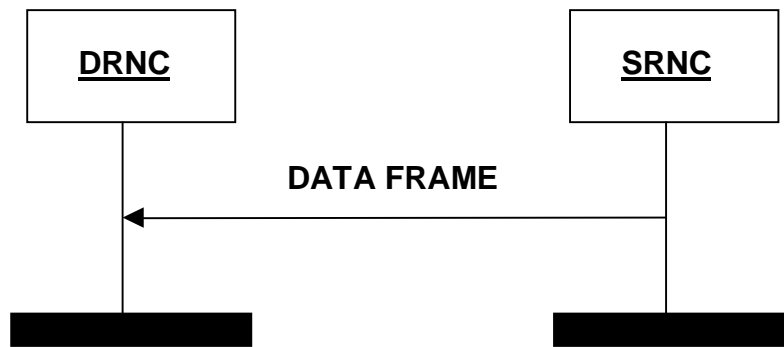

**Figure 4AA: HS-DSCH Data Transfer procedure**

The HS-DSCH Data Transfer procedure is used to transfer a HS-DSCH DATA FRAME (TYPE 1 or TYPE 2) from the SRNC to a DRNC. Two types of HS-DSCH Frame Protocols exist for HS-DSCH data transfer procedure, i.e., HS-DSCH Frame Protocol TYPE 1 (including HS-DSCH DATA FRAME TYPE 1 and HS-DSCH CAPACITY ALLOCATION TYPE 1 Control Frame) and HS-DSCH Frame Protocol TYPE 2 (including HS-DSCH DATA FRAME TYPE 2 and HS-DSCH CAPACITY ALLOCATION TYPE 2 Control Frame).

HS-DSCH DATA FRAME TYPE 2 is selected if the IE *HS-DSCH MAC-d PDU Size Format* in RNSAP (TS 25.423 [8]) is present and set to "Flexible MAC-d PDU Size" [FDD and 1.28Mcps TDD - or if the IE *Enhanced FACH Support Indicator* in RNSAP (TS 25.423 [8]) is present]. HS-DSCH DATA FRAME TYPE 1 is selected in any other case.

HS-DSCH CAPACITY ALLOCATION TYPE 1 Control Frame shall be associated only with HS-DSCH DATA FRAME TYPE 1 while HS-DSCH CAPACITY ALLOCATION TYPE 2 Control Frame shall be associated only with HS-DSCH DATA FRAME TYPE 2. HS-DSCH CAPACITY REQUEST Control Frame shall be used for both of HS-DSCH Frame Protocols. HS-DSCH Frame Protocol TYPE 2 is used for Flexible MAC-d PDU Size [FDD and 1.28Mcps TDD - and Enhanced FACH] as described in RNSAP (TS 25.423 [8]).

When the SRNC has been granted capacity by the DRNC via the HS-DSCH CAPACITY ALLOCATION (TYPE 1 or TYPE 2) Control Frame or via the HS-DSCH initial capacity allocation as described in TS 25.423 [8] and the SRNC has data waiting to be sent, then the HS-DSCH DATA FRAME (TYPE 1 or TYPE 2) is used to transfer the data. If the SRNC has been granted capacity by the DRNC via the HS-DSCH initial capacity allocation as described in TS 25.423 [8], this capacity is valid for only the first HS-DSCH DATA FRAME (TYPE 1 or TYPE 2) transmission. If the HS-DSCH Frame Protocol TYPE 2 has been selected by the DRNC, the granted capacity shall be interpreted as the total number of octets which is retrieved by multiplying the maximum MAC-d PDU length (indicated by the *Maximum MAC-d PDU Length Type 2* IE) with the number of MAC-d PDUs (indicated by the *HS-DSCH Credits* IE). When data is waiting to be transferred, and a CAPACITY ALLOCATION (TYPE 1 or TYPE 2) is received, a DATA FRAME (TYPE 1 or TYPE 2) will be transmitted immediately according to allocation received. If the allocation received is  $>0$  but less than the data waiting to be transferred, then the RNC may send one HS-DSCH DATA FRAME TYPE 2 containing one MAC-d PDU with a length up to the RNSAP *Maximum MAC-d PDU Size Extended* IE value. In such a case, the amount of data exceeding the allocated capacity for the first HS-DSCH Interval shall be credited from the following HS-DSCH Intervals, if available.

In case of HS-DSCH Frame Protocol TYPE 1, multiple MAC-d PDUs of same length and same priority level (CmCH-PI) may be transmitted in one MAC-d flow in the same HS-DSCH DATA FRAME TYPE 1.

In case of HS-DSCH Frame Protocol TYPE 2, MAC-d PDUs with the same logical channel ID shall be associated to one unique priority level (CmCH-PI).

The HS-DSCH DATA FRAME (TYPE 1 and TYPE 2) includes a *User Buffer Size* IE to indicate the amount of data pending for the respective MAC-d flow for the indicated priority level. Within one priority level (CmCH-PI) and size the MAC-d PDUs shall be transmitted by the DRNS on the Uu interface in the same order as they were received from the SRNC.

If the *Flush* IE in the HS-DSCH DATA FRAME (TYPE 1 and TYPE 2) is set to "flush" the DRNS should remove all MAC-d PDUs from the corresponding MAC-hs Priority Queue that have been received prior to this data frame on the same transport bearer.

For the purpose of TNL Congestion Control on HSDPA, the *Frame Sequence Number* and the *DRT* IEs may be included by the SRNC depending on higher layer configuration.

### 5.1.6 E-DCH for CELL\_FACH and Idle Data Transfer [FDD and 1.28Mcps TDD]

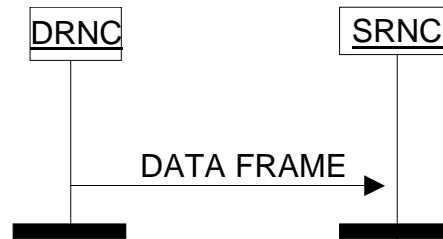

**Figure 4AB: E-DCH for CELL\_FACH and Idle Data Transfer procedure**

The E-DCH for CELL\_FACH and Idle Data Transfer procedure is used to transfer an E-DCH DATA FRAME from the DRNC to the SRNC.

### 5.1.7 Indication of UE State Transition [1.28Mcps TDD]

In 1.28Mcps TDD, for UE in CELL\_PCH or URA\_PCH states with stored H-RNTI, the network use the stored dedicated H-RNTI to inform the UE to establish the uplink synchronization via HS-SCCH before transmitting DCCH and DTCH to the UE. And when UE receives dedicated H-RNTI on HS-SCCH, the UE shall initiate the uplink synchronization procedure and transit to CELL\_FACH state. The serving DRNC shall send the UE State Transition Indication to SRNC to inform that the UE's state has been transited from CELL\_PCH/URA\_PCH to CELL\_FACH.

The UE State Transition Indication is indicated in a user data frame with values set as follows:

- The *CFN* and *Subframe Number* IE values shall reflect the time when the state transition was detected
- The *Number of MAC-is PDUs* IE shall be set to zero. As a consequence there are no *MAC-is PDU descriptor* IE and there are no *MAC-is PDUs* IEs in the payload part of the data frame related to UE state transition indication.

### 5.1.8 HS-DSCH UL Synchronization Establishment Failure [1.28Mcps TDD]



**Figure 4AC: HS-DSCH UL Synchronization Establishment Failure procedure**

In 1.28Mcps TDD, when the DRNC was notified by the Node B that the HS-DSCH data transmission to the UE in CELL\_FACH state is failed because of the uplink synchronization failure TS 25.224 [10], the DRNC could use HS-DSCH UL SYNCHRONIZATION ESTABLISHMENT FAILURE control frame to notify the SRNC to terminate the HS-DSCH data transmission.



## 5.2 Flow Control

### 5.2.1 FACH Flow Control

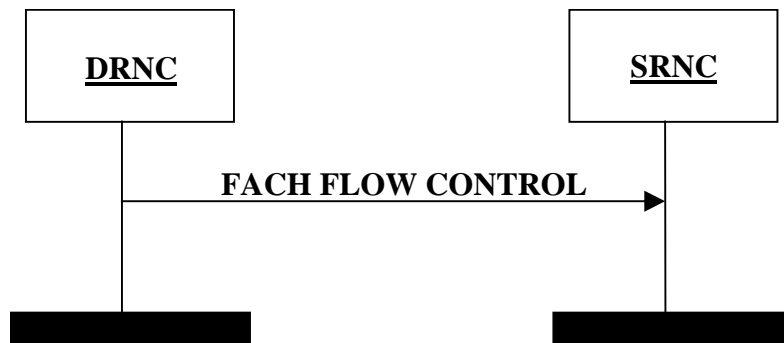

Figure 4A: FACH Flow Control procedure

The FACH Flow Control procedure is used by the DRNC to control the user data flow. It may be generated in response to a FACH Capacity Request procedure or at any other time. The *Credits* IE indicates the number of MAC-c/sh SDUs the SRNC is allowed to transmit for the UE identified by the *SRNTI* IE and the associated priority level indicated by the *Common Transport Channel Priority Indicator* IE.

The *Credits* IE indicates the total amount of credits granted. Any credits previously granted are withdrawn.

If *Credits* IE = 0 (e.g. due to congestion in the DRNC), the SRNC shall immediately stop transmission of MAC-c/sh SDUs.

*Credits* IE = 'unlimited' indicates that the SRNC may transmit an unlimited number of MAC-c/sh SDUs.

### 5.2.2 DSCH Capacity Request [TDD]

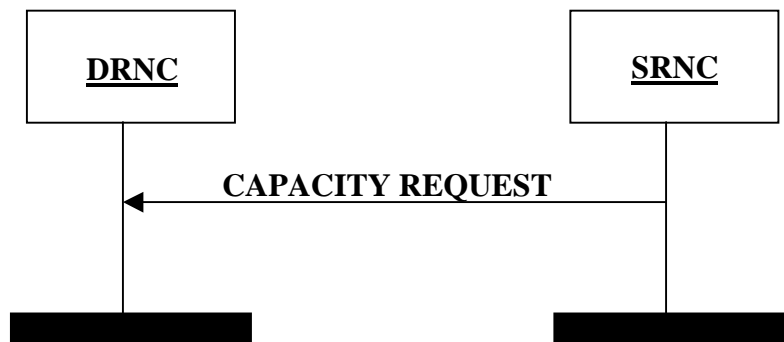

Figure 5: DSCH Capacity Request procedure

The DSCH Capacity Request procedure provides means for the SRNC to request DSCH capacity by indicating the user buffer size in the SRNC for a given priority level.

The SRNC is allowed to reissue the DSCH Capacity Request if no CAPACITY ALLOCATION has been received within an appropriate time threshold.

### 5.2.3 DSCH Capacity Allocation [TDD]

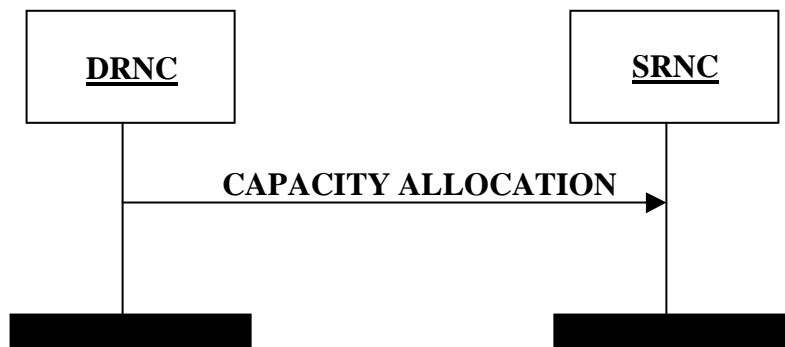

Figure 6: DSCH Capacity Allocation procedure

DSCH Capacity Allocation procedure is generated within the DRNC. It may be generated either in response to a DSCH Capacity Request or at any other time.

The DRNC may use this message to modify the capacity at any time, irrespective of the reported user buffer status.

The DSCH CAPACITY ALLOCATION frame is used by the DRNC to control the user data flow. *Credits* IE indicates the number of MAC-c/sh SDUs that the SRNC is allowed to transmit for the UE and the associated priority level indicated by the *Common Transport Channel Priority Indicator* IE.

The *Maximum MAC-c/sh SDU length*, *Credits*, *Interval* and *Repetition Period* IEs indicates the total amount of capacity granted. Any capacity previously granted is replaced.

If *Credits* IE = 0 (e.g. due to congestion in the DRNC), the SRNC shall immediately stop transmission of MAC-c/sh SDUs. If *Credits* IE = 255, the SRNC can transmit MAC-c/sh SDUs with unlimited capacity.

The IEs used in the DSCH CAPACITY ALLOCATION Control Frame are the *Common Transport Channel Priority Indicator*, *Credits*, *Maximum MAC-c/sh SDU Length*, *Interval* and the *Repetition Period*.

If the *Repetition Period* IE = 'unlimited repetition period' it indicates that the SRNC may transmit the specified number of MAC-c/sh SDUs for an unlimited period according to the bounds of *Maximum MAC-c/sh SDU Length*, *Credits* and *Interval* IEs.

### 5.2.4 FACH Capacity Request

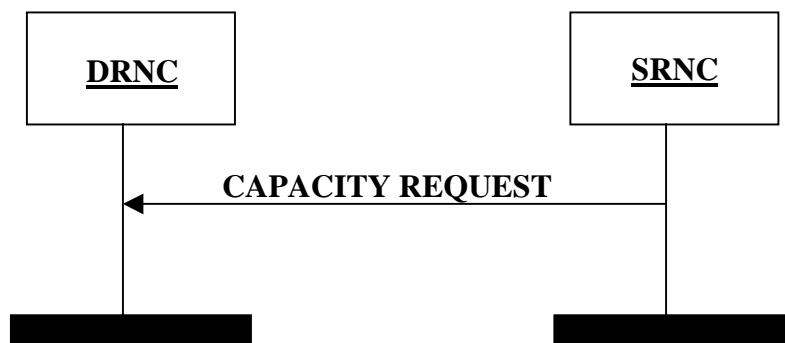

Figure 6A: FACH Capacity Request procedure

The FACH Capacity Request procedure provides the means for the SRNC to notify the DRNC about the user buffer size for a given priority level. It may be sent if no FACH FLOW CONTROL frame has been received within an appropriate time threshold, or to signal an event such as data arrival or user buffer discard.

## 5.2.5 HS-DSCH Capacity Request

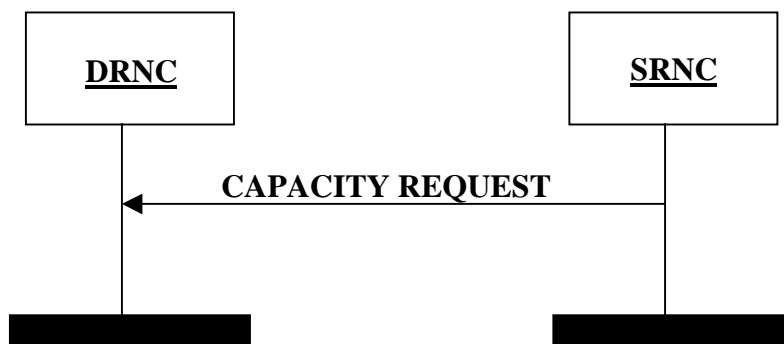

Figure 6B: HS-DSCH Capacity Request procedure

The HS-DSCH Capacity Request procedure provides means for the SRNC to request HS-DSCH capacity by indicating the user buffer size in the SRNC for a given priority level.

The SRNC is allowed to reissue the HS-DSCH Capacity Request if no CAPACITY ALLOCATION (TYPE 1 or TYPE 2) has been received within an appropriate time threshold.

## 5.2.6 HS-DSCH Capacity Allocation

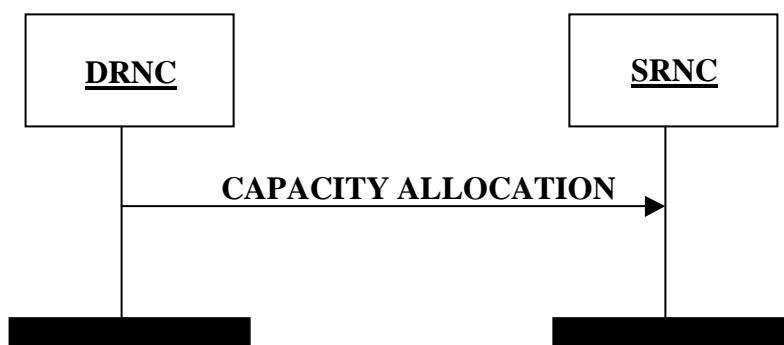

Figure 6C: HS-DSCH Capacity Allocation procedure

HS-DSCH Capacity Allocation procedure is generated within the DRNC. It may be generated either in response to a HS-DSCH Capacity Request or at any other time.

The DRNC may use this message to modify the capacity at any time, irrespective of the reported user buffer status.

The HS-DSCH CAPACITY ALLOCATION (TYPE 1 and TYPE 2) Control Frame are used by the DRNC to control the user data flow. In case of HS-DSCH Frame Protocol TYPE 1, *HS-DSCH Credits* IE indicates the number of MAC-d PDUs that the SRNC is allowed to transmit for the MAC-d flow and the associated priority level indicated by the *Common Transport Channel Priority Indicator* IE. In case of HS-DSCH Frame Protocol TYPE 2, the *HS-DSCH Credits* IE multiplied by the *Maximum MAC-d PDU Length Type 2* IE indicates the number of MAC-d PDU octets that the SRNC is allowed to transmit for the MAC-d flow and the associated priority level indicated by the *Common Transport Channel Priority Indicator* IE.

The *Maximum MAC-d PDU length* (in case of HS-DSCH Frame Protocol TYPE 1) or *Maximum MAC-d PDU Length Type 2* (in case of HS-DSCH Frame Protocol TYPE 2), *HS-DSCH Credits*, *HS-DSCH Interval* and *HS-DSCH Repetition Period* IEs indicates the total amount of capacity granted. Any capacity previously granted is replaced.

If *HS-DSCH Credits* IE = 0 (e.g. due to congestion in the DRNC), the SRNC shall immediately stop transmission of MAC-d PDUs. If *HS-DSCH Credits* IE = 2047 in case of HS-DSCH CAPACITY ALLOCATION TYPE 1 Control Frame or 65535 in case of HS-DSCH CAPACITY ALLOCATION TYPE 2 Control Frame, the SRNC can transmit MAC-d PDUs with unlimited capacity.

The IEs used in the HS-DSCH CAPACITY ALLOCATION (TYPE 1 and TYPE 2) Control Frame are the *Common Transport Channel Priority Indicator*, *HS-DSCH Credits*, *Maximum MAC-d PDU Length* (in case of HS-DSCH Frame

Protocol TYPE 1) or *Maximum MAC-d PDU Length Type 2* (in case of HS-DSCH Frame Protocol TYPE 2), *HS-DSCH Interval* and the *HS-DSCH Repetition Period*.

If the *HS-DSCH Repetition Period* IE = "unlimited repetition period" it indicates that the SRNC may transmit the amount of granted capacity for an unlimited period according to the bounds of *Maximum MAC-d PDU Length* IE (TYPE 1) or *Maximum MAC-d PDU length Type 2* IE (TYPE 2), *HS-DSCH Credits* IE and *HS-DSCH Interval* IE.

## 5.2A Node Synchronisation

The Node Synchronisation procedure is used by the SRNC to acquire information on the Node B timing.

The procedure is initiated by the SRNC by sending a DL NODE SYNCHRONISATION control frame containing the parameter T1 to the DRNS.

Upon reception of a DL NODE SYNCHRONISATION control frame, the DRNS shall respond with UL NODE SYNCHRONISATION control frame, including the parameters T2 and T3, as well as the T1 which was indicated in the initiating DL NODE SYNCHRONISATION control frame.

The T1, T2, T3 parameters are defined as:

- T1: RNC specific frame number (RFN) that indicates the time when RNC sends the DL NODE SYNCHRONISATION control frame through the SAP to the transport layer.
- T2: Node B specific frame number (BFN) that indicates the time when Node B receives the correspondent DL NODE SYNCHRONISATION control frame through the SAP from the transport layer.
- T3: Node B specific frame number (BFN) that indicates the time when Node B sends the UL NODE SYNCHRONISATION control frame through the SAP to the transport layer.

The general overview on the Node Synchronisation procedure is reported in TS 25.401 [5].

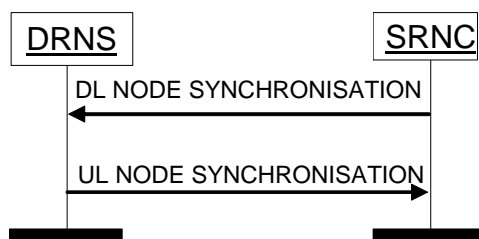

Figure 6D: Node Synchronisation procedure

## 5.3 General

### 5.3.1 DSCH / USCH transport bearer replacement [TDD]

As described in RNSAP (TS 25.423 [8]), transport bearer replacement can be achieved for a DSCH or USCH by using the Synchronised Radio Link Reconfiguration Preparation procedure in combination with the Synchronised Radio Link Reconfiguration Commit procedure. In both cases the following steps can be discerned:

- 1) The new transport bearer is established after which 2 transport bearers exist in parallel.
- 2) The transport channel(s) is/are switched to the new transport bearer.
- 3) The old transport bearer is released.

In step 1), communication on the old transport bearer continues as normal.

In step 2), the moment of switching is determined as follows:

- The DSCH DATA FRAMEs or USCH DATA FRAMEs shall be transported on the new transport bearer from the CFN indicated in the RADIO LINK RECONFIGURATION COMMIT message.

Starting from this CFN the RNCs shall support all the applicable Common Transport Channels frame protocol procedures on the new transport bearer and no requirements exist regarding support of Common Transport Channels frame protocol procedures on the old transport bearer.

Finally in step 3), the old transport bearer is released.

### 5.3.2 HS-DSCH Transport Bearer Replacement

As described in RNSAP (TS 25.423 [8]), transport bearer replacement can be achieved for a HS-DSCH MAC-d Flow by using the Synchronised Radio Link Reconfiguration Preparation procedure in combination with the Synchronised Radio Link Reconfiguration Commit procedure, or by using the Unsynchronised Radio Link Reconfiguration procedure. In both cases the following steps can be discerned:

- 1) The new transport bearer is established after which 2 transport bearers exist in parallel.
- 2) The HS-DSCH MAC-d Flow is switched to the new transport bearer.
- 3) The old transport bearer is released.

#### **HS-DSCH Transport Bearer Replacement, step 1:**

Communication on the old transport bearer continues as normal. In addition, the DRNS shall support HS-DSCH DATA FRAMEs (TYPE 1 or TYPE 2), the HS-DSCH CAPACITY REQUEST Control Frame (see sub-clause 5.2.5) and may support the HS-DSCH CAPACITY ALLOCATION (TYPE 1 or TYPE 2) Control Frame (see sub-clause 5.2.6) on the new transport bearer. HS-DSCH DATA FRAMEs (TYPE 1 or TYPE 2) transported on the new transport bearer shall be transmitted on the Uu Interface in the same way as those received on the old transport bearer (see sub-clause 5.1.5).

The DRNS may use the old or the new transport bearer for the HS-DSCH CAPACITY ALLOCATION (TYPE 1 or TYPE 2) Control Frame. The HS-DSCH CAPACITY ALLOCATION (TYPE 1 or TYPE 2) Control Frame indicates the total amount of capacity granted for the MAC-d flow and the indicated priority level, irrespective of the transport bearer used. Any capacity previously granted is replaced.

The SRNC may use the old or the new transport bearer for the HS-DSCH CAPACITY REQUEST Control Frame. The rules for reissuing a HS-DSCH CAPACITY REQUEST Control Frame as outlined in sub-clause 5.2.5 still apply.

#### **HS-DSCH Transport Bearer Replacement, step 2:**

Regarding step 2), the moment of switching is determined as follows:

Starting from the CFN indicated in the RADIO LINK RECONFIGURATION COMMIT message – or directly when using the unsynchronised Radio Link Reconfiguration procedure, the DRNS shall support all applicable Common Transport Channels frame protocol procedures on the new transport bearer and no requirements exist regarding support of Common Transport Channels frame protocol procedures on the old transport bearer.

#### **HS-DSCH Transport Bearer Replacement, step 3:**

Finally in step 3), the old transport bearer is released.

## 5.4 HS-DSCH PDU DROP INDICATION

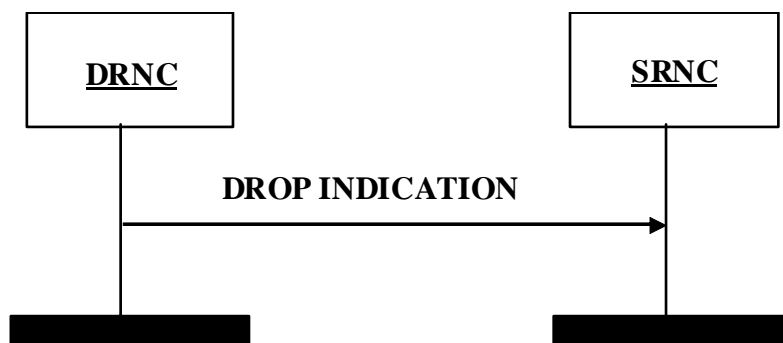

Figure 6E: HS-DSCH PDU DROP INDICATION procedure

The HS-DSCH PDU DROP INDICATION Control Frame is used by the DRNS to report to SRNC the PDU drop events. It is used when DRNS drops the PDUs. The content of the dropped PDU or Data Frame is available in the DRNS so in this case direct identification of the PDUs is possible.

## 6 Frame Structure and Coding

### 6.1 General

The general structure of a Common Transport Channel frame consists of a header and a payload. This structure is depicted in the figure 7.

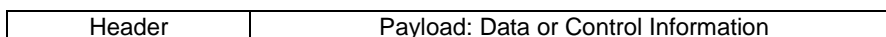

Figure 7: General Frame Structure

The header shall contain the frame type field and information related to the frame type.

There are two types of frames (indicated by the Frame Type field).

1. Data frame.
2. Control frame.

In the present document the structure of frames will be specified by using pictures similar to the following figure 8.

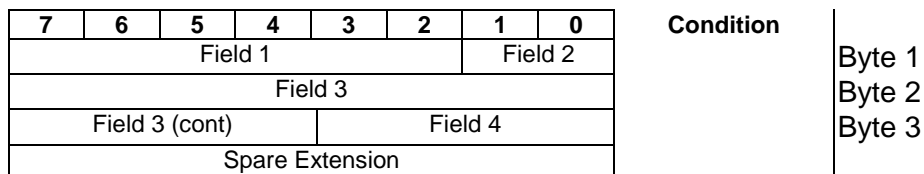

Figure 8: Example frame structure

Unless otherwise indicated, fields which consist of multiple bits within a byte will have the more significant bit located at the higher bit position (indicated above frame in figure 8). In addition, if a field spans several bytes, more significant bits will be located in lower numbered bytes (right of frame in figure 8).

On the Iur interface, the frame will be transmitted starting from the lowest numbered byte. Within each byte, the bits are sent according decreasing bit position (bit position 7 first).

The Spare Extension indicates the location where new IEs can in the future be added in a backward compatible way.

The Spare Extension shall not be used by the transmitter and shall be ignored by the receiver.

Spare bits shall be set to 0 by the transmitter and shall be ignored by the receiver.

The parameters are specified giving the value range and the step (if not 1). The coding is done as follows (unless otherwise specified):

- Lowest value (in the range) coded as a sequence of 0's;
- Highest value in the range coded as a sequence of 1's.

## 6.2 Data Frame structure

### 6.2.1 RACH Channels

RACH Iur data stream corresponds to the data stream of one specific UE. The used transport bearer for the transport of FACH/RACH or FACH is bi-directional.

The RACH/FACH FP does not facilitate multiplexing of data streams from different UEs onto the same data frame, but does allow multiple UEs to share the same transport bearer.

The RACH DATA FRAME structure is defined as common for FDD and TDD with conditional fields.

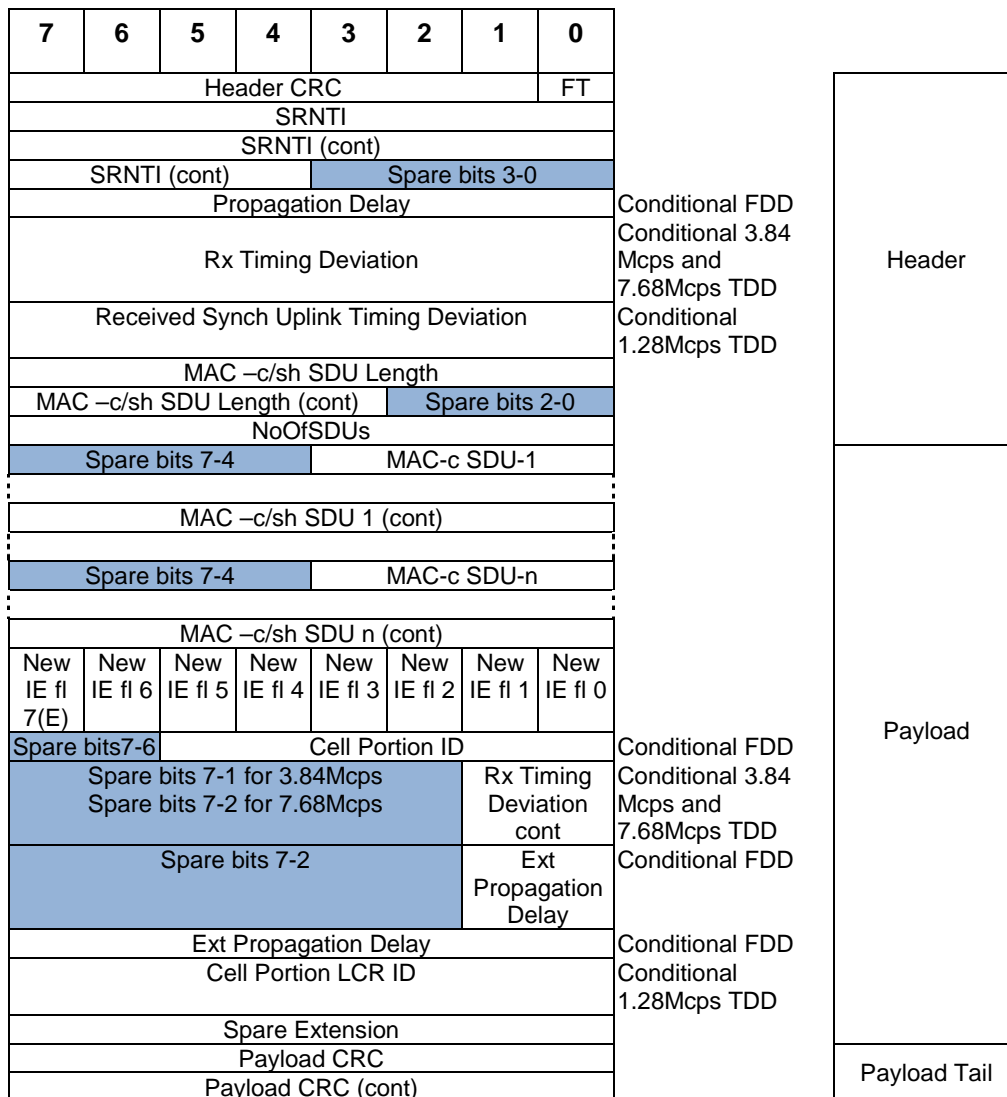

**Figure 9: RACH DATA FRAME structure**

Propagation delay is a conditional Information Element which is only present when the Cell supporting the RACH Transport Channel is a FDD Cell.

Rx Timing Deviation is a conditional Information Element which is only present when the Cell supporting the RACH Transport Channel is a 3.84 Mcps or 7.68 Mcps TDD Cell.

Received SYNC UL Timing Deviation is a conditional Information Element which is only present when the Cell supporting the RACH Transport Channel is a 1.28 Mcps TDD Cell.

With respect to new IEs, for which the presence is indicated by the *New IE Flags* IE, the Figure 9 is an example of how a frame is structured when all such new IEs are present. Note that non-presence of such a new IE changes the position of all subsequent IEs on octet level.

[FDD- Bit 0 of New IE Flags in RACH DATA FRAME indicates if a Cell Portion ID is present (1) or not present (0) in the byte (bits 0-5) following the *New IE Flags* IE.]

[FDD- Bit 1 of New IE Flags in RACH DATA FRAME indicates if the *Ext Propagation Delay* IE is present (1) or not present (0).]

[FDD - Bits 2 through 6 of New IE Flags in RACH DATA FRAME shall be set to 0.]

[FDD - Field length of *Spare Extension* IE in RACH DATA FRAME is 0-28 octets.]

[3.84 Mcps and 7.68 Mcps TDD - Bit 0 of New IE Flags in RACH DATA FRAME indicates if the extended bits of the Rx Timing Deviation are present (1) or not present (0) in the byte (bit 0 for 3.84 Mcps TDD, bits 0 and 1 for 7.68 Mcps TDD) following the *New IE Flags* IE. Bits 1 through 6 of New IE Flags in RACH DATA FRAME shall be set to 0. Field length of *Spare Extension* IE in RACH DATA FRAME is 0-30 octets.]

[1.28Mcps TDD - Bit 0 of New IE Flags in RACH DATA FRAME indicates if *Cell Portion LCR* IE is present (1) or not present (0)

[1.28Mcps TDD – Bits 1 through 6 of New IE Flags in RACH DATA FRAME shall be set to 0.]

[1.28Mcps TDD – Field length of Spare Extension IE in RACH DATA FRAME is 0-30 octets.]

### 6.2.2 FACH Channels

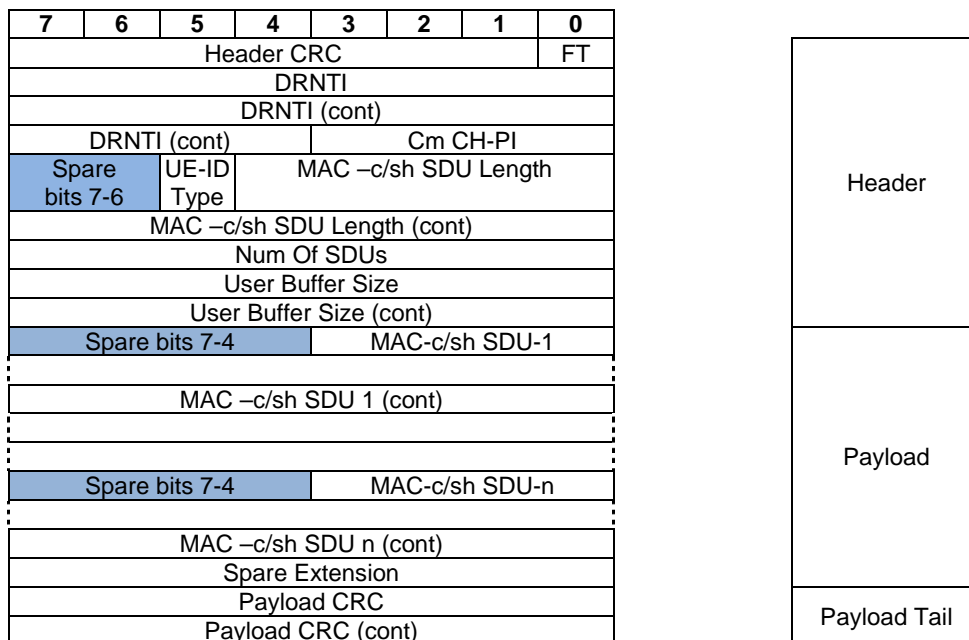

Figure 10: FACH DATA FRAME structure



### 6.2.3 USCH Channels [TDD]

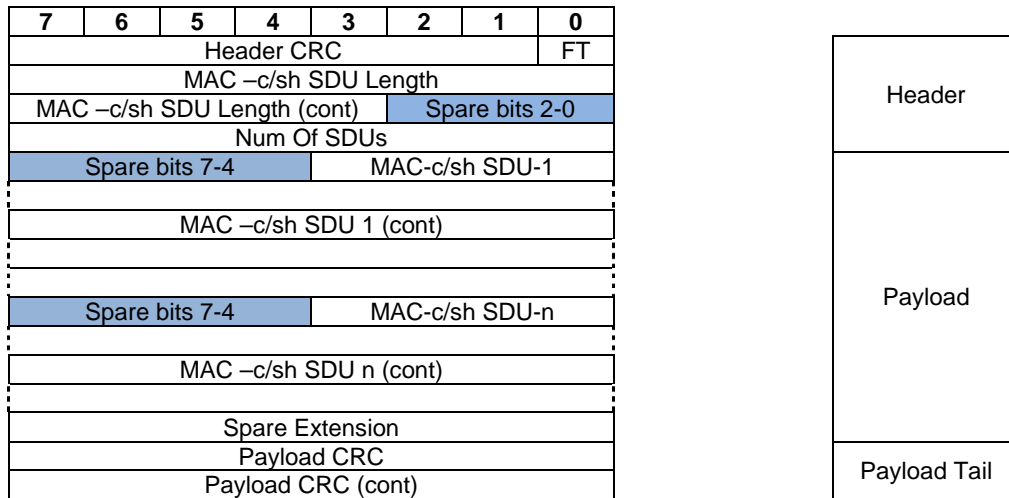

Figure 11: USCH DATA FRAME structure

### 6.2.4 DSCH Channels [TDD]

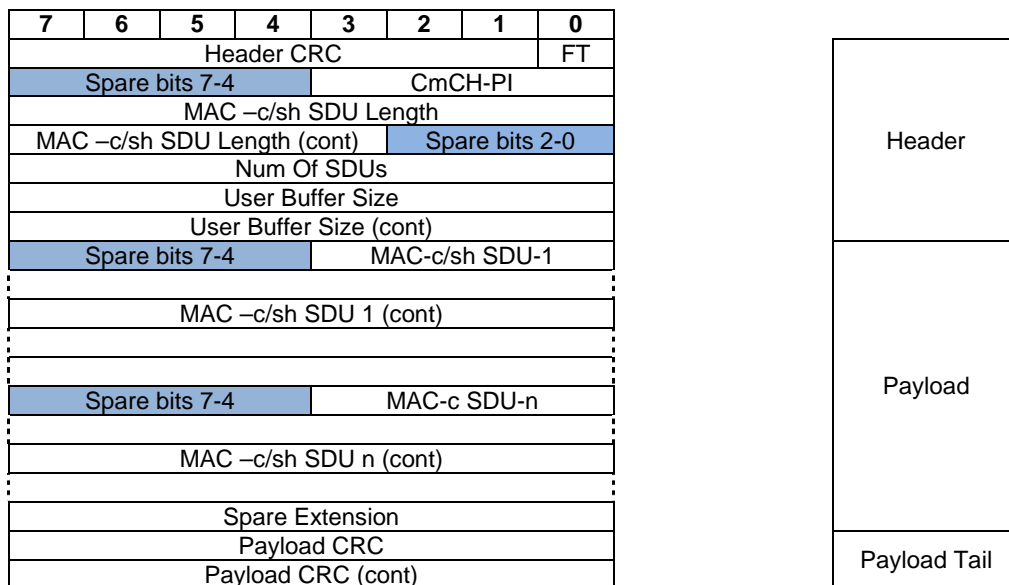
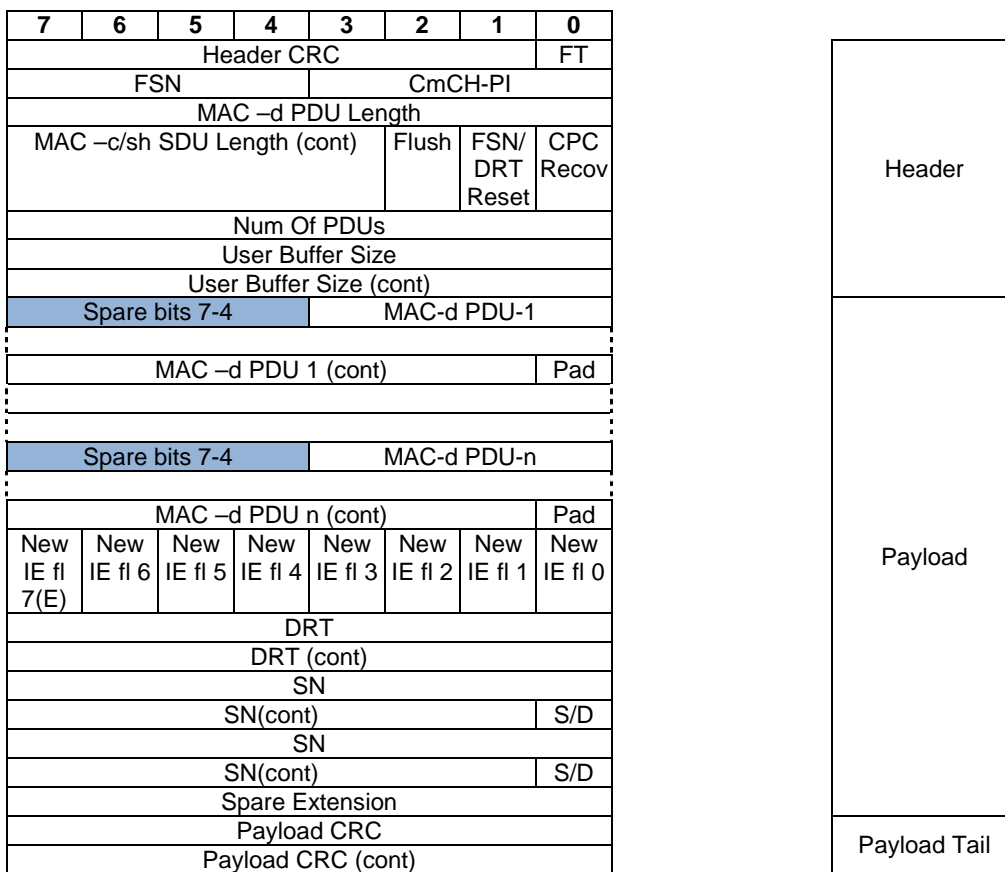

Figure 12: DSCH DATA FRAME structure

#### 6.2.4A HS-DSCH Channels

Two types of HS-DSCH DATA FRAME exist for the HS-DSCH data transfer, i.e. HS-DSCH DATA FRAME TYPE 1 and HS-DSCH DATA FRAME TYPE 2.



**Figure 12A: HS-DSCH DATA TYPE 1 FRAME structure**

Bit 0 of New IE Flags in HS-DSCH DATA FRAME TYPE 1 indicates if a DRT is present (1) or not (0) in the 2 octets following the *New IE Flags* IE. Bit 1 of New IE Flags in HS-DSCH DATA FRAME TYPE1 indicates if SN is present (1) or not (0) in the third and the forth octets following the *New IE Flags* IE. Bit 0 in the forth octet is allocated for IE S/D. Bit 2 of New IE Flags in HS-DSCH DATA FRAME TYPE1 indicates if SN is present (1) or not (0) in the fifth and the sixth octets following the *New IE Flags* IE. Bit 0 in the sixth octet is allocated for IE S/D. Bits 3 through 6 of New IE Flags in HS-DSCH DATA FRAME TYPE 1 shall be set to 0.

Field length of *Spare Extension* IE in HS-DSCH DATA FRAME TYPE 1 is 0-25 octets.

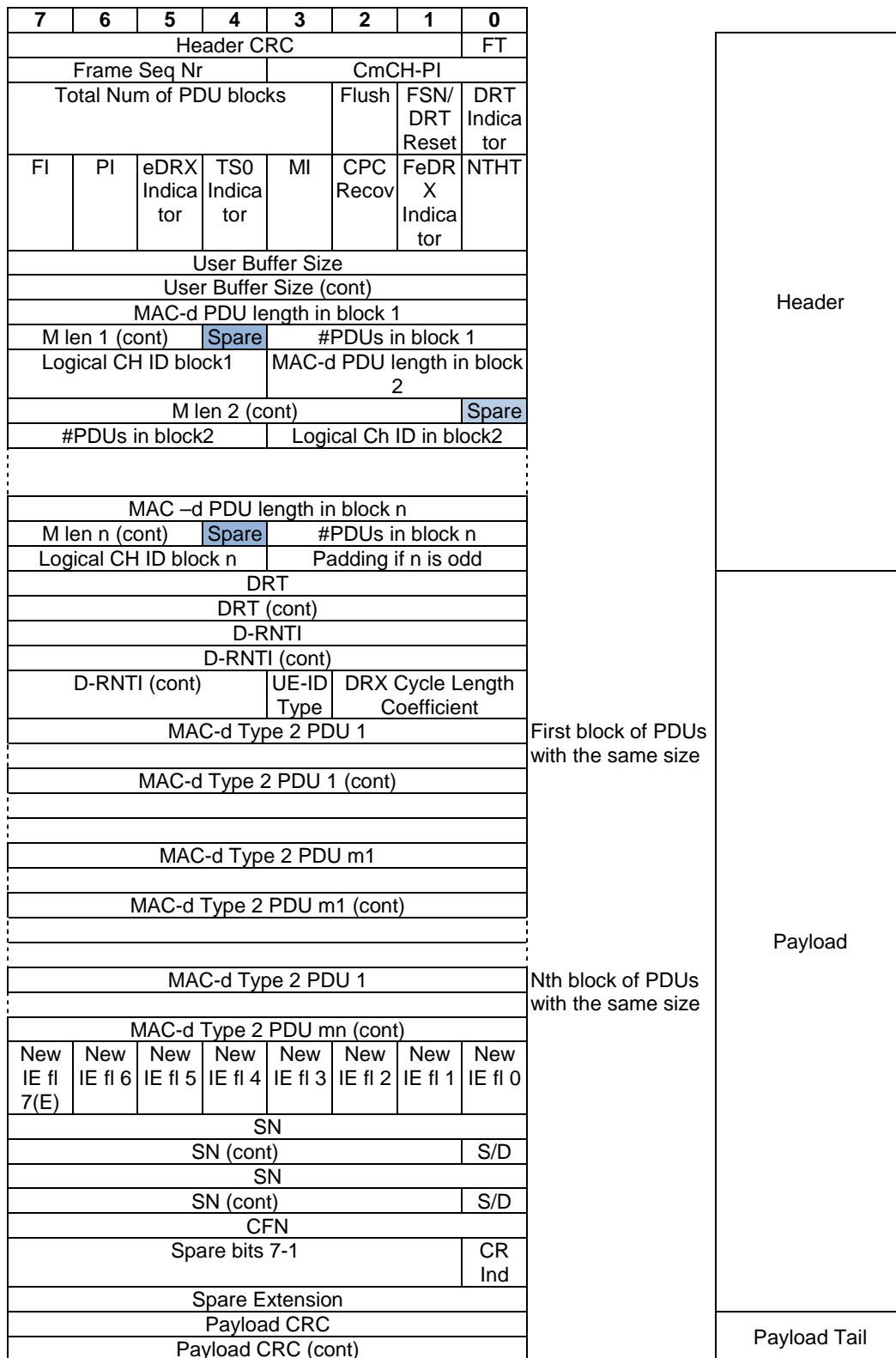

**Figure 12B: HS-DSCH DATA FRAME TYPE 2 structure**

Bit 0 of New IE Flags in HS-DSCH DATA FRAME TYPE 2 indicates if SN is present (1) or not (0) in the following 2 octets following the *New IE Flags* IE. Bit 0 in the 2nd octet is allocated for IE S/D. Bit 1 of New IE Flags in HS-DSCH DATA FRAME TYPE2 indicates if SN is present (1) or not (0) in the 3rd and the 4th octets following the *New IE Flags* IE. Bit 0 in the 4th octet is allocated for IE S/D.

Bit 2 of New IE Flags in HS-DSCH DATA FRAME TYPE 2 indicates if a CFN is present (1) or not (0) in the fifth octet following the *New IE Flags* IE.

Bit 3 of New IE Flags in HS-DSCH DATA FRAME TYPE 2 indicates if a *Cell Reselection Indication (CR Ind)* IE is present (1) or not (0) in the sixth octet following the *New IE Flags* IE. Bits 4 through 6 of New IE Flags in HS-DSCH DATA FRAME TYPE 2 shall be set to 0.

Field length of Spare Extension IE in HS-DSCH DATA FRAME TYPE 2 is 0-26 octets.

## 6.2.4B E-DCH for CELL\_FACH and Idle Channels [FDD and 1.28Mcps TDD]

The structure of the E-DCH DATA FRAME is shown in Figure 12C. This frame structure is used for carrying MAC-is PDUs in Cell\_FACH and Idle state (TS 25.321 [9]) for one UE.

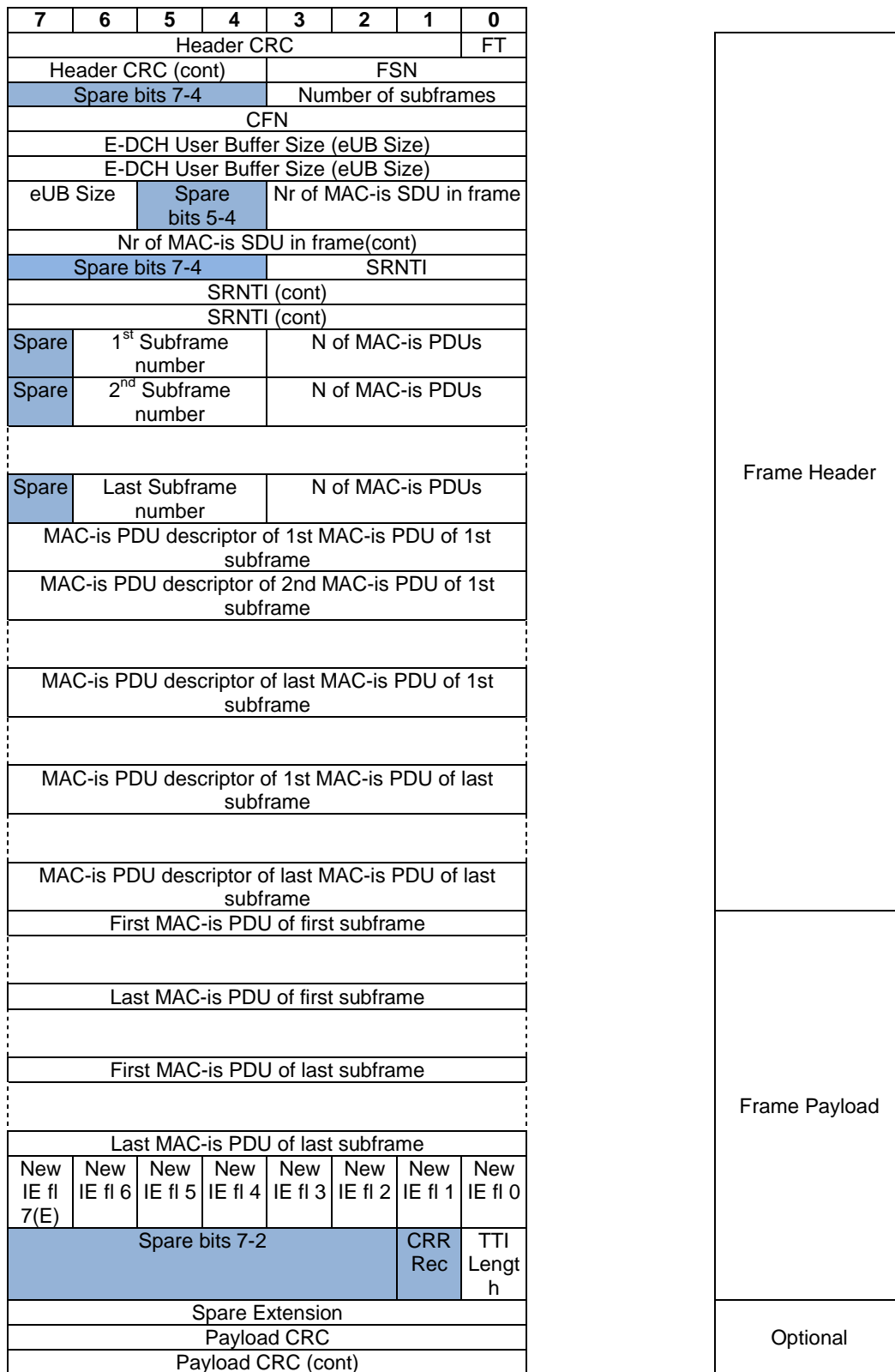

**Figure 12C: E-DCH DATA FRAME structure**

For the description of the fields see subclause 6.2.5.

Bit 0 of New IE Flags in E-DCH DATA FRAME indicates if a TTI length is present (1) or not (0).

Bit 1 of New IE Flags in E-DCH DATA FRAME indicates if *Cell Reselection Request Received (CRR Rec)* IE is present (1) or not (0). Bits 2 through 6 of New IE Flags in E-DCH DATA FRAME shall be set to 0.

The *Payload CRC* IE is optional in frames that contain a Payload, i.e. the whole 2 bytes field may or may not be present in the frame structure (this is defined at the setup of the transport bearer). The *Payload CRC* IE may only be present if the E-DCH data frame contains payload.

## 6.2.5 Coding of Information Elements in DATA FRAMES

### 6.2.5.1 Header CRC

**Description:** Cyclic Redundancy Checksum calculated on the header of a data frame with polynomial  $X^7+X^6+X^2+1$  for the 7 bit header CRC [FDD and 1.28Mcps TDD - and  $X^{11}+X^9+X^8+X^2+X+1$  for the 11 bit header CRC]. The CRC calculation shall cover all bits in the header, starting from bit 0 in the first byte (FT field) up to the end of the header.

**Value range:** {0-127} [FDD and 1.28Mcps TDD - , {0..2047} for E-DCH DATA FRAME].

**Field length:** 7 bits [FDD and 1.28Mcps TDD - , 11 bits for E-DCH DATA FRAME].

### 6.2.5.2 Frame Type (FT)

**Description:** Describes if it is a control frame or a data frame.

**Value range:** {0=data, 1=control}.

**Field Length:** 1 bit.

### 6.2.5.3 DRNTI

**Description:** Identifies the UE in the DRNC.

**Value range:** {0-1048575}.

**Field length:** 20 bits.

### 6.2.5.4 S-RNTI

**Description:** S-RNTI is defined in TS 25.401 [5]. S-RNTI is used in UL control frames [FDD and 1.28Mcps TDD - and E-DCH data frames] to identify the UE context in the SRNC.

**Value range:** {0-1048575}.

**Field length:** 20 bits.

### 6.2.5.5 UE-ID Type Indicator (UE-ID Type)

**Description:** Indicates the UE Identifier Type to be included by MAC-c/sh in the MAC header.

**Value range:** {0=U-RNTI, 1=C-RNTI}.

**Field Length:** 1 bit.

### 6.2.5.6 S-CCPCH Indicator (S-CI)

Void.

### 6.2.5.7 Common Transport Channel Priority Indicator (CmCH-PI)

**Description:** CmCH-PI is the relative priority of the data frame and the SDUs included.

**Value range:** {0-15, where 0=lowest priority, 15=highest priority}.

**Field length:** 4 bits.

### 6.2.5.8 MAC-c/sh SDU Length

**Description:** The value of that field indicates the length of every MAC-c/sh SDU in the payload of the [TDD - DSCH, USCH and] FACH DATA FRAME in number of bits.

**Value range:** {0-5000}.

**Field Length:** 13 bits.

### 6.2.5.9 NumOfSDU

**Description:** Indicates the number of MAC-c/sh SDUs in the payload.

**Value range:** {1-255}.

**Field Length:** 8 bits.

### 6.2.5.10 Propagation delay [FDD]

**Description:** One-way radio interface delay as measured during RACH access. If the measured value exceeds the range of this information element, the information element shall be set to its maximum value, and the *Ext Propagation Delay* IE shall be used to represent the measured value, see subclause 6.2.5.10A.

**Value range:** {0 - 765 chips}.

**Granularity:** 3 chips.

**Field length:** 8 bits.

### 6.2.5.10A Ext Propagation Delay [FDD]

**Description:** One-way radio interface delay as measured during RACH access, extended value part. This IE shall be present only if the range of the *Propagation Delay* IE is insufficient to represent the measured value.

**Value range:** {0 - 3069 chips}.

**Granularity:** 3 chips.

**Field length:** 10 bits.

### 6.2.5.11 Rx Timing Deviation [3.84Mcps TDD]

**Description:** Measured Rx Timing Deviation as a basis for timing advance.

**Value range:** {-1024, ..., +1023} chips

$$\{N*4 - 256\} \text{ chips} \leq \text{RxTiming Deviation} < \{(N+1)*4 - 256\} \text{ chips}$$

With N = 0, 1, ...,127

$$\{(N-128)*4 - 1024\} \text{ chips} \leq \text{Rx Timing Deviation} < \{(N-127)*4 - 1024\} \text{ chips}$$

With N = 128, 129, ...,319

$$\{N*4 - 1024\} \text{ chips} \leq \text{Rx Timing Deviation} < \{(N+1)*4 - 1024\} \text{ chips}$$

With N = 320, 321, ...,511

**Granularity:** 4 chips.

**Field length:** 9 bits. The least significant 8 bits are contained in the RX timing deviation field and the most significant bit is contained in the RX timing deviation (continuation) field.

### 6.2.5.11A Received SYNC UL Timing Deviation [1.28Mcps TDD]

**Description:** Measured Received SYNC UL Timing Deviation as a basis for propagation delay.

**Value range:** {0, ..., +255} chips

**Granularity:** 1 chip.

**Field length:** 8 bits.

### 6.2.5.11B Rx Timing Deviation [7.68Mcps TDD]

**Description:** Measured Rx Timing Deviation as a basis for timing advance.

**Value range:** {-2056, ..., +2055} chips

$$\{N*4 - 2056\} \text{ chips} \leq \text{RxTiming Deviation} < \{(N+1)*4 - 2056\} \text{ chips}$$

With  $N = 0, 1, \dots, 1027$

**Granularity:** 4 chips.

**Field length:** 10 bits. The least significant 8 bits are contained in the RX timing deviation field and the most significant 2 bits are contained in the RX timing deviation (continuation) field.

### 6.2.5.12 User Buffer Size

**Description:** Indicates the users' buffer size (i.e. the amount of data in the buffer) in octets for a given Common Transport Channel Priority Indicator level.

**Value range:** {0-65535}.

**Field length:** 16 bits.

### 6.2.5.13 MAC-c/sh SDU

**Description:** A MAC-c/sh SDU contains the *C/T* IE field (TS 25.321 [7]) of the MAC header followed by one RLC PDU. Field length: See the value of the *MAC-c/sh SDU Length* IE.

### 6.2.5.14 Payload CRC

**Description:** Cyclic Redundancy Checksum calculated on the payload of a data frame with polynomial  $X^{16}+X^{15}+X^2+1$ . The CRC calculation shall cover all bits in the data frame payload, starting from bit 7 in the first byte up to bit 0 in the byte before the payload CRC.

**Field length:** 16 bits.

### 6.2.5.15 Spare Extension

**Description:** Indicates the location where new IEs can in the future be added in a backward compatible way.

**Field length:** 0-32 octets.

### 6.2.5.16 MAC-d PDU Length

**Description:** The value of that field indicates the length of every MAC-d PDU in the payload of the HS-DSCH DATA FRAME in number of bits.

**Value range:** {0-5000}.

**Field Length:** 13 bits.



### 6.2.5.17 NumOfPDU

**Description:** Indicates the number of MAC-d PDUs in the payload.

**Value range:** {1-255}.

**Field Length:** 8 bits.

### 6.2.5.18 MAC-d PDU

**Description:** A MAC-d PDU contains the MAC-d PDU as defined in TS 25.321 [9].

**Field length:** See the value of the *MAC-d PDU Length* IE.

### 6.2.5.19 Cell Portion ID [FDD]

**Description:** Cell Portion ID indicates the cell portion with highest SIR during RACH access. Cell Portion ID is configured by O&M.

**Value range:** {0-63}.

**Field Length:** 6 bits.

### 6.2.5.20 New IE Flags

**Description:** The *New IE Flags* IE is only present if at least one new IE is present. The *New IE Flags* IE contains flags indicating which new IEs that are present following the *New IE Flags* IE. The last bit position of the *New IE Flags* IE is used as the Extension Flag to allow the extension of the *New IE Flags* IE in the future. Extension octets of the *New IE Flags* IE shall follow directly after the first octet of the *New IE Flags* IE. When an extension octet of the *New IE Flags* IE is present, then all previous extension octets of the *New IE Flags* IE and the *New IE Flags* IE shall also be present, even if they have all their flag bits indicating no presence of their respective new IEs.

**Value range:**

Bit 0-6 of each octet: Indicates if a new IE is present (1) or not present (0) in the bytes following the *New IE Flags* IE. The meaning of each bit is explained in the corresponding DATA FRAME subclause;

Bit 7 of each octet: Indicates if an extension octet of the *New IE Flags* IE follows (1) or not (0).

**Field length:** 1 – 31 octets.

### 6.2.5.21 Flush

**Description:** Indicates whether the DRNS should remove (1) or not (0) all the MAC-d PDUs from the corresponding MAC-hs Priority Queue that have been received prior to this HS-DSCH DATA FRAME on the same transport bearer.

**Value range:** {0 = no flush, 1 = flush}.

**Field Length:** 1 bit.

### 6.2.5.22 DRT (Delay Reference Time)

**Description:** *DRT* is a 16-bit *Delay Reference Time*. *DRT* can be used for dynamic delay measurements. The *DRT* counter bridges the same time span as RFN and BFN. *DRT* is locked to RFN in SRNC and is a 40960 counter with 1 ms resolution.

**Value range:** {0..40959<sub>DEC</sub> ms (0..9FFF<sub>HEX</sub> ms)}.

**Granularity:** 1 ms.

**Field length:** 16 bits.

### 6.2.5.23 Frame Sequence Number

**Description:** The 4-bit *Frame Sequence Number* (FSN) is incremented for each transmitted HS-DSCH data frame belonging to one MAC-d flow [FDD and 1.28Mcps TDD – or E-DCH DATA FRAME belonging to one E-DCH for CELL\_FACH and Idle data stream]. At wraparound of the Frame Sequence Number, the value "0" shall not be used. Each flow generates its own Frame Sequence Number.

**Value range:**

0 is a special value and indicates that the *Frame Sequence Number* IE shall be treated as spare.

1 – 15 indicates the Frame Sequence Number.

**Granularity:** 1.

**Field length:** 4 bits.

### 6.2.5.24 Logical Channel ID in block n

**Description:** This field provides identification of the logical channel instance associated with the PDUs of the n-th *block of PDUs with the same size* in the HS-DSCH DATA FRAME TYPE 2. Multiple logical channels may be carried on the same Transport Network flow.

**Value range:** {0-15}, where 0-14 identifies logical channels 1-15, 15 identifies BCCH or PCCH logical channel mapped on HS-DSCH.

**Field length:** 4 bits.

### 6.2.5.25 Total Number of PDU blocks

**Description:** The field indicates the number of blocks of *block of PDUs with the same size* in this HS-DSCH DATA FRAME.

**Value range:** {0-31}, 0 – not used.

**Field length:** 5 bits.

### 6.2.5.26 MAC-d PDU length in block n

**Description:** The value of this field indicates the length of every MAC-d PDU in the n-th *block of PDUs with the same size* in number of octets.

**Value range:** {0-1505}, 0 – not used.

**Field length:** 11 bits.

### 6.2.5.27 Number of MAC-d PDUs in block n (#PDUs in block n)

**Description:** Indicates the number of MAC-d PDUs in the n-th *block of PDUs with the same size*.

**Value range:** {0-15}, 0 – not used.

**Field length:** 4 bits.

### 6.2.5.28 DRT Indicator

**Description:** Indicates whether a DRT is present.

**Value range:** {0 = DRT not present, 1= DRT present}.

**Field length:** 1 bit.

### 6.2.5.29 FACH Indicator (FI) [FDD and 1.28Mcps TDD]

**Description:** Indicates whether D-RNTI and UE-ID Type Indicator are present (i.e. whether UE in CELL\_FACH).

**Value range:** {0 = D-RNTI and UE-ID Type Indicator not present, 1= D-RNTI and UE-ID Type Indicator present}.

**Field length:** 1 bit.

NOTE: In case FI is set to 1, PI shall be set to 0

### 6.2.5.30 S-RNTI [FDD and 1.28Mcps TDD]

Void.

### 6.2.5.31 UE-ID Type Indicator (UE-ID Type)

Void.

### 6.2.5.32 FSN/DRT Reset

**Description:** When the Node B receives a HS-DSCH DATA FRAME where the 1-bit *FSN/DRT Reset* IE is set to 1, the Node B should reset any state of congestion estimation based on previously received FSN and DRT values. Node B may instead decide to start a new estimation of congestion detection initiated with the FSN and DRT values included in this HS-DSCH data frame. *FSN/DRT Reset* IE set to 1 may indicate a discontinuity in the sequence of the transmitted DRT and FSN values in the transmitted HS-DSCH data frames belonging to the associated MAC-d flow.

If the 1-bit *FSN/DRT Reset* IE is set to 0, Node B may use the included DRT and FSN values for congestion detection.

**Value range:**

0 Node B may use the included DRT and FSN values for congestion detection.

1 Node B should not use previously received FSN and DRT values for congestion detection.

**Field length:** 1 bit.

### 6.2.5.33 MAC-d Type 2 PDU

**Description:** A MAC-d Type 2 PDU contains the MAC-ehs SDU [FDD and 1.28Mcps TDD – or MAC-c SDU] as defined in TS 25.321 [9].

**Field length:** For length of MAC-d Type 2 PDU of block n, see the value of the *MAC-d PDU length in block n* IE.

### 6.2.5.34 PCH Indicator (PI) [FDD]

**Description:** Indicates whether the D-RNTI and DRX Cycle Length Coefficient are present (i.e. whether UE in CELL\_URA\_PCH).

**Value range:** {0 = D-RNTI and DRX Cycle Length Coefficient not present, 1= D-RNTI and DRX Cycle Length Coefficient present}.

**Field length:** 1 bit.

NOTE: In case PI is set to 1, FI shall be set to 0.

### 6.2.5.35 DRX Cycle Length Coefficient [FDD]

**Description:** The DRX Cycle Length Coefficient is used as input for the formula to establish the paging occasions to be used in DRX.

DRX Cycle Length Coefficient is given in the unit DRX\_CYCLE\_LENGTH\_COEFFICIENT where:

DRX\_CYCLE\_LENGTH\_COEFFICIENT = 0 Reserved

DRX_CYCLE_LENGTH_COEFFICIENT = 1	DRX Cycle Length Coefficient = 3
DRX_CYCLE_LENGTH_COEFFICIENT = 2	DRX Cycle Length Coefficient = 4
...	
DRX_CYCLE_LENGTH_COEFFICIENT = 6	DRX Cycle Length Coefficient = 8
DRX_CYCLE_LENGTH_COEFFICIENT = 7	DRX Cycle Length Coefficient = 9

**Value range:** {3...9}.

**Field length:** 3 bits.

### 6.2.5.36 Number of Subframes [FDD and 1.28Mcps TDD]

**Description:** The *Number of Subframes* field indicates how many subframes that follows in the frame.

NOTE: A subframe has both a header portion and a payload portion in the frame.

**Value range:** {1-16}

The binary coding is derived from the value minus 1. E.g. value 1 is coded as binary '0000' and value 16 is coded as binary '1111'.

Values {11, 12, 13, 14, 15, 16}: Reserved in this user plane revision. Shall be ignored by the receiver.

**Field length:** 4 bits.

### 6.2.5.37 Number of MAC-is SDU in frame [FDD and 1.28Mcps TDD]

**Description:** Total number of MAC-is SDUs in all MAC-is PDUs in the E-DCH DATA FRAME.

**Value range:** {0-4095}.

**Field length:** 12 bits.

### 6.2.5.38 Number of MAC-is PDUs [FDD and 1.28Mcps TDD]

**Description:** Indicates the number of MAC-is PDUs in the user data frame in the payload part for the corresponding subframe number.

**Value range:** {0-15}

**Field length:** 4 bits.

### 6.2.5.39 Subframe Number [FDD and 1.28Mcps TDD]

**Description:** Indicates the subframe number in which the payload was received.

**Value range:** {0-4}

**Field length:** 3 bits.

### 6.2.5.40 E-DCH User Buffer Size [FDD and 1.28Mcps TDD]

**Description:** Indicates the total size of the E-DCH DATA FRAME in octets

**Value range:** {0-262 140}

**Field length:** 18 bits.

#### 6.2.5.41 MAC-is PDU descriptor [FDD and 1.28Mcps TDD]

**Description:** The *MAC-is PDU descriptor* contains the Length (L), Logical channel identifier (LCH-ID) and Flag (F) fields mapped directly from the "MAC-i Header n" field (n>0) received over the Uu (TS 25.321 [9]).

**Field length:** variable; length of *MAC-is PDU descriptor* in octets = 2 \* number of MAC-is SDU contained in the corresponding MAC-is PDU as described in TS 25.321 [9].

#### 6.2.5.42 eDRX Indication [FDD]

**Description:** Indicates whether the UE in Cell\_FACH state supports Enhanced UE DRX or not.

**Value range:** {0 = Enhanced UE DRX not supported, 1= Enhanced UE DRX supported}.

**Field length:** 1 bit.

#### 6.2.5.43 Cell Portion LCR ID [1.28Mcps TDD]

**Description:** Cell Portion LCR ID indicates the cell portion with best received quality during RACH access. Cell Portion LCR ID is configured by O&M.

**Value range:** {0-255}.

**Field Length:** 8 bits.

#### 6.2.5.44 TS0 Indication [1.28Mcps TDD]

**Description:** Indicates whether the UE supports TS0 enhancement or not.

**Value range:** {0 = Enhanced TS0 not supported, 1= Enhanced TS0 supported}.

**Field length:** 1 bit.

#### 6.2.5.45 MU-MIMO Indication(MI) [1.28Mcps TDD]

**Description:** Indicates whether the UE in Cell\_FACH state supports MU-MIMO or not.

**Value range:** {0 = MU-MIMO not supported, 1= MU-MIMO supported}.

**Field length:** 1 bit.

#### 6.2.5.46 CPC Recovery (CPC Recov) [FDD]

**Description:** Describes if UE is CPC non-uniform related to HS-SCCH order and CPC recovery is needed in the serving DRNS. It indicates that the dynamic DTX/DRX (de)activation using HS-SCCH order is needed.

**Value range:** {0=no Recovery, 1=Recovery}.

**Field Length:** 1 bit.

Note: This is not applicable when HS-SCCH order is not used.

#### 6.2.5.47 FeDRX Indication [FDD]

**Description:** Indicates whether the UE in Cell\_FACH state supports Further Enhanced UE DRX or not.

**Value range:** {0 = Further Enhanced UE DRX not supported, 1= Further Enhanced UE DRX supported}.

**Field length:** 1 bit.

#### 6.2.5.48 NodeB Triggered HS-DPCCH Transmission(NTHT) [FDD]

**Description:** Indicates whether the UE in Cell\_FACH and CELL\_PCH state supports NodeB Triggered HS-DPCCH Transmission or not.

**Value range:** {0 = NodeB Triggered HS-DPCCH Transmission not supported, 1= NodeB Triggered HS-DPCCH Transmission supported}.

**Field length:** 1 bit.

#### 6.2.5.49 TTI length [FDD]

**Description:** Indicates which type of TTI length UE in Cell\_FACH and Idle state is in use for 2ms/10ms concurrent deployment.

**Value range:** {0 = 2ms, 1 = 10ms}.

**Field length:** 1 bit.

#### 6.2.5.50 SN, Frame Number

**Description:** SN is a sequence number assigned to each HS-DSCH data frame by RNC and can be used by Node B to identify the set of MAC-d PDU's sent in the frame. This is also used by RNC to indicate the HS-DSCH data frame that the Node B can discard.

**Value range:** {0...32767}.

**Field length:** 15 bits.

#### 6.2.5.51 S/D, Store/Discard indicator

**Description:** The S/D indicator indicates if Node B can store or discard data frame associated with SN.

**Value range:** {0 = Discard data associated with SN, 1 = Store and associate MAC-d PDUs in the frame with SN}.

**Field length:** 1 bit

#### 6.2.5.52 Connection Frame Number (CFN)

**Description:** The CFN corresponding to the SFN of the frame in which the payload was received on Uplink. If the payload was received in several frames, the CFN corresponding to the last Uu frame in which the information was received shall be indicated.

**Value range:** (other): {0..255}.

**Field length:** (other): 8 bits.

#### 6.2.5.53 CR Ind (Cell Reselection Indication)

**Description:** Indicates that the Node B may release the common E-DCH resource due to a cell reselection indication.

**Value range:** {0 = Release common E-DCH resource not permitted due to a cell reselection indication, 1 = Release common E-DCH resource permitted due to a cell reselection indication}.

**Field length:** 1 bit.

#### 6.2.5.54 CRR Rec (Cell Reselection Request Received)

**Description:** Indicates that the Node B has received Cell Reselection Request from UE or not.

**Value range:** {0 = Cell Reselection Request from UE not received, 1 = Cell Reselection Request from UE received}.

**Field length:** 1 bit.

## 6.3 Control Frame structure

### 6.3.1 Introduction

Control Frames are used to transport control information between SRNC and DRNC.

Figure 13 defines the Control Frame structure for common transport channels.

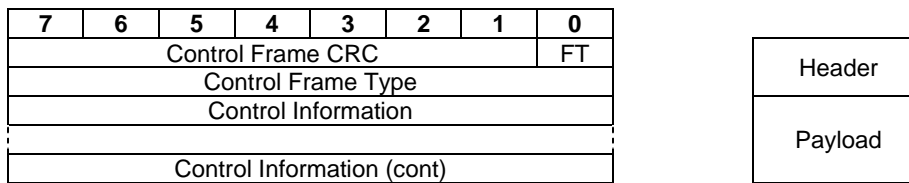

**Figure 13: Iur Common Transport Channel Control Frame Format**

The *Control Frame Type* IE defines the type of the control frames.

The length of the payload is variable accordingly to the control frame type.

The structure of the header and the payload of the control frames is defined in the following subclauses.

## 6.3.2 Header structure of the control frames

### 6.3.2.1 Control frame CRC

**Description:** Cyclic Redundancy Checksum calculated on a control frame with polynomial  $X^7+X^6+X^2+1$ . The CRC calculation shall cover all bits in the control frame, starting from bit 0 in the first byte (FT field) up to the end of the control frame.

**Value range:** {0-127}.

**Field length:** 7 bits.

### 6.3.2.2 Frame type (FT)

Refer to subclause 6.2.5.2.

### 6.3.2.3 Control Frame Type

**Description:** Indicates the type of the control information (information elements and length) contained in the payload (=type of control frame).

**Value:** values of the *Control Frame Type* IE parameter are defined in the table 1.

**Table 1: Control Frame Type**

Type of control frame	Value
FACH Flow Control	0000 0010
FACH Capacity Request	0000 0011
DSCH Capacity Request	0000 0100
DSCH Capacity Allocation	0000 0101
DL NODE SYNCHRONISATION	0000 0110
UL NODE SYNCHRONISATION	0000 0111
HS-DSCH Capacity Request	0000 1010
HS-DSCH Capacity Allocation TYPE 1	0000 1011
HS-DSCH Capacity Allocation TYPE 2	0000 1100
HS-DSCH UL Synchronization Establishment Failure (1.28Mcps TDD only)	0000 1101
HS-DSCH PDU Drop Indication	0000 1110

### 6.3.3 Payload structure and information elements

#### 6.3.3.1 FACH FLOW CONTROL

Figure 14 shows the payload structure when the control frame is used for the above mentioned purpose. This control information is sent in the UL only.

7	6	5	4	3	2	1	0
SRNTI							
SRNTI (cont)							
SRNTI (cont)				CmCH-PI			
Credits							
Spare Extension							

**Figure 14: FACH FLOW CONTROL payload structure**

##### 6.3.3.1.1 S-RNTI

Refer to subclause 6.2.5.4.

##### 6.3.3.1.2 Common Transport Channel Priority Indicator (CmCH-PI)

Refer to subclause 6.2.5.7.

##### 6.3.3.1.3 Credits

**Description:** The *Credits* IE indicates the number of MAC-c/sh SDUs that a user may transmit.

**Value range:** {0-255, where 0=stop transmission, 255=unlimited}.

**Field length:** 8 bits.

##### 6.3.3.1.4 Spare Extension

**Description:** Indicates the location where new IEs can in the future be added in a backward compatible way.

**Field length:** 0-32 octets.

#### 6.3.3.2 DSCH CAPACITY REQUEST [TDD]

7	6	5	4	3	2	1	0
Spare bits 7-4				Cm CH-PI			
User Buffer Size							
User Buffer Size (cont)							
Spare Extension							

**Figure 15: CAPACITY REQUEST payload structure**

DSCH Capacity Request is sent for each priority group to indicate the user buffer size. The control frame is sent by the DSCH CAPACITY REQUEST is sent for each priority group to indicate the user buffer size. The control frame is sent by the SRNC when the SRNC considers the user buffer status needs an increased buffer reporting frequency. This may be sent to signal an event, such as, data arrival or user-buffer discard. This control frame is used to improve user-buffer reporting above the level produced by the user-buffer reporting associated with the DSCH DATA FRAMES.

##### 6.3.3.2.1 Common Transport Channel Priority Indicator (CmCH-PI)

Refer to subclause 6.2.5.7.



### 6.3.3.2.2 User Buffer Size

Refer to subclause 6.2.5.12.

### 6.3.3.2.3 Spare Extension

Refer to subclause 6.3.3.1.4.

## 6.3.3.3 DSCH CAPACITY ALLOCATION [TDD]

7	6	5	4	3	2	1	0
Spare bits 7-4				Cm CH-PI			
Max MAC -c/sh SDU Length (cont)							
Max MAC -c/sh SDU Length				Spare bits 2-0			
Credits							
Interval							
Repetition Period							
Spare Extension							

**Figure 16: CAPACITY ALLOCATION payload structure**

The CAPACITY ALLOCATION Control Frame describes an allocation that the SRNC may use. When the *Credits* IE has a value of 0 it signifies that there is no resources allocated for transmission and to thus stop transmission. When the *Credits* IE has a value of 255, it signifies unlimited capacity for transmission of SDUs. When the *Repetition Period* IE has a value of 0, it signifies that the allocation (*Maximum MAC-c/sh SDU Length*, *Credits* and *Interval* IEs) can be repeated without limit.

### 6.3.3.3.1 Common Transport Channel Priority Indicator (CmCH-PI)

Refer to subclause 6.2.5.7.

### 6.3.3.3.2 Maximum MAC-c/sh SDU Length

**Description:** The values indicated the maximum allowable SDU size. MAC-c/sh SDU contains the C/T field of the MAC header followed by one RLC PDU.

**Field length:** See the value of the *MAC-c/sh SDU Length* IE.

### 6.3.3.3.3 Credits

**Description:** The *Credits* IE indicates the number of MAC-c/sh SDUs that a SRNC may transmit during one Interval granted in the DSCH CAPACITY ALLOCATION Control Frame.

**Value range:** Refer to subclause 6.3.3.1.3.

**Field Length:** Refer to subclause 6.3.3.1.3.

### 6.3.3.3.4 Interval

**Description:** The value of this field indicates the time interval during which the *Credits* granted in the DSCH CAPACITY ALLOCATION Control Frame may be used. The first interval starts immediately after reception of the DSCH CAPACITY ALLOCATION control frame, subsequent intervals start immediately after the previous interval has elapsed. This value is only applied to the DSCH transport channel.

**Value range:** {0-2550 ms}. Value 0 shall be interpreted that none of the credits shall be used.

**Granularity:** 10ms.

**Field Length:** 8 bits.

6.3.3.3.5 Repetition Period

**Description:** The value of this field indicates the number of subsequent intervals that the *Credits* IE granted in the DSCH CAPACITY ALLOCATION Control Frame may be used. These values represent an integer number of Intervals (see subclause 6.3.3.3.4). This field is only applied to the DSCH transport channel.

**Value range:** {0-255, where 0= unlimited repetition period}.

**Field Length:** 8 bits.

6.3.3.3.6 Spare Extension

Refer to subclause 6.3.3.1.4.

6.3.3.4 FACH CAPACITY REQUEST

Figure 17 shows the payload structure when the control frame is used for the above mentioned purpose. This control information is sent in the DL only.

7	6	5	4	3	2	1	0
DRNTI							
DRNTI (cont)							
DRNTI (cont)				CmCH -PI			
User Buffer Size							
User Buffer Size (cont)							
Spare Extension							

Figure 17: FACH CAPACITY REQUEST payload structure

6.3.3.4.1 D-RNTI

Refer to subclause 6.2.5.3.

6.3.3.4.2 Common Transport Channel Priority Indicator (CmCH-PI)

Refer to subclause 6.2.5.7.

6.3.3.4.3 User Buffer Size

Refer to subclause 6.2.5.12.

6.3.3.4.4 Spare extension

Refer to subclause 6.3.3.1.4.

6.3.3.5 HS-DSCH CAPACITY REQUEST

7	6	5	4	3	2	1	0
Spare bits 7-4				Cm CH-PI			
User Buffer Size							
User Buffer Size (cont)							
New IE fl 7(E)	New IE fl 6	New IE fl 5	New IE fl 4	New IE fl 3	New IE fl 2	New IE fl 1	New IE fl 0
DRNTI							
DRNTI (cont)							
DRNTI (cont)				Spare bits 3-0			
Spare Extension							

**Figure 18: CAPACITY REQUEST payload structure**

The HS-DSCH CAPACITY REQUEST control frame is sent for each priority group to indicate the user buffer size. The control frame is sent by the SRNC when the SRNC considers the user buffer status needs an increased buffer reporting frequency. This may be sent to signal an event, such as, data arrival or user-buffer discard. This control frame is used to improve user-buffer reporting above the level produced by the user-buffer reporting associated with the HS-DSCH DATA FRAMES (TYPE 1 or TYPE 2).

[FDD and 1.28Mcps TDD - Bit 0 of New IE Flags in HS-DSCH CAPACITY REQUEST indicates if a DRNTI is present (1) or not (0) in the 3 octets following the *New IE Flags* IE. Bits 1 through 6 of New IE Flags in HS-DSCH CAPACITY REQUEST shall be set to 0. Field length of *Spare Extension* IE in HS-DSCH CAPACITY REQUEST is 0-28 octets.]

#### 6.3.3.5.1 Common Transport Channel Priority Indicator (CmCH-PI)

**Description:** CmCH-PI, configured via the Scheduling Priority Indicator in RNSAP (TS 25.423 [8]), is the relative priority of the data frame and the SDUs included.

**Value range:** {0-15, where 0=lowest priority, 15=highest priority}.

**Field length:** 4 bits.

#### 6.3.3.5.2 User Buffer Size

Refer to subclause 6.2.5.12.

#### 6.3.3.5.3 Spare Extension

Refer to subclause 6.3.3.1.4.

#### 6.3.3.5.4 DRNTI [FDD]

Refer to subclause 6.2.5.3.

### 6.3.3.6 HS-DSCH CAPACITY ALLOCATION

Two types of HS-DSCH CAPACITY ALLOCATION Control Frames exist for the HS-DSCH capacity allocation, i.e. HS-DSCH CAPACITY ALLOCATION TYPE 1 Control Frame and HS-DSCH CAPACITY ALLOCATION TYPE 2 Control Frame.

7	6	5	4	3	2	1	0
Spare bits 7-6		Congestion Status		Cm CH-PI			
Max MAC -d PDU Length							
Max MAC -d PDU Length(cont)				HS-DSCH Credits			
HS-DSCH Credits (cont)							
HS-DSCH Interval							
HS-DSCH Repetition Period							
Spare Extension							

**Figure 19: CAPACITY ALLOCATION TYPE 1 payload structure**

The CAPACITY ALLOCATION TYPE 1 Control Frame describes an allocation that the SRNC may use. When the *HS-DSCH Credits* IE has a value of 0 it signifies that there is no resources allocated for transmission and to thus stop transmission. When the *HS-DSCH Credits* IE has a value of 2047, it signifies unlimited capacity for transmission of PDUs. When the *HS-DSCH Repetition Period* IE has a value of 0, it signifies that the allocation (*Maximum MAC-d PDU Length*, *HS-DSCH Credits* and *HS-DSCH Interval* IEs) can be repeated without limit. In addition to this the CAPACITY ALLOCATION TYPE 1 Control Frame may inform the SRNC about the detection of congestion in the DL transport network layer with the *Congestion Status* Bits.

7	6	5	4	3	2	1	0
Spare bits 7-6		Congestion Status		Cm CH-PI			
Spare bits 7-4				SRNT   Indica tor	Max MAC –d PDU		
Max MAC –d PDU Length Type 2(cont)							
HS-DSCH Credits							
HS-DSCH Credits (cont)							
HS-DSCH Interval							
HS-DSCH Repetition Period							
S-RNTI							
S-RNTI (cont)							
S-RNTI (cont)				Spare bits 3-0			
Spare Extension							

**Figure 20: CAPACITY ALLOCATION TYPE 2 payload structure**

The CAPACITY ALLOCATION TYPE 2 Control Frame describes an allocation that the SRNC may use. When the *HS-DSCH Credits* IE has a value of 0 it signifies that there is no resources allocated for transmission and to thus stop transmission. When the *HS-DSCH Credits* IE has a value of 65535, it signifies unlimited capacity for transmission of PDUs. When the *HS-DSCH Repetition Period* IE has a value of 0, it signifies that the allocation (*Maximum MAC-d PDU Length Type 2*, *HS-DSCH Credits* and *HS-DSCH Interval* IEs) can be repeated without limit. In addition to this the CAPACITY ALLOCATION TYPE 2 Control Frame may inform the SRNC about the detection of congestion in the DL transport network layer with the *Congestion Status* Bits.

#### 6.3.3.6.1 Common Transport Channel Priority Indicator (CmCH-PI)

Refer to subclause 6.2.5.7.

#### 6.3.3.6.2 Maximum MAC-d PDU Length

**Description:** The *Maximum MAC-d PDU Length* IE is used in HS-DSCH CAPACITY ALLOCATION TYPE 1 Control Frame. The value indicates the maximum allowable PDU size among the MAC-d PDU sizes configured via RNSAP (TS 25.423 [8]).

**Value range:** Refer to subclause 6.2.5.16.

**Field length:** Refer to subclause 6.2.5.16.

#### 6.3.3.6.3 HS-DSCH Credits

**Description:** The *HS-DSCH Credits* IE is used in HS-DSCH CAPACITY ALLOCATION (TYPE 1 and TYPE 2) Control Frame. It is used to indicate the granted amount of MAC-d PDU data that a SRNC may transmit during one HS-DSCH Interval.

In case of HS-DSCH CAPACITY ALLOCATION TYPE 1 Control Frame, it indicates the number of MAC-d PDU that a SRNC may transmit during one HS-DSCH Interval granted in the HS-DSCH CAPACITY ALLOCATION TYPE 1 Control Frame.

In case of HS-DSCH CAPACITY ALLOCATION TYPE 2 Control Frame, the granted amount of MAC-d PDU data in octets is obtained by multiplying the maximum MAC-d PDU length (indicated by the *Maximum MAC-d PDU Length Type 2* IE) with the number of MAC-d PDUs (indicated by the *HS-DSCH Credits* IE).

**Value range:** {0-2047, where 0=stop transmission, 2047=unlimited} in case of HS-DSCH CAPACITY ALLOCATION TYPE 1 Control Frame, {0-65535, where 0=stop transmission, 65535=unlimited} in case of HS-DSCH CAPACITY ALLOCATION TYPE 2 Control Frame.

**Field length:** 11 bits in case of HS-DSCH CAPACITY ALLOCATION TYPE 1 Control Frame, 16 bits in case of HS-DSCH CAPACITY ALLOCATION TYPE 2 Control Frame.

#### 6.3.3.6.4 HS-DSCH Interval

**Description:** The value of this field indicates the time interval during which the *HS-DSCH Credits* IE granted in the HS-DSCH CAPACITY ALLOCATION (TYPE 1 or TYPE 2) Control Frame may be used. The first interval starts immediately after reception of the HS-DSCH CAPACITY ALLOCATION (TYPE 1 or TYPE 2) control frame, subsequent intervals start immediately after the previous interval has elapsed. This value is only applied to the HS-DSCH transport channel.

**Value range:** {0-2550 ms}. Value 0 shall be interpreted that none of the credits shall be used.

**Granularity:** 10ms.

**Field Length:** 8 bits.

#### 6.3.3.6.5 HS-DSCH Repetition Period

**Description:** The value of this field indicates the number of subsequent intervals that the *HS-DSCH Credits* IE granted in the HS-DSCH CAPACITY ALLOCATION (TYPE 1 or TYPE 2) Control Frame may be used. These values represent an integer number of Intervals (see subclause 6.3.3.6.4). This field is only applied to the HS-DSCH transport channel.

**Value range:** {0-255, where 0= unlimited repetition period}.

**Field Length:** 8 bits.

#### 6.3.3.6.8 Spare Extension

Refer to subclause 6.3.3.1.4.

#### 6.3.3.6.9 Congestion Status

**Description:** The *Congestion Status* Bits are used by the DRNC to indicate a congestion status received. The DRNC provides the congestion status in HS-DSCH CAPACITY ALLOCATION (TYPE 1 or TYPE 2) Control Frame when it has been received towards the SRNC.

**Value range:**

- 0 No TNL Congestion
- 1 Reserved for future use
- 2 TNL Congestion – detected by delay build-up
- 3 TNL Congestion – detected by frame loss

**Field Length:** 2 bits.

#### 6.3.3.6.10 SRNTI Indicator [FDD and 1.28Mcps TDD]

**Description:** Indicates whether S-RNTI is present.

**Value range:** {0 = S-RNTI not present, 1= S-RNTI present}.

**Field length:** 1 bit.

#### 6.3.3.6.11 S-RNTI [FDD and 1.28Mcps TDD]

Refer to subclause 6.2.5.4.

#### 6.3.3.6.12 Maximum MAC-d PDU Length Type 2

**Description:** The *Maximum MAC-d PDU Length Type 2* IE is used in HS-DSCH CAPACITY ALLOCATION TYPE 2 Control Frame. The value is a factor in the granted amount of MAC-d PDU data that a SRNC may transmit during

one HS-DSCH Interval. The amount of MAC-d PDU data in octets is obtained by multiplying the MACd PDU length (indicated by the *Maximum MAC-d PDU Length Type 2 IE*) with the number of MAC-d PDUs (indicated by the HS-DSCH Credits IE).

**Value range:** {0-1505}, 0 – not used.

**Field length:** 11 bits.

### 6.3.3.7 DL NODE SYNCHRONISATION

#### 6.3.3.7.1 Payload structure

Figure 21 shows the structure of the payload for the DL NODE SYNCHRONISATION control frame.

7	6	5	4	3	2	1	0
T1							
T1 (cont)							
T1 (cont)							
Spare Extension							

**Figure 21: Structure of the payload for the DL NODE SYNCHRONISATION control frame**

#### 6.3.3.7.2 T1

**Description:** RNC specific frame number (RFN) that indicates the time when RNC sends the frame through the SAP to the transport layer.

**Value range:** {0-40959.875 ms}.

**Field length:** 24 bits.

#### 6.3.3.7.3 Spare Extension

The *Spare Extension* IE is described in subclause 6.3.3.1.4.

### 6.3.3.8 UL NODE SYNCHRONISATION

#### 6.3.3.8.1 Payload structure

The payload of the UL NODE SYNCHRONISATION control frames is shown in figure 22.

7	6	5	4	3	2	1	0
T1							
T1 (cont)							
T1 (cont)							
T2							
T2 (cont)							
T2 (cont)							
T3							
T3 (cont)							
T3 (cont)							
Spare Extension							

**Figure 22: Structure of the payload for UL NODE SYNCHRONISATION control frame**

#### 6.3.3.8.2 T1

**Description:** T1 timer is extracted from the correspondent DL NODE SYNCHRONISATION control frame.

**Value range:** {0-40959.875 ms}.

**Granularity:** 0.125 ms.

**Field length:** 24 bits.

### 6.3.3.8.3 T2

**Description:** Node B specific frame number (BFN) that indicates the time when Node B received the correspondent DL NODE SYNCHRONISATION control frame through the SAP from the transport layer.

**Value range:** {0-40959.875 ms}.

**Granularity:** 0.125 ms.

**Field length:** 24 bits.

### 6.3.3.8.4 T3

**Description:** Node B specific frame number (BFN) that indicates the time when Node B sends the frame through the SAP to the transport layer.

**Value range:** {0-40959.875 ms}.

**Granularity:** 0.125 ms.

**Field length:** 24 bits.

### 6.3.3.8.5 Spare Extension

The *Spare Extension* IE is described in subclause 6.3.3.1.4.

## 6.3.3.9 HS-DSCH UL SYNCHRONIZATION ESTABLISHMENT FAILURE [1.28Mcps TDD]

### 6.3.3.9.1 Payload structure

The payload of the HS-DSCH UL Synchronization Establishment Failure control frames is shown in figure 23.

7	6	5	4	3	2	1	0
S-RNTI							
S-RNTI (cont)							
S-RNTI (cont)				Spare bits 3-0			
Spare Extension							

**Figure 23: HS-DSCH UL SYNCHRONIZATION ESTABLISHMENT FAILURE payload structure**

### 6.3.3.9.2 S-RNTI

Refer to subclause 6.2.5.4.

## 6.3.3.10 HS-DSCH PDU DROP INDICATION

### 6.3.3.10.1 Payload structure

The payload of the HS-DSCH PDU Drop Indication control frame is shown in figure 24.

7	6	5	4	3	2	1	0
Spare bits 7-3				Drop Reason			
Number of PDUs Dropped							
SN 1							
SN 1 (cont)						Spare	
PDU 1 index							
⋮							
SN N							
SN N(cont)						Spare	
PDU N Index							
Spare Extension							

Figure 24: HS-DSCH PDU DROP INDICATION payload structure

### 6.3.3.10.2 Drop Reason

**Description:** The *Drop Reason* IE is used in HS-DSCH PDU DROP INDICATION Control Frame. It indicates the reason of drop of HS-DSCH PDUs in DRNS.

**Value range:**

- 0 too long delay in MAC-hs/ehs buffer
- 1 unsuccessful HARQ due to T1 timer expiry
- 2 TNL Congestion – detected by frame loss
- 3 to 7 are reserved

**Field length:** 3 bits

### 6.3.3.10.3 PDU Index

**Description:** The *PDU Index* IE identifies the PDU Index in the HS-DSCH DATA FRAME.

**Value range:** {0-255}

**Field length:** 8 bits

---

## 7 Handling of Unknown, Unforeseen and Erroneous Protocol Data

### 7.1 General

A Frame Protocol frame with an unknown IE or an illegal IE value shall be ignored.



## Annex A (informative): Change History

TSG #	TSG Doc.	CR	Rev	Subject/Comment	New
09/2008	-	-	-	Creation of Rel-8 version based on v 7.8.0	8.0.0
41	RP-080587	0129	1	Introduction of frame formats supporting E-DCH for CELL_FACH and Idle over Iur	8.0.0
41	RP-080588	0131		Introduction of Enhanced UE DRX	8.0.0
42	RP-080850	0133	1	Introduction of the Enhanced CELL_FACH, CELL_PCH, URA_PCH state for 1.28Mcps TDD	8.1.0
42	RP-080837	0136		Correction of CR127, adding codepoints for the new control frames	8.1.0
42	RP-080858	0137		Corrections to IE definitions for E-DCH DATA FRAME and "Definitions" chapter	8.1.0
43	RP-090073	0139	1	Correction of handling of Capacity Allocation and HS-DSCH Credits	8.2.0
44	RP-090630	0141		Correction of the value range of MAC PDU Size Extended IE in CCH FP Iur	8.3.0
46	RP-091181	0145		Correction on value range for Number of MAC-is SDU in frame	8.4.0
46	RP-091180	0146	1	Correction to the NodeB procedure when receiving uplink synchronization failure from physical layer for 1.28Mcp TDD	8.4.0
12/2009	-	-	-	Creation of Rel-9 version based on v. 8.4.0	9.0.0
46	RP-091188	0143		Introduction of Cell Portion for 1.28 Mcps TDD	9.0.0
47	RP-100229	0147	-	Corrections to the TS0 enhancement for the UE in CELL_FACH state for 1.28Mcps TDD	9.1.0
47	RP-100217	0149	-	Clarification of eDRX Indication for 1.28Mcp TDD	9.1.0
12/2010				Creation of Rel-10 version based on v. 9.1.0	10.0.0
50	RP-101277	0150		Introduction of MU-MIMO to CTCH of Iur user plane	10.0.0
SP-49	SP-100629			Clarification on the use of References (TS 21.801 CR#0030)	10.0.1
52	RP-110684	0155		Correction of references	10.1.0
52	RP-110681	0157		Correction of Logical Channel ID range used in Enhanced Cell-FACH	10.1.0
52	RP-110688	0158		Correction to mapping of MAC-is SDU to MAC-d PDU	10.1.0
54	RP-111645	0162		Indicator for DTXDRX HS-SCCH order	10.2.0
09/2012				Update to Rel-11 version (MCC)	11.0.0
58	RP-121725	0165		Introduction of Further Enhancements to CELL_FACH feature	11.1.0
58	RP-121727	0166	2	Supporting Multiflow Operation	11.1.0
58	RP-121725	0167	1	2nd DRX cycle and fallback to PRACH R99	11.1.0
59	RP-130206	0169	1	Clean-up for Multiflow	11.2.0
60	RP-130643	0171		Correction of Spare bit allocation	11.3.0
06/2014				Update to Rel-12 version (MCC)	12.0.0
64	RP-140875	0180	3	Introduction of Cell Reselection indications	12.0.0
65	RP-141608	0181	2	Rapporteur Review – change figures to table style	12.1.0

---

## History

<b>Document history</b>		
V12.1.0	September 2014	Publication