

# ETSI TS 125 435 V10.5.0 (2013-01)



Technical Specification

**Universal Mobile Telecommunications System (UMTS);  
UTRAN Iub interface user plane protocols  
for Common Transport Channel data streams  
(3GPP TS 25.435 version 10.5.0 Release 10)**



---

**Reference**

RTS/TSGR-0325435va50

---

**Keywords**

UMTS

**ETSI**

---

650 Route des Lucioles  
F-06921 Sophia Antipolis Cedex - FRANCE

Tel.: +33 4 92 94 42 00 Fax: +33 4 93 65 47 16

Siret N° 348 623 562 00017 - NAF 742 C  
Association à but non lucratif enregistrée à la  
Sous-Préfecture de Grasse (06) N° 7803/88

---

**Important notice**

Individual copies of the present document can be downloaded from:

<http://www.etsi.org>

The present document may be made available in more than one electronic version or in print. In any case of existing or perceived difference in contents between such versions, the reference version is the Portable Document Format (PDF). In case of dispute, the reference shall be the printing on ETSI printers of the PDF version kept on a specific network drive within ETSI Secretariat.

Users of the present document should be aware that the document may be subject to revision or change of status. Information on the current status of this and other ETSI documents is available at

<http://portal.etsi.org/tb/status/status.asp>

If you find errors in the present document, please send your comment to one of the following services:

[http://portal.etsi.org/chaicor/ETSI\\_support.asp](http://portal.etsi.org/chaicor/ETSI_support.asp)

---

**Copyright Notification**

No part may be reproduced except as authorized by written permission.  
The copyright and the foregoing restriction extend to reproduction in all media.

© European Telecommunications Standards Institute 2013.  
All rights reserved.

**DECT™**, **PLUGTESTS™**, **UMTS™** and the ETSI logo are Trade Marks of ETSI registered for the benefit of its Members.  
**3GPP™** and **LTE™** are Trade Marks of ETSI registered for the benefit of its Members and  
of the 3GPP Organizational Partners.  
**GSM®** and the GSM logo are Trade Marks registered and owned by the GSM Association.

---

## Intellectual Property Rights

IPRs essential or potentially essential to the present document may have been declared to ETSI. The information pertaining to these essential IPRs, if any, is publicly available for **ETSI members and non-members**, and can be found in ETSI SR 000 314: *"Intellectual Property Rights (IPRs); Essential, or potentially Essential, IPRs notified to ETSI in respect of ETSI standards"*, which is available from the ETSI Secretariat. Latest updates are available on the ETSI Web server (<http://ipr.etsi.org>).

Pursuant to the ETSI IPR Policy, no investigation, including IPR searches, has been carried out by ETSI. No guarantee can be given as to the existence of other IPRs not referenced in ETSI SR 000 314 (or the updates on the ETSI Web server) which are, or may be, or may become, essential to the present document.

---

## Foreword

This Technical Specification (TS) has been produced by ETSI 3rd Generation Partnership Project (3GPP).

The present document may refer to technical specifications or reports using their 3GPP identities, UMTS identities or GSM identities. These should be interpreted as being references to the corresponding ETSI deliverables.

The cross reference between GSM, UMTS, 3GPP and ETSI identities can be found under <http://webapp.etsi.org/key/queryform.asp>.

# Contents

|   |    |
|---|----|
| Intellectual Property Rights .....  | 2  |
| Foreword.....   | 2  |
| Foreword.....   | 7  |
| 1 Scope .....   | 8  |
| 2 References .....  | 8  |
| 3 Definitions and abbreviations.....  | 8  |
| 3.1 Definitions .....   | 8  |
| 3.2 Abbreviations .....   | 9  |
| 3.3 Specification Notations .....   | 9  |
| 4 General aspects.....  | 10 |
| 4.1 Common Transport Channel Data Stream User Plane Protocol Services ..... | 10 |
| 4.2 Services expected from the Data Transport Network layer .....           | 10 |
| 4.3 Protocol Version.....   | 11 |
| 5 Data Streams User Plane Procedures .....                                  | 11 |
| 5.1 Data Transfer.....  | 11 |
| 5.1.1 RACH Channels .....   | 11 |
| 5.1.2 CPCH Channels [FDD] .....   | 11 |
| 5.1.3 Secondary-CCPCH related transport Channels .....                      | 11 |
| 5.1.4 Downlink Shared Channels [TDD].....                                   | 12 |
| 5.1.5 Uplink Shared Channels [TDD].....                                     | 13 |
| 5.1.6 High Speed Downlink Shared Channels .....                             | 13 |
| 5.1.7 E-DCH Channels for CELL_FACH and Idle[FDD and 1.28Mcps TDD].....      | 15 |
| 5.2 Node Synchronisation .....  | 15 |
| 5.3 DL Transport Channels Synchronisation .....                             | 16 |
| 5.4 DL Timing Adjustment .....  | 16 |
| 5.5 Dynamic PUSCH Assignment [TDD].....                                     | 17 |
| 5.6 DSCH TFCI Signalling [FDD].....   | 17 |
| 5.7 Timing Advance [3.84 Mcps and 7.68Mcps TDD].....                        | 18 |
| 5.7A Outer Loop PC Information Transfer [1.28 Mcps TDD].....                | 18 |
| 5.8 General .....   | 18 |
| 5.8.1 Association between transport bearer and data/control frames.....     | 18 |
| 5.8.2 DSCH / USCH transport bearer replacement [TDD].....                   | 19 |
| 5.8.3 HS-DSCH Transport Bearer Replacement .....                            | 20 |
| 5.9 HS-DSCH Capacity Request.....   | 21 |
| 5.10 HS-DSCH Capacity Allocation.....                                       | 21 |
| 5.11 Indication of UE State Transition [1.28Mcps TDD] .....                 | 22 |
| 5.12 HS-DSCH UL Synchronization Establishment Failure [1.28Mcps TDD] .....  | 22 |
| 6 Frame Structure and Coding.....   | 23 |
| 6.1 General .....   | 23 |
| 6.2 Data frame structure .....  | 24 |
| 6.2.1 RACH Channels .....   | 24 |
| 6.2.2 CPCH Channels [FDD] .....   | 25 |
| 6.2.3 FACH Channels.....  | 25 |
| 6.2.4 PCH Channels.....   | 26 |
| 6.2.5 Downlink Shared Channels [TDD].....                                   | 27 |
| 6.2.6 Uplink Shared Channels [TDD].....                                     | 28 |
| 6.2.6A HS-DSCH Channels .....   | 29 |
| 6.2.6B E-DCH Channels for CELL_FACH and Idle[FDD and 1.28Mcps TDD].....     | 34 |
| 6.2.7 Coding of information elements in data frames .....                   | 36 |
| 6.2.7.1 Header CRC .....  | 36 |
| 6.2.7.2 Frame Type .....  | 36 |
| 6.2.7.3 Connection Frame Number (CFN).....                                  | 36 |

|          |  |    |
|----------|--|----|
| 6.2.7.4  | Transport Format Indicator .....                                 | 37 |
| 6.2.7.5  | Propagation Delay [FDD] .....                                    | 37 |
| 6.2.7.5A | Ext Propagation Delay [FDD] .....                                | 37 |
| 6.2.7.6  | Rx Timing Deviation [3.84Mcps TDD] .....                         | 37 |
| 6.2.7.6A | Received SYNC UL Timing Deviation [1.28Mcps TDD] .....           | 38 |
| 6.2.7.6B | Rx Timing Deviation [7.68Mcps TDD] .....                         | 38 |
| 6.2.7.7  | Transport Block .....  | 38 |
| 6.2.7.8  | CRC Indicator .....  | 38 |
| 6.2.7.9  | Payload CRC .....  | 38 |
| 6.2.7.10 | Transmit Power Level .....                                       | 38 |
| 6.2.7.11 | Paging Indication (PI) .....                                     | 39 |
| 6.2.7.12 | Paging Indication bitmap (PI-bitmap) .....                       | 39 |
| 6.2.7.13 | Rx Timing Deviation on RACH [3.84Mcps TDD] .....                 | 39 |
| 6.2.7.14 | PDSCH Set Id [TDD] .....   | 39 |
| 6.2.7.15 | Code Number [FDD] .....  | 39 |
| 6.2.7.16 | Spreading Factor (SF) [FDD] .....                                | 39 |
| 6.2.7.17 | Power Offset [FDD] .....   | 39 |
| 6.2.7.18 | MC Info [FDD] .....  | 40 |
| 6.2.7.19 | Spare Extension .....  | 40 |
| 6.2.7.20 | Quality Estimate (QE) [TDD] .....                                | 40 |
| 6.2.7.21 | Common Transport Channel Priority Indicator (CmCH-PI) .....      | 40 |
| 6.2.7.22 | User Buffer Size .....   | 40 |
| 6.2.7.23 | MAC-d PDU Length .....   | 40 |
| 6.2.7.24 | NumOfPDU .....   | 40 |
| 6.2.7.25 | MAC-d PDU .....  | 40 |
| 6.2.7.26 | Cell Portion ID [FDD] .....                                      | 41 |
| 6.2.7.27 | New IE Flags .....   | 41 |
| 6.2.7.28 | Flush .....  | 41 |
| 6.2.7.29 | DRT (Delay Reference Time) .....                                 | 41 |
| 6.2.7.30 | Frame Sequence Number .....                                      | 41 |
| 6.2.7.31 | Logical Channel ID in block n .....                              | 42 |
| 6.2.7.32 | Total Number of PDU blocks .....                                 | 42 |
| 6.2.7.33 | MAC-d/c PDU Length in block n .....                              | 42 |
| 6.2.7.34 | Number of MAC-d/c PDUs in block n (#PDUs in block n) .....       | 42 |
| 6.2.7.35 | DRT Indicator .....  | 42 |
| 6.2.7.36 | FACH Indicator (FI) [FDD and 1.28Mcps TDD] .....                 | 42 |
| 6.2.7.37 | H-RNTI [FDD and 1.28Mcps TDD] .....                              | 43 |
| 6.2.7.38 | RACH Measurement Result [FDD and 1.28Mcps TDD] .....             | 43 |
| 6.2.7.39 | H-RNTI Indicator (HI) [FDD and 1.28Mcps TDD] .....               | 43 |
| 6.2.7.40 | FSN/DRT Reset .....  | 43 |
| 6.2.7.41 | MAC-d/c PDU .....  | 43 |
| 6.2.7.42 | AOA (Angle of Arrival) [1.28Mcps TDD] .....                      | 44 |
| 6.2.7.43 | Ext Received SYNC UL Timing Deviation [1.28Mcps TDD] .....       | 44 |
| 6.2.7.44 | Number of Subframes [FDD and 1.28Mcps TDD] .....                 | 44 |
| 6.2.7.45 | Number of MAC-is SDU in frame [FDD and 1.28Mcps TDD] .....       | 44 |
| 6.2.7.46 | Number of MAC-is PDUs [FDD and 1.28Mcps TDD] .....               | 44 |
| 6.2.7.47 | Subframe Number [FDD and 1.28Mcps TDD] .....                     | 44 |
| 6.2.7.48 | E-DCH User Buffer Size [FDD and 1.28Mcps TDD] .....              | 44 |
| 6.2.7.49 | E-RNTI [FDD and 1.28Mcps TDD] .....                              | 45 |
| 6.2.7.50 | MAC-is PDU descriptor [FDD and 1.28Mcps TDD] .....               | 45 |
| 6.2.7.51 | Dedicated H-RNTI [FDD and 1.28Mcps TDD] .....                    | 45 |
| 6.2.7.52 | eDRX Indication [FDD] .....                                      | 45 |
| 6.2.7.53 | HS-DSCH physical layer category [FDD] .....                      | 45 |
| 6.2.7.54 | Cell Portion LCR ID [1.28Mcps TDD] .....                         | 45 |
| 6.2.7.55 | TS0 Indication [1.28Mcps TDD] .....                              | 46 |
| 6.2.7.56 | Enhanced HS-SCCH support indicator (EI) [FDD] .....              | 46 |
| 6.2.7.57 | MU-MIMO Indication(MI) [1.28Mcps TDD] .....                      | 46 |
| 6.2.7.58 | Propagation Delay Full Range [FDD] .....                         | 46 |
| 6.2.7.59 | CPC Recovery (CPC Recov) [FDD] .....                             | 46 |
| 6.3      | Control frame structure .....                                    | 46 |
| 6.3.1    | Introduction .....   | 46 |
| 6.3.2    | Coding of information elements of the Control frame header ..... | 47 |

|            |   |    |
|------------|---|----|
| 6.3.2.1    | Frame CRC .....   | 47 |
| 6.3.2.2    | Frame Type (FT) .....   | 47 |
| 6.3.2.3    | Control Frame Type .....  | 47 |
| 6.3.3      | Payload structure and information elements .....                      | 48 |
| 6.3.3.1    | TIMING ADJUSTMENT .....   | 48 |
| 6.3.3.1.1  | Payload Structure.....  | 48 |
| 6.3.3.1.2  | CFN .....   | 48 |
| 6.3.3.1.3  | Time of arrival (ToA).....  | 49 |
| 6.3.3.1.4  | Spare Extension .....   | 49 |
| 6.3.3.2    | DL SYNCHRONISATION .....  | 49 |
| 6.3.3.2.1  | Payload Structure.....  | 49 |
| 6.3.3.2.2  | CFN .....   | 50 |
| 6.3.3.2.3  | Spare Extension .....   | 50 |
| 6.3.3.3    | UL SYNCHRONISATION .....  | 50 |
| 6.3.3.3.1  | Payload Structure.....  | 50 |
| 6.3.3.3.2  | CFN .....   | 50 |
| 6.3.3.3.3  | Time of Arrival (TOA).....  | 51 |
| 6.3.3.3.4  | Spare Extension .....   | 51 |
| 6.3.3.4    | DL NODE SYNCHRONISATION .....   | 51 |
| 6.3.3.4.1  | Payload Structure.....  | 51 |
| 6.3.3.4.2  | T1 .....  | 51 |
| 6.3.3.4.3  | Spare Extension .....   | 51 |
| 6.3.3.5    | UL NODE SYNCHRONISATION .....   | 51 |
| 6.3.3.5.1  | Payload Structure.....  | 51 |
| 6.3.3.5.2  | T1 .....  | 52 |
| 6.3.3.5.3  | T2 .....  | 52 |
| 6.3.3.5.4  | T3 .....  | 52 |
| 6.3.3.5.5  | Spare Extension .....   | 53 |
| 6.3.3.6    | DYNAMIC PUSCH ASSIGNMENT [TDD] .....                                  | 53 |
| 6.3.3.6.1  | Payload structure .....   | 53 |
| 6.3.3.6.2  | PUSCH Set Id.....   | 53 |
| 6.3.3.6.3  | Activation CFN .....  | 53 |
| 6.3.3.6.4  | Duration.....   | 53 |
| 6.3.3.7    | DSCH TFCI SIGNALLING [FDD].....                                       | 53 |
| 6.3.3.7.1  | Payload structure .....   | 53 |
| 6.3.3.7.2  | TFCI (field 2) .....  | 53 |
| 6.3.3.7.3  | Spare Extension.....  | 54 |
| 6.3.3.8    | TIMING ADVANCE [3.84Mcps and 7.68Mcps TDD].....                       | 54 |
| 6.3.3.8.1  | Payload structure .....   | 54 |
| 6.3.3.8.2  | CFN .....   | 54 |
| 6.3.3.8.3  | TA [3.84 Mcps] .....  | 54 |
| 6.3.3.8.3A | TA [7.68 Mcps] .....  | 54 |
| 6.3.3.8.4  | Spare Extension .....   | 54 |
| 6.3.3.9    | OUTER LOOP POWER CONTROL [1.28 Mcps TDD].....                         | 54 |
| 6.3.3.9.1  | Payload structure .....   | 54 |
| 6.3.3.9.2  | SIR Target .....  | 55 |
| 6.3.3.9.3  | Spare Extension .....   | 55 |
| 6.3.3.10   | HS-DSCH CAPACITY REQUEST .....  | 55 |
| 6.3.3.10.1 | Common Transport Channel Priority Indicator (CmCH-PI) .....           | 56 |
| 6.3.3.10.2 | User Buffer Size .....  | 56 |
| 6.3.3.10.3 | Spare Extension .....   | 56 |
| 6.3.3.11   | HS-DSCH CAPACITY ALLOCATION .....                                     | 56 |
| 6.3.3.11.1 | Common Transport Channel Priority Indicator (CmCH-PI) .....           | 57 |
| 6.3.3.11.2 | Maximum MAC-d PDU Length.....   | 57 |
| 6.3.3.11.3 | HS-DSCH Credits .....   | 57 |
| 6.3.3.11.4 | HS-DSCH Interval.....   | 58 |
| 6.3.3.11.5 | HS-DSCH Repetition Period .....                                       | 58 |
| 6.3.3.11.6 | Spare Extension .....   | 58 |
| 6.3.3.11.7 | Congestion Status .....   | 58 |
| 6.3.3.11.8 | Maximum MAC-d/c PDU Length.....                                       | 58 |
| 6.3.3.12   | HS-DSCH UL SYNCHRONIZATION ESTABLISHMENT FAILURE [1.28Mcps TDD] ..... | 59 |
| 6.3.3.12.1 | Payload structure .....   | 59 |

6.3.3.12.2 H-RNTI .....59

7 Frame protocol error handling.....59

7.1 Error detection.....59

7.1.1 CRC Calculation.....59

7.1.1.1 Relation between input and output of the Cyclic Redundancy Check .....60

**Annex A (informative): Change History .....61**

History .....62

---

## Foreword

This Technical Specification (TS) has been produced by the 3<sup>rd</sup> Generation Partnership Project (3GPP).

The contents of the present document are subject to continuing work within the TSG and may change following formal TSG approval. Should the TSG modify the contents of the present document, it will be re-released by the TSG with an identifying change of release date and an increase in version number as follows:

Version x.y.z

where:

- x the first digit:
  - 1 presented to TSG for information;
  - 2 presented to TSG for approval;
  - 3 or greater indicates TSG approved document under change control.
- y the second digit is incremented for all changes of substance, i.e. technical enhancements, corrections, updates, etc.
- z the third digit is incremented when editorial only changes have been incorporated in the document.



---

# 1 Scope

The present document provides a description of the UTRAN RNC-Node B (Iub) interface user plane protocols for Common Transport Channel data streams as agreed within the TSG-RAN working group 3.

NOTE: By Common Transport Channel one must understand RACH, FACH/PCH, DSCH, USCH [FDD – and 1.28Mcps TDD -, E-DCH for CELL\_FACH and Idle] and HS-DSCH.

---

# 2 References

The following documents contain provisions which, through reference in this text, constitute provisions of the present document.

- References are either specific (identified by date of publication, edition number, version number, etc.) or non-specific.
- For a specific reference, subsequent revisions do not apply.
- For a non-specific reference, the latest version applies. In the case of a reference to a 3GPP document (including a GSM document), a non-specific reference implicitly refers to the latest version of that document *in the same Release as the present document*.

- [1] Void
- [2] 3GPP TS 25.402: "Synchronisation in UTRAN, Stage 2".
- [3] 3GPP TS 25.302: "Services provided by the Physical Layer".
- [4] 3GPP TS 25.221: "Physical channels and mapping of transport channels to physical channels (TDD)".
- [5] 3GPP TS 25.211: "Physical channels and mapping of transport channels onto physical channels (FDD)".
- [6] 3GPP TS 25.433: "UTRAN Iub interface Node B Application Part (NBAP) signalling".
- [7] Void
- [8] 3GPP TS 25.331: "Radio Ressource Control (RRC) protocol specification".
- [9] 3GPP TS 25.321: "Medium Access Control (MAC) protocol specification".
- [10] 3GPP TS 25.214: " Physical layer procedures (FDD)".
- [11] 3GPP TS 25.401: "UTRAN overall description".
- [12] 3GPP TS 25.306: "UE Radio Access capabilities".
- [13] 3GPP TS 25.427: "UTRAN Iub/Iur interface user plane protocol for DCH data streams".
- [14] 3GPP TS 25.224: "Physical layer procedures (TDD)".

---

# 3 Definitions and abbreviations

## 3.1 Definitions

For the purposes of the present document, the terms and definitions in TS 25.401 [11] and the following apply:

**Transport Connection:** service provided by the transport layer and used by Frame Protocol for the delivery of FP PDU

## 3.2 Abbreviations

For the purposes of the present document, the following abbreviations apply:

|         |                                      |
|---------|--------------------------------------|
| CFN     | Connection Frame Number              |
| CRC     | Cyclic Redundancy Checksum           |
| CRCI    | CRC Indicator                        |
| DCH     | Dedicated Transport Channel          |
| DL      | Downlink                             |
| DRT     | Delay Reference Time                 |
| DSCH    | Downlink Shared Channel              |
| E-DCH   | Enhanced Dedicated Transport Channel |
| FP      | Frame Protocol                       |
| FSN     | Frame Sequence Number                |
| FT      | Frame Type                           |
| HSDPA   | High Speed Downlink Packet Access    |
| HS-DSCH | High Speed Downlink Shared Channel   |
| MFN     | Multicast Frame Number               |
| PC      | Power Control                        |
| PDSCH   | Physical Downlink Shared Channel     |
| PUSCH   | Physical Uplink Shared Channel       |
| QE      | Quality Estimate                     |
| TB      | Transport Block                      |
| TBS     | Transport Block Set                  |
| TFI     | Transport Format Indicator           |
| TNL     | Transport Network Layer              |
| ToA     | Time of Arrival                      |
| ToAWE   | Time of Arrival Window Endpoint      |
| ToAWS   | Time of Arrival Window Startpoint    |
| TTI     | Transmission Time Interval           |
| UL      | Uplink                               |
| USCH    | Uplink Shared Channel                |

## 3.3 Specification Notations

For the purposes of the present document, the following notations apply:

|                |   |
|----------------|---|
| [FDD]          | This tagging of a word indicates that the word preceding the tag "[FDD]" applies only to FDD. This tagging of a heading indicates that the heading preceding the tag "[FDD]" and the section following the heading applies only to FDD.   |
| [TDD]          | This tagging of a word indicates that the word preceding the tag "[TDD]" applies only to TDD, including 7.68Mcps TDD, 3.84Mcps TDD and 1.28Mcps TDD. This tagging of a heading indicates that the heading preceding the tag "[TDD]" and the section following the heading applies only to TDD, including 7.68Mcps TDD, 3.84Mcps TDD and 1.28Mcps TDD. |
| [7.68Mcps TDD] | This tagging of a word indicates that the word preceding the tag "[7.68Mcps TDD]" applies only to 7.68Mcps TDD. This tagging of a heading indicates that the heading preceding the tag "[7.68Mcps TDD]" and the section following the heading applies only to 7.68Mcps TDD.   |
| [3.84Mcps TDD] | This tagging of a word indicates that the word preceding the tag "[3.84Mcps TDD]" applies only to 3.84Mcps TDD. This tagging of a heading indicates that the heading preceding the tag "[3.84Mcps TDD]" and the section following the heading applies only to 3.84Mcps TDD.   |
| [1.28Mcps TDD] | This tagging of a word indicates that the word preceding the tag "[1.28Mcps TDD]" applies only to 1.28Mcps TDD. This tagging of a heading indicates that the heading preceding the tag "[1.28Mcps TDD]" and the section following the heading applies only to 1.28Mcps TDD.   |

|                      |   |
|----------------------|---|
| [FDD - ...]          | This tagging indicates that the enclosed text following the "[FDD - " applies only to FDD. Multiple sequential paragraphs applying only to FDD are enclosed separately to enable insertion of TDD specific (or common) paragraphs between the FDD specific paragraphs.  |
| [TDD - ...]          | This tagging indicates that the enclosed text following the "[TDD - " applies only to TDD, including 7.68Mcps TDD, 3.84Mcps TDD and 1.28Mcps TDD. Multiple sequential paragraphs applying only to TDD are enclosed separately to enable insertion of FDD specific (or common) paragraphs between the TDD specific paragraphs. |
| [7.68Mcps TDD - ...] | This tagging indicates that the enclosed text following the "[7.68Mcps TDD - " applies only to 7.68Mcps TDD. Multiple sequential paragraphs applying only to 7.68Mcps TDD are enclosed separately to enable insertion of FDD and TDD specific (or common) paragraphs between the 7.68Mcps TDD specific paragraphs.            |
| [3.84Mcps TDD - ...] | This tagging indicates that the enclosed text following the "[3.84Mcps TDD - " applies only to 3.84Mcps TDD. Multiple sequential paragraphs applying only to 1.28Mcps TDD are enclosed separately to enable insertion of FDD and TDD specific (or common) paragraphs between the 3.84Mcps TDD specific paragraphs.            |
| [1.28Mcps TDD - ...] | This tagging indicates that the enclosed text following the "[1.28Mcps TDD - " applies only to 1.28Mcps TDD. Multiple sequential paragraphs applying only to 1.28Mcps TDD are enclosed separately to enable insertion of FDD and TDD specific (or common) paragraphs between the 1.28Mcps TDD specific paragraphs.            |
| Procedure            | When referring to a procedure in the specification the Procedure Name is written with the first letters in each word in upper case characters followed by the word "procedure", e.g. Node Synchronisation procedure.  |
| Frame                | When referring to a control or data frame in the specification the CONTROL/DATA FRAME NAME is written with all letters in upper case characters followed by the words "control/data frame", e.g. TIMING ADJUSTMENT control frame.   |
| IE                   | When referring to an information element (IE) in the specification the <i>Information Element Name</i> is written with the first letters in each word in upper case characters and all letters in Italic font followed by the abbreviation "IE", e.g. <i>Frame Type</i> IE.   |
| Value of an IE       | When referring to the value of an information element (IE) in the specification the "Value" is written as it is specified in subclause 6.2.7 or 6.3.3 enclosed by quotation marks, e.g. "0" or "255".   |

---

## 4 General aspects

### 4.1 Common Transport Channel Data Stream User Plane Protocol Services

Common transport channel provides the following services:

- Transport of TBS between the Node B and the CRNC for common transport channels.
- Support of transport channel synchronisation mechanism.
- Support of Node Synchronisation mechanism.

### 4.2 Services expected from the Data Transport Network layer

The following services are expected from the transport layer:

- Delivery of Frame Protocol PDUs.

In sequence delivery is not required. However, frequent out-of-sequence delivery may impact the performance and should be avoided.

## 4.3 Protocol Version

This revision of the specification specifies version 1 of the protocols.

---

# 5 Data Streams User Plane Procedures

## 5.1 Data Transfer

### 5.1.1 RACH Channels

Data Transfer procedure is used to transfer data received from Uu interface from Node B to CRNC. Data Transfer procedure consists of a transmission of Data Frame from Node B to CRNC.

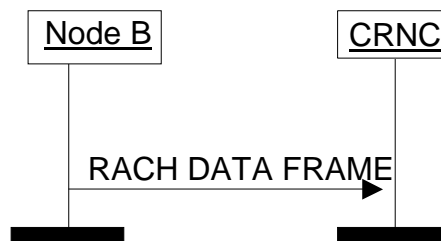

Figure 1: RACH Data Transfer procedure

### 5.1.2 CPCH Channels [FDD]

Void.

### 5.1.3 Secondary-CCPCH related transport Channels

For the FACH transport channel, a Data Transfer procedure is used to transfer data from CRNC to Node B. Data Transfer procedure consists of a transmission of Data Frame from CRNC to Node B.

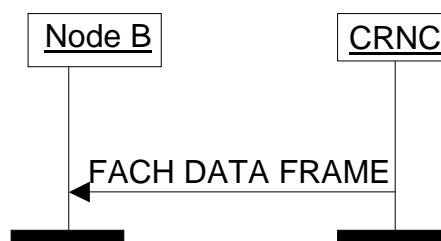
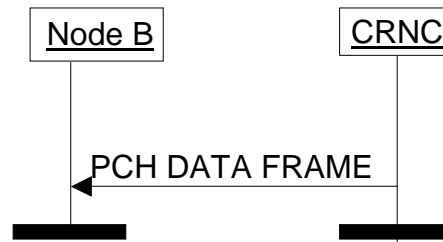

Figure 3: FACH Data Transfer procedure

For the PCH transport channel, a Data Transfer procedure is used to transfer data from CRNC to Node B. Data Transfer procedure consists of a transmission of Data Frame from CRNC to Node B.



**Figure 4: PCH Data Transfer procedure**

In this case the PCH DATA FRAME may also transport information related to the PICH channel.

If the Node B does not receive a valid FP frame in a TTI, it assumes that there is no data to be transmitted in that TTI for this transport channel. For the FACH and PCH transport channels, the TFS shall never define a Transport Block Size of zero bits.

If the Node B is aware of a TFI value corresponding to zero bits for this transport channel, this TFI is assumed. When combining the TFI's of the different transport channels, a valid TFCI might result and in this case data shall be transmitted on the Uu.

If the Node B is not aware of a TFI value corresponding to zero bits for this transport channel or if combining the TFI corresponding to zero bits with other TFI's results in an unknown TFI combination, the handling as described in the following paragraph shall be applied.

At each frame, the Node B shall build the TFCI value of each secondary-CCPCH according to the TFIs of the transport channels multiplexed on this secondary-CCPCH and scheduled for that frame. [FDD - In case the Node B receives an unknown TFI combination, no pilot bits, TFCI bits or Data bits shall be transmitted.] [TDD - In case the Node B receives an unknown TFI combination, it shall apply DTX, i.e. suspend transmission on the corresponding S-CCPCH - except if this S-CCPCH provides the "beacon function", in which case the Node B shall maintain the physical layer transmission as specified in TS 25.221] [4].

If the Node B does not receive a valid FP frame in a TTI or a frame without paging indication information, it assumes that no UE's have to be paged on the Uu in this TTI. In this case the default PICH bit pattern of all zeros shall be transmitted.

Data Frames sent on Iub for different transport channels multiplexed on one secondary-CCPCH might indicate different transmission power levels to be used in a certain Uu frame. Node-B shall determine the highest DL power level required for any of the transport channels multiplexed in a certain Uu frame and use this power level as the desired output level for the data.

In the case there is no data (i.e. no TB in the FP frame or no FP frame) in any transport channel for a given TTI and a TFCI is defined for no transmission on all transport channels multiplexed on the S-CCPCH, the TFCI transmit power is unspecified.

**NOTE:** It can be for example 0 or determined by the Node B relatively to  $P_{\text{ref-no data}} = \text{Min}(\text{PCH Power, Max FACH1 Power, Max FACH2 Power, ..., Max FACHn Power})$  where PCH, FACH1, FACH2, ..., FACHn are the transport channels of the S-CCPCH [FDD, using the respective PO1 and PO3 offsets specified in TS 25.214 [10]].

#### 5.1.4 Downlink Shared Channels [TDD]

The Data Transfer procedure is used to transfer a DSCH DATA FRAME from the CRNC to a Node B.

If the Node B does not receive a valid DSCH DATA FRAME for transmission in a given TTI, it assumes that there is no data to be transmitted in that TTI for this transport channel. For the DSCH transport channel, the TFS shall never define a Transport Block Size of zero bits.

The Node B shall use the header information in the DSCH DATA FRAME to determine which PDSCH Set [3.84Mcps and 7.68 Mcps TDD - and Transmit Power Level if no closed loop TPC power control is used] should be used in the PDSCH Uu frames associated to the specified CFN. The specified PDSCH Set [3.84Mcps and 7.68 Mcps TDD - and Transmit Power Level if no closed loop TPC power control is used] shall then be used for DSCH transmission for as long as there is data to transmit or until a new DSCH DATA FRAME arrives that specifies that a different PDSCH Set

[3.84Mcps and 7.68 Mcps TDD - and/or Transmit Power Level if no closed loop TPC power control is used] should be used. This feature enables multiple DSCH's with different TTI to be supported.

The Node B may receive a DSCH data frame which contains a TFI value corresponding to there being no data to transmit, such a DSCH DATA FRAME will have no transport blocks. On receiving such a DATA FRAME the Node B shall apply the specified PDSCH Set [3.84Mcps and 7.68 Mcps TDD - and Transmit Power Level if no closed loop TPC power control is used] as described above starting in the PDSCH Uu frame associated to the specified CFN. This feature enables multiple DSCH's with different TTI to be supported, the use of such a zero payload DSCH DATA FRAME solves the problem of how the Node B should determine what PDSCH Set [3.84Mcps and 7.68 Mcps TDD - and Transmit Power Level if no closed loop TPC power control is used] should be used in the event that transmission of a transport block set being transmitted with a short TTI comes to an end, whilst the transmission of a TBS with a long TTI continues.

Data Frames sent on Iub for different DSCH transport channels multiplexed on one CCTrCH might indicate different transmission power levels to be used in a certain Uu frame. Node-B shall determine the highest DL power level required for any of the transport channels multiplexed in a certain Uu frame and use this power level as the desired output level.

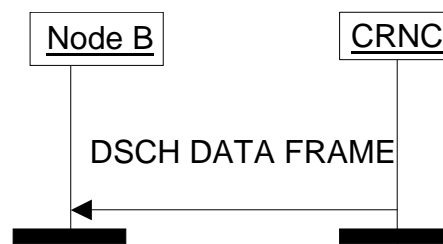

Figure 5: DSCH Data Transfer procedure

### 5.1.5 Uplink Shared Channels [TDD]

Data Transfer procedure is used to transfer data received from Uu interface from Node B to CRNC. Data Transfer procedure consists of a transmission of Data Frame from Node B to CRNC.

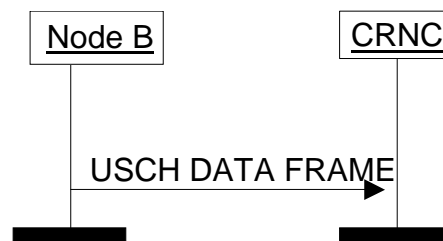

Figure 6: USCH Data Transfer procedure

Node B shall always send an USCH DATA FRAME to the CRNC provided the Transport Format addressed by the TFI indicates that the number of Transport Blocks is greater than 0.

When UL synchronisation is lost or not yet achieved on the Uu, USCH DATA FRAMEs shall not be sent to the CRNC.

When Node B receives an invalid TFCI in the PUSCH, USCH DATA FRAMEs shall not be sent to the CRNC.

### 5.1.6 High Speed Downlink Shared Channels

The Data Transfer procedure is used to transfer a HS-DSCH DATA FRAME (TYPE 1, TYPE 2 [FDD and 1.28Mcps TDD - or TYPE3]) from the CRNC to a Node B. HS-DSCH DATA FRAME TYPE 2 is selected if the IE *HS-DSCH MAC-d PDU Size Format* in NBAP (TS 25.433 [6]) is present and set to "Flexible MAC-d PDU Size" [FDD and 1.28Mcps TDD - or if the IE *HS-DSCH Common System Information* is present and the UE is in Cell\_FACH state. HS-DSCH DATA FRAME TYPE 3 is selected if the IE *HS-DSCH Paging System Information* in NBAP (TS 25.433 [6]) is present and the UE is in Cell\_PCH state or URA\_PCH state]. HS-DSCH DATA FRAME TYPE 1 is selected in any other case.

[FDD and 1.28Mcps TDD – Three types of HS-DSCH Frame Protocols exist for HS-DSCH data transfer procedure, i.e., HS-DSCH Frame Protocol TYPE 1 (including HS-DSCH DATA FRAME TYPE 1 and HS-DSCH CAPACITY ALLOCATION TYPE 1 Control Frame), HS-DSCH Frame Protocol TYPE 2 (including HS-DSCH DATA FRAME TYPE 2 and HS-DSCH CAPACITY ALLOCATION TYPE 2 Control Frame) and HS-DSCH Frame Protocol TYPE 3 (including HS-DSCH DATA FRAME TYPE 3).]

[3.84Mcps TDD and 7.68 Mcps TDD – Two types of HS-DSCH Frame Protocols exist for HS-DSCH data transfer procedure, i.e., HS-DSCH Frame Protocol TYPE 1 (including HS-DSCH DATA FRAME TYPE 1 and HS-DSCH CAPACITY ALLOCATION TYPE 1 Control Frame) and HS-DSCH Frame Protocol TYPE 2 (including HS-DSCH DATA FRAME TYPE 2 and HS-DSCH CAPACITY ALLOCATION TYPE 2 Control Frame).]

HS-DSCH CAPACITY ALLOCATION TYPE 1 Control Frame shall be associated only with HS-DSCH DATA FRAME TYPE 1 while HS-DSCH CAPACITY ALLOCATION TYPE 2 Control Frame shall be associated only with HS-DSCH DATA FRAME TYPE 2. HS-DSCH CAPACITY REQUEST Control Frame shall be used for both of HS-DSCH Frame Protocols. HS-DSCH Frame Protocol TYPE 2 is used for Flexible MAC-d PDU Size [FDD and 1.28Mcps TDD - and Enhanced Cell\_FACH Operation] as described in NBAP (TS 25.433 [6]).

When the CRNC has been granted capacity by the Node B via the HS-DSCH CAPACITY ALLOCATION (TYPE 1 or TYPE 2) Control Frame or via the HS-DSCH initial capacity allocation as described in TS 25.433 [6] and the CRNC has data waiting to be sent, then the HS-DSCH DATA FRAME (TYPE 1 or TYPE 2) is used to transfer the data. If the CRNC has been granted capacity by the Node B via the HS-DSCH initial capacity allocation as described in TS 25.433 [6], this capacity is valid for only the first HS-DSCH DATA FRAME (TYPE 1 or TYPE 2) transmission. If the HS-DSCH Frame Protocol TYPE 2 has been selected by the Node B, the granted capacity shall be interpreted as the total number of octets which is retrieved by multiplying the maximum MAC-d PDU [FDD and 1.28Mcps TDD - or MAC-c PDU] length (indicated by the *Maximum MAC-d/c PDU Length* IE) with the number of MAC-d PDUs [FDD and 1.28Mcps TDD - or MAC-c PDUs] (indicated by the *HS-DSCH Credits* IE). When data is waiting to be transferred, and a CAPACITY ALLOCATION (TYPE 1 or TYPE 2) is received, a DATA FRAME (TYPE 1 or TYPE 2) will be transmitted immediately according to allocation received. If the allocation received is >0 but less than the data waiting to be transferred, then the CRNC may send one HS-DSCH DATA FRAME TYPE 2 containing one MAC-d PDU [FDD - or MAC-c PDU] with a length up to the NBAP *Maximum MAC-d PDU Size Extended* [FDD and 1.28Mcps TDD - or *Maximum MAC-c PDU Size*] IE value. In such a case, the amount of data exceeding the allocated capacity for the first HS-DSCH Interval shall be credited from the following HS-DSCH Intervals, if available.

In case of HS-DSCH Frame Protocol TYPE 1, multiple MAC-d PDUs of same length and same priority level (CmCH-PI) may be transmitted in one MAC-d flow in the same HS-DSCH DATA FRAME TYPE 1.

In case of HS-DSCH Frame Protocol TYPE 2, MAC-d PDUs [FDD and 1.28Mcps TDD - or MAC-c PDUs] with the same logical channel ID shall be associated to one unique priority level (CmCH-PI).

The HS-DSCH DATA FRAME (TYPE 1 and TYPE 2) includes a *User Buffer Size* IE to indicate the amount of data pending for the respective MAC-d flow for the indicated priority level. [FDD and 1.28Mcps TDD - The HS-DSCH DATA FRAME TYPE 2 includes PDUs for UE in Cell\_FACH includes a *User Buffer Size* IE to indicate the amount of data pending for the respective Common MAC flow for the indicated priority level.] Within one priority level (CmCH-PI) and size the MAC-d PDUs [FDD and 1.28Mcps TDD - or MAC-c PDUs] shall be transmitted by the Node B on the Uu interface in the same order as they were received from the CRNC.

FDD - In case of HS-DSCH Frame Protocol TYPE 2 or TYPE 3 and when the UE is not in Cell\_DCH state, then (see TS 25.331 [8] and TS 25.321 [9]):]

- [FDD - When transmitting the MAC-ehs PDU on the Uu interface using the dedicated H-RNTI for DCCH/DTCH the Node B shall:]
  - [FDD - if supported use the actual HS-DSCH physical layer category for MAC-ehs of the UE, or]
  - [FDD - if the actual HS-DSCH physical layer category is not known to Node B or the usage of the actual UE category is not supported - use category 12 and limit the MAC-ehs PDU size to not more than 1572 bits, if supported]
- [FDD - When transmitting the MAC-ehs PDU on the Uu interface for other channels than BCCH and not using the dedicated H-RNTI the Node B shall if supported use the "Total number of soft channel bits" as defined for a UE of category 12 (see Table 5.1a in TS 25.306 [12])]
- [FDD - When transmitting the MAC-ehs PDU on the Uu interface for BCCH, the Node B shall, if supported, use category 12 and limit the MAC-ehs PDU size to 1572 bits.]

If the *Flush* IE in the HS-DSCH DATA FRAME (TYPE 1 and TYPE 2) is set to "flush" the Node B should remove all MAC-d PDUs [FDD and 1.28Mcps TDD - or MAC-c PDUs] from the corresponding MAC-hs Priority Queue that have been received prior to this data frame on the same transport bearer.

For the purpose of TNL Congestion Control on HSDPA, the *Frame Sequence Number* and the *DRT* IEs may be included by the CRNC.

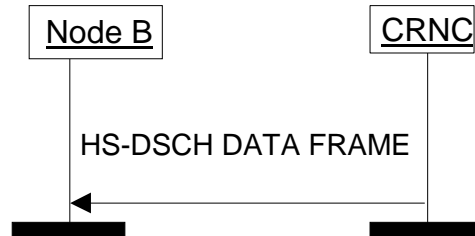

Figure 6A: HS-DSCH Data Transfer procedure

### 5.1.7 E-DCH Channels for CELL\_FACH and Idle[FDD and 1.28Mcps TDD]

The E-DCH Data Transfer procedure for CELL\_FACH and Idle is used to transfer an E-DCH DATA FRAME from the Node B to the CRNC. The E-DCH user-plane payload is transmitted using the E-DCH DATA FRAME only when some payload has been successfully received in same way as E-DCH Data Transfer procedure for Cell\_DCH defined in TS 25.427 [13], i.e., only silent mode defined in TS 25.427 [13] is used.

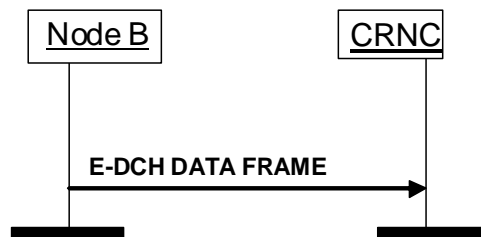

Figure 6B : E-DCH Enhanced Data Transfer procedure in CELL\_FACH and Idle

## 5.2 Node Synchronisation

In the Node Synchronisation procedure, the RNC sends a DL NODE SYNCHRONISATION control frame to Node B containing the parameter T1. Upon reception of a DL NODE SYNCHRONISATION control frame, the Node B shall respond with UL NODE SYNCHRONISATION control frame, indicating T2 and T3, as well as T1 which was indicated in the initiating DL NODE SYNCHRONISATION control frame.

The T1, T2, T3 parameters are defined as:

- T1: RNC specific frame number (RFN) that indicates the time when RNC sends the frame through the SAP to the transport layer.
- T2: Node B specific frame number (BFN) that indicates the time when Node B receives the correspondent DL NODE SYNCHRONISATION control frame through the SAP from the transport layer.
- T3: Node B specific frame number (BFN) that indicates the time when Node B sends the frame through the SAP to the transport layer.

The general overview on the Node Synchronisation procedure is reported in TS 25.402 [2].

The procedure shall not be applied on transport bearers with IP multicast option.



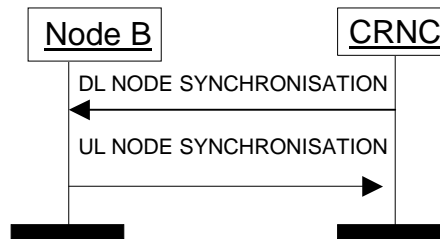

Figure 7: Node Synchronisation procedure

## 5.3 DL Transport Channels Synchronisation

CRNC sends a DL SYNCHRONISATION control frame to Node B. This message indicates the target CFN.

Upon reception of the DL SYNCHRONISATION control frame Node B shall immediately respond with UL SYNCHRONISATION control frame indicating the ToA for the DL SYNCHRONISATION control frame and the CFN indicated in the received message.

The procedure shall not be applied on transport bearers transporting UL traffic channels RACH [FDD and 1.28Mcps TDD – , E-DCH for CELL\_FACH and Idle] or USCH.

In case a CRNC sends DL SYNCHRONISATION control frame to Node B via IP multicast transport bearer, the target CFN indicates the target MFN. Upon reception of the DL SYNCHRONISATION control frame Node B shall immediately respond with UL SYNCHRONISATION control frame via one unicast transport bearer indicating the ToA for the DL SYNCHRONISATION control frame and the MFN indicated in the received message.

In case a transport bearer without IP multicast option is used by several FACH channels, the procedure shall take place for all these FACH channels.

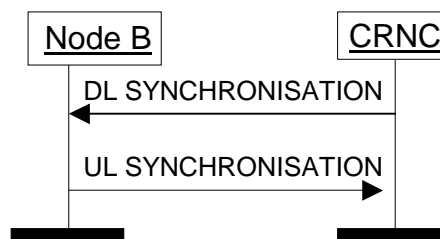

Figure 8: Transport Channels Synchronisation procedure

## 5.4 DL Timing Adjustment

Timing Adjustment procedure is used to indicate for the CRNC the incorrect arrival time of downlink data to Node B.

Timing Adjustment procedure is initiated by the Node B if a DL frame arrives outside of the defined arrival window.

If the DL frame has arrived before the ToAWS or after the ToAWE Node B includes the ToA and the target CFN as message parameters for TIMING ADJUSTMENT control frame.

In case a transport bearer without IP multicast option is used by several FACH channels, the procedure shall take place for all these FACH channels.

The arrival window and the time of arrival are defined as follows:

- **Time of Arrival Window Endpoint (ToAWE):** ToAWE represents the time point by which the DL data shall arrive to the Node B from Iub. The ToAWE is defined as the amount of milliseconds before the last time point from which a timely DL transmission for the identified CFN would still be possible taking into account the Node B internal delays. ToAWE is set via control plane. If data does not arrive before ToAWE a TIMING ADJUSTMENT control frame shall be sent by Node B.

- **Time of Arrival Window Startpoint (ToAWS):** ToAWS represents the time after which the DL data shall arrive to the Node B from Iub. The ToAWS is defined as the amount of milliseconds from the ToAWE. ToAWS is set via control plane. If data arrives before ToAWS a TIMING ADJUSTMENT control frame shall be sent by Node B.
- **Time of Arrival (ToA):** ToA is the time difference between the end point of the DL arrival window (ToAWE) and the actual arrival time of DL frame for a specific CFN. A positive ToA means that the frame is received before the ToAWE, a negative ToA means that the frame is received after the ToAWE.

The general overview on the timing adjustment procedure is reported in TS 25.402 [2].

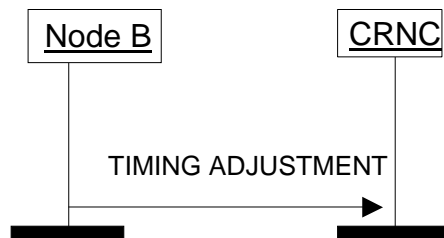

Figure 9: Timing Adjustment procedure

## 5.5 Dynamic PUSCH Assignment [TDD]

Procedure for dynamic allocation of physical resources to uplink shared channels (USCH) in the Node B. The control frame includes a parameter "PUSCH Set Id" which is a pointer to a pre-configured table of PUSCH Sets in the Node B.

When this control frame is sent via a certain Iub USCH data port, then it applies to that USCH and in addition to any other USCH channel which is multiplexed into the same CCTrCH in the Node B.

The time limitation of the PUSCH allocation is expressed with the parameters "Activation CFN" and "Duration".

*Node B behaviour:* When the Node B receives the "DYNAMIC PUSCH ASSIGNMENT" from the CRNC in the USCH frame protocol over an Iub USCH data port within a Traffic Termination Point, it shall behave as follows:

- 1) The Node B shall extract the PUSCH Set Id.
- 2) It shall extract the parameters "Activation CFN" and "Duration" which identify the allocation period of that physical channel.
- 3) It shall retrieve the PUSCH Set which is referred to by the PUSCH Set Id.
- 4) It shall identify the CCTrCH to which the USCH is multiplexed, and hence the TFCS which is applicable for the USCH.
- 5) Within the time interval indicated by Activation CFN and Duration, the Node B shall make the specified PUSCH Set available to the CCTrCH.

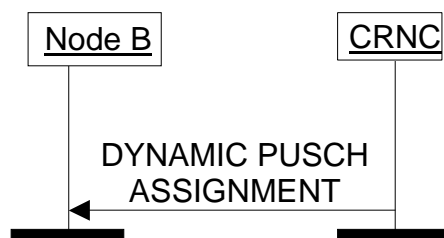

Figure 10: Dynamic PUSCH Assignment procedure

## 5.6 DSCH TFCI Signalling [FDD]

Void.

## 5.7 Timing Advance [3.84 Mcps and 7.68Mcps TDD]

This procedure is used in order to signal to the Node B the adjustment to be performed by the UE in the uplink timing.

The Node B shall use the CFN and timing adjustment values to adjust its layer 1 to allow for accurate impulse averaging.

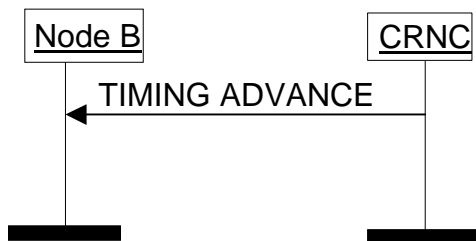

Figure 12: Timing Advance procedure

### 5.7A Outer Loop PC Information Transfer [1.28 Mcps TDD]

Based, for example, on the CRCI values and on the quality estimate in the USCH data frames, CRNC modifies the SIR target of the associated CCTrCH by including the absolute value of the new SIR target in the OUTER LOOP PC control frame sent to the Node B.

At the reception of the OUTER LOOP PC control frame from the CRNC via a Transport Bearer used for an USCH, the Node B shall immediately update the SIR target used for the inner loop power control for the respective CCTrCH with the specified value.

The OUTER LOOP PC control frame can be sent via any of the transport bearers carrying USCHs which belong to the CCTrCH for which the UL SIR Target shall be adjusted.

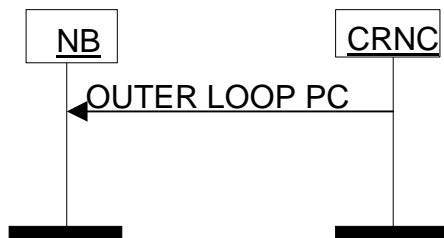

Figure 12A: Outer Loop Power Control Information Transfer procedure

## 5.8 General

### 5.8.1 Association between transport bearer and data/control frames

Table 1 shows how the data and control frames are associated to the transport bearers. 'yes' indicates that the control frame is applicable to the transport bearer, 'no' indicates that the control frame is not applicable to the transport bearer.

Table 1

| Transport bearer used for    | Associated data frame     | Associated control frames |  |                       |                           |                |                             |                          |                                    |                                 |
|------------------------------|---------------------------|---------------------------|--|-----------------------|---------------------------|----------------|-----------------------------|--------------------------|------------------------------------|---------------------------------|
|                              |                           | Timing Adjust-ment        | DL Transport Channels Synchroni-sation | Node Synchroni-sation | Dynamic PUSCH Assign-ment | Timing Advance | Outer Loop PC Info Transfer | HS-DSCH Capacity Request | HS-DSCH Capacity Allocation TYPE 1 | HS-DSC Capacit Allocatic TYPE 2 |
| RACH                         | RACH DATA FRAME           | no                        | no                                     | no                    | no                        | no             | no                          | no                       | no                                 | no                              |
| FACH                         | FACH DATA FRAME           | yes                       | yes                                    | yes <sup>1</sup>      | no                        | no             | no                          | no                       | no                                 | no                              |
| PCH                          | PCH DATA FRAME            | yes                       | yes                                    | yes                   | no                        | no             | no                          | no                       | no                                 | no                              |
| DSCH                         | DSCH DATA FRAME           | yes                       | yes                                    | yes                   | no                        | no             | no                          | no                       | no                                 | no                              |
| USCH                         | USCH DATA FRAME           | no                        | no                                     | no                    | yes                       | yes            | yes                         | no                       | no                                 | no                              |
| HS-DSCH                      | HS-DSCH DATA FRAME TYPE 1 | no                        | no                                     | yes                   | no                        | no             | no                          | yes                      | yes                                | no                              |
| HS-DSCH                      | HS-DSCH DATA FRAME TYPE 2 | no                        | no                                     | yes                   | no                        | no             | no                          | yes                      | no                                 | yes                             |
| HS-DSCH                      | HS-DSCH DATA FRAME TYPE 3 | yes                       | yes                                    | yes                   | no                        | no             | no                          | no                       | no                                 | no                              |
| E-DCH for CELL FACH and Idle | E-DCH DATA FRAME          | no                        | no                                     | no                    | no                        | no             | no                          | no                       | no                                 | no                              |

NOTE: <sup>1</sup>: The associated control frame is not applicable to the transport bearer with IP multicast option.

## 5.8.2 DSCH / USCH transport bearer replacement [TDD]

As described in NBAP (TS 25.433 [6]), transport bearer replacement can be achieved for a DSCH or USCH by using the Synchronised Radio Link Reconfiguration Preparation procedure in combination with the Synchronised Radio Link Reconfiguration Commit procedure. The following steps can be discerned:

- 1) The new transport bearer is established after which 2 transport bearers exist in parallel.
- 2) The transport channel(s) is/are switched to the new transport bearer.
- 3) The old transport bearer is released.

### DSCH transport bearer replacement, step 1:

Communication on the old transport bearer continues as normal. In addition, the Node B shall support DSCH DATA FRAMES, the DL Transport Channel Synchronisation procedure (see sub-clause 5.3) and the DL Timing Adjustment procedure (see sub-clause 5.4) on the new bearer. This enables the CRNC to determine the timing on the new transport bearer. DSCH DATA FRAMES transported on the new transport bearer shall not be transmitted on the Uu Interface before the CFN indicated in the RADIO LINK RECONFIGURATION COMMIT message.

### USCH transport bearer replacement, step 1:

Communication on the old transport bearer continues as normal.

**DSCH / USCH Transport Bearer Replacement step 2:**

Regarding step 2), the moment of switching is determined as follows:

- The DSCH DATA FRAMEs or USCH DATA FRAMEs shall be transported on the new transport bearer from the CFN indicated in the RADIO LINK RECONFIGURATION COMMIT message.

Starting from this CFN the Node B shall support all applicable Common Transport Channels frame protocol procedures on the new transport bearer and no requirements exist regarding support of Common Transport Channels frame protocol procedures on the old transport bearer.

**DSCH / USCH Transport Bearer Replacement step 3:**

Finally in step 3), the old transport bearer is released.

### 5.8.3 HS-DSCH Transport Bearer Replacement

As described in NBAP (TS 25.433 [6]), transport bearer replacement can be achieved for a HS-DSCH MAC-d Flow by using the Synchronised Radio Link Reconfiguration Preparation procedure in combination with the Synchronised Radio Link Reconfiguration Commit procedure, or by using the Unsynchronised Radio Link Reconfiguration procedure. In both cases the following steps can be discerned:

- 1) The new transport bearer is established after which 2 transport bearers exist in parallel.
- 2) The HS-DSCH MAC-d Flow is switched to the new transport bearer.
- 3) The old transport bearer is released.

**HS-DSCH Transport Bearer Replacement, step 1:**

Communication on the old transport bearer continues as normal. In addition, the Node B shall support HS-DSCH DATA FRAMEs (TYPE 1 or TYPE 2), the HS-DSCH CAPACITY REQUEST Control Frame (see sub-clause 5.9) and may support the HS-DSCH CAPACITY ALLOCATION (TYPE 1 or TYPE 2) Control Frame (see sub-clause 5.10) on the new transport bearer. HS-DSCH DATA FRAMEs (TYPE 1 or TYPE 2) transported on the new transport bearer shall be transmitted on the Uu Interface in the same way as those received on the old transport bearer (see sub-clause 5.1.6).

The Node B may use the old or the new transport bearer for the HS-DSCH CAPACITY ALLOCATION (TYPE 1 or TYPE 2) Control Frame. The HS-DSCH CAPACITY ALLOCATION (TYPE 1 or TYPE 2) Control Frame indicates the total amount of capacity granted for the MAC-d flow and the indicated priority level, irrespective of the transport bearer used. Any capacity previously granted is replaced.

The RNC may use the old or the new transport bearer for the HS-DSCH CAPACITY REQUEST Control Frame. The rules for reissuing a HS-DSCH CAPACITY REQUEST Control Frame as outlined in sub-clause 5.9 still apply.

**HS-DSCH Transport Bearer Replacement, step 2:**

Regarding step 2), the moment of switching is determined as follows:

Starting from the CFN indicated in the RADIO LINK RECONFIGURATION COMMIT message – or directly when using the unsynchronised Radio Link Reconfiguration procedure, the Node B shall support all applicable Common Transport Channels frame protocol procedures on the new transport bearer and no requirements exist regarding support of Common Transport Channels frame protocol procedures on the old transport bearer.

**HS-DSCH Transport Bearer Replacement, step 3:**

Finally in step 3), the old transport bearer is released.

## 5.9 HS-DSCH Capacity Request

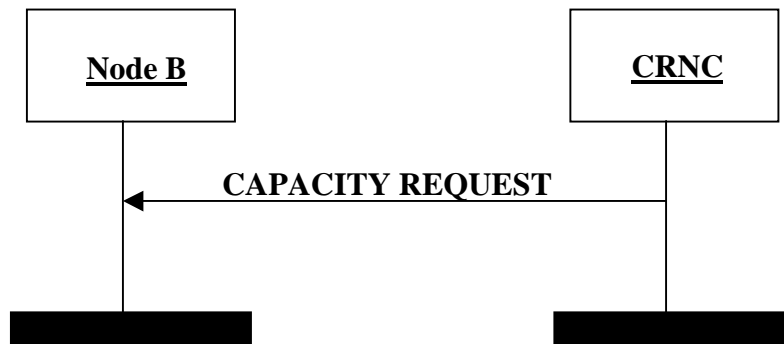

Figure 12B: HS-DSCH Capacity Request procedure

The HS-DSCH Capacity Request procedure provides means for the CRNC to request HS-DSCH capacity by indicating the user buffer size in the CRNC for a given priority level.

The CRNC is allowed to reissue the HS-DSCH Capacity Request if no CAPACITY ALLOCATION (TYPE 1 or TYPE 2) has been received within an appropriate time threshold.

## 5.10 HS-DSCH Capacity Allocation

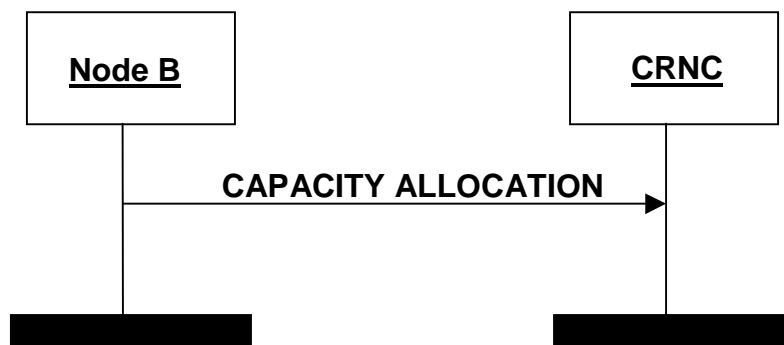

Figure 12C: HS-DSCH Capacity Allocation procedure

HS-DSCH Capacity Allocation procedure is generated within the Node B. It may be generated either in response to a HS-DSCH Capacity Request or at any other time.

The Node B may use this message to modify the capacity at any time, irrespective of the reported user buffer status.

The HS-DSCH CAPACITY ALLOCATION (TYPE 1 and TYPE 2) Control Frame is used by the Node B to control the user data flow. In case of HS-DSCH Frame Protocol TYPE 1, the *HS-DSCH Credits* IE indicates the number of MAC-d PDUs that the CRNC is allowed to transmit for the MAC-d flow and the associated priority level indicated by the *Common Transport Channel Priority Indicator* IE. In case of HS-DSCH Frame Protocol TYPE 2, the *HS-DSCH Credits* IE multiplied by the *Maximum MAC - d/c PDU Length* IE indicates the number of MAC-d PDU [FDD and 1.28Mcps TDD - or MAC-c PDU] octets that the CRNC is allowed to transmit for the MAC-d flow [FDD and 1.28Mcps TDD - or Common MAC flow] and the associated priority level indicated by the *Common Transport Channel Priority Indicator* IE.

The *Maximum MAC-d PDU Length* (in case of HS-DSCH Frame Protocol TYPE 1) or *Maximum MAC- d/c PDU Length* (in case of HS-DSCH Frame Protocol TYPE 2), *HS-DSCH Credits*, *HS-DSCH Interval* and *HS-DSCH Repetition Period* IEs indicates the total amount of capacity granted. Any capacity previously granted is replaced.

If *HS-DSCH Credits* IE = 0 (e.g. due to congestion in the Node B), the CRNC shall immediately stop transmission of MAC-d PDUs [FDD and 1.28Mcps TDD - or MAC-c PDUs]. If *HS-DSCH Credits* IE = 2047 in case of HS-DSCH CAPACITY ALLOCATION TYPE 1 Control Frame or 65535 in case of HS-DSCH CAPACITY ALLOCATION TYPE 2 Control Frame, the CRNC can transmit MAC-d PDUs [FDD and 1.28Mcps TDD - or MAC-c PDUs] with unlimited capacity.

The IEs used in the HS-DSCH CAPACITY ALLOCATION Control Frame (TYPE 1 and TYPE 2) are the *Common Transport Channel Priority Indicator*, *HS-DSCH Credits*, *Maximum MAC-d PDU Length* (in case of HS-DSCH Frame Protocol TYPE 1) or *Maximum MAC-d/c PDU Length* (in case of HS-DSCH Frame Protocol TYPE 2), *HS-DSCH Interval* and the *HS-DSCH Repetition Period*.

If the *HS-DSCH Repetition Period* IE = "unlimited repetition period" it indicates that the CRNC may transmit the amount of granted capacity for an unlimited period according to the bounds of *Maximum MAC-d PDU Length* IE (TYPE 1) or *Maximum MAC-d/c PDU length* IE (TYPE 2), *HS-DSCH Credits* IE and *HS-DSCH Interval* IE.

## 5.11 Indication of UE State Transition [1.28Mcps TDD]

In 1.28Mcps TDD, for UE in CELL\_PCH state with dedicated H-RNTI, the network will inform the UE to establish the uplink synchronization via HS-SCCH before transmitting DCCH and DTCH to the UE. And when UE receives dedicated H-RNTI on HS-SCCH, the UE shall initiate the uplink synchronization procedure and transit to CELL\_FACH state. After the Node B received the confirmation from UE (upon detection of the UE's E-RUCCH), it shall send the UE State Transition Indication to RNC through E-DCH user data frame with dedicated E-RNTI to inform that the UE's state has been transited from CELL\_PCH to CELL\_FACH.

The UE State Transition Indication is indicated in E-DCH user data frame with values set as follows:

- The *CFN* and *Subframe Number* IE values shall reflect the time when the state transition was detected
- The *Number of MAC-is SDUs* IE shall be set to zero. As a consequence there are no *MAC-is PDU descriptor* IE and there are no *MAC-is PDUs* IEs in the payload part of the data frame related to UE state transition indication.

## 5.12 HS-DSCH UL Synchronization Establishment Failure [1.28Mcps TDD]



Figure 12D: HS-DSCH UL Synchronization Establishment Failure procedure

In 1.28Mcps TDD, when the Node B needs to transmit HS-DSCH data to the UE in CELL\_FACH state, the Node B will inform the UE to establish the uplink synchronization via HS-SCCH before HS-DSCH data transmission (TS 25.224 [14]). During this uplink synchronization establishment procedure, if the uplink synchronization failure indication from lower layer is received (TS 25.224 [14]), the Node B could use the HS-DSCH UL SYNCHRONIZATION ESTABLISHMENT FAILURE control frame to notify the RNC to terminate the HS-DSCH data transmission. The *H-RNTI* IE contains the same value as the H-RNTI currently allocated to the UE.

## 6 Frame Structure and Coding

### 6.1 General

The general structure of a Common Transport Channel frame consists of a header and a payload. This structure is depicted in figure 13.

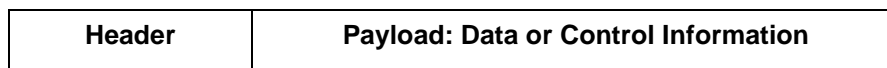

**Figure 13: General Frame Structure**

The header shall contain the Frame Type field and information related to the frame type.

There are two types of frames (indicated by the Frame Type field).

- Data frame.
- Control frame.

In the present document the structure of frames will be specified by using pictures similar to figure 14.

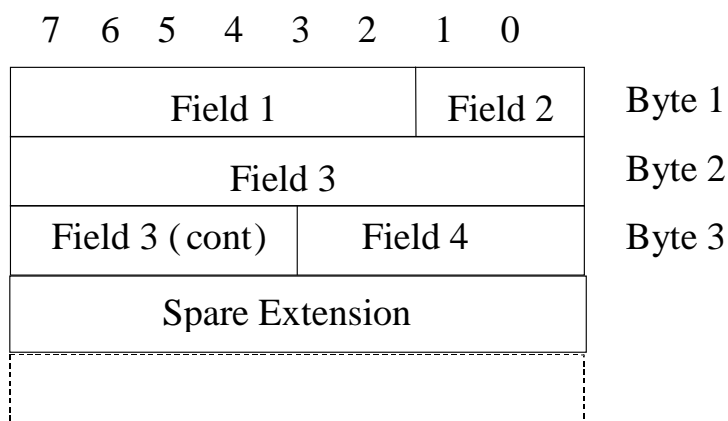

**Figure 14: Example frame structure**

Unless otherwise indicated, fields which consist of multiple bits within a byte will have the more significant bit located at the higher bit position (indicated above frame in figure 14). In addition, if a field spans several bytes, more significant bits will be located in lower numbered bytes (right of frame in figure 14).

On the Iub interface, the frame will be transmitted starting from the lowest numbered byte. Within each byte, the bits are sent according decreasing bit position (bit position 7 first).

The parameters are specified giving the value range and the step (if not 1). The coding is done as follows (unless otherwise specified):

- Unsigned values are binary coded.
- Signed values are 2's complement binary coded.

The Spare Extension indicates the location where new IEs can in the future be added in a backward compatible way. The Spare Extension shall not be used by the transmitter and shall be ignored by the receiver.

Bits labelled "Spare" shall be set to zero by the transmitter and shall be ignored by the receiver.



## 6.2 Data frame structure

### 6.2.1 RACH Channels

The RACH DATA FRAME includes the CFN corresponding to the SFN of the frame in which the payload was received. If the payload was received in several frames, the CFN corresponding to the first Uu frame in which the information was received shall be indicated.

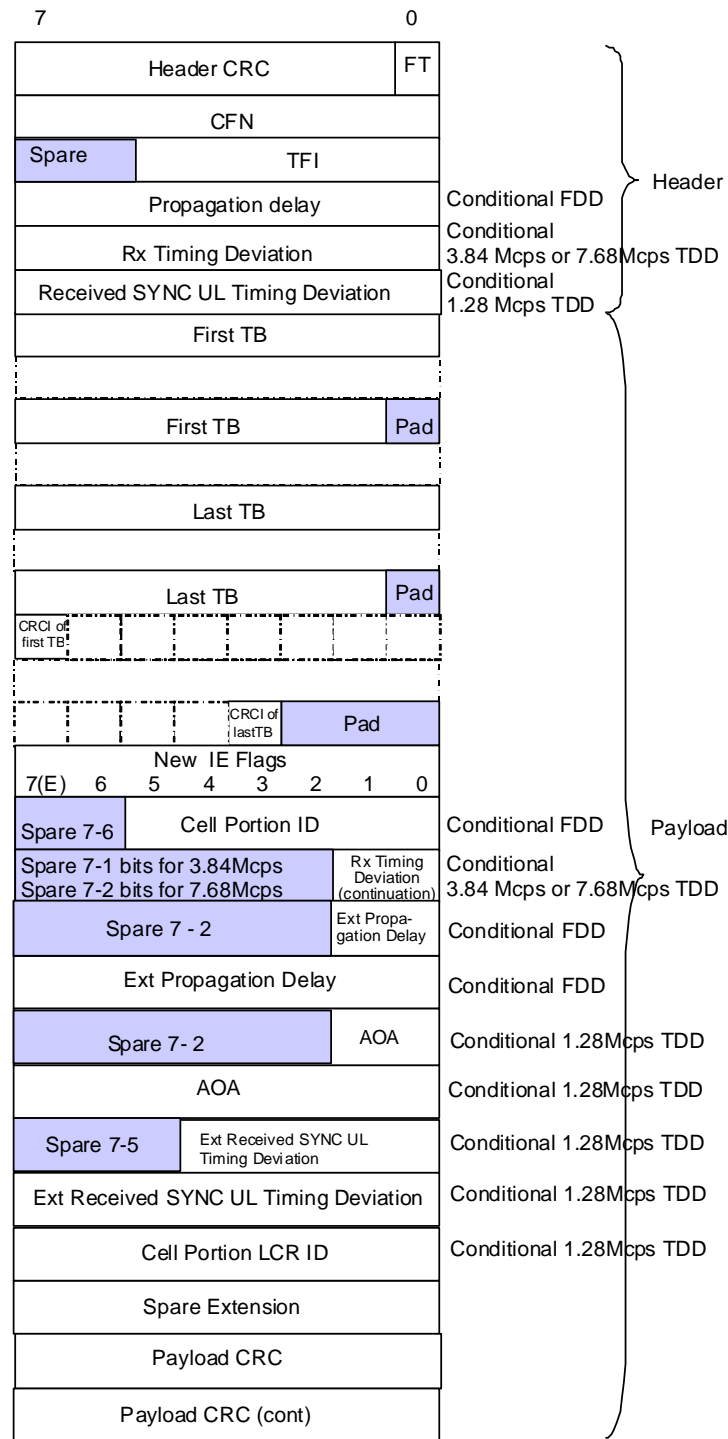

Figure 15: RACH DATA FRAME structure

Propagation Delay is a conditional Information Element which is only present when the Cell supporting the RACH Transport Channel is a FDD Cell.

*Rx Timing Deviation* is a conditional Information Element which is only present when the Cell supporting the RACH Transport Channel is a 3.84 Mcps or 7.68Mcps TDD Cell.

*Received SYNC UL Timing Deviation* is a conditional Information Element which is only present when the Cell supporting the RACH Transport Channel is a 1.28Mcps TDD Cell. The RNC shall ignore this IE if the measured Received SYNC UL Timing Deviation is sent in Ext Received SYNC UL Timing Deviation IE

With respect to new IEs, for which the presence is indicated by the *New IE Flags* IE, the Figure 15 is an example of how a frame is structured when all such new IEs are present. Note that non-presence of such a new IE changes the position of all subsequent IEs on octet level.

[FDD- Bit 0 of New IE Flags in RACH DATA FRAME indicates if a Cell Portion ID is present (1) or not present (0) in the byte (bits 0-5) following the *New IE Flags* IE.]

[FDD - Bit 1 of New IE Flags in RACH DATA FRAME indicates if *Ext Propagation Delay* IE is present (1) or not present (0)]

[FDD - Bits 2 through 6 of New IE Flags in RACH DATA FRAME shall be set to 0.]

[FDD - Field length of *Spare Extension* IE in RACH DATA FRAME is 0-28 octets.]

[3.84 Mcps and 7.68 Mcps TDD - Bit 0 of New IE Flags in RACH DATA FRAME indicates if the extended bits of the Rx Timing Deviation are present (1) or not present (0) in the byte (bit 0 for 3.84 Mcps TDD, bits 0 and 1 for 7.68 Mcps TDD) following the *New IE Flags* IE. Bits 1 through 6 of New IE Flags in RACH DATA FRAME shall be set to 0. Field length of *Spare Extension* IE in RACH DATA FRAME is 0-30 octets.]

[1.28Mcps TDD - Bit 0 of New IE Flags in RACH DATA FRAME indicates if the *AOA* IE is present (1) or not present (0).]

[1.28Mcps TDD - Bit 1 of New IE Flags in RACH DATA FRAME indicates if *Ext Received SYNC UL Timing Deviation* IE is present (1) or not present (0)]

[1.28Mcps TDD - Bit 2 of New IE Flags in RACH DATA FRAME indicates if *Cell Portion LCR* IE is present (1) or not present (0).]

[1.28Mcps TDD – Bits 3 through 6 of New IE Flags in RACH DATA FRAME shall be set to 0.]

[1.28Mcps TDD – Field length of Spare Extension IE in RACH DATA FRAME is 0-26 octets.]

## 6.2.2 CPCH Channels [FDD]

Void.

## 6.2.3 FACH Channels

FACH DATA FRAME includes the CFN corresponding to the Uu frame at which this data in which the payload (FACH TBS) has to be transmitted. If the payload is to be sent in several frames, the CFN corresponding to the first frame shall be indicated. In case a transport bearer is used by several FACH channels, the CFN and Transmit power level are valid for all these FACH channels.

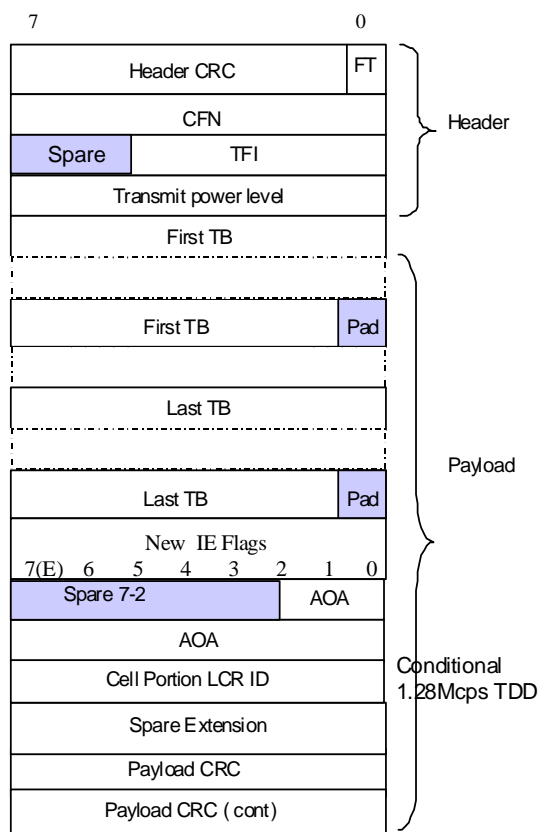

**Figure 17: FACH DATA FRAME structure**

[1.28Mcps TDD - Bit 0 of New IE Flags in FACH DATA FRAME indicates if the AOA IE is present (1) or not present (0).]

[1.28Mcps TDD - Bit 1 of New IE Flags in FACH DATA FRAME indicates if Cell Portion LCR ID IE is present (1) or not present (0).]

[1.28Mcps TDD – Field length of Spare Extension IE in FACH DATA FRAME is 0-29 octets.]

## 6.2.4 PCH Channels

The PCH DATA FRAME includes the paging indication information and paging messages [FDD - To page one User Equipment, two consecutive PCH DATA FRAMEs with consecutive CFN numbers are transmitted, the first frame contains the Paging Indication Information and the second contains the Paging Message.] [TDD – To page one User Equipment, one or more PCH DATA FRAMEs are transmitted.]

[TDD - If two or more consecutive frames are used, the first frame contains the Paging Indication Information and the rest contain the Paging Messages. If PI-bitmap and PCH TBS are both transmitted within the PCH DATA FRAME, the CFN is related to the PCH TBS only. The PI bitmap is mapped to the PICH frames, transmitted at the beginning of the paging block.]

The paging messages are transmitted in S-CCPCH frames. The CFN in the PCH DATA FRAME header corresponds to the Cell SFN of the frame in which the start of the S-CCPCH frame is located. [TDD - If the paging messages are to be sent in several frames, the CFN corresponding to the first frame shall be indicated.]

[FDD - The timing of the PICH frame (containing the paging indication information) is  $\tau_{\text{PICH}}$  prior to the S-CCPCH frame timing (TS 25.211 [5]).]

In contrast to all other Common Transport Channel data frames, which use a CFN of length 8, the PCH DATA FRAME includes a CFN of length 12.

The Node B has no responsibility to ensure the consistency between the paging indication information and the corresponding paging messages. E.g. if the paging indication information is lost over the Iub, the paging messages might be sent over the Uu while no UE is actually listening.

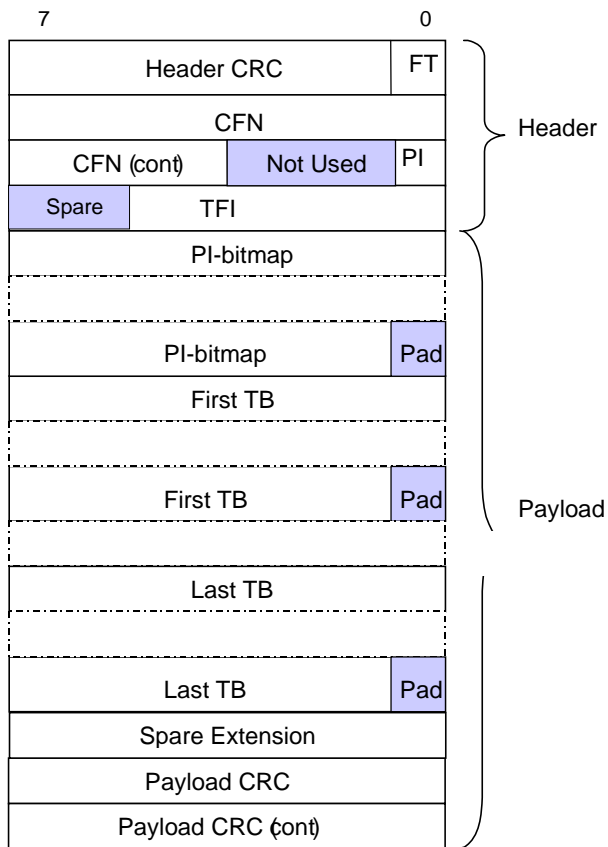
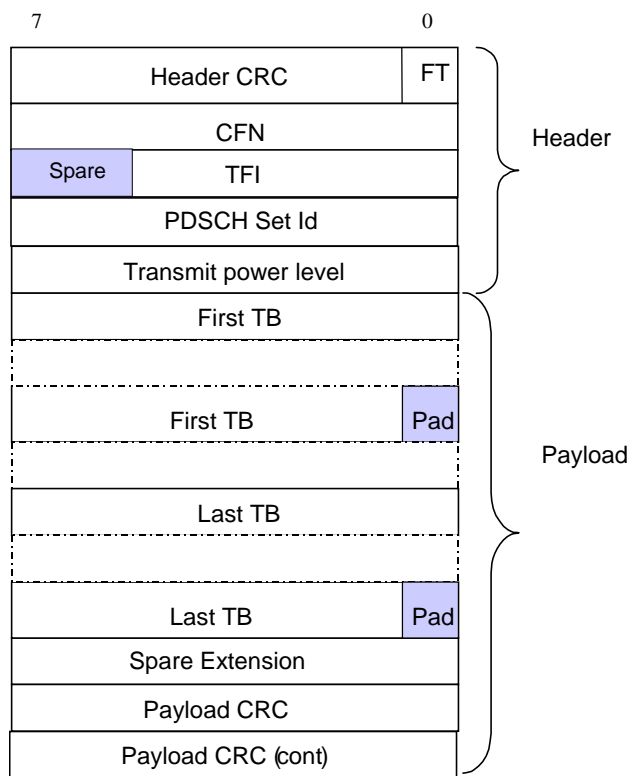

**Figure 18: PCH DATA FRAME structure**

"Not Used" bits shall be set to 0 by the RNC and ignored by the Node B.

### 6.2.5 Downlink Shared Channels [TDD]

DSCH DATA FRAME includes a CFN indicating the SFN of the PDSCH in which the payload shall be sent. If the payload is to be sent over several frames, the CFN corresponding to the first frame shall be indicated.



**Figure 20: DSCH DATA FRAME structure**

### 6.2.6 Uplink Shared Channels [TDD]

USCH DATA FRAME includes the CFN in which the payload was received. If the payload was received in several frames, the CFN corresponding to the first frame will be indicated.

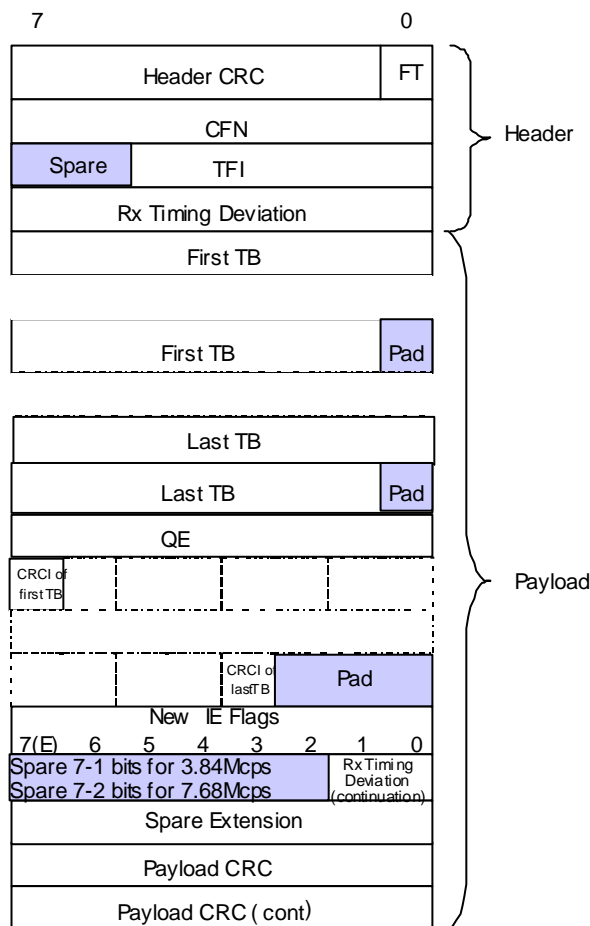

**Figure 21: USCH DATA FRAME structure**

[3.84 Mcps and 7.68 Mcps TDD - Field length of *Spare Extension* IE in USCH DATA FRAME is 0-30 octets.

Bit 0 of New IE Flags in USCH DATA FRAME indicates if the extended bits of the Rx Timing Deviation are present (1) or not present (0) in the byte (bit 0 for 3.84 Mcps TDD, bits 0 and 1 for 7.68 Mcps TDD) following the *New IE Flags* IE. Bits 1 through 6 of New IE Flags in USCH DATA FRAME shall be set to 0.]

### 6.2.6A HS-DSCH Channels

[FDD and 1.28 Mcps TDD - Three types of HS-DSCH DATA FRAME exist for the HS-DSCH data transfer, i.e. HS-DSCH DATA FRAME TYPE 1, HS-DSCH DATA FRAME TYPE 2 and HS-DSCH DATA FRAME TYPE 3.]

[3.84 Mcps and 7.68 Mcps TDD - Two types of HS-DSCH DATA FRAME exist for the HS-DSCH data transfer, i.e. HS-DSCH DATA FRAME TYPE 1 and HS-DSCH DATA FRAME TYPE 2.]

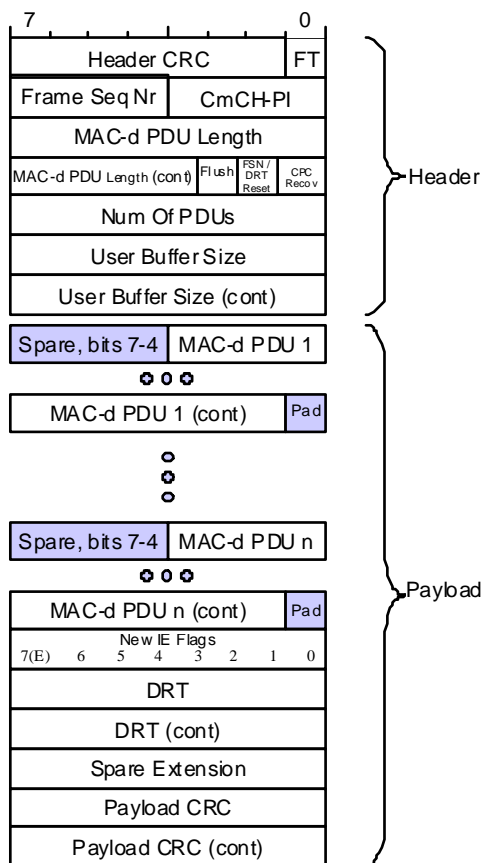

**Figure 21A: HS-DSCH DATA FRAME TYPE 1 structure**

Bit 0 of New IE Flags in HS-DSCH DATA FRAME TYPE 1 indicates if a DRT is present (1) or not (0) in the 2 octets following the *New IE Flags* IE. Bits 1 through 6 of New IE Flags in HS-DSCH DATA FRAME TYPE 1 shall be set to 0.

Field length of *Spare Extension* IE in HS-DSCH DATA FRAME TYPE 1 is 0-29 octets.

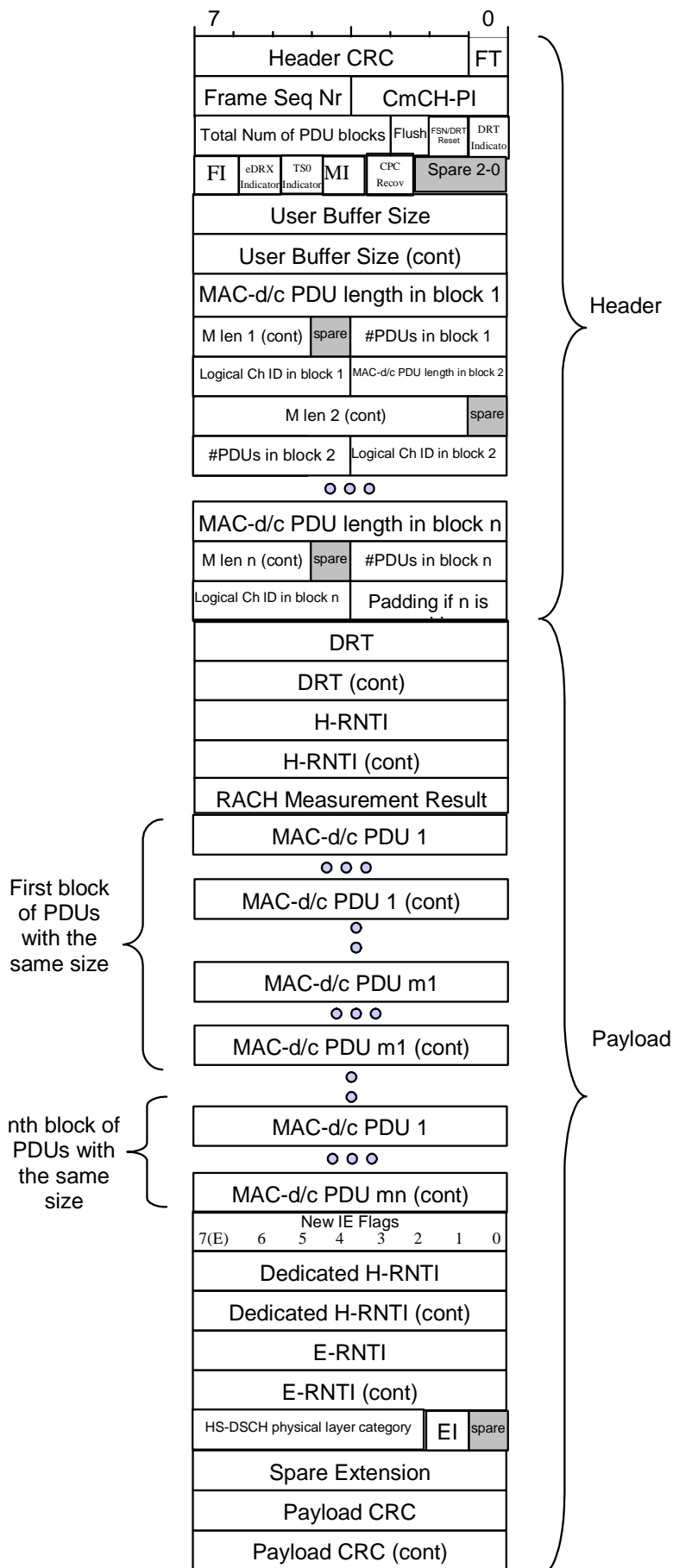



**Figure 21B: HS-DSCH DATA FRAME TYPE 2 structure**

[FDD and 1.28Mcps TDD - Bit 0 of New IE Flags in HS-DSCH DATA FRAME TYPE 2 indicates if the *Dedicated H-RNTI* IE and the *E-RNTI* IE is present (1) or not (0) in the 4 octets following the *New IE Flags* IE. Bit 1 of New IE Flags in HS-DSCH DATA FRAME TYPE 2 indicates if the HS-DSCH physical layer category [FDD] is present (1) or not (0) in the 5<sup>th</sup> octet following the *New IE Flags* IE. Bit 2 of the New IE Flags in HS-DSCH DATA FRAME TYPE 2 indicates if the EI [FDD] is present (1) or not (0) in the 5<sup>th</sup> octet following the *New IE Flags* IE. Bits 3 through 6 of New IE Flags in HS-DSCH DATA FRAME TYPE 2 shall be set to 0.]

With respect to new IEs, for which the presence is indicated by the *New IE Flags* IE, the Figure 21B is an example of how a frame is structured when all such new IEs are present. Note that non-presence of such a new IE changes the position of all subsequent IEs on octet level.

[FDD and 1.28Mcps TDD - Field length of *Spare Extension* IE in HS-DSCH DATA FRAME TYPE 2 is 0-26 octets.]

[FDD – If the received *H-RNTI* IE sets to same value as the *BCCH Specific HS-DSCH RNTI* IE configured in NBAP (TS 25.433 [6]), the Node B shall ignore *RACH Measurement Result* IE in the frame.]

[FDD – If the received *H-RNTI* IE sets to same value as the *BCCH Specific HS-DSCH RNTI Information* IE configured in NBAP (TS 25.433 [6]), the Node B should not calculate FACH measurement occasion for scheduling the data in the frame.]

[FDD – If the received *H-RNTI* IE sets to same value as the *Common HS-DSCH RNTI Information* IE configured in NBAP (TS 25.433 [6]), the Node B should not calculate FACH measurement occasion for scheduling the data in the frame.]

[1.28Mcps TDD - If the received *H-RNTI* IE sets to the same value as the *BCCH Specific HS-DSCH RNTI* IE configured in NBAP (TS 25.433 [6]), the Node B shall ignore *RACH Measurement Result* IE in the frame.]

[FDD and 1.28Mcps TDD – when a UE using E-DCH for CELL\_FACH and Idle is provided with a new H-RNTI and/or a new E-RNTI signalled to the UE in the RRC message contained in this HS-DSCH data frame, the *Dedicated H-RNTI* IE and the *E-RNTI* IE contains the values to be used after successful execution of the RRC procedure (TS 25.331 [8]). The *H-RNTI* IE either contains the same value as the *BCCH Specific HS-DSCH RNTI* IE configured in NBAP (TS 25.433 [6]) or the H-RNTI currently allocated to the UE.]

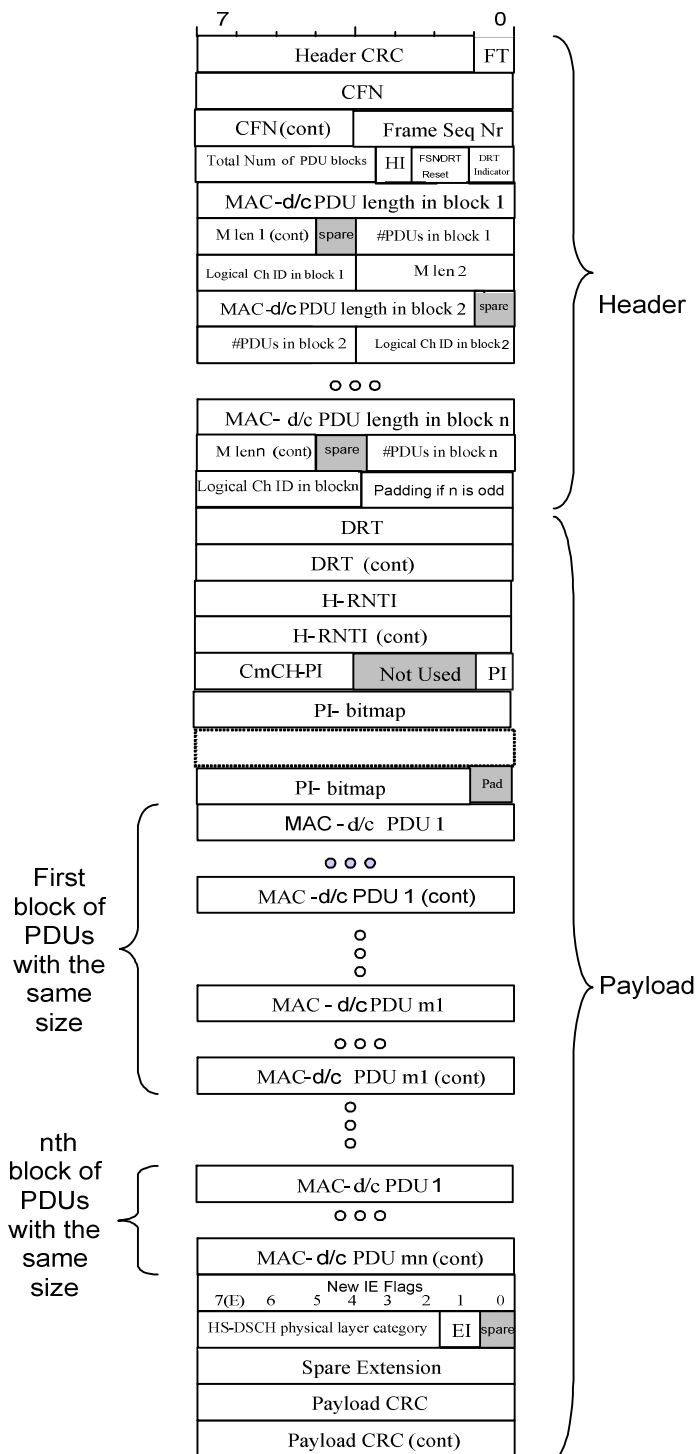

**Figure 21C: HS-DSCH DATA FRAME TYPE 3 structure [FDD and 1.28Mcps TDD only]**

[FDD - The CFN in the HS-DSCH DATA FRAME TYPE 3 header corresponds to the Cell SFN of the frame in which the start of the HS-SCCH frame is located. The timing of the PICH frame (containing the paging indication information) is the same as the HS-SCCH frame timing (TS 25.211 [5]).

[1.28Mcps TDD - In case *Total Number of PDU blocks* IE is not set to 0, or *Total Number of PDU blocks* IE is set to 0 and *Paging Indication (PI)* IE is set to 0, i.e. PI-bitmap not present in payload, the CFN in the HS-DSCH DATA FRAME TYPE 3 header corresponds to the Cell SFN of the frame in which the start of the HS-SCCH frame is located. The timing of the PICH frame (containing the paging indication information) is  $N_{GAP}$  prior to the HS-SCCH or the HS-PDSCH frame timing (TS 25.221 [4]).

[1.28Mcps TDD –In case *Total Number of PDU blocks* IE is set to 0 and *Paging Indication (PI)* IE is set to 1, i.e. PI-bitmap present in payload, the CFN in the HS-DSCH DATA FRAME TYPE 3 header corresponds to the Cell SFN of the frame in which the start of the PICH frame].

[1.28Mcps TDD - If PI-bitmap and MAC-c PDU are both transmitted within the HS-DSCH DATA FRAME TYPE 3, the CFN is related to the MAC-c PDU only. The PI bitmap is mapped to the PICH frames, transmitted at the beginning of the paging block.]

[FDD and 1.28Mcps TDD - Note: The HS-SCCH frame is not sent if *HI* IE is set to 0, i.e. H-RNTI not present.]

[FDD - Bit 0 of New IE Flags in HS-DSCH DATA FRAME TYPE 3 indicates if the HS-DSCH physical layer category is present (1) or not (0) in the 1<sup>st</sup> octet following the *New IE Flags* IE. Bit 1 of New IE Flags in HS-DSCH DATA FRAME TYPE 3 indicates if EI [FDD] is present (1) or not (0) in the 1<sup>st</sup> octet following the New IE Flags IE. Bits 2 through 6 of New IE Flags in HS-DSCH DATA FRAME TYPE 3 shall be set to 0.]

[FDD - Field length of *Spare Extension* IE in HS-DSCH DATA FRAME TYPE 3 is 0-30 octets.]

## 6.2.6B E-DCH Channels for CELL\_FACH and Idle[FDD and 1.28Mcps TDD]

The structure of the E-DCH DATA FRAME is shown in Figure 21D. This frame structure is used for carrying MAC-is PDUs in Cell\_FACH and Idle UE state (TS 25.321 [9]) for one UE.

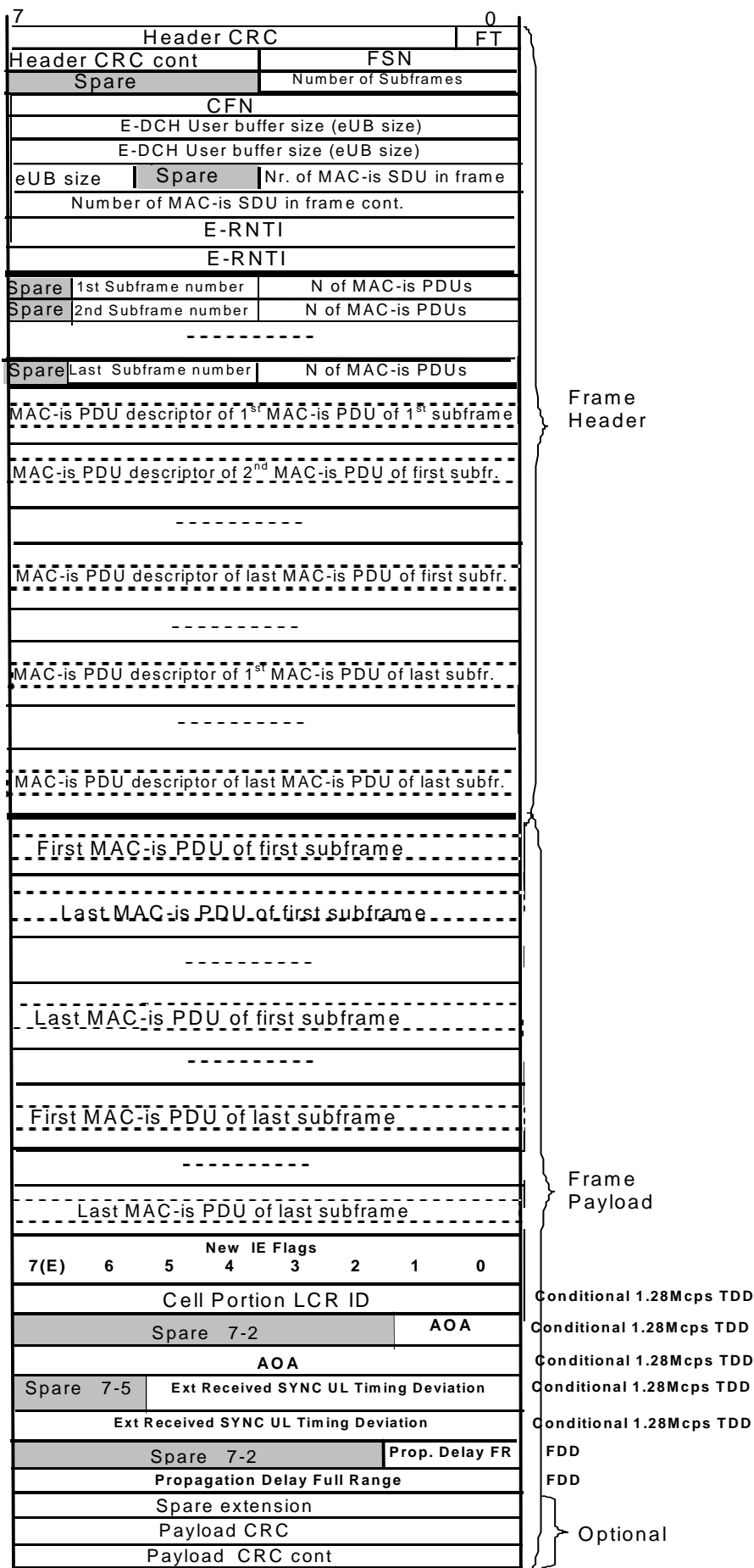

### Figure 21D: E-DCH DATA FRAME structure

For the description of the fields see subclause 6.2.7.

The *Payload CRC* IE is optional in frames that contain a Payload, i.e. the whole 2 bytes field may or may not be present in the frame structure (this is defined at the setup of the transport bearer). The *Payload CRC* IE may only be present if the E-DCH DATA FRAME contains payload.

[1.28Mcps TDD - Bit 0 of New IE Flags in E-DCH DATA FRAME indicates if the *Cell Portion LCR ID* IE is present (1) or not present (0).]

[1.28Mcps TDD - Bit 1 of New IE Flags in E-DCH DATA FRAME indicates if *AOA* IE is present (1) or not present (0)]

[1.28Mcps TDD - Bit 2 of New IE Flags in E-DCH DATA FRAME indicates if *Ext Received SYNC UL Timing Deviation* IE is present (1) or not present (0)]

[1.28Mcps TDD – Bits 2 through 6 of New IE Flags in E-DCH DATA FRAME shall be set to 0.]

[FDD - Bit 0 of *New IE Flags* IE in E-DCH DATA FRAME indicates if *Propagation Delay Full Range* IE is present (1) or not present (0)]

[FDD - Bits 1 through 6 of *New IE Flags* IE in E-DCH DATA FRAME shall be set to 0.]

[FDD - Field length of *Spare Extension* IE in E-DCH DATA FRAME is 0-29 octets.]

## 6.2.7 Coding of information elements in data frames

### 6.2.7.1 Header CRC

**Description:** Cyclic Redundancy Checksum calculated on the header of a data frame with polynomial:  $X^7+X^6+X^2+1$  for the 7 bit header CRC [FDD and 1.28Mcps TDD - ,  $X^{11}+X^9+X^8+ X^2+X+1$  for the 11 bit header CRC].

The CRC calculation shall cover all bits in the header, starting from bit 0 in the first byte (FT field) up to the end of the header. See subclause 7.1.

**Value range:** {0..127} [FDD and 1.28Mcps TDD – , {0..2047} for E-DCH DATA FRAME].

**Field length:** 7 bits [FDD and 1.28Mcps TDD - , 11 bits for E-DCH DATA FRAME].

### 6.2.7.2 Frame Type

**Description:** Describes if it is a control frame or a data frame.

**Value range:** {0=data, 1=control}.

**Field Length:** 1 bit.

### 6.2.7.3 Connection Frame Number (CFN)

**Description:** Indicator as to which radio frame the first data was received on uplink or shall be transmitted on downlink. In case a transport bearer is used by several FACH channels with IP multicast option, the radio frame in which the first data shall be transmitted on a FACH mapping on the transport bearer shall be calculated according to:

$$CFN = (MFN - CFN \text{ Offset}) \bmod 256,$$

where:

- MFN is the value of CFN field in the data frame;
- CFN Offset is a FACH parameter indicated by RNC (TS 25.433 [6]).

The value range and field length depend on the transport channel for which the CFN is used.

**Value range (PCH):** {0..4095}.

**Value range (other):** {0..255}.

**Field length (PCH):** 12 bits.

**Field length (other):** 8 bits.

#### 6.2.7.4 Transport Format Indicator

**Description:** TFI is the local number of the transport format used for the transmission time interval. For information about what the transport format includes see TS 25.302 [3].

**Value range:** {0..31}.

**Field length:** 5 bits.

#### 6.2.7.5 Propagation Delay [FDD]

**Description:** One-way radio interface delay as measured during RACH access. If the measured value exceeds the range of this information element, the information element shall be set to its maximum value, and the *Ext Propagation Delay* IE shall be used to represent the measured value, see subclause 6.2.7.5A.

**Value range:** {0..765 chips}.

**Granularity:** 3 chips.

**Field length:** 8 bits.

#### 6.2.7.5A Ext Propagation Delay [FDD]

**Description:** One-way radio interface delay as measured during RACH access, extended value part. This IE shall be present only if the range of the *Propagation Delay* IE is insufficient to represent the measured value.

**Value range:** {0 - 3069 chips}, values 0 -765 are not used.

**Granularity:** 3 chips.

**Field length:** 10 bits.

#### 6.2.7.6 Rx Timing Deviation [3.84Mcps TDD]

**Description:** Measured Rx Timing Deviation as a basis for timing advance. This value should consider measurements made in all frames and all timeslots that contain the transport blocks in the payload. In case the *Timing Advance Applied* IE indicates "No" (see TS 25.433 [6]) in a cell, the Rx Timing Deviation field shall be set to  $N = 0$ .

**Value range:** {-1024 .. +1023 chips}.

$\{N*4 - 256\}$  chips  $\leq$  RxTiming Deviation  $< \{(N+1)*4 - 256\}$  chips.

With  $N = 0, 1, \dots, 127$ .

$\{(N-128)*4 - 1024\}$  chips  $\leq$  Rx Timing Deviation  $< \{(N-127)*4 - 1024\}$  chips

With  $N = 128, 129, \dots, 319$

$\{N*4 - 1024\}$  chips  $\leq$  Rx Timing Deviation  $< \{(N+1)*4 - 1024\}$  chips

With  $N = 320, 321, \dots, 511$

**Granularity:** 4 chips.

**Field length:** 9 bits. The least significant 8 bits are contained in the RX timing deviation field and the most significant bit is contained in the RX timing deviation (continuation) field.

### 6.2.7.6A Received SYNC UL Timing Deviation [1.28Mcps TDD]

**Description:** Measured Received SYNC UL Timing Deviation as a basis for propagation delay.

**Value range:** {0, ..., +255} chips

**Granularity:** 1 chip.

**Field length:** 8 bits.

### 6.2.7.6B Rx Timing Deviation [7.68Mcps TDD]

**Description:** Measured Rx Timing Deviation as a basis for timing advance. This value should consider measurements made in all frames and all timeslots that contain the transport blocks in the payload. In case the *Timing Advance Applied* IE indicates "No" (see TS 25.433 [6]) in a cell, the Rx Timing Deviation field shall be set to  $N = 0$ .

**Value range:** {-2056, ..., +2055} chips

$$\{N*4 -2056\} \text{ chips} \leq \text{RxTiming Deviation} < \{(N+1)*4 -2056\} \text{ chips}$$

With  $N = 0, 1, \dots, 1027$

**Granularity:** 4 chips.

**Field length:** 10 bits. The least significant 8 bits are contained in the RX timing deviation field and the most significant 2 bits are contained in the RX timing deviation (continuation) field.

### 6.2.7.7 Transport Block

**Description:** A block of data to be transmitted or have been received over the radio interface. The transport format indicated by the TFI describes the transport block length and transport block set size. See TS 25.302 [3].

### 6.2.7.8 CRC Indicator

**Description:** Shows if the transport block has a correct CRC. The UL Outer Loop Power Control may use the CRC indication.

**Value range:** {0=Correct, 1=Not Correct}.

**Field length:** 1 bit.

### 6.2.7.9 Payload CRC

**Description:** Cyclic Redundancy Checksum calculated on the payload of a data frame with polynomial  $X^{16}+X^{15}+X^2+1$ .

The CRC calculation shall cover all bits in the data frame payload, starting from bit 7 in the first byte up to bit 0 in the byte before the payload CRC. See subclause 7.1.

**Field length:** 16 bits.

### 6.2.7.10 Transmit Power Level

**Description:** Preferred transmission power level during this TTI for the corresponding transport channel. The indicated value is the negative offset relative to the maximum power configured for the physical channel(s) used for the respective transport channel. [1.28Mcps TDD - The Node B shall ignore the Transmit Power Level in the TDD DSCH DATA FRAME.] [3.84Mcps and 7.68Mcps TDD - The Node B shall ignore the Transmit Power Level in the TDD DSCH DATA FRAME if closed loop TPC power control is used.]

**Value range:** {0 .. 25.5 dB}.

**Granularity:** 0,1 dB.

**Field length:** 8 bits.

### 6.2.7.11 Paging Indication (PI)

**Description:** Describes if the PI Bitmap is present in the payload.

**Value range:** {0=no PI-bitmap in payload, 1=PI-bitmap in payload}.

**Field length:** 1 bit.

### 6.2.7.12 Paging Indication bitmap (PI-bitmap)

**Description:** Bitmap of Paging Indications  $PI_0..PI_{N-1}$ . Bit 7 of the first byte contains  $PI_0$ , Bit6 of the first byte contains  $PI_1,..$ , Bit7 of the second byte contains  $PI_8$  and so on.

**Value range:** [FDD - {18, 36, 72 or 144 Paging Indications}.]

[3.84Mcps TDD – {30, 34, 60, 68, 120 and 136} Paging Indications for 2 PICH frames,  
{60, 68, 120, 136, 240 and 272} Paging Indications for 4 PICH frames].

[1.28Mcps TDD – {44, 88 and 176} Paging Indications for 2 PICH frames,  
{88, 176 and 352} Paging Indications for 4 PICH frames].

[7.68Mcps TDD – {30, 34, 60, 68, 120 and 136} Paging Indications for 2 PICH frames,  
{60, 68, 120, 136, 240 and 272} Paging Indications for 4 PICH frames,  
..... {120, 136, 240, 272, 480 and 544} Paging Indications for 8 PICH frames].

**Field length:** [FDD - 3, 5, 9 or 18 bytes (the PI-bitmap field is padded at the end up to an octet boundary)].

[3.84Mcps TDD – 4, 5, 8, 9, 15, 17, 30 or 34 bytes (the PI-bitmap field is padded at the end up to an octet boundary)].

[1.28Mcps TDD – 6, 11, 22 or 44 bytes (the PI-bitmap field is padded at the end up to an octet boundary)].

[7.68Mcps TDD – 4, 5, 8, 9, 15, 17, 30, 34, 60 or 68 bytes (the PI-bitmap field is padded at the end up to an octet boundary)].

### 6.2.7.13 Rx Timing Deviation on RACH [3.84Mcps TDD]

Void.

### 6.2.7.14 PDSCH Set Id [TDD]

**Description:** A pointer to the PDSCH Set which shall be used to transmit the DSCH DATA FRAME over the radio interface.

**Value range:** {0..255}.

**Field length:** 8 bits.

### 6.2.7.15 Code Number [FDD]

Void.

### 6.2.7.16 Spreading Factor (SF) [FDD]

Void.

### 6.2.7.17 Power Offset [FDD]

Void.



#### 6.2.7.18 MC Info [FDD]

Void.

#### 6.2.7.19 Spare Extension

**Description:** Indicates the location where new IEs can in the future be added in a backward compatible way.

**Field length:** 0-32 octets.

#### 6.2.7.20 Quality Estimate (QE) [TDD]

**Description:** The quality estimate is derived from the Transport channel BER.

If the USCH FP frame includes TB's for the USCH then the QE is the Transport channel BER for the selected USCH. If no Transport channel BER is available the QE shall be set to 0.

The quality estimate shall be set to the Transport channel BER and be measured in the units TrCH\_BER\_LOG respectively (see TS 25.433 [6]). The UL Outer Loop Power Control may use the quality estimate.

**Value range:** {0..255}.

**Granularity:** 1.

**Field length:** 8 bits.

#### 6.2.7.21 Common Transport Channel Priority Indicator (CmCH-PI)

**Description:** CmCH-PI, configured via the Scheduling Priority Indicator in NBAP (TS 25.433 [6]), is the relative priority of the data frame and the SDUs included.

**Value range:** {0-15, where 0=lowest priority, 15=highest priority}.

**Field length:** 4 bits.

#### 6.2.7.22 User Buffer Size

**Description:** Indicates the users' buffer size (i.e. the amount of data in the buffer) in octets for a given Common Transport Channel Priority Indicator level.

**Value range:** {0-65535}.

**Field length:** 16 bits.

#### 6.2.7.23 MAC-d PDU Length

**Description:** The value of that field indicates the length of every MAC-d PDU in the payload of the HS-DSCH DATA FRAME in number of bits.

**Value range:** {0-5000}.

**Field Length:** 13 bits.

#### 6.2.7.24 NumOfPDU

**Description:** Indicates the number of MAC-d PDUs in the payload.

**Value range:** {1-255}.

**Field Length:** 8 bits.

#### 6.2.7.25 MAC-d PDU

**Description:** A MAC-d PDU contains the MAC-d PDU as defined in TS 25.321 [9].

**Field length:** See the value of the *MAC-d PDU Length* IE.

### 6.2.7.26 Cell Portion ID [FDD]

**Description:** Cell Portion ID indicates the cell portion with highest SIR during RACH access. Cell Portion ID is configured by O&M.

**Value range:** {0-63}.

**Field Length:** 6 bits.

### 6.2.7.27 New IE Flags

**Description:** The *New IE Flags* IE is only present if at least one new IE is present. The *New IE Flags* IE contains flags indicating which new IEs that are present following the *New IE Flags* IE. The last bit position of the *New IE Flags* IE is used as the Extension Flag to allow the extension of the *New IE Flags* IE in the future. Extension octets of the *New IE Flags* IE shall follow directly after the first octet of the *New IE Flags* IE. When an extension octet of the *New IE Flags* IE is present, then all previous extension octets of the *New IE Flags* IE and the *New IE Flags* IE shall also be present, even if they have all their flag bits indicating no presence of their respective new IEs.

**Value range:**

Bit 0-6 of each octet: Indicates if a new IE is present (1) or not present (0) in the bytes following the *New IE Flags* IE. The meaning of each bit is explained in the corresponding DATA FRAME subclause;

Bit 7 of each octet: Indicates if an extension octet of the *New IE Flags* IE follows (1) or not (0).

**Field length:** 1 – 31 octets.

### 6.2.7.28 Flush

**Description:** Indicates whether the DRNS should remove (1) or not (0) all the MAC-d PDUs from the corresponding MAC-hs Priority Queue that have been received prior to this data frame HS-DSCH DATA FRAME on the same transport bearer.

**Value range:** {0 = no flush, 1 = flush}.

**Field Length:** 1 bit.

### 6.2.7.29 DRT (Delay Reference Time)

**Description:** *DRT* is a 16-bit *Delay Reference Time*. *DRT* can be used for dynamic delay measurements. The *DRT* counter bridges the same time span as RFN and BFN. *DRT* is locked to RFN in SRNC and is a 40960 counter with 1 ms resolution.

**Value range:** {0..40959<sub>DEC</sub> ms (0..9FFF<sub>HEX</sub> ms)}.

**Granularity:** 1 ms.

**Field length:** 16 bits.

### 6.2.7.30 Frame Sequence Number

**Description:** The 4-bit *Frame Sequence Number* (FSN) is incremented for each transmitted HS-DSCH data frame belonging to one MAC-d flow [FDD and 1.28Mcps TDD – , common MAC flow or E-DCH DATA FRAME belonging to one E-DCH data flow for CELL\_FACH and Idle]. At wraparound of the Frame Sequence Number, the value "0" shall not be used. Each flow generates its own Frame Sequence.

**Value range:**

0 is a special value and indicates that the *Frame Sequence Number* IE shall be treated as spare.

1 – 15 indicates the Frame Sequence Number.

**Granularity:** 1.

**Field length:** 4 bits.

### 6.2.7.31 Logical Channel ID in block n

**Description:** This field provides identification of the logical channel instance associated with the PDUs of the n-th *block of PDUs with the same size* in the HS-DSCH DATA FRAME TYPE 2 [FDD and 1.28Mcps TDD – and TYPE 3]. Multiple logical channels may be carried on the same MAC-d flow [FDD and 1.28Mcps TDD –, Common MAC flow or Paging MAC flow].

**Value range:** {0-15}, where 0-14 identifies logical channels 1-15, 15 identifies BCCH or PCCH logical channel mapped on HS-DSCH.

**Field length:** 4 bits.

### 6.2.7.32 Total Number of PDU blocks

**Description:** The field indicates the number of blocks of *block of PDUs with the same size* in this HS-DSCH DATA FRAME.

**Value range:** {0-31}, 0 only for 1.28Mcps TDD HS-DSCH DATA FRAME TYPE 3.

**Field length:** 5 bits.

### 6.2.7.33 MAC-d/c PDU Length in block n

**Description:** The value of this field indicates the length of every MAC-d PDU [FDD and 1.28Mcps TDD - or MAC-c PDU] in the n-th *block of PDUs with the same size* in number of octets.

**Value range:** {0-1505}, 0 – not used.

**Field length:** 11 bits.

### 6.2.7.34 Number of MAC-d/c PDUs in block n (#PDUs in block n)

**Description:** Indicates the number of MAC-d PDUs [FDD and 1.28Mcps TDD - or MAC-c PDUs] in the n-th *block of PDUs with the same size*.

**Value range:** {0-15}, 0 – not used.

**Field length:** 4 bits.

### 6.2.7.35 DRT Indicator

**Description:** Indicates whether a DRT is present.

**Value range:** {0 = DRT not present, 1 = DRT present}.

**Field length:** 1 bit.

### 6.2.7.36 FACH Indicator (FI) [FDD and 1.28Mcps TDD]

**Description:** Indicates whether an H-RNTI and a RACH Measurement Result are present (i.e. whether UE in CELL\_FACH).

**Value range:** {0 = H-RNTI and RACH Measurement Result not present, 1 = H-RNTI and RACH Measurement Result present}.

**Field length:** 1 bit.

### 6.2.7.37 H-RNTI [FDD and 1.28Mcps TDD]

**Description:** H-RNTI is defined in TS 25.401 [11]. The field identifies an UE having a HS-PDSCH assignment within a cell [FDD and 1.28Mcps TDD - or has the same value as the *BCCH Specific HS-DSCH RNTI* IE configured in TS 25.433 [6]].

**Value range:** {0-65535}, 0 – not used.

**Field length:** 16 bits.

### 6.2.7.38 RACH Measurement Result [FDD and 1.28Mcps TDD]

**Description:** [FDD - This field indicates the values received in RACH Measurement. The type of the measured value in the field is configured via NBAP (TS 25.433 [6]).] [1.28Mcps TDD - This field indicates the pathloss value (in dB) calculated based on the *Primary CCPCH RSCP* IE in the measurement result on RACH according to the formula in TS 25.331 [8].]

**Value range:** [FDD - {0-158, 255}

255 is a special value for FDD and indicates that the Node B may ignore the RACH Measurement Results IE.]

[1.28Mcps TDD - {0-112}

Note: The value '0' of the IE corresponds to the pathloss value of '46', the value '1' corresponds to the pathloss value of '47',..., the value '112' corresponds to the pathloss value of '158'.]

**Field length:** [FDD - 8 bits].

[1.28Mcps TDD - 7 bits (Bit 7 of the RACH Measurement Result field is not used)].

### 6.2.7.39 H-RNTI Indicator (HI) [FDD and 1.28Mcps TDD]

**Description:** Indicates whether an H-RNTI and a CmCH-PI are present.

**Value range:** {0 = H-RNTI and CmCH-PI not present, 1= H-RNTI and CmCH-PI present}.

**Field length:** 1 bit.

### 6.2.7.40 FSN/DRT Reset

**Description:** When the Node B receives a HS-DSCH DATA FRAME where the 1-bit *FSN/DRT Reset* IE is set to 1, the Node B should reset any state of congestion estimation based on previously received FSN and DRT values. Node B may instead decide to start a new estimation of congestion detection initiated with the FSN and DRT values included in this HS-DSCH data frame. *FSN/DRT Reset* IE set to 1 may indicate a discontinuity in the sequence of the transmitted DRT and FSN values in the transmitted HS-DSCH data frames belonging to the associated MAC-d flow.

If the 1-bit *FSN/DRT Reset* IE is set to 0, Node B may use the included DRT and FSN values for congestion detection.

**Value range:**

0 Node B may use the included DRT and FSN values for congestion detection.

1 Node B should not use previously received FSN and DRT values for congestion detection.

**Field length:** 1 bit.

### 6.2.7.41 MAC-d/c PDU

**Description:** A MAC-d/c PDU contains the MAC-ehs SDU as defined in TS 25.321 [9].

**Field length:** For length of MAC-d/c PDU of block n, see the value of the *MAC-d/c PDU length in block n* IE.

#### 6.2.7.42 AOA (Angle of Arrival) [1.28Mcps TDD]

**Description:** This field indicates the angle of arrival information of UE measured by Node B.

**Value range:** {0-719}

**Field length:** 10 bit.

#### 6.2.7.43 Ext Received SYNC UL Timing Deviation [1.28Mcps TDD]

**Description:** Measured Received SYNC UL Timing Deviation as a basis for propagation delay.

**Value range:** {0, ..., +1023} chips

**Granularity:** 1/8 chip.

**Field length:** 13 bits.

#### 6.2.7.44 Number of Subframes [FDD and 1.28Mcps TDD]

**Description:** The *Number of Subframes* field indicates how many subframes that follows in the frame. [1.28Mcps TDD – This will always be set to "1".]

NOTE: A subframe has both a header portion and a payload portion in the frame.

**Value range:** {1-16}

The binary coding is derived from the value minus 1. E.g. value 1 is coded as binary "0000" and value 16 is coded as binary "1111".

Values {11, 12, 13, 14, 15, 16}: Reserved in this user plane revision. Shall be ignored by the receiver.

**Field length:** 4 bits.

#### 6.2.7.45 Number of MAC-is SDU in frame [FDD and 1.28Mcps TDD]

**Description:** Total number of MAC-is SDUs in all MAC-is PDUs in the E-DCH DATA FRAME.

**Value range:** {0-4095}.

**Field length:** 12 bits.

#### 6.2.7.46 Number of MAC-is PDUs [FDD and 1.28Mcps TDD]

**Description:** Indicates the number of MAC-is PDUs in the user data frame in the payload part for the corresponding subframe number.

**Value range:** {0-15}

**Field length:** 4 bits.

#### 6.2.7.47 Subframe Number [FDD and 1.28Mcps TDD]

**Description:** Indicates the subframe number in which the payload was received. [1.28 Mcps TDD – This will be set to {0-1}.]

**Value range:** {0-4}

**Field length:** 3 bits.

#### 6.2.7.48 E-DCH User Buffer Size [FDD and 1.28Mcps TDD]

**Description:** Indicates the the total size of the E-DCH DATA FRAME in octets

**Value range:** {0-262 140}

**Field length:** 18 bits.

#### 6.2.7.49 E-RNTI [FDD and 1.28Mcps TDD]

**Description:** E-RNTI is defined in TS 25.401 [11].

In the E-DCH DATA FRAME: the field identifies a UE having an E-DCH assignment within a cell or the allocated E-RNTI to a UE requesting E-DCH resources for CELL\_FACH and Idle in a cell.

In HS-DSCH DATA FRAME TYPE 2: E-RNTI identifies the UE using E-DCH in Cell\_FACH and Idle state.

**Value range:** {0-65535}, 0 – not used.

**Field length:** 16 bits.

#### 6.2.7.50 MAC-is PDU descriptor [FDD and 1.28Mcps TDD]

**Description:** The *MAC-is PDU descriptor* contains the Length (L), Logical channel identifier (LCH-ID) and Flag (F) fields mapped directly from the "MAC-i Header n" field (n>0) received over the Uu (TS 25.321 [9]).

**Field length:** variable; length of *MAC-is PDU descriptor* in octets = 2 \* number of MAC-is SDU contained in the corresponding MAC-is PDU as described in TS 25.321 [9].

#### 6.2.7.51 Dedicated H-RNTI [FDD and 1.28Mcps TDD]

**Description:** *Dedicated H-RNTI* identifies the H-RNTI for a UE using E-DCH in Cell\_FACH and Idle state. H-RNTI is defined in TS 25.401 [11].

**Value range:** {0-65535}, 0 – not used.

Field length: 16 bits

#### 6.2.7.52 eDRX Indication [FDD]

**Description:** Indicates whether the UE in Cell\_FACH state supports Enhanced UE DRX or not.

**Value range:** {0 = Enhanced UE DRX not supported, 1= Enhanced UE DRX supported}.

Field length: 1 bit.

#### 6.2.7.53 HS-DSCH physical layer category [FDD]

**Description:** HS-DSCH physical layer category is defined in TS 25.306 [12]. The value of the field identifies the HS-DSCH physical layer category number of the UE, which is not applicable to the case that the *H-RNTI* IE sets to the same value as the *BCCH Specific HS-DSCH RNTI* IE.

**Value range:** {1 - 63}, where the valid values are defined in TS 25.306 [12].

**Field length:** 6 bit.

#### 6.2.7.54 Cell Portion LCR ID [1.28Mcps TDD]

**Description:** Cell Portion LCR ID indicates the cell portion with best received quality during RACH access. Cell Portion LCR ID is configured by O&M.

**Value range:** {0-255}.

**Field Length:** 8 bits.

### 6.2.7.55 TS0 Indication [1.28Mcps TDD]

**Description:** Indicates whether the UE supports TS0 enhancement or not.

**Value range:** {0 = Enhanced TS0 not supported, 1= Enhanced TS0 supported}.

**Field length:** 1 bit.

### 6.2.7.56 Enhanced HS-SCCH support indicator (EI) [FDD]

**Description:** Indicates whether the UE in Cell\_FACH state supports enhanced different HS-SCCHs in consecutive TTIs support or not.

**Value range:** {0 = Enhanced different HS-SCCHs in consecutive TTIs not supported, 1= Enhanced different HS-SCCHs in consecutive TTIs supported}.

**Field length:** 1 bit.

### 6.2.7.57 MU-MIMO Indication(MI) [1.28Mcps TDD]

**Description:** Indicates whether the UE in Cell\_FACH state supports MU-MIMO or not.

**Value range:** {0 = MU-MIMO not supported, 1= MU-MIMO supported}.

**Field length:** 1 bit.

### 6.2.7.58 Propagation Delay Full Range [FDD]

**Description:** One-way radio interface delay as measured during random access on Common E-DCH.

**Value range:** {0..3069 chips}.

**Granularity:** 3 chips.

**Field length:** 10 bits.

### 6.2.7.59 CPC Recovery (CPC Recov) [FDD]

**Description:** Describes if UE is CPC non-uniform related to HS-SCCH order and CPC recovery is needed in the serving Node-B. It indicates that the dynamic DTX/DRX (de)activation using HS-SCCH order is needed.

**Value range:** {0=no Recovery, 1=Recovery}.

**Field Length:** 1 bit.

Note: This is not applicable when HS-SCCH order is not used.

## 6.3 Control frame structure

### 6.3.1 Introduction

The Common Control Channel control frames are used to transport control information between the CRNC and the Node B. Figure 22 defines the Control Frame structure for common transport channels.

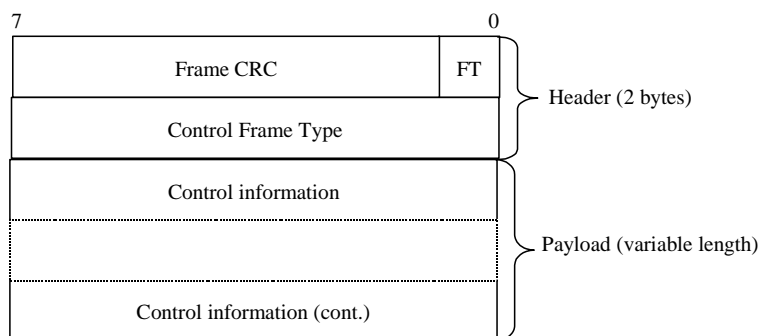

**Figure 22: lub Common Transport Channel Control Frame Format**

The structure of the header and the payload of the control frames is defined in the following subclauses.

## 6.3.2 Coding of information elements of the Control frame header

### 6.3.2.1 Frame CRC

**Description:** Cyclic Redundancy Checksum calculated on a control frame with polynom:  
 $X^7+X^6+X^2+1$ .

The CRC calculation shall cover all bits in the control frame, starting from bit 0 in the first byte (FT field) up to the end of the control frame. See subclause 7.1.

**Value range:** {0..127}.

**Field length:** 7 bits.

### 6.3.2.2 Frame Type (FT)

Refer to subclause 6.2.7.2.

### 6.3.2.3 Control Frame Type

**Description:** Indicates the type of the control information (information elements and length) contained in the payload.

**Value:** Values of the Control Frame Type parameter are defined in table 2.

**Table 2**

| Type of control frame  | Value     |
|--|-----------|
| OUTER LOOP POWER CONTROL   | 0000 0001 |
| TIMING ADJUSTMENT  | 0000 0010 |
| DL SYNCHRONISATION   | 0000 0011 |
| UL SYNCHRONISATION   | 0000 0100 |
| Reserved Value   | 0000 0101 |
| DL NODE SYNCHRONISATION  | 0000 0110 |
| UL NODE SYNCHRONISATION  | 0000 0111 |
| DYNAMIC PUSCH ASSIGNMENT   | 0000 1000 |
| TIMING ADVANCE   | 0000 1001 |
| HS-DSCH Capacity Request   | 0000 1010 |
| HS-DSCH Capacity Allocation TYPE 1                                   | 0000 1011 |
| HS-DSCH Capacity Allocation TYPE 2                                   | 0000 1100 |
| HS-DSCH UL Synchronization Establishment Failure (1.28Mcps TDD only) | 0000 1101 |



**Field Length:** 8 bits.

The "Reserved Value" for the *Control Frame Type* IE shall not be used by the SRNC. A control frame whose *Control Frame Type* IE is set to the "Reserved Value" shall be ignored by the Node B.

### 6.3.3 Payload structure and information elements

#### 6.3.3.1 TIMING ADJUSTMENT

##### 6.3.3.1.1 Payload Structure

Figures 23 and 24 shows the structure of the payload when control frame is used for the timing adjustment.

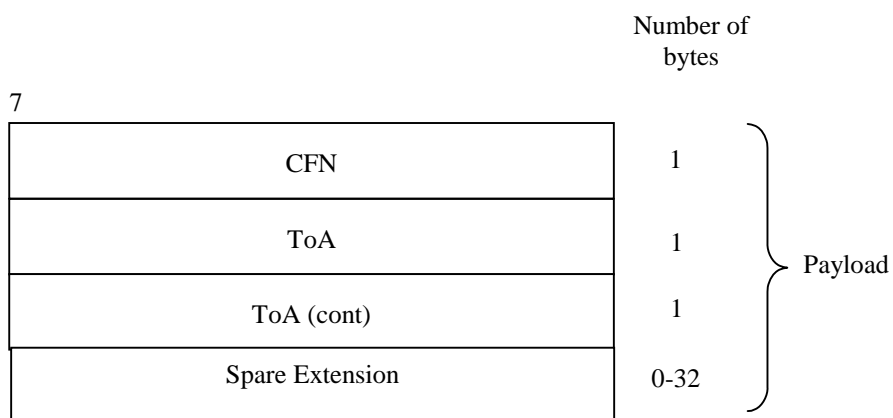

**Figure 23: TIMING ADJUSTMENT payload structure (non-PCH transport bearers)**

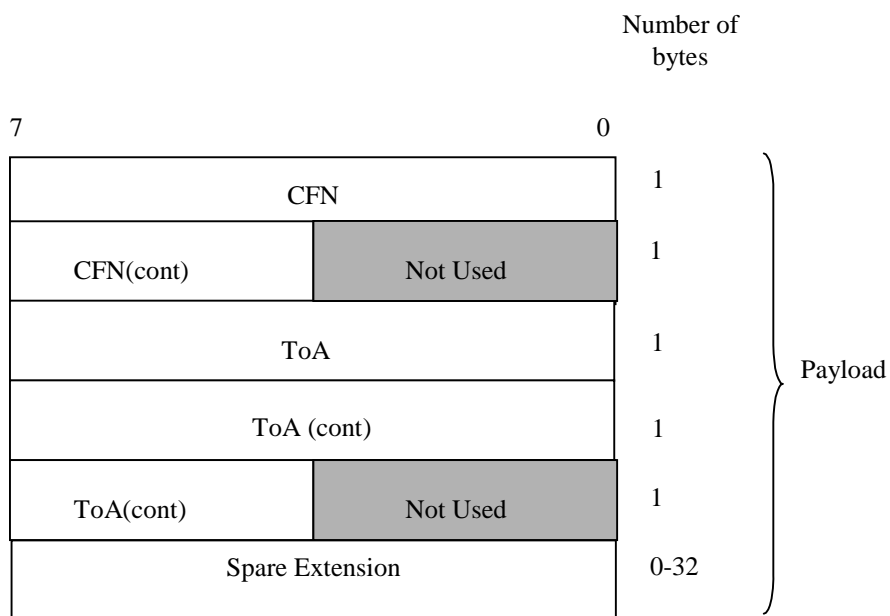

**Figure 24: TIMING ADJUSTMENT payload structure (PCH transport bearer)**

##### 6.3.3.1.2 CFN

Refer to subclause 6.2.7.3.

### 6.3.3.1.3 Time of arrival (ToA)

**Description:** Time difference between the arrival of the DL frame with respect to TOAWE (based on the CFN in the frame). The value range and field length depend on the transport channel for which the CFN is used.

**Value range (PCH):** {-20480ms, +20479.875ms}.

**Value range (other):** {-1280ms, +1279.875ms}.

**Granularity:** 125µs.

**Field length (PCH):** 20 bits.

**Field length (other):** 16 bits.

### 6.3.3.1.4 Spare Extension

**Description:** Indicates the location where new IEs can in the future be added in a backward compatible way.

**Field length:** 0-32 octets.

## 6.3.3.2 DL SYNCHRONISATION

### 6.3.3.2.1 Payload Structure

Figures 25 and 26 shows the structure of the payload when control frame is used for the user plane synchronisation.

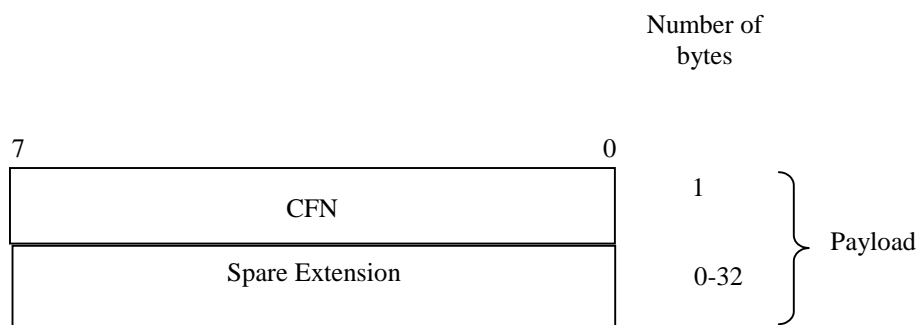

**Figure 25: DL SYNCHRONISATION payload structure (non-PCH transport bearers)**

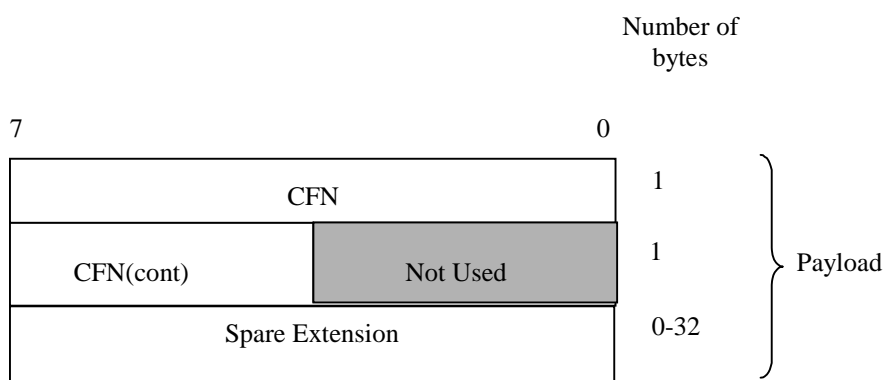

**Figure 26: DL SYNCHRONISATION payload structure (PCH transport bearers)**

6.3.3.2.2 CFN

Refer to subclause 6.2.7.3.

6.3.3.2.3 Spare Extension

Refer to subclause 6.3.3.1.4.

6.3.3.3 UL SYNCHRONISATION

6.3.3.3.1 Payload Structure

Figures 27 and 28 shows the structure of the payload when the control frame is used for the user plane synchronisation (UL).

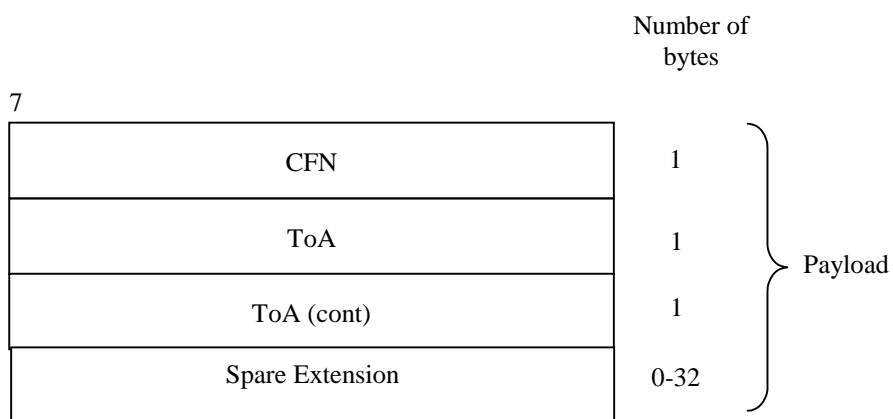

Figure 27: UL SYNCHRONISATION payload structure (non-PCH transport bearers)

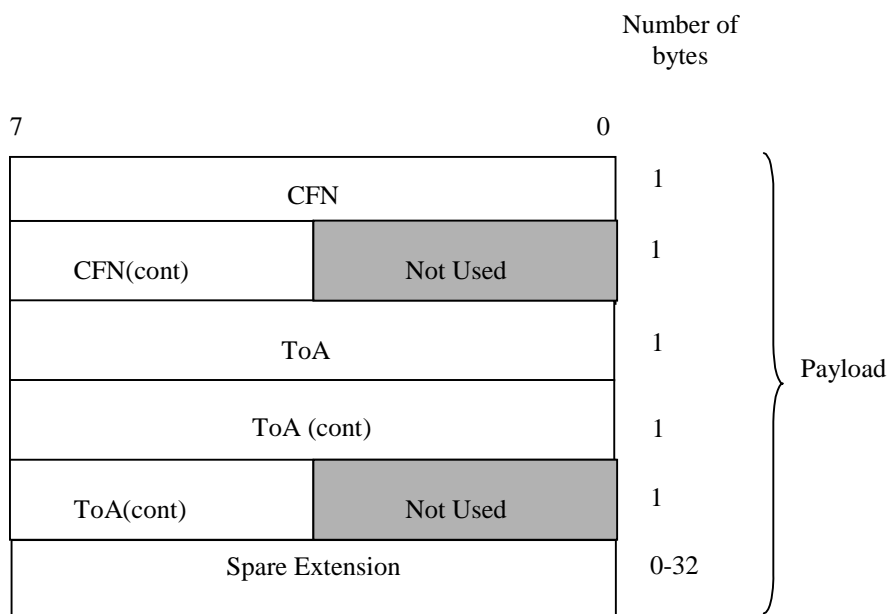

Figure 28: UL SYNCHRONISATION payload structure (PCH transport bearers)

6.3.3.3.2 CFN

Refer to subclause 6.2.7.3.

6.3.3.3.3 Time of Arrival (TOA)

Refer to subclause 6.3.3.1.3.

6.3.3.3.4 Spare Extension

Refer to subclause 6.3.3.1.4.

6.3.3.4 DL NODE SYNCHRONISATION

6.3.3.4.1 Payload Structure

The payload of the DL Node synchronisation control frames is shown in figure 29.

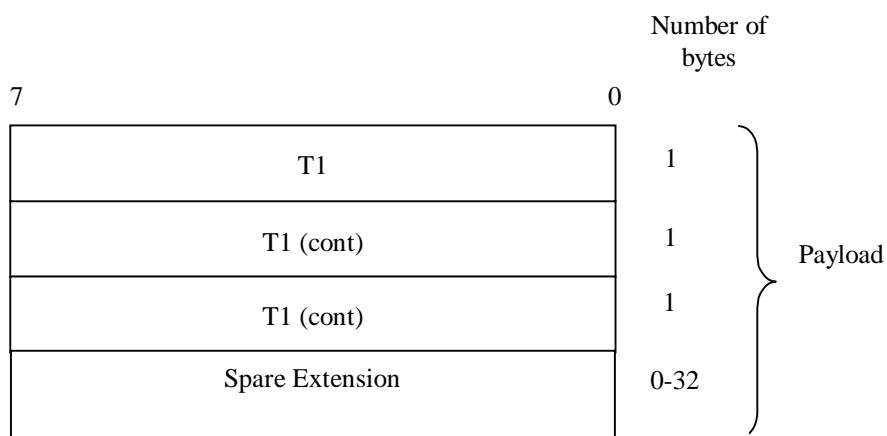

Figure 29: DL NODE SYNCHRONISATION payload structure

6.3.3.4.2 T1

**Description:** RNC specific frame number (RFN) that indicates the time when RNC sends the frame through the SAP to the transport layer.

**Value range:** {0 .. 40959.875 ms}.

**Granularity:** 0.125ms.

**Field length:** 24 bits.

6.3.3.4.3 Spare Extension

Refer to subclause 6.3.3.1.4.

6.3.3.5 UL NODE SYNCHRONISATION

6.3.3.5.1 Payload Structure

The payload of the UL Node synchronisation control frames is shown in figure 30.

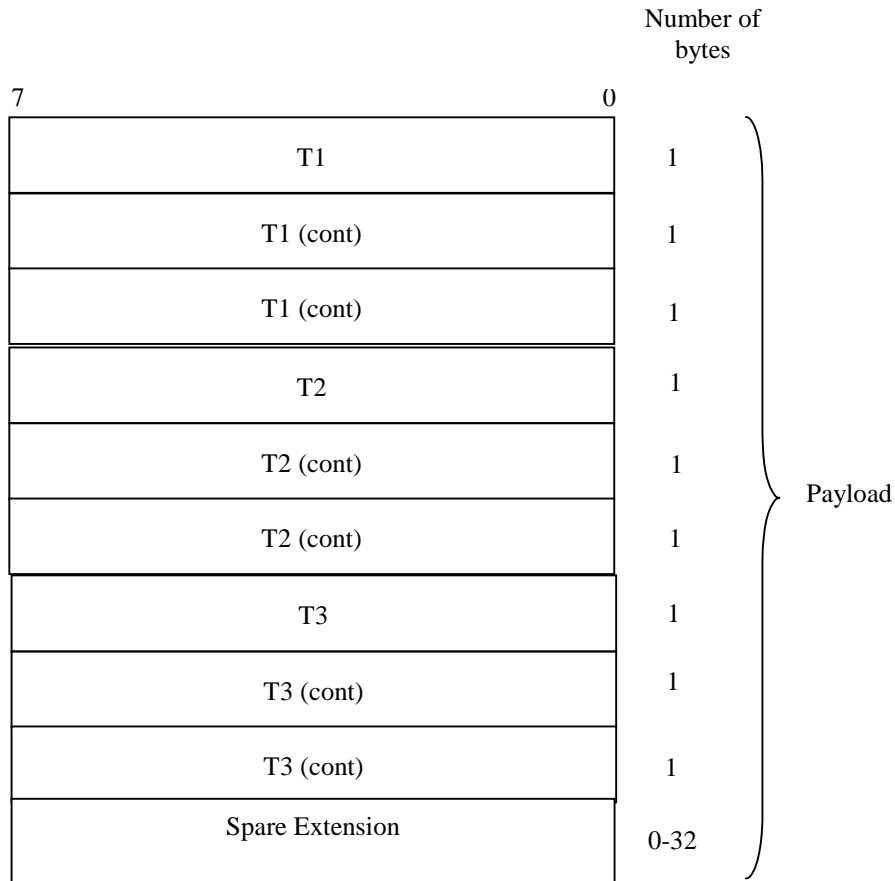

**Figure 30: UL NODE SYNCHRONISATION payload structure**

6.3.3.5.2 T1

**Description:** T1 timer is extracted from the correspondent DL Node synchronisation control frame.

**Value range:** {0 .. 40959.875 ms.}

**Granularity:** 0.125ms.

**Field length:** 24 bits.

6.3.3.5.3 T2

**Description:** Node B specific frame number (BFN) that indicates the time when Node B received the correspondent DL synchronisation frame through the SAP from the transport layer.

**Value range:** {0 .. 40959.875 ms}.

**Granularity:** 0.125ms.

**Field length:** 24 bits.

6.3.3.5.4 T3

**Description:** Node B specific frame number (BFN) that indicates the time when Node B sends the frame through the SAP to the transport layer.

**Value range:** {0 .. 40959.875 ms}.

**Granularity:** 0.125ms.

**Field length:** 24 bits.

#### 6.3.3.5.5 Spare Extension

Refer to subclause 6.3.3.1.4.

### 6.3.3.6 DYNAMIC PUSCH ASSIGNMENT [TDD]

#### 6.3.3.6.1 Payload structure

The payload of the Dynamic PUSCH Assignment control frames is shown in figure 31.

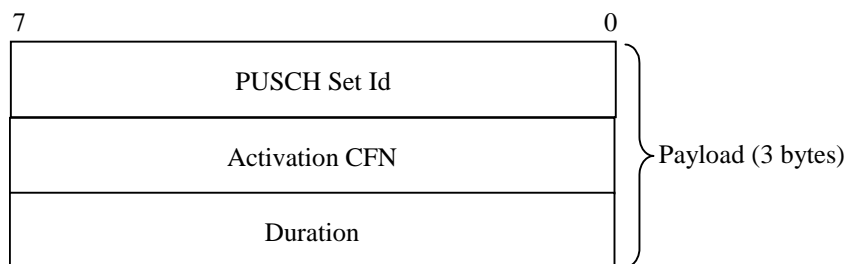

**Figure 31: DYNAMIC PUSCH ASSIGNMENT payload structure**

#### 6.3.3.6.2 PUSCH Set Id

**Description:** Identifies a PUSCH Set from the collection of PUSCH Sets which have been pre-configured in the Node B, for the respective cell in which the USCH exists. The PUSCH Set Id is unique within a cell.

**Value range:** {0..255}.

**Field length:** 8 bits.

#### 6.3.3.6.3 Activation CFN

**Description:** Activation CFN, specifies the Connection Frame Number where the allocation period of that PUSCH Set starts.

**Value range:** Integer {0..255}.

**Field length:** 8 bits.

#### 6.3.3.6.4 Duration

**Description:** Indicates the duration of the activation period of the PUSCH Set, in radio frames.

**Value range:** 0..255 means: 0 to 255 radio frames, i.e. 0 to 2550 msec.

**Field length:** 8 bits.

### 6.3.3.7 DSCH TFCI SIGNALLING [FDD]

#### 6.3.3.7.1 Payload structure

Void.

#### 6.3.3.7.2 TFCI (field 2)

Void.

## 6.3.3.7.3 Spare Extension

Void.

## 6.3.3.8 TIMING ADVANCE [3.84Mcps and 7.68Mcps TDD]

## 6.3.3.8.1 Payload structure

Figure 33 shows the structure of the payload when the control frame is used for timing advance.

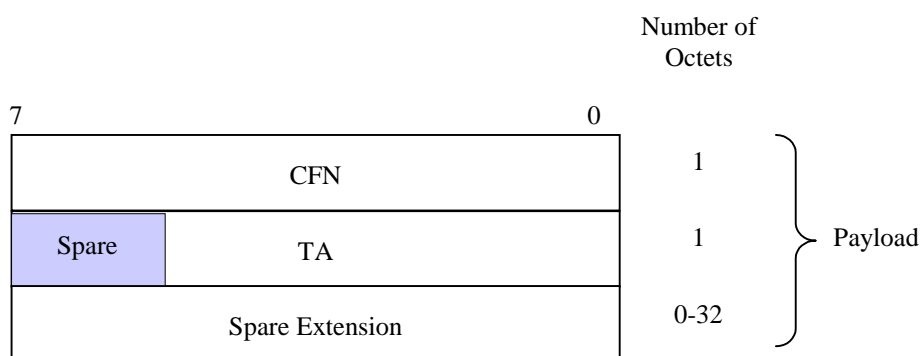

**Figure 33: TIMING ADVANCE payload structure**

## 6.3.3.8.2 CFN

Refer to subclause 6.2.7.3.

## 6.3.3.8.3 TA [3.84 Mcps]

**Description:** UE applied UL timing advance adjustment.

**Value range:** {0 .. 252 chips}.

**Granularity:** 4 chips.

**Field length:** 6 bits.

## 6.3.3.8.3A TA [7.68 Mcps]

**Description:** UE applied UL timing advance adjustment.

**Value range:** {0 .. 508 chips}.

**Granularity:** 4 chips.

**Field length:** 7 bits.

## 6.3.3.8.4 Spare Extension

Refer to subclause 6.3.3.1.4.

## 6.3.3.9 OUTER LOOP POWER CONTROL [1.28 Mcps TDD]

## 6.3.3.9.1 Payload structure

Figure 34 shows the structure of the payload when control frame is used for the UL outer loop power control.

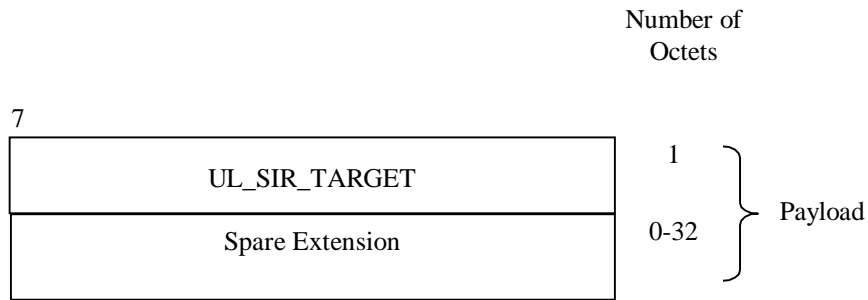

**Figure 34: Structure of the payload for OUTER LOOP PC control frame**

**6.3.3.9.2 SIR Target**

**Description:** Value (in dB) of the SIR target to be used by the UL inner loop power control.

SIR Target is given in the unit UL\_SIR\_TARGET where:

|                     |                      |
|---------------------|----------------------|
| UL_SIR_TARGET = 000 | SIR Target = -8.2 dB |
| UL_SIR_TARGET = 001 | SIR Target = -8.1 dB |
| UL_SIR_TARGET = 002 | SIR Target = -8.0 dB |
| ...                 |                      |
| UL_SIR_TARGET = 254 | SIR Target = 17.2 dB |
| UL_SIR_TARGET = 255 | SIR Target = 17.3 dB |

**Value range:** {-8.2 .. 17.3 dB}.

**Granularity:** 0.1 dB.

**Field length:** 8 bits.

**6.3.3.9.3 Spare Extension**

Refer to subclause 6.3.3.1.4.

**6.3.3.10 HS-DSCH CAPACITY REQUEST**

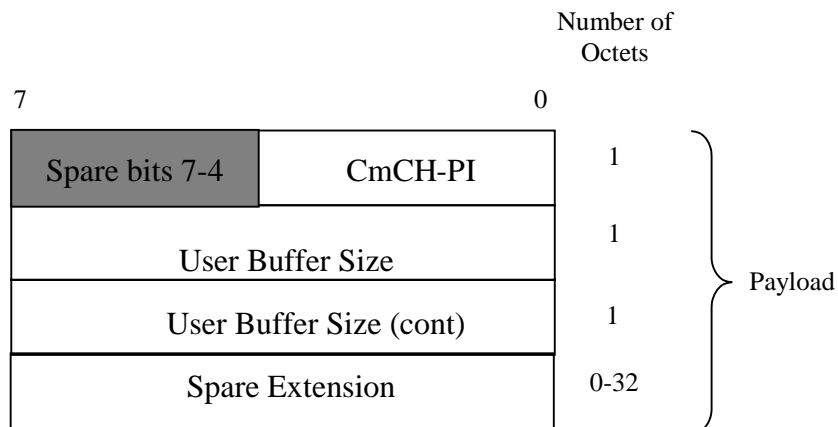

**Figure 35: CAPACITY REQUEST payload structure**

The HS-DSCH CAPACITY REQUEST control frame is sent for each priority group to indicate the user buffer size. The control frame is sent by the CRNC when the CRNC considers the user buffer status needs an increased buffer reporting frequency. This may be sent to signal an event, such as, data arrival or user-buffer discard. This control frame



is used to improve user-buffer reporting above the level produced by the user-buffer reporting associated with the HS-DSCH DATA FRAMEs.

6.3.3.10.1 Common Transport Channel Priority Indicator (CmCH-PI)

Refer to subclause 6.2.7.21.

6.3.3.10.2 User Buffer Size

Refer to subclause 6.2.7.22.

6.3.3.10.3 Spare Extension

Refer to subclause 6.3.3.1.4.

6.3.3.11 HS-DSCH CAPACITY ALLOCATION

Two types of HS-DSCH CAPACITY ALLOCATION exist for the HS-DSCH capacity allocation, i.e. HS-DSCH CAPACITY ALLOCATION TYPE 1 Control Frame and HS-DSCH CAPACITY ALLOCATION TYPE 2 Control Frame.

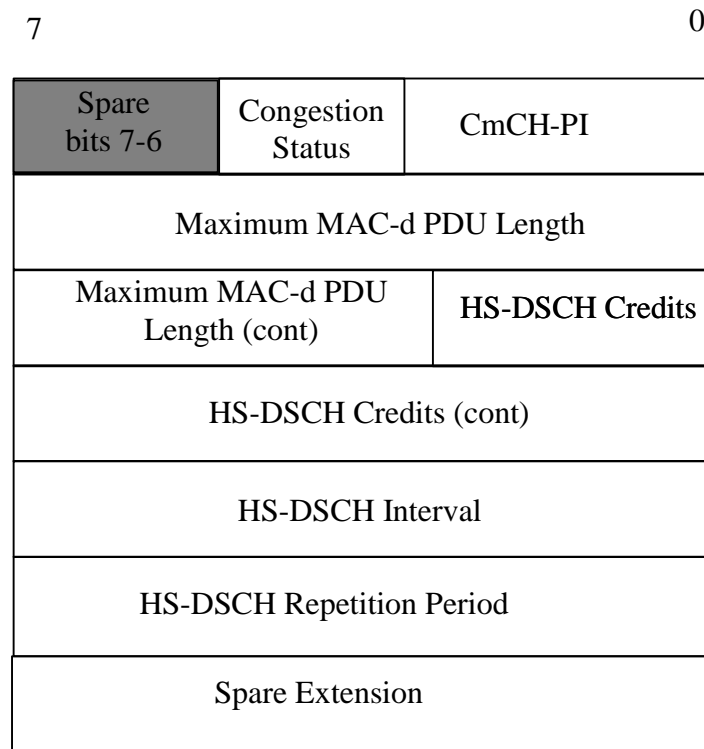

**Figure 36: CAPACITY ALLOCATION TYPE 1 payload structure**

The CAPACITY ALLOCATION TYPE 1 Control Frame describes an allocation that the CRNC may use. When the *HS-DSCH Credits* IE has a value of 0 it signifies that there is no resources allocated for transmission and to thus stop transmission. When the *HS-DSCH Credits* IE has a value of 2047, it signifies unlimited capacity for transmission of PDUs. When the *HS-DSCH Repetition Period* IE has a value of 0, it signifies that the allocation (*Maximum MAC-d PDU Length*, *HS-DSCH Credits* and *HS-DSCH Interval* IEs) can be repeated without limit. In addition to this the CAPACITY ALLOCATION TYPE 1 Control Frame informs the CRNC about the detection of congestion in the DL transport network layer with the *Congestion Status* Bits.

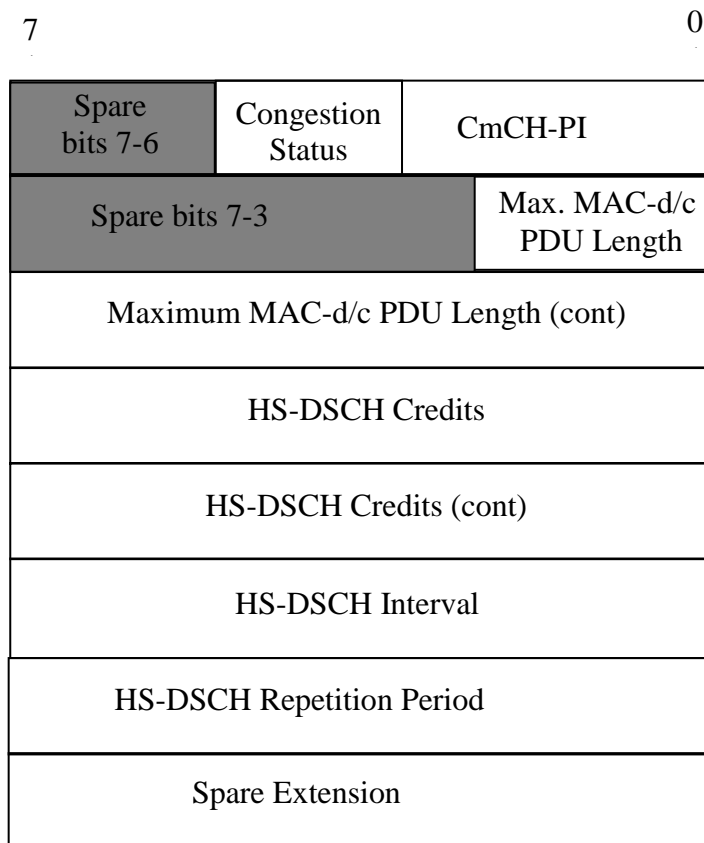

**Figure 37: CAPACITY ALLOCATION TYPE 2 payload structure**

The CAPACITY ALLOCATION TYPE 2 Control Frame describes an allocation that the CRNC may use. When the *HS-DSCH Credits* IE has a value of 0 it signifies that there is no resources allocated for transmission and to thus stop transmission. When the *HS-DSCH Credits* IE has a value of 65535, it signifies unlimited capacity for transmission of PDUs. When the *HS-DSCH Repetition Period* IE has a value of 0, it signifies that the allocation (*Maximum MAC-d/c PDU Length*, *HS-DSCH Credits* and *HS-DSCH Interval* IEs) can be repeated without limit. In addition to this the CAPACITY ALLOCATION TYPE 2 Control Frame informs the CRNC about the detection of congestion in the DL transport network layer with the *Congestion Status* Bits.

#### 6.3.3.11.1 Common Transport Channel Priority Indicator (CmCH-PI)

Refer to subclause 6.2.7.21.

#### 6.3.3.11.2 Maximum MAC-d PDU Length

**Description:** The *Maximum MAC-d PDU Length* IE is used in HS-DSCH CAPACITY ALLOCATION TYPE 1 Control Frame. The value indicates the maximum allowable PDU size among the MAC-d PDU sizes configured via NBAP (TS 25.433 [6]).

**Value range:** Refer to subclause 6.2.7.23.

**Field length:** Refer to subclause 6.2.7.23.

#### 6.3.3.11.3 HS-DSCH Credits

**Description:** The *HS-DSCH Credits* IE is used in HS-DSCH CAPACITY ALLOCATION (TYPE 1 and TYPE 2) Control Frame. It indicates the granted amount of MAC-d PDU data that CRNC may transmit during one HS-DSCH interval

In case of HS-DSCH CAPACITY ALLOCATION TYPE 1 Control Frame, it indicates the number of MAC-d PDUs that a CRNC may transmit during one HS-DSCH Interval granted in the HS-DSCH CAPACITY ALLOCATION TYPE 1 Control Frame.

In case of HS-DSCH CAPACITY ALLOCATION TYPE 2 Control Frame, the granted amount of MAC-d [FDD and 1.28Mcps TDD – or MAC-c] PDU data in octets is obtained by multiplying the MAC-d PDU length [FDD and 1.28Mcps TDD – or the MAC-c PDU length] (indicated by the *Maximum MAC- d/c PDU Length* IE) with the number of MAC-d PDUs [FDD and 1.28Mcps TDD – or MAC-c PDUs] (indicated by the *HS-DSCH Credits* IE).

**Value range:** {0-2047, where 0=stop transmission, 2047=unlimited} in case of HS-DSCH CAPACITY ALLOCATION TYPE 1 Control Frame, {0-65535, where 0=stop transmission, 65535=unlimited} in case of HS-DSCH CAPACITY ALLOCATION TYPE 2 Control Frame.

**Field length:** 11 bits in case of HS-DSCH CAPACITY ALLOCATION TYPE 1 Control Frame, 16 bits in case of HS-DSCH CAPACITY ALLOCATION TYPE 2 Control Frame.

#### 6.3.3.11.4 HS-DSCH Interval

**Description:** The value of this field indicates the time interval during which the *HS-DSCH Credits* granted in the HS-DSCH CAPACITY ALLOCATION (TYPE 1 or TYPE 2) Control Frame may be used. The first interval starts immediately after reception of the HS-DSCH CAPACITY ALLOCATION (TYPE 1 or TYPE 2) Control Frame, subsequent intervals start immediately after the previous interval has elapsed. This value is only applied to the HS-DSCH transport channel.

**Value range:** {0-2550 ms}. Value 0 shall be interpreted that none of the credits shall be used.

**Granularity:** 10ms.

**Field Length:** 8 bits.

#### 6.3.3.11.5 HS-DSCH Repetition Period

**Description:** The value of this field indicates the number of subsequent intervals that the *HS-DSCH Credits* IE granted in the HS-DSCH CAPACITY ALLOCATION (TYPE 1 or TYPE 2) Control Frame may be used. These values represent an integer number of Intervals (see subclause 6.3.3.11.4). This field is only applied to the HS-DSCH transport channel.

**Value range:** {0-255, where 0= unlimited repetition period}.

**Field Length:** 8 bits.

#### 6.3.3.11.6 Spare Extension

Refer to subclause 6.3.3.1.4.

#### 6.3.3.11.7 Congestion Status

**Description:** The *Congestion Status* Bits are used by the Node B to indicate whether a congestion situation is detected in a DL transport network layer or not. The Node B provides the congestion status in every HS-DSCH CAPACITY ALLOCATION (TYPE 1 or TYPE 2) Control Frame, which the CRNC may use.

**Value range:**

- 0 No TNL Congestion
- 1 Reserved for future use
- 2 TNL Congestion – detected by delay build-up
- 3 TNL Congestion – detected by frame loss

**Field Length:** 2 bits.

#### 6.3.3.11.8 Maximum MAC-d/c PDU Length

**Description:** The *Maximum MAC-d/c PDU Length* IE is used in HS-DSCH CAPACITY ALLOCATION TYPE 2 Control Frame. The value is a factor in the granted amount of MAC-d PDU data that a CRNC may transmit during one HS-DSCH Interval. The amount of MAC-d [FDD and 1.28Mcps TDD - or MAC-c ] PDU data in octets is obtained by

multiplying the MAC-d [FDD and 1.28Mcps TDD – or MAC-c ] PDU length (indicated by the *Maximum MAC d/c PDU Length* IE) with the number of MAC-d PDUs [FDD and 1.28Mcps TDD – or MAC-c PDUs] (indicated by the *HS-DSCH Credits* IE).

**Value range:** {0-1505}, 0 – not used.

**Field length:** 11 bits.

### 6.3.3.12 HS-DSCH UL SYNCHRONIZATION ESTABLISHMENT FAILURE [1.28Mcps TDD]

#### 6.3.3.12.1 Payload structure

The payload of the HS-DSCH UL Synchronization Establishment Failure control frames is shown in figure 38.

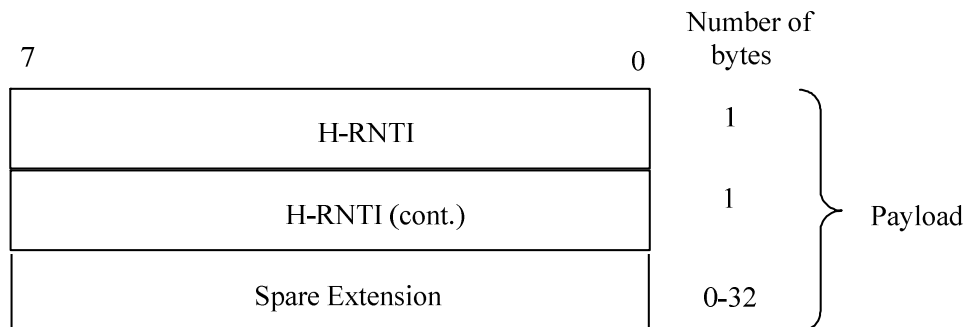

**Figure 38: HS-DSCH UL SYNCHRONIZATION ESTABLISHMENT FAILURE payload structure**

#### 6.3.3.12.2 H-RNTI

Refer to subclause 6.2.7.37.

## 7 Frame protocol error handling

A received frame protocol frame with unknown Information element or with illegal Information element value shall be ignored. Frame protocol frames sent with a CFN in which the radio resources assigned to the associated Iub data port are not available, shall be ignored.

### 7.1 Error detection

Error detection is provided on frames through a Cyclic Redundancy Check. The CRC for the payload is 16 and for the data frame header is 7 [FDD - or 11] bits and for control frames is 7 bits.

#### 7.1.1 CRC Calculation

The parity bits are generated by one of the following cyclic generator polynomials:

$$g_{\text{CRC16}}(D) = D^{16} + D^{15} + D^2 + 1.$$

$$\text{[FDD - } g_{\text{CRC11}}(D) = D^{11} + D^9 + D^8 + D^2 + D + 1.]$$

$$g_{\text{CRC7}}(D) = D^7 + D^6 + D^2 + 1.$$

Denote the bits in a frame by  $a_1, a_2, a_3, \dots, a_{A_i}$ , and the parity bits by  $p_1, p_2, p_3, \dots, p_{L_i}$ .  $A_i$  is the length of a protected data and  $L_i$  is 16 or 7 depending on the CRC length.

The encoding is performed in a systematic form, which means that in GF (2), the polynomial for the payload.

$$a_1D^{A_i+15} + a_2D^{A_i+14} + \dots + a_{A_i}D^{16} + p_1D^{15} + p_2D^{14} + \dots + p_{15}D^1 + p_{16}$$

yields a remainder equal to 0 when divided by  $g_{\text{CRC16}}(D)$ , [FDD - the polynomial for the data frame header with 11 bit CRC

$$a_1D^{A_i+11} + a_2D^{A_i+10} + \dots + a_{A_i}D^{11} + p_1D^{10} + p_2D^9 + \dots + p_{10}D^1 + p_{11}$$

yields a remainder equal to 0 when divided by  $g_{\text{CRC11}}(D)$ , ] the polynomial for the data frame header and control frames with 7 bit CRC.

$$a_1D^{A_i+6} + a_2D^{A_i+5} + \dots + a_{A_i}D^7 + p_1D^6 + p_2D^5 + \dots + p_6D^1 + p_7$$

yields a remainder equal to 0 when divided by  $g_{\text{CRC7}}(D)$ .

### 7.1.1.1 Relation between input and output of the Cyclic Redundancy Check

The bits after CRC attachment are denoted by  $b_1, b_2, b_3, \dots, b_{B_i}$ , where  $B_i = A_i + L_i$ .

The parity bits for the payload are attached at the end of the frame:

$$b_k = a_k \quad k = 1, 2, 3, \dots, A_i$$

$$b_k = p_{(k-A_i)} \quad k = A_i + 1, A_i + 2, A_i + 3, \dots, A_i + L_i$$

The parity bits for the frame header and the control frames are attached at the beginning of the frame:

$$b_k = p_k \quad k = 1, 2, 3, \dots, L_i$$

$$b_k = a_{(k-L_i)} \quad k = L_i + 1, L_i + 2, L_i + 3, \dots, L_i + A_i$$

## Annex A (informative): Change History

| TSG #   | TSG Doc.  | CR   | Rev | Subject/Comment   | New    |
|---------|-----------|------|-----|---|--------|
| 09/2008 |           |      |     | Creation of Rel-8 version based on v7.9.0.  | 8.0.0  |
| 41      | RP-080587 | 0186 |     | Introduction of frame formats supporting E-DCH for CELL_FACH and Idle over Iub                                      | 8.0.0  |
| 41      | RP-080588 | 0188 |     | Introduction of Enhanced UE DRX   | 8.0.0  |
| 42      | RP-080856 | 0190 | 1   | Improve the data rate for Enhanced Cell_FACH state in FDD   | 8.1.0  |
| 42      | RP-080850 | 0191 | 1   | Introduction of the Enhanced CELL_FACH, CELL_PCH, URA_PCH state for 1.28Mcps TDD                                    | 8.1.0  |
| 42      | RP-080858 | 0192 |     | Corrections to IE definitions for E-DCH DATA FRAME and Common MAC flow  | 8.1.0  |
| 42      | RP-080839 | 0194 |     | Correction of CR182, allow node sync also for enhanced L2   | 8.1.0  |
| 43      | RP-090073 | 0196 | 1   | Correction of handling of Capacity Allocation and HS-DSCH Credits   | 8.2.0  |
| 43      | RP-090074 | 0198 | 1   | Correction of value range for Ext Propagation Delay   | 8.2.0  |
| 43      | RP-090076 | 0199 |     | Correction of length of spare extension field   | 8.2.0  |
| 44      | RP-090638 | 0200 | 1   | Clarification of HS-DSCH FP frame structure for enhanced CELL_FACH for 1.28Mcps TDD                                 | 8.3.0  |
| 44      | RP-090630 | 0204 |     | Correction of the value range of MAC PDU Size Extended IE in CCH FP Iub   | 8.3.0  |
| 46      | RP-091180 | 0206 | 4   | Correction to the NodeB procedure when receiving uplink synchronization failure from physical layer for 1.28Mcp TDD | 8.4.0  |
| 46      | RP-091179 | 0208 |     | Correction on the description of HS-DSCH DATA FRAME TYPE2   | 8.4.0  |
| 46      | RP-091181 | 0211 |     | Silent Mode for Common E-DCH  | 8.4.0  |
| 46      | RP-091181 | 0212 |     | Correction on value range for Number of MAC-is SDU in frame   | 8.4.0  |
| 46      | RP-091180 | 0214 | 1   | Correction of the limitation to FACH indicator for 1.28Mcps TDD   | 8.4.0  |
| 46      | RP-091180 | 0216 | 1   | Clarification for eDRX Indication   | 8.4.0  |
| 12/2009 | -         | -    | -   | Creation of Rel-9 version based on v 8.4.0  | 9.0.0  |
| 46      | RP-091188 | 0207 |     | Introduction of Cell Portion for 1.28 Mcps TDD  | 9.0.0  |
| 47      | RP-100217 | 0218 | 1   | Clarification DCCH/DTCH transmission mechanism in enhanced CELL_PCH state   | 9.1.0  |
| 47      | RP-100217 | 0220 |     | Correction of the value range for RACH Measurement Result IE for 1.28Mcps TDD                                       | 9.1.0  |
| 47      | RP-100229 | 0225 |     | Corrections to the TS0 enhancement for the UE in CELL_FACH state for 1.28Mcps TDD                                   | 9.1.0  |
| 48      | RP-100599 | 0233 |     | Correction of HS-DSCH DATA FRAME TYPE3  | 9.2.0  |
| 49      | RP-100904 | 0240 | 1   | Addition of enhanced HS-SCCH support indicator in CELL_FACH   | 9.3.0  |
| 49      | RP-100905 | 0244 |     | HS-DSCH data transmission in enhanced CELL_FACH state and the relation to HS-DSCH physical layer category           | 9.3.0  |
| 12/2010 |           |      |     | Creation of Rel-10 version based on v. 9.3.0  | 10.0.0 |
| 50      | RP-101277 | 0245 |     | Introduction of MU-MIMO to CTCH of Iub user plane   | 10.0.0 |
| SP-49   | SP-100629 |      |     | Clarification on the use of References (TS 21.801 CR#0030)  | 10.1.0 |
| 51      | RP-110225 | 0251 |     | Correction of propagation delay handling for E-DCH Data Frame   | 10.1.0 |
| 52      | RP-110689 | 0255 |     | Introduction of NodeB Operation for Common HS-DSCH SRB1 Transmission  | 10.2.0 |
| 52      | RP-110688 | 0256 | 2   | Correction to mapping of MAC-is SDU to MAC-d PDU  | 10.2.0 |
| 52      | RP-110683 | 0259 |     | Special value for HS-DSCH DATA FRAME TYPE 2 RACH Measurement Result   | 10.2.0 |
| 52      | RP-110685 | 0260 |     | Correction to the References in 25.435  | 10.2.0 |
| 52      | RP-110681 | 0263 |     | Correction of Logical Channel ID range used in Enhanced Cell-FACH   | 10.2.0 |
| 53      | RP-111196 | 0268 | 2   | Addition of Cell Portion ID in the FACH DATA FRAME for 1.28Mcps TDD   | 10.3.0 |
| 54      | RP-111651 | 0272 | 1   | Clarification on the timing of PICH/HS-SCCH   | 10.4.0 |
| 54      | RP-111645 | 0275 | 1   | Indicator for DTXDRX HS-SCCH order  | 10.4.0 |
| 58      | RP-121724 | 0291 |     | Correction of missing EI in Figure 2B of HS-DSCH DATA FRAME TYPE 2  | 10.5.0 |

---

## History

| <b>Document history</b> |              |             |
|-------------------------|--------------|-------------|
| V10.1.0                 | April 2011   | Publication |
| V10.2.0                 | July 2011    | Publication |
| V10.3.0                 | October 2011 | Publication |
| V10.4.0                 | January 2012 | Publication |
| V10.5.0                 | January 2013 | Publication |