

ETSI TS 125 435 V4.2.0 (2001-09)

Technical Specification

Universal Mobile Telecommunications System (UMTS); UTRAN Iub Interface User Plane Protocols for Common Transport Channel Data Streams (3GPP TS 25.435 version 4.2.0 Release 4)



Reference

RTS/TSGR-0325435Uv4R2

Keywords

UMTS

ETSI

650 Route des Lucioles
F-06921 Sophia Antipolis Cedex - FRANCE

Tel.: +33 4 92 94 42 00 Fax: +33 4 93 65 47 16

Siret N° 348 623 562 00017 - NAF 742 C
Association à but non lucratif enregistrée à la
Sous-Préfecture de Grasse (06) N° 7803/88

Important notice

Individual copies of the present document can be downloaded from:

<http://www.etsi.org>

The present document may be made available in more than one electronic version or in print. In any case of existing or perceived difference in contents between such versions, the reference version is the Portable Document Format (PDF). In case of dispute, the reference shall be the printing on ETSI printers of the PDF version kept on a specific network drive within ETSI Secretariat.

Users of the present document should be aware that the document may be subject to revision or change of status. Information on the current status of this and other ETSI documents is available at

<http://portal.etsi.org/tb/status/status.asp>

If you find errors in the present document, send your comment to:

editor@etsi.fr

Copyright Notification

No part may be reproduced except as authorized by written permission.
The copyright and the foregoing restriction extend to reproduction in all media.

© European Telecommunications Standards Institute 2001.
All rights reserved.

Intellectual Property Rights

IPRs essential or potentially essential to the present document may have been declared to ETSI. The information pertaining to these essential IPRs, if any, is publicly available for **ETSI members and non-members**, and can be found in ETSI SR 000 314: "*Intellectual Property Rights (IPRs); Essential, or potentially Essential, IPRs notified to ETSI in respect of ETSI standards*", which is available from the ETSI Secretariat. Latest updates are available on the ETSI Web server (<http://www.etsi.org/legal/home.htm>).

Pursuant to the ETSI IPR Policy, no investigation, including IPR searches, has been carried out by ETSI. No guarantee can be given as to the existence of other IPRs not referenced in ETSI SR 000 314 (or the updates on the ETSI Web server) which are, or may be, or may become, essential to the present document.

Foreword

This Technical Specification (TS) has been produced by ETSI 3rd Generation Partnership Project (3GPP).

The present document may refer to technical specifications or reports using their 3GPP identities, UMTS identities or GSM identities. These should be interpreted as being references to the corresponding ETSI deliverables.

The cross reference between GSM, UMTS, 3GPP and ETSI identities can be found under www.etsi.org/key.

Contents

Intellectual Property Rights	2
Foreword.....	2
Foreword.....	6
1 Scope	7
2 References	7
3 Definitions and abbreviations.....	7
3.1 Definitions	7
3.2 Abbreviations	7
4 General aspects.....	8
4.1 Common Transport Channel Data Stream User Plane Protocol Services	8
4.2 Services expected from the Data Transport Network layer.....	8
4.3 Protocol Version.....	8
5 Data Streams User Plane Procedures	8
5.1 Data Transfer.....	8
5.1.1 RACH Channels	8
5.1.2 CPCH Channels [FDD]	9
5.1.3 Secondary-CCPCH related transport Channels	9
5.1.4 Downlink Shared Channels	10
5.1.5 Uplink Shared Channels [TDD].....	11
5.2 Node Synchronisation	11
5.3 DL Transport Channels Synchronisation	12
5.4 DL Timing Adjustment	12
5.5 Dynamic PUSCH Assignment [TDD].....	13
5.6 DSCH TFCI Signalling [FDD].....	13
5.7 Timing Advance [3.84 Mcps TDD]	14
5.8 Outer Loop PC Information Transfer [1.28 Mcps TDD].....	14
5.9 General	14
5.9.1 Association between transport bearer and data/control frames.....	14
6 Frame Structure and Coding.....	15
6.1 General	15
6.2 Data frame structure	16
6.2.1 RACH Channels	16
6.2.2 [FDD - CPCH Channels]	17
6.2.3 FACH Channels.....	17
6.2.4 PCH Channels.....	18
6.2.5 Downlink Shared Channels	19
6.2.6 [TDD - Uplink Shared Channels]	21
6.2.7 Coding of information elements in data frames	21
6.2.7.1 Header CRC	21
6.2.7.2 Frame Type	21
6.2.7.3 Connection Frame Number (CFN).....	22
6.2.7.4 Transport Format Indicator	22
6.2.7.5 [FDD - Propagation Delay]	22
6.2.7.6 [3.84Mcps TDD - Rx Timing Deviation].....	22
6.2.7.6A [1.28Mcps TDD - Received SYNC UL Timing Deviation].....	22
6.2.7.7 Transport Block.....	22
6.2.7.8 CRC Indicator	23
6.2.7.9 Payload CRC.....	23
6.2.7.10 Transmit Power Level	23
6.2.7.11 Paging Indication (PI)	23
6.2.7.12 Paging Indication bitmap (PI-bitmap).....	23
6.2.7.13 [3.84 Mcps TDD - Rx Timing Deviation on RACH].....	23

6.2.7.14	[TDD - PDSCH Set Id]	23
6.2.7.15	[FDD - Code Number]	24
6.2.7.16	[FDD - Spreading Factor (SF)]	24
6.2.7.17	[FDD - Power Offset].....	24
6.2.7.18	[FDD - MC Info].....	24
6.2.7.19	Spare Extension.....	24
6.2.7.20	[TDD - Quality Estimate (QE)].....	24
6.3	Control frame structure	25
6.3.1	Introduction.....	25
6.3.2	Coding of information elements of the Control frame header	25
6.3.2.1	Frame CRC	25
6.3.2.2	Frame Type (FT).....	25
6.3.2.3	Control Frame Type	25
6.3.3	Payload structure and information elements.....	26
6.3.3.1	TIMING ADJUSTMENT	26
6.3.3.1.1	Payload Structure.....	26
6.3.3.1.2	CFN	27
6.3.3.1.3	Time of arrival (ToA).....	27
6.3.3.1.4	Spare Extension	27
6.3.3.2	DL SYNCHRONISATION	27
6.3.3.2.1	Payload Structure.....	27
6.3.3.2.2	CFN	28
6.3.3.2.3	Spare Extension	28
6.3.3.3	UL SYNCHRONISATION	28
6.3.3.3.1	Payload Structure.....	28
6.3.3.3.2	CFN	29
6.3.3.3.3	Time of Arrival (TOA).....	29
6.3.3.3.4	Spare Extension	29
6.3.3.4	DL NODE SYNCHRONISATION	29
6.3.3.4.1	Payload Structure.....	29
6.3.3.4.2	T1	30
6.3.3.4.3	Spare Extension	30
6.3.3.5	UL NODE SYNCHRONISATION	30
6.3.3.5.1	Payload Structure.....	30
6.3.3.5.2	T1	31
6.3.3.5.3	T2	31
6.3.3.5.4	T3	31
6.3.3.5.5	Spare Extension.....	32
6.3.3.6	[TDD – DYNAMIC PUSCH ASSIGNMENT]	32
6.3.3.6.1	Payload structure	32
6.3.3.6.2	PUSCH Set Id.....	32
6.3.3.6.3	Activation CFN	32
6.3.3.6.4	Duration.....	32
6.3.3.7	[FDD - DSCH TFCI SIGNALLING]	32
6.3.3.7.1	Payload structure	32
6.3.3.7.2	TFCI (field 2)	33
6.3.3.7.3	Spare Extension	33
6.3.3.8	[3.84 Mcps TDD - TIMING ADVANCE]	33
6.3.3.8.1	Payload structure	33
6.3.3.8.2	CFN	33
6.3.3.8.3	TA.....	33
6.3.3.8.4	Spare Extension	34
6.3.3.9	OUTER LOOP POWER CONTROL [1.28 Mcps TDD].....	34
6.3.3.9.1	Payload structure	34
6.3.3.9.2	SIR Target	34
6.3.3.9.3	Spare Extension	34
7	Frame protocol error handling.....	34
7.1	Error detection.....	35
7.1.1	CRC Calculation.....	35
7.1.1.1	Relation between input and output of the Cyclic Redundancy Check	35

Annex A (informative): Change History36
History37

Foreword

This Technical Specification (TS) has been produced by the 3rd Generation Partnership Project (3GPP).

The contents of the present document are subject to continuing work within the TSG and may change following formal TSG approval. Should the TSG modify the contents of the present document, it will be re-released by the TSG with an identifying change of release date and an increase in version number as follows:

Version x.y.z

where:

- x the first digit:
 - 1 presented to TSG for information;
 - 2 presented to TSG for approval;
 - 3 or greater indicates TSG approved document under change control.
- y the second digit is incremented for all changes of substance, i.e. technical enhancements, corrections, updates, etc.
- z the third digit is incremented when editorial only changes have been incorporated in the document.

1 Scope

The present document provides a description of the UTRAN RNC-Node B (Iub) interface user plane protocols for Common Transport Channel data streams as agreed within the TSG-RAN working group 3.

NOTE: By Common Transport Channel one must understand RACH, CPCH [FDD], FACH/PCH, DSCH and USCH.

2 References

The following documents contain provisions which, through reference in this text, constitute provisions of the present document.

- References are either specific (identified by date of publication, edition number, version number, etc.) or non-specific.
- For a specific reference, subsequent revisions do not apply.
- For a non-specific reference, the latest version applies. In the case of a reference to a 3GPP document (including a GSM document), a non-specific reference implicitly refers to the latest version of that document *in the same Release as the present document*.

- [1] 3GPP TS 25.301: "Radio Interface Protocol Architecture".
- [2] 3GPP TS 25.402: "Synchronisation in UTRAN, Stage 2".
- [3] 3GPP TS 25.302: "Services provided by the Physical Layer".
- [4] 3GPP TS 25.221: "Physical channels and mapping of transport channels to physical channels (TDD)".
- [5] 3GPP TS 25.211: "Physical channels and mapping of transport channels onto physical channels (FDD)".
- [6] 3GPP TS 25.433: "UTRAN Iub interface NBAP signalling".
- [7] 3GPP TS 25.225: "Physical layer – Measurements (TDD)".
- [8] 3GPP TS 25.331: "Radio Ressource Control (RRC) protocol specification".

3 Definitions and abbreviations

3.1 Definitions

For the purposes of the present document, the terms and definitions in [2] and the following apply:

Transport Connection: service provided by the transport layer and used by Frame Protocol for the delivery of FP PDU

3.2 Abbreviations

For the purposes of the present document, the abbreviations in [2] and the following apply:

CFN	Connection Frame Number
CPCH	Common Packet Channel
CRC	Cyclic Redundancy Checksum
CRCI	CRC Indicator
DCH	Dedicated Transport Channel

DL	Downlink
DSCH	Downlink Shared Channel
FP	Frame Protocol
FT	Frame Type
LTOA	Latest Time of Arrival
PC	Power Control
PDSCH	Physical Downlink Shared Channel
PUSCH	Physical Uplink Shared Channel
QE	Quality Estimate
TB	Transport Block
TBS	Transport Block Set
TFI	Transport Format Indicator
ToA	Time of Arrival
ToAWE	Time of Arrival Window Endpoint
ToAWS	Time of Arrival Window Startpoint
TTI	Transmission Time Interval
UL	Uplink
USCH	Uplink Shared Channel

4 General aspects

4.1 Common Transport Channel Data Stream User Plane Protocol Services

Common transport channel provides the following services:

- Transport of TBS between the Node B and the CRNC for common transport channels.
- Support of transport channel synchronisation mechanism.
- Support of Node Synchronisation mechanism.

4.2 Services expected from the Data Transport Network layer

The following services are expected from the transport layer:

- Delivery of Frame Protocol PDUs.

In sequence delivery is not required. However, frequent out-of-sequence delivery may impact the performance and should be avoided.

4.3 Protocol Version

This revision of the specification specifies version 1 of the protocols.

5 Data Streams User Plane Procedures

5.1 Data Transfer

5.1.1 RACH Channels

Data Transfer procedure is used to transfer data received from Uu interface from Node B to CRNC. Data Transfer procedure consists of a transmission of Data Frame from Node B to CRNC.

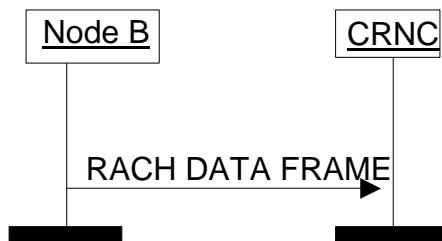

Figure 1: RACH Data Transfer procedure

5.1.2 CPCH Channels [FDD]

Data Transfer procedure is used to transfer data received from Uu interface from Node B to CRNC. Data Transfer procedure consists of a transmission of Data Frame from Node B to CRNC.

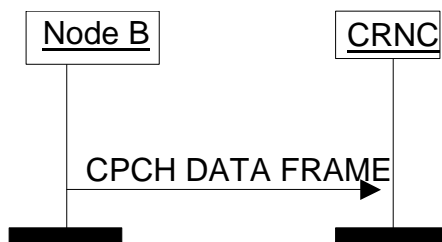

Figure 2: CPCH [FDD] Data Transfer procedure

5.1.3 Secondary-CCPCH related transport Channels

For the FACH transport channel, a Data Transfer procedure is used to transfer data from CRNC to Node B. Data Transfer procedure consists of a transmission of Data Frame from CRNC to Node B.

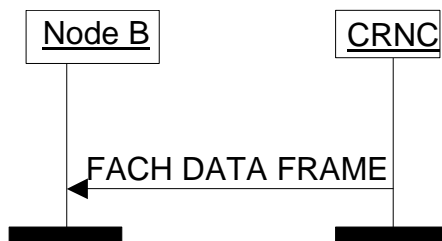

Figure 3: FACH Data Transfer procedure

For the PCH transport channel, a Data Transfer procedure is used to transfer data from CRNC to Node B. Data Transfer procedure consists of a transmission of Data Frame from CRNC to Node B.

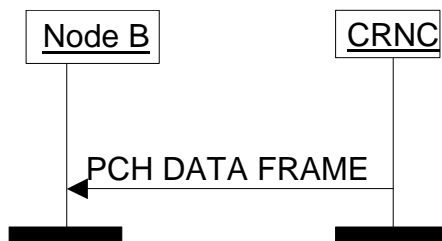

Figure 4: PCH Data Transfer procedure

In this case the PCH DATA FRAME may also transport information related to the PICH channel.

If the Node B does not receive a valid FP frame in a TTI, it assumes that there is no data to be transmitted in that TTI for this transport channel. For the FACH and PCH transport channels, the TFS shall never define a Transport Block Size of zero bits.

If the Node B is aware of a TFI value corresponding to zero bits for this transport channel, this TFI is assumed. When combining the TFI's of the different transport channels, a valid TFCI might result and in this case data shall be transmitted on the Uu.

If the Node B is not aware of a TFI value corresponding to zero bits for this transport channel or if combining the TFI corresponding to zero bits with other TFI's results in an unknown TFI combination, the handling as described in the following paragraph shall be applied.

At each frame, the Node B shall build the TFCI value of each secondary-CCPCH according to the TFIs of the transport channels multiplexed on this secondary-CCPCH and scheduled for that frame. [FDD - In case the Node B receives an unknown TFI combination, no pilot bits, TFCI bits or Data bits shall be transmitted.] [TDD - In case the Node B receives an unknown TFI combination, it shall apply DTX, i.e. suspend transmission on the corresponding S-CCPCH - except if this S-CCPCH provides the "beacon function", in which case the Node B shall maintain the physical layer transmission as specified in TS 25.221].

If the Node B does not receive a valid FP frame in a TTI or a frame without paging indication information, it assumes that no UE's have to be paged on the Uu in this TTI. In this case the default PICH bit pattern of all zeros shall be transmitted.

Data Frames sent on Iub for different transport channels multiplexed on one secondary-CCPCH might indicate different transmission power levels to be used in a certain Uu frame. Node-B shall determine the highest DL power level required for any of the transport channels multiplexed in a certain Uu frame and use this power level as the desired output level.

5.1.4 Downlink Shared Channels

The Data Transfer procedure is used to transfer a DSCH DATA FRAME from the CRNC to a Node B.

If the Node B does not receive a valid DSCH DATA FRAME for transmission in a given TTI, it assumes that there is no data to be transmitted in that TTI for this transport channel. For the DSCH transport channel, the TFS shall never define a Transport Block Size of zero bits.

[FDD - The Node B shall use the header information in the DSCH DATA FRAME to determine which channelisation code(s) and power offset should be used in the PDSCH Uu frame associated to the specified CFN. The specified channelisation code(s) and power offset shall then be used for PDSCH transmission for as long as there is data to transmit or until a new DSCH DATA FRAME arrives that specifies that a different PDSCH channelisation code(s) and/or power offset should be used. This feature enables multiple DSCH's with different TTI to be supported].

[FDD - In the event that the DSCH FP header indicates that a multi-code PDSCH transmission is to be applied ('MC Info' value > 1) then the 'power offset' field indicates the power offset at which each individual code should be transmitted relative to the power of the TFCI bits of the downlink DPCCCH directed to the same UE as the DSCH].

[FDD - The Node B may receive a DSCH DATA FRAME which contains a TFI value corresponding to there being no data to transmit, such a DSCH DATA FRAME will have no transport blocks. On receiving such a data frame the Node B shall apply the specified channelisation code(s) and power offset as described above starting in the PDSCH Uu frame associated to the specified CFN. This feature enables multiple DSCH's with different TTI to be supported, the use of such a zero payload DSCH DATA FRAME solves the problem of how the Node B should determine what channelisation code(s) and power offset should be used in the event that transmission of a transport block set being transmitted with a short TTI comes to an end, whilst the transmission of a TBS with a long TTI continues].

[TDD - The Node B shall use the header information in the DSCH DATA FRAME to determine which PDSCH Set and power offset should be used in the PDSCH Uu frames associated to the specified CFN. The specified PDSCH Set and power offset shall then be used for DSCH transmission for as long as there is data to transmit or until a new DSCH DATA FRAME arrives that specifies that a different PDSCH Set and/or power offset should be used. This feature enables multiple DSCH's with different TTI to be supported].

[TDD - The Node B may receive a DSCH data frame which contains a TFI value corresponding to there being no data to transmit, such a DSCH DATA FRAME will have no transport blocks. On receiving such a DATA FRAME the Node B shall apply the specified PDSCH Set and power offset as described above starting in the PDSCH Uu frame associated to the specified CFN. This feature enables multiple DSCH's with different TTI to be supported, the use of such a zero payload DSCH DATA FRAME solves the problem of how the Node B should determine what PDSCH Set and power offset should be used in the event that transmission of a transport block set being transmitted with a short TTI comes to an end, whilst the transmission of a TBS with a long TTI continues].

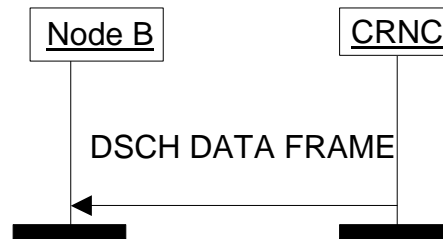

Figure 5: DSCH Data Transfer procedure

5.1.5 Uplink Shared Channels [TDD]

Data Transfer procedure is used to transfer data received from Uu interface from Node B to CRNC. Data Transfer procedure consists of a transmission of Data Frame from Node B to CRNC.

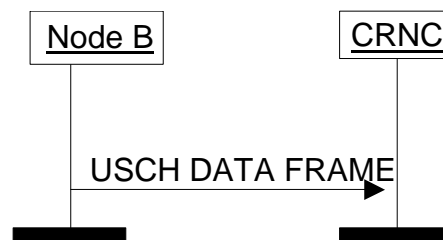

Figure 6: USCH Data Transfer procedure

Node B shall always send an USCH DATA FRAME to the CRNC provided the Transport Format addressed by the TFI indicates that the number of Transport Blocks is greater than 0.

When UL synchronisation is lost or not yet achieved on the Uu, USCH DATA FRAMEs shall not be sent to the CRNC.

When Node B receives an invalid TFCI in the PUSCH, USCH DATA FRAMEs shall not be sent to the CRNC.

5.2 Node Synchronisation

In the Node Synchronisation procedure, the RNC sends a DL NODE SYNCHRONISATION control frame to Node B containing the parameter T1. Upon reception of a DL NODE SYNCHRONISATION control frame, the Node B shall respond with UL NODE SYNCHRONISATION control frame, indicating T2 and T3, as well as T1 which was indicated in the initiating DL NODE SYNCHRONISATION control frame.

The T1, T2, T3 parameters are defined as:

T1: RNC specific frame number (RFN) that indicates the time when RNC sends the frame through the SAP to the transport layer.

T2: Node B specific frame number (BFN) that indicates the time when Node B receives the correspondent DL NODE SYNCHRONISATION control frame through the SAP from the transport layer.

T3: Node B specific frame number (BFN) that indicates the time when Node B sends the frame through the SAP to the transport layer.

The general overview on the Node Synchronisation procedure is reported in [2].

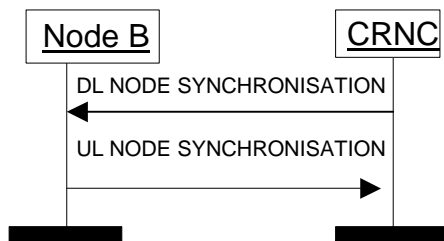

Figure 7: Node Synchronisation procedure

5.3 DL Transport Channels Synchronisation

CRNC sends a DL SYNCHRONISATION control frame to Node B. This message indicates the target CFN.

Upon reception of the DL SYNCHRONISATION control frame Node B shall immediately respond with UL SYNCHRONISATION control frame indicating the ToA for the DL SYNCHRONISATION control frame and the CFN indicated in the received message.

The procedure shall not be applied on transport bearers transporting UL traffic channels RACH or USCH.

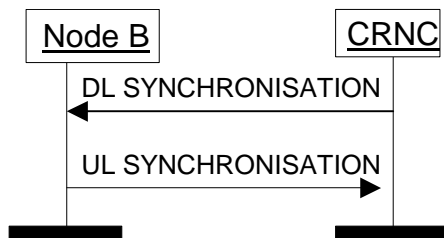

Figure 8: Transport Channels Synchronisation procedure

5.4 DL Timing Adjustment

Timing Adjustment procedure is used to indicate for the CRNC the incorrect arrival time of downlink data to Node B.

Timing Adjustment procedure is initiated by the Node B if a DL frame arrives outside of the defined arrival window.

If the DL frame has arrived before the ToAWS or after the ToAWE Node B includes the ToA and the target CFN as message parameters for TIMING ADJUSTMENT control frame.

The arrival window and the time of arrival are defined as follows:

- **Time of Arrival Window Endpoint (ToAWE):** ToAWE represents the time point by which the DL data shall arrive to the Node B from Iub. The ToAWE is defined as the amount of milliseconds before the last time point from which a timely DL transmission for the identified CFN would still be possible taking into account the Node B internal delays. ToAWE is set via control plane. If data does not arrive before ToAWE a TIMING ADJUSTMENT control frame shall be sent by Node B.
- **Time of Arrival Window Startpoint (ToAWS):** ToAWS represents the time after which the DL data shall arrive to the Node B from Iub. The ToAWS is defined as the amount of milliseconds from the ToAWE. ToAWS is set via control plane. If data arrives before ToAWS a TIMING ADJUSTMENT control frame shall be sent by Node B.
- **Time of Arrival (ToA):** ToA is the time difference between the end point of the DL arrival window (ToAWE) and the actual arrival time of DL frame for a specific CFN. A positive ToA means that the frame is received before the ToAWE, a negative ToA means that the frame is received after the ToAWE.

The general overview on the timing adjustment procedure is reported in [2].

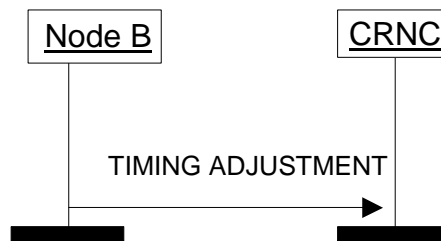

Figure 9: Timing Adjustment procedure

5.5 Dynamic PUSCH Assignment [TDD]

Procedure for dynamic allocation of physical resources to uplink shared channels (USCH) in the Node B. The control frame includes a parameter "PUSCH Set Id" which is a pointer to a pre-configured table of PUSCH Sets in the Node B.

When this control frame is sent via a certain Iub USCH data port, then it applies to that USCH and in addition to any other USCH channel which is multiplexed into the same CCTrCH in the Node B.

The time limitation of the PUSCH allocation is expressed with the parameters "Activation CFN" and "Duration".

Node B behaviour: When the Node B receives the "DYNAMIC PUSCH ASSIGNMENT" from the CRNC in the USCH frame protocol over an Iub USCH data port within a Traffic Termination Point, it shall behave as follows:

- 1) The Node B shall extract the PUSCH Set Id.
- 2) It shall extract the parameters "Activation CFN" and "Duration" which identify the allocation period of that physical channel.
- 3) It shall retrieve the PUSCH Set which is referred to by the PUSCH Set Id.
- 4) It shall identify the CCTrCH to which the USCH is multiplexed, and hence the TFCS which is applicable for the USCH.
- 5) Within the time interval indicated by Activation CFN and Duration, the Node B shall make the specified PUSCH Set available to the CCTrCH.

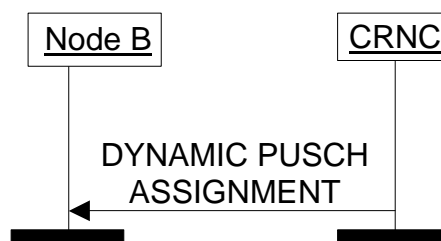

Figure 10: Dynamic PUSCH Assignment procedure

5.6 DSCH TFCI Signalling [FDD]

This procedure is used in order to signal to the Node B the TFCI (field 2). This allows the Node B to build the TFCI word(s) which have to be transmitted on the DPCCCH.

The procedure consists in sending the DSCH TFCI signalling control frame from the CRNC to the Node B. The frame contains the TFCI (field 2) and the correspondent Connection Frame Number. The DSCH TFCI SIGNALLING frame is sent once every U_u frame interval (10 ms) for as long as there is DSCH data for that UE to be transmitted in the associated PDSCH U_u frame.

In the event that the Node B does not receive a DSCH TFCI SIGNALLING control frame then the Node B shall infer that no DSCH data is to be transmitted to the UE on the associated PDSCH U_u frame and will build the TFCI word(s) accordingly.

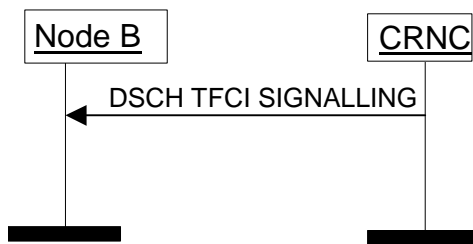

Figure 11: DSCH TFCI Signalling procedure

5.7 Timing Advance [3.84 Mcps TDD]

This procedure is used in order to signal to the Node B the adjustment to be performed by the UE in the uplink timing.

The Node B shall use the CFN and timing adjustment values to adjust its layer 1 to allow for accurate impulse averaging.

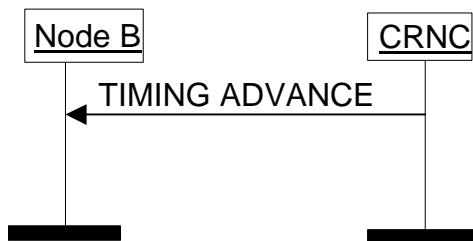

Figure 12: Timing Advance procedure

5.8 Outer Loop PC Information Transfer [1.28 Mcps TDD]

Based, for example, on the CRCI values and on the quality estimate in the USCH data frames, CRNC modifies the SIR target of the associated CCTrCH by including the absolute value of the new SIR target in the OUTER LOOP PC control frame sent to the Node B.

At the reception of the OUTER LOOP PC control frame from the CRNC via a Transport Bearer used for an USCH, the Node B shall immediately update the SIR target used for the inner loop power control for the respective CCTrCH with the specified value.

The OUTER LOOP PC control frame can be sent via any of the transport bearers carrying USCHs which belong to the CCTrCH for which the UL SIR Target shall be adjusted.

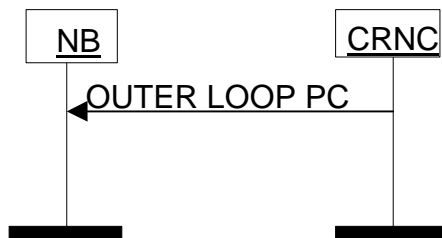

Figure 12A: Outer Loop Power Control Information Transfer procedure

5.9 General

5.9.1 Association between transport bearer and data/control frames

Table 1 shows how the data and control frames are associated to the transport bearers. 'yes' indicates that the control frame is applicable to the transport bearer, 'no' indicates that the control frame is not applicable to the transport bearer.

Table 1

Transport bearer used for	Associated data frame	Associated control frames						
		Timing Adjustment	DL Transport Channels Synchronisation	Node Synchronisation	Dynamic PUSCH Assignment	Timing Advance	DSCH TFCI Signalling	Outer Loop PC Info Xfer
RACH	RACH DATA FRAME	no	no	no	no	no	no	no
FACH	FACH DATA FRAME	yes	yes	yes	no	no	no	no
CPCH	CPCH DATA FRAME	no	no	no	no	no	no	no
PCH	PCH DATA FRAME	yes	yes	yes	no	no	no	no
DSCH	DSCH DATA FRAME	yes	yes	yes	no	no	no	no
USCH	USCH DATA FRAME	no	no	no	yes	yes	no	yes
TFCI2	-	yes	yes	yes	no	no	yes	no

6 Frame Structure and Coding

6.1 General

The general structure of a Common Transport Channel frame consists of a header and a payload. This structure is depicted in figure 13.

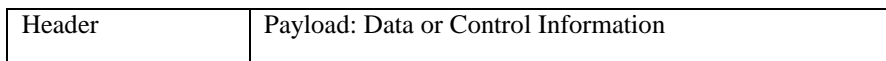

Figure 13: General Frame Structure

The header shall contain the Frame Type field and information related to the frame type.

There are two types of frames (indicated by the Frame Type field).

- Data frame.
- Control frame.

In the present document the structure of frames will be specified by using pictures similar to figure 14.

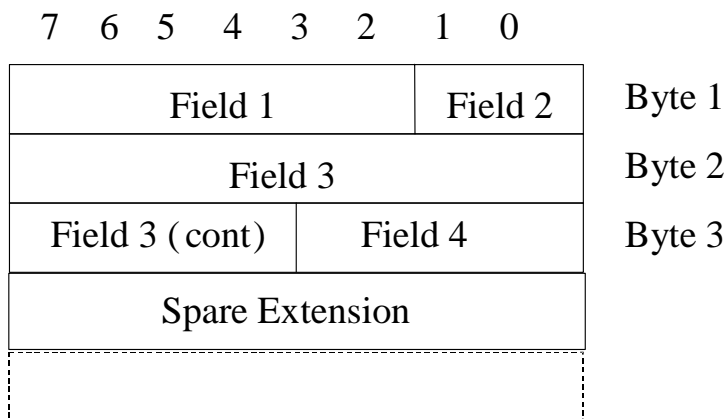

Figure 14: Example frame structure

Unless otherwise indicated, fields which consist of multiple bits within a byte will have the more significant bit located at the higher bit position (indicated above frame in figure 14). In addition, if a field spans several bytes, more significant bits will be located in lower numbered bytes (right of frame in figure 14).

On the Iub interface, the frame will be transmitted starting from the lowest numbered byte. Within each byte, the bits are sent according decreasing bit position (bit position 7 first).

The parameters are specified giving the value range and the step (if not 1). The coding is done as follows (unless otherwise specified):

- Unsigned values are binary coded.
- Signed values are 2's complement binary coded.

The Spare Extension indicates the location where new IEs can in the future be added in a backward compatible way. The Spare Extension shall not be used by the transmitter and shall be ignored by the receiver.

Bits labelled "Spare" shall be set to zero by the transmitter and shall be ignored by the receiver.

6.2 Data frame structure

6.2.1 RACH Channels

The RACH DATA FRAME includes the CFN corresponding to the SFN of the frame in which the payload was received. If the payload was received in several frames, the CFN corresponding to the first Uu frame in which the information was received shall be indicated.

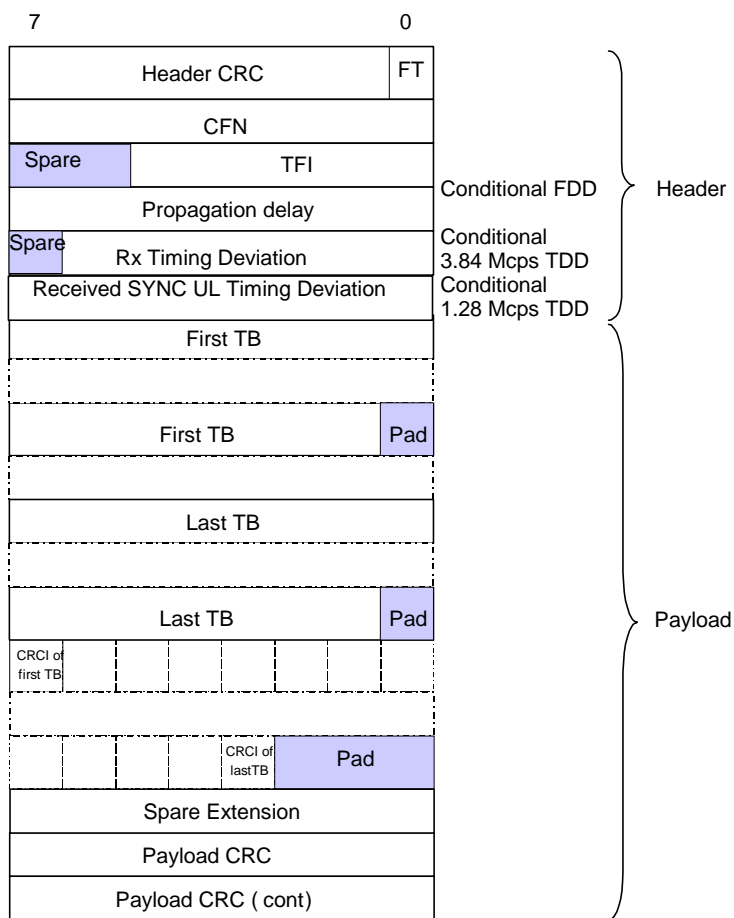

Figure 15: RACH DATA FRAME structure

Propagation Delay is a conditional Information Element which is only present when the Cell supporting the RACH Transport Channel is a FDD Cell.

Rx Timing Deviation is a conditional Information Element which is only present when the Cell supporting the RACH Transport Channel is a 3.84 Mcps TDD Cell.

Received SYNC UL Timing Deviation is a conditional Information Element which is only present when the Cell supporting the RACH Transport Channel is a 1.28Mcps TDD Cell.

6.2.2 [FDD - CPCH Channels]

The CPCH [FDD] DATA FRAME includes the CFN corresponding to the 8 least significant bits of the SFN of the frame in which the payload was received. If the payload was received in several frames, the CFN corresponding to the first Uu frame in which the information was received shall be indicated.

Data frame structure is only applicable to FDD.

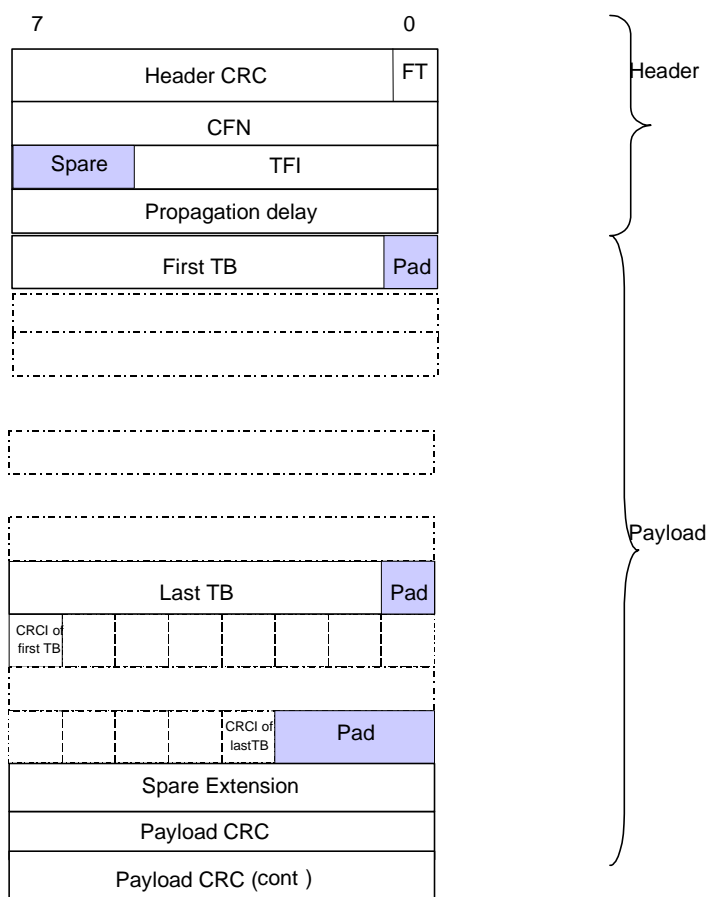

Figure 16: FDD CPCH DATA FRAME structure

6.2.3 FACH Channels

FACH DATA FRAME includes the CFN corresponding to the Uu frame at which this data in which the payload (FACH TBS) has to be transmitted. If the payload is to be sent in several frames, the CFN corresponding to the first frame shall be indicated.

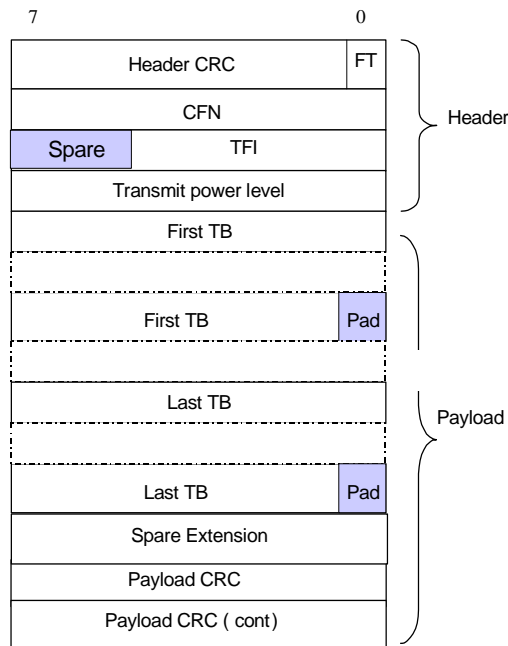

Figure 17: FACH DATA FRAME structure

6.2.4 PCH Channels

The PCH DATA FRAME includes the paging indication information and paging messages. To page one User Equipment, two consecutive PCH DATA FRAMEs with consecutive CFN numbers are transmitted, the first frame contains the Paging Indication Information and the second contains the Paging Message.

[TDD- If PI-bitmap and PCH TBS are transmitted within the PCH DATA FRAME, the CFN is related to the PCH TBS only. The PI bitmap is mapped to the PICH frames, transmitted at the beginning of the paging block.]

The paging messages are transmitted in S-CCPCH frames. The CFN in the PCH DATA FRAME header corresponds to the Cell SFN of the frame in which the start of the S-CCPCH frame is located. [TDD - If the paging messages are to be sent in several frames, the CFN corresponding to the first frame shall be indicated.]

[FDD - The timing of the PICH frame (containing the paging indication information) is τ_{PICH} prior to the S-CCPCH frame timing [5]].

In contrast to all other Common Transport Channel data frames, which use a CFN of length 8, the PCH DATA FRAME includes a CFN of length 12.

The Node B has no responsibility to ensure the consistency between the paging indication information and the corresponding paging messages. E.g. if the paging indication information is lost over the Iub, the paging messages might be sent over the Uu while no UE is actually listening.

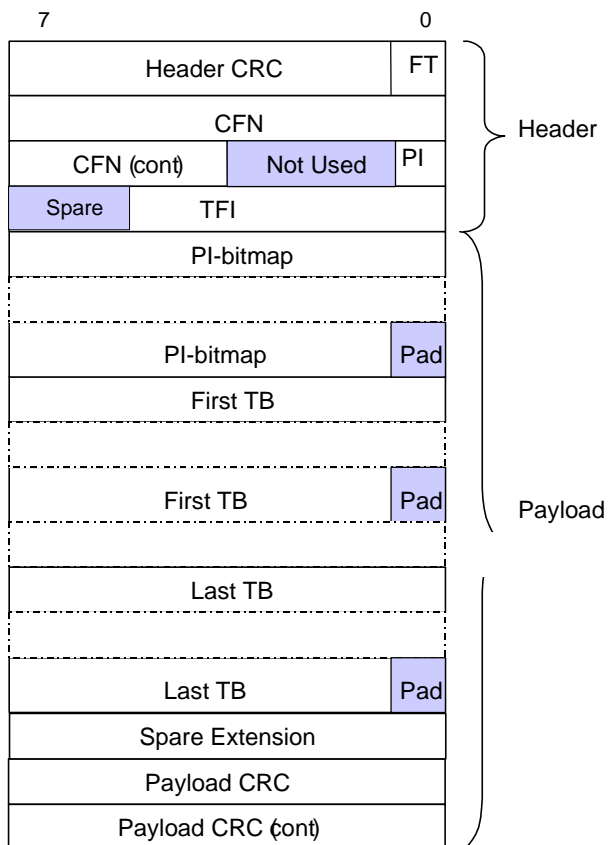

Figure 18: PCH DATA FRAME structure

"Not Used" bits shall be set to 0 by the RNC and ignored by the Node B.

6.2.5 Downlink Shared Channels

DSCH DATA FRAME includes a CFN indicating the SFN of the PDSCH in which the payload shall be sent. If the payload is to be sent over several frames, the CFN corresponding to the first frame shall be indicated.

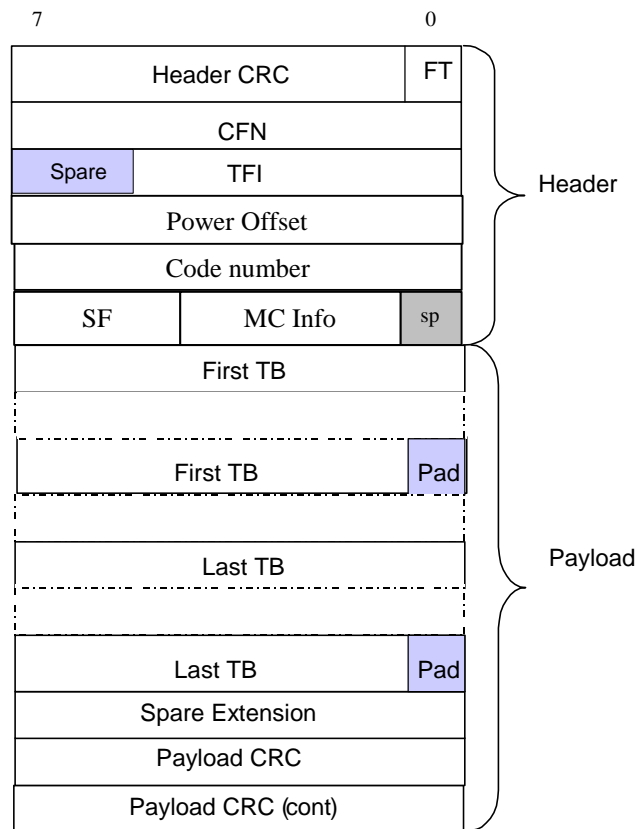

Figure 19: FDD DSCH DATA FRAME structure

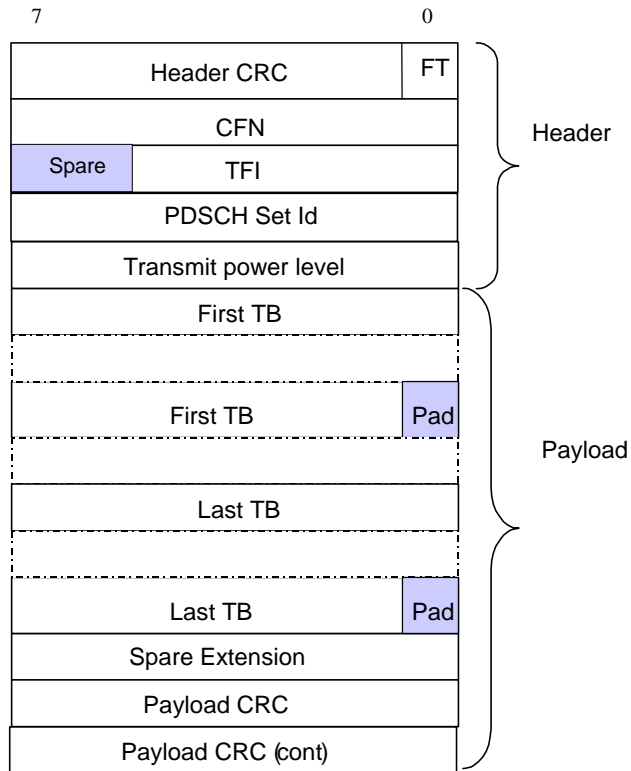

Figure 20: TDD DSCH DATA FRAME structure

Transmit Power Level is a conditional Information Element which is only present when the Cell supporting the DSCH Transport Channel is a TDD Cell.

6.2.6 [TDD - Uplink Shared Channels]

USCH DATA FRAME includes the CFN in which the payload was received. If the payload was received in several frames, the CFN corresponding to the first frame will be indicated.

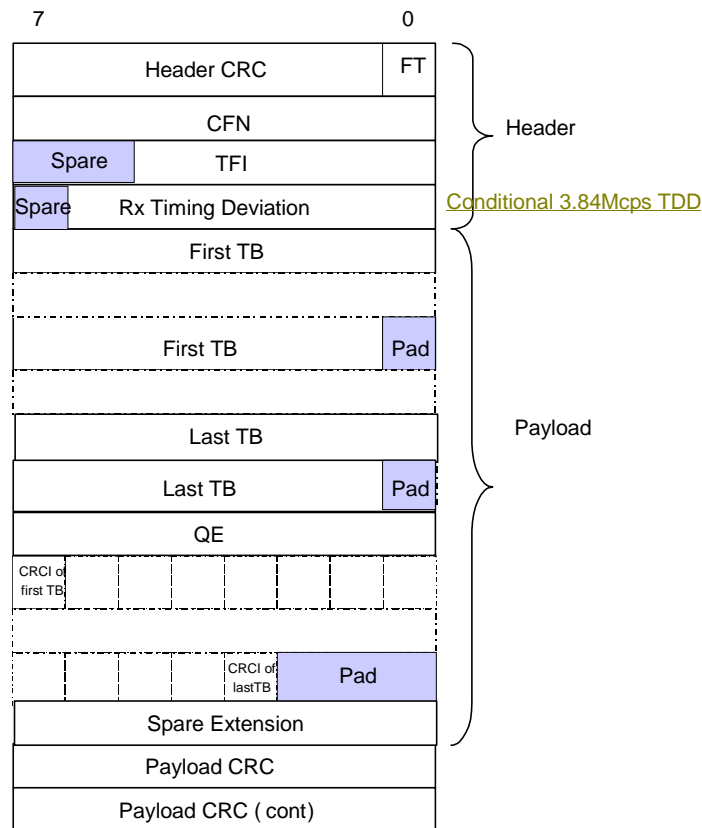

Figure 21: USCH DATA FRAME structure

6.2.7 Coding of information elements in data frames

6.2.7.1 Header CRC

Description: Cyclic Redundancy Polynomial calculated on the header of a data frame with polynom: $X^7+X^6+X^2+1$.

The CRC calculation shall cover all bits in the header, starting from bit 0 in the first byte (FT field) up to the end of the header. See subclause 7.1.

Value range: {0..127}.

Field length: 7 bits.

6.2.7.2 Frame Type

Description: Describes if it is a control frame or a data frame.

Value range: {0=data, 1=control}.

Field Length: 1 bit.

6.2.7.3 Connection Frame Number (CFN)

Description: Indicator as to which radio frame the first data was received on uplink or shall be transmitted on downlink. The value range and field length depend on the transport channel for which the CFN is used.

Value range (PCH): {0..4095}.

Value range (other): {0..255}.

Field length (PCH): 12 bits.

Field length (other): 8 bits.

6.2.7.4 Transport Format Indicator

Description: TFI is the local number of the transport format used for the transmission time interval. For information about what the transport format includes see [3].

Value range: {0..31}.

Field length: 5 bits.

6.2.7.5 [FDD - Propagation Delay]

Description: One-way radio interface delay as measured during RACH access.

Value range: {0..765 chips}.

Granularity: 3 chips.

Field length: 8 bits.

6.2.7.6 [3.84Mcps TDD - Rx Timing Deviation]

Description: Measured Rx Timing Deviation as a basis for timing advance. This value should consider measurements made in all frames and all timeslots that contain the transport blocks in the payload. In case the *Timing Advance Applied* IE indicates "No" (see [6]) in a cell, the Rx Timing Deviation field shall be set to $N = 0$.

Value range: {-256 .. +256 chips}.

$\{N*4 - 256\} \text{ chips} \leq \text{RxTiming Deviation} < \{(N+1)*4 - 256\} \text{ chips}$.

With $N = 0, 1, \dots, 127$.

Granularity: 4 chips.

Field length: 7 bits.

6.2.7.6A [1.28Mcps TDD - Received SYNC UL Timing Deviation]

Description: Measured Received SYNC UL Timing Deviation as a basis for propagation delay.

Value range: {0, ..., +256} chips

Granularity: 1 chip.

Field length: 8 bits.

6.2.7.7 Transport Block

Description: A block of data to be transmitted or have been received over the radio interface. The transport format indicated by the TFI describes the transport block length and transport block set size. See [3].

6.2.7.8 CRC Indicator

Description: Shows if the transport block has a correct CRC. The UL Outer Loop Power Control may use the CRC indication.

Value range: {0=Correct, 1=Not Correct}.

Field length: 1 bit.

6.2.7.9 Payload CRC

Description: Cyclic Redundancy Polynomial calculated on the payload of a data frame with polynomial $X^{16}+X^{15}+X^2+1$.

The CRC calculation shall cover all bits in the data frame payload, starting from bit 7 in the first byte up to bit 0 in the byte before the payload CRC. See subclause 7.1.

Field length: 16 bits.

6.2.7.10 Transmit Power Level

Description: Preferred transmission power level during this TTI for the corresponding transport channel. The indicated value is the negative offset relative to the maximum power configured for the physical channel(s) used for the respective transport channel.

Value range: {0 .. 25.5 dB}.

Granularity: 0,1 dB.

Field length: 8 bits.

6.2.7.11 Paging Indication (PI)

Description: Describes if the PI Bitmap is present in the payload.

Value range: {0=no PI-bitmap in payload, 1=PI-bitmap in payload}.

Field length: 1 bit.

6.2.7.12 Paging Indication bitmap (PI-bitmap)

Description: Bitmap of Paging Indications $PI_0..PI_{N-1}$. Bit 7 of the first byte contains PI_0 , Bit 6 of the first byte contains PI_1, \dots , Bit 7 of the second byte contains PI_8 and so on.

Value range: [FDD - {18, 36, 72 or 144 Paging Indications}].
 [TDD - {30, 34, 60, 68, 120 and 136} Paging Indications for 2 PICH frames,
 {60, 68, 120, 136, 240 and 272} Paging Indications for 4 PICH frames].

Field length: [FDD - 3, 5, 9 or 18 bytes (the PI-bitmap field is padded at the end up to an octet boundary)].

[TDD - 4, 5, 8, 9, 15, 17, 30 or 34 bytes (the PI-bitmap field is padded at the end up to an octet boundary)].

6.2.7.13 [3.84 Mcps TDD - Rx Timing Deviation on RACH]

Void.

6.2.7.14 [TDD - PDSCH Set Id]

Description: A pointer to the PDSCH Set which shall be used to transmit the DSCH DATA FRAME over the radio interface.

Value range: {0..255}.

Field length: 8 bits.

6.2.7.15 [FDD - Code Number]

Description: The code number of the PDSCH (the same mapping is used as for the 'code number' IE in [8]).

Value Range: {0..255}.

Field length: 8 bits.

6.2.7.16 [FDD - Spreading Factor (SF)]

Description: The spreading factor of the PDSCH.

Spreading factor = 0 Spreading factor to be used = 4.

Spreading factor = 1 Spreading factor to be used = 8.

Spreading factor = 6 Spreading factor to be used = 256.

Value Range: {4,8,16,32,64,128, 256}.

Field length: 3 bits.

6.2.7.17 [FDD - Power Offset]

Description: Used to indicate the preferred FDD PDSCH transmission power level. The indicated value is the offset relative to the power of the TFCI bits of the downlink DPCCCH directed to the same UE as the DSCH.

Power offset = 0 Power offset to be applied = -32 dB.

Power offset = 1 Power offset to be applied = -31.75 dB.

Power offset = 255 Power offset to be applied = +31.75 dB.

Value range: {-32 .. +31.75 dB}.

Granularity: 0.25 dB.

Field length: 8 bits.

6.2.7.18 [FDD - MC Info]

Description: Used to indicate the number of parallel PDSCH codes on which the DSCH data will be carried. Where multi-code transmission is used the SF of all codes is the same and code numbers are contiguous within the code tree with increasing code number values starting from the code number indicated in the 'code number' field.

Value range: {1..16}.

Field length: 4 bits.

6.2.7.19 Spare Extension

Description: Indicates the location where new IEs can in the future be added in a backward compatible way.

Field length: 0-2 octets.

6.2.7.20 [TDD - Quality Estimate (QE)]

Description: The quality estimate is derived from the Transport channel BER.

If the USCH FP frame includes TB's for the USCH then the QE is the Transport channel BER for the selected USCH. If no Transport channel BER is available the QE shall be set to 0.

The quality estimate shall be set to the Transport channel BER and be measured in the units TrCH_BER_LOG respectively (see [6]). The UL Outer Loop Power Control may use the quality estimate.

Value range: {0..255}.

Granularity: 1.

Field length: 8 bits.

6.3 Control frame structure

6.3.1 Introduction

The Common Control Channel control frames are used to transport control information between the CRNC and the Node B. Figure 22 defines the Control Frame structure for common transport channels.

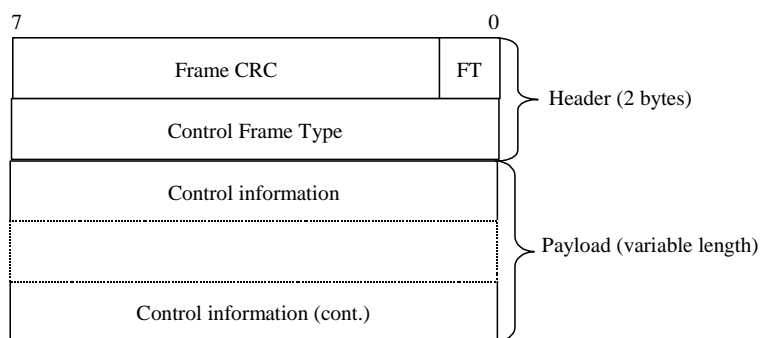

Figure 22: Iub Common Transport Channel Control Frame Format

The structure of the header and the payload of the control frames is defined in the following subclauses.

6.3.2 Coding of information elements of the Control frame header

6.3.2.1 Frame CRC

Description: Cyclic Redundancy Polynomial calculated on a control frame with polynomial:
 $X^7 + X^6 + X^2 + 1$.

The CRC calculation shall cover all bits in the control frame, starting from bit 0 in the first byte (FT field) up to the end of the control frame. See subclause 7.1.

Value range: {0..127}.

Field length: 7 bits.

6.3.2.2 Frame Type (FT)

Refer to subclause 6.2.7.2.

6.3.2.3 Control Frame Type

Description: Indicates the type of the control information (information elements and length) contained in the payload.

Value: Values of the Control Frame Type parameter are defined in table 2.

Table 2

Type of control frame	Value
OUTER LOOP POWER CONTROL	0000 0001
TIMING ADJUSTMENT	0000 0010
DL SYNCHRONISATION	0000 0011
UL SYNCHRONISATION	0000 0100
DSCH TFCI SIGNALLING	0000 0101
DL NODE SYNCHRONISATION	0000 0110
UL NODE SYNCHRONISATION	0000 0111
DYNAMIC PUSCH ASSIGNMENT	0000 1000
TIMING ADVANCE	0000 1001

Field Length: 8 bits.

6.3.3 Payload structure and information elements

6.3.3.1 TIMING ADJUSTMENT

6.3.3.1.1 Payload Structure

Figures 23 and 24 shows the structure of the payload when control frame is used for the timing adjustment.

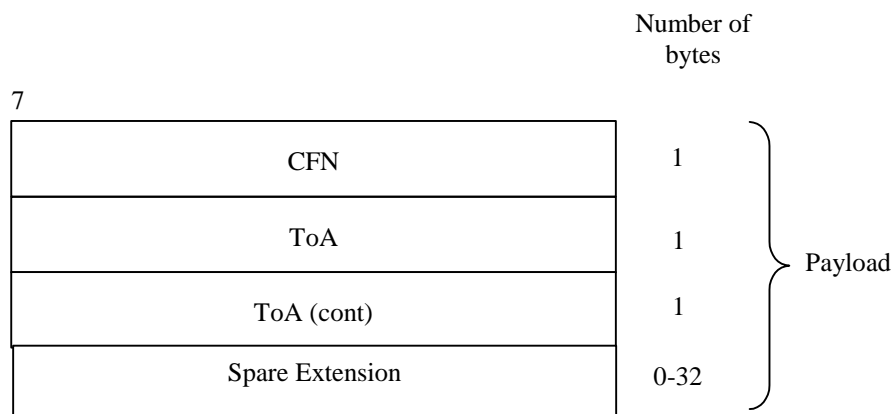

Figure 23: TIMING ADJUSTMENT payload structure (non-PCH transport bearers)

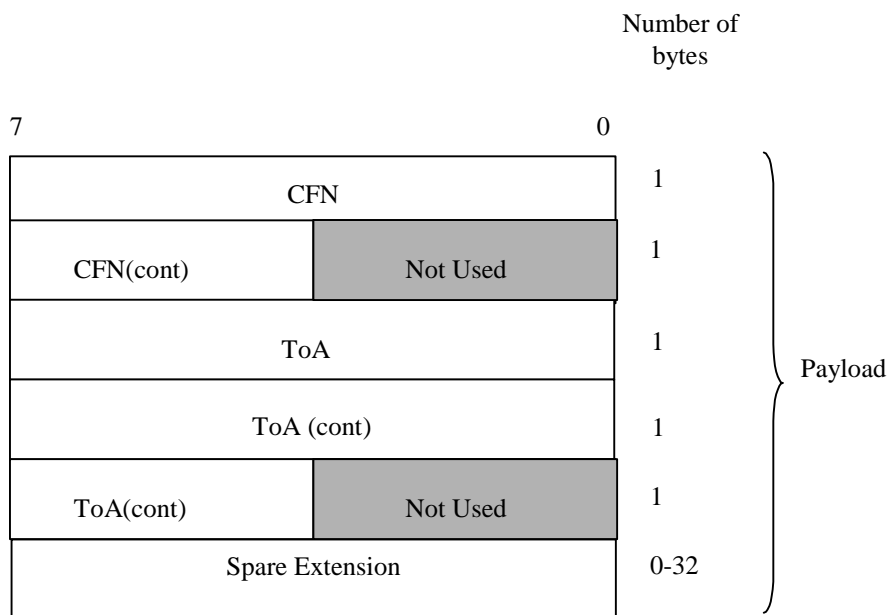

Figure 24: TIMING ADJUSTMENT payload structure (PCH transport bearer)

6.3.3.1.2 CFN

Refer to subclause 6.2.7.3.

6.3.3.1.3 Time of arrival (ToA)

Description: Time difference between the arrival of the DL frame with respect to TOAWE (based on the CFN in the frame). The value range and field length depend on the transport channel for which the CFN is used.

Value range (PCH): {-20480ms, +20479.875ms}.

Value range (other): {-1280ms, +1279.875ms}.

Granularity: 125µs.

Field length (PCH): 20 bits.

Field length (other): 16 bits.

6.3.3.1.4 Spare Extension

Description: Indicates the location where new IEs can in the future be added in a backward compatible way.

Field length: 0-32 octets.

6.3.3.2 DL SYNCHRONISATION

6.3.3.2.1 Payload Structure

Figures 25 and 26 shows the structure of the payload when control frame is used for the user plane synchronisation.

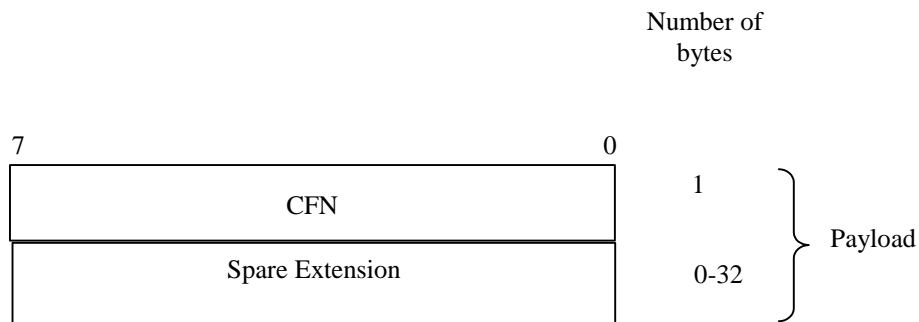

Figure 25: DL SYNCHRONISATION payload structure (non-PCH transport bearers)

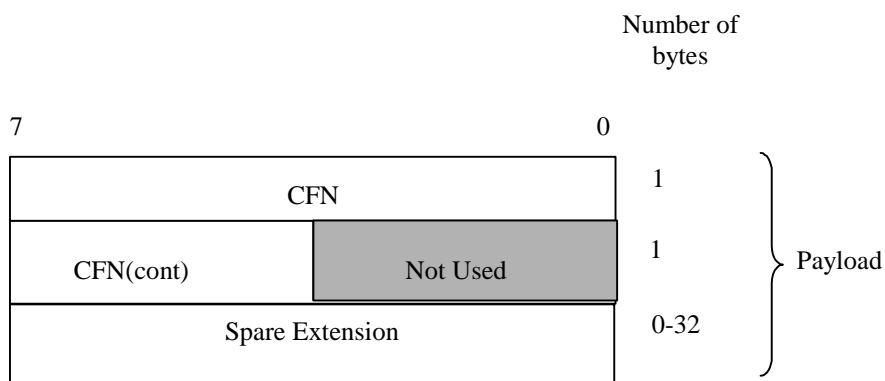

Figure 26: DL SYNCHRONISATION payload structure (PCH transport bearers)

6.3.3.2.2 CFN

Refer to subclause 6.2.7.3.

6.3.3.2.3 Spare Extension

Refer to subclause 6.3.3.1.4.

6.3.3.3 UL SYNCHRONISATION

6.3.3.3.1 Payload Structure

Figures 27 and 28 shows the structure of the payload when the control frame is used for the user plane synchronisation (UL).

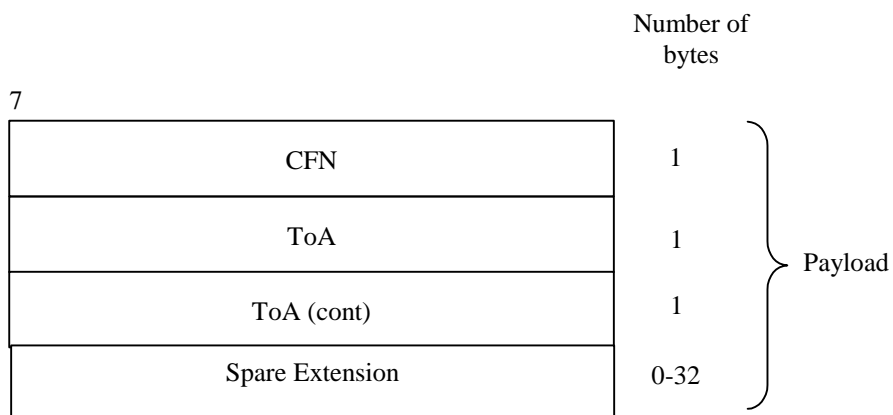

Figure 27: UL SYNCHRONISATION payload structure (non-PCH transport bearers)

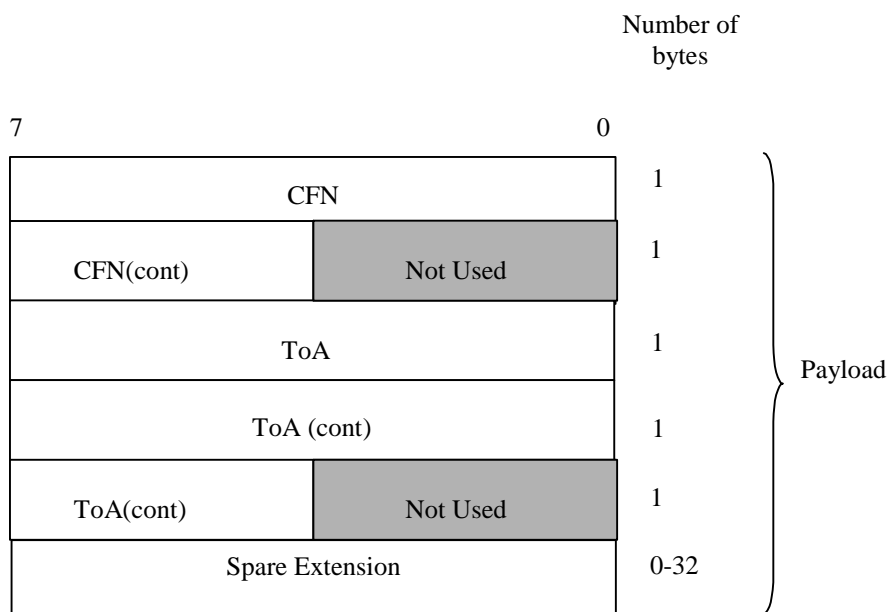

Figure 28: UL SYNCHRONISATION payload structure (PCH transport bearers)

6.3.3.3.2 CFN

Refer to subclause 6.2.7.3.

6.3.3.3.3 Time of Arrival (TOA)

Refer to subclause 6.3.3.1.3.

6.3.3.3.4 Spare Extension

Refer to subclause 6.3.3.1.4.

6.3.3.4 DL NODE SYNCHRONISATION

6.3.3.4.1 Payload Structure

The payload of the DL Node synchronisation control frames is shown in figure 29.

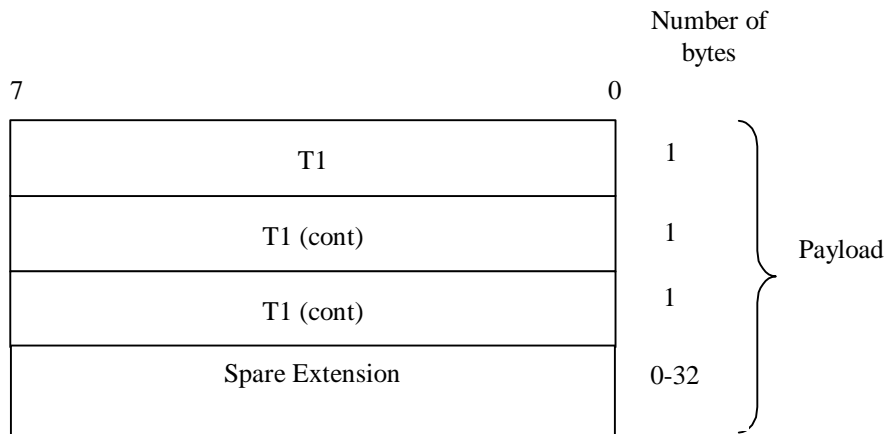

Figure 29: DL NODE SYNCHRONISATION payload structure

6.3.3.4.2 T1

Description: RNC specific frame number (RFN) that indicates the time when RNC sends the frame through the SAP to the transport layer.

Value range: {0 .. 40959.875 ms}.

Granularity: 0.125ms.

Field length: 24 bits.

6.3.3.4.3 Spare Extension

Refer to subclause 6.3.3.1.4.

6.3.3.5 UL NODE SYNCHRONISATION

6.3.3.5.1 Payload Structure

The payload of the UL Node synchronisation control frames is shown in figure 30.

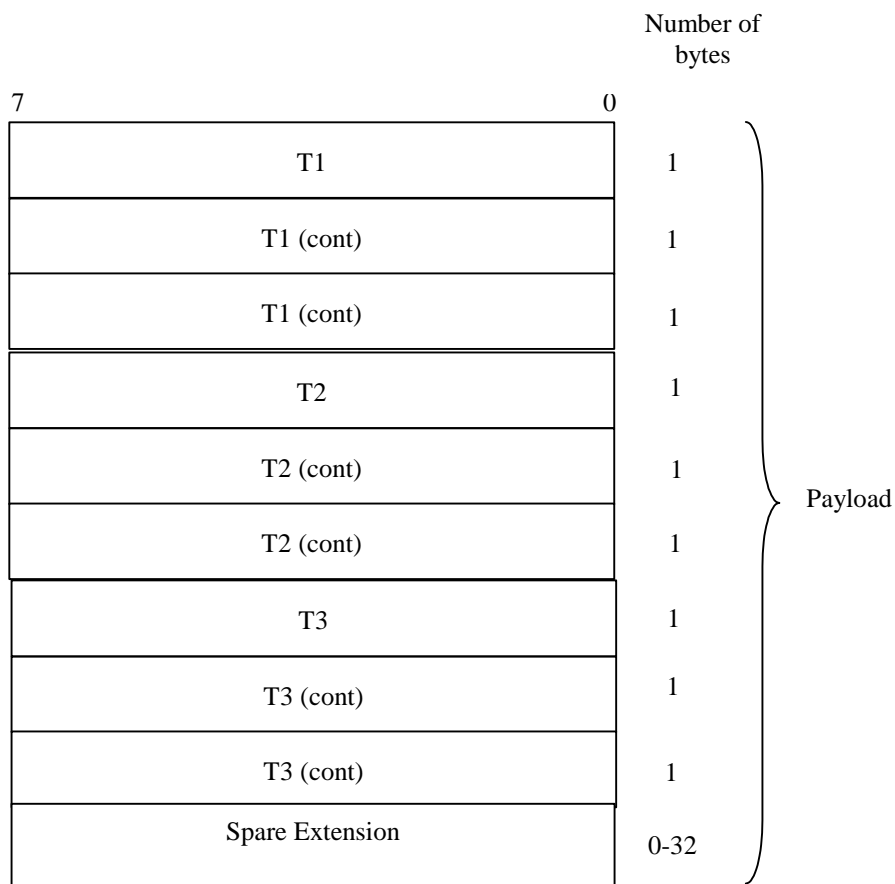

Figure 30: UL NODE SYNCHRONISATION payload structure

6.3.3.5.2 T1

Description: T1 timer is extracted from the correspondent DL Node synchronisation control frame.

Value range: {0 .. 40959.875 ms.}

Granularity: 0.125ms.

Field length: 24 bits.

6.3.3.5.3 T2

Description: Node B specific frame number (BFN) that indicates the time when Node B received the correspondent DL synchronisation frame through the SAP from the transport layer.

Value range: {0 .. 40959.875 ms}.

Granularity: 0.125ms.

Field length: 24 bits.

6.3.3.5.4 T3

Description: Node B specific frame number (BFN) that indicates the time when Node B sends the frame through the SAP to the transport layer.

Value range: {0 .. 40959.875 ms}.

Granularity: 0.125ms.

Field length: 24 bits.

6.3.3.5.5 Spare Extension

Refer to subclause 6.3.3.1.4.

6.3.3.6 [TDD – DYNAMIC PUSCH ASSIGNMENT]

6.3.3.6.1 Payload structure

The payload of the Dynamic PUSCH Assignment control frames is shown in figure 31.

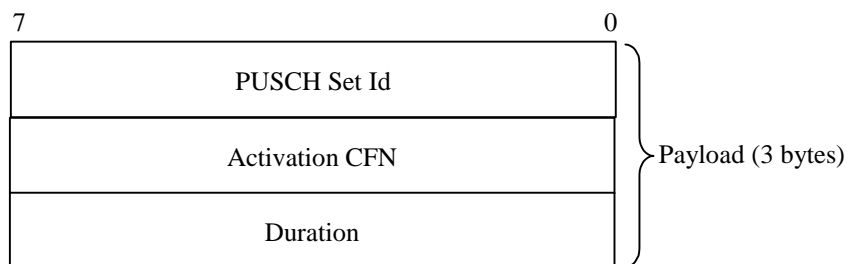

Figure 31: DYNAMIC PUSCH ASSIGNMENT payload structure

6.3.3.6.2 PUSCH Set Id

Description: Identifies a PUSCH Set from the collection of PUSCH Sets which have been pre-configured in the Node B, for the respective cell in which the USCH exists. The PUSCH Set Id is unique within a cell.

Value range: {0..255}.

Field length: 8 bits.

6.3.3.6.3 Activation CFN

Description: Activation CFN, specifies the Connection Frame Number where the allocation period of that PUSCH Set starts.

Value range: Integer {0..255}.

Field length: 8 bits.

6.3.3.6.4 Duration

Description: Indicates the duration of the activation period of the PUSCH Set, in radio frames.

Value range: 0..255 means: 0 to 255 radio frames, i.e. 0 to 2550 msec.

Field length: 8 bits.

6.3.3.7 [FDD - DSCH TFCI SIGNALLING]

6.3.3.7.1 Payload structure

Figure 32 shows the structure of the payload when the control frame is used for signalling TFCI (field 2) bits. The TFCI (field 2) bits are used by the Node B to create the TFCI word(s) for transmission on the DPCCH.

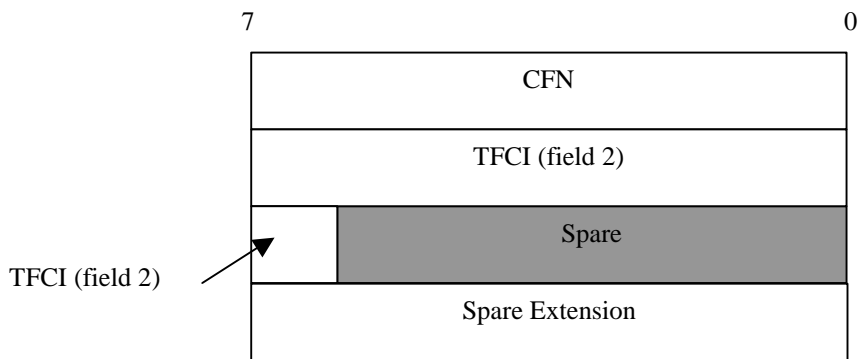

Figure 32: DSCH TFCI SIGNALLING payload structure

6.3.3.7.2 TFCI (field 2)

Description: TFCI (field 2) is as described in [6], it takes the same values as the TFCI (field 2) which is transmitted over the Uu interface.

Value range: {0..1023}

Field length: 10 bits

6.3.3.7.3 Spare Extension

Refer to subclause 6.3.3.1.4.

6.3.3.8 [3.84 Mcps TDD - TIMING ADVANCE]

6.3.3.8.1 Payload structure

Figure 33 shows the structure of the payload when the control frame is used for timing advance.

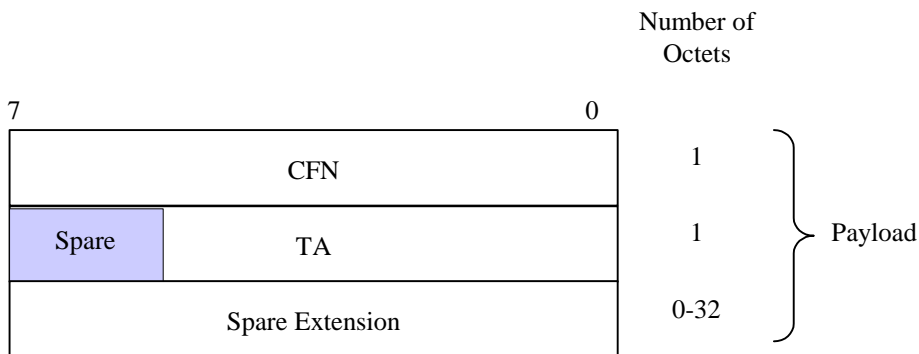

Figure 33: TIMING ADVANCE payload structure

6.3.3.8.2 CFN

Refer to subclause 6.2.7.3.

6.3.3.8.3 TA

Description: UE applied UL timing advance adjustment.

Value range: {0 .. 252 chips}.

Granularity: 4 chips.

Field length: 6 bits.

6.3.3.8.4 Spare Extension

Refer to subclause 6.3.3.1.4.

6.3.3.9 OUTER LOOP POWER CONTROL [1.28 Mcps TDD]

6.3.3.9.1 Payload structure

Figure 34 shows the structure of the payload when control frame is used for the UL outer loop power control.

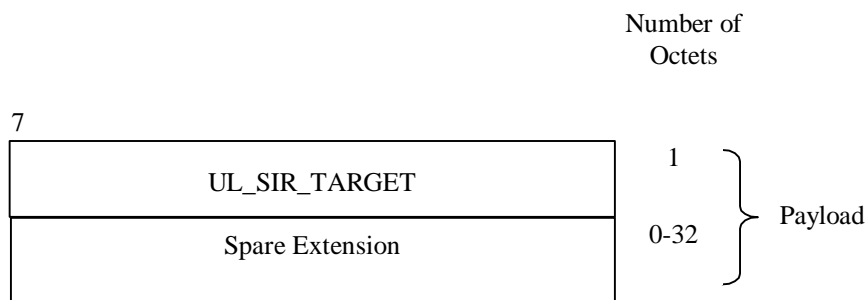

Figure 34: Structure of the payload for OUTER LOOP PC control frame

6.3.3.9.2 SIR Target

Description: Value (in dB) of the SIR target to be used by the UL inner loop power control.

SIR Target is given in the unit UL_SIR_TARGET where:

UL_SIR_TARGET = 000	SIR Target = -8.2 dB
UL_SIR_TARGET = 001	SIR Target = -8.1 dB
UL_SIR_TARGET = 002	SIR Target = -8.0 dB
...	
UL_SIR_TARGET = 254	SIR Target = 17.2 dB
UL_SIR_TARGET = 255	SIR Target = 17.3 dB

Value range: {-8.2 .. 17.3 dB}.

Granularity: 0.1 dB.

Field length: 8 bits.

6.3.3.9.3 Spare Extension

Refer to subclause 6.3.3.1.4.

7 Frame protocol error handling

A received frame protocol frame with unknown Information element or with illegal Information element value shall be ignored. Frame protocol frames sent with a CFN in which the radio resources assigned to the associated Iub data port are not available, shall be ignored.

7.1 Error detection

Error detection is provided on frames through a Cyclic Redundancy Check. The CRC for the payload is 16 and for the header and control frames is 7 bits.

7.1.1 CRC Calculation

The parity bits are generated by one of the following cyclic generator polynomials:

$$g_{\text{CRC16}}(D) = D^{16} + D^{15} + D^2 + 1.$$

$$g_{\text{CRC7}}(D) = D^7 + D^6 + D^2 + 1.$$

Denote the bits in a frame by $a_1, a_2, a_3, \dots, a_{A_i}$, and the parity bits by $p_1, p_2, p_3, \dots, p_{L_i}$. A_i is the length of a protected data and L_i is 16 or 7 depending on the CRC length.

The encoding is performed in a systematic form, which means that in GF (2), the polynomial for the payload.

$$a_1 D^{A_i+15} + a_2 D^{A_i+14} + \dots + a_{A_i} D^{16} + p_1 D^{15} + p_2 D^{14} + \dots + p_{15} D^1 + p_{16}$$

yields a remainder equal to 0 when divided by $g_{\text{CRC16}}(D)$, the polynomial for the header and control frames.

$$a_1 D^{A_i+6} + a_2 D^{A_i+5} + \dots + a_{A_i} D^7 + p_1 D^6 + p_2 D^5 + \dots + p_6 D^1 + p_7$$

yields a remainder equal to 0 when divided by $g_{\text{CRC7}}(D)$.

7.1.1.1 Relation between input and output of the Cyclic Redundancy Check

The bits after CRC attachment are denoted by $b_1, b_2, b_3, \dots, b_{B_i}$, where $B_i = A_i + L_i$.

The parity bits for the payload are attached at the end of the frame:

$$b_k = a_k \quad k = 1, 2, 3, \dots, A_i$$

$$b_k = p_{(k-A_i)} \quad k = A_i + 1, A_i + 2, A_i + 3, \dots, A_i + L_i$$

The parity bits for the frame header and the control frames are attached at the beginning of the frame:

$$b_k = p_k \quad k = 1, 2, 3, \dots, L_i$$

$$b_k = a_{(k-L_i)} \quad k = L_i + 1, L_i + 2, L_i + 3, \dots, L_i + A_i$$

Annex A (informative): Change History

Change history					
TSG RAN#	Version	CR	Tdoc RAN	New Version	Subject/Comment
RAN_05	-	-	-	3.0.0	Approved at TSG RAN #5 and placed under Change Control
RAN_06	3.0.0	001	RP-99765	3.1.0	Approved at TSG RAN #6
RAN_06	3.0.0	002	RP-99766	3.1.0	Approved at TSG RAN #6
RAN_07	3.1.0	-	-	3.2.0	Approved at TSG RAN #7
RAN_08	3.2.0	-	RP-000254	3.3.0	Approved at TSG RAN #8
RAN_09	3.3.0	022 026 027 028 029 030	RP-000391	3.4.0	Approved at TSG RAN #9
RAN_10	3.4.0	032 033 035 036	RP-000632	3.5.0	Approved at TSG RAN #10
RAN_11	3.5.0	038 039	RP-010128	3.6.0	Approved at TSG RAN #11

Change history							
Date	TSG #	TSG Doc.	CR	Rev	Subject/Comment	Old	New
March 01	11	RP-010164	037		Approved at TSG RAN #11 and placed under Change Control	-	4.0.0
06/2001	12	RP-010386	041		Approved at TSG RAN #12	4.0.0	4.1.0
06/2001	12	RP-010398	042		Approved at TSG RAN #12	4.0.0	4.1.0
09/2001	13	RP-010589	047		Addition of missing control frame type	4.1.0	4.2.0
09/2001	13	RP-010589	052	1	Applicability of the control frames on transport bearers	4.1.0	4.2.0
09/2001	13	RP-010589	056		General Corrections to TS 25.435	4.1.0	4.2.0
09/2001	13	RP-010589	058	1	General Corrections on CTrCH Data Stream	4.1.0	4.2.0
09/2001	13	RP-010600	048	1	Uplink power control for LCR TDD	4.1.0	4.2.0
09/2001	13	RP-010600	049		Correction on RACH data frame in lub interface	4.1.0	4.2.0
09/2001	13	RP-010600	059	1	Uplink Power Control for TDD	4.1.0	4.2.0

History

Document history		
V4.0.0	March 2001	Publication
V4.1.0	June 2001	Publication
V4.2.0	September 2001	Publication