

# ETSI TS 126 114 V9.4.0 (2011-01)

---

*Technical Specification*

**Universal Mobile Telecommunications System (UMTS);  
LTE;  
IP Multimedia Subsystem (IMS);  
Multimedia telephony;  
Media handling and interaction  
(3GPP TS 26.114 version 9.4.0 Release 9)**

---



---

Reference

RTS/TSGS-0426114v940

---

Keywords

LTE, UMTS

**ETSI**

650 Route des Lucioles  
F-06921 Sophia Antipolis Cedex - FRANCE

Tel.: +33 4 92 94 42 00 Fax: +33 4 93 65 47 16

Siret N° 348 623 562 00017 - NAF 742 C  
Association à but non lucratif enregistrée à la  
Sous-Préfecture de Grasse (06) N° 7803/88

---

**Important notice**

Individual copies of the present document can be downloaded from:

<http://www.etsi.org>

The present document may be made available in more than one electronic version or in print. In any case of existing or perceived difference in contents between such versions, the reference version is the Portable Document Format (PDF). In case of dispute, the reference shall be the printing on ETSI printers of the PDF version kept on a specific network drive within ETSI Secretariat.

Users of the present document should be aware that the document may be subject to revision or change of status. Information on the current status of this and other ETSI documents is available at

<http://portal.etsi.org/tb/status/status.asp>

If you find errors in the present document, please send your comment to one of the following services:

[http://portal.etsi.org/chaicor/ETSI\\_support.asp](http://portal.etsi.org/chaicor/ETSI_support.asp)

---

**Copyright Notification**

No part may be reproduced except as authorized by written permission.  
The copyright and the foregoing restriction extend to reproduction in all media.

© European Telecommunications Standards Institute 2011.  
All rights reserved.

**DECT**<sup>TM</sup>, **PLUGTESTS**<sup>TM</sup>, **UMTS**<sup>TM</sup>, **TIPHON**<sup>TM</sup>, the TIPHON logo and the ETSI logo are Trade Marks of ETSI registered for the benefit of its Members.

**3GPP**<sup>TM</sup> is a Trade Mark of ETSI registered for the benefit of its Members and of the 3GPP Organizational Partners.

**LTE**<sup>TM</sup> is a Trade Mark of ETSI currently being registered

for the benefit of its Members and of the 3GPP Organizational Partners.

**GSM**<sup>®</sup> and the GSM logo are Trade Marks registered and owned by the GSM Association.

---

## Intellectual Property Rights

IPRs essential or potentially essential to the present document may have been declared to ETSI. The information pertaining to these essential IPRs, if any, is publicly available for **ETSI members and non-members**, and can be found in ETSI SR 000 314: *"Intellectual Property Rights (IPRs); Essential, or potentially Essential, IPRs notified to ETSI in respect of ETSI standards"*, which is available from the ETSI Secretariat. Latest updates are available on the ETSI Web server (<http://webapp.etsi.org/IPR/home.asp>).

Pursuant to the ETSI IPR Policy, no investigation, including IPR searches, has been carried out by ETSI. No guarantee can be given as to the existence of other IPRs not referenced in ETSI SR 000 314 (or the updates on the ETSI Web server) which are, or may be, or may become, essential to the present document.

---

## Foreword

This Technical Specification (TS) has been produced by ETSI 3rd Generation Partnership Project (3GPP).

The present document may refer to technical specifications or reports using their 3GPP identities, UMTS identities or GSM identities. These should be interpreted as being references to the corresponding ETSI deliverables.

The cross reference between GSM, UMTS, 3GPP and ETSI identities can be found under <http://webapp.etsi.org/key/queryform.asp>.

# Contents

Intellectual Property Rights .....	2
Foreword.....	2
Foreword.....	9
Introduction .....	9
1 Scope .....	10
2 References .....	10
3 Definitions and abbreviations.....	14
3.1 Definitions .....	14
3.2 Abbreviations .....	14
4 System description .....	16
4.1 System .....	16
4.2 Client .....	16
4.3 MRFP and MGW .....	18
5 Media codecs.....	18
5.1 Media components .....	18
5.2 Codecs for MTSI clients in terminals.....	19
5.2.1 Speech.....	19
5.2.2 Video .....	19
5.2.3 Real-time text.....	20
6 Media configuration .....	21
6.1 General .....	21
6.2 Session setup procedures.....	21
6.2.1 General.....	21
6.2.1a RTP profile negotiation .....	22
6.2.1a.1 General .....	22
6.2.1a.2 Using SDPCapNeg in SDP offer.....	22
6.2.1a.3 Answering to an SDP offer using SDPCapNeg .....	22
6.2.2 Speech.....	22
6.2.2.1 General .....	22
6.2.2.2 Generating SDP offers for AMR-NB and AMR-WB .....	23
6.2.2.3 Generating the SDP answer.....	25
6.2.3 Video .....	30
6.2.4 Text.....	30
6.2.5 Bandwidth negotiation.....	30
6.2.6 The Synchronization Info attribute "3gpp_sync_info" .....	30
6.2.7 Negotiated QoS parameters .....	31
6.3 Session control procedures .....	32
7 Data transport .....	32
7.1 General .....	32
7.2 RTP profiles .....	32
7.3 RTCP usage.....	32
7.3.1 General.....	32
7.3.2 Speech.....	33
7.3.3 Video .....	33
7.3.4 Real-time text.....	34
7.3.5 Void .....	34
7.3.6 Reduced-Size RTCP .....	34
7.4 RTP payload formats for MTSI clients .....	35
7.4.1 General.....	35
7.4.2 Speech.....	35
7.4.3 Video .....	36

7.4.4	Real-time text.....	36
7.5	Media flow .....	36
7.5.1	General.....	36
7.5.2	Media specific.....	36
7.5.2.1	Speech.....	36
7.5.2.1.1	General .....	36
7.5.2.1.2	Default operation.....	36
7.5.2.1.3	HSPA.....	37
7.5.2.1.4	EGPRS.....	37
7.5.2.1.5	GIP .....	37
7.5.2.1.6	Initial codec mode for AMR and AMR-WB .....	37
7.5.2.1.7	E-UTRAN .....	38
7.5.2.2	Video.....	38
7.5.2.3	Text .....	38
7.5.3	Media synchronization.....	39
7.5.3.1	General.....	39
7.5.3.2	Text .....	39
7.5.4	ECN usage in RTP sessions.....	39
8	Jitter buffer management in MTSI clients in terminals.....	39
8.1	General .....	39
8.2	Speech .....	39
8.2.1	Terminology .....	39
8.2.2	Functional requirements for jitter-buffer management .....	41
8.2.3	Minimum performance requirements for jitter-buffer management .....	41
8.2.3.1	General .....	41
8.2.3.2	Objective performance requirements .....	42
8.2.3.2.1	General .....	42
8.2.3.2.2	Jitter buffer delay criteria .....	42
8.2.3.2.3	Jitter induced concealment operations.....	43
8.2.3.3	Delay and error profiles .....	44
8.2.3.4	Speech material for JBM minimum performance evaluation.....	44
8.3	Video.....	44
8.4	Text .....	44
9	Packet-loss handling.....	45
9.1	General .....	45
9.2	Speech .....	45
9.2.1	General.....	45
9.2.2	Transmitting redundant frames .....	45
9.2.3	Receiving redundant frames .....	48
9.3	Video.....	49
9.4	Text .....	49
10	Adaptation .....	49
10.1	General .....	49
10.2	Speech .....	49
10.2.0	General.....	49
10.2.1	RTCP-APP with codec control requests .....	50
10.2.2	Example use cases .....	54
10.3	Video.....	57
10.4	Text .....	57
10.5	Explicit Congestion Notification.....	57
11	Front-end handling .....	57
11.1	General .....	57
12	Inter-working.....	58
12.1	General .....	58
12.2	3G-324M .....	59
12.2.1	General.....	59
12.2.2	Codec usage.....	59
12.2.2.1	General.....	59
12.2.2.2	Text .....	59

12.2.3	Payload format.....	59
12.2.4	MTSI media gateway trans-packetization.....	59
12.2.4.1	General.....	59
12.2.4.2	Speech de-jitter buffer.....	59
12.2.4.3	Video bitrate equalization .....	59
12.2.4.4	Data loss detection .....	60
12.2.4.5	Data integrity indication.....	60
12.2.4.6	Packet size considerations.....	60
12.2.4.6.0	General	60
12.2.4.6.1	The Maximum Receive SDU Size attribute “3gpp_MaxRecvSDUSize”.....	60
12.2.4.7	Setting RTP timestamps.....	61
12.2.4.8	Protocol termination.....	61
12.2.4.9	Media synchronization.....	61
12.2.5	Session control.....	61
12.3	GERAN/UTRAN CS inter-working.....	62
12.3.0	3G-324M .....	62
12.3.1	Codecs for MTSI media gateways .....	62
12.3.1.1	Speech.....	62
12.3.1.2	Text.....	62
12.3.2	RTP payload formats for MTSI media gateways.....	63
12.3.2.1	Speech.....	63
12.3.2.2	Text.....	64
12.3.3	Explicit Congestion Notification .....	64
12.4	PSTN.....	64
12.4.1	3G-324M .....	64
12.4.2	Text.....	64
12.5	GIP inter-working.....	65
12.5.1	Text.....	65
12.5.2	Speech.....	65
12.6	TISPAN/NGN inter-working .....	65
12.6.1	Text.....	65
12.6.2	Speech.....	65
12.7	Inter-working with other IMS and non-IMS IP networks .....	65
12.7.1	General.....	65
12.7.2	Speech.....	65
12.7.2.1	General.....	65
12.7.2.2	Speech codecs and formats .....	66
12.7.2.3	Codec preference order for session negotiation .....	66
12.7.2.4	RTP profiles .....	67
12.7.2.5	RTP payload formats.....	67
12.7.2.6	Packetization .....	67
12.7.2.7	RTCP usage and adaptation .....	67
12.7.2.8	RTP usage .....	68
12.7.2.9	Session setup and session modification.....	68
12.7.3	Explicit Congestion Notification .....	69
13	Void.....	69
13a	Media types, codecs and formats used for MSRP transport.....	69
13a.1	General .....	69
13a.2	Difference relative to 3GPP TS 26.141 .....	69
13a.2.1	Video .....	69
14	Supplementary services.....	70
14.1	General .....	70
14.2	Media formats and transport.....	70
14.3	Media handling in hold procedures .....	71
15	Network preference management object.....	71
15.1	General .....	71
15.2	Nodes Definition .....	71
15.3	Example Configuration of 3GPP MTSINP MO.....	82
16	Quality of Experience.....	83

16.1	General .....	83
16.2	Metrics Definition .....	84
16.2.1	Corruption duration metric .....	84
16.2.2	Successive loss of RTP packets .....	84
16.2.3	Frame rate .....	85
16.2.4	Jitter duration .....	85
16.2.4	Sync loss duration .....	85
16.2.5	Round-trip time .....	86
16.2.6	Average codec bitrate .....	86
16.2.7	Codec information .....	86
16.3	Metric Configuration .....	87
16.3.1	QoE metrics reporting management object .....	87
This leaf indicates if QoE reporting is requested by the provider. ....		88
16.3.2	QoE metric reporting configuration .....	91
16.3.3	QoE reporting rule definition .....	91
16.4	Metrics Reporting .....	92
16.4.1	XML schema for QoE report message .....	93
16.4.2	Example XML for QoE report message .....	94
17	Management of Media Adaptation .....	95
17.1	General .....	95
17.2	Media adaptation management object .....	95
17.3	Management procedures .....	114
17.3.1	Management of speech adaptation .....	114
17.3.2	Management of video adaptation .....	116
<b>Annex A (informative): Examples of SDP offers and answers .....</b>		<b>118</b>
A.1	SDP offers for speech sessions initiated by MTSI client in terminal .....	118
A.1.1	HSPA or unknown access technology .....	118
A.1.1.1	Only AMR-NB supported by MTSI client in terminal .....	118
A.1.1.2	AMR and AMR-WB are supported by MTSI client in terminal .....	119
A.1.1.2.1	One-phase approach .....	119
A.1.1.2.2	Two-phase approach .....	120
A.1.2	EGPRS .....	121
A.1.3	Generic Access .....	121
A.2	SDP offers for speech sessions initiated by media gateway .....	122
A.2.1	General .....	122
A.2.2	MGW between GERAN UE and MTSI .....	122
A.2.3	MGW between legacy UTRAN UE and MTSI .....	122
A.2.4	MGW between CS UE and MTSI .....	123
A.2.5	MGW between GERAN UE and MTSI when wideband speech is supported .....	123
A.3	SDP answers to SDP speech session offers .....	124
A.3.1	General .....	124
A.3.1a	SDP answer from an MTSI client in terminal when only narrowband speech was offered .....	125
A.3.2	SDP answer from an MTSI client in terminal .....	125
A.3.2a	SDP answer from a non-MTSI UE with AVP .....	126
A.3.3	SDP answer from an MTSI client in terminal supporting only AMR .....	127
A.3.4	SDP answer from an MTSI client in terminal using EGPRS access when both AMR and AMR-WB are supported .....	128
A.3.4a	SDP answer from an MTSI client in terminal using EGPRS access when only AMR is supported .....	129
A.3.4b	SDP answer from an MTSI client in terminal using WLAN .....	129
A.3.5	SDP answer from MTSI MGW supporting only one codec mode set for AMR and AMR-WB each .....	130
A.3.5a	SDP answer from MTSI MGW supporting only one codec mode set for AMR .....	132
A.3.6	SDP answer from MTSI client in terminal on HSPA for session initiated from MTSI MGW interfacing UE on GERAN .....	132
A.3.7	SDP answer from MTSI client in terminal on HSPA for session initiated from MTSI MGW interfacing legacy UE on UTRAN .....	133
A.4	SDP offers and answers for video sessions .....	134
A.4.1	H.263 and MPEG-4 Visual .....	134
A.4.2	H.264/AVC with H.263 as fallback .....	135

A.4.3	MPEG-4 Visual and H.263 with "imageattr" attribute .....	136
A.4.4	H.264/AVC with H.263 as fallback with "imageattr" attribute .....	138
A.5	SDP offers for text.....	139
A.5.1	T.140 with and without redundancy .....	139
A.6	SDP example with bandwidth information .....	139
A.7	SDP examples with "3gpp_sync_info" attribute .....	140
A.7.1	Synchronized streams.....	140
A.7.2	Nonsynchronized streams.....	140
A.8	SDP example with QoS negotiation.....	141
A.9	Void.....	143
A.9a	SDP offer/answer regarding the use of Reduced-Size RTCP.....	143
A.10	Examples of SDP offers and answers for inter-working with other IMS or non-IMS IP networks .....	144
A.10.1	General .....	144
A.10.2	Session initiated by MTSI client in terminal .....	145
A.10.2.1	SDP offers from an MTSI client in terminal.....	145
A.10.2.2	SDP offers modified by MTSI MGW when pre-emptively adding inter-working formats .....	145
A.10.2.3	SDP modified by MGW when adding inter-working formats only when the original SDP offer was rejected.....	147
A.11	Adding a video component to an on-going video call session .....	148
A.12	SDP examples when using ECN .....	151
<b>Annex B (informative): Examples of adaptation scenarios .....</b>		<b>152</b>
B.1	Video bitrate adaptation .....	152
<b>Annex C (informative): Example adaptation mechanisms for speech.....</b>		<b>153</b>
C.1	Example of feedback and adaptation for speech and video.....	153
C.1.1	Introduction .....	153
C.1.2	Signalling state considerations .....	154
C.1.3	Adaptation state machine implementations .....	156
C.1.3.1	General.....	156
C.1.3.2	Adaptation state machine with four states .....	158
C.1.3.3	Adaptation state machine with four states (simplified version without frame aggregation).....	161
C.1.3.4	Adaptation state machine with two states .....	163
C.1.3.5	Adaptation when using ECN .....	164
C.2	Example criteria for video bit rate feedback and adaptation .....	166
C.2.1	Introduction .....	166
C.2.2	Media sender side.....	167
C.2.3	Media receiver side .....	167
<b>Annex D (informative): Reference delay computation algorithm.....</b>		<b>168</b>
<b>Annex E (informative): QoS profiles .....</b>		<b>170</b>
E.1	General .....	170
E.2	Bi-directional speech (AMR12.2 over IPv4, RTCP).....	170
E.3	Bi-directional video (128 kbps, IPv4 and RTCP) .....	170
E.4	Bi-directional real-time text (3 kbps, IPv4, RTCP).....	172
<b>Annex F (Normative): Void .....</b>		<b>174</b>
<b>Annex G (Normative): DTMF events.....</b>		<b>175</b>
G.1	General .....	175
G.2	Encoding of DTMF signals .....	175



G.3	Session setup .....	175
G.4	Data transport .....	176
<b>Annex H (informative):</b>	<b>Network Preference Management Object Device Description Framework .....</b>	<b>178</b>
<b>Annex I (informative):</b>	<b>QoE Reporting Management Object Device Description Framework ...</b>	<b>193</b>
<b>Annex J (informative):</b>	<b>Media Adaptation Management Object Device Description Framework .....</b>	<b>198</b>
<b>Annex K (informative):</b>	<b>Change history .....</b>	<b>219</b>
History .....		221

---

## Foreword

This Technical Specification has been produced by the 3<sup>rd</sup> Generation Partnership Project (3GPP).

The contents of the present document are subject to continuing work within the TSG and may change following formal TSG approval. Should the TSG modify the contents of the present document, it will be re-released by the TSG with an identifying change of release date and an increase in version number as follows:

Version x.y.z

where:

- x the first digit:
  - 1 presented to TSG for information;
  - 2 presented to TSG for approval;
  - 3 or greater indicates TSG approved document under change control.
- y the second digit is incremented for all changes of substance, i.e. technical enhancements, corrections, updates, etc.
- z the third digit is incremented when editorial only changes have been incorporated in the document.

---

## Introduction

Multimedia Telephony Service for IMS (MTSI), here also referred to as Multimedia Telephony, is a standardized IMS telephony service in 3GPP Release 7 that builds on the IMS capabilities already provided in 3GPP Releases 5 and 6. The objective of defining a service is to specify the minimum set of capabilities required in the IP Multimedia Subsystem to secure multi-vendor and multi-operator inter-operability for Multimedia Telephony and related Supplementary Services.

The user experience of multimedia telephony is expected to be equivalent to or better than corresponding circuit-switched telephony services. Multimedia telephony also exploits the richer capabilities of IMS. In particular, multiple media components can be used and dynamically added or dropped during a session.

---

# 1 Scope

The present document specifies a client for the Multimedia Telephony Service for IMS (MTSI) supporting conversational speech (including DTMF), video and text transported over RTP with the scope to deliver a user experience equivalent to or better than that of Circuit Switched (CS) conversational services using the same amount of network resources. It defines media handling (e.g. signalling, transport, jitter buffer management, packet-loss handling, adaptation), as well as interactivity (e.g. adding or dropping media during a call). The focus is to ensure a reliable and interoperable service with a predictable media quality, while allowing for flexibility in the service offerings.

The scope includes maintaining backward compatibility in order to ensure seamless inter-working with existing services available in the CS domain, such as CS speech and video telephony, as well as with terminals of earlier 3GPP releases. In addition, inter-working with traditional PSTN and emerging TISPAN network is covered.

The client may also support the IMS Messaging service. The scope therefore also includes media handling for non-conversational media using MSRP.

The specification is written in a forward-compatible way in order to allow additions of media components and functionality in releases after Release 7.

NOTE 1: MTSI clients can support more than conversational speech, video and text, which is the scope of the present document. See 3GPP TS 22.173 [2] for the definition of the Multimedia Telephony Service for IMS.

NOTE 2: 3GPP TS 26.235 [3] and 3GPP TS 26.236 [4] do not include the specification of an MTSI client, although they include conversational multimedia applications. Only those parts of 3GPP TS 26.235 [3] and 3GPP TS 26.236 [4] that are specifically referenced by the present document apply to Multimedia Telephony Service for IMS.

NOTE 3: The present document was started as a conclusion from the study in 3GPP TR 26.914 [5] on optimization opportunities in Multimedia Telephony for IMS (3GPP TR 22.973 [6]).

NOTE 4: For ECN, the present specification assumes that an interface enables the MTSI client to read and write the ECN field. This interface is outside the scope of this specification.

---

# 2 References

The following documents contain provisions which, through reference in this text, constitute provisions of the present document.

- References are either specific (identified by date of publication, edition number, version number, etc.) or non-specific.
- For a specific reference, subsequent revisions do not apply.
- For a non-specific reference, the latest version applies. In the case of a reference to a 3GPP document (including a GSM document), a non-specific reference implicitly refers to the latest version of that document *in the same Release as the present document*.

- [1] 3GPP TR 21.905: "Vocabulary for 3GPP Specifications".
- [2] 3GPP TS 22.173: "IP Multimedia Core Network Subsystem (IMS) Multimedia Telephony Service and supplementary services; Stage 1".
- [3] 3GPP TS 26.235: "Packet switched conversational multimedia applications; Default codecs".
- [4] 3GPP TS 26.236: "Packet switched conversational multimedia applications; Transport protocols".
- [5] 3GPP TR 26.914: "Multimedia telephony over IP Multimedia Subsystem (IMS); Optimization opportunities".
- [6] 3GPP TR 22.973: "IMS Multimedia Telephony service; and supplementary services".

- [7] 3GPP TS 24.229: "IP multimedia call control protocol based on Session Initiation Protocol (SIP) and Session Description Protocol (SDP); Stage 3".
- [8] IETF RFC 4566 (2006): "SDP: Session Description Protocol", M. Handley, V. Jacobson and C. Perkins.
- [9] IETF RFC 3550 (2003): "RTP: A Transport Protocol for Real-Time Applications", H. Schulzrinne, S. Casner, R. Frederick and V. Jacobson.
- [10] IETF RFC 3551 (2003): "RTP Profile for Audio and Video Conferences with Minimal Control", H. Schulzrinne and S. Casner.
- [11] 3GPP TS 26.071: "Mandatory Speech Codec speech processing functions; AMR Speech CODEC; General description".
- [12] 3GPP TS 26.090: "Mandatory Speech Codec speech processing functions; Adaptive Multi-Rate (AMR) speech codec; Transcoding functions".
- [13] 3GPP TS 26.073: "ANSI C code for the Adaptive Multi Rate (AMR) speech codec".
- [14] 3GPP TS 26.104: "ANSI-C code for the floating-point Adaptive Multi Rate (AMR) speech codec".
- [15] 3GPP TS 26.093: "Mandatory speech codec speech processing functions; Adaptive Multi-Rate (AMR) speech codec; Source controlled rate operation".
- [16] 3GPP TS 26.103: "Speech codec list for GSM and UMTS".
- [17] 3GPP TS 26.171: "Speech codec speech processing functions; Adaptive Multi-Rate - Wideband (AMR-WB) speech codec; General description".
- [18] 3GPP TS 26.190: "Speech codec speech processing functions; Adaptive Multi-Rate - Wideband (AMR-WB) speech codec; Transcoding functions".
- [19] 3GPP TS 26.173: "ANSI-C code for the Adaptive Multi Rate - Wideband (AMR-WB) speech codec".
- [20] 3GPP TS 26.204: "Speech codec speech processing functions; Adaptive Multi-Rate - Wideband (AMR-WB) speech codec; ANSI-C code".
- [21] 3GPP TS 26.193: "Speech codec speech processing functions; Adaptive Multi-Rate - Wideband (AMR-WB) speech codec; Source controlled rate operation".
- [22] ITU-T Recommendation H.263 (2005): "Video coding for low bit rate communication".
- [23] ISO/IEC 14496-2:2004: "Information technology - Coding of audio-visual objects - Part 2: Visual".
- [24] ITU-T Recommendation H.264 (2005): "Advanced video coding for generic audiovisual services" | ISO/IEC 14496-10:2005: "Information technology - Coding of audio-visual objects - Part 10: Advanced Video Coding".
- [25] IETF RFC 3984 (2005): "RTP Payload Format for H.264 Video", S. Wenger, M.M. Hannuksela, T. Stockhammer, M. Westerlund and D. Singer.
- [26] ITU-T Recommendation T.140 (1998): "Protocol for multimedia application text conversation".
- [27] ITU-T Recommendation T.140 (2000): "Protocol for multimedia application text conversation - Addendum 1".
- [28] IETF RFC 4867 (2007): "RTP Payload Format and File Storage Format for the Adaptive Multi-Rate (AMR) and Adaptive Multi-Rate Wideband (AMR-WB) Audio Codecs", J. Sjöberg, M. Westerlund, A. Lakaniemi and Q. Xie.
- [29] IETF RFC 4629 (2007): "RTP Payload Format for ITU-T Rec. H.263 Video", J. Ott, C. Bormann, G. Sullivan, S. Wenger and R. Even.

- [30] IETF RFC 3016 (2000): "RTP Payload Format for MPEG-4 Audio/Visual Streams", Y. Kikuchi, T. Nomura, S. Fukunaga, Y. Matsui and H. Kimata.
- [31] IETF RFC 4103 (2005): "RTP Payload for Text Conversation", G. Hellstrom and P. Jones.
- [32] IETF RFC 3555 (2003): "MIME Type Registration of RTP Payload Formats", S. Casner and P. Hoschka.
- [33] 3GPP TR 25.993: "Typical examples of Radio Access Bearers (RABs) and Radio Bearers (RBs) supported by Universal Terrestrial Radio Access (UTRA)".
- [34] 3GPP TS 22.105: "Services and service capabilities".
- [35] 3GPP TS 26.131: "Terminal acoustic characteristics for telephony; Requirements".
- [36] 3GPP TS 26.132: "Speech and video telephony terminal acoustic test specification".
- [37] 3GPP TS 28.062: "Inband Tandem Free Operation (TFO) of speech codecs; Service description; Stage 3".
- [38] 3GPP TS 23.153: "Out of band transcoder control; Stage 2".
- [39] IETF RFC 0768 (1980): "User Datagram Protocol", J. Postel.
- [40] IETF RFC 4585 (2006): "Extended RTP Profile for Real-time Transport Control Protocol (RTCP) - Based Feedback (RTP/AVPF)", J. Ott, S. Wenger, N. Sato, C. Burmeister and J. Rey.
- [41] RTP Tools: <http://www.cs.columbia.edu/IRT/software/rtptools/>.
- [42] IETF RFC 3556 (2003): "Session Description Protocol (SDP) Bandwidth Modifiers for RTP Control Protocol (RTCP) Bandwidth", S. Casner.
- [43] IETF RFC 5104 (2008): "Codec Control Messages in the RTP Audio-Visual Profile with Feedback (AVPF)", S. Wenger, U. Chandra, M. Westerlund and B. Burman.
- [44] Void.
- [45] 3GPP TS 26.111: "Codec for circuit switched multimedia telephony service; Modifications to H.324".
- [46] 3GPP TS 23.172: "Technical realization of Circuit Switched (CS) multimedia service; UDI/RDI fallback and service modification; Stage 2".
- [47] 3GPP TS 23.002: "Network Architecture".
- [48] IETF RFC 3388 (2002): "Grouping of Media Lines in the Session Description Protocol (SDP)", G. Camarillo, G. Eriksson, J. Holler and H. Schulzrinne.
- [49] IETF RFC 4102 (2005): "Registration of the text/red MIME Sub-Type", P. Jones.
- [50] ITU-T H.248: "Packages for text conversation, fax and call discrimination".
- [51] ETSI EG 202 320: "Duplex Universal Text and Voice".
- [52] 3GPP TS 26.226: "Cellular text telephone modem; General description".
- [53] IETF RFC 4504 (2006): "SIP Telephony Device Requirements and Configuration", H. Sinnreich, Ed., S. Lass and C. Stredicke.
- [54] ITU-T Recommendation V.151: "Procedures for end-to-end connection of analogue PSTN text telephones over an IP network utilizing text relay".
- [55] ITU-T Recommendation V.152: "Procedures for supporting Voice Band Data over IP networks".
- [56] IETF RFC 3448 (2003): "TCP Friendly Rate Control (TFRC): Protocol Specification", M. Handley, S. Floyd, J. Padhye and J. Widmer.

- [57] 3GPP TS 24.173: "IMS Multimedia Telephony Communication Service and Supplementary Services".
- [58] IETF RFC 3264 (2002): "An Offer/Answer Model with the Session Description Protocol (SDP)", J. Rosenberg and H. Schulzrinne.
- [59] 3GPP TS 26.141: "IP Multimedia System (IMS) Messaging and Presence; Media formats and codecs".
- [60] 3GPP TS 26.234: "Transparent end-to-end Packet-switched Streaming Service; Protocols and codecs".
- [61] IETF RFC 4733 (2006): "RTP Payload for DTMF Digits, Telephony Tones, and Telephony Signals", H. Schulzrinne and T.Taylor.
- [62] 3GPP TS 23.014. "Support of Dual Tone Multi-Frequency (DTMF) signalling",
- [63] ETSI ES 201 235-2, v1.2.1: "Specification of Dual Tone Multi-Frequency (DTMF); Transmitters and Receivers; Part 2: Transmitters".
- [64] 3GPP TS 23.107: "Quality of Service (QoS) concept and architecture".
- [65] 3GPP TS 29.163: "Interworking between the IP Multimedia (IM) Core Network (CN) subsystem and Circuit Switched (CS) networks".
- [66] Void.
- [67] OMA-ERELED-DM-V1\_2-20070209-A: "Enabler Release Definition for OMA Device Management, Approved Version 1.2".
- [68] Void.
- [69] IETF RFC 5939 (2010): "Session Description Protocol (SDP) Capability Negotiation", F. Andreasen.
- [70] 3GPP TS 22.042: "Network Identity and Time Zone (NITZ), Stage 1".
- [71] IETF RFC 1952 (May 1996): "GZIP file format specification version 4.3", P. Deutsch.
- [72] IETF RFC 2326: "Real Time Streaming Protocol (RTSP)".
- [73] IETF RFC 2616 (June 1999): "Hypertext Transfer Protocol -- HTTP/1.1".
- [74] 3GPP TS 26.346 "Multimedia Broadcast/Multicast Service (MBMS); Protocols and codecs".
- [75] 3GPP TS 23.040: "Technical realization of Short Message Service (SMS)".
- [76] IETF Internet draft (2008): "Negotiation of Generic Image Attributes in SDP", I. Johansson, K. Jung, <http://tools.ietf.org/id/draft-johansson-mmusic-image-attributes-02.txt>.
- [77] ITU-T G.711: "Pulse code modulation (PCM) of voice frequencies".
- [78] ITU-T G.722: "7 kHz audio-coding within 64 kbit/s".
- [79] IETF RFC 4821 (2007), "Packetization Layer Path MTU Discovery".
- [80] 3GPP TS 23.003 "Numbering, addressing and identification".
- [81] IETF RFC 4796 "The session description protocol (SDP) content attribute", J. Hautakorpi and G. Camarillo.
- [82] 3GPP TS 24.247 "Messaging service using the IP Multimedia (IM) Core Network (CN) subsystem".
- [83] IETF RFC 3168 (2001): "The Addition of Explicit Congestion Notification (ECN) to IP", K. Ramakrishnan, S. Floyd and D. Black.

- [84] IETF Internet draft (2009): "Explicit Congestion Notification (ECN) for RTP over UDP", M. Westerlund, et. al., <http://tools.ietf.org/wg/avt/draft-westerlund-avt-ecn-for-rtp-02.txt>.
- [85] 3GPP TS 36.300: "Evolved Universal Terrestrial Radio Access (E-UTRA) and Evolved Universal Terrestrial Radio Access Network (E-UTRAN); Overall description".
- [86] 3GPP TS 23.401: "General Packet Radio Service (GPRS) enhancements for Evolved Universal Terrestrial Radio Access Network (E-UTRAN) access".
- [87] IETF RFC 5506 (2009) "Support for Reduced-Size Real-Time Transport Control Protocol (RTCP): Opportunities and Consequences".

## 3 Definitions and abbreviations

### 3.1 Definitions

For the purposes of the present document, the terms and definitions given in 3GPP TR 21.905 [1] and the following apply:

**NOTE:** A term defined in the present document takes precedence over the definition of the same term, if any, in 3GPP TR 21.905 [1].

**example:** text used to clarify abstract rules by applying them literally.

**Evolved UTRAN:** Evolved UTRAN is an evolution of the 3G UMTS radio-access network towards a high-data-rate, low-latency and packet-optimized radio-access network.

**MTSI client:** A function in a terminal or in a network entity (e.g. a MRFP) that supports MTSI.

**MTSI client in terminal:** An MTSI client that is implemented in a terminal or UE. The term "MTSI client in terminal" is used in this document when entities such as MRFP, MRFC or media gateways are excluded.

**MTSI media gateway (or MTSI MGW):** A media gateway that provides interworking between an MTSI client and a non MTSI client, e.g. a CS UE. The term MTSI media gateway is used in a broad sense, as it is outside the scope of the current specification to make the distinction whether certain functionality should be implemented in the MGW or in the MGCF.

### 3.2 Abbreviations

For the purposes of the present document, the abbreviations given in 3GPP TR 21.905 [1] and the following apply:

**NOTE:** An abbreviation defined in the present document takes precedence over the definition of the same abbreviation, if any, in 3GPP TR 21.905 [1].

AC	Alternating Current
AL-SDU	Application Layer - Service Data Unit
AMR	Adaptive Multi-Rate
AMR-NB	Adaptive Multi-Rate - NarrowBand
AMR-WB	Adaptive Multi-Rate - WideBand
APP	APPLication-defined RTCP packet
ARQ	Automatic repeat ReQuest
AS	Application Server
AVC	Advanced Video Coding
CCM	Codec Control Messages
CDF	Cumulative Distribution Function
CMR	Codec Mode Request
cps	characters per second
CS	Circuit Switched
CSCF	Call Session Control Function
CTM	Cellular Text telephone Modem

DTMF	Dual Tone Multi-Frequency
DTX	Discontinuous Transmission
ECN	Explicit Congestion Notification
ECN-CE	ECN Congestion Experienced
ECT	ECN Capable Transport
eNodeB	E-UTRAN Node B
E-UTRAN	Evolved UTRAN
GIP	Generic IP access
GOB	Group Of Blocks
H-ARQ	Hybrid - ARQ
HSPA	High Speed Packet Access
ICM	Initial Codec Mode
IDR	Instantaneous Decoding Refresh
IMS	IP Multimedia Subsystem
IP	Internet Protocol
IPv4	Internet Protocol version 4
ITU-T	International Telecommunications Union - Telecommunications
JBM	Jitter Buffer Management
MGCF	Media Gateway Control Function
MGW	Media GateWay
MIME	Multipurpose Internet Mail Extensions
MO	Management Object
MPEG	Moving Picture Experts Group
MRFC	Media Resource Function Controller
MRFP	Media Resource Function Processor
MSRP	Message Session Relay Protocol
MTSI	Multimedia Telephony Service for IMS
MTU	Maximum Transfer Unit
NACK	Negative ACKnowledgment
NNI	Network-to-Network Interface
NTP	Network Time Protocol
PCM	Pulse Code Modulation
PDP	Packet Data Protocol
PLI	Picture Loss Indication
POI	Point Of Interconnect
PSTN	Public Switched Telephone Network
QoE	Quality of Experience
QoS	Quality of Service
QP	Quantization Parameter
RoHC	Robust HeaderCompression
RR	Receiver Report
RTCP	RTP Control Protocol
RTP	Real-time Transport Protocol
SB-ADPCM	Sub-Band Adaptive Differential PCM
SDP	Session Description Protocol
SDPCapNeg	SDP Capability Negotiation
SID	SIlence Descriptor
SIP	Session Initiation Protocol
SR	Sender Report
TFO	Tandem-Free Operation
TISPAN	Telecoms and Internet converged Services and Protocols for Advanced Network
TMMBN	Temporary Maximum Media Bit-rate Notification
TMMBR	Temporary Maximum Media Bit-rate Request
TrFO	Transcoder-Free Operation
UDP	User Datagram Protocol
UE	User Equipment
VoIP	Voice over IP
VOP	Video Object Plane



# 4 System description

## 4.1 System

A Multimedia Telephony Service for IMS call uses the Call Session Control Function (CSCF) mechanisms to route control-plane signalling between the UEs involved in the call (see figure 4.1). In the control plane, Application Servers (AS) should be present and may provide supplementary services such as call hold/resume, call forwarding and multi-party calls, etc.

The scope of the present document is to specify the media path. In the example in figure 4.1, it is routed directly between the GGSNs outside the IMS.

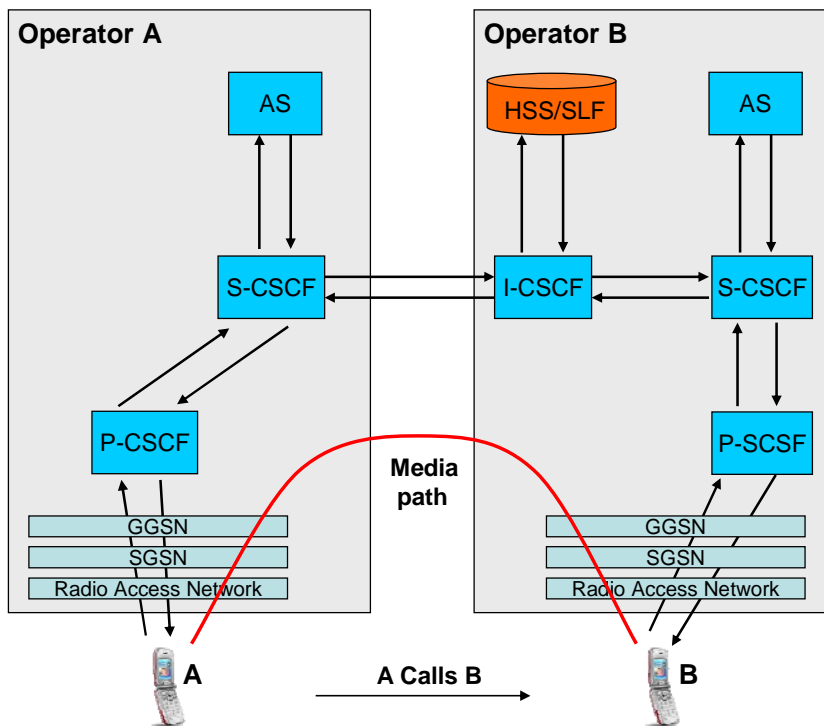
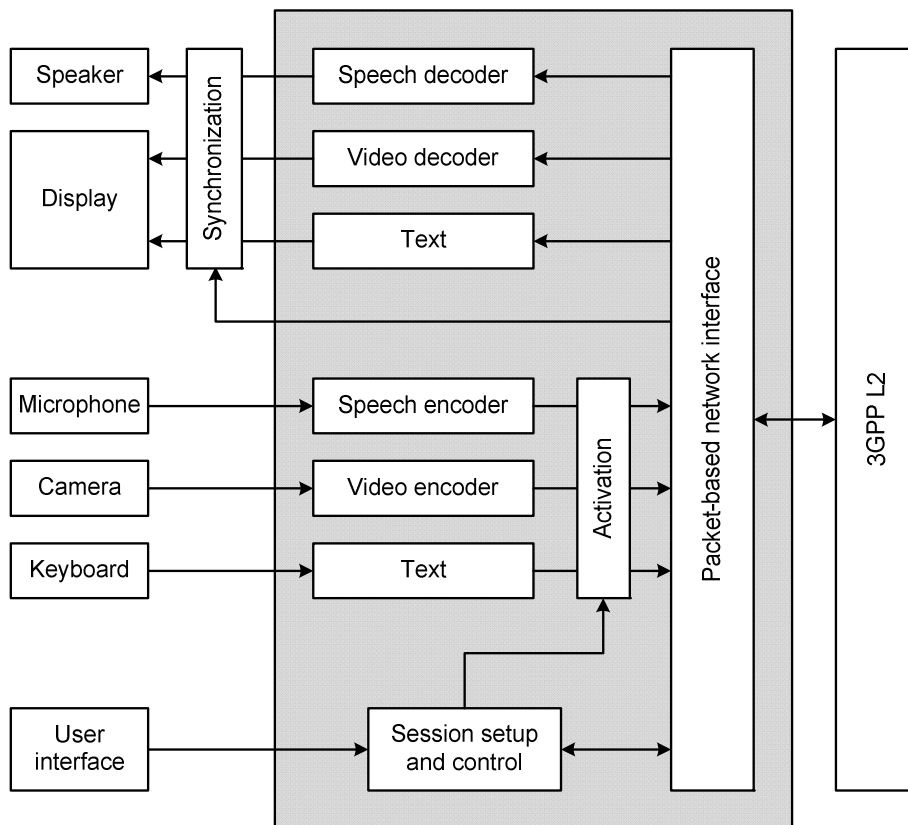

Figure 4.1: High-level architecture figure showing the nodes involved in an MTSI call set-up

## 4.2 Client

The functional components of a terminal including an MTSI client are shown in figure 4.2.



NOTE: The grey box marks the scope of the present document.

**Figure 4.2: Functional components of a terminal including an MTSI client**

The scope of the present document is to specify media handling and interaction, which includes media control, media codecs, as well as transport of media and control data. General control-related elements of an MTSI client, such as SIP signalling (3GPP TS 24.229 [7]), fall outside this scope, albeit parts of the session setup handling and session control for conversational media are defined here:

- usage of SDP (RFC 4566 [8]) and SDP capability negotiation (SDPCapNeg [69]) in SIP invitations for capability negotiation and media stream setup.
- set-up and control of the individual media streams between clients. It also includes interactivity, such as adding and dropping of media components.

Transport of media consists of the encapsulation of the coded media in a transport protocol as well as handling of coded media received from the network. This is shown in figure 4.2 as the "packet based network interface" and is displayed, for conversational media, in more detail in the user-plane protocol stack in figure 4.3. The basic MTSI client defined here specifies media codecs for speech, video and text (see clause 5). All conversational media components are transported over RTP with each respective payload format mapped onto the RTP (RFC 3550 [9]) streams.

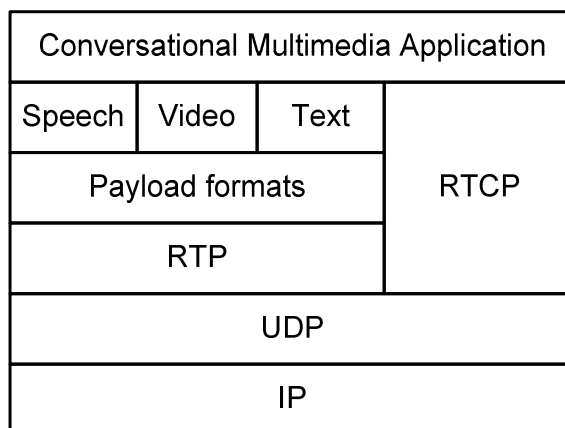

Figure 4.3: User plane protocol stack for a basic MTSI client

An MTSI client may also support non-conversational media, for example IMS messaging. The functional entities and the protocols used for IMS messaging are described in 3GPP TS 24.247 [82].

## 4.3 MRFP and MGW

A Media Resource Function Processor (MRFP), see 3GPP TS.23.002 [47], may be inserted in the media path for certain supplementary services (e.g. conference) and/or to provide transcoding and may therefore act as a MTSI client together with other network functions, such as a MRFC.

A Media Gateway (MGW), see 3GPP TS 23.002 [47], may be used to provide inter-working between different networks and services. For example, a MTSI MGW may provide inter-working between MTSI and 3G-324M services. The MTSI MGW may have more limited functionality than other MTSI clients, e.g. when it comes to the supported bitrates of media. The inter-working aspects are described in more detail in clause 12.

---

# 5 Media codecs

## 5.1 Media components

The Multimedia Telephony Service for IMS supports simultaneous transfer of multiple media components with real-time characteristics. Media components denote the actual components that the end-user experiences.

The following media components are considered as core components. Multiple media components (including media components of the same media type) may be present in a session. At least one of these components is present in all conversational multimedia telephony sessions.

- **Speech:** The sound that is picked up by a microphone and transferred from terminal A to terminal B and played out in an earphone/loudspeaker. Speech includes detection and generation of DTMF signals.
- **Video:** The moving image that is, for example, captured by a camera of terminal A, transmitted to terminal B and, for example, rendered on the display of terminal B.
- **Text:** The characters typed on a keyboard or drawn on a screen on terminal A and rendered in real time on the display of terminal B. The flow is time-sampled so that no specific action is needed from the user to request transmission.

The above core media components are transported in real time from one MTSI client to the other using RTP (RFC 3550 [9]). All media components can be added or dropped during an ongoing session as required either by the end-user or by controlling nodes in the network, assuming that when adding components, the capabilities of the MTSI client support the additional component.

NOTE: The terms voice and speech are synonyms. The present document uses the term speech.

## 5.2 Codecs for MTSI clients in terminals

### 5.2.1 Speech

MTSI clients in terminals offering speech communication shall support:

- AMR speech codec (3GPP TS 26.071 [11], 3GPP TS 26.090 [12], 3GPP TS 26.073 [13] and 3GPP TS 26.104 [14]) including all 8 modes and source controlled rate operation 3GPP TS 26.093 [15]. The MTSI client in terminal shall be capable of operating with any subset of these 8 codec modes.

The codec mode set Config-NB-Code=1 (3GPP TS 26.103 [16]) {AMR-NB12.2, AMR-NB7.4, AMR-NB5.9 and AMR-NB4.75} should be used unless the session-setup negotiation determines that other codec modes shall be used.

When transmitting, the MTSI client in terminal shall be capable of aligning codec mode changes to every frame border, and shall also be capable of restricting codec mode changes to be aligned to every other frame border, e.g. like UMTS\_AMR\_2 (3GPP TS 26.103 [16]). The MTSI client in terminal shall also be capable of restricting codec mode changes to neighbouring codec modes within the negotiated codec mode set. When receiving, the MTSI client in terminal shall allow codec mode changes at any frame border and to any codec mode within the negotiated codec mode set.

MTSI clients in terminals offering wideband speech communication at 16 kHz sampling frequency shall support:

- AMR wideband codec (3GPP TS 26.171 [17], 3GPP TS 26.190 [18], 3GPP TS 26.173 [19] and 3GPP TS 26.204 [20]) including all 9 modes and source controlled rate operation 3GPP TS 26.193 [21]. The MTSI client in terminal shall be capable of operating with any subset of these 9 codec modes.

The codec mode set Config-WB-Code=0 (3GPP TS 26.103 [16]) {AMR-WB12.65, AMR-WB8.85 and AMR-WB6.60} should be used unless the session-setup negotiation determines that other codec modes shall be used.

When transmitting, the MTSI client in terminal shall be capable of aligning codec mode changes to every frame border, and shall also be capable of restricting codec mode changes to be aligned to every other frame border, e.g. like UMTS\_AMR\_WB (3GPP TS 26.103 [16]). The MTSI client in terminal shall also be capable of restricting codec mode changes to neighbouring codec modes within the negotiated codec mode set. When receiving, the MTSI client in terminal shall allow codec mode changes at any frame border and to any codec mode within the negotiated codec mode set.

MTSI clients in terminals offering wideband speech communication shall also offer narrowband speech communications. When offering both wideband speech and narrowband speech communication, wideband shall be listed as the first payload type in the m line of the SDP offer (RFC 4566 [8]).

Encoding of DTMF is described in Annex G.

### 5.2.2 Video

MTSI clients in terminals offering video communication shall support:

- ITU-T Recommendation H.263 [22] Profile 0 Level 45.

In addition they should support:

- ITU-T Recommendation H.263 [22] Profile 3 Level 45;
- MPEG-4 (Part 2) Visual [23] Simple Profile Level 3 with the following constraints:
  - Number of Visual Objects supported shall be limited to 1.
  - The maximum frame rate shall be 30 frames per second.
  - The maximum f\_code shall be 2.
  - The intra\_dc\_vlc\_threshold shall be 0.
  - The maximum horizontal luminance pixel resolution shall be 352 pels/line.

- The maximum vertical luminance pixel resolution shall be 288 pels/VOP.
- If AC prediction is used, the following restriction applies: QP value shall not be changed within a VOP (or within a video packet if video packets are used in a VOP). If AC prediction is not used, there are no restrictions to changing QP value.
- ITU-T Recommendation H.264 / MPEG-4 (Part 10) AVC [24] Baseline Profile Level 1.1 with `constraint_set1_flag=1` and without requirements on output timing conformance (annex C of [24]). Each sequence parameter set of H.264 (AVC) shall contain the `vui_parameters` syntax structure including the `num_reorder_frames` syntax element set equal to 0.

When H.264 (AVC) is used it is recommended to transmit H.264 (AVC) parameter sets within the SDP description of a stream (using `sprop-parameter-sets` MIME/SDP parameter – RFC3984 [25]). Moreover, it is not recommended to reuse any parameter set identifier value that appeared previously in the SDP description or in the RTP stream.

The H.264 (AVC) decoder in a multimedia MTSI client in terminal shall either start decoding immediately when it receives data (even if the stream does not start with an IDR access unit) or alternatively no later than it receives the next IDR access unit or the next recovery point SEI message, whichever is earlier in decoding order. The decoding process for a stream not starting with an IDR access unit shall be the same as for a valid H.264 (AVC) bit stream. However, the MTSI client in terminal shall be aware that such a stream may contain references to pictures not available in the decoded picture buffer. The display behaviour of the MTSI client in terminal is out of scope of the present document.

MTSI terminals offering video support other than H.263 Profile 0 Level 45 shall also offer H.263 Profile 0 Level 45 video.

NOTE 1: If a codec is supported at a certain level, then all (hierarchically) lower levels shall be supported as well. Examples of lower levels include Level 10 for H.263 Profile 0 and 3, Level 0 for MPEG-4 Visual Simple Profile and Level 1 for H.264 (AVC) Baseline Profile. However, as for instance Level 20 is not hierarchically lower than Level 45 of H.263 Profile 0 and 3, support for Level 45 does not imply support for Level 20.

NOTE 2: All levels are minimum requirements. Higher levels may be supported and used for negotiation.

NOTE 3: MTSI clients in terminals may use full-frame freeze and full-frame freeze release SEI messages of H.264 (AVC) to control the display process.

NOTE 4: An H.264 (AVC) encoder should code redundant slices only if it knows that the far-end decoder makes use of this feature (which is signalled with the `redundant-pic-cap` MIME/SDP parameter as specified in RFC 3984 [25]). H.264 (AVC) encoders should also pay attention to the potential implications on end-to-end delay.

NOTE 5: If a codec is supported at a certain level, it implies that on the receiving side, the decoder is required to support the decoding of bitstreams up to the maximum capability of this level. On the sending side, the support of a particular level does not imply that the encoder may produce a bitstream up to the maximum capability of the level.

NOTE 6: If video is used in a session, an MTSI client in terminal should offer at least one video stream with a picture aspect ratio in the range from 0.7 to 1.4. For all offered video streams, the width and height of the picture should be integer multiples of 16 pixels. For example, 224x176, 272x224, and 320x240 are image sizes that satisfy these conditions.

### 5.2.3 Real-time text

MTSI clients in terminals offering real time text conversation shall support:

- ITU-T Recommendation T.140 [26] and [27].

T.140 specifies coding and presentation features of real-time text usage. Text characters are coded according to the UTF-8 transform of ISO 10646-1 (Unicode).

A minimal subset of the Unicode character set, corresponding to the Latin-1 part shall be supported, while the languages in the regions where the MTSI client in terminal is intended to be used should be supported.

Presentation control functions from ISO 6429 are allowed in the T.140 media stream. A mechanism for extending control functions is included in ITU-T Recommendation T.140 [26] and [27]. Any received non-implemented control code must not influence presentation.

A MTSI client in terminal shall store the conversation in a presentation buffer during a call for possible scrolling, saving, display re-arranging, erasure, etc. At least 800 characters shall be kept in the presentation buffer during a call.

Note that erasure (backspace) of characters is included in the T.140 editing control functions. It shall be possible to erase all characters in the presentation buffer. The display of the characters in the buffer shall also be impacted by the erasure.

---

## 6 Media configuration

### 6.1 General

MTSI uses SIP, SDP and SDPCapNeg for media negotiation and configuration. General SIP signalling and session setup for IMS are defined in 3GPP TS 24.229 [7], whereas this clause specifies SDP and SDPCapNeg usage and media handling specifically for MTSI, including offer/answer considerations in the capability negotiation. The MTSI client in the terminal may use the OMA-DM solution specified in Clause 15 for enhancing SDP negotiation and PDP context activation process.

The support for ECN is limited to speech, as specified in [86], and has been specified for E-UTRAN in [85]. MTSI may use Explicit Congestion Notification (ECN) to perform rate adaptation. When the MTSI client in terminal supports, and the session allows, adapting the media encoding at multiple bit rates and the radio access bearer technology is known to the MTSI client to be E-UTRAN, the MTSI client may negotiate the use of ECN [83] to perform ECN triggered media bit-rate adaptation. An MTSI MGW supporting ECN supports ECN in the same way as the MTSI client in terminal as described in clauses 12.3.3 and 12.7.3.

The support of ECN is optional for both MTSI client in terminal and MTSI MGW.

It is assumed that the network properly handles ECN-marked packets as described in [84] end-to-end between the MTSI clients in terminals.

An MTSI MGW can be used for inter-working with:

- a client that does not use ECN;
- a client that supports ECN in different way than what is specified for MTSI clients;
- a CS network;
- a network which does not handle ECN-marked packets properly.

In such cases, the ECN protocol, as specified for MTSI clients, is terminated in the MTSI MGW.

### 6.2 Session setup procedures

#### 6.2.1 General

The session setup for RTP transported media shall determine for each media: IP address(es), RTP profile, UDP port number(s); codec(s); RTP Payload Type number(s), RTP Payload Format(s). The session setup may also determine: ECN usage and any additional session parameters.

An MTSI client shall offer at least one RTP profile for each RTP media stream. Multiple RTP profiles may be offered using SDPCapNeg as described in Clause 6.2.1a. The first SDP offer for a media type shall include at least the AVP profile. Subsequent SDP offers may include only other RTP profiles if it is known from a preceding offer that this RTP profile is supported by the answerer. The MTSI client shall accept both AVP and AVPF offers in order to support interworking.

The configuration of ECN for speech media transported with RTP is described in clause 6.2.2. The negotiation of ECN at session setup is described in [84]. The adaptation response to congestion events is described in clause 10.

## 6.2.1a RTP profile negotiation

### 6.2.1a.1 General

MTSI clients shall support the complete SDPCapNeg framework to be able to negotiate RTP profiles for all media types where AVPF is supported. SDPCapNeg is described in [69]. This clause only describes the SDPCapNeg attributes that are directly applicable for the RTP profile negotiation, i.e. the *tcap*, *pcfg* and *acfg* attributes. TS 24.229 [7] may outline further requirements needed for supporting SDPCapNeg in SDP messages.

NOTE: This clause describes only how to use the SDPCapNeg framework for RTP profile negotiation using the *tcap*, *pcfg* and *acfg* attributes. Implementers may therefore (incorrectly) assume that it is sufficient to implement only those specific parts of the framework that are needed for RTP profile negotiation. Doing so would however not be future proof since future versions may use other parts of the framework and there are currently no mechanisms for declaring that only a subset of the framework is supported. Hence, MTSI clients are required to support the complete framework.

### 6.2.1a.2 Using SDPCapNeg in SDP offer

SDPCapNeg shall be used when offering AVPF the first time for a new media type in the session since the support for AVPF in the answering client is not known at this stage. Subsequent SDP offers, in a re-INVITE or UPDATE, may offer AVPF without SDPCapNeg if it is known from an earlier re-INVITE or UPDATE that the answering client supports this RTP profile. If the offer includes only AVP then SDPCapNeg does not need to be used, which can occur for: text; speech if RTCP is not used; and in re-INVITES or UPDATES where the RTP profile has already been negotiated for the session in a preceding INVITE or UPDATE.

When offering using AVP and AVPF SDPCapNeg, the MTSI client shall offer AVP on the media (m=) line and shall offer AVPF using SDPCapNeg mechanisms. The SDPCapNeg mechanisms are used as follows:

- The support for AVPF is indicated in an attribute (a=) line using the transport capability attribute 'tcap'. AVPF shall be preferred over AVP.
- At least one configuration using AVPF shall be listed using the attribute for potential configurations 'pcfg'.

### 6.2.1a.3 Answering to an SDP offer using SDPCapNeg

An invited MTSI client should accept using AVPF whenever supported. If AVPF is to be used in the session then the MTSI client:

- Shall select one configuration out of the potential configurations defined in the SDP offer for using AVPF.
- Indicate in the media (m=) line of the SDP answer that the profile to use is AVPF.
- Indicate the selected configuration for using AVPF in the attribute for actual configurations 'acfg'.

If AVP is to be used then the MTSI shall not indicate any SDPCapNeg attributes for using AVPF in the SDP answer.

## 6.2.2 Speech

### 6.2.2.1 General

For AMR or AMR-WB encoded media, the session setup shall determine what RTP profile to use; if all codec modes can be used or if the operation needs to be restricted to a subset; if the bandwidth-efficient payload format can be used or if the octet-aligned payload format must be used; if codec mode changes shall be restricted to be aligned to only every other frame border or if codec mode changes can occur at any frame border; if codec mode changes must be restricted to only neighbouring modes within the negotiated codec mode set or if codec mode changes can be performed to any mode within the codec mode set; the number of speech frames that should be encapsulated in each RTP packet and the maximum number of speech frames that may be encapsulated in each RTP packet.

If the session setup negotiation concludes that multiple configuration variants are possible in the session then the default operation should be used as far as the agreed parameters allow, see clause 7.5.2.1. It should be noted that the default configurations are slightly different for different access types.

An MTSI client offering a speech media session for narrow-band speech and/or wide-band speech should offer SDP according to the examples in clauses A.1 to A.3.

An MTSI client shall offer AVPF for speech media streams. An MTSI client may offer AVP if RTCP is not used or if RTCP-APP based adaptation is not used. RTP profile negotiation shall be done as described in clause 6.2.1a.

If an MTSI client in terminal offers to use ECN for speech in RTP streams then the MTSI client in terminal shall offer ECN Capable Transport as defined below. If an MTSI client in terminal accepts an offer for ECN for speech then the MTSI client in terminal shall declare ECN Capable Transport in the SDP answer as defined below. The SDP negotiation of ECN Capable Transport is described in [84].

ECN shall not be used when the codec negotiation concludes that only fixed-rate operation is used.

The use of ECN for a speech stream in RTP is negotiated with the 'ecn-capable-rtp' SDP attribute, [84]. ECN is enabled when both clients agree to use ECN as configured below. The SDP attribute uses a set of parameters to further configure the usage of ECN within the RTP media stream, as described in Clause 7.5.4. An MTSI client in terminal using ECN shall therefore also include the following parameters and parameter values for the ECN attribute:

- 'leap', to indicate that the leap-of-faith initiation method shall be used;
- 'ect=0', to indicate that ECT(0) shall be set for every packet.

The use of ECN is disabled when a client sends an SDP without the 'ecn-capable-rtp' SDP attribute.

SDP examples for offering and accepting ECT are shown in Annex A.12.

Session setup for sessions including speech and DTMF events is described in Annex G.

### 6.2.2.2 Generating SDP offers for AMR-NB and AMR-WB

When speech is offered, an MTSI client in terminal sending a first SDP offer in the initial offer-answer negotiation shall include at least one RTP payload type for AMR-NB and the MTSI client in terminal shall support a configuration where the MTSI client in terminal includes the parameter settings as defined in Table 6.1 and in Table 6.2. If wideband speech is also offered then the SDP offer shall also include at least one RTP payload type for AMR-WB and the MTSI client in terminal shall support a configuration where the MTSI client in terminal includes the parameter settings as defined in Table 6.1 and in Table 6.2.

NOTE: While it is required that the MTSI client in terminal supports the configurations of the SDP parameters as specified, other configurations may be used due to terminal resources, network resources or operator specified settings.



**Table 6.1: SDP parameters for AMR-NB or AMR-WB when the MTSI client in terminal offers the bandwidth-efficient payload format**

Parameter	Usage
octet-align	Shall not be included
mode-set	Shall not be included
mode-change-period	Shall not be included
mode-change-capability	Shall be set to 2
mode-change-neighbor	Shall not be included
maxptime	Shall be set to 240, see also Table 7.1
crc	Shall not be included
robust-sorting	Shall not be included
interleaving	Shall not be included
ptime	Shall be set according to Table 7.1
channels	Shall be set to 1
max-red	Shall be included and shall be set to 220 or less
ecn-capable-rtp: leap; ect=0	Shall be included if offering to use ECN and if the session setup allows for bit-rate adaptation

**Table 6.2: SDP parameters for AMR-NB or AMR-WB when the MTSI client in terminal offers the octet-aligned payload format**

Parameter	Usage
octet-align	Shall be set to 1
mode-set	Shall not be included
mode-change-period	Shall not be included
mode-change-capability	Shall be set to 2
mode-change-neighbor	Shall not be included
maxptime	Shall be set to 240, see also Table 7.1
crc	Shall not be included
robust-sorting	Shall not be included
interleaving	Shall not be included
ptime	Shall be set according to Table 7.1
channels	Shall be set to 1
max-red	Shall be included and shall be set to 220 or less
ecn-capable-rtp: leap; ect=0	Shall be included if offering to use ECN and if the session setup allows for bit-rate adaptation

An example of an SDP offer for AMR-NB is shown in Table A.1.1. An example of an SDP offer for both AMR-NB and AMR-WB is shown in Table A.1.2.

An MTSI client in terminal may divide the offer-answer negotiation into several phases and offer different configurations in different SDP offers. If this is done then the first SDP offer in the initial offer-answer negotiation shall include the most preferable configurations. For AMR, this means that the first SDP offer in the initial offer-answer negotiation shall include at least one RTP payload type for AMR-NB with the parameters as defined in Table 6.1. If wideband speech is offered then the first SDP offer in the initial offer-answer negotiation shall include also at least one RTP payload type for AMR-WB with the parameters as defined in Table 6.1. This also means that offers for octet-aligned payload format do not need to be included in the first SDP offer. One example of dividing the offer-answer negotiation into two phases, and the corresponding SDP offers, is shown in clause A.1.1.2.2.

**NOTE:** Dividing the offer-answer negotiation into several phases may lead to never offering the less preferred configurations if the other end-points accepts to use at least one of the configurations offered in the initial SDP offer.

If the speech media is re-negotiated during the session then the knowledge from earlier offer-answer negotiations should be used in order to shorten the session re-negotiation time. I.e., failed offer-answer transactions shall not be repeated.

### 6.2.2.3 Generating the SDP answer

An MTSI client in terminal must understand all the payload format options that are defined in RFC 4867 [28]. It does not have to support operating according to all these options but must be capable to properly accepting or rejecting all options.

The SDP answer depends on many factors, for example:

- what is included in the SDP offer and in what preference order that is defined. The SDP offer will probably be different if it is generated by another MTSI client in terminal, by an MTSI MGW, a TISIPAN client or some other VoIP client that does not follow this specification;
- if terminal and/or network resources are available; and:
- if there are other configurations, for example defined with OMA-DM, that mandate, recommend or prevent some configurations.

Table 6.3 describes requirements and recommendations for handling of the AMR payload format parameters and for how to generate the SDP answer.

**NOTE:** An MTSI client in terminal may support more features than what is required by this specification, e.g. crc, robust sorting and interleaving. Table 6.3 describes the handling of the AMR payload format parameters when the MTSI client implementation supports only those features that are required by this specification.

**Table 6.3: Handling of the AMR-NB and AMR-WB SDP parameters in the received SDP offer and in the SDP answer**

Parameter in the received SDP offer	Comments	Handling
Codec	Wide-band speech is preferable over narrow-band speech	<p>If both AMR-WB and AMR-NB are offered and if AMR-WB is supported by the answering MTSI client in terminal then it shall select to use the AMR-WB codec and include this codec in the SDP answer, unless another preference order is indicated in the SDP offer. If the MTSI client in terminal only supports AMR-NB then this codec shall be selected to be used and shall be included in the SDP answer.</p> <p>The SDP answer shall only include one RTP Payload Type for speech, see NOTE 1.</p>
octet-align	<p>Both the bandwidth-efficient and the octet-aligned payload formats are supported by the MTSI client in terminal.</p> <p>MTSI MGWs for GERAN or UTRAN are likely to either not include the octet-align parameter or to offer octet-align=0.</p> <p>The bandwidth-efficient payload format is preferable over the octet-aligned payload format.</p>	<p>The offer shall not be rejected purely based on the offered payload format variant.</p> <p>If both bandwidth-efficient and octet-aligned are included in the received SDP offer then the MTSI client in terminal shall select the bandwidth-efficient payload format and include it in the configuration in the SDP answer.</p>
mode-set	<p>The MTSI client in terminal can interoperate properly with whatever mode-set the other end-point offers or if no mode-set is offered.</p> <p>The possibilities to use the higher bit rate codec modes also depend on the offered bandwidth.</p> <p>MTSI MGWs for GERAN or UTRAN inter-working are likely to include the mode-set in the offer if in case the intention is to use TFO or TrFO.</p> <p>Mode sets that gives more adaptation possibilities are preferable over mode-sets with fewer or no adaptation possibilities.</p> <p>If the mode-set must be restricted to include only a few codec modes then the preferred mode-set for AMR-NB is {12.2, 7.4, 5.9, 4.75} and for AMR-WB it is {12.65, 8.85 and 6.60}.</p>	<p>The offer shall not be rejected purely based on the offered mode-set.</p> <p>If only one mode-set is offered MTSI client in terminal shall select to use this and include the same mode-set as in the SDP answer.</p> <p>If several different mode-sets are included in the received SDP offer or if some RTP Payload Types do not specify any mode-set then the MTSI client in terminal should select in the first hand the mode-set that provides the largest degrees of freedom for codec mode adaptation and in the second hand the mode-set that is closest to the preferred mode sets.</p>
mode-change-period	<p>The MTSI client in terminal can interoperate properly with whatever mode-change-period the other end-point offers.</p> <p>MTSI MGWs for GERAN or UTRAN inter-working are likely to include mode-change-period=2 in the offer if in case the intention is to use TFO or TrFO.</p>	<p>The offer shall not be rejected purely based on the offered mode-change-period.</p> <p>If the received SDP offer defines mode-change-period=2 then this information shall be used to determine the mode changes for AMR-NB or AMR-WB encoded media that the MTSI client in terminal sends.</p> <p>The MTSI client in terminal should not include the mode-change-period parameter in the SDP answer since it has no corresponding limitations.</p>
mode-change-capability	The MTSI client in terminal can interoperate with whatever capabilities the other end-point declares.	<p>The offer shall not be rejected purely based on the offered mode-change-capability.</p> <p>The mode-change-capability information should be used to determine a proper value, or prevent using an improper value, for mode-change-period in the SDP answer, see above. If the offer includes mode-change-capability=1, then the MTSI client in terminal shall not offer mode-change-period=2 in the answer.</p> <p>The MTSI client in terminal shall include mode-change-capability=2 in the SDP answer since it is required to support restricting mode changes to every other frame.</p>

Parameter in the received SDP offer	Comments	Handling
mode-change-neighbor	The MTSI client in terminal can interoperate with whatever limitations the other end-point offers.	<p>The offer shall not be rejected purely based on the offered mode-change-neighbor.</p> <p>The MTSI client in terminal shall use this information to determine how mode changes can be performed for AMR-NB or AMR-WB encoded media that the MTSI client in terminal sends.</p> <p>The MTSI client in terminal shall not include the mode-change-neighbor parameter in the SDP answer since it has no corresponding limitations.</p>
maxptime	<p>The MTSI client in terminal can interoperate with whatever value that is offered.</p> <p>The MTSI client in terminal may also use this information to determine a suitable value for max-red in the SDP answer.</p>	<p>The offer shall not be rejected purely based on the offered maxptime.</p> <p>The MTSI client in terminal shall use this information to control the packetization when sending RTP packets to the other end-point, see also clause 7.4.2.</p> <p>The maxptime parameter shall be included in the SDP answer and shall be an integer multiple of 20.</p> <p>If the received SDP offer includes both the max-red and ptime parameter then the MTSI client in terminal may choose to use this information to define a suitable value for maxptime in the SDP answer, see NOTE 2. The MTSI client in terminal may also choose to set the maxptime value to 240, regardless of the ptime and/or max-red parameters in the SDP offer.</p> <p>The maxptime value in the SDP answer shall not be smaller than ptime value in the SDP answer. The maxptime value should be selected to give at least some room for adaptation.</p>
crc	The MTSI client in terminal is not required to support this option.	The MTSI client in terminal may have to reject offered RTP payload types including this option.
robust-sorting	The MTSI client in terminal is not required to support this option.	The MTSI client in terminal may have to reject offered RTP payload types including this option.
interleaving	The MTSI client in terminal is not required to support this option.	The MTSI client in terminal may have to reject offered RTP payload types including this option.
ptime	The MTSI client in terminal can interoperate with whatever value that is offered.	<p>The offer shall not be rejected purely based on the offered ptime.</p> <p>The MTSI client in terminal should use this information and should use the requested packetization when sending RTP packets to the other end-point. The MTSI client should use the ptime value to determine how many non-redundant speech frames that can be packed into the RTP packets. The requirements in clause 7.4.2 shall be followed even if ptime in the SDP offer is larger than 80.</p> <p>The ptime parameter shall be included in the SDP answer and shall be an integer multiple of 20.</p> <p>If the received SDP offer includes the ptime parameters then the MTSI client in terminal may choose to use this information to define a suitable value for ptime in the SDP answer, see NOTE 3. The MTSI client in terminal may also choose to set the ptime value in the SDP answer according to Table 7.1, regardless of the ptime parameter in the SDP offer.</p> <p>The ptime value in the SDP answer shall not be larger than the maxptime value in the SDP answer.</p>

Parameter in the received SDP offer	Comments	Handling
Channels	The MTSI client in terminal is only required to support 1 channel. Offered RTP payload types with more than 1 channel may therefore have to be rejected.	The number of channels shall be included in the SDP answer.
max-red	The MTSI client in terminal may use this information to bound the delay for receiving redundant frames. The MTSI client in terminal may also use this information to determine a suitable value for maxptime in the SDP answer.	The max-red parameter shall be included in the SDP answer and shall be an integer multiple of 20. If the received SDP offer includes both the ptime and maxptime parameters then the MTSI client in terminal may choose to use this information to define a suitable value for max-red in the SDP answer, see NOTE 2. The MTSI client in terminal may also choose to set the max-red value to 220. The max-red value in the SDP answer should be selected to give at least some room for adaptation.
ecn-capable-rtp: leap; ect=0	An MTSI client in terminal uses this SDP attribute to offer ECN for RTP-transported media	Shall be included in the SDP answer if accepting an offer to use ECN and if the session setup allows for bit-rate adaptation
<p>NOTE 1: An MTSI client may include both a speech coded, e.g. AMR-NB or AMR-WB, and 'telephone-events' for DTMF in the SDP answer, see 3GPP TS 24.229 Clause 6.1, [7].</p> <p>NOTE 2: It is possible to use the following relationship between maxptime, ptime and max-red:  <math display="block">\text{maxptime} = \text{ptime} + \text{max-red}.</math> There is however no mandatory requirement that these parameters must be aligned in this way.</p> <p>NOTE 3: It may be wise to use the same ptime value in the SDP answer as was given in the SDP offer, especially if the ptime in the SDP offer is larger than 20, since a value larger than the frame length indicates that the other end-point is somehow packet rate limited.</p>		

If an SDP offer is received from another MTSI client in terminal then the SDP offer will include configurations as described in Table 6.1 and Table 6.2. If the MTSI client in terminal chooses to accept the offer for using the AMR-NB or AMR-WB codec, as configured in Table 6.1 or Table 6.2 then the MTSI client in terminal shall support a configuration where the MTSI client in terminal creates an SDP answer containing an RTP payload type for the AMR-NB and AMR-WB codec as shown in Table 6.4.

**Table 6.4: SDP parameters for AMR-NB or AMR-WB for SDP answer when the SDP offer is received from another MTSI client in terminal**

Parameter	Usage
octet-align	Shall not be included
mode-set	Shall not be included or shall be set to the preferred mode-set, see Table 6.3
mode-change-period	Shall not be included
mode-change-capability	May be included. If it is included then it shall be set to 2
mode-change-neighbor	Shall not be included
maxptime	Shall be set to 240, see also Table 7.1
crc	Shall not be included
robust-sorting	Shall not be included
interleaving	Shall not be included
ptime	Shall be set according to Table 7.1
channels	Shall be set to 1
max-red	Shall be included and shall be set to 220 or less
ecn-capable-rtp: leap; ect=0	Shall be included in the SDP answer if accepting an offer to use ECN and if the session setup allows for bit-rate adaptation

If an SDP offer is received from a MTSI MGW inter-working with CS GERAN/UTRAN, and when the MTSI MGW supports ECN (see also Clause 12.3.3), then it is likely to be configured as shown in Table 6.5 if the MTSI MGW does not support redundancy.

**Table 6.5: Expected configuration of SDP parameters for AMR-NB or AMR-WB in an SDP offer from an MTSI MGW inter-working with CS GERAN/UTRAN**

Parameter	Usage
octet-align	Either not included or set to 0
mode-set	Included and indicates the codec modes that are allowed in the CS network
mode-change-period	Set to 2
mode-change-capability	Set to 2
mode-change-neighbor	Set to 1 if the CS network is GERAN
maxptime	Set to 80, see also Table 12.1
crc	Not included
robust-sorting	Not included
interleaving	Not included
ptime	Set according to Table 12.1
channels	Set to 1
max-red	Set to 0
ecn-capable-rtp: leap; ect=0	Shall be included in the SDP answer if accepting an offer to use ECN and if the session setup allows for bit-rate adaptation

If the MTSI client in terminal accepts the offer included in Table 6.5 then the MTSI client in terminal shall support a configuration where the MTSI client in terminal creates an SDP answer containing an RTP payload type for the AMR-NB and AMR-WB codecs as shown in Table 6.6.

**Table 6.6: SDP parameters for AMR-NB or AMR-WB for SDP answer when the SDP offer is received from another MTSI MGW**

Parameter	Usage
octet-align	Shall be set according to the offer
mode-set	Shall be set according to the offer
mode-change-period	Shall not be included
mode-change-capability	May be included. If it is included then it shall be set to 2
mode-change-neighbor	Shall not be included
maxptime	Shall be set to 240, see also Table 7.1
crc	Shall not be included
robust-sorting	Shall not be included
interleaving	Shall not be included
ptime	Shall be set according to Table 7.1
channels	Shall be set according to the offer
max-red	Shall be included and shall be set to 220 or less
ecn-capable-rtp: leap; ect=0	Shall be included in the SDP answer if accepting an offer to use ECN and if the session setup allows for bit-rate adaptation

### 6.2.3 Video

If video is used in a session, the session setup shall determine the bandwidth, RTP profile, video codec, profile and level. The "imageattr" attribute as specified in [76] should be supported.

An MTSI client shall offer AVPF for all media streams containing video. RTP profile negotiation shall be done as described in clause 6.2.1a.

Examples of SDP offers and answers for video can be found in clause A.4.

NOTE: For H.264 / MPEG-4 (Part 10) AVC, the optional max-rcmd-nalu-size receiver-capability parameter of RFC 3984 [25] should be set to the smaller of the MTU size (if known) minus header size or 1 400 bytes (otherwise).

### 6.2.4 Text

An MTSI client should offer AVP for all media streams containing text. Only in cases where there is an explicit demand for the AVPF RTCP reporting timing or feedback messages AVPF shall be used. If AVPF is offered then RTP profile negotiation shall be done as described in clause 6.2.1a.

Examples of SDP offers for text can be found in clause A.5.

An MTSI client configured to automatically enable global text telephony (GTT), e.g. because the MTSI client is used by a deaf or hearing-impaired person or a person wanting to communicate with such an impaired person, shall accept an initial INVITE request for a SIP dialogue if the SDP offer does not include real time text media. It shall then send a new SDP offer (e.g. in a SIP UPDATE request during call establishment) adding text media for real time text conversation.

NOTE: As one example, incoming calls from a PSTN interworked by an MGCF will not contain media for real time text conversation in the initial SDP offer. The new offer adding media for real time text conversation enables the transport of real time text towards the MTSI client.

### 6.2.5 Bandwidth negotiation

The SDP shall include bandwidth information for each media stream and also for the session in total. The bandwidth information for each media stream and for the session is defined by the Application Specific (AS) bandwidth modifier as defined in RFC 4566 [8].

SDP examples incorporating bandwidth modifiers are shown in annex A.

### 6.2.6 The Synchronization Info attribute "3gpp\_sync\_info"

Synchronization jitter (also known as synchronization or inter-media skew) is defined as the amount of synchronization delay between media streams that needs to be maintained during the synchronization process (at the receiver side), which is acceptable to a session (or the sender of the multimedia streams) for a good user experience.

Tight synchronization between the constituent streams is not necessary for all types of MTSI sessions. For instance, during a VoIP call, one of the call participants may wish to share a video clip or share his/her camera view. In this situation, the sender may want to relax the requirement on the receiver to synchronize the audio and the video streams in order to maintain a good video quality without stressing on tight audio/video synchronization. The Synchronization Info attribute defined in the present document is not just limited to lip-sync between audio/video streams, but is also applicable to any two media streams that need to be synchronized during an MTSI session. This attribute allows an MTSI client to specify whether or not media streams should be synchronized. In case the choice is to have synchronization between different streams, it is up to the implementation, use case and application to decide the exact amount of synchronization jitter allowed between the streams to synchronize.

The ABNF for the synchronization info attribute is described as follows:

```
Synchronization-Info    = "a" "=" "3gpp_sync_info" ":" sync-value
sync-value              = "Sync" / "No Sync"
```

The value "Sync" indicates that synchronization between media shall be maintained. The value "No Sync" indicates that No Synchronization is required between the media.

The parameter "3gpp\_sync\_info" should be included in the SDP at the session level and/or at the media level. Its usage is governed by the following rules:

1. At the session level, the "3gpp\_sync\_info" attribute shall be used with the group attribute defined in RFC 3388 [48]. The group attribute indicates to the receiver which streams (identified by their mid attributes) that are to be synchronized. The "3gpp\_sync\_info" attribute shall follow the "group: LS" line in the SDP.
2. At the media level, the "3gpp\_sync\_info" attribute shall assume a value of "No Sync" only. It indicates to the receiver that this particular media stream is not required to be synchronized with any other media stream in the session. The use of the "mid" attribute of RFC 3388 [48] is optional in this case. If the "mid" attribute is used for any other media in the session, then "mid" with this media line shall be used also according to RFC 3388 [48]. Otherwise, it is not necessary to tie the "3gpp\_sync\_info" attribute with the "mid" attribute.
3. When the "3gpp\_sync\_info" attribute is defined at both session level (with the "group" attribute) and media level, then the media level attribute shall override the session level attribute. Thus if the "3gpp\_sync\_info" attribute is defined at the media level, then that particular media stream is not to be synchronized with any other media stream in the session (even if the "3gpp\_sync\_info" is defined at the session level for this media stream).

The calling party (or the initiator or offerer of the multimedia stream) should include the "3gpp\_sync\_info" attribute in the SDP which is carried in the initial INVITE message. Upon reception of the INVITE message that includes the "3gpp\_sync\_info" attribute, the other party in the session should include its own "3gpp\_sync\_info" attribute (with its own wish for synchronization or no synchronization) in the 200/OK response message.

There are no offer/answer implications on the "3gpp\_sync\_info" attribute; it provides synchronization requirement between the specified media streams to the receiver. The "3gpp\_sync\_info" attribute in the calling party SDP is only an indication to the called party of the synchronization requirement that should be maintained between the specified media streams that it receives. Similarly the "3gpp\_sync\_info" attribute value from the called party is an indication to the calling party of the synchronization requirements between specified media streams. The "3gpp\_sync\_info" attribute value can be different for the calling and the called parties.

SDP examples using the "3gpp\_sync\_info" attribute are given in clause A.7.

NOTE: Default operation in the absence of the "3gpp\_sync\_info" attribute in SDP is to maintain synchronization between media streams.

## 6.2.7 Negotiated QoS parameters

The term "negotiated" in the present document describes the end result of a QoS negotiation between an MTSI client in terminal and the network (or the end result of what the network grants to the MTSI client in terminal even if no negotiation takes place).

In case an MTSI client in terminal is made aware that the value of the negotiated Guaranteed Bit Rate and if this value (taking into account the RTCP bandwidth usage) is not approximately equal to the b=AS bandwidth modifier attribute during the initial session setup in an MTSI client in terminal (sender or receiver), the MTSI client in terminal shall send to the other party the negotiated Guaranteed Bit Rate (taking into account the RTCP bandwidth usage) via the SIP UPDATE (or in a SIP re-INVITE) method using the b=AS bandwidth modifier attribute. If an MTSI client in a terminal (receiver or sender) receives a new bandwidth value in a SIP UPDATE (or in a SIP re-INVITE) then it shall respond by sending its known negotiated Guaranteed Bit Rate (taking into account the RTCP bandwidth usage) via the SIP 200/OK response to the UPDATE (or re-INVITE) message.

NOTE: The b=AS bandwidth and the GBR bandwidth are not directly comparable since the b=AS bandwidth does not include the RTCP bandwidth while the GBR bandwidth allocation must include some headroom for RTCP. The bandwidths will therefore almost always be different. The GBR bandwidth may also differ from the b=AS bandwidth because of other reasons, for example: bearer allocation and header compression. It is an implementation consideration to handle such impacts and how to judge whether the bandwidth values differ and what bandwidth value to send in the UPDATE message.

Any subsequent QoS changes indicated to the MTSI client in terminal during an MTSI session (including the cases described in Clause 10.3) shall be signalled by the MTSI client in terminal (subject to the QoS update procedure) to the other party using the same signalling described above.

Examples of SDP using negotiated QoS are given in clause A.8.



## 6.3 Session control procedures

During session renegotiation for adding or removing media components, the SDP offerer should continue to use the same media (m=) line(s) from the previously negotiated SDP for the media components that are not being added or removed.

An MTSI client in terminal may support multiple media components including media components of the same media type. An MTSI client in terminal may support adding one or more media components to an on-going session which already contains a media component of the same media type. If an MTSI client in terminal needs to have multiple media components of the same media type in a single MTSI session, then the MTSI client in terminal should use the SDP content attributes as defined in [81] for identifying different media components. An SDP example for adding a second video stream to an ongoing video telephony session is given in Annex A.11.

The content attribute can be used in combination with the group attributes defined in RFC 3388 [48] and also in combination with the synchronization attributes defined in Clause 6.2.6, for example to identify two (or more) media components are related to each other and if synchronization is needed.

---

# 7 Data transport

## 7.1 General

MTSI clients shall support an IP-based network interface for the transport of session control and media data. Control-plane signalling is sent using SIP; see 3GPP TS 24.229 [7] for further details. User plane media data is sent over RTP/UDP/IP. An overview of the user plane protocol stack can be found in figure 4.3 of the present document.

## 7.2 RTP profiles

MTSI clients shall transport speech, video and real-time text using RTP (RFC 3550 [9]) over UDP (RFC 0768 [39]). The following profiles of RTP shall be supported:

- RTP Profile for Audio and Video Conferences with Minimal Control (RFC 3551 [10]), also called RTP/AVP;
- Extended RTP Profile for RTCP-based Feedback (RTP/AVPF) (RFC 4585 [40]), also called RTP/AVPF.

The support of AVPF requires an MTSI client in terminal to implement the RTCP transmission rules, the signalling mechanism for SDP and the feedback messages explicitly mentioned in the present document.

For a given RTP based media stream, the MTSI client in terminal shall use the same port number for sending and receiving RTP packets. This facilitates interworking with fixed/broadband access. However, the MTSI client shall accept RTP packets that are not received from the same remote port where RTP packets are sent by the MTSI client.

## 7.3 RTCP usage

### 7.3.1 General

The RTP implementation shall include an RTCP implementation.

For a given RTP based media stream, the MTSI client in terminal shall use the same port number for sending and receiving RTCP packets. This facilitates interworking with fixed/broadband access. However, the MTSI client shall accept RTCP packets that are not received from the same remote port where RTCP packets are sent by the MTSI client.

The bandwidth for RTCP traffic shall be described using the "RS" and "RR" SDP bandwidth modifiers at media level, as specified by RFC 3556 [42]. Therefore, an MTSI client shall include the "b=RS:" and "b=RR:" fields in SDP, and shall be able to interpret them. There shall be an upper limit on the allowed RTCP bandwidth for each RTP session signalled by the MTSI client. This limit is defined as follows:

- 4 000 bps for the RS field (at media level);

- 3 000 bps for the RR field (at media level).

If the session described in the SDP is a point-to-point speech only session, the MTSI client may request the deactivation of RTCP by setting its RTCP bandwidth modifiers to zero.

If a MTSI client receives SDP bandwidth modifiers for RTCP equal to zero from the originating MTSI client, it should reply (via the SIP protocol) by setting its RTCP bandwidth using SDP bandwidth modifiers with values equal to zero.

RTCP packets should be sent for all types of multimedia sessions to enable synchronization with other RTP transported media, remote end-point aliveness information, monitoring of the transmission quality, and carriage of feedback messages such as TMMBR for video and RTCP APP for speech. Point-to-point speech only sessions may not require these functionalities and may therefore turn off RTCP by setting the SDP bandwidth modifiers (RR and RS) to zero. When RTCP is turned off (for point-to-point speech only sessions) and the media is put on hold, the MTSI client should re-negotiate the RTCP bandwidth with SDP bandwidth modifiers values greater than zero, and send RTCP packets to the other end. This allows the remote end to detect link aliveness during hold. When media is resumed, the resuming MTSI client should turn off the RTCP sending again through a re-negotiation of the RTCP bandwidth with SDP bandwidth modifiers equal to zero.

When RTCP is turned off (for point-to-point speech only sessions) and if sending of an additional associated RTP stream becomes required and both RTP streams need to be synchronized, or if transport feedback due to lack of end-to-end QoS guarantees is needed, a MTSI client should re-negotiate the bandwidth for RTCP by sending an SDP with the RS bandwidth modifier greater than zero.

NOTE 1: Deactivating RTCP will disable the adaptation mechanism for speech defined in clause 10.2.

## 7.3.2 Speech

MTSI clients in terminals offering speech shall support AVPF (RFC 4585 [40]) configured to operate in early mode. When allocating RTCP bandwidth, it is recommended to allocate RTCP bandwidth and set the values for the "b=RR:" and the "b=RS:" parameters such that a good compromise between the RTCP reporting needs for the application and bandwidth utilization is achieved, see also Annex A.6. The value of "trr-int" should be set to zero or not transmitted at all (in which case the default "trr-int" value of zero will be assumed) when Reduced-Size RTCP (see clause 7.3.6) is not used.

For speech sessions it is beneficial to keep the size of RTCP packets as small as possible in order to reduce the potential disruption of RTCP onto the RTP stream in bandwidth-limited channels. RTCP packet sizes can be minimized by using Reduced-Size RTCP packets or using the parts of RTCP compound packets (according to RFC 3550 [9]) which are required by the application. RTCP compound packet sizes should be at most as large as 1 time and, at the same time, shall be at most as large as 4 times the size of the RTP packets (including UDP/IP headers) corresponding to the highest bit rate of the speech codec modes used in the session. Reduced-Size RTCP and semi-compound RTCP packet sizes should be at most as large as 1 time and, at the same time, shall be at most as large as 2 times the size of the RTP packets (including UDP/IP headers) corresponding to the highest bit rate of the speech codec modes used in the session.

An MTSI client in terminal using ECN for speech in RTP sessions with non-zero RTCP bandwidth shall support RTCP in accordance with [84]. The receiver may initiate a session re-negotiation to disable ECN to resolve ECN-related error cases. An ECN-related error case may, for example, be detecting non-ECT in the received packets when ECT(0) was expected or detecting a very high packet loss rate when ECN is used.

For speech, RTCP APP packets are used for adaptation (see clause 10.2).

## 7.3.3 Video

MTSI clients offering video shall support AVPF (RFC 4585 [40]) configured to operate in early mode. The behaviour can be controlled by allocating enough RTCP bandwidth using "b=RR:" and "b=RS:" (see section 7.3.1) and setting the value of "trr-int".

MTSI clients offering video shall support transmission and reception of AVPF NACK messages, as an indication of non-received media packets. MTSI terminals offering video shall also support reception of AVPF Picture Loss Indication (PLI). An MTSI client receiving NACK or PLI should take appropriate action to improve the situation for the MTSI client that sent NACK or PLI, although no action is mandated nor specified. Note that by setting the bitmask of following lost packets (BLP) the frequency of transmitting NACK can be reduced, but the repairing action by the MTSI client receiving the message can be delayed correspondingly.

The Temporary Maximum Media Bit-rate Request (TMMBR) and Temporary Maximum Media Bit-rate Notification (TMMBN) messages of Codec-Control Messages (CCM) [43] shall be supported by MTSI clients in terminals supporting video. The TMMBR notification messages along with RTCP sender reports and receiver reports are used for dynamic video rate adaptation. See clause 10.3 for usage and Annexes B and C for examples of bitrate adaptation.

MTSI clients supporting video shall support Full Intra Request of CCM [43].

### 7.3.4 Real-time text

For real-time text, RTCP reporting should be used according to general recommendations for RTCP.

### 7.3.5 Void

### 7.3.6 Reduced-Size RTCP

MTSI clients should support the use of Reduced-Size RTCP reports [87]. A Reduced-Size RTCP packet is an RTCP packet that does not follow the sending rules outlined in RFC 3550 [9] in the aspect that it does not necessarily contain the mandated RR/SR report blocks and SDES CNAME items.

As specified in RFC5506 [87], a client that support Reduced-Size RTCP shall also support AVPF, see clause 7.2 An SDP offer to use Reduced-Size RTCP shall also offer using AVPF.

When Reduced-Size RTCP is used, the following requirements apply on the RTCP receiver:

- The RTCP receiver shall be capable of parsing and decoding report blocks of the RTCP packet correctly even though some of the items mandated by RFC3550 [9] are missing.
- An SDP attribute "a=rtcp-rsize" is used to enable Reduced-Size RTCP. A receiver that accepts the use of Reduced-Size RTCP shall include the attribute in the SDP answer. If this attribute is not set in offer/answer, then Reduced-Size RTCP shall not be used in any direction.

When Reduced-Size RTCP is used, an RTCP sender transmitting Reduced-Size RTCP packets shall follow the requirements listed below:

- AVPF early or immediate mode shall be used according to RFC4585 [40].
- The "a=rtcp-rsize" attribute shall be included in the SDP offer, see Annex A.9a.
- Reduced-Size RTCP packets should be used for transmission of adaptation feedback messages, for example APP packets as defined in Clause 10.2 and TMMBR as defined in Clause 10.3. When regular feedback packets are transmitted, the individual packets that would belong to a compound RTCP packet shall be transmitted in a serial fashion, although adaptation feedback packets shall take precedence.
- Two or more RTCP packets should be stacked together, within the limits allowed by the maximum size of Reduced-Size RTCP packets (see clause 7.3.2) (i.e., to form a semi-compound RTCP packet which is smaller than a compound RTCP packet). The RTCP sender should not send Reduced-Size RTCP packets that are larger than the regularly scheduled compound RTCP packets.
- Compound RTCP packets with an SR/RR report block and CNAME SDES item should be transmitted on a regular basis as outlined in RFC 3550 [9] and RFC 4585 [40]. In order to control the allocation of bandwidth between Reduced-Size RTCP and compound RTCP, the AVPF "trr-int" parameter should be used to set the minimum report interval for compound RTCP packets.
- The first transmitted RTCP packet shall be a compound RTCP packet as defined in RFC3550 [9] without the size restrictions defined in clause 7.3.2.

The application should verify that the Reduced-Size RTCP packets are successfully received by the other end-point. Verification can be done by implicit means, for instance the RTCP sender that sends an adaptation feedback requests is expected to detect some kind of a response to the requests in the media stream. If verification fails then the RTCP sender shall switch to the use of compound RTCP packets according to the rules outlined in RFC3550 [9].

Examples of SDP negotiation for Reduced-Size RTCP given in Clause A.9a.

## 7.4 RTP payload formats for MTSI clients

### 7.4.1 General

This clause specifies RTP payload formats for MTSI clients, except for MTSI media gateways that is specified in clause 12.3.2, for all codecs supported by MTSI in clause 5.2. Note that each RTP payload format also specifies media type signalling for usage in SDP.

### 7.4.2 Speech

When transmitting AMR or AMR-WB encoded media in RTP

- the AMR (and AMR-WB) payload format shall be used [28].

MTSI clients (except MTSI MGW) shall support both the bandwidth-efficient and the octet-aligned payload format. The bandwidth-efficient payload format shall be preferred over the octet-aligned payload format.

The MTSI clients (except MTSI MGW) should use the SDP parameters defined in table 7.1 for the session. For all access technologies, and for normal operating conditions, the MTSI client should encapsulate the number of non-redundant (a.k.a. primary) speech frames in the RTP packets that corresponds to the ptime value received in SDP from the other MTSI client, or if no ptime value has been received then according to "Recommended encapsulation" defined in table 7.1. The MTSI client may encapsulate more non-redundant speech frames in the RTP packet but shall not encapsulate more than 4 non-redundant speech frames in the RTP packets. The MTSI client may encapsulate any number of redundant speech frames in an RTP packet but the length of an RTP packet, measured in ms, shall never exceed the maxptime value.

NOTE: The terminology "non-redundant speech frames" refers to speech frames that have not been transmitted in any preceding packet.

**Table 7.1: Encapsulation parameters (to be used as defined above)**

Radio access bearer technology	Recommended encapsulation (if no ptime and no RTCP_APP_REQ_AGG has been received)	ptime	maxptime
Default	1 non-redundant speech frame per RTP packet Max 12 speech frames in total but not more than a received maxptime value requires	20	240
HSPA E-UTRAN	1 non-redundant speech frame per RTP packet Max 12 speech frames in total but not more than a received maxptime value requires	20	240
EGPRS	2 non-redundant speech frames per RTP packet, but not more than a received maxptime value requires Max 12 speech frames in total but not more than a received maxptime value requires	40	240
GIP	1 to 4 non-redundant speech frames per RTP packet but not more than a received maxptime value requires. Max 12 speech frames in total but not more than a received maxptime	20, 40, 60 or 80	240

NOTE: It is possible to send only redundant speech frames in one RTP packet.

When the radio access bearer technology is not known to the MTSI client, the default encapsulation parameters defined in Table 7.1 shall be used.

For all radio access bearer technologies, the bandwidth-efficient payload format should be used unless the session setup concludes that the octet-aligned payload format is the only payload format that all parties support. The SDP offer shall include an RTP payload type where octet-align=0 is defined or where octet-align is not specified and should include another RTP payload type with octet-align=1. MTSI client offering wide-band speech shall offer these parameters and parameter settings also for the RTP payload types used for wide-band speech.

For examples of SDP offers and answers, see annex A.

The RTP payload format for DTMF events is described in Annex G.

### 7.4.3 Video

The following RTP payload formats shall be used:

- H.263 video codec RTP payload format according to RFC 4629 [29];
- MPEG-4 video codec RTP payload format according to RFC 3016 [30];
- H.264 (AVC) video codec RTP payload format according to RFC 3984 [25], where the interleaved packetization mode shall not be used. Receivers shall support both the single NAL unit packetization mode and the non-interleaved packetization mode of RFC 3984 [25], and transmitters may use either one of these packetization modes.

### 7.4.4 Real-time text

The following RTP payload format shall be used:

- T.140 text conversation RTP payload format according to RFC 4103 [31].

Real-time text shall be the only payload type in its RTP stream because the RTP sequence numbers are used for loss detection and recovery. The redundant transmission format shall be used for keeping the effect of packet loss low.

Media type signalling for usage in SDP is specified in section 10 of RFC 4103 [31] and section 3 of RFC 4102 [49].

## 7.5 Media flow

### 7.5.1 General

This clause contains considerations on how to use media in RTP, packetization guidelines, and other transport considerations. The use of ECN for RTP sessions is also described for speech in this clause.

### 7.5.2 Media specific

#### 7.5.2.1 Speech

##### 7.5.2.1.1 General

This clause describes how the speech media should be packetized during a session. It includes definitions both for the cases where the access type is known and one default operation for the case when the access type is not known.

Requirements for transmission of DTMF events are described in Annex G.

##### 7.5.2.1.2 Default operation

When the radio access bearer technology is not known to the MTSI client, the default encapsulation parameters defined in Table 7.1 shall be used.

If AMR is used, the codec mode set Config-NB-Code=1 [16] {AMR-NB12.2, AMR-NB7.4, AMR-NB5.9 and AMR-NB4.75} should be used unless the session-setup negotiation determines that other codec modes shall be used.

If AMR-WB is used, the codec mode set Config-WB-Code=0 [16] {AMR-WB12.65, AMR-WB8.85 and AMR-WB6.60} should be used unless the session-setup negotiation determines that other codec modes shall be used.

In the transmitted media, codec mode changes should be aligned to every other frame border and should be performed to one of the neighbouring codec modes in the negotiated mode set, except for a MTSI media gateway, see clause 12.3.1.1. In the received media, codec mode changes shall be accepted at any frame border and to any codec mode within the negotiated mode set.

The adaptation of codec mode, aggregation and redundancy is defined in clause 10.2. The MTSI client in terminal should indicate that no mode request is present (i.e. value 15) in the CMR bits in the AMR payload format [28]. It shall however accept requests signalled with the CMR bits in the AMR payload format.

The AMR bandwidth-efficient payload format should be used unless the session setup determines that the octet-aligned payload format must be used.

The MTSI client should send one speech frame encapsulated in each RTP packet unless the session setup or adaptation request defines that the other MTSI client wants to receive another encapsulation variant.

The MTSI client should request to receive one speech frame encapsulated in each RTP packet but shall accept any number of frames per RTP packet up to the maximum limit of 12 speech frames per RTP packet.

For application-layer redundancy, see clause 9.2.

#### 7.5.2.1.3 HSPA

Use default operation as defined in clause 7.5.2.1.2.

NOTE: The RLC PDU sizes defined in 3GPP TR 25.993 [33] have been optimized for the codec modes, payload formats and frame encapsulations defined in the default operation in clause 7.5.2.1.2.

#### 7.5.2.1.4 EGPRS

Use default operation as defined in clause 7.5.2.1.2, except that the MTSI client in terminal

- should send two speech frames encapsulated in each RTP packet unless the session setup or adaptation request defines that the other PS end-point want to receive another encapsulation variant;
- should request receiving two speech frames encapsulated in each RTP packet but shall accept any number of frames per RTP packet up to the maximum limit of 12 speech frames per RTP packet.

#### 7.5.2.1.5 GIP

Use default operation as defined in clause 7.5.2.1.2, except that the MTSI client in terminal:

- should send 0, 1, 2, 3 or 4 non-redundant speech frames encapsulated in each RTP packet unless the session setup or adaptation request defines that other PS end-point want to receive another encapsulation variant;
- should request receiving 1 to 4 speech frames in each RTP packet but shall accept any number of frames per RTP packet up to the maximum limit of 12 speech frames per RTP packet;
- may use application layer redundancy, in which case the MTSI client in terminal may encapsulate up to 12 speech frames in each RTP packet, with a maximum of four non-redundant speech frames.

#### 7.5.2.1.6 Initial codec mode for AMR and AMR-WB

To avoid congestion on the link and to improve inter-working with CS GERAN when AMR or AMR-WB is used and when more than one codec mode is allowed in the session, the MTSI client in terminal should limit the initial codec mode (ICM) to one of the lowest codec modes for an Initial Waiting Time from the beginning of the RTP stream, or until it receives one of the following:

- a frame-block with rate control information; or
- an RTCP message with rate control information; or
- reception quality feedback information, e.g. PLR or jitter in RTCP Sender Reports or Receiver Reports, indicating that the currently used codec mode is too high for the current operating condition.

The value for the Initial Waiting Time is 600 ms when ECN is not used and 500 ms when ECN is used, unless configured differently by the MTSI Media Adaptation Management as described in Clause 17.

The rate control information can either be: a CMR with a value other than '15' in the RTP payload; or a CMR with a value other than '15' in an RTCP\_APP message (see Clause 10.2.1).

NOTE: A CMR with a value of '15' means that no mode request is present [28].

If no rate control information is received within the Initial Waiting Time, then the sending MTSI client in terminal should gradually increase the codec mode from the ICM towards the highest codec mode allowed in the session. While not detecting poor transmission performance or not receiving rate control information, the sending MTSI client in terminal should use step-wise up-switch to avoid introducing congestion during the upwards adaptation. The step-wise up-switch should be performed by switching to the next higher codec mode in the allowed mode set and then waiting for an Initial Up-switch Waiting Time before each subsequent up-switch until the first down-switch occurs.

The value for the Initial Up-switch Waiting Time is 600 ms when ECN is not used and 500 ms when ECN is used, unless configured differently by the MTSI Media Adaptation Management as described in Clause 17.

The following rules can be used for determining the ICM:

- If 1 codec mode is included in the mode-set then this should be the ICM.
- If 2 or 3 codec modes are included in the mode-set then the ICM should be the codec mode with the lowest rate.
- If 4 or more codec modes are included in the mode-set then the ICM should be the codec mode with the 2<sup>nd</sup> lowest rate.

NOTE: Without ECN, the Initial Waiting Time needs to be long enough to allow the receiver to collect reliable statistics for the adaptation, e.g. for PLR-triggered or jitter-triggered adaptation. With ECN, a congested network can immediately mark IP packets with ECN-CE, which allows the ECN-triggered adaptation react sooner. The Initial Waiting Time can therefore be shorter when ECN is used. The same applies for the Initial Up-switch Waiting Time.

#### 7.5.2.1.7 E-UTRAN

Use the default operation as defined in Clause 7.5.2.1.2.

#### 7.5.2.2 Video

An MTSI client should follow general strategies for error-resilient coding (segmentation) and packetization as specified by each codec [22], [23], [24] and RTP payload format [25], [29], [39] specification. Further guidelines on how the video media data should be packetized during a session are provided in this clause.

Coded pictures should be encoded into individual segments:

- For H.263 Profile 0, a Picture Start Code (PSC) or non-empty Group of Block (GOB) header indicates the beginning of such a segment.
- For H.263 Profile 3, MPEG-4 (Part 2) Visual, and H.264 / MPEG-4 (Part 10) AVC, a slice corresponds to such a segment.

Each individual segment should be encapsulated in one RTP packet. Each RTP packet should be smaller than the Maximum Transfer Unit (MTU) size.

NOTE 1: Unnecessary video segmentation, e.g. within RTP packets, may reduce coding efficiency.

NOTE 2: RTP packet fragmentation, e.g. across UDP boundaries, may decrease transport overhead and reduce error robustness. Hence, packet size granularity is a trade-off between error robustness and overhead that may be tuned according to bearer access characteristics if available.

NOTE 3: In most cases, the MTU-size has a direct relationship with the bearer of the radio network.

#### 7.5.2.3 Text

Real-time text is intended for human conversation applications. Text shall not be transferred with higher rate than 30 characters per second (as defined for cps in section 6 of RFC 4103 [31]). A text-capable MTSI client shall be able to receive text with cps set up to 30.

## 7.5.3 Media synchronization

### 7.5.3.1 General

RTCP SR shall be used for media synchronization by setting the NTP and RTP timestamps according to RFC 3550 [9]. To enable quick media synchronization when a new media component is added, or an MTSI session is initiated, the RTP sender should send RTCP Sender Reports for all newly started media components as early as possible.

NOTE: An MTSI sender can signal in SDP that no synchronization between media components is required. See clause 6.2.6 and clause A.7.

### 7.5.3.2 Text

The media synchronization requirements for real-time text are relaxed. A synchronization error between text and other media of a maximum of 3 seconds is accepted. Since this is longer than the maximum accepted latency, no specific methods need to be applied to assure to meet the requirement

## 7.5.4 ECN usage in RTP sessions

Once the ECN negotiation has been completed as defined in [84], then only ECT(0) shall be used when marking packets with ECT, [83]. When ECN is used for an RTP stream then the sending MTSI client shall mark every packet with ECT until the end of the session or until the session is re-negotiated to no longer use ECN. The leap-of-faith method is used for the ECN initiation.

Handling of ECN Congestion Experience (ECN-CE) marked packets is described in clause 10.

---

# 8 Jitter buffer management in MTSI clients in terminals

## 8.1 General

This clause specifies mechanisms to handle delay jitter in MTSI clients in terminals.

## 8.2 Speech

### 8.2.1 Terminology

In the following paragraph(s), Jitter Buffer Management (JBM) denotes the actual buffer as well as any control, adaptation and media processing algorithm (excluding speech decoder) used in the management of the jitter induced in the transport channel. An illustration of an exemplary structure of an MTSI speech receiver with adaptive jitter buffer is shown in figure 8.1 to clarify the terminology and the relation between different functional components.



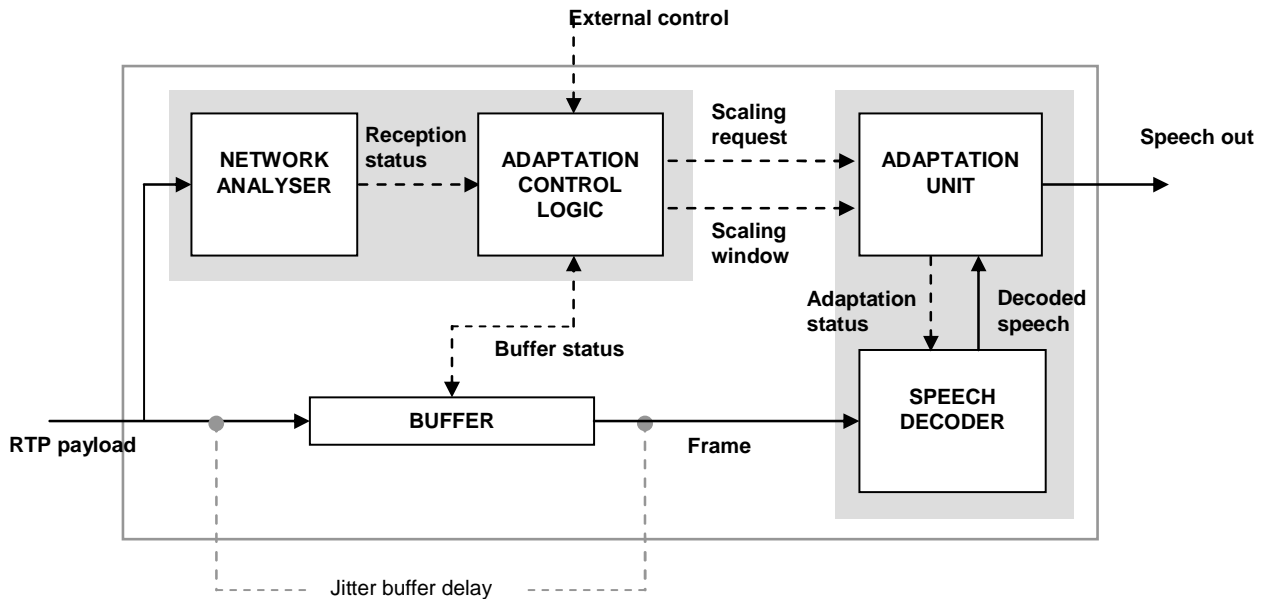

**Figure 8.1: Example structure of an MTSI speech receiver**

The blocks "network analyzer" and "adaptation control logic" together with the information on buffer status form the actual buffer control functionality, whereas "speech decoder" and "adaptation unit" provide the media processing functionality. Note that the external playback device control driving the media processing is not shown in figure 8.1.

The grey dashed lines indicate the measurement points for the jitter buffer delay, i.e. the difference between the decoder consumption time and the arrival time of the speech frame to the JBM.

The functional processing blocks are as follows:

- **Buffer:** The jitter buffer unpacks the incoming RTP payloads and stores the received speech frames. The buffer status may be used as input to the adaptation decision logic. Furthermore, the buffer is also linked to the speech decoder to provide frames for decoding when they are requested for decoding.
- **Network analyser:** The network analysis functionality is used to monitor the incoming packet stream and to collect reception statistics (e.g. jitter, packet loss) that are needed for jitter buffer adaptation. Note that this block can also include e.g. the functionality needed to maintain statistics required by the RTCP if it is being used.
- **Adaptation control logic:** The control logic adjusting playback delay and operating the adaptation functionality makes decisions on the buffering delay adjustments and required media adaptation actions based on the buffer status (e.g. average buffering delay, buffer occupancy, etc.) and input from the network analyser. Furthermore, external control input can be used e.g. to enable inter-media synchronisation or other external scaling requests. The control logic may utilize different adaptation strategies such as fixed jitter buffer (without adaptation and time scaling), simple adaptation during comfort noise periods or buffer adaptation also during active speech. The general operation is controlled with desired proportion of frames arriving late, adaptation strategy and adaptation rate.
- **Speech decoder:** The standard AMR or AMR-WB speech decoder. Note that the speech decoder is also assumed to include error concealment / bad frame handling functionality. Speech decoder may be used with or without the adaptation unit.
- **Adaptation unit:** The adaptation unit shortens or extends the output signal length according to requests given by the adaptation control logic to enable buffer delay adjustment in a transparent manner. The adaptation is performed using the frame based or sample based time scaling on the decoder output signal during comfort noise periods only or during active speech and comfort noise. The buffer control logic should have a mechanism to limit the maximum scaling ratio. Providing a scaling window in which the targeted time scale modifications are performed improves the situation in certain scenarios - e.g. when reacting to the clock drift or to a request of inter-media (re)synchronization - by allowing flexibility in allocating the scaling request on several frames and

performing the scaling on a content-aware manner. The adaptation unit may be implemented either in a separate entity from the speech decoder or embedded within the decoder.

## 8.2.2 Functional requirements for jitter-buffer management

The functional requirements for the speech JBM guarantee appropriate management of jitter which shall be the same for all speech JBM implementations used in MTSI clients in terminals. A JBM implementation used in MTSI shall support the following requirements, but is not limited in functionality to these requirements. They are to be seen as a minimum set of functional requirements supported by every speech JBM used in MTSI.

Speech JBM used in MTSI shall:

- support all the codecs as defined in clause 5.2.1;
- support source-controlled rate operation as well as non-source-controlled rate operation;
- be able to receive the de-packetized frames out of order and present them in order for decoder consumption;
- be able to receive duplicate speech frames and only present unique speech frames for decoder consumption;
- be able to handle clock drift between the encoding and decoding end-points.

## 8.2.3 Minimum performance requirements for jitter-buffer management

### 8.2.3.1 General

The jitter buffering time is the time spent by a speech frame in the JBM. It is measured as the difference between the decoding start time and the arrival time of the speech frame to the JBM. The frames that are discarded by the JBM are not counted in the measure.

The minimum performance requirements consist of objective criteria for delay and jitter-induced concealment operations. In order for a JBM implementation to pass the minimum performance requirements all objective criteria shall be met.

A JBM implementation used in MTSI shall comply with the following design guidelines:

1. The overall design of the JBM shall be to minimize the buffering time at all times while still conforming to the minimum performance requirements of jitter induced concealment operations and the design guidelines for sample-based timescaling (as set in bullet point 3);
2. If the limit of jitter induced concealment operations cannot be met, it is always preferred to increase the buffering time in order to avoid growing jitter induced concealment operations going beyond the stated limit above. This guideline applies even if that means that end-to-end delay requirement given in 3GPP TS 22.105 [34] can no longer be met;
3. If sample-based time scaling is used (after speech decoder), then artefacts caused by time scaling operation shall be kept to a minimum. Time scaling means the modification of the signal by stretching and/or compressing it over the time axis. The following guidelines on time scaling apply:
  - Use of a high-quality time scaling algorithm is recommended;
  - The amount of scaling should be as low as possible;
  - Scaling should be applied as infrequently as possible;
  - Oscillating behaviour is not allowed.

**NOTE:** If the end-to-end delay for the ongoing session is known to the MTSI client in terminal and measured to be less than 150 ms (as defined in 3GPP TS 22.105 [34]), the JBM may relax its buffering time minimization criteria in favour of reduced JBM adaptation artefacts if such a relaxation will improve the media quality. Note that a relaxation is not allowed when testing for compliance with the minimum performance requirements specified in clauses 8.2.3.2.2 and 8.2.3.2.3.

## 8.2.3.2 Objective performance requirements

### 8.2.3.2.1 General

The objective performance requirements consist of criteria for delay, time scaling and jitter-induced concealment operations.

The objective minimum performance requirements are divided into three parts:

1. Limiting the jitter buffering time to provide as low end-to-end delay as possible.
2. Limiting the jitter induced concealment operations, i.e. setting limits on the allowed induced losses in the jitter buffer due to late losses, re-bufferings, and buffer overflows.
3. Limiting the use of time scaling to adapt the buffering depth in order to avoid introducing time scaling artefacts on the speech media.

In order to fulfil the objective performance requirements, the JBM under test needs to pass the respective criteria using the six channels as defined in clause 8.2.3.3. Note that in order to pass the criteria for a specific channel, all three requirements must be fulfilled.

### 8.2.3.2.2 Jitter buffer delay criteria

The reference delay computation algorithm in Annex D defines the performance requirements for the set of delay and error profiles described in clause 8.2.3.3. The JBM algorithm under test shall meet these performance requirements. The performance requirements shall be a threshold for the Cumulative Distribution Function (CDF) of the speech-frame delay introduced by the reference delay computation algorithm. A CDF threshold is set by shifting the reference delay computation algorithm CDF 60 ms. The speech-frame delay CDF is defined as:

$$P(x) = \text{Probability}(\text{delay\_compensation\_by\_JBM} \leq x)$$

The relation between the reference delay computation algorithm and the CDF threshold is outlined in figure 8.2.

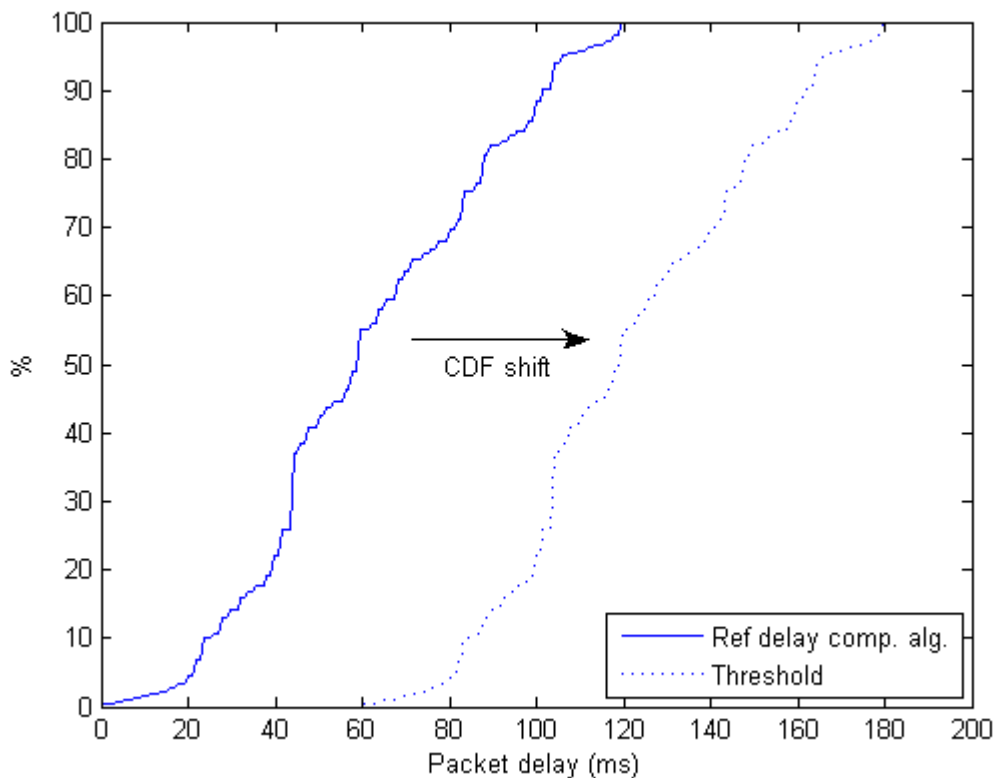

**Figure 8.2: Example showing the relation between the reference delay algorithm and the CDF threshold - the delay and error profile 4 in table 8.1 has been used**

The JBM algorithm under test shall achieve lower or same delay than that set by the CDF threshold for at least 90 % of the speech frames. The values for the CDF shall be collected for the full length of each delay and error profile. The delay measure in the criteria is measured as the time each speech frame spends in the JBM; i.e. the difference between the decoder consumption time and the arrival time of the speech frame to the JBM.

The parameter settings for the reference delay computation algorithm are:

- adaptation\_lookback = 200;
- delay\_delta\_max = 20;
- target\_loss= 0.5.

### 8.2.3.2.3 Jitter induced concealment operations

The jitter induced concealment operations include:

- JBM induced removal of a speech frame, i.e. buffer overflow or intentional frame dropping when reducing the buffer depth during adaptation.
- Deletion of a speech frame because it arrived at the JBM too late.
- Modification of the output timeline due to link loss.
- Jitter-induced insertion of a speech frame controlled by the JBM (e.g. buffer underflow).

Link losses handled as error concealment and not changing the output timeline shall not be counted in the jitter induced concealment operations.

$$\text{Jitter loss rate} = \text{JBM triggered concealed frames} / \text{Number of transmitted frames}$$

The jitter loss rate shall be calculated for active speech frames only.

NOTE: SID\_FIRST and SID\_UPDATE frames belong to the non-active speech period, hence concealment for losses of such frames should not be included in the statistics.

The jitter loss rate shall be below 1% for every channel measured over the full length of the respective channel. The value of 1 % was chosen because such a loss rate will usually not significantly reduce the speech quality.

### 8.2.3.3 Delay and error profiles

Six different delay and error profiles are used to check the tested JBM for compliance with the minimum performance requirements. The profiles span a large range of operating conditions in which the JBM shall provide sufficient performance for the MTSI service. All profiles are 7 500 IP packets long.

**Table 8.1: Delay and error profile overview - The channels are attached electronically**

Profile	Characteristics	Packet loss rate (%)	Filename
1	Low-amplitude, static jitter characteristics, 1 frame/packet	0	dly_error_profile_1.dat
2	Hi-amplitude, semi-static jitter characteristics, 1 frame/packet	0.24	dly_error_profile_2.dat
3	Low/high/low amplitude, changing jitter, 1 frame/packet	0.51	dly_error_profile_3.dat
4	Low/high/low/high, changing jitter, 1 frame/packet	2.4	dly_error_profile_4.dat
5	Moderate jitter with occasional delay spikes, 2 frames/packet (7 500 IP packets, 15 000 speech frames)	5.9	dly_error_profile_5.dat
6	Moderate jitter with severe delay spikes, 1 frame/packet	0.1	dly_error_profile_6.dat

The attached profiles in the zip-archive "delay\_and\_error\_profiles.zip" are formatted as raw text files with one delay entry per line. The delay entries are written in milliseconds and packet losses are entered as "-1". Note that when testing for compliance, the starting point in the delay and error profile shall be randomized.

### 8.2.3.4 Speech material for JBM minimum performance evaluation

The files described in table 8.2 and attached to the present document in the zip-archive "JBM\_evaluation\_files.zip" shall be used for evaluation of a JBM against the minimum performance requirements. The data is stored as RTP packets, formatted according to "RTP dump" format [41]. The input to these files is AMR or AMR-WB encoded frames, encapsulated into RTP packets using the octet-aligned mode of the AMR RTP payload format [28].

**Table 8.2: Input files for JBM performance evaluation - The files are attached electronically**

Codec	Frames per RTP packet	Filename
AMR (12.2 kbps)	1	test_amr122_fpp1.rtp
AMR (12.2 kbps)	2	test_amr122_fpp2.rtp
AMR-WB (12.65 kbps)	1	test_amrwb1265_fpp1.rtp
AMR-WB (12.65 kbps)	2	test_amrwb1265_fpp2.rtp

## 8.3 Video

Video receivers should implement an adaptive video de-jitter buffer. The overall design of the buffer should aim to minimize delay, maintain synchronization with speech, and minimize dropping of late packets. The exact implementation is left to the implementer.

## 8.4 Text

Conversational quality of real-time text is experienced as being good, even with up to one second end-to-end text delay. Strict jitter buffer management is therefore not needed for text. Basic jitter buffer management for text is described in section 5 of RFC 4103 [31] where a calculation is described for the time allowed before an extra delayed text packet may be regarded to be lost.

## 9 Packet-loss handling

### 9.1 General

This clause specifies some methods to handle conditions with packet losses. Packet losses in general will also trigger adaptation, which is specified in clause 10.

### 9.2 Speech

#### 9.2.1 General

This clause provides a recommendation for a simple application layer redundancy scheme that is useful in order to handle operational conditions with severe packet loss rates. Simple application layer redundancy is generated by encapsulating one or more previously transmitted speech frames into the same RTP packet as the current previously not transmitted frame(s). An RTP packet may thus contain zero, one or several redundant speech frames and zero, one or several non-redundant speech frames.

When transmitting redundancy, the MTSI client should switch to a lower codec mode. The MTSI client shall utilize the codec mode rates within the negotiated codec mode set with the negotiated adaptation steps and limitations as defined by mode-change-neighbor and mode-change-period. It is recommended to not send redundant speech frames before the targeted codec mode is reached. Table 9.1 defines the recommended codec modes for different redundancy level combinations.

When application layer redundancy is used for AMR or AMR-WB encoded speech media, the transmitting application may use up to 300 % redundancy, i.e. a speech frame transported in one RTP packet may be repeated in 3 other RTP packets.

**Table 9.1: Recommended codec modes and redundancy level combinations when redundancy is supported**

Redundancy level	No redundancy	100 % redundancy
Narrow-band speech	AMR 12.2	AMR 5.9
Wide-band speech (when wide-band is supported)	AMR12.65	AMR 6.60

#### 9.2.2 Transmitting redundant frames

When transmitting redundant frames, the redundant frames should be encapsulated together with non-redundant media data as shown in figure 9.1. The frames shall be consecutive with the oldest frame placed first in the packet and the most recent frame placed last in the packet. The RTP Timestamp shall represent the sampling time of the first sample in the oldest frame transmitted in the packet.

NOTE: When switching from no redundancy to using redundancy, the RTP Timestamp may be the same for consecutive RTP packets.

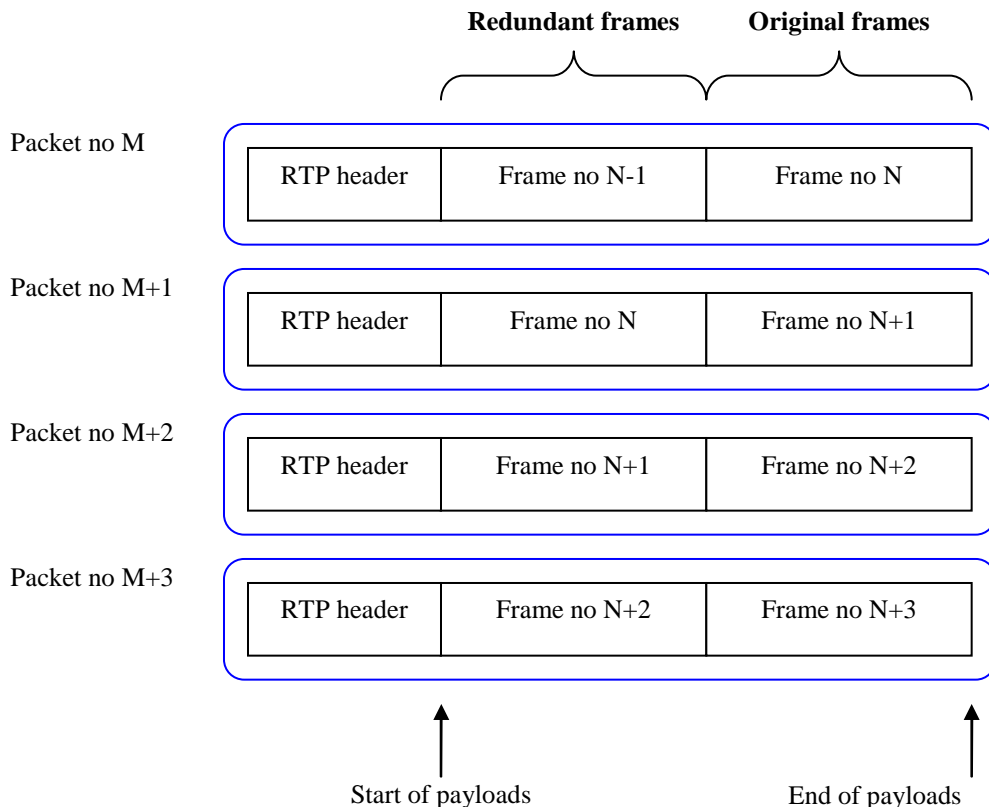

**Figure 9.1: Redundant and non-redundant frames in the case of 100 % redundancy, when the original packing is 1 frame per packet**

Figure 9.1 shows only one non-redundant frame encapsulated together with one redundant frame. It is allowed to encapsulate several non-redundant frames with one or several redundant frames. The following combinations of non-redundant frames and redundant frames can be used.

**Table 9.2: Example frame encapsulation with different redundancy levels and when maxptime is 240**

Original encapsulation (without redundancy)	Encapsulation with 100 % redundancy	Encapsulation with 200 % redundancy	Encapsulation with 300 % redundancy
1 frame per packet	≤ 1 non-redundant frame and ≤ 1 redundant frame	≤ 1 non-redundant frame and ≤ 2 redundant frames	≤ 1 non-redundant frame and ≤ 3 redundant frames
2 frames per packet	≤ 2 non-redundant frames and ≤ 2 redundant frames	≤ 2 non-redundant frames and ≤ 4 redundant frames	≤ 2 non-redundant frames and ≤ 6 redundant frames
3 frames per packet	≤ 3 non-redundant frames and ≤ 3 redundant frames	≤ 3 non-redundant frames and ≤ 6 redundant frames	≤ 3 non-redundant frames and ≤ 9 redundant frames
4 frames per packet	≤ 4 non-redundant frames and ≤ 4 redundant frames	≤ 4 non-redundant frames and ≤ 8 redundant frames	Not allowed since maxptime does not allow more than 12 frames per RTP packet in this example

With a maxptime value of 240, it is possible to encapsulate up to 12 frames per packet. It is therefore not allowed to use 300 % when the original encapsulation is 4 frames per packet, as shown in table 9.2. If the receiver's maxptime value is lower than 240 then even more combinations of original encapsulation and redundancy level will be prohibited.

Figure 9.2 shows an example where the frame aggregation is 2 frames per packet and when 100 % redundancy added.

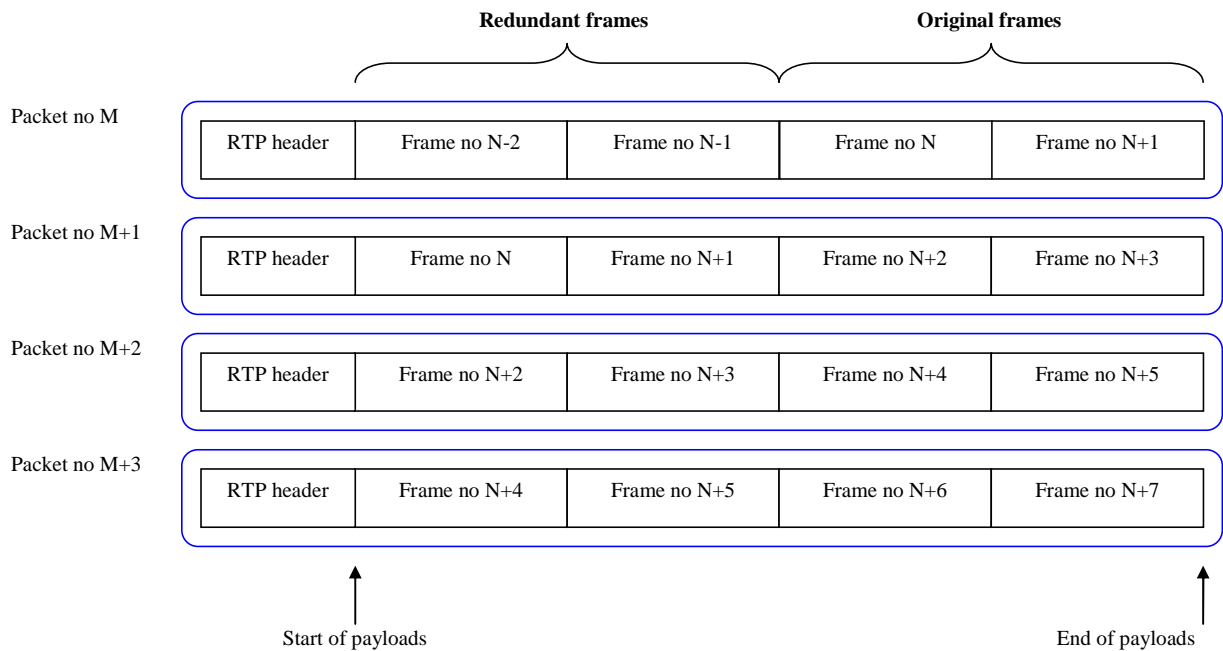

**Figure 9.2: Redundant and non-redundant frames in the case of 100 % redundancy, when the original packing is 2 frames per packet**

A redundant frame may be replaced by a NO\_DATA frame. If the transmitter wants to encapsulate non-consecutive frames into one RTP packet, then NO\_DATA frames shall be inserted for the frames that are not transmitted in order to create frames that are consecutive within the packet. This method is used when sending redundancy with an offset, see figure 9.3.



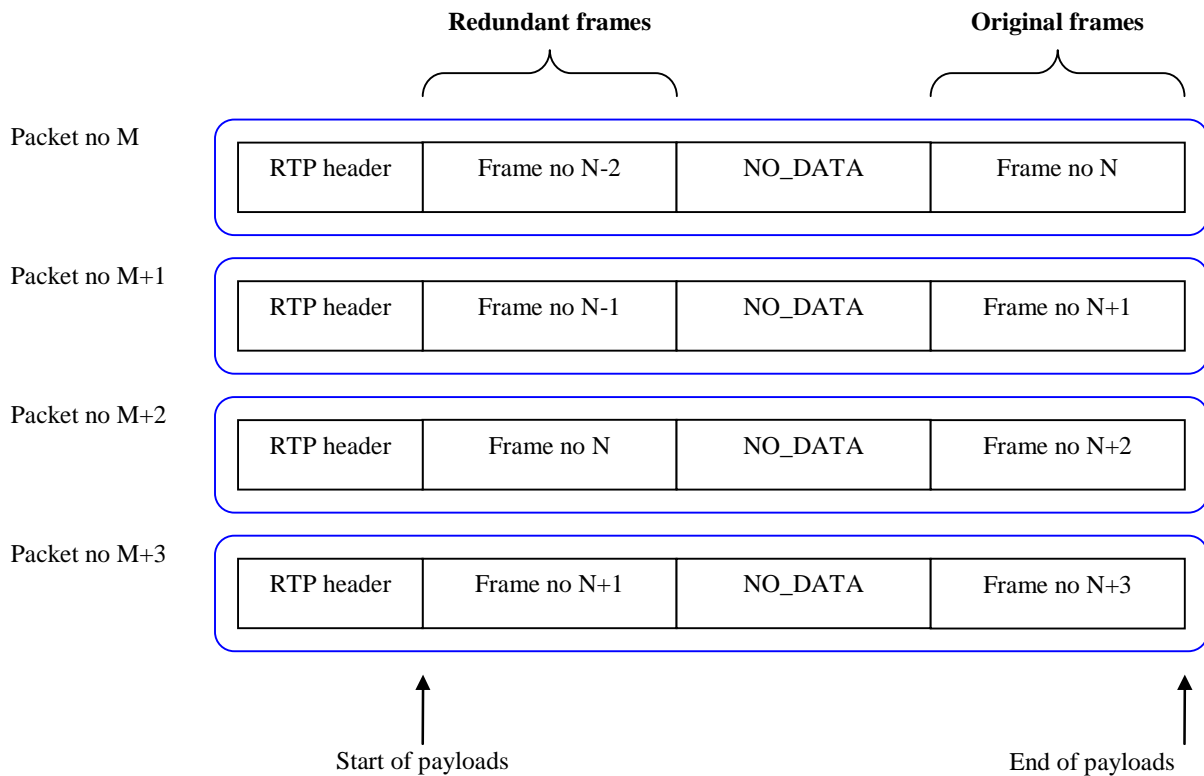

**Figure 9.3: Redundant and non-redundant frames in the case of 100 % redundancy, when the original packing is 1 frame per packet and when the redundancy is transmitted with an offset of 20 ms**

Note that with this scheme, the receiver may receive a frame 3 times: first the non-redundant encoding; then as a NO\_DATA frame; and finally the redundant frame. Other combinations of redundancy and offset may result in receiving even more copies of a frame. The proper receiver behaviour is described in the AMR payload format [28].

For any combinations of frame aggregation, redundancy and redundancy offset, the transmitter shall not exceed the frame encapsulation limit indicated by the receiver's maxptime value when constructing the RTP packet.

When source controlled rate operation is used, it is allowed to send redundant media data without any non-redundant media, if no non-redundant media is available.

NOTE 1: When going from active speech to DTX, there may be no non-redundant frames in the end of the talk spurt while there still are redundant frames that need to be transmitted.

In the end of a talk spurt, when there are no more non-redundant frames to transmit, it is allowed to drop the redundant frames that are in the queue for transmission.

NOTE 2: This ensures that it is possible to use redundancy without increasing the packet rate. The quality degradation by having less redundancy for the last frames should be negligible since these last frames typically contain only background noise.

NOTE 3: The RTP Marker Bit shall be set according to Section 4.1 of the AMR payload format [28].

### 9.2.3 Receiving redundant frames

In order to receive and decode redundant media properly, the receiving application shall sort the received frames based on the RTP Timestamp and shall remove duplicated frames. If multiple versions of a frame are received, i.e. encoded with different bitrates, then the frame encoded with the highest bitrate should be used for decoding.

## 9.3 Video

AVPF NACK messages are used by MTSI clients to indicate non-received RTP packets for video (see clause 7.3.3). An MTSI client transmitting video can use this information, as well as the AVPF Picture Loss Indication (PLI), to at its earliest opportunity take appropriate action such that the situation for the MTSI client that sent the NACK or PLI is improved. It is recommended that an MTSI client considers whether such action could improve the situation better than ignoring the received message and maintaining the current video encoding process. In other words the client should take action only when it is deemed necessary,

## 9.4 Text

Redundant transmission provided by the RTP payload format as described in RFC 4103 [31] shall be supported. The transmitting application may use up to 200 % redundancy, i.e. a T140block transported in one RTP packet may be repeated once or twice in subsequent RTP packets. 200 % redundancy shall be used when the conditions along the call path are not known to be free of loss. However, the result of media negotiation shall be followed, and transmission without redundancy used if one of the parties does not show capability for redundancy.

The sampling time shall be 300 ms as a minimum (in order to keep the bandwidth down) and should not be longer than 500 ms. New text after an idle period shall be sent as soon as possible. The first packet after an idle-period shall have the M-bit set.

The procedure described in section 5 of RFC 4103 [31], or a procedure with equivalent or better performance, shall be used for packet-loss handling in the receiving MTSI client in terminal.

---

# 10 Adaptation

## 10.1 General

Adaptive mechanisms are used to optimize the session quality given the current transport characteristics. The mechanisms provided in MTSI are bit-rate, packet-rate and error resilience adaptation. These mechanisms can be used in different ways; however, they should only be used when the result of the adaptation is assumed to increase the session quality even if e.g. the source bit-rate is reduced.

Adaptive mechanisms that act upon measured or signalled changes in the transport channel characteristics may be used in a conservative manner. Examples of measured changes in transport characteristics are variations in Packet Loss Rate (PLR) and delay jitter. An example of signalled changes in transport characteristics is ECN Congestion Experienced (ECN-CE) marking in IP packet headers. A conservative use of adaptation is characterized by a fast response to degrading conditions, and a slower, careful upwards adaptation intended to return the session media settings to the original default state of the session. The long-term goal of any adaptive mechanism is assumed to be a restoration of the session quality to the originally negotiated quality. The short-term goal is to maximize the session quality given the current transport characteristics, even if that means that the adapted state of the session will give a lower session quality compared to the session default state if transported on an undisturbed channel.

## 10.2 Speech

### 10.2.0 General

To reduce the risk for confusion in the sender, it is beneficial if the signaling for the media adaptation is the same regardless of which triggers are used in the adaptation. The adaptation for AMR and AMR-WB includes adapting the media bit-rate, the frame aggregation and the redundancy level.

The boundaries of the adaptation may be controlled by a set of parameters. These parameters may be configured into the MTSI client based on operator policy, for example using OMA-DM.

Table 10.1 defines a mandatory set of parameters that are used by the ECN triggered adaptation. The default values for the parameters are also specified. Alternate values for these parameters may be configured into the MTSI client based on operator policy, for example using OMA-DM.

**Table 10.1: Configuration parameters when ECN is used as a trigger**

Parameter	Description
ECN_min_rate	Lower boundary for the media bit-rate adaptation in response to ECN-CE marking. The media bit-rate shall not be reduced below this value as a reaction to the received ECN-CE. The ECN_min_rate should be selected to maintain an acceptable service quality while reducing the resource utilization. Default value: For AMR and AMR-WB, the default value shall be the rate of the recommended Initial Codec Mode, see Clause 7.5.2.1.6.
ECN_congestion_wait	The waiting time after an ECN-CE marking for which an up-switch shall not be attempted. A negative value indicates an infinite waiting time, i.e. to prevent up-switch for the whole remaining session. Default value: 5 seconds

The configuration of adaptation parameters, and the actions taken during the adaptation, are specific to the particular triggers. For example, the adaptation may be configured to reduce the media bit-rate to AMR5.9 when ECN-CE is detected, while it may reduce the media bit-rate to AMR4.75 for bad radio conditions when high PLR is detected.

Multiple ECN-CE markings within one RTP-level round-trip time is considered as the same congestion event. Each time an MTSI client detects a congestion event it shall send an adaptation request to reduce the media bit-rate unless already operating at the ECN\_min\_rate or below. An MTSI client detecting a congestion event shall not send an adaptation request to increase the media bit-rate for a time period ECN\_congestion\_wait after the end of the congestion event.

Multiple adaptation algorithms can be used in parallel, for example both ECN-triggered adaptation and PLR-triggered adaptation. When multiple adaptation algorithms are used for the rate adaptation, the rate that the MTSI client is allowed to use should be no higher than any of the rates determined by each adaptation algorithm.

**NOTE:** For example, if the ECN-triggered adaptation indicates that AMR5.9 should be used and if the PLR-triggered adaptation indicates that AMR4.75 should be used then the rate that the MTSI client uses should be no higher than  $\min(\text{AMR5.9}, \text{AMR4.75}) = \text{AMR4.75}$ . An example adaptation scheme is described in Annex C.

## 10.2.1 RTCP-APP with codec control requests

When signalling adaptation requests for speech in MTSI, an RTCP-APP packet should be used. This application-specific packet format supports three different adaptation requests; bit-rate requests, packet rate requests and redundancy requests. The RTCP-APP packet is put in a compound RTCP packets according to the rules outlined in RFC 3550 [9] and RFC 4585 [40]. In order to keep the size of the RTCP packets as small as possible it is strongly recommended that the RTCP packets are transmitted as minimal compound RTCP packets, meaning that they contain only the items:

- SR or RR;
- SDES CNAME item;
- APP (when applicable).

The recommended RTCP mode is RTCP-AVPF early mode since it will enable transmission of RTCP reports when needed and still comply with RTCP bandwidth rules. The RTCP-APP packets should not be transmitted in each RTCP packet, but rather as a result in the transport characteristics which require end-point adaptation.

The signalling allows for a request that the other endpoint modifies the packet stream to better fit the characteristics of the current transport link. Note that the media sender can, if having good reasons, choose to not comply with the request received from the media receiver. One such reason could be knowledge of that the local conditions do not allow the requested format.

The RTCP-APP packet defined to be used for adaptation signalling for speech in MTSI is constructed as shown in figure 10.1.

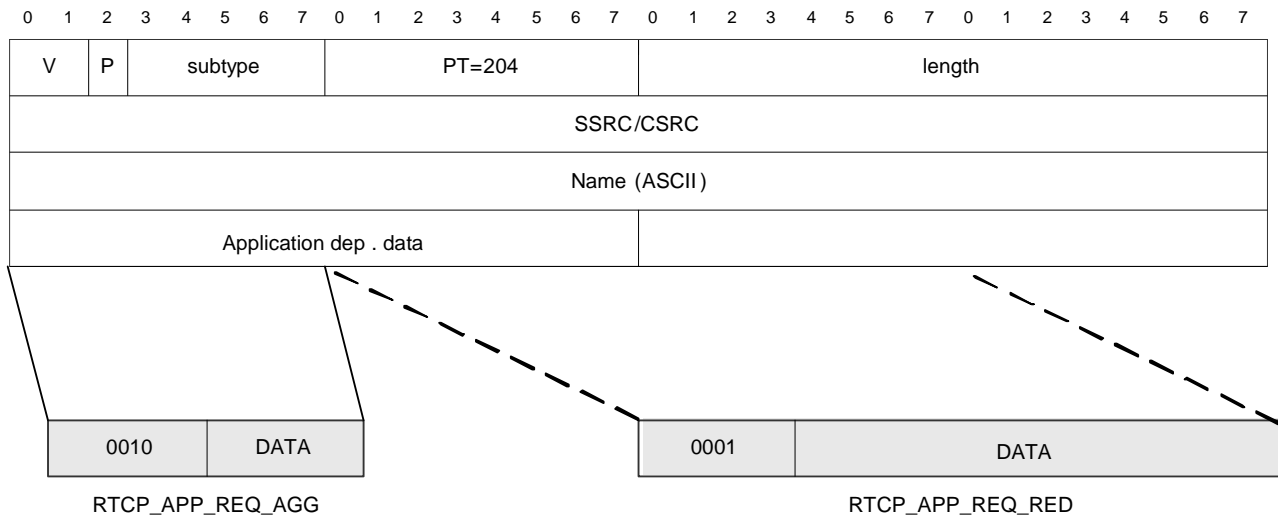
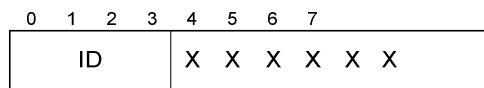

**Figure 10.1: RTCP-APP formatting**

The RTCP-APP specific fields are defined as follows:

- Subtype - the subtype value shall be set to "0".
- Name - the name shall be set to "3GM7", meaning 3GPP MTSI Release 7.

The application-dependent data field contains the requests listed below. The length of the application-dependent data shall be a multiple of 32 bits. The unused bytes shall be set to zero.



**Figure 10.2: Basic syntax of the application-dependent data fields**

The length of the messages is 1 or 2 bytes depending on request type.

The ID field identifies the request type. ID Code points [0000], [0001], [0010] and [0011] are specified in the present document, whereas the other ID code points are reserved for future use.

The signalling for three different adaptation requests is defined.

**RTCP\_APP\_REQ\_RED**: Request for redundancy level and offset of redundant data.

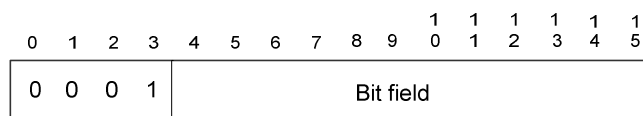

**Figure 10.3: Redundancy request**

The Bit field is a 12 bit bitmask that signals a request on how non-redundant payloads chunks are to be repeated in subsequent packets.

The position of the bit set indicates which earlier non-redundant payload chunks is requested to be added as redundant payload chunks to the current packet.

- If the LSB (rightmost bit) is set equal to 1 it indicates that the last previous payload chunk is requested to be repeated as redundant payload in the current packet.

- If the MSB (leftmost bit) is set equal to 1 it indicates that the payload chunk that was transmitted 12 packets ago is requested to be repeated as redundant payload chunk in the current packet. Note that it is not guaranteed that the sender has access to such old payload chunks.

The maximum amount of redundancy is 300 %, i.e., at maximum three bits can be set in the Bit field.

See clause 10.2.1 for example use cases.

**RTCP\_APP\_REQ\_AGG**: Request for a change of frame aggregation.

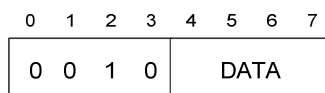

**Figure 10.4: Frame aggregation request**

The DATA field is a 4 bit value field:

- 0000 - 1 frame / packet.
- 0001 - 2 frames / packet.
- 0010 - 3 frames / packet.
- 0011 - 4 frames / packet.

The values 0100...1111 are reserved for future use.

The maximum allowed frame aggregation is also limited by the maxptime parameter in the session SDP since the sender is not allowed to send more frames in an RTP packet than what the maxptime parameter defines.

The default aggregation is governed by the ptime parameter in the session SDP. It is allowed to send fewer frames in an RTP packet, for example if there are no more frames available at the end of a talk spurt. It is also allowed to send more frames in an RTP packet, but such behaviour is not recommended.

See clauses 7.4.2 and 12.3.2.1 for further information.

**RTCP\_APP\_CMR**: Codec Mode Request

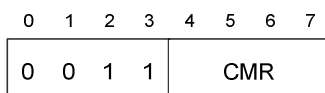

**Figure 10.5: Codec mode request**

The definition of the CMR bits in the RTCP\_APP\_CMR message is identical to the definition of the CMR bits defined in [28].

For an MTSI client in terminal the CMR should be transmitted in an RTCP\_APP\_CMR.

When the MTSI MGW has an interworking session with a circuit-switched (CS) system using transcoding, the CMR should be transmitted in an RTCP\_APP\_CMR to the MTSI client in terminal and the CMR in the AMR payload should be set to 15 (no mode request present [28]).

When the MTSI MGW has an interworking session with a circuit-switched (CS) system using TFO/TrFO, then the MTSI media gateway should translate the CMR bits (in GERAN case) or the Iu/Nb rate control messages (in UTRAN case) from the CS client into the CMR bits in the AMR payload. If the MTSI media gateway prefers to receive a lower codec mode rate from the MTSI client in terminal than what the CMR from the CS side indicates, then the MTSI media gateway may replace the CMR from the CS side with the CMR that the MTSI media gateway prefers. The value 15 (no mode request present [28]) shall be used in the CMR bits in the AMR payload towards the PS side if on the CS side no mode request has been received and if the MTSI media gateway has no preference on the used codec mode. The RTCP\_APP\_CMR should not be used in the direction from the MTSI media gateway towards the MTSI client when TFO/TrFO is used.

If an MTSI client receives CMR bits both in the AMR payload and in an RTCP\_APP\_CMR message, the mode with the lowest bit rate of the two indicated modes should be used. A codec mode request received in a RTCP\_APP\_CMR is valid until the next received RTCP\_APP\_CMR.

Figure 10.6 below illustrates how the three requests are used by the transmitter. In this case, RTCP\_APP\_REQ\_RED is equal to "000000000101".

- The speech encoder generates frames every 20 ms.
- The speech frames are buffered in the aggregation buffer until it is possible to generate a payload chunk with the number of frames requested by either pttime at session setup or by RTCP\_APP\_REQ\_AGG during a session.
- The current payload chunk is used when constructing the current RTP packet.
- The history buffer contains previously transmitted payload chunks. The length of this buffer needs to be dimensioned to store the maximum number of payload chunks that are possible. This value is based on the max-red value, the maxptime values and from the minimum number of frames that the transmitter will encapsulate in the RTP packets. In this case, the buffer length is selected to 11 payload chunks since this corresponds to the worst case of max-red=220, maxptime=240 and one frame per payload chunk.
- After transmitting the current RTP packet, the content of the history buffer is shifted, the current payload chunk is shifted in to the history buffer as P(n-1) and the oldest payload chunk P(n-11) is shifted out.
- When constructing the (provisional) RTP payload, the selected preceding payload chunks are selected from the history buffer and added to the current payload chunk. In order to form a valid RTP payload, the transmitter needs to verify that the maxptime value is not exceeded. If the provisional RTP payload is longer than what maxptime allows, then the oldest speech frames shall be removed until the length (in time) of the payload no longer violates the maxptime value. NO\_DATA frames in the beginning or at the end of the payload does not need to be transmitted and are therefore removed. The RTP Time Stamp needs to be incremented when a NO\_DATA frames are removed from the beginning of the payload. A (provisional) RTP packet containing only NO\_DATA frames does not need to be transmitted.

Note also that the transmitter is not allowed to send frames that are older than the max-red value that the transmitter has indicated in the SDP.

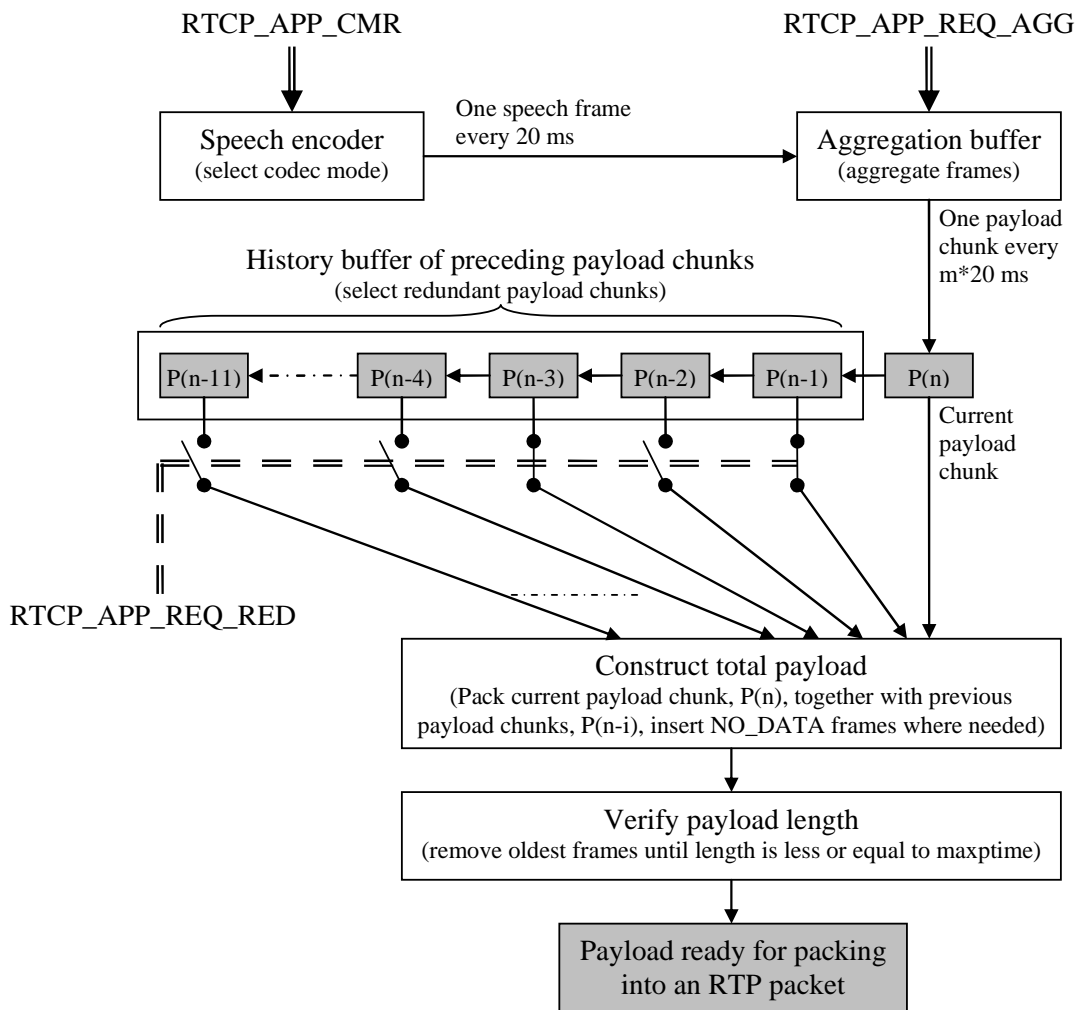

**Figure 10.6: Visualization of how the different adaptation requests affect the encoding and the payload packetization**

It should be noted that RTCP\_APP\_REQ\_AGG and RTCP\_APP\_REQ\_RED are independent. Furthermore, it should also be noted that different redundant payload chunks may contain different number of speech frames.

### 10.2.2 Example use cases

The following examples demonstrate how requests for redundancy and frame aggregation are realised in the RTP stream.

All examples assume that the speech codec generates frames numbered N-10...N in a continuous flow.

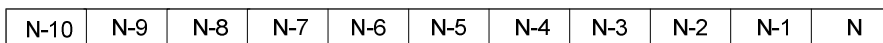

**Figure 10.7: Flow of parameter sets for encoded frames  
Each increment corresponds to a time difference of 20 ms**

In the examples below, P-1...P denote the sequence numbers of the packets.

EXAMPLE 1:

An RTCP\_APP\_REQ\_RED request with bit field 000000000000 (no redundancy) and RTCP\_APP\_REQ\_AGG request with value = 0 (no frame aggregation) will yield packets as shown in figure 10.8.

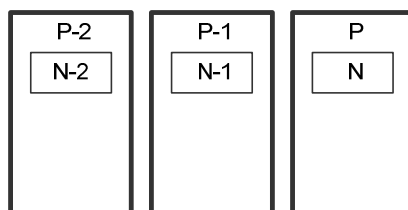

Figure 10.8: Default frame aggregation with one frame per packet

EXAMPLE 2:

An RTCP\_APP\_REQ\_RED request with bit field 000000000001 (100% redundancy and no offset) and an RTCP\_APP\_REQ\_AGG request with value = 0 (no frame aggregation) will yield packets as shown in figure 10.9.

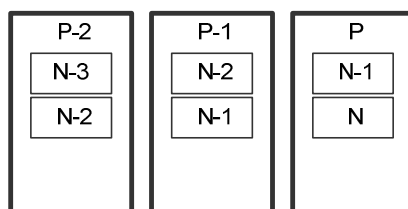

Figure 10.9: Payload packetization with 100 % redundancy and an offset of one packet

EXAMPLE 3:

An RTCP\_APP\_REQ\_RED request with bit field 000000000010 (100% redundancy with offset 1 extra packet) and an RTCP\_APP\_REQ\_AGG request with value = 0 (no frame aggregation) will yield packets as shown in figure 10.10.

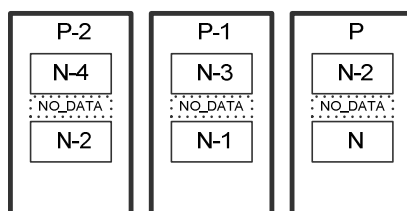

Figure 10.10: Payload packetization with 100 % redundancy and an extra offset of one packet

NO\_DATA frames must be inserted to fill the gaps between two non-consecutive frames, e.g. between N-2 and N.



EXAMPLE 4:

An RTCP\_APP\_REQ\_RED request with bit field 000000000000 (no redundancy) and RTCP\_APP\_REQ\_AGG request with value = 1 (frame aggregation 2 frames/packet) will yield packets as shown in figure 10.11.

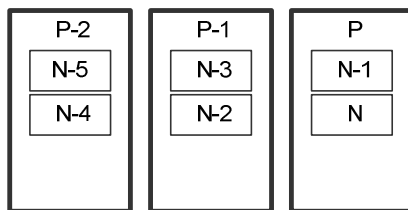

Figure 10.11: Payload packetization with 2 frames aggregated per packet

EXAMPLE 5:

An RTCP\_APP\_REQ\_RED request with bit field 000000000001 (100% redundancy) and an RTCP\_APP\_REQ\_AGG request with value = 1 (frame aggregation 2 frames/packet) will yield packets as shown in figure 10.12.

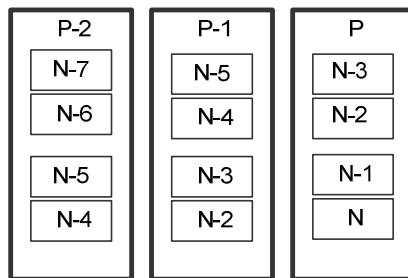

Figure 10.12: Payload packetization with 100 % redundancy and 2 frames aggregated per packet

EXAMPLE 6:

An RTCP\_APP\_REQ\_RED request with bit field 000000000010 (100% redundancy with offset 1 extra packet) and an RTCP\_APP\_REQ\_AGG request with value = 1 (frame aggregation 2 frames/packet) will yield packets as shown in figure 10.13.

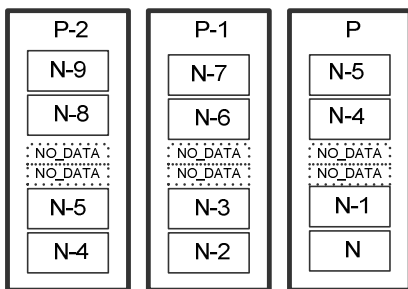

Figure 10.13: Payload packetization with 100 % redundancy, one extra offset and 2 frames aggregated per packet

## 10.3 Video

MTSI clients receiving RTCP Receiver Reports (RR) indicating nonzero packet loss should adjust their outgoing bitrate accordingly (see RFC 3550 [9]). Note that for IMS networks, which normally have nonzero packet loss and fairly long round-trip delay, the amount of bitrate reduction specified in RFC 3448 [56] is generally too restrictive for video and may, if used as specified, result in very low video bitrates already at (for IMS) moderate packet loss rates.

It is recommended that a video sender adapts its video output rate based on RTCP reports and TMMBR messages. This adaptation should be performed while maintaining a balance between spatial quality and temporal resolution, which matches the bitrate and image size. Some examples are given in clause B. For the handling of packet loss signaled through AVPF NACK and PLI, or for rate adaptation with RTCP reports and TMMBR messages, it is recommended that video sender is able to dynamically adapt to the reported conditions, in particular to facilitate the operation of quality-recovery techniques pertinent to the situations. Quality-recovery techniques include, but may not be limited to, adapted intra frame periods, adaptation of random intra macroblock refresh ratios, and adaptation of the bit rates.

If the receiving MTSI client in terminal is made aware of a reduction in downlink bandwidth allocation through an explicit indication of the available bandwidth from the network (e.g. due to QoS renegotiation or handoff to another radio access technology), or from measurements such as increased delay at the receiver it shall notify the sender of the new current maximum bitrate using TMMBR. In this context the TMMBR message is used to quickly signal to the other party a reduction in available bitrate. The sending MTSI client, receiving TMMBR, shall respond by sending TMMBN, as described in CCM [43]. To determine TMMBR and TMMBN content, both sending MTSI client and receiving MTSI client in terminal shall use their best estimates of packet measured overhead size when measured overhead values are not available. If the TMMBR message was sent due to an explicit indication of available bandwidth, the MTSI client in terminal that sent the TMMBR message shall, after receiving the TMMBN, send a SIP UPDATE to the other party to establish the new rate as specified in clause 6.2.7.

If the receiving MTSI client in terminal is made aware of an increase in downlink bandwidth allocation (determined via separate negotiation) through an explicit indication from the network (e.g. due to QoS renegotiation or handoff to another radio access technology) then, if this has not yet occurred, it shall send a SIP UPDATE to the other party to establish the new rate as specified in clause 6.2.7.

## 10.4 Text

Rate adaptation (downgrade of used bandwidth) of text shall follow the recommendation in clause 9 of RFC 4103 [31]. RTCP reports are used as indicator of loss rate over the channel.

When the transmission interval has been increased in order to handle a congestion situation, return to normal interval shall be done when RTCP reports low loss.

## 10.5 Explicit Congestion Notification

When the eNodeB experiences congestion it may set the ECN bits in the IP header to '11' to indicate "Congestion Experienced" for packets that have been marked with ECN Capable Transport (ECT), [83], [84].

Adaptation requests should be sent in response to ECN congestion events. Clause 10.2 describes adaptation for speech when ECN-CE is detected.

---

# 11 Front-end handling

## 11.1 General

Terminals used for MTSI shall conform to the minimum performance requirements on the acoustic characteristics of 3G terminals specified in 3GPP TS 26.131 [35]. The codec modes and source control rate operation (DTX) settings shall be as specified in 3GPP TS 26.132 [36].

Furthermore, the test point (Point-of-Interconnect (POI)) specified in [35] shall be a reference terminal capable of receiving digital speech data at the send side and producing a digital output of the received signal (see figure 11.1).

During the testing, the radio conditions should be error free and the jitter and packet loss in the IP transport shall be kept to a minimum.

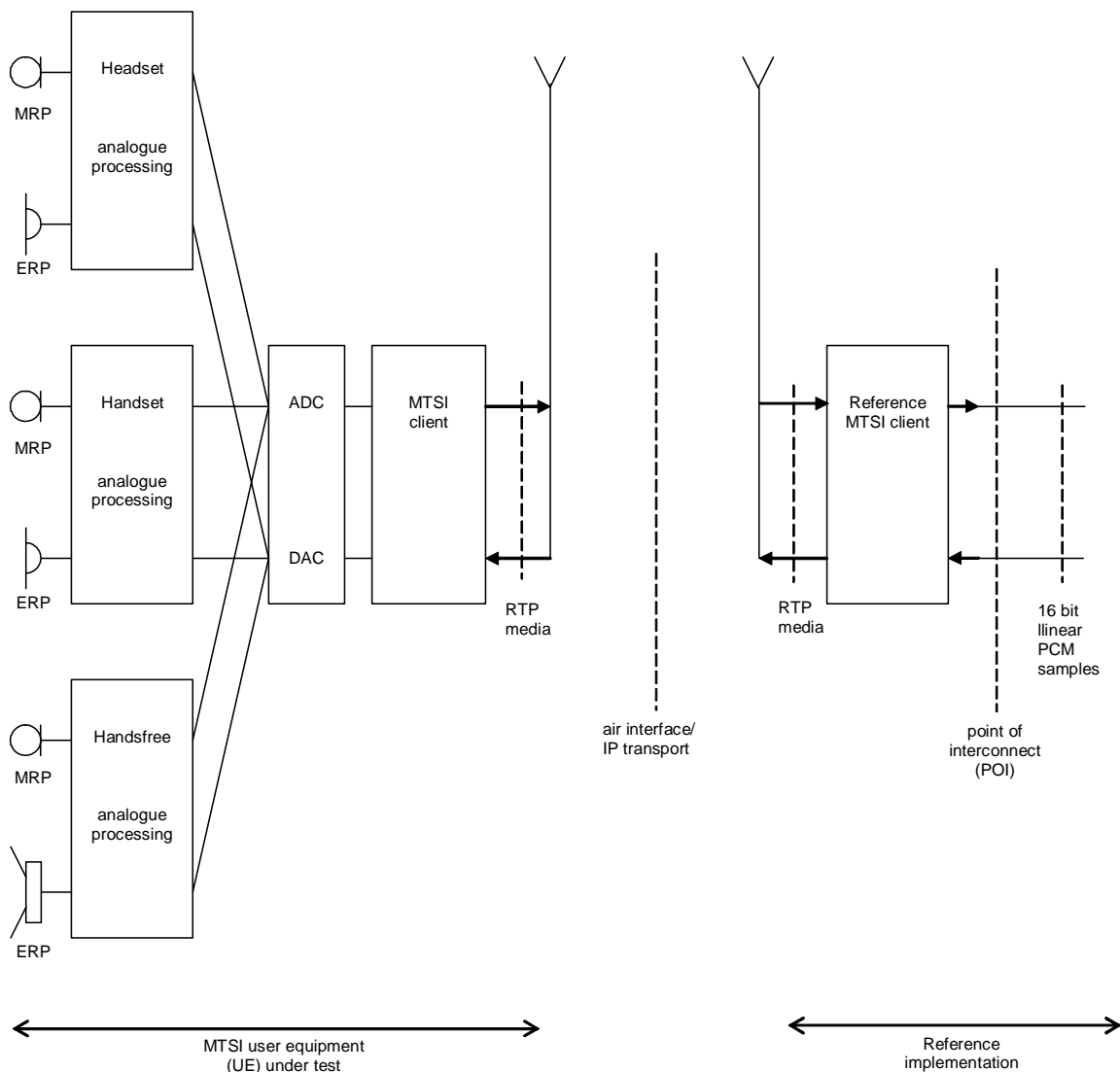

Figure 11.1: Interface for testing acoustic properties of a terminal used for MTSI

## 12 Inter-working

### 12.1 General

In order to support inter-working between different networks it is good if common codecs for the connection can be found. Requirements for different networks are described in this clause. In some cases functionality is also needed in the network to make the inter-working possible (e.g. MGCF and MGW).

**NOTE:** The term MTSI MGW (or MTSI Media gateway) is used in a broad sense, as it is outside the scope of the current specification to make the distinction whether certain functionality should be implemented in the MGW or in the MGCF.

## 12.2 3G-324M

### 12.2.1 General

Inter-working functions are required between IMS and CS. There are separate functions, in e.g. a MGCF, for control-plane inter-working (see 3GPP TS 29.163 [65]) and, in e.g. a IM-MGW, for user-plane inter-working. Control-plane inter-working includes for instance SIP ↔ BICC and SIP ↔ H.245 protocol translations, whereas user-plane inter-working requires transport protocol translations and possibly transcoding.

### 12.2.2 Codec usage

#### 12.2.2.1 General

An interoperable set of speech, video and real-time text codecs is specified for 3G-324M and MTSI. For video there is a difference in levels, which mainly affects the maximum bitrate. Both video codec level and maximum bitrate can be specified as part of the call setup negotiation (see clause 12.2.5). Thus, it is very likely that the MTSI client in terminal and a CS UE can agree on a common codec end-to-end without the need for MGW transcoding.

If a common codec is not found and the MTSI MGW does not support transcoding between any of the supported codecs, then the controlling MGCF may drop the unsupported media component. If the speech part cannot be supported, then the connection should not be set up.

#### 12.2.2.2 Text

A channel for real-time text is specified in ITU-T H.324. Presentation and coding is specified according to ITU-T Recommendation T.140, which is also used for MTSI clients (see clause 7.4.4). Inter-working is a matter of establishing the text transport channels and moving the text contents between the two transport levels.

### 12.2.3 Payload format

See clause 7.4 of the present document.

### 12.2.4 MTSI media gateway trans-packetization

#### 12.2.4.1 General

The MTSI MGW shall offer conversion between H.223 as used in 3G-324M on the CS side and RTP as used in IMS. This clause contains a list inter-working functionalities that should be included.

#### 12.2.4.2 Speech de-jitter buffer

The MTSI MGW should use a speech de-jitter buffer in the direction IMS to CS with sufficient performance to meet the 10 milliseconds maximum jitter requirement in clause 6.7.2 of ITU-T Recommendation H.324. H.324 specifies that transmission of each speech AL-SDU at the H.223 multiplex shall commence no later than 10 milliseconds after a whole multiple of the speech frame interval, measured from transmission of the first speech frame.

#### 12.2.4.3 Video bitrate equalization

Temporary video rate variations can occur on the IMS side for example due to congestion. The video rate on the CS side, in contrast, is under full control of the CS side UE and the MGCF.

During session setup, the MGCF shall negotiate a video bitrate on the IMS side that allows all video bits to be conveyed to/from the CS link.

A buffer shall be maintained at the IM-MGW in the direction from the IMS to the CS side. The size of the buffer should be kept small enough to allow for a low end-to-end delay, yet large enough to conceal most network jitter on the IMS side. Temporary uneven traffic on the IMS side, beyond the handling capability of the buffer, should be handled as follows: if the buffer overflows, RTP packets should be dropped and the resulting loss and observed jitter should be

reported by the means of an RTCP RR at the earliest possible sending time. The drop strategy may preferably be implemented media aware (i.e. favouring dropping predicted information over non-predicted information and similar techniques), or may be drop-head. If the buffer runs empty, the CS side should insert appropriate flag stuffing.

A buffer shall be maintained in the direction from the CS to the IMS side. The size of the buffer should be kept small enough to allow for a low end-to-end delay, but large enough to conceal most network jitter on the CS side. If the buffer overflows, then video bits must be dropped, preferably in a media-aware fashion, i.e. at GOB/slice/picture boundaries. IM-MGWs may also take into account the type of media data, i.e. coded with or without prediction. When the buffer runs empty, no activity is required on the IMS side.

If the CS video call is changed to a speech-only call [46], the video component on the IMS side shall be dropped.

#### 12.2.4.4 Data loss detection

If RTP packet loss is detected on input to the MTSI MGW at the IMS side, including losses caused by buffer-full condition as described above, corresponding H.223 AL-SDU sequence number increments should be made on the CS side to enable loss detection and proper concealment in the receiving CS UE.

If packet loss is detected on the CS side, e.g. through H.223 AL-SDU sequence numbers, those losses should be indicated towards the IMS side through corresponding RTP packet sequence number increments. The deliberate increments made for this reason will be visible in the RTCP RR from the MTSI client and the MTSI MGW should take that into account when acting on RTCP RR from the MTSI client, as the CS side losses are not related to the IMS network conditions.

#### 12.2.4.5 Data integrity indication

This is mainly relevant in the direction from CS to IMS. The H.223 AL-SDUs include a CRC that forms an unreliable indication of data corruption. On the IMS side, no generic protocol mechanisms are available to convey this CRC and/or the result of a CRC check. The MTSI MGW shall discard any AL-SDUs which fail a CRC check and are not of a payload type that supports the indication of possible bit errors in the RTP payload header or data. If such payload type is in use, the MTSI MGW may forward corrupted packets, but in this case shall indicate the possible corruption by the means available in the payload header or data. One example is setting the Q bit of RFC 3267 [28] to 0 for AMR speech data that was carried in an H.223 AL-SDU with CRC indicating errors. Another example is setting the F bit of RFC 3984 [25] for H.264 NAL units that may contain bit errors.

The H.223 AL-SDU CRC is not fully fail-safe and it is therefore recommended that a MTSI client is designed to be robust and make concealment of corrupt media data, similar to the CS UE.

#### 12.2.4.6 Packet size considerations

##### 12.2.4.6.0 General

The same packet size and alignment requirements and considerations as defined in clause 7.5.2 of the present document and in 3GPP TS 26.111 [45] apply to the MTSI MGW and controlling MGCF, as it in that sense acts both as a MTSI client towards the IMS and as a CS UE towards the CS side. Maximum available buffer size for packetization of media data may differ between IMS and CS UE. To avoid non-favourable segmentation of data (especially video) by the MTSI MGW, the controlling MGCF should indicate the SDP 'a' attribute "3gpp\_MaxRecvSDUSize" to the MTSI client in terminal. This attribute indicates the maximum SDU size of the application data (excluding RTP/UDP/IP headers) that can be transmitted to the receiver without segmentation. The specific maximum SDU size limit is determined by the MGCF from the H.245 bearer capability exchange between the CS UE and the MGCF. For example, the MTSI MGW determines this through the maximumA12SDUSize and maximumA13SDUSize fields of the H223Capability member in H.245 TerminalCapabilitySet message.

##### 12.2.4.6.1 The Maximum Receive SDU Size attribute "3gpp\_MaxRecvSDUSize"

The ABNF for the maximum receive SDU size attribute is described as follows:

```
Max-recv-SDU-size-def = "a" "=" "3gpp_MaxRecvSDUSize" ":" size-value CRLF
```

```
size-value           = 1*5DIGIT; 0 to 65535 in octets
```

The value "size-value" indicates the maximum SDU size of application data, excluding RTP/UDP/IP headers, that can be transmitted to the other end point without segmentation.

The parameter "3gpp\_MaxRecvSDUSize" should be included in the SDP at the session level and/or at the media level. Its usage is governed by the following rules:

1. At the session level, the "3gpp\_MaxRecvSDUSize" attribute shall apply to the combination of the data from all the media streams in the session.
2. At the media level, the "3gpp\_MaxRecvSDUSize" attribute indicates to the MTSI client in terminal that this particular media stream in the session has a specific maximum SDU size limit beyond which received SDUs will be segmented before delivery to the CS UE.
3. If the "3gpp\_MaxRecvSDUSize" attribute is included at the session and media levels, then the particular media streams have specific maximum SDU size limits for their own data while the session has an overall maximum SDU size limit for all the media data in the session.

The MGCF includes the "3gpp\_MaxRecvSDUSize" attribute in the SDP offer or answer sent to the MTSI client in terminal after the MGCF determines the bearer capability of the CS UE (see Annex E of [65]). Upon reception of the SDP offer or answer that includes the "3gpp\_MaxRecvSDUSize" attribute, the MTSI client in terminal need not include this attribute in its subsequent exchange of messages with the MTSI MGW.

There are no offer/answer implications on the "3gpp\_MaxRecvSDUSize" attribute. The "3gpp\_MaxRecvSDUSize" attribute in the SDP from the MTSI MGW is only an indication to the MTSI client in terminal of the maximum SDU size that avoids segmentation for the specified media streams and/or session.

NOTE: Default operation in the absence of the "3gpp\_MaxRecvSDUSize" attribute in SDP is to not have any SDU size limits for any of the media streams or session.

#### 12.2.4.7 Setting RTP timestamps

In general, no explicit timestamps exist at the CS side. Even without transcoding functionality, the MTSI MGW may have to inspect and be able to interpret media data to set correct RTP timestamps.

#### 12.2.4.8 Protocol termination

The MTSI MGW shall terminate the H.223 protocol at the CS side. Similarly, the MTSI MGW shall terminate RTP and RTCP at the IMS side.

#### 12.2.4.9 Media synchronization

The IM-MGW and controlling MGCF should forward and translate the timing information between the IMS side (RTP timestamps, RTCP sender reports) and the CS side (H.245 message H223SkewIndication) to allow for media synchronization in the MTSI client in terminal and the CS UE. The MTSI MGW shall account for its own contribution to the skew in both directions. Note that transmission timing of H223SkewIndication and RTCP SR must be decoupled. H223SkewIndication has no timing restrictions, but is typically sent only once in the beginning of the session. RTCP SR timing is strictly regulated in RFC 3550 [9], RFC 4585[40], and clause 7.3. To decouple send timings, the time shift information conveyed in H223SkewIndication and RTCP SR must be kept as part of the MTSI MGW/MGCF session state. H223SkewIndication should be sent at least once, and may be sent again when RTCP SR indicates a synchronization change. A synchronization change of less than 50 ms (value to be confirmed) should be considered insignificant and need not be signalled.

NOTE: This procedure is not supported in the present Release in a decomposed MGCF and IM-MGW, as H.245 is treated on the MGCF and RTCP is sent at the IM-MGW, and no means are defined to forward information from the H223SkewIndication over the Mn interface.

#### 12.2.5 Session control

The MGCF shall offer translation between H.245 and SIP/SDP signalling according to 3GPP TS 29.163 [65] to allow for end-to-end capability negotiation.

## 12.3 GERAN/UTRAN CS inter-working

This clause defines requirements only for the PS side of the MGW, i.e. for the PS session in-between the MTSI client in a terminal and the MGW. The CS side of the MGW, i.e. in-between the MGW and the CS terminal, is out of scope of this clause.

### 12.3.0 3G-324M

If 3G-324M is supported in the GERAN/UTRAN CS, then the inter-working can be made as specified in clause 12.2.

### 12.3.1 Codecs for MTSI media gateways

#### 12.3.1.1 Speech

MTSI media gateways supporting speech communication between MTSI clients and non-MTSI networks and terminals operating in the CS domain in GERAN and UTRAN should support Tandem-Free Operation (TFO) according to 3GPP TS 28.062 [37], and Transcoder-Free Operation (TrFO), see 3GPP TS 23.153 [38].

MTSI media gateways supporting speech communication and supporting TFO and/or TrFO shall support:

- AMR speech codec modes 12.2, 7.4, 5.9 and 4.75 [11], [12], [13], [14] and source-controlled rate operation [15].

MTSI media gateways should also support the other codec types and configurations as defined in Clause 5.4 in [16].

In the receiving direction, from the MTSI client in the terminal, the MTSI media gateway shall be capable of restricting codec mode changes to be aligned to every other frame border and shall be capable of restricting codec mode changes to neighbouring codec modes within the negotiated codec mode set.

NOTE: This means that the MTSI client in a terminal will apply and accept mode changes according to UMTS AMR2 [16]. An example of an SDP offer for how the MTSI MGW can restrict AMR mode changes in the MTSI client in a terminal is shown in Table A.2.1. An example of an SDP answer from the MTSI MGW for restricting the mode changes in the MTSI client in a terminal is shown in Table A.3.4a.

MTSI media gateways supporting wideband speech communication at 16 kHz sampling frequency and supporting TFO and/or TrFO for wideband speech shall support:

- AMR wideband codec 12.65, 8.85 and 6.60 [17], [18], [19], [20] and source controlled rate operation [21].

MTSI media gateways supporting wideband speech communication at 16 kHz sampling frequency should also support the other codec types and configurations as defined in [16].

In the receiving direction, from the MTSI client in the terminal, the MTSI media gateway shall be capable of restricting codec mode changes to be aligned to every other frame border and shall be capable of restricting codec mode changes to neighbouring codec modes within the negotiated codec mode set.

NOTE: This means that the MTSI client in a terminal will apply and accept mode changes according to UMTS AMR-WB [16]. An example of an SDP offer for how the MTSI MGW can restrict AMR and AMR-WB mode changes in the MTSI client in a terminal is shown in Table A.2.4. An example of an SDP answer from the MTSI MGW for restricting the mode changes in the MTSI client in a terminal is shown in Table A.3.4.

MTSI clients supporting wideband speech communication shall also support narrowband speech communications. When offering both wideband speech and narrowband speech communication, wideband shall be listed as the first payload type in the m line of the SDP offer (RFC 4566 [8]).

Requirements applicable to MTSI media gateways for DTMF events are described in Annex G.

#### 12.3.1.2 Text

The CTM coding format defined in 3GPP TS 26.226 [52] is used for real time text in CS calls. In order to arrange inter-working, a transcoding function between CTM and RFC 4103 is required in the MTSI media gateway. A buffer shall be used for rate adaptation between receiving text from a real-time text transmitter according to the present

document and transmitting to a CTM receiver. A gateway buffer of 2K characters is considered sufficient according to clause 13.2.4 in EG 202 320 [51].

## 12.3.2 RTP payload formats for MTSI media gateways

### 12.3.2.1 Speech

MTSI media gateways shall support the bandwidth-efficient payload format and should support the octet-aligned payload format. When offering both payload formats, the bandwidth-efficient payload format shall be listed before the octet-aligned payload format in the preference order defined in the SDP.

The MTSI media gateway should use the SDP parameters defined in table 12.1 for the session.

For all access technologies and for normal operating conditions, the MTSI media gateway should encapsulate the number of non-redundant speech frames in the RTP packets that corresponds to the ptime value received in SDP from the other MTSI client, or if no ptime value has been received then according to "Recommended encapsulation" defined in table 12.1. The MTSI media gateway may encapsulate more non-redundant speech frames in the RTP packet but shall not encapsulate more than 4 non-redundant speech frames in the RTP packets. The MTSI media gateway may encapsulate any number of redundant speech frames in an RTP packet but the length of an RTP packet, measured in ms, shall never exceed the maxptime value.

**Table 12.1: Recommended encapsulation parameters**

Access technology	Recommended encapsulation (if no ptime and no RTCP_APP_REQ_AGG has been received)	ptime	maxptime when redundancy is not supported	maxptime when redundancy is supported
Default	1 non-redundant speech frame per RTP packet Max 4 or 12 speech frames in total depending on whether redundancy is supported but not more than a received maxptime value requires	20	80	240
HSPA E-UTRAN	1 non-redundant speech frame per RTP packet Max 4 or 12 speech frames in total depending on whether redundancy is supported but not more than a received maxptime value requires	20	80	240
EGPRS	2 non-redundant speech frames per RTP packet but not more than a received maxptime value requires Max 4 or 12 speech frames in total depending on whether redundancy is supported but not more than a received maxptime value requires	40	80	240
GIP	1 to 4 non-redundant speech frames per RTP packet but not more than a received maxptime value requires Max 12 speech frames in total but not more than a received maxptime value requires	20, 40, 60 or 80	N/A	240

When the access technology is not known to the MTSI media gateway, the default encapsulation parameters defined in Table 12.1 shall be used.



The SDP offer shall include an RTP payload type where `octet-align=0` is defined or where `octet-align` is not specified and should include another RTP payload type with `octet-align=1`. MTSI media gateways offering wide-band speech shall offer these parameters and parameter settings also for the RTP payload types used for wide-band speech.

MTSI media gateways should support redundancy according to clause 9.

NOTE: Support of transmitting redundancy may be especially useful in the case an MTSI media gateway is aware of the used access technology and knows that the Generic Access technology is used.

### 12.3.2.2 Text

Both CTM according to TS 26.226 [52] and RFC 4103 make use of ITU-T Recommendation T.140 presentation and character coding. Therefore inter-working is a matter of payload packetization and CTM modulation/demodulation.

## 12.3.3 Explicit Congestion Notification

An MTSI MGW can be used to enable ECN between the MTSI client in terminal and the MTSI MGW when inter-working with CS GERAN/UTRAN.

If ECN is supported in the MTSI MGW, then the MTSI MGW shall also:

- support ECN as described in this specification for the MTSI client in terminal, except that the MTSI MGW does not determine whether ECN can be used based on the Radio Access Technology that is used towards the MTSI client in terminal;
- support RTP/AVPF and SDPCapNeg;
- be capable of enabling end-to-end rate adaptation between the MTSI client in terminal and the CS terminal by performing the following:
  - negotiate the use of ECN with the MTSI client in terminal, if it can be confirmed that the network used towards the MTSI client in terminal properly handles ECN-marked packets;
  - inter-work adaptation requests between the MTSI client in terminal and the CS GERAN/UTRAN;

## 12.4 PSTN

### 12.4.1 3G-324M

If 3G-324M is supported in the PSTN, then the inter-working can be made as specified in clause 12.2.

### 12.4.2 Text

PSTN text telephony inter-working with PS environments is described in ITU-T Recommendation H.248.2 [50] and further elaborated in EG 202 320 [51].

Text telephony modem tones are sensitive to packet loss, jitter and echo canceller behaviour. Therefore, conversion of modem based transmission of real-time text is best done at the border of the PSTN. If PSTN text telephone tones need to be carried audio coded in a PS network, considerations must be taken to carry them reliably as for example specified in ITU-T Recommendations V.151 [54] and V.152 [55].

When inter-working with PSTN text telephones, it must be considered that in PSTN most text telephone communication methods do not allow simultaneous speech and text transmission. An MTSI client in terminal indicating text capability shall not automatically initiate text connection efforts on the PSTN circuit. Instead, either a requirement for text support should be required from the MTSI client in terminal, active transmission of text from the MTSI client in terminal, or active transmission of text telephone tones from the PSTN terminal. See clause 13 of EG 202 320 [51].

Note that the primary goal of real-time text support in MTSI is not to offer a replica of PSTN text telephony functionality. On the contrary, real-time text in MTSI is aiming at being a generally useful mainstream feature, complementing the general usability of the Multimedia Telephony Service for IMS.

## 12.5 GIP inter-working

### 12.5.1 Text

RFC 4103 [31] and T.140 are specified as default real-time text codec in SIP telephony devices in RFC 4504 [53]. When GIP implements this codec, the media stream contents are identical for the two environments. Packetization will also in many cases be equal, while consideration must be taken to cope with different levels of redundancy and possible use of different media security and integrity measures.

### 12.5.2 Speech

See Clause 12.7.

## 12.6 TISPAN/NGN inter-working

### 12.6.1 Text

The codec and other considerations for real-time text described in the present document apply also to TISPAN/NGN. There are thus no inter-working considerations on the media level.

### 12.6.2 Speech

See Clause 12.7.

## 12.7 Inter-working with other IMS and non-IMS IP networks

### 12.7.1 General

IMS and MTSI services are required to support inter-working with similar services operating on other IP networks, both IMS based and non-IMS based, [2]. It is an operator option to provide transcoding when the end-to-end codec negotiation fails to agree on a codec to be used for the session. The requirements herein applies to MTSI MGWs when such transcoding is provided.

These requirements were designed for sessions carried with IP end-to-end, possibly inter-connected through one or more other IP networks.

A main objective is to harmonize the requirements for this inter-working case with the requirements for GERAN/UTRAN CS inter-working defined in Clause 12.3. There is however one major difference as the MGW requirements in Clause 12.3 apply only to the PS side of the MTSI MGW, i.e. between the MTSI MGW and the MTSI client in the terminal, while here there are requirements for the MTSI MGW both towards the MTSI client in the terminal and towards the remote network.

Most requirements included here apply only to the PS access towards the remote network but there are also requirements that target both the local MTSI client in terminal and the remote network or even only the local MTSI client.

### 12.7.2 Speech

#### 12.7.2.1 General

This clause defines how speech media should be handled in MTSI MGWs in inter-working scenarios between an MTSI client in terminal operating within a 3GPP IMS network and a non-3GPP IP network. This clause therefore define requirements for what the MTSI MGW needs to support and how it should behave during session setup and session modification. A few SDP examples are included in Annex A.10.

### 12.7.2.2 Speech codecs and formats

MTSI MGWs offering speech communication between an MTSI client in a terminal and a client in another IP network through a Network-to-Network Interface (NNI) shall support:

- AMR speech codec modes 12.2, 7.4, 5.9 and 4.75 [11], [12], [13], [14] and source-controlled rate operation [15], both towards the local MTSI client in terminal and towards the remote network;
- G.711, both A-law and  $\mu$ -law PCM, [77], towards the remote network.

and should support:

- linear 16 bit PCM (L16) at 8 kHz sampling frequency, towards the remote network.

When such MTSI MGWs also offer wideband speech communication they shall support:

- AMR wideband codec 12.65, 8.85 and 6.60 [17], [18], [19], [20] and source controlled rate operation [21] , both towards the local MTSI client in terminal and towards the remote network;

and should support:

- G.722 (SB-ADPCM) at 64 kbps, [78], towards the remote network; and
- linear 16 bit PCM (L16) at 16 kHz sampling frequency, towards the remote network.

If the remote network supports AMR for narrowband speech and/or AMR-WB for wideband speech, then transcoding shall be avoided whenever possible. In this case, the MTSI MGW should not be included in the RTP path. If the MTSI MGW is included in the RTP path then it shall support forwarding the RTP payload regardless of codec mode and packetization.

**NOTE:** An example of where transcoding may be required when AMR and/or AMR-WB are supported by the remote network is when the remote terminal is limited to modes that are not supported by the local MTSI client in terminal due to operator configuration.

If the MTSI MGW is performing transcoding of AMR or AMR-WB then it shall be capable of restricting mode changes, both mode change period and mode changes to neighboring mode, if this is required by the remote network.

Requirements applicable to MTSI MGW for DTMF events are described in Annex G.

### 12.7.2.3 Codec preference order for session negotiation

It is important to optimize the quality-bandwidth compromise, even though the NNI uses a fixed IP network. For this reason, the following preference order should be used by MTSI MGWs unless another preference order is defined in bilateral agreements between the operators or configured otherwise by the operator:

- The best option is if a codec can be used end-to-end. For example, using AMR or AMR-WB end-to-end is preferable over transcoding through G.711 or G.722 respectively.
- The second best solution is to use G.711 or G.722 as inter-connection codecs, for narrow-band and wide-band speech respectively, since these codecs offer a good quality while keeping a reasonable bit rate.
- The linear 16 bit PCM format should only be used as the last resort, when none of the above solutions are possible.

If a wide-band speech session is possible, then fall-back to narrow-band speech should be avoided whenever possible, unless another preference order is indicated in the SDP.

**NOTE:** There may be circumstances, for example bit rate constraints, when a fall-back to narrow-band speech is acceptable since the alternative would be a session setup failure.

#### 12.7.2.4 RTP profiles

MTSI MGWs offering speech communication over the NNI shall support the RTP/AVP profile and should support the RTP/AVPF profile, [40]. If the RTP/AVPF profile is supported then the SDP Capability Negotiation (SDPCapNeg) framework shall also be supported, [69].

#### 12.7.2.5 RTP payload formats

The payload format to be used for AMR and AMR-WB encoded media is defined in Clause 12.3.2.1. The MTSI MGW shall support the following payload SDP parameters for AMR and AMR-WB: octet-align, mode-set, mode-change-period, mode-change-capability, mode-change-neighbor, maxptime, ptime, channels and max-red.

The payload format to be used for G.711 encoded media is defined in RFC 3551, [10], for both  $\mu$ -law (PCMU) and A-law (PCMA).

The payload format to be used for G.722 encoded media is defined in RFC 3551, [10].

NOTE: The sampling frequency for G.722 is 16 kHz but is set to 8000 Hz in SDP since it was (erroneously) defined this way in the original version of the RTP A/V profile, see [10].

The payload format to be used for linear 16 bit PCM is the L16 format defined in RFC 3551, [10]. When this format is used for narrow-band speech then the rate (sampling frequency) indicated on the a=rtpmap line shall be 8000. When this format is used for wide-band speech then the rate (sampling frequency) indicated on the a=rtpmap line shall be 16000.

#### 12.7.2.6 Packetization

For the G.711, G.722 and linear 16 bit PCM formats, the frame length shall be 20 ms, i.e. 160 and 320 speech samples in each frame for narrow-band and wide-band speech respectively.

MTSI MGWs offering speech communication over the NNI shall support encapsulating up to 4 non-redundant speech frames into the RTP packets.

MTSI MGWs may support application layer redundancy. If redundancy is supported then the MTSI MGW should support encapsulating up to 8 redundant speech frames in the RTP packets. Thereby, an RTP packet may contain up to 12 frames, up to 4 non-redundant and up to 8 redundant frames.

The MGW should use the packetization schemes indicated by the ptime value in the SDP offer and answer. If no ptime value is present in the SDP then the MGW should encapsulate 1 frame per packet or the packetization used by the end-point clients.

The MTSI MGW should preserve the packetization used by the end-point clients. The packet size can become quite large for some combinations of formats and packetization. If the packet size exceeds the Maximum Transfer Unit (MTU) of the network then the MTSI MGW should encapsulate fewer frames per packet.

NOTE: It is an implementation consideration to determine the MTU of the network. RFC 4821 [79] describes one method that can be used to discover the path MTU.

When the MTSI MGW does not perform any transcoding then it shall be transparent to the packetization schemes used by the end-point clients.

#### 12.7.2.7 RTCP usage and adaptation

The RTP implementation shall include an RTCP implementation.

MTSI MGWs offering speech should support AVPF (RFC 4585 [40]) configured to operate in early mode. When allocating RTCP bandwidth, it is recommended to allocate RTCP bandwidth and set the values for the "b=RR:" and "b=RS:" parameters such that a good compromise between the RTCP reporting needs for the application and bandwidth utilization is achieved, see also SDP examples in Annex A.10. The value of "trr-int" should be set to zero or not transmitted at all (in which case the default "trr-int" value of zero will be assumed) when Reduced-Size RTCP (see clause 7.3.6) is not used.

For speech sessions, between the MTSI client in terminal and the MTSI MGW, it is beneficial to keep the size of RTCP packets as small as possible in order to reduce the potential disruption of RTCP onto the RTP stream in bandwidth-limited channels. RTCP packet sizes can be minimized by using Reduced-Size RTCP packets or using the parts of RTCP compound packets (according to RFC 3550 [9]) which are required by the application.

The MTSI MGW shall be capable of adapting the session to handle possible congestion. For AMR and AMR-WB encoded media, the MTSI MGW shall support the adaptation signalling method using RTCP APP packets as defined in clause 10.2, both towards the MTSI client in terminal and towards the remote network. As the codec in the remote network may or may not support the RTCP APP signalling method, the MTSI MGW shall also be capable of using the inband CMR in the AMR payload. The MTSI MGW shall be capable of detecting whether the remote network is capable of using the RTCP APP signalling method. If this method is not supported then the MTSI MGW shall be capable of moving the AMR rate control signalling (CMR) from RTCP APP packets received, from the MTSI client in terminal, to the inband CMR in the payload that is sent to the remote network. When receiving inband CMR in the payload from the remote network, the MTSI MGW does not need to move the adaptation signalling to RTCP APP packets before sending it to the MTSI client in terminal.

For PCM, G.722 and linear 16 bit PCM encoded media, the MTSI MGW shall support RFC 3550 for signalling the experienced quality using RTCP Sender Reports and Receiver Reports.

For a given RTP based media stream to/from the MTSI client in terminal, the MTSI MGW shall transmit RTCP packets from and receive RTCP packets to the same port number.

For a given RTP based media stream to/from the remote network, the MTSI MGW shall transmit RTCP packets from and receive RTCP packets on the same port number, not necessarily the same port number as used to/from the MTSI client in terminal.

This facilitates inter-working with fixed/broadband access. However, the MTSI MGW may, based on configuration or local policy, accept RTCP packets that are not received from the same remote port where RTCP packets are sent by either the MTSI client in terminal or the remote network.

#### 12.7.2.8 RTP usage

For AMR and AMR-WB encoded media, the MTSI MGW shall follow the same requirements when inter-working with other IP network as when inter-working with GERAN/UTRAN CS, see clause 12.3.2.1.

For a given RTP based media stream to/from the MTSI client in terminal, the MTSI MGW shall transmit RTP packets from and receive RTP packets to the same port number.

For a given RTP based media stream to/from the remote network, the MTSI MGW shall transmit RTP packets from and receive RTP packets on the same port number, not necessarily the same port number as used to/from the MTSI client in terminal.

This facilitates inter-working with fixed/broadband access. However, the MTSI MGW may, based on configuration or local policy, accept RTP packets that are not received from the same remote port where RTP packets are sent by either the MTSI client in terminal or the remote network.

#### 12.7.2.9 Session setup and session modification

The MTSI MGW is a “middle-man” between the MTSI client in terminal inside the 3GPP IMS network and a non-3GPP IP network.

The MTSI MGW shall be capable of dynamically adding and dropping speech media during the session.

The MTSI MGW may use the original SDP offer received from the MTSI client in terminal when creating an SDP offer that is to be sent outbound to the remote network.

If the MTSI MGW adds codecs to the SDP offer then it shall follow the recommendations of Clause 12.7.2.3 when creating the outbound SDP offer and when selecting which codec to include in the outbound SDP answer.

If the MTSI MGW generates an SDP offer based on the offer received from the MTSI client in terminal, it should maintain the ptime and maxptime values as indicated by the MTSI client in terminal. If the MTSI MGW generates an SDP offer without using the SDP offer from the MTSI client in terminal then it should define the ptime and maxptime values in accordance in Clause 12.7.2.6, i.e. the preferred values for ptime and maxptime are 20 and 80 respectively.

If the MTSI MGW does not support AVPF (nor SDPCapNeg) then it shall not include the corresponding lines in the SDP offer that is sent to the remote network.

### 12.7.3 Explicit Congestion Notification

An MTSI MGW can be used to enable ECN within the local network when the local ECN-capable MTSI client in terminal is in a network that properly handles ECN-marked packets, and either the remote network cannot be confirmed to properly handle ECN-marked packets or the remote terminal does not support or use ECN.

If ECN is supported in the MTSI MGW, then the MTSI MGW shall also:

- support RTP/AVPF and SDPCapNeg;
- be capable of enabling end-to-end rate adaptation between the local MTSI client in terminal and the remote client by performing the following towards the local MTSI client in terminal:
  - negotiate the use of ECN;
  - support ECN as described in this specification for the MTSI client in terminal, except that the MTSI MGW does not determine whether ECN can be used based on the Radio Access Technology.

NOTE: The adaptation requests are transmitted between the local and the remote client without modification by the MTSI MGW.

An MTSI MGW can also be used to enable ECN end-to-end if the remote client uses ECN in a different way than what is described in this specification for the MTSI client in terminal, e.g. if the remote client only supports probing for the ECN initiation phase or it needs the ECN feedback.

---

## 13 Void

---

### 13a Media types, codecs and formats used for MSRP transport

#### 13a.1 General

The IMS messaging service is described in TS 26.141 [59]. The description of IMS messaging in clauses 1-6 of 3GPP TS 26.141 [59] is applicable for MSRP-transported media in MTSI. The MSRP transport itself is described in 3GPP TS 24.247 [82].

All statements in TS 26.141 regarding IMS messaging are valid for MSRP transported media in MTSI including the status of the statement (shall, should, may).

Any differences between IMS messaging in 3GPP TS 26.141 [59] and MSRP transported media in MTSI are described in clause 13a.2.

#### 13a.2 Difference relative to 3GPP TS 26.141

##### 13a.2.1 Video

For MSRP transported Media in MTSI, clause 5.3 in 3GPP TS 26.141 [59] is void and instead the following shall be used.

If an MSRP client supports video, ITU-T Recommendation H.263 profile 0 Level 45 decoder [22] shall be supported. In addition, an MSRP client should support:

- H.263 Profile 3 Level 45 decoder [22];
- MPEG-4 Visual Simple Profile Level 3 decoder [23] with the following constraints:
  - Number of Visual Objects supported shall be limited to 1.
  - The maximum frame rate shall be 30 frames per second.
  - The maximum `f_code` shall be 2.
  - The `intra_dc_vlc_threshold` shall be 0.
  - The maximum horizontal luminance pixel resolution shall be 352 pels/line.
  - The maximum vertical luminance pixel resolution shall be 288 pels/VOP.
  - If AC prediction is used, the following restriction applies: QP value shall not be changed within a VOP (or within a video packet if video packets are used in a VOP). If AC prediction is not used, there are no restrictions to changing QP value.
- H.264 (AVC) Baseline Profile Level 1.1 decoder [24] with `constraint_set1_flag=1.1` and without requirements on output timing conformance (Annex C of [24]).

The video buffer model given in Annex G of document [60] should be supported if H.263 or MPEG-4 Visual is supported. It shall not be used with H.264 (AVC).

NOTE: ITU-T Recommendation H.263 profile 0 has been mandated to ensure that video-enabled MSRP clients support a minimum baseline video capability. Both H.263 and MPEG-4 Visual decoders can decode an H.263 profile 0 bitstream. It is strongly recommended, though, that an H.263 profile 0 bitstream is transported and stored as H.263 and not as MPEG-4 Visual (short header), as MPEG-4 Visual is not mandated by MTSI.

---

## 14 Supplementary services

### 14.1 General

In this section media layer behaviour is specified for relevant supplementary services. The supplementary services included in MTSI are described in 3GPP TS 24.173 [57]. The requirements on the codec support and the data transport are identical to those listed in clauses 5.2 and 7. These requirements are listed here due to the fact that there might be other media-influencing nodes in MTSI whose behaviour is not explicitly covered by other parts of the present document.

The recommended behaviour described in the following sections is valid for MTSI clients, i.e. all session IP end-points; terminals, MTSI media gateways and other 3GPP network nodes acting as IP endpoints in MTSI sessions.

### 14.2 Media formats and transport

Any implementation of a supplementary service which affects media or media handling, e.g. such as media creation, media rendering and media manipulation, shall meet the same requirements as a MTSI client in terminal regarding codec support and codec usage. Where applicable,, speech codecs shall be supported according to clause 5.2.1, video according to clause 5.2.2 and text according to clause 5.2.3.

Similarly, the configuration and the transport of the media in any implementation of a supplementary service which affects media or media handling shall be done according to clause 7.

## 14.3 Media handling in hold procedures

Whenever a supplementary service includes a hold procedure according to RFC 3264 [58], e.g. when using the HOLD supplementary service, the media flow is changed in terms of the session flow attribute (e.g. changing the session attribute "sendrecv" into "sendonly" or "recvonly" or "inactive" and then back again). When this occurs, any involved media-originating or media-terminating node should take measures to ensure that the transitions between the different media flow states in the session occur with minimal impact on the media quality.

When a full-duplex session has put the media flow on hold (see section 8.4 in RFC 3264 [58]), the media flow has been changed into a unidirectional flow through changing the session attribute into either "sendonly" or "recvonly". When resuming the session, it is restored to full duplex by changing the flow attributes back into "sendrecv" from "sendonly" and "recvonly". In this case, the encoder and decoder states in the MTSI clients may not be aligned and a state mismatch could occur. This would result in media quality degradation. Therefore, the following actions are recommended whenever the media session is not being put on hold anymore and the session is restored to full duplex:

- for speech media, the speech decoders should be reset;
- for video media, the video encoders should start the updated session with a full infra refresh even if the previously allocated encoders are still active and no infra refresh is scheduled to be sent.

---

# 15 Network preference management object

## 15.1 General

The MTSI client in the terminal may use the OMA-DM solution specified in this clause for enhancing the SDP negotiation and PDP context activation process. If a MTSI client in the terminal uses this feature, it is mandatory for the MTSI client in the terminal to implement the Management Object (MO) as described in this clause.

The 3GPP MTSINP (MTSI Network Preference) MO defined in this clause may be used to manage the QoS profile settings which express the network preference for the MTSI client in the terminal. The MO covers parameters that the MTSI client in the terminal could make use of in SDP negotiation and PDP context activation process. If a MTSI client in the terminal supports the feature, the usage of the MO includes:

1. During SDP negotiation process, MTSI client in the terminal should start SDP negotiation based on the MO parameters.
2. During PDP context activation process, MTSI client in the terminal should start QoS negotiation based on the MO parameters.

The following parameters in MTSI should be included in the Management Object (MO):

Speech codec (AMR, AMR-WB) and bearer QoS parameters

Video codec (H.263, MP4, H.264) and bearer QoS parameters

Real Time text bearer QoS parameters

Indication of the priority when there are more than one alternative for a media type is included. Version numbering is included for possible extending of MO.

The Management Object Identifier shall be: urn:oma:mo:ext-3gpp-mtsinp:1.0.

Protocol compatibility: The MO is compatible with OMA Device Management protocol specifications, version 1.2 and upwards, and is defined using the OMA DM Device Description Framework as described in the Enabler Release Definition OMA-ERELED\_DM-V1\_2[67].

## 15.2 Nodes Definition

The following nodes and leaf objects in figure 15.1 shall be contained under the 3GPP\_MTSINP node if a MTSI client in the terminal support the feature described in this clause (information of DDF for this MO is given in Annex H):



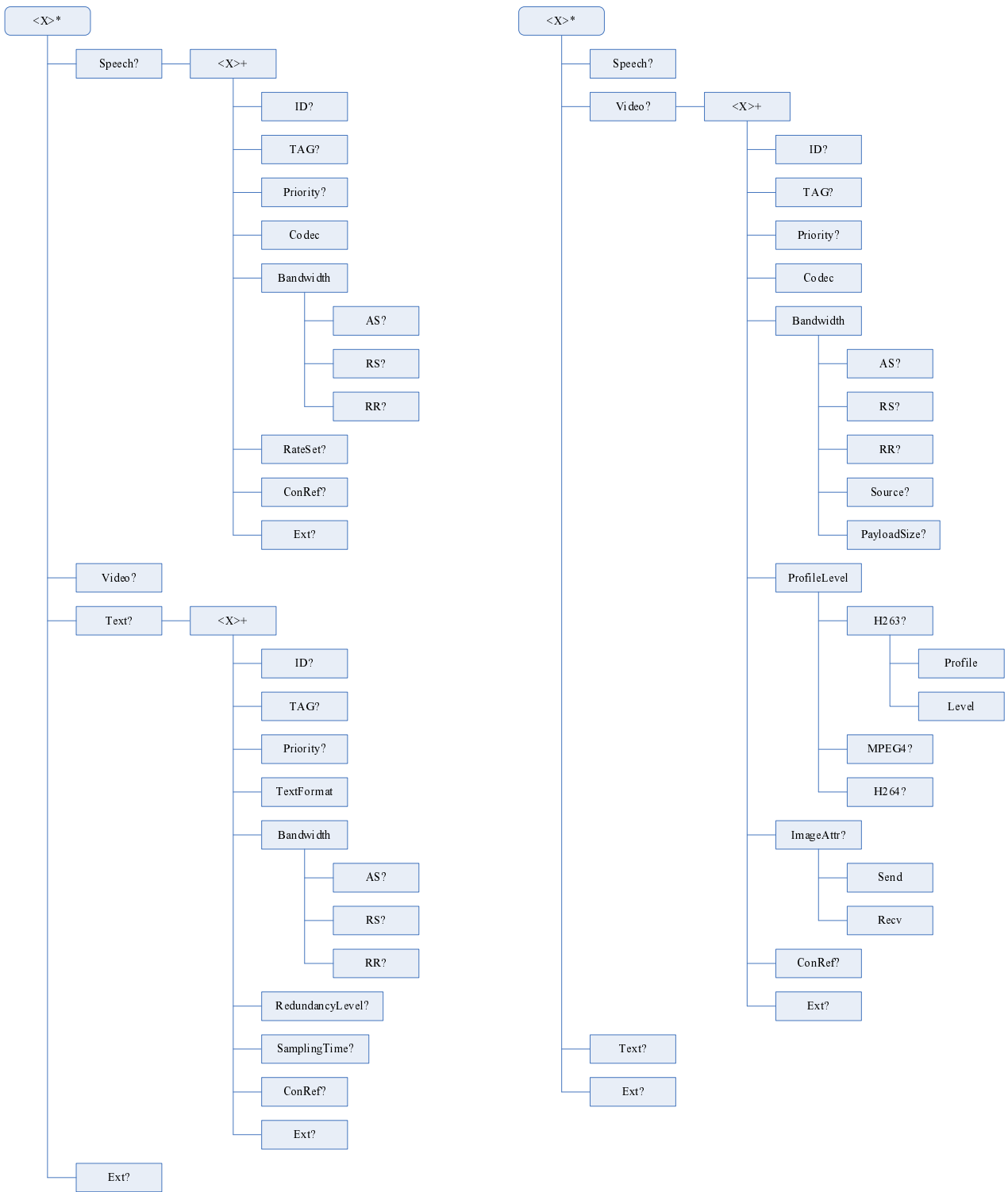

Figure 15.1: MTSI network preference management object tree

**Node: /<X>**

This interior node specifies the unique object id of a MTSI network preferences management object. The purpose of this interior node is to group together the parameters of a single object.

- Occurrence: ZeroOrOne
- Format: node
- Minimum Access Types: Get

The following interior nodes shall be contained if the MTSI client in the terminal supports the “MTSI network preferences Management Object”.

## **/*X*/Speech**

The Speech node is the starting point of the speech codec definitions (if any speech codec are available)

- Occurrence: ZeroOrOne
- Format: node
- Minimum Access Types: Get

## **/*X*/Speech/*X***

This interior node is used to allow a reference to a list of speech codec objects.

- Occurrence: OneOrMore
- Format: node
- Minimum Access Types: Get

## **/*X*/Speech/*X*/ID**

This leaf node represents the identification number of a set of parameters for speech session.

- Occurrence: ZeroOrOne
- Format: int
- Minimum Access Types: Get

## **/*X*/Speech/*X*/TAG**

This leaf node represents the identification tag of a set of parameters for speech session. It is recommended to have at least a node, for example, ID, TAG, or implementation-specific ones, for the identification purpose such that each set of parameters can be distinguished and accessed.

- Occurrence: ZeroOrOne
- Format: chr
- Minimum Access Types: Get

## **/*X*/Speech/*X*/Priority**

This leaf represents the priority of a set of parameters for speech session. Lower value means higher priority and the value is used in the terminal for client initiated QoS handling. The priority uses a 16 bit unsigned integer.

- Occurrence: ZeroOrOne
- Format: int
- Minimum Access Types: Get
- Values: Zero or higher

## **/*X*/Speech/*X*/Codec**

This leaf gives the MIME subtype name of speech codec. This leaf is preferably pre-configured by the device.

- Occurrence: One
- Format: chr

- Minimum Access Types: Get,
- Values: MIME subtype name of speech codec, e.g., “AMR”, “AMR-WB”.

The value “AMR” refers to the AMR speech codec as defined in 3GPP. The value “AMR-WB” refers to the AMR-WB speech codec as defined in 3GPP.

## **/<X>/Speech/<X>/Bandwidth**

This interior node is used to allow a reference to a list of parameters related to speech bandwidth assignment.

- Occurrence: One
- Format: node
- Minimum Access Types: Get
- Values: positive integer

## **/<X>/Speech/<X>/Bandwidth/AS**

This leaf gives the preferred speech codec bandwidth by the network for the bearer set-up, including RTP/UDP/IP headers. It provides the value for “b=AS” line for speech part used in the end-to-end SDP negotiation process, which represents the bit rate in kbits/sec.

- Occurrence: ZeroOrOne
- Format: int
- Minimum Access Types: Get

## **/<X>/Speech/<X>/Bandwidth/RS**

This leaf provides the value for “b=RS” line for speech part used in the end-to-end SDP negotiation process, which represents the bit rate in bits/sec.

- Occurrence: ZeroOrOne
- Format: int
- Minimum Access Types: Get

## **/<X>/Speech/<X>/Bandwidth/RR**

This leaf provides the value for “b=RR” line for speech part used in the end-to-end SDP negotiation process, which represents the bit rate in bits/sec.

- Occurrence: ZeroOrOne
- Format: int
- Minimum Access Types: Get

## **/<X>/Speech/<X>/RateSet**

This leaf node represents a list of bit rates used by speech codec. Depending on the codec, each value can be understood as either the highest rate or the average rate. The entries in the list may either be generic, i.e., usable for any codec, but can also be codec-specific. The default usage is the generic list where the bit rates in bits/sec are included, e.g., “5000, 6000, 7500, 12500”. A codec-specific list may indicate the desired modes. For example, in the case of AMR, the list could be “0, 2, 4, 7”.

- Occurrence: ZeroOrOne
- Format: chr

- Minimum Access Types: Get

### **/ $\langle X \rangle$ /Speech/ $\langle X \rangle$ /ConRef**

This node specifies a reference to QoS parameters Management Object. The interior node's leaf nodes specify the network preferred QoS parameters as defined in 3GPP TS 24.008 and they should be used in the bearer request when client initiated QoS happen. Implementation specific MO may be referenced.

- Occurrence: ZeroOrOne
- Format: chr
- Minimum Access Types: Get

### **/ $\langle X \rangle$ /Speech/ $\langle X \rangle$ /Ext**

The Ext is an interior node where the vendor specific information can be placed (vendor meaning application vendor, device vendor etc.). Usually the vendor extension is identified by vendor specific name under the ext node. The tree structure under the vendor identified is not defined and can therefore include one or more un-standardized sub-trees.

- Occurrence: ZeroOrOne
- Format: node
- Minimum Access Types: Get

### **/ $\langle X \rangle$ /Video**

The Video node is the starting point of the video codec definitions (if any video codec are available)

- Occurrence: ZeroOrOne
- Format: node
- Minimum Access Types: Get

### **/ $\langle X \rangle$ /Video/ $\langle X \rangle$**

This interior node is used to allow a reference to a list of video codec objects.

- Occurrence: OneOrMore
- Format: node
- Minimum Access Types: Get

### **/ $\langle X \rangle$ /Video/ $\langle X \rangle$ /ID**

This leaf node represents the identification number of a set of parameters for video session.

- Occurrence: ZeroOrOne
- Format: int
- Minimum Access Types: Get

### **/ $\langle X \rangle$ /Video/ $\langle X \rangle$ /TAG**

This leaf node represents the identification tag of a set of parameters for video session. It is recommended to have at least a node, for example, ID, TAG, or implementation-specific ones, for the identification purpose such that each set of parameters can be distinguished and accessed.

- Occurrence: ZeroOrOne

- Format: chr
- Minimum Access Types: Get

### **/`<X>`/Video/`<X>`/Priority**

This leaf represents the priority of a set of parameters for speech session. Lower value means higher priority and the value is used in the terminal for client initiated QoS handling. The priority uses a 16 bit unsigned integer.

- Occurrence: ZeroOrOne
- Format: int
- Minimum Access Types: Get
- Values: Zero or higher

### **/`<X>`/Video/`<X>`/Codec**

This leaf gives the MIME subtype name of video codec. This leaf is preferably pre-configured by the device.

- Occurrence: One
- Format: chr
- Minimum Access Types: Get,
- Values: MIME subtype name of video codec, e.g., "H263-2000", "MP4V-ES", "H264".

The value "H263-2000" refers to the H.263 video codec defined in ITU. The value "MP4V-ES" refers to the MPEG4 video codec as defined in MPEG. The value "H264" refers to the H.264 codec as defined by MPEG and ITU. The usage of the codecs (profiles, levels etc) is described in the document TS 26.114 Chapter 5.5.2.

### **/`<X>`/Video/`<X>`/Bandwidth**

This interior node is used to allow a reference to a list of parameters related to video bandwidth assignment.

- Occurrence: One
- Format: node
- Minimum Access Types: Get

### **/`<X>`/Video/`<X>`/Bandwidth/AS**

This leaf gives the preferred video codec bandwidth by the network for the bearer set-up, including RTP/UDP/IP headers. It provides the value for "b=AS" line for video part used in the end-to-end SDP negotiation process, which represents the bit rate in kbits/sec.

- Occurrence: ZeroOrOne
- Format: int
- Minimum Access Types: Get

### **/`<X>`/Video/`<X>`/Bandwidth/RS**

This leaf provides the value for "b=RS" line for video part used in the end-to-end SDP negotiation process, which represents the bit rate in bits/sec.

- Occurrence: ZeroOrOne
- Format: int
- Minimum Access Types: Get

## **/`<X>`/Video/`<X>`/Bandwidth/RR**

This leaf provides the value for “b=RR” line for video part used in the end-to-end SDP negotiation process, which represents the bit rate in bits/sec.

- Occurrence: ZeroOrOne
- Format: int
- Minimum Access Types: Get

## **/`<X>`/Video/`<X>`/Bandwidth/Source**

This leaf gives the preferred video encoding bandwidth in kbits/sec.

- Occurrence: ZeroOrOne
- Format: float
- Minimum Access Types: Get

## **/`<X>`/Video/`<X>`/Bandwidth/PayloadSize**

This leaf gives the preferred payload size for video, excluding payload header, which represents the amount of encoded video data in bytes transported over a RTP packet.

- Occurrence: ZeroOrOne
- Format: int
- Minimum Access Types: Get

## **/`<X>`/Video/`<X>`/ProfileLevel**

This interior node is used to allow a reference to a list of parameters related to the profile and level of video codec.

- Occurrence: One
- Format: node
- Minimum Access Types: Get

## **/`<X>`/Video/`<X>`/ProfileLevel/H263**

This interior node is used to allow a reference to a list of parameters related to the profile and level of H.263 video codec.

- Occurrence: ZeroOrOne
- Format: node
- Minimum Access Types: Get

## **/`<X>`/Video/`<X>`/ProfileLevel/H263/Profile**

This leaf gives the profile of H.263 video codec defined in [22], [29].

- Occurrence: One
- Format: int
- Minimum Access Types: Get

## **/`<X>`/Video/`<X>`/ProfileLevel/H263/Level**

This leaf gives the level of H.263 video codec defined in [22], [29], which indicates the maximum computational complexity supported by the offerer in performing decoding for the given profile.

- Occurrence: One
- Format: int
- Minimum Access Types: Get

### **/<X>/Video/<X>/ProfileLevel/MPEG4**

This leaf gives the profile-level-id of MPEG-4 video codec, which is a decimal representation of MPEG-4 Visual Profile and Level indication value, `profile_and_level_indication`, defined in [23], [30].

- Occurrence: ZeroOrOne
- Format: int
- Minimum Access Types: Get

### **/<X>/Video/<X>/ProfileLevel/H264**

This leaf gives the profile-level-id of H.264 video codec, which indicates the profile that the codec supports and the highest level supported for the signaled profile [24], [25].

- Occurrence: ZeroOrOne
- Format: chr
- Minimum Access Types: Get

### **/<X>/Video/<X>/ImageAttr**

This interior node is used to allow a reference to a list of parameters related to the image sizes supported or preferred, specified with the “imageattr” attribute. (see clause A.4)

- Occurrence: ZeroOrOne
- Format: node
- Minimum Access Types: Get

### **/<X>/Video/<X>/ImageAttr/Send**

This leaf gives the supported image sizes for the send direction. The value is a string such as “176, 144, 224, 176, 272, 224, 320, 240” which means four image sizes, 176x144, 224x176, 272x224, and 320x240 are supported for the send direction. The maximum image size in this leaf shall not exceed the maximum size limited by the offered codec level.

- Occurrence: One
- Format: chr
- Minimum Access Types: Get

### **/<X>/Video/<X>/ImageAttr/Recv**

This leaf gives the supported image sizes and their preferences for the receive direction. The value is a string such as “176, 144, 0.5, 224, 176, 0.5, 272, 224, 0.6, 320, 240, 0.5” which means four image sizes, 176x144, 224x176, 272x224, and 320x240 are supported for the receive direction but 272x224 is preferred since it might fit the available space on the display of the receiver better than the other image sizes. The maximum image size in this leaf shall not exceed the maximum size limited by the offered codec level. The value representing the level of preference by the offerer, defined in [76], is between 0 and 1 inclusive and 0.5 by default.

- Occurrence: One

- Format: chr
- Minimum Access Types: Get

### **/ $\langle X \rangle$ /Video/ $\langle X \rangle$ /ConRef**

This node specifies a reference to QoS parameters Management Object. The interior node's leaf nodes specify the network preferred QoS parameters as defined in 3GPP TS 24.008 and they should be used in the bearer request when client initiated QoS happen. Implementation specific MO may be referenced.

- Occurrence: ZeroOrOne
- Format: chr
- Minimum Access Types: Get

### **/ $\langle X \rangle$ /Video/ $\langle X \rangle$ /Ext**

The Ext is an interior node where the vendor specific information can be placed (vendor meaning application vendor, device vendor etc.). Usually the vendor extension is identified by vendor specific name under the ext node. The tree structure under the vendor identified is not defined and can therefore include one or more un-standardized sub-trees.

- Occurrence: ZeroOrOne
- Format: node
- Minimum Access Types: Get

### **/ $\langle X \rangle$ /Text**

The Text node is the starting point of the real time text codec definitions (if the real time text codec is available).

- Occurrence: ZeroOrOne
- Format: node
- Minimum Access Types: Get

### **/ $\langle X \rangle$ /Text/ $\langle X \rangle$**

This interior node is used to allow a reference to the real time text codec objects.

- Occurrence: OneOrMore
- Format: node
- Minimum Access Types: Get

### **/ $\langle X \rangle$ /Text/ $\langle X \rangle$ /ID**

This leaf node represents the identification number of a set of parameters for text session.

- Occurrence: ZeroOrOne
- Format: int
- Minimum Access Types: Get

### **/ $\langle X \rangle$ /Text/ $\langle X \rangle$ /TAG**

This leaf node represents the identification tag of a set of parameters for text session. It is recommended to have at least a node, for example, ID, TAG, or implementation-specific ones, for the identification purpose such that each set of parameters can be distinguished and accessed.



- Occurrence: ZeroOrOne
- Format: chr
- Minimum Access Types: Get

### **/`<X>`/Text/`<X>`/Priority**

This leaf represents the priority of a set of parameters for text session. Lower value means higher priority and the value is used in the terminal for client initiated QoS handling. The priority uses a 16 bit unsigned integer.

- Occurrence: ZeroOrOne
- Format: int
- Minimum Access Types: Get
- Values: Zero or higher

### **/`<X>`/Text/`<X>`/TextFormat**

This leaf node represents the MIME subtype name of text conversation protocol. The value "t140" refers to T.140 defined in ITU-T [26], [27].

- Occurrence: ZeroOrOne
- Format: chr
- Minimum Access Types: Get
- Values: MIME subtype name of the text conversation protocol, e.g., "t140"

### **/`<X>`/Text/`<X>`/Bandwidth**

This interior node is used to allow a reference to a list of parameters related to text bandwidth assignment.

- Occurrence: One
- Format: node
- Minimum Access Types: Get

### **/`<X>`/Text/`<X>`/Bandwidth/AS**

This leaf provides the value for "b=AS" line for text part used in the end-to-end SDP negotiation process, which represents the bit rate in kbits/sec.

- Occurrence: ZeroOrOne
- Format: int
- Minimum Access Types: Get

### **/`<X>`/Speech/`<X>`/Bandwidth/RS**

This leaf provides the value for "b=RS" line for text part used in the end-to-end SDP negotiation process, which represents the bit rate in bits/sec.

- Occurrence: ZeroOrOne
- Format: int
- Minimum Access Types: Get

### **/`<X>`/Speech/`<X>`/Bandwidth/RR**

This leaf provides the value for “b=RR” line for text part used in the end-to-end SDP negotiation process, which represents the bit rate in bits/sec.

- Occurrence: ZeroOrOne
- Format: int
- Minimum Access Types: Get

### **/~~X~~/Text/~~X~~/RedundancyLevel**

This leaf node represents the level of redundancy when redundancy is used with T.140 text.

- Occurrence: ZeroOrOne
- Format: int
- Minimum Access Types: Get
- Values: 0, 100, 200, 300

### **/~~X~~/Text/~~X~~/SamplingTime**

This leaf node, defined in clause 9.4, represents the period for which text may be buffered before transmission. Buffering time, defined in [31], has an identical meaning as this node, i.e., the shortest period between text transmissions. Default value is 300 ms.

- Occurrence: ZeroOrOne
- Format: int
- Minimum Access Types: Get

### **/~~X~~/Text/~~X~~/ConRef**

This node specifies a reference to QoS parameters Management Object. The interior node’s leaf nodes specify the network preferred QoS parameters as defined in 3GPP TS 24.008 and they should be used in the bearer request when client initiated QoS happen. Implementation specific MO may be referenced.

- Occurrence: ZeroOrOne
- Format: chr
- Minimum Access Types: Get

### **/~~X~~/Text/~~X~~/Ext**

The Ext is an interior node where the vendor specific information can be placed (vendor meaning application vendor, device vendor etc.). Usually the vendor extension is identified by vendor specific name under the ext node. The tree structure under the vendor identified is not defined and can therefore include one or more un-standardized sub-trees.

- Occurrence: ZeroOrOne
- Format: node
- Minimum Access Types: Get

### **/~~X~~/Ext**

The Ext is an interior node where the vendor specific information can be placed (vendor meaning application vendor, device vendor etc.). Usually the vendor extension is identified by vendor specific name under the ext node. The tree structure under the vendor identified is not defined and can therefore include one or more un-standardized sub-trees.

- Occurrence: ZeroOrOne

- Format: node
- Minimum Access Types: Get

## 15.3 Example Configuration of 3GPP MTSINP MO

The examples below are configurations of 3GPP MTSINP MO for selected speech, text, and video sessions in Annex A. An example of SDP offer for speech session is shown in Table A.6.1, which includes two RTP payload types for AMR-NB. Parameter values in Table 15.1 may apply to both payload types and additional SDP parameters such as max-red may be included under the Ext node as vendor extensions. Depending on the implementation, two sets of session parameters may be defined for the two payload types respectively.

**Table 15.1: Example configuration of MTSINP for speech session**

<b>Speech</b>	ID	4	
	TAG	Undefined	
	Priority	2	
	Codec	"AMR"	
	Bandwidth	AS	30
		RS	0
		RR	2000
	RateSet	Undefined	
ConRef	Undefined		

An example of SDP offer for text session is shown in Table A.5.1, which includes two RTP payload types, with and without redundancy, for T.140. Parameter set with a higher priority applies to the preferred case, i.e., sending text with 200 % of redundancy while parameter set with a lower priority corresponds to the case of no redundancy. Note that the value of the TextFormat node is used in the "a=rtpmap" line for no redundancy while "red" is used in the "a=rtpmap" line for redundancy.

**Table 15.2: Example configuration of MTSINP for text session**

<b>Text</b>	ID	3	
	TAG	Undefined	
	Priority	1	
	TextFormat	"t140"	
	Bandwidth	AS	Undefined
		RS	Undefined
		RR	Undefined
	RedundancyLevel	200	
ConRef	Undefined		
<b>Text</b>	ID	4	
	TAG	Undefined	
	Priority	2	
	TextFormat	"t140"	
	Bandwidth	AS	Undefined
		RS	Undefined
		RR	Undefined
	RedundancyLevel	0	
ConRef	Undefined		

An example of SDP offer for video session is shown in Table A.4.9, which includes two RTP payload types for H.264 and H.263 respectively. Although the "b=AS" value can also be computed with the Source and PayloadSize nodes, a different value with appropriate implementation margin can be directly assigned to the AS node. If the AS, Source, and PayloadSize nodes are defined together, the AS node value should be used for setting "b=AS". In Table 15.3, the "b=AS" values of 107 and 57 kbps, for H.264 and H.263 respectively, are computed assuming IPv4 addressing. Note

that the Priority nodes of H.264 and H.263 are assigned values of 5 and 3 respectively, which shows that depending on service policy, parameters sets of lower priority may be preferred in the construction of SDP offer. If the ImageAttr node is to be defined, as for H.264 in Table A.4.9, the maximum image size in either the Send or Recv node shall not exceed the maximum size limited by the offered codec level, which is 352x288 for Baseline profile at level 1.1.

**Table 15.3: Example configuration of MTSINP for video session**

Video	ID		4	
	TAG		Undefined	
	Priority		5	
	Codec		"H264"	
	Bandwidth	AS		107
		RS		0
		RR		2500
		Source		96
	PayloadSize		400	
	ProfileLevel	H263	Profile	Undefined
			Level	Undefined
		MPEG4		Undefined
	ImageAttr	Send		"176, 144, 224, 176, 272, 224, 320, 240"
Receive		"176, 144, 0.5, 224, 176, 0.5, 272, 224, 0.6, 320, 240, 0.5"		
ConRef		Undefined		
Video	ID		1	
	TAG		Undefined	
	Priority		3	
	Codec		"H263-2000"	
	Bandwidth	AS		57
		RS		0
		RR		2500
		Source		48
		PayloadSize		250
	ProfileLevel	H263	Profile	0
			Level	10
		MPEG4		Undefined
	H264		Undefined	
ImageAttr	Send		Undefined	
	Receive		Undefined	
ConRef		Undefined		

## 16 Quality of Experience

### 16.1 General

The MTSI Quality of Experience (QoE) metrics feature is optional for an MTSI client in a terminal and shall not disturb the MTSI service. Non-terminal MTSI clients (such as gateways) should not implement MTSI QoE reporting. An MTSI client that supports the QoE metrics feature shall support OMA-DM. The OMA-DM configuration server can configure the activation/deactivation and gathering of QoE metrics in the MTSI client. An MTSI client supporting the feature shall perform the quality measurements in accordance to the measurement definitions, aggregate them into client QoE metrics and report the metrics to the QoE server using the HTTP transport protocol. The MTSI client may send QoE

metrics reports to a receiving QoE server during the session and at the end of the session. The way how the QoE metrics are processed and made available is out of the scope of this specification.

## 16.2 Metrics Definition

An MTSI client supporting the QoE metrics feature shall support the reporting of the metrics in this clause. The metrics are valid for speech, video and text media, and are calculated for each measurement resolution interval "Measure-Resolution" (sub-clause 16.3.2). They are reported to the server according to the measurement reporting interval "Sending-Rate" (sub-clause 16.3.2) and after the end of the session (sub-clause 16.4).

### 16.2.1 Corruption duration metric

Corruption duration,  $M$ , is the time period from the NPT time of the last good frame (since the NPT time for the first corrupted frame cannot always be determined) before the corruption, to the NPT time of the first subsequent good frame. A corrupted frame may either be an entirely lost frame, or a media frame that has quality degradation and the decoded frame is not the same as in error-free decoding.

A good frame is a completely received frame:

- where all parts of the image are guaranteed to contain the correct content; or
- that is a refresh frame, that is, does not reference any previously decoded frames; or
- which only references previously decoded good frames

Completely received means that all the bits are received and no bit error has occurred.

Corruption duration,  $M$ , in milliseconds can be calculated as below:

- a)  $M$  can be derived by the client using the codec layer, in which case the codec layer signals the decoding of a good frame to the client. A good frame could also be derived by error tracking methods, but decoding quality evaluation methods shall not be used.
- b) Alternatively, the corruption is considered as ended after  $N$  milliseconds with consecutively completely received frames, or when a refresh frame has been completely received, whichever comes first..

The optional configuration parameter  $N$  can be set to define the average characteristics of the codec. If  $N$  has not been configured it shall default to the length of one measurement interval for video media, and to one frame duration for non-video media.

The syntax for the metrics "Corruption\_Duration" is as defined in sub-clause 16.3.2.

The  $N$  parameter is specified in milliseconds and is used with the "Corruption\_Duration" parameter in the "3GPP-QoE-Metrics" definition. The value of  $N$  may be set by the server. The syntax for  $N$  to be included in the "att-measure-spec" (sub-clause 16.3.2) is as follows:

- $N = "N" "=" 1 * DIGIT$

All the occurred corruption durations within each resolution period are summed and stored in the vector *TotalCorruptionDuration*. The unit of this metrics is expressed in milliseconds. Within each resolution period the number of individual corruption events are summed up and stored in the vector *NumberOfCorruptionEvents*. These two vectors are reported by the MTSI client as part of the reception report (sub-clause 16.4).

The parameter *CorruptionAlternative* indicates how the metric has been calculated, and shall be sent by the client via reception reporting (sub-clause 16.3.2) as "a", or "b".

### 16.2.2 Successive loss of RTP packets

The metric "Successive\_Loss" indicates the number of RTP packets lost in succession per media channel.

The syntax for the metrics "Successive\_Loss" is as defined in sub-clause 16.3.2.

All the number of successively lost RTP packets are summed up within each measurement resolution period of the stream and stored in the vector *TotalNumberOfSuccessivePacketLoss*. The unit of this metric is expressed as an integer equal to or larger than 0. The number of individual successive packet loss events within each measurement resolution period are summed up and stored in the vector *NumberOfSuccessiveLossEvents*. The number of received packets are also summed up within each measurement resolution period and stored in the vector *NumberOfReceivedPackets*. These three vectors are reported by the MTSI client as part of the QoE report (sub-clause 16.4)

### 16.2.3 Frame rate

Frame rate indicates the playback frame rate. The playback frame rate is equal to the number of frames displayed during the measurement resolution period divided by the time duration, in seconds, of the measurement resolution period.

The syntax for the metric "Frame\_Rate" is defined in sub-clause 16.3.2.

For the Metrics-Name "Frame\_Rate", the value field indicates the frame rate value. This metric is expressed in frames per second, and can be a fractional value. The frame rates for each resolution period are stored in the vector *FrameRate* and reported by the MTSI client as part of the QoE report (sub-clause 16.4).

### 16.2.4 Jitter duration

Jitter happens when the absolute difference between the actual playback time and the expected playback time is larger than *JitterThreshold* milliseconds. The expected time of a frame is equal to the actual playback time of the last played frame plus the difference between the NPT time of the frame and the NPT time of the last played frame.

The syntax for the metric "Jitter\_Duration" is defined in sub-clause 16.3.2.

The optional configuration parameter JT can be set to control the amount of allowed jitter. If the parameter has not been set, it defaults to 100 ms. The JT parameter is specified in ms and is used with the "Jitter\_Duration" parameter in the "3GPP-QoE-Metrics" definition. The value of JT may be set by the server. The syntax for JT to be included in the "att-measure-spec" (sub-clause 16.3.2) is as follows:

- JT = "JT" "=" 1\*DIGIT

All the jitter durations are summed up within each measurement resolution period and stored in the vector *TotalJitterDuration*. The unit of this metric is expressed in seconds, and can be a fractional value. The number of individual events within the measurement resolution period are summed up and stored in the vector *NumberOfJitterEvents*. These two vectors are reported by the MTSI client as part of the QoE report (sub-clause 16.4).

### 16.2.4 Sync loss duration

Sync loss happens when the absolute difference between value A and value B is larger than *SyncThreshold* milliseconds. Value A represents the difference between the playback time of the last played frame of the video stream and the playback time of the last played frame of the speech/audio stream. Value B represents the difference between the expected playback time of the last played frame of the video stream and the expected playback time of the last played frame of the speech/audio stream.

The syntax for the metric "SyncLoss\_Duration" is defined in sub-clause 16.3.2.

The optional configuration parameter ST can be set to control the amount of allowed sync mismatch. If the parameter has not been set, it defaults to 100 ms. The ST parameter is specified in ms and is used with the "SyncLoss\_Duration" parameter in the "3GPP-QoE-Metrics" definition. The value of ST may be set by the server. The syntax for ST to be included in the "att-measure-spec" (sub-clause 16.3.2) is as follows:

- ST = "ST" "=" 1\*DIGIT

All the sync loss durations are summed up within each measurement resolution period and stored in the vector *TotalSyncLossDuration*. The unit of this metric is expressed in seconds, and can be a fractional value. The number of individual events within the measurement resolution period are summed up and stored in the vector *NumberOfSyncLossEvents*. These two vectors are reported by the MTSI client as part of the QoE report (sub-clause 16.4).

## 16.2.5 Round-trip time

The round-trip time (RTT) consists of the RTP-level round-trip time, plus the additional two-way delay (RTP level->loudspeaker->microphone->RTP level) due to buffering and other processing in each client.

The syntax for the metric "Round\_Trip\_Time" is defined in sub-clause 16.3.2.

The last RTCP round-trip time value estimated during each measurement resolution period shall be stored in the vector *NetworkRTT*. The unit of this metrics is expressed in milliseconds.

The two-way additional internal client delay valid at the end of each measurement resolution period shall be stored in the vector *InternalRTT*. The unit of this metrics is expressed in milliseconds.

The two vectors are reported by the MTSI client as part of the QoE report (sub-clause 16.4).

Note that if the RTP and the RTCP packets for a media are not sent in the same RTP stream the estimated media round-trip time might be unreliable.

## 16.2.6 Average codec bitrate

The average codec bitrate is the bitrate used for coding "active" media information during the measurement resolution period.

For speech media "active" information is defined by frames containing speech, i.e. silence frames (SID-frames) and DTX periods are excluded from the calculation. Thus for speech media the average codec bitrate can be calculated as the number of speech bits received for "active" frames, divided by the total time, in seconds, covered by these frames. The total time covered is calculated as the number of "active" frames times the length of each speech frame.

For non-speech media the average codec bitrate is the total number of RTP payload bits received, divided by the length of the measurement resolution period.

The syntax for the metric "Average\_Codec\_Bitrate" is defined in sub-clause 16.3.2.

The average codec bitrate value for each measurement resolution period shall be stored in the vector *AverageCodecBitrate*. The unit of this metrics is expressed in kbit/s and can be a fractional value. The vector is reported by the MTSI client as part of the QoE report (sub-clause 16.4).

## 16.2.7 Codec information

The codec information metrics contain details of the media codec used during the measurement resolution period. If the codec information is changed during the measurement resolution period, the codec information valid when each measurement resolution period ends shall be reported. The unit of this metric is a string value. No "white space" characters are allowed in the string values, and shall be removed if necessary.

For speech media the codec information contains the speech codec type, represented as in an SDP offer, for instance "AMR-WB/1600/1".

For video media, the codec information contains the video codec type, represented as in an SDP offer, for instance "H263-2000/90000". Furthermore, the video profile and level used, as well as the image size used shall be reported. For instance "profile=0;level=45" for the profile and level information and "176x144" for the image size. In some cases the profile and level is reported together, for instance "profile-level-id=42e00a". Note that the image size reported for each measurement resolution period shall be the one actually used, not the maximum size allowed by the SDP negotiation.

For real-time text media, the codec information contains the text encoding, represented as in an SDP offer, for instance "t140/1000/1".

The syntax for the metric "Codec\_Info", "Codec\_ProfileLevel" and "Codec\_ImageSize" are defined in sub-clause 16.3.2.

The codec info, profile / level and codec image size value for each measurement resolution period shall be stored in the vectors *CodecInfo*, *CodecProfileLevel* and *CodecImageSize* respectively. If the metric values in these vectors for a measurement resolution period are unchanged from the previous values in the respective vector, it is allowed to put the

value “=” in the vector to indicate this. The *CodecInfo*, *CodecProfileLevel* and *CodecImageSize* vectors are reported by the MTSI client as part of the QoE report (sub-clause 16.4).

### 16.3 Metric Configuration

An MTSI client supporting the QoE metrics feature shall use the OMA-DM solution specified in this clause for configuration of QoE metrics and their activation. If an MTSI client uses this feature, it is mandatory for the MTSI client to implement the Management Object (MO) as described in this clause.

The 3GPP MTSIQOE (MTSI QoE metrics) MO defined in this clause may be used to configure the QoE metrics and reporting settings.

The metrics specified in the MO may be derived by the MTSI client. Version numbering is included for possible extension of the MO.

The Management Object Identifier shall be: urn:oma:mo:ext-3gpp-mtsique:1.0.

Protocol compatibility: The MO is compatible with OMA Device Management protocol specifications, version 1.2 and upwards, and is defined using the OMA DM Device Description Framework as described in the Enabler Release Definition OMA-ERELED\_DM-V1\_2 [67].

#### 16.3.1 QoE metrics reporting management object

The following nodes and leaf objects in figure 16.1 shall be contained under the 3GPP\_MTSIQOE node if an MTSI client supports the feature described in this clause (information of DDF for this MO is given in Annex I):

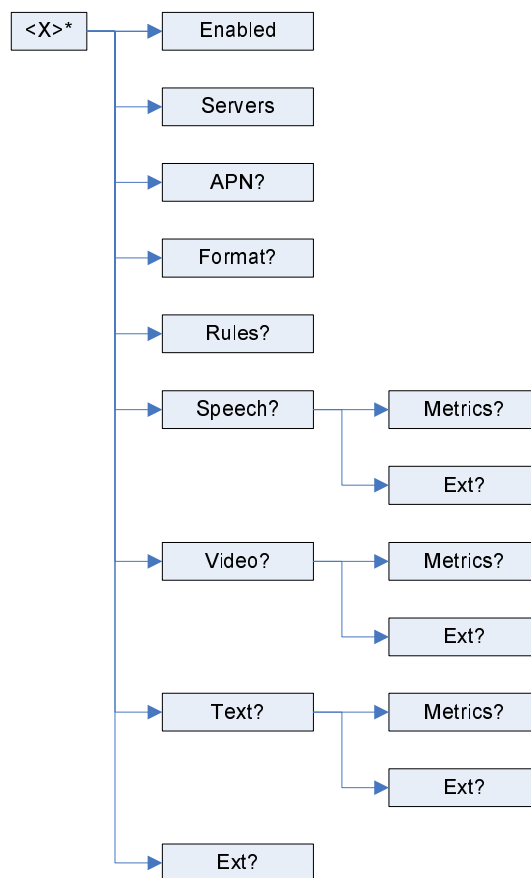

Figure 16.1: MTSI QoE metrics management object tree

**Node: /<X>**



This interior node specifies the unique object id of a MTSI QoE metrics management object. The purpose of this interior node is to group together the parameters of a single object.

- Occurrence: ZeroOrOne
- Format: node
- Minimum Access Types: Get

The following interior nodes shall be contained if the MTSI client supports the “MTSI QoE metrics Management Object”.

### **/~~X~~/Enabled**

This leaf indicates if QoE reporting is requested by the provider.

- Occurrence: One
- Format: bool
- Minimum Access Types: Get

### **/~~X~~/Servers**

This leaf contains a space-separated list of URL of servers to which the QoE reports can be transmitted. It is URI addresses, e.g. <http://qoeserver.operator.com>. In case of multiple servers, the MTSI client randomly selects one of the servers from the list, with uniform distribution.

- Occurrence: One
- Format: chr
- Minimum Access Types: Get
- Values: URI of the servers to receive the QoE report.

### **/~~X~~/APN**

This leaf contains the Access Point Name that should be used for establishing the PDP context on which the QoE metric reports will be transmitted. This may be used to ensure that no costs are charged for QoE metrics reporting.

- Occurrence: ZeroOrOne
- Format: chr
- Minimum Access Types: Get
- Values: the Access Point Name

### **/~~X~~/Format**

This leaf specifies the format of the report and if compression (Gzip XML) [71] is used.

- Occurrence: ZeroOrOne
- Format: chr
- Minimum Access Types: Get
- Values: “XML”, “GZIPXML”.

### **/~~X~~/Rules**

This leaf provides in textual format the rules used to decide whether metrics are to be reported to the QoE metrics report server. The syntax and semantics of this leaf are defined in clause 16.3.3.

- Occurrence: ZeroOrOne
- Format: chr
- Minimum Access Types: Get
- Values: See clause 16.3.3.

### **/*<X>*/Ext**

The Ext node is an interior node where the vendor specific information can be placed (vendor includes application vendor, device vendor etc.). Usually the vendor extension is identified by vendor specific name under the ext node. The tree structure under the vendor identified is not defined and can therefore include one or more un-standardized subtrees.

- Occurrence: ZeroOrOne
- Format: node
- Minimum Access Types: Get

### **/*<X>*/Speech**

The Speech node is the starting point of the speech media level QoE metrics definitions.

- Occurrence: ZeroOrOne
- Format: node
- Minimum Access Types: Get

### **/*<X>*/Speech/Metrics**

This leaf provides in textual format the QoE metrics that need to be reported, the measurement frequency, the reporting interval and the reporting range. The syntax and semantics of this leaf are defined in clause 16.3.2.

- Occurrence: ZeroOrOne
- Format: chr
- Minimum Access Types: Get
- Values: see clause 16.3.2.

### **/*<X>*/Speech/Ext**

The Ext node is an interior node where the vendor specific information can be placed (vendor meaning application vendor, device vendor etc.). Usually the vendor extension is identified by vendor specific name under the ext node. The tree structure under the vendor identified is not defined and can therefore include one or more un-standardized subtrees.

- Occurrence: ZeroOrOne
- Format: node
- Minimum Access Types: Get

### **/*<X>*/Video**

The Video node is the starting point of the video media level QoE metrics definitions.

- Occurrence: ZeroOrOne

- Format: node
- Minimum Access Types: Get

## **/*<X>*/Video/Metrics**

This leaf provides in textual format the QoE metrics that need to be reported, the measurement frequency, the reporting interval and the reporting range. The syntax and semantics of this leaf are defined in clause 16.3.2.

- Occurrence: ZeroOrOne
- Format: chr
- Access Types: Get
- Values: see clause 16.3.2.

## **/*<X>*/Video/Ext**

The Ext is an interior node where the vendor specific information can be placed (vendor meaning application vendor, device vendor etc.). Usually the vendor extension is identified by vendor specific name under the Ext node. The tree structure under the vendor identified is not defined and can therefore include one or more un-standardized sub-trees.

- Occurrence: ZeroOrOne
- Format: node
- Minimum Access Types: Get

## **/*<X>*/Text**

The Text node is the starting point of the real-time text media level QoE metrics definitions.

- Occurrence: ZeroOrOne
- Format: node
- Minimum Access Types: Get
- Values: see clause 16.3.2.

## **/*<X>*/Text/Metrics**

This leaf provides in textual format the QoE metrics that need to be reported, the measurement frequency, the reporting interval and the reporting range. The syntax and semantics of this leaf are defined in clause 16.3.2.

- Occurrence: ZeroOrOne
- Format: chr
- Minimum Access Types: Get
- Values: see clause 16.3.2.

## **/*<X>*/Text/Ext**

The Ext is an interior node where the vendor specific information can be placed (vendor meaning application vendor, device vendor etc.). Usually the vendor extension is identified by vendor specific name under the ext node. The tree structure under the vendor identified is not defined and can therefore include one or more un-standardized sub-trees.

- Occurrence: ZeroOrOne
- Format: node
- Minimum Access Types: Get

## 16.3.2 QoE metric reporting configuration

The syntax of the text contained in the Metrics leaf is similar to the "3GPP-QoE-Metrics" attribute syntax specified in 3GPP TS 26.234 [60] and 3GPP TS 26.346 [74]:

- QoE-Metrics = "3GPP-QoE-Metrics:" att-measure-spec \*(", " att-measure-spec) CRLF
- att-measure-spec = Metrics ";" Sending-rate [";" Measure-Range] [";" Measure-Resolution] \*([";" Parameter-Ext])
- Metrics = "metrics" "=" "{"Metrics-Name \*("|" Metrics-Name) "}"
- Metrics-Name = 1\*((0x21..0x2b) / (0x2d..0x3a) / (0x3c..0x7a) / 0x7e) ;VCHAR except ";", ",", "{" or "}"
- Sending-Rate = "rate" "=" 1\*DIGIT / "End"
- Measure-Resolution = "resolution" "=" 1\*DIGIT ; in seconds
- Measure-Range = "range" ":" Ranges-Specifier
- Parameter-Ext = (1\*DIGIT ["." 1\*DIGIT]) / (1\*((0x21..0x2b) / (0x2d..0x3a) / (0x3c..0x7a) / 0x7c / 0x7e))
- Ranges-Specifier = as defined in RFC 2326 [72].

This attribute is used to indicate which QoE metrics are supported, the reporting interval, the measurement interval and reporting range.

The "Metrics" field contains the list of names that describes the metrics/measurements that are required to be reported in a MTSI call, provided that the MTSI client supports these measurements and the reporting rule conditions are met (see clause 16.3.3). The names that are not included in the "Metrics" field shall not be reported during the session.

The "Sending-Rate" shall be set, and it expresses the maximum time period in seconds between two successive QoE reports. If the "Sending-Rate" value is 0, then the client shall decide the sending time of the reports depending on the events occurred in the client. Values  $\geq 1$  indicate a precise reporting interval. The shortest interval is one second and the longest interval is undefined. The reporting interval can be different for different media, but it is recommended to maintain a degree of synchronization in order to avoid extra traffic in the uplink direction. The value "End" indicates that only one report is sent at the end of the session.

The optional "Measure-Resolution" field, if used, shall define a time over which each metrics value is calculated. The "Measure-Resolution" field splits the session duration into a number of equally sized periods where each period is of the length specified by the "Measure-Resolution" field. The "Measure-Resolution" field is thus defining the time before the calculation of a QoE parameter starts over. If the "Measure-Resolution" field is not present, the metrics resolution shall cover the period specified by the "Measure-Range" field. If the "Measure-Range" field is not present the metrics resolution shall be the whole session duration.

The optional "Measure-Range" field, if used, shall define the time range in the stream for which the QoE metrics will be reported. There shall be only one range per measurement specification. The range format shall be any of the formats allowed by the media. If the "Measure-Range" field is not present, the metrics range shall be the whole call duration.

## 16.3.3 QoE reporting rule definition

This clause defines the syntax and semantics of a set of rules which are used to reduce the amount of reporting to the QoE metrics report server. The syntax of the metrics reporting rules is defined below:

- QoE-Rule = "3GPP-QoE-Rule" ":" rule-spec \*(", " rule-spec)
- rule-spec = rule-name [";" parameters]
- rule-name = "OnlyCallerReports" / "LimitSessionInterval" / "SamplePercentage"
- parameters = parameter \*(", " parameter)
- parameter = Param-Name ["=" Param-Value ]

- Param-Name = 1\*((0x21..0x2b) / (0x2d..0x3a) / (0x3c..0x7a) / 0x7e) ;VCHAR except ";", ",", "{", " or "}"
- Param-Value = (1\*DIGIT [ "." 1\*DIGIT]) / (1\*((0x21..0x2b) / (0x2d..0x3a) / (0x3c..0x7a) / 0x7c / 0x7e))

The semantics of the rules and the syntax of its parameters is defined below:

The *OnlyCallerReports* rule is used to determine the metrics reporting sources. When this rule is present, only the initiator of the call, i.e., caller, will report metrics to the QoE report server. When absent all parties report metrics.

The *SamplePercentage* rule can be used to set a percentage sample of calls which should report reception. This can be useful for statistical data analysis of large populations while increasing scalability due to reduced total uplink signalling. The *sample\_percentage* parameter takes on a value between 0 and 100, including the use of decimals. It is recommended that no more than 3 digits follow a decimal point (e.g. 67.323 is sufficient precision).

When the *SamplePercentage* rule is not present or its *sample\_percentage* parameter value is 100 each MTSI client shall send metric report(s). If the *sample\_percentage* value is less than 100, the UE generates a random number which is uniformly distributed in the range of 0 to 100. The UE sends the reception report when the generated random number is of a lower value than the *sample\_percentage* value.

The *LimitSessionInterval* rule is used to limit the time interval between consecutive calls that report metrics. The *min\_interval* parameter for this rule indicates the minimum time distance between the start of two calls that are allowed to report metrics. When this rule is absent there is no limitation on the minimum time interval.

In case multiple rules are defined in the Management Object, the MTSI client should only report metrics when all individual rules evaluate to true (i.e. the rules are logically ANDed). In case no rules are present the MTSI client should always report metrics (see also clause 16.4 for metrics reporting procedures).

An example for a QoE metric reporting rule is shown below:

```
3GPP-QoE-Rule:OnlyCallerReports,SamplePercentage;sample_percentage=10.0,
LimitSessionInterval;min_interval=300,
```

This example rule defines that only the caller shall report, and only for 10% of the sessions, with the minimum time interval between the start times of two consecutive calls that report metrics to be 5 minutes.

## 16.4 Metrics Reporting

When a session is started, the MTSI client must determine whether QoE reporting is required for the session. If the MO parameter "Enabled" is set to false, no QoE reporting shall be done. If the "Enabled" parameter is set to true the optional MO "Rule" parameters are checked (sub-clause 16.3.3) to define if QoE reporting shall be done.

Once the need for QoE reporting has been established, the client shall continuously compute all specified metrics for each measurement interval period, according to the "Measure-Resolution" parameter (sub-clause 16.3.2). In order to bound the resources used by metrics reporting, the minimum values for the Measure-Resolution and Sending-Rate are specified to be 5 seconds and 30 seconds respectively. The computed metrics are represented in a vector format, adding an additional metric value to each metric vector after each new measurement interval period.

Note that the calculated metrics shall only cover one measurement interval. For instance, if the corruption duration extends longer than to the end of the current measurement interval, only the portion which fits into the current measurement interval shall be reported. The remaining portion of the corruption duration shall be reported as belonging to the next measurement interval.

The end of the session will normally not correspond to the end of a measurement interval period, so the metrics for the last measurement interval period will typically be calculated over a time shorter than the configured measurement interval. Note, however, that these last metrics shall still be added to the metrics vectors and reported to the server.

It is possible for the server to use the start and stop timestamps, together with the knowledge of the configured measurement interval, to derive the actual length of the last measurement interval period, but any specific action or interpretation of these last shorter measurements is out of scope of this specification.

The MTSI client shall send QoE report messages to the server in accordance with the specified reporting interval "Sending-Rate" (sub-clause 16.3.2). All stored metrics data shall then be sent to the server, and then deleted from the metrics storage.

Note that if the reporting interval is not an integer multiple of the measurement interval, only the measurement interval periods which have been fully passed shall be included in the report. The ongoing not-passed measurement interval period shall be included in the next report. The only exception is at the end of the session, where also the last ongoing measurement interval period shall be directly calculated and included in the report.

The client shall send QoE reports using the HTTP (RFC 2616 [73]) POST request carrying XML formatted metadata. If the optional "APN" parameter is defined in the OMA managed object, that APN shall be used for establishing the PDP context on which the QoE metric reports will be transmitted. The MTSI client randomly selects one of the URIs from the MO "Server" parameter, with uniform distribution.

Each QoE report is formatted in XML according the following XML schema (sub-clause 16.4.1). An informative example of a single reception report XML object is also given (sub-clause 16.4.2). The reports should be compressed using GZIP only if the MO parameter "Format" specifies this.

Each QoE Metrics element has a set of attributes and any number of media level QoE Metrics elements. All attributes are defined in sub-clause 16.4.1 and correspond to the QoE metrics listed in sub-clause 16.2. Individual metrics can be selected as described in sub-clause 16.3.2.

Except for the media level QoE metrics, the following parameters shall be reported for each report:

- The *callId* attribute identifies the call identity of the SIP session.
- The *clientId* attribute is unique identifier for the receiver, e.g. an MSISDN of the UE as defined in [80].
- The *startTime* and *stopTime* attributes identifies the client NTP time when the measurements included in the report were started and stopped. The time is based on the local real-time clock in the client, and might not be consistent with the true NTP time. However, assuming that the reporting is done without any extra delay the server can use the *stopTime* attribute to correct the timestamps if necessary.
- The *mediaId* attribute shall be reported for each media level QoE report, and identifies the port number for the media.

### 16.4.1 XML schema for QoE report message

```
<?xml version="1.0" encoding="UTF-8"?>
<xs:schema xmlns:xs="http://www.w3.org/2001/XMLSchema"
targetNamespace="urn:3gpp:metadata:2008:MTSI:qoereport"
xmlns="urn:3gpp:metadata:2008:MTSI:qoereport"
elementFormDefault="qualified">
  <xs:element name="QoeReport" type="QoeReportType"/>

  <xs:complexType name="QoeReportType">
    <xs:sequence>
      <xs:element name="statisticalReport" type="starType" minOccurs="0"
maxOccurs="unbounded"/>
      <xs:any namespace="##other" processContents="skip" minOccurs="0"
maxOccurs="unbounded"/>
    </xs:sequence>
    <xs:anyAttribute processContents="skip"/>
  </xs:complexType>

  <xs:complexType name="starType">
    <xs:sequence>
      <xs:element name="mediaLevelQoeMetrics" type="mediaLevelQoeMetricsType" minOccurs="1"
maxOccurs="unbounded"/>
    </xs:sequence>
    <xs:attribute name="startTime" type="xs:unsignedLong" use="required"/>
    <xs:attribute name="stopTime" type="xs:unsignedLong" use="required"/>
    <xs:attribute name="callId" type="xs:string" use="required"/>
    <xs:attribute name="clientId" type="xs:string" use="required"/>
    <xs:anyAttribute processContents="skip"/>
  </xs:complexType>

  <xs:complexType name="mediaLevelQoeMetricsType">
    <xs:sequence>
      <xs:any namespace="##other" processContents="skip" minOccurs="0"
maxOccurs="unbounded"/>
    </xs:sequence>
    <xs:attribute name="mediaId" type="xs:integer" use="required"/>
    <xs:attribute name="totalCorruptionDuration" type="unsignedLongVectorType"
use="optional"/>
  </xs:complexType>
</xs:schema>
```

```

<xs:attribute name="numberOfCorruptionEvents" type="unsignedLongVectorType"
  use="optional"/>
<xs:attribute name="corruptionAlternative" type="xs:string" use="optional"/>
<xs:attribute name="totalNumberOfSuccessivePacketLoss" type="unsignedLongVectorType"
  use="optional"/>
<xs:attribute name="numberOfSuccessiveLossEvents" type="unsignedLongVectorType"
  use="optional"/>
<xs:attribute name="numberOfReceivedPackets" type="unsignedLongVectorType"
  use="optional"/>
<xs:attribute name="framerate" type="doubleVectorType" use="optional"/>
<xs:attribute name="totalJitterDuration" type="doubleVectorType" use="optional"/>
<xs:attribute name="numberOfJitterEvents" type="unsignedLongVectorType"
  use="optional"/>
<xs:attribute name="totalSyncLossDuration" type="doubleVectorType" use="optional"/>
<xs:attribute name="numberOfSyncLossEvents" type="unsignedLongVectorType"
  use="optional"/>
<xs:attribute name="networkRTT" type="unsignedLongVectorType" use="optional"/>
<xs:attribute name="internalRTT" type="unsignedLongVectorType" use="optional"/>
<xs:attribute name="codecInfo" type="stringVectorType" use="optional"/>
<xs:attribute name="codecProfileLevel" type="stringVectorType" use="optional"/>
<xs:attribute name="codecImageSize" type="stringVectorType" use="optional"/>
<xs:attribute name="averageCodecBitrate" type="doubleVectorType" use="optional"/>

  <xs:anyAttribute processContents="skip"/>
</xs:complexType>

<xs:simpleType name="doubleVectorType">
  <xs:list itemType="xs:double"/>
</xs:simpleType>

<xs:simpleType name="stringVectorType">
  <xs:list itemType="xs:string"/>
</xs:simpleType>

<xs:simpleType name="unsignedLongVectorType">
  <xs:list itemType="xs:unsignedLong"/>
</xs:simpleType>
</xs:schema>

```

## 16.4.2 Example XML for QoE report message

Below is one example of QoE report message, in this example the measurement interval is 20 seconds, the reporting interval is 5 minutes, but the call ends after 55 seconds.

```

<?xml version="1.0" encoding="UTF-8"?>
<QoeReport xmlns="urn:3gpp:metadata:2008:MTSI:qoereport"
  xmlns:xsi="http://www.w3.org/2001/XMLSchema-instance"
  xsi:schemaLocation="urn:3gpp:metadata:2008:MTSI:qoereport qoereport.xsd">
  <statisticalReport
    startTime="1219322514"
    stopTime="1219322569"
    clientId="clientID"
    callId="callID">
    <mediaLevelQoeMetrics
      mediaId="1234"
      totalCorruptionDuration="480 0 120"
      numberOfCorruptionEvents="5 0 2"
      corruptionAlternative="a"
      totalNumberOfSuccessivePacketLoss="24 0 6"
      numberOfSuccessiveLossEvents="5 0 2"
      numberOfReceivedPackets="535 645 300"
      framerate="50.0 49.2 50.0"
      numberOfJitterEvents="0 1 0"
      totalJitterDuration="0 0.346 0"
      networkRTT="120 132 125"
      internalRTT="20 24 20"
      codecInfo="AMR-WB/16000/1 = ="
      averageCodecBitRate="12.4 12.65 12.7"/>
    <mediaLevelQoeMetrics
      mediaId="1236"
      totalCorruptionDuration="83 0 0"
      numberOfCorruptionEvents="1 0 0"
      corruptionAlternative="b"
      totalNumberOfSuccessivePacketLoss="3 0 0"
      numberOfSuccessiveLossEvents="2 0 0"

```

```
numberOfReceivedPackets="297 300 225"  
framerate="14.7 15.0 14.9"  
numberOfJitterEvents="0 0 0"  
totalJitterDuration="0 0 0"  
numberOfSyncLossEvents="0 1 0"  
totalSyncLossDuration="0 0.789 0"  
networkRTT="220 232 215"  
internalRTT="27 20 25"  
codecInfo="H263-2000/90000 = ="  
codecProfileLevel="profile=0;level=45 = ="  
codecImageSize="176x144 = ="  
averageCodecBitRate="124.5 128.0 115.1"/>  
</statisticalReport>  
</QoeReport>
```

---

## 17 Management of Media Adaptation

### 17.1 General

For the purpose of quality control or network management, it can be necessary to adjust the speech and video adaptation of the MTSI client in terminal. To effectively manage, i.e., initialize and update, the media adaptation of a large number of terminals, which can be implemented in different fashions, the 3GPP MTSIMA (MTSI Media Adaptation) MO defined in this clause may be used.

The MO, which exploits the information estimated or received from various entities such as ongoing multimedia packet stream, the far-end MTSI client in terminal, IMS, and network node such as eNodeB, provides two sets of parameters that can be used in the design of adaptation state machines for speech and video respectively. The parameters are contrived such that dependence on media codec or radio access bearer technology is avoided as much as possible, not to constrain the evolution of these elements. In addition, vendor specific parameters taking advantage of the implementation can be placed under Ext nodes.

By altering the parameters of the MO via OMA-DM protocol, media adaptation behavior of the MTSI client in terminal can be modified up to extent allowed by the implementation. Note that due to the underlying uncertainties and complexities, one should expect only to shape the expected bit rate trajectory of multimedia stream over time-varying transmission conditions, rather than to control the media flow in a timely and stringent manner. Detailed descriptions of the speech and video adaptation parameters can be found in table 17.1 and 17.2.

The Management Object Identifier shall be: urn:oma:mo:ext-3gpp-mtsima:1.0.

Protocol compatibility: The MO is compatible with OMA Device Management protocol specifications, version 1.2 and upwards, and is defined using the OMA DM Device Description Framework as described in the Enabler Release Definition OMA-ERELED\_DM-V1\_2 [67].

### 17.2 Media adaptation management object

The following nodes and leaf objects in figure 17.1 shall be contained under the 3GPP\_MTSIMA node if the MTSI client in terminal supports the feature described in this clause. Information of DDF for this MO is given in Annex J.



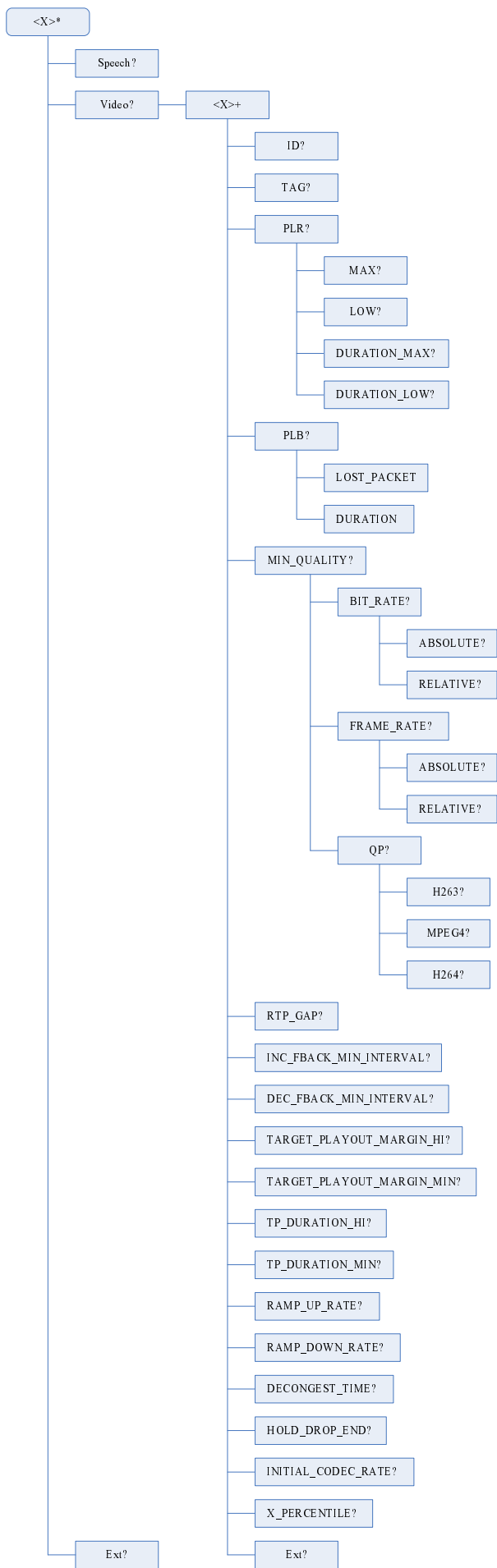
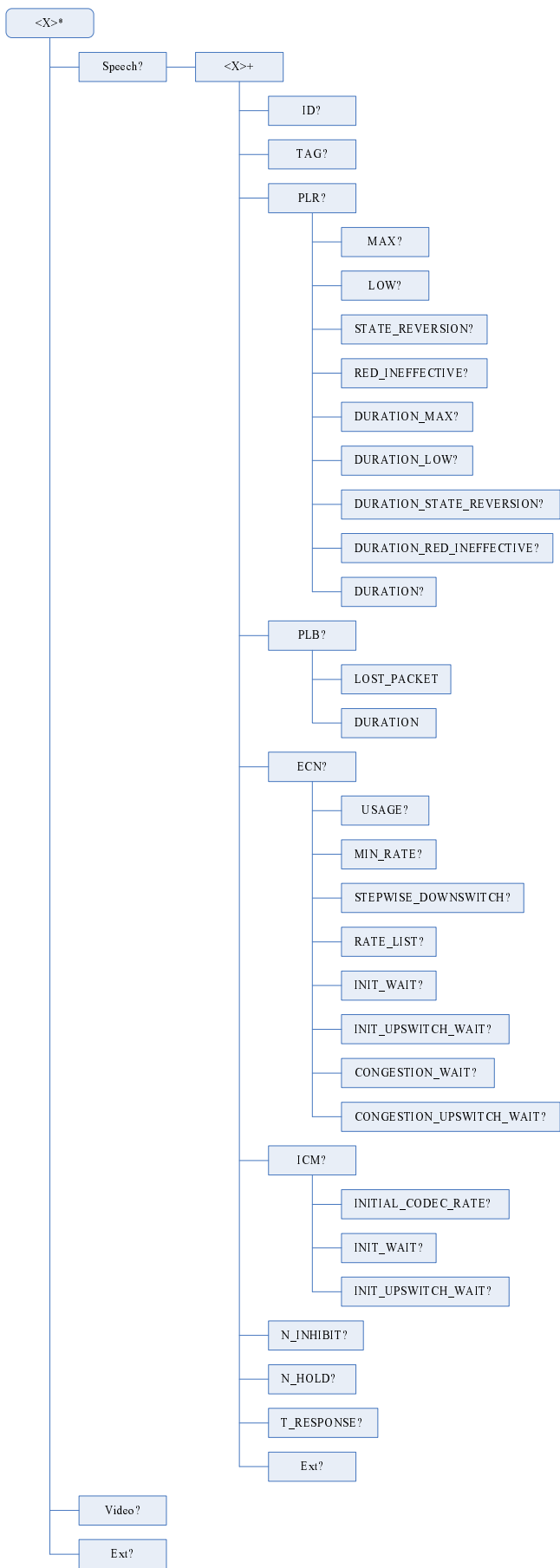

**Figure 17.1: MTSI media adaptation management object tree****Node: /<X>**

This interior node specifies the unique object id of a MTSI media adaptation management object. The purpose of this interior node is to group together the parameters of a single object.

- Occurrence: ZeroOrOne
- Format: node
- Minimum Access Types: Get

The following interior nodes shall be contained if the MTSI client in terminal supports the “MTSI media adaptation management object”.

**/<X>/Speech**

The Speech node is the starting point of parameters related to speech adaptation if any speech codec are available.

- Occurrence: ZeroOrOne
- Format: node
- Minimum Access Types: Get

**/<X>/Speech/<X>**

This interior node is used to allow a reference to a list of speech adaptation parameters.

- Occurrence: OneOrMore
- Format: node
- Minimum Access Types: Get

**/<X>/Speech/<X>/ID**

This leaf node represents the identification number of a set of parameters related to speech adaptation.

- Occurrence: ZeroOrOne
- Format: int
- Minimum Access Types: Get

**/<X>/Speech/<X>/TAG**

This leaf node represents the identification tag of a set of parameters for speech adaptation. It is recommended to have at least a node, for example, ID, TAG, or implementation-specific ones, for the identification purpose such that each set of parameters can be distinguished and accessed.

- Occurrence: ZeroOrOne
- Format: chr
- Minimum Access Types: Get

**/<X>/Speech/<X>/PLR**

This interior node is used to allow a reference to a list of parameters related to packet loss rate (PLR).

- Occurrence: ZeroOrOne

- Format: node
- Minimum Access Types: Get

### **/`<X>`/Speech/`<X>`/PLR/MAX**

This leaf node represents the maximum PLR tolerated when redundancy is not used, before the receiver signals the sender to attempt adaptation that reduces PLR or operate at modes more robust to packet loss.

- Occurrence: ZeroOrOne
- Format: float
- Minimum Access Types: Get
- Values: 0 ~ 100 %

### **/`<X>`/Speech/`<X>`/PLR/LOW**

This leaf node represents the minimum PLR tolerated, before the receiver signals the sender to probe for higher bit rate, increase the packet rate, reduce redundancy, or perform other procedures that could improve speech quality under such favorable conditions.

- Occurrence: ZeroOrOne
- Format: float
- Minimum Access Types: Get
- Values: 0 ~ 100 %

### **/`<X>`/Speech/`<X>`/PLR/STATE\_REVERSION**

This leaf node represents the maximum PLR tolerated after adaptation state machine has taken actions, based on the measured PLR lower than LOW. Once PLR exceeds this threshold, the receiver decides that the actions taken to improve speech quality were not successful.

- Occurrence: ZeroOrOne
- Format: float
- Minimum Access Types: Get
- Values: 0 ~ 100 %

### **/`<X>`/Speech/`<X>`/PLR/RED\_INEFFECTIVE**

This leaf node represents the maximum PLR tolerated, after adaptation state machine has taken actions to increase redundancy. Once PLR exceeds this threshold, the receiver decides that the situation was not improved but degraded.

- Occurrence: ZeroOrOne
- Format: float
- Minimum Access Types: Get
- Values: 0 ~ 100 %

### **/`<X>`/Speech/`<X>`/PLR/DURATION\_MAX**

This leaf node represents the duration (ms) of sliding window over which PLR is observed and computed. The computed value is compared with the MAX threshold.

- Occurrence: ZeroOrOne

- Format: int
- Minimum Access Types: Get

### **/<X>/Speech/<X>/PLR/DURATION\_LOW**

This leaf node represents the duration (ms) of sliding window over which PLR is observed and computed. The computed value is compared with the LOW threshold.

- Occurrence: ZeroOrOne
- Format: int
- Minimum Access Types: Get

### **/<X>/Speech/<X>/PLR/DURATION\_STATE\_REVERSION**

This leaf node represents the duration (ms) of sliding window over which PLR is observed and computed. The computed value is compared with the STATE\_REVERSION threshold.

- Occurrence: ZeroOrOne
- Format: int
- Minimum Access Types: Get

### **/<X>/Speech/<X>/PLR/DURATION\_RED\_INEFFECTIVE**

This leaf node represents the duration (ms) of sliding window over which PLR is observed and computed. The computed value is compared with the RED\_INEFFECTIVE threshold.

- Occurrence: ZeroOrOne
- Format: int
- Minimum Access Types: Get

### **/<X>/Speech/<X>/PLR/DURATION**

This leaf node represents the duration (ms) of sliding window over which PLR is observed and computed. The computed value is compared with the PLR thresholds.

- Occurrence: ZeroOrOne
- Format: int
- Minimum Access Types: Get

### **/<X>/Speech/<X>/PLB**

This interior node is used to allow a reference to a list of parameters related to an event, packet loss burst (PLB), in which a large number of packets are lost during a limited period.

- Occurrence: ZeroOrOne
- Format: node
- Minimum Access Types: Get

### **/<X>/Speech/<X>/PLB/LOST\_PACKET**

This leaf node represents the number of packets lost during a period of PLB/DURATION.

- Occurrence: One

- Format: int
- Minimum Access Types: Get

### **/`<X>`/Speech/`<X>`/PLB/DURATION**

This leaf node represents the period (ms) for which LOST\_PACKET is counted.

- Occurrence: One
- Format: int
- Minimum Access Types: Get

### **/`<X>`/Speech/`<X>`/ECN**

This interior node is used to allow a reference to a list of parameters related to Explicit Congestion Notification (ECN) to IP.

- Occurrence: ZeroOrOne
- Format: node
- Minimum Access Types: Get

### **/`<X>`/Speech/`<X>`/ECN/USAGE**

This leaf node represents a Boolean parameter that enables or disables ECN-based adaptation.

- Occurrence: ZeroOrOne
- Format: bool
- Minimum Access Types: Get

### **/`<X>`/Speech/`<X>`/ECN/MIN\_RATE**

This leaf node represents the minimum bit rate (bps, excluding IP, UDP, RTP and payload overhead) that speech encoder should use during ECN-based adaptation.

- Occurrence: ZeroOrOne
- Format: int
- Minimum Access Types: Get

### **/`<X>`/Speech/`<X>`/ECN/STEPWISE\_DOWNSWITCH**

This leaf node represents a Boolean parameter that selects which down-switch method to use, i.e., direct or step-wise, for ECN-triggered adaptation.

- Occurrence: ZeroOrOne
- Format: bool
- Minimum Access Types: Get

### **/`<X>`/Speech/`<X>`/ECN/RATE\_LIST**

This leaf node represents the list of bit rates to use during stepwise down-switch. This parameter is only applicable when stepwise down-switch is used.

- Occurrence: ZeroOrOne
- Format: chr

- Minimum Access Types: Get

### **/*X*/Speech/*X*/ECN/INIT\_WAIT**

This leaf node represents the time (ms) that the sender should wait before an up-switch is attempted in the beginning of the session if no rate control information or reception quality feedback information is received.

- Occurrence: ZeroOrOne
- Format: int
- Minimum Access Types: Get

### **/*X*/Speech/*X*/ECN/INIT\_UPSWITCH\_WAIT**

This leaf node represents the time (ms) that the sender should wait at each step during up-switch in the beginning of the session.

- Occurrence: ZeroOrOne
- Format: int
- Minimum Access Types: Get

### **/*X*/Speech/*X*/ECN/CONGESTION\_WAIT**

This leaf node represents the minimum interval (ms) between detection of ECN-CE and up-switch from the reduced rate.

- Occurrence: ZeroOrOne
- Format: int
- Minimum Access Types: Get

### **/*X*/Speech/*X*/ECN/CONGESTION\_UPSWITCH\_WAIT**

This leaf node represents the waiting time (ms) at each step during up-switch after a congestion event, except for the initial up-switch which uses the ECN/CONGESTION\_WAIT time.

- Occurrence: ZeroOrOne
- Format: int
- Minimum Access Types: Get

### **/*X*/Speech/*X*/ICM**

This interior node is used to allow a reference to a list of parameters related to Initial Codec Mode (ICM).

- Occurrence: ZeroOrOne
- Format: node
- Minimum Access Types: Get

### **/*X*/Speech/*X*/ICM/INITIAL\_CODEC\_RATE**

This leaf node represents the bit rate (bps, excluding IP, UDP, RTP and payload overhead) that the speech encoder should use when starting the encoding in the beginning of the session.

- Occurrence: ZeroOrOne
- Format: int

- Minimum Access Types: Get

### **/`<X>`/Speech/`<X>`/ICM/INIT\_WAIT**

This leaf node represents the time (ms) that the sender should wait before an up-switch is attempted in the beginning of the session if no rate control information or reception quality feedback information is received.

- Occurrence: ZeroOrOne
- Format: int
- Minimum Access Types: Get

### **/`<X>`/Speech/`<X>`/ICM/INIT\_UPSWITCH\_WAIT**

This leaf node represents the time (ms) that the sender should wait at each step during up-switch in the beginning of the session.

- Occurrence: ZeroOrOne
- Format: int
- Minimum Access Types: Get

### **/`<X>`/Speech/`<X>`/N\_INHIBIT**

This leaf node represents the period (number of speech frames) for which adaptation is disabled to avoid the ping-pong effects, when adaptation state machine transitions from one state to another then back to the original state.

- Occurrence: ZeroOrOne
- Format: int
- Minimum Access Types: Get

### **/`<X>`/Speech/`<X>`/N\_HOLD**

This leaf node represents the period (proportion of PLR/DURATION) that can substitute other periods such as DURATION\_LOW or DURATION\_RED\_INEFFECTIVE, when they are not available.

- Occurrence: ZeroOrOne
- Format: int
- Minimum Access Types: Get

### **/`<X>`/Speech/`<X>`/T\_RESPONSE**

This leaf node represents the expected response time (ms) for a request to be fulfilled. If a request transmitted to the far-end is not granted within a period of T\_RESPONSE, the request can be considered lost during transmission or the far-end MTSI client in terminal might have decided not to grant it.

- Occurrence: ZeroOrOne
- Format: int
- Minimum Access Types: Get

### **/`<X>`/Speech/`<X>`/Ext**

The Ext is an interior node where the vendor specific information can be placed (vendor meaning application vendor, device vendor etc.). Usually the vendor extension is identified by vendor specific name under the ext node. The tree structure under the vendor identified is not defined and can therefore include one or more un-standardized sub-trees.

- Occurrence: ZeroOrOne
- Format: node
- Minimum Access Types: Get

## **/`<X>`/Video**

The Video node is the starting point of parameters related to video adaptation if any video codec are available.

- Occurrence: ZeroOrOne
- Format: node
- Minimum Access Types: Get

## **/`<X>`/Video/`<X>`**

This interior node is used to allow a reference to a list of video adaptation parameters.

- Occurrence: OneOrMore
- Format: node
- Minimum Access Types: Get

## **/`<X>`/Video/`<X>`/ID**

This leaf node represents the identification number of a set of parameters related to video adaptation.

- Occurrence: ZeroOrOne
- Format: int
- Minimum Access Types: Get

## **/`<X>`/Video/`<X>`/TAG**

This leaf node represents the identification tag of a set of parameters for video adaptation. It is recommended to have at least a node, for example, ID, TAG, or implementation-specific ones, for the identification purpose such that each set of parameters can be distinguished and accessed.

- Occurrence: ZeroOrOne
- Format: chr
- Minimum Access Types: Get

## **/`<X>`/Video/`<X>`/PLR**

This interior node is used to allow a reference to a list of parameters related to PLR.

- Occurrence: ZeroOrOne
- Format: node
- Minimum Access Types: Get

## **/`<X>`/Video/`<X>`/PLR/MAX**

This leaf node represents the maximum PLR tolerated, before the receiver signals the sender to reduce the bit rate such that PLR is reduced.

- Occurrence: ZeroOrOne



- Format: float
- Minimum Access Types: Get
- Values: 0 ~ 100 %

### **/*X*/Video/*X*/PLR/LOW**

This leaf node represents the minimum PLR tolerated, before the receiver signals the sender to increase the bit rate.

- Occurrence: ZeroOrOne
- Format: float
- Minimum Access Types: Get
- Values: 0 ~ 100 %

### **/*X*/Video/*X*/PLR/DURATION\_MAX**

This leaf node represents the duration (ms) of sliding window over which PLR is observed and computed. The computed value is compared with the MAX threshold.

- Occurrence: ZeroOrOne
- Format: int
- Minimum Access Types: Get

### **/*X*/Video/*X*/PLR/DURATION\_LOW**

This leaf node represents the duration (ms) of sliding window over which PLR is observed and computed. The computed value is compared with the LOW threshold.

- Occurrence: ZeroOrOne
- Format: int
- Minimum Access Types: Get

### **/*X*/Video/*X*/PLB**

This interior node is used to allow a reference to a list of parameters related to PLB.

- Occurrence: ZeroOrOne
- Format: node
- Minimum Access Types: Get

### **/*X*/Video/*X*/PLB/LOST\_PACKET**

This leaf node represents the number of packets lost during a period of PLB/DURATION.

- Occurrence: One
- Format: int
- Minimum Access Types: Get

### **/*X*/Video/*X*/PLB/DURATION**

This leaf node represents the period (ms) for which LOST\_PACKET is counted.

- Occurrence: One

- Format: int
- Minimum Access Types: Get

### **/*<X>*/Video/*<X>*/MIN\_QUALITY**

This interior node is used to allow a reference to a list of parameters related to the minimum video quality.

- Occurrence: ZeroOrOne
- Format: node
- Minimum Access Types: Get

### **/*<X>*/Video/*<X>*/MIN\_QUALITY/BIT\_RATE**

This interior node is used to allow a reference to a list of parameters related to the minimum bit rate.

- Occurrence: ZeroOrOne
- Format: node
- Minimum Access Types: Get

### **/*<X>*/Video/*<X>*/MIN\_QUALITY/BIT\_RATE/ABSOLUTE**

This leaf node represents the minimum bit rate (kbps) that video encoder should use.

- Occurrence: ZeroOrOne
- Format: float
- Minimum Access Types: Get

### **/*<X>*/Video/*<X>*/MIN\_QUALITY/BIT\_RATE/RELATIVE**

This leaf node represents the minimum bit rate (proportion of the bit rate negotiated for the video session) that video encoder should use.

- Occurrence: ZeroOrOne
- Format: float
- Minimum Access Types: Get
- Values: 0 ~ 100 %

### **/*<X>*/Video/*<X>*/MIN\_QUALITY/FRAME\_RATE**

This interior node is used to allow a reference to a list of parameters related to the minimum frame rate.

- Occurrence: ZeroOrOne
- Format: node
- Minimum Access Types: Get

### **/*<X>*/Video/*<X>*/MIN\_QUALITY/FRAME\_RATE/ABSOLUTE**

This leaf node represents the minimum frame rate (fps, frames per second) that video encoder should use.

- Occurrence: ZeroOrOne
- Format: float

- Minimum Access Types: Get

### **/**

This leaf node represents the minimum frame rate (proportion of the maximum frame rate limited by the codec profile/level negotiated for the video session) that video encoder should use.

- Occurrence: ZeroOrOne
- Format: float
- Minimum Access Types: Get
- Values: 0 ~ 100 %

### **/**

This interior node is used to allow a reference to a list of parameters related to video quantisation.

- Occurrence: ZeroOrOne
- Format: node
- Minimum Access Types: Get

### **/**

This leaf node represents the maximum value of luminance quantization parameter QUANT that video encoder should use if H.263 is negotiated for the video session.

- Occurrence: ZeroOrOne
- Format: int
- Minimum Access Types: Get
- Values: 1 ~ 31

### **/**

This leaf node represents the maximum value of luminance quantization parameter quantiser\_scale that video encoder should use if MPEG-4 is negotiated for the video session.

- Occurrence: ZeroOrOne
- Format: int
- Minimum Access Types: Get
- Values: 1 ~ 31

### **/**

This leaf node represents the maximum value of luminance quantization parameter  $QP_Y$  that video encoder should use if H.264 is negotiated for the video session.

- Occurrence: ZeroOrOne
- Format: int
- Minimum Access Types: Get
- Values: 0 ~ 51

### **/**

This leaf node represents the maximum interval between packets (proportion of the estimated frame period) tolerated, before the receiver declares bursty packet loss or severe congestion condition.

- Occurrence: ZeroOrOne
- Format: float
- Minimum Access Types: Get

### **/`<X>`/Video/INC\_FBACK\_MIN\_INTERVAL**

This leaf node represents the minimum interval (ms) at which rate adaptation feedback such as TMMBR should be sent from the receiver to the sender, when the bit rate is being increased.

- Occurrence: ZeroOrOne
- Format: int
- Minimum Access Types: Get

### **/`<X>`/Video/`<X>`/DEC\_FBACK\_MIN\_INTERVAL**

This leaf node represents the minimum interval (ms) at which rate adaptation feedback such as TMMBR should be sent from the receiver to the sender, when the bit rate is being decreased.

- Occurrence: ZeroOrOne
- Format: int
- Minimum Access Types: Get

### **/`<X>`/Video/`<X>`/TP\_DURATION\_HI**

This leaf node represents the duration (ms) of sliding window over which the interval between packet arrival and playout is observed. The computed value is compared with TARGET\_PLAYOUT\_MARGIN\_HI.

- Occurrence: ZeroOrOne
- Format: int
- Minimum Access Types: Get

### **/`<X>`/Video/`<X>`/TP\_DURATION\_MIN**

This leaf node represents the duration (ms) of sliding window over which the interval between packet arrival and playout is observed. The computed value is compared with TARGET\_PLAYOUT\_MARGIN\_MIN.

- Occurrence: ZeroOrOne
- Format: int
- Minimum Access Types: Get

### **/`<X>`/Video/`<X>`/TARGET\_PLAYOUT\_MARGIN\_HI**

This leaf node represents the upper threshold of the interval (ms) between packet arrival and its properly scheduled playout.

- Occurrence: ZeroOrOne
- Format: int
- Minimum Access Types: Get

## **/<X>/Video/<X>/TARGET\_PLAYOUT\_MARGIN\_MIN**

This leaf node represents the lower threshold of the interval (ms) between packet arrival and its properly scheduled playout.

- Occurrence: ZeroOrOne
- Format: int
- Minimum Access Types: Get

## **/<X>/Video/<X>/RAMP\_UP\_RATE**

This leaf node represents the rate (kbps/s) at which video encoder should increase its maximum bit rate from current value to the value indicated in the most recently received TMMBR message.

- Occurrence: ZeroOrOne
- Format: float
- Minimum Access Types: Get

## **/<X>/Video/<X>/RAMP\_DOWN\_RATE**

This leaf node represents the rate (kbps/s) at which video encoder should decrease its maximum bit rate from current value to the value indicated in the most recently received TMMBR message.

- Occurrence: ZeroOrOne
- Format: float
- Minimum Access Types: Get

## **/<X>/Video/<X>/DECONGEST\_TIME**

This leaf node represents the time (ms) the receiver should command the sender to spend in decongesting the transmission path, before attempting to transmit at the sustainable rate of the path.

- Occurrence: ZeroOrOne
- Format: int
- Minimum Access Types: Get

## **/<X>/Video/<X>/HOLD\_DROP\_END**

This leaf node represents a tri-valued parameter that controls how the sender should behave in case video quality cannot meet the requirements set in BIT\_RATE, FRAME\_RATE, or QP.

- Occurrence: ZeroOrOne
- Format: int
- Minimum Access Types: Get
- Values: 0, 1, 2

## **/<X>/Video/<X>/INITIAL\_CODEC\_RATE**

This leaf node represents the initial bit rate (proportion of the bit rate negotiated for the video session) that the sender should begin encoding video at.

- Occurrence: ZeroOrOne

- Format: float
- Minimum Access Types: Get
- Values: 0 ~ 100 %

### **/<X>/Video/<X>/X\_PERCENTILE**

This leaf node represents the percentile point of packet arrival distribution used with the TARGET\_PLAYOUT\_MARGIN parameters.

- Occurrence: ZeroOrOne
- Format: float
- Minimum Access Types: Get
- Values: 0 ~ 100 %

### **/<X>/Video/<X>/Ext**

The Ext is an interior node where the vendor specific information can be placed (vendor meaning application vendor, device vendor etc.). Usually the vendor extension is identified by vendor specific name under the ext node. The tree structure under the vendor identified is not defined and can therefore include one or more un-standardized sub-trees.

- Occurrence: ZeroOrOne
- Format: node
- Minimum Access Types: Get

### **/<X>/Ext**

The Ext is an interior node where the vendor specific information can be placed (vendor meaning application vendor, device vendor etc.). Usually the vendor extension is identified by vendor specific name under the ext node. The tree structure under the vendor identified is not defined and can therefore include one or more un-standardized sub-trees.

- Occurrence: ZeroOrOne
- Format: node
- Minimum Access Types: Get

**Table 17.1: Speech adaptation parameters of 3GPP MTSIMA MO**

Parameter (Unit)	Usage
PLR/MAX (%)	Packet loss rate (PLR) above this threshold, when redundancy is not used, indicates that performance is not satisfactory. Adaptation state machine at the receiver should signal the sender to attempt adaptation that reduces PLR or operate at modes more robust to packet loss. When using the example adaptation state machines of Annex C, this parameter corresponds to PLR_1.
PLR/LOW (%)	PLR below this threshold indicates that conditions are favorable and better quality can be supported. Adaptation state machine at the receiver should signal the sender to probe for higher bit rate, increase the packet rate, reduce redundancy, or perform other procedures that could improve speech quality under such favorable conditions. When in the probing state, if PLR falls below this threshold, then the sender should adapt to a higher bit rate. When using the example adaptation state machines of Annex C, this parameter corresponds to PLR_2.
PLR/STATE_REVERSION (%)	PLR above this threshold, after adaptation state machine has taken actions based on PLR lower than LOW, indicates that the actions taken to improve speech quality were not successful. Adaptation state

	machine at the receiver should signal the sender to return to the previous state where it stayed before attempting to improve speech quality. When using the example adaptation state machines of Annex C, this parameter corresponds to PLR_3.
PLR/RED_INEFFECTIVE (%)	PLR above this threshold, after adaptation state machine has taken actions to increase redundancy, indicates that situation was not improved but degraded. Adaptation state machine at the receiver should signal the sender to use a lower bit rate and no redundancy. When using the example adaptation state machines of Annex C, this parameter corresponds to PLR_4.
PLR/DURATION_MAX (ms)	Duration of sliding window over which PLR is observed and computed. The computed value is compared with the MAX threshold.
PLR/DURATION_LOW (ms)	Duration of sliding window over which PLR is observed and computed. The computed value is compared with the LOW threshold.
PLR/DURATION_STATE_REVERSION (ms)	Duration of sliding window over which PLR is observed and computed. The computed value is compared with the STATE_REVERSION threshold.
PLR/DURATION_RED_INEFFECTIVE (ms)	Duration of sliding window over which PLR is observed and computed. The computed value is compared with the RED_INEFFECTIVE threshold.
PLR/DURATION (ms)	Duration of sliding window over which PLR is observed and computed. The computed value is compared with the PLR thresholds. This applies as the default duration in case no specific DURATION is specified.
PLB/LOST_PACKET (integer)	When loss of LOST_PACKET or more packets is detected in the latest period of PLB/DURATION, this event is categorized as a packet loss burst (PLB) and adaptation state machine should take appropriate actions to reduce the impact on speech quality.
PLB/DURATION (ms)	Duration of sliding window over which lost packets are counted.
ECN/USAGE (Boolean)	Switch to enable or disable ECN-based adaptation. This parameter should be translated as follows: "0" = OFF, "1" = ON.
ECN/MIN_RATE (bps)	<p>Lower boundary for the media bit-rate adaptation in response to ECN-CE marking. The media bit-rate shall not be reduced below this value as a reaction to the received ECN-CE. The value of this parameter is assigned to the ECN_min_rate parameter defined in Clause 10.2.0.</p> <p>The ECN_min_rate should be selected to maintain an acceptable service quality while reducing the resource utilization.</p> <p>Default value: Same as ICM/INITIAL_CODEC_RATE if defined, otherwise same as Initial Codec Mode (ICM), see Clause 7.5.2.1.6.</p>
ECN/STEPWISE_DOWNSWITCH (Boolean)	Switch to select down-switch method. This parameter should be translated as follows: "0" = direct down-switch to ECN/MIN_RATE; "1" = stepwise down-switch according to ECN/MODE_LIST (one step per congestion event).
ECN/RATE_LIST (character set)	<p>List of bit rates (e.g. codec modes) to use during stepwise down-switch. This parameter is only applicable when stepwise down-switch is used. If the codec does not support exactly the rate which is indicated then the highest rate supported by the codec below the indicated value should be used. Depending on the codec, the values can be understood as either the highest rate or the average rate.</p> <p>The entries in the list may either be generic, i.e. usable for any codec, but can also be codec-specific.</p> <p>The default usage is the generic list where the bit rates [in bps] are included, e.g. (5000, 6000, 7500, 12500).</p> <p>A codec-specific list may indicate desired modes, e.g. for AMR the list</p>

	<p>could be (0,2,4,7).</p> <p>If this parameter is not defined or contains bit rates not negotiated in the session, then the mode-set included in SDP is used. If no mode-set is defined in SDP, then "4750, 5900, 7400, 12200" is used for AMR, which corresponds to the "0, 2, 4, 7" modes.</p>
ECN/INIT_WAIT (ms)	<p>The waiting time before the first up-switch is attempted in the beginning of the session, to avoid premature up-switch.</p> <p>This parameter shall be used instead of the ICM/INIT_WAIT parameter if ECN is used in the session.</p> <p>Default value is defined in Clause 7.5.2.1.6.</p>
ECN/INIT_UPSWITCH_WAIT (ms)	<p>This parameter is used in up-switches in the beginning of the session. Note that the first up-switch in the beginning of the session uses the ECN/INIT_WAIT time. Only the subsequent up-switches use the ECN/INIT_UPSWITCH_WAIT time.</p> <p>This parameter shall be used instead of the ICM/INIT_UPSWITCH_WAIT parameter if ECN is used in the session.</p> <p>Default value: is defined in Clause 7.5.2.1.6.</p>
ECN/CONGESTION_WAIT (ms)	<p>The waiting time after an ECN-CE marking for which an up-switch shall not be attempted. The value of this parameter is assigned to the ECN_congestion_wait parameter defined in Clause 10.2.0.</p> <p>A negative value indicates an infinite waiting time, i.e. to prevent up-switch for the whole remaining session.</p> <p>Default value: Same as the ECN_congestion_wait parameter defined in Clause 10.2.0.</p>
ECN/CONGESTION_UPSWITCH_WAIT (ms)	<p>This parameter is used in up-switches after a congestion event. Note that the first up-switch after a congestion event uses the ECN/CONGESTION_WAIT time. Only the subsequent up-switches use the ECN/CONGESTION_UPSWITCH_WAIT time.</p> <p>Default value is 5000 ms.</p>
ICM/INITIAL_CODEC_RATE (bps)	<p>The bit rate that the speech encoder should use for the encoding of the speech at the start of the RTP stream.</p>
ICM/INIT_WAIT (ms)	<p>To avoid premature up-switch when ECN is not used in the session, this parameter defines the waiting time before the first up-switch is attempted in the beginning of the session.</p> <p>Default value: Same as Initial Waiting Time as defined in Clause 7.5.2.1.6.</p>
ICM/INIT_UPSWITCH_WAIT (ms)	<p>When ECN is not used in the session, this parameter is used in up-switches in the beginning of the session until the first down-switch occurs. Note that the first up-switch in the beginning uses the INIT_WAIT time. Only the subsequent up-switches use the INIT_UPSWITCH_WAIT time.</p> <p>Default value: Same as Initial Upswitch Waiting Time as defined in Clause 7.5.2.1.6.</p>
N_INHIBIT (integer)	<p>If adaptation state machine transitions from one state to another then back to the original state, adaptation state machine should not return to the other state in less than N_INHIBIT speech frames, to avoid the ping-pong effects.</p>
N_HOLD (integer)	<p>N_HOLD x PLR/DURATION can be used as the period for which PLR is observed and computed. For example, the computed value can be compared with the LOW threshold when DURATION_LOW is not defined.</p>



T_RESPONSE (ms)	If the receiver does not detect expected responses from the sender within a period of T_RESPONSE after having sent a request, the receiver should consider this request as not fulfilled and take appropriate actions.
-----------------	--

Table 17.2: Video adaptation parameters of 3GPP MTSIMA MO

Parameter (Unit)	Usage
PLR/MAX (%)	Upper threshold of PLR above which adaptation state machine at the receiver should signal the sender to reduce the bit rate. PLR is measured per RTP packet and in addition to packets that do not arrive at the receiver ever, packets that arrive but do not make it in time for their properly scheduled playout are considered as lost.
PLR/LOW (%)	Lower threshold of PLR below which adaptation state machine at the receiver may signal the sender to increase the bit rate.
PLR/DURATION_MAX (ms)	Duration of sliding window over which PLR is observed and computed. The computed value is compared with the MAX threshold.
PLR/DURATION_LOW (ms)	Duration of sliding window over which PLR is observed and computed. The computed value is compared with the LOW threshold.
PLB/LOST_PACKET (integer)	When loss of LOST_PACKET or more packets is detected in the last period of PLB/DURATION, this event is categorized as a packet loss burst (PLB) and adaptation state machine should take appropriate actions to reduce the impact on video quality.
PLB/DURATION (ms)	Duration of sliding window over which lost packets are counted.
MIN_QUALITY/BIT_RATE /ABSOLUTE (kbps)	Minimum bit rate that video encoder should use. If the MTSI client in terminal is unable to maintain this minimum bit rate, it should drop the video stream component or put it on hold.
MIN_QUALITY/BIT_RATE /RELATIVE (%)	Minimum bit rate that video encoder should use (proportion of the bit rate negotiated for the video session). If the MTSI client in terminal is unable to maintain this minimum bit rate, it should drop the video stream component or put it on hold.
MIN_QUALITY/FRAME_RATE /ABSOLUTE (fps)	Minimum frame rate that video encoder should use. If the MTSI client in terminal is unable to maintain this minimum frame rate, it should drop the video stream component or put it on hold. The minimum frame rate is considered unmet if the interval between encoding times of video frames is larger than the reciprocal of the minimum frame rate.
MIN_QUALITY/FRAME_RATE /RELATIVE (%)	Minimum frame rate that video encoder should use (proportion of maximum frame rate supported as specified by the video codec profile/level negotiated for the session). If the MTSI client in terminal is unable to maintain this minimum frame rate, it should drop the video stream component or put it on hold. The minimum frame rate is considered unmet if the interval between encoding times of video frames is larger than the reciprocal of the minimum frame rate.
MIN_QUALITY/QP/H263 (integer)	Maximum value of QUANT that video encoder should use if H.263 is negotiated for the video session. The encoder should generate video stream such that QUANT does not exceed $\min(31, \text{floor}(2^{((H263-12)/6+0.5)}))$ . If the MTSI client in terminal is unable to maintain this maximum QUANT value, it should drop the video stream component or put it on hold.
MIN_QUALITY/QP/MPEG4 (integer)	Maximum value of quantiser_scale that video encoder should use if MPEG-4 is negotiated for the video session. The encoder should generate video stream such that quantiser_scale does not exceed $\min(31, \text{floor}(2^{((MPEG4-12)/6+0.5)}))$ . If the MTSI client in terminal is unable to maintain this maximum quantiser_scale value, it should drop the video stream component or put it on hold.
MIN_QUALITY/QP/H264 (integer)	Maximum value of $QP_{\gamma}$ that video encoder should use if H.264 is negotiated for the video session. The encoder should generate video stream such that $QP_{\gamma}$ does not exceed H264. If the MTSI client in terminal is unable to maintain this maximum $QP_{\gamma}$ value, it should drop the video stream component or put it on hold.

RTP_GAP (float)	If no RTP packets are received for longer than this period (proportion of the estimated frame period), the receiver should declare bursty packet loss or severe congestion condition. Packet loss gap can be detected as follows: based on the reception history of video packets and their time-stamps, the receiver keeps a running estimate of the frame period, T_FRAME_EST. If the receiver does not receive any RTP packets for a duration of RTP_GAP x T_FRAME_EST, then it should react accordingly. Typical RTP_GAP values can range from 0.5 to 5.0.
INC_FBACK_MIN_INTERVAL (ms)	Minimum interval between transmitting TMMBR messages that increase the maximum rate limit.
DEC_FBACK_MIN_INTERVAL (ms)	Minimum interval between transmitting TMMBR messages that decrease the maximum rate limit.
TP_DURATION_HI (ms)	Duration of sliding window over which the interval between packet arrival and playout is observed and computed. The computed value is compared with the TARGET_PLAYOUT_MARGIN_HI threshold.
TP_DURATION_MIN (ms)	Duration of sliding window over which the interval between packet arrival and playout is observed and computed. The computed value is compared with the TARGET_PLAYOUT_MARGIN_MIN threshold.
TARGET_PLAYOUT_MARGIN_HI (ms)	Upper threshold of the interval between packet arrival and its properly scheduled playout. The interval is measured from playout time to the X percentile point (X_PERCENTILE) of the packet arrival distribution. When this upper threshold is exceeded, the receiver may signal the sender to increase the bit rate.
TARGET_PLAYOUT_MARGIN_MIN (ms)	Lower threshold of the interval between packet arrival and its properly scheduled playout. The interval is measured from playout time to the X percentile point (X_PERCENTILE) of the packet arrival distribution. When this lower threshold is exceeded, the receiver should signal the sender to decrease the bit rate.
RAMP_UP_RATE (kbps/s)	Rate at which video encoder should increase its target bit rate to a higher max rate limit.
RAMP_DOWN_RATE (kbps/s)	Rate at which video encoder should decrease its target bit rate to a lower max rate limit.
DECONGEST_TIME (ms)	Minimum time the receiver should command the sender to spend in decongesting the transmission path, before attempting to transmit at the sustainable rate of the path. The receiver can achieve decongestion by first sending a TMMBR message with a value below the sustainable rate of the path. Once the receiver concludes that congestion has been cleared, it can send a TMMBR message with a value closer to the sustainable rate of the path. If the receiver concludes that congestion has not been cleared yet, it may attempt to clear the remaining congestion for another period of DECONGEST_TIME. A short DECONGEST_TIME results in a quick and aggressive decongestion by reducing the bit rate radically while a long DECONGEST_TIME results in a long and conservative decongestion. A value of 0 indicates that the receiver should not attempt to perform any decongestion at all.
HOLD_DROP_END (integer)	Tri-valued parameter that controls how the sender should behave in case video quality cannot meet the requirements set in BIT_RATE, FRAME_RATE, or QP. This parameter indicates whether the sender should put the video stream on hold while maintaining QoS reservations, drop the video stream and release QoS reservations, or end the session. Allowed values of this parameter are defined as follows: "0" = HOLD, "1" = DROP, "2" = END.
INITIAL_CODEC_RATE (%)	Initial bit rate (proportion of the bit rate negotiated for the video session) that the sender should begin encoding video at.
X_PERCENTILE (%)	X percentile point of the packet arrival distribution used with TARGET_PLAYOUT_MARGIN parameters.

## 17.3 Management procedures

This clause explains how speech and video adaptation of the MTSI client in terminal can be managed using 3GPP MTSIMA MO and OMA-DM protocol. First, it is necessary to describe the expected behavior of media adaptation, i.e., reaction of the MTSI client in terminal to the received RTCP-APP and TMMBR messages, information on the transmission results such as RTCP RR and SR, signalled changes in transport characteristics such as ECN Congestion Experienced (ECN-CE) marking in IP packet headers, and analysis of packet reception status. Such descriptions, which include many parameters of different nature, can be made in the form of adaptation state machines or state transition tables, as in Annex C, based on the criteria for service quality or the policy for network management.

Some parameters in the descriptions can be determined in session setup or measured during session, and therefore do not require to be managed from outside. For example, the maximum or minimum bit rate of speech and video codecs, and round-trip time (RTT) belong to this class of parameters. It is also possible that other parameters are implementation-specific, or related to detailed features of media codec or underlying radio access bearer technology. These classes of parameters are not provided by 3GPP MTSIMA MO but still can be included under Ext nodes as vendor extensions.

The next step will be to select the parameters to be included in 3GPP MTSIMA MO. It might not be practical or necessary to update all parameters in the descriptions and selecting a subset of key parameters might simplify the management. The set of parameters selected should enable the behavior of media adaptation to be controlled up to the necessary extent.

The results of session setup may influence the selection of media adaptation methods to apply. For example, the negotiated media codec and the bandwidth, or whether to use ECN or not may determine the necessary adaptation procedures. Selection of session parameters from 3GPP MTSINP MO falls outside the scope of the present document. Information available to the MTSI client in terminal that may assist such decisions includes, but may not be limited to, the radio access bearer technology, information on service provider broadcast by (e)NodeB, date and time, and service policy.

### 17.3.1 Management of speech adaptation

3GPP MTSIMA MO contains a set of parameters which can be used in the construction of adaptation state machines. If available, information on the expected behavior of the network, such as the scheduling strategy applied to eNodeB, can assist the design and calibration process. Basically the receiver estimates the encoding and payload packetization status of the sender, and transmits appropriate RTCP-APP messages when the state of adaptation state machine needs to be switched.

Each PLR in table 17.1 is used to specify the conditions, usually as a threshold, to enter or exit a state. MAX, LOW, STATE\_REVERSION, and RED\_INEFFECTIVE correspond to PLR\_1, PLR\_2, PLR\_3, and PLR\_4 in Annex C respectively. Once the measured PLR exceeds or falls below the thresholds, while meeting certain conditions, adaptation state machine triggers the programmed transitions. A subset of PLRs can be used to construct adaptation state machines with fewer states. For example, the two-state adaptation state machine in Annex C can be built with MAX and LOW.

With each pair of a PLR and a DURATION, the observation period of each PLR can be controlled and the sensitivity of each transition path can be tailored to meet the requirements. For example, larger DURATION values are likely to smooth out the impact of bursty loss of packets and reduce the likelihood of frequent transitions between states, i.e., the ping-pong effects, but can delay the reaction to events that require immediate repairing actions. In general, transitions to states designed for better transmission conditions need to be taken more conservatively than transitions to states for worse transmission conditions. Other requirements can be combined with PLR to refine the conditions for transitions.

Packet loss burst (PLB) refers to a devastating event in which a large number of packets are lost during a limited period. Immediate measures, such as changing the bit rate or payload packetization are required to reduce the impact on the perceived speech quality. As PLR and PLR/DURATION enable detailed specification of PLR, PLB can be described efficiently with PLB and PLB/DURATION.

The parameters ICM/INITIAL\_CODEC\_RATE, ICM/INIT\_WAIT AND ICM/INIT\_UPSWITCH\_WAIT can be used to control the rate adaptation during the beginning of the session. ICM/INITIAL\_CODEC\_RATE is used to define what codec mode should be used when starting the encoding for the RTP stream. ICM/INIT\_WAIT defines the period over which the sending MTSI client in terminal should use the Initial Codec Mode when ECN is not used. If no codec mode request or other feedback information is received within this period then the sender is allowed to adapt to a higher rate. Since it is unknown in the beginning of the RTP stream whether the transmission path can support higher rates, the

adaptation to higher bit rates needs to be conservative. It is therefore recommended that when adapting to a higher rate the sender increases the rate only to the next higher rate in the list of codec modes allowed in the session. It is also recommended that the sender waits for a while in-between consecutive up-switches, to give the receiver a chance to evaluate whether the new rate can be sustained. This waiting period in-between consecutive up-switches can be controlled with the ICM/INIT\_UPSWITCH\_WAIT parameter when ECN is not used.

When ECN is used in the session, the ECN/INIT\_WAIT and ECN/INIT\_UPSWITCH\_WAIT parameters are used instead of the ICM/INIT\_WAIT and ICM/INIT\_UPSWITCH\_WAIT parameters, respectively.

N\_INHIBIT can be used to limit the earliest time for the next transition, after transition is temporarily disabled due to frequent transitions among a limited number of states. Use of N\_INHIBIT is suggested as a measure to avoid unnecessary transitions during rapid fluctuations of transmission conditions. It is left as the discretion of the implementation to handle RTCP-APP messages received before the sender is allowed to transition again.

T\_RESPONSE refers to the maximum period the receiver can tolerate, before declaring that either the transmitted RTCP-APP message was lost or its execution was denied by the sender. After the timer expires, the receiver may retransmit the request or transmit a new request, or choose to be satisfied with current status.

Adaptation state machines using above parameters collect the information on transmission path by analyzing the packet reception process. Another, more direct source of information can be provided by network nodes, such as eNodeB, in the form of Explicit Congestion Notification (ECN) to IP. A key benefit of ECN is more refined initiation of adaptation in which the receiver can be aware of incoming deterioration of transmission conditions even before any packets are dropped by network node, i.e., as an early-warning scheme for congestion.

STEPWISE\_DOWNSWITCH can be used to control the path of bit-rate reduction, i.e., whether to directly down-switch to ECN/MIN\_RATE or to gradually down-switch via several intermediate bit-rates specified in ECN/RATE\_LIST. The former path may be preferred when rapid reduction of the bit-rate is required while the latter path may be employed for more graceful degradation of speech quality.

To avoid premature up-switch before the congestion has been cleared, waiting periods during which the sender is not allowed to increase the bit-rate can be defined with ECN/CONGESTION\_WAIT parameter. The ECN/CONGESTION\_UPSWITCH\_WAIT parameter is used to prevent congestion from re-occurring during the upswitch after the ECN/CONGESTION\_WAIT period.

To align speech adaptation of the MTSI client in terminal with the purpose of quality control or network management, not only the terminals, which might be managed by different service providers, but also the behavior, such as scheduling strategy or ECN-marking policy, of network nodes should be considered in the construction of adaptation state machines. It is also possible to program the terminals to adapt differently, as a means of differentiating the quality of service.

With 3GPP MTSIMA MO, it is possible to shape a rough trajectory of the bit rate over time-varying transmission conditions but the maximum and minimum bit rates of speech codec are determined during session setup with mode-set, which can be managed with ModeSet leaf of 3GPP MTSINP MO (see clause 15).

Adaptation state machines designed to recover the once reduced bit or packet rate at an earliest opportunity might be considered as an adaptation policy oriented to service quality. However, such an aggressive up-switch before the transmission conditions fully recover takes the risk of degrading the quality or even backward transitions, i.e., the ping-pong effects. Such an optimistic adaptation strategy might not necessarily result in higher quality but can influence the service quality of other terminals sharing the same link. On the other hand, adaptation state machines that increase the once reduced bit or packet rate more conservatively are likely to avoid such situations but might be late in the recovery of speech quality after the transmission conditions are restored.

Even at similar total bit rates, bit stream consisting of a smaller number of larger packets can be at a disadvantage during transmission over packet networks or shared links, when the link quality deteriorates or the link becomes congested, than bit stream consisting of a larger number of smaller packets, since many types of schedulers installed in the network nodes base their decisions on the size of packets such that lower priorities are assigned to larger packets. RTCP\_APP\_REQ\_RED, RTCP\_APP\_REQ\_AGG, and RTCP\_APP\_CMR specify detailed request for the bit rate and packetization. Bit-fields of RTCP\_APP\_REQ\_RED and RTCP\_APP\_REQ\_AGG are restricted by parameters, such as max-red and maxptime, which are negotiated during session setup.

## 17.3.2 Management of video adaptation

Compared with speech adaptation where the number of allowed bit rates from speech encoder is limited and each encoded speech frame covers the same short period, e.g., 20 ms, or contains the same number of bits when voice activity is present, video adaptation should tolerate a higher level of uncertainty in the control of the bit rate. Moreover, due to the structural dependence between encoded video frames, from motion estimation and compensation, packetization is not likely to be used as an opportunity for adaptation. This dependence necessitates not only controlling the bit rate but also putting an end to error propagation with AVPF NACK or PLI.

Output bit rate from video encoder depends also on the scene being encoded and even if maintaining a constant bit rate is intended, actual output bit rate is likely to fluctuate around a target value. In the design of adaptation state machines for video, this uncertainty needs to be compensated for, for example, with additional implementation margin.

Encoded speech frames have a clear boundary in the bit stream and multiple speech frames can be transported over an RTP packet. In contrast, an encoded video frame, whose size depends on the bit rate, frame rate, and image size, is typically far larger than an encoded speech frame. Multiple packets are usually necessary to transport even a predicted frame, which is usually smaller than an intra frame.

As in speech adaptation, basic information on transmission path can be obtained from analyzing received packet stream. However, perceived video quality can be more sensitive to PLR since the compression ratio of video is typically higher than that of speech and even a minor level of packet loss can initiate error propagation to the following predicted frames, rendering them unrecognizable. For example, at comparable PLR values, speech quality can be acceptable but video quality can be significantly damaged such that dropping the media might be considered.

PLB and PLB/DURATION are also available for video but the fundamental differences in the frame structure need to be taken into account when the event of packet loss burst is defined for video.

INC\_FBACK\_MIN\_INTERVAL and DEC\_FBACK\_MIN\_INTERVAL can be used to control the rate of adaptation and also the amount of signaling overhead. These two minimum intervals are provided separately since the minimum interval between the feedback messages to decrease the bit rate typically needs to be shorter than the one to increase the bit rate. The urgency of rate-decreasing conditions generally requires shorter minimum feedback intervals.

Target bit rate for video is determined during session setup and can be considered as the maximum bit rate to be used during session, which can be configured with the Bandwidth leaf of 3GPP MTSINP MO. On the other hand, BIT\_RATE can be used to set a lower threshold for the bit rate. Whether ABSOLUTE or RELATIVE is to be used is left as the discretion of the implementation or service provider. For example, capability of setting a fixed minimum bit rate can be necessary when the lowest quality of MTSI is required to be comparable to the quality of 3G-324M, whose bit rate for video is in general set to 47 ~ 49 kbps.

In the case of speech adaptation, the MTSI client in terminal limits the initial codec mode (ICM) to a lower mode, among the modes included in the mode-set, until at least one frame block or an RTCP message is received with rate control information (see clause 7.5). This policy is recommended to avoid congestion during initial phase of session when the information on transmission path is known to neither the sender nor the receiver. INITIAL\_CODEC\_RATE can be used for video with similar objectives as that of ICM, i.e., a warming-up process in the beginning of session. Once the session starts and few packets are lost during delivery, the receiver will attempt to increase the bit rate by transmitting TMMBR messages requesting higher bit rates until the negotiated value is reached. However, low INITIAL\_CODEC\_RATE can reduce the video quality at session setup when the transmission path is free of congestion.

FRAME\_RATE can be used to set a lower threshold for the frame rate. As the bit rate is controlled during adaptation between two limits, the frame rate also needs to be controlled between the limits while maintaining a balance between spatial quality and temporal resolution (see clause 10.3). As the increase in codec profile/level can result in an abrupt increase of the maximum image size, e.g., from QCIF to CIF, so can quadruple the maximum frame rate, with a fixed image size. With "imageattr" attribute, it is possible that image sizes whose maximum frame rates are unspecified by codec profile/level, such as 272x224, can be negotiated (see clause A.4). In this case, the maximum frame rate is determined as the maximum value at the maximum image size supported by the profile/level negotiated. Whether ABSOLUTE or RELATIVE is used to specify the lower threshold of the frame rate is left as the discretion of the implementation or service provider.

RTP\_GAP can be used to set the maximum interval between received packets before the receiver considers repairing actions. During periods of severe congestion or packet loss, the receiver may not receive packets for an unexpectedly long period. Observing such gaps in the reception of packets can be used by the receiver to request the sender to decrease the bit or packet rate. In the case of severe packet loss, this gap can be detected before any other observations

are made and thus allows for faster reaction, while detection of packet loss requires reception of at least one packet after the loss.

However, estimating such gaps in the arrival of packets can be challenging because video encoder may not always output packets at regular intervals and typical scheduling strategy of network node, especially in the downlink, can cause jitter in the delivery of video packets. Therefore, it is recommended that RTP\_GAP is set conservatively and the measured gap is based on a moving average estimate of the frame period observed by the receiver. The timestamps of the received packets allow the receiver to estimate the frame period based on the past a few received video frames. Since typical video encoders are not likely to abruptly change their encoding frame rates, this estimate can serve as a fairly reliable basis for detecting the gaps in the transport of video packets.

Leaf nodes for luminance quantization parameter, H263, MPEG4, and H264, can be used to set a lower threshold for the image clarity to be maintained. Target range of the quantization parameters depends on the video codec negotiated.

If the MTSI client in terminal cannot maintain the bit rate or the frame rate higher than the lower thresholds, or cannot maintain the quantization parameter lower than the higher threshold, the video stream might be put on hold, dropped, or the session might be ended, depending on the criteria for service quality or policy for network management, with HOLD\_DROP\_END.

RAMP\_UP\_RATE and RAMP\_DOWN\_RATE can be used to control how fast the sender changes its target bit rate from its current target value to the value indicated in the most recently received TMMBR message, when the bit rate is being increased and decreased respectively. As with INC\_FBACK\_MIN\_INTERVAL and DEC\_FBACK\_MIN\_INTERVAL, rates for ramping up and down need to be different, as rapid ramping down is usually necessary whereas rapid ramping up is undesirable as it can cause sudden congestion in the transmission path.

DECONGEST\_TIME can be used to control the time spent in resolving the congestion of transmission path. Smaller values of this parameter can result in faster reduction of the bit rate while larger values can be used for slower decongestion. If the situation at the receiver does not improve at the end of initial decongesting, another round of decongestion can be attempted, or the video stream can be dropped or put on hold.

From received packets, video frames are typically reconstructed to YUV format, converted to formats such as RGB, and stored in the frame buffer, before being fed to the display for visual presentation. TARGET\_PLAYOUT\_MARGIN\_HI and TARGET\_PLAYOUT\_MARGIN\_MIN can be used to maintain appropriate playout margin, defined as the interval between packet arrival and its properly scheduled playout.

In general, video should be encoded, packetized, transmitted, de-packetized, decoded, and, played out within a total delay target. In addition, processing of video should be appropriately synchronized to that of speech. If the estimated playout margin exceeds TARGET\_PLAYOUT\_MARGIN\_HI, it is considered that video packets are arriving too early and there remains room for higher bit rate in the transmission path. Therefore the receiver may signal the sender to increase the bit rate with TMMBR messages. If the estimated playout margin falls below TARGET\_PLAYOUT\_MARGIN\_MIN, it is considered that video packets are arriving too late and current transmission path cannot sustain the bit rate. Therefore the receiver should signal the sender to reduce the bit rate to enable earlier arrival of video packets.

X\_PERCENTILE can be used to control the target playout margin but the packet arrival distribution is left to the discretion of the implementation, which might be implemented as statistical models or empirical data.

## Annex A (informative): Examples of SDP offers and answers

### A.1 SDP offers for speech sessions initiated by MTSI client in terminal

This Annex includes several SDP examples for session setup for speech. SDP examples for sessions with speech and DTMF are shown in Annex G. These SDP offer and answer examples are designed to highlight the respective area that is being described and should therefore not be considered as complete SDP offers and answers. See TS 24.229 [7] for a complete description of the SDPs.

Some of the SDP examples contain a=fmtp lines that are too long to meet the column width constraints of this document and are therefore folded into several lines using the backslash (“\”) character. In a real SDP, long lines would appear as one single line and not as such folded lines.

Some of the examples included in this Annex outline configurations that have been optimized for HSPA. These configurations are equally applicable to E-UTRAN access since the packetization recommendations for HSPA and E-UTRAN in Clauses 7.4.2 and 7.5.2.1 for MTSI clients and Clause 12.3.2 for MTSI media gateways are identical.

#### A.1.1 HSPA or unknown access technology

When the access technology is unknown to the MTSI client in terminal, the client uses the encapsulation parameters of default operation as defined in clause 7.5.2.1.2. The SDP examples below apply to HSPA as well as the default operation since the encapsulation parameters are the same.

##### A.1.1.1 Only AMR-NB supported by MTSI client in terminal

In this example one RTP Payload Type (97) is defined for the bandwidth-efficient payload format and another RTP payload type (98) for the octet-aligned payload format. In this case, the MTSI client in terminal supports mode changes at any time, mode changes to any mode and mode change restrictions.

**Table A.1.1: SDP example**

SDP offer
<pre>m=audio 49152 RTP/AVP 97 98 a=tcap:1 RTP/AVPF a=pcfg:1 t=1 a=rtptime:97 AMR/8000/1 a=fmtp:97 mode-change-capability=2; max-red=220 a=rtptime:98 AMR/8000/1 a=fmtp:98 mode-change-capability=2; max-red=220; octet-align=1 a=ptime:20 a=maxptime:240</pre>

#### Comments:

The UDP port number (49152) and the payload type numbers (97 and 98) are examples and the offerer is free to select other numbers within the restrictions of the UDP and RTP specifications. It is recommended to use the dynamic port numbers in the 49152 to 65535 range. RTP should use even numbers for RTP media and the next higher odd number for RTCP. It is however allowed to use any number within the registered port range 1 024 to 49 151. The receiver must be capable of using any combination of even and odd numbers for RTP and RTCP.

The SDP Capabilities Negotiation framework (SDPCapNeg) [69] is used to negotiate what RTP profile to use. The offer includes RTP/AVP in the conventional SDP part by including it in the media (m=) line, while RTP/AVPF is given

as a transport capability using the SDPCapNeg framework “a=tcap:1 RTP/AVPF”. A potential configuration gives RTP/AVPF as an alternative “a=pcfg:1 t=1”. Given by the rules in SDPCapNeg, the RTP/AVPF profile has higher preference than RTP/AVP.

It is important that the MTSI client in terminal does not define any mode-set because then the answerer is free to respond with any mode-set that it can support. If the MTSI client in terminal would define mode-set to any value, then the answerer only has the option to either accept it or reject it. The latter case might require several ping-pong between the MTSI clients before they can reach an agreement on what mode set to use in the session. This would increase the setup time significantly. This is also one important reason for why the MTSI clients in terminals must support the complete codec mode set of the AMR and AMR-WB codecs, because then a media gateway interfacing GERAN or UTRAN can immediately define the mode-set that it supports on the GERAN or UTRAN circuit switched access.

Since the MTSI client in terminal is required to support mode changes at any frame border and also to any mode in the received media stream, it does not set the mode-change-period and mode-change-neighbor parameters.

The mode-change-capability and max-red parameter are new in the updated AMR payload format [28]. With mode-change-capability=2, the MTSI client in terminal shows that it does support aligning mode changes every other frame and the answerer then knows that requesting mode-change-period=2 in the SDP answer will work properly. The max-red parameter indicates the maximum interval between a non-redundant frame and a redundant frame. Note that the maxptime and max-red parameters do not need to be synchronized.

The payload type for the bandwidth-efficient payload format (97) is listed before the payload type for the octet-aligned payload format (98) because it is the preferred one.

With the combination of ptime:20 and maxptime:240, the MTSI client in terminal shows that it desires to receive one speech frame per packet but can handle up to 12 speech frames per packet. However, no more than 4 original speech frames can be encapsulated in one packet.

A suitable SDP answer from another MTSI client in terminal is shown in Table A.3.0.

## A.1.1.2 AMR and AMR-WB are supported by MTSI client in terminal

### A.1.1.2.1 One-phase approach

The size of the SDP may become quite big, depending on how many configurations the MTSI client in terminal supports for different media. Therefore, the session setup may be divided into phases where the most desirable configurations are offered in the first phase. If the first phase fails, then the remaining configurations can be offered in a second phase.

In table A.1.2 an example is shown where a one-phase approach is used and where the SDP includes both AMR and AMR-WB and both the bandwidth-efficient and octet-aligned payload formats.

**Table A.1.2: SDP example: one-phase approach**

SDP offer
<pre> m=audio 49152 RTP/AVP 97 98 99 100 a=tcap:1 RTP/AVPF a=pcfg:1 t=1 a=rtpmap:97 AMR-WB/16000/1 a=fmtp:97 mode-change-capability=2; max-red=220 a=rtpmap:98 AMR-WB/16000/1 a=fmtp:98 mode-change-capability=2; max-red=220; octet-align=1 a=rtpmap:99 AMR/8000/1 a=fmtp:99 mode-change-capability=2; max-red=220 a=rtpmap:100 AMR/8000/1 a=fmtp:100 mode-change-capability=2; max-red=220; octet-align=1 a=ptime:20 a=maxptime:240 </pre>



**Comments:**

It is easy to imagine that the SDP offer can become quite large if the client supports many different configurations for one or several media. A solution to this problem is shown in Clause A.1.1.2.2.

A few possible SDP answers are outlined in Tables A.3.1, A.3.1a, A.3.2, A.3.3 and A.3.4.

**A.1.1.2.2 Two-phase approach**

Tables A.1.3 and A.1.4 show the same configurations as in table A.1.2 but when the SDP has been divided into 2 phases.

**Table A.1.3: SDP example: 1<sup>st</sup> phase SDP offer**

SDP offer
<pre>m=audio 49152 RTP/AVP 97 98 a=tcap:1 RTP/AVPF a=pcfg:1 t=1 a=rtpmap:97 AMR-WB/16000/1 a=fmtp:97 mode-change-capability=2; max-red=220 a=rtpmap:98 AMR/8000/1 a=fmtp:98 mode-change-capability=2; max-red=220 a=ptime:20 a=maxptime:240</pre>

**Table A.1.4: SDP example: 2<sup>nd</sup> phase SDP offer**

SDP offer
<pre>m=audio 49152 RTP/AVPF 97 98 a=rtpmap:97 AMR-WB/16000/1 a=fmtp:97 mode-change-capability=2; max-red=220; octet-align=1 a=rtpmap:98 AMR/8000/1 a=fmtp:98 mode-change-capability=2; max-red=220; octet-align=1 a=ptime:20 a=maxptime:240</pre>

**Comments:**

Many types of media and maybe even many different configurations for some or all media types, may give quite large SIP messages. When constructing the offer, the access type and the radio bearer(s) for the answerer are not yet known. To maintain a reasonable setup time, a 2-phase approach may be useful where the most desirable configurations are included in the 1<sup>st</sup> phase and the 2<sup>nd</sup> phase is entered only if all payload types for one media type are rejected.

There is however a drawback with the two-phase approach. If the 2<sup>nd</sup> phase is not entered, then a cell change that would require configurations from the 2<sup>nd</sup> phase SDP is likely to give long interruption times, several seconds, while the session parameters are re-negotiated.

The SDPCapNeg framework is only used in the 1<sup>st</sup> SDP offer because when generating the 2<sup>nd</sup> SDP offer the profile is already agreed. In this example, it is assumed that AVPF was accepted in the first round.

If the 1<sup>st</sup> SDP offer, shown in Table A.1.3, is accepted by the answerer then a few possible example SDP answers are shown in: Table A.3.1 if the answerer is an MTSI client in terminal and supports AMR-WB; Table A.3.2 if the answerer is an MTSI client in terminal but does not support AMR-WB; Table A.3.3 if the answerer is an MTSI client in terminal, supports AMR-WB and is using EGPRS access; Table A.3.4 if the answerer is a CS terminal, supports AMR-WB and an MTSI MGW is therefore needed.

## A.1.2 EGPRS

In this example one RTP Payload Type (97) is defined for the bandwidth-efficient payload format and another RTP Payload Type (98) is defined for the octet-aligned payload format.

**Table A.1.5: SDP example**

SDP offer
<pre>m=audio 49152 RTP/AVP 97 98 a=tcap:1 RTP/AVPF a=pcfg:1 t=1 a=rtpmap:97 AMR/8000/1 a=fmtp:97 mode-change-capability=2; max-red=200 a=rtpmap:98 AMR/8000/1 a=fmtp:98 mode-change-capability=2; max-red=200; octet-align=1 a=ptime:40 a=maxptime:240</pre>

### Comments:

The only difference compared with the SDP offer for HSPA is ptime: 40. This definition is used to optimize capacity by reducing the amount of overhead that lower layers introduce. Defining ptime:20 will also work, but will be less optimal. Thus, when performing a cell change from HSPA to EGPRS, it is not an absolute necessity to update the session parameters immediately. It can be done after a while, which would also reduce the amount of SIP signalling if a MTSI client in terminal is switching frequently between HSPA and EGPRS or some other access type.

It is recommended to set the max-red parameter to an integer multiple of the ptime.

An example of a suitable SDP answer to this SDP offer is shown in Table A.3.3a.

## A.1.3 Generic Access

In this example one RTP Payload Type (97) is defined for the bandwidth-efficient payload format and another RTP Payload Type (98) is defined for the octet-aligned payload format.

**Table A.1.6: SDP example**

SDP offer
<pre>m=audio 49152 RTP/AVP 97 98 a=tcap:1 RTP/AVPF a=pcfg:1 t=1 a=rtpmap:97 AMR/8000/1 a=fmtp:97 mode-change-capability=2; max-red=160 a=rtpmap:98 AMR/8000/1 a=fmtp:98 mode-change-capability=2; max-red=160; octet-align=1 a=ptime:80 a=maxptime:240</pre>

### Comments:

In this case the MTSI client in terminal has detected that the load on the WLAN network is quite high and therefore ptime is set to 80. For other operating conditions, it could set ptime to 20, 40 or 60. This parameter may be updated during the session if the load of the WLAN network changes.

An example of a suitable SDP answer to this SDP offer is shown in Table A.3.3b.

## A.2 SDP offers for speech sessions initiated by media gateway

### A.2.1 General

These examples show only SDP offers when the MTSI media gateway does not support the same configurations as for the MTSI terminal in clause A.1. A media gateway supporting the same configurations as for the examples in clause A.1 should create the same SDP offers.

### A.2.2 MGW between GERAN UE and MTSI

This example shows the SDP offer when the call is initiated from GSM CS using the AMR with the {12.2, 7.4, 5.9 and 4.75} codec mode set. In this example, it is also assumed that only the bandwidth-efficient payload format is supported and that it will not send any redundant speech frames.

**Table A.2.1: SDP example**

SDP offer
<pre>m=audio 49152 RTP/AVP 97 a=tcap:1 RTP/AVPF a=pcfg:1 t=1 a=rtptime:97 AMR/8000/1 a=fmtp:97 mode-set=0,2,4,7; mode-change-period=2, \ mode-change-neighbor=1; mode-change-capability=2; max-red=0 a=ptime:20 a=maxptime:80</pre>

#### Comments:

Since the MGW only supports a subset of the AMR codec modes, it needs to indicate this in the SDP. The same applies for the mode change restrictions.

An example of a suitable SDP answer to this SDP offer is shown in Table A.3.5.

### A.2.3 MGW between legacy UTRAN UE and MTSI

This example shows the SDP offer when the call is initiated from legacy UTRAN CS mobile that only the AMR 12.2 mode. In this example, it is also assumed that only the bandwidth-efficient payload format is supported.

**Table A.2.2: SDP example**

SDP offer
<pre>m=audio 49152 RTP/AVP 97 a=tcap:1 RTP/AVPF a=pcfg:1 t=1 a=rtptime:97 AMR/8000/1 a=fmtp:97 mode-set=7; max-red=0 a=ptime:20 a=maxptime:20</pre>

#### Comments:

Since only one mode is supported, the mode-change-period, mode-change-neighbor and mode-change-capability parameters do not apply.

In this case it is advisable to not allow redundancy since the legacy UTRAN CS mobile does not support any lower rate codec modes and then redundancy would almost double the bitrate on the PS access side. Therefore, maxptime is set to 20 and max-red is set to 0.

If a mode-set with several codec modes was defined and if max-red and maxptime are set to larger values than what Table A.1.8 shows, then redundancy is possible on the PS access side but not together with TFO.

An example of a suitable SDP answer to this SDP offer is shown in Table A.3.6.

## A.2.4 MGW between CS UE and MTSI

This example shows the SDP offer when two mode sets are supported by the MGW.

**Table A.2.3: SDP example**

SDP offer
<pre>m=audio 49152 RTP/AVP 97 98 a=tcap:1 RTP/AVPF a=pcfg:1 t=1 a=rtptime:97 AMR/8000/1 a=fmtp:97 mode-set=0,2,4,7; mode-change-period=2, \ mode-change-neighbor=1; mode-change-capability=2; max-red=20 a=rtptime:98 AMR/8000/1 a=fmtp:98 mode-set=0,3,5,6; mode-change-period=2, \ mode-change-neighbor=1; mode-change-capability=2; max-red=20 a=ptime:20 a=maxptime:80</pre>

### Comments:

Redundancy up to 100 % is supported in this case since max-red is set to 20.

An example of a suitable SDP answer to this SDP offer is shown in Table A.3.6.

## A.2.5 MGW between GERAN UE and MTSI when wideband speech is supported

This example shows the SDP offer when the call is initiated from GSM CS when AMR is supported with the {12.2, 7.4, 5.9 and 4.75} codec mode set and when AMR-WB is supported with the {12.65, 8.85 and 6.60} mode set. In this example, it is also assumed that only the bandwidth-efficient payload format is supported and that the MTSI MGW will not send any redundant speech frames.

Table A.2.4: SDP example

SDP offer
<pre>m=audio 49152 RTP/AVP 98 97 a=tcap:1 RTP/AVPF a=pcfg:1 t=1 a=rtpmap:97 AMR/8000/1 a=fmtp:97 mode-set=0,2,4,7; mode-change-period=2, \   mode-change-neighbor=1; mode-change-capability=2; max-red=0 a=rtpmap:98 AMR-WB/16000/1 a=fmtp:98 mode-set=0,1,2; mode-change-period=2, \   mode-change-neighbor=1; mode-change-capability=2; max-red=0 a=ptime:20 a=maxptime:80</pre>

**Comments:**

Since the MGW only supports a subset of the AMR codec modes and of the AMR-WB codec modes, it needs to indicate this in the SDP. The same applies for the mode change restrictions.

---

## A.3 SDP answers to SDP speech session offers

### A.3.1 General

This clause gives a few examples of possible SDP answers. The likelihood that these SDP answers will be used may vary from case to case since the SDP answer depends on circumstances outside the scope of this specification for example: availability of resources, radio bearer assignment and policy control. It is impossible to cover all the possible variants and hence these examples should be regarded as just a few examples of many possible alternatives. They were however selected because they span the range of possible SDP answers quite well.

The SDP offers are included to clarify what is being answered.

### A.3.1a SDP offer from an MTSI client in terminal when only narrowband speech was offered

These SDP offers and answer are likely when the offering MTSI client in terminal (or other client) only supports narrowband speech (AMR).

The SDP offer included in this example is identical to the SDP offer shown in Table A.1.1.

**Table A.3.0: SDP example**

SDP offer
<pre>m=audio 49152 RTP/AVP 97 98 a=tcap:1 RTP/AVPF a=pcfg:1 t=1 a=rtpmap:97 AMR/8000/1 a=fmtp:97 mode-change-capability=2; max-red=220 a=rtpmap:98 AMR/8000/1 a=fmtp:98 mode-change-capability=2; max-red=220; octet-align=1 a=ptime:20 a=maxptime:240</pre>
SDP answer
<pre>m=audio 49152 RTP/AVPF 99 a=acfg:1 t=1 a=rtpmap:99 AMR/8000/1 a=fmtp:99 mode-change-capability=2; max-red=220 a=ptime:20 a=maxptime:240</pre>

#### Comments:

The SDP answer contains only one encoding format since 3GPP TS 24.229 [7] requires that the answerer shall select exactly one codec for the answer. Since both MTSI clients in terminals support the same configurations for narrowband speech, it is likely that the selected configuration included in the answer is identical to the configuration in the offer and that no mode-set is defined by the terminating client.

The conclusion from this offer-answer procedure is that the offerer can only send AMR encoded speech to the answerer using the bandwidth-efficient payload type with RTP Payload Type 99, since this was the only configuration included in the answer. The answerer sends AMR encoded speech to the offerer using the bandwidth-efficient payload format, in this case RTP Payload Type 97.

Even though both MTSI clients in terminals support all codec modes, it is desirable to mainly use the codec modes from the AMR {12.2, 7.4, 5.9 and 4.75} mode set because the transport layer functions are optimized for these codec modes.

For similar reasons it is also desirable to encapsulate only 1 speech frame per packet, even though both MTSI clients in terminals support receiving several frames per packet.

In the above example it is assumed that AVPF will be accepted since the MTSI client is required to support this RTP profile.

### A.3.2 SDP answer from an MTSI client in terminal

These SDP offers and answers are likely when both MTSI clients in terminals support AMR and AMR-WB and also both the bandwidth-efficient and the octet-aligned payload formats.

The SDP offer included in this example is identical to the SDP offer shown in Table A.1.2.

**Table A.3.1: SDP example**

SDP offer
<pre> m=audio 49152 RTP/AVP 97 98 99 100 a=tcap:1 RTP/AVPF a=pcfg:1 t=1 a=rtpmap:97 AMR-WB/16000/1 a=fmtp:97 mode-change-capability=2; max-red=220 a=rtpmap:98 AMR-WB/16000/1 a=fmtp:98 mode-change-capability=2; max-red=220; octet-align=1 a=rtpmap:99 AMR/8000/1 a=fmtp:99 mode-change-capability=2; max-red=220 a=rtpmap:100 AMR/8000/1 a=fmtp:100 mode-change-capability=2; max-red=220; octet-align=1 a=ptime:20 a=maxptime:240 </pre>
SDP answer if AVPF is accepted
<pre> m=audio 49152 RTP/AVPF 97 a=acfg:1 t=1 a=rtpmap:97 AMR-WB/16000/1 a=fmtp:97 mode-change-capability=2; max-red=220 a=ptime:20 a=maxptime:240 </pre>

**Comments:**

The SDP answer contains only one encoding format since 3GPP TS 24.229 [7] requires that the answerer shall select exactly one codec for the answer. Since both MTSI clients in terminals support the same configurations, it is likely that the selected configuration included in the answer is identical to the configuration in the offer and that no mode-set is defined by the terminating client. The conclusion from this offer-answer process is that AMR-WB will be used during the session with RTP Payload Type 97.

Even though both MTSI clients in terminals support all codec modes, it is desirable to mainly use the codec modes from the AMR-WB {12.65, 8.85 and 6.60} mode set because the transport layer functions are optimized for these modes.

For similar reasons it is also desirable to encapsulate only 1 speech frame per packet, even though both MTSI clients in terminals support receiving several frames per packet.

In the above example it is assumed that AVPF will be accepted since the MTSI client is required to support this RTP profile.

This SDP answer is also a possible answer to the SDP offer shown in Table A.1.3.

## A.3.2a SDP answer from a non-MTSI UE with AVP

The MTSI client must be prepared to receive an SDP answer with AVP. This is likely to occur for legacy clients that do not support AVPF or SDPCapNeg. The example in Table A.3.1a shows a possible SDP answer with AVP to an SDP offer as shown in Table A.1.2.

**Table A.3.1a: SDP answer example with AVP**

SDP answer with AVP
<pre>m=audio 49152 RTP/AVP 97 a=rtpmap:97 AMR-WB/16000/1 a=fmtp:97 mode-change-capability=2; max-red=220 a=ptime:20 a=maxptime:240</pre>

**Comments:**

A client that does not support SDPCapNeg would not understand the attributes defined by the SDPCapNeg framework and would therefore ignore the lines with 'a=tcap' and 'a=pcfg'.

### A.3.3 SDP answer from an MTSI client in terminal supporting only AMR

These SDP offers and answers are likely when the answering MTSI client in terminal supports only AMR.

The SDP offer included in this example is identical to the SDP offer shown in Table A.1.2.

**Table A.3.2: SDP example**

SDP offer
<pre>m=audio 49152 RTP/AVP 97 98 99 100 a=tcap:1 RTP/AVPF a=pcfg:1 t=1 a=rtpmap:97 AMR-WB/16000/1 a=fmtp:97 mode-change-capability=2; max-red=220 a=rtpmap:98 AMR-WB/16000/1 a=fmtp:98 mode-change-capability=2; max-red=220; octet-align=1 a=rtpmap:99 AMR/8000/1 a=fmtp:99 mode-change-capability=2; max-red=220 a=rtpmap:100 AMR/8000/1 a=fmtp:100 mode-change-capability=2; max-red=220; octet-align=1 a=ptime:20 a=maxptime:240</pre>
SDP answer
<pre>m=audio 49152 RTP/AVPF 99 a=acfg:1 t=1 a=rtpmap:99 AMR/8000/1 a=fmtp:99 mode-change-capability=2; max-red=220 a=ptime:20 a=maxptime:240</pre>

**Comments:**

In the answer, RTP Payload Types 97 and 98 have been removed since AMR-WB is not supported and RTP Payload Type 100 is removed since the answerer is required to answer with only one encoding format.

Even though both MTSI clients in terminals support all codec modes, it is desirable to mainly use the codec modes from the AMR [12.2, 7.4 5.9 and 4.75] mode set because the transport layer functions are optimized for these modes.

This SDP answer is also a possible answer to the SDP offer shown in Table A.1.3.



## A.3.4 SDP answer from an MTSI client in terminal using EGPRS access when both AMR and AMR-WB are supported

In this case the answering MTSI client in terminal is using EGPRS access and supports both narrowband and wideband speech, i.e. both AMR and AMR-WB.

The SDP offer is identical to the SDP offer shown in Table A.1.2.

**Table A.3.3: SDP example**

SDP offer
<pre>m=audio 49152 RTP/AVP 97 98 99 100 a=tcap:1 RTP/AVPF a=pcfg:1 t=1 a=rtpmap:97 AMR-WB/16000/1 a=fmtp:97 mode-change-capability=2; max-red=220 a=rtpmap:98 AMR-WB/16000/1 a=fmtp:98 mode-change-capability=2; max-red=220; octet-align=1 a=rtpmap:99 AMR/8000/1 a=fmtp:99 mode-change-capability=2; max-red=220 a=rtpmap:100 AMR/8000/1 a=fmtp:100 mode-change-capability=2; max-red=220; octet-align=1 a=ptime:20 a=maxptime:240</pre>
SDP answer
<pre>m=audio 49152 RTP/AVPF 97 a=acfg:1 t=1 a=rtpmap:97 AMR-WB/16000/1 a=fmtp:97 mode-change-capability=2; max-red=200 a=ptime:40 a=maxptime:240</pre>

### Comments:

The answering MTSI client in terminal responds that it desires to receive 2 frames encapsulated in each packet. It will however send with 1 frame per packet since the offering MTSI client in terminal desires to receive this format. A future SIP UPDATE may change this so that 2 frames per packet are used in both directions.

The answering MTSI client in terminal also responds with max-red defined to 200 ms since this is the closes multiple of the desired frame aggregation. It should however be noted that it is not a requirement to define max-red to be a multiple of ptime, but it is recommended to do so.

This SDP answer is also a possible answer to the SDP offer shown in Table A.1.3.

## A.3.4a SDP answer from an MTSI client in terminal using EGPRS access when only AMR is supported

In this case the answering MTSI client in terminal is using EGPRS access but supports only narrowband speech, i.e. only AMR.

The SDP offer is identical to the SDP offer shown in Table A.1.2 although the SDP answer here would also work nicely as a response to the SDP offer shown in Table A.1.5.

**Table A.3.3a: SDP example**

SDP offer
<pre>m=audio 49152 RTP/AVP 97 98 99 100 a=tcap:1 RTP/AVPF a=pcfg:1 t=1 a=rtpmap:97 AMR-WB/16000/1 a=fmtp:97 mode-change-capability=2; max-red=220 a=rtpmap:98 AMR-WB/16000/1 a=fmtp:98 mode-change-capability=2; max-red=220; octet-align=1 a=rtpmap:99 AMR/8000/1 a=fmtp:99 mode-change-capability=2; max-red=220 a=rtpmap:100 AMR/8000/1 a=fmtp:100 mode-change-capability=2; max-red=220; octet-align=1 a=ptime:20 a=maxptime:240</pre>
SDP answer
<pre>m=audio 49152 RTP/AVPF 97 a=acfg:1 t=1 a=rtpmap:97 AMR/8000/1 a=fmtp:97 mode-change-capability=2; max-red=200 a=ptime:40 a=maxptime:240</pre>

### Comments:

The answering MTSI client in terminal responds that it desires to receive 2 frames encapsulated in each packet. It will however send with 1 frame per packet since the offering MTSI client in terminal desires to receive this format. A future SIP UPDATE may change this so that 2 frames per packet are used in both directions.

The answering MTSI client in terminal also responds with max-red defined to 200 ms since this is the closes multiple of the desired frame aggregation. It should however be noted that it is not a requirement to define max-red to be a multiple of ptime, but it is recommended to do so.

This SDP answer is also a suitable response to an SDP offer as shown in Table A.1.5, even if the answering MTSI client in a terminal is using HSPA access. This is because it is wise to harmonize the packetization, and the ptime in the SDP answer, with the ptime in the SDP offer so that 2 frames per packet will be used in both directions when one of the end-points is using EGPRS access.

## A.3.4b SDP answer from an MTSI client in terminal using WLAN

In this example, the MTSI client in terminal is using a WLAN network.

The SDP offer shown here is identical to the SDP offer shown in Table A.1.1.

Table A.3.3b: SDP example

SDP offer
<pre>m=audio 49152 RTP/AVP 97 98 a=tcap:1 RTP/AVPF a=pcfg:1 t=1 a=rtptime:97 AMR/8000/1 a=fmtp:97 mode-change-capability=2; max-red=220 a=rtptime:98 AMR/8000/1 a=fmtp:98 mode-change-capability=2; max-red=220; octet-align=1 a=ptime:20 a=maxptime:240</pre>
SDP answer
<pre>m=audio 49152 RTP/AVPF 97 a=acfg:1 t=1 a=rtptime:97 AMR/8000/1 a=fmtp:97 mode-change-capability=2; max-red=160 a=ptime:80 a=maxptime:240</pre>

**Comments:**

This SDP answer, with ptime=80, is suitable if the MTSI client in terminal can measure the load in the WLAN network and has detected that the load is high. If, on the other hand, the load is low then the MTSI client in terminal may very well choose to use a lower value for the ptime attribute, for example 20 or 40.

This SDP answer is also suitable when the answering MTSI client in terminal is using HSPA access but when the offerer is using WLAN and indicates ptime=80, e.g. as shown in the SDP offer in Table A.1.6. In such a case, it is wise to harmonize the ptime values in both directions to increase the likelihood that several frames will be encapsulated in the RTP packets.

This SDP answer is also a possible answer to the SDP offer shown in Table A.1.3.

### A.3.5 SDP answer from MTSI MGW supporting only one codec mode set for AMR and AMR-WB each

In this case the MTSI MGW supports only one codec mode set for AMR, {12.2, 7.4, 5.9 and 4.75}, and one codec mode set for AMR-WB, {12.65, 8.85 and 6.60}, since the CS terminal only supports these mode sets. The MTSI MGW also only supports the bandwidth-efficient payload format.

The SDP offer included in this example is identical to the SDP offer shown in Table A.1.2.

Table A.3.4: SDP example

SDP offer (from MTSI client in terminal on HSPA)
<pre> m=audio 49152 RTP/AVP 97 98 99 100 a=tcap:1 RTP/AVPF a=pcfg:1 t=1 a=rtpmap:97 AMR-WB/16000/1 a=fmtp:97 mode-change-capability=2; max-red=220 a=rtpmap:98 AMR-WB/16000/1 a=fmtp:98 mode-change-capability=2; max-red=220; octet-align=1 a=rtpmap:99 AMR/8000/1 a=fmtp:99 mode-change-capability=2; max-red=220 a=rtpmap:100 AMR/8000/1 a=fmtp:100 mode-change-capability=2; max-red=220; octet-align=1 a=ptime:20 a=maxptime:240 </pre>
SDP answer (from MTSI MGW)
<pre> m=audio 49152 RTP/AVPF 97 a=acfg:1 t=1 a=rtpmap:97 AMR-WB/16000/1 a=fmtp:97 mode-set=0,1,2; mode-change-period=2, mode-change-neighbor=1; \ mode-change-capability=2; max-red=0 a=ptime:20 a=maxptime:80 </pre>

**Comments:**

The MTSI MGW is allowed to define the mode-set parameter since the MTSI client in terminal did not define it. Thereby, it is possible to avoid several SDP offers and answers.

The SDP answer contains only one encoding format since 3GPP TS 24.229 [7] requires that the answerer shall select exactly one codec for the answer. In this case, the CS terminal supports wideband speech and the MTSI MGW therefore chooses to establish a wideband speech session.

Since the MTSI client in terminal has defined that it does support restrictions in mode changes, the MTSI MGW can safely set the mode-change-period and mode-change-neighbor parameters.

In this example, the MTSI MGW also does not support redundancy so it sets max-red to zero.

This SDP answer is also a possible answer to the SDP offer shown in Table A.1.3.

## A.3.5a SDP offer from MTSI MGW supporting only one codec mode set for AMR

In this case the MTSI MGW supports only one codec mode set for AMR, {12.2, 7.4, 5.9 and 4.75}, since the CS terminal supports only this mode set. The MTSI MGW also only supports the bandwidth-efficient payload format.

**Table A.3.4a: SDP example**

SDP offer (from MTSI client in terminal on HSPA)
<pre>m=audio 49152 RTP/AVP 97 98 99 100 a=tcap:1 RTP/AVPF a=pcfg:1 t=1 a=rtpmap:97 AMR-WB/16000/1 a=fmtp:97 mode-change-capability=2; max-red=220 a=rtpmap:98 AMR-WB/16000/1 a=fmtp:98 mode-change-capability=2; max-red=220; octet-align=1 a=rtpmap:99 AMR/8000/1 a=fmtp:99 mode-change-capability=2; max-red=220 a=rtpmap:100 AMR/8000/1 a=fmtp:100 mode-change-capability=2; max-red=220; octet-align=1 a=ptime:20 a=maxptime:240</pre>
SDP answer (from MTSI MGW)
<pre>m=audio 49152 RTP/AVPF 97 a=acfg:1 t=1 a=rtpmap:97 AMR/8000/1 a=fmtp:97 mode-set=0,2,4,7; mode-change-period=2, mode-change-neighbor=1; \ mode-change-capability=2; max-red=0 a=ptime:20 a=maxptime:80</pre>

### Comments:

The MTSI MGW is allowed to define the mode-set parameter since the MTSI client in terminal did not define it. Thereby, it is possible to avoid several SDP offers and answers.

The SDP answer contains only one encoding format since 3GPP TS 24.229 [7] requires that the answerer shall select exactly one codec for the answer. In this case, the CS terminal does not support wideband speech and the MTSI MGW therefore selects to establish a narrowband speech session.

Since the MTSI client in terminal has defined that it does support restrictions in mode changes, the MTSI MGW can safely set the mode-change-period and mode-change-neighbor parameters.

In this example, the MTSI MGW also does not support redundancy so it sets max-red to zero.

## A.3.6 SDP answer from MTSI client in terminal on HSPA for session initiated from MTSI MGW interfacing UE on GERAN

This example shows the offers and answers for a session between a GERAN CS UE, through a MTSI media gateway, and a MTSI client in terminal.

The SDP offer shown here is very similar to the SDP offer shown in Table A.2.1. The only difference is that maxptime is set to 20.

**Table A.3.5: SDP example**

<b>SDP offer (from MTSI MGW)</b>
<pre> m=audio 49152 RTP/AVP 97 a=tcap:1 RTP/AVPF a=pcfg:1 t=1 a=rtptime:97 AMR/8000/1 a=fmtp:97 mode-set=0,2,4,7; mode-change-period=2, \   mode-change-neighbor=1; mode-change-capability=2; max-red=0 a=ptime:20 a=maxptime:20 </pre>
<b>SDP answer (from MTSI client in terminal)</b>
<pre> m=audio 49152 RTP/AVPF 97 a=acfg:1 t=1 a=rtptime:97 AMR/8000/1 a=fmtp:97 mode-set=0,2,4,7; mode-change-period=2, \   mode-change-neighbor=1; mode-change-capability=2; max-red=0 a=ptime:20 a=maxptime:240 </pre>

**Comments:**

The MTSI media gateway offers only a restricted mode set since the CS terminal does not support anything else. The MTSI client in terminal has to accept this, if it wants to continue with the session setup.

This example also shows that the MTSI media gateway wants to receive only 1 frame per packet. The maxptime parameter is therefore set to 20. With max-red set to 0 the MTSI media gateway also shows that it will not send redundancy. The MTSI terminal can support receiving up to 12 frames per packet. It therefore sets the maxptime parameter to 240.

The MTSI client in terminal detects that the MTSI media gateway does not want to receive redundancy and therefore sets max-red to 0.

The SDP answer shown in this example is also a suitable answer to the SDP offer shown in Table A.2.1. This SDP answer is also suitable for the SDP offer shown in Table A.2.3 since the transport layer functions are optimized for the AMR {12.2, 7.4, 5.9 and 4.7} codec modes.

### A.3.7 SDP answer from MTSI client in terminal on HSPA for session initiated from MTSI MGW interfacing legacy UE on UTRAN

This example shows the offers and answers for a session between a legacy UTRAN CS UE that only supports AMR 12.2, through a MTSI media gateway, and a MTSI client in terminal.

The SDP offer shown here is identical to the SDP offer shown in Table A.2.2.

**Table A.3.6: SDP example**

SDP offer (from MTSI MGW)
<pre>m=audio 49152 RTP/AVP 97 a=tcap:1 RTP/AVPF a=pcfg:1 t=1 a=rtpmap:97 AMR/8000/1 a=fmtp:97 mode-set=7; max-red=0 a=ptime:20 a=maxptime:20</pre>
SDP answer (from MTSI client in terminal)
<pre>m=audio 49152 RTP/AVPF 97 a=acfg:1 t=1 a=rtpmap:97 AMR/8000/1 a=fmtp:97 mode-set=7; max-red=0 a=ptime:20 a=maxptime:240</pre>

**Comments:**

The MTSI media gateway offers only one codec mode set since the CS terminal does not support anything else. The MTSI client in terminal has to accept this, if it wants to continue with the session setup.

This example also shows that the MTSI media gateway want to receive only 1 frame per packet. The maxptime parameter is therefore set to 20. With max-red set to 0 the MTSI media gateway also shows that it will not send redundancy. The MTSI terminal can support receiving up to 12 frames per packet. It therefore set the maxptime parameter to 240.

The MTSI client in terminal detects that the MTSI media gateway does not want to receive redundancy and therefore sets max-red to 0.

---

## A.4 SDP offers and answers for video sessions

### A.4.1 H.263 and MPEG-4 Visual

In the following example the SDP offer includes two video codec options:

**Table A.4.1: Example SDP offer for H.263 and MPEG-4 Part 2 video**

SDP offer
<pre>m=video 49154 RTP/AVP 99 100 a=tcap:1 RTP/AVPF a=pcfg:1 t=1 b=AS:92 b=RS:0 b=RR:2500 a=rtpmap:99 H263-2000/90000 a=fmtp:99 profile=0;level=45 a=rtpmap:100 MP4V-ES/90000 a=fmtp:100 profile-level-id=9; \     config=000001b009000001b509000001000000012000845d4c282c2090a28f</pre>

The two options in table 4.1 are associated with the RTP Payload Type numbers 99 and 100. The first offer includes ITU-T Recommendation H.263 Profile 0 (Baseline) at level 45, which supports bitrates up to 128 kbps and maximum QCIF picture formats at 15 Hz. The second offer is MPEG-4 Visual (Part 2) Simple profile at level 0b, which also supports bitrates up to 128 kbps and QCIF at 15 Hz. Here profile-level-id=9 represents Simple profile at level 0b and may be used for negotiation, whereas the config parameter gives the configuration of the MPEG-4 Visual bit stream and is not used for negotiation. The bandwidth (including IP, UDP and RTP overhead) for video is 92 kbps.

An example SDP answer to the offer is given below.

Annex A.6 describes the b=RS and b=RR bandwidth modifiers and the values included here.

**Table A.4.2: Example SDP answer**

SDP answer
<pre>m=video 49154 RTP/AVPF 99 a=acfg:1 t=1 b=AS:57 b=RS:0 b=RR:2500 a=rtpmap:99 H263-2000/90000 a=fmtp:99 profile=0;level=10</pre>

The answer includes only the H.263 codec. The responding MTSI client has restricted the video bandwidth to 57 kbps and restricted the H.263 level to 10 which supports bitrates up to 64 kbps. The offerer must be able to comply with a reduced bitrate and lower level since support for level 45 implies the support of level 10 as well.

## A.4.2 H.264/AVC with H.263 as fallback

In this example the SDP offer includes H.264/AVC with H.263 as fallback.

**Table A.4.3: Example SDP offer for H.264/AVC with H.263 as fallback**

SDP offer
<pre>m=video 49154 RTP/AVP 99 100 a=tcap:1 RTP/AVPF a=pcfg:1 t=1 b=AS:57 b=RS:0 b=RR:2500 a=rtpmap:99 H264/90000 a=fmtp:99 packetization-mode=0;profile-level-id=42e00a; \     sprop-parameter-sets=J0LgCpWgsToB/UA=, KM4Gag== a=rtpmap:100 H263-2000/90000 a=fmtp:100 profile=0;level=10</pre>

The first (preferred) offer is H.264/AVC. The packetization-mode parameter indicates single NAL unit mode. This is the default mode and it is therefore not necessary to include this parameter (see RFC 3984). The profile-level-id parameter indicates Baseline profile at level 1, which supports bitrates up to 64 kbps. It also indicates, by using so-called constraint-set flags, that the bit stream can be decoded by any Baseline, Main or Extended profile decoder. The third parameter, sprop-parameter-sets, includes base-64 encoded sequence and picture parameter set NAL units that are referred by the video bit stream. The sequence parameter set used here includes syntax that specifies the number of re-ordered frames to be zero so that latency can be minimized. The second offer in the SDP is H.263 Profile 0 (Baseline) at level 10. It is used here as a fallback in case the other MTSI client does not support H.264/AVC. The bandwidth (including IP, UDP and RTP overhead) for video is restricted to 57 kbps.



An example SDP answer to the offer is given below.

**Table A.4.4: Example SDP answer**

SDP answer
<pre>m=video 49154 RTP/AVPF 99 a=acfg:1 t=1 b=AS:57 b=RS:0 b=RR:2500 a=rtpmap:99 H264/90000 a=fmtp:99 packetization-mode=0;profile-level-id=42e00a; \     sprop-parameter-sets=J0LgCpWgsToB/UA=,KM4Gag==</pre>

The responding MTSI client is capable of using H.264/AVC and has therefore removed the fallback offer H.263. As the offer already indicated the lowest level (level 1) of H.264/AVC as well as the minimum constraint set, there is no room for further negotiation of profiles and levels. However, the bandwidth could be constrained further by reducing the bandwidth in b=AS.

### A.4.3 MPEG-4 Visual and H.263 with "imageattr" attribute

In the following example the SDP offer includes two video codec options.

**Table A.4.5: Example SDP offer for MPEG-4 Part 2 and H.263 video**

SDP offer
<pre>a=tcap:1 RTP/AVPF m=video 49154 RTP/AVP 99 a=pcfg:1 t=1 b=AS:213 b=RS:0 b=RR:2500 a=rtpmap:99 MP4V-ES/90000 a=fmtp:99 profile-level-id=3; \     config=000001B003000001B509000001000000012000845D4C285020F0A21F a=imageattr:99 send [x=176,y=144] [x=224,y=176] [x=272,y=224] [x=320,y=240] recv [x=176,y=144] [x=224,y=176] [x=272,y=224,q=0.6] [x=320,y=240] m=video 49158 RTP/AVP 100 a=pcfg:1 t=1 b=AS:92 b=RS:0 b=RR:2500 a=rtpmap:100 H263-2000/90000 a=fmtp:100 profile=0;level=45</pre>

The two options in Table A.4.5 are associated with the RTP Payload Type numbers 99 and 100. The first offer is MPEG-4 Visual (Part 2) Simple profile at level 3, which also supports bitrates up to 384 kbps and CIF at 30 Hz. Here profile-level-id=3 represents Simple profile at level 3 and may be used for negotiation, whereas the config parameter gives the configuration of the MPEG-4 Visual bit stream and is not used for negotiation. The config parameter is constructed assuming the offered conditions and image size of 320x240, which is the largest of all offered sizes for send direction. The offering MTSI client offers four image sizes for both send and receive directions but prefers 272x224 for receive direction, which might fit the available space on its display better than the other image sizes. The bandwidth (including IP, UDP and RTP overhead) for video is 213 kbps. The second offer includes ITU-T Recommendation H.263 Profile 0 (Baseline) at level 45, which supports bitrates up to 128 kbps and maximum QCIF picture formats at 15 Hz. The bandwidth (including IP, UDP and RTP overhead) for video is 92 kbps.

An example SDP answer to the offer is given below.

Table A.4.6: Example SDP answer

SDP answer
<pre>m=video 0 RTP/AVP 99 m=video 49158 RTP/AVPF 100 a=acfg:1 t=1 b=AS:57 b=RS:0 b=RR:2500 a=rtpmap:100 H263-2000/90000 a=fmtp:100 profile=0;level=10</pre>

The port number in the first m-line is set to zero and all related a-lines are omitted. The answer includes the H.263 codec. The responding MTSI client has restricted the video bandwidth to 57 kbps and restricted the H.263 level to 10 which supports bitrates up to 64 kbps. The offerer must be able to comply with a reduced bitrate and lower level since support for level 45 implies the support of level 10 as well.

Table A.4.7: Example SDP answer

SDP answer
<pre>m=video 49154 RTP/AVPF 99 a=acfg:1 t=1 b=AS:107 b=RS:0 b=RR:2500 a=rtpmap:99 MP4V-ES/90000 a=fmtp:99 profile-level-id=2; \     config=000001B002000001B509000001000000012000845D4C284420E0A21F a=imageattr:99 send [x=272,y=224] recv [x=320,y=240,q=0.6] [x=272,y=224] m=video 0 RTP/AVP 100</pre>

In this alternative answer, the port number in the second m-line is set to zero and the answer includes the MPEG-4 codec. The responding MTSI client has restricted the video bandwidth to 107 kbps and restricted the MPEG-4 level to 2 which supports bitrates up to 128 kbps. The restricted MPEG-4 level should be high enough to enable the image sizes for both send and receive directions. From the four image sizes offered, the responding MTSI client included 272x224 for send direction, which was preferred by the offering MTSI client. For receive direction, the responding MTSI client included 320x240 as preferred and 272x224 as fallback. The responding MTSI client has yet to confirm whether the offering MTSI client can encode and decode video of different image sizes simultaneously. The responding MTSI client sent new config parameter for the video decoder of the offering MTSI client, which was constructed assuming the restricted conditions and image size of 272x224.

Table A.4.8: Example Second SDP offer

Second SDP Offer
<pre>m=video 49154 RTP/AVP 99 a=tcap:1 RTP/AVPF a=pcfg:1 t=1 b=AS:107 b=RS:0 b=RR:2500 a=rtpmap:99 MP4V-ES/90000 a=fmtp:99 profile-level-id=2; \     config=000001B002000001B509000001000000012000845D4C285020F0A21F a=imageattr:99 send [x=320,y=240] recv [x=272,y=224]</pre>

In this second offer, the offering MTSI client accepted the restricted conditions in the SDP answer in Table A.4.7 and included 320x240 for send direction. The offering MTSI client sent new config parameter for the video decoder of the responding MTSI client, which was constructed assuming the restricted conditions and image size of 320x240.

## A.4.4 H.264/AVC with H.263 as fallback with "imageattr" attribute

In this example the SDP offer includes H.264/AVC with H.263 as fallback.

**Table A.4.9: Example SDP offer for H.264/AVC with H.263 as fallback**

SDP offer
<pre> a=tcap:1 RTP/AVPF m=video 49154 RTP/AVP 99 a=pcfg:1 t=1 b=AS:107 b=RS:0 b=RR:2500 a=rtptime:99 H264/90000 a=fmtp:99 packetization-mode=0;profile-level-id=42e011; \     sprop-parameter-sets=Z0LgC5ZUCg/I,aM4BrFSAA a=imageattr:99 send [x=176,y=144] [x=224,y=176] [x=272,y=224] [x=320,y=240] rcv [x=176,y=144] [x=224,y=176] [x=272,y=224,q=0.6] [x=320,y=240] m=video 49158 RTP/AVP 100 a=pcfg:1 t=1 b=AS:57 b=RS:0 b=RR:2500 a=rtptime:100 H263-2000/90000 a=fmtp:100 profile=0;level=10           </pre>

The first (preferred) offer is H.264/AVC. The packetization-mode parameter indicates single NAL unit mode. This is the default mode and it is therefore not necessary to include this parameter (see RFC 3984). The profile-level-id parameter indicates Baseline profile at level 1.1, which supports bitrates up to 192 kbps. It also indicates, by using so-called constraint-set flags, that the bit stream can be decoded by any Baseline, Main or Extended profile decoder. The bandwidth (including IP, UDP and RTP overhead) for video is 107 kbps. The third parameter, sprop-parameter-sets, includes base-64 encoded sequence and picture parameter set NAL units that are referred by the video bit stream. The sequence parameter set used here includes syntax that specifies the number of re-ordered frames to be zero so that latency can be minimized. sprop-parameter-sets is constructed assuming the offered conditions and image size of 320x240, which is the largest of all offered sizes for send direction. The offering MTSI client offers four image sizes for both send and receive directions but prefers 272x224 for receive direction, which might fit the available space on its display better than the other image sizes. The second offer in the SDP is H.263 Profile 0 (Baseline) at level 10. It is used here as a fallback in case the other MTSI client does not support H.264/AVC. The bandwidth (including IP, UDP and RTP overhead) for video is 57 kbps.

An example SDP answer to the offer is given below.

**Table A.4.10: Example SDP answer**

SDP answer
<pre> m=video 49154 RTP/AVPF 99 a=acfg:1 t=1 b=AS:107 b=RS:0 b=RR:2500 a=rtptime:99 H264/90000 a=fmtp:99 packetization-mode=0;profile-level-id=42e011; \     sprop-parameter-sets=Z0LgC5ZUCg/I,aM4BrFSAA a=imageattr:99 send [x=320,y=240] rcv [x=320,y=240] m=video 0 RTP/AVP 100           </pre>

The responding MTSI client is capable of using H.264/AVC and has therefore set the port number in the second m-line to zero. The responding MTSI client agreed with the offered bandwidth of 107 kbps and Baseline profile at level 1.1. From the four image sizes offered, the responding MTSI client included 320x240 for both send and receive directions. Although the offering MTSI client preferred 272x224 for receive direction, the responding MTSI client might not be able to offer 272x224 or not allow encoding and decoding of video of different image sizes simultaneously. The responding MTSI client sent new sprop-parameter-sets for the video decoder of the offering MTSI client, which was constructed assuming the agreed conditions and image size of 320x240.

## A.5 SDP offers for text

### A.5.1 T.140 with and without redundancy

An offer to use T.140 real-time text may be realized by using SDP according to the following example in session setup or for addition of real-time text during a session.

**Table A.5.1: Example SDP offer for T.140 real-time text**

SDP offer
<pre>m=text 53490 RTP/AVP 100 98 a=rtpmap:100 red/1000/1 a=rtpmap:98 t140/1000/1 a=fmtp:100 98/98/98</pre>

The example in table A.5.1 shows that RTP payload type 98 is used for sending text without redundancy, whereas RTP payload type 100 is used for sending text with 200 % redundancy.

## A.6 SDP example with bandwidth information

This clause gives an example where the bandwidth modifiers have been included in the SDP offer.

**Table A.6.1: SDP example with bandwidth information**

SDP offer
<pre>v=0 o=Example_SERVER 3413526809 0 IN IP4 server.example.com s=Example of AS, TIAS and maxprate in MTSI c=IN IP4 aaa.bbb.ccc.ddd t=0 0 b=AS:78 a=tcap:1 RTP/AVPF m=audio 49152 RTP/AVP 97 98 a=pcfg:1 t=1 b=AS:30 b=RS:0 b=RR:2000 a=rtpmap:97 AMR/8000/1 a=fmtp:97 mode-change-capability=2; max-red=160 a=rtpmap:98 AMR/8000/1 a=fmtp:98 mode-change-capability=2; max-red=160; octet-align=1 a=ptime:20 a=maxptime:240 m=video 49154 RTP/AVP 99 a=pcfg:1 t=1 b=AS:48 b=RS:0 b=RR:2500 a=rtpmap:99 MP4V-ES/90000 a=fmtp:99 profile-level-id=8; \ config=000001B008000001B509000001010000012000884006682C2090A21F</pre>

The `b=AS` value indicates the media bandwidth, excluding RTCP, see RFC 3550, section 6.2. On session level, the `b=AS` value indicates the sum of the media bandwidths, excluding RTCP.

In this example, the bandwidth for RTCP is allocated such that it allows for sending at least 2 compound RTCP packets per second. The size of a RTCP Sender Report is estimated to 110 bytes, given IPv4 and point-to-point sessions. The corresponding bandwidth then becomes 1760 bps which means that compound RTCP packets can be sent a little more frequently than twice per second.

For speech sessions, the RTCP bandwidth is set to 2000 bps to give room for adaptation requests with APP packets according to clause 10.2 in at least some of the RTCP messages. This adds 16 bytes to the RTCP packet.

For video, the RTCP bandwidth is set to 2500 bps to give room for slightly more frequent reporting and also to give room for codec-control messages (CCM) [43].

Setting the `RS` value to 0 does not mean that senders are not allowed to send RTCP packets. It instead means that sending clients are treated in the same way as receive-only clients, see also RFC 3556 [42].

The `tcap` attribute is in this example given on the session level to avoid repeating it for each media type.

---

## A.7 SDP examples with "3gpp\_sync\_info" attribute

### A.7.1 Synchronized streams

In the example given below in table A.7.1, streams identified with "mid" attribute 1 and 2 are to be synchronized (default operation if the "3gpp\_sync\_info" attribute is absent).

**Table A.7.1: SDP example with requirement on synchronization**

SDP offer
<pre>v=0 o=Laura 289083124 289083124 IN IP4 one.example.com s=Demo c=IN IP4 224.2.17.12/127 t=0 0 a=group:LS 1 2 a=3gpp_sync_info:Sync a=tcap:1 RTP/AVPF m=audio 30000 RTP/AVP 0 a=pcfg:1 t=1 a=mid:1 m=video 30002 RTP/AVP 31 a=pcfg:1 t=1 a=mid:2 m=audio 30004 RTP/AVP 2 a=pcfg:1 t=1 i=This media stream contains the Spanish translation a=mid:3</pre>

### A.7.2 Nonsynchronized streams

The SDP in table A.7.2 gives an example of the usage of "3gpp\_sync\_info" attribute at media level. In this example, the MPEG-4 video stream should not be synchronized with any other media stream in the session.

**Table A.7.2: SDP example with no requirement on synchronization**

SDP offer
<pre>v=0 o=Laura 289084412 2890841235 IN IP4 123.124.125.1 s=Demo c=IN IP4 123.124.125.1 t=0 0 a=tcap:1 RTP/AVPF m=video 6000 RTP/AVP 98 a=pcfg:1 t=1 a=rtpmap:98 MP4V-ES/90000 a=3gpp_sync_info:No Sync m=video 5000 RTP/AVP 99 a=pcfg:1 t=1 a=rtpmap 99 H263-2000/90000 m=audio 7000 RTP/AVP 100 a=pcfg:1 t=1 a=rtpmap:100 AMR</pre>

## A.8 SDP example with QoS negotiation

This clause gives an example of an SDP interchange with negotiated QoS parameters.

**Table A.8.1: SDP example with QoS negotiation**

SDP offer from MTSI client in terminal A to B in SIP INVITE message
<pre>v=0 o=Example_SERVER 3413526809 0 IN IP4 server.example.com s=Example of using AS to indicate negotiated QoS in MTSI c=IN IP4 aaa.bbb.ccc.ddd t=0 0 b=AS:78 a=tcap:1 RTP/AVPF m=audio 49152 RTP/AVP 97 98 a=pcfg:1 t=1 b=AS:30 b=RS:0 b=RR:2000 a=rtpmap:97 AMR/8000/1 a=fmtp:97 mode-change-capability=2; max-red=220 a=rtpmap:98 AMR/8000/1 a=fmtp:98 mode-change-capability=2; max-red=220; octet-align=1 a=ptime:20 a=maxptime:240 m=video 49154 RTP/AVP 99 a=pcfg:1 t=1 b=AS:48 b=RS:0 b=RR:2500 a=rtpmap:99 MP4V-ES/90000 a=fmtp:99 profile-level-id=8; \   config=000001B008000001B509000001010000012000884006682C2090A21F</pre>

**SDP answer from UE B to A in 200/OK message**

```

v=0
o=Example_SERVER2 34135268010 IN IP4 server2.example.com
s=Example of using AS to indicate negotiated QoS in MTSI
c=IN IP4 aaa.bbb.ccc.ddd
t=0 0
b=AS:78
m=audio 49152 RTP/AVPF 97
a=pcfg:1 t=1
b=AS:30
b=RS:0
b=RR:2000
a=rtpmap:97 AMR/8000/1
a=fmtp:97 mode-change-capability=2; max-red=220
a=ptime:20
a=maxptime:240
m=video 49154 RTP/AVPF 99
a=acfg:1 t=1
b=AS:48
b=RS:0
b=RR:2500
a=rtpmap:99 MP4V-ES/90000
a=fmtp:99 profile-level-id=8; \
  config=000001B008000001B509000001010000012000884006682C2090A21F

```

**SDP offer from MTSI client in terminal B to A in SIP UPDATE message**

```

v=0
o=Example_SERVER2 34135268010 IN IP4 server2.example.com
s=Example of using AS to indicate negotiated QoS in MTSI
c=IN IP4 aaa.bbb.ccc.ddd
t=0 0
b=AS:60
m=audio 49252 RTP/AVPF 97
b=AS:30
b=RS:0
b=RR:2000
a=rtpmap:97 AMR/8000/1
a=fmtp:97 mode-change-capability=2; max-red=220
a=ptime:20
a=maxptime:240
m=video 49254 RTP/AVPF 99
b=AS:30
b=RS:0
b=RR:2500
a=rtpmap:99 MP4V-ES/90000
a=fmtp:99 profile-level-id=8; \
  config=000001B008000001B509000001010000012000884006682C2090A21F

```

**SDP answer from MTSI client in terminal A to B in 200/OK RESPONSE to UPDATE message**

```

v=0
o=Example_SERVER 3413526809 0 IN IP4 server.example.com
s=Example of using AS to indicate negotiated QoS in MTSI
c=IN IP4 aaa.bbb.ccc.ddd
t=0 0
b=AS:78
m=audio 49152 RTP/AVPF 97

```

```
b=AS:30
b=RS:0
b=RR:2000
a=rtpmap:97 AMR/8000/1
a=fmtp:97 mode-change-capability=2; max-red=220
a=ptime:20
a=maxptime:240
m=video 49154 RTP/AVPF 99
b=AS:48
b=RS:0
b=RR:2500
a=rtpmap:99 MP4V-ES/90000
a=fmtp:99 profile-level-id=8; \
  config=000001B008000001B509000001010000012000884006682C2090A21F
```

The example in table A.8.1 shows an SDP exchange that reflects the signalling of negotiated QoS during initial session setup when there is only one PDP context for the whole session. The first offer-answer procedure is initiated by the MTSI client in terminal A at session setup. The second offer-answer procedure is initiated by the MTSI client in terminal B when it receives a different negotiated QoS, only 30 kbps for video, than what was indicated in the first SDP offer from A. To notify A, B sends a new SDP offer, in this case embedded in an UPDATE message, to A indicating the lower negotiated QoS bit rate. The MTSI client in terminal A responds with its negotiated QoS value to B.

**NOTE:** The bit rate in the second SDP answer, 48 kbps, was deliberately chosen to show that this is a fully valid SDP answer even though the second SDP offer only defines 30 kbps. It is however recommended that the UEs choose the same bandwidths whenever possible.

The SDP offer in the SIP UPDATE message contains only one encoding format since the answerer has already removed all but one encoding format in the SDP answer to the initial SDP offer.

In this example it is assumed that the SDPCapNeg framework is not needed in the UPDATE since the RTP profile has already been chosen in the initial invitation.

---

## A.9 Void

### A.9a SDP offer/answer regarding the use of Reduced-Size RTCP

This example shows the offers and answers for a session between two MTSI clients controlling the use of Reduced-Size RTCP.



**Table A.9a.1: SDP example for Reduced-Size RTCP**

SDP offer
<pre> m=audio 49152 RTP/AVP 97 98 a=tcap:1 RTP/AVPF a=pcfg:1 t=1 a=rtcp-fb:* trr-int 5000 a=rtcp-rsize a=rtptime:97 AMR/8000/1 a=fmtp:97 mode-change-capability=2; max-red=220 a=rtptime:98 AMR/8000/1 a=fmtp:98 mode-change-capability=2; max-red=220; octet-align=1 a=ptime:20 a=maxptime:240 </pre>
SDP answer
<pre> m=audio 49152 RTP/AVPF 97 a=acfg:1 t=1 a=rtcp-fb:* trr-int 5000 a=rtcp-rsize a=rtptime:97 AMR/8000/1 a=fmtp:97 mode-change-capability=2; max-red=220 a=ptime:20 a=maxptime:240 </pre>

**Comments:**

This example allows the use of Reduced-Size RTCP (attribute `rtcp-rsize`) for the adaptation feedback. Moreover the minimum interval between two regular compound RTCP packets is set to 5000 milliseconds.

---

## A.10 Examples of SDP offers and answers for inter-working with other IMS or non-IMS IP networks

### A.10.1 General

The session between an MTSI client in a terminal and a client in a remote (IMS or non-IMS) network can be established in many ways, especially when the session is initiated by the remote network and when the remote network does not use the MTSI service.

The SDP will also depend on how and when the MTSI MGW chooses to add information about what formats (other than AMR and AMR-WB) that can be used for inter-working. There are, in general, two methods for MTSI MGWs to add information about the alternative formats. The first method is to add the alternative formats to the original SDP offer from the initiating client as a pre-emptive action. The second method is to leave the original SDP offer unchanged, forward it to the remote network and wait for the answerer to respond and only add the alternative formats if/when the SDP offer was rejected. A further complication is that there might be multiple MGWs in the path for this kind of inter-working and different MGWs might work differently.

The SDP examples included below should therefore be regarded as a few samples of possible SDPs and should not be regarded as a complete description of what might occur in a real implementation.

## A.10.2 Session initiated by MTSI client in terminal

### A.10.2.1 SDP offers from an MTSI client in terminal

The MTSI client in terminal could send an SDP offer as shown in Table A.10.1 (narrow-band speech only) or Table A.10.2 (wide-band and narrow-band speech).

**Table A.10.1: Original SDP offer from an MTSI client in terminal for narrow-band speech**

SDP offer
<pre>m=audio 49152 RTP/AVP 97 98 a=tcap:1 RTP/AVPF a=pcfg:1 t=1 a=rtpmap:97 AMR/8000/1 a=fmtp:97 mode-change-capability=2; max-red=220 a=rtpmap:98 AMR/8000/1 a=fmtp:98 mode-change-capability=2; max-red=220; octet-align=1 a=ptime:20 a=maxptime:240</pre>

**Comments:**

This SDP offer is identical to the SDP offer in Table A.1.1.

**Table A.10.2: Original SDP offer from an MTSI client in terminal for narrow-band and wide-band speech**

SDP offer
<pre>m=audio 49152 RTP/AVP 97 98 99 100 a=tcap:1 RTP/AVPF a=pcfg:1 t=1 a=rtpmap:97 AMR-WB/16000/1 a=fmtp:97 mode-change-capability=2; max-red=220 a=rtpmap:98 AMR-WB/16000/1 a=fmtp:98 mode-change-capability=2; max-red=220; octet-align=1 a=rtpmap:99 AMR/8000/1 a=fmtp:99 mode-change-capability=2; max-red=220 a=rtpmap:100 AMR/8000/1 a=fmtp:100 mode-change-capability=2; max-red=220; octet-align=1 a=ptime:20 a=maxptime:240</pre>

**Comments:**

This SDP offer is identical to the SDP offer in Table A.1.2.

### A.10.2.2 SDP offers modified by MTSI MGW when pre-emptively adding inter-working formats

In this example, the MTSI MGW intercepts the SIP INVITE with the original SDP offer from the MTSI client in terminal and adds the codecs and formats that are supported for inter-working before forwarding the SDP offer to the remote network.

When an MTSI MGW pre-emptively adds codecs and formats for inter-working it will also remove lines that it does not support. These examples show an MTSI MGW that does not support AVPF nor SDPCapNeg and it will therefore

remove the corresponding lines. The SDP offers could look like the examples included in Table A.10.3 (narrow-band speech only) and Table A.10.4 (wide-band and narrow-band speech).

**Table A.10.3: SDP offer for narrow-band speech which has been modified by the MTSI MGW before it is sent to the remote network**

Modified SDP offer
<pre>m=audio 49152 RTP/AVP 97 98 99 100 101 a=rtpmap:97 AMR/8000/1 a=fmtp:97 mode-change-capability=2; max-red=220 a=rtpmap:98 AMR/8000/1 a=fmtp:98 mode-change-capability=2; max-red=220; octet-align=1 a=rtpmap:99 PCMA/8000/1 a=rtpmap:100 PCMU/8000/1 a=rtpmap:101 L16/8000/1 a=ptime:20 a=maxptime:240</pre>

**Comments:**

The SDP offer from Table A.10.1 has been modified by adding RTP Payload Types 99 (A-law PCM), 100 ( $\mu$ -law PCM) and 101 (linear 16 bit PCM with 8 kHz sampling frequency).

The lines "a=tcap:1 RTP/AVPF" and "a=pcfg:1 t=1" are removed because the MTSI MGW does not support AVPF nor SDPCapNeg in this example.

To allow for end-to-end adaptation for AMR and AMR-WB, the MTSI MGW keeps a=maxptime:240.

If the remote network supports AMR, then the received SDP answer should contain at least one RTP Payload Type for AMR but there may also be one or more RTP Payload types for non-AMR codecs. In this case, the MTSI MGW does not need to perform transcoding and may forward the SDP offer to the MTSI client in terminal unchanged.

If the SDP answer contains no AMR RTP Payload Type then the MTSI MGW needs to perform transcoding to and from the format indicated by the remote network. In this case, the MTSI MGW needs to add AMR to the SDP answer that is sent back to the MTSI client in terminal.

**Table A.10.4: SDP offer for wide-band and narrow-band speech which has been modified by the MTSI MGW before it is sent to the remote network**

Modified SDP offer
<pre>m=audio 49152 RTP/AVP 97 98 101 102 99 100 103 104 105 a=rtpmap:97 AMR-WB/16000/1 a=fmtp:97 mode-change-capability=2; max-red=220 a=rtpmap:98 AMR-WB/16000/1 a=fmtp:98 mode-change-capability=2; max-red=220; octet-align=1 a=rtpmap:101 G722/8000/1 a=rtpmap:102 L16/16000/1 a=rtpmap:99 AMR/8000/1 a=fmtp:99 mode-change-capability=2; max-red=220 a=rtpmap:100 AMR/8000/1 a=fmtp:100 mode-change-capability=2; max-red=220; octet-align=1 a=rtpmap:103 PCMA/8000/1 a=rtpmap:104 PCMU/8000/1 a=rtpmap:105 L16/8000/1 a=ptime:20 a=maxptime:240</pre>

**Comments:**

The SDP offer from Table A.10.2 has been modified by adding RTP Payload Types 101 (G.722), 102 (linear 16 bit PCM with 16 kHz sampling frequency), 103 (A-law PCM), 104 ( $\mu$ -law PCM) and 105 (linear 16 bit PCM with 8 kHz sampling frequency).

NOTE: The sampling frequency for G.722 is 16 kHz but has been set to 8 kHz in the SDP because G.722 was (erroneously) assigned this value in the original version of the RTP A/V profile. Hence, one need to use "8000" for backwards compatibility reasons, see also [10].

The lines "a=tcap:1 RTP/AVPF" and "a=pcfg:1 t=1" are removed because the MTSI MGW does not support SDPCapNeg (in this example).

To allow for end-to-end adaptation for AMR and AMR-WB, the MTSI MGW keeps a=maxptime:240.

If the remote network supports AMR-WB or AMR, then the received SDP answer should contain at least one RTP Payload Type for AMR-WB or AMR but there may also be one or more RTP Payload Types for non-AMR codecs. In this case, the MTSI MGW does not need to perform transcoding and can remove the non-AMR RTP Payload Types before forwarding the SDP answer to the MTSI client in terminal.

If the SDP answer contains no AMR-WB or AMR RTP Payload Type then the MTSI MGW needs to perform transcoding to and from the format indicated by the remote network.

### A.10.2.3 SDP modified by MGW when adding inter-working formats only when the original SDP offer was rejected

In this example, the MTSI MGW either forwards the original SDP offer that was received from the MTSI client in terminal to the remote network or it is not involved in the session setup at all until it is concluded that the same codecs are not supported in the different networks. In this latter case, the MTSI MGW is invoked only if the remote network rejects the SDP offer.

In this case, when the MTSI MGW sends the (new) SDP offer to the remote network it knows that the AMR (and AMR-WB) codecs are not supported by the remote network because the original SDP offer was rejected. It is therefore unnecessary to include these codecs in the (new) SDP offer. The SDP offers could look like the examples included in Table A.10.5 (narrow-band speech only) and Table A.10.6 (wide-band and narrow-band speech).

The remote client may also suggest codecs and configurations when it rejects the SDP offer. Existence of such information can, of course, be used to increase the likelihood that the session setup will be successful. These SDP examples are however designed for the case when no such information is available from the remote network.

**Table A.10.5: New SDP offer for narrow-band speech sent by the MTSI MGW to the remote network**

New SDP offer
<pre>m=audio 49152 RTP/AVP 99 100 101 a=rtpmap:99 PCMA/8000/1 a=rtpmap:100 PCMU/8000/1 a=rtpmap:101 L16/8000/1 a=ptime:20 a=maxptime:80</pre>

**Comments:**

The new SDP offer includes RTP Payload Types 99 (A-law PCM), 100 ( $\mu$ -law PCM) and 101 (linear 16 bit PCM with 8 kHz sampling frequency).

In this case, the maxptime is set to 80, if the MTSI MGW does not support redundancy.

**Table A.10.6: New SDP offer for narrow-band and wide-band speech sent by the MTSI MGW to the remote network**

New SDP offer
<pre>m=audio 49152 RTP/AVP 101 102 103 104 105 a=rtpmap:101 G722/8000/1 a=rtpmap:102 L16/16000/1 a=rtpmap:103 PCMA/8000/1 a=rtpmap:104 PCMU/8000/1 a=rtpmap:105 L16/8000/1 a=ptime:20 a=maxptime:80</pre>

**Comments:**

The new SDP offer includes RTP Payload Types 101 (G.722), 102 (linear 16 bit PCM with 16 kHz sampling frequency), 103 (A-law PCM), 104 ( $\mu$ -law PCM) and 105 (linear 16 bit PCM with 8 kHz sampling frequency).

**NOTE:** The sampling frequency for G.722 is 16 kHz but has been set to 8 kHz in the SDP because G.722 was (erroneously) assigned this value in the original version of the RTP A/V profile. Hence, one need to use “8000” for backwards compatibility reasons, see also [10].

In this case, the `maxptime` is set to 80, if the MTSI MGW does not support redundancy.

---

## A.11 Adding a video component to an on-going video call session

The MTSI client in a terminal can add, remove and modify the media components during an ongoing MTSI session. This clause describes the SDP offer in the initial SIP INVITE message, see Table A.11.1, and the SDP in the subsequent re-INVITE or UPDATE message for adding a video stream to the ongoing MTSI video call session, see Table A.11.2. Corresponding SDP answers in the SIP 200/OK responses are also described.

The initial video call session contains one video component and one speech component. During the session, the MTSI client in terminal A adds a uni-directional video component (such as one video clip) to the ongoing video call session. The SDP content attribute “`a=content:main`” and “`a=content:alt`” are used to label the main and alternative video components respectively [81].

This example does not show how to use the content attribute in combination with the grouping attribute, nor does it show how to use the content attribute in combination with the synchronization attribute defined in Clause 6.2.6.

**Table A.11.1: SDP offer/answer for setting up a video telephony session**

<b>SDP offer from MTSI client in terminal A to B in SIP INVITE message</b>
<pre> a=tcap:1 RTP/AVPF m=audio 49150 RTP/AVP 96 a=pcfg:1 t=1 b=AS:30 b=RS:0 b=RR:2000 a=rtpmap:96 AMR/8000/1 a=fmtp:96 mode-change-capability=2; max-red=220 aptime:20 a=maxptime:240 m=video 54320 RTP/AVP 99 a=pcfg:1 t=1 b=AS:57 b=RS:0 b=RR:2500 a=rtpmap:99 MP4V-ES/90000 a=fmtp:99 profile-level-id=8; \ config=000001B008000001B509000001010000012000884006682C2090A21F </pre>
<b>SDP answer from MTSI client in terminal B to A in 200/OK RESPONSE message</b>
<pre> m=audio 49152 RTP/AVPF 96 a=acfg:1 t=1 b=AS:30 b=RS:0 b=RR:2000 a=rtpmap:96 AMR/8000/1 a=fmtp:96 mode-change-capability=2; max-red=220 aptime:20 a=maxptime:240  m=video 54320 RTP/AVPF 99  a=acfg:1 t=1 b=AS:57 b=RS:0 b=RR:2500 a=rtpmap:99 MP4V-ES/90000  a=fmtp:99 profile-level-id=8; \  config=000001B008000001B509000001010000012000884006682C2090A21F </pre>

**Table A.11.2: Second SDP offer/answer for adding one more video component**

<b>SDP offer from MTSI client in terminal A to B in SIP UPDATE/Re-INVITE message</b>
<pre> a=tcap:1 RTP/AVPF m=audio 49150 RTP/AVP 96 a=pcfg:1 t=1 b=AS:30 b=RS:0 b=RR:2000 a=rtpmap:96 AMR/8000/1 </pre>

```
a=fmtp:96 mode-change-capability=2; max-red=220
a=ptime:20
a=maxptime:240
m=video 54320 RTP/AVP 99
i=Main video
a=pcfg:1 t=1
b=AS:57
b=RS:0
b=RR:2500
a=rtpmap:99 MP4V-ES/90000
a=fmtp:99 profile-level-id=8; \
    config=000001B008000001B509000001010000012000884006682C2090A21F
a=content:main
m=video 43200 RTP/AVP 100
i=Alternative video
a=pcfg:1 t=1
b=AS:128
b=RS:0
b=RR:2500
a=rtpmap:100 H263-2000/90000
a=fmtp:100 profile=0;level=45;
a=content:alt
a=sendonly
```

**SDP answer from MTSI client in terminal B to A in 200/OK RESPONSE to UPDATE/Re-INVITE message**

```
m=audio 49152 RTP/AVPF 96
a=acfg:1 t=1
b=AS:30
b=RS:0
b=RR:2000
a=rtpmap:96 AMR/8000/1
a=fmtp:96 mode-change-capability=2; max-red=220
a=ptime:20
a=maxptime:240
m=video 54320 RTP/AVPF 99
a=acfg:1 t=1
b=AS:57
b=RS:0
b=RR:2500
a=rtpmap:99 MP4V-ES/90000
a=fmtp:99 profile-level-id=8; \
    config=000001B008000001B509000001010000012000884006682C2090A21F
a=content:main
m=video 43200 RTP/AVPF 100
a=acfg:1 t=1
b=AS:128
b=RS:0
b=RR:2500
a=rtpmap:100 H263-2000/90000
a=fmtp:100 profile=0;level=45;
a=content:alt
a=recvonly
```

## A.12 SDP examples when using ECN

The following SDP offer and SDP answer are likely when both MTSI clients in terminals use ECN for speech.

This SDP example is based on the SDP example found in Table A.3.0 although bandwidth information for the media and for RTCP has been added. The negotiation of Reduced-Size RTCP is added together with the ECN negotiation.

**Table A.12.1: SDP example**

SDP offer
<pre> m=audio 49152 RTP/AVP 97 98 a=tcap:1 RTP/AVPF a=pcfg:1 t=1 b=AS:30 b=RS:0 b=RR:2000 a=rtpmap:97 AMR/8000/1 a=fmtp:97 mode-change-capability=2; max-red=220 a=rtpmap:98 AMR/8000/1 a=fmtp:98 mode-change-capability=2; max-red=220; octet-align=1 a=ecn-capable-rtp: leap; ect=0 a=rtcp-rsize a=ptime:20 a=maxptime:240 </pre>
SDP answer
<pre> m=audio 49152 RTP/AVPF 99 a=acfg:1 t=1 b=AS:30 b=RS:0 b=RR:2000 a=rtpmap:99 AMR/8000/1 a=fmtp:99 mode-change-capability=2; max-red=220 a=ecn-capable-rtp: leap; ect=0 a=rtcp-rsize a=ptime:20 a=maxptime:240 </pre>

### Comments:

The SDP offer includes the SDP attribute 'ecn-capable-rtp' to indicate that ECN is supported. The SDP offer further includes the parameters: 'leap' to indicate that the leap-of-faith initiation method is to be used; and 'ect=0' to request that the other endpoint sets the ECN bits to ECT(0).

The SDP offer also includes an offer for AVPF to enable sending adaptation requests without following the normal rules for RTCP transmission intervals. In addition, the MTSI client also offers to use Reduced-Size RTCP ('a=rtcp-rsize') to enable sending the adaptation requests without including the RTCP SR/RR and SDES packets.

The SDP answer is configured in the same way as in the offer to indicate that the ECN usage and its configuration is agreeable to be used in the session.



---

## Annex B (informative): Examples of adaptation scenarios

### B.1 Video bitrate adaptation

It is recommended in clauses 7.3.3 and 10.3 that a video sender adapts its video output rate based on RTCP reports and TMMBR messages. The following examples illustrate the usage:

EXAMPLE 1 – Handover to a different cell:

1. A video session is established at 100kbps. 5kbps is allocated for RTCP and tr-int is set to 500 ms. This allows an MTSI client in terminal to send regular RTCP reports with an average 500 ms interval consuming less than 5 kbps for RTCP. At the same time it allows the MTSI client in terminal to send an early RTCP packet and then send the next one already after 800 ms instead of after 1 000 ms.
2. The receiver is now subject to a reduced bandwidth, e.g. 60 kbps, due to handover to a different cell. The network indicates the reduced bandwidth to the receiver. The receiver generates a TMMBR message to inform the sender of the new maximum bitrate, 60 kbps.
3. The sender receives the TMMBR message, adjusts its output bitrate and sends a TMMBN message back.
4. The receiver sends a SIP UPDATE message to the sender indicating 60 kbps
5. The receiver travels into an area with full radio coverage. A new bandwidth of 100 kbps is negotiated with the network. It sends a SIP UPDATE message for 100 kbps.
6. The sender receives the SIP UPDATE message, and adjusts its output bitrate.

EXAMPLE 2 – Bad coverage or congestion:

1. A video session is established at 100kbps. 5kbps is allocated for RTCP and tr-int is set to 500 ms. This allows an MTSI client in terminal to send regular RTCP reports with an average 500 ms interval consuming less than 5 kbps for RTCP. At the same time it allows the MTSI client in terminal to send an early RTCP packet and then send the next one already after 800 ms instead of after 1 000 ms.
2. The receiver detects congestion and estimates a preferred video transmission rate of e.g. 60 kbps. The receiver generates a TMMBR message to inform the sender of the new maximum bitrate, 60 kbps.
3. The sender receives the TMMBR message, adjusts its output bitrate and sends a TMMBN message back.

---

## Annex C (informative): Example adaptation mechanisms for speech

### C.1 Example of feedback and adaptation for speech and video

#### C.1.1 Introduction

This annex gives the outline of possible example adaptation implementations that make use of adaptation signalling for speech as described in section 10.2. Several different adaptation implementations are possible and the examples shown in this section are not to be seen as a set of different adaptive schemes excluding other designs. Implementers are free to use these examples or to use any other adaptation algorithms. The examples are only based on measured packet losses whereas a real implementation is free to use other adaptation triggers. The purpose of the section is to show a few different examples of how receiver state machines can be used both to control the signalling but also to control the signalling requests. Notice that the MTSI clients can have different implementations of the adaptation state machines.

The annex is divided into three sections:

- Signalling considerations - Implementation considerations on the signalling mechanism; the signalling state machine.
- Adaptation state machines - Three different examples of adaptation state machines either using the full set of adaptation dimensions or a subset thereof.
- Other issues and solutions - Default actions and lower layer triggers.

In this annex, a *media receiver* is the receiving end of the media flow, hence the *request sender* of any adaptation request. A *media sender* is the sending entity of the media, hence the *request receiver* of the adaptation request. The three different adaptation mechanisms available; bit-rate, packet-rate and error resilience, represents different ways to adapt to current transport characteristics:

- Bit-rate adaptation. Reducing the bit-rate is in all examples shown in this section the first action done whenever a measurement indicating that action is needed to further optimize the session quality. A bit-rate reduction will reduce the utilization of the network resources to transmit the data. In the radio case, this would reduce the required transmission power and free resources either for more data or added channel coding. It is reasonable to assume, also consistent with a proper behaviour on IP networks, that a reduction of bit-rate is a valid first measure to take whenever the transport characteristics indicate that the current settings of the session do not provide an optimized session quality.
- Packet-rate adaptation. In some of the examples, packet-rate adaptation is a second measure available to further adapt to the transport characteristics. A reduction of packet rate will in some cases improve the session quality, e.g. in transmission channels including WLAN. Further, a reduction of packet rate will also reduce the protocol overhead since more data is encapsulated into each RTP packet. Although robust header compression (RoHC) can reduce the protocol overhead over the wireless link, the core network will still see the full header and for speech data, it consists of a considerable part of the data transmitted. Hence, packet-rate adaptation serves as a second step in reducing the total bit-rate needed for the session.
- Error resilience. The last adaptive measure in these examples is the use of error resilience measures, or explicitly, application level redundancy. Application level redundancy does not reduce the amount of bits needed to be transmitted but instead transmit the data in a more robust way. Application level redundancy should only be seen as a last measure when no other adaptation action has succeeded in optimizing the session quality sufficiently well. For most normal use cases, application level redundancy is not foreseen to be used, rather it serves as the last resort when the session quality is severely jeopardized.

## C.1.2 Signalling state considerations

The control of the adaptation signalling can by itself be characterized as a state machine. The implementation of the state machine is in the decoder and each MTSI client has its own implementation. The decoder sends requests as described in clause 10.2 to the encoder in the other end.

The requests that are transmitted can be queued up in a send buffer to be transmitted the next time an RTCP-APP packet is to be sent. Hence, a sender might receive one, two or all three receiver requests at the same time. It should not expect any specific order of the requests. A receiver shall not send multiple requests of the same type in the same RTCP-APP packet. Transmission of the requests should preferably be done immediately using the AVPF early mode but in some cases it may be justified to delay the transmission a limited time or until the next DTX period in order to minimize disturbance on the RTP stream, in the latter case monitoring of the RTP stream described below must take the additional delay into account.

To summarize:

- A request can be sent immediately (alone in one RTCP-APP packet) but the subsequent RTCP-APP packet must follow the transmission rules for RTCP.
- RTCP-APP packets may be delayed until the next DTX period.

Reception of the transmitted RTCP-APP packets is not guaranteed. Similar to the RTP packets, the RTCP packets might be lost due to link losses. Monitoring that the adaptation requests are followed can to be done by means of inspection of the received RTP stream.

For various reasons the requests might not be followed even though they received successfully by the other end. This behaviour can be seen in the following ways:

- Request completely ignored: An example is a request for 1 frame/packet which might be rejected as the MTSI client decides that the default mode of operation 2 frames/packet or more and a frame aggregation reduction compared to the default state is not allowed.
- Request partially followed: An example here is when no redundancy is received and a request for 100 % redundancy with 1 extra frame offset is made which may be realized by the media sender as 100 % redundancy with no extra offset. Another example is when a request for 5.9 kbps codec rate is sent and it is realized as e.g. 6.7 kbps codec rate. Table C.1 displays how the requests and realizations are grouped. E.g. it can be seen (if  $N_{init} = 1$ ) that a request for 3 frames per packets realized as 2 frames per packet is considered to be fulfilled.

**Table C.1: Distinction of different settings for frame aggregation, redundancy and codec mode settings**

Codec rate	Frame aggregation	Redundancy
Highest rate in mode set	$N_{init}$ frame per packet	No redundancy
All other codec rates	$\geq N_{init}+1$ frames per packet	$\geq 100$ % redundancy , arbitrary offset

In table C.1 above  $N_{init}$  is 1 in most cases which corresponds to 1 frame per packet. In certain cases  $N_{init}$  might have another value, one such example is E-GPRS access where  $N_{init}$  may be 2.  $N_{init}$  is given by theptime SDP attribute.

Note that special care in the monitoring should be taken when DTX is used as DTX SID update packets are normally not aggregated or transmitted redundant. Important is also that it takes at least one roundtrip before the effect of a request is seen in the RTP flow, if transmission of RTCP is delayed due to e.g. bandwidth requirements this extra delay must also be taken into account in the monitoring.

If the requests are not followed as requested, the request should not be repeated infinitely as it will increase the total bit-rate without clear benefit. In order to avoid such behaviour the following recommendations apply:

- Partially fulfilled requests should be considered as obeyed.
- If a new request is not fulfilled within  $T_{RESPONSE}$  ms, the request is repeated again with a delay between trials of  $2 * T_{RESPONSE}$  ms. If the three attempts have been made without sender action, it should be assumed that the request cannot be fulfilled. In this case, the adaptation state machine will stay in the previous state or in a state that matches the current properties (codec mode, redundancy, frame aggregation). Any potential mismatch

between define states in the adaptation state machine and the current properties of the media stream should be resolved by the request sender.

- The default mode of operation for a MTSI client if the RTCP bandwidth for the session is greater than zero is that the requests received should be followed. Ignoring requests should be avoided as much as possible. However, it is required that any signalling requests are aligned with the agreed session parameters in the SDP.

In some cases the adaptation state machine may go out-of-synch with the received RTP stream. Such cases may occur if e.g. the other MTSI client makes a reset. These special cases can be sensed, e.g. through a detection of a large gap in timestamp and/or sequence number. The state machine should then reset to the default state and start over again.

The signalling state machine has three states according to table C.2.

**Table C.2: Signalling state machine states**

State	Description
T1	Idle state: This is the default state of the signalling state machine. The signalling state should always return here after a state transition and when it has been detected that the media sender has followed the request, either completely or partially. The signalling state machine remains in this state as long as the selected adaptation is "stable", i.e. as long as the adaptation measures are appropriate for the current operating conditions. When it has been detected that the operating conditions has changed so much that the current adaptation measures are no longer appropriate then the adaptation function triggers a request signalling and the signalling state machine goes to state T2.
T2	In this state, the received RTP stream is monitored to verify that the properties of a given adaptation state (redundancy, frame aggregation and codec mode) are detected in the received RTP stream. If necessary, some of the requests are repeated maximum 3 times. If any of the properties is considered to be not fulfilled, the signalling state machine enters state T3.
T3	In this state, the properties of the RTP stream (redundancy, frame aggregation and codec rate) is reverted back to the properties of the last successful state and a new state transition is tested in T2, or alternatively the adaptation state is set to the state that matches the current properties (codec mode, redundancy, frame aggregation).

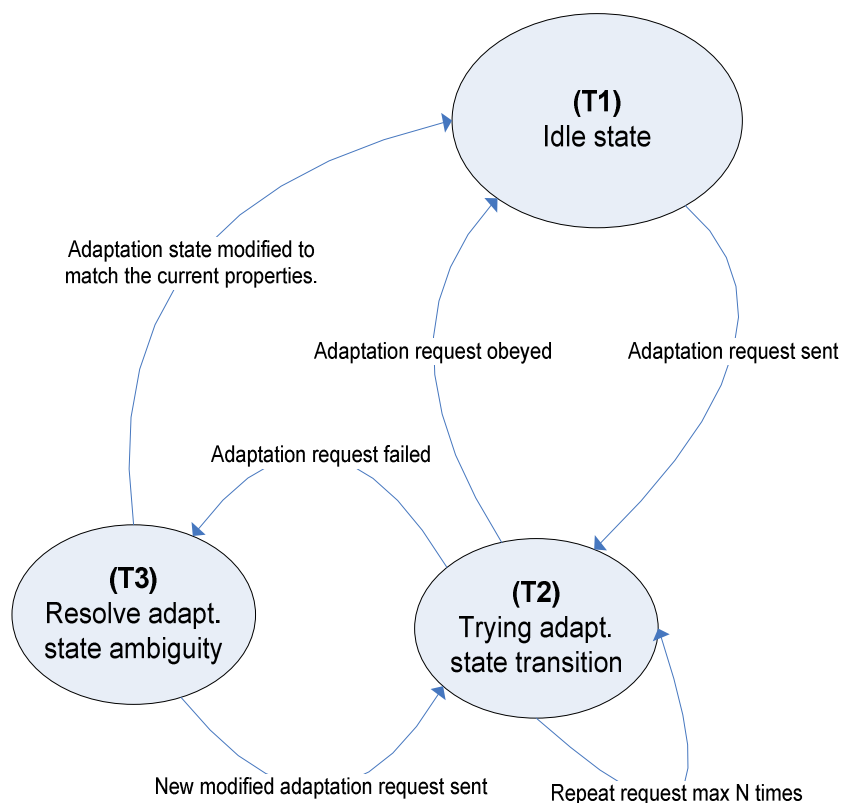

**Figure C.1: Signalling state machine, implemented in order to ensure safe adaptation state transitions**

## C.1.3 Adaptation state machine implementations

### C.1.3.1 General

The example adaptation state machines shown in this section are different realizations of the control algorithm for the adaptation requests. Note that this does not include how the actual signalling should be done but how various triggers will result in the transmission of different requests.

The example adaptation state machines make use of the signalling state machine outlined in clause B.2. Common to all adaptation state machines is that it is possible to implement all versions in the same code and just exclude appropriate states depending on desired mode of operation. All examples can transit between a number of states (denoted S1...S4). In these examples, it is assumed that the codec is AMR-NB and that it uses two coding rates (AMR 12.2 and AMR 5.9). However, this is not a limitation of the adaptation mechanism by itself. It is only the scenario used in these examples.

Since the purpose of the adaptation mechanism is to improve the quality of the session, any adaptation signalling is based upon some trigger; either a received indication or a measurement. In the case of a measurement trigger, it is important to gather reliable statistics. This requires a measurement period which is sufficiently long to give a reliable estimation of the channel quality but also sufficiently short to enable fast adaptation. For typical MTSI scenarios on 3GPP accesses, a measurement period in the order of 100 packets is recommended. Further, in order to have an adaptation control which is reliable and stable, a hangover period is needed after a new state has been entered (typically 100 to 200 packets). An even longer hangover period is suitable when transiting from an error resilient state or a reduced rate into the default, normal state. In the below examples, it is assumed that the metric used in the adaptation is the packet loss rate measured on the application layer. It is possible to use other metrics such as lower layer channel quality metrics.

Note that mode change requests must follow the rules outlined in clause 5.2.1.

The example solution is designed based on the following assumptions:

- When the packet loss rate increases, the adaptation should:
  - First try with a lower codec mode rate, i.e. bit-rate back off.
  - If this does not improve the situation, then one should try with packet rate back-off by increasing the frame aggregation.
  - If none of these methods help, then application layer redundancy should be added to save the session.
- When the packet loss rate increases, one should try to increase the bit rate in a "safe" manner. This is done by probing for higher bit rates by adding redundancy.
- The downwards adaptation, towards lower rates and redundancy, should be fast while the upwards adaptation should be slow.
- Hysteresis should be used to avoid oscillating behaviour between two states.

A description of the different states and what trigger the transition into the respective state is given in table C.3.

**Table C.3: Adaptation state machine states and their meaning**

State	Description
S1	<p>Default/normal state: Good channel conditions.</p> <p>This state has the properties:</p> <ul style="list-style-type: none"> <li>• Codec rate: Highest mode in mode set.</li> <li>• Frame aggregation: Equal to the ptime value in the agreed session parameters.</li> <li>• Redundancy: 0%.</li> </ul>
S2	<p>In this state the encoding bit-rate and the packet rate is reduced. The state is divided into 2 sub states (S2a and S2b). In state S2a the codec rate is reduced and in state S2b the packet rate is also reduced (the frame aggregation is increased). State S2a may also involve a gradual decrease of the codec-rate in order to be in agreement with the session parameters. If no restrictions are in place regarding mode changes (i.e. such as only allowing changing to a neighbouring mode), it changes bit-rate to the target reduced bit-rate directly. If restrictions are in place, several mode changes might be needed.</p> <p>This state has the properties:</p> <ul style="list-style-type: none"> <li>• Codec rate: Any codec rate except the highest rate in mode set, preferably a codec rate that is roughly half the highest rate.</li> <li>• Frame aggregation: <ul style="list-style-type: none"> <li>○ S2a: Equal to the ptime value in the agreed session parameters.</li> <li>○ S2b: <math>ptime+N*20ms</math> where <math>N &gt; 1</math>, limited by max-ptime.</li> </ul> </li> <li>• Redundancy: 0%.</li> </ul>
S3	<p>This is an interim state where the total bit-rate and packet rate is roughly equal to state S1. 100% redundancy is used with a lower codec mode than S1. This is done to probe the channel band-width with a higher tolerance to packet loss to determine if it is possible to revert back to S1 without significantly increase the packet loss rate.</p> <p>This state has the properties:</p> <ul style="list-style-type: none"> <li>• Codec rate: Any codec rate except the highest rate in mode set, preferably a codec rate that is roughly half the highest rate, target total rate (with redundancy) should be roughly the same as in S1.</li> <li>• Frame aggregation: Equal to the ptime value in the agreed session parameters.</li> <li>• Redundancy: 100%.</li> </ul>
S4	<p>In this state the encoding bit-rate is reduced (the same bit-rate as in S2) and redundancy is turned on. Optionally also the packet rate is kept the same as in state S2.</p> <p>This state has the properties:</p> <ul style="list-style-type: none"> <li>• Codec rate: Any codec rate except the highest rate in mode set, preferably a codec rate that is roughly half the highest rate.</li> <li>• Frame aggregation: Equal to the ptime value in the agreed session parameters.</li> <li>• Redundancy: 100%, possibly with offset.</li> </ul>

The parameters and other definitions controlling the behaviour of the adaptation state machine are described in table C.4. Example values are also shown, values which give good performance on a wide range of different channel conditions.

**Table C.4: State transition definitions, thresholds and temporal adaptation control parameters**

Parameter	Value/meaning	Comment
PLR_1	3 %	
PLR_2	1 %	
PLR_3	2 %	
PLR_4	10 %	
N_INHIBIT	1 000 frames	A random value may be used to avoid large scale oscillation problems.
N_HOLD	5 measurement periods	
T_RESPONSE	500 ms	Estimated response time for a request to be fulfilled.
Packet loss burst	2 or more packet losses in the last 20 packets.	

### C.1.3.2 Adaptation state machine with four states

The first example utilizes all adaptation possibilities, both in terms of possible states and transitions between the states. Figure C.2 shows the layout of the adaptation state machine and the signalling used in the transitions between the states.

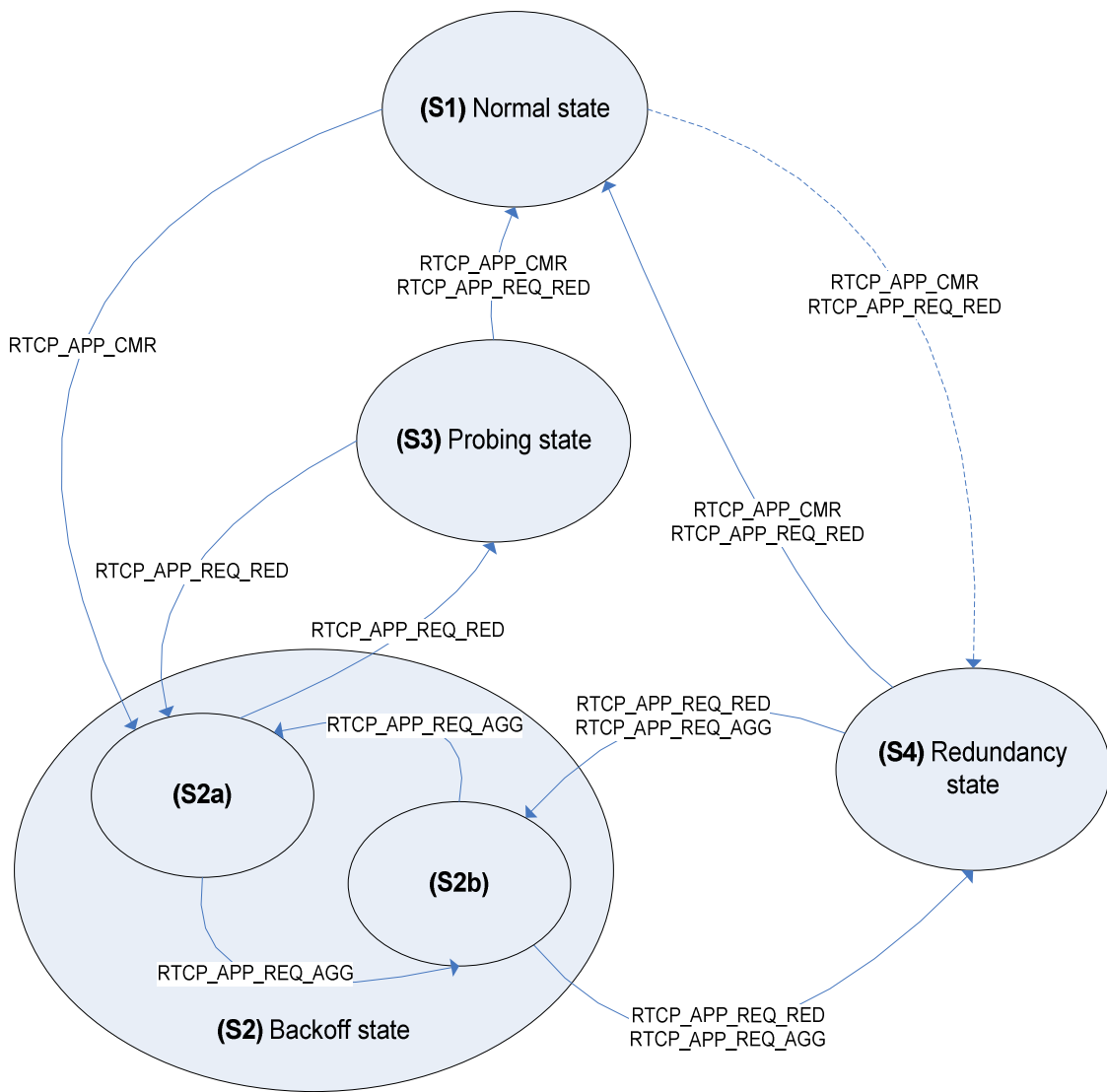

Figure C.2: State diagram for four-state adaptation state machine



**State transitions:**

Below are listed the possible state transitions and signalling that is involved. Note that the state can go from S1 to either S2 or state S4, this is explained below:

**Table C.5: State transitions for four-state adaptation state machine**

State transition	Conditions and actions
S1 → S2a	Condition: Packet loss $\geq$ PLR_1 or packet loss burst detected. A request to reduce the encoding bit-rate is sent using RTCP_APP_CM, e.g. change mode from AMR 12.2 to AMR 5.9.
S2a → S2b	Condition: Packet loss $\geq$ PLR_1. This state transition occurs if the packet loss is still high despite the reduction in codec rate. A request is sent to reduce the packet rate is reduced by means of an RTCP_APP_REQ_AGG message.
S2b → S2a	Condition: Packet loss $\leq$ PLR_2 for N_HOLD consecutive measurement periods. This state transition involves an increase of the packet rate restoring it to the same value as in S1. The request transmitted is RTCP_APP_REQ_AGG. If the state transition S2b→S2a→S2b occurs in sequence, the state will be locked to S2b for N_INHIBIT frames to avoid state oscillation.
S2a → S3	Condition: Packet loss $\leq$ PLR_2 for N_HOLD consecutive measurement periods. A request to turn on 100% redundancy is transmitted by means of request RTCP_APP_REQ_RED.
S3 → S2a	Condition: Packet loss $\geq$ PLR_3. Same actions as in transition from, S1→S2a. If the transition S2a→S3→S2a→S3→S2a occurs, the S3 is disabled for N_INHIBIT frames.
S3 → S1	Condition: Packet loss $\leq$ PLR_2 for N_HOLD consecutive measurement periods. A request to turn off redundancy is transmitted as RTCP_APP_REQ_RED. Encoding bit-rate is increased by means of RTCP_APP_CM.
S2b → S4	Condition: Packet loss $\geq$ PLR_3. A request to turn on 100% redundancy is transmitted by means of request RTCP_APP_REQ_RED. The packet rate is restored to same value as in S1 using RTCP_APP_REQ_AGG.
S4 → S2b	Condition: <ol style="list-style-type: none"> <li>If the previous transition was S2b→S4 and packet loss <math>\geq</math> to 4*PLR@ S2b→S4 (packet loss considerably increased since transition to state S4). This is indicative of that the total bit-rate is too high and that it is probably better to transmit with a lower packet rate/bit-rate instead. This case might occur if the packet loss is high in S2a due to a congested link, a switch to redundant mode S4 will then increase the packet loss even more</li> <li>If previous transition was S1→S4 and packet loss <math>\geq</math> PLR_4. This transition is made to test if a bitrate/packet rate reduction is better.</li> </ol>
S4 → S1	Condition: Packet loss $<$ PLR_3 for N_HOLD consecutive measurement periods. A request to turn off redundancy is transmitted using RTCP_APP_REQ_RED. Encoding bit-rate is requested to increase using RTCP_APP_CM.
S1 → S4	Condition: Packet loss $\geq$ PLR_1 or packet loss burst detected AND the previous transition was S4→S1, otherwise the transition S1→S2a will occur. A request to turn on 100% redundancy is transmitted using RTCP_APP_REQ_RED. The encoding bit-rate is requested to be reduced (in the example from AMR 12.2 to AMR 5.9) using RTCP_APP_CM.

### C.1.3.3 Adaptation state machine with four states (simplified version without frame aggregation)

This example is a simpler implementation with the frame aggregation removed.

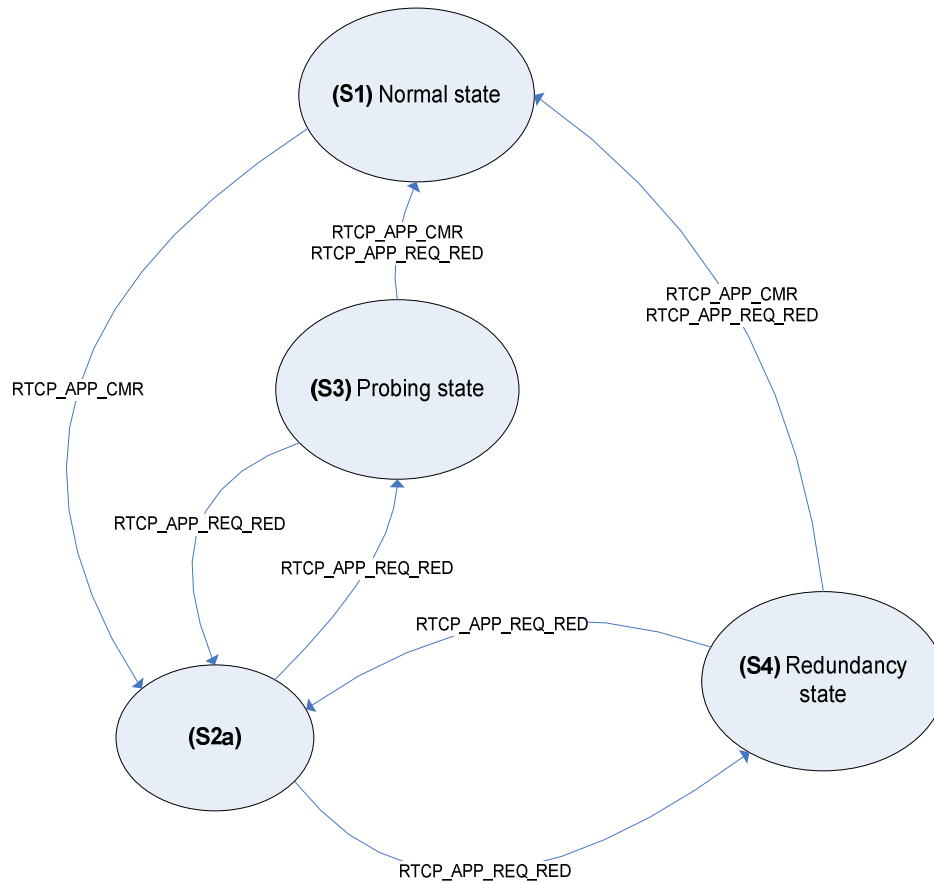

Figure C.3: State diagram for simplified four-state adaptation state machine

**State transitions:**

Below are listed the possible state transitions and signalling that is involved.

**Table C.6: State transitions for simplified four-state adaptation state machine**

<b>State transition</b>	<b>Conditions and actions</b>
S1 → S2a	Condition: Packet loss $\geq$ PLR_1 or packet loss burst detected. A request to reduce the encoding bit-rate is sent using RTCP_APP_CMRR, e.g. change mode from AMR 12.2 to AMR 5.9.
S2a → S3	Condition: Packet loss $\leq$ PLR_2 for N_HOLD consecutive measurement periods. A request to turn on 100% redundancy is transmitted by means of request RTCP_APP_REQ_RED.
S3 → S2a	Condition: Packet loss $\geq$ PLR_3. Same actions as in transition from, S1→S2a. If the transition S2a→S3→S2a→S3→S2a happens in sequence state S3 is disabled for N_INHIBIT frames.
S3 → S1	Condition: Packet loss $\leq$ PLR_2 for N_HOLD consecutive measurement periods. A request to turn off redundancy is transmitted as RTCP_APP_REQ_RED. Encoding bit-rate is increased by means of RTCP_APP_CMRR.
S2a → S4	Condition: Packet loss $\geq$ PLR_3. A request to turn on 100% redundancy is transmitted by means of request RTCP_APP_REQ_RED.
S4 → S2a	Condition: Packet loss $\geq$ to 4*PLR@ S2b→S4 (packet loss considerably increased since transition to state S4). This is indicative of that the total bit-rate is too high and that it is probably better to transmit with a lower packet rate/bit-rate instead. This case might occur if the packet loss is high in S2a due to a congested link, a switch to redundant mode S4 will then increase the packet loss even more.
S4 → S1	Condition: Packet loss $<$ PLR_3 for N_HOLD consecutive measurement periods. A request to turn off redundancy is transmitted using RTCP_APP_REQ_RED. Encoding bit-rate is requested to increase using RTCP_APP_CMRR.

### C.1.3.4 Adaptation state machine with two states

This example is an implementation with the redundant states removed.

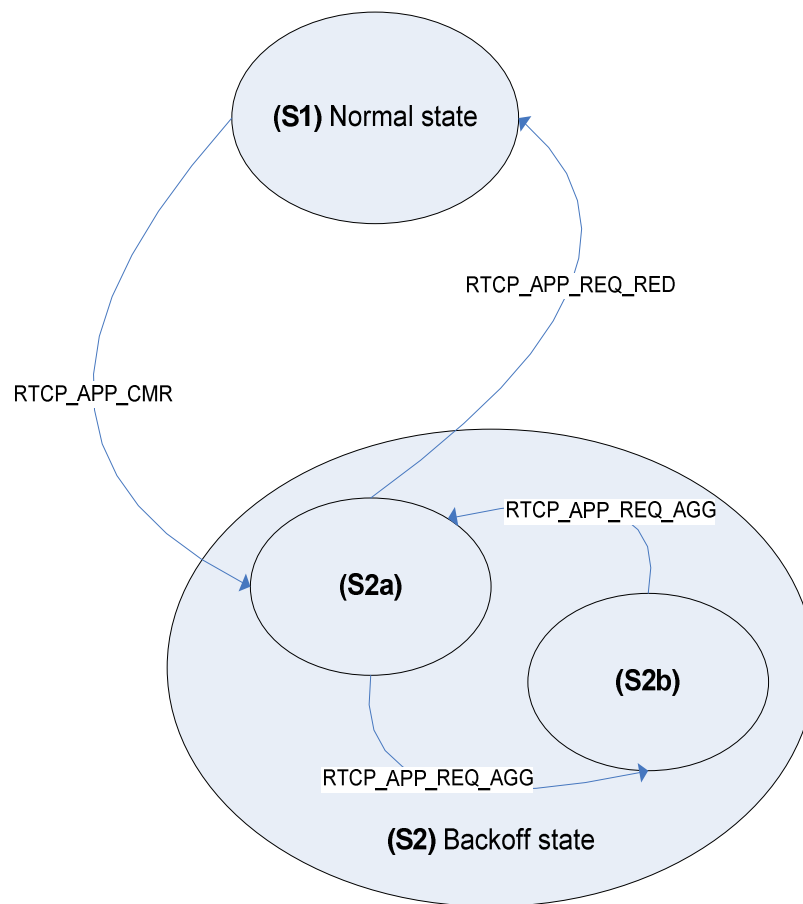

**Figure C.4: State diagram for two-state adaptation state machine**

**State transitions:**

Below are listed the possible state transitions and signalling that is involved.

**Table C.7: State transitions for two-state adaptation state machine**

State transition	Conditions and actions
S1 → S2a	Condition: Packet loss $\geq$ PLR_1 or packet loss burst detected. A request to reduce the encoding bit-rate is sent using RTCP_APP_CMRR, e.g. change mode from AMR 12.2 to AMR 5.9. A failed transition counter counts the number of consecutive switching attempts S2a→S1 that fails. In the number of failed attempts is two or more state S1 is inhibited for N_INHIBIT frames. A failed transition attempt occurs if the previous transition was S2a→S1 and the state transition immediately occurs back to S2a.
S2a → S2b	Condition: Packet loss $\geq$ PLR_1. This state transition occurs if the packet loss is still high despite the reduction in codec rate. A request is sent to reduce the packet rate is reduced by means of an RTCP_APP_REQ_AGG message.
S2b → S2a	Condition: Packet loss $\leq$ PLR_2 for N_HOLD consecutive measurement periods. This state transition involves an increase of the packet rate. Also packet rate is restored to same value as in State (1) RTCP_APP_REQ_AGG. If the state transition S2b→S2a→S2b occurs in sequence, the state will be locked to S2b for N_INHIBIT frames.
S2a → S1	Condition: Packet loss $\leq$ PLR_2 for N_HOLD consecutive measurement periods. Redundancy is turned on (100 %) by means of request RTCP_APP_REQ_RED.

### C.1.3.5 Adaptation when using ECN

This example shows how ECN may be used to trigger media bit-rate adaptation. ECN can be used in combination with other adaptation triggers, for example packet loss triggered adaptation schemes, although this is not included in this example.

In this example, the ECN-triggered adaptation is configured using the set of parameters as described in Table C.8.

**Table C.8: Configuration parameters used for the ECN triggered adaptation in this example**

Parameter	Description
ECN_min_rate	Used in accordance with Table 10.1
ECN_congestion_wait	Used in accordance with Table 10.1

Figure C.5 shows how the codec rate changes over the session if there is no congestion and therefore no ECN-CE marking (and no packet losses). The codec modes that can be used during the session are negotiated at session setup. In this case it is assumed that the recommended four AMR {4.75, 5.9, 7.4 and 12.2 kbps} codec modes can be used in the session. It is further assumed that the highest codec mode allowed in the session is AMR 12.2 kbps and the ECN\_min\_rate corresponds to AMR 5.9 kbps, see Clause 10.2.0.

NOTE: ECN can also be used for AMR-WB in a corresponding way, with the difference that the highest codec mode and ECN\_min\_rate would be selected based on the AMR-WB codec mode rates.

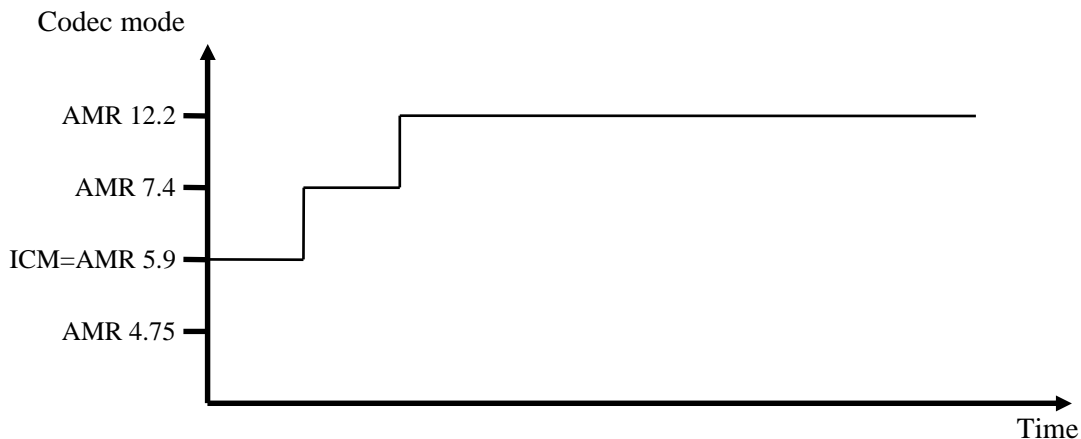
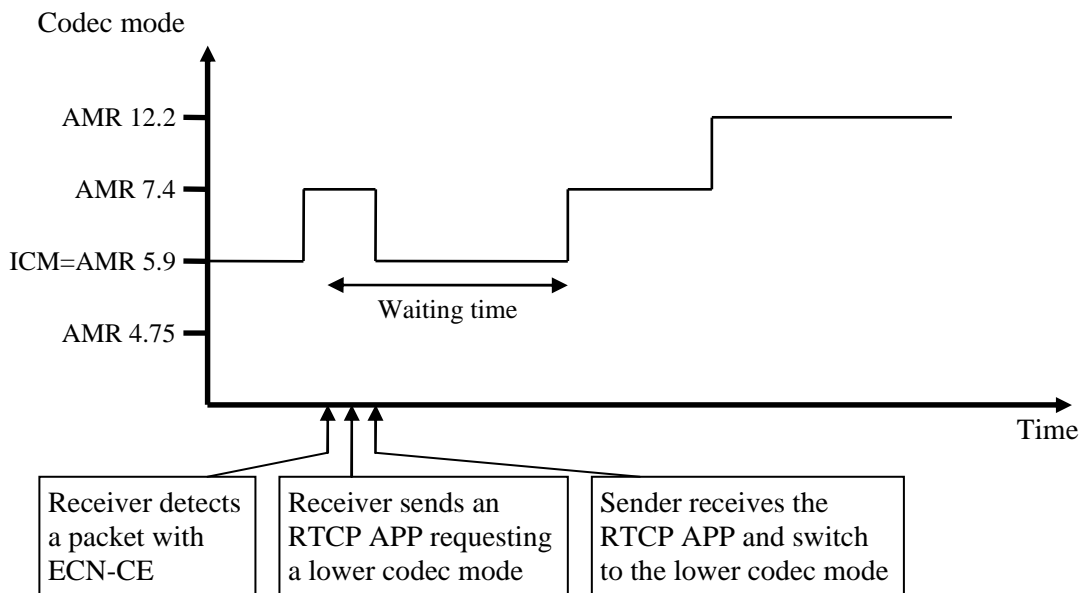

**Figure C.5: Example of codec mode usage in a session**

The session starts with the Initial Codec Mode (ICM), i.e. the AMR 5.9 kbps codec mode, see Clause 7.5.2.1.6. The receiving MTSI client evaluates the performance, for example by measuring the packet loss rate and detecting ECN-CE marked packets, and adapts the codec mode upwards (by sending adaptation requests backwards to the sender) in steps as long as no ECN-CE marked packets and no (or only marginal) performance problems are detected. In this case, this means that the MTSI client starts using the AMR 5.9 kbps mode, then switches to the AMR 7.4 kbps mode and then to the AMR 12.2 kbps mode.

The step-wise upswitching is used because the receiving MTSI client does not know whether the new and higher rate is sustainable or not. The transmission performance for each new rate needs to be verified over a time period before further upswitching can be attempted. If the new bit rate would prove to be not sustainable then the receiving MTSI client would switch back to the previously used rate or even a lower rate (not shown in these figures).

Figure C.6 shows how ECN-CE marked packets may trigger codec adaptation.



**Figure C.6: Example of how ECN may trigger codec adaptation**

Again, the session starts with ICM, i.e. the AMR 5.9 kbps codec mode. The MTSI client evaluates the performance, for example the packet loss rate and/or ECN-CE marked packets, and adapts the codec mode upwards if it is deemed possible to do so. During the upwards adaptation, the receiver detects in this example a congestion event since ECN-CE is set for at least one of the received IP packets. In this case a fast back-off strategy is used and the receiver therefore

sends an adaptation request back to the sender using RTCP APP with a request to switch to a low codec mode, in this case to adapt to the AMR 5.9 kbps mode. The AVPF profile allows for sending an (one) RTCP packet without waiting for the normal RTCP transmission interval, even if a regular compound RTCP was recently transmitted. This gives a faster reaction to ECN-CE.

After the down-switch, a waiting time is used to prevent upswitch too soon after the congestion event since too early upswitch is likely to trigger further congestion. The receiver uses RTCP APP also for the adaptation requests for upswitch. It is beneficial to use the normal RTCP transmission rules, defined for the AVP profile, for the upswitch adaptation signalling because this enables using the AVPF transmission rules in case congestion would occur immediately after the upswitch.

The response to the ECN-CE marking, the waiting time and the upswitching after a congestion event is the same regardless of when the congestion occurs, which is shown in Figure C.7. This is because the MTSI client is evaluating if the bit rate is sustainable also after switching up to the high bit rate.

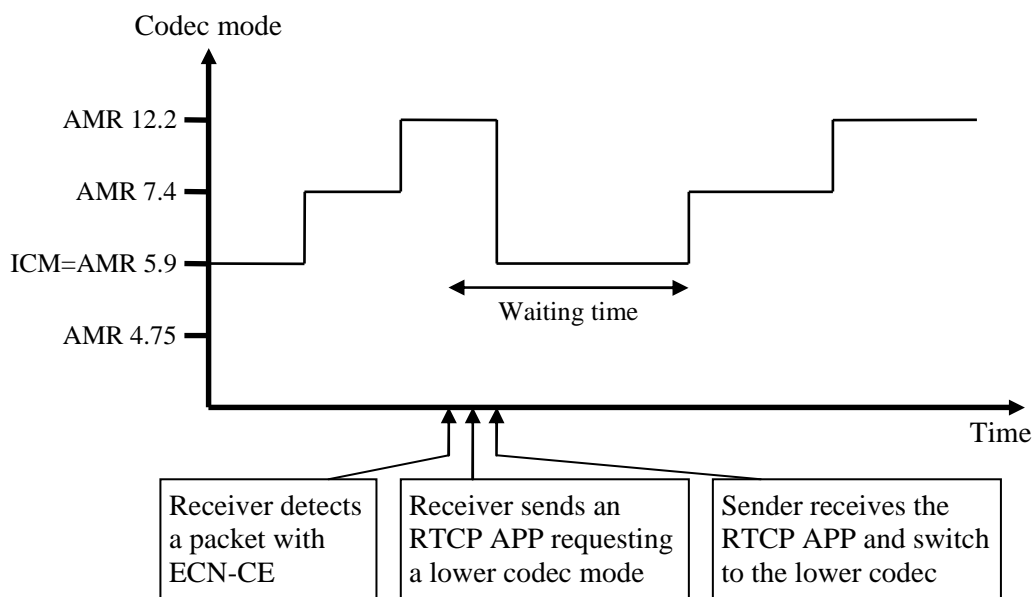

**Figure C.7: Example of codec mode usage in a session**

Figure C.7 also shows how the fast down-switch gives a rapid codec mode switch from the AMR 12.2 kbps to the AMR 5.9 kbps mode. The codec mode request (CMR) sent from the receiver may suggest a direct switch from the AMR 12.2 kbps mode to the AMR 5.9 kbps mode. However, if the MTSI client is inter-working with a CS GERAN then mode changes will be limited in the session setup to every other frame border and also to neighboring modes. The MTSI client obviously has to follow such rules for mode changes, if they are defined in the session setup. The sender may therefore be prevented from following the CMR directly and it may take a few frames until the target codec mode is reached.

## C.2 Example criteria for video bit rate feedback and adaptation

### C.2.1 Introduction

This annex gives the outline of possible example adaptation criteria that make use of adaptation signalling for video as described in section 10.3. Several different adaptation implementations are possible and the example criteria shown in this section are not to be seen as an adaptive scheme excluding other designs. Implementers are free to use these example criteria or to use any other adaptation algorithm. The description of the example criteria is split into two parts, one for the media sender side and one for the media receiver side.

## C.2.2 Media sender side

The basic rate adaptation algorithm on the media sender side serves to combine the received RTCP TMMBR and RTCP Receiver Report or Sender Report in a way that makes adaptation possible in the presence of any or both of the aforementioned reports. One important aspect is that the TMMBR reports will serve as an upper limit on the permitted bitrate while RTCP Receiver or Sender Reports provide a means for temporary adjustments based on e.g. the packet loss rate in a given interval. Note that the actual bitrate limit will also depend on the bandwidth attribute in the SDP. Typically adjustments of the permitted bitrate due to TMMBR reports are less frequent than adjustments due to RTCP Receiver or Sender Reports. The media sender may use the following conditions to adjust its video transmission rate:

1. Upon receiving a TMMBR message the media sender sets its maximum transmission rate to the requested rate.
2. If the requested rate in the TMMBR message is greater than the current video transmission rate the media sender (gradually) increases its transmission rate to the requested rate in the TMMBR message.
3. Examining the RTCP Receiver Report and Sender Report information to determine whether finer adaptations can be made to the video transmission rate. For example, the media sender may reduce its video transmission rate in response to an increase in the packet loss rate.
4. Reducing the video transmission rate if the media sender determines that the local radio uplink throughput is decreasing, e.g. detecting congestion in the uplink transmission buffers or examining other indicators of uplink quality.
5. Other conditions

## C.2.3 Media receiver side

The basic rate adaptation algorithm on the media receiver side may consist of both the well established RFC3550 RTCP RR and SR reporting (which is not described further) and the estimation and sending of TMMBR to the sender. Transmission of TMMBR reports is typically less frequent than RTCP Receiver Reports or Sender Reports.

The media receiver may use the following conditions to send a TMMBR message requesting a reduction in video transmission rate

1. The video packets are arriving too close or late for their scheduled playout
2. The receiver detects an unacceptably high packet loss rate
3. Other conditions

The MTSI media receiver may use the following conditions to send a TMMBR requesting an increase in video transmission rate

1. The video packets are arriving earlier than needed for their scheduled playout
2. Other conditions

Care must be taken when sending consecutive TMMBR messages to accommodate the media sender's reaction to previously sent TMMBR messages. When doing this, the media receiver should account for delays in the transmission of TMMBR messages due to RTCP bandwidth requirements.



## Annex D (informative): Reference delay computation algorithm

In this annex, the reference jitter management algorithm is described. It is written in pseudo code and is non-causal; hence non-implementable. The purpose of this algorithm is to define an "ideal" behaviour which all jitter buffers used in MTSI should strive to mimic. This buffer operates based on three input parameters:

- lookback factor to set the current target buffering depth;
- target late loss rate;
- maximum allowed time scaling percentage.

```
function ref_jb(channel,jb_adaptation_lookback,delay_delta_max,target_loss)
% channel          = file name of the channel
% lookback        = look back factor when estimating the max jitter
%                = buffer level [number of frames]
% delay_delta_max = max timescaling related modification (%) of the
%                = delay
% target_loss     = target late loss (%)
% example syntax:
% ref_jb('channel_1.dat',200,15,0.5);

framelength = 20;
% this value sets the speech data in each RTP packet to 20 ms. For 2 speech
% frames/RTP packet the value would be 40 ms.
jitter_est_window=50;
% Sets the jitter estimation window in number of frames
delay_delta_max_ms = framelength*delay_delta_max*0.01;
% Sets the maximum allowed time scaling
tscale = 1;
% Scale factor of delay data
% In this case the files are assumed to be ascii files with one delay
% entry per line, the entries are in ms, a negative value denotes
% a packet loss.
x = load(channel);
x =x';
% remove packet losses
% remove initial startup empty frames
ix = find(x > 0);
x(1:ix(1)-1) = x(ix(1));
% remove packet losses (replace with nearby delay values)
ix = find(x < 0);
packet_loss = length(ix)/length(x)*100;
for n=1:length(ix)
    if (ix(n) > 1)
        x(ix(n)) = x(ix(n)-1);
    end;
end;
% convert timescale to ms
x = x*tscale;
L = length(x);
T = 1:L;
% estimate min and max TX delay, estimate a delta_delay
for n=1:L
    ix = [max(1,n-jitter_est_window):n];
    max_delay(n) = max(x(ix));
    min_delay(n) = min(x(ix));
    delta_delay(n) = max_delay(n)-min_delay(n);
end
% compute the target max jitter buffer level with some slow adaptation
% downwards, just to mimick how a jitter buffer might behave
for n=1:L
    ix = [max(1,n-jb_adaptation_lookback):n];
    jb(n) = max(delta_delay(ix));
    % The timescaling is not allowed to adjust the jitterbuffer target max level
    % too fast.
    if n == 1
        jb_ = jb(n);
    end
    delta = abs(jb_-jb(n));
    if delta < delay_delta_max_ms;
```

```

        jb_ = jb(n);
    else
        if (jb(n) < jb_)
            jb_ = jb_-delay_delta_max_ms;
        else
            jb_ = jb_+delay_delta_max_ms;
        end
        jb(n) = jb_;
    end
    % jitter buffer target max level can only assume an integer number of frames
    jbq(n) = ceil(jb(n)/framelength)*framelength;
    % compute estimated delay
    del(n) = jbq(n)+min_delay(n);
end

if target_loss > 0
    % decrease the max jitter buffer level until a target late loss has been
    % reached.
    late_loss = length(find(del < x))/L*100.0;
    jbq_save = jbq; % as the max level is increased until the late loss > target one
    % must be able to revert back to the previous data
    while late_loss < target_loss
        jbq_save = jbq;
        jbq = min(max(jbq)-framelength,jbq);
        del = jbq+min_delay;
        late_loss = length(find(del < x))/L*100.0;
    end
    jbq = jbq_save;
    del = jbq+min_delay;
end

jdel = max(0,del-x);
%Calculate and plot the CDF of the reference buffer.
figure(1);plot(T,jbq,T,del,T,x);
[n,x] = hist(jdel,140); y = cumsum(n);y = y/max(y)*100;
figure(2);plot(x,y);axis([0 200 0 100]);ylabel('%');xlabel('ms');title('CDF of packet delay in JB');

```

## Annex E (informative): QoS profiles

### E.1 General

This annex contains examples with mappings of SDP parameters to UMTS QoS parameters [64] for MTSI.

### E.2 Bi-directional speech (AMR12.2 over IPv4, RTCP)

The bitrate for AMR 12.2 including IP overhead (one AMR frame per RTP packet, using bandwidth efficient mode) is 28.8 kbps which is rounded up to 29 kbps.

**Table E.1: QoS mapping for bi-directional speech (AMR 12.2 over IPv4, RTCP)**

Traffic class	Conversational class	Notes
Delivery order	No	The application should handle packet reordering.
Maximum SDU size (octets)	1 400	Maximum size of IP packets
Delivery of erroneous SDUs	No	
Residual BER	$10^{-5}$	Reflects the desire to have a medium level of protection to achieve an acceptable compromise between packet loss rate and speech transport delay and delay variation.
SDU error ratio	$7 \cdot 10^{-3}$	A packet loss rate of 0.7 % per wireless link is in general sufficient for speech services
Transfer delay (ms)	130 ms	Indicates maximum delay for 95 <sup>th</sup> percentile of the distribution of delay for all delivered SDUs between the UE and the GGSN during the lifetime of a bearer service. Permits the derivation of the RAN part of the total transfer delay for the UMTS bearer. This attribute allows RAN to set transport formats and H-ARQ/ARQ parameters such as the discard timer.
Guaranteed bit rate for uplink (kbps)	31	The bit-rate of AMR12.2 including IP/UDP/RTP overhead + 5 % for RTCP. This value applies for IPv4.
Maximum bitrate for uplink (kbps)	31	The same as the guaranteed bitrate.
Guaranteed bit rate for downlink (kbps)	31	The bit-rate of AMR12.2 including IP/UDP/RTP overhead + 5 % for RTCP. This value applies for IPv4.
Maximum bitrate for downlink (kbps)	31	The same as the guaranteed bitrate
Allocation/Retention priority	subscribed value	Indicates the relative importance to other UMTS bearers. It should be the next lower value to the priority of the signalling bearer.
Source statistics descriptor	'speech'	

### E.3 Bi-directional video (128 kbps, IPv4 and RTCP)

The video bandwidth is assumed to be 120 kbps and the IP overhead 8 kbps, resulting in 128 kbps. The transfer delay for video is different from other media.

**Table E.2: QoS mapping for bi-directional video (128 kbps, IPv4, RTCP)**

Traffic class	Conversational class	Notes
Delivery order	No	The application should handle packet reordering.
Maximum SDU size (octets)	1 400	Maximum size of IP packets
Delivery of erroneous SDUs	No	
Residual BER	$10^{-5}$	Reflects the desire to have a medium level of protection to achieve an acceptable compromise between packet loss rate and speech transport delay and delay variation.
SDU error ratio	$7 \cdot 10^{-3}$	A packet loss rate of 0.7 % per wireless link is in general sufficient for video services
Transfer delay (ms)	170 ms	Indicates maximum delay for 95 <sup>th</sup> percentile of the distribution of delay for all delivered SDUs between the UE and the GGSN during the lifetime of a bearer service. Permits the derivation of the RAN part of the total transfer delay for the UMTS bearer. This attribute allows RAN to set transport formats and H-ARQ/ARQ parameters such as the discard timer.
Guaranteed bit rate for downlink (kbps)	144	The bit-rate of a video codec running at 128 kbps including IP/UDP/RTP overhead (assumed to be 8 kbps) and RTCP (adds 5 %) rounded up to nearest 8kbps value. This value applies for IPv4.
Maximum bit rate for downlink (kbps)	144	The same as the guaranteed bitrate.
Guaranteed bit rate for uplink (kbps)	144	The bit-rate of a video codec running at 128 kbps including IP/UDP/RTP overhead (assumed to be 8 kbps) and RTCP (adds 5%) rounded up to nearest 8 kbps value. This value applies for IPv4.
Maximum bitrate for uplink (kbps)	144	The same as the guaranteed bitrate.
Allocation/Retention priority	subscribed value	Indicates the relative importance to other UMTS bearers. It should be the same or next lower value to the priority of a Conversational bearer with source statistics descriptor 'speech'.
Source statistics descriptor	'unknown'	

## E.4 Bi-directional real-time text (3 kbps, IPv4, RTCP)

Bi-directional text at 3 kbps all inclusive (text, IP overhead, RTCP).

**Table E.3: QoS mapping for bi-directional real-time text (3 kbps, IPv4, RTCP) when using a conversational class bearer**

Traffic class	Conversational class	Notes
Delivery order	No	The application should handle packet reordering.
Maximum SDU size (octets)	1 400	Maximum size of IP packets
Delivery of erroneous SDUs	No	
Residual BER	$10^{-5}$	Reflects the desire to have a medium level of protection to achieve an acceptable compromise between packet loss rate and speech transport delay and delay variation.
SDU error ratio	$1 \cdot 10^{-3}$	Text should have a higher level of protection than voice and video.
Transfer delay (ms)	130 ms	Indicates maximum delay for 95 <sup>th</sup> percentile of the distribution of delay for all delivered SDUs between the UE and the GGSN during the lifetime of a bearer service. Permits the derivation of the RAN part of the total transfer delay for the UMTS bearer. This attribute allows RAN to set transport formats and H-ARQ/ARQ parameters such as the discard timer.
Guaranteed bit rate (kbps)	3.0	An assumed bit-rate of a real-time text service including headers and RTCP.
Maximum bitrate (kbps)	3.0	The same as the guaranteed bitrate.
Guaranteed bit rate (kbps)	3.0	An assumed bit-rate of a real-time text service including headers and RTCP.
Maximum bitrate (kbps)	3.0	The same as the guaranteed bitrate.
Allocation/Retention priority	Subscribed value	Indicates the relative importance to other UMTS bearers. It should be a lower value to the priority of a Conversational bearer with source statistics descriptor 'speech'.
Source statistics descriptor	'unknown'	

Using a conversational class bearer means that resources are reserved throughout the session. Depending on the intended usage of real-time text, it might not be the most resource efficient choice to use a conversational class bearer, especially if it is foreseen that the sessions will be long-lived while the actual text conversations will be rare and bursty. Table E.4 therefore shows an example with QoS mapping for using an interactive class bearer.

**Table E.4: QoS mapping for bi-directional real-time text (3 kbps, IPv4, RTCP) when using an interactive bearer**

Traffic class	Interactive class	Notes
Delivery order	No	In sequence delivery is not required
Maximum SDU size (octets)	1 400	Maximum size of IP packets
Delivery of erroneous SDUs	No	
Residual BER	$10^{-5}$	Reflects the desire to have a medium level of protection to achieve an acceptable compromise between packet loss rate and voice transport delay and delay variation.
SDU error ratio	$10^{-4}$	Text should have a higher level of protection than voice and video.
Maximum bitrate (kbps)	[Depending on UE category]	Should be set as high as the UE category can handle
Allocation/Retention priority	Subscribed value	Indicates the relative importance to other UMTS bearers. It should be a lower value to the priority of a Conversational bearer with source statistics descriptor 'speech'.
Traffic handling priority	3	General purpose PDP context should use the lowest value.
Signalling indication	'No'	This is not a signalling PDP context.

## Annex F (Normative): Void

---

## Annex G (Normative): DTMF events

### G.1 General

This annex describes a method for sending DTMF events in the same RTP media stream as the speech.

- MTSI clients offering speech communication shall support the below described method in the transmitting direction and should support it in the receiving direction.
- MTSI media gateways offering speech communication shall support the below described method in both the transmitting direction and in the receiving direction. For MTSI media gateways, the described method applies only to the PS session between the gateway and an MTSI client in terminal.

This method was designed to send DTMF events in the same RTP streams as the speech.

---

### G.2 Encoding of DTMF signals

DTMF should be encoded and transmitted as DTMF events. DTMF events in this Annex refers to the DTMF named events described in Section 3.2, Table 3 in [61], i.e. events (0-9,A-D, \*, #) which are encoded with event codes 0—9, 10, 11 and 12 – 15 respectively. DTMF events can either be narrowband or wideband, i.e. use 8 kHz or 16 kHz sampling frequency respectively. MTSI clients that support both narrowband and wideband speech shall support both narrowband and wideband DTMF events. When switching between speech and DTMF, the DTMF events should use the same sampling frequency as for the speech that is currently being transmitted.

The encoding of DTMF events includes specifying the duration time for the events, [61]. Long-lasting DTMF events, where the duration time exceeds the maximum duration time expressible by the duration field, shall be divided into segments, see RFC 4733. To harmonize with legacy DTMF signalling, [62], [63], the tone duration of a DTMF event shall be at least 65 ms and the pause duration in-between two DTMF events shall be at least 65 ms. The duration of the DTMF event and the pause time to the next DTMF event, where applicable, should be selected such that it enables incrementing RTP Time Stamp with a multiple of the number of timestamp units corresponding to the frame length of the speech codec used for the speech media.

---

### G.3 Session setup

An MTSI client offering a speech media session for speech and DTMF events should include an offer for DTMF events according to the example in Table G.3.1 when narrowband speech is offered and according to the example in Table G.3.2 when both narrowband and wideband speech is offered. The answerer shall select DTMF payload format(s) that match the selected speech codec(s).



**Table G.3.1: SDP example for narrowband speech and DTMF**

SDP offer
<pre> m=audio 49152 RTP/AVPF 97 98 99 a=rtpmap:97 AMR/8000/1 a=fmtp:97 mode-change-capability=2; max-red=220 a=rtpmap:98 AMR/8000/1 a=fmtp:98 mode-change-capability=2; max-red=220; octet-align=1 a=rtpmap:99 telephone-event/8000/1 a=fmtp:99 0-15 a=ptime:20 a=maxptime:240 a=sendrecv </pre>

**Table G.3.2: SDP example for narrowband and wideband for both speech and DTMF**

SDP offer
<pre> m=audio 49152 RTP/AVPF 97 98 99 100 101 102 a=rtpmap:97 AMR-WB/16000/1 a=fmtp:97 mode-change-capability=2; max-red=220 a=rtpmap:98 AMR-WB/16000/1 a=fmtp:98 mode-change-capability=2; max-red=220; octet-align=1 a=rtpmap:99 telephone-event/16000/1 a=fmtp:99 0-15 a=rtpmap:100 AMR/8000/1 a=fmtp:100 mode-change-capability=2; max-red=220 a=rtpmap:101 AMR/8000/1 a=fmtp:101 mode-change-capability=2; max-red=220; octet-align=1 a=rtpmap:102 telephone-event/8000/1 a=fmtp:102 0-15 a=ptime:20 a=maxptime:240 a=sendrecv </pre>

**NOTE:** Due to lack of flexibility in SDP, the sendrecv attribute applies to all RTP payload types within the same media stream. To comply with the transmission rules defined in clause G.4, SDP offers and SDP answers include audio and telephone-event in the same media stream. The consequence of this is that MTSI clients that want to send DTMF events also allow the remote client to send DTMF events in the reverse direction. For MTSI clients in terminals, since support of DTMF events in the receiving direction is not mandatory, it is an implementation consideration to decide how to handle any received RTP packets containing DTMF.

## G.4 Data transport

When sending and receiving DTMF events with RTP the RTP payload format for DTMF digits, telephony tones, and telephony signals, RFC 4733 [61], shall be supported.

DTMF events shall use the same media stream as for speech, i.e. the same IP number, UDP port and RTP SSRC. Thereby, RTP Sequence Number and RTP Time Stamp shall be synchronized between speech and DTMF. For example, by setting the initial random values the same and when switching from speech to DTMF, or vice versa, the RTP Sequence Number and RTP Time Stamp shall continue from the value that was used for the other audio media (speech or media).

The RTP Sequence Number shall increment in the same way as for speech, i.e. by 1 for each transmitted packet.

The RTP Time Stamp should increment in the same way as for speech packets or with a multiple, i.e. if the RTP Time Stamp increments with 160 between speech packets then the increment during DTMF events and when switching between speech and DTMF events should be 160 or a multiple of 160. The RTP Time Stamp should not increment with a smaller interval for DTMF than for speech. The RTP Time Stamp should use the same sampling frequency as for the speech that is transmitted immediately before the start of the DTMF event(s).

NOTE: A DTMF event may be transmitted in several RTP packets even if the DTMF event has a shorter duration time than what is expressible by the duration field. In this case all RTP packets containing the same DTMF event within the same segment shall have the same RTP Time Stamp value according to RFC 4733 [61].

Speech packets shall not be transmitted when DTMF events are transmitted in the same RTP media stream.

## Annex H (informative): Network Preference Management Object Device Description Framework

This Device Description Framework (DDF) is the standardized minimal set. A vendor can define its own DDF for the complete device. This DDF can include more features than this minimal standardized version.

```

<?xml version="1.0" encoding="UTF-8"?>
<!DOCTYPE MgmtTree PUBLIC "-//OMA//DTD-DM-DDF 1.2//EN"
"http://www.openmobilealliance.org/tech/DTD/dm_ddf-v1_2.dtd">
<MgmtTree>
  <VerDTD>1.2</VerDTD>
  <Man>--The device manufacturer--</Man>
  <Mod>--The device model--</Mod>
  <Node>
    <NodeName>3GPP_MTSINP</NodeName>
    <DFProperties>
      <AccessType>
        <Get/>
      </AccessType>
      <Description>3GPP MTSI service network profile setting</Description>
      <DFFormat>
        <node/>
      </DFFormat>
      <Occurrence>
        <ZeroOrOne/>
      </Occurrence>
      <Scope>
        <Permanent/>
      </Scope>
      <DFTitle>The 3GPP MTSI Service Network Profile Management Object</DFTitle>
      <DFType>
        <DDFName/>
      </DFType>
    </DFProperties>
    <Node>
      <NodeName>Speech</NodeName>
      <DFProperties>
        <AccessType>
          <Get/>
        </AccessType>
        <DFFormat>
          <node/>
        </DFFormat>
        <Occurrence>
          <ZeroOrOne/>
        </Occurrence>
        <Scope>
          <Permanent/>
        </Scope>
        <DFTitle>Speech node</DFTitle>
        <DFType>
          <MIME>text/plain</MIME>
        </DFType>
      </DFProperties>
      <Node>
        <NodeName/>
        <DFProperties>
          <AccessType>
            <Get/>
          </AccessType>
          <DFFormat>
            <node/>
          </DFFormat>
          <Occurrence>
            <OneOrMore/>
          </Occurrence>
          <Scope>
            <Permanent/>
          </Scope>
          <DFTitle>Speech subnodes</DFTitle>
        </DFProperties>
      </Node>
    </Node>
  </Node>
</MgmtTree>

```

```

    <DFType>
      <MIME>text/plain</MIME>
    </DFType>
  </DFProperties>
</Node>
<Node>
  <NodeName>ID</NodeName>
  <DFProperties>
    <AccessType>
      <Get/>
    </AccessType>
    <DFFormat>
      <int/>
    </DFFormat>
    <Occurrence>
      <ZeroOrOne/>
    </Occurrence>
    <Scope>
      <Permanent/>
    </Scope>
    <DFTitle>Identification for speech session parameter set</DFTitle>
    <DFType>
      <MIME>text/plain</MIME>
    </DFType>
  </DFProperties>
</Node>
<Node>
  <NodeName>TAG</NodeName>
  <DFProperties>
    <AccessType>
      <Get/>
    </AccessType>
    <DFFormat>
      <chr/>
    </DFFormat>
    <Occurrence>
      <ZeroOrOne/>
    </Occurrence>
    <Scope>
      <Permanent/>
    </Scope>
    <DFTitle>Identification for speech session parameter set</DFTitle>
    <DFType>
      <MIME>text/plain</MIME>
    </DFType>
  </DFProperties>
</Node>
<Node>
  <NodeName>Priority</NodeName>
  <DFProperties>
    <AccessType>
      <Get/>
    </AccessType>
    <DFFormat>
      <int/>
    </DFFormat>
    <Occurrence>
      <ZeroOrOne/>
    </Occurrence>
    <Scope>
      <Permanent/>
    </Scope>
    <DFTitle>priority of codec</DFTitle>
    <DFType>
      <MIME>text/plain</MIME>
    </DFType>
  </DFProperties>
</Node>
<Node>
  <NodeName>Codec</NodeName>
  <DFProperties>
    <AccessType>
      <Get/>
    </AccessType>
    <DFFormat>
      <chr/>
    </DFFormat>
    <Occurrence>

```

```

        <One/>
      </Occurrence>
    <Scope>
      <Permanent/>
    </Scope>
    <DFTitle>Speech codec name</DFTitle>
    <DFType>
      <MIME>text/plain</MIME>
    </DFType>
  </DFProperties>
</Node>
<Node>
  <NodeName>Bandwidth</NodeName>
  <DFProperties>
    <AccessType>
      <Get/>
    </AccessType>
    <DFFormat>
      <node/>
    </DFFormat>
    <Occurrence>
      <One/>
    </Occurrence>
    <Scope>
      <Permanent/>
    </Scope>
    <DFTitle>Subnodes related to speech bandwidth</DFTitle>
    <DFType>
      <MIME>text/plain</MIME>
    </DFType>
  </DFProperties>
</Node>
<Node>
  <NodeName>AS</NodeName>
  <DFProperties>
    <AccessType>
      <Get/>
    </AccessType>
    <DFFormat>
      <int/>
    </DFFormat>
    <Occurrence>
      <ZeroOrOne/>
    </Occurrence>
    <Scope>
      <Permanent/>
    </Scope>
    <DFTitle>media bandwidth</DFTitle>
    <DFType>
      <MIME>text/plain</MIME>
    </DFType>
  </DFProperties>
</Node>
<Node>
  <NodeName>RS</NodeName>
  <DFProperties>
    <AccessType>
      <Get/>
    </AccessType>
    <DFFormat>
      <int/>
    </DFFormat>
    <Occurrence>
      <ZeroOrOne/>
    </Occurrence>
    <Scope>
      <Permanent/>
    </Scope>
    <DFTitle>RTCP bandwidth allocated to active data senders</DFTitle>
    <DFType>
      <MIME>text/plain</MIME>
    </DFType>
  </DFProperties>
</Node>
<Node>
  <NodeName>RR</NodeName>
  <DFProperties>
    <AccessType>

```

```

        <Get/>
      </AccessType>
    <DFFormat>
      <int/>
    </DFFormat>
  <Occurrence>
    <ZeroOrOne/>
  </Occurrence>
  <Scope>
    <Permanent/>
  </Scope>
  <DFTitle>RTCP bandwidth allocated to other participants in the RTP session</DFTitle>
  <DFType>
    <MIME>text/plain</MIME>
  </DFType>
</DFProperties>
</Node>
</Node>
<Node>
  <nodeName>RateSet</nodeName>
  <DFProperties>
    <AccessType>
      <Get/>
    </AccessType>
    <DFFormat>
      <chr/>
    </DFFormat>
  <Occurrence>
    <ZeroOrOne/>
  </Occurrence>
  <Scope>
    <Permanent/>
  </Scope>
  <DFTitle>Speech codec bit rates</DFTitle>
  <DFType>
    <MIME>text/plain</MIME>
  </DFType>
</DFProperties>
</Node>
<Node>
  <nodeName>ConRef</nodeName>
  <DFProperties>
    <AccessType>
      <Get/>
    </AccessType>
    <DFFormat>
      <chr/>
    </DFFormat>
  <Occurrence>
    <ZeroOrOne/>
  </Occurrence>
  <Scope>
    <Permanent/>
  </Scope>
  <DFTitle>QoS reference</DFTitle>
  <DFType>
    <MIME>text/plain</MIME>
  </DFType>
</DFProperties>
</Node>
<Node>
  <nodeName>Ext</nodeName>
  <DFProperties>
    <AccessType>
      <Get/>
    </AccessType>
    <DFFormat>
      <node/>
    </DFFormat>
  <Occurrence>
    <ZeroOrOne/>
  </Occurrence>
  <Scope>
    <Permanent/>
  </Scope>
  <DFTitle>A collection of all extension objects</DFTitle>
  <DFType>

```

```

        <DDFName/>
      </DFType>
    </DFProperties>
  </Node>
</Node>
<Node>
  <NodeName>Video</NodeName>
  <DFProperties>
    <AccessType>
      <Get/>
    </AccessType>
    <DFFormat>
      <node/>
    </DFFormat>
    <Occurrence>
      <ZeroOrOne/>
    </Occurrence>
    <Scope>
      <Permanent/>
    </Scope>
    <DFTitle>Video node</DFTitle>
    <DFType>
      <MIME>text/plain</MIME>
    </DFType>
  </DFProperties>
</Node>
  <NodeName/>
  <DFProperties>
    <AccessType>
      <Get/>
    </AccessType>
    <DFFormat>
      <node/>
    </DFFormat>
    <Occurrence>
      <OneOrMore/>
    </Occurrence>
    <Scope>
      <Permanent/>
    </Scope>
    <DFTitle>Video subnodes</DFTitle>
    <DFType>
      <MIME>text/plain</MIME>
    </DFType>
  </DFProperties>
</Node>
  <NodeName>ID</NodeName>
  <DFProperties>
    <AccessType>
      <Get/>
    </AccessType>
    <DFFormat>
      <int/>
    </DFFormat>
    <Occurrence>
      <ZeroOrOne/>
    </Occurrence>
    <Scope>
      <Permanent/>
    </Scope>
    <DFTitle>Identification for video session parameter set</DFTitle>
    <DFType>
      <MIME>text/plain</MIME>
    </DFType>
  </DFProperties>
</Node>
<Node>
  <NodeName>TAG</NodeName>
  <DFProperties>
    <AccessType>
      <Get/>
    </AccessType>
    <DFFormat>
      <chr/>
    </DFFormat>
    <Occurrence>

```

```

        <ZeroOrOne/>
      </Occurrence>
    <Scope>
      <Permanent/>
    </Scope>
    <DFTitle>Identification for video session parameter set</DFTitle>
  <DFType>
    <MIME>text/plain</MIME>
  </DFType>
</DFProperties>
</Node>
<Node>
  <NodeName>Priority</NodeName>
  <DFProperties>
    <AccessType>
      <Get/>
    </AccessType>
    <DFFormat>
      <int/>
    </DFFormat>
    <Occurrence>
      <ZeroOrOne/>
    </Occurrence>
    <Scope>
      <Permanent/>
    </Scope>
    <DFTitle>priority of codec</DFTitle>
  <DFType>
    <MIME>text/plain</MIME>
  </DFType>
</DFProperties>
</Node>
<Node>
  <NodeName>Codec</NodeName>
  <DFProperties>
    <AccessType>
      <Get/>
    </AccessType>
    <DFFormat>
      <chr/>
    </DFFormat>
    <Occurrence>
      <One/>
    </Occurrence>
    <Scope>
      <Permanent/>
    </Scope>
    <DFTitle>Video codec name</DFTitle>
  <DFType>
    <MIME>text/plain</MIME>
  </DFType>
</DFProperties>
</Node>
<Node>
  <NodeName>Bandwidth</NodeName>
  <DFProperties>
    <AccessType>
      <Get/>
    </AccessType>
    <DFFormat>
      <node/>
    </DFFormat>
    <Occurrence>
      <One/>
    </Occurrence>
    <Scope>
      <Permanent/>
    </Scope>
    <DFTitle>Subnodes related to video bandwidth</DFTitle>
  <DFType>
    <MIME>text/plain</MIME>
  </DFType>
</DFProperties>
<Node>
  <NodeName>AS</NodeName>
  <DFProperties>
    <AccessType>

```



```

    <Get/>
  </AccessType>
  <DFFormat>
    <int/>
  </DFFormat>
  <Occurrence>
    <ZeroOrOne/>
  </Occurrence>
  <Scope>
    <Permanent/>
  </Scope>
  <DFTitle>media bandwidth</DFTitle>
  <DFType>
    <MIME>text/plain</MIME>
  </DFType>
</DFProperties>
</Node>
<Node>
  <NodeName>RS</NodeName>
  <DFProperties>
    <AccessType>
      <Get/>
    </AccessType>
    <DFFormat>
      <int/>
    </DFFormat>
    <Occurrence>
      <ZeroOrOne/>
    </Occurrence>
    <Scope>
      <Permanent/>
    </Scope>
    <DFTitle>RTCP bandwidth allocated to active data senders</DFTitle>
    <DFType>
      <MIME>text/plain</MIME>
    </DFType>
  </DFProperties>
</Node>
<Node>
  <NodeName>RR</NodeName>
  <DFProperties>
    <AccessType>
      <Get/>
    </AccessType>
    <DFFormat>
      <int/>
    </DFFormat>
    <Occurrence>
      <ZeroOrOne/>
    </Occurrence>
    <Scope>
      <Permanent/>
    </Scope>
    <DFTitle>RTCP bandwidth allocated to other participants in the RTP session</DFTitle>
    <DFType>
      <MIME>text/plain</MIME>
    </DFType>
  </DFProperties>
</Node>
<Node>
  <NodeName>Source</NodeName>
  <DFProperties>
    <AccessType>
      <Get/>
    </AccessType>
    <DFFormat>
      <float/>
    </DFFormat>
    <Occurrence>
      <ZeroOrOne/>
    </Occurrence>
    <Scope>
      <Permanent/>
    </Scope>
    <DFTitle>Source encoding bit rate</DFTitle>
    <DFType>
      <MIME>text/plain</MIME>
    </DFType>
  </DFProperties>
</Node>

```

```

        </DFType>
      </DFProperties>
    </Node>
  <Node>
    <NodeName>PayloadSize</NodeName>
    <DFProperties>
      <AccessType>
        <Get/>
      </AccessType>
      <DFFormat>
        <int/>
      </DFFormat>
      <Occurrence>
        <ZeroOrOne/>
      </Occurrence>
      <Scope>
        <Permanent/>
      </Scope>
      <DFTitle>Payload size for RTP packet</DFTitle>
      <DFType>
        <MIME>text/plain</MIME>
      </DFType>
    </DFProperties>
  </Node>
</Node>
<Node>
  <NodeName>ProfileLevel</NodeName>
  <DFProperties>
    <AccessType>
      <Get/>
    </AccessType>
    <DFFormat>
      <node/>
    </DFFormat>
    <Occurrence>
      <One/>
    </Occurrence>
    <Scope>
      <Permanent/>
    </Scope>
    <DFTitle>Subnodes related to profile and level of video codec</DFTitle>
    <DFType>
      <MIME>text/plain</MIME>
    </DFType>
  </DFProperties>
</Node>
<Node>
  <NodeName>H263</NodeName>
  <DFProperties>
    <AccessType>
      <Get/>
    </AccessType>
    <DFFormat>
      <node/>
    </DFFormat>
    <Occurrence>
      <ZeroOrOne/>
    </Occurrence>
    <Scope>
      <Permanent/>
    </Scope>
    <DFTitle>Subnodes related to profile and level of H.263</DFTitle>
    <DFType>
      <MIME>text/plain</MIME>
    </DFType>
  </DFProperties>
</Node>
  <NodeName>Profile</NodeName>
  <DFProperties>
    <AccessType>
      <Get/>
    </AccessType>
    <DFFormat>
      <int/>
    </DFFormat>
    <Occurrence>
      <One/>
    </Occurrence>

```

```

    <Scope>
      <Permanent/>
    </Scope>
    <DFTitle>Profile of H.263</DFTitle>
    <DFType>
      <MIME>text/plain</MIME>
    </DFType>
  </DFProperties>
</Node>
<Node>
  <nodeName>Level</nodeName>
  <DFProperties>
    <AccessType>
      <Get/>
    </AccessType>
    <DFFormat>
      <int/>
    </DFFormat>
    <Occurrence>
      <One/>
    </Occurrence>
    <Scope>
      <Permanent/>
    </Scope>
    <DFTitle>Level of H.263</DFTitle>
    <DFType>
      <MIME>text/plain</MIME>
    </DFType>
  </DFProperties>
</Node>
</Node>
<Node>
  <nodeName>MPEG4</nodeName>
  <DFProperties>
    <AccessType>
      <Get/>
    </AccessType>
    <DFFormat>
      <int/>
    </DFFormat>
    <Occurrence>
      <ZeroOrOne/>
    </Occurrence>
    <Scope>
      <Permanent/>
    </Scope>
    <DFTitle>profile-level-id of MPEG-4</DFTitle>
    <DFType>
      <MIME>text/plain</MIME>
    </DFType>
  </DFProperties>
</Node>
<Node>
  <nodeName>H264</nodeName>
  <DFProperties>
    <AccessType>
      <Get/>
    </AccessType>
    <DFFormat>
      <chr/>
    </DFFormat>
    <Occurrence>
      <ZeroOrOne/>
    </Occurrence>
    <Scope>
      <Permanent/>
    </Scope>
    <DFTitle>profile-level-id of H.264</DFTitle>
    <DFType>
      <MIME>text/plain</MIME>
    </DFType>
  </DFProperties>
</Node>
</Node>
<Node>
  <nodeName>ImageAttr</nodeName>
  <DFProperties>

```

```

    <AccessType>
    <Get/>
  </AccessType>
  <DFFormat>
    <node/>
  </DFFormat>
  <Occurrence>
    <ZeroOrOne/>
  </Occurrence>
  <Scope>
    <Permanent/>
  </Scope>
  <DFTitle>Subnodes related to supported image size</DFTitle>
  <DFType>
    <MIME>text/plain</MIME>
  </DFType>
</DFProperties>
<Node>
  <NodeName>Send</NodeName>
  <DFProperties>
    <AccessType>
    <Get/>
  </AccessType>
  <DFFormat>
    <chr/>
  </DFFormat>
  <Occurrence>
    <One/>
  </Occurrence>
  <Scope>
    <Permanent/>
  </Scope>
  <DFTitle>Supported image sizes for send direction</DFTitle>
  <DFType>
    <MIME>text/plain</MIME>
  </DFType>
</DFProperties>
</Node>
<Node>
  <NodeName>Recv</NodeName>
  <DFProperties>
    <AccessType>
    <Get/>
  </AccessType>
  <DFFormat>
    <chr/>
  </DFFormat>
  <Occurrence>
    <One/>
  </Occurrence>
  <Scope>
    <Permanent/>
  </Scope>
  <DFTitle>Supported image sizes and their preferences for receive direction</DFTitle>
  <DFType>
    <MIME>text/plain</MIME>
  </DFType>
</DFProperties>
</Node>
</Node>
<Node>
  <NodeName>ConRef</NodeName>
  <DFProperties>
    <AccessType>
    <Get/>
  </AccessType>
  <DFFormat>
    <chr/>
  </DFFormat>
  <Occurrence>
    <ZeroOrOne/>
  </Occurrence>
  <Scope>
    <Permanent/>
  </Scope>
  <DFTitle>QoS reference</DFTitle>
  <DFType>

```

```

        <MIME>text/plain</MIME>
      </DFTType>
    </DFProperties>
  </Node>
  <Node>
    <NodeName>Ext</NodeName>
    <DFProperties>
      <AccessType>
        <Get/>
      </AccessType>
      <DFFormat>
        <node/>
      </DFFormat>
      <Occurrence>
        <ZeroOrOne/>
      </Occurrence>
      <Scope>
        <Permanent/>
      </Scope>
      <DFTitle>A collection of all extension objects</DFTitle>
      <DFTType>
        <DDFName/>
      </DFTType>
    </DFProperties>
  </Node>
</Node>
<Node>
  <NodeName>Text</NodeName>
  <DFProperties>
    <AccessType>
      <Get/>
    </AccessType>
    <DFFormat>
      <node/>
    </DFFormat>
    <Occurrence>
      <ZeroOrOne/>
    </Occurrence>
    <Scope>
      <Permanent/>
    </Scope>
    <DFTitle>Text node</DFTitle>
    <DFTType>
      <MIME>text/plain</MIME>
    </DFTType>
  </DFProperties>
  <Node>
    <NodeName/>
    <DFProperties>
      <AccessType>
        <Get/>
      </AccessType>
      <DFFormat>
        <node/>
      </DFFormat>
      <Occurrence>
        <OneOrMore/>
      </Occurrence>
      <Scope>
        <Permanent/>
      </Scope>
      <DFTitle>Text subnodes</DFTitle>
      <DFTType>
        <MIME>text/plain</MIME>
      </DFTType>
    </DFProperties>
  </Node>
  <NodeName>ID</NodeName>
  <DFProperties>
    <AccessType>
      <Get/>
    </AccessType>
    <DFFormat>
      <int/>
    </DFFormat>
    <Occurrence>

```

```

        <ZeroOrOne/>
      </Occurrence>
    <Scope>
      <Permanent/>
    </Scope>
    <DFTitle>Identification for text session parameter set</DFTitle>
    <DFType>
      <MIME>text/plain</MIME>
    </DFType>
  </DFProperties>
</Node>
<Node>
  <nodeName>TAG</nodeName>
  <DFProperties>
    <AccessType>
      <Get/>
    </AccessType>
    <DFFormat>
      <chr/>
    </DFFormat>
    <Occurrence>
      <ZeroOrOne/>
    </Occurrence>
    <Scope>
      <Permanent/>
    </Scope>
    <DFTitle>Identification for text session parameter set</DFTitle>
    <DFType>
      <MIME>text/plain</MIME>
    </DFType>
  </DFProperties>
</Node>
<Node>
  <nodeName>Priority</nodeName>
  <DFProperties>
    <AccessType>
      <Get/>
    </AccessType>
    <DFFormat>
      <int/>
    </DFFormat>
    <Occurrence>
      <ZeroOrOne/>
    </Occurrence>
    <Scope>
      <Permanent/>
    </Scope>
    <DFTitle>priority of text type</DFTitle>
    <DFType>
      <MIME>text/plain</MIME>
    </DFType>
  </DFProperties>
</Node>
<Node>
  <nodeName>TextFormat</nodeName>
  <DFProperties>
    <AccessType>
      <Get/>
    </AccessType>
    <DFFormat>
      <chr/>
    </DFFormat>
    <Occurrence>
      <One/>
    </Occurrence>
    <Scope>
      <Permanent/>
    </Scope>
    <DFTitle>Format of text conversation protocol</DFTitle>
    <DFType>
      <MIME>text/plain</MIME>
    </DFType>
  </DFProperties>
</Node>
<Node>
  <nodeName>Bandwidth</nodeName>
  <DFProperties>

```

```

    <AccessType>
      <Get/>
    </AccessType>
  </DFFormat>
  <node/>
</DFFormat>
<Occurrence>
  <One/>
</Occurrence>
<Scope>
  <Permanent/>
</Scope>
<DFTitle>Subnodes related to text bandwidth</DFTitle>
<DFType>
  <MIME>text/plain</MIME>
</DFType>
</DFProperties>
<Node>
  <NodeName>AS</NodeName>
  <DFProperties>
    <AccessType>
      <Get/>
    </AccessType>
    <DFFormat>
      <int/>
    </DFFormat>
    <Occurrence>
      <ZeroOrOne/>
    </Occurrence>
    <Scope>
      <Permanent/>
    </Scope>
    <DFTitle>media bandwidth</DFTitle>
    <DFType>
      <MIME>text/plain</MIME>
    </DFType>
  </DFProperties>
</Node>
<Node>
  <NodeName>RS</NodeName>
  <DFProperties>
    <AccessType>
      <Get/>
    </AccessType>
    <DFFormat>
      <int/>
    </DFFormat>
    <Occurrence>
      <ZeroOrOne/>
    </Occurrence>
    <Scope>
      <Permanent/>
    </Scope>
    <DFTitle>RTCP bandwidth allocated to active data senders</DFTitle>
    <DFType>
      <MIME>text/plain</MIME>
    </DFType>
  </DFProperties>
</Node>
<Node>
  <NodeName>RR</NodeName>
  <DFProperties>
    <AccessType>
      <Get/>
    </AccessType>
    <DFFormat>
      <int/>
    </DFFormat>
    <Occurrence>
      <ZeroOrOne/>
    </Occurrence>
    <Scope>
      <Permanent/>
    </Scope>
    <DFTitle>RTCP bandwidth allocated to other participants in the RTP session</DFTitle>
    <DFType>
      <MIME>text/plain</MIME>
    </DFType>
  </DFProperties>
</Node>

```

```

        </DFType>
      </DFProperties>
    </Node>
  </Node>
</Node>
<Node>
  <nodeName>RedundancyLevel</nodeName>
  <DFProperties>
    <AccessType>
      <Get/>
    </AccessType>
    <DFFormat>
      <int/>
    </DFFormat>
    <Occurrence>
      <ZeroOrOne/>
    </Occurrence>
    <Scope>
      <Permanent/>
    </Scope>
    <DFTitle>Level of redundancy</DFTitle>
    <DFType>
      <MIME>text/plain</MIME>
    </DFType>
  </DFProperties>
</Node>
<Node>
  <nodeName>SamplingTime</nodeName>
  <DFProperties>
    <AccessType>
      <Get/>
    </AccessType>
    <DFFormat>
      <int/>
    </DFFormat>
    <Occurrence>
      <ZeroOrOne/>
    </Occurrence>
    <Scope>
      <Permanent/>
    </Scope>
    <DFTitle>Shortest period between text transmissions</DFTitle>
    <DFType>
      <MIME>text/plain</MIME>
    </DFType>
  </DFProperties>
</Node>
<Node>
  <nodeName>ConRef</nodeName>
  <DFProperties>
    <AccessType>
      <Get/>
    </AccessType>
    <DFFormat>
      <chr/>
    </DFFormat>
    <Occurrence>
      <ZeroOrOne/>
    </Occurrence>
    <Scope>
      <Permanent/>
    </Scope>
    <DFTitle>QoS reference</DFTitle>
    <DFType>
      <MIME>text/plain</MIME>
    </DFType>
  </DFProperties>
</Node>
<Node>
  <nodeName>Ext</nodeName>
  <DFProperties>
    <AccessType>
      <Get/>
    </AccessType>
    <DFFormat>
      <node/>
    </DFFormat>
    <Occurrence>

```



```
        <ZeroOrOne/>
      </Occurrence>
    <Scope>
      <Permanent/>
    </Scope>
    <DFTitle>A collection of all extension objects</DFTitle>
    <DFType>
      <DDFName/>
    </DFType>
  </DFProperties>
</Node>
</Node>
</Node>
<Node>
  <NodeName>Ext</NodeName>
  <DFProperties>
    <AccessType>
      <Get/>
    </AccessType>
    <DFFormat>
      <node/>
    </DFFormat>
    <Occurrence>
      <ZeroOrOne/>
    </Occurrence>
    <Scope>
      <Permanent/>
    </Scope>
    <DFTitle>A collection of all extension objects</DFTitle>
    <DFType>
      <DDFName/>
    </DFType>
  </DFProperties>
</Node>
</Node>
</MgmtTree>
```

# Annex I (informative): QoE Reporting Management Object Device Description Framework

This Device Description Framework (DDF) is the standardized minimal set. A vendor can define its own DDF for the complete device. This DDF can include more features than this minimal standardized version.

```
<?xml version="1.0" encoding="UTF-8"?>
<!DOCTYPE MgmtTree PUBLIC "-//OMA//DTD-DM-DDF 1.2//EN"
"http://www.openmobilealliance.org/tech/DTD/dm_ddf-v1_2.dtd">
<MgmtTree>
  <VerDTD>1.2</VerDTD>
  <Man>--The device manufacturer--</Man>
  <Mod>--The device model--</Mod>
  <Node>
    <NodeName>3GPP_MTSIQOE</NodeName>
    <DFProperties>
      <AccessType>
        <Get/>
      </AccessType>
      <DFFormat>
        <node/>
      </DFFormat>
      <Occurrence>
        <ZeroOrOne/>
      </Occurrence>
      <Scope>
        <Permanent/>
      </Scope>
      <DFTitle>The interior node holding all 3GPP MTSI QoE Metrics Reporting objects</DFTitle>
      <DFType>
        <DDFName/>
      </DFType>
    </DFProperties>
  </Node>
  <Node>
    <NodeName>Enabled</NodeName>
    <DFProperties>
      <AccessType>
        <Get/>
      </AccessType>
      <DFFormat>
        <bool/>
      </DFFormat>
      <Occurrence>
        <One/>
      </Occurrence>
      <Scope>
        <Permanent/>
      </Scope>
      <DFTitle>The QoE reporting requested indicator</DFTitle>
      <DFType>
        <DDFName/>
      </DFType>
    </DFProperties>
  </Node>
  <Node>
    <NodeName>Servers</NodeName>
    <DFProperties>
      <AccessType>
        <Get/>
      </AccessType>
      <DFFormat>
        <chr/>
      </DFFormat>
      <Occurrence>
        <ZeroOrOne/>
      </Occurrence>
      <DFTitle>The URL of the QoE report server</DFTitle>
      <DFType>
        <DDFName/>
      </DFType>
    </DFProperties>
  </Node>
</MgmtTree>
```

```

    </DFType>
  </DFProperties>
</Node>
<Node>
  <nodeName>APN</nodeName>
  <DFProperties>
    <AccessType>
      <Get/>
    </AccessType>
    <DFFormat>
      <chr/>
    </DFFormat>
    <Occurrence>
      <ZeroOrOne/>
    </Occurrence>
    <DFTitle>The Access Point Name for QoE reporting</DFTitle>
    <DFType>
      <DDFName/>
    </DFType>
  </DFProperties>
</Node>
<Node>
  <nodeName>Format</nodeName>
  <DFProperties>
    <AccessType>
      <Get/>
    </AccessType>
    <DFFormat>
      <chr/>
    </DFFormat>
    <Occurrence>
      <ZeroOrOne/>
    </Occurrence>
    <DFTitle>The QoE metrics report format</DFTitle>
    <DFType>
      <DDFName/>
    </DFType>
  </DFProperties>
</Node>
<Node>
  <nodeName>Rules</nodeName>
  <DFProperties>
    <AccessType>
      <Get/>
    </AccessType>
    <DFFormat>
      <chr/>
    </DFFormat>
    <Occurrence>
      <ZeroOrOne/>
    </Occurrence>
    <DFTitle>A QoE metrics rule</DFTitle>
    <DFType>
      <DDFName/>
    </DFType>
  </DFProperties>
</Node>
<Node>
  <nodeName>Speech</nodeName>
  <DFProperties>
    <AccessType>
      <Get/>
    </AccessType>
    <DFFormat>
      <node/>
    </DFFormat>
    <Occurrence>
      <ZeroOrOne/>
    </Occurrence>
    <DFTitle>The QoE speech metrics node</DFTitle>
    <DFType>
      <DDFName/>
    </DFType>
  </DFProperties>
  <Node>
    <nodeName>Metrics</nodeName>
    <DFProperties>
      <AccessType>

```

```

        <Get/>
      </AccessType>
    <DFFormat>
      <chr/>
    </DFFormat>
  <Occurrence>
    <ZeroOrOne/>
  </Occurrence>
  <DFType>
    <DDFName/>
  </DFType>
</DFProperties>
</Node>
<Node>
  <nodeName>Ext</nodeName>
  <DFProperties>
    <AccessType>
      <Get/>
    </AccessType>
    <DFFormat>
      <node/>
    </DFFormat>
    <Occurrence>
      <ZeroOrOne/>
    </Occurrence>
    <Scope>
      <Permanent/>
    </Scope>
    <DFTitle> A collection of all extension objects</DFTitle>
    <DFType>
      <DDFName/>
    </DFType>
  </DFProperties>
</Node>
</Node>
<Node>
  <nodeName>Video</nodeName>
  <DFProperties>
    <AccessType>
      <Get/>
    </AccessType>
    <DFFormat>
      <node/>
    </DFFormat>
    <Occurrence>
      <ZeroOrOne/>
    </Occurrence>
    <DFTitle>The QoE video metrics node</DFTitle>
    <DFType>
      <DDFName/>
    </DFType>
  </DFProperties>
</Node>
<Node>
  <nodeName>Metrics</nodeName>
  <DFProperties>
    <AccessType>
      <Get/>
    </AccessType>
    <DFFormat>
      <chr/>
    </DFFormat>
    <Occurrence>
      <ZeroOrOne/>
    </Occurrence>
    <DFType>
      <DDFName/>
    </DFType>
  </DFProperties>
</Node>
<Node>
  <nodeName>Ext</nodeName>
  <DFProperties>
    <AccessType>
      <Get/>
    </AccessType>
    <DFFormat>
      <node/>
    </DFFormat>

```

```

    <Occurrence>
      <ZeroOrOne/>
    </Occurrence>
  </Scope>
  <Scope>
    <Permanent/>
  </Scope>
  <DFTitle>A collection of all extension objects</DFTitle>
  <DFType>
    <DDFName/>
  </DFType>
</DFProperties>
</Node>
</Node>
<Node>
  <NodeName>Text</NodeName>
  <DFProperties>
    <AccessType>
      <Get/>
    </AccessType>
    <DFFormat>
      <node/>
    </DFFormat>
    <Occurrence>
      <ZeroOrOne/>
    </Occurrence>
    <DFTitle>The QoE text metrics node</DFTitle>
    <DFType>
      <DDFName/>
    </DFType>
  </DFProperties>
  <Node>
    <NodeName>Metrics</NodeName>
    <DFProperties>
      <AccessType>
        <Get/>
      </AccessType>
      <DFFormat>
        <chr/>
      </DFFormat>
      <Occurrence>
        <ZeroOrOne/>
      </Occurrence>
      <DFType>
        <DDFName/>
      </DFType>
    </DFProperties>
  </Node>
  <Node>
    <NodeName>Ext</NodeName>
    <DFProperties>
      <AccessType>
        <Get/>
      </AccessType>
      <DFFormat>
        <node/>
      </DFFormat>
      <Occurrence>
        <ZeroOrOne/>
      </Occurrence>
      <Scope>
        <Permanent/>
      </Scope>
      <DFTitle>A collection of all extension objects</DFTitle>
      <DFType>
        <DDFName/>
      </DFType>
    </DFProperties>
  </Node>
</Node>
<Node>
  <NodeName>Ext</NodeName>
  <DFProperties>
    <AccessType>
      <Get/>
    </AccessType>
    <DFFormat>
      <node/>
    </DFFormat>
  </DFProperties>

```

```
<Occurrence>
  <ZeroOrOne/>
</Occurrence>
<Scope>
  <Permanent/>
</Scope>
<DFTitle>A collection of all extension objects</DFTitle>
<DFType>
  <DDFName/>
</DFType>
</DFProperties>
</Node>
</Node>
</MgmtTree>
```

## Annex J (informative): Media Adaptation Management Object Device Description Framework

This Device Description Framework (DDF) is the standardized minimal set. A vendor can define its own DDF for the complete device. This DDF can include more features than this minimal standardized version.

```
<?xml version="1.0" encoding="UTF-8"?>
<!DOCTYPE MgmtTree PUBLIC "-//OMA//DTD-DM-DDF 1.2//EN"
"http://www.openmobilealliance.org/tech/DTD/dm_ddf-v1_2.dtd">
<MgmtTree>
  <VerDTD>1.2</VerDTD>
  <Man>--The device manufacturer--</Man>
  <Mod>--The device model--</Mod>
  <Node>
    <NodeName>3GPP_MTSIMA</NodeName>
    <DFProperties>
      <AccessType>
        <Get/>
      </AccessType>
      <Description>3GPP MTSI Media Adaptation</Description>
      <DFFormat>
        <node/>
      </DFFormat>
      <Occurrence>
        <ZeroOrOne/>
      </Occurrence>
      <Scope>
        <Permanent/>
      </Scope>
      <DFTitle>3GPP MTSI Media Adaptation Management Object</DFTitle>
      <DFType>
        <DDFName/>
      </DFType>
    </DFProperties>
    <Node>
      <NodeName>Speech</NodeName>
      <DFProperties>
        <AccessType>
          <Get/>
        </AccessType>
        <DFFormat>
          <node/>
        </DFFormat>
        <Occurrence>
          <ZeroOrOne/>
        </Occurrence>
        <Scope>
          <Permanent/>
        </Scope>
        <DFTitle>Speech node</DFTitle>
        <DFType>
          <MIME>text/plain</MIME>
        </DFType>
      </DFProperties>
      <Node>
        <NodeName/>
        <DFProperties>
          <AccessType>
            <Get/>
          </AccessType>
          <DFFormat>
            <node/>
          </DFFormat>
          <Occurrence>
            <OneOrMore/>
          </Occurrence>
          <Scope>
            <Permanent/>
          </Scope>
          <DFTitle>Speech subnodes</DFTitle>
        </DFProperties>
      </Node>
    </Node>
  </Node>
</MgmtTree>
```

```

    <DFType>
      <MIME>text/plain</MIME>
    </DFType>
  </DFProperties>
</Node>
<Node>
  <nodeName>ID</nodeName>
  <DFProperties>
    <AccessType>
      <Get/>
    </AccessType>
    <DFFormat>
      <int/>
    </DFFormat>
    <Occurrence>
      <ZeroOrOne/>
    </Occurrence>
    <Scope>
      <Permanent/>
    </Scope>
    <DFTitle>Identification for video adaptation state machine</DFTitle>
    <DFType>
      <MIME>text/plain</MIME>
    </DFType>
  </DFProperties>
</Node>
<Node>
  <nodeName>TAG</nodeName>
  <DFProperties>
    <AccessType>
      <Get/>
    </AccessType>
    <DFFormat>
      <chr/>
    </DFFormat>
    <Occurrence>
      <ZeroOrOne/>
    </Occurrence>
    <Scope>
      <Permanent/>
    </Scope>
    <DFTitle>Identification for speech adaptation state machine</DFTitle>
    <DFType>
      <MIME>text/plain</MIME>
    </DFType>
  </DFProperties>
</Node>
<Node>
  <nodeName>PLR</nodeName>
  <DFProperties>
    <AccessType>
      <Get/>
    </AccessType>
    <DFFormat>
      <node/>
    </DFFormat>
    <Occurrence>
      <ZeroOrOne/>
    </Occurrence>
    <Scope>
      <Permanent/>
    </Scope>
    <DFTitle>Subnodes related to packet loss rate</DFTitle>
    <DFType>
      <MIME>text/plain</MIME>
    </DFType>
  </DFProperties>
</Node>
<Node>
  <nodeName>MAX</nodeName>
  <DFProperties>
    <AccessType>
      <Get/>
    </AccessType>
    <DFFormat>
      <float/>
    </DFFormat>
    <Occurrence>
      <ZeroOrOne/>
    </Occurrence>
  </DFProperties>

```



```

        </Occurrence>
        <Scope>
          <Permanent/>
        </Scope>
        <DFTitle>Maximum packet loss rate tolerated when redundancy is not employed</DFTitle>
        <DFType>
          <MIME>text/plain</MIME>
        </DFType>
      </DFProperties>
    </Node>
    <Node>
      <nodeName>LOW</nodeName>
      <DFProperties>
        <AccessType>
          <Get/>
        </AccessType>
        <DFFormat>
          <float/>
        </DFFormat>
        <Occurrence>
          <ZeroOrOne/>
        </Occurrence>
        <Scope>
          <Permanent/>
        </Scope>
        <DFTitle>Packet loss rate below which up-switch is attempted</DFTitle>
        <DFType>
          <MIME>text/plain</MIME>
        </DFType>
      </DFProperties>
    </Node>
    <Node>
      <nodeName>STATE_REVERSION</nodeName>
      <DFProperties>
        <AccessType>
          <Get/>
        </AccessType>
        <DFFormat>
          <float/>
        </DFFormat>
        <Occurrence>
          <ZeroOrOne/>
        </Occurrence>
        <Scope>
          <Permanent/>
        </Scope>
        <DFTitle>Packet loss rate above which the state is reversed</DFTitle>
        <DFType>
          <MIME>text/plain</MIME>
        </DFType>
      </DFProperties>
    </Node>
    <Node>
      <nodeName>RED_INEFFECTIVE</nodeName>
      <DFProperties>
        <AccessType>
          <Get/>
        </AccessType>
        <DFFormat>
          <float/>
        </DFFormat>
        <Occurrence>
          <ZeroOrOne/>
        </Occurrence>
        <Scope>
          <Permanent/>
        </Scope>
        <DFTitle>Packet loss rate above which redundancy is ineffective</DFTitle>
        <DFType>
          <MIME>text/plain</MIME>
        </DFType>
      </DFProperties>
    </Node>
    <Node>
      <nodeName>DURATION_MAX</nodeName>
      <DFProperties>
        <AccessType>

```

```

    <Get/>
  </AccessType>
</DFFormat>
  <int/>
</DFFormat>
<Occurrence>
  <ZeroOrOne/>
</Occurrence>
<Scope>
  <Permanent/>
</Scope>
<DFTitle>Duration for which MAX is computed</DFTitle>
<DFType>
  <MIME>text/plain</MIME>
</DFType>
</DFProperties>
</Node>
<Node>
  <nodeName>DURATION_LOW</nodeName>
  <DFProperties>
    <AccessType>
      <Get/>
    </AccessType>
    <DFFormat>
      <int/>
    </DFFormat>
    <Occurrence>
      <ZeroOrOne/>
    </Occurrence>
    <Scope>
      <Permanent/>
    </Scope>
    <DFTitle>Duration for which LOW is computed</DFTitle>
    <DFType>
      <MIME>text/plain</MIME>
    </DFType>
  </DFProperties>
</Node>
<Node>
  <nodeName>DURATION_STATE_REVERSION</nodeName>
  <DFProperties>
    <AccessType>
      <Get/>
    </AccessType>
    <DFFormat>
      <int/>
    </DFFormat>
    <Occurrence>
      <ZeroOrOne/>
    </Occurrence>
    <Scope>
      <Permanent/>
    </Scope>
    <DFTitle>Duration for which STATE_REVERSION is computed</DFTitle>
    <DFType>
      <MIME>text/plain</MIME>
    </DFType>
  </DFProperties>
</Node>
<Node>
  <nodeName>DURATION_RED_INEFFECTIVE</nodeName>
  <DFProperties>
    <AccessType>
      <Get/>
    </AccessType>
    <DFFormat>
      <int/>
    </DFFormat>
    <Occurrence>
      <ZeroOrOne/>
    </Occurrence>
    <Scope>
      <Permanent/>
    </Scope>
    <DFTitle>Duration for which RED_INEFFECTIVE is computed</DFTitle>
    <DFType>
      <MIME>text/plain</MIME>
    </DFType>
  </DFProperties>
</Node>

```

```

        </DFType>
      </DFProperties>
    </Node>
  <Node>
    <NodeName>DURATION</NodeName>
    <DFProperties>
      <AccessType>
        <Get/>
      </AccessType>
      <DFFormat>
        <int/>
      </DFFormat>
      <Occurrence>
        <ZeroOrOne/>
      </Occurrence>
      <Scope>
        <Permanent/>
      </Scope>
      <DFTitle>Default duration for which unspecified PLRs are computed</DFTitle>
      <DFType>
        <MIME>text/plain</MIME>
      </DFType>
    </DFProperties>
  </Node>
</Node>
<Node>
  <NodeName>PLB</NodeName>
  <DFProperties>
    <AccessType>
      <Get/>
    </AccessType>
    <DFFormat>
      <node/>
    </DFFormat>
    <Occurrence>
      <ZeroOrOne/>
    </Occurrence>
    <DFTitle>Subnodes related to packet loss burst</DFTitle>
    <DFType>
      <MIME>text/plain</MIME>
    </DFType>
  </DFProperties>
</Node>
  <NodeName>LOST_PACKET</NodeName>
  <DFProperties>
    <AccessType>
      <Get/>
    </AccessType>
    <DFFormat>
      <int/>
    </DFFormat>
    <Occurrence>
      <One/>
    </Occurrence>
    <DFTitle>Number of packets lost during DURATION</DFTitle>
    <DFType>
      <MIME>text/plain</MIME>
    </DFType>
  </DFProperties>
</Node>
  <NodeName>DURATION</NodeName>
  <DFProperties>
    <AccessType>
      <Get/>
    </AccessType>
    <DFFormat>
      <int/>
    </DFFormat>
    <Occurrence>
      <One/>
    </Occurrence>
    <Scope>
      <Permanent/>
    </Scope>
    <DFTitle>Duration for which LOST_PACKET is counted</DFTitle>
    <DFType>

```

```

        <MIME>text/plain</MIME>
      </DFTType>
    </DFProperties>
  </Node>
</Node>
<Node>
  <NodeName>ECN</NodeName>
  <DFProperties>
    <AccessType>
      <Get/>
    </AccessType>
    <DFFormat>
      <node/>
    </DFFormat>
    <Occurrence>
      <ZeroOrOne/>
    </Occurrence>
    <Scope>
      <Permanent/>
    </Scope>
    <DFTitle>Subnodes related to explicit congestion notification to IP</DFTitle>
  <DFType>
    <MIME>text/plain</MIME>
  </DFType>
</DFProperties>
<Node>
  <NodeName>USAGE</NodeName>
  <DFProperties>
    <AccessType>
      <Get/>
    </AccessType>
    <DFFormat>
      <bool/>
    </DFFormat>
    <Occurrence>
      <ZeroOrOne/>
    </Occurrence>
    <Scope>
      <Permanent/>
    </Scope>
    <DFTitle>Switch to enable or disable ECN-based adaptation</DFTitle>
  <DFType>
    <MIME>text/plain</MIME>
  </DFType>
</DFProperties>
</Node>
<Node>
  <NodeName>MIN_RATE</NodeName>
  <DFProperties>
    <AccessType>
      <Get/>
    </AccessType>
    <DFFormat>
      <int/>
    </DFFormat>
    <Occurrence>
      <ZeroOrOne/>
    </Occurrence>
    <Scope>
      <Permanent/>
    </Scope>
    <DFTitle>Minimum bit rate to use during ECN-based adaptation</DFTitle>
  <DFType>
    <MIME>text/plain</MIME>
  </DFType>
</DFProperties>
</Node>
<Node>
  <NodeName>STEPWISE_DOWNSWITCH</NodeName>
  <DFProperties>
    <AccessType>
      <Get/>
    </AccessType>
    <DFFormat>
      <bool/>
    </DFFormat>
    <Occurrence>

```

```

        <ZeroOrOne/>
      </Occurrence>
    </Scope>
  </Permanent/>
</Scope>
<DFTitle>Switch to enable or disable stepwise downswitch</DFTitle>
<DFType>
  <MIME>text/plain</MIME>
</DFType>
</DFProperties>
</Node>
<Node>
  <nodeName>RATE_LIST</nodeName>
  <DFProperties>
    <AccessType>
      <Get/>
    </AccessType>
    <DFFormat>
      <chr/>
    </DFFormat>
    <Occurrence>
      <ZeroOrOne/>
    </Occurrence>
    <Scope>
      <Permanent/>
    </Scope>
    <DFTitle>List of bit rates to use during stepwise downswitch</DFTitle>
    <DFType>
      <MIME>text/plain</MIME>
    </DFType>
  </DFProperties>
</Node>
<Node>
  <nodeName>INIT_WAIT</nodeName>
  <DFProperties>
    <AccessType>
      <Get/>
    </AccessType>
    <DFFormat>
      <int/>
    </DFFormat>
    <Occurrence>
      <ZeroOrOne/>
    </Occurrence>
    <Scope>
      <Permanent/>
    </Scope>
    <DFTitle>Minimum waiting time before upswitch is attempted</DFTitle>
    <DFType>
      <MIME>text/plain</MIME>
    </DFType>
  </DFProperties>
</Node>
<Node>
  <nodeName>INIT_UPSWITCH_WAIT</nodeName>
  <DFProperties>
    <AccessType>
      <Get/>
    </AccessType>
    <DFFormat>
      <int/>
    </DFFormat>
    <Occurrence>
      <ZeroOrOne/>
    </Occurrence>
    <Scope>
      <Permanent/>
    </Scope>
    <DFTitle>Waiting time at each step during upswitch after session start</DFTitle>
    <DFType>
      <MIME>text/plain</MIME>
    </DFType>
  </DFProperties>
</Node>
<Node>
  <nodeName>CONGESTION_WAIT</nodeName>
  <DFProperties>

```

```

    <AccessType>
      <Get/>
    </AccessType>
  <DFFormat>
    <int/>
  </DFFormat>
  <Occurrence>
    <ZeroOrOne/>
  </Occurrence>
  <Scope>
    <Permanent/>
  </Scope>
  <DFTitle>Minimum interval between detection of ECN-CE and upswitch</DFTitle>
  <DFType>
    <MIME>text/plain</MIME>
  </DFType>
</DFProperties>
</Node>
<Node>
  <nodeName>CONGESTION_UPSWITCH_WAIT</nodeName>
  <DFProperties>
    <AccessType>
      <Get/>
    </AccessType>
  <DFFormat>
    <int/>
  </DFFormat>
  <Occurrence>
    <ZeroOrOne/>
  </Occurrence>
  <Scope>
    <Permanent/>
  </Scope>
  <DFTitle>Waiting time at each step during upswitch after congestion</DFTitle>
  <DFType>
    <MIME>text/plain</MIME>
  </DFType>
</DFProperties>
</Node>
</Node>
<Node>
  <nodeName>ICM</nodeName>
  <DFProperties>
    <AccessType>
      <Get/>
    </AccessType>
  <DFFormat>
    <node/>
  </DFFormat>
  <Occurrence>
    <ZeroOrOne/>
  </Occurrence>
  <Scope>
    <Permanent/>
  </Scope>
  <DFTitle>Subnodes related to initial codec mode</DFTitle>
  <DFType>
    <MIME>text/plain</MIME>
  </DFType>
</DFProperties>
</Node>
<Node>
  <nodeName>INITIAL_CODEC_RATE</nodeName>
  <DFProperties>
    <AccessType>
      <Get/>
    </AccessType>
  <DFFormat>
    <int/>
  </DFFormat>
  <Occurrence>
    <ZeroOrOne/>
  </Occurrence>
  <Scope>
    <Permanent/>
  </Scope>
  <DFTitle>Initial bit rate speech encoder should begin encoding speech at</DFTitle>
  <DFType>

```

```

        <MIME>text/plain</MIME>
      </DFTType>
    </DFProperties>
  </Node>
  <Node>
    <NodeName>INIT_WAIT</NodeName>
    <DFProperties>
      <AccessType>
        <Get/>
      </AccessType>
      <DFFormat>
        <int/>
      </DFFormat>
      <Occurrence>
        <ZeroOrOne/>
      </Occurrence>
      <Scope>
        <Permanent/>
      </Scope>
      <DFTitle>Waiting time the sender should use before an up-switch is attempted in the initial phase of session if no rate
control information is received</DFTitle>
    </DFTType>
    <MIME>text/plain</MIME>
  </DFTType>
</DFProperties>
</Node>
<Node>
  <NodeName>INIT_UPSWITCH_WAIT</NodeName>
  <DFProperties>
    <AccessType>
      <Get/>
    </AccessType>
    <DFFormat>
      <int/>
    </DFFormat>
    <Occurrence>
      <ZeroOrOne/>
    </Occurrence>
    <Scope>
      <Permanent/>
    </Scope>
    <DFTitle>Waiting time at each step during up-switch in the beginning of session</DFTitle>
  </DFTType>
  <MIME>text/plain</MIME>
</DFTType>
</DFProperties>
</Node>
</Node>
<Node>
  <NodeName>N_INHIBIT</NodeName>
  <DFProperties>
    <AccessType>
      <Get/>
    </AccessType>
    <DFFormat>
      <int/>
    </DFFormat>
    <Occurrence>
      <ZeroOrOne/>
    </Occurrence>
    <Scope>
      <Permanent/>
    </Scope>
    <DFTitle>Probation period during which transition is prohibited after ping-pong effects</DFTitle>
  </DFTType>
  <MIME>text/plain</MIME>
</DFTType>
</DFProperties>
</Node>
<Node>
  <NodeName>N_HOLD</NodeName>
  <DFProperties>
    <AccessType>
      <Get/>
    </AccessType>
    <DFFormat>
      <int/>

```

```

    </DFFormat>
    <Occurrence>
      <ZeroOrOne/>
    </Occurrence>
    <Scope>
      <Permanent/>
    </Scope>
    <DFTitle>Measurement period multiplied by PLR/DURATION to substitute undefined DURATIONS</DFTitle>
    <DFType>
      <MIME>text/plain</MIME>
    </DFType>
  </DFProperties>
</Node>
<Node>
  <nodeName>T_RESPONSE</nodeName>
  <DFProperties>
    <AccessType>
      <Get/>
    </AccessType>
    <DFFormat>
      <int/>
    </DFFormat>
    <Occurrence>
      <ZeroOrOne/>
    </Occurrence>
    <Scope>
      <Permanent/>
    </Scope>
    <DFTitle>Maximum response time tolerated before the receiver considers repairing actions</DFTitle>
    <DFType>
      <MIME>text/plain</MIME>
    </DFType>
  </DFProperties>
</Node>
<Node>
  <nodeName>Ext</nodeName>
  <DFProperties>
    <AccessType>
      <Get/>
    </AccessType>
    <DFFormat>
      <node/>
    </DFFormat>
    <Occurrence>
      <ZeroOrOne/>
    </Occurrence>
    <Scope>
      <Permanent/>
    </Scope>
    <DFTitle>A collection of all extension objects</DFTitle>
    <DFType>
      <DDFName/>
    </DFType>
  </DFProperties>
</Node>
</Node>
<Node>
  <nodeName>Video</nodeName>
  <DFProperties>
    <AccessType>
      <Get/>
    </AccessType>
    <DFFormat>
      <node/>
    </DFFormat>
    <Occurrence>
      <ZeroOrOne/>
    </Occurrence>
    <Scope>
      <Permanent/>
    </Scope>
    <DFTitle>Video node</DFTitle>
    <DFType>
      <MIME>text/plain</MIME>
    </DFType>
  </DFProperties>

```



```

<Node>
  <NodeName/>
  <DFProperties>
    <AccessType>
      <Get/>
    </AccessType>
    <DFFormat>
      <node/>
    </DFFormat>
    <Occurrence>
      <OneOrMore/>
    </Occurrence>
    <Scope>
      <Permanent/>
    </Scope>
    <DFTitle>Video subnodes</DFTitle>
    <DFType>
      <MIME>text/plain</MIME>
    </DFType>
  </DFProperties>
</Node>
<Node>
  <NodeName>ID</NodeName>
  <DFProperties>
    <AccessType>
      <Get/>
    </AccessType>
    <DFFormat>
      <int/>
    </DFFormat>
    <Occurrence>
      <ZeroOrOne/>
    </Occurrence>
    <Scope>
      <Permanent/>
    </Scope>
    <DFTitle>Identification for video adaptation state machine</DFTitle>
    <DFType>
      <MIME>text/plain</MIME>
    </DFType>
  </DFProperties>
</Node>
<Node>
  <NodeName>TAG</NodeName>
  <DFProperties>
    <AccessType>
      <Get/>
    </AccessType>
    <DFFormat>
      <chr/>
    </DFFormat>
    <Occurrence>
      <ZeroOrOne/>
    </Occurrence>
    <Scope>
      <Permanent/>
    </Scope>
    <DFTitle>Identification for speech adaptation state machine</DFTitle>
    <DFType>
      <MIME>text/plain</MIME>
    </DFType>
  </DFProperties>
</Node>
<Node>
  <NodeName>PLR</NodeName>
  <DFProperties>
    <AccessType>
      <Get/>
    </AccessType>
    <DFFormat>
      <node/>
    </DFFormat>
    <Occurrence>
      <ZeroOrOne/>
    </Occurrence>
    <Scope>
      <Permanent/>
    </Scope>
  </DFProperties>
</Node>

```

```

    <DFTitle>Subnodes related to packet loss rate</DFTitle>
    <DFType>
      <MIME>text/plain</MIME>
    </DFType>
  </DFProperties>
  <Node>
    <NodeName>MAX</NodeName>
    <DFProperties>
      <AccessType>
        <Get/>
      </AccessType>
      <DFFormat>
        <float/>
      </DFFormat>
      <Occurrence>
        <ZeroOrOne/>
      </Occurrence>
      <Scope>
        <Permanent/>
      </Scope>
      <DFTitle>Maximum packet loss rate tolerated before the receiver asks the sender to reduce bit rate</DFTitle>
      <DFType>
        <MIME>text/plain</MIME>
      </DFType>
    </DFProperties>
  </Node>
  <Node>
    <NodeName>LOW</NodeName>
    <DFProperties>
      <AccessType>
        <Get/>
      </AccessType>
      <DFFormat>
        <float/>
      </DFFormat>
      <Occurrence>
        <ZeroOrOne/>
      </Occurrence>
      <Scope>
        <Permanent/>
      </Scope>
      <DFTitle>Minimum packet loss rate tolerated before the receiver asks the sender to increase bit rate</DFTitle>
      <DFType>
        <MIME>text/plain</MIME>
      </DFType>
    </DFProperties>
  </Node>
  <Node>
    <NodeName>DURATION_MAX</NodeName>
    <DFProperties>
      <AccessType>
        <Get/>
      </AccessType>
      <DFFormat>
        <int/>
      </DFFormat>
      <Occurrence>
        <ZeroOrOne/>
      </Occurrence>
      <Scope>
        <Permanent/>
      </Scope>
      <DFTitle>Duration for which MAX is computed</DFTitle>
      <DFType>
        <MIME>text/plain</MIME>
      </DFType>
    </DFProperties>
  </Node>
  <Node>
    <NodeName>DURATION_LOW</NodeName>
    <DFProperties>
      <AccessType>
        <Get/>
      </AccessType>
      <DFFormat>
        <int/>
      </DFFormat>

```

```

        <Occurrence>
          <ZeroOrOne/>
        </Occurrence>
      <Scope>
        <Permanent/>
      </Scope>
      <DFTitle>Duration for which LOW is computed</DFTitle>
      <DFType>
        <MIME>text/plain</MIME>
      </DFType>
    </DFProperties>
  </Node>
</Node>
<Node>
  <nodeName>PLB</nodeName>
  <DFProperties>
    <AccessType>
      <Get/>
    </AccessType>
    <DFFormat>
      <node/>
    </DFFormat>
    <Occurrence>
      <ZeroOrOne/>
    </Occurrence>
    <DFTitle>Subnodes related to packet loss burst</DFTitle>
    <DFType>
      <MIME>text/plain</MIME>
    </DFType>
  </DFProperties>
  <Node>
    <nodeName>LOST_PACKET</nodeName>
    <DFProperties>
      <AccessType>
        <Get/>
      </AccessType>
      <DFFormat>
        <int/>
      </DFFormat>
      <Occurrence>
        <One/>
      </Occurrence>
      <DFTitle>Number of packets lost during DURATION</DFTitle>
      <DFType>
        <MIME>text/plain</MIME>
      </DFType>
    </DFProperties>
  </Node>
  <Node>
    <nodeName>DURATION</nodeName>
    <DFProperties>
      <AccessType>
        <Get/>
      </AccessType>
      <DFFormat>
        <int/>
      </DFFormat>
      <Occurrence>
        <One/>
      </Occurrence>
      <Scope>
        <Permanent/>
      </Scope>
      <DFTitle>Duration for which LOST_PACKET is counted</DFTitle>
      <DFType>
        <MIME>text/plain</MIME>
      </DFType>
    </DFProperties>
  </Node>
</Node>
<Node>
  <nodeName>MIN_QUALITY</nodeName>
  <DFProperties>
    <AccessType>
      <Get/>
    </AccessType>
    <DFFormat>

```

```

    </node/>
  </DFFormat>
  <Occurrence>
    <ZeroOrOne/>
  </Occurrence>
  <DFTitle>Subnodes related to minimum video quaity</DFTitle>
  <DFType>
    <MIME>text/plain</MIME>
  </DFType>
</DFProperties>
<Node>
  <NodeName>BIT_RATE</NodeName>
  <DFProperties>
    <AccessType>
      <Get/>
    </AccessType>
    <DFFormat>
      <node/>
    </DFFormat>
    <Occurrence>
      <ZeroOrOne/>
    </Occurrence>
    <Scope>
      <Permanent/>
    </Scope>
    <DFTitle>Subnodes related to minimum bit rate</DFTitle>
    <DFType>
      <MIME>text/plain</MIME>
    </DFType>
  </DFProperties>
  <Node>
    <NodeName>ABSOLUTE</NodeName>
    <DFProperties>
      <AccessType>
        <Get/>
      </AccessType>
      <DFFormat>
        <float/>
      </DFFormat>
      <Occurrence>
        <ZeroOrOne/>
      </Occurrence>
      <Scope>
        <Permanent/>
      </Scope>
      <DFTitle>Minimum bit rate tolerated (kps)</DFTitle>
      <DFType>
        <MIME>text/plain</MIME>
      </DFType>
    </DFProperties>
  </Node>
  <Node>
    <NodeName>RELATIVE</NodeName>
    <DFProperties>
      <AccessType>
        <Get/>
      </AccessType>
      <DFFormat>
        <float/>
      </DFFormat>
      <Occurrence>
        <ZeroOrOne/>
      </Occurrence>
      <Scope>
        <Permanent/>
      </Scope>
      <DFTitle>Minimum bit rate tolerated (proportion of the bit rate negotiated)</DFTitle>
      <DFType>
        <MIME>text/plain</MIME>
      </DFType>
    </DFProperties>
  </Node>
</Node>
<Node>
  <NodeName>FRAME_RATE</NodeName>
  <DFProperties>
    <AccessType>

```

```

    <Get/>
  </AccessType>
  <DFFormat>
    <node/>
  </DFFormat>
  <Occurrence>
    <ZeroOrOne/>
  </Occurrence>
  <Scope>
    <Permanent/>
  </Scope>
  <DFTitle>Subnodes related to minimum frame rate</DFTitle>
  <DFType>
    <MIME>text/plain</MIME>
  </DFType>
</DFProperties>
<Node>
  <NodeName>ABSOLUTE</NodeName>
  <DFProperties>
    <AccessType>
      <Get/>
    </AccessType>
    <DFFormat>
      <float/>
    </DFFormat>
    <Occurrence>
      <ZeroOrOne/>
    </Occurrence>
    <Scope>
      <Permanent/>
    </Scope>
    <DFTitle>Minimum frame rate tolerated (fps)</DFTitle>
    <DFType>
      <MIME>text/plain</MIME>
    </DFType>
  </DFProperties>
</Node>
<Node>
  <NodeName>RELATIVE</NodeName>
  <DFProperties>
    <AccessType>
      <Get/>
    </AccessType>
    <DFFormat>
      <float/>
    </DFFormat>
    <Occurrence>
      <ZeroOrOne/>
    </Occurrence>
    <Scope>
      <Permanent/>
    </Scope>
    <DFTitle>Minimum frame rate tolerated (proportion of maximum frame rate specified by codec profile/level
negotiated)</DFTitle>
    <DFType>
      <MIME>text/plain</MIME>
    </DFType>
  </DFProperties>
</Node>
</Node>
<Node>
  <NodeName>QP</NodeName>
  <DFProperties>
    <AccessType>
      <Get/>
    </AccessType>
    <DFFormat>
      <node/>
    </DFFormat>
    <Occurrence>
      <ZeroOrOne/>
    </Occurrence>
    <Scope>
      <Permanent/>
    </Scope>
    <DFTitle>Subnodes related to maximum luminance quantization parameter</DFTitle>
    <DFType>

```

```

        <MIME>text/plain</MIME>
      </DFTType>
    </DFProperties>
  </Node>
  <Node>
    <NodeName>H263</NodeName>
    <DFProperties>
      <AccessType>
        <Get/>
      </AccessType>
      <DFFormat>
        <int/>
      </DFFormat>
      <Occurrence>
        <ZeroOrOne/>
      </Occurrence>
      <Scope>
        <Permanent/>
      </Scope>
      <DFTitle>Maximum luminance quantization parameter QUANT</DFTitle>
      <DFTType>
        <MIME>text/plain</MIME>
      </DFTType>
    </DFProperties>
  </Node>
  <Node>
    <NodeName>MPEG4</NodeName>
    <DFProperties>
      <AccessType>
        <Get/>
      </AccessType>
      <DFFormat>
        <int/>
      </DFFormat>
      <Occurrence>
        <ZeroOrOne/>
      </Occurrence>
      <Scope>
        <Permanent/>
      </Scope>
      <DFTitle>Maximum luminance quantization parameter quantiser_scale</DFTitle>
      <DFTType>
        <MIME>text/plain</MIME>
      </DFTType>
    </DFProperties>
  </Node>
  <Node>
    <NodeName>H264</NodeName>
    <DFProperties>
      <AccessType>
        <Get/>
      </AccessType>
      <DFFormat>
        <int/>
      </DFFormat>
      <Occurrence>
        <ZeroOrOne/>
      </Occurrence>
      <Scope>
        <Permanent/>
      </Scope>
      <DFTitle>Maximum luminance quantization parameter QPY</DFTitle>
      <DFTType>
        <MIME>text/plain</MIME>
      </DFTType>
    </DFProperties>
  </Node>
  </Node>
  <Node>
    <NodeName>RTP_GAP</NodeName>
    <DFProperties>
      <AccessType>
        <Get/>
      </AccessType>
      <DFFormat>
        <float/>
      </DFFormat>

```

```

    <Occurrence>
      <ZeroOrOne/>
    </Occurrence>
  <Scope>
    <Permanent/>
  </Scope>
  <DFTitle>Maximum tolerated interval between packet arrivals</DFTitle>
  <DFType>
    <MIME>text/plain</MIME>
  </DFType>
</DFProperties>
</Node>
<Node>
  <nodeName>INC_FBACK_MIN_INTERVAL</nodeName>
  <DFProperties>
    <AccessType>
      <Get/>
    </AccessType>
    <DFFormat>
      <int/>
    </DFFormat>
    <Occurrence>
      <ZeroOrOne/>
    </Occurrence>
    <Scope>
      <Permanent/>
    </Scope>
    <DFTitle>Minimum interval between TMMBR messages increasing maximum rate limit</DFTitle>
    <DFType>
      <MIME>text/plain</MIME>
    </DFType>
  </DFProperties>
</Node>
<Node>
  <nodeName>DEC_FBACK_MIN_INTERVAL</nodeName>
  <DFProperties>
    <AccessType>
      <Get/>
    </AccessType>
    <DFFormat>
      <int/>
    </DFFormat>
    <Occurrence>
      <ZeroOrOne/>
    </Occurrence>
    <Scope>
      <Permanent/>
    </Scope>
    <DFTitle>Minimum interval between TMMBR messages decreasing maximum rate limit</DFTitle>
    <DFType>
      <MIME>text/plain</MIME>
    </DFType>
  </DFProperties>
</Node>
<Node>
  <nodeName>TP_DURATION_HI</nodeName>
  <DFProperties>
    <AccessType>
      <Get/>
    </AccessType>
    <DFFormat>
      <int/>
    </DFFormat>
    <Occurrence>
      <ZeroOrOne/>
    </Occurrence>
    <Scope>
      <Permanent/>
    </Scope>
    <DFTitle>Duration of sliding window for TARGET_PLAYOUT_MARGIN_HI</DFTitle>
    <DFType>
      <MIME>text/plain</MIME>
    </DFType>
  </DFProperties>
</Node>
<Node>
  <nodeName>TP_DURATION_MIN</nodeName>

```

```

<DFProperties>
  <AccessType>
    <Get/>
  </AccessType>
  <DFFormat>
    <int/>
  </DFFormat>
  <Occurrence>
    <ZeroOrOne/>
  </Occurrence>
  <Scope>
    <Permanent/>
  </Scope>
  <DFTitle>Duration of sliding window for TARGET_PLAYOUT_MARGIN_MIN</DFTitle>
  <DFTType>
    <MIME>text/plain</MIME>
  </DFTType>
</DFProperties>
</Node>
<Node>
  <NodeName>TARGET_PLAYOUT_MARGIN_HI</NodeName>
  <DFProperties>
    <AccessType>
      <Get/>
    </AccessType>
    <DFFormat>
      <int/>
    </DFFormat>
    <Occurrence>
      <ZeroOrOne/>
    </Occurrence>
    <Scope>
      <Permanent/>
    </Scope>
    <DFTitle>Upper threshold of interval between video packet arrival and its properly scheduled playback</DFTitle>
    <DFTType>
      <MIME>text/plain</MIME>
    </DFTType>
  </DFProperties>
</Node>
<Node>
  <NodeName>TARGET_PLAYOUT_MARGIN_MIN</NodeName>
  <DFProperties>
    <AccessType>
      <Get/>
    </AccessType>
    <DFFormat>
      <int/>
    </DFFormat>
    <Occurrence>
      <ZeroOrOne/>
    </Occurrence>
    <Scope>
      <Permanent/>
    </Scope>
    <DFTitle>Lower threshold of interval between video packet arrival and its properly scheduled playback</DFTitle>
    <DFTType>
      <MIME>text/plain</MIME>
    </DFTType>
  </DFProperties>
</Node>
<Node>
  <NodeName>RAMP_UP_RATE</NodeName>
  <DFProperties>
    <AccessType>
      <Get/>
    </AccessType>
    <DFFormat>
      <float/>
    </DFFormat>
    <Occurrence>
      <ZeroOrOne/>
    </Occurrence>
    <Scope>
      <Permanent/>
    </Scope>
    <DFTitle>Rate at which the sender should increase target bit rate to a higher max rate limit</DFTitle>
  </DFProperties>
</Node>

```



```

    <DFTType>
      <MIME>text/plain</MIME>
    </DFTType>
  </DFProperties>
</Node>
<Node>
  <NodeName>RAMP_DOWN_RATE</NodeName>
  <DFProperties>
    <AccessType>
      <Get/>
    </AccessType>
    <DFFormat>
      <float/>
    </DFFormat>
    <Occurrence>
      <ZeroOrOne/>
    </Occurrence>
    <Scope>
      <Permanent/>
    </Scope>
    <DFTitle>Rate at which the sender should decrease target bit rate to a lower max rate limit</DFTitle>
    <DFTType>
      <MIME>text/plain</MIME>
    </DFTType>
  </DFProperties>
</Node>
<Node>
  <NodeName>DECONGEST_TIME</NodeName>
  <DFProperties>
    <AccessType>
      <Get/>
    </AccessType>
    <DFFormat>
      <int/>
    </DFFormat>
    <Occurrence>
      <ZeroOrOne/>
    </Occurrence>
    <Scope>
      <Permanent/>
    </Scope>
    <DFTitle>Time the receiver should command the sender to spend in decongesting</DFTitle>
    <DFTType>
      <MIME>text/plain</MIME>
    </DFTType>
  </DFProperties>
</Node>
<Node>
  <NodeName>HOLD_DROP_END</NodeName>
  <DFProperties>
    <AccessType>
      <Get/>
    </AccessType>
    <DFFormat>
      <int/>
    </DFFormat>
    <Occurrence>
      <ZeroOrOne/>
    </Occurrence>
    <Scope>
      <Permanent/>
    </Scope>
    <DFTitle>Tri-valued parameter to control how the sender should behave in case video quality cannot meet
requirements</DFTitle>
    <DFTType>
      <MIME>text/plain</MIME>
    </DFTType>
  </DFProperties>
</Node>
<Node>
  <NodeName>INITIAL_CODEC_RATE</NodeName>
  <DFProperties>
    <AccessType>
      <Get/>
    </AccessType>
    <DFFormat>
      <float/>

```

```

    </DFFormat>
    <Occurrence>
      <ZeroOrOne/>
    </Occurrence>
  </Scope>
  <Scope>
    <Permanent/>
  </Scope>
  <DFTitle>Initial bit rate ((proportion of the bit rate negotiated) video codec should begin encoding at</DFTitle>
  <DFType>
    <MIME>text/plain</MIME>
  </DFType>
</DFProperties>
</Node>
<Node>
  <NodeName>X_PERCENTILE</NodeName>
  <DFProperties>
    <AccessType>
      <Get/>
    </AccessType>
    <DFFormat>
      <float/>
    </DFFormat>
    <Occurrence>
      <ZeroOrOne/>
    </Occurrence>
    <Scope>
      <Permanent/>
    </Scope>
    <DFTitle>X percentile point of packet arrival distribution used with TARGET_PLAYOUT_MARGIN</DFTitle>
    <DFType>
      <MIME>text/plain</MIME>
    </DFType>
  </DFProperties>
</Node>
<Node>
  <NodeName>Ext</NodeName>
  <DFProperties>
    <AccessType>
      <Get/>
    </AccessType>
    <DFFormat>
      <node/>
    </DFFormat>
    <Occurrence>
      <ZeroOrOne/>
    </Occurrence>
    <Scope>
      <Permanent/>
    </Scope>
    <DFTitle>A collection of all extension objects</DFTitle>
    <DFType>
      <DDFName/>
    </DFType>
  </DFProperties>
</Node>
</Node>
</Node>
<Node>
  <NodeName>Ext</NodeName>
  <DFProperties>
    <AccessType>
      <Get/>
    </AccessType>
    <DFFormat>
      <node/>
    </DFFormat>
    <Occurrence>
      <ZeroOrOne/>
    </Occurrence>
    <Scope>
      <Permanent/>
    </Scope>
    <DFTitle>A collection of all extension objects</DFTitle>
    <DFType>
      <DDFName/>
    </DFType>
  </DFProperties>

```

```
</Node>  
</Node>  
</MgmtTree>
```

## Annex K (informative): Change history

Change history							
Date	TSG #	TSG Doc.	CR	Rev	Subject/Comment	Old	New
2007-03	35	SP-070110			Approved at TSG SA #35	2.0.0	7.0.0
2007-06	36	SP-070318	0001	2	Addition of non-compound RTCP	7.0.0	7.1.0
2007-06	36	SP-070318	0002	1	Addition of DTMF	7.0.0	7.1.0
2007-06	36	SP-070318	0005	2	Video QoS Profile	7.0.0	7.1.0
2007-06	36	SP-070318	0006	1	Correction of the reference to the AMR/AMR-WB RTP payload format	7.0.0	7.1.0
2007-06	36	SP-070318	0007	1	Video rate adaptation in MTSI	7.0.0	7.1.0
2007-06	36	SP-070318	0008	1	Improved Video support for MTSI	7.0.0	7.1.0
2007-09	37	SP-070631	0009	1	Correction of List of Abbreviations, Section 13, and Annex F	7.1.0	7.2.0
2007-09	37	SP-070631	0010		Clarification text for Media Synchronization Info	7.1.0	7.2.0
2007-12	38	SP-070763	0012	1	Correction of minor errors	7.2.0	7.3.0
2007-12	38	SP-070763	0013	1	Correction of references in MTSI	7.2.0	7.3.0
2007-12	38	SP-070763	0014	1	Synchronization information	7.2.0	7.3.0
2007-12	38	SP-070763	0015		Encapsulation parameters	7.2.0	7.3.0
2007-12	38	SP-070763	0016	1	Video codec in MTSI	7.2.0	7.3.0
					Inclusion of attachments	7.3.0	7.3.1
2008-03	39	SP-080005	0017	2	Correction of the SDP example	7.3.1	7.4.0
2008-03	39	SP-080005	0018	1	Alignment of SDP examples	7.3.1	7.4.0
2008-03	39	SP-080005	0020	1	Codec mode requests	7.3.1	7.4.0
2008-03	39	SP-080005	0022	1	Correction to Figure 10.1	7.3.1	7.4.0
2008-06	40	SP-080248	0019	1	DTMF clarifications	7.4.0	7.5.0
2008-06	40	SP-080249	0024	2	Introduction of network preference management object	7.4.0	7.5.0
2008-06	40	SP-080248	0025		max-red alignment and clarifications	7.4.0	7.5.0
2008-06	40	SP-080248	0026	1	Addition of QoS mapping for interactive bearer for real-time text	7.4.0	7.5.0
2008-06	40	SP-080248	0027	2	Clarifications on bandwidths in SDP	7.4.0	7.5.0
2008-06	40	SP-080248	0028	1	Codec Control Messages (CCM) update	7.4.0	7.5.0
2008-06	40	SP-080248	0029	1	Terminology improvements	7.4.0	7.5.0
2008-06	40	SP-080248	0030		3G-324M inter-working in GERAN/UTRAN CS	7.4.0	7.5.0
2008-06	40	SP-080248	0031	1	ptime and encapsulation alignment	7.4.0	7.5.0
2008-09	41	SP-080469	0032	1	Introduction of SDP Capability Negotiation	7.5.0	7.6.0
2008-09	41	SP-080469	0033	2	Clarifications on the usage of AVPF NACK and PLI	7.5.0	7.6.0
2008-09	41	SP-080469	0035	1	Transmission of H.264 parameter sets	7.5.0	7.6.0
2008-09	41	SP-080469	0036		Clarification of H.263 support in MTSI	7.5.0	7.6.0
2008-09	41	SP-080476	0034	1	Improvements to MTSI 3G324M interworking	7.6.0	8.0.0
2008-12	42	SP-080679	0039	2	MTSI QoE configuration and reporting	8.0.0	8.1.0
2008-12	42	SP-080673	0041	1	MTSI QoE configuration and reporting	8.0.0	8.1.0
2008-12	42	SP-080673	0043	1	Negotiated GBR and AS bandwidths	8.0.0	8.1.0
2008-12	42	SP-080673	0045	1	Additional SDP examples for SDP answers	8.0.0	8.1.0
2008-12	42	SP-080673	0047		Initial codec mode	8.0.0	8.1.0
2008-12	42	SP-080679	0048	2	RTP/RTCP symmetric media stream	8.0.0	8.1.0
2009-03	43	SP-090013	0049	1	SDP Offer/Answer Examples for Video Sessions using "a=imageattr"	8.1.0	8.2.0
2009-03	43	SP-090005	0051	1	Session setup clarifications	8.1.0	8.2.0
2009-03	43	SP-090012	0052	1	Inter-working enhancements	8.1.0	8.2.0
2009-03	43	SP-090013	0053	1	Dynamic video rate adaptation	8.1.0	8.2.0
2009-03	43	SP-090012	0054		MTSI QoE Corrections	8.1.0	8.2.0
2009-03	43	SP-090012	0055	1	Adding second stream of same media type	8.1.0	8.2.0
2009-03	43	SP-090005	0057	2	Session setup clarifications	8.1.0	8.2.0
2009-03					Attachments added to the .zip file	8.2.0	8.2.1
2009-06	44	SP-090255	0059		MTSI QoE Correction	8.2.1	8.3.0
2009-06	44	SP-090255	0060		Cross reference correction	8.2.1	8.3.0
2009-06	44	SP-090258	0061	2	Packetization for E-UTRAN	8.2.1	8.3.0
2009-06	44	SP-090246	0063		Correction of unclear packetization recommendation for unknown RAT	8.2.1	8.3.0
2009-06	44	SP-090246	0065	1	Corrections to example in clause A.6	8.2.1	8.3.0
2009-06	44	SP-090246	0067	1	Correction to comments in sub-clause A.3.1a	8.2.1	8.3.0
2009-06	44	SP-090246	0069	1	Correction of inconsistent packetization requirements	8.2.1	8.3.0
2009-06	44	SP-090246	0071	1	Corrections to examples in clauses A.7 and A.8	8.2.1	8.3.0
2009-06	44	SP-090246	0073	1	Correction to CTM Interworking	8.2.1	8.3.0
2009-09	45	SP-090566	0076		MSRP corrections	8.3.0	8.4.0
2009-09	45	SP-090566	0077		QoE Corrections for MTSI	8.3.0	8.4.0
2009-09	45	SP-090566	0083	1	Session setup clarifications	8.3.0	8.4.0
2009-09	45	SP-090566	0085	1	Correction of OMA-DM MO DTD DFFormat in 3GPP MTSINP MO	8.3.0	8.4.0
2009-09	45	SP-090571	0074	1	Maintaining temporalspatial tradeoff during video adaptation / equalization of font and size for MO DDF specifications	8.4.0	9.0.0

Change history							
Date	TSG #	TSG Doc.	CR	Rev	Subject/Comment	Old	New
2009-09	45	SP-090573	0081	1	Initial Codec Mode Selection for AMR and AMR-WB	8.4.0	9.0.0
2009-12	46	SP-090716	0075	4	Replacement of non-compound RTCP with Reduced-Size RTCP	9.0.0	9.1.0
2009-12	46	SP-090704	0082	6	Adding Support for Explicit Congestion Notification	9.0.0	9.1.0
2009-12	46	SP-090708	0088	1	Managing MTSI Media Adaptation	9.0.0	9.1.0
2009-12	46	SP-090716	0089	1	MTSI DDF for QoE	9.0.0	9.1.0
2009-12	46	SP-090716	0091	1	Variable encoding of video to facilitate quality-recovery techniques	9.0.0	9.1.0
2010-03	47	SP-100020	0094	2	UE behaviour on the receipt of ECN-CE	9.1.0	9.2.0
2010-03	47	SP-100020	0095	1	OMA-DM configuration parameters for ECN-triggered adaptation	9.1.0	9.2.0
2010-03	47	SP-100020	0096	2	ECN adaptation example	9.1.0	9.2.0
2010-03	47	SP-100019	0101	1	H324M interworking procedures in decomposed MGCF and IM-MGW	9.1.0	9.2.0
2010-03	47	SP-100028	0102	1	MTSI Client Global Text Telephony negotiation procedures	9.1.0	9.2.0
2010-06	48	SP-100300	0103	4	Work Split of 3GPP MTSINP and MTSIMA MOs	9.2.0	9.3.0
2010-06	48	SP-100296	0107	1	Correction of AVP-AVPF negotiation procedure	9.2.0	9.3.0
2010-12	50	SP-100784	0111	3	Correction of AMR and AMR-WB codec mode adaptation in the beginning of the session	9.3.0	9.4.0
2010-12	50	SP-100784	0113		Removal of ECN Nonce	9.3.0	9.4.0

---

# History

<b>Document history</b>		
V9.1.0	January 2010	Publication
V9.2.0	April 2010	Publication
V9.3.0	June 2010	Publication
V9.4.0	January 2011	Publication