

# ETSI TS 126 233 V10.2.0 (2014-01)



**Universal Mobile Telecommunications System (UMTS);  
LTE;  
Transparent end-to-end Packet-switched  
Streaming service (PSS);  
General description  
(3GPP TS 26.233 version 10.2.0 Release 10)**



---

**Reference**

RTS/TSGS-0426233va20

---

**Keywords**

LTE,UMTS

**ETSI**

650 Route des Lucioles  
F-06921 Sophia Antipolis Cedex - FRANCE

---

Tel.: +33 4 92 94 42 00 Fax: +33 4 93 65 47 16

Siret N° 348 623 562 00017 - NAF 742 C  
Association à but non lucratif enregistrée à la  
Sous-Préfecture de Grasse (06) N° 7803/88

---

**Important notice**

---

Individual copies of the present document can be downloaded from:

<http://www.etsi.org>

The present document may be made available in more than one electronic version or in print. In any case of existing or perceived difference in contents between such versions, the reference version is the Portable Document Format (PDF). In case of dispute, the reference shall be the printing on ETSI printers of the PDF version kept on a specific network drive within ETSI Secretariat.

Users of the present document should be aware that the document may be subject to revision or change of status. Information on the current status of this and other ETSI documents is available at

<http://portal.etsi.org/tb/status/status.asp>

If you find errors in the present document, please send your comment to one of the following services:

[http://portal.etsi.org/chaicor/ETSI\\_support.asp](http://portal.etsi.org/chaicor/ETSI_support.asp)

---

**Copyright Notification**

---

No part may be reproduced except as authorized by written permission.  
The copyright and the foregoing restriction extend to reproduction in all media.

© European Telecommunications Standards Institute 2014.  
All rights reserved.

**DECT™**, **PLUGTESTS™**, **UMTS™** and the ETSI logo are Trade Marks of ETSI registered for the benefit of its Members.  
**3GPP™** and **LTE™** are Trade Marks of ETSI registered for the benefit of its Members and of the 3GPP Organizational Partners.  
**GSM®** and the GSM logo are Trade Marks registered and owned by the GSM Association.

---

## Intellectual Property Rights

IPRs essential or potentially essential to the present document may have been declared to ETSI. The information pertaining to these essential IPRs, if any, is publicly available for **ETSI members and non-members**, and can be found in ETSI SR 000 314: *"Intellectual Property Rights (IPRs); Essential, or potentially Essential, IPRs notified to ETSI in respect of ETSI standards"*, which is available from the ETSI Secretariat. Latest updates are available on the ETSI Web server (<http://ipr.etsi.org>).

Pursuant to the ETSI IPR Policy, no investigation, including IPR searches, has been carried out by ETSI. No guarantee can be given as to the existence of other IPRs not referenced in ETSI SR 000 314 (or the updates on the ETSI Web server) which are, or may be, or may become, essential to the present document.

---

## Foreword

This Technical Specification (TS) has been produced by ETSI 3rd Generation Partnership Project (3GPP).

The present document may refer to technical specifications or reports using their 3GPP identities, UMTS identities or GSM identities. These should be interpreted as being references to the corresponding ETSI deliverables.

The cross reference between GSM, UMTS, 3GPP and ETSI identities can be found under <http://webapp.etsi.org/key/queryform.asp>.

---

# Contents

Intellectual Property Rights .....	3
Foreword.....	3
Foreword.....	5
Introduction .....	5
1 Scope .....	6
2 References .....	6
3 Abbreviations .....	7
4 Usage scenarios .....	7
4.1 Applications .....	7
4.2 Use case descriptions.....	7
4.2.1 Simple streaming (Release 4) .....	7
4.2.2 Enhanced streaming service (Release 5).....	9
4.2.3 Streaming and download framework for commercial content (Release 6).....	9
4.2.3.1 Progressive Downloading .....	10
4.2.4 PSS with fast content switching (Release 7).....	10
4.2.5 IMS based PSS, PSS time-shifting and EPC (Release 8) .....	11
4.2.6 Adaptive HTTP Streaming, Timed graphics (Release 9).....	11
4.2.7 Dynamic and Adaptive Streaming over HTTP (Releases 10 onwards) .....	12
5 General service architecture .....	12
6 Functional components of a PSS terminal.....	14
6.1 Session protocols and data transport .....	14
6.2 Codecs .....	14
6.3 Adaptation of continuous media (Releases 6, 9 and 10).....	14
7 File format .....	15
8 Interworking with other core network services .....	16
8.1 Interworking with WAP .....	16
8.2 Interworking with MMS.....	16
8.3 Interworking with charging/billing services.....	16
9 Security.....	16
10 Digital Rights Management (Release 6).....	16
<b>Annex A (informative): Change history .....</b>	<b>18</b>
History .....	19

---

## Foreword

This Technical Specification has been produced by the 3<sup>rd</sup> Generation Partnership Project (3GPP).

The contents of the present document are subject to continuing work within the TSG and may change following formal TSG approval. Should the TSG modify the contents of the present document, it will be re-released by the TSG with an identifying change of release date and an increase in version number as follows:

Version x.y.z

where:

- x the first digit:
  - 1 presented to TSG for information;
  - 2 presented to TSG for approval;
  - 3 or greater indicates TSG approved document under change control.
- y the second digit is incremented for all changes of substance, i.e. technical enhancements, corrections, updates, etc.
- z the third digit is incremented when editorial only changes have been incorporated in the specification.

The 3GPP packet-switched streaming service (PSS) specification consists of six 3GPP TSs; 3GPP TS 22.233 "Transparent end-to-end packet switched streaming service; Stage 1 [6], 3GPP TS 26.234 [1], 3GPP TS 26.244 [7], 3GPP TS 26.245 [8], 3GPP TS 26.246 [9] and the present document. The service requirements for PSS are listed in [6]. The present document provides an overview of the 3GPP PSS and [1] specifies the set of PSS protocols and codecs used by the service; [7] defines the 3GPP file format, [8] defines the 3GPP Timed Text, and [9] defines the 3GPP SMIL Language Profile, which are all used by the 3GPP PSS.

---

## Introduction

Streaming refers to the ability of an application to play synchronised media streams like audio and video streams in a continuous way while those streams are being transmitted to the client over a data network.

Applications, which can be built on top of streaming services, can be classified into on-demand and live information delivery applications. Examples of the first category are music and news-on-demand applications. Live delivery of radio and television programs are examples of the second category.

Streaming over fixed-IP networks is already a major application today. While IETF and W3C have developed a set of protocols used in fixed-IP streaming services, no complete standardised streaming framework has yet been defined. For 3G systems, the 3G packet-switched streaming service (PSS) fills the gap between 3G MMS, e.g. downloading, and conversational services.

PSS enables mobile streaming applications, where the protocol and terminal complexity is lower than for conversational services, which in contrast to a streaming terminal require media input devices, media encoders and more complex protocols.

The present document describes the transparent 3G packet-switched streaming services (3G PSS) on a general application level.

---

# 1 Scope

The present document contains a general description of a transparent packet-switched streaming service in 3GPP-defined networks. In particular, it defines the usage scenarios, overall high-level end-to-end service concept, and lists terminal related functional components. It also lists any identified service interworking requirements.

---

# 2 References

The following documents contain provisions which, through reference in this text, constitute provisions of the present document.

- References are either specific (identified by date of publication, edition number, version number, etc.) or non-specific.
- For a specific reference, subsequent revisions do not apply.
- For a non-specific reference, the latest version applies. In the case of a reference to a 3GPP document (including a GSM document), a non-specific reference implicitly refers to the latest version of that document *in the same Release as the present document*.

The present document may contain references to pre-Release-4 GSM specifications. These references shall be taken to refer to the Release 5 or 6 versions where that version exists. Conversion from the pre-Release-4 number to the Release 4 (onwards) number is given in clause 6.1 of 3GPP TR 41.001[2].

- [1] 3GPP TS 26.234: "Transparent end-to-end packet switched streaming service (PSS); Protocols and codecs".
- [2] 3GPP TR 41.001: "GSM Specification set".
- [3] 3GPP TS 22.140: "Service aspects; Stage 1; Multimedia Messaging Service".
- [4] 3GPP TS 23.140: "Multimedia Messaging Service (MMS), Functional description stage 2/3".
- [5] 3GPP TS 23.060: "General Packet Radio Service (GPRS); Service description; Stage 2".
- [6] 3GPP TS 22.233: "Transparent end-to-end packet switched streaming service; Stage 1".
- [7] 3GPP TS 26.244: "Transparent end-to-end packet switched streaming service (PSS); 3GPP file format (3GP)".
- [8] 3GPP TS 26.245: "Transparent end-to-end packet switched streaming service (PSS); Timed text format".
- [9] 3GPP TS 26.246: "Transparent end-to-end packet switched streaming service (PSS); 3GPP SMIL Language Profile".
- [10] Open Mobile Alliance: 'OMA DRM Specification, V2.0'.
- [11] 3GPP TS 26.237: "IP Multimedia Subsystem (IMS) based Packet Switch Streaming (PSS) and Multimedia Broadcast/Multicast Service (MBMS) User Service; Protocols".
- [12] 3GPP TS 26.142: "Dynamic and Interactive Multimedia Scenes (DIMS)".
- [13] 3GPP TS 26.430: "Timed Graphics".
- [14] 3GPP TS 23.401: "General Packet Radio Service (GPRS) enhancements for Evolved Universal Terrestrial Radio Access Network (E-UTRAN) access".
- [15] 3GPP TS 26.247: "Transparent end-to-end Packet-switched Streaming Service (PSS); Progressive Download and Dynamic Adaptive Streaming over HTTP (3GP-DASH)".
- [16] 3GPP TS 21.905: "Vocabulary for 3GPP Specifications".

---

## 3 Abbreviations

For the purposes of the present document, the abbreviations given in 3GPP TR 21.905 [16] and the following apply:

DASH	Dynamic Adaptive Streaming over HTTP
DRM	Digital Rights Management
GIF	Graphics Interchange Format
HTML	HyperText Markup Language
MMS	Multimedia Messaging Service
MPD	Media Presentation Description
P-GW	Packet Gateway
PCRF	Policy and Charging Rules Function
PKI	Public Key Infrastructure
PSS	Packet-switched Streaming Service
RTSP	Real-Time Streaming Protocol
SMIL	Synchronised Multimedia Integration Language
XHTML	eXtensible Hyper Text Markup Language

---

## 4 Usage scenarios

### 4.1 Applications

The streaming platform supports a multitude of different applications including streaming of news at very low bitrates using still images and speech, music listening at various bitrates and qualities, video clips and watching live sports events. In addition to streaming, the platform supports also progressive downloading of media for selective media types. Media used by the applications can also be protected with a standardised digital rights management (DRM) technology.

In the following use case descriptions, a per release structure is used to highlight new features and improvements added in each release. Unless stated otherwise, features of a particular release are present in subsequent releases and are also backwards compatible to previous releases.

### 4.2 Use case descriptions

#### 4.2.1 Simple streaming (Release 4)

The simple streaming service includes a basic set of streaming control protocols, transport protocols, media codecs and scene description protocol. In this basic case defined for the first time in the Release 4 version of this specification, there is neither explicit capability exchange, nor any encryption or digital rights management.

A mobile user gets a URI to specific content that suits his or her terminal. This URI may come from a WWW-browser, a WAP-browser, or typed in by hand. This URI specifies a streaming server and the address of the content on that server. A PSS application that establishes the multimedia session shall understand a Session Description Protocol (SDP) file. Sessions containing only non-streamable content such as a SMIL file, still images and text to form a time-synchronised presentation don't require use of an SDP file in session establishment. Instead HTTP protocol shall be used for receiving the presentation files. PSS SMIL [9] sessions can also include URIs to streamable content, requiring parsing a SDP file and/or RTSP signalling.

The SDP file may be obtained in a number of ways. It may be provided in a link inside the HTML page that the user downloads, via an embed tag. It may also be directly obtained by typing it as a URI. It may also be obtained through RTSP signalling via the DESCRIBE method. In case of streaming delivery option of MMS service, the SDP file is obtained via the MMS user agent that receives a modified MMS message from the MMS relay or server. The SDP file contains the description of the session (session name, author,...), the type of media to be presented, and the bitrate of the media.

The session establishment is the process in which the browser or the mobile user invokes a streaming client to set up the session against the server. The UE is expected to have an active PDP context in accordance with [5] or other type of radio bearer that enables IP packet transmission at the start of session establishment signalling. The client may be able

to ask for more information about the content. The client shall initiate the provisioning of a bearer with appropriate QoS for the streaming media.

The set up of the streaming service is done by sending an RTSP SETUP message for each media stream chosen by the client. This returns the UDP and/or TCP port etc. to be used for the respective media stream. The client sends a RTSP PLAY message to the server that starts to send one or more streams over the IP network.

This case is illustrated below in figure 1a. Figure 1b illustrates the service use case when the SDP file is obtained via MMS.

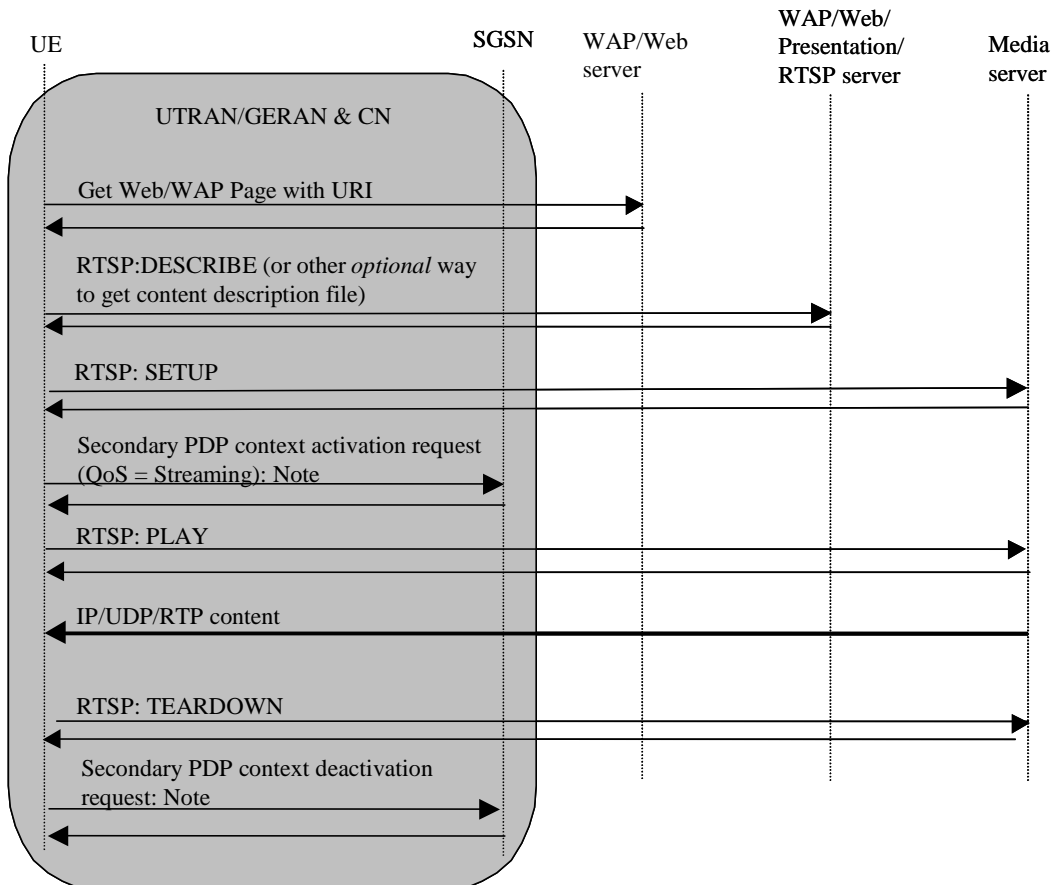

NOTE: These messages are one example of how to establish and terminate the bearer with the desired QoS. Other alternatives exist, e.g., an existing PDP context might be modified.

Figure 1a : Schematic view of a basic streaming session



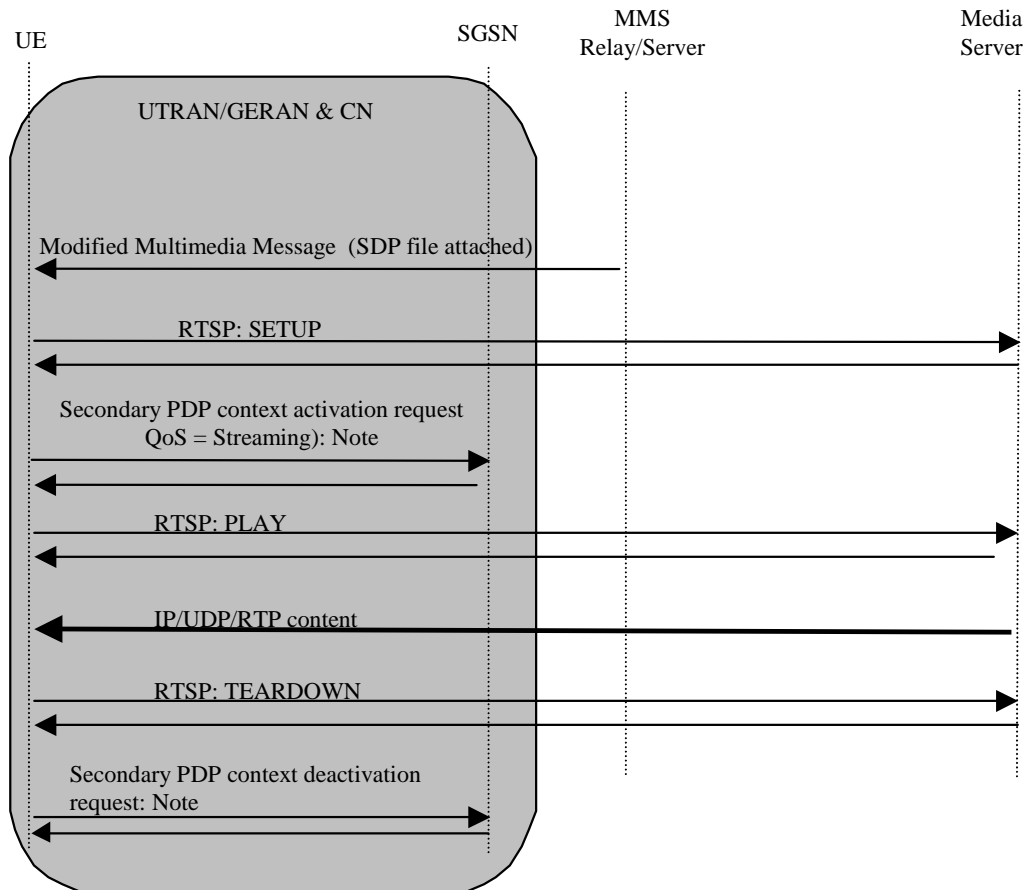

Figure 1b: Schematic view for streaming session originated via MMS

### 4.2.2 Enhanced streaming service (Release 5)

The streaming service defined in Release 5 of PSS supports all features defined for the Release 4 streaming case in a fully backwards compatible manner, and may additionally include more advanced service features, such as capability exchange.

### 4.2.3 Streaming and download framework for commercial content (Release 6)

Release 6 of PSS, while remaining essentially backwards compatible to content servers using earlier PSS releases, completes the PSS feature set to a comprehensive content delivery framework. The Release 6 framework updates the list of recommended media types and codecs to achieve higher service quality within the 3GPP environments.

It consists of already defined download and streaming framework appended with alternative of progressive downloading, in an end-to-end delivery context which enables optional use of strong content encryption and integrity protection capabilities, as well as interoperability with cryptographic key management systems. A standardised container file exchange between PSS providers is possible as a specific server file format.

PSS allows selection of streaming session alternatives (alternative SDP) and dynamic, link-aware bandwidth adaptation to adapt the session bandwidth to the potentially time-varying cellular network bandwidth, especially useful in cellular networks where QoS-enabled bearers are not available. There is also a defined mechanism to gather streaming session Quality of Experience metrics at the PSS service provider's premises.

The capability exchange mechanisms of Release 5 have been strengthened and upgraded to enable service filtering better for both streaming and static media contents.

### 4.2.3.1 Progressive Downloading

Progressive downloading is the ability to start media playback while the file or media data is still being 'downloaded'. The function works by using a HTTP download over TCP/IP connection, and this service option is available for specific media types that have a container format suitable for progressive download – audio, video, timed text [8] that will use progressive download profile of [7] and vector graphics.

A progressive-download session is established with one or more HTTP GET requests issued by the client to the server. The media resource (e.g. a progressively downloadable 3GP file) is pointed by a valid HTTP URL. Figure 1c illustrates the data flow and signalling in progressive downloading session.

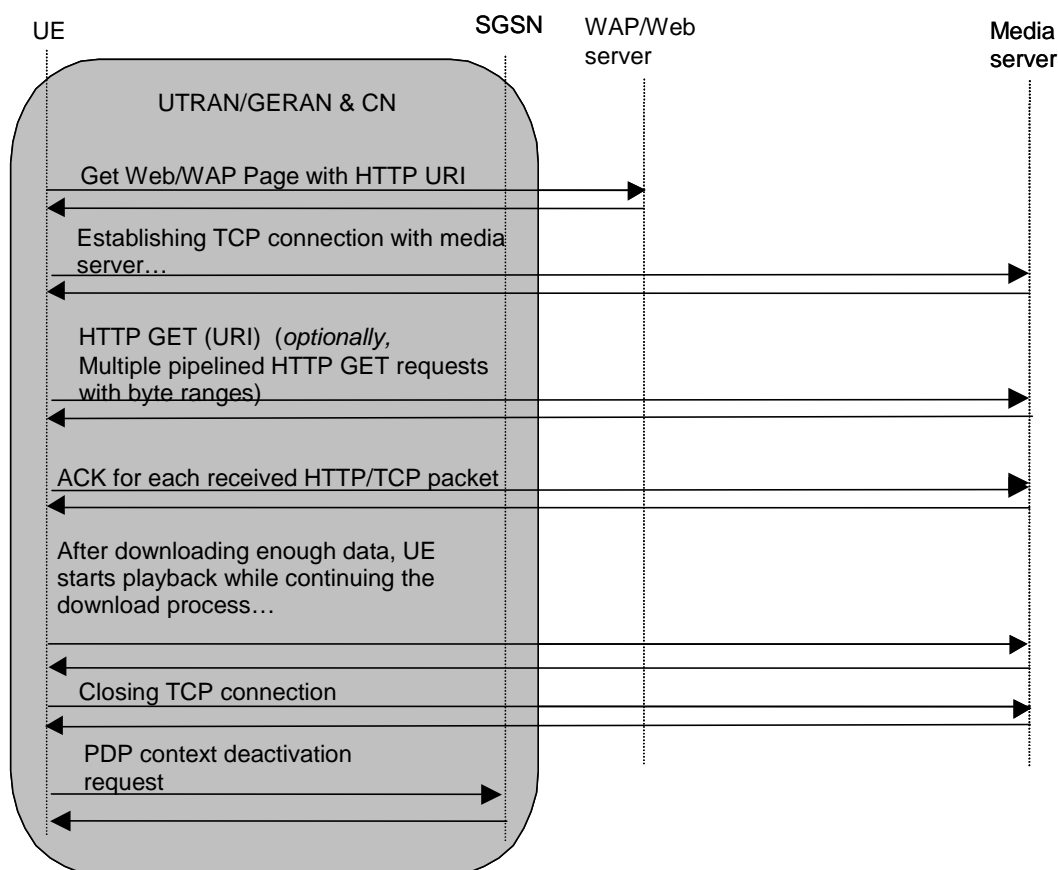

Figure 1c: Schematic view of Progressive Downloading Use Case

### 4.2.4 PSS with fast content switching (Release 7)

The Rel-7 of PSS improves user experience introducing procedures to allow faster start up and switching of content for both on-demand and live applications by reducing the client/server interactions to a minimum. Various general RTSP extensions are required for support of fast content start-up and switching. PSS clients are enabled to reuse the existing RTSP control session and RTP resources while switching to new content.

Release 7 also sees the introduction of DIMS [12]. Dynamic and Interactive Multimedia Scenes (DIMS) is a dynamic, interactive, scene-based media system which enables display and interactive control of multimedia data such as audio, video, graphics, images and text. It ranges from a movie enriched with vector graphic overlays and interactivity (possibly enhanced with closed captions), to complex multi-step services with fluid interaction/interactivity and different media types at each step.

## 4.2.5 IMS based PSS, PSS time-shifting and EPC (Release 8)

The 3GPP IP Multimedia Subsystem (IMS) enables the deployment of IP multimedia applications. PSS and MBMS User Services are IP multimedia services but they were specified before IMS. IMS brings enablers and features to operators and subscribers that can enhance the experience of PSS and MBMS User Services.

IMS based PSS architecture and protocols are specified in [11]. It describes the use of the IMS to initiate and control PSS and enables deployment of PSS as IMS services. This specification allows convergence with IMS based IPTV systems as specified by Open IPTV Forum and ETSI TISPAN.

Time shifting functionality is designed to enhance the access to live streaming sessions. For this reason, the PSS server maintains a time-shift buffer for each live feed. The server side timeshift buffer allows the PSS client to pause live sessions and even navigate (rewind, fast forward) in the offered time-shift buffer range. A timeshift supporting PSS client, which is connected to a timeshift supporting PSS server is able to perform some or all of the following operations on timeshifted streaming sessions:

- Pause and resume the playout at a later point in time
- Start playout from (or seek to) a position in the stream that corresponds to a past time instant in the live streaming session
- Perform operations such as Fast and Slow Forward or Rewind (i.e. Trick Mode).

From Rel-8 onward, when EPC/LTE is used then Secondary PDP Context Activation/Deactivation procedure is replaced by Dedicated Bearer establishment/Deactivation procedure [14].

## 4.2.6 Adaptive HTTP Streaming, Timed graphics (Release 9)

3GPP Adaptive HTTP-Streaming provides a streaming service. It enables delivering content from standard HTTP servers to an HTTP-Streaming client and enables caching content by standard HTTP caches. Figure 1d shows the architecture for Adaptive HTTP streaming.

The HTTP-Streaming Client has access to a Media Presentation Description (MPD). An MPD provides sufficient information for the HTTP-Streaming Client to provide a streaming service to the user by sequentially downloading media data from an HTTP server and rendering the included media appropriately.

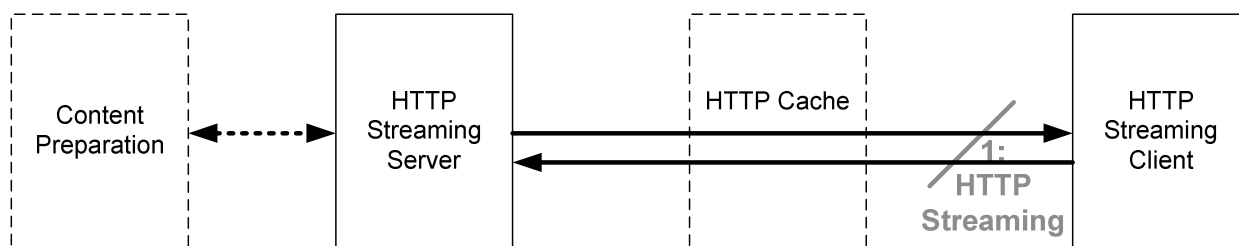

**Figure 1d System Architecture for Adaptive HTTP Streaming**

To initiate the streaming service to the user, the HTTP Streaming Client establishes a Media Presentation by downloading the relevant metadata and subsequently the media data.

The media presentation, protocols, the use of 3GP file format as media container format, the codecs, guidelines on the client behaviour and security related aspects are specified in [1]. The HTTP streaming file format extensions are defined in [7].

Timed graphics is a media type that enables advanced subtitle like services in parallel to video. It enables high quality text and graphics at a low cost. Timed Graphics is specified in [13].

In low bit-rate video, the areas which are often perceived as the worst are subtitles and graphics or tables (encoded as part of the video). Encoding subtitles as timed text instead of as part of the video can increase the perceived quality of the video substantially. Timed Text [4] solves the problem of subtitles and when used gives a perceptual quality much higher than encoding the text as part of the video stream. DIMS [5] allows the placement of vector graphics on top of video - but from an application perspective and requires DIMS to control the media. Timed Graphics works together with these abovementioned specifications, or independently, to enable better "video" quality.

## 4.2.7 Dynamic and Adaptive Streaming over HTTP (Releases 10 onwards)

3GPP Dynamic Adaptive Streaming over HTTP (3GP-DASH as specified in 3GPP TS 26.247 [15]) defines a streaming format from 3GPP Release 10 onwards. It enables delivering content from PSS Server including HTTP server to a PSS Client including a 3GP-DASH client and enables caching content by standard HTTP caches. Figure 1e shows the architecture for Adaptive HTTP streaming.

The PSS Client has access to a Media Presentation Description (MPD). An MPD provides sufficient information for the 3GP-DASH Client to provide a streaming service to the user by sequentially downloading media data from an HTTP server and rendering the included media appropriately.

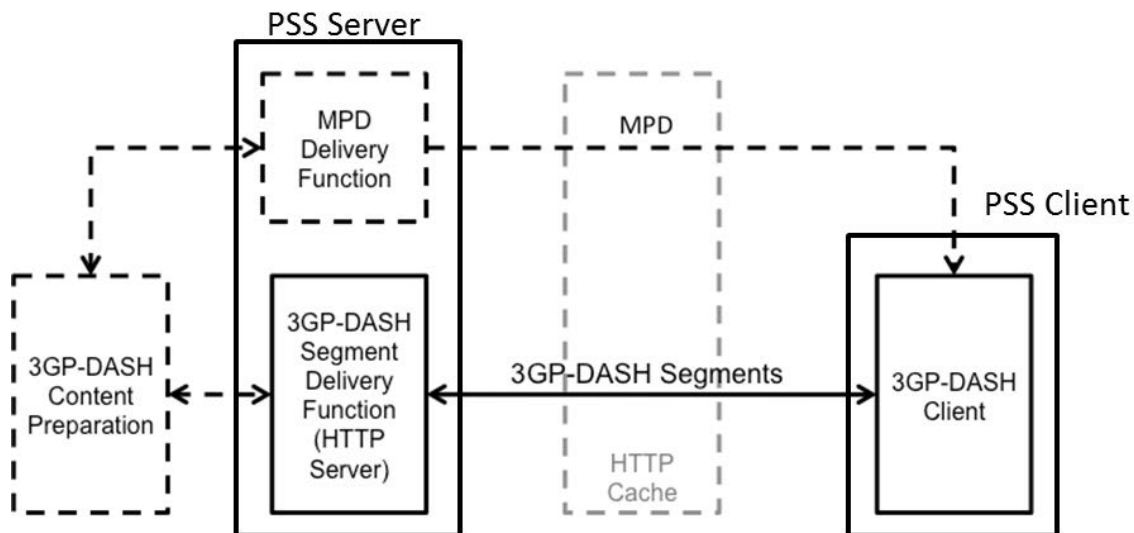

**Figure 1e System Architecture for Dynamic Adaptive Streaming over HTTP (3GP-DASH)**

To initiate the streaming service to the user, the 3GP-DASH Client establishes a Media Presentation by downloading the relevant metadata and subsequently the media data.

The media presentation, protocols, the use of 3GP file format as media container format, the codecs, guidelines on the client behaviour and security related aspects are specified in [15]. The 3GP-DASH file format extensions are defined in [15].

## 5 General service architecture

Figure 2a shows the most important service specific entities involved in a 3G packet-switched streaming service. A streaming service requires at least a content server and a streaming client. A streaming or download server is located behind the Gi interface. Additional components like portals, profile servers, caching servers and proxies located behind the Gi interface might be involved as well to provide additional services or to improve the overall service quality.

Portals are servers allowing convenient access to streamed media content. For instance, a portal might offer content browse and search facilities. In the simplest case, it is simply a (X)HTML/WAP-page with a list of links to streaming or downloadable content. The content itself is usually stored on content servers, which can be located elsewhere in the network.

User and device profile servers are used to store user preferences and device capabilities. This information can be used to control the presentation of streamed media content to a mobile user. A high-level illustration of the capability exchange framework can be seen in figure 3.

NOTE: specific user preference attributes have not yet been defined for PSS. The extensible device capability attributes allow specifying such attributes in the future releases.

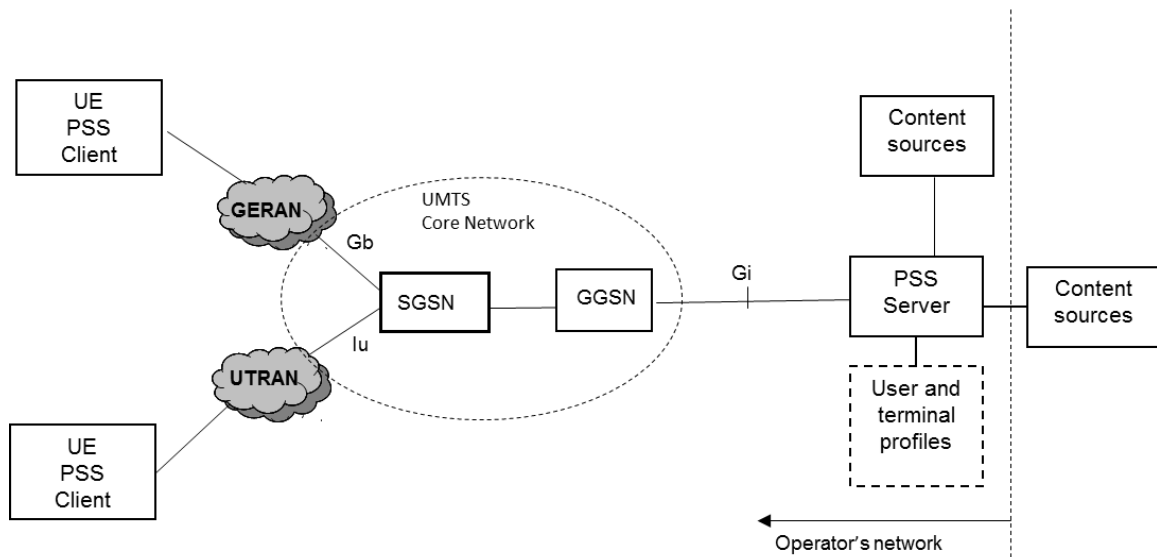

Figure 2a: Network elements involved in a 3G packet switched streaming service for GPRS core

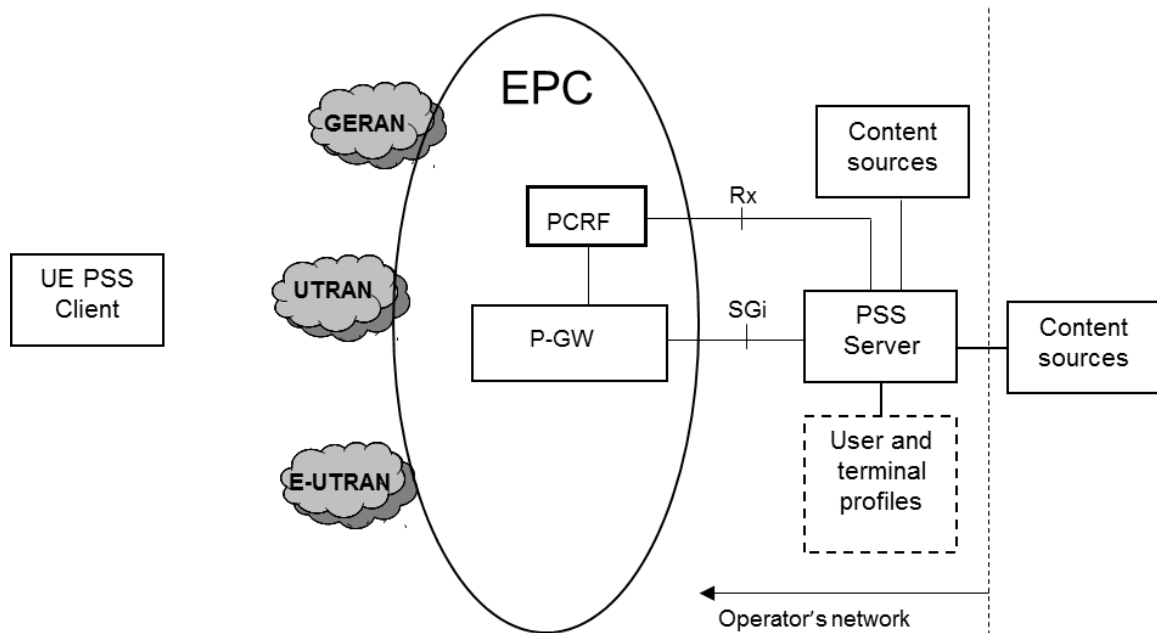
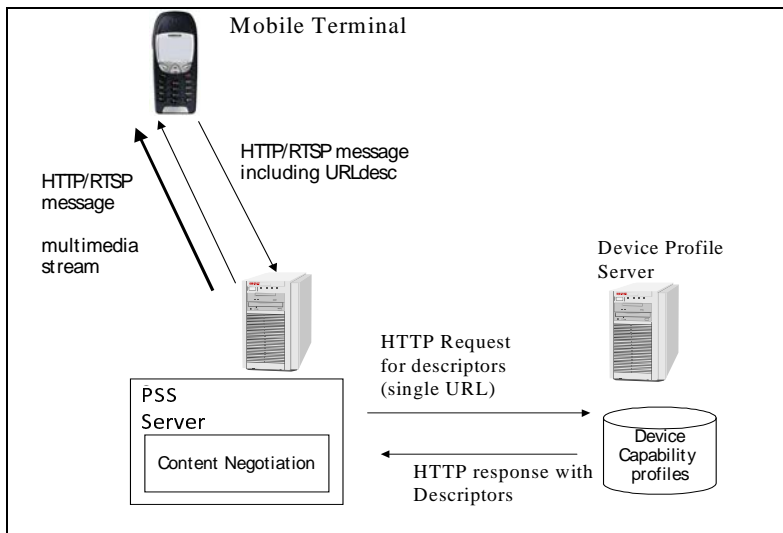

Figure 2b: Network elements involved in a 2G/3G and LTE packet switched streaming service for EPC core (see [14])



**Figure 3. Logical system architecture of the capability negotiation mechanism applied in PSS.**

## 6 Functional components of a PSS terminal

This clause lists the 3G packet-switched streaming service components, which belong to the terminal. Note that not all of the components are mandatory. The functional behaviour of the different components is discussed in the following.

### 6.1 Session protocols and data transport

Protocols are needed for PSS session establishment, session set-up, capability exchange, session control, scene description, and data transport of streaming media and other data. The PSS protocols to be used are specified in [1].

Note that for the simple streaming case defined in clause 4.2.1, no specific capability exchange protocol in addition to the session description mechanism is required. In Release 6, capability exchange can easily be separated to streaming, progressive download and scene description (SMIL) specific capabilities.

The normative part of device capability and user preference profile exchange mechanism is defined in clause 5.2 and Annex F of [1]. An informative part is included in Annex A.4 of [1].

In Release 6 the RTP transport defined in clause 6.2 of [1] supports a payload format for RTP retransmission and streaming of timed text content.

### 6.2 Codecs

Decoders are needed for speech, natural and synthetic audio, video, still images, bitmap graphics, vector graphics and static and timed text [8]. The codecs to be used are specified in [1].

### 6.3 Adaptation of continuous media (Releases 6, 9 and 10)

PSS Release 6 includes a number of protocols and functionalities that can be utilized to allow the PSS session to adapt transmission and content rates to the available network resources. The goal of this is of course to achieve highest possible quality of experience for the end-user with the available resources, while maintaining interrupt-free playback of the media. This requires that the available network resources are estimated and that transmission rates are adapted to the available network link rates. This can prevent overflowing network buffers and thereby avoid packet losses. The real-time properties of the transmitted media must be considered so that media does not arrive too late to be useful. This will require that media content rate is adapted to the transmission rate.

To avoid buffer overflows, resulting in that the client must discard useful data, while still allowing the server to deliver as much data as possible into the client buffer, a functionality for client buffer feedback is defined within clauses 5.3.2,

5.3.3 and 6.2 of [1]. This allows the server to closely monitor the buffering situation on the client side and to do what it is capable in order to avoid client buffer underflow.

The client specifies how much buffer space the server can utilise and the desired target level of protection with aid of new RTSP signalling defined in clause 5.3.2.2 . When the desired level of protection is achieved, the server may utilise any resources beyond what is needed to maintain that protection level to increase the quality of the media. The server can also utilise the buffer feedback information to decide if the media quality needs to be lowered in order to avoid a buffer underflow and the resulting play-back interruption.

PSS Release-9 Adaptive HTTP Streaming includes bit-rate adaptation driven by the client and based on available alternative Representations of media content.

PSS Release-10 onwards 3GP-DASH enables delivering continuous media content over Hypertext Transfer Protocol (HTTP) in a sense that all resources that compose the service are accessible through HTTP-URLs and the HTTP/1.1 protocol as specified in RFC 2616 [9]. 3GP-DASH includes bit-rate adaptation driven by the client and based on available alternative Representations of media content.

---

## 7 File format

The file format is an important element of the content manipulation chain. Conceptually, there is a difference between the coding format and the file format. The coding format is related to the action of a specific coding algorithm that codes the content information into a codestream. The file format is instead a way of organising the prestored codestream in such way that it can be accessed for local decoding and playback, or transferred as a file on different media, or streamed over different transport. Some file formats are optimised for one or more of these functions, others aim instead at achieving a higher flexibility.

When a single media type is involved, the coding and the file format are often considered, and referred to, as a single entity. When multimedia information is involved, instead, it is appropriate to maintain, at least conceptually, the distinction between these two instances. The file format can play an important role in facilitating the organisation and the access to the coded information, independently of the specific coding formats.

The basic profile, as defined in clause 5.4.3 of the 3GPP File Format specification [7], specifies how the 3GPP MMS [3] shall utilise a file format. The format establishes a standardised content transport for audio-visual content between MMS elements. It also allows the delivery of the content to the recipient both as a file download or through streaming. A priori knowledge of the delivery mechanism is not needed when the message is created. See also clause 8.2.

In addition to basic profile, [7] defines several file profiles:

- The general profile is a superset of all other profiles. It provides a generic umbrella, which covers all 3GP files.
- The streaming-server profile is used in PSS and defines the conformance level of a server-side 3GP file, which contains specific information related to PSS streaming as well as streaming-server extensions as defined in clause 7 of [7].
- The progressive-download profile defines the conformance level of a progressively downloadable 3GP file within the PSS context.
- The extended-presentation profile enables a 3GP file to carry any kind of multimedia presentation composed of tracks, media files and a scene description.
- The media stream recording profile is used to label 3GP files that contain recordings of multimedia streams e.g. from a PSS session.
- The file-delivery server profile guarantees interoperability between content creation tools and file delivery servers.
- The adaptive-streaming profile is used to label 3GP files that are primarily suitable for adaptive file-based streaming.
- Media Segment Profile is used to label segments for adaptive file-based streaming.

[7] also defines the file format-level registration mechanism of the non-ISO based codecs in clause 6.

As part of the DRM commitment, clause 10 of [7] defines how encrypted content is to be stored in a 3GP file.

---

## 8 Interworking with other core network services

### 8.1 Interworking with WAP

Not required. As shown in Figure 1 the service may be initiated by an URI or a SDP file received via WAP.

### 8.2 Interworking with MMS

TS 23.140 [4] defines a new optional feature for the MMS, which enables streaming of the MMS messages by the message recipient. The MMS streaming option uses the codecs and protocols in accordance with TS 26.234 [1].

Additionally, [4] mandates the use of the interchange format recommendation specified in 3GPP TS 26.244 [7], clause 5.4.3 for MMS purposes.

### 8.3 Interworking with charging/billing services

Interworking with charging/billing services can be part of a future release of PSS.

---

## 9 Security

Security has been greatly enhanced in Release 6 of PSS. Streamed and downloaded content may be encrypted and protected for integrity while in transport. Release 6 supports transport-level integrity protection and content-level encryption, which may be applied at content creation time, making sure that content is protected for confidentiality at all times. A high level of security for the purpose of protecting commercial content can be achieved by using a Digital Rights Management framework. The component-based design provides maximum flexibility for building security features into services.

---

## 10 Digital Rights Management (Release 6)

The Release 6 of PSS adds support for streaming and downloading of encrypted content, as well as co-operation with key management systems governing access to cryptographic keys required for playback. Encryption is supported in all file format profiles and additional meta-information is used to carry key management system specific parameters. Streaming supports protected payloads and SDP attributes for signalling DRM information. 3GPP has worked together with OMA for supporting the OMA DRM Release 2.0 [10] in Release 6 of PSS and file format, while keeping the formats open for using other key management systems in a later phase. The OMA DRM Release 2.0 is an open standard, which is enjoying a substantial commitment from the mobile and content industries and 3GPP Release 6 is building on this momentum.



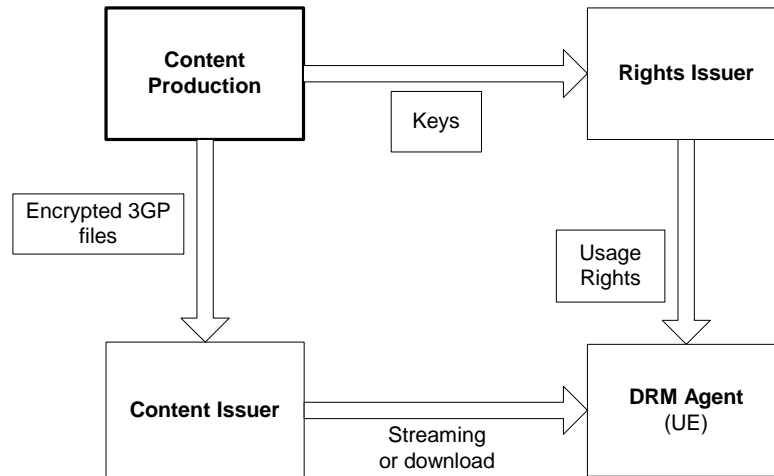

**Figure 4: OMA DRM system architecture**

The OMA DRM Release 2.0 is based on Public Key Infrastructure (PKI) and strong cryptographic algorithms to provide a high level of security for commercial content. It is an end-to-end system architecture with roles and trust relationships, providing flexible and robust components to be integrated to services. Main features include content superdistribution, preview, subscription, export and user domains support, which enable many different business models and good user experience.

OMA DRM 2.0 system consists of a Rights Issuer, Content Issuer and a DRM Agent (typically one per device). A Rights Issuer is responsible for setting usage permissions and authorising devices with keys, Content Issuer is typically a download or streaming service, and DRM Agent is responsible for enforcing the set of Rights expressed for a piece of content. When combined with PSS Release 6, content in 3GP files is pre-encrypted at a production facility, delivered through a download or streaming service to a device, and during delivery or playback, the OMA DRM Agent in the device handles authorisation by acquiring Rights from a Rights Issuer.

## Annex A (informative): Change history

Change history							
Date	TSG SA#	TSG Doc.	CR	R ev	Subject/Comment	Old	New
03-2001	11	SP-010093			Version for Release 4		4.0.0
12-2001	14	SP-010702	001	1	Correction of RTSP TEARDOWN protocol flow in Figure 1	4.0.0	4.1.0
03-2002	15	SP-020085	002	1	Correction of missing use case example: PSS service activation via MMS	4.1.0	4.2.0
03-2002	15	SP-020086	003		Consolidated addition of Release 5 PSS-E features to TS 26.233 Rel-4	4.2.0	5.0.0
09-2004	25	SP-040651	005	1	Addition of Release 6 functionality	5.0.0	6.0.0
06-2007	36				Version for Release 7	6.0.0	7.0.0
12-2008	42				Version for Release 8	7.0.0	8.0.0
12-2009	46				Version for Release 9	8.0.0	9.0.0
03-2011	51				Version for Release 10	9.0.0	10.0.0
06-2011	52	SP-110303	0007	1	Inclusion of LTE/EPC and Rel-7 to Rel-9 features in PSS General Description	10.0.0	10.1.0
12-2013	62	SP-130565	0009	1	Missing PSS Server Description	10.1.0	10.2.0

---

## History

<b>Document history</b>		
V10.0.0	April 2011	Publication
V10.1.0	June 2011	Publication
V10.2.0	January 2014	Publication