

ETSI TS 129 002 V5.12.0 (2006-06)

Technical Specification

**Digital cellular telecommunications system (Phase 2+);
Universal Mobile Telecommunications System (UMTS);
Mobile Application Part (MAP) specification
(3GPP TS 29.002 version 5.12.0 Release 5)**



Reference

RTS/TSGC-0429002v5c0

Keywords

GSM, UMTS

ETSI

650 Route des Lucioles
F-06921 Sophia Antipolis Cedex - FRANCE

Tel.: +33 4 92 94 42 00 Fax: +33 4 93 65 47 16

Siret N° 348 623 562 00017 - NAF 742 C
Association à but non lucratif enregistrée à la
Sous-Préfecture de Grasse (06) N° 7803/88

Important notice

Individual copies of the present document can be downloaded from:

<http://www.etsi.org>

The present document may be made available in more than one electronic version or in print. In any case of existing or perceived difference in contents between such versions, the reference version is the Portable Document Format (PDF). In case of dispute, the reference shall be the printing on ETSI printers of the PDF version kept on a specific network drive within ETSI Secretariat.

Users of the present document should be aware that the document may be subject to revision or change of status. Information on the current status of this and other ETSI documents is available at

<http://portal.etsi.org/tb/status/status.asp>

If you find errors in the present document, please send your comment to one of the following services:

http://portal.etsi.org/chaicor/ETSI_support.asp

Copyright Notification

No part may be reproduced except as authorized by written permission.
The copyright and the foregoing restriction extend to reproduction in all media.

© European Telecommunications Standards Institute 2006.
All rights reserved.

DECT™, PLUGTESTS™ and UMTS™ are Trade Marks of ETSI registered for the benefit of its Members.
TIPHON™ and the TIPHON logo are Trade Marks currently being registered by ETSI for the benefit of its Members.
3GPP™ is a Trade Mark of ETSI registered for the benefit of its Members and of the 3GPP Organizational Partners.

Intellectual Property Rights

IPRs essential or potentially essential to the present document may have been declared to ETSI. The information pertaining to these essential IPRs, if any, is publicly available for **ETSI members and non-members**, and can be found in ETSI SR 000 314: "*Intellectual Property Rights (IPRs); Essential, or potentially Essential, IPRs notified to ETSI in respect of ETSI standards*", which is available from the ETSI Secretariat. Latest updates are available on the ETSI Web server (<http://webapp.etsi.org/IPR/home.asp>).

Pursuant to the ETSI IPR Policy, no investigation, including IPR searches, has been carried out by ETSI. No guarantee can be given as to the existence of other IPRs not referenced in ETSI SR 000 314 (or the updates on the ETSI Web server) which are, or may be, or may become, essential to the present document.

Foreword

This Technical Specification (TS) has been produced by ETSI 3rd Generation Partnership Project (3GPP).

The present document may refer to technical specifications or reports using their 3GPP identities, UMTS identities or GSM identities. These should be interpreted as being references to the corresponding ETSI deliverables.

The cross reference between GSM, UMTS, 3GPP and ETSI identities can be found under <http://webapp.etsi.org/key/queryform.asp>.

Contents

Intellectual Property Rights	2
Foreword.....	2
Foreword.....	25
1 Scope	26
2 References	26
3 Abbreviations	31
4 Void.....	32
5 Overload and compatibility overview	32
5.1 Overload control.....	32
5.1.1 Overload control for MSC (outside MAP)	32
5.1.2 Overload control for MAP entities	32
5.1.3 Congestion control for Signalling System No. 7	36
5.2 Compatibility.....	36
5.2.1 General.....	36
5.2.2 Strategy for selecting the Application Context (AC) version	36
5.2.2.1 Proposed method.....	36
5.2.2.2 Managing the version look-up table.....	37
5.2.2.3 Optimising the method.....	38
6 Requirements concerning the use of SCCP and TC	38
6.1 Use of SCCP.....	38
6.1.1 SCCP Class	38
6.1.2 Sub-System Number (SSN)	38
6.1.3 SCCP addressing	39
6.1.3.1 Introduction	39
6.1.3.2 The Mobile-services Switching Centre (MSC)	41
6.1.3.2.1 MSC interaction during handover or relocation	41
6.1.3.2.2 MSC for short message routing	41
6.1.3.2.3 MSC for location request routing	41
6.1.3.2.4 MSC for LMU Control	41
6.1.3.3 The Home Location Register (HLR).....	41
6.1.3.3.1 During call set-up	41
6.1.3.3.2 Before location updating completion.....	42
6.1.3.3.3 After location updating completion	42
6.1.3.3.4 VLR restoration	43
6.1.3.3.5 During Network-Requested PDP Context Activation	43
6.1.3.3.6 Before GPRS location updating completion.....	43
6.1.3.3.7 After GPRS location updating completion	44
6.1.3.3.8 Query for a Location Request.....	44
6.1.3.4 The Visitor Location Register (VLR)	44
6.1.3.4.1 Inter-VLR information retrieval	44
6.1.3.4.2 HLR request	44
6.1.3.5 The Interworking MSC (IWMSC) for Short Message Service	44
6.1.3.6 The Equipment Identity Register (EIR)	44
6.1.3.7 The Shared Inter Working Function (SIWF)	45
6.1.3.8 The Serving GPRS Support Node (SGSN)	45
6.1.3.9 The Gateway GPRS Support Node (GGSN).....	45
6.1.3.10 The Gateway MSC (GMSC) for Short Message Service	45
6.1.3.10A Void.....	45
6.1.3.10A.1 Void.....	45
6.1.3.10A.2 Void.....	45
6.1.3.10B The Gateway Mobile Location Centre (GMLC)	45
6.1.3.11 Summary table	45

6.2	Use of TC	48
7	General on MAP services.....	48
7.1	Terminology and definitions	48
7.2	Modelling principles.....	48
7.3	Common MAP services.....	49
7.3.1	MAP-OPEN service.....	50
7.3.2	MAP-CLOSE service	53
7.3.3	MAP-DELIMITER service.....	53
7.3.4	MAP-U-ABORT service	53
7.3.5	MAP-P-ABORT service	54
7.3.6	MAP-NOTICE service	55
7.3.7	void	56
7.3.8	void	56
7.3.9	void	56
7.3.10	void	56
7.4	Sequencing of services	56
7.5	General rules for mapping of services onto TC.....	57
7.5.1	Mapping of common services.....	57
7.5.2	Mapping of user specific services.....	58
7.6	Definition of parameters.....	59
7.6.1	Common parameters	61
7.6.1.1	Invoke Id	61
7.6.1.2	Linked Id	61
7.6.1.3	Provider error	61
7.6.1.4	User error	62
7.6.2	Numbering and identification parameters.....	65
7.6.2.1	IMSI	65
7.6.2.2	TMSI.....	65
7.6.2.3	IMEI.....	65
7.6.2.3a	IMEISV	65
7.6.2.4	Previous location area Id	65
7.6.2.5	Stored location area Id	66
7.6.2.6	Current location area Id.....	66
7.6.2.7	Target location area Id	66
7.6.2.8	Target cell Id	66
7.6.2.8A	Target RNC Id.....	66
7.6.2.9	Void.....	66
7.6.2.10	Originating entity number	66
7.6.2.11	MSC number	66
7.6.2.12	Target MSC number.....	66
7.6.2.13	HLR number	66
7.6.2.14	VLR number	66
7.6.2.15	HLR Id	66
7.6.2.16	LMSI.....	66
7.6.2.17	MS ISDN	66
7.6.2.18	OMC Id	67
7.6.2.19	Roaming number.....	67
7.6.2.19A	Relocation Number List	67
7.6.2.20	Void.....	67
7.6.2.21	Handover number.....	67
7.6.2.22	Forwarded-to number.....	67
7.6.2.22A	Long forwarded-to number	67
7.6.2.22B	Long FTN Supported	67
7.6.2.23	Forwarded-to subaddress	67
7.6.2.24	Called number	67
7.6.2.25	Calling number.....	67
7.6.2.26	Originally dialled number	67
7.6.2.27	Service centre address	67
7.6.2.28	Zone Code	67
7.6.2.29	MSISdn-Alert	68
7.6.2.30	Location Information	68

7.6.2.30a	Location Information for GPRS	68
7.6.2.31	GMSC Address	68
7.6.2.32	VMSC Address	68
7.6.2.33	Group Id	68
7.6.2.34	North American Equal Access preferred Carrier Id	68
7.6.2.35	SIWFS Number	68
7.6.2.36	B-subscriber address	68
7.6.2.37	Serving cell Id	68
7.6.2.38	SGSN number	68
7.6.2.39	SGSN address	68
7.6.2.40	GGSN address	69
7.6.2.41	GGSN number	69
7.6.2.42	APN	69
7.6.2.43	Network Node number	69
7.6.2.44	PDP-Type	69
7.6.2.45	PDP-Address	69
7.6.2.46	Additional number	69
7.6.2.47	P-TMSI	69
7.6.2.48	B-subscriber number	69
7.6.2.49	B-subscriber subaddress	69
7.6.2.50	LMU Number	69
7.6.2.51	MLC Number	69
7.6.2.52	Multicall Bearer Information	69
7.6.2.53	Multiple Bearer Requested	69
7.6.2.54	Multiple Bearer Not Supported	70
7.6.2.55	PDP-Charging Characteristics	70
7.6.2.56	Selected RAB ID	70
7.6.2.57	RAB ID	70
7.6.2.58	gsmSCF Address	70
7.6.2.59	Routeing Number	70
7.6.3	Subscriber management parameters	70
7.6.3.1	Category	70
7.6.3.2	Equipment status	70
7.6.3.2a	BMUEF	70
7.6.3.3	Extensible Bearer service	70
7.6.3.4	Extensible Teleservice	70
7.6.3.5	Extensible Basic Service Group	71
7.6.3.6	GSM bearer capability	71
7.6.3.7	Subscriber Status	71
7.6.3.8	CUG Outgoing Access indicator	71
7.6.3.9	Operator Determined Barring General Data	71
7.6.3.10	ODB HPLMN Specific Data	73
7.6.3.11	Regional Subscription Data	73
7.6.3.12	Regional Subscription Response	73
7.6.3.13	Roaming Restriction Due To Unsupported Feature	74
7.6.3.14	Extensible SS-Info	74
7.6.3.15	Extensible forwarding information	74
7.6.3.16	Extensible forwarding feature	74
7.6.3.17	Extensible SS-Status	74
7.6.3.18	Extensible Forwarding Options	74
7.6.3.19	Extensible No reply condition timer	75
7.6.3.20	Extensible Call barring information	75
7.6.3.21	Extensible Call barring feature	75
7.6.3.22	CUG info	75
7.6.3.23	CUG subscription	75
7.6.3.24	CUG interlock	75
7.6.3.25	CUG index	76
7.6.3.26	CUG feature	76
7.6.3.27	Inter CUG options	76
7.6.3.28	Intra CUG restrictions	76
7.6.3.29	Extensible SS-Data	76
7.6.3.30	Subscriber State	76

7.6.3.31	Requested Info	77
7.6.3.31A	Requested Domain	77
7.6.3.32	Suppression of Announcement.....	77
7.6.3.33	Suppress T-CSI	77
7.6.3.34	GMSC CAMEL Subscription Info.....	77
7.6.3.35	VLR CAMEL Subscription Info	77
7.6.3.36	Supported CAMEL Phases in the VLR.....	77
7.6.3.36A	Supported CAMEL Phases in the SGSN	77
7.6.3.36B	Offered CAMEL4 CSIs in the VLR.....	77
7.6.3.36C	Offered CAMEL4 CSIs in the SGSN	77
7.6.3.36D	Offered CAMEL4 CSIs.....	77
7.6.3.36E	Offered CAMEL4 CSIs in interrogating node	77
7.6.3.36F	Offered CAMEL4 CSIs in VMSC	78
7.6.3.36G	Offered CAMEL4 Functionalities.....	78
7.6.3.36H	Supported CAMEL Phases	78
7.6.3.36I	Supported CAMEL Phases in interrogating node	78
7.6.3.37	CUG Subscription Flag	78
7.6.3.38	CAMEL Subscription Info Withdraw	78
7.6.3.39	Voice Group Call Service (VGCS) Data.....	78
7.6.3.40	Voice Broadcast Service (VBS) Data	78
7.6.3.41	ISDN bearer capability.....	78
7.6.3.42	Lower layer Compatibility	78
7.6.3.43	High Layer Compatibility	78
7.6.3.44	Alerting Pattern	78
7.6.3.45	GPRS Subscription Data Withdraw	78
7.6.3.46	GPRS Subscription Data	79
7.6.3.47	QoS-Subscribed	79
7.6.3.48	VPLMN address allowed	79
7.6.3.49	Roaming Restricted In SGSN Due To Unsupported Feature	79
7.6.3.50	Network Access Mode	79
7.6.3.51	Mobile Not Reachable Reason.....	79
7.6.3.52	Cancellation Type	79
7.6.3.53	All GPRS Data	79
7.6.3.54	Complete Data List Included.....	79
7.6.3.55	PDP Context Identifier.....	79
7.6.3.56	LSA Information	79
7.6.3.57	SoLSA support indicator.....	79
7.6.3.58	LSA Information Withdraw	79
7.6.3.59	LMU Indicator	80
7.6.3.60	LCS Information	80
7.6.3.61	GMLC List.....	80
7.6.3.62	LCS Privacy Exception List.....	80
7.6.3.62A	Additional LCS Privacy Exception List.....	80
7.6.3.63	LCS Privacy Exception Parameters	80
7.6.3.64	External Client List	81
7.6.3.65	Internal Client List	81
7.6.3.65A	MO-LR List.....	81
7.6.3.65B	Privacy Notification to MS User.....	81
7.6.3.65C	GMLC List Withdraw	81
7.6.3.65D	Service Type List	81
7.6.3.66	IST Alert Timer.....	81
7.6.3.67	Call Termination Indicator.....	81
7.6.3.68	IST Information Withdraw.....	81
7.6.3.69	IST Support Indicator.....	81
7.6.3.70	Super-Charger Supported In HLR.....	82
7.6.3.71	Super-Charger Supported In Serving Network Entity.....	82
7.6.3.72	Age Indicator.....	82
7.6.3.73	GPRS enhancements support indicator	82
7.6.3.74	Extension QoS-Subscribed.....	82
7.6.3.75	SGSN CAMEL Subscription Info	82
7.6.3.76	MO-SMS-CSI	82
7.6.3.76a	MT-SMS-CSI.....	82

7.6.3.77	GPRS-CSI	82
7.6.3.78	CAMEL subscription info	82
7.6.3.83	Call Barring Data	83
7.6.3.84	Call Forwarding Data	83
7.6.3.85	ODB Data	83
7.6.3.86	Requested Subscription Info	83
7.6.3.87	CS Allocation/Retention priority	83
7.6.3.88	ODB Info	83
7.6.3.89	Suppress VT-CSI	83
7.6.3.90	Suppress Incoming Call Barring	84
7.6.3.91	gsmSCF Initiated Call	84
7.6.3.92	MNP Requested Info	84
7.6.3.93	MNP Info Result	84
7.6.3.94	Allowed Services	84
7.6.3.95	Unavailability Cause	84
7.6.3.96	Extension-2 QoS-Subscribed	84
7.6.4	Supplementary services parameters	84
7.6.4.1	SS-Code	84
7.6.4.1A	SS-Code 2	85
7.6.4.2	SS-Status	85
7.6.4.3	SS-Data	85
7.6.4.4	Override Category	85
7.6.4.5	CLI Restriction Option	86
7.6.4.6	Forwarding Options	86
7.6.4.7	No reply condition timer	86
7.6.4.8 - 7.6.4.14	Void	86
7.6.4.15	Forwarding information	86
7.6.4.16	Forwarding feature	86
7.6.4.17	Void	87
7.6.4.18	Call barring information	87
7.6.4.19	Call barring feature	87
7.6.4.20	New password	87
7.6.4.21	Current password	87
7.6.4.22	Guidance information	87
7.6.4.23	Void	87
7.6.4.24	SS-Info	87
7.6.4.25 - 7.6.4.35	Void	88
7.6.4.36	USSD Data Coding Scheme	88
7.6.4.37	USSD String	88
7.6.4.38	Bearer service	88
7.6.4.38A	Bearer Service 2	88
7.6.4.39	Teleservice	88
7.6.4.40	Basic Service Group	88
7.6.4.39A	Teleservice 2	88
7.6.4.41	eMLPP information	88
7.6.4.42	SS-event	89
7.6.4.43	SS-event data	89
7.6.4.44	LCS Privacy Exceptions	89
7.6.4.45	Mobile Originating Location Request (MO-LR)	89
7.6.4.46	NbrUser	89
7.6.4.47	MC Subscription Data	89
7.6.4.48	MC Information	90
7.6.4.49	CCBS Request State	90
7.6.4.50	Basic Service Group 2	90
7.6.5	Call parameters	90
7.6.5.1	Call reference number	90
7.6.5.2	Interrogation type	90
7.6.5.3	OR interrogation	90
7.6.5.4	OR capability	90
7.6.5.5	Forwarding reason	91
7.6.5.6	Forwarding interrogation required	91
7.6.5.7	O-CSI	91

7.6.5.7A	D-CSI	91
7.6.5.7B	T-CSI	91
7.6.5.7C	VT-CSI	91
7.6.5.7D	O-IM-CSI	91
7.6.5.7E	D-IM-CSI	91
7.6.5.7F	VT-IM-CSI	91
7.6.5.8	Call Direction	91
7.6.5.9	Channel Type	91
7.6.5.10	Chosen Channel	92
7.6.5.11	CCBS Feature	92
7.6.5.12	UU Data	92
7.6.5.14	Number Portability Status	92
7.6.5.15	Pre-paging supported	92
7.6.6	Radio parameters	92
7.6.6.1 - 7.6.6.3	Void	92
7.6.6.4	GERAN Classmark	92
7.6.6.5	BSSMAP Service Handover	92
7.6.6.5A	BSSMAP Service Handover List	92
7.6.6.6	RANAP Service Handover	92
7.6.6.7	HO-Number Not Required	93
7.6.6.8	Integrity Protection Information	93
7.6.6.9	Encryption Information	93
7.6.6.10	Radio Resource Information	93
7.6.6.10A	Radio Resource List	93
7.6.6.10B	Chosen Radio Resource Information	93
7.6.6.11	Key Status	93
7.6.6.12	Selected UMTS Algorithms	93
7.6.6.13	Allowed GSM Algorithms	93
7.6.6.14	Allowed UMTS Algorithms	93
7.6.6.15	Selected GSM Algorithm	93
7.6.6.16	Iu-Currently Used Codec	93
7.6.6.17	IuSupported Codecs List	93
7.6.6.17A	Iu-Available Codecs List	94
7.6.6.18	Iu-Selected Codec	94
7.6.6.19	RAB Configuration Indicator	94
7.6.6.20	UESBI-Iu	94
7.6.7	Authentication parameters	94
7.6.7.1	Authentication set list	94
7.6.7.2	Rand	94
7.6.7.3	Sres	94
7.6.7.4	Kc	94
7.6.7.5	Xres	94
7.6.7.5A	Ck	94
7.6.7.5B	Ik	94
7.6.7.5C	Autn	94
7.6.7.6	Cksn	95
7.6.7.6A	Ksi	95
7.6.7.6B	Auts	95
7.6.7.7	Ciphering mode	95
7.6.7.8	Current Security Context	95
7.6.7.9	Failure cause	95
7.6.7.10	Re-attempt	95
7.6.7.11	Access Type	95
7.6.8	Short message parameters	95
7.6.8.1	SM-RP-DA	95
7.6.8.2	SM-RP-OA	96
7.6.8.3	MWD status	96
7.6.8.4	SM-RP-UI	96
7.6.8.5	SM-RP-PRI	96
7.6.8.6	SM Delivery Outcome	96
7.6.8.7	More Messages To Send	96
7.6.8.8	Alert Reason	96

7.6.8.9	Absent Subscriber Diagnostic SM	96
7.6.8.10	Alert Reason Indicator	96
7.6.8.11	Additional SM Delivery Outcome	96
7.6.8.12	Additional Absent Subscriber Diagnostic SM	97
7.6.8.13	Delivery Outcome Indicator.....	97
7.6.8.14	GPRS Node Indicator.....	97
7.6.8.15	GPRS Support Indicator.....	97
7.6.8.16	SM-RP-MTI.....	97
7.6.8.17	SM-RP-SMEA	97
7.6.9	Access and signalling system related parameters	97
7.6.9.1	AN-apdu.....	97
7.6.9.2	CM service type	97
7.6.9.3	Access connection status.....	98
7.6.9.4	External Signal Information.....	98
7.6.9.5	Access signalling information.....	98
7.6.9.6	Location update type.....	98
7.6.9.7	Protocol ID.....	98
7.6.9.8	Network signal information	98
7.6.9.8A	Network signal information 2	99
7.6.9.9	Call Info	99
7.6.9.10	Additional signal info.....	99
7.6.10	System operations parameters.....	100
7.6.10.1	Network resources.....	100
7.6.10.2	Trace reference.....	100
7.6.10.3	Trace type.....	100
7.6.11	Location Service Parameters.....	100
7.6.11.1	Age of Location Estimate.....	100
7.6.11.2	Deferred MT-LR Response Indicator.....	100
7.6.11.3	Deferred MT-LR Data.....	100
7.6.11.4	LCS Client ID	100
7.6.11.5	LCS Event	100
7.6.11.7	LCS Priority	101
7.6.11.8	LCS QoS	101
7.6.11.9	CS LCS Not Supported by UE.....	101
7.6.11.10	PS LCS Not Supported by UE	101
7.6.11.11	Location Estimate	101
7.6.11.11A	GERAN Positioning Data	101
7.6.11.11B	UTRAN Positioning Data	102
7.6.11.12	Location Type	102
7.6.11.13	NA-ESRD	102
7.6.11.14	NA-ESRK	102
7.6.11.15	LCS Service Type Id.....	102
7.6.11.16	Privacy Override	102
7.6.11.17	Supported LCS Capability Sets.....	102
7.6.11.18	LCS Codeword.....	102
7.6.11.19	NA-ESRK Request.....	102
7.6.11.20	Supported GAD Shapes	102
7.6.11.21	Additional Location Estimate.....	103
7.6.11.22	Void.....	103
7.6.11.23	LCS-Reference Number	103
7.6.12	void	103
7.7	Representation of a list of a basic parameter in service-primitives	103
8	Mobility services	104
8.1	Location management services.....	104
8.1.1	Void	104
8.1.1.1	Void.....	104
8.1.1.2	Void.....	104
8.1.1.3	Void.....	104
8.1.2	MAP_UPDATE_LOCATION service	104
8.1.2.1	Definition	104
8.1.2.2	Service primitives	104

8.1.2.3	Parameter definitions and use	104
8.1.3	MAP_CANCEL_LOCATION service	106
8.1.3.1	Definition	106
8.1.3.2	Service primitives	106
8.1.3.3	Parameter definitions and use	106
8.1.4	MAP_SEND_IDENTIFICATION service	107
8.1.4.1	Definition	107
8.1.4.2	Service primitives	107
8.1.4.3	Parameter definitions and use	107
8.1.5	Void	108
8.1.5.1	Void.....	108
8.1.5.2	Void.....	108
8.1.5.3	Void.....	108
8.1.6	MAP_PURGE_MS service.....	108
8.1.6.1	Definition	108
8.1.6.2	Service primitives	109
8.1.6.3	Parameter definitions and use	109
8.1.7	MAP_UPDATE_GPRS_LOCATION service	110
8.1.7.1	Definition	110
8.1.7.2	Service primitives	110
8.1.7.3	Parameter definitions and use	110
8.1.8	MAP-NOTE-MM-EVENT	112
8.1.8.1	Definition	112
8.1.8.2	Service primitives	112
8.1.8.3	Parameter use	112
8.2	Paging and search.....	113
8.2.1	MAP_PAGE service	113
8.2.1.1	Definition	113
8.2.1.2	Service primitives	113
8.2.1.3	Parameter definitions and use	114
8.2.2	MAP_SEARCH_FOR_MS service	114
8.2.2.1	Definition	114
8.2.2.2	Service primitives	114
8.2.2.3	Parameter definitions and use	115
8.3	Access management services	115
8.3.1	MAP_PROCESS_ACCESS_REQUEST service	115
8.3.1.1	Definition	115
8.3.1.2	Service primitives	115
8.3.1.3	Parameter definitions and use	116
8.4	Handover services	117
8.4.1	MAP_PREPARE_HANDOVER service.....	117
8.4.1.1	Definition	117
8.4.1.2	Service primitives	117
8.4.1.3	Parameter use	118
8.4.2	MAP_SEND_END_SIGNAL service	121
8.4.2.1	Definition	121
8.4.2.2	Service primitives	121
8.4.2.3	Parameter use	121
8.4.3	MAP_PROCESS_ACCESS_SIGNALLING service	121
8.4.3.1	Definition	121
8.4.3.2	Service primitives	122
8.4.3.3	Parameter use	122
8.4.4	MAP_FORWARD_ACCESS_SIGNALLING service	123
8.4.4.1	Definition	123
8.4.4.2	Service primitives	123
8.4.4.3	Parameter use	123
8.4.5	MAP_PREPARE_SUBSEQUENT_HANDOVER service.....	125
8.4.5.1	Definition	125
8.4.5.2	Service primitives	125
8.4.5.3	Parameter use	125
8.4.6	MAP_ALLOCATE_HANDOVER_NUMBER service	126
8.4.6.1	Definition	126

8.4.6.2	Service primitives	126
8.4.6.3	Parameter use	126
8.4.7	MAP_SEND_HANOVER_REPORT service.....	127
8.4.7.1	Definition	127
8.4.7.2	Service primitives	127
8.4.7.3	Parameter use	127
8.5	Authentication management services	127
8.5.1	MAP_AUTHENTICATE service.....	127
8.5.1.1	Definition	128
8.5.1.2	Service primitives	128
8.5.1.3	Parameter use	128
8.5.2	MAP_SEND_AUTHENTICATION_INFO service.....	128
8.5.2.1	Definition	128
8.5.2.2	Service primitives	129
8.5.2.3	Parameter use	129
8.5.3	MAP_AUTHENTICATION_FAILURE_REPORT service	130
8.5.3.1	Definition	130
8.5.3.2	Service primitives	130
8.5.3.3	Parameter use	130
8.6	Security management services	131
8.6.1	MAP_SET_CIPHERING_MODE service	131
8.6.1.1	Definitions.....	131
8.6.1.2	Service primitives	131
8.6.1.3	Parameter use	132
8.7	International mobile equipment identities management services	132
8.7.1	MAP_CHECK_IMEI service	132
8.7.1.1	Definition	132
8.7.1.2	Service primitives	132
8.7.1.3	Parameter use	132
8.7.2	MAP_OBTAIN_IMEI service.....	133
8.7.2.1	Definition	133
8.7.2.2	Service primitives	133
8.7.2.3	Parameter use	134
8.8	Subscriber management services.....	134
8.8.1	MAP-INSERT-SUBSCRIBER-DATA service	134
8.8.1.1	Definition	134
8.8.1.2	Service primitives	134
8.8.1.3	Parameter use	135
8.8.1.4	Basic service information related to supplementary services.....	144
8.8.2	MAP-DELETE-SUBSCRIBER-DATA service	145
8.8.2.1	Definition	145
8.8.2.2	Service primitives	145
8.8.2.3	Parameter use	145
8.9	Identity management services	148
8.9.1	MAP-PROVIDE-IMSI service	148
8.9.1.1	Definition	148
8.9.1.2	Service primitives	148
8.9.1.3	Parameter use	148
8.9.2	MAP-FORWARD-NEW-TMSI service	149
8.9.2.1	Definition	149
8.9.2.2	Service primitives	149
8.9.2.3	Parameter use	149
8.10	Fault recovery services	149
8.10.1	MAP_RESET service	149
8.10.1.1	Definition	149
8.10.1.2	Service primitives	149
8.10.1.3	Parameter definition and use	149
8.10.2	MAP_FORWARD_CHECK_SS_INDICATION service	150
8.10.2.1	Definition	150
8.10.2.2	Service primitives	150
8.10.2.3	Parameter definition and use	150
8.10.3	MAP_RESTORE_DATA service.....	150

8.10.3.1	Definition	150
8.10.3.2	Service primitives	150
8.10.3.3	Parameter definitions and use	151
8.11	Subscriber Information services	152
8.11.1	MAP-ANY-TIME-INTERROGATION service.....	152
8.11.1.1	Definition	152
8.11.1.2	Service primitives	152
8.11.1.3	Parameter definition and use	153
8.11.2	MAP-PROVIDE-SUBSCRIBER-INFO service.....	153
8.11.2.1	Definition	153
8.11.2.2	Service primitives	154
8.11.2.3	Parameter definition and use	154
8.11.3	MAP-ANY-TIME-SUBSCRIPTION-INTERROGATION service	154
8.11.3.1	Definition	154
8.11.3.2	Service primitives	154
8.11.3.3	Parameter definition and use	155
8.11.4	MAP-ANY-TIME-MODIFICATION service	155
8.11.4.1	Definition	155
8.11.4.2	Service primitives	155
8.11.4.3	Parameter definition and use	156
8.11.5	MAP-NOTE-SUBSCRIBER-DATA-MODIFIED service.....	156
8.11.5.1	Definition	156
8.11.5.2	Service primitives	157
8.11.5.3	Parameter definition and use	157
9	Operation and maintenance services	158
9.1	Subscriber tracing services	158
9.1.1	MAP-ACTIVATE-TRACE-MODE service.....	158
9.1.1.1	Definition	158
9.1.1.2	Service primitives	158
9.1.1.3	Parameter use	158
9.1.2	MAP-DEACTIVATE-TRACE-MODE service.....	159
9.1.2.1	Definition	159
9.1.2.2	Service primitives	159
9.1.2.3	Parameter use	159
9.1.3	MAP-TRACE-SUBSCRIBER-ACTIVITY service	160
9.1.3.1	Definition	160
9.1.3.2	Service primitives	160
9.1.3.3	Parameter use	160
9.2	Other operation and maintenance services	160
9.2.1	MAP-SEND-IMSI service.....	160
9.2.1.1	Definition	160
9.2.1.2	Service primitives	161
9.2.1.3	Parameter use	161
10	Call handling services	161
10.1	MAP_SEND_ROUTING_INFORMATION service.....	161
10.1.1	Definition.....	161
10.1.2	Service primitives	161
10.1.3	Parameter use.....	162
10.2	MAP_PROVIDE_ROAMING_NUMBER service.....	167
10.2.1	Definition.....	167
10.2.2	Service primitives	167
10.2.3	Parameter use.....	168
10.3	MAP_RESUME_CALL_HANDLING service.....	170
10.3.1	Definition.....	170
10.3.2	Service primitives	170
10.3.3	Parameter use.....	170
10.4	MAP_PREPARE_GROUP_CALL service.....	172
10.4.1	Definition.....	172
10.4.2	Service primitives	172
10.4.3	Parameter definitions and use	172

10.5	MAP_PROCESS_GROUP_CALL_SIGNALLING service	173
10.5.1	Definitions	173
10.5.2	Service primitives	173
10.5.3	Parameter definitions and use	173
10.6	MAP_FORWARD_GROUP_CALL_SIGNALLING service	174
10.6.1	Definitions	174
10.6.2	Service primitives	174
10.6.3	Parameter definitions and use	174
10.7	MAP_SEND_GROUP_CALL_END_SIGNAL service	175
10.7.1	Definitions	175
10.7.2	Service primitives	175
10.7.3	Parameter definitions and use	175
10.8	MAP_Provide_SIWFS_Number	175
10.8.1	Definition	175
10.8.2	Service primitive	175
10.8.3	Parameter use	176
10.9	MAP_SIWFS_Signalling_Modify	177
10.9.1	Definition	177
10.9.2	Service primitive	177
10.9.3	Parameter use	177
10.10	MAP_SET_REPORTING_STATE service	178
10.10.1	Definition	178
10.10.2	Service primitives	178
10.10.3	Parameter use	178
10.11	MAP_STATUS_REPORT service	179
10.11.1	Definition	179
10.11.2	Service primitives	179
10.11.3	Parameter use	179
10.12	MAP_REMOTE_USER_FREE service	180
10.12.1	Definition	180
10.12.2	Service primitives	180
10.12.3	Parameter use	180
10.13	MAP_IST_ALERT service	181
10.13.1	Definition	181
10.13.2	Service primitives	181
10.13.3	Parameter use	181
10.14	MAP_IST_COMMAND service	182
10.14.1	Definition	182
10.14.2	Service primitives	182
10.14.3	Parameter use	182
11	Supplementary services related services	182
11.1	MAP_REGISTER_SS service	182
11.1.1	Definition	182
11.1.2	Service primitives	183
11.1.3	Parameter use	183
11.2	MAP_ERASE_SS service	184
11.2.1	Definition	184
11.2.2	Service primitives	184
11.2.3	Parameter use	184
11.3	MAP_ACTIVATE_SS service	185
11.3.1	Definition	185
11.3.2	Service primitives	185
11.3.3	Parameter use	186
11.4	MAP_DEACTIVATE_SS service	187
11.4.1	Definitions	187
11.4.2	Service primitives	187
11.4.3	Parameter use	187
11.5	MAP_INTERROGATE_SS service	188
11.5.1	Definitions	188
11.5.2	Service primitives	188
11.5.3	Parameter use	189

11.6	Void.....	190
11.7	MAP_REGISTER_PASSWORD service	190
11.7.1	Definitions	190
11.7.2	Service primitives	190
11.7.3	Parameter use.....	191
11.8	MAP_GET_PASSWORD service.....	191
11.8.1	Definitions	191
11.8.2	Service primitives	191
11.8.3	Parameter use.....	192
11.9	MAP_PROCESS_UNSTRUCTURED_SS_REQUEST service.....	192
11.9.1	Definitions	192
11.9.2	Service primitives	192
11.9.3	Parameter use.....	192
11.10	MAP_UNSTRUCTURED_SS_REQUEST service.....	193
11.10.1	Definitions	193
11.10.2	Service primitives	193
11.10.3	Parameter use.....	193
11.11	MAP_UNSTRUCTURED_SS_NOTIFY service	194
11.11.1	Definitions	194
11.11.2	Service primitives	195
11.11.3	Parameter use.....	195
11.12	MAP_SS_INVOCATION_NOTIFY	196
11.12.1	Definition.....	196
11.12.2	Service primitives	196
11.12.3	Parameter use.....	196
11.13	MAP_REGISTER_CC_ENTRY service	196
11.13.1	Definition.....	196
11.13.2	Service primitives	197
11.13.3	Parameter use.....	197
11.14	MAP_ERASE_CC_ENTRY service.....	198
11.14.1	Definition.....	198
11.14.2	Service primitives	198
11.14.3	Parameter use.....	198
12	Short message service management services	199
12.1	MAP-SEND-ROUTING-INFO-FOR-SM service	199
12.1.1	Definition.....	199
12.1.2	Service primitives	199
12.1.3	Parameter use.....	199
12.2	MAP-MO-FORWARD-SHORT-MESSAGE service.....	201
12.2.1	Definition.....	201
12.2.2	Service primitives	201
12.2.3	Parameter use.....	201
12.3	MAP-REPORT-SM-DELIVERY-STATUS service.....	202
12.3.1	Definition.....	202
12.3.2	Service primitives	202
12.3.3	Parameter use.....	202
12.4	MAP-READY-FOR-SM service.....	203
12.4.1	Definition.....	203
12.4.2	Service primitives	204
12.4.3	Parameter use.....	204
12.5	MAP-ALERT-SERVICE-CENTRE service	204
12.5.1	Definition.....	204
12.5.2	Service primitives	205
12.5.3	Parameter use.....	205
12.6	MAP-INFORM-SERVICE-CENTRE service.....	205
12.6.1	Definition.....	205
12.6.2	Service primitives	206
12.6.3	Parameter use.....	206
12.7	MAP-SEND-INFO-FOR-MT-SMS service	206
12.7.1	Definition.....	206
12.7.2	Service primitives	206

12.7.3	Parameter use.....	207
12.8	MAP-SEND-INFO-FOR-MO-SMS service.....	207
12.8.1	Definition.....	207
12.8.2	Service primitives	207
12.8.3	Parameter use.....	208
12.9	MAP-MT-FORWARD-SHORT-MESSAGE service	208
12.9.1	Definition.....	208
12.9.2	Service primitives	208
12.9.3	Parameter use.....	208
13	Network-Requested PDP Context Activation services	210
13.1	MAP_SEND_ROUTING_INFO_FOR_GPRS service.....	210
13.1.1	Definition.....	210
13.1.2	Service primitives	210
13.1.3	Parameter definition and use.....	210
13.2	MAP_FAILURE_REPORT service.....	211
13.2.1	Definition.....	211
13.2.2	Service primitives	211
13.2.3	Parameter definition and use.....	211
13.3	MAP_NOTE_MS_PRESENT_FOR_GPRS service.....	212
13.3.1	Definition.....	212
13.3.2	Service primitives	212
13.3.3	Parameter definition and use.....	212
13A	Location Service Management Services	213
13A.1	MAP-SEND-ROUTING-INFO-FOR-LCS Service.....	213
13A.1.1	Definition.....	213
13A.1.2	Service Primitives.....	213
13A.1.3	Parameter Use.....	213
13A.2	MAP-PROVIDE-SUBSCRIBER-LOCATION Service.....	214
13A.2.1	Definition.....	214
13A.2.2	Service Primitives.....	214
13A.2.3	Parameter Definition and Use.....	215
13A.3	MAP-SUBSCRIBER-LOCATION-REPORT Service.....	217
13A.3.1	Definition.....	217
13A.3.2	Service Primitives.....	217
13A.3.3	Parameter Definition and Use.....	217
13A.4	Void.....	220
13A.4.1	Void.....	220
13A.4.2	Void.....	220
13A.4.3	Void.....	220
13A.5	Void.....	220
13A.5.1	Void.....	220
13A.5.2	Void.....	220
13A.5.3	Void.....	220
13A.6	Void.....	220
13A.6.1	Void.....	220
13A.6.2	Void.....	220
13A.6.3	Void.....	220
13A.7	Void.....	220
13A.7.1	Void.....	220
13A.7.2	Void.....	220
13A.7.3	Void.....	220
13A.8	Void.....	220
13A.8.1	Void.....	220
13A.8.2	Void.....	220
13A.8.3	Void.....	220
13A.9	Void.....	220
13A.9.1	Void.....	220
13A.9.2	Void.....	221
13A.9.3	Void.....	221
14	General	221

14.1	Overview	221
14.2	Underlying services	221
14.3	Model	221
14.4	Conventions	221
15	Elements of procedure	222
15.1	Handling of unknown operations	222
15.2	Dialogue establishment	222
15.2.1	Behaviour at the initiating side	223
15.2.2	Behaviour at the responding side	223
15.3	Dialogue continuation	224
15.4	Load control	224
15.5	Procedures for MAP specific services	224
15.5.1	Service invocation	225
15.5.2	void	225
15.5.3	Service invocation receipt	225
15.5.4	void	225
15.5.5	Handling of components received from TC	225
15.6	SDL descriptions	225
16	Mapping on to TC services	258
16.1	Dialogue control	258
16.1.1	Directly mapped parameters	258
16.1.2	Use of other parameters of dialogue handling primitives	258
16.1.2.1	Dialogue Id	258
16.1.2.2	Application-context-name	258
16.1.2.3	User information	258
16.1.2.4	Component present	258
16.1.2.5	Termination	258
16.1.2.6	P-Abort-Cause	258
16.1.2.7	Quality of service	258
16.2	Service specific procedures	259
16.2.1	Directly mapped parameters	259
16.2.2	Use of other parameters of component handling primitives	259
16.2.2.1	Dialogue Id	259
16.2.2.2	Class	259
16.2.2.3	Linked Id	259
16.2.2.4	Operation	260
16.2.2.5	Error	261
16.2.2.6	Parameters	261
16.2.2.7	Time out	261
16.2.2.8	Last component	261
16.2.2.9	Problem code	261
16.2.2.9.1	Mapping to MAP User Error	261
16.2.2.9.2	Mapping to MAP Provider Error parameter	262
16.2.2.9.3	Mapping to diagnostic parameter	262
17	Abstract syntax of the MAP protocol	263
17.1	General	263
17.1.1	Encoding rules	263
17.1.2	Use of TC	263
17.1.2.1	Use of Global Operation and Error codes defined outside MAP	264
17.1.3	Use of information elements defined outside MAP	264
17.1.4	Compatibility considerations	264
17.1.5	Structure of the Abstract Syntax of MAP	265
17.1.6	Application Contexts	267
17.2	Operation packages	268
17.2.1	General aspects	268
17.2.2	Packages specifications	269
17.2.2.1	Location updating	269
17.2.2.2	Location cancellation	269
17.2.2.3	Roaming number enquiry	270
17.2.2.4	Information retrieval	270

17.2.2.5	Inter-VLR information retrieval.....	270
17.2.2.6	IMSI retrieval.....	270
17.2.2.7	Call control transfer.....	271
17.2.2.8	void.....	271
17.2.2.9	Void.....	271
17.2.2.10	Interrogation.....	271
17.2.2.11	Void.....	271
17.2.2.12	Handover Control.....	271
17.2.2.13	Subscriber Data management stand alone.....	272
17.2.2.14	Equipment management.....	272
17.2.2.15	Subscriber data management.....	272
17.2.2.16	Location register restart.....	272
17.2.2.17	Tracing stand-alone.....	272
17.2.2.18	Functional SS handling.....	273
17.2.2.19	Tracing.....	273
17.2.2.20	Binding.....	273
17.2.2.21	Unstructured SS handling.....	273
17.2.2.22	MO Short message relay services.....	274
17.2.2.23	Short message gateway services.....	274
17.2.2.24	MT Short message relay services.....	274
17.2.2.25	Void.....	275
17.2.2.26	Message waiting data management.....	275
17.2.2.27	Alerting.....	275
17.2.2.28	Data restoration.....	275
17.2.2.29	Purging.....	275
17.2.2.30	Subscriber information enquiry.....	276
17.2.2.31	Any time information enquiry.....	276
17.2.2.32	Group Call Control.....	276
17.2.2.33	Provide SIWFS number.....	276
17.2.2.34	SIWFS Signalling Modify.....	276
17.2.2.35	Gprs location updating.....	277
17.2.2.36	Gprs Interrogation.....	277
17.2.2.37	Failure reporting.....	277
17.2.2.38	GPRS notifying.....	277
17.2.2.39	Supplementary Service invocation notification.....	278
17.2.2.40	Set Reporting State.....	278
17.2.2.41	Status Report.....	278
17.2.2.42	Remote User Free.....	278
17.2.2.43	Call Completion.....	278
17.2.2.44	Location service gateway services.....	278
17.2.2.45	Location service enquiry.....	279
17.2.2.45A	Location service reporting.....	279
17.2.2.46	Void.....	279
17.2.2.47	Void.....	279
17.2.2.48	Void.....	279
17.2.2.49	IST Alerting.....	279
17.2.2.50	Service Termination.....	279
17.2.2.51	Mobility Management event notification.....	280
17.2.2.53	Subscriber Data modification notification.....	280
17.2.2.54	Authentication Failure Report.....	280
17.3	Application contexts.....	280
17.3.1	General aspects.....	280
17.3.2	Application context definitions.....	281
17.3.2.1	Void.....	281
17.3.2.2	Location Updating.....	281
17.3.2.3	Location Cancellation.....	282
17.3.2.4	Roaming number enquiry.....	282
17.3.2.5	Void.....	282
17.3.2.6	Location Information Retrieval.....	282
17.3.2.7	Call control transfer.....	283
17.3.2.8	void.....	283
17.3.2.9 - 17.3.2.10	Void.....	283

17.3.2.11	Location registers restart	283
17.3.2.12	Handover control.....	283
17.3.2.13	IMSI Retrieval.....	283
17.3.2.14	Equipment Management	284
17.3.2.15	Information retrieval	284
17.3.2.16	Inter-VLR information retrieval.....	284
17.3.2.17	Stand Alone Subscriber Data Management.....	285
17.3.2.18	Tracing	285
17.3.2.19	Network functional SS handling	285
17.3.2.20	Network unstructured SS handling	286
17.3.2.21	Short Message Gateway.....	286
17.3.2.22	Mobile originating Short Message Relay.....	286
17.3.2.23	Void.....	287
17.3.2.24	Short message alert	287
17.3.2.25	Short message waiting data management.....	287
17.3.2.26	Mobile terminating Short Message Relay	287
17.3.2.27	MS purging	288
17.3.2.28	Subscriber information enquiry.....	288
17.3.2.29	Any time information enquiry.....	288
17.3.2.30	Group Call Control.....	288
17.3.2.31	Provide SIWFS Number	288
17.3.2.32	Gprs Location Updating.....	289
17.3.2.33	Gprs Location Information Retrieval	289
17.3.2.34	Failure Reporting	289
17.3.2.35	GPRS Notifying	289
17.3.2.36	Supplementary Service invocation notification.....	289
17.3.2.37	Reporting.....	290
17.3.2.38	Call Completion	290
17.3.2.39	Location Service Gateway	290
17.3.2.40	Location Service Enquiry.....	290
17.3.2.41	Void.....	291
17.3.2.42	Void.....	291
17.3.2.43	Void.....	291
17.3.2.44	IST Alerting	291
17.3.2.45	Service Termination	291
17.3.2.46	Mobility Management event notification	291
17.3.2.48	Subscriber Data modification notification	292
17.3.2.49	Authentication Failure Report.....	292
17.3.3	ASN.1 Module for application-context-names	292
17.4	MAP Dialogue Information.....	294
17.5	MAP operation and error codes.....	296
17.6	MAP operations and errors.....	298
17.6.1	Mobile Service Operations	298
17.6.2	Operation and Maintenance Operations.....	305
17.6.3	Call Handling Operations	306
17.6.4	Supplementary service operations	309
17.6.5	Short message service operations	314
17.6.6	Errors	316
17.6.7	Group Call operations.....	323
17.6.8	Location service operations	324
17.6.9	void	325
17.7	MAP constants and data types.....	325
17.7.1	Mobile Service data types.....	325
17.7.2	Operation and maintenance data types.....	358
17.7.3	Call handling data types.....	359
17.7.4	Supplementary service data types.....	366
17.7.5	Supplementary service codes.....	371
17.7.6	Short message data types	373
17.7.7	Error data types.....	377
17.7.8	Common data types	382
17.7.9	Teleservice Codes.....	389
17.7.10	Bearer Service Codes.....	391

17.7.11	Extension data types	393
17.7.12	Group Call data types	393
17.7.13	Location service data types	395
17.7.14	void	403
18	General on MAP user procedures	403
18.1	Introduction	403
18.2	Common aspects of user procedure descriptions	403
18.2.1	General conventions	403
18.2.2	Naming conventions	403
18.2.3	Convention on primitives parameters	405
18.2.3.1	Open service	405
18.2.3.2	Close service	405
18.2.4	Version handling at dialogue establishment	405
18.2.4.1	Behaviour at the initiating side	405
18.2.4.2	Behaviour at the responding side	405
18.2.5	Abort Handling	405
18.2.6	SDL conventions	405
18.3	Interaction between MAP Provider and MAP Users	406
19	Mobility procedures	407
19.1	Location management Procedures	407
19.1.1	Location updating	409
19.1.1.1	General	409
19.1.1.2	Procedures in the VLR	413
19.1.1.3	Procedure in the PVLN	413
19.1.1.4	Procedure in the SGSN	413
19.1.1.5	Procedures in the HLR	414
19.1.2	Location Cancellation	434
19.1.2.1	General	434
19.1.2.2	Procedure in the HLR	434
19.1.2.3	Procedure in the VLR	435
19.1.2.4	Procedure in the SGSN	435
19.1.3	Void	442
19.1.4	MS Purging	442
19.1.4.1	General	442
19.1.4.2	Procedure in the VLR	442
19.1.4.3	Procedure in the SGSN	442
19.1.4.4	Detailed procedure in the HLR	443
19.2	Handover procedures	448
19.2.1	General	448
19.2.2	Procedure in MSC-A	451
19.2.2.1	Basic handover	451
19.2.2.2	Handling of access signalling	452
19.2.2.3	Subsequent handover	452
19.2.3	Procedure in MSC-B	452
19.2.3.1	Basic handover	453
19.2.3.2	Handling of access signalling	453
19.2.3.3	Subsequent handover	453
19.2.4	Macro Receive_Error_From_HO_CA	453
19.2.5	Procedure in VLR-B	453
19.3	Fault recovery procedures	472
19.3.1	VLR fault recovery procedures	472
19.3.1.1	General	472
19.3.1.2	Procedure in the VLR	473
19.3.1.3	Procedure in the HLR	473
19.3.2	HLR fault recovery procedures	475
19.3.2.1	General	475
19.3.2.2	Procedure in the HLR	476
19.3.2.3	Procedure in the VLR	476
19.3.2.4	Procedure in the SGSN	477
19.4	Mobility Management event notification procedure	483

19.4.1	General.....	483
19.4.2	Procedure in the VLR or SGSN.....	483
19.4.3	Procedure in the gsmSCF	483
19.5	HLR Insert Subscriber Data macros.....	486
19.5.1	Macro Insert_Subscriber_Data_Framed_HLR.....	486
19.5.2	Macro Insert_GPRS_Subscriber_Data_Framed_HLR.....	486
20	Operation and maintenance procedures.....	489
20.1	General	489
20.1.1	Tracing Co-ordinator for the VLR.....	489
20.1.2	Tracing Co-ordinator for the SGSN.....	489
20.1.3	Subscriber Data Management Co-ordinator for the VLR.....	489
20.1.4	Subscriber Data Management Co-ordinator for the SGSN.....	489
20.2	Tracing procedures.....	494
20.2.1	Subscriber tracing activation procedure.....	497
20.2.1.1	Procedures in the HLR.....	497
20.2.1.2	Procedure in the VLR.....	497
20.2.1.3	Procedure in the SGSN	497
20.2.2	Subscriber tracing deactivation procedure.....	497
20.2.2.1	Procedures in the HLR.....	497
20.2.2.2	Procedure in the VLR.....	498
20.2.2.3	Procedure in the SGSN	498
20.3	Subscriber data management procedures	511
20.3.1	Subscriber deletion procedure.....	512
20.3.1.1	Procedure in the HLR.....	512
20.3.1.2	Procedure in the VLR.....	512
20.3.1.3	Procedure in the SGSN	513
20.3.2	Subscriber data modification procedure	513
20.3.2.1	Procedure in the HLR.....	513
20.3.2.2	Procedure in the VLR.....	514
20.3.2.3	Procedure in the SGSN	514
20.4	Subscriber Identity procedure.....	526
20.4.2	Procedure in the VLR	526
20.4.2	Procedure in the HLR.....	526
21	Call handling procedures.....	530
21.1	General	530
21.2	Retrieval of routing information.....	530
21.2.1	General.....	530
21.2.2	Procedure in the GMSC	533
21.2.9	Process in the gsmSCF	534
21.2.3	Procedures in the HLR.....	534
21.2.4	Process in the VLR to provide a roaming number.....	536
21.2.5	Process in the VLR to restore subscriber data	537
21.2.6	Process in the VLR to provide subscriber information.....	538
21.3	Transfer of call handling	547
21.3.1	General.....	547
21.3.2	Process in the VMSC.....	547
21.3.3	Process in the GMSC.....	548
21.4	Inter MSC Group Call Procedures	551
21.4.1	General.....	551
21.4.2	Process in the Anchor MSC.....	552
21.4.3	Process in the Relay MSC	552
21.5	Void.....	557
21.6	CCBS: monitoring and reporting the status of the subscriber	557
21.6.1	Reporting co-ordinator process in the VLR.....	557
21.6.2	Setting the reporting state – stand-alone.....	557
21.6.2.1	Process in the HLR.....	557
21.6.2.2	Process in the VLR.....	557
21.6.3	Status Reporting.....	558
21.6.3.1	Process in the VLR	558
21.6.3.2	Process in the HLR.....	559

21.6.3	Remote User Free	559
21.6.3.1	Process in the HLR.....	560
21.6.3.2	Process in the VLR.....	560
21.7	Void.....	573
21.8	Void.....	573
21.9	Immediate Service Termination (IST).....	573
21.9.1	IST Alert.....	573
21.9.1.1	Procedure in the MSC	573
21.9.1.2	Procedure in the HLR.....	573
21.9.2	IST Command.....	573
21.9.2.1	Procedure in the HLR.....	574
21.9.2.2	Procedure in the MSC	574
22	Supplementary services procedures	579
22.1	Supplementary service co-ordinator processes.....	579
22.1.1	Supplementary service co-ordinator process for the MSC.....	579
22.1.2	Void	579
22.1.3	Functional supplementary service co-ordinator process for the HLR.....	579
22.1.4	Call completion supplementary service co-ordinator process for the HLR	579
22.2	Registration procedure	584
22.2.1	General.....	584
22.2.2	Procedure in the MSC.....	585
22.2.3	Procedure in the VLR	585
22.2.4	Procedure in the HLR	585
22.3	Erasure procedure.....	591
22.3.1	General.....	591
22.3.2	Procedure in the MSC.....	592
22.3.3	Procedure in the VLR	592
22.3.4	Procedure in the HLR	592
22.4	Activation procedure	592
22.4.1	General.....	592
22.4.2	Procedure in the MSC.....	593
22.4.3	Procedure in the VLR	594
22.4.4	Procedure in the HLR	594
22.5	Deactivation procedure.....	600
22.5.1	General.....	600
22.5.2	Procedure in the MSC.....	601
22.5.3	Procedure in the VLR	601
22.5.4	Procedure in the HLR	601
22.6	Interrogation procedure	601
22.6.1	General.....	601
22.6.2	Procedure in the MSC.....	602
22.6.3	Procedures in the VLR.....	602
22.6.4	Procedure in the HLR	603
22.7	Void.....	607
22.8	Password registration procedure.....	608
22.8.1	General.....	608
22.8.2	Procedure in the MSC.....	610
22.8.3	Procedure in the VLR	610
22.8.4	Procedure in the HLR	610
22.9	Mobile Initiated USSD procedure	613
22.9.1	General.....	613
22.9.2	Procedure in the MSC.....	613
22.9.3	Procedure in the VLR	613
22.9.4	Procedure in the HLR	614
22.9.5	Procedures in the gsmSCF/secondary HLR.....	614
22.10	Network initiated USSD procedure.....	628
22.10.1	General.....	628
22.10.2	Procedure in the MSC.....	628
22.10.3	Procedure in the VLR	628
22.10.4	Procedure in the HLR	629
22.10.5	Procedure in the gsmSCF or secondary HLR	629

22.11	Common macros for clause 22	649
22.11.1	SS Password handling macros	649
22.11.2	Void	649
22.12	Supplementary Service Invocation Notification procedure.....	653
22.12.1	General.....	653
22.12.2	Procedure in the MSC.....	653
22.12.3	Procedure in the gsmSCF	653
22.13	Activation of a CCBS request	656
22.13.1	General.....	656
22.13.2	Procedure in the VLR	656
22.13.3	Procedure in the HLR	656
22.14	Deactivation of a CCBS request.....	659
22.14.1	General.....	659
22.14.2	Procedure in the VLR	659
22.14.3	Procedure in the HLR	659
23	Short message service procedures	662
23.1	General	662
23.1.1	Mobile originated short message service Co-ordinator for the MSC.....	662
23.1.2	Short message Gateway Co-ordinator for the HLR	662
23.2	The mobile originated short message transfer procedure	666
23.2.1	Procedure in the serving MSC	666
23.2.2	Procedure in the VLR	667
23.2.3	Procedure in the SGSN	667
23.2.4	Procedure in the SMS Interworking MSC (SMS-IWMSC).....	667
23.3	The mobile terminated short message transfer procedure	678
23.3.1	Procedure in the SMS-GMSC.....	680
23.3.2	Procedure in the HLR	681
23.3.3	Procedure in the Serving MSC	682
23.3.4	Procedure in the VLR	682
23.3.5	Procedure in the SGSN	682
23.4	The Short Message Alert procedure	720
23.4.1	Procedure in the Serving MSC – the MS has memory available	722
23.4.2	Procedures in the VLR.....	722
23.4.2.1	The Mobile Subscriber is present.....	722
23.4.2.2	The MS has memory available.....	722
23.4.3	Procedures in the SGSN	723
23.4.3.1	The Mobile Subscriber is present.....	723
23.4.3.2	The Mobile Equipment has memory available.....	723
23.4.4	Procedure in the HLR	723
23.4.5	Procedure in the SMS Interworking MSC	723
23.5	The SM delivery status report procedure	732
23.5.1	Procedure in the SMS-GMSC.....	732
23.5.2	Procedure in the HLR	732
23.6	The macro Report_SM_Delivery_Stat_HLR	735
24	GPRS process description	738
24.1	Procedure for retrieval of routing information for GPRS	738
24.1.1	Process in the GGSN	738
24.1.2	Process in the HLR	738
24.2	Procedure for reporting failure to establish a network requested PDP context	741
24.2.1	Process in the GGSN	741
24.2.2	Process in the HLR	741
24.3	Procedure for reporting that an MS has become reachable for GPRS.....	744
24.3.1	Process in the HLR	744
24.3.2	Process in the GGSN	744
24A	CSE interrogation and control of subscriber data.....	747
24A.1	General	747
24A.2	Any Time Subscription Interrogation procedure.....	749
24A.2.1	General.....	749
24A.2.2	Process in the gsmSCF	749
24A.2.3	Process in the HLR	749

24A.3	Any Time Modification procedure	752
24A.3.1	General.....	752
24A.3.2	Process in the gsmSCF	752
24A.3.3	Process in the HLR	752
24A.4	Subscriber Data Modification Notification procedure.....	755
24A.4.1	General.....	755
24A.4.2	Process in the HLR	755
24A.4.3	Process in the gsmSCF	755
24A.5	Any Time Interrogation procedure.....	760
24A.5.2	Procedure in the gsmSCF	761
24A.5/3	Procedure in the HLR	761
24A.5.4	Procedure in the GMLC.....	761
24B	Location Services process description.....	767
24B.1	Routeing information retrieval procedure for LCS	767
24B.1.1	General.....	767
24B.1.2	Process in the GMLC.....	767
24B.1.3	Process in the HLR	767
24B.2	Provide Subscriber Location procedure	770
24B.2.1	General.....	770
24B.2.2	Process in the GMLC.....	770
24B.2.3	Process in the MSC.....	770
24B.2.4	Process in the SGSN	770
24B.3	Subscriber Location Report procedure	774
24B.3.1	General.....	774
24B.3.2	Process in the MSC.....	774
24B.3.3	Process in the SGSN	774
24B.3.4	Process in the GMLC.....	774
25	General macro description.....	778
25.1	MAP_OPEN handling macros	778
25.1.1	Macro Receive_Open_Ind	778
25.1.2	Macro Receive_Open_Cnf	778
25.2	Macros to check the content of indication and confirmation primitives.....	783
25.2.1	Macro Check_Indication.....	783
25.2.2	Macro Check_Confirmation	783
25.3	The page and search macros.....	786
25.3.1	Macro Page_MSC.....	786
25.3.2	Macro Search_For_MS_MSC	786
25.4	Macros for handling an Access Request.....	789
25.4.1	Macro Process_Access_Request_MSC	789
25.4.2	Macro Process_Access_Request_VLR.....	789
25.4.3	Macro Obtain_Identity_VLR.....	789
25.4.4	Process Update Location VLR.....	789
25.5	Authentication macros and processes.....	799
25.5.1	Macro Authenticate_MSC	799
25.5.2	Macro Authenticate_VLR.....	799
25.5.3	Macro Obtain_Authent_Params_VLR.....	799
25.5.4	Process Obtain_Authentication_Sets_VLR	799
25.5.5	Process Obtain_Authent_Sets_SGSN.....	799
25.5.6	Process Obtain_Auth_Sets_HLR	799
25.5.7	Authentication Failure Reporting	800
25.5.7.1	General	800
25.5.7.2	Process in the VLR.....	800
25.5.7.3	Process in the SGSN	800
25.5.7.4	Process in the HLR.....	800
25.6	IMEI Handling macros and processes	816
25.6.1	Macro Check_IMEI_MSC.....	816
25.6.2	Macro Check_IMEI_VLR	816
25.6.3	Process Check_IMEI_SGSN	816
25.6.4	Process Check_IMEI_EIR.....	816
25.6.5	Macro Obtain_IMEI_MSC	816

25.6.5	Macro Obtain_IMEI_VLR	816
25.7	Insert Subscriber Data macros and processes.....	825
25.7.1	Macro Insert_Subscriber_Data_VLR.....	825
25.7.2	Macro Insert_Subscriber_Data_SGSN	825
25.7.3	Process Insert_Subscriber_Data_Stand_Alone_HLR	825
25.7.4	Process Insert_GPRS_Subscriber_Data_Stand_Alone_HLR	825
25.7.5	Macro Wait_for_Insert_Subscriber_Data_Cnf	826
25.7.6	Macro Wait_for_Insert_GPRS_Subscriber_Data_Cnf	826
25.7.7	Process Send_Insert_Subscriber_Data_HLR	826
25.8	Request IMSI Macros.....	836
25.8.1	Macro Obtain_IMSI_MSC	836
25.8.2	Macro Obtain_IMSI_VLR.....	836
25.9	Tracing macros.....	839
25.9.1	Macro Trace_Subscriber_Activity_MSC	839
25.9.2	Macro Trace_Subscriber_Activity_VLR	839
25.9.3	Macro Trace_Subscriber_Activity_SGSN.....	839
25.9.4	Macro Activate_Tracing_VLR	839
25.9.5	Macro Activate_Tracing_SGSN.....	839
25.9.6	Macro Control_Tracing_With_VLR_HLR.....	839
25.9.7	Macro Control_Tracing_With_SGSN_HLR	839
25.10	Short Message Alert procedures.....	847
25.10.1	Process Subscriber_Present_VLR	847
25.10.2	Process Subscriber_Present_SGSN	847
25.10.3	Macro Alert_Service_Centre_HLR	847
25.10.4	Process Alert_SC_HLR	847
Annex A (informative):	Cross-reference for abstract syntaxes of MAP	852
Annex B (informative):	Fully expanded ASN.1 sources for abstract syntaxes of MAP.....	1071
B.1	Fully Expanded ASN.1 Source of MAP-Protocol/TCAPMessages.....	1071
B.2	Fully Expanded ASN.1 Source of MAP-DialogueInformation.....	1205
Annex C :	Void	1209
Annex D (informative):	Clause mapping table	1210
D.1	Mapping of Clause numbers.....	1210
Annex E (informative):	Change History	1211
History		1222

Foreword

This Technical Specification (TS) has been produced by the 3rd Generation Partnership Project (3GPP).

The present document specifies the Mobile Application Part (MAP), the requirements for the signalling system and procedures within the 3GPP system at application level.

The contents of the present document are subject to continuing work within the TSG and may change following formal TSG approval. Should the TSG modify the contents of the present document, it will be re-released by the TSG with an identifying change of release date and an increase in version number as follows:

Version x.y.z

where:

- x the first digit:
 - 1 presented to TSG for information;
 - 2 presented to TSG for approval;
 - 3 or greater indicates TSG approved document under change control.
- y the second digit is incremented for all changes of substance, i.e. technical enhancements, corrections, updates, etc.
- z the third digit is incremented when editorial only changes have been incorporated in the document.

1 Scope

It is necessary to transfer between entities of a Public Land Mobile Network (PLMN) information specific to the PLMN in order to deal with the specific behaviour of roaming Mobile Stations (MS)s. The Signalling System No. 7 specified by CCITT is used to transfer this information.

The present document describes the requirements for the signalling system and the procedures needed at the application level in order to fulfil these signalling needs.

Clauses 1 to 6 are related to general aspects such as terminology, mobile network configuration and other protocols required by MAP.

MAP consists of a set of MAP services that are provided to MAP service-users by a MAP service-provider.

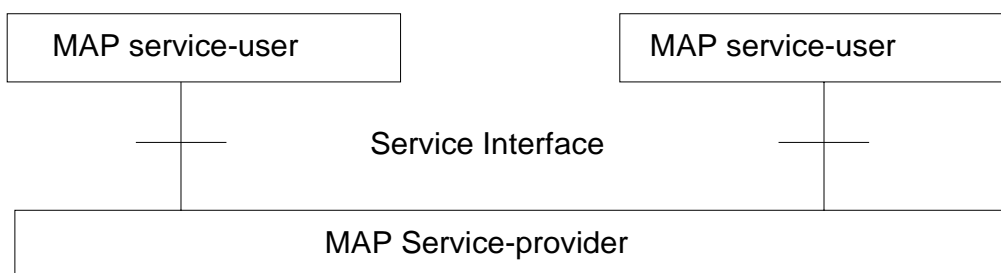

Figure 1.1/1: Modelling principles

Clauses 7 to 13A of the present document describe the MAP services.

Clauses 14 to 17 define the MAP protocol specification and the behaviour of service provider (protocol elements to be used to provide MAP services, mapping on to TC service primitives, abstract syntaxes, etc.).

Clauses 18 to 25 describe the MAP user procedures that make use of MAP services.

2 References

The following documents contain provisions which, through reference in this text, constitute provisions of the present document.

- References are either specific (identified by date of publication, edition number, version number, etc.) or non-specific.
- For a specific reference, subsequent revisions do not apply.
- For a non-specific reference, the latest version applies. In the case of a reference to a 3GPP document (including a GSM document), a non-specific reference implicitly refers to the latest version of that document *in the same Release as the present document*.

- [1] 3GPP TS 21.905: "3G Vocabulary".
- [2] 3GPP TS 22.001: "Digital cellular telecommunications system (Phase 2+); Principles of telecommunication services supported by a Public Land Mobile Network (PLMN)".
- [3] 3GPP TS 22.002: "Bearer Services Supported by a Public Land Mobile Network (PLMN)".
- [4] 3GPP TS 22.003: "Circuit Teleservices Supported by a Public Land Mobile Network (PLMN)".
- [5] 3GPP TS 22.004: "General on Supplementary Services".
- [6] 3GPP TS 42.009: "Digital cellular telecommunications system (Phase 2+); Security aspects".
- [7] 3GPP TS 22.016: "International Mobile station Equipment Identities (IMEI)".

- [8] 3GPP TS 22.041: "Operator Determined Barring".
- [9] 3GPP TS 22.081: "Line identification supplementary services - Stage 1".
- [10] 3GPP TS 22.082: "Call Forwarding (CF) supplementary services - Stage 1".
- [11] 3GPP TS 22.083: "Call Waiting (CW) and Call Hold (HOLD) Supplementary Services - Stage 1".
- [12] 3GPP TS 22.084: "Multi Party (MPTY) Supplementary Services - Stage 1".
- [13] 3GPP TS 22.085: "Closed User Group (CUG) supplementary services - Stage 1".
- [14] 3GPP TS 22.086: "Advice of charge (AoC) Supplementary Services - Stage 1".
- [15] 3GPP TS 22.088: "Call Barring (CB) supplementary services - Stage 1".
- [16] 3GPP TS 22.090: "Unstructured Supplementary Service Data (USSD); - Stage 1".
- [17] 3GPP TS 23.003: "Numbering, addressing and identification".
- [18] Void
- [19] 3GPP TS 23.007: "Restoration procedures".
- [20] 3GPP TS 23.008: "Organisation of subscriber data".
- [21] 3GPP TS 23.009: "Handover procedures".
- [22] 3GPP TS 23.011: "Technical realization of Supplementary Services - General Aspects".
- [23] 3GPP TS 23.012: "Location registration procedures".
- [24] 3GPP TS 43.020: "Security related network functions".
- [25] 3GPP TS 23.038: "Alphabets and language".
- [25a] 3GPP TS 23.039: " Interface protocols for the connection of Short Message Service Centres (SMSCs) to Short Message Entities (SMEs)".
- [26] 3GPP TS 23.040: "Technical realization of the Short Message Service (SMS) Point to Point (PP)".
- [26a] 3GPP TS 23.271: "Functional stage2 description of LCS".
- [27] 3GPP TS 23.081: "Line Identification Supplementary Services - Stage 2".
- [28] 3GPP TS 23.082: "Call Forwarding (CF) Supplementary Services - Stage 2".
- [29] 3GPP TS 23.083: "Call Waiting (CW) and Call Hold (HOLD) Supplementary Services - Stage 2".
- [30] 3GPP TS 23.084: "Multi Party (MPTY) Supplementary Services - Stage 2".
- [31] 3GPP TS 23.085: "Closed User Group (CUG) Supplementary Services - Stage 2".
- [32] 3GPP TS 23.086: "Advice of Charge (AoC) Supplementary Services - Stage 2".
- [33] 3GPP TS 23.088: "Call Barring (CB) Supplementary Services - Stage 2".
- [34] 3GPP TS 23.090: "Unstructured Supplementary Services Data (USSD) - Stage 2".
- [34a] 3GPP TS 33.200: "3G Security; Network domain security; MAP application layer security".
- [35] 3GPP TS 24.008: "Mobile Radio Interface Layer 3 specification; Core Network Protocols - Stage 3".
- [36] 3GPP TS 24.010: "Mobile radio interface layer 3 Supplementary Services specification - General aspects".
- [37] 3GPP TS 24.011: "Point-to-Point (PP) Short Message Service (SMS) support on mobile radio interface".

- [37a] 3GPP TS 44.071: "Location Services (LCS) – stage 3".
- [38] 3GPP TS 24.080: "Mobile radio interface layer 3 supplementary services specification - Formats and coding".
- [39] 3GPP TS 24.081: "Line identification supplementary services - Stage 3".
- [40] 3GPP TS 24.082: "Call Forwarding (CF) Supplementary Services - Stage 3".
- [41] 3GPP TS 24.083: "Call Waiting (CW) and Call Hold (HOLD) supplementary services - Stage 3".
- [42] 3GPP TS 24.084: "Multi Party (MPTY) Supplementary Services - Stage 3".
- [43] 3GPP TS 24.085: "Closed User Group (CUG) Supplementary Services - Stage 3".
- [44] 3GPP TS 24.086: "Advice of Charge (AoC) Supplementary Services - Stage 3".
- [45] 3GPP TS 24.088: "Call Barring (CB) Supplementary Services - Stage 3".
- [46] 3GPP TS 24.090: "Unstructured Supplementary Services Data - Stage 3".
- [47] 3GPP TS 48.002: " Base Station System - Mobile-services Switching Centre (BSS - MSC) interface principles".
- [48] 3GPP TS 48.006: "Signalling transport mechanism specification for the Base Station System - Mobile-services Switching Centre (BSS - MSC) interface".
- [49] 3GPP TS 48.008: "Mobile Switching Centre - Base Station System (MSC - BSS) interface; Layer 3 specification".
- [49a1] 3GPP TS 48.031: "Location Services (LCS); Serving Mobile Location Centre (SMLC) – Serving Mobile Location Centre (SMLC); SMLC Peer Protocol (SMLCPP)".
- [49b] 3GPP TS 48.071: "Location Services (LCS); Serving Mobile Location Centre - Base Station System (SMLC - BSS) interface Layer 3 specification".
- [50] 3GPP TS 49.001: "General network interworking scenarios".
- [51] 3GPP TS 29.002: "Mobile Application Part (MAP) specification".
- [52] Void
- [53] Void
- [54] Void
- [55] 3GPP TS 29.006: "Interworking between a Public Land Mobile Network (PLMN) and a Packet Switched Public Data Network/Integrated Services Digital Network (PSPDN/ISDN) for the support of Packet Switched data transmission services".
- [56] 3GPP TS 29.007: "General requirements on interworking between the Public Land Mobile Network (PLMN) and the Integrated Services Digital Network (ISDN) or Public Switched Telephone Network (PSTN)".
- [57] 3GPP TS 29.008: "Application of the Base Station System Application Part (BSSAP) on the E-interface".
- [58] 3GPP TS 29.010: "Information element mapping between Mobile Station - Base Station System and BSS - Mobile-services Switching Centre (MS - BSS - MSC) Signalling procedures and the Mobile Application Part (MAP)".
- [59] 3GPP TS 29.011: "Signalling interworking for Supplementary Services".
- [59a] 3GPP TS 49.031: "Digital cellular telecommunications system (Phase 2+); Location Services (LCS); Base Station System Application Part LCS Extension (BSSAP-LE)".
- [60] Void

- [61] GSM 12.08: "Digital cellular telecommunications system (Phase 2); Subscriber and Equipment Trace".
- [62] ETS 300 102-1 (1990): "Integrated Services Digital Network (ISDN); User-network interface layer 3 specifications for basic call control".
- [63] ETS 300 136 (1992): "Integrated Services Digital Network (ISDN); Closed User Group (CUG) supplementary service description".
- [64] ETS 300 138 (1992): "Integrated Services Digital Network (ISDN); Closed User Group (CUG) supplementary service Digital Subscriber Signalling System No.one (DSS1) protocol".
- [65] ETS 300 287: "Integrated Services Digital Network (ISDN); Signalling System No.7; Transaction Capabilities (TC) version 2".
- [66] ETR 060: "Signalling Protocols and Switching (SPS); Guide-lines for using Abstract Syntax Notation One (ASN.1) in telecommunication application protocols".
- [66b] ETR 091: "ETSI object identifier tree; Common domain Mobile domain"
- [67] ITU-T Recommendation E.164: " The international public telecommunication numbering plan".
- [68] ITU-T Recommendation E.212: " The international identification plan for mobile terminals and mobile users".
- [69] ITU-T Recommendation E.213: " Telephone and ISDN numbering plan for land mobile stations in public land mobile networks (PLMN) ".
- [70] ITU-T Recommendation E.214: " Structure of the land mobile global title for the signalling connection control part (SCCP) ".
- [71] ITU-T Recommendation Q.699: " Interworking between ISDN access and non-ISDN access over ISDN User Part of Signalling System No. 7 ".
- [72] ITU-T Recommendation Q.711: "Specifications of Signalling System No.7; Functional description of the Signalling Connection Control Part".
- [73] ITU-T Recommendation Q.712: "Definition and function of SCCP messages".
- [74] ITU-T Recommendation Q.713: "Specifications of Signalling System No.7; SCCP formats and codes".
- [75] ITU-T Recommendation Q.714: "Specifications of Signalling System No.7; Signalling Connection Control Part procedures".
- [76] ITU-T Recommendation Q.716: "Specifications of Signalling System No.7; Signalling connection control part (SCCP) performances".
- [77] ITU-T Recommendation Q.721 (1988): "Specifications of Signalling System No.7; Functional description of the Signalling System No.7 Telephone user part".
- [78] ITU-T Recommendation Q.722 (1988): "Specifications of Signalling System No.7; General function of Telephone messages and signals".
- [79] ITU-T Recommendation Q.723 (1988): "Specifications of Signalling System No.7; Formats and codes".
- [80] ITU-T Recommendation Q.724 (1988): "Specifications of Signalling System No.7; Signalling procedures".
- [81] ITU-T Recommendation Q.725 (1988): "Specifications of Signalling System No.7; Signalling performance in the telephone application".
- [82] ITU-T Recommendation Q.761 (1988): "Specifications of Signalling System No.7; Functional description of the ISDN user part of Signalling System No.7".

- [83] ITU-T Recommendation Q.762 (1988): "Specifications of Signalling System No.7; General function of messages and signals".
- [84] ITU-T Recommendation Q.763 (1988): "Specifications of Signalling System No.7; Formats and codes".
- [85] ITU-T Recommendation Q.764 (1988): "Specifications of Signalling System No.7; Signalling procedures".
- [86] ITU-T Recommendation Q.767: "Specifications of Signalling System No.7; Application of the ISDN user part of CCITT signalling System No.7 for international ISDN interconnections".
- [87] ITU-T Recommendation Q.771: "Specifications of Signalling System No.7; Functional description of transaction capabilities".
- [88] ITU-T Recommendation Q.772: "Specifications of Signalling System No.7; Transaction capabilities information element definitions".
- [89] ITU-T Recommendation Q.773: "Specifications of Signalling System No.7; Transaction capabilities formats and encoding".
- [90] ITU-T Recommendation Q.774: "Specifications of Signalling System No.7; Transaction capabilities procedures".
- [91] ITU-T Recommendation Q.775: "Specifications of Signalling System No.7; Guide-lines for using transaction capabilities".
- [92] ITU-T Recommendation X.200: "Reference Model of Open systems interconnection for CCITT Applications".
- [93] ITU-T Recommendation X.680: "Information technology – Abstract Syntax Notation One (ASN.1): Specification of basic notation".
- [93b] ITU-T Recommendation X.681: "Information technology – Abstract Syntax Notation One (ASN.1): Information object specification"
- [94] ITU-T Recommendation X.690: "Information technology – ASN.1 encoding rules: Specification of Basic Encoding Rules (BER), Canonical Encoding Rules (CER) and Distinguished Encoding Rules (DER)".
- [95] ITU-T Recommendation X.210: "Open systems interconnection layer service definition conventions".
- [97] 3GPP TS 23.018: "Basic Call Handling".
- [98] 3GPP TS 23.078: "Customised Applications for Mobile network Enhanced Logic (CAMEL) Phase 4 - Stage 2".
- [99] 3GPP TS 23.079: "Support of Optimal Routeing (SOR) - Stage 2".
- [100] 3GPP TS 43.068: "Voice Group Call Service (VGCS) - Stage 2".
- [101] 3GPP TS 43.069: "Voice Broadcast service (VBS) - Stage 2".
- [102] ANSI T1.113: "Signaling System No. 7 (SS7) - ISDN User Part".
- [103] Void
- [104] 3GPP TS 23.060: "General Packet Radio Service (GPRS) Description; Stage 2".
- [105] 3GPP TS 29.060: "General Packet Radio Service (GPRS); GPRS Tunnelling Protocol (GTP) across the Gn and Gp Interface".
- [106] 3GPP TS 29.018: "General Packet Radio Service (GPRS); Serving GPRS Support Node (SGSN) - Visitors Location Register (VLR); Gs interface layer 3 specification".

- [107] 3GPP TS 23.093: "Technical Realization of Completion of Calls to Busy Subscriber (CCBS); Stage 2".
- [108] 3GPP TS 23.066: "Support of Mobile Number Portability (MNP); Technical Realisation Stage 2".
- [109] ANSI T1.112 (1996): "Telecommunication – Signalling No. 7 - Signaling Connection Control Part (SCCP)".
- [110] 3GPP TS 23.116: "Super-Charger Technical Realisation; Stage 2."
- [111] Void.
- [112] Void
- [113] Void
- [114] Void
- [115] Void
- [116] ITU-T Recommendation Q.850 (May 1998): "Usage of cause and location in the Digital Subscriber Signalling System No. 1 and the Signalling System No. 7 ISDN User Part".
- [117] 3GPP TS 22.135: "Multicall; Service description; Stage 1".
- [118] 3GPP TS 23.135: "Multicall supplementary service; Stage 2".
- [119] 3GPP TS 24.135: "Multicall supplementary service; Stage 3".
- [120] 3GPP TS 25.413: "UTRAN Iu Interface RANAP Signalling".
- [121] 3GPP TS 29.202: "SS7 signalling transport in core network"
- [122] 3GPP TS 23.032: "Universal Geographical Area Description (GAD)"
- [123] 3GPP TS 22.071: " Location Services (LCS); Service description, Stage 1"
- [124] ITU-T Recommendation X.880: "Data networks and open system communication - Open System Interconnection - Service definitions - Remote operations: Concepts, model and notation".
- [125] 3GPP TS 23.278: 'Customised Applications for Mobile Network Enhanced Logic (CAMEL) Phase 4 – Stage 2 IM CN Interworking (Rel-5)'
- [126] 3GPP TS 23.172: "Technical realization of Circuit Switched (CS) multimedia service; UDI/RDI fallback and service modification"
- [127] 3GPP TS 26.103: "Speech codec list for GSM and UMTS".
- [128] 3GPP TS 32.215: "3rd Generation Partnership Project; Technical Specification Group Services and System Aspects; Telecommunication Management; Charging Management; Charging data description for the Packet Switched (PS) domain"

3 Abbreviations

Abbreviations used in the present document are listed in 3GPP TS 21.905.

4 Void

5 Overload and compatibility overview

5.1 Overload control

There is a requirement for an overload/congestion control for all entities of the Public Land Mobile Network and the underlying Signalling System No. 7.

5.1.1 Overload control for MSC (outside MAP)

For the entity MSC the following two procedures (outside MAP) may be applied to control the processor load:

- ISDN
CCITT Recommendation Q.764 (Automatic Congestion Control), applicable to reduce the mobile terminating traffic;
- BSSAP
3GPP TS 48.008 [49] (A-interface Flow Control), applicable to reduce the mobile originating traffic.

5.1.2 Overload control for MAP entities

For all MAP entities, especially the HLR, the following overload control method is applied.

If overload of a MAP entity is detected requests for certain MAP operations (see tables 5.1/1, 5.1/2, 5.1/3 and 5.1/4) may be ignored by the responder. The decision as to which MAP Operations may be ignored is made by the MAP service provider and is based upon the priority of the application context.

Since most of the affected MAP operations are supervised in the originating entity by TC timers (medium) an additional delay effect is achieved for the incoming traffic.

If overload levels are applicable in the Location Registers the MAP operations should be discarded taking into account the priority of their application context (see table 5.1/1 for HLR, table 5.1/2 for MSC/VLR, table 5.1/3 for the SGSN and table 5.1/4 for the SMLC; the lowest priority is discarded first).

The ranking of priorities given in the tables 5.1/1, 5.1/2, 5.1/3 and 5.1/4 is not normative. The tables can only be seen as a proposal that might be changed due to network operator/implementation matters.

Table 5.1/1: Priorities of Application Contexts for HLR as Responder

	Responder = HLR	Initiating Entity	
Priority high	<u>Mobility Management</u>		
	networkLocUp (updateLocation), (restoreData/v2), (sendParameters/v1)	VLR	
	gprsLocationUpdate (updateGPRSLocation/v3),	SGSN	
	infoRetrieval (sendAuthenticationInfo/v2/v3), (sendParameters/v1)	VLR/SGSN	
	istAlerting (istAlert/v3) (purgeMS/v2/v3)	MSC msPurging	VLR
	msPurging (purgeMS/v3)	SGSN	
	<u>Short Message Service</u>		
	shortMsgGateway (sendRoutingInfoforSM), (reportSM-DeliveryStatus)	GMSC	
	mwdMngt VLR/SGSN (readyForSM/v2/v3), (noteSubscriberPresent/v1)		
	<u>Mobile Terminating Traffic</u>		
	locInfoRetrieval (sendRoutingInfo)	GMSC	
	anyTimeEnquiry (anyTimeInterrogation/v3)	gsmSCF	
	reporting (statusReport)	VLR	
	<u>Location Services</u>		
	locationSvcGateway (sendRoutingInfoforLCS/v3)	GMLC	
	<u>Subscriber Controlled Inputs (Supplementary Services)</u>		
	networkFunctionalSs (registerSS), (eraseSS), (activateSS), (deactivateSS), (interrogateSS), (registerPassword), (processUnstructuredSS-Data/v1), (beginSubscriberActivity/v1)	VLR	
	callCompletion (registerCCEnter), (eraseCCEnter)	VLR	
	networkUnstructuredSs (processUnstructuredSS-Request/v2)	VLR	
	imsiRetrieval (sendIMSI/v2)	VLR	
	gprsLocationInfoRetrieval (sendRoutingInfoForGprs/v3/v4)	GGSN/SGSN	
	failureReport (failureReport/v3)	GGSN/SGSN	
	authenticationFailureReport (authenticationFailureReport/v3)	VLR/SGSN	
	Priority low		

NOTE: The application context name is the last component but one of the object identifier.
Operation names are given in brackets for information with "/vn" appended to vn only operations.

Table 5.1/3: Priorities of Application Contexts for SGSN as Responder

Responder = SGSN	Initiating Entity
Priority high	
<u>Mobility and Location Register Management</u>	
locationCancel (cancelLocation v3)	HLR
reset (reset)	HLR
subscriberDataMngt (insertSubscriberData v3), (deleteSubscriberData v3)	HLR
tracing (activateTraceMode), (deactivateTraceMode)	HLR
<u>Short Message Service</u>	
shortMsgMT-Relay (MT-ForwardSM v3), (forwardSM v1/v2)	MSC
<u>Location Services</u>	
locationSvcEnquiry (provideSubscriberLocation v3)	GMLC
<u>Network-Requested PDP context activation</u>	
gprsNotify (noteMsPresentForGprs v3),	HLR
<u>(Subscriber Location & State retrieval)</u>	
subscriberInfoEnquiry (provideSubscriberInformation/v3)	HLR
Priority low	

NOTE: The application context name is the last component but one of the object identifier.
Operation names are given in brackets for information with "/vn" appended to vn.

Table 5.1/2: Priorities of Application Contexts for MSC/VLR as Responder

Responder = MSC/VLR	Initiating Entity
<i>Priority high</i>	
<u>Handover</u>	
handoverControl (prepareHandover/v2/v3), (performHandover/v1)	MSC
<u>Group call and Broadcast call</u>	
groupCallControl (prepareGroupCall/v3)	MSC
<u>Mobility and Location Register Management</u>	
locationCancel (cancelLocation)	HLR
reset (reset)	HLR
immediateTermination (istCommand/v3)	HLR
interVlrInfoRetrieval (sendIdentification/v2/v3), (sendParameters/v1)	VLR
subscriberDataMngt (insertSubscriberData), (deleteSubscriberData)	HLR
tracing (activateTraceMode), (deactivateTraceMode)	HLR
<u>Short Message Service</u>	
shortMsgMO-Relay (MO-ForwardSM v3), (forwardSM v1/v2)	MSC/SGSN
shortMsgMT-Relay (MT-ForwardSM v3), (forwardSM v1/v2)	MSC
shortMsgAlert (alertServiceCentre/v2), (alertServiceCentreWithoutResult/v1)	HLR
<u>Mobile Terminating Traffic</u>	
roamingNbEnquiry (provideRoamingNumber)	HLR
callControlTransfer (resumeCallHandling)	MSC
subscriberInfoEnquiry (provideSubscriberInformation/v3)	HLR
reporting (remoteUserFree), (SetReportingState)	HLR
<u>Location Services</u>	
locationSvcEnquiry (provideSubscriberLocation/v3)	GMLC
<u>Network-Initiated USSD</u>	
networkUnstructuredSs (unstructuredSS-Request/v2), (unstructuredSS-Notify/v2)	HLR
<i>Priority low</i>	

NOTE: The application context name is the last component but one of the object identifier.
Operation names are given in brackets for information with "/vn" appended to vn only operations.

5.1.3 Congestion control for Signalling System No. 7

The requirements of SS7 Congestion control have to be taken into account as far as possible.

Means that could be applied to achieve the required traffic reductions are described in clauses 5.1.1 and 5.1.2.

5.2 Compatibility

5.2.1 General

The present document of the Mobile Application Part is designed in such a way that an implementation which conforms to it can also conform to the Mobile Application Part operational version 1 specifications, except on the MSC-VLR interface.

A version negotiation mechanism based on the use of an application-context-name is used to negotiate the protocol version used between two entities for supporting a MAP-user signalling procedure.

When starting a signalling procedure, the MAP-user supplies an application-context-name to the MAP-provider. This name refers to the set of application layer communication capabilities required for this dialogue. This refers to the required TC facilities (e.g. version 1 or 2) and the list of operation packages (i.e. set of operations) from which operations can be invoked during the dialogue.

A version one application-context-name may only be transferred to the peer user in a MAP-U-ABORT to an entity of version two or higher (i.e. to trigger a dialogue which involves only communication capabilities defined for MAP operational version 1).

If the proposed application-context-name can be supported by the responding entity the dialogue continues on this basis otherwise the dialogue is refused and the initiating user needs to start a new dialogue, which involves another application-context-name which requires less communication capabilities but provides similar functionality (if possible).

When a signalling procedure can be supported by several application contexts that differ by their version number, the MAP-User needs to select a name. It can either select the name that corresponds to the highest version it supports or follow a more specific strategy so that the number of protocol fallbacks due to version compatibility problems is minimised.

5.2.2 Strategy for selecting the Application Context (AC) version

A method should be used to minimise the number of protocol fall-backs which would occur sometimes if the highest supported AC-Name were always the one selected by GSM entities when initiating a dialogue. The following method is an example that can be used mainly at transitory phase stage when the network is one of mixed phase entities.

5.2.2.1 Proposed method

A table (table 1) may be set up by administrative action to define the highest application context (AC) version supported by each destination; a destination may be another node within the same or a different PLMN, or another PLMN considered as a single entity. The destination may be defined by an E.164 number or an E.214 number derived from an IMSI or in North America (World Zone 1) by an E.164 number or an IMSI (E.212 number). The table also includes the date when each destination is expected to be able to handle at least one AC of the latest version of the MAP protocol. When this date is reached, the application context supported by the node is marked as "unknown", which will trigger the use of table 2.

A second table (table 2) contains an entry for each destination that has an entry in table 1. For a given entity, the entry in table 2 may be a single application context version or a vector of different versions applying to different application contexts for that entity. Table 2 is managed as described in clause 5.2.2.2.

The data for each destination will go through the following states:

- a) the version shown in table 1 is "version n-1", where 'n' is the highest version existing in this specification; table 2 is not used;

- b) the version shown in table 1 is "unknown"; table 2 is used, and maintained as described in clause 5.2.2.2;
- c) when the PLMN operator declares that an entity (single node or entire PLMN) has been upgraded to support all the MAP version n ACs defined for the relevant interface, the version shown in table 1 is set to "version n" by administrative action; table 2 is no longer used, and the storage space may be recovered.

5.2.2.2 Managing the version look-up table

WHEN it receives a MAP-OPEN and the MAP-User determines the originating entity number either using the originating address parameter or the originating reference parameter or retrieving it from the subscriber data using the IMSI or the MSISDN.

IF the entity number is known:

THEN

It updates (if required) the associated list of highest supported ACs.

ELSE

It creates an entry for this entity and includes the received AC-name in the list of highest supported ACs.

WHEN starting a procedure, the originating MAP-user looks up its version control table.

IF the destination address is known and not timed-out.

THEN

It retrieves the appropriate AC-name and uses it

IF the dialogue is accepted by the peer

THEN

It does not modify the version control table

ELSE (this should never occur)

It starts a new dialogue with the common highest version supported (based on information implicitly or explicitly provided by the peer).

It replaces the old AC-name by the new one in the list of associated highest AC supported.

ELSE

It uses the AC-name that corresponds to the highest version it supports.

IF the dialogue is accepted by the peer.

THEN

It adds the destination node in its version control table and includes the AC-Name in the list of associated highest AC supported.

ELSE

It starts a new dialogue with the common highest version supported (based on information implicitly or explicitly provided by the peer).

IF the destination node was not known

THEN

It adds the destination node in its version control table and includes the new AC-Name in the list of associated highest AC supported.

ELSE

It replaces the old AC-name by the new one in the list of highest supported AC and reset the timer.

5.2.2.3 Optimising the method

A table look-up may be avoided in some cases if both the HLR and the VLR or both the HLR and the SGSN store for each subscriber the version of the AC-name used at location updating. Then:

- for procedures which make use of the same application-context, the same AC-name (thus the same version) can be selected (without any table look-up) when the procedure is triggered;
- for procedures which make use of a different application-context but which includes one of the packages used by the location updating AC, the same version can be selected (without any table look-up) when the procedure is triggered;

for HLR:

- Subscriber data modification (stand alone);

for VLR:

- Data Restoration.

6 Requirements concerning the use of SCCP and TC

6.1 Use of SCCP

The Mobile Application Part (MAP) makes use of the services offered by the Signalling Connection Control Part (SCCP).

MAP supports the following SCCP versions:

- Signalling Connection Control Part, Signalling System no. 7 CCITT ("Blue Book SCCP");
- Signalling Connection Control Part, Signalling System no. 7 ITU-T Recommendation (07/96) Q.711 to Q.716 ("White Book SCCP"). Support of White Book SCCP at the receiving side shall be mandated from 00:01hrs, 1st July 2002(UTC). However, for signalling over the MAP E-interface to support inter-MSC handover/relocation, the support of White Book SCCP shall be mandated with immediate effect.

A White Book SCCP message will fail if any signalling point used in the transfer of the message does not support White Book SCCP. Therefore it is recommended that the originator of the White Book SCCP message supports a drop back mechanism or route capability determination mechanism to interwork with signalling points that are beyond the control of GSM/UMTS network operators.

In North America (World Zone 1) the national version of SCCP is used as specified in ANSI T1.112. Interworking between a PLMN in North America and a PLMN outside North America will involve an STP to translate between ANSI SCCP and ITU-T/CCITT SCCP.

The SCCP is identified as an MTP3-user and the transport of SCCP messages between two entities shall be accomplished according to the 3GPP TS 29.202 [121].

6.1.1 SCCP Class

MAP will only make use of the connectionless classes (0 or 1) of the SCCP.

6.1.2 Sub-System Number (SSN)

The Application Entities (AEs) defined for MAP consist of several Application Service Elements (ASEs) and are addressed by sub-system numbers (SSNs). The SSNs for MAP are specified in 3GPP TS 23.003 [17].

When the SGSN emulates MSC behaviour for processing messages (MAP-MO-FORWARD-SHORT-MESSAGE, MAP_CHECK_IMEI, MAP_SUBSCRIBER_LOCATION_REPORT) towards entities which do not support interworking to SGSNs, it shall use the MSC SSN in the calling party address instead of the SGSN SSN.

6.1.3 SCCP addressing

6.1.3.1 Introduction

Within the GSM System there will be a need to communicate between entities within the same PLMN and in different PLMNs. Using the Mobile Application Part (MAP) for this function implies the use of Transaction Capabilities (TC) and the Signalling Connection Control Part (SCCP) of CCITT Signalling System No. 7.

Only the entities that should be addressed are described below. If the CCITT or ITU-T SCCP is used, the format and coding of address parameters carried by the SCCP for that purpose shall comply with CCITT Recommendation Q.713 with the following restrictions:

1) Intra-PLMN addressing

For communication between entities within the same PLMN, a MAP SSN shall always be included in the called and calling party addresses. All other aspects of SCCP addressing are network specific.

2) Inter-PLMN addressing

a) Called Party Address

- SSN indicator = 1 (MAP SSN always included);
- Global title indicator = 0100 (Global title includes translation type, numbering plan, encoding scheme and nature of address indicator);
- the translation type field will be coded "00000000" (Not used). For call related messages for non-optimal routed calls (as described in 3GPP TS 23.066 [108]) directed to another PLMN the translation type field may be coded "10000000" (CRMNP);
- Routing indicator = 0 (Routing on global title);

b) Calling Party Address

- SSN indicator = 1 (MAP SSNs always included);
- Point code indicator = 0;
- Global title indicator = 0100 (Global title includes translation type, numbering plan, encoding scheme and nature of address indicator);
- Numbering Plan = 0001 (ISDN Numbering Plan, E.164; In Case of Inter-PLMN Signalling, the dialogue initiating entity and dialogue responding entity shall always include its own E.164 Global Title as Calling Party Address);
- the translation type field will be coded "00000000" (Not used);
- Routing indicator = 0 (Routing on Global Title).

If ANSI T1.112 SCCP is used, the format and coding of address parameters carried by the SCCP for that purpose shall comply with ANSI specification T1.112 with the following restrictions:

1) Intra-PLMN addressing

For communication between entities within the same PLMN, a MAP SSN shall always be included in the called and calling party addresses. All other aspects of SCCP addressing are network specific.

2) Inter-PLMN addressing

a) Called Party Address

- SSN indicator = 1 (MAP SSN always included);
- Global title indicator = 0010 (Global title includes translation type);
- the Translation Type (TT) field will be coded as follows:
 - TT = 9, if IMSI is included;
 - TT = 14, if MSISDN is included;
 - Or TT = 10, if Network Element is included. (If TT=10, then Number Portability GTT is not invoked, if TT=14, then Number Portability GTT may be invoked).
- Routing indicator = 0 (Routing on global title);

b) Calling Party Address

- SSN indicator = 1 (MAP SSNs always included);
- Point code indicator = 0;
- Global Title indicator = 0010 (Global title includes translation type);
 - TT = 9, if IMSI is included;
 - TT = 14, if MSISDN is included;
 - Or TT = 10, if Network Element is included. (If TT=10, then Number Portability GTT is not invoked, if TT=14, then Number Portability GTT may be invoked).

Routing indicator = 0 (Routing on Global Title).

If a Global Title translation is required for obtaining routing information, one of the numbering plans E.164, E.212 and E.214 is applicable.

- E.212 numbering plan.

When CCITT or ITU-T SCCP is used, an E.212 number must not be included as Global Title in an SCCP UNITDATA message. The translation of an E.212 number into a Mobile Global Title is applicable in a dialogue initiating VLR, SGSN or GGSN if the routing information towards the HLR is derived from the subscriber's IMSI. In World Zone 1 when ANSI SCCP is used, the IMSI (E.212 number) is used as a Global Title to address the HLR. When an MS moves from one VLR service area to another, the new VLR may derive the address of the previous VLR from the Location Area Identification provided by the MS in the location registration request. The PLMN where the previous VLR is located is identified by the E.212 numbering plan elements of the Location Area Identification, i.e. the Mobile Country Code (MCC) and the Mobile Network Code (MNC).

- E.214 and E.164 numbering plans.

When CCITT or ITU-T SCCP is used, only address information belonging to either E.214 or E.164 numbering plan is allowed to be included as Global Title in the Called and Calling Party Address. In World Zone 1 when ANSI SCCP is used, the IMSI (E.212 number) is used as a Global Title to address the HLR.

If the Calling Party Address associated with the dialogue initiating message contains a Global Title, the sending network entity shall include its E.164 entity number.

When receiving an SCCP UNITDATA message, SCCP shall accept either of the valid numbering plans in the Called Party Address and in the Calling Party Address.

When CCITT or ITU-T SCCP is used and an N-UNITDATA-REQUEST primitive from TC is received, SCCP shall accept an E.164 number or an E.214 number in the Called Address and in the Calling Address. In World Zone 1 when ANSI SCCP is used, the IMSI (E.212 number) is used instead of E.214 number.

The following clauses describe the method of SCCP addressing appropriate for each entity both for the simple intra-PLMN case and where an inter-PLMN communication is required. The following entities are considered:

- the Mobile-services Switching Centre (MSC);

- the Home location Register (HLR);
- the Visitor Location Register (VLR);
- the Gateway Mobile-services Switching Centre (GMSC);
- the GSM Service Control Function (gsmSCF);
- the Interworking Mobile-services Switching Centre (IWMSC);
- the Shared Inter Working Function (SIWF);
- the Serving GPRS Support Node (SGSN);
- the Gateway GPRS Support Node (GGSN);
- the Gateway Mobile Location Centre (GMLC).

6.1.3.2 The Mobile-services Switching Centre (MSC)

There are several cases where it is necessary to address the MSC.

6.1.3.2.1 MSC interaction during handover or relocation

The address is derived from the target Cell id or from the target RNC id.

6.1.3.2.2 MSC for short message routing

When a short message has to be routed to an MS, the GMSC addresses the VMSC by an MSC identity received from the HLR that complies with E.164 rules.

For MS originating short message, the IWMSC address is derived from the Service Centre address.

6.1.3.2.3 MSC for location request routing

When a location request for a particular MS needs to be sent to the MS's VMSC, the GMLC addresses the VMSC using an E.164 address received from the MS's HLR.

6.1.3.2.4 MSC for LMU Control

When a control message has to be routed to an LMU from an SMLC, the SMLC addresses the serving MSC for the LMU using an E.164 address.

6.1.3.3 The Home Location Register (HLR)

There are several cases where the HLR has to be addressed.

6.1.3.3.1 During call set-up

When a call is initiated the HLR of the called mobile subscriber will be interrogated to discover the whereabouts of the MS. The addressing required by the SCCP will be derived from the MSISDN dialled by the calling subscriber. The dialled number will be translated into either an SPC, in the case of communications within a PLMN, or a Global Title if other networks are involved (i.e. if the communication is across a PLMN boundary).

If the calling subscriber is a fixed network subscriber, the interrogation can be initiated from the Gateway MSC of the home PLMN in the general case. If the topology of the network allows it, the interrogation could be initiated from any Signalling Point that has MAP capabilities, e.g. local exchange, outgoing International Switching Centre (ISC), etc.

6.1.3.3.2 Before location updating completion

When an MS registers for the first time in a VLR, the VLR has to initiate the update location dialogue with the MS's HLR and a preceding dialogue for authentication information retrieval if the authentication information must be retrieved from the HLR. When initiating either of these dialogues, the only data for addressing the HLR that the VLR has available is contained in the IMSI, and addressing information for SCCP must be derived from it. When continuing the established update location dialogue (as with any other dialogue), the VLR must derive the routing information towards the HLR from the Calling Party Address received with the first responding CONTINUE message until the dialogue terminating message is received. This means that the VLR must be able to address the HLR based on:

- an E.214 Mobile Global Title originally derived by the VLR from the IMSI (when CCITT or ITU-T SCCP is used), or an E.212 number originally derived from IMSI (when ANSI SCCP is used, an IMSI); or
- an E.164 HLR address; or
- in the case of intra-PLMN signalling, an SPC.

When answering with Global Title to the VLR, the HLR shall insert its E.164 address in the Calling Party Address of the SCCP message containing the first responding CONTINUE message.

If the HLR is in the same PLMN as the VLR, local translation tables may exist to derive an SPC. For authentication information retrieval and location updating via the international PSTN/ISDN signalling network that requires the use of CCITT or ITU-T SCCP, the Global Title must be derived from the IMSI, using the principles contained in CCITT Recommendation E.214 and the Numbering Plan Indicator (NPI) value referenced by the SCCP Specifications. In World Zone 1 where the ANSI SCCP is used, IMSI (E.212 number) is used as Global Title. A summary of the translation from the IMSI (CCITT Recommendation E.212) to Mobile Global Title (described in CCITT Recommendation E.214) is shown below:

- E.212 Mobile Country Code translates to E.164 Country Code;
- E.212 Mobile Network Code translates to E.164 National Destination Code;
- E.212 Mobile Subscriber Identification Number (MSIN) is carried unchanged if within the E.164 number maximum length (15 digits). If the Mobile Global Title is more than 15 digits the number is truncated to 15 by deleting the least significant digits.

This translation will be done either at the application or at SCCP level in the VLR. The Mobile Global Title thus derived will be used to address the HLR.

If location updating is triggered by an MS that roams from one MSC Area into a different MSC Area served by the same VLR, the VLR shall address the HLR in the same way as if the MS registers for the first time in the VLR.

6.1.3.3.3 After location updating completion

In this case, the subscriber's basic MSISDN has been received from the HLR during the subscriber data retrieval procedure as well as the HLR number constituting a parameter of the MAP message indicating successful completion of the update location dialogue. From either of these E.164 numbers the address information for initiating dialogues with the roaming subscriber's HLR can be derived. Also the subscriber's IMSI may be used for establishing the routing information towards the HLR. This may apply in particular if the dialogue with the HLR is triggered by subscriber controlled input.

Thus the SCCP address of the roaming subscriber's HLR may be an SPC, or it may be a Global title consisting of the E.164 MSISDN or the E.164 number allocated to the HLR or either the E.214 Mobile Global Title derived from the IMSI if CCITT or ITU-T SCCP is used, or the IMSI if ANSI SCCP is used (ANSI SCCP is used in World Zone 1).

6.1.3.3.4 VLR restoration

If a roaming number is requested by the HLR for an IMSI that has no data record in the interrogated VLR, the VLR provides the roaming number in the dialogue terminating message. Subsequently the VLR must retrieve the authentication data from the MS's HLR, if required, and must then trigger the restore data procedure. For this purpose, the VLR has to initiate in succession two independent dialogues with the MS's HLR. The MTP and SCCP address information needed for routing towards the HLR can be derived from the IMSI received as a parameter of the MAP message requesting the roaming number. In this case, the IMSI received from the HLR in the roaming number request shall be processed in the same way as the IMSI that is received from an MS that registers for the first time within a VLR. Alternatively to the IMSI, the Calling Party Address associated with the roaming number request may be used to obtain the routing information towards the HLR.

6.1.3.3.5 During Network-Requested PDP Context Activation

When receiving a PDP PDU the GGSN may interrogate the HLR of the MS for information retrieval. When initiating such a dialogue, the only data for addressing the HLR that the GGSN has available is contained in the IMSI, and addressing information must be derived from it. The IMSI is obtained from the IP address or the X.25 address in the incoming IP message by means of a translation table. This means that the GGSN shall be able to address the HLR based on an E.214, (if CCITT or ITU-T SCCP is used), or E.212 (if ANSI SCCP is used), Mobile Global Title originally derived by the GGSN from the IMSI in the case of inter-PLMN signalling. In the case of intra-PLMN signalling, an SPC may also be used.

If the HLR is in the same PLMN as the GGSN, local translation tables may exist to derive an SPC. For information retrieval via the international PSTN/ISDN signalling network, the Global title must be derived from the IMSI, using the principles contained in CCITT Recommendation E.214 and the Numbering Plan Indicator (NPI) value referenced by the SCCP Specifications. A summary of the translation from the IMSI (CCITT Recommendation E.212) to Mobile Global Title (described in CCITT Recommendation E.214) is shown below:

- E.212 Mobile Country Code translates to E.164 Country Code;
- E.212 Mobile Network Code translates to E.164 National Destination Code;
- E.212 Mobile Subscriber Identification Number (MSIN) is carried unchanged if within the E.164 number maximum length (15 digits). If the Mobile Global Title is more than 15 digits the number is truncated to 15 by deleting the least significant digits.

This translation will be done either at the application or at SCCP level in the GGSN. The Mobile Global Title thus derived will be used to address the HLR.

6.1.3.3.6 Before GPRS location updating completion

When an MS registers for the first time in an SGSN, the SGSN has to initiate the update location dialogue with the MS's HLR and a preceding dialogue for authentication information retrieval if the authentication information must be retrieved from the HLR. When initiating either of these dialogues, the only data for addressing the HLR that the SGSN has available is contained in the IMSI, and addressing information for SCCP must be derived from it. When continuing the established update location dialogue (as with any other dialogue), the SGSN must derive the routing information towards the HLR from the Calling Party Address received with the first responding CONTINUE message until the dialogue terminating message is received. This means that the SGSN must be able to address the HLR based on:

- an E.214 (if CCITT or ITU-T SCCP is used) or E.212 (if ANSI SCCP is used) Mobile Global Title originally derived by the SGSN from the IMSI; or
- an E.164 HLR address; or
- in the case of intra-PLMN signalling, an SPC.

If the HLR is in the same PLMN as the SGSN, local translation tables may exist to derive an SPC. For authentication information retrieval and location updating via the international PSTN/ISDN signalling network, the Global title must be derived from the IMSI, using the principles contained in CCITT Recommendation E.214 and the Numbering Plan Indicator (NPI) value referenced by the SCCP Specifications. A summary of the translation from the IMSI (CCITT Recommendation E.212) to Mobile Global Title (described in CCITT Recommendation E.214) is shown below:

- E.212 Mobile Country Code translates to E.164 Country Code;

- E.212 Mobile Network Code translates to E.164 National Destination Code;
- E.212 Mobile Subscriber Identification Number (MSIN) is carried unchanged if within the E.164 number maximum length (15 digits). If the Mobile Global Title is more than 15 digits the number is truncated to 15 by deleting the least significant digits.

This translation will be done either at the application or at SCCP level in the SGSN. The Mobile Global Title thus derived will be used to address the HLR.

6.1.3.3.7 After GPRS location updating completion

In this case, the subscriber's Basic MSISDN has been received from the HLR during the subscriber data retrieval procedure as well as the HLR number constituting a parameter of the MAP message indicating successful completion of the update location dialogue. From either of these E.164 numbers the address information for initiating dialogues with the roaming subscriber's HLR can be derived. Also the subscriber's IMSI may be used for establishing the routing information towards the HLR.

Thus the SCCP address of the roaming subscriber's HLR may be an SPC, or it may be a Global title consisting of the E.164 MSISDN or the E.164 number allocated to the HLR or the E.214 Mobile Global Title derived from the IMSI.

6.1.3.3.8 Query for a Location Request

For a location request from an external client, the GMLC needs to address the home HLR of the target MS to obtain the address of the target MS's serving MSC. The GMLC uses either the international E.164 MSISDN, the international E.214 number (if CCITT or ITU-T SCCP is used) or the international E.212 number (if ANSI SCCP is used) of the MS as means to route a query to the HLR.

6.1.3.4 The Visitor Location Register (VLR)

There are several cases when the VLR needs to be addressed.

6.1.3.4.1 Inter-VLR information retrieval

When an MS moves from one VLR service area to another, the new VLR may request the IMSI and authentication sets from the previous VLR. The new VLR derives the address of the previous VLR from the Location Area Identification provided by the MS in the location registration request.

6.1.3.4.2 HLR request

The HLR will only request information from a VLR if it is aware that one of its subscribers is in the VLR service area. This means that a location updating dialogue initiated by the VLR has been successfully completed, i.e. the HLR has indicated successful completion of the update location procedure to the VLR.

When initiating dialogues towards the VLR after successful completion of location updating, the routing information used by the HLR is derived from the E.164 VLR number received as a parameter of the MAP message initiating the update location dialogue. If the VLR is in the same PLMN as the HLR, the VLR may be addressed directly by an SPC derived from the E.164 VLR number. For dialogues via the international PSTN/ISDN signalling network, presence of the E.164 VLR number in the Called Party Address is required.

6.1.3.5 The Interworking MSC (IWMSC) for Short Message Service

The IWMSC is the interface between the mobile network and the network to access to the Short Message Service Centre. This exchange has an E.164 address known in the SGSN or in the MSC.

6.1.3.6 The Equipment Identity Register (EIR)

The EIR address is either unique or could be derived from the IMEI. The type of address is not defined.

6.1.3.7 The Shared Inter Working Function (SIWF)

When the Visited MSC detects a data or fax call and the IWF in the V-MSC cannot handle the required service an SIWF can be invoked. The SIWF is addressed with an E.164 number.

6.1.3.8 The Serving GPRS Support Node (SGSN)

The HLR will initiate dialogues towards the SGSN if it is aware that one of its subscribers is in the SGSN serving area. This means that a GPRS location updating has been successfully completed, i.e., the HLR has indicated successful completion of the GPRS location update to the SGSN. The routing information used by the HLR is derived from the E.164 SGSN number received as parameter of the MAP message initiating the GPRS update location procedure. If the SGSN is in the same PLMN as the HLR, the SGSN may be addressed directly by an SPC derived from the E.164 SGSN number. For dialogues via the international PSTN/ISDN signalling network, the presence of the E.164 SGSN number in the Called Party Address is required.

When the GMSC initiates dialogues towards the SGSN the SGSN (MAP) SSN (See 3GPP TS 23.003 [17]) shall be included in the called party address. The routing information used by the GMSC is derived from the E.164 SGSN number received as a parameter of the MAP message initiating the forward short message procedure. If the GMSC does not support the GPRS functionality the MSC (MAP) SSN value shall be included in the called party address.

NOTE: Every VMSC and SGSN shall have uniquely identifiable application using E.164 numbers, for the purpose of SMS over GPRS when the GMSC does not support the GPRS functionality.

6.1.3.9 The Gateway GPRS Support Node (GGSN)

The GGSN provides interworking with external packet-switched networks, network screens and routing of the Network-Requested PDP Context activation. If a Network-Requested PDP Context activation fails, the HLR will alert the GGSN when the subscriber becomes reachable. The HLR will use the E.164 GGSN number received as parameter of the MAP message reporting the failure.

6.1.3.10 The Gateway MSC (GMSC) for Short Message Service

The GMSC provides interworking with the network to access the Short Message Service Centre, the mobile network and routing of Send Routing Info For SM. The GMSC has an E.164 address known in the HLR, SGSN or MSC.

6.1.3.10A Void

6.1.3.10A.1 Void

6.1.3.10A.2 Void

6.1.3.10B The Gateway Mobile Location Centre (GMLC)

The GMLC initiates location requests on behalf of external clients. The E.164 address of the GMLC is provided to an HLR when the GMLC requests a serving MSC address or SGSN address from the HLR for a target MS. The E.164 address of the GMLC is also provided to a serving MSC or SGSN when the GMLC requests the location of a target MS served by this MSC or SGSN.

6.1.3.11 Summary table

The following tables summarise the SCCP address used for invoke operations. As a principle, within a PLMN either an SPC or a GT may be used (network operation option), whereas when addressing an entity outside the PLMN the GT must be used. The address type mentioned in the table (e.g. MSISDN) is used as GT or to derive the SPC.

For a response, the originating address passed in the invoke is used as SCCP Called Party Address. For extra-PLMN addressing the own E.164 entity address is used as SCCP Calling Party Address; for intra-PLMN addressing an SPC derived from the entity number may be used instead. When using an SPC, the SPC may be taken directly from MTP.

Table 6.1/1

to from	fixed net work	HLR	VLR	MSC	EIR	gsmSCF	SIWF	SGSN	GGSN
fixed network	---	E:GT T:MSISDN	---	---	---	---	---	---	---
Home Location Register	---	---	I:SPC/GT E:GT T:VLR NUMBER	---	---	I:SPC/GT E:GT T:gsmSCF NUMBER	---	I:SPC/GT E:GT T:SGSN NUMBER	I:SPC/GT E:GT T:GGSN NUMBER
Visitor Location Register	---	I:SPC/GT E:GT T:MGT (outside World Zone 1)/MSISDN (World Zone 1)/HLR NUMBER (note)	I:SPC/GT E:GT T:VLR NUMBER	---	---	I:SPC/GT E:GT T:gsmSCF NUMBER	---	---	---
mobile-services switching centre	---	I:SPC/GT E:GT T:MSISDN	I:SPC/GT E:GT T:VLR NUMBER	I:SPC/GT E:GT T:MSC NUMBER	I:SPC/GT E:GT T:EIR NUMBER	I:SPC/GT E:GT T:gsmSCF NUMBER	I:SPC/GT E:GT T:SIWF NUMBER	I:SPC/GT E:GT T:SGSN NUMBER	---
gsm Service Control Function	---	I:SPC/GT E:GT T:MSISDN	---	---	---	---	---	---	---
Shared Inter Working Function	---	---	---	I:SPC/GT E:GT T:MSC NUMBER	---	---	---	---	---
Serving GPRS Support Node	---	I:SPC/GT E:GT T:MGT/ MSISDN/HL R NUMBER	---	I:SPC/GT E:GT T:MSC NUMBER	I:SPC/GT E:GT T:EIR NUMBER	I:SPC/GT E:GT T:gsmSCF NUMBER	---	---	---
Gateway GPRS Support Node	---	I:SPC/GT E:GT T:MGT	---	---	---	---	---	---	---
Gateway Mobile Location Centre	---	I:SPC/GT E:GT T:MSISDN, MGT (outside World Zone 1) or IMSI (World Zone 1) (note)	---	I:SPC/GT E:GT T:MSC NUMBER	---	---	---	I:SPC/GT E:GT T:SGSN NUMBER	---

I:	Intra-PLMN.
E:	Extra (Inter)-PLMN.
T:	Address Type.
GT:	Global Title.
MGT:	E.214 Mobile Global Title.
SPC:	Signalling Point Code.
NOTE:	<p>For initiating the location updating procedure and an authentication information retrieval from the HLR preceding it, the VLR has to derive the HLR address from the IMSI of the MS. The result can be an SPC or an E.214 Mobile Global Title if CCITT or ITU-T SCCP is used, or IMSI itself if ANSI SCCP is used (ANSI SCCP is used in World Zone 1). When continuing the established update location dialogue (as with any other dialogue) the VLR must derive the routing information towards the HLR from the Calling Party Address received with the first responding CONTINUE message until the dialogue terminating message is received.</p> <p>For transactions invoked by the VLR after update location completion, the VLR may derive the information for addressing the HLR from addresses received in the course of the update location procedure (MSISDN or HLR number) or from the IMSI.</p> <p>When invoking the Restore Data procedure and an authentication information retrieval from the HLR preceding it, the VLR must derive the information for addressing the HLR from the address information received in association with the roaming number request. This may be either the IMSI received as a parameter of the MAP message requesting the Roaming Number or the Calling Party Address associated with the MAP message requesting the Roaming Number.</p> <p>The gsmSCF shall be addressed using more than one Global Title number. The first Global Title number is used to address a gsmSCF for MAP. The second Global Title number is used to address a gsmSCF for CAP.</p> <p>For querying the HLR to obtain the VMSC address to support location services, the GMLC has to derive the HLR address from either the MSISDN or IMSI of the target MS. When using the IMSI, the result can be an SPC or an E.214 Mobile Global Title if CCITT or ITU-T SCCP is used, or IMSI itself if ANSI SCCP is used (ANSI SCCP is used in World Zone 1).</p>

Table 6.1/2

to from		GMLC
fixed network		---
Home Location Register		---
Visitor Location Register		---
Mobile-services Switching Centre		I:SPC/GT E:GT T:MLC Number
gsm Service Control Function		I:SPC/GT E:GT T:MSISDN
Shared Inter Working Function		---
Serving GPRS Support Node		I:SPC/GT E:GT T:MLC Number
Gateway GPRS Support Node		---
Gateway Mobile Location Centre		
I:	Intra-PLMN.	
E:	Extra (Inter)-PLMN.	
T:	Address Type.	
GT:	Global Title.	
MGT:	E.214 Mobile Global Title.	
SPC:	Signalling Point Code.	

6.2 Use of TC

The Mobile Application part makes use of the services offered by the Transaction Capabilities (TC) of Signalling System No. 7. ETS 300 287, which is based on CCITT White Book Recommendations Q.771 to Q.775, should be consulted for the full specification of TC.

The MAP uses all the services provided by TC except the ones related to the unstructured dialogue facility.

From a modelling perspective, the MAP is viewed as a single Application Service Element. Further structuring of it is for further study.

Transaction Capabilities refers to a protocol structure above the network layer interface (i.e., the SCCP service interface) up to the application layer including common application service elements but not the specific application service elements using them.

TC is structured as a Component sub-layer above a Transaction sub-layer.

The Component sub-layer provides two types of application services: services for the control of end-to-end dialogues and services for Remote Operation handling. These services are accessed using the TC-Dialogue handling primitives and TC-Component handling primitives respectively.

Services for dialogue control include the ability to exchange information related to application-context negotiation as well as initialisation data.

Services for Remote Operation handling provide for the exchange of protocol data units invoking tasks (operations), and reporting their outcomes (results or errors) plus any non-application-specific protocol errors detected by the component sub-layer. The reporting of application-specific protocol errors by the TC user, as distinct from application process errors, is also provided. The Transaction sub-layer provides a simple end-to-end connection association service over which several related protocol data units (i.e. built by the Component Sub-Layer) can be exchanged. A Transaction termination can be prearranged (no indication provided to the TC user) or basic (indication provided).

7 General on MAP services

7.1 Terminology and definitions

The term service is used in clauses 7 to 12 as defined in CCITT Recommendation X.200. The service definition conventions of CCITT Recommendation X.210 are also used.

7.2 Modelling principles

MAP provides its users with a specified set of services and can be viewed by its users as a "black box" or abstract machine representing the MAP service-provider. The service interface can then be depicted as shown in figure 7.2/1.

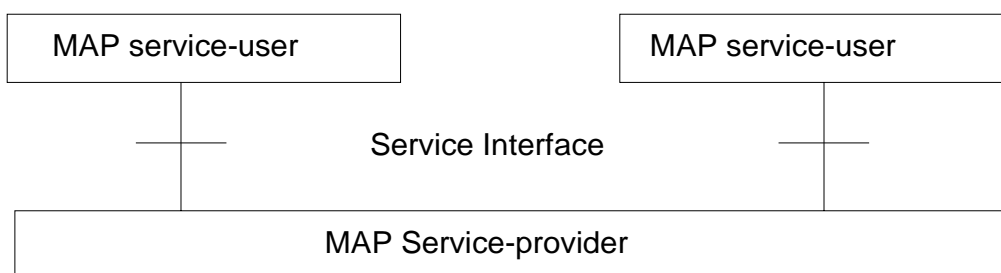

Figure 7.2/1: Modelling principles

The MAP service-users interact with the MAP service-provider by issuing or receiving MAP service-primitives at the service interface.

A MAP service-user may receive services from several instances of the MAP service-provider at the same time. In such cases the overall procedure is synchronised by the service-user.

The MAP service-primitives are named using the following notation:

MAP-ServicePrimitiveName type

where **type** can be any of: request (req), indication (ind), response (rsp) or confirm (cnf). (In the user arrow diagrams type is not indicated in the case of req/ind and indicated as "ack" in the case of rsp/cnf).

The services are further classified as unconfirmed-service, confirmed-service and provider-initiated-service where the first two categories refer to whether or not the service is confirmed by the service-provider. The confirmation may or may not correspond to a response provided by the other service-user.

MAP services are also classified as common MAP services that are available to all MAP service-users, and MAP service-user specific services, which are services available to one or several, but not all, MAP service-users.

A MAP dialogue is defined as an exchange of information between two MAP users in order to perform a common task. A MAP dialogue will consist of one or several MAP services.

7.3 Common MAP services

All MAP service-users require access to services for performing basic application layer functions:

- for establishing and clearing MAP dialogues between peer MAP service-users;
- for accessing functions supported by layers below the applications layer;
- for reporting abnormal situations;
- for handling of different MAP versions;
- for testing whether or not a persistent MAP dialogue is still active at each side.

For these purposes the following common services are defined:

- MAP-OPEN service;
- MAP-CLOSE service;
- MAP-DELIMITER service;
- MAP-U-ABORT service;
- MAP-P-ABORT service;
- MAP-NOTICE service.

In defining the service-primitives the following convention is used for categorising parameters:

- M** the inclusion of the parameter is mandatory. The M category can be used for any primitive type and specifies that the corresponding parameter must be present in the indicated primitive type;
- O** the inclusion of the parameter is a service-provider option. The O category can be used in indication and confirm type primitives and is used for parameters that may optionally be included by the service-provider;
- U** the inclusion of the parameter is a service-user option. The U category can be used in request and response type primitives. The inclusion of the corresponding parameter is the choice of the service-user;
- C** the inclusion of the parameter is conditional. The C category can be used for the following purposes:
 - to indicate that if the parameter is received from another entity it must be included for the service being considered;
 - to indicate that the service user must decide whether to include the parameter, based on the context on which the service is used;

- to indicate that one of a number of mutually exclusive parameters must be included (e.g. parameters indicating a positive result versus parameters indicating a negative result);
 - to indicate that a service user optional parameter (marked "U") or a conditional parameter (marked "C") presented by the service user in a request or response type primitive is to be presented to the service user in the corresponding indication or confirm type primitive;
- (=) when appended to one of the above, this symbol means that the parameter takes the same value as the parameter appearing immediately to its left;

blank the parameter is not present.

A primitive type may also be without parameters, i.e. no parameter is required with the primitive type; in this case the corresponding column of the table is empty.

7.3.1 MAP-OPEN service

This service is used for establishing a MAP dialogue between two MAP service-users. The service is a confirmed service with service primitives as shown in table 7.3/1.

Table 7.3/1: Service-primitives for the MAP-OPEN service

Parameters	Request	Indication	Response	Confirm
Application context name	M	M(=)	U	C(=)
Destination address	M	M(=)		
Destination reference	U	C(=)		
Originating address	U	O		
Originating reference	U	C(=)		
Specific information	U	C(=)	U	C(=)
Responding address			U	C(=)
Result			M	M(=)
Refuse-reason			C	C(=)
Provider error				O

Application context name:

This parameter identifies the type of application context being established. If the dialogue is accepted the received application context name shall be echoed. In case of refusal of dialogue this parameter shall indicate the highest version supported.

Destination address:

A valid SCCP address identifying the destination peer entity (see also clause 6). As an implementation option, this parameter may also, in the indication, be implicitly associated with the service access point at which the primitive is issued.

Destination-reference:

This parameter is a reference that refines the identification of the called process. It may be identical to Destination address but its value is to be carried at MAP level. Table 7.3/2 describes the MAP services using this parameter. Only these services are allowed to use it.

Table 7.3/2: Use of the destination reference

MAP service	Reference type	Use of the parameter
MAP-REGISTER-SS	IMSI	Subscriber identity
MAP-ERASE-SS	IMSI	Subscriber identity
MAP-ACTIVATE-SS	IMSI	Subscriber identity
MAP-DEACTIVATE-SS	IMSI	Subscriber identity
MAP-INTERROGATE-SS	IMSI	Subscriber identity
MAP-REGISTER-PASSWORD	IMSI	Subscriber identity
MAP-PROCESS-UNSTRUCTURED-SS-REQUEST	IMSI (note 1)	Subscriber identity
MAP-UNSTRUCTURED-SS-REQUEST	IMSI (note 2)	Subscriber identity
MAP-UNSTRUCTURED-SS-NOTIFY	IMSI (note 2)	Subscriber identity
MAP-FORWARD-SHORT-MESSAGE	IMSI (note 3)	Subscriber identity
MAP-REGISTER-CC-ENTRY	IMSI	Subscriber identity
MAP-ERASE-CC-ENTRY	IMSI	Subscriber identity

NOTE 1: On the HLR - HLR interface and on the HLR - gsmSCF interface the Destination reference shall be either IMSI or MSISDN.

NOTE 2: On the gsmSCF - HLR interface and on the HLR - HLR interface the Destination reference shall be either IMSI or MSISDN.

NOTE 3: Only when the IMSI and the LMSI are received together from the HLR in the mobile terminated short message transfer.

Originating address:

A valid SCCP address identifying the requestor of a MAP dialogue (see also clause 6). As an implementation option, this parameter may also, in the request, be implicitly associated with the service access point at which the primitive is issued.

Originating-reference:

This parameter is a reference that refines the identification of the calling process. It may be identical to the Originating address but its value is to be carried at MAP level. Table 7.3/3 describes the MAP services using the parameter. Only these services are allowed to use it. Processing of the Originating-reference shall be performed according to the supplementary service descriptions and other service descriptions, e.g. operator determined barring. Furthermore the receiving entity may be able to use the value of the Originating-reference to screen the service indication.

Table 7.3/3: Use of the originating reference

MAP service	Reference type	Use of the parameter
MAP-REGISTER-SS	ISDN-Address-String	Originated entity address
MAP-ERASE-SS	ISDN-Address-String	Originated entity address
MAP-ACTIVATE-SS	ISDN-Address-String	Originated entity address
MAP-DEACTIVATE-SS	ISDN-Address-String	Originated entity address
MAP-INTERROGATE-SS	ISDN-Address-String	Originated entity address
MAP-REGISTER-PASSWORD	ISDN-Address-String	Originated entity address
MAP-PROCESS-UNSTRUCTURED-SS-REQUEST	ISDN-Address-String	Originated entity address
MAP-UNSTRUCTURED-SS-REQUEST	ISDN-Address-String (note)	Originated entity address
MAP-UNSTRUCTURED-SS-NOTIFY	ISDN-Address-String (note)	Originated entity address
MAP-REGISTER-CC-ENTRY	ISDN-Address-String	Originated entity address
MAP-ERASE-CC-ENTRY	ISDN-Address-String	Originated entity address

NOTE: The Originating reference may be omitted.

Specific information:

This parameter may be used for passing any user specific information. Establishment and processing of the Specific information is not specified by GSM and shall be performed according to operator specific requirements.

Responding address:

An address identifying the responding entity. The responding address is included if required by the context (e.g. if it is different from the destination address).

Result:

This parameter indicates whether the peer accepts the dialogue.

Refuse reason:

This parameter is present only if the Result parameter indicates that the dialogue is refused. It takes one of the following values:

- Application-context-not-supported;
- Invalid-destination-reference;
- Invalid-originating-reference;
- No-reason-given;
- Remote node not reachable;
- Potential version incompatibility.

7.3.2 MAP-CLOSE service

This service is used for releasing a previously established MAP dialogue. The service may be invoked by either MAP service-user depending on rules defined within the service-user. The service is an unconfirmed service with parameters as shown in table 7.3/4.

Table 7.3/4: Service-primitives for the MAP-CLOSE service

Parameters	Request	Indication
Release method	M	
Specific Information	U	C(=)

Release method:

This parameter can take the following two values:

- normal release; in this case the primitive is mapped onto the protocol and sent to the peer;
- prearranged end; in this case the primitive is not mapped onto the protocol. Prearranged end is managed independently by the two users, i.e. only the request type primitive is required in this case.

Specific information:

This parameter may be used for passing any user specific information. Establishment and processing of the Specific information is not specified by GSM GSM and shall be performed according to operator specific requirements.

7.3.3 MAP-DELIMITER service

This service is used to explicitly request the transfer of the MAP protocol data units to the peer entities.

See also clause 7.4 and 7.5 for the detailed use of the MAP-DELIMITER service.

The service is an unconfirmed service with service-primitives as shown in table 7.3/5.

Table 7.3/5: Service-primitives for the MAP-DELIMITER service

Parameters	Request	Indication

7.3.4 MAP-U-ABORT service

This service enables the service-user to request the MAP dialogue to be aborted. The service is an unconfirmed service with service-primitives as shown in table 7.3/6.

Table 7.3/6: Service-primitives for the MAP-U-ABORT service

Parameters	Request	Indication
User reason	M	M(=)
Diagnostic information	U	C(=)
Specific information	U	C(=)

User reason:

This parameter can take the following values:

- resource limitation (congestion);
the requested user resource is unavailable due to congestion;
- resource unavailable;

the requested user resource is unavailable for reasons other than congestion;

- application procedure cancellation;

the procedure is cancelled for reasons detailed in the diagnostic information parameter;

- procedure error;

processing of the procedure is terminated for procedural reasons.

Diagnostic information:

This parameter may be used to give additional information for some of the values of the user-reason parameter:

Table 7.3/7: User reason and diagnostic information

User reason	Diagnostic information
Resource limitation (congestion)	-
Resource unavailable	Short term/long term problem
Application procedure cancellation	Handover cancellation/ Radio Channel release/ Network path release/ Call release/ Associated procedure failure/ Tandem dialogue released/ Remote operations failure
Procedure error	-

Specific information:

This parameter may be used for passing any user specific information. Establishment and processing of the Specific information is not specified by GSM and shall be performed according to operator specific requirements.

7.3.5 MAP-P-ABORT service

This service enables the MAP service-provider to abort a MAP dialogue. The service is a provider-initiated service with service-primitives as shown in table 7.3/8.

Table 7.3/8: Service-primitives for the MAP-P-ABORT service

Parameters		Indication
Provider reason		M
Source		M

Provider reason:

This parameter indicates the reason for aborting the MAP dialogue:

- provider malfunction;
- supporting dialogue/transaction released;
- resource limitation;
- maintenance activity;
- version incompatibility;
- abnormal MAP dialogue.

Source:

This parameter indicates the source of the abort. For Transaction Capabilities (TC) applications the parameter may take the following values:

- MAP problem;
- TC problem;
- network service problem.

Table 7.3/9: Values of provider reason and source parameters and examples of corresponding events

Provider reason	Source	Corresponding event
Provider malfunction	MAP	Malfunction at MAP level at peer entity
	TC	"Unrecognised message type" or "Badly formatted transaction portion" or "Incorrect transaction portion" received in TC-P-ABORT "Abnormal dialogue"
	Network service	Malfunction at network service level at peer entity
Supporting dialogue/ transaction released	TC	"Unrecognised transaction ID" received in TC-ABORT
Resource limitation	MAP	Congestion towards MAP peer service-user
	TC	"Resource limitation" received in TC-P-ABORT
Maintenance activity	MAP	Maintenance at MAP peer service-user
	Network service	Maintenance at network peer service level
Abnormal MAP dialogue	MAP	MAP dialogue is not in accordance with specified application context
Version incompatibility	TC	A Provider Abort indicating "No common dialogue portion" is received in the dialogue initiated state

7.3.6 MAP-NOTICE service

This service is used to notify the MAP service-user about protocol problems related to a MAP dialogue not affecting the state of the protocol machines.

The service is a provider-initiated service with service-primitive as shown in table 7.3/10.

Table 7.3/10: Service-primitive for the MAP-NOTICE service

Parameters	Indication
Problem diagnostic	M

Problem diagnostic:

This parameter can take one of the following values:

- abnormal event detected by the peer;
- response rejected by the peer;
- abnormal event received from the peer;
- message cannot be delivered to the peer.

7.3.7 void

7.3.8 void

7.3.9 void

7.3.10 void

7.4 Sequencing of services

The sequencing of services is shown in figure 7.4/1 and is as follows:

Opening:

The MAP-OPEN service is invoked before any user specific service-primitive is accepted. The sequence may contain none, one or several user specific service-primitives. If no user specific service-primitive is contained between the MAP-OPEN and the MAP-DELIMITER primitives, then this will correspond to sending an empty Begin message in TC. If more than one user specific service-primitive is included, all are to be sent in the same Begin message. The sequence ends with a MAP-DELIMITER primitive.

Continuing:

This sequence may not be present in some MAP dialogues. If it is present, it ends with a MAP-DELIMITER primitive. If more than one user specific service-primitive is included, all are to be included in the same Continue message.

Closing:

The sequence can only appear after an opening sequence or a continuing sequence. The sequence may contain none, one or several user specific service-primitives if the MAP-CLOSE primitive specifies normal release. If no user specific service-primitive is included, then this will correspond to sending an empty End message in TC. If more than one user specific service-primitive is included, all are to be sent in the same End message. If prearranged end is specified, the sequence cannot contain any user specific service-primitive. The MAP-CLOSE primitive must be sent after all user specific service-primitives have been delivered to the MAP service-provider.

Aborting:

A MAP service-user can issue a MAP-U-ABORT primitive at any time after the MAP dialogue has been opened or as a response to an attempt to open a MAP dialogue.

The MAP service-provider may issue at any time a MAP-P-ABORT primitive towards a MAP service-user for which a MAP dialogue exists.

MAP-U-ABORT primitives and MAP-P-ABORT primitives terminate the MAP dialogue.

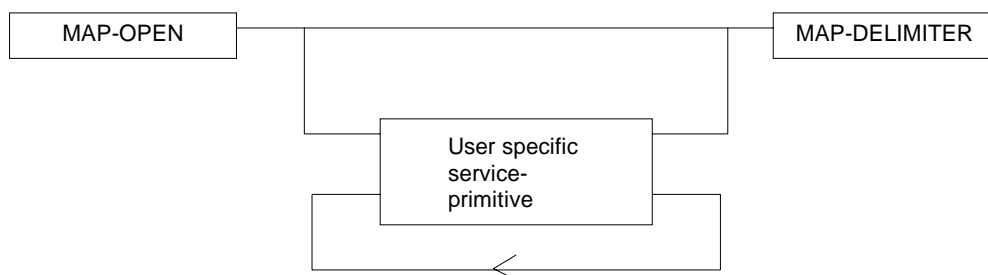

a) Opening

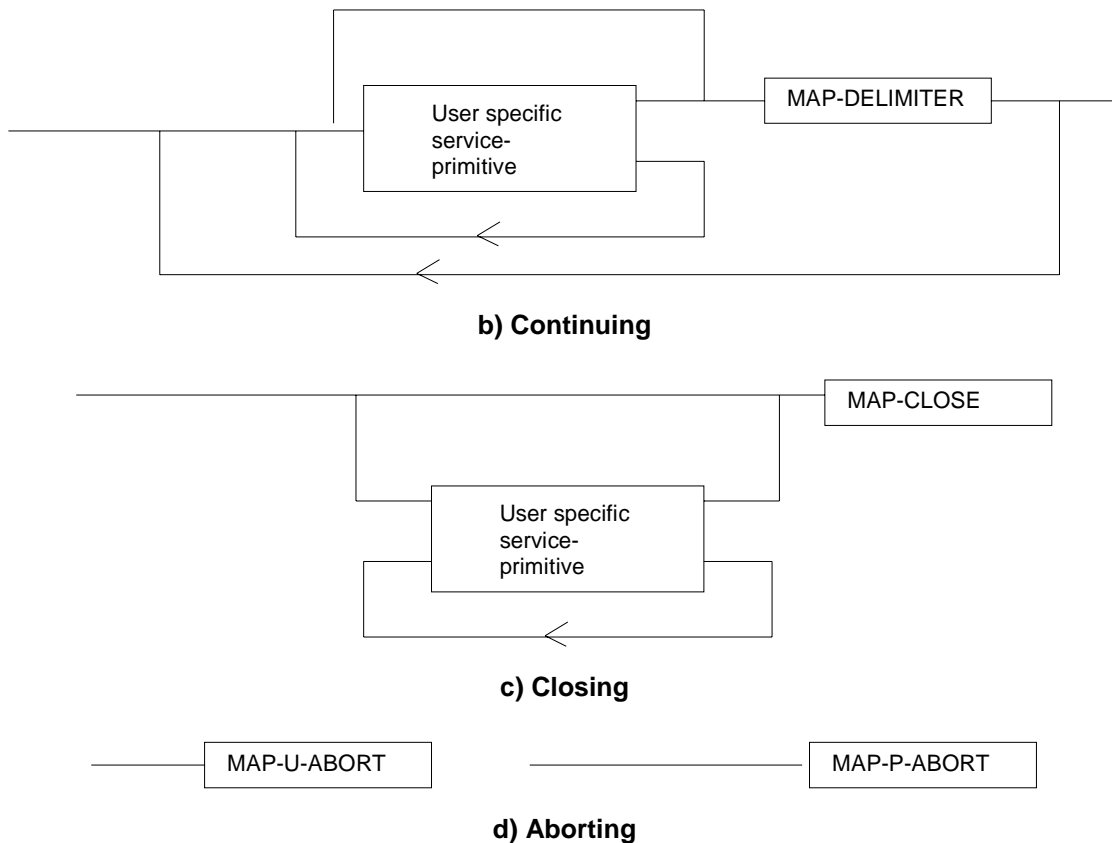

Figure 7.4/1: Sequencing of services

If the reason "resource unavailable (short term problem)" is indicated in the MAP-U-ABORT indication primitive, the MAP service-user may decide to attempt a new MAP dialogue establishment immediately.

Sequencing of user specific service-primitives is done by the MAP service-user and based on rules applicable for each MAP service-user instance.

A MAP-NOTICE indication primitive may be received at any time during the active period of a MAP dialogue.

7.5 General rules for mapping of services onto TC

7.5.1 Mapping of common services

Table 7.5/1 gives an overview of the mapping rules for mapping of common services onto TC-services. Table 7.5/2 gives the mapping rules for mapping of TC-services onto common services.

Protocol machine description is given in clauses 14 to 17.

Table 7.5/1: Mapping of common services onto TC services

MAP service-primitive	TC service-primitive
MAP-OPEN request (+ any user specific service primitives) + MAP-DELIMITER request	TC-BEGIN request (+ component handling primitives)
MAP-OPEN response (+ any user specific service primitives) + MAP-DELIMITER request	TC-CONTINUE request (note) (+ component handling primitives)
(any user specific service primitives) + MAP-DELIMITER request	TC-CONTINUE request (+ component handling primitives)
(any user specific service primitives) + MAP-CLOSE request	TC-END request (+ component handling primitives)

MAP-U-ABORT request	TC-U-ABORT request
NOTE: Or TC-END if the MAP-CLOSE request has been received before the MAP-DELIMITER request.	

Table 7.5/2: Mapping of TC services onto common service

TC service-primitive	MAP service-primitive
TC-BEGIN indication (+ component handling primitives)	MAP-OPEN indication (+ user specific service primitives) + MAP-DELIMITER indication (note 1)
TC-CONTINUE indication (+ component handling primitives)	First time: MAP-OPEN confirm (+ user specific service primitives) + MAP-DELIMITER indication (note 1) Subsequent times: (user specific service primitives) + MAP-DELIMITER indication (note 1)
TC-END indication (+ component handling primitives)	MAP-OPEN confirm (note 6) (user specific service primitives) + MAP-CLOSE indication
TC-U-ABORT indication	MAP-U-ABORT indication or MAP-P-ABORT indication (note 2) MAP-OPEN confirmation (note 3)
TC-P-ABORT indication	MAP-P-ABORT indication (note 4) MAP-OPEN confirmation (note 5)
NOTE 1: It may not be necessary to present this primitive to the user for MAP version 2 applications.	
NOTE 2: The mapping depends on whether the TC-U-ABORT indication primitive contains a MAP-abort-PDU from the remote MAP service-provider or a MAP-user-abort-PDU from the remote MAP service-user.	
NOTE 3: Only if the opening sequence is pending and if the "Abort Reason" in the TC-U-ABORT indication is set to "Application Context Not Supported".	
NOTE 4: If the "Abort Reason" in the TC-P-ABORT indication is set to a value different from "Incorrect Transaction Portion".	
NOTE 5: Only if the opening sequence is pending and if the "Abort Reason" in the TC-P-ABORT indication is set to "Incorrect Transaction Portion".	
NOTE 6: Only if opening sequence is pending.	

7.5.2 Mapping of user specific services

Table 7.5/3 gives the general mapping rules which apply to mapping of MAP user specific services onto TC services and table 7.5/4 gives the similar rules for mapping of TC services onto MAP user specific services. Detailed mapping is given in clauses 14 to 17.

Table 7.5/3: Mapping of MAP user specific services onto TC services

MAP service-primitive	TC-service-primitive
MAP-xx request	TC-INVOKE request
MAP-xx response (note 1)	TC-RESULT-L request TC-U-ERROR request TC-U-REJECT request TC-INVOKE request (note 2)

Table 7.5/4: Mapping of TC services onto MAP user specific services

TC-service-primitive	MAP service-primitive
TC-INVOKE indication	MAP-xx indication
TC-RESULT-L indication (note 4) TC-U-ERROR indication TC-INVOKE indication (note 2)	MAP-xx confirm

TC-L-CANCEL indication	
TC-U-REJECT indication	MAP-xx confirm or
TC-L-REJECT indication	MAP-NOTICE indication (note 3)
TC-R-REJECT indication	

Notes to tables 7.5/3 and 7.5/4:

NOTE 1: The mapping is determined by parameters contained in the MAP-xx response primitive.

NOTE 2: This applies only to TC class 4 operations where the operation is used to pass a result of another class 2 or class 4 operation.

NOTE 3: The detailed mapping rules are given in clause 16.

NOTE 4: If RESULT-NL components are present they are mapped onto the same MAP-xx confirm.

7.6 Definition of parameters

Following is an alphabetic list of parameters used in the common MAP-services in clause 7.3:

Application context name	7.3.1	Refuse reason	7.3.1
Destination address	7.3.1	Release method	7.3.2
Destination reference	7.3.1	Responding address	7.3.1
Diagnostic information	7.3.4	Result	7.3.1
Originating address	7.3.1	Source	7.3.5
Originating reference	7.3.1	Specific information	7.3.1/7.3.2/7.3.4
Problem diagnostic	7.3.6	User reason	7.3.4
Provider reason	7.3.5		

Following is an alphabetic list of parameters contained in this clause:

Absent Subscriber Diagnostic SM	7.6.8.9	Location Information	7.6.2.30
Access connection status	7.6.9.3	Location Information for GPRS	7.6.2.30a
Access signalling information	7.6.9.5	Location update type	7.6.9.6
Additional Absent Subscriber Diagnostic SM	7.6.8.12	Long Forwarded-to Number	7.6.2.22A
Additional Location Estimate	7.6.11.21	Long FTN Supported	7.6.2.22B
Additional number	7.6.2.46	Lower Layer Compatibility	7.6.3.42
Additional signal info	7.6.9.10	LSA Information	7.6.3.56
Additional SM Delivery Outcome	7.6.8.11	LSA Information Withdraw	7.6.3.58
Age Indicator	7.6.3.72	MC Information	7.6.4.48
Alert Reason	7.6.8.8	MC Subscription Data	7.6.4.47
Alert Reason Indicator	7.6.8.10	MNP Info Result	7.6.3.93
Alerting Pattern	7.6.3.44	MNP Requested Info	7.6.3.92
All GPRS Data	7.6.3.53	Mobile Not Reachable Reason	7.6.3.51
All Information Sent	7.6.1.5	Modification request for CSI	7.6.3.81
Allowed Services	7.6.3.94	Modification request for SS Information	7.6.3.82
AN-apdu	7.6.9.1	More Messages To Send	7.6.8.7
APN	7.6.2.42	MS ISDN	7.6.2.17
Authentication set list	7.6.7.1	MSC number	7.6.2.11
B-subscriber Address	7.6.2.36	MSIsdn-Alert	7.6.2.29
B subscriber Number	7.6.2.48	Multicall Bearer Information	7.6.2.52
B subscriber subaddress	7.6.2.49	Multiple Bearer Requested	7.6.2.53
Basic Service Group	7.6.4.40	Multiple Bearer Not Supported	7.6.2.54
Basic Service Group 2	7.6.4.50	MWD status	7.6.8.3
Bearer service	7.6.4.38	NbrUser	7.6.4.45
Bearer Service 2	7.6.4.38A	Network Access Mode	7.6.3.50
BSSMAP Service Handover	7.6.6.5	Network node number	7.6.2.43
BSSMAP Service Handover List	7.6.6.5A	Network resources	7.6.10.1
Call Barring Data	7.6.3.83	Network signal information	7.6.9.8

Call barring feature	7.6.4.19	Network signal information 2	7.6.9.8A
Call barring information	7.6.4.18	New password	7.6.4.20
Call Direction	7.6.5.8	No reply condition timer	7.6.4.7
Call Forwarding Data	7.6.3.84	North American Equal Access preferred Carrier Id	7.6.2.34
Call Info	7.6.9.9	Number Portability Status	7.6.5.14
Call reference	7.6.5.1	ODB Data	7.6.3.85
Call Termination Indicator	7.6.3.67	ODB General Data	7.6.3.9
Called number	7.6.2.24	ODB HPLMN Specific Data	7.6.3.10
Calling number	7.6.2.25	OMC Id	7.6.2.18
CAMEL Subscription Info	7.6.3.78	Originally dialled number	7.6.2.26
CAMEL Subscription Info Withdraw	7.6.3.38	Originating entity number	7.6.2.10
Cancellation Type	7.6.3.52	Override Category	7.6.4.4
Category	7.6.3.1	P-TMSI	7.6.2.47
CCBS Feature	7.6.5.8	PDP-Address	7.6.2.45
CCBS Request State	7.6.4.49	PDP-Context identifier	7.6.3.55
Channel Type	7.6.5.9	PDP-Type	7.6.2.44
Chosen Channel	7.6.5.10	Positioning Data	7.6.11.11A
Chosen Radio Resource Information	7.6.6.10B	Pre-paging supported	7.6.5.15
Ciphering mode	7.6.7.7	Previous location area Id	7.6.2.4
Cksn	7.6.7.5	Protocol Id	7.6.9.7
CLI Restriction	7.6.4.5	Provider error	7.6.1.3
CM service type	7.6.9.2	PS LCS Not Supported by UE	7.6.11.10
Complete Data List Included	7.6.3.54	QoS-Subscribed	7.6.3.47
CS Allocation Retention priority	7.6.3.87	Radio Resource Information	7.6.6.10
CS LCS Not Supported by UE	7.6.11.9	Radio Resource List	7.6.6.10A
CUG feature	7.6.3.26	RANAP Service Handover	7.6.6.6
CUG index	7.6.3.25	Rand	7.6.7.2
CUG info	7.6.3.22	LCS-Reference Number	7.6.11.23
CUG interlock	7.6.3.24	Regional Subscription Data	7.6.3.11
CUG Outgoing Access indicator	7.6.3.8	Regional Subscription Response	7.6.3.12
CUG subscription	7.6.3.23	Relocation Number List	7.6.2.19A
CUG Subscription Flag	7.6.3.37	Requested Info	7.6.3.31
Current location area Id	7.6.2.6	Requested Subscription Info	7.6.3.86
Current password	7.6.4.21	Roaming number	7.6.2.19
Deferred MT-LR Data	7.6.11.3	Roaming Restricted In SGSN Due To Unsupported Feature	7.6.3.49
Deferred MT-LR Response Indicator	7.6.11.2	Roaming Restriction Due To Unsupported Feature	7.6.3.13
eMLPP Information	7.6.4.41	Routing Number	7.6.2.59
Encryption Information	7.6.6.9	Current Security Context	7.6.7.8
Equipment status	7.6.3.2	Selected RAB ID	7.6.2.56
Extensible Basic Service Group	7.6.3.5	Service centre address	7.6.2.27
Extensible Bearer service	7.6.3.3	Serving Cell Id	7.6.2.37
Extensible Call barring feature	7.6.3.21	SGSN address	7.6.2.39
Extensible Call barring information	7.6.3.20	SGSN CAMEL Subscription Info	7.6.3.75
Extensible Call barring information for CSE	7.6.3.79	SGSN number	7.6.2.38
Extensible Forwarding feature	7.6.3.16	SIWF Number	7.6.2.35
Extensible Forwarding info	7.6.3.15	SoLSA Support Indicator	7.6.3.57
Extensible Forwarding information for CSE	7.6.3.80	SM Delivery Outcome	7.6.8.6
Extensible Forwarding Options	7.6.3.18	SM-RP-DA	7.6.8.1
Extensible No reply condition timer	7.6.3.19	SM-RP-MTI	7.6.8.16
Extensible QoS-Subscribed	7.6.3.74	SM-RP-OA	7.6.8.2
Extensible SS-Data	7.6.3.29	SM-RP-PRI	7.6.8.5
Extensible SS-Info	7.6.3.14	SM-RP-SMEA	7.6.8.17
Extensible SS-Status	7.6.3.17	SM-RP-UI	7.6.8.4
Extensible Teleservice	7.6.3.4	Sres	7.6.7.3
External Signal Information	7.6.9.4	SS-Code	7.6.4.1
Failure Cause	7.6.7.9	SS-Code 2	7.6.4.1A
Forwarded-to number	7.6.2.22	SS-Data	7.6.4.3
Forwarded-to subaddress	7.6.2.23	SS-Event	7.6.4.42
Forwarding feature	7.6.4.16	SS-Event-Data	7.6.4.43
Forwarding information	7.6.4.15	SS-Info	7.6.4.24
Forwarding Options	7.6.4.6	SS-Status	7.6.4.2
GERAN Classmark	7.6.6.4	Stored location area Id	7.6.2.5
GGSN address	7.6.2.40	Subscriber State	7.6.3.30
GGSN number	7.6.2.41	Subscriber Status	7.6.3.7

GMSC CAMEL Subscription Info	7.6.3.34	Super-Charger Supported in HLR	7.6.3.70
GPRS enhancements support indicator	7.6.3.73	Super-Charger Supported in Serving Network Entity	7.6.3.71
GPRS Node Indicator	7.6.8.14	Offered Camel4 CSIs	7.6.3.36D
GPRS Subscription Data	7.6.3.46	Offered Camel4 CSIs in interrogating node	7.6.3.36E
GPRS Subscription Data Withdraw	7.6.3.45	Offered Camel4 CSIs in VMSC	7.6.3.36F
GPRS Support Indicator	7.6.8.15	Offered Camel4 CSIs in VLR	7.6.3.36B
Group Id	7.6.2.33	Offered Camel4 CSIs in SGSN	7.6.3.36C
GSM bearer capability	7.6.3.6	Offered Camel4 Functionalities	7.6.3.36G
gsmSCF Address	7.6.2.58	Supported CAMEL Phases	7.6.3.36H
gsmSCF Initiated Call	7.6.3.c	Supported CAMEL Phases in VLR	7.6.3.36
Guidance information	7.6.4.22	Supported CAMEL Phases in SGSN	7.6.3.36A
Handover number	7.6.2.21	Supported CAMEL Phases in interrogating node	7.6.3.36I
High Layer Compatibility	7.6.3.43	Supported GAD Shapes	7.6.11.20
HLR Id	7.6.2.15	Supported LCS Capability Sets	7.6.11.17
HLR number	7.6.2.13	Suppress Incoming Call Barring	7.6.3.b
HO-Number Not Required	7.6.6.7	Suppress T-CSI	7.6.3.33
IMEI	7.6.2.3	Suppress VT-CSI	7.6.3.a
IMSI	7.6.2.1	Suppression of Announcement	7.6.3.32
Integrity Protection Information	7.6.6.8	Target cell Id	7.6.2.8
Inter CUG options	7.6.3.27	Target location area Id	7.6.2.7
Intra CUG restrictions	7.6.3.28	Target RNC Id	7.6.2.8A
Invoke Id	7.6.1.1	Target MSC number	7.6.2.12
ISDN Bearer Capability	7.6.3.41	Teleservice	7.6.4.39
IST Alert Timer	7.6.3.66	Teleservice 2	7.6.4.39A
IST Information Withdrawn	7.6.3.68	TMSI	7.6.2.2
IST Support Indicator	7.6.3.69	Trace reference	7.6.10.2
LCS Codeword	7.6.11.18	Trace type	7.6.10.3
LCS Information	7.6.3.60	UESBI-lu	7.6.6.20
LCS Service Type Id	7.6.11.15	Unavailability Cause	7.6.3.95
Kc	7.6.7.4	User error	7.6.1.4
Linked Id	7.6.1.2	USSD Data Coding Scheme	7.6.4.36
LMSI	7.6.2.16	USSD String	7.6.4.37
		UU Data	7.6.5.12
		UUS CF Interaction	7.6.5.13
		VBS Data	7.6.3.40
		VGCS Data	7.6.3.39
		VLR CAMEL Subscription Info	7.6.3.35
		VLR number	7.6.2.14
		VPLMN address allowed	7.6.3.48
		Zone Code	7.6.2.28

7.6.1 Common parameters

The following set of parameters is used in several MAP service-primitives.

7.6.1.1 Invoke Id

This parameter identifies corresponding service primitives. The parameter is supplied by the MAP service-user and must be unique over each service-user/service-provider interface.

7.6.1.2 Linked Id

This parameter is used for linked services and it takes the value of the invoke Id of the service linked to.

7.6.1.3 Provider error

This parameter is used to indicate a protocol related type of error:

- duplicated invoke Id;

- not supported service;
- mistyped parameter;
- resource limitation;
- initiating release, i.e. the peer has already initiated release of the dialogue and the service has to be released;
- unexpected response from the peer;
- service completion failure;
- no response from the peer;
- invalid response received.

7.6.1.4 User error

This parameter can take values as follows:

NOTE: The values are grouped in order to improve readability; the grouping has no other significance.

a) Generic error:

- system failure, i.e. a task cannot be performed because of a problem in another entity. The type of entity or network resource may be indicated by use of the network resource parameter;
- data missing, i.e. an optional parameter required by the context is missing;
- unexpected data value, i.e. the data type is formally correct but its value or presence is unexpected in the current context;
- resource limitation;
- initiating release, i.e. the receiving entity has started the release procedure;
- facility not supported, i.e. the requested facility is not supported by the PLMN with detailed reasons as follows:
 - Shape of location estimate not supported;
 - Needed LCS capability not supported in serving node;
- incompatible terminal, i.e. the requested facility is not supported by the terminal.

b) Identification or numbering problem:

- unknown subscriber, i.e. no such subscription exists;
- number changed, i.e. the subscription does not exist for that number any more;
- unknown MSC;
- unidentified subscriber, i.e. if the subscriber is not contained in the database and it has not or cannot be established whether or not a subscription exists;
- unallocated roaming number;
- unknown equipment;
- unknown location area.

c) Subscription problem:

- roaming not allowed, i.e. a location updating attempt is made in an area not covered by the subscription;
- illegal subscriber, i.e. illegality of the access has been established by use of authentication procedure;

- bearer service not provisioned;
 - teleservice not provisioned;
 - illegal equipment, i.e. the IMEI check procedure has shown that the IMEI is blacklisted or not whitelisted.
- d) Handover problem:
- no handover number available, i.e. the VLR cannot allocate a number for handover or cannot allocate the required amount of numbers for relocation;
 - subsequent handover failure, i.e. handover to a third MSC failed for some reason;
 - target cell outside group call area.
- e) Operation and maintenance problem:
- tracing buffer full, i.e. tracing cannot be performed because the tracing capacity is exceeded.
- f) Call set-up problem:
- no roaming number available, i.e. a roaming number cannot be allocated because all available numbers are in use;
 - absent subscriber, i.e. the subscriber has activated the detach service or the system detects the absence condition. This error may be qualified to indicate whether the subscriber was IMSI detached, in a restricted area or did not respond to paging;
 - busy subscriber. This error may be qualified to indicate that the subscriber was busy due to CCBS and that CCBS is possible;
 - no subscriber reply;
 - forwarding violation, i.e. the call has already been forwarded the maximum number of times that is allowed;
 - CUG reject, i.e. the call does not pass a CUG check; additional information may also be given in order to indicate rejection due to e.g. incoming call barred or non-CUG membership;
 - call barred. Optionally, additional information may be included for indicating either that the call meets a barring condition set by the subscriber or that the call is barred for operator reasons. In the case of barring of Mobile Terminating Short Message, the additional information may indicate a barring condition due to "Unauthorised Message Originator";
 - optimal routing not allowed, i.e. the entity which sends the error does not support optimal routing, or the HLR will not accept an optimal routing interrogation from the GMSC, or the call cannot be optimally routed because it would contravene optimal routing constraints;
 - forwarding failed, i.e. the GMSC interrogated the HLR for forwarding information but the HLR returned an error.
- g) Supplementary services problem:
- call barred;
 - illegal SS operation;
 - SS error status;
 - SS not available;
 - SS subscription violation;
 - SS incompatibility;
 - negative password check;
 - password registration failure;

- Number of Password Attempts;
- USSD Busy;
- Unknown Alphabet;
- short term denial;
- long term denial.

For definition of these errors see 3GPP TS 24.080 [38].

h) Short message problem:

- SM delivery failure with detailed reason as follows:
 - memory capacity exceeded;
 - MS protocol error;
 - MS not equipped;
 - unknown service centre (SC);
 - SC congestion;
 - invalid SME address;
 - subscriber is not an SC subscriber;
 - and possibly detailed diagnostic information, coded as specified in 3GPP TS 23.040, under SMS-SUBMIT-REPORT and SMS-DELIVERY-REPORT. If the SM entity that returns the SM Delivery Failure error includes detailed diagnostic information, it shall be forwarded in the MAP_MO_FORWARD_SHORT_MESSAGE and in the MAP_MT_FORWARD_SHORT_MESSAGE response.
- message waiting list full, i.e. no further SC address can be added to the message waiting list.
- Subscriber busy for MT SMS, i.e. the mobile terminated short message transfer cannot be completed because:
 - another mobile terminated short message transfer is going on and the delivery node does not support message buffering; or
 - another mobile terminated short message transfer is going on and it is not possible to buffer the message for later delivery; or
 - the message was buffered but it is not possible to deliver the message before the expiry of the buffering time defined in 3GPP TS 23.040;
- Absent Subscriber SM, i.e. the mobile terminated short message transfer cannot be completed because the network cannot contact the subscriber. Diagnostic information regarding the reason for the subscriber's absence may be included with this error.

i) Location services problem:

- Unauthorised Requesting Network
- Unauthorised LCS Client with detailed reasons as follows:
 - NoAdditional Information
 - Client not in MS Privacy Exception List
 - Call to Client not setup
 - Disallowed by Local Regulatory Requirements

- Unauthorised Privacy Class
- Unauthorised Call/Session Unrelated External Client
- Unauthorised Call/Session Related External Client
- Privacy override not applicable
- Position method failure with detailed reasons as follows:
 - Congestion
 - Insufficient resources
 - Insufficient Measurement Data
 - Inconsistent Measurement Data
 - Location procedure not completed
 - QoS not attainable
 - Position Method Not Available in Network
 - Position Method Not Available in Location Area
 - Unknown or unreachable LCS Client.
- j) Problem detected by an application using secure transport:
 - Secure transport error. This error indicates that the application using secure transport returned an error. The parameter of the error indicates:
 - The protected payload, which carries the result of applying the protection function specified in 3GPP TS 33.200 to the encoding of the parameter of the original error.

7.6.1.5 All Information Sent

This parameter indicates to the receiving entity when the sending entity has sent all necessary information.

7.6.2 Numbering and identification parameters

7.6.2.1 IMSI

This parameter is the International Mobile Subscriber Identity defined in 3GPP TS 23.003 [17].

7.6.2.2 TMSI

This parameter is the Temporary Mobile Subscriber Identity defined in 3GPP TS 23.003 [17].

7.6.2.3 IMEI

This parameter is the International Mobile Equipment Identity defined in 3GPP TS 23.003 [17].

7.6.2.3a IMEISV

This parameter is the International Mobile Equipment Identity and Software Version Number defined in 3GPP TS 23.003 [17].

7.6.2.4 Previous location area Id

This parameter refers to the identity of the location area from which the subscriber has roamed.

7.6.2.5 Stored location area Id

This parameter refers to the location area where the subscriber is assumed to be located.

7.6.2.6 Current location area Id

This parameter is used to indicate the location area in which the subscriber is currently located.

7.6.2.7 Target location area Id

This parameter refers to the location area into which the subscriber intends to roam.

7.6.2.8 Target cell Id

This parameter refers to the identity of the cell to which a call has to be handed over.

7.6.2.8A Target RNC Id

This parameter refers to the identity of the RNC to which a call has to be relocated.

7.6.2.9 Void

7.6.2.10 Originating entity number

This parameter refers to an application layer identification of a system component in terms of its associated ISDN number.

7.6.2.11 MSC number

This parameter refers to the ISDN number of an MSC.

7.6.2.12 Target MSC number

This parameter refers to the ISDN number of an MSC to which a call has to be handed over.

7.6.2.13 HLR number

This parameter refers to the ISDN number of an HLR.

7.6.2.14 VLR number

This parameter refers to the ISDN number of a VLR.

7.6.2.15 HLR Id

This parameter refers to the identity of an HLR derived from the IMSI defined in CCITT Recommendation E.212.

7.6.2.16 LMSI

This parameter refers to a local identity allocated by the VLR to a given subscriber for internal management of data in the VLR. LMSI shall not be sent to the SGSN.

7.6.2.17 MS ISDN

This parameter refers to one of the ISDN numbers assigned to a mobile subscriber in accordance with CCITT Recommendation E.213.

7.6.2.18 OMC Id

This parameter refers to the identity of an Operation and Maintenance Centre.

7.6.2.19 Roaming number

This parameter refers to the roaming number as defined in CCITT Recommendation E.213.

7.6.2.19A Relocation Number List

This parameter refers to the number(s) used for routing one call or several calls between MSCs during relocation.

7.6.2.20 Void

7.6.2.21 Handover number

This parameter refers to the number used for routing a call between MSCs during handover.

7.6.2.22 Forwarded-to number

This parameter refers to the address to which a call is to be forwarded. A subaddress may be appended. For subscribers having an originating CAMEL Phase 2 or higher subscription, this address need not be in E.164 international format.

7.6.2.22A Long forwarded-to number

This parameter refers to the address to which a call is to be forwarded. A subaddress may be appended. For subscribers having an originating CAMEL Phase 2 or higher subscription this address need not be in international format.

7.6.2.22B Long FTN Supported

This parameter indicates that the sending entity supports Long Forwarded-to Numbers.

7.6.2.23 Forwarded-to subaddress

This parameter refers to the sub-address attached to the address to which a call is to be forwarded.

7.6.2.24 Called number

This parameter refers to a called party number as defined in CCITT Recommendation Q.767.

7.6.2.25 Calling number

This parameter refers to a calling party number as defined in CCITT Recommendation Q.767.

7.6.2.26 Originally dialled number

This parameter refers to the number dialled by the calling party in order to reach a mobile subscriber.

7.6.2.27 Service centre address

This parameter represents the address of a Short Message Service Centre.

7.6.2.28 Zone Code

This parameter is used to define location areas into which the subscriber is allowed or not allowed to roam (regional subscription). With a complete list of Zone Codes the VLR or the SGSN is able to determine for all its location areas whether roaming is allowed or not.

7.6.2.29 MSISdn-Alert

This parameter refers to the MSISDN stored in a Message Waiting Data File in the HLR. It is used to alert the Service Centre when the MS is again attainable.

7.6.2.30 Location Information

This parameter indicates the location of the served subscriber as defined in 3GPP TS 23.018 [97].

7.6.2.30a Location Information for GPRS

This parameter indicates the location of the served subscriber as defined in 3GPP TS 23.078 [98].

7.6.2.31 GMSC Address

This parameter refers to the E.164 address of a GMSC.

7.6.2.32 VMSC Address

This parameter refers to the E.164 address of a VMSC.

7.6.2.33 Group Id

This parameter is used to describe groups a subscriber can be a member of. A subscriber can partake in all group calls (VBS/VGCS) where he subscribed to the respective groups.

7.6.2.34 North American Equal Access preferred Carrier Id

This parameter refers to the carrier identity preferred by the subscriber for calls requiring routing via an inter-exchange carrier. This identity is used at:

- outgoing calls: when the subscriber does not specify at call set-up a carrier identity;
- forwarded calls: when a call is forwarded by the subscriber;
- incoming calls: applicable to the roaming leg of the call.

7.6.2.35 SIWFS Number

This parameter refers to the number used for routing a call between the MSC and the SIWFS (used by ISUP).

7.6.2.36 B-subscriber address

This parameter refers to the address used by the SIWFS to route the outgoing call from the SIWFS to either the B-subscriber in case of the non-loop method or back to the VMSC in case of the loop method.

7.6.2.37 Serving cell Id

This parameter indicates the cell currently being used by the served subscriber.

7.6.2.38 SGSN number

This parameter refers to the ISDN number of a SGSN.

7.6.2.39 SGSN address

This parameter refers to the IP-address of a SGSN. This parameter is defined in 3GPP TS 23.003 [17].

7.6.2.40 GGSN address

This parameter refers to the IP-address of a GGSN. This parameter is defined in 3GPP TS 23.003 [17].

7.6.2.41 GGSN number

This parameter refers to the ISDN number of a GGSN or the ISDN number of the protocol-converter if a protocol-converting GSN is used between the GGSN and the HLR.

7.6.2.42 APN

This parameter refers to the DNS name of a GGSN. This parameter is defined in 3GPP TS 23.060 [104].

7.6.2.43 Network Node number

This parameter refers either to the ISDN number of SGSN or to the ISDN number of MSC.

7.6.2.44 PDP-Type

This parameter indicates which type of protocol is used by the MS as defined in 3GPP TS 23.060 [104].

7.6.2.45 PDP-Address

This parameter indicates the address of the data protocol as defined in 3GPP TS 23.060 [104].

7.6.2.46 Additional number

This parameter can refer either to the SGSN number or to the MSC number.

7.6.2.47 P-TMSI

This parameter is the Packet Temporary Mobile Subscriber Identity defined in 3GPP TS 23.003 [17].

7.6.2.48 B-subscriber number

This parameter refers to the number of the destination B dialled by the A user. This may include a subaddress.

7.6.2.49 B-subscriber subaddress

This parameter refers to the sub-address attached to the destination B dialled by the A user.

7.6.2.50 LMU Number

This parameter refers to a local number assigned to an LMU by an SMLC.

7.6.2.51 MLC Number

This parameter refers to the ISDN (E.164) number of an MLC.

7.6.2.52 Multicall Bearer Information

This parameter refers to the number of simultaneous bearers supported per user by the serving network.

7.6.2.53 Multiple Bearer Requested

This parameter indicates whether multiple bearers are requested for a relocation.

7.6.2.54 Multiple Bearer Not Supported

This parameter indicates whether multiple bearers are supported.

7.6.2.55 PDP-Charging Characteristics

This parameter indicates the charging characteristics associated with a specific PDP context as defined in 3GPP TS 32.015.

7.6.2.56 Selected RAB ID

The selected radio access bearer to be kept at subsequent inter-MSC handover from UMTS to GSM.

7.6.2.57 RAB ID

This parameter indicates the radio access bearer identifier as defined in 3GPP TS 25.413. This parameter is used to relate the radio resources with the radio access bearers.

7.6.2.58 gsmSCF Address

This parameter refers to the ISDN number assigned to the gsmSCF address. In an IP Multimedia Core Network, the gsmSCF-address shall contain the IM-SSF address when the IM-SSF takes the role of the gsmSCF.

7.6.2.59 Routeing Number

This parameter refers to a number used for routeing purpose and identifying a network operator. See 3GPP TS 23.066 [108].

7.6.3 Subscriber management parameters

7.6.3.1 Category

This parameter refers to the calling party category as defined in CCITT Recommendation Q.767.

7.6.3.2 Equipment status

This parameter refers to the status of the mobile equipment as defined in 3GPP TS 22.016 [7].

7.6.3.2a BMUEF

This parameter refers to the Bit Map of UE Faults and corresponds to the UESBI-Iu parameter defined in 3GPP TS 25.413 [120].

7.6.3.3 Extensible Bearer service

This parameter may refer to a single bearer service, a set of bearer services or to all bearer services as defined in 3GPP TS 22.002 [3]. This parameter is used only for subscriber profile management. Extensible Bearer service values include all values defined for a Bearer service parameter (7.6.4.38).

7.6.3.4 Extensible Teleservice

This parameter may refer to a single teleservice, a set of teleservices or to all teleservices as defined in 3GPP TS 22.003 [4]. This parameter is used only for subscriber profile management. Extensible Teleservice values include all values defined for a Teleservice parameter (7.6.4.39).

7.6.3.5 Extensible Basic Service Group

This parameter refers to the Basic Service Group either as an extensible bearer service (see clause 7.6.3.3) or an extensible teleservice (see clause 7.6.3.4). This parameter is used only for subscriber profile management. The null value (i.e. neither extensible bearer service nor extensible teleservice) is used to denote the group containing all extensible bearer services and all extensible teleservices.

7.6.3.6 GSM bearer capability

This parameter refers to the GSM bearer capability information element defined in 3GPP TS 24.008 [35].

7.6.3.7 Subscriber Status

This parameter refers to the barring status of the subscriber:

- service granted;
- Operator Determined Barring.

7.6.3.8 CUG Outgoing Access indicator

This parameter represents the Outgoing Access as defined in ETS 300 136.

7.6.3.9 Operator Determined Barring General Data

This parameter refers to the set of subscriber features that the network operator or the service provider can regulate. This set only includes those limitations that can be

- a) controlled in the VLR,
- b) controlled in the SGSN,
- c) controlled in the SGSN applied for short message transfer only,
- d) interrogated or modified by the gsmSCF:

ODB category	Controlled in the VLR	Controlled in the SGSN	Controlled in the SGSN applied for short message transfer only	Interrogatable and modifyable by the gsmSCF
All outgoing calls barred	X		X	X
International outgoing calls barred	X		X	X
International outgoing calls except those to the home PLMN country barred	X		X	X
Interzonal outgoing calls barred	X		X	X
Interzonal outgoing calls except those to the home PLMN country barred	X		X	X
Interzonal outgoing calls AND international outgoing calls except	X		X	X

those directed to the home PLMN country barred				
Premium rate (information) outgoing calls barred	X			X
Premium rate (entertainment) outgoing calls barred	X			X
Supplementary service access barred	X			X
Invocation of call transfer barred	X			X
Invocation of chargeable call transfer barred	X			X
Invocation of internationally chargeable call transfer barred	X			X
Invocation of interzonally chargeable call transfer barred	X			X
Invocation of call transfer where both legs are chargeable barred	X			X
Invocation of call transfer if there is already an ongoing transferred call for the served subscriber in the serving MSC/VLR barred	X			X
All packet Oriented Services barred		X		X
Roamer Access to HPLMN-AP barred		X		X
Roamer Access to VPLMN-AP barred		X		X
Outgoing calls when roaming outside the home PLMN country				X
All incoming calls				X
Incoming calls when roaming outside the home PLMN country				X
Incoming calls when roaming outside the				X

zone of the home PLMN country				
Roaming outside the home PLMN				X
Roaming outside the home PLMN country				X
Registration of any call forwarded-to number				X
Registration of any international call forwarded-to number				X
Registration of any international call forwarded-to number except to a number within the HPLMN country				X
Registration of any inter-zone call forwarded-to number				X
Registration of any inter-zone call forwarded-to number except to a number within the HPLMN country				X

7.6.3.10 ODB HPLMN Specific Data

This parameter refers to the set of subscriber features that the network operator or the service provider can regulate only when the subscriber is registered in the HPLMN. This set only includes those limitations that can be controlled in the VLR or in the SGSN:

- Operator Determined Barring Type 1;
- Operator Determined Barring Type 2;
- Operator Determined Barring Type 3;
- Operator Determined Barring Type 4.

7.6.3.11 Regional Subscription Data

This parameter defines the regional subscription area in which the subscriber is allowed to roam. It consists of a list of Zone Codes (see clause 7.6.2.28).

7.6.3.12 Regional Subscription Response

This parameter indicates either that the regional subscription data cannot be handled or that the current MSC or SGSN area is entirely restricted because of regional subscription.

7.6.3.13 Roaming Restriction Due To Unsupported Feature

This parameter defines that a subscriber is not allowed to roam in the current MSC area. It may be used by the HLR if a feature or service is indicated as unsupported by the VLR.

7.6.3.14 Extensible SS-Info

This parameter refers to all the information related to a supplementary service and is a choice between:

- extensible forwarding information (see clause 7.6.3.15);
- extensible call barring information (see clause 7.6.3.20);
- CUG info (see clause 7.6.3.22);
- extensible SS-Data (see clause 7.6.3.29).

7.6.3.15 Extensible forwarding information

This parameter represents the information related to each call forwarding service:

- the SS-Code of the relevant call forwarding service (see clause 7.6.4.1);
- if required, a list of extensible forwarding feature parameters (see clause 7.6.3.16).

The list may contain one item per Basic Service Group.

7.6.3.16 Extensible forwarding feature

This parameter applies to each combination of call forwarding service and Basic Service Group and contains the following information, as required:

- extensible Basic Service Group (see clause 7.6.3.5);
- extensible SS-Status (see clause 7.6.3.17);
- forwarded-to number (see clause 7.6.2.22);
- forwarded-to subaddress (see clause 7.6.2.23);
- extensible forwarding options (see clause 7.6.3.18);
- extensible no reply condition timer (see clause 7.6.4.19);
- long forwarded-to number (see clause 7.6.2.22A).

If a number is required to define the forwarded-to destination then:

- If the VLR supports Long Forwarded-to Numbers then the long forwarded-to number shall be present and the forwarded-to number shall be absent;
- If the VLR does not support Long Forwarded-to Numbers then the forwarded-to number shall be present and the long forwarded-to number shall be absent.

7.6.3.17 Extensible SS-Status

This parameter refers to the state information of individual supplementary services as defined in 3GPP TS 23.011 [22].

7.6.3.18 Extensible Forwarding Options

This parameter refers to a set of forwarding options attached to a supplementary service. It contains the following information:

- notification to forwarding party (see 3GPP TS 22.082 [10] for the meaning of this parameter);
- redirection notification to the forwarded-to party (see 3GPP TS 22.082 [10] for the meaning of this parameter);
- notification to calling party (see 3GPP TS 22.082 [10] for the meaning of this parameter);
- redirecting presentation (see 3GPP TS 22.082 [10] for the meaning of this parameter);
- forwarding reason (see 3GPP TS 22.082 [10] for the meaning of this parameter).

7.6.3.19 Extensible No reply condition timer

This parameter refers to the extensible no reply condition timer for call forwarding on no reply.

7.6.3.20 Extensible Call barring information

This parameter contains for each call barring service:

- SS-Code (see clause 7.6.4.1);
- a list of extensible call barring feature parameters (see clause 7.6.3.21).

The list may contain one item per Basic Service Group.

7.6.3.21 Extensible Call barring feature

This parameter gives the status of call barring services as applicable to each Basic Service Group. The parameter contains the following information:

- Extensible Basic Service Group (see clause 7.6.3.5);
- provisioned SS-Status (see clause 7.6.3.17).

7.6.3.22 CUG info

This parameter refers to the overall information required for operation for each CUG:

- CUG subscriptionList;
- CUG featureList.

7.6.3.23 CUG subscription

This parameter refers to the set of basic information for each CUG defined in that subscription. The following information is stored:

- CUG index;
- CUG interlock;
- Intra CUG restrictions;
- Basic Service Group List.

7.6.3.24 CUG interlock

This parameter represents the CUG interlock code defined in ETS 300 138.

7.6.3.25 CUG index

This parameter represents the CUG index defined in ETS 300 138.

7.6.3.26 CUG feature

This parameter contains two parameters that are associated with the Basic Service Group. If the Basic Service Group Code is not present the feature applies to all Basic Services. The following parameters are included:

- Preferential CUG indicator:
 - indicates which CUG index is to be used at outgoing call set-up using the associated Basic Service Group;
- Inter CUG Option:
 - describes whether it for the associated Basic Service Group is allowed to make calls outside the CUG and whether incoming calls are allowed;
- Basic Service Group.

See 3GPP TS 22.085 [13] for meaning of this parameter.

7.6.3.27 Inter CUG options

This parameter indicates the subscribers' ability to make and receive calls outside a specific closed user group. It takes any of the following values:

- CUG only facility (only calls within CUG are allowed);
- CUG with outgoing access (calls outside CUG allowed);
- CUG with incoming access (calls from outside CUG into CUG allowed);
- CUG with both incoming and outgoing access (all calls allowed).

7.6.3.28 Intra CUG restrictions

This parameter describes whether or not the subscriber is allowed to originate calls to or to receive calls from within the CUG. It can take any of the following values:

- no CUG restrictions;
- CUG incoming calls barred;
- CUG outgoing calls barred.

7.6.3.29 Extensible SS-Data

This parameter refers to the necessary set of information required in order to characterise one supplementary service:

- SS-Code (see clause 7.6.4.1);
- Extensible SS-Status (if applicable) (see clause 7.6.3.17);
- Extensible Override subscription option (if applicable) (see clause 7.6.3.30);
- Extensible CLI Restriction (if applicable) (see clause 7.6.3.31);
- Extensible Basic Service Group Code (see clause 7.6.3.5).

7.6.3.30 Subscriber State

This parameter indicates the state of the MS as defined in 3GPP TS 23.018 [97].

7.6.3.31 Requested Info

This parameter indicates the subscriber information being requested as defined in 3GPP TS 23.018 [97] and 3GPP TS 23.078 [98].

7.6.3.31A Requested Domain

This parameter indicates the domain (circuit switched, i.e. from the MSC/VLR, or packet switched, i.e. from the SGSN) from which the requested information should be retrieved.

7.6.3.32 Suppression of Announcement

This parameter indicates if the announcement or tones shall be suppressed as defined in 3GPP TS 23.078 [98].

7.6.3.33 Suppress T-CSI

This parameter is used to suppress the invocation of terminating CAMEL services.

7.6.3.34 GMSC CAMEL Subscription Info

This parameter contains CAMEL subscription information, i.e. O-CSI and/or D-CSI and/or T-CSI, which indicates to the GMSC that originating and/or terminating CAMEL services shall be invoked for the incoming call.

7.6.3.35 VLR CAMEL Subscription Info

This parameter identifies the subscriber as having CAMEL services that are invoked in the MSC or VLR.

7.6.3.36 Supported CAMEL Phases in the VLR

This parameter indicates which phases of CAMEL are supported in the VLR.

7.6.3.36A Supported CAMEL Phases in the SGSN

This parameter indicates which phases of CAMEL are supported in the SGSN.

7.6.3.36B Offered CAMEL4 CSIs in the VLR

This parameter indicates which CSIs of CAMEL phase 4 are offered in the VLR as defined in 3GPP TS 23.078.

7.6.3.36C Offered CAMEL4 CSIs in the SGSN

This parameter indicates which CSIs of CAMEL phase 4 are offered in the SGSN as defined in 3GPP TS 23.078.

7.6.3.36D Offered CAMEL4 CSIs

This parameter indicates which CSIs of CAMEL phase 4 are offered as defined in 3GPP TS 23.078.

7.6.3.36E Offered CAMEL4 CSIs in interrogating node

This parameter indicates which CSIs of CAMEL phase 4 are offered in the GMSC or in the gsmSCF as defined in 3GPP TS 23.078.

7.6.3.36F Offered CAMEL4 CSIs in VMSC

This parameter indicates which CSIs of CAMEL phase 4 are offered in the VMSC as defined in 3GPP TS 23.078.

7.6.3.36G Offered CAMEL4 Functionalities

This parameter indicates which functionalities of CAMEL phase 4 are offered as defined in 3GPP TS 23.078.

7.6.3.36H Supported CAMEL Phases

This parameter indicates which phases of CAMEL are supported as defined in 3GPP TS 23.078.

7.6.3.36I Supported CAMEL Phases in interrogating node

This parameter indicates which phases of CAMEL are supported as defined in 3GPP TS 23.078. The interrogating node may be a GMSC or a gsmSCF.

7.6.3.37 CUG Subscription Flag

This parameter indicates that a subscriber with a T-CSI also has a CUG subscription. It is defined in 3GPP TS 23.078.

7.6.3.38 CAMEL Subscription Info Withdraw

This parameter indicates that CAMEL Subscription Info shall be deleted from the VLR or SGSN.

7.6.3.39 Voice Group Call Service (VGCS) Data

This parameter refers to one or more groups a subscriber may be a member of for voice group calls.

7.6.3.40 Voice Broadcast Service (VBS) Data

This parameter refers to one or more groups a subscriber may be a member of for the voice broadcast service. Per group it is further indicated whether the subscriber is only allowed to listen to respective group calls or whether he is in addition entitled to initiate respective voice broadcast calls.

7.6.3.41 ISDN bearer capability

This parameter refers to the ISDN bearer capability information element defined in 3GPP TS 29.007 [56].

7.6.3.42 Lower layer Compatibility

This parameter refers to the lower layer compatibility information element defined in 3GPP TS 24.008 [35].

7.6.3.43 High Layer Compatibility

This parameter refers to the high layer compatibility information element defined in 3GPP TS 24.008 [35].

7.6.3.44 Alerting Pattern

This parameter is an indication that can be used by the MS to alert the user in a specific manner in case of mobile terminating traffic (switched call or USSD). That indication can be an alerting level or an alerting category.

7.6.3.45 GPRS Subscription Data Withdraw

This parameter indicates that GPRS Subscription Data shall be deleted from the SGSN.

7.6.3.46 GPRS Subscription Data

This parameter refers to the list of PDP-Contexts that subscriber has subscribed to.

7.6.3.47 QoS-Subscribed

This parameter indicates the quality of service subscribed for a certain service. It is defined in 3GPP TS 23.060 [104].

7.6.3.48 VPLMN address allowed

This parameter specifies whether the MS is allowed to use a dynamic address allocated in the VPLMN. It is defined in 3GPP TS 23.060 [104].

7.6.3.49 Roaming Restricted In SGSN Due To Unsupported Feature

This parameter defines that a subscriber is not allowed to roam in the current SGSN area. It may be used by the HLR if a feature or service is indicated as unsupported by the SGSN.

7.6.3.50 Network Access Mode

This parameter is defined in 3GPP TS 23.108.

7.6.3.51 Mobile Not Reachable Reason

This parameter stores the reason for the MS being absent when an attempt to deliver a short message to an MS fails at the MSC, SGSN or both. It is defined in 3GPP TS 23.040.

7.6.3.52 Cancellation Type

This parameter indicates the reason of location cancellation. It is defined in 3GPP TS 23.060 [104].

7.6.3.53 All GPRS Data

This parameter indicates to the SGSN that all GPRS Subscription Data shall be deleted for the subscriber.

7.6.3.54 Complete Data List Included

This parameter indicates to the SGSN that the complete GPRS Subscription Data stored for the Subscriber shall be replaced with the GPRS Subscription Data received.

7.6.3.55 PDP Context Identifier

This parameter is used to identify a PDP context for the subscriber.

7.6.3.56 LSA Information

This parameter refers to one or more localised service areas a subscriber may be a member of, together with the priority, the preferential access indicator, the active mode support indicator and active mode indication of each localised service area. The access right outside these localised service areas is also indicated.

7.6.3.57 SoLSA support indicator

This parameter indicates that the VLR or the SGSN supports SoLSA subscription.

7.6.3.58 LSA Information Withdraw

This parameter indicates that LSA information shall be deleted from the VLR or the SGSN.

7.6.3.59 LMU Indicator

This parameter indicates the presence of an LMU.

7.6.3.60 LCS Information

This parameter defines the LCS related information for an MS subscriber and contains the following components:

- GMLC List (see clause 7.6.3.61).
- LCS Privacy Exception List (see clause 7.6.3.62).
- MO-LR List (see clause 7.6.3.65A).
- Additional LCS Privacy Exception List (see clause 7.6.3.62A).

7.6.3.61 GMLC List

This parameter contains the addresses of all GMLCs that are permitted to issue a call/session unrelated or call/session related MT-LR location request for this MS. Usage of this parameter is defined in 3GPP TS 23.271.

7.6.3.62 LCS Privacy Exception List

This parameter defines the classes of LCS Client that are allowed to locate any target MS. For each class, the following information is provided:

- SS-Code (see clause 7.6.4.1);
- a list of LCS privacy exception parameters (see clause 7.6.3.63).

7.6.3.62A Additional LCS Privacy Exception List

This parameter defines the classes of LCS Client that are allowed to locate any target MS. For each class, the following information is provided:

- SS-Code (see clause 7.6.4.1);
- a list of LCS privacy exception parameters (see clause 7.6.3.63).

The Additional LCS Privacy Exception List shall be present only if the LCS Privacy Exception List is present and contains LCS privacy exception parameters for 4 privacy exception classes.

7.6.3.63 LCS Privacy Exception Parameters

This parameter gives the status of each LCS privacy exception class and any additional parameters relevant to this class. The parameter contains the following information:

- provisioned SS-Status (see clause 7.6.3.17);
- privacy notification to MS user (see clause 7.6.3.65B);
- external client List (see clause 7.6.3.64);
- internal client List (see clause 7.6.3.65).
- service type List (see clause 7.6.3.65D);

7.6.3.64 External Client List

This parameter is only applicable to the call/session unrelated privacy class and call/session related privacy class, and gives the identities of the external clients that are allowed to locate a target MS for a MT-LR. Each identity is an international (e.g.E.164) address. For each identified external client, GMLC restrictions may be defined. It may also be indicated if the MS shall be notified of a non-restricted MT-LR from each identified LCS client and, if so, whether notification only or notification with privacy verification shall apply. Usage of this parameter is defined in 3GPP TS 23.271.

7.6.3.65 Internal Client List

This parameter is only applicable to the PLMN operator privacy class and gives the identities of the internal PLMN operator clients that are allowed to locate a target MS for an NI-LR or MT-LR. Usage of this parameter is defined in 3GPP TS 23.271.

7.6.3.65A MO-LR List

This parameter defines the classes of MO-LR for which a subscription exists for a particular MS. For each class, the following information is provided:

- SS-Code (see clause 7.6.4.1).

7.6.3.65B Privacy Notification to MS User

This parameter is applicable to the call/session unrelated privacy class and call/session related privacy class. For non-call/call related privacy class it indicates whether the MS user shall be notified for that class MT-LR from any value added LCS client when the MT-LR is restricted and be enabled to accept or override the restriction. Usage of this parameter is defined in 3GPP TS 23.271.

7.6.3.65C GMLC List Withdraw

This parameter indicates whether the subscriber's LCS GMLC list shall be deleted from the VLR or SGSN.

7.6.3.65D Service Type List

This parameter is only applicable to the Service type privacy class and gives the identities of the service type of the clients that are allowed to locate a target MS for an MT-LR. Usage of this parameter is defined in 3GPP TS 23.271.

7.6.3.66 IST Alert Timer

This parameter indicates the IST Alert Timer value that must be used in the MSC to inform the HLR about the call activities that the subscriber performs. Units are minutes.

7.6.3.67 Call Termination Indicator

This parameter indicates whether the MSC shall terminate a specific ongoing call, or all the call activities related to a specified subscriber.

7.6.3.68 IST Information Withdraw

This parameter indicates that IST information shall be deleted from the VMSC.

7.6.3.69 IST Support Indicator

This parameter indicates the degree of IST functionality supported by the MSC (Visited MSC or Gateway MSC). It can take one of the following values:

- Basic IST functionality;

- IST command service (in addition to the basic IST functionality and including the ability to terminate all calls being carried for the identified subscriber).

7.6.3.70 Super-Charger Supported In HLR

This parameter is used by the HLR to indicate support of the Super-Charger functionality and an indication of the age of the subscription data stored in the HLR.

7.6.3.71 Super-Charger Supported In Serving Network Entity

This parameter is used to indicate support of the Super-Charger functionality by the originating entity and to indicate either that subscription data is required or the date and time of the last know subscriber data modification.

7.6.3.72 Age Indicator

This parameter is used by the HLR to determine the validity of the subscription data retained by the serving network entity in a Super-Charged network.

7.6.3.73 GPRS enhancements support indicator

This parameter indicates to the HLR that the SGSN supports GPRS enhancements.

7.6.3.74 Extension QoS-Subscribed

This parameter indicates the enhanced QoS subscribed for a certain service. It is defined in 3GPP TS 23.060. This parameter is an extension to QoS-Subscribed.

7.6.3.75 SGSN CAMEL Subscription Info

This parameter identifies the subscriber as having CAMEL services that are invoked in the SGSN.

7.6.3.76 MO-SMS-CSI

This parameter identifies the subscriber as having mobile originating SMS CAMEL services as defined in 3GPP TS 23.078. For the CAMEL phase 3 the MO-SMS-CSI is the same as the SMS-CSI.

7.6.3.76a MT-SMS-CSI

This parameter identifies the subscriber as having mobile terminating SMS CAMEL services as defined in 3GPP TS 23.078.

7.6.3.77 GPRS-CSI

This parameter identifies the subscriber as having GPRS CAMEL services as defined in 3GPP TS 23.078.

7.6.3.78 CAMEL subscription info

This parameter indicates the CSI that can be controlled by CSE.

7.6.3.79 Extensible Call barring information for CSE

This parameter contains for each call barring service for CSE:

- SS-Code;
- a list of extensible call barring feature parameters.

The list may contain one item per Basic Service Group.

- password;
- wrong password attempt counter;
- notification-to-CSE flag.

7.6.3.80 Extensible Forwarding information for CSE

This parameter represents the information for CSE related to each call forwarding service:

- the SS-Code of the relevant call forwarding service;
- if required, a list of extensible forwarding feature parameters;
- the list may contain one item per Basic Service Group;
- notification-to-CSE flag.

7.6.3.81 Modification Request for CSI

This parameter indicates the CAMEL subscription information to be modified by CSE.

7.6.3.81a Modification Request for ODB data

This parameter indicates the operator determined barring data to be modified by CSE.

7.6.3.82 Modification Request for SS Information

This parameter indicates the call forwarding and call barring supplementary service data to be modified by CSE.

7.6.3.83 Call Barring Data

This parameter contains the extensible call barring feature list (see clause 7.6.3.21) and Notification to CSE flag.

7.6.3.84 Call Forwarding Data

This parameter contains the extensible call forwarding feature list (see clause 7.6.3.16) and Notification to CSE flag.

7.6.3.85 ODB Data

This parameter contains the ODB general data, ODB HPLMN specific data.

7.6.3.86 Requested Subscription Info

This parameter indicates the subscription information being requested.

7.6.3.87 CS Allocation/Retention priority

This parameter indicates the allocation/retention priority for Circuit Switched (CS). It corresponds to the allocation/retention priority that is defined in 3GPP TS 23.107.

7.6.3.88 ODB Info

This parameter contains the ODB data and Notification to CSE flag.

7.6.3.89 Suppress VT-CSI

This parameter is used to suppress the invocation of terminating CAMEL services at the VMSC.

7.6.3.90 Suppress Incoming Call Barring

This parameter is used to suppress the invocation of Incoming Call Barrings.

7.6.3.91 gsmSCF Initiated Call

This parameter is used to indicate that the call was initiated by the gsmSCF.

7.6.3.92 MNP Requested Info

This parameter indicates by its presence that Mobile Number Portability (MNP) information is requested for the subscriber, as defined in 3GPP TS 23.078 [98].

7.6.3.93 MNP Info Result

This parameter refers to the Mobile Number Portability (MNP) information result (see 3GPP TS 23.078 [98] and 3GPP TS 23.066 [108]). This parameter may contain the following information:

- Routing Number (see clause 7.6.2.59).
- IMSI (see 3GPP TS 23.078[98], see also clause 7.6.2.1).
- MSISDN (see clause 7.6.2.17).
- Number Portability Status (see clause 7.6.5.14).

7.6.3.94 Allowed Services

This parameter is used by the HLR to indicate which services are available for a call when two services have been requested, for the SCUDIF feature described in 3GPP TS 23.172 [126].

7.6.3.95 Unavailability Cause

This parameter is used to indicate the reason for the unavailability of one of the services as indicated by the Allowed Services IE (see 7.6.3.94) when two services have been requested, for the SCUDIF feature described in 3GPP TS 23.172 [126].

7.6.3.96 Extension-2 QoS-Subscribed

This parameter indicates the additional QoS information to the Extension QoS-subscribed parameter. It is a further extension to Extension QoS-Subscribed. This parameter shall be used when the maximum bit rate exceeds 8640 kbps. For more details, refer to 3GPP TS 24.008 [35].

7.6.4 Supplementary services parameters

7.6.4.1 SS-Code

This parameter may refer to one supplementary service or a set of supplementary services as defined in 3GPP TS 22.004. For MAP this includes:

- Calling Line Identification Presentation service (CLIP);
- Calling Line Identification Restriction service (CLIR);
- Connected Line Identification Presentation service (COLP);
- Connected Line Identification Restriction service (COLR);

- Calling Name Presentation (CNAP);
- All Call Forwarding services, including Call Deflection;
- Call Waiting (CW);
- Call Hold (HOLD);
- Multi-Party service (MPTY);
- Closed User Group (CUG);
- All Charging services;
- All Call Restriction services;
- Explicit Call Transfer service (ECT);
- enhanced Multi-Level Precedence and Pre-emption service (eMLPP);
- Completion of Calls to Busy Subscriber, originating side (CCBS-A);
- Completion of Calls to Busy Subscriber, destination side (CCBS-B);
- All LCS privacy exceptions (see clause 7.6.4.44);
- Mobile Originating Location Request (MO-LR) (see clause 7.6.4.45);
- Multicall (MC).

7.6.4.1A SS-Code 2

This parameter is used to refer to one or a set of supplementary services (as 7.6.4.1 "SS-Code") related to Network Signal Info 2 for SCUDIF calls (see 3GPP TS 23.172 [126]).

7.6.4.2 SS-Status

This parameter refers to the state information of individual supplementary services as defined in 3GPP TS 23.011.

7.6.4.3 SS-Data

This parameter refers to the necessary set of information required in order to characterise one supplementary service:

- SS-Code (see clause 7.6.4.1);
- SS-Status (if applicable) (see clause 7.6.4.2);
- Override subscription option (see clause 7.6.4.4);
- CLI Restriction (see clause 7.6.4.5);
- Basic Service Group Code (see clause 7.6.4.40).

7.6.4.4 Override Category

This parameter refers to the subscription option Override Category attached to a supplementary service. It can take the following two values:

- Enabled;
- Disabled.

7.6.4.5 CLI Restriction Option

This parameter refers to the subscription option Restriction mode attached to the CLIR supplementary service. It can take the following three values:

- Permanent;
- Temporary (Default Restricted);
- Temporary (Default Allowed).

7.6.4.6 Forwarding Options

This parameter refers to a forwarding option attached to a supplementary service. It can take one of the following values:

- notification to forwarding party (see 3GPP TS 22.082 [10] for the meaning of this parameter);
- notification to calling party (see 3GPP TS 22.082 [10] for the meaning of this parameter);
- redirecting presentation (see 3GPP TS 22.082 [10] for the meaning of this parameter);
- Forwarding reason (see 3GPP TS 22.082 [10] for the meaning of this parameter).

7.6.4.7 No reply condition timer

This parameter refers to the no reply condition timer for call forwarding on no reply.

7.6.4.8 - 7.6.4.14 Void

7.6.4.15 Forwarding information

This parameter represents the information related to each call forwarding service:

- the SS-Code of the relevant call forwarding service (see clause 7.6.4.1);
- if required, a list of forwarding feature parameters (see clause 7.6.4.16).

the list may contain one item per Basic Service Group.

7.6.4.16 Forwarding feature

This parameter applies to each combination of call forwarding service and Basic Service Group and contains the following information, as required:

- Basic Service Group (see clause 7.6.4.40);
- SS-Status (see clause 7.6.4.2);
- forwarded-to number (see clause 7.6.2.22);
- forwarded-to subaddress (see clause 7.6.2.23);
- forwarding options (see clause 7.6.4.6);
- no reply condition timer (see clause 7.6.4.7);
- long forwarded-to number (see clause 7.6.2.22A).

If a number is required to define the forwarded-to destination then:

- If the VLR supports Long Forwarded-to Numbers then the long forwarded-to number shall be present and the forwarded-to number shall be absent.

- If the VLR does not support Long Forwarded-to Numbers then the forwarded-to number shall be present and the long forwarded-to number shall be absent.

7.6.4.17 Void

7.6.4.18 Call barring information

This parameter contains for each call barring service:

- SS-Code (see clause 7.6.4.1);
- a list of call barring feature parameters (see clause 7.6.4.19).

The list may contain one item per Basic Service Group.

7.6.4.19 Call barring feature

This parameter gives the status of call barring services as applicable to each Basic Service Group. The parameter contains the following information:

- Basic Service Group (see clause 7.6.4.40);
- SS-Status (see clause 7.6.4.2).

7.6.4.20 New password

This parameter refers to the password which the subscriber just registered in the network.

This parameter refers to a password used by the subscriber for supplementary service control.

7.6.4.21 Current password

This parameter refers to a password used by the subscriber for supplementary service control.

7.6.4.22 Guidance information

This parameter refers to guidance information given to a subscriber who is requested to provide a password. One of the following information may be given:

- "enter password";
this information is used for checking of the old password;
- "enter new password";
this information is used during password registration for the request of the first new password;
- "enter new password again";
this information is used during password registration for the request of the new password again for verification.

7.6.4.23 Void

7.6.4.24 SS-Info

This parameter refers to all the information related to a supplementary service and is a choice between:

- forwarding information (see clause 7.6.4.15);
- call barring information (see clause 7.6.4.18);
- CUG info (see clause 7.6.4.8);

- SS-Data (see clause 7.6.4.3).
- eMLPP information (see clause 7.6.4.41).

7.6.4.25 - 7.6.4.35 Void

7.6.4.36 USSD Data Coding Scheme

This parameter contains the information of the alphabet and the language used for the unstructured information in an Unstructured Supplementary Service Data operation. The coding of this parameter is according to the Cell Broadcast Data Coding Scheme as specified in 3GPP TS 23.038 [25].

7.6.4.37 USSD String

This parameter contains a string of unstructured information in an Unstructured Supplementary Service Data operation. The string is sent either by the mobile user or the network. The contents of a string sent by the MS are interpreted by the network as specified in 3GPP TS 22.090 [16].

7.6.4.38 Bearer service

This parameter may refer to a single bearer service, a set of bearer services or to all bearer services as defined in 3GPP TS 22.002 [3]. This parameter is used only for supplementary service management.

7.6.4.38A Bearer Service 2

This parameter is used to indicate the bearer service or set of bearer services (as 7.6.4.38 "Bearer service") related to Network Signal Info 2 for SCUDIF calls (see 3GPP TS 23.172 [126]).

7.6.4.39 Teleservice

This parameter may refer to a single teleservice, a set of teleservices or to all teleservices as defined in 3GPP TS 22.003 [4]. This parameter is used only for supplementary service management.

7.6.4.40 Basic Service Group

This parameter refers to the Basic Service Group either as a bearer service (see clause 7.6.4.38) or a teleservice (see clause 7.6.4.39). This parameter is used only for supplementary service management. The null value (i.e. neither bearer service nor teleservice) is used to denote the group containing all bearer services and all teleservices.

7.6.4.39A Teleservice 2

This parameter is used to indicate the teleservice or set of teleservices (as 7.6.4.39 "Teleservice") related to Network Signal Info 2 for SCUDIF calls (see 3GPP TS 23.172 [126]).

7.6.4.41 eMLPP information

This parameter contains two parameters which are associated with the eMLPP service. The following two parameters are included:

- maximum entitled priority:
 - indicates the highest priority level the subscriber is allowed to apply for an outgoing call set-up;
- default priority:
 - defines the priority level which shall be assigned to a call if no explicit priority is indicated during call set-up.

7.6.4.42 SS-event

This parameter indicates the Supplementary Service for which an invocation notification is sent towards the gsmSCF. It can indicate one of the following services:

- Explicit Call Transfer (ECT)
- Call Deflection (CD)
- Multi-Party call (MPTY)
- Completion of Calls to Busy Subscriber (CCBS)

7.6.4.43 SS-event data

This parameter contains additional information related to Supplementary Service invocation. Depending on the service invoked it can contain the following information:

- ECT A list with all Called Party Numbers involved.
- CD The called Party number involved.

7.6.4.44 LCS Privacy Exceptions

Distinct SS codes are assigned to the following classes of LCS client in a target MS subscriber's privacy exception list.

- Universal Class;
- Call/session related value added class;
- Call/session unrelated value added class;
- PLMN operator class.
- Service type class.

7.6.4.45 Mobile Originating Location Request (MO-LR)

Distinct SS codes are assigned to the following classes of MO-LR:

- Basic Self Location;
- Autonomous Self Location;
- Transfer to Third Party.

7.6.4.46 NbrUser

This parameter indicates the maximum number of parallel bearers that may be used as defined by the user at registration of the MC SS.

7.6.4.47 MC Subscription Data

This parameter contains two parameters which are associated with the MC service. The following two parameters are included:

- NbrUser:
indicates the maximum number of parallel bearers that may be used as defined by the user at registration of the MC SS
- NbrSB:

indicates the maximum number of parallel bearers that may be used as defined by the user's subscription.

7.6.4.48 MC Information

This parameter contains three parameters which are associated with the MC service. The following parameters are included:

- NbrSB;
- NbrUser;
- NbrSN.

Definitions of these parameters are provided in 3GPP TS 23.135.

7.6.4.49 CCBS Request State

This parameter indicates the current state of the CCBS request. It can take one of seven values:

- request;
- recall;
- active;
- completed;
- suspended;
- frozen;
- deleted.

7.6.4.50 Basic Service Group 2

This parameter refers to the Basic Service Group either as a bearer service (see clause 7.6.4.38) or a teleservice (see clause 7.6.4.39). This parameter is used only for supplementary service management.

7.6.5 Call parameters

7.6.5.1 Call reference number

This parameter refers to a call reference number allocated by a call control MSC.

7.6.5.2 Interrogation type

This parameter refers to the type of interrogation for routing information which is sent from a GMSC to an HLR. It can take either of two values:

- basic call (for information to route a call before the call has been extended to the VMSC of the called party);
- forwarding (for information to route the call to the forwarded-to destination after the VMSC of the forwarding party has requested the GMSC to resume handling of the call).

7.6.5.3 OR interrogation

This parameter indicates that the GMSC which interrogated the HLR for routing information is not in the same PLMN as the HLR, and therefore that the call will potentially be optimally routed.

7.6.5.4 OR capability

This parameter indicates the phase of OR which the GMSC supports.

7.6.5.5 Forwarding reason

This parameter indicates the reason for which the call is to be forwarded. It can take one of three values:

- busy subscriber;
- mobile subscriber not reachable;
- no subscriber reply.

7.6.5.6 Forwarding interrogation required

This parameter indicates that if the VMSC of the forwarding subscriber requests the GMSC to resume handling of the call the GMSC shall interrogate the HLR for forwarding information.

7.6.5.7 O-CSI

This parameter identifies the subscriber as having originating CAMEL services as defined in 3GPP TS 23.078.

7.6.5.7A D-CSI

This parameter identifies the subscriber as having originating CAMEL dialled services as defined in 3GPP TS 23.078.

7.6.5.7B T-CSI

This parameter identifies the subscriber as having terminating CAMEL services in the GMSC, as defined in 3GPP TS 23.078.

7.6.5.7C VT-CSI

This parameter identifies the subscriber as having terminating CAMEL services in the VMSC, as defined in 3GPP TS 23.078.

7.6.5.7D O-IM-CSI

This parameter identifies the subscriber as having originating IP Multimedia Core Network CAMEL services as defined in 3GPP TS 23.278.

7.6.5.7E D-IM-CSI

This parameter identifies the subscriber as having originating IP Multimedia Core Network CAMEL dialled services as defined in 3GPP TS 23.278.

7.6.5.7F VT-IM-CSI

This parameter identifies the subscriber as having terminating IP Multimedia Core Network CAMEL services as defined in 3GPP TS 23.278.

7.6.5.8 Call Direction

This parameter is used to indicate the direction of the call.

7.6.5.9 Channel Type

This parameter is the result of a Channel Mode Modification for TS 61/62. It contains the changed Air Interface User Rate. The information is sent from the SIWFS to the MSC to assign the correct radio resource. This parameter is defined in 3GPP TS 48.008 [49].

7.6.5.10 Chosen Channel

This parameter is sent from the MSC to the SIWFS to adjust the interworking unit to the assigned radio resources. This parameter is defined in 3GPP TS 48.008 [49].

7.6.5.11 CCBS Feature

This parameter corresponds to the 'CCBS Description' parameter in 3GPP TS 23.093. It refers to the necessary set of information required in order to characterise a certain CCBS request. The parameter may contain the following information:

- CCBS Index (see 3GPP TS 23.093 for the use of this parameter);
- B-subscriber number (see clause 7.6.2.48);
- B-subscriber subaddress (see clause 7.6.2.49);
- Basic Service Group Code (see clause 7.6.4.40).

7.6.5.12 UU Data

This parameter includes User-To-User Data. It is defined in 3GPP TS 23.087.

7.6.5.13 UUS CF Interaction

This parameter indicates if the call forwarding or call deflection has been activated after UUS1 request has been accepted . It is defined in 3GPP TS 23.087.

7.6.5.14 Number Portability Status

This parameter indicates the number portability status of subscriber. See 3GPP TS 23.066 [108].

7.6.5.15 Pre-paging supported

This parameter indicates that the entity which sent it supports pre-paging.

7.6.6 Radio parameters

7.6.6.1 - 7.6.6.3 Void

7.6.6.4 GERAN Classmark

This information element is sent from one MSC to the other MSC in the signalling for inter MSC handover. It is used to convey information related to cell capabilities, as defined in 3GPP TS 48.008.

7.6.6.5 BSSMAP Service Handover

This parameter refers to the Service Handover information element defined in 3GPP TS 48.008

7.6.6.5A BSSMAP Service Handover List

This parameter refers to the list of Service Handover information elements defined in 3GPP TS 48.008. This parameter shall be used when there are multiple bearers and at least one of the bearers has an associated BSSMAP Service Handover parameter.

7.6.6.6 RANAP Service Handover

This parameter refers to the Service Handover information element defined in 3GPP TS 25.413.

7.6.6.7 HO-Number Not Required

This parameter indicates that no handover or relocation number allocation is necessary.

7.6.6.8 Integrity Protection Information

This parameter refers to the Integrity Protection Information element defined in 3GPP TS 25.413.

7.6.6.9 Encryption Information

This parameter refers to the Encryption Information element defined in 3GPP TS 25.413.

7.6.6.10 Radio Resource Information

This parameter refers to the Channel Type information element defined in 3GPP TS 48.008 [49].

7.6.6.10A Radio Resource List

This parameter refers to list of RAB-id's and their associated Channel Type information elements defined in 3GPP TS 48.008. This parameter shall be used when there are multiple bearers and at least one of the bearers has an associated Radio Resource Information parameter.

7.6.6.10B Chosen Radio Resource Information

This parameter refers to the Chosen Channel and Speech Version information elements defined in 3GPP TS 48.008.

7.6.6.11 Key Status

This parameter refers to the Key Status element defined in 3GPP TS 25.413.

7.6.6.12 Selected UMTS Algorithms

This parameters identifies the UMTS integrity and optionally encryption algorithms selected by MSC-B. Coding of this parameter is defined in 3GPP TS 25.413.

7.6.6.13 Allowed GSM Algorithms

This parameters identifies the allowed GSM algorithms in MSC-B. Coding of this parameter is defined in 3GPP TS 48.008.

7.6.6.14 Allowed UMTS Algorithms

This parameters identifies the allowed UMTS algorithms in MSC-B. Coding of this parameter is defined in 3GPP TS 25.413.

7.6.6.15 Selected GSM Algorithm

This parameter identifies the GSM algorithm selected by GSM BSC controlled by MSC-B. Coding of this parameter is defined in 3GPP TS 48.008.

7.6.6.16 Iu-Currently Used Codec

This parameter indicates the codec used at the Iu interface before handover .

7.6.6.17 IuSupported Codecs List

This parameter indicates the codecs supported by the UE and by MSC-A and the associated modes in priority order (the first entry being the highest priority codec). MSC-B uses this information to select the associated transcoder resources.

7.6.6.17A Iu-Available Codecs List

This parameter indicates the codecs available at the Iu interface in MSC-B and the associated modes. MSC-A uses this information to decide whether a change to a different codec at the Iu interface is possible.

7.6.6.18 Iu-Selected Codec

When sent by MSC-B, this parameter indicates the codec selected by MSC-B for the Iu interface. When sent by MSC-A, this parameter indicates the codec to be used by MSC-B at the Iu interface.

7.6.6.19 RAB Configuration Indicator

This parameter indicates by its presence that MSC-A (or MSC-B in case of subsequent handover) has generated the RAB parameters according to the preferred codec (first entry in the Available Codecs List).

7.6.6.20 UESBI-Iu

This parameter refers to the UESBI-Iu (UE Specific Behaviour Information over the Iu interface) information element defined in 3GPP TS 25.413.

7.6.7 Authentication parameters

7.6.7.1 Authentication set list

This parameter represents a list of sets of authentication parameters for a given subscriber.

The list either contains Authentication Triplets (Rand, Sres, Kc) or Authentication Quintuplets (Rand, Xres, Ck, Ik, Autn). If the list contains Authentication Quintuplets, the order of sequence in this list is chronological, the first quintuplet in the list is the oldest one.

7.6.7.2 Rand

This parameter represents a random number used for authentication.

7.6.7.3 Sres

This parameter represents the response to an authentication request.

7.6.7.4 Kc

This parameter refers to a key used for ciphering purposes.

7.6.7.5 Xres

This parameter represents the response to an UMTS authentication request.

7.6.7.5A Ck

This parameter refers to a key used for UMTS ciphering purposes.

7.6.7.5B Ik

This parameter refers to the Integrity Key.

7.6.7.5C Autn

This parameter refers to the Authentication Token.

7.6.7.6 Cksn

This parameter refers to a ciphering key sequence number.

7.6.7.6A Ksi

This parameter refers to a key set identifier.

7.6.7.6B Auts

This parameter refers to the resynchronisation token.

7.6.7.7 Ciphering mode

This parameter refers to the ciphering mode which is associated with a radio channel. It may take values as follows:

- no encryption;
- identification of specific ciphering algorithm.

7.6.7.8 Current Security Context

This parameter represents a list of security context parameters for a given subscriber.

The list either contains GSM Security Context data (Kc, Cksn) or UMTS Security Context Data (Ck, Ik, Ksi).

7.6.7.9 Failure cause

This parameter refers to an authentication failure which has occurred. It may take values as follows:

- wrong user response;
- wrong network signature.

7.6.7.10 Re-attempt

It indicates whether the failure occurred in a normal authentication attempt or in an authentication reattempt (there was a previous unsuccessful authentication).

7.6.7.11 Access Type

It indicates whether the authentication procedure was initiated due to a call, an emergency call, a location updating, a supplementary service procedure, a short message transfer, a GPRS attach procedure, a routing area updating, a service request, a MS initiated Detach in GPRS, a PDP context activation or a PDP context deactivation procedure.

7.6.8 Short message parameters

7.6.8.1 SM-RP-DA

This parameter represents the destination address used by the short message service relay sub-layer protocol. It can be either of the following:

- IMSI (see clause 7.6.2.1);
- LMSI (see clause 7.6.2.16);
- MS-ISDN (see clause 7.6.2.17);
- roaming number (see clause 7.6.2.19);
- service centre address (see clause 7.6.2.27).

7.6.8.2 SM-RP-OA

This parameter refers to the originating address used by the short message service relay sub-layer protocol. It can be either of the following:

- MS-ISDN (see clause 7.6.2.17);
- service centre address (see clause 7.6.2.27).

7.6.8.3 MWD status

This parameter indicates whether or not the address of the originator service centre is already contained in the Message Waiting Data file. In addition, it contains the status of the Memory Capacity Exceeded Flag (MCEF), the status of the Mobile subscriber Not Reachable Flag (MNRF) and the status of the Mobile station Not Reachable for GPRS flag (MNRG).

7.6.8.4 SM-RP-UI

This parameter represents the user data field carried by the short message service relay sub-layer protocol.

7.6.8.5 SM-RP-PRI

This parameter is used to indicate whether or not delivery of the short message shall be attempted when a service centre address is already contained in the Message Waiting Data file.

7.6.8.6 SM Delivery Outcome

This parameter indicates the cause for setting the message waiting data. It can take one of the following values:

- Absent subscriber;
- MS memory capacity exceeded;
- Successful transfer.

7.6.8.7 More Messages To Send

This parameter is used to indicate whether or not the service centre has more short messages to send.

7.6.8.8 Alert Reason

This parameter is used to indicate the reason why the service centre is alerted. It can take one of the following values:

- MS present;
- Memory Available.

7.6.8.9 Absent Subscriber Diagnostic SM

This parameter is used to indicate the reason why the subscriber is absent. For the values for this parameter see 3GPP TS 23.040.

7.6.8.10 Alert Reason Indicator

This parameter indicates that the alert reason is sent to the HLR due to GPRS activity.

7.6.8.11 Additional SM Delivery Outcome

This parameter is used to indicate the GPRS delivery outcome in case a combination between delivery outcome for GPRS and non-GPRS are sent to the HLR.

7.6.8.12 Additional Absent Subscriber Diagnostic SM

This parameter indicates the reason of the additional SM Delivery Outcome.

7.6.8.13 Delivery Outcome Indicator

This parameter indicates that the delivery outcome sent to the HLR is for GPRS.

7.6.8.14 GPRS Node Indicator

This parameter indicates that the Network Node Number sent by the HLR is the SGSN number.

7.6.8.15 GPRS Support Indicator

This parameter indicates that the SMS-GMSC supports GPRS specific procedure of combine delivery of Short Message via MSC and/or via the SGSN.

7.6.8.16 SM-RP-MTI

This parameter represents the RP-Message Type Indicator of the Short Message. It is used to distinguish a SM sent to the mobile station in order to acknowledge an MO-SM initiated by the mobile from a normal MT-SM. This parameter is formatted according to the formatting rules of address fields as described in 3GPP TS 23.040.

7.6.8.17 SM-RP-SMEA

This parameter represents the RP-Originating SME-address of the Short Message Entity that has originated the SM. This parameter is used by the short message service relay sub-layer protocol and is formatted according to the formatting rules of address fields as described in 3GPP TS 23.040.

7.6.9 Access and signalling system related parameters

7.6.9.1 AN-apdu

This parameter includes one or two concatenated complete 3GPP TS 25.413 or 3GPP TS 48.006 [48] messages, as described in 3GPP TS 23.009 and 3GPP TS 29.010. The access network protocol ID indicates that the message or messages are according to either 3GPP TS 48.006 [48] or 3GPP TS 25.413. For the coding of the messages see 3GPP TS 25.413, 3GPP TS 48.006 [48] and 3GPP TS 48.008 [49].

7.6.9.2 CM service type

This parameter identifies the service category being requested by the subscriber:

- mobile originating call;
- emergency call establishment;
- short message service;
- mobile originating call re-establishment;
- mobile terminating call;
- SS request;
- Voice group call set-up;
- Voice broadcast set-up.

7.6.9.3 Access connection status

This parameter represents the following access connection status information:

- RR-connection status (established/not established);
- ciphering mode (on/off);
- authentication status (authenticated/not authenticated).

7.6.9.4 External Signal Information

This parameter contains concatenated information elements (including tag and length) which are defined by a common protocol version, preceded by the associated protocol ID. It is used to transport information of the indicated protocol via MAP interfaces.

7.6.9.5 Access signalling information

This parameter refers to any set of information elements imported from 3GPP TS 24.008 [35].

7.6.9.6 Location update type

This parameter refers to the location update type (normal, periodic or IMSI attach) contained in the 3GPP TS 24.008 [35] LOCATION REGISTRATION REQUEST message.

7.6.9.7 Protocol ID

This parameter refers to the protocol to which the coding of the content of the associated External Signal Information conforms.

The following values are defined:

- 04.08;
- 08.06;
- ETS 300 102-1.

This value indicates the protocol defined by ETS 300 102-1 (EDSS1).

7.6.9.8 Network signal information

This parameter is transported as external signal information. The protocol ID shall be set to "ETS 300 102-1".

The network signal information may include the following information elements as defined in 3GPP TS 29.007 [56]:

- ISDN BC; the tag and length are defined by ETS 300 102-1.
For the content, see 3GPP TS 29.007 [56].
- HLC; the tag and length are defined by ETS 300 102-1.
For the content, see 3GPP TS 29.007 [56].
- LLC; the tag and length are defined by ETS 300 102-1.
For the content, see 3GPP TS 29.007 [56].

They are contained in the Signal Information parameter according to figure 7.6/1 (irrespective of the order):

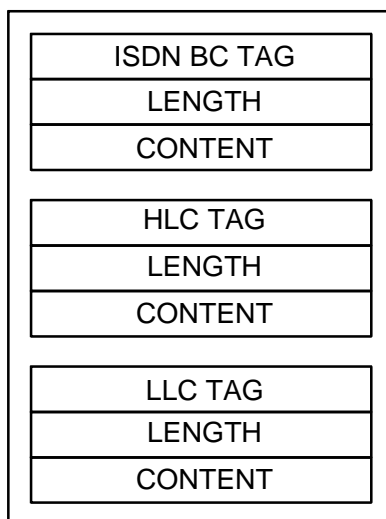

Figure 7.6/1: Network signal information parameter

7.6.9.8A Network signal information 2

This parameter is transported as additional external signal information for SCUDIF calls, described in 3GPP TS 23.172 [126]. The protocol ID and possibly included information elements are identical to Network Signal Information, defined in 7.6.9.8, "Network signal information".

7.6.9.9 Call Info

This parameter is transported as external signal information. The protocol ID shall be set to "3GPP TS 24.008 [35]".

The Call Info includes the set of information elements from the original SETUP message and is imported from 3GPP TS 24.008 [35].

7.6.9.10 Additional signal info

This parameter is transported as external signal information. The protocol ID shall be set to "ETS 300 356".

The additional signal information may include the following information elements:

- Calling Party Number as defined by ETS 300 356.
- Generic Number as defined by ETS 300 356.

They are contained in the Signal Information parameter according to figure 7.6/2 (irrespective of the order):

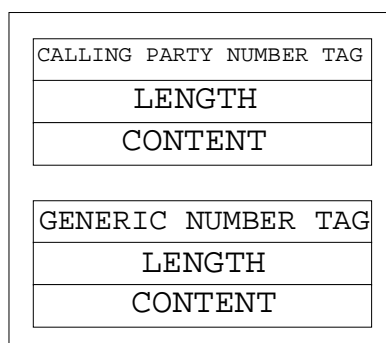

Figure 7.6/2: Additional signal information parameter

7.6.10 System operations parameters

7.6.10.1 Network resources

This parameter refers to a class or type of network resource:

- PLMN;
- HLR;
- VLR (current or previous);
- MSC (controlling or current);
- EIR;
- radio sub-system.

7.6.10.2 Trace reference

This parameter represents a reference associated with a tracing request. The parameter is managed by OMC.

7.6.10.3 Trace type

This parameter identifies the type of trace. Trace types are fully defined in GSM 12.08.

7.6.11 Location Service Parameters

7.6.11.1 Age of Location Estimate

This parameter indicates how long ago the location estimate was obtained.

7.6.11.2 Deferred MT-LR Response Indicator

This parameter shows that this is a response to a deferred mt-lr request.

7.6.11.3 Deferred MT-LR Data

This parameter is used to report the deferred location event type, the location information and reason why the serving node aborted monitoring the event to the GMLC. The termination cause mt-lrRestart shall be used to trigger the GMLC to restart the location procedure in all the cases where the sending node detects that the location procedure cannot be successfully performed anymore by the sending node and that it could be successfully performed by another node (as for example when Cancel Location or Send Identification has been received). The location information shall be included only if the termination cause is mt-lrRestart. The network node number contained in the location information refers to the node where the MS/UE has moved to and shall be included if available, like in case Send Identification has been received.

7.6.11.4 LCS Client ID

This parameter provides information related to the identity of an LCS client.

7.6.11.5 LCS Event

This parameter identifies an event associated with the triggering of a location estimate.

7.6.11.6 Void

7.6.11.7 LCS Priority

This parameter gives the priority of the location request.

7.6.11.8 LCS QoS

This parameter defines the Quality of Service (QoS) for any location request. It is composed of the following elements.

1) Response Time

Indicates the category of response time – 'low delay' or 'delay tolerant'.

2) Horizontal Accuracy

Indicates the required horizontal accuracy of the location estimate.

3) Vertical Coordinate

Indicates if a vertical coordinate is required (in addition to horizontal coordinates).

4) Vertical Accuracy

Indicates the required vertical accuracy of the location estimate (inclusion is optional).

7.6.11.9 CS LCS Not Supported by UE

This parameter is used by the VLR to indicate to the HLR that the UE does not support neither UE Based nor UE Assisted positioning methods for Circuit Switched Location Services. VLR defines the presence of this parameter on the basis of the Classmark 3 information.

7.6.11.10 PS LCS Not Supported by UE

This parameter is used by the SGSN to indicate to the HLR that the UE does not support neither UE Based nor UE Assisted positioning methods for Packet Switched Location Services. SGSN defines the presence of this parameter on the basis of the UE capability information.

7.6.11.11 Location Estimate

This parameter gives an estimate of the location of an MS in universal coordinates and the accuracy of the estimate. The estimate is expressed in terms of the geographical shapes defined by 3GPP TS 23.032, and is composed of the type of shape plus the encoding of the shape itself. Any type of shape defined in 3GPP TS 23.032 can be filled in in the Location Estimate parameter, but only the encoding of the following shapes shall be carried by Location Estimate:

- Ellipsoid point with uncertainty circle
- Ellipsoid point with uncertainty ellipse
- Ellipsoid point with altitude and uncertainty ellipsoid
- Ellipsoid arc
- Ellipsoid point

The encoding for the remaining types of shape, defined in the 3GPP TS 23.032, shall be filled in in the Additional Location Estimate parameter.

7.6.11.11A GERAN Positioning Data

This parameter provides positioning data associated with a successful or unsuccessful location attempt for a target MS as described in 3GPP TS 49.031 [59a].

7.6.11.11B UTRAN Positioning Data

This parameter provides positioning data associated with a successful location attempt for a target MS as described in 3GPP TS 25.413 [120]. It contains the positioningDataDiscriminator and positioningDataSet parts of the RANAP PositionData element only.

7.6.11.12 Location Type

This parameter indicates the type of location estimate required by the LCS client. Possible location estimate types include:

- current location;
- current or last known location;
- initial location for an emergency services call;
- deferred location event type.

7.6.11.13 NA-ESRD

This parameter only applies to location for an emergency services call in North America and gives the North American Emergency Services Routing Digits.

7.6.11.14 NA-ESRK

This parameter only applies to location for an emergency services call in North America and gives the North American Emergency Services Routing Key.

7.6.11.15 LCS Service Type Id

This parameter defines the LCS Service Type of the current positioning request. The possible values are defined in 3GPP TS 22.071 [123]

7.6.11.16 Privacy Override

This parameter indicates if MS privacy is overridden by the LCS client when the GMLC and VMSC/SGSN for an MT-LR are in the same country.

7.6.11.17 Supported LCS Capability Sets

This parameter indicates which capability sets of LCS are supported in the VLR or SGSN.

7.6.11.18 LCS Codeword

This parameter contains the codeword associated to current positioning request as described in 3GPP TS 23.271 [26a].

7.6.11.19 NA-ESRK Request

This parameter allows the MSC to indicate that it requires the GMLC to allocate a NA-ESRK based on the target MS location estimate. This parameter only applies to emergency services calls in North America.

7.6.11.20 Supported GAD Shapes

This parameter indicates which of the shapes defined in 3GPP TS 23.032 are supported. If the parameter is not provided then the receiving node shall assume that the sending entity supports the following shapes:

- Ellipsoid point with uncertainty circle

- Ellipsoid point with uncertainty ellipse
- Ellipsoid point with altitude and uncertainty ellipsoid
- Ellipsoid arc
- Ellipsoid point

7.6.11.21 Additional Location Estimate

This parameter gives an estimate of the location of an MS/UE in universal coordinates and the accuracy of the estimate. This parameter allows the location estimate to be expressed in any of the geographical shapes defined in 3GPP TS 23.032

7.6.11.22 Void

7.6.11.23 LCS-Reference Number

This parameter represents a reference between a request and a response of a deferred mt-lr procedure as described in 3GPP TS 23.271 [26a].

7.6.12 void

7.7 Representation of a list of a basic parameter in service-primitives

In some service-primitives several instances of a basic parameter of clause 7.6 are required. In the service descriptions such cases will be represented as



in the tables where ParameterName refers to one of the parameters defined in clause 7.6. This corresponds to the following construction rule:

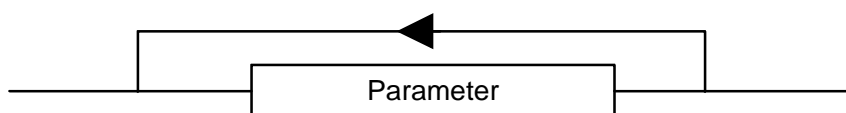

Figure 7.7/1: Construction of Lists

8 Mobility services

8.1 Location management services

8.1.1 Void

8.1.1.1 Void

8.1.1.2 Void

8.1.1.3 Void

8.1.2 MAP_UPDATE_LOCATION service

8.1.2.1 Definition

This service is used by the VLR to update the location information stored in the HLR.

The MAP_UPDATE_LOCATION service is a confirmed service using the service primitives given in table 8.1/2.

8.1.2.2 Service primitives

Table 8.1/2: MAP_UPDATE_LOCATION

Parameter name	Request	Indication	Response	Confirm
Invoke Id	M	M(=)	M(=)	M(=)
IMSI	M	M(=)		
MSC Address	M	M(=)		
VLR number	M	M(=)		
LMSI	U	C(=)		
Supported CAMEL Phases	C	C(=)		
SoLSA Support Indicator	C	C(=)		
IST Support Indicator	C	C(=)		
Super-Charger Supported in Serving Network Entity	C	C(=)		
Long FTN Supported	C	C(=)		
Supported LCS Capability Sets	C	C(=)		
Offered CAMEL 4 CSIs	C	C(=)		
Inform Previous Network Entity	C	C(=)		
CS LCS Not Supported by UE	C	C(=)		
HLR number			C	C(=)
User error			C	C(=)
Provider error				O

8.1.2.3 Parameter definitions and use

Invoke Id

See definition in clause 7.6.1.

IMSI

See definition in clause 7.6.2.

MSC Address

See definition for MSC number in clause 7.6.2. The MSC address is used for short message delivery only and for each incoming call set-up attempt the MSRN will be requested from the VLR.

VLR number

See definition in clause 7.6.2.

LMSI

See definition in clause 7.6.2. It is an operator option to provide the LMSI from the VLR; it is mandatory for the HLR to support the LMSI handling procedures.

Supported CAMEL Phases

This parameter indicates which phases of CAMEL are supported. Must be present if a CAMEL phase different from phase 1 is supported. Otherwise may be absent.

HLR number

See definition in clause 7.6.2. The presence of this parameter is mandatory in case of successful HLR updating.

SoLSA Support Indicator

This parameter is used by the VLR to indicate to the HLR in the Update Location indication that SoLSA is supported. If this parameter is not included in the Update Location indication and the Subscriber is marked as only allowed to roam in Subscribed LSAs, then the HLR shall reject the roaming and indicate to the VLR that roaming is not allowed to that Subscriber in the VLR.

This SoLSA Support Indicator shall be stored by the HLR per VLR where there are Subscribers roaming. If a Subscriber is marked as only allowed to roam in Subscribed LSAs while roaming in a VLR and no SoLSA Support indicator is stored for that VLR, the location status of that Subscriber shall be set to Restricted.

IST Support Indicator

This parameter is used to indicate to the HLR that the VMSC supports basic IST functionality, that is, the VMSC is able to terminate the Subscriber Call Activity that originated the IST Alert when it receives the IST alert response indicating that the call(s) shall be terminated. If this parameter is not included in the Update Location indication and the Subscriber is marked as an IST Subscriber, then the HLR may limit the service for the subscriber (by inducing an Operator Determined barring of Roaming, Incoming or Outgoing calls), or allow service assuming the associated risk of not having the basic IST mechanism available.

This parameter can also indicate that the VMSC supports the IST Command service, including the ability to terminate all calls being carried for the identified subscriber by using the IMSI as a key. If this additional capability is not included in the Update Location indication and the HLR supports the IST Command capability, then the HLR may limit the service for the subscriber (by inducing an Operator Determined barring of Roaming, Incoming or Outgoing calls), or allow service assuming the associated risk of not having the IST Command mechanism available.

Long FTN Supported

This parameter indicates that the VLR supports Long Forwarded-to Numbers.

Super-Charger Supported in Serving Network Entity

This parameter is used by the VLR to indicate to the HLR that the VLR supports the Super-Charger functionality and whether subscription data has been retained by the VLR. If subscription data has been retained by the VLR the age indicator shall be included. Otherwise the VLR shall indicate that subscriber data is required.

If this parameter is absent then the VLR does not support the Super-Charger functionality.

Supported LCS Capability Sets

This parameter indicates, if present, the capability sets of LCS which are supported. If the parameter is sent but no capability set is marked as supported then the VLR does not support LCS at all.

If this parameter is absent then the VLR may support at most LCS capability set 1, that is LCS Release98 or Release99 version.

Offered CAMEL 4 CSIs

This parameter indicates the CAMEL phase 4 CSIs offered in the VMSC/VLR (see clause 7.6.3.36D).

Inform Previous Network Entity

This parameter is used by the VLR to ask the HLR to inform the previous network entity about the update by sending the previous network entity a Cancel Location message. It is used in case Super-Charger is supported in the network and the serving network entity has not been able to inform the previous network entity that MS has moved, that is if it has not sent Send Identification to the previous serving entity.

CS LCS Not Supported by UE

See definition in clause 7.6.11.

User error

In case of unsuccessful updating, an error cause shall be returned by the HLR. The following error causes defined in clause 7.6.1 may be used, depending on the nature of the fault:

- unknown subscriber;
- roaming not allowed;

This cause will be sent if the MS is not allowed to roam into the PLMN indicated by the VLR number. The cause is qualified by the roaming restriction reason "PLMN Not Allowed" or "Operator Determined Barring". If no qualification is received (HLR with MAP Version 1), "PLMN Not Allowed" is taken as default.

- system failure;
- unexpected data value.

Provider error

For definition of provider errors see clause 7.6.1.

8.1.3 MAP_CANCEL_LOCATION service

8.1.3.1 Definition

This service is used between HLR and VLR to delete a subscriber record from the VLR. It may be invoked automatically when an MS moves from one VLR area to another, to remove the subscriber record from the old VLR, or by the HLR operator to enforce a location updating from the VLR to the HLR, e.g. on withdrawal of a subscription.

Also this service is used between HLR and SGSN to delete a subscriber record from the SGSN. It may be invoked automatically when an MS moves from one SGSN area to another, to remove the subscriber record from the old SGSN, or by the HLR operator to enforce a location updating from the SGSN to the HLR.

The MAP_CANCEL_LOCATION service is a confirmed service using the primitives defined in table 8.1/3.

8.1.3.2 Service primitives

Table 8.1/3: MAP_CANCEL_LOCATION

Parameter name	Request	Indication	Response	Confirm
Invoke Id	M	M(=)	M(=)	M(=)
IMSI	M	M(=)		
LMSI	C	C(=)		
Cancellation Type	C	C(=)		
User error			C	C(=)
Provider error				O

8.1.3.3 Parameter definitions and use

Invoke Id

See definition in clause 7.6.1.

IMSI

See definition in clause 7.6.2.

LMSI

See definition in clause 7.6.2. The LMSI shall be included if it has been received from VLR. LMSI is not applicable between SGSN and HLR.

Value 0000 0000 can be used to indicate that the LMSI is not in use.

Cancellation Type

See definition in clause 7.6.3. The presence of this parameter is mandatory when the Cancel Location is sent to the SGSN. If the VLR receives this parameter and do not understand it the VLR shall ignore it.

User error

If the cancellation fails, an error cause is to be returned by the VLR or by the SGSN. One of the following error causes defined in clause 7.6.1 shall be used:

- unexpected data value;
- data missing.

Provider error

For definition of provider errors see clause 7.6.1.

8.1.4 MAP_SEND_IDENTIFICATION service

8.1.4.1 Definition

The MAP_SEND_IDENTIFICATION service is used between a VLR and a previous VLR to retrieve IMSI and authentication data for a subscriber registering afresh in that VLR.

The MAP_SEND_IDENTIFICATION service is a confirmed service using the service primitives defined in table 8.1/4.

8.1.4.2 Service primitives

Table 8.1/4: MAP_SEND_IDENTIFICATION

Parameter name	Request	Indication	Response	Confirm
Invoke Id	M	M(=)	M(=)	M(=)
TMSI	M	M(=)		
Number of requested vectors	M	M(=)		
Segmentation prohibited indicator	C	C(=)		
IMSI			C	C(=)
Authentication set			U	C(=)
Current Security Context			U	C(=)
User error			C	C(=)
Provider error				O

8.1.4.3 Parameter definitions and use

Invoke Id

See definition in clause 7.6.1.

TMSI

See definition in clause 7.6.2.

If multiple service requests are present in a dialogue then this parameter shall be present in every service request.

Number of requested vectors

A number indicating how many authentication vectors the new VLR is prepared to receive. The previous VLR shall not return more vectors than indicated by this parameter.

This parameter shall be present in the first (or only) request of the dialogue. If multiple service requests are present in a dialogue then this parameter shall not be present in any service request other than the first one

Segmentation prohibited indicator

This parameter indicates if the new VLR or SGSN allows segmentation of the response at MAP user level.

This parameter may be present only in the first request of the dialogue.

IMSI

See definition in clause 7.6.2. The IMSI is to be returned if the service succeeds.

If multiple service requests are present in a dialogue and the service succeeds then this parameter shall not be present in any service response other than the first one

Authentication set

See definition in clause 7.6.7. If the service succeeds a list of up to five authentication sets is returned, if there are any available.

Current Security Context

See definition in clause 7.6.7. If the service succeeds, a list of either GSM or UMTS Security Context parameters can be returned.

User error

This parameter is mandatory if the service fails. The following error cause defined in clause 7.6.1 may be used, depending on the nature of the fault:

- unidentified subscriber.

Provider error

For definition of provider errors see clause 7.6.1.

8.1.5 Void

8.1.5.1 Void

8.1.5.2 Void

8.1.5.3 Void

8.1.6 MAP_PURGE_MS service

8.1.6.1 Definition

This service is used between the VLR and the HLR to cause the HLR to mark its data for an MS so that any request for routing information for a mobile terminated call or a mobile terminated short message will be treated as if the MS is not reachable. It is invoked when the subscriber record for the MS is to be deleted in the VLR, either by MMI interaction or automatically, e.g. because the MS has been inactive for several days. This service shall not be used if both the VLR and HLR support the Super-Charger functionality.

Also this service is used between the SGSN and the HLR to cause the HLR to mark its data for an MS so that any request for routing information for a mobile terminated short message or a network requested PDP-context activation will be treated as if the MS is not reachable. It is invoked when the subscriber record for the MS is to be deleted in the SGSN, either by MMI interaction or automatically, e.g. because the MS has been inactive for several days. This service shall not be used if both the SGSN and HLR support the Super-Charger functionality.

The MAP_PURGE_MS service is a confirmed service using the primitives defined in table 8.1/6.

8.1.6.2 Service primitives

Table 8.1/6: MAP_PURGE_MS

Parameter name	Request	Indication	Response	Confirm
Invoke Id	M	M(=)	M(=)	M(=)
IMSI	M	M(=)		
VLR number	C	C(=)		
Freeze TMSI			C	C(=)
Freeze P-TMSI			C	C(=)
SGSN number	C	C(=)		
User error			C	C(=)
Provider error				O

8.1.6.3 Parameter definitions and use

Invoke ID

See definition in clause 7.6.1.

IMSI

See definition in clause 7.6.2.

VLR number

Shall be present if the sender is VLR. See definition in clause 7.6.2.

SGSN number

Shall be present if the sender is SGSN. See definition in clause 7.6.2.

Freeze TMSI

This parameter is sent to the VLR to indicate that the TMSI has to be frozen. It shall be present if the received VLR number matches the stored VLR number.

Freeze P-TMSI

This parameter is sent to the SGSN to indicate that the P-TMSI has to be frozen. It shall be present if the received SGSN number matches the stored SGSN number.

User error

This parameter is sent by the responder when an error is detected and if present, takes one of the following values:

- Data Missing;
- Unexpected Data Value;
- Unknown Subscriber.

Provider error

See definition of provider errors in clause 7.6.1.

8.1.7 MAP_UPDATE_GPRS_LOCATION service

8.1.7.1 Definition

This service is used by the SGSN to update the location information stored in the HLR.

The MAP_UPDATE_GPRS_LOCATION service is a confirmed service using the service primitives given in table 8.1/7.

8.1.7.2 Service primitives

Table 8.1/7: MAP_UPDATE_GPRS_LOCATION

Parameter name	Request	Indication	Response	Confirm
Invoke Id	M	M(=)	M(=)	M(=)
IMSI	M	M(=)		
SGSN number	M	M(=)		
SGSN address	M	M(=)		
Supported CAMEL Phases	C	C(=)		
SoLSA Support Indicator	C	C(=)		
Super-Charger Supported in Serving Network Entity	C	C(=)		
GPRS enhancements support indicator	C	C(=)		
Supported LCS Capability Sets	C	C(=)		
Offered CAMEL 4 CSIs	C	C(=)		
Inform Previous Network Entity	C	C(=)		
PS LCS Not Supported by UE	C	C(=)		
HLR number			C	C(=)
User error			C	C(=)
Provider error				O

8.1.7.3 Parameter definitions and use

Invoke Id

See definition in clause 7.6.1.

IMSI

See definition in clause 7.6.2.

SGSN number

See definition in clause 7.6.2.

SGSN address

See definition in clause 7.6.2.

Supported CAMEL Phases

This parameter indicates which phases of CAMEL are supported. The SGSN can only support CAMEL phase 3 or greater.

SoLSA Support Indicator

This parameter is used by the SGSN to indicate to the HLR in the Update GPRS Location indication that SoLSA is supported. If this parameter is not included in the Update GPRS Location indication and the Subscriber is marked as only allowed to roam in Subscribed LSAs, then the HLR shall reject the roaming and indicate to the SGSN that roaming is not allowed to that Subscriber in the SGSN.

This SoLSA Support Indicator shall be stored by the HLR per SGSN where there are Subscribers roaming. If a Subscriber is marked as only allowed to roam in Subscribed LSAs while roaming in a SGSN and no SoLSA Support indicator is stored for that SGSN, the location status of that Subscriber has to be set to Restricted.

Super-Charger Supported in Serving Network Entity

This parameter is used by the SGSN to indicate to the HLR that the SGSN supports the Super-Charger functionality and whether subscription data has been retained by the SGSN. If subscription data has been retained by the SGSN the age indicator shall be included. Otherwise the SGSN shall indicate that subscriber data is required.

If this parameter is absent then the SGSN does not support the Super-Charger functionality.

GPRS enhancements support indicator

This parameter is used by the SGSN to indicate to the HLR in the Update GPRS Location indication that GPRS enhancements are supported. If this parameter is included in the Update GPRS Location indication the HLR may send the extension QoS parameter in the PDP contexts to the SGSN. The HLR may send the extension-2 QoS parameter with the extension QoS parameter.

HLR number

See definition in clause 7.6.2. The presence of this parameter is mandatory in case of successful HLR updating.

Supported LCS Capability Sets

This parameter indicates, if present, the capability sets of LCS which are supported. If the parameter is sent but no capability set is marked as supported then the SGSN does not support LCS at all.

The SGSN is not allowed to indicate support for LCS capability set 1.

If this parameter is absent then the SGSN does not support LCS at all.

Offered CAMEL 4 CSIs

This parameter indicates the CAMEL phase 4 CSIs offered in the SGSN (see clause 7.6.3.36D).

Inform Previous Network Entity

This parameter is used by the SGSN to ask the HLR to inform the previous network entity about the update by sending the previous network entity a Cancel Location message. It is used in case Super-Charger is supported in the network and the serving network entity has not been able to inform the previous network entity that MS has moved, that is if it has not sent SGSN Context Request to the previous serving entity.

PS LCS Not Supported by UE

See definition in clause 7.6.11.

User error

In case of unsuccessful updating, an error cause shall be returned by the HLR. The following error causes defined in clause 7.6.1 may be used, depending on the nature of the fault:

- unknown subscriber;
- roaming not allowed.

This cause will be sent if the MS is not allowed to roam into the PLMN indicated by the SGSN number. The cause is qualified by the roaming restriction reason "PLMN Not Allowed" or "Operator Determined Barring".

- system failure;
- unexpected data value.

The diagnostic in the Unknown Subscriber may indicate 'Imsi Unknown' or 'Gprs Subscription Unknown'.

Provider error

For definition of provider errors see clause 7.6.1.

8.1.8 MAP-NOTE-MM-EVENT

8.1.8.1 Definition

This service is used between the VLR and the gsmSCF or between the SGSN and the gsmSCF when a mobility management event for a subscriber has been processed successfully, that subscriber is provisioned with M-CSI or MG-CSI and the relevant mobility management event is marked for reporting.

8.1.8.2 Service primitives

The service primitives are shown in table 8.1/8.

Table 8.1/8: MAP_NOTE_MM_EVENT parameters

Parameter name	Request	Indication	Response	Confirm
Invoke id	M	M(=)	M(=)	M(=)
Event Met	M	M(=)		
Service Key	M	M(=)		
IMSI	M	M(=)		
Basic MSISDN	M	M(=)		
Location Information for GPRS	C	C(=)		
Location Information	C	C(=)		
LSA Identity	C	C(=)		
Supported CAMEL Phases	M	M(=)		
Offered CAMEL 4 Functionalities	C	C(=)		
User error			C	C(=)
Provider error				O

8.1.8.3 Parameter use

Event Met

This parameter indicates the mobility management event that has lead to the notification. It shall have one of the following values for a mobility management event reported by the VLR:

- Location update in the same VLR service area;
- Location update to another VLR service area;
- IMSI attach;
- MS initiated IMSI detach (explicit detach);
- Network initiated IMSI detach (implicit detach).

It shall have one of the following values for a mobility management event reported by the SGSN:

- Routeing area update in the same SGSN service area;
- Routeing area update to another SGSN service area;
- GPRS attach;
- MS initiated GPRS detach;
- Network initiated GPRS detach;
- Network initiated transfer to the "not reachable for paging" state.

Service Key

See clause 7.6.x.

IMSI

See clause 7.6.x.

Basic MSISDN

See clause 7.6.x.

Location Information

See clause 7.6.2.30. This information shall be sent when the event is reported by a VLR, if available.

Location Information for GPRS

See clause 7.6.2.30a. This information shall be sent when the event is reported by an SGSN, if available.

LSA Identity

See clause 7.6.x. This information shall be sent, if available.

Supported CAMEL Phases

See clause 7.6.x. This information shall always be sent.

Offered CAMEL 4 Functionalities

This parameter indicates the CAMEL phase 4 functionalities offered by the sending entity, VMSC/VLR or SGSN (see clause 7.6.3.36G).

User error

This parameter is sent by the receiving entity when an error is detected. It shall have one of the following values:

- Data Missing;
- Unexpected Data Value;
- Unknown Subscriber;
- MM-EventNotSupported.

Provider error

This is defined in clause 7.6.1.

8.2 Paging and search

8.2.1 MAP_PAGE service

8.2.1.1 Definition

This service is used between VLR and MSC to initiate paging of an MS for mobile terminated short message or unstructured SS notification.

The MAP_PAGE service is a confirmed service using the primitives from table 8.2/1.

8.2.1.2 Service primitives

Table 8.2/1: MAP_PAGE

Parameter name	Request	Indication	Response	Confirm
Invoke Id	M	M(=)	M(=)	M(=)
IMSI	M	M(=)		
Stored location area Id	M	M(=)		
TMSI	U	C(=)		
User error			C	C(=)

Provider error				O
----------------	--	--	--	---

8.2.1.3 Parameter definitions and use

Invoke Id

See definition in clause 7.6.1.

IMSI

See definition in clause 7.6.2. The IMSI is used to define the paging subgroup. If the TMSI is not supplied, paging on the radio path uses the IMSI as an identifier.

Stored location area Id

See definition in clause 7.6.2.

TMSI

See definition in clause 7.6.2. The TMSI is included if paging on the radio channel is to use the TMSI as an identifier.

User error

The following error causes defined in clause 7.6.1 may be sent by the user in case of a paging error, depending on the failure reason:

- absent subscriber;
- unknown location area;
- busy subscriber;
- system failure;
- this corresponds to the case where there is no call associated with the MAP_PAGE service, i.e. if the call has been released but the dialogue to the VLR has not been aborted;
- unexpected data value.

Provider error

See definition in clause 7.6.1.

8.2.2 MAP_SEARCH_FOR_MS service

8.2.2.1 Definition

This service is used between VLR and MSC to initiate paging of an MS in all location areas of that VLR. It is used if the VLR does not hold location area information confirmed by radio contact.

The MAP_SEARCH_FOR_MS service is a confirmed service using the primitives from table 8.2/2.

8.2.2.2 Service primitives

Table 8.2/2: MAP_SEARCH_FOR_MS

Parameter name	Request	Indication	Response	Confirm
Invoke Id	M	M(=)	M(=)	M(=)
IMSI	M	M(=)		
Current location area Id			C	C(=)
User error			C	C(=)
Provider error				O

8.2.2.3 Parameter definitions and use

Invoke Id

See definition in clause 7.6.1.

IMSI

See definition in clause 7.6.2. The IMSI is used to identify the subscriber when paging on the radio path.

Current location area Id

See definition in clause 7.6.2. In case of successful outcome of the service, i.e. if the MS responds to paging, the Location Area Id of the area in which the MS responded is given in the response.

User error

The following error causes defined in clause 7.6.1 shall be sent by the user if the search procedure fails, depending on the failure reason:

- absent subscriber;
this error cause is returned by the MSC if the MS does not respond to the paging request;
- system failure;
- this corresponds to the case where there is no call associated with the MAP_SEARCH_FOR_MS service, i.e. if the call has been released but the dialogue to the VLR has not been aborted;
- busy subscriber;
- unexpected data value.

Provider error

See definition in clause 7.6.1.

8.3 Access management services

8.3.1 MAP_PROCESS_ACCESS_REQUEST service

8.3.1.1 Definition

This service is used between MSC and VLR to initiate processing of an MS access to the network, e.g. for mobile originated short message submission or after being paged by the network.

The MAP_PROCESS_ACCESS_REQUEST service is a confirmed service using the primitives from table 8.3/1.

8.3.1.2 Service primitives

Table 8.3/1: MAP_PROCESS_ACCESS_REQUEST

Parameter name	Request	Indication	Response	Confirm
Invoke Id	M	M(=)	M(=)	M(=)
CM service type	M	M(=)		
Access connection status	M	M(=)		
Current Location Area Id	M	M(=)		
Serving cell Id	M	M(=)		
TMSI	C	C(=)		
Cksn	C	C(=)		
IMSI	C	C(=)	C	C(=)
IMEI	C	C(=)	C	C(=)
MSISDN			U	C(=)

User error			C	C(=)
Provider error				O

8.3.1.3 Parameter definitions and use

Invoke Id

See definition in clause 7.6.1.

CM service type

See definition in clause 7.6.9.

Access connection status

See definition in clause 7.6.9.

Current Location Area Id

See definition in clause 7.6.2. This parameter is used to update the VLR in case of previous VLR failure.

Serving cell Id

See definition in clause 7.6.2.

TMSI

See definition in clause 7.6.2. Either TMSI or IMSI as received from the MS are included in the Request/Indication, but one shall be present. In case of CM Service Type "Emergency Call Establishment", the IMEI may replace IMSI/TMSI.

Cksn

See definition in clause 7.6.7. In case of access with TMSI, the Cksn shall be present.

IMSI

See definition in clause 7.6.2. Either TMSI or IMSI as received from the MS are included in the Request/Indication, but one shall be present. In case of CM Service Type "Emergency Call Establishment", the IMEI may replace IMSI/TMSI.

In the Response/Confirmation, the IMSI is to be sent in case of successful outcome of the service. In case of CM Service Type "Emergency Call Establishment", IMEI may replace IMSI.

IMEI

See definition in clause 7.6.2. The IMEI may replace IMSI/TMSI in the Request/Indication and IMSI in the Response/Confirmation only in case the CM Service Type indicates "Emergency Call Establishment".

MSISDN

See definition in clause 7.6.2. The MSISDN is included in case of successful outcome of the service as an operator option, e.g. if it is needed at the MSC for charging purposes in case of call forwarding.

User error

One of the following error causes defined in clause 7.6.1 shall be sent by the user if the access request fails, depending on the failure reason:

- unidentified subscriber;
- illegal subscriber;
this error is sent if a correlated authentication procedure has not authenticated the subscriber;
- illegal equipment;
this error is sent if an IMEI check failed, i.e. the IMEI is blacklisted or not white-listed;

- roaming not allowed;
- this cause is used after VLR restart if the subscriber has no subscription for the current location area, e.g. due to regional subscription. The cause will be qualified by "location area not allowed" or "national roaming not allowed", respectively;
- unknown location area;
- system failure;
- unexpected data value.

Provider error

For definition of provider errors see clause 7.6.1.

8.4 Handover services

It should be noted that the handover services used on the B-interface have not been updated for Release 99. The B-interface is not fully operational specified. It is strongly recommended not to implement the B-interface as an external interface.

8.4.1 MAP_PREPARE_HANOVER service

8.4.1.1 Definition

This service is used between MSC-A and MSC-B (E-interface) when a call is to be handed over or relocated from MSC-A to MSC-B.

The MAP_PREPARE_HANOVER service is a confirmed service using the primitives from table 8.4/1.

8.4.1.2 Service primitives

Table 8.4/1: MAP_PREPARE_HANOVER

Parameter name	Request	Indication	Response	Confirm
Invoke Id	M	M(=)	M(=)	M(=)
Target Cell Id	C	C(=)		
Target RNC Id	C	C(=)		
HO-NumberNotRequired	C	C(=)		
IMSI	C	C(=)		
Integrity Protection Information	C	C(=)		
Encryption Information	C	C(=)		
Radio Resource Information	C	C(=)		
AN-APDU	C	C(=)	C	C(=)
Allowed GSM Algorithms	C	C(=)		
Allowed UMTS Algorithms	C	C(=)		
Radio Resource List	C	C(=)		
RAB ID	C	C(=)		
GERAN Classmark	C	C(=)		
BSSMAP Service Handover	C	C(=)		
BSSMAP Service Handover List	C	C(=)		
RANAP Service Handover	C	C(=)		
Iu-Currently Used Codec	C	C(=)		
Iu-Supported Codecs List	C	C(=)		
RAB Configuration Indicator	C	C(=)		
ASCI Call Reference	C	C(=)		
UESBI-Iu	C	C(=)		
Handover Number			C	C(=)
Relocation Number List			C	C(=)
Multicall Bearer Information			C	C(=)

Multiple Bearer Requested	C	C(=)		
Multiple Bearer Not Supported			C	C(=)
Selected UMTS Algorithms			C	C(=)
Chosen Radio Resource Information			C	C(=)
lu-Selected Codec			C	C(=)
lu-Available Codecs List			C	C(=)
User error			C	C(=)
Provider error				O

8.4.1.3 Parameter use

Invoke Id

For definition of this parameter see clause 7.6.1.

Target Cell Id

For definition of this parameter see clause 7.6.2. This parameter is only included if the service is not in an ongoing transaction. This parameter shall also be excluded if the service is a part of the Inter-MSC SRNS Relocation procedure or the inter-system handover GSM to UMTS procedure described in 3GPP TS 23.009.

Target RNC Id

For definition of this parameter see clause 7.6.2. This parameter shall be included if the service is a part of the Inter-MSC SRNS Relocation procedure or the inter-system handover GSM to UMTS procedure described in 3GPP TS 23.009.

HO-Number Not Required

For definition of this parameter see clause 7.6.6.

IMSI

For definition of this parameter see clause 7.6.2. This UMTS parameter shall be included if:

- available and
- if the access network protocol is BSSAP and
- there is an indication that the MS also supports UMTS.

Integrity Protection Information

For definition of this parameter see clause 7.6.6. This UMTS parameter shall be included if available and if the access network protocol is BSSAP.

Encryption Information

For definition of this parameter see clause 7.6.6. This UMTS parameter shall be included if available and if the access network protocol is BSSAP.

Radio Resource Information

For definition of this parameter see clause 7.6.6. This GSM parameter shall be included if the access network protocol is RANAP and there is an indication that the UE also supports GSM. If the parameter Radio Resource List is sent, the parameter Radio Resource Information shall not be sent.

AN-APDU

For definition of this parameter see clause 7.6.9.

Allowed GSM Algorithms

For definition of this parameter see clause 7.6.6. This parameter includes allowed GSM algorithms. This GSM parameter shall be included if:

- the service is a part of the Inter-MSC SRNS Relocation procedure and
- Ciphering or Security Mode Setting procedure has been performed.and
- there is an indication that the UE also supports GSM.

Allowed UMTS Algorithms

For definition of this parameter see clause 7.6.6. This UMTS parameter shall be included if all of the following conditions apply:

- access network protocol is BSSAP and
- Integrity Protection Information and Encryption Information are not available and

Ciphering or Security Mode Setting procedure has been performed.

Radio Resource List

For definition of this parameter see clause 7.6.6. This parameter shall be included if the access network protocol is RANAP and there is an indication that the UE also supports GSM. This parameter shall be sent when MSC-A requests multiple bearers to MSC-B. If the parameter Radio Resource Information is sent , the parameter Radio Resource List shall not be sent.

RAB ID

For definition of this parameter see subclause 7.6.2. This parameter shall be included when MSC-A supports multiple bearers and access network protocol is BSSAP and the RAB ID has a value other than 1.

GERAN Classmark

For definition of this parameter see subclause 7.6.6 This parameter shall be included if available.

BSSMAP Service Handover

For definition of this parameter see clause 7.6.6. It shall be present if it is available and the access network protocol is RANAP. If the parameter BSSMAP Service Handover List is sent, the parameter BSSMAP Service Handover shall not be sent.

BSSMAP Service Handover List

For definition of this parameter see clause 7.6.6. It shall be present if it is available and the access network protocol is RANAP. This parameter shall be sent when MSC-A requests multiple bearers to MSC-B. If the parameter BSSMAP Service Handover is sent, the parameter BSSMAP Service Handover List shall not be sent.

RANAP Service Handover

For definition of this parameter see clause 7.6.6. It shall be present if it is available and the access network protocol is BSSAP.

Iu-Currently Used Codec

For definition of this parameter see subclause 7.6.6. This parameter shall be included if the handover is requested for a speech bearer and the MS is in UMTS or GERAN Iu-mode access. This parameter shall not be included if the Iu-Supported Codecs List is not included.

Iu-Supported Codecs List

For definition of this parameter see subclause 7.6.6. This parameter shall be included by MSC-A, if the handover is requested for a speech bearer.

RAB Configuration Indicator

For definition of this parameter see subclause 7.6.6. This parameter may be included if the handover is requested for a speech bearer and MSC-A knows by means of configuration information that MSC-B supports the use of the Iu-Supported Codecs List parameter. This parameter shall not be included if the Iu-Supported Codecs List is not included.

ASCI Call Reference

This parameter contains either the broadcast call reference or group call reference. It shall be included if a subscriber is undergoing Signalling Only handover during a VGCS or VBS call, where MSC-B already has a Bearer established, so that MSC-B can determine the Group or Broadcast Call to which it shall attach the subscriber, see 3GPP TS 48.008 [49].

UESBI-Iu

For definition of this parameter see clause 7.6.6. It shall be present if it is available and the access network protocol is BSSAP.

Handover Number

For definition of this parameter see clause 7.6.2. This parameter shall be returned at handover, unless the parameter HO-NumberNotRequired is sent. If the parameter Handover Number is returned, the parameter Relocation Number List shall not be returned.

Relocation Number List

For definition of this parameter see clause 7.6.2. This parameter shall be returned at relocation, unless the parameter HO-NumberNotRequired is sent. If the parameter Relocation Number List is returned, the parameter Handover Number shall not be returned.

Multicall Bearer Information

For a definition of this parameter see clause 7.6.2. This parameter shall be returned at relocation in the case that MSC-B supports multiple bearers.

Multiple Bearer Requested

For a definition of this parameter see clause 7.6.2. This parameter shall be sent when MSC-A requests multiple bearers to MSC-B.

Multiple Bearer Not Supported

For a definition of this parameter see clause 7.6.2. This parameter shall be returned at relocation when MSC-B receives Multiple Bearer Requested parameter and MSC-B does not support multiple bearers.

Selected UMTS Algorithms

For definition of this parameter see clause 7.6.6. This parameters includes the UMTS integrity and optionally encryption algorithms selected by RNC under the control of MSC-B. This UMTS parameter shall be included if the service is a part of the inter MSC inter system handover from GSM to UMTS.

Chosen Radio Resource Information

For definition of this parameter see clause 7.6.6. This parameter shall be returned at relocation if the encapsulated PDU is RANAP RAB Assignment Response and MS is in GSM access.

Iu-Selected Codec

For definition of this parameter see subclause 7.6.6. This parameter shall be included if an Iu-Supported Codecs List was received in the service request and MSC-B supports the selection of codec based on the Iu-Supported Codecs List, even if the Iu-Selected Codec is equal to the Iu-Currently Used Codec received in the service request. This parameter shall not be included if the Iu-Supported Codecs List was not received in the service request.

Iu-Available Codecs List

For definition of this parameter see subclause 7.6.6. This parameter shall be included by an MSC-B supporting TrFO, if the Iu-Supported Codecs List was included by MSC-A and the target radio access is UMTS or GERAN Iu-mode.

User error

For definition of this parameter see clause 7.6.1. The following errors defined in clause 7.6.1 may be used, depending on the nature of the fault:

- No handover number available.
- Target cell outside group call area;
- System failure.
- Unexpected data value.
- Data Missing.

Provider error

See definition of provider errors in clause 7.6.1.

8.4.2 MAP_SEND_END_SIGNAL service

8.4.2.1 Definition

This service is used between MSC-B and MSC-A (E-interface) indicating that the radio path has been established by MSC-B to the MS. MSC-A retains then the main control of the call until it clears.

The response is used by MSC-A to inform MSC-B that all resources for the call can be released in MSC-B, either because the call has been released in MSC-A or because the call has been successfully handed over or relocated from MSC-B to another MSC.

The MAP_SEND_END_SIGNAL service is a confirmed service using the primitives from table 8.4/2.

8.4.2.2 Service primitives

Table 8.4/2: MAP_SEND_END_SIGNAL

Parameter name	Request	Indication	Response	Confirm
Invoke Id	M	M(=)	M(=)	M(=)
AN-APDU	M	M(=)		
Provider error				O

8.4.2.3 Parameter use

Invoke Id

For definition of this parameter see clause 7.6.1.

AN-APDU

For definition of this parameter see clause 7.6.9.

Provider error

For definition of this parameter see clause 7.6.1.

8.4.3 MAP_PROCESS_ACCESS_SIGNALLING service

8.4.3.1 Definition

This service is used between MSC-B and MSC-A (E-interface) to pass information received on the A-interface or Iu-interface in MSC-B to MSC-A.

The MAP_PROCESS_ACCESS_SIGNALLING service is a non-confirmed service using the primitives from table 8.4/3.

8.4.3.2 Service primitives

Table 8.4/3: MAP_PROCESS_ACCESS_SIGNALLING

Parameter name	Request	Indication
Invoke Id	M	M(=)
AN-APDU	M	M(=)
Selected GSM Algorithm	C	C(=)
Selected UMTS Algorithms	C	C(=)
Chosen Radio Resource Information	C	C(=)
Selected RAB id	C	C(=)
Iu-Selected Codec	C	C(=)
Iu-Available Codecs List	C	C(=)

8.4.3.3 Parameter use

Invoke Id

For definition of this parameter see clause 7.6.1.

AN-APDU

For definition of this parameter see clause 7.6.9.

Selected GSM algorithm

For definition of this parameter see clause 7.6.6. This parameter shall be present if the encapsulated PDU is Security Mode Complete and MS is in GSM access.

Selected UMTS Algorithms

For definition of this parameter see clause 7.6.6. This parameters includes the UMTS integrity and optionally encryption algorithms selected by RNC under the control of MSC-B. This UMTS parameter shall be included if the encapsulated PDU is BSSMAP Cipher Mode Complete and the MS is in UMTS, or an interystem handover to UMTS is performed in MSC-B, or in the case of intra MSC-B intra UMTS relocation.

Chosen Radio Resource Information

For definition of this parameter see clause 7.6.6. This parameter shall be sent if the encapsulated PDU is RANAP RAB Assignment Response and MS is in GSM access.

Selected RAB ID

The selected radio access bearer that was kept at subsequent intra-MSC handover from UMTS to GSM after multiple bearers were used.

Iu-Selected Codec

For definition of this parameter see subclause 7.6.6. This parameter shall be included

- if MSC-B changes the selected codec;
- if intersystem handover to UMTS or GERAN Iu-mode is performed in MSC-B; or
- if MSC-B received a Forward Access Signalling service request including an Iu-Supported Codecs List and the MS is in UMTS or GERAN Iu-mode access.

This parameter shall not be included if the Iu-Supported Codecs List was not received either in the Prepare Handover service request or in the Forward Access Signalling service request.

Iu-Available Codecs List

For definition of this parameter see subclause 7.6.6. This parameter shall be included by an MSC-B supporting TrFO

- if the Iu-Available Codecs List has changed in MSC-B;
- if intersystem handover to UMTS or GERAN Iu-mode is performed in MSC-B; or
- if MSC-B received a Forward Access Signalling service request including an Iu-Supported Codecs List and the MS is in UMTS or GERAN Iu-mode access.

8.4.4 MAP_FORWARD_ACCESS_SIGNALLING service

8.4.4.1 Definition

This service is used between MSC-A and MSC-B (E-interface) to pass information to be forwarded to the A-interface or Iu-interface of MSC-B.

The MAP_FORWARD_ACCESS_SIGNALLING service is a non-confirmed service using the primitives from table 8.4/4.

8.4.4.2 Service primitives

Table 8.4/4: MAP_FORWARD_ACCESS_SIGNALLING

Parameter name	Request	Indication
Invoke Id	M	M(=)
Integrity Protection Information	C	C(=)
Encryption Information	C	C(=)
Key Status	C	C(=)
AN-APDU	M	M(=)
Allowed GSM Algorithms	C	C(=)
Allowed UMTS Algorithms	C	C(=)
Radio Resource Information	C	C(=)
Radio Resource List	C	C(=)
BSSMAP Service Handover	C	C(=)
BSSMAP Service Handover List	C	C(=)
RANAP Service Handover	C	C(=)
Iu-Currently Used Codec	C	C(=)
Iu-Supported Codecs List	C	C(=)
RAB Configuration Indicator	C	C(=)
Iu-Selected Codec	C	C(=)

8.4.4.3 Parameter use

For the definition and use of all parameters and errors, see clause 7.6.1.

Invoke Id

For definition of this parameter see clause 7.6.1.

Integrity Protection Information

For definition of this parameter see clause 7.6.6. This UMTS parameter shall be included if available and if the encapsulated PDU is BSSMAP Cipher Mode Command.

Encryption Information

For definition of this parameter see clause 7.6.6. This UMTS parameter shall be included if available and if the encapsulated PDU is BSSMAP Cipher Mode Command.

Key Status

For definition of this parameter see clause 7.6.6. This UMTS parameter shall be included if available and if the encapsulated PDU is BSSMAP Cipher Mode Command.

AN-APDU

For definition of this parameter see clause 7.6.9.

Allowed GSM Algorithms

This parameters includes allowed GSM algorithms. This GSM parameter shall be included if the encapsulated PDU is RANAP Security Mode Command and there is an indication that the UE also supports GSM.

Allowed UMTS Algorithms

For definition of this parameter see clause 7.6.6. This UMTS parameter shall be included if Integrity Protection Information and Encryption Information are not available and the encapsulated PDU is BSSMAP Cipher Mode Command.

Radio Resource Information

For definition of this parameter see clause 7.6.6. This parameter shall be sent if the encapsulated PDU is RANAP RAB Assignment Request. If the parameter Radio Resource List is sent, the parameter Radio Resource Information shall not be sent.

Radio Resource List

For definition of this parameter see clause 7.6.6. This parameter shall be sent if the encapsulated PDU is RANAP RAB Assignment Request and MSC-A requests modification of multiple bearers. If the parameter Radio Resource Information is sent, the parameter Radio Resource List shall not be sent.

BSSMAP Service Handover

For definition of this parameter see clause 7.6.6. It shall be present if it is available and the encapsulated PDU is RANAP RAB Assignment Request. If the parameter BSSMAP Service Handover List is sent, the parameter BSSMAP Service Handover shall not be sent.

BSSMAP Service Handover List

For definition of this parameter see clause 7.6.6. It shall be present if it is available and the encapsulated PDU is RANAP RAB Assignment Request and MSC-A requests modification of multiple bearers. If the parameter BSSMAP Service Handover is sent, the parameter BSSMAP Service Handover List shall not be sent.

RANAP Service Handover

For definition of this parameter see clause 7.6.6.. It shall be present if it is available and the encapsulated PDU is BSSMAP Assignment Request.

Iu-Currently Used Codec

For definition of this parameter see subclause 7.6.6. This parameter shall be included if the encapsulated PDU is a RANAP RAB Assignment Request or BSSMAP Assignment Request for a speech bearer and the MS is in UMTS or GERAN Iu-mode access. This parameter shall not be included if the Iu-Supported Codecs List is not included.

Iu-Supported Codecs List

For definition of this parameter see subclause 7.6.6. This parameter shall be included if the encapsulated PDU is a RANAP RAB Assignment Request or BSSMAP Assignment Request and

- a new bearer is allocated for speech;
- an existing bearer is modified from data to speech; or
- for an existing speech bearer the order of priority in the Iu-Supported Codecs List needs to be modified.

This parameter shall not be included if the Iu-Selected Codec is included.

RAB Configuration Indicator

For definition of this parameter see subclause 7.6.6. This parameter may be included if the encapsulated PDU is a RANAP RAB Assignment Request for a speech bearer and MSC-A knows by means of configuration information that MSC-B supports the use of Iu-Supported Codecs List parameter. This parameter shall not be included if the Iu-Supported Codecs List is not included.

Iu-Selected Codec

For definition of this parameter see subclause 7.6.6. This parameter shall be included if

- the encapsulated PDU is a RANAP RAB Assignment Request or BSSMAP Assignment Request for an existing speech bearer;
- the MS is in UMTS or GERAN Iu-mode access; and
- an Iu-Available Codecs List was received by MSC-A for this speech bearer before, either in the Prepare Handover service response or in the Process Access Signalling service request.

This parameter shall not be included if the Iu-Supported Codecs List is included.

8.4.5 MAP_PREPARE_SUBSEQUENT_HANOVER service

8.4.5.1 Definition

This service is used between MSC-B and MSC-A (E-interface) to inform MSC-A that it has been decided that a handover or relocation to either MSC-A or a third MSC (MSC-B') is required.

The MAP_PREPARE_SUBSEQUENT_HANOVER service is a confirmed service using the primitives from table 8.4/5.

8.4.5.2 Service primitives

Table 8.4/5: MAP_PREPARE_SUBSEQUENT_HANOVER

Parameter name	Request	Indication	Response	Confirm
Invoke Id	M	M(=)	M(=)	M(=)
Target Cell Id	C	C(=)		
Target RNC Id	C	C(=)		
Target MSC Number	M	M(=)		
Selected RAB ID	C	C(=)		
GERAN Classmark	C	C(=)		
RAB Configuration Indicator	C	C(=)		
AN-APDU	M	M(=)	C	C(=)
User error			C	C(=)
Provider error				O

8.4.5.3 Parameter use

Invoke Id

For definition of this parameter see clause 7.6.1.

Target Cell Id

For definition of this parameter see clause 7.6.2. This parameter shall be excluded if the service is a part of the Inter-MSC SRNS Relocation procedure or the inter-system handover GSM to UMTS procedure described in 3GPP TS 23.009.

Target RNC Id

For definition of this parameter see clause 7.6.2. This parameter shall be included if the service is a part of the Inter-MSC SRNS Relocation procedure or the inter-system handover GSM to UMTS procedure described in 3GPP TS 23.009.

Target MSC Number

For definition of this parameter see clause 7.6.2.

Selected RAB ID

For definition of this parameter see clause 7.6.2.

GERAN Classmark

For definition of this parameter see subclause 7.6.6 This parameter shall be included if available.

RAB Configuration Indicator

For definition of this parameter see subclause 7.6.6. This parameter may be included if the call is a speech call and MSC-B knows by means of configuration information that MSC-B' (and MSC-A) supports the use of Available Codecs List parameter.

AN-APDU

For definition of this parameter see clause 7.6.9.

User error

For definition of this parameter see clause 7.6.1. The following error causes defined in clause 7.6.1 may be used, depending on the nature of the fault:

- Unknown MSC;
- Subsequent handover failure;
- Unexpected data value;
- Data Missing.

Provider error

For definition of this parameter see clause 7.6.1.

8.4.6 MAP_ALLOCATE_HANDOVER_NUMBER service

8.4.6.1 Definition

This service is used between MSC and VLR (B-interface) to request a handover number.

The MAP_ALLOCATE_HANDOVER_NUMBER service is a confirmed service using the primitives from table 8.4/6.

8.4.6.2 Service primitives

Table 8.4/6: MAP_ALLOCATE_HANDOVER_NUMBER

Parameter name	Request	Indication	Response	Confirm
Invoke Id	M	M(=)	M(=)	M(=)
User error			C	C(=)
Provider error				O

8.4.6.3 Parameter use

Invoke Id

For definition of this parameter see clause 7.6.1.

User error

For definition of this parameter see clause 7.6.1. The following errors defined in clause 7.6.1 may be used, depending on the nature of the fault:

- No handover number available.

Provider error

For definition of this parameter see clause 7.6.1.

8.4.7 MAP_SEND_HANOVER_REPORT service

8.4.7.1 Definition

This service is used between VLR and MSC-B (B-interface) to transfer the handover number to be forwarded to and used by MSC-A.

The MAP_SEND_HANOVER_REPORT service is a confirmed service using the primitives from table 8.4/7.

8.4.7.2 Service primitives

Table 8.4/7: MAP_SEND_HANOVER_REPORT

Parameter name	Request	Indication	Response	Confirm
Invoke Id	M	M(=)	M(=)	M(=)
Handover Number	M	M(=)		
Linked Id	M	M(=)		
Provider error				O

8.4.7.3 Parameter use

Invoke Id

For definition of this parameter see clause 7.6.1.

Handover Number

For definition of this parameter see clause 7.6.2.

Linked Id

For definition of this parameter see clause 7.6.1. This service is linked with MAP_ALLOCATE_HANOVER_NUMBER.

Provider error

For definition of this parameter see clause 7.6.1.

8.5 Authentication management services

8.5.1 MAP_AUTHENTICATE service

The MAP_AUTHENTICATE service is used on the MAP B interface. This interface is not fully operational specified. It is strongly recommended not to implement the B-interface as an external interface.

8.5.1.1 Definition

This service is used between the VLR and the MSC when the VLR receives a MAP service indication from the MSC concerning a location registration, call set-up, operation on a supplementary service or a request from the MSC to initiate authentication.

The service is a confirmed service and consists of four service primitives.

8.5.1.2 Service primitives

The service primitives are shown in table 8.5/1.

Table 8.5/1: MAP_AUTHENTICATE parameters

Parameter name	Request	Indication	Response	Confirm
Invoke id	M	M(=)	M(=)	M(=)
RAND	M	M(=)		
CKSN	M	M(=)		
SRES			M	M(=)
Provider error				O

8.5.1.3 Parameter use

Invoke id

See clause 7.6.1 for the use of this parameter.

RAND

See clause 7.6.7 for the use of this parameter.

CKSN

See clause 7.6.7 for the use of this parameter.

SRES

See clause 7.6.7 for the use of this parameter.

Provider error

See clause 7.6.1 for the use of this parameter.

8.5.2 MAP_SEND_AUTHENTICATION_INFO service

8.5.2.1 Definition

This service is used between the VLR and the HLR for the VLR to retrieve authentication information from the HLR. The VLR requests up to five authentication vectors.

Also this service is used between the SGSN and the HLR for the SGSN to retrieve authentication information from the HLR. The SGSN requests up to five authentication vectors.

If the user is a UMTS subscriber, the HLR shall return authentication quintuplets. If the user is a GSM subscriber, the HLR shall return authentication triplets.

If the HLR cannot provide the VLR or the SGSN with triplets, an empty response is returned. The VLR or the SGSN may then re-use old authentication triplets, except where this is forbidden under the conditions specified in 3GPP TS 43.020 [24].

If the HLR cannot provide the VLR or the SGSN with quintuplets, an empty response is returned. The VLR or the SGSN shall not re-use old authentication quintuplets.

If the VLR or SGSN receives a MAP_SEND_AUTHENTICATION_INFO response containing a User Error parameter as part of the handling of an authentication procedure, the authentication procedure in the VLR or SGSN shall fail.

Security related network functions are further described in 3GPP TS 43.020 [24] and 3GPP TS 33.200.

The service is a confirmed service and consists of four service primitives.

8.5.2.2 Service primitives

The service primitives are shown in table 8.5/2.

Table 8.5/2: MAP_SEND_AUTHENTICATION_INFO parameters

Parameter name	Request	Indication	Response	Confirm
Invoke id	M	M(=)	M(=)	M(=)
IMSI	C	C(=)		
Number of requested vectors	C	C(=)		
Requesting node type	C	C(=)		
Re-synchronisation Info	C	C(=)		
Segmentation prohibited indicator	C	C(=)		
Immediate response preferred indicator	U	C(=)		
AuthenticationSetList			C	C(=)
User error			C	C(=)
Provider error				O

8.5.2.3 Parameter use

Invoke id

See clause 7.6.1 for the use of this parameter.

IMSI

See clause 7.6.2 for the use of this parameter.

This parameter shall be present in the first (or only) request of the dialogue. If multiple service requests are present in a dialogue then this parameter shall not be present in any service request other than the first one.

Number of requested vectors

A number indicating how many authentication vectors the VLR or SGSN is prepared to receive. The HLR shall not return more vectors than indicated by this parameter.

This parameter shall be present in the first (or only) request of the dialogue. If multiple service requests are present in a dialogue then this parameter shall not be present in any service request other than the first one.

Requesting node type

The type of the requesting node (SGSN or VLR).

This parameter shall be present in the first (or only) request of the dialogue. If multiple service requests are present in a dialogue then this parameter shall not be present in any service request other than the first one.

Re-synchronisation Info

For definition and use of this parameter see 3GPP TS 33.200.

If multiple service requests are present in a dialogue then this parameter shall not be present in any service request other than the first one..

Segmentation prohibited indicator

This parameter indicates if the VLR or SGSN allows segmentation of the response at MAP user level.

This parameter may be present only in the first request of the dialogue.

Immediate response preferred indicator

This parameter indicates that one of the requested authentication vectors is requested for immediate use in the VLR or SGSN. It may be used by the HLR together with the number of requested vectors and the number of vectors stored in the HLR to determine the number of vectors to be obtained from the AuC. It shall be ignored if the number of available vectors is greater than the number of requested vectors.

If multiple service requests are present in a dialogue then this parameter shall not be present in any service request other than the first one.

AuthenticationSetList

A set of one to five authentication vectors are transferred from the HLR to the VLR or from the HLR to the SGSN, if the outcome of the service was successful.

User error

One of the following error causes defined in clause 7.6.1 shall be sent by the user in case of unsuccessful outcome of the service, depending on the respective failure reason:

- unknown subscriber;
- unexpected data value;
- system failure;
- data missing.

Provider error

See clause 7.6.1 for the use of this parameter.

8.5.3 MAP_AUTHENTICATION_FAILURE_REPORT service

8.5.3.1 Definition

This service is used between the VLR and the HLR or between the SGSN or HLR for reporting of authentication failures.

8.5.3.2 Service primitives

The service primitives are shown in table 8.5/3.

Table 8.5/3: MAP_AUTHENTICATION_FAILURE_REPORT parameters

Parameter name	Request	Indication	Response	Confirm
Invoke id	M	M(=)	M(=)	M(=)
IMSI	M	M(=)		
Failure cause	M	M(=)		
Re-attempt	M	M(=)		
Access Type	M	M(=)		
Rand	M	M(=)		
VLR number	C	C(=)		
SGSN number	C	C(=)		
User error			C	C(=)
Provider error				O

8.5.3.3 Parameter use

Invoke id

See clause 7.6.1 for the use of this parameter.

IMSI

See clause 7.6.2 for the use of this parameter.

Failure Cause

See clause 7.6.7 for use of this parameter.

Re-attempt

See clause 7.6.7 for use of this parameter.

Access Type

See clause 7.6.7 for use of this parameter.

Rand

This parameter identifies the specific AV that failed authentication.

See clause 7.6.7 for use of this parameter.

VLR number

Shall be present if the sender is VLR. See definition in clause 7.6.2.

SGSN number

Shall be present if the sender is SGSN. See definition in clause 7.6.2.

User error

This parameter is sent by the responder upon unsuccessful outcome of the service, and then takes one of the following values defined in clause 7.6.1:

- Unknown Subscriber;
- System Failure;
- Unexpected Data Value.

Provider error

These are defined in clause 7.6.

8.6 Security management services

8.6.1 MAP_SET_CIPHERING_MODE service

8.6.1.1 Definitions

This service is used between the VLR and the MSC to set the ciphering mode and to start ciphering if applicable. It is called when another service requires that information is to be sent on the radio path in encrypted form.

The service is a non-confirmed service and consists of two service primitives.

8.6.1.2 Service primitives

The service primitives are shown in table 8.6/1.

Table 8.6/1: MAP_SET_CIPHERING_MODE parameters

Parameter name	Request	Indication
Invoke id	M	M(=)
Ciphering mode	M	M(=)
Kc	C	C(=)

8.6.1.3 Parameter use

Invoke id

See clause 7.6.1 for the use of this parameter.

Ciphering mode

See clause 7.6.7 for the use of this parameter.

Kc

The Kc parameter should be included when the ciphering mode parameter indicates that ciphering must be performed.

8.7 International mobile equipment identities management services

8.7.1 MAP_CHECK_IMEI service

8.7.1.1 Definition

This service is used between the VLR and the MSC and between the MSC and the EIR and between the SGSN and EIR to request check of IMEI. If the IMEI is not available in the MSC or in the SGSN, it is requested from the MS and transferred to the EIR in the service request.

This service may also be used to request the BMUEF from the EIR.

The service is a confirmed service and consists of four service primitives.

8.7.1.2 Service primitives

The service primitives are shown in table 8.7/1.

Table 8.7/1: MAP_CHECK_IMEI parameters

Parameter name	Request	Indication	Response	Confirm
Invoke id	M	M(=)	M(=)	M(=)
IMEI	C	C(=)	C	C(=)
IMEISV	C	C(=)	C(=)	C(=)
Requested Equipment Info	M	M(=)		
Equipment status			C	C(=)
BMUEF			C	C(=)
User error			C	C(=)
Provider error				O

8.7.1.3 Parameter use

Invoke id

See clause 7.6.1 for the use of this parameter.

Requested Equipment Info

This parameter indicates whether Equipment Status or BMUEF or both is requested.

IMEI

See clause 7.6.2 for the use of this parameter. The parameter shall not be included in the service request between the VLR and the MSC, but one of IMEI and IMEISV is mandatory in the service request from the MSC to the EIR and from the SGSN to the EIR. It is not included in the service response from the EIR to the MSC or to the SGSN, but one of IMEI and IMEISV is mandatory in the service response from the MSC to the VLR on successful outcome.

IMEISV

See clause 7.6.2 for the use of this parameter. IMEISV shall be present if BMUEF is requested.

Equipment status

See clause 7.6.3 for the use of this parameter. This parameter is sent by the responder in case of successful outcome of the service if Equipment status was requested.

BMUEF

See clause 7.6.4 for the use of this parameter. This parameter is sent by the responder in case of successful outcome of the service if BMUEF was requested.

User error

One of the following error causes defined in clause 7.6.1 shall be sent by the user in case of unsuccessful outcome of the service, depending on the respective failure reason:

- unknown equipment;
this error is returned by the responder when the IMEI is not known in the EIR;
- system failure;
- unexpected data value.

Provider error

See clause 7.6.1 for the use of this parameter.

8.7.2 MAP_OBTAIN_IMEI service

8.7.2.1 Definition

This service is used between the VLR and the MSC to request the IMEI. If the IMEI is not available in the MSC, it is requested from the MS.

The service is a confirmed service and consists of four service primitives.

8.7.2.2 Service primitives

The service primitives are shown in table 8.7/2.

Table 8.7/2: MAP_OBTAIN_IMEI parameters

Parameter name	Request	Indication	Response	Confirm
Invoke id	M	M(=)	M(=)	M(=)
IMEI			C	C(=)
User error			C	C(=)
Provider error				O

8.7.2.3 Parameter use

Invoke id

See clause 7.6.1 for the use of this parameter.

IMEI

See clause 7.6.2 for the use of this parameter. The parameter is included in the service response from the MSC to the VLR on successful outcome of the service.

User error

If the service fails, the VLR sends the user error System Failure (see clause 7.6.1) to the MSC.

Provider error

See clause 7.6.1 for the use of this parameter.

8.8 Subscriber management services

8.8.1 MAP-INSERT-SUBSCRIBER-DATA service

8.8.1.1 Definition

This service is used by an HLR to update a VLR with certain subscriber data in the following occasions:

- the operator has changed the subscription of one or more supplementary services, basic services or data of a subscriber. Note that in case of withdrawal of a Basic or Supplementary service this primitive shall not be used;
- the operator has applied, changed or removed Operator Determined Barring;
- the subscriber has changed data concerning one or more supplementary services by using a subscriber procedure;
- the HLR provides the VLR with subscriber parameters at location updating of a subscriber or at restoration. In this case, this service is used to indicate explicitly that a supplementary service is not provisioned, if the supplementary service specification requires it. The only supplementary services which have this requirement are the CLIR and COLR services. Network access mode is provided only in restoration. If the Super-Charger functionality is supported the HLR may not need to provide the VLR with subscriber parameters at location updating of a subscriber. See TS 23.116.

Also this service is used by an HLR to update an SGSN with certain subscriber data in the following occasions:

- if the GPRS subscription has changed;
- if the network access mode is changed;
- the operator has applied, changed or removed Operator Determined Barring;
- the subscriber has changed data concerning one or more supplementary services by using a subscriber procedure;
- the HLR provides the SGSN with subscriber parameters at GPRS location updating of a subscriber. If the Super-Charger functionality is supported the HLR may not need to provide the SGSN with subscriber parameters. See 3GPP TS 23.116.

It is a confirmed service and consists of the primitives shown in table 8.8/1.

8.8.1.2 Service primitives

Table 8.8/1: MAP-INSERT-SUBSCRIBER-DATA

Parameter name	Request	Indication	Response	Confirm
Invoke Id	M	M(=)	M(=)	M(=)

Parameter name	Request	Indication	Response	Confirm
IMSI	C	C(=)		
MSISDN	C	C(=)		
Category	C	C(=)		
Subscriber Status	C	C(=)		
Bearer service List	C	C(=)	C	C(=)
Teleservice List	C	C(=)	C	C(=)
Forwarding information List	C	C(=)		
Call barring information List	C	C(=)		
CUG information List	C	C(=)		
SS-Data List	C	C(=)		
eMLPP Subscription Data	C	C(=)		
MC-Subscription Data	C	C(=)		
Operator Determined Barring General data	C	C(=)	C	C(=)
Operator Determined Barring HPLMN data	C	C(=)		
Roaming Restriction Due To Unsupported Feature	C	C(=)		
Regional Subscription Data	C	C(=)		
VLR CAMEL Subscription Info	C	C(=)		
Voice Broadcast Data	C	C(=)		
Voice Group Call Data	C	C(=)		
Network access mode	C	C(=)		
GPRS Subscription Data	C	C(=)		
Roaming Restricted In SGSN Due To Unsupported Feature	C	C(=)		
North American Equal Access preferred Carrier Id List	U	C(=)		
SGSN CAMEL Subscription Info	C	C(=)		
LSA Information	C	C(=)		
IST Alert Timer	C	C(=)		
SS-Code List			C	C(=)
LMU Identifier	C	C(=)		
LCS Information	C	C(=)		
CS Allocation/Retention priority	C	C(=)		
Super-Charger Supported In HLR	C	C(=)		
Subscribed Charging Characteristics	C	C(=)		
Regional Subscription Response			C	C(=)
Supported CAMEL Phases			C	C(=)
Offered CAMEL 4 CSIs			C	C(=)
User error			U	C(=)
Provider error				O

8.8.1.3 Parameter use

All parameters are described in clause 7.6. The following clarifications are applicable:

Network access mode

This parameter defines if the subscriber has access to MSC/VLR and/or to SGSN. This parameter is used by SGSN and MSC/VLR. In VLR, the parameter is used only as part of Restore Data Procedure and the parameter is not stored in the VLR. This parameter shall always be sent to the SGSN as part of the GPRS subscriber data at GPRS location updating. It shall be sent to the SGSN if it is changed as a result of administrative action.

IMSI

It is only included if the service is not used in an ongoing transaction (e.g. location updating). This parameter is used by the VLR and the SGSN.

MSISDN

It is included either at location updating or when it is changed. The MSISDN sent shall be the basic MSISDN. This parameter is used by the VLR and the SGSN.

Category

It is included either at location updating or when it is changed. This parameter is used only by the VLR and if the SGSN receives this parameter it shall ignore it.

Subscriber Status

It is included either at location updating or when it is changed.

To apply, remove or update Operator Determined Barring Categories the Subscriber Status is set to Operator Determined Barring. In this case ODB General Data shall also be present. If the Operator Determined Barring applies and the subscriber is registered in the HPLMN and HPLMN specific Operator Determined Barring applies then ODB HPLMN Specific Data shall also be present.

To remove all Operator Determined Barring Categories the Subscriber Status shall be set to "Service Granted". This parameter is used by the VLR and the SGSN.

Bearer service List

A list of Extensible Bearer service parameters (Extensible Bearer service is defined in clause 7.6). An Extensible Bearer service parameter must be the code for an individual Bearer service, except in the cases described below.

The codes for the Bearer service groups "allAlternateSpeech-DataCDA" and "allAlternateSpeech-DataCDS" shall, if applicable, be sent from the HLR to the VLR as a pair. The codes for the Bearer service groups "allSpeechFollowedByDataCDA" and "allSpeechFollowedByDataCDS" shall, if applicable, be sent from the HLR to the VLR as a pair.

If it is included in the Request/Indication, it includes either all Extensible Bearer services subscribed (at location updating or at restoration) or only the ones added (at subscriber data modification).

If the VLR receives an Indication containing any Extensible Bearer service parameters which it does not support/allocate it returns them in the response to the HLR and discards the unsupported Extensible Bearer services (no error is sent back), except in the cases described below.

If the VLR receives the codes for the Bearer service groups "allSpeechFollowedByDataCDA" and "allSpeechFollowedByDataCDS" and supports one or more of the circuit-switched synchronous or asynchronous data rates specified for simple data bearer services, it shall accept the bearer service codes, and not return them in the response to the HLR. If the VLR does not support any of the circuit-switched synchronous or asynchronous data rates specified for simple data bearer services, and receives the pair of codes for "allAlternateSpeech-DataCDA" and "allAlternateSpeech-DataCDS" or the pair of codes for "allSpeechFollowedByDataCDA" and "allSpeechFollowedByDataCDS", it shall reject the pair of codes by returning them in the response to the HLR. This parameter is used only by the VLR and if the SGSN receives this parameter it shall ignore it.

Teleservice List

A list of Extensible Teleservice parameters (Extensible Teleservice is defined in clause 7.6). An Extensible Teleservice parameter must be the code for an individual Teleservice.

If it is included in the Request/Indication, it contains either all Extensible Teleservices subscribed (at location updating or at restoration) or the ones added (at subscriber data modification). Only the Extensible Teleservices that are relevant to the node at which the message is received should be included in the Teleservice List.

If the VLR or the SGSN receives an Indication containing any Extensible Teleservice parameters which it does not support/allocate it returns them in the response to the HLR and discards the unsupported Extensible Teleservices (no error is sent back). This parameter is used by the VLR and the SGSN.

Forwarding information List

A list of Extensible Forwarding information parameters (Extensible Forwarding information is defined in clause 7.6). It includes Call Forwarding services either at location updating or at restoration or when they are changed. Each Extensible Forwarding information parameter shall be treated independently of all other parameters in the primitive.

The Extensible Forwarding information shall include the SS-Code for an individual call forwarding supplementary service. The Extensible Forwarding information shall contain one or more Extensible Forwarding Features (Extensible Forwarding Feature is defined in clause 7.6).

The Extensible Forwarding Feature may include an Extensible Basic Service Group. This shall be interpreted according to the rules in clause 8.8.1.4.

The Extensible Forwarding Feature shall contain an Extensible SS-Status parameter.

If the Extensible SS-Status indicates that call forwarding is registered then (except for call forwarding unconditional) the Extensible Forwarding Feature shall contain a number to define the forwarded-to destination and, if available, the forwarded-to subaddress. In other states the forwarded-to number and, if applicable, the forwarded-to subaddress shall not be included. For call forwarding unconditional the forwarded-to number and, if applicable, the forwarded-to subaddress shall not be included. If the VLR does not receive a forwarded-to subaddress then it shall assume that a forwarded-to subaddress has not been registered.

The Extensible Forwarding Feature shall contain the extensible forwarding options (except for call forwarding unconditional where the extensible forwarding options shall not be included). Bits 3 and 4 of the extensible forwarding options shall be ignored by the VLR, and may be set to any value by the HLR.

For call forwarding on no reply: If the extensible SS-Status indicates that call forwarding is registered then the Extensible Forwarding Feature shall contain an extensible no reply condition timer. In other states the no reply condition timer shall not be included.

For call forwarding services other than call forwarding on no reply: The Extensible Forwarding Feature shall not contain a no reply condition timer.

If the VLR receives an Indication containing any Call Forwarding service codes which it does not support/allocate it returns them to the HLR in the parameter SS-Code List and discards the unsupported Call Forwarding service codes (no error is sent back). This parameter is used only by the VLR and if the SGSN receives this parameter it shall ignore it.

Call barring information List

A list of Extensible Call barring information parameters (Extensible Call barring information is defined in clause 7.6). It includes Call Barring services either at location updating or at restoration or when they are changed. Each Extensible Call barring information parameter shall be treated independently of all other parameters in the primitive.

The Extensible Call barring information shall include the SS-Code for an individual call barring supplementary service. The Extensible Call barring information shall contain one or more Extensible Call Barring Features (Extensible Call Barring Feature is defined in clause 7.6).

The Extensible Call Barring Feature may include an Extensible Basic Service Group. This shall be interpreted according to the rules in clause 8.8.1.4.

The Extensible Call Barring Feature shall contain an extensible SS-Status parameter.

If the VLR receives an Indication containing any Extensible Call Barring service codes which it does not support/allocate it returns them to the HLR in the parameter SS-Code List and discards the unsupported Extensible Call Barring service codes (no error is sent back). This parameter is used only by the VLR and if the SGSN receives this parameter it shall ignore it.

CUG information List

A list of CUG information list parameters (CUG information is defined in clause 7.6). It includes CUG information either at location updating or at restoration or when it is changed.

At location updating, restoration or when there is a change in CUG data, the HLR shall include the complete CUG-SubscriptionList and, if there are options per basic group, it shall also include the complete CUG-FeatureList. If there are not options per extensible basic service group the CUG-FeatureList shall not be included.

In any dialogue, the first insertSubscriberData message which contains CUG information shall include a non-empty CUG-SubscriptionList.

When the VLR receives CUG data it shall replace the stored CUG data with the received data set.

If CUG-FeatureList is omitted in the Insert Subscriber Data operation VLR shall interpret that no options per extensible basic service group exist, and then it shall apply the default values i.e. no outgoing access, no incoming access, no preferential CUG exists.

If CUG-Feature is received without preferential CUG, the VLR shall interpret that no preferential CUG applies.

If the VLR detects that there is overlapping in the information received within a dialogue, it shall send the error Unexpected Data Value.

Note that data consistency between CUG subscription data and CUG feature data is the responsibility of the HLR.

If the VLR does not support the CUG service it returns its code to the HLR in the parameter SS-Code List and discards the received information (no error is sent back). This parameter is used only by the VLR and if the SGSN receives this parameter it shall ignore it.

SS-Data List

A list of Extensible SS-Data parameters (Extensible SS-Data is defined in clause 7.6). It is sent for any other supplementary service than Call Forwarding, Call Barring, CUG and eMLPP either at location updating or at restoration or when they are changed. Each SS-Data parameter shall be treated independently of all other parameters in the primitive.

The Extensible SS-Data shall include the SS-Code for an individual supplementary service.

The Extensible SS-Data shall contain an Extensible SS-Status parameter and any subscription options that are applicable to the service defined by the SS-Code.

The SS-Data may include a Basic Service Group List. This shall be interpreted according to the rules in clause 8.8.1.4.

If the VLR receives an Indication containing any supplementary service codes which it does not support/allocate it returns them to the HLR in the parameter SS-Code List and therefore discards the unsupported service codes received (no error is sent back).

This parameter is used by the SGSN only for LCS. If the SGSN receives an Indication containing any LCS related supplementary service codes which it does not support/allocate it returns them to the HLR in the parameter SS-Code List and therefore discards the unsupported service codes received (no error is sent back). SS-codes not related to the supported LCS capability set shall be discarded.

Operator Determined Barring General data

If it is included in a Request/Indication, it includes all the Operator Determined Barring categories that may be applied to a subscriber registered in any PLMN. This parameter is only included in a Request/Indication when the parameter Subscriber Status is set to the value Operator Determined Barring. Note that all General Operator Determined Barring Categories shall be set to their actual status.

If the VLR or the SGSN receives an Indication containing Operator Determined Barring General Data which shows that the subscriber is subject to barring not supported / not allocated by the VLR or by the SGSN, it returns Operator Determined Barring General Data in the response to the HLR to show the barring categories which are not supported / not allocated by the VLR or by the SGSN. This parameter is used by the VLR and the SGSN.

Operator Determined Barring HPLMN data

It includes all the Operator Determined Barring categories that may be applied only to a subscriber registered in the HPLMN. Therefore, it shall only be transferred to the VLR or to the SGSN when the subscriber is roaming into the HPLMN and when the parameter Subscriber Status is set to the value Operator Determined Barring. Note that all HPLMN Operator Determined Barring Categories shall be set to their actual status.

If Subscriber Status is set to the value Operator Determined Barring and no Operator Determined Barring HPLMN data is present then the VLR or the SGSN shall not apply any HPLMN specific ODB services to the subscriber. This parameter is used by the VLR and the SGSN.

eMLPP Subscription Data

If included in the Insert Subscriber Data request this parameter defines the priorities the subscriber might apply for a call (as defined in clause 7.6). It contains both subparameters of eMLPP.

If the VLR does not support the eMLPP service it returns its code to the HLR in the parameter SS-Code List and therefore discards the received information (no error is sent back).

eMLPP subscription data that have been stored previously in a subscriber data record in the VLR are completely replaced by the new eMLPP subscription data received in a MAP_INSERT_SUBSCRIBER_DATA during either an

Update Location or Restore Data procedure or a stand alone Insert Subscriber data procedure. This parameter is used only by the VLR and if the SGSN receives this parameter it shall ignore it.

MC Subscription Data

If included in the Insert Subscriber Data request, this parameter provides the MC Subscription Data as defined in clause 7.6.

If the VLR does not support the MC service, it returns its code to the HLR in the parameter SS-Code List and therefore discards the received information (no error is sent back).

MC subscription data that have been stored previously in a subscriber data record in the VLR are completely replaced by the new MC subscription data received in a MAP_INSERT_SUBSCRIBER_DATA during either an Update Location or Restore Data procedure or a stand alone Insert Subscriber data procedure. This parameter is used only by the VLR and if the SGSN receives this parameter it shall ignore it.

Roaming Restriction Due To Unsupported Feature

The HLR may decide to include this parameter in the request if certain services or features are indicated as not supported by the MSC/VLR (e.g. Advice of Charge Charging Level).

If this parameter is sent to the VLR the MSC area is restricted by the HLR and the VLR. This parameter is used only by the VLR and if the SGSN receives this parameter it shall ignore it.

Regional Subscription Data

If included in the Insert Subscriber Data request this parameter defines the subscriber's subscription area for the addressed VLR or for the addressed SGSN (as defined in clause 7.6). It contains the complete list of up to 10 Zone Codes that apply to a subscriber in the currently visited PLMN. The HLR shall send only those Zone Codes which are stored against the CC and NDC of the VLR or the CC and NDC of the SGSN to be updated.

NOTE: Support of this parameter is a network operator option and it will not be sent to networks which do not support Regional Subscription.

Regional subscription data that have been stored previously in a subscriber data record in the VLR or in the SGSN are completely replaced by the regional subscription data received in an Insert Subscriber Data indication during either an Update Location or Restore Data procedure or a stand alone Insert Subscriber data procedure.

After the regional subscription data are inserted the VLR or the SGSN shall derive whether its location areas are allowed or not. If the whole MSC or SGSN area is restricted it will be reported to HLR by returning the Regional Subscription Response.

The VLR or the SGSN returns a Regional Subscription Response indicating that a problem with the Zone Code has been detected in one of the following cases:

- Too Many Zone Codes: more than 10 Zone Codes are to be stored in the VLR or in the SGSN.
- Regional Subscription Not Supported by the VLR or the SGSN.
- Zone Codes Conflict: the VLR or the SGSN detects that the zone codes indicate conflicting service permission for a location area.

Zone codes which have no mapping to location areas shall be ignored.

If a sequence of MAP_INSERT_SUBSCRIBER_DATA services is used during a dialogue, Regional Subscription Data shall be accepted only in one service. Regional Subscription Data received in a subsequent service shall be rejected with the error Unexpected Data Value.

If Regional Subscription Data are not included in any MAP_INSERT_SUBSCRIBER_DATA service, there is no restriction of roaming due to Regional Subscription. This parameter is used by the VLR and the SGSN.

Voice Broadcast Data

This parameter contains a list of group id's a user might have subscribed to; (VBS-Data is defined in clause 7.6). It includes VBS information either at location updating or at restoration or when it is changed.

At location updating, restoration or when there is a change in VBS data, the HLR shall include the complete VBS-Data.

When the VLR receives VBS-Data within a dialogue it shall replace the stored VBS-data with the received data set. All subsequent VBS-data received within this dialogue shall be interpreted as add-on data.

If VBS-data is omitted in the Insert Subscriber Data operation the VLR shall keep the previously stored VBS data.

If the VLR detects that there is overlapping in the information received within a dialogue, it shall send the error Unexpected Data Value. This parameter is used only by the VLR and if the SGSN receives this parameter it shall ignore it.

Voice Group Call Data

This parameter contains a list of group id's a user might have subscribed to; see clause 7.6.

At location updating, restoration or when there is a change in VGCS data, the HLR shall include the complete VGCS-Data.

When the VLR receives VGCS-Data within a dialogue it shall replace the stored VGCS-Data with the received data set. All VGCS-Data received within this dialogue shall be interpreted as add-on data.

If VGCS-Data is omitted in the Insert Subscriber Data operation the VLR shall keep the previously stored VGCS-Data.

If the VLR detects that there is overlapping in the information received within a dialogue, it shall send the error Unexpected Data Value. This parameter is used only by the VLR and if the SGSN receives this parameter it shall ignore it.

North American Equal Access preferred Carrier Id List

A list of the preferred carrier identity codes that are subscribed to.

When the VLR receives this parameter from the HLR, it shall replace the previously stored preferred carrier identity codes with the received ones. It is not possible to delete all the preferred carrier identity codes from the VLR using this service. To delete all the preferred carrier identity codes from the VLR, the HLR shall use the MAP_CANCEL_LOCATION service.

LSA Information

If included in the ISD request, this parameter contains a list of localised service area identities a user might have subscribed to together with the priority, the preferential access indicator, the active mode support indicator and active mode indication of each localised service area; see clause 7.6. The access right outside these localised service areas is also indicated. In all cases mentioned below, the LSA information shall only include LSA Data applicable to the VPLMN where the Subscriber is located. The VLR number, received in the MAP-UPDATE_LOCATION primitive, or the SGSN number, received in the MAP_UPDATE_GPRS_LOCATION primitive, can be used, alongside data stored in the HLR, to determine the LSA Data applicable to the VPLMN.

At restoration, location updating or GPRS location updating the HLR shall include the complete set of applicable LSA Information.

When there is a change in LSA data the HLR shall include at least the new and/or modified LSA data.

When there is a change in the access right outside the localised service areas the HLR shall include the LSA only access indicator.

When the SGSN or the VLR receives LSA information within a dialogue it shall check if the received data has to be considered as the entire LSA information. If so, it shall replace the stored LSA information with the received data set, otherwise it shall replace the data only for the modified LSA data (if any) and/or access right, and add the new LSA data (if any) to the stored LSA Information.

If the entire LSA information is received, it shall always include the LSA only access indicator value together with the LSA data applicable for the PLMN (if any).

If LSA Information is omitted in the Insert Subscriber Data operation the SGSN or the VLR shall keep the previously stored LSA Information.

If the SGSN or the VLR detects that there is overlapping in the information received within a dialogue, it shall send the error Unexpected Data Value. This parameter is used by the VLR and the SGSN.

IST Alert Timer

This parameter contains the IST Alert timer value that must be used to inform the HLR about the call activities that the subscriber performs.

At Location Updating, restoration, or when there is a change in the IST data defined for the Subscriber, the HLR shall include the IST Alert timer.

LMU Identifier

This parameter indicates the presence of an LMU. This parameter is used only by the VLR and shall be ignored if received by an SGSN.

LCS Information

This parameter provides the following LCS related information for an MS subscriber:

- list of GMLCs in the HPLMN;
- privacy exception list;
- MO-LR list.

At restoration and location updating, the HLR shall include the complete LCS data of the subscriber.

When there is a change in LCS subscriber data the HLR shall include at least the new and/or modified LCS data. LCS data that is not modified need not be included.

The VLR/SGSN shall keep any previously stored LCS Information that is not included in an Insert Subscriber Data operation.

If the VLR/SGSN detects that there is overlapping in the LCS information received within a dialogue, it shall send the error Unexpected Data Value. However, if the VLR receives the LCS code in both the LCS Information and the SS-Data List, then the VLR shall not interpret this as overlapping data.

Super-Charger Supported In HLR

This parameter is used by the HLR to indicate support for the Super-Charger functionality. If this parameter is present it shall include an indication of the age of the subscription data stored in the HLR.

If this parameter is absent then the HLR does not support the Super-Charger functionality.

SS-Code List

The list of SS-Code parameters for the services that are provided to a subscriber but are not supported/allocated by the VLR (SS-Code is defined in clause 7.6). The list can only include individual SS-Codes that were sent in the service request. For the VLR, this list can also include SS-Codes for the eMLPP and/or CUG services if the above mentioned conditions, as described in eMLPP Subscription Data and/or CUG information List, are met (that is, eMLPP Subscription Data and/or CUG information List are received). This parameter is used only by the VLR.

Regional Subscription Response

If included in the response this parameter indicates one of:

- MSC Area Restricted entirely because of regional subscription;
- SGSN Area Restricted entirely because of regional subscription;
- Too Many Zone Codes to be inserted;
- Zone Codes Conflict;
- Regional Subscription not Supported by the VLR or by the SGSN.

If the VLR determines after insertion of Regional Subscription Data that the entire MSC area is restricted, the VLR shall respond with a Regional Subscription Response indicating MSC Area Restricted. Otherwise MSC Area Restricted is not sent. The HLR shall check whether the current MSC area is no longer restricted.

If the SGSN determines after insertion of Regional Subscription Data that the entire SGSN area is restricted, the SGSN shall respond with a Regional Subscription Response indicating SGSN Area Restricted. Otherwise SGSN Area Restricted is not sent. The HLR shall check whether the current SGSN area is no longer restricted. This parameter is used by the VLR and by the SGSN.

VLR CAMEL Subscription Info

This parameter is sent for subscribers who have CAMEL services which are invoked in the MSC.

- In CAMEL phase 1, this parameter contains only the O-CSI.
- In CAMEL Phase 2, this parameter may contain O-CSI, SS-CSI and TIF-CSI. In CAMEL Phase 2 and onwards, TDP-Criteria for O-CSI may be associated with O-CSI.
- In CAMEL Phase 3, this parameter may contain O-CSI, D-CSI, SS-CSI, VT-CSI, MO-SMS-CSI, M-CSI and TIF-CSI. In CAMEL Phase 3 and onwards, TDP-Criteria for VT-CSI may be associated with VT-CSI.
- In CAMEL Phase 4, this parameter may contain O-CSI, D-CSI, SS-CSI, VT-CSI, MO-SMS-CSI, MT-SMS-CSI, M-CSI and TIF-CSI. In CAMEL Phase 4, TDP-Criteria for MT-SMS-CSI may be associated with MT-SMS-CSI.

The VLR CAMEL Subscription Info is sent at location updating or when any information in the applicable CAMEL Subscription Info in the HLR has been changed.

At location updating, the complete set of VLR CAMEL Subscription Info is sent in one dialogue.

When CAMEL Subscription Information is changed in the HLR and changed data have to be sent to the VLR, then:

- for CAMEL Phase 1 and CAMEL Phase 2, the complete set of VLR CAMEL Subscription Info is sent in one dialogue;
- for CAMEL Phase 3 or higher, one or more specific elements of VLR CAMEL Subscription Info are sent in one dialogue.

When the VLR receives a specific element of VLR CAMEL Subscription Info, it shall overwrite the corresponding specific element of VLR CAMEL Subscription Info (if any) which it has stored for that subscriber.

For CAMEL Phase 1 and CAMEL Phase 2, the VLR CAMEL Subscription Info consists of any one or more of:

- O-CSI (irrespective of the value of the 'CAMEL Capability Handling' inside O-CSI), TDP-Criteria for O-CSI, SS-CSI and TIF-CSI.

(The complete set of above shall be sent even if only one CSI has changed in case of stand alone ISD. The omitted elements of above list will be withdrawn in the VLR.)

From CAMEL phase 3 onwards, the specific elements of VLR CAMEL Subscription Info which may be sent are:

- O-CSI (irrespective of the value of the 'CAMEL Capability Handling' inside O-CSI), TDP criteria for O-CSI, SS-CSI and TIF-CSI;

(The complete set of above shall be sent even if only one CSI has changed in case of stand alone ISD. The omitted elements of above list will be withdrawn in the VLR.)

- D-CSI;
- VT-CSI;
- TDP-Criteria for VT-CSI;
- MO-SMS-CSI;
- MT-SMS-CSI;

- TDP-Criteria for MT-SMS-CSI;
- M-CSI.

If the VLR CAMEL Subscription Info is omitted in the Insert Subscriber Data operation the VLR shall keep the previously stored VLR CAMEL Subscription Info. Within one dialogue subsequent received data are interpreted as add-on data. If the VLR detects that there is overlapping in the information received within a dialogue, it shall send the error Unexpected Data Value. This parameter is used only by the VLR and if the SGSN receives this parameter it shall ignore it.

The VLR CAMEL Subscription Info may contain the TIF-CSI (Translation Information Flag) for CAMEL Phase 2 and higher. See 3GPP TS 23.072 for the use of this parameter and the conditions for its presence.

Supported CAMEL Phases

The use of this parameter and the requirements for its presence are specified in 3GPP TS 23.078. This parameter is used by the VLR and SGSN.

A VLR or SGSN not supporting any CAMEL Phase may omit this parameter.

GPRS Subscription Data

This parameter contains a list of PDP-contexts a user has subscribed to; see clause 7.6.

At GPRS location updating the HLR shall include the complete GPRS Subscription Data.

When there is a change in GPRS subscriber data the HLR shall include only the new and/or modified PDP contexts.

When the SGSN receives GPRS Subscription Data within a dialogue it shall check if the received data has to be considered as the entire GPRS subscription data. If so, it shall replace the stored GPRS Subscription Data with the received data set, otherwise it shall replace the data only for the modified PDP contexts (if any) and add the new PDP contexts (if any) to the stored GPRS Subscription Data.

If GPRS Subscription Data is omitted in the Insert Subscriber Data operation the SGSN shall keep the previously stored GPRS Subscription Data.

If the SGSN detects that there is overlapping in the information received within a dialogue, it shall send the error Unexpected Data Value. This parameter is used only by the SGSN and if the VLR receives this parameter it shall ignore it.

SGSN CAMEL Subscription Info

The SGSN CAMEL Subscription Info is sent at GPRS location updating or when any information in the applicable SGSN CAMEL Subscription Info in the HLR has been changed.

- In CAMEL Phase 3, this parameter may contain one or both of GPRS-CSI and MO-SMS-CSI.
- In CAMEL Phase 4, this parameter may contain GPRS-CSI, MO-SMS-CSI and MT-SMS-CSI and TDP-Criteria for MT-SMS-CSI.

At GPRS location updating the complete set of SGSN CAMEL Subscription Info is sent.

When CAMEL Subscription Information is changed in the HLR and changed data have to be sent to the SGSN, then one or more specific elements of SGSN CAMEL Subscription Info are sent in one dialogue.

When the SGSN receives a specific element of SGSN CAMEL Subscription Info, it shall overwrite the corresponding specific element of SGSN CAMEL Subscription Info (if any) which it has stored for that subscriber.

The specific elements of SGSN CAMEL Subscription Info which may be sent are:

- MO-SMS-CSI;
- MT-SMS-CSI;
- TDP-Criteria for MT-SMS-CSI;
- GPRS-CSI;

- MC-CSI.

This parameter is used only by the SGSN and if the VLR receives this parameter it shall ignore it.

Roaming Restricted In SGSN Due To Unsupported Feature

The HLR may decide to include this parameter in the request if certain services or features are indicated as not supported by the SGSN. This parameter is used only by the SGSN and if the VLR receives this parameter it shall ignore it.

CS Allocation/Retention priority

The CS Allocation/Retention priority is used only for Circuit Switched (CS). This parameter specifies relative importance to compare with other bearers about allocation and retention of bearer. This parameter is used only by the VLR and if the SGSN receives this parameter it shall ignore it.

Offered CAMEL 4 CSIs

This parameter indicates the CAMEL phase 4 CSIs offered in the VMSC/VLR or SGSN (see clause 7.6.3.36D).

Subscribed Charging Characteristics

This parameter refers to the Subscribed Charging Characteristics as defined in 3GPP TS 32.215 [128].

For a detailed description of the use of the parameter, see 3GPP TS 32.215 [128].

This parameter is used only by the SGSN and if the VLR receives this parameter it shall ignore it.

User error

Only one of the following values is applicable:

- Unidentified subscriber;
- Data missing;
- Unexpected data value.

8.8.1.4 Basic service information related to supplementary services

A number of parameters that relate to supplementary services can be qualified by a Basic Service Group (or a Basic Service Group List). This clause explains how this information is to be interpreted. Supplementary service parameters to which this clause is applicable only apply to the basic service groups described in this clause, and only those basic service groups shall be overwritten at the VLR.

The Basic Service Group (or Basic Service Group List) is optional.

If present the Basic Service Group (or the elements of the Basic Service Group List) shall be one of:

- an Elementary Basic Service Group for which the supplementary service is applicable to at least one basic service in the group; and to which the subscriber has a subscription to at least one basic service in the group;
- the group "All Teleservices" provided that the service is applicable to at least one teleservice and that the subscriber has a subscription to at least one teleservice that is in the same Elementary Basic Service Group as a teleservice to which the service is applicable;
- the group "All Bearer Services" provided that the service is applicable to at least one bearer service and that the subscriber has a subscription to at least one bearer service that is in the same Elementary Basic Service Group as a basic service to which the service is applicable.

If the Basic Service Group (or Basic Service Group List) is not present then the parameter shall apply to all Basic Service Groups.

If the basic service information is not a single Elementary Basic Service Group then the parameter shall be taken as applying individually to all the Elementary Basic Service Groups for which:

- the supplementary service is applicable to at least one basic service in the Basic Service Group; and
- the subscriber has a subscription to at least one basic service in the Basic Service Group.

The VLR is not required to store supplementary services data for Basic Service Groups that are not supported at the VLR.

8.8.2 MAP-DELETE-SUBSCRIBER-DATA service

8.8.2.1 Definition

This service is used by an HLR to remove certain subscriber data from a VLR if the subscription of one or more supplementary services or basic services is withdrawn. Note that this service is not used in case of erasure or deactivation of supplementary services.

Also this service is used by an HLR to remove GPRS subscription data from a SGSN.

It is a confirmed service and consists of the primitives shown in table 8.8/2.

8.8.2.2 Service primitives

Table 8.8/2: MAP-DELETE-SUBSCRIBER-DATA

Parameter name	Request	Indication	Response	Confirm
Invoke Id	M	M(=)	M(=)	M(=)
IMSI	M	M(=)		
Basic service List	C	C(=)		
SS-Code List	C	C(=)		
Roaming Restriction Due To				
Unsupported Feature	C	C(=)		
Camel Subscription Info Withdraw	C	C(=)		
Specific CSI Withdraw	C	C(=)		
Regional Subscription Data	C	C(=)		
VBS Group Indication	C	C(=)		
VGCS Group Indication	C	C(=)		
GPRS Subscription Data Withdraw	C	C(=)		
Roaming Restricted In SGSN Due To	C	C(=)		
Unsupported Feature				
LSA Information Withdraw	C	C(=)		
IST Information Withdraw	C	C(=)		
Regional Subscription Response			C	C(=)
GMLC List Withdraw	C	C(=)		
Subscribed Charging Characteristics Withdraw	C	C(=)		
User error			C	C(=)
Provider error				O

8.8.2.3 Parameter use

All parameters are described in clause 7.6. The following clarifications are applicable:

Basic service List

A list of Extensible Basic service parameters (Extensible Basic service is defined in clause 7.6). It is used when one, several or all basic services are to be withdrawn from the subscriber. If the VLR or the SGSN receives a value for an Extensible Basic Service which it does not support, it shall ignore that value. This parameter is used by the VLR and by the SGSN.

SS-Code List

A list of SS-Code parameters (SS-Code is defined in clause 7.6). It is used when several or all supplementary services are to be withdrawn from the subscriber.

There are three possible options:

- deletion of basic service(s);
The parameter Basic service List is only included.
- deletion of supplementary service(s);
The parameter SS-Code List is only included.
- deletion of basic and supplementary services;
Both Basic service List and SS-Code List are included.

This parameter is used by the VLR and SGSN for LCS. Otherwise, this parameter is used only by the VLR and if the SGSN receives this parameter it shall ignore it.

Roaming Restriction Due To Unsupported Feature

This parameter is used if Roaming Restriction Due To Unsupported Feature is deleted from the subscriber data. This may occur if unsupported features or services are removed from the subscriber data in the HLR.

If this parameter is sent the VLR shall check if the current Location Area is possibly allowed now. This parameter is used only by the VLR and if the SGSN receives this parameter it shall ignore it.

CAMEL Subscription Info Withdraw

This parameter is used to indicate that CAMEL Subscription Info shall be deleted from the VLR or from the SGSN. All CAMEL Subscription Info for the subscriber shall be deleted. This parameter is used by the VLR and by the SGSN. This parameter should not be sent in the same message as the Specific CSI Withdraw parameter.

Specific CSI Withdraw

This parameter is used to indicate that one or more specific elements of CAMEL Subscription Info shall be deleted from the VLR or from the SGSN.

The specific elements of CAMEL Subscription Info which may be withdrawn are:

- O-CSI with TDP criteria for O-CSI;
- SS-CSI;
- TIF-CSI;
- D-CSI;
- VT-CSI with TDP criteria for VT-CSI;
- MO-SMS-CSI;
- MT-SMS-CSI with TDP-Criteria for MT-SMS-CSI;
- M-CSI;
- MG-CSI;
- GPRS-CSI.

This parameter is used by the VLR and by the SGSN. It shall not be sent to VLRs that do not support CAMEL phase 3 or higher. This parameter should not be sent in the same message as the CAMEL Subscription Info Withdraw parameter.

Regional Subscription Identifier

Contains one single Zone Code (as defined in clause 7.6) and is used if all Zone Codes shall be deleted from the subscriber data. When all the Zone Codes are deleted, the VLR or the SGSN shall check for its location areas whether they are allowed or not. If the whole MSC area is restricted, VLR will report it to HLR by returning the Regional

Subscription Response "MSC Area Restricted". If the whole SGSN area is restricted, SGSN will report it to HLR by returning the Regional Subscription Response "SGSN Area Restricted".

The binary coding of the Zone Code value received in a Delete Subscriber Data request shall not be checked by the VLR or by the SGSN.

Note that support of this parameter is a network operator option and it shall not be sent to networks which do not support Regional Subscription.

If Regional Subscription is not supported by the VLR or by the SGSN, the request for deletion of Zone Codes is refused by sending the Regional Subscription Response "Regional Subscription Not Supported" to the HLR.

If no Zone Codes are stored in the respective subscriber data record, the request for deleting all Zone Code information shall be ignored and no Regional Subscription Response shall be returned. This parameter is used by the VLR and by the SGSN.

VBS Group Indication

Contains an indication (flag) which is used if all Group Ids shall be deleted from the subscriber data for the Voice Broadcast teleservice.

If VBS is not supported in the VLR or no Group Ids are stored for VBS in the respective subscriber record, the request for deletion of all Group Ids shall be ignored. This parameter is used only by the VLR and if the SGSN receives this parameter it shall ignore it.

VGCS Group Indication

Contains an indication (flag) which is used if all Group Id's shall be deleted from the subscriber data for the Voice Group Call teleservice. This parameter is used only by the VLR and if the SGSN receives this parameter it shall ignore it.

If VGCS is not supported in the VLR or no Group Ids are stored for VGCS in the respective subscriber record, the request for deletion of all Group Ids shall be ignored.

GPRS Subscription Data Withdraw

This parameter is used to indicate whether all GPRS Subscription Data for the subscriber shall be deleted or if only a subset of the stored GPRS Subscription Data for the subscriber shall be deleted. In the latter case only those PDP contexts whose identifiers are included in the subsequent identifier list will be deleted. This parameter is used only by the SGSN and if the VLR receives this parameter it shall ignore it.

Roaming Restricted In SGSN Due To Unsupported Feature

This parameter is used if Roaming Restricted In SGSN Due To Unsupported Feature is deleted from the GPRS subscriber data. This may occur if unsupported features or services are removed from the GPRS subscriber data in the HLR.

If this parameter is sent the SGSN shall check if the current Location Area is possibly allowed now. This parameter is used only by the SGSN and if the VLR receives this parameter it shall ignore it.

LSA Information Withdraw

This parameter is used to indicate whether all LSA Information for the subscriber shall be deleted or if only a subset of the stored LSA Information for the subscriber shall be deleted. In the latter case only the LSA data whose LSA identities are included in the subsequent LSA data list will be deleted. This parameter is used by the VLR and the SGSN.

IST Information Withdraw

This parameter is used to indicate that the IST condition has been removed for the subscriber. See 3GPP TS 43.035 for the use of this parameter.

Regional Subscription Response

If included in the Delete Subscriber Data response this parameter indicates one of:

- MSC Area Restricted;
- SGSN Area Restricted;
- Regional Subscription Not Supported.

This parameter is used by the VLR and by the SGSN.

GMLC List Withdraw

This parameter indicates that the subscriber's LCS GMLC List shall be deleted from the VLR or SGSN.

Subscribed Charging Characteristics Withdraw

This parameter indicates that the Subscribed Charging Characteristics shall be replaced with a local default value in the SGSN (see 3GPP TS 32.215 [128]).

This parameter is used only by the SGSN and if the VLR receives this parameter it shall ignore it.

User error

Only one of the following values is applicable:

- Unidentified subscriber;
- Data missing;
- Unexpected data value.

8.9 Identity management services

8.9.1 MAP-PROVIDE-IMSI service

8.9.1.1 Definition

This service is used by a VLR in order to get, via the MSC, the IMSI of a subscriber (e.g. when a subscriber has identified itself with a TMSI not allocated to any subscriber in the VLR).

It is a confirmed service and consists of the primitives shown in table 8.9/1.

8.9.1.2 Service primitives

Table 8.9/1: MAP-PROVIDE-IMSI

Parameter name	Request	Indication	Response	Confirm
Invoke Id	M	M(=)	M(=)	M(=)
IMSI			C	C(=)
User error			C	C(=)
Provider error				O

8.9.1.3 Parameter use

All parameters are described in clause 7.6. The following clarifications are applicable:

IMSI

This parameter is received when the request is successfully carried out. It contains the requested IMSI.

User error

Only one of the following values is applicable:

- Absent subscriber.

8.9.2 MAP-FORWARD-NEW-TMSI service

8.9.2.1 Definition

This service is used by a VLR to allocate, via MSC, a new TMSI to a subscriber during an ongoing transaction (e.g. call set-up, location updating or supplementary services operation).

It is a confirmed service and consists of the primitives shown in table 8.9/2.

8.9.2.2 Service primitives

Table 8.9/2: MAP-FORWARD-NEW-TMSI

Parameter name	Request	Indication	Response	Confirm
Invoke Id	M	M(=)	M(=)	M(=)
TMSI	M	M(=)		
Provider error				O

8.9.2.3 Parameter use

The parameter TMSI is described in clause 7.6.

8.10 Fault recovery services

8.10.1 MAP_RESET service

8.10.1.1 Definition

This service is used by the HLR, after a restart, to indicate to a list of VLRs or SGSNs that a failure occurred.

The MAP_RESET service is a non-confirmed service using the service primitives defined in table 8.10/1.

8.10.1.2 Service primitives

Table 8.10/1: MAP_RESET

Parameter name	Request	Indication
Invoke Id	M	M(=)
HLR number	M	M(=)
HLR Id LIST	U	C(=)

8.10.1.3 Parameter definition and use

Invoke Id

See definition in clause 7.6.1.

HLR number

See definition in clause 7.6.2.

HLR Id LIST

The HLR Id List is a list of HLR Ids. If the parameter is present in the indication, the VLR or SGSN may base the retrieval of subscribers to be restored on their IMSI: the subscribers affected by the reset are those whose IMSI leading digits are equal to one of these numbers. If the parameter is absent, subscribers to be restored are those for which the OriginatingEntityNumber received at location updating time matches the equivalent parameter of the Reset Indication.

8.10.2 MAP_FORWARD_CHECK_SS_INDICATION service**8.10.2.1 Definition**

This service may be used by an HLR as an implementation option, to indicate to a mobile subscriber that supplementary services parameters may have been altered, e.g. due to a restart. If received from the HLR, the VLR shall forward this indication to the MSC, which in turn forwards it to the MS. The HLR only sends this indication after successful completion of the subscriber data retrieval from HLR to VLR that ran embedded in a MAP_UPDATE_LOCATION procedure.

The MAP_FORWARD_CHECK_SS_INDICATION service is a non-confirmed service using the service primitives defined in table 8.10/2.

8.10.2.2 Service primitives**Table 8.10/2: MAP_FORWARD_CHECK_SS_INDICATION**

Parameter name	Request	Indication
Invoke Id	M	M(=)

8.10.2.3 Parameter definition and useInvoke Id

See definition in clause 7.6.1.

8.10.3 MAP_RESTORE_DATA service**8.10.3.1 Definition**

This service is invoked by the VLR on receipt of a MAP_PROVIDE_ROAMING_NUMBER indication for an unknown IMSI, or for a known IMSI with the indicator "Confirmed by HLR" set to "Not confirmed". The service is used to update the LMSI in the HLR, if provided, and to request the HLR to send all data to the VLR that are to be stored in the subscriber's IMSI record.

The MAP_RESTORE_DATA service is a confirmed service using the service primitives defined in table 8.10/3.

8.10.3.2 Service primitives**Table 8.10/3: MAP_RESTORE_DATA**

Parameter name	Request	Indication	Response	Confirm
Invoke Id	M	M(=)	M(=)	M(=)
IMSI	M	M(=)		
LMSI	U	C(=)		
Supported CAMEL phases	C	C(=)		
SoLSA Support Indicator	C	C(=)		
IST Support Indicator	C	C(=)		
Super-Charger Supported in Serving Network Entity	C	C(=)		
Long FTN Supported	C	C(=)		
Supported LCS Capability	C	C(=)		

Sets				
HLR number			C	C(=)
Offered CAMEL 4 CSIs	C	C(=)		
MS Not Reachable Flag			C	C(=)
User error			C	C(=)
Provider error				O

8.10.3.3 Parameter definitions and use

Invoke Id

See definition in clause 7.6.1.

IMSI

See definition in clause 7.6.2.

LMSI

See definition in clause 7.6.2. It is an operator option to provide the LMSI from the VLR; it is mandatory for the HLR to support the LMSI handling procedures.

Supported CAMEL Phases

This parameter indicates which phases of CAMEL are supported. Must be present if a CAMEL phase different from phase 1 is supported. Otherwise may be absent.

SoLSA Support Indicator

This parameter is used by the VLR to indicate to the HLR in the Restore Data indication that SoLSA is supported. If this parameter is not included in the Restore Data indication then the HLR shall not perform any specific error handling.

This SoLSA Support Indicator shall be stored by the HLR per VLR where there are Subscribers roaming. If a Subscriber is marked as only allowed to roam in Subscribed LSAs while roaming in a VLR and no SoLSA Support indicator is stored for that VLR, the location status of that Subscriber shall be set to Restricted.

IST Support Indicator

This parameter is used to indicate to the HLR that the VMSC supports basic IST functionality, that is, the VMSC is able to terminate the Subscriber Call Activity that originated the IST Alert when it receives the IST alert response indicating that the call(s) shall be terminated. If this parameter is not included in the Restore Data indication and the Subscriber is marked as an IST Subscriber, then the HLR may limit the service for the subscriber (by inducing an Operator Determined barring of Outgoing calls), or allow service assuming the associated risk of not having the basic IST mechanism available.

This parameter can also indicate that the VMSC supports the IST Command service, including the ability to terminate all calls being carried for the identified subscriber by using the IMSI as a key. If this additional capability is not included in the Restore Data indication and the HLR supports the IST Command capability, then the HLR may limit the service for the subscriber (by inducing an Operator Determined barring of Outgoing calls), or allow service assuming the associated risk of not having the IST Command mechanism available.

Long FTN Supported

This parameter indicates that the VLR supports Long Forwarded-to Numbers.

Super-Charger Supported in Serving Network Entity

This parameter is used by the VLR to indicate to the HLR that the VLR supports the Super-Charger functionality and that subscriber data is required.

If this parameter is absent then the VLR does not support the Super-Charger functionality.

Supported LCS Capability Sets

This parameter indicates, if present, the capability sets of LCS which are supported. If the parameter is sent but no capability set is marked as supported then the VLR does not support LCS at all.

If this parameter is absent then the VLR may support at most LCS capability set 1, that is LCS Release98 or Release99 version.

Offered CAMEL 4 CSIs

This parameter indicates the CAMEL phase 4 CSIs offered in the VMSC/VLR (see clause 7.6.3.36D).

HLR number

See definition in clause 7.6.2. The presence of this parameter is mandatory in case of successful outcome of the service.

MS Not Reachable Flag

See definition in clause 7.6.8. This parameter shall be present in case of successful outcome of the service, if the "MS Not Reachable flag" was set in the HLR.

User error

In case of unsuccessful outcome of the service, an error cause shall be returned by the HLR. The following error causes defined in clause 7.6.1 may be used, depending on the nature of the fault:

- unknown subscriber;
- system failure;
- unexpected data value;
- data missing.

Provider error

For definition of provider errors see clause 7.6.1.

8.11 Subscriber Information services

8.11.1 MAP-ANY-TIME-INTERROGATION service

8.11.1.1 Definition

This service is used by the gsmSCF, to request information (e.g. subscriber state and location) from the HLR or the GMLC at any time. This service may also be used by the gsmSCF to request the Mobile Number Portability (MNP) information from the NPLR.

When this service is used to the HLR, the subscriber state or location may be requested.

When this service is used to the GMLC, only the location may be requested.

When this service is used to the NPLR, only the MNP information may be requested.

The MAP-ANY-TIME-INTERROGATION service is a confirmed service using the service primitives defined in table 8.11/1.

8.11.1.2 Service primitives

Table 8.11/1: Any_Time_Interrogation

Parameter name	Request	Indication	Response	Confirm
Invoke id	M	M(=)	M(=)	M(=)
Requested Info	M	M(=)		
Requested domain	C	C(=)		
MNP Requested Info	C	C(=)		

gsmSCF-Address	M	M(=)		
IMSI	C	C(=)	C	C(=)
MSISDN	C	C(=)	C	C(=)
Location Information			C	C(=)
Location Information for GPRS			C	C(=)
Subscriber State			C	C(=)
PS Subscriber State			C	C(=)
IMEI			C	C(=)
MS Classmark 2			C	C(=)
GPRS MS Class			C	C(=)
MNP info Result			C	C(=)
User error			C	C(=)
Provider error				O

8.11.1.3 Parameter definition and use

All parameters are described in clause 7.6. The use of these parameters and the requirements for their presence are specified in 3GPP TS 23.018 [97] and 3GPP TS 23.078 [98].

The HLR or GMLC may be able to use the value of the parameter gsmSCF-address to screen a MAP_Any_Time_Interrogation indication.

The use of the parameters and the requirements for their presence are specified in 3GPP TS 23.078.

User error

This parameter is sent by the responder when an error is detected and if present, takes one of the following values:

- System Failure;
- Any Time Interrogation Not Allowed;
- Data Missing;
- Unexpected Data Value;
- Unknown Subscriber.

Provider error

These are defined in clause 7.6.1.

8.11.2 MAP-PROVIDE-SUBSCRIBER-INFO service

8.11.2.1 Definition

This service is used to request information (e.g. subscriber state and location) from the VLR or SGSN at any time.

The MAP-PROVIDE-SUBSCRIBER-INFO service is a confirmed service using the primitives defined in table 8.11/2.

8.11.2.2 Service primitives

Table 8.11/2: Provide_Subscriber_Information

Parameter name	Request	Indication	Response	Confirm
Invoke id	M	M(=)	M(=)	M(=)
Requested Info	M	M(=)		
IMSI	M	M(=)		
LMSI	U	O		
Location Information			C	C(=)
Location Information for GPRS			C	C(=)
Subscriber State			C	C(=)
PS Subscriber State			C	C(=)
IMEI			C	C(=)
MS Classmark 2			C	C(=)
GPRS MS Class			C	C(=)
User error			C	C(=)
Provider error				O

8.11.2.3 Parameter definition and use

All parameters are defined in clause 7.6. The use of these parameters and the requirements for their presence are specified in 3GPP TS 23.018 [97] and 3GPP TS 23.078 [98].

User error

This parameter is sent by the responder when an error is detected and if present, takes one of the following values:

- Data Missing;
- Unexpected Data Value.

Provider error

These are defined in clause 7.6.1.

8.11.3 MAP-ANY-TIME-SUBSCRIPTION-INTERROGATION service

8.11.3.1 Definition

This service is used by the gsmSCF, to request subscription information (e.g. call forwarding supplementary service data or CSI) from the HLR at any time. In an IP Multimedia Core Network, an IM-SSF can take on the role of a gsmSCF for this service.

8.11.3.2 Service primitives

Table 8.11/3: Any_Time_Subscription_Interrogation

Parameter name	Request	Indication	Response	Confirm
Invoke id	M	M(=)	M(=)	M(=)
Requested Subscription Info	M	M(=)		
GsmSCF-Address	M	M(=)		
IMSI	C	C(=)		
MSISDN	C	C(=)		
Long FTN Supported	C	C(=)		
Call Forwarding Data			C	C(=)
Call Barring Data			C	C(=)
ODB Info			C	C(=)
CAMEL Subscription Info			C	C(=)

Supported CAMEL phases in VLR			C	C(=)
Supported CAMEL phases in SGSN			C	C(=)
Offered CAMEL 4 CSIs in VLR			C	C(=)
Offered CAMEL 4 CSIs in SGSN			C	C(=)
User error			C	C(=)
Provider error				O

8.11.3.3 Parameter definition and use

All parameters are described in clause 7.6.

The HLR may be able to use the value of the parameter gsmSCF-address to screen a MAP_Any_Time_Subscription_Interrogation indication. The gsmSCF-address shall contain the IM-SSF address when the IM-SSF takes the role of the gsmSCF.

The use of the parameters and the requirements for their presence are specified in 3GPP TS 23.078 and 3GPP TS 23.278.

User error

This parameter is sent by the responder when an error is detected and if present, takes one of the following values:

- Unexpected Data Value;
- Unknown Subscriber;
- BearerServiceNotProvisioned;
- TeleserviceNotProvisioned;
- CallBarred;
- IllegalSS-Operation;
- SS-NotAvailable;
- InformationNotAvailable;
- Any Time Subscription Interrogation Not Allowed;
- Data Missing.

Provider error

These are defined in clause 7.6.1.

8.11.4 MAP-ANY-TIME-MODIFICATION service

8.11.4.1 Definition

This service is used by the gsmSCF, to modify information of the HLR at any time.

8.11.4.2 Service primitives

Table 8.11/4: Any_Time_Modification

Parameter name	Request	Indication	Response	Confirm
Invoke id	M	M(=)	M(=)	M(=)
gsmSCF-Address	M	M(=)		
IMSI	C	C(=)		
MSISDN	C	C(=)		

Modification request for ODB data	C	C(=)		
Modification request for SS information	C	C(=)		
Modification request for CSI	C	C(=)		
Long FTN Supported	C	C(=)		
Ext Forwarding information-for-CSE			C	C(=)
Ext Call barring information-for-CSE			C	C(=)
ODB Info			C	C(=)
CAMEL subscription info			C	C(=)
User error			C	C(=)
Provider error				O

8.11.4.3 Parameter definition and use

All parameters are described in clause 7.6.

The HLR may be able to use the value of the parameter gsmSCF-address to screen a MAP_Any_Time_Modification indication.

The use of these parameters and the requirements for their presence are specified in 3GPP TS 23.078 and 3GPP TS 23.278.

User error

This parameter is sent by the responder when an error is detected and if present, takes one of the following values:

- Any Time Modification Not Allowed;
- Data Missing;
- Unexpected Data Value;
- Unknown Subscriber;
- Bearer service not provisioned;

This error is returned only if not even a subset of the requested bearer service group has been subscribed to;

- Teleservice not provisioned;

This error is returned only if not even a subset of the requested teleservice group has been subscribed to;

- Call Barred;
- Illegal SS operation;
- SS error status;
- SS incompatibility;
- SS subscription violation;
- Information Not Available.

Provider error

These are defined in clause 7.6.1.

8.11.5 MAP-NOTE-SUBSCRIBER-DATA-MODIFIED service

8.11.5.1 Definition

This service is used by the HLR to inform the gsmSCF that subscriber data have been modified. In an IP Multimedia Core Network, an IM-SSF can take on the role of a gsmSCF for this service.

8.11.5.2 Service primitives

Table 8.11/5: Note_Subscriber_Data_Modified

Parameter name	Request	Indication	Response	Confirm
Invoke id	M	M(=)	M(=)	M(=)
IMSI	M	M(=)		
MSISDN	M	M(=)		
Ext Forwarding information-for-CSE	C	C(=)		
Ext Call barring information-for-CSE	C	C(=)		
ODB Info	C	C(=)		
CAMEL subscription info	C	C(=)		
All Information Sent	C	C(=)		
User error			C	C(=)
Provider error				O

8.11.5.3 Parameter definition and use

Invoke id

See clause 7.6.1 for the use of this parameter.

IMSI

See clause 7.6.2 for the use of this parameter.

MSISDN

See clause 7.6.2 for the use of this parameter. In an IP Multimedia Core Network, if no MSISDN is available, the HLR shall populate this parameter with a dummy MSISDN.

Ext Forwarding information-for-CSE

See clause 7.6.3 for the use of this parameter. The use of this parameter and the requirements for their presence are specified in 3GPP TS 23.078.

Ext Call barring information-for-CSE

See clause 7.6.3 for the use of this parameter. The use of this parameter and the requirements for their presence are specified in 3GPP TS 23.078.

ODB Info

See clause 7.6.3 for the use of this parameter. The use of this parameter and the requirements for their presence are specified in 3GPP TS 23.078.

CAMEL subscription info

See clause 7.6.3 for the use of this parameter. The use of this parameter and the requirements for their presence are specified in 3GPP TS 23.078 and 3GPP TS 23.278.

All Information Sent

This parameter is set when the HLR has sent all information to gsmSCF.

User error

This parameter is sent by the responder when an error is detected and if present, takes one of the following values:

- Data Missing;

- Unexpected Data Value;
- Unknown Subscriber.

Provider error

These are defined in clause 7.6.1.

The use of the parameters and the requirements for their presence are specified in 3GPP TS 23.078 and 3GPP TS 23.278.

9 Operation and maintenance services

9.1 Subscriber tracing services

9.1.1 MAP-ACTIVATE-TRACE-MODE service

9.1.1.1 Definition

This service is used between the HLR and the VLR to activate subscriber tracing in the VLR.

Also this service is used between the HLR and the SGSN to activate subscriber tracing in the SGSN.

The MAP-ACTIVATE-TRACE-MODE service is a confirmed service using the primitives from table 9.1/1.

9.1.1.2 Service primitives

Table 9.1/1: MAP-ACTIVATE-TRACE-MODE

Parameter name	Request	Indication	Response	Confirm
Invoke id	M	M(=)	M(=)	M(=)
IMSI	C	C(=)		
Trace reference	M	M(=)		
Trace type	M	M(=)		
OMC Id	U	C(=)		
User error			C	C(=)
Provider error				O

9.1.1.3 Parameter use

Invoke id

See definition in clause 7.6.1.

IMSI

See definition in clause 7.6.2. The IMSI is a mandatory parameter in a stand-alone operation.

Trace reference

See definition in clause 7.6.10.

Trace type

See definition in clause 7.6.10.

OMC Id

See definition in clause 7.6.2. The use of this parameter is an operator option.

User error

The following errors defined in clause 7.6.1 may be used, depending on the nature of the fault:

- Unidentified Subscriber;
- Facility Not Supported;
- Tracing Buffer Full;
- System Failure;
- Unexpected Data Value;
- Data missing.

Provider error

For definition of provider errors see clause 7.6.1.

9.1.2 MAP-DEACTIVATE-TRACE-MODE service

9.1.2.1 Definition

This service is used between the VLR and the HLR for deactivating subscriber tracing in the VLR.

Also this service is used between the SGSN and the HLR for deactivating subscriber tracing in the SGSN.

The MAP-DEACTIVATE-TRACE-MODE service is a confirmed service using the primitives from table 9.1/2.

9.1.2.2 Service primitives

Table 9.1/2: MAP-DEACTIVATE-TRACE-MODE

Parameter name	Request	Indication	Response	Confirm
Invoke id	M	M(=)	M(=)	M(=)
IMSI	C	C(=)		
Trace reference	M	M(=)		
User error			C	C(=)
Provider error				O

9.1.2.3 Parameter use

Invoke id

See definition in clause 7.6.1.

IMSI

See definition in clause 7.6.2. The IMSI is a mandatory parameter in a stand-alone operation.

Trace reference

See definition in clause 7.6.10.

User error

The following errors defined in clause 7.6.1 may be used, depending on the nature of the fault:

- Unidentified Subscriber;
- Facility Not Supported;
- System Failure;

- Unexpected Data Value;
- Data missing.

Provider error

For definition of provider errors see clause 7.6.1.

9.1.3 MAP-TRACE-SUBSCRIBER-ACTIVITY service

9.1.3.1 Definition

This service is used between the VLR and the MSC to activate the subscriber tracing in the MSC.

The MAP-TRACE-SUBSCRIBER-ACTIVITY service is a non-confirmed service using the primitives from table 9.1/3.

9.1.3.2 Service primitives

Table 9.1/3: MAP-TRACE-SUBSCRIBER-ACTIVITY

Parameter name	Request	Indication
Invoke id	M	M(=)
IMSI	C	C(=)
Trace reference	M	M(=)
Trace type	M	M(=)
OMC Id	U	C(=)

9.1.3.3 Parameter use

Invoke id

See definition in clause 7.6.1.

IMSI

See definition in clause 7.6.2. The controlling MSC shall provide either the IMSI or the IMEI to the servicing MSC.

Trace reference

See definition in clause 7.6.10.

Trace type

See definition in clause 7.6.10.

OMC Id

See definition in clause 7.6.2. The use of this parameter is an operator option.

9.2 Other operation and maintenance services

9.2.1 MAP-SEND-IMSI service

9.2.1.1 Definition

This service is used by a VLR in order to fetch the IMSI of a subscriber in case of some Operation & Maintenance procedure where subscriber data are needed in the Visited PLMN and MSISDN is the only subscriber's identity known.

It is a confirmed service and consists of the primitives shown in table 9.2/1.

9.2.1.2 Service primitives

Table 9.2/1: MAP-SEND-IMSI

Parameter name	Request	Indication	Response	Confirm
Invoke Id	M	M(=)	M(=)	M(=)
MSISDN	M	M(=)		
IMSI			C	C(=)
User error			C	C(=)
Provider error				O

9.2.1.3 Parameter use

All parameters are described in clause 7.6. The following clarifications are applicable.

User error

Only one of the following values is applicable:

- Unknown subscriber;
- Unexpected data value;
- Data missing.

10 Call handling services

10.1 MAP_SEND_ROUTING_INFORMATION service

10.1.1 Definition

This service is used between the Gateway MSC and the HLR. The service is invoked by the Gateway MSC to perform the interrogation of the HLR in order to route a call towards the called MS.

This is a confirmed service using the primitives listed in table 10.1/1.

This service is also used between the GMSC and the NPLR and between the gsmSCF and the HLR.

10.1.2 Service primitives

Table 10.1/1: MAP_SEND_ROUTING_INFORMATION parameters

Parameter name	Request	Indication	Response	Confirm
Invoke Id	M	M(=)	M(=)	M(=)
Interrogation Type	M	M(=)		
GMSC or gsmSCF Address	M	M(=)		
MSISDN	M	M(=)	C	C(=)
OR Interrogation	C	C(=)		
OR Capability	C	C(=)		
CUG Interlock	C	C(=)	C	C(=)
CUG Outgoing Access	C	C(=)	C	C(=)
Number of Forwarding	C	C(=)		
Network Signal Info	C	C(=)		
Supported CAMEL Phases	C	C(=)	C	C(=)
Suppress T-CSI	C	C(=)		
Offered CAMEL 4 CSIs	C	C(=)		
Suppression of Announcement	C	C(=)		
Call Reference Number	C	C(=)		
Forwarding Reason	C	C(=)		
Basic Service Group	C	C(=)		

Parameter name	Request	Indication	Response	Confirm
Basic Service Group 2	C	C(=)		
Alerting Pattern	C	C(=)		
CCBS Call	C	C(=)		
Supported CCBS Phase	C	C(=)		
Additional Signal Info	C	C(=)		
IST Support Indicator	C	C(=)		
Pre-paging supported	C	C(=)		
Call Diversion Treatment Indicator	C	C(=)		
Long FTN Supported	C	C(=)		
Suppress VT-CSI	C	C(=)		
Suppress Incoming Call Barring	C	C(=)		
gsmSCF Initiated Call	C	C(=)		
Network Signal Info 2	C	C(=)		
IMSI			C	C(=)
MSRN			C	C(=)
Forwarding Data			C	C(=)
Forwarding Interrogation Required			C	C(=)
VMSC address			C	C(=)
GMSC Camel Subscription Info			C	C(=)
Location Information			C	C(=)
Subscriber State			C	C(=)
Basic Service Code			C	C(=)
CUG Subscription Flag			C	C(=)
North American Equal Access preferred			U	C(=)
Carrier Id				
User error			C	C(=)
SS-List			U	C(=)
CCBS Target			C	C(=)
Keep CCBS Call Indicator			C	C(=)
IST Alert Timer			C	C(=)
Number Portability Status			U	C(=)
Supported CAMEL Phases in VMSC			C	
Offered CAMEL 4 CSIs in VMSC			C	C(=)
MSRN 2			C	C(=)
Forwarding Data 2			C	C(=)
SS-List 2			C	C(=)
Basic Service Code 2			C	C(=)
Allowed Services			C	C(=)
Unavailability Cause			C	C(=)
Provider error				O

10.1.3 Parameter use

See clause 7.6 for a definition of the parameters used in addition to the following. Note that:

- a conditional parameter whose use is defined only in 3GPP TS 23.078 shall be absent if the sending entity does not support CAMEL;
- a conditional parameter whose use is defined only in 3GPP TS 23.079 [99] shall be absent if the sending entity does not support optimal routing;
- a conditional parameter whose use is defined only in 3GPP TS 23.078 & 3GPP TS 23.079 [99] shall be absent if the sending entity supports neither CAMEL nor optimal routing.

Interrogation Type

See 3GPP TS 23.079 [99] for the use of this parameter.

GMSC or gsmSCF address

The E.164 address of the GMSC or the gsmSCF. This parameter contains the gsmSCF address if the gsmSCF initiated call parameter is present, otherwise it is the GMSC address.

MSISDN

This is the Mobile Subscriber ISDN number assigned to the called subscriber. In the Request & Indication it is the number received by the GMSC in the ISUP IAM. If the call is to be forwarded and the HLR supports determination of the redirecting number, the HLR inserts the basic MSISDN in the Response.

See 3GPP TS 23.066 [108] for the use of this parameter and the conditions for its presence in the response.

OR Interrogation

See 3GPP TS 23.079 [99] for the use of this parameter and the conditions for its presence.

OR Capability

See 3GPP TS 23.079 [99] for the use of this parameter and the conditions for its presence.

CUG Interlock

See 3GPP TS 23.018 [97] for the use of this parameter and the conditions for its presence.

CUG Outgoing Access

See 3GPP TS 23.018 [97] for the use of this parameter and the conditions for its presence.

Number of Forwarding

See 3GPP TS 23.018 [97] for the use of this parameter and the conditions for its presence.

Network Signal Info

See 3GPP TS 23.018 [97] for the conditions for the presence of the components of this parameter.

Supported CAMEL Phases

The use of this parameter and the requirements for its presence are specified in 3GPP TS 23.078.

T-CSI Suppression

The use of this parameter and the requirements for its presence are specified in 3GPP TS 23.078.

Offered CAMEL 4 CSIs

This parameter indicates the CAMEL phase 4 CSIs offered in the GMSC/VLR (see clause 7.6.3.36D).

Suppression Of Announcement

The use of this parameter and the requirements for its presence are specified in 3GPP TS 23.078.

Call Reference Number

The use of this parameter and the conditions for its presence are specified in 3GPP TS 23.078 [98] and 3GPP TS 23.079 [99].

Forwarding Reason

See 3GPP TS 23.079 [99] for the use of this parameter and the conditions for its presence.

Basic Service Group

See 3GPP TS 23.079 [99] for the use of this parameter and the conditions for its presence.

Basic Service Group 2

See 3GPP TS 23.079[99] for the use of this parameter and the conditions for its presence.

Alerting Pattern

See 3GPP TS 23.018 [97] and 3GPP TS 23.078 [98] for the use of this parameter and the conditions for its presence.

CCBS Call

See 3GPP TS 23.093 [107] for the use of this parameter and the conditions for its presence.

Supported CCBS Phase

This parameter indicates by its presence that CCBS is supported and the phase of CCBS which is supported.

Additional Signal Info

See 3GPP TS 23.081 [27] for the conditions for the presence of the components of this parameter.

IST Support Indicator

This parameter is used to indicate to the HLR that the GMSC supports basic IST functionality, that is, the GMSC is able to terminate the subscriber call activity that originated the IST Alert when it receives the IST Alert response indicating that the call(s) shall be terminated. If this parameter is not included in the Send Routing Information indication and the subscriber is marked as an IST subscriber, then the HLR may limit the service for the call (by barring the incoming call if it is not subject to forwarding, or suppressing Call Forwarding from the GMSC), or allow the call assuming the associated risk of not having the basic IST mechanism available.

This parameter can also indicate that the GMSC supports the IST Command, including the ability to terminate all calls being carried for the identified subscriber by using the IMSI as a key. If this additional capability is not included in the Send Routing Information indication and the subscriber is marked as an IST subscriber, then the HLR may limit the service for the subscriber (by barring the incoming calls if they are not subject to forwarding, or suppressing Call Forwarding from the GMSC), or allow the incoming calls assuming the associated risk of not having the IST Command mechanism available.

Pre-paging supported

See 3GPP TS 23.018 for the use of this parameter and the conditions for its presence.

Call Diversion Treatment Indicator

This parameter indicates whether or not call diversion is allowed.

Network Signal Info 2

See 3GPP TS 23.172 [126] for the conditions for the presence of the components of this parameter.

IMSI

See 3GPP TS 23.018 [97] and 3GPP TS 23.066 [108] for the use of this parameter and the conditions for its presence.

MSRN

See 3GPP TS 23.018 [97], 3GPP TS 23.066 [108] and 3GPP TS 23.079 [99] for the use of this parameter and the conditions for its presence. If the NPLR returns only the MSISDN-number without Routeing Number to the GMSC, the MSISDN-number shall be returned as MSRN.

Forwarding Data

This parameter includes a number to define the forwarded-to destination, the forwarding reason and the forwarding options Notification to calling party and Redirecting presentation, and can include the forwarded-to subaddress. See 3GPP TS 23.018 [97] and 3GPP TS 23.079 [99] for the conditions for the presence of its components.

Forwarding Interrogation Required

See 3GPP TS 23.079 [99] for the use of this parameter and the conditions for its presence.

Long FTN Supported

This parameter indicates that the GMSC supports Long Forwarded-to Numbers.

Suppress VT-CSI

The use of this parameter and the requirements for its presence are specified in 3GPP TS 23.078.

Suppress Incoming Call Barring

The use of this parameter and the requirements for its presence are specified in 3GPP TS 23.078.

gsmSCF Initiated Call

The use of this parameter and the requirements for its presence are specified in 3GPP TS 23.078.

VMSC address

See 3GPP TS 23.079 [99] and 3GPP TS 23.078 [98] for the use of this parameter and the conditions for its presence.

GMSC CAMEL Subscription Info

The use of this parameter and the requirements for its presence are specified in 3GPP TS 23.078.

Location Information

The use of this parameter and the requirements for its presence are specified in 3GPP TS 23.078.

Subscriber State

The use of this parameter and the requirements for its presence are specified in 3GPP TS 23.078.

CUG Subscription Flag

The use of this parameter and the requirements for its presence are specified in 3GPP TS 23.078.

North American Equal Access preferred Carrier Id

This parameter is returned to indicate the preferred carrier identity to be used to set-up the call (i.e. forwarding the call or establishing the roaming leg).

SS-List

This parameter includes SS-codes and will be returned as an operator option. The HLR shall not send PLMN-specific SS-codes across PLMN boundaries. However if the GMSC receives PLMN-specific SS-codes from a foreign PLMN's HLR the GMSC may ignore it. If the GMSC attempts to process the PLMN-specific SS-codes, this may lead to unpredictable behaviour but the GMSC shall continue call processing.

Basic Service Code

The use of this parameter and the requirements for its presence are specified in 3GPP TS 23.078.

If the CAMEL service is not involved, this parameter includes the basic service code and will be returned as an operator option. The HLR shall not send a PLMN-specific Basic Service Code across PLMN boundaries. However if the GMSC receives a PLMN-specific Basic Service Code from a foreign PLMN's HLR the GMSC may ignore it. If the GMSC attempts to process the PLMN specific Basic Service codes, this may lead to unpredictable behaviour but the GMSC shall continue call processing.

CCBS Target

See 3GPP TS 23.093 [107] for the use of this parameter and the conditions for its presence.

Keep CCBS Call Indicator

See 3GPP TS 23.093 [107] for the use of this parameter and the conditions for its presence.

IST Alert Timer

It includes the IST Alert timer value that must be used to inform the HLR about the call activities that the subscriber performs. This parameter is only sent to the GMSC in response to a Send Routing Information request which indicates the the GMSC supports IST.

Number Portability Status

This parameter indicates the number portability status of the subscriber. This parameter may be present if the sender of SRIack is NPLR.

Supported CAMEL Phases in VMSC

The use of this parameter and the requirements for its presence are specified in 3GPP TS 23.078.

Offered CAMEL 4 CSIs in VMSC

This parameter is defined in clause 7.6.3.36F.

MSRN 2

The use of this parameter and the requirements for its presence are specified in 3GPP TS 23.172 [126].

Forwarding Data 2

The use of this parameter and the requirements for its presence are specified in 3GPP TS 23.172 [126].

SS-List 2

The use of this parameter and the requirements for its presence are specified in 3GPP TS 23.172 [126].

Basic Service Code 2

The use of this parameter and the requirements for its presence are specified in 3GPP TS 23.172 [126].

Allowed Services

The use of this parameter and the requirements for its presence are specified in 3GPP TS 23.172 [126].

Unavailability Cause

The use of this parameter and the requirements for its presence are specified in 3GPP TS 23.172 [126].

User error

This parameter is sent by the responder when an error is detected and if present, takes one of the following values:

- Unknown Subscriber;

The diagnostic for the Unknown Subscriber error may indicate 'NPDB Mismatch'.

- Number changed;
- Call Barred;

This error will indicate that either incoming calls are barred for this MS or that calls are barred due to Operator Determined Barring (see 3GPP TS 22.041 [8] for a definition of this network feature);

- CUG Reject;

The value of this error cause will indicate the reason for CUG Reject;

- Bearer Service Not Provisioned;
- Teleservice Not Provisioned;

A subscription check has been performed and the call has not passed the check due to incompatibility with regard to the requested service. Depending on the nature of the incompatibility, either of these messages will be returned;

- Facility Not Supported;
- Absent Subscriber;

This indicates that the location of the MS is not known (either the station is not registered and there is no location information available or the Provide Roaming Number procedure fails due to IMSI detached flag being

set), or the GMSC requested forwarding information with a forwarding reason of not reachable, and the call forwarding on MS not reachable service is not active;

- Busy Subscriber;

This indicates that Call Forwarding on Busy was not active for the specified basic service group when the GMSC requested forwarding information with a forwarding reason of busy;

The error may also indicate that the subscriber is busy due to an outstanding CCBS recall. In the error data it may then be specified that CCBS is possible for the busy encountered call;

- No Subscriber Reply;

This indicates that Call Forwarding on No Reply was not active for the specified basic service group when the GMSC requested forwarding information with a forwarding reason of no reply;

- OR Not Allowed;

This indicates that the HLR is not prepared to accept an OR interrogation from the GMSC, or that calls to the specified subscriber are not allowed to be optimally routed;

- Forwarding Violation;
- System Failure;
- Data Missing;
- Unexpected Data Value.

See clause 7.6 for a definition of these errors.

Provider error

These are defined in clause 7.6.

10.2 MAP_PROVIDE_ROAMING_NUMBER service

10.2.1 Definition

This service is used between the HLR and VLR. The service is invoked by the HLR to request a VLR to send back a roaming number to enable the HLR to instruct the GMSC to route an incoming call to the called MS.

This is a confirmed service which uses the primitives described in table 10.2/1.

10.2.2 Service primitives

Table 10.2/1: MAP_PROVIDE_ROAMING_NUMBER parameters

Parameter name	Request	Indication	Response	Confirm
Invoke Id	M	M(=)	M(=)	M(=)
IMSI	M	M(=)		
MSC Number	M	M(=)		
MSISDN	U	C(=)		
LMSI	C	C(=)		
GSM Bearer Capability	C	C(=)		
Network Signal Info	C	C(=)		
Suppression Of Announcement	C	C(=)		
Call Reference Number	C	C(=)		
GMSC Address	C	C(=)		
OR Interrogation	C	C(=)		
OR Not Supported in GMSC	C	C(=)		
Alerting Pattern	C	C(=)		
CCBS Call	C	C(=)		
Supported CAMEL Phases in	C	C(=)		

Parameter name	Request	Indication	Response	Confirm
interrogating node				
Additional Signal Info	C	C(=)		
Pre-paging supported	C	C(=)		
Long FTN Supported	C	C(=)		
Suppress VT-CSI	C	C(=)		
Roaming Number			C	C(=)
Offered CAMEL 4 CSIs in interrogating node	C	C(=)		
User error			C	C(=)
Provider error				O

10.2.3 Parameter use

See clause 7.6 for a definition of the parameters used, in addition to the following. Note that:

- a conditional parameter whose use is defined only in 3GPP TS 23.078 [98] shall be absent if the sending entity does not support CAMEL;
- a conditional parameter whose use is defined only in 3GPP TS 23.079 [99] shall be absent if the sending entity does not support optimal routing;
- a conditional parameter whose use is defined only in 3GPP TS 23.078 [98] & 3GPP TS 23.079 [99] shall be absent if the sending entity supports neither CAMEL nor optimal routing.

IMSI

This is the IMSI of the called Subscriber.

MSC Number

This is the ISDN number assigned to the MSC currently serving the MS. The MSC number will have been stored in the HLR as provided at location updating.

MSISDN

See 3GPP TS 23.018 [97] for the use of this parameter and the conditions for its presence.

LMSI

See 3GPP TS 23.018 [97] for the use of this parameter and the conditions for its presence.

GSM Bearer Capability

See 3GPP TS 23.018 [97] for the use of this parameter and the conditions for its presence.

This information is passed according to the rules specified in TS 3GPP TS 29.007 [56].

There may be two GSM Bearer Capabilities supplied.

Network Signal Info

See 3GPP TS 23.018 [97] for the conditions for the presence of the components of this parameter.

Suppression Of Announcement

The use of this parameter and the requirements for its presence are specified in 3GPP TS 23.078 [98].

Call Reference Number

The use of this parameter and the conditions for its presence are specified in 3GPP TS 23.078 [98] and 3GPP TS 23.079 [99].

GMSC Address

The use of this parameter and the conditions for its presence are specified in 3GPP TS 23.078 [98] and 3GPP TS 23.079 [99].

OR Interrogation

See 3GPP TS 23.079 [99] for the use of this parameter and the conditions for its presence.

OR Not Supported in GMSC

See 3GPP TS 23.079 [99] for the use of this parameter and the conditions for its presence.

Supported CAMEL Phases in interrogating node

This parameter is defined in clause 7.6.3.36I.

Alerting Pattern

See 3GPP TS 23.078 [98] for the use of this parameter and the conditions for its presence.

CCBS Call

See 3GPP TS 23.093 [107] for the use of this parameter and the conditions for its presence.

Additional Signal Info

See 3GPP TS 23.081 [27] for the conditions for the presence of the components of this parameter.

Pre-paging supported

See 3GPP TS 23.018 for the use of this parameter and the conditions for its presence.

Long FTN supported

See 3GPP TS 23.082 for the use of this parameter and the conditions for its presence.

Suppress VT-CSI

See 3GPP TS 23.078 for the use of this parameter and the conditions for its presence.

Offered CAMEL 4 CSIs in interrogating node

This parameter is defined in clause 7.6.3.36E.

Roaming Number

See 3GPP TS 23.018 [97] for the use of this parameter and the conditions for its presence.

User error

This parameter is sent by the responder when an error is detected and if present, takes one of the following values:

- Absent Subscriber;
This error will be returned if the IMSI detach flag is set.
- No Roaming Number Available;
- OR Not Allowed;
This indicates that the MAP_PROVIDE_ROAMING_NUMBER indication included the OR interrogation indicator, but the VLR does not support optimal routeing.
- Facility Not Supported;
- System Failure;
- Data Missing;
- Unexpected Data Value.

See clause 7.6 for a definition of these reasons.

Provider error

These are defined in clause 7.6.

10.3 MAP_RESUME_CALL_HANDLING service

10.3.1 Definition

This service is used between the terminating VMSC and the GMSC. The service is invoked by the terminating VMSC to request the GMSC to resume handling the call and forward it to the specified destination.

This is a confirmed service which uses the Primitives listed in table 10.3/1.

10.3.2 Service primitives

Table 10.3/1: MAP_RESUME_CALL_HANDLING parameters

Parameter name	Request	Indication	Response	Confirm
Invoke Id	M	M(=)	M(=)	M(=)
Call Reference Number	C	C(=)		
Basic Service Group	C	C(=)		
Basic Service Group 2	C	C(=)		
IMSI	C	C(=)		
Forwarding Data	C	C(=)		
CUG Interlock	C	C(=)		
CUG Outgoing Access	C	C(=)		
O-CSI	C	C(=)		
D-CSI	C	C(=)		
CCBS Target	C	C(=)		
UU Data	C	C(=)		
UUS CF Interaction	C	C(=)		
All Information Sent	C	C(=)		
MSISDN	C	C(=)		
User error			C	C(=)
Provider error				O

10.3.3 Parameter use

Information received in subsequent segment of a segmented dialogue shall not overwrite information received in an earlier segment.

See clause 7.6 for a definition of the parameters used, in addition to the following.

Call Reference Number

See 3GPP TS 23.079 [99] for the use of this parameter. This parameter shall be present in the first segment of the dialogue.

Basic Service Group

See 3GPP TS 23.079 [99] for the use of this parameter. This parameter shall be present in the first segment of the dialogue.

Basic Service Group 2

See 3GPP TS 23.079[99] for the use of this parameter. If this parameter is present, it shall be in a first segment of the dialogue.

IMSI

This is the IMSI of the forwarding Subscriber. This parameter shall be present in the first segment of the dialogue.

Forwarding Data

This parameter includes a number to define the forwarded-to destination, the forwarding reason and the forwarding options Notification to calling party and Redirecting presentation, and can include the forwarded-to subaddress. See 3GPP TS 23.079 [99] for the conditions for the presence of its components. This parameter shall be present in a first segment of the dialogue.

CUG Interlock

See 3GPP TS 23.079 [99] for the use of this parameter and the conditions for its presence.

CUG Outgoing Access

See 3GPP TS 23.079 [99] for the use of this parameter and the conditions for its presence.

O-CSI

See 3GPP TS 23.078 for the use of this parameter and the conditions for its presence.

For CAMEL phases 1 & 2, the O-CSI shall contain only one set of O-BCSM TDP data.

D-CSI

The Dialed Services-CSI.

See 3GPP TS 23.078 for the use of this parameter and the conditions for its presence.

CCBS Target

See 3GPP TS 23.093 [107] for the use of this parameter and the conditions for its presence.

UU Data

See 3GPP TS 23.087 for the use of this parameter and the conditions for its presence.

UUS CF Interaction

See 3GPP TS 23.087 for the use of this parameter and the conditions for its presence.

All Information Sent

This parameter is set when the VMSC has sent all information to GMSC.

MSISDN

This parameter is the basic MSISDN of the forwarding subscriber. It shall be present if the VMSC supports determination of the redirecting number.

User error

This parameter is sent by the responder when an error is detected and if present, takes one of the following values:

- Optimal Routeing not allowed;
- Forwarding failed;
- Unexpected Data Value;
- Data Missing.

Provider error

These are defined in clause 7.6.

10.4 MAP_PREPARE_GROUP_CALL service

10.4.1 Definition

This service is used by the Anchor_MSC to inform the Relay_MSC about a group call set-up.

The MAP_PREPARE_GROUP_CALL service is a confirmed service using the service primitives given in table 10.4/1.

10.4.2 Service primitives

Table 10.4/1: MAP_PREPARE_GROUP_CALL service

Parameter name	Request	Indication	Response	Confirm
Invoke Id	M	M(=)	M(=)	M(=)
Teleservice	M	M(=)		
ASCI Call Reference	M	M(=)		
Ciphering Algorithm	M	M(=)		
Group Key Number	C	C(=)		
Group Key	C	C(=)		
Priority	C	C(=)		
CODEC-Information	M	M(=)		
Uplink Free Indicator	M	M(=)		
Group Call Number			M	M(=)
User Error			C	C(=)
Provider Error				O

10.4.3 Parameter definitions and use

Invoke Id

See definition in clause 7.6.1.

Teleservice

Voice Broadcast Service or Voice Group Call Service.

ASCI Call Reference

Broadcast call reference or group call reference. This item is used to access the VBS-GCR or VGCS-GCR within the Relay_MSC.

Ciphering Algorithm

The ciphering algorithm to be used for the group call.

Group Key Number

This number has to be broadcasted and is used by the mobile station to select the chosen group key.

Shall be present if the ciphering applies.

Group Key

This key is used for ciphering on the radio interface.

Shall be present if the ciphering applies.

Priority

Default priority level related to the call if eMLPP applies.

CODEC-Information

Information on the codecs allowed for this call.

Uplink Free Indicator

A flag indicating whether the call is initiated from a dispatcher.

Group Call Number

This temporary allocated E.164 number is used for routing the call from the Anchor MSC to the Relay MSC.

User Error

For definition of this parameter see clause 7.6.1 The following errors defined in clause 7.6.1 may be used, depending on the nature of the fault:

- No Group Call Number available;
- System Failure;
- Unexpected Data Value.

Provider Error

See definition of provider error in clause 7.6.1.

10.5 MAP_PROCESS_GROUP_CALL_SIGNALLING service

10.5.1 Definitions

This service is used between Relay MSC and Anchor MSC for transmission of Group Call notifications.

The MAP_PROCESS_GROUP_CALL_SIGNALLING service is a non-confirmed service using the service primitives given in table 10.5/1.

10.5.2 Service primitives

Table 10.5/1: MAP_PROCESS_GROUP_CALL_SIGNALLING service

Parameter name	Request	Indication
Invoke Id	M	M(=)
Uplink Request	C	C(=)
Uplink Release Indication	C	C(=)
Release Group Call	C	C(=)

10.5.3 Parameter definitions and use

Invoke Id

See definition in clause 7.6.1

Uplink Request

This information element indicates to the anchor MSC that a service subscriber roaming in the relay MSC area requests access to the uplink.

Uplink Release Indication

This information element if included by the Relay MSC indicates to the Anchor MSC that the uplink has become free.

Release Group Call

This information element if included by the Relay MSC indicates to the Anchor MSC that the service subscriber who has initiated the call and who currently has access to the uplink terminates the call.

10.6 MAP_FORWARD_GROUP_CALL_SIGNALLING service

10.6.1 Definitions

This service is used between Anchor MSC and Relay MSC for transmission of Group Call notifications.

The MAP_FORWARD_GROUP_CALL_SIGNALLING service is a non-confirmed service using the service primitives given in table 10.6/1.

10.6.2 Service primitives

Table 10.6/1: MAP_FORWARD_GROUP_CALL_SIGNALLING service

Parameter name	Request	Indication
Invoke Id	M	M(=)
IMSI	C	C(=)
Uplink Request Acknowledgement	C	C(=)
Uplink Release Indication	C	C(=)
Uplink Reject Command	C	C(=)
Uplink Seized Command	C	C(=)
Uplink Release Command	C	C(=)
State Attributes	C	C(=)

10.6.3 Parameter definitions and use

IMSI

Identity of the service subscriber who has established the call and who is allowed to terminate the call.

Invoke Id

See definition in clause 7.6.1.

Uplink Request Acknowledgement

This information element is used for positive acknowledgement of an uplink request.

Uplink Release Indication

This information element if included by the Anchor MSC indicates to the Relay MSC that the uplink has become free.

Uplink Reject Command

This information element is used for negative acknowledgement of an uplink request.

Uplink Seized Command

This information element if included by the Anchor MSC indicates to the Relay MSC that the uplink is no longer free.

Uplink Release Command

This information element if included by the Anchor MSC indicates to the Relay MSC that the uplink which is granted to a MS in the relay MSC area shall be released.

State Attributes

This information element is used to allow service logic running in an Anchor MSC to mute a VGCS talker even when the talker is served on a Relay MSC. The IE is used to build a GCC message that provides a mechanism to induce the VGCS talker terminal to mute/unmute the downlink at the Anchor MSC, as defined in 3GPP TS 44.068.

10.7 MAP_SEND_GROUP_CALL_END_SIGNAL service

10.7.1 Definitions

This service is used between the Relay MSC and the Anchor MSC indicating that VGCS / VBS channels have been established in the Relay MSC area. The response is used by the Anchor MSC to inform the Relay MSC that all resources for the call can be released in the Relay MSC because the call has been released in the Anchor MSC.

The MAP_SEND_GROUP_CALL_END_SIGNAL service is a confirmed service using the service primitives given in table 10.7/1.

10.7.2 Service primitives

Table 10.7/1: MAP_SEND_GROUP_CALL_END_SIGNAL service

Parameter name	Request	Indication	Response	Confirm
Invoke Id	M	M(=)	M(=)	M(=)
IMSI	C	C(=)		
Provider Error				O

10.7.3 Parameter definitions and use

IMSI

Identity of the service subscriber who has established the call and who is allowed to terminate the call.

Shall be present if the call was established by a service subscriber roaming in the relay MSC area.

Invoke Id

See definition in clause 7.6.1

Provider Error

See definition of provider error in clause 7.6.1.

10.8 MAP_Provide_SIWFS_Number

10.8.1 Definition

This service is used between an MSC and SIWFS. It is invoked by an MSC receiving an incoming call (call to or from MS) to request the SIWFS to allocate IWU resources. The service is defined in GSM 03.54.

This is a confirmed service using the primitives described in table 10.8/1.

10.8.2 Service primitive

Table 10.8/1: MAP_Provide_SIWFS_Number service

Parameter name	Request	Indication	Response	Confirm
Invoke ID	M	M(=)	M(=)	M(=)
GSM Bearer Capability	M	M(=)		
ISDN Bearer Capability	M	M(=)		
Call Direction	M	M(=)		

B-subscriber address	M	M(=)		
Chosen Channel	M	M(=)		
Lower Layer Compatibility	C	C(=)		
High Layer Compatibility	C	C(=)		
SIWFS number			C	C(=)
User error			C	C(=)
Provider error				O

10.8.3 Parameter use

See clause 7.6 for a definition of the parameters used, in addition to the following.

GSM Bearer Capability

This information is the result from the negotiation with the mobile station. The information is sent from the MSC to the SIWFS to allocate the correct IWU.

ISDN Bearer Capability

This parameter refers to the ISDN Bearer Capability information element. For the MTC this parameter is received in the ISUP User Service Information parameter. For the MOC call this parameter is mapped from the GSM BC parameter according to 3GPP TS 29.007 [56]. The parameter is used by the SIWFS to route the call and to allocate the outgoing circuit.

Call Direction

This parameter indicates the direction of the call (mobile originated or mobile terminated) at call set-up.

B-subscriber address

This parameter is sent from the MSC to the SIWFS to inform the SIWFS where to route the call i.e. where to send the IAM. If the loop method is used this parameter will indicate the address to the VMSC. This address is allocated by the VMSC in the same way as a MSRN and is used to correlate the incoming IAM to the corresponding MAP dialogue. If the non-loop method is used this parameter will indicate the address to the B-subscriber.

Chosen Channel

This parameter is sent from the MSC to the SIWFS to adjust the interworking unit to the assigned radio resources. This parameter is defined in 3GPP TS 48.008 [49].

Lower Layer Compatibility

This parameter is sent from the MSC to the SIWF to allow the interworking unit to perform a compatibility check. This parameter is handled as specified in 3GPP TS 29.007 [56]. This parameter is defined in 3GPP TS 24.008 [35].

High Layer Compatibility

This parameter is sent from the MSC to the SIWF to allow the interworking unit to perform a compatibility check. This parameter is handled as specified in 3GPP TS 29.007 [56]. This parameter is defined in 3GPP TS 24.008 [35].

SIWFS number

This parameter is sent from the SIWFS to the MSC. This address is used by the visited MSC to route the call, i.e. the IAM to the SIWFS (similar to MSRN) and will be used by the SIWFS to correlate the incoming IAM to the corresponding MAP message. This parameter must always be sent from the SIWFS when a successful allocation of SIWFS resources has been made.

User error

This parameter is sent by the responder when an error is detected and if present, takes one of the following values:

- Resource limitation;
- Facility Not Supported;

- Unexpected Data Value;
- System Failure.

See clause 7.6 for a definition of these reasons.

Provider error

These are defined in clause 7.6.

10.9 MAP_SIWFS_Signalling_Modify

10.9.1 Definition

This service is used to transport signalling information between an MSC and an SIWFS in the case of a request to modify the configuration (e.g. HSCSD). It is invoked either by an MSC or by the SIWFS. The service is defined in GSM 03.54.

This is a confirmed service using the primitives described in table 10.9/1.

10.9.2 Service primitive

Table 10.9/1: MAP_SIWFS_Signalling_Modify service

Parameter name	Request	Indication	Response	Confirm
Invoke ID	M	M(=)	M(=)	M(=)
Channel Type	C	C(=)		
Chosen Channel	C	C(=)	C(=)	C(=)
User error			C	C(=)
Provider error				O

10.9.3 Parameter use

See clause 7.6 for a definition of the parameter used, in addition to the following.

Channel Type

This parameter is the result of a Channel Mode Modification for TS61/62. It contains the changed Air Interface User Rate. The information is sent from the SIWFS to the MSC to assign the correct radio resource. This parameter is defined in 3GPP TS 48.008 [49].

Chosen Channel

This parameter is sent from the MSC to the SIWFS to adjust the interworking unit to the assigned radio resources. This parameter is defined in 3GPP TS 48.008 [49].

User error

This parameter is sent by the responder when an error is detected and if present , takes one of the following values:

- Resource limitation;
- Facility Not Supported;
- Data Missing;
- Unexpected Data Value;
- System Failure.

See clause 7.6 for a definition of these reasons.

Provider error

These are defined in clause 7.6.

10.10 MAP_SET_REPORTING_STATE service

10.10.1 Definition

This service is used between the HLR and the VLR to set the reporting state for a requested service. It is a confirmed service using the service primitives shown in table 10.10/1.

10.10.2 Service primitives

Table 10.10/1: MAP_SET_REPORTING_STATE parameters

Parameter name	Request	Indication	Response	Confirm
Invoke id	M	M(=)	M(=)	M(=)
IMSI	C	C(=)		
LMSI	C	C(=)		
CCBS Monitoring	C	C(=)		
CCBS Subscriber Status			C	C(=)
User error			C	C(=)
Provider error				O

10.10.3 Parameter use

See clause 7.6 for a definition of the parameters used, in addition to the following.

IMSI

The IMSI is a mandatory parameter if the service is used as the only one in a dialogue.

CCBS Monitoring

This parameter indicates whether monitoring for CCBS shall be started or stopped. If it indicates that monitoring shall be started this service corresponds to the message 'Start Reporting' in 3GPP TS 23.093 [107]; if it indicates that monitoring shall be stopped this service corresponds to the message 'Stop Reporting' in 3GPP TS 23.093 [107].

CCBS Subscriber Status

See 3GPP TS 23.093 [107] for the use of this parameter and the conditions for its presence.

User error

This parameter is sent by the responder upon unsuccessful outcome of the service, and then takes one of the following values defined in clause 7.6.1:

- System Failure;
- Unidentified Subscriber;
- Unexpected Data Value;
- Data Missing;
- Resource Limitation;
- Facility Not Supported.

NOTE: This error is reserved for future use.

Provider error

These are defined in clause 7.6.

10.11 MAP_STATUS_REPORT service

10.11.1 Definition

This service is used by the VLR to report an event or call outcome to the HLR. It is a confirmed service using the service primitives shown in table 10.11/1.

10.11.2 Service primitives

Table 10.11/1: MAP_STATUS_REPORT parameters

Parameter name	Request	Indication	Response	Confirm
Invoke id	M	M(=)	M(=)	M(=)
IMSI	M	M(=)		
CCBS Subscriber Status	C	C(=)		
Monitoring Mode	C	C(=)		
Call Outcome	C	C(=)		
User error			C	C(=)
Provider error				O

10.11.3 Parameter use

See clause 7.6 for a definition of the parameters used, in addition to the following.

CCBS Subscriber Status

If this parameter is present without Monitoring Mode and Call Outcome this service corresponds to the message 'Event Report' in 3GPP TS 23.093 [107]. See 3GPP TS 23.093 [107] for the use of this parameter and the conditions for its presence.

Monitoring Mode

If this parameter is present with CCBS Call Outcome this service corresponds to the message 'CCBS Call Report' in 3GPP TS 23.093 [107]. See 3GPP TS 23.093 [107] for the use of this parameter and the conditions for its presence.

Call Outcome

See 3GPP TS 23.093 [107] for the use of this parameter and the conditions for its presence.

User error

This parameter is sent by the responder upon unsuccessful outcome of the service, and then takes one of the following values defined in clause 7.6.1:

- Unknown Subscriber;
- System Failure;
- Unexpected Data Value;
- Data Missing.

Provider error

These are defined in clause 7.6.

10.12 MAP_REMOTE_USER_FREE service

10.12.1 Definition

This service is used between the HLR and the VLR to report that the B subscriber is now idle and that the A subscriber can be notified. It is a confirmed service using the service primitives shown in table 10.12/1.

10.12.2 Service primitives

Table 10.12/1: MAP_REMOTE_USER_FREE parameters

Parameter name	Request	Indication	Response	Confirm
Invoke id	M	M(=)	M(=)	M(=)
IMSI	M	M(=)		
Call Info	M	M(=)		
CCBS Feature	M	M(=)		
Translated B Number	M	M(=)		
Replace B Number	C	C(=)		
Alerting Pattern	C	C(=)		
RUF Outcome			C	C(=)
User error			C	C(=)
Provider error				O

10.12.3 Parameter use

See clause 7.6 for a definition of the parameters used, in addition to the following.

Call Info

See 3GPP TS 23.093 [107] for the use of this parameter.

CCBS Feature

See 3GPP TS 23.093 [107] for the conditions for the presence of the parameters included in the CCBS feature.

Translated B Number

See 3GPP TS 23.093 [107] for the use of this parameter.

Replace B Number

See 3GPP TS 23.093 [107] for the use of this parameter and the conditions for its presence.

Alerting Pattern

See 3GPP TS 23.093 [107] for the use of this parameter and the conditions for its presence.

RUF Outcome

See 3GPP TS 23.093 [107] for the use of this parameter and the conditions for its presence.

User error

This parameter is sent by the responder upon unsuccessful outcome of the service, and then takes one of the following values defined in clause 7.6.1:

- Unexpected Data Value;
- Data Missing;
- Incompatible Terminal;

- This error is returned by the responder when the terminal used for CCBS activation is not compatible with the terminal used for the CCBS recall. For details refer to 3GPP TS 24.008 [35];
- Absent Subscriber (IMSI Detach; Restricted Area; No Page Response);
- System Failure;
- Busy Subscriber (CCBS Busy).

Provider error

These are defined in clause 7.6.

10.13 MAP_IST_ALERT service

10.13.1 Definition

This service is used between the MSC (Visited MSC or Gateway MSC) and the HLR, to report that the IST timer running for a call for the Subscriber has expired. It is a confirmed service using the service primitives shown in table 10.13/1.

10.13.2 Service primitives

Table 10.13/1: MAP_IST_ALERT parameters

Parameter name	Request	Indication	Response	Confirm
Invoke Id	M	M(=)	M(=)	M(=)
IMSI	M	M(=)		
IST Alert Timer			C	C(=)
IST Information Withdraw			C	C(=)
Call termination Indicator			C	C(=)
User error			C	C(=)
Provider error				O

10.13.3 Parameter use

All parameters are described in clause 7.6. The following clarifications are applicable:

IST Alert Timer

If included in the IST Alert response, it includes the new IST Alert timer value that must be used to inform the HLR about the call activities that the subscriber performs.

IST Information Withdraw

If included in the IST Alert response, this parameter is used to indicate that the IST condition has been removed for the subscriber. When the MSC receives this parameter, IST control for that call shall be terminated.

Call termination Indicator

If included in the IST Alert response, this parameter is used to indicate whether the MSC shall terminate the call activity that had previously triggered the IST Alert procedure, or it shall also release all other call activities for the specified subscriber (outgoing call activities if the IST Alert is initiated by the VMSC, or incoming call activities if the IST Alert is initiated by the GMSC). Release of all other call activities is possible only if the MSC has the capability to link the call activities for the Subscriber by using the IMSI as key.

User error

This parameter is sent by the responder when an error is detected and if present, takes one of the following values:

- System Failure;

- Unexpected Data Value;
- Resource Limitation;
- Facility Not Supported;
- Unknown Subscriber.

10.14 MAP_IST_COMMAND service

10.14.1 Definition

This service is used by the HLR to instruct the MSC (Visited MSC or Gateway MSC) to terminate ongoing call activities for a specific subscriber. It is a confirmed service using the service primitives shown in table 10.14/1.

10.14.2 Service primitives

Table 10.14/1: MAP_IST_COMMAND parameters

Parameter name	Request	Indication	Response	Confirm
Invoke Id	M	M(=)	M(=)	M(=)
IMSI	M	M(=)		
User error			C	C(=)
Provider error				O

10.14.3 Parameter use

All parameters are described in clause 7.6. The following clarifications are applicable:

User error

This parameter is sent by the responder when an error is detected and if present, takes one of the following values:

- System Failure;
- Unexpected Data Value;
- Resource Limitation;
- Facility Not Supported;
- Unknown Subscriber.

11 Supplementary services related services

11.1 MAP_REGISTER_SS service

11.1.1 Definition

This service is used between the MSC and the VLR and between the VLR and the HLR to register data related to a supplementary service. The VLR will relay the message to the HLR.

The service is a confirmed service and uses the service primitives shown in table 11.1./1.

11.1.2 Service primitives

Table 11.1/1: MAP_REGISTER_SS parameters

Parameter name	Request	Indication	Response	Confirm
Invoke id	M	M(=)	M(=)	M(=)
SS-Code	M	M(=)		
Basic service	C	C(=)		
Forwarded-to number with subaddress	C	C(=)		
No reply condition time	C	C(=)		
EMLPP default priority	C	C(=)	C	C(=)
Long FTN Supported	C	C(=)		
NbrUser	C	C(=)	C	C(=)
Forwarding information			C	C(=)
User error			C	C(=)
Provider error				O

11.1.3 Parameter use

Invoke id

See clause 7.6.1 for the use of this parameter.

SS-Code

This parameter indicates the supplementary service which the mobile subscriber wants to register.

Basic service

This parameter indicates for which basic service group the supplementary service is to be registered. If it is not included, the registration request applies to all basic services.

Forwarded-to number with subaddress

This parameter is obligatory if the registration applies to one or more call forwarding supplementary services. It can optionally include a sub-address.

No reply condition time

This parameter is included if the registration applies to the Call Forwarding on No Reply supplementary service (or a superset of this service) and the mobile subscriber supplies a value for this time.

EMLPP default priority

This parameter is sent by the initiator to register the eMLPP default priority level and is returned by the responder at successful outcome of the service.

Long FTN Supported

This parameter indicates that the mobile station supports Long Forwarded-to Numbers.

NbrUser

This parameter is sent by the initiator to register the MC maximum number of user defined circuit switched bearers to be used.

Forwarding information

This parameter is returned by the responder at successful outcome of the service, if the registration request concerned one or a group of Call Forwarding supplementary services.

User error

This parameter is sent by the responder upon unsuccessful outcome of the service, and then takes one of the following values defined in clause 7.6.1:

- System failure;
- Data missing;
- Unexpected data value;
- Call Barred;
- Bearer service not provisioned;
- This error is returned only if not even a subset of the requested bearer service group has been subscribed to;
- Teleservice not provisioned;

This error is returned only if not even a subset of the requested teleservice group has been subscribed to;

- Illegal SS operation;
- SS error status;
- SS incompatibility.

Provider error

See clause 7.6.1 for the use of this parameter.

11.2 MAP_ERASE_SS service

11.2.1 Definition

This service is used between the MSC and the VLR and between the VLR and the HLR to erase data related to a supplementary service. The VLR will relay the message to the HLR.

The service is a confirmed service and uses the service primitives shown in table 11.2/1.

11.2.2 Service primitives

Table 11.2/1: MAP_ERASE_SS parameters

Parameter name	Request	Indication	Response	Confirm
Invoke id	M	M(=)	M(=)	M(=)
SS-Code	M	M(=)		
Basic service	C	C(=)		
Forwarding information			C	C(=)
User error			C	C(=)
Provider error				O

11.2.3 Parameter use

Invoke id

See clause 7.6.1 for the use of this parameter.

SS-Code

This parameter indicates the supplementary service which the mobile subscriber wants to erase.

Basic service

This parameter indicates for which basic service group the supplementary service should be erased. If it is not included, the erasure request applies to all basic services.

Forwarding information

This parameter is returned by the responder at successful outcome of the service, if the erasure request concerned one or a group of Call Forwarding supplementary services.

User error

This parameter is sent by the responder upon unsuccessful outcome of the service, and then takes one of the following values, defined in clause 7.6.1:

- System failure;
- Data Missing;
- Unexpected data value;
- Bearer service not provisioned;

This error is returned only if not even a subset of the requested bearer service group has been subscribed to;

- Teleservice not provisioned;

This error is returned only if not even a subset of the requested teleservice group has been subscribed to;

- Call Barred;
- Illegal SS operation;
- SS error status.

Provider error

See clause 7.6.1 for the use of this parameter.

11.3 MAP_ACTIVATE_SS service

11.3.1 Definition

This service is used between the MSC and the VLR and between the VLR and the HLR to activate a supplementary service. The VLR will relay the message to the HLR.

The service is a confirmed service and uses the service primitives shown in table 11.3/1.

11.3.2 Service primitives

Table 11.3/1: MAP_ACTIVATE_SS parameters

Parameter name	Request	Indication	Response	Confirm
Invoke id	M	M(=)	M(=)	M(=)
SS-Code	M	M(=)		
Long FTN Supported	C	C(=)		
Basic service	C	C(=)		
Forwarding information			C	C(=)
Call barring information			C	C(=)
SS-Data			C	C(=)
User error			C	C(=)
Provider error				O

11.3.3 Parameter use

Invoke id

See clause 7.6.1 for the use of this parameter.

SS-Code

This parameter indicates the supplementary service which the mobile subscriber wants to activate.

Basic service

This parameter indicates for which basic service groups the requested supplementary service(s) should be activated. If it is not included, the activation request applies to all basic services.

Forwarding information

This parameter is returned by the responder at successful outcome of the service, if the activation request concerned Call Forwarding.

Long FTN Supported

This parameter indicates that the mobile station supports Long Forwarded-to Numbers.

Call barring information

This parameter is returned by the responder at successful outcome of the service, if the activation request concerned Call Barring.

SS-Data

This parameter is returned by the responder at successful outcome of the service, if the activation request concerned for example Call Waiting.

User error

This parameter is sent by the responder upon unsuccessful outcome of the service, and then takes one of the following values, defined in clause 7.6.1:

- System failure;
- Data Missing;
- Unexpected data value;
- Bearer service not provisioned;
- This error is returned only if not even a subset of the requested bearer service group has been subscribed to.
- Teleservice not provisioned;
- This error is returned only if not even a subset of the requested teleservice group has been subscribed to.
- Call Barred;
- Illegal SS operation;
- SS error status;
- SS subscription violation;
- SS incompatibility;
- Negative PW check;
- Number Of PW Attempts Violation.

Provider error

See clause 7.6.1 for the use of this parameter.

11.4 MAP_DEACTIVATE_SS service

11.4.1 Definitions

This service is used between the MSC and the VLR and between the VLR and the HLR to deactivate a supplementary service. The VLR will relay the message to the HLR.

The service is a confirmed service and uses the service primitives shown in table 11.4/1.

11.4.2 Service primitives

Table 11.4/1: MAP_DEACTIVATE_SS parameters

Parameter name	Request	Indication	Response	Confirm
Invoke id	M	M(=)	M(=)	M(=)
SS-Code	M	M(=)		
Basic service	C	C(=)		
Forwarding information			C	C(=)
Call barring information			C	C(=)
SS-Data			C	C(=)
User error			C	C(=)
Provider error				O

11.4.3 Parameter use

Invoke id

See clause 7.6.1 for the use of this parameter.

SS-Code

This parameter indicates the supplementary service which the mobile subscriber wants to deactivate.

Basic service

This parameter indicates for which basic service group the requested supplementary service(s) should be deactivated. If it is not included the deactivation request applies to all basic services.

Forwarding information

This parameter is returned by the responder at successful outcome of the service, if the deactivation request concerned one or a group of Call Forwarding supplementary services.

Call barring information

This parameter is returned by the responder at successful outcome of the service, if the activation request concerned one or a group of Call Barring supplementary services.

SS-Data

This parameter is returned by the responder at successful outcome of the service, for example if the deactivation request concerned the Call Waiting supplementary service.

User error

This parameter is sent by the responder upon unsuccessful outcome of the service, and then takes one of the following values, defined in clause 7.6.1:

- System failure;
- Data Missing;
- Unexpected data value;
- Bearer service not provisioned;

This error is returned only if not even a subset of the requested bearer service group has been subscribed to;

- Teleservice not provisioned;

This error is returned only if not even a subset of the requested teleservice group has been subscribed to;

- Call Barred;
- Illegal SS operation;
- SS error status;
- SS subscription violation;
- Negative PW check;
- Number Of PW Attempts Violation.

Provider error

See clause 7.6.1 for the use of this parameter.

11.5 MAP_INTERROGATE_SS service

11.5.1 Definitions

This service is used between the MSC and the VLR and between the VLR and the HLR to retrieve information related to a supplementary service. The VLR will relay the message to the HLR if necessary.

The service is a confirmed service and consists of four service primitives.

11.5.2 Service primitives

The service primitives are shown in table 11.5/1.

Table 11.5/1: MAP_INTERROGATE_SS parameters

Parameter name	Request	Indication	Response	Confirm
Invoke id	M	M(=)	M(=)	M(=)
SS-Code	M	M(=)		
Basic service	C	C(=)		
Long FTN Supported	C	C(=)		
SS-Status			C	C(=)
Basic service Group LIST			C	C(=)
Forwarding feature LIST			C	C(=)
CLI restriction Info			C	C(=)
EMLPP Info			C	C(=)
MC Information			C	C(=)
CCBS Feature LIST			C	C(=)
User error			C	C(=)
Provider error				O

11.5.3 Parameter use

For additional information on parameter use refer to the GSM 04.8x and 04.9x-series of technical specifications.

Invoke id

See clause 7.6.1 for the use of this parameter.

SS-Code

The mobile subscriber can only interrogate a single supplementary service per service request.

Basic service

This parameter indicates for which basic service group the given supplementary service is interrogated. If it is not included, the interrogation request applies to all basic services.

SS-Status

This parameter is included by the responder if:

- the interrogated supplementary service can only be subscribed for all applicable basic services simultaneously;
or
- the interrogated supplementary service is not active for any of the interrogated basic services, or
- the interrogation was for the CCBS supplementary service and no CCBS request is active or the service is not provisioned.

Basic service group LIST

This parameter LIST is used to include one or a series of basic service groups for which the interrogated supplementary service is active. If the interrogated supplementary service is not active for any of the interrogated (and provisioned) basic service groups, the SS-Status parameter is returned.

Long FTN Supported

This parameter indicates that the mobile station supports Long Forwarded-to Numbers.

Forwarding feature LIST

The forwarding feature parameter is described in clause 7.6.4. A list of one or more forwarding features is returned by the responder when the interrogation request applied to Call Forwarding supplementary service.

If no basic service code parameter is provided within this sequence, the forwarding feature parameter applies to all provisioned basic services.

CLI restriction Info

The CLI-RestrictionInfo parameter is returned by the responder when the interrogation request applies to the CLIR supplementary service.

EMLPP Info

The eMLPP info (maximum entitled priority and default priority) is returned by the responder if the interrogation request applies to the eMLPP supplementary service.

MC Information

The MC information (NbrSB, NbrUser and NbrSN) is returned by the responder if the interrogation request applies to the MC supplementary service. For a definition of these 3 components, refer to 3GPP TS 23.135 and 3GPP TS 24.135.

CCBS Feature LIST

The CCBS feature parameter is described in clause 7.6. A list of one or more CCBS features is returned by the responder when the interrogation request applied to the CCBS supplementary service. See 3GPP TS 23.093 [107] for the conditions for the presence of the parameters included in the CCBS feature.

User error

This error is sent by the responder upon unsuccessful outcome of the interrogation service, and then takes one of the following values, defined in clause 7.6.1:

- System failure;
- Data Missing;
- Unexpected data value;
- Bearer Service not provisioned;

This error is returned only if not even a subset of the interrogated bearer services are provided;

- Teleservice not provisioned;

This error is returned only if not even a subset of the interrogated teleservices are provided;

- Call Barred;
- Illegal SS operation;
- SS not available.

Provider error

See clause 7.6.1 for the use of this parameter.

11.6 Void

11.7 MAP_REGISTER_PASSWORD service

11.7.1 Definitions

This service is used between the MSC and the VLR and between the VLR and the HLR if the mobile subscriber requests to register a new password. The VLR will relay the message to the HLR.

The service is a confirmed service and consists of four service primitives.

11.7.2 Service primitives

The service primitives are shown in table 11.7/1.

Table 11.7/1: MAP_REGISTER_PASSWORD parameters

Parameter name	Request	Indication	Response	Confirm
Invoke id	M	M(=)	M(=)	M(=)
SS-Code	M	M(=)		
New password			C	C(=)
User error			C	C(=)
Provider error				O

11.7.3 Parameter use

Invoke id

See clause 7.6.1 for the use of this parameter.

SS-Code

This parameter indicates for which supplementary service(s) the password should be registered.

New Password

See clause 7.6.4 for the use of this parameter.

User error

This parameter is sent by the responder upon unsuccessful outcome of the service, and then takes one of the following values, defined in clause 7.6.1:

- System failure;
- Data Missing;
- Unexpected data value;
- Call Barred;
- SS subscription violation;
- Password registration failure;
- Negative PW check;
- Number Of PW Attempts Violation.

Provider error

See clause 7.6.1 for the use of this parameter.

11.8 MAP_GET_PASSWORD service

11.8.1 Definitions

This service is used between the HLR and the VLR and between the VLR and the MSC when the HLR receives a request from the mobile subscriber for an operation on a supplementary service which requires a password from the subscriber. The VLR will relay the message to the MSC.

The service is a confirmed service and uses the service primitives shown in table 11.8/1.

11.8.2 Service primitives

Table 11.8/1: MAP_GET_PASSWORD parameters

Parameter name	Request	Indication	Response	Confirm
Invoke id	M	M(=)	M(=)	M(=)
Linked id	C	C(=)		
Guidance info	M	M(=)		
Current password			M	M(=)
Provider error				O

11.8.3 Parameter use

Invoke id

See clause 7.6.1 for the use of this parameter.

Linked Id

See clause 7.6.1 for the use of this parameter. If the MAP_GET_PASSWORD service is used in conjunction with the MAP_REGISTER_PASSWORD service, this parameter must be present; otherwise it must be absent.

Guidance info

See clause 7.6.4 for the use of this parameter.

Current password

See clause 7.6.4 for the use of this parameter.

Provider error

See clause 7.6.1 for the use of this parameter.

11.9 MAP_PROCESS_UNSTRUCTURED_SS_REQUEST service

11.9.1 Definitions

This service is used between the MSC and the VLR, between the VLR and the HLR, between the HLR and gsmSCF and between the HLR and HLR to relay information in order to allow unstructured supplementary service operation.

The MAP_PROCESS_UNSTRUCTURED_SS_REQUEST service is a confirmed service using the primitives from table 11.9/1.

11.9.2 Service primitives

Table 11.9/1: MAP_PROCESS_UNSTRUCTURED_SS_REQUEST parameters

Parameter name	Request	Indication	Response	Confirm
Invoke id	M	M(=)	M(=)	M(=)
USSD Data Coding Scheme	M	M(=)	C	C(=)
USSD String	M	M(=)	C	C(=)
MSISDN	U	C(=)		
User error			C	C(=)
Provider error				O

11.9.3 Parameter use

Invoke id

See clause 7.6.1 for the use of this parameter.

USSD Data Coding Scheme

See clause 7.6.4 for the use of this parameter. The presence of the parameter in the response is dependent on the unstructured supplementary service application. If this parameter is present, then the USSD String parameter has to be present.

USSD String

See clause 7.6.1 for the use of this parameter. The presence of the parameter in the response is dependent on the unstructured supplementary service application. If this parameter is present, then the USSD Data Coding Scheme parameter has to be present.

MSISDN

The subscriber's basic MSISDN.

See definition in clause 7.6.2. The MSISDN is included as an operator option, e.g. to allow addressing the subscriber's data in the gsmSCF with the MSISDN.

User error

This parameter is sent by the responder upon unsuccessful outcome of the service, and then takes one of the following values defined in clause 7.6.1:

- System failure;
- Data missing;
- Unexpected data value;

This error is returned by the responder if it is not able to deal with the contents of the USSD string.

- Call Barred;
- Unknown Alphabet.

Provider error

See clause 7.6.1 for the use of this parameter.

11.10 MAP_UNSTRUCTURED_SS_REQUEST service

11.10.1 Definitions

This service is used between the gsmSCF and the HLR, the HLR and the VLR and between the VLR and the MSC when the invoking entity requires information from the mobile user, in connection with unstructured supplementary service handling.

The MAP_UNSTRUCTURED_SS_REQUEST service is a confirmed service using the primitives from table 11.10/1.

11.10.2 Service primitives

Table 11.10/1: MAP_UNSTRUCTURED_SS_REQUEST parameters

Parameter name	Request	Indication	Response	Confirm
Invoke id	M	M(=)	M(=)	M(=)
USSD Data Coding Scheme	M	M(=)	C	C(=)
USSD String	M	M(=)	C	C(=)
Alerting Pattern	C	C(=)		
User error			C	C(=)
Provider error				O

11.10.3 Parameter use

Invoke id

See clause 7.6.1 for the use of this parameter.

USSD Data Coding Scheme

See clause 7.6.4 for the use of this parameter. The presence of the parameter in the response is dependent on the mobile user's MMI input. If this parameter is present, then the USSD String parameter has to be present.

USSD String

See clause 7.6.1 for the use of this parameter. The presence of the parameter in the response is dependent on the mobile user's MMI input. If this parameter is present, then the USSD Data Coding Scheme parameter has to be present.

Alerting Pattern

See clause 7.6.3 for the use of this parameter.

User error

This parameter is sent by the responder upon unsuccessful outcome of the service, and then takes one of the following values defined in clause 7.6.1:

- System failure;
- Data missing;
- Unexpected data value;

This error is returned by the responder if it is not able to deal with the contents of the USSD string;

- Absent Subscriber;
- Illegal Subscriber;

This error indicates that delivery of the unstructured supplementary service data failed because the MS failed authentication;

- Illegal Equipment;
- USSD Busy;
- Unknown Alphabet.

Provider error

See clause 7.6.1 for the use of this parameter.

11.11 MAP_UNSTRUCTURED_SS_NOTIFY service

11.11.1 Definitions

This service is used between the gsmSCF and the HLR, the HLR and the VLR and between the VLR and the MSC when the invoking entity requires a notification to be sent to the mobile user, in connection with unstructured supplementary services handling.

The MAP_UNSTRUCTURED_SS_NOTIFY service is a confirmed service using the primitives from table 11.11/1.

11.11.2 Service primitives

Table 11.11/1: MAP_UNSTRUCTURED_SS_NOTIFY parameters

Parameter name	Request	Indication	Response	Confirm
Invoke id	M	M(=)	M(=)	M(=)
USSD Data Coding Scheme	M	M(=)		
USSD String	M	M(=)		
Alerting Pattern	C	C(=)		
User error			C	C(=)
Provider error				O

11.11.3 Parameter use

Invoke id

See clause 7.6.1 for the use of this parameter.

USSD Data Coding Scheme:

See clause 7.6.4 for the use of this parameter.

USSD String:

See clause 7.6.1 for the use of this parameter.

Alerting Pattern

See clause 7.6.3 for the use of this parameter.

User error

This parameter is sent by the responder upon unsuccessful outcome of the service, and then takes one of the following values defined in clause 7.6.1:

- System failure;
- Data missing;
- Unexpected data value;

This error is returned by the responder if it is not able to deal with the contents of the USSD string.

- Absent Subscriber;
- Illegal Subscriber;

This error indicates that delivery of the unstructured supplementary service data failed because the MS failed authentication.

- Illegal Equipment;
- USSD Busy;
- Unknown Alphabet.

Provider error

See clause 7.6.1 for the use of this parameter.

11.12 MAP_SS_INVOCATION_NOTIFY

11.12.1 Definition

This service is used between the MSC and the gsmSCF when the subscriber invokes one of the following supplementary services; Call Deflection (CD), Explicit Call Transfer (ECT) or Multi Party (MPTY).

This service is used between the HLR and the gsmSCF when the subscriber invokes the CCBS supplementary service.

11.12.2 Service primitives

The service primitives are shown in table 11.12/1.

Table 11.12/1: SS_INVOCATION_NOTIFY parameters

Parameter name	Request	Indication	Response	Confirm
Invoke id	M	M(=)	M(=)	M(=)
MSISDN	M	M(=)		
IMSI	M	M(=)		
SS- event	M	M(=)		
SS- event data	C	C(=)		
B-subscriber Number	C	C(=)		
CCBS Request State	C	C(=)		
User error			C	C(=)
Provider error				O

11.12.3 Parameter use

All parameters are described in clause 7.6. The use of these parameters and the requirements for their presence are specified in 3GPP TS 23.078.

User error

This parameter is sent by the responder when an error is detected and if present, takes one of the following values:

- Data Missing;
- Unexpected Data Value;
- Unknown Subscriber.

Provider error

This is defined in clause 7.6.1.

11.13 MAP_REGISTER_CC_ENTRY service

11.13.1 Definition

This service is used between the MSC and the VLR and between the VLR and the HLR to register data for a requested call completion supplementary service. The VLR will relay the message to the HLR.

The service is a confirmed service and uses the service primitives shown in table 11.13/1.

11.13.2 Service primitives

Table 11.13/1: MAP_REGISTER_CC_ENTRY parameters

Parameter name	Request	Indication	Response	Confirm
Invoke id	M	M(=)	M(=)	M(=)
SS Code	M	M(=)		
CCBS Feature	C	C(=)	C	C(=)
Translated B number	C	C(=)		
Service Indicator	C	C(=)		
Call Info	C	C(=)		
Network Signal Info	C	C(=)		
User error			C	C(=)
Provider error				O

11.13.3 Parameter use

See clause 7.6 for a definition of the parameters used, in addition to the following.

SS-Code

This parameter indicates the call completion supplementary service for which the mobile subscriber wants to register an entry.

CCBS Feature

See 3GPP TS 23.093 [107] for the conditions for the presence of the parameters included in the CCBS feature.

Translated B Number

See 3GPP TS 23.093 [107] for the use of this parameter and the conditions for its presence.

Service Indicator

This parameter corresponds to the parameters 'Presentation Indicator' and 'CAMEL Invoked' in 3GPP TS 23.093 [107]. It indicates which services have been invoked for the original call (e.g. CLIR, CAMEL). See 3GPP TS 23.093 [107] for the use of this parameter and the conditions for its presence.

Call Info

See 3GPP TS 23.093 [107] for the use of this parameter and the conditions for its presence.

Network Signal Info

See 3GPP TS 23.093 [107] for the use of this parameter and the conditions for its presence.

User error

This parameter is sent by the responder upon unsuccessful outcome of the service, and then takes one of the following values, defined in clause 7.6.1:

- System failure;
- Data missing;
- Unexpected data value;
- Call Barred;
- Illegal SS operation;
- SS error status;
- SS incompatibility.

- Short Term Denial;
- Long Term Denial;
- Facility Not Supported;

NOTE: This error is reserved for future use.

Private Extensions shall not be sent with these user errors for this operation.

Provider error

See clause 7.6.1 for the use of this parameter.

11.14 MAP_ERASE_CC_ENTRY service

11.14.1 Definition

This service is used between the MSC and the VLR and between the VLR and the HLR to erase data related to a call completion supplementary service. The VLR will relay the message to the HLR.

The service is a confirmed service and uses the service primitives shown in table 11.14/1.

11.14.2 Service primitives

Table 11.14/1: MAP_ERASE_CC_ENTRY parameters

Parameter name	Request	Indication	Response	Confirm
Invoke id	M	M(=)	M(=)	M(=)
SS-Code	M	M(=)	C(=)	C(=)
CCBS Index	C	C(=)		
SS-Status			C	C(=)
User error			C	C(=)
Provider error				O

11.14.3 Parameter use

See clause 7.6 for a definition of the parameters used, in addition to the following.

SS-Code

This parameter indicates the call completion supplementary service for which the mobile subscriber wants to erase an entry/entries.

CCBS Index

See 3GPP TS 23.093 [107] for the use of this parameter and the condition for its presence.

SS-Status

Depending on the outcome of the service request this parameter may indicate either provisioned and active or not provisioned.

User error

This parameter is sent by the responder upon unsuccessful outcome of the service, and then takes one of the following values, defined in clause 7.6.1:

- System failure;
- Data Missing;

- Unexpected data value;
- Call Barred;
- Illegal SS operation;
- SS error status.

Private Extensions shall not be sent with these user errors for this operation.

Provider error

See clause 7.6.1 for the use of this parameter.

12 Short message service management services

12.1 MAP-SEND-ROUTING-INFO-FOR-SM service

12.1.1 Definition

This service is used between the gateway MSC and the HLR to retrieve the routing information needed for routing the short message to the servicing MSC.

The MAP-SEND-ROUTING-INFO-FOR-SM is a confirmed service using the primitives from table 12.1/1.

12.1.2 Service primitives

Table 12.1/1: MAP-SEND-ROUTING-INFO-FOR-SM

Parameter name	Request	Indication	Response	Confirm
Invoke Id	M	M(=)	M(=)	M(=)
MSISDN	M	M(=)		
SM-RP-PRI	M	M(=)		
Service Centre Address	M	M(=)		
SM-RP-MTI	C	C(=)		
SM-RP-SMEA	C	C(=)		
GPRS Support Indicator	C	C(=)		
IMSI			C	C(=)
Network Node Number			C	C(=)
LMSI			C	C(=)
GPRS Node Indicator			C	C(=)
Additional Number			C	C(=)
User error			C	C(=)
Provider error				O

12.1.3 Parameter use

Invoke id

See definition in clause 7.6.1.

MSISDN

See definition in clause 7.6.2.

SM-RP-PRI

See definition in clause 7.6.8.

Service Centre Address

See definition in clause 7.6.2.

SM-RP-MTI

See definition in clause 7.6.8. This parameter shall be present when the feature « SM filtering by the HPLMN » is supported by the SMS-GMSC and when the equivalent parameter is received from the short message service relay sub-layer protocol.

SM-RP-SMEA

See definition in clause 7.6.8. This parameter shall be present when the feature « SM filtering by the HPLMN » is supported by the SMS-GMSC and when the equivalent parameter is received from the short message service relay sub-layer protocol.

GPRS Support Indicator

See definition in clause 7.6.8. The presence of this parameter is mandatory if the SMS-GMSC supports receiving of the two numbers from the HLR.

IMSI

See definition in clause 7.6.2. The presence of this parameter is mandatory in a successful case.

Network Node Number

See definition in clause 7.6.2. This parameter is provided in a successful response.

LMSI

See definition in clause 7.6.2. It is an operator option to provide this parameter from the VLR; it is mandatory for the HLR to include the LMSI in a successful response, if the VLR has used the LMSI.

GPRS Node Indicator

See definition in clause 7.6.8. The presence of this parameter is mandatory if only the SGSN number is sent in the Network Node Number.

Additional Number

See definition in clause 7.6.2. This parameter is provided in a successful response.

User error

The following errors defined in clause 7.6.1 may be used, depending on the nature of the fault:

- Unknown subscriber;
- Call Barred;
- Teleservice Not Provisioned;
- Absent Subscriber_SM;
- Facility Not Supported;
- System failure;
- Unexpected Data Value;
- Data missing.

Provider error

For definition of provider errors see clause 7.6.1.

12.2 MAP-MO-FORWARD-SHORT-MESSAGE service

12.2.1 Definition

This service is used between the serving MSC or the SGSN and the SMS Interworking MSC to forward mobile originated short messages.

The MAP-MO-FORWARD-SHORT-MESSAGE service is a confirmed service using the service primitives given in table 12.2/1.

12.2.2 Service primitives

Table 12.2/1: MAP-MO-FORWARD-SHORT-MESSAGE

Parameter name	Request	Indication	Response	Confirm
Invoke Id	M	M(=)	M(=)	M(=)
SM RP DA	M	M(=)		
SM RP OA	M	M(=)		
SM RP UI	M	M(=)	C	C(=)
IMSI	C	C(=)		
User error			C	C(=)
Provider error				O

12.2.3 Parameter use

Invoke id

See definition in clause 7.6.1.

SM RP DA

See definition in clause 7.6.8.

In the mobile originated SM transfer this parameter contains the Service Centre address received from the mobile station.

SM RP OA

See definition in clause 7.6.8.

The MSISDN received from the VLR or from the SGSN is inserted in this parameter in the mobile originated SM transfer.

SM RP UI

See definition in clause 7.6.8. The short message transfer protocol data unit received from the Service Centre is inserted in this parameter.

IMSI

See definition in clause 7.6.2.1. The IMSI of the originating subscriber is inserted in this parameter in the mobile originated SM transfer.

This parameter shall be included if the sending entity, whether MSC or SGSN, supports mobile number portability.

User error

The following errors defined in clause 7.6.1 may be used, depending on the nature of the fault:

- Facility Not Supported;
- System Failure;

- SM Delivery Failure;
 - The reason of the SM Delivery Failure can be one of the following in the mobile originated SM:
 - unknown Service Centre address;
 - Service Centre congestion;
 - invalid Short Message Entity address;
 - subscriber not Service Centre subscriber;
 - protocol error.
- Unexpected Data Value

Provider error

For definition of provider errors see clause 7.6.1.

12.3 MAP-REPORT-SM-DELIVERY-STATUS service

12.3.1 Definition

This service is used between the gateway MSC and the HLR. The MAP-REPORT-SM-DELIVERY-STATUS service is used to set the Message Waiting Data into the HLR or to inform the HLR of successful SM transfer after polling. This service is invoked by the gateway MSC.

The MAP-REPORT-SM-DELIVERY-STATUS service is a confirmed service using the service primitives given in table 12.3/1.

12.3.2 Service primitives

Table 12.3/1: MAP-REPORT-SM-DELIVERY-STATUS

Parameter name	Request	Indication	Response	Confirm
Invoke Id	M	M(=)	M(=)	M(=)
MSISDN	M	M(=)		
Service Centre Address	M	M(=)		
SM Delivery Outcome	M	M(=)		
Absent Subscriber Diagnostic SM	C	C(=)		
GPRS Support Indicator	C	C(=)		
Delivery Outcome Indicator	C	C(=)		
Additional SM Delivery Outcome	C	C(=)		
Additional Absent Subscriber Diagnostic SM	C	C(=)		
MSISdn-Alert			C	C(=)
User error			C	C(=)
Provider error				O

12.3.3 Parameter use

Invoke id

See definition in clause 7.6.1.

MSISDN

See definition in clause 7.6.2.

Service Centre Address

See definition in clause 7.6.2.

SM Delivery Outcome

See definition in clause 7.6.8. This parameter indicates the status of the mobile terminated SM delivery.

Absent Subscriber Diagnostic SM

See definition in clause 7.6.8.

GPRS Support Indicator

See definition in clause 7.6.8. The presence of this parameter is mandatory if the SMS-GMSC supports handling of two delivery outcomes.

Delivery Outcome Indicator

See definition in clause 7.6.8.

Additional SM Delivery Outcome

See definition in clause 7.6.8.

Additional Absent Subscriber Diagnostic SM

See definition in clause 7.6.8.

MSIsdn-Alert

See definition in clause 7.6.2. This parameter shall be present in case of unsuccessful delivery, when the MSISDN received in the operation is different from the stored MSIsdn-Alert; the stored MSIsdn-Alert is the value that is returned to the gateway MSC.

User error

The following errors defined in clause 7.6.1 may be used, depending on the nature of the fault:

- Unknown Subscriber;
- Message Waiting List Full;
- Unexpected Data Value;
- Data missing.

Provider error

For definition of provider errors see clause 7.6.1.

12.4 MAP-READY-FOR-SM service

12.4.1 Definition

This service is used between the MSC and VLR as well as between the VLR and the HLR. The MSC initiates this service if a subscriber indicates memory available situation. The VLR uses the service to indicate this to the HLR.

The VLR initiates this service if a subscriber, whose message waiting flag is active in the VLR, has radio contact in the MSC.

Also this service is used between the SGSN and the HLR. The SGSN initiates this service if a subscriber indicates memory available situation. The SGSN uses the service to indicate this to the HLR.

The SGSN initiates this service if a subscriber, whose message waiting flag is active in the SGSN, has radio contact in the GPRS.

The MAP-READY-FOR-SM service is a confirmed service using the primitives from table 12.4/1.

12.4.2 Service primitives

Table 12.4/1: MAP-READY-FOR-SM

Parameter name	Request	Indication	Response	Confirm
Invoke Id	M	M(=)	M(=)	M(=)
IMSI	C	C(=)		
TMSI	C	C(=)		
Alert Reason	M	M(=)		
Alert Reason Indicator	C	C(=)		
User error			C	C(=)
Provider error				O

12.4.3 Parameter use

Invoke id

See definition in clause 7.6.1.

IMSI

See definition in clause 7.6.2. The IMSI is used always between the VLR and the HLR and between the SGSN and the HLR. Between the MSC and the VLR the identification can be either IMSI or TMSI.

TMSI

See definition in clause 7.6.2. The identification can be either IMSI or TMSI between MSC and VLR.

Alert Reason

See definition in clause 7.6.8. This parameter indicates if the mobile subscriber is present or the MS has memory available.

Alert Reason Indicator

See definition in clause 7.6.8.

User error

The following errors defined in clause 7.6.1 may be used, depending on the nature of the fault:

- Unknown Subscriber;
- Facility Not Supported;
- System Failure;
- Unexpected Data Value;
- Data missing.

Provider error

For definition of provider errors see clause 7.6.1.

12.5 MAP-ALERT-SERVICE-CENTRE service

12.5.1 Definition

This service is used between the HLR and the interworking MSC. The HLR initiates this service, if the HLR detects that a subscriber, whose MSISDN is in the Message Waiting Data file, is active or the MS has memory available.

The MAP-ALERT-SERVICE-CENTRE service is a confirmed service using the primitives from table 12.5/1.

12.5.2 Service primitives

Table 12.5/1: MAP-ALERT-SERVICE-CENTRE

Parameter name	Request	Indication	Response	Confirm
Invoke Id	M	M(=)	M(=)	M(=)
MSIsdn-Alert	M	M(=)		
Service Centre Address	M	M(=)		
User error			C	C(=)
Provider error				O

12.5.3 Parameter use

Invoke id

See definition in clause 7.6.1.

MSIsdn-Alert

See definition in clause 7.6.2. The provided MSISDN shall be the one which is stored in the Message Waiting Data file.

Service Centre Address

See definition in clause 7.6.2.

User error

The following errors defined in clause 7.6.1 may be used, depending on the nature of the fault:

- System Failure;
- Unexpected Data Value;
- Data missing.

Provider error

For definition of provider errors see clause 7.6.1.

12.6 MAP-INFORM-SERVICE-CENTRE service

12.6.1 Definition

This service is used between the HLR and the gateway MSC to inform the Service Centre which MSISDN number is stored in the Message Waiting Data file. If the stored MSISDN number is not the same as the one received from the gateway MSC in the MAP-SEND-ROUTING-INFO-FOR-SM service primitive the stored MSISDN number is included in the message.

Additionally the status of MCEF, MNRF and MNRG flags and the inclusion of the particular Service Centre address in the Message Waiting Data list is informed to the gateway MSC when appropriate.

If the HLR has stored a single MNRR, the value is included in the Absent Subscriber Diagnostic SM parameter.

If the HLR has stored a second MNRR, the value of the MNRR for the MSC is included in the Absent Subscriber Diagnostic SM parameter and the value of the MNRR for the SGSN is included in the Additional Absent Subscriber Diagnostic SM parameter.

The MAP-INFORM-SERVICE-CENTRE service is a non-confirmed service using the primitives from table 12.6/1.

12.6.2 Service primitives

Table 12.6/1: MAP-INFORM-SERVICE-CENTRE

Parameter name	Request	Indication
Invoke Id	M	M(=)
MSIsdn-Alert	C	C(=)
MWD Status	C	C(=)
Absent Subscriber Diagnostic SM	C	C(=)
Additional Absent Subscriber Diagnostic SM	C	C(=)

12.6.3 Parameter use

Invoke id

See definition in clause 7.6.1.

MSIsdn-Alert

See definition in clause 7.6.2. This parameter refers to the MSISDN stored in a Message Waiting Data file in the HLR.

MWD Status

See definition in clause 7.6.8. This parameter indicates the status of the MCEF, MNRF and MNRG flags and the status of the particular SC address presence in the Message Waiting Data list.

Absent Subscriber Diagnostic SM

See definition in clause 7.6.8.

Additional Absent Subscriber Diagnostic SM

See definition in clause 7.6.8.

12.7 MAP-SEND-INFO-FOR-MT-SMS service

12.7.1 Definition

This service is used between the MSC and the VLR. The service is invoked by the MSC receiving a mobile terminated short message to request subscriber related information from the VLR.

The MAP-SEND-INFO-FOR-MT-SMS service is a confirmed service using the primitives from table 12.7/1.

12.7.2 Service primitives

Table 12.7/1: MAP-SEND-INFO-FOR-MT-SMS

Parameter name	Request	Indication	Response	Confirm
Invoke Id	M	M(=)	M(=)	M(=)
SM RP DA	M	M(=)		
IMSI	C	C(=)		
MSISDN			C	C(=)
User error			C	C(=)
Provider error				O

12.7.3 Parameter use

Invoke id

See definition in clause 7.6.1.

SM RP DA

See definition in clause 7.6.8. This parameter shall contain either an IMSI or an LMSI.

IMSI

See definition in clause 7.6.2. This parameter shall be present if the SM RP DA parameter contains an LMSI; otherwise it shall be absent.

MSISDN

See definition in clause 7.6.2.

User error

The following errors defined in clause 7.6.1 may be used, depending on the nature of the fault:

- Unknown subscriber;
- Unidentified Subscriber;
- Absent subscriber;
- Unexpected Data Value;
- Data Missing;
- Illegal subscriber;
- Illegal equipment;
- Subscriber busy for MT SMS;
- System Failure.

Provider error

For definition of provider errors see clause 7.6.1.

12.8 MAP-SEND-INFO-FOR-MO-SMS service

12.8.1 Definition

This service is used between the MSC and the VLR. The service is invoked by the MSC which has to handle a mobile originated short message request to request the subscriber related information from the VLR.

The MAP-SEND-INFO-FOR-MO-SMS service is a confirmed service using the primitives from table 12.8/1.

12.8.2 Service primitives

Table 12.8/1: MAP-SEND-INFO-FOR-MO-SMS

Parameter name	Request	Indication	Response	Confirm
Invoke Id	M	M(=)	M(=)	M(=)
Service Centre Address	M	M(=)		
MSISDN			C	C(=)
User error			C	C(=)
Provider error				O

12.8.3 Parameter use

Invoke id

See definition in clause 7.6.1.

Service Centre Address

See definition in clause 7.6.2.

MSISDN

See definition in clause 7.6.2.

User error

The following errors defined in clause 7.6.1 may be used, depending on the nature of the fault:

- Teleservice Not Provisioned;
- Call Barred;
- Unexpected Data Value;
- Data Missing.

Provider error

For definition of provider errors see clause 7.6.1.

12.9 MAP-MT-FORWARD-SHORT-MESSAGE service

12.9.1 Definition

This service is used between the gateway MSC and the servicing MSC or the SGSN to forward mobile terminated short messages.

The MAP-MT-FORWARD-SHORT-MESSAGE service is a confirmed service using the service primitives given in table 12.9/1.

12.9.2 Service primitives

Table 12.9/1: MAP-MT-FORWARD-SHORT-MESSAGE

Parameter name	Request	Indication	Response	Confirm
Invoke Id	M	M(=)	M(=)	M(=)
SM RP DA	M	M(=)		
SM RP OA	M	M(=)		
SM RP UI	M	M(=)	C	C(=)
More Messages To Send	C	C(=)		
User error			C	C(=)
Provider error				O

12.9.3 Parameter use

Invoke id

See definition in clause 7.6.1.

SM RP DA

See definition in clause 7.6.8. This parameter can contain either an IMSI or a LMSI. The use of the LMSI is an operator option. The LMSI can be provided if it is received from the HLR. The IMSI is used if the use of the LMSI is not available.

This parameter is omitted in the mobile terminated subsequent SM transfers.

SM RP OA

See definition in clause 7.6.8. The Service Centre address received from the originating Service Centre is inserted in this parameter.

This parameter is omitted in the mobile terminated subsequent SM transfers.

SM RP UI

See definition in clause 7.6.8. The short message transfer protocol data unit received from the Service Centre is inserted in this parameter. A short message transfer protocol data unit may also be inserted in this parameter in the message delivery acknowledgement from the MSC or from the SGSN to the Service Centre.

More Messages To Send

See definition in clause 7.6.8. The information from the MMS indication received from the Service Centre is inserted in this parameter.

User error

The following errors defined in clause 7.6.1 may be used, depending on the nature of the fault:

- Unidentified subscriber;
- Absent Subscriber_SM;
- Subscriber busy for MT SMS;
- Facility Not Supported;
- Illegal Subscriber indicates that delivery of the mobile terminated short message failed because the mobile station failed authentication;
- Illegal equipment indicates that delivery of the mobile terminated short message failed because an IMEI check failed, i.e. the IMEI was blacklisted or not white-listed;
- System Failure;
- SM Delivery Failure:
 - The reason of the SM Delivery Failure can be one of the following in the mobile terminated SM:
 - memory capacity exceeded in the mobile equipment;
 - protocol error;
 - mobile equipment does not support the mobile terminated short message service.
- Unexpected Data Value;
- Data Missing.

Provider error

For definition of provider errors see clause 7.6.1.

13 Network-Requested PDP Context Activation services

13.1 MAP_SEND_ROUTING_INFO_FOR_GPRS service

13.1.1 Definition

This service is used by the GGSN to request GPRS routing information from the HLR.

13.1.2 Service primitives

Table 13.1/1: MAP_SEND_ROUTING_INFO_FOR_GPRS

Parameter name	Request	Indication	Response	Confirm
Invoke id	M	M(=)	M(=)	M(=)
IMSI	M	M(=)		
GGSN address	C	C(=)	C	C(=)
GGSN number	M	M(=)		
SGSN address			C	C(=)
Mobile Not Reachable Reason			C	C(=)
User error			C	C(=)
Provider error				O

13.1.3 Parameter definition and use

Invoke Id

See definition in clause 7.6.1.

IMSI

See definition in clause 7.6.2.

GGSN address

This parameter shall be present if the protocol-converting GSN is used between the GGSN and the HLR.

GGSN number

See definition in clause 7.6.2.

SGSN address

This parameter shall be present if the outcome of the Send Routing Info For GPRS request to the GPRS application process in the HLR is positive.

Mobile Not Reachable Reason

This parameter shall be present if the outcome of the Send Routing Info For GPRS request to the GPRS application process in the HLR is positive and the MNRG flag in the HLR is set. See definition in clause 7.6.3.51.

User error

This parameter is sent by the responder when an error is detected and if present, takes one of the following values:

- Absent Subscriber;
- System Failure;
- Data Missing;
- Unexpected Data Value;

- Unknown Subscriber.

The diagnostic in the Unknown Subscriber may indicate 'Imsi Unknown' or 'Gprs Subscription Unknown'.

- Call Barred;

This error will indicate that the received PDP PDUs in the GGSN shall be barred for this MS due to Operator Determined Barring. (The CallBarringCause must be the operatorBarring.)

Provider error

These are defined in clause 7.6.1.

13.2 MAP_FAILURE_REPORT service

13.2.1 Definition

This service is used by the GGSN to inform the HLR that network requested PDP-context activation has failed.

13.2.2 Service primitives

Table 13.2/1: MAP_FAILURE_REPORT

Parameter name	Request	Indication	Response	Confirm
Invoke id	M	M(=)	M(=)	M(=)
IMSI	M	M(=)		
GGSN address	C	C(=)	C	C(=)
GGSN number	M	M(=)		
User error			C	C(=)
Provider error				O

13.2.3 Parameter definition and use

Invoke Id

See definition in clause 7.6.1.

IMSI

See definition in clause 7.6.2.

GGSN address

This parameter shall be present if the protocol-converting GSN is used between the GGSN and the HLR.

GGSN number

See definition in clause 7.6.2.

User error

This parameter is sent by the responder when an error is detected and if present, takes one of the following values:

- System Failure;
- Data Missing;
- Unexpected Data Value;
- Unknown Subscriber.

Provider error

These are defined in clause 7.6.1.

13.3 MAP_NOTE_MS_PRESENT_FOR_GPRS service

13.3.1 Definition

This service is used by the HLR to inform the GGSN that the MS is present for GPRS again.

13.3.2 Service primitives

Table 13.3/1: MAP_NOTE_MS_PRESENT_FOR_GPRS

Parameter name	Request	Indication	Response	Confirm
Invoke id	M	M(=)	M(=)	M(=)
IMSI	M	M(=)		
GGSN address	C	C(=)		
SGSN address	M	M(=)		
User error			C	C(=)
Provider error				O

13.3.3 Parameter definition and use

Invoke Id

See definition in clause 7.6.1.

IMSI

See definition in clause 7.6.2.

GGSN address

This parameter shall be present if the protocol-converting GSN is used between the GGSN and the HLR.

SGSN address

See definition in clause 7.6.2.

User error

This parameter is sent by the responder when an error is detected and if present, takes one of the following values:

- System Failure;
- Data Missing;
- Unexpected Data Value;
- Unknown Subscriber.

Provider error

These are defined in clause 7.6.1.

13A Location Service Management Services

13A.1 MAP-SEND-ROUTING-INFO-FOR-LCS Service

13A.1.1 Definition

This service is used between the GMLC and the HLR to retrieve the routing information needed for routing a location service request to the servicing VMSC or SGSN. The MAP-SEND-ROUTING-INFO-FOR-LCS is a confirmed service using the primitives from table 13A.1/1.

13A.1.2 Service Primitives

Table 13A.1/1: MAP-SEND-ROUTING-INFO-FOR-LCS

Parameter name	Request	Indication	Response	Confirm
Invoke Id	M	M(=)	M(=)	M(=)
MLC Number	M	M(=)		
MSISDN	C	C(=)	C	C(=)
IMSI	C	C(=)	C	C(=)
LMSI			C	C(=)
Network Node Number			C	C(=)
GPRS Node Indicator			C	C(=)
Additional Number			C	C(=)
User error			C	C(=)
Provider error				O

13A.1.3 Parameter Use

Invoke id

See definition in clause 7.6.1.

MLC Number

See definition in clause 7.6.2.

MSISDN

See definition in clause 7.6.2. The request shall carry either the IMSI or MSISDN. The response shall carry whichever of these was not included in the request (see 3GPP TS 23.271 for details).

IMSI

See definition in clause 7.6.2.

LMSI

See definition in clause 7.6.2. It is an operator option to provide this parameter from the VLR; it is mandatory for the HLR to include the LMSI in a successful response, if the VLR has used the LMSI.

Network Node Number

See definition in clause 7.6.2. This parameter is provided in a successful response. If the 'Network Node Number' and 'Additional Number' are received in the GMLC, the "Network Node Number" is used in preference to the "Additional Number".

GPRS Node Indicator

See definition in clause 7.6.8. The presence of this parameter is mandatory only if the SGSN number is sent in the Network Node Number.

Additional Number

See definition in clause 7.6.2. This parameter is provided in a successful response. If the 'Network Node Number' and 'Additional Number' are received in the GMLC, the "Network Node Number" is used in preference to the "Additional Number".

User error

The following errors defined in clause 7.6.1 may be used, depending on the nature of the fault:

- Unknown subscriber;
- Absent Subscriber;
- Facility Not Supported;
- System failure;
- Unexpected Data Value;
- Data missing;
- Unauthorised requesting network.

Provider error

For definition of provider errors see clause 7.6.1.

13A.2 MAP-PROVIDE-SUBSCRIBER-LOCATION Service

13A.2.1 Definition

This service is used by a GMLC to request the location of a target MS from the visited MSC or SGSN at any time. This is a confirmed service using the primitives from table 13A.2/1.

13A.2.2 Service Primitives

Table 13A.2/1: Provide_Subscriber_Location

Parameter name	Request	Indication	Response	Confirm
Invoke id	M	M(=)	M(=)	M(=)
Location Type	M	M(=)		
MLC Number	M	M(=)		
LCS Client ID	M	M(=)		
Privacy Override	U	C(=)		
IMSI	C	C(=)		
MSISDN	C	C(=)		
LMSI	C	C(=)		
LCS Priority	C	C(=)		
LCS QoS	C	C(=)		
IMEI	U	C(=)		
Supported GAD Shapes	C	C(=)		
LCS-Referencne Number	C	C(=)		
LCS Codeword	C	C(=)		
LCS Service Type Id	C	C(=)		
Location Estimate			M	M(=)
GERAN Positioning Data			C	C(=)
UTRAN Positioning Data			C	C(=)
Age of Location Estimate			C	C(=)
Additional Location Estimate			C	C(=)
Deferred MT-LR Response Indicator			C	C(=)

User error			C	C(=)
Provider error				O

13A.2.3 Parameter Definition and Use

All parameters are defined in clause 7.6. The use of these parameters and the requirements for their presence are specified in 3GPP TS 23.271 [26a].

Location Type

This parameter identifies the type of location information requested.

MLC Number

This is the E.164 number of the requesting GMLC.

LCS Client ID

This parameter provides information related to the identity of an LCS client.

Privacy Override

This parameter indicates if MS privacy is overridden by the LCS client when the GMLC and VMSC or SGSN for an MT-LR are in the same country.

IMSI

The IMSI is provided to identify the target MS. At least one of the IMSI or MSISDN is mandatory.

MSISDN

The MSISDN is provided to identify the target MS. At least one of the IMSI or MSISDN is mandatory.

LMSI

The LMSI shall be provided if previously supplied by the HLR. This parameter is only used in the case of the MT-LR for CS domain.

LCS Priority

This parameter indicates the priority of the location request.

LCS QoS

This parameter indicates the required quality of service in terms of response time and accuracy.

IMEI

Inclusion of the IMEI is optional.

Supported GAD Shapes

This parameter indicates which of the shapes defined in 3GPP TS 23.032 [122] are supported.

LCS-Reference Number

This parameter shall be included if a deferred mt-lr procedure is performed.

LCS Codeword

See definition in clause 7.6.11.18. The requirements for its presence are specified in 3GPP TS 23.271 [26a].

LCS Service Type Id

See definition in clause 7.6.11.15. The requirements for its presence are specified in 3GPP TS 23.271 [26a].

Location Estimate

This parameter provides the location estimate if this is encoded in one of the supported geographical shapes. Otherwise this parameter shall consist of one octet, which shall be discarded by the receiving node.

GERAN Positioning Data

This parameter indicates the usage of each positioning method that was attempted to determine the location estimate either successfully or unsuccessfully. If Positioning Data received from the RAN contains no Positioning Methods, GERAN Positioning Data is excluded from the MAP message. It may be included in the message only if the access network is GERAN, see 3GPP TS 23.271 [26a].

UTRAN Positioning Data

This parameter indicates the usage of each positioning method that was successfully attempted to determine the location estimate. If Position Data received from the RAN contains no Positioning Methods, UTRAN Positioning Data is excluded from the MAP message. It may be included in the message only if the access network is UTRAN, see 3GPP TS 23.271 [26a].

Age of Location Estimate

This parameter indicates how long ago the location estimate was obtained.

Additional Location Estimate

This parameter provides the location estimate when not provided by the Location Estimate parameter. It may be sent only if the parameter Supported GAD Shapes has been received in the Provide Subscriber Location indication and the shape to be included is supported by the GMLC.

Deferred MT-LR Response Indicator

See definition in clause 7.6.11.2.

User error

This parameter is sent by the responder when the location request has failed or cannot proceed and if present, takes one of the following values defined in clause 7.6.1.

- System Failure;
- Data Missing;
- Unexpected Data Value;
- Facility Not Supported;
- Unidentified Subscriber;
- Illegal Subscriber;
- Illegal Equipment;
- Absent Subscriber (diagnostic information may also be provided);
- Unauthorised requesting network;
- Unauthorised LCS Client with detailed reason;
- Position method failure with detailed reason.

Provider error

These are defined in clause 7.6.1.

13A.3 MAP-SUBSCRIBER-LOCATION-REPORT Service

13A.3.1 Definition

This service is used by a VMSC or SGSN to provide the location of a target MS to a GMLC when a request for location is either implicitly administered or made at some earlier time. This is a confirmed service using the primitives from table 13A.3/1.

13A.3.2 Service Primitives

Table 13A.3/1: Subscriber_Location_Report

Parameter name	Request	Indication	Response	Confirm
Invoke id	M	M(=)	M(=)	M(=)
LCS Event	M	M(=)		
LCS Client ID	M	M(=)		
Network Node Number	M	M(=)		
IMSI	C	C(=)		
MSISDN	C	C(=)		
NA-ESRD	C	C(=)		
NA-ESRK	C	C(=)	C	C(=)
IMEI	U	C(=)		
Location Estimate	C	C(=)		
Positioning Data	C	C(=)		
UTRAN Positioning Data	C	C(=)		
Age of Location Estimate	C	C(=)		
LMSI	U	C(=)		
GPRS Node Indicator	C	C(=)		
Additional Location Estimate	C	C(=)		
Deferred MT-LR Data	C	C(=)		
LCS-Reference Number	C	C(=)		
NA-ESRK Request	C	C(=)		
User error			C	C(=)
Provider error				O

13A.3.3 Parameter Definition and Use

All parameters are defined in clause 7.6. The use of these parameters and the requirements for their presence are specified in 3GPP TS 23.271 [26a].

LCS Event

This parameter indicates the event that triggered the Subscriber Location Report.

LCS Client ID

This parameter provides information related to the identity of the recipient LCS client.

Network Node Number

See definition in clause 7.6.2. This parameter provides the address of the sending node.

IMSI

The IMSI shall be provided if available to the VMSC or SGSN.

MSISDN

The MSISDN shall be provided if available to the VMSC or SGSN.

NA-ESRD

If the target MS has originated an emergency service call in North America, the NA-ESRD shall be provided by the VMSC if available.

NA-ESRK

If the target MS has originated an emergency service call in North America, the NA-ESRK shall be provided by the VMSC if assigned.

If the target MS has originated an emergency service call in North America and NA-ESRK Request is included in Subscriber_Location_Report-Arg, NA-ESRK may also be included in the response to the MSC, see 3GPP TS 23.271 [26a].

IMEI

Inclusion of the IMEI is optional.

Location Estimate

This parameter provides the location estimate. The absence of this parameter implies that a location estimate was not available or could not be successfully obtained. If the obtained location estimate is not encoded in one of the supported geographical shapes then this parameter shall consist of one octet, which shall be discarded by the receiving node.

GERAN Positioning Data

This parameter indicates the usage of each positioning method that was attempted to determine the location estimate either successfully or unsuccessfully. If Positioning Data received from the RAN contains no Positioning Methods, GERAN Positioning Data is excluded from the MAP message. It may be included in the message only if the access network is GERAN, see 3GPP TS 23.271 [26a].

UTRAN Positioning Data

This parameter indicates the usage of each positioning method that was successfully attempted to determine the location estimate. If Position Data received from the RAN contains no Positioning Methods, UTRAN Positioning Data is excluded from the MAP message. It may be included in the message only if the access network is UTRAN, see 3GPP TS 23.271 [26a].

Age of Location Estimate

This parameter indicates how long ago the location estimate was obtained.

LMSI

The LMSI may be provided if assigned by the VLR.

GPRS Node Indicator

See definition in clause 7.6.8. This presence of this parameter is mandatory only if the SGSN number is sent in the Network Node Number.

Additional Location Estimate

This parameter provides the location estimate when not provided by the Location Estimate parameter..

Deferred MT-LR Data

See definition in clause 7.6.11.3.

LCS-Reference Number

This parameter shall be included if the Subscriber Location Report is the response to a deferred MT location request.

NA-ESRK Request

If the target MS has originated an emergency service call in North America, NA-ESRK Request may be included to indicate that the MSC is able to accept NA-ESRK in the Response message, see section 7.6.11.19.

User error

This parameter is sent by the responder when the received message contains an error, cannot be forwarded or stored for an LCS client or cannot be accepted for some other reason and if present, takes one of the following values defined in clause 7.6.1.

- System Failure;
- Data Missing;
- Unexpected Data Value;
- Resource Limitation;
- Unknown Subscriber;
- Unauthorised requesting network;
- Unknown or unreachable LCS Client.

Provider error

These are defined in clause 7.6.1.

13A.4 Void

13A.4.1 Void

13A.4.2 Void

13A.4.3 Void

13A.5 Void

13A.5.1 Void

13A.5.2 Void

13A.5.3 Void

13A.6 Void

13A.6.1 Void

13A.6.2 Void

13A.6.3 Void

13A.7 Void

13A.7.1 Void

13A.7.2 Void

13A.7.3 Void

13A.8 Void

13A.8.1 Void

13A.8.2 Void

13A.8.3 Void

13A.9 Void

13A.9.1 Void

13A.9.2 Void

13A.9.3 Void

14 General

14.1 Overview

Clauses 14 to 17 specify the protocol elements to be used to provide the MAP services described in clause 7.

Clause 15 specifies the elements of procedures for the MAP protocol. Clause 16 specifies the mapping onto TC service primitives. Clause 17 specifies the application contexts, operation packages and abstract syntaxes for the MAP protocol as well as the encoding rules to be applied.

14.2 Underlying services

The MAP protocol relies on the services provided by the Transaction Capabilities (TC) of Signalling System Number No. 7, as referenced in clause 6.

14.3 Model

The MAP Protocol Machine (MAP PM) can be modelled as a collection of service state machines (SSMs) - one per MAP specific service invoked - coordinated by a MAP dialogue control function with its one state machine: MAP dialogue state machine (DSM). There are two types of Service State Machines: Requesting Service State Machines (RSM) and Performing Service State Machines (PSM).

A new invocation of a MAP PM is employed on the receipt of a MAP-OPEN request primitive or a TC-BEGIN indication primitive. Each invocation controls exactly one MAP dialogue. For each MAP specific service invoked during a dialogue, a MAP RSM is created at the requestor's side and a MAP PSM is created at the performer's side.

This modelling is used only to facilitate understanding and the MAP behaviour descriptions and is not intended to suggest any implementation. SDL descriptions are organised according to this model.

How the MAP-service-user and the MAP refer to a MAP dialogue (i.e. a MAP PM invocation) is a local implementation matter.

How TC dialogue identifiers are assigned to a MAP PM invocation is also a local implementation matter.

14.4 Conventions

The behaviour of the MAP PM depends on the application-context-name associated with the dialogue. One major difference is that the MAP requests the transfer of the application-context-name by TC only for those contexts which do not belong to the so-called "version one context set".

The "version one context set" is a set of application-contexts which model the behaviour of a MAP V1 implementation according to the latest phase 1 version of GSM 09.02. This set is defined in clause 15.

The procedures described in clause 15 are used when the application-context-name does not refer to a dialogue between an MSC and its VLR. When the application-context-name refers to a dialogue between an MSC and its VLR the MAP PM procedures are a local implementation matter.

15 Elements of procedure

15.1 Handling of unknown operations

Unknown operations (i.e. a standard operation introduced in a later version of the MAP specification, or a private operation) can be introduced into MAP in a backwards compatible way. This means that the receiver of an unknown operation shall, if the dialogue state allows it, send a TC-REJECT component to the sender of the operation indicating 'unrecognised operation' and continue with the processing of further components or messages exchanged within the dialogue as if the unknown operation had not been received.

The standardised structure of a MAP dialogue shall not be affected by the invocation of unknown operations, i.e. if a dialogue uses only a TC-BEGIN message which is acknowledged by a TC-END message, a TC-CONTINUE message shall not be used to invoke an unknown operation. However the standardised structure of a MAP dialogue may be affected by the rejection of unknown operations, i.e. if a dialogue uses only a TC-BEGIN message which is acknowledged by a TC-END message, a TC-CONTINUE message followed by a TC-END message may be used to carry the rejection of an unknown operation and the response to the standardised operation. The entity which initiated a dialogue whose standardised structure is a TC-BEGIN message which is acknowledged by a TC-END message shall not send any messages in that dialogue after the TC-BEGIN. Note that if the dialogue structure is affected as described in this paragraph the TC-CONTINUE shall include the dialogue portion required to confirm the acceptance of the dialogue.

Unknown operations may be invoked in the following types of message (there is no restriction as to how many unknown operations can be invoked in a message):

- TC-BEGIN: the component to invoke the unknown operation shall follow the component of the standard operation which is included in this message.
- TC-CONTINUE: the component to invoke the unknown operation may be transported as the only component in a stand-alone message or may be grouped with existing operations. In the latter case a specific sequencing of components is not required.
- TC-END: if the component to invoke the unknown operation is grouped with an existing operation a specific sequencing of components is not required

The TC-REJECT component may be sent in the following messages:

- TC-CONTINUE or TC-END: either as the only component of the message or grouped with an existing component. The choice is up to the MAP-Service User.

If the received message contains only unknown operations the MAP-Service User shall send the TC-REJECT components in a TC-CONTINUE message to the peer entity, if the dialogue state allows it.

If the received message contains unknown operations and standard operations and the standardised structure of the dialogue requires the response to the standard operation to be sent within a TC-END message, then the MAP-Service User may send the response to the standard operations and the TC-REJECT components for the unknown operations in a TC-CONTINUE message followed by a TC-END message. Neither a specific distribution of the components to the TC messages nor a specific sequencing of components is required.

Note that the SDL diagrams of clauses 19 - 25 do not show the report to the MAP-Service User about the reception of the unknown operation. This has been done for simplicity of description; the MAP PM may inform the MAP-Service User.

The sender of the unknown operation shall ensure that there is enough room in the used message for the unknown operation.

15.2 Dialogue establishment

The establishment of a MAP dialogue involves two MAP-service-users: the dialogue-initiator and the dialogue-responder.

This procedure is driven by the following signals:

- a MAP-OPEN request primitive from the dialogue-initiator;
- a TC-BEGIN indication primitive occurring at the responding side;
- a MAP-OPEN response primitive from the dialogue-responder;
- the first TC-CONTINUE indication primitive occurring at the initiating side;

and under specific conditions:

- a TC-END indication primitive occurring at the initiating side;
- a TC-U-ABORT indication primitive occurring at the initiating side;
- a TC-P-ABORT indication primitive occurring at the initiating side.

One instance of the MAP dialogue state machine runs at the initiating side, and one at the responding side.

15.2.1 Behaviour at the initiating side

The behaviour of the MAP dialogue state machine at the initiating side is defined in sheets 1 – 8 of the process MAP_DSM (figure 15.6/3).

Sheet 3: When the MAP dialogue state machine at the initiating side is waiting for a response from the responding side, a TC-END indication which echoes the AC name which was sent in the TC-BEGIN indicates acceptance of the dialogue.

Sheet 3: If the dialogue opening is accepted, any components included in the TC-END are processed and passed to the MAP-Service User. The dialogue is closed by sending a MAP-CLOSE to the MAP-Service User.

Sheet 3, sheet 4, sheet 5, sheet 6, sheet 7, sheet 8: when a dialogue is terminated, the MAP dialogue state machine terminates all instances of the Requesting_MAP_SSM which are active for this dialogue.

Sheet 4: A TC-P-ABORT with an abort parameter Incorrect_Transaction_Portion indicates that the responding side does not support a MAP version higher than 1. This triggers a MAP-OPEN confirm indicating that the dialogue is refused, with a refuse reason potential version incompatibility. The MAP-Service User may then decide to retry the dialogue at MAP version 1.

Sheet 8: When the MAP dialogue state machine at the initiating side is waiting for a response from the responding side, a TC-CONTINUE indication which echoes the AC name which was sent in the TC-BEGIN indicates acceptance of the dialogue.

Sheet 8: If the dialogue opening is accepted, any components included in the TC-CONTINUE are processed and passed to the MAP-Service User. The dialogue has then reached the established state.

15.2.2 Behaviour at the responding side

The behaviour of the MAP dialogue state machine at the responding side is defined in sheets 9 – 14 of the process MAP_DSM (figure 15.6/3).

Sheet 9: If no application context information is included in the TC-BEGIN indication, this implies a MAP version 1 dialogue. An explicit application context indicating version 1 is treated as abnormal behaviour.

Sheet 11: The v1 application context name which corresponds to a v1 operation is derived using the information in table 15.2/1.

Table 15.2/1: Mapping of V1 operation codes on to application-context-names

Operation	Application-context-name (note 1)
updateLocation	networkLocUpContext-v1
cancelLocation	locationCancellationContext-v1
provideRoamingNumber	roamingNumberEnquiryContext-v1
insertSubscriberData	subscriberDataMngtContext-v1
deleteSubscriberData	subscriberDataMngtContext-v1
sendParameters	infoRetrievalContext-v1 networkLocUpContext-v1 (note 2)
beginSubscriberActivity	networkFunctionalSsContext-v1
sendRoutingInfo	locationInfoRetrievalContext-v1
performHandover	handoverControlContext-v1
reset	resetContext-v1
activateTraceMode	tracingContext-v1
deactivateTraceMode	tracingContext-v1
sendRoutingInfoForSM	shortMsgGatewayContext-v1
forwardSM	shortMsgRelayContext-v1
reportSM-deliveryStatus	shortMsgGatewayContext-v1
noteSubscriberPresent	mwdMngtContext-v1
alertServiceCentreWithoutResult	shortMsgAlertContext-v1
checkIMEI	EquipmentMngtContext-v1

NOTE 1: These symbolic names refer to the object identifier value defined in clause 17 and allocated to each application-context used for the MAP.

NOTE 2: The choice between the application contexts is based on the parameters received in the operation.

Sheet 12: If the dialogue is accepted, each component present in the TC-BEGIN is forwarded to an instance of a Performing_MAP_SSM, by executing the procedure Process_Components.

Sheet 13: If the MAP dialogue state machine receives a MAP-OPEN response with a result accepted, it waits for any MAP specific service request or response primitives or a MAP-DELIMITER request.

Sheet 13, sheet 14: When a dialogue is terminated, the MAP dialogue state machine terminates all instances of the Requesting_MAP_SSM or Performing_MAP_SSM which are active for this dialogue.

Sheet 14: A MAP-DELIMITER request triggers a TC-CONTINUE request to accept the dialogue. The dialogue has then reached the established state.

15.3 Dialogue continuation

Once established the dialogue is said to be in a continuation phase. The behaviour of the MAP dialogue state machine in this phase is defined in sheets 15 – 17 of the process MAP_DSM (figure 15.6/3).

Both MAP users can request the transfer of MAP APDUs until one of them requests the termination of the dialogue.

Normal closure of an established dialogue is shown on sheet 16; abnormal termination is shown on sheet 17.

15.4 Load control

If an entity which should respond to a MAP dialogue opening request is overloaded, it uses the AC of the request to determine whether to discard the request.

The priority level allocated to each application-context is described in clause 5, tables 5.1/1, 5.1/2 and 5.1/3.

15.5 Procedures for MAP specific services

This clause describes the MAP procedures for MAP specific services. These procedures are driven by the following types of event:

- a MAP specific request or a MAP specific response primitive;

- a component handling primitive from TC.

A Service State Machine is activated when one of the following signals is received:

- a MAP request primitive, which activates a requesting SSM;
- a TC-INVOKE indication primitive without a linked identifier, which activates a performing SSM.

For component handling primitives there are two types of event:

- events which activate a Service State Machine or which can be related to an existing one;
- events which cannot be related to a Service State Machine.

15.5.1 Service invocation

The behaviour of the requesting SSM which handles a service is defined by the SDL for the process `Requesting_MAP_SSM`. The requesting SSM receives a MAP service request from the MAP-Service User via the MAP dialogue state machine and sends a TC-INVOKE request to TCAP. When a confirm is received from TCAP via the MAP dialogue state machine, the requesting SSM forwards a MAP service confirm to the MAP-Service User.

The response to a MAP service invocation may come in the form of a linked request. If the linked request corresponds to a class 4 operation, this is handled by the requesting SSM. If the linked request corresponds to a class 1, 2 or 3 operation, the MAP dialogue state machine sends a notification to the requesting SSM and creates an instance of a performing SSM to handle the linked request. The test "`Linked_Operation_Allowed`" on sheet 3 of the process `Requesting_MAP_SSM` takes the (TRUE) exit if the definition of the parent operation includes the received linked operation as a permitted linked operation; otherwise the test takes the (FALSE) exit.

The mapping of MAP specific services on to remote operations is given in table 16.2/1.

15.5.2 void

15.5.3 Service invocation receipt

The behaviour of the performing SSM which handles a service is defined by the SDL for the process `Performing_MAP_SSM`. The performing SSM receives a TC-INVOKE component from TCAP via the MAP dialogue state machine and sends a MAP service indication to the MAP-Service User. When a MAP service response is received from the MAP-Service User via the MAP dialogue state machine, the performing SSM forwards a TC-RESULT or TC-U-ERROR component to TCAP.

15.5.4 void

15.5.5 Handling of components received from TC

The procedure `Process_Components` shows the handling of components received in a TC-BEGIN, TC-CONTINUE or TC-END message.

Sheet 2: If a linked invoke component corresponds to a class 4 operation, the MAP dialogue state machine sends it to the requesting SSM instance identified by the linked invoke ID. If a linked invoke component corresponds to any other class of operation, the MAP dialogue state machine sends a notification to the requesting SSM instance identified by the linked invoke ID, creates an instance of a performing SSM and sends the invoke component to it.

15.6 SDL descriptions

The following SDL specification describes a system which includes three blocks: MAP-user, MAP-provider and TC.

Such a system resides in each network component supporting MAP and communicates with its peers via the lower layers of the signalling network which are part of the environment.

Only the MAP-provider is fully described in this clause. The various types of processes which form the MAP-User block and the TC block are described respectively in clauses 18 to 25 of the present document and in CCITT Recommendation Q.774.

The MAP-Provider block communicates with the MAP_USER via two channels U1 and U2. Via U1 the MAP-provider receives the MAP request and response primitives. Via U2 it sends the MAP indication and confirm primitives.

The MAP-Provider block communicates with TC via two channels P1 and P2. Via P1 the MAP-Provider sends all the TC request primitives. Via P2 it receives all the TC indication primitives.

The MAP-Provider block is composed of the four following types of process:

- a) MAP_DSM: This type of process handles a dialogue for transport of MAP messages. There exists one process instance per MAP dialogue.
- b) Load_Ctrl: This type of process is in charge of load control. There is only one instance of this process in each system.
- c) Requesting_MAP_SSM: This type of process handles a MAP service requested during a dialogue. An instance of this process is created by the instance of the Secure_MAP_DSM process for each requested MAP service.
- d) Performing_MAP_SSM: This type of process handles a MAP service performed during a dialogue. An instance of this process is created by the instance of the Secure_MAP_DSM process for each MAP service to be performed.

A process MAP_DSM exchanges external signals with other blocks as well as internal signals with the other processes of the MAP-Provider block. The external signals are either MAP service primitives or TC service primitives.

The signal routes used by the various processes are organised as follows:

- a) A process MAP_DSM receives and sends events from/to the MAP_user via signal route User1/User2. These routes use channels U1 and U2 respectively.
- b) A process MAP_DSM receives and sends events from/to the TCAP via signal route TC1/TC2. These routes use channels P1 and P2 respectively.
- c) A process MAP_DSM receives and sends events from/to the LOAD_CTRL process via signal route Load1/Load2. These routes are internal.
- d) A process MAP_DSM sends events to the Performing_MAP_SSM processes via signal route Intern1. This route is internal.
- e) A process MAP_DSM sends events to the Requesting_MAP_SSM processes via signal route Intern2. This route is internal.
- f) A process Performing_MAP_SSM sends events to the MAP_USER via signal route User3. This route uses channel U2.
- g) A process Performing_MAP_SSM sends events to the TCAP via signal route TC3. This route uses channel P1.
- h) A process Requesting_MAP_SSM sends events to the MAP_USER via signal route User4. This route uses channel U2.
- i) A process Requesting_MAP_SSM sends events to the TCAP via signal route TC4. This route uses channel P1.

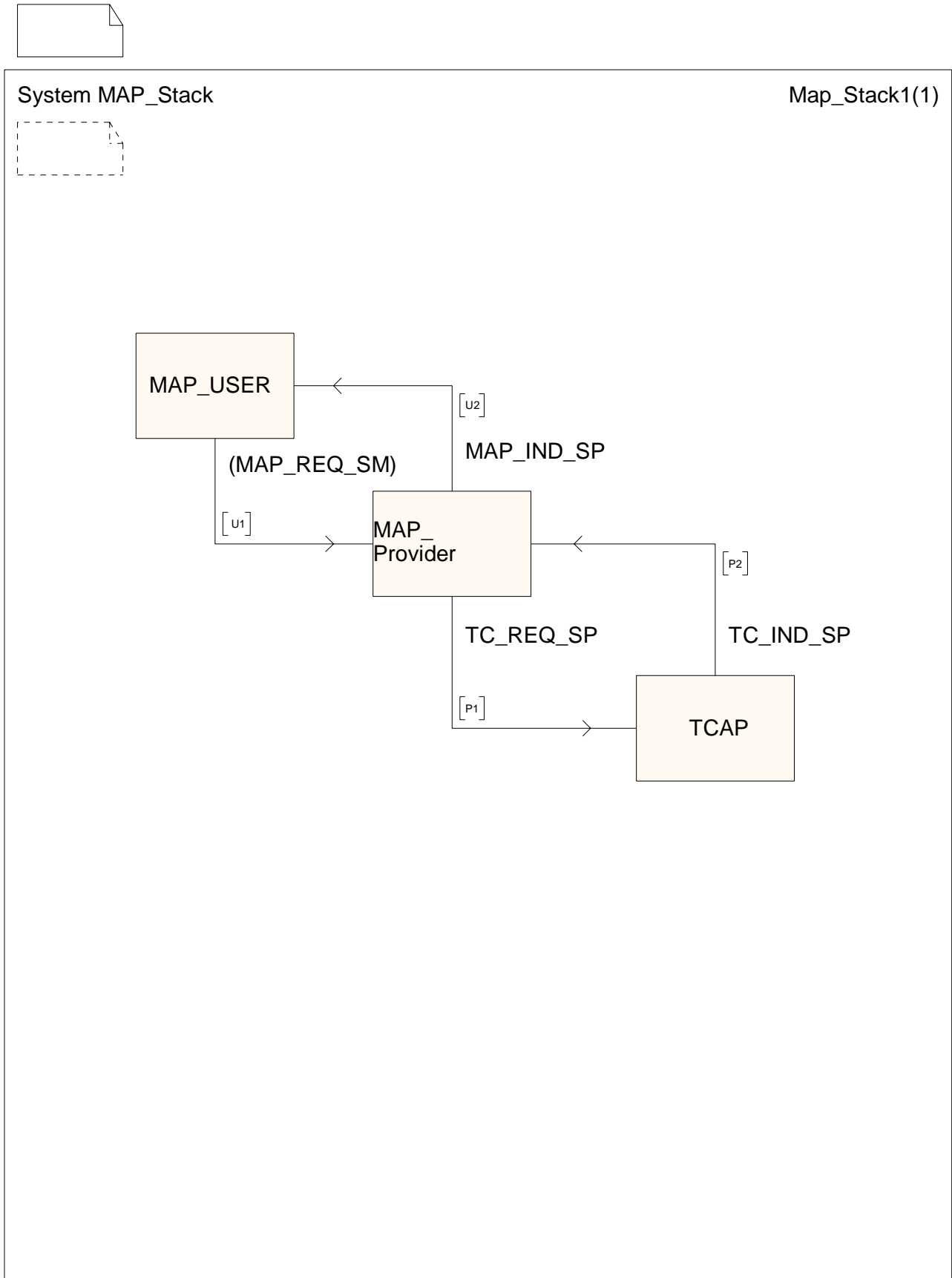

Figure 15.6/1: System MAP_Stack

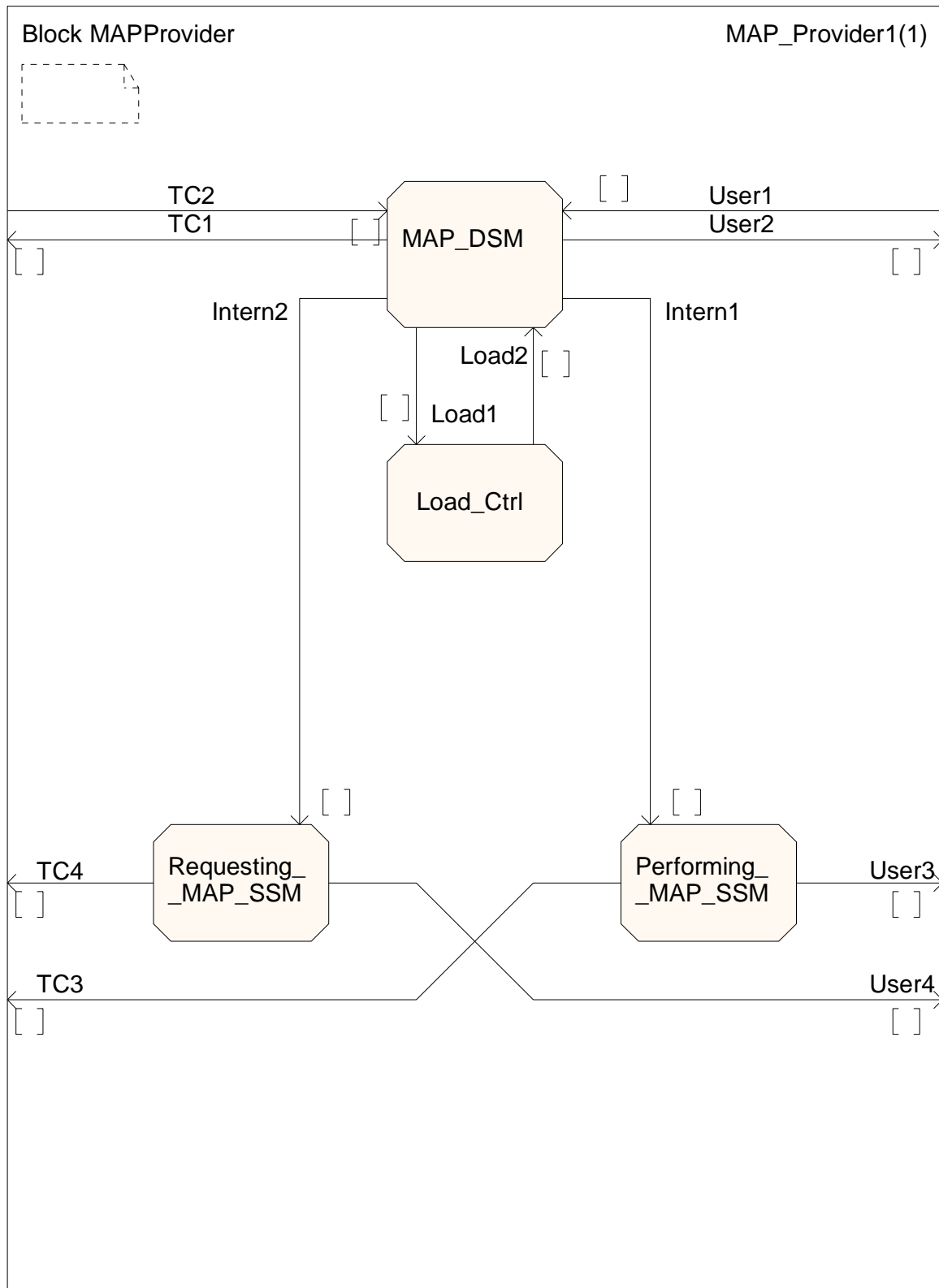

Figure 15.6/2: Block MAP_Provider

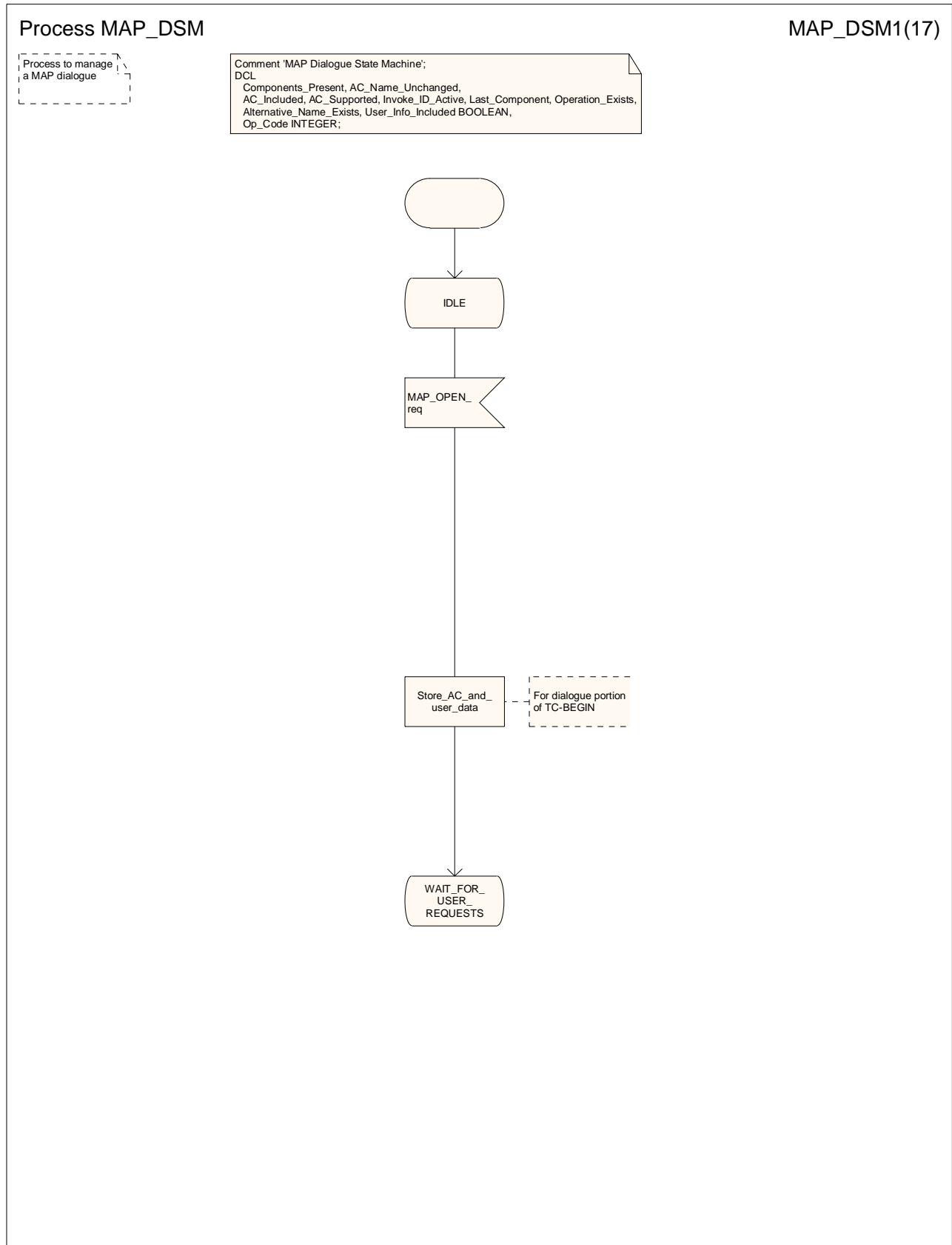

Figure 15.6/3a: Process MAP_DSM (sheet 1)

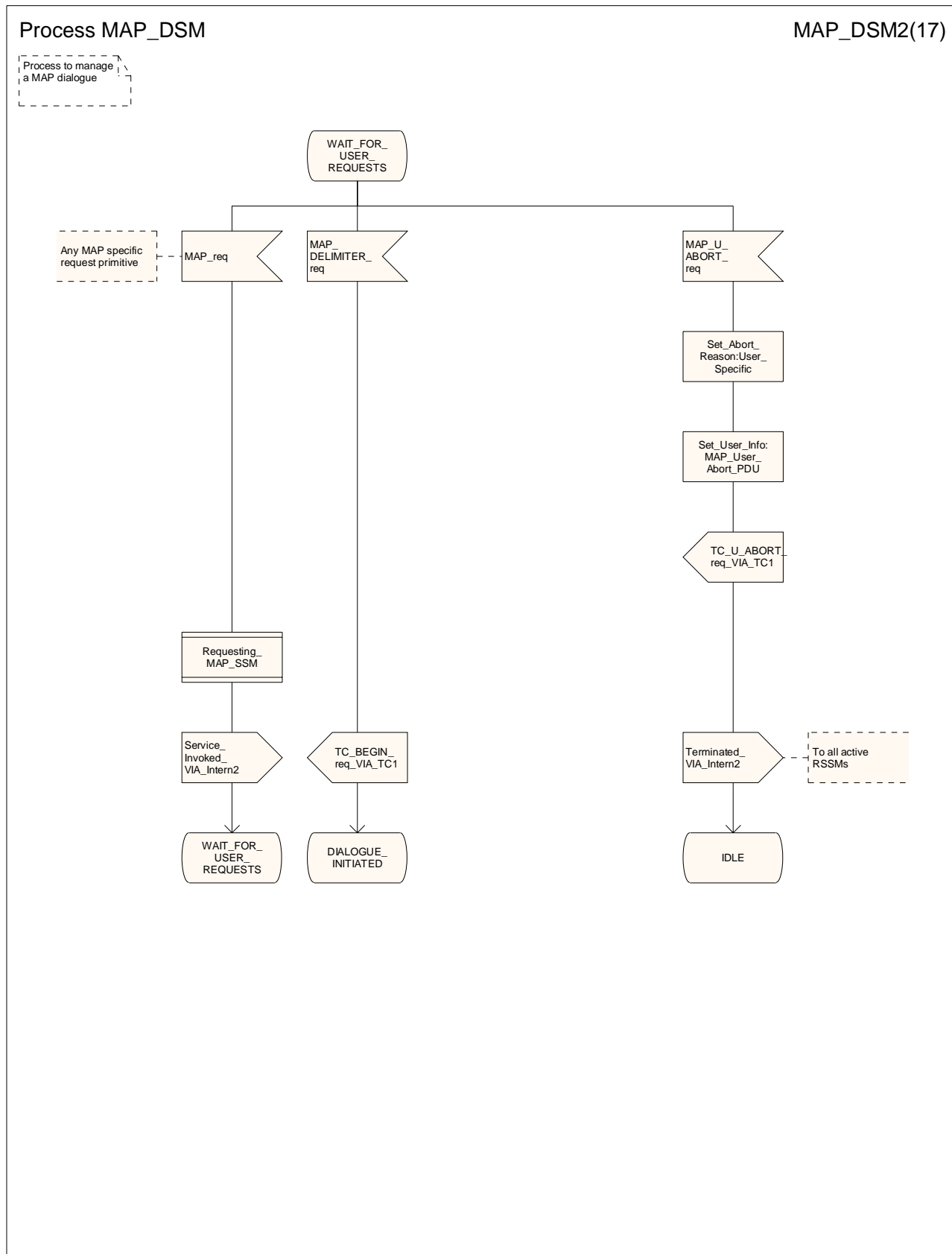

Figure 15.6/3b: Process MAP_DSM (sheet 2)

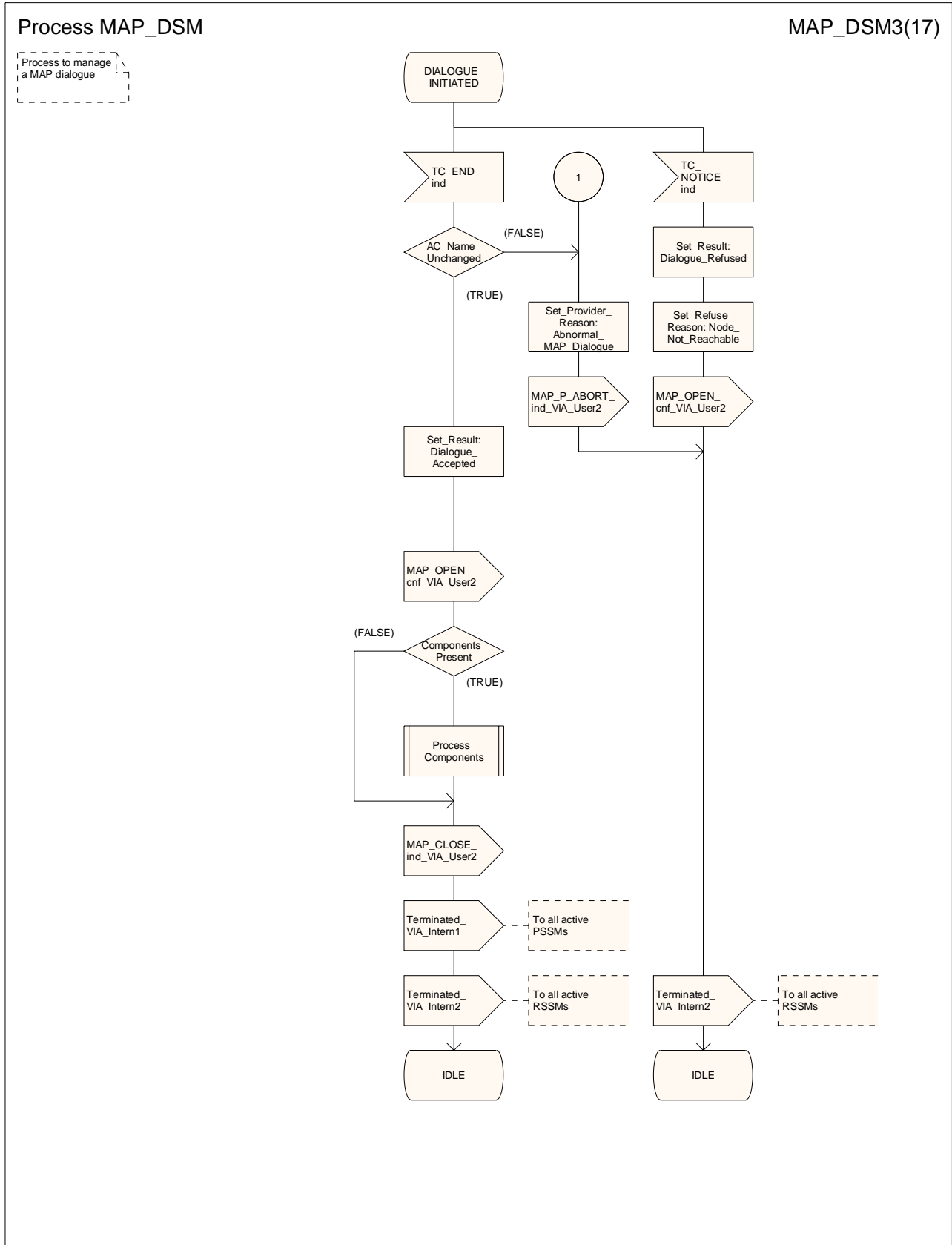

Figure 15.6/3c: Process MAP_DSM (sheet 3)

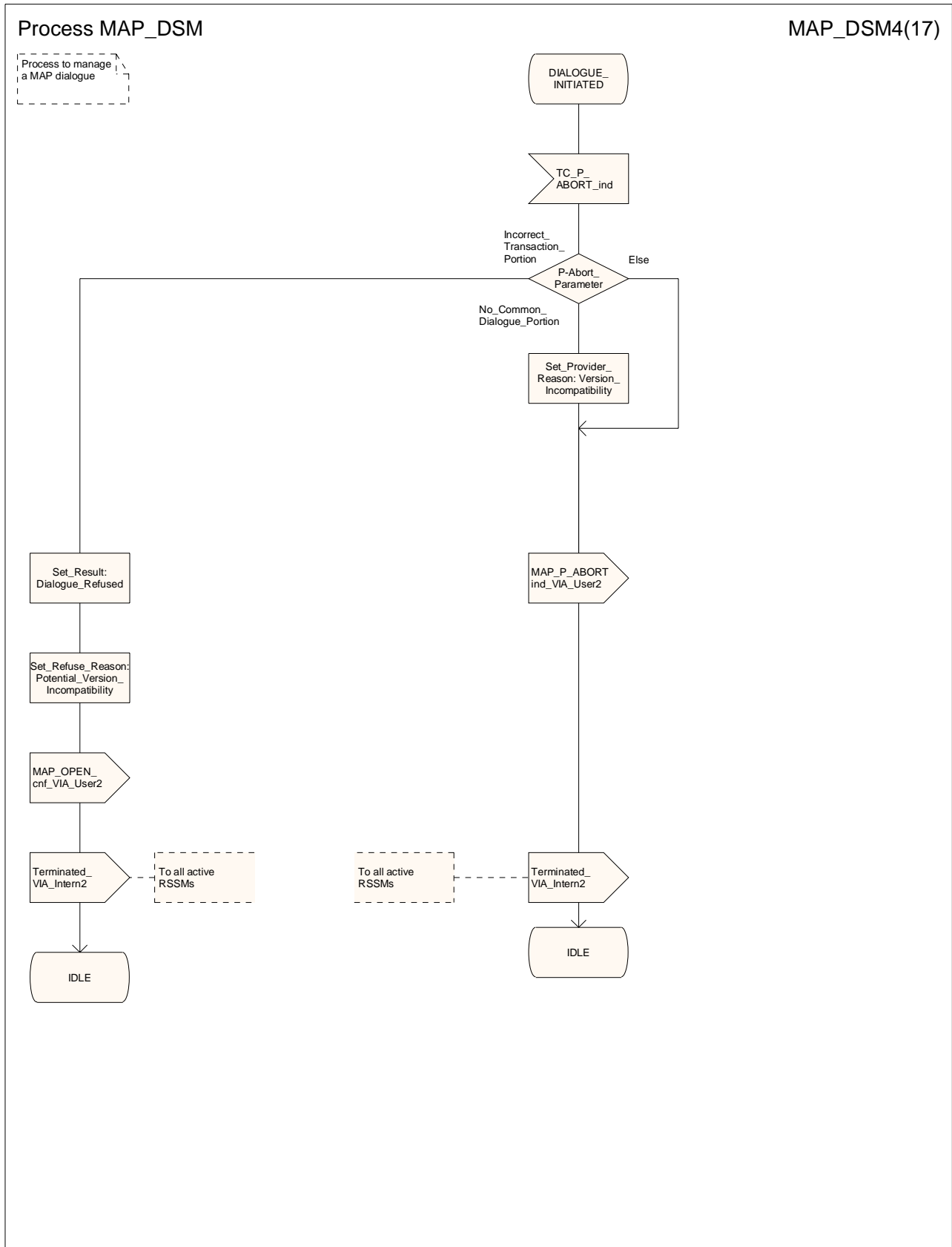

Figure 15.6/3d: Process MAP_DSM (sheet 4)

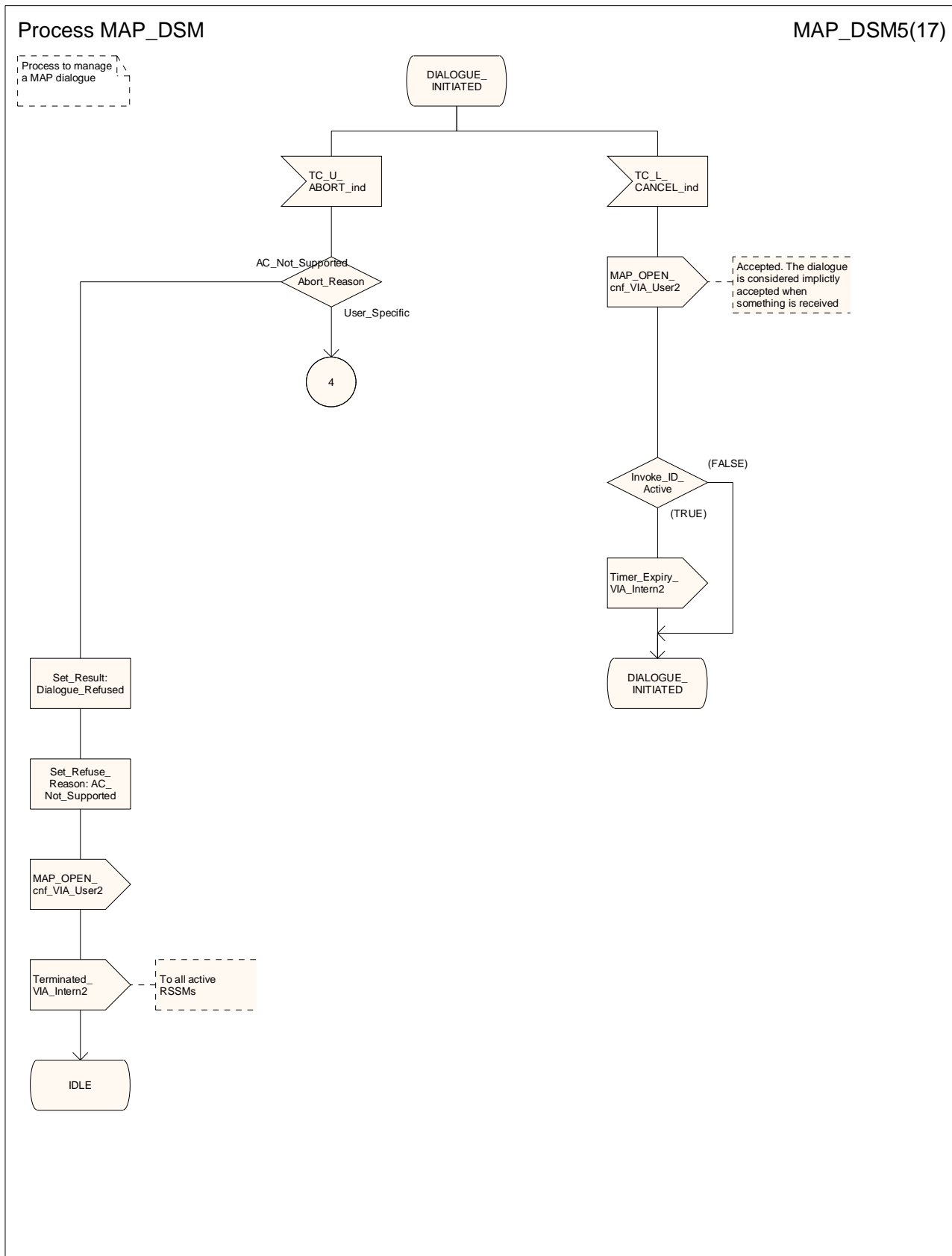

Figure 15.6/3e: Process MAP_DSM (sheet 5)

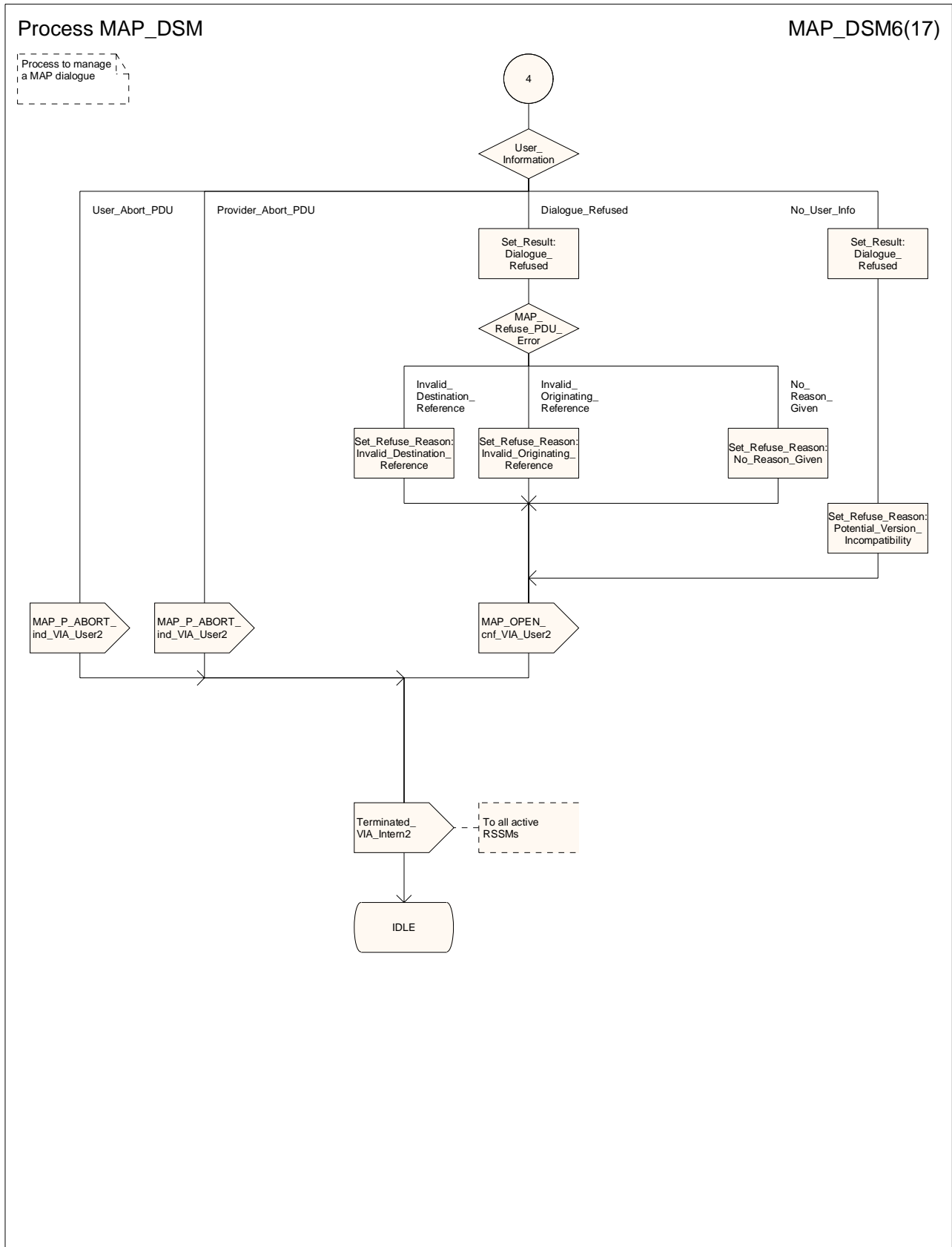

Figure 15.6/3f: Process MAP_DSM (sheet 6)

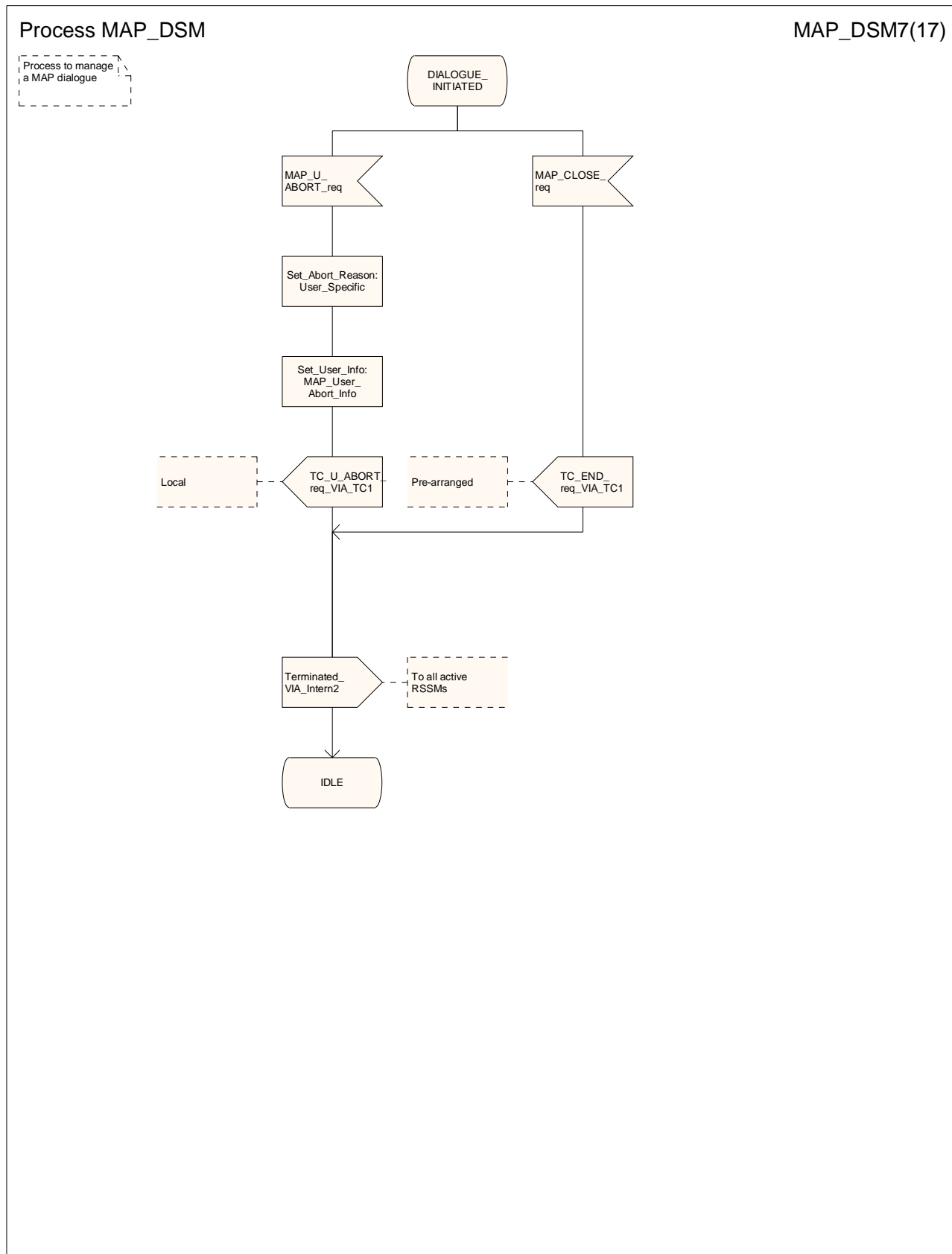

Figure 15.6/3g: Process MAP_DSM (sheet 7)

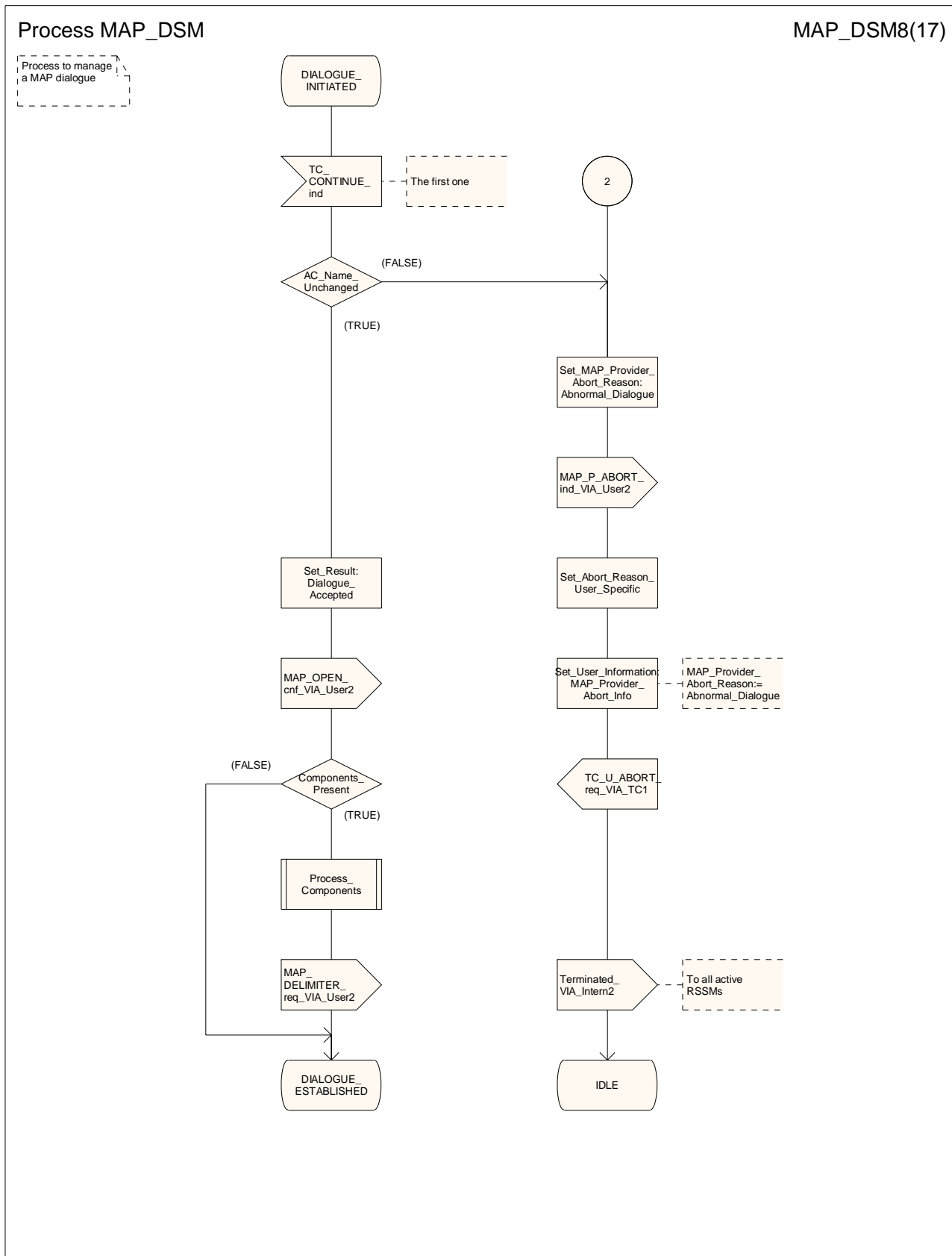

Figure 15.6/3h: Process MAP_DSM (sheet 8)

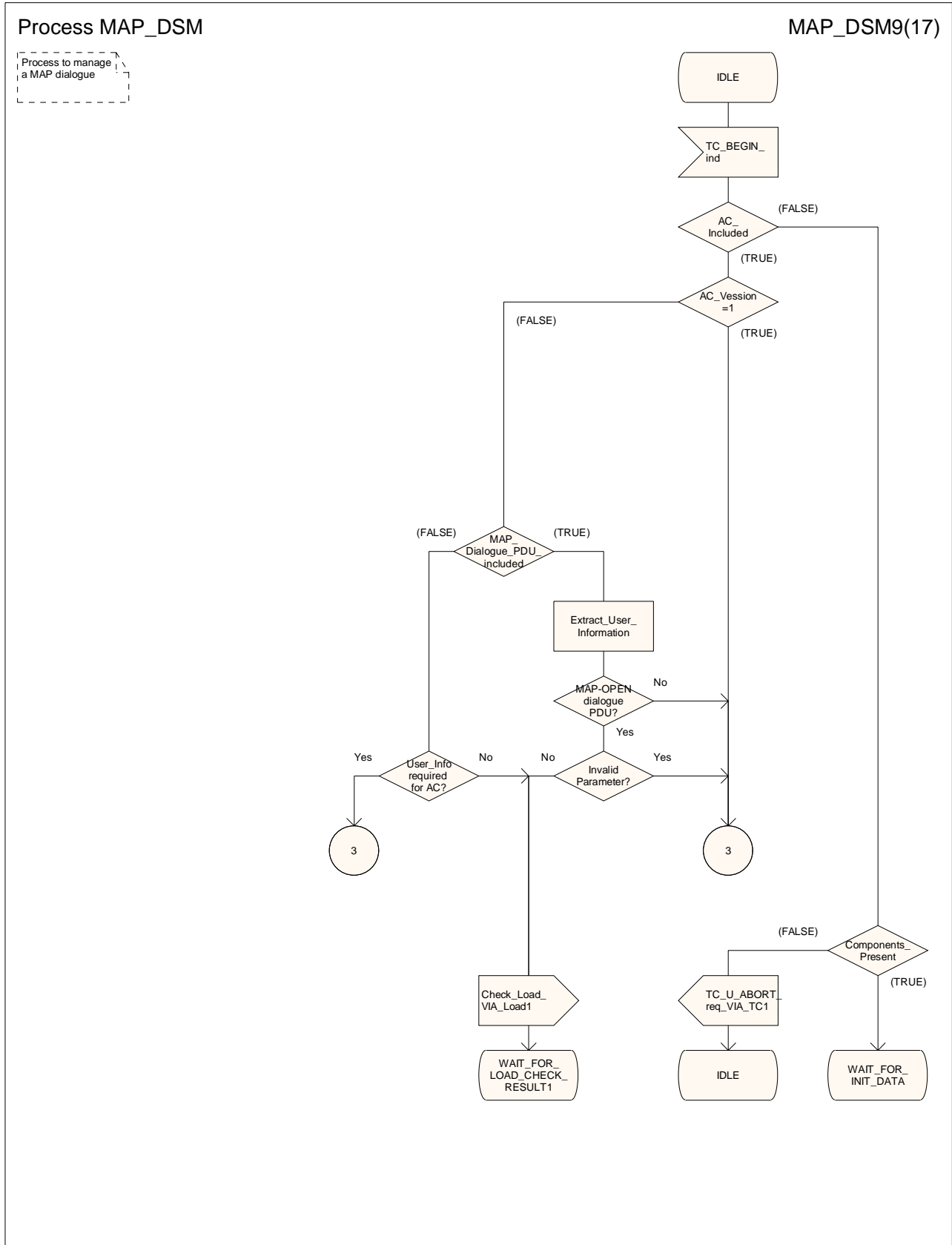

Figure 15.6/3i: Process MAP_DSM (sheet 9)

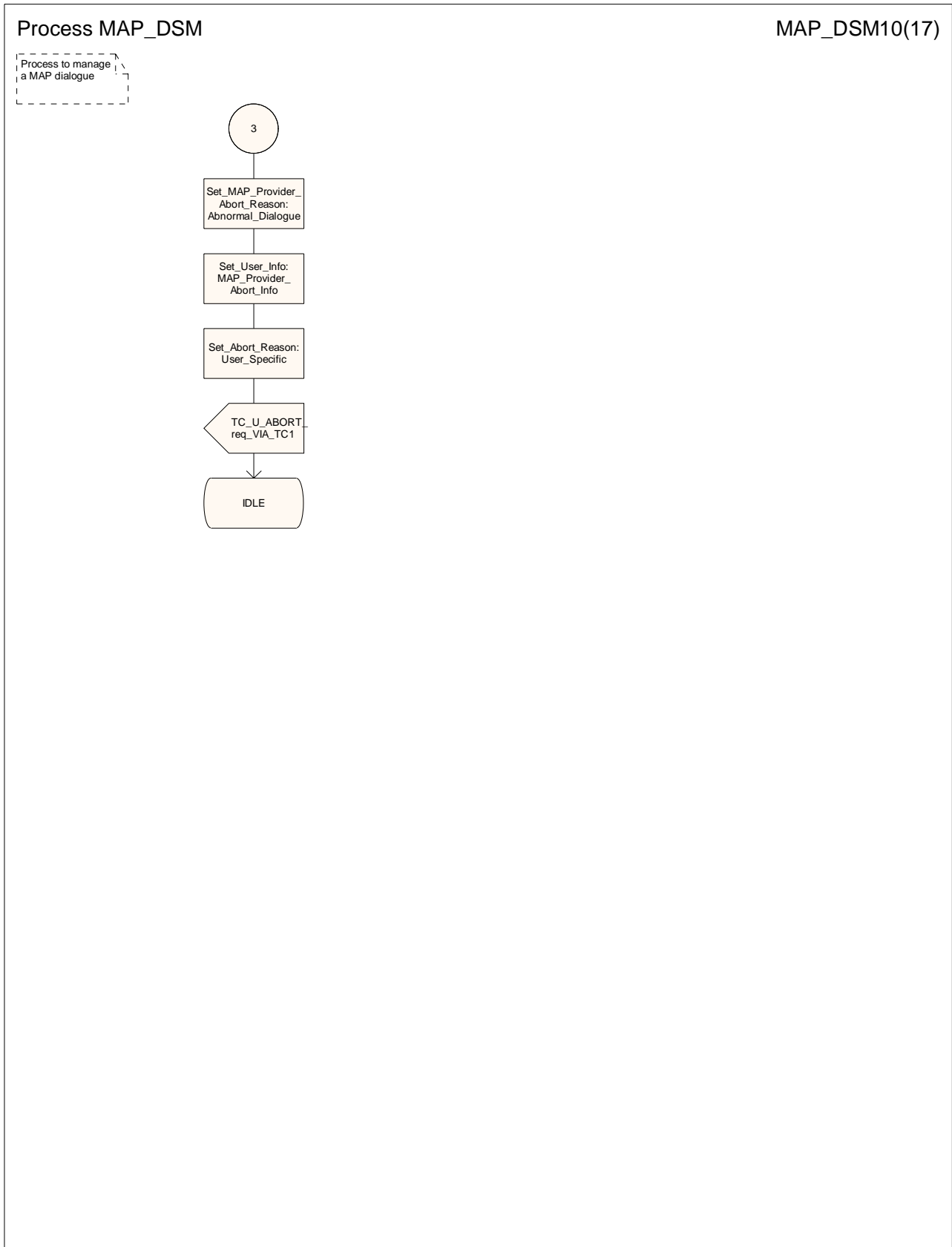

Figure 15.6/3j: Process MAP_DSM (sheet 10)

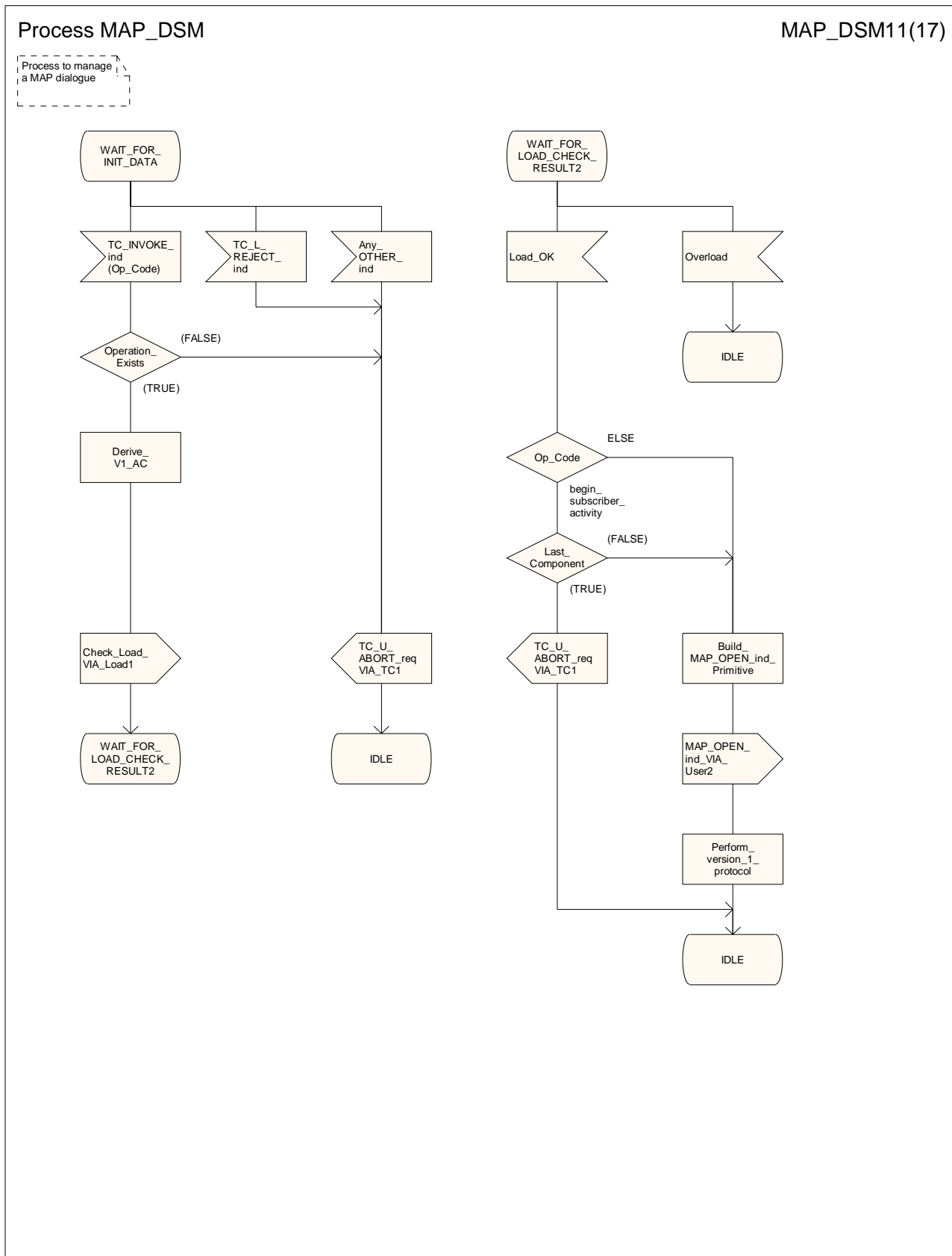

Figure 15.6/3k: Process MAP_DSM (sheet 11)

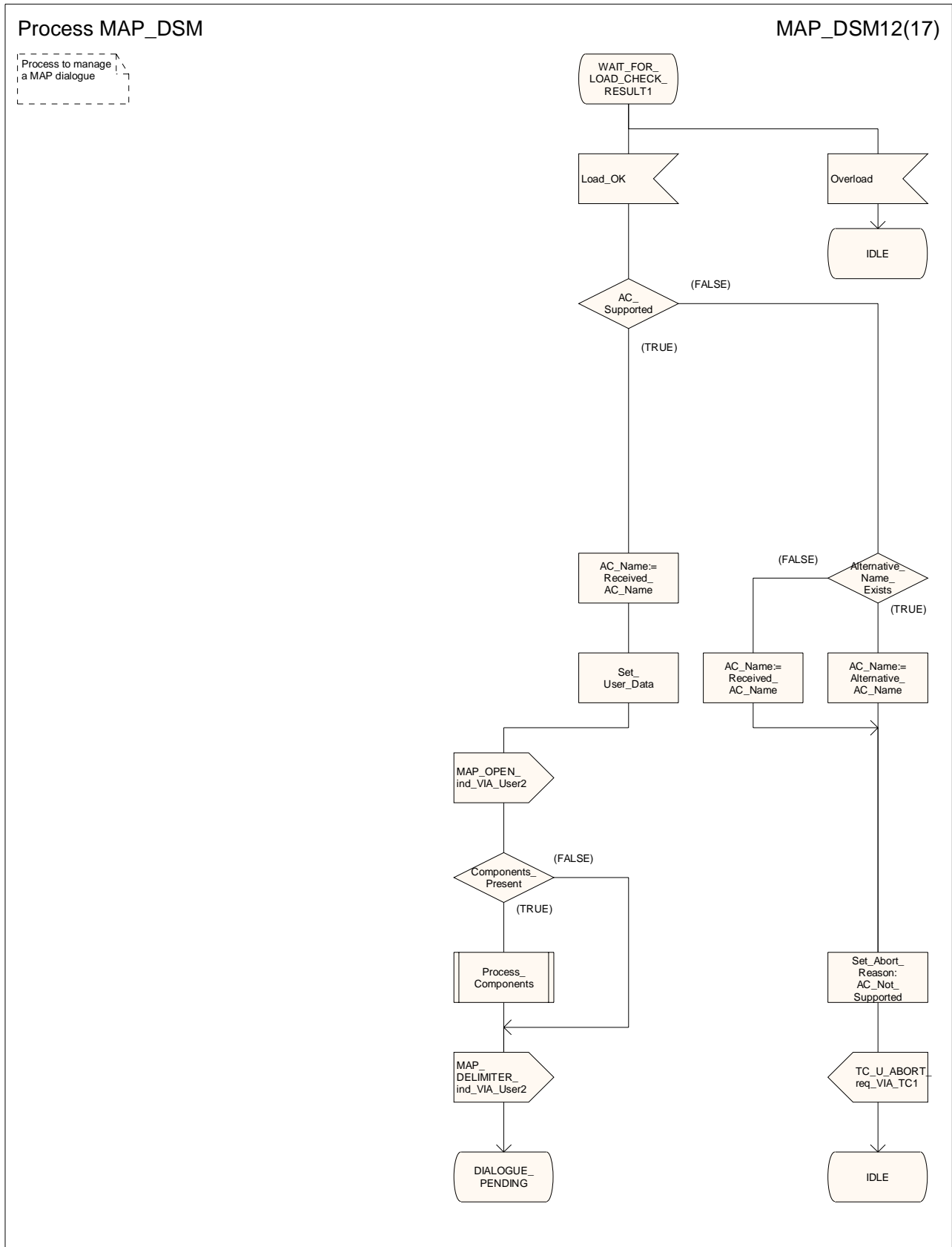

Figure 15.6/31: Process MAP_DSM (sheet 12)

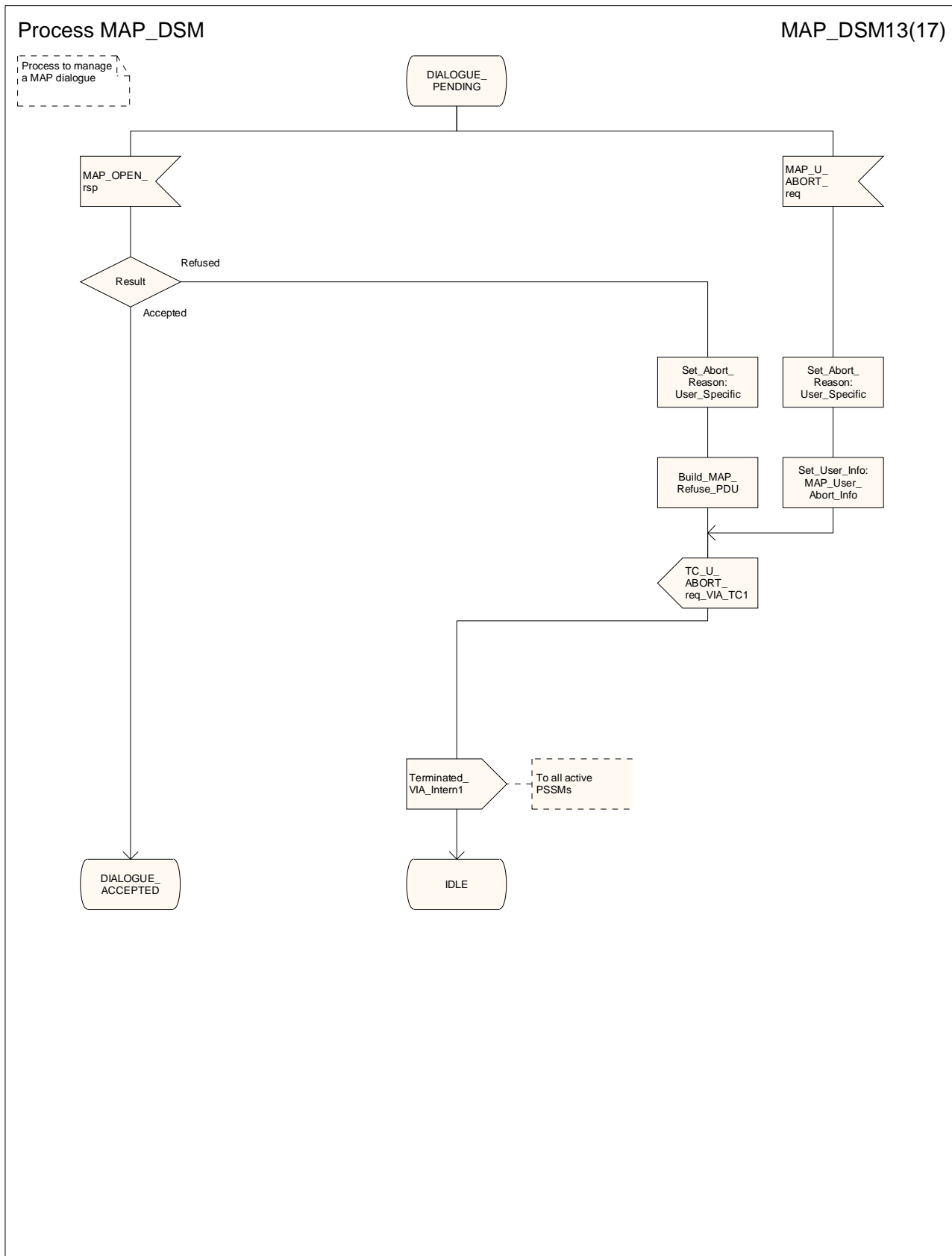

Figure 15.6/3m: Process MAP_DSM (sheet 13)

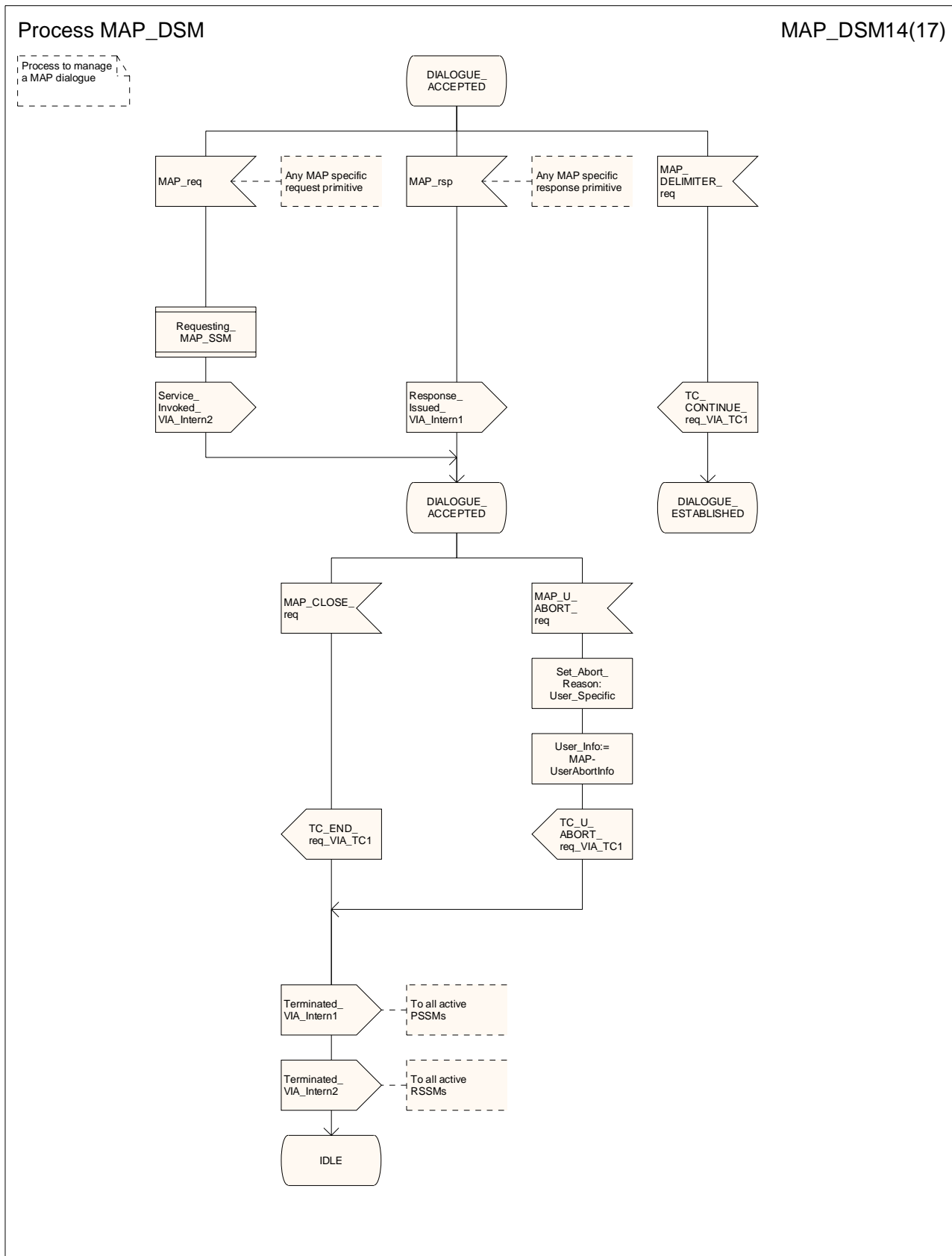

Figure 15.6/3n: Process MAP_DSM (sheet 14)

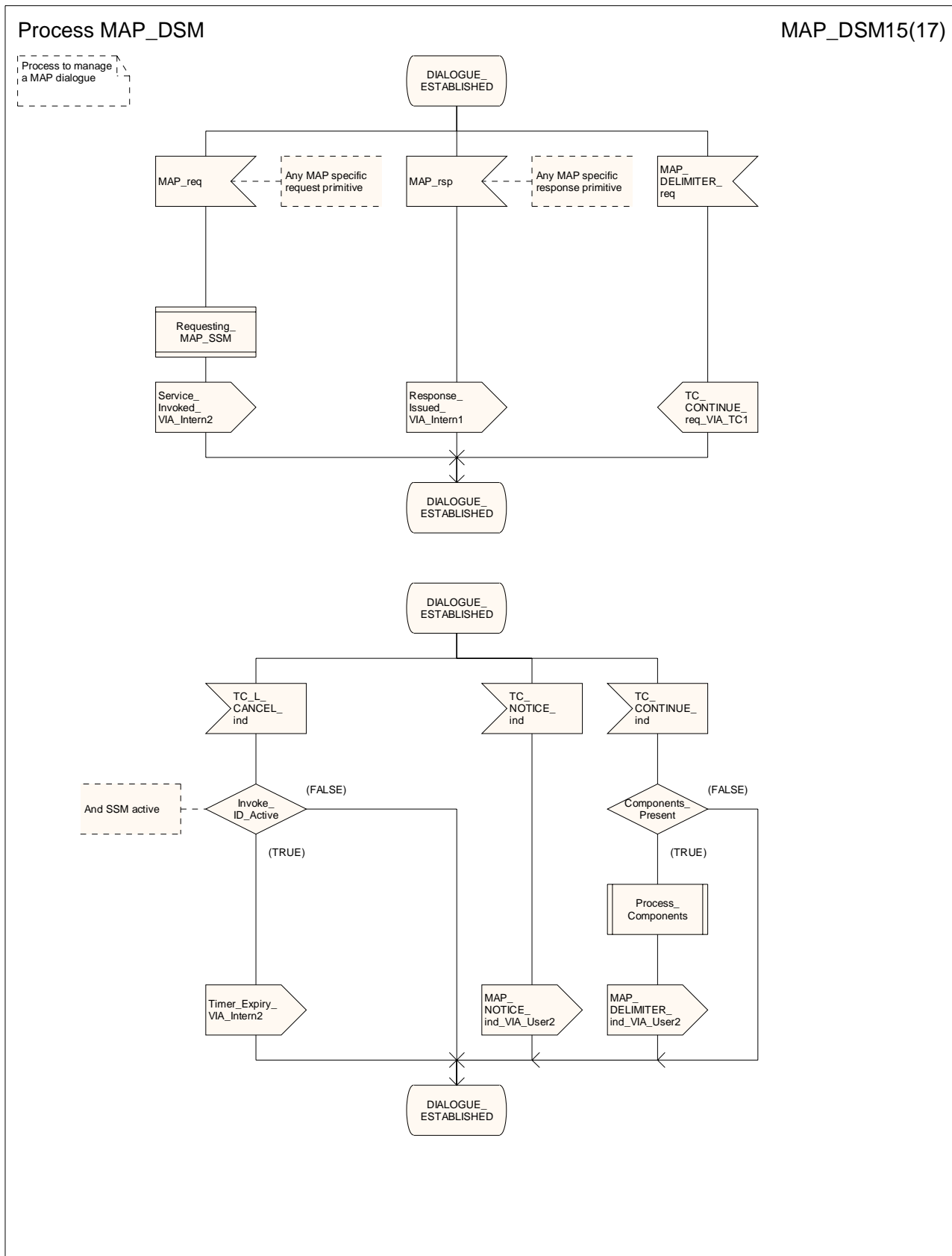

Figure 15.6/3o: Process MAP_DSM (sheet 15)

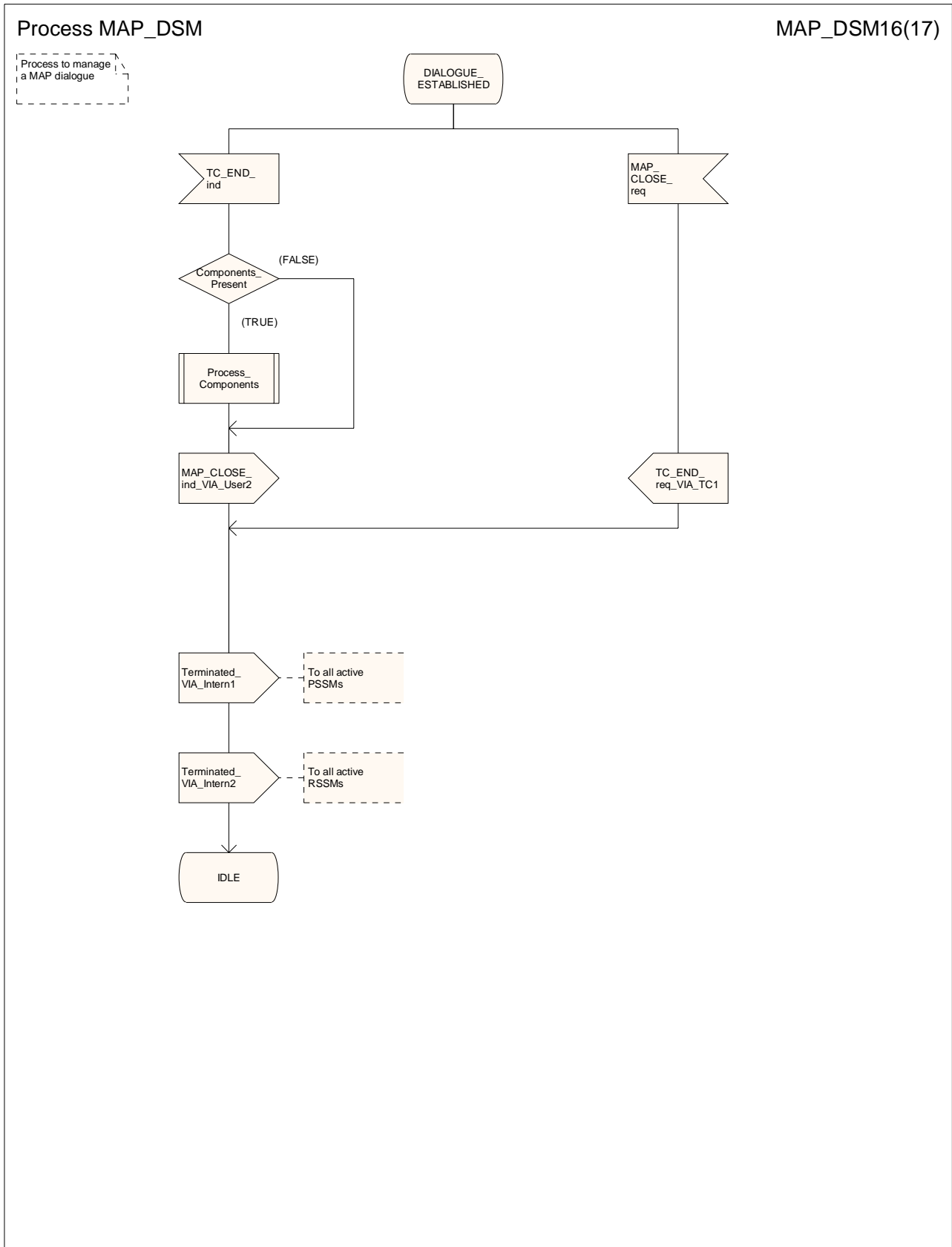

Figure 15.6/3p: Process MAP_DSM (sheet 16)

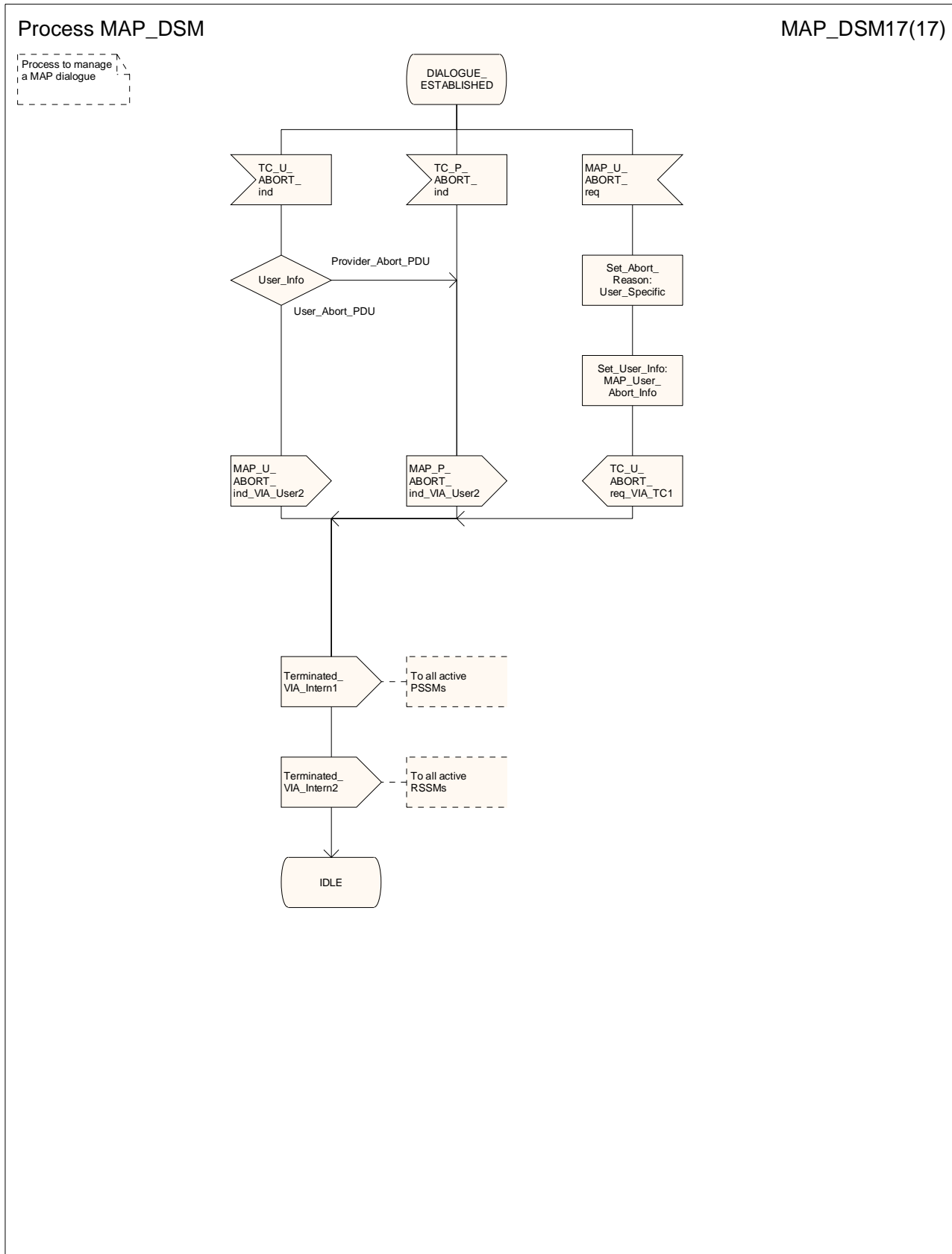

Figure 15.6/3q: Process MAP_DSM (sheet 17)

Procedure Process_Components

Proc_Comp1(5)

Procedure to process components received in a TC message

Comment: 'Components from TCAP'
 DCL
 Op_Code, Operation_Class INTEGER,
 Operation_Exists, Last_Component, Invoke_ID_Present, Invoke_ID_Assigned, Linked_ID_Present, Linked_ID_Assigned,
 Linked_Operation_Allowed, v3_Or_Higher_Dialogue BOOLEAN;

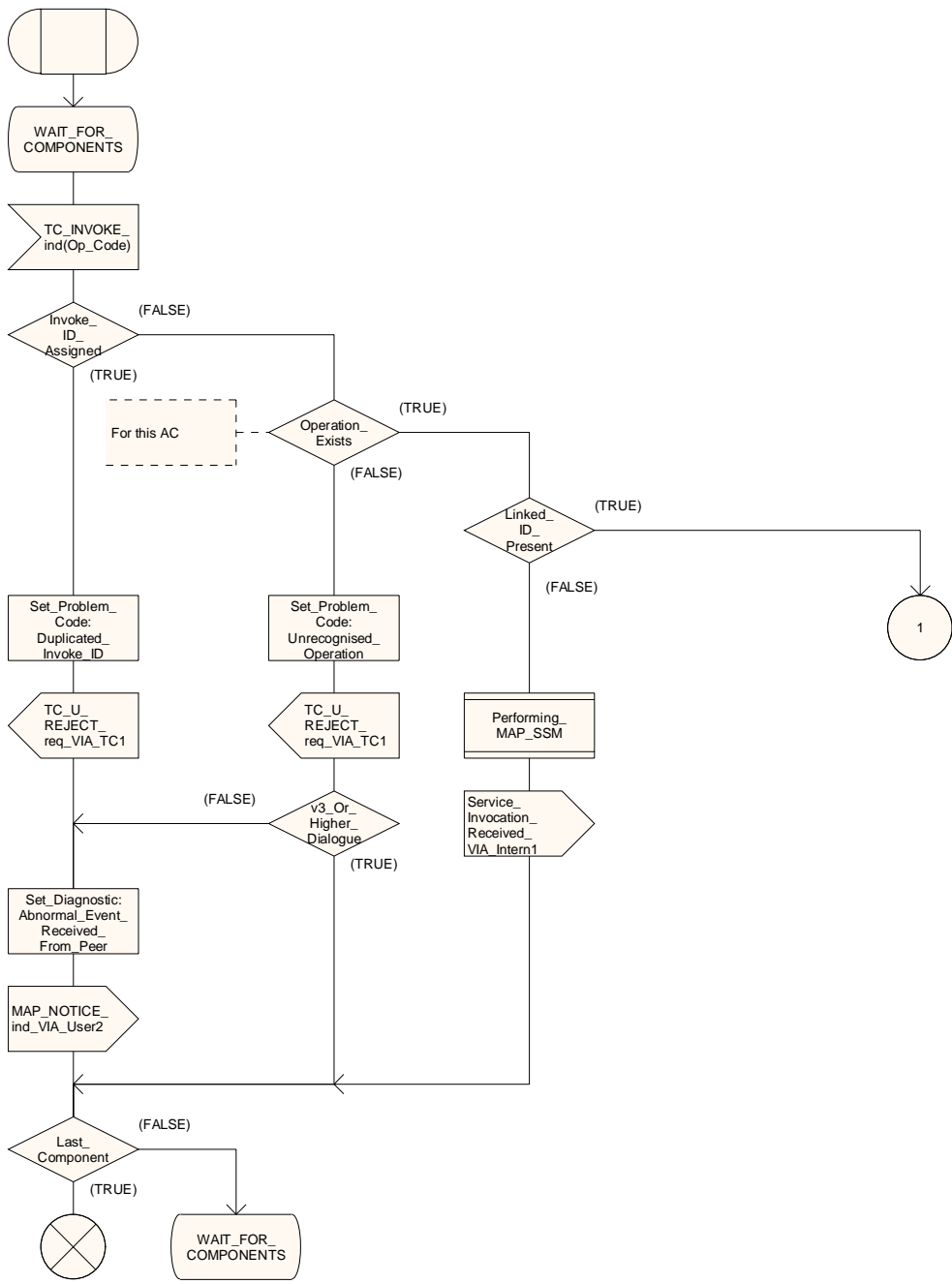

Figure 15.6/4a: Procedure Process_Components (sheet 1)

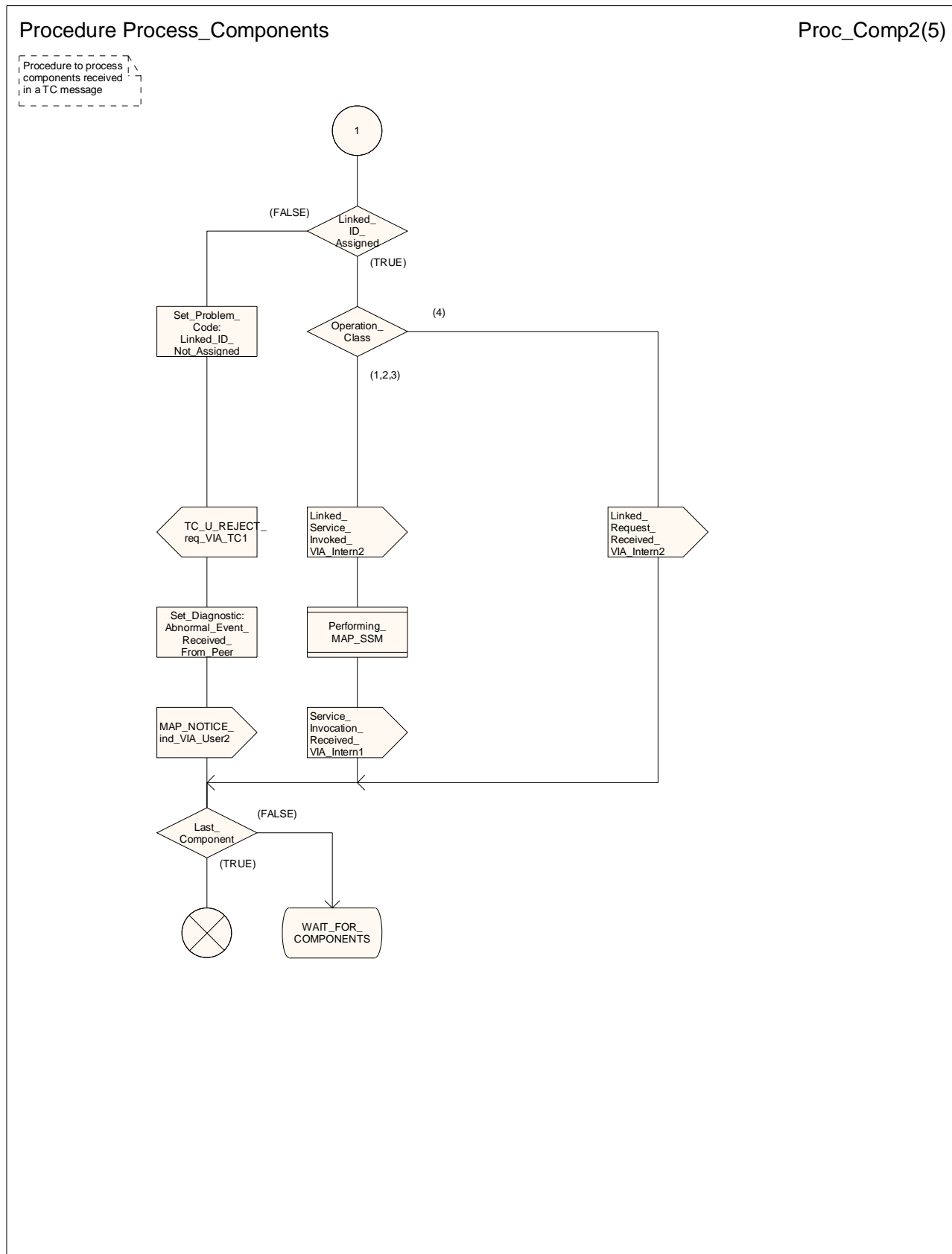

Figure 15.6/4b: Procedure Process_Components (sheet 2)

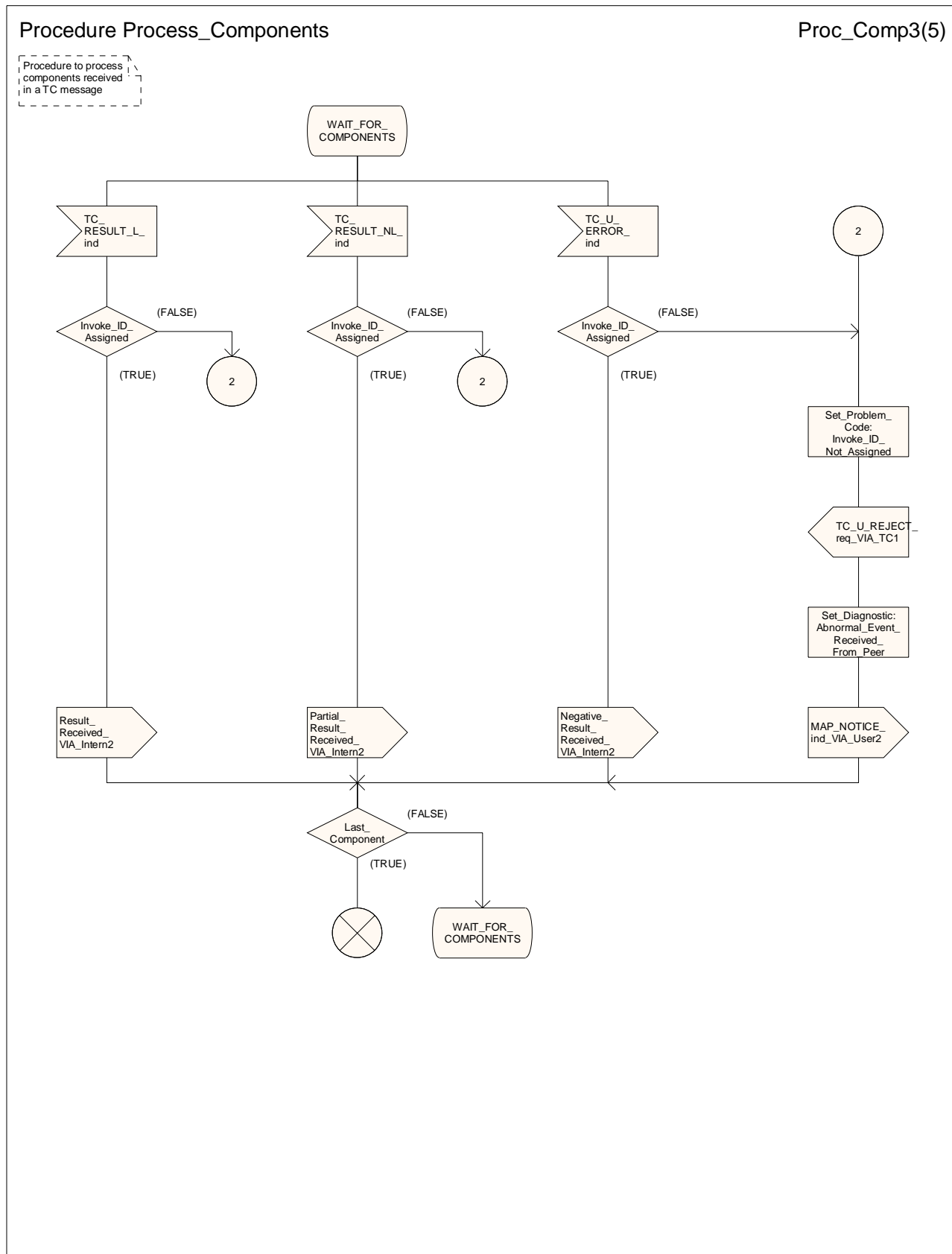

Figure 15.6/4c: Procedure Process_Components (sheet 3)

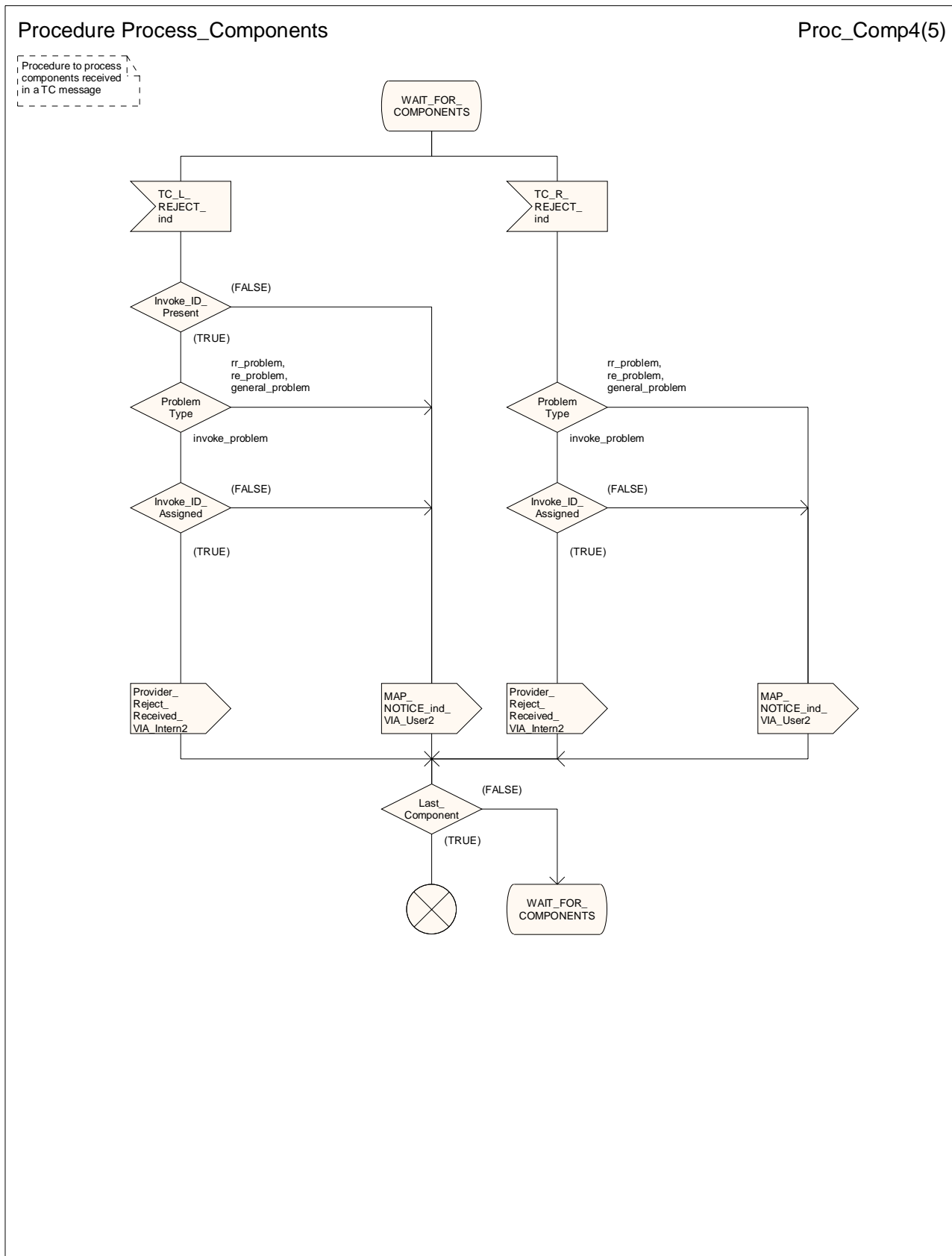

Figure 15.6/4d: Procedure Process_Components (sheet 4)

Procedure Process_Components

Proc_Comp5(5)

Procedure to process components received in a TC message

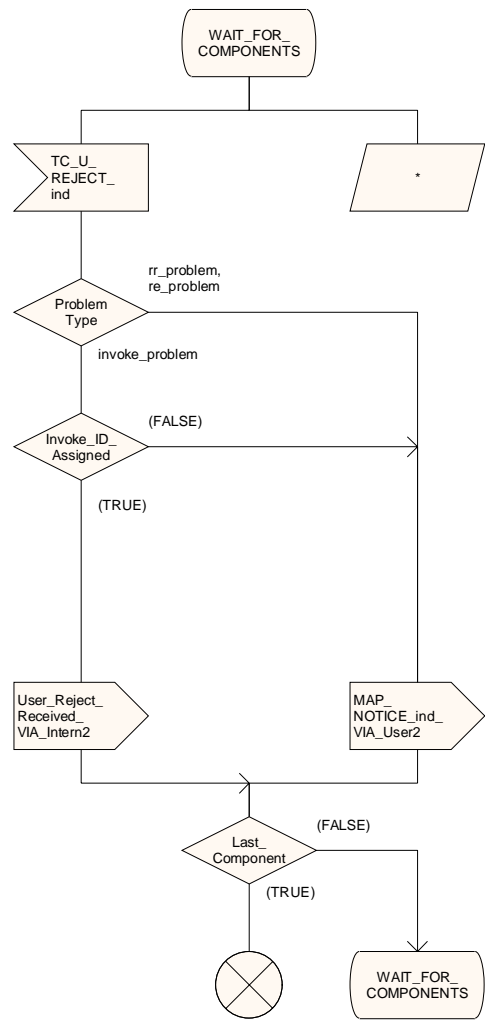

Figure 15.6/4e: Procedure Process_Components (sheet 5)

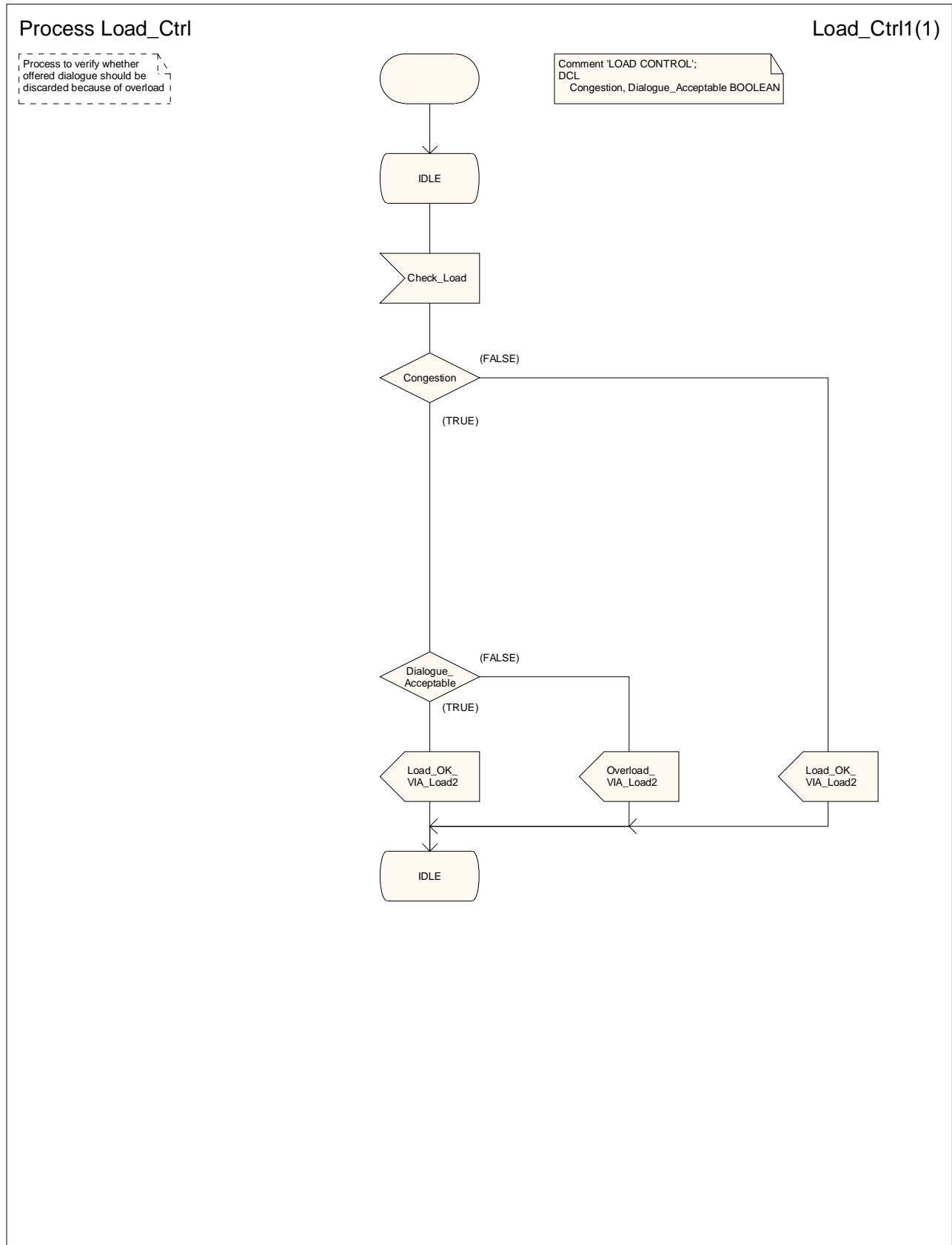

Figure 15.6/5: Process Load_Ctrl

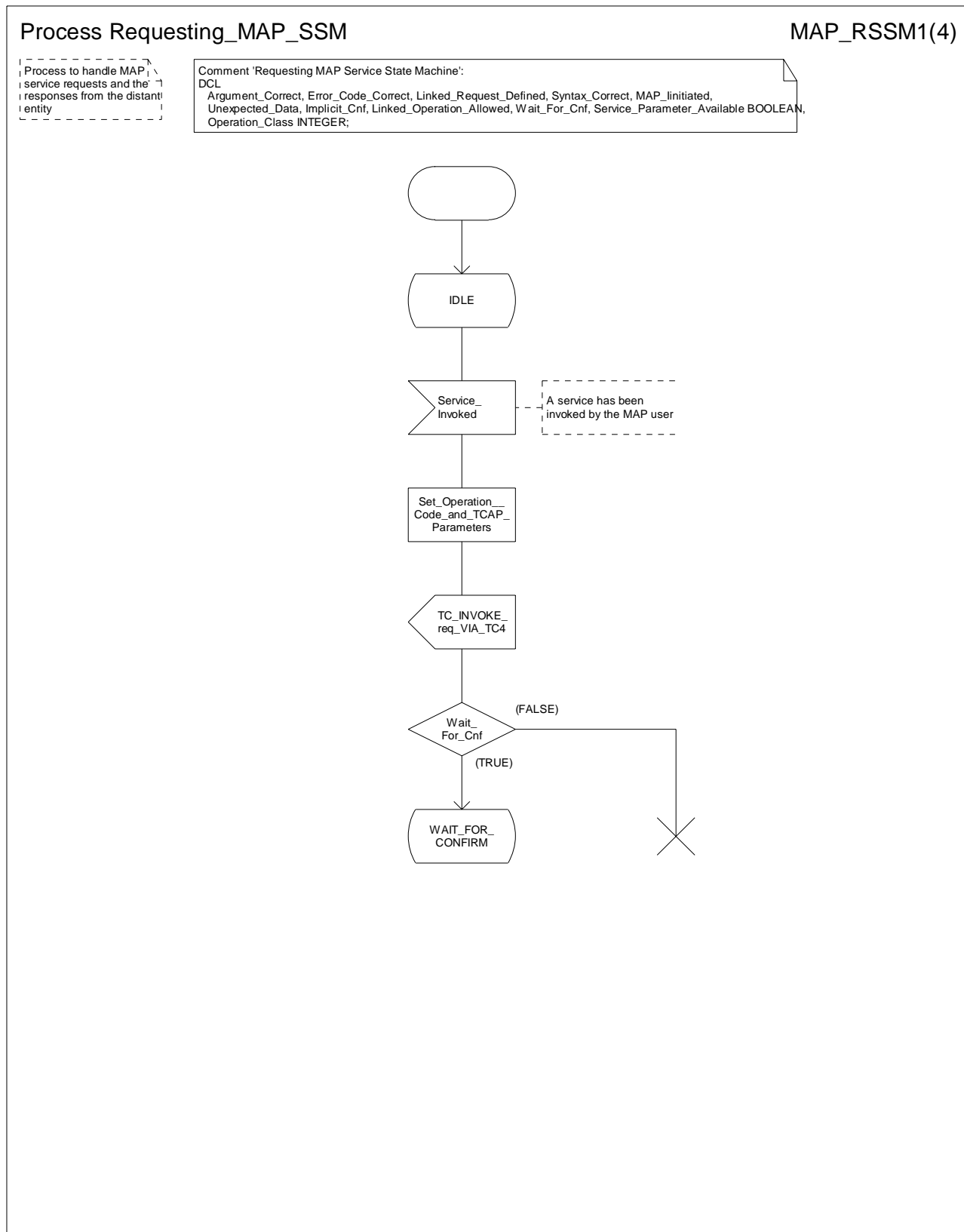

Figure 15.6/6a: Process Requesting_MAP_SSM (sheet 1)

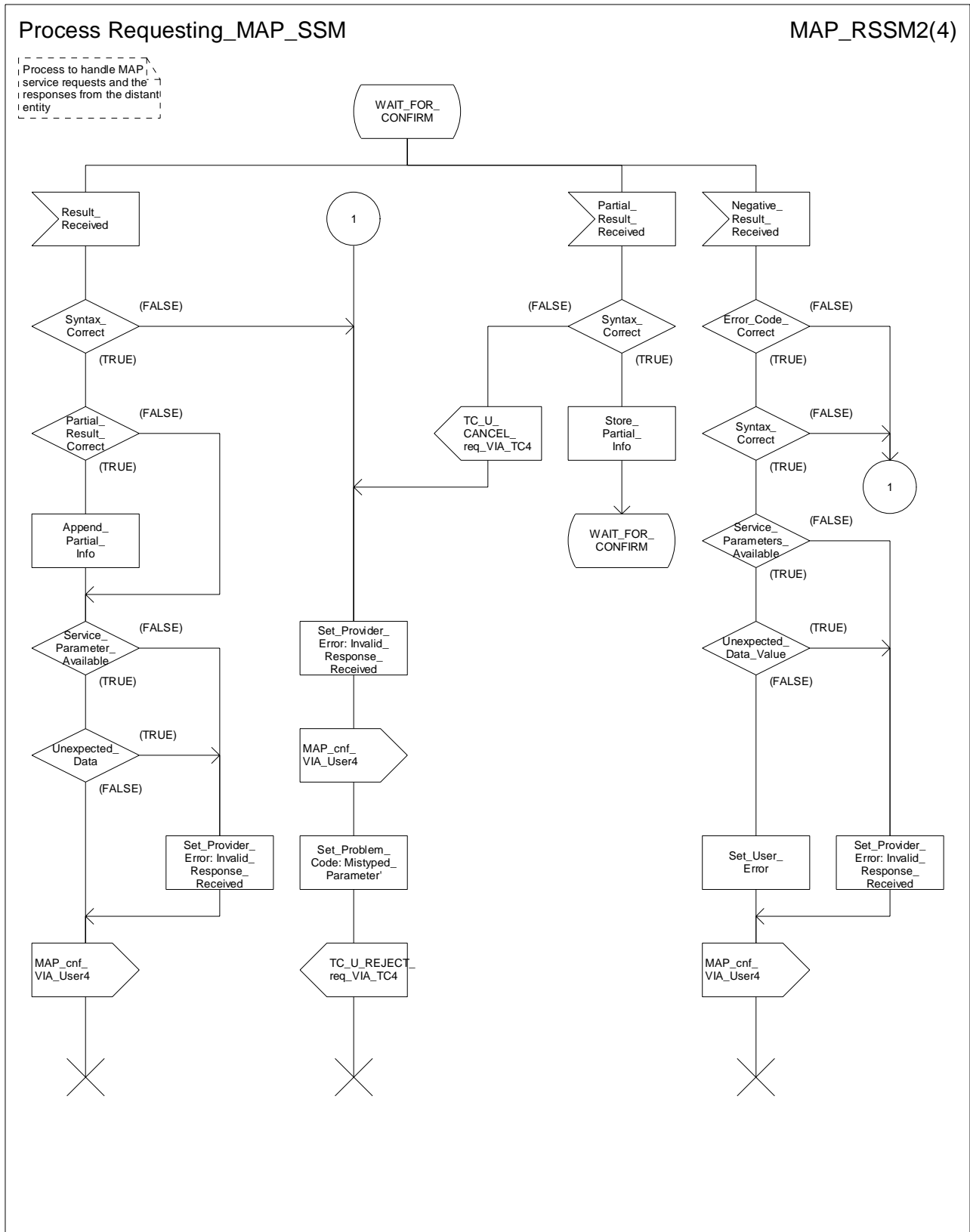

Figure 15.6/6b: Process Requesting_MAP_SSM (sheet 2)

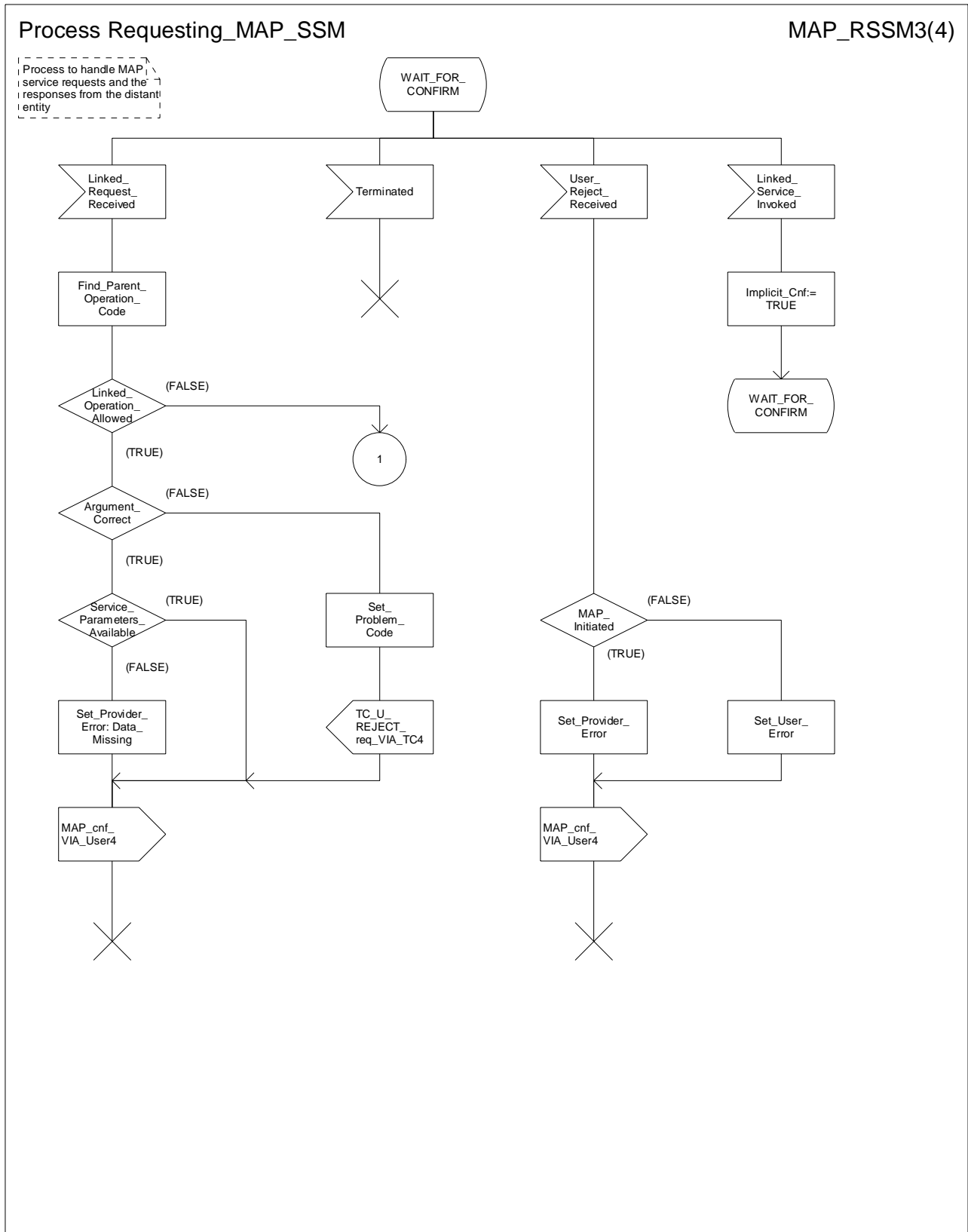

Figure 15.6/6c: Process Requesting_MAP_SSM (sheet 3)

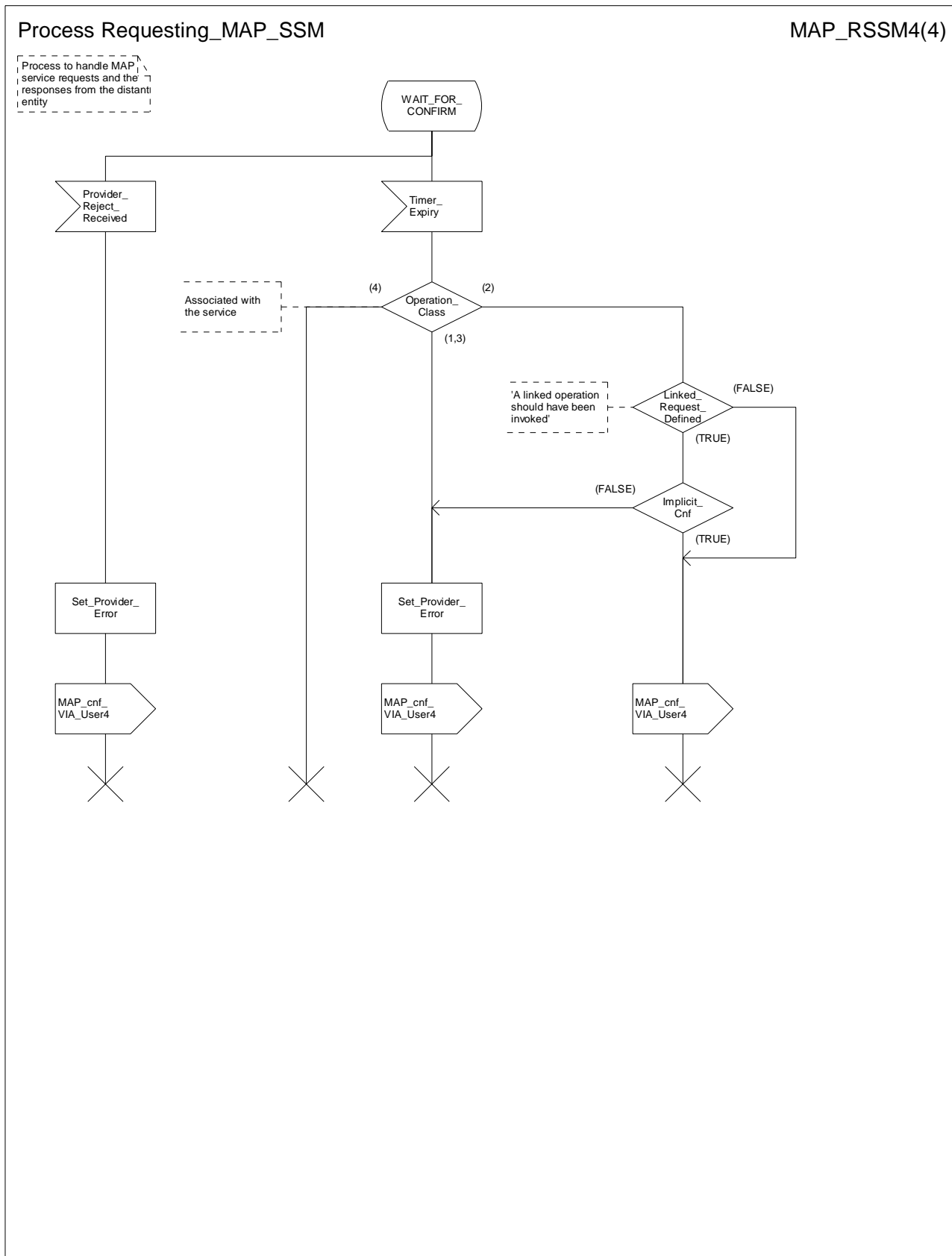

Figure 15.6/6d: Process Requesting_MAP_SSM (sheet 4)

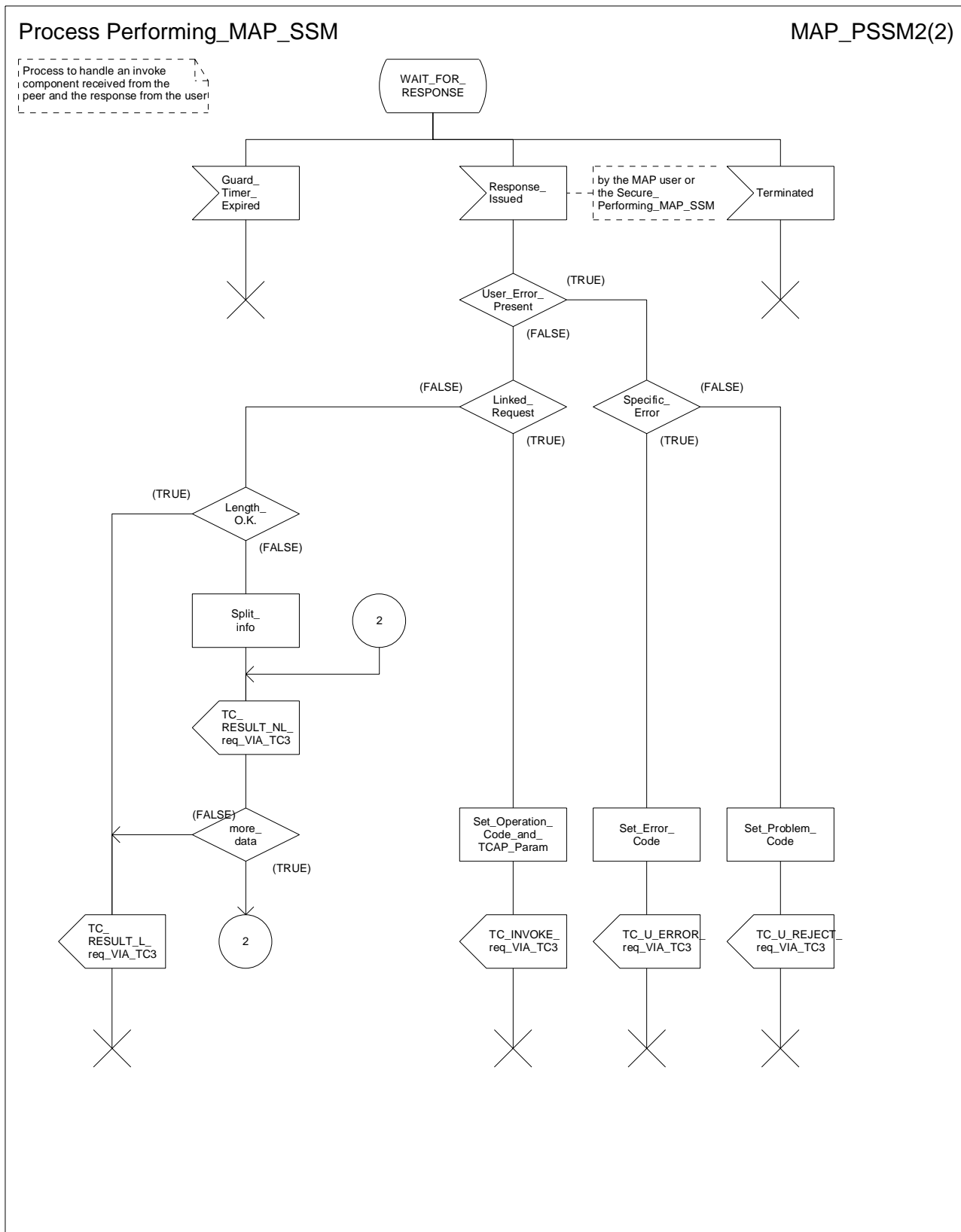

Figure 15.6/8b: Process Performing_MAP_SSM (sheet 2)

16 Mapping on to TC services

16.1 Dialogue control

Dialogue control services are mapped to TC dialogue handling services. The TC-UNI service is not used by the MAP PM.

16.1.1 Directly mapped parameters

The following parameters of the MAP-OPEN request and indication primitives are directly mapped on to the corresponding parameters of the TC-BEGIN primitives:

- destination address;
- originating address.

16.1.2 Use of other parameters of dialogue handling primitives

16.1.2.1 Dialogue Id

The value of this parameter is associated with the MAP PM invocation in an implementation dependent manner.

16.1.2.2 Application-context-name

The application-context-name parameter of a MAP primitive is mapped to the application-context-name parameter of TC dialogue handling primitives according to the rules described in clause 15.1.

16.1.2.3 User information

The user information parameter of TC dialogue primitives is used to carry the MAP dialogue APDUs.

16.1.2.4 Component present

This parameter is used by the MAP PM as described in CCITT Recommendation Q.771. It is not visible to the MAP user.

16.1.2.5 Termination

The value of this parameter of the TC-END request primitive is set by the MAP PM on the basis of the release method parameter of the MAP-CLOSE request primitive, except when the dialogue state machine is in the state DIALOGUE INITIATED, in which case the Termination parameter shall always indicate "pre-arranged end".

16.1.2.6 P-Abort-Cause

Values of the P-abort-cause parameter are mapped to the values of the provider-reason parameter of the MAP-P-ABORT indication primitive according to table 16.1/1, except in the dialogue initiated phase for the "incorrectTransactionPortion" and "noCommonDialoguePortion" values which are mapped to the "potential incompatibility problem" value of the refuse-reason parameter of the MAP-OPEN cnf primitive. The source parameter in the MAP-P-ABORT ind takes the value "TC problem".

16.1.2.7 Quality of service

The quality of service of TC request primitives is set by the MAP as shown below.

- Return option: "Return message on error" or "Discard message on error" as required by the network operator;

- Sequence control: "Sequence guaranteed" or "Sequence result not guaranteed" as required by the network operator;
- "Sequence guaranteed" shall be used when a segmented result is to be transferred (e.g. subscriber data in response to SendParameters). It may also be appropriate to use Sequence guaranteed when a series of InsertSubscriberData, ProcessAccessSignalling or ForwardAccessSignalling operations is used.

It is essential that the TC message which indicates acceptance of a dialogue opening request is received by the dialogue initiator before any subsequent message in that dialogue; otherwise the dialogue opening will fail. The dialogue responder shall ensure that this requirement is met by:

- Sending the dialogue acceptance message in a TC-END, if the dialogue structure requires it; or
- Using "Sequence guaranteed", if the dialogue acceptance message is sent in a TC-CONTINUE; or
- Waiting until the dialogue acceptance message has been acknowledged by the dialogue initiator before sending a subsequent message, if the dialogue acceptance message is sent in a TC-CONTINUE.

Table 16.1/1: Mapping of P-Abort cause in TC-P-ABORT indication on to provider-reason in MAP-P-ABORT indication

TC P-Abort cause	MAP provider-reason
unrecognised message type	provider malfunction
unrecognised transaction Id	supporting dialogue released
badlyFormattedTransactionPortion	provider malfunction
incorrectTransactionPortion	provider malfunction (note)
resourceLimitation	resource limitation
abnormalDialogue	provider malfunction
noCommonDialoguePortion	version incompatibility
NOTE: Or version incompatibility in the dialogue initiated phase.	

16.2 Service specific procedures

Specific services are mapped to TC component handling services.

16.2.1 Directly mapped parameters

The Invoke Id parameter of the MAP request and indication primitive is directly mapped on to the Invoke Id parameter of the component handling primitives.

16.2.2 Use of other parameters of component handling primitives

16.2.2.1 Dialogue Id

The value of this parameter is associated with the MAP PM invocation in an implementation dependent manner.

16.2.2.2 Class

The value of this parameter is set by the MAP PM according to the type of the operation to be invoked.

16.2.2.3 Linked Id

When a service response is mapped to a class 4 operation, the value of this parameter is set by the MAP PM and corresponds to the value assigned by the user to the initial service request (i.e. the value of the invoke ID parameter of the request primitive). Otherwise if such a parameter is included in MAP request/indication primitives it is directly mapped to the linked ID parameter of the associated TC-INVOKE request/indication primitives.

16.2.2.4 Operation

When mapping a request primitive on to a Remote Operations PDU (invoke), the MAP PM shall set the operation code according to the mapping described in table 16.2/1.

When mapping a response primitive on to a Remote Operations service, the MAP PM shall set the operation code of the TC-RESULT-L/NL primitive (if required) to the same value as the one received at invocation time.

Table 16.2/1: Mapping of MAP specific services on to MAP operations

MAP-SERVICE	operation
MAP-ACTIVATE-SS	activateSS
MAP-ACTIVATE-TRACE-MODE	activateTraceMode
MAP-ALERT-SERVICE-CENTRE	alertServiceCentre
MAP-ANY-TIME-INTERROGATION	anyTimeInterrogaton
MAP_AUTHENTICATION_FAILURE_REPORT	authenticationFailureReport
MAP-ANY-TIME-MODIFICATION	anyTimeModification
MAP-ANY-TIME-SUBSCRIPTION-INTERROGATION	anyTimeSubscriptionInterrogation
MAP-CANCEL-LOCATION	cancelLocation
MAP-CHECK-IMEI	checkIMEI
MAP-DEACTIVATE-SS	deactivateSS
MAP-DEACTIVATE-TRACE-MODE	deactivateTraceMode
MAP-DELETE-SUBSCRIBER-DATA	deleteSubscriberData
MAP-ERASE-CC-ENTRY	eraseCC-Entry
MAP-ERASE-SS	eraseSS
MAP-FAILURE-REPORT	failureReport
MAP-FORWARD-ACCESS-SIGNALLING	forwardAccessSignalling
MAP-FORWARD-CHECK-SS-INDICATION	forwardCheckSsIndication
MAP-FORWARD-GROUP-CALL-SIGNALLING	forwardGroupCallSignalling
MAP-MT-FORWARD-SHORT-MESSAGE	mt-forwardSM
MAP-MO-FORWARD-SHORT-MESSAGE	mo-forwardSM
MAP-GET-PASSWORD	getPassword
MAP-INFORM-SERVICE-CENTRE	informServiceCentre
MAP-INSERT-SUBSCRIBER-DATA	insertSubscriberData
MAP-INTERROGATE-SS	interrogateSs
MAP-IST-ALERT	istAlert
MAP-IST-COMMAND	istCommand
MAP-NOTE-MS-PRESENT-FOR-GPRS	noteMsPresentForGprs
MAP-NOTE-SUBSCRIBER-DATA-MODIFIED	noteSubscriberDataModified
MAP-PREPARE-GROUP-CALL	prepareGroupCall
MAP-PREPARE-HANDOVER	prepareHandover
MAP-PREPARE-SUBSEQUENT-HANDOVER	prepareSubsequentHandover
MAP-PROCESS-ACCESS-SIGNALLING	processAccessSignalling
MAP-PROCESS-GROUP-CALL-SIGNALLING	processGroupCallSignalling
MAP-PROCESS-UNSTRUCTURED-SS-REQUEST	processUnstructuredSS-Request
MAP-PROVIDE-ROAMING-NUMBER	provideRoamingNumber
MAP-PROVIDE-SIWFS-NUMBER	provideSIWFSNumber
MAP-PROVIDE-SUBSCRIBER-LOCATION	provideSubscriberLocation
MAP-PROVIDE-SUBSCRIBER-INFO	provideSubscriberInfo
MAP-PURGE-MS	purgeMS
MAP-READY-FOR-SM	readyForSM
MAP-REGISTER-CC-ENTRY	registerCC-Entry
MAP-REGISTER-PASSWORD	registerPassword
MAP-REGISTER-SS	registerSS
MAP-REMOTE-USER-FREE	remoteUserFree
MAP-REPORT-SM-DELIVERY-STATUS	reportSmDeliveryStatus
MAP-RESET	reset
MAP-RESTORE-DATA	restoreData
MAP-SEND_GROUP_CALL_END_SIGNAL	sendGroupCallEndSignal
MAP-SEND-END-SIGNAL	sendEndSignal
MAP-SEND-AUTHENTICATION-INFO	sendAuthenticationInfo
MAP-SEND-IMSI	sendIMSI
MAP-SEND-IDENTIFICATION	sendIdentification
MAP-SEND-ROUTING-INFO-FOR-SM	sendRoutingInfoForSM

MAP-SEND-ROUTING-INFO-FOR-GPRS	sendRoutingInfoForGprs
MAP-SEND-ROUTING-INFO-FOR-LCS	sendRoutingInfoForLCS
MAP-SEND-ROUTING-INFORMATION	sendRoutingInfo
MAP-SET-REPORTING-STATE	setReportingState
MAP-SIWFS-SIGNALING-MODIFY	SIWFSSignallingModify
MAP-STATUS-REPORT	statusReport
MAP-SUBSCRIBER-LOCATION-REPORT	subscriberLocationReport
MAP-SUPPLEMENTARY-SERVICE-INVOCATION-NOTIFICATION	ss-Invocation-Notification
MAP-UNSTRUCTURED-SS-NOTIFY	unstructuredSS-Notify
MAP-UNSTRUCTURED-SS-REQUEST	unstructuredSS-Request
MAP-UPDATE-GPRS-LOCATION	updateGprsLocation
MAP-UPDATE-LOCATION	updateLocation
MAP-NOTE-MM-EVENT	NoteMM-Event

16.2.2.5 Error

The error parameter in a TC-U-ERROR indication primitive is mapped to the user error parameter in the MAP confirm primitive of the service associated with the operation to which the error is attached.

The user error parameter in MAP response primitives is mapped to the error parameter of the TC-U-ERROR request primitive, except for "initiating-release" and "resource-limitation" which are mapped to the problem code parameter of the TC-U-REJECT request primitive.

16.2.2.6 Parameters

The parameters of MAP specific request and indication primitives are mapped to the argument parameter of TC-INVOKE primitives.

The parameters of MAP specific response and confirm primitives are mapped to the result parameter of TC-RESULT-L primitives, the parameter of TC-U-ERROR primitives or the argument of TC-INVOKE primitives when mapping on linked class 4 operations is used.

16.2.2.7 Time out

The value of this parameter is set by the MAP PM according to the type of operation invoked.

16.2.2.8 Last component

This parameter is used by the MAP PM as described in CCITT Recommendation Q.711. It is not visible from the MAP user.

16.2.2.9 Problem code

16.2.2.9.1 Mapping to MAP User Error

The following values of the user error parameter are mapped as follows to values of the TC problem code parameter. These values are generated by the MAP user. This mapping is valid from the TC-U-REJECT indication primitive to the MAP confirm service primitive and from the MAP response service primitive to the TC-U-REJECT request primitive.

Table 16.2/2: Mapping of MAP User Error parameter on to TC problem code in TC-U-REJECT primitives

MAP User Error	TC problem code
resource limitation	resource limitation
initiating release	initiating release

16.2.2.9.2 Mapping to MAP Provider Error parameter

The following values of the TC problem code parameter of the TC-U-REJECT indication primitive are mapped as follows to values of the MAP Provider Error parameter of the MAP confirm primitive.

Table 16.2/3: Mapping of TC problem code in TC-U-REJECT on to MAP Provider Error parameter

TC problem code	MAP Provider Error
duplicated invoke Id	duplicated invoke id
unrecognised operation	service not supported
mistyped parameter	mistyped parameter

The following values of the problem code parameters of the TC-L-REJECT primitive are mapped to values of the provider error parameter of the MAP confirm primitive as follows.

Table 16.2/4: Mapping of TC problem code in TC-L-REJECT on to MAP Provider Error parameter

TC problem code	MAP Provider Error
return result unexpected	unexpected response from the peer
return error unexpected	unexpected response from the peer

16.2.2.9.3 Mapping to diagnostic parameter

The following values of the problem code parameter of the TC-R-REJECT and TC-U-REJECT primitive are mapped to values of the diagnostic parameter of the MAP-NOTICE indication primitive as follows:

Table 16.2/5: Mapping of TC problem code of TC-R-REJECT and TC-U-REJECT on to diagnostic parameter

TC problem code	MAP diagnostic
General problem	- abnormal event detected by the peer
Invoke problem	
- unrecognised linked ID	- abnormal event detected by the peer
- linked response unexpected	- response rejected by the peer
- unexpected linked operation	- response rejected by the peer
Return result problem	
- unrecognised invoke ID	- response rejected by the peer
- return result unexpected	- response rejected by the peer
- mistyped parameter	- response rejected by the peer
Return error problem	
- unrecognised invoke ID	- response rejected by the peer
- return error unexpected	- response rejected by the peer
- unrecognised error	- response rejected by the peer
- unexpected error	- response rejected by the peer
- mistyped parameter	- response rejected by the peer

The following values of the problem code parameter of the TC-L-REJECT primitive are mapped to values of the diagnostic parameter of the MAP-NOTICE indication primitive as follows.

Table 16.2/6: Mapping of TC problem code of TC-L-REJECT on to diagnostic parameter

TC problem code	MAP diagnostic
General problems	- abnormal event received from the peer
Invoke problem	
- unrecognised linked ID	- abnormal event received from the peer
Return result problem	
- unrecognised invoke ID	- abnormal event received from the peer
Return error problem	
- unrecognised invoke ID	- abnormal event received from the peer

17 Abstract syntax of the MAP protocol

17.1 General

This clause specifies the Abstract Syntaxes for the Mobile Application Part as well as the associated set of Operations and Errors, using the Abstract Syntax Notation One (ASN.1), defined in ITU-T Recommendations X.680 and X.681 with additions as defined in clause 17.1.4 on Compatibility Considerations and the OPERATION and ERROR external information object classes, defined in ITU-T Recommendation X.880.

The Abstract Syntax is defined for all interfaces specified in clause 4.4 except for the A- and B-interfaces.

The Mobile Application Part protocol is defined by two Abstract Syntaxes:

- one Abstract Syntax which encompass all Operations and Errors identified by the various MAP subsystem numbers.

This Abstract Syntax represents the set of values each of which is a value of the ASN.1 type TCAPMessages.TCMessage as defined in ITU-T Recommendation Q.773 with the component relationconstraint sections resolved by the operation and error codes included in the ASN.1 modules MAP-*Operations and MAP-Errors. However, only the subset of this abstract syntax which is required by the procedures defined for an entity needs to be supported.

- one Abstract Syntax identified by the OBJECT IDENTIFIER value MAP-DialogueInformation.map-DialogueAS.

This Abstract Syntax represents the set of values each of which is a value of the ASN.1 type MAP-DialogueInformation.MAP-DialoguePDU. Such a value of the ASN.1 single-ASN.1-type element is contained within the user-information element of the TCAPMessages.DialoguePortion ASN.1 type. This Abstract Syntax name is to be used as a direct reference.

17.1.1 Encoding rules

The encoding rules which are applicable to the defined Abstract Syntaxes are the Basic Encoding Rules for Abstract Syntax Notation One, defined in ITU-T Recommendation X.690 with the same exceptions as in ITU-T Recommendation Q.773, clause 4 Message Representation.

When the definite form is used for length encoding, a data value of length less than 128 octets must have the length encoded in the short form.

When the long form is employed to code a length, the minimum number of octets shall be used to code the length field.

OCTET STRING values and BIT STRING values must be encoded in a primitive form.

There is no restriction to the use of empty constructors (e.g. an empty SEQUENCE type). That is, the encoding of the content of any data value shall consist of zero, one or more octets.

17.1.2 Use of TC

The mapping of OPERATION and ERROR to TC components is defined in ETS 300 287 (version 2) which is based on ITU-T Recommendation Q.773.

NOTE 1: The class of an operation is not stated explicitly but is specified as well in the ASN.1 operation definition.

Class 1: RESULT and ERROR appear in ASN.1 operation definition.

Class 2: only ERROR appears in ASN.1 operation definition.

Class 3: only RESULT appears in ASN.1 operation definition.

Class 4: both RESULT and ERROR do not appear in ASN.1 operation definition.

The field "ARGUMENT", "PARAMETER" or "RESULT" (for information objects of class OPERATION and ERROR) is always optional from a syntactic point of view. However, except when specifically mentioned with the

ASN.1 comment "-- optional" , the "parameter" part of a component has to be considered as mandatory from a semantic point of view.

When an optional element is missing in an invoke component or in an inner data structure while it is required by the context, an error component is returned if specified in the information object associated with the operation ; the associated type of error is "DataMissing". This holds also when the entire parameter of an invoke component is missing while it is required by the context.

NOTE 2: When a mandatory element is missing in the parameter or inner data structure of any component, a reject component is returned (if the dialogue still exists). The problem code to be used is "Mistyped parameter".

The Timer Values used in the operation definitions are indicated as ASN.1 comments. The Timer Value Ranges are:

s = from 3 seconds to 10 seconds;

m = from 15 seconds to 30 seconds;

ml = from 1 minute to 10 minutes;

l = from 28 hours to 38 hours.

17.1.2.1 Use of Global Operation and Error codes defined outside MAP

An entity supporting an application context greater than 2 shall be capable of receiving an operation or error code, within an application context defined in GSM 29.002, encoded as either an Object Identifier (as defined in ITU-T Recommendation X.690) or an integer value (as defined in clause 17.5). Related restrictions regarding the use of Object Identifiers are as follows:

- The length of the Object Identifier shall not exceed 16 octets and the number of components of the Object Identifier shall not exceed 16.
- Object Identifiers shall be used only for operations or errors defined outside of GSM 29.002.
- Global error codes may be sent only in response to a global operation. If a standard operation is received then a global error code shall not be sent in response.

Handling of an unknown operation codes by the receiving entity is defined in clause 15.1.1.

17.1.3 Use of information elements defined outside MAP

An information element or a set of information elements (messages) transparently carried in the Mobile Application Part but defined in other recommendations/technical specifications are handled in one of the following ways:

- i) The contents of each information element (without the octets encoding the identifier and the length in the recommendation/technical specification where it is defined unless explicitly stated otherwise) is carried as the value of an ASN.1 type derived from the OCTET STRING data type. Additionally, the internal structure may be explained by means of comments. In case of misalignment the referred to recommendation/technical specification takes precedence.
- ii) The complete information element (including the octets encoding the identifier and the length in the recommendation/technical specification where it is defined) or set of information elements and the identity of the associated protocol are carried as the value of the ExternalSignalInfo data type defined in the present document. Where more than one information element is carried, the information elements are sent contiguously with no filler octets between them.

17.1.4 Compatibility considerations

The following ASN.1 modules conform to ITU-T Recommendation X.680 and X.681 . An extension marker ("...") is used wherever future protocol extensions are foreseen.

The "..." construct applies only to SEQUENCE and ENUMERATED data types. An entity supporting a version greater than 1 shall not reject an unsupported extension following "..." of that SEQUENCE or ENUMERATED data type. The

Encoding Rules from clause 17.1.1 apply to every element of the whole Transfer Syntax especially to the ASN.1 type EXTERNAL.

The extension container "privateExtensionList" is defined in this specification in order to carry extensions which are defined outside this specification. Private extensions can be defined by, for example, network operators, manufacturers, and regional standardisation bodies.

Private extensions shall:

- 1) if included in operations of an AC of V2, follow the extension marker and be tagged using PRIVATE tags up to and including 29.

NOTE: This type of extension is in most cases used only within a PLMN.

- 2) if included in operations of an AC of V3 or higher: be included only in the Private Extension Container that is defined in the specification.

NOTE: This type of extension can be used between PLMNs.

Private extensions shall not be included in v2 supplementary service operations.

Private extensions shall not be included within user error for RegisterCCEntry and EraseCCEntry operations.

PCS extensions shall be included in the PCS Extension Container that is defined in this specification.

In order to improve extensibility, a few error parameters have been defined as a CHOICE between the version 2 description and a SEQUENCE including the version 2 description and an extension container. Operations used in a v2-application-context must consider only the first alternative while operations used in a vn-application-context (n>2) must consider only the second alternative.

17.1.5 Structure of the Abstract Syntax of MAP

For each MAP parameter which has to be transferred by a MAP Protocol Data Unit (MAP message), there is a PDU field (an ASN.1 type) which has the same name as the corresponding parameter, except for the differences required by the ASN.1 notation (blanks between words are removed or replaced by hyphen, the first letter of the first word is capital and the first letter of each of the following words is capitalised, e.g. "no reply condition time" is mapped to "NoReplyConditionTime"). Additionally some words may be abbreviated as follows:

bs basic service
ch call handling
cug closed user group
ho handover
ic incoming call
id identity
info information
mm mobility management
lcs location services
ms mobile service
oc outgoing call
om operation & maintenance
pw Password
sm short message service
ss supplementary service

The MAP protocol is composed of several ASN.1 modules dealing with either operations, errors, data types, and, if applicable, split into those dealing with mobile services, call handling services, supplementary services and short message services. For operations and errors the code values are given as parameters, in order to allow use of the defined information objects also by other protocols (e.g. 3GPP TS 24.080 [38]). The ASN.1 source lines are preceded by line-numbers at the left margin in order to enable the usage of the cross-reference in annex A.

The module containing the definition of the operation packages for MAP is:

1. MAP-OperationPackages.

The module containing the definition of the application contexts for MAP is:

2. MAP-ApplicationContexts.

The module containing the data types for the Abstract Syntax to be used for TCAPMessages.DialoguePortion for MAP is:

3. MAP-DialogueInformation.

The module containing the supported operations is:

4. MAP-Protocol.

The modules containing all operation definitions for MAP are:

5. MAP-MobileServiceOperations;
6. MAP-OperationAndMaintenanceOperations;
7. MAP-CallHandlingOperations;
8. MAP-SupplementaryServiceOperations;
9. MAP-ShortMessageServiceOperations;
10. MAP-Group-Call-Operations;
11. MAP-LocationServiceOperations.

The module containing all error definitions for MAP is:

12. MAP-Errors.

Modules containing all data type definitions for MAP are:

13. MAP-MS-DataTypes;
14. MAP-OM-DataTypes;
15. MAP-CH-DataTypes;
16. MAP-SS-DataTypes;
17. MAP-SS-Code;
18. MAP-SM-DataTypes;
19. MAP-ER-DataTypes;
20. MAP-CommonDataTypes;
21. MAP-TS-Code;
22. MAP-BS-Code;
23. MAP-ExtensionDataTypes;
24. MAP-GR-DataTypes;

25. MAP-LCS-DataTypes.

References are made also to modules defined outside of the present document. They are defined in the technical specification Mobile Services Domain, technical specification Transaction Capability and ITU-T Recommendation X.880 respectively:

MobileDomainDefinitions;

TCAPMessages, DialoguePDUs ;

Remote-Operations-Information-Objects.

17.1.6 Application Contexts

The following informative table lists the latest versions of the Application Contexts used in this specification, with the operations used by them and, where applicable, whether or not the operation description is exactly the same as for previous versions. Information in 17.6 & 17.7 relates only to the ACs in this table.

AC Name	AC Version	Operations Used	Comments
locationCancellationContext	v3	cancelLocation	
equipmentMngtContext	V3	checkIMEI	
imsiRetrievalContext	v2	sendIMSI	
infoRetrievalContext	v3	sendAuthenticationInfo	
interVlrInfoRetrievalContext	v3	sendIdentification	
handoverControlContext	v3	prepareHandover forwardAccessSignalling sendEndSignal processAccessSignalling prepareSubsequentHandover	the syntax of this operation has been extended in comparison with release 98 version
mwdMngtContext	v3	readyForSM	
msPurgingContext	v3	purgeMS	
shortMsgAlertContext	v2	alertServiceCentre	
resetContext	v2	reset	
networkUnstructuredSsContext	v2	processUnstructuredSS-Request unstructuredSS-Request unstructuredSS-Notify	
tracingContext	v3	activateTraceMode deactivateTraceMode	
networkFunctionalSsContext	v2	registerSS eraseSS activateSS deactivateSS registerPassword interrogateSS getPassword	
shortMsgMO-RelayContext	v3	mo-forwardSM	
shortMsgMT-RelayContext	v3	mt-forwardSM	
shortMsgGatewayContext	v3	sendRoutingInfoForSM reportSM-DeliveryStatus InformServiceCentre	the syntax of this operation has been extended in comparison with release 96 version
networkLocUpContext	v3	updateLocation forwardCheckSs-Indication restoreData insertSubscriberData activateTraceMode	the syntax is the same in v1 & v2
gprsLocationUpdateContext	v3	updateGprsLocation insertSubscriberData activateTraceMode	
subscriberDataMngtContext	v3	insertSubscriberData deleteSubscriberData	

AC Name	AC Version	Operations Used	Comments
roamingNumberEnquiryContext	v3	provideRoamingNumber	
locationInfoRetrievalContext	v3	sendRoutingInfo	
gprsNotifyContext	v3	noteMsPresentForGprs	
gprsLocationInfoRetrievalContext	v4	sendRoutingInfoForGprs	
failureReportContext	v3	failureReport	
callControlTransferContext	v4	resumeCallHandling	
subscriberInfoEnquiryContext	v3	provideSubscriberInfo	
anyTimeEnquiryContext	v3	anyTimeInterrogation	
anyTimeInfoHandlingContext	v3	anyTimeSubscriptionInterrogation anyTimeModification	
ss-InvocationNotificationContext	v3	ss-InvocationNotification	
sIWFSAllocationContext	v3	provideSIWFSNumber sIWFSsignallingModify	
groupCallControlContext	v3	prepareGroupCall processGroupCallSignalling forwardGroupCallSignalling sendGroupCallEndSignal	
reportingContext	v3	setReportingState statusReport remoteUserFree	
callCompletionContext	v3	registerCC-Entry eraseCC-Entry	
istAlertingContext	v3	istAlert	
ImmediateTerminationContext	v3	istCommand	
locationSvcEnquiryContext	v3	provideSubscriberLocation subscriberLocationReport	
locationSvcGatewayContext	v3	sendRoutingInfoForLCS	
mm-EventReportingContext	v3	noteMM-Event	
subscriberDataModificationNotificationContext	v3	noteSubscriberDataModified	
authenticationFailureReportContext	v3	authenticationFailureReport	

NOTE (*): The syntax of the operations is not the same as in previous versions unless explicitly stated

17.2 Operation packages

17.2.1 General aspects

This clause describes the operation-packages which are used to build the application-contexts defined in clause 17.3.

Each operation-package is a specification of the roles of a pair of communicating objects (i.e. a pair of MAP-Providers), in terms of operations which they can invoke of each other.

The grouping of operations into one or several packages does not necessarily imply any grouping in terms of Application Service Elements.

The following ASN.1 information object class is used to describe operation-packages in this clause:

```

OPERATION-PACKAGE ::= CLASS {
    &Both OPERATION OPTIONAL,
    &Consumer OPERATION OPTIONAL,
    &Supplier OPERATION OPTIONAL,
    &id OBJECT IDENTIFIER UNIQUE OPTIONAL }
WITH SYNTAX {
    [ OPERATIONS &Both ]
    [ CONSUMER INVOKES &Supplier ]
    [ SUPPLIER INVOKES &Consumer ]
    [ ID &id ] }

```

Since the application-context definitions provided in clause 17.3 use only an informal description technique, only the type notation is used in the following clauses to define operation-packages.

The following definitions are used throughout this clause ($n \geq 2$):

- v1-only operation: An operation which shall be used only in v1 application-contexts;
- vn-only operation: An operation which shall be used only in vn application-contexts;
- v(n-1)-operation: An operation whose specification has not been modified since the MAP v(n-1) specifications or if the modifications are considered as not affecting v(n-1) implementations;
- v(n-1)-equivalent operation: The version of an operation which excludes all the information elements and errors which have been added since the MAP v(n-1) specification;
- vn-only package: An operation package which contains only vn-only operations;
- v(n-1)-package: An operation package which contains only v(n-1)- operations.

The names of vn-packages are suffixed by "-vn" where $n \geq 2$.

For each operation package which is not vn-only ($n \geq 2$) and which does not include only v(n-1)-operations, there is a v(n-1)-equivalent package. Except when a definition is explicitly provided in the following clauses, the v(n-1)-equivalent package includes the v(n-1)-equivalent operations of the operations which belong to this package.

17.2.2 Packages specifications

17.2.2.1 Location updating

This operation package includes the operations required for location management procedures between HLR and VLR.

```

LocationUpdatingPackage-v3 OPERATION-PACKAGE ::= {
    -- Supplier is HLR if Consumer is VLR
    CONSUMER INVOKES {
        updateLocation}
    SUPPLIER INVOKES {
        forwardCheckSs-Indication} }

```

The v1-equivalent and v2-equivalent packages can be determined according to the rules described in clause 17.2.1.

17.2.2.2 Location cancellation

This operation package includes the operations required for location cancellation and MS purging procedures between HLR and VLR and between HLR and SGSN.

```

LocationCancellationPackage-v3 OPERATION-PACKAGE ::= {
    -- Supplier is VLR or SGSN if Consumer is HLR
    CONSUMER INVOKES {
        cancelLocation} }

```

The v1-equivalent and v2-equivalent packages can be determined according to the rules described in clause 17.2.1.

17.2.2.3 Roaming number enquiry

This operation package includes the operations required for roaming number enquiry procedures between HLR and VLR.

```

roamingNumberEnquiryPackage-v3 OPERATION-PACKAGE ::= {
  -- Supplier is VLR if Consumer is HLR
  CONSUMER INVOKES {
    provideRoamingNumber } }

```

The v1-equivalent and v2-equivalent packages can be determined according to the rules described in clause 17.2.1.

17.2.2.4 Information retrieval

This operation package includes the operation required for the authentication information retrieval procedure between HLR and VLR and between HLR and SGSN.

```

infoRetrievalPackage-v3 OPERATION-PACKAGE ::= {
  -- Supplier is HLR if Consumer is VLR
  -- Supplier is HLR if Consumer is SGSN
  CONSUMER INVOKES {
    sendAuthenticationInfo } }

```

The v2-equivalent package is defined as follows:

```

infoRetrievalPackage-v2 OPERATION-PACKAGE ::= {
  -- Supplier is HLR if Consumer is VLR
  -- Supplier is HLR if Consumer is SGSN
  CONSUMER INVOKES {
    sendAuthenticationInfo } }

```

The v1-equivalent package is defined as follows:

```

infoRetrievalPackage-v1 OPERATION-PACKAGE ::= {
  -- Supplier is HLR or VLR if Consumer is VLR
  -- Supplier is HLR if Consumer is SGSN
  CONSUMER INVOKES {
    sendParameters } }

```

17.2.2.5 Inter-VLR information retrieval

This operation package includes the operations required for inter VLR information retrieval procedures.

```

interVlrInfoRetrievalPackage-v3 OPERATION-PACKAGE ::= {
  -- Supplier is VLR if Consumer is VLR
  CONSUMER INVOKES {
    sendIdentification } }

```

The v2-equivalent package is defined as follows:

```

interVlrInfoRetrievalPackage-v2 OPERATION-PACKAGE ::= {
  -- Supplier is VLR if Consumer is VLR
  CONSUMER INVOKES {
    sendIdentification } }

```

The v1-equivalent package is : infoRetrievalPackage-v1.

17.2.2.6 IMSI retrieval

This operation package includes the operation required for the IMSI retrieval procedure between HLR and VLR.

```

imsiRetrievalPackage-v2 OPERATION-PACKAGE ::= {
  -- Supplier is HLR if Consumer is VLR
  CONSUMER INVOKES {
    sendIMSI } }

```

This package is v2 only.

17.2.2.7 Call control transfer

This operation package includes the operation required for the call control transfer procedure between VMSC and GMSC.

```
callControlTransferPackage-v4 OPERATION-PACKAGE ::= {
  -- Supplier is GMSC if Consumer is VMSC
  CONSUMER INVOKES {
    resumeCallHandling } }
```

The v3-equivalent package can be determined according to the rules described in clause 17.2.1.

17.2.2.8 void

17.2.2.9 Void

17.2.2.10 Interrogation

This operation package includes the operations required for interrogation procedures between MSC and HLR or NPLR or between HLR and gsmSCF.

```
interrogationPackage-v3 OPERATION-PACKAGE ::= {
  -- Supplier is HLR or NPLR if Consumer is MSC
  -- Supplier is HLR if Consumer is gsmSCF
  CONSUMER INVOKES {
    sendRoutingInfo } }
```

The v1-equivalent and v2-equivalent packages can be determined according to the rules described in clause 17.2.1.

17.2.2.11 Void

17.2.2.12 Handover Control

This operation package includes the operations required for handover procedures between MSCs.

```
handoverControlPackage-v3 OPERATION-PACKAGE ::= {
  -- Supplier is MSCB if Consumer is MSCA
  CONSUMER INVOKES {
    prepareHandover |
    forwardAccessSignalling }
  SUPPLIER INVOKES {
    sendEndSignal |
    processAccessSignalling |
    prepareSubsequentHandover } }
```

The v2-equivalent package can be determined according to the rules described in clause 17.2.1.

The v1-equivalent package is defined as follows.

```
handoverControlPackage-v1 OPERATION-PACKAGE ::= {
  -- Supplier is MSCB if Consumer is MSCA
  CONSUMER INVOKES {
    performHandover |
    forwardAccessSignalling |
    traceSubscriberActivity }
  SUPPLIER INVOKES {
    sendEndSignal |
    noteInternalHandover |
    processAccessSignalling |
    performSubsequentHandover } }
```

17.2.2.13 Subscriber Data management stand alone

This operation package includes the operations required for stand alone subscriber data management procedures between HLR and VLR or between HLR and SGSN.

```
subscriberDataMngtStandAlonePackage-v3 OPERATION-PACKAGE ::= {
  -- Supplier is VLR or SGSN if Consumer is HLR
  CONSUMER INVOKES {
    insertSubscriberData |
    deleteSubscriberData } }
```

The v1-equivalent and v2-equivalent packages can be determined according to the rules described in clause 17.2.1.

17.2.2.14 Equipment management

This operation package includes the operations required for equipment management procedures between EIR and MSC or between EIR and SGSN.

```
equipmentMngtPackage-v3 OPERATION-PACKAGE ::= {
  -- Supplier is EIR if Consumer is MSC
  -- Supplier is EIR if Consumer is SGSN
  CONSUMER INVOKES {
    checkIMEI } }
```

The v1-equivalent and v2-equivalent packages can be determined according to the rules described in clause 17.2.1.

17.2.2.15 Subscriber data management

This operation package includes the operations required for subscriber data management procedures between HLR and VLR or between HLR and SGSN.

```
subscriberDataMngtPackage-v3 OPERATION-PACKAGE ::= {
  -- Supplier is VLR or SGSN if Consumer is HLR
  CONSUMER INVOKES {
    insertSubscriberData } }
```

The v1-equivalent and v2-equivalent packages can be determined according to the rules described in clause 17.2.1.

17.2.2.16 Location register restart

This operation package includes the operations required for location register restart procedures between HLR and VLR or between HLR and SGSN.

```
resetPackage-v2 OPERATION-PACKAGE ::= {
  -- Supplier is VLR or SGSN if Consumer is HLR
  CONSUMER INVOKES {
    reset } }
```

The v1-equivalent package can be determined according to the rules described in clause 17.2.1.

17.2.2.17 Tracing stand-alone

This operation package includes the operations required for stand alone tracing procedures between HLR and VLR or between HLR and SGSN.

```
tracingStandAlonePackage-v3 OPERATION-PACKAGE ::= {
  -- Supplier is VLR or SGSN if Consumer is HLR
  CONSUMER INVOKES {
    activateTraceMode |
    deactivateTraceMode } }
```

The v1-equivalent and v2-equivalent packages can be determined according to the rules described in clause 17.2.1.

17.2.2.18 Functional SS handling

This operation package includes the operations required for functional supplementary services procedures between VLR and HLR.

```

functionalSsPackage-v2 OPERATION-PACKAGE ::= {
  -- Supplier is HLR if Consumer is VLR
  CONSUMER INVOKES {
    registerSS |
    eraseSS |
    activateSS |
    deactivateSS |
    registerPassword |
    interrogateSS}
  SUPPLIER INVOKES {
    getPassword} }

```

The v1-equivalent package can be determined according to the rules described in clause 17.2.1.

17.2.2.19 Tracing

This operation package includes the operations required for tracing procedures between HLR and VLR or between HLR and SGSN.

```

tracingPackage-v3 OPERATION-PACKAGE ::= {
  -- Supplier is VLR or SGSN if Consumer is HLR
  CONSUMER INVOKES {
    activateTraceMode} }

```

The v1-equivalent and v2-equivalent packages can be determined according to the rules described in clause 17.2.1.

17.2.2.20 Binding

This operation package includes the operation required to initialise a supplementary service procedure between VLR and HLR or between gsmSCF and HLR.

```

bindingPackage-v1 OPERATION-PACKAGE ::= {
  -- Supplier is HLR if Consumer is VLR
  -- Supplier is gsmSCF if Consumer is HLR
  CONSUMER INVOKES {
    beginSubscriberActivity} }

```

This package is v1 only.

17.2.2.21 Unstructured SS handling

This operation package includes the operations required for unstructured supplementary services procedures between VLR and HLR, between the HLR and the gsmSCF, and between HLR and HLR.

```

unstructuredSsPackage-v2 OPERATION-PACKAGE ::= {
  -- Supplier is HLR if Consumer is VLR
  -- Supplier is gsmSCF or HLR if Consumer is HLR
  CONSUMER INVOKES {
    processUnstructuredSS-Request}
  SUPPLIER INVOKES {
    unstructuredSS-Request |
    unstructuredSS-Notify} }

```

The v1-equivalent package is defined as follows:

```

unstructuredSsPackage-v1 OPERATION-PACKAGE ::= {
  -- Supplier is HLR if Consumer is VLR
  -- Supplier is gsmSCF if Consumer is HLR
  CONSUMER INVOKES {
    processUnstructuredSS-Data} }

```

17.2.2.22 MO Short message relay services

This operation package includes the operations required for short message relay service procedures between IWMSC and VMSC or between GMSC and MSC or between SGSN and IWMSC.

```
mo-ShortMsgRelayPackage-v3 OPERATION-PACKAGE ::= {
  -- Supplier is IWMSC if Consumer is MSC
  -- Supplier is IWMSC if Consumer is SGSN
  CONSUMER INVOKES {
    mo-forwardSM } }
```

The v2-equivalent package is defined as follows:

```
shortMsgRelayPackage-v2 OPERATION-PACKAGE ::= {
  -- Supplier is IWMSC if Consumer is MSC
  -- Supplier is MSC or SGSN if Consumer is GMSC
  -- Supplier is IWMSC if Consumer is SGSN
  CONSUMER INVOKES {
    forwardSM } }
```

The v1-equivalent package can be determined according to the rules described in clause 17.2.1.

17.2.2.23 Short message gateway services

This operation package includes the operations required for short message service gateway procedures between MSC and HLR.

```
shortMsgGatewayPackage-v3 OPERATION-PACKAGE ::= {
  -- Supplier is HLR if Consumer is GMSC
  CONSUMER INVOKES {
    sendRoutingInfoForSM |
    reportSM-DeliveryStatus }
  SUPPLIER INVOKES {
    informServiceCentre } }
```

The v2-equivalent package can be determined according to the rules described in clause 17.2.1.

The v1-equivalent package is defined as follows:

```
shortMsgGatewayPackage-v1 OPERATION-PACKAGE ::= {
  -- Supplier is HLR if Consumer is GMSC
  CONSUMER INVOKES {
    sendRoutingInfoForSM |
    reportSMDeliveryStatus } }
```

17.2.2.24 MT Short message relay services

This operation package includes the operations required for short message relay service procedures between GMSC and MSC or between GMSC and SGSN.

```
mt-ShortMsgRelayPackage-v3 OPERATION-PACKAGE ::= {
  -- Supplier is MSC or SGSN if Consumer is GMSC
  CONSUMER INVOKES {
    mt-forwardSM } }
```

The v2-equivalent package is: **shortMsgRelayPackage-v2**

17.2.2.25 Void

17.2.2.26 Message waiting data management

This operation package includes the operations required for short message waiting data procedures between HLR and VLR, between HLR and SGSN.

```
mwdMngtPackage-v3 OPERATION-PACKAGE ::= {
  -- Supplier is HLR if Consumer is SGSN
  -- Supplier is HLR if Consumer is VLR
  CONSUMER INVOKES {
    readyForSM} }
```

The v2-equivalent package can be determined according to the rules described in clause 17.2.1.

The v1-equivalent package is defined as follows:

```
mwdMngtPackage-v1 OPERATION-PACKAGE ::= {
  -- Supplier is HLR if Consumer is VLR
  CONSUMER INVOKES {
    noteSubscriberPresent} }
```

17.2.2.27 Alerting

This operation package includes the operations required for alerting between HLR and IWMSC.

```
alertingPackage-v2 OPERATION-PACKAGE ::= {
  -- Supplier is IWMSC if Consumer is HLR
  CONSUMER INVOKES {
    alertServiceCentre} }
```

The v1-equivalent package is defined as follows.

```
alertingPackage-v1 OPERATION-PACKAGE ::= {
  -- Supplier is IWMSC if Consumer is HLR
  CONSUMER INVOKES {
    alertServiceCentreWithoutResult} }
```

17.2.2.28 Data restoration

This operation package includes the operations required for VLR data restoration between HLR and VLR.

```
dataRestorationPackage-v3 OPERATION-PACKAGE ::= {
  -- Supplier is HLR if Consumer is VLR
  CONSUMER INVOKES {
    restoreData} }
```

The v2-equivalent package can be determined according to the rules described in clause 17.2.1.

The v1-equivalent package is: infoRetrievalPackage-v1

17.2.2.29 Purging

This operation package includes the operations required for purging between HLR and VLR or between HLR and SGSN.

```
purgingPackage-v3 OPERATION-PACKAGE ::= {
  -- Supplier is HLR if Consumer is VLR
  -- Supplier is HLR if Consumer is SGSN
  CONSUMER INVOKES {
    purgeMS} }
```

The v2-equivalent package can be determined according to the rules described in clause 17.2.1.

17.2.2.30 Subscriber information enquiry

This operation package includes the operations required for subscriber information enquiry procedures between HLR and VLR or between HLR and SGSN.

```
subscriberInformationEnquiryPackage-v3 OPERATION-PACKAGE ::= {
  -- Supplier is VLR or SGSN if Consumer is HLR
  CONSUMER INVOKES {
    provideSubscriberInfo } }
```

This package is v3 only.

17.2.2.31 Any time information enquiry

This operation package includes the operations required for any time information enquiry procedures between gsmSCF and HLR or between gsmSCF and GMLC or between gsmSCF and NPLR.

```
anyTimeInformationEnquiryPackage-v3 OPERATION-PACKAGE ::= {
  -- Supplier is HLR or GMLC or NPLR if Consumer is gsmSCF
  CONSUMER INVOKES {
    anyTimeInterrogation} }
```

This package is v3 only.

17.2.2.32 Group Call Control

This operation package includes the operations required for group call and broadcast call procedures between MSCs.

```
groupCallControlPackage-v3 OPERATION-PACKAGE ::= {
  -- Supplier is relay MSC if Consumer is anchor MSC
  CONSUMER INVOKES {
    prepareGroupCall |
    forwardGroupCallSignalling}
  SUPPLIER INVOKES {
    sendGroupCallEndSignal |
    processGroupCallSignalling} }
```

This package is v3 only.

17.2.2.33 Provide SIWFS number

This operation package includes the operations required between VMSC and SIWF for requesting resources from an SIWF.

```
provideSIWFSNumberPackage-v3 OPERATION-PACKAGE ::= {
  -- Supplier is SIWF if Consumer is VMSC
  CONSUMER INVOKES {
    provideSIWFSNumber} }
```

This package is v3 only.

17.2.2.34 SIWFS Signalling Modify

This operation package includes the operations required for the modification of the resources in an SIWF between the VMSC and SIWF.

```
siwfs-SignallingModifyPackage-v3 OPERATION-PACKAGE ::= {
  -- Supplier is SIWF if Consumer is VMSC
  CONSUMER INVOKES {
    siwfs-SignallingModify} }
```

This package is v3 only.

17.2.2.35 Gprs location updating

This operation package includes the operations required for the gprs location management procedures between HLR and SGSN.

```
gprsLocationUpdatingPackage-v3 OPERATION-PACKAGE ::= {  
  -- Supplier is HLR if Consumer is SGSN  
  CONSUMER INVOKES {  
    updateGprsLocation } }
```

This package is v3 only.

17.2.2.36 Gprs Interrogation

This operation package includes the operations required for interrogation procedures between HLR and GGSN.

```
gprsInterrogationPackage-v4 OPERATION-PACKAGE ::= {  
  -- Supplier is HLR if Consumer is GGSN  
  CONSUMER INVOKES {  
    sendRoutingInfoForGprs } }
```

The v3-equivalent package is defined as follows.

```
gprsInterrogationPackage-v3 OPERATION-PACKAGE ::= {  
  -- Supplier is HLR if Consumer is GGSN  
  CONSUMER INVOKES {  
    sendRoutingInfoForGprs } }
```

17.2.2.37 Failure reporting

This operation package includes the operations required for failure reporting between HLR and GGSN.

```
failureReportingPackage-v3 OPERATION-PACKAGE ::= {  
  -- Supplier is HLR if Consumer is GGSN  
  CONSUMER INVOKES {  
    failureReport } }
```

This package is v3 only.

17.2.2.38 GPRS notifying

This operation package includes the operations required for notifying that GPRS subscriber is present between HLR and GGSN.

```
gprsNotifyingPackage-v3 OPERATION-PACKAGE ::= {  
  -- Supplier is GGSN if Consumer is HLR  
  CONSUMER INVOKES {  
    noteMsPresentForGprs } }
```

This package is v3 only.

17.2.2.39 Supplementary Service invocation notification

This operation package includes the operations required for Supplementary Service invocation notification procedures between the MSC and the gsmSCF and between the HLR and the gsmSCF.

```
ss-InvocationNotificationPackage-v3 OPERATION-PACKAGE ::= {
  -- Supplier is gsmSCF if Consumer is MSC
  -- Supplier is gsmSCF if Consumer is HLR
  CONSUMER INVOKES {
    ss-InvocationNotification} }
```

This package is v3 only.

17.2.2.40 Set Reporting State

This operation package includes the operation required for procedures between HLR and VLR to set the reporting state.

```
setReportingStatePackage-v3 OPERATION-PACKAGE ::= {
  -- Supplier is VLR if Consumer is HLR
  CONSUMER INVOKES {
    setReportingState} }
```

This package is v3 only.

17.2.2.41 Status Report

This operation package includes the operation required for procedures between VLR and HLR to report call results and events.

```
statusReportPackage-v3 OPERATION-PACKAGE ::= {
  -- Supplier is HLR if Consumer is VLR
  CONSUMER INVOKES {
    statusReport} }
```

This package is v3 only.

17.2.2.42 Remote User Free

This operation package includes the operation required by the HLR to indicate to the VLR that the remote user is free.

```
remoteUserFreePackage-v3 OPERATION-PACKAGE ::= {
  -- Supplier is VLR if Consumer is HLR
  CONSUMER INVOKES {
    remoteUserFree} }
```

This package is v3 only.

17.2.2.43 Call Completion

This operation package includes the operations required for procedures between VLR and HLR for subscriber control of call completion services.

```
callCompletionPackage-v3 OPERATION-PACKAGE ::= {
  -- Supplier is HLR if Consumer is VLR
  CONSUMER INVOKES {
    registerCC-Entry |
    eraseCC-Entry} }
```

This package is v3 only.

17.2.2.44 Location service gateway services

This operation package includes the operations required for location service gateway procedures between GMLC and HLR.

```

locationSvcGatewayPackage-v3 OPERATION-PACKAGE ::= {
  -- Supplier is HLR if Consumer is GMLC
  CONSUMER INVOKES {
    sendRoutingInfoForLCS } }

```

This package is v3 only.

17.2.2.45 Location service enquiry

This operation package includes the operations required for the location service enquiry procedures between GMLC and MSC and between GMLC and SGSN.

```

locationSvcEnquiryPackage-v3 OPERATION-PACKAGE ::= {
  -- Supplier is MSC or SGSN if Consumer is GMLC
  CONSUMER INVOKES {
    provideSubscriberLocation } }

```

This package is v3 only.

17.2.2.45A Location service reporting

This operation package includes the operations required for the location service enquiry procedures between MSC and GMLC and between SGSN and GMLC.

```

locationSvcReportingPackage-v3 OPERATION-PACKAGE ::= {
  -- Supplier is GMLC if Consumer is MSC
  -- Supplier is GMLC if Consumer is SGSN
  CONSUMER INVOKES {
    subscriberLocationReport } }

```

17.2.2.46 Void

17.2.2.47 Void

17.2.2.48 Void

17.2.2.49 IST Alerting

This operation package includes the operation required for alerting procedures between the MSC (Visited MSC or Gateway MSC) and HLR.

```

ist-AlertingPackage-v3 OPERATION-PACKAGE ::= {
  -- Supplier is HLR if Consumer is VMSC
  -- Supplier is HLR if Consumer is GMSC
  CONSUMER INVOKES {
    istAlert } }

```

This package is v3 only.

17.2.2.50 Service Termination

This operation package includes the operation required for immediate service termination procedures between the HLR and the Visited MSC or between the HLR and the Gateway MSC.

```

serviceTerminationPackage-v3 OPERATION-PACKAGE ::= {
  -- Supplier is VMSC or GMSC if Consumer is HLR
  CONSUMER INVOKES {
    istCommand } }

```

This package is v3 only.

17.2.2.51 Mobility Management event notification

This operation package includes the operations required for Mobility Management event notification procedures between VLR and gsmSCF.

```
mm-EventReportingPackage-v3 OPERATION-PACKAGE ::= {
  -- Supplier is gsmSCF if Consumer is VLR
  CONSUMER INVOKES {
    noteMM-Event} }
```

This package is v3 only.

17.2.2.52 Any time information handling

This operation package includes the operations required for any time information handling procedures between gsmSCF and HLR.

```
anyTimeInformationHandlingPackage-v3 OPERATION-PACKAGE ::= {
  -- Supplier is HLR if Consumer is gsmSCF
  CONSUMER INVOKES {
    anyTimeSubscriptionInterrogation |
    anyTimeModification} }
```

This package is v3 only.

17.2.2.53 Subscriber Data modification notification

This operation package includes the operations required for Subscriber Data modification notification procedures between HLR and gsmSCF.

```
subscriberDataModificationNotificationPackage-v3 OPERATION-PACKAGE ::= {
  -- Supplier is gsmSCF if Consumer is HLR
  CONSUMER INVOKES {
    noteSubscriberDataModified} }
```

This package is v3 only.

17.2.2.54 Authentication Failure Report

This operation package includes the operation required for procedures between VLR and HLR or the SGSN and the HLR for reporting of authentication failures.

```
authenticationFailureReportPackage-v3 OPERATION-PACKAGE ::= {
  -- Supplier is HLR if Consumer is VLR
  -- Supplier is HLR if Consumer is SGSN
  CONSUMER INVOKES {
    authenticationFailureReport} }
```

This package is v3 only.

17.3 Application contexts

17.3.1 General aspects

An application-context is assigned for each dialogue established by a MAP-user. In the present document each application-context is assigned a name which is supplied in the MAP-OPEN Req primitive by the MAP-User and transmitted to the peer under certain circumstances.

The following ASN.1 information object class is used to describe the main aspects of application-contexts in the following clauses:

```
APPLICATION-CONTEXT ::= CLASS {
    &Symmetric                OPERATION-PACKAGE OPTIONAL,
    &InitiatorConsumerOf     OPERATION-PACKAGE OPTIONAL,
    &ResponderConsumerOf     OPERATION-PACKAGE OPTIONAL,
    &code                     OBJECT IDENTIFIER }
WITH SYNTAX {
    [ OPERATIONS OF          &Symmetric ]
    [ INITIATOR CONSUMER OF &InitiatorConsumerOf
      RESPONDER CONSUMER OF &ResponderConsumerOf ]
    ID &code }
```

The following definitions are used throughout this clause:

- v1-application-context: An application-context which contains only v1-packages and uses only TC v1 facilities;
- v1 context set: the set of v1-application-contexts defined in the present document.
- vn-application-context (n>=2): An application-context which contains only vn-packages;

The names of v1-application-contexts are suffixed by "-v1" while other names are suffixed by "-vn" where n>=2.

Application-contexts which do not belong to the v1 context set use v2 TC facilities.

The last component of each application-context-name (i.e. the last component of the object identifier value) assigned to an application-context which belongs to the v1 context set indicates explicitly "version1".

For each application-context which does not belong to the "v1 context set" there is a v1-equivalent application context. This is a v1-application-context which includes the v1-equivalents of the packages included in the original context.

Each application-context uses the abstract-syntax associated with the operation-packages it includes and uses the transfer-syntax derived from it by applying the encoding rules defined in clause 17.1.1.

ACs which do not belong to the v1 context set require the support of the abstract-syntax identified by the object identifier value: MAP-DialogueInformation.map-Dialogue-AS defined in clause 17.4.

17.3.2 Application context definitions

17.3.2.1 Void

17.3.2.2 Location Updating

This application context is used between HLR and VLR for location updating procedures.

```
networkLocUpContext-v3 APPLICATION-CONTEXT ::= {
    -- Responder is HLR if Initiator is VLR
    INITIATOR CONSUMER OF {
        locationUpdatingPackage-v3 |
        dataRestorationPackage-v3}
    RESPONDER CONSUMER OF {
        subscriberDataMngtPackage-v3 |
        tracingPackage-v3}
    ID {map-ac networkLocUp(1) version3(3)} }
```

The following application-context-name is assigned to the v2-equivalent application-context:

```
ID {map-ac networkLocUp(1) version2(2)}
```

The following application-context-name is assigned to the v1-equivalent application-context:

```
ID {map-ac networkLocUp(1) version1(1)}
```

17.3.2.3 Location Cancellation

This application context is used between HLR and VLR or between HLR and SGSN for location cancellation procedures. For the HLR - SGSN interface only version 3 of this application context is applicable.

```
locationCancellationContext-v3 APPLICATION-CONTEXT ::= {
  -- Responder is VLR or SGSN if Initiator is HLR
  INITIATOR CONSUMER OF {
    locationCancellationPackage-v3}
  ID {map-ac locationCancel(2) version3(3)} }
```

The following application-context-name is assigned to the v2-equivalent application-context:

```
ID {map-ac locationCancel(2) version2(2)}
```

The following application-context-name is assigned to the v1-equivalent application-context:

```
ID {map-ac locationCancel(2) version1(1)}
```

17.3.2.4 Roaming number enquiry

This application context is used between HLR and VLR for roaming number enquiry procedures.

```
roamingNumberEnquiryContext-v3 APPLICATION-CONTEXT ::= {
  -- Responder is VLR if Initiator is HLR
  INITIATOR CONSUMER OF {
    roamingNumberEnquiryPackage-v3}
  ID {map-ac roamingNbEnquiry(3) version3(3)} }
```

The following application-context-name is assigned to the v2-equivalent application-context:

```
ID {map-ac roamingNbEnquiry(3) version2(2)}
```

The following application-context-name is assigned to the v1-equivalent application-context:

```
ID {map-ac roamingNbEnquiry(3) version1(1)}
```

17.3.2.5 Void

17.3.2.6 Location Information Retrieval

This application-context is used between GMSC and HLR or between GMSC and NPLR or between gsmSCF and HLR when retrieving location information. For the GMSC - NPLR interface version 1, version 2 and version 3 of this application context are applicable.

```
locationInfoRetrievalContext-v3 APPLICATION-CONTEXT ::= {
  -- Responder is HLR or NPLR if Initiator is GMSC
  -- Responder is HLR if Initiator is gsmSCF
  INITIATOR CONSUMER OF {
    interrogationPackage-v3}
  ID {map-ac locInfoRetrieval(5) version3(3)} }
```

The following application-context-name is assigned to the v2-equivalent application-context:

```
ID {map-ac locInfoRetrieval(5) version2(2)}
```

The following application-context-name is assigned to the v1-equivalent application-context:

```
ID {map-ac locInfoRetrieval(5) version1(1)}
```

17.3.2.7 Call control transfer

This application context is used for the call control transfer procedure between the VMSC and the GMSC.

```
callControlTransferContext-v4 APPLICATION-CONTEXT ::= {
  -- Responder is GMSC if Initiator is VMSC
  INITIATOR CONSUMER OF {
    callControlTransferPackage-v4
  }
  ID {map-ac callControlTransfer(6) version4(4)} }
```

The following application-context-name is assigned to the v3-equivalent application-context:

```
ID {map-ac callControlTransfer(6) version3(3)}
```

17.3.2.8 void

17.3.2.9 - 17.3.2.10 Void

17.3.2.11 Location registers restart

This application context is used between HLR and VLR or between HLR and SGSN for location register restart procedures. For the HLR - SGSN interface version 1 and version 2 of this application context are applicable.

```
resetContext-v2 APPLICATION-CONTEXT ::= {
  -- Responder is VLR or SGSN if Initiator is HLR
  INITIATOR CONSUMER OF {
    resetPackage-v2
  }
  ID {map-ac reset(10) version2(2)} }
```

The following application-context-name is assigned to the v1-equivalent application-context:

```
ID {map-ac reset(10) version1(1)}
```

17.3.2.12 Handover control

This application context is used for handover procedures between MSCs.

```
handoverControlContext-v3 APPLICATION-CONTEXT ::= {
  -- Responder is MSCB if Initiator is MSCA
  INITIATOR CONSUMER OF {
    handoverControlPackage-v3
  }
  ID {map-ac handoverControl(11) version3(3)} }
```

The following application-context-name is assigned to the v2-equivalent application-context:

```
ID {map-ac handoverControl(11) version2(2)}
```

The following application-context-name is assigned to the v1-equivalent application-context:

```
ID {map-ac handoverControl(11) version1(1)}
```

17.3.2.13 IMSI Retrieval

This application context is used for IMSI retrieval between HLR and VLR.

```
imsiRetrievalContext-v2 APPLICATION-CONTEXT ::= {
  -- Responder is HLR if Initiator is VLR
  INITIATOR CONSUMER OF {
    imsi-RetrievalPackage-v2
  }
  ID {map-ac imsiRetrieval(26) version2(2)} }
```

This application-context is v2 only.

17.3.2.14 Equipment Management

This application context is used for equipment checking between MSC and EIR or between SGSN and EIR. For the SGSN - EIR interface version 1 and version 2 and version 3 of this application context are applicable:

```
equipmentMngtContext-v3 APPLICATION-CONTEXT ::= {
  -- Responder is EIR if Initiator is MSC
  -- Responder is EIR if Initiator is SGSN
  INITIATOR CONSUMER OF {
    equipmentMngtPackage-v3}
  ID {map-ac equipmentMngt(13) version3(3)} }
```

The following application-context-name is assigned to the v2-equivalent application-context:

```
equipmentMngtContext-v2 APPLICATION-CONTEXT ::= {
  -- Responder is EIR if Initiator is MSC
  -- Responder is EIR if Initiator is SGSN
  INITIATOR CONSUMER OF {
    equipmentMngtPackage-v2}
  ID {map-ac equipmentMngt(13) version2(2)} }
```

The following application-context-name is assigned to the v1-equivalent application-context:

```
ID {map-ac equipmentMngt(13) version1(1)}
```

17.3.2.15 Information retrieval

This application context is used for authentication information retrieval between HLR and VLR or between HLR and SGSN. For the HLR - SGSN interface version 1 and version 2 and version 3 of this application context are applicable.

```
infoRetrievalContext-v3 APPLICATION-CONTEXT ::= {
  -- Responder is HLR if Initiator is VLR
  -- Responder is HLR if Initiator is SGSN
  INITIATOR CONSUMER OF {
    infoRetrievalPackage-v3}
  ID {map-ac infoRetrieval(14) version3(3)} }
```

The following application-context-name is assigned to the v2-equivalent application-context:

```
infoRetrievalContext-v2 APPLICATION-CONTEXT ::= {
  -- Responder is HLR if Initiator is VLR
  -- Responder is HLR if Initiator is SGSN
  INITIATOR CONSUMER OF {
    infoRetrievalPackage-v2}
  ID {map-ac infoRetrieval(14) version2(2)} }
```

The following application-context-name is assigned to the v1-equivalent application-context:

```
ID {map-ac infoRetrieval(14) version1(1)}
```

17.3.2.16 Inter-VLR information retrieval

This application context is used for information retrieval between VLRs.

```
interVlrInfoRetrievalContext-v3 APPLICATION-CONTEXT ::= {
  -- Responder is VLR if Initiator is VLR
  INITIATOR CONSUMER OF {
    interVlrInfoRetrievalPackage-v3}
  ID {map-ac interVlrInfoRetrieval(15) version3(3)} }
```

The v2-equivalent application-context is:

```
interVlrInfoRetrievalContext-v2 APPLICATION-CONTEXT ::= {
  -- Responder is VLR if Initiator is VLR
  INITIATOR CONSUMER OF {
    interVlrInfoRetrievalPackage-v2}
  ID {map-ac interVlrInfoRetrieval(15) version2(2)} }
```

The v1-equivalent application-context is:

```
ID {map-ac infoRetrieval(14) version1(1)}
```

17.3.2.17 Stand Alone Subscriber Data Management

This application context is used for stand alone subscriber data management between HLR and VLR or between HLR and SGSN. For the HLR - SGSN interface only version 3 of this application context is applicable:

```
subscriberDataMngtContext-v3 APPLICATION-CONTEXT ::= {
  -- Responder is VLR or SGSN if Initiator is HLR
  INITIATOR CONSUMER OF {
    subscriberDataMngtStandAlonePackage-v3
  }
  ID {map-ac subscriberDataMngt(16) version3(3)} }
```

The following application-context-name is assigned to the v2-equivalent application-context:

```
ID {map-ac subscriberDataMngt(16) version2(2)}
```

The following application-context-name is assigned to the v1-equivalent application-context:

```
ID {map-ac subscriberDataMngt(16) version1(1)}
```

17.3.2.18 Tracing

This application context is used between HLR and VLR or between HLR and SGSN for stand alone tracing control procedures. For the HLR - SGSN interface version 1, version 2 and version 3 of this application context are applicable.

```
tracingContext-v3 APPLICATION-CONTEXT ::= {
  -- Responder is VLR or SGSN if Initiator is HLR
  INITIATOR CONSUMER OF {
    tracingStandAlonePackage-v3
  }
  ID {map-ac tracing(17) version3(3)} }
```

The following application-context-name is assigned to the v2-equivalent application-context:

```
ID {map-ac tracing(17) version2(2)}
```

The following application-context-name is assigned to the v1-equivalent application-context:

```
ID {map-ac tracing(17) version1(1)}
```

17.3.2.19 Network functional SS handling

This application context is used for functional-like SS handling procedures between VLR and HLR.

```
networkFunctionalSsContext-v2 APPLICATION-CONTEXT ::= {
  -- Responder is HLR, Initiator is VLR
  INITIATOR CONSUMER OF {
    functionalSsPackage-v2
  }
  ID {map-ac networkFunctionalSs(18) version2(2)} }
```

The v1-equivalent application-context is defined as follows:

```
networkFunctionalSsContext-v1 APPLICATION-CONTEXT ::= {
  -- Responder is HLR, Initiator is VLR
  INITIATOR CONSUMER OF {
    functionalSsPackage-v1 |
    unstructuredSsPackage-v1 |
    bindingPackage-v1
  }
  ID {map-ac networkFunctionalSs(18) version1(1)} }
```

17.3.2.20 Network unstructured SS handling

This application context is used for handling stimuli-like procedures between HLR and VLR, between the HLR and gsmSCF, and between HLR and HLR.

```

networkUnstructuredSsContext-v2 APPLICATION-CONTEXT ::= {
  -- Responder is HLR, Initiator is VLR
  -- Responder is VLR, Initiator is HLR
  -- Responder is gsmSCF, Initiator is HLR
  -- Responder is HLR, Initiator is gsmSCF
  -- Responder is HLR, Initiator is HLR
  OPERATIONS OF {
    unstructuredSsPackage-v2}
  ID {map-ac networkUnstructuredSs(19) version2(2)} }

```

The following application-context-name is assigned to the v1-equivalent application-context:

```
ID {map-ac networkFunctionalSs(18) version1(1)}
```

17.3.2.21 Short Message Gateway

This application context is used for short message gateway procedures.

```

shortMsgGatewayContext-v3 APPLICATION-CONTEXT ::= {
  -- Responder is HLR if Initiator is GMSC
  INITIATOR CONSUMER OF {
    shortMsgGatewayPackage-v3}
  ID {map-ac shortMsgGateway(20) version3(3)} }

```

The following application-context-name is assigned to the v2-equivalent application-context:

```
ID {map-ac shortMsgGateway(20) version2(2)}
```

The following application-context-name is assigned to the v1-equivalent application-context:

```
ID {map-ac shortMsgGateway(20) version1(1)}
```

17.3.2.22 Mobile originating Short Message Relay

This application context is used between MSC and IWMSC or between SGSN and IWMSC for mobile originating short message relay procedures. For the SGSN - IWMSC interface version 1, version 2 and version 3 of this application context are applicable.

```

shortMsgMO-RelayContext-v3 APPLICATION-CONTEXT ::= {
  -- Responder is IWMSC if Initiator is MSC
  -- Responder is IWMSC if Initiator is SGSN
  INITIATOR CONSUMER OF {
    mo-ShortMsgRelayPackage-v3}
  ID {map-ac shortMsgMO-Relay(21) version3(3)} }

```

The following application-context-name is assigned to the v2-equivalent application-context:

```
ID {map-ac shortMsgMO-Relay(21) version2(2)}
```

The following application-context-name is assigned to the v1-equivalent application-context:

```
ID {map-ac shortMsg-Relay(21) version1(1)}
```

17.3.2.23 Void

17.3.2.24 Short message alert

This application context is used for short message alerting procedures.

```
shortMsgAlertContext-v2 APPLICATION-CONTEXT ::= {
  -- Responder is IWMSC if Initiator is HLR
  INITIATOR CONSUMER OF {
    alertingPackage-v2}
  ID {map-ac shortMsgAlert(23) version2(2)} }
```

The following application-context-name is symbolically assigned to the v1-equivalent application-context:

```
ID {map-ac shortMsgAlert(23) version1(1)}
```

17.3.2.25 Short message waiting data management

This application context is used between VLR and HLR or between SGSN and HLR for short message waiting data management procedures. For the SGSN - HLR interface only version 3 of this application context is applicable.

```
mwdMngtContext-v3 APPLICATION-CONTEXT ::= {
  -- Responder is HLR if Initiator is SGSN
  -- Responder is HLR if Initiator is VLR
  INITIATOR CONSUMER OF {
    mwdMngtPackage-v3}
  ID {map-ac mwdMngt(24) version3(3)} }
```

The following application-context-name is assigned to the v2-equivalent application-context:

```
ID {map-ac mwdMngt(24) version2(2)}
```

The following application-context-name is assigned to the v1-equivalent application-context:

```
ID {map-ac mwdMngt(24) version1(1)}
```

17.3.2.26 Mobile terminating Short Message Relay

This application context is used between GMSC and MSC or between GMSC and SGSN for mobile terminating short message relay procedures. For the GMSC - SGSN interface version 2 and version 3 of this application context and the equivalent version 1 application context are applicable.

```
shortMsgMT-RelayContext-v3 APPLICATION-CONTEXT ::= {
  -- Responder is MSC or SGSN if Initiator is GMSC
  INITIATOR CONSUMER OF {
    mt-ShortMsgRelayPackage-v3}
  ID {map-ac shortMsgMT-Relay(25) version3(3)} }
```

The following application-context-name is assigned to the v2-equivalent application-context:

```
ID {map-ac shortMsgMT-Relay(25) version2(2)}
```

The following application-context-name is assigned to the v1-equivalent application-context:

```
ID {map-ac shortMsgMO-Relay(21) version1(1)}
```

17.3.2.27 MS purging

This application context is used between HLR and VLR or between HLR and SGSN for MS purging procedures. For the SGSN - HLR interface only version 3 of this application context is applicable.

```
msPurgingContext-v3 APPLICATION-CONTEXT ::= {
  -- Responder is HLR if Initiator is VLR
  -- Responder is HLR if Initiator is SGSN
  INITIATOR CONSUMER OF {
    purgingPackage-v3
  }
  ID {map-ac msPurging(27) version3(3)} }
```

The following application-context-name is assigned to the v2-equivalent application-context:

```
ID {map-ac msPurging(27) version2(2)}
```

17.3.2.28 Subscriber information enquiry

This application context is used between HLR and VLR or between HLR and SGSN for subscriber information enquiry procedures.

```
subscriberInfoEnquiryContext-v3 APPLICATION-CONTEXT ::= {
  -- Responder is VLR or SGSN if Initiator is HLR
  INITIATOR CONSUMER OF {
    subscriberInformationEnquiryPackage-v3
  }
  ID {map-ac subscriberInfoEnquiry(28) version3(3)} }
```

This application-context is v3 only.

17.3.2.29 Any time information enquiry

This application context is used between gsmSCF and HLR or between gsmSCF and GMLC or between gsmSCF and NPLR for any time information enquiry procedures.

```
anyTimeInfoEnquiryContext-v3 APPLICATION-CONTEXT ::= {
  -- Responder is HLR or GMLC or NPLR if Initiator is gsmSCF
  INITIATOR CONSUMER OF {
    anyTimeInformationEnquiryPackage-v3
  }
  ID {map-ac anyTimeInfoEnquiry(29) version3(3)} }
```

This application-context is v3 only.

17.3.2.30 Group Call Control

This application context is used between anchor MSC and relay MSC for group call and broadcast call procedures.

```
groupCallControlContext-v3 APPLICATION-CONTEXT ::= {
  -- Responder is relay MSC if Initiator is anchor MSC
  INITIATOR CONSUMER OF {
    groupCallControlPackage-v3
  }
  ID {map-ac groupCallControl(31) version3(3)} }
```

This application-context is v3 only.

17.3.2.31 Provide SIWFS Number

This application context is used for activation or modification of SIWF resources.

```
sIWFSAllocationContext-v3 APPLICATION-CONTEXT ::= {
  -- Responder is SIWF if Initiator is VMSC
  INITIATOR CONSUMER OF {
    providesIWFSNumberPackage-v3 |
    siwfs-SignallingModifyPackage-v3
  }
  ID {map-ac sIWFSAllocation (12) version3(3)} }
```

This application-context is v3 only.

17.3.2.32 Gprs Location Updating

This application context is used between HLR and SGSN for gprs location updating procedures.

```
gprsLocationUpdateContext-v3 APPLICATION-CONTEXT ::= {
  -- Responder is HLR if Initiator is SGSN
  INITIATOR CONSUMER OF {
    gprsLocationUpdatingPackage-v3}
  RESPONDER CONSUMER OF {
    subscriberDataMngtPackage-v3 |
    tracingPackage-v3}
  ID {map-ac gprsLocationUpdate(32) version3(3)} }
```

This application-context is v3 only.

17.3.2.33 Gprs Location Information Retrieval

This application context is used between HLR and GGSN when retrieving gprs location information.

```
gprsLocationInfoRetrievalContext-v4 APPLICATION-CONTEXT ::= {
  -- Responder is HLR if Initiator is GGSN
  INITIATOR CONSUMER OF {
    gprsInterrogationPackage-v4}
  ID {map-ac gprsLocationInfoRetrieval(33) version4(4)} }
```

The following application-context-name is assigned to the v3-equivalent application-context:

```
ID {map-ac gprsLocationInfoRetrieval(33) version3(3)}
```

17.3.2.34 Failure Reporting

This application context is used between HLR and GGSN to inform that network requested PDP-context activation has failed.

```
failureReportContext-v3 APPLICATION-CONTEXT ::= {
  -- Responder is HLR if Initiator is GGSN
  INITIATOR CONSUMER OF {
    failureReportingPackage-v3}
  ID {map-ac failureReport(34) version3(3)} }
```

This application-context is v3 only.

17.3.2.35 GPRS Notifying

This application context is used between HLR and GGSN for notifying that GPRS subscriber is present again.

```
gprsNotifyContext-v3 APPLICATION-CONTEXT ::= {
  -- Responder is GGSN if Initiator is HLR
  INITIATOR CONSUMER OF {
    gprsNotifyingPackage-v3}
  ID {map-ac gprsNotify(35) version3(3)} }
```

This application-context is v3 only.

17.3.2.36 Supplementary Service invocation notification

This application context is used between the MSC and the gsmSCF and between the HLR and the gsmSCF for Supplementary Service invocation notification procedures.

```
ss-InvocationNotificationContext-v3 APPLICATION-CONTEXT ::= {
  -- Responder is gsmSCF, Initiator is MSC
  -- Responder is gsmSCF, Initiator is HLR
  INITIATOR CONSUMER OF {
    ss-InvocationNotificationPackage-v3}
  ID {map-ac ss-InvocationNotification(36) version3(3)} }
```

This application-context is v3 only.

17.3.2.37 Reporting

This application context is used between HLR and VLR for reporting procedures.

```
reportingContext-v3 APPLICATION-CONTEXT ::= {
  -- Responder is VLR if Initiator is HLR
  -- Responder is HLR if Initiator is VLR
  INITIATOR CONSUMER OF {
    setReportingStatePackage-v3 |
    statusReportPackage-v3 |
    remoteUserFreePackage-v3}
  RESPONDER CONSUMER OF {
    setReportingStatePackage-v3 |
    statusReportPackage-v3}
  ID {map-ac reporting(7) version3(3)} }
```

This application-context is v3 only.

17.3.2.38 Call Completion

This application context is used between VLR and the HLR for subscriber control of call completion services.

```
callCompletionContext-v3 APPLICATION-CONTEXT ::= {
  -- Responder is HLR if Initiator is VLR
  INITIATOR CONSUMER OF {
    callCompletionPackage-v3}
  ID {map-ac callCompletion(8) version3(3)} }
```

This application-context is v3 only.

17.3.2.39 Location Service Gateway

This application context is used for location service gateway procedures.

```
locationSvcGatewayContext-v3 APPLICATION-CONTEXT ::= {
  -- Responder is HLR if Initiator is GMLC
  INITIATOR CONSUMER OF {
    locationSvcGatewayPackage-v3}
  ID {map-ac locationSvcGateway(37) version3(3)} }
```

17.3.2.40 Location Service Enquiry

This application context is used for location service enquiry procedures.

```
locationSvcEnquiryContext-v3 APPLICATION-CONTEXT ::= {
  -- Responder is MSC or SGSN if Initiator is GMLC
  -- Responder is GMLC if Initiator is MSC
  -- Responder is GMLC if Initiator is SGSN
  INITIATOR CONSUMER OF {
    locationSvcEnquiryPackage-v3 |
    locationSvcReportingPackage-v3}
  ID {map-ac locationSvcEnquiry(38) version3(3)} }
```

17.3.2.41 Void

17.3.2.42 Void

17.3.2.43 Void

17.3.2.44 IST Alerting

This application context is used between MSC (Visited MSC or Gateway MSC) and HLR for alerting services within IST procedures.

```
istAlertingContext-v3 APPLICATION-CONTEXT ::= {
  -- Responder is HLR if Initiator is VMSC
  -- Responder is HLR if Initiator is GMSC
  INITIATOR CONSUMER OF {
    ist-AlertingPackage-v3}
  ID {map-ac alerting(4) version3(3)} }
```

This application-context is v3 only.

17.3.2.45 Service Termination

This application context is used between HLR and MSC (Visited MSC or Gateway MSC) for service termination services within IST procedures.

```
serviceTerminationContext-v3 APPLICATION-CONTEXT ::= {
  -- Responder is VMSC or GMSC if Initiator is HLR
  INITIATOR CONSUMER OF {
    serviceTerminationPackage-v3}
  ID {map-ac serviceTermination(9) version3(3)} }
```

This application-context is v3 only.

17.3.2.46 Mobility Management event notification

This application context is used between VLR and gsmSCF for Mobility Management event notification procedures.

```
mm-EventReportingContext-v3 APPLICATION-CONTEXT ::= {
  -- Responder is gsmSCF, Initiator is VLR
  INITIATOR CONSUMER OF {
    mm-EventReportingPackage-v3}
  ID {map-ac mm-EventReporting(42) version3(3)} }
```

This application-context is v3 only.

17.3.2.47 Any time information handling

This application context is used between gsmSCF and HLR for any time information handling procedures.

```
anyTimeInfohandlingContext-v3 APPLICATION-CONTEXT ::= {
  -- Responder is HLR if Initiator is gsmSCF
  INITIATOR CONSUMER OF {
    anyTimeInformationHandlingPackage-v3}
  ID {map-ac anyTimeInfoHandling(43) version3(3)} }
```

This application-context is v3 only.

17.3.2.48 Subscriber Data modification notification

This application context is used between HLR and gsmSCF for Subscriber Data modification notification procedures.

```
subscriberDataModificationNotificationContext-v3 APPLICATION-CONTEXT ::= {
  -- Responder is gsmSCF, Initiator is HLR
  INITIATOR CONSUMER OF {
    subscriberDataModificationNotificationPackage-v3
  }
  ID {map-ac subscriberDataModificationNotification(22) version3(3)} }
```

This application-context is v3 only.

17.3.2.49 Authentication Failure Report

This application context is used between VLR and HLR or SGSN and HLR for reporting of authentication failures.

```
authenticationFailureReportContext-v3 APPLICATION-CONTEXT ::= {
  -- Responder is HLR if Initiator is VLR
  -- Responder is HLR if Initiator is SGSN
  INITIATOR CONSUMER OF {
    authenticationFailureReportPackage-v3
  }
  ID {map-ac authenticationFailureReport(39) version3(3)} }
```

This application-context is v3 only.

17.3.3 ASN.1 Module for application-context-names

The following ASN.1 module summarises the application-context-name assigned to MAP application-contexts.

```
MAP-ApplicationContexts {
  itu-t identified-organization (4) etsi (0) mobileDomain (0)
  gsm-Network (1) modules (3) map-ApplicationContexts (2) version8 (8)}
```

DEFINITIONS

::=

BEGIN

-- EXPORTS everything

IMPORTS

gsm-NetworkId,
ac-Id

```
FROM MobileDomainDefinitions {
  itu-t (0) identified-organization (4) etsi (0) mobileDomain (0)
  mobileDomainDefinitions (0) version1 (1)}
;
```

-- application-context-names

```
map-ac OBJECT IDENTIFIER ::= {gsm-NetworkId ac-Id}
```

```
networkLocUpContext-v3 OBJECT IDENTIFIER ::=
  {map-ac networkLocUp(1) version3(3)}
```

```
locationCancellationContext-v3 OBJECT IDENTIFIER ::=
  {map-ac locationCancel(2) version3(3)}
```

```
roamingNumberEnquiryContext-v3 OBJECT IDENTIFIER ::=
  {map-ac roamingNbEnquiry(3) version3(3)}
```

```
authenticationFailureReportContext-v3 OBJECT IDENTIFIER ::=
  {map-ac authenticationFailureReport(39) version3(3)}
```

```
locationInfoRetrievalContext-v3 OBJECT IDENTIFIER ::=
  {map-ac locInfoRetrieval(5) version3(3)}
```

```
resetContext-v2 OBJECT IDENTIFIER ::=
  {map-ac reset(10) version2(2)}
```

handoverControlContext-v3 OBJECT IDENTIFIER ::= {map-ac handoverControl(11) version3(3)}
equipmentMngtContext-v3 OBJECT IDENTIFIER ::= {map-ac equipmentMngt(13) version3(3)}
infoRetrievalContext-v3 OBJECT IDENTIFIER ::= {map-ac infoRetrieval(14) version3(3)}
interVlrInfoRetrievalContext-v3 OBJECT IDENTIFIER ::= {map-ac interVlrInfoRetrieval(15) version3(3)}
subscriberDataMngtContext-v3 OBJECT IDENTIFIER ::= {map-ac subscriberDataMngt(16) version3(3)}
tracingContext-v3 OBJECT IDENTIFIER ::= {map-ac tracing(17) version3(3)}
networkFunctionalSsContext-v2 OBJECT IDENTIFIER ::= {map-ac networkFunctionalSs(18) version2(2)}
networkUnstructuredSsContext-v2 OBJECT IDENTIFIER ::= {map-ac networkUnstructuredSs(19) version2(2)}
shortMsgGatewayContext-v3 OBJECT IDENTIFIER ::= {map-ac shortMsgGateway(20) version3(3)}
shortMsgMO-RelayContext-v3 OBJECT IDENTIFIER ::= {map-ac shortMsgMO-Relay(21) version3(3)}
shortMsgAlertContext-v2 OBJECT IDENTIFIER ::= {map-ac shortMsgAlert(23) version2(2)}
mwdMngtContext-v3 OBJECT IDENTIFIER ::= {map-ac mwdMngt(24) version3(3)}
shortMsgMT-RelayContext-v3 OBJECT IDENTIFIER ::= {map-ac shortMsgMT-Relay(25) version3(3)}
imsiRetrievalContext-v2 OBJECT IDENTIFIER ::= {map-ac imsiRetrieval(26) version2(2)}
msPurgingContext-v3 OBJECT IDENTIFIER ::= {map-ac msPurging(27) version3(3)}
subscriberInfoEnquiryContext-v3 OBJECT IDENTIFIER ::= {map-ac subscriberInfoEnquiry(28) version3(3)}
anyTimeInfoEnquiryContext-v3 OBJECT IDENTIFIER ::= {map-ac anyTimeInfoEnquiry(29) version3(3)}
callControlTransferContext-v4 OBJECT IDENTIFIER ::= {map-ac callControlTransfer(6) version4(4)}
ss-InvocationNotificationContext-v3 OBJECT IDENTIFIER ::= {map-ac ss-InvocationNotification(36) version3(3)}
sIWFSAllocationContext-v3 OBJECT IDENTIFIER ::= {map-ac sIWFSAllocation(12) version3(3)}
groupCallControlContext-v3 OBJECT IDENTIFIER ::= {map-ac groupCallControl(31) version3(3)}
gprsLocationUpdateContext-v3 OBJECT IDENTIFIER ::= {map-ac gprsLocationUpdate(32) version3(3)}
gprsLocationInfoRetrievalContext-v4 OBJECT IDENTIFIER ::= {map-ac gprsLocationInfoRetrieval(33) version4(4)}
failureReportContext-v3 OBJECT IDENTIFIER ::= {map-ac failureReport(34) version3(3)}
gprsNotifyContext-v3 OBJECT IDENTIFIER ::= {map-ac gprsNotify(35) version3(3)}

```
reportingContext-v3 OBJECT IDENTIFIER ::=
  {map-ac reporting(7) version3(3)}
```

```
callCompletionContext-v3 OBJECT IDENTIFIER ::=
  {map-ac callCompletion(8) version3(3)}
```

```
istAlertingContext-v3 OBJECT IDENTIFIER ::=
  {map-ac istAlerting(4) version3(3)}
```

```
serviceTerminationContext-v3 OBJECT IDENTIFIER ::=
  {map-ac immediateTermination(9) version3(3)}
```

```
locationSvcGatewayContext-v3 OBJECT IDENTIFIER ::=
  {map-ac locationSvcGateway(37) version3(3)}
```

```
locationSvcEnquiryContext-v3 OBJECT IDENTIFIER ::=
  {map-ac locationSvcEnquiry(38) version3(3)}
```

```
mm-EventReportingContext-v3 OBJECT IDENTIFIER ::=
  {map-ac mm-EventReporting(42) version3(3)}
```

```
anyTimeInfoHandlingContext-v3 OBJECT IDENTIFIER ::=
  {map-ac anyTimeInfoHandling(43) version3(3)}
```

```
subscriberDataModificationNotificationContext-v3 OBJECT IDENTIFIER ::=
  {map-ac subscriberDataModificationNotification(22) version3(3)}
```

```
-- The following Object Identifiers are reserved for application-contexts
-- existing in previous versions of the protocol
```

AC Name & Version	Object Identifier
--	
-- networkLocUpContext-v1	map-ac networkLocUp (1) version1 (1)
-- networkLocUpContext-v2	map-ac networkLocUp (1) version2 (2)
-- locationCancellationContext-v1	map-ac locationCancellation (2) version1 (1)
-- locationCancellationContext-v2	map-ac locationCancellation (2) version2 (2)
-- roamingNumberEnquiryContext-v1	map-ac roamingNumberEnquiry (3) version1 (1)
-- roamingNumberEnquiryContext-v2	map-ac roamingNumberEnquiry (3) version2 (2)
-- locationInfoRetrievalContext-v1	map-ac locationInfoRetrieval (5) version1 (1)
-- locationInfoRetrievalContext-v2	map-ac locationInfoRetrieval (5) version2 (2)
-- resetContext-v1	map-ac reset (10) version1 (1)
-- handoverControlContext-v1	map-ac handoverControl (11) version1 (1)
-- handoverControlContext-v2	map-ac handoverControl (11) version2 (2)
-- equipmentMngtContext-v1	map-ac equipmentMngt (13) version1 (1)
-- equipmentMngtContext-v2	map-ac equipmentMngt (13) version2 (2)
-- infoRetrievalContext-v1	map-ac infoRetrieval (14) version1 (1)
-- infoRetrievalContext-v2	map-ac infoRetrieval (14) version2 (2)
-- interVlrlInfoRetrievalContext-v2	map-ac interVlrlInfoRetrieval (15) version2 (2)
-- subscriberDataMngtContext-v1	map-ac subscriberDataMngt (16) version1 (1)
-- subscriberDataMngtContext-v2	map-ac subscriberDataMngt (16) version2 (2)
-- tracingContext-v1	map-ac tracing (17) version1 (1)
-- tracingContext-v2	map-ac tracing (17) version2 (2)
-- networkFunctionalSsContext-v1	map-ac networkFunctionalSs (18) version1 (1)
-- shortMsgGatewayContext-v1	map-ac shortMsgGateway (20) version1 (1)
-- shortMsgGatewayContext-v2	map-ac shortMsgGateway (20) version2 (2)
-- shortMsgRelayContext-v1	map-ac shortMsgRelay (21) version1 (1)
-- shortMsgAlertContext-v1	map-ac shortMsgAlert (23) version1 (1)
-- mwdMngtContext-v1	map-ac mwdMngt (24) version1 (1)
-- mwdMngtContext-v2	map-ac mwdMngt (24) version2 (2)
-- shortMsgMT-RelayContext-v2	map-ac shortMsgMT-Relay (25) version2 (2)
-- msPurgingContext-v2	map-ac msPurging (27) version2 (2)
-- callControlTransferContext-v3	map-ac callControlTransferContext (6) version3 (3)
-- gprsLocationInfoRetrievalContext-v3	map-ac gprsLocationInfoRetrievalContext (33) version3 (3)

END

17.4 MAP Dialogue Information

```
MAP-DialogueInformation {
  itu-t identified-organization (4) etsi (0) mobileDomain (0)
  gsm-Network (1) modules (3) map-DialogueInformation (3) version8 (8)}
```

DEFINITIONS

IMPLICIT TAGS

::=

BEGIN

EXPORTS

map-DialogueAS,
MAP-DialoguePDU

;

IMPORTS

gsm-NetworkId,
as-Id

FROM MobileDomainDefinitions {

itu-t (0) identified-organization (4) etsi (0) mobileDomain (0)
mobileDomainDefinitions (0) version1 (1)}

AddressString

FROM MAP-CommonDataTypes {

itu-t identified-organization (4) etsi (0) mobileDomain (0)
gsm-Network(1) modules (3) map-CommonDataTypes (18) version8 (8)}

ExtensionContainer

FROM MAP-ExtensionDataTypes {

itu-t identified-organization (4) etsi (0) mobileDomain (0)
gsm-Network (1) modules (3) map-ExtensionDataTypes (21) version8 (8)}

;

-- abstract syntax name for MAP-DialoguePDU

map-DialogueAS OBJECT IDENTIFIER ::=
{gsm-NetworkId as-Id map-DialoguePDU (1) version1 (1)}

MAP-DialoguePDU ::= CHOICE {
map-open [0] MAP-OpenInfo,
map-accept [1] MAP-AcceptInfo,
map-close [2] MAP-CloseInfo,
map-refuse [3] MAP-RefuseInfo,
map-userAbort [4] MAP-UserAbortInfo,
map-providerAbort [5] MAP-ProviderAbortInfo}

MAP-OpenInfo ::= SEQUENCE {
destinationReference [0] AddressString OPTIONAL,
originationReference [1] AddressString OPTIONAL,
...
extensionContainer ExtensionContainer OPTIONAL
-- extensionContainer must not be used in version 2
}

MAP-AcceptInfo ::= SEQUENCE {
...
extensionContainer ExtensionContainer OPTIONAL
-- extensionContainer must not be used in version 2
}

MAP-CloseInfo ::= SEQUENCE {
...
extensionContainer ExtensionContainer OPTIONAL
-- extensionContainer must not be used in version 2
}

MAP-RefuseInfo ::= SEQUENCE {
reason Reason,
...
extensionContainer ExtensionContainer OPTIONAL,
-- extensionContainer must not be used in version 2
alternativeApplicationContext OBJECT IDENTIFIER OPTIONAL
-- alternativeApplicationContext must not be used in version 2
}

```
Reason ::= ENUMERATED {
    noReasonGiven (0),
    invalidDestinationReference (1),
    invalidOriginatingReference (2) }
```

```
MAP-UserAbortInfo ::= SEQUENCE {
    map-UserAbortChoice MAP-UserAbortChoice,
    ...,
    extensionContainer ExtensionContainer OPTIONAL
    -- extensionContainer must not be used in version 2
}
```

```
MAP-UserAbortChoice ::= CHOICE {
    userSpecificReason [0] NULL,
    userResourceLimitation [1] NULL,
    resourceUnavailable [2] ResourceUnavailableReason,
    applicationProcedureCancellation [3] ProcedureCancellationReason }
```

```
ResourceUnavailableReason ::= ENUMERATED {
    shortTermResourceLimitation (0),
    longTermResourceLimitation (1) }
```

```
ProcedureCancellationReason ::= ENUMERATED {
    handoverCancellation (0),
    radioChannelRelease (1),
    networkPathRelease (2),
    callRelease (3),
    associatedProcedureFailure (4),
    tandemDialogueRelease (5),
    remoteOperationsFailure (6) }
```

```
MAP-ProviderAbortInfo ::= SEQUENCE {
    map-ProviderAbortReason MAP-ProviderAbortReason,
    ...,
    extensionContainer ExtensionContainer OPTIONAL
    -- extensionContainer must not be used in version 2
}
```

```
MAP-ProviderAbortReason ::= ENUMERATED {
    abnormalDialogue (0),
    invalidPDU (1) }
```

END

17.5 MAP operation and error codes

```
MAP-Protocol {
    itu-t identified-organization (4) etsi (0) mobileDomain (0)
    gsm-Network (1) modules (3) map-Protocol (4) version8 (8) }
```

DEFINITIONS

::=

BEGIN

IMPORTS

OPERATION

```
FROM Remote-Operations-Information-Objects {
    joint-iso-itu-t remote-operations(4) informationObjects(5) version1(0) }
```

```
updateLocation,
cancelLocation,
purgeMS,
sendIdentification,
updateGprsLocation,
prepareHandover,
sendEndSignal,
processAccessSignalling,
forwardAccessSignalling,
prepareSubsequentHandover,
sendAuthenticationInfo,
authenticationFailureReport,
checkIMEI,
insertSubscriberData,
deleteSubscriberData,
```

```
reset,  
forwardCheckSS-Indication,  
restoreData,  
provideSubscriberInfo,  
anyTimeInterrogation,  
anyTimeSubscriptionInterrogation,  
anyTimeModification,  
sendRoutingInfoForGprs,  
failureReport,  
noteMsPresentForGprs,  
noteMM-Event,  
noteSubscriberDataModified
```

```
FROM MAP-MobileServiceOperations {  
  itu-t identified-organization (4) etsi (0) mobileDomain (0)  
  gsm-Network (1) modules (3) map-MobileServiceOperations (5)  
  version8 (8)}  
  
  activateTraceMode,  
  deactivateTraceMode,  
  sendIMSI  
FROM MAP-OperationAndMaintenanceOperations {  
  itu-t identified-organization (4) etsi (0) mobileDomain (0)  
  gsm-Network (1) modules (3) map-OperationAndMaintenanceOperations (6)  
  version8 (8)}  
  
  sendRoutingInfo,  
  provideRoamingNumber,  
  resumeCallHandling,  
  provideSIWFSNumber,  
  siwfs-SignallingModify,  
  setReportingState,  
  statusReport,  
  remoteUserFree,  
  ist-Alert,  
  ist-Command  
FROM MAP-CallHandlingOperations {  
  itu-t identified-organization (4) etsi (0) mobileDomain (0)  
  gsm-Network (1) modules (3) map-CallHandlingOperations (7)  
  version8 (8)}  
  
  registerSS,  
  eraseSS,  
  activateSS,  
  deactivateSS,  
  interrogateSS,  
  processUnstructuredSS-Request,  
  unstructuredSS-Request,  
  unstructuredSS-Notify,  
  registerPassword,  
  getPassword,  
  ss-InvocationNotification,  
  registerCC-Entry,  
  eraseCC-Entry  
FROM MAP-SupplementaryServiceOperations {  
  itu-t identified-organization (4) etsi (0) mobileDomain (0)  
  gsm-Network (1) modules (3) map-SupplementaryServiceOperations (8)  
  version8 (8)}  
  
  sendRoutingInfoForSM,  
  mo-ForwardSM,  
  mt-ForwardSM,  
  reportSM-DeliveryStatus,  
  alertServiceCentre,  
  informServiceCentre,  
  readyForSM  
FROM MAP-ShortMessageServiceOperations {  
  itu-t identified-organization (4) etsi (0) mobileDomain (0)  
  gsm-Network (1) modules (3) map-ShortMessageServiceOperations (9)  
  version8 (8)}  
  
  prepareGroupCall,  
  processGroupCallSignalling,  
  forwardGroupCallSignalling,  
  sendGroupCallEndSignal  
FROM MAP-Group-Call-Operations {  
  itu-t identified-organization (4) etsi (0) mobileDomain (0)  
  gsm-Network (1) modules (3) map-Group-Call-Operations (22)
```

```

version8 (8)}

provideSubscriberLocation,
sendRoutingInfoForLCS,
subscriberLocationReport
FROM MAP-LocationServiceOperations {
itu-t identified-organization (4) etsi (0) mobileDomain (0)
gsm-Network (1) modules (3) map-LocationServiceOperations (24)
version8 (8)}

;
Supported-MAP-Operations OPERATION ::= {updateLocation | cancelLocation | purgeMS |
sendIdentification | updateGprsLocation | prepareHandover | sendEndSignal |
processAccessSignalling | forwardAccessSignalling | prepareSubsequentHandover |
sendAuthenticationInfo | authenticationFailureReport | checkIMEI | insertSubscriberData |
deleteSubscriberData | reset | forwardCheckSS-Indication | restoreData | provideSubscriberInfo |
anyTimeInterrogation | anyTimeSubscriptionInterrogation | anyTimeModification |
sendRoutingInfoForGprs | failureReport | noteMsPresentForGprs | noteMM-Event |
noteSubscriberDataModified | activateTraceMode | deactivateTraceMode | sendIMSI |
sendRoutingInfo | provideRoamingNumber | resumeCallHandling | provideSIWFSNumber |
siwfs-SignallingModify | setReportingState | statusReport | remoteUserFree | ist-Alert |
ist-Command | registerSS | eraseSS | activateSS | deactivateSS | interrogateSS |
processUnstructuredSS-Request | unstructuredSS-Request | unstructuredSS-Notify |
registerPassword | getPassword | ss-InvocationNotification | registerCC-Entry | eraseCC-Entry |
sendRoutingInfoForSM | mo-ForwardSM | mt-ForwardSM | reportSM-DeliveryStatus |
alertServiceCentre | informServiceCentre | readyForSM | prepareGroupCall |
processGroupCallSignalling | forwardGroupCallSignalling | sendGroupCallEndSignal |
provideSubscriberLocation | sendRoutingInfoForLCS | subscriberLocationReport }

-- The following operation codes are reserved for operations
-- existing in previous versions of the protocol

```

-- Operation Name	AC used	Oper. Code
-- sendParameters	map-ac infoRetrieval (14) version1 (1)	local:9
-- processUnstructuredSS-Data	map-ac networkFunctionalSs (18) version1 (1)	local:19
-- performHandover	map-ac handoverControl (11) version1 (1)	local:28
-- performSubsequentHandover	map-ac handoverControl (11) version1 (1)	local:30
-- noteInternalHandover	map-ac handoverControl (11) version1 (1)	local:35
-- noteSubscriberPresent	map-ac mwdMngt (24) version1 (1)	local:48
-- alertServiceCentreWithoutResult	map-ac shortMsgAlert (23) version1 (1)	local:49
-- traceSubscriberActivity	map-ac handoverControl (11) version1 (1)	local:52
-- beginSubscriberActivity	map-ac networkFunctionalSs (18) version1 (1)	local:54

```

-- The following error codes are reserved for errors
-- existing in previous versions of the protocol

```

-- Error Name	AC used	Error Code
-- unknownBaseStation	map-ac handoverControl (11) version1 (1)	local:2
-- invalidTargetBaseStation	map-ac handoverControl (11) version1 (1)	local:23
-- noRadioResourceAvailable	map-ac handoverControl (11) version1 (1)	local:24

END

17.6 MAP operations and errors

17.6.1 Mobile Service Operations

```

MAP-MobileServiceOperations {
itu-t identified-organization (4) etsi (0) mobileDomain (0)
gsm-Network (1) modules (3) map-MobileServiceOperations (5)
version8 (8)}

```

DEFINITIONS

::=

BEGIN

EXPORTS

```
-- location registration operations
updateLocation,
cancelLocation,
purgeMS,
sendIdentification,

-- gprs location registration operations
updateGprsLocation,

-- subscriber information enquiry operations
provideSubscriberInfo,

-- any time information enquiry operations
anyTimeInterrogation,

-- any time information handling operations
anyTimeSubscriptionInterrogation,
anyTimeModification,

-- subscriber data modification notification operations
noteSubscriberDataModified,

-- handover operations
prepareHandover,
sendEndSignal,
processAccessSignalling,
forwardAccessSignalling,
prepareSubsequentHandover,

-- authentication management operations
sendAuthenticationInfo,
authenticationFailureReport,

-- IMEI management operations
checkIMEI,

-- subscriber management operations
insertSubscriberData,
deleteSubscriberData,

-- fault recovery operations
reset,
forwardCheckSS-Indication,
restoreData,

-- gprs location information retrieval operations
sendRoutingInfoForGprs,

-- failure reporting operations
failureReport,

-- gprs notification operations
noteMsPresentForGprs,

-- Mobility Management operations
noteMM-Event

;

IMPORTS
OPERATION
FROM Remote-Operations-Information-Objects {
    joint-iso-itu-t remote-operations(4)
    informationObjects(5) version1(0)}

    systemFailure,
    dataMissing,
    unexpectedDataValue,
    unknownSubscriber,
    unknownMSC,
    unidentifiedSubscriber,
    unknownEquipment,
    roamingNotAllowed,
    ati-NotAllowed,
    noHandoverNumberAvailable,
```

subsequentHandoverFailure,
absentSubscriber,
mm-EventNotSupported,
atsi-NotAllowed,
atm-NotAllowed,
bearerServiceNotProvisioned,
teleserviceNotProvisioned,
callBarred,
illegalSS-Operation,
ss-ErrorStatus,
ss-NotAvailable,
ss-Incompatibility,
ss-SubscriptionViolation,
informationNotAvailable,
targetCellOutsideGroupCallArea

FROM MAP-Errors {
itu-t identified-organization (4) etsi (0) mobileDomain (0)
gsm-Network (1) modules (3) map-Errors (10) version8 (8)}

UpdateLocationArg,
UpdateLocationRes,
CancelLocationArg,
CancelLocationRes,
PurgeMS-Arg,
PurgeMS-Res,
SendIdentificationArg,
SendIdentificationRes,
UpdateGprsLocationArg,
UpdateGprsLocationRes,
PrepareHO-Arg,
PrepareHO-Res,
ForwardAccessSignalling-Arg,
ProcessAccessSignalling-Arg,
SendEndSignal-Arg,
SendEndSignal-Res,
PrepareSubsequentHO-Res,
PrepareSubsequentHO-Arg,
SendAuthenticationInfoArg,
SendAuthenticationInfoRes,
AuthenticationFailureReportArg,
AuthenticationFailureReportRes,
CheckIMEI-Arg,
CheckIMEI-Res,
InsertSubscriberDataArg,
InsertSubscriberDataRes,
DeleteSubscriberDataArg,
DeleteSubscriberDataRes,
ResetArg,
RestoreDataArg,
RestoreDataRes,
ProvideSubscriberInfoArg,
ProvideSubscriberInfoRes,
AnyTimeSubscriptionInterrogationArg,
AnyTimeSubscriptionInterrogationRes,
AnyTimeModificationArg,
AnyTimeModificationRes,
NoteSubscriberDataModifiedArg,
NoteSubscriberDataModifiedRes,
AnyTimeInterrogationArg,
AnyTimeInterrogationRes,
SendRoutingInfoForGprsArg,
SendRoutingInfoForGprsRes,
FailureReportArg,
FailureReportRes,
NoteMsPresentForGprsArg,
NoteMsPresentForGprsRes,
NoteMM-EventArg,
NoteMM-EventRes

FROM MAP-MS-DataTypes {
itu-t identified-organization (4) etsi (0) mobileDomain (0)
gsm-Network (1) modules (3) map-MS-DataTypes (11) version8 (8)}

;

-- location registration operations

```

updateLocation OPERATION ::= {                                     --Timer m
  ARGUMENT
    UpdateLocationArg
  RESULT
    UpdateLocationRes
  ERRORS {
    systemFailure |
    dataMissing |
    unexpectedDataValue |
    unknownSubscriber |
    roamingNotAllowed}
  CODE local:2 }

```

```

cancelLocation OPERATION ::= {                                   --Timer m
  ARGUMENT
    CancelLocationArg
  RESULT
    CancelLocationRes
    -- optional
  ERRORS {
    dataMissing |
    unexpectedDataValue}
  CODE local:3 }

```

```

purgeMS OPERATION ::= {                                         --Timer m
  ARGUMENT
    PurgeMS-Arg
  RESULT
    PurgeMS-Res
    -- optional
  ERRORS{
    dataMissing |
    unexpectedDataValue|
    unknownSubscriber}
  CODE local:67 }

```

```

sendIdentification OPERATION ::= {                             --Timer s
  ARGUMENT
    SendIdentificationArg
  RESULT
    SendIdentificationRes
  ERRORS {
    dataMissing |
    unidentifiedSubscriber}
  CODE local:55 }

```

-- gprs location registration operations

```

updateGprsLocation OPERATION ::= {                             --Timer m
  ARGUMENT
    UpdateGprsLocationArg
  RESULT
    UpdateGprsLocationRes
  ERRORS {
    systemFailure |
    unexpectedDataValue |
    unknownSubscriber |
    roamingNotAllowed}
  CODE local:23 }

```

-- subscriber information enquiry operations

```

provideSubscriberInfo OPERATION ::= {                          --Timer m
  ARGUMENT
    ProvideSubscriberInfoArg
  RESULT
    ProvideSubscriberInfoRes
  ERRORS {
    dataMissing |
    unexpectedDataValue}
  CODE local:70 }

```

-- any time information enquiry operations

```

anyTimeInterrogation OPERATION ::= {                                     --Timer m
  ARGUMENT
    AnyTimeInterrogationArg
  RESULT
    AnyTimeInterrogationRes
  ERRORS {
    systemFailure |
    ati-NotAllowed |
    dataMissing |
    unexpectedDataValue |
    unknownSubscriber}
  CODE local:71 }

```

-- any time information handling operations

```

anyTimeSubscriptionInterrogation OPERATION ::= {                       --Timer m
  ARGUMENT
    AnyTimeSubscriptionInterrogationArg
  RESULT
    AnyTimeSubscriptionInterrogationRes
  ERRORS {
    atsi-NotAllowed |
    dataMissing |
    unexpectedDataValue |
    unknownSubscriber |
    bearerServiceNotProvisioned |
    teleserviceNotProvisioned |
    callBarred |
    illegalSS-Operation |
    ss-NotAvailable |
    informationNotAvailable}
  CODE local:62 }

```

```

anyTimeModification OPERATION ::= {                                   --Timer m
  ARGUMENT
    AnyTimeModificationArg
  RESULT
    AnyTimeModificationRes
  ERRORS {
    atm-NotAllowed |
    dataMissing |
    unexpectedDataValue |
    unknownSubscriber |
    bearerServiceNotProvisioned |
    teleserviceNotProvisioned |
    callBarred |
    illegalSS-Operation |
    ss-SubscriptionViolation |
    ss-ErrorStatus |
    ss-Incompatibility |
    informationNotAvailable}
  CODE local:65 }

```

-- subscriber data modification notification operations

```

noteSubscriberDataModified OPERATION ::= {                             --Timer m
  ARGUMENT
    NoteSubscriberDataModifiedArg
  RESULT
    NoteSubscriberDataModifiedRes
    -- optional
  ERRORS {
    dataMissing |
    unexpectedDataValue |
    unknownSubscriber}
  CODE local:5 }

```

-- handover operations

```

prepareHandover OPERATION ::= {                                     --Timer m
  ARGUMENT
    PrepareHO-Arg
  RESULT
    PrepareHO-Res
  ERRORS {
    systemFailure |
    dataMissing |
    unexpectedDataValue |
    noHandoverNumberAvailable |
    targetCellOutsideGroupCallArea }
  CODE local:68 }

```

```

sendEndSignal OPERATION ::= {                                     --Timer l
  ARGUMENT
    SendEndSignal-Arg
  RESULT
    SendEndSignal-Res
  CODE local:29 }

```

```

processAccessSignalling OPERATION ::= {                         --Timer s
  ARGUMENT
    ProcessAccessSignalling-Arg
  CODE local:33 }

```

```

forwardAccessSignalling OPERATION ::= {                         --Timer s
  ARGUMENT
    ForwardAccessSignalling-Arg
  CODE local:34 }

```

```

prepareSubsequentHandover OPERATION ::= {                       --Timer m
  ARGUMENT
    PrepareSubsequentHO-Arg
  RESULT
    PrepareSubsequentHO-Res
  ERRORS {
    unexpectedDataValue |
    dataMissing |
    unknownMSC |
    subsequentHandoverFailure}
  CODE local:69 }

```

-- authentication management operations

```

sendAuthenticationInfo OPERATION ::= {                           --Timer m
  ARGUMENT
    SendAuthenticationInfoArg
    -- optional
    -- within a dialogue sendAuthenticationInfoArg shall not be present in
    -- subsequent invoke components. If received in a subsequent invoke component
    -- it shall be discarded.

  RESULT
    SendAuthenticationInfoRes
    -- optional

  ERRORS {
    systemFailure |
    dataMissing |
    unexpectedDataValue |
    unknownSubscriber}
  CODE local:56 }

```

```

authenticationFailureReport OPERATION ::= {                     --Timer m
  ARGUMENT
    AuthenticationFailureReportArg
  RESULT
    AuthenticationFailureReportRes
    -- optional

  ERRORS {
    systemFailure |
    unexpectedDataValue |
    unknownSubscriber}
  CODE local:15 }

```

-- IMEI management operations

```

checkIMEI OPERATION ::= {                                     --Timer m
  ARGUMENT
    CheckIMEI-Arg
  RESULT
    CheckIMEI-Res
  ERRORS {
    systemFailure |
    dataMissing |
    unknownEquipment}
  CODE local:43 }

```

-- subscriber management operations

```

insertSubscriberData OPERATION ::= {                       --Timer m
  ARGUMENT
    InsertSubscriberDataArg
  RESULT
    InsertSubscriberDataRes
    -- optional
  ERRORS {
    dataMissing |
    unexpectedDataValue |
    unidentifiedSubscriber}
  CODE local:7 }

```

```

deleteSubscriberData OPERATION ::= {                     --Timer m
  ARGUMENT
    DeleteSubscriberDataArg
  RESULT
    DeleteSubscriberDataRes
    -- optional
  ERRORS {
    dataMissing |
    unexpectedDataValue |
    unidentifiedSubscriber}
  CODE local:8 }

```

-- fault recovery operations

```

reset OPERATION ::= {                                     --Timer m
  ARGUMENT
    ResetArg
  CODE local:37 }

```

```

forwardCheckSS-Indication OPERATION ::= {               --Timer s
  CODE local:38 }

```

```

restoreData OPERATION ::= {                               --Timer m
  ARGUMENT
    RestoreDataArg
  RESULT
    RestoreDataRes
  ERRORS {
    systemFailure |
    dataMissing |
    unexpectedDataValue |
    unknownSubscriber}
  CODE local:57 }

```

-- gprs location information retrieval operations

```

sendRoutingInfoForGprs OPERATION ::= {                   --Timer m
  ARGUMENT
    SendRoutingInfoForGprsArg
  RESULT
    SendRoutingInfoForGprsRes
  ERRORS {
    absentSubscriber |
    systemFailure |
    dataMissing |
    unexpectedDataValue |
    unknownSubscriber |
    callBarred }
  CODE local:24 }

```

-- failure reporting operations

```

failureReport OPERATION ::= {                                     --Timer m
  ARGUMENT
    FailureReportArg
  RESULT
    FailureReportRes
    -- optional
  ERRORS {
    systemFailure |
    dataMissing |
    unexpectedDataValue |
    unknownSubscriber}
  CODE local:25 }

```

-- gprs notification operations

```

noteMsPresentForGprs OPERATION ::= {                             --Timer m
  ARGUMENT
    NoteMsPresentForGprsArg
  RESULT
    NoteMsPresentForGprsRes
    -- optional
  ERRORS {
    systemFailure |
    dataMissing |
    unexpectedDataValue |
    unknownSubscriber}
  CODE local:26 }

```

```

noteMM-Event OPERATION ::= {                                     --Timer m
  ARGUMENT
    NoteMM-EventArg
  RESULT
    NoteMM-EventRes
  ERRORS {
    dataMissing |
    unexpectedDataValue |
    unknownSubscriber |
    mm-EventNotSupported}
  CODE local:89 }

```

END

17.6.2 Operation and Maintenance Operations

```

MAP-OperationAndMaintenanceOperations {
  itu-t identified-organization (4) etsi (0) mobileDomain (0)
  gsm-Network (1) modules (3) map-OperationAndMaintenanceOperations (6)
  version8 (8)}

```

DEFINITIONS

::=

BEGIN

EXPORTS

```

  activateTraceMode,
  deactivateTraceMode,
  sendIMSI
;

```

IMPORTS

OPERATION

```

FROM Remote-Operations-Information-Objects {
  joint-iso-itu-t remote-operations(4)
  informationObjects(5) version1(0)}

```

```

  systemFailure,
  dataMissing,
  unexpectedDataValue,
  facilityNotSupported,
  unknownSubscriber,
  unidentifiedSubscriber,
  tracingBufferFull

```

FROM MAP-Errors {

```

  itu-t identified-organization (4) etsi (0) mobileDomain (0)
  gsm-Network (1) modules (3) map-Errors (10) version8 (8)}

```

```

    ActivateTraceModeArg,
    ActivateTraceModeRes,
    DeactivateTraceModeArg,
    DeactivateTraceModeRes
FROM MAP-OM-DataTypes {
    itu-t identified-organization (4) etsi (0) mobileDomain (0)
    gsm-Network (1) modules (3) map-OM-DataTypes (12) version8 (8)}

    ISDN-AddressString,
    IMSI
FROM MAP-CommonDataTypes {
    itu-t identified-organization (4) etsi (0) mobileDomain (0)
    gsm-Network (1) modules (3) map-CommonDataTypes (18) version8 (8)}
;

```

```

activateTraceMode OPERATION ::= {                                     --Timer m
    ARGUMENT
        ActivateTraceModeArg
    RESULT
        ActivateTraceModeRes
        -- optional
    ERRORS {
        systemFailure |
        dataMissing |
        unexpectedDataValue |
        facilityNotSupported |
        unidentifiedSubscriber |
        tracingBufferFull}
    CODE local:50 }

```

```

deactivateTraceMode OPERATION ::= {                                   --Timer m
    ARGUMENT
        DeactivateTraceModeArg
    RESULT
        DeactivateTraceModeRes
        -- optional
    ERRORS {
        systemFailure |
        dataMissing |
        unexpectedDataValue |
        facilityNotSupported |
        unidentifiedSubscriber}
    CODE local:51 }

```

```

sendIMSI OPERATION ::= {                                           --Timer m
    ARGUMENT
        ISDN-AddressString
    RESULT
        IMSI
    ERRORS {
        dataMissing |
        unexpectedDataValue |
        unknownSubscriber}
    CODE local:58 }

```

END

17.6.3 Call Handling Operations

```

MAP-CallHandlingOperations {
    itu-t identified-organization (4) etsi (0) mobileDomain (0)
    gsm-Network (1) modules (3) map-CallHandlingOperations (7)
    version8 (8)}

```

DEFINITIONS

::=

BEGIN

EXPORTS

```

    sendRoutingInfo,
    provideRoamingNumber,
    resumeCallHandling,
    provideSIWFSNumber,
    siwfs-SignallingModify,

```

```
    setReportingState,
    statusReport,
    remoteUserFree,
    ist-Alert,
    ist-Command
;

IMPORTS
    OPERATION
FROM Remote-Operations-Information-Objects {
    joint-iso-itu-t remote-operations(4)
    informationObjects(5) version1(0)}

    systemFailure,
    dataMissing,
    unexpectedDataValue,
    facilityNotSupported,
    or-NotAllowed,
    unknownSubscriber,
    numberChanged,
    bearerServiceNotProvisioned,
    teleserviceNotProvisioned,
    noRoamingNumberAvailable,
    absentSubscriber,
    busySubscriber,
    noSubscriberReply,
    callBarred,
    forwardingViolation,
    forwardingFailed,
    cug-Reject,
    resourceLimitation,
    incompatibleTerminal,
    unidentifiedSubscriber

FROM MAP-Errors {
    itu-t identified-organization (4) etsi (0) mobileDomain (0)
    gsm-Network (1) modules (3) map-Errors (10) version8 (8)}
    SendRoutingInfoArg,
    SendRoutingInfoRes,
    ProvideRoamingNumberArg,
    ProvideRoamingNumberRes,
    ResumeCallHandlingArg,
    ResumeCallHandlingRes,
    ProvideSIWFSNumberArg,
    ProvideSIWFSNumberRes,
    SIWFSSignallingModifyArg,
    SIWFSSignallingModifyRes,
    SetReportingStateArg,
    SetReportingStateRes,
    StatusReportArg,
    StatusReportRes,
    RemoteUserFreeArg,
    RemoteUserFreeRes,
    IST-AlertArg,
    IST-AlertRes,
    IST-CommandArg,
    IST-CommandRes
FROM MAP-CH-DataTypes {
    itu-t identified-organization (4) etsi (0) mobileDomain (0)
    gsm-Network (1) modules (3) map-CH-DataTypes (13) version8 (8)}
;

```

```

sendRoutingInfo OPERATION ::= {                                     --Timer m
-- The timer is set to the upper limit of the range if the GMSC supports pre-paging.
  ARGUMENT
    SendRoutingInfoArg
  RESULT
    SendRoutingInfoRes
  ERRORS {
    systemFailure |
    dataMissing |
    unexpectedDataValue |
    facilityNotSupported |
    or-NotAllowed |
    unknownSubscriber |
    numberChanged |
    bearerServiceNotProvisioned |
    teleserviceNotProvisioned |
    absentSubscriber |
    busySubscriber |
    noSubscriberReply |
    callBarred |
    cug-Reject |
    forwardingViolation}
  CODE local:22 }

```

```

provideRoamingNumber OPERATION ::= {                               --Timer m
-- The timer is set to the upper limit of the range if the HLR supports pre-paging.
  ARGUMENT
    ProvideRoamingNumberArg
  RESULT
    ProvideRoamingNumberRes
  ERRORS {
    systemFailure |
    dataMissing |
    unexpectedDataValue |
    facilityNotSupported |
    or-NotAllowed |
    absentSubscriber |
    noRoamingNumberAvailable}
  CODE local:4 }

```

```

resumeCallHandling OPERATION ::= {                               --Timer m
  ARGUMENT
    ResumeCallHandlingArg
  RESULT
    ResumeCallHandlingRes
    -- optional
  ERRORS {
    forwardingFailed |
    or-NotAllowed |
    unexpectedDataValue |
    dataMissing }
  CODE local:6 }

```

```

provideSIWFSNumber OPERATION ::= {                                 --Timer m
  ARGUMENT
    ProvideSIWFSNumberArg
  RESULT
    ProvideSIWFSNumberRes
  ERRORS {
    resourceLimitation |
    dataMissing |
    unexpectedDataValue |
    systemFailure}
  CODE local:31 }

```

```

siwfs-SignallingModify OPERATION ::= {                             --Timer m
  ARGUMENT
    SIWFSsignallingModifyArg
  RESULT
    SIWFSsignallingModifyRes
    -- optional
  ERRORS {
    resourceLimitation |
    dataMissing |
    unexpectedDataValue |
    systemFailure}
  CODE local:32 }

```

```

setReportingState OPERATION ::= {                                     --Timer m
  ARGUMENT
    SetReportingStateArg
  RESULT
    SetReportingStateRes
    -- optional
  ERRORS {
    systemFailure |
    unidentifiedSubscriber |
    unexpectedDataValue |
    dataMissing |
    resourceLimitation |
    facilityNotSupported}
  CODE local:73 }

```

```

statusReport OPERATION ::= {                                       --Timer m
  ARGUMENT
    StatusReportArg
  RESULT
    StatusReportRes
    -- optional
  ERRORS {
    unknownSubscriber |
    systemFailure |
    unexpectedDataValue |
    dataMissing}
  CODE local:74 }

```

```

remoteUserFree OPERATION ::= {                                     --Timer m1
  ARGUMENT
    RemoteUserFreeArg
  RESULT
    RemoteUserFreeRes
  ERRORS {
    unexpectedDataValue |
    dataMissing |
    incompatibleTerminal |
    absentSubscriber |
    systemFailure |
    busySubscriber}
  CODE local:75 }

```

```

ist-Alert OPERATION ::= {                                         --Timer m
  ARGUMENT
    IST-AlertArg
  RESULT
    IST-AlertRes
    -- optional
  ERRORS {
    unexpectedDataValue |
    resourceLimitation |
    unknownSubscriber |
    systemFailure |
    facilityNotSupported}
  CODE local:87 }

```

```

ist-Command OPERATION ::= {                                       --Timer m
  ARGUMENT
    IST-CommandArg
  RESULT
    IST-CommandRes
    -- optional
  ERRORS {
    unexpectedDataValue |
    resourceLimitation |
    unknownSubscriber |
    systemFailure |
    facilityNotSupported}
  CODE local:88 }

```

END

17.6.4 Supplementary service operations

```
MAP-SupplementaryServiceOperations {
  itu-t identified-organization (4) etsi (0) mobileDomain (0)
  gsm-Network (1) modules (3) map-SupplementaryServiceOperations (8)
  version8 (8)}
```

DEFINITIONS

::=

BEGIN

EXPORTS

```
  registerSS,
  eraseSS,
  activateSS,
  deactivateSS,
  interrogateSS,
  processUnstructuredSS-Request,
  unstructuredSS-Request,
  unstructuredSS-Notify,
  registerPassword,
  getPassword,
  ss-InvocationNotification,
  registerCC-Entry,
  eraseCC-Entry
;
```

IMPORTS

OPERATION

```
FROM Remote-Operations-Information-Objects {
  joint-iso-itu-t remote-operations(4)
  informationObjects(5) version1(0)}
```

```
  systemFailure,
  dataMissing,
  unexpectedDataValue,
  unknownSubscriber,
  bearerServiceNotProvisioned,
  teleserviceNotProvisioned,
  callBarred,
  illegalSS-Operation,
  ss-ErrorStatus,
  ss-NotAvailable,
  ss-SubscriptionViolation,
  ss-Incompatibility,
  pw-RegistrationFailure,
  negativePW-Check,
  numberOfPW-AttemptsViolation,
  unknownAlphabet,
  ussd-Busy,
  absentSubscriber,
  illegalSubscriber,
  illegalEquipment,
  shortTermDenial,
  longTermDenial,
  facilityNotSupported
```

```
FROM MAP-Errors {
  itu-t identified-organization (4) etsi (0) mobileDomain (0)
  gsm-Network (1) modules (3) map-Errors (10) version8 (8)}
```

```
  RegisterSS-Arg,
  SS-Info,
  SS-ForBS-Code,
  InterrogateSS-Res,
  USSD-Arg,
  USSD-Res,
  Password,
  GuidanceInfo,
  SS-InvocationNotificationArg,
  SS-InvocationNotificationRes,
  RegisterCC-EntryArg,
  RegisterCC-EntryRes,
  EraseCC-EntryArg,
  EraseCC-EntryRes
```

```
FROM MAP-SS-DataTypes {
  itu-t identified-organization (4) etsi (0) mobileDomain (0)
  gsm-Network (1) modules (3) map-SS-DataTypes (14) version8 (8)}
```

SS-Code

```

FROM MAP-SS-Code {
  itu-t identified-organization (4) etsi (0) mobileDomain (0)
  gsm-Network (1) modules (3) map-SS-Code (15) version8 (8)}
;

```

-- supplementary service handling operations

```

registerSS OPERATION ::= {                                     --Timer m
  ARGUMENT
    RegisterSS-Arg
  RESULT
    SS-Info
    -- optional
  ERRORS {
    systemFailure |
    dataMissing |
    unexpectedDataValue |
    bearerServiceNotProvisioned |
    teleserviceNotProvisioned |
    callBarred |
    illegalSS-Operation |
    ss-ErrorStatus |
    ss-Incompatibility}
  CODE local:10 }

```

```

eraseSS OPERATION ::= {                                     --Timer m
  ARGUMENT
    SS-ForBS-Code
  RESULT
    SS-Info
    -- optional
  ERRORS {
    systemFailure |
    dataMissing |
    unexpectedDataValue |
    bearerServiceNotProvisioned |
    teleserviceNotProvisioned |
    callBarred |
    illegalSS-Operation |
    ss-ErrorStatus
  }
  CODE local:11 }

```

```

activateSS OPERATION ::= {                                 --Timer m
  ARGUMENT
    SS-ForBS-Code
  RESULT
    SS-Info
    -- optional
  ERRORS {
    systemFailure |
    dataMissing |
    unexpectedDataValue |
    bearerServiceNotProvisioned |
    teleserviceNotProvisioned |
    callBarred |
    illegalSS-Operation |
    ss-ErrorStatus |
    ss-SubscriptionViolation |
    ss-Incompatibility |
    negativePW-Check |
    numberOfPW-AttemptsViolation}
  CODE local:12 }

```



```

deactivateSS OPERATION ::= {                                     --Timer m
  ARGUMENT
    SS-ForBS-Code
  RESULT
    SS-Info
    -- optional
  ERRORS {
    systemFailure |
    dataMissing |
    unexpectedDataValue |
    bearerServiceNotProvisioned |
    teleserviceNotProvisioned |
    callBarred |
    illegalSS-Operation |
    ss-ErrorStatus |
    ss-SubscriptionViolation |
    negativePW-Check |
    numberOfPW-AttemptsViolation}
  CODE local:13 }

```

```

interrogateSS OPERATION ::= {                                 --Timer m
  ARGUMENT
    SS-ForBS-Code
  RESULT
    InterrogateSS-Res
  ERRORS {
    systemFailure |
    dataMissing |
    unexpectedDataValue |
    bearerServiceNotProvisioned |
    teleserviceNotProvisioned |
    callBarred |
    illegalSS-Operation |
    ss-NotAvailable}
  CODE local:14 }

```

```

processUnstructuredSS-Request OPERATION ::= {                --Timer 10
minutes
  ARGUMENT
    USSD-Arg
  RESULT
    USSD-Res
  ERRORS {
    systemFailure |
    dataMissing |
    unexpectedDataValue |
    unknownAlphabet |
    callBarred}
  CODE local:59 }

```

```

unstructuredSS-Request OPERATION ::= {                       --Timer m1
  ARGUMENT
    USSD-Arg
  RESULT
    USSD-Res
    -- optional
  ERRORS {
    systemFailure |
    dataMissing |
    unexpectedDataValue |
    absentSubscriber |
    illegalSubscriber |
    illegalEquipment |
    unknownAlphabet |
    ussd-Busy}
  CODE local:60 }

```

```

unstructuredSS-Notify OPERATION ::= {                                     --Timer m1
  ARGUMENT
    USSD-Arg
  RETURN RESULT TRUE
  ERRORS {
    systemFailure |
    dataMissing |
    unexpectedDataValue |
    absentSubscriber |
    illegalSubscriber |
    illegalEquipment |
    unknownAlphabet |
    ussG-Busy}
  CODE local:61 }

```

```

registerPassword OPERATION ::= {                                       --Timer m1
  ARGUMENT
    SS-Code
  RESULT
    Password
  ERRORS {
    systemFailure |
    dataMissing |
    unexpectedDataValue |
    callBarred |
    ss-SubscriptionViolation |
    pw-RegistrationFailure |
    negativePW-Check |
    numberOfPW-AttemptsViolation}
  LINKED {
    getPassword}
  CODE local:17 }

```

```

getPassword OPERATION ::= {                                           --Timer m
  ARGUMENT
    GuidanceInfo
  RESULT
    Password
  CODE local:18 }

```

```

ss-InvocationNotification OPERATION ::= {                             --Timer m
  ARGUMENT
    SS-InvocationNotificationArg
  RESULT
    SS-InvocationNotificationRes
    -- optional
  ERRORS {
    dataMissing |
    unexpectedDataValue |
    unknownSubscriber}
  CODE local:72 }

```

```

registerCC-Entry OPERATION ::= {                                       --Timer m
  ARGUMENT
    RegisterCC-EntryArg
  RESULT
    RegisterCC-EntryRes
  ERRORS {
    systemFailure |
    dataMissing |
    unexpectedDataValue |
    callBarred |
    illegalSS-Operation |
    ss-ErrorStatus |
    ss-Incompatibility |
    shortTermDenial |
    longTermDenial |
    facilityNotSupported}
  CODE local:76 }

```

```

eraseCC-Entry OPERATION ::= {                                     --Timer m
  ARGUMENT
    EraseCC-EntryArg
  RESULT
    EraseCC-EntryRes
  ERRORS {
    systemFailure |
    dataMissing |
    unexpectedDataValue |
    callBarred |
    illegalSS-Operation |
    ss-ErrorStatus}
  CODE local:77 }

```

END

17.6.5 Short message service operations

```

MAP-ShortMessageServiceOperations {
  itu-t identified-organization (4) etsi (0) mobileDomain (0)
  gsm-Network (1) modules (3) map-ShortMessageServiceOperations (9)
  version8 (8)}

```

DEFINITIONS

::=

BEGIN

EXPORTS

```

  sendRoutingInfoForSM,
  mo-ForwardSM,
  mt-ForwardSM,
  reportSM-DeliveryStatus,
  alertServiceCentre,
  informServiceCentre,
  readyForSM
;

```

IMPORTS

OPERATION

```

FROM Remote-Operations-Information-Objects {
  joint-iso-itu-t remote-operations(4)
  informationObjects(5) version1(0)}

```

```

  systemFailure,
  dataMissing,
  unexpectedDataValue,
  facilityNotSupported,
  unknownSubscriber,
  unidentifiedSubscriber,
  illegalSubscriber,
  illegalEquipment,
  teleserviceNotProvisioned,
  callBarred,
  subscriberBusyForMT-SMS,
  sm-DeliveryFailure,
  messageWaitingListFull,
  absentSubscriberSM

```

FROM MAP-Errors {

```

  itu-t identified-organization (4) etsi (0) mobileDomain (0)
  gsm-Network (1) modules (3) map-Errors (10) version8 (8)}

```

```

  RoutingInfoForSM-Arg,
  RoutingInfoForSM-Res,
  MO-ForwardSM-Arg,
  MO-ForwardSM-Res,
  MT-ForwardSM-Arg,
  MT-ForwardSM-Res,
  ReportSM-DeliveryStatusArg,
  ReportSM-DeliveryStatusRes,
  AlertServiceCentreArg,
  InformServiceCentreArg,
  ReadyForSM-Arg,
  ReadyForSM-Res

```

FROM MAP-SM-DataTypes {

```

  itu-t identified-organization (4) etsi (0) mobileDomain (0)
  gsm-Network (1) modules (3) map-SM-DataTypes (16) version8 (8)}

```

;

```

sendRoutingInfoForSM OPERATION ::= {                                     --Timer m
  ARGUMENT
    RoutingInfoForSM-Arg
  RESULT
    RoutingInfoForSM-Res
  ERRORS {
    systemFailure |
    dataMissing |
    unexpectedDataValue |
    facilityNotSupported |
    unknownSubscriber |
    teleserviceNotProvisioned |
    callBarred |
    absentSubscriberSM}
  CODE local:45 }

```

```

mo-ForwardSM OPERATION ::= {                                         --Timer ml
  ARGUMENT
    MO-ForwardSM-Arg
  RESULT
    MO-ForwardSM-Res
    -- optional
  ERRORS {
    systemFailure |
    unexpectedDataValue |
    facilityNotSupported |
    sm-DeliveryFailure}
  CODE local:46 }

```

```

mt-ForwardSM OPERATION ::= {                                         --Timer ml
  ARGUMENT
    MT-ForwardSM-Arg
  RESULT
    MT-ForwardSM-Res
    -- optional
  ERRORS {
    systemFailure |
    dataMissing |
    unexpectedDataValue |
    facilityNotSupported |
    unidentifiedSubscriber |
    illegalSubscriber |
    illegalEquipment |
    subscriberBusyForMT-SMS |
    sm-DeliveryFailure |
    absentSubscriberSM}
  CODE local:44 }

```

```

reportSM-DeliveryStatus OPERATION ::= {                               --Timer s
  ARGUMENT
    ReportSM-DeliveryStatusArg
  RESULT
    ReportSM-DeliveryStatusRes
    -- optional
  ERRORS {
    dataMissing |
    unexpectedDataValue |
    unknownSubscriber |
    messageWaitingListFull}
  CODE local:47 }

```

```

alertServiceCentre OPERATION ::= {                                   --Timer s
  ARGUMENT
    AlertServiceCentreArg
  RETURN RESULT TRUE
  ERRORS {
    systemFailure |
    dataMissing |
    unexpectedDataValue}
  CODE local:64 }

```

```
informServiceCentre OPERATION ::= {                                --Timer s
  ARGUMENT
    InformServiceCentreArg
  CODE local:63 }
```

```
readyForSM OPERATION ::= {                                       --Timer m
  ARGUMENT
    ReadyForSM-Arg
  RESULT
    ReadyForSM-Res
    -- optional
  ERRORS {
    dataMissing |
    unexpectedDataValue |
    facilityNotSupported |
    unknownSubscriber}
  CODE local:66 }
```

END

17.6.6 Errors

```
MAP-Errors {
  itu-t identified-organization (4) etsi (0) mobileDomain (0)
  gsm-Network (1) modules (3) map-Errors (10) version8 (8)}
```

DEFINITIONS

::=

BEGIN

EXPORTS

```
-- generic errors
systemFailure,
dataMissing,
unexpectedDataValue,
facilityNotSupported,
incompatibleTerminal,
resourceLimitation,

-- identification and numbering errors
unknownSubscriber,
numberChanged,
unknownMSC,
unidentifiedSubscriber,
unknownEquipment,

-- subscription errors
roamingNotAllowed,
illegalSubscriber,
illegalEquipment,
bearerServiceNotProvisioned,
teleserviceNotProvisioned,

-- handover errors
noHandoverNumberAvailable,
subsequentHandoverFailure,
targetCellOutsideGroupCallArea,

-- operation and maintenance errors
tracingBufferFull,

-- call handling errors
or-NotAllowed,
noRoamingNumberAvailable,
busySubscriber,
noSubscriberReply,
absentSubscriber,
callBarred,
forwardingViolation,
forwardingFailed,
cug-Reject,

-- any time interrogation errors
ati-NotAllowed,
```

```

-- any time information handling errors
atsi-NotAllowed,
atm-NotAllowed,
informationNotAvailable,

-- supplementary service errors
illegalSS-Operation,
ss-ErrorStatus,
ss-NotAvailable,
ss-SubscriptionViolation,
ss-Incompatibility,
unknownAlphabet,
ussd-Busy,
pw-RegistrationFailure,
negativePW-Check,
numberOfPW-AttemptsViolation,
shortTermDenial,
longTermDenial,

-- short message service errors
subscriberBusyForMT-SMS,
sm-DeliveryFailure,
messageWaitingListFull,
absentSubscriberSM,

-- Group Call errors
noGroupCallNumberAvailable,

-- location service errors
unauthorizedRequestingNetwork,
unauthorizedLCSCClient,
positionMethodFailure,
unknownOrUnreachableLCSCClient,

-- Mobility Management errors
mm-EventNotSupported

;

IMPORTS
  ERROR
FROM Remote-Operations-Information-Objects {joint-iso-itu-t remote-operations(4)
  informationObjects(5) version1(0) }

  SS-Status
FROM MAP-SS-DataTypes {
  itu-t identified-organization (4) etsi (0) mobileDomain (0)
  gsm-Network (1) modules (3) map-SS-DataTypes (14) version8 (8)}

  SS-IncompatibilityCause,
  PW-RegistrationFailureCause,
  SM-DeliveryFailureCause,
  SystemFailureParam,
  DataMissingParam,
  UnexpectedDataParam,
  FacilityNotSupParam,
  UnknownSubscriberParam,
  NumberChangedParam,
  UnidentifiedSubParam,
  RoamingNotAllowedParam,
  IllegalSubscriberParam,
  IllegalEquipmentParam,
  BearerServNotProvParam,
  TeleservNotProvParam,
  TracingBufferFullParam,
  NoRoamingNbParam,
  OR-NotAllowedParam,
  AbsentSubscriberParam,
  BusySubscriberParam,
  NoSubscriberReplyParam,
  CallBarredParam,
  ForwardingViolationParam,
  ForwardingFailedParam,
  CUG-RejectParam,
  ATI-NotAllowedParam,
  SubBusyForMT-SMS-Param,
  MessageWaitListFullParam,
  AbsentSubscriberSM-Param,

```

```

ResourceLimitationParam,
NoGroupCallNbParam,
IncompatibleTerminalParam,
ShortTermDenialParam,
LongTermDenialParam,
UnauthorizedRequestingNetwork-Param,
UnauthorizedLCSCClient-Param,
PositionMethodFailure-Param,
UnknownOrUnreachableLCSCClient-Param,
MM-EventNotSupported-Param,
ATSI-NotAllowedParam,
ATM-NotAllowedParam,
IllegalSS-OperationParam,
SS-NotAvailableParam,
SS-SubscriptionViolationParam,
InformationNotAvailableParam,
TargetCellOutsideGCA-Param

```

```

FROM MAP-ER-DataTypes {
  itu-t identified-organization (4) etsi (0) mobileDomain (0)
  gsm-Network (1) modules (3) map-ER-DataTypes (17) version8 (8)}
;

```

-- generic errors

```

systemFailure ERROR ::= {
  PARAMETER
    SystemFailureParam
    -- optional
  CODE local:34 }

```

```

dataMissing ERROR ::= {
  PARAMETER
    DataMissingParam
    -- optional
    -- DataMissingParam must not be used in version <3
  CODE local:35 }

```

```

unexpectedDataValue ERROR ::= {
  PARAMETER
    UnexpectedDataParam
    -- optional
    -- UnexpectedDataParam must not be used in version <3
  CODE local:36 }

```

```

facilityNotSupported ERROR ::= {
  PARAMETER
    FacilityNotSupParam
    -- optional
    -- FacilityNotSupParam must not be used in version <3
  CODE local:21 }

```

```

incompatibleTerminal ERROR ::= {
  PARAMETER
    IncompatibleTerminalParam
    -- optional
  CODE local:28 }

```

```

resourceLimitation ERROR ::= {
  PARAMETER
    ResourceLimitationParam
    -- optional
  CODE local:51 }

```

-- identification and numbering errors

```

unknownSubscriber ERROR ::= {
  PARAMETER
    UnknownSubscriberParam
    -- optional
    -- UnknownSubscriberParam must not be used in version <3
  CODE local:1 }

```

```

numberChanged ERROR ::= {
  PARAMETER
    NumberChangedParam
    -- optional
  CODE local:44 }

```

```

unknownMSC ERROR ::= {
  CODE local:3 }

```

```

unidentifiedSubscriber ERROR ::= {
  PARAMETER
    UnidentifiedSubParam
    -- optional
    -- UnidentifiedSubParam must not be used in version <3
  CODE local:5 }

```

```

unknownEquipment ERROR ::= {
  CODE local:7 }

```

-- subscription errors

```

roamingNotAllowed ERROR ::= {
  PARAMETER
    RoamingNotAllowedParam
  CODE local:8 }

```

```

illegalSubscriber ERROR ::= {
  PARAMETER
    IllegalSubscriberParam
    -- optional
    -- IllegalSubscriberParam must not be used in version <3
  CODE local:9 }

```

```

illegalEquipment ERROR ::= {
  PARAMETER
    IllegalEquipmentParam
    -- optional
    -- IllegalEquipmentParam must not be used in version <3
  CODE local:12 }

```

```

bearerServiceNotProvisioned ERROR ::= {
  PARAMETER
    BearerServNotProvParam
    -- optional
    -- BearerServNotProvParam must not be used in version <3
  CODE local:10 }

```

```

teleserviceNotProvisioned ERROR ::= {
  PARAMETER
    TeleservNotProvParam
    -- optional
    -- TeleservNotProvParam must not be used in version <3
  CODE local:11 }

```

-- handover errors

```

noHandoverNumberAvailable ERROR ::= {
  CODE local:25 }

```

```

subsequentHandoverFailure ERROR ::= {
  CODE local:26 }

```

```

targetCellOutsideGroupCallArea ERROR ::= {
  PARAMETER
    TargetCellOutsideGCA-Param
    -- optional
  CODE local:42 }

```

-- operation and maintenance errors

```
tracingBufferFull ERROR ::= {  
  PARAMETER  
    TracingBufferFullParam  
    -- optional  
  CODE local: 40 }
```

-- call handling errors

```
noRoamingNumberAvailable ERROR ::= {  
  PARAMETER  
    NoRoamingNbParam  
    -- optional  
  CODE local:39 }
```

```
absentSubscriber ERROR ::= {  
  PARAMETER  
    AbsentSubscriberParam  
    -- optional  
    -- AbsentSubscriberParam must not be used in version <3  
  CODE local:27 }
```

```
busySubscriber ERROR ::= {  
  PARAMETER  
    BusySubscriberParam  
    -- optional  
  CODE local:45 }
```

```
noSubscriberReply ERROR ::= {  
  PARAMETER  
    NoSubscriberReplyParam  
    -- optional  
  CODE local:46 }
```

```
callBarred ERROR ::= {  
  PARAMETER  
    CallBarredParam  
    -- optional  
  CODE local:13 }
```

```
forwardingViolation ERROR ::= {  
  PARAMETER  
    ForwardingViolationParam  
    -- optional  
  CODE local:14 }
```

```
forwardingFailed ERROR ::= {  
  PARAMETER  
    ForwardingFailedParam  
    -- optional  
  CODE local:47 }
```

```
cug-Reject ERROR ::= {  
  PARAMETER  
    CUG-RejectParam  
    -- optional  
  CODE local:15 }
```

```
or-NotAllowed ERROR ::= {  
  PARAMETER  
    OR-NotAllowedParam  
    -- optional  
  CODE local:48 }
```

-- any time interrogation errors

```
ati-NotAllowed ERROR ::= {  
  PARAMETER  
    ATI-NotAllowedParam  
    -- optional  
  CODE local:49 }
```

-- any time information handling errors

```
atsi-NotAllowed ERROR ::= {
  PARAMETER
    ATSI-NotAllowedParam
    -- optional
  CODE local:60 }
```

```
atm-NotAllowed ERROR ::= {
  PARAMETER
    ATM-NotAllowedParam
    -- optional
  CODE local:61 }
```

```
informationNotAvailable ERROR ::= {
  PARAMETER
    InformationNotAvailableParam
    -- optional
  CODE local:62 }
```

-- supplementary service errors

```
illegalSS-Operation ERROR ::= {
  PARAMETER
    IllegalSS-OperationParam
    -- optional
    -- IllegalSS-OperationParam must not be used in version <3
  CODE local:16 }
```

```
ss-ErrorStatus ERROR ::= {
  PARAMETER
    SS-Status
    -- optional
  CODE local:17 }
```

```
ss-NotAvailable ERROR ::= {
  PARAMETER
    SS-NotAvailableParam
    -- optional
    -- SS-NotAvailableParam must not be used in version <3
  CODE local:18 }
```

```
ss-SubscriptionViolation ERROR ::= {
  PARAMETER
    SS-SubscriptionViolationParam
    -- optional
    -- SS-SubscriptionViolationParam must not be used in version <3
  CODE local:19 }
```

```
ss-Incompatibility ERROR ::= {
  PARAMETER
    SS-IncompatibilityCause
    -- optional
  CODE local:20 }
```

```
unknownAlphabet ERROR ::= {
  CODE local:71 }
```

```
ussd-Busy ERROR ::= {
  CODE local:72 }
```

```
pw-RegistrationFailure ERROR ::= {
  PARAMETER
    PW-RegistrationFailureCause
  CODE local:37 }
```

```
negativePW-Check ERROR ::= {
  CODE local:38 }
```

```
numberOfPW-AttemptsViolation ERROR ::= {
  CODE local:43 }
```

```

shortTermDenial ERROR ::= {
  PARAMETER
    ShortTermDenialParam
    -- optional
  CODE local:29 }

```

```

longTermDenial ERROR ::= {
  PARAMETER
    LongTermDenialParam
    -- optional
  CODE local:30 }

```

-- short message service errors

```

subscriberBusyForMT-SMS ERROR ::= {
  PARAMETER
    SubBusyForMT-SMS-Param
    -- optional
  CODE local:31 }

```

```

sm-DeliveryFailure ERROR ::= {
  PARAMETER
    SM-DeliveryFailureCause
  CODE local:32 }

```

```

messageWaitingListFull ERROR ::= {
  PARAMETER
    MessageWaitListFullParam
    -- optional
  CODE local:33 }

```

```

absentSubscriberSM ERROR ::= {
  PARAMETER
    AbsentSubscriberSM-Param
    -- optional
  CODE local:6 }

```

-- Group Call errors

```

noGroupCallNumberAvailable ERROR ::= {
  PARAMETER
    NoGroupCallNbParam
    -- optional
  CODE local:50 }

```

-- location service errors

```

unauthorizedRequestingNetwork ERROR ::= {
  PARAMETER
    UnauthorizedRequestingNetwork-Param
    -- optional
  CODE local:52 }

```

```

unauthorizedLCSCClient ERROR ::= {
  PARAMETER
    UnauthorizedLCSCClient-Param
    -- optional
  CODE local:53 }

```

```

positionMethodFailure ERROR ::= {
  PARAMETER
    PositionMethodFailure-Param
    -- optional
  CODE local:54 }

```

```

unknownOrUnreachableLCSCClient ERROR ::= {
  PARAMETER
    UnknownOrUnreachableLCSCClient-Param
    -- optional
  CODE local:58 }

```

```

mm-EventNotSupported ERROR ::= {
  PARAMETER
    MM-EventNotSupported-Param
    -- optional
  CODE local:59 }

```

END

17.6.7 Group Call operations

```

MAP-Group-Call-Operations {
    itu-t identified-organization (4) etsi (0) mobileDomain (0)
    gsm-Network (1) modules (3) map-Group-Call-Operations (22)
    version8 (8)}

DEFINITIONS

 ::=

BEGIN

EXPORTS
    prepareGroupCall,
    sendGroupCallEndSignal,
    forwardGroupCallSignalling,
    processGroupCallSignalling
;

IMPORTS
    OPERATION
FROM Remote-Operations-Information-Objects {
    joint-iso-itu-t remote-operations(4)
    informationObjects(5) version1(0)}

    systemFailure,
    unexpectedDataValue,
    noGroupCallNumberAvailable
FROM MAP-Errors {
    itu-t identified-organization (4) etsi (0) mobileDomain (0)
    gsm-Network (1) modules (3) map-Errors (10) version8 (8)}

    PrepareGroupCallArg,
    PrepareGroupCallRes,
    SendGroupCallEndSignalArg,
    SendGroupCallEndSignalRes,
    ForwardGroupCallSignallingArg,
    ProcessGroupCallSignallingArg
FROM MAP-GR-DataTypes {
    itu-t identified-organization (4) etsi (0) mobileDomain (0)
    gsm-Network (1) modules (3) map-GR-DataTypes (23) version8 (8)}

;

```

```

prepareGroupCall OPERATION ::= {                                     --Timer m
    ARGUMENT
        PrepareGroupCallArg
    RESULT
        PrepareGroupCallRes
    ERRORS {
        systemFailure |
        noGroupCallNumberAvailable |
        unexpectedDataValue}
    CODE local:39 }

```

```

sendGroupCallEndSignal OPERATION ::= {                               --Timer l
    ARGUMENT
        SendGroupCallEndSignalArg
    RESULT
        SendGroupCallEndSignalRes
    CODE local:40 }

```

```

processGroupCallSignalling OPERATION ::= {                          --Timer s
    ARGUMENT
        ProcessGroupCallSignallingArg
    CODE local:41 }

```

```

forwardGroupCallSignalling OPERATION ::= {
    ARGUMENT
        ForwardGroupCallSignallingArg
    CODE local:42 }

```

END

17.6.8 Location service operations

```

1 MAP-LocationServiceOperations {
2     itu-t identified-organization (4) etsi (0) mobileDomain (0)
3     gsm-Network (1) modules (3) map-LocationServiceOperations (24)
4     version8 (8)}
5
6 DEFINITIONS
7
8 ::=
9
10 BEGIN
11
12 EXPORTS
13     provideSubscriberLocation,
14     sendRoutingInfoForLCS,
15     subscriberLocationReport
16 ;
17
18 IMPORTS
19     OPERATION
20 FROM Remote-Operations-Information-Objects {
21     joint-iso-itu-t remote-operations(4)
22     informationObjects(5) version1(0)}
23
24     systemFailure,
25     dataMissing,
26     unexpectedDataValue,
27     facilityNotSupported,
28     unknownSubscriber,
29     absentSubscriber,
30     unauthorizedRequestingNetwork,
31     unauthorizedLCSCClient,
32     positionMethodFailure,
33     resourceLimitation,
34     unknownOrUnreachableLCSCClient,
35     unidentifiedSubscriber,
36     illegalEquipment,
37     illegalSubscriber
38 FROM MAP-Errors {
39     itu-t identified-organization (4) etsi (0) mobileDomain (0)
40     gsm-Network (1) modules (3) map-Errors (10) version8 (8)}
41
42     RoutingInfoForLCS-Arg,
43     RoutingInfoForLCS-Res,
44     ProvideSubscriberLocation-Arg,
45     ProvideSubscriberLocation-Res,
46     SubscriberLocationReport-Arg,
47     SubscriberLocationReport-Res
48 FROM MAP-LCS-DataTypes {
49     itu-t identified-organization (4) etsi (0) mobileDomain (0)
50     gsm-Network (1) modules (3) map-LCS-DataTypes (25) version8 (8)}
51 ;
52
53 sendRoutingInfoForLCS OPERATION ::= {
54     ARGUMENT
55         RoutingInfoForLCS-Arg
56     RESULT
57         RoutingInfoForLCS-Res
58     ERRORS {
59         systemFailure |
60         dataMissing |
61         unexpectedDataValue |
62         facilityNotSupported |
63         unknownSubscriber |
64         absentSubscriber |
65         unauthorizedRequestingNetwork }
66     CODE local:85 }
67

```

```

68 provideSubscriberLocation OPERATION ::= {                                --Timer ml
69     ARGUMENT
70         ProvideSubscriberLocation-Arg
71     RESULT
72         ProvideSubscriberLocation-Res
73     ERRORS {
74         systemFailure |
75         dataMissing |
76         unexpectedDataValue |
77         facilityNotSupported |
78         unidentifiedSubscriber |
79         illegalSubscriber |
80         illegalEquipment |
81         absentSubscriber |
82         unauthorizedRequestingNetwork |
83         unauthorizedLCSCClient |
84         positionMethodFailure }
85     CODE local:83 }
86
87 subscriberLocationReport OPERATION ::= {                                --Timer m
88     ARGUMENT
89         SubscriberLocationReport-Arg
90     RESULT
91         SubscriberLocationReport-Res
92     ERRORS {
93         systemFailure |
94         dataMissing |
95         resourceLimitation |
96         unexpectedDataValue |
97         unknownSubscriber |
98         unauthorizedRequestingNetwork |
99         unknownOrUnreachableLCSCClient}
100    CODE local:86 }
101
102
103 END

```

17.6.9 void

17.7 MAP constants and data types

17.7.1 Mobile Service data types

```

MAP-MS-DataTypes {
    itu-t identified-organization (4) etsi (0) mobileDomain (0)
    gsm-Network (1) modules (3) map-MS-DataTypes (11) version8 (8)}

```

DEFINITIONS

IMPLICIT TAGS

::=

BEGIN

EXPORTS

```

-- location registration types
UpdateLocationArg,
UpdateLocationRes,
CancelLocationArg,
CancelLocationRes,
PurgeMS-Arg,
PurgeMS-Res,
SendIdentificationArg,
SendIdentificationRes,
UpdateGprsLocationArg,
UpdateGprsLocationRes,
IST-SupportIndicator,
SupportedLCS-CapabilitySets,

-- gprs location registration types
GSN-Address,

```

```
-- handover types
ForwardAccessSignalling-Arg,
PrepareHO-Arg,
PrepareHO-Res,
PrepareSubsequentHO-Arg,
PrepareSubsequentHO-Res,
ProcessAccessSignalling-Arg,
SendEndSignal-Arg,
SendEndSignal-Res,

-- authentication management types
SendAuthenticationInfoArg,
SendAuthenticationInfoRes,
AuthenticationFailureReportArg,
AuthenticationFailureReportRes,

-- security management types
Kc,

-- equipment management types
CheckIMEI-Arg,
CheckIMEI-Res,

-- subscriber management types
InsertSubscriberDataArg,
InsertSubscriberDataRes,
LSAIdentity,
DeleteSubscriberDataArg,
DeleteSubscriberDataRes,
Ext-QoS-Subscribed,
Ext2-QoS-Subscribed,
SubscriberData,
ODB-Data,
SubscriberStatus,
ZoneCodeList,
maxNumOfZoneCodes,
O-CSI,
D-CSI,
O-BcsmCamelTDPCriteriaList,
T-BCSM-CAMEL-TDP-CriteriaList,
SS-CSI,
ServiceKey,
DefaultCallHandling,
CamelCapabilityHandling,
BasicServiceCriteria,
SupportedCamelPhases,
OfferedCamel4CSIs,
OfferedCamel4Functionalities,
maxNumOfCamelTDPData,
CUG-Index,
CUG-Info,
CUG-Interlock,
InterCUG-Restrictions,
IntraCUG-Options,
NotificationToMSUser,
QoS-Subscribed,
IST-AlertTimerValue,
T-CSI,
T-BcsmTriggerDetectionPoint,
APN,

-- fault recovery types
ResetArg,
RestoreDataArg,
RestoreDataRes,

-- provide subscriber info types
GeographicalInformation,
MS-Classmark2,
GPRSMSCClass,

-- subscriber information enquiry types
ProvideSubscriberInfoArg,
ProvideSubscriberInfoRes,
SubscriberInfo,
LocationInformation,
LocationInformationGPRS,
```

```
RAIdentity,
SubscriberState,
GPRSChargingID,
MNPInfoRes,
RouteingNumber,

-- any time information enquiry types
AnyTimeInterrogationArg,
AnyTimeInterrogationRes,

-- any time information handling types
AnyTimeSubscriptionInterrogationArg,
AnyTimeSubscriptionInterrogationRes,
AnyTimeModificationArg,
AnyTimeModificationRes,

-- subscriber data modification notification types
NoteSubscriberDataModifiedArg,
NoteSubscriberDataModifiedRes,

-- gprs location information retrieval types
SendRoutingInfoForGprsArg,
SendRoutingInfoForGprsRes,

-- failure reporting types
FailureReportArg,
FailureReportRes,

-- gprs notification types
NoteMsPresentForGprsArg,
NoteMsPresentForGprsRes,

-- Mobility Management types
NoteMM-EventArg,
NoteMM-EventRes,
NumberPortabilityStatus

;

IMPORTS
  maxNumOfSS,
  SS-SubscriptionOption,
  SS-List,
  SS-ForBS-Code,
  Password
FROM MAP-SS-DataTypes {
  itu-t identified-organization (4) etsi (0) mobileDomain (0)
  gsm-Network (1) modules (3) map-SS-DataTypes (14) version8 (8)}

  SS-Code
FROM MAP-SS-Code {
  itu-t identified-organization (4) etsi (0) mobileDomain (0)
  gsm-Network (1) modules (3) map-SS-Code (15) version8 (8)}

  Ext-BearerServiceCode
FROM MAP-BS-Code {
  itu-t identified-organization (4) etsi (0) mobileDomain (0)
  gsm-Network (1) modules (3) map-BS-Code (20) version8 (8)}

  Ext-TeleserviceCode
FROM MAP-TS-Code {
  itu-t identified-organization (4) etsi (0) mobileDomain (0)
  gsm-Network (1) modules (3) map-TS-Code (19) version8 (8)}

  AddressString,
  ISDN-AddressString,
  ISDN-SubaddressString,
  FTN-AddressString,
  AccessNetworkSignalInfo,
  IMSI,
  IMEI,
  TMSI,
  HLR-List,
  LMSI,
  Identity,
  GlobalCellId,
```



```

CellGlobalIdOrServiceAreaIdOrLAI,
Ext-BasicServiceCode,
NAEA-PreferredCI,
EMLPP-Info,
MC-SS-Info,
SubscriberIdentity,
AgeOfLocationInformation,
LCSCClientExternalID,
LCSCClientInternalID,
Ext-SS-Status,
LCSSTypeID,
ASCI-CallReference,
TBCD-STRING
FROM MAP-CommonDataTypes {
itu-t identified-organization (4) etsi (0) mobileDomain (0)
gsm-Network (1) modules (3) map-CommonDataTypes (18) version8 (8)}

ExtensionContainer
FROM MAP-ExtensionDataTypes {
itu-t identified-organization (4) etsi (0) mobileDomain (0)
gsm-Network (1) modules (3) map-ExtensionDataTypes (21) version8 (8)}

AbsentSubscriberDiagnosticSM
FROM MAP-ER-DataTypes {
itu-t identified-organization (4) etsi (0) mobileDomain (0)
gsm-Network (1) modules (3) map-ER-DataTypes (17) version8 (8)}

;

```

-- location registration types

UpdateLocationArg ::= SEQUENCE {			
imsi	IMSI,		
msc-Number	[1] ISDN-AddressString,		
vlr-Number	ISDN-AddressString,		
lmsi	[10] LMSI OPTIONAL,		
extensionContainer	ExtensionContainer		OPTIONAL,
...			
vlr-Capability	[6] VLR-Capability		OPTIONAL,
informPreviousNetworkEntity	[11] NULL		OPTIONAL,
cs-LCS-NotSupportedByUE	[12] NULL		OPTIONAL }

VLR-Capability ::= SEQUENCE{			
supportedCamelPhases	[0] SupportedCamelPhases		OPTIONAL,
extensionContainer	ExtensionContainer		OPTIONAL,
...			
solsaSupportIndicator	[2] NULL		OPTIONAL,
istSupportIndicator	[1] IST-SupportIndicator		OPTIONAL,
superChargerSupportedInServingNetworkEntity	[3] SuperChargerInfo		OPTIONAL,
longFTN-Supported	[4] NULL		OPTIONAL,
supportedLCS-CapabilitySets	[5] SupportedLCS-CapabilitySets		OPTIONAL,
offeredCamel4CSIs	[6] OfferedCamel4CSIs		OPTIONAL }

SuperChargerInfo ::= CHOICE {	
sendSubscriberData	[0] NULL,
subscriberDataStored	[1] AgeIndicator }

AgeIndicator ::= OCTET STRING (SIZE (1..6))
-- The internal structure of this parameter is implementation specific.

IST-SupportIndicator ::= ENUMERATED {	
basicISTSupported	(0),
istCommandSupported	(1),
...}	
-- exception handling:	
-- reception of values > 1 shall be mapped to ' istCommandSupported '	

```
SupportedLCS-CapabilitySets ::= BIT STRING {
    lcsCapabilitySet1 (0),
    lcsCapabilitySet2 (1),
    lcsCapabilitySet3 (2) } (SIZE (2..16))
-- Core network signalling capability set1 indicates LCS Release98 or Release99 version.
-- Core network signalling capability set2 indicates LCS Release4.
-- Core network signalling capability set3 indicates LCS Release5 or later version.
-- A node shall mark in the BIT STRING all LCS capability sets it supports.
-- If no bit is set then the sending node does not support LCS.
-- If the parameter is not sent by an VLR then the VLR may support at most capability set1.
-- If the parameter is not sent by an SGSN then no support for LCS is assumed.
-- An SGSN is not allowed to indicate support of capability set1.
-- Other bits than listed above shall be discarded.
```

```
UpdateLocationRes ::= SEQUENCE {
    hlr-Number
    extensionContainer
    ... }
    ISDN-AddressString,
    ExtensionContainer
    OPTIONAL,
```

```
CancelLocationArg ::= [3] SEQUENCE {
    identity
    cancellationType
    extensionContainer
    ... }
    Identity,
    CancellationType
    ExtensionContainer
    OPTIONAL,
    OPTIONAL,
```

```
CancellationType ::= ENUMERATED {
    updateProcedure
    subscriptionWithdraw
    ... }
-- The HLR shall not send values other than listed above
```

```
CancelLocationRes ::= SEQUENCE {
    extensionContainer
    ... }
    ExtensionContainer
    OPTIONAL,
```

```
PurgeMS-Arg ::= [3] SEQUENCE {
    imsi
    vlr-Number
    sgsn-Number
    extensionContainer
    ... }
    IMSI,
    [0] ISDN-AddressString
    [1] ISDN-AddressString
    ExtensionContainer
    OPTIONAL,
    OPTIONAL,
    OPTIONAL,
```

```
PurgeMS-Res ::= SEQUENCE {
    freezeTMSI
    freezeP-TMSI
    extensionContainer
    ... }
    [0] NULL
    [1] NULL
    ExtensionContainer
    OPTIONAL,
    OPTIONAL,
    OPTIONAL,
```

```
SendIdentificationArg ::= SEQUENCE {
    tmsi
    numberOfRequestedVectors
    -- within a dialogue numberOfRequestedVectors shall be present in
    -- the first service request and shall not be present in subsequent service requests.
    -- If received in a subsequent service request it shall be discarded.
    segmentationProhibited
    extensionContainer
    ... }
    TMSI,
    NumberOfRequestedVectors
    NULL
    ExtensionContainer
    OPTIONAL,
    OPTIONAL,
```

```
SendIdentificationRes ::= [3] SEQUENCE {
    imsi
    authenticationSetList
    currentSecurityContext
    extensionContainer
    ... }
    IMSI
    AuthenticationSetList
    [2] CurrentSecurityContext
    [3] ExtensionContainer
    OPTIONAL,
    OPTIONAL,
    OPTIONAL,
```

-- authentication management types

```
AuthenticationSetList ::= CHOICE {
    tripletList
    quintupletList
    ... }
    [0] TripletList,
    [1] QuintupletList }
```

```
TripletList ::= SEQUENCE SIZE (1..5) OF
    AuthenticationTriplet
```

```

QuintupletList ::= SEQUENCE SIZE (1..5) OF
    AuthenticationQuintuplet

```

```

AuthenticationTriplet ::= SEQUENCE {
    rand                RAND,
    sres                SRES,
    kc                  Kc,
    ... }

```

```

AuthenticationQuintuplet ::= SEQUENCE {
    rand                RAND,
    xres                XRES,
    ck                  CK,
    ik                  IK,
    autn                AUTN,
    ... }

```

```

CurrentSecurityContext ::= CHOICE {
    gsm-SecurityContextData    [0] GSM-SecurityContextData,
    umts-SecurityContextData   [1] UMTS-SecurityContextData }

```

```

GSM-SecurityContextData ::= SEQUENCE {
    kc                  Kc,
    cksn                Cksn,
    ... }

```

```

UMTS-SecurityContextData ::= SEQUENCE {
    ck                  CK,
    ik                  IK,
    ksi                 KSI,
    ... }

```

```

RAND ::= OCTET STRING (SIZE (16))

```

```

SRES ::= OCTET STRING (SIZE (4))

```

```

Kc ::= OCTET STRING (SIZE (8))

```

```

XRES ::= OCTET STRING (SIZE (4..16))

```

```

CK ::= OCTET STRING (SIZE (16))

```

```

IK ::= OCTET STRING (SIZE (16))

```

```

AUTN ::= OCTET STRING (SIZE (16))

```

```

AUTS ::= OCTET STRING (SIZE (14))

```

```

Cksn ::= OCTET STRING (SIZE (1))
    -- The internal structure is defined in 3GPP TS 24.008

```

```

KSI ::= OCTET STRING (SIZE (1))
    -- The internal structure is defined in 3GPP TS 24.008

```

```

AuthenticationFailureReportArg ::= SEQUENCE {
    imsi                IMSI,
    failureCause        FailureCause,
    extensionContainer  ExtensionContainer                OPTIONAL,
    ... ,
    re-attempt          BOOLEAN                        OPTIONAL,
    accessType          AccessType                    OPTIONAL,
    rand                RAND                          OPTIONAL,
    vlr-Number          [0] ISDN-AddressString        OPTIONAL,
    sgsn-Number         [1] ISDN-AddressString        OPTIONAL }

```

```

AccessType ::= ENUMERATED {
    call (0),
    emergencyCall (1),
    locationUpdating (2),
    supplementaryService (3),
    shortMessage (4),
    gprsAttach (5),
    routingAreaUpdating (6),
    serviceRequest (7),
    pdpContextActivation (8),
    pdpContextDeactivation (9),
    ...,
    gprsDetach (10)}
-- exception handling:
-- received values greater than 10 shall be ignored.

```

```

AuthenticationFailureReportRes ::= SEQUENCE {
    extensionContainer          ExtensionContainer          OPTIONAL,
    ...}

```

```

FailureCause ::= ENUMERATED {
    wrongUserResponse (0),
    wrongNetworkSignature (1)}

```

-- gprs location registration types

```

UpdateGprsLocationArg ::= SEQUENCE {
    imsi                      IMSI,
    sgsn-Number              ISDN-AddressString,
    sgsn-Address             GSN-Address,
    extensionContainer        ExtensionContainer          OPTIONAL,
    ...,
    sgsn-Capability          [0] SGSN-Capability        OPTIONAL,
    informPreviousNetworkEntity [1] NULL                OPTIONAL,
    ps-LCS-NotSupportedByUE  [2] NULL                OPTIONAL }

```

```

SGSN-Capability ::= SEQUENCE{
    solsaSupportIndicator     NULL                OPTIONAL,
    extensionContainer        [1] ExtensionContainer    OPTIONAL,
    ...,
    superChargerSupportedInServingNetworkEntity [2] SuperChargerInfo  OPTIONAL,
    gprsEnhancementsSupportIndicator [3] NULL                OPTIONAL,
    supportedCamelPhases     [4] SupportedCamelPhases  OPTIONAL,
    supportedLCS-CapabilitySets [5] SupportedLCS-CapabilitySets  OPTIONAL,
    offeredCamel4CSIs       [6] OfferedCamel4CSIs     OPTIONAL }

```

```

GSN-Address ::= OCTET STRING (SIZE (5..17))
-- Octets are coded according to TS 3GPP TS 23.003 [17]

```

```

UpdateGprsLocationRes ::= SEQUENCE {
    hlr-Number              ISDN-AddressString,
    extensionContainer        ExtensionContainer          OPTIONAL,
    ...}

```

-- handover types

```

ForwardAccessSignalling-Arg ::= [3] SEQUENCE {
    an-APDU                  AccessNetworkSignalInfo,
    integrityProtectionInfo  [0] IntegrityProtectionInformation  OPTIONAL,
    encryptionInfo          [1] EncryptionInformation          OPTIONAL,
    keyStatus                [2] KeyStatus                    OPTIONAL,
    allowedGSM-Algorithms    [4] AllowedGSM-Algorithms          OPTIONAL,
    allowedUMTS-Algorithms   [5] AllowedUMTS-Algorithms        OPTIONAL,
    radioResourceInformation [6] RadioResourceInformation      OPTIONAL,
    extensionContainer        [3] ExtensionContainer            OPTIONAL,
    ...,
    radioResourceList        [7] RadioResourceList            OPTIONAL,
    bssmap-ServiceHandover   [9] BSSMAP-ServiceHandover        OPTIONAL,
    ranap-ServiceHandover    [8] RANAP-ServiceHandover          OPTIONAL,
    bssmap-ServiceHandoverList [10] BSSMAP-ServiceHandoverList  OPTIONAL,
    currentlyUsedCodec        [11] Codec                      OPTIONAL,
    iuSupportedCodecsList    [12] SupportedCodecsList          OPTIONAL,
    rab-ConfigurationIndicator [13] NULL                OPTIONAL,
    iuSelectedCodec          [14] Codec                      OPTIONAL }

```

```

AllowedGSM-Algorithms ::= OCTET STRING (SIZE (1))
-- internal structure is coded as Algorithm identifier octet from
-- Permitted Algorithms defined in 3GPP TS 48.008
-- A node shall mark all GSM algorithms that are allowed in MSC-B

```

```

AllowedUMTS-Algorithms ::= SEQUENCE {
  integrityProtectionAlgorithms [0] PermittedIntegrityProtectionAlgorithms
  OPTIONAL,
  encryptionAlgorithms [1] PermittedEncryptionAlgorithms OPTIONAL,
  extensionContainer [2] ExtensionContainer OPTIONAL,
  ...}

```

```

PermittedIntegrityProtectionAlgorithms ::=
  OCTET STRING (SIZE (1..maxPermittedIntegrityProtectionAlgorithmsLength))
-- Octets contain a complete PermittedIntegrityProtectionAlgorithms data type
-- as defined in 3GPP TS 25.413, encoded according to the encoding scheme
-- mandated by 3GPP TS 25.413.
-- Padding bits are included, if needed, in the least significant bits of the
-- last octet of the octet string.

```

```

maxPermittedIntegrityProtectionAlgorithmsLength INTEGER ::= 9

```

```

PermittedEncryptionAlgorithms ::=
  OCTET STRING (SIZE (1..maxPermittedEncryptionAlgorithmsLength))
-- Octets contain a complete PermittedEncryptionAlgorithms data type
-- as defined in 3GPP TS 25.413, encoded according to the encoding scheme
-- mandated by 3GPP TS 25.413
-- Padding bits are included, if needed, in the least significant bits of the
-- last octet of the octet string.

```

```

maxPermittedEncryptionAlgorithmsLength INTEGER ::= 9

```

```

KeyStatus ::= ENUMERATED {
  old (0),
  new (1),
  ...}
-- exception handling:
-- received values in range 2-31 shall be treated as "old"
-- received values greater than 31 shall be treated as "new"

```

```

PrepareHO-Arg ::= [3] SEQUENCE {
  targetCellId [0] GlobalCellId OPTIONAL,
  ho-NumberNotRequired NULL OPTIONAL,
  targetRNCId [1] RNCId OPTIONAL,
  an-APDU [2] AccessNetworkSignalInfo OPTIONAL,
  multipleBearerRequested [3] NULL OPTIONAL,
  imsi [4] IMSI OPTIONAL,
  integrityProtectionInfo [5] IntegrityProtectionInformation OPTIONAL,
  encryptionInfo [6] EncryptionInformation OPTIONAL,
  radioResourceInformation [7] RadioResourceInformation OPTIONAL,
  allowedGSM-Algorithms [9] AllowedGSM-Algorithms OPTIONAL,
  allowedUMTS-Algorithms [10] AllowedUMTS-Algorithms OPTIONAL,
  radioResourceList [11] RadioResourceList OPTIONAL,
  extensionContainer [8] ExtensionContainer OPTIONAL,
  ... ,
  rab-Id [12] RAB-Id OPTIONAL,
  bssmap-ServiceHandover [13] BSSMAP-ServiceHandover OPTIONAL,
  ranap-ServiceHandover [14] RANAP-ServiceHandover OPTIONAL,
  bssmap-ServiceHandoverList [15] BSSMAP-ServiceHandoverList OPTIONAL,
  asciiCallReference [20] ASCII-CallReference OPTIONAL,
  geran-classmark [16] GERAN-Classmark OPTIONAL,
  iuCurrentlyUsedCodec [17] Codec OPTIONAL,
  iuSupportedCodecsList [18] SupportedCodecsList OPTIONAL,
  rab-ConfigurationIndicator [19] NULL OPTIONAL,
  uesbi-Iu [21] UESBI-Iu OPTIONAL }

```

```

BSSMAP-ServiceHandoverList ::= SEQUENCE SIZE (1.. maxNumOfServiceHandovers) OF
  BSSMAP-ServiceHandoverInfo

```

```

BSSMAP-ServiceHandoverInfo ::= SEQUENCE {
  bssmap-ServiceHandover BSSMAP-ServiceHandover,
  rab-Id RAB-Id,
  -- RAB Identity is needed to relate the service handovers with the radio access bearers.
  ...}

```

```
maxNumOfServiceHandovers INTEGER ::= 7
```

```
BSSMAP-ServiceHandover ::= OCTET STRING (SIZE (1))
-- Octets are coded according the Service Handover information element in
-- 3GPP TS 48.008.
```

```
RANAP-ServiceHandover ::= OCTET STRING (SIZE (1))
-- Octet contains a complete Service-Handover data type
-- as defined in 3GPP TS 25.413, encoded according to the encoding scheme
-- mandated by 3GPP TS 25.413
-- Padding bits are included in the least significant bits.
```

```
RadioResourceList ::= SEQUENCE SIZE (1.. maxNumOfRadioResources) OF
RadioResource
```

```
RadioResource ::= SEQUENCE {
radioResourceInformation RadioResourceInformation,
rab-Id RAB-Id,
-- RAB Identity is needed to relate the radio resources with the radio access bearers.
...}
```

```
maxNumOfRadioResources INTEGER ::= 7
```

```
PrepareHO-Res ::= [3] SEQUENCE {
handoverNumber [0] ISDN-AddressString OPTIONAL,
relocationNumberList [1] RelocationNumberList OPTIONAL,
an-APDU [2] AccessNetworkSignalInfo OPTIONAL,
multicallBearerInfo [3] MulticallBearerInfo OPTIONAL,
multipleBearerNotSupported NULL OPTIONAL,
selectedUMTS-Algorithms [5] SelectedUMTS-Algorithms OPTIONAL,
chosenRadioResourceInformation [6] ChosenRadioResourceInformation OPTIONAL,
extensionContainer [4] ExtensionContainer OPTIONAL,
...,
iuSelectedCodec [7] Codec OPTIONAL,
iuAvailableCodecsList [8] CodecList OPTIONAL }
```

```
SelectedUMTS-Algorithms ::= SEQUENCE {
integrityProtectionAlgorithm [0] ChosenIntegrityProtectionAlgorithm OPTIONAL,
encryptionAlgorithm [1] ChosenEncryptionAlgorithm OPTIONAL,
extensionContainer [2] ExtensionContainer OPTIONAL,
...}
```

```
ChosenIntegrityProtectionAlgorithm ::= OCTET STRING (SIZE (1))
-- Octet contains a complete IntegrityProtectionAlgorithm data type
-- as defined in 3GPP TS 25.413, encoded according to the encoding scheme
-- mandated by 3GPP TS 25.413
-- Padding bits are included in the least significant bits.
```

```
ChosenEncryptionAlgorithm ::= OCTET STRING (SIZE (1))
-- Octet contains a complete EncryptionAlgorithm data type
-- as defined in 3GPP TS 25.413, encoded according to the encoding scheme
-- mandated by 3GPP TS 25.413
-- Padding bits are included in the least significant bits.
```

```
ChosenRadioResourceInformation ::= SEQUENCE {
chosenChannelInfo [0] ChosenChannelInfo OPTIONAL,
chosenSpeechVersion [1] ChosenSpeechVersion OPTIONAL,
...}
```

```
ChosenChannelInfo ::= OCTET STRING (SIZE (1))
-- Octets are coded according the Chosen Channel information element in 3GPP TS 48.008
```

```
ChosenSpeechVersion ::= OCTET STRING (SIZE (1))
-- Octets are coded according the Speech Version (chosen) information element in 3GPP TS
-- 48.008
```

```

PrepareSubsequentHO-Arg ::= [3] SEQUENCE {
  targetCellId           [0] GlobalCellId           OPTIONAL,
  targetMSC-Number       [1] ISDN-AddressString,
  targetRNCId           [2] RNCId                 OPTIONAL,
  an-APDU                [3] AccessNetworkSignalInfo OPTIONAL,
  selectedRab-Id         [4] RAB-Id               OPTIONAL,
  extensionContainer      [5] ExtensionContainer    OPTIONAL,
  ...,
  geran-classmark        [6] GERAN-Classmark       OPTIONAL,
  rab-ConfigurationIndicator [7] NULL              OPTIONAL }

```

```

PrepareSubsequentHO-Res ::= [3] SEQUENCE {
  an-APDU                AccessNetworkSignalInfo,
  extensionContainer      [0] ExtensionContainer    OPTIONAL,
  ...}

```

```

ProcessAccessSignalling-Arg ::= [3] SEQUENCE {
  an-APDU                AccessNetworkSignalInfo,
  selectedUMTS-Algorithms [1] SelectedUMTS-Algorithms OPTIONAL,
  selectedGSM-Algorithm  [2] SelectedGSM-Algorithm  OPTIONAL,
  chosenRadioResourceInformation [3] ChosenRadioResourceInformation OPTIONAL,
  selectedRab-Id         [4] RAB-Id               OPTIONAL,
  extensionContainer      [0] ExtensionContainer    OPTIONAL,
  ...,
  iUSelectedCodec        [5] Codec                 OPTIONAL,
  iUAvailableCodecsList  [6] CodecList             OPTIONAL }

```

```

SupportedCodecsList ::= SEQUENCE {
  utranCodecList         [0] CodecList             OPTIONAL,
  geranCodecList         [1] CodecList             OPTIONAL,
  extensionContainer      [2] ExtensionContainer    OPTIONAL,
  ...}

```

```

CodecList ::= SEQUENCE {
  codec1                 [1] Codec,
  codec2                 [2] Codec                 OPTIONAL,
  codec3                 [3] Codec                 OPTIONAL,
  codec4                 [4] Codec                 OPTIONAL,
  codec5                 [5] Codec                 OPTIONAL,
  codec6                 [6] Codec                 OPTIONAL,
  codec7                 [7] Codec                 OPTIONAL,
  codec8                 [8] Codec                 OPTIONAL,
  extensionContainer      [9] ExtensionContainer    OPTIONAL,
  ...}
-- Codecs are sent in priority order where codec1 has highest priority

```

```

Codec ::= OCTET STRING (SIZE (1..4))

-- The internal structure is defined as follows:
-- octet 1           Coded as Codec Identification code in 3GPP TS 26.103
-- octets 2,3,4      Parameters for the Codec as defined in 3GPP TS
--                   26.103, if available, length depending on the codec

```

```

GERAN-Classmark ::= OCTET STRING (SIZE (2..87))
-- Octets are coded according the GERAN Classmark information element in 3GPP TS 48.008

```

```

SelectedGSM-Algorithm ::= OCTET STRING (SIZE (1))
-- internal structure is coded as Algorithm identifier octet from Chosen Encryption
-- Algorithm defined in 3GPP TS 48.008
-- A node shall mark only the selected GSM algorithm

```

```

SendEndSignal-Arg ::= [3] SEQUENCE {
  an-APDU                AccessNetworkSignalInfo,
  extensionContainer      [0] ExtensionContainer    OPTIONAL,
  ...}

```

```

SendEndSignal-Res ::= SEQUENCE {
  extensionContainer      [0] ExtensionContainer    OPTIONAL,
  ...}

```

```

RNCId ::= OCTET STRING (SIZE (7))
-- The internal structure is defined as follows:
-- octet 1 bits 4321      Mobile Country Code 1st digit
--      bits 8765      Mobile Country Code 2nd digit
-- octet 2 bits 4321      Mobile Country Code 3rd digit
--      bits 8765      Mobile Network Code 3rd digit
--                        or filler (1111) for 2 digit MNCs
-- octet 3 bits 4321      Mobile Network Code 1st digit
--      bits 8765      Mobile Network Code 2nd digit
-- octets 4 and 5      Location Area Code according to 3GPP TS 24.008
-- octets 6 and 7      RNC Id value according to 3GPP TS 25.413

```

```

RelocationNumberList ::= SEQUENCE SIZE (1..maxNumOfRelocationNumber) OF
    RelocationNumber

```

```

MulticallBearerInfo ::= INTEGER (1..maxNumOfRelocationNumber)

```

```

RelocationNumber ::= SEQUENCE {
    handoverNumber          ISDN-AddressString,
    rab-Id                  RAB-Id,
    -- RAB Identity is needed to relate the calls with the radio access bearers.
    ...}

```

```

RAB-Id ::= INTEGER (1..maxNrOfRABs)

```

```

maxNrOfRABs INTEGER ::= 255

```

```

maxNumOfRelocationNumber INTEGER ::= 7

```

```

RadioResourceInformation ::= OCTET STRING (SIZE (3..13))
-- Octets are coded according the Channel Type information element in 3GPP TS 48.008

```

```

IntegrityProtectionInformation ::= OCTET STRING (SIZE (18..maxNumOfIntegrityInfo))
-- Octets contain a complete IntegrityProtectionInformation data type
-- as defined in 3GPP TS 25.413, encoded according to the encoding scheme
-- mandated by 3GPP TS 25.413
-- Padding bits are included, if needed, in the least significant bits of the
-- last octet of the octet string.

```

```

maxNumOfIntegrityInfo INTEGER ::= 100

```

```

EncryptionInformation ::= OCTET STRING (SIZE (18..maxNumOfEncryptionInfo))
-- Octets contain a complete EncryptionInformation data type
-- as defined in 3GPP TS 25.413, encoded according to the encoding scheme
-- mandated by 3GPP TS 25.413
-- Padding bits are included, if needed, in the least significant bits of the
-- last octet of the octet string.

```

```

maxNumOfEncryptionInfo INTEGER ::= 100

```

-- authentication management types

```

SendAuthenticationInfoArg ::= SEQUENCE {
    imsi                [0] IMSI,
    numberOfRequestedVectors    NumberOfRequestedVectors,
    segmentationProhibited    NULL                                OPTIONAL,
    immediateResponsePreferred    [1] NULL                            OPTIONAL,
    re-synchronisationInfo    Re-synchronisationInfo                OPTIONAL,
    extensionContainer        [2] ExtensionContainer                OPTIONAL,
    ...,
    requestingNodeType        [3] RequestingNodeType                OPTIONAL}

```

```

NumberOfRequestedVectors ::= INTEGER (1..5)

```

```

Re-synchronisationInfo ::= SEQUENCE {
    rand                RAND,
    auts                AUTS,
    ...}

```

```

SendAuthenticationInfoRes ::= [3] SEQUENCE {
    authenticationSetList    AuthenticationSetList                OPTIONAL,
    extensionContainer        ExtensionContainer                OPTIONAL,
    ...}

```



```

RequestingNodeType ::= ENUMERATED {
    vlr (0),
    sgsn (1),
    ...}
-- exception handling:
-- received values in the range 2-15 shall be treated as "vlr"
-- received values greater than 15 shall be treated as "sgsn"

```

-- equipment management types

```

CheckIMEI-Arg ::= SEQUENCE {
    imei                               IMEI,
    requestedEquipmentInfo             RequestedEquipmentInfo,
    extensionContainer                 ExtensionContainer           OPTIONAL,
    ...}

```

```

CheckIMEI-Res ::= SEQUENCE {
    equipmentStatus                    EquipmentStatus           OPTIONAL,
    bmuef                              UESBI-Iu                OPTIONAL,
    extensionContainer                 [0] ExtensionContainer  OPTIONAL,
    ...}

```

```

RequestedEquipmentInfo ::= BIT STRING {
    equipmentStatus (0),
    bmuef (1)} (SIZE (2..8))
-- exception handling: reception of unknown bit assignments in the
-- RequestedEquipmentInfo data type shall be discarded by the receiver

```

```

UESBI-Iu ::= SEQUENCE {
    uesbi-IuA [0] UESBI-IuA           OPTIONAL,
    uesbi-IuB [1] UESBI-IuB           OPTIONAL,
    ...}

```

```

UESBI-IuA ::= BIT STRING (SIZE(1..128))
-- See 3GPP TS 25.413

```

```

UESBI-IuB ::= BIT STRING (SIZE(1..128))
-- See 3GPP TS 25.413

```

```

EquipmentStatus ::= ENUMERATED {
    whiteListed (0),
    blackListed (1),
    greyListed (2)}

```

-- subscriber management types

```

InsertSubscriberDataArg ::= SEQUENCE {
    imsi [0] IMSI                               OPTIONAL,
    COMPONENTS OF SubscriberData,
    extensionContainer [14] ExtensionContainer  OPTIONAL,
    ... ,
    naea-PreferredCI [15] NAEA-PreferredCI     OPTIONAL,
    -- naea-PreferredCI is included at the discretion of the HLR operator.
    gprsSubscriptionData [16] GPRSSubscriptionData OPTIONAL,
    roamingRestrictedInSgsnDueToUnsupportedFeature [23] NULL
    OPTIONAL,
    networkAccessMode [24] NetworkAccessMode   OPTIONAL,
    lsaInformation [25] LSAInformation          OPTIONAL,
    lmu-Indicator [21] NULL                     OPTIONAL,
    lcsInformation [22] LCSInformation          OPTIONAL,
    istAlertTimer [26] IST-AlertTimerValue     OPTIONAL,
    superChargerSupportedInHLR [27] AgeIndicator OPTIONAL,
    mc-SS-Info [28] MC-SS-Info                 OPTIONAL,
    cs-AllocationRetentionPriority [29] CS-AllocationRetentionPriority OPTIONAL,
    sgsn-CAMEL-SubscriptionInfo [17] SGSN-CAMEL-SubscriptionInfo OPTIONAL,
    chargingCharacteristics [18] ChargingCharacteristics OPTIONAL
}
-- If the Network Access Mode parameter is sent, it shall be present only in
-- the first sequence if segmentation is used

```

```

CS-AllocationRetentionPriority ::= OCTET STRING (SIZE (1))
-- This data type encodes each priority level defined in TS 23.107 as the binary value
-- of the priority level.

```

```

IST-AlertTimerValue ::= INTEGER (15..255)

```

```

LCSInformation ::= SEQUENCE {
    gmlc-List [0] GMLC-List OPTIONAL,
    lcs-PrivacyExceptionList [1] LCS-PrivacyExceptionList OPTIONAL,
    molr-List [2] MOLR-List OPTIONAL,
    ...,
    add-lcs-PrivacyExceptionList [3] LCS-PrivacyExceptionList OPTIONAL }
-- add-lcs-PrivacyExceptionList may be sent only if lcs-PrivacyExceptionList is
-- present and contains four instances of LCS-PrivacyClass. If the mentioned condition
-- is not satisfied the receiving node shall discard add-lcs-PrivacyExceptionList.
-- If an LCS-PrivacyClass is received both in lcs-PrivacyExceptionList and in
-- add-lcs-PrivacyExceptionList with the same SS-Code, then the error unexpected
-- data value shall be returned.

```

```

GMLC-List ::= SEQUENCE SIZE (1..maxNumOfGMLC) OF
    ISDN-AddressString
-- if segmentation is used, the complete GMLC-List shall be sent in one segment

```

```

maxNumOfGMLC INTEGER ::= 5

```

```

NetworkAccessMode ::= ENUMERATED {
    bothMSCAndSGSN (0),
    onlyMSC (1),
    onlySGSN (2),
    ... }
-- if unknown values are received in NetworkAccessMode
-- they shall be discarded.

```

```

GPRSDataList ::= SEQUENCE SIZE (1..maxNumOfPDP-Contexts) OF
    PDP-Context

```

```

maxNumOfPDP-Contexts INTEGER ::= 50

```

```

PDP-Context ::= SEQUENCE {
    pdp-ContextId ContextId,
    pdp-Type [16] PDP-Type,
    pdp-Address [17] PDP-Address OPTIONAL,
    qos-Subscribed [18] QoS-Subscribed,
    vplmnAddressAllowed [19] NULL OPTIONAL,
    apn [20] APN,
    extensionContainer [21] ExtensionContainer OPTIONAL,
    ...,
    ext-QoS-Subscribed [0] Ext-QoS-Subscribed OPTIONAL,
    pdp-ChargingCharacteristics [1] ChargingCharacteristics OPTIONAL,
    ext2-QoS-Subscribed [2] Ext2-QoS-Subscribed OPTIONAL }
-- ext2-QoS-Subscribed may be present only if ext-QoS-Subscribed is present.

```

```

ContextId ::= INTEGER (1..maxNumOfPDP-Contexts)

```

```

GPRSSubscriptionData ::= SEQUENCE {
    completeDataListIncluded NULL OPTIONAL,
    -- If segmentation is used, completeDataListIncluded may only be present in the
    -- first segment.
    gprsDataList [1] GPRSDataList,
    extensionContainer [2] ExtensionContainer OPTIONAL,
    ... }

```

```

SGSN-CAMEL-SubscriptionInfo ::= SEQUENCE {
    gprs-CSI [0] GPRS-CSI OPTIONAL,
    mo-sms-CSI [1] SMS-CSI OPTIONAL,
    extensionContainer [2] ExtensionContainer OPTIONAL,
    ...,
    mt-sms-CSI [3] SMS-CSI OPTIONAL,
    mt-smsCAMELTDP-CriteriaList [4] MT-smsCAMELTDP-CriteriaList OPTIONAL,
    mg-csi [5] MG-CSI OPTIONAL
}

```

```

GPRS-CSI ::= SEQUENCE {
  gprs-CamelTDPDataList          [0] GPRS-CamelTDPDataList          OPTIONAL,
  camelCapabilityHandling        [1] CamelCapabilityHandling        OPTIONAL,
  extensionContainer             [2] ExtensionContainer             OPTIONAL,
  notificationToCSE              [3] NULL                          OPTIONAL,
  csi-Active                     [4] NULL                          OPTIONAL,
  ...}
-- notificationToCSE and csi-Active shall not be present when GPRS-CSI is sent to SGSN.
-- They may only be included in ATSI/ATM ack/NSDC message.
-- GPRS-CamelTDPData and camelCapabilityHandling shall be present in
-- the GPRS-CSI sequence.
-- If GPRS-CSI is segmented, gprs-CamelTDPDataList and camelCapabilityHandling shall be
-- present in the first segment

```

```

GPRS-CamelTDPDataList ::= SEQUENCE SIZE (1..maxNumOfCamelTDPData) OF
  GPRS-CamelTDPData
-- GPRS-CamelTDPDataList shall not contain more than one instance of
-- GPRS-CamelTDPData containing the same value for gprs-TriggerDetectionPoint.

```

```

GPRS-CamelTDPData ::= SEQUENCE {
  gprs-TriggerDetectionPoint     [0] GPRS-TriggerDetectionPoint,
  serviceKey                     [1] ServiceKey,
  gsmSCF-Address                 [2] ISDN-AddressString,
  defaultSessionHandling         [3] DefaultGPRS-Handling,
  extensionContainer             [4] ExtensionContainer             OPTIONAL,
  ...
}

```

```

DefaultGPRS-Handling ::= ENUMERATED {
  continueTransaction (0) ,
  releaseTransaction (1) ,
  ...}
-- exception handling:
-- reception of values in range 2-31 shall be treated as "continueTransaction"
-- reception of values greater than 31 shall be treated as "releaseTransaction"

```

```

GPRS-TriggerDetectionPoint ::= ENUMERATED {
  attach                          (1),
  attachChangeOfPosition         (2),
  pdp-ContextEstablishment       (11),
  pdp-ContextEstablishmentAcknowledgement (12),
  pdp-ContextChangeOfPosition    (14),
  ... }
-- exception handling:
-- For GPRS-CamelTDPData sequences containing this parameter with any
-- other value than the ones listed the receiver shall ignore the whole
-- GPRS-CamelTDPData sequence.

```

```

APN ::= OCTET STRING (SIZE (2..63))
-- Octets are coded according to TS 3GPP TS 23.003 [17]

```

```

PDP-Type ::= OCTET STRING (SIZE (2))
-- Octets are coded according to TS 3GPP TS 29.060 [105]

```

```

PDP-Address ::= OCTET STRING (SIZE (1..16))
-- Octets are coded according to TS 3GPP TS 29.060 [105]
-- The possible size values are:
-- 1-7 octets X.25 address type
-- 4 octets IPv4 address type
-- 16 octets IPv6 address type

```

```

QoS-Subscribed ::= OCTET STRING (SIZE (3))
-- Octets are coded according to TS 3GPP TS 24.008 [35] Quality of Service Octets
-- 3-5.

```

```

Ext-QoS-Subscribed ::= OCTET STRING (SIZE (1..9))
-- OCTET 1:
-- Allocation/Retention Priority (This octet encodes each priority level defined in
-- 23.107 as the binary value of the priority level, declaration in 29.060)
-- Octets 2-9 are coded according to 3GPP TS 24.008[35] Quality of Service Octets
-- 6-13.

```

```

Ext2-QoS-Subscribed ::= OCTET STRING (SIZE (1..3))
-- Octets 1-3 are coded according to 3GPP TS 24.008 [35] Quality of Service Octets 14-16.
-- If Quality of Service information is structured with 14 octet length, then
-- Octet 1 is coded according to 3GPP TS 24.008 [35] Quality of Service Octet 14.

```

ChargingCharacteristics ::= OCTET STRING (SIZE (2))
 -- Octets are coded according to 3GPP TS 32.015.

LSAOnlyAccessIndicator ::= ENUMERATED {
 accessOutsideLSAsAllowed (0),
 accessOutsideLSAsRestricted (1)}

LSADataList ::= SEQUENCE SIZE (1..maxNumOfLSAs) OF
 LSAData

maxNumOfLSAs INTEGER ::= 20

LSAData ::= SEQUENCE {
 lsaIdentity [0] LSAIdentity,
 lsaAttributes [1] LSAAttributes,
 lsaActiveModeIndicator [2] NULL OPTIONAL,
 extensionContainer [3] ExtensionContainer OPTIONAL,
 ...}

LSAInformation ::= SEQUENCE {
 completeDataListIncluded NULL OPTIONAL,
 -- If segmentation is used, completeDataListIncluded may only be present in the
 -- first segment.
 lsaOnlyAccessIndicator [1] LSAOnlyAccessIndicator OPTIONAL,
 lsaDataList [2] LSADataList OPTIONAL,
 extensionContainer [3] ExtensionContainer OPTIONAL,
 ...}

LSAIdentity ::= OCTET STRING (SIZE (3))
 -- Octets are coded according to TS 3GPP TS 23.003 [17]

LSAAttributes ::= OCTET STRING (SIZE (1))
 -- Octets are coded according to TS 3GPP TS 48.008 [49]

SubscriberData ::= SEQUENCE {
 msisdn [1] ISDN-AddressString OPTIONAL,
 category [2] Category OPTIONAL,
 subscriberStatus [3] SubscriberStatus OPTIONAL,
 bearerServiceList [4] BearerServiceList OPTIONAL,
 -- The exception handling for reception of unsupported / not allocated
 -- bearerServiceCodes is defined in section 8.8.1
 teleserviceList [6] TeleserviceList OPTIONAL,
 -- The exception handling for reception of unsupported / not allocated
 -- teleserviceCodes is defined in section 8.8.1
 provisionedSS [7] Ext-SS-InfoList OPTIONAL,
 odb-Data [8] ODB-Data OPTIONAL,
 roamingRestrictionDueToUnsupportedFeature [9] NULL OPTIONAL,
 regionalSubscriptionData [10] ZoneCodeList OPTIONAL,
 vbsSubscriptionData [11] VBSDataList OPTIONAL,
 vgcSubscriptionData [12] VGCSDataList OPTIONAL,
 vlrCamelSubscriptionInfo [13] VlrCamelSubscriptionInfo OPTIONAL,
 }

Category ::= OCTET STRING (SIZE (1))
 -- The internal structure is defined in ITU-T Rec Q.763.

SubscriberStatus ::= ENUMERATED {
 serviceGranted (0),
 operatorDeterminedBarring (1)}

BearerServiceList ::= SEQUENCE SIZE (1..maxNumOfBearerServices) OF
 Ext-BearerServiceCode

maxNumOfBearerServices INTEGER ::= 50

TeleserviceList ::= SEQUENCE SIZE (1..maxNumOfTeleservices) OF
 Ext-TeleserviceCode

maxNumOfTeleservices INTEGER ::= 20

ODB-Data ::= SEQUENCE {
 odb-GeneralData ODB-GeneralData,
 odb-HPLMN-Data ODB-HPLMN-Data OPTIONAL,
 extensionContainer ExtensionContainer OPTIONAL,
 ...}

```

ODB-GeneralData ::= BIT STRING {
    allOG-CallsBarred (0),
    internationalOGCallsBarred (1),
    internationalOGCallsNotToHPLMN-CountryBarred (2),
    interzonalOGCallsBarred (6),
    interzonalOGCallsNotToHPLMN-CountryBarred (7),
    interzonalOGCallsAndInternationalOGCallsNotToHPLMN-CountryBarred (8),
    premiumRateInformationOGCallsBarred (3),
    premiumRateEntertainmentOGCallsBarred (4),
    ss-AccessBarred (5),
    allECT-Barred (9),
    chargeableECT-Barred (10),
    internationalECT-Barred (11),
    interzonalECT-Barred (12),
    doublyChargeableECT-Barred (13),
    multipleECT-Barred (14),
    allPacketOrientedServicesBarred (15),
    roamerAccessToHPLMN-AP-Barred (16),
    roamerAccessToVPLMN-AP-Barred (17),
    roamingOutsidePLMNOG-CallsBarred (18),
    allIC-CallsBarred (19),
    roamingOutsidePLMNIC-CallsBarred (20),
    roamingOutsidePLMNICountryIC-CallsBarred (21),
    roamingOutsidePLMN-Barred (22),
    roamingOutsidePLMN-CountryBarred (23),
    registrationAllCF-Barred (24),
    registrationCFNotToHPLMN-Barred (25),
    registrationInterzonalCF-Barred (26),
    registrationInterzonalCFNotToHPLMN-Barred (27),
    registrationInternationalCF-Barred (28)} (SIZE (15..32))
-- exception handling: reception of unknown bit assignments in the
-- ODB-GeneralData type shall be treated like unsupported ODB-GeneralData
-- When the ODB-GeneralData type is removed from the HLR for a given subscriber,
-- in NoteSubscriberDataModified operation sent toward the gsmSCF
-- all bits shall be set to '0'.

```

```

ODB-HPLMN-Data ::= BIT STRING {
    plmn-SpecificBarringType1 (0),
    plmn-SpecificBarringType2 (1),
    plmn-SpecificBarringType3 (2),
    plmn-SpecificBarringType4 (3)} (SIZE (4..32))
-- exception handling: reception of unknown bit assignments in the
-- ODB-HPLMN-Data type shall be treated like unsupported ODB-HPLMN-Data
-- When the ODB-HPLMN-Data type is removed from the HLR for a given subscriber,
-- in NoteSubscriberDataModified operation sent toward the gsmSCF
-- all bits shall be set to '0'.

```

```

Ext-SS-InfoList ::= SEQUENCE SIZE (1..maxNumOfSS) OF
    Ext-SS-Info

```

```

Ext-SS-Info ::= CHOICE {
    forwardingInfo [0] Ext-ForwInfo,
    callBarringInfo [1] Ext-CallBarInfo,
    cug-Info [2] CUG-Info,
    ss-Data [3] Ext-SS-Data,
    emlpp-Info [4] EMLPP-Info}

```

```

Ext-ForwInfo ::= SEQUENCE {
    ss-Code SS-Code,
    forwardingFeatureList Ext-ForwFeatureList,
    extensionContainer [0] ExtensionContainer OPTIONAL,
    ...}

```

```

Ext-ForwFeatureList ::= SEQUENCE SIZE (1..maxNumOfExt-BasicServiceGroups) OF
    Ext-ForwFeature

```

```

Ext-ForwFeature ::= SEQUENCE {
    basicService                Ext-BasicServiceCode                OPTIONAL,
    ss-Status                   [4] Ext-SS-Status,
    forwardedToNumber           [5] ISDN-AddressString              OPTIONAL,
    -- When this data type is sent from an HLR which supports CAMEL Phase 2
    -- to a VLR that supports CAMEL Phase 2 the VLR shall not check the
    -- format of the number
    forwardedToSubaddress       [8] ISDN-SubaddressString          OPTIONAL,
    forwardingOptions           [6] Ext-ForwOptions                OPTIONAL,
    noReplyConditionTime        [7] Ext-NoRepCondTime              OPTIONAL,
    extensionContainer           [9] ExtensionContainer              OPTIONAL,
    ...,
    longForwardedToNumber       [10] FTN-AddressString              OPTIONAL }

```

```

Ext-ForwOptions ::= OCTET STRING (SIZE (1..5))

    -- OCTET 1:

    -- bit 8: notification to forwarding party
    -- 0 no notification
    -- 1 notification

    -- bit 7: redirecting presentation
    -- 0 no presentation
    -- 1 presentation

    -- bit 6: notification to calling party
    -- 0 no notification
    -- 1 notification

    -- bit 5: 0 (unused)

    -- bits 4:3: forwarding reason
    -- 00 ms not reachable
    -- 01 ms busy
    -- 10 no reply
    -- 11 unconditional

    -- bits 2:1: 00 (unused)

    -- OCTETS 2-5: reserved for future use. They shall be discarded if
    -- received and not understood.

```

```

Ext-NoRepCondTime ::= INTEGER (1..100)
    -- Only values 5-30 are used.
    -- Values in the ranges 1-4 and 31-100 are reserved for future use
    -- If received:
    --     values 1-4 shall be mapped on to value 5
    --     values 31-100 shall be mapped on to value 30

```

```

Ext-CallBarInfo ::= SEQUENCE {
    ss-Code                    SS-Code,
    callBarringFeatureList     Ext-CallBarFeatureList,
    extensionContainer          ExtensionContainer                    OPTIONAL,
    ...}

```

```

Ext-CallBarFeatureList ::= SEQUENCE SIZE (1..maxNumOfExt-BasicServiceGroups) OF
    Ext-CallBarringFeature

```

```

Ext-CallBarringFeature ::= SEQUENCE {
    basicService                Ext-BasicServiceCode                OPTIONAL,
    ss-Status                   [4] Ext-SS-Status,
    extensionContainer           ExtensionContainer                    OPTIONAL,
    ...}

```

```

CUG-Info ::= SEQUENCE {
    cug-SubscriptionList       CUG-SubscriptionList,
    cug-FeatureList            CUG-FeatureList                    OPTIONAL,
    extensionContainer          [0] ExtensionContainer              OPTIONAL,
    ...}

```

```

CUG-SubscriptionList ::= SEQUENCE SIZE (0..maxNumOfCUG) OF
    CUG-Subscription

```

```

CUG-Subscription ::= SEQUENCE {
    cug-Index CUG-Index,
    cug-Interlock                               CUG-Interlock,
    intraCUG-Options                           IntraCUG-Options,
    basicServiceGroupList                      Ext-BasicServiceGroupList    OPTIONAL,
    extensionContainer                          [0] ExtensionContainer      OPTIONAL,
    ...}

```

```

CUG-Index ::= INTEGER (0..32767)
-- The internal structure is defined in ETS 300 138.

```

```

CUG-Interlock ::= OCTET STRING (SIZE (4))

```

```

IntraCUG-Options ::= ENUMERATED {
    noCUG-Restrictions (0),
    cugIC-CallBarred (1),
    cugOG-CallBarred (2)}

```

```

maxNumOfCUG INTEGER ::= 10

```

```

CUG-FeatureList ::= SEQUENCE SIZE (1..maxNumOfExt-BasicServiceGroups) OF
    CUG-Feature

```

```

Ext-BasicServiceGroupList ::= SEQUENCE SIZE (1..maxNumOfExt-BasicServiceGroups) OF
    Ext-BasicServiceCode

```

```

maxNumOfExt-BasicServiceGroups INTEGER ::= 32

```

```

CUG-Feature ::= SEQUENCE {
    basicService                               Ext-BasicServiceCode        OPTIONAL,
    preferentialCUG-Indicator                  CUG-Index OPTIONAL,
    interCUG-Restrictions                      InterCUG-Restrictions,
    extensionContainer                          ExtensionContainer          OPTIONAL,
    ...}

```

```

InterCUG-Restrictions ::= OCTET STRING (SIZE (1))
-- bits 876543: 000000 (unused)
-- Exception handling:
-- bits 876543 shall be ignored if received and not understood
-- bits 21
-- 00 CUG only facilities
-- 01 CUG with outgoing access
-- 10 CUG with incoming access
-- 11 CUG with both outgoing and incoming access

```

```

Ext-SS-Data ::= SEQUENCE {
    ss-Code                                     SS-Code,
    ss-Status                                  [4] Ext-SS-Status,
    ss-SubscriptionOption                      SS-SubscriptionOption      OPTIONAL,
    basicServiceGroupList                      Ext-BasicServiceGroupList  OPTIONAL,
    extensionContainer                          [5] ExtensionContainer      OPTIONAL,
    ...}

```

```

LCS-PrivacyExceptionList ::= SEQUENCE SIZE (1..maxNumOfPrivacyClass) OF
    LCS-PrivacyClass

```

```

maxNumOfPrivacyClass INTEGER ::= 4

```

```

LCS-PrivacyClass ::= SEQUENCE {
    ss-Code                SS-Code,
    ss-Status              Ext-SS-Status,
    notificationToMSUser  [0] NotificationToMSUser          OPTIONAL,
    -- notificationToMSUser may be sent only for SS-codes callSessionRelated
    -- and callSessionUnrelated. If not received for SS-codes callSessionRelated
    -- and callSessionUnrelated,
    -- the default values according to 3GPP TS 23.271 shall be assumed.
    externalClientList    [1] ExternalClientList            OPTIONAL,
    -- externalClientList may be sent only for SS-code callSessionUnrelated to a
    -- visited node that does not support LCS Release 4 or later versions.
    -- externalClientList may be sent only for SS-codes callSessionUnrelated and
    -- callSessionRelated to a visited node that supports LCS Release 4 or later versions.
    plmnClientList        [2] PLMNClientList                OPTIONAL,
    -- plmnClientList may be sent only for SS-code plmnoperator.
    extensionContainer    [3] ExtensionContainer            OPTIONAL,
    ...,
    ext-externalClientList [4] Ext-ExternalClientList      OPTIONAL,
    -- Ext-externalClientList may be sent only if the visited node supports LCS Release 4 or
    -- later versions, the user did specify more than 5 clients, and White Book SCCP is used.
    serviceTypeList       [5] ServiceTypeList              OPTIONAL
    -- serviceTypeList may be sent only for SS-code serviceType and if the visited node
    -- supports LCS Release 5 or later versions.
    --
    -- if segmentation is used, the complete LCS-PrivacyClass shall be sent in one segment
}

```

```

ExternalClientList ::= SEQUENCE SIZE (0..maxNumOfExternalClient) OF
    ExternalClient

```

```

maxNumOfExternalClient  INTEGER ::= 5

```

```

PLMNClientList ::= SEQUENCE SIZE (1..maxNumOfPLMNClient) OF
    LCSCClientInternalID

```

```

maxNumOfPLMNClient  INTEGER ::= 5

```

```

Ext-ExternalClientList ::= SEQUENCE SIZE (1..maxNumOfExt-ExternalClient) OF
    ExternalClient

```

```

maxNumOfExt-ExternalClient  INTEGER ::= 35

```

```

ExternalClient ::= SEQUENCE {
    clientIdentity          LCSCClientExternalID,
    gmlc-Restriction       [0] GMLC-Restriction            OPTIONAL,
    notificationToMSUser  [1] NotificationToMSUser          OPTIONAL,
    -- If notificationToMSUser is not received, the default value according to
    -- 3GPP TS 23.271 shall be assumed.
    extensionContainer     [2] ExtensionContainer            OPTIONAL,
    ... }

```

```

GMLC-Restriction ::= ENUMERATED {
    gmlc-List                (0),
    home-Country             (1),
    ... }
-- exception handling:
-- At reception of any other value than the ones listed the receiver shall ignore
-- GMLC-Restriction.

```

```

NotificationToMSUser ::= ENUMERATED {
    notifyLocationAllowed    (0),
    notifyAndVerify-LocationAllowedIfNoResponse (1),
    notifyAndVerify-LocationNotAllowedIfNoResponse (2),
    ...,
    locationNotAllowed (3) }
-- exception handling:
-- At reception of any other value than the ones listed the receiver shall ignore
-- NotificationToMSUser.

```

```

ServiceTypeList ::= SEQUENCE SIZE (1..maxNumOfServiceType) OF
    ServiceType

```

```

maxNumOfServiceType  INTEGER ::= 32

```



```

ServiceType ::= SEQUENCE {
    serviceTypeIdentity          LCSServiceTypeID,
    gmlc-Restriction             [0] GMLC-Restriction           OPTIONAL,
    notificationToMSUser        [1] NotificationToMSUser       OPTIONAL,
    -- If notificationToMSUser is not received, the default value according to
    -- 3GPP TS 23.271 shall be assumed.
    extensionContainer           [2] ExtensionContainer         OPTIONAL,
    ... }

```

```

MOLR-List ::= SEQUENCE SIZE (1..maxNumOfMOLR-Class) OF
    MOLR-Class

```

```

maxNumOfMOLR-Class INTEGER ::= 3

```

```

MOLR-Class ::= SEQUENCE {
    ss-Code                     SS-Code,
    ss-Status                   Ext-SS-Status,
    extensionContainer           [0] ExtensionContainer         OPTIONAL,
    ... }

```

```

ZoneCodeList ::= SEQUENCE SIZE (1..maxNumOfZoneCodes)
    OF ZoneCode

```

```

ZoneCode ::= OCTET STRING (SIZE (2))
    -- internal structure is defined in TS 3GPP TS 23.003 [17]

```

```

maxNumOfZoneCodes INTEGER ::= 10

```

```

InsertSubscriberDataRes ::= SEQUENCE {
    teleserviceList             [1] TeleserviceList           OPTIONAL,
    bearerServiceList           [2] BearerServiceList         OPTIONAL,
    ss-List                     [3] SS-List                   OPTIONAL,
    odb-GeneralData             [4] ODB-GeneralData           OPTIONAL,
    regionalSubscriptionResponse [5] RegionalSubscriptionResponse OPTIONAL,
    supportedCamelPhases        [6] SupportedCamelPhases       OPTIONAL,
    extensionContainer           [7] ExtensionContainer         OPTIONAL,
    ... ,
    offeredCamel4CSIs           [8] OfferedCamel4CSIs         OPTIONAL }

```

```

RegionalSubscriptionResponse ::= ENUMERATED {
    networkNode-AreaRestricted (0),
    tooManyZoneCodes          (1),
    zoneCodesConflict         (2),
    regionalSubscNotSupported (3)}

```

```

DeleteSubscriberDataArg ::= SEQUENCE {
    imsi                        [0] IMSI,
    basicServiceList            [1] BasicServiceList           OPTIONAL,
    -- The exception handling for reception of unsupported/not allocated
    -- basicServiceCodes is defined in section 6.8.2
    ss-List                     [2] SS-List                   OPTIONAL,
    roamingRestrictionDueToUnsupportedFeature [4] NULL           OPTIONAL,
    regionalSubscriptionIdentifier [5] ZoneCode                 OPTIONAL,
    vbsGroupIndication          [7] NULL                       OPTIONAL,
    vgcsGroupIndication         [8] NULL OPTIONAL,
    camelSubscriptionInfoWithdraw [9] NULL OPTIONAL,
    extensionContainer           [6] ExtensionContainer         OPTIONAL,
    ... ,
    gprsSubscriptionDataWithdraw [10] GPRSSubscriptionDataWithdraw OPTIONAL,
    roamingRestrictedInSgsnDueToUnsupportedFeature [11] NULL       OPTIONAL,
    lsaInformationWithdraw       [12] LSAInformationWithdraw     OPTIONAL,
    gmlc-ListWithdraw           [13] NULL                       OPTIONAL,
    istInformationWithdraw       [14] NULL                       OPTIONAL,
    specificCSI-Withdraw        [15] SpecificCSI-Withdraw       OPTIONAL,
    chargingCharacteristicsWithdraw [16] NULL                   OPTIONAL }

```

```

SpecificCSI-Withdraw ::= BIT STRING {
  o-csi (0),
  ss-csi (1),
  tif-csi (2),
  d-csi (3),
  vt-csi (4),
  mo-sms-csi (5),
  m-csi (6),
  gprs-csi (7),
  t-csi (8),
  mt-sms-csi (9),
  mg-csi (10),
  o-IM-CSI (11),
  d-IM-CSI (12),
  vt-IM-CSI (13) } (SIZE(8..32))
-- exception handling:
-- bits 11 to 31 shall be ignored if received by a non-IP Multimedia Core Network entity.
-- bits 0-10 and 14-31 shall be ignored if received by an IP Multimedia Core Network entity.
-- bits 11-13 are only applicable in an IP Multimedia Core Network.
-- Bit 8 and bits 11-13 are only applicable for the NoteSubscriberDataModified operation.

```

```

GPRSSubscriptionDataWithdraw ::= CHOICE {
  allGPRSData          NULL,
  contextIdList        ContextIdList}

```

```

ContextIdList ::= SEQUENCE SIZE (1..maxNumOfPDP-Contexts) OF
  ContextId

```

```

LSAInformationWithdraw ::= CHOICE {
  allLSAData          NULL,
  lsaIdentityList     LSAIdentityList }

```

```

LSAIdentityList ::= SEQUENCE SIZE (1..maxNumOfLSAs) OF
  LSAIdentity

```

```

BasicServiceList ::= SEQUENCE SIZE (1..maxNumOfBasicServices) OF
  Ext-BasicServiceCode

```

```

maxNumOfBasicServices INTEGER ::= 70

```

```

DeleteSubscriberDataRes ::= SEQUENCE {
  regionalSubscriptionResponse [0] RegionalSubscriptionResponse OPTIONAL,
  extensionContainer           ExtensionContainer           OPTIONAL,
  ...}

```

```

VlrCamelSubscriptionInfo ::= SEQUENCE {
  o-CSI [0] O-CSI OPTIONAL,
  extensionContainer [1] ExtensionContainer OPTIONAL,
  ...,
  ss-CSI [2] SS-CSI OPTIONAL,
  o-BcsmCamelTDP-CriteriaList [4] O-BcsmCamelTDPCriteriaList OPTIONAL,
  tif-CSI [3] NULL OPTIONAL,
  m-CSI [5] M-CSI OPTIONAL,
  mo-sms-CSI [6] SMS-CSI OPTIONAL,
  vt-CSI [7] T-CSI OPTIONAL,
  t-BCSM-CAMEL-TDP-CriteriaList [8] T-BCSM-CAMEL-TDP-CriteriaList OPTIONAL,
  d-CSI [9] D-CSI OPTIONAL,
  mt-sms-CSI [10] SMS-CSI OPTIONAL,
  mt-smsCAMELTDP-CriteriaList [11] MT-smsCAMELTDP-CriteriaList OPTIONAL
}

```

```

MT-smsCAMELTDP-CriteriaList ::= SEQUENCE SIZE (1.. maxNumOfCamelTDPData) OF
  MT-smsCAMELTDP-Criteria

```

```

MT-smsCAMELTDP-Criteria ::= SEQUENCE {
  sms-TriggerDetectionPoint SMS-TriggerDetectionPoint,
  tpdu-TypeCriterion [0] TPDU-TypeCriterion OPTIONAL,
  ... }

```

```

TPDU-TypeCriterion ::= SEQUENCE SIZE (1..maxNumOfTPDUtypes) OF
  MT-SMS-TPDU-Type

```

```

maxNumOfTPDUtypes INTEGER ::= 5

```

```

MT-SMS-TPDU-Type ::= ENUMERATED {
    sms-DELIVER                (0),
    sms-SUBMIT-REPORT          (1),
    sms-STATUS-REPORT          (2),
    ... }

-- exception handling:
-- For TPDU-TypeCriterion sequences containing this parameter with any
-- other value than the ones listed above the receiver shall ignore
-- the whole TPDU-TypeCriterion sequence.
-- In CAMEL phase 4, sms-SUBMIT-REPORT shall not be used and a received TPDU-TypeCriterion
-- sequence containing sms-SUBMIT-REPORT shall be wholly ignored.

```

```

D-CSI ::= SEQUENCE {
    dp-AnalysedInfoCriteriaList [0] DP-AnalysedInfoCriteriaList OPTIONAL,
    camelCapabilityHandling     [1] CamelCapabilityHandling   OPTIONAL,
    extensionContainer           [2] ExtensionContainer         OPTIONAL,
    notificationToCSE            [3] NULL                     OPTIONAL,
    csi-Active                   [4] NULL                     OPTIONAL,
    ...}
-- notificationToCSE and csi-Active shall not be present when D-CSI is sent to VLR/GMSC.
-- They may only be included in ATSI/ATM ack/NSDC message.
-- DP-AnalysedInfoCriteria and camelCapabilityHandling shall be present in
-- the D-CSI sequence.
-- If D-CSI is segmented, then the first segment shall contain dp-AnalysedInfoCriteriaList
-- and camelCapabilityHandling. Subsequent segments shall not contain
-- camelCapabilityHandling, but may contain dp-AnalysedInfoCriteriaList.

```

```

DP-AnalysedInfoCriteriaList ::= SEQUENCE SIZE (1..maxNumOfDP-AnalysedInfoCriteria) OF
    DP-AnalysedInfoCriterion

```

```

maxNumOfDP-AnalysedInfoCriteria INTEGER ::= 10

```

```

DP-AnalysedInfoCriterion ::= SEQUENCE {
    dialledNumber                ISDN-AddressString,
    serviceKey                   ServiceKey,
    gsmSCF-Address               ISDN-AddressString,
    defaultCallHandling          DefaultCallHandling,
    extensionContainer            ExtensionContainer             OPTIONAL,
    ...}

```

```

SS-CSI ::= SEQUENCE {
    ss-CamelData                 SS-CamelData,
    extensionContainer            ExtensionContainer             OPTIONAL,
    ...,
    notificationToCSE            [0] NULL                     OPTIONAL,
    csi-Active                   [1] NULL                     OPTIONAL
-- notificationToCSE and csi-Active shall not be present when SS-CSI is sent to VLR.
-- They may only be included in ATSI/ATM ack/NSDC message.
}

```

```

SS-CamelData ::= SEQUENCE {
    ss-EventList                 SS-EventList,
    gsmSCF-Address               ISDN-AddressString,
    extensionContainer            [0] ExtensionContainer         OPTIONAL,
    ...}

```

```

SS-EventList ::= SEQUENCE SIZE (1..maxNumOfCamelsSEvents) OF SS-Code
-- Actions for the following SS-Code values are defined in CAMEL Phase 3:
-- ect                SS-Code ::= '00110001'B
-- multiPTY           SS-Code ::= '01010001'B
-- cd                 SS-Code ::= '00100100'B
-- ccbs               SS-Code ::= '01000100'B
-- all other SS codes shall be ignored
-- When SS-CSI is sent to the VLR, it shall not contain a marking for ccbs.
-- If the VLR receives SS-CSI containing a marking for ccbs, the VLR shall discard the
-- ccbs marking in SS-CSI.

```

```

maxNumOfCamelsSEvents INTEGER ::= 10

```

```

O-CSI ::= SEQUENCE {
  o-BcsmCamelTDPDataList          O-BcsmCamelTDPDataList,
  extensionContainer                ExtensionContainer                OPTIONAL,
  ...,
  camelCapabilityHandling          [0] CamelCapabilityHandling  OPTIONAL,
  notificationToCSE                [1] NULL                    OPTIONAL,
  csiActive                        [2] NULL                    OPTIONAL}
-- notificationtoCSE and csiActive shall not be present when O-CSI is sent to VLR/GMSC.
-- They may only be included in ATSI/ATM ack/NSDC message.
-- O-CSI shall not be segmented.

```

```

O-BcsmCamelTDPDataList ::= SEQUENCE SIZE (1..maxNumOfCamelTDPData) OF
  O-BcsmCamelTDPData
-- O-BcsmCamelTDPDataList shall not contain more than one instance of
-- O-BcsmCamelTDPData containing the same value for o-BcsmTriggerDetectionPoint.
-- For CAMEL Phase 2, this means that only one instance of O-BcsmCamelTDPData is allowed
-- with o-BcsmTriggerDetectionPoint being equal to DP2.

```

```

maxNumOfCamelTDPData INTEGER ::= 10

```

```

O-BcsmCamelTDPData ::= SEQUENCE {
  o-BcsmTriggerDetectionPoint      O-BcsmTriggerDetectionPoint,
  serviceKey                       ServiceKey,
  gsmSCF-Address                   [0] ISDN-AddressString,
  defaultCallHandling              [1] DefaultCallHandling,
  extensionContainer                [2] ExtensionContainer      OPTIONAL,
  ...
}

```

```

ServiceKey ::= INTEGER (0..2147483647)

```

```

O-BcsmTriggerDetectionPoint ::= ENUMERATED {
  collectedInfo (2),
  ...,
  routeSelectFailure (4) }
-- exception handling:
-- For O-BcsmCamelTDPData sequences containing this parameter with any
-- other value than the ones listed the receiver shall ignore the whole
-- O-BcsmCamelTDPData sequence.
-- For O-BcsmCamelTDP-Criteria sequences containing this parameter with any
-- other value than the ones listed the receiver shall ignore the whole
-- O-BcsmCamelTDP-Criteria sequence.

```

```

O-BcsmCamelTDPCriteriaList ::= SEQUENCE SIZE (1..maxNumOfCamelTDPData) OF
  O-BcsmCamelTDP-Criteria

```

```

T-BCSM-CAMEL-TDP-CriteriaList ::= SEQUENCE SIZE (1..maxNumOfCamelTDPData) OF
  T-BCSM-CAMEL-TDP-Criteria

```

```

O-BcsmCamelTDP-Criteria ::= SEQUENCE {
  o-BcsmTriggerDetectionPoint      O-BcsmTriggerDetectionPoint,
  destinationNumberCriteria        [0] DestinationNumberCriteria  OPTIONAL,
  basicServiceCriteria             [1] BasicServiceCriteria        OPTIONAL,
  callTypeCriteria                 [2] CallTypeCriteria            OPTIONAL,
  ...,
  o-CauseValueCriteria             [3] O-CauseValueCriteria        OPTIONAL,
  extensionContainer                [4] ExtensionContainer      OPTIONAL }

```

```

T-BCSM-CAMEL-TDP-Criteria ::= SEQUENCE {
  t-BCSM-TriggerDetectionPoint      T-BcsmTriggerDetectionPoint,
  basicServiceCriteria              [0] BasicServiceCriteria        OPTIONAL,
  t-CauseValueCriteria              [1] T-CauseValueCriteria        OPTIONAL,
  ...
}

```

```

DestinationNumberCriteria ::= SEQUENCE {
  matchType                        [0] MatchType,
  destinationNumberList             [1] DestinationNumberList      OPTIONAL,
  destinationNumberLengthList      [2] DestinationNumberLengthList  OPTIONAL,
-- one or both of destinationNumberList and destinationNumberLengthList
-- shall be present
...
}

```

```

DestinationNumberList ::= SEQUENCE SIZE (1..maxNumOfCamelDestinationNumbers) OF
  ISDN-AddressString
-- The receiving entity shall not check the format of a number in
-- the dialled number list

```

```
DestinationNumberLengthList ::= SEQUENCE SIZE (1..maxNumOfCamelDestinationNumberLengths) OF
    INTEGER(1..maxNumOfISDN-AddressDigits)
```

```
BasicServiceCriteria ::= SEQUENCE SIZE(1..maxNumOfCamelBasicServiceCriteria) OF
    Ext-BasicServiceCode
```

```
maxNumOfISDN-AddressDigits INTEGER ::= 15
```

```
maxNumOfCamelDestinationNumbers INTEGER ::= 10
```

```
maxNumOfCamelDestinationNumberLengths INTEGER ::= 3
```

```
maxNumOfCamelBasicServiceCriteria INTEGER ::= 5
```

```
CallTypeCriteria ::= ENUMERATED {
    forwarded (0),
    notForwarded (1)}
```

```
MatchType ::= ENUMERATED {
    inhibiting (0),
    enabling (1)}
```

```
O-CauseValueCriteria ::= SEQUENCE SIZE(1..maxNumOfCAMEL-O-CauseValueCriteria) OF
    CauseValue
```

```
T-CauseValueCriteria ::= SEQUENCE SIZE(1..maxNumOfCAMEL-T-CauseValueCriteria) OF
    CauseValue
```

```
maxNumOfCAMEL-O-CauseValueCriteria INTEGER ::= 5
```

```
maxNumOfCAMEL-T-CauseValueCriteria INTEGER ::= 5
```

```
CauseValue ::= OCTET STRING (SIZE(1))
-- Type extracted from Cause parameter in ITU-T Recommendation Q.763.
-- For the use of cause value refer to ITU-T Recommendation Q.850.
```

```
DefaultCallHandling ::= ENUMERATED {
    continueCall (0) ,
    releaseCall (1) ,
    ...}
-- exception handling:
-- reception of values in range 2-31 shall be treated as "continueCall"
-- reception of values greater than 31 shall be treated as "releaseCall"
```

```
CamelCapabilityHandling ::= INTEGER(1..16)
-- value 1 = CAMEL phase 1,
-- value 2 = CAMEL phase 2,
-- value 3 = CAMEL Phase 3,
-- value 4 = CAMEL phase 4:
-- reception of values greater than 4 shall be treated as CAMEL phase 4.
```

```
SupportedCamelPhases ::= BIT STRING {
    phase1 (0),
    phase2 (1),
    phase3 (2),
    phase4 (3)} (SIZE (1..16))
-- A node shall mark in the BIT STRING all CAMEL Phases it supports.
-- Other values than listed above shall be discarded.
```

```
OfferedCamel4CSIs ::= BIT STRING {
    o-csi (0),
    d-csi (1),
    vt-csi (2),
    t-csi (3),
    mt-sms-csi (4),
    mg-csi (5),
    psi-enhancements (6)
} (SIZE (7..16))
-- A node supporting Camel phase 4 shall mark in the BIT STRING all Camel4 CSIs
-- it offers.
-- Other values than listed above shall be discarded.
```

```

OfferedCamel4Functionalities ::= BIT STRING {
    initiateCallAttempt      (0),
    splitLeg                 (1),
    moveLeg                  (2),
    disconnectLeg           (3),
    entityReleased          (4),
    dfc-WithArgument        (5),
    playTone                 (6),
    dtmf-MidCall            (7),
    chargingIndicator       (8),
    alertingDP              (9),
    locationAtAlerting     (10),
    changeOfPositionDP     (11),
    or-Interactions         (12),
    warningToneEnhancements (13),
    cf-Enhancements        (14)
} (SIZE (15..64))
-- A node supporting Camel phase 4 shall mark in the BIT STRING all CAMEL4
-- functionalities it offers.
-- Other values than listed above shall be discarded.

```

```

SMS-CSI ::= SEQUENCE {
    sms-CAMEL-TDP-DataList      [0] SMS-CAMEL-TDP-DataList      OPTIONAL,
    camelCapabilityHandling     [1] CamelCapabilityHandling   OPTIONAL,
    extensionContainer          [2] ExtensionContainer       OPTIONAL,
    notificationToCSE           [3] NULL                    OPTIONAL,
    csi-Active                  [4] NULL                    OPTIONAL,
    ...}
-- notificationToCSE and csi-Active shall not be present
-- when MO-SMS-CSI or MT-SMS-CSI is sent to VLR or SGSN.
-- They may only be included in ATSI/ATM ack/NSDC message.
-- SMS-CAMEL-TDP-Data and camelCapabilityHandling shall be present in
-- the SMS-CSI sequence.
-- If SMS-CSI is segmented, sms-CAMEL-TDP-DataList and camelCapabilityHandling shall be
-- present in the first segment

```

```

SMS-CAMEL-TDP-DataList ::= SEQUENCE SIZE (1..maxNumOfCamelTDPData) OF
    SMS-CAMEL-TDP-Data
-- SMS-CAMEL-TDP-DataList shall not contain more than one instance of
-- SMS-CAMEL-TDP-Data containing the same value for sms-TriggerDetectionPoint.

```

```

SMS-CAMEL-TDP-Data ::= SEQUENCE {
    sms-TriggerDetectionPoint [0] SMS-TriggerDetectionPoint,
    serviceKey                [1] ServiceKey,
    gsmSCF-Address            [2] ISDN-AddressString,
    defaultSMS-Handling       [3] DefaultSMS-Handling,
    extensionContainer        [4] ExtensionContainer          OPTIONAL,
    ...
}

```

```

SMS-TriggerDetectionPoint ::= ENUMERATED {
    sms-CollectedInfo (1),
    ...,
    sms-DeliveryRequest (2)
}
-- exception handling:
-- For SMS-CAMEL-TDP-Data and MT-smsCAMELTDP-Criteria sequences containing this
-- parameter with any other value than the ones listed the receiver shall ignore
-- the whole sequence.
--
-- If this parameter is received with any other value than sms-CollectedInfo
-- in an SMS-CAMEL-TDP-Data sequence contained in mo-sms-CSI, then the receiver shall
-- ignore the whole SMS-CAMEL-TDP-Data sequence.
--
-- If this parameter is received with any other value than sms-DeliveryRequest
-- in an SMS-CAMEL-TDP-Data sequence contained in mt-sms-CSI then the receiver shall
-- ignore the whole SMS-CAMEL-TDP-Data sequence.
--
-- If this parameter is received with any other value than sms-DeliveryRequest
-- in an MT-smsCAMELTDP-Criteria sequence then the receiver shall
-- ignore the whole MT-smsCAMELTDP-Criteria sequence.

```

```

DefaultSMS-Handling ::= ENUMERATED {
    continueTransaction (0) ,
    releaseTransaction (1) ,
    ...}
-- exception handling:
-- reception of values in range 2-31 shall be treated as "continueTransaction"
-- reception of values greater than 31 shall be treated as "releaseTransaction"

```

```

M-CSI ::= SEQUENCE {
    mobilityTriggers           MobilityTriggers,
    serviceKey                 ServiceKey,
    gsmSCF-Address             [0] ISDN-AddressString,
    extensionContainer         [1] ExtensionContainer           OPTIONAL,
    notificationToCSE          [2] NULL                       OPTIONAL,
    csi-Active                 [3] NULL                       OPTIONAL,
    ...}
-- notificationToCSE and csi-Active shall not be present when M-CSI is sent to VLR.
-- They may only be included in ATSI/ATM ack/NSDC message.

```

```

MG-CSI ::= SEQUENCE {
    mobilityTriggers           MobilityTriggers,
    serviceKey                 ServiceKey,
    gsmSCF-Address             [0] ISDN-AddressString,
    extensionContainer         [1] ExtensionContainer           OPTIONAL,
    notificationToCSE          [2] NULL                       OPTIONAL,
    csi-Active                 [3] NULL                       OPTIONAL,
    ...}
-- notificationToCSE and csi-Active shall not be present when MG-CSI is sent to SGSN.
-- They may only be included in ATSI/ATM ack/NSDC message.

```

```

MobilityTriggers ::= SEQUENCE SIZE (1..maxNumOfMobilityTriggers) OF
    MM-Code

```

```

maxNumOfMobilityTriggers INTEGER ::= 10

```

```

MM-Code ::= OCTET STRING (SIZE (1))
-- This type is used to indicate a Mobility Management event.
-- Actions for the following MM-Code values are defined in CAMEL Phase 4:
--
-- CS domain MM events:
-- Location-update-in-same-VLR           MM-Code ::= '00000000'B
-- Location-update-to-other-VLR         MM-Code ::= '00000001'B
-- IMSI-Attach                          MM-Code ::= '00000010'B
-- MS-initiated-IMSI-Detach             MM-Code ::= '00000011'B
-- Network-initiated-IMSI-Detach       MM-Code ::= '00000100'B
--
-- PS domain MM events:
-- Routeing-Area-update-in-same-SGSN    MM-Code ::= '10000000'B
-- Routeing-Area-update-to-other-SGSN-update-from-new-SGSN
--                                     MM-Code ::= '10000001'B
-- Routeing-Area-update-to-other-SGSN-disconnect-by-detach
--                                     MM-Code ::= '10000010'B
-- GPRS-Attach                          MM-Code ::= '10000011'B
-- MS-initiated-GPRS-Detach             MM-Code ::= '10000100'B
-- Network-initiated-GPRS-Detach       MM-Code ::= '10000101'B
-- Network-initiated-transfer-to-MS-not-reachable-for-paging
--                                     MM-Code ::= '10000110'B
--
-- If the MSC receives any other MM-code than the ones listed above for the
-- CS domain, then the MSC shall ignore that MM-code.
-- If the SGSN receives any other MM-code than the ones listed above for the
-- PS domain, then the SGSN shall ignore that MM-code.

```

```

T-CSI ::= SEQUENCE {
    t-BcsmCamelTDPDataList         T-BcsmCamelTDPDataList,
    extensionContainer              ExtensionContainer           OPTIONAL,
    ...,
    camelCapabilityHandling         [0] CamelCapabilityHandling   OPTIONAL,
    notificationToCSE              [1] NULL                       OPTIONAL,
    csi-Active                     [2] NULL                       OPTIONAL}
-- notificationToCSE and csi-Active shall not be present when VT-CSI/T-CSI is sent
-- to VLR/GMSC.
-- They may only be included in ATSI/ATM ack/NSDC message.
-- T-CSI shall not be segmented.

```

```

T-BcsmCamelTDPDataList ::= SEQUENCE SIZE (1..maxNumOfCamelTDPData) OF
  T-BcsmCamelTDPData
  --- T-BcsmCamelTDPDataList shall not contain more than one instance of
  --- T-BcsmCamelTDPData containing the same value for t-BcsmTriggerDetectionPoint.
  --- For CAMEL Phase 2, this means that only one instance of T-BcsmCamelTDPData is allowed
  --- with t-BcsmTriggerDetectionPoint being equal to DP12.
  --- For CAMEL Phase 3, more TDP"s are allowed.

```

```

T-BcsmCamelTDPData ::= SEQUENCE {
  t-BcsmTriggerDetectionPoint      T-BcsmTriggerDetectionPoint,
  serviceKey                       ServiceKey,
  gsmSCF-Address                   [0] ISDN-AddressString,
  defaultCallHandling               [1] DefaultCallHandling,
  extensionContainer                 [2] ExtensionContainer           OPTIONAL,
  ...}

```

```

T-BcsmTriggerDetectionPoint ::= ENUMERATED {
  termAttemptAuthorized (12),
  ... ,
  tBusy (13),
  tNoAnswer (14)}
  -- exception handling:
  -- For T-BcsmCamelTDPData sequences containing this parameter with any other
  -- value than the ones listed above, the receiver shall ignore the whole
  -- T-BcsmCamelTDPData sequence.

```

-- gprs location information retrieval types

```

SendRoutingInfoForGprsArg ::= SEQUENCE {
  imsi                             [0] IMSI,
  ggsn-Address                       [1] GSN-Address           OPTIONAL,
  ggsn-Number                         [2] ISDN-AddressString,
  extensionContainer                 [3] ExtensionContainer     OPTIONAL,
  ...}

```

```

SendRoutingInfoForGprsRes ::= SEQUENCE {
  sgsn-Address                       [0] GSN-Address,
  ggsn-Address                       [1] GSN-Address           OPTIONAL,
  mobileNotReachableReason           [2] AbsentSubscriberDiagnosticSM OPTIONAL,
  extensionContainer                 [3] ExtensionContainer     OPTIONAL,
  ...}

```

-- failure report types

```

FailureReportArg ::= SEQUENCE {
  imsi                             [0] IMSI,
  ggsn-Number                       [1] ISDN-AddressString    ,
  ggsn-Address                       [2] GSN-Address           OPTIONAL,
  extensionContainer                 [3] ExtensionContainer     OPTIONAL,
  ...}

```

```

FailureReportRes ::= SEQUENCE {
  ggsn-Address                       [0] GSN-Address           OPTIONAL,
  extensionContainer                 [1] ExtensionContainer     OPTIONAL,
  ...}

```

-- gprs notification types

```

NoteMsPresentForGprsArg ::= SEQUENCE {
  imsi                             [0] IMSI,
  sgsn-Address                       [1] GSN-Address,
  ggsn-Address                       [2] GSN-Address           OPTIONAL,
  extensionContainer                 [3] ExtensionContainer     OPTIONAL,
  ...}

```

```

NoteMsPresentForGprsRes ::= SEQUENCE {
  extensionContainer                 [0] ExtensionContainer     OPTIONAL,
  ...}

```

-- fault recovery types

```

ResetArg ::= SEQUENCE {
  hlr-Number                         ISDN-AddressString,
  hlr-List                           HLR-List                 OPTIONAL,
  ...}

```



```
RestoreDataArg ::= SEQUENCE {
    imsi                IMSI,
    lmsi                LMSI                OPTIONAL,
    extensionContainer  ExtensionContainer OPTIONAL,
    ... ,
    vlr-Capability     [6] VLR-Capability OPTIONAL }
```

```
RestoreDataRes ::= SEQUENCE {
    hlr-Number          ISDN-AddressString,
    msNotReachable     NULL                OPTIONAL,
    extensionContainer  ExtensionContainer OPTIONAL,
    ... }
```

-- VBS/VGCS types

```
VBSDataList ::= SEQUENCE SIZE (1..maxNumOfVBSGroupIds) OF
    VoiceBroadcastData
```

```
VGCSDataList ::= SEQUENCE SIZE (1..maxNumOfVGCSGroupIds) OF
    VoiceGroupCallData
```

```
maxNumOfVBSGroupIds INTEGER ::= 50
```

```
maxNumOfVGCSGroupIds INTEGER ::= 50
```

```
VoiceGroupCallData ::= SEQUENCE {
    groupId             GroupId,
    extensionContainer  ExtensionContainer OPTIONAL,
    ... }
```

```
VoiceBroadcastData ::= SEQUENCE {
    groupid             GroupId,
    broadcastInitEntitlement NULL          OPTIONAL,
    extensionContainer  ExtensionContainer OPTIONAL,
    ... }
```

```
GroupId ::= TBCD-STRING (SIZE (3))
-- When Group-Id is less than six characters in length, the TBCD filler (1111)
-- is used to fill unused half octets.
-- Refers to the Group Identification as specified in 3GPP TS 23.003
-- and 3GPP TS 43.068/ 43.069
```

-- provide subscriber info types

```
ProvideSubscriberInfoArg ::= SEQUENCE {
    imsi      [0] IMSI,
    lmsi      [1] LMSI                OPTIONAL,
    requestedInfo [2] RequestedInfo,
    extensionContainer [3] ExtensionContainer OPTIONAL,
    ... }
```

```
ProvideSubscriberInfoRes ::= SEQUENCE {
    subscriberInfo      SubscriberInfo,
    extensionContainer  ExtensionContainer OPTIONAL,
    ... }
```

```
SubscriberInfo ::= SEQUENCE {
    locationInformation      [0] LocationInformation OPTIONAL,
    subscriberState         [1] SubscriberState     OPTIONAL,
    extensionContainer       [2] ExtensionContainer  OPTIONAL,
    ... ,
    locationInformationGPRS [3] LocationInformationGPRS OPTIONAL,
    ps-SubscriberState      [4] PS-SubscriberState  OPTIONAL,
    imei                    [5] IMEI                OPTIONAL,
    ms-Classmark2           [6] MS-Classmark2       OPTIONAL,
    gprs-MS-Class           [7] GPRSMSClass         OPTIONAL,
    mnpInfoRes              [8] MNPInfoRes          OPTIONAL }
-- If the HLR receives locationInformation, subscriberState or ms-Classmark2 from an SGSN
-- it shall discard them.
-- If the HLR receives locationInformationGPRS, ps-SubscriberState or gprs-MS-Class from
-- a VLR it shall discard them.
-- If the HLR receives parameters which it has not requested, it shall discard them.
```

```

MNPInfoRes ::= SEQUENCE {
    routingNumber          [0] RoutingNumber          OPTIONAL,
    imsi                   [1] IMSI                    OPTIONAL,
    msisdn                 [2] ISDN-AddressString      OPTIONAL,
    numberPortabilityStatus [3] NumberPortabilityStatus OPTIONAL,
    extensionContainer     [4] ExtensionContainer      OPTIONAL,
    ... }

-- The IMSI parameter contains a generic IMSI, i.e. it is not tied necessarily to the
-- Subscriber. MCC and MNC values in this IMSI shall point to the Subscription Network of
-- the Subscriber. See 3GPP TS 23.066 [108].

```

```

RoutingNumber ::= TBCD-STRING (SIZE (1..5))

```

```

NumberPortabilityStatus ::= ENUMERATED {
    notKnownToBePorted      (0),
    ownNumberPortedOut      (1),
    foreignNumberPortedToForeignNetwork (2),
    ...,
    ownNumberNotPortedOut   (4),
    foreignNumberPortedIn   (5)
}

-- exception handling:
-- reception of other values than the ones listed the receiver shall ignore the
-- whole NumberPortabilityStatus;
-- ownNumberNotPortedOut or foreignNumberPortedIn may only be included in Any Time
-- Interrogation message.

```

```

MS-Classmark2 ::= OCTET STRING (SIZE (3))
-- This parameter carries the value part of the MS Classmark 2 IE defined in
-- 3GPP TS 24.008 [35].

```

```

GPRSMSClass ::= SEQUENCE {
    mSNetworkCapability      [0] MSNetworkCapability,
    mSRadioAccessCapability [1] MSRadioAccessCapability OPTIONAL
}

```

```

MSNetworkCapability ::= OCTET STRING (SIZE (1..8))
-- This parameter carries the value part of the MS Network Capability IE defined in
-- 3GPP TS 24.008 [35].

```

```

MSRadioAccessCapability ::= OCTET STRING (SIZE (1..50))
-- This parameter carries the value part of the MS Radio Access Capability IE defined in
-- 3GPP TS 24.008 [35].

```

```

RequestedInfo ::= SEQUENCE {
    locationInformation      [0] NULL                  OPTIONAL,
    subscriberState         [1] NULL                  OPTIONAL,
    extensionContainer       [2] ExtensionContainer    OPTIONAL,
    ...,
    currentLocation         [3] NULL                  OPTIONAL,
    requestedDomain         [4] DomainType            OPTIONAL,
    imei                    [6] NULL                  OPTIONAL,
    ms-classmark            [5] NULL                  OPTIONAL,
    mnpRequestedInfo        [7] NULL                  OPTIONAL }

-- currentLocation shall be absent if locationInformation is absent

```

```

DomainType ::= ENUMERATED {
    cs-Domain                (0),
    ps-Domain                (1),
    ...}

-- exception handling:
-- reception of values > 1 shall be mapped to 'cs-Domain'

```

```

LocationInformation ::= SEQUENCE {
    ageOfLocationInformation      AgeOfLocationInformation      OPTIONAL,
    geographicalInformation       [0] GeographicalInformation    OPTIONAL,
    vlr-number                   [1] ISDN-AddressString        OPTIONAL,
    locationNumber               [2] LocationNumber            OPTIONAL,
    cellGlobalIdOrServiceAreaIdOrLAI [3] CellGlobalIdOrServiceAreaIdOrLAI OPTIONAL,
    extensionContainer           [4] ExtensionContainer         OPTIONAL,
    ... ,
    selectedLSA-Id              [5] LSAIdentity              OPTIONAL,
    msc-Number                  [6] ISDN-AddressString        OPTIONAL,
    geodeticInformation          [7] GeodeticInformation      OPTIONAL,
    currentLocationRetrieved     [8] NULL                    OPTIONAL,
    sai-Present                  [9] NULL                    OPTIONAL }
-- sai-Present indicates that the cellGlobalIdOrServiceAreaIdOrLAI parameter contains
-- a Service Area Identity.
-- currentLocationRetrieved shall be present
-- if the location information were retrieved after a successful paging.

```

```

LocationInformationGPRS ::= SEQUENCE {
    cellGlobalIdOrServiceAreaIdOrLAI [0] CellGlobalIdOrServiceAreaIdOrLAI OPTIONAL,
    routeingAreaIdentity            [1] RAIdentity              OPTIONAL,
    geographicalInformation          [2] GeographicalInformation    OPTIONAL,
    sgsn-Number                    [3] ISDN-AddressString        OPTIONAL,
    selectedLSAIdentity             [4] LSAIdentity              OPTIONAL,
    extensionContainer              [5] ExtensionContainer         OPTIONAL,
    ... ,
    sai-Present                    [6] NULL                    OPTIONAL,
    geodeticInformation            [7] GeodeticInformation      OPTIONAL,
    currentLocationRetrieved        [8] NULL                    OPTIONAL,
    ageOfLocationInformation        [9] AgeOfLocationInformation    OPTIONAL }
-- sai-Present indicates that the cellGlobalIdOrServiceAreaIdOrLAI parameter contains
-- a Service Area Identity.
-- currentLocationRetrieved shall be present if the location information
-- was retrieved after successful paging.

```

```

RAIdentity ::= OCTET STRING (SIZE (6))
-- Routing Area Identity is coded in accordance with 3GPP TS 29.060 [105].
-- It shall contain the value part defined in 3GPP TS 29.060 only. I.e. the 3GPP TS 29.060
-- type identifier octet shall not be included.

```

```

GeographicalInformation ::= OCTET STRING (SIZE (8))
-- Refers to geographical Information defined in 3GPP TS 23.032.
-- Only the description of an ellipsoid point with uncertainty circle
-- as specified in 3GPP TS 23.032 is allowed to be used
-- The internal structure according to 3GPP TS 23.032 is as follows:
--   Type of shape (ellipsoid point with uncertainty circle)      1 octet
--   Degrees of Latitude                                         3 octets
--   Degrees of Longitude                                       3 octets
--   Uncertainty code                                           1 octet

```

```

GeodeticInformation ::= OCTET STRING (SIZE (10))
-- Refers to Calling Geodetic Location defined in Q.763 (1999).
-- Only the description of an ellipsoid point with uncertainty circle
-- as specified in Q.763 (1999) is allowed to be used
-- The internal structure according to Q.763 (1999) is as follows:
--   Screening and presentation indicators                       1 octet
--   Type of shape (ellipsoid point with uncertainty circle)    1 octet
--   Degrees of Latitude                                       3 octets
--   Degrees of Longitude                                       3 octets
--   Uncertainty code                                           1 octet
--   Confidence                                               1 octet

```

```

LocationNumber ::= OCTET STRING (SIZE (2..10))
-- the internal structure is defined in ITU-T Rec Q.763

```

```

SubscriberState ::= CHOICE {
    assumedIdle                [0] NULL,
    camelBusy                  [1] NULL,
    netDetNotReachable         NotReachableReason,
    notProvidedFromVLR        [2] NULL}

```

```

PS-SubscriberState ::= CHOICE {
    notProvidedFromSGSN          [0] NULL,
    ps-Detached                  [1] NULL,
    ps-AttachedNotReachableForPaging [2] NULL,
    ps-AttachedReachableForPaging [3] NULL,
    ps-PDP-ActiveNotReachableForPaging [4] PDP-ContextInfoList,
    ps-PDP-ActiveReachableForPaging [5] PDP-ContextInfoList,
    netDetNotReachable          NotReachableReason }

```

```

PDP-ContextInfoList ::= SEQUENCE SIZE (1..maxNumOfPDP-Contexts) OF
    PDP-ContextInfo

```

```

PDP-ContextInfo ::= SEQUENCE {
    pdp-ContextIdentifier          [0] ContextId,
    pdp-ContextActive              [1] NULL OPTIONAL,
    pdp-Type                       [2] PDP-Type,
    pdp-Address                    [3] PDP-Address OPTIONAL,
    apn-Subscribed                 [4] APN OPTIONAL,
    apn-InUse                      [5] APN OPTIONAL,
    nsapi                          [6] NSAPI OPTIONAL,
    transactionId                  [7] TransactionId OPTIONAL,
    teid-ForGnAndGp               [8] TEID OPTIONAL,
    teid-ForIu                     [9] TEID OPTIONAL,
    ggsn-Address                  [10] GSN-Address OPTIONAL,
    qos-Subscribed                 [11] Ext-QoS-Subscribed OPTIONAL,
    qos-Requested                  [12] Ext-QoS-Subscribed OPTIONAL,
    qos-Negotiated                 [13] Ext-QoS-Subscribed OPTIONAL,
    chargingID                     [14] GPRSChargingID OPTIONAL,
    chargingCharacteristics         [15] ChargingCharacteristics OPTIONAL,
    rnc-Address                    [16] GSN-Address OPTIONAL,
    extensionContainer             [17] ExtensionContainer OPTIONAL,
    ...,
    qos2-Subscribed                [18] Ext2-QoS-Subscribed OPTIONAL,
    -- qos2-Subscribed may be present only if qos-Subscribed is present.
    qos2-Requested                 [19] Ext2-QoS-Subscribed OPTIONAL,
    -- qos2-Requested may be present only if qos-Requested is present.
    qos2-Negotiated                [20] Ext2-QoS-Subscribed OPTIONAL,
    -- qos2-Negotiated may be present only if qos-Negotiated is present.
}

```

```

NSAPI ::= INTEGER (0..15)
-- This type is used to indicate the Network layer Service Access Point

```

```

TransactionId ::= OCTET STRING (SIZE (1..2))
-- This type carries the value part of the transaction identifier which is used in the
-- session management messages on the access interface. The encoding is defined in
-- 3GPP TS 24.008

```

```

TEID ::= OCTET STRING (SIZE (4))
-- This type carries the value part of the Tunnel Endpoint Identifier which is used to
-- distinguish between different tunnels between the same pair of entities which communicate
-- using the GPRS Tunneling Protocol The encoding is defined in 3GPP TS 29.060.

```

```

GPRSChargingID ::= OCTET STRING (SIZE (4))
-- The Charging ID is a unique four octet value generated by the GGSN when
-- a PDP Context is activated. A Charging ID is generated for each activated context.
-- The encoding is defined in 3GPP TS 29.060.

```

```

NotReachableReason ::= ENUMERATED {
    msPurged (0),
    imsiDetached (1),
    restrictedArea (2),
    notRegistered (3)}

```

-- any time interrogation info types

```

AnyTimeInterrogationArg ::= SEQUENCE {
    subscriberIdentity            [0] SubscriberIdentity,
    requestedInfo                 [1] RequestedInfo,
    gsmSCF-Address                [3] ISDN-AddressString,
    extensionContainer            [2] ExtensionContainer OPTIONAL,
    ...}

```

```

AnyTimeInterrogationRes ::= SEQUENCE {
    subscriberInfo          SubscriberInfo,
    extensionContainer      ExtensionContainer          OPTIONAL,
    ...}

```

-- any time information handling types

```

AnyTimeSubscriptionInterrogationArg ::= SEQUENCE {
    subscriberIdentity      [0] SubscriberIdentity,
    requestedSubscriptionInfo [1] RequestedSubscriptionInfo,
    gsmSCF-Address          [2] ISDN-AddressString,
    extensionContainer      [3] ExtensionContainer          OPTIONAL,
    longFTN-Supported       [4] NULL                      OPTIONAL,
    ...}

```

```

AnyTimeSubscriptionInterrogationRes ::= SEQUENCE {
    callForwardingData      [1] CallForwardingData          OPTIONAL,
    callBarringData         [2] CallBarringData             OPTIONAL,
    odb-Info                [3] ODB-Info                    OPTIONAL,
    camel-SubscriptionInfo  [4] CAMEL-SubscriptionInfo      OPTIONAL,
    supportedVLR-CAMEL-Phases [5] SupportedCamelPhases      OPTIONAL,
    supportedSGSN-CAMEL-Phases [6] SupportedCamelPhases      OPTIONAL,
    extensionContainer      [7] ExtensionContainer          OPTIONAL,
    ... ,
    offeredCamel4CSIsInVLR  [8] OfferedCamel4CSIs          OPTIONAL,
    offeredCamel4CSIsInSGSN [9] OfferedCamel4CSIs          OPTIONAL }

```

```

RequestedSubscriptionInfo ::= SEQUENCE {
    requestedSS-Info        [1] SS-ForBS-Code              OPTIONAL,
    odb                    [2] NULL                      OPTIONAL,
    requestedCAMEL-SubscriptionInfo [3] RequestedCAMEL-SubscriptionInfo OPTIONAL,
    supportedVLR-CAMEL-Phases [4] NULL                      OPTIONAL,
    supportedSGSN-CAMEL-Phases [5] NULL                      OPTIONAL,
    extensionContainer      [6] ExtensionContainer          OPTIONAL,
    ... ,
    additionalRequestedCAMEL-SubscriptionInfo [7] AdditionalRequestedCAMEL-SubscriptionInfo OPTIONAL }

```

```

RequestedCAMEL-SubscriptionInfo ::= ENUMERATED {
    o-CSI (0),
    t-CSI (1),
    vt-CSI (2),
    tif-CSI (3),
    gprs-CSI (4),
    mo-sms-CSI (5),
    ss-CSI (6),
    m-CSI (7),
    d-csi (8)}

```

```

AdditionalRequestedCAMEL-SubscriptionInfo ::= ENUMERATED {
    mt-sms-CSI (0),
    mg-csi (1),
    o-IM-CSI (2),
    d-IM-CSI (3),
    vt-IM-CSI (4),
    ...}
-- exception handling: unknown values shall be discarded by the receiver.

```

```

CallForwardingData ::= SEQUENCE {
    forwardingFeatureList    Ext-ForwFeatureList,
    notificationToCSE        NULL                      OPTIONAL,
    extensionContainer       [0] ExtensionContainer      OPTIONAL,
    ...}

```

```

CallBarringData ::= SEQUENCE {
    callBarringFeatureList    Ext-CallBarFeatureList,
    password                  Password                  OPTIONAL,
    wrongPasswordAttemptsCounter WrongPasswordAttemptsCounter OPTIONAL,
    notificationToCSE        NULL                      OPTIONAL,
    extensionContainer       ExtensionContainer          OPTIONAL,
    ...}

```

```

WrongPasswordAttemptsCounter ::= INTEGER (0..4)

```

ODB-Info ::= SEQUENCE {		
oddb-Data	ODB-Data,	
notificationToCSE	NULL	OPTIONAL,
extensionContainer	ExtensionContainer	OPTIONAL,
...}		

CAMEL-SubscriptionInfo ::= SEQUENCE {		
o-CSI	[0] O-CSI	OPTIONAL,
o-BcsmCamelTDP-CriteriaList	[1] O-BcsmCamelTDPCriteriaList	OPTIONAL,
d-CSI	[2] D-CSI	OPTIONAL,
t-CSI	[3] T-CSI	OPTIONAL,
t-BCSM-CAMEL-TDP-CriteriaList	[4] T-BCSM-CAMEL-TDP-CriteriaList	OPTIONAL,
vt-CSI	[5] T-CSI	OPTIONAL,
vt-BCSM-CAMEL-TDP-CriteriaList	[6] T-BCSM-CAMEL-TDP-CriteriaList	OPTIONAL,
tif-CSI	[7] NULL	OPTIONAL,
tif-CSI-NotificationToCSE	[8] NULL	OPTIONAL,
gprs-CSI	[9] GPRS-CSI	OPTIONAL,
mo-sms-CSI	[10] SMS-CSI	OPTIONAL,
ss-CSI	[11] SS-CSI	OPTIONAL,
m-CSI	[12] M-CSI	OPTIONAL,
extensionContainer	[13] ExtensionContainer	OPTIONAL,
...,		
specificCSIDeletedList	[14] SpecificCSI-Withdraw	OPTIONAL,
mt-sms-CSI	[15] SMS-CSI	OPTIONAL,
mt-smsCAMELTDP-CriteriaList	[16] MT-smsCAMELTDP-CriteriaList	OPTIONAL,
mg-csi	[17] MG-CSI	OPTIONAL,
o-IM-CSI	[18] O-CSI	OPTIONAL,
o-IM-BcsmCamelTDP-CriteriaList	[19] O-BcsmCamelTDPCriteriaList	OPTIONAL,
d-IM-CSI	[20] D-CSI	OPTIONAL,
vt-IM-CSI	[21] T-CSI	OPTIONAL,
vt-IM-BCSM-CAMEL-TDP-CriteriaList	[22] T-BCSM-CAMEL-TDP-CriteriaList	OPTIONAL
...}		

AnyTimeModificationArg ::= SEQUENCE {		
subscriberIdentity	[0] SubscriberIdentity,	
gsmSCF-Address	[1] ISDN-AddressString,	
modificationRequestFor-CF-Info	[2] ModificationRequestFor-CF-Info	OPTIONAL,
modificationRequestFor-CB-Info	[3] ModificationRequestFor-CB-Info	OPTIONAL,
modificationRequestFor-CSI	[4] ModificationRequestFor-CSI	OPTIONAL,
extensionContainer	[5] ExtensionContainer	OPTIONAL,
longFTN-Supported	[6] NULL	OPTIONAL,
...,		
modificationRequestFor-ODB-data	[7] ModificationRequestFor-ODB-data	OPTIONAL }

AnyTimeModificationRes ::= SEQUENCE {		
ss-InfoFor-CSE	[0] Ext-SS-InfoFor-CSE	OPTIONAL,
camel-SubscriptionInfo	[1] CAMEL-SubscriptionInfo	OPTIONAL,
extensionContainer	[2] ExtensionContainer	OPTIONAL,
...,		
oddb-Info	[3] ODB-Info	OPTIONAL }

ModificationRequestFor-CF-Info ::= SEQUENCE {		
ss-Code	[0] SS-Code,	
basicService	[1] Ext-BasicServiceCode	OPTIONAL,
ss-Status	[2] Ext-SS-Status	OPTIONAL,
forwardedToNumber	[3] AddressString	OPTIONAL,
forwardedToSubaddress	[4] ISDN-SubaddressString	OPTIONAL,
noReplyConditionTime	[5] Ext-NoRepCondTime	OPTIONAL,
modifyNotificationToCSE	[6] ModificationInstruction	OPTIONAL,
extensionContainer	[7] ExtensionContainer	OPTIONAL,
...}		

ModificationRequestFor-CB-Info ::= SEQUENCE {		
ss-Code	[0] SS-Code,	
basicService	[1] Ext-BasicServiceCode	OPTIONAL,
ss-Status	[2] Ext-SS-Status	OPTIONAL,
password	[3] Password	OPTIONAL,
wrongPasswordAttemptsCounter	[4] WrongPasswordAttemptsCounter	OPTIONAL,
modifyNotificationToCSE	[5] ModificationInstruction	OPTIONAL,
extensionContainer	[6] ExtensionContainer	OPTIONAL,
...}		

ModificationRequestFor-ODB-data ::= SEQUENCE {		
oddb-data	[0] ODB-Data	OPTIONAL,
modifyNotificationToCSE	[1] ModificationInstruction	OPTIONAL,
extensionContainer	[2] ExtensionContainer	OPTIONAL,
...}		

```

ModificationRequestFor-CSI ::= SEQUENCE {
    requestedCamel-SubscriptionInfo [0] RequestedCAMEL-SubscriptionInfo,
    modifyNotificationToCSE [1] ModificationInstruction OPTIONAL,
    modifyCSI-State [2] ModificationInstruction OPTIONAL,
    extensionContainer [3] ExtensionContainer OPTIONAL,
    ...,
    additionalRequestedCAMEL-SubscriptionInfo
                                     [4] AdditionalRequestedCAMEL-SubscriptionInfo
                                     OPTIONAL }
-- requestedCamel-SubscriptionInfo shall be discarded if
-- additionalRequestedCAMEL-SubscriptionInfo is received

```

```

ModificationInstruction ::= ENUMERATED {
    deactivate (0),
    activate (1)}

```

-- subscriber data modification notification types

```

NoteSubscriberDataModifiedArg ::= SEQUENCE {
    imsi IMSI,
    msisdn ISDN-AddressString,
    forwardingInfoFor-CSE [0] Ext-ForwardingInfoFor-CSE OPTIONAL,
    callBarringInfoFor-CSE [1] Ext-CallBarringInfoFor-CSE OPTIONAL,
    odb-Info [2] ODB-Info OPTIONAL,
    camel-SubscriptionInfo [3] CAMEL-SubscriptionInfo OPTIONAL,
    allInformationSent [4] NULL OPTIONAL,
    extensionContainer ExtensionContainer OPTIONAL,
    ...}

```

```

NoteSubscriberDataModifiedRes ::= SEQUENCE {
    extensionContainer ExtensionContainer OPTIONAL,
    ...}

```

-- mobility management event notification info types

```

NoteMM-EventArg ::= SEQUENCE {
    serviceKey ServiceKey,
    eventMet [0] MM-Code,
    imsi [1] IMSI,
    msisdn [2] ISDN-AddressString,
    locationInformation [3] LocationInformation OPTIONAL,
    supportedCAMELPhases [5] SupportedCamelPhases OPTIONAL,
    extensionContainer [6] ExtensionContainer OPTIONAL,
    ...,
    locationInformationGPRS [7] LocationInformationGPRS OPTIONAL,
    offeredCamel4Functionalities [8] OfferedCamel4Functionalities OPTIONAL
}

```

```

NoteMM-EventRes ::= SEQUENCE {
    extensionContainer ExtensionContainer OPTIONAL,
    ...}

```

```

Ext-SS-InfoFor-CSE ::= CHOICE {
    forwardingInfoFor-CSE [0] Ext-ForwardingInfoFor-CSE,
    callBarringInfoFor-CSE [1] Ext-CallBarringInfoFor-CSE
}

```

```

Ext-ForwardingInfoFor-CSE ::= SEQUENCE {
    ss-Code [0] SS-Code,
    forwardingFeatureList [1] Ext-ForwFeatureList,
    notificationToCSE [2] NULL OPTIONAL,
    extensionContainer [3] ExtensionContainer OPTIONAL,
    ...}

```

```

Ext-CallBarringInfoFor-CSE ::= SEQUENCE {
    ss-Code [0] SS-Code,
    callBarringFeatureList [1] Ext-CallBarFeatureList,
    password [2] Password OPTIONAL,
    wrongPasswordAttemptsCounter [3] WrongPasswordAttemptsCounter OPTIONAL,
    notificationToCSE [4] NULL OPTIONAL,
    extensionContainer [5] ExtensionContainer OPTIONAL,
    ...}

```

END

17.7.2 Operation and maintenance data types

```

MAP-OM-DataTypes {
    itu-t identified-organization (4) etsi (0) mobileDomain (0)
    gsm-Network (1) modules (3) map-OM-DataTypes (12) version8 (8)}

DEFINITIONS

IMPLICIT TAGS

::=

BEGIN

EXPORTS
    ActivateTraceModeArg,
    ActivateTraceModeRes,
    DeactivateTraceModeArg,
    DeactivateTraceModeRes
;

IMPORTS
    AddressString,
    IMSI
FROM MAP-CommonDataTypes {
    itu-t identified-organization (4) etsi (0) mobileDomain (0)
    gsm-Network (1) modules (3) map-CommonDataTypes (18) version8 (8)}

    ExtensionContainer
FROM MAP-ExtensionDataTypes {
    itu-t identified-organization (4) etsi (0) mobileDomain (0)
    gsm-Network (1) modules (3) map-ExtensionDataTypes (21) version8 (8)}

;

```

ActivateTraceModeArg ::= SEQUENCE {		
imsi	[0] IMSI	OPTIONAL,
traceReference	[1] TraceReference,	
traceType	[2] TraceType,	
omc-Id	[3] AddressString	OPTIONAL,
extensionContainer	[4] ExtensionContainer	OPTIONAL,
...}		

TraceReference ::= OCTET STRING (SIZE (1..2))
--

TraceType ::= INTEGER
(0..255)
-- Trace types are fully defined in TS GSM 12.08.

ActivateTraceModeRes ::= SEQUENCE {		
extensionContainer	[0] ExtensionContainer	OPTIONAL,
...}		

DeactivateTraceModeArg ::= SEQUENCE {		
imsi	[0] IMSI	OPTIONAL,
traceReference	[1] TraceReference,	
extensionContainer	[2] ExtensionContainer	OPTIONAL,
...}		

DeactivateTraceModeRes ::= SEQUENCE {		
extensionContainer	[0] ExtensionContainer	OPTIONAL,
...}		

END

17.7.3 Call handling data types

```

MAP-CH-DataTypes {
    itu-t identified-organization (4) etsi (0) mobileDomain (0)
    gsm-Network (1) modules (3) map-CH-DataTypes (13) version8 (8)}

DEFINITIONS

IMPLICIT TAGS

::=

```

BEGIN

EXPORTS

SendRoutingInfoArg,
SendRoutingInfoRes,
ProvideRoamingNumberArg,
ProvideRoamingNumberRes,
ResumeCallHandlingArg,
ResumeCallHandlingRes,
NumberOfForwarding,
SuppressionOfAnnouncement,
CallReferenceNumber,
ProvideSIWFSNumberArg,
ProvideSIWFSNumberRes,
SIWFSSignallingModifyArg,
SIWFSSignallingModifyRes,
SetReportingStateArg,
SetReportingStateRes,
StatusReportArg,
StatusReportRes,
RemoteUserFreeArg,
RemoteUserFreeRes,
IST-AlertArg,
IST-AlertRes,
IST-CommandArg,
IST-CommandRes

;

IMPORTS

SubscriberInfo,
SupportedCamelPhases,
OfferedCamel4CSIs,
CUG-Interlock,
O-CSI,
D-CSI,
O-BcsmCamelTDPCriteriaList,
T-BCSM-CAMEL-TDP-CriteriaList,
IST-SupportIndicator,
IST-AlertTimerValue,
T-CSI,
NumberPortabilityStatus

FROM MAP-MS-DataTypes {
itu-t identified-organization (4) etsi (0) mobileDomain (0)
gsm-Network (1) modules (3) map-MS-DataTypes (11) version8 (8)}

ForwardingOptions,
SS-List,
CCBS-Feature

FROM MAP-SS-DataTypes {
itu-t identified-organization (4) etsi (0) mobileDomain (0)
gsm-Network (1) modules (3) map-SS-DataTypes (14) version8 (8)}

ISDN-AddressString,
ISDN-SubaddressString,
FTN-AddressString,
ExternalSignalInfo,
Ext-ExternalSignalInfo,
IMSI,
LMSI,
Ext-BasicServiceCode,
AlertingPattern,
NAEA-PreferredCI

FROM MAP-CommonDataTypes {
itu-t identified-organization (4) etsi (0) mobileDomain (0)
gsm-Network (1) modules (3) map-CommonDataTypes (18) version8 (8)}

ExtensionContainer

FROM MAP-ExtensionDataTypes {
itu-t identified-organization (4) etsi (0) mobileDomain (0)
gsm-Network (1) modules (3) map-ExtensionDataTypes (21) version8 (8)}

;

```

CUG-CheckInfo ::= SEQUENCE {
    cug-Interlock          CUG-Interlock,
    cug-OutgoingAccess     NULL,
    extensionContainer     ExtensionContainer
    ...}

```

```

NumberOfForwarding ::= INTEGER (1..5)

```

```

SendRoutingInfoArg ::= SEQUENCE {
    msisdn                 [0] ISDN-AddressString,
    cug-CheckInfo          [1] CUG-CheckInfo OPTIONAL,
    numberOfForwarding     [2] NumberOfForwarding OPTIONAL,
    interrogationType      [3] InterrogationType,
    or-Interrogation       [4] NULL OPTIONAL,
    or-Capability          [5] OR-Phase OPTIONAL,
    gsmc-OrGsmSCF-Address [6] ISDN-AddressString,
    callReferenceNumber    [7] CallReferenceNumber OPTIONAL,
    forwardingReason       [8] ForwardingReason OPTIONAL,
    basicServiceGroup     [9] Ext-BasicServiceCode OPTIONAL,
    networkSignalInfo     [10] ExternalSignalInfo OPTIONAL,
    camelInfo              [11] CamelInfo OPTIONAL,
    suppressionOfAnnouncement [12] SuppressionOfAnnouncement OPTIONAL,
    extensionContainer     [13] ExtensionContainer OPTIONAL,
    ...,
    alertingPattern       [14] AlertingPattern OPTIONAL,
    ccbs-Call             [15] NULL OPTIONAL,
    supportedCCBS-Phase  [16] SupportedCCBS-Phase OPTIONAL,
    additionalSignalInfo [17] Ext-ExternalSignalInfo OPTIONAL,
    istSupportIndicator   [18] IST-SupportIndicator OPTIONAL,
    pre-pagingSupported  [19] NULL OPTIONAL,
    callDiversionTreatmentIndicator [20] CallDiversionTreatmentIndicator OPTIONAL,
    longFTN-Supported    [21] NULL OPTIONAL,
    suppress-VT-CSI      [22] NULL OPTIONAL,
    suppressIncomingCallBarring [23] NULL OPTIONAL,
    gsmSCF-InitiatedCall [24] NULL OPTIONAL,
    basicServiceGroup2   [25] Ext-BasicServiceCode OPTIONAL,
    networkSignalInfo2   [26] ExternalSignalInfo OPTIONAL
}

```

```

SuppressionOfAnnouncement ::= NULL

```

```

InterrogationType ::= ENUMERATED {
    basicCall (0),
    forwarding (1)}

```

```

OR-Phase ::= INTEGER (1..127)

```

```

CallReferenceNumber ::= OCTET STRING (SIZE (1..8))

```

```

ForwardingReason ::= ENUMERATED {
    notReachable (0),
    busy (1),
    noReply (2)}

```

```

SupportedCCBS-Phase ::= INTEGER (1..127)
-- exception handling:
-- Only value 1 is used.
-- Values in the ranges 2-127 are reserved for future use.
-- If received values 2-127 shall be mapped on to value 1.

```

```

CallDiversionTreatmentIndicator ::= OCTET STRING (SIZE(1))
-- callDiversionAllowed (xxxx xx01)
-- callDiversionNotAllowed (xxxx xx10)
-- network default is call diversion allowed

```

```

SendRoutingInfoRes ::= [3] SEQUENCE {
  imsi                               [9] IMSI                               OPTIONAL,
  -- IMSI must be present if SendRoutingInfoRes is not segmented.
  -- If the TC-Result-NL segmentation option is taken the IMSI must be
  -- present in one segmented transmission of SendRoutingInfoRes.
  extendedRoutingInfo                ExtendedRoutingInfo                OPTIONAL,
  cug-CheckInfo                      [3] CUG-CheckInfo                OPTIONAL,
  cugSubscriptionFlag                [6] NULL                               OPTIONAL,
  subscriberInfo                     [7] SubscriberInfo                OPTIONAL,
  ss-List                             [1] SS-List                               OPTIONAL,
  basicService                       [5] Ext-BasicServiceCode          OPTIONAL,
  forwardingInterrogationRequired     [4] NULL                               OPTIONAL,
  vmsc-Address                       [2] ISDN-AddressString            OPTIONAL,
  extensionContainer                  [0] ExtensionContainer            OPTIONAL,
  ... ,
  naea-PreferredCI                   [10] NAEA-PreferredCI            OPTIONAL,
  -- naea-PreferredCI is included at the discretion of the HLR operator.
  ccbs-Indicators                    [11] CCBS-Indicators              OPTIONAL,
  msisdn                              [12] ISDN-AddressString            OPTIONAL,
  numberPortabilityStatus            [13] NumberPortabilityStatus      OPTIONAL,
  istAlertTimer                      [14] IST-AlertTimerValue          OPTIONAL,
  supportedCamelPhasesInVMSC         [15] SupportedCamelPhases          OPTIONAL,
  offeredCamel4CSIsInVMSC           [16] OfferedCamel4CSIs            OPTIONAL,
  routingInfo2                       [17] RoutingInfo                  OPTIONAL,
  ss-List2                           [18] SS-List                               OPTIONAL,
  basicService2                      [19] Ext-BasicServiceCode          OPTIONAL,
  allowedServices                    [20] AllowedServices              OPTIONAL,
  unavailabilityCause                 [21] UnavailabilityCause          OPTIONAL
}

```

```

AllowedServices ::= BIT STRING {
  firstServiceAllowed                (0),
  secondServiceAllowed                (1)} (SIZE (2..8))
  -- firstService is the service indicated in the networkSignalInfo
  -- secondService is the service indicated in the networkSignalInfo2
  -- Other bits than listed above shall be discarded

```

```

UnavailabilityCause ::= ENUMERATED {
  bearerServiceNotProvisioned        (1),
  teleserviceNotProvisioned          (2),
  absentSubscriber                    (3),
  busySubscriber                     (4),
  callBarred                          (5),
  cug-Reject                          (6),
  ...}
  -- exception handling:
  -- Reception of other values than the ones listed shall result in the service
  -- being unavailable for that call.

```

```

CCBS-Indicators ::= SEQUENCE {
  ccbs-Possible                      [0] NULL                               OPTIONAL,
  keepCCBS-CallIndicator              [1] NULL                               OPTIONAL,
  extensionContainer                  [2] ExtensionContainer            OPTIONAL,
  ...}

```

```

RoutingInfo ::= CHOICE {
  roamingNumber                       ISDN-AddressString,
  forwardingData                      ForwardingData}

```

```

ForwardingData ::= SEQUENCE {
  forwardedToNumber                   [5] ISDN-AddressString                OPTIONAL,
  -- When this datatype is sent from an HLR which supports CAMEL Phase 2
  -- to a GMSC which supports CAMEL Phase 2 the GMSC shall not check the
  -- format of the number
  forwardedToSubaddress               [4] ISDN-SubaddressString            OPTIONAL,
  forwardingOptions                   [6] ForwardingOptions                OPTIONAL,
  extensionContainer                  [7] ExtensionContainer            OPTIONAL,
  ... ,
  longForwardedToNumber               [8] FTN-AddressString                OPTIONAL}

```

```

ProvideRoamingNumberArg ::= SEQUENCE {
    imsi [0] IMSI,
    msc-Number [1] ISDN-AddressString,
    msisdn [2] ISDN-AddressString OPTIONAL,
    lmsi [4] LMSI OPTIONAL,
    gsm-BearerCapability [5] ExternalSignalInfo OPTIONAL,
    networkSignalInfo [6] ExternalSignalInfo OPTIONAL,
    suppressionOfAnnouncement [7] SuppressionOfAnnouncement OPTIONAL,
    gmsc-Address [8] ISDN-AddressString OPTIONAL,
    callReferenceNumber [9] CallReferenceNumber OPTIONAL,
    or-Interrogation [10] NULL OPTIONAL,
    extensionContainer [11] ExtensionContainer OPTIONAL,
    ... ,
    alertingPattern [12] AlertingPattern OPTIONAL,
    ccbs-Call [13] NULL OPTIONAL,
    supportedCamelPhasesInInterrogatingNode [15] SupportedCamelPhases OPTIONAL,
    additionalSignalInfo [14] Ext-ExternalSignalInfo OPTIONAL,
    orNotSupportedInGMSC [16] NULL OPTIONAL,
    pre-pagingSupported [17] NULL OPTIONAL,
    longFTN-Supported [18] NULL OPTIONAL,
    suppress-VT-CSI [19] NULL OPTIONAL,
    offeredCamel4CSIsInInterrogatingNode [20] OfferedCamel4CSIs OPTIONAL
}

```

```

ProvideRoamingNumberRes ::= SEQUENCE {
    roamingNumber ISDN-AddressString,
    extensionContainer ExtensionContainer OPTIONAL,
    ...}

```

```

ResumeCallHandlingArg ::= SEQUENCE {
    callReferenceNumber [0] CallReferenceNumber OPTIONAL,
    basicServiceGroup [1] Ext-BasicServiceCode OPTIONAL,
    forwardingData [2] ForwardingData OPTIONAL,
    imsi [3] IMSI OPTIONAL,
    cug-CheckInfo [4] CUG-CheckInfo OPTIONAL,
    o-CSI [5] O-CSI OPTIONAL,
    extensionContainer [7] ExtensionContainer OPTIONAL,
    ccbs-Possible [8] NULL OPTIONAL,
    msisdn [9] ISDN-AddressString OPTIONAL,
    uu-Data [10] UU-Data OPTIONAL,
    allInformationSent [11] NULL OPTIONAL,
    ... ,
    d-csi [12] D-CSI OPTIONAL,
    o-BcsmCamelTDPCriteriaList [13] O-BcsmCamelTDPCriteriaList OPTIONAL,
    basicServiceGroup2 [14] Ext-BasicServiceCode OPTIONAL
}

```

```

UU-Data ::= SEQUENCE {
    uuIndicator [0] UUIndicator OPTIONAL,
    uui [1] UUI OPTIONAL,
    uusCFInteraction [2] NULL OPTIONAL,
    extensionContainer [3] ExtensionContainer OPTIONAL,
    ...}

```

```

UUIndicator ::= OCTET STRING (SIZE (1))
-- Octets are coded according to ETS 300 356

```

```

UUI ::= OCTET STRING (SIZE (1..131))
-- Octets are coded according to ETS 300 356

```

```

ResumeCallHandlingRes ::= SEQUENCE {
    extensionContainer ExtensionContainer OPTIONAL,
    ...}

```

```

CamelInfo ::= SEQUENCE {
    supportedCamelPhases SupportedCamelPhases,
    suppress-T-CSI NULL OPTIONAL,
    extensionContainer ExtensionContainer OPTIONAL,
    ... ,
    offeredCamel4CSIs [0] OfferedCamel4CSIs OPTIONAL }

```

```

ExtendedRoutingInfo ::= CHOICE {
    routingInfo RoutingInfo,
    camelRoutingInfo [8] CamelRoutingInfo}

```

```

CamelRoutingInfo ::= SEQUENCE {
    forwardingData          ForwardingData          OPTIONAL,
    gsmcCamelSubscriptionInfo [0] GsmcCamelSubscriptionInfo,
    extensionContainer      [1] ExtensionContainer    OPTIONAL,
    ...}

```

```

GsmcCamelSubscriptionInfo ::= SEQUENCE {
    t-CSI [0] T-CSI OPTIONAL,
    o-CSI [1] O-CSI OPTIONAL,
    extensionContainer [2] ExtensionContainer OPTIONAL,
    ...,
    o-BcsmCamelTDP-CriteriaList [3] O-BcsmCamelTDPCriteriaList OPTIONAL,
    t-BCSM-CAMEL-TDP-CriteriaList [4] T-BCSM-CAMEL-TDP-CriteriaList OPTIONAL,
    d-csi [5] D-CSI OPTIONAL}

```

```

ProvidesIWFSNumberArg ::= SEQUENCE {
    gsm-BearerCapability [0] ExternalSignalInfo,
    isdn-BearerCapability [1] ExternalSignalInfo,
    call-Direction [2] CallDirection,
    b-Subscriber-Address [3] ISDN-AddressString,
    chosenChannel [4] ExternalSignalInfo,
    lowerLayerCompatibility [5] ExternalSignalInfo OPTIONAL,
    highLayerCompatibility [6] ExternalSignalInfo OPTIONAL,
    extensionContainer [7] ExtensionContainer OPTIONAL,
    ...}

```

```

CallDirection ::= OCTET STRING (SIZE (1))
    -- OCTET 1

    -- bit 1 (direction of call)
    -- 0 Mobile Originated Call (MOC)
    -- 1 Mobile Terminated Call (MTC)

```

```

ProvidesIWFSNumberRes ::= SEQUENCE {
    sIWFSNumber [0] ISDN-AddressString,
    extensionContainer [1] ExtensionContainer OPTIONAL,
    ...}

```

```

SIWFSSignallingModifyArg ::= SEQUENCE {
    channelType [0] ExternalSignalInfo OPTIONAL,
    chosenChannel [1] ExternalSignalInfo OPTIONAL,
    extensionContainer [2] ExtensionContainer OPTIONAL,
    ...}

```

```

SIWFSSignallingModifyRes ::= SEQUENCE {
    chosenChannel [0] ExternalSignalInfo OPTIONAL,
    extensionContainer [1] ExtensionContainer OPTIONAL,
    ...}

```

```

SetReportingStateArg ::= SEQUENCE {
    imsi [0] IMSI OPTIONAL,
    lmsi [1] LMSI OPTIONAL,
    ccbs-Monitoring [2] ReportingState OPTIONAL,
    extensionContainer [3] ExtensionContainer OPTIONAL,
    ...}

```

```

ReportingState ::= ENUMERATED {
    stopMonitoring (0),
    startMonitoring (1),
    ...}
    -- exception handling:
    -- reception of values 2-10 shall be mapped to 'stopMonitoring'
    -- reception of values > 10 shall be mapped to 'startMonitoring'

```

```

SetReportingStateRes ::= SEQUENCE{
    ccbs-SubscriberStatus [0] CCBS-SubscriberStatus OPTIONAL,
    extensionContainer [1] ExtensionContainer OPTIONAL,
    ...}

```

```

CCBS-SubscriberStatus ::= ENUMERATED {
  ccbsNotIdle           (0),
  ccbsIdle              (1),
  ccbsNotReachable     (2),
  ...}
-- exception handling:
-- reception of values 3-10 shall be mapped to 'ccbsNotIdle'
-- reception of values 11-20 shall be mapped to 'ccbsIdle'
-- reception of values > 20 shall be mapped to 'ccbsNotReachable'

```

```

StatusReportArg ::= SEQUENCE{
  imsi                    [0] IMSI,
  eventReportData        [1] EventReportData           OPTIONAL,
  callReportdata         [2] CallReportData             OPTIONAL,
  extensionContainer     [3] ExtensionContainer         OPTIONAL,
  ...}

```

```

EventReportData ::= SEQUENCE{
  ccbs-SubscriberStatus [0] CCBS-SubscriberStatus     OPTIONAL,
  extensionContainer     [1] ExtensionContainer         OPTIONAL,
  ...}

```

```

CallReportData ::= SEQUENCE{
  monitoringMode         [0] MonitoringMode           OPTIONAL,
  callOutcome           [1] CallOutcome               OPTIONAL,
  extensionContainer     [2] ExtensionContainer         OPTIONAL,
  ...}

```

```

MonitoringMode ::= ENUMERATED {
  a-side                 (0),
  b-side                 (1),
  ...}
-- exception handling:
-- reception of values 2-10 shall be mapped 'a-side'
-- reception of values > 10 shall be mapped to 'b-side'

```

```

CallOutcome ::= ENUMERATED {
  success                (0),
  failure                (1),
  busy                   (2),
  ...}
-- exception handling:
-- reception of values 3-10 shall be mapped to 'success'
-- reception of values 11-20 shall be mapped to 'failure'
-- reception of values > 20 shall be mapped to 'busy'

```

```

StatusReportRes ::= SEQUENCE {
  extensionContainer     [0] ExtensionContainer         OPTIONAL,
  ...}

```

```

RemoteUserFreeArg ::= SEQUENCE{
  imsi                    [0] IMSI,
  callInfo                [1] ExternalSignalInfo,
  ccbs-Feature            [2] CCBS-Feature,
  translatedB-Number     [3] ISDN-AddressString,
  replaceB-Number        [4] NULL                     OPTIONAL,
  alertingPattern        [5] AlertingPattern           OPTIONAL,
  extensionContainer     [6] ExtensionContainer         OPTIONAL,
  ...}

```

```

RemoteUserFreeRes ::= SEQUENCE{
  ruf-Outcome            [0] RUF-Outcome,
  extensionContainer     [1] ExtensionContainer         OPTIONAL,
  ...}

```

```

RUF-Outcome ::= ENUMERATED{
  accepted (0),
  rejected (1),
  noResponseFromFreeMS (2), -- T4 Expiry
  noResponseFromBusyMS (3), -- T10 Expiry
  udubFromFreeMS (4),
  udubFromBusyMS (5),
  ...}
-- exception handling:
-- reception of values 6-20 shall be mapped to 'accepted'
-- reception of values 21-30 shall be mapped to 'rejected'
-- reception of values 31-40 shall be mapped to 'noResponseFromFreeMS'
-- reception of values 41-50 shall be mapped to 'noResponseFromBusyMS'
-- reception of values 51-60 shall be mapped to 'udubFromFreeMS'
-- reception of values > 60 shall be mapped to 'udubFromBusyMS'

```

```

IST-AlertArg ::= SEQUENCE{
  imsi [0] IMSI,
  extensionContainer [1] ExtensionContainer OPTIONAL,
  ...}

```

```

IST-AlertRes ::= SEQUENCE{
  istAlertTimer [0] IST-AlertTimerValue OPTIONAL,
  istInformationWithdraw [1] NULL OPTIONAL,
  callTerminationIndicator [2] CallTerminationIndicator OPTIONAL,
  extensionContainer [3] ExtensionContainer OPTIONAL,
  ...}

```

```

IST-CommandArg ::= SEQUENCE{
  imsi [0] IMSI,
  extensionContainer [1] ExtensionContainer OPTIONAL,
  ...}

```

```

IST-CommandRes ::= SEQUENCE{
  extensionContainer ExtensionContainer OPTIONAL,
  ...}

```

```

CallTerminationIndicator ::= ENUMERATED {
  terminateCallActivityReferred (0),
  terminateAllCallActivities (1),
  ...}
-- exception handling:
-- reception of values 2-10 shall be mapped to ' terminateCallActivityReferred '
-- reception of values > 10 shall be mapped to ' terminateAllCallActivities '

-- In MSCs not supporting linkage of all call activities, any value received shall
-- be interpreted as ' terminateCallActivityReferred '

```

END

17.7.4 Supplementary service data types

```

MAP-SS-DataTypes {
  itu-t identified-organization (4) etsi (0) mobileDomain (0)
  gsm-Network (1) modules (3) map-SS-DataTypes (14) version8 (8)}

```

DEFINITIONS

IMPLICIT TAGS

::=

BEGIN

EXPORTS

```

  RegisterSS-Arg,
  SS-Info,
  SS-Status,
  SS-SubscriptionOption,
  SS-ForBS-Code,
  InterrogateSS-Res,
  USSD-Arg,
  USSD-Res,
  USSD-DataCodingScheme,
  USSD-String,
  Password,
  GuidanceInfo,

```

```

SS-List,
SS-InfoList,
OverrideCategory,
CliRestrictionOption,
NoReplyConditionTime,
ForwardingOptions,
maxNumOfSS,
SS-Data,
SS-InvocationNotificationArg,
SS-InvocationNotificationRes,
CCBS-Feature,
RegisterCC-EntryArg,
RegisterCC-EntryRes,
EraseCC-EntryArg,
EraseCC-EntryRes
;

```

IMPORTS

```

AddressString,
ISDN-AddressString,
ISDN-SubaddressString,
FTN-AddressString,
IMSI,
BasicServiceCode,
AlertingPattern,
EMLPP-Priority,
MaxMC-Bearers,
MC-Bearers,
ExternalSignalInfo
FROM MAP-CommonDataTypes {
    itu-t identified-organization (4) etsi (0) mobileDomain (0)
    gsm-Network (1) modules (3) map-CommonDataTypes (18) version8 (8)}

ExtensionContainer
FROM MAP-ExtensionDataTypes {
    itu-t identified-organization (4) etsi (0) mobileDomain (0)
    gsm-Network (1) modules (3) map-ExtensionDataTypes (21) version8 (8)}

SS-Code
FROM MAP-SS-Code {
    itu-t identified-organization (4) etsi (0) mobileDomain (0)
    gsm-Network (1) modules (3) map-SS-Code (15) version8 (8)}
;

```

RegisterSS-Arg ::= SEQUENCE {		
ss-Code	SS-Code,	
basicService	BasicServiceCode	OPTIONAL,
forwardedToNumber	[4] AddressString	OPTIONAL,
forwardedToSubaddress	[6] ISDN-SubaddressString	OPTIONAL,
noReplyConditionTime	[5] NoReplyConditionTime	OPTIONAL,
...		
defaultPriority	[7] EMLPP-Priority	OPTIONAL,
nbrUser	[8] MC-Bearers	OPTIONAL,
longFTN-Supported	[9] NULL	OPTIONAL }

NoReplyConditionTime ::= INTEGER (5..30)

SS-Info ::= CHOICE {	
forwardingInfo	[0] ForwardingInfo,
callBarringInfo	[1] CallBarringInfo,
ss-Data	[3] SS-Data}

ForwardingInfo ::= SEQUENCE {		
ss-Code	SS-Code	OPTIONAL,
forwardingFeatureList	ForwardingFeatureList,	
...		

ForwardingFeatureList ::=	
SEQUENCE SIZE (1..maxNumOfBasicServiceGroups) OF	ForwardingFeature

```

ForwardingFeature ::= SEQUENCE {
    basicService                BasicServiceCode                OPTIONAL,
    ss-Status                   [4] SS-Status                 OPTIONAL,
    forwardedToNumber           [5] ISDN-AddressString         OPTIONAL,
    forwardedToSubaddress       [8] ISDN-SubaddressString       OPTIONAL,
    forwardingOptions           [6] ForwardingOptions           OPTIONAL,
    noReplyConditionTime        [7] NoReplyConditionTime        OPTIONAL,
    ...,
    longForwardedToNumber       [9] FTN-AddressString           OPTIONAL }

```

```

SS-Status ::= OCTET STRING (SIZE (1))

-- bits 8765: 0000 (unused)
-- bits 4321: Used to convey the "P bit", "R bit", "A bit" and "Q bit",
--             representing supplementary service state information
--             as defined in TS 3GPP TS 23.011 [22]

-- bit 4: "Q bit"
-- bit 3: "P bit"
-- bit 2: "R bit"
-- bit 1: "A bit"

```

```

ForwardingOptions ::= OCTET STRING (SIZE (1))

-- bit 8: notification to forwarding party
-- 0 no notification
-- 1 notification

-- bit 7: redirecting presentation
-- 0 no presentation
-- 1 presentation

-- bit 6: notification to calling party
-- 0 no notification
-- 1 notification

-- bit 5: 0 (unused)

-- bits 43: forwarding reason
-- 00 ms not reachable
-- 01 ms busy
-- 10 no reply
-- 11 unconditional when used in a SRI Result,
--     or call deflection when used in a RCH Argument
-- bits 21: 00 (unused)

```

```

CallBarringInfo ::= SEQUENCE {
    ss-Code                    SS-Code                        OPTIONAL,
    callBarringFeatureList     CallBarringFeatureList,
    ...}

```

```

CallBarringFeatureList ::= SEQUENCE SIZE (1..maxNumOfBasicServiceGroups) OF
    CallBarringFeature

```

```

CallBarringFeature ::= SEQUENCE {
    basicService                BasicServiceCode                OPTIONAL,
    ss-Status [4] SS-Status    OPTIONAL,
    ...}

```

```

SS-Data ::= SEQUENCE {
    ss-Code                    SS-Code                        OPTIONAL,
    ss-Status                  [4] SS-Status                 OPTIONAL,
    ss-SubscriptionOption      SS-SubscriptionOption         OPTIONAL,
    basicServiceGroupList     BasicServiceGroupList         OPTIONAL,
    ...,
    defaultPriority            EMLPP-Priority                 OPTIONAL,
    nbrUser                    [5] MC-Bearers                 OPTIONAL
}

```

```

SS-SubscriptionOption ::= CHOICE {
    cliRestrictionOption       [2] CliRestrictionOption,
    overrideCategory           [1] OverrideCategory}

```

```

CliRestrictionOption ::= ENUMERATED {
    permanent (0),
    temporaryDefaultRestricted (1),
    temporaryDefaultAllowed (2)}

```

```

OverrideCategory ::= ENUMERATED {
    overrideEnabled (0),
    overrideDisabled (1)}

```

```

SS-ForBS-Code ::= SEQUENCE {
    ss-Code                               SS-Code,
    basicService                           BasicServiceCode           OPTIONAL,
    ...,
    longFTN-Supported                       [4] NULL                       OPTIONAL }

```

```

GenericServiceInfo ::= SEQUENCE {
    ss-Status SS-Status,
    cliRestrictionOption                   CliRestrictionOption         OPTIONAL,
    ...,
    maximumEntitledPriority                 [0] EMLPP-Priority           OPTIONAL,
    defaultPriority                         [1] EMLPP-Priority           OPTIONAL,
    ccbs-FeatureList                       [2] CCBS-FeatureList         OPTIONAL,
    nbrSB                                   [3] MaxMC-Bearers            OPTIONAL,
    nbrUser                                 [4] MC-Bearers                OPTIONAL,
    nbrSN                                   [5] MC-Bearers                OPTIONAL }

```

```

CCBS-FeatureList ::= SEQUENCE SIZE (1..maxNumOfCCBS-Requests) OF
    CCBS-Feature

```

```

maxNumOfCCBS-Requests INTEGER ::= 5

```

```

CCBS-Feature ::= SEQUENCE {
    ccbs-Index                             [0] CCBS-Index               OPTIONAL,
    b-subscriberNumber                     [1] ISDN-AddressString       OPTIONAL,
    b-subscriberSubaddress                 [2] ISDN-SubaddressString    OPTIONAL,
    basicServiceGroup                     [3] BasicServiceCode         OPTIONAL,
    ...}

```

```

CCBS-Index ::= INTEGER (1..maxNumOfCCBS-Requests)

```

```

InterrogateSS-Res ::= CHOICE {
    ss-Status                               [0] SS-Status,
    basicServiceGroupList                   [2] BasicServiceGroupList,
    forwardingFeatureList                   [3] ForwardingFeatureList,
    genericServiceInfo                     [4] GenericServiceInfo }

```

```

USSD-Arg ::= SEQUENCE {
    ussd-DataCodingScheme                   USSD-DataCodingScheme,
    ussd-String                             USSD-String,
    ...,
    alertingPattern                         AlertingPattern               OPTIONAL,
    msisdn                                  [0] ISDN-AddressString       OPTIONAL }

```

```

USSD-Res ::= SEQUENCE {
    ussd-DataCodingScheme                   USSD-DataCodingScheme,
    ussd-String                             USSD-String,
    ...}

```

```

USSD-DataCodingScheme ::= OCTET STRING (SIZE (1))
-- The structure of the USSD-DataCodingScheme is defined by
-- the Cell Broadcast Data Coding Scheme as described in
-- TS 3GPP TS 23.038 [25]

```

```

USSD-String ::= OCTET STRING (SIZE (1..maxUSSD-StringLength))
-- The structure of the contents of the USSD-String is dependent
-- on the USSD-DataCodingScheme as described in TS 3GPP TS 23.038 [25].

```

```

maxUSSD-StringLength INTEGER ::= 160

```

```

Password ::= NumericString
    (FROM ("0"|"1"|"2"|"3"|"4"|"5"|"6"|"7"|"8"|"9"))
    (SIZE (4))

```

<pre> GuidanceInfo ::= ENUMERATED { enterPW (0), enterNewPW (1), enterNewPW-Again (2)} -- How this information is really delivered to the subscriber -- (display, announcement, ...) is not part of this -- specification. </pre>
<pre> SS-List ::= SEQUENCE SIZE (1..maxNumOfSS) OF SS-Code </pre>
<pre> maxNumOfSS INTEGER ::= 30 </pre>
<pre> SS-InfoList ::= SEQUENCE SIZE (1..maxNumOfSS) OF SS-Info </pre>
<pre> BasicServiceGroupList ::= SEQUENCE SIZE (1..maxNumOfBasicServiceGroups) OF BasicServiceCode </pre>
<pre> maxNumOfBasicServiceGroups INTEGER ::= 13 </pre>
<pre> SS-InvocationNotificationArg ::= SEQUENCE { imsi [0] IMSI, msisdn [1] ISDN-AddressString, ss-Event [2] SS-Code, -- The following SS-Code values are allowed : -- ect SS-Code ::= '00110001'B -- multiPTY SS-Code ::= '01010001'B -- cd SS-Code ::= '00100100'B -- ccbs SS-Code ::= '01000100'B ss-EventSpecification [3] SS-EventSpecification OPTIONAL, extensionContainer [4] ExtensionContainer OPTIONAL, ..., b-subscriberNumber [5] ISDN-AddressString OPTIONAL, ccbs-RequestState [6] CCBS-RequestState OPTIONAL } </pre>
<pre> CCBS-RequestState ::= ENUMERATED { request (0), recall (1), active (2), completed (3), suspended (4), frozen (5), deleted (6) } </pre>
<pre> SS-InvocationNotificationRes ::= SEQUENCE { extensionContainer ExtensionContainer OPTIONAL, ... } </pre>
<pre> SS-EventSpecification ::= SEQUENCE SIZE (1..maxEventSpecification) OF AddressString </pre>
<pre> maxEventSpecification INTEGER ::= 2 </pre>
<pre> RegisterCC-EntryArg ::= SEQUENCE { ss-Code [0] SS-Code, ccbs-Data [1] CCBS-Data OPTIONAL, ... } </pre>
<pre> CCBS-Data ::= SEQUENCE { ccbs-Feature [0] CCBS-Feature, translatedB-Number [1] ISDN-AddressString, serviceIndicator [2] ServiceIndicator OPTIONAL, callInfo [3] ExternalSignalInfo, networkSignalInfo [4] ExternalSignalInfo, ... } </pre>
<pre> ServiceIndicator ::= BIT STRING { clir-invoked (0), camel-invoked (1)} (SIZE(2..32)) -- exception handling: -- bits 2 to 31 shall be ignored if received and not understood </pre>

```
RegisterCC-EntryRes ::= SEQUENCE {
    ccbs-Feature          [0] CCBS-Feature          OPTIONAL,
    ...}

```

```
EraseCC-EntryArg ::= SEQUENCE {
    ss-Code              [0] SS-Code,
    ccbs-Index          [1] CCBS-Index          OPTIONAL,
    ...}

```

```
EraseCC-EntryRes ::= SEQUENCE {
    ss-Code              [0] SS-Code,
    ss-Status           [1] SS-Status          OPTIONAL,
    ...}

```

END

17.7.5 Supplementary service codes

```
MAP-SS-Code {
    itu-t identified-organization (4) etsi (0) mobileDomain (0)
    gsm-Network (1) modules (3) map-SS-Code (15) version8 (8)}

```

DEFINITIONS

::=

BEGIN

```
SS-Code ::= OCTET STRING (SIZE (1))
-- This type is used to represent the code identifying a single
-- supplementary service, a group of supplementary services, or
-- all supplementary services. The services and abbreviations
-- used are defined in TS 3GPP TS 22.004 [5]. The internal structure is
-- defined as follows:
--
-- bits 87654321: group (bits 8765), and specific service
-- (bits 4321)

```

```
allSS          SS-Code ::= '00000000'B
-- reserved for possible future use
-- all SS

```

```
allLineIdentificationSS  SS-Code ::= '00010000'B
-- reserved for possible future use
-- all line identification SS
clip          SS-Code ::= '00010001'B
-- calling line identification presentation
clir          SS-Code ::= '00010010'B
-- calling line identification restriction
colp          SS-Code ::= '00010011'B
-- connected line identification presentation
colr          SS-Code ::= '00010100'B
-- connected line identification restriction
mci          SS-Code ::= '00010101'B
-- reserved for possible future use
-- malicious call identification

allNameIdentificationSS  SS-Code ::= '00011000'B
-- all name identification SS
cnap          SS-Code ::= '00011001'B
-- calling name presentation

-- SS-Codes '00011010'B to '00011111'B are reserved for future
-- NameIdentification Supplementary Service use.

```

allForwardingSS	SS-Code ::= '00100000'B
<i>-- all forwarding SS</i>	
cfu	SS-Code ::= '00100001'B
<i>-- call forwarding unconditional</i>	
allCondForwardingSS	SS-Code ::= '00101000'B
<i>-- all conditional forwarding SS</i>	
cfb	SS-Code ::= '00101001'B
<i>-- call forwarding on mobile subscriber busy</i>	
cfnry	SS-Code ::= '00101010'B
<i>-- call forwarding on no reply</i>	
cfnrc	SS-Code ::= '00101011'B
<i>-- call forwarding on mobile subscriber not reachable</i>	
cd	SS-Code ::= '00100100'B
<i>-- call deflection</i>	

allCallOfferingSS	SS-Code ::= '00110000'B
<i>-- reserved for possible future use</i>	
<i>-- all call offering SS includes also all forwarding SS</i>	
ect	SS-Code ::= '00110001'B
<i>-- explicit call transfer</i>	
mah	SS-Code ::= '00110010'B
<i>-- reserved for possible future use</i>	
<i>-- mobile access hunting</i>	

allCallCompletionSS	SS-Code ::= '01000000'B
<i>-- reserved for possible future use</i>	
<i>-- all Call completion SS</i>	
cw	SS-Code ::= '01000001'B
<i>-- call waiting</i>	
hold	SS-Code ::= '01000010'B
<i>-- call hold</i>	
ccbs-A	SS-Code ::= '01000011'B
<i>-- completion of call to busy subscribers, originating side</i>	
ccbs-B	SS-Code ::= '01000100'B
<i>-- completion of call to busy subscribers, destination side</i>	
<i>-- this SS-Code is used only in InsertSubscriberData and DeleteSubscriberData</i>	
mc	SS-Code ::= '01000101'B
<i>-- multical</i>	

allMultiPartySS	SS-Code ::= '01010000'B
<i>-- reserved for possible future use</i>	
<i>-- all multiparty SS</i>	
multiPTY	SS-Code ::= '01010001'B
<i>-- multiparty</i>	

allCommunityOfInterest-SS	SS-Code ::= '01100000'B
<i>-- reserved for possible future use</i>	
<i>-- all community of interest SS</i>	
cug	SS-Code ::= '01100001'B
<i>-- closed user group</i>	

allChargingSS	SS-Code ::= '01110000'B
<i>-- reserved for possible future use</i>	
<i>-- all charging SS</i>	
aoci	SS-Code ::= '01110001'B
<i>-- advice of charge information</i>	
aocc	SS-Code ::= '01110010'B
<i>-- advice of charge charging</i>	

allAdditionalInfoTransferSS	SS-Code ::= '10000000'B
<i>-- reserved for possible future use</i>	
<i>-- all additional information transfer SS</i>	
uus1	SS-Code ::= '10000001'B
<i>-- UUS1 user-to-user signalling</i>	
uus2	SS-Code ::= '10000010'B
<i>-- UUS2 user-to-user signalling</i>	
uus3	SS-Code ::= '10000011'B
<i>-- UUS3 user-to-user signalling</i>	

allBarringSS	SS-Code ::= '10010000'B
-- all barring SS	
barringOfOutgoingCalls	SS-Code ::= '10010001'B
-- barring of outgoing calls	
baoc	SS-Code ::= '10010010'B
-- barring of all outgoing calls	
boic	SS-Code ::= '10010011'B
-- barring of outgoing international calls	
boicExHC	SS-Code ::= '10010100'B
-- barring of outgoing international calls except those directed to the home PLMN	
barringOfIncomingCalls	SS-Code ::= '10011001'B
-- barring of incoming calls	
baic	SS-Code ::= '10011010'B
-- barring of all incoming calls	
bicRoam	SS-Code ::= '10011011'B
-- barring of incoming calls when roaming outside home PLMN Country	

allPLMN-specificSS	SS-Code ::= '11110000'B
plmn-specificSS-1	SS-Code ::= '11110001'B
plmn-specificSS-2	SS-Code ::= '11110010'B
plmn-specificSS-3	SS-Code ::= '11110011'B
plmn-specificSS-4	SS-Code ::= '11110100'B
plmn-specificSS-5	SS-Code ::= '11110101'B
plmn-specificSS-6	SS-Code ::= '11110110'B
plmn-specificSS-7	SS-Code ::= '11110111'B
plmn-specificSS-8	SS-Code ::= '11111000'B
plmn-specificSS-9	SS-Code ::= '11111001'B
plmn-specificSS-A	SS-Code ::= '11111010'B
plmn-specificSS-B	SS-Code ::= '11111011'B
plmn-specificSS-C	SS-Code ::= '11111100'B
plmn-specificSS-D	SS-Code ::= '11111101'B
plmn-specificSS-E	SS-Code ::= '11111110'B
plmn-specificSS-F	SS-Code ::= '11111111'B

allCallPrioritySS	SS-Code ::= '10100000'B
-- reserved for possible future use	
-- all call priority SS	
emlpp	SS-Code ::= '10100001'B
-- enhanced Multilevel Precedence Pre-emption (EMLPP) service	

allLCSPrivacyException	SS-Code ::= '10110000'B
-- all LCS Privacy Exception Classes	
universal	SS-Code ::= '10110001'B
-- allow location by any LCS client	
callSessionRelated	SS-Code ::= '10110010'B
-- allow location by any value added LCS client to which a call/session is established from the target MS	
callSessionUnrelated	SS-Code ::= '10110011'B
-- allow location by designated external value added LCS clients	
plmnoperator	SS-Code ::= '10110100'B
-- allow location by designated PLMN operator LCS clients	
serviceType	SS-Code ::= '10110101'B
-- allow location by LCS clients of a designated LCS service type	

allMOLR-SS	SS-Code ::= '11000000'B
-- all Mobile Originating Location Request Classes	
basicSelfLocation	SS-Code ::= '11000001'B
-- allow an MS to request its own location	
autonomousSelfLocation	SS-Code ::= '11000010'B
-- allow an MS to perform self location without interaction with the PLMN for a predetermined period of time	
transferToThirdParty	SS-Code ::= '11000011'B
-- allow an MS to request transfer of its location to another LCS client	

END

17.7.6 Short message data types

```
MAP-SM-DataTypes {
  itu-t identified-organization (4) etsi (0) mobileDomain (0)
  gsm-Network (1) modules (3) map-SM-DataTypes (16) version8 (8)}
```

DEFINITIONS

IMPLICIT TAGS

```
 ::=
```

```
 BEGIN
```

```
 EXPORTS
```

```
 RoutingInfoForSM-Arg,
 RoutingInfoForSM-Res,
 MO-ForwardSM-Arg,
 MO-ForwardSM-Res,
 MT-ForwardSM-Arg,
 MT-ForwardSM-Res,
 ReportSM-DeliveryStatusArg,
 ReportSM-DeliveryStatusRes,
 AlertServiceCentreArg,
 InformServiceCentreArg,
 ReadyForSM-Arg,
 ReadyForSM-Res,
 SM-DeliveryOutcome,
 AlertReason,
 Additional-Number
```

```
 ;
```

```
 IMPORTS
```

```
 AddressString,
 ISDN-AddressString,
 SignalInfo,
 IMSI,
 LMSI
```

```
 FROM MAP-CommonDataTypes {
   itu-t identified-organization (4) etsi (0) mobileDomain (0)
   gsm-Network (1) modules (3) map-CommonDataTypes (18) version8 (8)}
```

```
 AbsentSubscriberDiagnosticSM
```

```
 FROM MAP-ER-DataTypes {
   itu-t identified-organization (4) etsi (0) mobileDomain (0)
   gsm-Network (1) modules (3) map-ER-DataTypes (17) version8 (8)}
```

```
 ExtensionContainer
```

```
 FROM MAP-ExtensionDataTypes {
   itu-t identified-organization (4) etsi (0) mobileDomain (0)
   gsm-Network (1) modules (3) map-ExtensionDataTypes (21) version8 (8)}
```

```
 ;
```

```
 RoutingInfoForSM-Arg ::= SEQUENCE {
   msisdn                [0] ISDN-AddressString,
   sm-RP-PRI             [1] BOOLEAN,
   serviceCentreAddress [2] AddressString,
   extensionContainer    [6] ExtensionContainer OPTIONAL,
   ... ,
   gprsSupportIndicator [7] NULL OPTIONAL,
   -- gprsSupportIndicator is set only if the SMS-GMSC supports
   -- receiving of two numbers from the HLR
   sm-RP-MTI             [8] SM-RP-MTI OPTIONAL,
   sm-RP-SMEA           [9] SM-RP-SMEA OPTIONAL }
```

```
 SM-RP-MTI ::= INTEGER (0..10)
   -- 0 SMS Deliver
   -- 1 SMS Status Report
   -- other values are reserved for future use and shall be discarded if
   -- received
```

```
 SM-RP-SMEA ::= OCTET STRING (SIZE (1..12))
   -- this parameter contains an address field which is encoded
   -- as defined in 3GPP TS 23.040. An address field contains 3 elements :
   --     address-length
   --     type-of-address
   --     address-value
```

```
 RoutingInfoForSM-Res ::= SEQUENCE {
   imsi                IMSI,
   locationInfoWithLMSI [0] LocationInfoWithLMSI,
   extensionContainer  [4] ExtensionContainer OPTIONAL,
   ... }
```

```

LocationInfoWithLMSI ::= SEQUENCE {
    networkNode-Number          [1] ISDN-AddressString,
    lmsi                        LMSI                                OPTIONAL,
    extensionContainer          ExtensionContainer                OPTIONAL,
    ...,
    gprsNodeIndicator          [5] NULL                        OPTIONAL,
    -- gprsNodeIndicator is set only if the SGSN number is sent as the
    -- Network Node Number
    additional-Number          [6] Additional-Number            OPTIONAL
    -- NetworkNode-number can be either msc-number or sgsn-number
}

```

```

Additional-Number ::= CHOICE {
    msc-Number                  [0] ISDN-AddressString,
    sgsn-Number                 [1] ISDN-AddressString}
-- additional-number can be either msc-number or sgsn-number
-- if received networkNode-number is msc-number then the
-- additional number is sgsn-number
-- if received networkNode-number is sgsn-number then the
-- additional number is msc-number

```

```

MO-ForwardSM-Arg ::= SEQUENCE {
    sm-RP-DA                    SM-RP-DA,
    sm-RP-OA                    SM-RP-OA,
    sm-RP-UI                    SignalInfo,
    extensionContainer          ExtensionContainer                OPTIONAL,
    ... ,
    imsi                        IMSI                            OPTIONAL }

```

```

MO-ForwardSM-Res ::= SEQUENCE {
    sm-RP-UI                    SignalInfo                    OPTIONAL,
    extensionContainer          ExtensionContainer                OPTIONAL,
    ...}

```

```

MT-ForwardSM-Arg ::= SEQUENCE {
    sm-RP-DA                    SM-RP-DA,
    sm-RP-OA                    SM-RP-OA,
    sm-RP-UI                    SignalInfo,
    moreMessagesToSend         NULL                        OPTIONAL,
    extensionContainer          ExtensionContainer                OPTIONAL,
    ...}

```

```

MT-ForwardSM-Res ::= SEQUENCE {
    sm-RP-UI                    SignalInfo                    OPTIONAL,
    extensionContainer          ExtensionContainer                OPTIONAL,
    ...}

```

```

SM-RP-DA ::= CHOICE {
    imsi                        [0] IMSI,
    lmsi                        [1] LMSI,
    serviceCentreAddressDA     [4] AddressString,
    noSM-RP-DA                 [5] NULL}

```

```

SM-RP-OA ::= CHOICE {
    msisdn                      [2] ISDN-AddressString,
    serviceCentreAddressOA     [4] AddressString,
    noSM-RP-OA                 [5] NULL}

```



```

ReportSM-DeliveryStatusArg ::= SEQUENCE {
    msisdn                ISDN-AddressString,
    serviceCentreAddress  AddressString,
    sm-DeliveryOutcome    SM-DeliveryOutcome,
    absentSubscriberDiagnosticSM  [0] AbsentSubscriberDiagnosticSM
                                OPTIONAL,
    extensionContainer    [1] ExtensionContainer      OPTIONAL,
    ...,
    gprsSupportIndicator  [2] NULL                    OPTIONAL,
    -- gprsSupportIndicator is set only if the SMS-GMSC supports
    -- handling of two delivery outcomes
    deliveryOutcomeIndicator  [3] NULL                OPTIONAL,
    -- DeliveryOutcomeIndicator is set when the SM-DeliveryOutcome
    -- is for GPRS
    additionalSM-DeliveryOutcome  [4] SM-DeliveryOutcome  OPTIONAL,
    -- If received, additionalSM-DeliveryOutcome is for GPRS
    -- If DeliveryOutcomeIndicator is set, then AdditionalSM-DeliveryOutcome shall be absent
    additionalAbsentSubscriberDiagnosticSM  [5] AbsentSubscriberDiagnosticSM OPTIONAL
    -- If received additionalAbsentSubscriberDiagnosticSM is for GPRS
    -- If DeliveryOutcomeIndicator is set, then AdditionalAbsentSubscriberDiagnosticSM
    -- shall be absent
}

```

```

SM-DeliveryOutcome ::= ENUMERATED {
    memoryCapacityExceeded (0),
    absentSubscriber (1),
    successfulTransfer (2)}

```

```

ReportSM-DeliveryStatusRes ::= SEQUENCE {
    storedMSISDN          ISDN-AddressString          OPTIONAL,
    extensionContainer    ExtensionContainer          OPTIONAL,
    ...}

```

```

AlertServiceCentreArg ::= SEQUENCE {
    msisdn                ISDN-AddressString,
    serviceCentreAddress  AddressString,
    ...}

```

```

InformServiceCentreArg ::= SEQUENCE {
    storedMSISDN          ISDN-AddressString          OPTIONAL,
    mw-Status MW-Status  OPTIONAL,
    extensionContainer    ExtensionContainer          OPTIONAL,
    ...,
    absentSubscriberDiagnosticSM  AbsentSubscriberDiagnosticSM  OPTIONAL,
    additionalAbsentSubscriberDiagnosticSM  [0] AbsentSubscriberDiagnosticSM OPTIONAL }
    -- additionalAbsentSubscriberDiagnosticSM may be present only if
    -- absentSubscriberDiagnosticSM is present.
    -- if included, additionalAbsentSubscriberDiagnosticSM is for GPRS and
    -- absentSubscriberDiagnosticSM is for non-GPRS

```

```

MW-Status ::= BIT STRING {
    sc-AddressNotIncluded (0),
    mnrf-Set (1),
    mcef-Set (2),
    mnrg-Set (3)} (SIZE (6..16))
    -- exception handling:
    -- bits 4 to 15 shall be ignored if received and not understood

```

```

ReadyForSM-Arg ::= SEQUENCE {
    imsi                [0] IMSI,
    alertReason          AlertReason,
    alertReasonIndicator  NULL                    OPTIONAL,
    -- alertReasonIndicator is set only when the alertReason
    -- sent to HLR is for GPRS
    extensionContainer    ExtensionContainer          OPTIONAL,
    ...}

```

```

ReadyForSM-Res ::= SEQUENCE {
    extensionContainer    ExtensionContainer          OPTIONAL,
    ...}

```

```

AlertReason ::= ENUMERATED {
    ms-Present (0),
    memoryAvailable (1)}

```

END

17.7.7 Error data types

```
MAP-ER-DataTypes {
  itu-t identified-organization (4) etsi (0) mobileDomain (0)
  gsm-Network (1) modules (3) map-ER-DataTypes (17) version8 (8)}
```

DEFINITIONS

IMPLICIT TAGS

::=

BEGIN

EXPORTS

```
RoamingNotAllowedParam,
CallBarredParam,
CUG-RejectParam,
SS-IncompatibilityCause,
PW-RegistrationFailureCause,
SM-DeliveryFailureCause,
SystemFailureParam,
DataMissingParam,
UnexpectedDataParam,
FacilityNotSupParam,
OR-NotAllowedParam,
UnknownSubscriberParam,
NumberChangedParam,
UnidentifiedSubParam,
IllegalSubscriberParam,
IllegalEquipmentParam,
BearerServNotProvParam,
TeleservNotProvParam,
TracingBufferFullParam,
NoRoamingNbParam,
AbsentSubscriberParam,
BusySubscriberParam,
NoSubscriberReplyParam,
ForwardingViolationParam,
ForwardingFailedParam,
ATI-NotAllowedParam,
SubBusyForMT-SMS-Param,
MessageWaitListFullParam,
AbsentSubscriberSM-Param,
AbsentSubscriberDiagnosticSM,
ResourceLimitationParam,
NoGroupCallNbParam,
IncompatibleTerminalParam,
ShortTermDenialParam,
LongTermDenialParam,
UnauthorizedRequestingNetwork-Param,
UnauthorizedLCSCClient-Param,
PositionMethodFailure-Param,
UnknownOrUnreachableLCSCClient-Param,
MM-EventNotSupported-Param,
ATSI-NotAllowedParam,
ATM-NotAllowedParam,
IllegalSS-OperationParam,
SS-NotAvailableParam,
SS-SubscriptionViolationParam,
InformationNotAvailableParam,
TargetCellOutsideGCA-Param
```

;

IMPORTS

```
SS-Status
```

```
FROM MAP-SS-DataTypes {
  itu-t identified-organization (4) etsi (0) mobileDomain (0)
  gsm-Network (1) modules (3) map-SS-DataTypes (14) version8 (8)}
```

```
SignalInfo,
BasicServiceCode,
NetworkResource
```

```
FROM MAP-CommonDataTypes {
```

```
itu-t identified-organization (4) etsi (0) mobileDomain (0)
gsm-Network (1) modules (3) map-CommonDataTypes (18) version8 (8)}
```

```
SS-Code
FROM MAP-SS-Code {
  itu-t identified-organization (4) etsi (0) mobileDomain (0)
  gsm-Network (1) modules (3) map-SS-Code (15) version8 (8)}

ExtensionContainer
FROM MAP-ExtensionDataTypes {
  itu-t identified-organization (4) etsi (0) mobileDomain (0)
  gsm-Network (1) modules (3) map-ExtensionDataTypes (21) version8 (8)}
;
```

```
RoamingNotAllowedParam ::= SEQUENCE {
  roamingNotAllowedCause          RoamingNotAllowedCause,
  extensionContainer              ExtensionContainer          OPTIONAL,
  ...}
```

```
RoamingNotAllowedCause ::= ENUMERATED {
  plmnRoamingNotAllowed (0),
  operatorDeterminedBarring (3)}
```

```
CallBarredParam ::= CHOICE {
  callBarringCause              CallBarringCause,
  -- call BarringCause must not be used in version 3 and higher
  extensibleCallBarredParam     ExtensibleCallBarredParam
  -- extensibleCallBarredParam must not be used in version <3
}
```

```
CallBarringCause ::= ENUMERATED {
  barringServiceActive (0),
  operatorBarring (1)}
```

```
ExtensibleCallBarredParam ::= SEQUENCE {
  callBarringCause              CallBarringCause          OPTIONAL,
  extensionContainer            ExtensionContainer          OPTIONAL,
  ... ,
  unauthorisedMessageOriginator [1] NULL                OPTIONAL }
```

```
CUG-RejectParam ::= SEQUENCE {
  cug-RejectCause              CUG-RejectCause          OPTIONAL,
  extensionContainer            ExtensionContainer          OPTIONAL,
  ...}
```

```
CUG-RejectCause ::= ENUMERATED {
  incomingCallsBarredWithinCUG (0),
  subscriberNotMemberOfCUG (1),
  requestedBasicServiceViolatesCUG-Constraints (5),
  calledPartySS-InteractionViolation (7)}
```

```
SS-IncompatibilityCause ::= SEQUENCE {
  ss-Code                      [1] SS-Code              OPTIONAL,
  basicService                  BasicServiceCode         OPTIONAL,
  ss-Status                     [4] SS-Status            OPTIONAL,
  ...}
```

```
PW-RegistrationFailureCause ::= ENUMERATED {
  undetermined (0),
  invalidFormat (1),
  newPasswordsMismatch (2)}
```

```
SM-EnumeratedDeliveryFailureCause ::= ENUMERATED {
  memoryCapacityExceeded (0),
  equipmentProtocolError (1),
  equipmentNotSM-Equipped (2),
  unknownServiceCentre (3),
  sc-Congestion (4),
  invalidSME-Address (5),
  subscriberNotSC-Subscriber (6)}
```

```

SM-DeliveryFailureCause ::= SEQUENCE {
    sm-EnumeratedDeliveryFailureCause SM-EnumeratedDeliveryFailureCause,
    diagnosticInfo                      SignalInfo                      OPTIONAL,
    extensionContainer                  ExtensionContainer              OPTIONAL,
    ...}

```

```

AbsentSubscriberSM-Param ::= SEQUENCE {
    absentSubscriberDiagnosticSM        AbsentSubscriberDiagnosticSM    OPTIONAL,
    -- AbsentSubscriberDiagnosticSM can be either for non-GPRS
    -- or for GPRS
    extensionContainer                  ExtensionContainer              OPTIONAL,
    ...,
    additionalAbsentSubscriberDiagnosticSM [0] AbsentSubscriberDiagnosticSM OPTIONAL }
    -- if received, additionalAbsentSubscriberDiagnosticSM
    -- is for GPRS and absentSubscriberDiagnosticSM is
    -- for non-GPRS

```

```

AbsentSubscriberDiagnosticSM ::= INTEGER (0..255)
    -- AbsentSubscriberDiagnosticSM values are defined in 3GPP TS 23.040

```

```

SystemFailureParam ::= CHOICE {
    networkResource                    NetworkResource,
    -- networkResource must not be used in version 3
    extensibleSystemFailureParam       ExtensibleSystemFailureParam
    -- extensibleSystemFailureParam must not be used in version <3
}

```

```

ExtensibleSystemFailureParam ::= SEQUENCE {
    networkResource                    NetworkResource                OPTIONAL,
    extensionContainer                  ExtensionContainer              OPTIONAL,
    ...}

```

```

DataMissingParam ::= SEQUENCE {
    extensionContainer                  ExtensionContainer              OPTIONAL,
    ...}

```

```

UnexpectedDataParam ::= SEQUENCE {
    extensionContainer                  ExtensionContainer              OPTIONAL,
    ...}

```

```

FacilityNotSupParam ::= SEQUENCE {
    extensionContainer                  ExtensionContainer              OPTIONAL,
    ...,
    shapeOfLocationEstimateNotSupported [0] NULL                      OPTIONAL,
    neededLcsCapabilityNotSupportedInServingNode [1] NULL              OPTIONAL }

```

```

OR-NotAllowedParam ::= SEQUENCE {
    extensionContainer                  ExtensionContainer              OPTIONAL,
    ...}

```

```

UnknownSubscriberParam ::= SEQUENCE {
    extensionContainer                  ExtensionContainer              OPTIONAL,
    ...,
    unknownSubscriberDiagnostic         UnknownSubscriberDiagnostic     OPTIONAL}

```

```

UnknownSubscriberDiagnostic ::= ENUMERATED {
    imsiUnknown (0),
    gprsSubscriptionUnknown (1),
    ...,
    npdbMismatch (2)}
    -- if unknown values are received in
    -- UnknownSubscriberDiagnostic they shall be discarded

```

```

NumberChangedParam ::= SEQUENCE {
    extensionContainer                  ExtensionContainer              OPTIONAL,
    ...}

```

```

UnidentifiedSubParam ::= SEQUENCE {
    extensionContainer                  ExtensionContainer              OPTIONAL,
    ...}

```

```

IllegalSubscriberParam ::= SEQUENCE {
    extensionContainer                  ExtensionContainer              OPTIONAL,
    ...}

```

IllegalEquipmentParam ::= SEQUENCE { extensionContainer ...}	ExtensionContainer	OPTIONAL,
BearerServNotProvParam ::= SEQUENCE { extensionContainer ...}	ExtensionContainer	OPTIONAL,
TeleservNotProvParam ::= SEQUENCE { extensionContainer ...}	ExtensionContainer	OPTIONAL,
TracingBufferFullParam ::= SEQUENCE { extensionContainer ...}	ExtensionContainer	OPTIONAL,
NoRoamingNbParam ::= SEQUENCE { extensionContainer ...}	ExtensionContainer	OPTIONAL,
AbsentSubscriberParam ::= SEQUENCE { extensionContainer ..., absentSubscriberReason	ExtensionContainer [0] AbsentSubscriberReason	OPTIONAL, OPTIONAL}
AbsentSubscriberReason ::= ENUMERATED { imsiDetach (0), restrictedArea (1), noPageResponse (2), ..., purgedMS (3)} -- exception handling: at reception of other values than the ones listed the -- AbsentSubscriberReason shall be ignored. -- The AbsentSubscriberReason: purgedMS is defined for the Super-Charger feature -- (see TS 23.116). If this value is received in a Provide Roaming Number response -- it shall be mapped to the AbsentSubscriberReason: imsiDetach in the Send Routing -- Information response		
BusySubscriberParam ::= SEQUENCE { extensionContainer ..., ccbs-Possible ccbs-Busy	ExtensionContainer [0] NULL [1] NULL	OPTIONAL, OPTIONAL, OPTIONAL}
NoSubscriberReplyParam ::= SEQUENCE { extensionContainer ...}	ExtensionContainer	OPTIONAL,
ForwardingViolationParam ::= SEQUENCE { extensionContainer ...}	ExtensionContainer	OPTIONAL,
ForwardingFailedParam ::= SEQUENCE { extensionContainer ...}	ExtensionContainer	OPTIONAL,
ATI-NotAllowedParam ::= SEQUENCE { extensionContainer ...}	ExtensionContainer	OPTIONAL,
ATSI-NotAllowedParam ::= SEQUENCE { extensionContainer ...}	ExtensionContainer	OPTIONAL,
ATM-NotAllowedParam ::= SEQUENCE { extensionContainer ...}	ExtensionContainer	OPTIONAL,
IllegalSS-OperationParam ::= SEQUENCE { extensionContainer ...}	ExtensionContainer	OPTIONAL,
SS-NotAvailableParam ::= SEQUENCE { extensionContainer ...}	ExtensionContainer	OPTIONAL,

```

PositionMethodFailure-Diagnostic ::= ENUMERATED {
    congestion (0),
    insufficientResources (1),
    insufficientMeasurementData (2),
    inconsistentMeasurementData (3),
    locationProcedureNotCompleted (4),
    locationProcedureNotSupportedByTargetMS (5),
    qosNotAttainable (6),
    positionMethodNotAvailableInNetwork (7),
    positionMethodNotAvailableInLocationArea (8),
    ... }
-- exception handling:
-- any unrecognized value shall be ignored

```

```

UnknownOrUnreachableLCSClient-Param ::= SEQUENCE {
    extensionContainer          ExtensionContainer          OPTIONAL,
    ...}

```

```

MM-EventNotSupported-Param ::= SEQUENCE {
    extensionContainer          ExtensionContainer          OPTIONAL,
    ...}

```

```

TargetCellOutsideGCA-Param ::= SEQUENCE {
    extensionContainer          ExtensionContainer          OPTIONAL,
    ...}

```

END

17.7.8 Common data types

```

MAP-CommonDataTypes {
    itu-t identified-organization (4) etsi (0) mobileDomain (0)
    gsm-Network (1) modules (3) map-CommonDataTypes (18) version8 (8)}

```

DEFINITIONS

IMPLICIT TAGS

::=

BEGIN

EXPORTS

-- general data types and values

```

AddressString,
ISDN-AddressString,
maxISDN-AddressLength,
FTN-AddressString,
ISDN-SubaddressString,
ExternalSignalInfo,
Ext-ExternalSignalInfo,
AccessNetworkSignalInfo,
SignalInfo,
maxSignalInfoLength,
AlertingPattern,
TBCD-STRING,

```

-- data types for numbering and identification

```

IMSI,
TMSI,
Identity,
SubscriberId,
IMEI,
HLR-List,
LMSI,
GlobalCellId,
NetworkResource,
NAEA-PreferredCI,
NAEA-CIC,
ASCI-CallReference,
SubscriberIdentity,

```

-- data types for CAMEL

```

CellGlobalIdOrServiceAreaIdOrLAI,

```

```

-- data types for subscriber management
BasicServiceCode,
Ext-BasicServiceCode,
EMLPP-Info,
EMLPP-Priority,
MC-SS-Info,
MaxMC-Bearers,
MC-Bearers,
Ext-SS-Status,

-- data types for geographic location
AgeOfLocationInformation,
LCSCClientExternalID,
LCSCClientInternalID,
LCSServiceTypeID
;

IMPORTS
  TeleserviceCode,
  Ext-TeleserviceCode
FROM MAP-TS-Code {
  itu-t identified-organization (4) etsi (0) mobileDomain (0)
  gsm-Network (1) modules (3) map-TS-Code (19) version8 (8)}

  BearerServiceCode,
  Ext-BearerServiceCode
FROM MAP-BS-Code {
  itu-t identified-organization (4) etsi (0) mobileDomain (0)
  gsm-Network (1) modules (3) map-BS-Code (20) version8 (8)}

  SS-Code
FROM MAP-SS-Code {
  itu-t identified-organization (4) etsi (0) mobileDomain (0)
  gsm-Network (1) modules (3) map-SS-Code (15) version8 (8)}

  ExtensionContainer
FROM MAP-ExtensionDataTypes {
  itu-t identified-organization (4) etsi (0) mobileDomain (0)
  gsm-Network (1) modules (3) map-ExtensionDataTypes (21) version8 (8)}
;

-- general data types

```

```
TBCD-STRING ::= OCTET STRING
```

```

-- This type (Telephony Binary Coded Decimal String) is used to
-- represent several digits from 0 through 9, *, #, a, b, c, two
-- digits per octet, each digit encoded 0000 to 1001 (0 to 9),
-- 1010 (*), 1011 (#), 1100 (a), 1101 (b) or 1110 (c); 1111 used
-- as filler when there is an odd number of digits.

-- bits 8765 of octet n encoding digit 2n
-- bits 4321 of octet n encoding digit 2(n-1) +1

```



```

AddressString ::= OCTET STRING (SIZE (1..maxAddressLength))
-- This type is used to represent a number for addressing
-- purposes. It is composed of
-- a) one octet for nature of address, and numbering plan
-- indicator.
-- b) digits of an address encoded as TBCD-String.

-- a) The first octet includes a one bit extension indicator, a
-- 3 bits nature of address indicator and a 4 bits numbering
-- plan indicator, encoded as follows:

-- bit 8: 1 (no extension)

-- bits 765: nature of address indicator
-- 000 unknown
-- 001 international number
-- 010 national significant number
-- 011 network specific number
-- 100 subscriber number
-- 101 reserved
-- 110 abbreviated number
-- 111 reserved for extension

-- bits 4321: numbering plan indicator
-- 0000 unknown
-- 0001 ISDN/Telephony Numbering Plan (Rec ITU-T E.164)
-- 0010 spare
-- 0011 data numbering plan (ITU-T Rec X.121)
-- 0100 telex numbering plan (ITU-T Rec F.69)
-- 0101 spare
-- 0110 land mobile numbering plan (ITU-T Rec E.212)
-- 0111 spare
-- 1000 national numbering plan
-- 1001 private numbering plan
-- 1111 reserved for extension

-- all other values are reserved.

-- b) The following octets representing digits of an address
-- encoded as a TBCD-STRING.

```

```

maxAddressLength INTEGER ::= 20

```

```

ISDN-AddressString ::=
    AddressString (SIZE (1..maxISDN-AddressLength))
-- This type is used to represent ISDN numbers.

```

```

maxISDN-AddressLength INTEGER ::= 9

```

```

FTN-AddressString ::=
    AddressString (SIZE (1..maxFTN-AddressLength))
-- This type is used to represent forwarded-to numbers.
-- For long forwarded-to numbers (longer than 15 digits) NPI shall be unknown;
-- if NAI = international the first digits represent the country code (CC)
-- and the network destination code (NDC) as for E.164.

```

```

maxFTN-AddressLength INTEGER ::= 15

```

```

ISDN-SubaddressString ::=
    OCTET STRING (SIZE (1..maxISDN-SubaddressLength))
    -- This type is used to represent ISDN subaddresses.
    -- It is composed of
    -- a) one octet for type of subaddress and odd/even indicator.
    -- b) 20 octets for subaddress information.

    -- a) The first octet includes a one bit extension indicator, a
    --     3 bits type of subaddress and a one bit odd/even indicator,
    --     encoded as follows:

    -- bit 8: 1 (no extension)

    -- bits 765: type of subaddress
    --     000 NSAP (X.213/ISO 8348 AD2)
    --     010 User Specified
    --     All other values are reserved

    -- bit 4: odd/even indicator
    --     0 even number of address signals
    --     1 odd number of address signals
    --     The odd/even indicator is used when the type of subaddress
    --     is "user specified" and the coding is BCD.

    -- bits 321: 000 (unused)

    -- b) Subaddress information.
    -- The NSAP X.213/ISO8348AD2 address shall be formatted as specified
    -- by octet 4 which contains the Authority and Format Identifier
    -- (AFI). The encoding is made according to the "preferred binary
    -- encoding" as defined in X.213/ISO834AD2. For the definition
    -- of this type of subaddress, see ITU-T Rec I.334.

    -- For User-specific subaddress, this field is encoded according
    -- to the user specification, subject to a maximum length of 20
    -- octets. When interworking with X.25 networks BCD coding should
    -- be applied.

```

```

maxISDN-SubaddressLength INTEGER ::= 21

```

```

ExternalSignalInfo ::= SEQUENCE {
    protocolId                ProtocolId,
    signalInfo                SignalInfo,
    -- Information about the internal structure is given in
    -- clause 7.6.9.
    extensionContainer        ExtensionContainer           OPTIONAL,
    -- extensionContainer must not be used in version 2
    ...}

```

```

SignalInfo ::= OCTET STRING (SIZE (1..maxSignalInfoLength))

```

```

maxSignalInfoLength INTEGER ::= 200
    -- This NamedValue represents the theoretical maximum number of octets which is
    -- available to carry a single instance of the SignalInfo data type,
    -- without requiring segmentation to cope with the network layer service.
    -- However, the actual maximum size available for an instance of the data
    -- type may be lower, especially when other information elements
    -- have to be included in the same component.

```

```

ProtocolId ::= ENUMERATED {
    gsm-0408 (1),
    gsm-0806 (2),
    gsm-BSSMAP (3),
    -- Value 3 is reserved and must not be used
    ets-300102-1 (4)}

```

```

Ext-ExternalSignalInfo ::= SEQUENCE {
    ext-ProtocolId            Ext-ProtocolId,
    signalInfo                SignalInfo,
    -- Information about the internal structure is given in
    -- clause 7.6.9.10
    extensionContainer        ExtensionContainer           OPTIONAL,
    ...}

```

```

Ext-ProtocolId ::= ENUMERATED {
    ets-300356 (1),
    ...
}
-- exception handling:
-- For Ext-ExternalSignalInfo sequences containing this parameter with any
-- other value than the ones listed the receiver shall ignore the whole
-- Ext-ExternalSignalInfo sequence.

```

```

AccessNetworkSignalInfo ::= SEQUENCE {
    accessNetworkProtocolId      AccessNetworkProtocolId,
    signalInfo                    LongSignalInfo,
    -- Information about the internal structure is given in clause 7.6.9.1
    extensionContainer            ExtensionContainer OPTIONAL,
    ...
}

```

```

LongSignalInfo ::= OCTET STRING (SIZE (1..maxLongSignalInfoLength))

```

```

maxLongSignalInfoLength INTEGER ::= 2560
-- This Named Value represents the maximum number of octets which is available
-- to carry a single instance of the LongSignalInfo data type using
-- White Book SCCP with the maximum number of segments.
-- It takes account of the octets used by the lower layers of the protocol, and
-- other information elements which may be included in the same component.

```

```

AccessNetworkProtocolId ::= ENUMERATED {
    ts3G-48006 (1),
    ts3G-25413 (2),
    ...
}
-- exception handling:
-- For AccessNetworkSignalInfo sequences containing this parameter with any
-- other value than the ones listed the receiver shall ignore the whole
-- AccessNetworkSignalInfo sequence.

```

```

AlertingPattern ::= OCTET STRING (SIZE (1) )
-- This type is used to represent Alerting Pattern

-- bits 8765 : 0000 (unused)

-- bits 43 : type of Pattern
-- 00 level
-- 01 category
-- 10 category
-- all other values are reserved.

-- bits 21 : type of alerting

alertingLevel-0 AlertingPattern ::= '00000000'B
alertingLevel-1 AlertingPattern ::= '00000001'B
alertingLevel-2 AlertingPattern ::= '00000010'B
-- all other values of Alerting level are reserved
-- Alerting Levels are defined in GSM 02.07

alertingCategory-1 AlertingPattern ::= '00000100'B
alertingCategory-2 AlertingPattern ::= '00000101'B
alertingCategory-3 AlertingPattern ::= '00000110'B
alertingCategory-4 AlertingPattern ::= '00000111'B
alertingCategory-5 AlertingPattern ::= '00001000'B
-- all other values of Alerting Category are reserved
-- Alerting categories are defined in GSM 02.07

```

```

-- data types for numbering and identification

```

```

IMSI ::= TBCD-STRING (SIZE (3..8))
-- digits of MCC, MNC, MSIN are concatenated in this order.

```

```

Identity ::= CHOICE {
    imsi                    IMSI,
    imsi-WithLMSI           IMSI-WithLMSI
}

```

```

IMSI-WithLMSI ::= SEQUENCE {
    imsi                    IMSI,
    lmsi                    LMSI,
    -- a special value 00000000 indicates that the LMSI is not in use
    ...
}

```

```

ASCII-CallReference ::= TBCD-STRING (SIZE (1..8))
-- digits of VGCS/VBC-area,Group-ID are concatenated in this order.

```

```

TMSI ::= OCTET STRING (SIZE (1..4))

```

```

SubscriberId ::= CHOICE {
    imsi                               [0] IMSI,
    tmsi                               [1] TMSI}

```

```

IMEI ::= TBCD-STRING (SIZE (8))
-- Refers to International Mobile Station Equipment Identity
-- and Software Version Number (SVN) defined in TS 3GPP TS 23.003 [17].
-- If the SVN is not present the last octet shall contain the
-- digit 0 and a filler.
-- If present the SVN shall be included in the last octet.

```

```

HLR-Id ::= IMSI
-- leading digits of IMSI, i.e. (MCC, MNC, leading digits of
-- MSIN) forming HLR Id defined in TS 3GPP TS 23.003 [17].

```

```

HLR-List ::= SEQUENCE SIZE (1..maxNumOfHLR-Id) OF
                HLR-Id

```

```

maxNumOfHLR-Id INTEGER ::= 50

```

```

LMSI ::= OCTET STRING (SIZE (4))

```

```

GlobalCellId ::= OCTET STRING (SIZE (5..7))
-- Refers to Cell Global Identification defined in TS 3GPP TS 23.003 [17].
-- The internal structure is defined as follows:
-- octet 1 bits 4321      Mobile Country Code 1st digit
--           bits 8765      Mobile Country Code 2nd digit
-- octet 2 bits 4321      Mobile Country Code 3rd digit
--           bits 8765      Mobile Network Code 3rd digit
--                               or filler (1111) for 2 digit MNCs
-- octet 3 bits 4321      Mobile Network Code 1st digit
--           bits 8765      Mobile Network Code 2nd digit
-- octets 4 and 5        Location Area Code according to TS 3GPP TS 24.008
[35]
-- octets 6 and 7        Cell Identity (CI) according to TS 3GPP TS 24.008
[35]

```

```

NetworkResource ::= ENUMERATED {
    plmn (0),
    hlr (1),
    vlr (2),
    pvlr (3),
    controllingMSC (4),
    vmsc (5),
    eir (6),
    rss (7)}

```

```

NAEA-PreferredCI ::= SEQUENCE {
    naea-PreferredCIC                [0] NAEA-CIC,
    extensionContainer                [1] ExtensionContainer           OPTIONAL,
    ...}

```

```

NAEA-CIC ::= OCTET STRING (SIZE (3))
-- The internal structure is defined by the Carrier Identification
-- parameter in ANSI T1.113.3. Carrier codes between '000' and '999' may
-- be encoded as 3 digits using '000' to '999' or as 4 digits using
-- '0000' to '0999'. Carrier codes between '1000' and '9999' are encoded
-- using 4 digits.

```

```

SubscriberIdentity ::= CHOICE {
    imsi                               [0] IMSI,
    msisdn                             [1] ISDN-AddressString
}

```

```

LCSCClientExternalID ::= SEQUENCE {
    externalAddress                    [0] ISDN-AddressString           OPTIONAL,
    extensionContainer                  [1] ExtensionContainer           OPTIONAL,
    ... }

```

```

LCSCClientInternalID ::= ENUMERATED {
    broadcastService          (0),
    o-andM-HPLMN             (1),
    o-andM-VPLMN             (2),
    anonymousLocation         (3),
    targetMSsubscribedService (4),
    ... }
-- for a CAMEL phase 3 PLMN operator client, the value targetMSsubscribedService shall be used

```

```

LCSServiceTypeID ::= INTEGER (0..127)
-- the integer values 0-63 are reserved for Standard LCS service types
-- the integer values 64-127 are reserved for Non Standard LCS service types

```

```

emergencyServices LCSServiceTypeID ::= 0
emergencyAlertServices LCSServiceTypeID ::= 1
personTracking LCSServiceTypeID ::= 2
fleetManagement LCSServiceTypeID ::= 3
assetManagement LCSServiceTypeID ::= 4
trafficCongestionReporting LCSServiceTypeID ::= 5
roadsideAssistance LCSServiceTypeID ::= 6
routingToNearestCommercialEnterprise LCSServiceTypeID ::= 7
navigation LCSServiceTypeID ::= 8
citySightseeing LCSServiceTypeID ::= 9
localizedAdvertising LCSServiceTypeID ::= 10
mobileYellowPages LCSServiceTypeID ::= 11
-- The values of LCSServiceTypeID are defined according to 3GPP TS 22.071.

```

-- data types for CAMEL

```

CellGlobalIdOrServiceAreaIdOrLAI ::= CHOICE {
    cellGlobalIdOrServiceAreaIdFixedLength [0] CellGlobalIdOrServiceAreaIdFixedLength,
    laiFixedLength [1] LAIFixedLength}

```

```

CellGlobalIdOrServiceAreaIdFixedLength ::= OCTET STRING (SIZE (7))
-- Refers to Cell Global Identification or Service Area Identification
-- defined in 3GPP TS 23.003.
-- The internal structure is defined as follows:
-- octet 1 bits 4321 Mobile Country Code 1st digit
-- bits 8765 Mobile Country Code 2nd digit
-- octet 2 bits 4321 Mobile Country Code 3rd digit
-- bits 8765 Mobile Network Code 3rd digit
-- or filler (1111) for 2 digit MNCs
-- octet 3 bits 4321 Mobile Network Code 1st digit
-- bits 8765 Mobile Network Code 2nd digit
-- octets 4 and 5 Location Area Code according to 3GPP TS 24.008
-- octets 6 and 7 Cell Identity (CI) value or
-- Service Area Code (SAC) value
-- according to 3GPP TS 23.003

```

```

LAIFixedLength ::= OCTET STRING (SIZE (5))
-- Refers to Location Area Identification defined in TS 3GPP TS 23.003 [17].
-- The internal structure is defined as follows:
-- octet 1 bits 4321 Mobile Country Code 1st digit
-- bits 8765 Mobile Country Code 2nd digit
-- octet 2 bits 4321 Mobile Country Code 3rd digit
-- bits 8765 Mobile Network Code 3rd digit
-- or filler (1111) for 2 digit MNCs
-- octet 3 bits 4321 Mobile Network Code 1st digit
-- bits 8765 Mobile Network Code 2nd digit
-- octets 4 and 5 Location Area Code according to TS 3GPP TS 24.008
[35]

```

-- data types for subscriber management

```

BasicServiceCode ::= CHOICE {
    bearerService [2] BearerServiceCode,
    teleservice [3] TeleserviceCode}

```

```

Ext-BasicServiceCode ::= CHOICE {
    ext-BearerService [2] Ext-BearerServiceCode,
    ext-Teleservice [3] Ext-TeleserviceCode}

```

```

EMLPP-Info ::= SEQUENCE {
    maximumTitledPriority          EMLPP-Priority,
    defaultPriority                EMLPP-Priority,
    extensionContainer             ExtensionContainer          OPTIONAL,
    ...}

```

```

EMLPP-Priority ::= INTEGER (0..15)
-- The mapping from the values A,B,0,1,2,3,4 to the integer-value is
-- specified as follows where A is the highest and 4 is the lowest
-- priority level
-- the integer values 7-15 are spare and shall be mapped to value 4

```

```

priorityLevelA          EMLPP-Priority ::= 6
priorityLevelB          EMLPP-Priority ::= 5
priorityLevel0          EMLPP-Priority ::= 0
priorityLevel1          EMLPP-Priority ::= 1
priorityLevel2          EMLPP-Priority ::= 2
priorityLevel3          EMLPP-Priority ::= 3
priorityLevel4          EMLPP-Priority ::= 4

```

```

MC-SS-Info ::= SEQUENCE {
    ss-Code                    [0] SS-Code,
    ss-Status                  [1] Ext-SS-Status,
    nbrSB                      [2] MaxMC-Bearers,
    nbrUser                    [3] MC-Bearers,
    extensionContainer         [4] ExtensionContainer          OPTIONAL,
    ...}

```

```

MaxMC-Bearers ::= INTEGER (2..maxNumOfMC-Bearers)

```

```

MC-Bearers ::= INTEGER (1..maxNumOfMC-Bearers)

```

```

maxNumOfMC-Bearers INTEGER ::= 7

```

```

Ext-SS-Status ::= OCTET STRING (SIZE (1..5))

-- OCTET 1:
--
-- bits 8765: 0000 (unused)
-- bits 4321: Used to convey the "P bit","R bit","A bit" and "Q bit",
--            representing supplementary service state information
--            as defined in TS 3GPP TS 23.011 [22]

-- bit 4: "Q bit"

-- bit 3: "P bit"

-- bit 2: "R bit"

-- bit 1: "A bit"

-- OCTETS 2-5: reserved for future use. They shall be discarded if
-- received and not understood.

```

```

-- data types for geographic location

```

```

AgeOfLocationInformation ::= INTEGER (0..32767)
-- the value represents the elapsed time in minutes since the last
-- network contact of the mobile station (i.e. the actuality of the
-- location information).
-- value '0' indicates that the MS is currently in contact with the
-- network
-- value '32767' indicates that the location information is at least
-- 32767 minutes old

```

```

END

```

17.7.9 Teleservice Codes

```

MAP-TS-Code {
    itu-t identified-organization (4) etsi (0) mobileDomain (0)
    gsm-Network (1) modules (3) map-TS-Code (19) version8 (8)}

```

```

DEFINITIONS

```

```
 ::=
```

```
 BEGIN
```

```
 TeleserviceCode ::= OCTET STRING (SIZE (1))
  -- This type is used to represent the code identifying a single
  -- teleservice, a group of teleservices, or all teleservices. The
  -- services are defined in TS GSM 22.003 [4].
  -- The internal structure is defined as follows:

  -- bits 87654321: group (bits 8765) and specific service
  -- (bits 4321)
```

```
 Ext-TeleserviceCode ::= OCTET STRING (SIZE (1..5))
  -- This type is used to represent the code identifying a single
  -- teleservice, a group of teleservices, or all teleservices. The
  -- services are defined in TS GSM 22.003 [4].
  -- The internal structure is defined as follows:

  -- OCTET 1:
  -- bits 87654321: group (bits 8765) and specific service
  -- (bits 4321)

  -- OCTETS 2-5: reserved for future use. If received the
  -- Ext-TeleserviceCode shall be
  -- treated according to the exception handling defined for the
  -- operation that uses this type.

  -- Ext-TeleserviceCode includes all values defined for TeleserviceCode.
```

```
 allTeleservices TeleserviceCode ::= '00000000'B
```

```
 allSpeechTransmissionServices TeleserviceCode ::= '00010000'B
 telephony TeleserviceCode ::= '00010001'B
 emergencyCalls TeleserviceCode ::= '00010010'B
```

```
 allShortMessageServices TeleserviceCode ::= '00100000'B
 shortMessageMT-PP TeleserviceCode ::= '00100001'B
 shortMessageMO-PP TeleserviceCode ::= '00100010'B
```

```
 allFacsimileTransmissionServices TeleserviceCode ::= '01100000'B
 facsimileGroup3AndAlterSpeech TeleserviceCode ::= '01100001'B
 automaticFacsimileGroup3 TeleserviceCode ::= '01100010'B
 facsimileGroup4 TeleserviceCode ::= '01100011'B
```

```
 -- The following non-hierarchical Compound Teleservice Groups
  -- are defined in TS 3GPP TS 22.030:
  allDataTeleservices TeleserviceCode ::= '01110000'B
    -- covers Teleservice Groups 'allFacsimileTransmissionServices'
    -- and 'allShortMessageServices'
  allTeleservices-ExeptSMS TeleserviceCode ::= '10000000'B
    -- covers Teleservice Groups 'allSpeechTransmissionServices' and
    -- 'allFacsimileTransmissionServices'
  --
  -- Compound Teleservice Group Codes are only used in call
  -- independent supplementary service operations, i.e. they
  -- are not used in InsertSubscriberData or in
  -- DeleteSubscriberData messages.
```

```
 allVoiceGroupCallServices TeleserviceCode ::= '10010000'B
 voiceGroupCall TeleserviceCode ::= '10010001'B
 voiceBroadcastCall TeleserviceCode ::= '10010010'B
```

allPLMN-specificTS	TeleserviceCode ::= '11010000'B
plmn-specificTS-1	TeleserviceCode ::= '11010001'B
plmn-specificTS-2	TeleserviceCode ::= '11010010'B
plmn-specificTS-3	TeleserviceCode ::= '11010011'B
plmn-specificTS-4	TeleserviceCode ::= '11010100'B
plmn-specificTS-5	TeleserviceCode ::= '11010101'B
plmn-specificTS-6	TeleserviceCode ::= '11010110'B
plmn-specificTS-7	TeleserviceCode ::= '11010111'B
plmn-specificTS-8	TeleserviceCode ::= '11011000'B
plmn-specificTS-9	TeleserviceCode ::= '11011001'B
plmn-specificTS-A	TeleserviceCode ::= '11011010'B
plmn-specificTS-B	TeleserviceCode ::= '11011011'B
plmn-specificTS-C	TeleserviceCode ::= '11011100'B
plmn-specificTS-D	TeleserviceCode ::= '11011101'B
plmn-specificTS-E	TeleserviceCode ::= '11011110'B
plmn-specificTS-F	TeleserviceCode ::= '11011111'B

END

17.7.10 Bearer Service Codes

```
MAP-BS-Code {
  itu-t identified-organization (4) etsi (0) mobileDomain (0)
  gsm-Network (1) modules (3) map-BS-Code (20) version8 (8)}
```

DEFINITIONS

::=

BEGIN

<pre>BearerServiceCode ::= OCTET STRING (SIZE (1)) -- This type is used to represent the code identifying a single -- bearer service, a group of bearer services, or all bearer -- services. The services are defined in TS 3GPP TS 22.002 [3]. -- The internal structure is defined as follows: -- -- plmn-specific bearer services: -- bits 87654321: defined by the HPLMN operator -- -- rest of bearer services: -- bit 8: 0 (unused) -- bits 7654321: group (bits 7654), and rate, if applicable -- (bits 321)</pre>
--

<pre>Ext-BearerServiceCode ::= OCTET STRING (SIZE (1..5)) -- This type is used to represent the code identifying a single -- bearer service, a group of bearer services, or all bearer -- services. The services are defined in TS 3GPP TS 22.002 [3]. -- The internal structure is defined as follows: -- -- OCTET 1: -- plmn-specific bearer services: -- bits 87654321: defined by the HPLMN operator -- -- rest of bearer services: -- bit 8: 0 (unused) -- bits 7654321: group (bits 7654), and rate, if applicable -- (bits 321) -- -- OCTETS 2-5: reserved for future use. If received the -- Ext-TeleserviceCode shall be -- treated according to the exception handling defined for the -- operation that uses this type. -- -- Ext-BearerServiceCode includes all values defined for BearerServiceCode.</pre>
--

allBearerServices	BearerServiceCode ::= '00000000'B
--------------------------	-----------------------------------

allDataCDA-Services	BearerServiceCode ::= '00010000'B
dataCDA-300bps	BearerServiceCode ::= '00010001'B
dataCDA-1200bps	BearerServiceCode ::= '00010010'B
dataCDA-1200-75bps	BearerServiceCode ::= '00010011'B
dataCDA-2400bps	BearerServiceCode ::= '00010100'B
dataCDA-4800bps	BearerServiceCode ::= '00010101'B
dataCDA-9600bps	BearerServiceCode ::= '00010110'B
general-dataCDA	BearerServiceCode ::= '00010111'B

allDataCDS-Services	BearerServiceCode ::= '00011000'B
dataCDS-1200bps	BearerServiceCode ::= '00011010'B
dataCDS-2400bps	BearerServiceCode ::= '00011100'B
dataCDS-4800bps	BearerServiceCode ::= '00011101'B
dataCDS-9600bps	BearerServiceCode ::= '00011110'B
general-dataCDS	BearerServiceCode ::= '00011111'B

allPadAccessCA-Services	BearerServiceCode ::= '00100000'B
padAccessCA-300bps	BearerServiceCode ::= '00100001'B
padAccessCA-1200bps	BearerServiceCode ::= '00100010'B
padAccessCA-1200-75bps	BearerServiceCode ::= '00100011'B
padAccessCA-2400bps	BearerServiceCode ::= '00100100'B
padAccessCA-4800bps	BearerServiceCode ::= '00100101'B
padAccessCA-9600bps	BearerServiceCode ::= '00100110'B
general-padAccessCA	BearerServiceCode ::= '00100111'B

allDataPDS-Services	BearerServiceCode ::= '00101000'B
dataPDS-2400bps	BearerServiceCode ::= '00101100'B
dataPDS-4800bps	BearerServiceCode ::= '00101101'B
dataPDS-9600bps	BearerServiceCode ::= '00101110'B
general-dataPDS	BearerServiceCode ::= '00101111'B

allAlternateSpeech-DataCDA	BearerServiceCode ::= '00110000'B
-----------------------------------	-----------------------------------

allAlternateSpeech-DataCDS	BearerServiceCode ::= '00111000'B
-----------------------------------	-----------------------------------

allSpeechFollowedByDataCDA	BearerServiceCode ::= '01000000'B
-----------------------------------	-----------------------------------

allSpeechFollowedByDataCDS	BearerServiceCode ::= '01001000'B
-----------------------------------	-----------------------------------

<i>-- The following non-hierarchical Compound Bearer Service</i>	
<i>-- Groups are defined in TS 3GPP TS 22.030:</i>	
allDataCircuitAsynchronous	BearerServiceCode ::= '01010000'B
<i>-- covers "allDataCDA-Services", "allAlternateSpeech-DataCDA" and</i>	
<i>-- "allSpeechFollowedByDataCDA"</i>	
allAsynchronousServices	BearerServiceCode ::= '01100000'B
<i>-- covers "allDataCDA-Services", "allAlternateSpeech-DataCDA",</i>	
<i>-- "allSpeechFollowedByDataCDA" and "allPadAccessCDA-Services"</i>	
allDataCircuitSynchronous	BearerServiceCode ::= '01011000'B
<i>-- covers "allDataCDS-Services", "allAlternateSpeech-DataCDS" and</i>	
<i>-- "allSpeechFollowedByDataCDS"</i>	
allSynchronousServices	BearerServiceCode ::= '01101000'B
<i>-- covers "allDataCDS-Services", "allAlternateSpeech-DataCDS",</i>	
<i>-- "allSpeechFollowedByDataCDS" and "allDataPDS-Services"</i>	
<i>--</i>	
<i>-- Compound Bearer Service Group Codes are only used in call</i>	
<i>-- independent supplementary service operations, i.e. they</i>	
<i>-- are not used in InsertSubscriberData or in</i>	
<i>-- DeleteSubscriberData messages.</i>	

allPLMN-specificBS	BearerServiceCode ::= '11010000'B
plmn-specificBS-1	BearerServiceCode ::= '11010001'B
plmn-specificBS-2	BearerServiceCode ::= '11010010'B
plmn-specificBS-3	BearerServiceCode ::= '11010011'B
plmn-specificBS-4	BearerServiceCode ::= '11010100'B
plmn-specificBS-5	BearerServiceCode ::= '11010101'B
plmn-specificBS-6	BearerServiceCode ::= '11010110'B
plmn-specificBS-7	BearerServiceCode ::= '11010111'B
plmn-specificBS-8	BearerServiceCode ::= '11011000'B
plmn-specificBS-9	BearerServiceCode ::= '11011001'B
plmn-specificBS-A	BearerServiceCode ::= '11011010'B
plmn-specificBS-B	BearerServiceCode ::= '11011011'B
plmn-specificBS-C	BearerServiceCode ::= '11011100'B
plmn-specificBS-D	BearerServiceCode ::= '11011101'B
plmn-specificBS-E	BearerServiceCode ::= '11011110'B
plmn-specificBS-F	BearerServiceCode ::= '11011111'B

END

17.7.11 Extension data types

```
MAP-ExtensionDataTypes {
    itu-t identified-organization (4) etsi (0) mobileDomain (0)
    gsm-Network (1) modules (3) map-ExtensionDataTypes (21) version8 (8)}
```

DEFINITIONS

IMPLICIT TAGS

::=

BEGIN

EXPORTS

```
PrivateExtension,
ExtensionContainer,
SLR-ArgExtensionContainer;
```

-- IOC for private MAP extensions

```
MAP-EXTENSION ::= CLASS {
    &ExtensionType                                OPTIONAL,
    &extensionId                                  OBJECT IDENTIFIER }
-- The length of the Object Identifier shall not exceed 16 octets and the
-- number of components of the Object Identifier shall not exceed 16
```

-- data types

```
ExtensionContainer ::= SEQUENCE {
    privateExtensionList [0]PrivateExtensionList OPTIONAL,
    pcs-Extensions      [1]PCS-Extensions      OPTIONAL,
    ...}
```

```
SLR-ArgExtensionContainer ::= SEQUENCE {
    privateExtensionList [0]PrivateExtensionList OPTIONAL,
    slr-Arg-PCS-Extensions [1]SLR-Arg-PCS-Extensions OPTIONAL,
    ...}
```

```
PrivateExtensionList ::= SEQUENCE SIZE (1..maxNumOfPrivateExtensions) OF
    PrivateExtension
```

```
PrivateExtension ::= SEQUENCE {
    extId                MAP-EXTENSION.&extensionId
                        ({ExtensionSet}),
    extType              MAP-EXTENSION.&ExtensionType
                        ({ExtensionSet}@extId) OPTIONAL}
```

```
maxNumOfPrivateExtensions INTEGER ::= 10
```

```
ExtensionSet                MAP-EXTENSION ::=
    {...}
-- ExtensionSet is the set of all defined private extensions
-- Unsupported private extensions shall be discarded if received.
```

```
PCS-Extensions ::= SEQUENCE {
    ...}
```

```
SLR-Arg-PCS-Extensions ::= SEQUENCE {
    ...,
    na-ESRK-Request [0] NULL OPTIONAL }
```

END

17.7.12 Group Call data types

```
MAP-GR-DataTypes {
    itu-t identified-organization (4) etsi (0) mobileDomain (0)
    gsm-Network (1) modules (3) map-GR-DataTypes (23) version8 (8)}
```

DEFINITIONS

IMPLICIT TAGS

::=

BEGIN

EXPORTS

```

PrepareGroupCallArg,
PrepareGroupCallRes,
SendGroupCallEndSignalArg,
SendGroupCallEndSignalRes,
ForwardGroupCallSignallingArg,
ProcessGroupCallSignallingArg

```

;

IMPORTS

```

ISDN-AddressString,
IMSI,
EMLPP-Priority,
ASCII-CallReference

```

```

FROM MAP-CommonDataTypes {
itu-t identified-organization (4) etsi (0) mobileDomain (0)
gsm-Network (1) modules (3) map-CommonDataTypes (18) version8 (8)}

```

```

Ext-TeleserviceCode

```

```

FROM MAP-TS-Code {
itu-t identified-organization (4) etsi (0) mobileDomain (0)
gsm-Network (1) modules (3) map-TS-Code (19) version8 (8)}

```

```

Kc

```

```

FROM MAP-MS-DataTypes {
itu-t identified-organization (4) etsi (0) mobileDomain (0)
gsm-Network (1) modules (3) map-MS-DataTypes (11) version8 (8)}

```

```

ExtensionContainer

```

```

FROM MAP-ExtensionDataTypes {
itu-t identified-organization (4) etsi (0) mobileDomain (0)
gsm-Network (1) modules (3) map-ExtensionDataTypes (21) version8 (8)}

```

;

PrepareGroupCallArg ::= SEQUENCE {			
teleservice	Ext-TeleserviceCode,		
asciiCallReference	ASCII-CallReference,		
codec-Info	CODEC-Info,		
cipheringAlgorithm	CipheringAlgorithm,		
groupKeyNumber	[0] GroupKeyNumber		OPTIONAL,
groupKey	[1] Kc		OPTIONAL,
priority	[2] EMLPP-Priority		OPTIONAL,
uplinkFree	[3] NULL		OPTIONAL,
extensionContainer	[4] ExtensionContainer		OPTIONAL,
...			

PrepareGroupCallRes ::= SEQUENCE {			
groupCallNumber	ISDN-AddressString,		
extensionContainer	ExtensionContainer		OPTIONAL,
...			

SendGroupCallEndSignalArg ::= SEQUENCE {			
imsi	IMSI		OPTIONAL,
extensionContainer	ExtensionContainer		OPTIONAL,
...			

SendGroupCallEndSignalRes ::= SEQUENCE {			
extensionContainer	ExtensionContainer		OPTIONAL,
...			

```

ForwardGroupCallSignallingArg ::= SEQUENCE {
    imsi                               IMSI                               OPTIONAL,
    uplinkRequestAck                   [0] NULL                       OPTIONAL,
    uplinkReleaseIndication            [1] NULL                       OPTIONAL,
    uplinkRejectCommand                [2] NULL                       OPTIONAL,
    uplinkSeizedCommand                [3] NULL                       OPTIONAL,
    uplinkReleaseCommand               [4] NULL                       OPTIONAL,
    extensionContainer                 ExtensionContainer            OPTIONAL,
    . . . ,
    stateAttributes                    [5] StateAttributes          OPTIONAL }

```

```

ProcessGroupCallSignallingArg ::= SEQUENCE {
    uplinkRequest                       [0] NULL                       OPTIONAL,
    uplinkReleaseIndication             [1] NULL                       OPTIONAL,
    releaseGroupCall                   [2] NULL                       OPTIONAL,
    extensionContainer                  ExtensionContainer            OPTIONAL,
    . . . }

```

```

GroupKeyNumber ::= INTEGER (0..15)

```

```

CODEC-Info ::= OCTET STRING (SIZE (5..10))
    -- Refers to channel type
    -- coded according to 3GPP TS 48.008 [49] and including Element identifier and Length

```

```

CipheringAlgorithm ::= OCTET STRING (SIZE (1))
    -- Refers to 'permitted algorithms' in 'encryption information'
    -- coded according to 3GPP TS 48.008 [49]:

    -- Bits 8-1
    -- 8765 4321
    -- 0000 0001           No encryption
    -- 0000 0010           GSM A5/1
    -- 0000 0100           GSM A5/2
    -- 0000 1000           GSM A5/3
    -- 0001 0000           GSM A5/4
    -- 0010 0000           GSM A5/5
    -- 0100 0000           GSM A5/6
    -- 1000 0000           GSM A5/7

```

```

StateAttributes ::= SEQUENCE {
    downlinkAttached                    [5] NULL                       OPTIONAL,
    uplinkAttached                      [6] NULL                       OPTIONAL,
    dualCommunication                   [7] NULL                       OPTIONAL,
    callOriginator                      [8] NULL                       OPTIONAL }

    -- Refers to 3GPP TS 44.068 for definitions of StateAttributes fields.

```

END

17.7.13 Location service data types

```

1 MAP-LCS-DataTypes {
2   itu-t identified-organization (4) etsi (0) mobileDomain (0)
3   gsm-Network (1) modules (3) map-LCS-DataTypes (25) version8 (8)}
4
5 DEFINITIONS
6 IMPLICIT TAGS
7 ::=
8 BEGIN
9

```

```

10 EXPORTS
11   RoutingInfoForLCS-Arg,
12   RoutingInfoForLCS-Res,
13   ProvideSubscriberLocation-Arg,
14   ProvideSubscriberLocation-Res,
15   SubscriberLocationReport-Arg,
16   SubscriberLocationReport-Res,
17   LocationType,
18   LCSClientName,
19   LCS-QoS,
20   Horizontal-Accuracy,
21   ResponseTime,
22   Ext-GeographicalInformation,
23   SupportedGADShapes,
24   Add-GeographicalInformation,
25   LCSRequestorID,
26   LCSCodeword
27 ;
28
29 IMPORTS
30   AddressString,
31   ISDN-AddressString,
32   IMEI,
33   IMSI,
34   LMSI,
35   SubscriberIdentity,
36   AgeOfLocationInformation,
37   LCSClientExternalID,
38   LCSClientInternalID,
39   LCSServiceTypeID
40 FROM MAP-CommonDataTypes {
41   itu-t identified-organization (4) etsi (0) mobileDomain (0)
42   gsm-Network (1) modules (3) map-CommonDataTypes (18) version8 (8)}
43
44   ExtensionContainer,
45   SLR-ArgExtensionContainer
46 FROM MAP-ExtensionDataTypes {
47   itu-t identified-organization (4) etsi (0) mobileDomain (0)
48   gsm-Network (1) modules (3) map-ExtensionDataTypes (21) version8 (8)}
49
50   USSD-DataCodingScheme,
51   USSD-String
52 FROM MAP-SS-DataTypes {
53   itu-t identified-organization (4) etsi (0) mobileDomain (0) gsm-Network (1) modules (3)
54   map-SS-DataTypes (14) version8 (8)}
55
56   APN
57 FROM MAP-MS-DataTypes {
58   itu-t identified-organization (4) etsi (0) mobileDomain (0)
59   gsm-Network (1) modules (3) map-MS-DataTypes (11) version8 (8)}
60
61   Additional-Number
62 FROM MAP-SM-DataTypes {
63   itu-t identified-organization (4) etsi (0) mobileDomain (0)
64   gsm-Network (1) modules (3) map-SM-DataTypes (16) version8 (8)}
65 ;
66
67

```

<pre> 68 RoutingInfoForLCS-Arg ::= SEQUENCE { 69 mlcNumber 70 targetMS 71 extensionContainer 72 ...} </pre>	<pre> [0] ISDN-AddressString, [1] SubscriberIdentity, [2] ExtensionContainer OPTIONAL, </pre>
---	---

<pre> 74 RoutingInfoForLCS-Res ::= SEQUENCE { 75 targetMS 76 lcsLocationInfo 77 extensionContainer 78 ... 79 } </pre>	<pre> [0] SubscriberIdentity, [1] LCSLocationInfo, [2] ExtensionContainer OPTIONAL, </pre>
---	--

```

81 LCSLocationInfo ::= SEQUENCE {
82     networkNode-Number          ISDN-AddressString,
83     -- NetworkNode-number can be either msc-number or sgsn-number
84     lmsi                        [0] LMSI                OPTIONAL,
85     extensionContainer          [1] ExtensionContainer    OPTIONAL,
86     ... ,
87     gprsNodeIndicator           [2] NULL                OPTIONAL,
88     -- gprsNodeIndicator is set only if the SGSN number is sent as the Network Node Number
89     additional-Number           [3] Additional-Number     OPTIONAL
90 }
91
92 ProvideSubscriberLocation-Arg ::= SEQUENCE {
93     locationType                LocationType,
94     mlc-Number                  ISDN-AddressString,
95     lcs-ClientID                [0] LCS-ClientID        OPTIONAL,
96     privacyOverride             [1] NULL                OPTIONAL,
97     imsi                        [2] IMSI                OPTIONAL,
98     msisdn                      [3] ISDN-AddressString    OPTIONAL,
99     lmsi                        [4] LMSI                OPTIONAL,
100    imei                         [5] IMEI                OPTIONAL,
101    lcs-Priority                 [6] LCS-Priority         OPTIONAL,
102    lcs-QoS                      [7] LCS-QoS             OPTIONAL,
103    extensionContainer           [8] ExtensionContainer    OPTIONAL,
104    ... ,
105    supportedGADShapes          [9] SupportedGADShapes    OPTIONAL,
106    lcs-ReferenceNumber          [10] LCS-ReferenceNumber  OPTIONAL,
107    lcsServiceTypeID             [11] LCSServiceTypeID    OPTIONAL,
108    lcsCodeword                 [12] LCSCodeword          OPTIONAL }
109
110    -- one of imsi or msisdn is mandatory
111    -- If a location estimate type indicates activate deferred location or cancel deferred
112    -- location, a lcs-Reference number shall be included.
113
114 LocationType ::= SEQUENCE {
115     locationEstimateType        [0] LocationEstimateType,
116     ... ,
117     deferredLocationEventType   [1] DeferredLocationEventType OPTIONAL }
118
119 LocationEstimateType ::= ENUMERATED {
120     currentLocation              (0),
121     currentOrLastKnownLocation   (1),
122     initialLocation              (2),
123     ... ,
124     activateDeferredLocation     (3),
125     cancelDeferredLocation       (4) }
126 -- exception handling:
127 -- a ProvideSubscriberLocation-Arg containing an unrecognized LocationEstimateType
128 -- shall be rejected by the receiver with a return error cause of unexpected data value
129
130 DeferredLocationEventType ::= BIT STRING {
131     msAvailable                  (0) } (SIZE (1..16))
132 -- exception handling
133 -- a ProvideSubscriberLocation-Arg containing other values than listed above in
134 -- DeferredLocationEventType shall be rejected by the receiver with a return error cause of
135 -- unexpected data value.
136
137 LCS-ClientID ::= SEQUENCE {
138     lcsClientType                [0] LCSClientType,
139     lcsClientExternalID          [1] LCSClientExternalID  OPTIONAL,
140     lcsClientDialedByMS         [2] AddressString      OPTIONAL,
141     lcsClientInternalID         [3] LCSClientInternalID  OPTIONAL,
142     lcsClientName               [4] LCSClientName        OPTIONAL,
143     ... ,
144     lcsAPN                      [5] APN                 OPTIONAL,
145     lcsRequestorID              [6] LCSRequestorID       OPTIONAL }
146
147 LCSClientType ::= ENUMERATED {
148     emergencyServices            (0),
149     valueAddedServices           (1),
150     plmnOperatorServices         (2),
151     lawfulInterceptServices      (3),
152     ... }
153 -- exception handling:
154 -- unrecognized values may be ignored if the LCS client uses the privacy override
155 -- otherwise, an unrecognized value shall be treated as unexpected data by a receiver
156 -- a return error shall then be returned if received in a MAP invoke
157

```

```

158 LCSClientName ::= SEQUENCE {
159     dataCodingScheme          [0] USSD-DataCodingScheme,
160     nameString                [2] NameString,
161     ...}
162
163 -- The USSD-DataCodingScheme shall indicate use of the default alphabet through the
164 -- following encoding
165 -- bit 7 6 5 4 3 2 1 0
166 --     0 0 0 0 1 1 1 1
167
168 NameString ::= USSD-String (SIZE (1..maxNameStringLength))
169
170 maxNameStringLength INTEGER ::= 63
171
172 LCSRequestorID ::= SEQUENCE {
173     dataCodingScheme          [0] USSD-DataCodingScheme,
174     requestorIDString         [1] RequestorIDString,
175     ...}
176
177 RequestorIDString ::= USSD-String (SIZE (1..maxRequestorIDStringLength))
178
179 maxRequestorIDStringLength INTEGER ::= 63
180
181 LCS-Priority ::= OCTET STRING (SIZE (1))
182 -- 0 = highest priority
183 -- 1 = normal priority
184 -- all other values treated as 1
185
186 LCS-QoS ::= SEQUENCE {
187     horizontal-accuracy        [0] Horizontal-Accuracy          OPTIONAL,
188     verticalCoordinateRequest [1] NULL                      OPTIONAL,
189     vertical-accuracy          [2] Vertical-Accuracy           OPTIONAL,
190     responseTime               [3] ResponseTime               OPTIONAL,
191     extensionContainer          [4] ExtensionContainer          OPTIONAL,
192     ...}
193
194 Horizontal-Accuracy ::= OCTET STRING (SIZE (1))
195 -- bit 8 = 0
196 -- bits 7-1 = 7 bit Uncertainty Code defined in 3GPP TS 23.032. The horizontal location
197 -- error should be less than the error indicated by the uncertainty code with 67%
198 -- confidence.
199
200 Vertical-Accuracy ::= OCTET STRING (SIZE (1))
201 -- bit 8 = 0
202 -- bits 7-1 = 7 bit Vertical Uncertainty Code defined in 3GPP TS 23.032.
203 -- The vertical location error should be less than the error indicated
204 -- by the uncertainty code with 67% confidence.
205
206 ResponseTime ::= SEQUENCE {
207     responseTimeCategory      ResponseTimeCategory,
208     ...}
209 -- note: an expandable SEQUENCE simplifies later addition of a numeric response time.
210
211 ResponseTimeCategory ::= ENUMERATED {
212     lowdelay (0),
213     delaytolerant (1),
214     ... }
215 -- exception handling:
216 -- an unrecognized value shall be treated the same as value 1 (delaytolerant)
217
218 SupportedGADShapes ::= BIT STRING {
219     ellipsoidPoint (0),
220     ellipsoidPointWithUncertaintyCircle (1),
221     ellipsoidPointWithUncertaintyEllipse (2),
222     polygon (3),
223     ellipsoidPointWithAltitude (4),
224     ellipsoidPointWithAltitudeAndUncertaintyElipsoid (5),
225     ellipsoidArc (6) } (SIZE (7..16))
226 -- A node shall mark in the BIT STRING all Shapes defined in 3GPP TS 23.032 it supports.
227 -- exception handling: bits 7 to 15 shall be ignored if received.
228
229 LCS-ReferenceNumber ::= OCTET STRING (SIZE(1))
230

```

```

231 LCSCodeword ::= SEQUENCE {
232     dataCodingScheme          [0] USSD-DataCodingScheme,
233     lcsCodewordString        [1] LCSCodewordString,
234     ... }
235
236 LCSCodewordString ::= USSD-String (SIZE (1..maxLCSCodewordStringLength))
237
238 maxLCSCodewordStringLength INTEGER ::= 20
239
240 ProvideSubscriberLocation-Res ::= SEQUENCE {
241     locationEstimate          Ext-GeographicalInformation,
242     ageOfLocationEstimate     [0] AgeOfLocationInformation     OPTIONAL,
243     extensionContainer        [1] ExtensionContainer           OPTIONAL,
244     ... ,
245     add-LocationEstimate      [2] Add-GeographicalInformation  OPTIONAL,
246     deferredmt-lrResponseIndicator [3] NULL                OPTIONAL,
247     geranPositioningData      [4] PositioningDataInformation  OPTIONAL,
248     utranPositioningData      [5] UtranPositioningDataInfo    OPTIONAL }
249
250 -- if deferredmt-lrResponseIndicator is set, locationEstimate is ignored.
251
252 -- the add-LocationEstimate parameter shall not be sent to a node that did not indicate the
253 -- geographic shapes supported in the ProvideSubscriberLocation-Arg
254 -- The locationEstimate and the add-locationEstimate parameters shall not be sent if
255 -- the supportedGADShapes parameter has been received in ProvideSubscriberLocation-Arg
256 -- and the shape encoded in locationEstimate or add-LocationEstimate is not marked
257 -- as supported in supportedGADShapes. In such a case ProvideSubscriberLocation
258 -- shall be rejected with error FacilityNotSupported with additional indication
259 -- shapeOfLocationEstimateNotSupported
260

```



```

261 Ext-GeographicalInformation ::= OCTET STRING (SIZE (1..maxExt-GeographicalInformation))
262 -- Refers to geographical Information defined in 3GPP TS 23.032.
263 -- This is composed of 1 or more octets with an internal structure according to
264 -- 3GPP TS 23.032
265 -- Octet 1: Type of shape, only the following shapes in 3GPP TS 23.032 are allowed:
266 -- (a) Ellipsoid point with uncertainty circle
267 -- (b) Ellipsoid point with uncertainty ellipse
268 -- (c) Ellipsoid point with altitude and uncertainty ellipsoid
269 -- (d) Ellipsoid Arc
270 -- (e) Ellipsoid Point
271 -- Any other value in octet 1 shall be treated as invalid
272 -- Octets 2 to 8 for case (a) - Ellipsoid point with uncertainty circle
273 -- Degrees of Latitude 3 octets
274 -- Degrees of Longitude 3 octets
275 -- Uncertainty code 1 octet
276 -- Octets 2 to 11 for case (b) - Ellipsoid point with uncertainty ellipse:
277 -- Degrees of Latitude 3 octets
278 -- Degrees of Longitude 3 octets
279 -- Uncertainty semi-major axis 1 octet
280 -- Uncertainty semi-minor axis 1 octet
281 -- Angle of major axis 1 octet
282 -- Confidence 1 octet
283 -- Octets 2 to 14 for case (c) - Ellipsoid point with altitude and uncertainty ellipsoid
284 -- Degrees of Latitude 3 octets
285 -- Degrees of Longitude 3 octets
286 -- Altitude 2 octets
287 -- Uncertainty semi-major axis 1 octet
288 -- Uncertainty semi-minor axis 1 octet
289 -- Angle of major axis 1 octet
290 -- Uncertainty altitude 1 octet
291 -- Confidence 1 octet
292 -- Octets 2 to 13 for case (d) - Ellipsoid Arc
293 -- Degrees of Latitude 3 octets
294 -- Degrees of Longitude 3 octets
295 -- Inner radius 2 octets
296 -- Uncertainty radius 1 octet
297 -- Offset angle 1 octet
298 -- Included angle 1 octet
299 -- Confidence 1 octet
300 -- Octets 2 to 7 for case (e) - Ellipsoid Point
301 -- Degrees of Latitude 3 octets
302 -- Degrees of Longitude 3 octets
303 --
304 --
305 -- An Ext-GeographicalInformation parameter comprising more than one octet and
306 -- containing any other shape or an incorrect number of octets or coding according
307 -- to 3GPP TS 23.032 shall be treated as invalid data by a receiver.
308 --
309 -- An Ext-GeographicalInformation parameter comprising one octet shall be discarded
310 -- by the receiver if an Add-GeographicalInformation parameter is received
311 -- in the same message.
312 --
313 -- An Ext-GeographicalInformation parameter comprising one octet shall be treated as
314 -- invalid data by the receiver if an Add-GeographicalInformation parameter is not
315 -- received in the same message.

```

```

316
317 maxExt-GeographicalInformation INTEGER ::= 20
318 -- the maximum length allows for further shapes in 3GPP TS 23.032 to be included in later
319 -- versions of 3GPP TS 29.002

```

```

320
321 PositioningDataInformation ::= OCTET STRING (SIZE (2..maxPositioningDataInformation))
322 -- Refers to the Positioning Data defined in 3GPP TS 49.031.
323 -- This is composed of 2 or more octets with an internal structure according to
324 -- 3GPP TS 49.031.

```

```

325
326 maxPositioningDataInformation INTEGER ::= 10
327 --

```

```

328
329 UtranPositioningDataInfo ::= OCTET STRING (SIZE (3..maxUtranPositioningDataInfo))
330 -- Refers to the Position Data defined in 3GPP TS 25.413.
331 -- This is composed of the positioningDataDiscriminator and the positioningDataSet
332 -- included in positionData as defined in 3GPP TS 25.413.

```

```

333
334 maxUtranPositioningDataInfo INTEGER ::= 11
335 --

```

```

336

```

```

337 Add-GeographicalInformation ::= OCTET STRING (SIZE (1..maxAdd-GeographicalInformation))
338 -- Refers to geographical Information defined in 3GPP TS 23.032.
339 -- This is composed of 1 or more octets with an internal structure according to
340 -- 3GPP TS 23.032
341 -- Octet 1: Type of shape, all the shapes defined in 3GPP TS 23.032 are allowed:
342 -- Octets 2 to n (where n is the total number of octets necessary to encode the shape
343 -- according to 3GPP TS 23.032) are used to encode the shape itself in accordance with
344 the
345 -- encoding defined in 3GPP TS 23.032
346 --
347 -- An Add-GeographicalInformation parameter, whether valid or invalid, received
348 -- together with a valid Ext-GeographicalInformation parameter in the same message
349 -- shall be discarded.
350 --
351 -- An Add-GeographicalInformation parameter containing any shape not defined in
352 -- 3GPP TS 23.032 or an incorrect number of octets or coding according to
353 -- 3GPP TS 23.032 shall be treated as invalid data by a receiver if not received
354 -- together with a valid Ext-GeographicalInformation parameter in the same message.
355

```

```

356 maxAdd-GeographicalInformation INTEGER ::= 91
357 -- the maximum length allows support for all the shapes currently defined in 3GPP TS
358 23.032
359

```

```

360 SubscriberLocationReport-Arg ::= SEQUENCE {
361   lcs-Event                LCS-Event,
362   lcs-ClientID             LCS-ClientID,
363   lcsLocationInfo          LCSLocationInfo,
364   msisdn                   [0] ISDN-AddressString      OPTIONAL,
365   imsi                     [1] IMSI                    OPTIONAL,
366   imei                     [2] IMEI                    OPTIONAL,
367   na-ESRD                  [3] ISDN-AddressString      OPTIONAL,
368   na-ESRK                  [4] ISDN-AddressString      OPTIONAL,
369   locationEstimate         [5] Ext-GeographicalInformation OPTIONAL,
370   ageOfLocationEstimate    [6] AgeOfLocationInformation OPTIONAL,
371   slr-ArgExtensionContainer [7] SLR-ArgExtensionContainer  OPTIONAL,
372   ... ,
373   add-LocationEstimate     [8] Add-GeographicalInformation OPTIONAL,
374   deferredmt-lrData        [9] Deferredmt-lrData        OPTIONAL,
375   lcs-ReferenceNumber       [10] LCS-ReferenceNumber     OPTIONAL,
376   geranPositioningData     [11] PositioningDataInformation OPTIONAL,
377   utranPositioningData     [12] UtranPositioningDataInfo  OPTIONAL }
378
379 -- one of msisdn or imsi is mandatory
380 -- a location estimate that is valid for the locationEstimate parameter should
381 -- be transferred in this parameter in preference to the add-LocationEstimate.
382 -- the deferredmt-lrData parameter shall be included if and only if the lcs-Event
383 -- indicates a deferredmt-lrResponse.
384 -- if the lcs-Event indicates a deferredmt-lrResponse then the locationEstimate
385 -- and the add-locationEstimate parameters shall not be sent if the
386 -- supportedGADShapes parameter had been received in ProvideSubscriberLocation-Arg
387 -- and the shape encoded in locationEstimate or add-LocationEstimate was not marked
388 -- as supported in supportedGADShapes. In such a case terminationCause
389 -- in deferredmt-lrData shall be present with value
390 -- shapeOfLocationEstimateNotSupported.
391 -- If a lcs event indicates deferred mt-lr response, the lcs-Reference number shall be
392 -- included.
393

```

```

394 Deferredmt-lrData ::= SEQUENCE {
395   deferredLocationEventType DeferredLocationEventType,
396   terminationCause         [0] TerminationCause          OPTIONAL,
397   lcsLocationInfo          [1] LCSLocationInfo           OPTIONAL,
398   ... }
399 -- lcsLocationInfo may be included only if a terminationCause is present
400 -- indicating mt-lrRestart.
401

```

```

402 LCS-Event ::= ENUMERATED {
403   emergencyCallOrigination (0),
404   emergencyCallRelease (1),
405   mo-lr (2),
406   ...,
407   deferredmt-lrResponse (3) }
408 -- exception handling:
409 -- a SubscriberLocationReport-Arg containing an unrecognized LCS-Event
410 -- shall be rejected by a receiver with a return error cause of unexpected data value
411

```

```
412 TerminationCause ::= ENUMERATED {
413     normal (0),
414     errorundefined (1),
415     internalTimeout (2),
416     congestion (3),
417     mt-lrRestart (4),
418     privacyViolation (5),
419     ...,
420     shapeOfLocationEstimateNotSupported (6) }
421 -- mt-lrRestart shall be used to trigger the GMLC to restart the location procedure,
422 -- either because the sending node knows that the terminal has moved under coverage
423 -- of another MSC or SGSN (e.g. Send Identification received), or because the subscriber
424 -- has been deregistered due to a Cancel Location received from HLR.
425 --
426 -- exception handling
427 -- an unrecognized value shall be treated the same as value 1 (errorundefined)
428
429 SubscriberLocationReport-Res ::= SEQUENCE {
430     extensionContainer          ExtensionContainer          OPTIONAL,
431     ...,
432     na-ESRK                    [0] ISDN-AddressString    OPTIONAL }
433
434
435
436 END
437
```

17.7.14 void

18 General on MAP user procedures

18.1 Introduction

Clauses 18 to 25 describe the use of MAP services for GSM signalling procedures. GSM signalling procedures may involve one or several interfaces running one or several application protocols. The present document addresses only the signalling procedures which require at least the use of one MAP service.

When a signalling procedure takes place in the network, an application process invocation is created in each system component involved. Part of the application process invocation acts as a MAP user and handles one or several MAP dialogues. For each dialogue it employs an instance of the MAP service provider. It may also use other communication services to exchange information on other interfaces, but detailed description of these aspects is outside the scope of the present document.

18.2 Common aspects of user procedure descriptions

18.2.1 General conventions

For each signalling procedure the present document provides a brief textual overview accompanied by a flow diagram which represent the functional interactions between system components. Functional interactions are labelled using the MAP service name when the interaction results from a service request or by this service name followed by the symbol "ack" when this interaction results from a service response.

For each of the system components involved, the present document also provides a detailed textual description of the application process behaviour as well as an SDL diagram. SDL diagrams describe the sequence of events, as seen by the MAP-User, which occurs at MAP service provider boundaries as well as external events which occur at other interfaces and which impact on the previous sequence.

External events do not necessarily correspond to the messages of other protocols used in the system component. The MAP-user procedures are described as if a set of interworking functions (IWF) between the MAP-user and the other protocol entities was implemented (see figure 18.2/1). Such interworking functions are assumed to perform either an identity mapping or some processing or translation as required to eliminate information irrelevant to the MAP-user.

The mapping of service primitives on to protocol elements is described in clauses 14 to 17.

GSM signalling procedures are built from one or more sub-procedures (e.g. authentication, ciphering, ...). Sub-procedures from which signalling procedures are built are represented using SDL MACRO descriptions.

In case of any discrepancy between the textual descriptions and the SDL descriptions, the latter take precedence.

18.2.2 Naming conventions

Events related to MAP are represented by MAP service primitives. The signal names used in the SDL diagrams are derived from the service primitive names defined in clauses 7 to 12, with some lexical transformations for readability and parsability purposes (blanks between words are replaced by underscores, the first letter of each word is capitalised).

Events received and sent on other interfaces are named by appending the message or signal name to a symbol representing the interface type, with some lexical transformations for readability and parsability purposes (blanks between words are replaced by underscores, the first letter of each word is capitalised).

The following symbols are used to represent the interface types:

"I": For interfaces to the fixed network. "I" stands for ISUP interface.

"A": For interfaces to BSS (i.e. A-interfaces);

"OM": For network management interfaces (communication with OMC, MML interface, ...);

"SC": For interfaces to a Service Centre;

"HO_CA": For internal interfaces to the Handover Control Application.

"US": For a local USSD application.

These naming conventions can be summarised by the following BNF description:

```

<Event_Name> ::= <MAP_Primitive> | <External_Event>
<MAP_Primitive> ::= <MAP_Open> | <MAP_Close> | <MAP_U_Abort> | <MAP_P_Abort> |
<MAP_Specific> | <MAP_Notice>
<MAP_Open> ::= MAP_Open_Req | MAP_Open_Ind | MAP_Open_Rsp | MAP_Open_Cnf
<MAP_Close> ::= MAP_Close_Req | MAP_Close_Ind
<MAP_U_Abort> ::= MAP_U_Abort_Req | MAP_U_Abort_Ind
<MAP_P_Abort> ::= MAP_P_Abort_Ind
<MAP_Notice> ::= MAP_Notice_Ind
<MAP_Specific> ::= <MAP_Req> | <MAP_Ind> | <MAP_Rsp> | <MAP_Cnf>
<MAP_Req> ::= MAP_<Service_Name>_Req
<MAP_Ind> ::= MAP_<Service_Name>_Ind
<MAP_Rsp> ::= MAP_<Service_Name>_Rsp
<MAP_Cnf> ::= MAP_<Service_Name>_Cnf
<External_Event> ::= <Interface_Type>_<External_Signal>
<Interface_Type> ::= I | A | OM | SC | HO AC | US
<External_Signal> ::= <Lexical_Unit>
<Service_Name> ::= <Lexical_Unit>
<Lexical_Unit> ::= <Lexical_Component> | <Lexical_Unit>_<Lexical_Component>
<Lexical_Component> ::= <Upper_Case_Letter><Letter_Or_Digit_List>
<Letter_Or_Digit_List> ::= <Letter_Or_Digit> | <Letter_Or_Digit_List><Letter_Or_Digit>
<Letter_Or_Digit> ::= <Letter> | <Digit>
<Letter> ::= <Lower_Case_Letter> | <Upper_Case_Letter>
<Upper_Case_Letter> ::= A|B|C|D|E|F|G|H|I|J|K|L|M|N|O|P|Q|R|S|T|U|V|W|X|Y|Z
<Lower_Case_Letter> ::= a|b|c|d|e|f|g|h|i|j|k|l|m|n|o|p|q|r|s|t|u|v|w|x|y|z
<Digit> ::= 1|2|3|4|5|6|7|8|9|0

```

Figure 18.2/1: Interfaces applicable to the MAP-User

18.2.3 Convention on primitives parameters

18.2.3.1 Open service

When the originating and destination reference parameters shall be included in the MAP-OPEN request primitive, their value are indicated as a comment to the signal which represents this primitive.

18.2.3.2 Close service

When a pre-arranged released is requested, a comment is attached to the signal which represents the MAP-CLOSE request primitive. In the absence of comment, a normal release is assumed.

18.2.4 Version handling at dialogue establishment

Unless explicitly indicated in subsequent clauses, the following principles regarding version handling procedures at dialogue establishment are applied by the MAP-user.

18.2.4.1 Behaviour at the initiating side

When a MAP user signalling procedure has to be executed, the MAP-user issues a MAP-OPEN request primitive with an appropriate application-context-name. If several names are supported (i.e. several versions) a suitable one is selected using the procedures described in clause 5.

If version n is selected (where $1 < n \leq$ highest existing version) and a MAP-OPEN Confirm primitive is received in response to the MAP-OPEN request with a result parameter set to "refused" and a diagnostic parameter indicating "application context not supported" or "potential version incompatibility problem", the MAP-User issues a new MAP-OPEN request primitive with the equivalent version y context (where $1 \leq y < n$). This is informally represented in the SDL diagrams by task symbols indicating "Perform V_r procedure".

18.2.4.2 Behaviour at the responding side

On receipt of a MAP-OPEN indication primitive, the MAP-User analyses the application-context-name and executes the procedure associated with the requested version context. For example, if it refers to a version one context, the associated V_1 procedure is executed; if it refers to a version two context, the associated V_2 procedure is executed; etc.

18.2.5 Abort Handling

Unless explicitly indicated in subsequent clauses, the following principles are applied by the MAP-user regarding abort handling procedures:

On receipt of a MAP-P-ABORT indication or MAP-U-ABORT Indication primitive from any MAP-provider invocation, the MAP-User issues a MAP-U-ABORT Request primitive to each MAP-provider invocation associated with the same user procedure.

If applicable a decision is made to decide if the affected user procedure has to be retried or not.

18.2.6 SDL conventions

The MAP SDLs make use of a number of SDL concepts and conventions, where not all of them may be widely known. Therefore, this clause outlines the use of a few concepts and conventions to improve understanding of the MAP SDLs.

The MAP User SDLs make use of SDL Processes, Procedures and Macros. Processes are independent from each other even if one process starts another one: The actions of both of them have no ordering in time. SDL Procedures and Macros are just used to ease writing of the specification: They contain parts of a behaviour used in several places, and the corresponding Procedure/Macro definition has to be expanded at the position of the Procedure/Macro call.

All Processes are started at system initialisation and live forever, unless process creation/termination is indicated explicitly (i.e. a process is created by some other process).

The direction of Input/Output Signals in the SDL graphs is used to indicate the entity to which/from which communication is directed. If a process A communicates in parallel with processes B and C, all Inputs/Outputs to/from B are directed to one side, whereas communication with C is directed to the other side. However, there has been no formal convention used that communication to a certain entity (e.g. a HLR) will always be directed to a certain side (e.g. right).

In each state all those Input Signals are listed, which result in an action and/or state change. If an Input Signal is not listed in a state, receipt of this input should lead to an implicit consumption without any action or state change (according to the SDL rules). This implicit consumption is mainly used for receipt of the MAP DELIMITER indication and for receipt of a MAP CLOSE indication, except for a premature MAP CLOSE.

18.3 Interaction between MAP Provider and MAP Users

Each MAP User is defined by at least one SDL process. On the dialogue initiating side, the MAP User will create a new instance of a MAP Provider implicit by issuing a MAP-OPEN request. This instance corresponds to a TC Dialogue and lives as long as the dialogue exists (see also clause 14.3). There is a fixed relation between MAP User and this Provider instance, i.e. all MAP service primitives from the MAP User for this dialogue are sent to this instance and all TC components received by this MAP Provider are mapped onto service primitives sent to this MAP User.

On the receiving side a MAP Provider instance is created implicit by receipt of a TC BEGIN indication. The corresponding MAP User is determined by the Application Context name included in this primitive, i.e. each Application Context is associated with one and only one MAP User. An instance of this User will be created implicitly by receiving a MAP-OPEN indication. Note that in some cases there exist several SDL Processes for one MAP User (Application Context), e.g. the processes Register_SS_HLR, Erase_SS_HLR, Activate_SS_HLR, Deactivate_SS_HLR, Interrogate_SS_HLR, and Register_Password for the AC Network_Functional_SS_Handling. In these cases, a coordinator process is introduced acting as a MAP User, which in turn starts a sub-process depending on the first MAP service primitive received.

19 Mobility procedures

19.1 Location management Procedures

The signalling procedures in this subclause support:

- Interworking between the VLR and the HLR and between the VLR and the previous VLR (PVLR) when a non-GPRS subscriber performs a location update to a new VLR service area;
- Interworking between the SGSN, the HLR and the VLR when a subscriber with both GPRS and non-GPRS subscriptions performs a routing area update in an SGSN and the Gs interface is implemented;
- Interworking between the SGSN and the VLR when a GPRS subscriber performs a routing area update to a new SGSN service area;
- Interworking between the HLR and the VLR and between the HLR and the SGSN to delete a subscriber record from the VLR or the SGSN;
- Interworking between the VLR and the HLR and between the SGSN and the HLR to report to the HLR that a subscriber record has been purged from the VLR or the SGSN.

The MAP co-ordinating process in the HLR to handle a dialogue opened with the network location updating context is shown in figure 19.1/1. The MAP process invokes a macro not defined in this clause; the definition of this macro can be found as follows:

Receive_Open_Ind see clause 25.1.1.

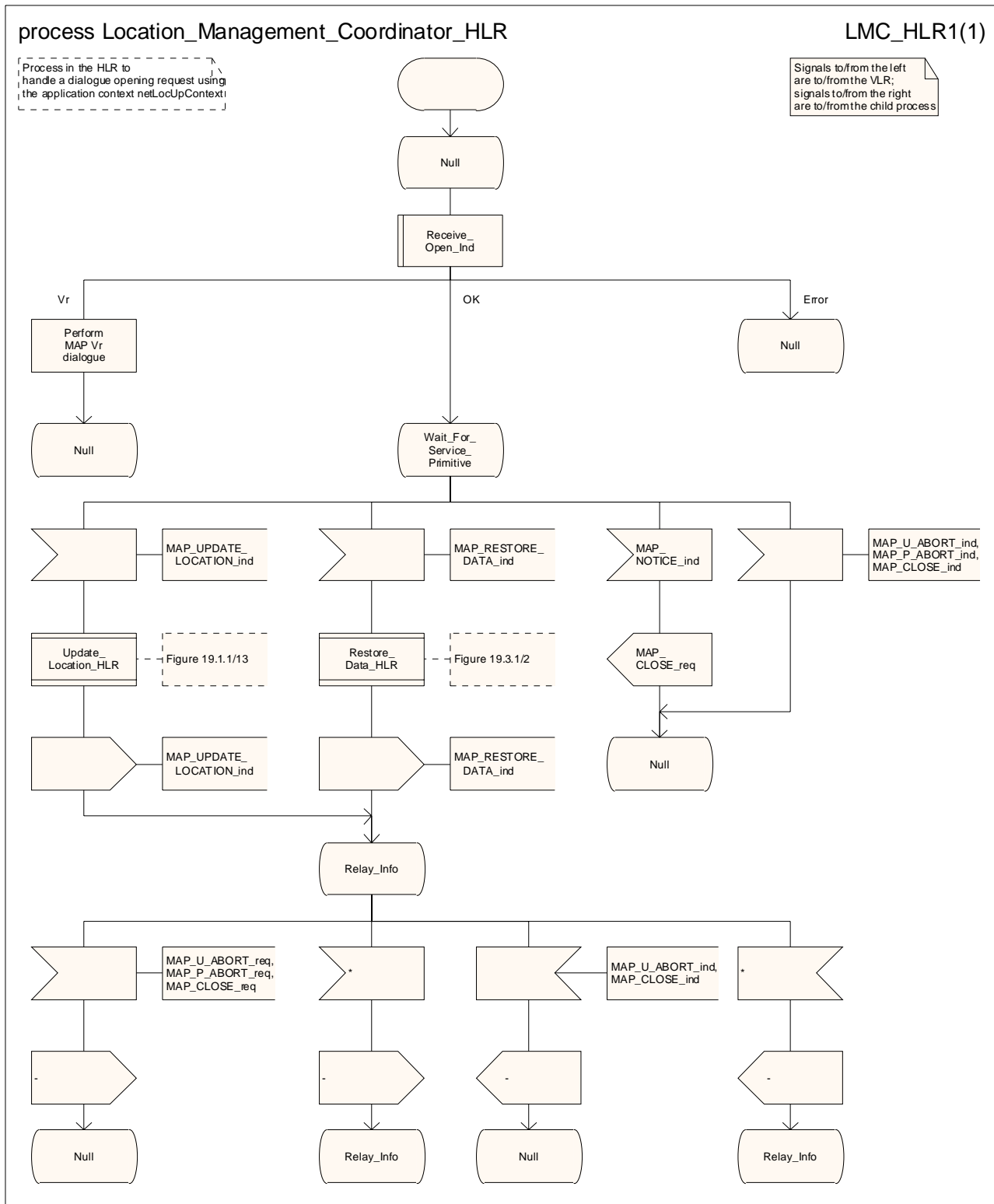

Figure 19.1/1: Process Location_Management_Coordinator_HLR

19.1.1 Location updating

19.1.1.1 General

The stage 2 specification for location management for a non-GPRS subscriber is 3GPP TS 23.012 [23]. The interworking between the MAP signalling procedures and the location management procedures in the VLR, the PVLR and the HLR is shown by the transfer of signals between these procedures.

The stage 2 specification for GPRS is in 3GPP TS 23.060 [104]. The interworking between the MAP signalling procedures and the GPRS procedures in the SGSN and the HLR is shown by the transfer of signals between these procedures.

The message flow for successful inter-VLR location updating when the IMSI can be retrieved from the PVLR is shown in figure 19.1.1/2.

The message flow for successful inter-VLR location updating when the IMSI cannot be retrieved from the PVLR is shown in figure 19.1.1/3.

The message flow for successful GPRS Attach/RA update procedure (Gs interface not installed) is shown in figure 19.1.1/4.

The message flow for successful GPRS Attach/RA update procedure combined with a successful VLR location updating (Gs interface installed) is shown in figure 19.1.1/5.

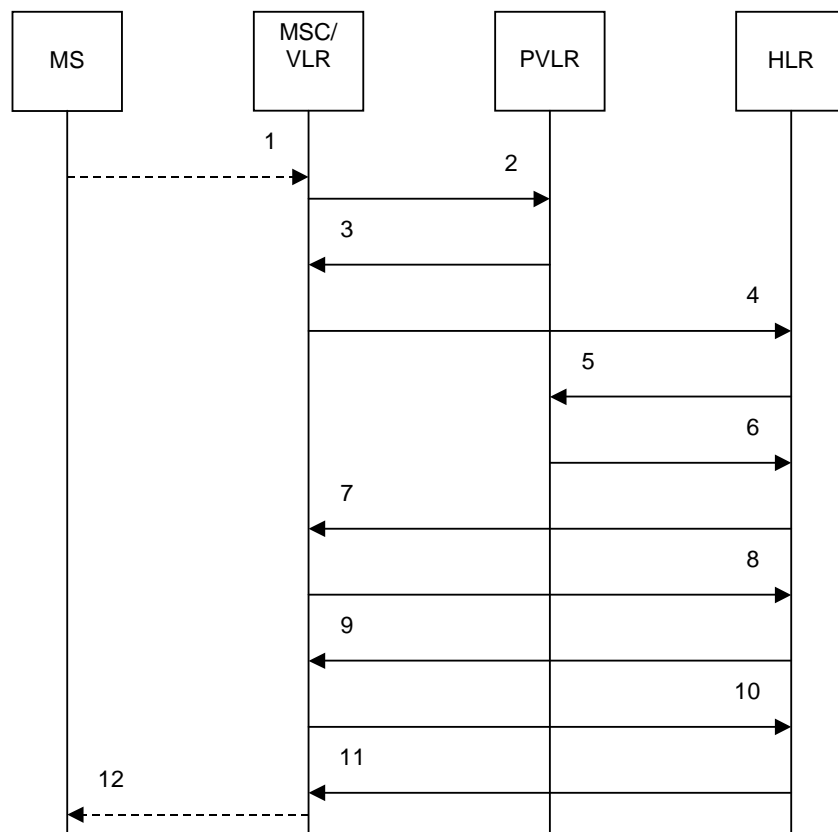

PVLR = Previous VLR

- 1) A_LU_REQUEST (Note 1)
- 2) MAP_SEND_IDENTIFICATION_req/ind
- 3) MAP_SEND_IDENTIFICATION_rsp/cnf
- 4) MAP_UPDATE_LOCATION_req/ind
- 5) MAP_CANCEL_LOCATION_req/ind
- 6) MAP_CANCEL_LOCATION_rsp/cnf
- 7) MAP_ACTIVATE_TRACE_MODE_req/ind (Note 2)
- 8) MAP_ACTIVATE_TRACE_MODE_rsp/cnf (Note 2)

- 9) MAP_INSERT_SUBSCRIBER_DATA_req/ind
- 10) MAP_INSERT_SUBSCRIBER_DATA_rsp/cnf
- 11) MAP_UPDATE_LOCATION_rsp/cnf
- 12) A_LU_CONFIRM (Note 1)

NOTE 1: For details of the procedure on the radio path, see 3GPP TS 24.008 [35]. Services shown in dotted lines indicate the trigger provided by the signalling on the radio path, and the signalling triggered on the radio path.

NOTE 2: Services printed in *italics* are optional.

Figure 19.1.1/2: Message flow for location updating to a new VLR area, when the IMSI can be retrieved from the previous VLR

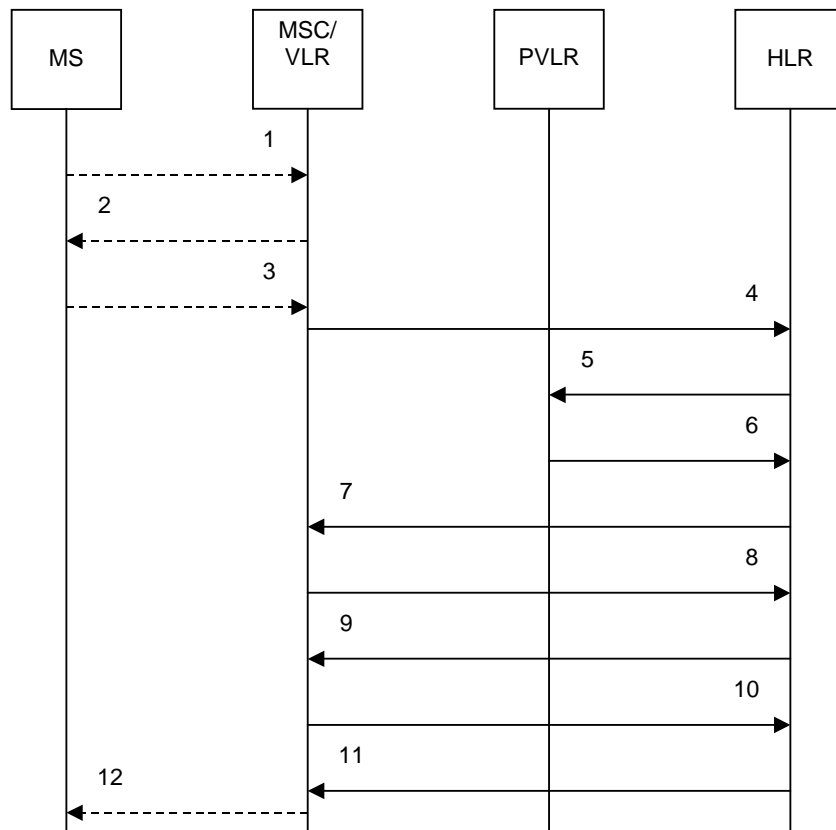

PVLR = Previous VLR

- 1) A_LU_REQUEST (Note 1)
- 2) A_IDENTITY_REQUEST (Note 1)
- 3) A_IDENTITY_RESPONSE (Note 1)
- 4) MAP_UPDATE_LOCATION_req/ind
- 5) MAP_CANCEL_LOCATION_req/ind
- 6) MAP_CANCEL_LOCATION_rsp/cnf
- 7) *MAP_ACTIVATE_TRACE_MODE_req/ind* (Note 2)
- 8) *MAP_ACTIVATE_TRACE_MODE_rsp/cnf* (Note 2)
- 9) MAP_INSERT_SUBSCRIBER_DATA_req/ind
- 10) MAP_INSERT_SUBSCRIBER_DATA_rsp/cnf
- 11) MAP_UPDATE_LOCATION_rsp/cnf
- 12) A_LU_CONFIRM (Note 1)

NOTE 1: For details of the procedure on the radio path, see 3GPP TS 24.008 [35]. Services shown in dotted lines indicate the trigger provided by the signalling on the radio path, and the signalling triggered on the radio path.

NOTE 2: Services printed in *italics* are optional.

Figure 19.1.1/3: Message flow for location updating to a new VLR area, when the IMSI cannot be retrieved from the previous VLR

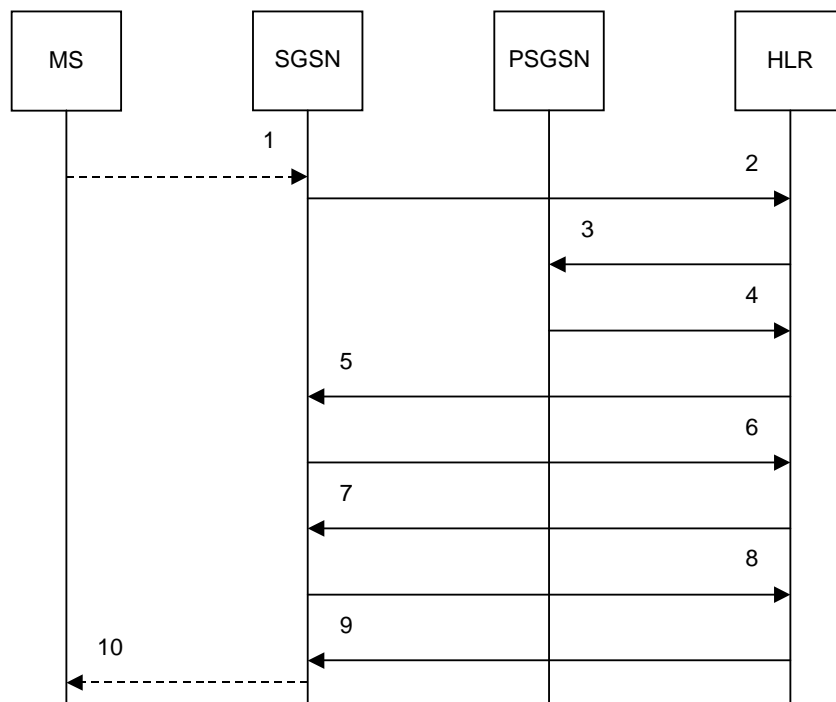

PSGSN = Previous SGSN

- 1) Gb_ATTACH_REQUEST or RA_UPDATE_REQUEST (Note 1, note 2)
- 2) MAP_UPDATE_GPRS_LOCATION_req/ind
- 3) MAP_CANCEL_LOCATION_req/ind
- 4) MAP_CANCEL_LOCATION_rsp/cnf
- 5) MAP_ACTIVATE_TRACE_MODE_req/ind (Note 3)
- 6) MAP_ACTIVATE_TRACE_MODE_rsp/cnf (Note 3)
- 7) MAP_INSERT_SUBSCRIBER_DATA_req/ind
- 8) MAP_INSERT_SUBSCRIBER_DATA_rsp/cnf
- 9) MAP_UPDATE_GPRS_LOCATION_rsp/cnf
- 10) Gb_ATTACH_ACCEPT or RA_UPDATE_ACCEPT (Note 1)

NOTE 1: For details of the procedure on the radio path, see 3GPP TS 24.008 [35]. The services shown in dotted lines indicate the trigger provided by the signalling on the radio path, and the signalling triggered on the radio path.

NOTE 2: For security functions (authentication, ciphering, IMEI check) triggering refer to 3GPP TS 23.060 [104]. The MAP signalling invoked for these functions is described in clause 25 of the present document.

NOTE 3: Services are printed in *italics* are optional.

NOTE 4: Refer to 3GPP TS 23.060 [104] for termination of the procedure and triggering of the signalling on the interface between the BSS and the SGSN.

Figure 19.1.1/4: Message flow for GPRS location updating (Gs interface not installed)

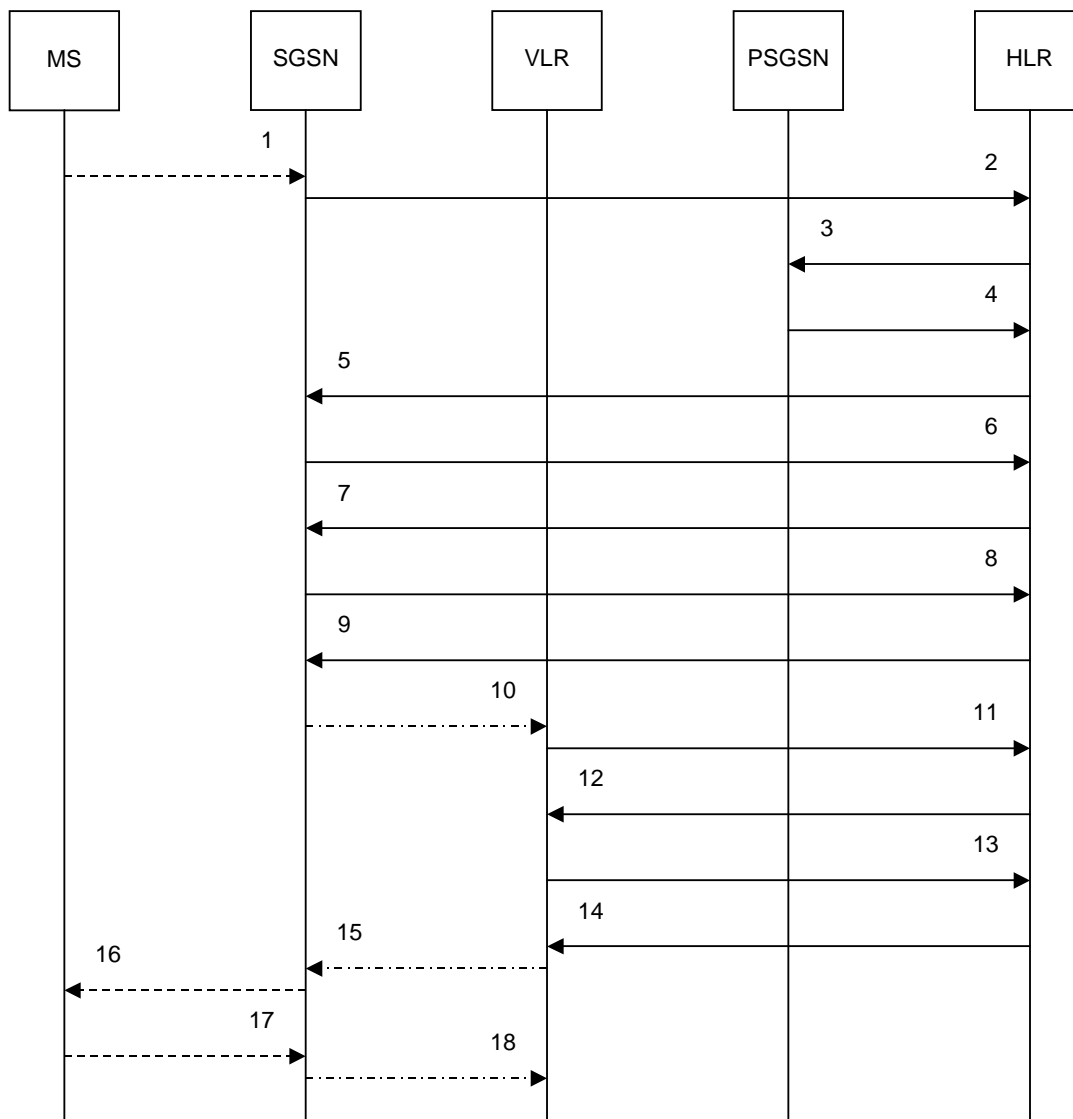

- 1) Gb_ATTACH_REQUEST or RA_UPDATE_REQUEST (Note 1, note 2)
- 2) MAP_UPDATE_GPRS_LOCATION_req/ind
- 3) MAP_CANCEL_LOCATION_req/ind
- 4) MAP_CANCEL_LOCATION_rsp/cnf
- 5) MAP_ACTIVATE_TRACE_MODE_req/ind (Note 3)
- 6) MAP_ACTIVATE_TRACE_MODE_rsp/cnf (Note 3)
- 7) MAP_INSERT_SUBSCRIBER_DATA_req/ind
- 8) MAP_INSERT_SUBSCRIBER_DATA_rsp/cnf
- 9) MAP_UPDATE_GPRS_LOCATION_rsp/cnf
- 10) Gs_LOCATION_UPDATE_REQUEST (Note 4)
- 11) MAP_UPDATE_LOCATION_req/ind (Note 5)
- 12) MAP_INSERT_SUBSCRIBER_DATA_req/ind
- 13) MAP_INSERT_SUBSCRIBER_DATA_rsp/cnf
- 14) MAP_UPDATE_LOCATION_rsp/cnf
- 15) Gs_LOCATION_UPDATE_ACCEPT (Note 4)
- 16) Gb_ATTACH_ACCEPT or RA_UPDATE_ACCEPT (Note 1)
- 17) Gb_TMSI_REALLOCATION_COMPLETE (Note 1)
- 18) Gs_TMSI_REALLOCATION_COMPLETE (Note 4)

NOTE 1: For details of the procedure on the radio path, see 3GPP TS 24.008 [35]. The services shown in dotted lines indicate the trigger provided by the signalling on the radio path, and the signalling triggered on the radio path.

NOTE 2: For security functions (authentication, ciphering, IMEI check) triggering refer to 3GPP TS 23.060 [104]. MAP processes invoked for those procedures are described in subclause 25.5.

NOTE 3: Services printed in *italics* are optional.

NOTE 5: For details of the procedure on the path between the SGSN and the VLR, see 3GPP TS 29.018 [106]. The services shown in chain lines indicate the trigger provided by the signalling on the path between the SGSN and the VLR, and the signalling triggered on the path between the SGSN and the VLR.

NOTE 4: Refer to 3GPP TS 23.060 [104] for termination of the procedure and triggering of the signalling on the interface between the BSS and the SGSN.

NOTE 5: For simplicity, the Location Cancellation procedure towards the previous VLR and optional tracing activation towards the new VLR are not shown in this figure.

Figure 19.1.1/5: Message flow for GPRS location updating (Gs interface installed)

19.1.1.2 Procedures in the VLR

The MAP process in the VLR for location updating for a non-GPRS subscriber is shown in figure 19.1.1/6. The MAP process invokes macros not defined in this clause; the definitions of these macros can be found as follows:

Receive_Open_Cnf see subclause 25.1.2;

Check_Confirmation see subclause 25.2.2.

The MAP process in the VLR to retrieve the IMSI of a subscriber from the previous VLR (PVLR) is shown in figure 19.1.1/7. The MAP process invokes macros not defined in this clause; the definitions of these macros can be found as follows:

Receive_Open_Cnf see subclause 25.1.2;

Check_Confirmation see subclause 25.2.2.

The process in the VLR for location updating for a GPRS subscriber when the Gs interface is installed is shown in figure 19.1.1/8.

The macro GPRS_Location_Update_Completion_VLR is shown in figure 19.1.1/9. The macro invokes a process not defined in this clause; the definition of this process can be found as follows:

Subscriber_Present_VLR see subclause 25.10.1.

The macro GPRS_Update_HLR_VLR is shown in figure 19.1.1/10. The macro invokes macros not defined in this clause; the definitions of these macros can be found as follows:

Receive_Open_Cnf see subclause 25.1.2;

Check_Confirmation see subclause 25.2.2;

Insert_Subs_Data_VLR see subclause 25.7.1;

Activate_Tracing_VLR see subclause 25.9.4.

19.1.1.3 Procedure in the PVLR

The MAP process in the PVLR to handle a request for the IMSI of a subscriber from the new VLR is shown in figure 19.1.1/11. The MAP process invokes a macro not defined in this clause; the definition of this macro can be found as follows:

Receive_Open_Ind see subclause 25.1.1.

19.1.1.4 Procedure in the SGSN

The MAP process in the SGSN for location updating for a GPRS subscriber is shown in figure 19.1.1/12. The MAP process invokes macros not defined in this clause; the definitions of these macros can be found as follows:

Receive_Open_Cnf see subclause 25.1.2;

Check_Confirmation see subclause 25.2.2;

Insert_Subs_Data_SGSN see subclause 25.7.2;

Activate_Tracing_SGSN see subclause 25.9.5.

Sheet 2: The procedure Check_User_Error_In_Serving_Network_Entity is specific to Super-Charger; it is specified in 3GPP TS 23.116 [110].

19.1.1.5 Procedures in the HLR

The MAP process in the HLR to handle a location updating request from a VLR is shown in figure 19.1.1/13. The MAP process invokes a macro not defined in this clause; the definition of this macro can be found as follows:

Check_Confirmation see subclause 25.2.2.

The MAP process in the HLR to handle a location updating request from an SGSN is shown in figure 19.1.1/14. The MAP process invokes macros not defined in this clause; the definitions of these macros can be found as follows:

Receive_Open_Ind see subclause 25.1.1;

Check_Indication see subclause 25.2.1;

Check_Confirmation see subclause 25.2.2;

Control_Tracing_With_SGSN_HLR see subclause 25.9.7.

Sheet 2: The procedure Super_Charged_Cancel_Location_HLR is specific to Super-Charger; it is specified in 3GPP TS 23.116 [110]. If the HLR does not support the Super-Charger functionality, processing continues from the "No" exit of the test "Result=Pass?".

Sheet 2: The procedure Super_Charged_Location_Updating_HLR is specific to Super-Charger; it is specified in 3GPP TS 23.116 [110]. If the HLR does not support the Super-Charger functionality, processing continues from the "No" exit of the test "Result=Pass?".

The MAP process in the HLR to notify Short Message Service Centres that a subscriber is now reachable is shown in figure 19.1.1/15. The MAP process invokes a macro not defined in this clause; the definition of this macro can be found as follows:

Alert_Service_Centre_HLR see subclause 25.10.3.

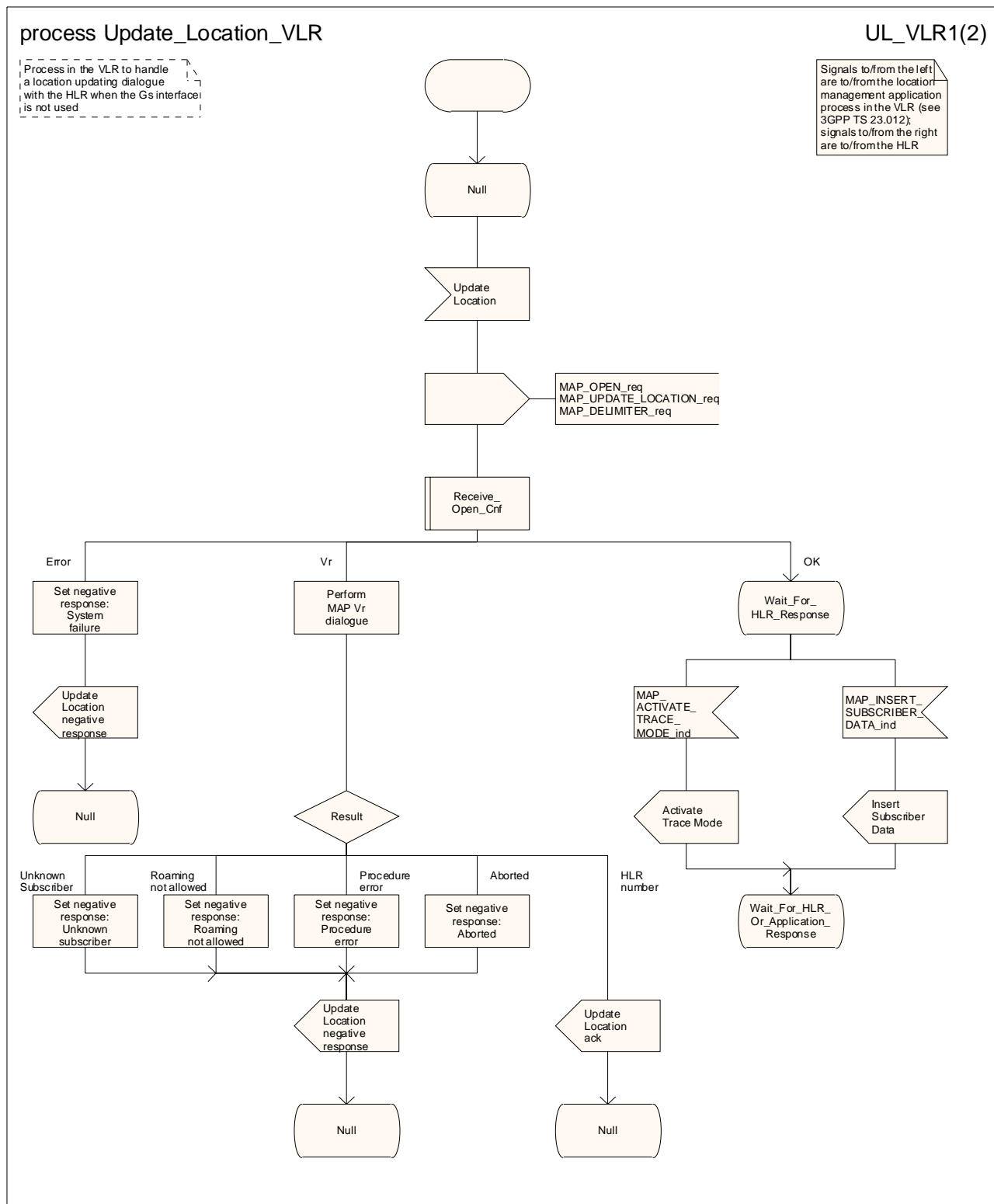

Figure 19.1.1/6 (sheet 1 of 2): Process Update_Location_VLR

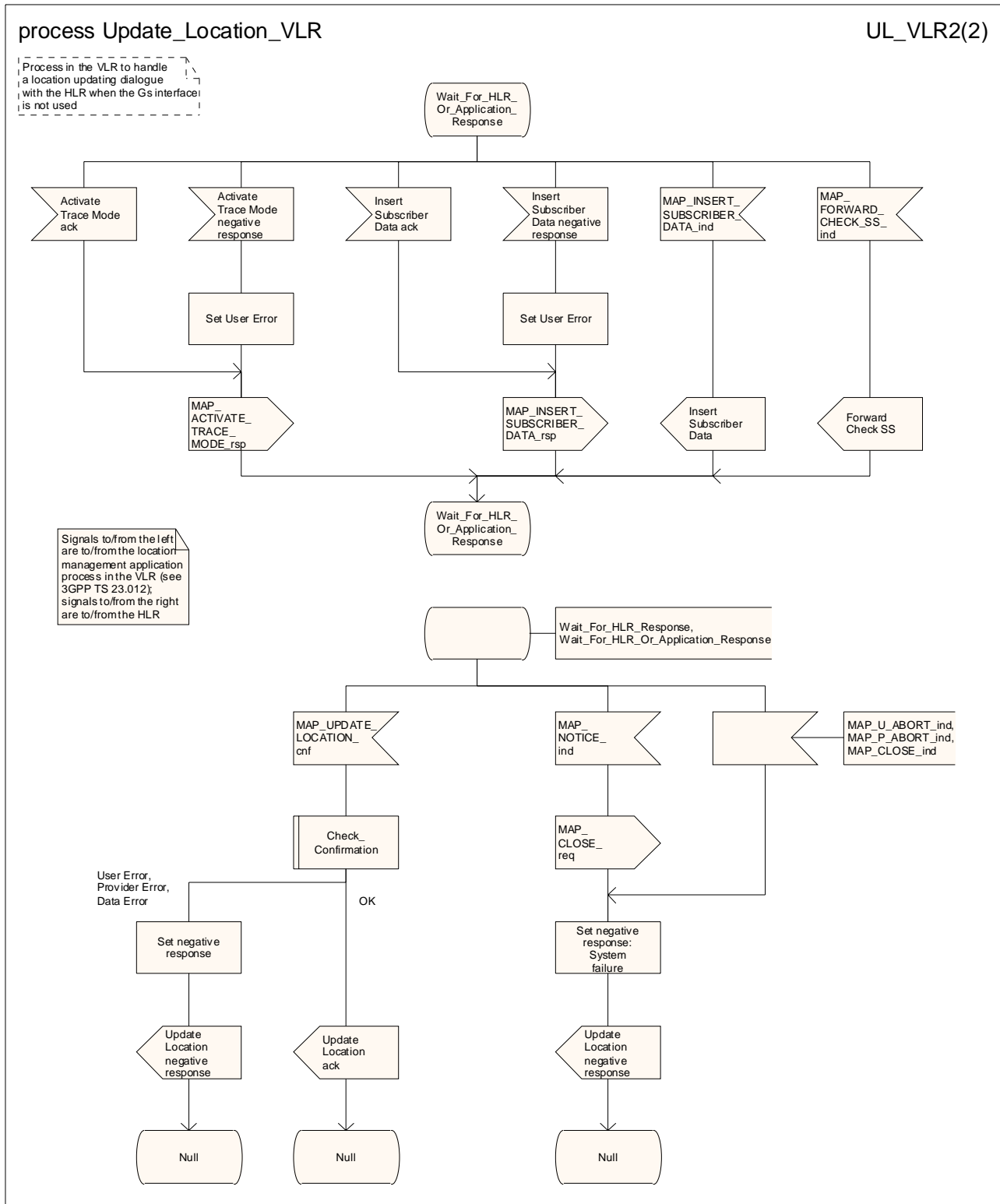

Figure 19.1.1/6 (sheet 2 of 2): Process Update_Location_VLR

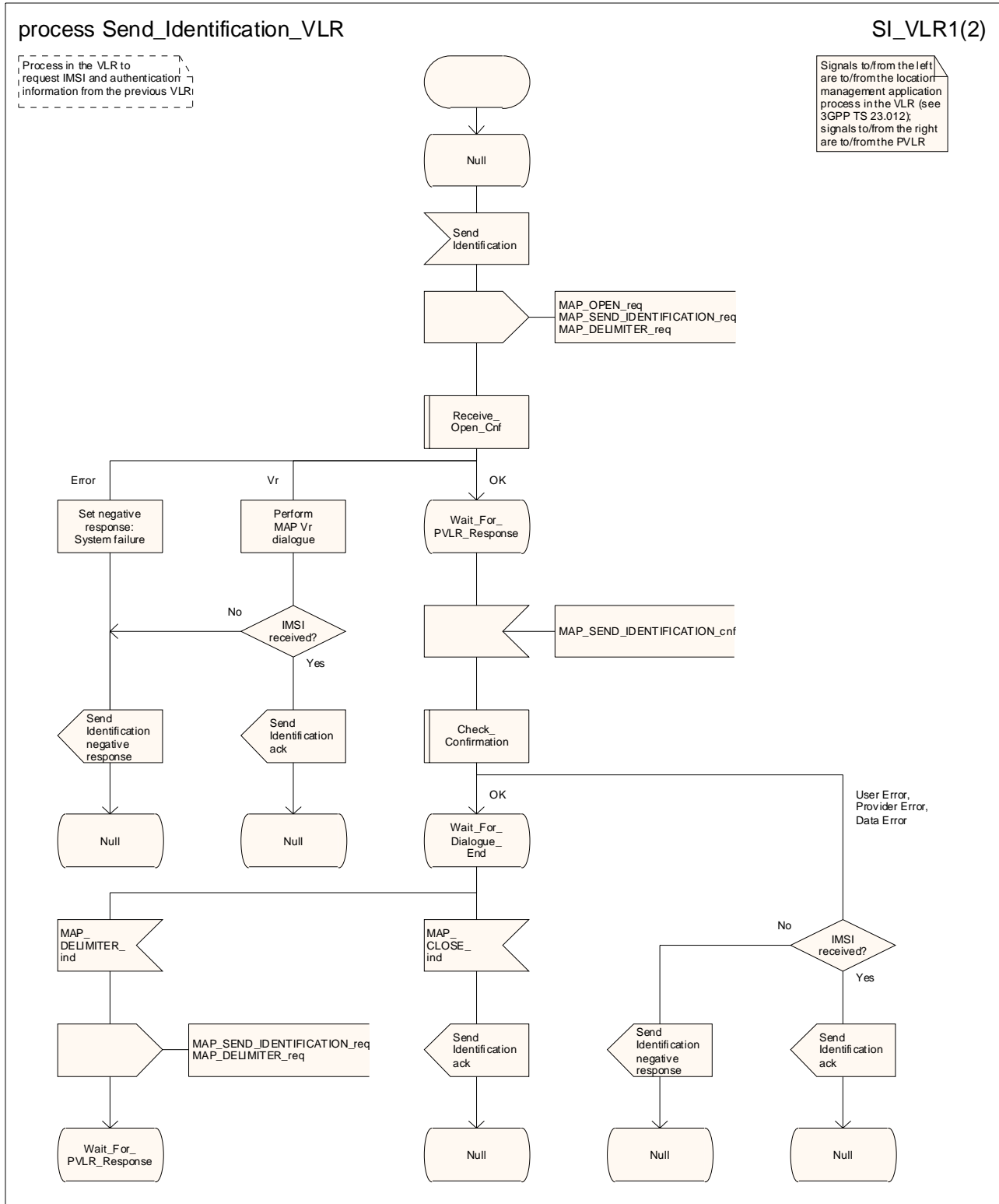

Figure 19.1.1/7 (sheet 1 of 2): Process Send_Identification_VLR

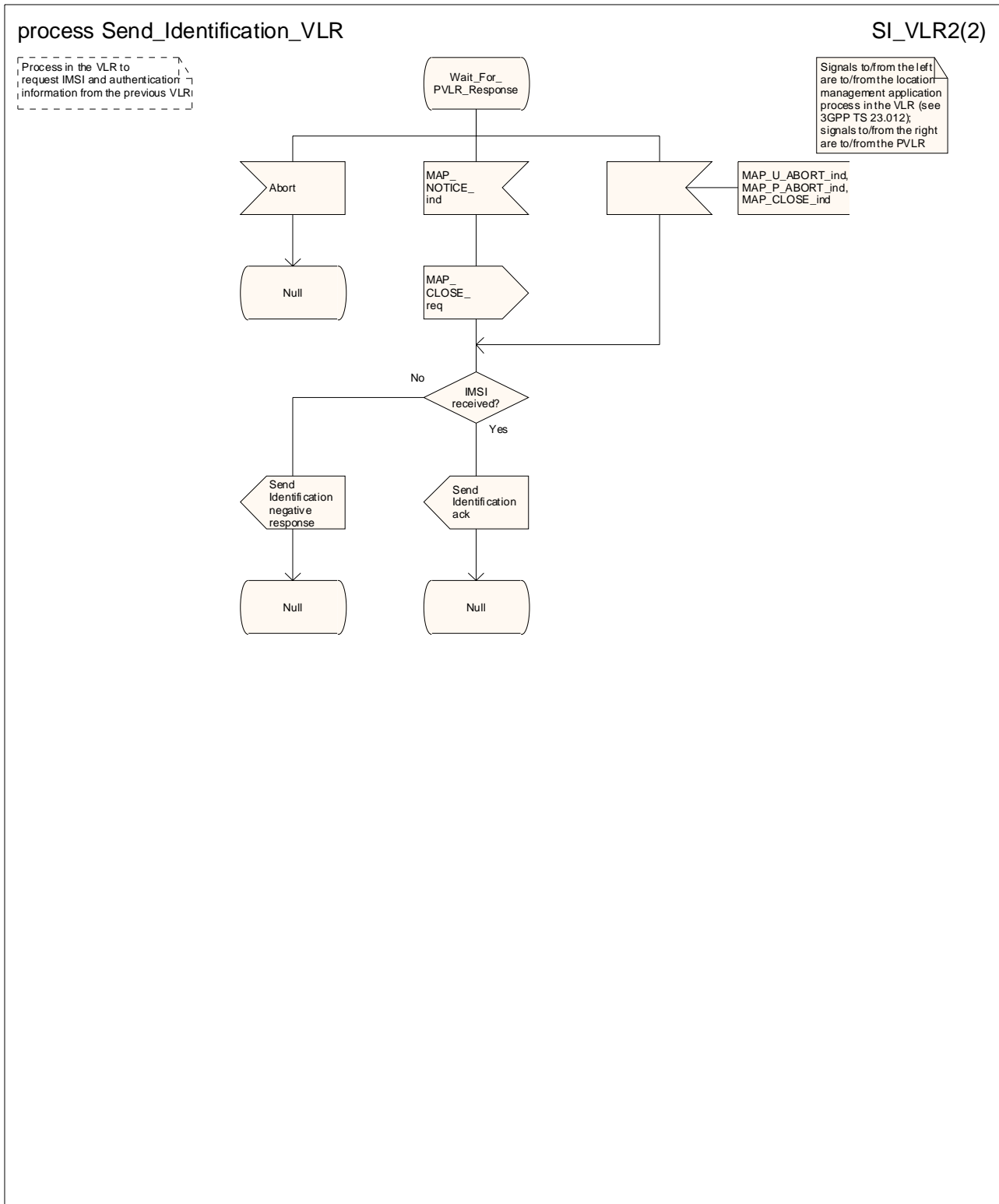

Figure 19.1.1/7 (sheet 2 of 2): Process Send_Identification_VLR

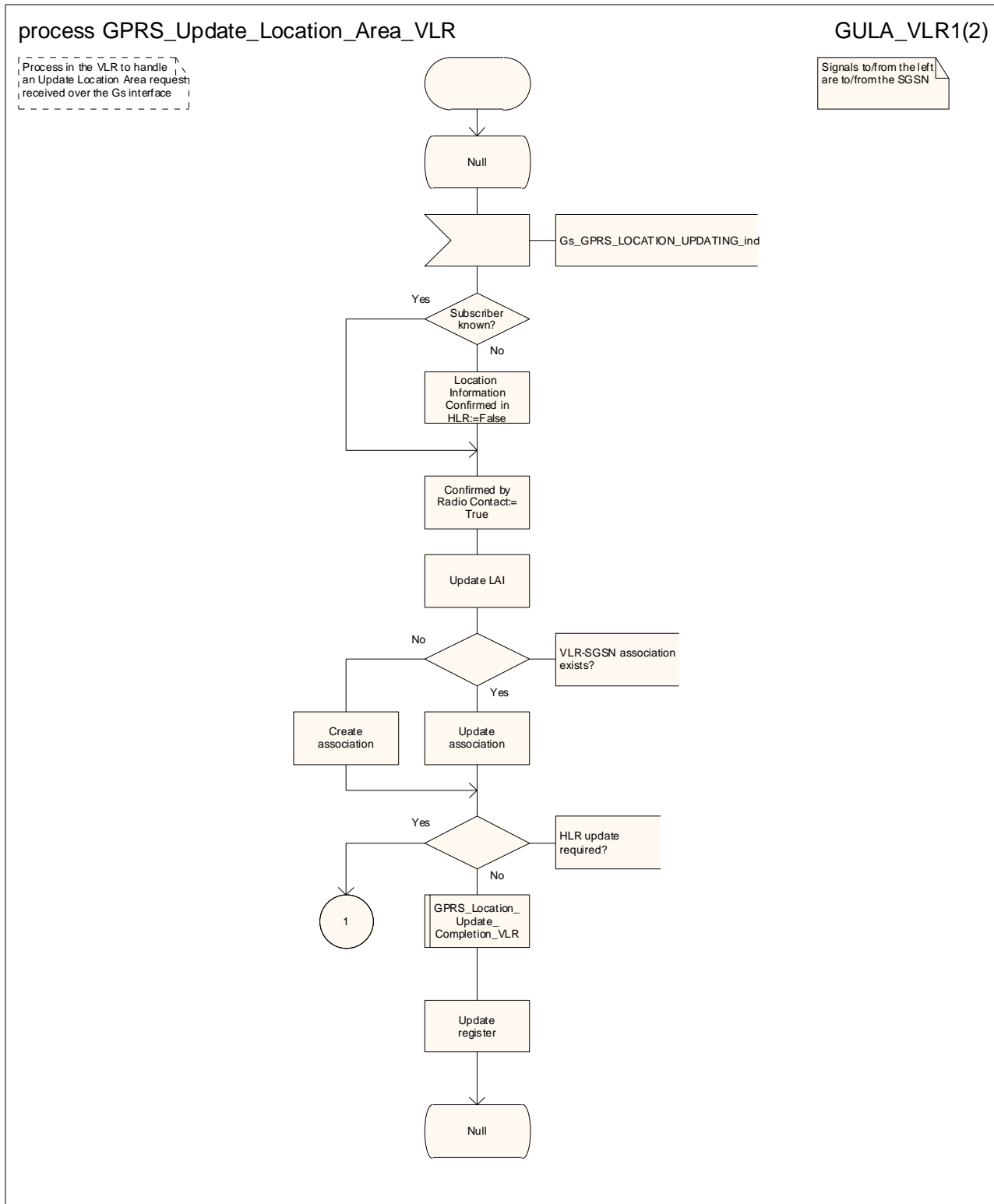

Figure 19.1.1/8 (sheet 1 of 2): Process GPRS_Update_Location_Area_VLR

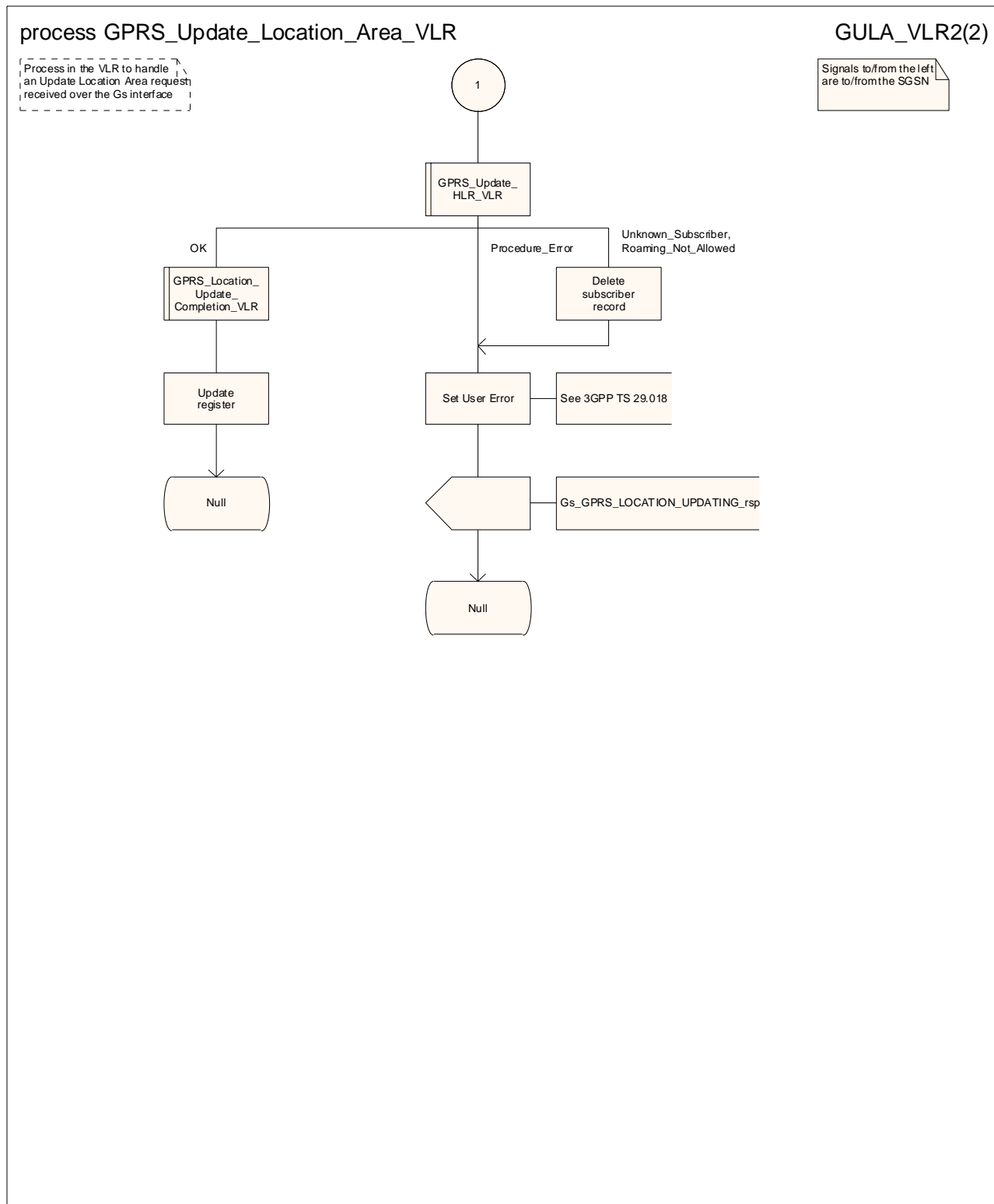

Figure 19.1.1/8 (sheet 2 of 2): Process GPRS_Update_Location_Area_VLR

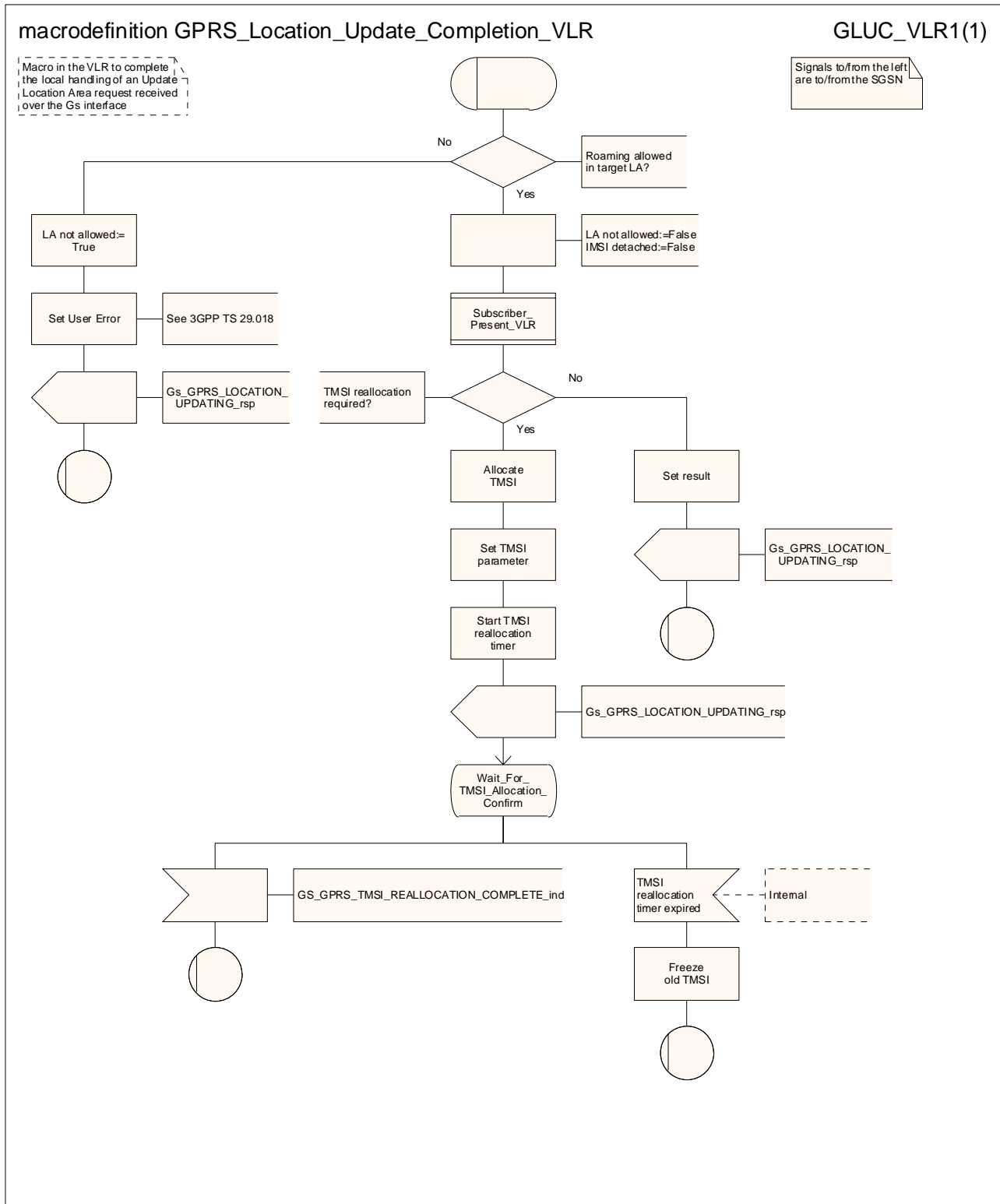

Figure 19.1.1/9: Macro GPRS_Location_Update_Completion_VLR

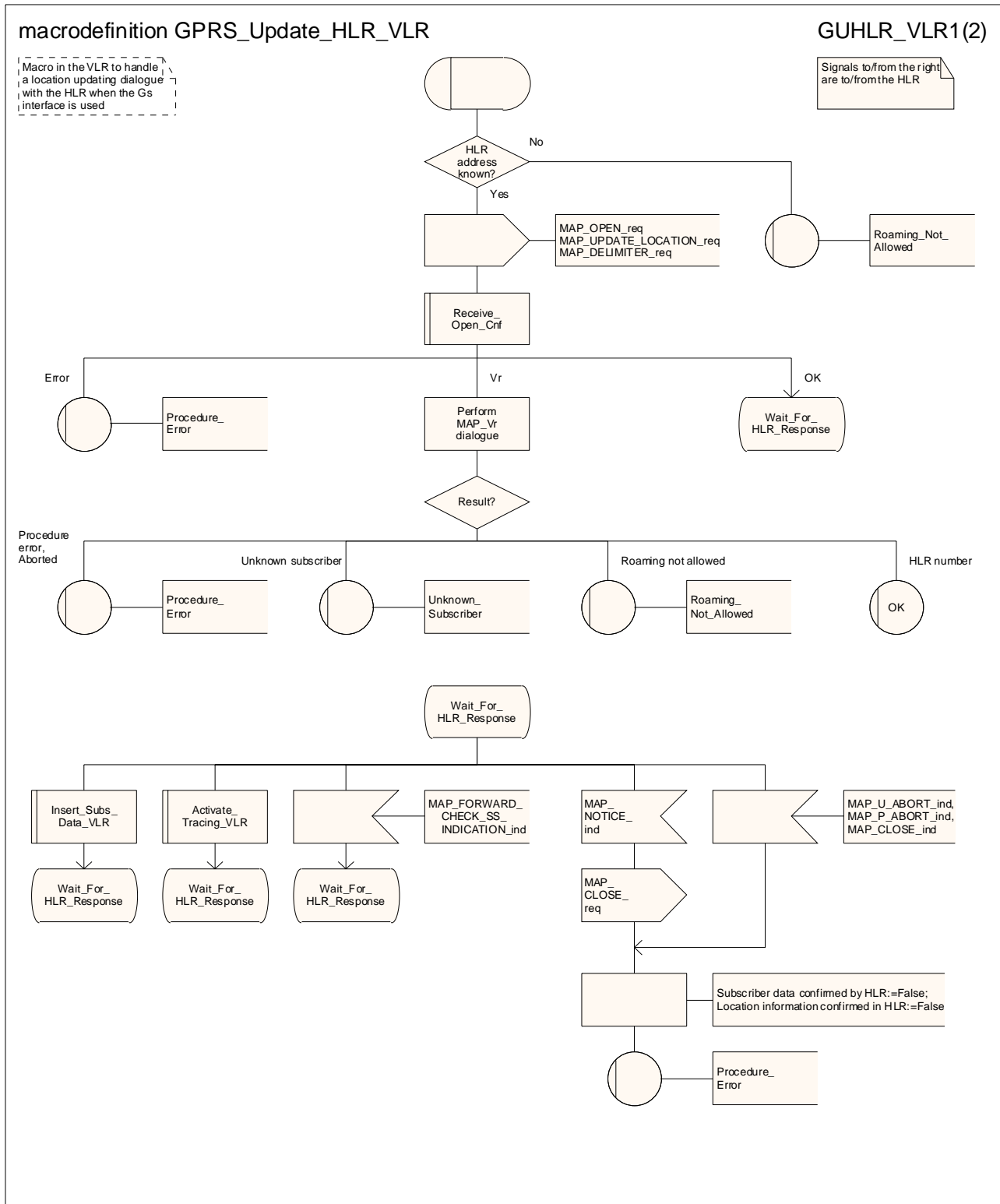

Figure 19.1.1/10 (sheet 1 of 2): Macro GPRS_Update_HLR_VLR

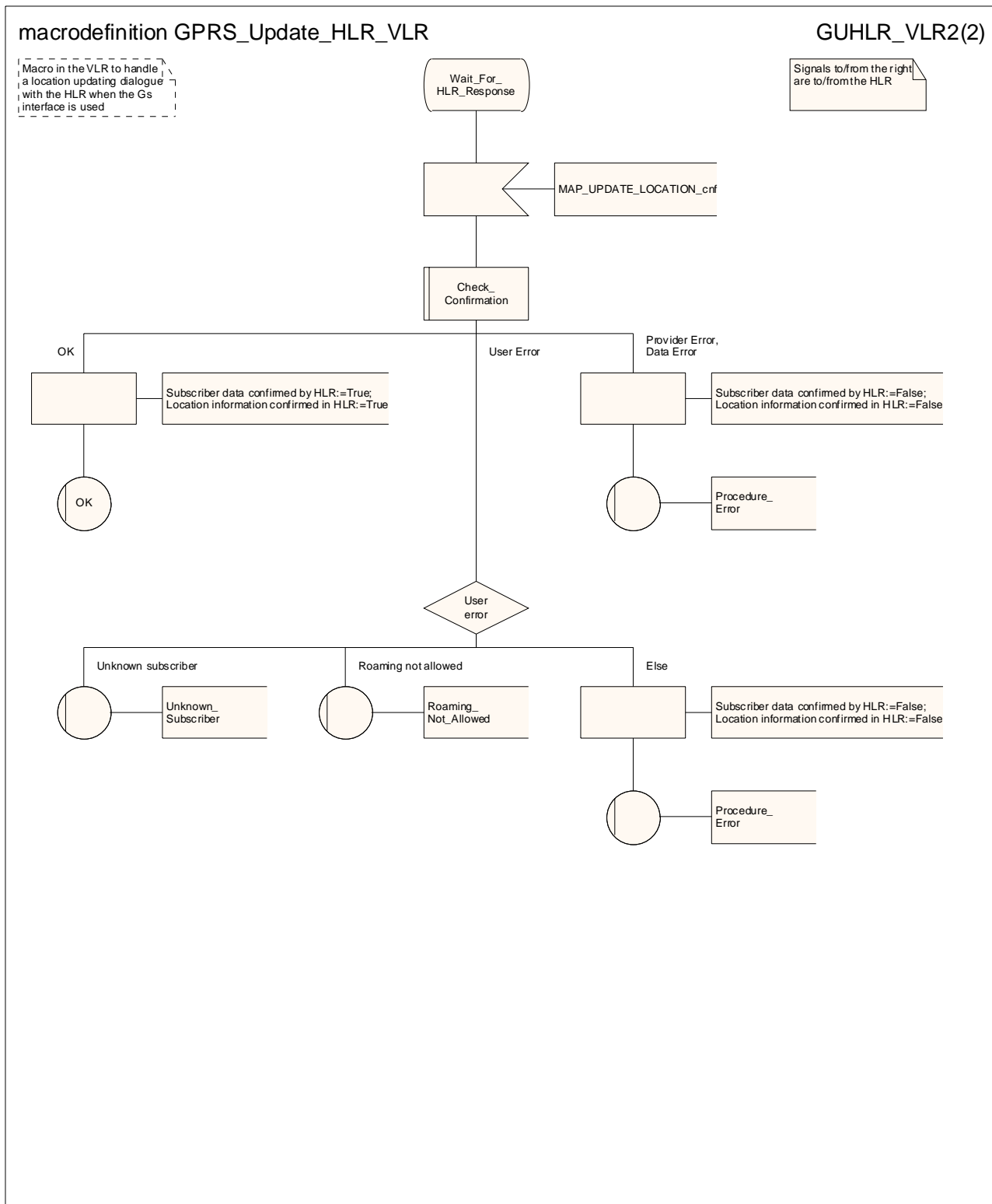

Figure 19.1.1/10 (sheet 2 of 2): Macro GPRS_Update_HLR_VLR

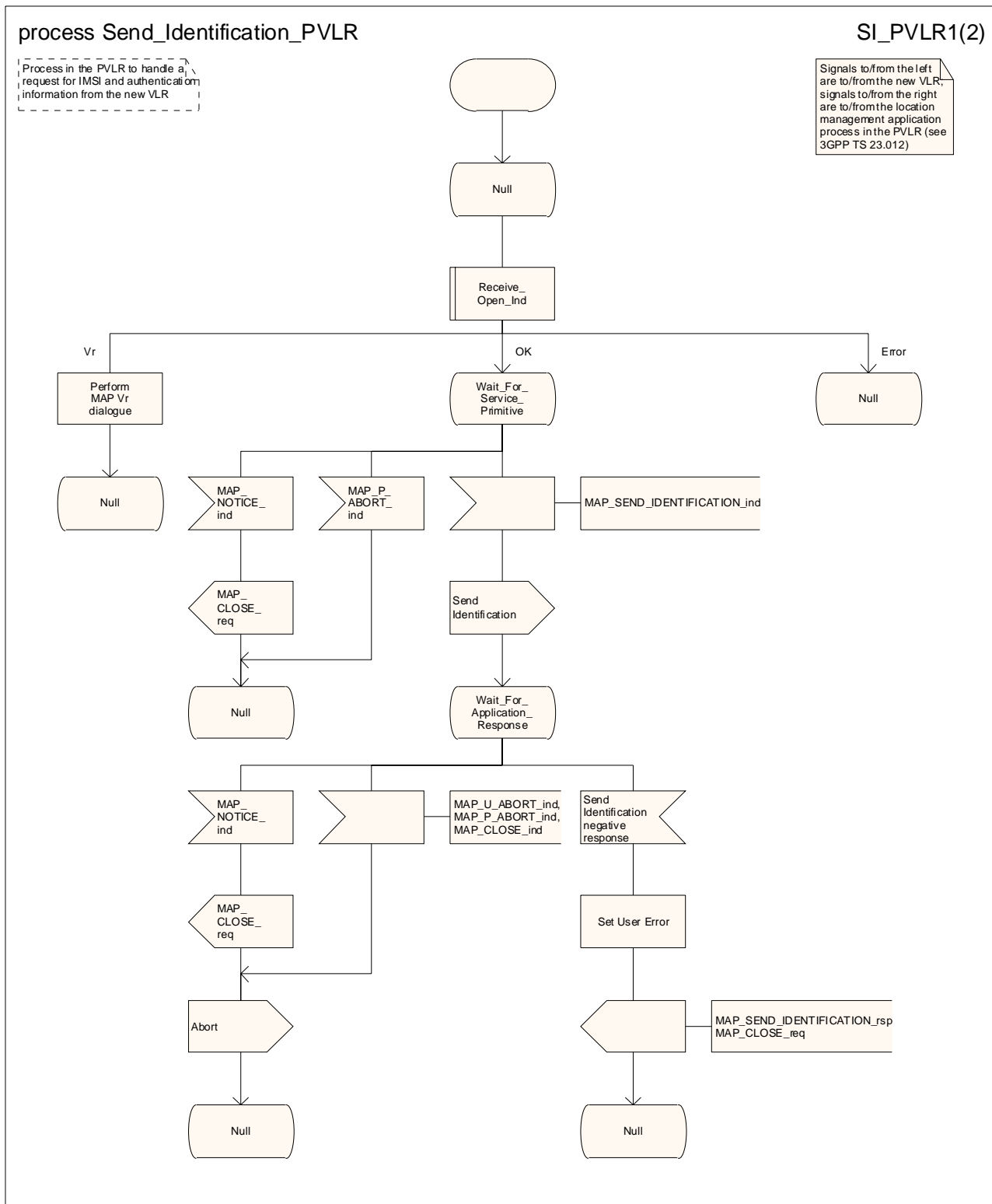

Figure 19.1.1/11 (sheet 1 of 2): Process Send_Identification_PVLR

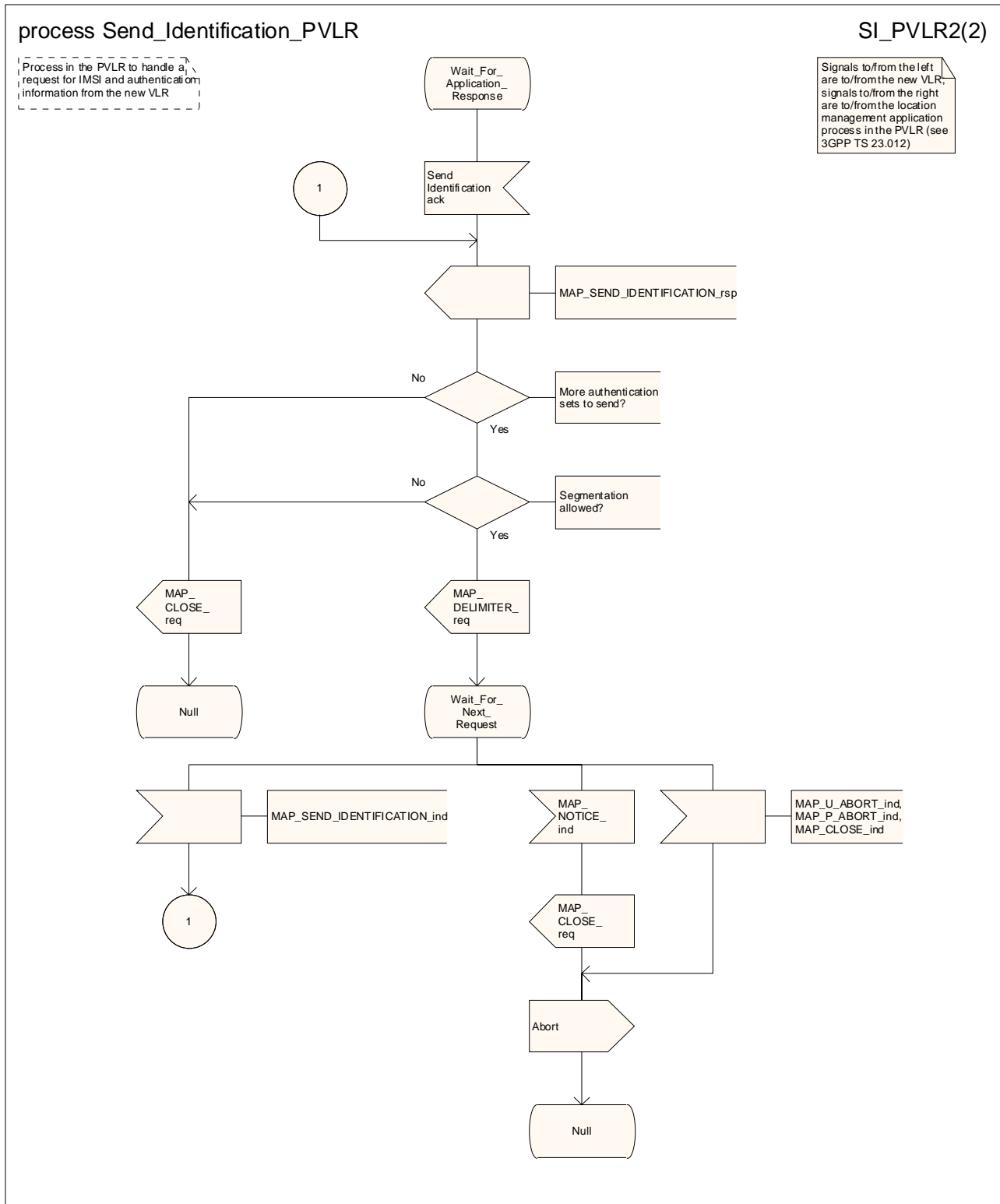

Figure 19.1.1/11 (sheet 2 of 2): Process Send_Identification_PVLR

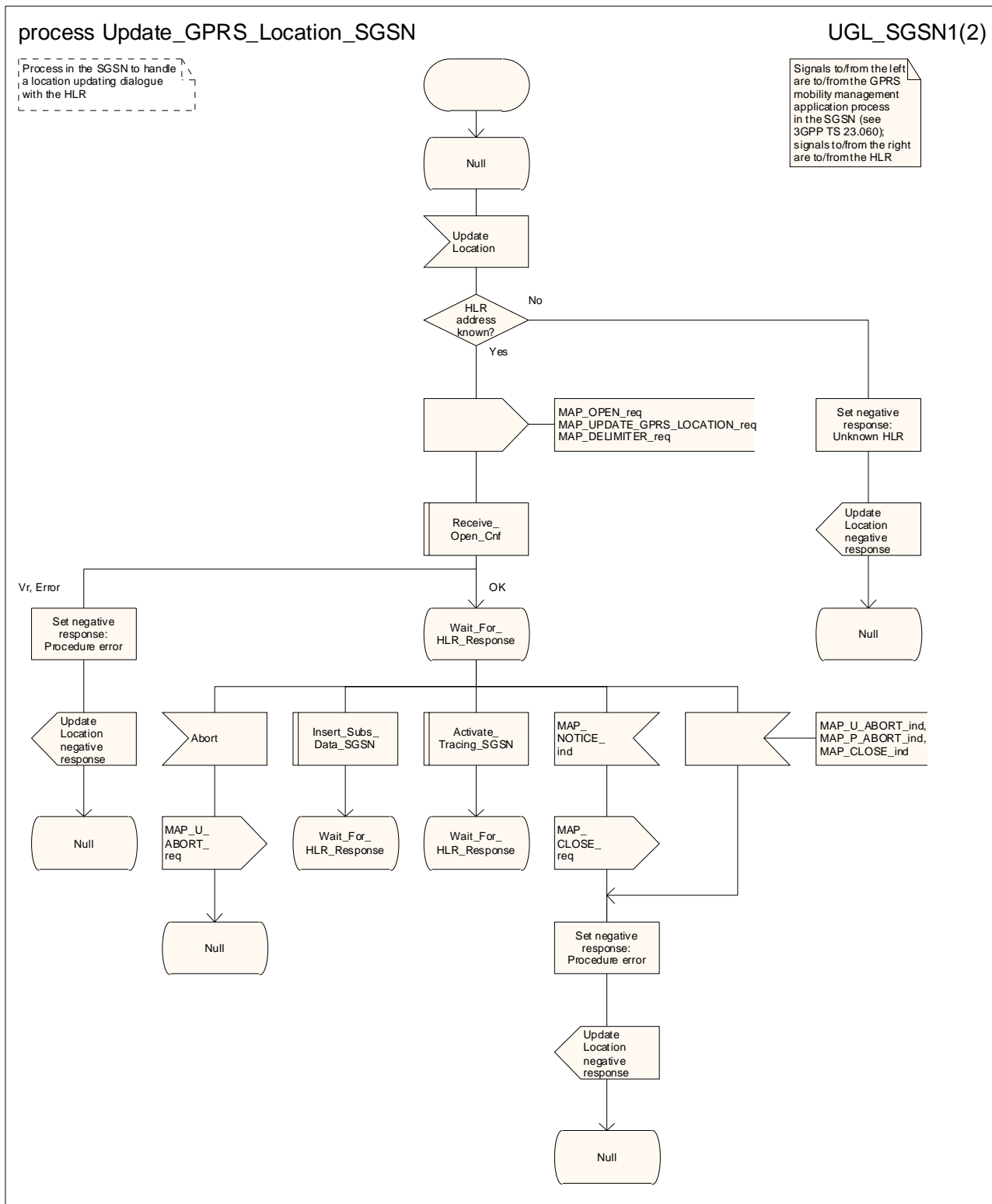

Figure 19.1.1/12 (sheet 1 of 2): Process Update_GPRS_Location_SGSN

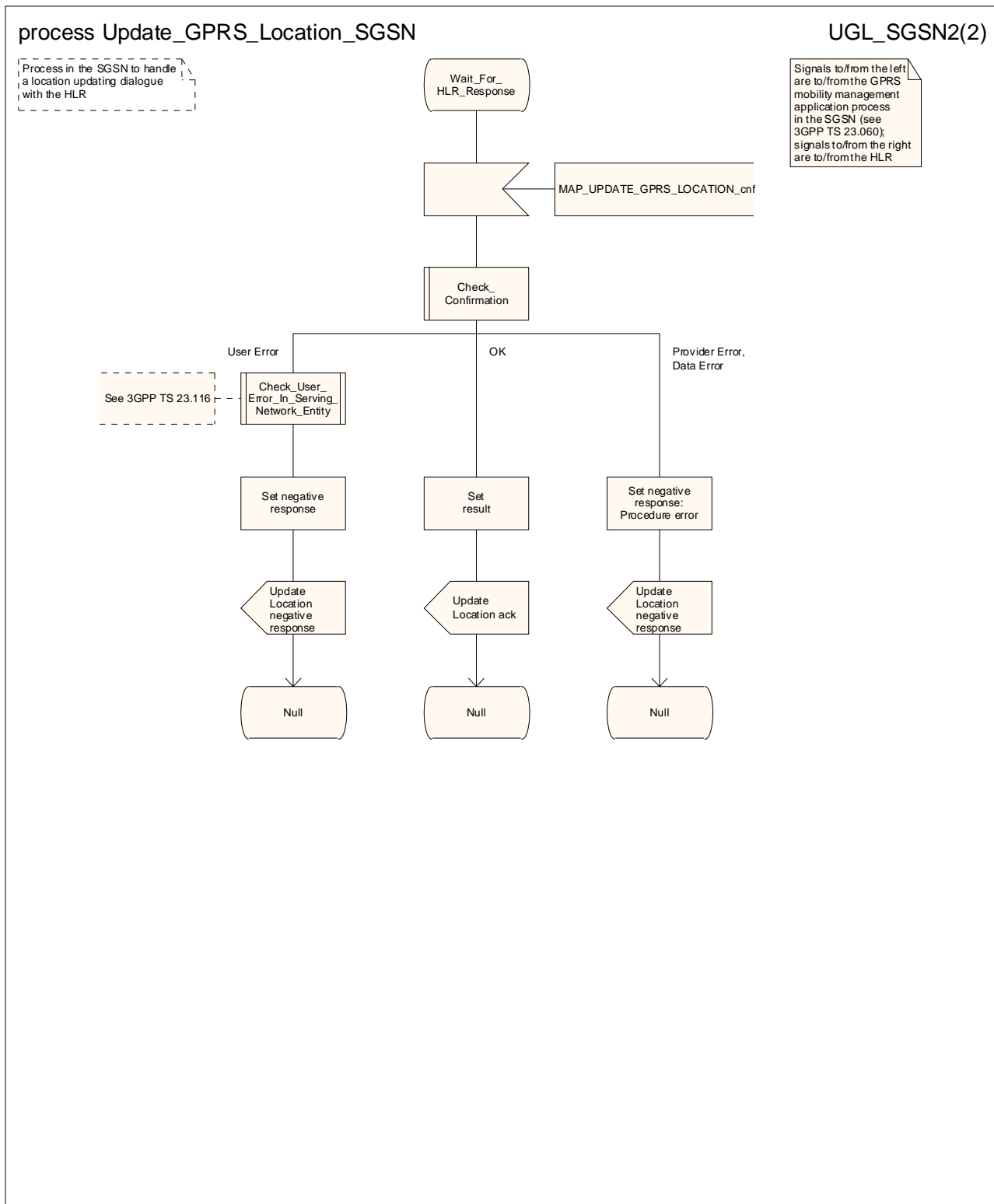

Figure 19.1.1/12 (sheet 2 of 2): Process Update_GPRS_Location_SGSN

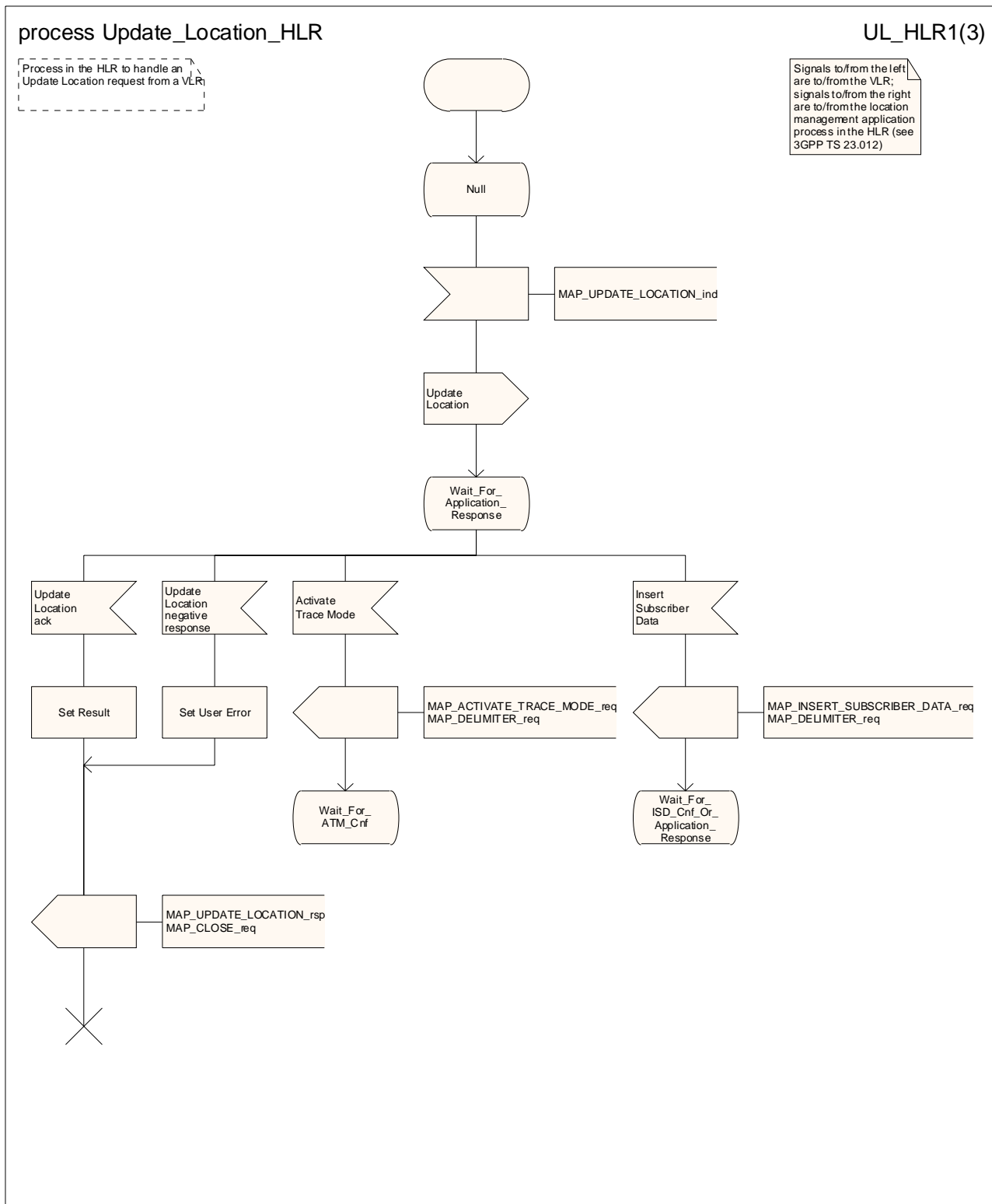

Figure 19.1.1/13 (sheet 1 of 3): Process Update_Location_HLR

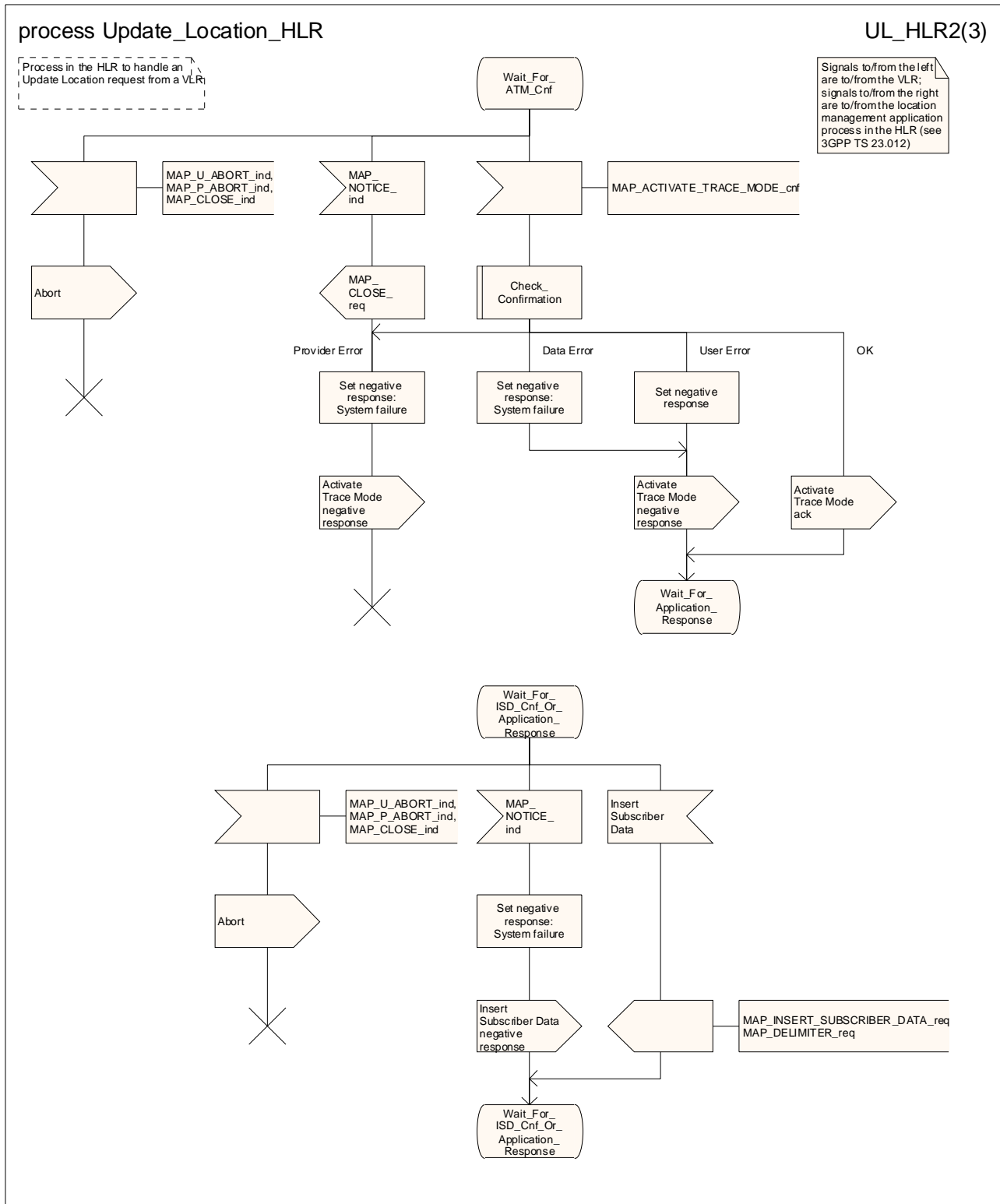

Figure 19.1.1/13 (sheet 2 of 3): Process Update_Location_HLR

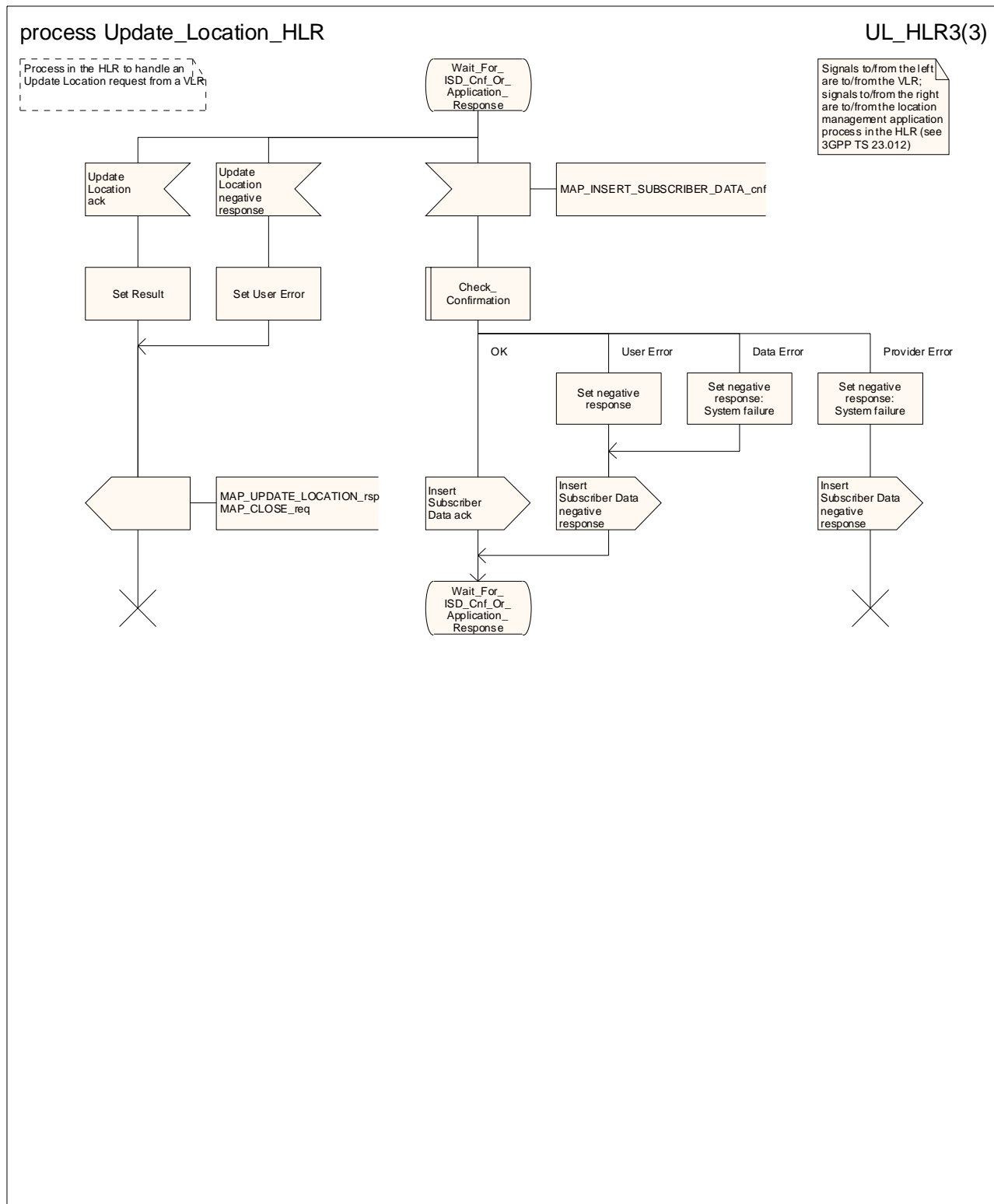

Figure 19.1.1/13 (sheet 3 of 3): Process Update_Location_HLR

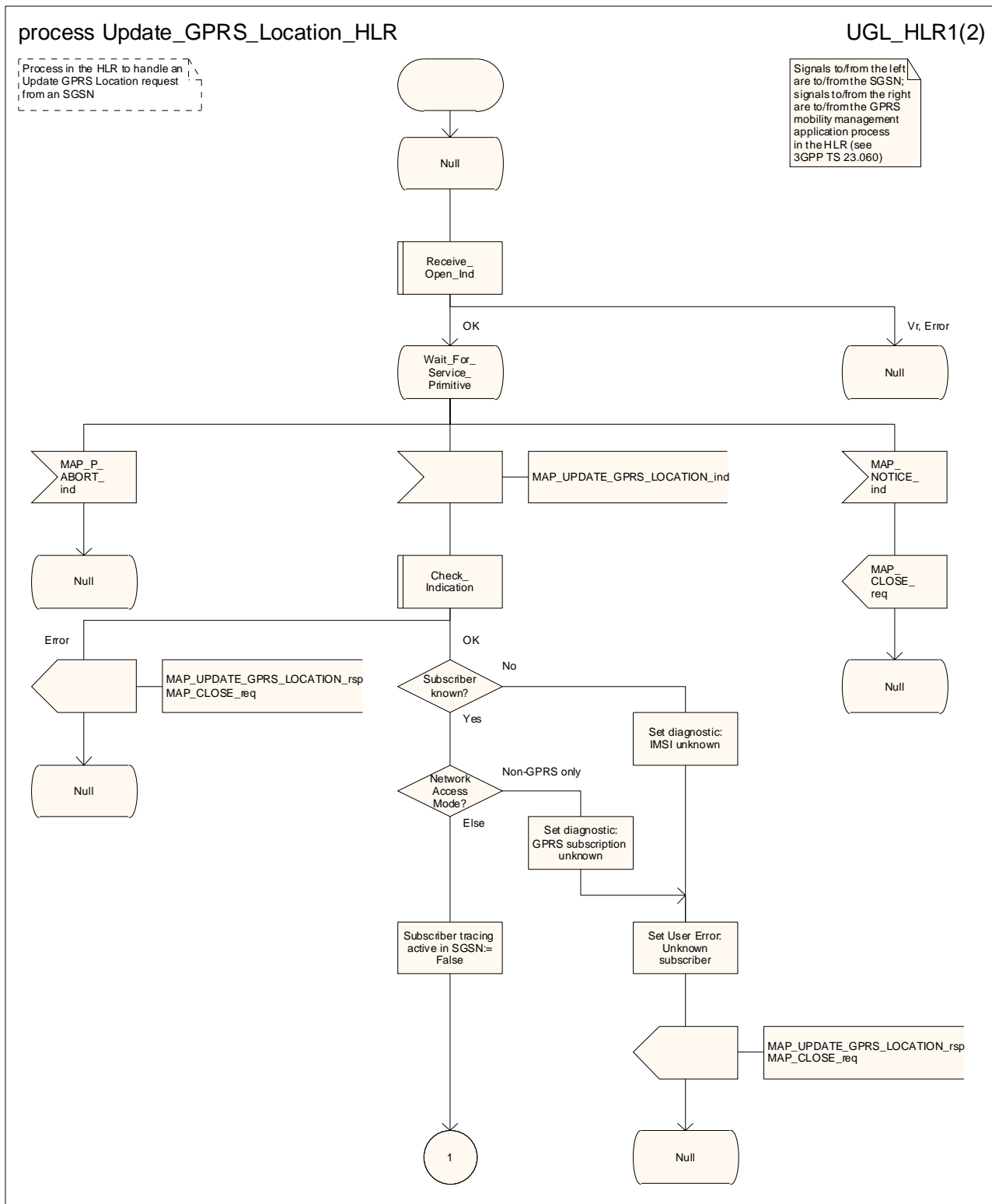

Figure 19.1.1/14 (sheet 1 of 2): Process Update_GPRS_Location_HLR

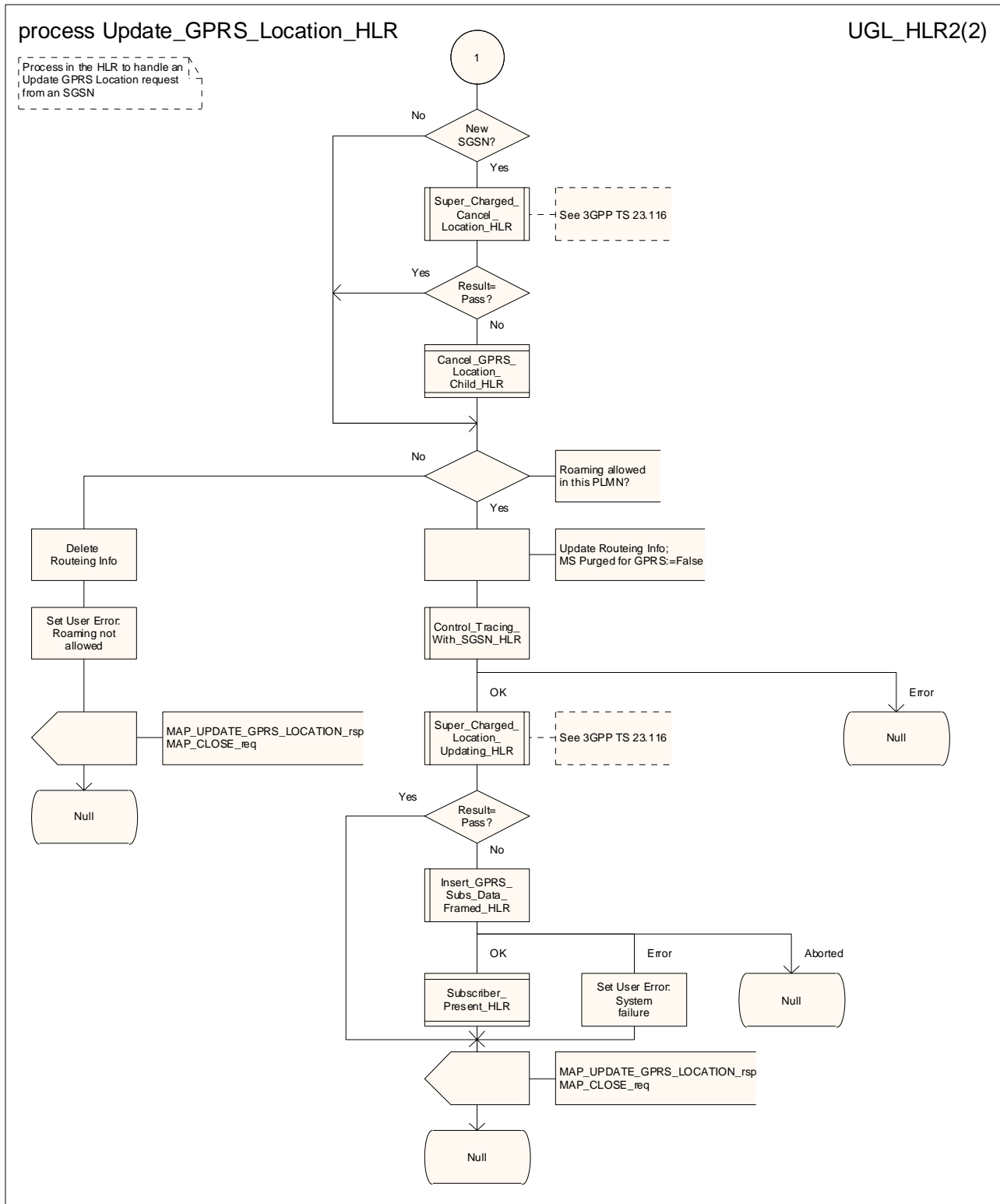

Figure 19.1.1/14 (sheet 2 of 2): Process Update_GPRS_Location_HLR

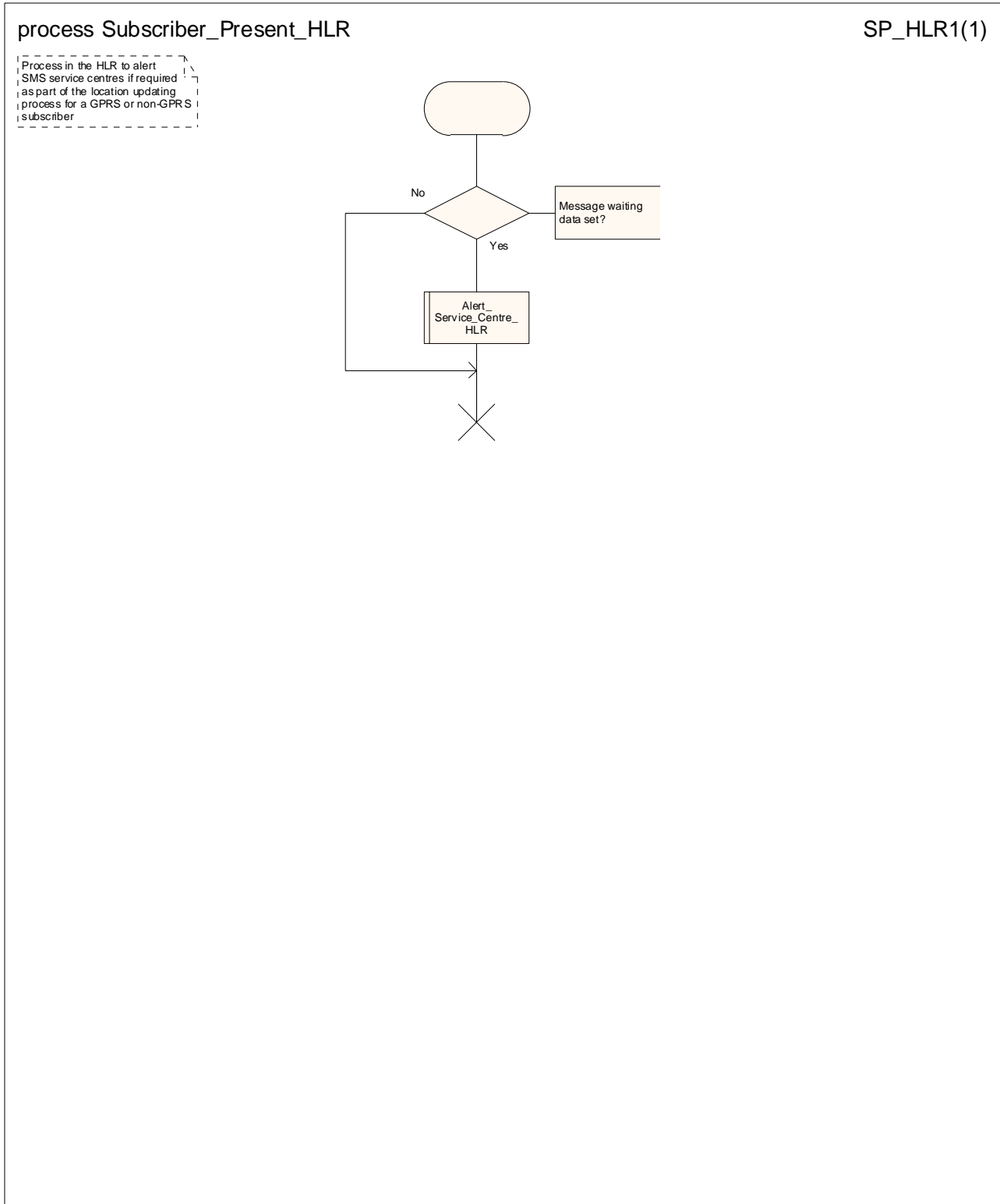

Figure 19.1.1/15: Process Subscriber_Present_HLR

19.1.2 Location Cancellation

19.1.2.1 General

Location cancellation is used to delete a subscriber record from the serving node (VLR or SGSN). The procedure is invoked:

- because the subscriber has registered with a new serving node, or
- because the HPLMN operator has decided to delete the subscriber record from the serving node, e.g. because the subscription has been withdrawn, or because roaming restrictions have been imposed. Location cancellation can be used to force location updating including updating of subscriber data in the serving node at the next subscriber access.

The message flow for location cancellation for a non-GPRS subscriber is shown in figure 19.1.2/1.

The message flow for location cancellation for a GPRS subscriber is shown in figure 19.1.2/2.

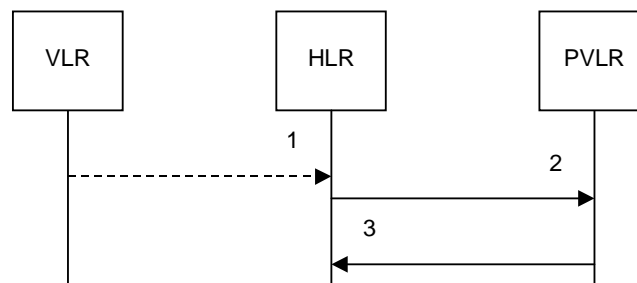

- 1) MAP_UPDATE_LOCATION_req/ind
- 2) MAP_CANCEL_LOCATION_req/ind
- 3) MAP_CANCEL_LOCATION_rsp/cnf

NOTE: The service shown in dotted lines indicates the trigger provided by other MAP signalling.

Figure 19.1.2/1: Message flow for Location Cancellation (non-GPRS)

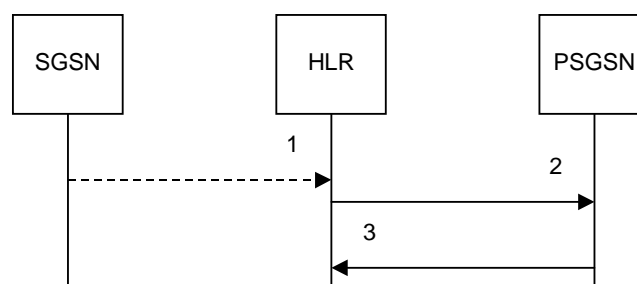

- 1) MAP_UPDATE_GPRS_LOCATION_req/ind
- 2) MAP_CANCEL_LOCATION_req/ind
- 3) MAP_CANCEL_LOCATION_rsp/cnf

NOTE: The service shown in dotted lines indicates the trigger provided by other MAP signalling.

Figure 19.1.2/2: Message flow for Location Cancellation (GPRS)

19.1.2.2 Procedure in the HLR

The MAP process in the HLR to cancel the location information in a VLR is shown in figure 19.1.2/3. The MAP process invokes macros not defined in this clause; the definitions of these macros can be found as follows:

Receive_Open_Cnf see subclause 25.1.2;

Check_Confirmation see subclause 25.2.2.

The MAP process in the HLR to cancel the location information in a VLR as an independent process invoked from another process is shown in figure 19.1.2/4.

The MAP process in the HLR to cancel the location information in an SGSN is shown in figure 19.1.2/5. The MAP process invokes macros not defined in this clause; the definitions of these macros can be found as follows:

Receive_Open_Cnf see subclause 25.1.2;

Check_Confirmation see subclause 25.2.2.

The MAP process in the HLR to cancel the location information in an SGSN as an independent process invoked from another process is shown in figure 19.1.2/6.

19.1.2.3 Procedure in the VLR

The MAP process in the VLR to handle a location cancellation request is shown in figure 19.1.2/7. The MAP process invokes a macro not defined in this clause; the definition of this macro can be found as follows:

Receive_Open_Ind see subclause 25.1.1.

19.1.2.4 Procedure in the SGSN

The MAP process in the SGSN to handle a location cancellation request is shown in figure 19.1.2/8. The MAP process invokes a macro not defined in this clause; the definition of this macro can be found as follows:

Receive_Open_Ind see subclause 25.1.1.

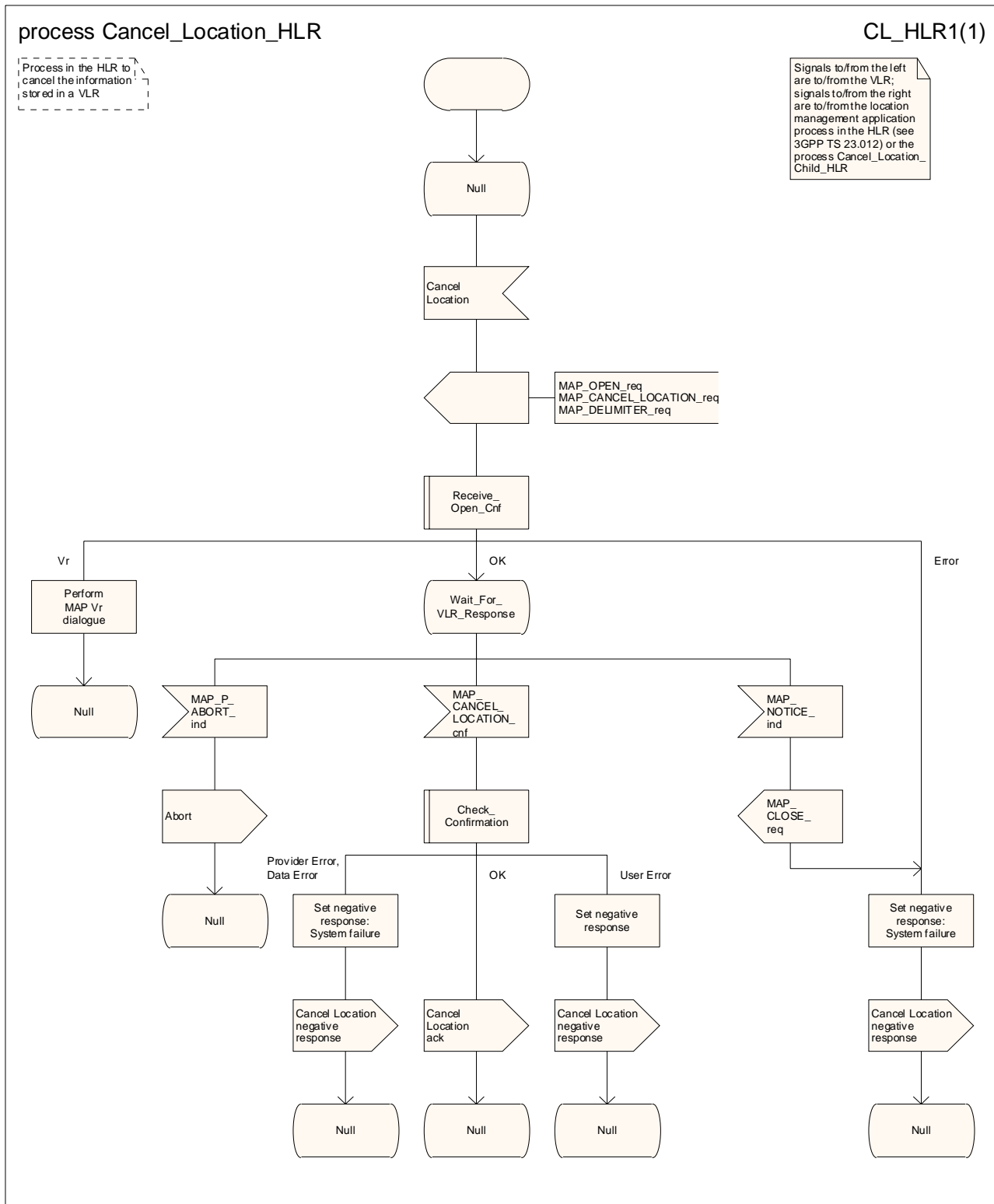

Figure 19.1.2/3: Process Cancel_Location_HLR

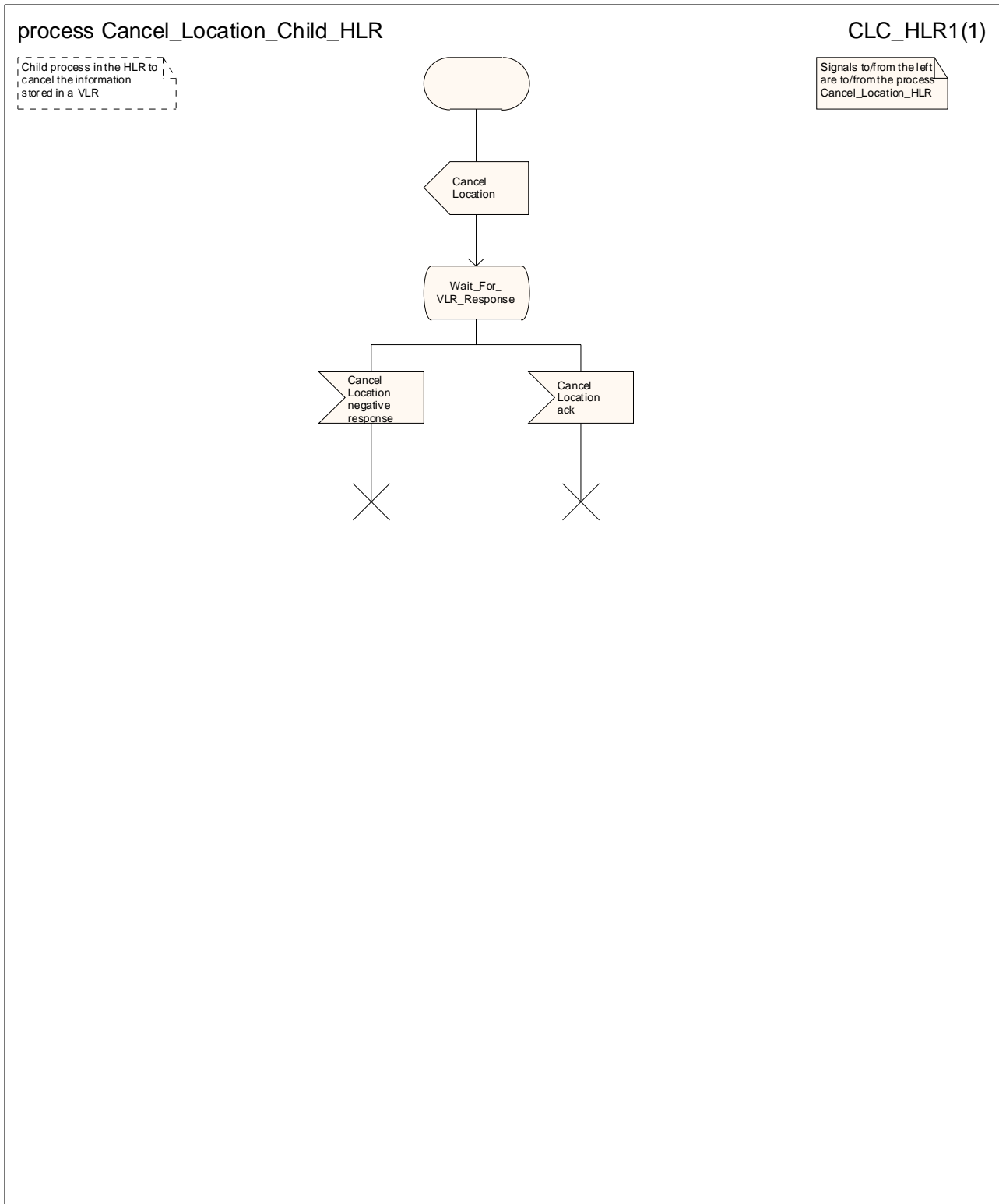

Figure 19.1.2/4: Process Cancel_Location_Child_HLR

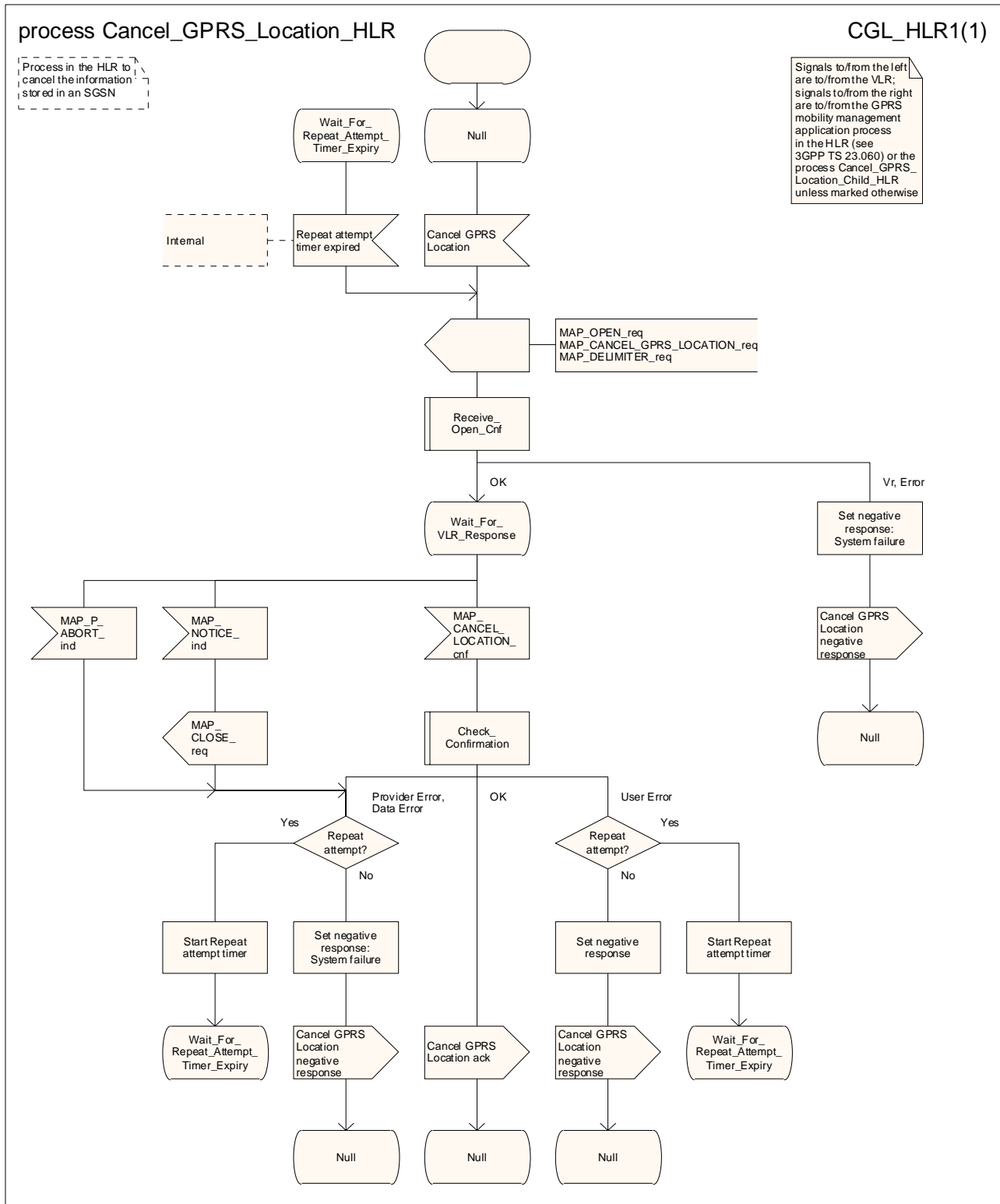

Figure 19.1.2/5: Process Cancel_GPRS_Location_HLR

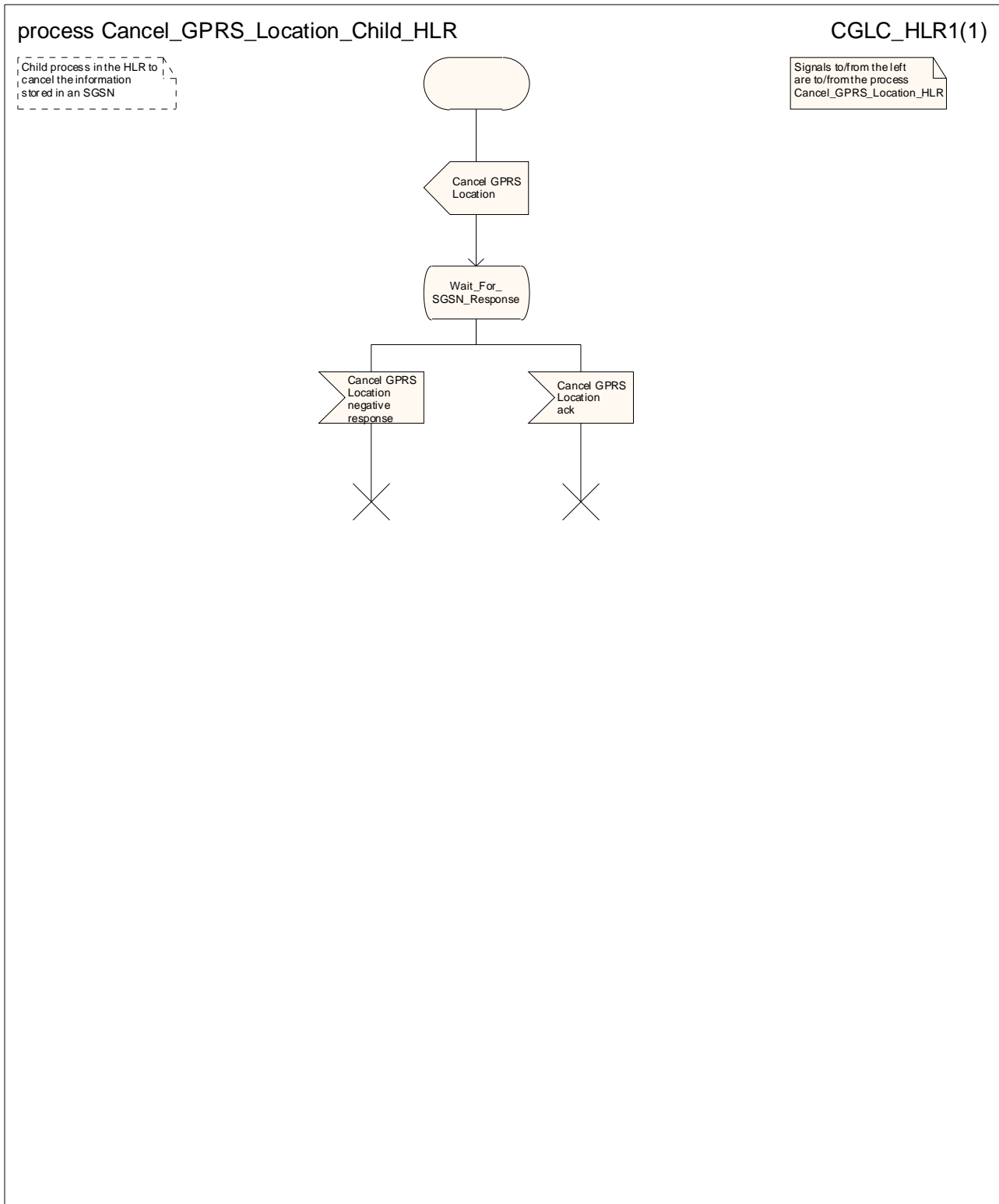

Figure 19.1.2/6: Process Cancel_GPRS_Location_Child_HLR

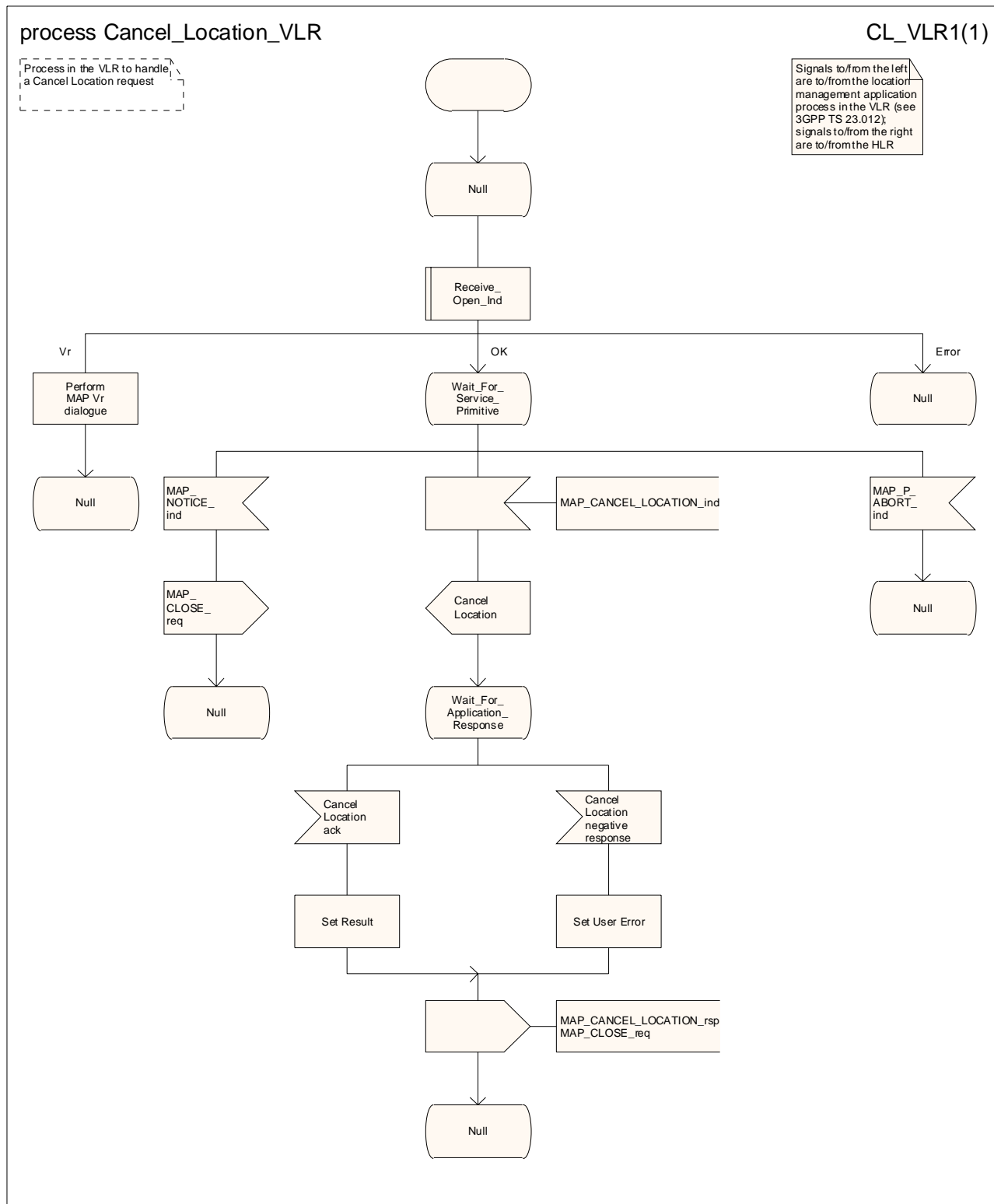

Figure 19.1.2/7: Process Cancel_Location_VLR

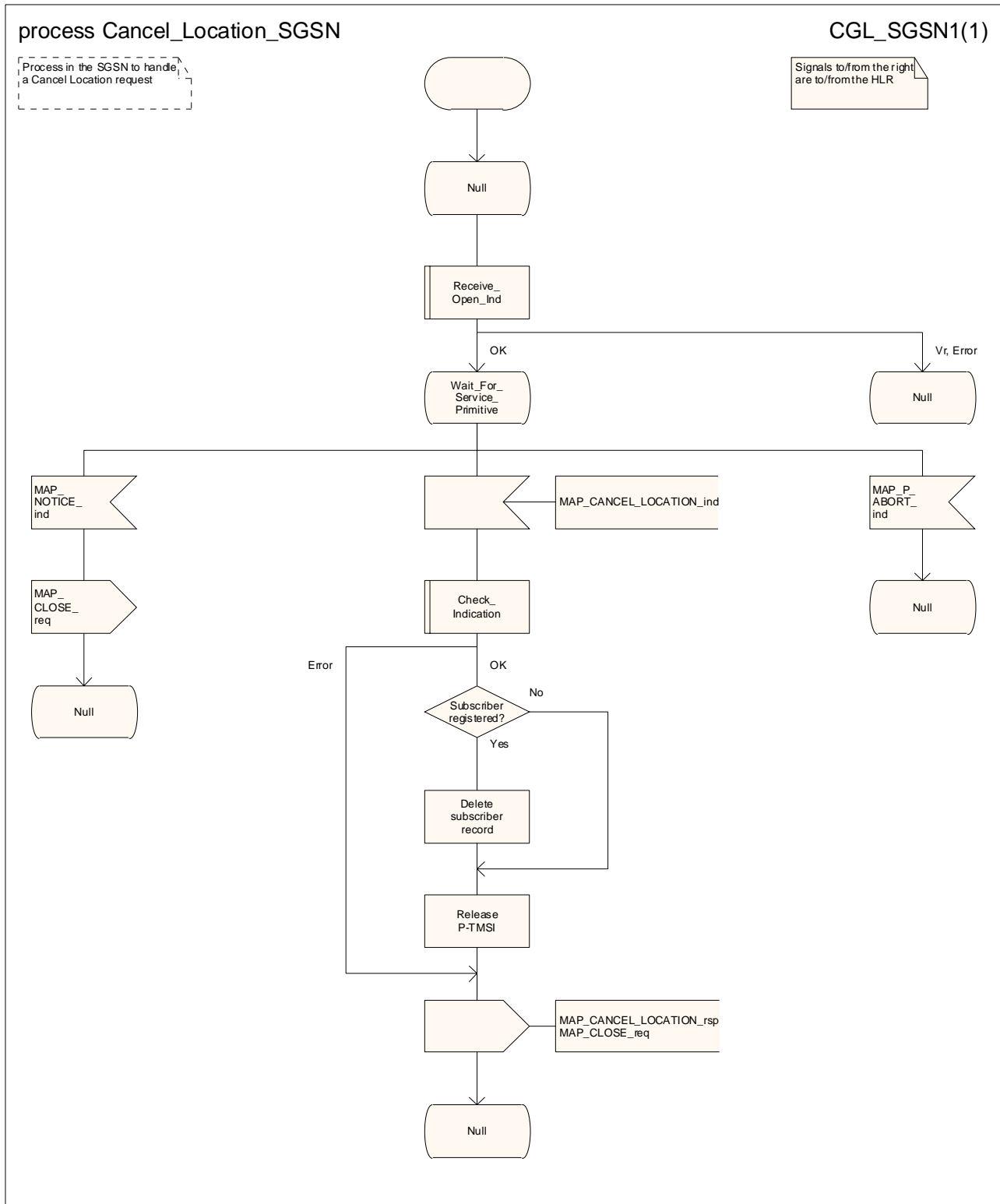

Figure 19.1.2/8: Process Cancel_Location_SGSN

19.1.3 Void

19.1.4 MS Purging

19.1.4.1 General

O&M procedures in the VLR or SGSN can trigger MS purging either because of administrative action or because the MS has been inactive for an extended period. The O&M process in the VLR or in the SGSN should ensure that during the MS purging procedure any other attempt to access the MS record is blocked, to maintain consistency of data.

The message flow for a VLR to report MS purging to the HLR is shown in figure 19.1.4/1.

The message flow for an SGSN to report MS purging to the HLR is shown in figure 19.1.4/2.

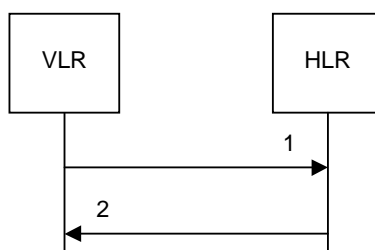

- 1) MAP_PURGE_MS_req/ind
- 2) MAP_PURGE_MS_rsp/cnf

Figure 19.1.4/1: Message flow for MS purging (non-GPRS)

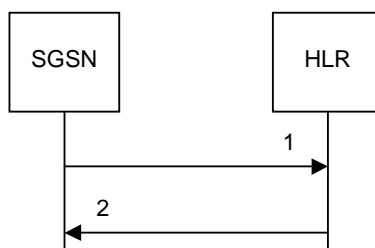

- 1) MAP_PURGE_MS_req/ind
- 2) MAP_PURGE_MS_rsp/cnf

Figure 19.1.4/2: Message flow for MS purging (GPRS)

19.1.4.2 Procedure in the VLR

The MAP process in the VLR to report MS purging to the HLR is shown in figure 19.1.4/3. The MAP process invokes macros not defined in this clause; the definitions of these macros can be found as follows:

- | | |
|--------------------|-----------------------|
| Receive_Open_Cnf | see subclause 25.1.2; |
| Check_Confirmation | see subclause 25.2.2. |

19.1.4.3 Procedure in the SGSN

The MAP process in the SGSN to report MS purging to the HLR is shown in figure 19.1.4/4. The MAP process invokes macros not defined in this clause; the definitions of these macros can be found as follows:

- | | |
|------------------|-----------------------|
| Receive_Open_Cnf | see subclause 25.1.2; |
|------------------|-----------------------|

Check_Confirmation see subclause 25.2.2.

Sheet 1: The procedure Purge_MS_In_Serving_Network_Entity is specific to Super-Charger; it is specified in 3GPP TS 23.116 [110]. If the HLR does not support the Super-Charger functionality, processing continues from the "No" exit of the test "Result=Pass?".

19.1.4.4 Detailed procedure in the HLR

The MAP process in the HLR to handle a notification from a VLR or an SGSN that an MS record has been purged is shown in figure 19.1.4/5. The MAP process invokes macros not defined in this clause; the definitions of these macros can be found as follows:

Receive_Open_Ind see subclause 25.1.1;

Check_Indication see subclause 25.2.1.

If the notification was received from a VLR, the MAP process communicates with the location management application process specified in 3GPP TS 23.012 [23]; if the notification was received from an SGSN, the MAP process communicates with the GPRS mobility management application process specified in 3GPP TS 23.060 [104].

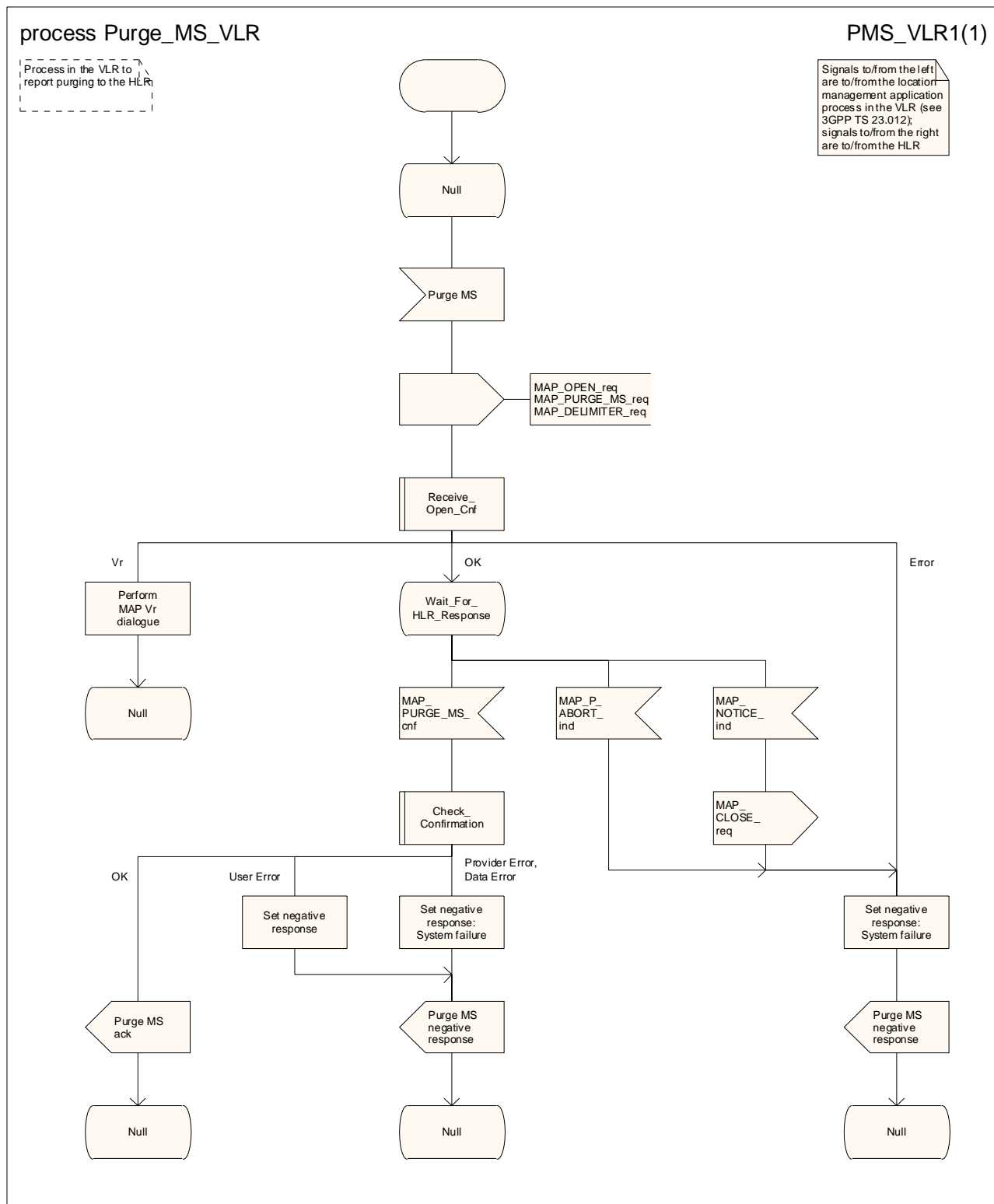

Figure 19.1.4/3: Process Purge_MS_VLR

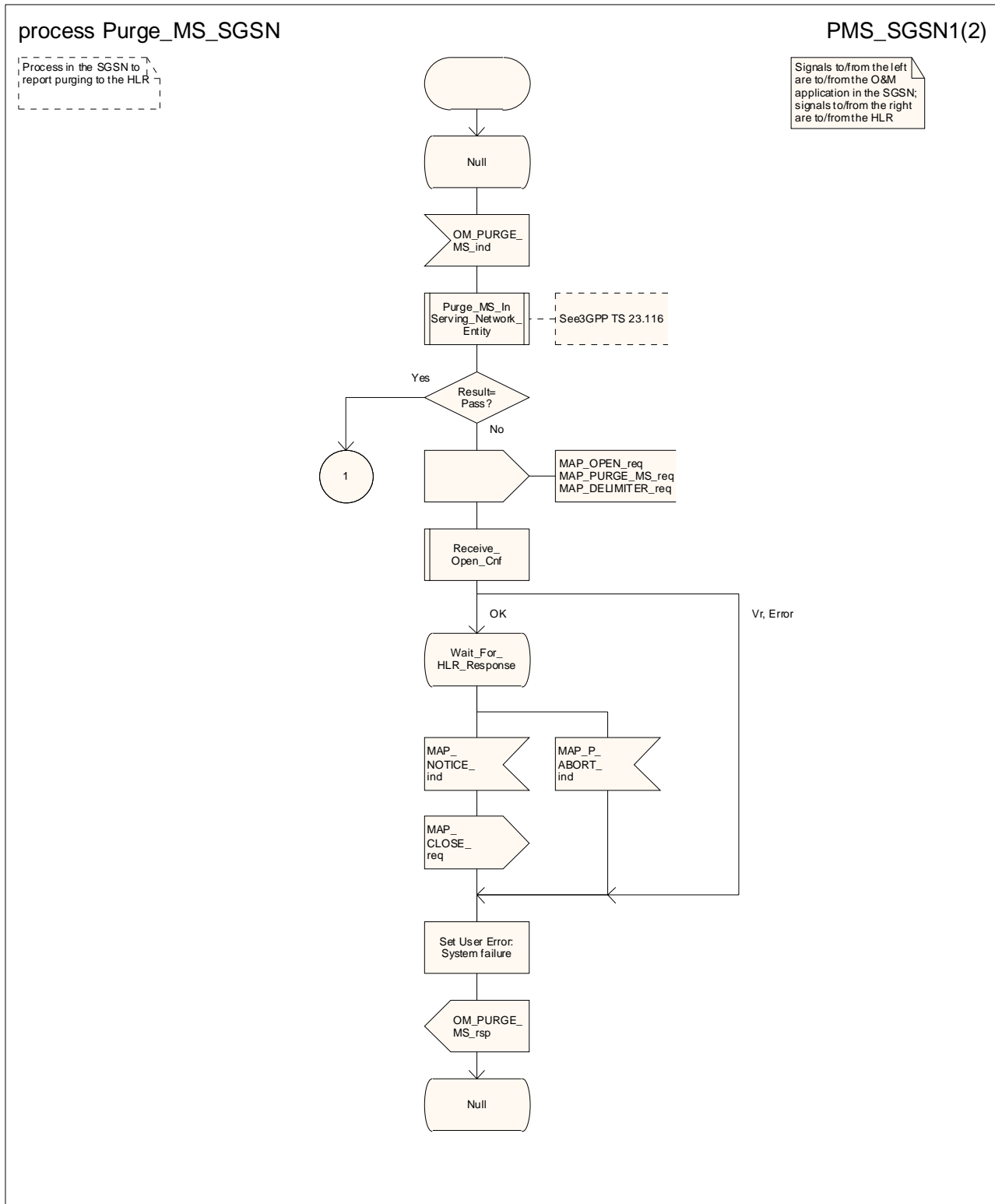

Figure 19.1.4/4 (sheet 1 of 2): Process Purge_MS_SGSN

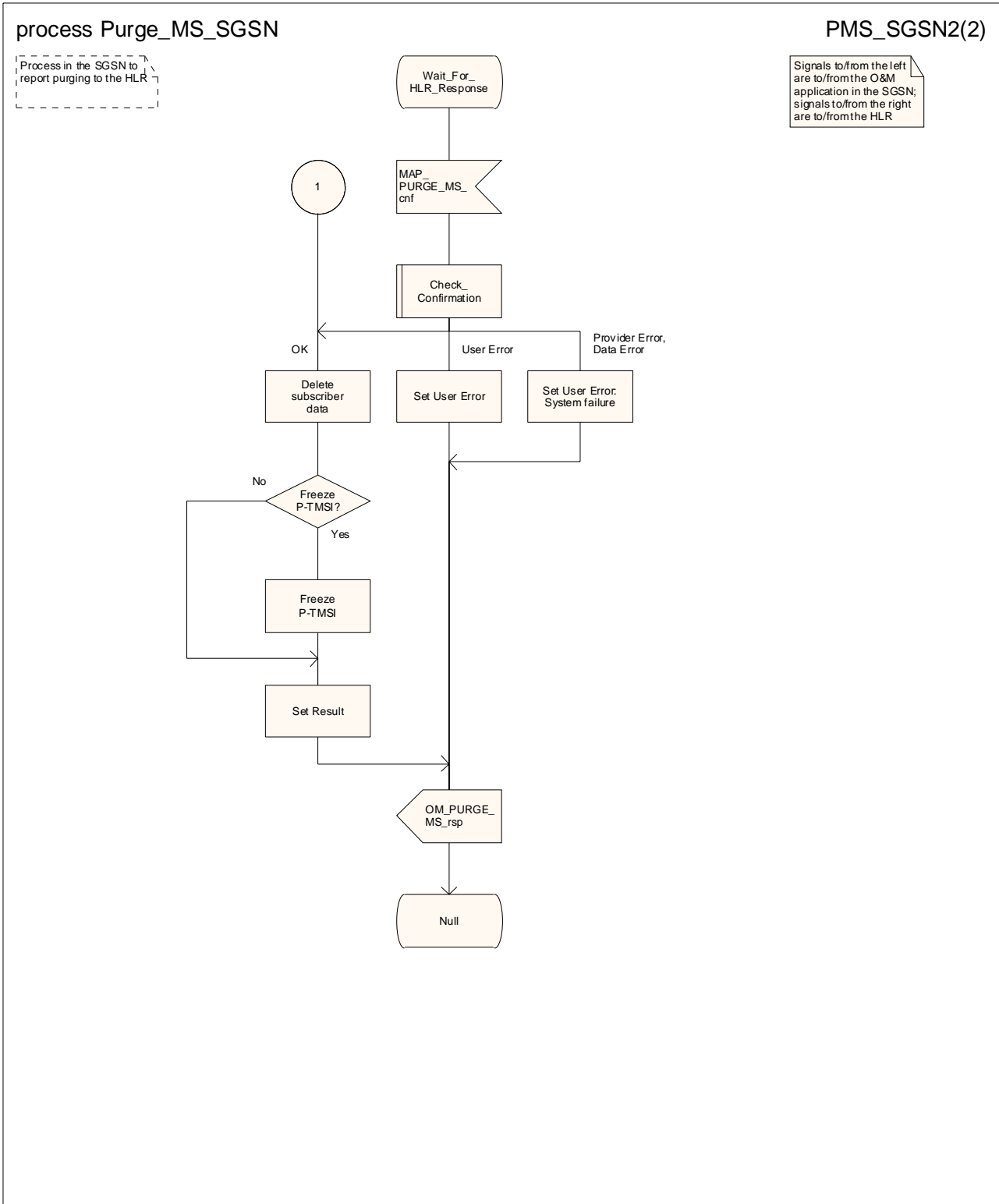

Figure 19.1.4/4 (sheet 2 of 2): Process Purge_MS_SGSN

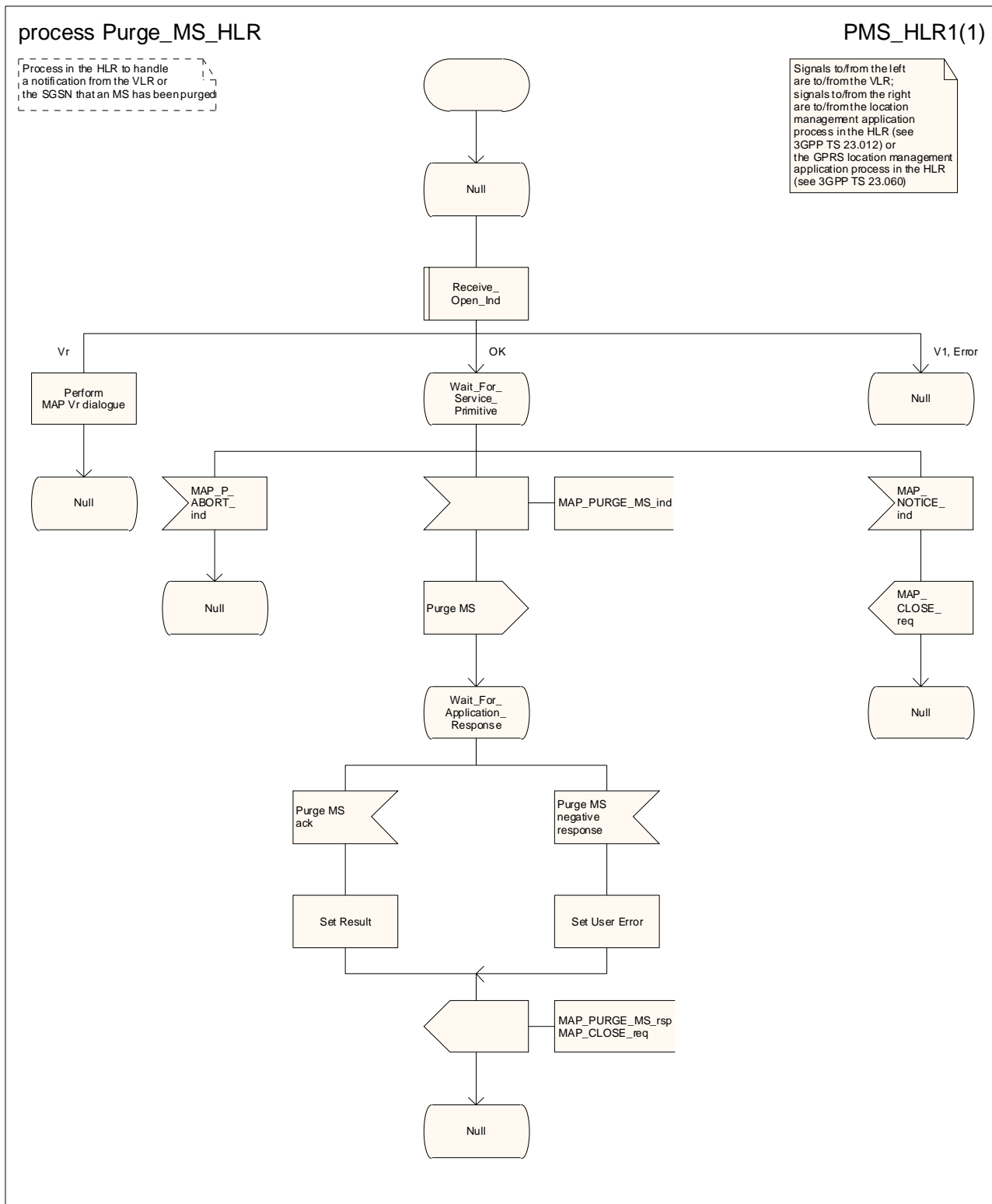

Figure 19.1.4/5: Process Purge_MS_HLR

19.2 Handover procedures

19.2.1 General

In this subclause, the term "Inter-MSC handover" is used to denote handover or relocation between different MSCs.

The interfaces involved for Inter-MSC handover are shown in figure 19.2/1. There are two Inter-MSC handover procedures:

1) Basic Inter-MSC handover:

The call is handed over from the controlling MSC (MSC-A) to another MSC (MSC-B) (figure 19.2/1a).

Figure 19.2/2 shows the message flow for a successful handover between MSC-A and MSC-B including a request for handover number allocation from MSC-B to VLR-B.

2) Subsequent Inter-MSC handover:

After the call has been handed over from MSC-A to MSC-B, a further handover either to MSC-A (figure 19.2/1a) or to a third MSC (MSC-B') (figure 19.2/1b) may be necessary in order to continue the call.

Figure 19.2/3 shows the message flow for a successful subsequent handover to MSC-B'. For a successful subsequent handover to MSC-A, the messages to and from MSC-B' and VLR-B' are omitted.



a) Basic handover procedure MSC-A to MSC-B and subsequent handover procedure MSC-B to MSC-A.

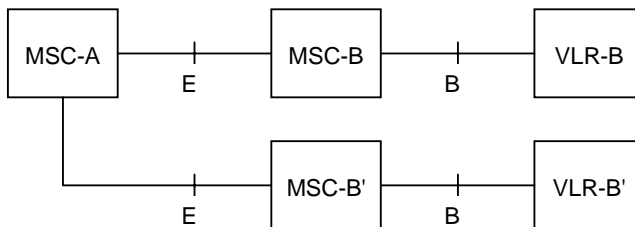

b) Subsequent handover procedure MSC-B to MSC-B'.

Figure 19.2/1: Interface structure for handover

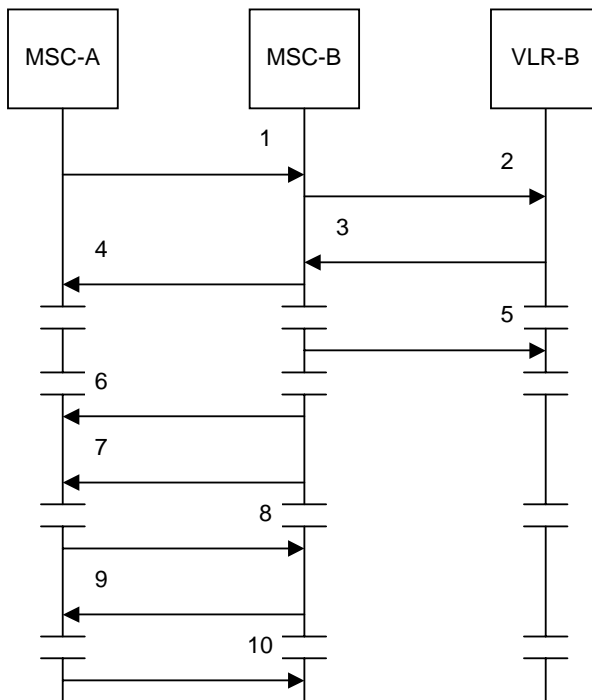

- 1) MAP_PREPARE_HANOVER_req/ind
- 2) MAP_ALLOCATE_HANOVER_NUMBER_req/ind
- 3) MAP_SEND_HANOVER_REPORT_req/ind
- 4) MAP_PREPARE_HANOVER_rsp/cnf
- 5) MAP_SEND_HANOVER_REPORT_rsp/cnf (Note)
- 6) MAP_PROCESS_ACCESS_SIGNALLING_req/ind
- 7) MAP_SEND_END_SIGNAL_req/ind
- 8) MAP_FORWARD_ACCESS_SIGNALLING_req/ind
- 9) MAP_PROCESS_ACCESS_SIGNALLING_req/ind
- 10) MAP_SEND_END_SIGNAL_rsp/cnf

NOTE: This can be sent at any time after the connection between MSC-A and MSC-B is established.

Figure 19.2/2: Example of a successful basic handover procedure to MSC-B

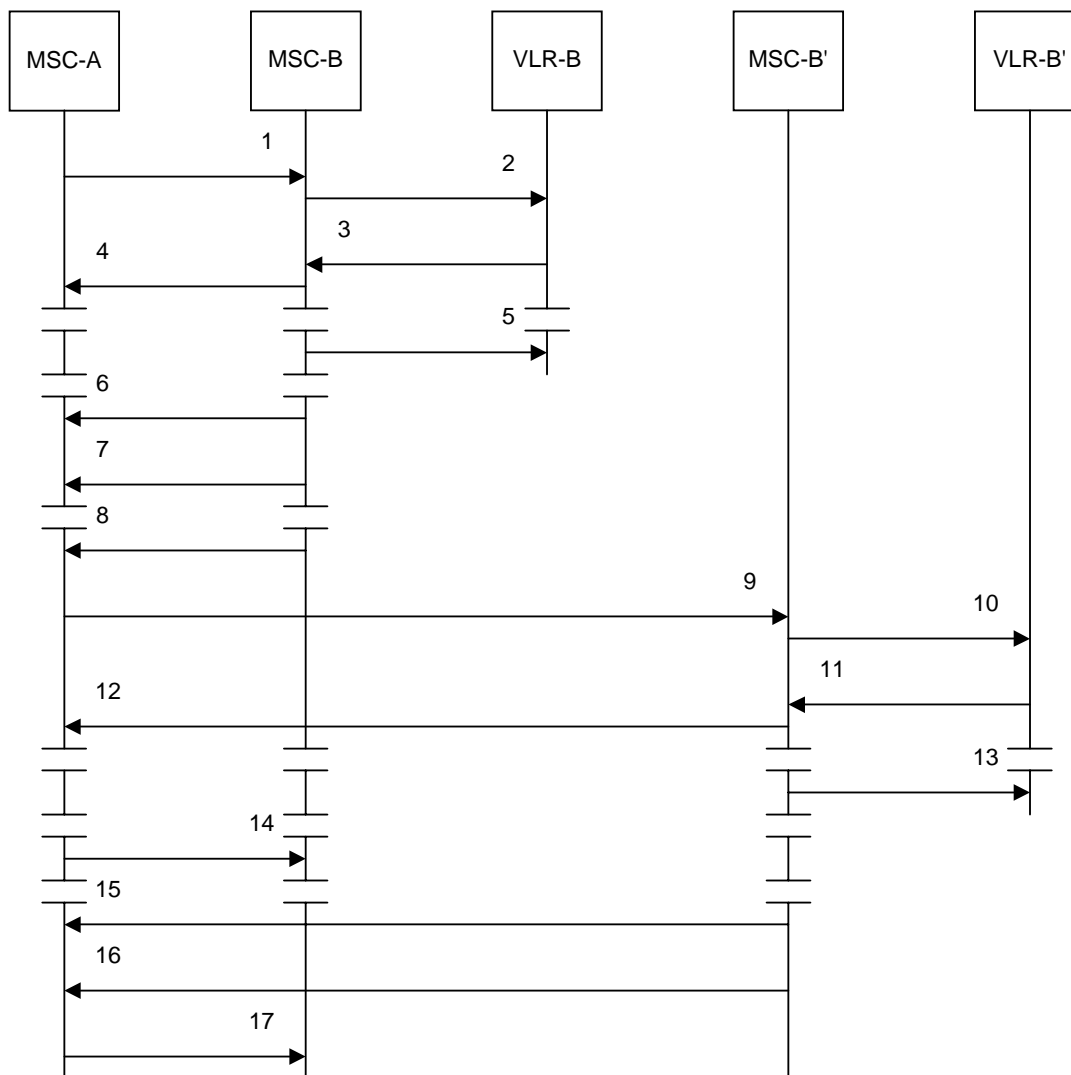

- 1) MAP_PREPARE_HANDOVER_req/ind
- 2) MAP_ALLOCATE_HANDOVER_NUMBER_req/ind
- 3) MAP_SEND_HANDOVER_REPORT_req/ind
- 4) MAP_PREPARE_HANDOVER_rsp/cnf
- 5) MAP_SEND_HANDOVER_REPORT_rsp/cnf (Note 1)
- 6) MAP_PROCESS_ACCESS_SIGNALLING_req/ind
- 7) MAP_SEND_END_SIGNAL_req/ind
- 8) MAP_PREPARE_SUBSEQUENT_HANDOVER_req/ind
- 9) MAP_PREPARE_HANDOVER_req/ind
- 10) MAP_ALLOCATE_HANDOVER_NUMBER_req/ind
- 11) MAP_SEND_HANDOVER_REPORT_req/ind
- 12) MAP_PREPARE_HANDOVER_rsp/cnf
- 13) MAP_SEND_HANDOVER_REPORT_rsp/cnf (Note 2)
- 14) MAP_PREPARE_SUBSEQUENT_HANDOVER_rsp/cnf
- 15) MAP_PROCESS_ACCESS_SIGNALLING_req/ind
- 16) MAP_SEND_END_SIGNAL_req/ind
- 17) MAP_SEND_END_SIGNAL_rsp/cnf (Note 3)

NOTE 1: This can be sent at any time after the connection between MSC-A and MSC-B is established.

NOTE 2: This can be sent at any time after the connection between MSC-A and MSC-B' is established.

NOTE 3: At this stage, the subsequent handover is complete. Any further interworking between MSC-A and MSC-B' is the same as the interworking between MSC-A and MSC-B after basic handover

Figure 19.2/3: Example of a successful subsequent handover to a third MSC

The MAP signalling procedures for inter-MSC handover support the allocation of a handover number or one or more relocation numbers and the transfer of encapsulated BSSAP or RANAP messages.

The minimum application context version for the MAP handover application context shall be:

- version 3 for inter-MSC UTRAN to UTRAN handover;
- version 3 for inter-MSC intersystem handover from GSM BSS to UTRAN;
- version 2 for inter-MSC intersystem handover from UTRAN to GSM BSS.

NOTE: If the MAP handover application context version 2 is used, subsequent handover to UTRAN is not possible.

The minimum application context version for the MAP handover application context should be version 2 for inter-MSC handover from GSM BSS to GSM BSS.

NOTE: If the MAP handover application context version 2 or lower is used, subsequent handover to UTRAN is not possible.

The BSSAP or RANAP messages encapsulated in MAP messages are processed by the Handover Control Application in each MSC. The information in the encapsulated BSSAP or RANAP messages is passed from the Handover Control Application to the MAP process at the sending end; the notation used in the SDL diagrams for the MAP processes is "HO_CA_MESSAGE_ind(Message transfer)". The information in the encapsulated BSSAP or RANAP messages is passed from the MAP process to the Handover Control Application at the sending end; the notation used in the SDL diagrams for the MAP processes is "HO_CA_MESSAGE_req(Message transfer)".

For details of the interworking between the A-interface and MAP procedures or the Iu-interface and MAP procedures, see 3GPP TS 23.009 [21] and 3GPP TS 29.010 [58].

19.2.2 Procedure in MSC-A

This subclause describes the inter-MSC handover procedure in MSC-A; it covers basic inter-MSC handover to another MSC (MSC-B) and subsequent inter-MSC handover to a third MSC (MSC-B') or back to the controlling MSC (MSC-A).

The MAP process in MSC-A to handle inter-MSC handover is shown in figure 19.2/4. The MAP process invokes macros not defined in this clause; the definitions of these macros can be found as follows:

Receive_Open_Cnf	see subclause 25.1.2;
Check_Indication	see subclause 25.2.1.
Check_Confirmation	see subclause 25.2.2.

Communication between the MAP handover process and the Handover Control application is represented by the HO_CA_MESSAGE service. For a detailed description of the interworking between the Handover Control applications in different MSCs for the inter-MSC handover procedure, see 3GPP TS 23.009 [21].

19.2.2.1 Basic handover

The handling in MSC-A for basic inter-MSC handover is shown in sheets 1 to 6 of figure 19.2/4.

Sheet 1: The MAP_PREPARE_HANDOVER request may contain:

- an indication that handover number allocation is not required;
- the target Cell ID, for compatibility for handover to GSM;
- the target RNC ID, for SRNS relocation or inter-system handover from GSM to UMTS;
- the IMSI;
- UMTS encryption information and UMTS integrity protection information, which are necessary for inter-system handover from GSM to UMTS;

- GSM radio resource information (channel type).

The conditions for the presence of these parameters and the processing in MSC-B (3G_MSC-B) are described in detail in 3GPP TS 29.010 [58] and 3GPP TS 23.009 [21].

Sheet 2: The MAP_PREPARE_HANOVER confirmation contains one of:

- no handover number, if the MAP_PREPARE_HANOVER request included an indication that handover number allocation is not required;
- a handover number;
- one or more relocation numbers.

Sheet 2: The MAP_PREPARE_HANOVER confirmation contains BSSAP or RANAP signalling information, which is passed to the Handover Control application in MSC-A.

Sheet 2: If the MAP_PREPARE_HANOVER confirmation contains an indication that MSC-B does not support multiple bearers, the Handover Control application in MSC-A may request handover of one bearer to the same cell in MSC-B.

Sheet 5: If the original MAP_PREPARE_HANOVER request included a parameter indicating that handover number allocation is not required, the Handover Control application in MSC-A may request a handover number (or one or more relocation numbers); this triggers a further MAP_PREPARE_HANOVER request towards MSC-B

19.2.2.2 Handling of access signalling

The Handover Control application in MSC-A may forward access signalling to any of the MS, RNS-B or BSS-B using the MAP_FORWARD_ACCESS_SIGNALLING service; any of the MS, RNS-B or BSS-B may forward access signalling to the Handover Control application in MSC-A using the MAP_PROCESS_ACCESS_SIGNALLING service. These are non-confirmed services.

19.2.2.3 Subsequent handover

The handling in MSC-A for subsequent inter-MSC handover is shown in sheets 7 & 8 of figure 19.2/4. If the Handover Control Application determines that the call is to be handed over to a third MSC (MSC-B') it triggers another instance of the MAP process to handle the basic handover to MSC-B', and reports the result of the subsequent handover to the instance of the MAP process which handles the dialogue with MSC-B.

Sheet 8: While the MAP process in MSC-A is waiting for the completion of subsequent handover, it relays access signalling between the Handover Control application and the MS, RNS-B or BSS-B as described in subclause 19.2.2.2.

19.2.3 Procedure in MSC-B

This subclause describes the handover or relocation procedure in MSC-B; it covers basic handover or relocation from the controlling MSC (MSC-A) and subsequent handover or relocation.

The MAP process in MSC-B to handle handover or relocation is shown in figure 19.2/5. The MAP process invokes macros not defined in this clause; the definitions of these macros can be found as follows:

Receive_Open_Ind	see subclause 25.1.1;
Receive_Open_Cnf	see subclause 25.1.2;
Check_Indication	see subclause 25.2.1.
Check_Confirmation	see subclause 25.2.2.

Communication between the MAP handover process and the Handover Control application is represented by the HO_CA_MESSAGE service. For a detailed description of the interworking between the Handover Control applications in different MSCs for the inter-MSC handover procedure, see 3GPP TS 23.009 [21].

The ordering of allocation of handover number and radio resources shown in the SDL diagrams is not mandatory.

19.2.3.1 Basic handover

The handling in MSC-B for basic inter-MSC handover is shown in sheets 1 to 7 of figure 19.2/5.

Sheet 2: If the MAP_PREPARE_HANOVER indication included a parameter requesting multiple bearers but MSC-B does not support multiple bearers, MSC-B sends a MAP_PREPARE_HANOVER response indicating that multiple bearers are not supported, and waits for a possible MAP_PREPARE_HANOVER indication requesting handover of a single bearer.

Sheet 6: If the original MAP_PREPARE_HANOVER indication included a parameter indicating that handover number allocation is not required, MSC-A may send a further MAP_PREPARE_HANOVER request to request the allocation of a handover number (or one or more relocation numbers).

19.2.3.2 Handling of access signalling

The Handover Control application in MSC-A may forward access signalling to any of the MS, RNS-B or BSS-B using the MAP_FORWARD_ACCESS_SIGNALLING service; any of the MS, RNS-B or BSS-B may forward access signalling to the Handover Control application in MSC-A using the MAP_PROCESS_ACCESS_SIGNALLING service. These are non-confirmed services. Signals to or from any of the MS, RNS-B or BSS-B are routed through the Handover Control application in MSC-B.

19.2.3.3 Subsequent handover

The handling in MSC-B for subsequent inter-MSC handover is shown in sheet 8 of figure 19.2/5.

While the MAP process in MSC-B is waiting for the completion of subsequent handover, it relays access signalling between MSC-A and the MS, RNS-B or BSS-B through the Handover Control application as described in subclause 19.2.3.2.

19.2.4 Macro Receive_Error_From_HO_CA

This macro is used by the handover processes in MSC-A and MSC-B to receive errors from the Handover Control Application at any state of a handover process.

19.2.5 Procedure in VLR-B

The process in VLR-B to handle a request for a handover number is shown in figure 19.2/7. The process invokes macros not defined in this clause; the definitions of these macros can be found as follows:

Receive_Open_Ind	see subclause 25.1.1;
Check_Indication	see subclause 25.2.1.

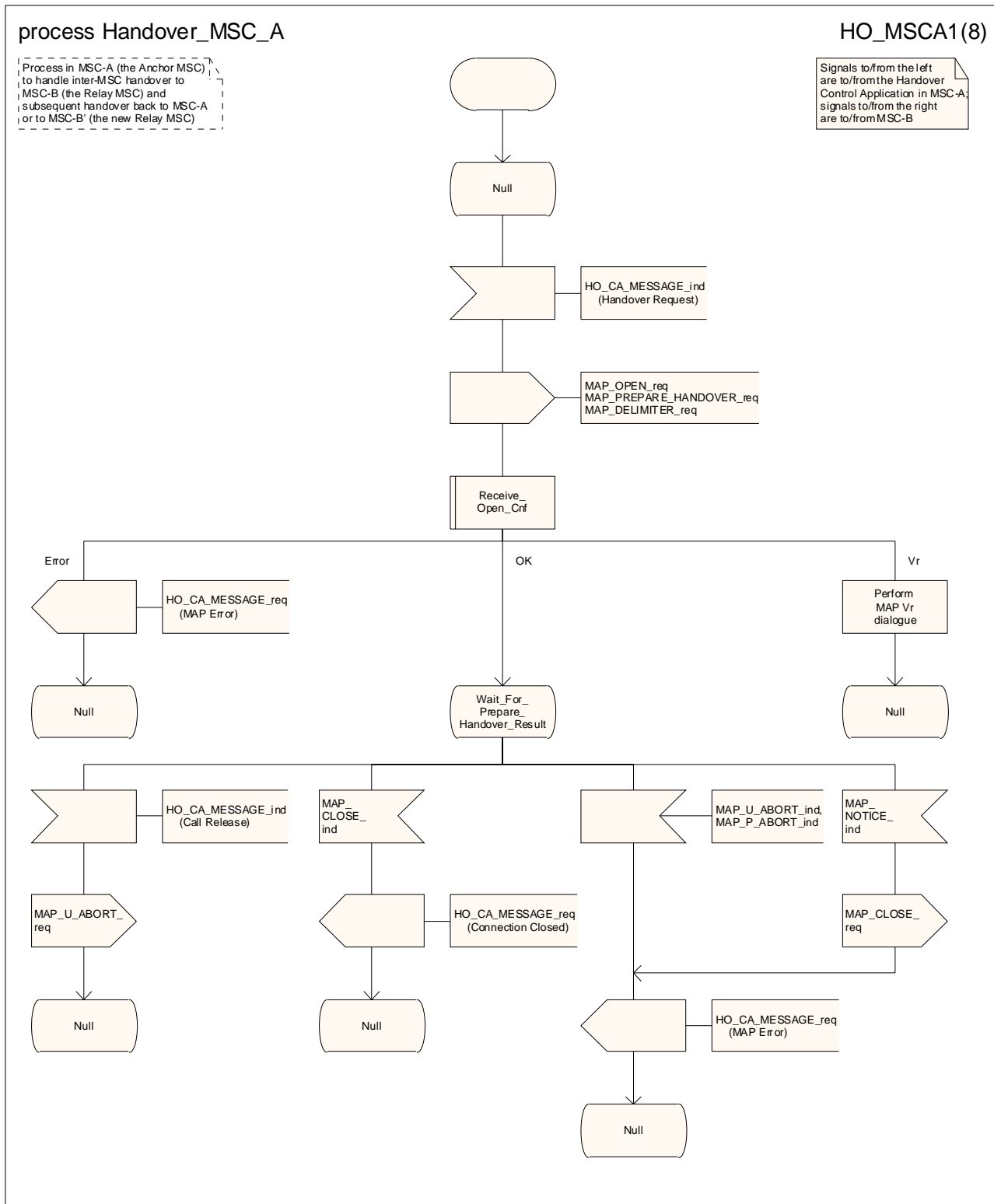

Figure 19.2/4 (sheet 1 of 8): Process HO_MSC_A

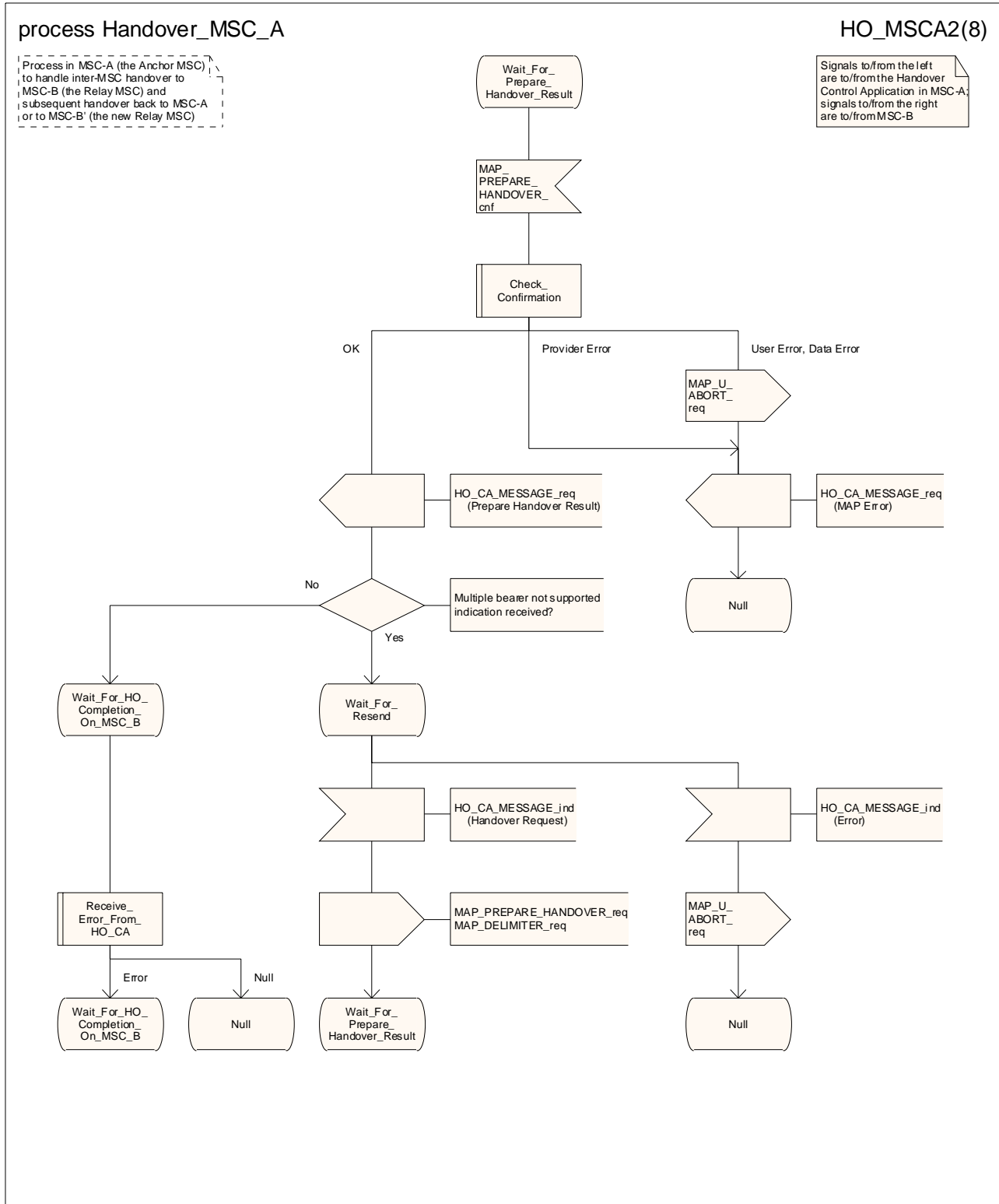

Figure 19.2/4 (sheet 2 of 8): Process HO_MSC_A

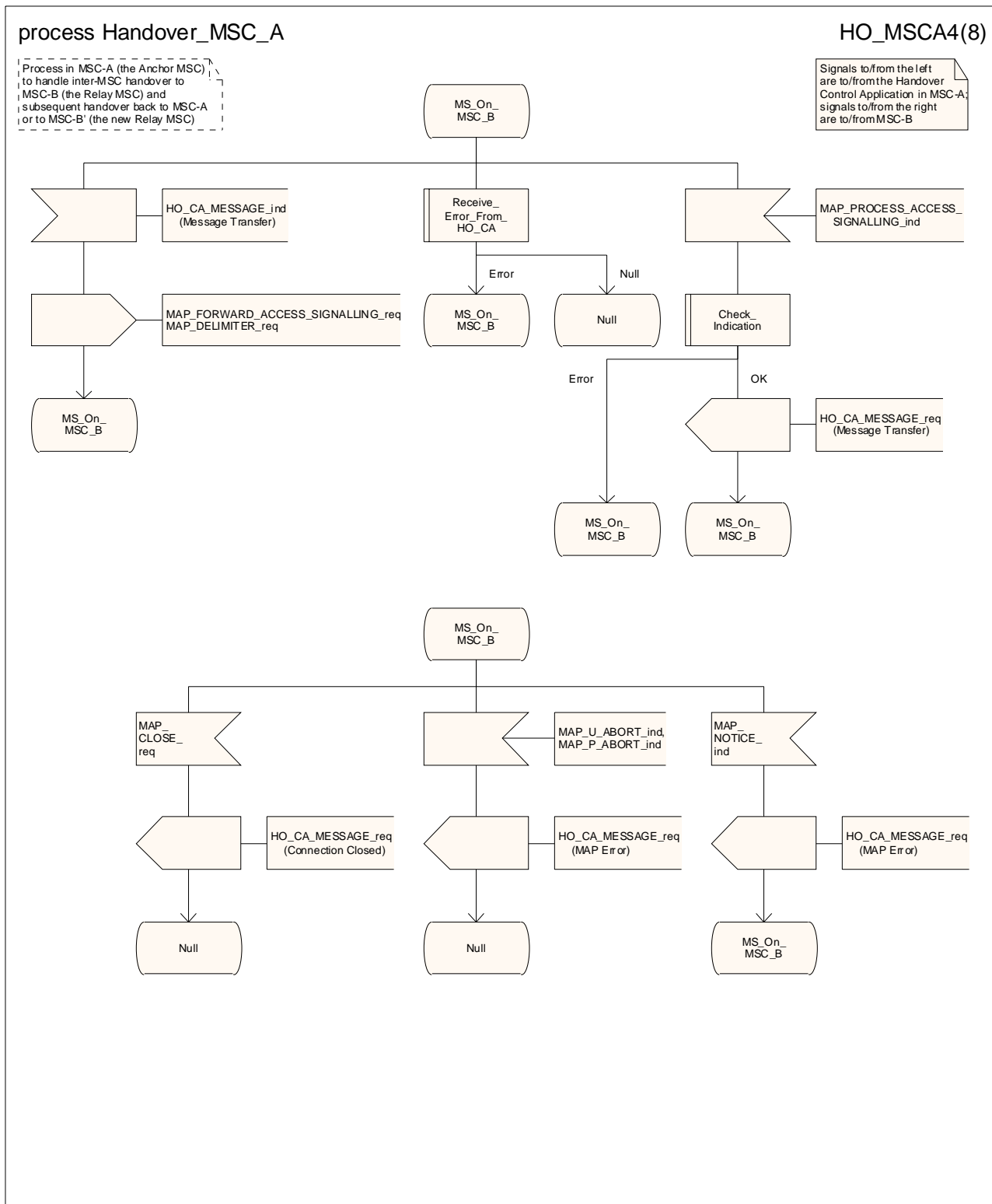

Figure 19.2/4 (sheet 4 of 8): Process HO_MSC_A

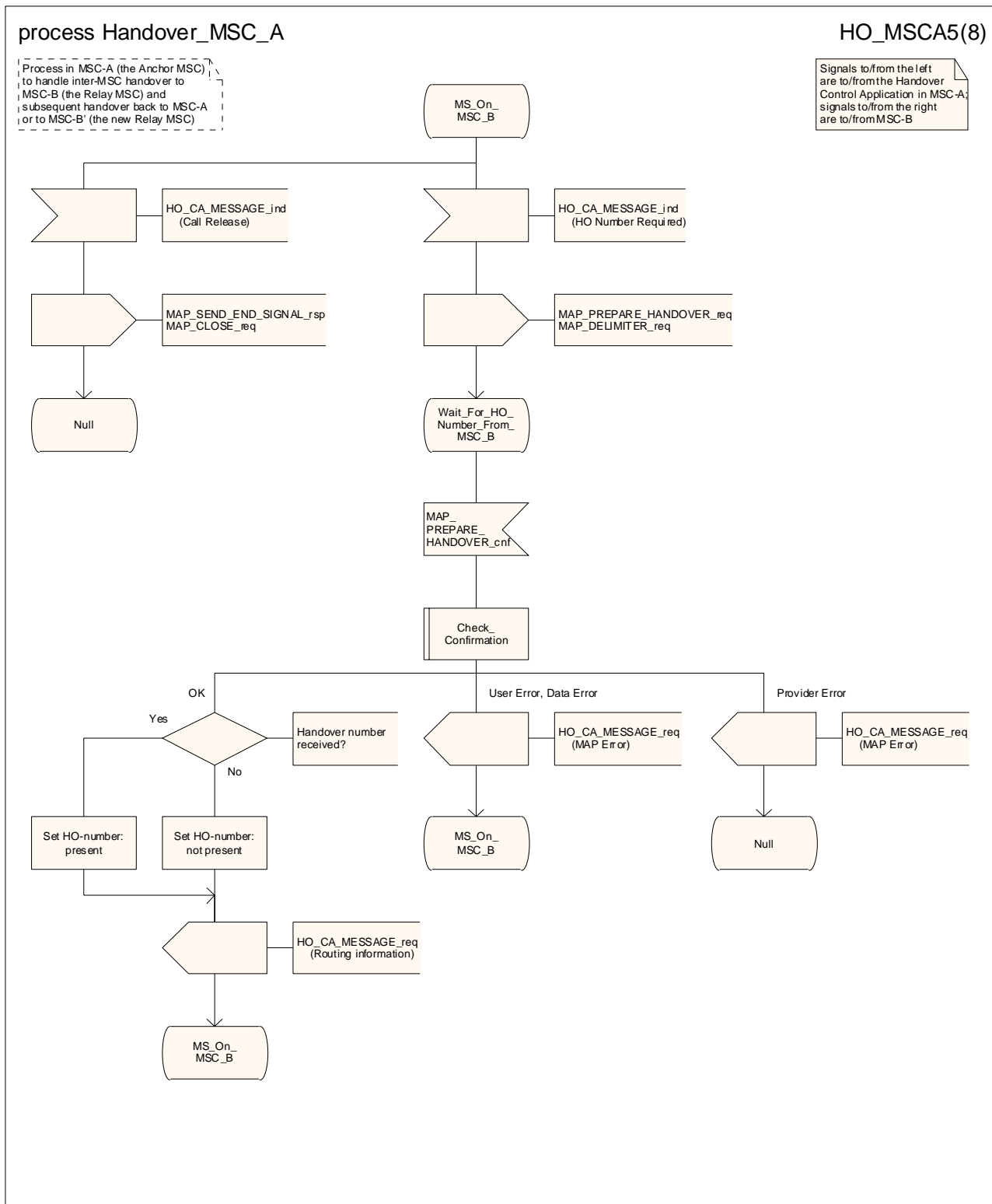

Figure 19.2/4 (sheet 5 of 8): Process HO_MSC_A

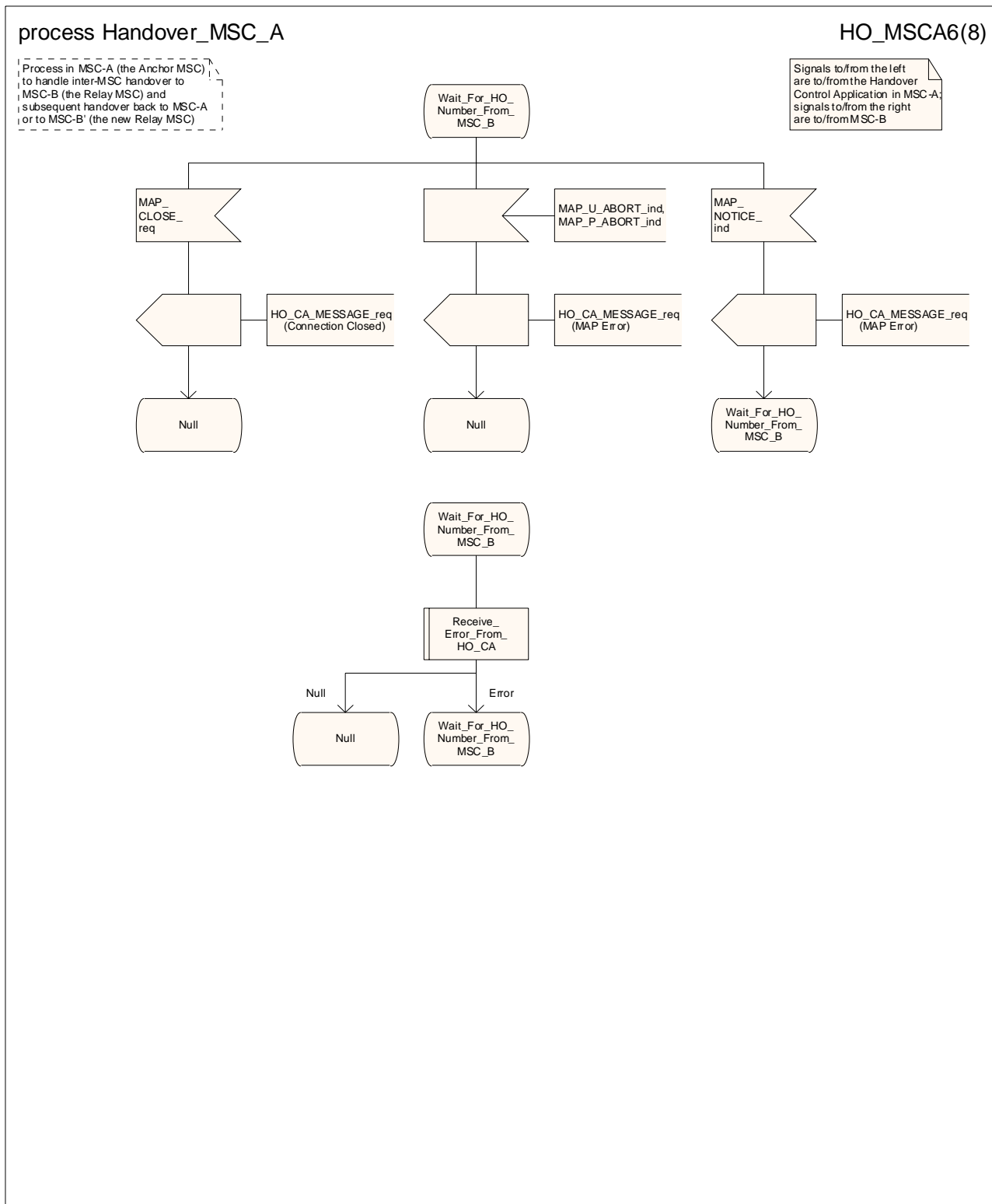

Figure 19.2/4 (sheet 6 of 8): Process HO_MSC_A

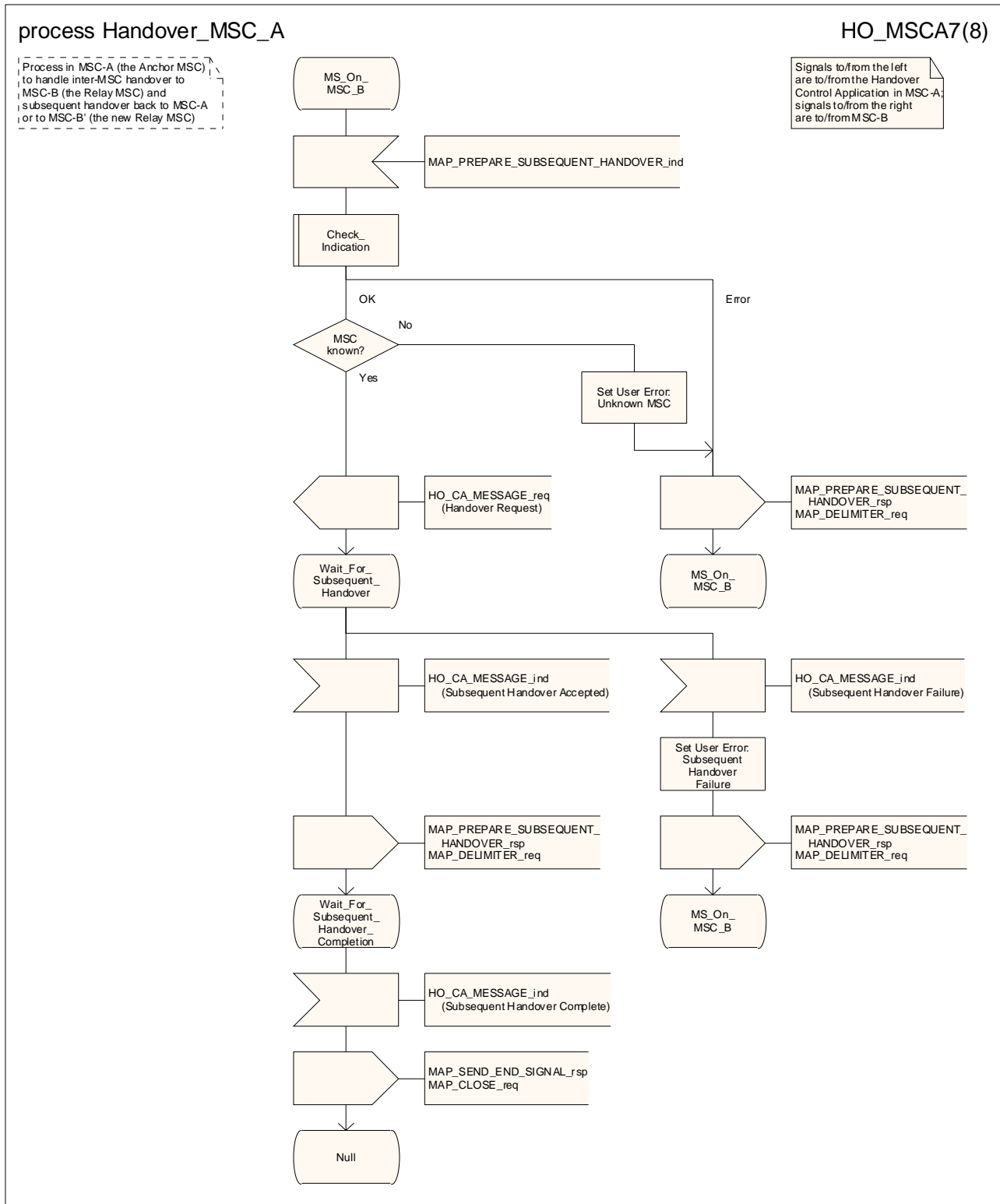

Figure 19.2/4 (sheet 7 of 8): Process HO_MSC_A

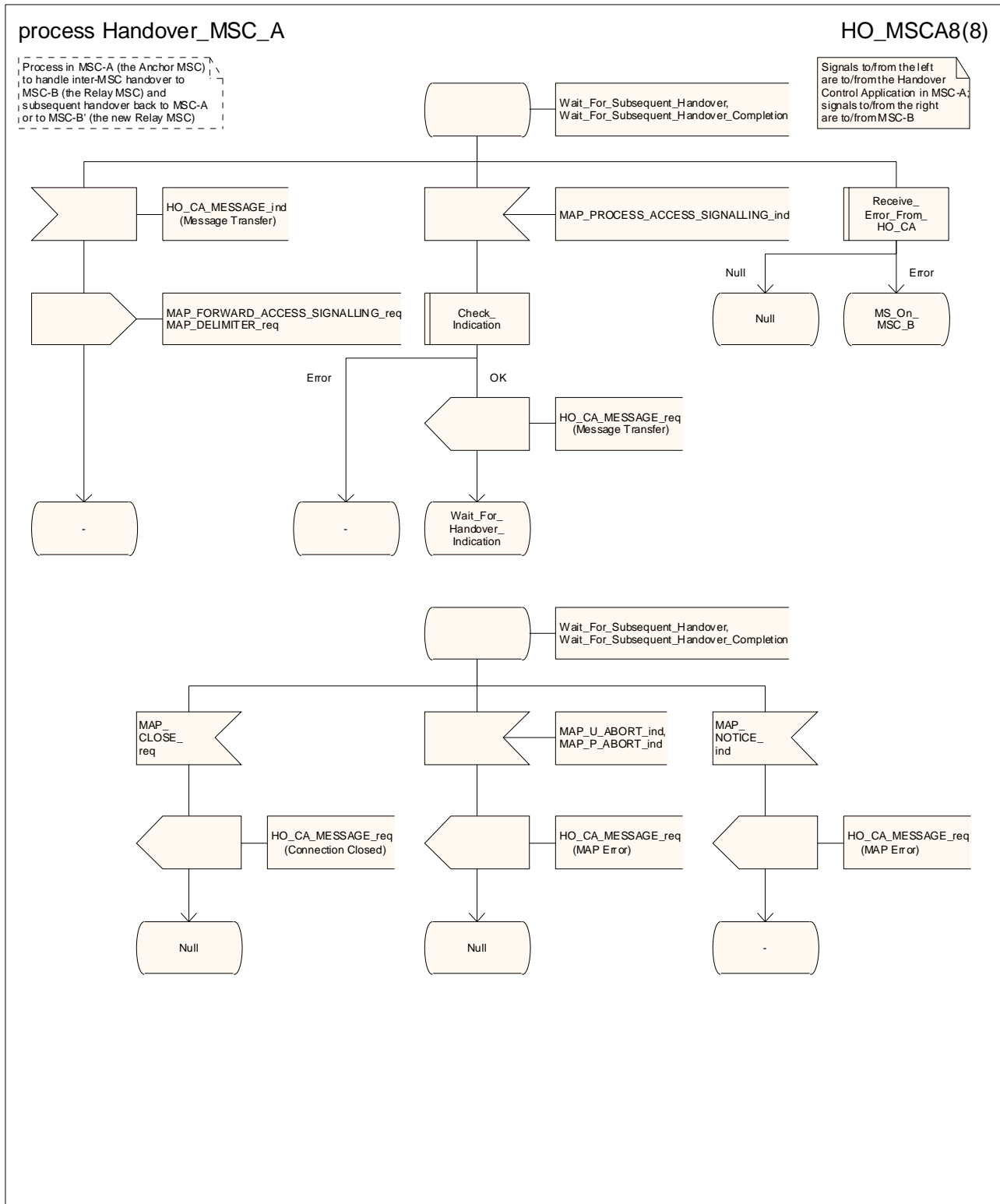

Figure 19.2/4 (sheet 8 of 8): Process HO_MSC_A

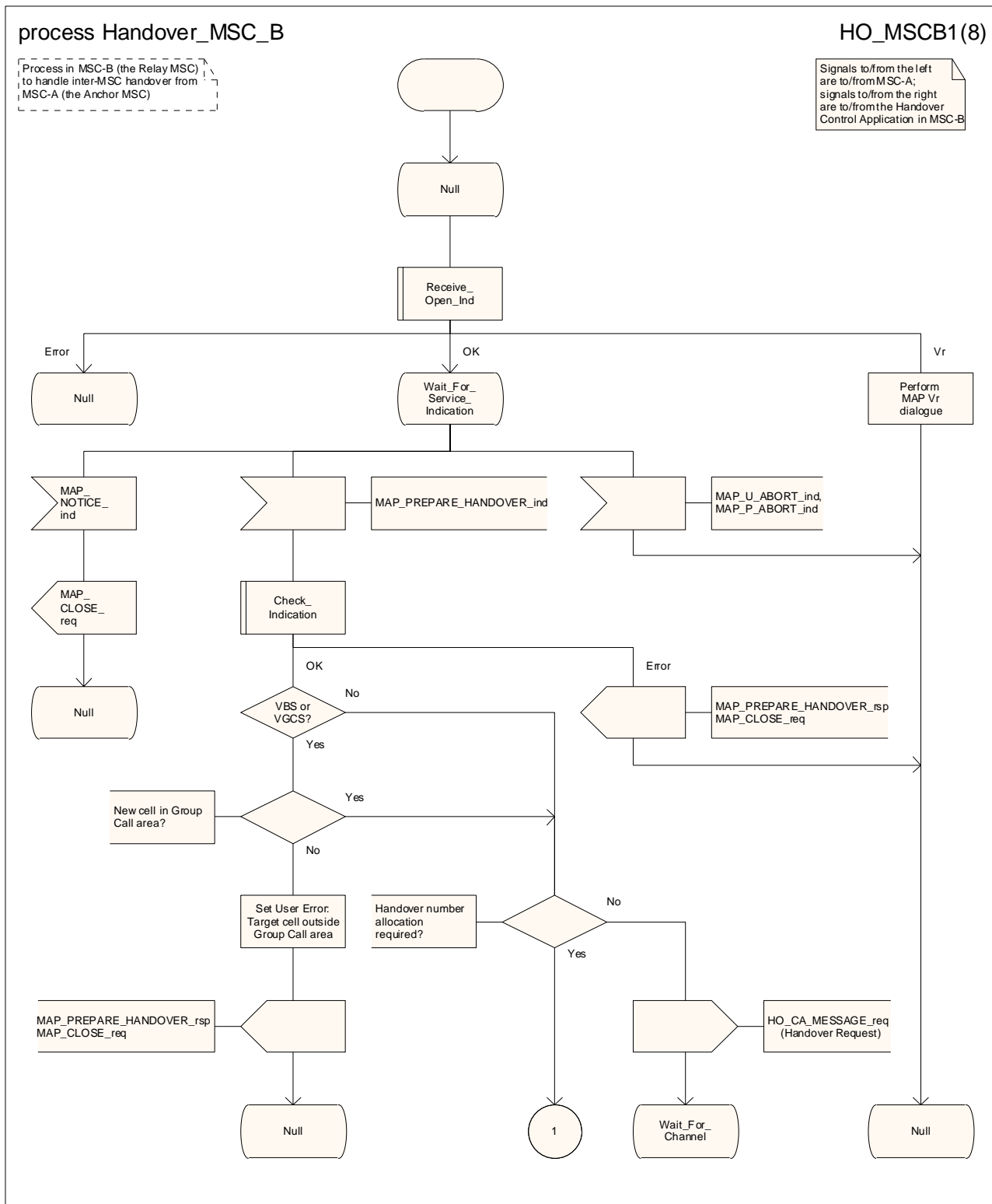

Figure 19.2/5 (sheet 1 of 8): Process HO_MSC_B

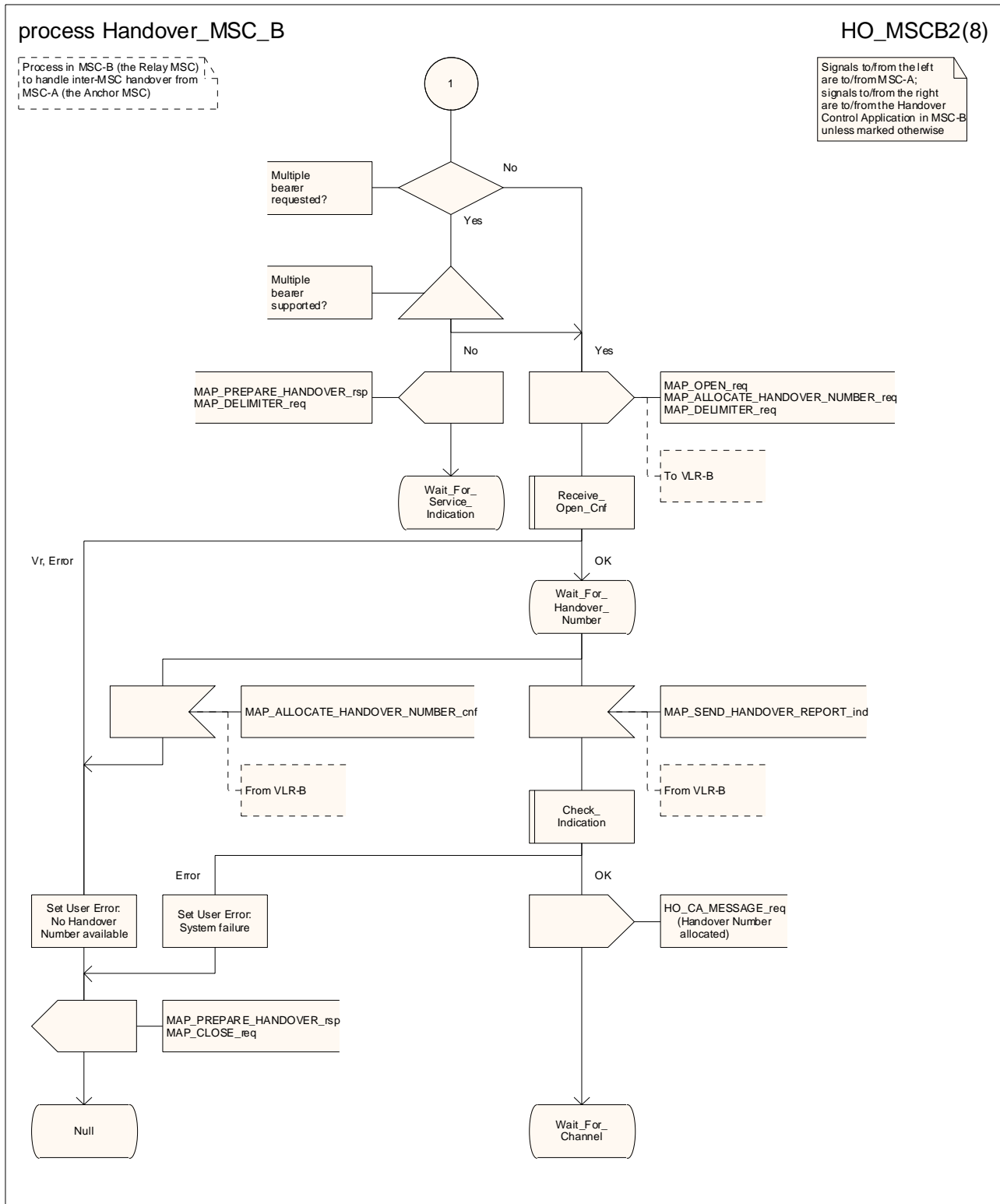

Figure 19.2/5 (sheet 2 of 8): Process HO_MSC_B

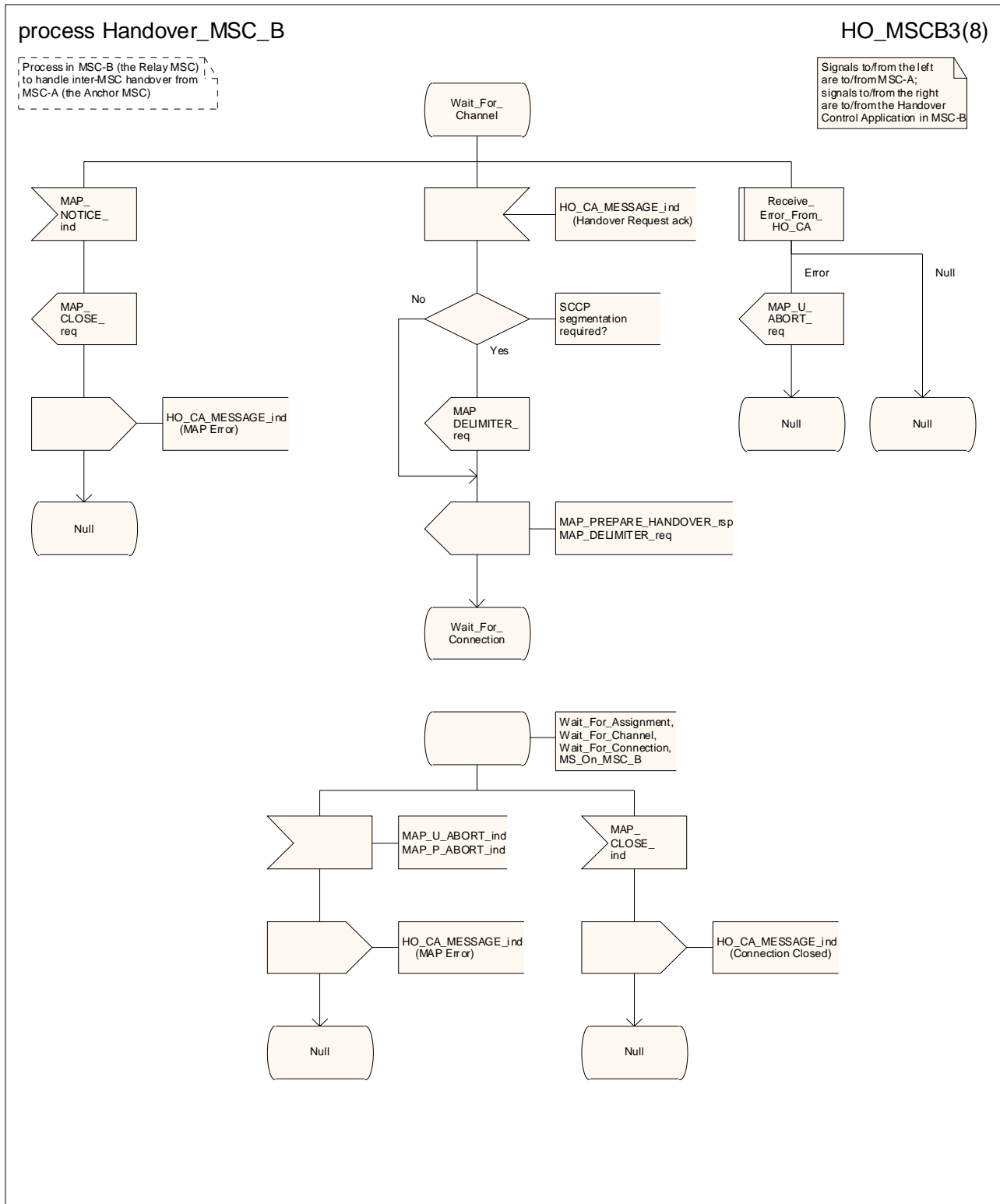

Figure 19.2/5 (sheet 3 of 8): Process HO_MSC_B

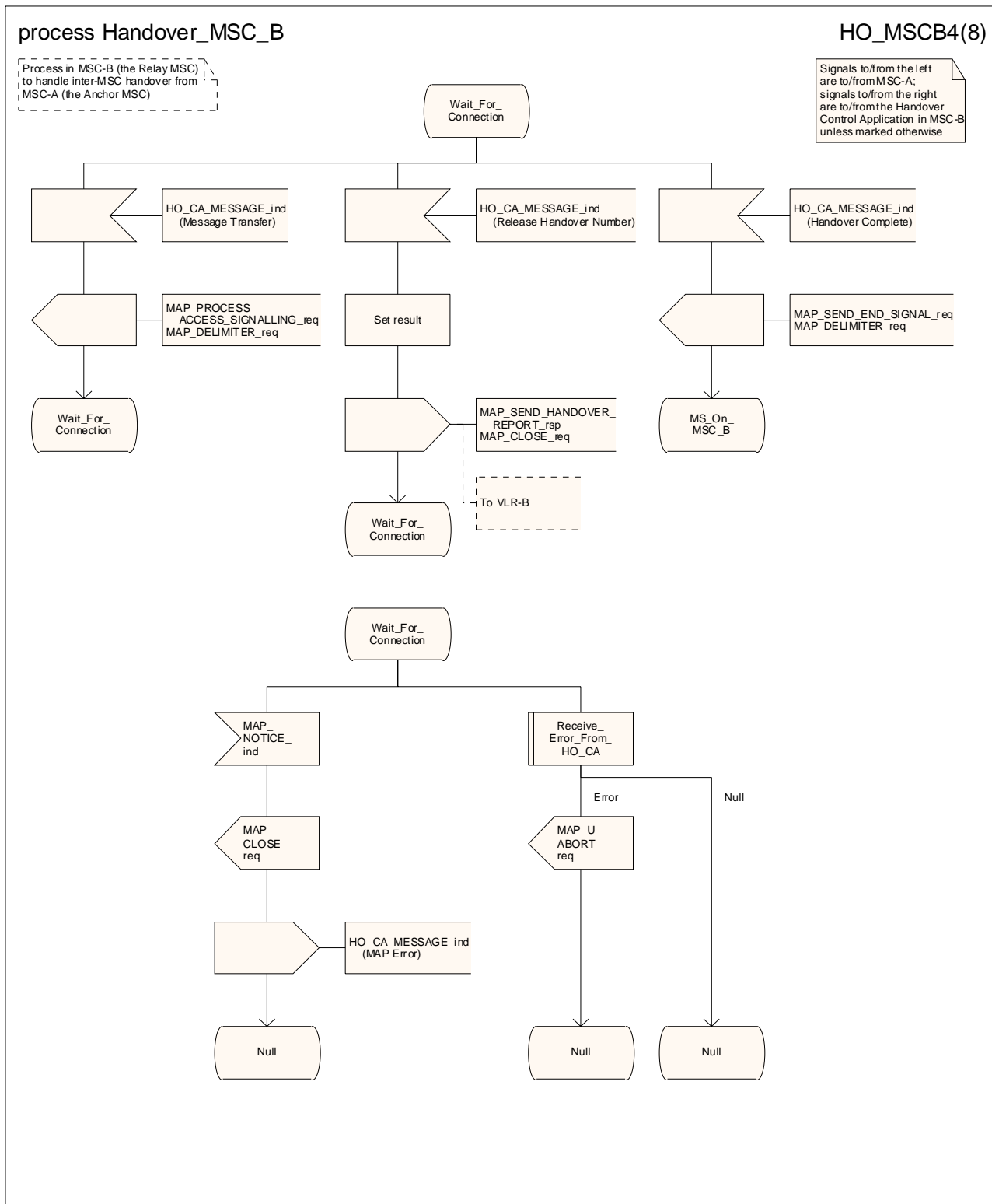

Figure 19.2/5 (sheet 4 of 8): Process HO_MSC_B

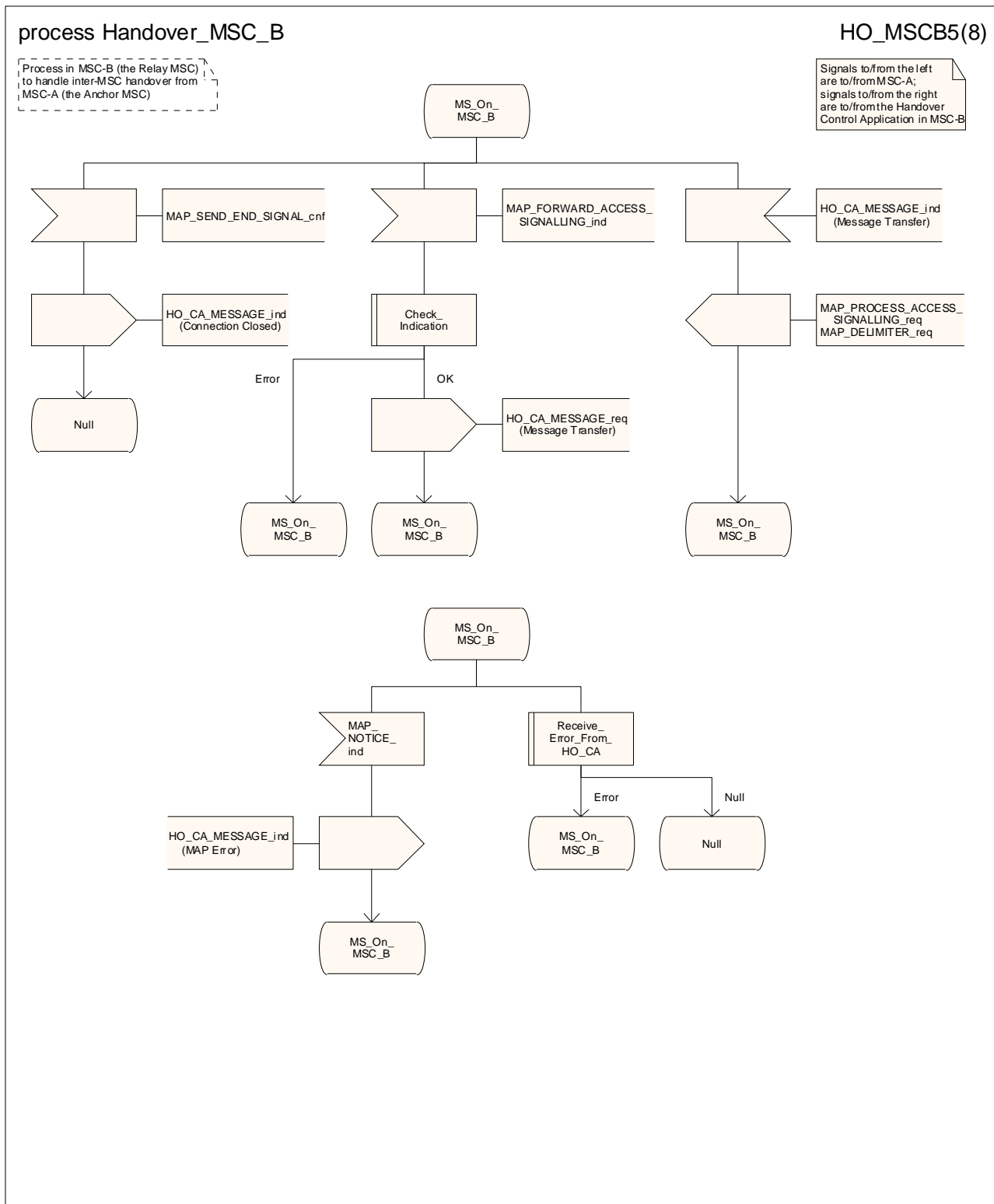

Figure 19.2/5 (sheet 5 of 8): Process HO_MSC_B

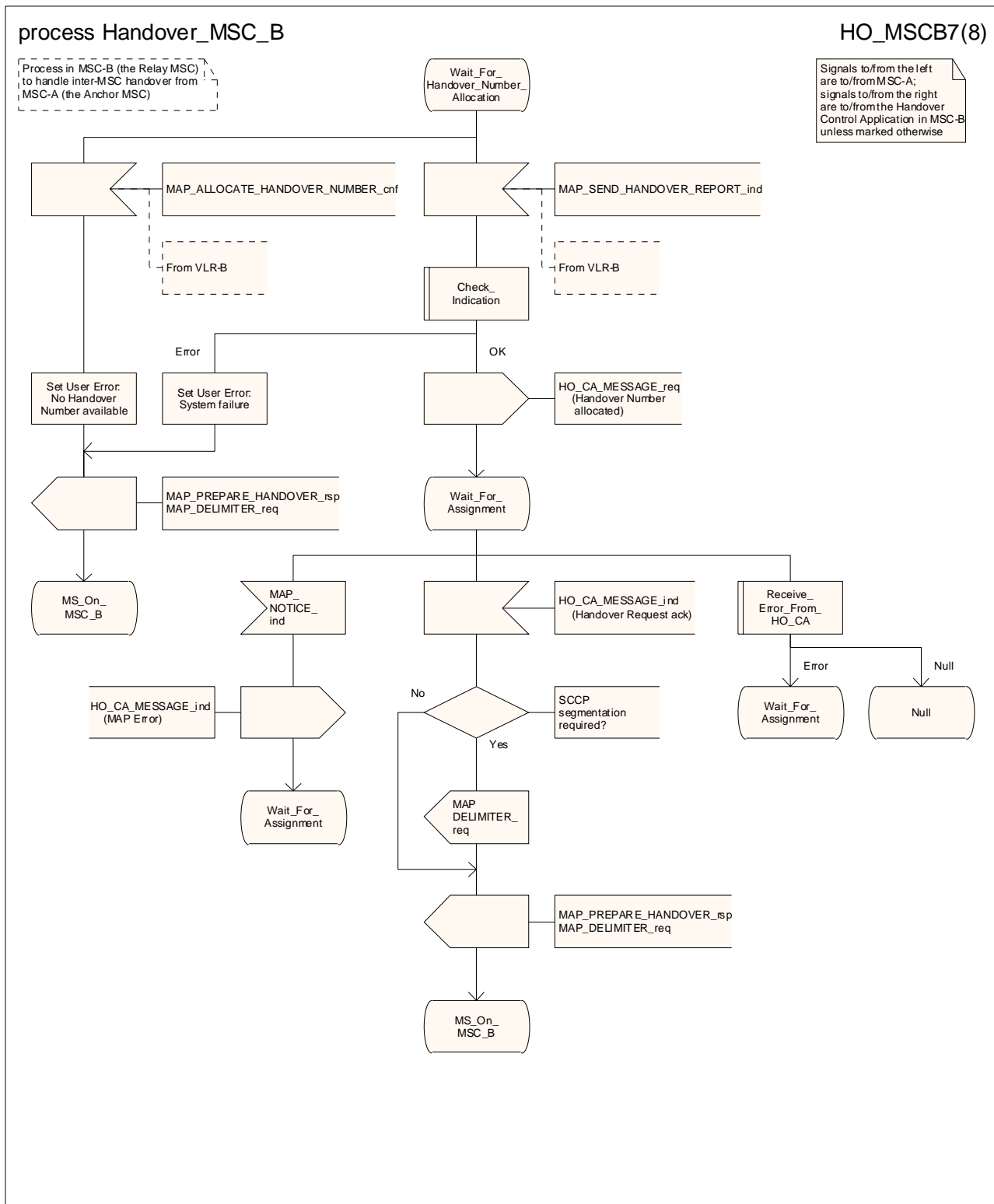

Figure 19.2/5 (sheet 7 of 8): Process HO_MSC_B

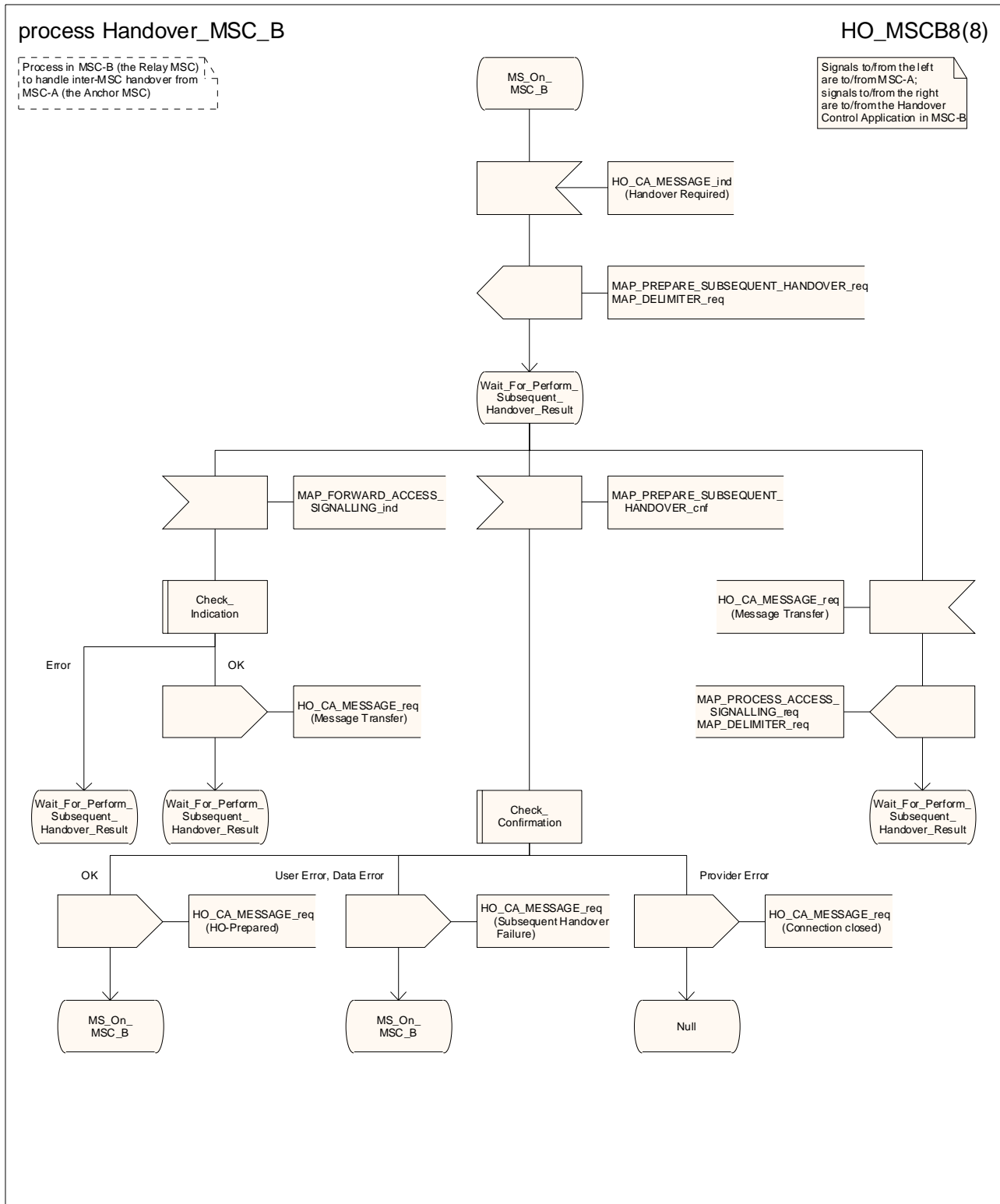

Figure 19.2/5 (sheet 8 of 8): Process HO_MSC_B

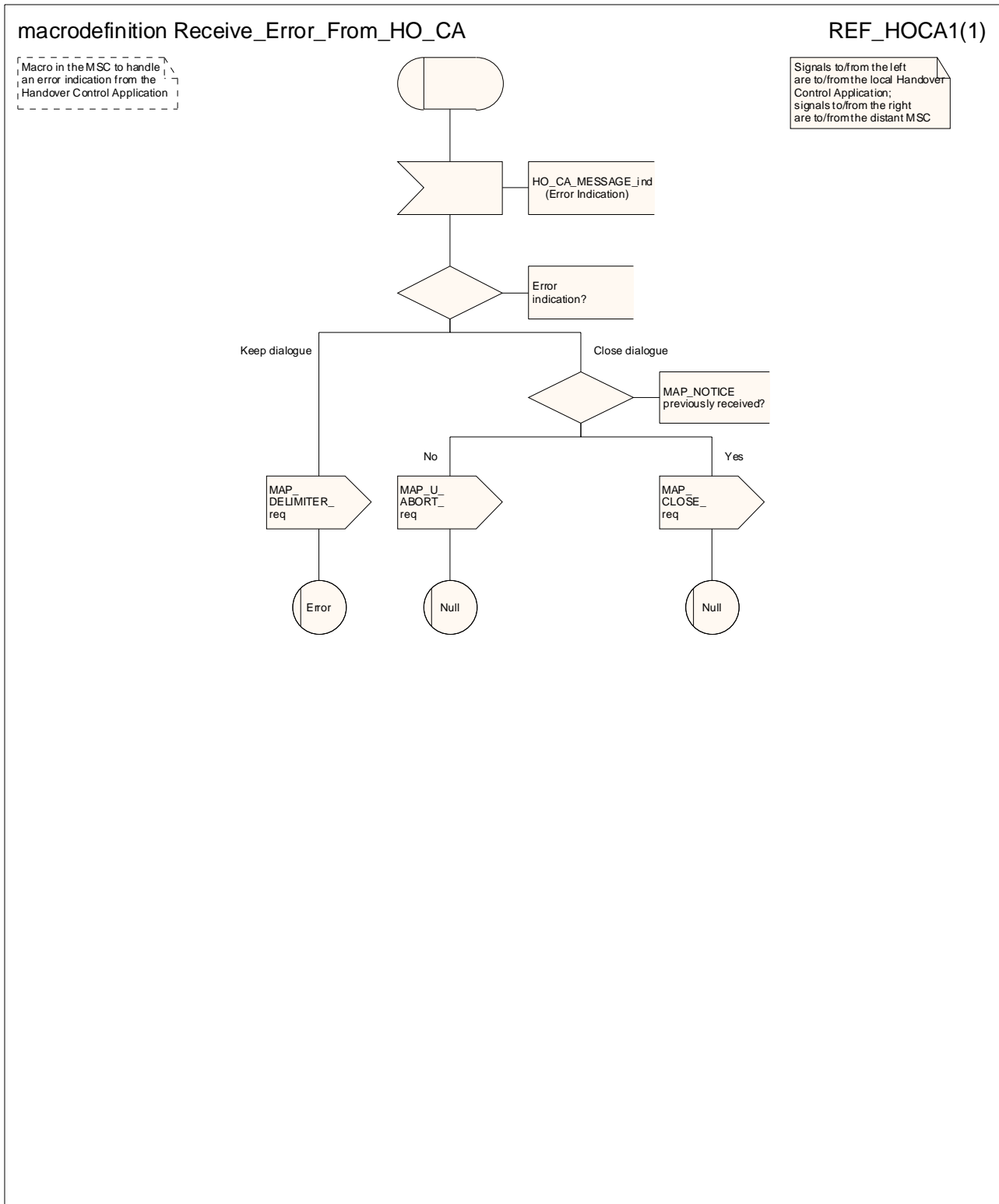

Figure 19.2/6: Macro Receive_error_from_HO_CA

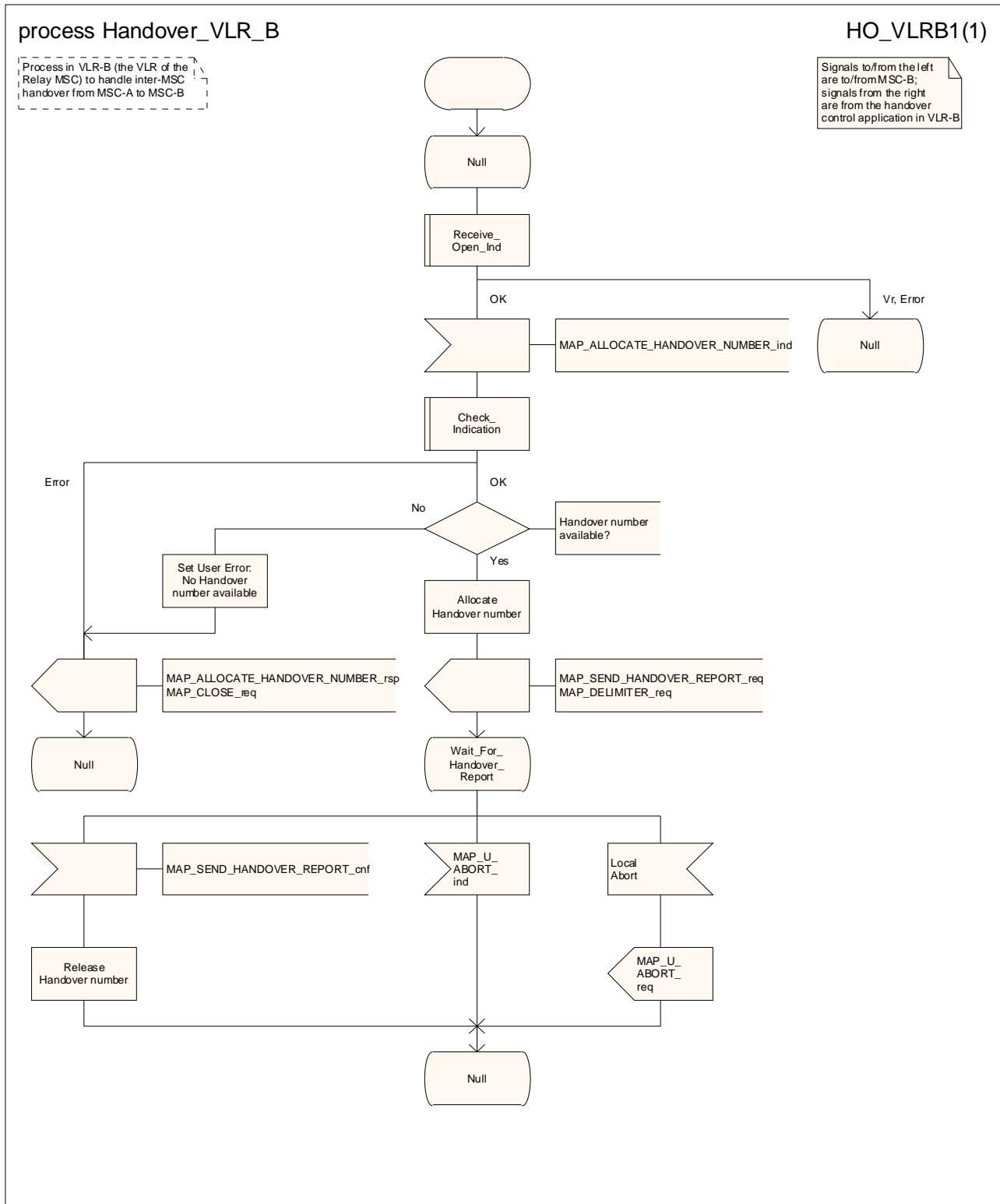

Figure 19.2/7: Process HO_VLR_B

19.3 Fault recovery procedures

When a location register has restarted after a fault, the fault recovery procedures ensure that the subscriber data in the VLR or in the SGSN become consistent with the subscriber data that are stored in the HLR for the MS concerned and that the location information in the HLR, the VLR and the SGSN reflect accurately the current location of the MS.

The stage 2 specification of fault recovery procedures in location registers is 3GPP TS 23.007 [19].

19.3.1 VLR fault recovery procedures

19.3.1.1 General

Restoration of an IMSI record in a VLR can be triggered by a location registration request from the MS or by a request from the HLR for a roaming number to route a mobile terminated call to the MS. If the restoration is triggered by a location registration request from the MS, the VLR performs the location updating procedure described in 3GPP TS 23.012 [23] and subclause 19.1.1 of the present document. If the restoration is triggered by a request for a roaming number, the VLR provides the roaming number and triggers an independent dialogue to restore the subscriber data as described in 3GPP TS 23.018 [97]. The message flow for data restoration triggered by a request for a roaming number is shown in figure 19.3.1/1.

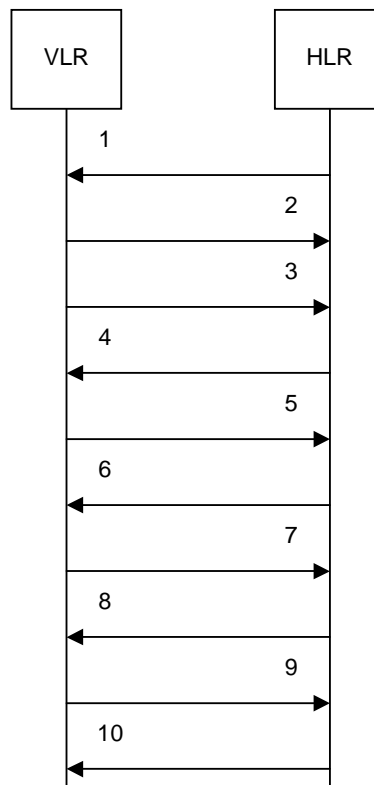

- 1) MAP_PROVIDE_ROAMING_NUMBER_req/ind
- 2) MAP_PROVIDE_ROAMING_NUMBER_rsp/cnf
- 3) *MAP_SEND_AUTHENTICATION_INFO_req/ind* (Note 1, note 2)
- 4) *MAP_SEND_AUTHENTICATION_INFO_rsp/cnf* (Note 1, note 2)
- 5) MAP_RESTORE_DATA_req/ind
- 6) *MAP_ACTIVATE_TRACE_MODE_req/ind* (Note 1, note 3)
- 7) *MAP_ACTIVATE_TRACE_MODE_rsp/cnf* (Note 1, note 3)
- 8) MAP_INSERT_SUBSCRIBER_DATA_req/ind
- 9) MAP_INSERT_SUBSCRIBER_DATA_rsp/cnf
- 10) MAP_RESTORE_DATA_rsp/cnf

NOTE 1: Services printed in *italics* are optional.

NOTE 2: If authentication is required.

NOTE 3: If subscriber tracing is active in the HLR.

Figure 19.3.1/1: Message flow for VLR restoration at mobile terminated call set-up

19.3.1.2 Procedure in the VLR

The procedure in the VLR to handle a dialogue for subscriber data restoration is defined in subclause 21.2.6 of the present document.

19.3.1.3 Procedure in the HLR

The MAP process in the HLR to handle a request for data restoration in the VLR is shown in figure 19.3.1/2. The MAP process invokes macros not defined in this clause; the definitions of these macros can be found as follows:

Check_Indication see subclause 25.2.1;

Control_Tracing_With_VLR_HLR see subclause 25.9.6.

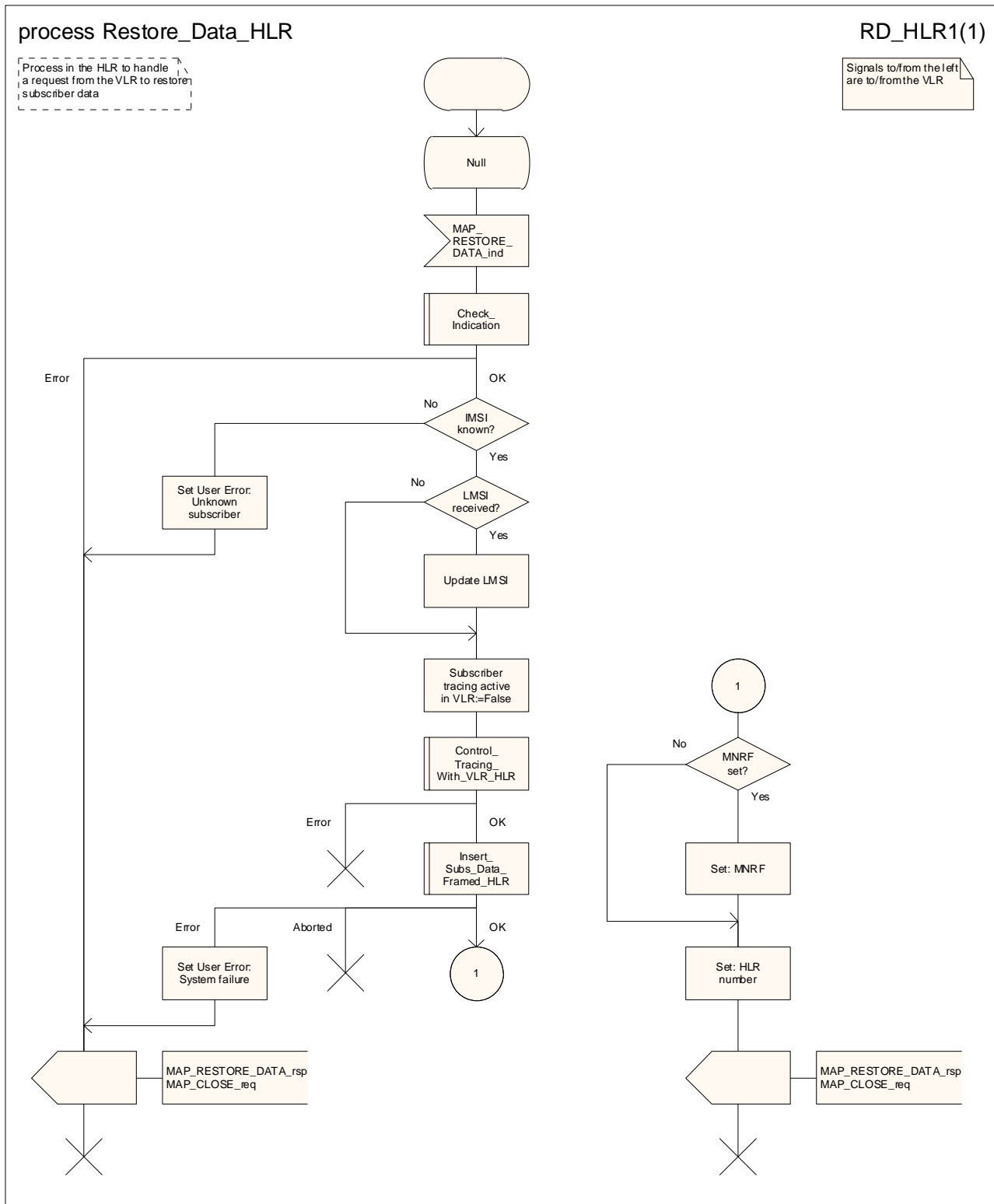

Figure 19.3.1/2: Process Restore_Data_HLR

19.3.2 HLR fault recovery procedures

19.3.2.1 General

For the HLR, periodic back-up of data to non-volatile memory is mandatory.

Data that have been changed after the last back-up and before the restart of the HLR cannot be recovered by reload from the non-volatile memory. Therefore, a restoration procedure is triggered for each IMSI record that has been affected by the HLR fault at the first authenticated radio contact with the MS concerned.

As an implementation option, a notification can be forwarded to the MS to alert the subscriber to check the parameters for supplementary services that allow subscriber controlled input (*MAP_FORWARD_CHECK_SS_INDICATION* service). If the VLR receives this notification from the HLR it shall forward the notification to the MS. If the Gs-interface is implemented the VLR shall not forward this notification.

The message flow for HLR restoration for a non-GPRS subscriber is shown in figure 19.3.2/1.

The message flow for HLR restoration for a GPRS subscriber is shown in figure 19.3.2/2.

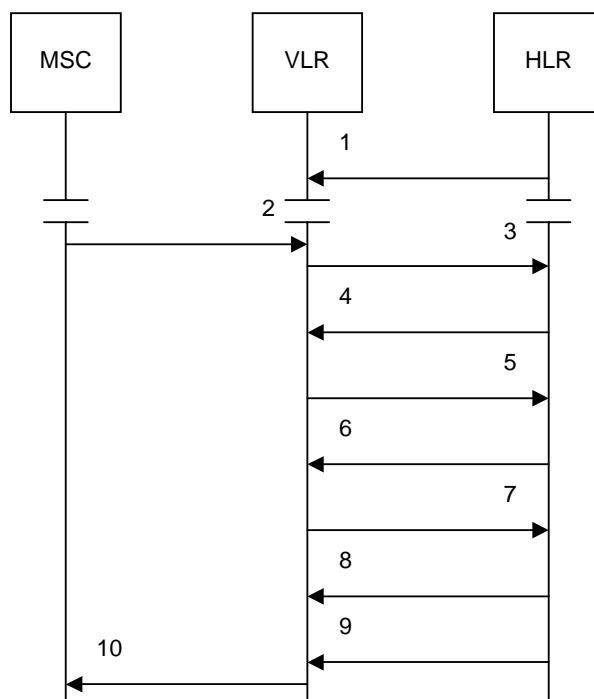

- 1) *MAP_RESET_req/ind*
- 2) *MAP_PROCESS_ACCESS_REQUEST_req/ind*
- 3) *MAP_UPDATE_LOCATION_req/ind*
- 4) *MAP_ACTIVATE_TRACE_MODE_req/ind* (Note 1, Note 2)
- 5) *MAP_ACTIVATE_TRACE_MODE_rsp/cnf* (Note 1, Note 2)
- 6) *MAP_INSERT_SUBSCRIBER_DATA_req/ind*
- 7) *MAP_INSERT_SUBSCRIBER_DATA_rsp/cnf*
- 8) *MAP_UPDATE_LOCATION_rsp/cnf*
- 9) *MAP_FORWARD_CHECK_SS_INDICATION_req/ind* (Note 1)
- 10) *MAP_FORWARD_CHECK_SS_INDICATION_req/ind* (Note 1)

NOTE 1: Services printed in *italics* are optional.

NOTE 2: If subscriber tracing is active in the HLR.

Figure 19.3.2/1: Message flow for HLR restoration (non-GPRS)

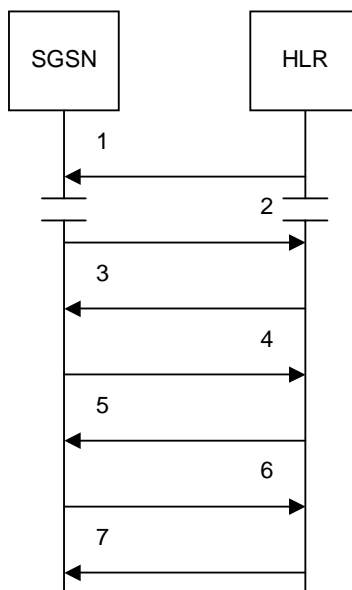

- 1) MAP_RESET_req/ind
- 2) MAP_UPDATE_GPRS_LOCATION_req/ind
- 3) *MAP_ACTIVATE_TRACE_MODE_req/ind* (Note 1, Note 2)
- 4) *MAP_ACTIVATE_TRACE_MODE_rsp/cnf* (Note 1, Note 2)
- 5) MAP_INSERT_SUBSCRIBER_DATA_req/ind
- 6) MAP_INSERT_SUBSCRIBER_DATA_rsp/cnf
- 7) MAP_UPDATE_GPRS_LOCATION_rsp/cnf

NOTE 1: Services printed in *italics* are optional.

NOTE 2: If subscriber tracing is active in the HLR.

Figure 19.3.2/2: Message flow for HLR restoration (GPRS)

19.3.2.2 Procedure in the HLR

The MAP process in the HLR to notify the relevant serving nodes that the HLR has restarted is shown in figure 19.3.2/3.

The SGSN address list includes one instance of the address of each SGSN in which (according to the HLR data retrieved from the non-volatile memory) there is at least one subscriber registered who is affected by the HLR restart.

The VLR address list includes one instance of the address of each VLR in which (according to the HLR data retrieved from the non-volatile memory) there is at least one subscriber registered who is affected by the HLR restart.

The MAP process in the HLR to notify a VLR that the HLR has restarted is shown in figure 19.3.2/4. The MAP process invokes a macro not defined in this clause; the definition of this macro can be found as follows:

Receive_Open_Cnf see subclause 25.1.2.

The MAP process in the HLR to notify an SGSN that the HLR has restarted is shown in figure 19.3.2/5. The MAP process invokes a macro not defined in this clause; the definition of this macro can be found as follows:

Receive_Open_Cnf see subclause 25.1.2.

19.3.2.3 Procedure in the VLR

The MAP process in the VLR to handle a notification that an HLR has restarted is shown in figure 19.3.2/6. The MAP process invokes a macro not defined in this clause; the definition of this macro can be found as follows:

Receive_Open_Ind see subclause 25.1.1.

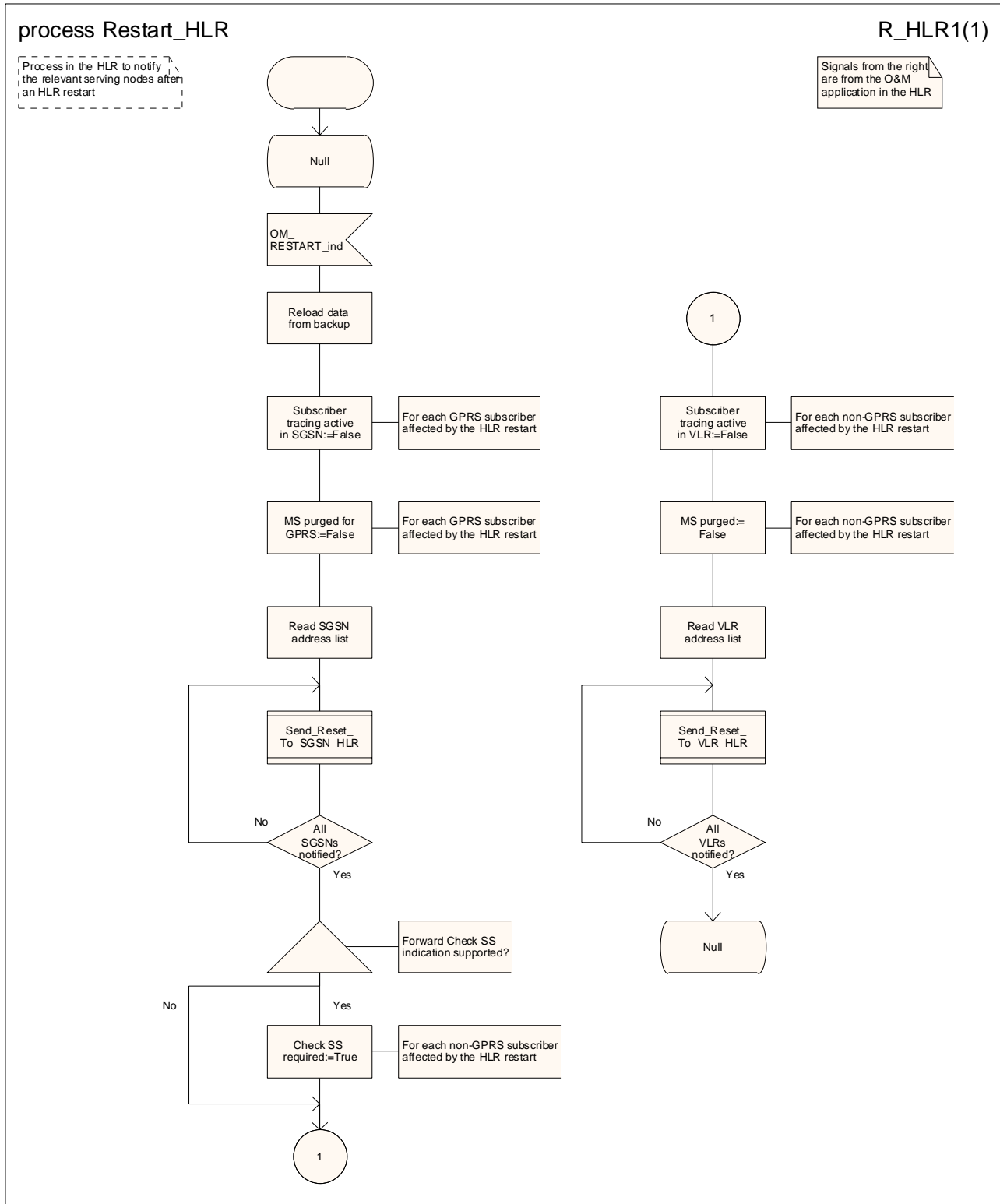

Figure 19.3.2/3: Process Restart_HLR

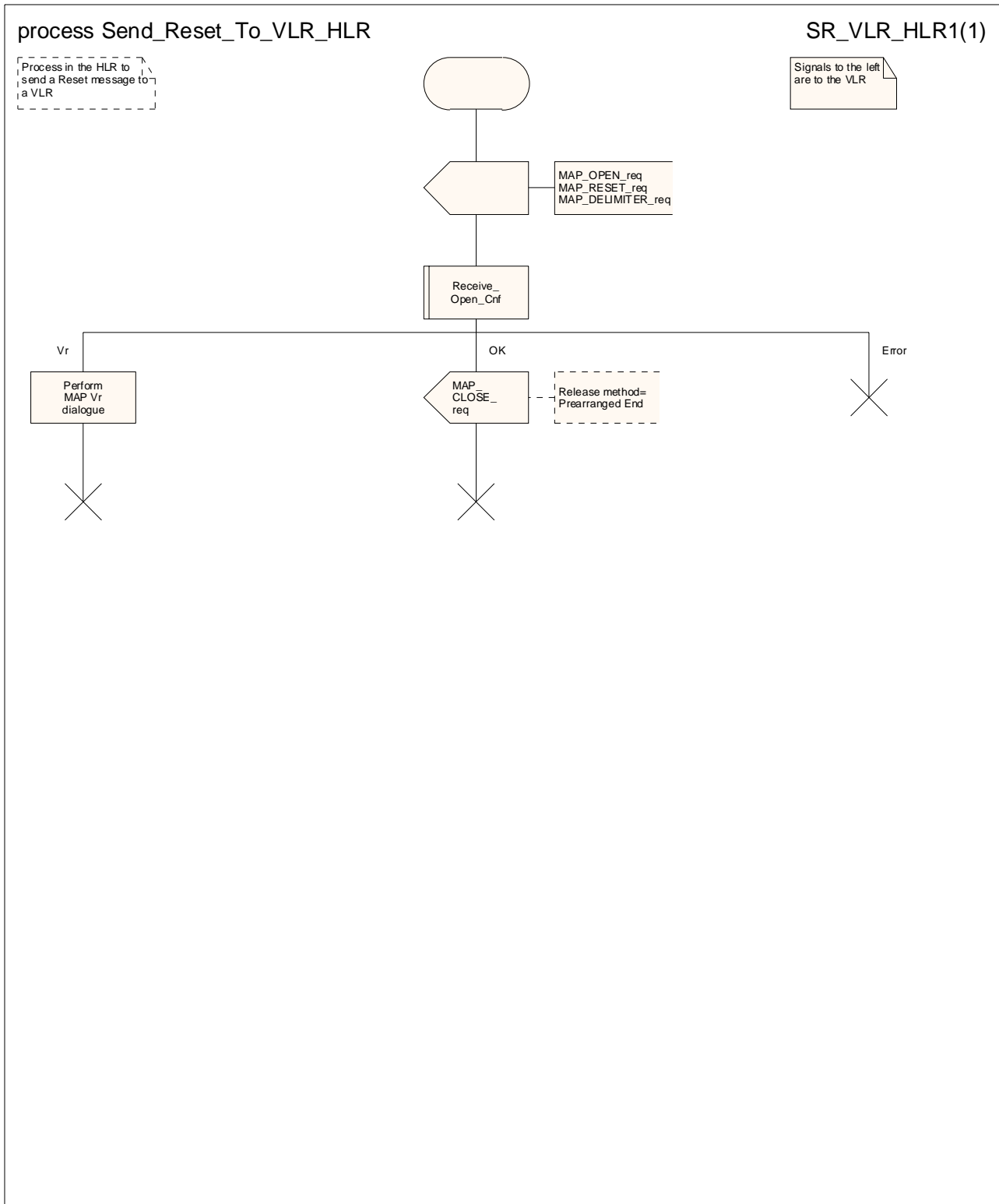

Figure 19.3.2/4: Process Send_Reset_To_VLR_HLR

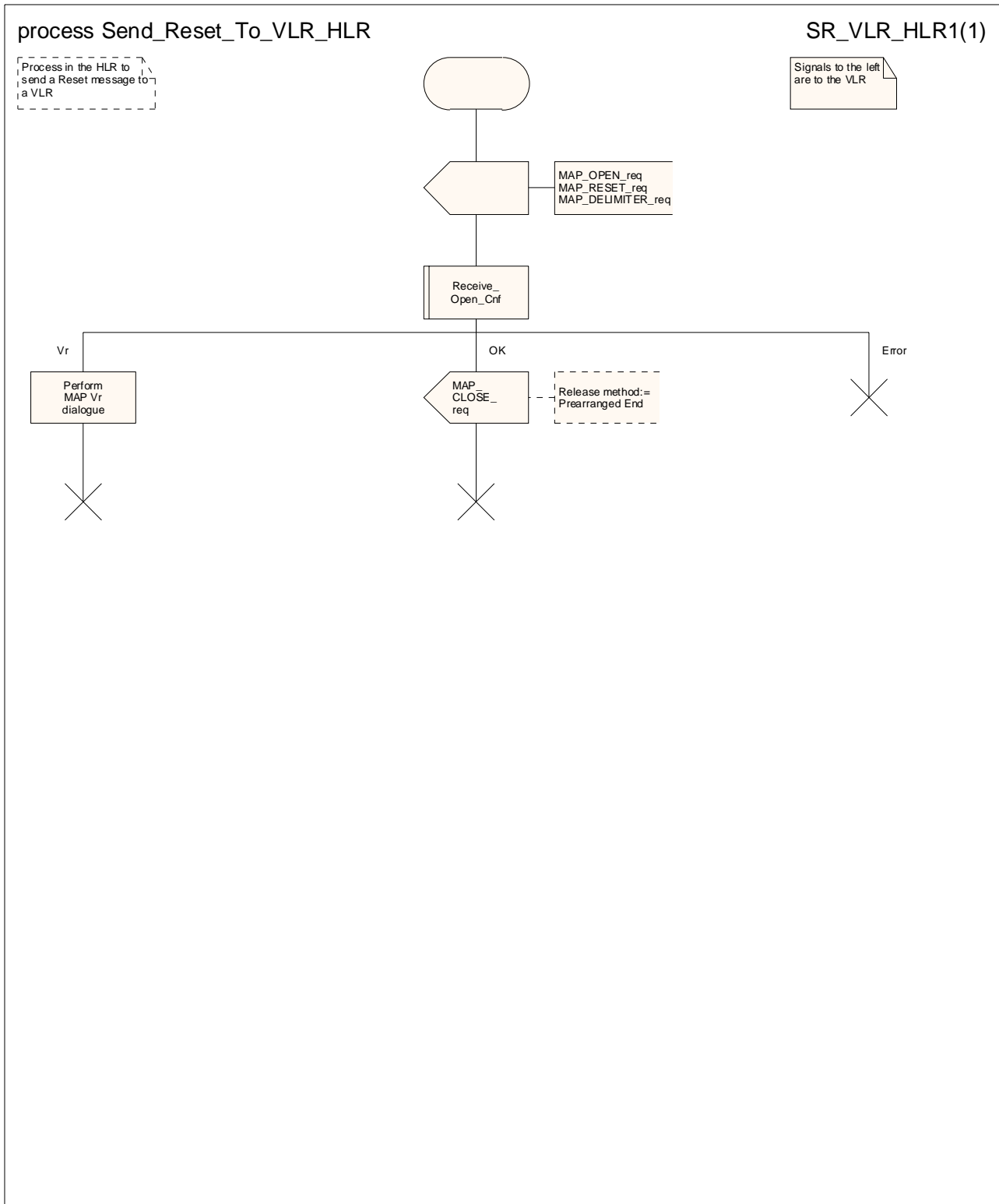

Figure 19.3.2/5: Process Send_Reset_To_SGSN_HLR

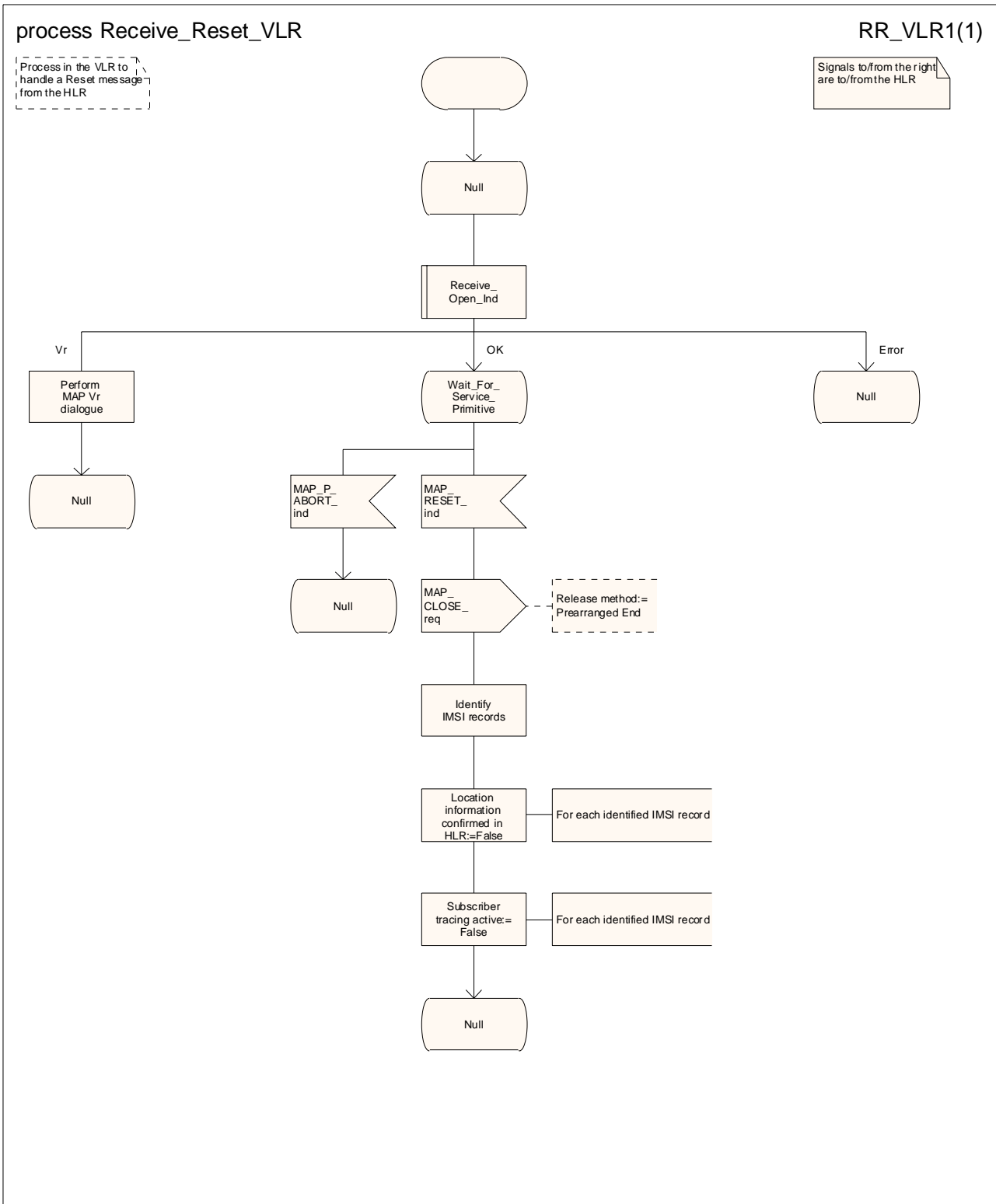

Figure 19.3.2/6: Process Receive_Reset_VLR

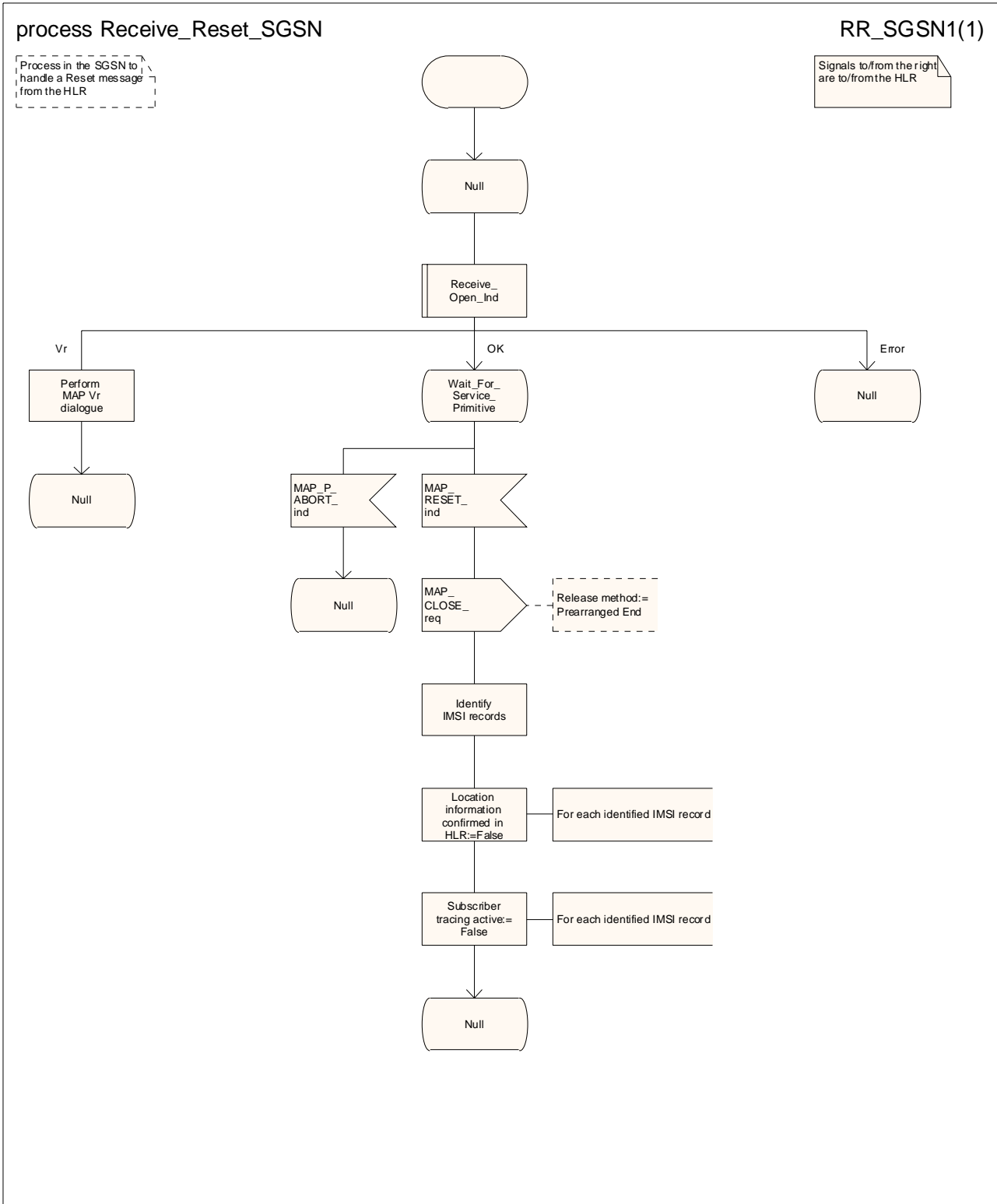

Figure 19.3.2/7: Process Receive_Reset_SGSN

19.4 Mobility Management event notification procedure

19.4.1 General

The Mobility Management event notification procedure is used to notify a gsmSCF about the successful completion of a Mobility Management event.

The message flow for Mobility Management event notification is shown in figure 19.4/1.

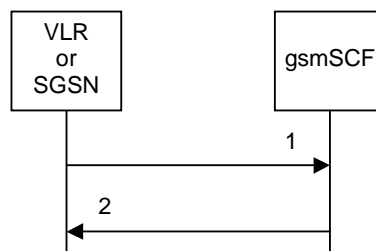

- 1) MAP_REPORT_MM_EVENT_req/ind
- 2) MAP_REPORT_MM_EVENT_rsp/cnf

Figure 19.4/1: Message flow for Mobility Management event notification

19.4.2 Procedure in the VLR or SGSN

The MAP process in the VLR or the SGSN to report a Mobility Management event to the gsmSCF is shown in figure 19.4/2. The MAP process invokes macros not defined in this clause; the definitions of these macros can be found as follows:

- | | |
|---------------------|-----------------------|
| Receive_Open_Cnf | see subclause 25.1.2; |
| Check_Confirmation: | see subclause 25.2.2. |

19.4.3 Procedure in the gsmSCF

The MAP process in the gsmSCF to handle the report of a Mobility Management event is shown in figure 19.4/3. The MAP process invokes a macro not defined in this clause; the definition of this macro can be found as follows:

- | | |
|------------------|-----------------------|
| Receive_Open_Ind | see subclause 25.1.1; |
|------------------|-----------------------|

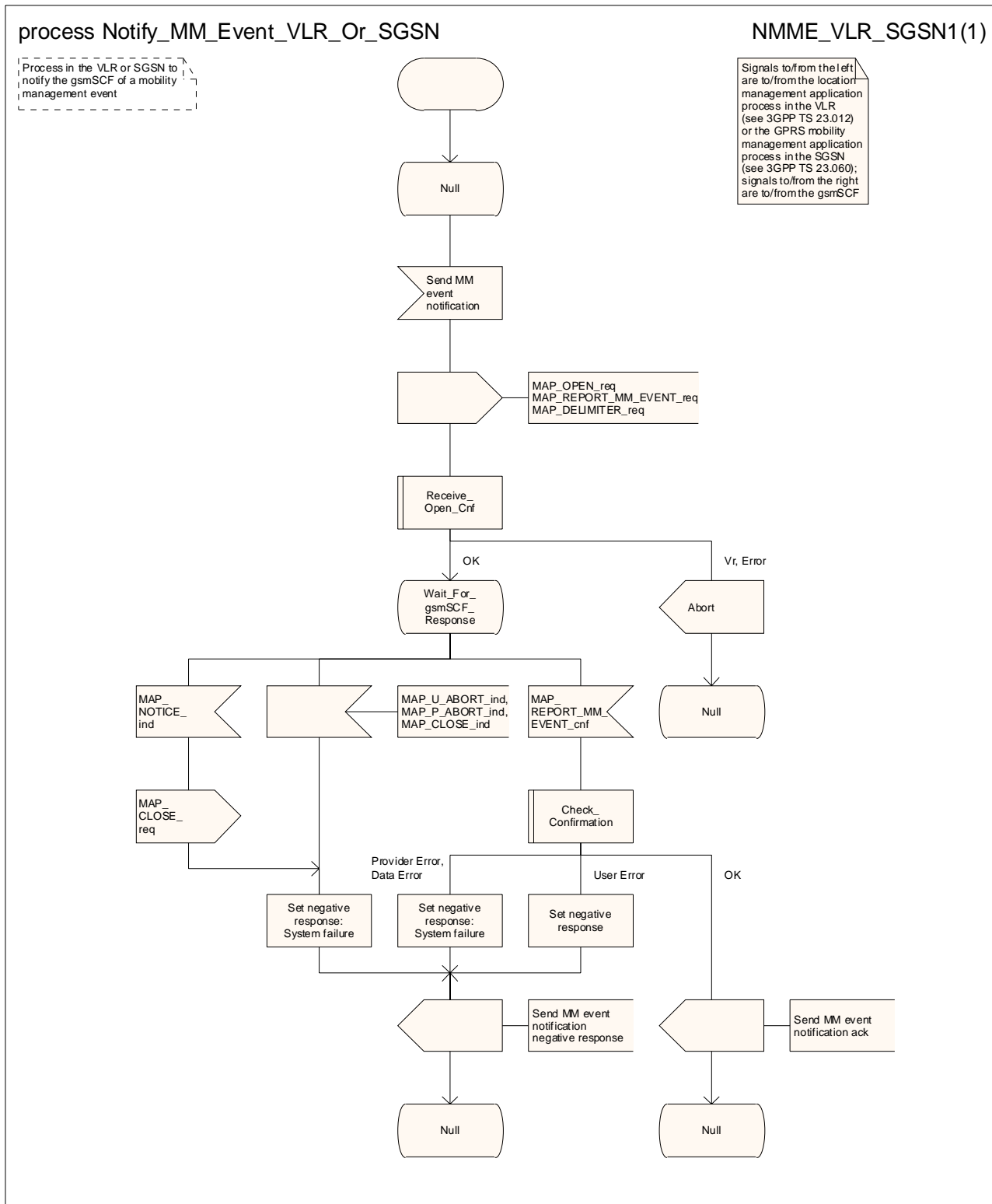

Figure 19.4/2: Process Notify_MM_Event_VLR_Or_SGSN

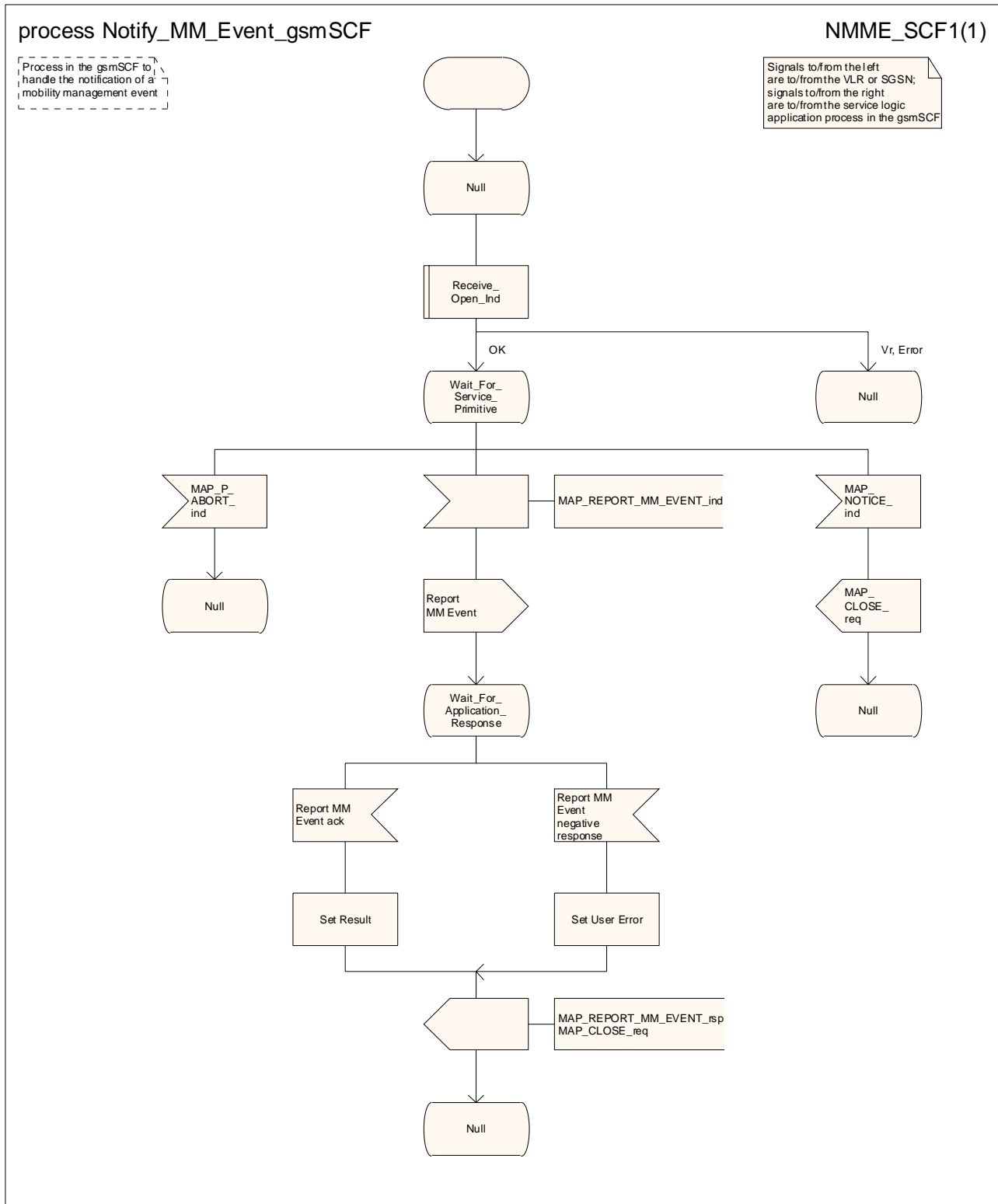

Figure 19.4/3: Process Notify_MM_Event_gsmSCF

19.5 HLR Insert Subscriber Data macros

19.5.1 Macro Insert_SubData_Framed_HLR

This macro is used to transfer subscriber data to the VLR as part of an existing dialogue for location updating or data restoration. The macro invokes a macro and a process not defined in this clause; the definitions of the macro and the process can be found as follows:

Wait_For_Insert_SubData_Cnf see subclause 25.7.5;
Send_Insert_SubData_HLR: see subclause 25.7.7.

The HLR may wait for each MAP_INSERT_SUBSCRIBER_DATA request to be acknowledged before it sends the next request, or it may handle the requests and the confirmations in parallel.

If the VLR has indicated that it does not support a service or feature (e.g. Closed User Group or Advice Of Charge Charging Level) which the HLR operator regards as essential for the subscriber, the macro Wait_for_Insert_SubData_Cnf takes the Replace_Service exit; the HLR sets the Roaming Restriction Due To Unsupported Feature flag to roaming restricted and sends Roaming Restriction Due To Unsupported Feature in a subsequent MAP_INSERT_SUBSCRIBER_DATA request.

If the HLR operator does not regard the unsupported service or feature as essential for the subscriber but the macro Wait_for_Insert_SubData_Cnf takes the Replace_Service exit, the HLR sends the data for a replacement service in a subsequent MAP_INSERT_SUBSCRIBER_DATA request.

If subscriber data for CAMEL Phase 2 or later services are sent to a VLR which does not support the appropriate phase of CAMEL, the service behaviour may be unpredictable or incorrect. The HLR should therefore ensure that at the conclusion of a stand alone Insert Subscriber data procedure the data in the VLR do not require a capability that the VLR does not have. Possible mechanisms to ensure this are described in 3GPP TS 23.078 [98].

The HLR should send a Forwarded-to number which is not in E.164 international format to the VLR only when the HLR has ascertained that the VLR supports CAMEL Phase 2 or later. Thus, the ISD message containing the Forwarded-to number which is not in E.164 international format shall be sent to the VLR only if the HLR previously received confirmation from the VLR at Location Update that CAMEL Phase 2 or later is supported.

19.5.2 Macro Insert_GPRS_SubData_Framed_HLR

This macro is used to transfer subscriber data to the SGSN as part of an existing dialogue for location updating. The macro invokes a macro and a process not defined in this clause; the definitions of the macro and the process can be found as follows:

Wait_For_Insert_GPRS_SubData_Cnf see subclause 25.7.5;
Send_Insert_SubData_HLR: see subclause 25.7.7.

The HLR may wait for each MAP_INSERT_SUBSCRIBER_DATA request to be acknowledged before it sends the next request, or it may handle the requests and the confirmations in parallel.

If the SGSN has indicated that it does not support a service or feature which the HLR operator regards as essential for the subscriber, the macro Wait_for_Insert_GPRS_SubData_Cnf takes the Replace_Service exit; the HLR sets the Roaming Restricted In SGSN Due To Unsupported Feature flag to roaming restricted and sends Roaming Restricted In SGSN Due To Unsupported Feature in a subsequent MAP_INSERT_SUBSCRIBER_DATA request.

If the HLR operator does not regard the unsupported service or feature as essential for the subscriber but the macro Wait_for_Insert_GPRS_SubData_Cnf takes the Replace_Service exit, the HLR sends the data for a replacement service in a subsequent MAP_INSERT_SUBSCRIBER_DATA request.

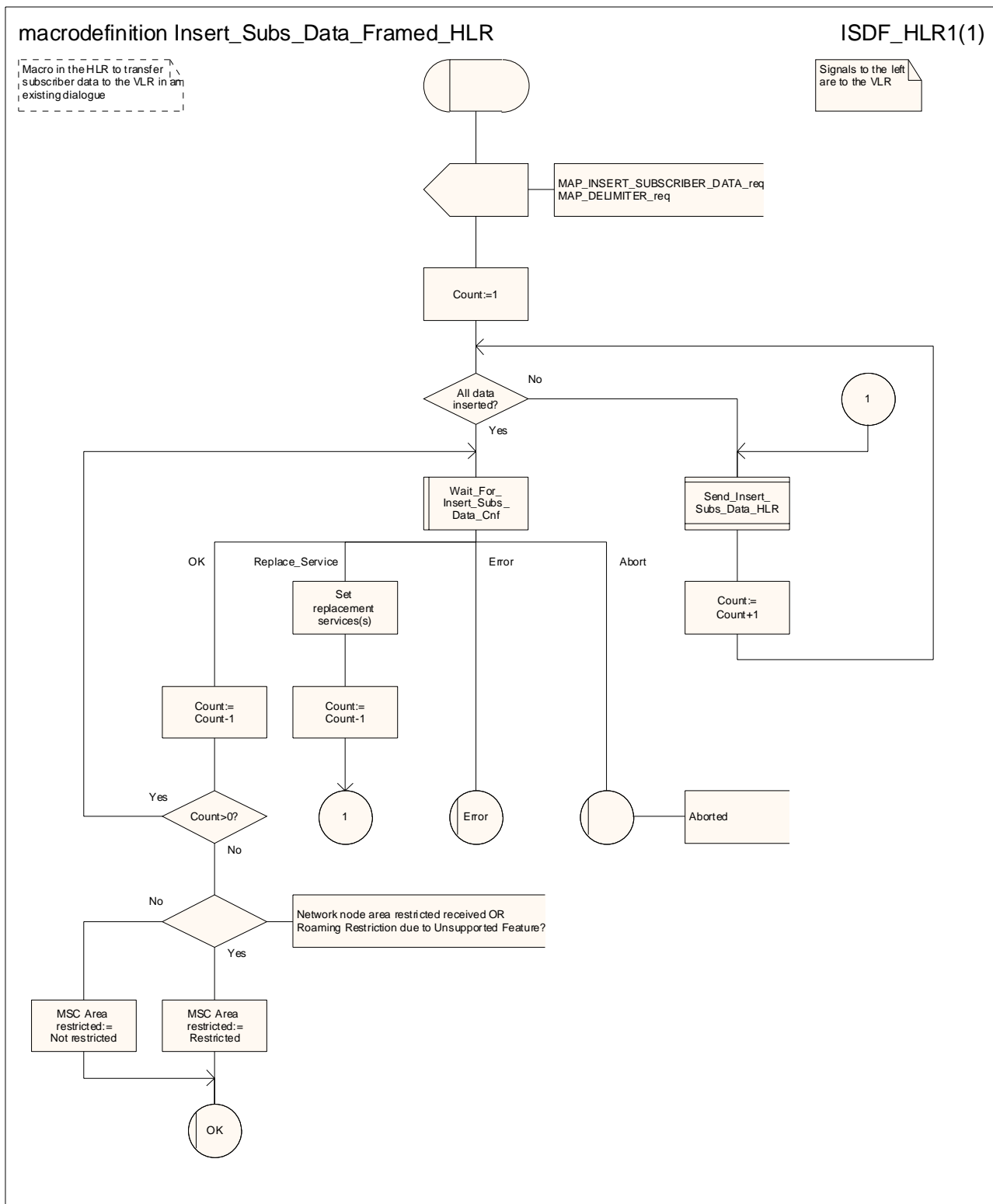

Figure 19.5/1: Macro Insert_Subscriber_Data_Framed_HLR

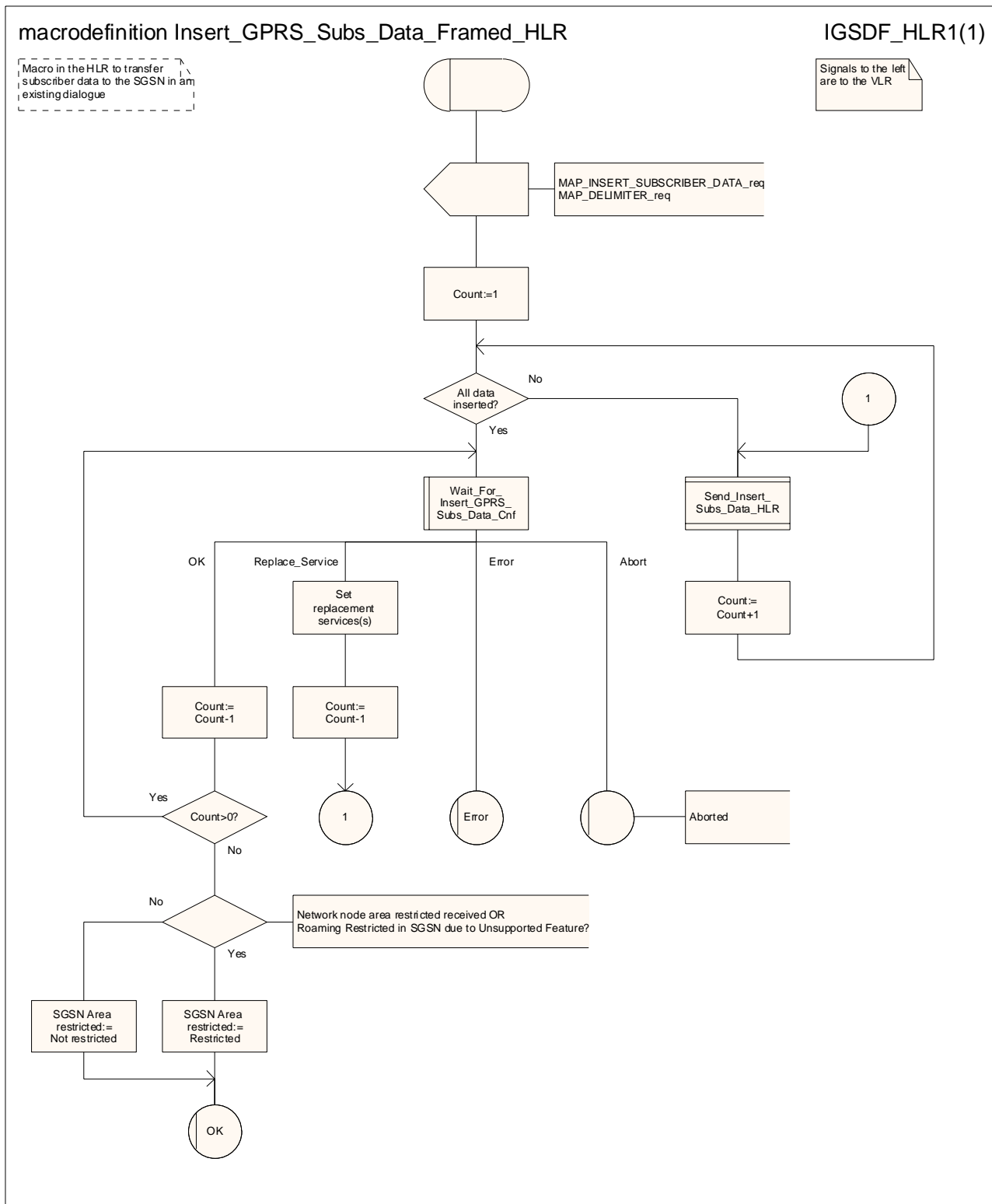

Figure 19.5/2: Macro Insert_GPRS_Subscriber_Data_Framed_HLR

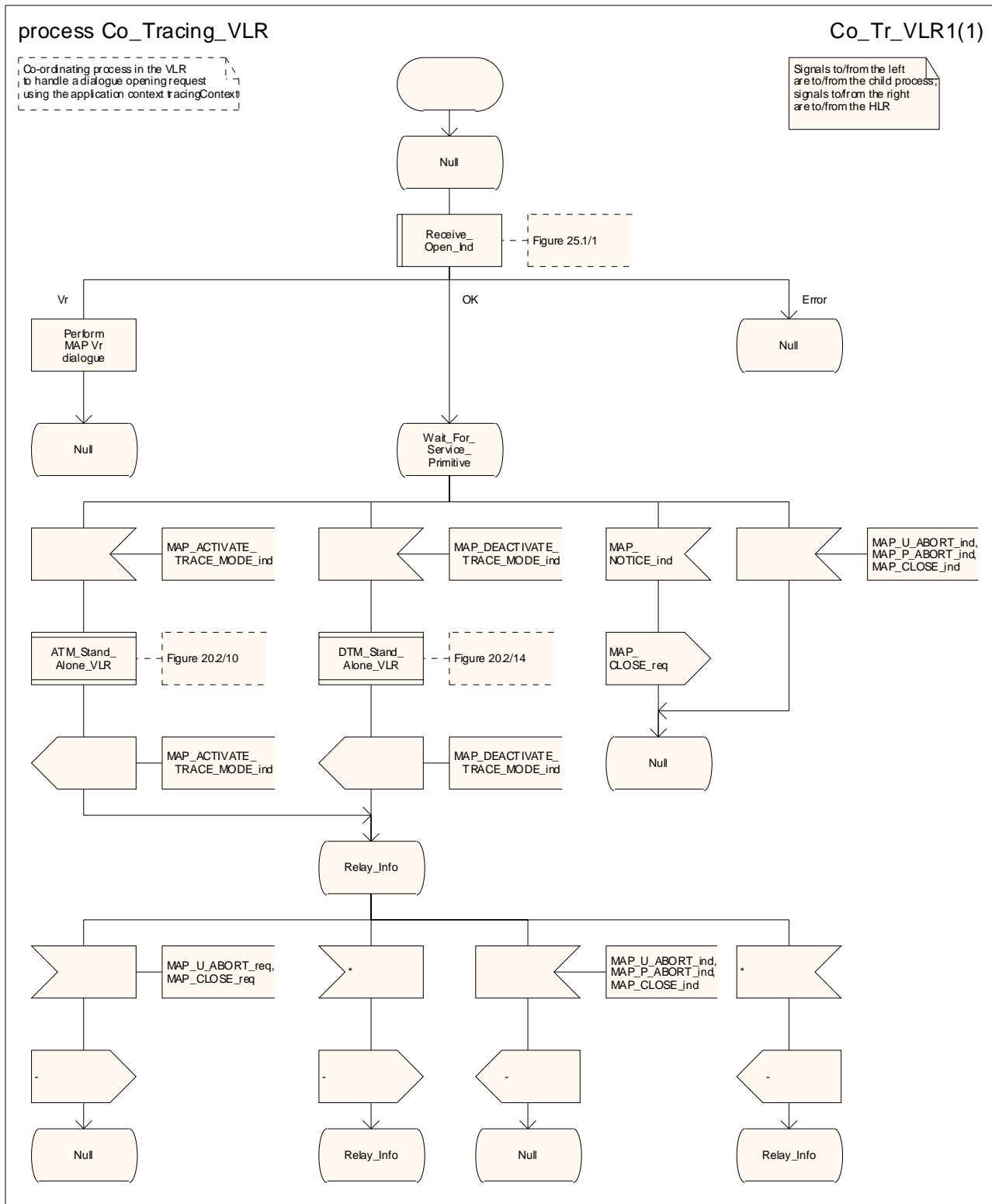

Figure 20.1/1: Process Co_Tracing_VLR

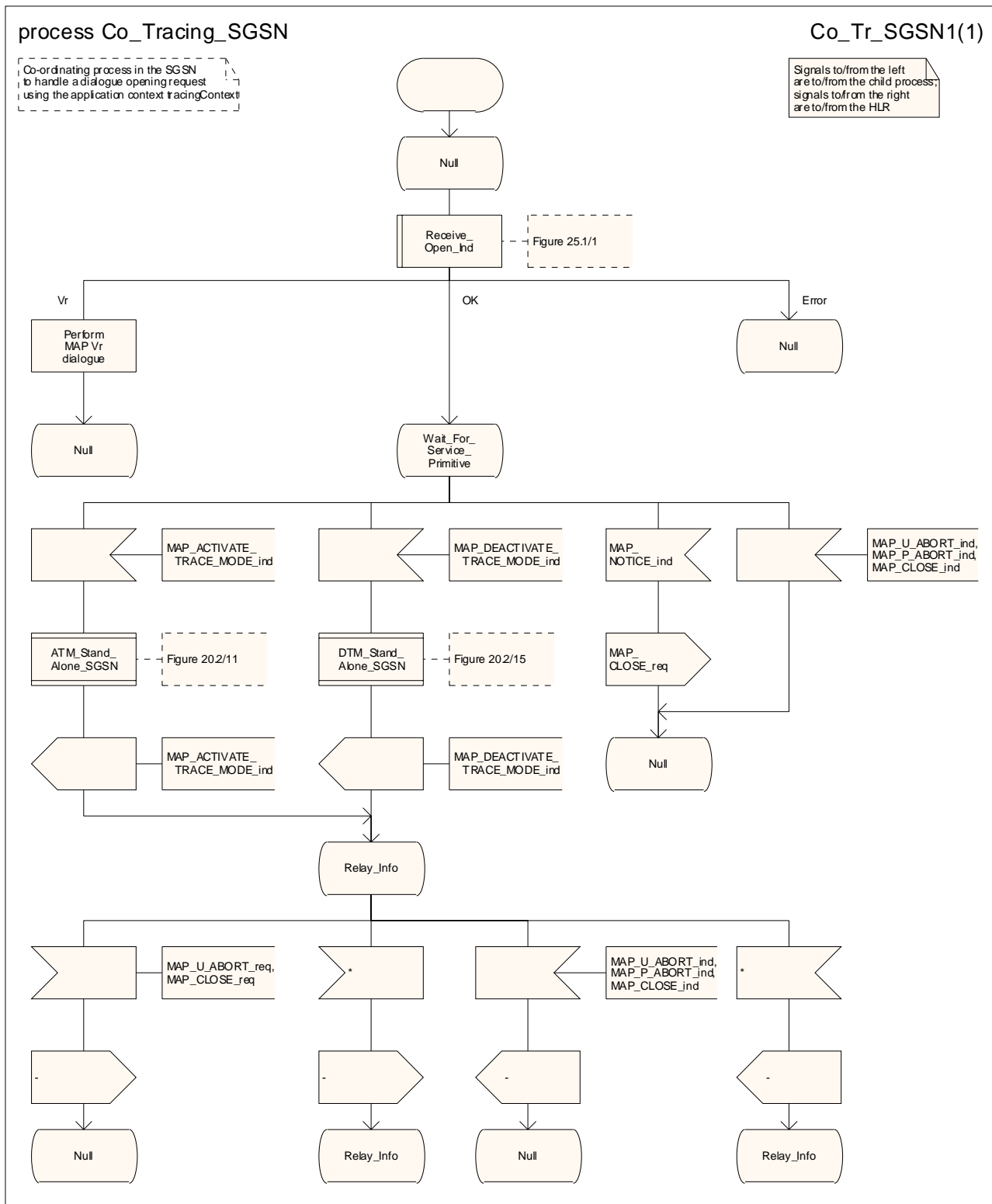

Figure 20.1/2: Process Co_Tracing_SGSN

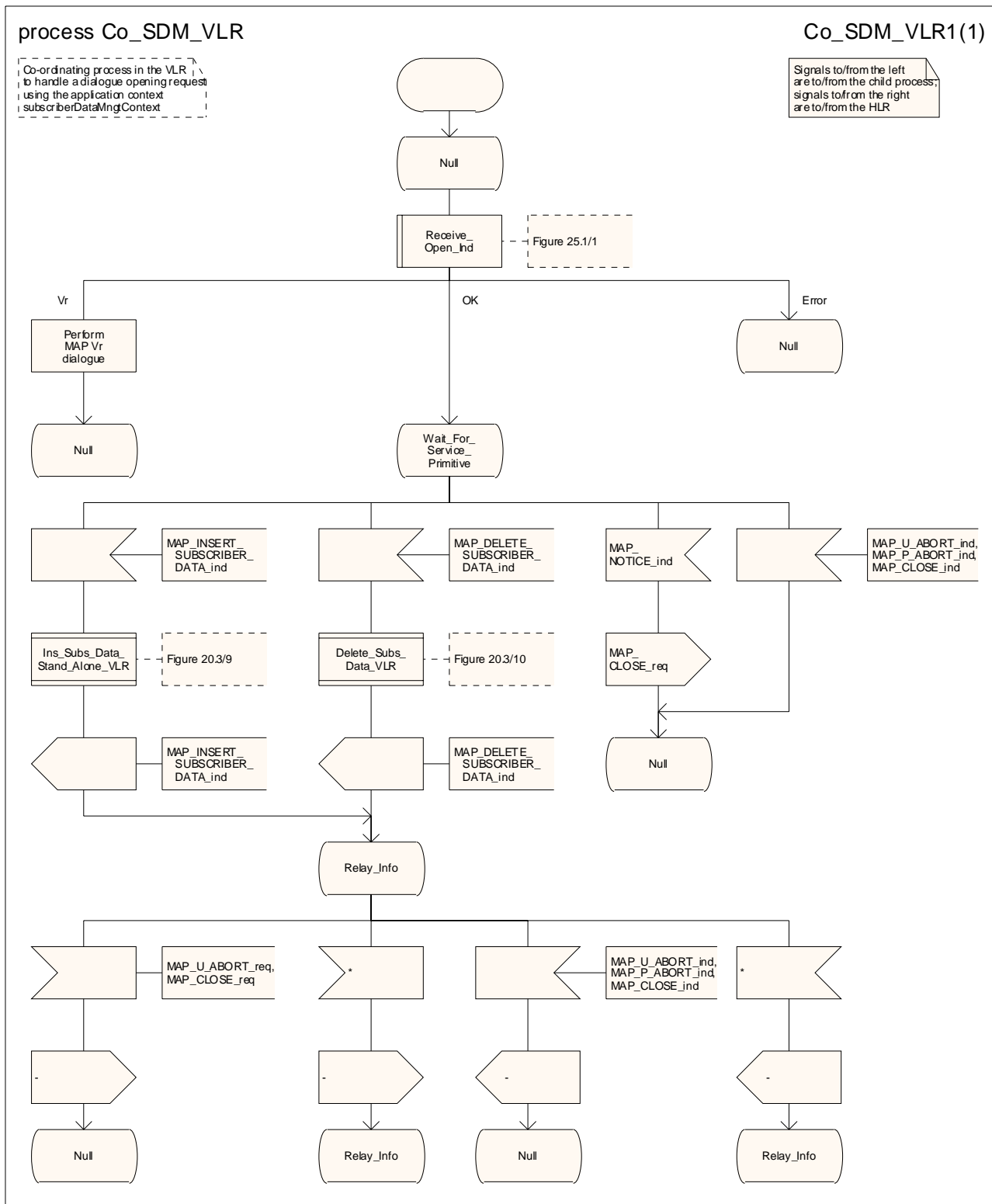

Figure 20.1/3: Process Co_SDM_VLR

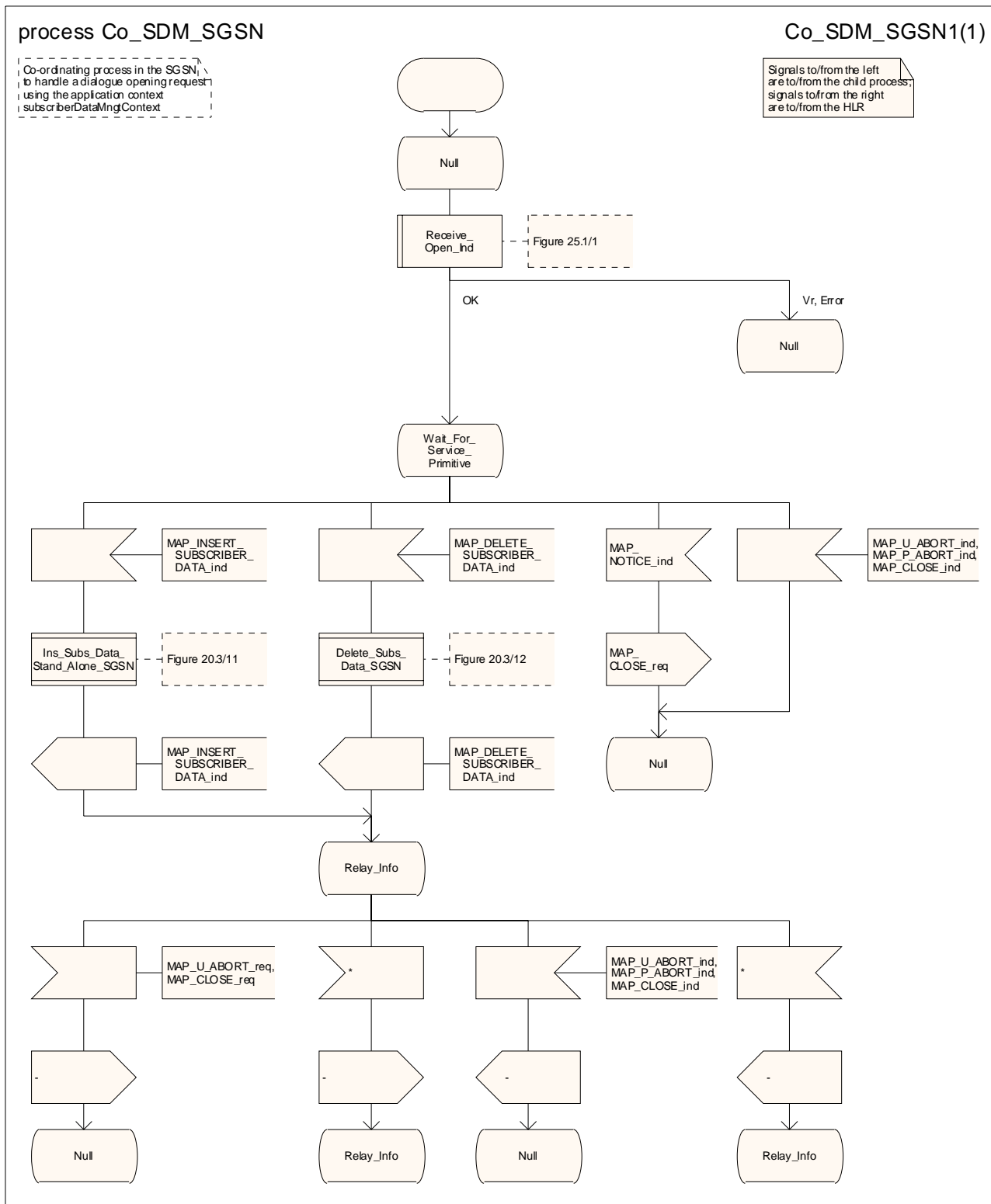

Figure 20.1/4: Process Co_SDM_SGSN

20.2 Tracing procedures

Three types of tracing procedures exist:

- i) Subscriber tracing management procedures;
- ii) Subscriber tracing procedures;
- iii) Event tracing procedures.

The subscriber tracing management procedures are used to manage the status and the type of the tracing. The subscriber tracing activation procedure is used at location updating or data restoration when the trace mode of a subscriber is set active in the HLR or, as a stand-alone procedure, when the subscriber is already registered and the trace mode becomes active in the HLR. The procedures to activate tracing in the VLR are shown in figures 20.2/1 and 20.2/3. The procedures to activate tracing in the SGSN are shown in figures 20.2/2 and 20.2/4.

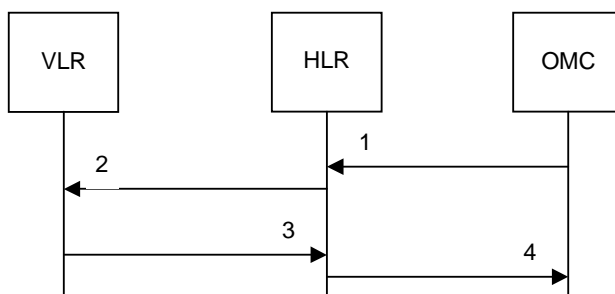

- 1) Subscriber Tracing Activation
- 2) MAP_ACTIVATE_TRACE_MODE_req/ind
- 3) MAP_ACTIVATE_TRACE_MODE_rsp/cnf
- 4) Subscriber Tracing Activation Accepted

Figure 20.2/1: Stand-alone subscriber tracing activation procedure for non-GPRS

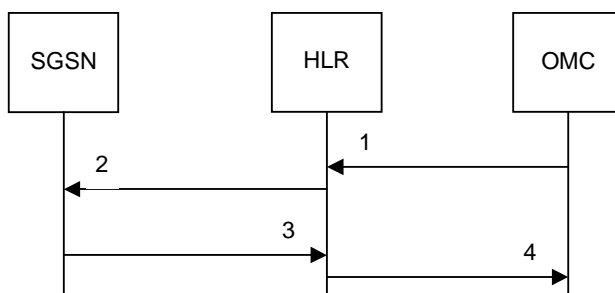

- 1) Subscriber Tracing Activation
- 2) MAP_ACTIVATE_TRACE_MODE_req/ind
- 3) MAP_ACTIVATE_TRACE_MODE_rsp/cnf
- 4) Subscriber Tracing Activation Accepted

Figure 20.2/2: Stand-alone subscriber tracing activation procedure for GPRS

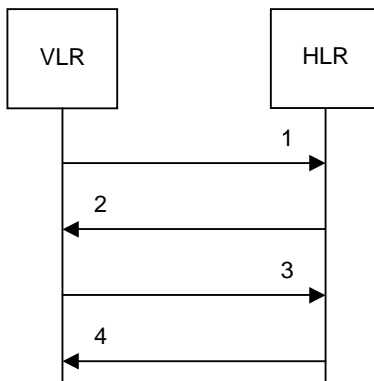

- 1) MAP_UPDATE_LOCATION_req/ind or MAP_RESTORE_DATA_req/ind
- 2) MAP_ACTIVATE_TRACE_MODE_req/ind
- 3) MAP_ACTIVATE_TRACE_MODE_rsp/cnf
- 4) MAP_UPDATE_LOCATION_rsp/cnf or MAP_RESTORE_DATA_rsp/cnf

Figure 20.2/3: Subscriber tracing activation procedure at location updating or data restoration

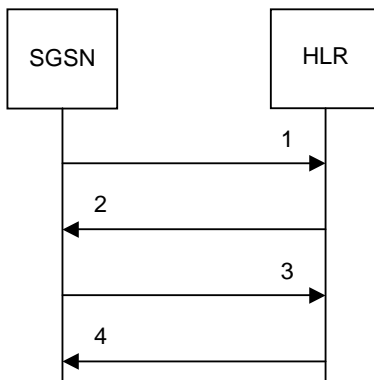

- 1) MAP_UPDATE_GPRS_LOCATION_req/ind
- 2) MAP_ACTIVATE_TRACE_MODE_req/ind
- 3) MAP_ACTIVATE_TRACE_MODE_rsp/cnf
- 4) MAP_UPDATE_GPRS_LOCATION_rsp/cnf

Figure 20.2/4: Subscriber tracing activation procedure at GPRS location updating

The MAP_ACTIVATE_TRACE_MODE request includes the IMSI, trace reference, trace type and identity of the OMC.

The subscriber tracing deactivation procedure is used when tracing of a subscriber in the VLR or in the SGSN is no longer required. The procedures are shown in figures 20.2/5 and 20.2/6.

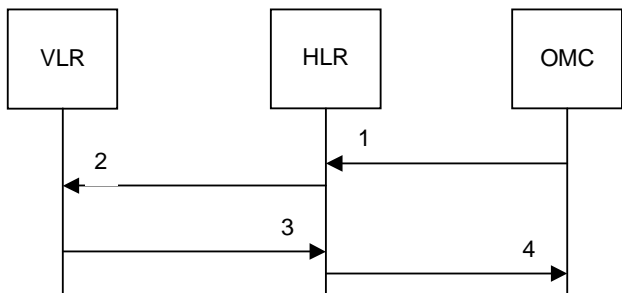

- 1) Subscriber Tracing Deactivation
- 2) MAP_DEACTIVATE_TRACE_MODE_req/ind
- 3) MAP_DEACTIVATE_TRACE_MODE_rsp/cnf
- 4) Subscriber Tracing Deactivation Accepted

Figure 20.2/5: Subscriber tracing deactivation procedure for non-GPRS

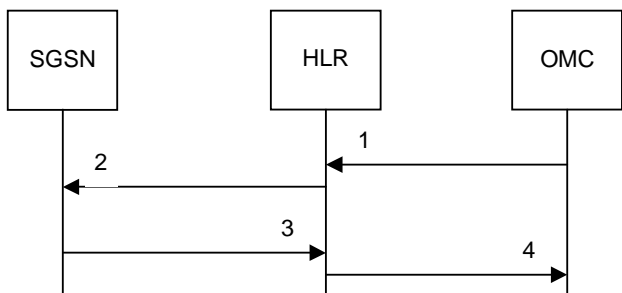

- 1) Subscriber Tracing Deactivation
- 2) MAP_DEACTIVATE_TRACE_MODE_req/ind
- 3) MAP_DEACTIVATE_TRACE_MODE_rsp/cnf
- 4) Subscriber Tracing Deactivation Accepted

Figure 20.2/6: Subscriber tracing deactivation procedure for GPRS

The subscriber tracing procedures are used when the VLR detects any subscriber related activity for which the trace mode is activated, e.g. the VLR receives a MAP_PROCESS_ACCESS_REQUEST indication. The procedure is shown in figure 20.2/7.

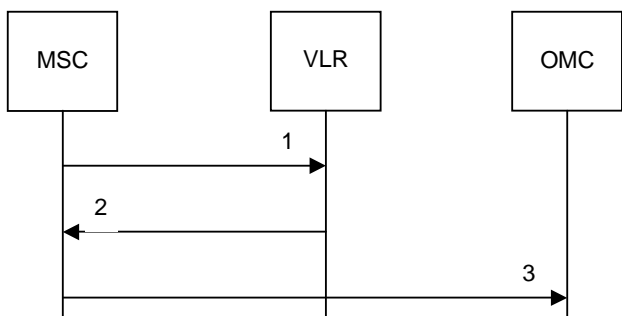

- 1) MAP_PROCESS_ACCESS_REQUEST_req/ind
- 2) MAP_TRACE_SUBSCRIBER_ACTIVITY_req/ind
- 3) Subscriber tracing information

Figure 20.2/4: Subscriber tracing procedure in the serving MSC

20.2.1 Subscriber tracing activation procedure

20.2.1.1 Procedures in the HLR

A subscriber tracing activation request from the OMC starts the appropriate process in the HLR: ATM_HLR_With_VLR if tracing is required in the MSC/VLR, ATM_HLR_With_SGSN if tracing is required in the SGSN.

The process in the HLR to activate tracing in the VLR is shown in figure 20.2/8. The MAP process invokes macros not defined in this clause; the definitions of these macros can be found as follows:

Receive_Open_Cnf	see subclause 25.1.2;
Check_Confirmation	see subclause 25.2.2.

Sheet 1: If the Repeat attempt counter has reached its limit, the test "Repeat Attempt" takes the "No" exit; otherwise the test takes the "Yes" exit. The number of repeat attempts and the interval between successive repeat attempts are operator options.

The process in the HLR to activate tracing in the SGSN is shown in figure 20.2/9. The MAP process invokes macros not defined in this clause; the definitions of these macros can be found as follows:

Receive_Open_Cnf	see subclause 25.1.2;
Check_Confirmation	see subclause 25.2.2.

Sheet 1: If the Repeat attempt counter has reached its limit, the test "Repeat Attempt" takes the "No" exit; otherwise the test takes the "Yes" exit. The number of repeat attempts and the interval between successive repeat attempts are operator options.

20.2.1.2 Procedure in the VLR

The process in the VLR to activate tracing in a stand-alone dialogue is shown in figure 20.2/10. The MAP process invokes a macro not defined in this clause; the definition of this macro can be found as follows:

Check_Indication	see subclause 25.2.1.
------------------	-----------------------

20.2.1.3 Procedure in the SGSN

The process in the SGSN to activate tracing in a stand-alone dialogue is shown in figure 20.2/11. The MAP process invokes a macro not defined in this clause; the definition of this macro can be found as follows:

Check_Indication	see subclause 25.2.1.
------------------	-----------------------

20.2.2 Subscriber tracing deactivation procedure

20.2.2.1 Procedures in the HLR

A subscriber tracing deactivation request from the OMC starts the appropriate process in the HLR: DTM_HLR_With_VLR if tracing is no longer required in the MSC/VLR, DTM_HLR_With_SGSN if tracing is no longer required in the SGSN.

The process in the HLR to deactivate tracing in the VLR is shown in figure 20.2/12. The MAP process invokes macros not defined in this clause; the definitions of these macros can be found as follows:

Receive_Open_Cnf	see subclause 25.1.2;
Check_Confirmation	see subclause 25.2.2.

Sheet 1: If the Repeat attempt counter has reached its limit, the test "Repeat Attempt" takes the "No" exit; otherwise the test takes the "Yes" exit. The number of repeat attempts and the interval between successive repeat attempts are operator options.

The process in the HLR to deactivate tracing in the SGSN is shown in figure 20.2/13. The MAP process invokes macros not defined in this clause; the definitions of these macros can be found as follows:

Receive_Open_Cnf see subclause 25.1.2;

Check_Confirmation see subclause 25.2.2.

Sheet 1: If the Repeat attempt counter has reached its limit, the test "Repeat Attempt" takes the "No" exit; otherwise the test takes the "Yes" exit. The number of repeat attempts and the interval between successive repeat attempts are operator options.

20.2.2.2 Procedure in the VLR

The process in the VLR to deactivate tracing is shown in figure 20.2/14. The MAP process invokes a macro not defined in this clause; the definition of this macro can be found as follows:

Check_Indication see subclause 25.2.1.

20.2.2.3 Procedure in the SGSN

The process in the SGSN to deactivate tracing is shown in figure 20.2/15. The MAP process invokes a macro not defined in this clause; the definition of this macro can be found as follows:

Check_Indication see subclause 25.2.1.

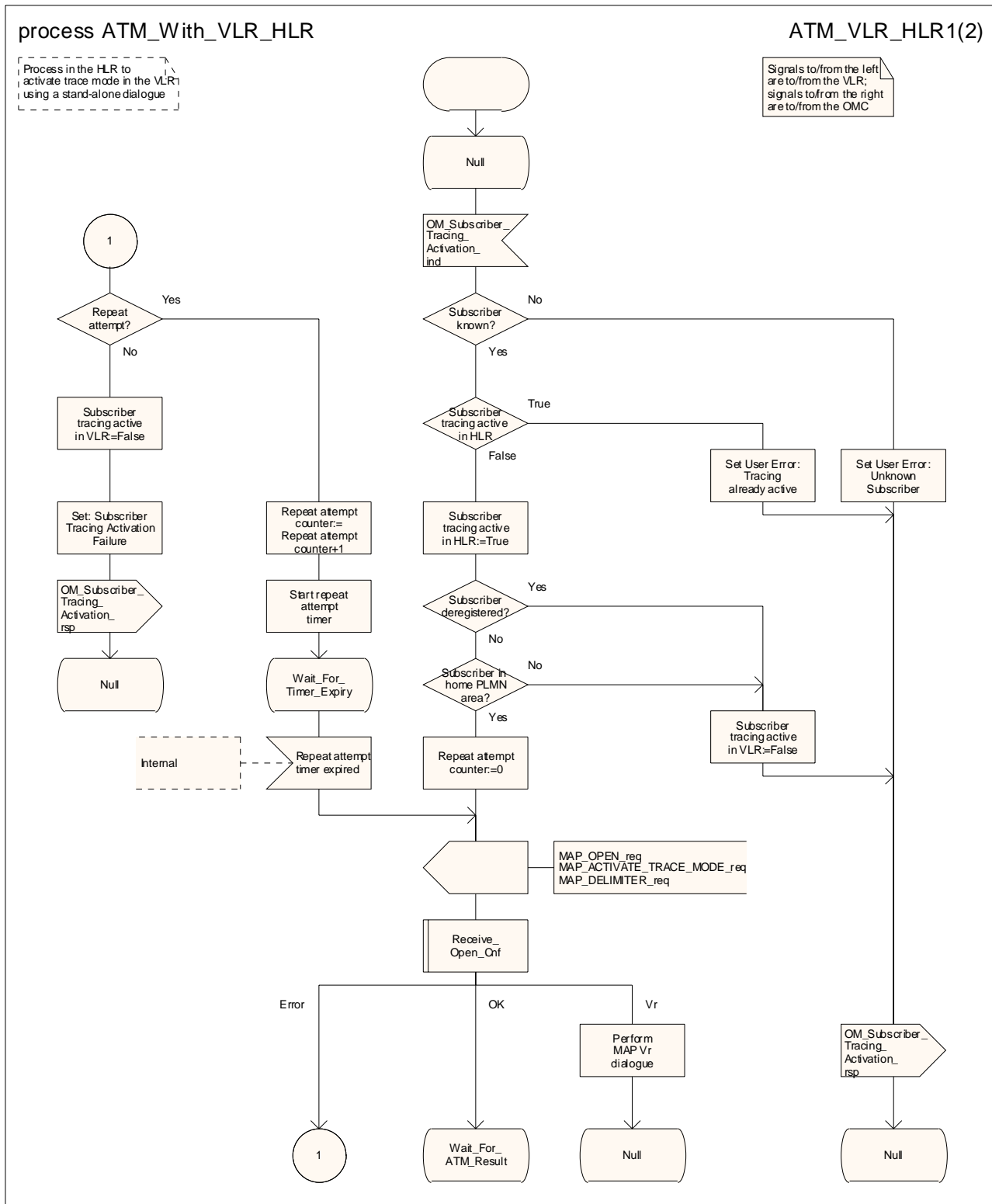

Figure 20.2/8 (sheet 1 of 2): Process ATM_With_VLR_HLR

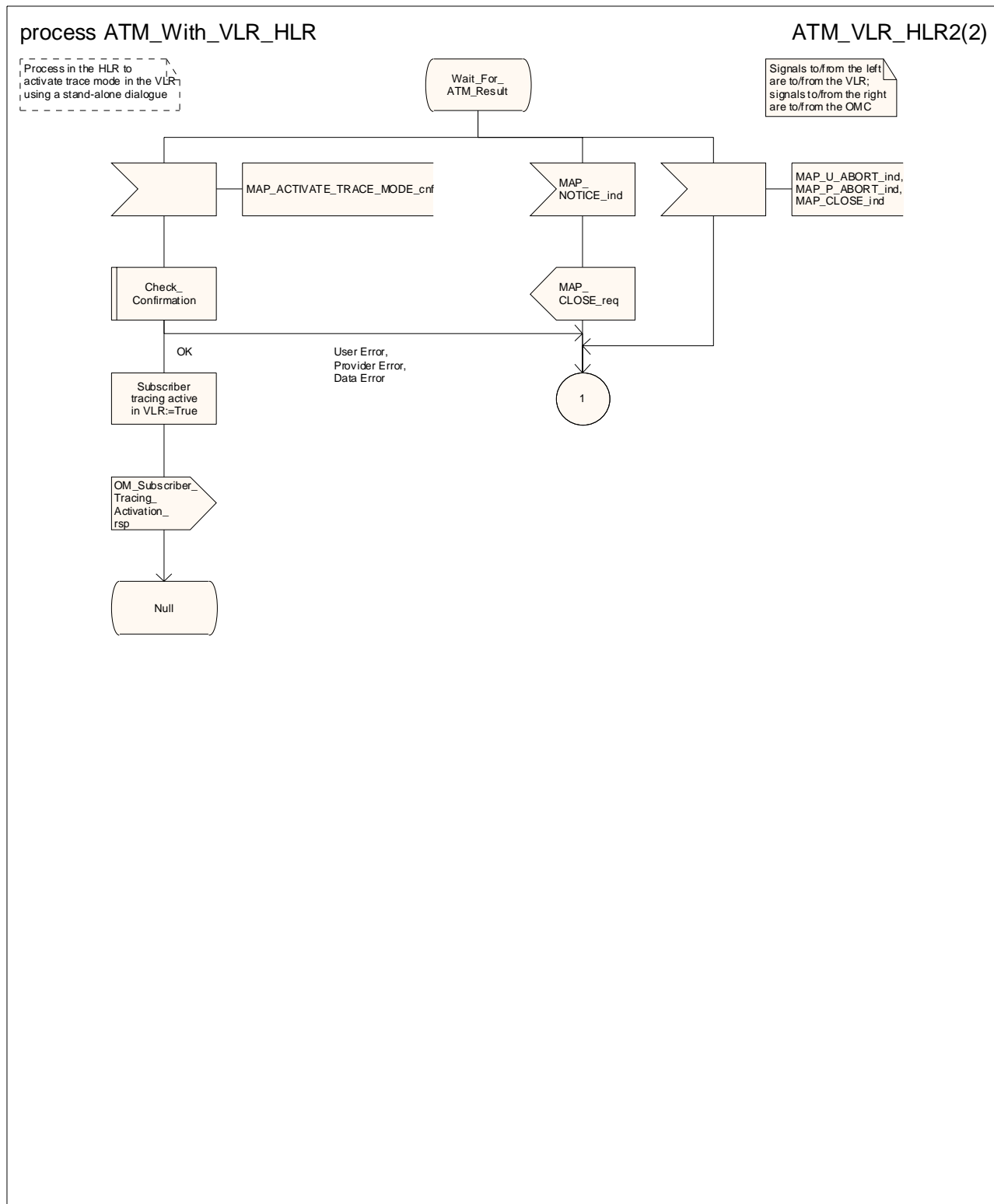

Figure 20.2/8 (sheet 2 of 2): Process ATM_With_VLR_HLR

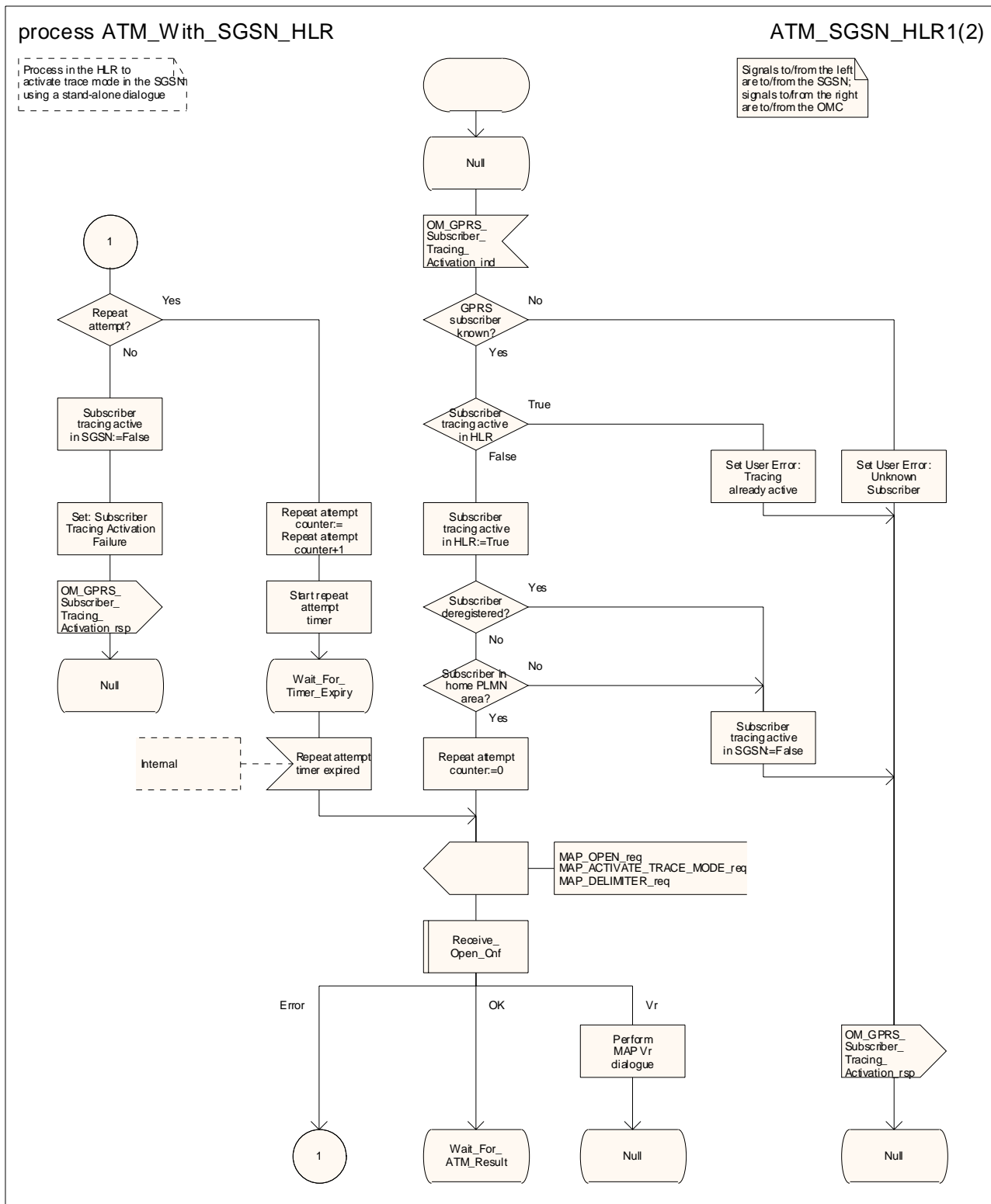

Figure 20.2/9 (sheet 1 of 2): Process ATM_With_SGSN_HLR

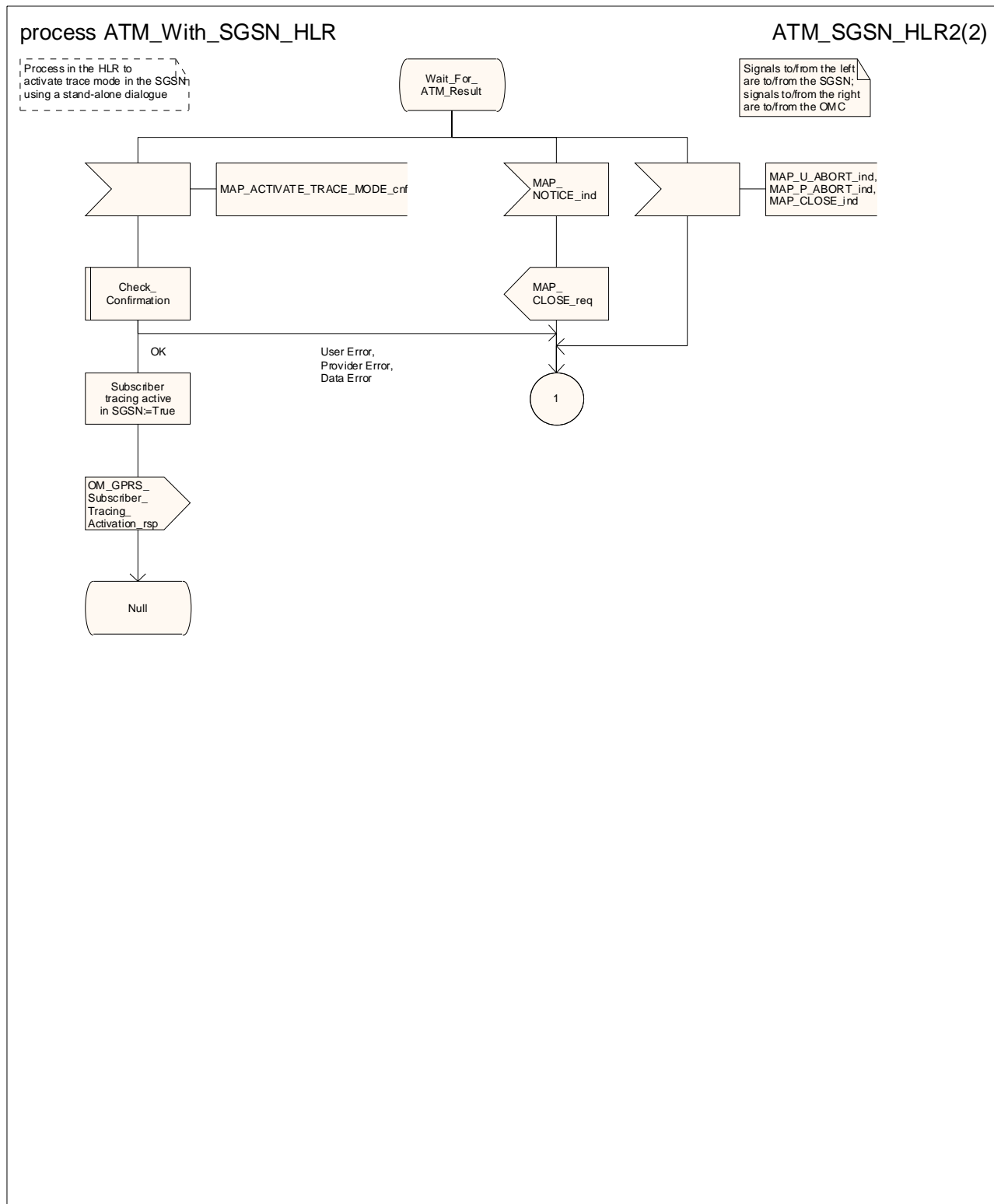

Figure 20.2/9 (sheet 2 of 2): Process ATM_With_SGSN_HLR

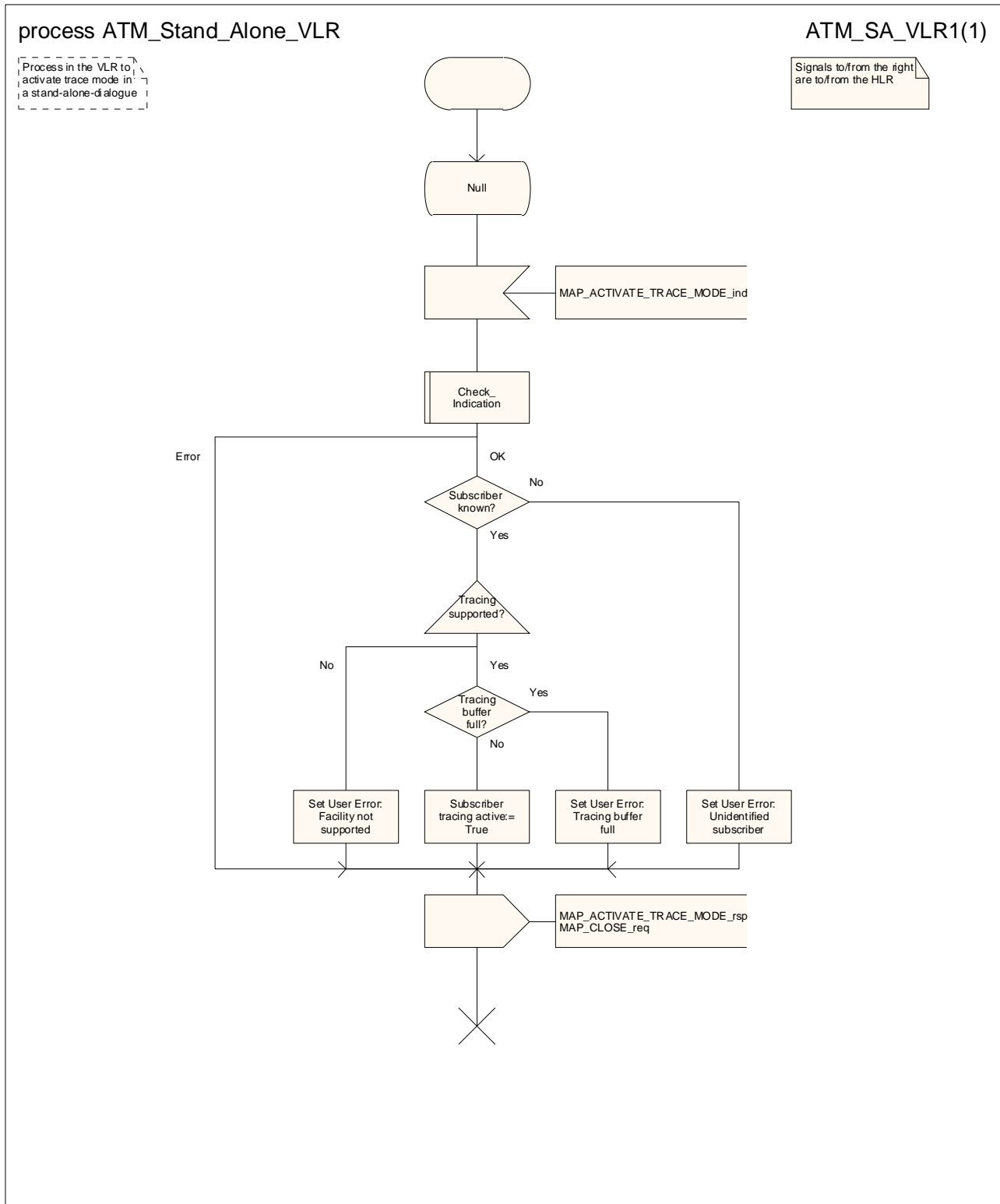

Figure 20.2/10: Process ATM_Stand_Alone_VLR

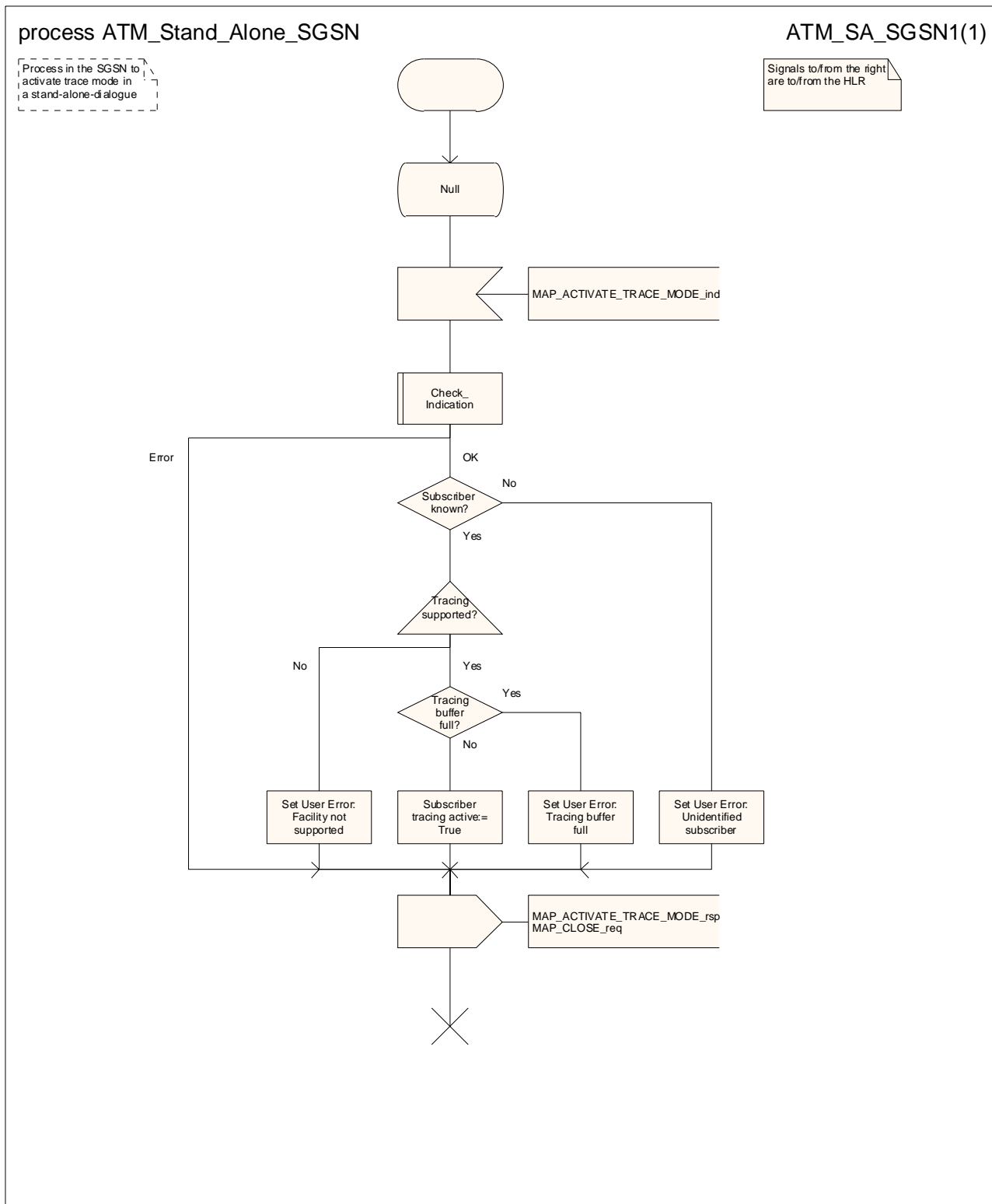

Figure 20.2/11: Process ATM_Stand_Alone_SGSN

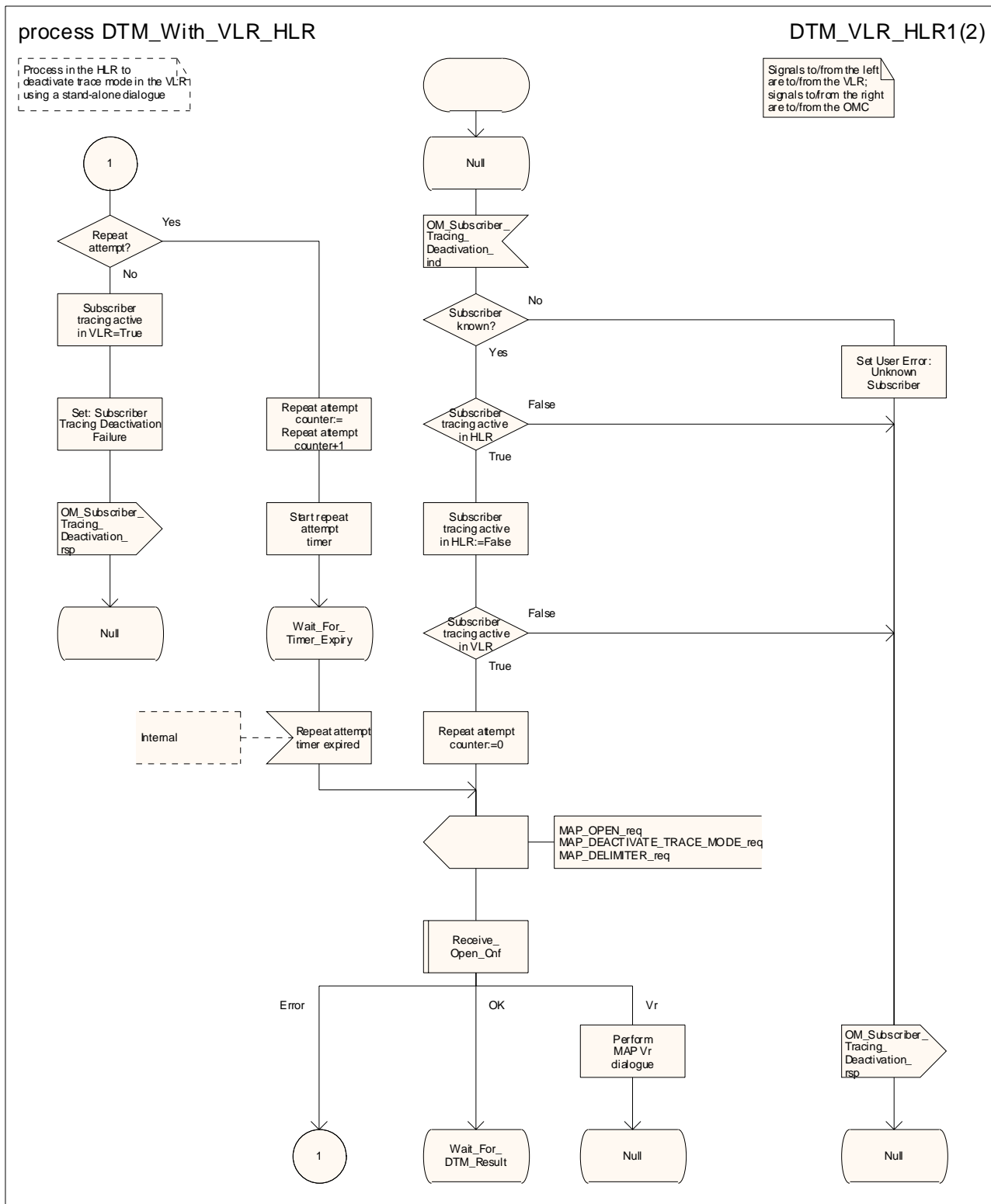

Figure 20.2/12 (sheet 1 of 2): Process DTM_With_VLR_HLR

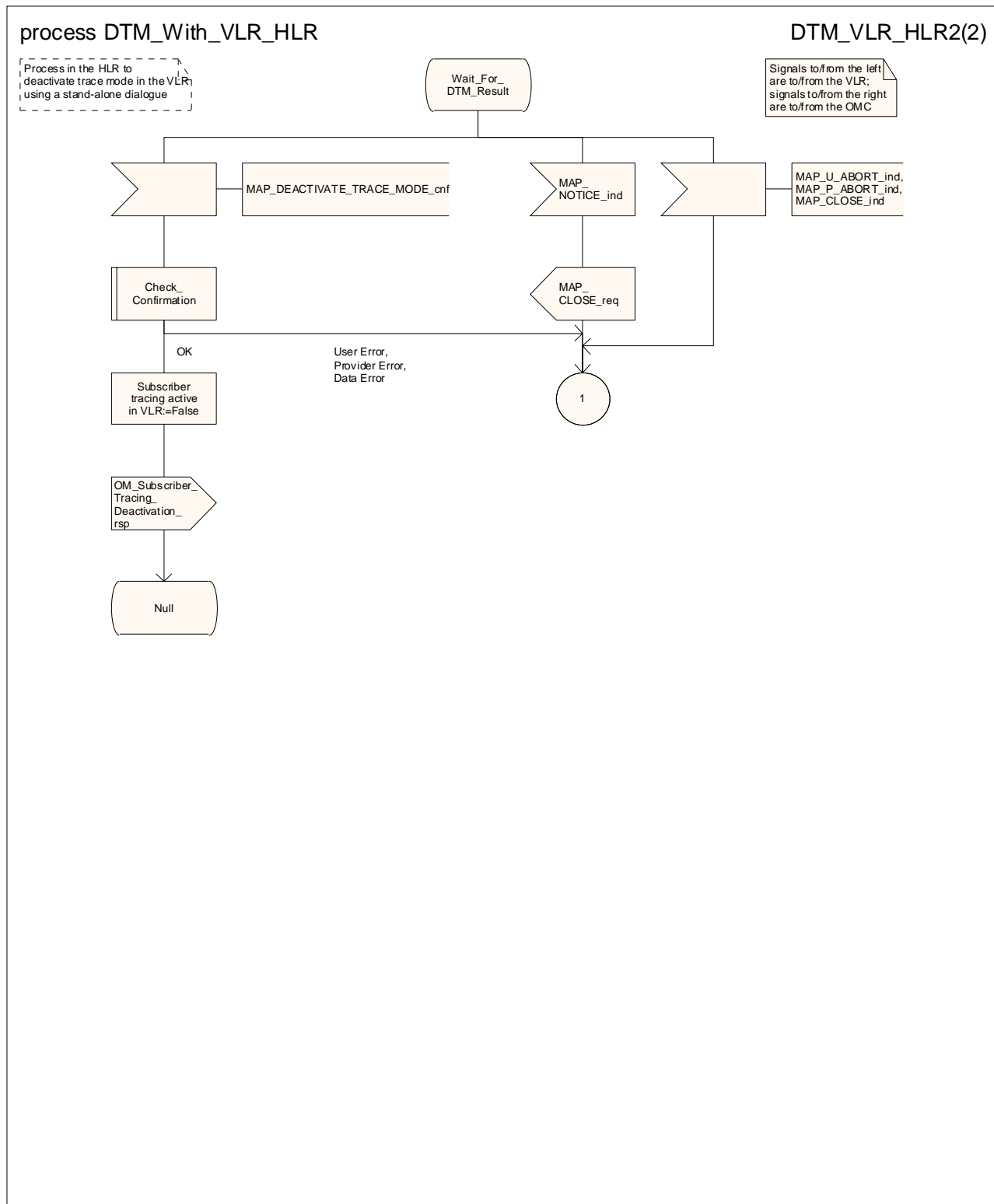

Figure 20.2/12 (sheet 2 of 2): Process DTM_With_VLR_HLR

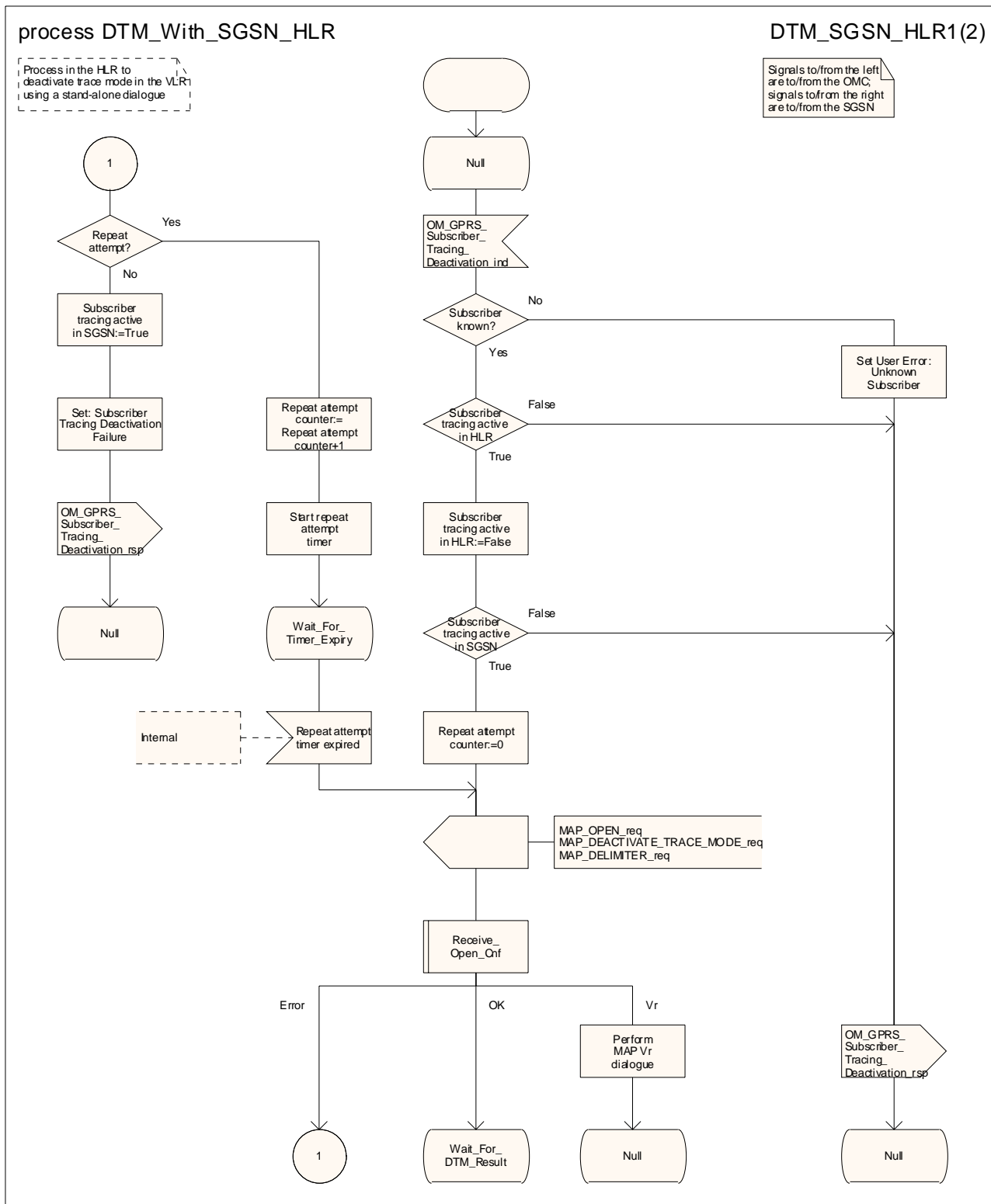

Figure 20.2/13 (sheet 1 of 2): Process DTM_With_SGSN_HLR

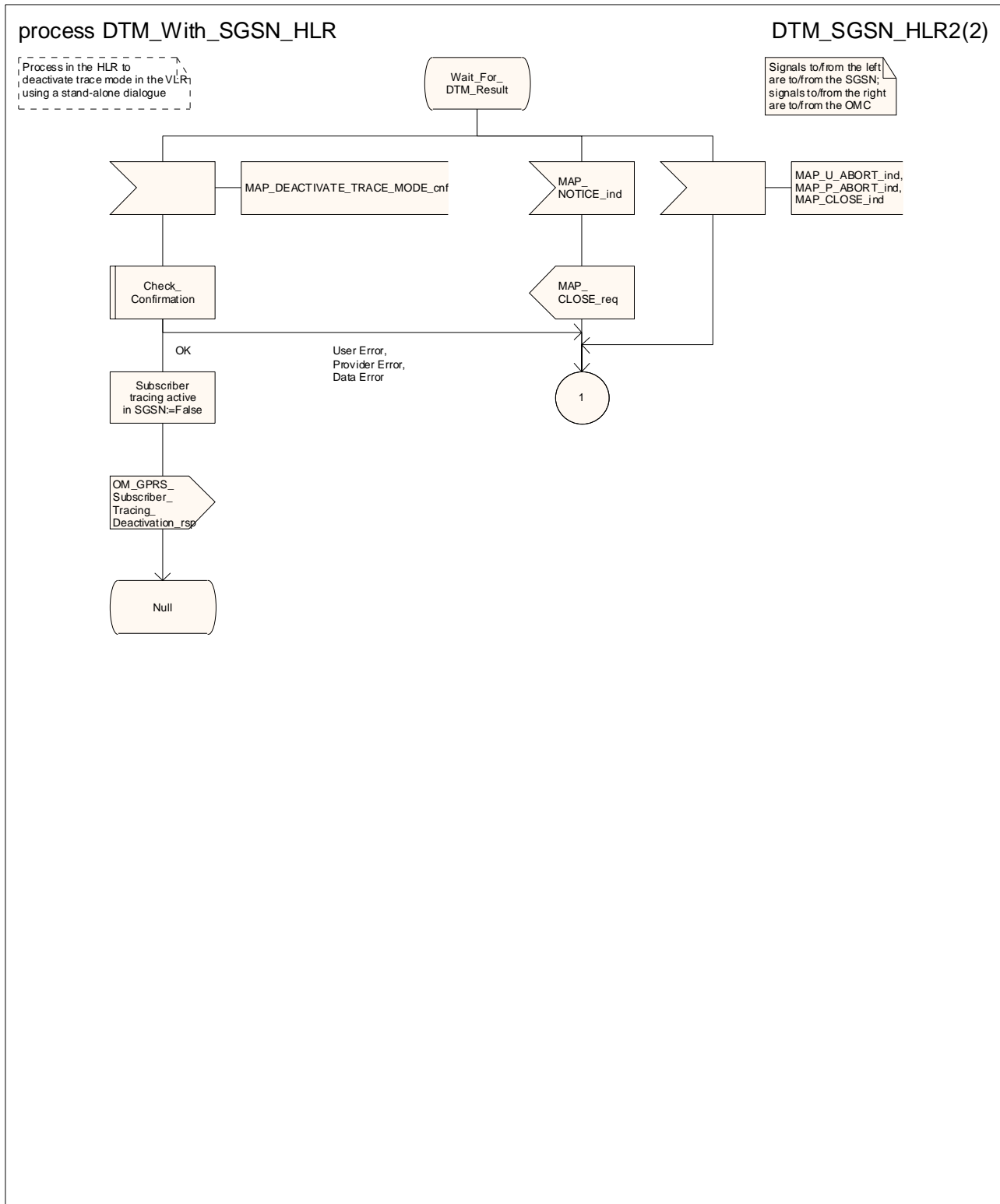

Figure 20.2/13 (sheet 2 of 2): Process DTM_With_SGSN_HLR

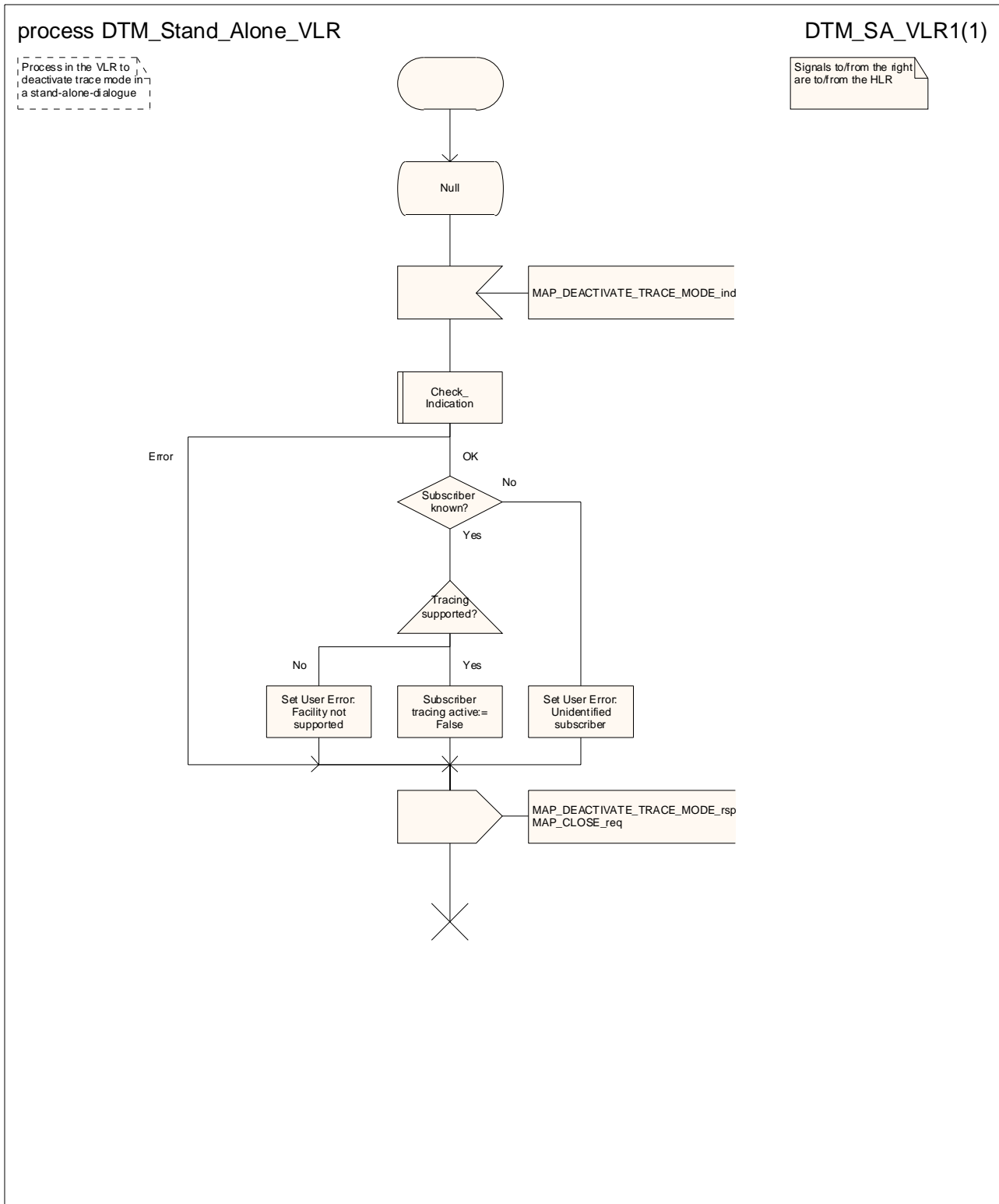

Figure 20.2/14: Process DTM_Stand_Alone_VLR

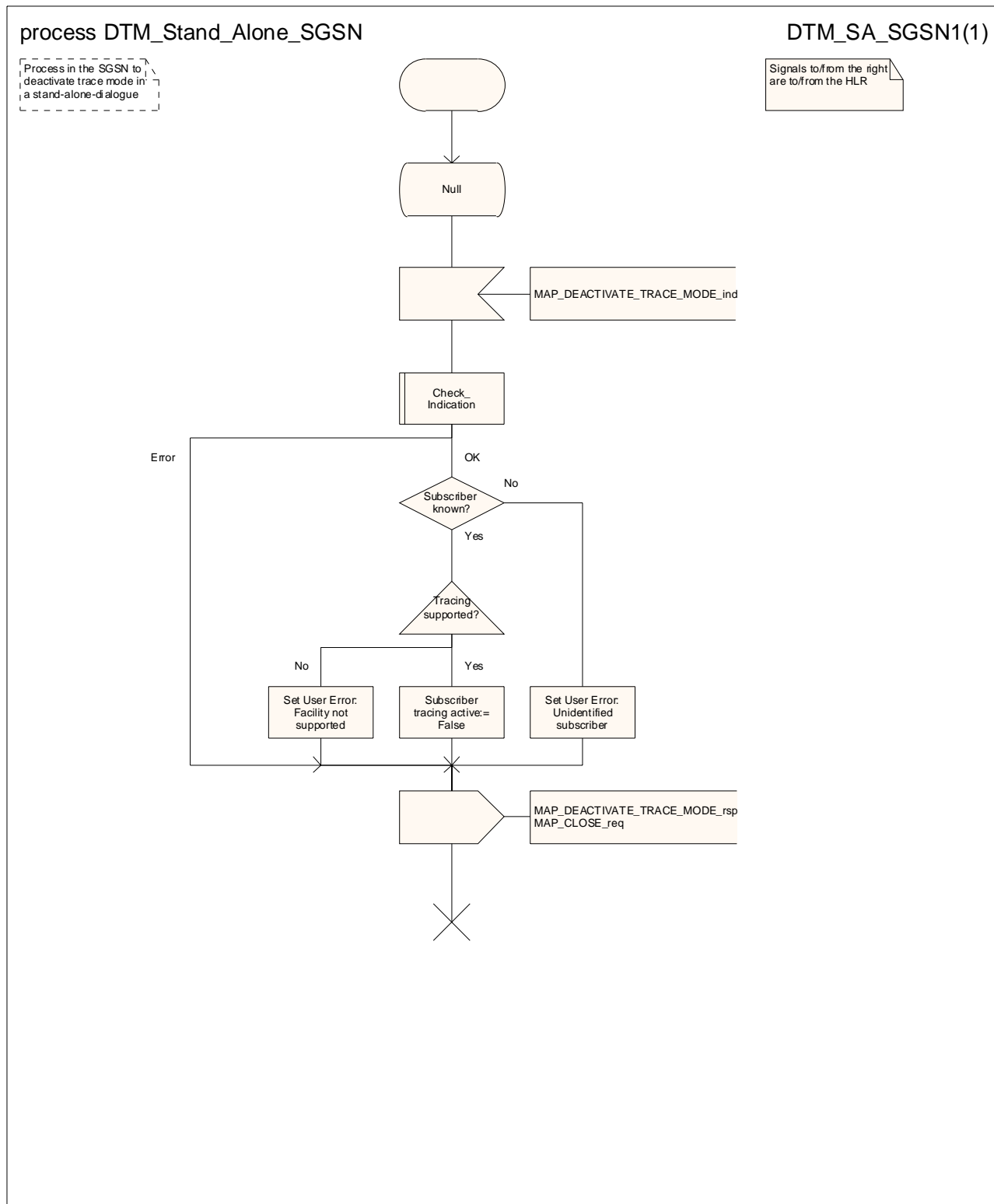

Figure 20.2/15: Process DTM_Stand_Alone_SGSN

20.3 Subscriber data management procedures

Two types of subscriber data management procedures exist:

- 1) Subscriber Deletion;
- 2) Subscriber Data Modification.

The subscriber deletion and subscriber data modification procedures are initiated by the OMC (see figures 20.3/1 , 20.3/2, 20.3/3 and 20.3/4).

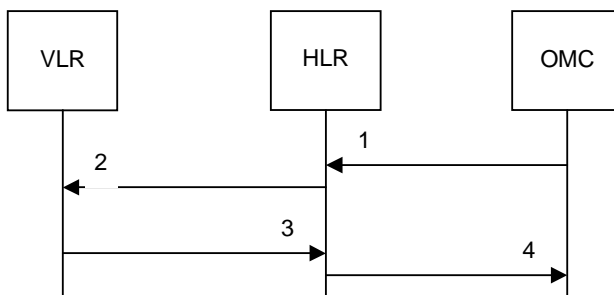

- 1) Delete Subscriber
- 2) MAP_CANCEL_LOCATION_req/ind
- 3) MAP_CANCEL_LOCATION_rsp/cnf
- 4) Subscriber Deleted

Figure 20.3/1: Subscriber deletion procedure for non-GPRS

In the subscriber deletion procedure for a non-GPRS subscriber the subscriber data are removed from the VLR and the HLR. The HLR uses the MAP_CANCEL_LOCATION service.

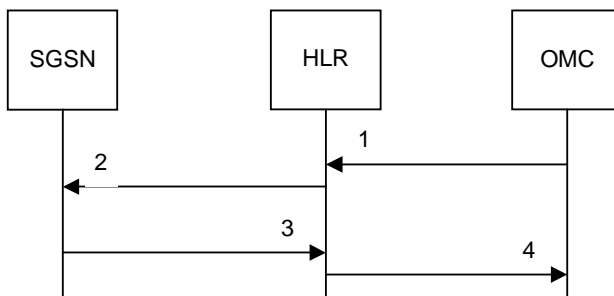

- 1) Delete GPRS Subscriber
- 2) MAP_CANCEL_LOCATION_req/ind
- 3) MAP_CANCEL_LOCATION_rsp/cnf
- 4) GPRS Subscriber Deleted

Figure 20.3/2: Subscriber deletion procedure for GPRS

In the subscriber deletion procedure for a GPRS subscriber the subscriber data are removed from the SGSN and the HLR. The HLR uses the MAP_CANCEL_LOCATION service.

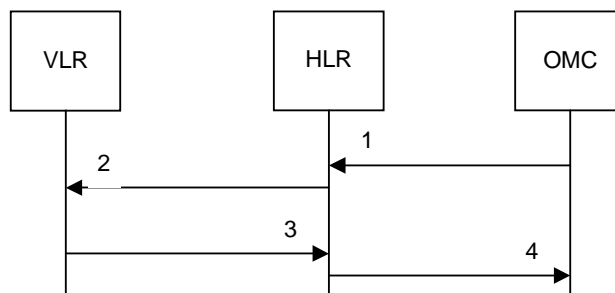

- 1) Modify Subscriber Data
- 2) MAP_CANCEL_LOCATION_req/ind, MAP_INSERT_SUBSCRIBER_DATA_req/ind or MAP_DELETE_SUBSCRIBER_DATA_req/ind
- 3) MAP_CANCEL_LOCATION_rsp/cnf, MAP_INSERT_SUBSCRIBER_DATA_rsp/cnf or MAP_DELETE_SUBSCRIBER_DATA_rsp/cnf
- 4) Subscriber Data Modified

Figure 20.3/2: Subscriber data modification procedure for non-GPRS

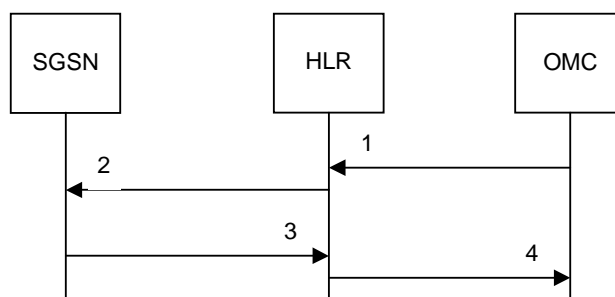

- 1) Modify Subscriber Data
- 2) MAP_CANCEL_LOCATION_req/ind, MAP_INSERT_SUBSCRIBER_DATA_req/ind or MAP_DELETE_SUBSCRIBER_DATA_req/ind
- 3) MAP_CANCEL_LOCATION_rsp/cnf, MAP_INSERT_SUBSCRIBER_DATA_rsp/cnf or MAP_DELETE_SUBSCRIBER_DATA_rsp/cnf
- 4) Subscriber Data Modified

Figure 20.3/4: Subscriber data modification procedure for GPRS

In the subscriber data modification procedure the subscriber data are modified in the HLR and when necessary also in the VLR or the SGSN. The HLR initiates one of the MAP_INSERT_SUBSCRIBER_DATA, MAP_DELETE_SUBSCRIBER_DATA or MAP_CANCEL_LOCATION services depending on the modified data.

20.3.1 Subscriber deletion procedure

20.3.1.1 Procedure in the HLR

The subscriber deletion process in the HLR is shown in figure 20.3/5. The MAP process invokes processes not defined in this clause; the definitions of these processes can be found as follows:

- | | |
|--------------------------------|-------------------------|
| Cancel_GPRS_Location_Child_HLR | see subclause 19.1.2.2; |
| Cancel_Location_Child_HLR | see subclause 19.1.2.2. |

20.3.1.2 Procedure in the VLR

The subscriber deletion procedure in the VLR is described in subclause 19.1.2.3 of the present document.

20.3.1.3 Procedure in the SGSN

The subscriber deletion procedure in the SGSN is described in subclause 19.1.2.4 of the present document.

20.3.2 Subscriber data modification procedure

20.3.2.1 Procedure in the HLR

The OMC can modify the subscriber data in several different ways. The modifications can be categorised in the following groups:

- 1) data shall be modified in the HLR; no effect in the VLR;
- 2) data shall be modified in both the HLR and the VLR;
- 3) withdrawal of a basic service or a supplementary service requiring change to VLR data;
- 4) modification affects the roaming permission for the subscriber and the subscriber record shall be removed from the VLR data base;
- 5) withdrawal of non-GPRS Subscription caused by a change of Network Access Mode;
- 6) data shall be modified in the HLR; no effect in the SGSN;
- 7) data shall be modified in both the HLR and the SGSN;
- 8) withdrawal of GPRS subscription data or a basic service or a supplementary service requiring change to SGSN data;
- 9) modification affects the roaming permission for the subscriber and the subscriber record shall be removed from the SGSN data base;
- 10) withdrawal of GPRS Subscription related to Network Access Mode;
- 11) authentication algorithm or authentication key of the subscriber is modified.

In cases 2 and 7 the HLR uses the MAP_INSERT_SUBSCRIBER_DATA service.

In cases 3 and 8 the HLR uses the MAP_DELETE_SUBSCRIBER_DATA service.

In cases 4, 5, 9, 10 and 11 the HLR uses the MAP_CANCEL_LOCATION service

If the deletion of subscriber data fails, the HLR may repeat the request; the number of repeat attempts and the time in between are HLR operator options, depending on the error returned by the VLR or the SGSN.

The subscriber data modification process in the HLR is shown in figure 20.3/6. The MAP process invokes processes not defined in this clause; the definitions of these processes can be found as follows:

Insert_Subs_Data_Stand_Alone_HLR	see subclause 25.7.3;
Cancel_Location_Child_HLR	see subclause 19.1.2.2;
Insert_GPRS_Subs_Data_Stand_Alone_HLR	see subclause 25.7.4;
Cancel_GPRS_Location_Child_HLR	see subclause 19.1.2.2.

The macro Delete_Subscriber_Data_HLR is shown in figure 20.3/7. The macro invokes macros not defined in this clause; the definitions of these macros can be found as follows:

Receive_Open_Cnf	see subclause 25.1.2;
Check_Confirmation	see subclause 25.2.2.

The macro Delete_GPRS_Subscriber_Data_HLR is shown in figure 20.3/8. The macro invokes macros not defined in this clause; the definitions of these macros can be found as follows:

Receive_Open_Cnf	see subclause 25.1.2;
Check_Confirmation	see subclause 25.2.2.

20.3.2.2 Procedure in the VLR

The process in the VLR to update subscriber data in a stand-alone dialogue is shown in figure 20.3/9. The MAP process invokes macros not defined in this clause; the definitions of these macros can be found as follows:

Check_Indication	see subclause 25.2.1;
Insert_SubData_VLR	see subclause 25.7.1.

The process in the VLR to delete subscriber data is shown in figure 20.3/10. The MAP process invokes a macro not defined in this clause; the definition of this macro can be found as follows:

Check_Indication	see subclause 25.2.1.
------------------	-----------------------

20.3.2.3 Procedure in the SGSN

The process in the SGSN to update subscriber data in a stand-alone dialogue is shown in figure 20.3/11. The MAP process invokes macros not defined in this clause; the definitions of these macros can be found as follows:

Check_Indication	see subclause 25.2.1;
Insert_SubData_SGSN	see subclause 25.7.2.

The process in the SGSN to delete subscriber data is shown in figure 20.3/12. The MAP process invokes a macro not defined in this clause; the definition of this macro can be found as follows:

Check_Indication	see subclause 25.2.1.
------------------	-----------------------

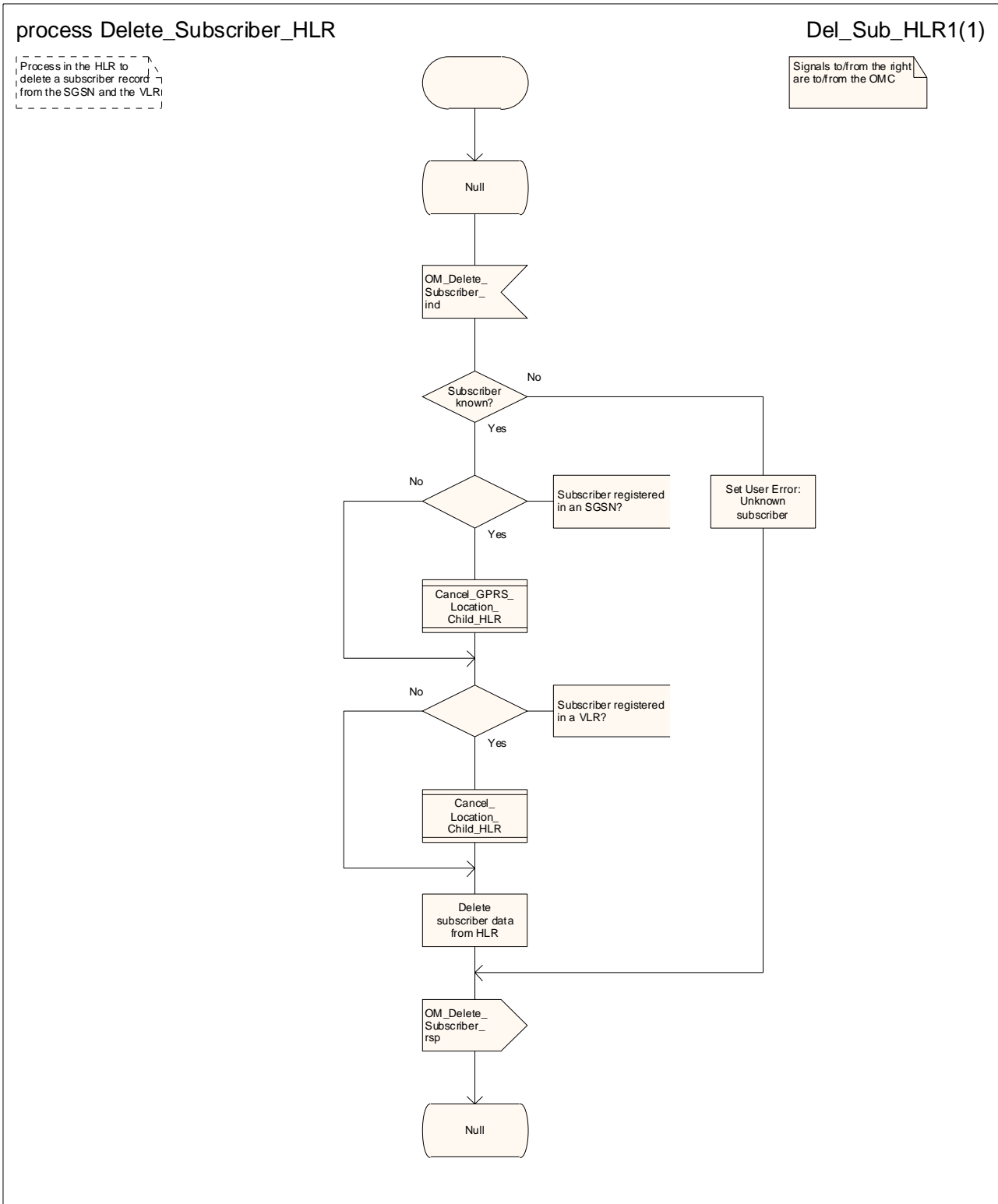

Figure 20.3/5: Process Delete_Subscriber_HLR

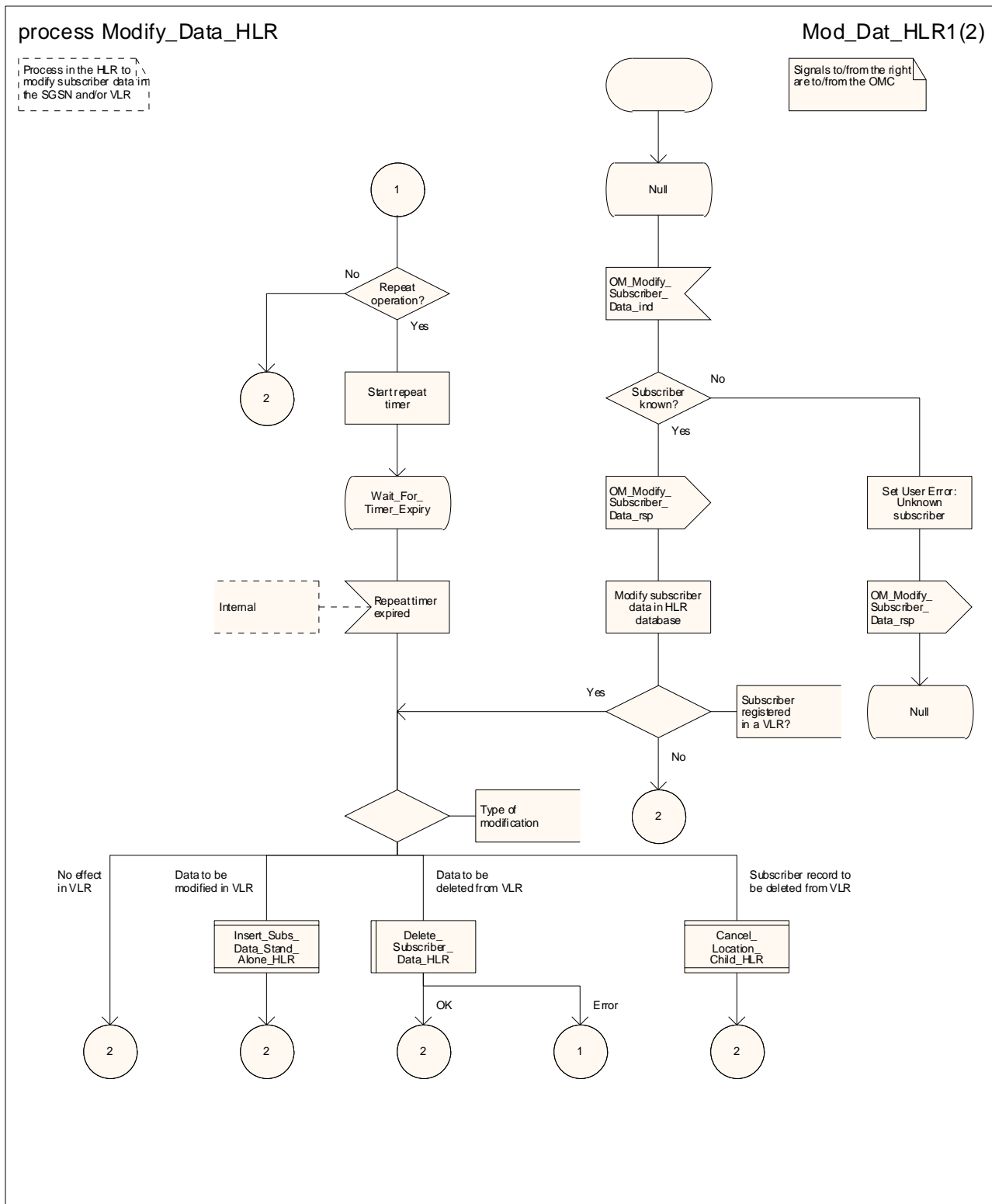

Figure 20.3/6 (sheet 1 of 2): Process Modify_Data_HLR

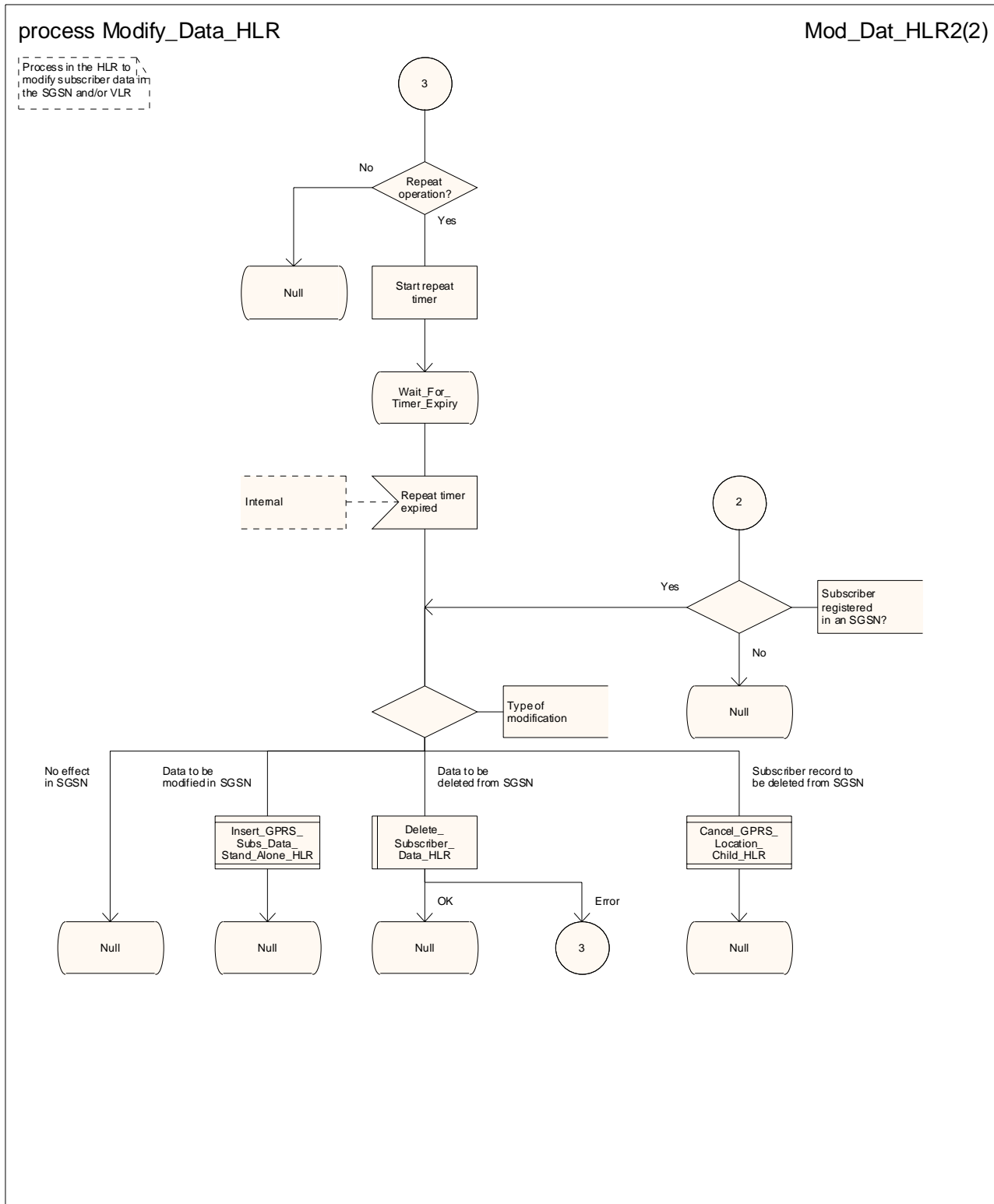

Figure 20.3/6 (sheet 2 of 2): Process Modify_Data_HLR

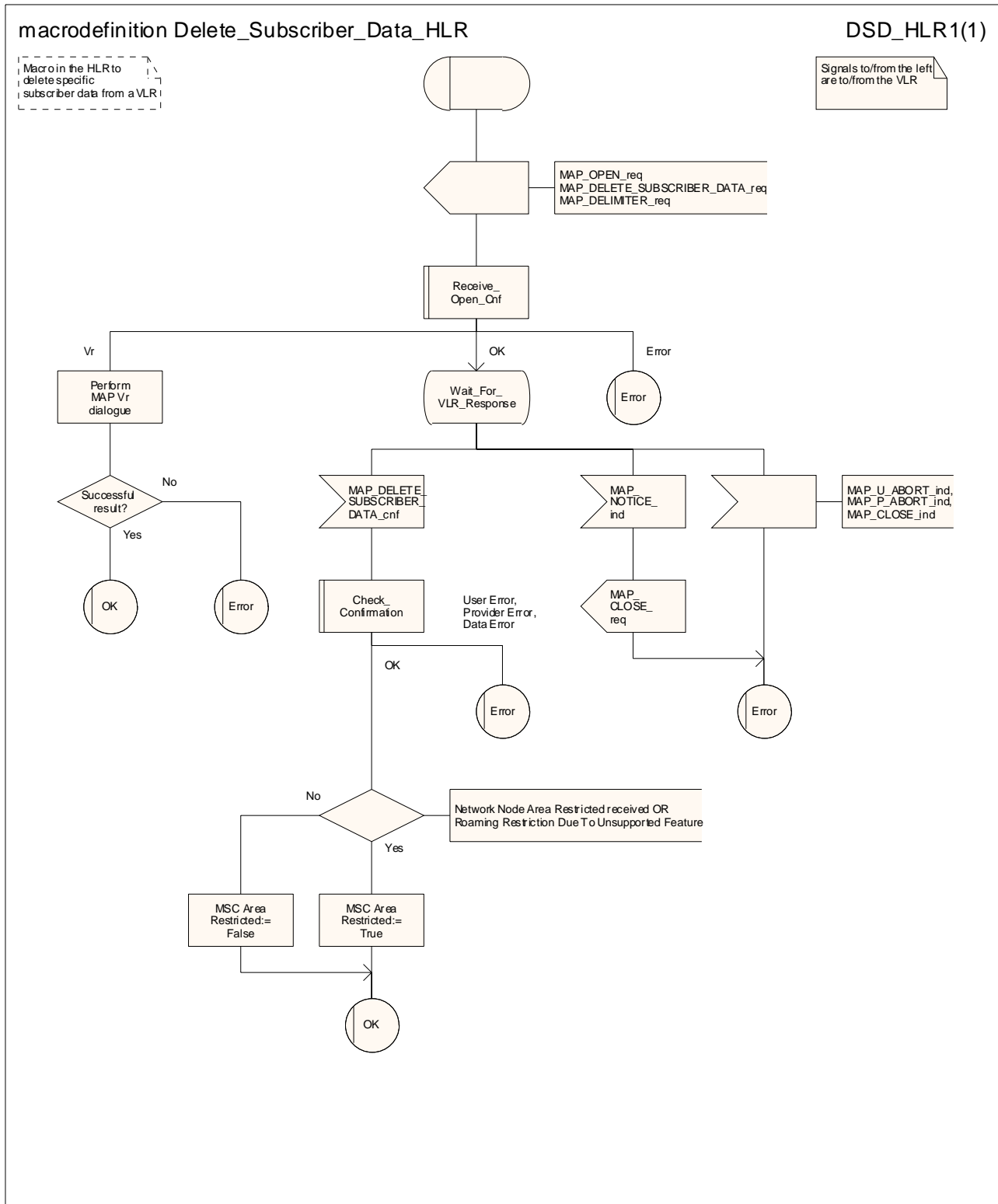

Figure 20.3/7: Macro Delete_Subscriber_Data_HLR

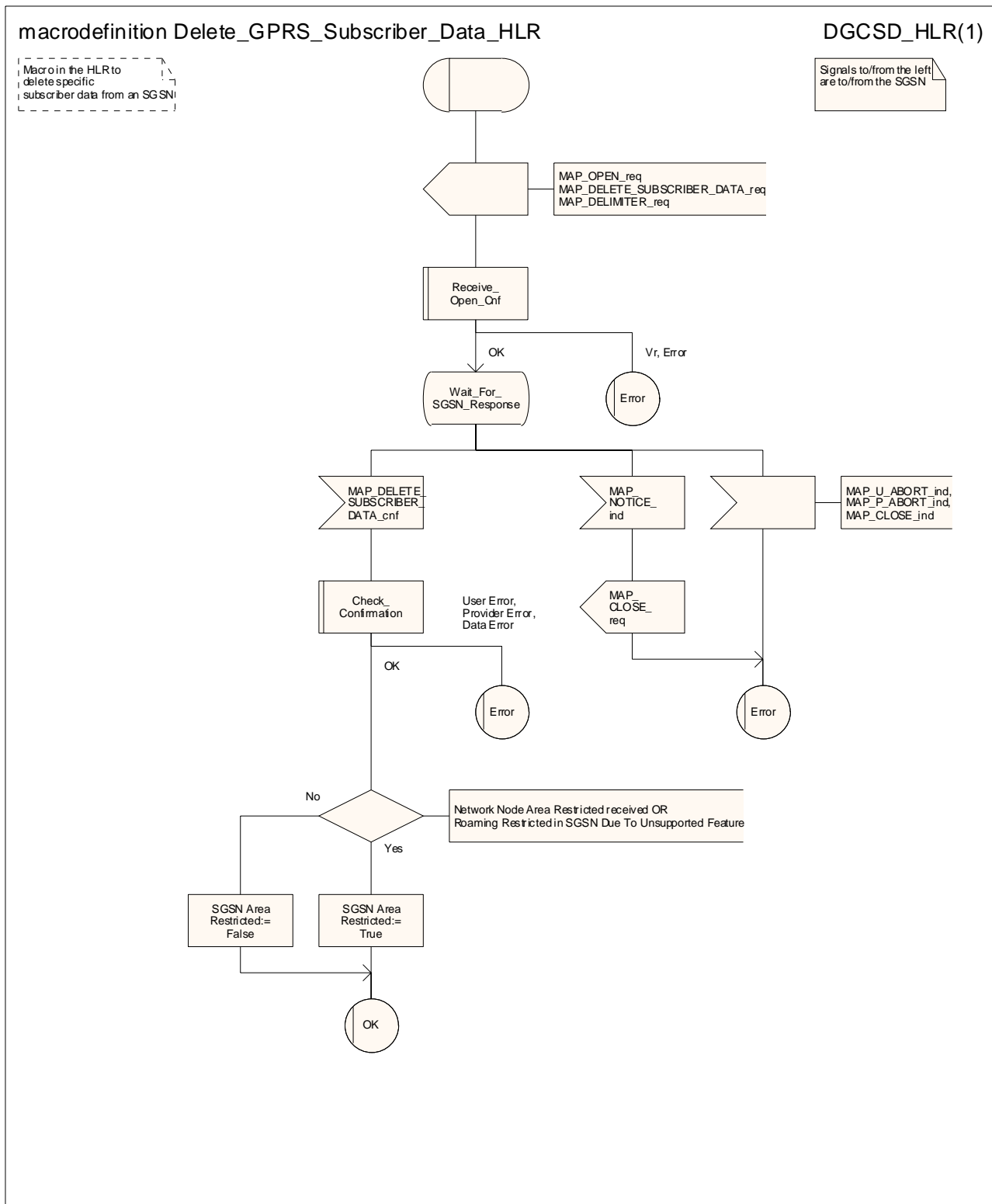

Figure 20.3/8: Macro Delete_GPRS_Subscriber_Data_HLR

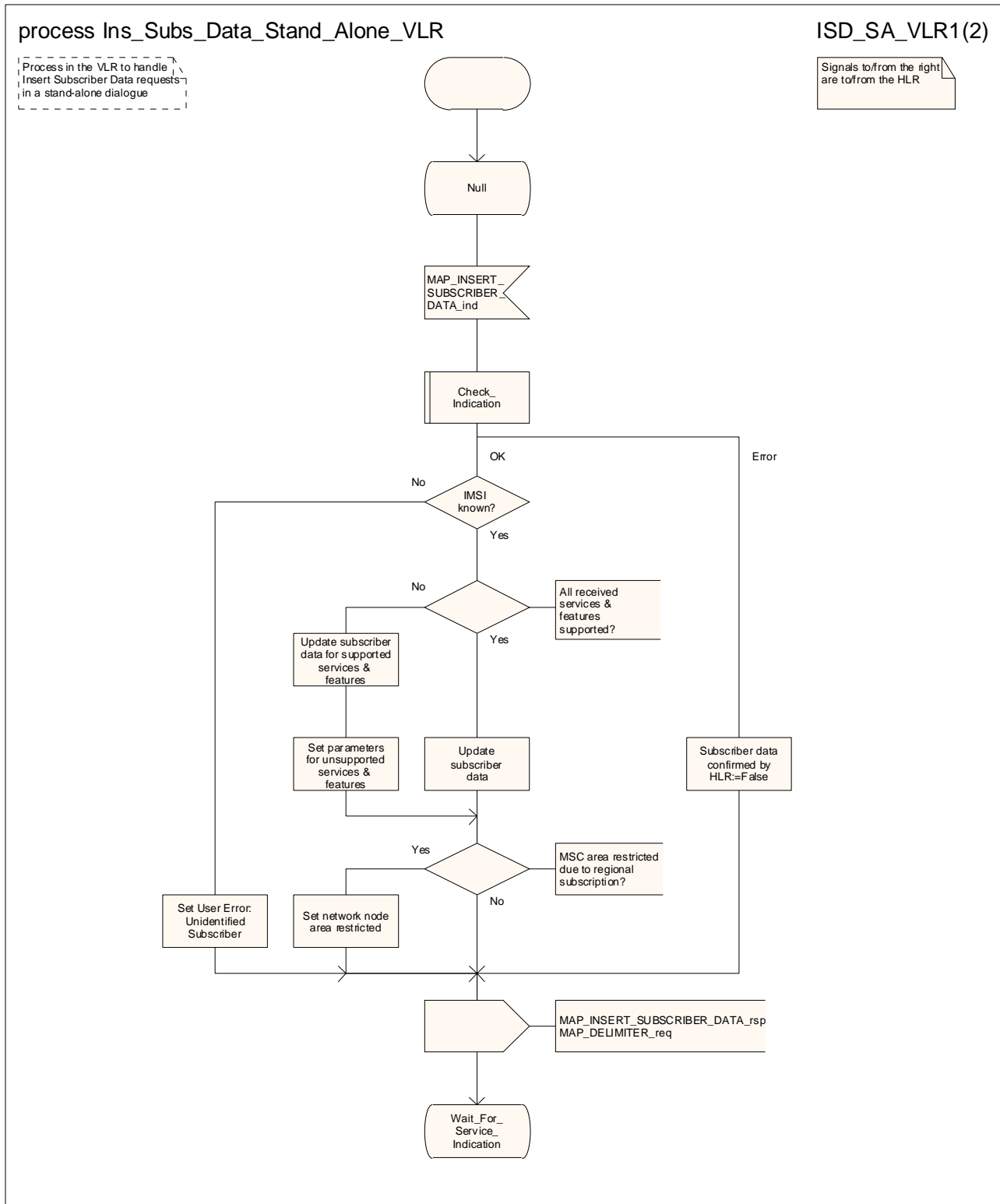

Figure 20.3/9 (sheet 1 of 2): Process Ins_Subscriber_Data_Stand_Alone_VLR

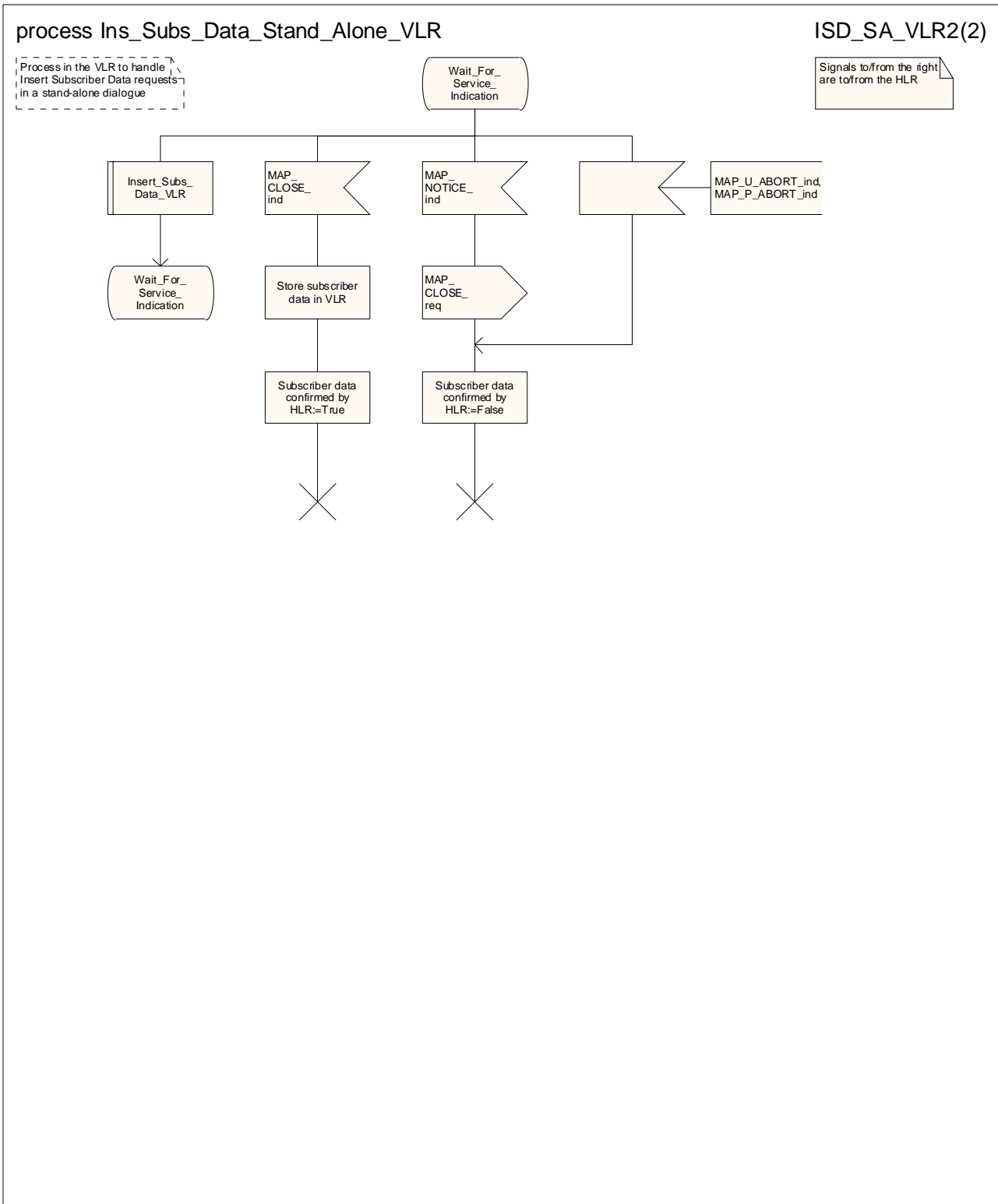

Figure 20.3/9 (sheet 2 of 2): Process Ins_Subscriber_Data_Stand_Alone_VLR

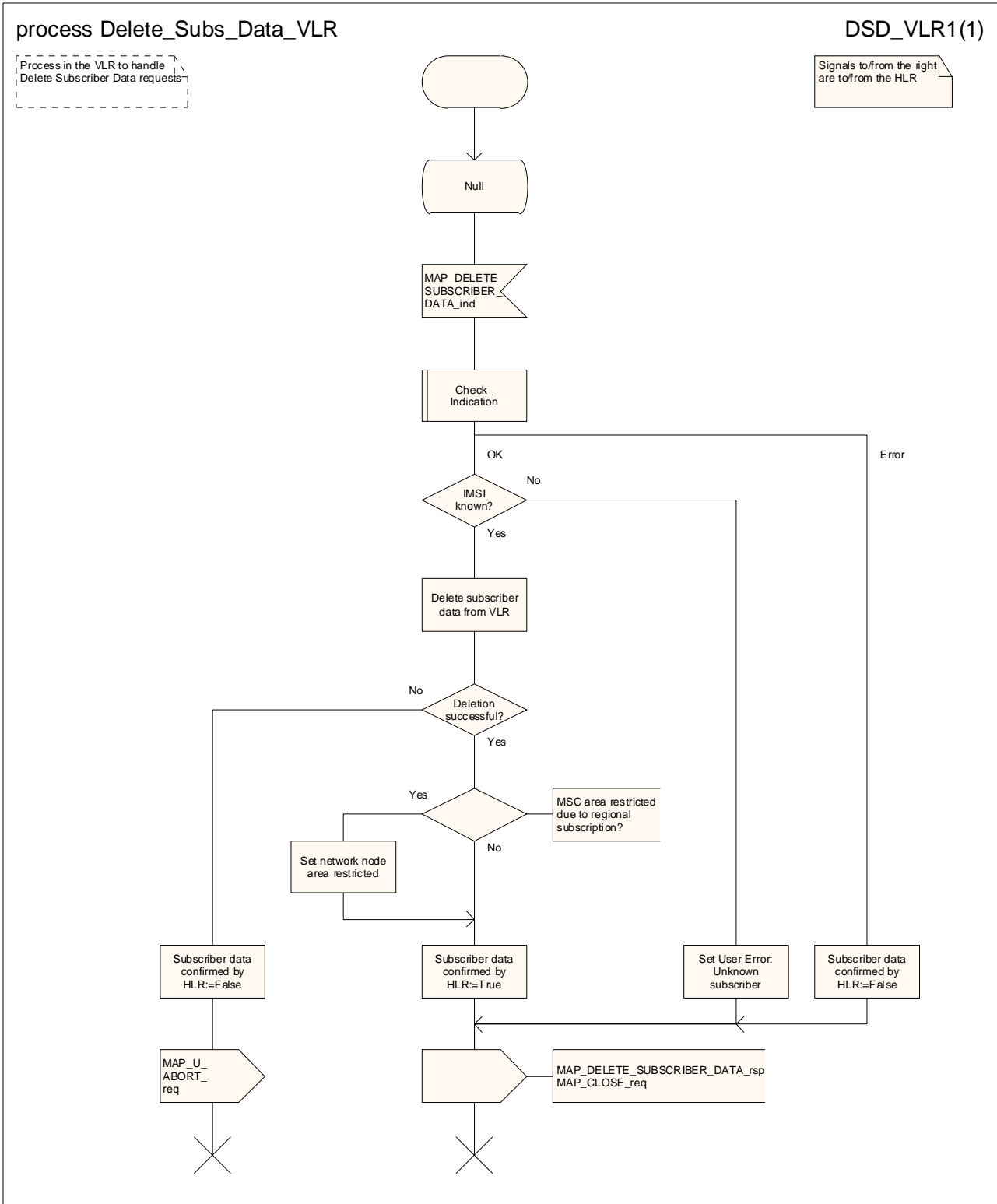

Figure 20.3/10: Process Delete_Subs_Data_VLR

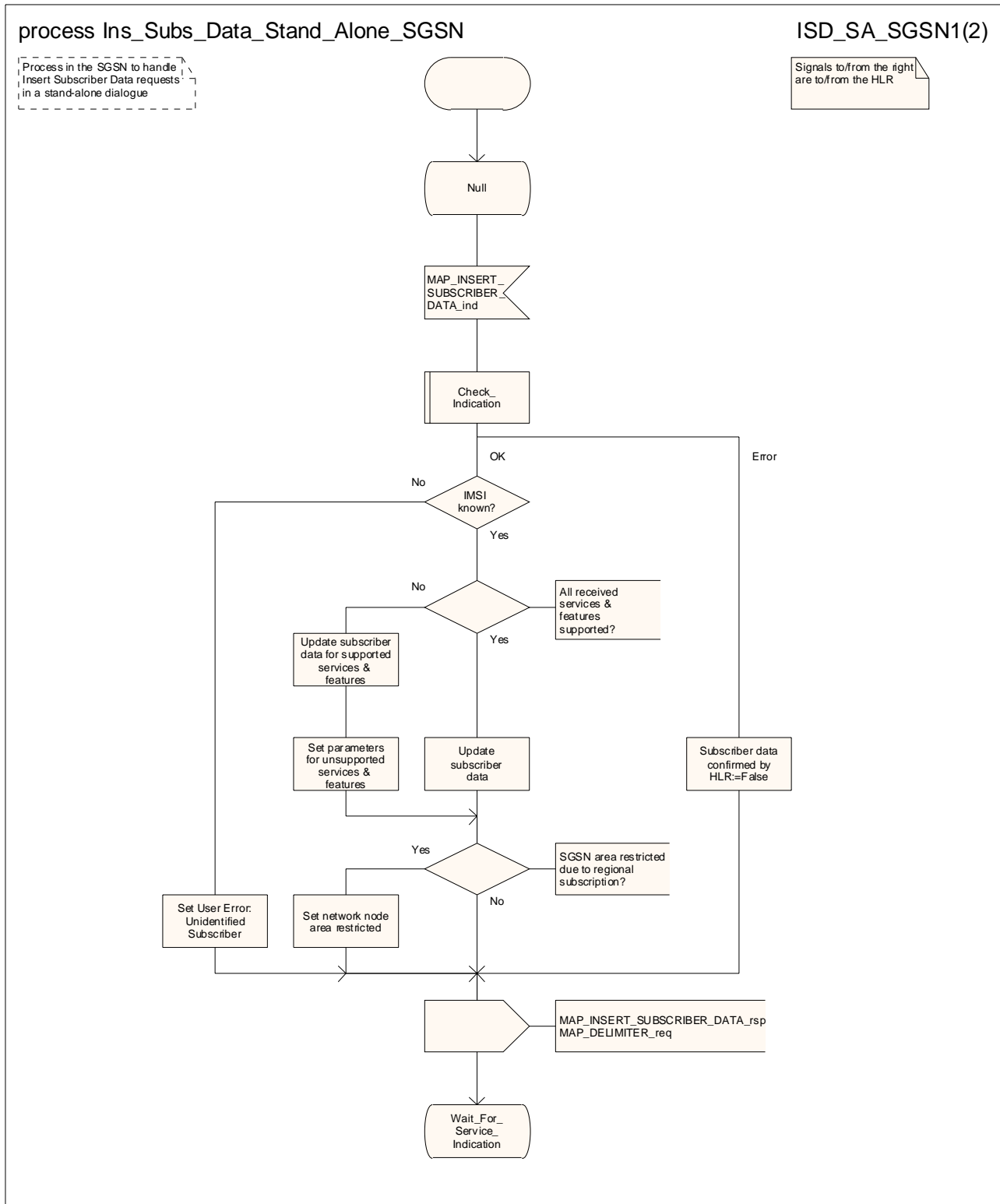

Figure 20.3/11 (sheet 1 of 2): Process Ins_Subscriber_Data_Stand_Alone_SGSN

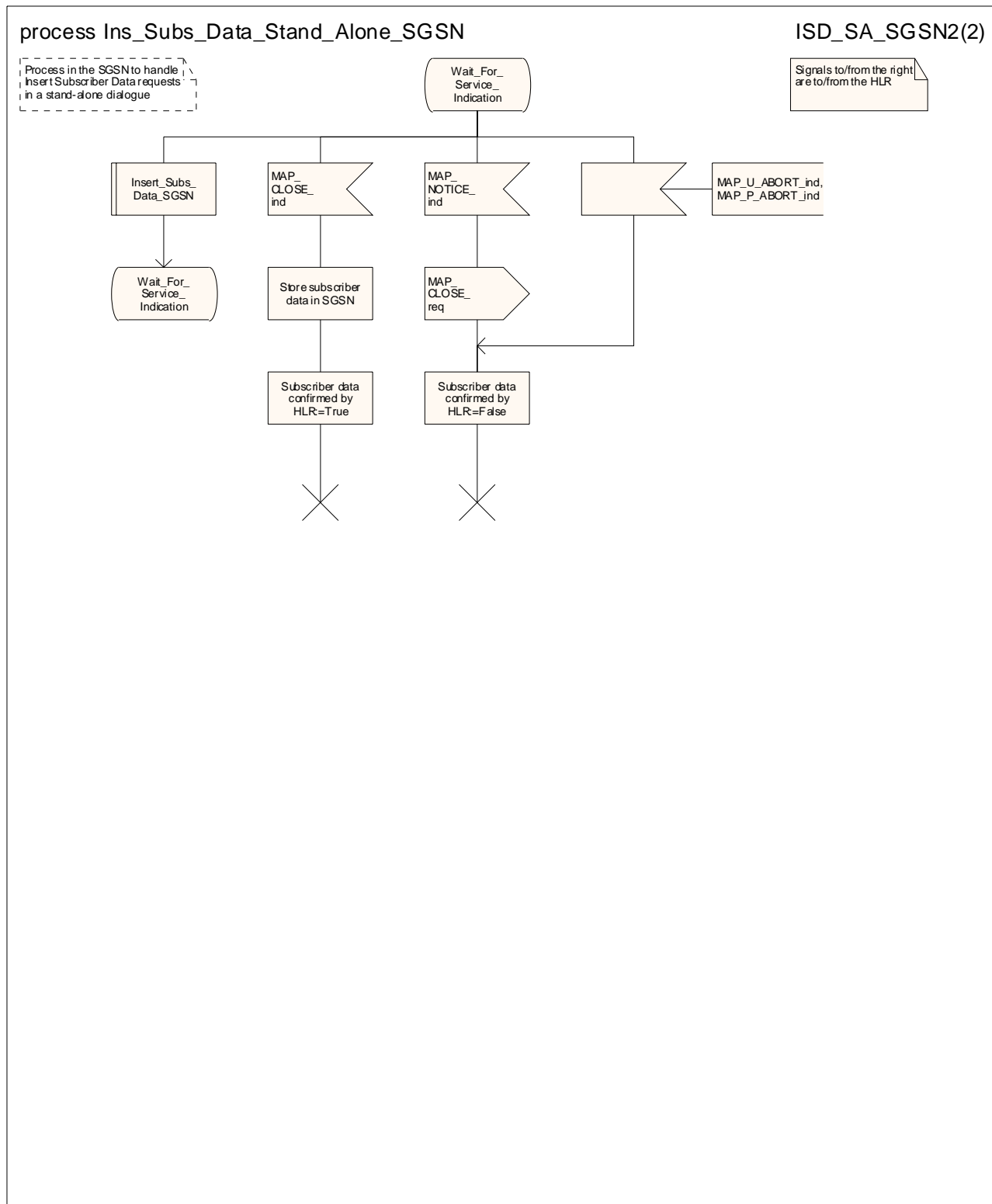

Figure 20.3/11 (sheet 2 of 2): Process Ins_Sub_Data_Stand_Alone_SGSN

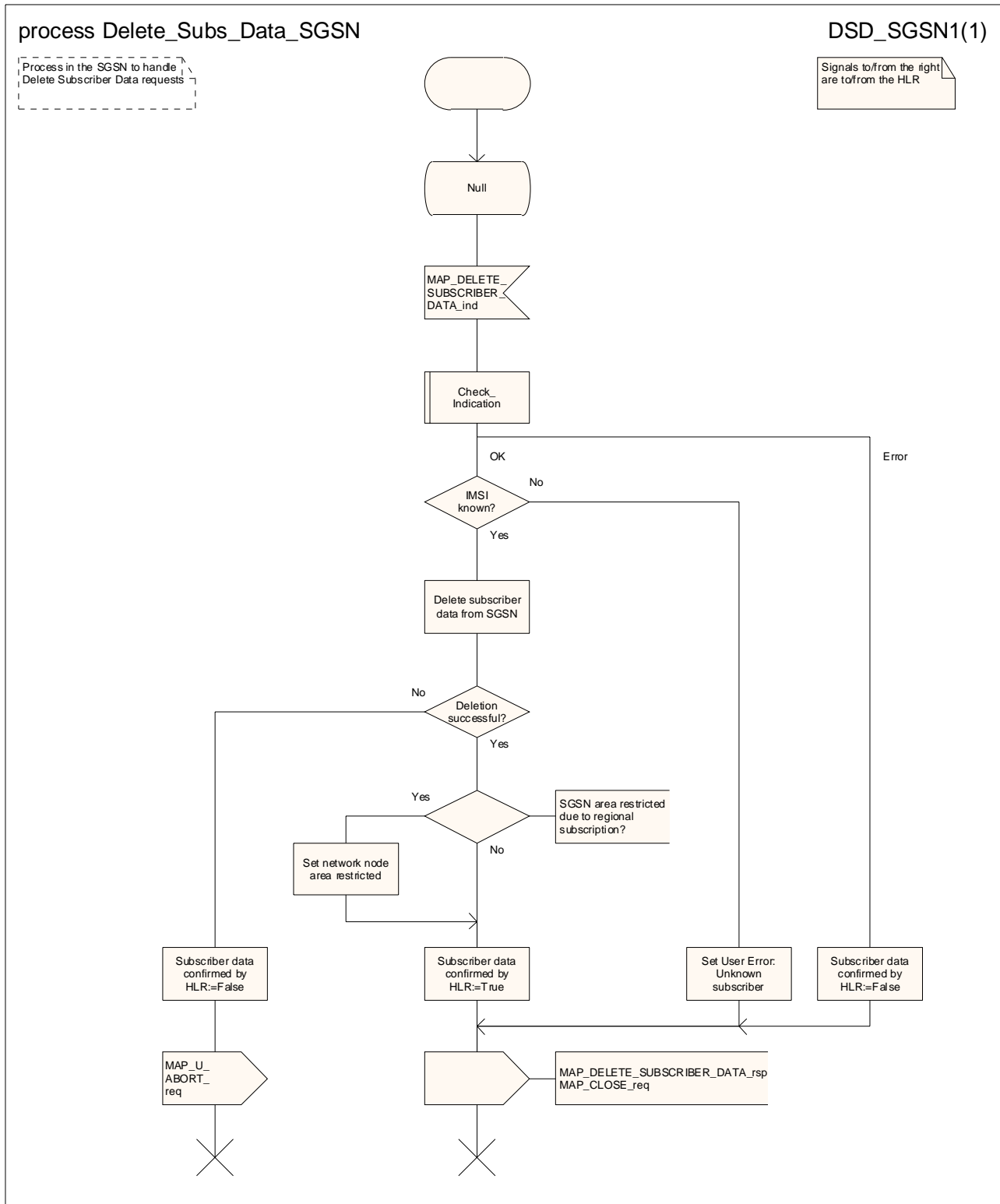
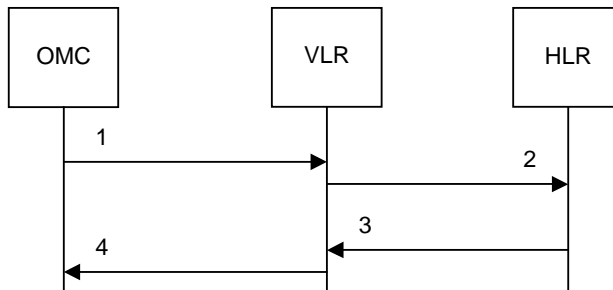

Figure 20.3/12: Process Delete_Subs_Data_SGSN

20.4 Subscriber Identity procedure

In the subscriber identity procedure the IMSI of the subscriber is retrieved from the HLR. The procedure is shown in figure 20.4/1.



- 1) Identity request
- 2) MAP_SEND_IMSI_req/ind
- 3) MAP_SEND_IMSI_rsp/cnf
- 4) Identity confirm

Figure 20.4/1: The subscriber identity procedure

20.4.2 Procedure in the VLR

The subscriber identity process in the VLR is shown in figure 20.4/2. The MAP process invokes macros not defined in this clause; the definitions of these macros can be found as follows:

- | | |
|--------------------|-----------------------|
| Receive_Open_Cnf | see subclause 25.1.2; |
| Check_Confirmation | see subclause 25.2.2. |

20.4.2 Procedure in the HLR

The subscriber identity process in the HLR is shown in figure 20.4/3. The MAP process invokes macros not defined in this clause; the definitions of these macros can be found as follows:

Receive_Open_Ind

see subclause 25.1.1;

Check_Indication

see subclause 25.2.1.

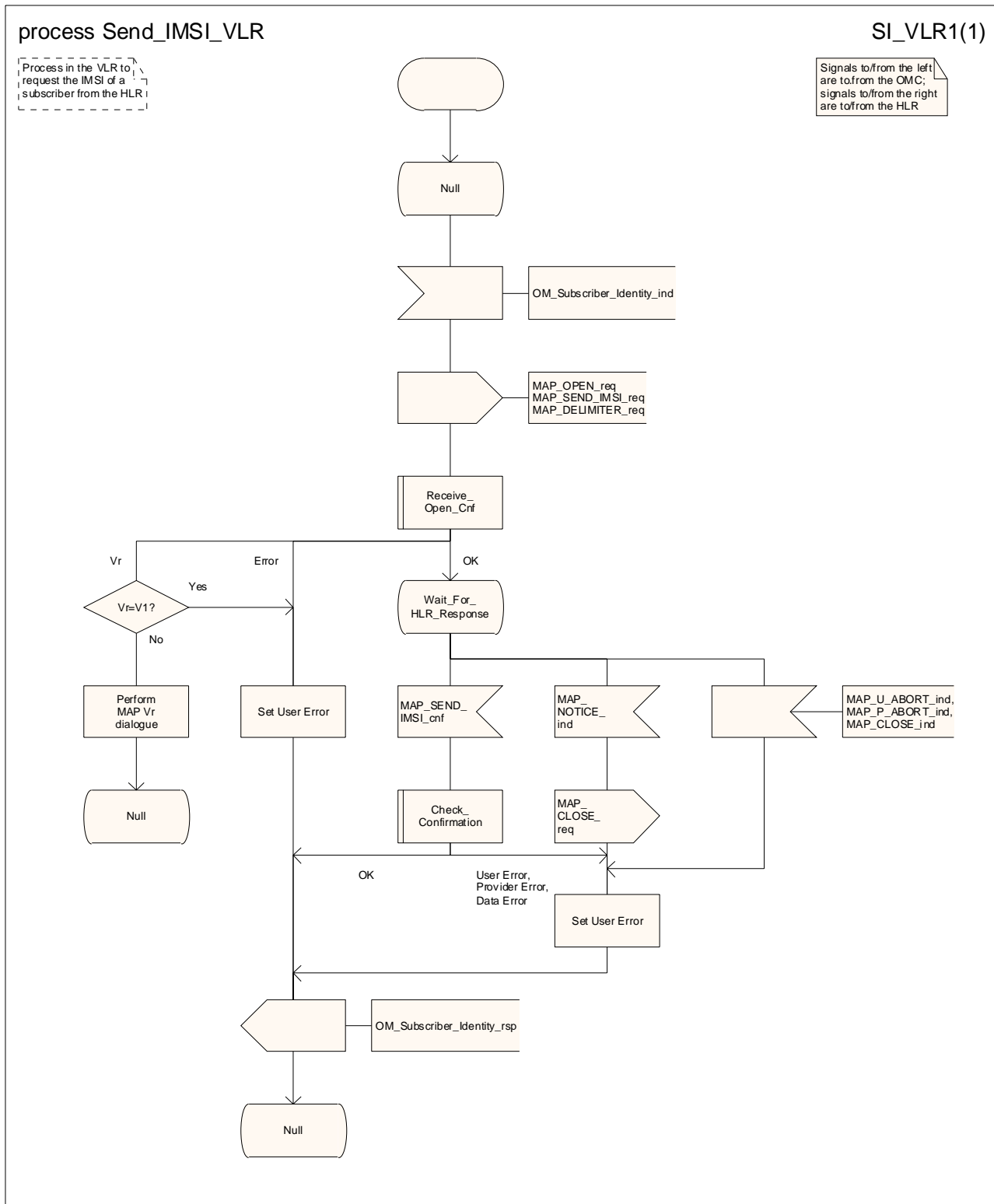

Figure 20.4/2: Process Send_IMSI_VLR

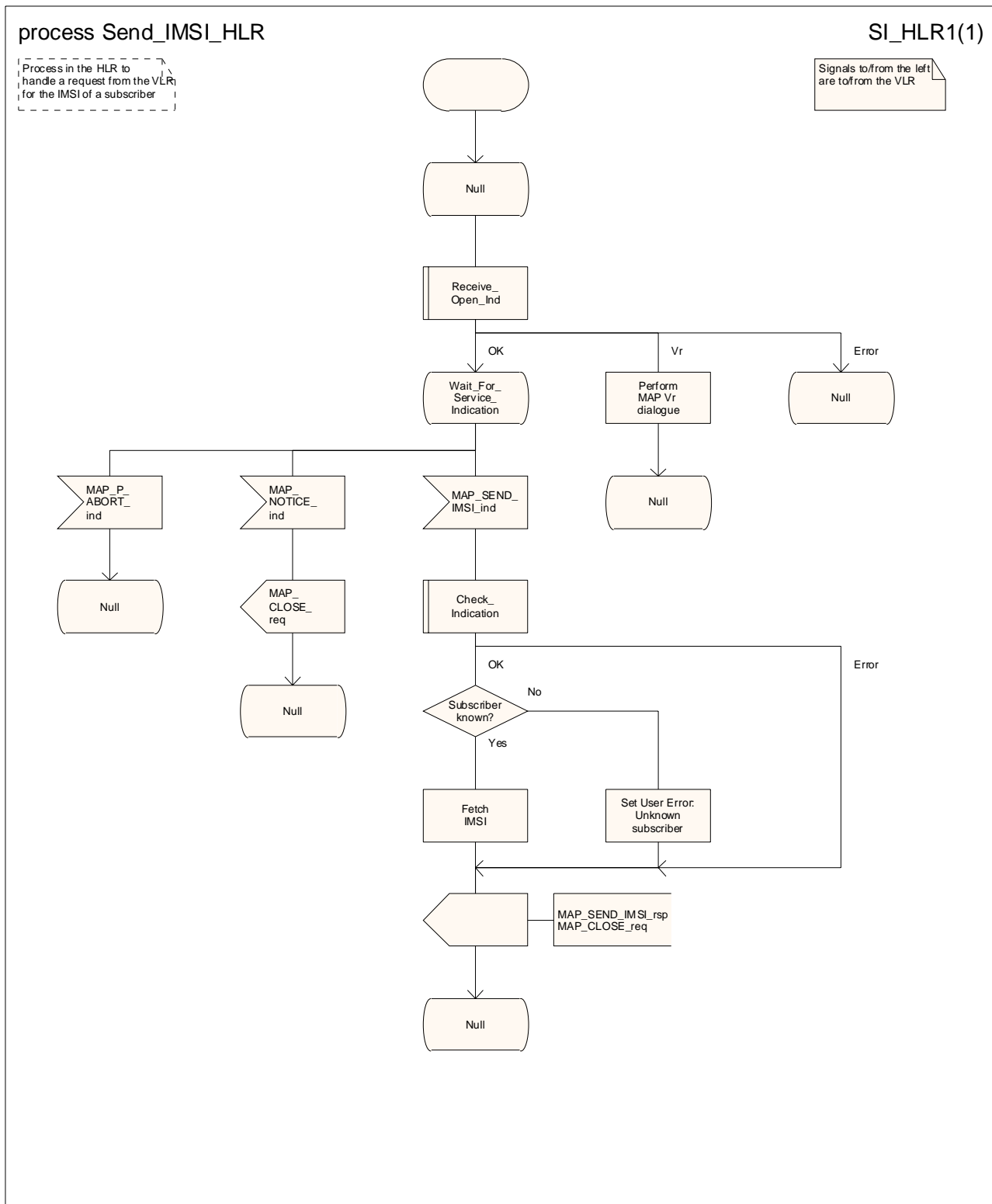

Figure 20.4/3: Process Send_IMSI_HLR

21 Call handling procedures

21.1 General

The MAP call handling procedures are used:

- to retrieve routing information to handle a mobile terminating call;
- to transfer control of a call back to the GMSC if the call is to be forwarded;
- to retrieve and transfer information between anchor MSC and relay MSC for inter MSC group calls / broadcast calls;
- to handle the reporting of MS status for call completion services;
- to handle the notification of remote user free for CCBS;
- to handle the alerting and termination of ongoing call activities for a specific subscriber.

The procedures to handle a mobile originating call and a mobile terminating call after the call has arrived at the destination MSC do not require any signalling over a MAP interface. These procedures are specified in 3GPP TS 23.018 [97].

The stage 2 specification for the retrieval of routing information to handle a mobile terminating call is in 3GPP TS 23.018 [97]; modifications to this procedure for CAMEL are specified in 3GPP TS 23.078 [98], for optimal routing of a basic mobile-to-mobile call in 3GPP TS 23.079 [99] and for CCBS in 3GPP TS 23.093 [107]. The interworking between the MAP signalling procedures and the call handling procedures for each entity (GMSC, HLR and VLR) is shown by the transfer of signals between these procedures.

The stage 2 specification for the transfer of control of a call back to the GMSC if the call is to be forwarded is in 3GPP TS 23.079 [99]. The interworking between the MAP signalling procedures and the call handling procedures for each entity (VMSC and GMSC) is shown by the transfer of signals between these procedures.

The stage 2 specifications for inter MSC group calls / broadcast calls are in 3GPP TS 43.068 [100] and 3GPP TS 43.069 [101]. The interworking between the MAP signalling procedures and the group call / broadcast call procedures for each entity (Anchor MSC and Relay MSC) is shown by the transfer of signals between these procedures.

The interworking between the call handling procedures and signalling protocols other than MAP is shown in 3GPP TS 23.018 [97], 3GPP TS 23.078 [98] and 3GPP TS 23.079 [99].

The stage 2 specification for the handling of reporting of MS status for call completion services and notification of remote user free for CCBS is in 3GPP TS 23.093 [107].

21.2 Retrieval of routing information

21.2.1 General

The message flows for successful retrieval of routing information for a mobile terminating call are shown in figure 21.2/1 (mobile terminating call which has not been optimally routed) and 21.2/2 (mobile-to-mobile call which has been optimally routed). The message flow for successful retrieval of routing information for a gsmSCF initiated call is shown in figure 21.2/3.

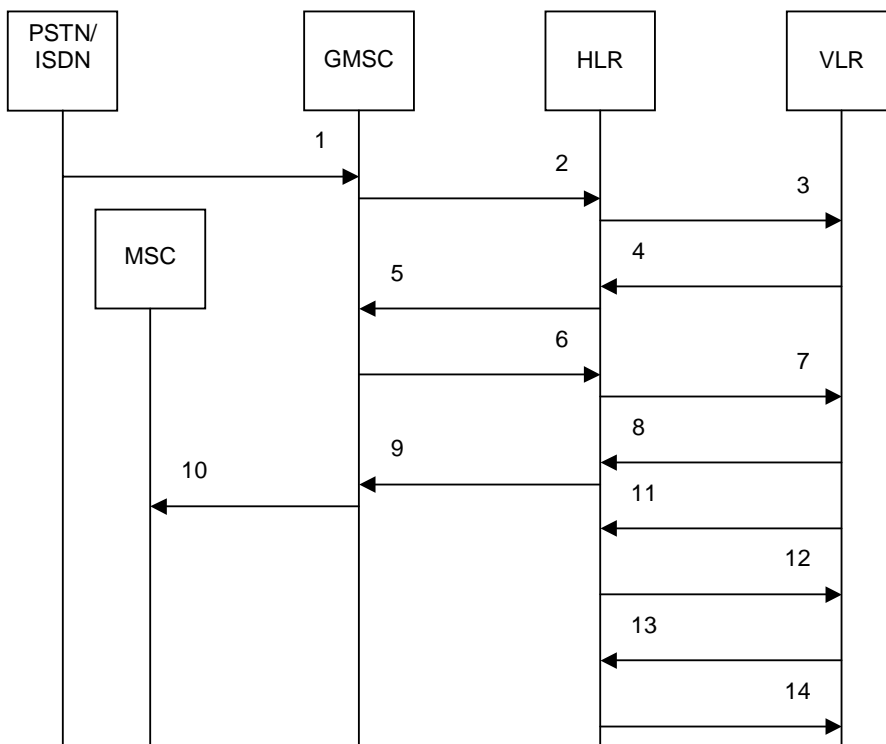

- 1) I_IAM (Note 1)
- 2) MAP_SEND_ROUTING_INFORMATION_req/ind (Note 2)
- 3) MAP_PROVIDE_SUBSCRIBER_INFO_req/ind (Note 3, Note 4)
- 4) MAP_PROVIDE_SUBSCRIBER_INFO_rsp/cnf (Note 4)
- 5) MAP_SEND_ROUTING_INFORMATION_rsp/cnf (Note 4)
- 6) MAP_SEND_ROUTING_INFORMATION_req/ind (Note 4)
- 7) MAP_PROVIDE_ROAMING_NUMBER_req/ind
- 8) MAP_PROVIDE_ROAMING_NUMBER_rsp/cnf
- 9) MAP_SEND_ROUTING_INFORMATION_rsp/cnf
- 10) I_IAM (Note 1)
- 11) MAP_RESTORE_DATA_req/ind (Note 4)
- 12) MAP_INSERT_SUBSCRIBER_DATA_req/ind (Note 4)
- 13) MAP_INSERT_SUBSCRIBER_DATA_rsp/cnf (Note 4)
- 14) MAP_RESTORE_DATA_rsp/cnf (Note 4)

NOTE 1: TUP or ISUP may be used in signalling between MSCs, depending on the network type between the MSCs. For further details on the TUP and ISUP procedures refer to the following ITU-T Recommendations and ETSI specification:

- Q.721-725 - Telephone User Part (TUP);
- ETS 300 356-1 - Integrated Services Digital Network (ISDN); Signalling System No.7; ISDN User Part (ISUP) version 2 for the international interface; Part 1: Basic services.

NOTE 2: This service may also be used by an ISDN exchange for obtaining routing information from the HLR.

NOTE 3: As a network operator option, the HLR sends MAP_PROVIDE_SUBSCRIBER_INFORMATION to the VLR. For further details on the CAMEL procedures refer to 3GPP TS 23.078 [98].

NOTE 4: Services printed in *italics* are optional.

Figure 21.2/1: Message flow for retrieval of routing information (non-optimally routed call)

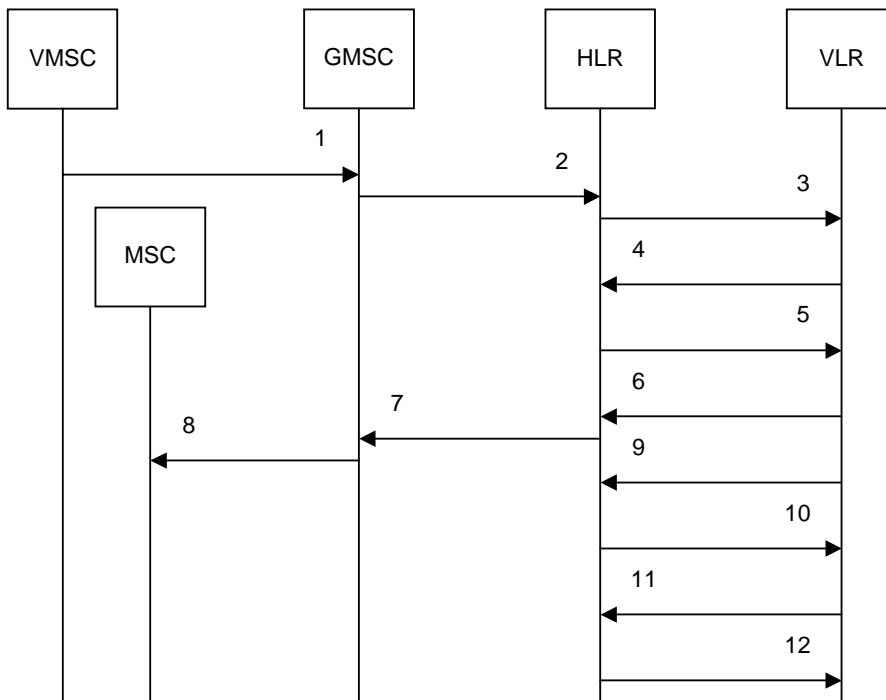

- 1) *I_IAM* (Note 1)
- 2) *MAP_SEND_ROUTING_INFORMATION_req/ind*
- 3) *MAP_PROVIDE_SUBSCRIBER_INFO_req/ind* (Note 2)
- 4) *MAP_PROVIDE_SUBSCRIBER_INFO_rsp/cnf* (Note 2)
- 5) *MAP_PROVIDE_ROAMING_NUMBER_req/ind* (Note 2)
- 6) *MAP_PROVIDE_ROAMING_NUMBER_rsp/cnf* (Note 2)
- 7) *MAP_SEND_ROUTING_INFORMATION_rsp/cnf*
- 8) *I_IAM* (Note 1)
- 9) *MAP_RESTORE_DATA_req/ind* (Note 3)
- 10) *MAP_INSERT_SUBSCRIBER_DATA_req/ind* (Note 3)
- 11) *MAP_INSERT_SUBSCRIBER_DATA_rsp/cnf* (Note 3)
- 12) *MAP_RESTORE_DATA_rsp/cnf* (Note 3)

NOTE 1: TUP or ISUP may be used in signalling between MSCs, depending on the network type between the MSCs. For further details on the TUP and ISUP procedures refer to the following ITU-T Recommendations & ETSI specification:

- Q.721-725 - Telephone User Part (TUP);
- ETS 300 356-1 - Integrated Services Digital Network (ISDN); Signalling System No.7; ISDN User Part (ISUP) version 2 for the international interface; Part 1: Basic services.

NOTE 2: For Optimal Routeing phase 1, only one of the information flows for Provide Subscriber Info and Provide Roaming Number is used.

NOTE 3: Services printed in *italics* are optional.

Figure 21.2/2: Message flow for retrieval of routing information (optimally routed call)

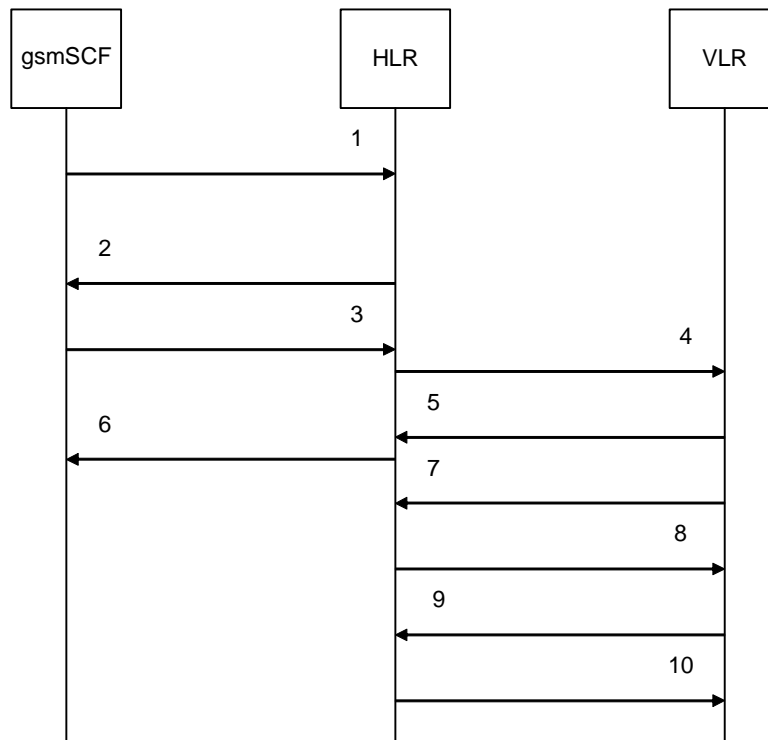

- 1) *MAP_SEND_ROUTING_INFORMATION_req/ind*
- 2) *MAP_SEND_ROUTING_INFORMATION_rsp/cnf* (Note 1)
- 3) *MAP_SEND_ROUTING_INFORMATION_req/ind* (Note 1)
- 4) *MAP_PROVIDE_ROAMING_NUMBER_req/ind*
- 5) *MAP_PROVIDE_ROAMING_NUMBER_rsp/cnf*
- 6) *MAP_SEND_ROUTING_INFORMATION_rsp/cnf*
- 7) *MAP_RESTORE_DATA_req/ind* (Note 1)
- 8) *MAP_INSERT_SUBSCRIBER_DATA_req/ind* (Note 1)
- 9) *MAP_INSERT_SUBSCRIBER_DATA_rsp/cnf* (Note 1)
- 10) *MAP_RESTORE_DATA_rsp/cnf* (Note 1)

NOTE 1: Services printed in *italics* are optional.

Figure 21.2/3: Message flow for retrieval of routing information for a gsmSCF initiated call

The following MAP services are used to retrieve routing information:

MAP_SEND_ROUTING_INFORMATION	see subclause 10.1;
MAP_PROVIDE_ROAMING_NUMBER	see subclause 10.2;
MAP_PROVIDE_SUBSCRIBER_INFO	see subclause 8.11.2;
MAP_RESTORE_DATA	see subclause 8.10.3.

21.2.2 Procedure in the GMSC

The MAP process in the GMSC to retrieve routing information for a mobile terminating call is shown in figure 21.2/3. The MAP process invokes macros not defined in this clause; the definitions of these macros can be found as follows:

Receive_Open_Cnf	see clause 25.1.2;
Check_Confirmation	see clause 25.2.2.

Successful Outcome

When the MAP process receives a Send Routing Info request from the call handling process in the GMSC, it requests a dialogue with the HLR whose identity is contained in the Send Routing Info request by sending a MAP_OPEN service

request, requests routing information using a MAP_SEND_ROUTING_INFORMATION service request and invokes the macro Receive_Open_Cnf to wait for the response to the dialogue opening request. If the dialogue opening is successful, the MAP process waits for a response from the HLR.

If the MAP process receives a MAP_SEND_ROUTING_INFORMATION service confirm from the HLR, the MAP process invokes the macro Check_Confirmation to check the content of the confirm. If the MAP_SEND_ROUTING_INFORMATION confirm from the HLR cannot be carried in a single TC-Result component, it is carried in one or more TC-Result-NL components (each sent in a TC-CONTINUE), followed by a TC-Result-L component in a TC-END message.

If the macro Check_Confirmation takes the OK exit, the MAP process sends a Send Routing Info ack containing the routing information received from the HLR to the call handling process in the GMSC and returns to the idle state.

Earlier version MAP dialogue with the HLR

If the macro Receive_Open_Cnf takes the Vr exit, the MAP process checks whether this is an OR interrogation (indicated by the inclusion of the OR interrogation parameter in the MAP_SEND_ROUTING_INFORMATION service request).

If this is not an OR interrogation, the GMSC performs the earlier version MAP dialogue as specified in [51] and the process returns to the idle state.

If this is an OR interrogation, the MAP process sends a Send Routing Info negative response indicating OR not allowed to the call handling process in the GMSC and returns to the idle state.

Dialogue opening failure

If the macro Receive_Open_Cnf indicates that the dialogue with the HLR could not be opened, the MAP process sends an Abort to the call handling process in the GMSC and returns to the idle state.

Error in MAP_SEND_ROUTING_INFORMATION confirm

If the MAP_SEND_ROUTING_INFORMATION service confirm contains a user error or a provider error, or the macro Check_Confirmation indicates that there is a data error, the MAP process sends a Send Routing Info negative response to the call handling process in the GMSC and returns to the idle state.

Call release

If the call handling process in the GMSC indicates that the call has been aborted (i.e. prematurely released by the calling subscriber), the MAP process returns to the idle state. Any response from the HLR will be discarded.

Abort of HLR dialogue

After the dialogue with the HLR has been established, the MAP service provider may abort the dialogue by issuing a MAP_P_ABORT indication, or the HLR may send a MAP_U_ABORT indication or a MAP_CLOSE indication. In any of these cases, the MAP process sends a Send Routing Info negative response to the call handling process in the GMSC and returns to the idle state.

If the MAP provider indicates a protocol problem by sending a MAP_NOTICE indication, the MAP process closes the dialogue with the HLR, sends a Send Routing Info negative response indicating system failure to the call handling process in the GMSC and returns to the idle state.

21.2.9 Process in the gsmSCF

For the purposes of retrieving routing information from the HLR, the gsmSCF takes the role of the GMSC and follows the process specified in subclause 21.2.2.

21.2.3 Procedures in the HLR

The MAP process in the HLR to retrieve routing information for a mobile terminating call is shown in figure 21.2/4. The MAP process invokes macros not defined in this clause; the definitions of these macros can be found as follows:

Receive_Open_Ind see clause 25.1.1;

Receive_Open_Cnf	see clause 25.1.2;
Check_Confirmation	see clause 25.2.2.

Successful outcome

When the MAP process receives a MAP_OPEN indication with the application context locInfoRetrieval, it checks it by invoking the macro Receive_Open_Ind.

If the macro takes the OK exit, the MAP process waits for a service indication.

If a MAP_SEND_ROUTING_INFORMATION service indication is received, the MAP process sends a Send Routeing Info request to the call handling process in the HLR, and waits for a response. The Send Routeing Info request contains the parameters received in the MAP_SEND_ROUTING_INFORMATION service indication.

If the call handling process in the HLR returns a Send Routeing Info ack, the MAP process constructs a MAP_SEND_ROUTING_INFORMATION service response containing the routeing information contained in the Send Routeing Info ack, constructs a MAP_CLOSE service request, sends them to the GMSC and returns to the idle state. If the MAP_SEND_ROUTING_INFORMATION response cannot be carried in a single TC-Result component, it is carried in one or more TC-Result-NL components (each sent in a TC-CONTINUE), followed by a TC-Result-L component in a TC-END message.

If the call handling process in the HLR returns a Provide Subscriber Info request, the MAP process requests a dialogue with the VLR whose identity is contained in the Provide Subscriber Info request by sending a MAP_OPEN service request, requests the subscriber status using a MAP_PROVIDE_SUBSCRIBER_INFO service request, and invokes the macro Receive_Open_Cnf to wait for the response to the dialogue opening request.

If the macro takes the OK exit, the MAP process waits for the response from the VLR.

If the MAP process receives a MAP_PROVIDE_SUBSCRIBER_INFO service confirm, it invokes the macro Check_Confirmation to check the content of the confirm.

If the Check_Confirmation macro takes the OK exit, the MAP process sends a Provide Subscriber Info ack containing the information received in the MAP_PROVIDE_SUBSCRIBER_INFO service confirm to the call handling process in the HLR, and waits for a response. The handling of the response from the call handling process in the HLR is described above.

If the MAP_PROVIDE_SUBSCRIBER_INFO service confirm contains a provider error or a data error, the MAP process sends a Provide Subscriber Info negative response indicating the type of error to the call handling process in the HLR, and waits for a response. The handling of the response from the call handling process in the HLR is described above.

NOTE: The 'User Error' exit from the macro Check_Confirmation is shown for formal completeness; the MAP_PROVIDE_SUBSCRIBER_INFO_cnf primitive cannot contain a user error.

If the call handling process in the HLR returns a Provide Roaming Number request, the MAP process requests a dialogue with the VLR whose identity is contained in the Provide Roaming Number request by sending a MAP_OPEN service request, requests a roaming number using a MAP_PROVIDE_ROAMING_NUMBER service request, and invokes the macro Receive_Open_Cnf to wait for the response to the dialogue opening request.

If the macro takes the OK exit, the MAP process waits for the response from the VLR.

If the MAP process receives a MAP_PROVIDE_ROAMING_NUMBER service confirm, it invokes the macro Check_Confirmation to check the content of the confirm.

If the Check_Confirmation macro takes the OK exit, the MAP process sends a Provide Roaming Number ack containing the MSRN received in the MAP_PROVIDE_ROAMING_NUMBER service confirm to the call handling process in the HLR, and waits for a response. The handling of the response from the call handling process in the HLR is described above.

If the MAP_PROVIDE_ROAMING_NUMBER service confirm contains a user error or a provider error, or the macro Check_Confirmation indicates that there is a data error, the MAP process sends a Provide Roaming Number negative response indicating the type of error to the call handling process in the HLR, and waits for a response. The handling of the response from the call handling process in the HLR is described above.

Negative response from HLR call handling process

If the call handling process in the HLR returns a negative response, either before or after a dialogue with the VLR to obtain a roaming number, the MAP process constructs a MAP_SEND_ROUTING_INFORMATION service response containing the appropriate error, constructs a MAP_CLOSE service request, sends them to the GMSC and returns to the idle state.

Earlier version MAP Provide Roaming Number dialogue with the VLR

If the macro Receive_Open_Cnf takes the Vr exit after the MAP process has requested opening of a Provide Roaming Number dialogue with the VLR, the MAP process checks whether this is an OR interrogation (indicated by the inclusion of the OR interrogation parameter in the MAP_PROVIDE_ROAMING_NUMBER service request).

If this is not an OR interrogation, the HLR performs the earlier version MAP dialogue as specified in [51], relays the result of the dialogue to the HLR call handling process, and waits for a response. The handling of the response from the call handling process in the HLR is described above.

If this is an OR interrogation, the MAP process sends a Provide Roaming Number negative response indicating OR not allowed to the call handling process in the HLR and waits for a response. The handling of the response from the call handling process in the HLR is described above.

Failure of Provide Subscriber Info dialogue with the VLR

If the Receive_Open_Cnf macro takes the Vr exit or the Error exit after the MAP process has requested opening of a Provide Subscriber Info dialogue with the VLR, the MAP process sends a Provide Subscriber Info negative response indicating system failure to the call handling process in the HLR, and waits for a response. The handling of the response from the call handling process in the HLR is described above.

Failure of Provide Roaming Number dialogue with the VLR

If the Receive_Open_Cnf macro takes the Error exit after the MAP process has requested opening of a Provide Roaming Number dialogue with the VLR, the MAP process sends a Provide Roaming Number negative response indicating system failure to the call handling process in the HLR, and waits for a response. The handling of the response from the call handling process in the HLR is described above.

If the MAP process receives a MAP_U_ABORT, a MAP_P_ABORT or a premature MAP_CLOSE from the MAP provider, it sends a Provide Roaming Number negative response indicating system failure to the call handling process in the HLR, and waits for a response. The handling of the response from the call handling process in the HLR is described above.

If the MAP process receives a MAP_NOTICE from the MAP provider, it returns a MAP_CLOSE request to the MAP provider, sends a Provide Roaming Number negative response indicating system failure to the call handling process in the HLR, and waits for a response. The handling of the response from the call handling process in the HLR is described above.

Earlier version MAP dialogue with the GMSC

If the macro Receive_Open_Ind takes the Vr exit, the HLR performs the earlier version MAP dialogue as specified in [51] and the process returns to the idle state.

Failure of dialogue opening with the GMSC

If the macro Receive_Open_Ind takes the Error exit, the MAP process returns to the idle state.

If the MAP provider sends a MAP_P_ABORT while the MAP process is waiting for a service indication, the MAP process returns to the idle state.

If the MAP provider sends a MAP_NOTICE while the MAP process is waiting for a service indication, the MAP process sends a MAP_CLOSE request to terminate the dialogue and returns to the idle state.

21.2.4 Process in the VLR to provide a roaming number

The MAP process in the VLR to provide a roaming number for a mobile terminating call is shown in figure 21.2/5. The MAP process invokes a macro not defined in this clause; the definition of this macro can be found as follows:

Receive_Open_Ind see clause 25.1.1;

Successful outcome

When the MAP process receives a MAP_OPEN indication with the application context roamingNbEnquiry, it checks it by invoking the macro Receive_Open_Ind.

If the macro takes the OK exit, the MAP process waits for a service indication.

If a MAP_PROVIDE_ROAMING_NUMBER service indication is received, the MAP process sends a Provide Roaming Number request to the call handling process in the VLR, and waits for a response. The Provide Roaming Number request contains the parameters received in the MAP_PROVIDE_ROAMING_NUMBER service indication.

If the call handling process in the VLR returns a Provide Roaming Number ack, the MAP process constructs a MAP_PROVIDE_ROAMING_NUMBER service response containing the roaming number contained in the Send Routeing Info ack, constructs a MAP_CLOSE service request, sends them to the HLR and returns to the idle state.

Earlier version MAP dialogue with the HLR

If the macro Receive_Open_Ind takes the Vr exit, the VLR performs the earlier version MAP dialogue as specified in [51] and the process returns to the idle state.

Failure of dialogue opening with the HLR

If the macro Receive_Open_Ind takes the Error exit, the MAP process returns to the idle state.

If the MAP provider sends a MAP_P_ABORT while the MAP process is waiting for a service indication, the MAP process returns to the idle state.

If the MAP provider sends a MAP_NOTICE while the MAP process is waiting for a service indication, the MAP process sends a MAP_CLOSE request to terminate the dialogue and returns to the idle state.

Negative response from VLR call handling process

If the call handling process in the HLR returns a negative response, the MAP process constructs a MAP_PROVIDE_ROAMING_NUMBER service response containing the appropriate error, constructs a MAP_CLOSE service request, sends them to the HLR and returns to the idle state.

21.2.5 Process in the VLR to restore subscriber data

The MAP process in the HLR to restore subscriber data is shown in figure 21.2/6. The MAP process invokes macros not defined in this clause; the definitions of these macros can be found as follows:

Receive_Open_Cnf	see clause 25.1.2;
Check_Confirmation	see clause 25.2.2;
Insert_SubData_VLR	see clause 25.7.1;
Activate_Tracing_VLR	see clause 25.9.4.

Successful outcome

When the MAP process receives a Restore Data request from the data restoration process in the VLR, it requests a dialogue with the HLR whose identity is contained in the Restore Data request by sending a MAP_OPEN service request, requests data restoration using a MAP_RESTORE_DATA service request and invokes the macro Receive_Open_Cnf to wait for the response to the dialogue opening request. If the dialogue opening is successful, the MAP process waits for a response from the HLR.

The VLR may receive a MAP_INSERT_SUBSCRIBER_DATA service indication from the HLR; this is handled by the macro Insert_SubData_VLR as described in clause 25.7.1, and the MAP process waits for a further response from the HLR.

The VLR may receive a MAP_ACTIVATE_TRACE_MODE service indication from the HLR; this is handled by the macro Activate_Tracing_VLR as described in clause 25.9.4, and the MAP process waits for a further response from the HLR.

If the MAP process receives a MAP_RESTORE_DATA service confirm, it invokes the macro Check_Confirmation to check the content of the confirm.

If the Check_Confirmation macro takes the OK exit, the MAP process sends a Restore Data ack containing the information received from the HLR to the data restoration process in the VLR and returns to the idle state.

Error in MAP_RESTORE_DATA confirm

If the MAP_RESTORE_DATA service confirm contains a user error or a provider error, or the macro Check_Confirmation indicates that there is a data error, the MAP process sends a Restore Data negative response indicating the type of error to the call handling process in the HLR, and returns to the idle state.

Earlier version MAP dialogue with the HLR

If the macro Receive_Open_Cnf takes the Vr exit, the VLR performs the earlier MAP version dialogue as specified in [51] and the process terminates.

Dialogue opening failure

If the macro Receive_Open_Cnf indicates that the dialogue with the HLR could not be opened, the MAP process sends a negative response indicating system failure to the data restoration process in the GMSC and returns to the idle state.

21.2.6 Process in the VLR to provide subscriber information

The MAP process in the VLR to provide subscriber information for a mobile terminating call subject to CAMEL invocation is shown in figure 21.2/6. The MAP process invokes a macro not defined in this clause; the definition of this macro can be found as follows:

Receive_Open_Ind see clause 25.1.1;

Successful outcome

When the MAP process receives a MAP_OPEN indication with the application context subscriberInfoEnquiry, it checks it by invoking the macro Receive_Open_Ind.

If the macro takes the OK exit, the MAP process waits for a service indication.

If a MAP_PROVIDE_SUBSCRIBER_INFO service indication is received, the MAP process sends a Provide Subscriber Info request to the subscriber information request process in the VLR, and waits for a response. The Provide Subscriber Info request contains the parameters received in the MAP_PROVIDE_SUBSCRIBER_INFO service indication.

If the subscriber information request process in the VLR returns a Provide Subscriber Info ack, the MAP process constructs a MAP_PROVIDE_SUBSCRIBER_INFO service response containing the information contained in the Provide Subscriber Info ack, constructs a MAP_CLOSE service request, sends them to the HLR and returns to the idle state.

Failure of dialogue opening with the HLR

If the macro Receive_Open_Ind takes the Vr exit or the Error exit, the MAP process returns to the idle state.

If the MAP provider sends a MAP_P_ABORT while the MAP process is waiting for a service indication, the MAP process returns to the idle state.

If the MAP provider sends a MAP_NOTICE while the MAP process is waiting for a service indication, the MAP process sends a MAP_CLOSE request to terminate the dialogue and returns to the idle state.

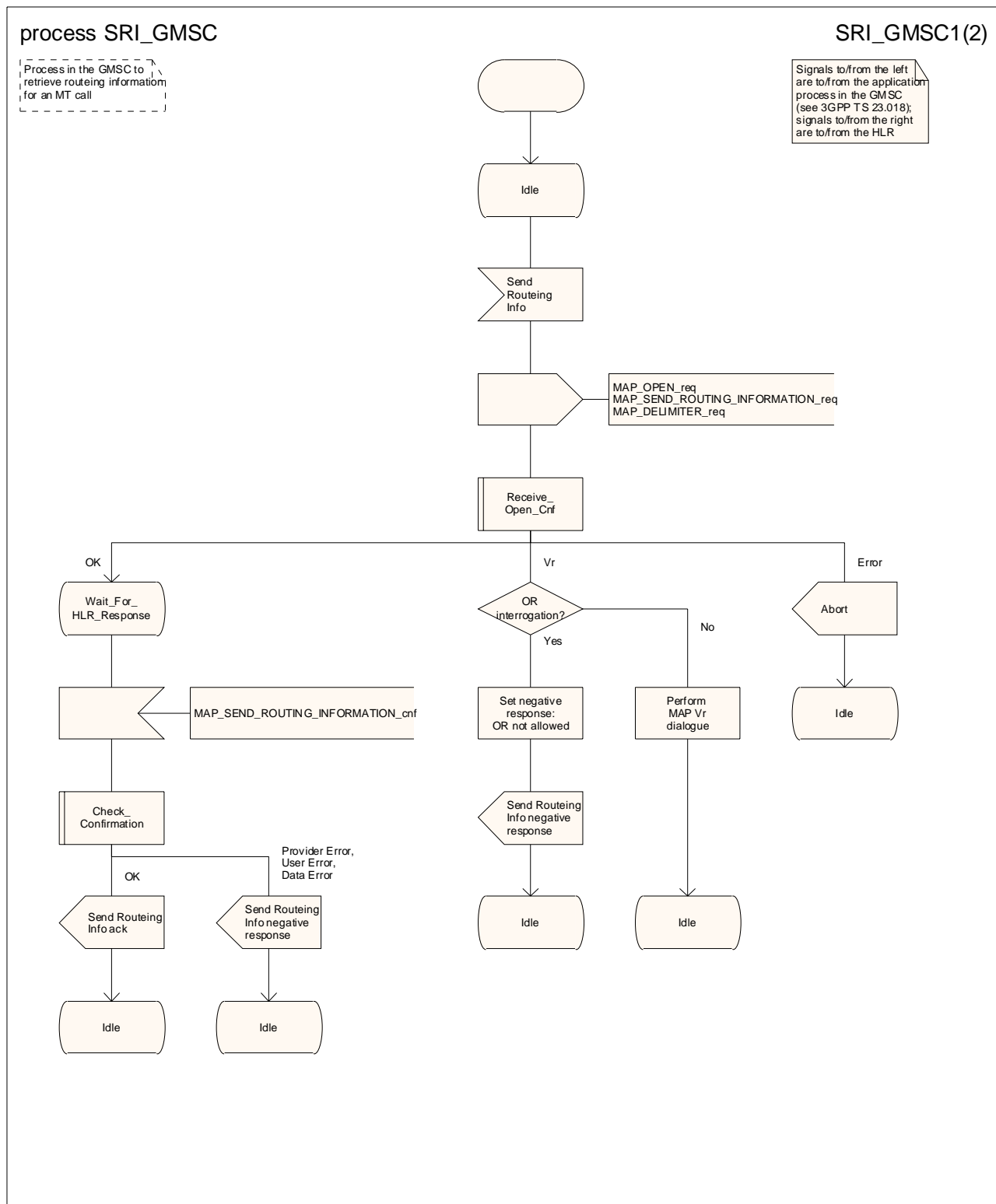

Figure 21.2/6 (sheet 1 of 2): Process SRI_GMSC

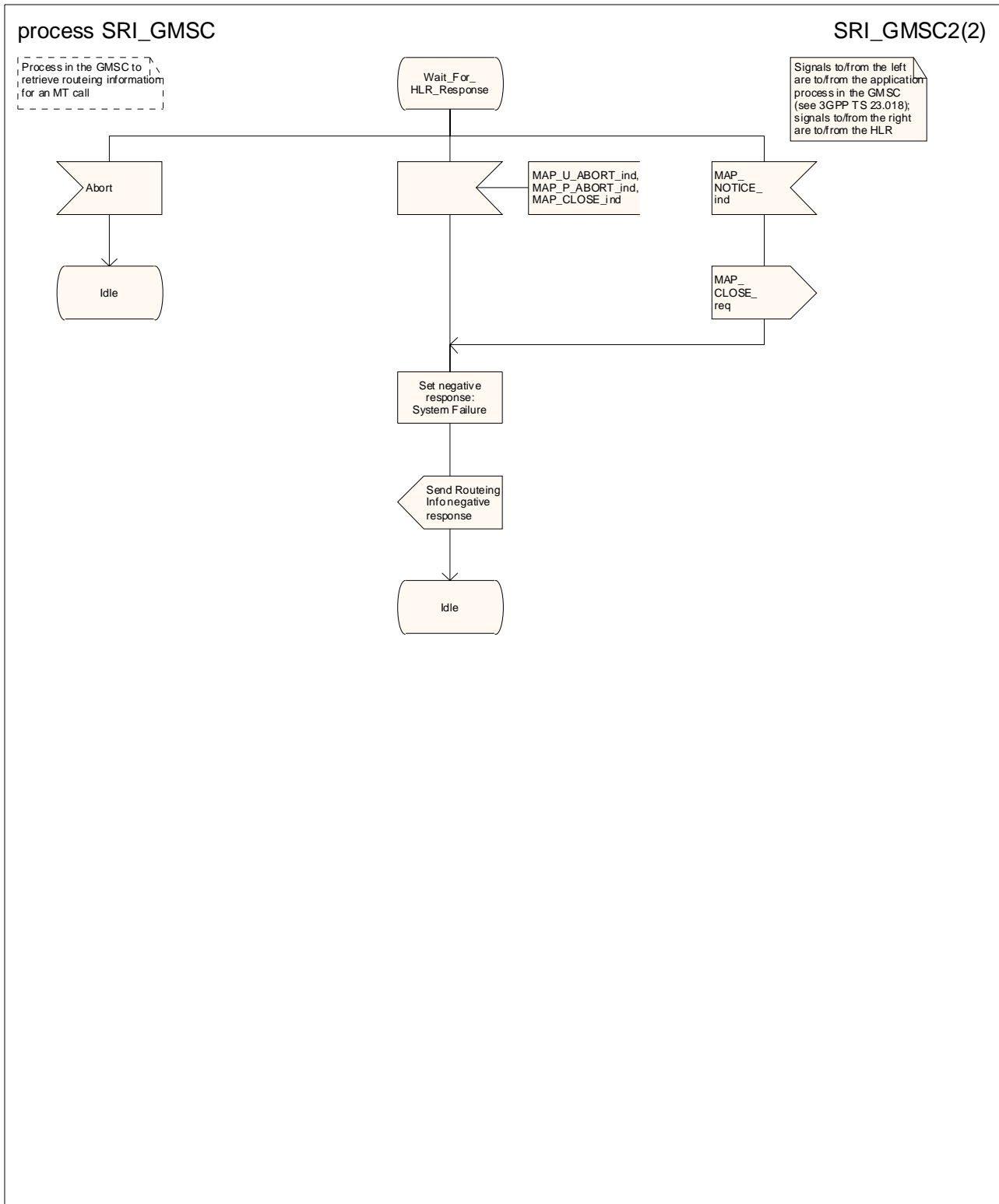

Figure 21.2/6 (sheet 2 of 2): Process SRI_GMSC

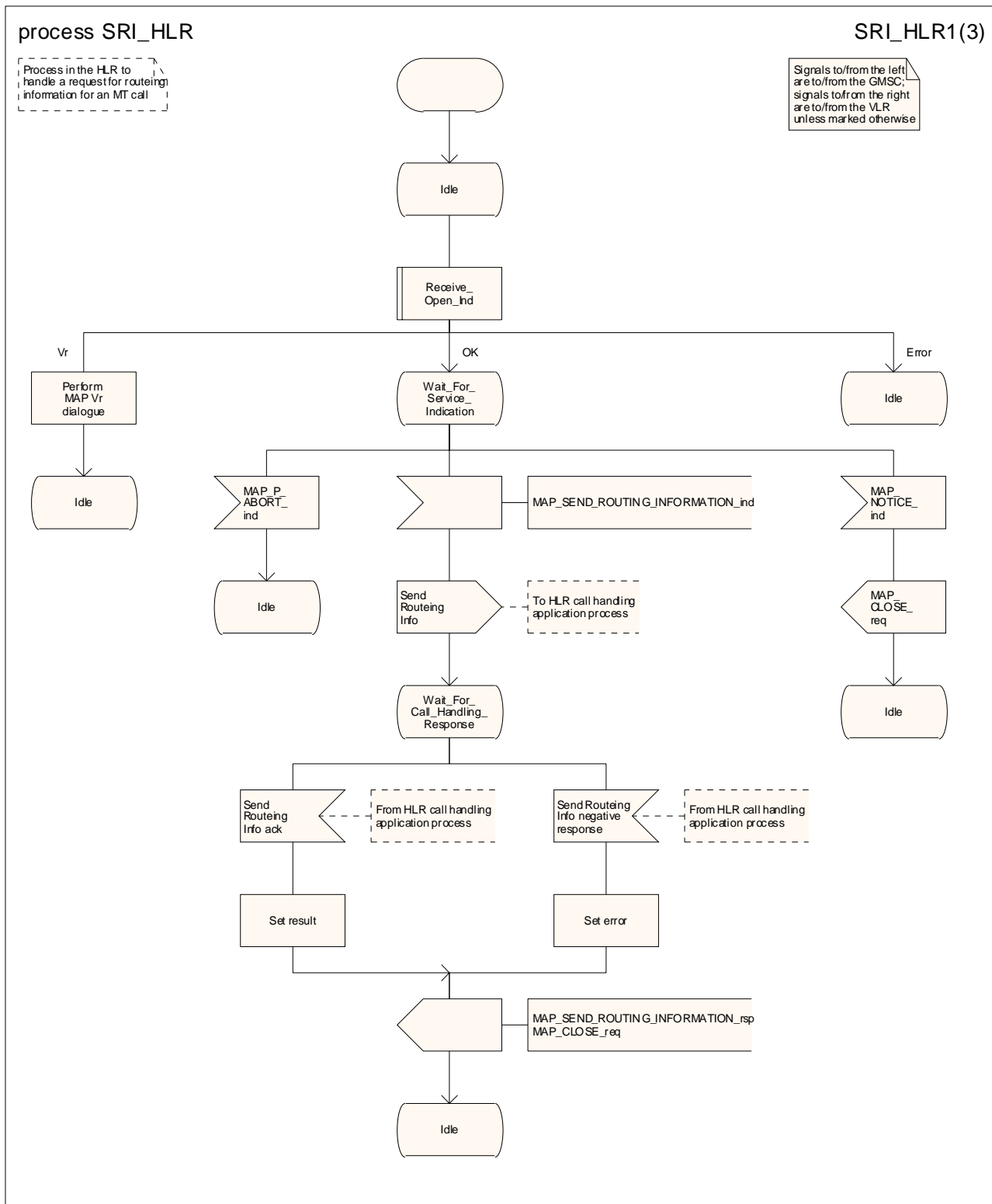

Figure 21.2/7 (sheet 1 of 3): Process SRI_HLR

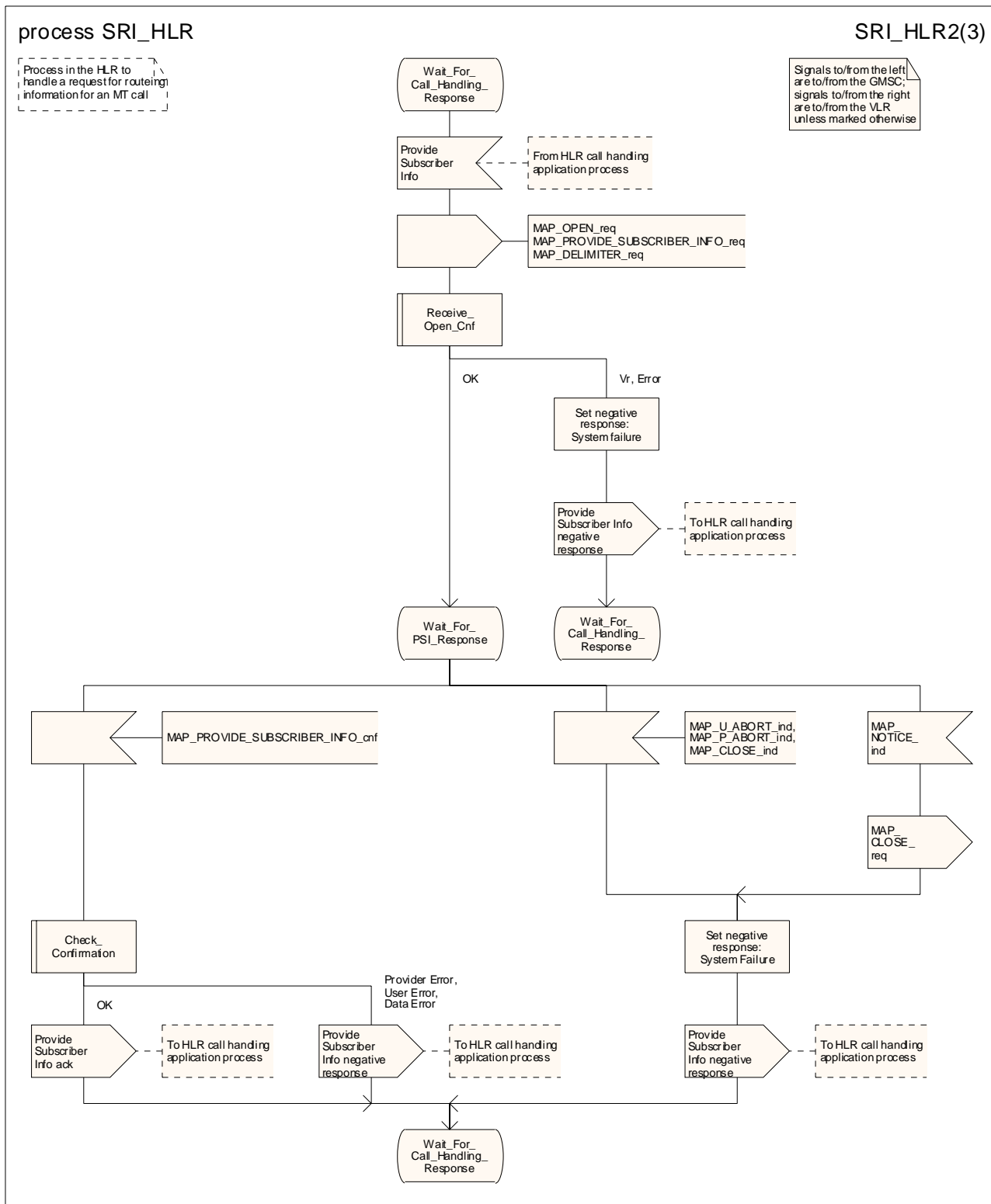

Figure 21.2/7 (sheet 2 of 3): Process SRI_HLR

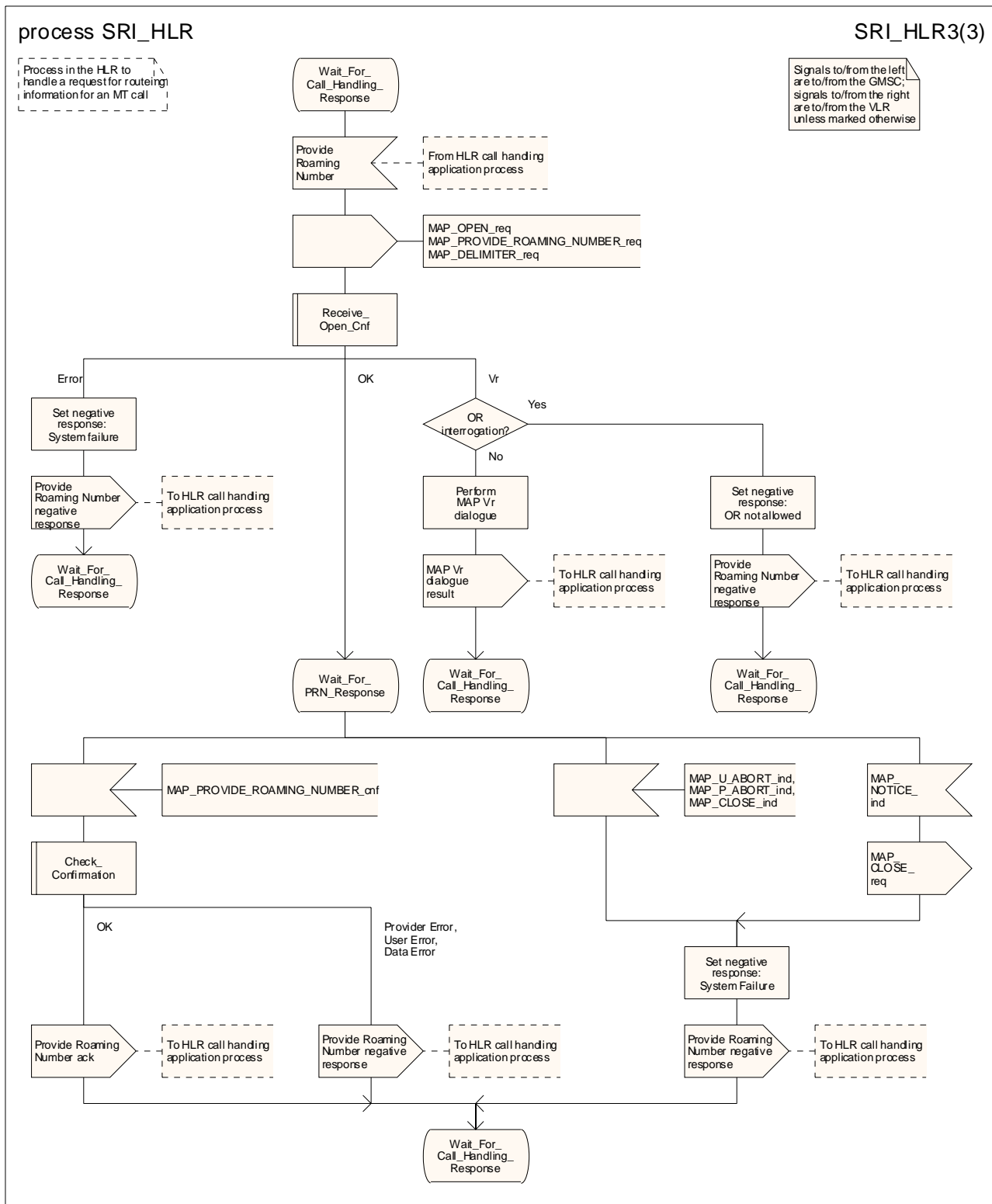

Figure 21.2/7 (sheet 3 of 3): Process SRI_HLR

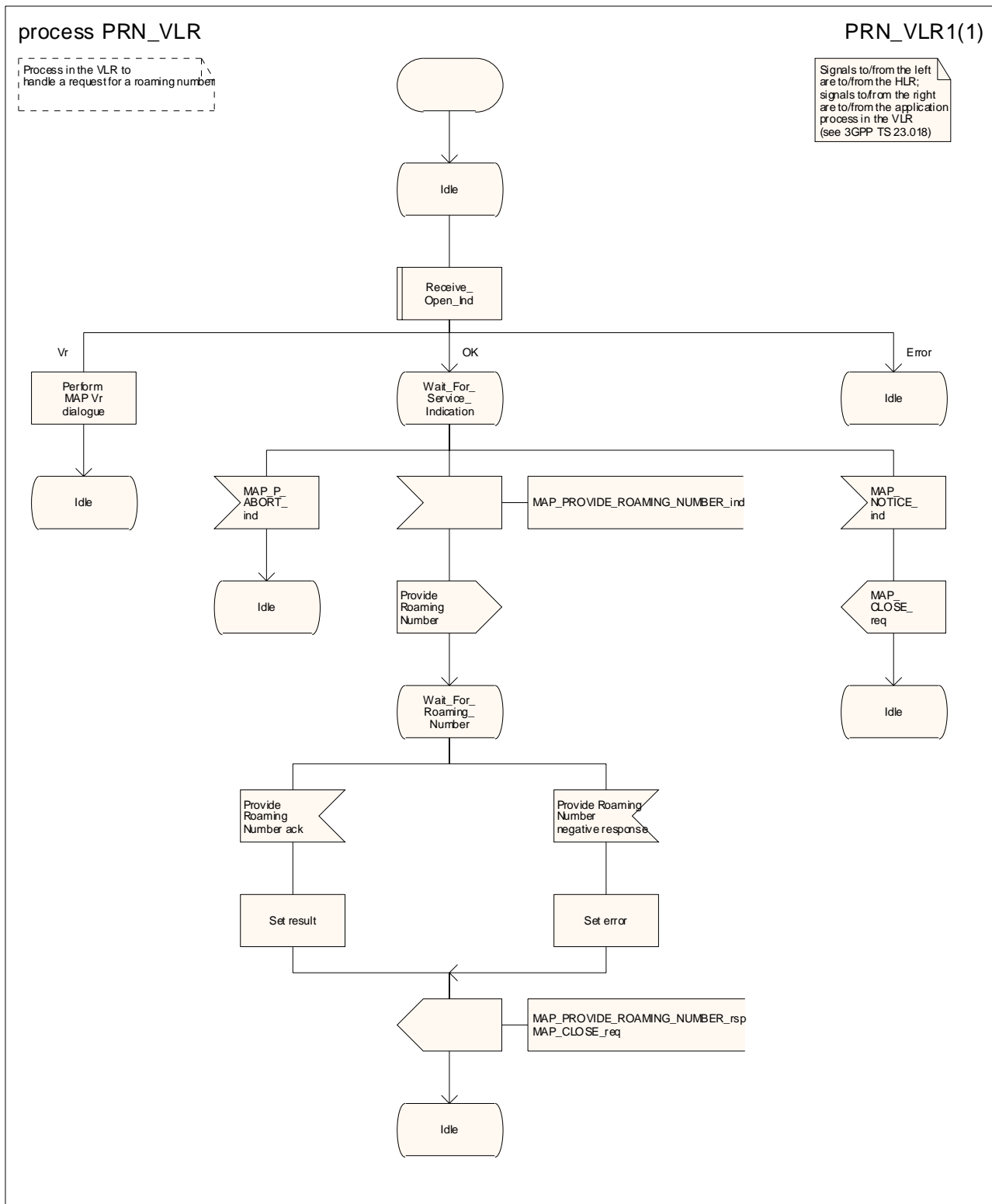

Figure 21.2/8: Process PRN_VLR

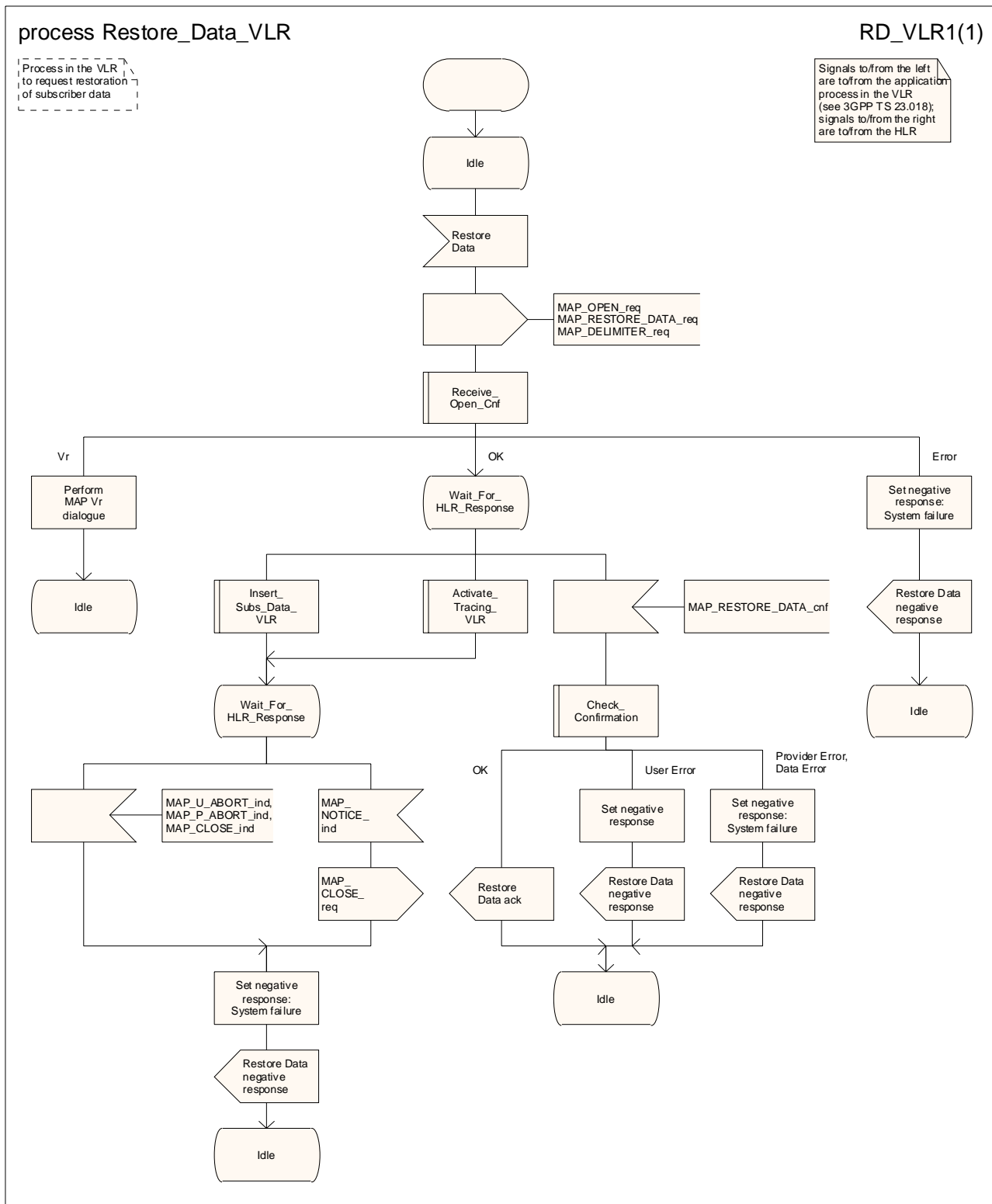

Figure 21.2/9: Process Restore_Data_VLR

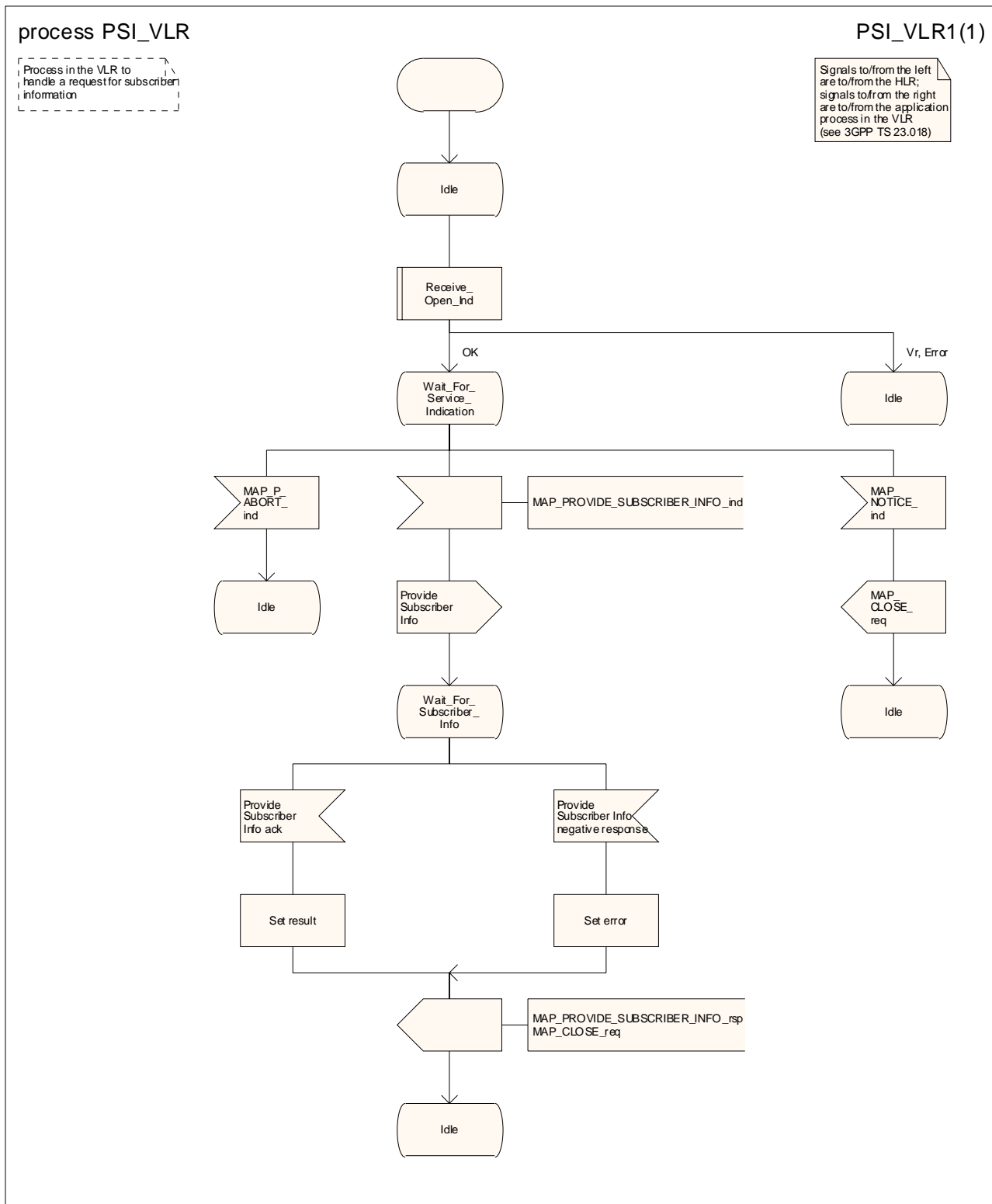
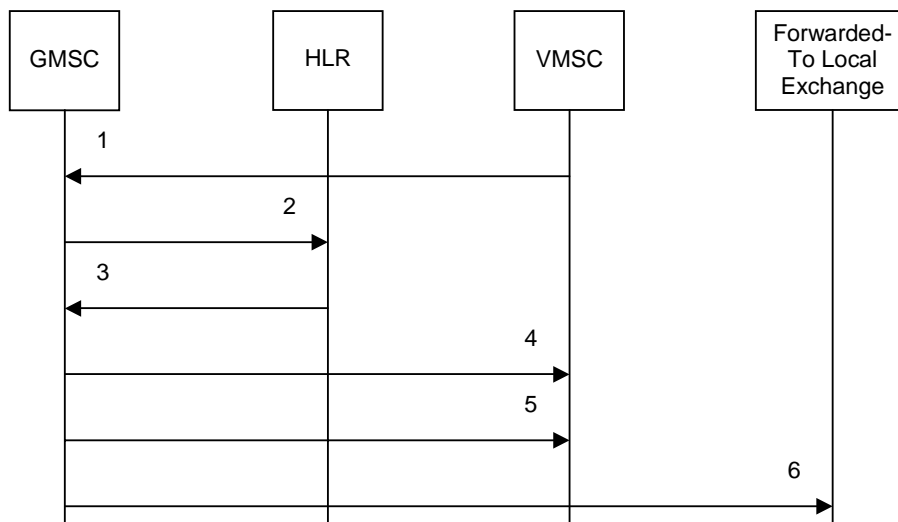

Figure 21.2/10: Process PSI_VLR

21.3 Transfer of call handling

21.3.1 General

The message flow for successful transfer of call handling to forward a call is shown in figure 21.3/1.



- 1) MAP_RESUME_CALL_HANDLING_req/ind
- 2) MAP_SEND_ROUTING_INFORMATION_req/ind (Note 2)
- 3) MAP_SEND_ROUTING_INFORMATION_rsp/cnf (Note 2)
- 4) MAP_RESUME_CALL_HANDLING_rsp/cnf
- 5) I_REL (Note 1)
- 6) I_IAM (Note 1)

NOTE: TUP or ISUP may be used in signalling between MSCs, depending on the network type between the MSCs. For further details on the TUP and ISUP procedures refer to the following ITU-T Recommendations & ETSI specification:

- Q.721-725 - Telephone User Part (TUP);
- ETS 300 356-1 - Integrated Services Digital Network (ISDN); Signalling System No.7; ISDN User Part (ISUP) version 2 for the international interface; Part 1: Basic services.

NOTE 2: Services printed in *italics* are optional.

Figure 21.3/1: Message flow for transfer of call handling

If the HLR indicated in the response to the original request for routing information that forwarding interrogation is required, the GMSC executes the Send Routing Information procedure with the HLR to obtain forwarding information; otherwise the GMSC uses the forwarding data which were sent in the MAP_RESUME_CALL_HANDLING req/ind.

21.3.2 Process in the VMSC

The MAP process in the VMSC to retrieve routing information for a mobile terminating call is shown in figure 21.3/2. The MAP process invokes macros not defined in this clause; the definitions of these macros can be found as follows:

- | | |
|--------------------|-----------------------|
| Receive_Open_Cnf | see subclause 25.1.2; |
| Check_Confirmation | see subclause 25.2.2. |

If the capacity of a message signal unit in the lower layers of the protocol is enough to carry all the information which has to be sent to the GMSC, the test "Segmentation needed?" takes the "No" exit; otherwise the test takes the "Yes" exit.

21.3.3 Process in the GMSC

The MAP process in the GMSC to handle a request for the GMSC to resume call handling is shown in figure 21.3/3. The MAP process invokes a macro not defined in this clause; the definition of this macro can be found as follows:

Receive_Open_Ind see subclause 25.1.1;

If the parameter All Information Sent was present in the MAP_RESUME_CALL_HANDLING indication, the test "All Information Sent" takes the "Yes" exit; otherwise the test takes the "No" exit.

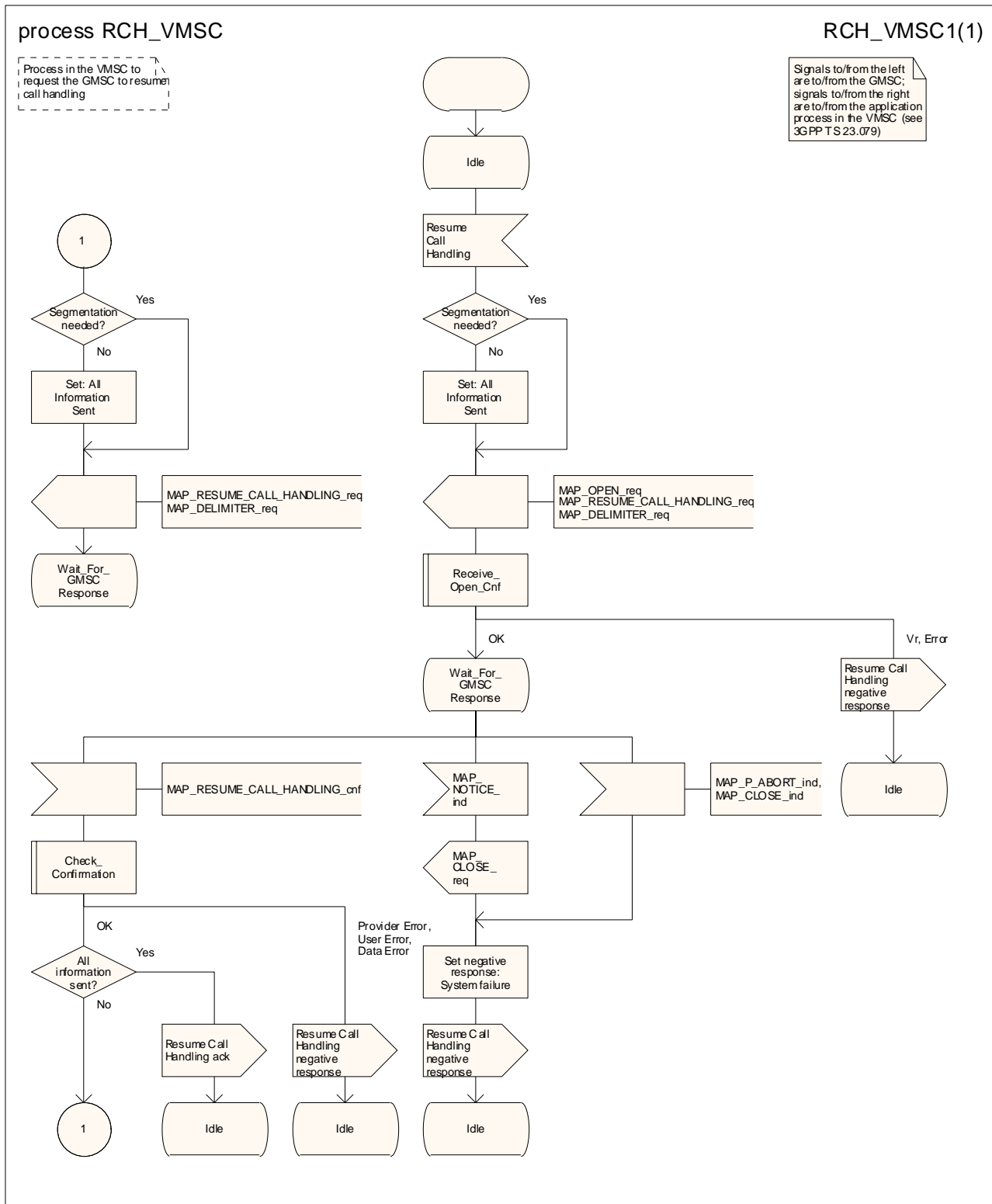

Figure 21.3/2: Process RCH_VMSC

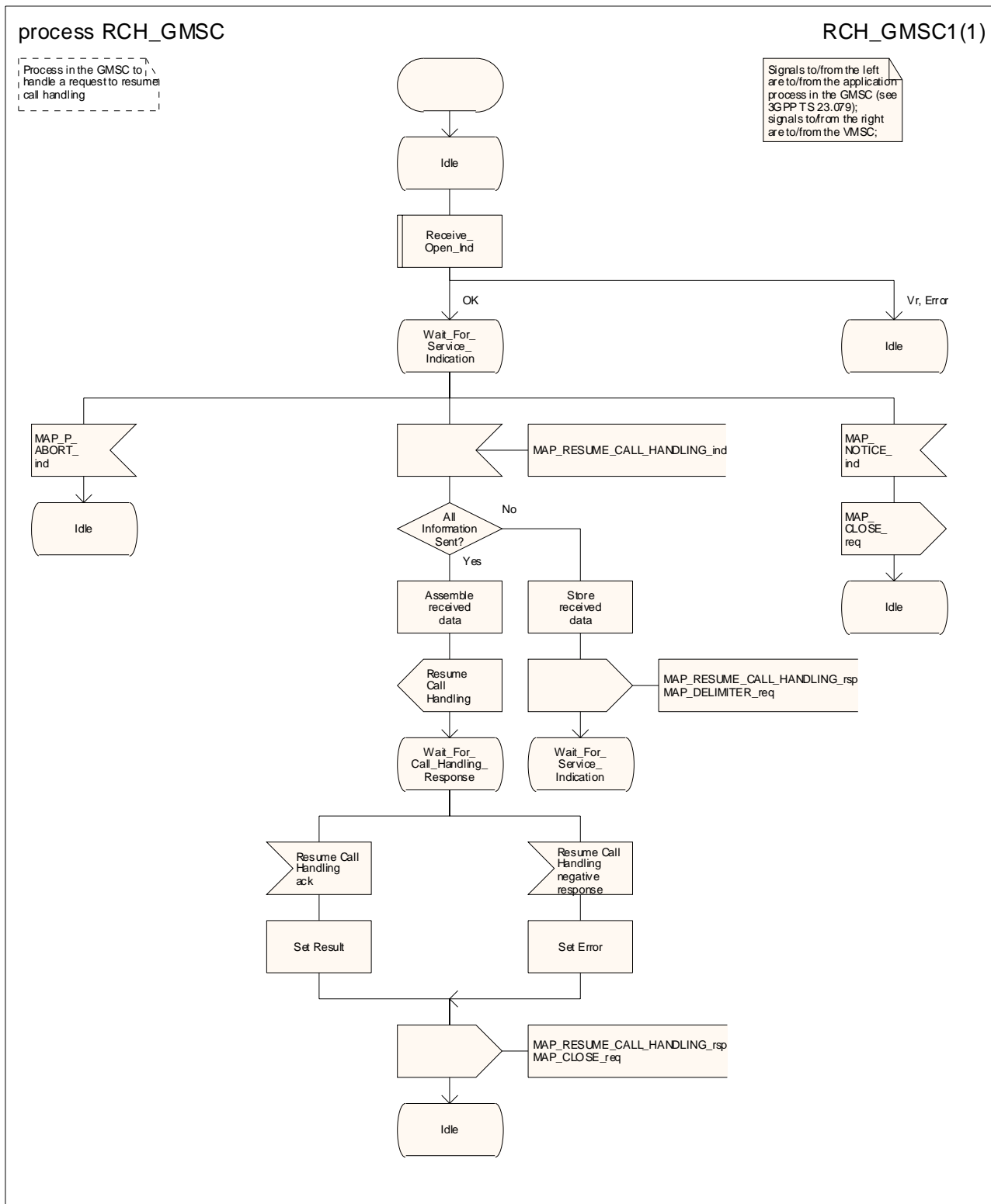
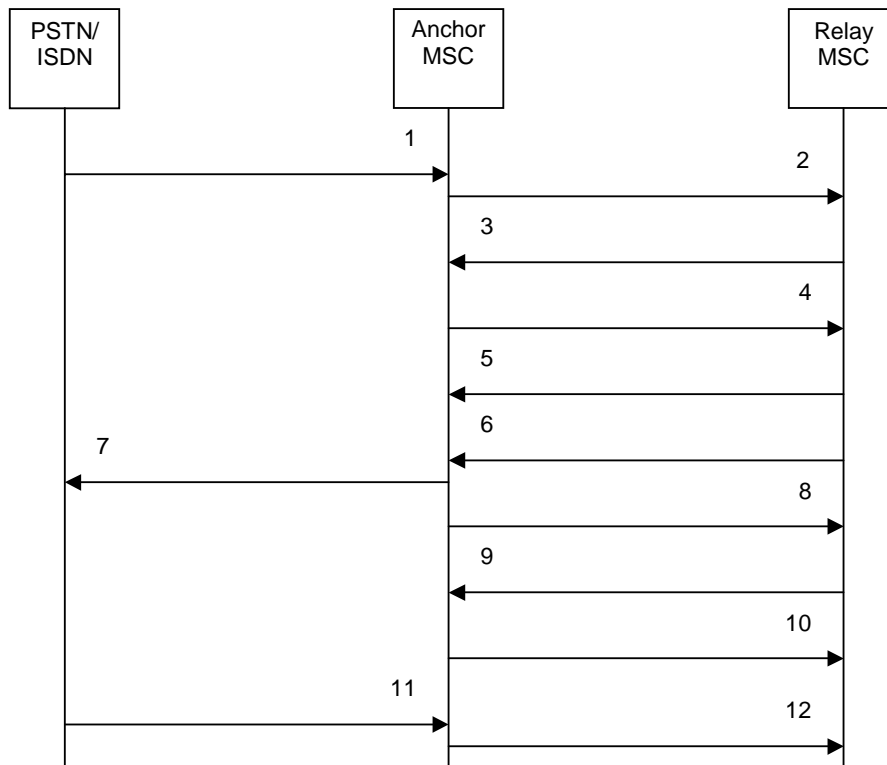

Figure 21.3/3: Process RCH_GMSC

21.4 Inter MSC Group Call Procedures

21.4.1 General

The message flows for successful inter MSC group call / broadcast call set-up is shown in figure 21.4/1.



- 1) I_IAM (Note 1)
- 2) MAP_PREPARE_GROUP_CALL_req/ind
- 3) MAP_PREPARE_GROUP_CALL_rsp/cnf
- 4) I_IAM (Note 1)
- 5) MAP_SEND_GROUP_CALL_END_SIGNAL_req/ind
- 6) I_ACM (Note 1)
- 7) I_ACM (Note 1)
- 8) MAP_FORWARD_GROUP_CALL_SIGNALLING_req/ind (Note 2)
- 9) MAP_PROCESS_GROUP_CALL_SIGNALLING_req/ind (Note 2)
- 10) MAP_SEND_GROUP_CALL_END_SIGNAL_rsp/cnf
- 11) I_REL (Note 3)
- 12) I_REL (Note 3)

NOTE 1: TUP or ISUP may be used in signalling between MSCs, depending on the network type between the MSCs. For further details on the TUP and ISUP procedures refer to the following ITU-T Recommendations and ETSI specification:

- Q.721-725 - Telephone User Part (TUP);
- ETS 300 356-1 - Integrated Services Digital Network (ISDN); Signalling System No.7; ISDN User Part (ISUP) version 2 for the international interface; Part 1: Basic services.

NOTE 2: The MAP_FORWARD_GROUP_CALL_SIGNALLING and MAP_PROCESS_GROUP_CALL_SIGNALLING services are not applicable for voice broadcast calls.

NOTE 3: The call can be released from the PSTN/ISDN or the Relay MSC

Figure 21.4/1: Message flow for inter MSC group call/broadcast call

21.4.2 Process in the Anchor MSC

The MAP process in the Anchor MSC to retrieve and transfer information from / to the Relay MSC for VBS and VGCS calls is shown in figure 21.4/2. The MAP process invokes macros not defined in this clause; the definitions of these macros can be found as follows:

Receive_Open_Cnf	see subclause 25.1.2;
Check_Indication	see subclause 25.2.1;
Check_Confirmation	see subclause 25.2.2.

21.4.3 Process in the Relay MSC

The MAP process in the Relay MSC to receive and transfer information from / to the Anchor MSC for VBS and VGCS calls is shown in figure 21.4/3. The MAP process invokes macros not defined in this clause; the definitions of these macros can be found as follows:

Receive_Open_Ind	see subclause 25.1.2;
Check_Indication	see subclause 25.2.1.

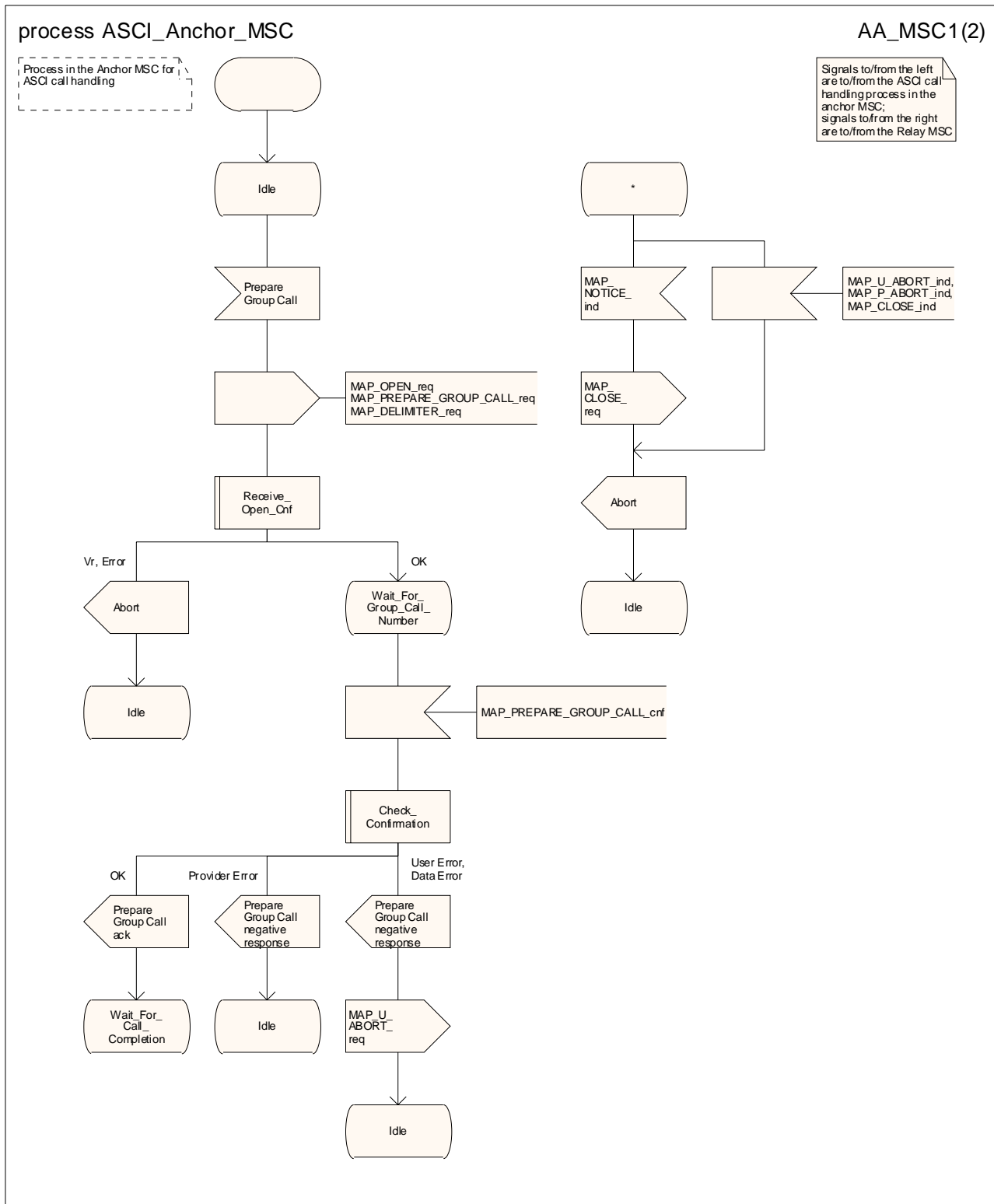

Figure 21.4/2 (sheet 1 of 2): Process ASCI_Anchor_MSC

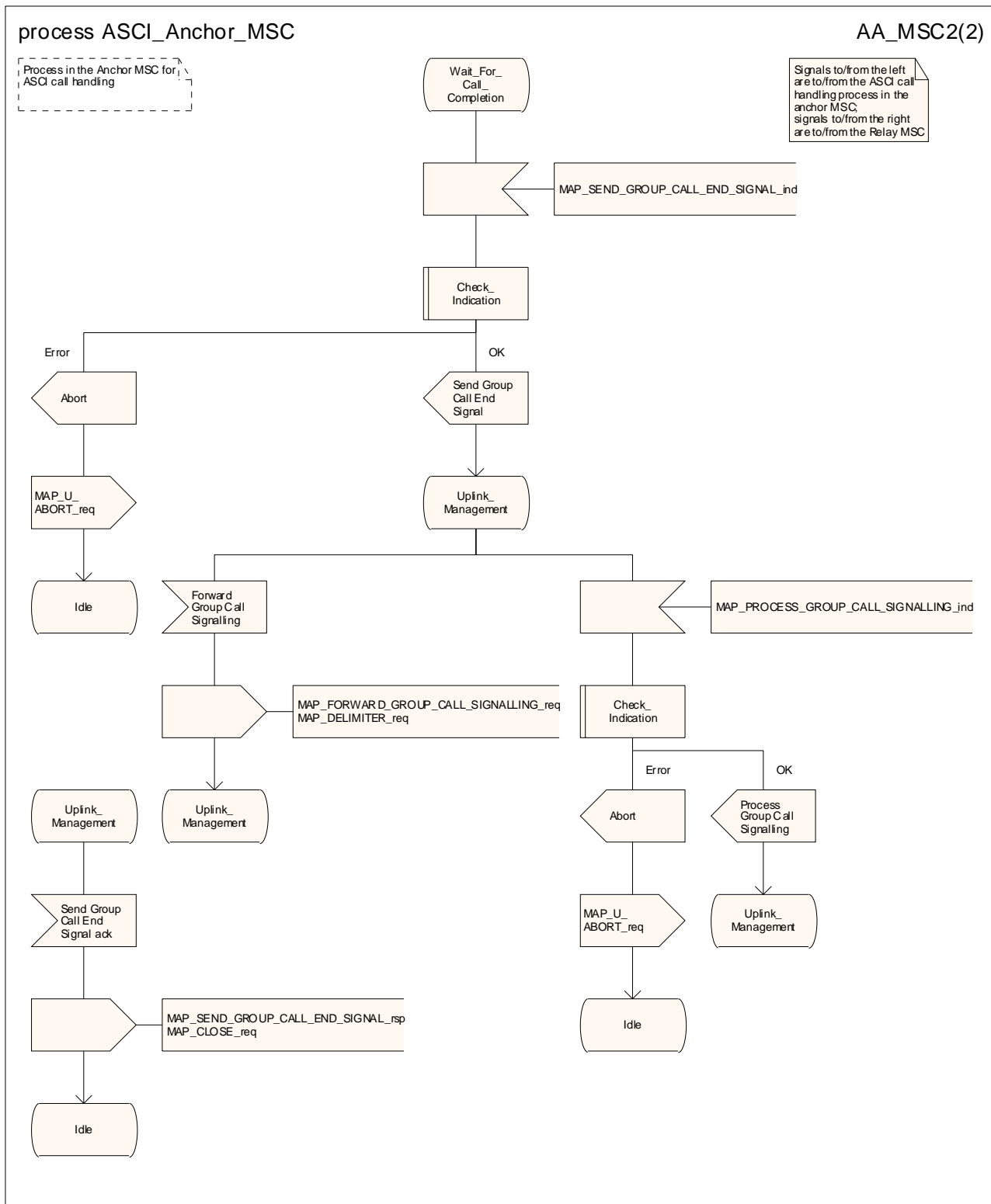

Figure 21.4/2 (sheet 2 of 2): Process ASCI_Anchor_MSC

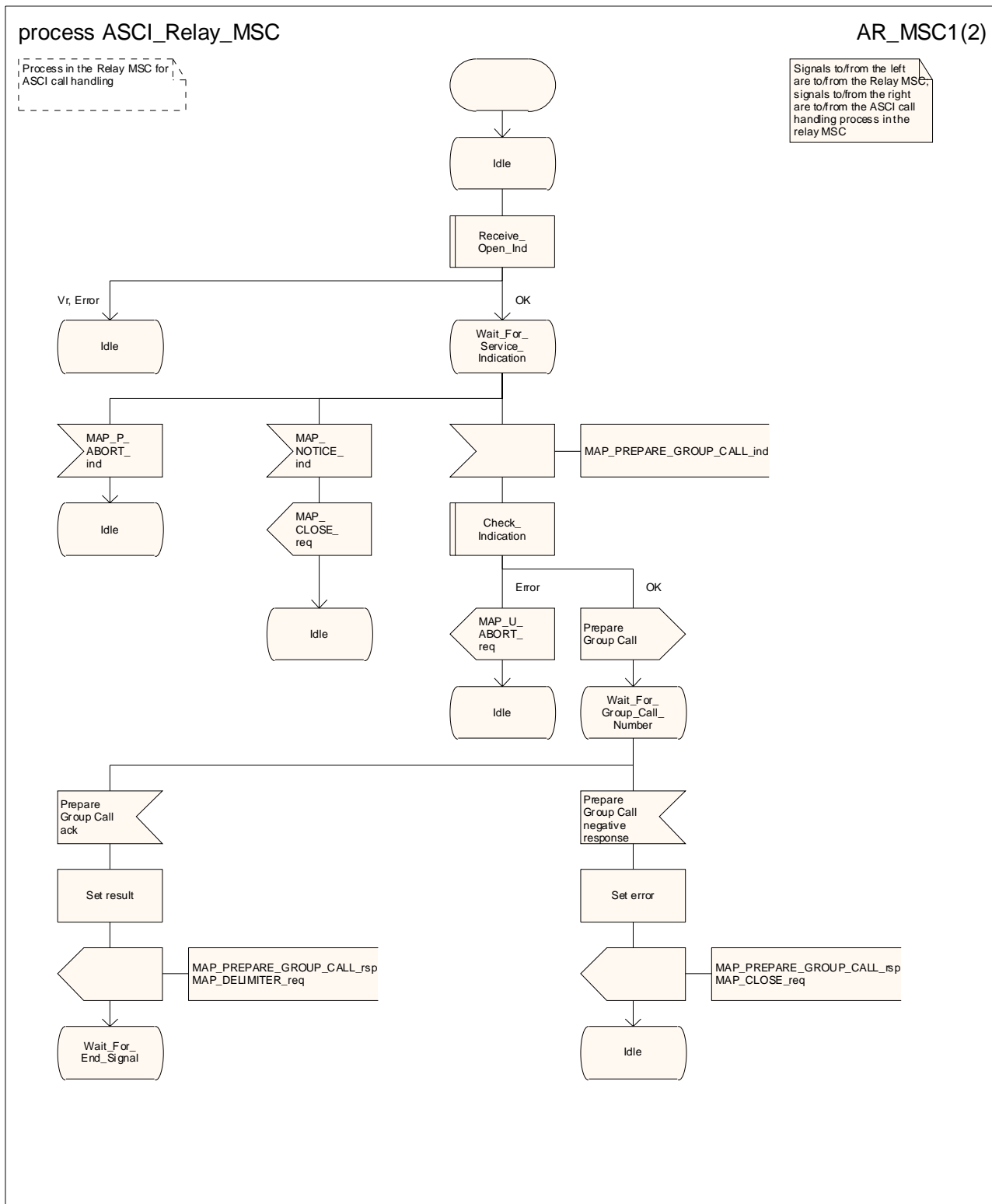

Figure 21.4/3 (sheet 1 of 2): Process ASCII_Relay_MSC

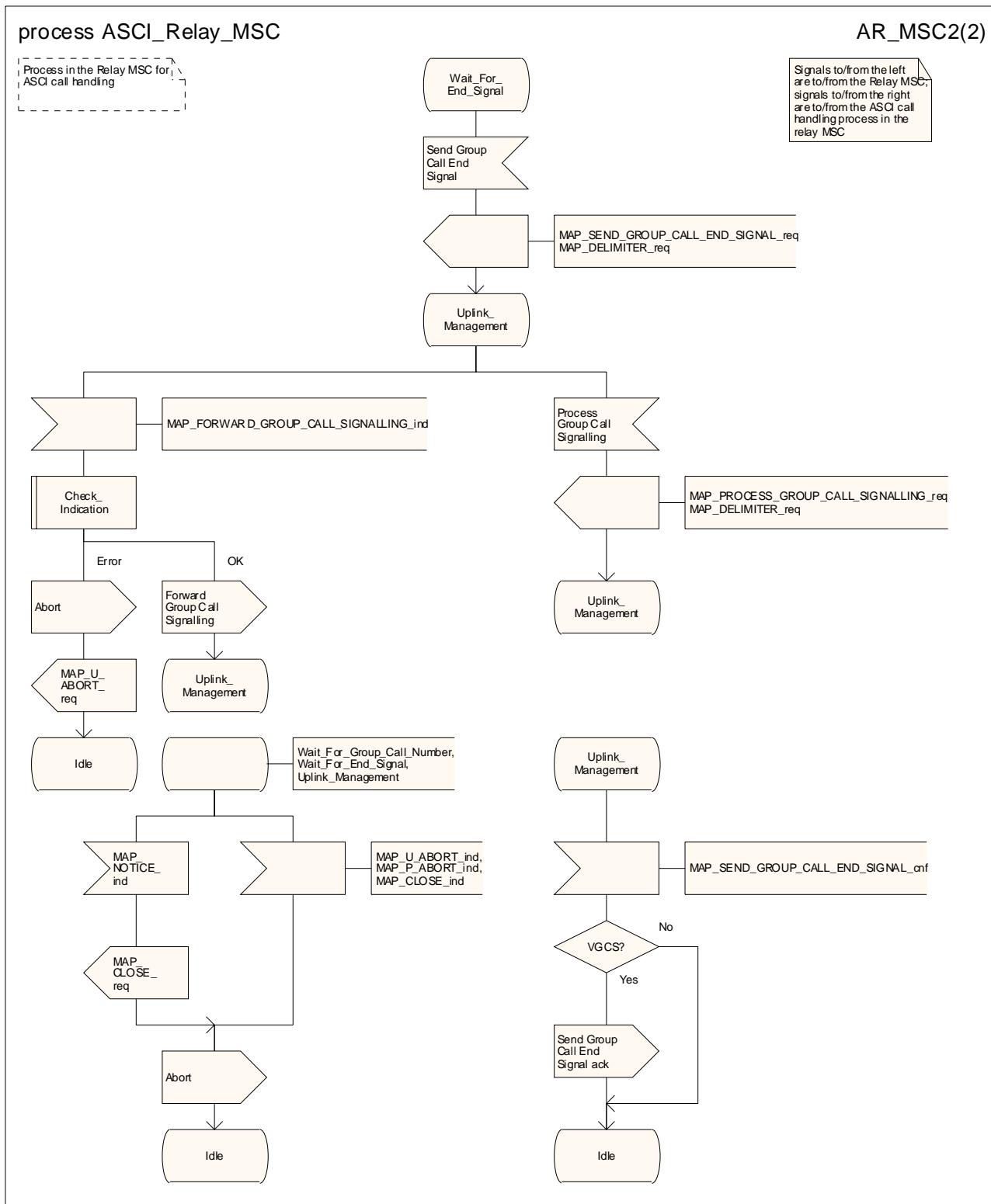

Figure 21.4/3 (sheet 2 of 2): Process ASCI_Relay_MSC

21.5 Void

21.6 CCBS: monitoring and reporting the status of the subscriber

21.6.1 Reporting co-ordinator process in the VLR

The MAP co-ordinating process in the VLR to handle a dialogue opened with the reporting application context is shown in figure 21.6/6. The MAP process invokes a macro not defined in this clause; the definition of this macro can be found as follows:

Receive_Open_Ind see clause 25.1.1.

21.6.2 Setting the reporting state – stand-alone

The message flow for setting the reporting state in a stand-alone dialogue is shown in figure 21.6/1.

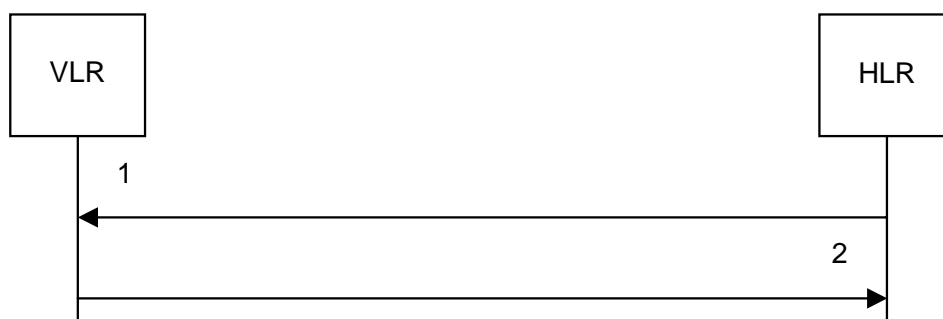

- 1) MAP_SET_REPORTING_STATE_req/ind
- 2) MAP_SET_REPORTING_STATE_rsp/cnf

Figure 21.6/1: Message Flow for Setting the Reporting State

The MAP_SET_REPORTING_STATE request can be used to start or stop monitoring in the VLR.

21.6.2.1 Process in the HLR

The MAP process in the HLR to set the reporting state in the VLR in a stand-alone dialogue is shown in figure 21.6/7. The MAP process invokes macros not defined in this clause; the definitions of these macros can be found as follows:

Receive_Open_Cnf see subclause 25.1.2;

Check_Confirmation see subclause 25.2.2.

The result of a request to stop reporting is not reported to the CCBS application in the HLR.

21.6.2.2 Process in the VLR

The MAP process in the VLR to set the reporting state is shown in figure 21.6/8.

The macro Set_Reporting_State_VLR is shown in figure 21.6/9.

The MAP process does not wait for a response from the CCBS application process if the required reporting state is Stop.

21.6.3 Status Reporting

The message flows for reporting the status of a subscriber are shown in figures 21.6/2 and 21.6/3.

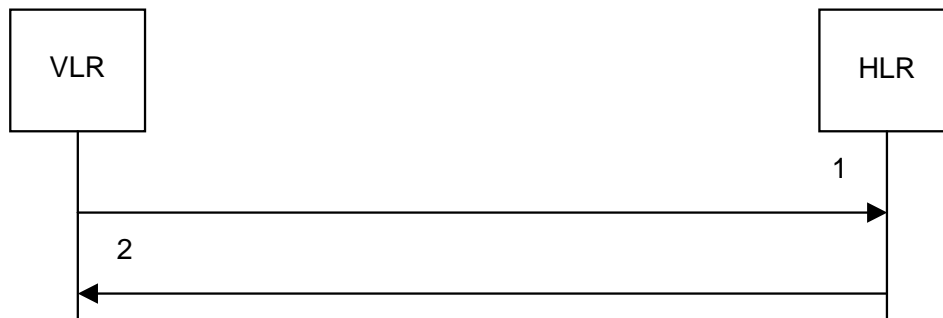

- 1) MAP_STATUS_REPORT_req/ind
- 2) MAP_STATUS_REPORT_rsp/cnf

Figure 21.6/2: Message flow for status reporting, when monitoring continues in the VLR

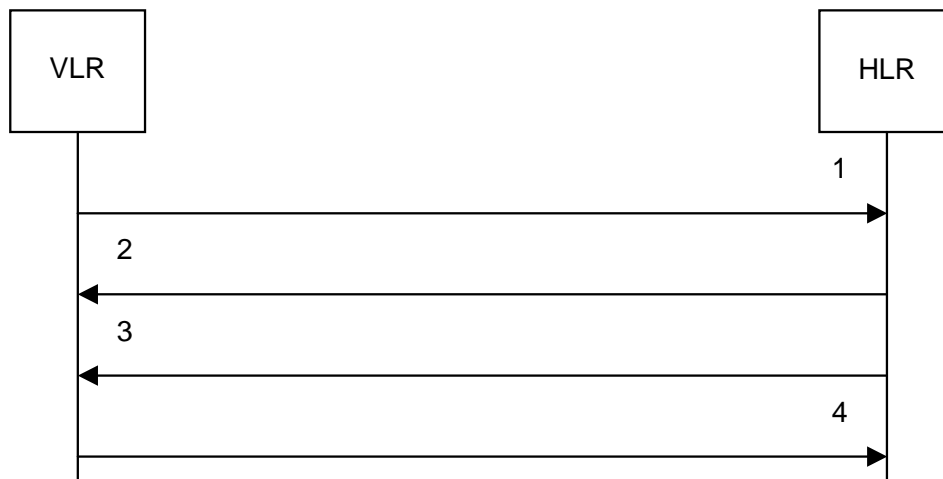

- 1) MAP_STATUS_REPORT_req/ind
- 2) MAP_STATUS_REPORT_rsp/cnf
- 3) MAP_SET_REPORTING_STATE_req/ind
- 4) MAP_SET_REPORTING_STATE_rsp/cnf

Figure 21.6/3: Message flow for status reporting, when monitoring stops

The MAP_SET_REPORTING_STATE request is used to stop monitoring in the VLR. If the HLR requires the VLR to continue monitoring, it closes the dialogue without sending a MAP_SET_REPORTING_STATE request.

21.6.3.1 Process in the VLR

The MAP process in the VLR to send a status report to the HLR is shown in figure 21.6/10. The MAP process invokes macros not defined in this clause; the definitions of these macros can be found as follows:

- Receive_Open_Cnf see subclause 25.1.2;
- Check_Confirmation see subclause 25.2.2.

This process can be used to report:

- an event, such as the user becoming free, or
- the result of a CCBS call attempt

to the HLR

21.6.3.2 Process in the HLR

The MAP process in the HLR to handle a status report is shown in figure 21.6/11. The MAP process invokes a macro not defined in this clause; the definition of this macros can be found as follows:

Receive_Open_Ind see subclause 25.1.1;

It is an implementation option whether to send the MAP_DELIMITER request before invoking the macro Set_Reporting_State_HLR.

The macro Receive_Status_Report_HLR is shown in figure 21.6/12.

The macro Set_Reporting_State_HLR is shown in figure 21.6/13. The macro invokes a macro not defined in this clause; the definition of this macro can be found as follows:

Check_Confirmation see subclause 25.2.2.

21.6.3 Remote User Free

The message flows for handling remote user free are shown in figures 21.6/4 and 21.6/5.

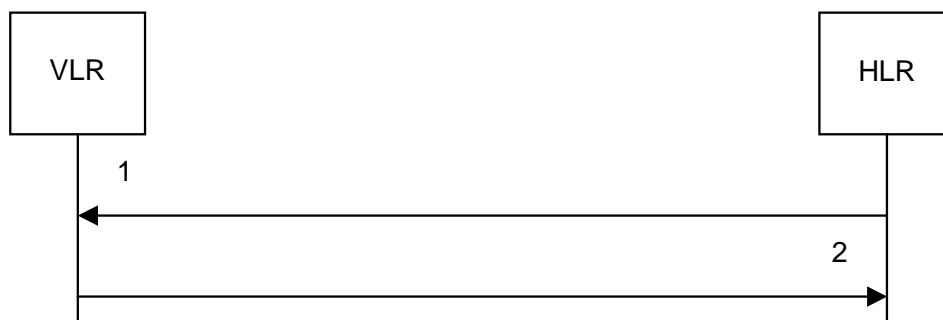

- 1) MAP_REMOTE_USER_FREE_req/ind
- 2) MAP_REMOTE_USER_FREE_rsp/cnf

Figure 21.6/48/1: Message flow for Remote User Free: recall not accepted



- 1) MAP_REMOTE_USER_FREE_req/ind
- 2) MAP_REMOTE_USER_FREE_rsp/cnf
- 3) MAP_STATUS_REPORT_req/ind
- 4) MAP_STATUS_REPORT_rsp/cnf

Figure 21.6/5: Message flow for Remote User Free: recall accepted

21.6.3.1 Process in the HLR

The MAP process in the HLR to handle Remote User Free is shown in figure 21.6/14. The MAP process invokes macros not defined in this clause; the definitions of these macros can be found as follows:

Receive_Open_Cnf see subclause 25.1.2;

Check_Confirmation see subclause 25.2.2.

21.6.3.2 Process in the VLR

The MAP process in the VLR to handle Remote User Free is shown in figure 21.6/15. The MAP process invokes a macro not defined in this clause; the definitions of this macro can be found as follows:

Check_Confirmation see subclause 25.2.2.

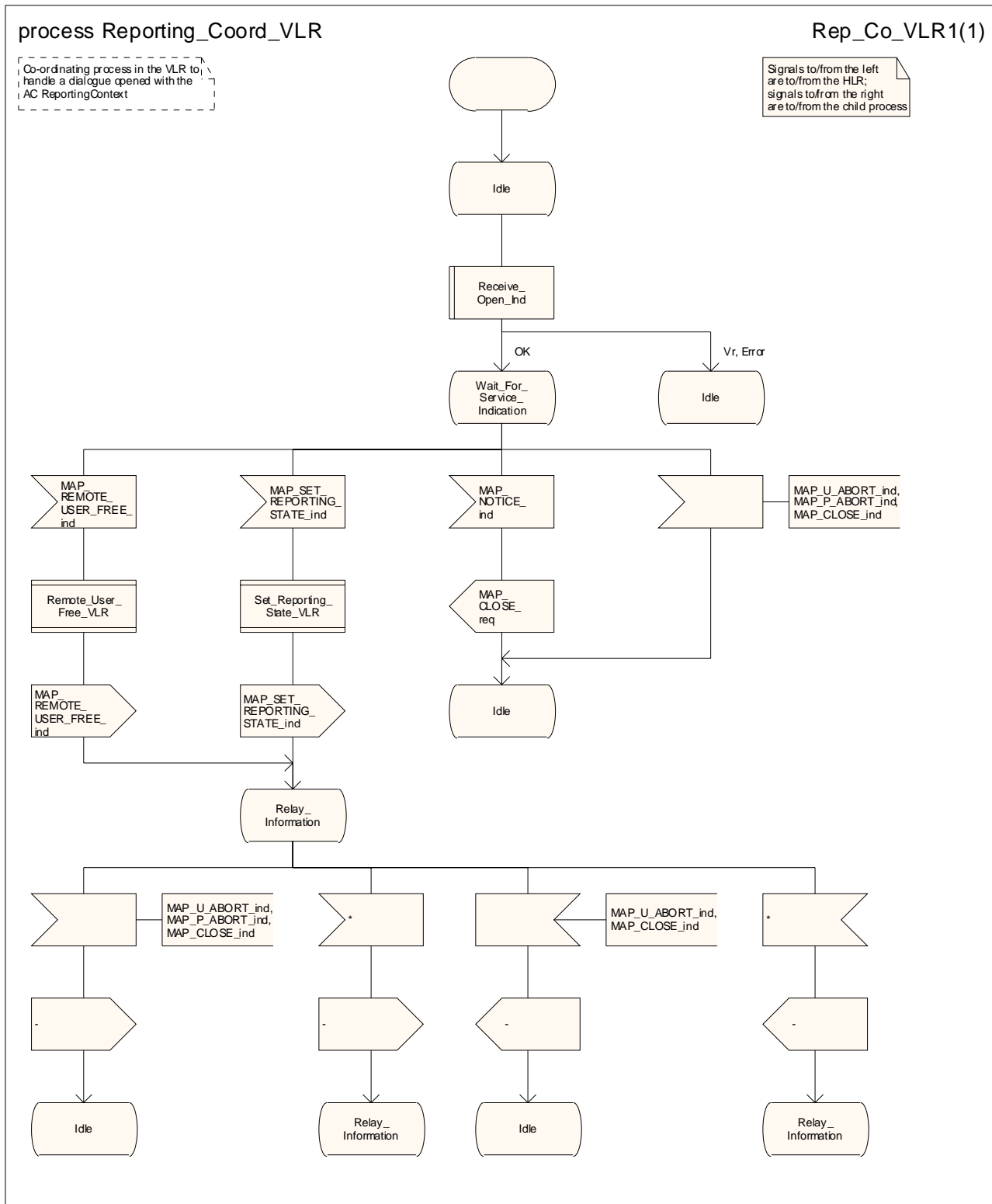

Figure 21.6/6: Process Reporting_Coord_VLR

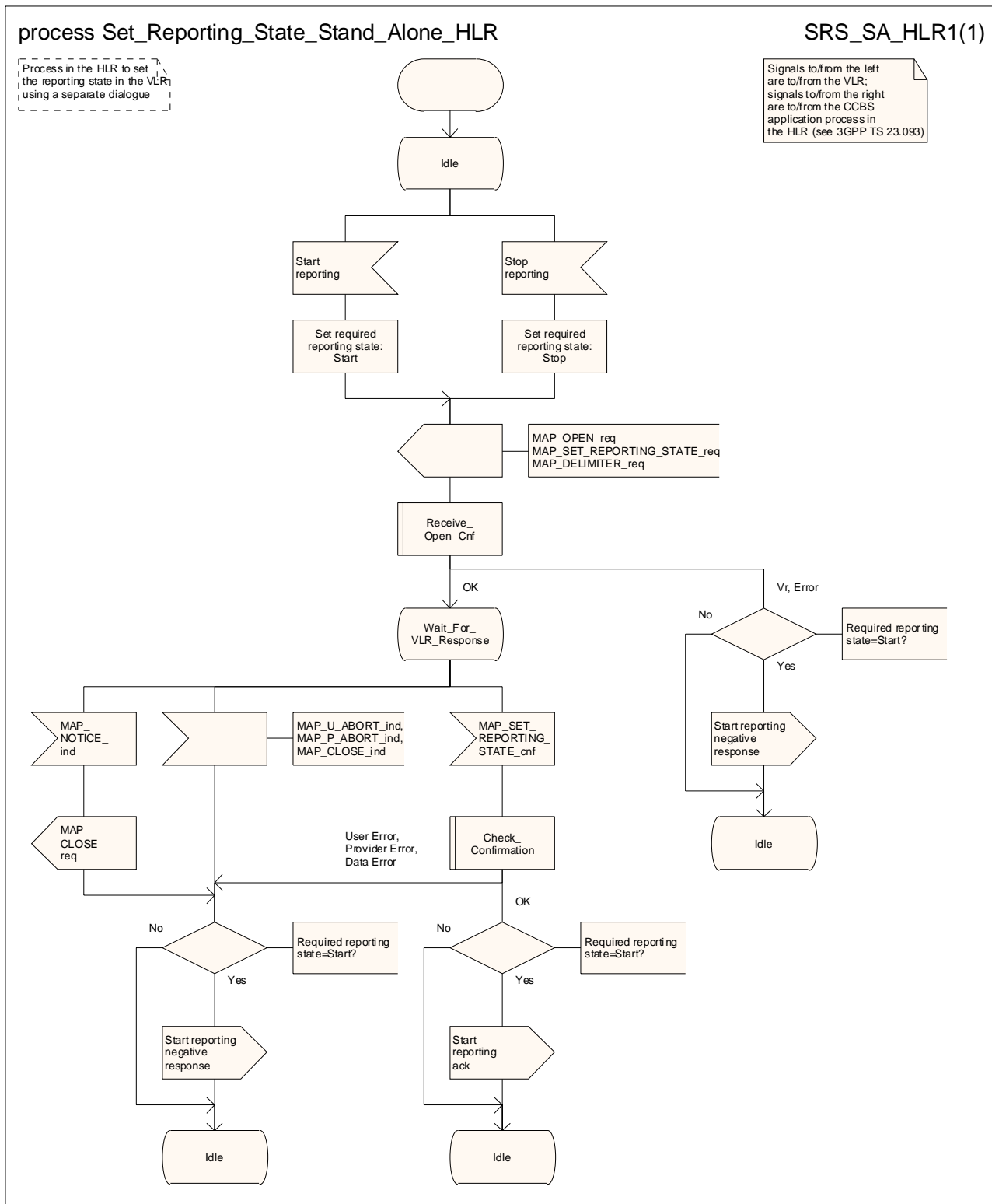

Figure 21.6/7: Process Set_Reporting_State_Stand_Alone_HLR

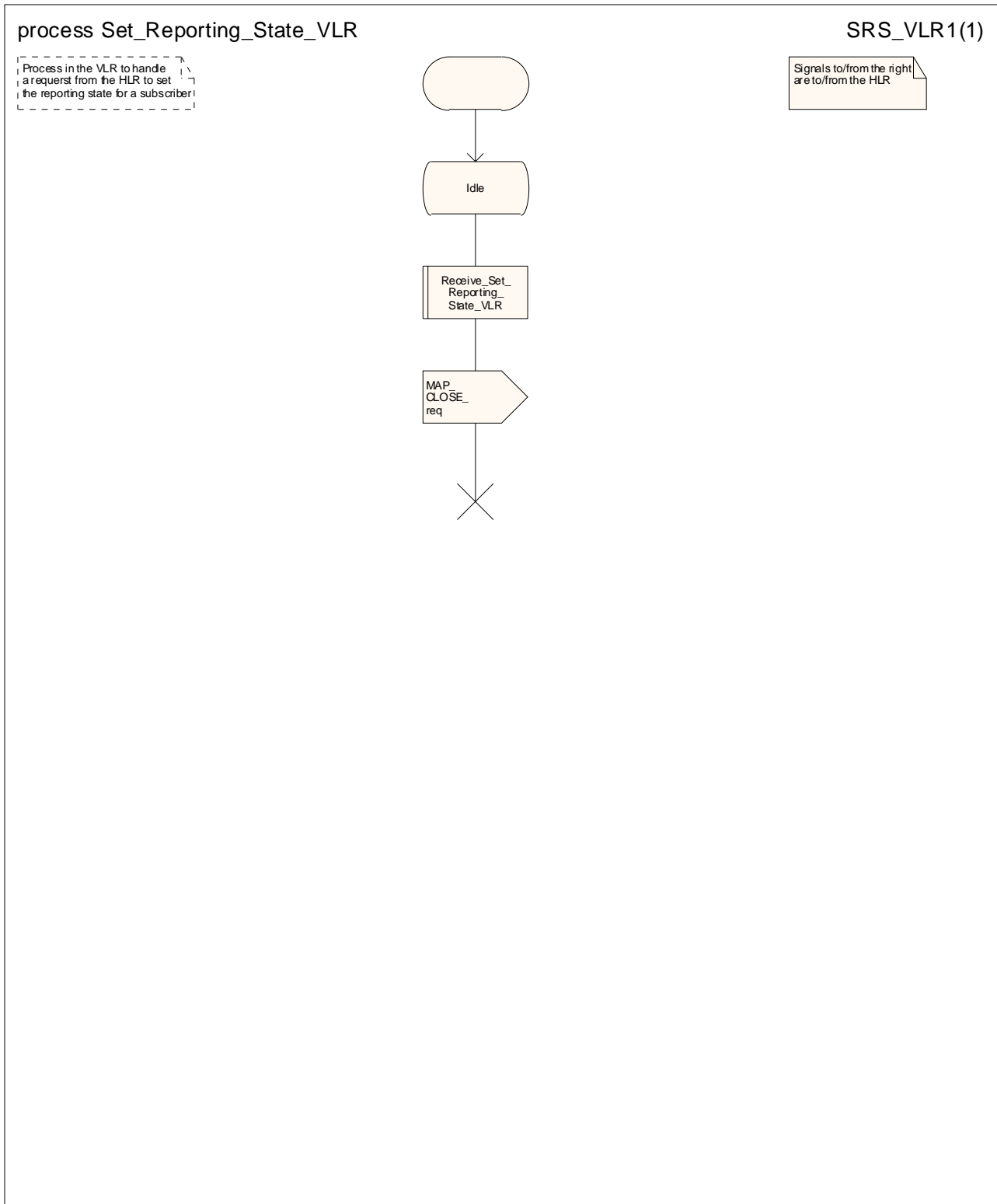

Figure 21.6/8: Process Set_Reporting_State_VLR

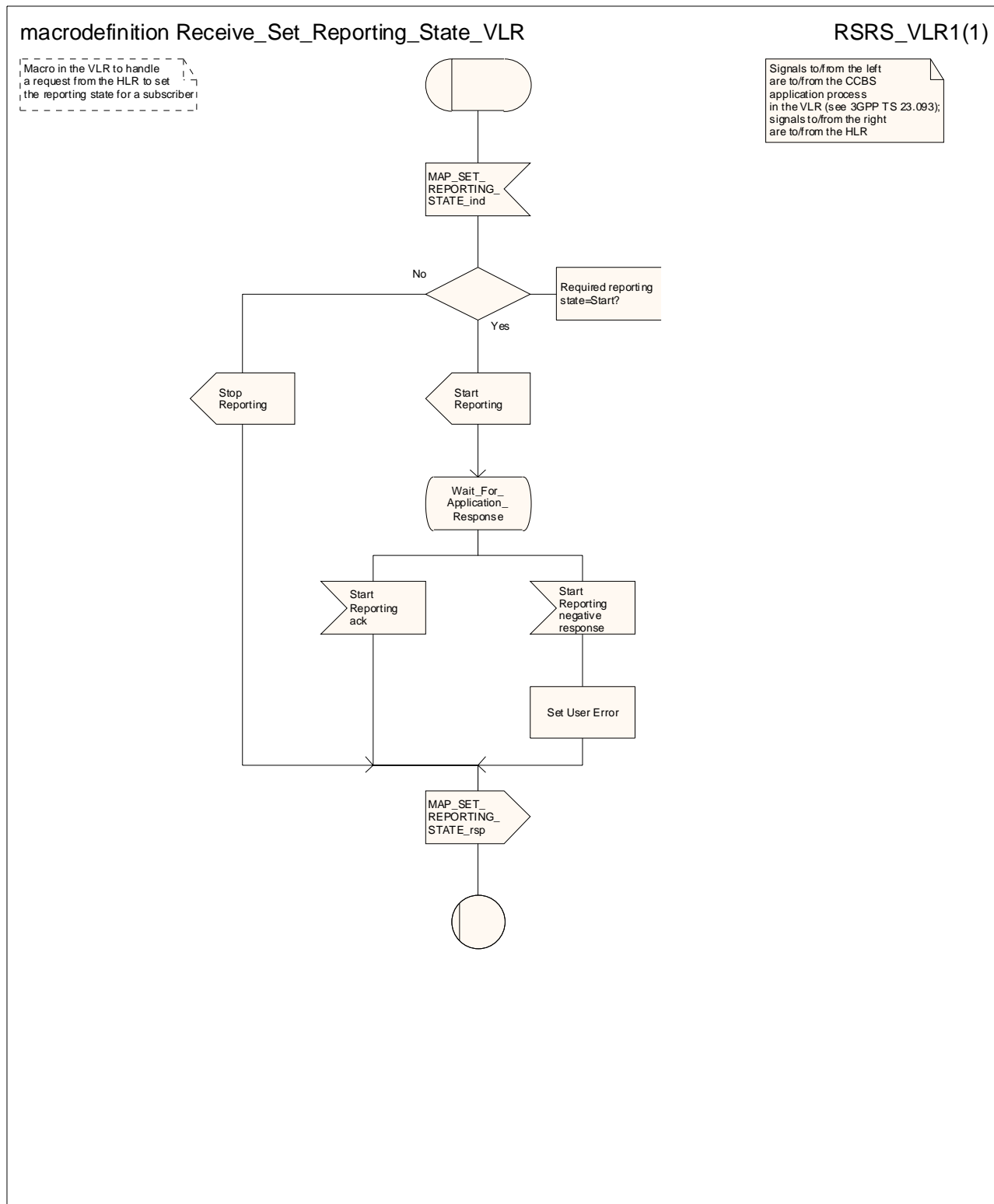

Figure 21.6/9: Macro Receive_Set_Reporting_State_VLR

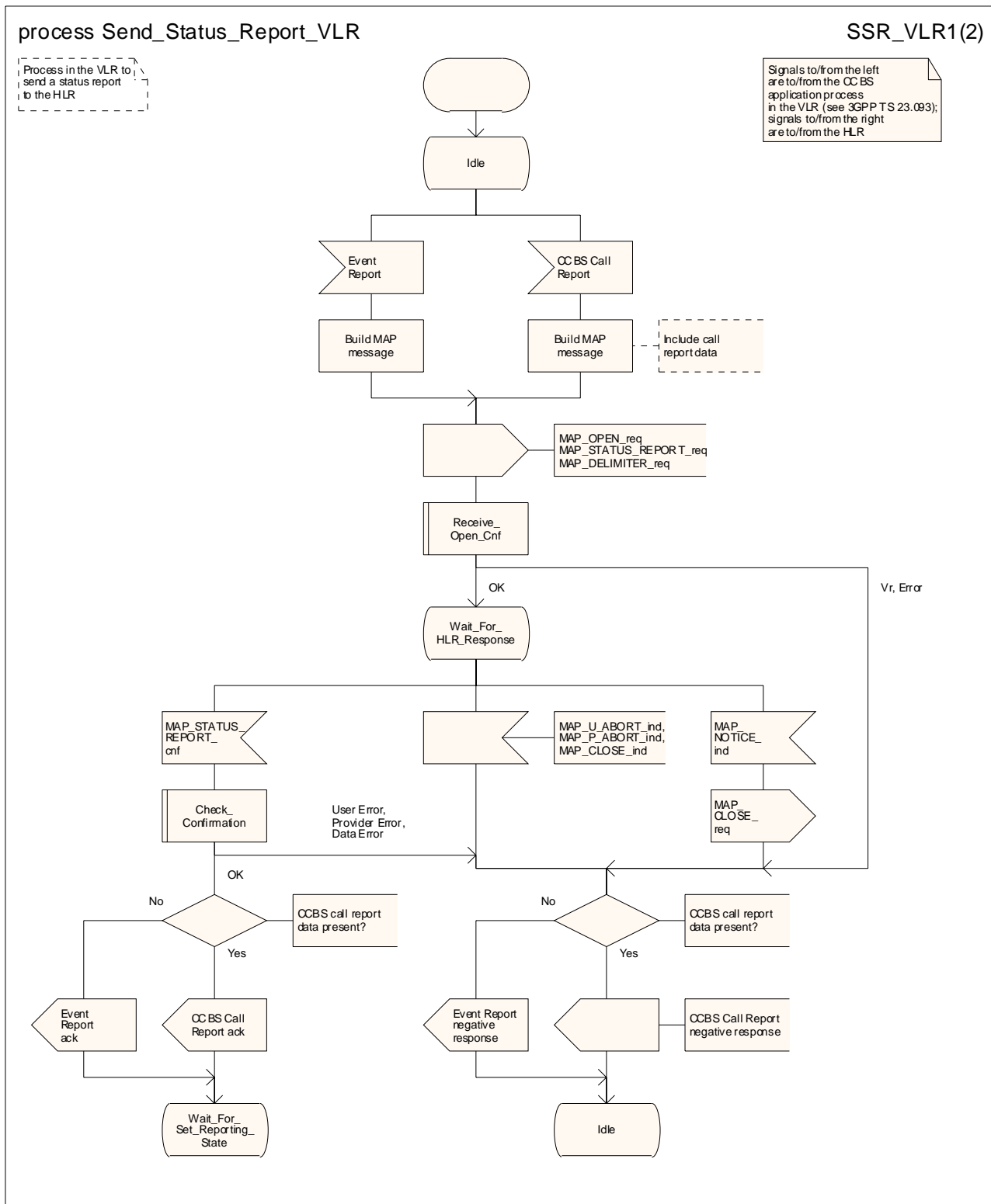

Figure 21.6/10 (sheet 1 of 2): Process Send_Status_Report_VLR

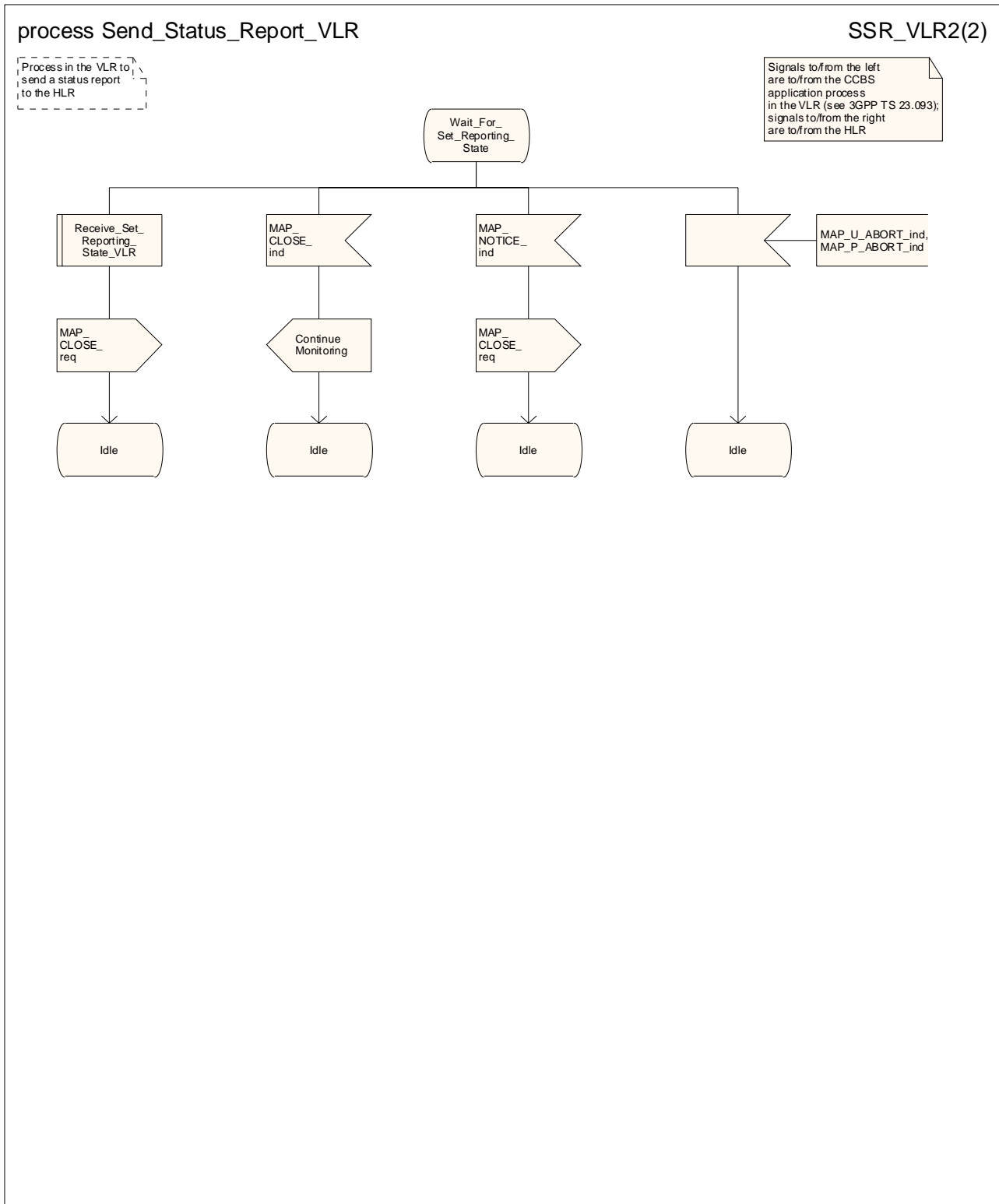

Figure 21.6/10 (sheet 2 of 2): Process Send_Status_Report_VLR

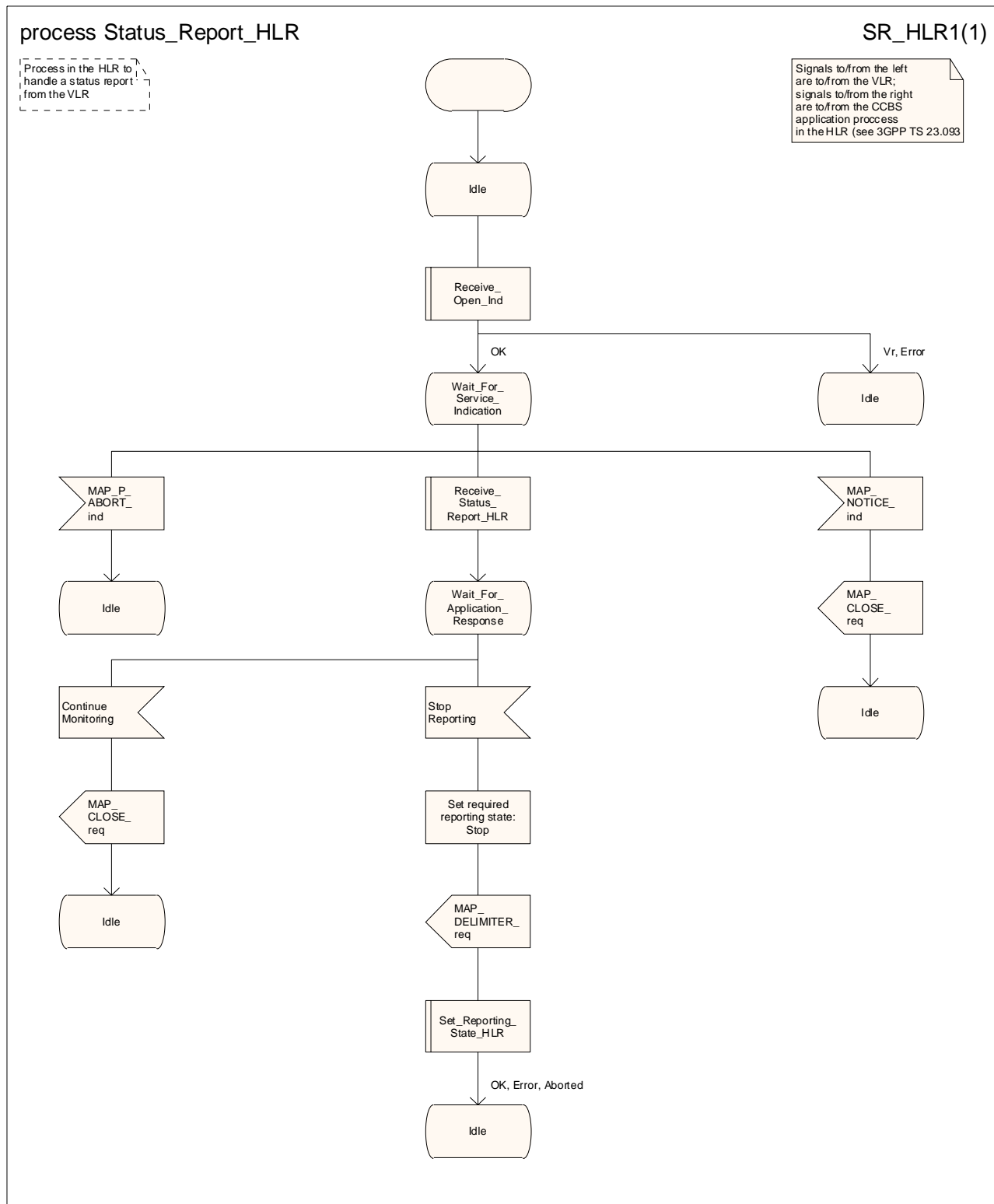

Figure 21.6/11: Process Status Report_HLR

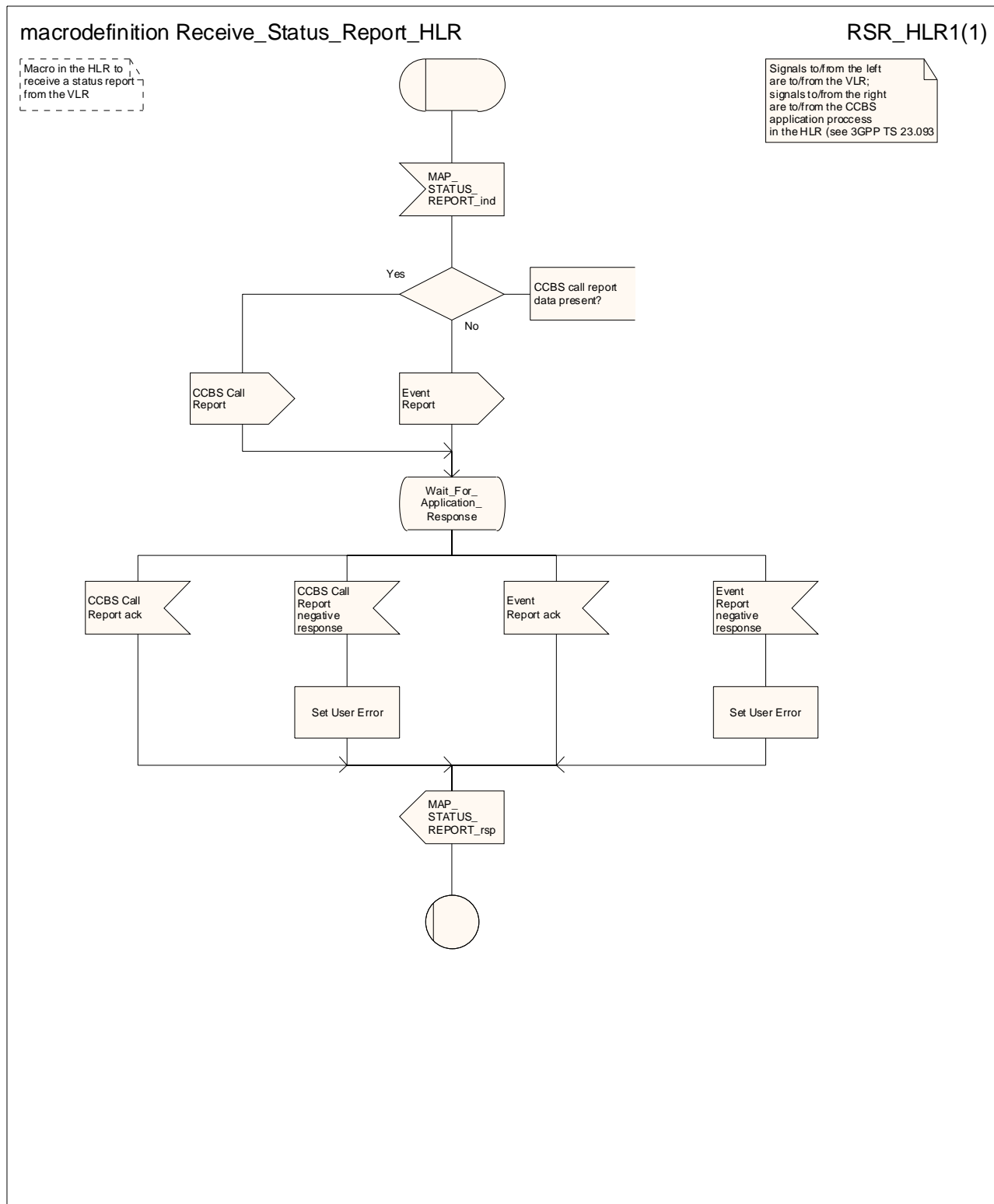

Figure 21.6/12: Macro Receive_Status_Report_HLR

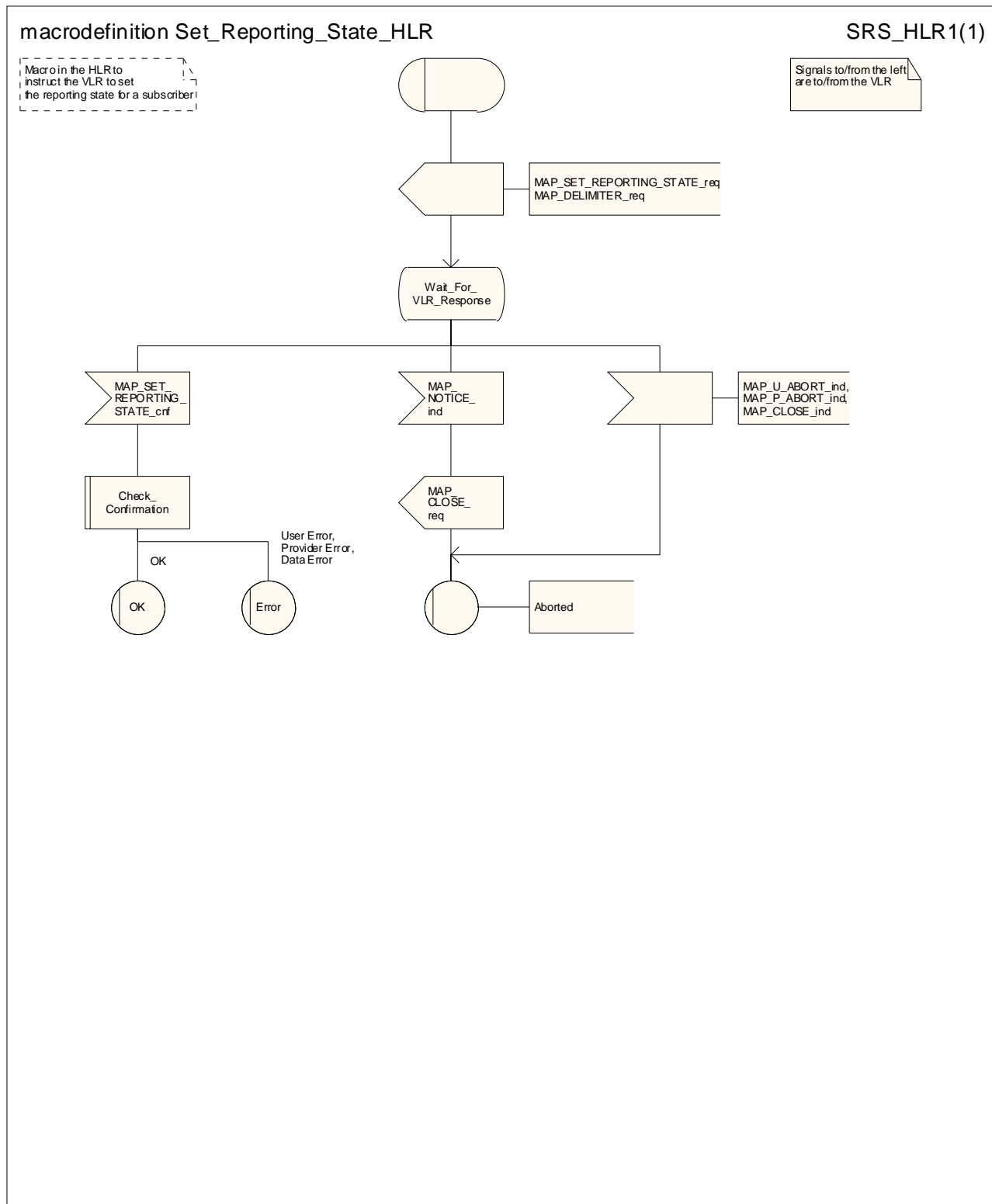

Figure 21.6/13: Macro Set_Reporting_State_HLR

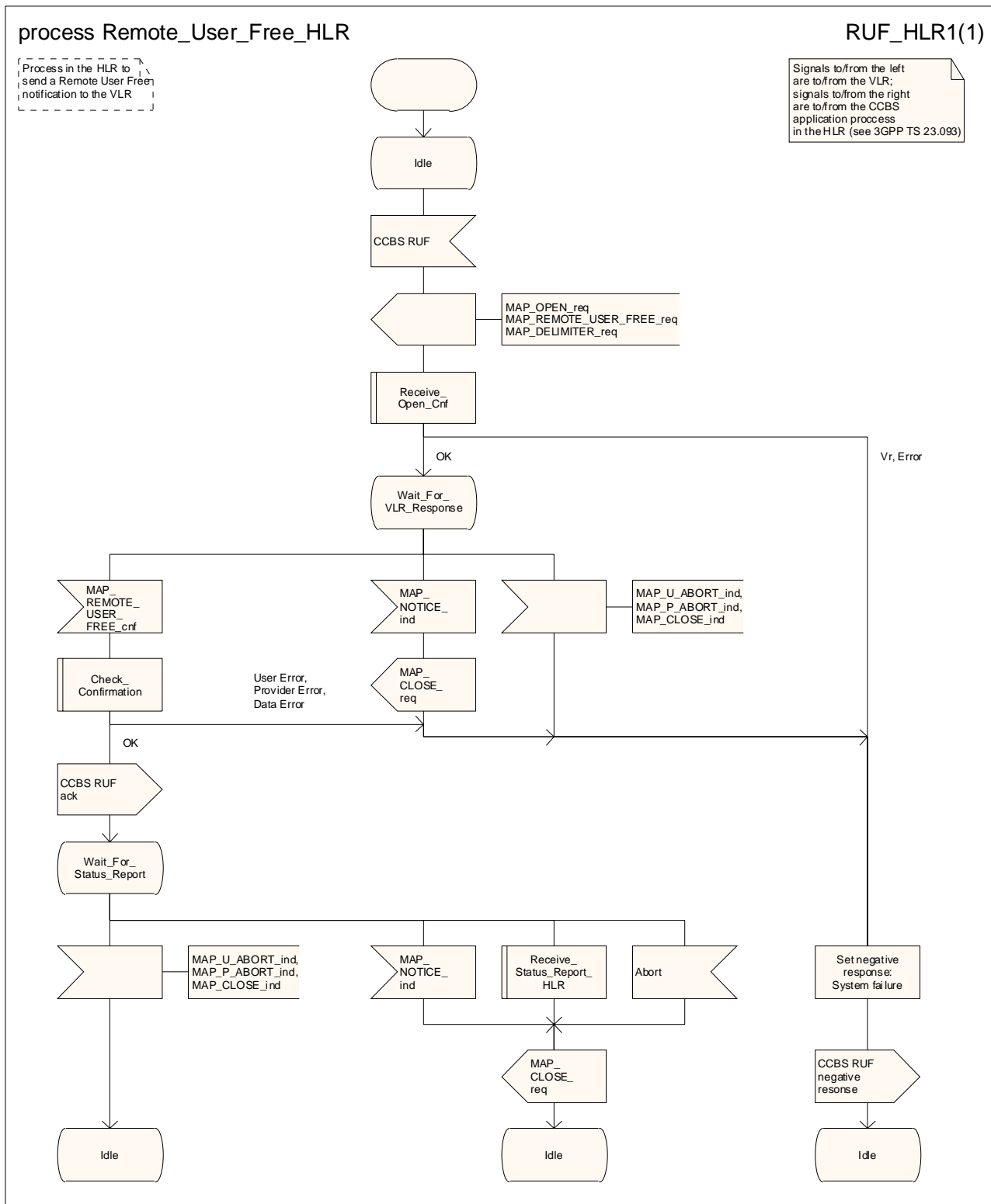

Figure 21.6/14: Process Remote_User_Free_HLR

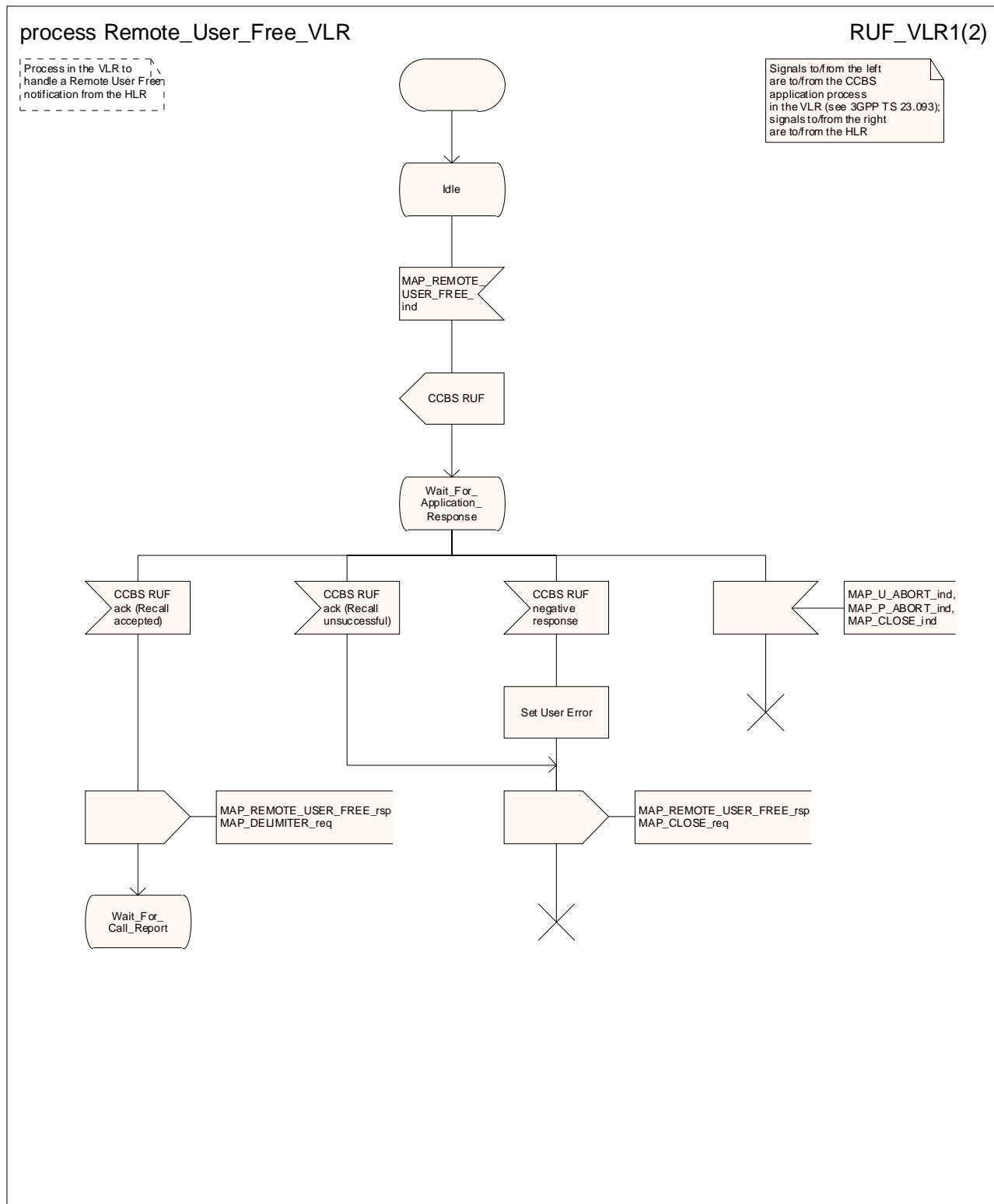

Figure 21.6/15 (sheet 1 of 2): Process Remote_User_Free_VLR

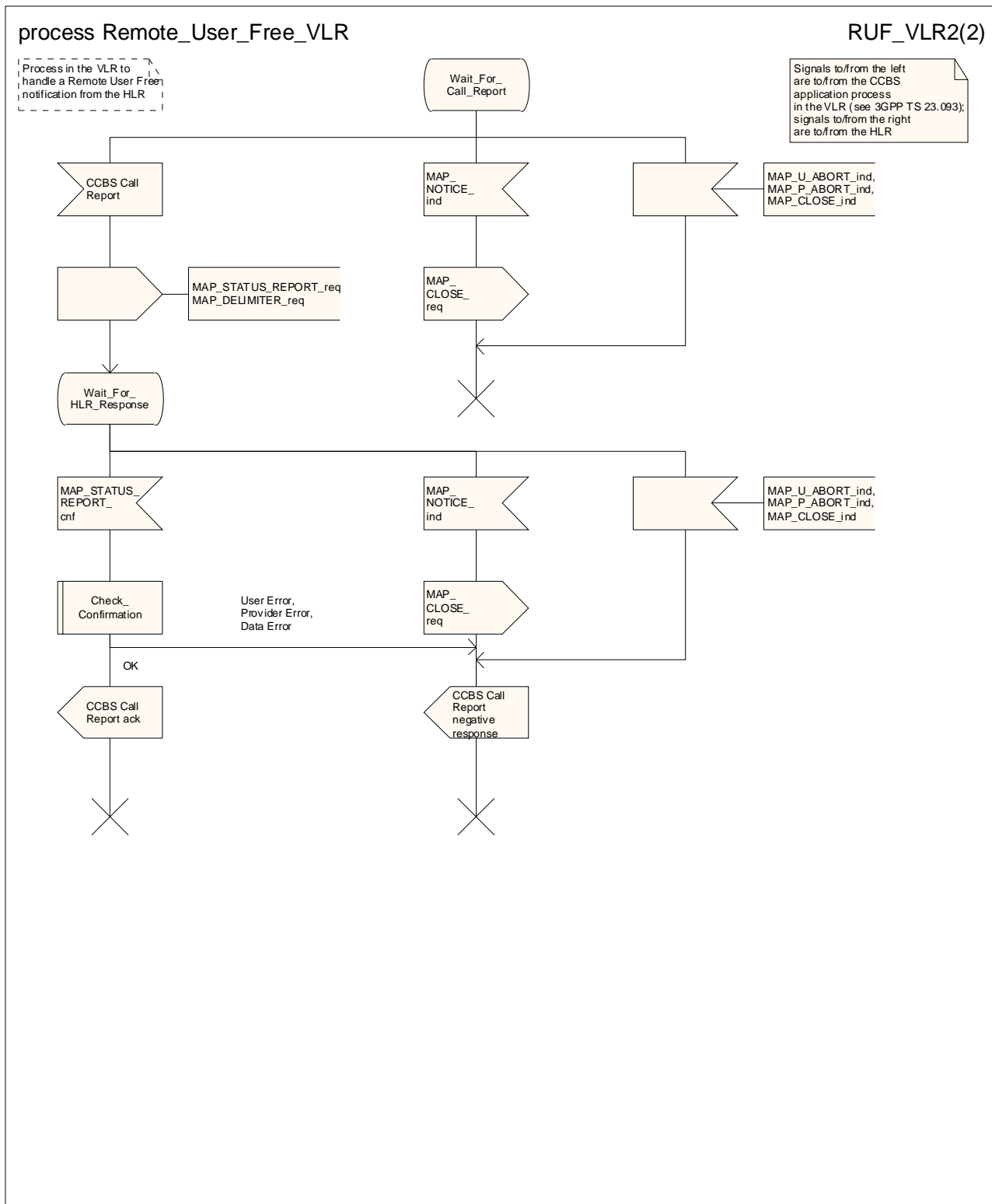

Figure 21.6/15 (sheet 2 of 2): Process Remote_User_Free_VLR

21.7 Void

21.8 Void

21.9 Immediate Service Termination (IST)

21.9.1 IST Alert

The Immediate Service Termination Alert procedure is used to keep track of the call activities performed by subscribers who are marked as being subject to IST monitoring and, possibly, to terminate the call activities for which the alert was sent, or all the call activities related to the subscriber for whom the alert was sent.

The message flow for alerting is shown in figure 21.9/1; the MSC may be a Visited MSC or a Gateway MSC.

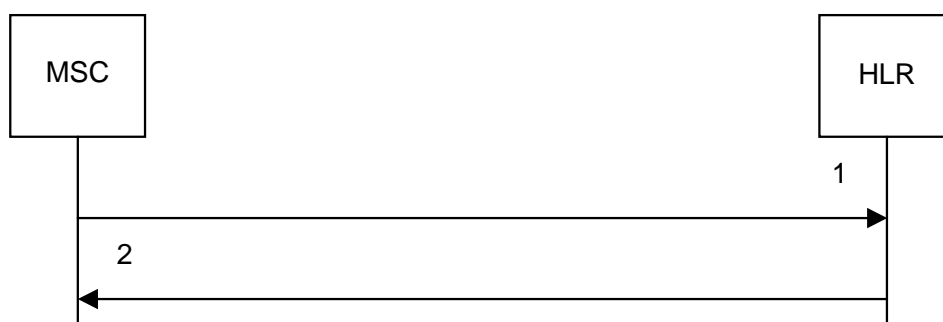

- 1) MAP_IST_ALERT_req/ind
- 2) MAP_IST_ALERT_rsp/cnf

Figure 21.9/1: Message flow for IST Alert

21.9.1.1 Procedure in the MSC

The MAP process in the MSC (Visited MSC or Gateway MSC) is shown in figure 21.9/3. The MAP process invokes macros not defined in this clause; the definitions of these macros can be found as follows:

- | | |
|--------------------|-----------------------|
| Receive_Open_Cnf | see subclause 25.1.2; |
| Check_Confirmation | see subclause 25.2.2. |

21.9.1.2 Procedure in the HLR

The MAP process in the HLR is shown in figure 21.9/4. The MAP process invokes a macro not defined in this clause; the definition of this macro can be found as follows:

- | | |
|------------------|-----------------------|
| Receive_Open_Ind | see subclause 25.1.1; |
|------------------|-----------------------|

21.9.2 IST Command

The Immediate Service Termination Command procedure is used to terminate the call activities related to a subscriber.

The message flow for the IST Command procedure is shown in figure 21.19/2; the MSC may be a Visited MSC or a Gateway MSC.

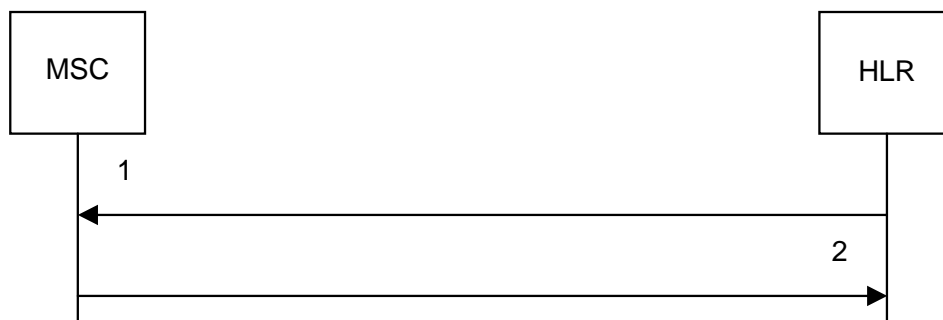

- 1) MAP_IST_COMMAND_req/ind
- 2) MAP_IST_COMMAND_rsp/cnf

Figure 21.9/2: Message flow for IST Command

21.9.2.1 Procedure in the HLR

The MAP process in the HLR is shown in figure 21.9/5. The MAP process invokes macros not defined in this clause; the definitions of these macros can be found as follows:

Receive_Open_Cnf see subclause 25.1.2;

Check_Confirmation see subclause 25.2.2.

21.9.2.2 Procedure in the MSC

The MAP process in the MSC is shown in figure 21.9/6. The MAP process invokes a macro not defined in this clause; the definition of this macro can be found as follows:

Receive_Open_Ind see subclause 25.1.1.

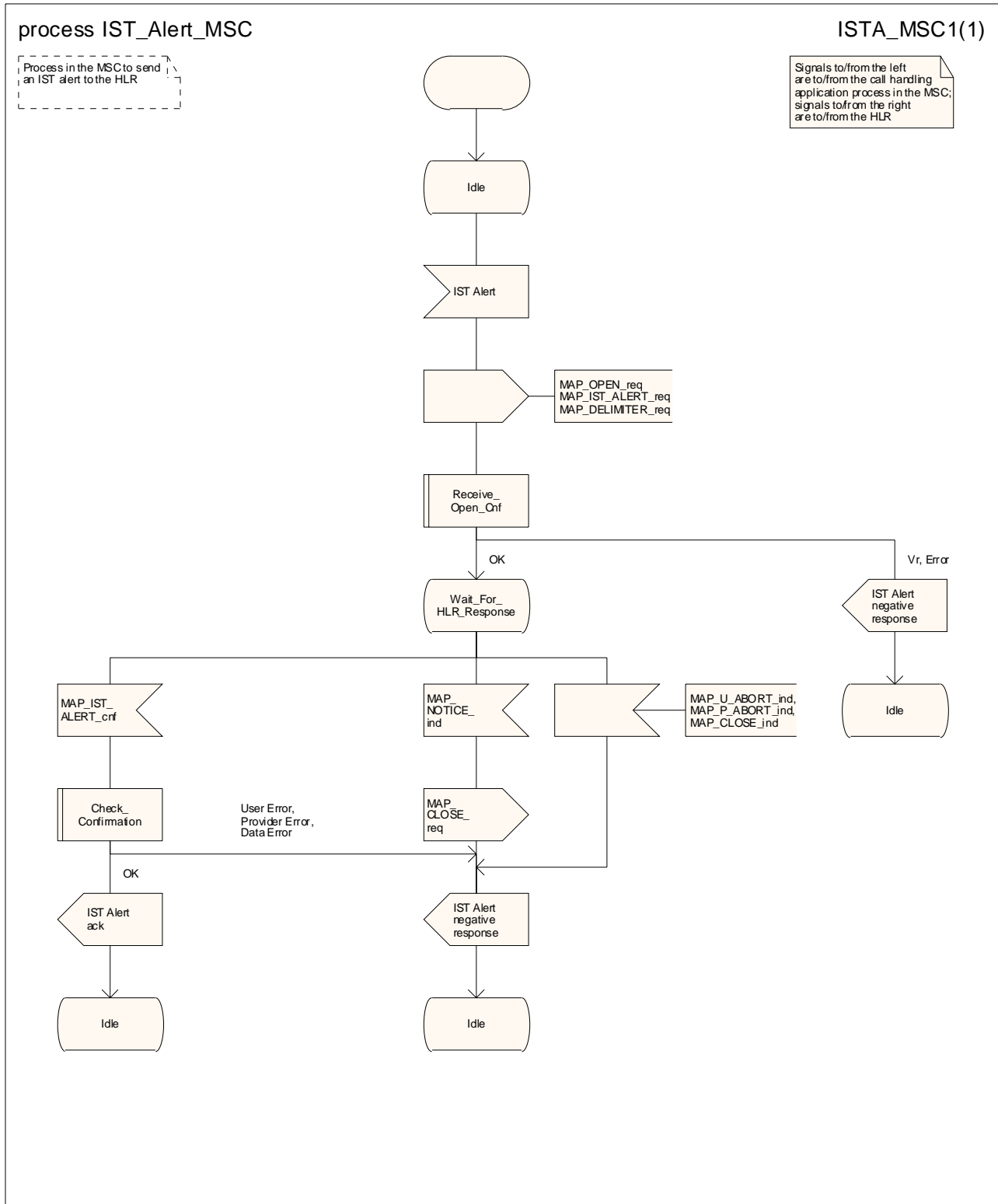

Figure 21.9/3: Process IST_Alert_MSC

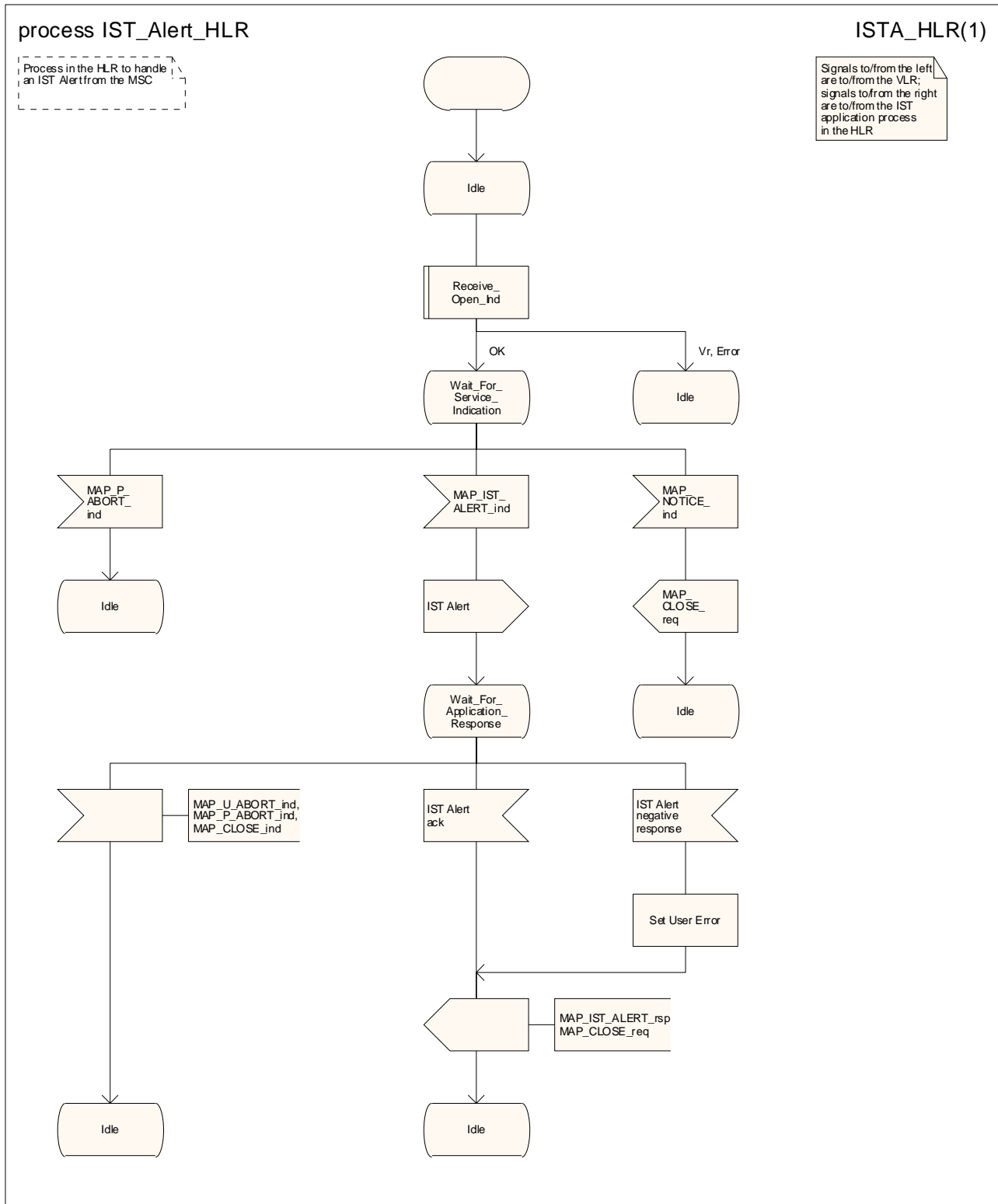

Figure 21.9/4: Process IST_Alert_HLR

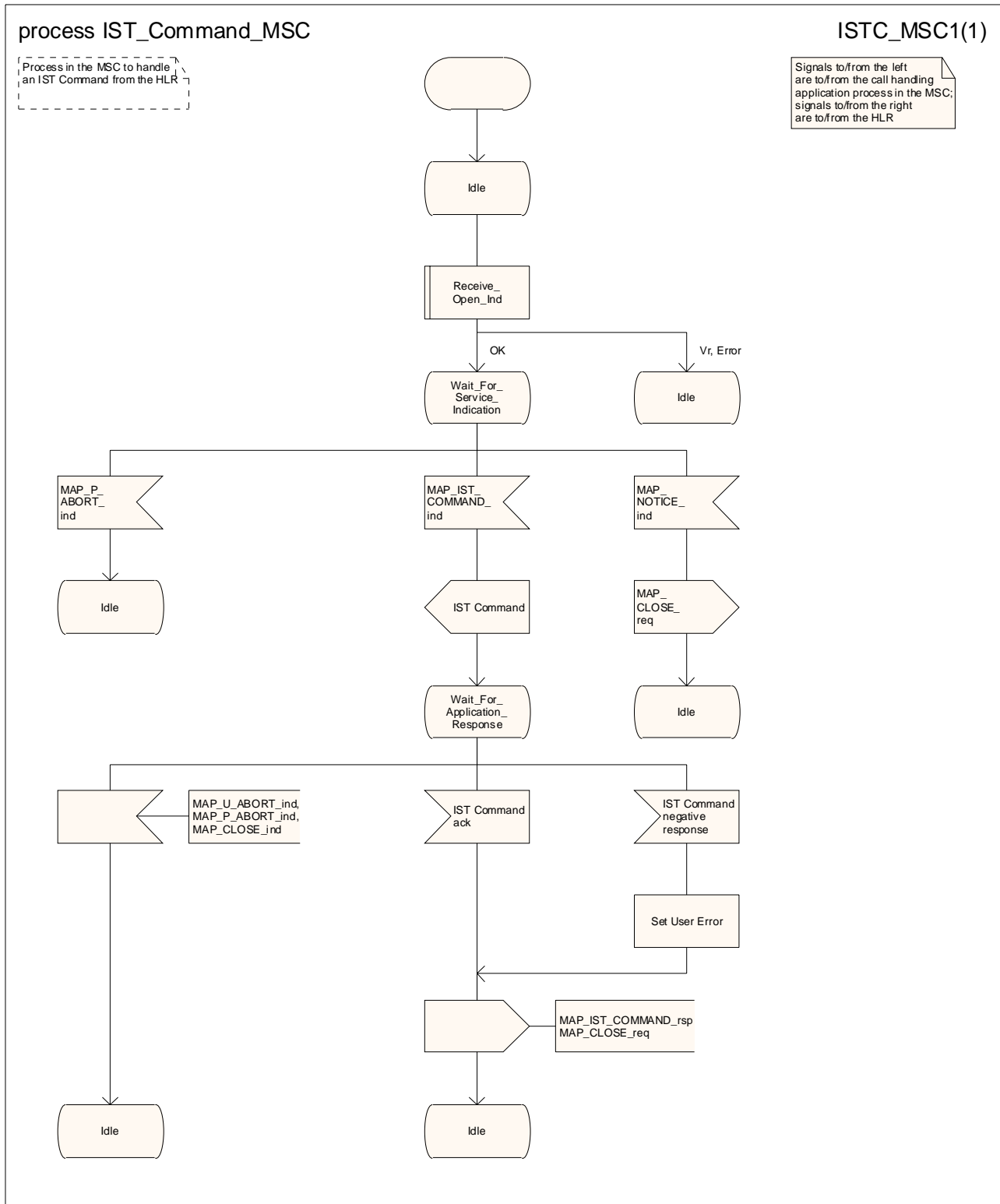

Figure 21.9/6: Process IST_Command_MSC

22 Supplementary services procedures

22.1 Supplementary service co-ordinator processes

22.1.1 Supplementary service co-ordinator process for the MSC

The co-ordinator process in the MSC to handle a CM connection request with CM service type Supplementary service activation is shown in figure 22.1/1. The process invokes a macro not defined in this clause; the definition of this macro can be found as follows:

Process_Access_Request_MSC see subclause 25.4.1.

22.1.2 Void

22.1.3 Functional supplementary service co-ordinator process for the HLR

The MAP co-ordinator process in the HLR to handle a dialogue opened with the networkFunctionalSS application context is shown in figure 22.1/3. The MAP process invokes a macro not defined in this clause; the definition of this macro can be found as follows:

Receive_Open_Ind see subclause 25.1.1.

22.1.4 Call completion supplementary service co-ordinator process for the HLR

The MAP co-ordinator process in the HLR to handle a dialogue opened with the callCompletion application context is shown in figure 22.1/4. The MAP process invokes a macro not defined in this clause; the definition of this macro can be found as follows:

Receive_Open_Ind see subclause 25.1.1.

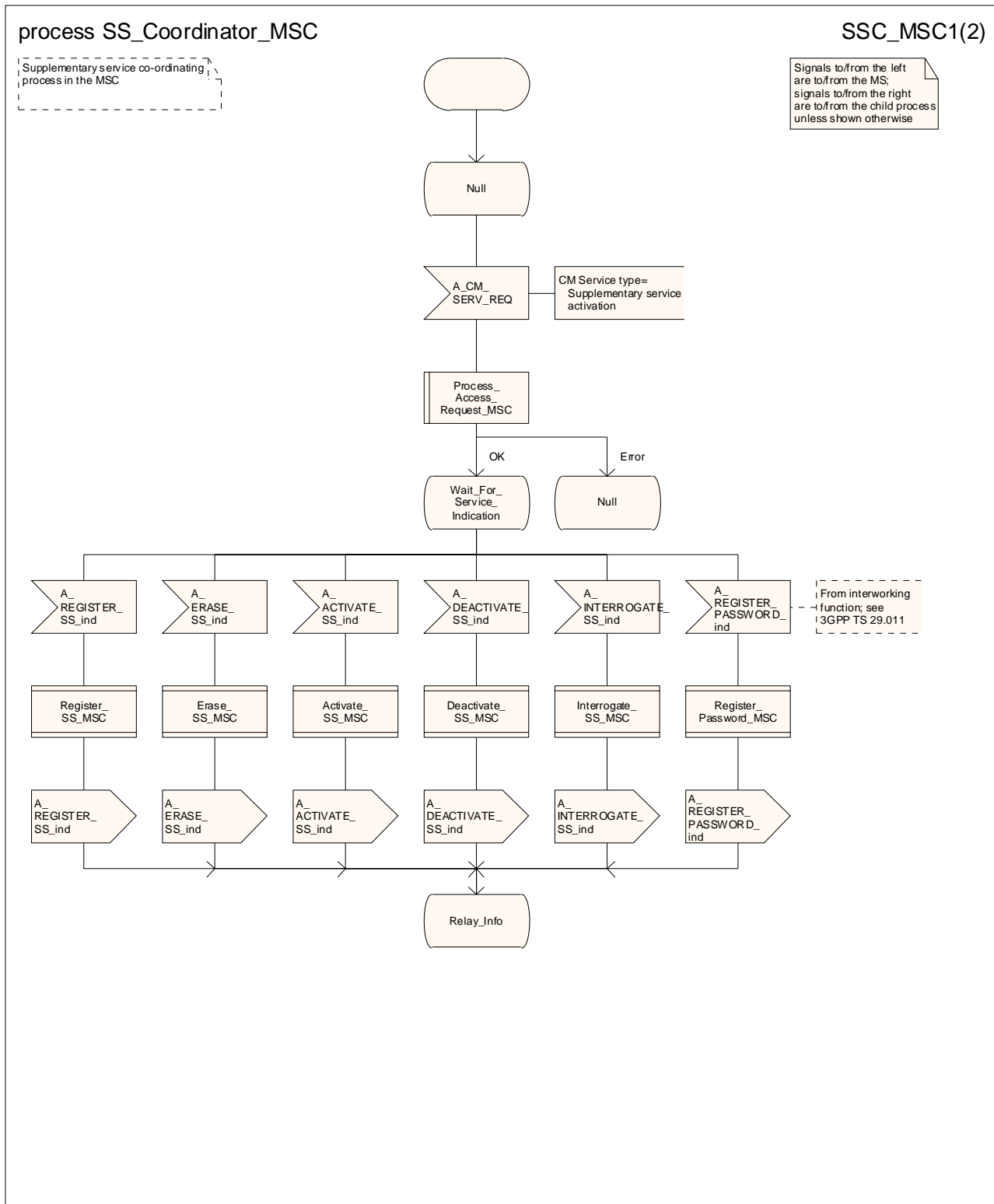

Figure 22.1/1 (sheet 1 of 2): Process SS_Coordinator_MSC

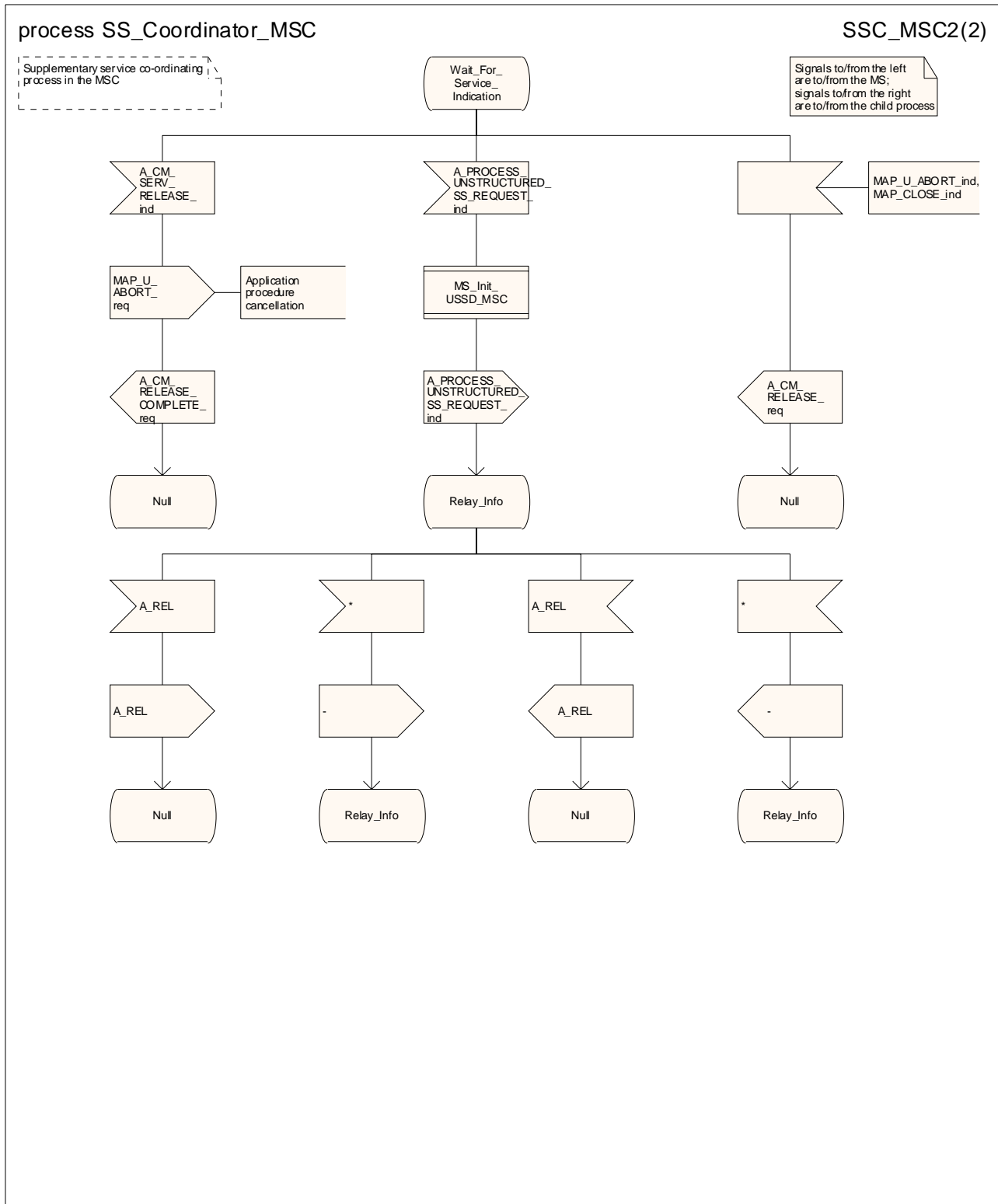

Figure 22.1/1 (sheet 2 of 2): Process SS_Coordinator_MSC

Figure 22.1/2 void

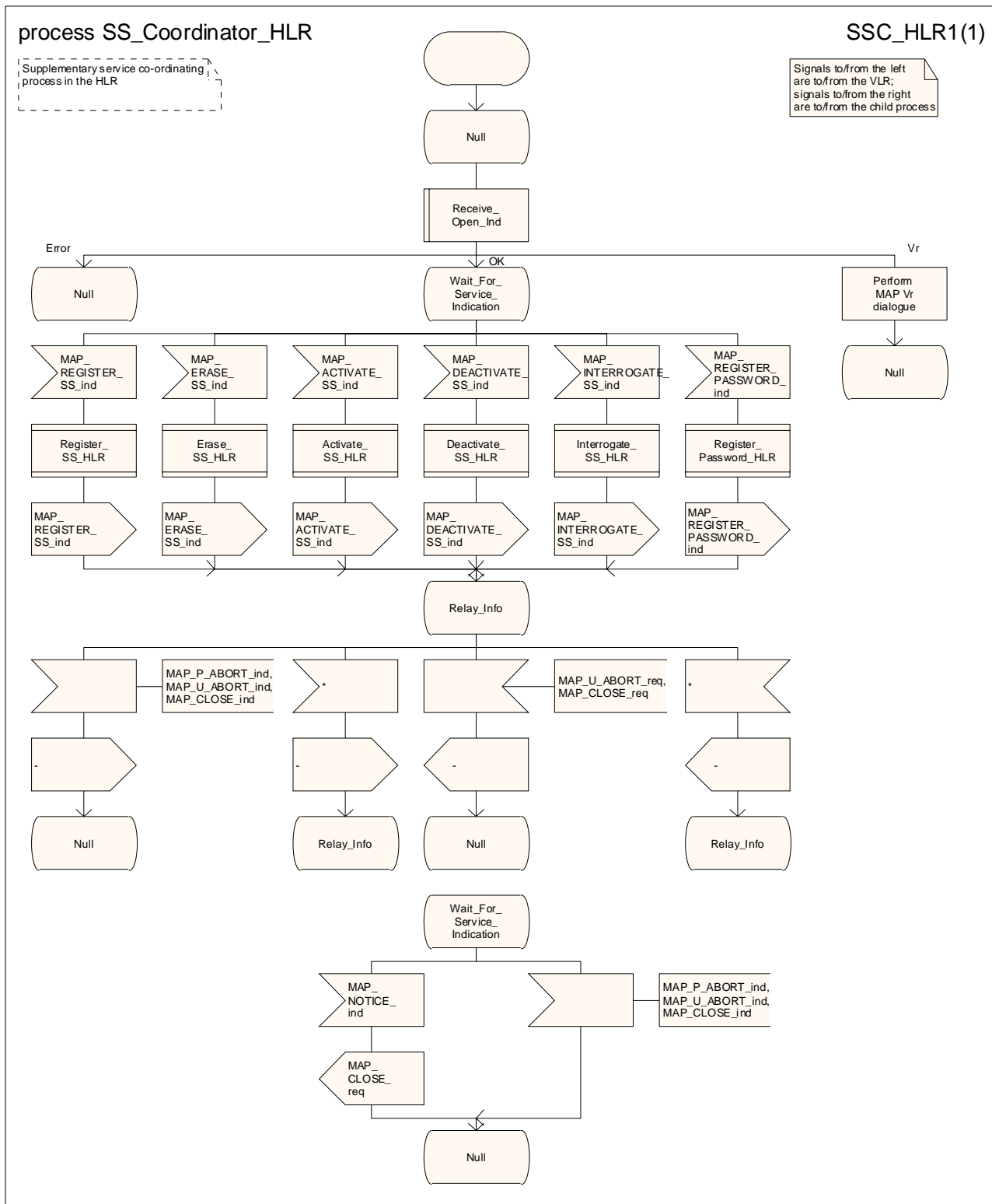

Figure 22.1/3: Process SS_Coordinator_HLR

22.2 Registration procedure

22.2.1 General

The registration procedure is used to register data related to a supplementary service in the HLR. The registration procedure is a fully transparent communication between the MS and the HLR, except that some services may be invoked as a result of the procedure, as described in the clauses below.

The registration procedure is shown in figure 22.2.1/1.

The following services may be used:

- MAP_PROCESS_ACCESS_REQUEST (see clauses 8 and 25);
- MAP_TRACE_SUBSCRIBER_ACTIVITY (see clauses 9 and 25);
- MAP_PROVIDE_IMSI (see clauses 8 and 25);
- MAP_FORWARD_NEW_TMSI (see clauses 8 and 25);
- MAP_AUTHENTICATE (see clauses 8 and 25);
- MAP_SET_CIPHERING_MODE (see clauses 8 and 25);
- MAP_CHECK_IMEI (see clauses 8 and 25);
- MAP_READY_FOR_SM (see clauses 12 and 25);
- MAP_INSERT_SUBSCRIBER_DATA (see clauses 8 and 25);

The following service is certainly used:

- MAP_REGISTER_SS (defined in clause 11).

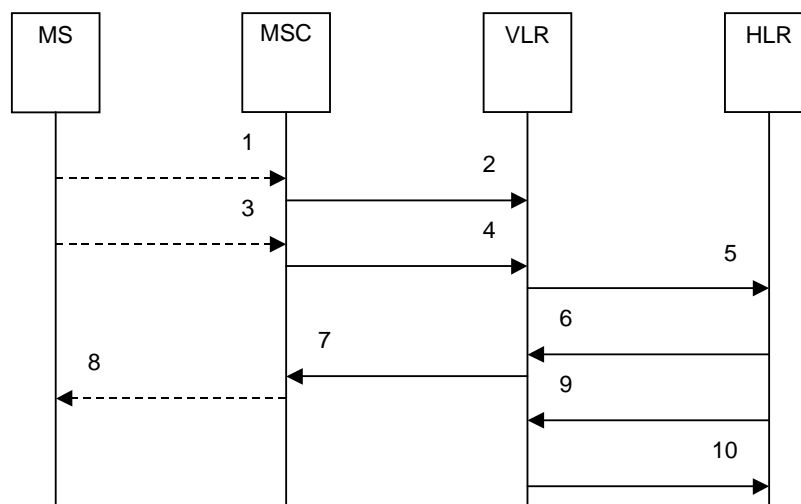

- 1) A_CM_SERV_REQ (Note 1)
- 2) MAP_PROCESS_ACCESS_REQUEST (Note 2)
- 3) A_REGISTER_SS (Note 1)
- 4) MAP_REGISTER_SS_req/ind
- 5) MAP_REGISTER_SS_req/ind
- 6) MAP_REGISTER_SS_rsp/cnf
- 7) MAP_REGISTER_SS_rsp/cnf
- 8) A_REGISTER_SS ack (Note 1)
- 9) MAP_INSERT_SUBSCRIBER_DATA_req/ind (Note 3)
- 10) MAP_INSERT_SUBSCRIBER_DATA_rsp/cnf (Note 3)

NOTE 1: For details of the procedure on the radio path, see 3GPP TS 24.008 [35], 3GPP TS 24.010 [36], 3GPP TS 24.08x and 3GPP TS 24.09x. Services shown in dotted lines indicate the trigger provided by the signalling on the radio path, and the signalling triggered on the radio path.

NOTE 2: For details of the Process Access Request procedure, refer to subclause 25.4 in the present document.

NOTE 3: Services printed in *italics* are optional.

Figure 22.2.1/1: Message flow for supplementary service registration

22.2.2 Procedure in the MSC

The A_REGISTER_SS service indication received by the MAP process in the MSC contains the SS-Code and any parameters that are related to the supplementary service.

The MAP user transfers the received information to the VLR in the MAP_REGISTER_SS request without checking the contents of the service indication. Rules for the mapping are described in 3GPP TS 29.011 [59].

The information in the MAP_REGISTER_SS confirm from the VLR is reported to the MS in the A_REGISTER_SS response message as described in 3GPP TS 24.08x, 3GPP TS 24.08x and 3GPP TS 29.011.

For call independent SS operations, each message shall contain only a single component. Messages which contain more than one component will be stopped at the air interface (as specified in 3GPP TS 29.011 [59]).

The registration process in the MSC is shown in figure 22.2.2/1.

22.2.3 Procedure in the VLR

The MAP process invokes macros not defined in this clause; the definitions of these macros can be found as follows:

Receive_Open_Ind	see subclause 25.1.1;
Receive_Open_Cnf	see subclause 25.1.2;
Check_Confirmation	see subclause 25.2.2;
Process_Access_Request_VLR	see subclause 25.4.2.

The MAP process in the VLR transfers the information received in the MAP_REGISTER_SS indication to the HLR in the MAP_REGISTER_SS request without checking the contents. The MAP_OPEN request includes the IMSI of the subscriber as the destination reference and the VLR number as the originating reference.

If the MAP_REGISTER_SS confirm is properly formed and contains a result or a user error, the MAP process in the VLR shall transfer the information contained in this primitive to the MSC in the MAP_REGISTER_SS response.

For call independent SS operations, each message shall contain only a single component. Messages which contain more than one component will be stopped at the air interface (as specified in 3GPP TS 29.011 [59]).

The registration process in the VLR is shown in figure 22.2.3/1.

22.2.4 Procedure in the HLR

The MAP process invokes a macro and a process not defined in this clause; the definitions of the macro and process can be found as follows:

Check_Indication	see subclause 25.2.1;
Insert_Subst_Data_Stand_Alone_HLR	see subclause 25.7.3.

The supplementary service request shall be processed according to 3GPP TS 23.011 [22] and the 23.08x and 23.09x-series of technical specifications. This handling may lead to a successful result, a partially successful result or an error being returned.

For call independent SS operations, each message shall contain only a single component. Messages which contain more than one component will be stopped at the air interface (as specified in 3GPP TS 29.011 [59]):

The registration process in the HLR is shown in figure 22.2.4/1.

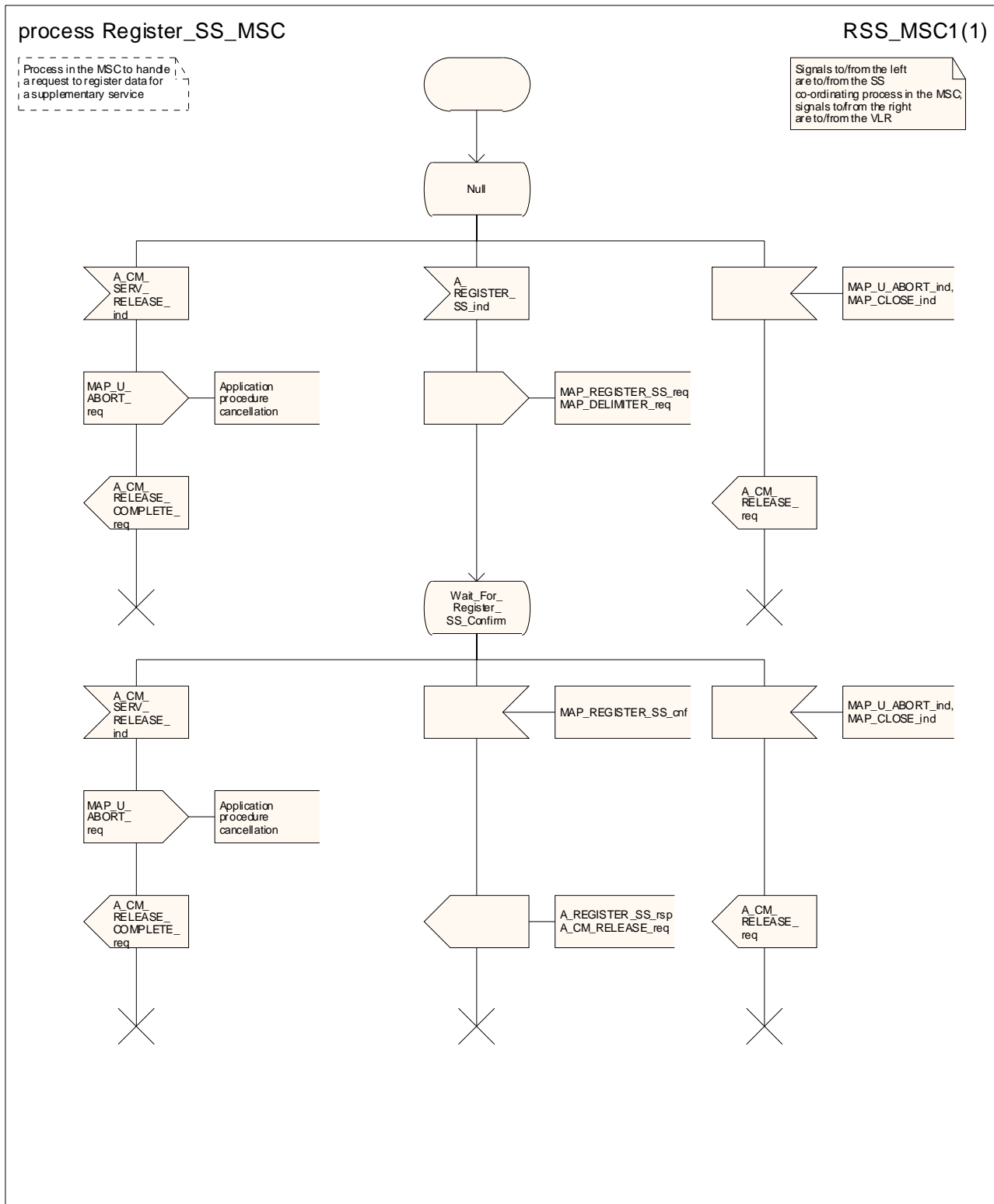

Figure 22.2.2/1: Process Register_SS_MSC

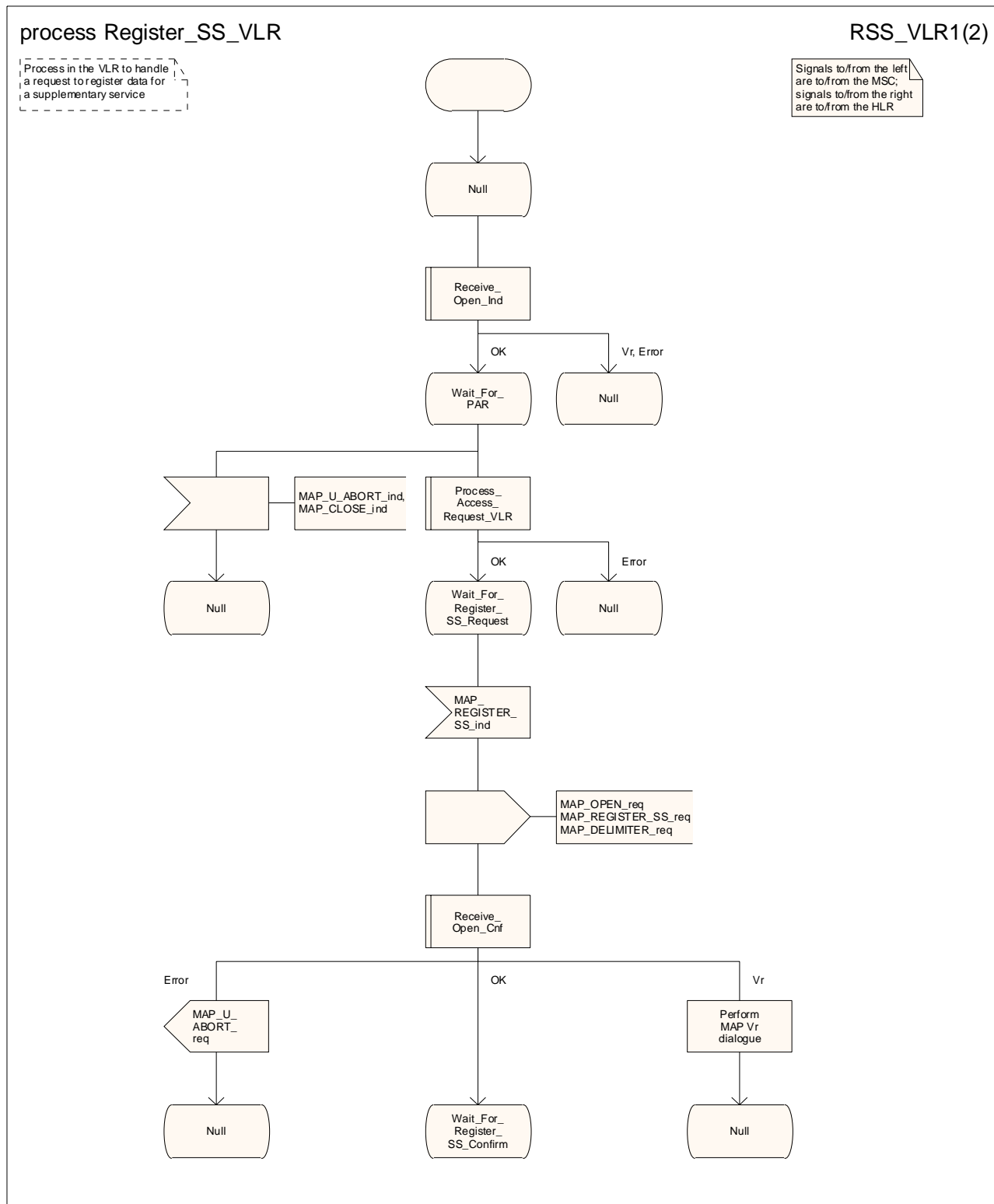

Figure 22.2.3/1 (sheet 1 of 2): Process Register_SS_VLR

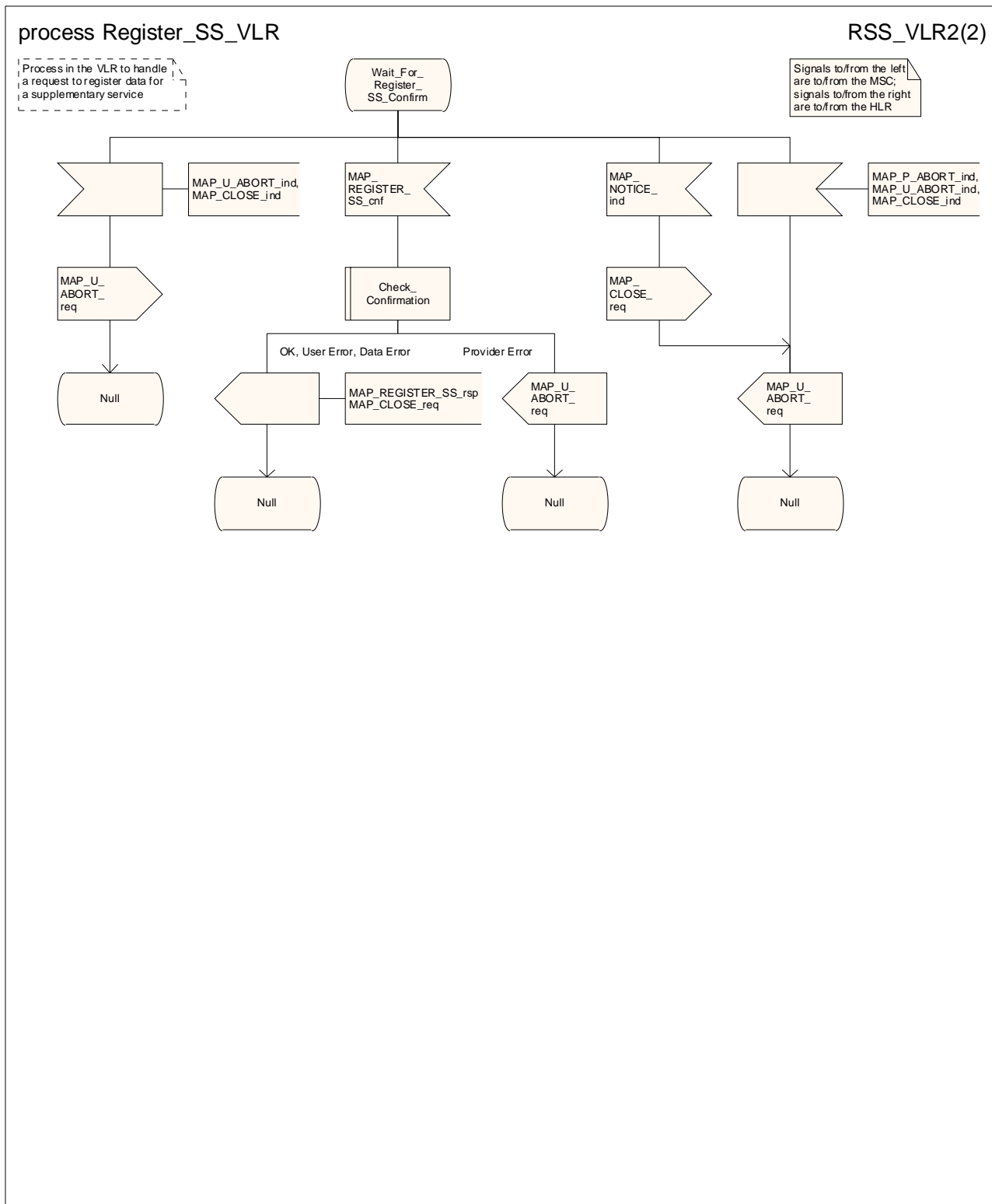

Figure 22.2.3/1 (sheet 2 of 2): Process Register_SS_VLR

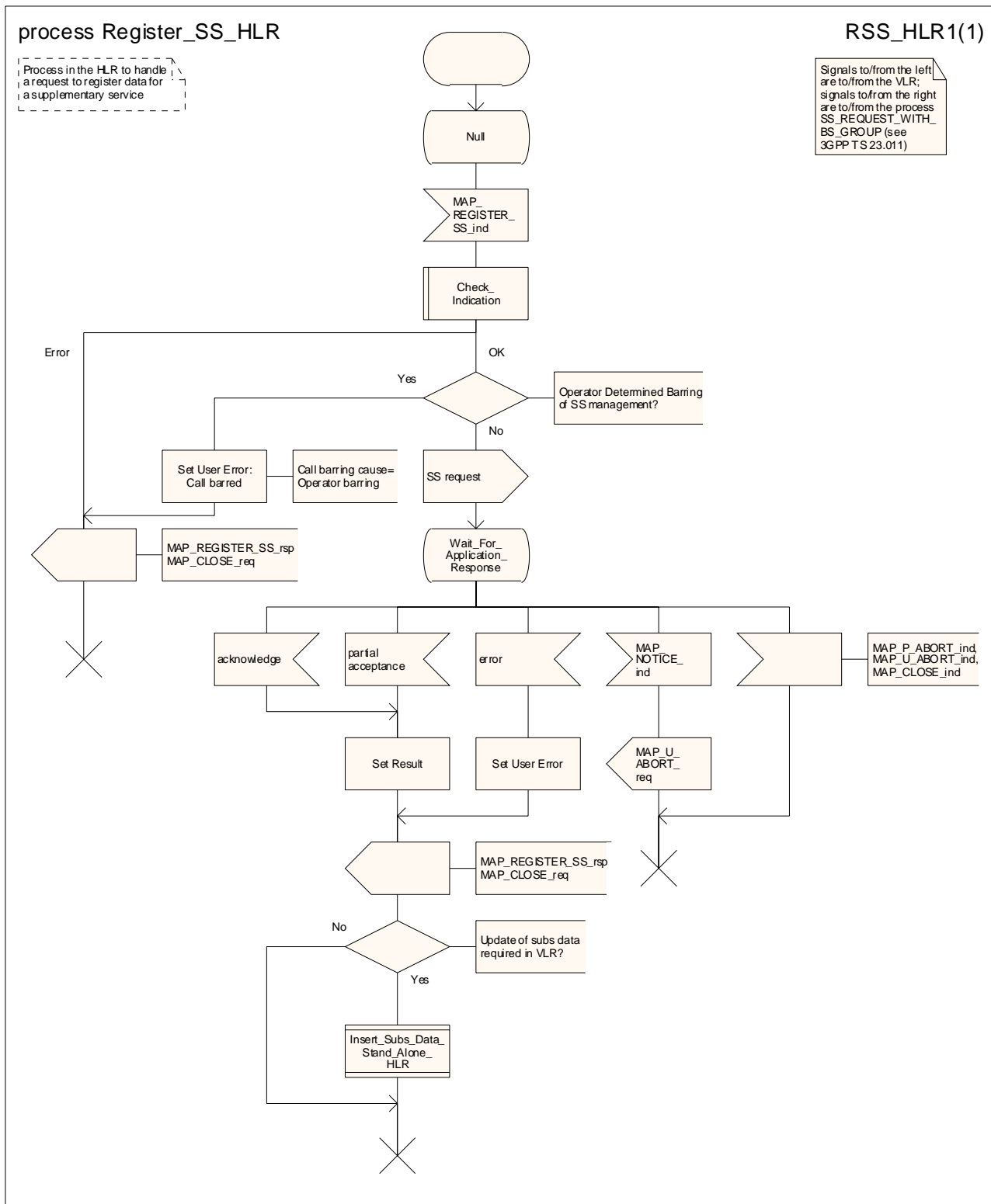

Figure 22.2.4/1: Process Register_SS_HLR

22.3 Erasure procedure

22.3.1 General

The erasure procedure is used to erase data related to a supplementary service in the HLR. The erasure procedure is a fully transparent communication between the MS and the HLR, except that some services may be invoked as a result of the procedure, as described in the clauses below.

The erasure procedure is shown in figure 22.3.1/1.

The following services may be used:

MAP_PROCESS_ACCESS_REQUEST	(see clauses 8 and 25);
MAP_TRACE_SUBSCRIBER_ACTIVITY	(see clauses 9 and 25);
MAP_PROVIDE_IMSI	(see clauses 8 and 25);
MAP_FORWARD_NEW_TMSI	(see clauses 8 and 25);
MAP_AUTHENTICATE	(see clauses 8 and 25);
MAP_SET_CIPHERING_MODE	(see clauses 8 and 25);
MAP_CHECK_IMEI	(see clauses 8 and 25);
MAP_READY_FOR_SM	(see clauses 12 and 25);
MAP_INSERT_SUBSCRIBER_DATA	(see clauses 8 and 25);

The following service is certainly used:

MAP_ERASE_SS	(defined in clause 11).
--------------	-------------------------

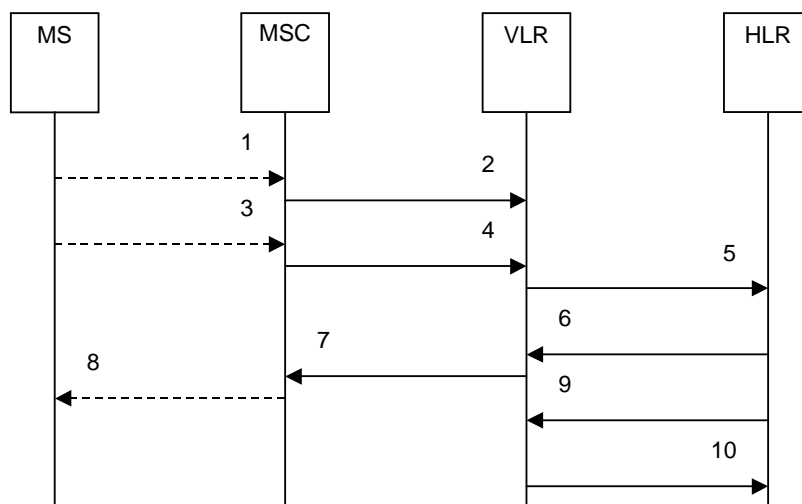

- 1) A_CM_SERV_REQ (Note 1)
- 2) MAP_PROCESS_ACCESS_REQUEST (Note 2)
- 3) A_ERASE_SS (Note 1)
- 4) MAP_ERASE_SS_req/ind
- 5) MAP_ERASE_SS_req/ind
- 6) MAP_ERASE_SS_rsp/cnf
- 7) MAP_ERASE_SS_rsp/cnf
- 8) A_ERASE_SS ack (Note 1)
- 9) MAP_INSERT_SUBSCRIBER_DATA_req/ind (Note 3)
- 10) MAP_INSERT_SUBSCRIBER_DATA_rsp/cnf (Note 3)

NOTE 1: For details of the procedure on the radio path, see 3GPP TS 24.008 [35], 3GPP TS 24.010 [36], 3GPP TS 24.08x and 3GPP TS 24.09x. Services shown in dotted lines indicate the trigger provided by the signalling on the radio path, and the signalling triggered on the radio path.

NOTE 2: For details of the Process Access Request procedure, refer to subclause 25.4 in the present document.

NOTE 3: Services printed in *italics* are optional.

Figure 22.3.1/1: Message flow for supplementary service erasure

22.3.2 Procedure in the MSC

The MSC procedure for erasure is identical to that specified for registration in subclause 22.2.2. The text and diagrams in subclause 22.2.2 apply with all references to registration changed to erasure.

22.3.3 Procedure in the VLR

The VLR procedure for erasure is identical to that specified for registration in subclause 22.2.3. The text and diagrams in subclause 22.2.3 apply with all references to registration changed to erasure.

22.3.4 Procedure in the HLR

The HLR procedure for erasure is identical to that specified for registration in subclause 22.2.4. The text and diagrams in subclause 22.2.4 apply with all references to registration changed to erasure.

22.4 Activation procedure

22.4.1 General

The activation procedure is used to activate a supplementary service in the HLR. The activation procedure is a fully transparent communication between the MS and the HLR, except that some services may be invoked as a result of the procedure, as described in the clauses below.

The activation procedure is shown in figure 22.4.1/1.

The following services may be used:

MAP_PROCESS_ACCESS_REQUEST	(see clauses 8 and 25);
MAP_TRACE_SUBSCRIBER_ACTIVITY	(see clauses 9 and 25);
MAP_PROVIDE_IMSI	(see clauses 8 and 25);
MAP_FORWARD_NEW_TMSI	(see clauses 8 and 25);
MAP_AUTHENTICATE	(see clauses 8 and 25);
MAP_SET_CIPHERING_MODE	(see clauses 8 and 25);
MAP_CHECK_IMEI	(see clauses 8 and 25);
MAP_READY_FOR_SM	(see clauses 12 and 25);
MAP_GET_PASSWORD	(defined in clause 11);
MAP_INSERT_SUBSCRIBER_DATA	(see clauses 8 and 25);

The following service is certainly used:

MAP_ACTIVATE_SS	(defined in clause 11).
-----------------	-------------------------

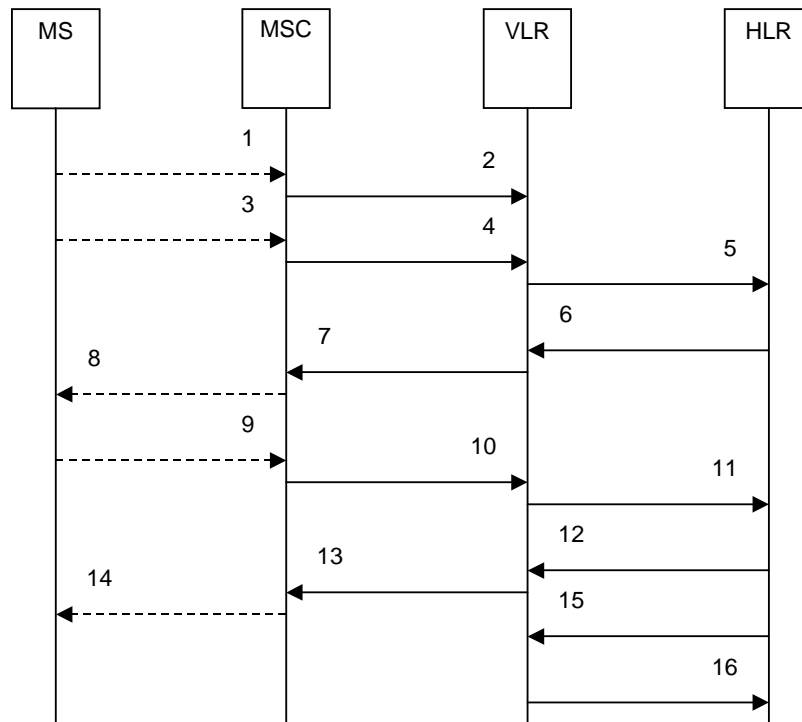

- 1) A_CM_SERV_REQ (Note 1)
- 2) MAP_PROCESS_ACCESS_REQUEST (Note 2)
- 3) A_ACTIVATE_SS (Note 1)
- 4) MAP_ACTIVATE_SS_req/ind
- 5) MAP_ACTIVATE_SS_req/ind
- 6) *MAP_GET_PASSWORD_req/ind* (Note 3)
- 7) *MAP_GET_PASSWORD_req/ind* (Note 3)
- 8) *A_GET_PASSWORD* (Note 1, Note 3)
- 9) *A_GET_PASSWORD ack* (Note 1, Note 3)
- 10) *MAP_GET_PASSWORD_rsp/cnf* (Note 3)
- 11) *MAP_GET_PASSWORD_rsp/cnf* (Note 3)
- 12) *MAP_ACTIVATE_SS_rsp/cnf*
- 13) *MAP_ACTIVATE_SS_rsp/cnf*
- 14) A_ACTIVATE_SS ack (Note 1)
- 15) *MAP_INSERT_SUBSCRIBER_DATA_req/ind* (Note 3)
- 16) *MAP_INSERT_SUBSCRIBER_DATA_rsp/cnf* (Note 3)

NOTE 1: For details of the procedure on the radio path, see 3GPP TS 24.008 [35], 3GPP TS 24.010 [36], 3GPP TS 24.08x and 3GPP TS 24.09x. Services shown in dotted lines indicate the trigger provided by the signalling on the radio path, and the signalling triggered on the radio path.

NOTE 2: For details of the Process Access Request procedure, refer to subclause 25.4 in the present document.

NOTE 3: Services printed in *italics* are optional.

Figure 22.4.1/1: Message flow for supplementary service activation

22.4.2 Procedure in the MSC

The A_ACTIVATE_SS service indication received by the MAP user in the MSC contains the SS-Code and any parameters related to the supplementary service.

The MSC transfers the received information to the VLR in the MAP_ACTIVATE_SS request without checking the contents of the service indication. Rules for the mapping are described in 3GPP TS 29.011 [59].

The information in the MAP_ACTIVATE_SS confirm from the VLR is relayed to the MS in the A_ACTIVATE_SS response message as described in 3GPP TS 24.08x, 3GPP TS 24.08x and 3GPP TS 29.011.

For call independent SS operations, each message shall contain only a single component. Messages which contain more than one component will be stopped at the air interface (as specified in 3GPP TS 29.011 [59]).

The activation process in the MSC is shown in figure 22.4.2/1.

22.4.3 Procedure in the VLR

The MAP process invokes macros not defined in this clause; the definitions of these macros can be found as follows:

Receive_Open_Ind	see subclause 25.1.1;
Receive_Open_Cnf	see subclause 25.1.2;
Check_Confirmation	see subclause 25.2.2;
Process_Access_Request_VLR	see subclause 25.4.2.

The MAP process in the VLR transfers the information received in the MAP_ACTIVATE_SS indication to the HLR in the MAP_ACTIVATE_SS request without checking the contents. The MAP_OPEN request includes the IMSI of the subscriber as the destination reference and the VLR number as the originating reference.

If the MAP_REGISTER_SS confirm is properly formed and contains a result or a user error, the MAP process in the VLR shall transfer the information contained in this primitive to the MSC in the MAP_ACTIVATE_SS response.

For call independent SS operations, each message shall contain only a single component. Messages which contain more than one component will be stopped at the air interface (as specified in 3GPP TS 29.011 [59]).

The activation process in the VLR is shown in figure 22.4.3/1.

22.4.4 Procedure in the HLR

The MAP process invokes a macro and a process not defined in this clause; the definitions of the macro and process can be found as follows:

Check_Indication	see subclause 25.2.1;
Insert_Sub_Data_Stand_Alone_HLR	see subclause 25.7.3.

The supplementary service request shall be processed according to 3GPP TS 23.011 [22] and the 23.08x and 23.09x-series of technical specifications. This handling may lead to a successful result, a partially successful result or an error being returned.

For call independent SS operations, each message shall contain only a single component. Messages which contain more than one component will be stopped at the air interface (as specified in 3GPP TS 29.011 [59]):

The activation process in the HLR is shown in figure 22.4.4/1.

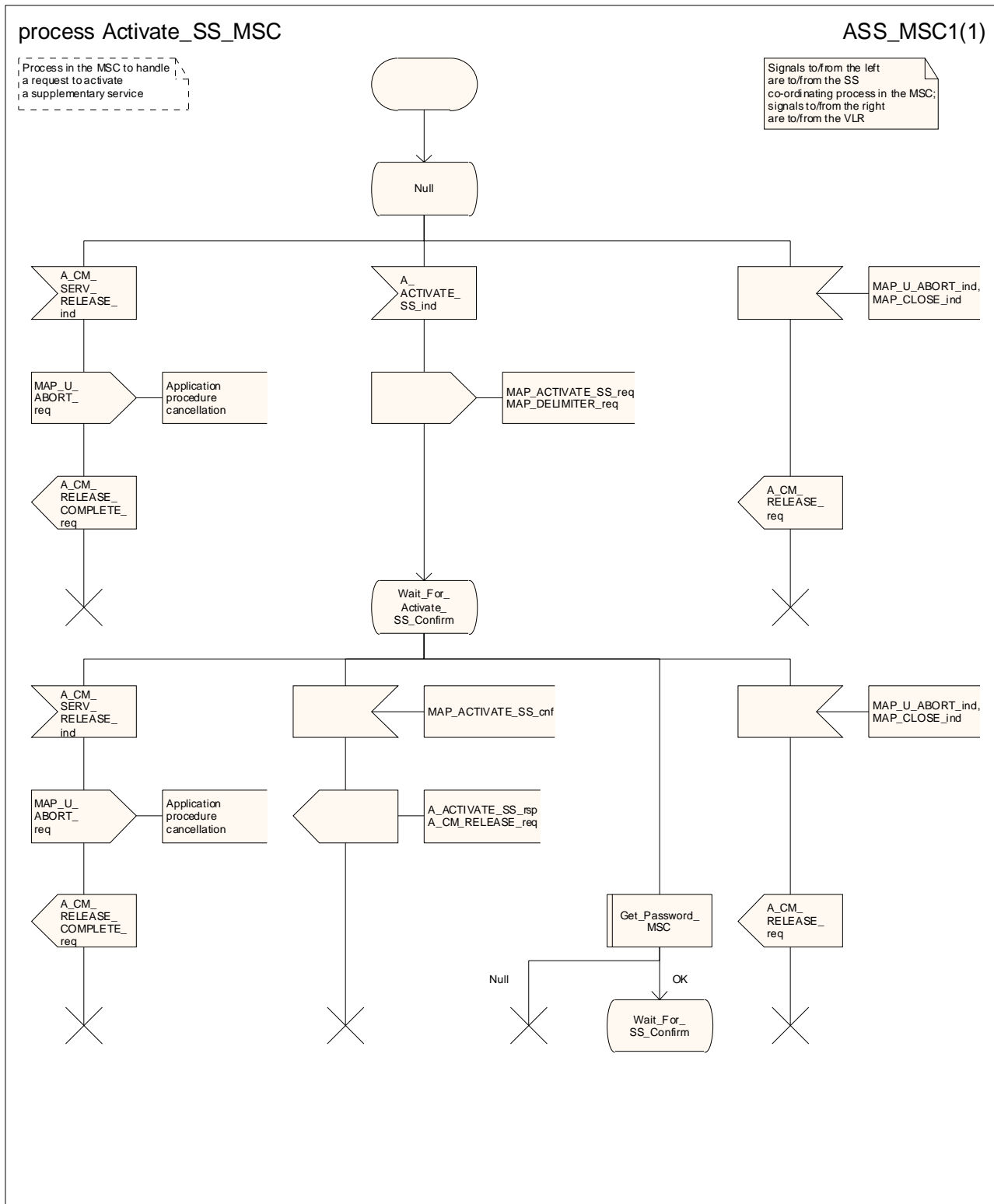

Figure 22.4.2/1: Process Activate_SS_MSC

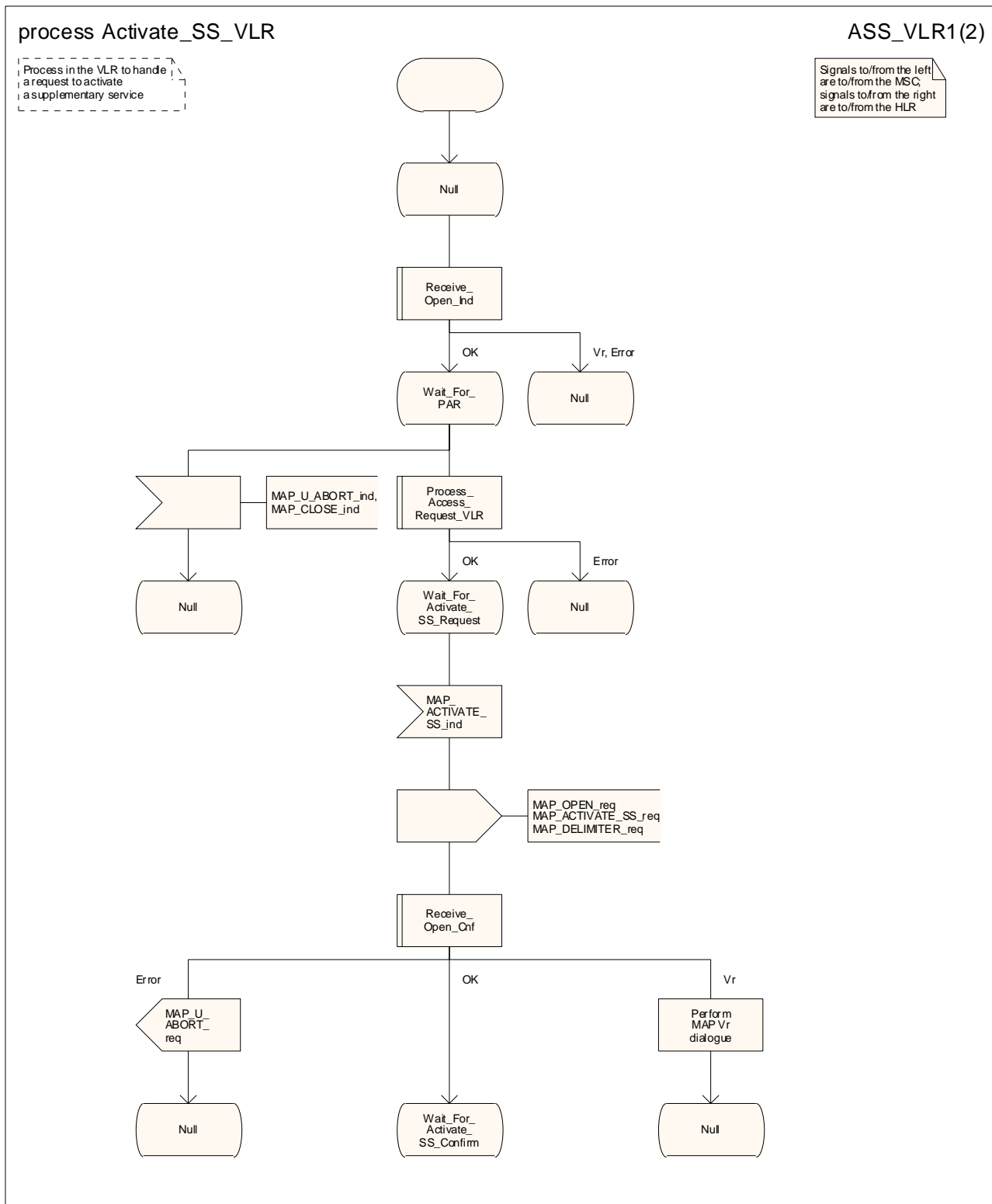

Figure 22.4.3/1 (sheet 1 of 2): Process Activate_SS_VLR

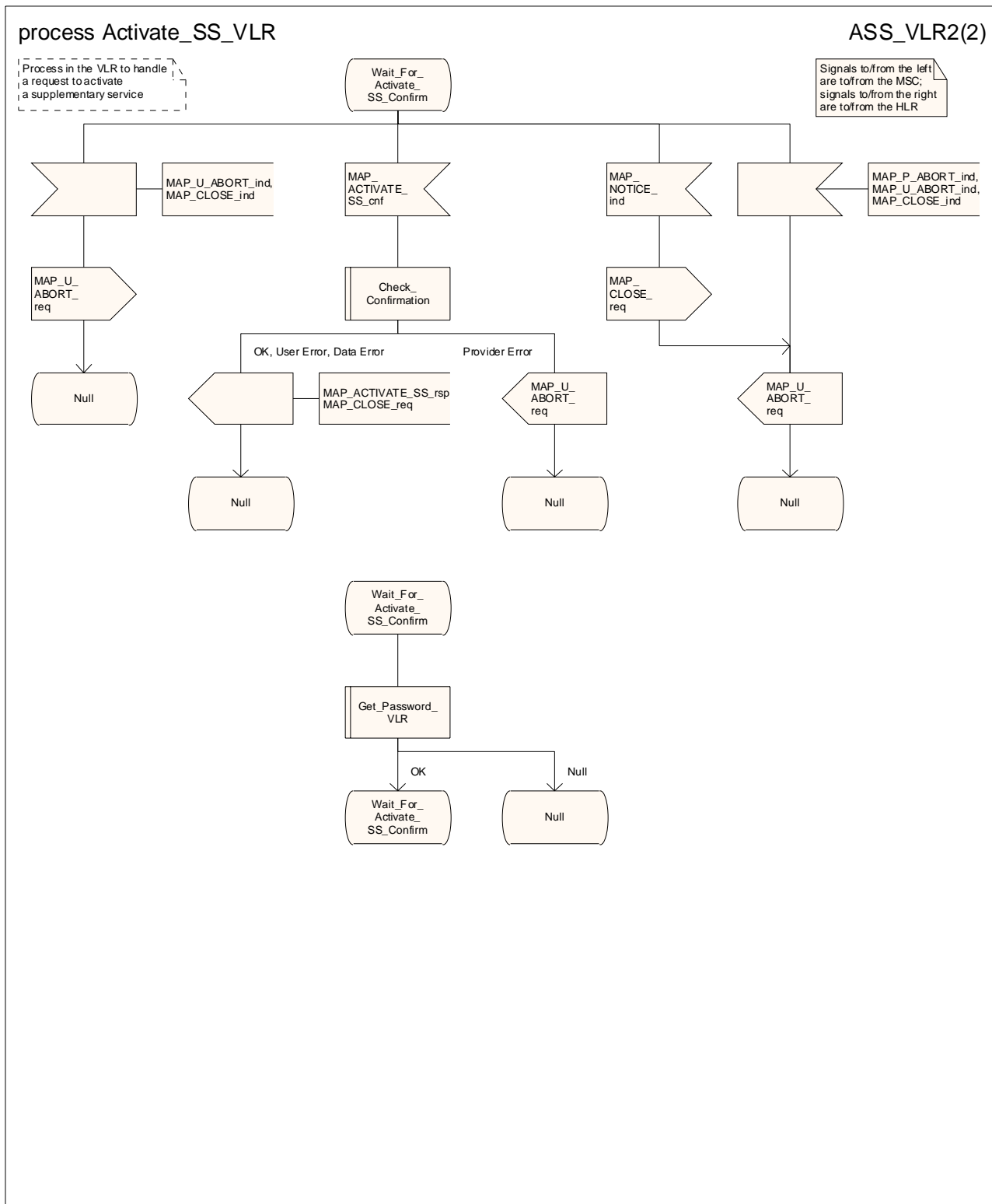

Figure 22.4.3/1 (sheet 2 of 2): Process Activate_SS_VLR

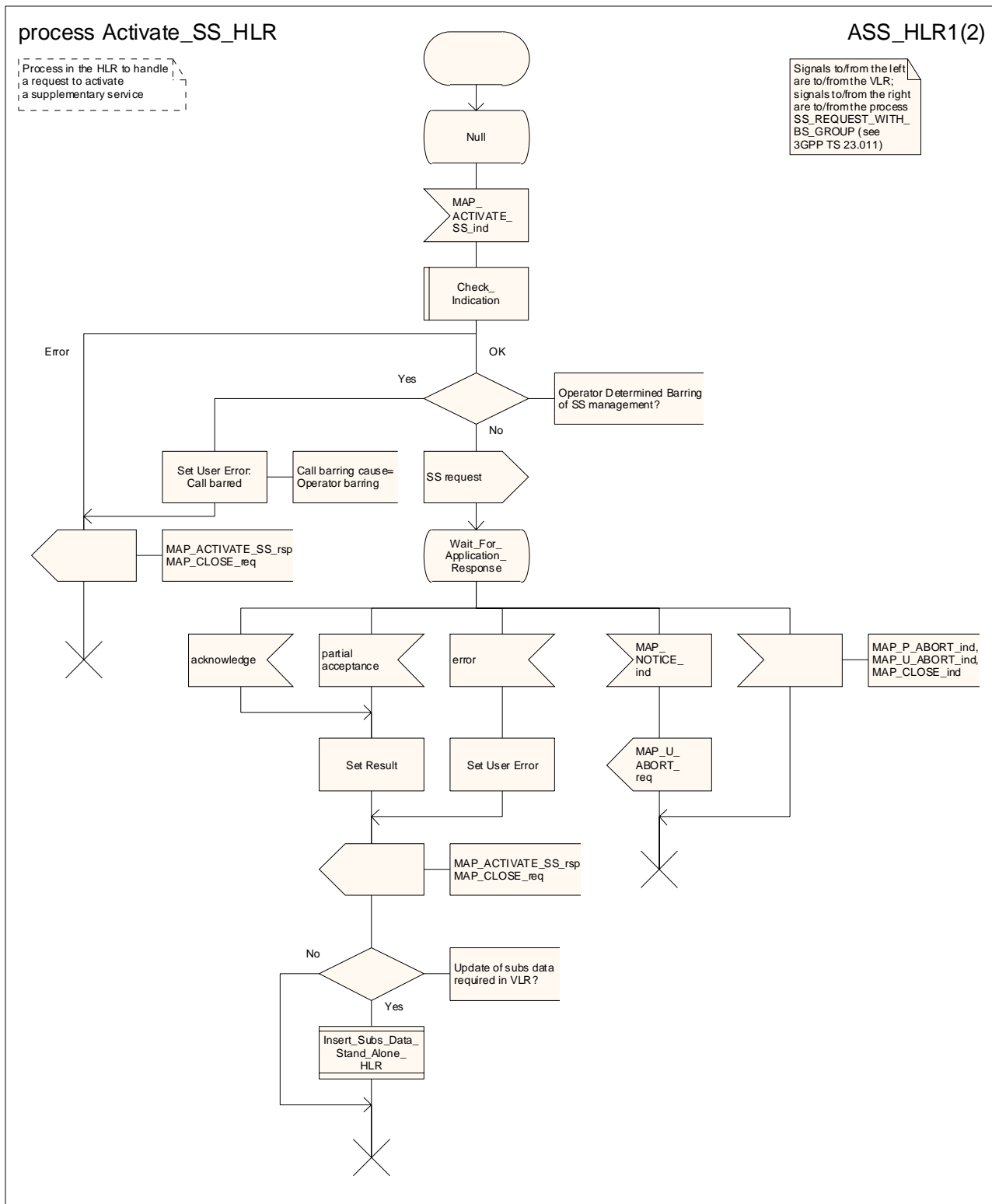

Figure 22.4.4/1 (sheet 1 of 2): Process Activate_SS_HLR

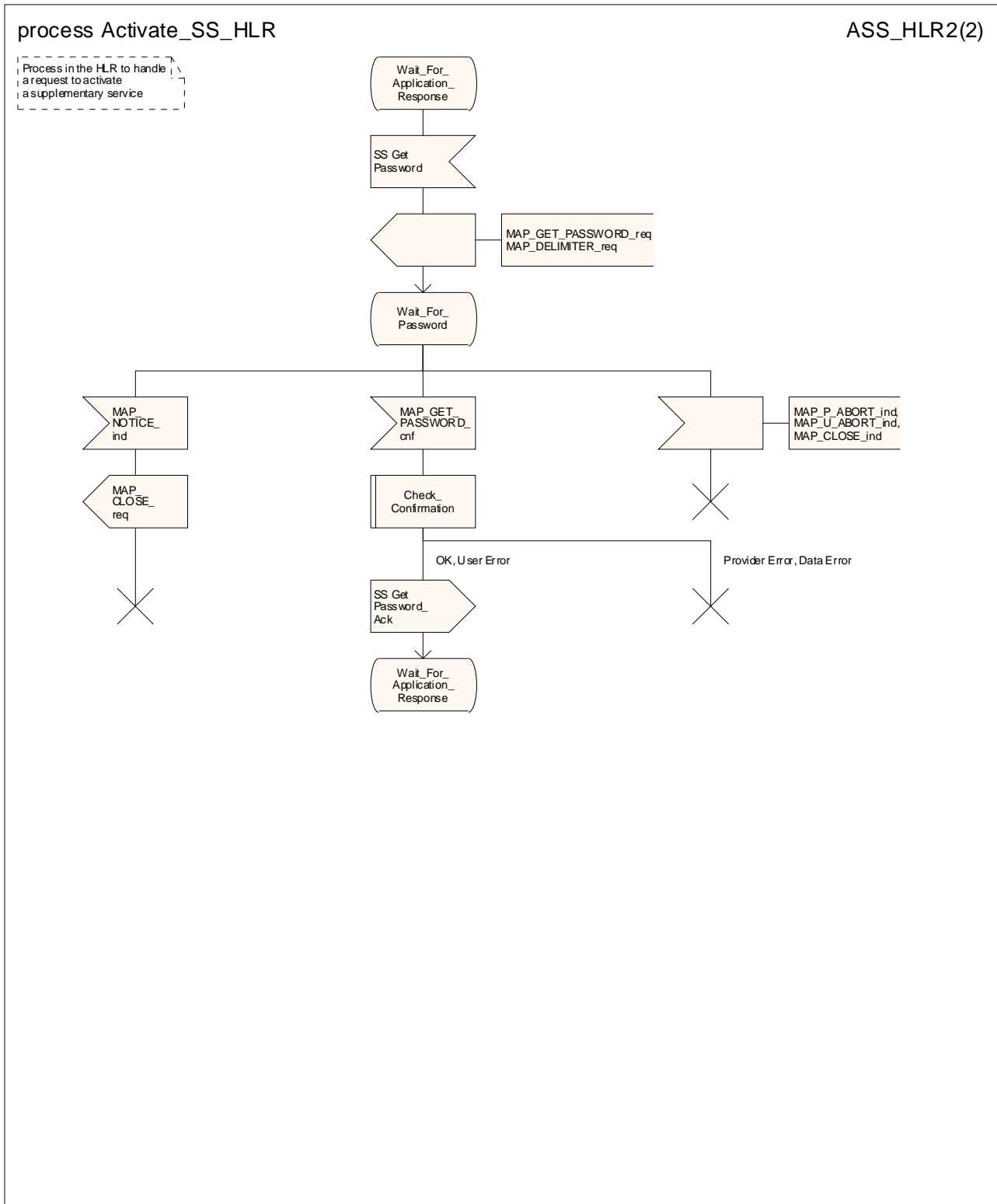

Figure 22.4.4/1 (sheet 2 of 2): Process Activate_SS_HLR

22.5 Deactivation procedure

22.5.1 General

The deactivation procedure is used to deactivate a supplementary service in the HLR. The deactivation procedure is a fully transparent communication between the MS and the HLR, except that some services may be invoked as a result of the procedure, as described in the clauses below.

The deactivation procedure is shown in figure 22.5.1/1.

The following services may be used:

- MAP_PROCESS_ACCESS_REQUEST (see clauses 8 and 25);
- MAP_TRACE_SUBSCRIBER_ACTIVITY (see clauses 9 and 25);
- MAP_PROVIDE_IMSI (see clauses 8 and 25);
- MAP_FORWARD_NEW_TMSI (see clauses 8 and 25);
- MAP_AUTHENTICATE (see clauses 8 and 25);
- MAP_SET_CIPHERING_MODE (see clauses 8 and 25);
- MAP_CHECK_IMEI (see clauses 8 and 25);
- MAP_READY_FOR_SM (see clauses 12 and 25);
- MAP_GET_PASSWORD (defined in clause 11);
- MAP_INSERT_SUBSCRIBER_DATA (see clauses 8 and 25);

The following service is certainly used:

- MAP_DEACTIVATE_SS (defined in clause 11).

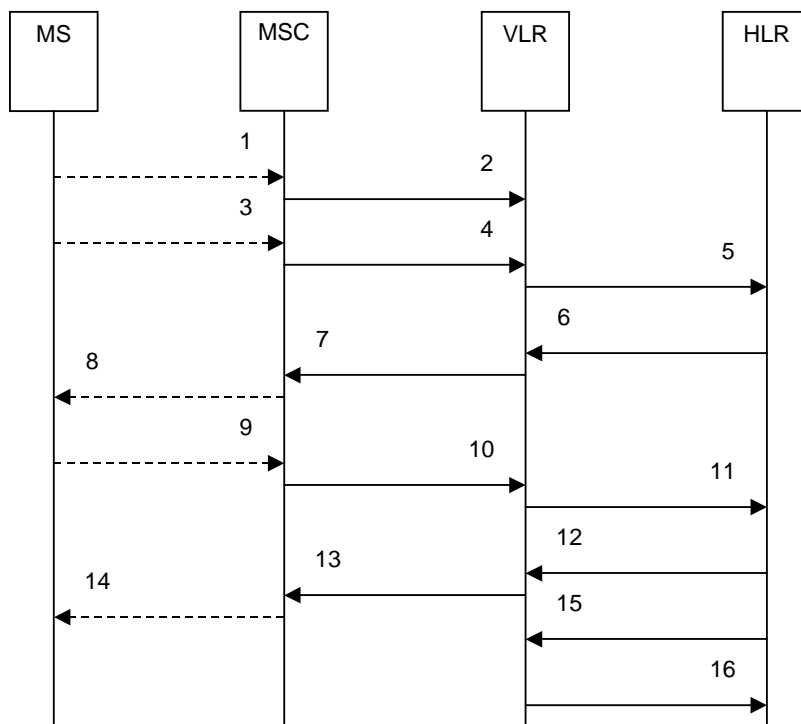

1) A_CM_SERV_REQ (Note 1)

- 2) MAP_PROCESS_ACCESS_REQUEST (Note 2)
- 3) A_DEACTIVATE_SS (Note 1)
- 4) MAP_DEACTIVATE_SS_req/ind
- 5) MAP_DEACTIVATE_SS_req/ind
- 6) *MAP_GET_PASSWORD_req/ind* (Note 3)
- 7) *MAP_GET_PASSWORD_req/ind* (Note 3)
- 8) A_GET_PASSWORD (Note 1, Note 3)
- 9) A_GET_PASSWORD_ack (Note 1, Note 3)
- 10) *MAP_GET_PASSWORD_rsp/cnf* (Note 3)
- 11) *MAP_GET_PASSWORD_rsp/cnf* (Note 3)
- 12) MAP_DEACTIVATE_SS_rsp/cnf
- 13) MAP_DEACTIVATE_SS_rsp/cnf
- 14) A_DEACTIVATE_SS_ack (Note 1)
- 15) *MAP_INSERT_SUBSCRIBER_DATA_req/ind* (Note 3)
- 16) *MAP_INSERT_SUBSCRIBER_DATA_rsp/cnf* (Note 3)

NOTE 1: For details of the procedure on the radio path, see 3GPP TS 24.008 [35], 3GPP TS 24.010 [36], 3GPP TS 24.08x and 3GPP TS 24.09x. Services shown in dotted lines indicate the trigger provided by the signalling on the radio path, and the signalling triggered on the radio path.

NOTE 2: For details of the Process Access Request procedure, refer to subclause 25.4 in the present document.

NOTE 3: Services printed in *italics* are optional.

Figure 22.5.1/1: Message flow for supplementary service deactivation

22.5.2 Procedure in the MSC

The MSC procedure for deactivation is identical to that specified for activation in subclause 22.4.2. The text and diagrams in subclause 22.4.2 apply with all references to activation changed to deactivation.

22.5.3 Procedure in the VLR

The VLR procedure for deactivation is identical to that specified for activation in subclause 22.4.3. The text and diagrams in subclause 22.4.3 apply with all references to activation changed to deactivation.

22.5.4 Procedure in the HLR

The HLR procedure for deactivation is identical to that specified for activation in subclause 22.4.4. The text and diagrams in subclause 22.4.4 apply with all references to activation changed to deactivation.

22.6 Interrogation procedure

22.6.1 General

The interrogation procedure is used to retrieve information related to a supplementary service from the VLR or the HLR. It is the VLR which decides whether an interrogation request should be forwarded to the HLR or not. Some non-supplementary service related services may be invoked as a result of the procedure, as described in the clauses below.

The interrogation procedure is shown in figure 22.6.1/1.

The following services may be used:

MAP_PROCESS_ACCESS_REQUEST	(see clauses 8 and 25);
MAP_TRACE_SUBSCRIBER_ACTIVITY	(see clauses 9 and 25);
MAP_PROVIDE_IMSI	(see clauses 8 and 25);
MAP_FORWARD_NEW_TMSI	(see clauses 8 and 25);
MAP_AUTHENTICATE	(see clauses 8 and 25);
MAP_SET_CIPHERING_MODE	(see clauses 8 and 25);

MAP_CHECK_IMEI (see clauses 8 and 25);

MAP_READY_FOR_SM (see clauses 12 and 25);

The following service is certainly used:

MAP_INTERROGATE_SS (defined in clause 11).

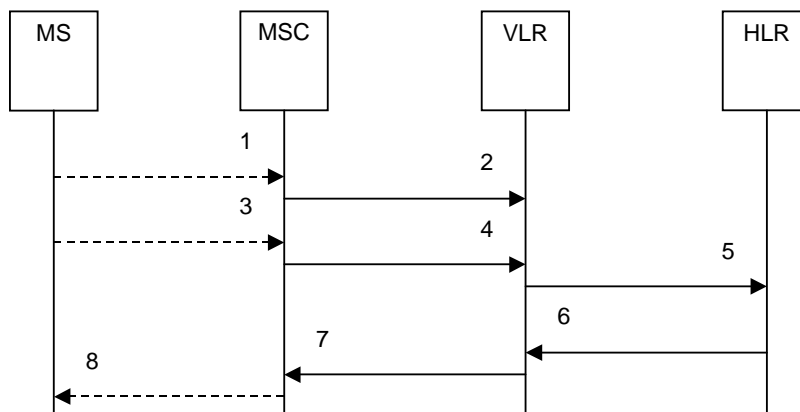

- 1) A_CM_SERV_REQ (Note 1)
- 2) MAP_PROCESS_ACCESS_REQUEST (Note 2)
- 3) A_INTERROGATE_SS (Note 1)
- 4) MAP_INTERROGATE_SS_req/ind
- 5) *MAP_INTERROGATE_SS_req/ind*
- 6) *MAP_INTERROGATE_SS_rsp/cnf*
- 7) MAP_INTERROGATE_SS_rsp/cnf
- 8) A_INTERROGATE_SS ack (Note 1)

NOTE 1: For details of the procedure on the radio path, see 3GPP TS 24.008 [35], 3GPP TS 24.010 [36], 3GPP TS 24.08x and 3GPP TS 24.09x. Services shown in dotted lines indicate the trigger provided by the signalling on the radio path, and the signalling triggered on the radio path.

NOTE 2: For details of the Process Access Request procedure, refer to subclause 25.5 in the present document.

NOTE 3: Services printed in *italics* are optional.

Figure 22.6.1/1: Message flow for supplementary service interrogation

22.6.2 Procedure in the MSC

The MSC procedure for interrogation is identical to that specified for registration in subclause 22.2.2. The text and diagrams in subclause 22.2.2 apply with all references to registration changed to interrogation.

22.6.3 Procedures in the VLR

The MAP process invokes macros not defined in this clause; the definitions of these macros can be found as follows:

- | | |
|----------------------------|-----------------------|
| Receive_Open_Ind | see subclause 25.1.1; |
| Receive_Open_Cnf | see subclause 25.1.2; |
| Check_Confirmation | see subclause 25.2.2; |
| Process_Access_Request_VLR | see subclause 25.4.2. |

The interrogation is answered either by the VLR or by the HLR, depending on the service interrogated.

1) Interrogation to be handled by the VLR

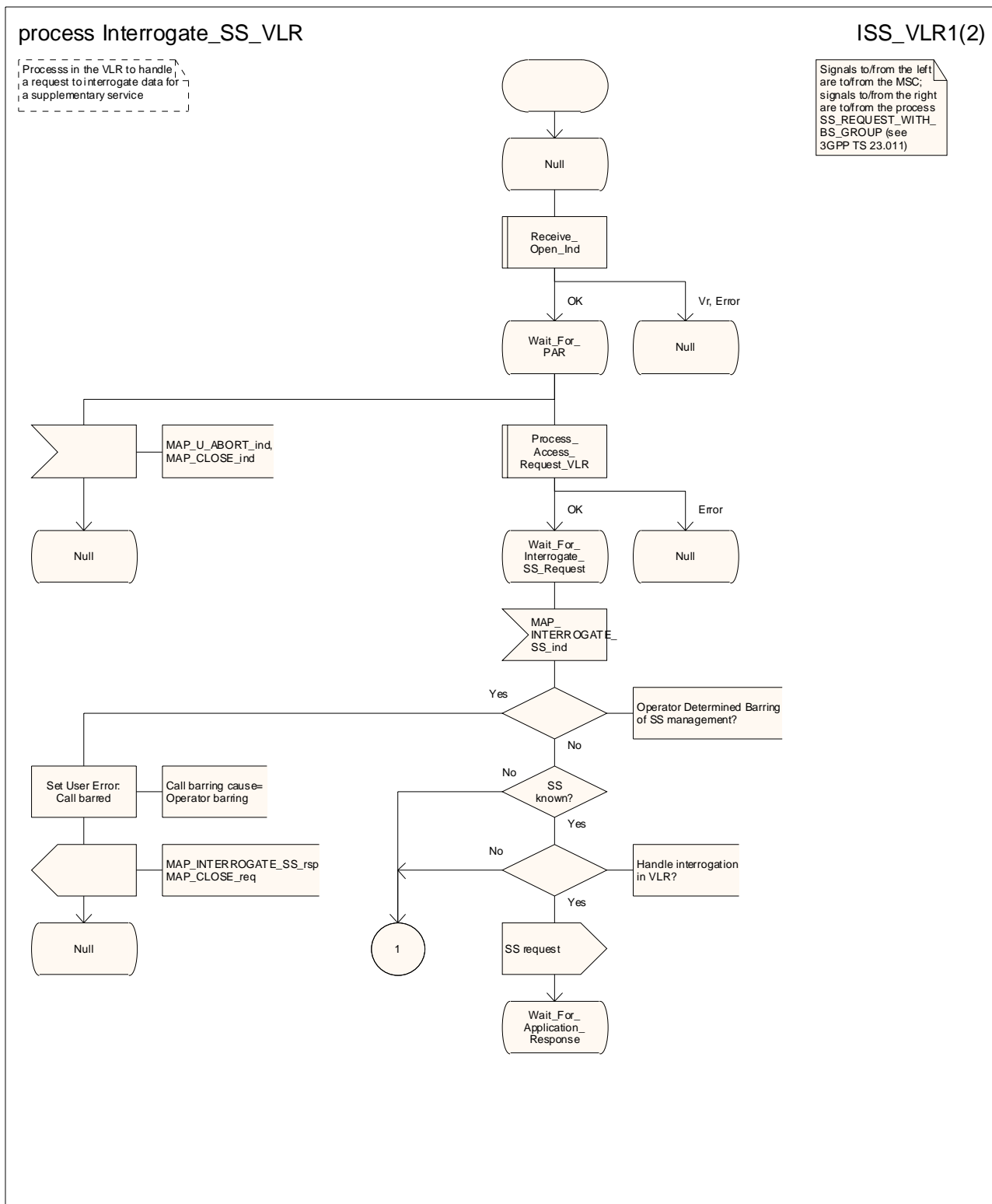

Figure 22.6.3/1 (sheet 1 of 2): Process Interrogate_SS_VLR

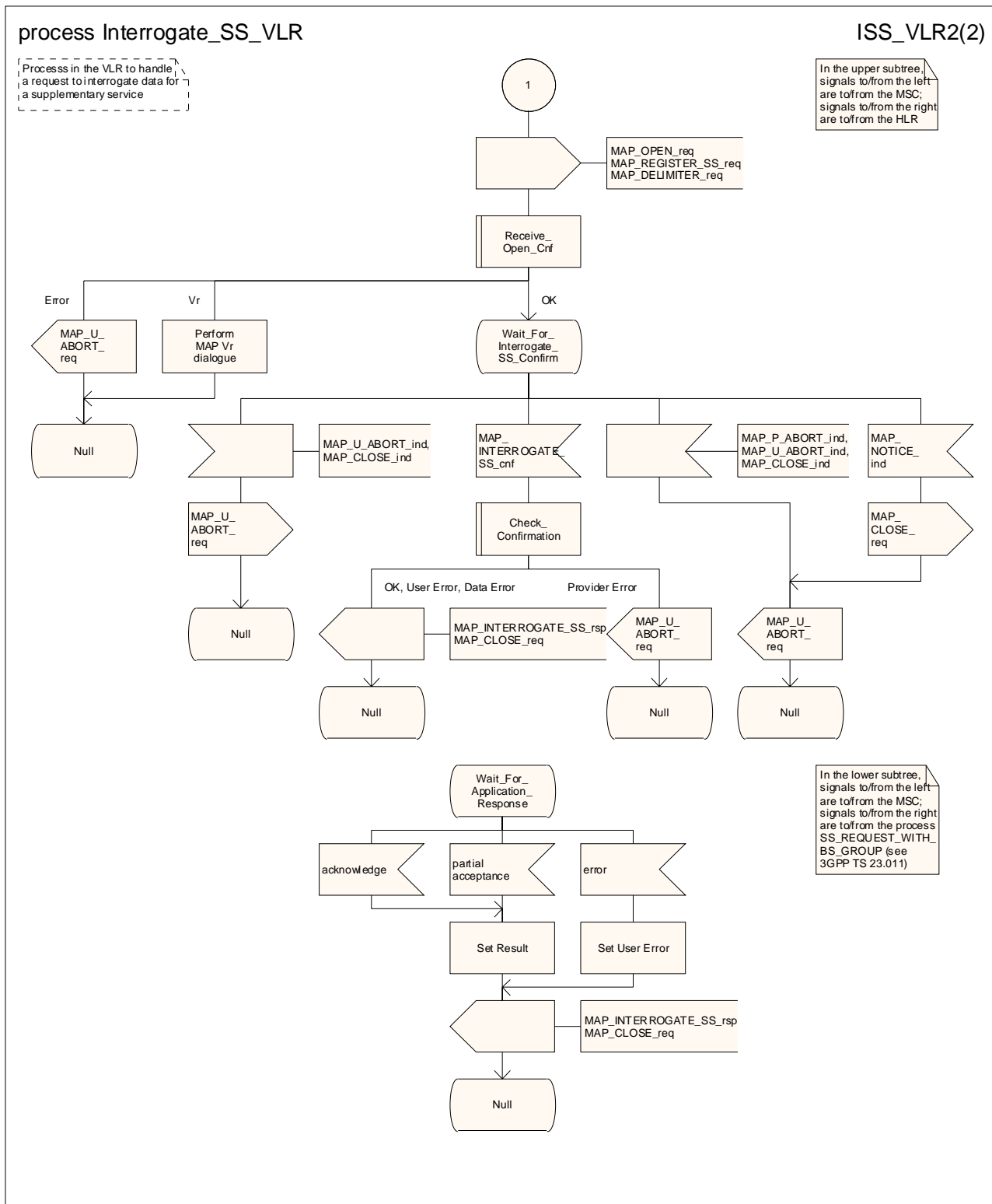

Figure 22.6.3/1 (sheet 2 of 2): Process Interrogate_SS_VLR

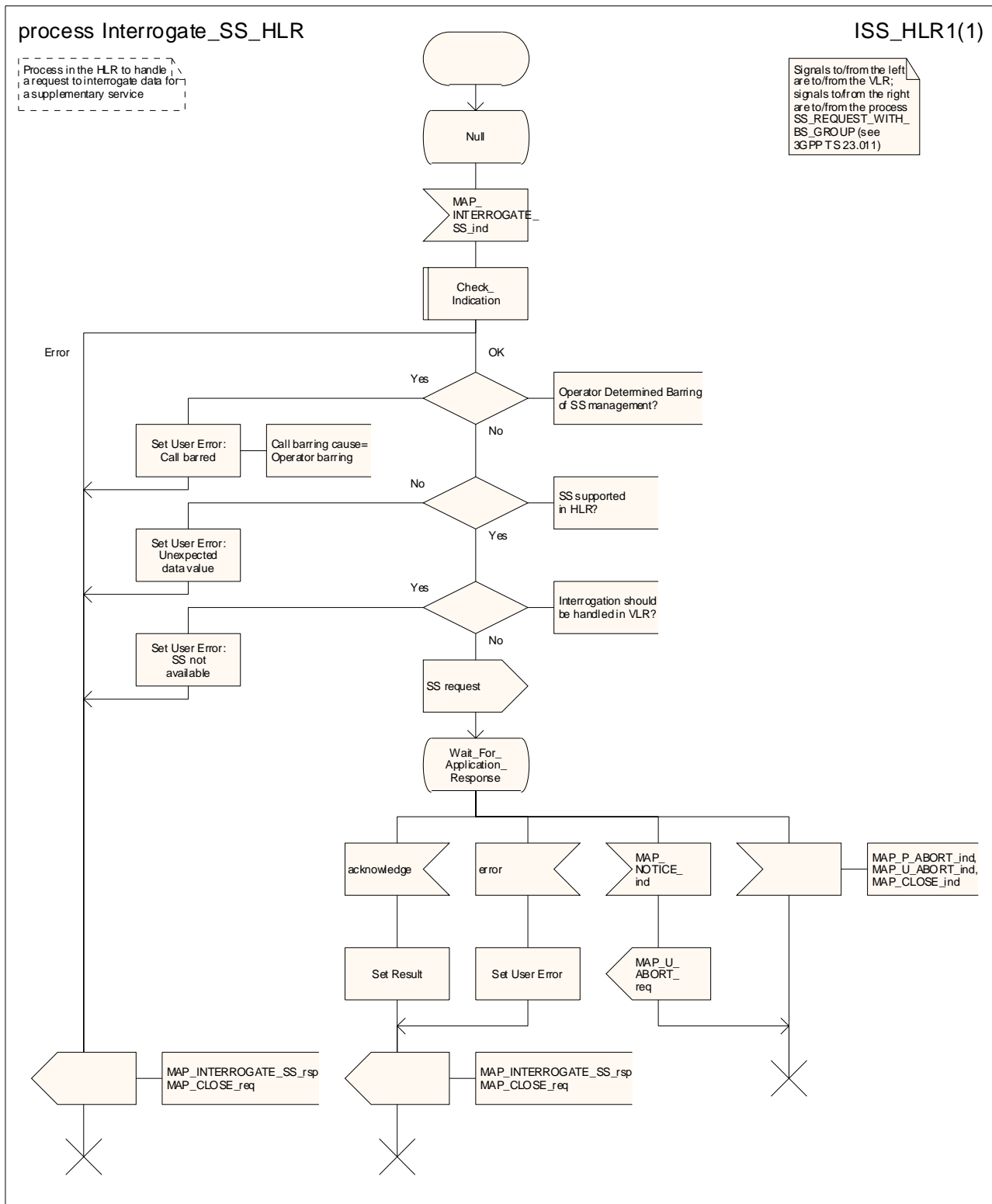

Figure 22.6.4/1: Process Interrogate_SS_HLR

22.7 Void

Figure 22.7.2/1 void

Figure 22.7.3/1 void

22.8 Password registration procedure

22.8.1 General

The password registration procedure is used to register a password in the HLR. The password registration procedure is a fully transparent communication between the MS and the HLR, except that some services may be invoked as a result of the procedure, as described below.

The password registration procedure is shown in figure 22.8.1/1.

The following services may be used:

MAP_PROCESS_ACCESS_REQUEST	(see clauses 8 and 25);
MAP_TRACE_SUBSCRIBER_ACTIVITY	(see clauses 9 and 25);
MAP_PROVIDE_IMSI	(see clauses 8 and 25);
MAP_FORWARD_NEW_TMSI	(see clauses 8 and 25);
MAP_AUTHENTICATE	(see clauses 8 and 25);
MAP_SET_CIPHERING_MODE	(see clauses 8 and 25);
MAP_CHECK_IMEI	(see clauses 8 and 25);
MAP_READY_FOR_SM	(see clauses 12 and 25);

The following services are certainly used:

MAP_REGISTER_PASSWORD	(defined in clause 11);
MAP_GET_PASSWORD	(defined in clause 11).

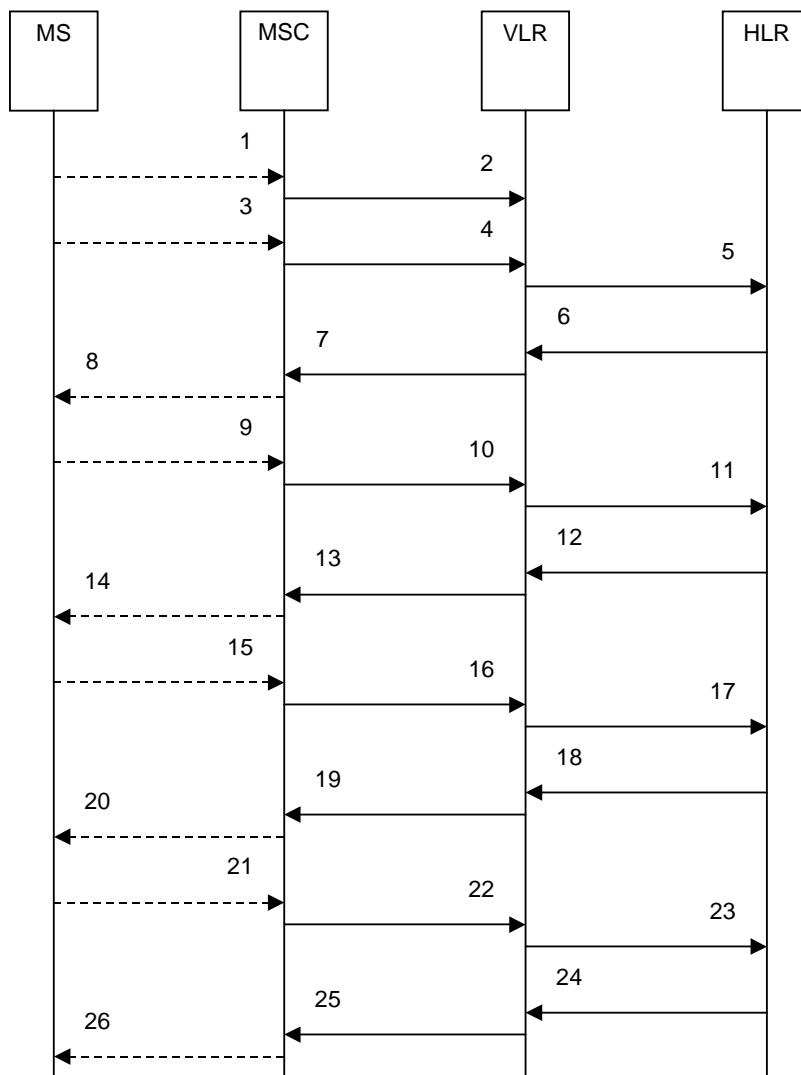

- 1) A_CM_SERV_REQ (Note 1)
- 2) MAP_PROCESS_ACCESS_REQUEST (Note 2)
- 3) A_REGISTER_PASSWORD (Note 1)
- 4) MAP_REGISTER_PASSWORD_req/ind
- 5) MAP_REGISTER_PASSWORD_req/ind
- 6) MAP_GET_PASSWORD_req/ind (Note 3)
- 7) MAP_GET_PASSWORD_req/ind (Note 3)
- 8) A_GET_PASSWORD (Note 1, Note 3)
- 9) A_GET_PASSWORD ack (Note 1, Note 3)
- 10) MAP_GET_PASSWORD_rsp/cnf (Note 3)
- 11) MAP_GET_PASSWORD_rsp/cnf (Note 3)
- 12) MAP_GET_PASSWORD_req/ind (Note 3)
- 13) MAP_GET_PASSWORD_req/ind (Note 3)
- 14) A_GET_PASSWORD (Note 1, Note 3)
- 15) A_GET_PASSWORD ack (Note 1, Note 3)
- 16) MAP_GET_PASSWORD_rsp/cnf (Note 3)
- 17) MAP_GET_PASSWORD_rsp/cnf (Note 3)
- 18) MAP_GET_PASSWORD_req/ind (Note 3)
- 19) MAP_GET_PASSWORD_req/ind (Note 3)
- 20) A_GET_PASSWORD (Note 1, Note 3)
- 21) A_GET_PASSWORD ack (Note 1, Note 3)
- 22) MAP_GET_PASSWORD_rsp/cnf (Note 3)
- 23) MAP_GET_PASSWORD_rsp/cnf (Note 3)
- 24) MAP_REGISTER_PASSWORD_rsp/cnf
- 25) MAP_REGISTER_PASSWORD_rsp/cnf
- 26) A_REGISTER_PASSWORD (Note 1)

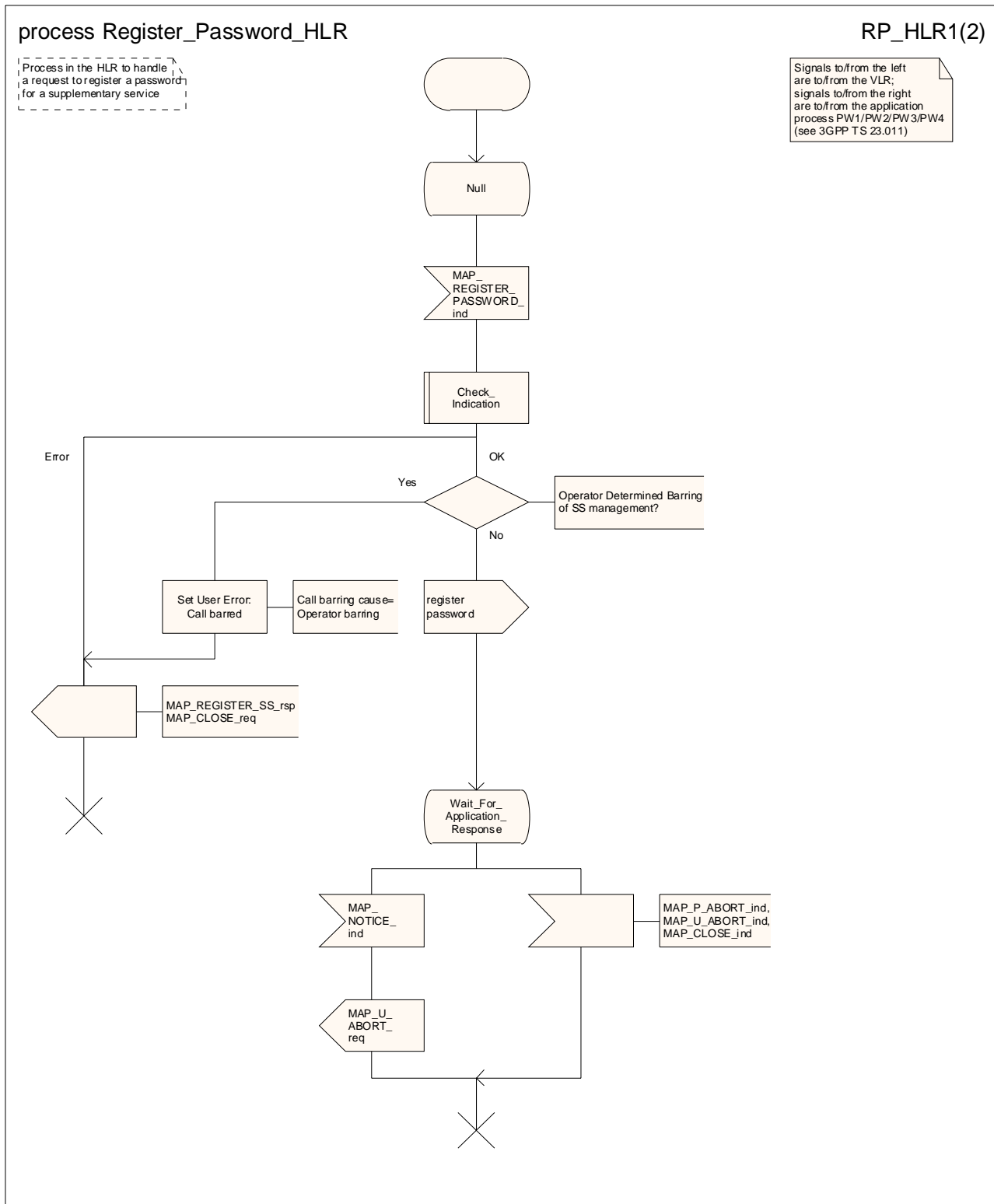

Figure 22.8.4/1 (sheet 1 of 2): Process Register_PW_HLR

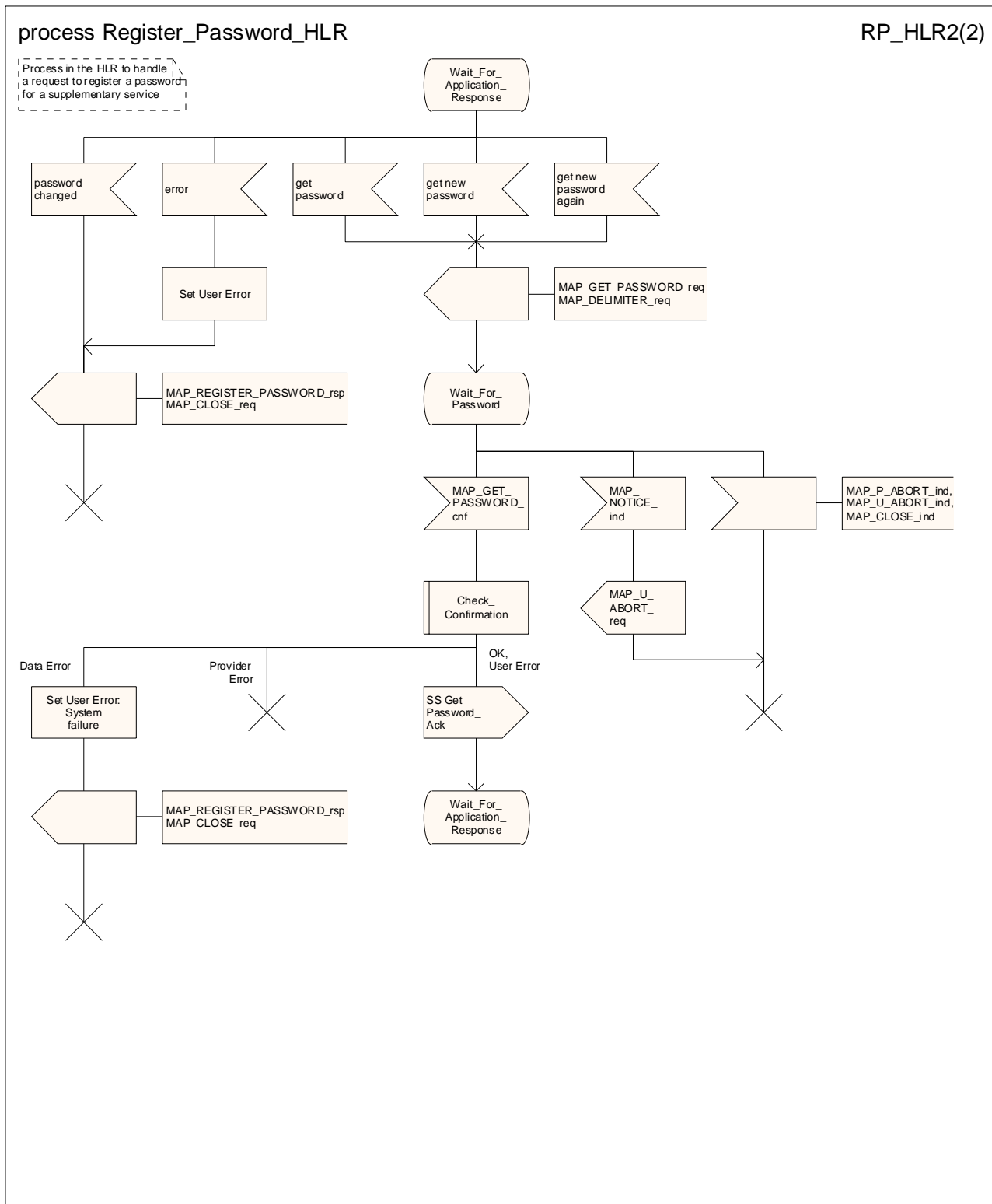

Figure 22.8.4/1 (sheet 2 of 2): Process Register_PW_HLR

22.9 Mobile Initiated USSD procedure

22.9.1 General

The procedure supports supplementary service signalling procedures which allow PLMN specific services to be introduced.

The message flow for the procedure can be found in 3GPP TS 23.090 [34].

The following services may be used:

MAP_PROCESS_ACCESS_REQUEST	(see clauses 8 and 25);
MAP_TRACE_SUBSCRIBER_ACTIVITY	(see clauses 9 and 25);
MAP_PROVIDE_IMSI	(see clauses 8 and 25);
MAP_FORWARD_NEW_TMSI	(see clauses 8 and 25);
MAP_AUTHENTICATE	(see clauses 8 and 25);
MAP_SET_CIPHERING_MODE	(see clauses 8 and 25);
MAP_CHECK_IMEI	(see clauses 8 and 25);
MAP_READY_FOR_SM	(see clauses 12 and 25);
MAP_UNSTRUCTURED_SS_REQUEST	(defined in clause 11);
MAP_UNSTRUCTURED_SS_NOTIFY	(defined in clause 11).

The following service is certainly used:

MAP_PROCESS_UNSTRUCTURED_SS_REQUEST (defined in clause 11).

22.9.2 Procedure in the MSC

The process invokes a macro not defined in this clause; the definition of this macro can be found as follows:

Check_Confirmation see subclause 25.2.2.

The A_PROCESS_UNSTRUCTURED_SS_REQUEST from the MS contains information input by the user; the message may be fed to an application contained locally in the MSC or to the VLR. The rules for determining this are specified in 3GPP TS 23.090 [34].

1) Message Destined for the VLR

If the message is destined for the VLR then the MSC shall transfer the message to the VLR using the mapping specified in detail in 3GPP TS 29.011 [59].

2) Message Destined for the Local Application

If the message is destined for the local USSD application then the MSC shall transfer the information contained in the message to the application.

The process in the MSC is shown in figure 22.9.2/1.

22.9.3 Procedure in the VLR

The MAP process invokes macros not defined in this clause; the definitions of these macros can be found as follows:

Receive_Open_Cnf see subclause 25.1.2;
 Check_Confirmation see subclause 25.2.2;

Process_Access_Request_VLR see subclause 25.4.2.

The MAP_PROCESS_UNSTRUCTURED_SS_REQUEST from the MSC contains information input by the user; the message may be fed to an application contained locally in the VLR or to the HLR. The rules for determining this are specified in 3GPP TS 23.090 [34].

1) Message Destined for the HLR

If the message is destined for the HLR then the VLR shall transfer the message transparently to the HLR.

2) Message Destined for the Local Application

If the message is destined for the local USSD application then the VLR shall transfer the information contained in the message to the application.

When the VLR receives the result of the original operation from the application then it shall pass this to the MSC and initiate release of the CM connection.

The process in the VLR is shown in figure 22.9.3/1.

22.9.4 Procedure in the HLR

The MAP process invokes macros not defined in this clause; the definitions of these macros can be found as follows:

Receive_Open_Ind see subclause 25.1.1;

Receive_Open_Cnf see subclause 25.1.2;

Check_Confirmation see subclause 25.2.2.

The MAP_PROCESS_UNSTRUCTURED_SS_REQUEST from the VLR contains information input by the user. If the alphabet used for the message is understood then the message shall be fed to an application contained locally in the HLR or to the gsmSCF or a secondary HLR where the USSD application is located.

1) Message Destined for the Local Application

If the message is destined for the local USSD application then the HLR shall transfer the information contained in the message to the local application.

2) Message Destined for the gsmSCF or the secondary HLR

If the message is destined for the gsmSCF or the secondary HLR then the primary HLR shall transfer the message transparently to the next node.

The process in the primary HLR is shown in figure 22.9.4/1.

22.9.5 Procedures in the gsmSCF/secondary HLR

The MAP process invokes a macro not defined in this clause; the definition of this macros can be found as follows:

Receive_Open_Ind see subclause 25.1.1.

The process in the gsmSCF or secondary HLR is shown in figure 22.9.5/1.

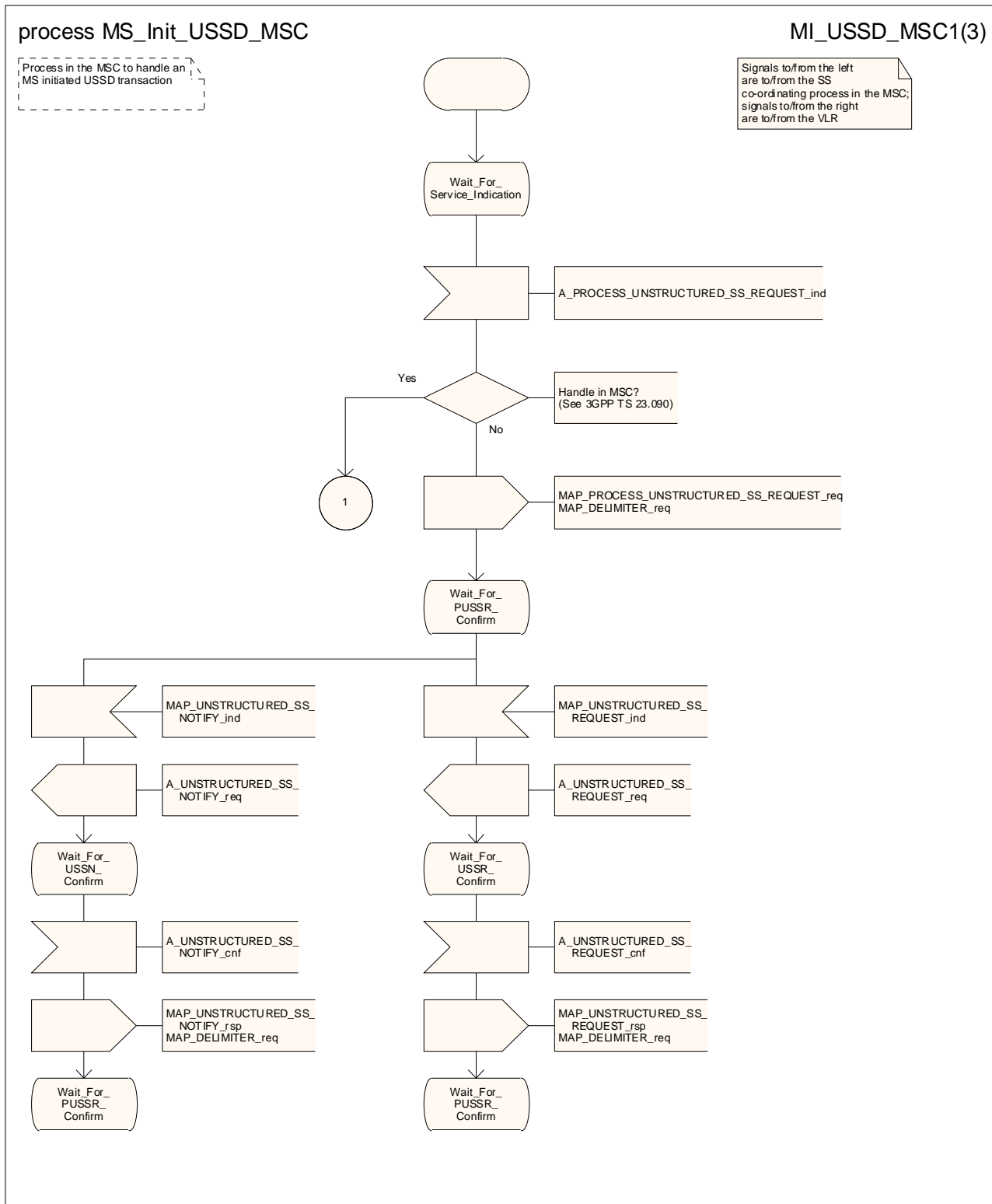

Figure 22.9.2/1 (sheet 1 of 3): Process MS_Init_USSD_MSC

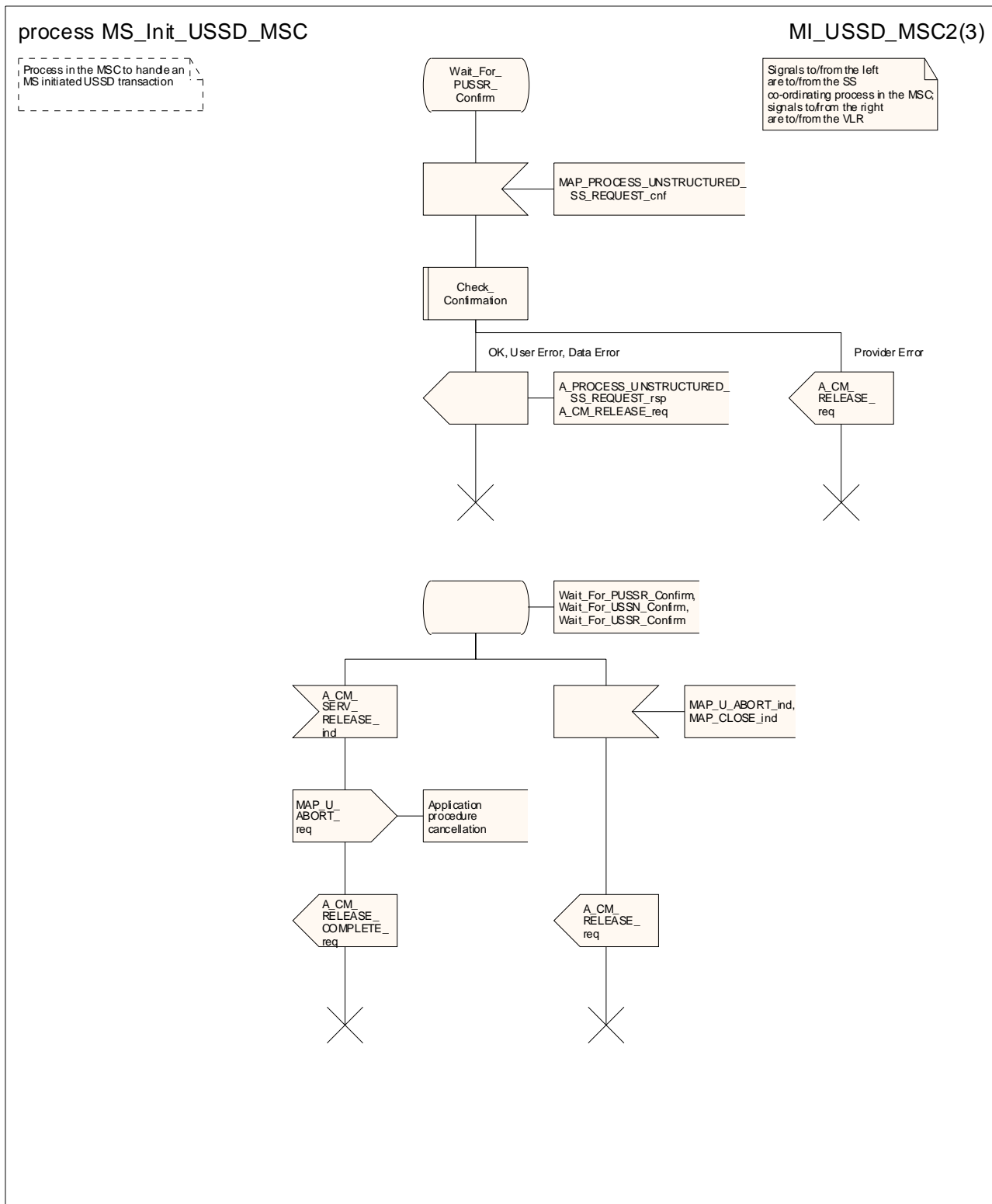

Figure 22.9.2/1 (sheet 2 of 3): Process MS_Init_USSD_MSC

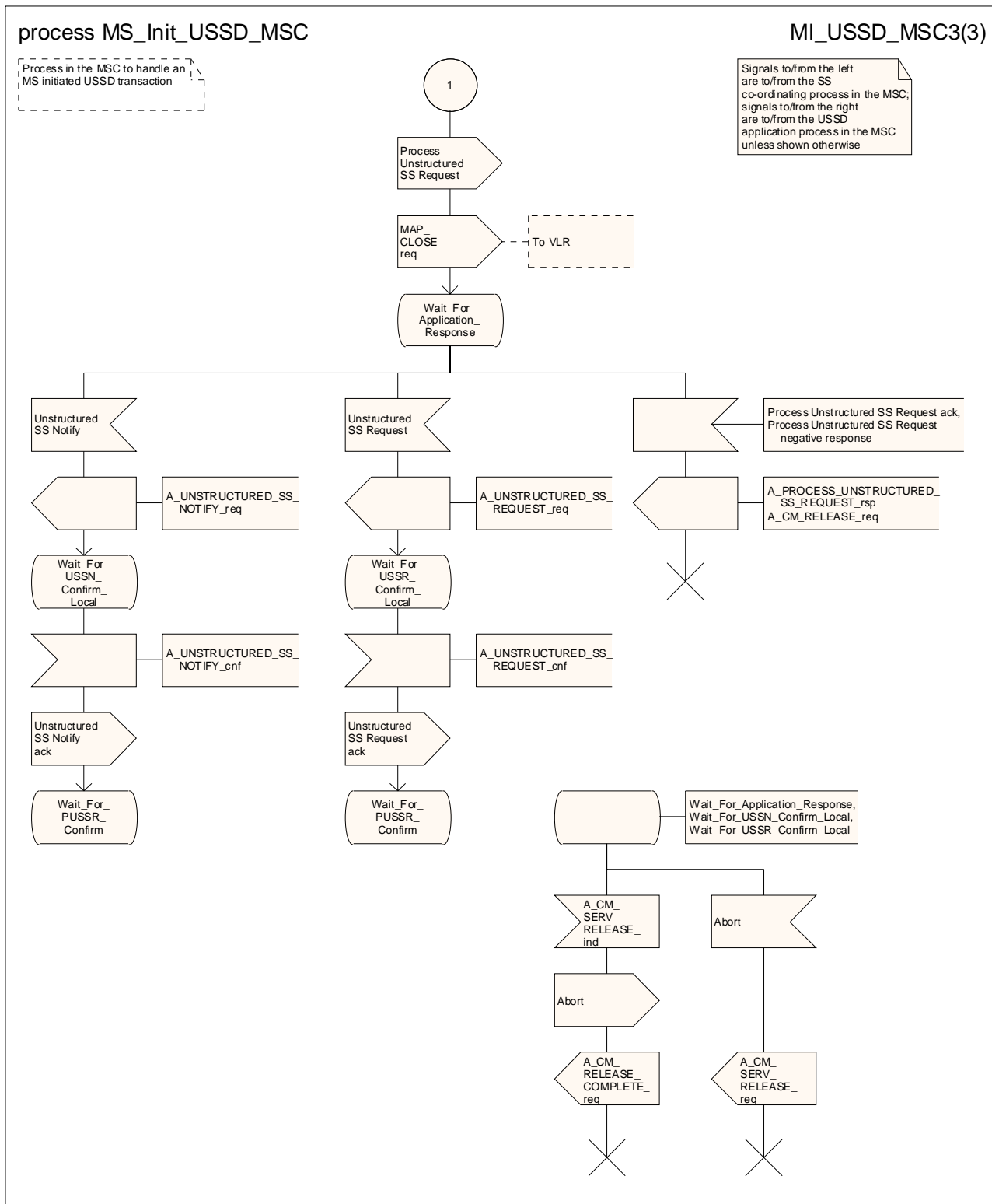

Figure 22.9.2/1 (sheet 3 of 3): Process MS_Init_USSD_MSC

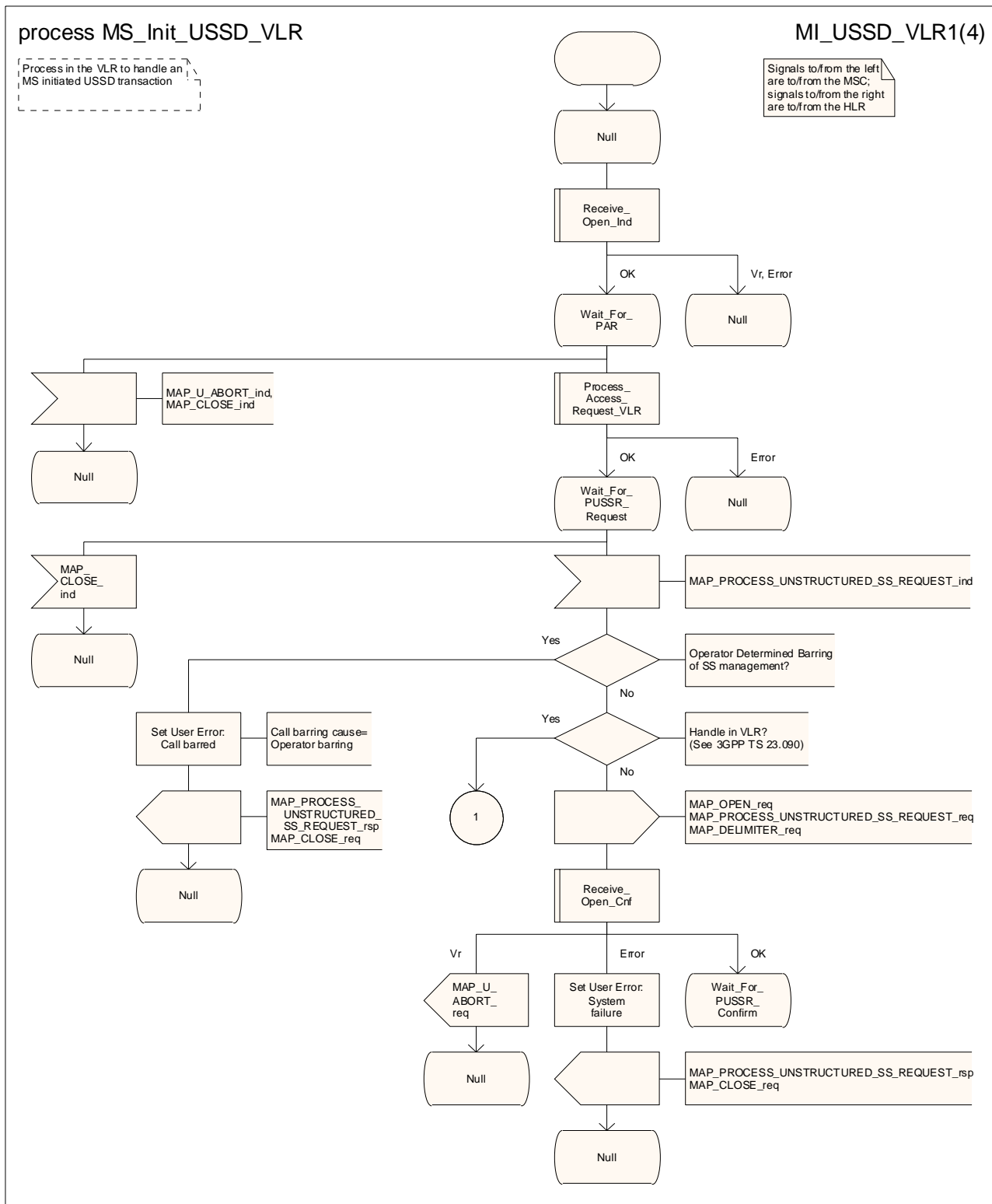

Figure 22.9.3/1 (sheet 1 of 4): Process MS_Init_USSD_VLR

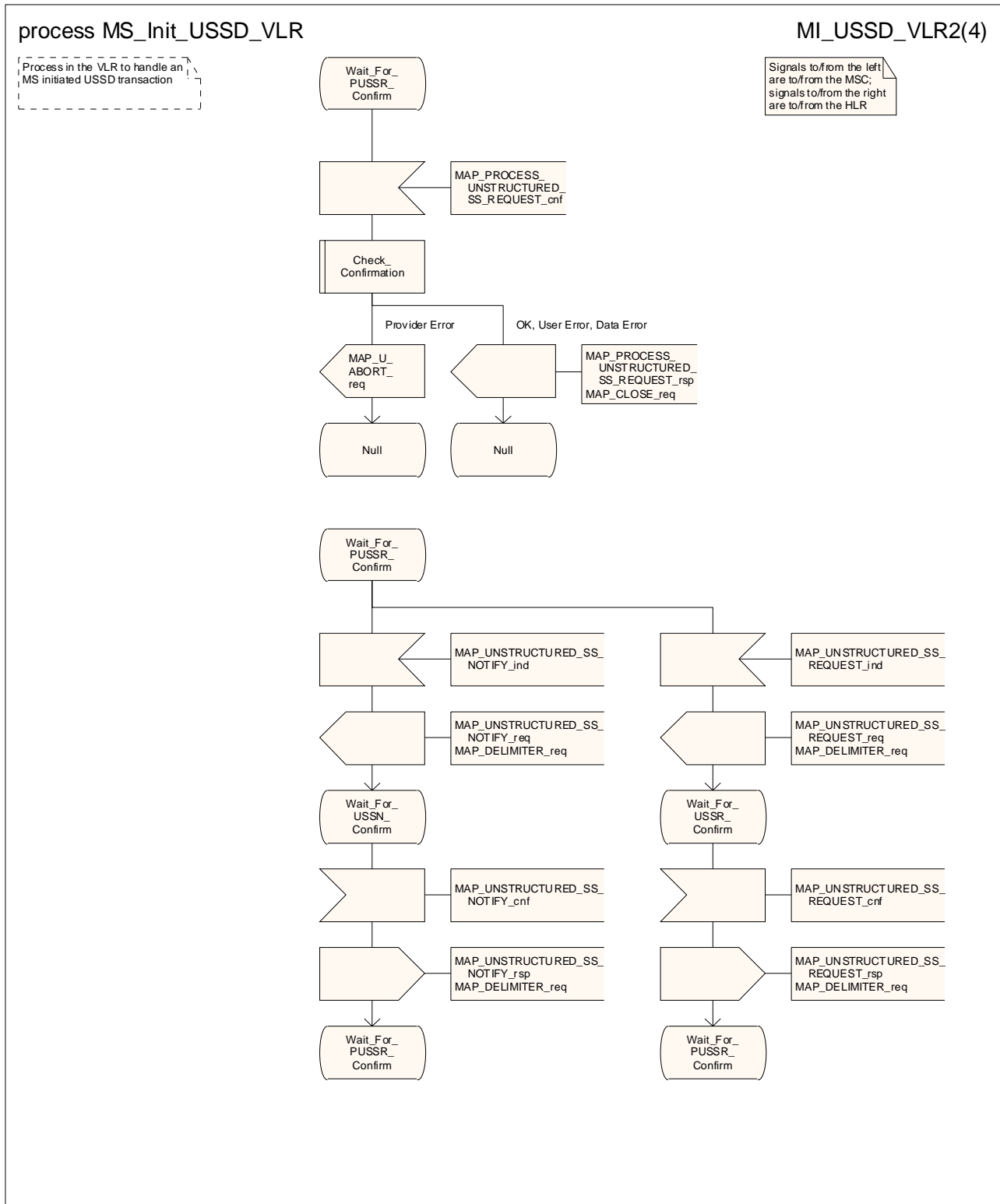

Figure 22.9.3/1 (sheet 2 of 4): Process MS_Init_USSD_VLR

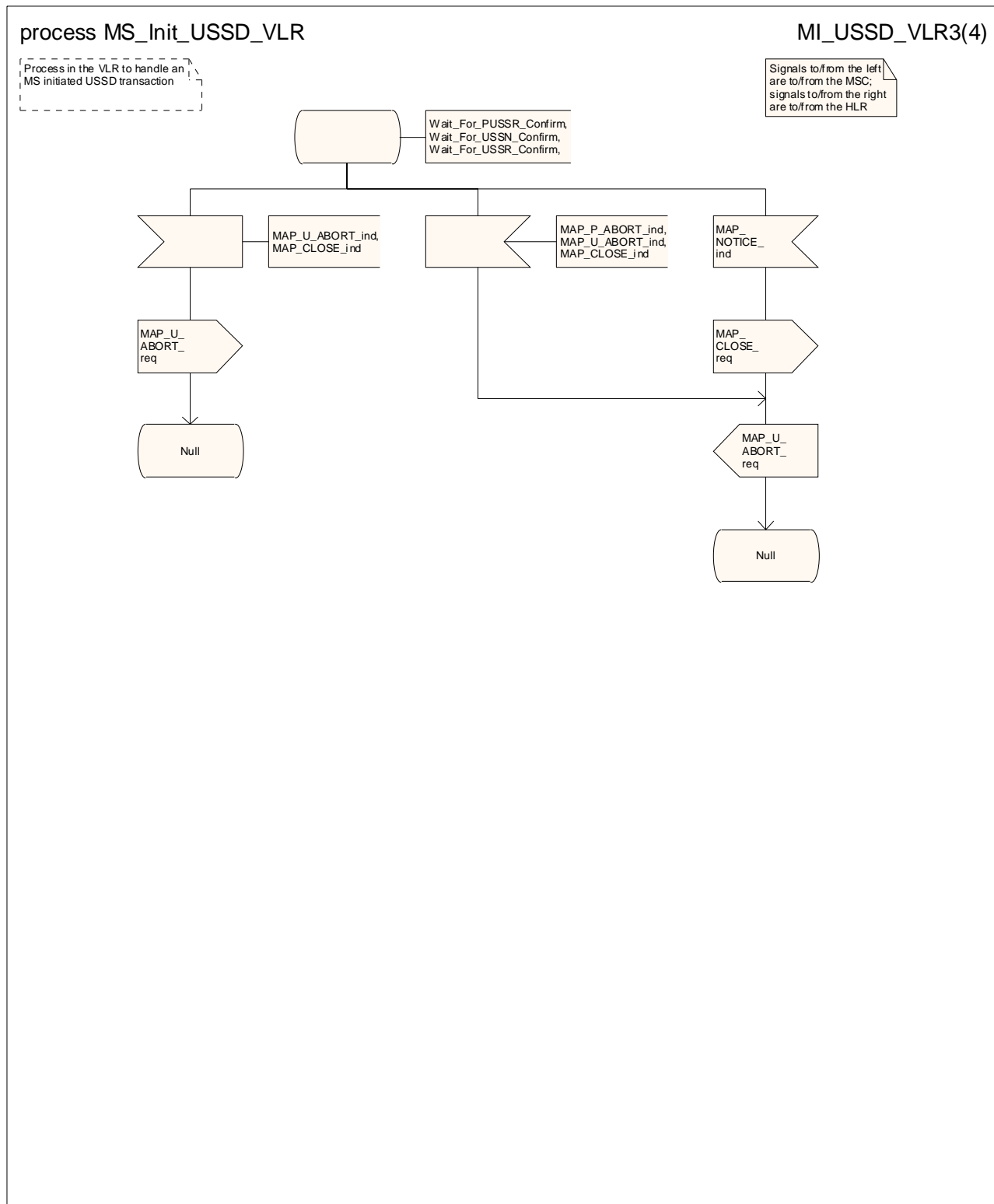

Figure 22.9.3/1 (sheet 3 of 4): Process_MS_Init_USSD_VLR

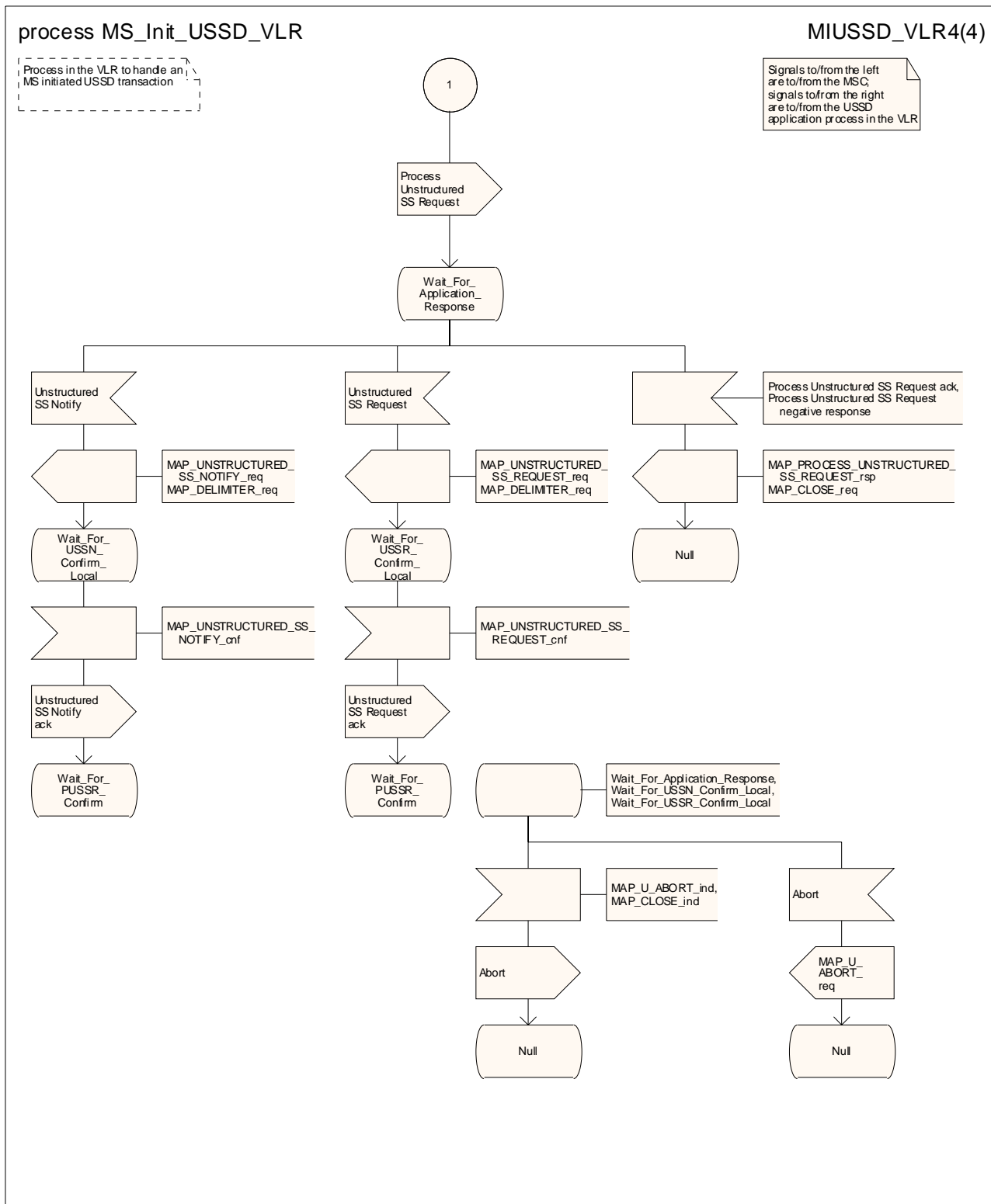

Figure 22.9.3/1 (sheet 4 of 4): Process_MS_Init_USSD_VLR

Figure 22.9.3/2 void

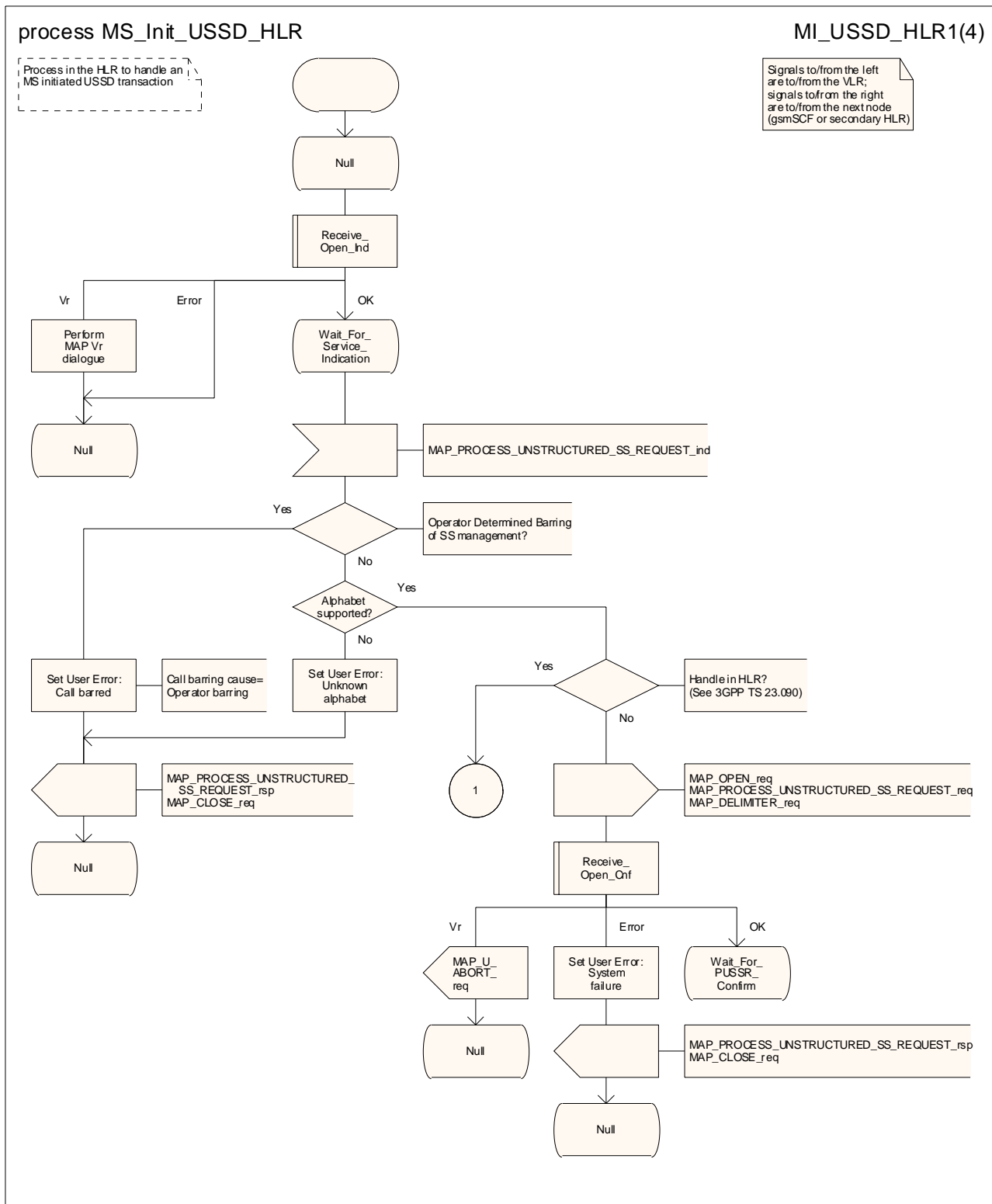

Figure 22.9.4/1 (sheet 1 of 4): Process MS_Init_USSD_HLR

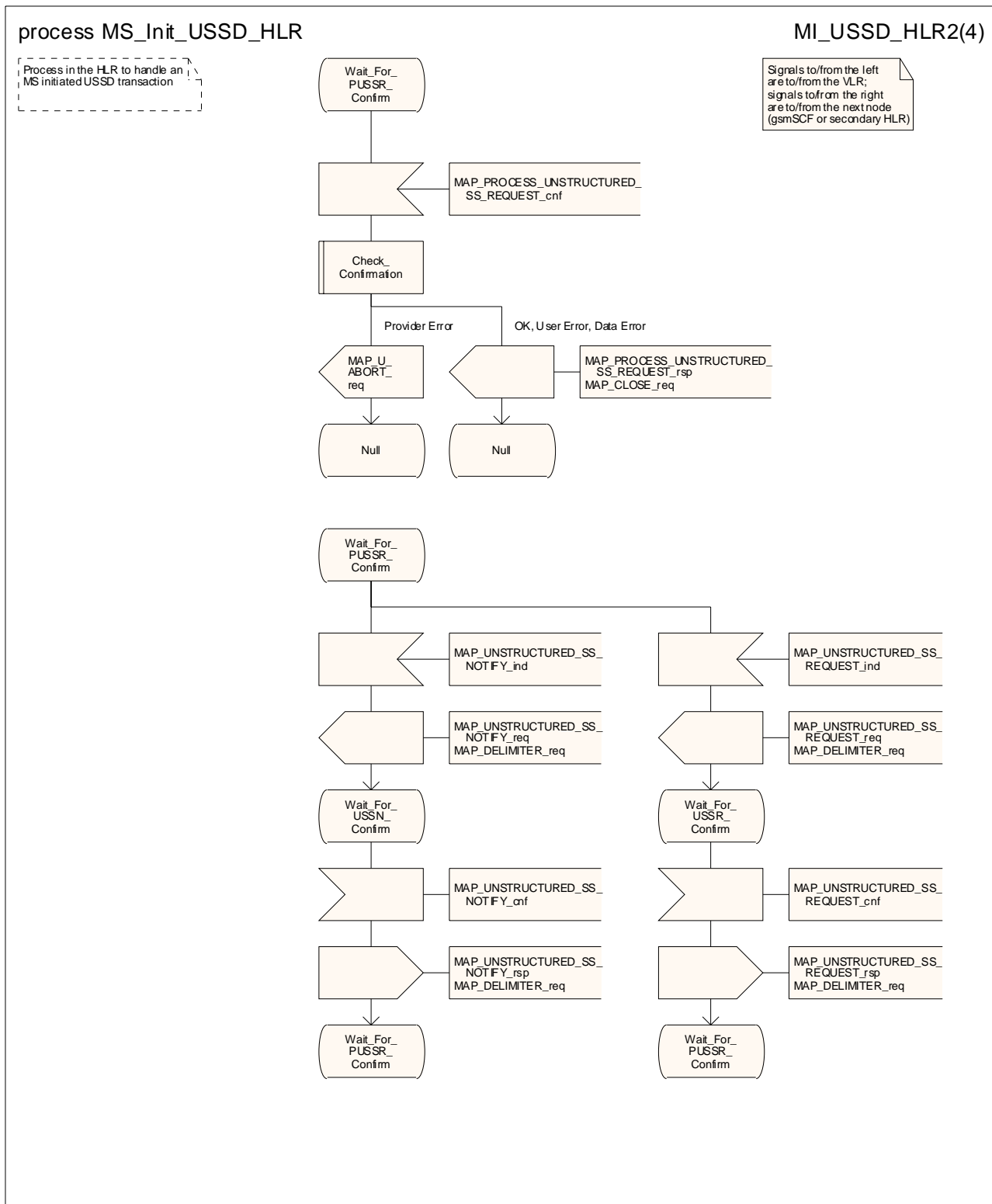

Figure 22.9.4/1 (sheet 2 of 4): Process MS_Init_USSD_HLR

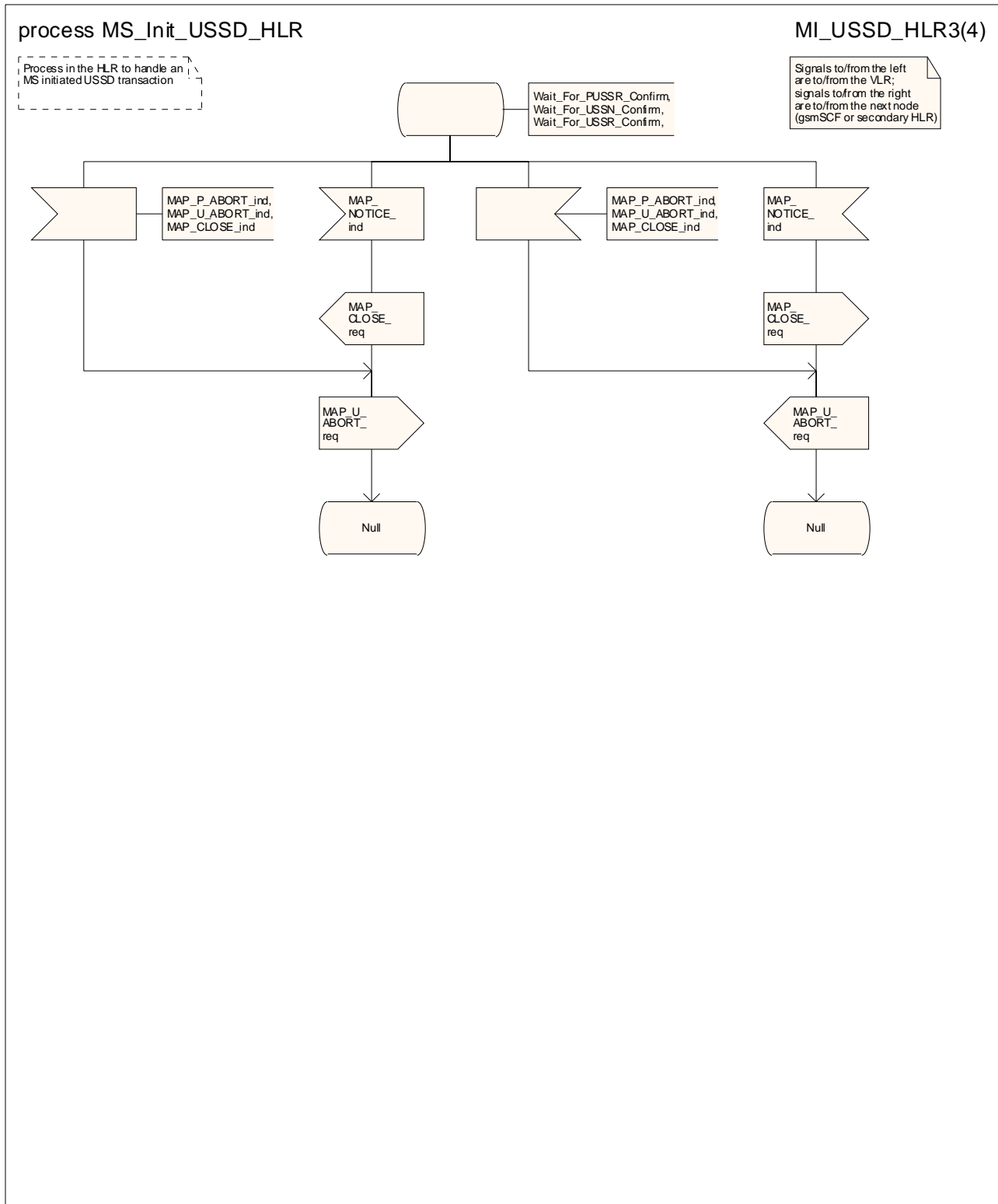

Figure 22.9.4/1 (sheet 3 of 4): Process MS_Init_USSD_HLR

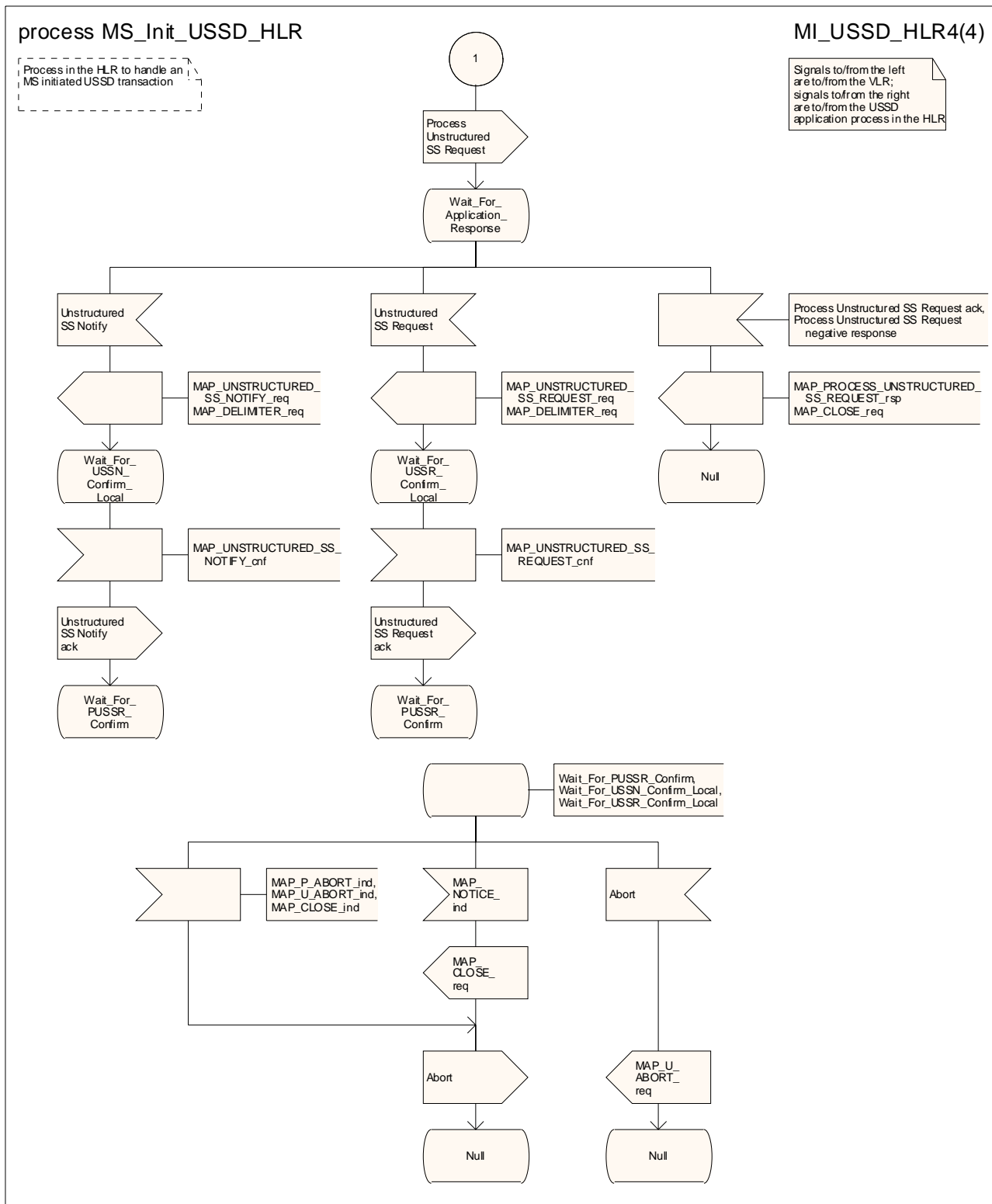

Figure 22.9.4/1 (sheet 4 of 4): Process MS_Init_USSD_HLR

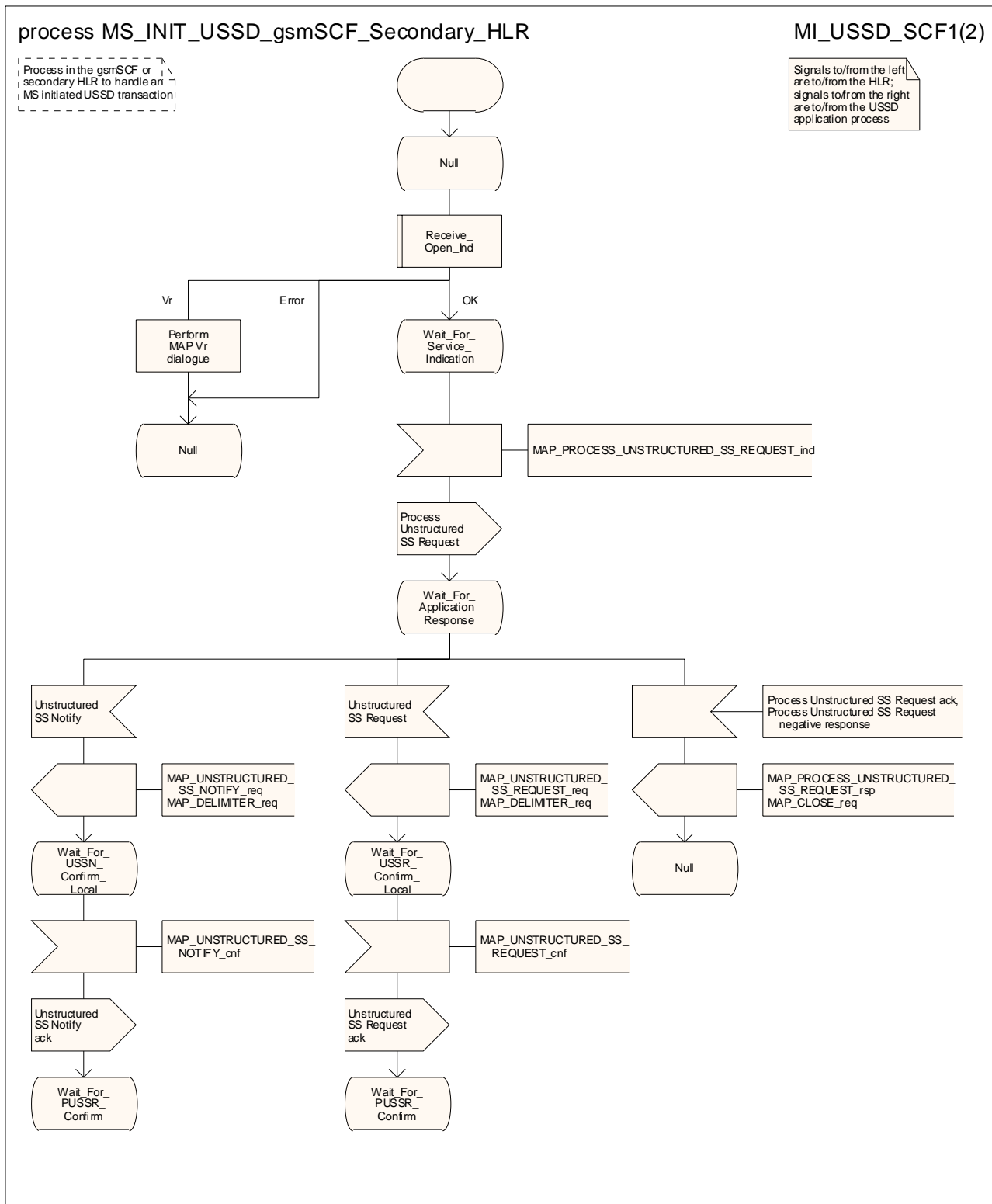

Figure 22.9.5/1 (sheet 1 of 2): Process MS_Init_USSD_gsmSCF_Secondary_HLR

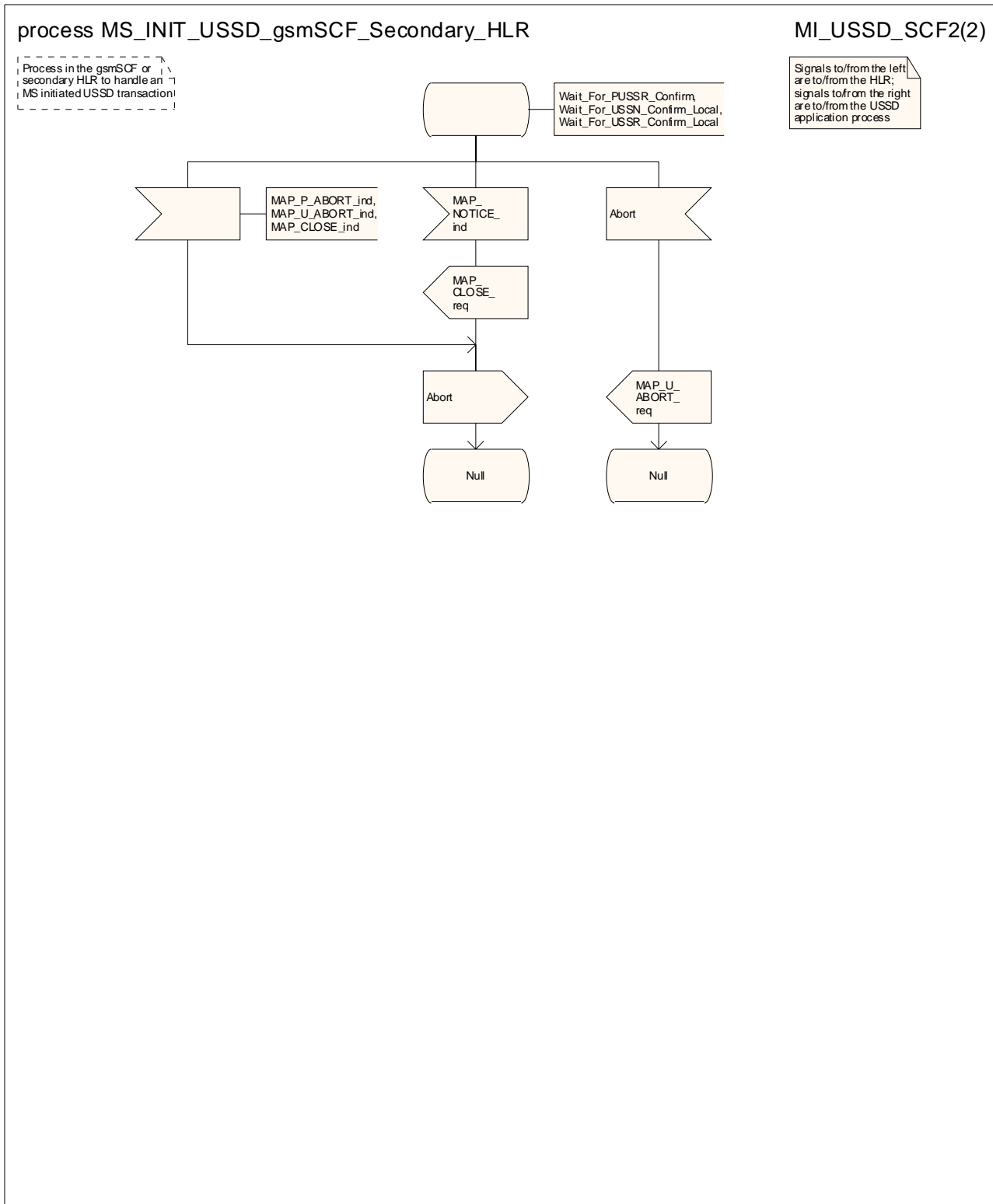

Figure 22.9.5/1 (sheet 2 of 2): Process MS_Init_USSD_gsmSCF_Secondary_HLR

22.10 Network initiated USSD procedure

22.10.1 General

The procedure supports supplementary service signalling procedures which allow PLMN specific services to be introduced.

The message flow for the procedure can be found in 3GPP TS 23.090 [34].

The following services may be used:

MAP_PAGE	(see clauses 8 and 25);
MAP_SEARCH_FOR_MOBILE_SUBSCRIBER	(see clauses 8 and 25);
MAP_PROCESS_ACCESS_REQUEST	(see clauses 8 and 25);
MAP_AUTHENTICATE	(see clauses 8 and 25);
MAP_SET_CIPHERING_MODE	(see clauses 8 and 25);
MAP_FORWARD_NEW_TMSI	(see clauses 8 and 25);
MAP_READY_FOR_SM	(see clauses 12 and 25).

At least one of the following services will certainly be used, and both may be used:

MAP_UNSTRUCTURED_SS_REQUEST	(defined in clause 11);
MAP_UNSTRUCTURED_SS_NOTIFY	(defined in clause 11).

22.10.2 Procedure in the MSC

The process invokes macros not defined in this clause; the definitions of these macros can be found as follows:

Receive_Open_Ind	see subclause 25.1.1;
Receive_Open_Cnf	see subclause 25.1.2;
Page_MSC	see subclause 25.3.1;
Search_For_MS_MSC	see subclause 25.3.2;
Process_Access_Request_MSC	see subclause 25.4.1.

The process in the MSC is shown in figure 22.10.2/1.

22.10.3 Procedure in the VLR

The MAP process invokes macros not defined in this clause; the definitions of these macros can be found as follows:

Receive_Open_Ind	see subclause 25.1.1;
Receive_Open_Cnf	see subclause 25.1.2;
Check_Indication	see subclause 25.2.1;
Check_Confirmation	see subclause 25.2.2.

The process in the VLR is shown in figure 22.10.3/1.

MSC Initiated USSD

If a USSD application in the MSC wishes to use the network initiated USSD procedure, and a connection to the MS does not exist then the MSC opens a dialogue with the VLR. This dialogue leads to the VLR performing page or search using the macro Start_USSD_VLR.

Macro Start_USSD_VLR

The macro invokes macros not defined in this clause; the definitions of these macros can be found as follows:

Check_Confirmation	see subclause 25.2.1;
Process_Access_Request_VLR	see subclause 25.4.2.

The macro is shown in figure 22.10.3/2.

22.10.4 Procedure in the HLR

The MAP process invokes macros not defined in this clause; the definitions of these macros can be found as follows:

Receive_Open_Ind	see subclause 25.1.1;
Receive_Open_Cnf	see subclause 25.1.2;
Check_Indication	see subclause 25.2.1;
Check_Confirmation	see subclause 25.2.2.

The process in the primary HLR is shown in figures 22.10.4/1 and 22.10.4/2.

22.10.5 Procedure in the gsmSCF or secondary HLR

The MAP process invokes macros not defined in this clause; the definitions of these macros can be found as follows:

Receive_Open_Cnf	see subclause 25.1.2;
Check_Confirmation	see subclause 25.2.2.

The process in the gsmSCF or secondary HLR is shown in figure 22.10.5/1.

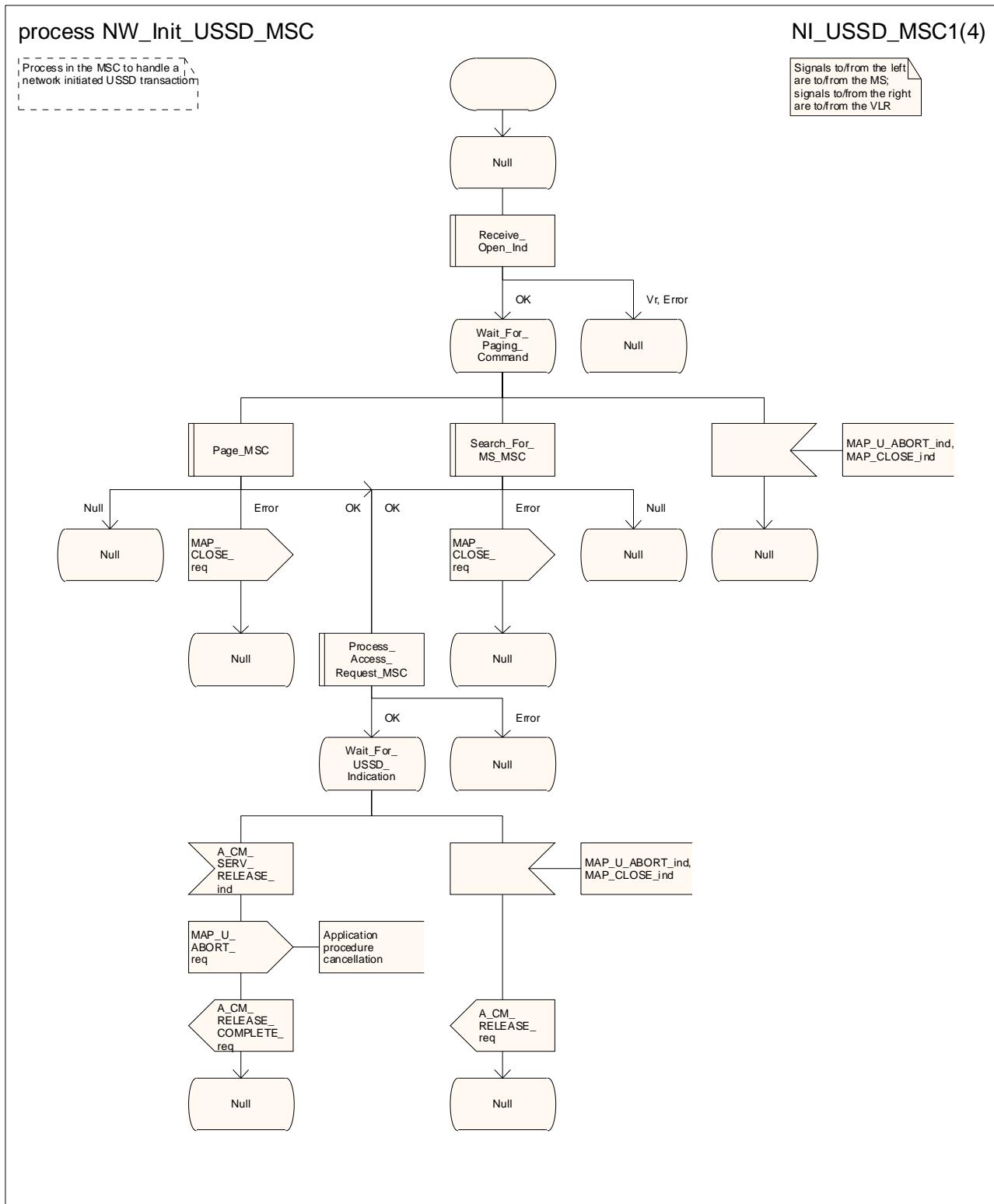

Figure 22.10.2/1 (sheet 1 of 4): Process NW_Init_USSD_MSC

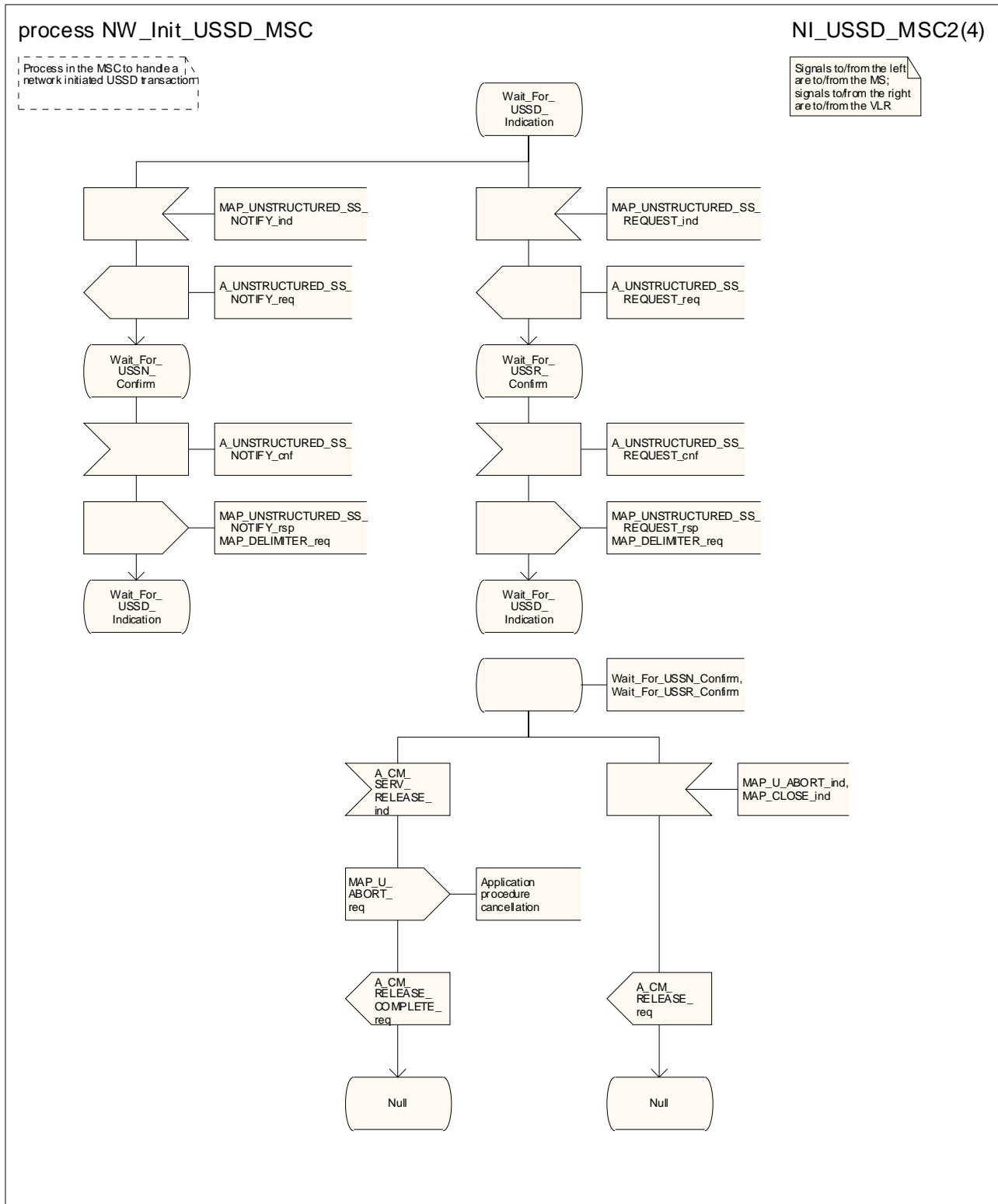

Figure 22.10.2/1 (sheet 2 of 4): Process NW_Init_USSD_MSC

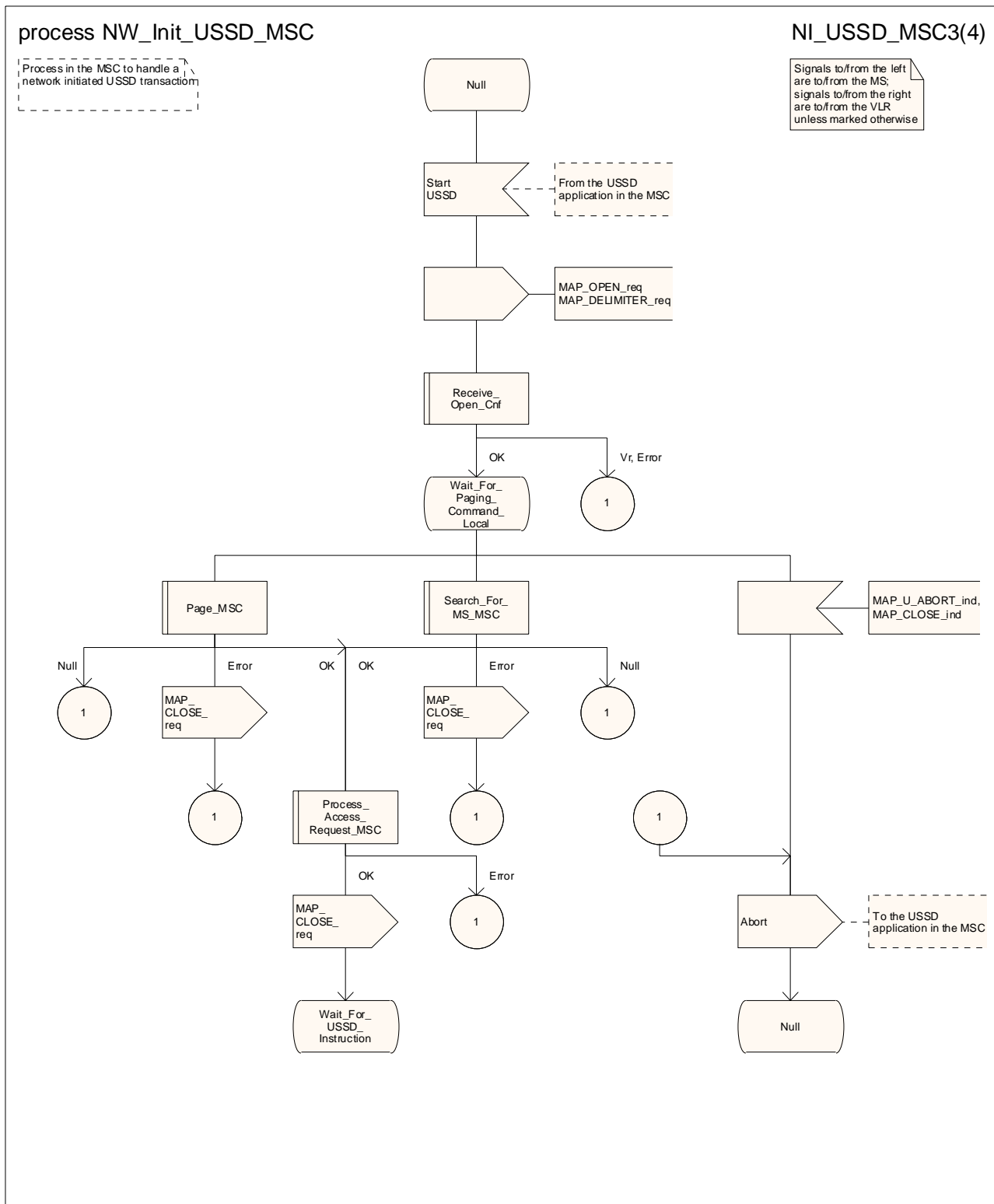

Figure 22.10.2/1 (sheet 3 of 4): Process NW_Init_USSD_MSC

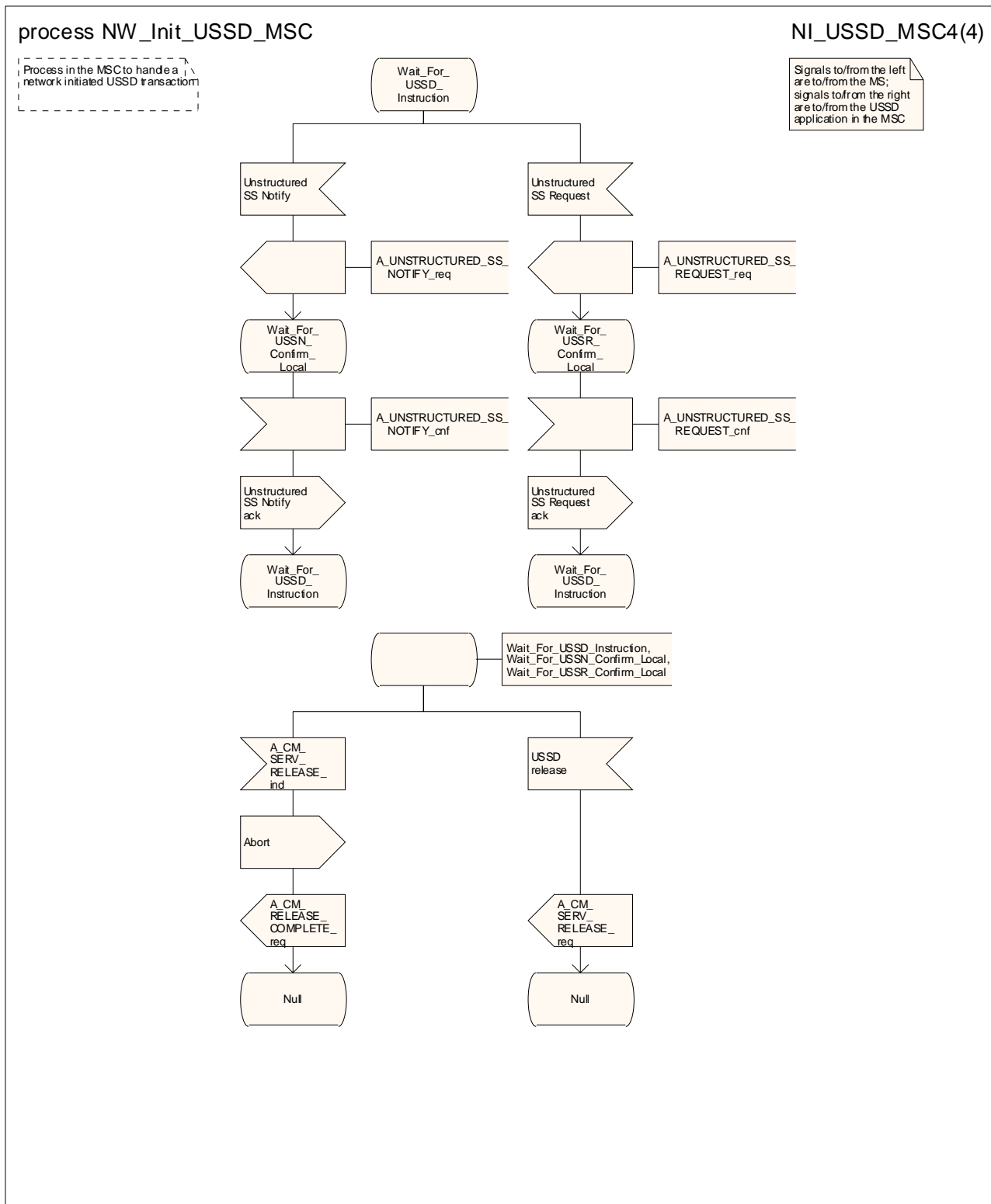

Figure 22.10.2/1 (sheet 4 of 4): Process NW_Init_USSD_MSC

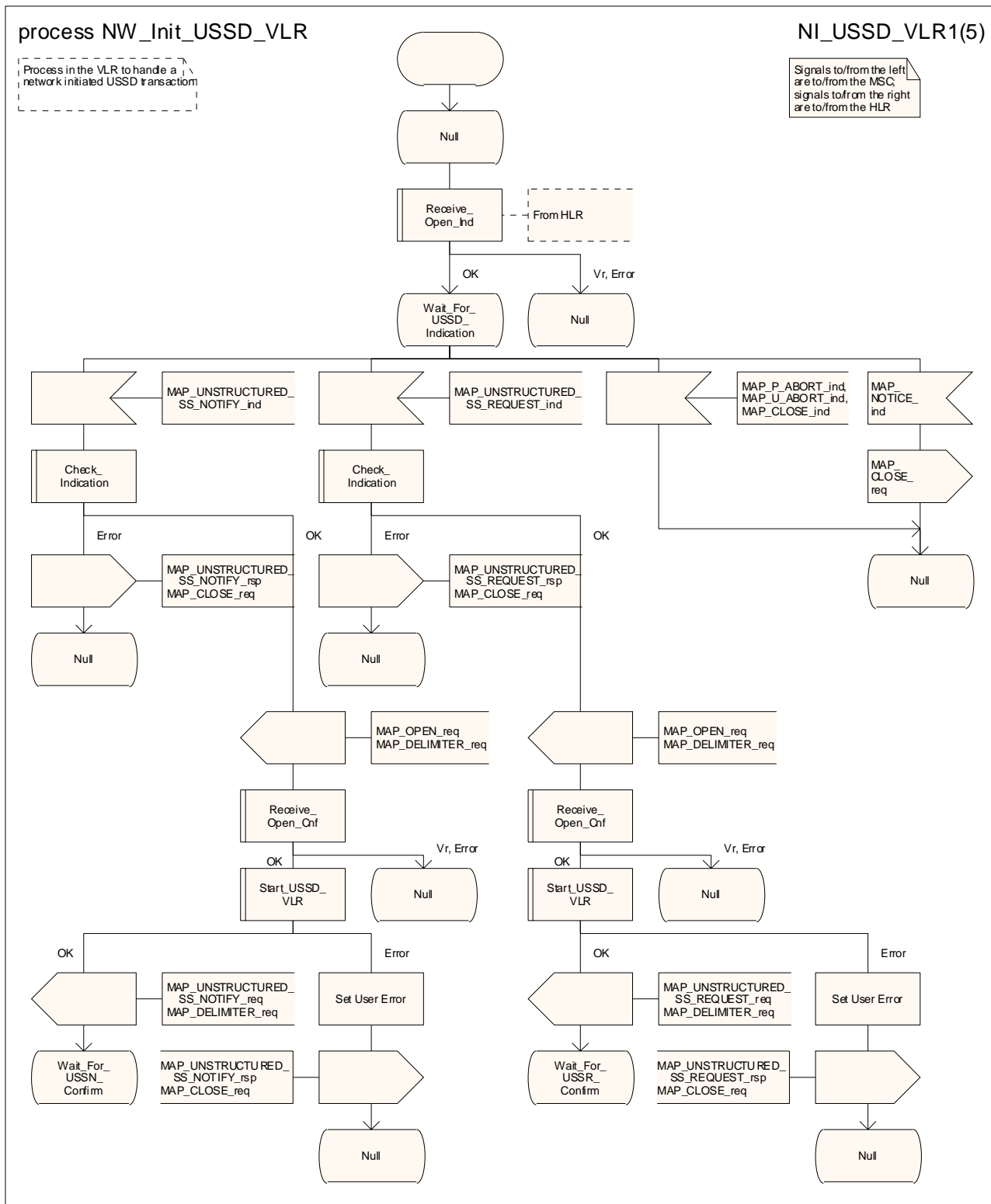

Figure 22.10.3/1 (sheet 1 of 5): Process NW_Init_USSD_VLR

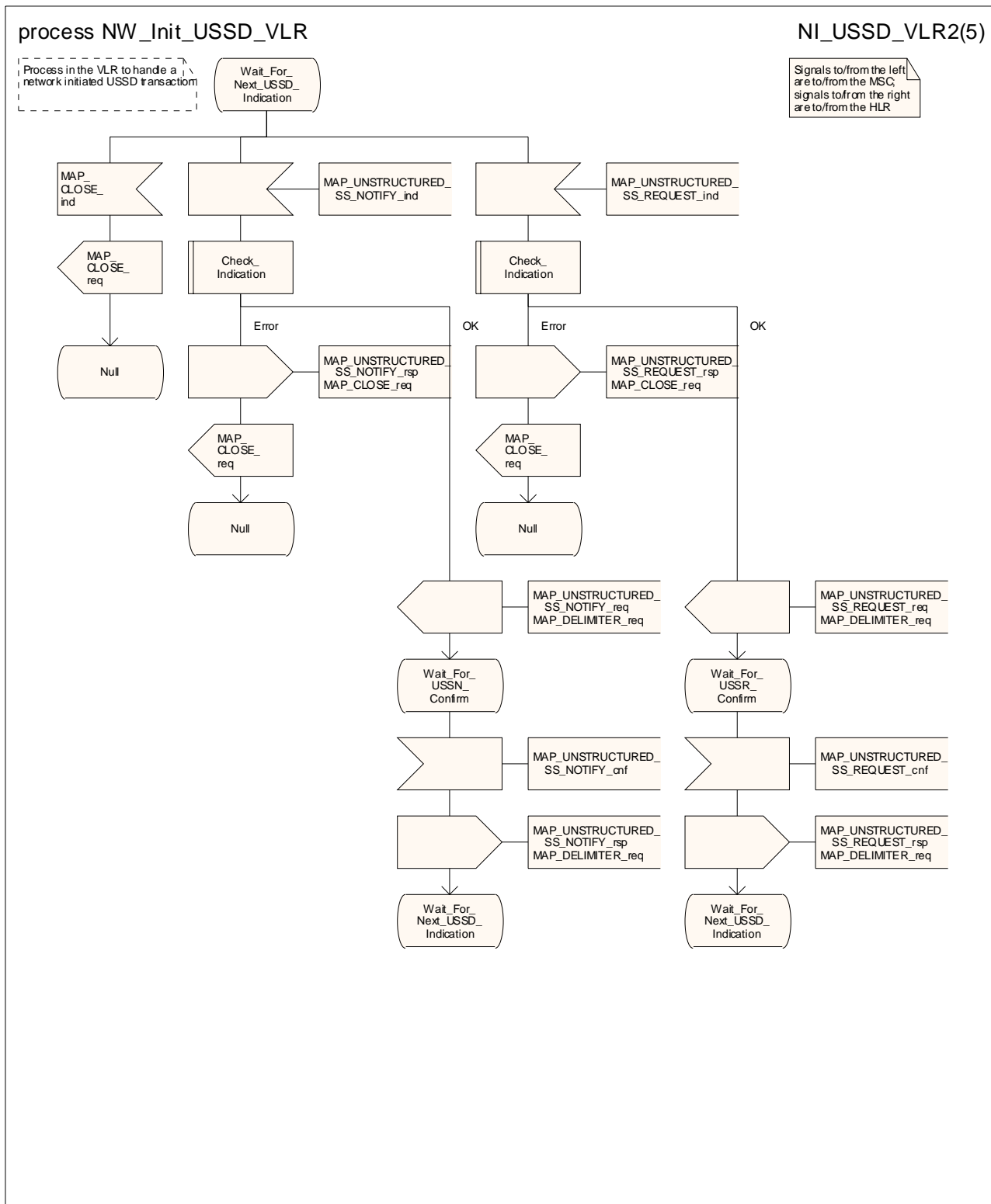

Figure 22.10.3/1 (sheet 2 of 5): Process NW_Init_USSD_VLR

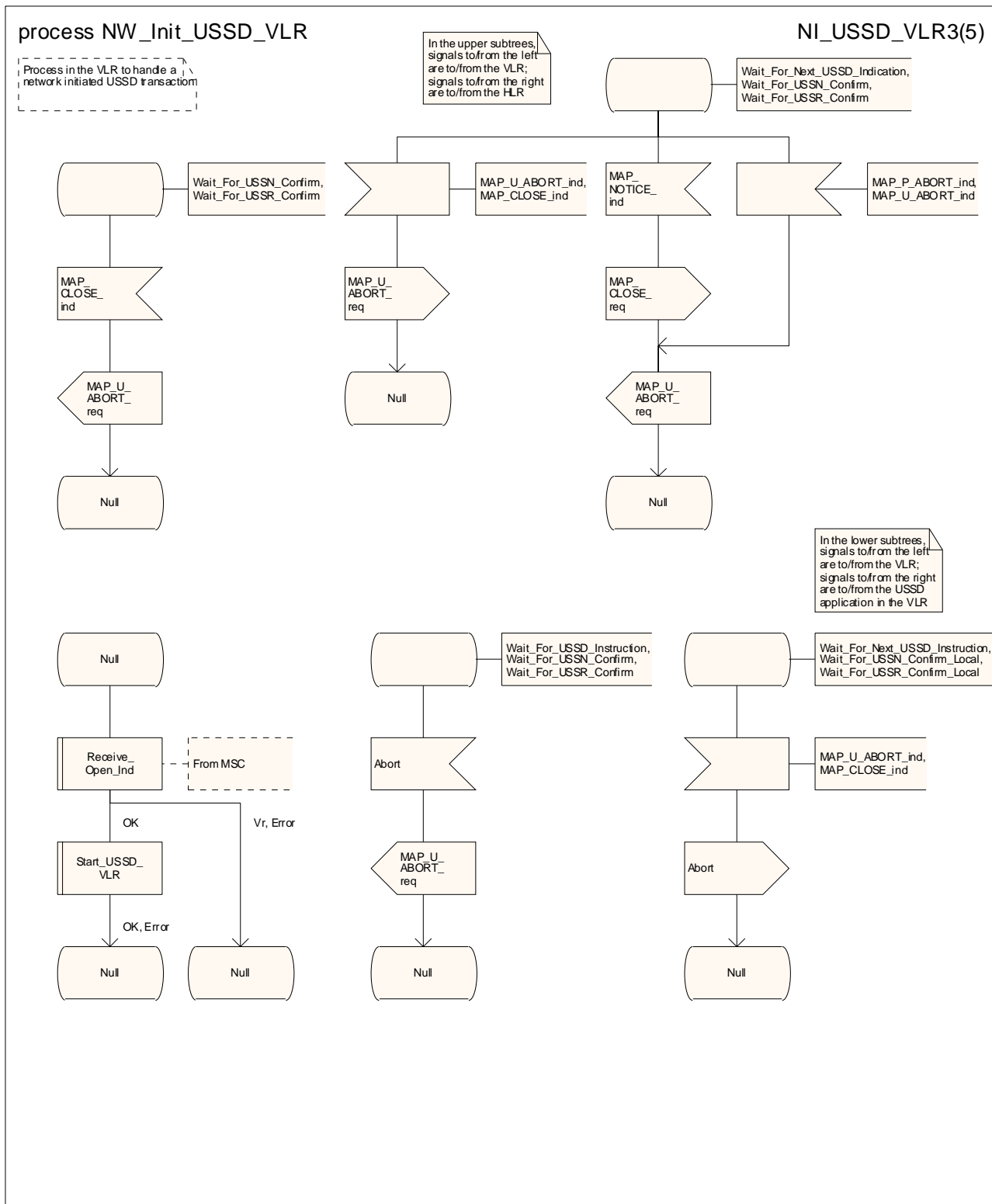

Figure 22.10.3/1 (sheet 3 of 5): Process NW_Init_USSD_VLR

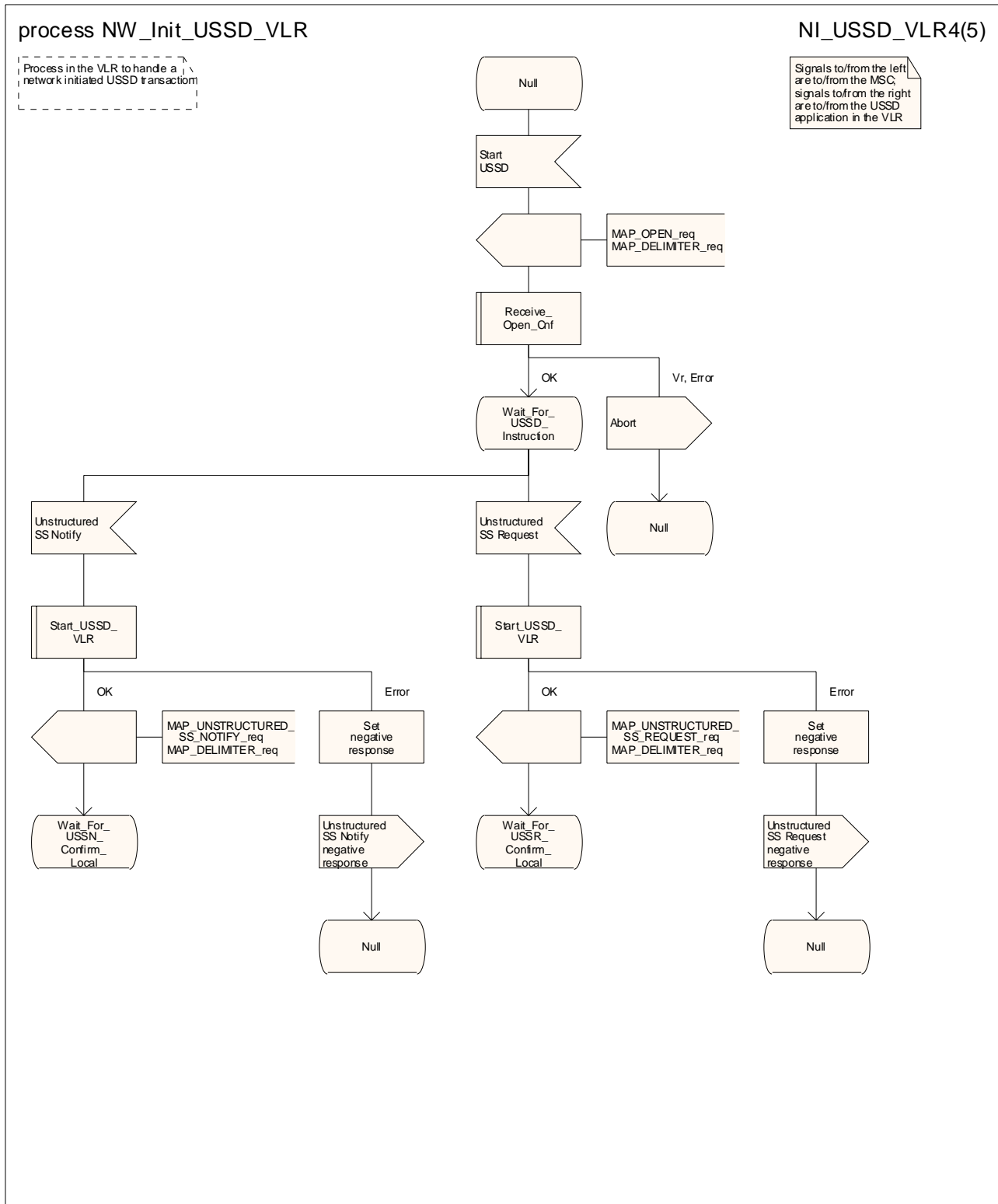

Figure 22.10.3/1 (sheet 4 of 5): Process NW_Init_USSD_VLR

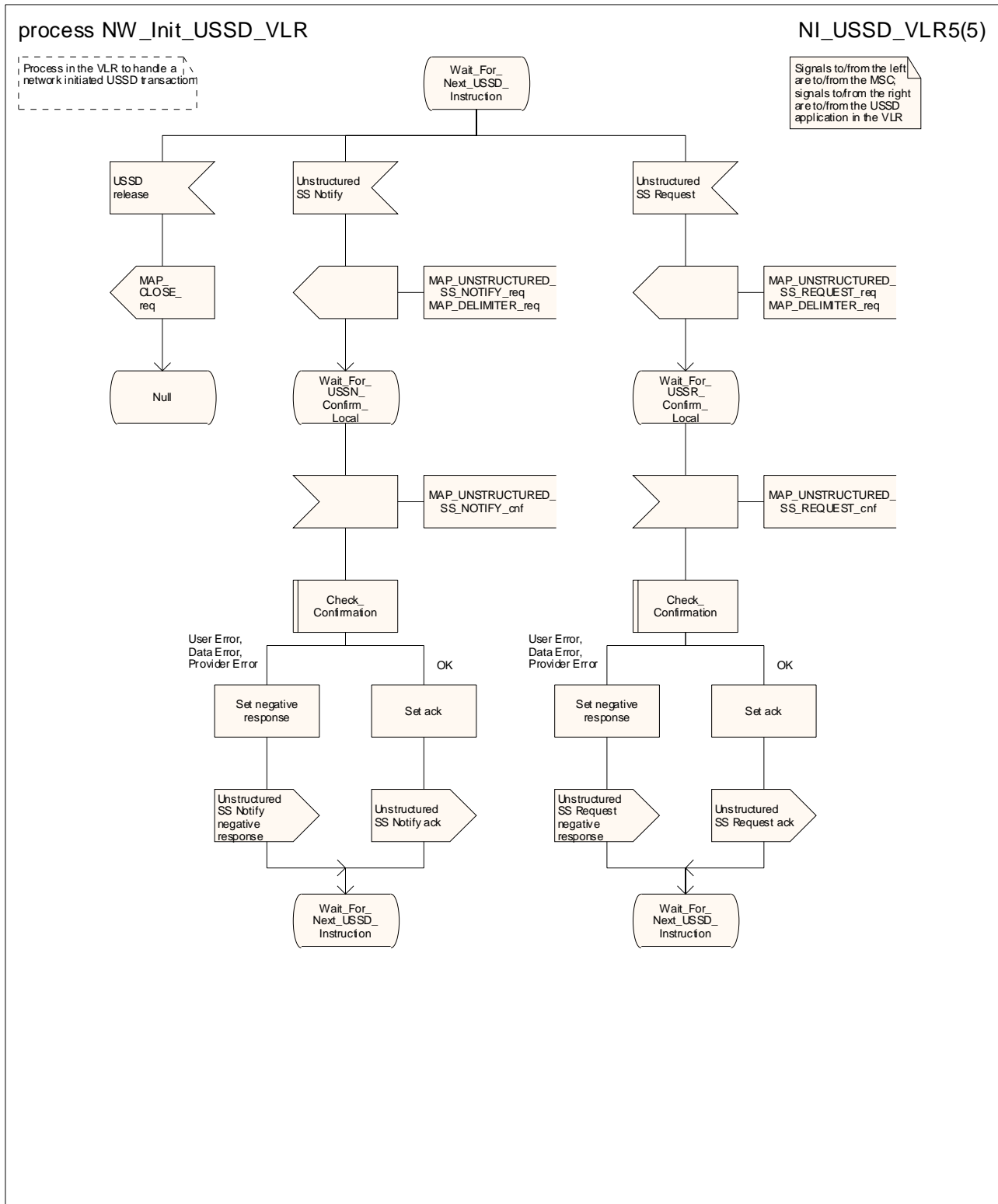

Figure 22.10.3/1 (sheet 5 of 5): Process NW_Init_USSD_VLR

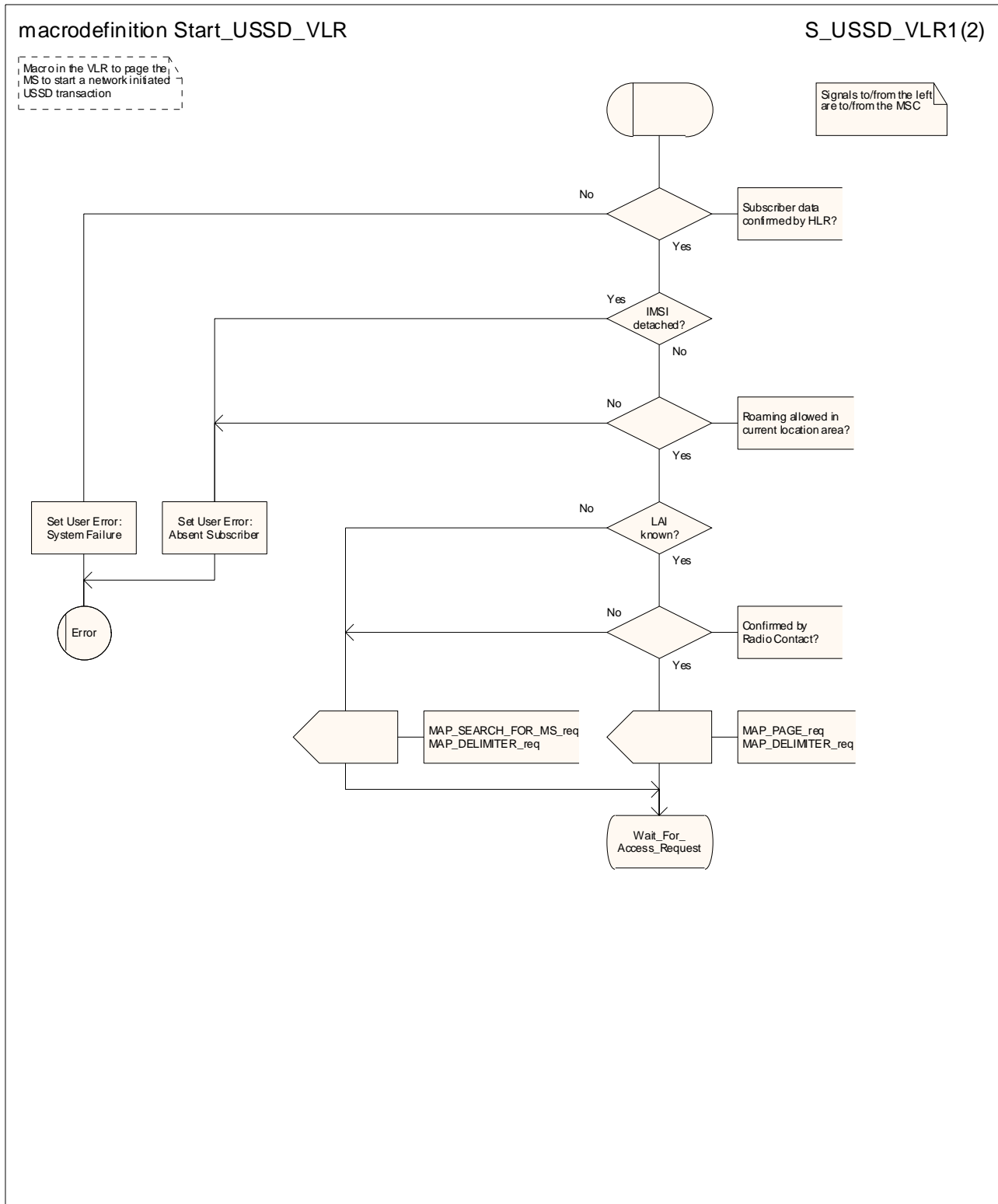

Figure 22.10.3/2 (sheet 1 of 2): Macro Start_USSD_VLR

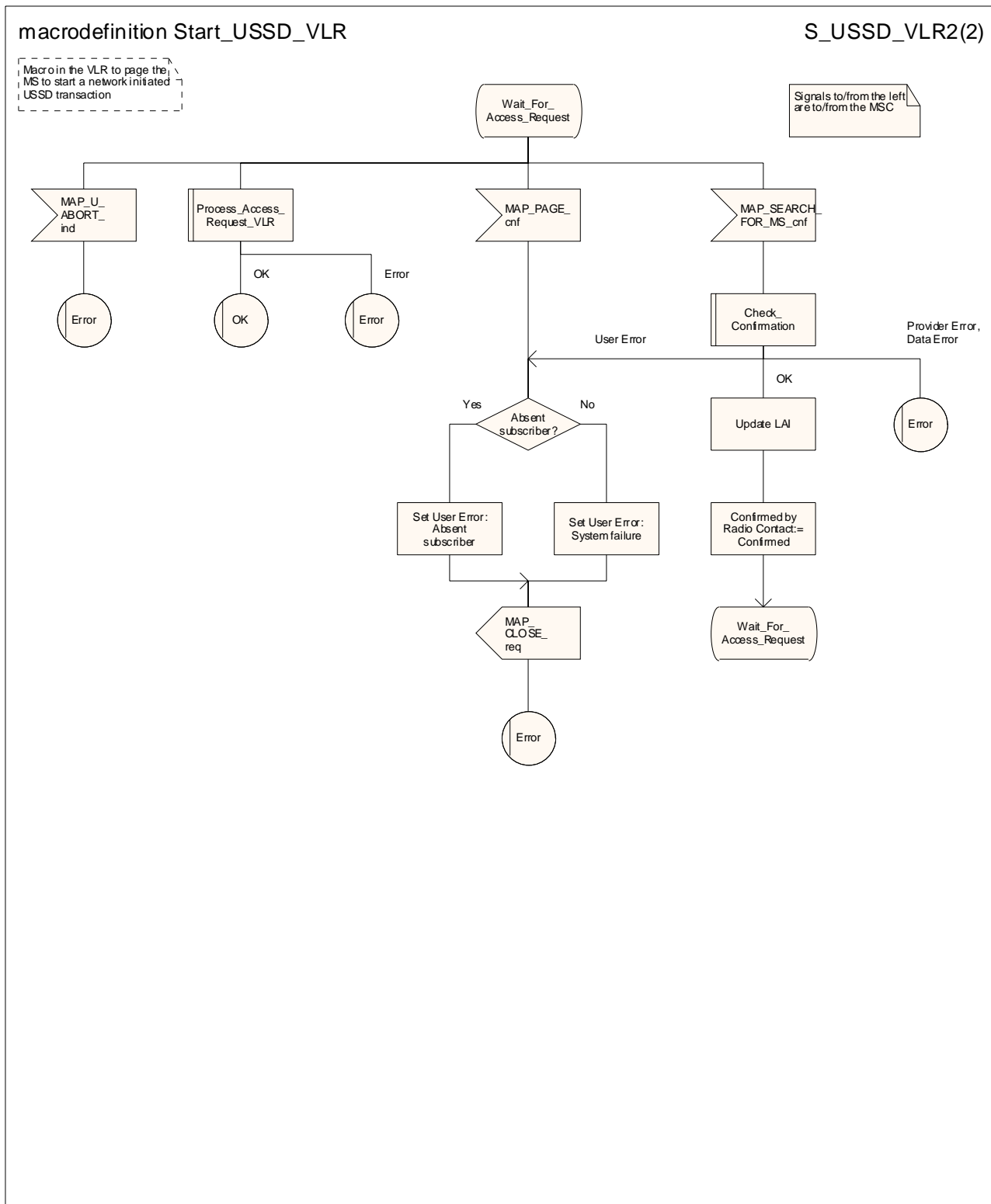

Figure 22.10.3/2 (sheet 2 of 2): Macro Start_USSD_VLR

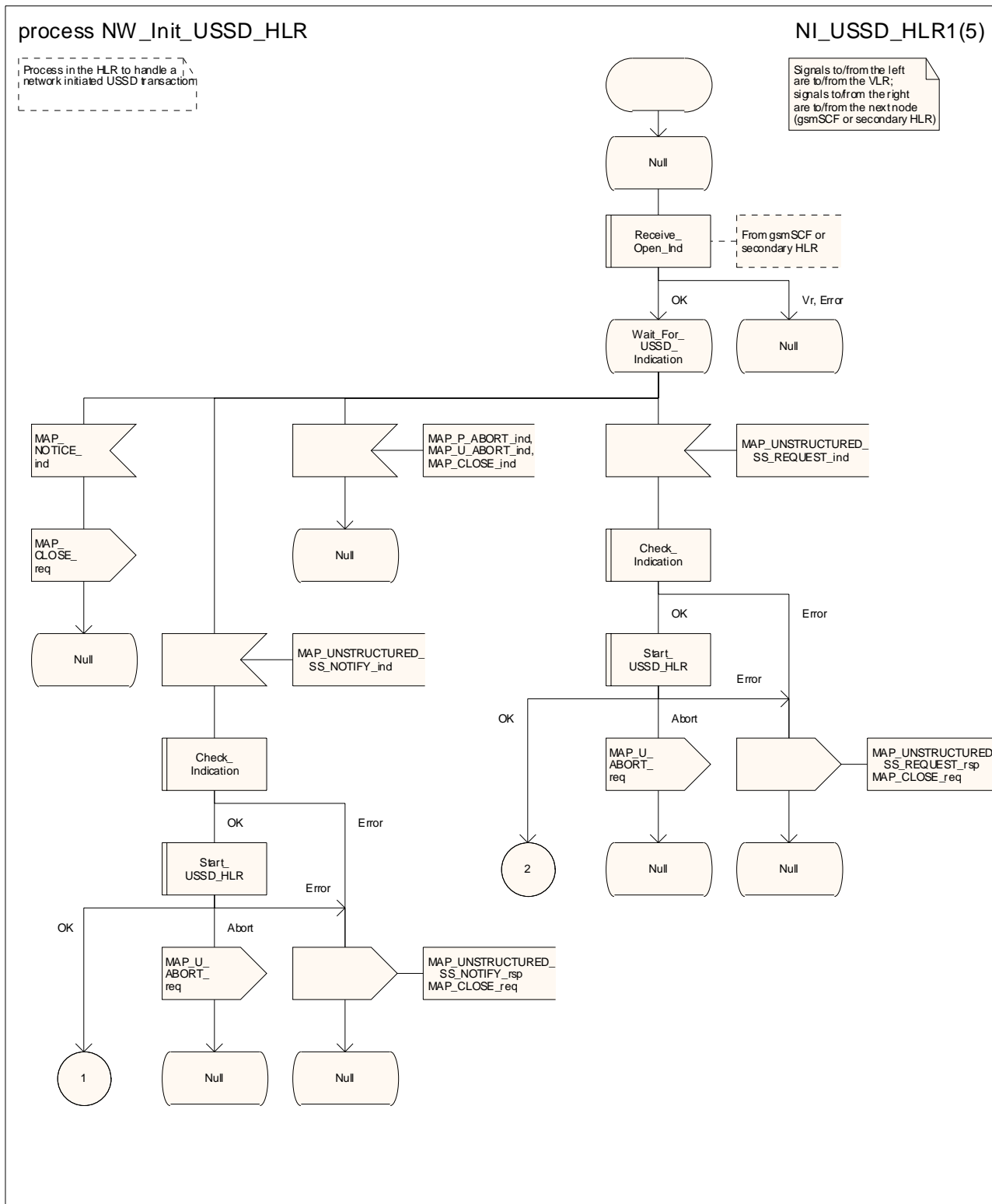

Figure 22.10.4/1 (sheet 1 of 5): Process NW_Init_USSD_HLR

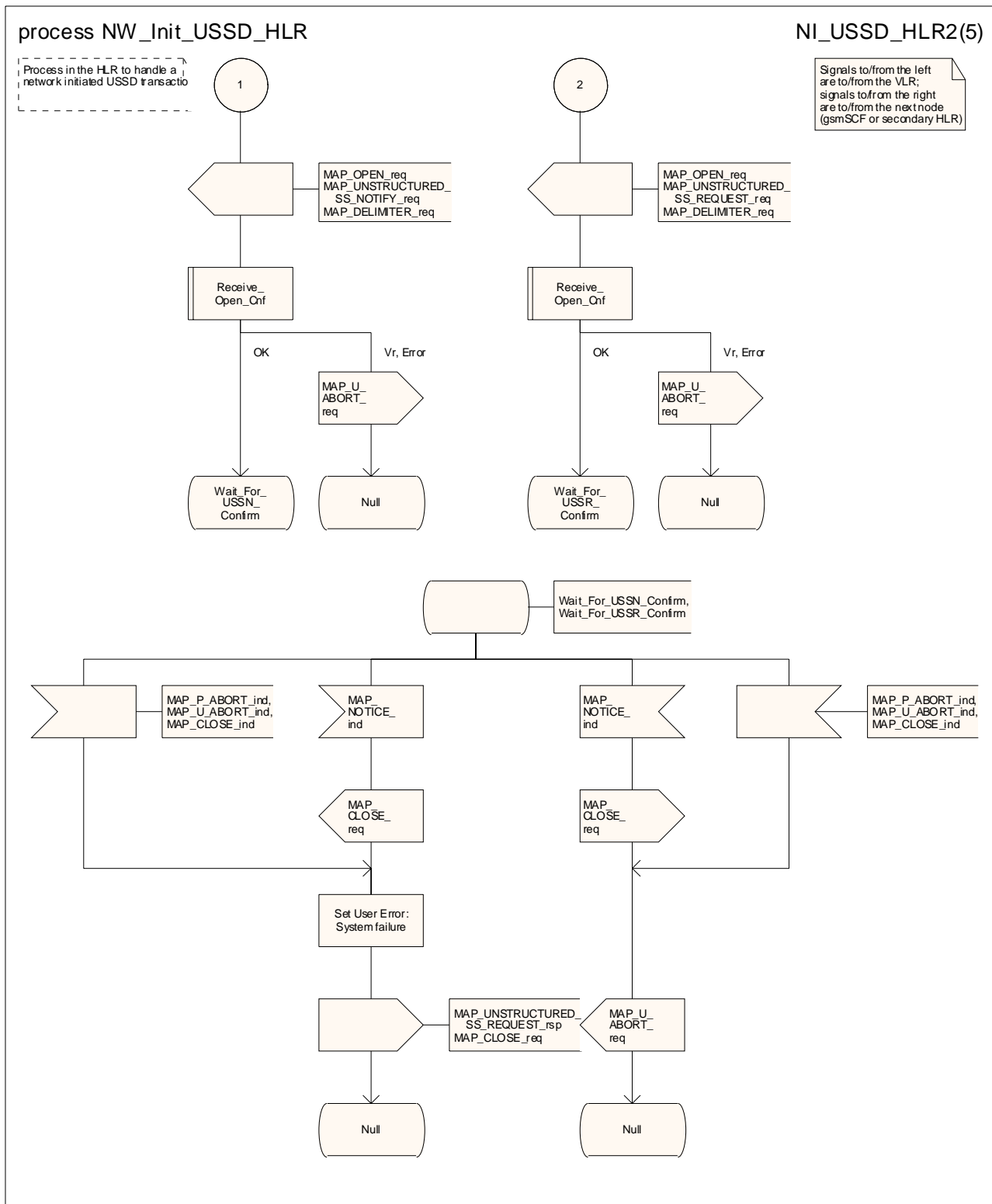

Figure 22.10.4/1 (sheet 2 of 5): Process NW_Init_USSD_HLR

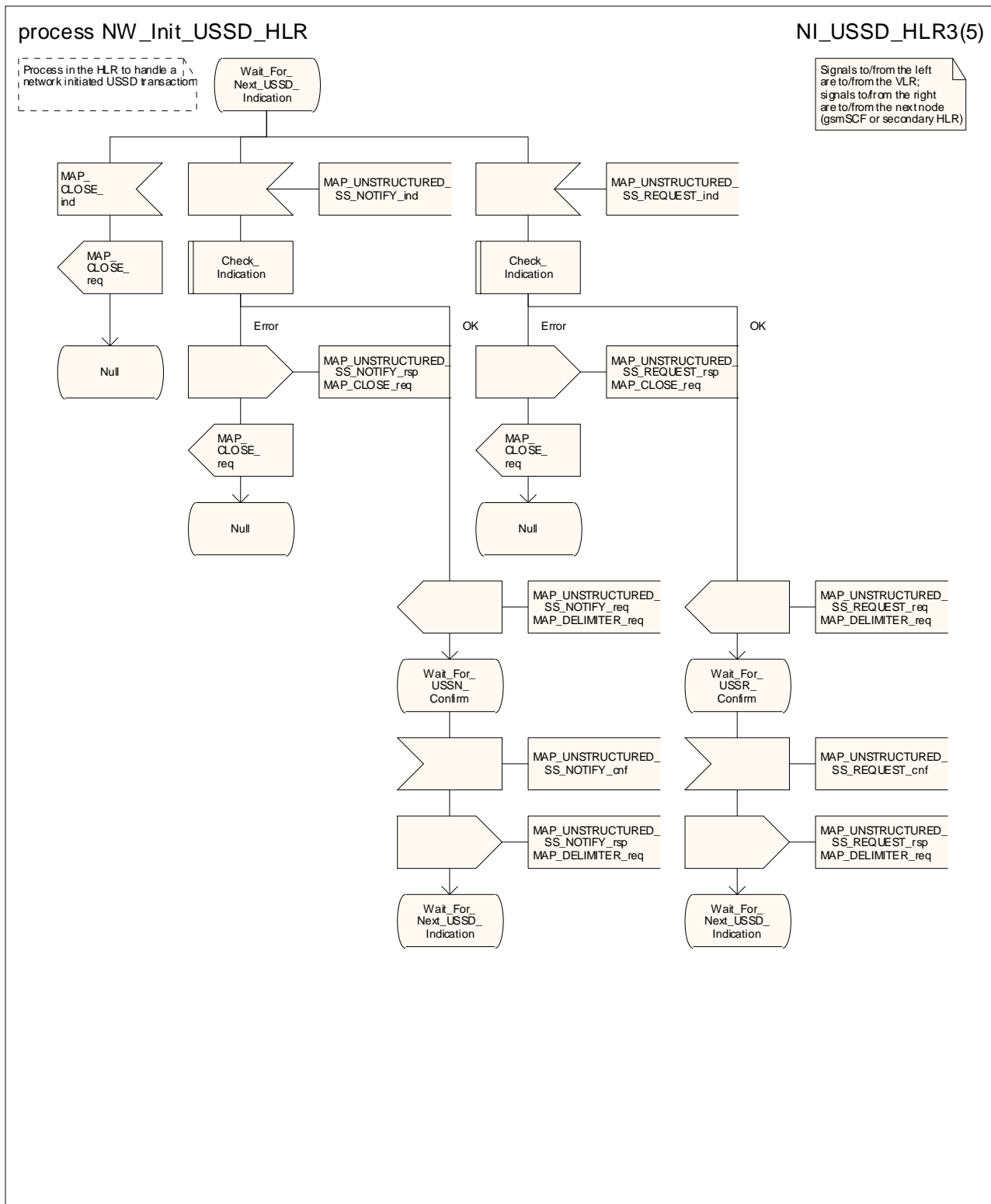

Figure 22.10.4/1 (sheet 3 of 5): Process NW_Init_USSD_HLR

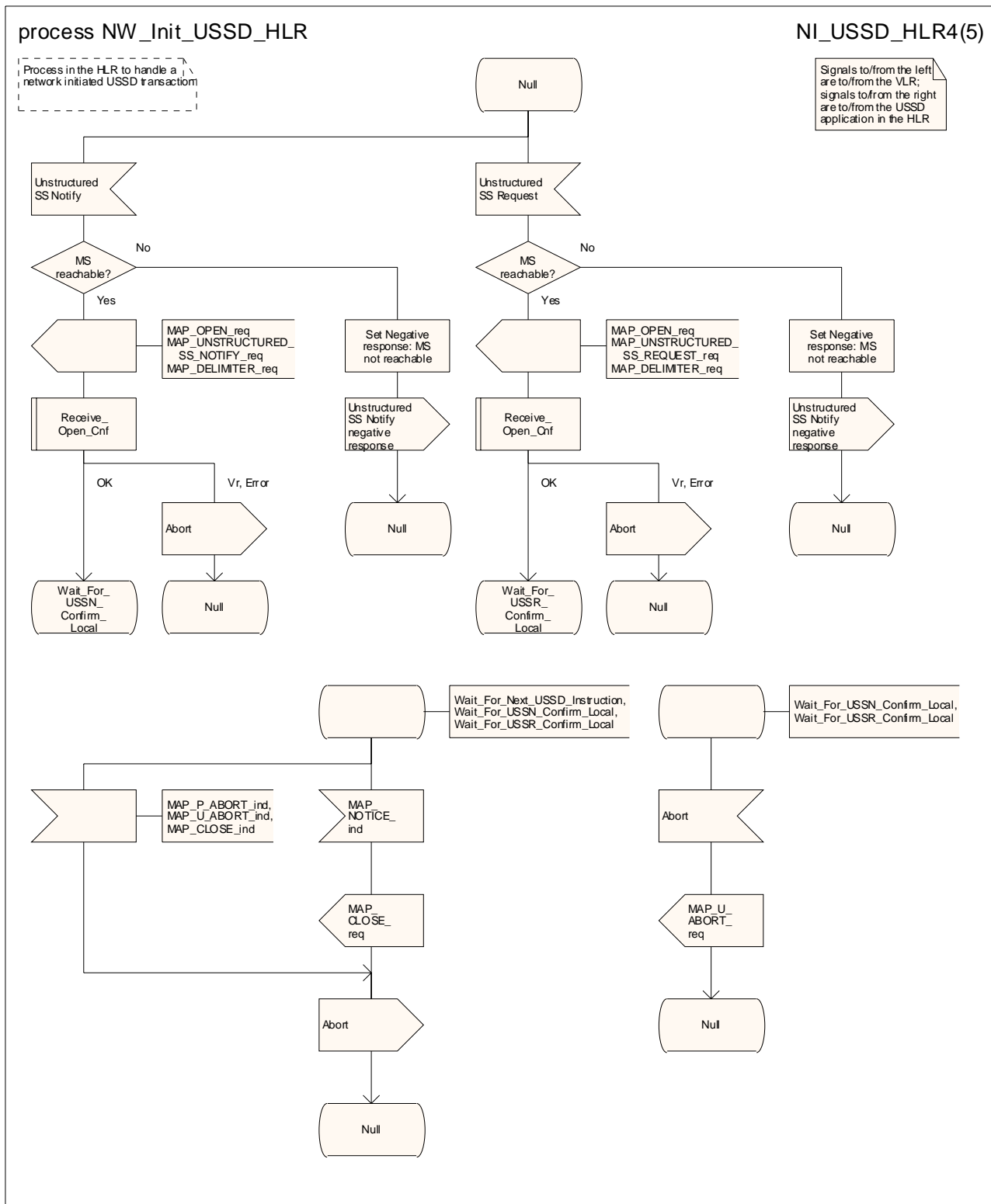

Figure 22.10.4/1 (sheet 4 of 5): Process NW_Init_USSD_HLR

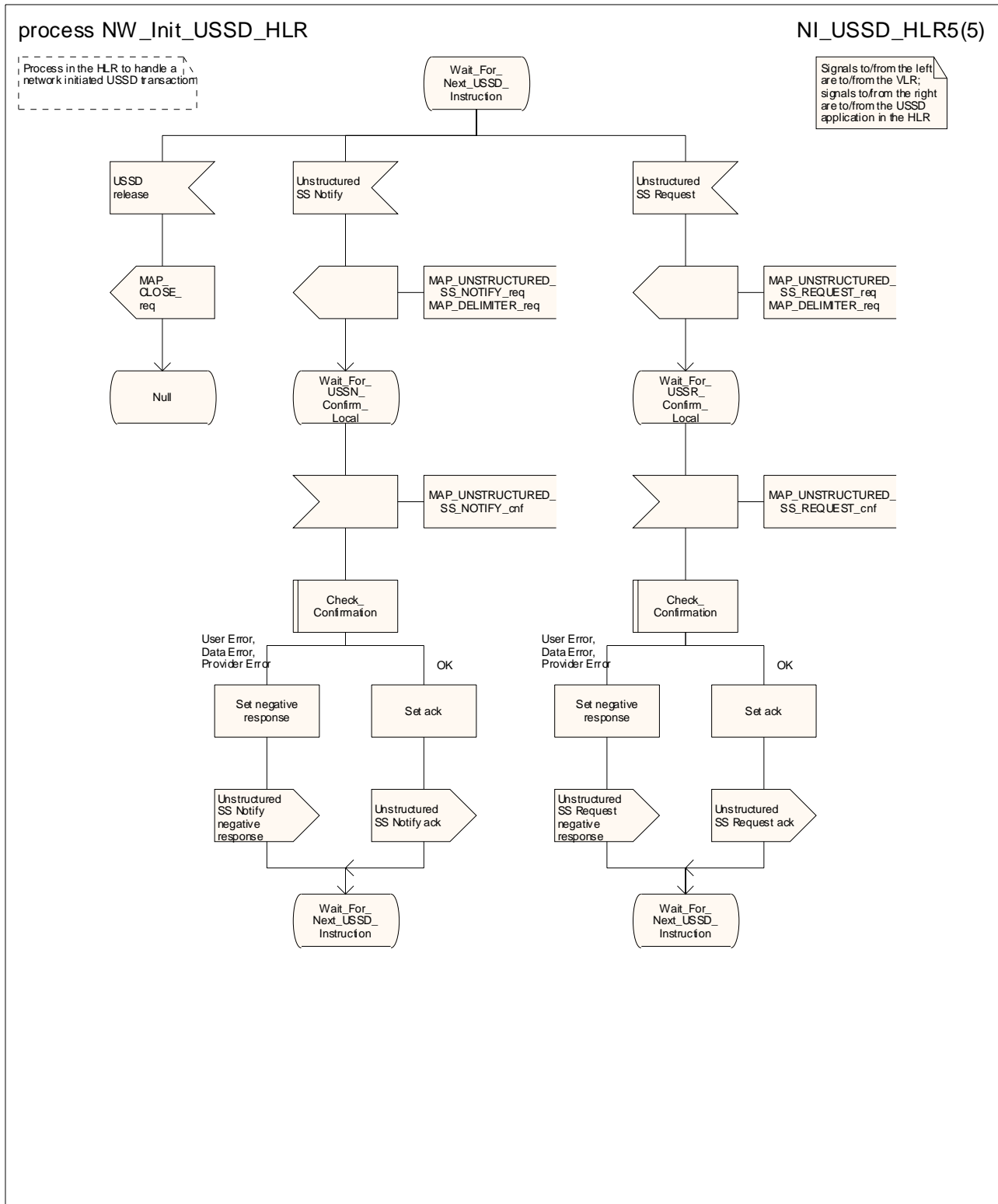

Figure 22.10.4/1 (sheet 5 of 5): Process NW_Init_USSD_HLR

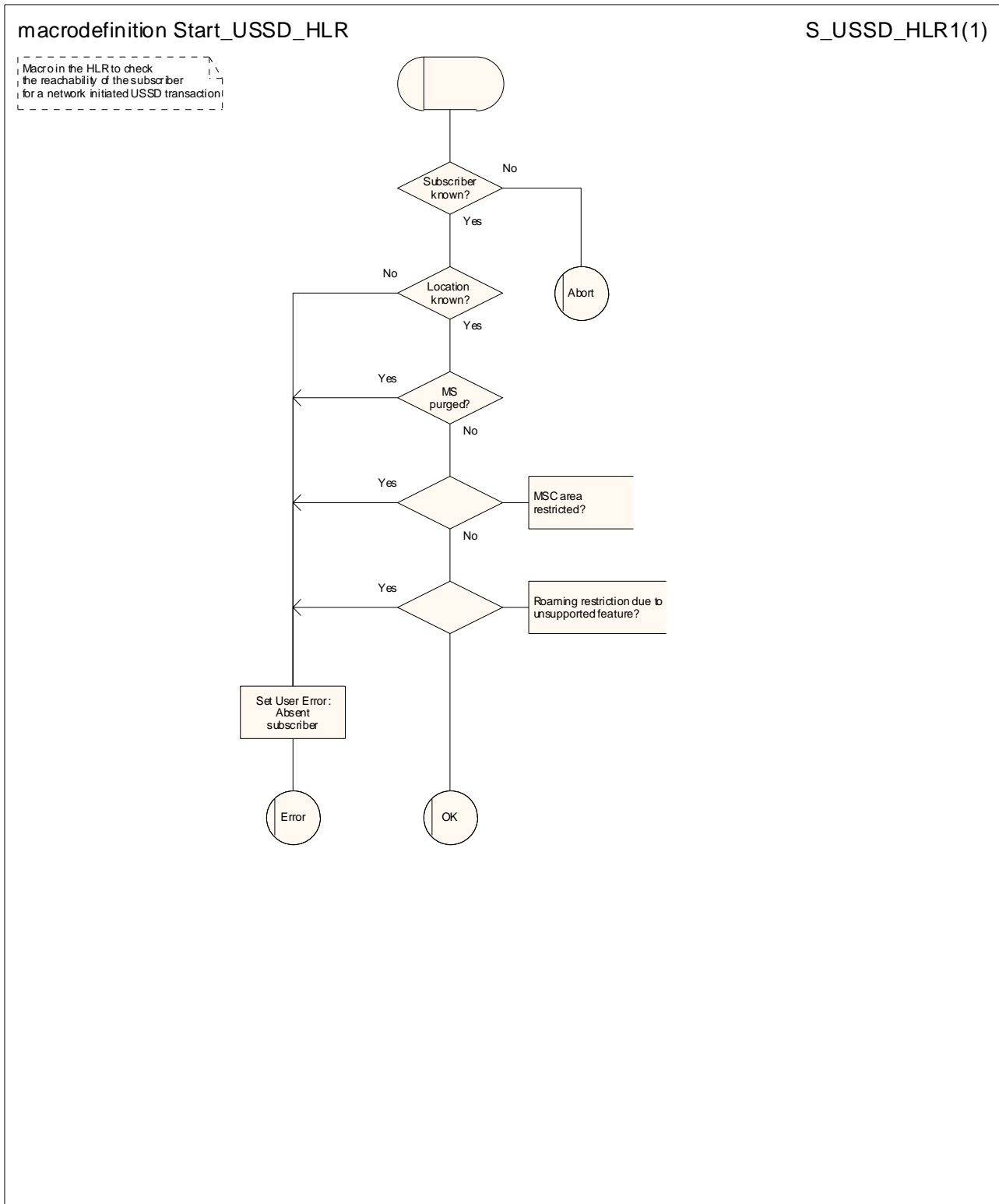

Figure 22.10.4/2: Macro Start_USSD_HLR

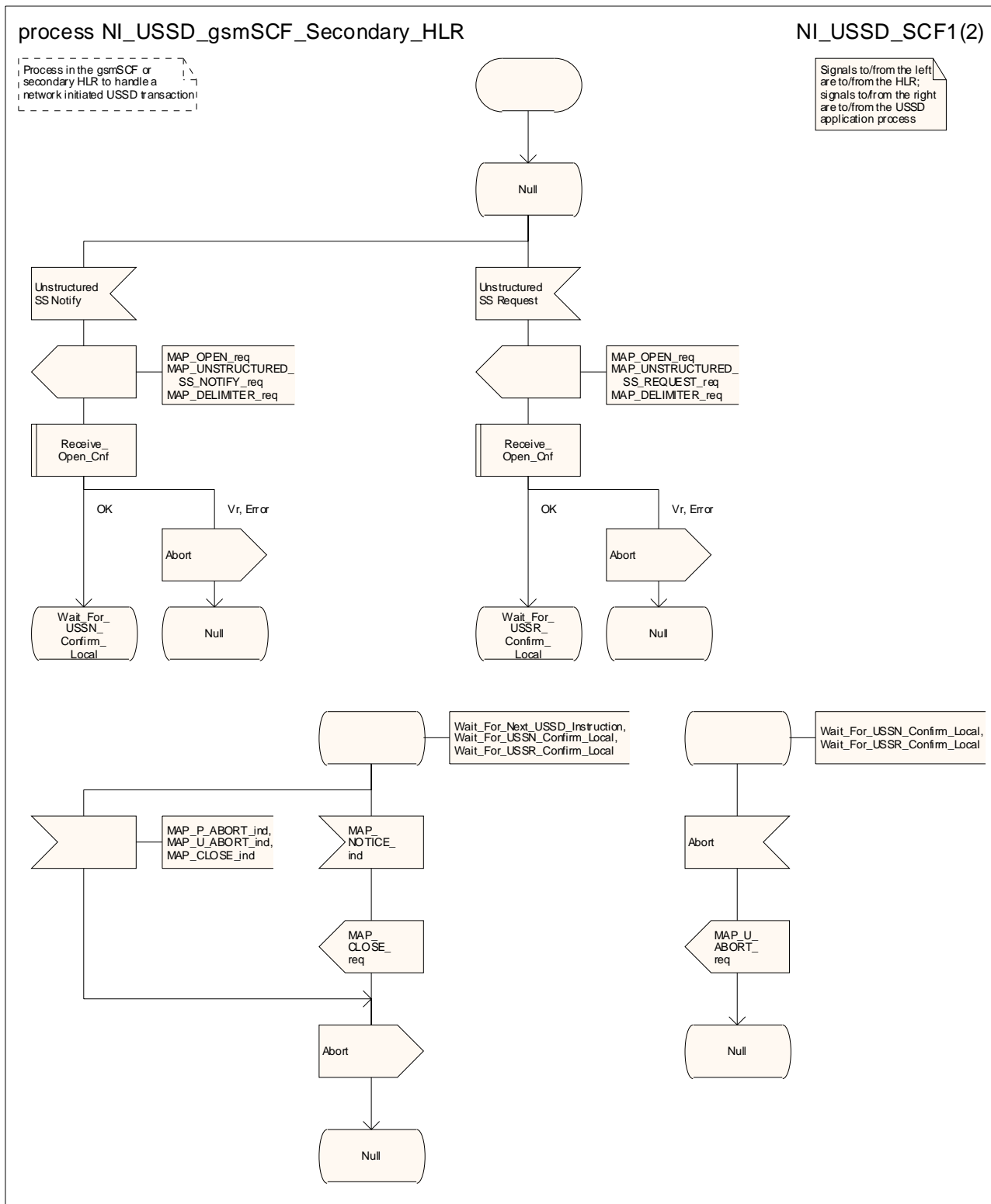

Figure 22.10.5/1 (sheet 1 of 2): Process NW_Init_USSD_gsmSCF_Secondary_HLR

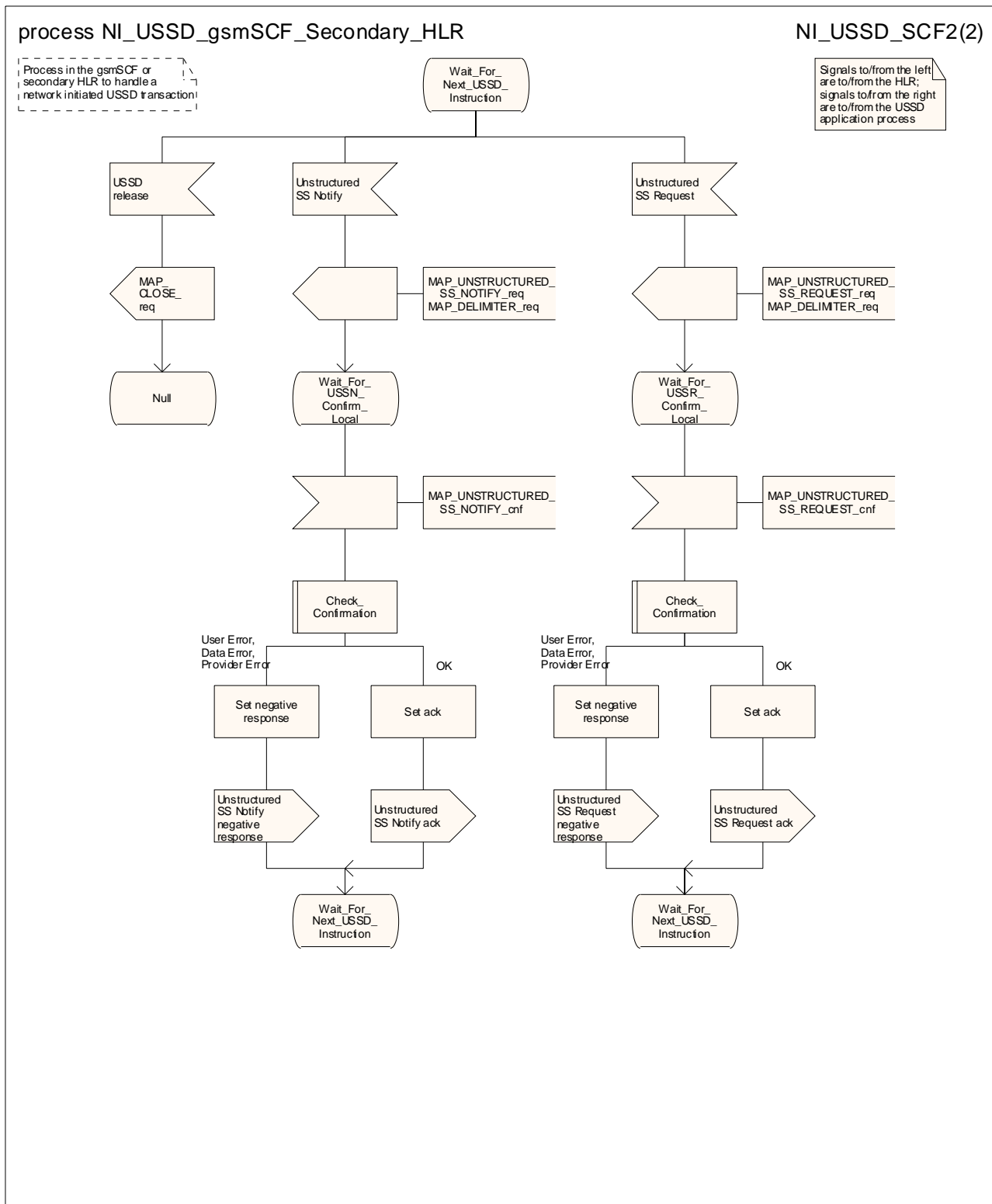

Figure 22.10.5/1 (sheet 2 of 2): Process NW_Init_USSD_gsmSCF_Secondary_HLR

22.11 Common macros for clause 22

The following macros are used for the description of more than one of the supplementary service processes described in clause 22.

22.11.1 SS Password handling macros

Macro Get_Password_MSC

This macro is used by the MSC to relay a request for password from the VLR to the MS, and to relay a response from the MS back to the VLR. The macro is shown in figure 22.11.1/1.

Macro Get_Password_VLR

This macro is used by the VLR to relay a request for password from the HLR to the MSC, and to relay a response from the MSC back to the HLR. The macro invokes a macro not defined in this clause; the definition of this macro can be found as follows:

Check_Indication see subclause 25.2.1.

The macro is shown in figure 22.11.1/2.

22.11.2 Void

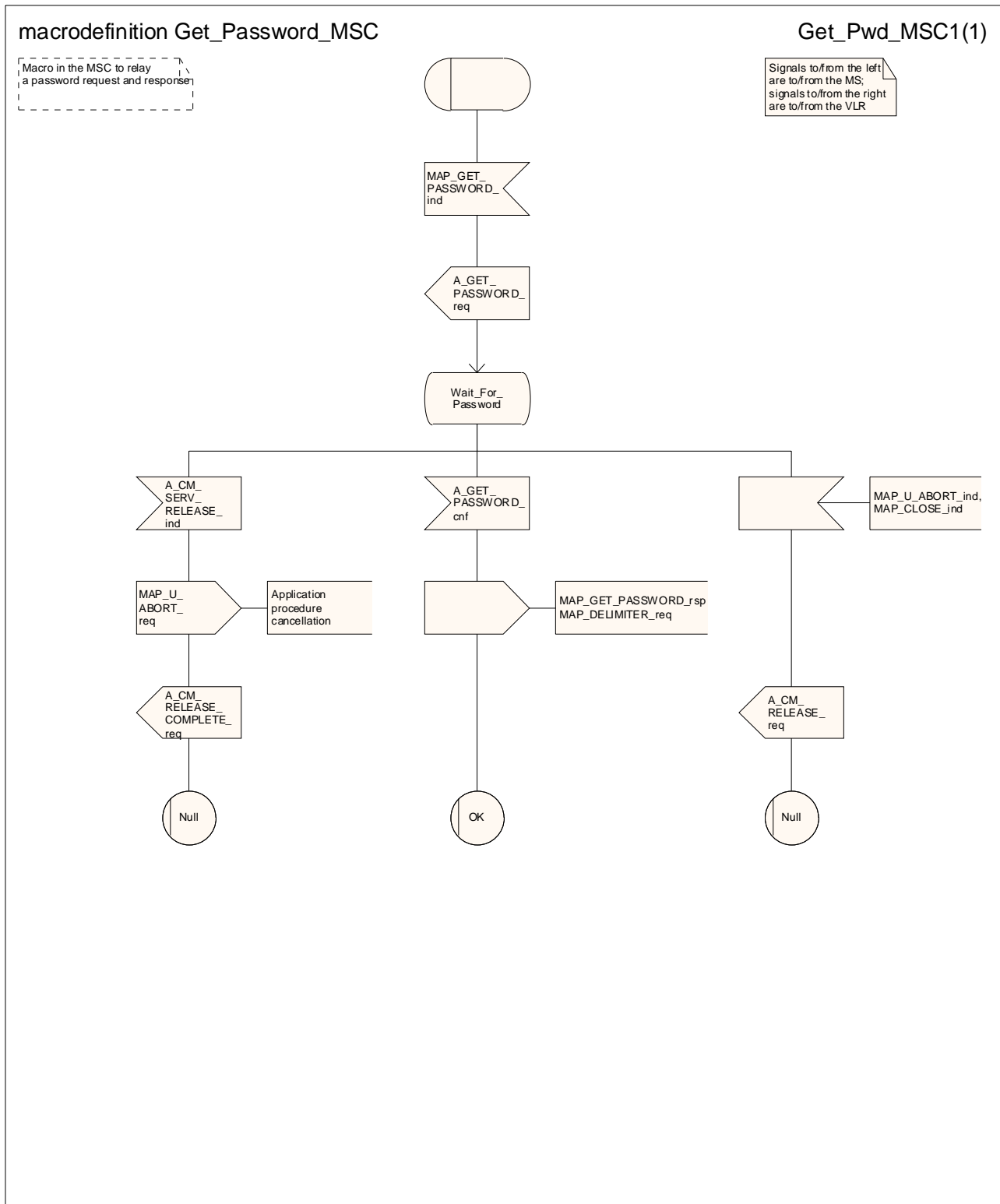

Figure 22.11.1/1: Macro Get_Password_MSC

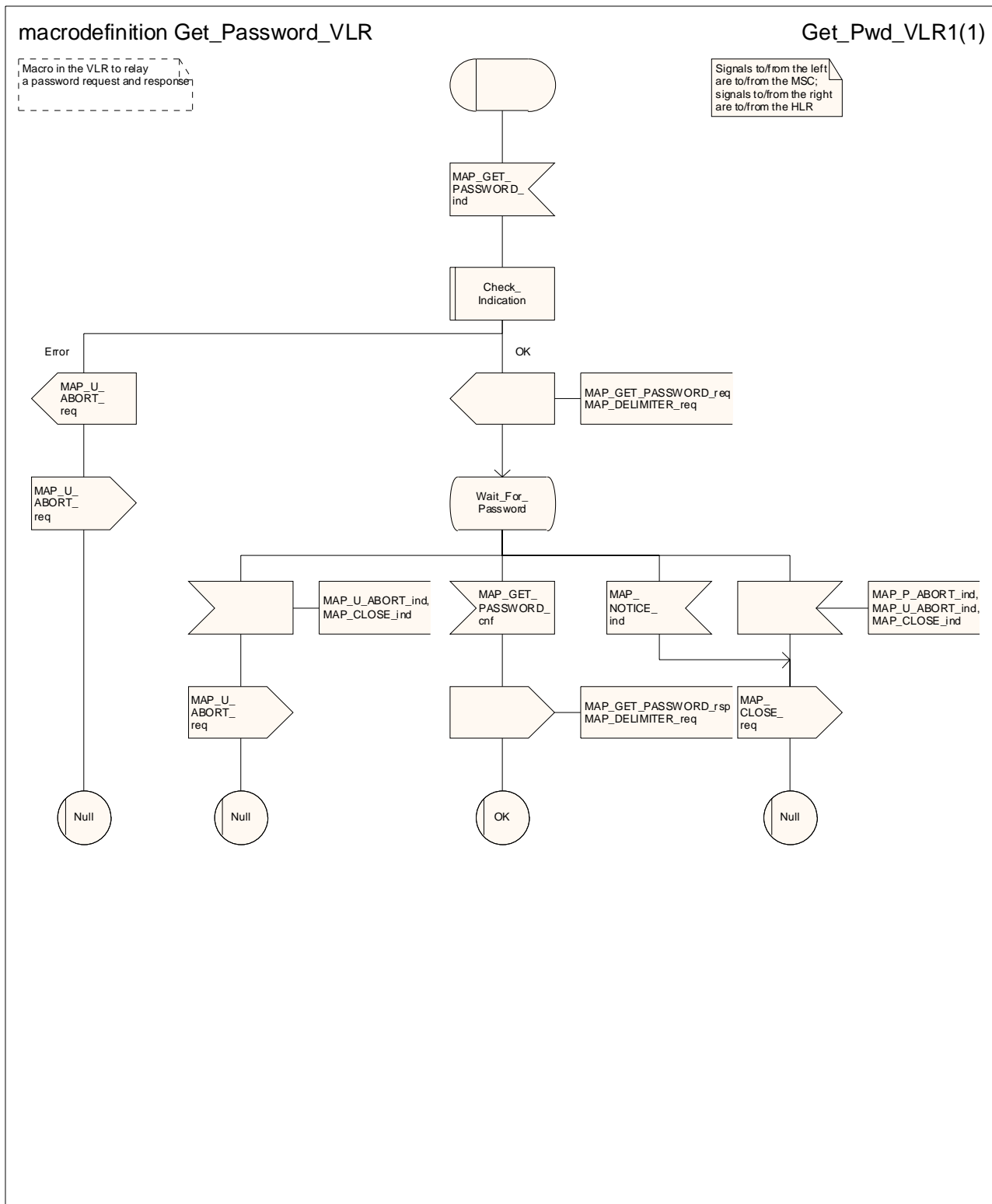

Figure 22.11.1/2: Macro Get_Password_VLR

Figure 22.11.2/1 void

Figure 22.11.2/2 void

Figure 22.11.2/3 void

Figure 22.11.2/4 void

Figure 22.11.2/5 void

22.12 Supplementary Service Invocation Notification procedure

22.12.1 General

The Supplementary Service Invocation Notification procedure is used to notify a gsmSCF about the invocation of a GSM Supplementary Service.

The supplementary service invocation notification procedure is shown in figure 22.12.1/1.

The following service is certainly used:

MAP_SS_INVOCATION_NOTIFY (defined in clause 11).

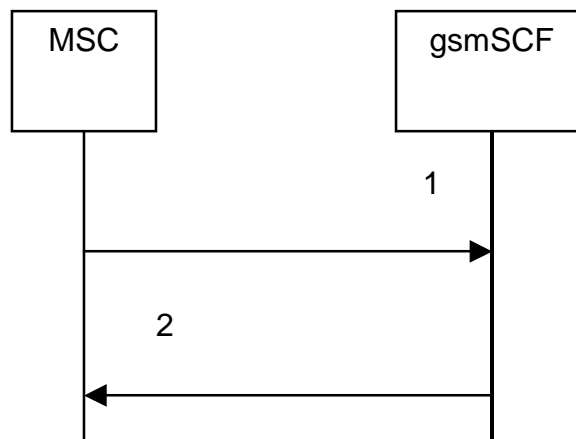

- 1) MAP_SS_INVOCATION_NOTIFY_req/ind
- 2) MAP_SS_INVOCATION_NOTIFY_rsp/cnf

Figure 22.12.1/1: Message flow for supplementary service invocation notification

22.12.2 Procedure in the MSC

The MAP process invokes macros not defined in this clause; the definitions of these macros can be found as follows:

- | | |
|--------------------|-----------------------|
| Receive_Open_Cnf | see subclause 25.1.2; |
| Check_Confirmation | see subclause 25.2.2. |

The supplementary service invocation notification process in the MSC is shown in figure 22.12.2/1.

22.12.3 Procedure in the gsmSCF

The MAP process invokes a macro not defined in this clause; the definition of this macro can be found as follows:

- | | |
|------------------|-----------------------|
| Receive_Open_Ind | see subclause 25.1.1. |
|------------------|-----------------------|

The supplementary service invocation notification process in the gsmSCF is shown in figure 22.12.3/1.

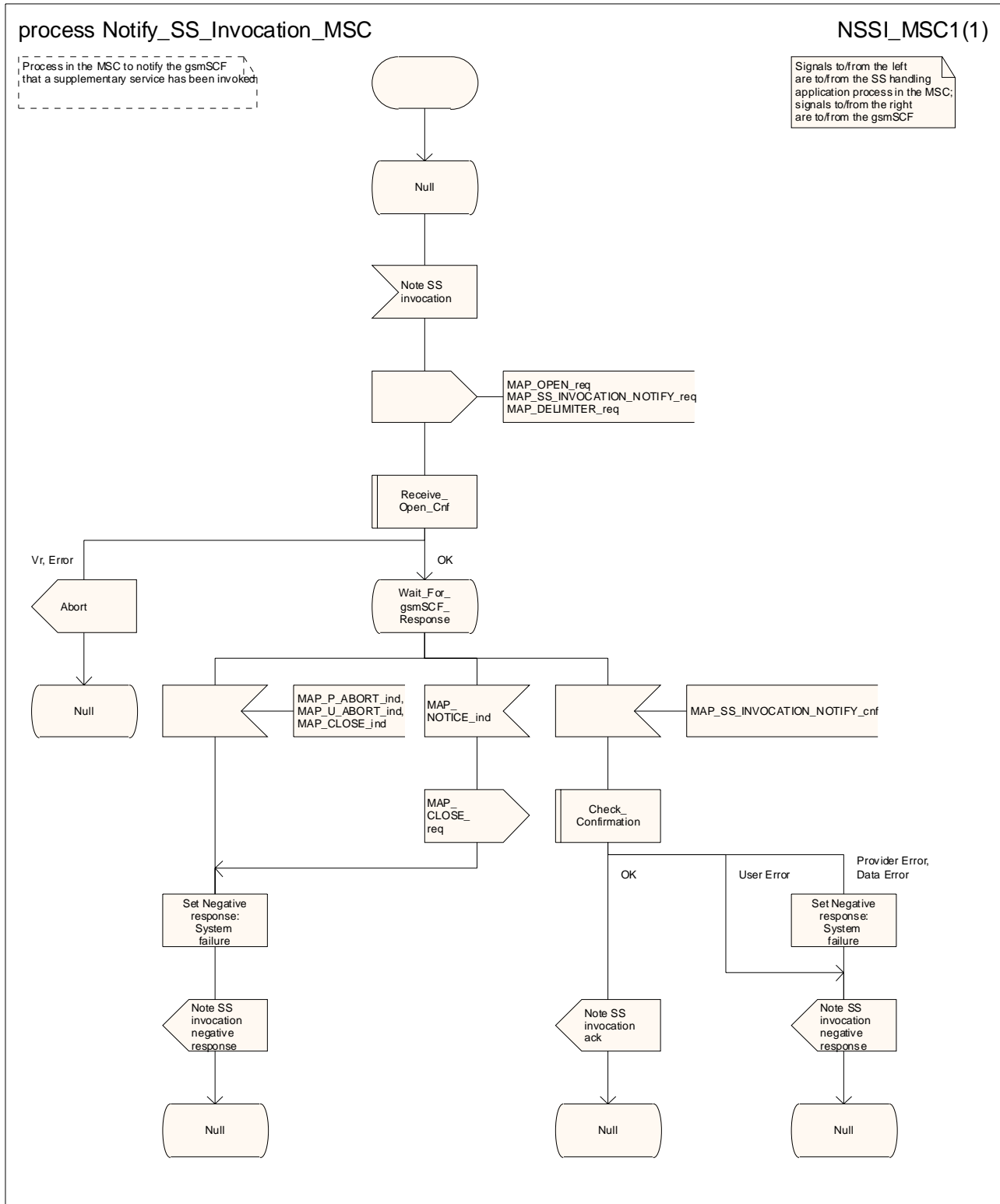

Figure 22.12.2/1: Process Notify_SS_Invocation_MSC

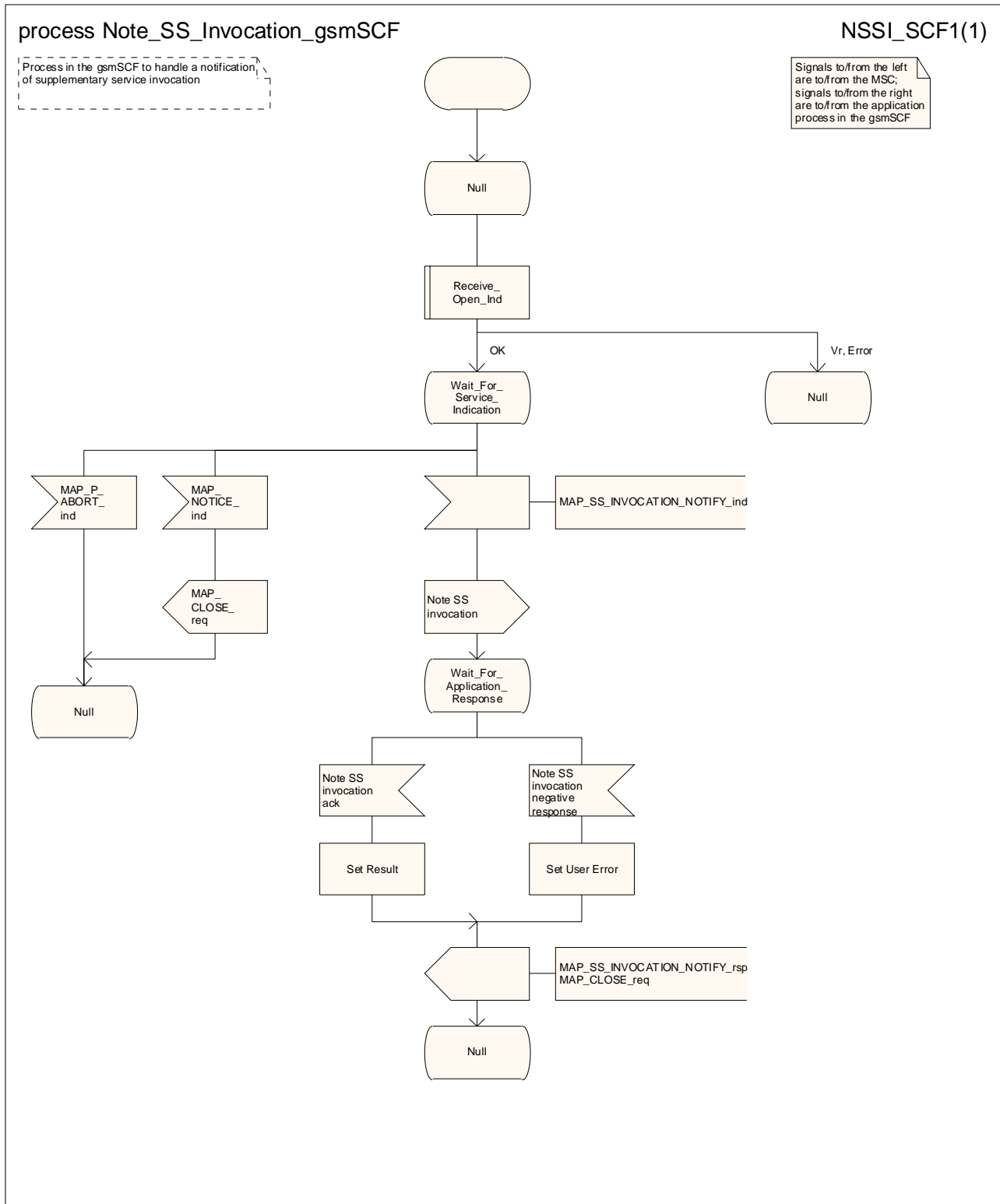

Figure 22.12.3/1: Process Note_SS_Invocation_gsmSCF

22.13 Activation of a CCBS request

22.13.1 General

The message flow to activate a CCBS request is shown in figure 22.13.1/1.

The following service is certainly used:

MAP_REGISTER_CC_ENTRY (defined in clause 11).

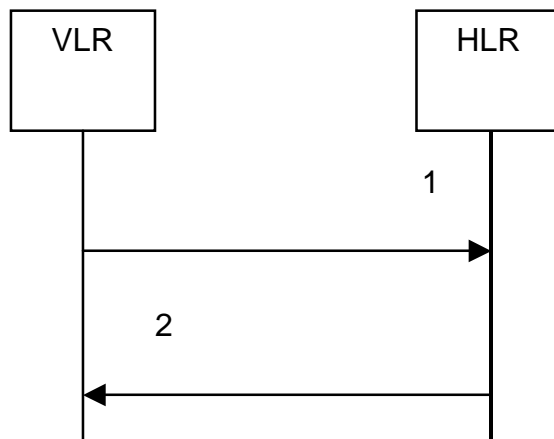

- 1) MAP_REGISTER_CC_ENTRY_req/ind
- 2) MAP_REGISTER_CC_ENTRY_rsp/cnf

Figure 22.13.1/1: Message flow to activate a CCBS request

22.13.2 Procedure in the VLR

The MAP process in the VLR to activate a CCBS request is shown in figure 22.13.2/1. The MAP process invokes macros not defined in this clause; the definitions of these macros can be found as follows:

- | | |
|--------------------|-----------------------|
| Receive_Open_Cnf | see subclause 25.1.2; |
| Check_Confirmation | see subclause 25.2.2. |

22.13.3 Procedure in the HLR

The MAP process in the HLR to activate a CCBS request is shown in figure 22.13.2/1.

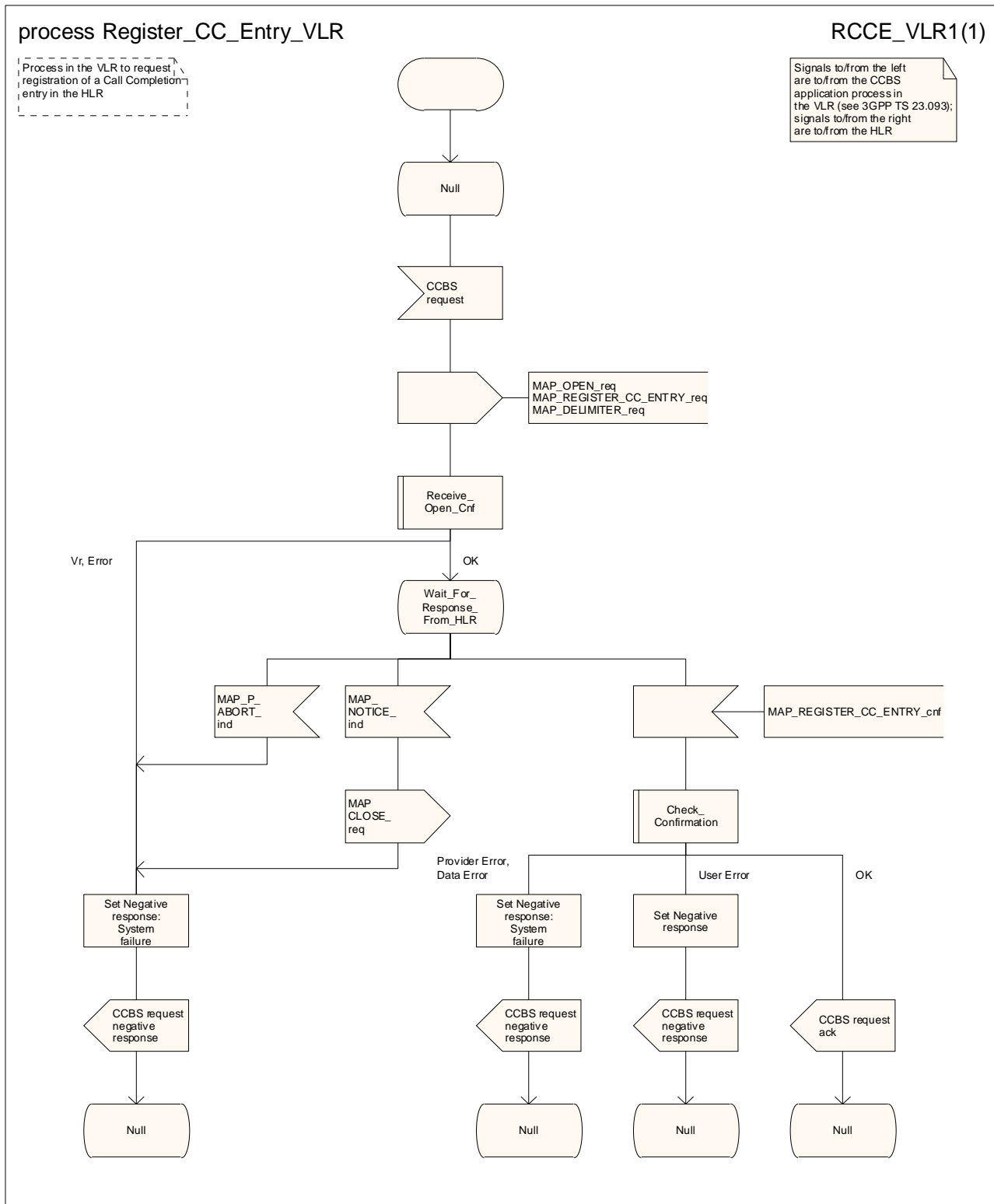

Figure 22.13.2/1: Process Register_CC_Entry_VLR

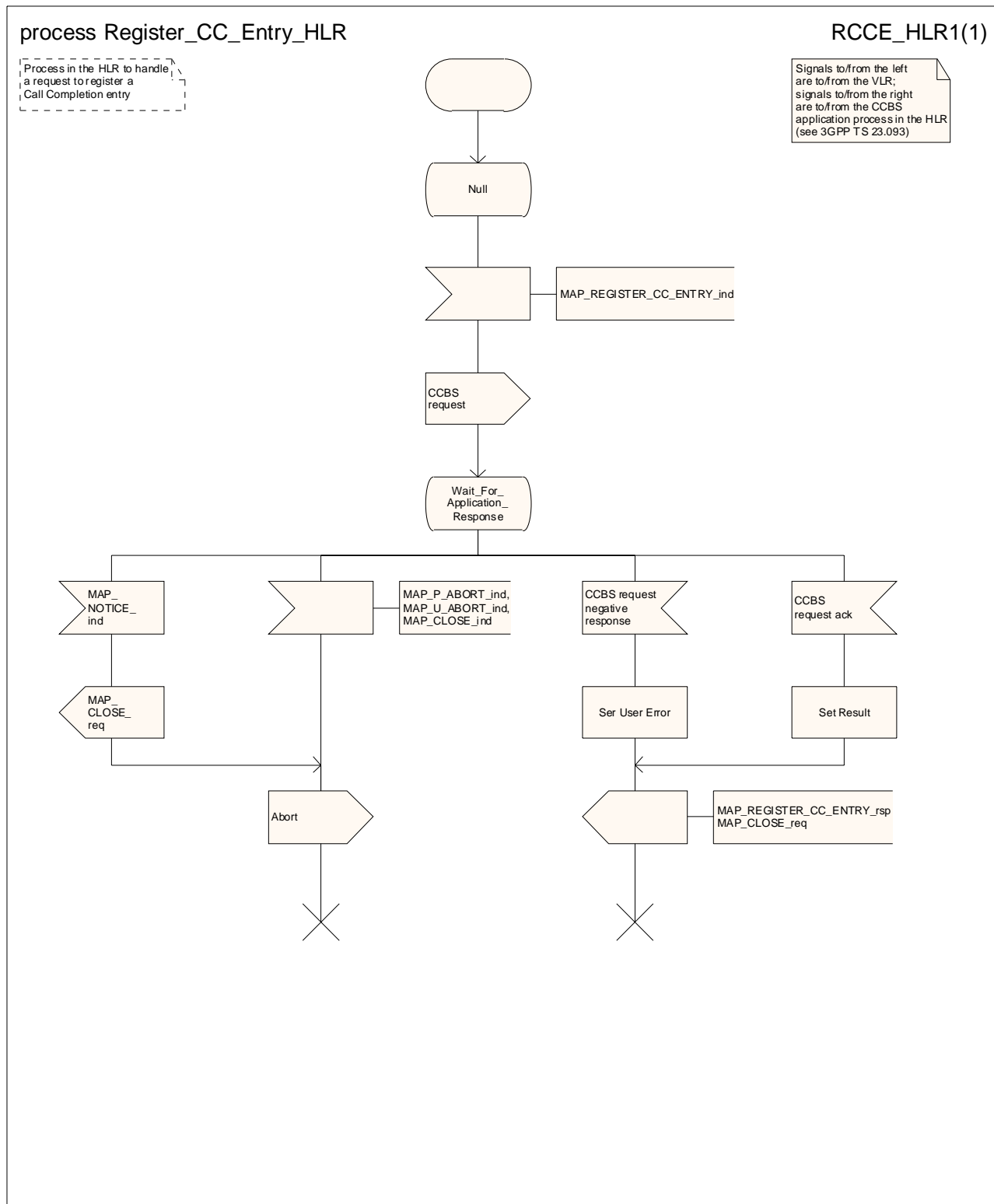

Figure 22.13.3/1: Process Register_CC_Entry_HLR

22.14 Deactivation of a CCBS request

22.14.1 General

The message flow to deactivate a CCBS request is shown in figure 22.14.1/1.

The following service is certainly used:

MAP_ERASE_CC_ENTRY (defined in clause 11).

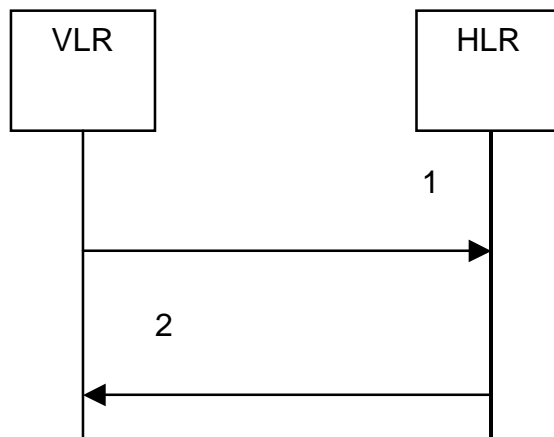

- 1) MAP_ERASE_CC_ENTRY_req/ind
- 2) MAP_ERASE_CC_ENTRY_rsp/cnf

Figure 22.14.1/1: Message flow to deactivate a CCBS request

22.14.2 Procedure in the VLR

The MAP process in the VLR to deactivate a CCBS request is shown in figure 22.14.2/1. The MAP process invokes macros not defined in this clause; the definitions of these macros can be found as follows:

- | | |
|--------------------|-----------------------|
| Receive_Open_Cnf | see subclause 25.1.2; |
| Check_Confirmation | see subclause 25.2.2. |

22.14.3 Procedure in the HLR

The MAP process in the HLR to deactivate a CCBS request is shown in figure 22.14.2/1.

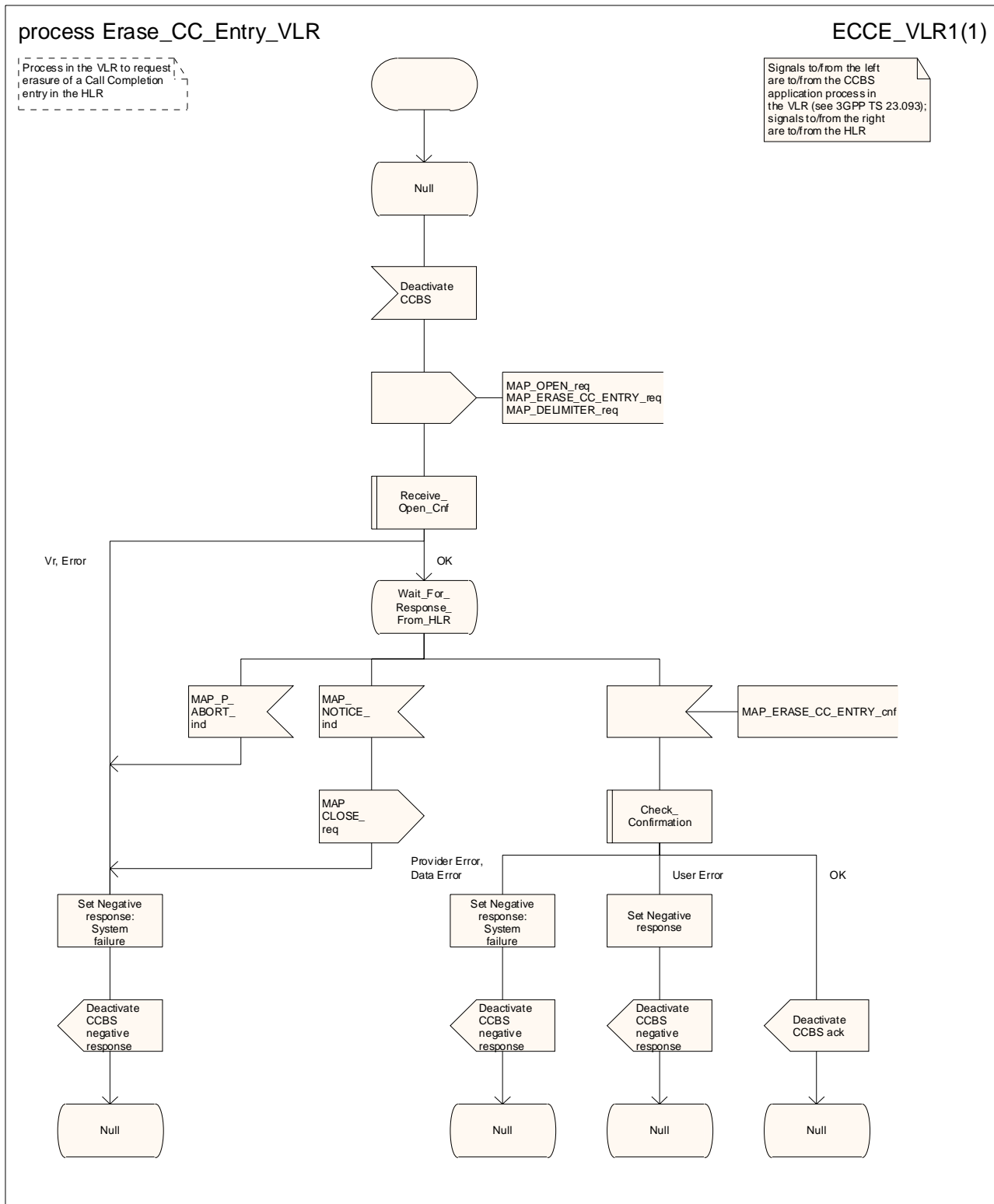

Figure 22.14.2/1: Process Erase_CC_Entry_VLR

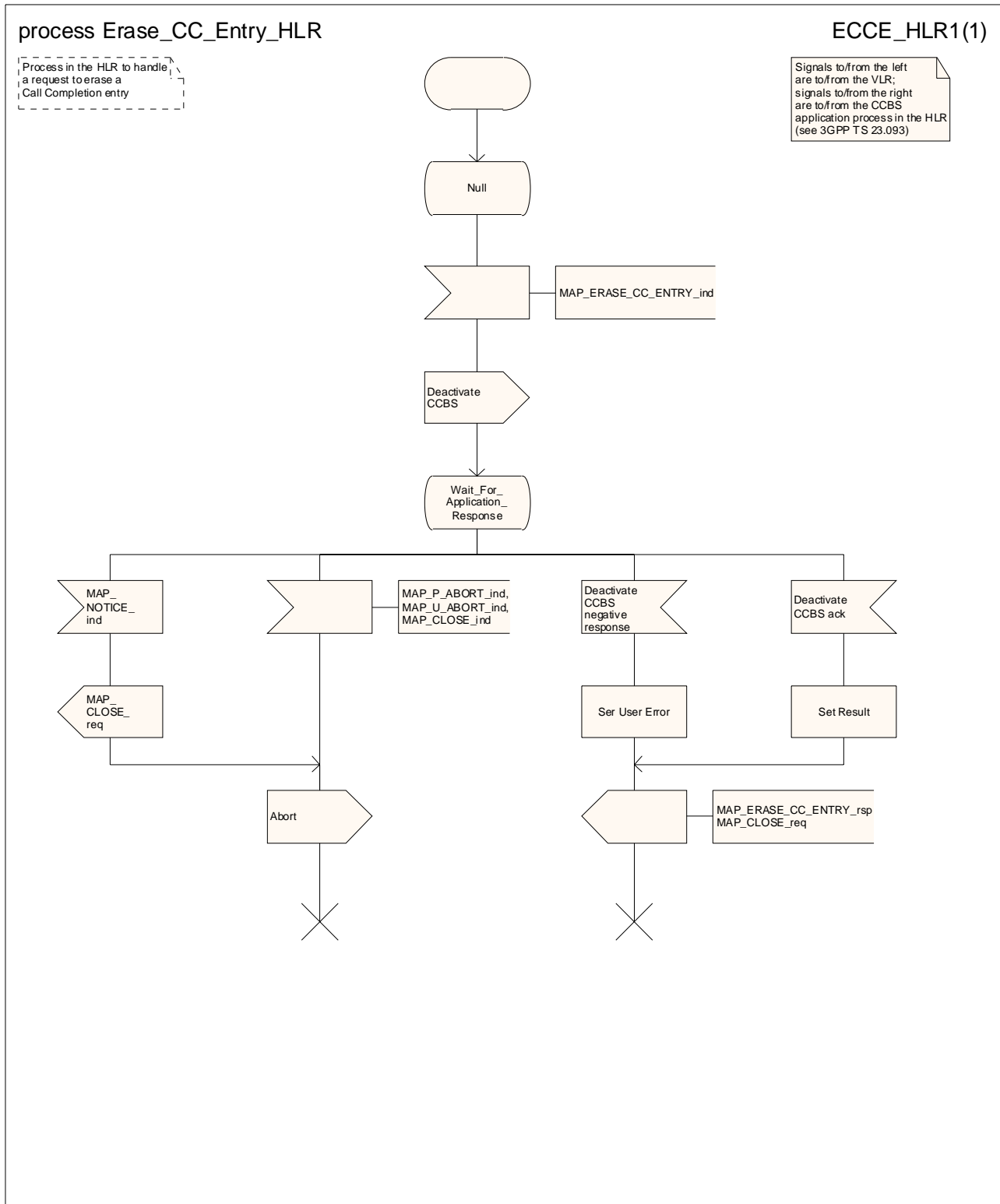

Figure 22.14.3/1: Process Erase_CC_Entry_HLR

23 Short message service procedures

23.1 General

The short message service procedures are used to control both mobile originated and mobile terminated short message transfer.

Four procedures exist for short message services:

- mobile originated short message service transfer;
- mobile terminated short message service transfer;
- short message alert procedure;
- short message delivery status report procedure.

The following application context refers to a complex MAP user consisting of several processes:

- shortMessageGatewayContext.

This application context needs a co-ordinating process in the HLR. Additionally a co-ordinating process is needed for the mobile originated situation in the MSC, because the A_CM_SERV_REQ message does not distinguish between mobile originated short message transfer and the short message alert procedures.

NOTE: the A_CM_SERV_REQ message is not used for SMS over GPRS. The modelling is based on the assumption that the SGSN will trigger the appropriate process, according to whether an RP_MO_DATA or an RP_SM_MEMORY_AVAILABLE is received over the LLC layer.

23.1.1 Mobile originated short message service Co-ordinator for the MSC

The process starts when the MSC receives an A_CM_SERV_REQ message (see 3GPP TS 24.008 [35]), with a CM service type indicating short message service, from the A-interface. The process invokes a macro not defined in this clause; the definition of this macro can be found as follows:

Process_Access_Request_MSC see subclause 25.4.1.

If the macro Process_Access_Request_MSC takes the "OK" exit (which means that the MSC has sent an A_CM_SERVICE_ACCEPT to the MS), the MS initiates mobile originated short message transfer or sends an indication that it has memory available for more short messages.

The SMS Co-ordinator process in the MSC is shown in figure 23.1/1.

23.1.2 Short message Gateway Co-ordinator for the HLR

The process starts when the HLR receives a MAP_OPEN indication using the application context shortMessageGatewayContext. The MAP process invokes a macro not defined in this clause; the definition of this macro can be found as follows:

Receive_Open_Ind see subclause 25.1.1.

The SM Gateway Co-ordinator process in the HLR is shown in figure 23.1/2.

If the Receive_Open_Ind macro takes the Vr exit then HLR shall perform the MAP dialogue as specified for the appropriate application context version. Depending on the subscriber data, handling at the MAP user application level may be performed as specified in subclauses 23.3.2 and 23.5.2 of the present document.

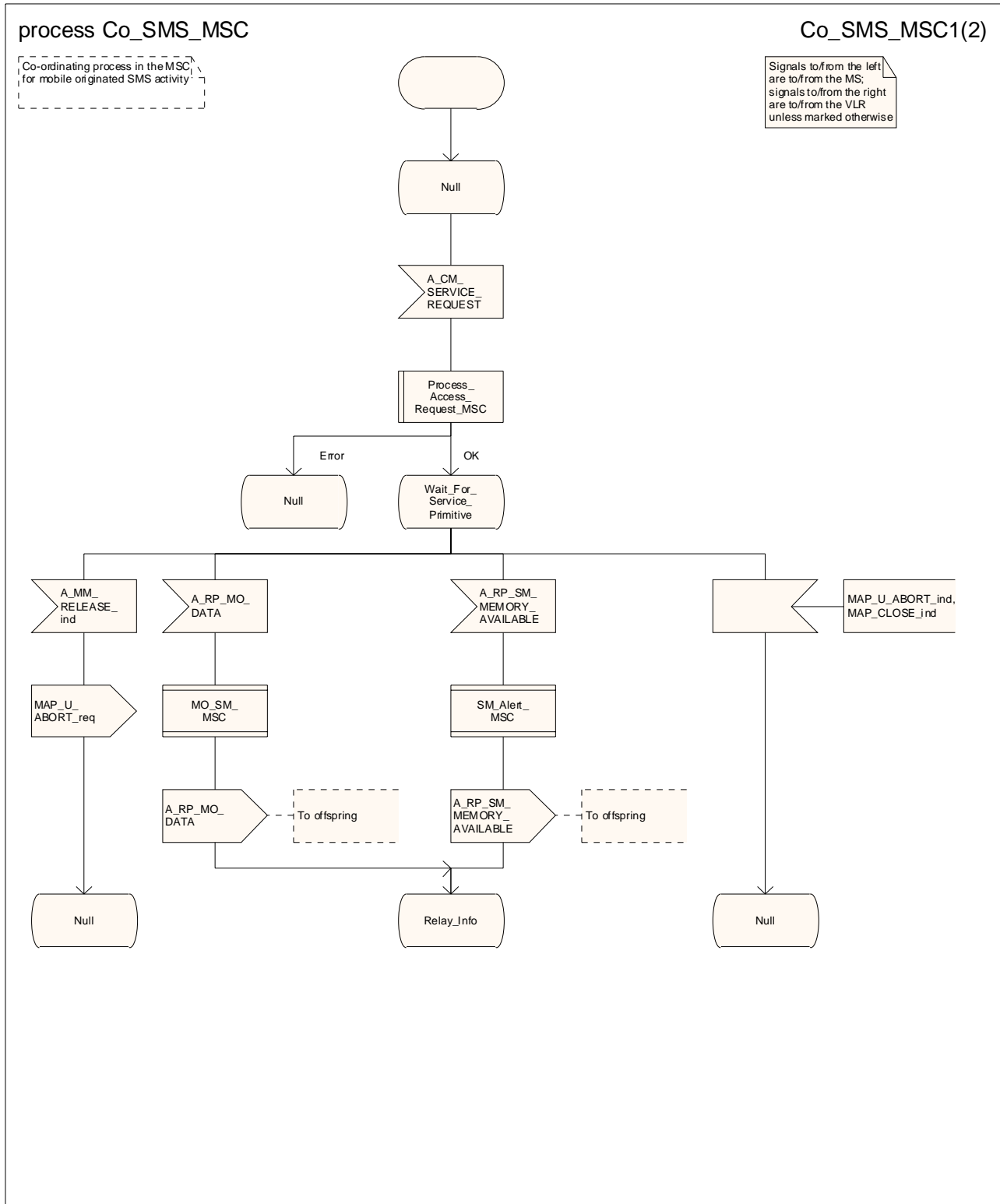

Figure 23.1/1 (sheet 1 of 2): Process Co_SMS_MSC

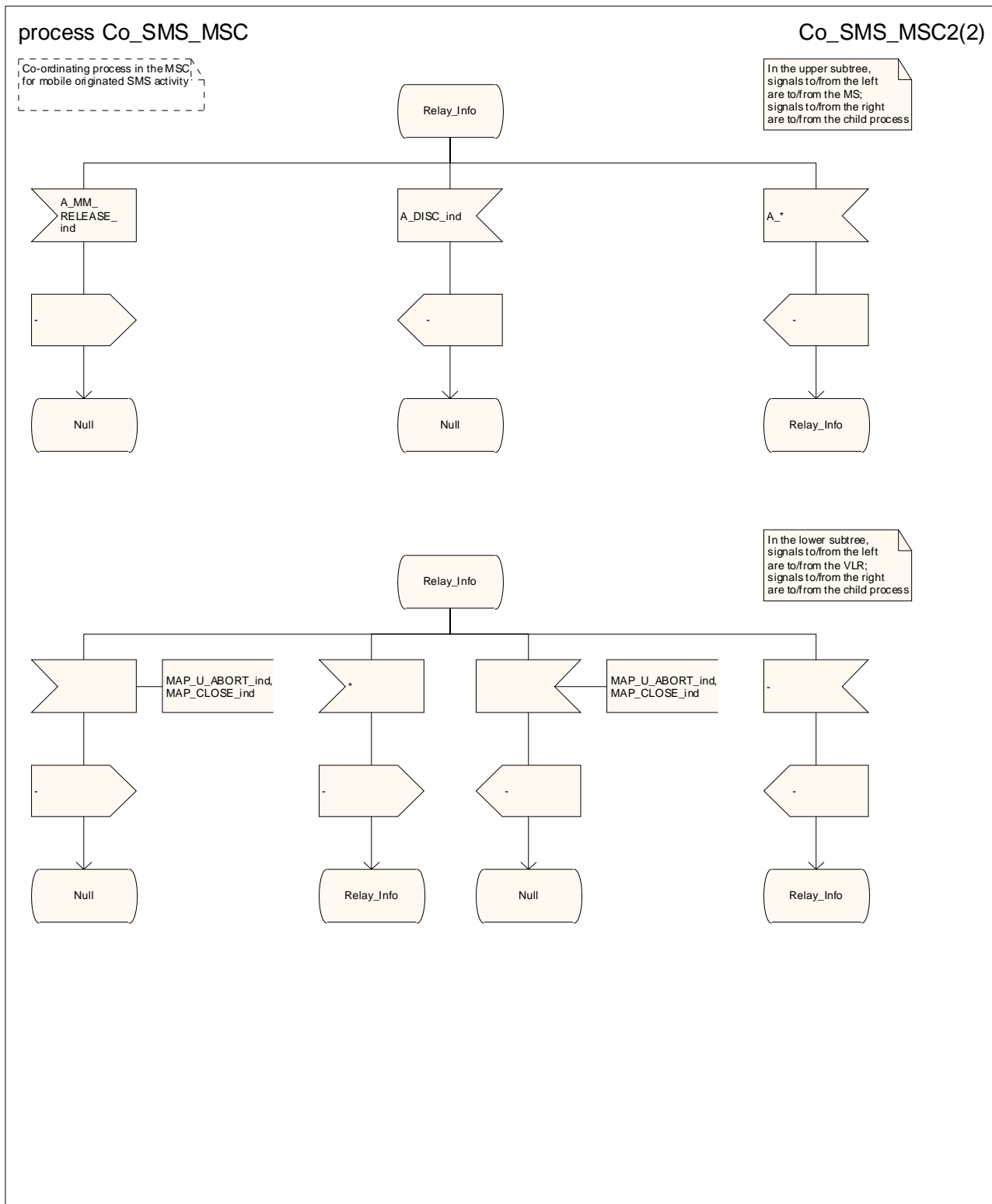

Figure 23.1/1 (sheet 2 of 2): Process Co_SMS_MSC

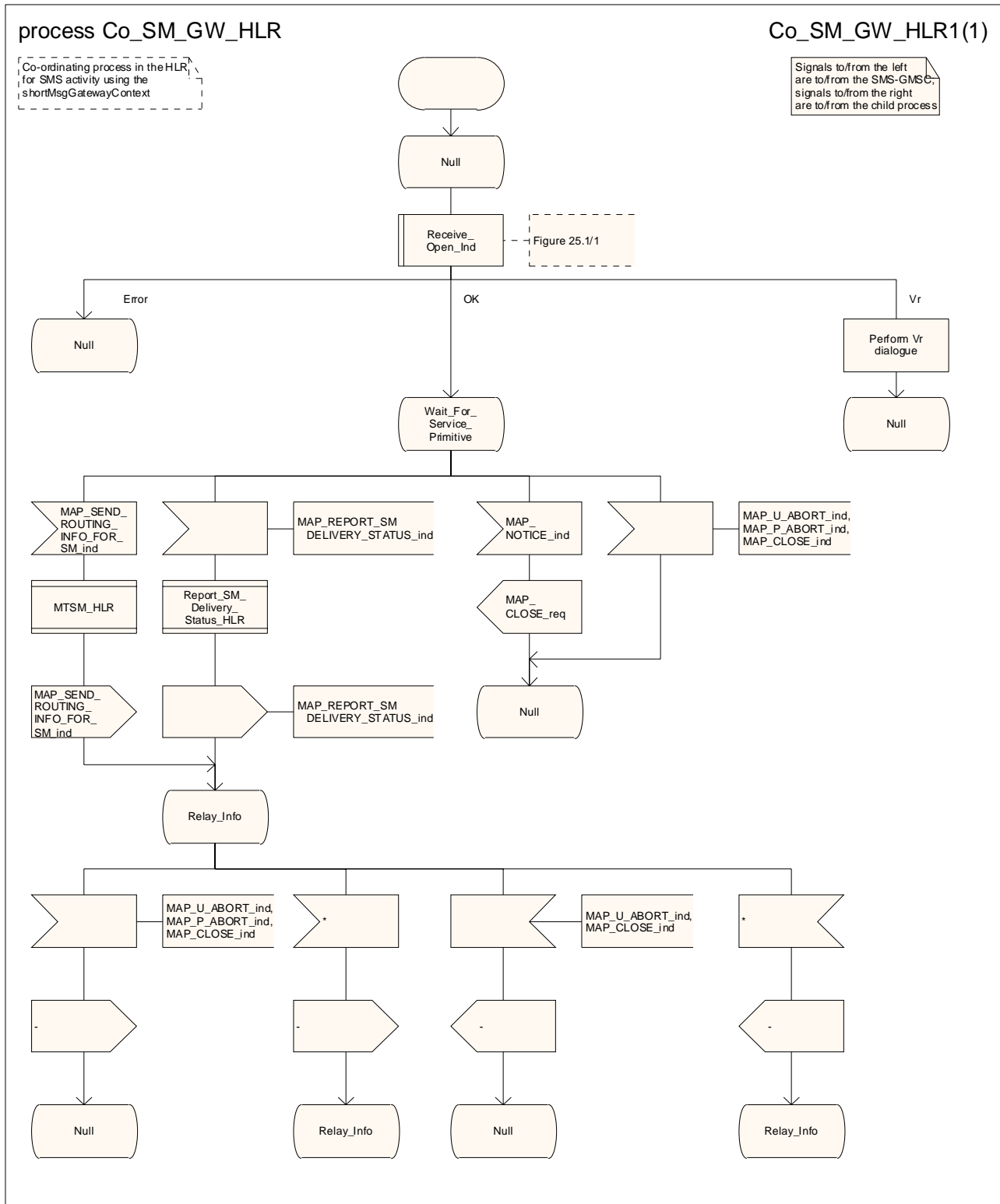
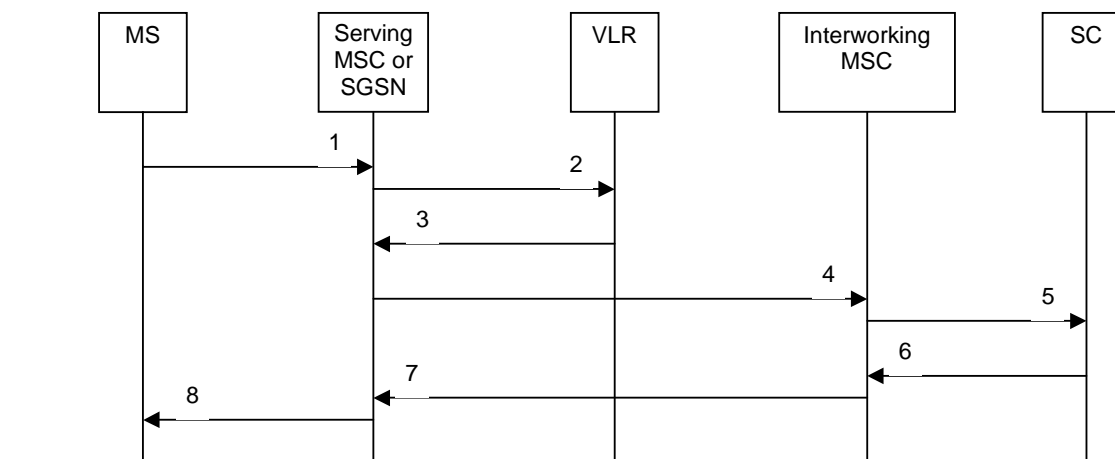

Figure 23.1/2: Process Co_SM_Gateway_HLR

23.2 The mobile originated short message transfer procedure

The mobile originated short message service procedure is used to forward a short message from a mobile subscriber to a Service Centre. The message flow for the mobile originated short message service procedure is shown in figure 23.2/1.



- 1) Short Message (3GPP TS 24.011 [37]).
 - 2) MAP_SEND_INFO_FOR_MO_SMS (*).
 - 3) MAP_SEND_INFO_FOR_MO_SMS_ACK (*).
 - 4) MAP_MO_FORWARD_SHORT_MESSAGE.
 - 5) Short message (3GPP TS 23.040).
 - 6) Short message Acknowledgement (3GPP TS 23.040).
 - 7) MAP_MO_FORWARD_SHORT_MESSAGE_ACK.
 - 8) Short Message Acknowledgement (3GPP TS 24.011 [37]).
- (*) Messages 2) and 3) are not used by the SGSN.

Figure 23.2/1: Mobile originated short message transfer

In addition the following MAP services are used:

MAP_PROCESS_ACCESS_REQUEST	(see subclause 8.3); (*)
MAP_AUTHENTICATE	(see subclause 8.5); (*)
MAP_SET_CIPHERING_MODE	(see subclause 8.6); (*)
MAP_PROVIDE_IMSI	(see subclause 8.9); (*)
MAP_CHECK_IMEI	(see subclause 8.7);
MAP_FORWARD_NEW_TMSI	(see subclause 8.9); (*)
MAP_TRACE_SUBSCRIBER_ACTIVITY	(see subclause 9.1); (*)
MAP_READY_FOR_SM	(see subclause 12.4).

(*) These services are not used by the SGSN.

23.2.1 Procedure in the serving MSC

Any CAMEL-specific handling defined in this subclause is omitted if the MSC does not support CAMEL control of MO SMS, or if the subscriber does not have a subscription for CAMEL control of MO SMS.

The process starts when the MSC receives a short message from the MS. The process invokes macros not defined in this clause; the definitions of these macros can be found as follows:

Receive_Open_Cnf	see subclause 25.1.2;
Check_Indication	see subclause 25.2.1;

Check_Confirmation see subclause 25.2.2.

Sheet 1: If the MSC is integrated with the SMS-IWMSC, it communicates directly with the Short Message Service Centre (SMSC) using one of the protocols described in 3GPP TS 23.039 [25a]; otherwise it communicates with the SMS-IWMSC using MAP.

Sheet 3: If the capacity of a message signal unit in the lower layers of the protocol is enough to carry the content of the MAP_OPEN request and the content of the MAP_MO_FORWARD_SHORT_MESSAGE request in a single TC message, the test "Message segmentation needed" takes the "No" exit; otherwise the test takes the "Yes" exit.

The mobile originated short message service process in the MSC is shown in figure 23.2/2.

23.2.2 Procedure in the VLR

Any CAMEL-specific handling defined in this subclause is omitted if the VLR does not support CAMEL control of MO SMS.

The process starts when the VLR receives a dialogue opening request followed by a MAP_PROCESS_ACCESS_REQUEST including a CM service type Short Message Service. The process invokes macros not defined in this clause; the definitions of these macros can be found as follows:

Receive_Open_Ind see subclause 25.1.1;
Check_Indication see subclause 25.2.1;
Process_Access_Request_VLR see subclause 25.4.2.

The mobile originated short message transfer process in the VLR is shown in figure 23.2/3.

23.2.3 Procedure in the SGSN

Any CAMEL-specific handling defined in this subclause is omitted if the SGSN does not support CAMEL control of MO SMS, or if the subscriber does not have a subscription for CAMEL control of MO SMS.

The process starts when the SGSN receives a short message from the MS over the Gb interface. The MAP process invokes macros not defined in this clause; the definitions of these macros can be found as follows:

Receive_Open_Cnf see subclause 25.1.2;
Check_Confirmation see subclause 25.2.2.

Sheet 2: If the capacity of a message signal unit in the lower layers of the protocol is enough to carry the content of the MAP_OPEN request and the content of the MAP_MO_FORWARD_SHORT_MESSAGE request in a single TC message, the test "Message segmentation needed" takes the "No" exit; otherwise the test takes the "Yes" exit.

The mobile originated short message service process in the SGSN is shown in figure 23.2/4.

23.2.4 Procedure in the SMS Interworking MSC (SMS-IWMSC)

This procedure applies only when the SMS-IWMSC is not integrated with the serving MSC or SGSN.

The process starts when the SMS-IWMSC receives a dialogue opening request with the application context shortMsgMO-RelayContext. The MAP process invokes macros not defined in this clause; the definitions of these macros can be found as follows:

Receive_Open_Ind see subclause 25.1.1;
Check_Indication see subclause 25.2.1.

The mobile originated short message service transfer process in the SMS-IWMSC is shown in figure 23.2/5.

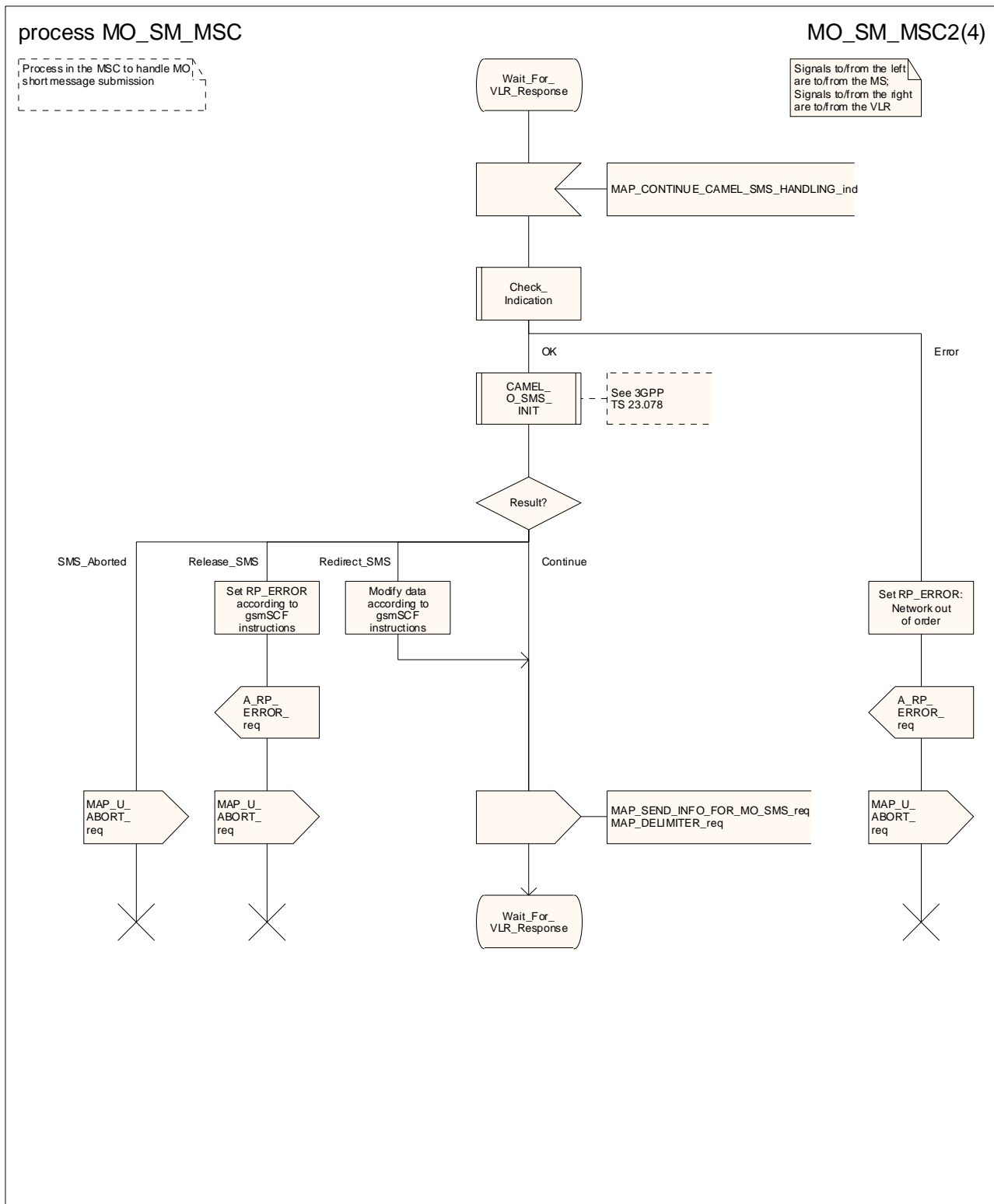

Figure 23.2/2 (sheet 2 of 4): Process MO_SM_MSC

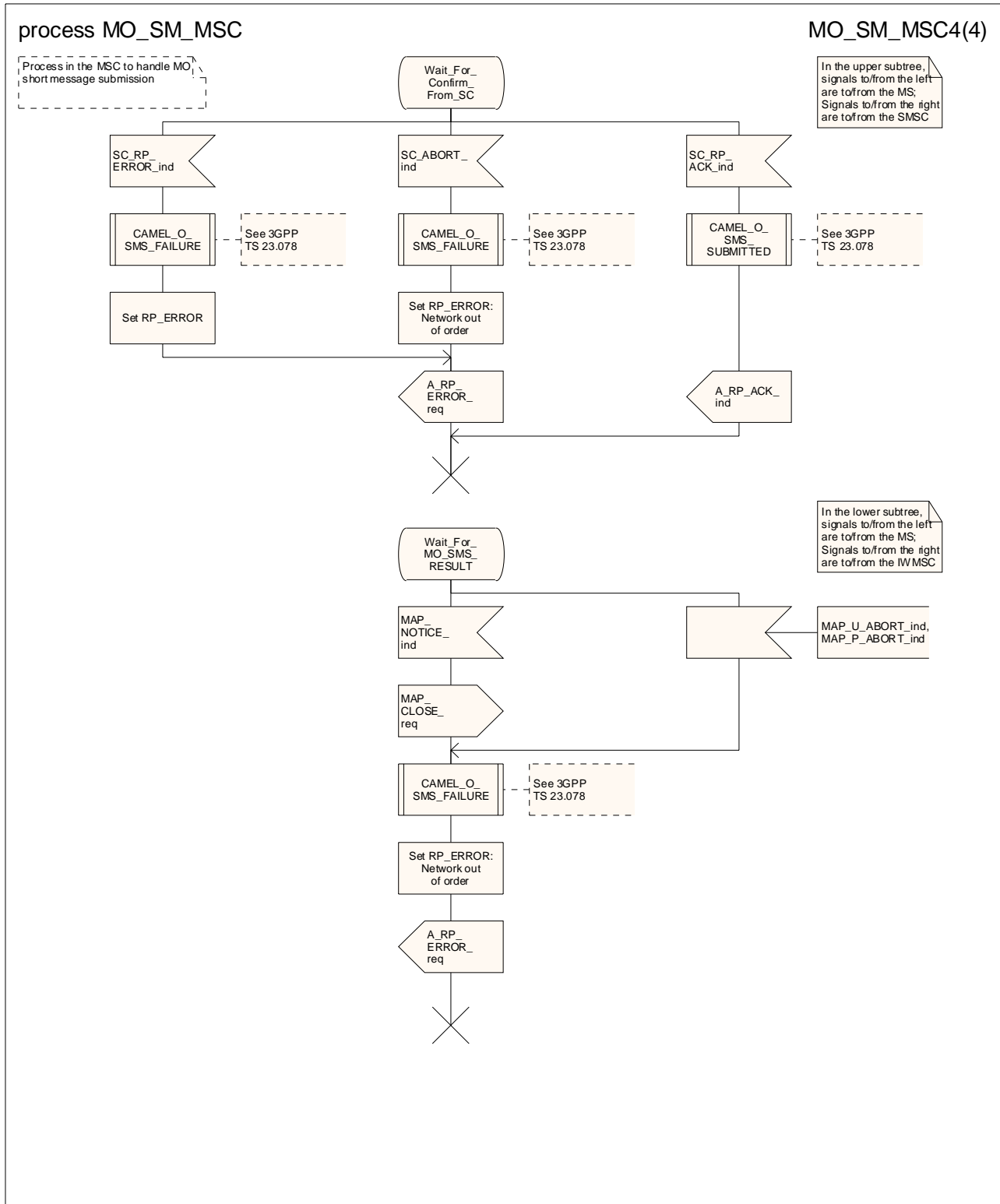

Figure 23.2/2 (sheet 4 of 4): Process MO_SM_MSC

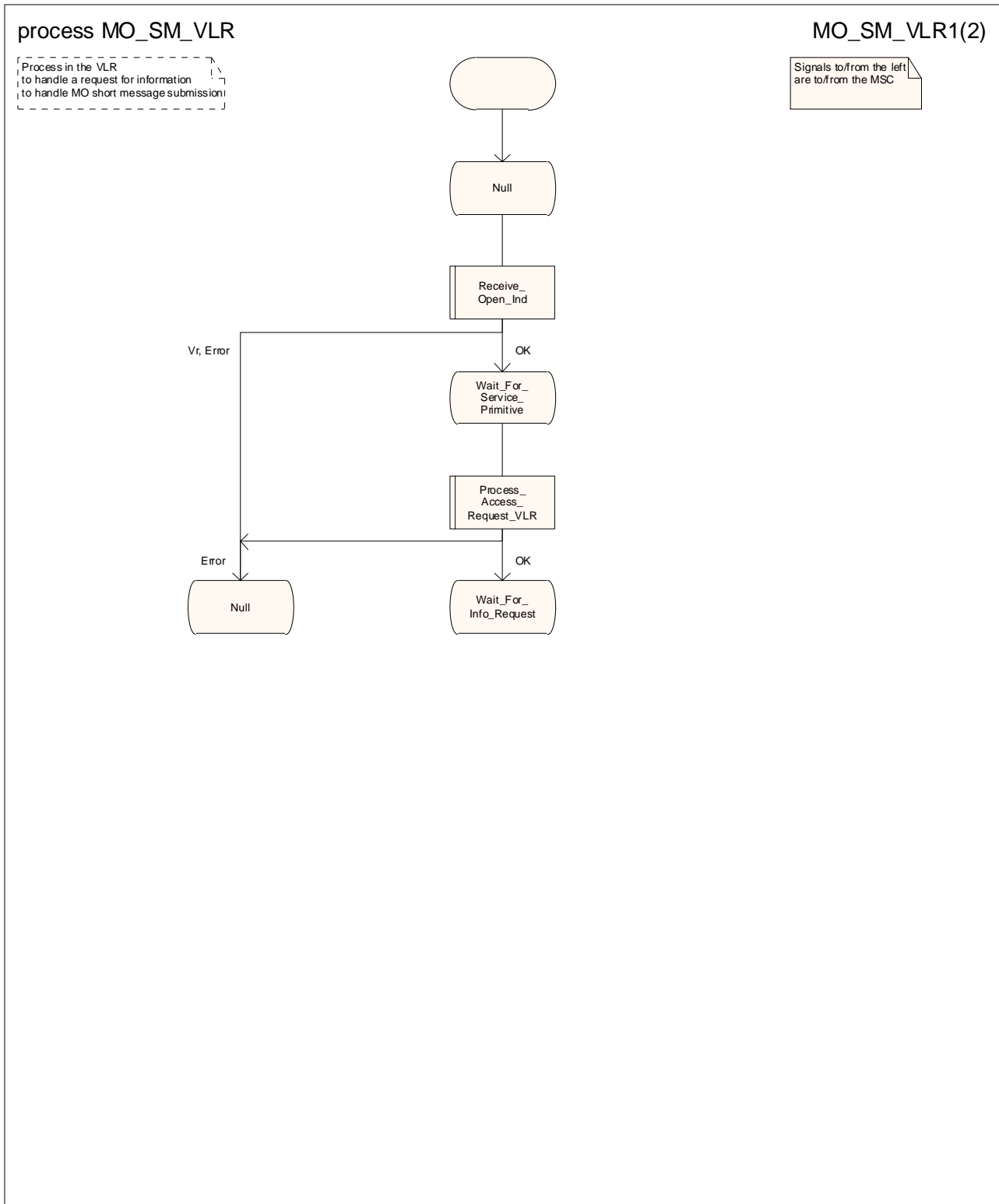

Figure 23.2/3 (sheet 1 of 2): Process MO_SM_VLR

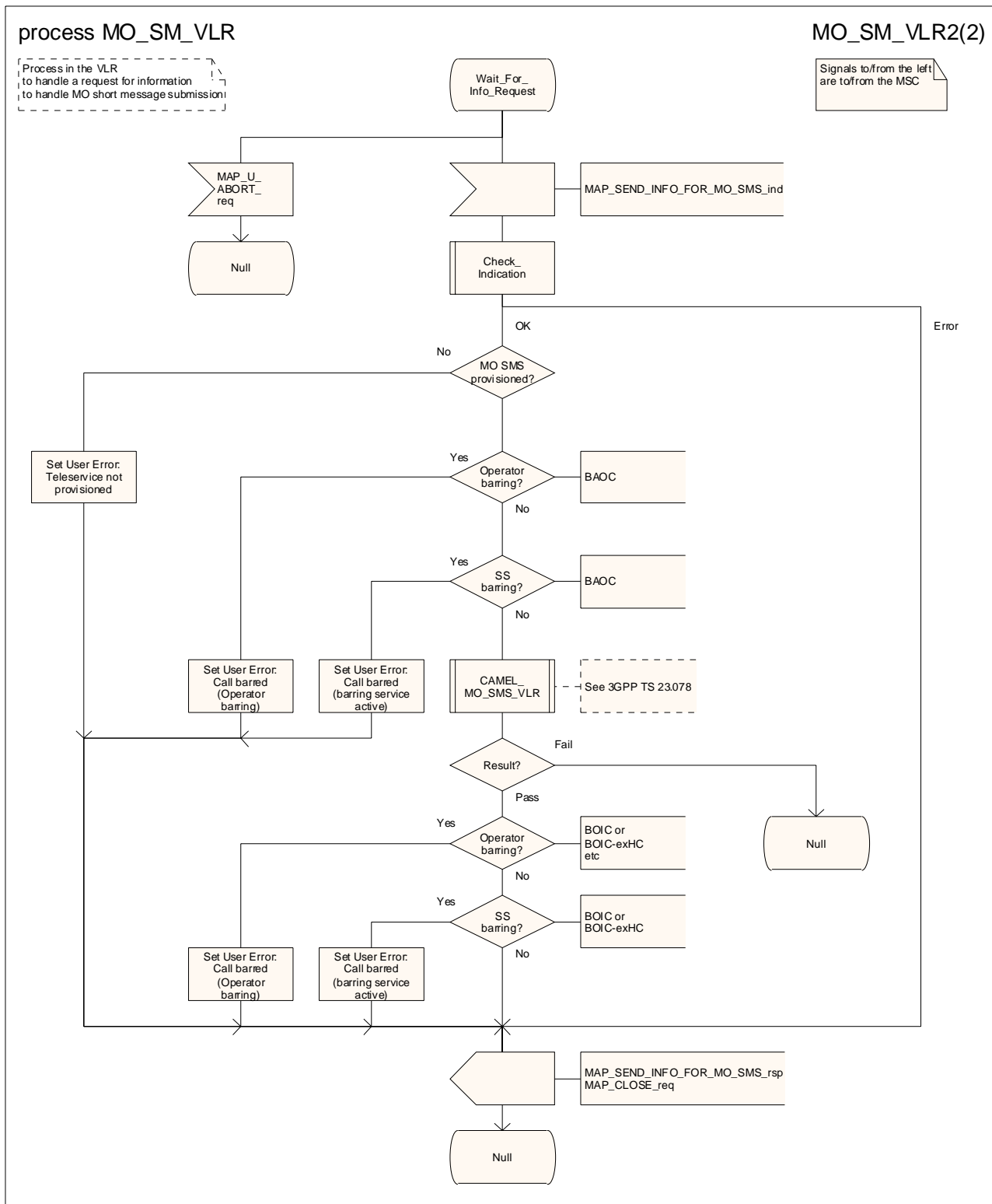

Figure 23.2/3 (sheet 2 of 2): Process MO_SM_VLR

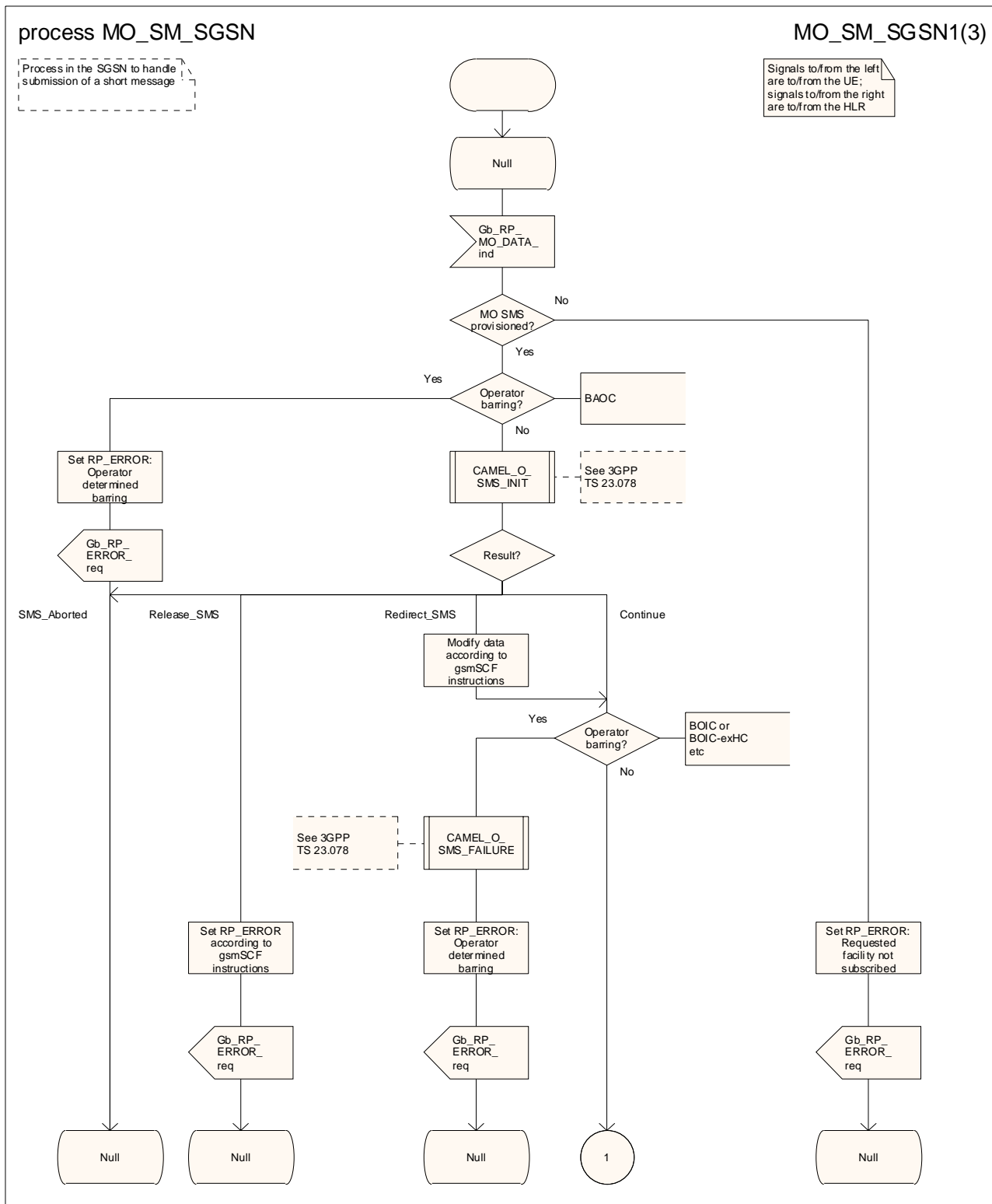

Figure 23.2/4 (sheet 1 of 3): Process MO_SM_SGSN

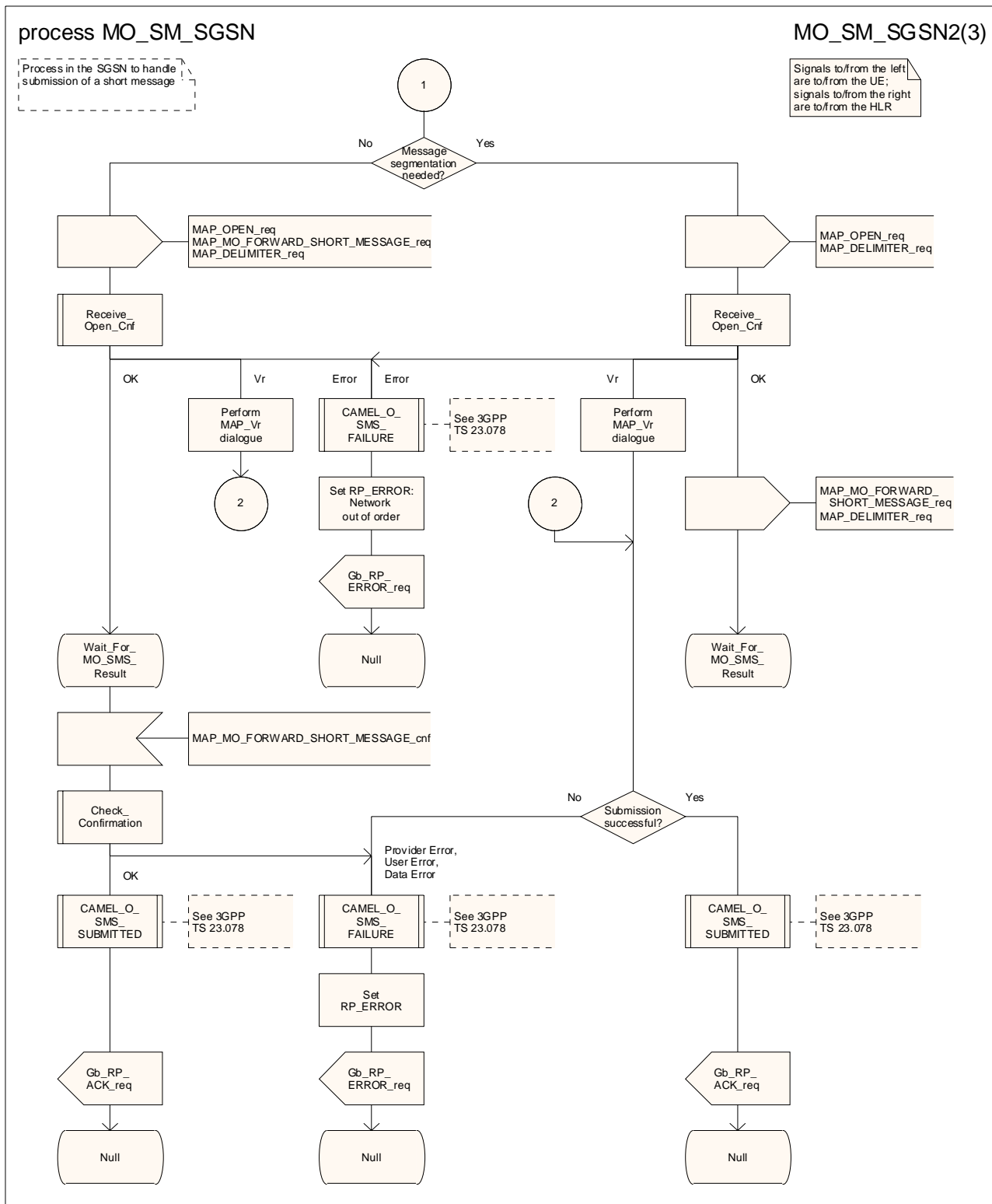

Figure 23.2/4 (sheet 2 of 3): Process MO_SM_SGSN

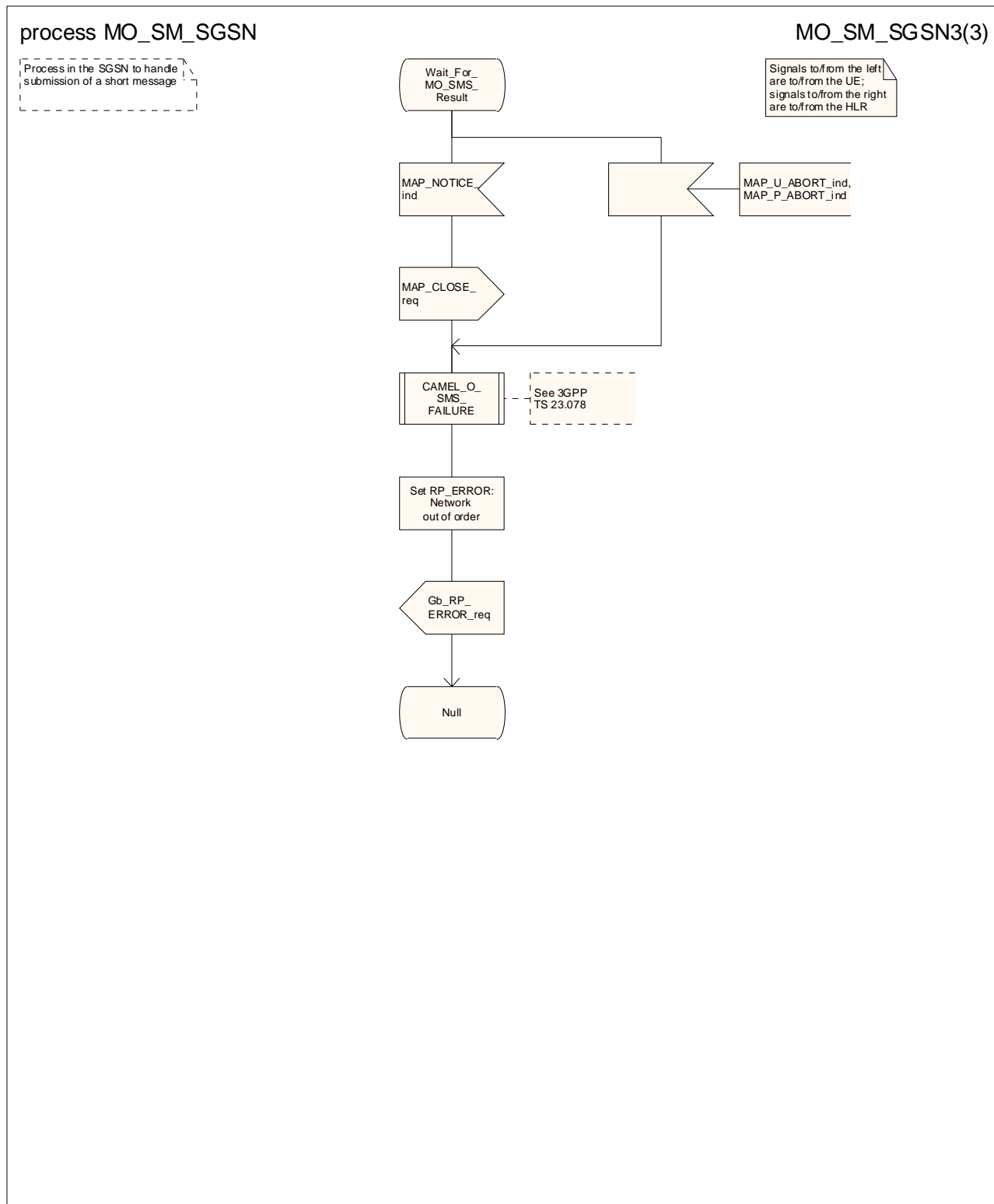

Figure 23.2/4 (sheet 3 of 3): Process MO_SM_SGSN

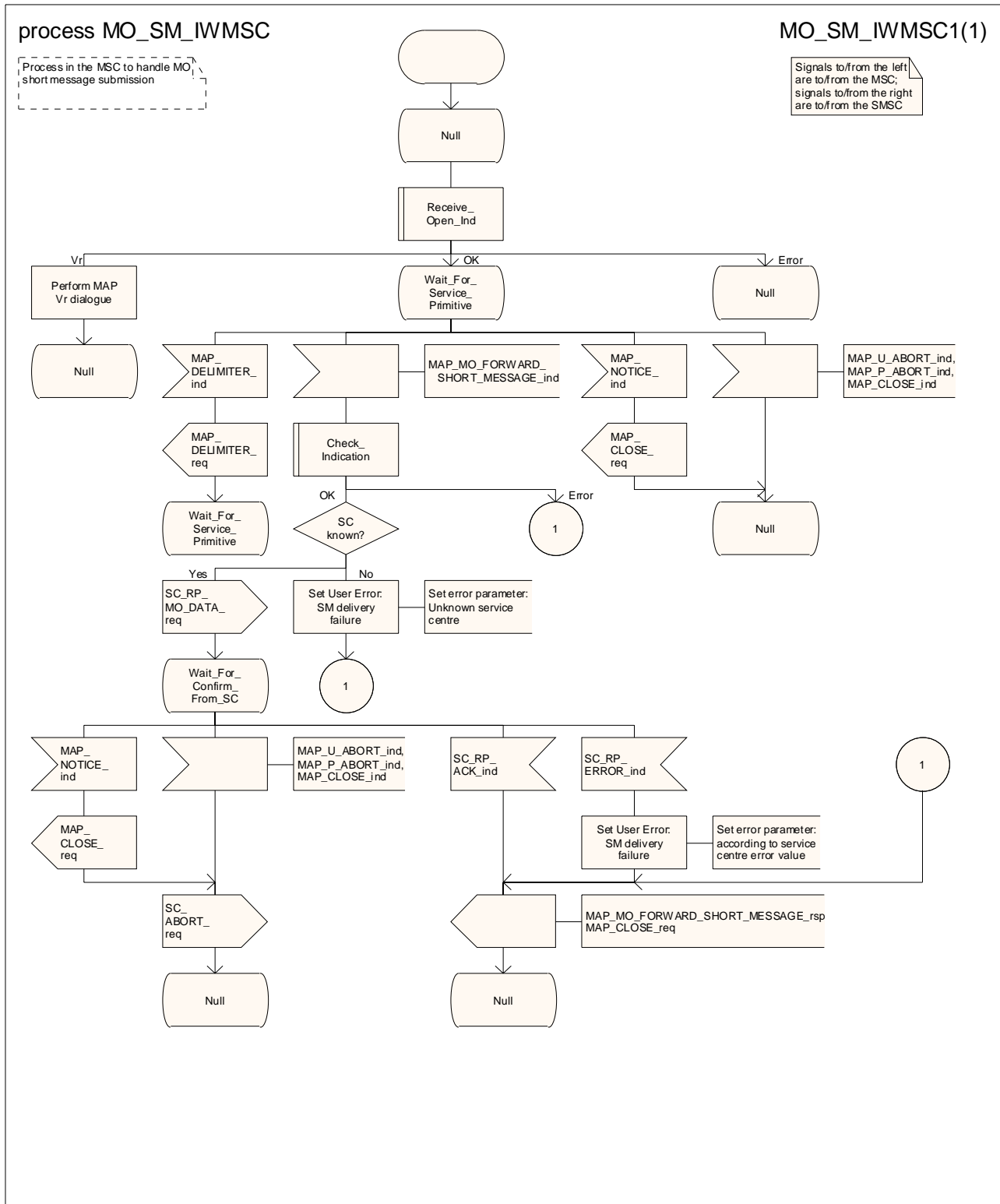

Figure 23.2/5: Process MO_SM_IWMSC

23.3 The mobile terminated short message transfer procedure

The mobile terminated short message transfer procedure is used for forwarding a short message or several short messages from a Service Centre to a mobile subscriber. The message flow for the mobile terminated short message procedure for a single short message transfer is shown in figure 23.3/1.

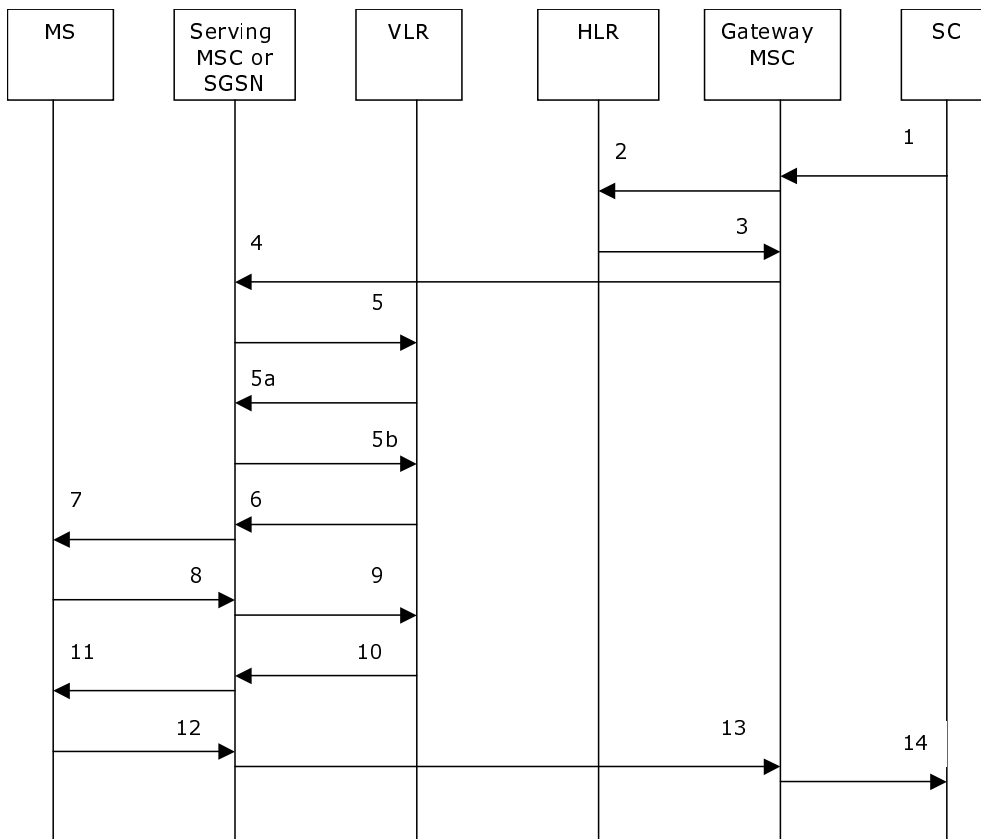

Figure 23.3/1: Mobile terminated short message service procedures

- 1) Short Message (3GPP TS 23.040).
- 2) MAP_SEND_ROUTING_INFO_FOR_SM.
- 3) MAP_SEND_ROUTING_INFO_FOR_SM_ACK.
- 4) MAP_MT_FORWARD_SHORT_MESSAGE.
- 5) MAP_SEND_INFO_FOR_MT_SMS (*).
- 5a) MAP_CONTINUE_CAMEL_SMS_HANDLING (*)(**)
- 5b) MAP_SEND_INFO_FOR_MT_SMS (*)(**)
- 6) MAP_PAGE/MAP_SEARCH_FOR_MOBILE_SUBSCRIBER (*).
- 7) Page (3GPP TS 24.008 [35]).
- 8) Page response (3GPP TS 24.008 [35]).
- 9) MAP_PROCESS_ACCESS_REQUEST_ACK and MAP_SEARCH_FOR_MOBILE_SUBSCRIBER_ACK (*).
- 10) MAP_SEND_INFO_FOR_MT_SMS_ACK (*).
- 11) Short Message (3GPP TS 24.011 [37]).
- 12) Short Message Acknowledgement (3GPP TS 24.011 [37]).
- 13) MAP_MT_FORWARD_SHORT_MESSAGE_ACK.
- 14) Short Message Acknowledgement (3GPP TS 23.040).

(*) Messages 5), 5a), 5b), 6), 9), and 10) are not used by the SGSN.

(**) These messages are used only for a subscriber provisioned with MT-SMS-CSI in the VLR.

The message flow for the mobile terminated short message procedure for multiple short message transfer is shown in figure 23.3/2.

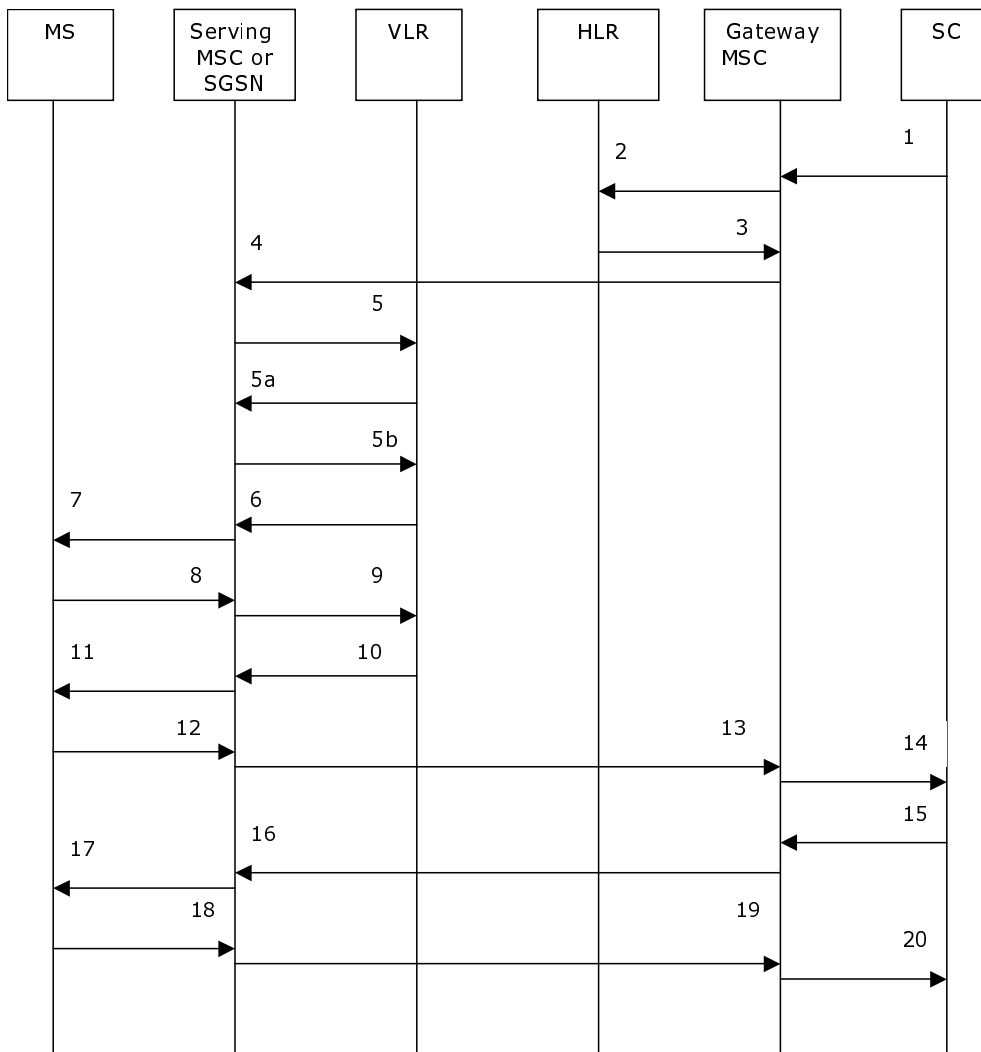

Figure 23.3/2: Mobile terminated short message procedure for multiple short message transfer

- 1) Short Message (3GPP TS 23.040).
- 2) MAP_SEND_ROUTING_INFO_FOR_SM.
- 3) MAP_SEND_ROUTING_INFO_FOR_SM_ACK.
- 4) MAP_MT_FORWARD_SHORT_MESSAGE (note 1).
- 5) MAP_SEND_INFO_FOR_MT_SMS (*).
- 5a) MAP_CONTINUE_CAMEL_SMS_HANDLING (*)(**)
- 5b) MAP_SEND_INFO_FOR_MT_SMS (*)(**)
- 6) MAP_PAGE/MAP_SEARCH_FOR_MOBILE_SUBSCRIBER (*).
- 7) Page (3GPP TS 48.008 [49]).
- 8) Page response (3GPP TS 24.008 [35]).
- 9) MAP_PROCESS_ACCESS_REQUEST_ACK and MAP_SEARCH_FOR_MOBILE_SUBSCRIBER_ACK (*).
- 10) MAP_SEND_INFO_FOR_MT_SMS_ACK (*).
- 11) Short Message (3GPP TS 24.011 [37]).
- 12) Short Message Acknowledgement (3GPP TS 24.011 [37]).
- 13) MAP_MT_FORWARD_SHORT_MESSAGE_ACK.
- 14) Short Message Acknowledgement (3GPP TS 23.040).
- 15) Short Message (3GPP TS 23.040).
- 16) MAP_MT_FORWARD_SHORT_MESSAGE (note 2).
- 17) Short Message (3GPP TS 24.011 [37]).
- 18) Short Message Acknowledgement (3GPP TS 24.011 [37]).
- 19) MAP_MT_FORWARD_SHORT_MESSAGE_ACK.
- 20) Short Message Acknowledgement (3GPP TS 23.040).

- (*) Messages 5), 5a), 5b) 6), 9), and 10) are not used by the SGSN.
 (**) These messages are used only for a subscriber provisioned with MT-SMS-CSI in the VLR.

NOTE 1: The 'More Messages To Send' flag is TRUE.
 NOTE 2: The 'More Messages To Send' flag is FALSE.

In the multiple short message transfer the service MAP_MT_FORWARD_SHORT_MESSAGE can be used several times. However, the short message transfer is always acknowledged to the Service Centre before the next short message is sent.

In addition the following MAP services are used:

MAP_PROCESS_ACCESS_REQUEST	(see subclause 8.3); (*)
MAP_PAGE	(see subclause 8.2); (*)
MAP_SEARCH_FOR_MS	(see subclause 8.2); (*)
MAP_AUTHENTICATE	(see subclause 8.5); (*)
MAP_SET_CIPHERING_MODE	(see subclause 8.6); (*)
MAP_CHECK_IMEI	(see subclause 8.7);
MAP_FORWARD_NEW_TMSI	(see subclause 8.9); (*)
MAP_REPORT_SM_DELIVERY_STATUS	(see subclause 12.3);
MAP_INFORM_SERVICE_CENTRE	(see subclause 12.6);
MAP_TRACE_SUBSCRIBER_ACTIVITY	(see subclause 9.1); (*)
MAP_READY_FOR_SM	(see subclause 12.4).

(*) These services are not used by the SGSN.

23.3.1 Procedure in the SMS-GMSC

Any CAMEL-specific handling described in this subclause is omitted if the SMS-GMSC does not support CAMEL. CAMEL-specific handling is invoked only if the SMS-GMSC is integrated with the VMSC.

The process starts when the SMS-GMSC receives an SC_RP_MT_DATA indication from a Service Centre. The MAP process invokes macros not defined in this clause; the definitions of these macros can be found as follows:

Receive_Open_Cnf	see subclause 25.1.2;
Check_Confirmation	see subclause 25.2.2.

Process MT_SM_GMSC sheet 1: If the MAP_SEND_ROUTING_INFO_FOR_SM confirmation included an LMSI, it may be included in the sm-RP-DA information field of the first MAP_MT_FORWARD_SHORT_MESSAGE request sent to the serving MSC. In this case, the IMSI shall be included in the Destination Reference of the MAP_OPEN request. The SMS-GMSC shall not send an LMSI to an SGSN. If the SMS-GMSC does not send an LMSI to the serving node, the sm-RP-DA information field in the first MAP_MT_FORWARD_SHORT_MESSAGE request sent to the serving MSC or SGSN shall contain the IMSI, and the Destination Reference in the MAP_OPEN request shall not be present. The parameter SM_RP_OA shall contain the Service Centre address.

Process MT_SM_GMSC sheet 1: The indication of which number belongs to the SGSN and which to the MSC, received from the HLR in the MAP_SEND_ROUTING_INFO_FOR_SM confirm (see subclause 23.3.2) will enable the SMS-GMSC to map the causes received from one or both serving nodes into the appropriate causes for non GPRS, GPRS or both, and send them to the SC and the HLR.

Process MT_SM_GMSC sheet 2: The SMS-GMSC maps "Unexpected data value" and "System failure" MAP errors from the serving node to a "System failure" RP_ERROR error cause. The mapping between other MAP error causes and the RP_ERROR error cause is given in 3GPP TS 23.040 [26] and 3GPP TS 24.011 [37].

23.3.3 Procedure in the Serving MSC

Any CAMEL-specific handling defined in this subclause is omitted if the MSC does not support CAMEL control of MT SMS, or if the subscriber does not have a subscription for CAMEL control of MT SMS.

The process starts when the MSC receives a dialogue opening request with the application context shortMsgMT-RelayContext. The MAP process invokes macros not defined in this clause; the definitions of these macros can be found as follows:

Receive_Open_Ind	see subclause 25.1.1;
Check_Indication	see subclause 25.2.1.

The mobile terminated short message transfer process in the serving MSC is shown in figure 23.3/6.

The macro MT_SM_Transfer_MSC may be invoked either in a stand-alone serving MSC or in a serving MSC which is integrated with the SMS-GMSC. It is used to transfer the first MT short message of a possible sequence of messages. The macro invokes macros not defined in this clause; the definitions of these macros can be found as follows:

Check_Confirmation	see subclause 25.2.2.
Page_MSC	see subclause 25.3.1;
Search_for_MS_MSC	see subclause 25.3.2;
Process_Access_Request_MSC	see subclause 25.4.1;
Trace_Subscriber_Activity_MSC	see subclause 25.9.1.

The macro MT_SM_Transfer_MSC is shown in figure 23.3/7. The macro Check_Subscr_Identity_For_MT_SMS is shown in figure 23.3/8.

23.3.4 Procedure in the VLR

Any CAMEL-specific handling defined in this subclause is omitted if the VLR does not support CAMEL control of MT SMS.

The process starts when the VLR receives a dialogue opening request from the MSC. The process invokes macros not defined in this clause; the definitions of these macros can be found as follows:

Receive_Open_Ind	see subclause 25.1.1;
Check_Indication	see subclause 25.2.1;
Check_Confirmation	see subclause 25.2.2;
Process_Access_Request_VLR	see subclause 25.4.2.

The mobile terminated short message transfer process in the VLR is shown in figure 23.3/9.

23.3.5 Procedure in the SGSN

Any CAMEL-specific handling defined in this subclause is omitted if the SGSN does not support CAMEL control of MT SMS, or if the subscriber does not have a subscription for CAMEL control of MT SMS.

The process starts when the SGSN receives a dialogue opening request with the application context shortMsgMT-RelayContext. The MAP process invokes macros not defined in this clause; the definitions of these macros can be found as follows:

Receive_Open_Ind	see subclause 25.1.1;
Check_Indication	see subclause 25.2.1.

The mobile terminated short message transfer process in the SGSN is shown in figure 23.3/10.

The macro `MT_SM_Transfer_SGSN` is used to transfer the first MT short message of a possible sequence of messages. It is shown in figure 23.3/11.

The macro `Check_Subscr_Identity_For_MT_SMS` is shown in figure 23.3/8. The page and search procedures are shown in figures 23.3/12 and 23.3/13.

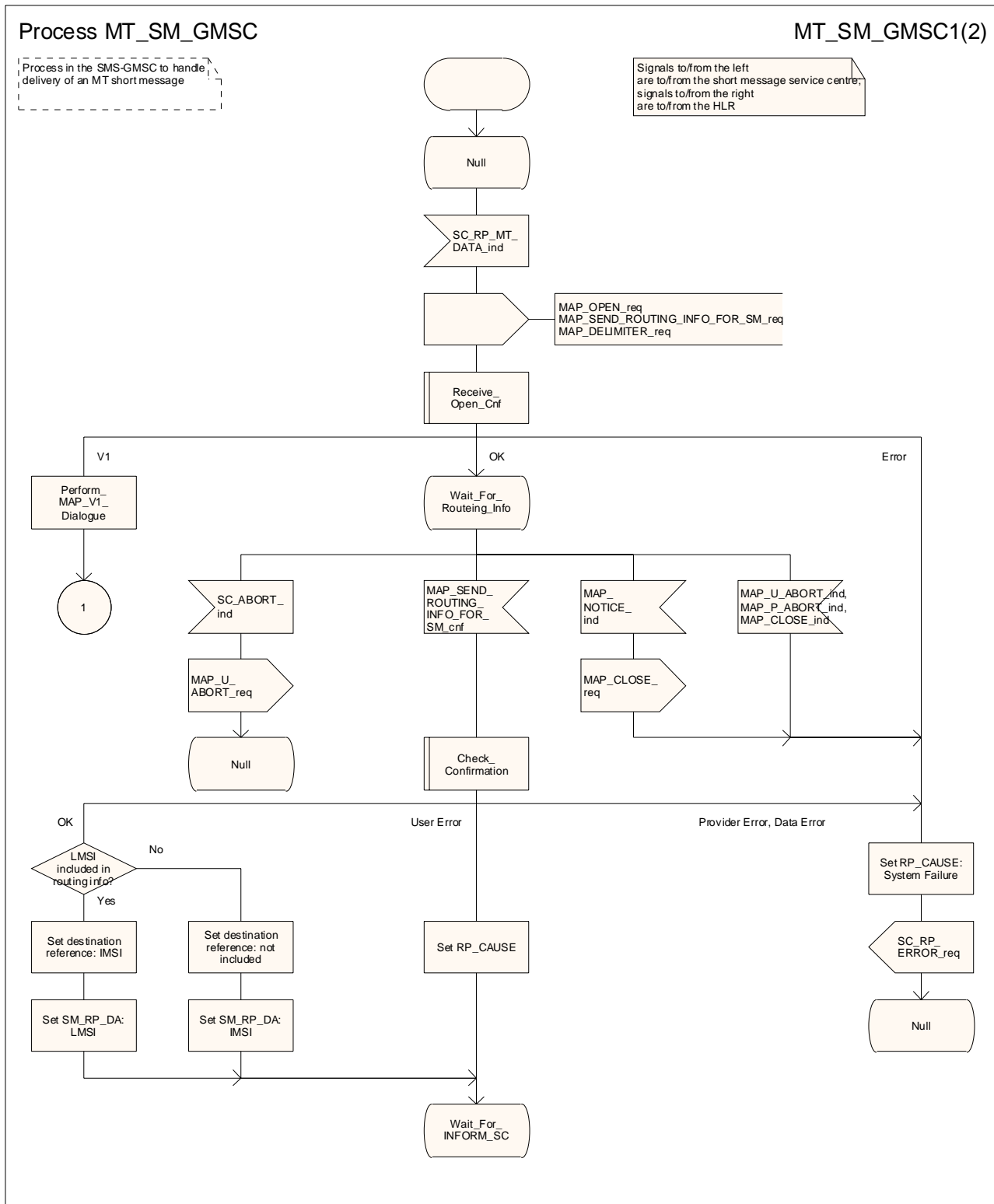

Figure 23.3/3 (sheet 1 of 2): Process MT_SM_GMSC

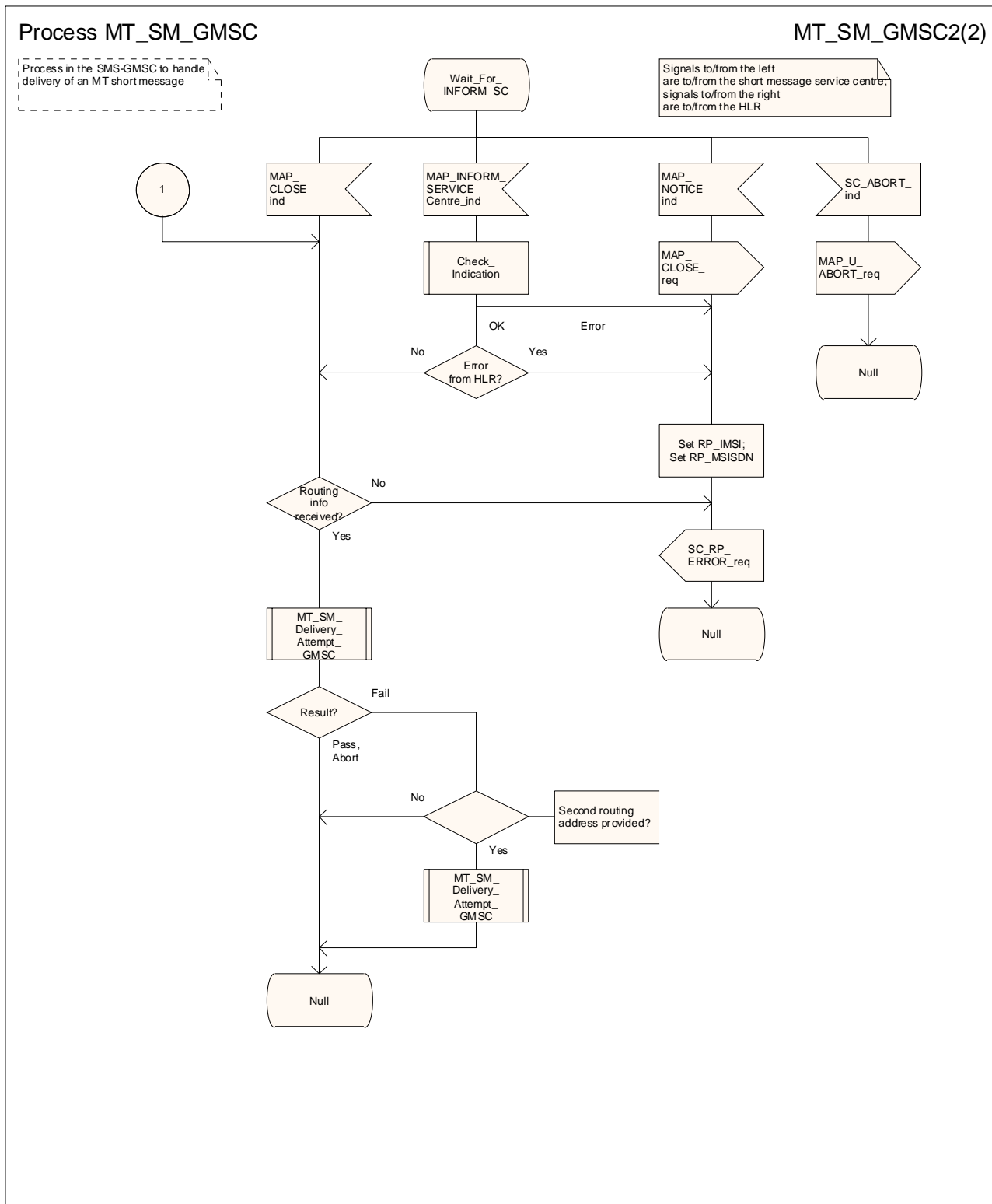

Figure 23.3/3 (sheet 2 of 2): Process MT_SM_GMSC

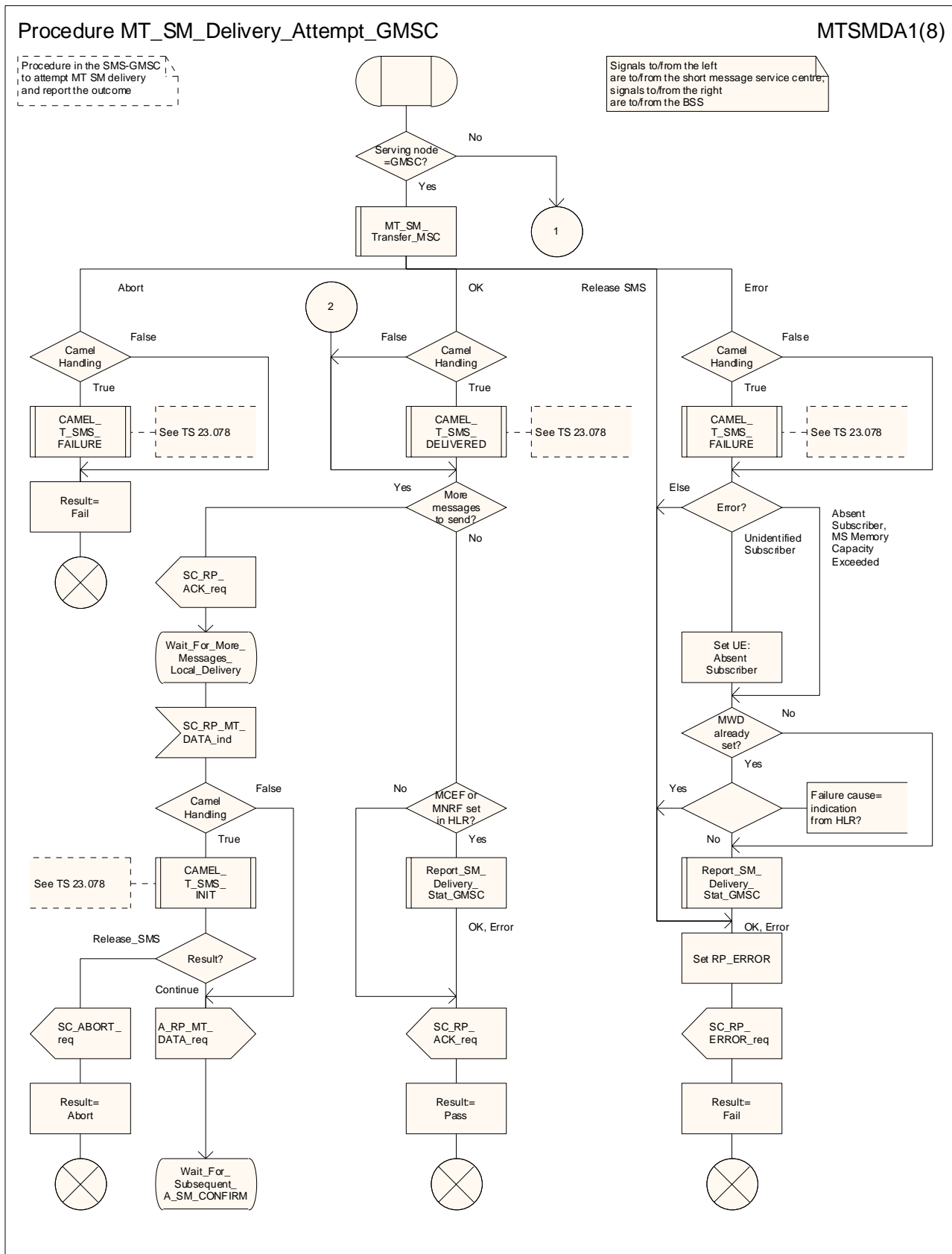

Figure 23.3/4 (sheet 1 of 8): Procedure MT_SM_Delivery_Attempt_GMSC

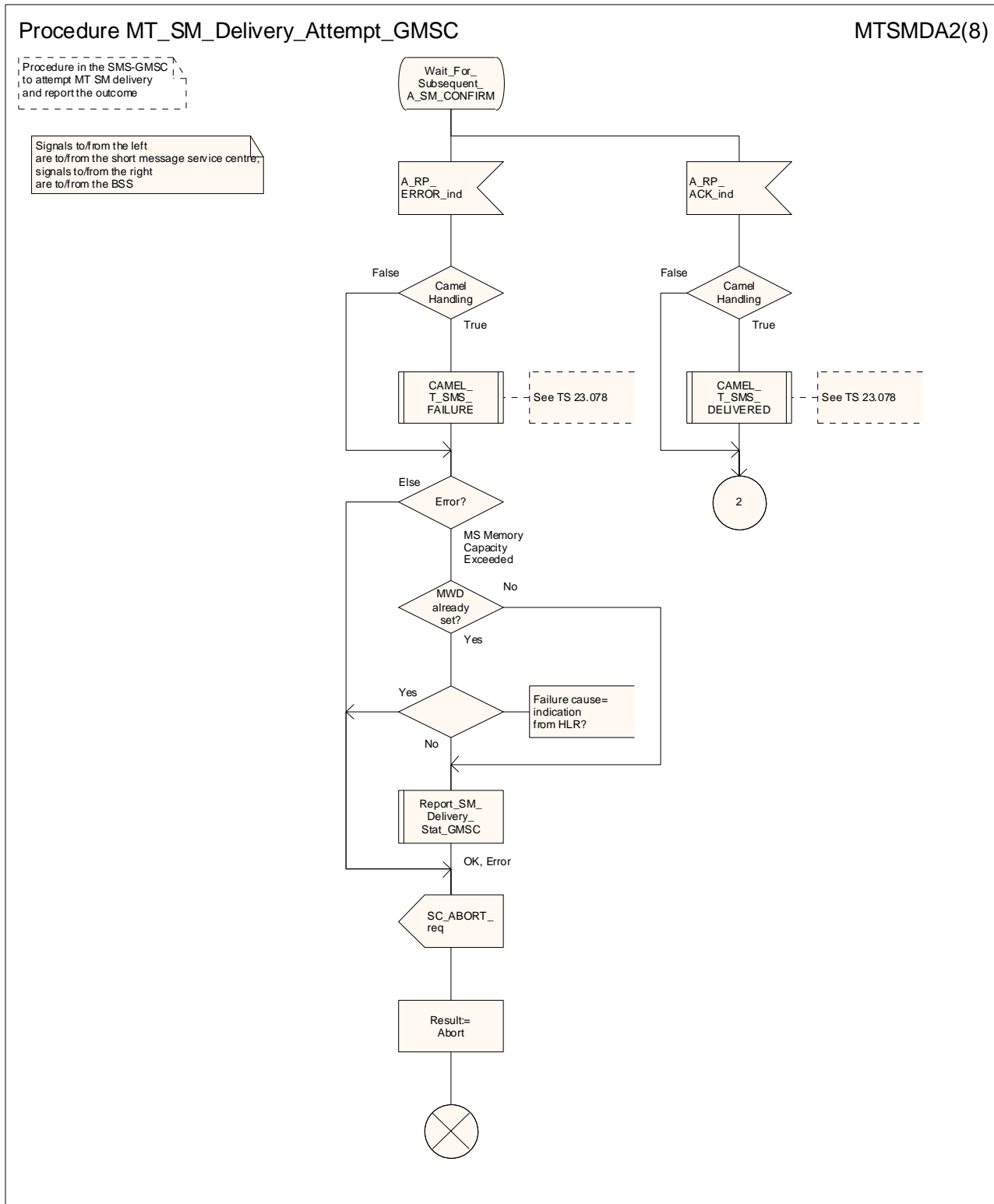

Figure 23.3/4 (sheet 2 of 8): Procedure MT_SM_Delivery_Attempt_GMSC

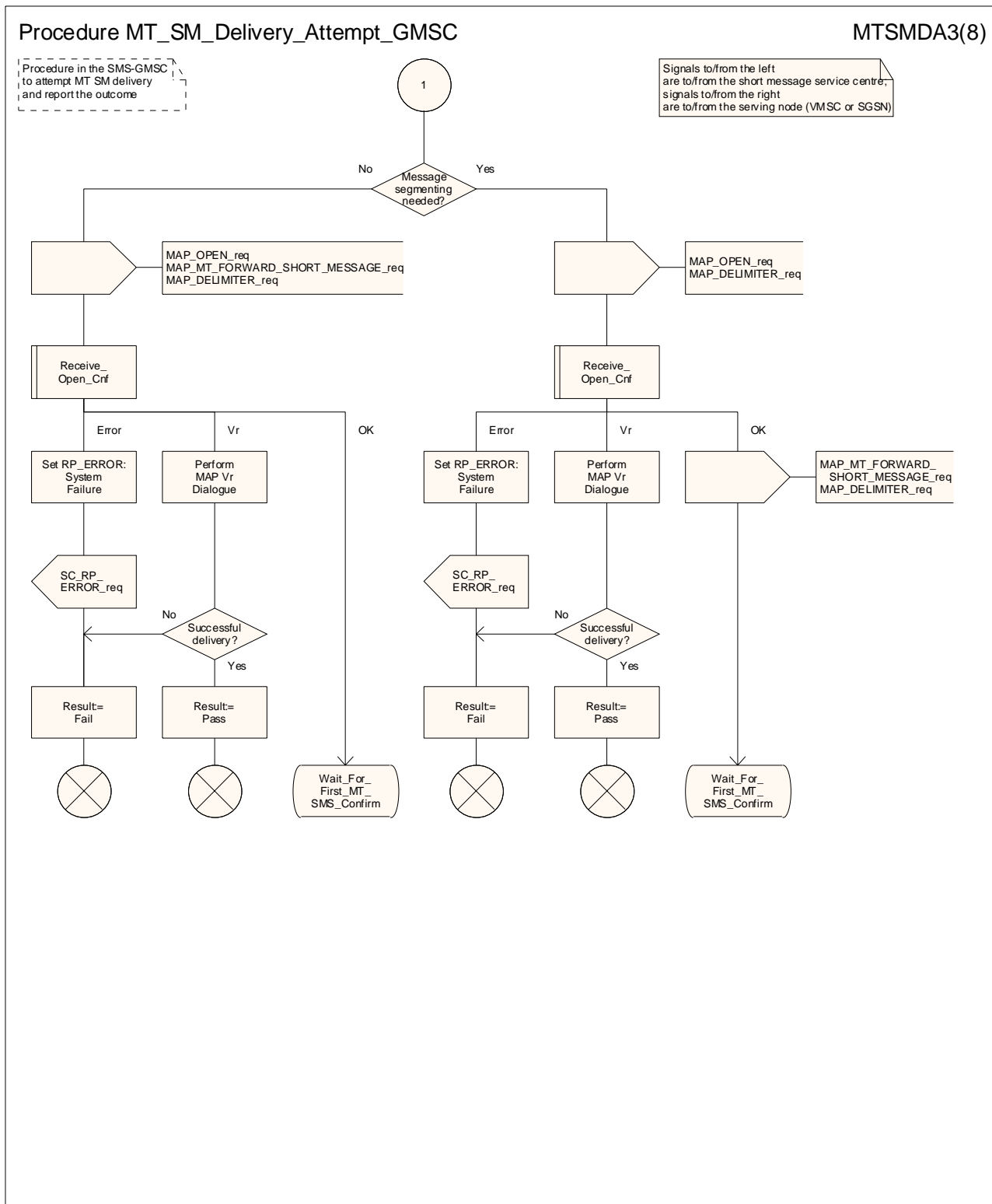

Figure 23.3/4 (sheet 3 of 8): Procedure MT_SM_Delivery_Attempt_GMSC

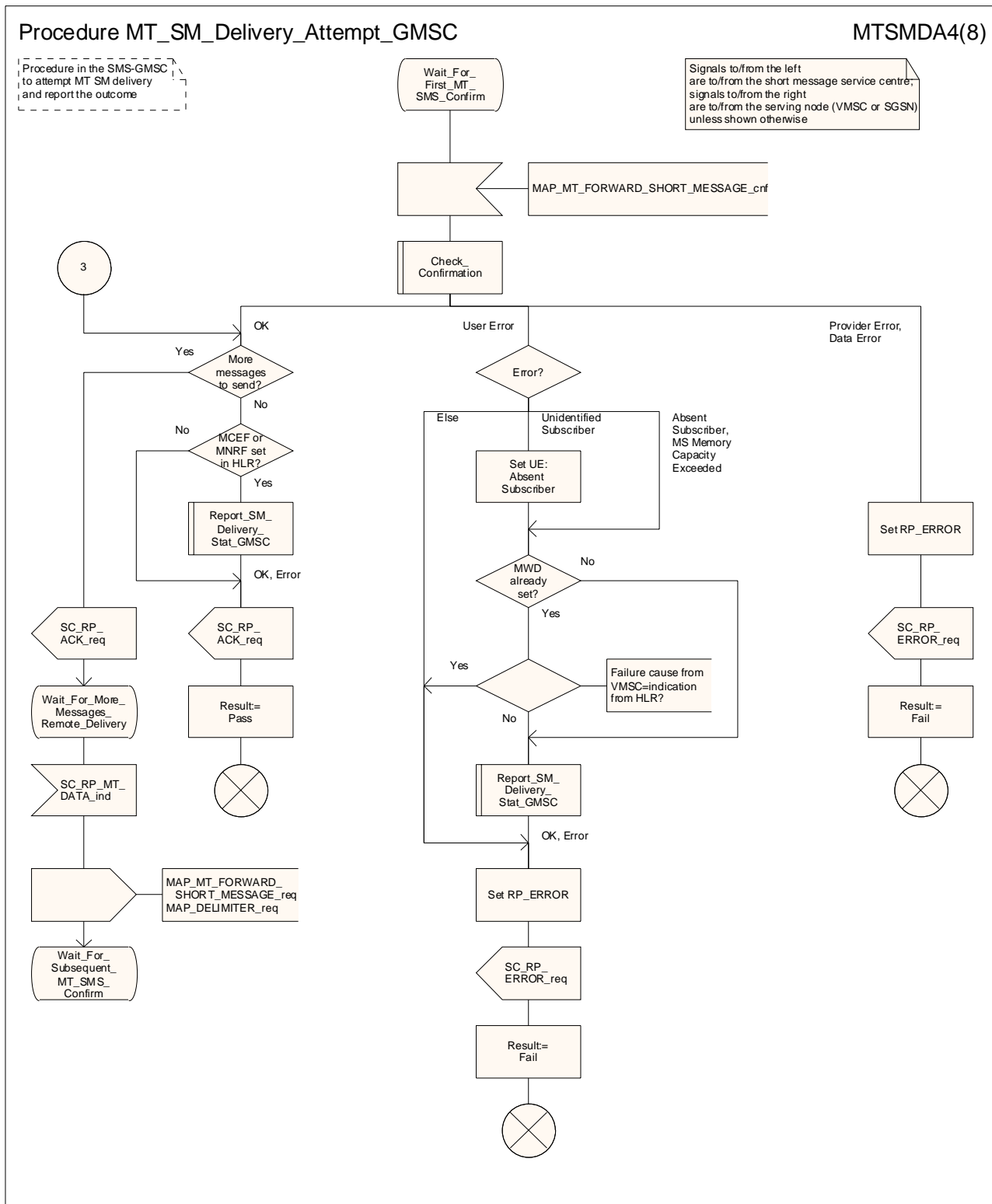

Figure 23.3/4 (sheet 4 of 8): Procedure MT_SM_Delivery_Attempt_GMSC

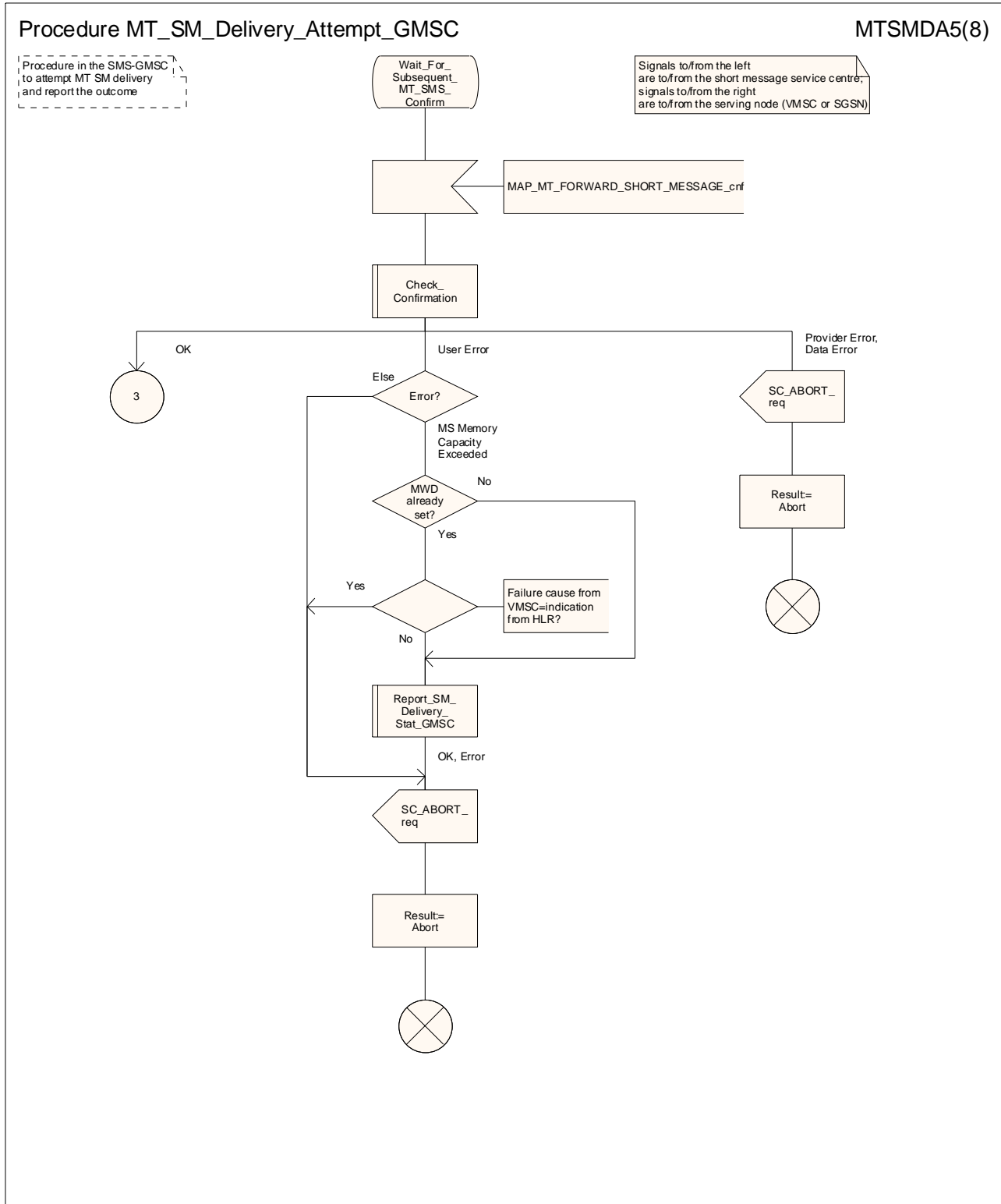

Figure 23.3/4 (sheet 5 of 8): Procedure MT_SM_Delivery_Attempt_GMSC

Procedure MT_SM_Delivery_Attempt_GMSC

MTSMDA6(8)

Procedure in the SMS-GMSC to attempt MT SM delivery and report the outcome

Signals to/from the left are to/from the short message service centre; signals to/from the right are to/from the serving node (VMSC or SGSN) unless shown otherwise

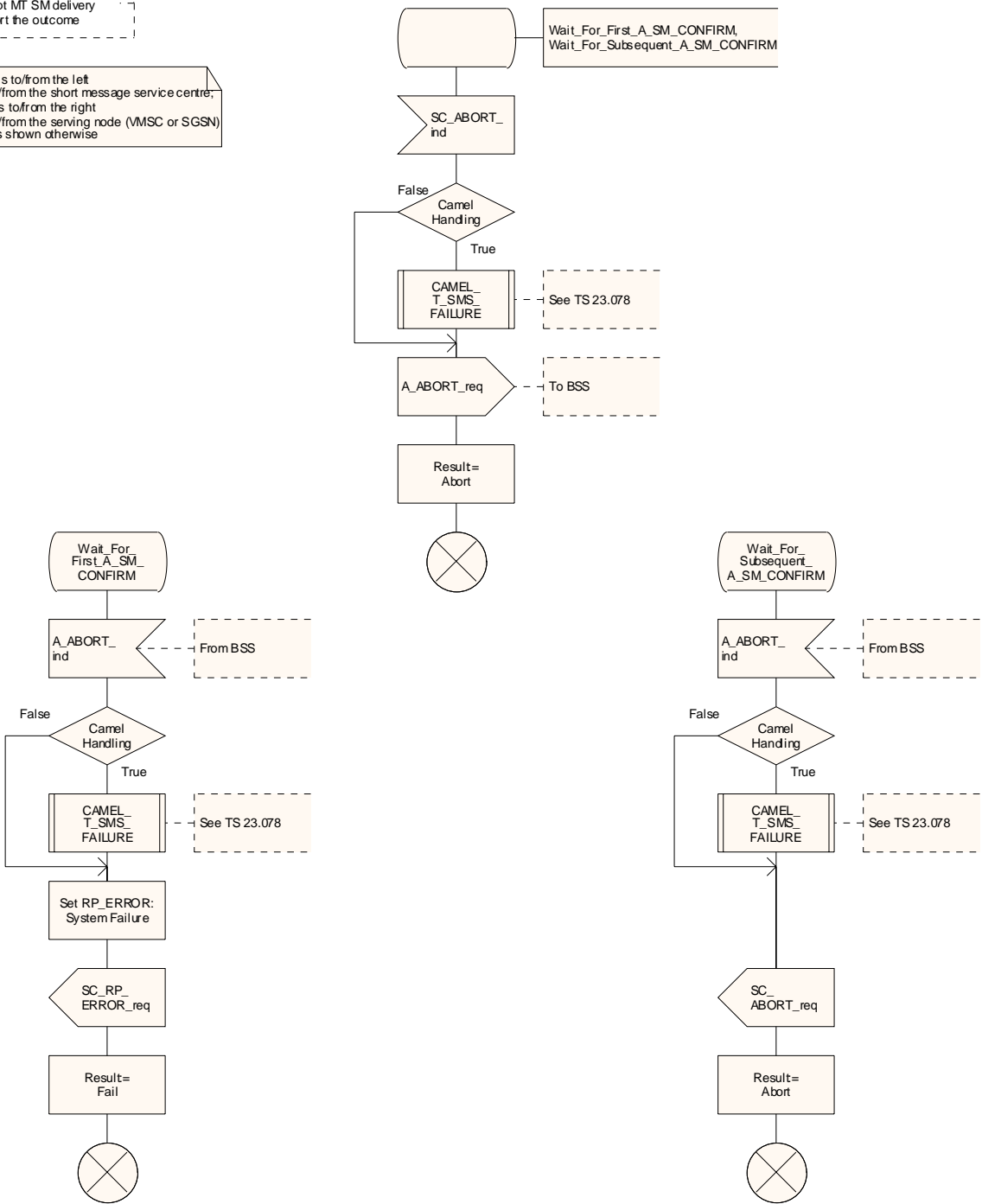

Figure 23.3/4 (sheet 6 of 8): Procedure MT_SM_Delivery_Attempt_GMSC

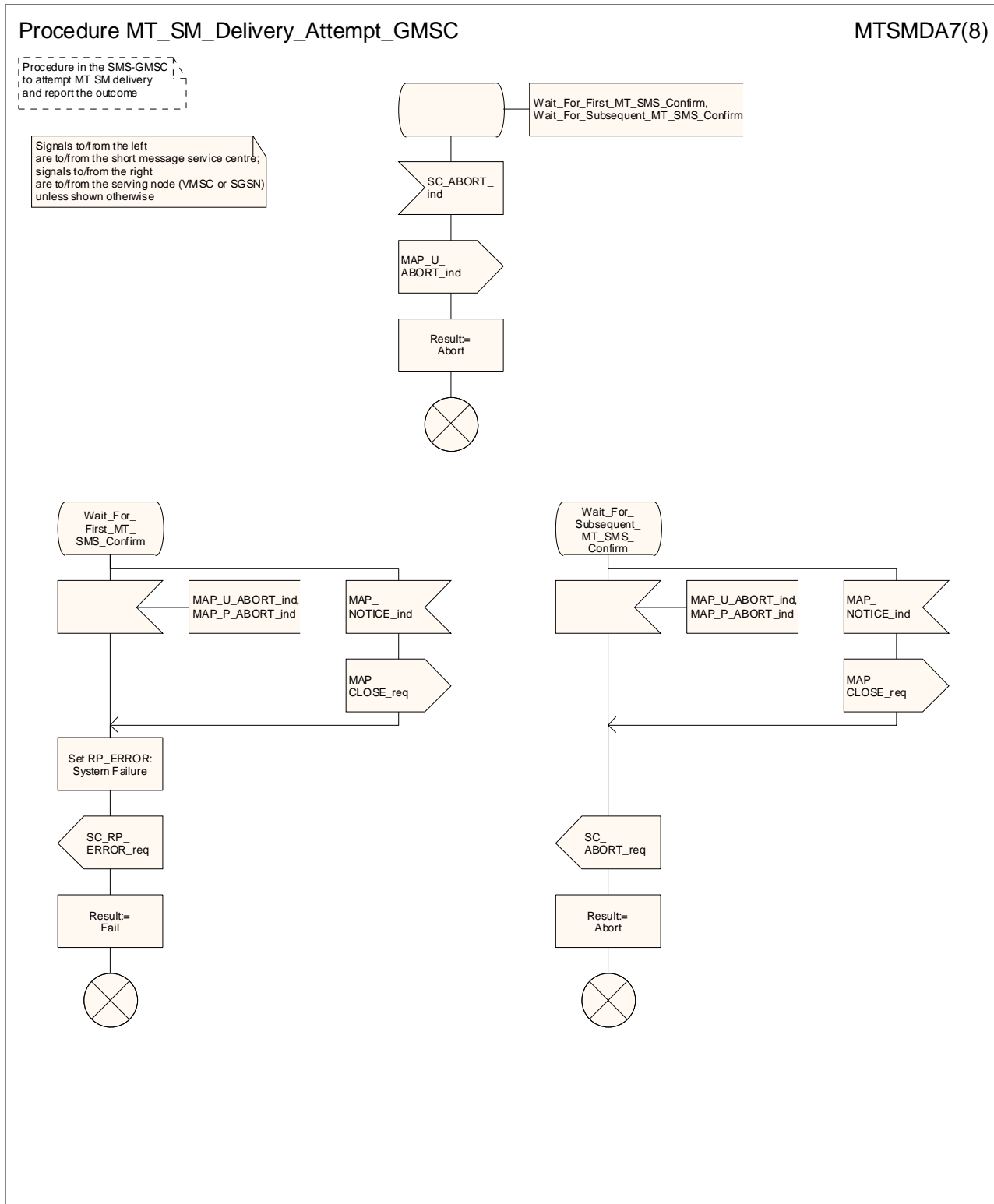

Figure 23.3/4 (sheet 7 of 8): Procedure MT_SM_Delivery_Attempt_GMSC

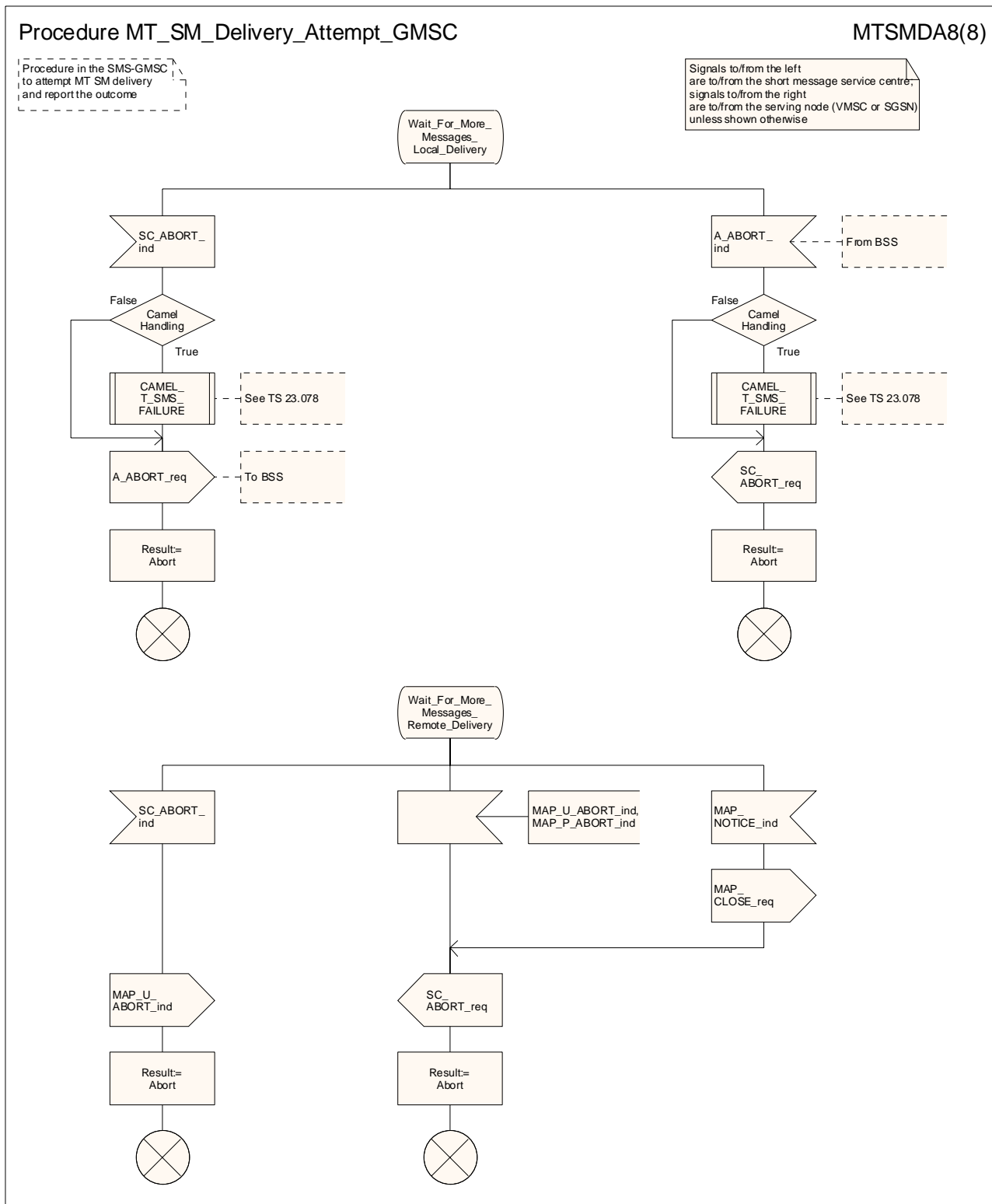

Figure 23.3/4 (sheet 8 of 8): Procedure MT_SM_Delivery_Attempt_GMSC

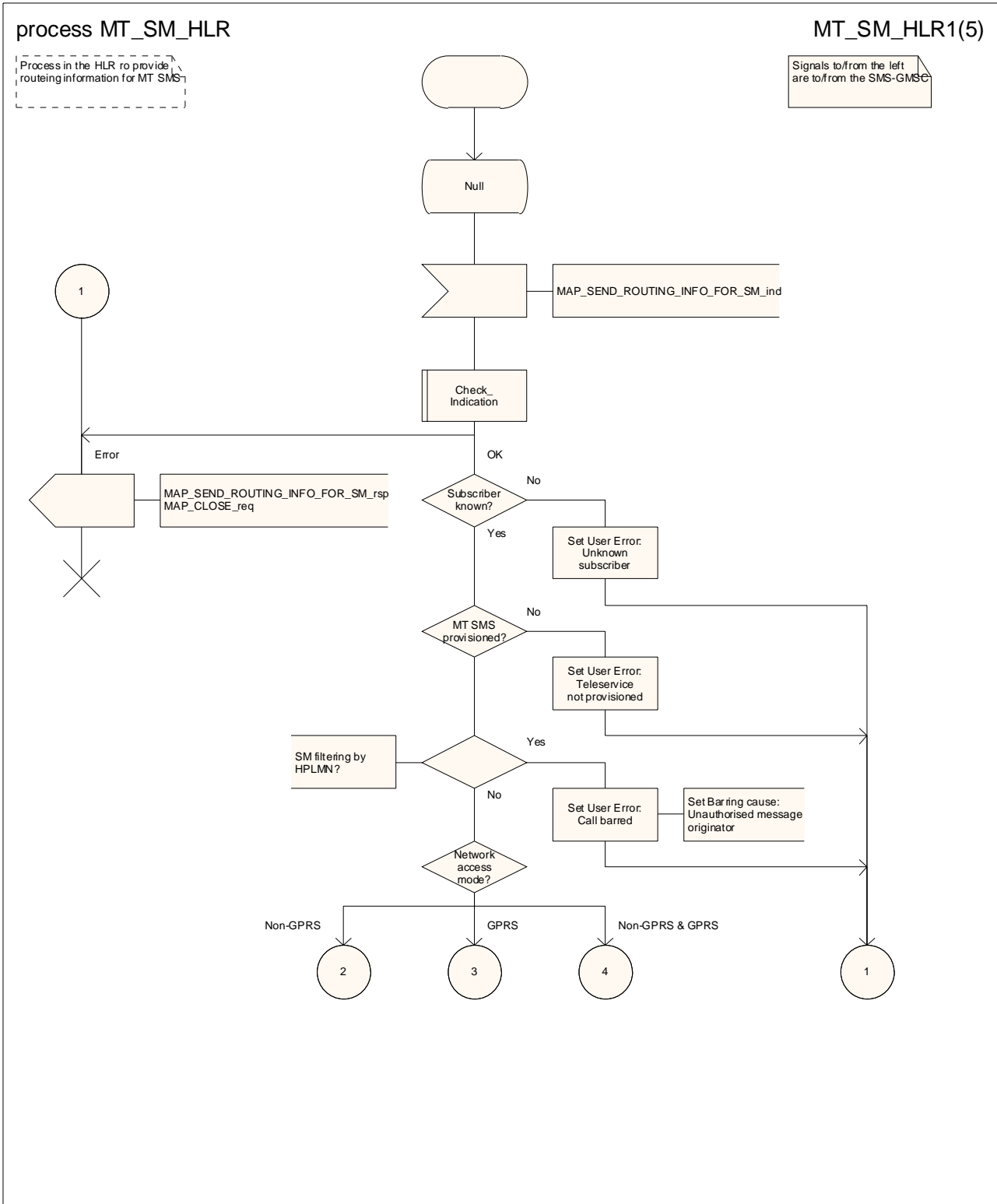

Figure 23.3/5 (sheet 1 of 5): Process MT_SM_HLR

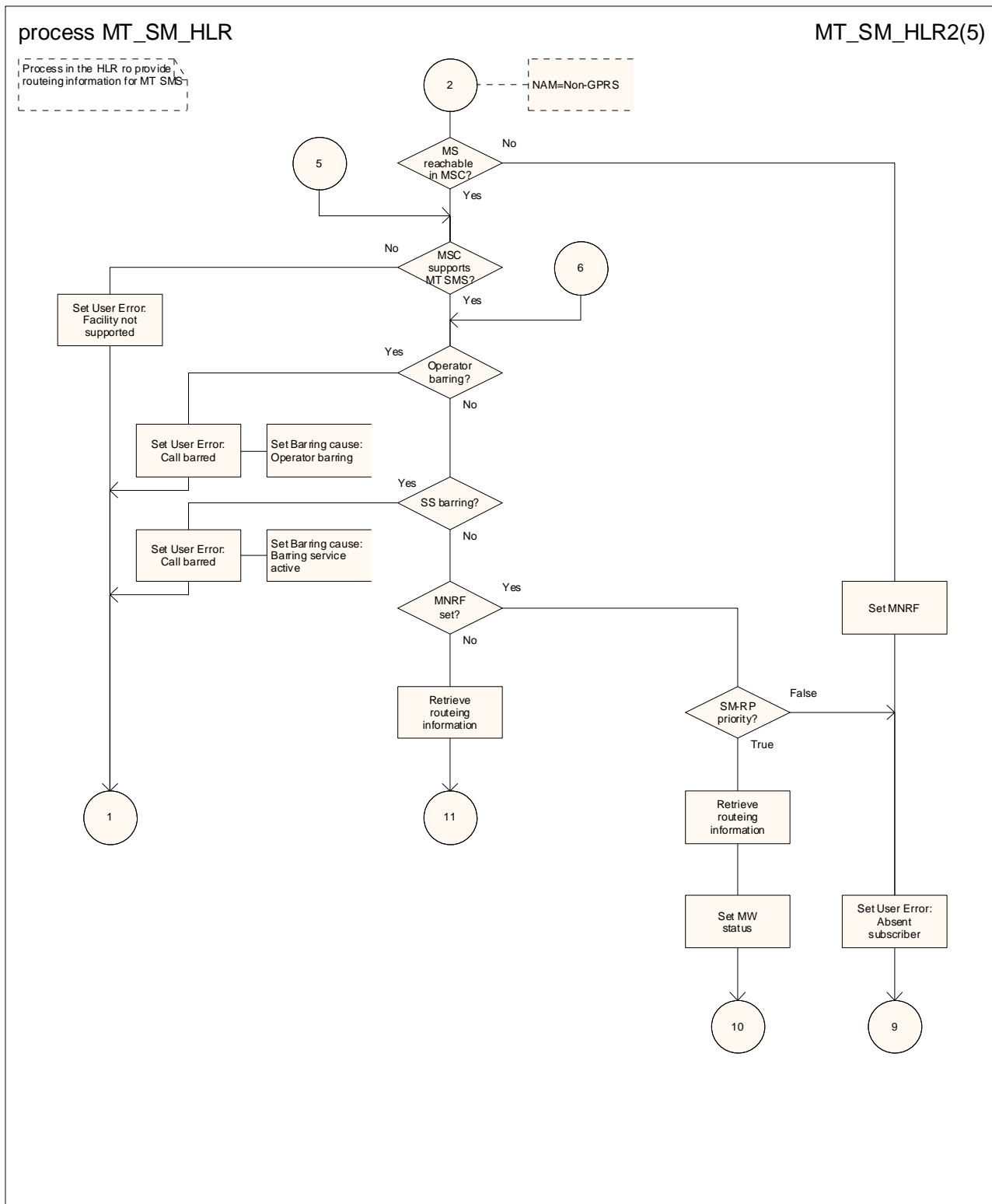

Figure 23.3/5 (sheet 2 of 5): Process MT_SM_HLR

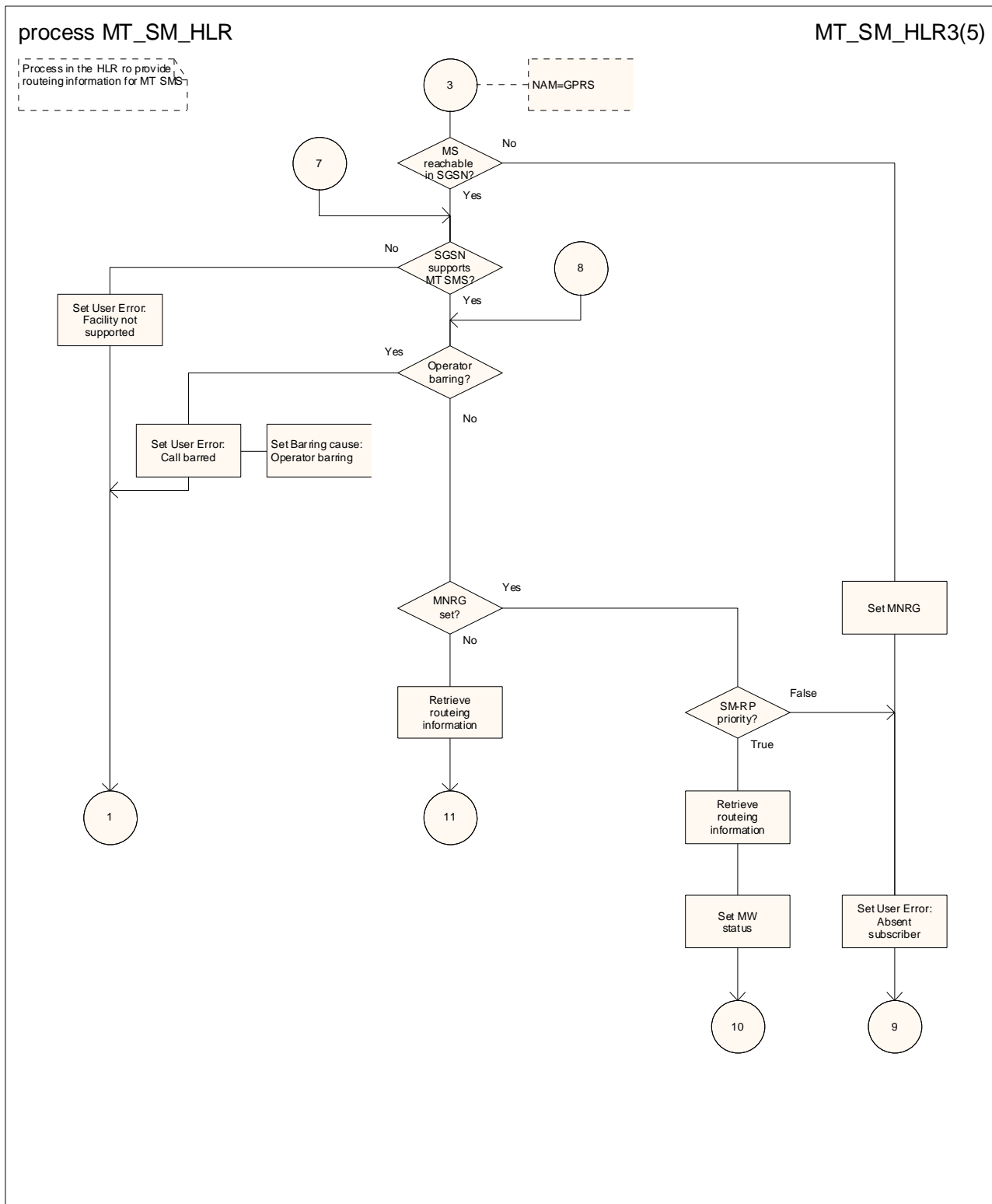

Figure 23.3/5 (sheet 3 of 5): Process MT_SM_HLR

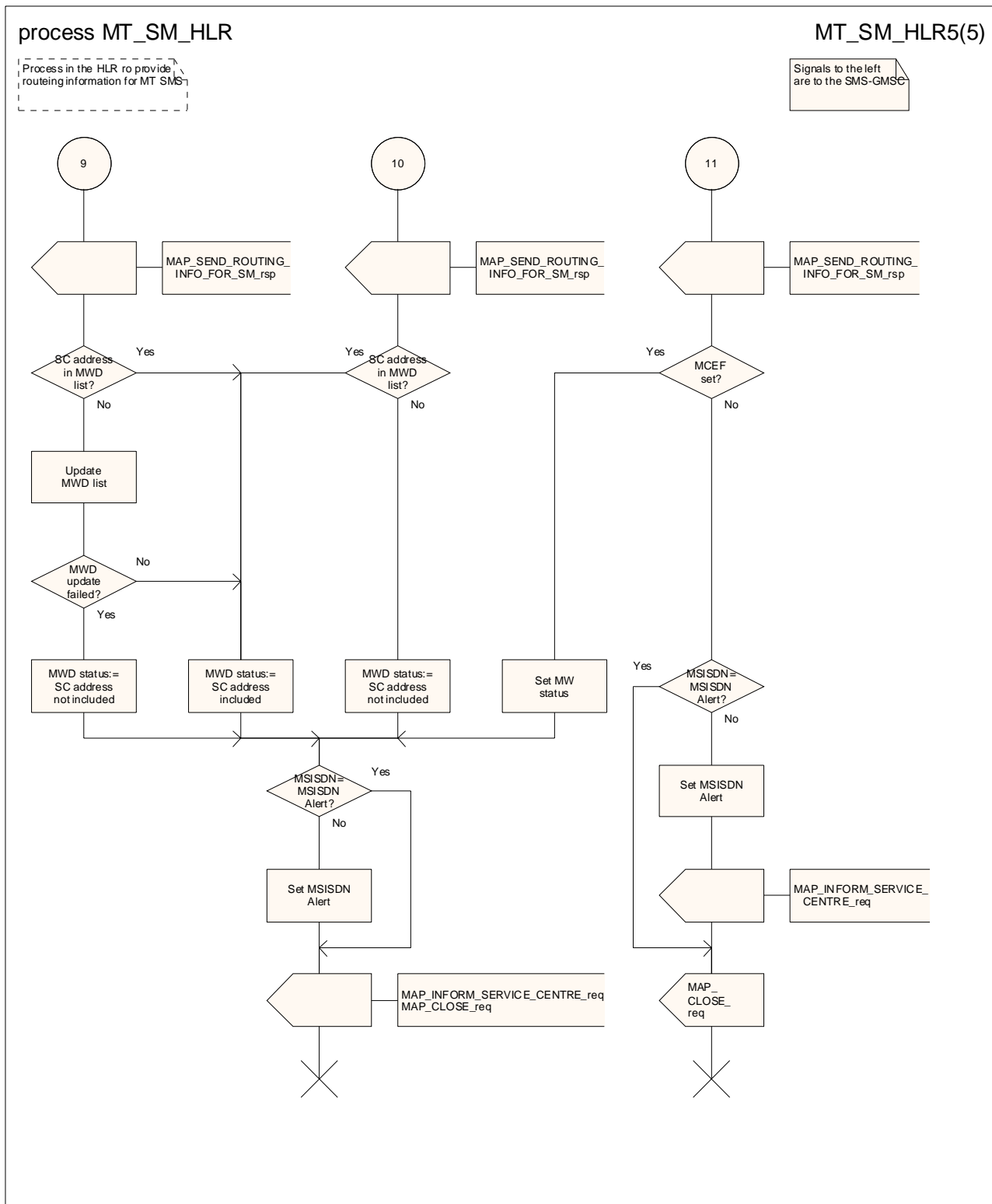

Figure 23.3/5 (sheet 5 of 5): Process MT_SM_HLR

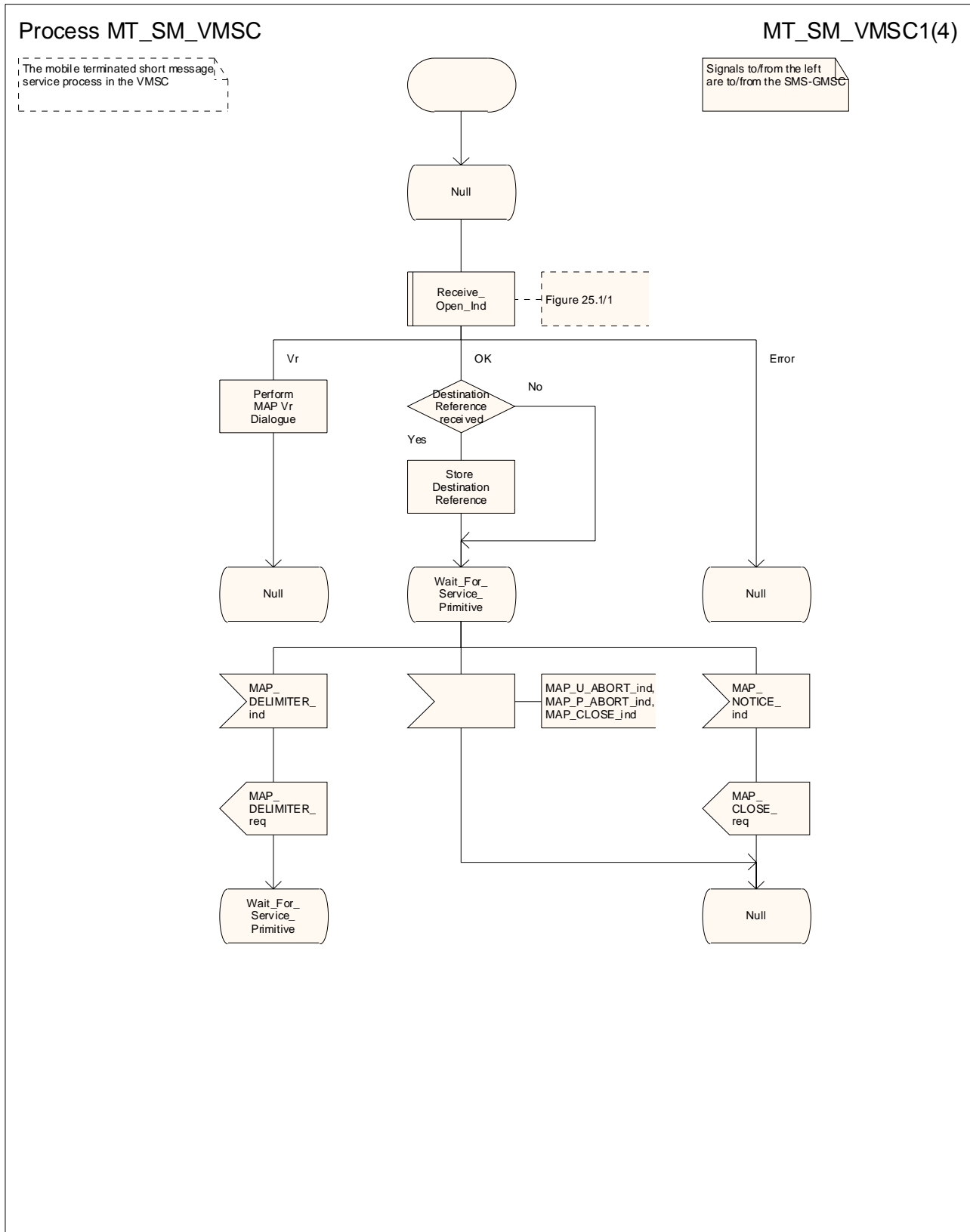

Figure 23.3/6 (sheet 1 of 4): Procedure MT_SM_VMSC

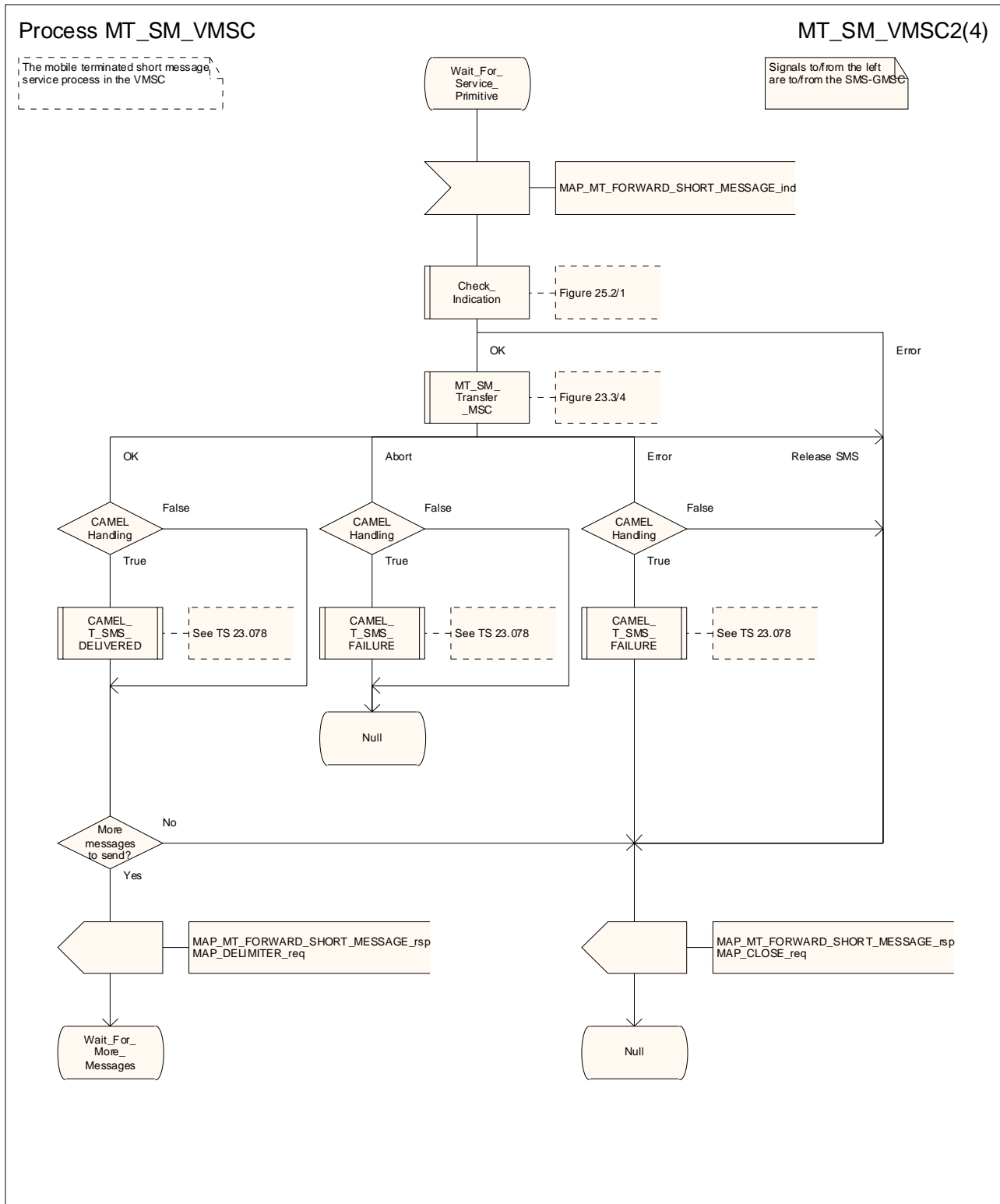

Figure 23.3/6 (sheet 2 of 4): Procedure MT_SM_VMSC

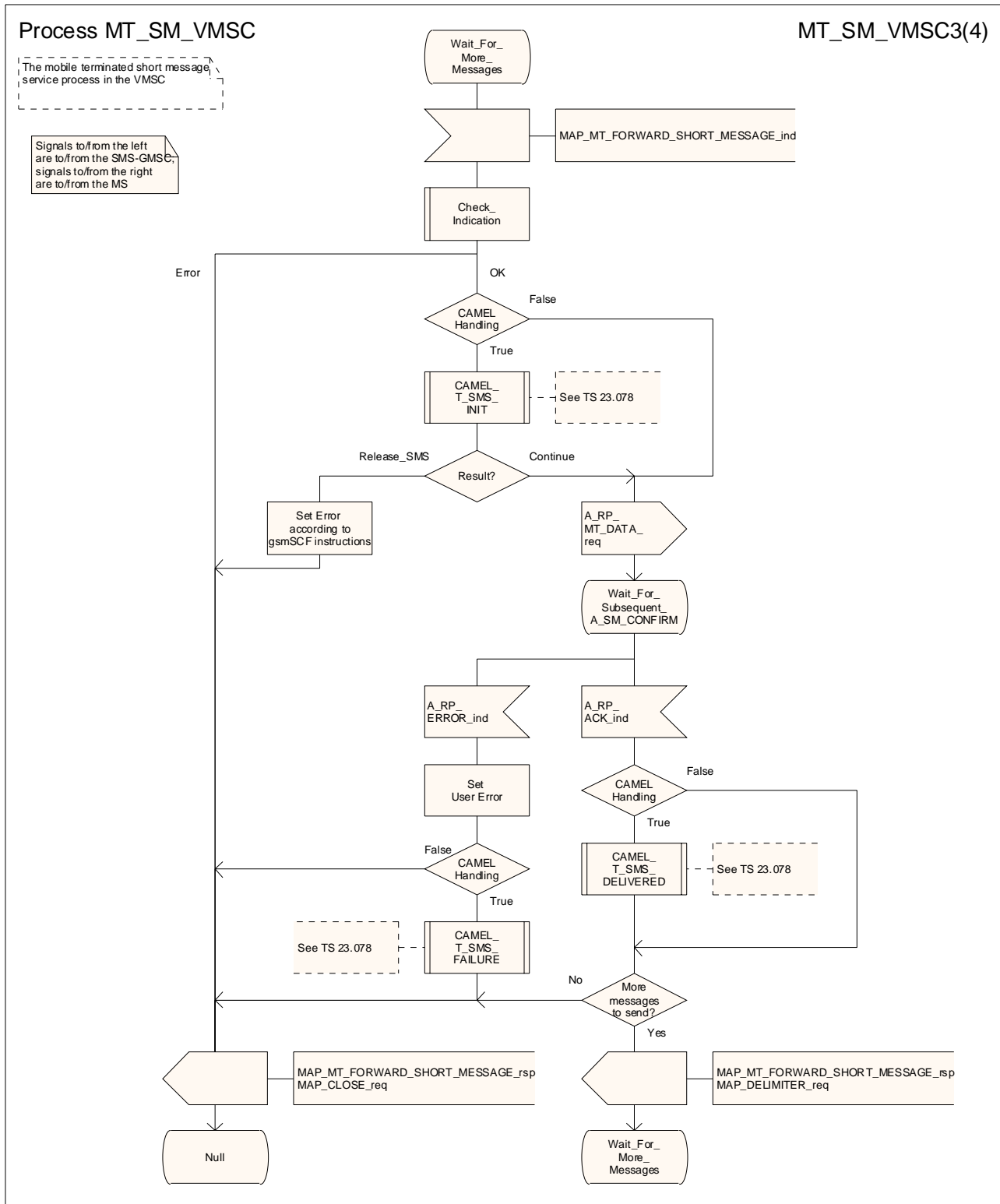

Figure 23.3/6 (sheet 3 of 4): Procedure MT_SM_VMSC

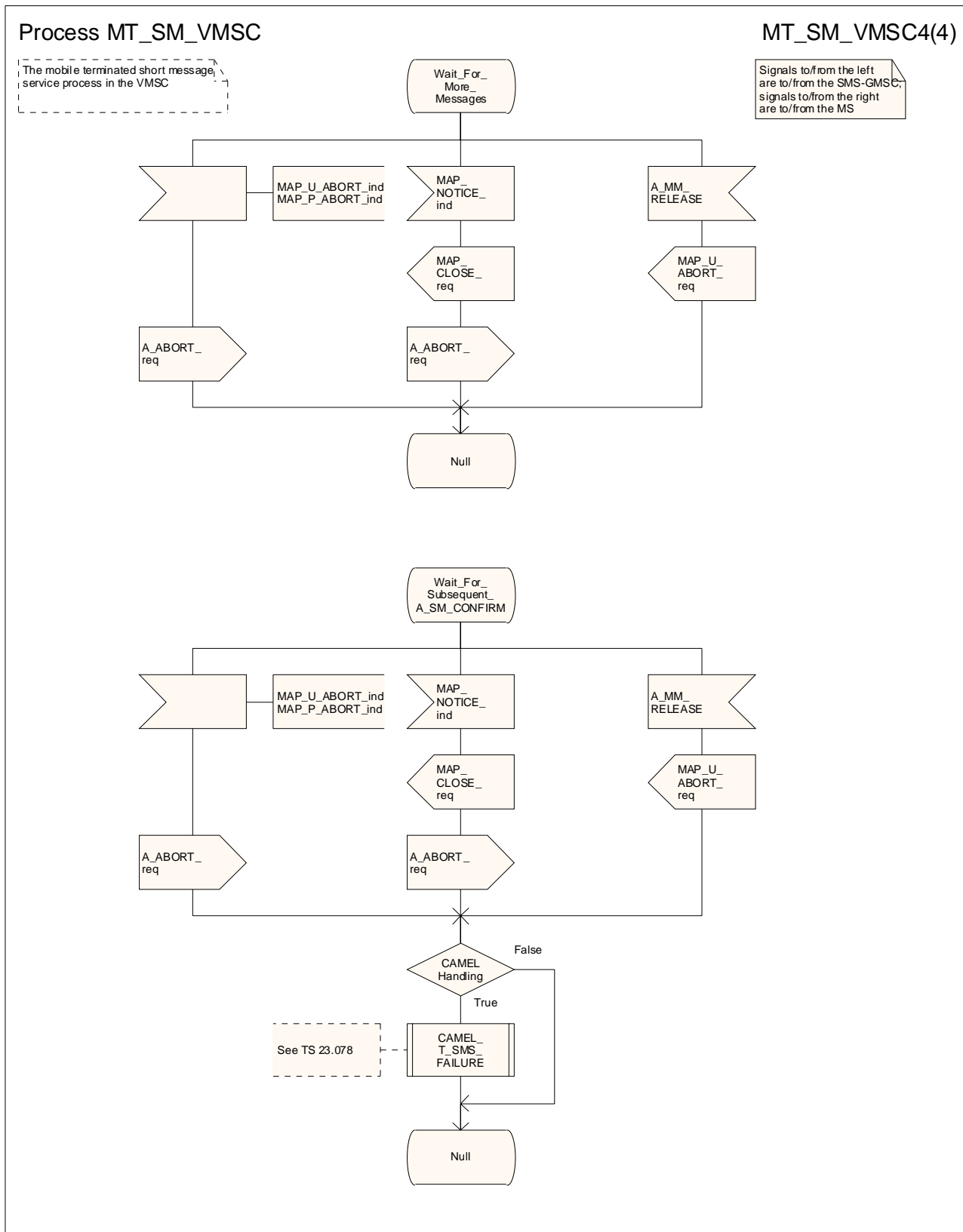

Figure 23.3/6 (sheet 4 of 4): Procedure MT_SM_VMSC

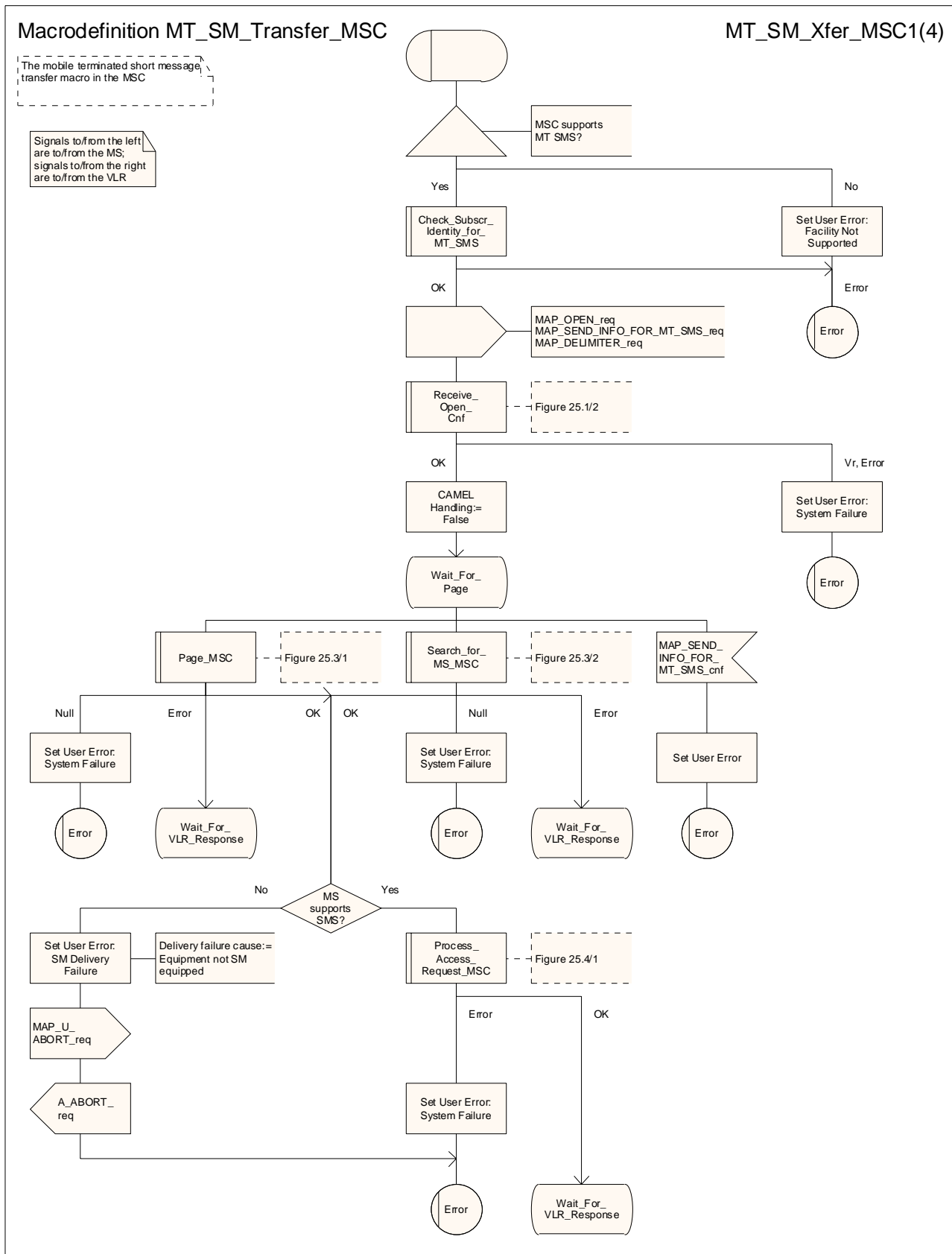

Figure 23.3/7 (sheet 1 of 4): Macro MT_SM_Transfer_MSC

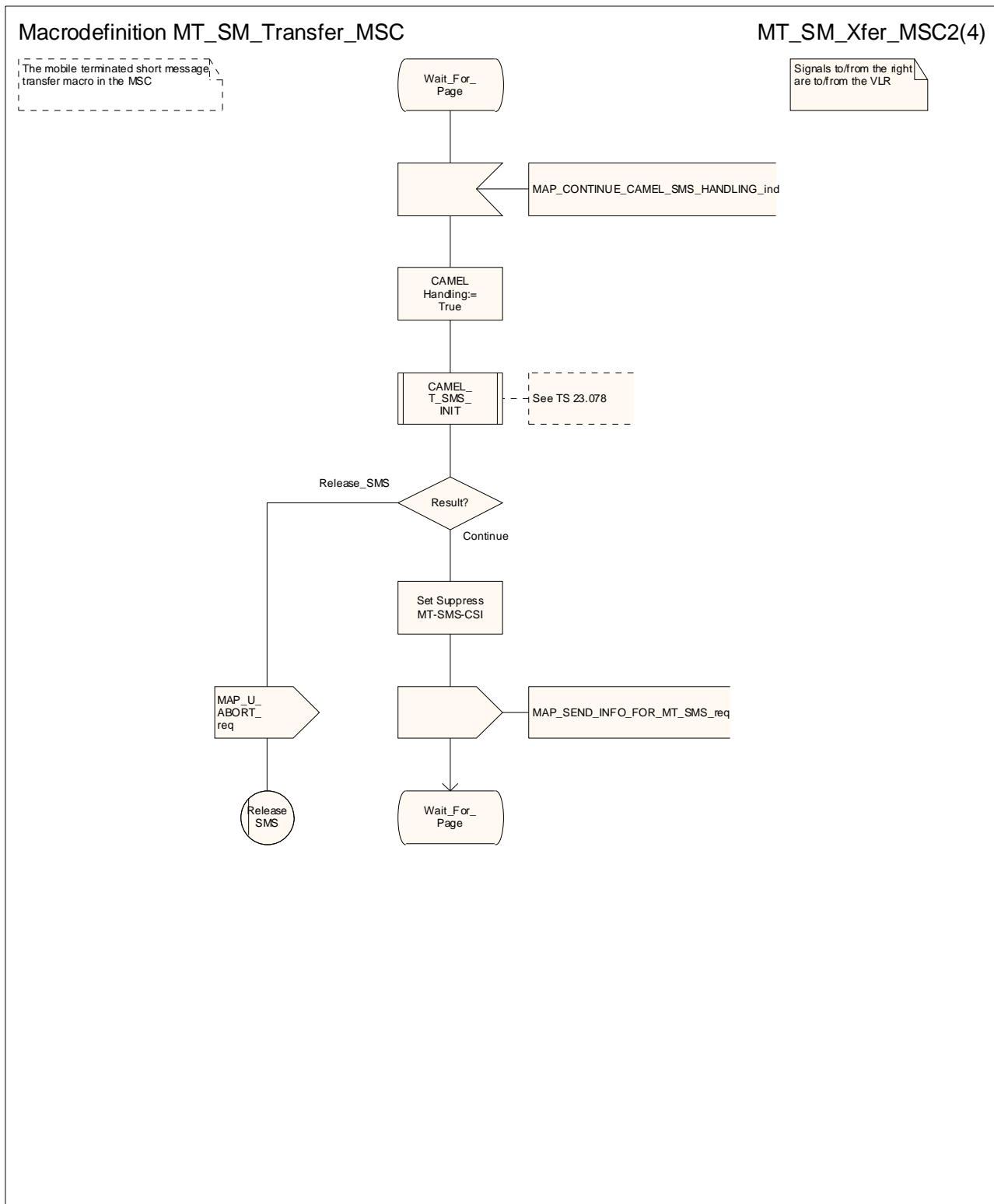

Figure 23.3/7 (sheet 2 of 4): Macro MT_SM_Transfer_MSC

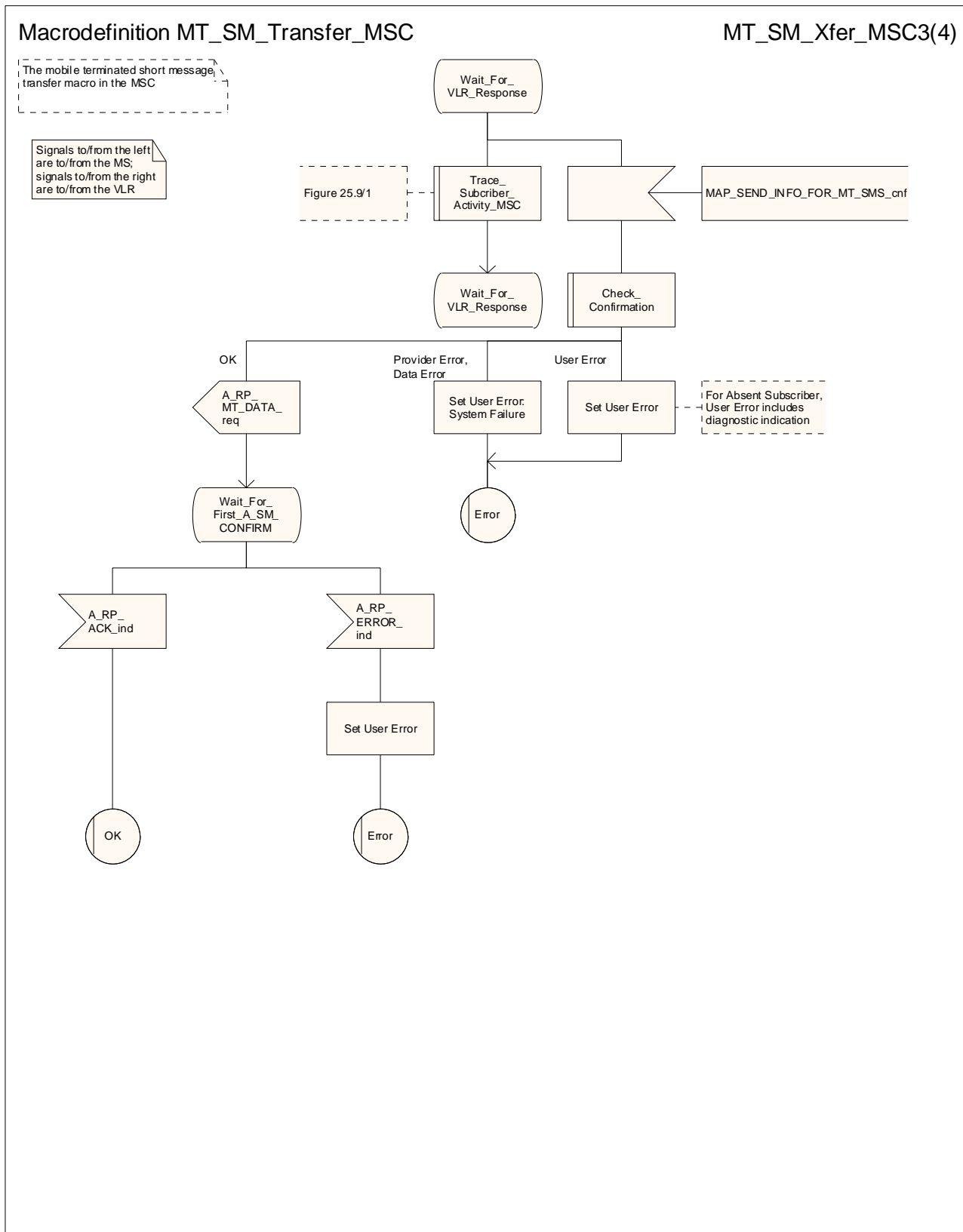

Figure 23.3/7 (sheet 3 of 4): Macro MT_SM_Transfer_MSC

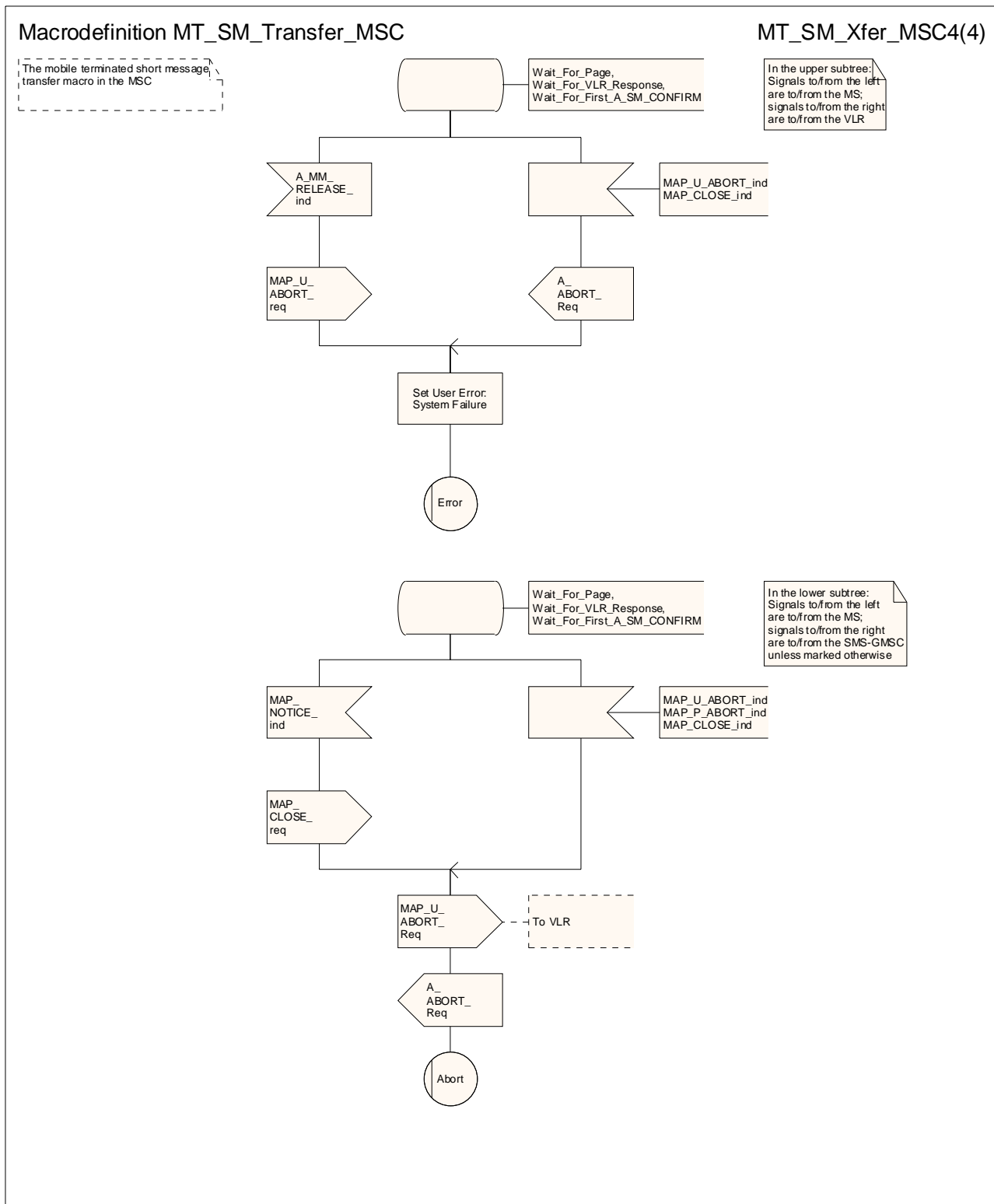

Figure 23.3/7 (sheet 4 of 4): Macro MT_SM_Transfer_MSC

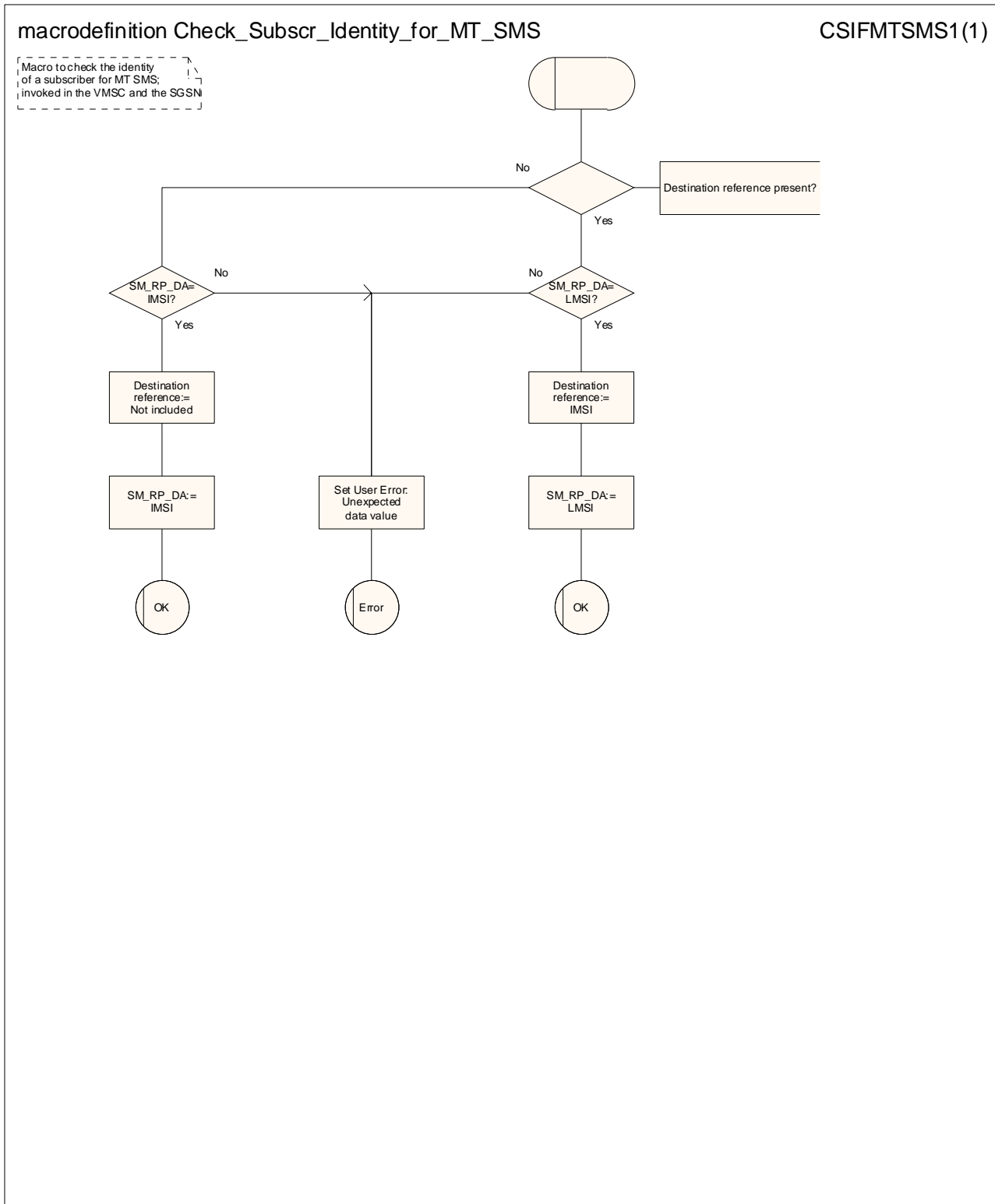

Figure 23.3/8: Macro Check_Subscr_Identity_For_MT_SMS

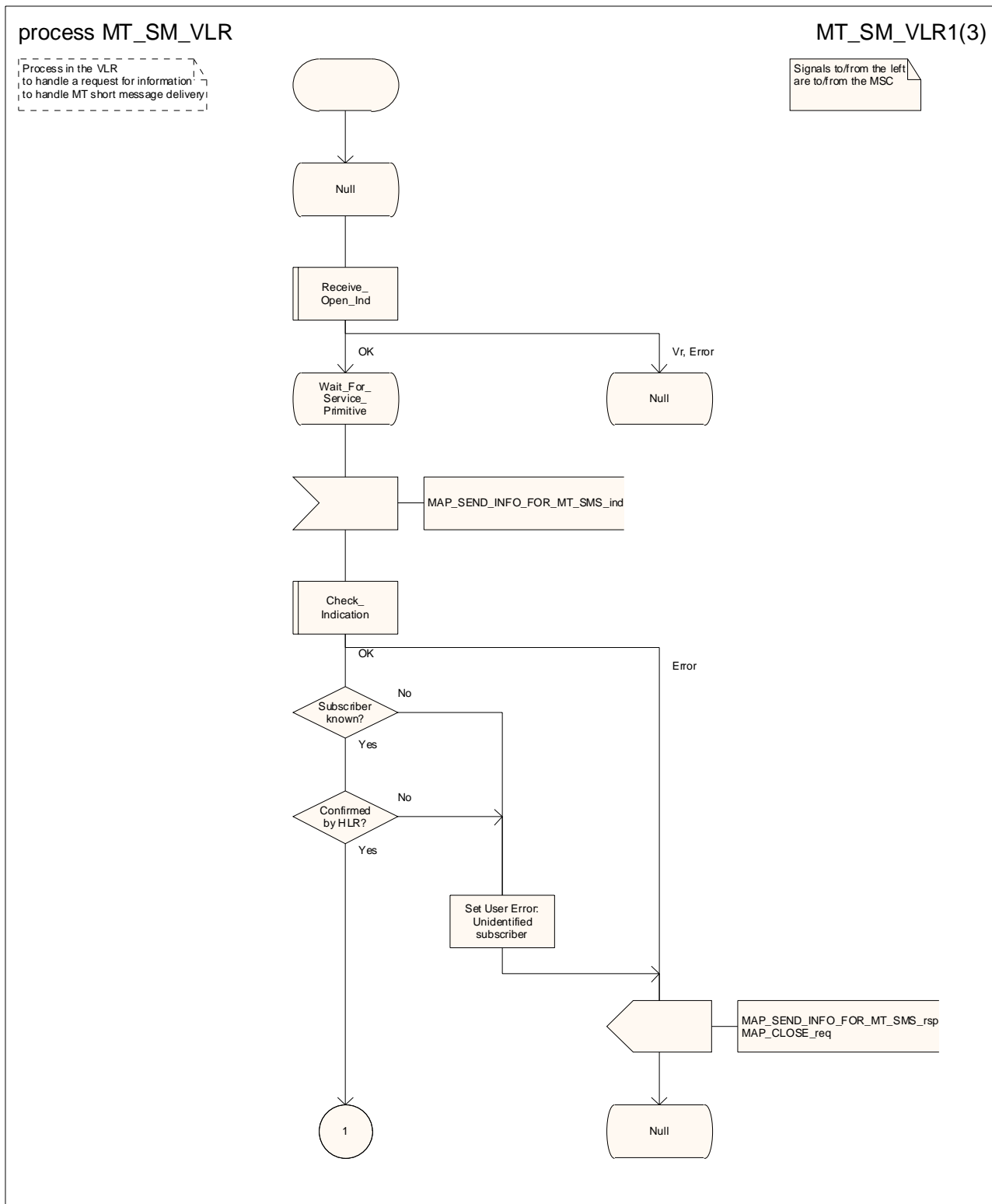

Figure 23.3/9 (sheet 1 of 3): Process MT_SM_VLR

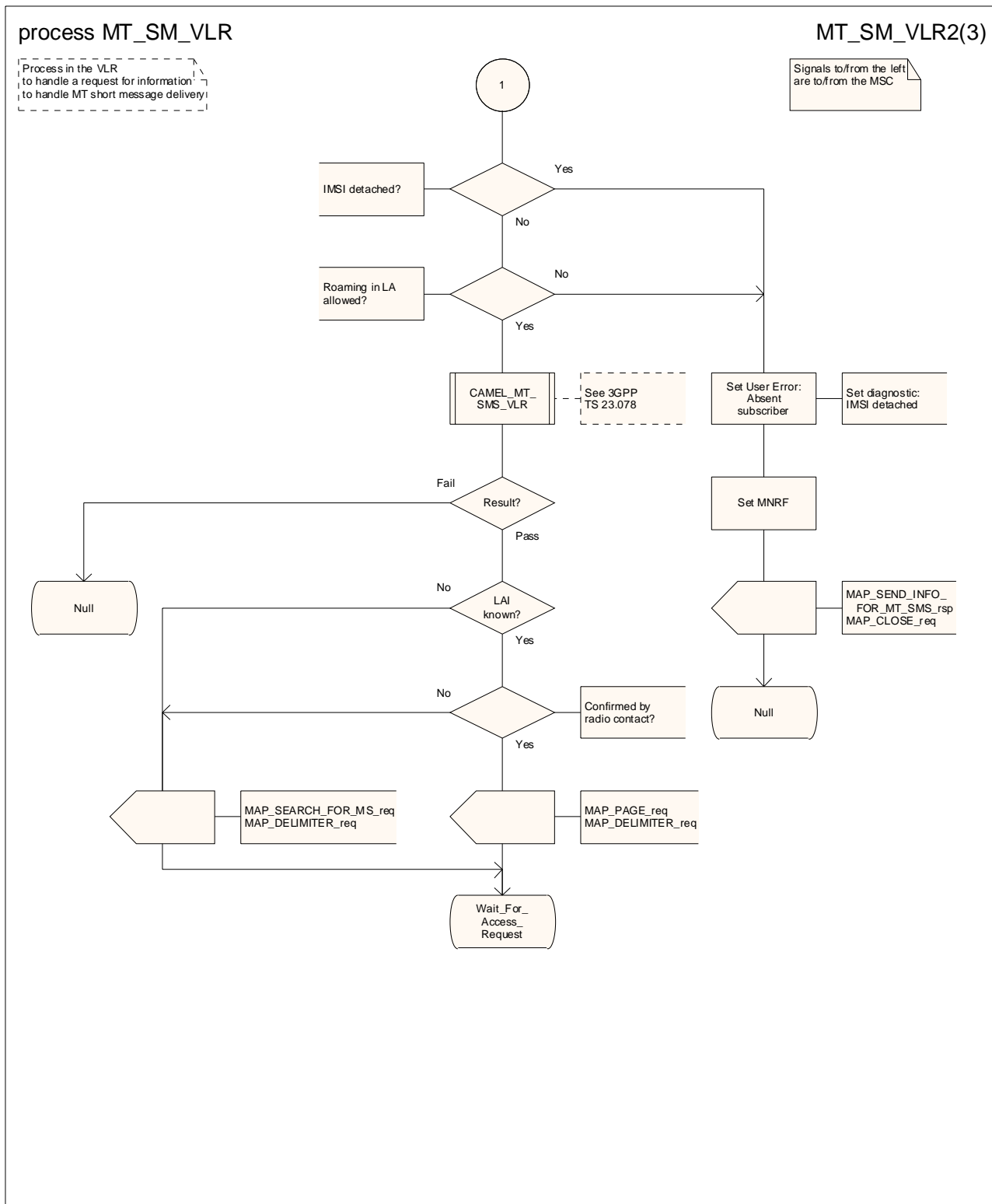

Figure 23.3/9 (sheet 2 of 3): Process MT_SM_VLR

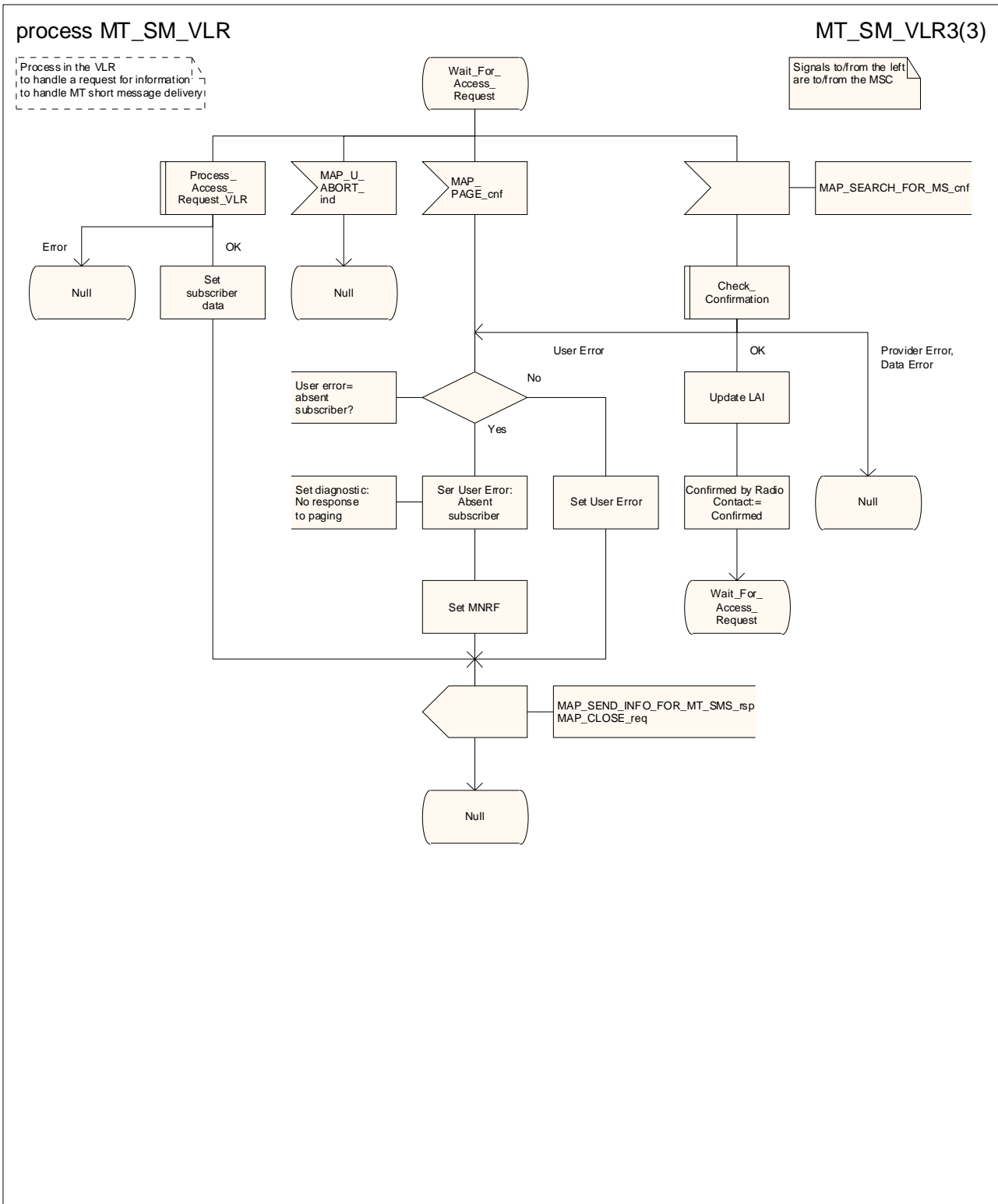

Figure 23.3/9 (sheet 3 of 3): Process MT_SM_VLR

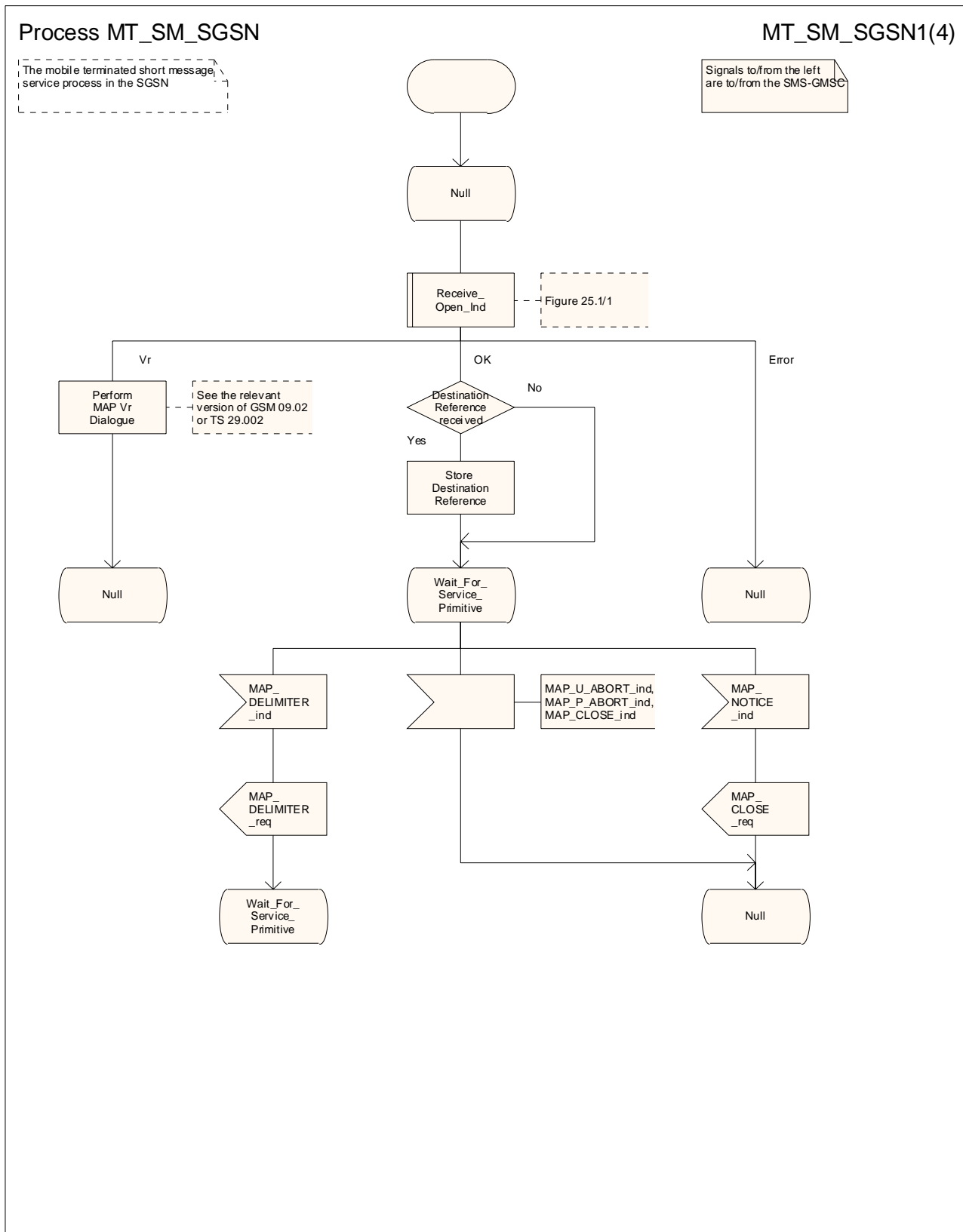

Figure 23.3/10 (sheet 1 of 4): Process MT_SM_SGSN

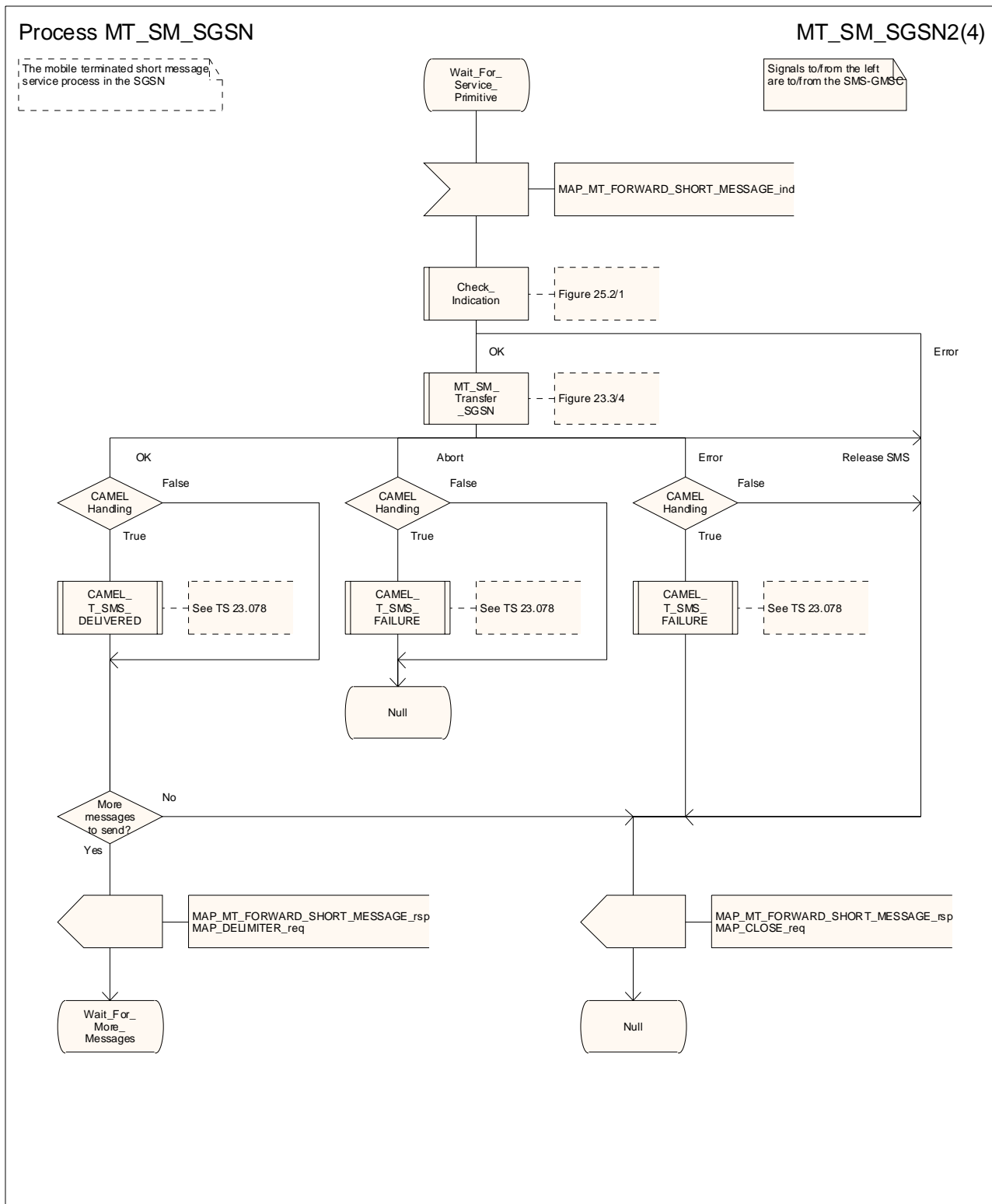

Figure 23.3/10 (sheet 2 of 4): Process MT_SM_SGSN

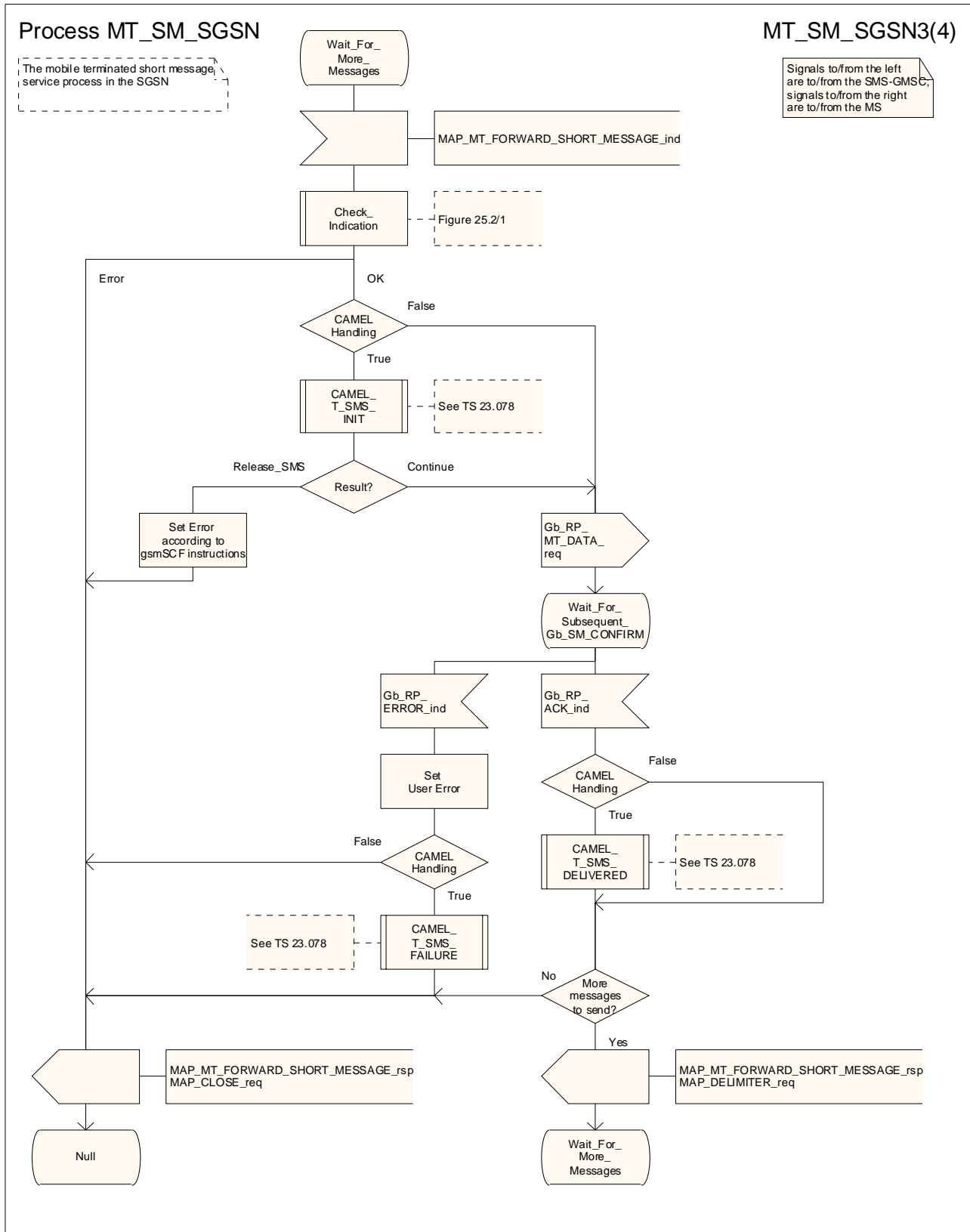

Figure 23.3/10 (sheet 3 of 4): Process MT_SM_SGSN

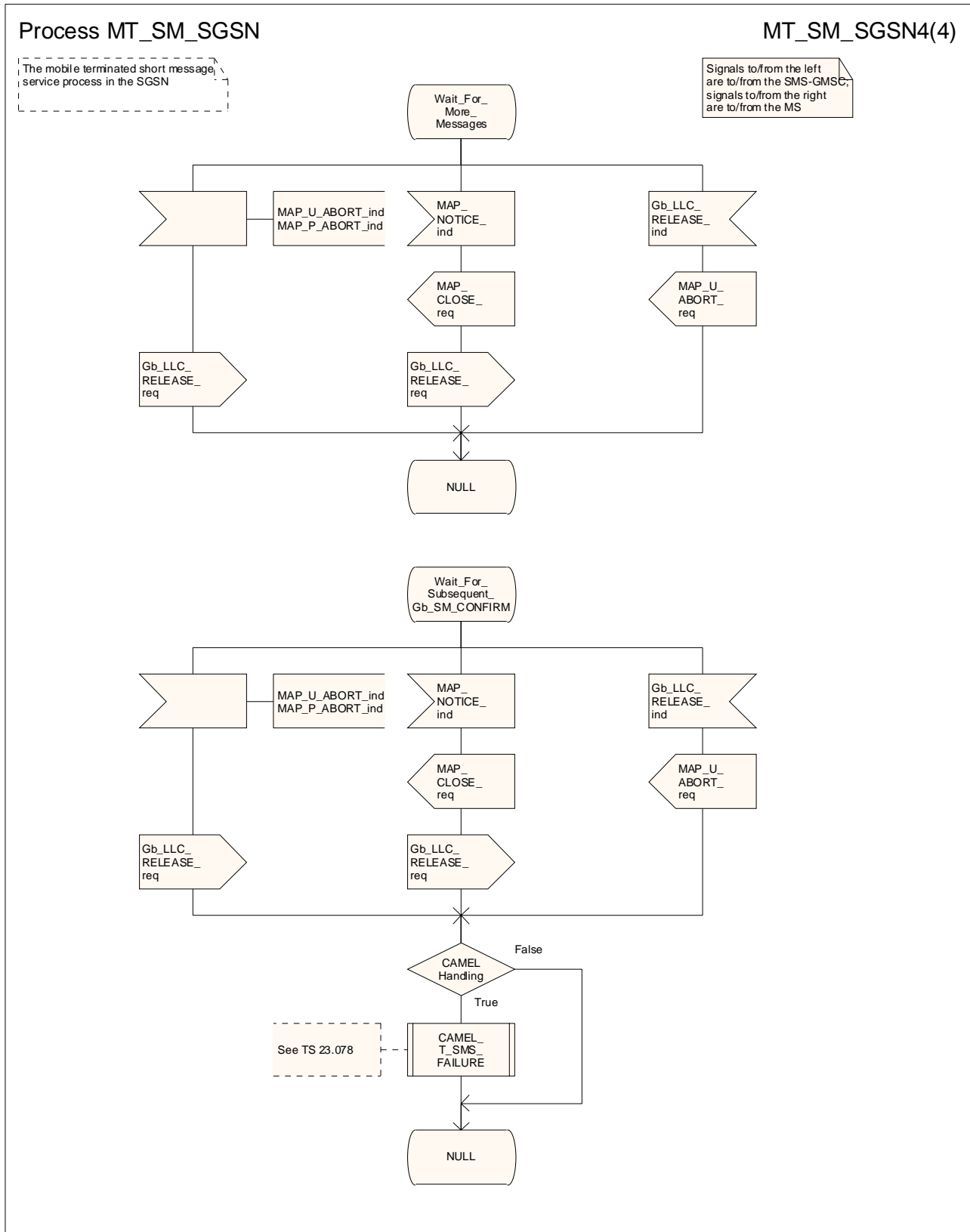

Figure 23.3/10 (sheet 4 of 4): Process MT_SM_SGSN

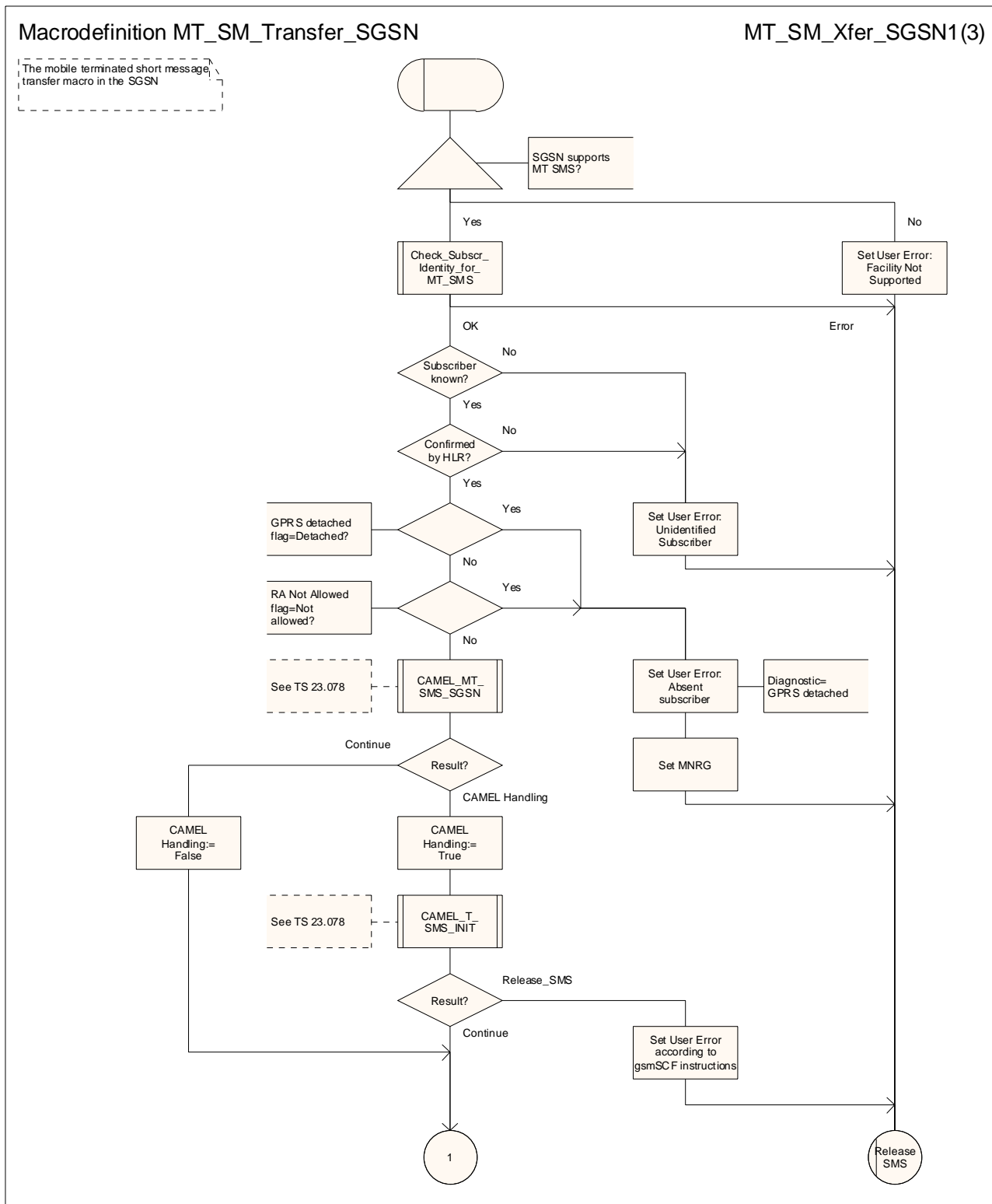

Figure 23.3/11 (sheet 1 of 3): Macro MT_SM_TRANSFER_SGSN

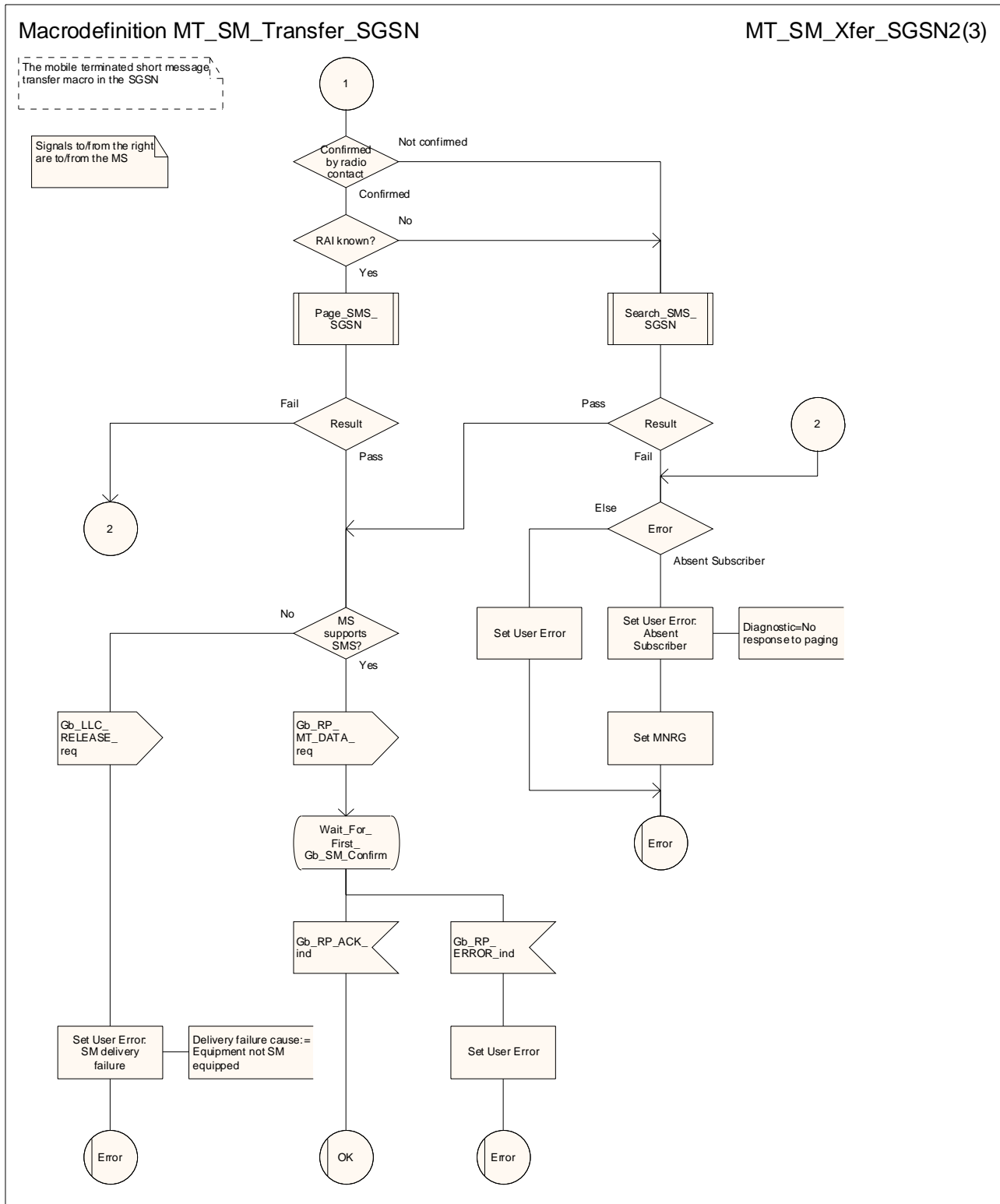

Figure 23.3/11 (sheet 2 of 3): Macro MT_SM_TRANSFER_SGSN

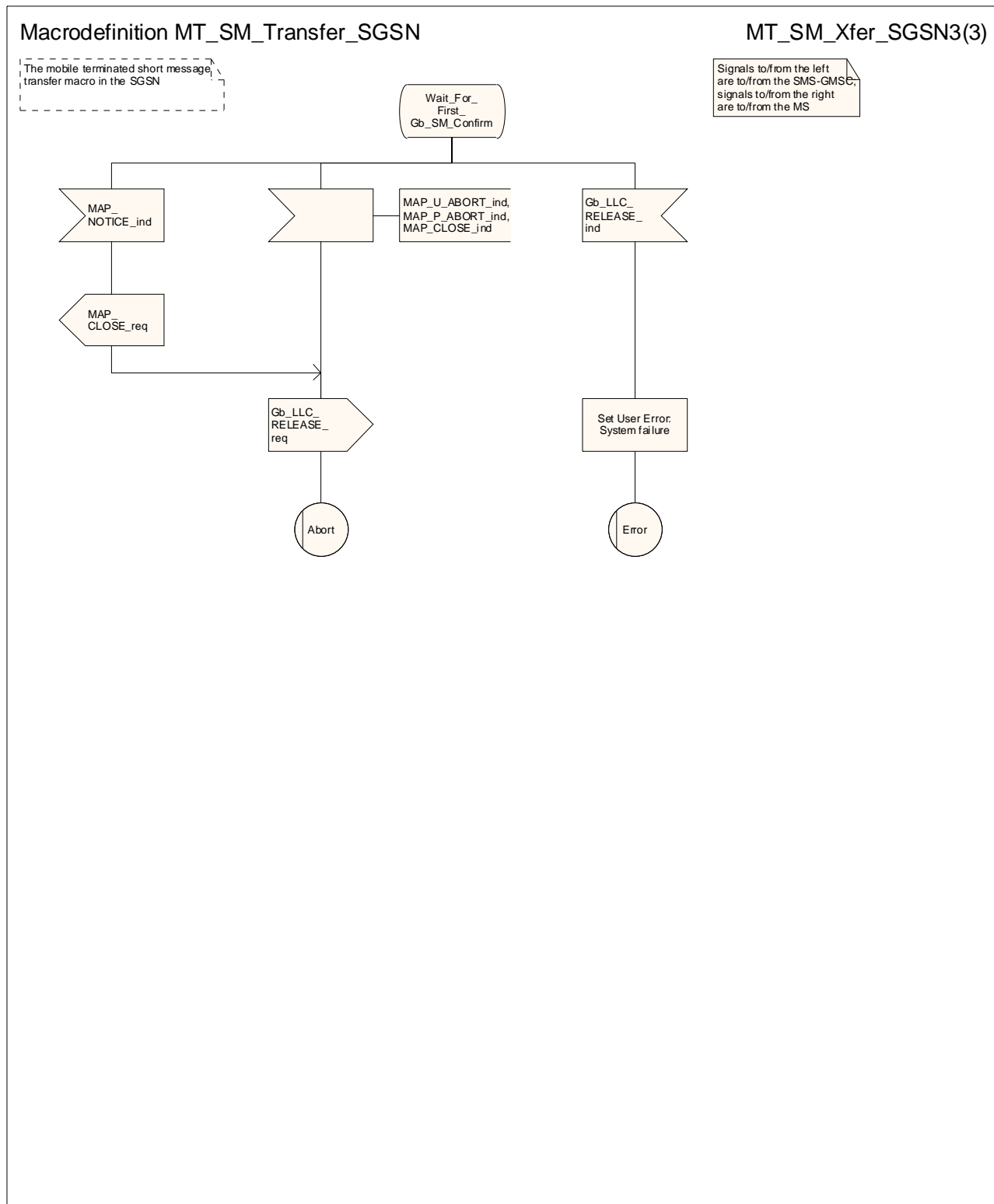

Figure 23.3/11 (sheet 3 of 3): Macro MT_SM_TRANSFER_SGSN

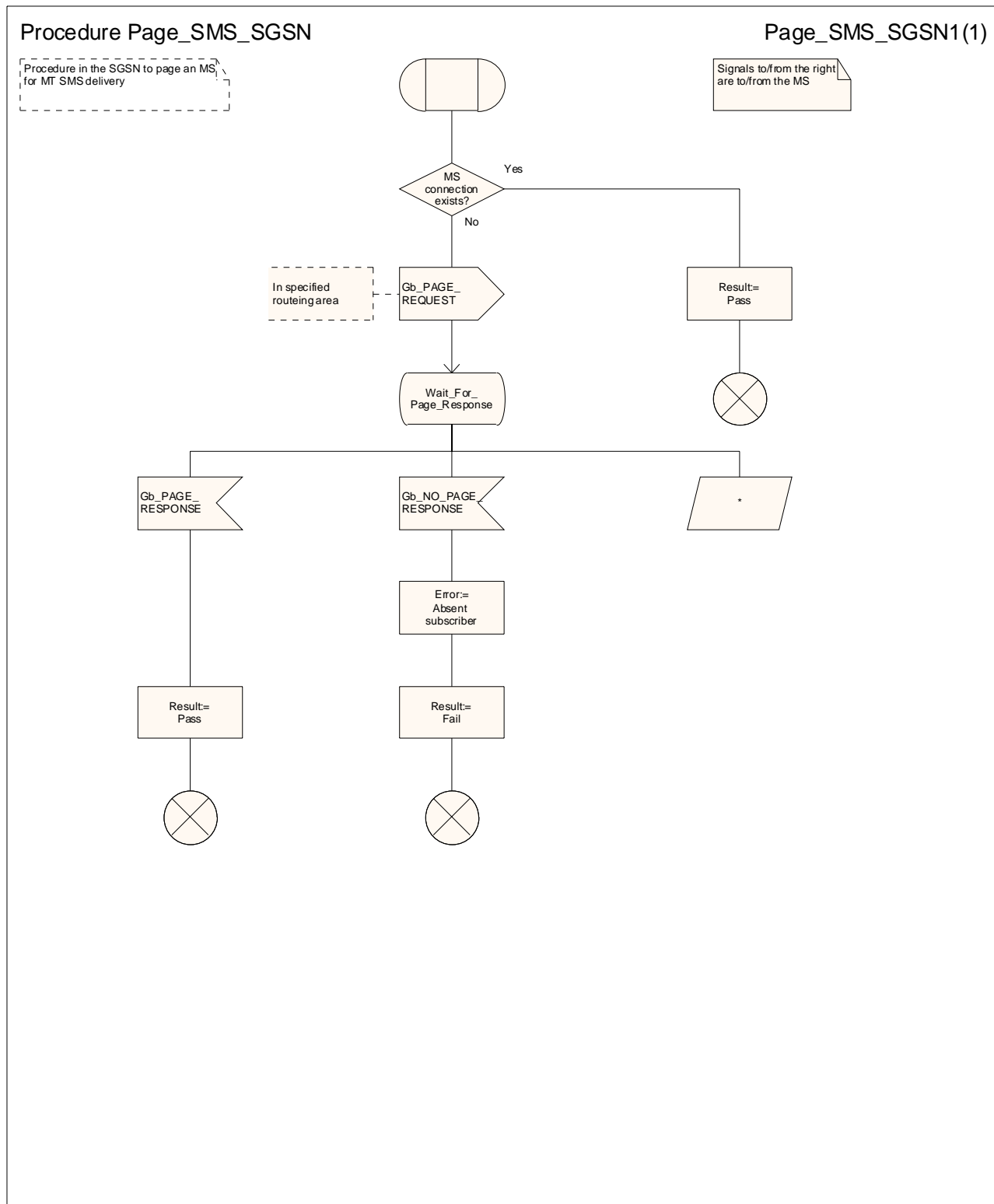

Figure 23.3/12 (sheet 1 of 1): Procedure Page_SMS_SGSN

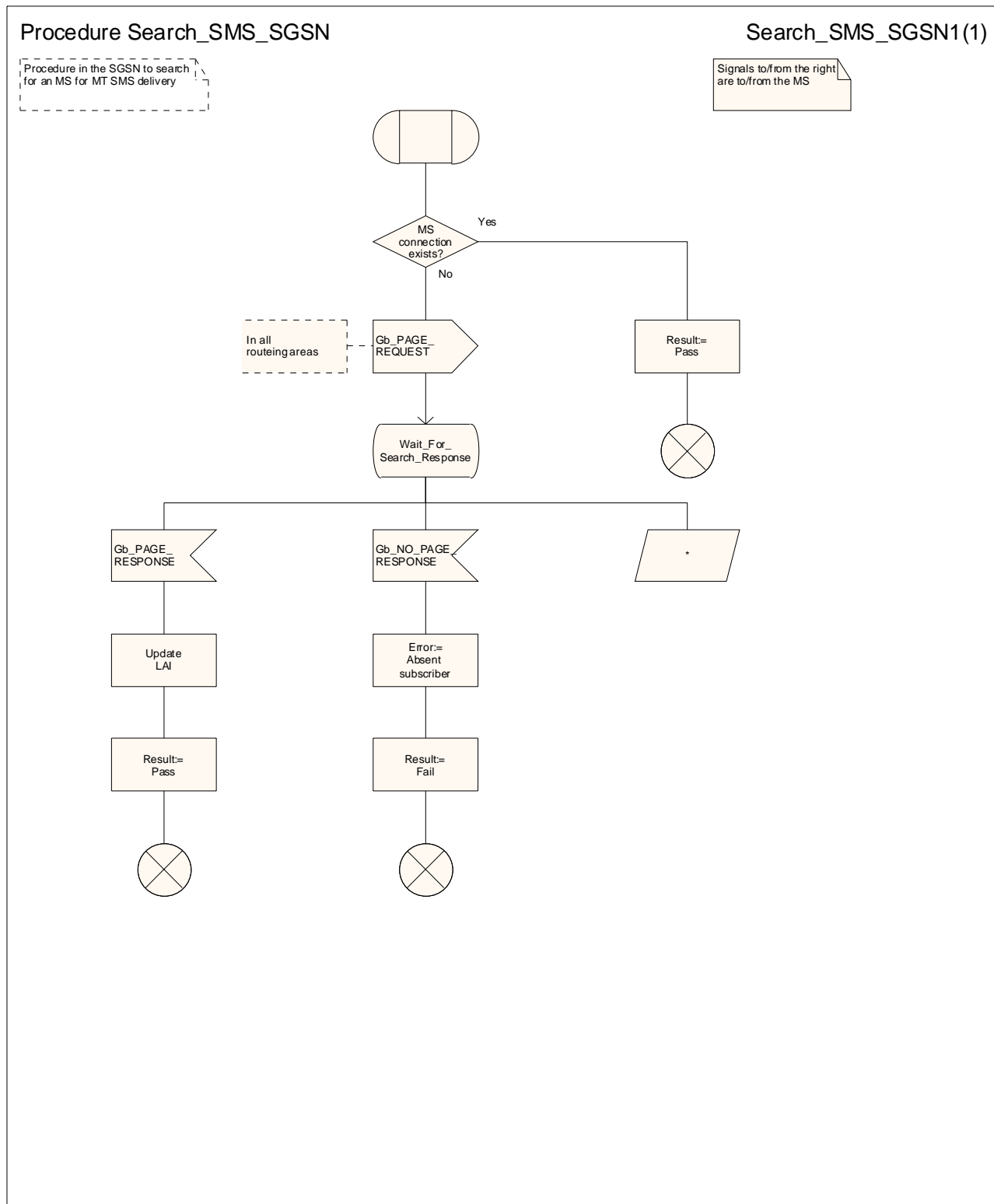
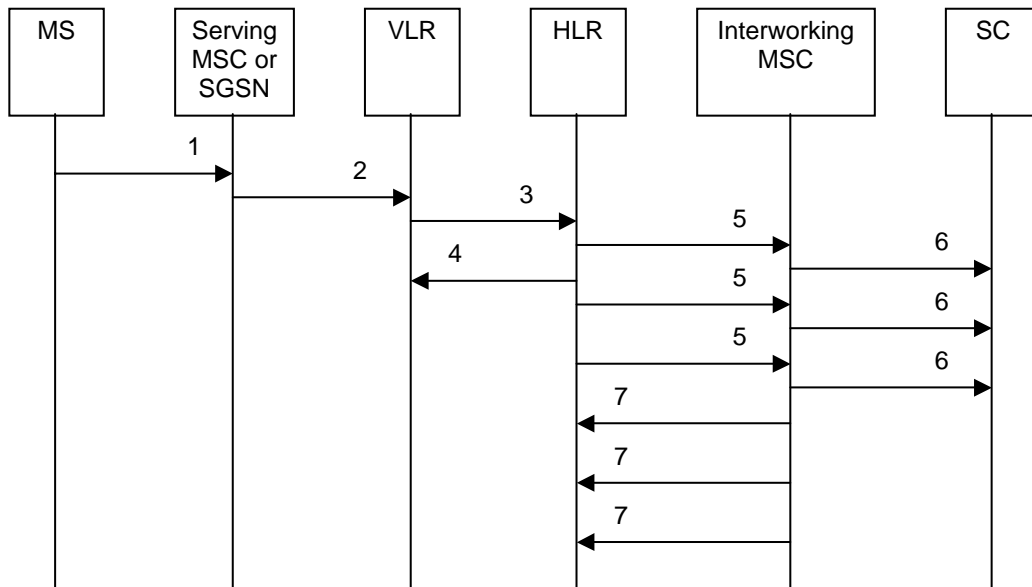

Figure 23.3/13 (sheet 1 of 1): Procedure Search_SMS_SGSN

23.4 The Short Message Alert procedure

The Short Message Alert procedure is used to alert the Service Centre when the mobile subscriber is active after a short message transfer has failed because the mobile subscriber is not reachable, or when the MS has indicated that it has memory capacity to accept a short message.

The message flow for the Short Message Alert procedure for the case when the mobile subscriber was not reachable is shown in figure 23.4/1.



- 1) CM Service Request (**), Page response or Location Updating (3GPP TS 24.008 [35]).
 - 2) MAP_PROCESS_ACCESS_REQUEST / MAP_UPDATE_LOCATION_AREA (**).
 - 3) MAP_READY_FOR_SM (Mobile Present) / MAP_UPDATE_LOCATION / Supplementary Service Control Request (*).
 - 4) MAP_READY_FOR_SM_ACK (*).
 - 5) MAP_ALERT_SERVICE_CENTRE (notes 1 and 2).
 - 6) Alert Service Centre (3GPP TS 23.040).
 - 7) MAP_ALERT_SERVICE_CENTRE_ACK.
- NOTE 1: To all Service Centres in the Message Waiting List.
 NOTE 2: The HLR initiates the MAP_ALERT_SERVICE_CENTRE service only if the MS Memory Capacity Exceeded flag is clear.
- (*) For of GPRS, messages 3) and 4) are sent/received by the SGSN.
 (**) These messages are not used by the SGSN.

Figure 23.4/1: Short message alert procedure (Mobile is present)

The message flow for the Short Message Alert procedure for the case where the MS indicates that it has memory capacity to accept one or more short messages is shown in figure 23.4/2.

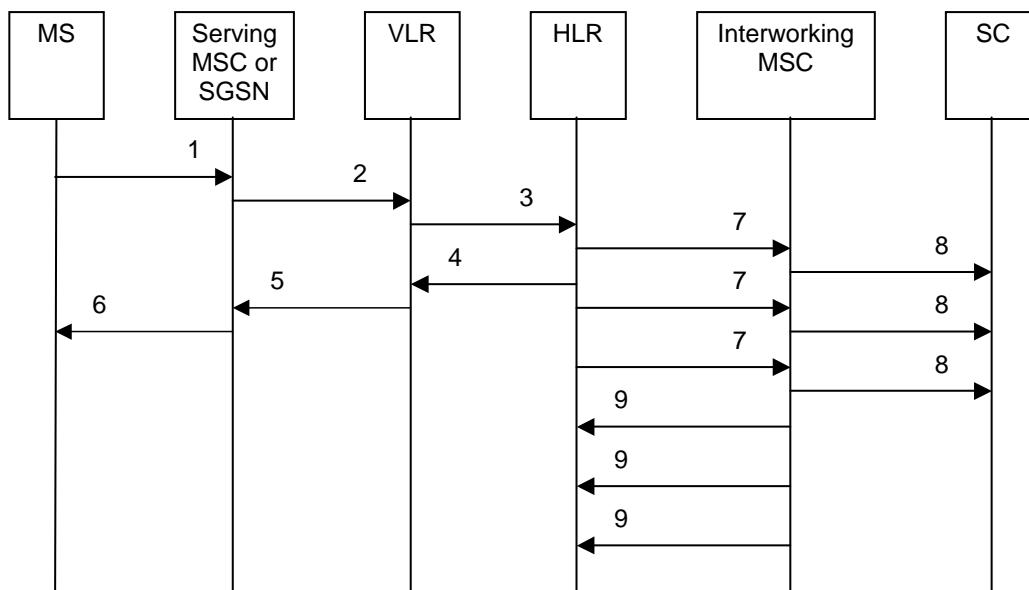

- 1) SM memory capacity available (3GPP TS 24.011 [37]).
 - 2) MAP_READY_FOR_SM (Memory Available) (*).
 - 3) MAP_READY_FOR_SM (Memory Available) (**).
 - 4) MAP_READY_FOR_SM_ACK (**).
 - 5) MAP_READY_FOR_SM_ACK (*).
 - 6) SM memory capacity available (Acknowledge) (3GPP TS 24.011 [37]).
 - 7) MAP_ALERT_SERVICE_CENTRE (note).
 - 8) Alert Service Centre (3GPP TS 23.040).
 - 9) MAP_ALERT_SERVICE_CENTRE_ACK.
- NOTE: To all Service Centres in the Message Waiting List.
- (*) Messages 2) and 5) are not used by the SGSN.
- (**) For GPRS, messages 3) and 4) are sent/received by the SGSN.

Figure 23.4/2: Short message alert procedure (MS memory capacity available)

In addition the following MAP services are used in the MS memory available case:

MAP_PROCESS_ACCESS_REQUEST	(see subclause 8.3); (*)
MAP_AUTHENTICATE	(see subclause 8.5); (*)
MAP_SET_CIPHERING_MODE	(see subclause 8.6); (*)
MAP_PROVIDE_IMSI	(see subclause 8.9); (*)
MAP_CHECK_IMEI	(see subclause 8.7);
MAP_FORWARD_NEW_TMSI	(see subclause 8.9); (*)
MAP_TRACE_SUBSCRIBER_ACTIVITY	(see subclause 9.1). (*)

(*) These services are not used by the SGSN.

The Short Message Alert procedure when the MS indicates successful transfer after polling is shown in figure 23.4/3.

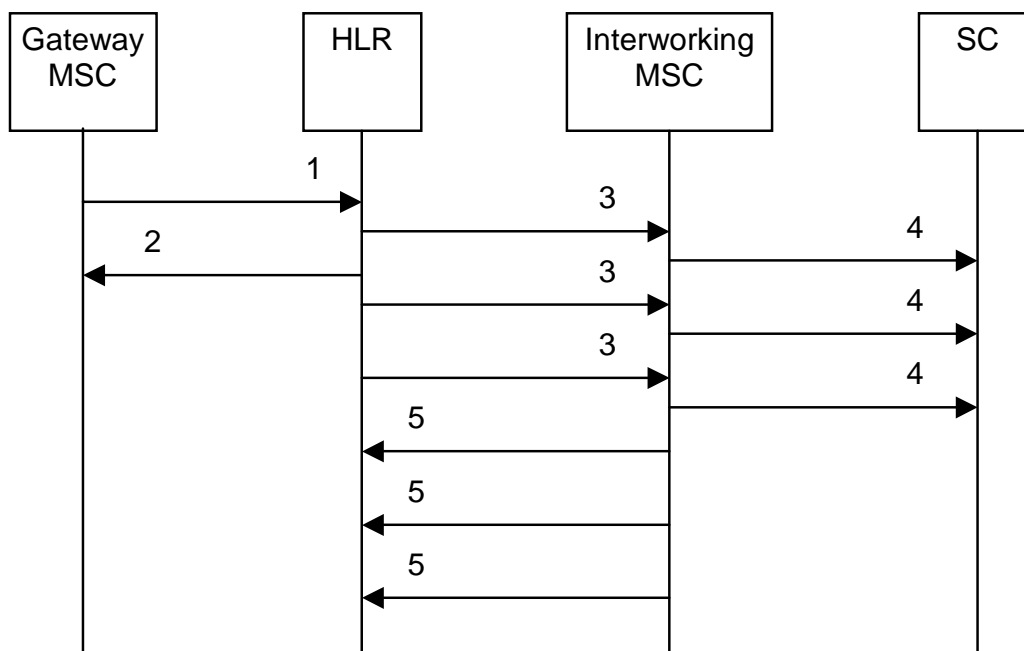

- 1) MAP_REPORT_SM_DELIVERY_STATUS (Successful Transfer).
- 2) MAP_REPORT_SM_DELIVERY_STATUS_ACK.
- 3) MAP_ALERT_SERVICE_CENTRE (note).
- 4) Alert Service Centre (3GPP TS 23.040).
- 5) MAP_ALERT_SERVICE_CENTRE_ACK.

NOTE: To all Service Centres in the Message Waiting List.

Figure 23.4/3: Short message alert procedure (Successful transfer after polling)

23.4.1 Procedure in the Serving MSC – the MS has memory available

The process starts when the MSC receives a notification from the MS that it has memory available. The process invokes a macro not defined in this clause; the definition of this macro can be found as follows:

Check_Confirmation see subclause 25.2.2.

The short message alert process in the MSC for the MS memory capacity available case is shown in figure 23.4/4.

23.4.2 Procedures in the VLR

23.4.2.1 The Mobile Subscriber is present

If the VLR successfully handles a MAP_PROCESS_ACCESS_REQUEST indication or a MAP_UPDATE_LOCATION_AREA indication while the MS Not Reachable Flag (MNRF) is set, the VLR sends a MAP_READY_FOR_SM request to the HLR. The Alert Reason is set to indicate that the mobile subscriber is present for non GPRS. If authentication fails during the handling of a MAP_PROCESS_ACCESS_REQUEST indication or a MAP_UPDATE_LOCATION_AREA indication, the VLR shall not send a MAP_READY_FOR_SM request to the HLR. The process in the VLR is described in detail in subclause 25.10.1.

23.4.2.2 The MS has memory available

The process starts when the VLR receives a dialogue opening request followed by a MAP_PROCESS_ACCESS_REQUEST indication including a CM service type Short Message Service. The MAP process invokes macros not defined in this clause; the definitions of these macros can be found as follows:

Receive_Open_Ind see subclause 25.1.1;

Receive_Open_Cnf see subclause 25.1.2;

Check_Indication	see subclause 25.2.1;
Check_Confirmation	see subclause 25.2.2.

The short message alert process in the VLR for the MS memory capacity available case is shown in figure 23.4/5.

23.4.3 Procedures in the SGSN

23.4.3.1 The Mobile Subscriber is present

If the SGSN successfully handles a Page response, Attach request or Routing Area Update request message (3GPP TS 24.008 [35]), while the MS Not Reachable for GPRS (MNRG) flag is set, the SGSN sends a MAP_READY_FOR_SM request to the HLR. The Alert Reason is set to indicate that the mobile subscriber is present for GPRS. If authentication fails during the handling of a Page response, Attach request or Routing Area Update request, the SGSN shall not send a MAP_READY_FOR_SM request to the HLR

The process in the SGSN is described in detail in subclause 25.10.2.

23.4.3.2 The Mobile Equipment has memory available

The process starts when the SGSN receives an RP_SM_MEMORY_AVAILABLE indication from the MS. The MAP process invokes macros not defined in this clause; the definitions of these macros can be found as follows:

Receive_Open_Cnf	see subclause 25.1.2;
Check_Confirmation	see subclause 25.2.2.

The short message alert procedure in the SGSN for the MS memory capacity available case is shown in figure 23.4/6.

23.4.4 Procedure in the HLR

The process starts when the HLR receives a dialogue opening request using the application context mwdMngtContext. The MAP process invokes macros not defined in this clause; the definitions of these macros can be found as follows:

Receive_Open_Ind	see subclause 25.1.1;
Check_Indication	see subclause 25.2.1;
Alert_Service_Centre_HLR	see subclause 25.10.3.

Sheet 1: If the dialogue opening request is from an SGSN, version 2 and version 1 of the application context are not applicable.

The short message alert process in the HLR is shown in figure 23.4/7.

23.4.5 Procedure in the SMS Interworking MSC

The process starts when the SMS-IW MSC receives a dialogue opening request using the application context shortMsgAlertContext. The MAP process invokes macros not defined in this clause; the definitions of these macros can be found as follows:

Receive_Open_Ind	see subclause 25.1.1;
Check_Indication	see subclause 25.2.1.

The short message alert process in the SMS-IW MSC is shown in figure 23.4/8.

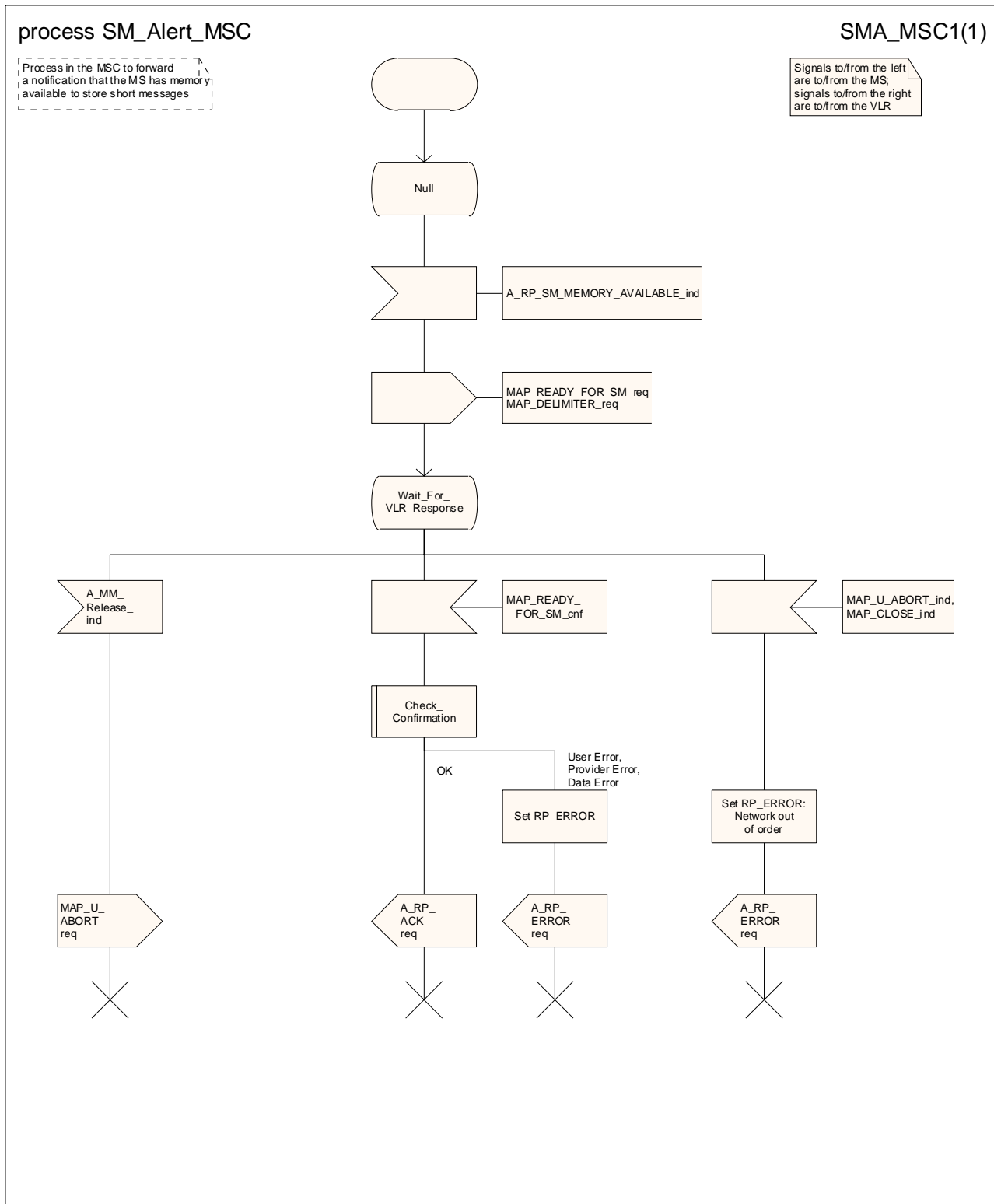

Figure 23.4/4: Procedure SM_Alert_MSC

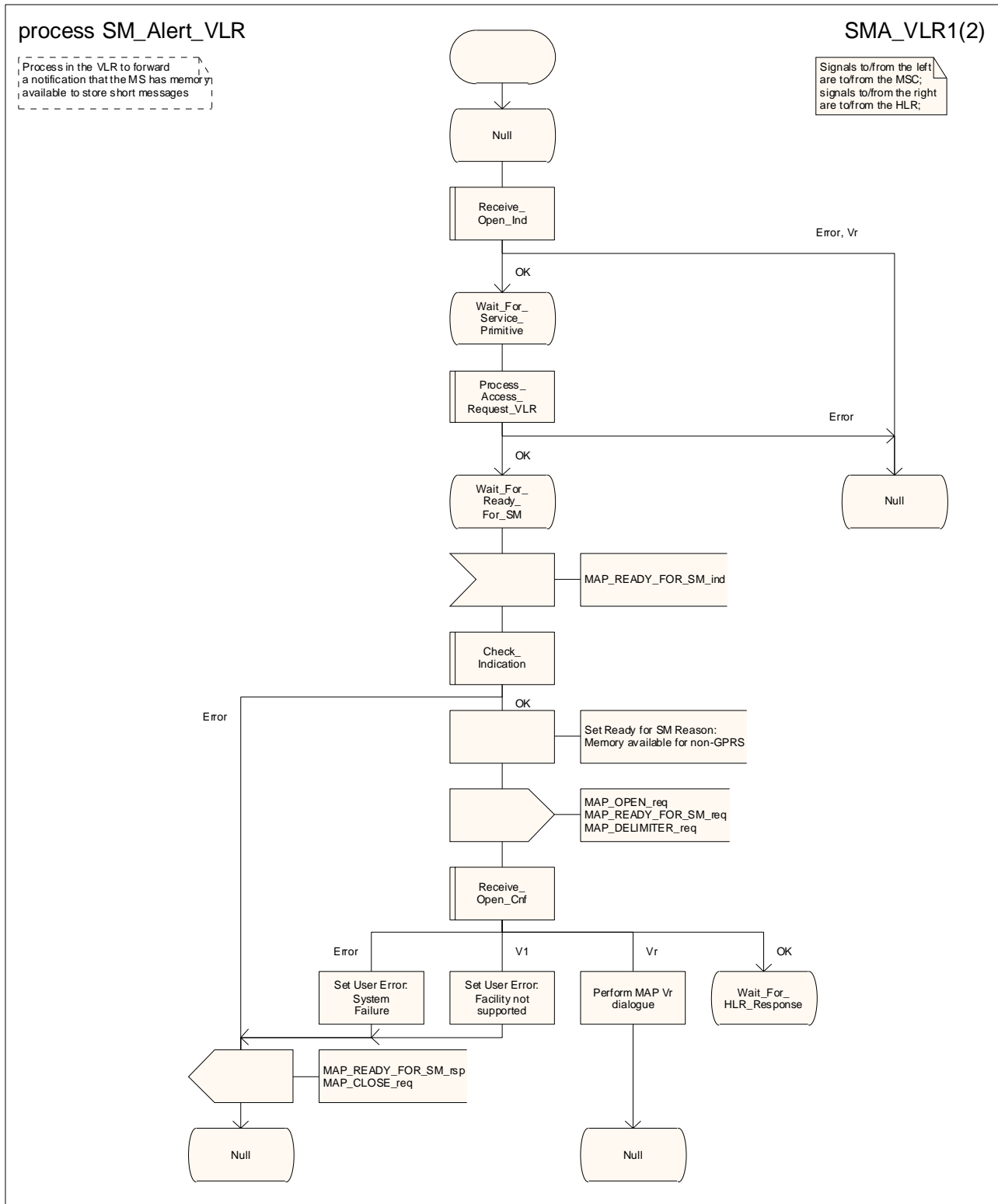

Figure 23.4/5 (sheet 1 of 2): Procedure SM_Alert_VLR

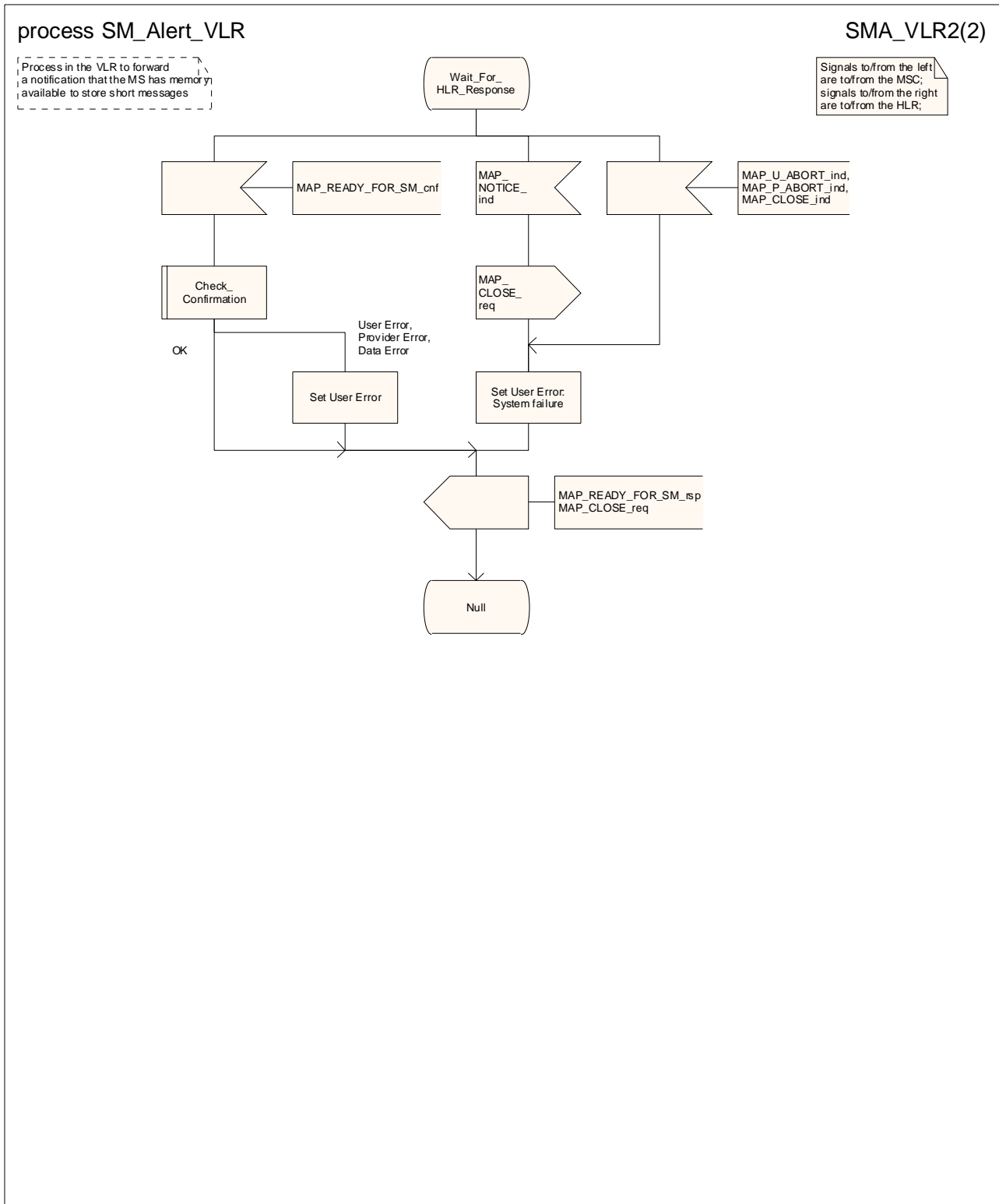

Figure 23.4/5 (sheet 2 of 2): Procedure SM_Alert_VLR

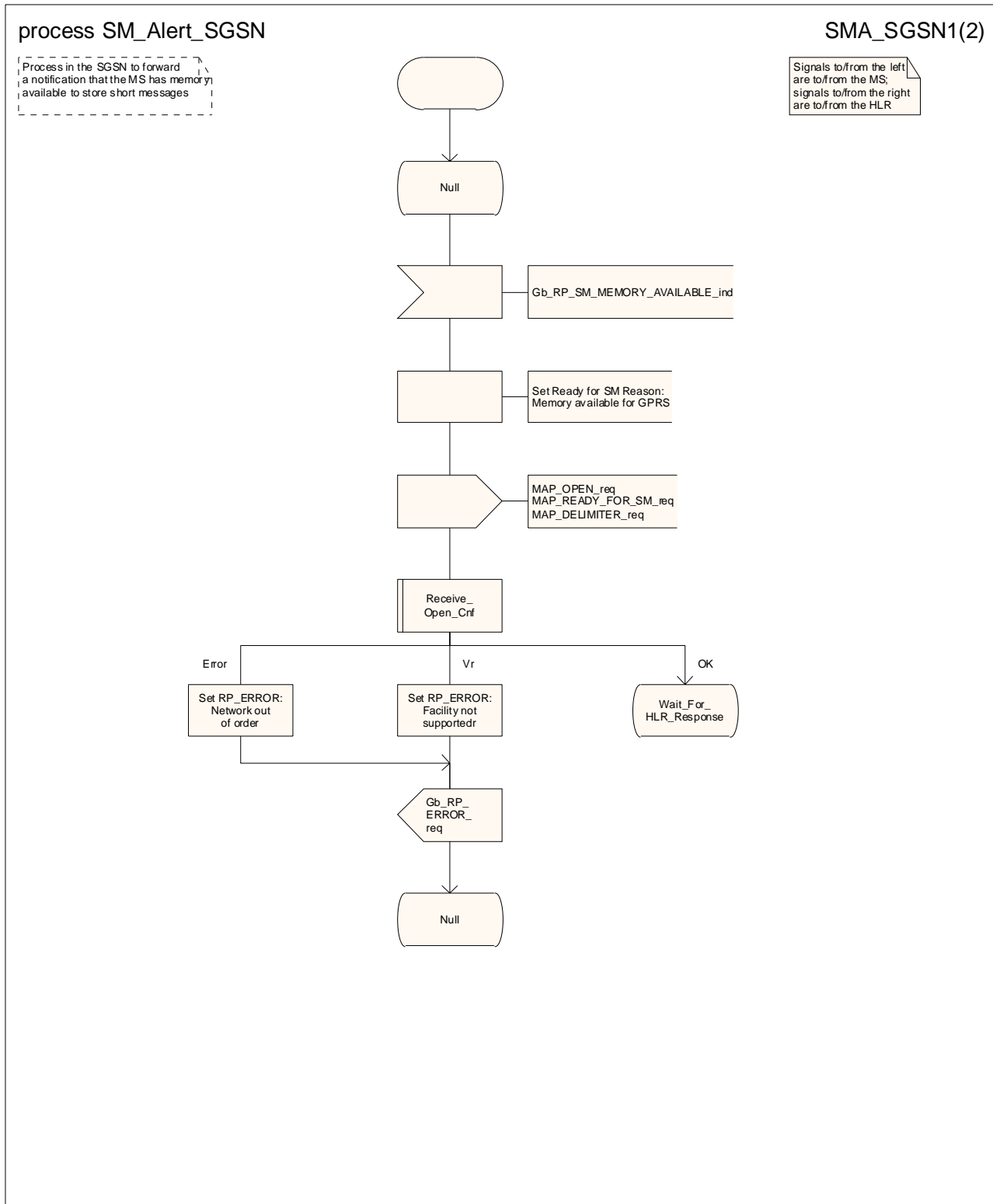

Figure 23.4/6 (sheet 1 of 2): SM_Alert_SGSN

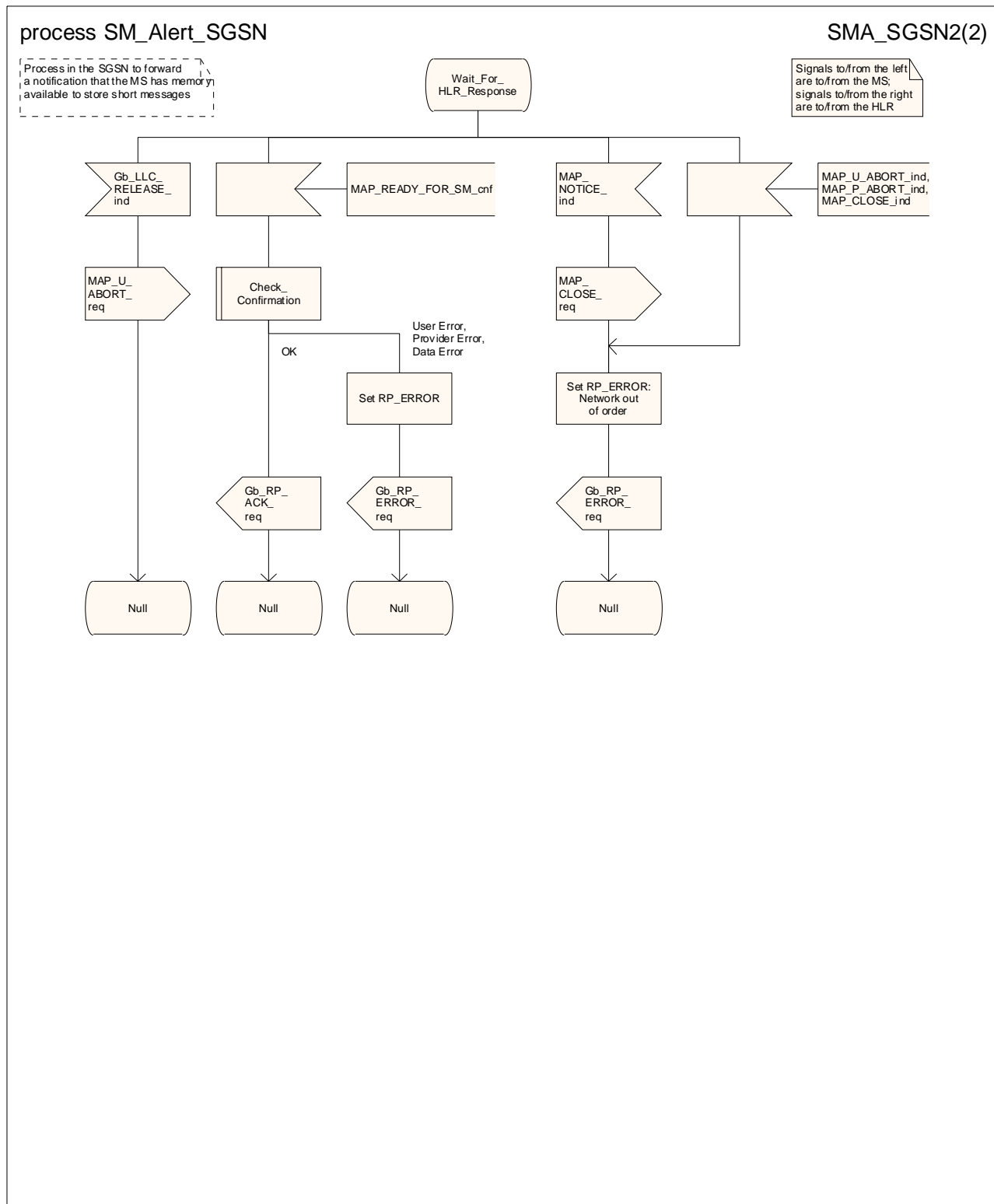

Figure 23.4/6 (sheet 2 of 2): Process SM_Alert_SGSN

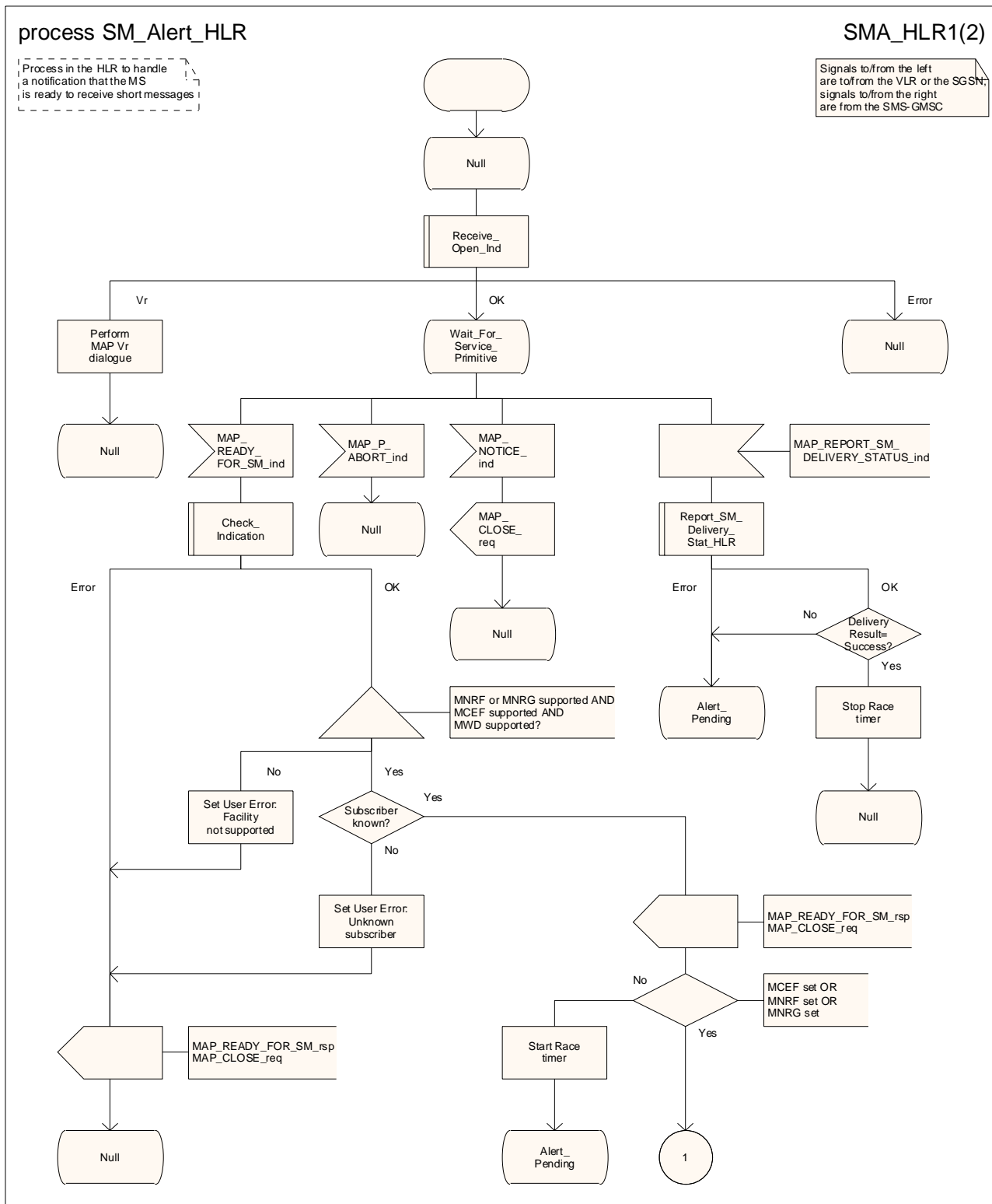

Figure 23.4/7 (sheet 1 of 2): Process SM_Alert_HLR

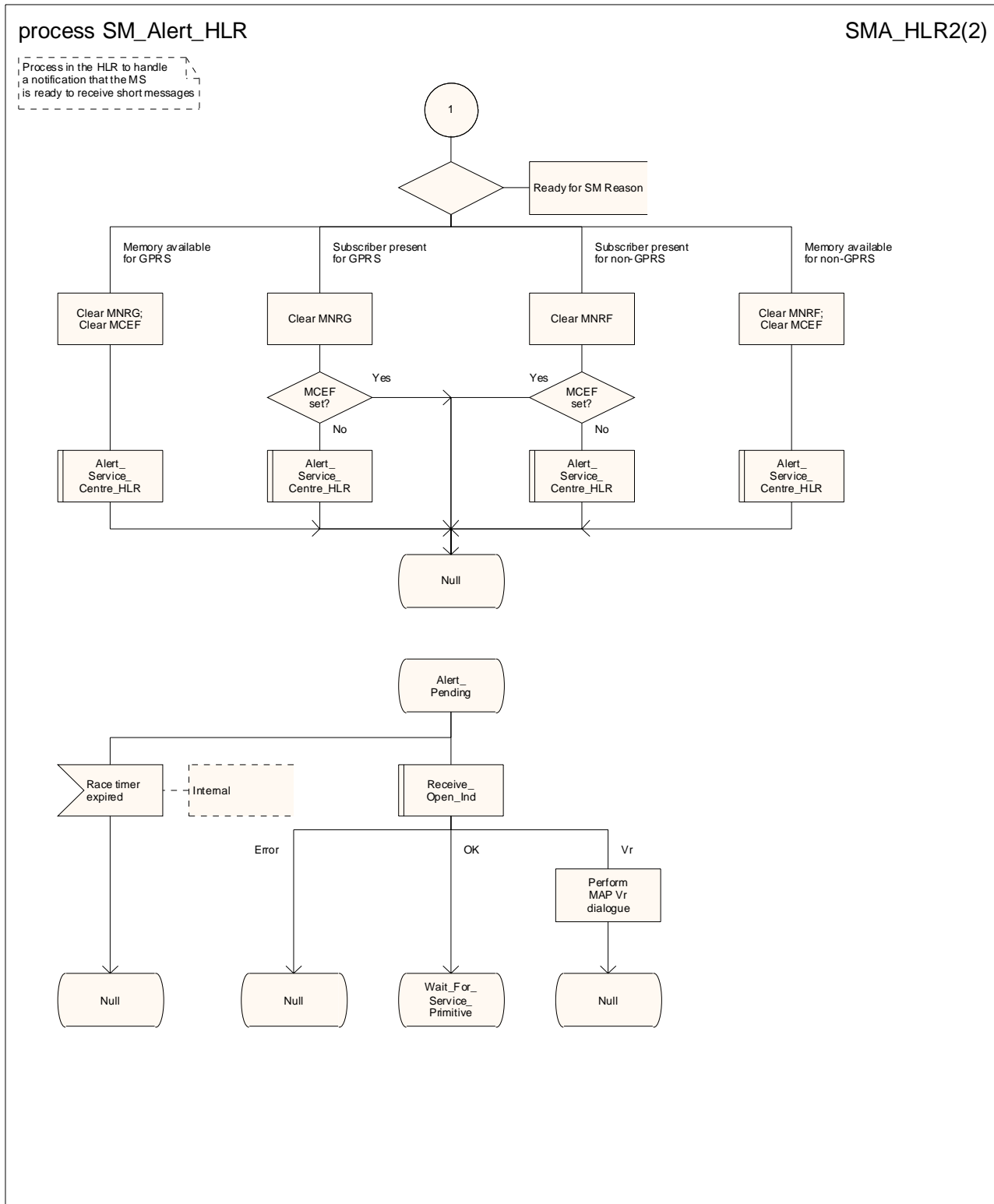

Figure 23.4/7 (sheet 2 of 2): Process SM_Alert_HLR

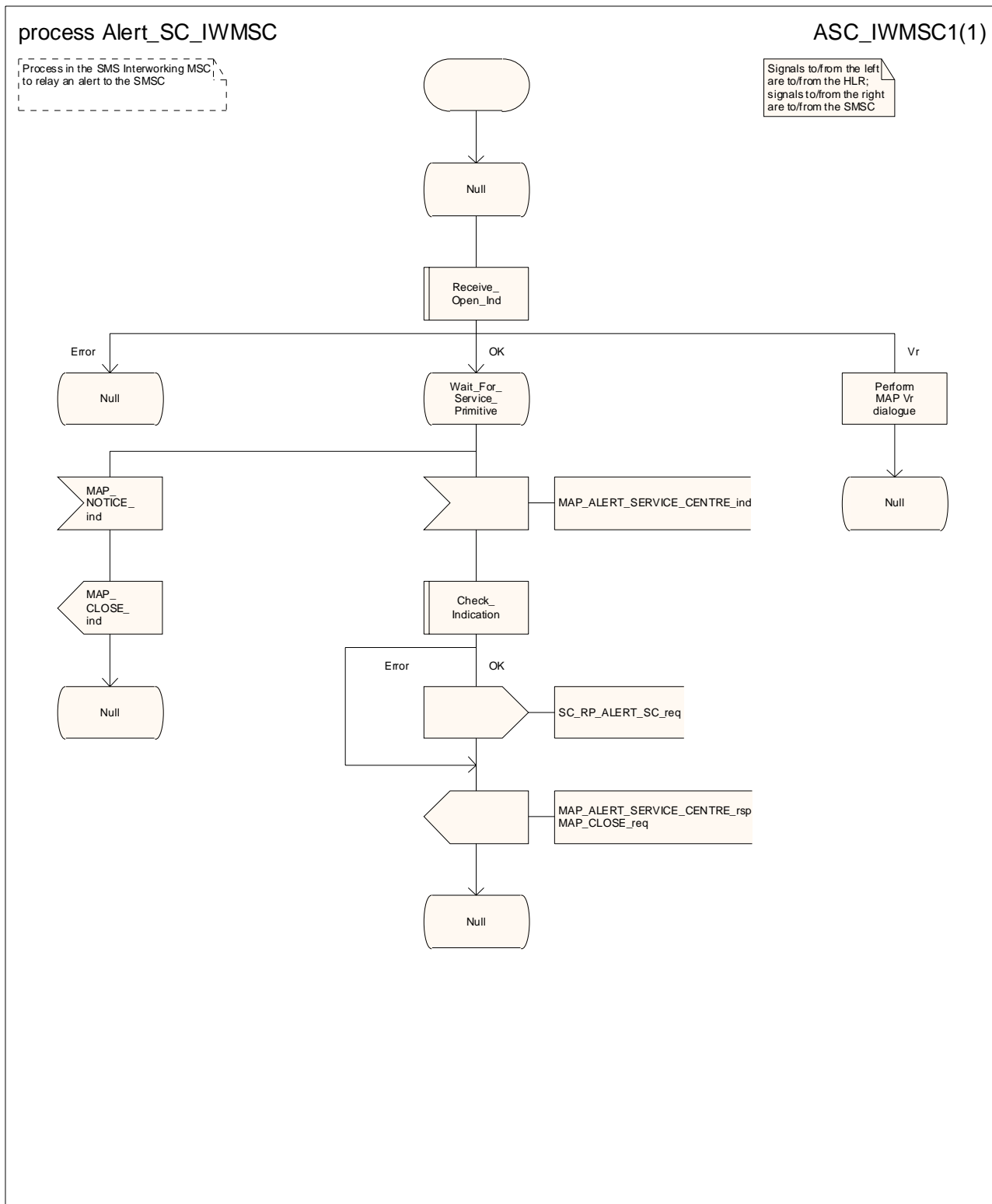

Figure 23.4/8: Process Alert_SC_IWMSC

23.5 The SM delivery status report procedure

The SM delivery status report procedure is used:

- to set the Service Centre address into the message waiting list in the HLR after short message delivery has failed because the subscriber is absent or unidentified or the memory capacity is exceeded. The procedure sets:
 - the Memory Capacity Exceeded Flag (MCEF) in the HLR if the MS memory does not have room for more messages;
 - and/or the MS Not Reachable Flag for non-GPRS if there is no record for the subscriber in the VLR or the subscriber does not respond to paging for delivery via the MSC;
 - and/or the MS Not Reachable for GPRS (MNRG) flag if there is no record for the subscriber in the SGSN or the subscriber does not respond to paging for delivery via the SGSN.
- to report to the HLR that delivery has succeeded. The conditions for report of a successful delivery are described in subclause 23.3.1.

The message flow for the SM delivery status report procedure is shown in figure 23.5/1.

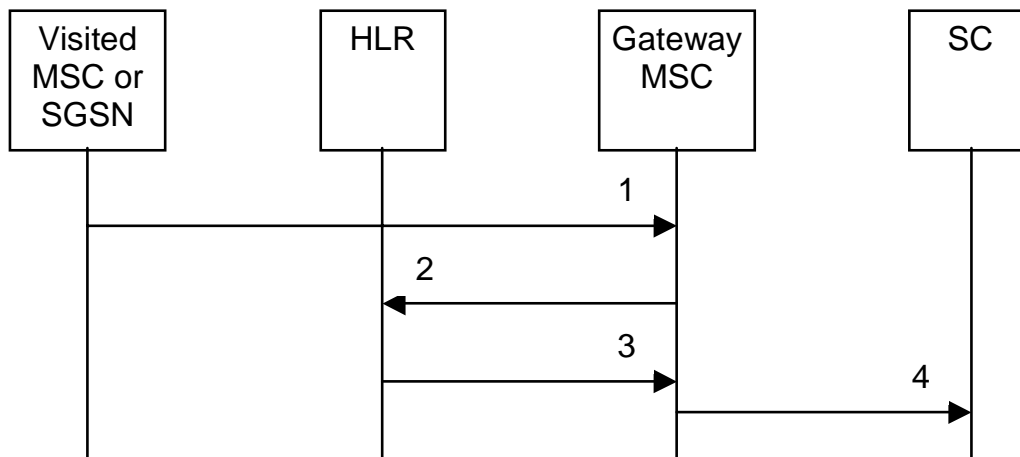

- 1) MAP_MT_FORWARD_SHORT_MESSAGE_ACK/_NACK (Absent subscriber_SM, unidentified subscriber or memory capacity exceeded).
- 2) MAP_REPORT_SM_DELIVERY_STATUS.
- 3) MAP_REPORT_SM_DELIVERY_STATUS_ACK.
- 4) Short Message Negative Acknowledgement (3GPP TS 23.040).

Figure 23.5/1: Short message delivery status report procedure

23.5.1 Procedure in the SMS-GMSC

The conditions for the GMSC to invoke the short message delivery status report procedure are specified in subclause 23.3.1.

The short message delivery status report macro in the SMS-GMSC is shown in figure 23.5/2.

23.5.2 Procedure in the HLR

When the HLR receives a MAP_REPORT_SM_DELIVERY_STATUS indication, it acts as described in subclause 23.6, macro Report_SM_Delivery_Stat_HLR.

The short message delivery status report process in the HLR is shown in figure 23.5/3.

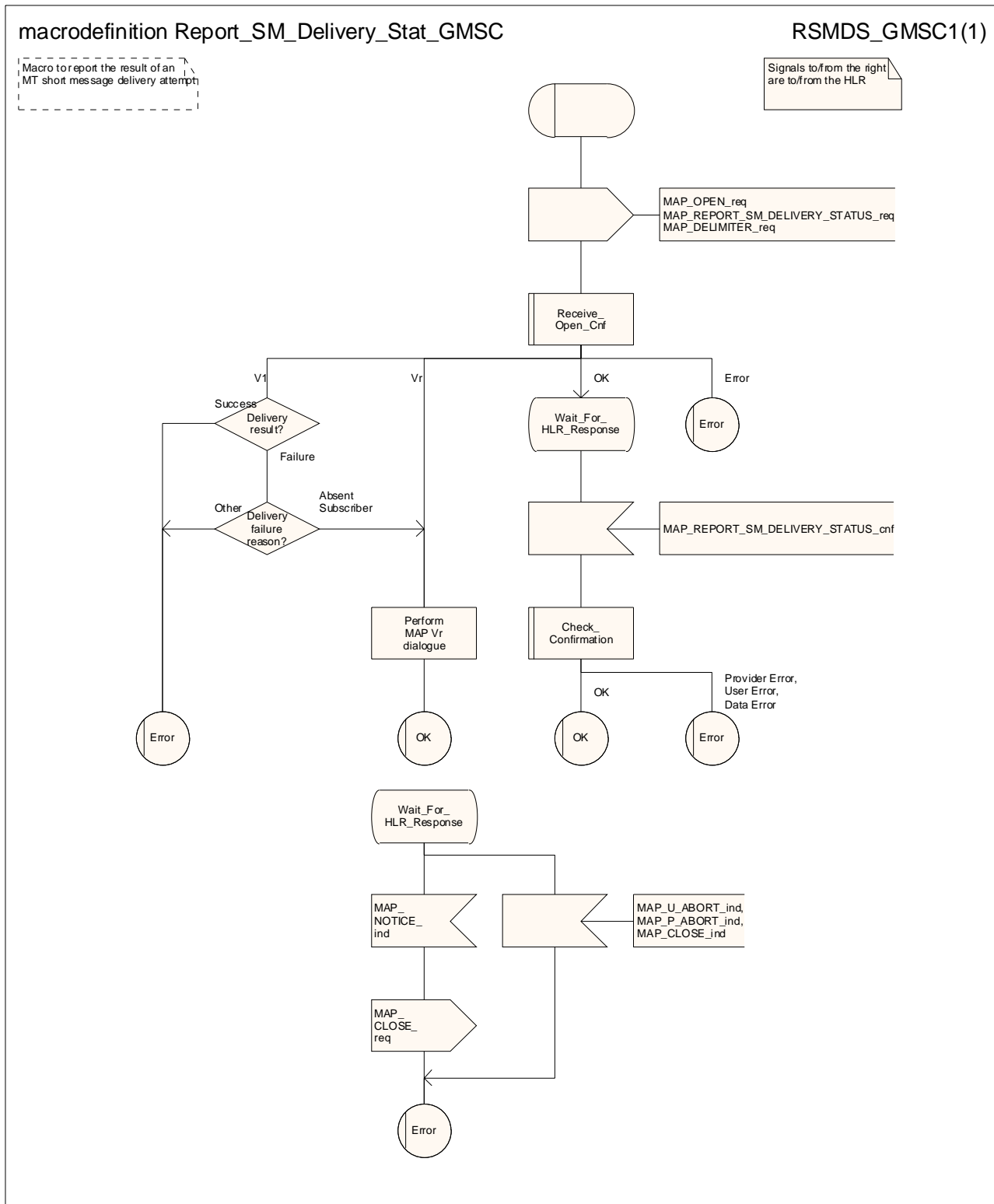

Figure 23.5/2: Macro Report_SM_Delivery_Stat_GMSC

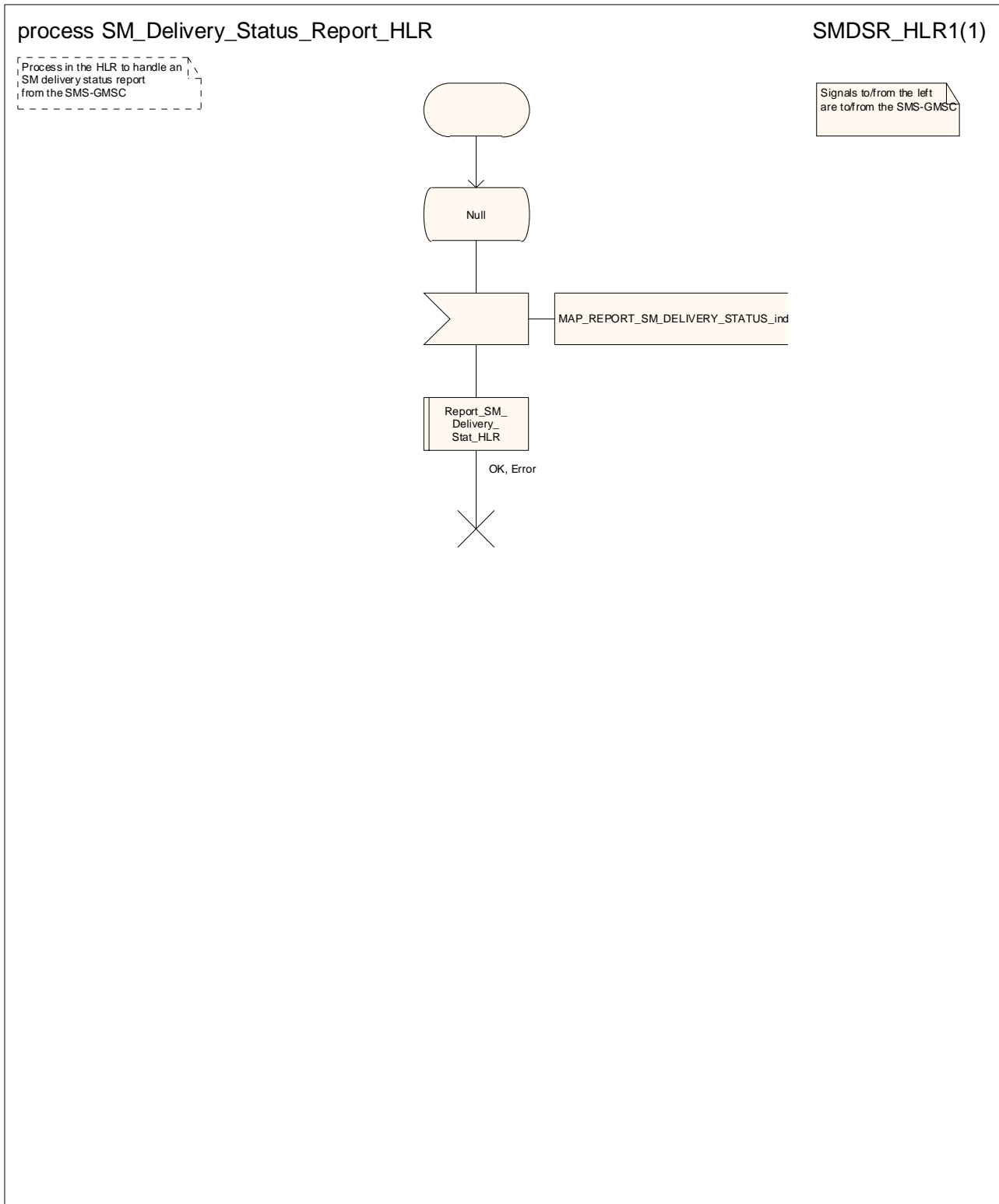

Figure 23.5/3: Process SM_Delivery_Status_Report_HLR

23.6 The macro Report_SM_Delivery_Stat_HLR

This macro is invoked when the HLR receives a MAP_REPORT_SM_DELIVERY_STATUS indication from the SMS-GMSC. The macro invokes macros not defined in this clause; the definitions of these macros can be found as follows:

Check_Indication see subclause 25.2.1;

Alert_Service_Centre_HLR see subclause 25.10.3.

Sheet 1: If the MAP_REPORT_SM_DELIVERY_STATUS indication did not include the GPRS support indicator, the HLR deduces the domain for which the delivery report applies as follows:

- if the subscriber is a GPRS-only subscriber, the report applies for GPRS;
- if the subscriber is a non-GPRS-only subscriber, the report applies for non-GPRS;
- if the subscriber is a GPRS and non-GPRS subscriber and the subscription option for MT SMS delivery when the SMS-GMSC does not support GPRS is set to "Delivery via the SGSN", the report applies for GPRS;
- if the subscriber is a GPRS and non-GPRS subscriber and the subscription option for MT SMS delivery when the SMS-GMSC does not support GPRS is set to "Delivery via the MSC", the report applies for non-GPRS;

The short message delivery status report macro in the HLR is shown in figure 23.6/1.

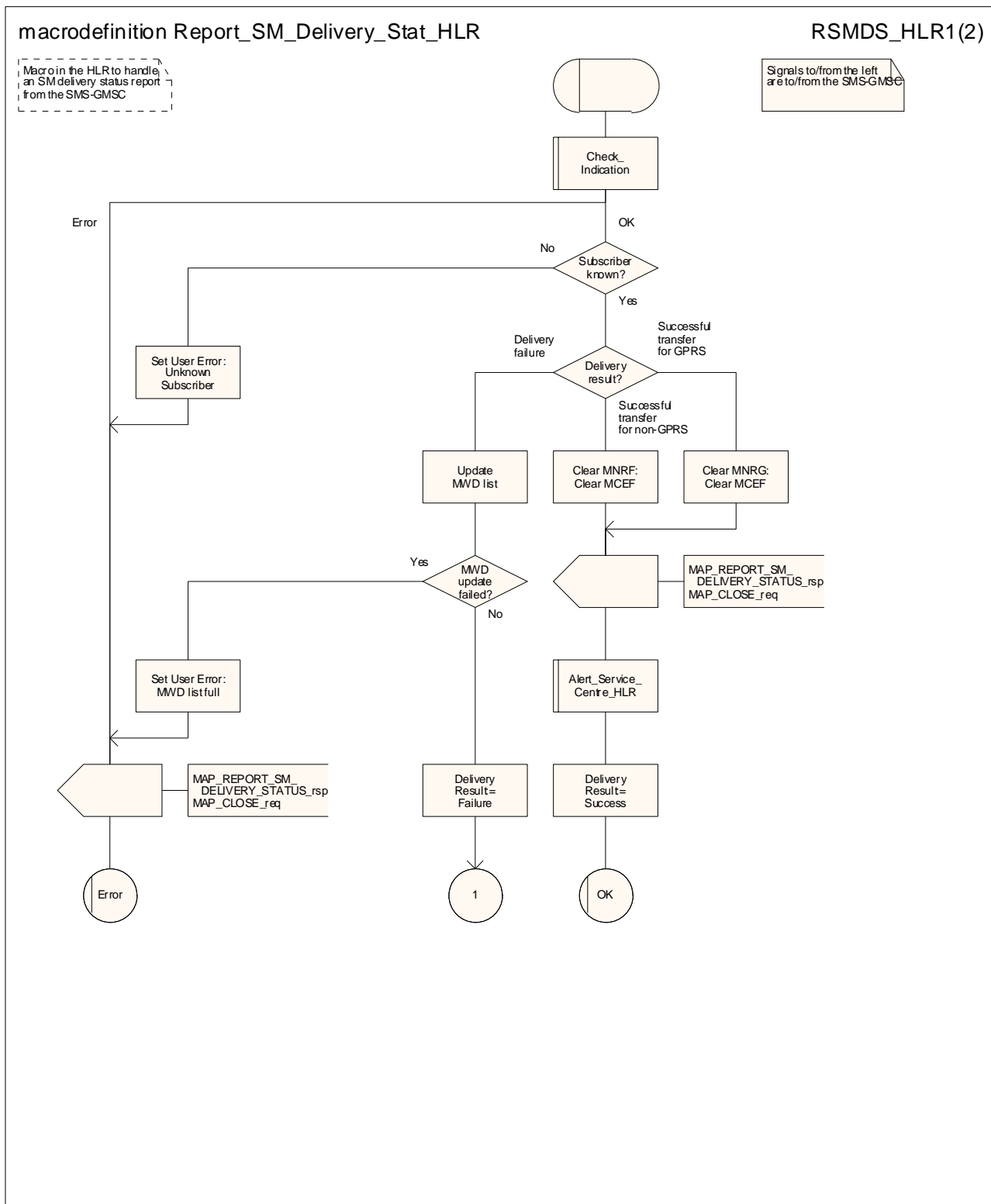

Figure 23.6/1 (sheet 1 of 2): Macro Report_SM_Delivery_Stat_HLR

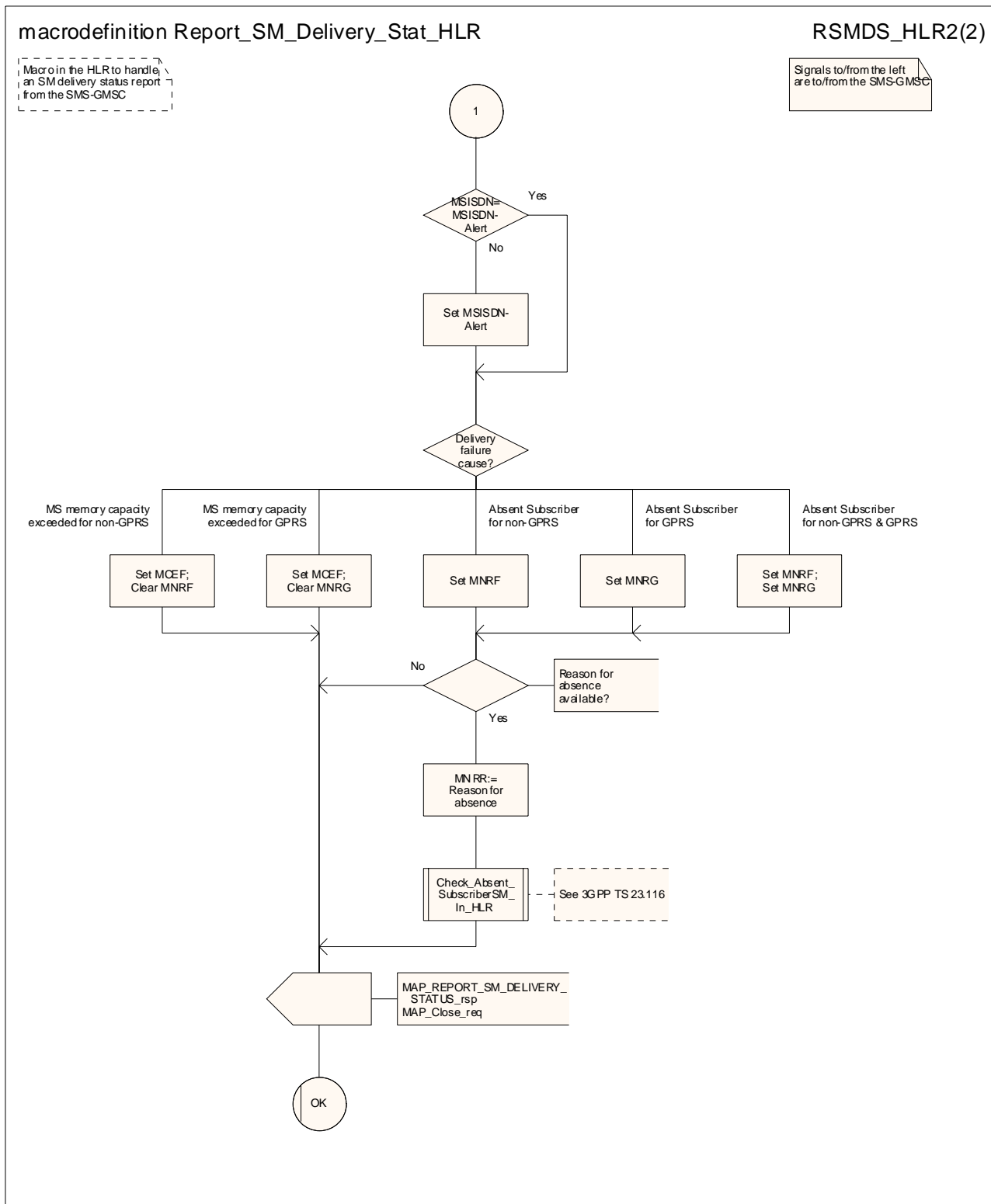

Figure 23.6/1 (sheet 2 of 2): Macro Report_SM_Delivery_Stat_HLR

24 GPRS process description

The MAP GPRS procedures are used for the Network Requested PDP Context Activation procedures.

The stage 2 specification for General Packet Radio Service (GPRS) is in 3GPP TS 23.060 [104].

24.1 Procedure for retrieval of routing information for GPRS

24.1.1 Process in the GGSN

The MAP process in the GGSN to request routing information for a network requested PDP context activation is shown in figure 24.1/2. The MAP process invokes macros not defined in this clause; the definitions of these macros can be found as follows:

Receive_Open_Cnf see subclause 25.1.2;

Check_Confirmation see subclause 25.2.2.

24.1.2 Process in the HLR

The MAP process in the HLR to provide routing information for a network-requested PDP context activation is shown in figure 24.1/1. The MAP process invokes macros not defined in this clause; the definitions of these macros can be found as follows:

Receive_Open_Ind see subclause 25.1.1;

Check_Indication see subclause 25.2.1.

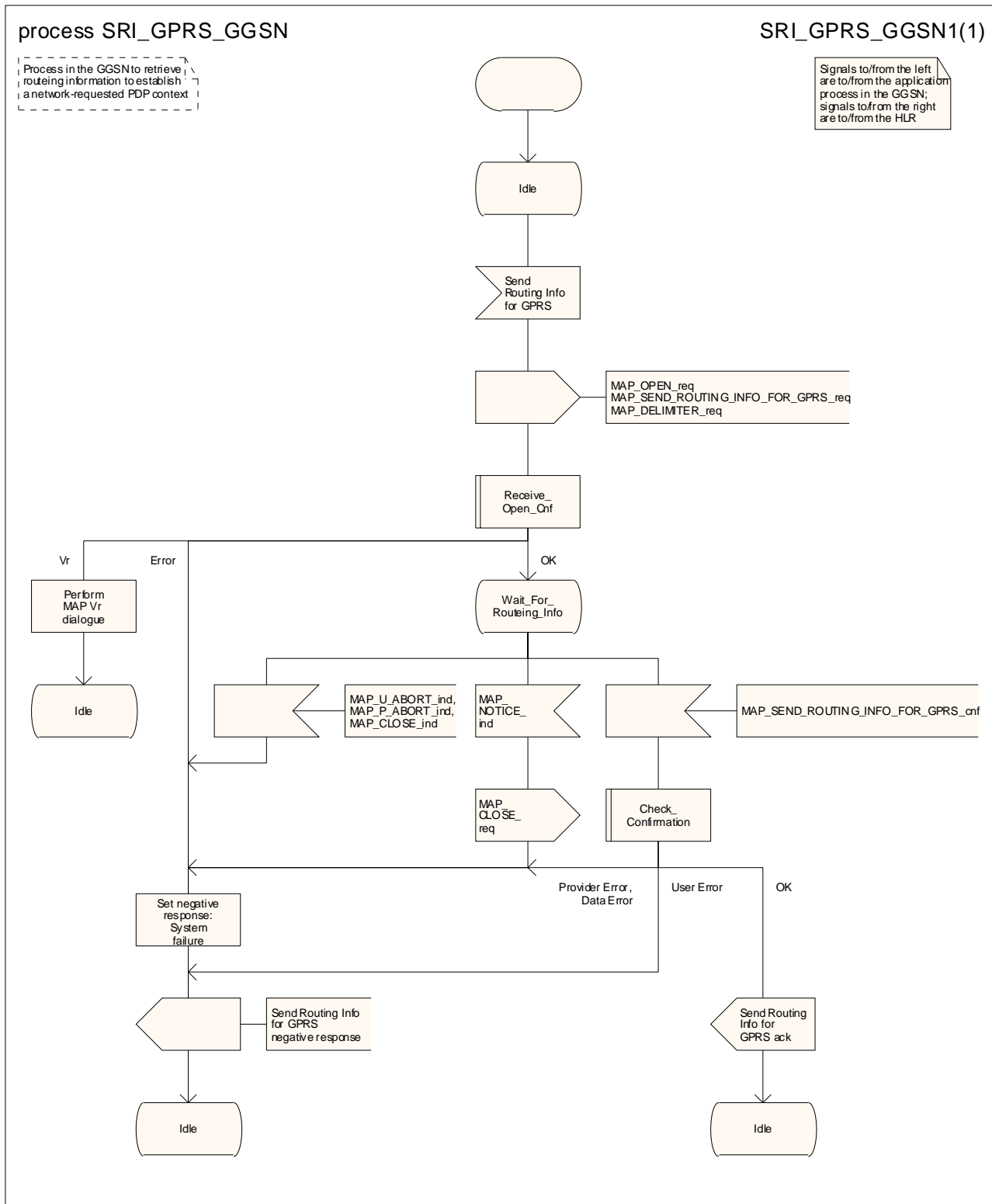

Figure 24.1/1: Process SRI_GPRS_GGSN

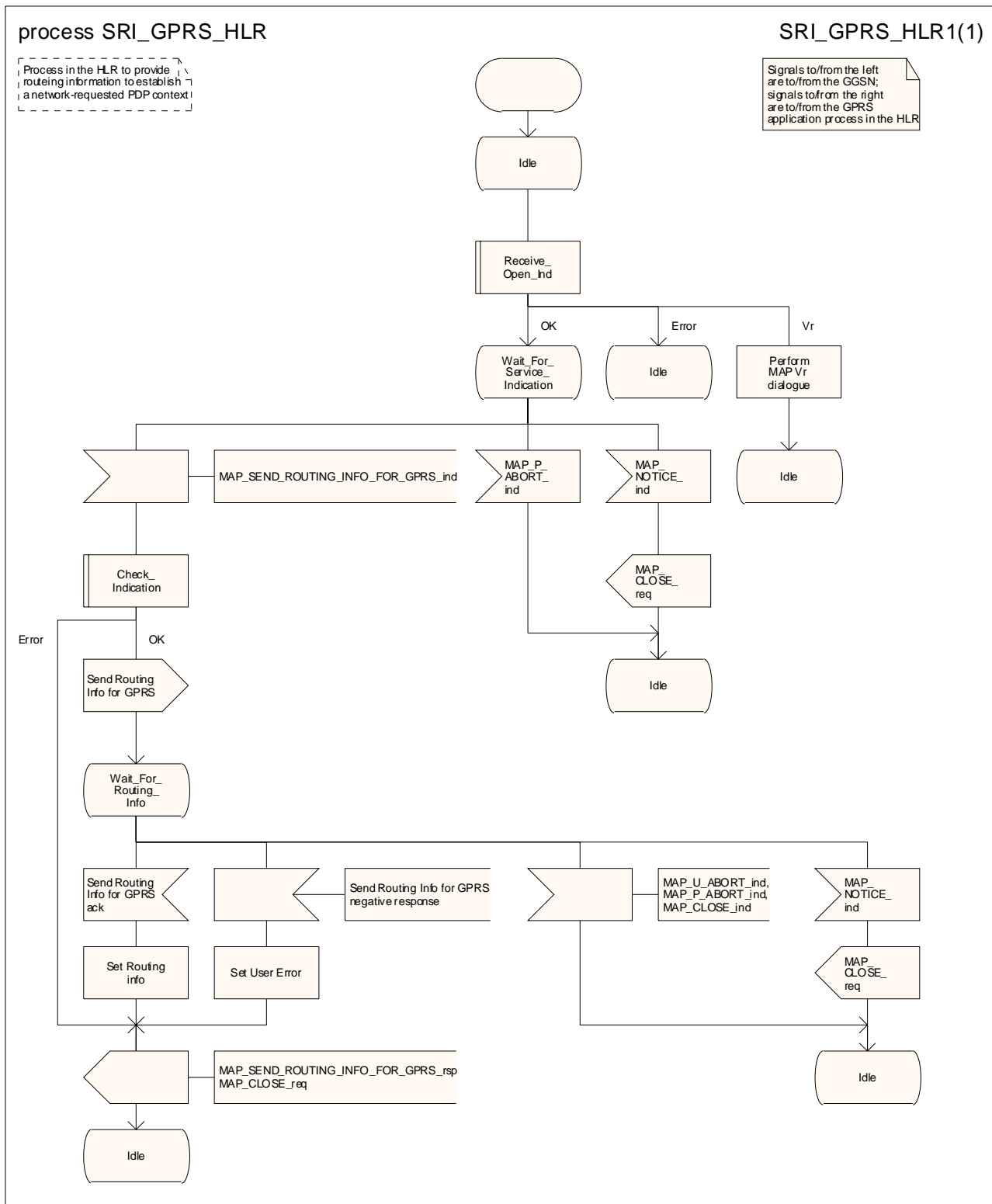

Figure 24.1/2: SRI_GPRS_HLR

24.2 Procedure for reporting failure to establish a network requested PDP context

24.2.1 Process in the GGSN

The MAP process in the GGSN to report the failure to establish a network requested PDP context is shown in figure 24.2/2. The MAP process invokes macros not defined in this clause; the definitions of these macros can be found as follows:

Receive_Open_Cnf see subclause 25.1.2;

Check_Confirmation see subclause 25.2.2.

24.2.2 Process in the HLR

The MAP process in the HLR to handle a notification from the GGSN that a network requested PDP context could not be established is shown in figure 24.2/2. The MAP process invokes macros not defined in this clause; the definitions of these macros can be found as follows:

Receive_Open_Ind see subclause 25.1.1;

Check Indication see subclause 25.2.1.

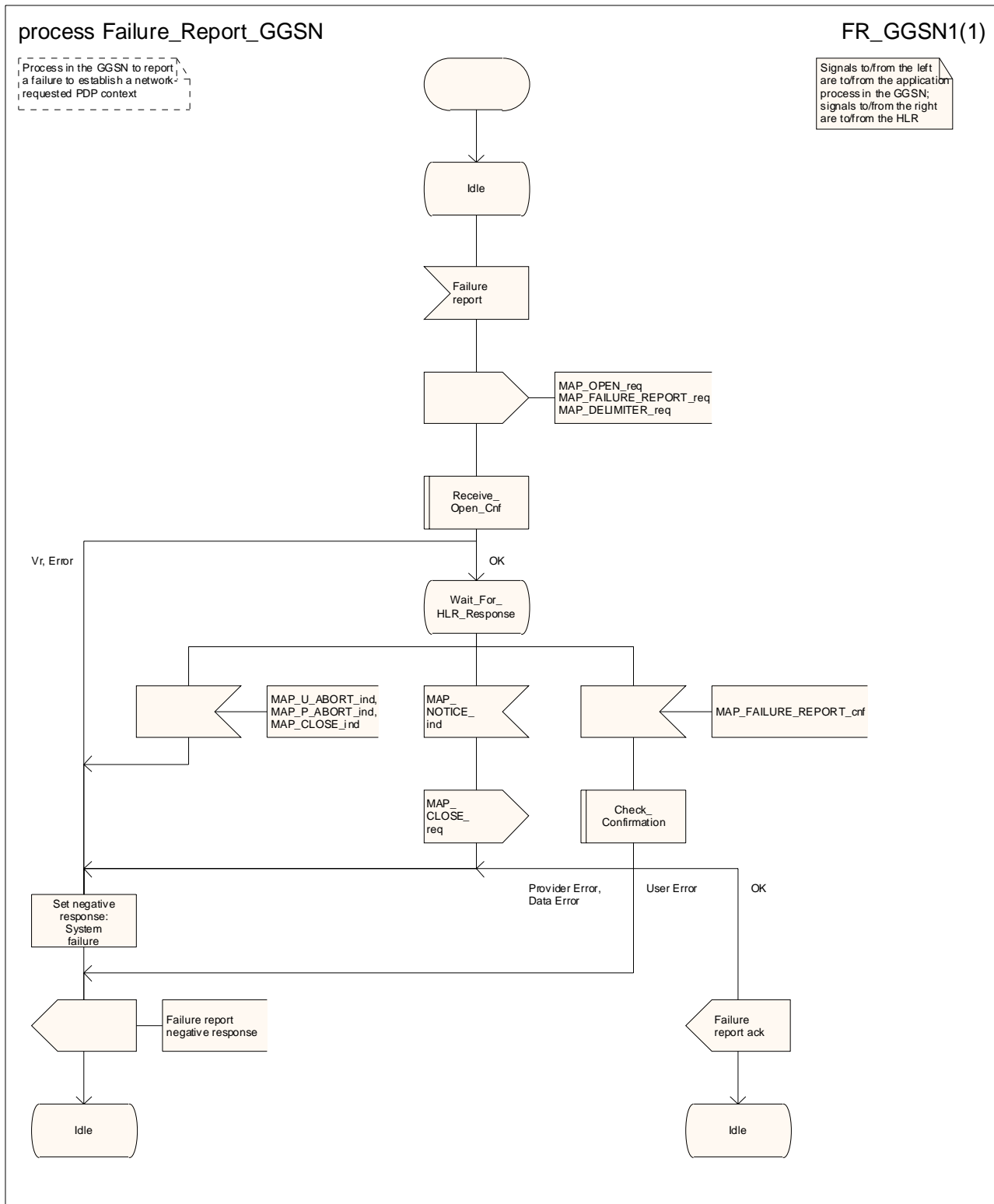

Figure 24.2/1: Process Failure_Report_GGSN

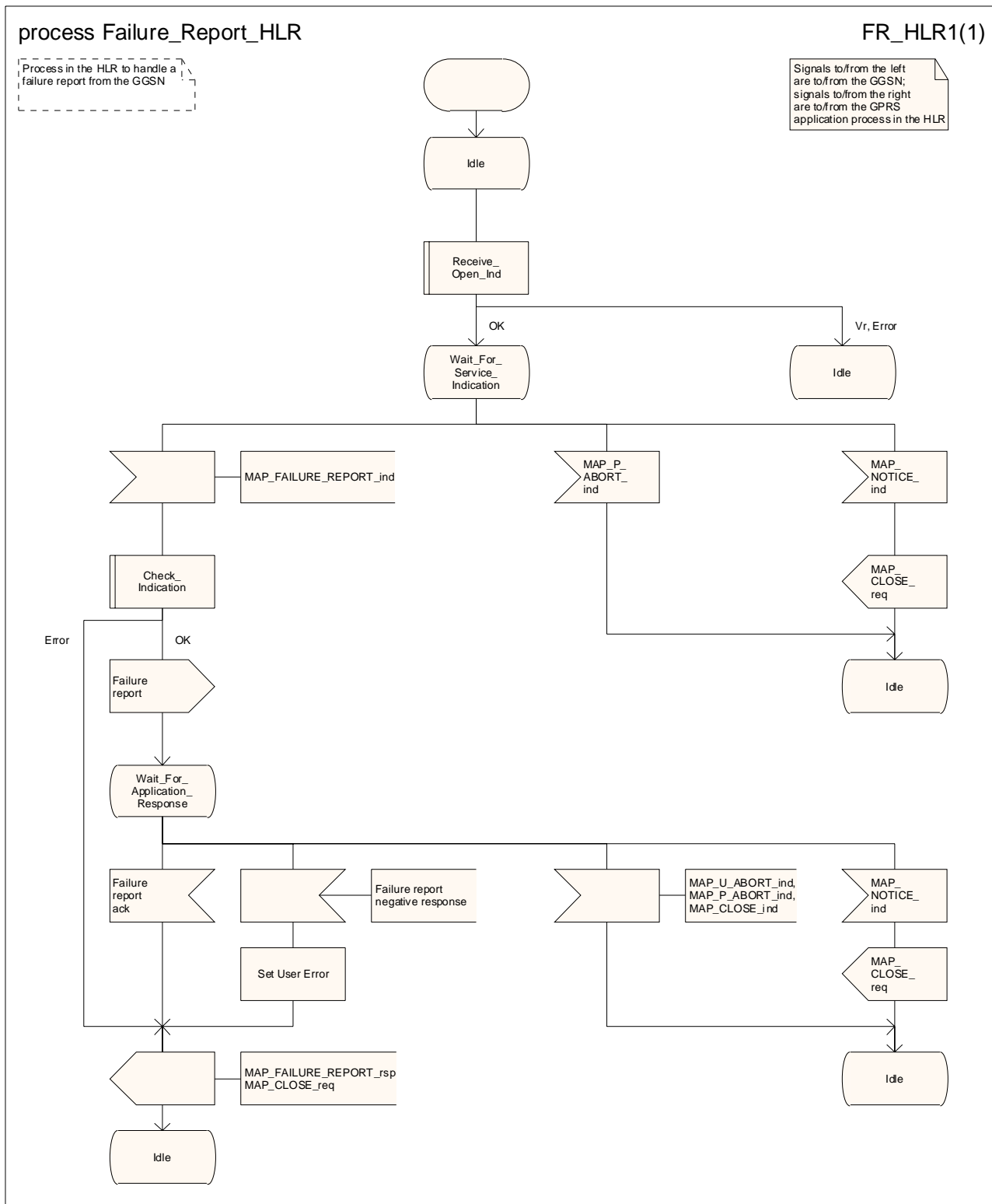

Figure 24.2/2: Process Failure_Report_HLR

24.3 Procedure for reporting that an MS has become reachable for GPRS

24.3.1 Process in the HLR

The MAP process in the HLR to report that an MS is reachable for GPRS is shown in figure 24.3/1. The MAP process invokes macros not defined in this clause; the definitions of these macros can be found as follows:

Receive_Open_Cnf see subclause 25.1.2;
Check_Confirmation see subclause 25.2.2.

24.3.2 Process in the GGSN

The MAP process in the GGSN to handle a notification that the subscriber is present for GPRS again is shown in figure 24.3/2. The MAP process invokes macros not defined in this clause; the definitions of these macros can be found as follows:

Receive_Open_Ind see subclause 25.1.1;
Check_Indication see subclause 25.2.1.

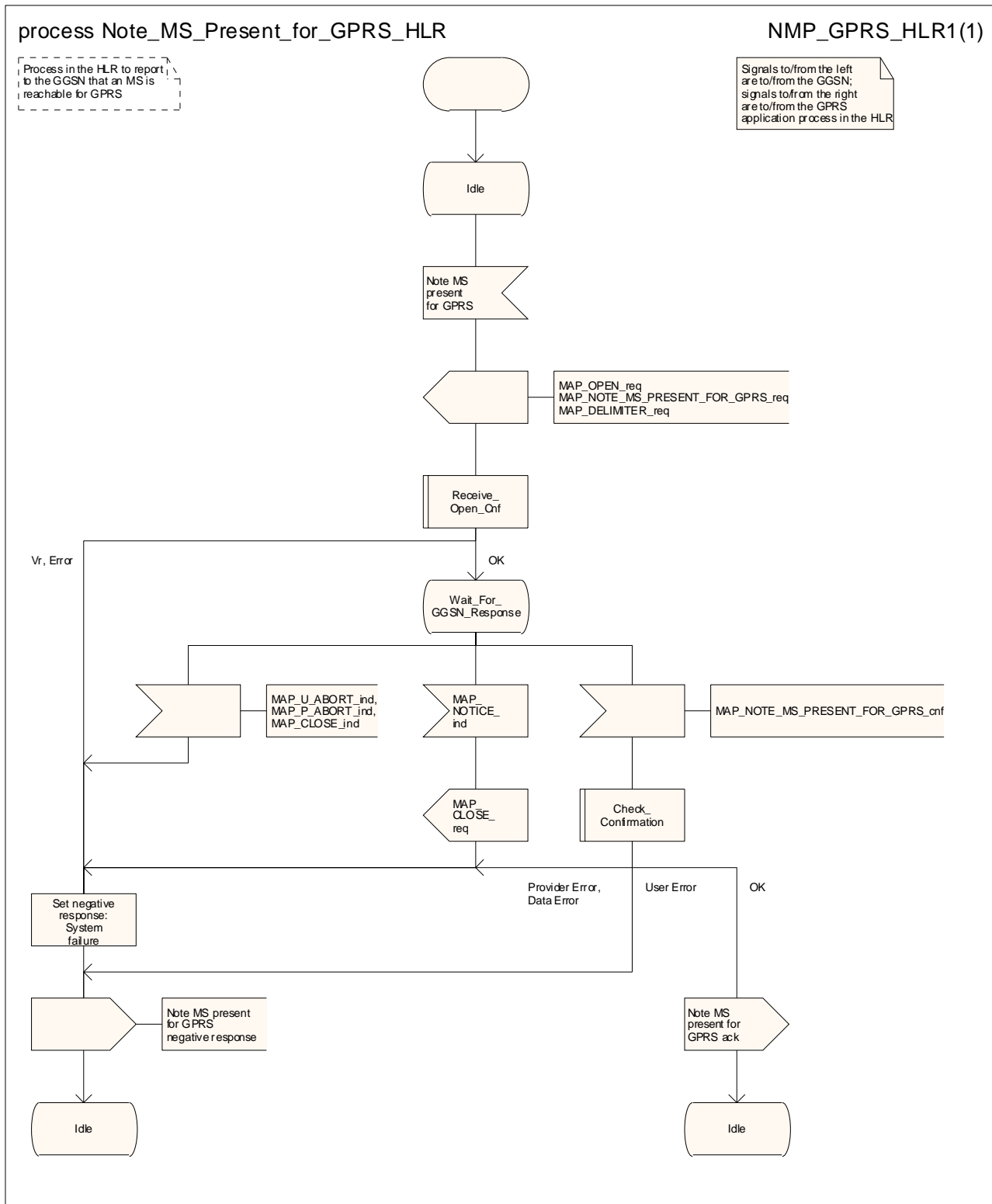

Figure 24.3/1: Process Note_MS_Present_For_GPRS_HLR

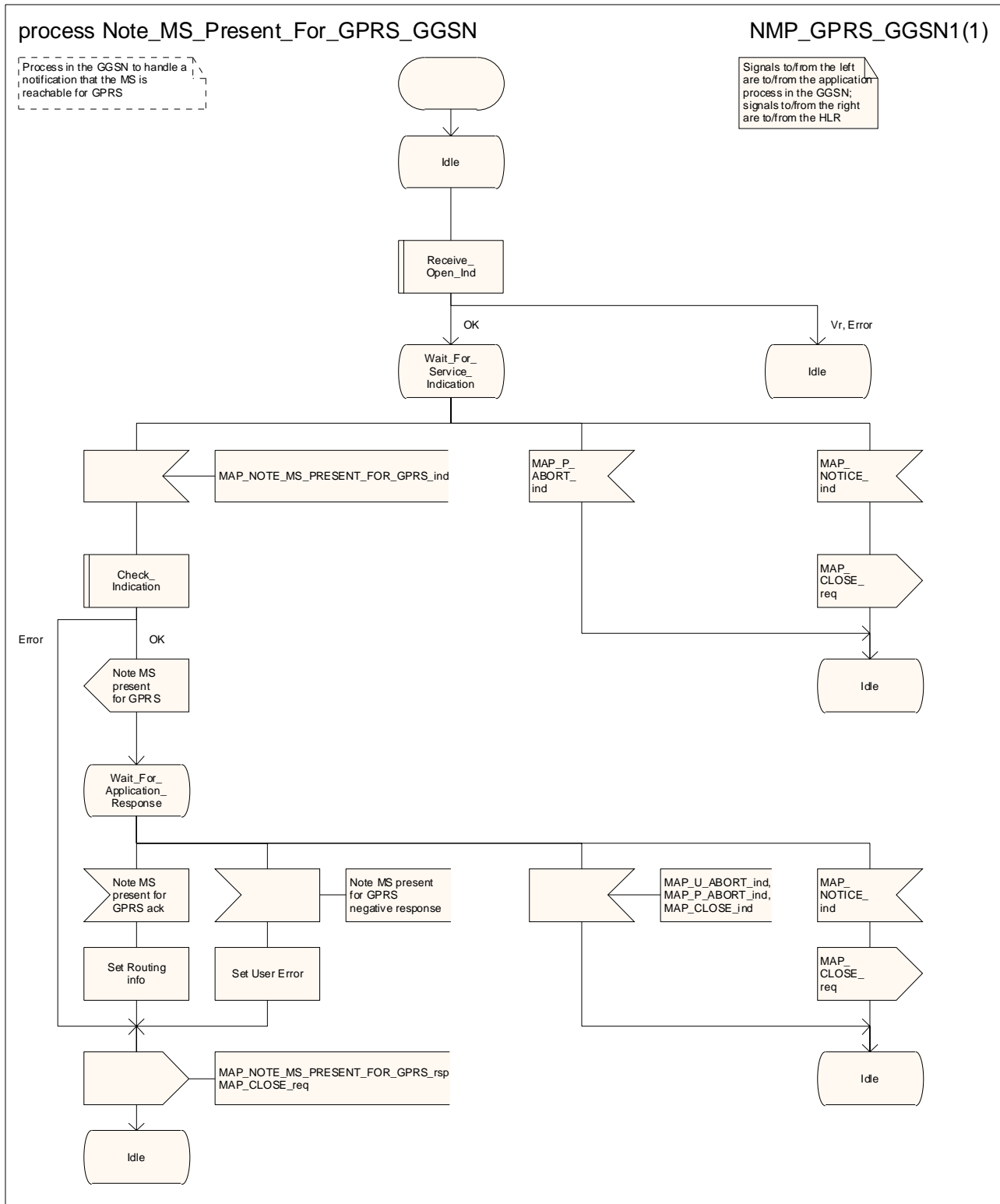

Figure 24.3/2: Process Note_MS_Present_For_GPRS_GGSN

24A CSE interrogation and control of subscriber data

24A.1 General

The MAP procedures for interrogation and control of subscriber data are used to allow the CSE:

- to retrieve subscriber data from the HLR;
- to modify subscriber data in the HLR;
- to receive notification from the HLR when there is a change in subscriber data;
- to request information about the location of a subscriber from the HLR or the GMLC;
- to request information about the state of a subscriber from the HLR.

The following application context refers to a complex MAP user consisting of several processes:

- anyTimeInfoHandlingContext

This application context needs a co-ordinating process in the HLR.

The MAP process invokes a macro not defined in this clause; the definition of this macro can be found as follows:

Receive_Open_Ind see subclause 25.1.1;

The Any Time Info Handling Co-ordinator process in the HLR is shown in figure 24A.1/1.

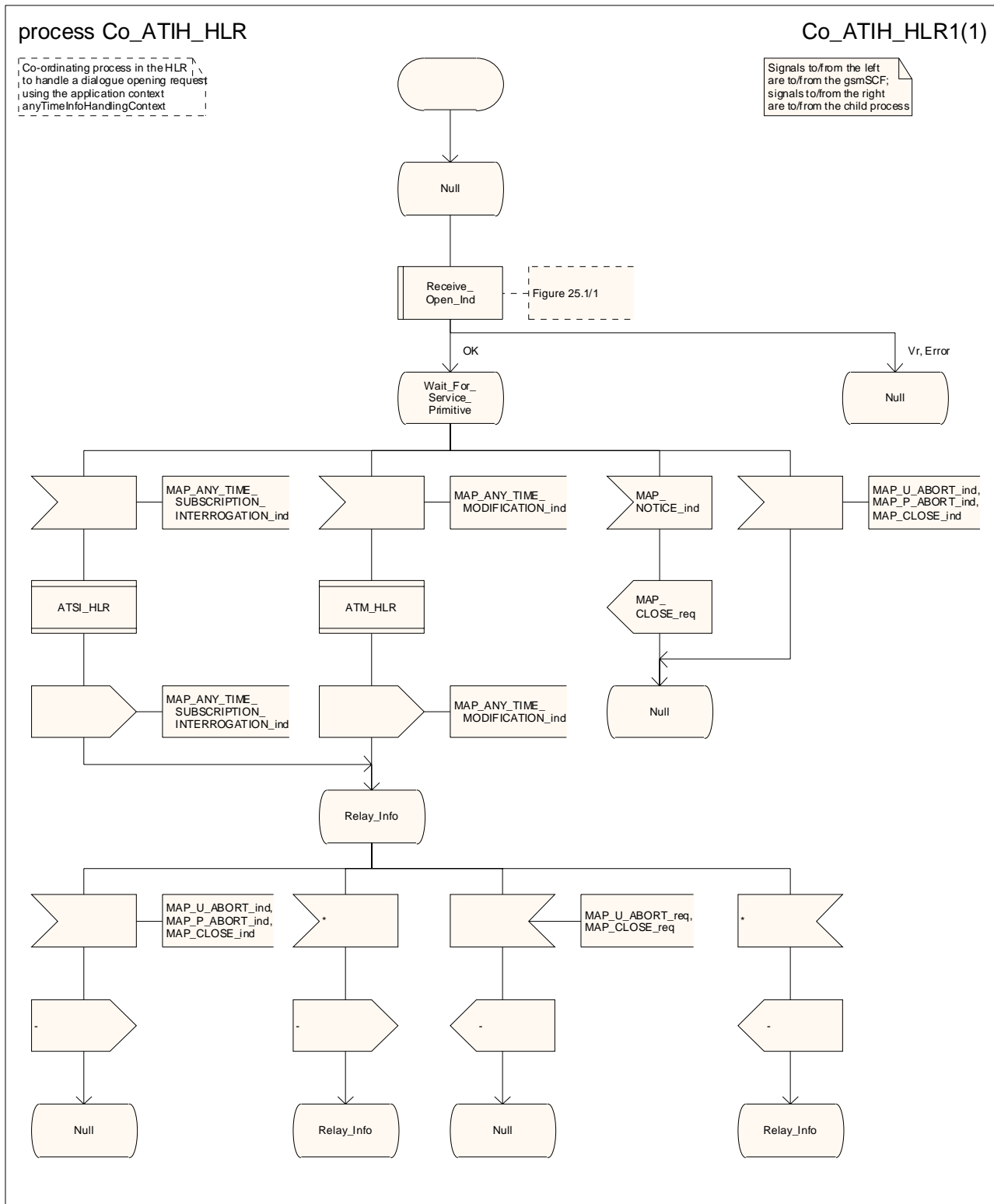

Figure 24A.1/1: Process Co_ATIH_HLR

24A.2 Any Time Subscription Interrogation procedure

24A.2.1 General

The message flow for successful retrieval of subscription information related to an any time subscription interrogation from the CAMEL server are shown in figure 24A.2/1. In an IP Multimedia Core Network, an IM-SSF can take on the role of a gsmSCF for this procedure (see 3GPP TS 23.278 [125]).

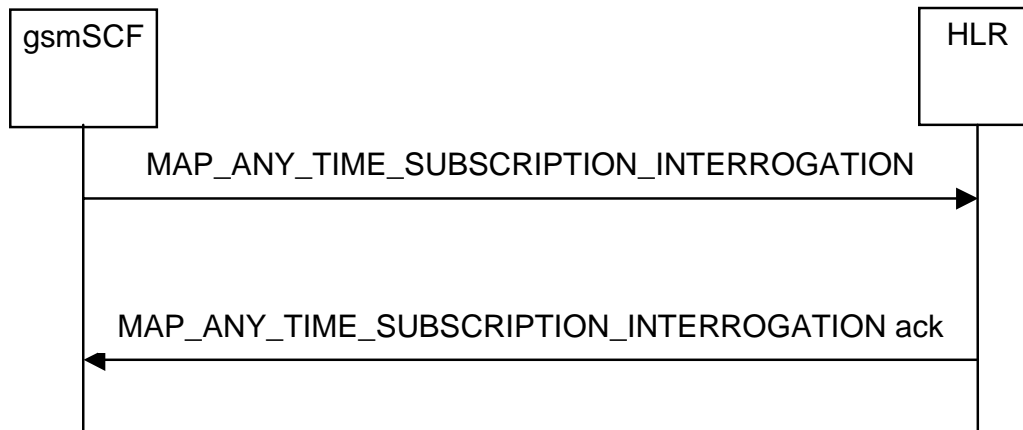

Figure 24A.2/1: Message flow for any time subscription interrogation

The following MAP service is used to retrieve the requested information:

MAP_ANY_TIME_SUBSCRIPTION_INTERROGATION see subclause 8.11.3.

24A.2.2 Process in the gsmSCF

The MAP process in the gsmSCF to obtain subscription information in response to a request from the application process in the gsmSCF is shown in figure 24A.2/2. The MAP process invokes macros not defined in this clause; the definitions of these macros can be found as follows:

Receive_Open_Cnf see subclause 25.1.2;

Check_Confirmation see subclause 25.2.2

24A.2.3 Process in the HLR

The MAP process in the HLR to provide subscription information in response to an interrogation from the CAMEL server is shown in figure 24A.2/3. The MAP process invokes a macro not defined in this clause; the definition of this macros can be found as follows:

Check_Indication see subclause 25.2.2

If the MAP_ANY_TIME_SUBSCRIPTION_INTERROGATION service response cannot be carried in a single TC-Result component, it is carried in one or more TC-Result-NL components (each sent in a TC-CONTINUE), followed by a TC-Result-L component in a TC-END message.

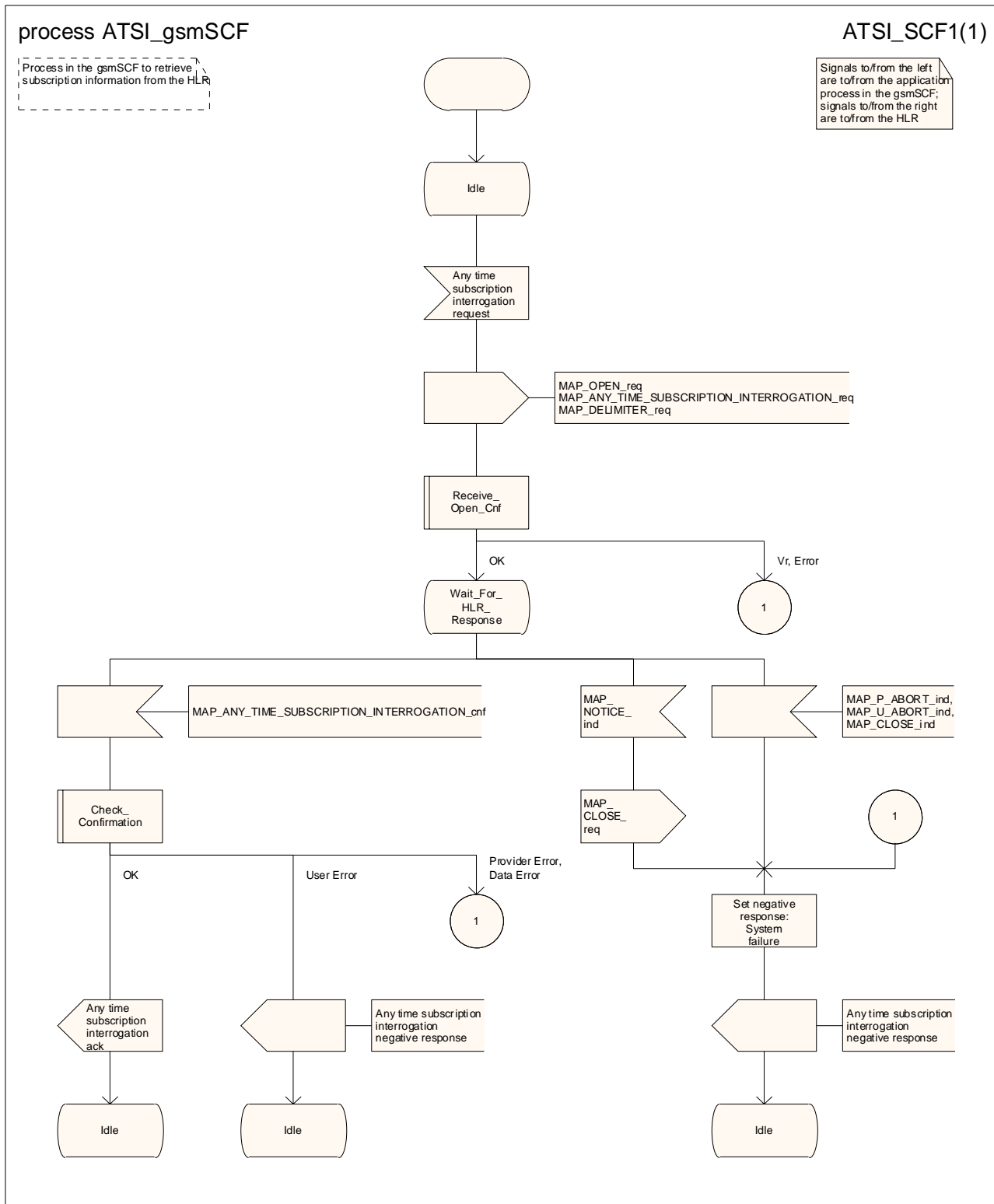

Figure 24A.2/2: Process ATSI_gsmSCF

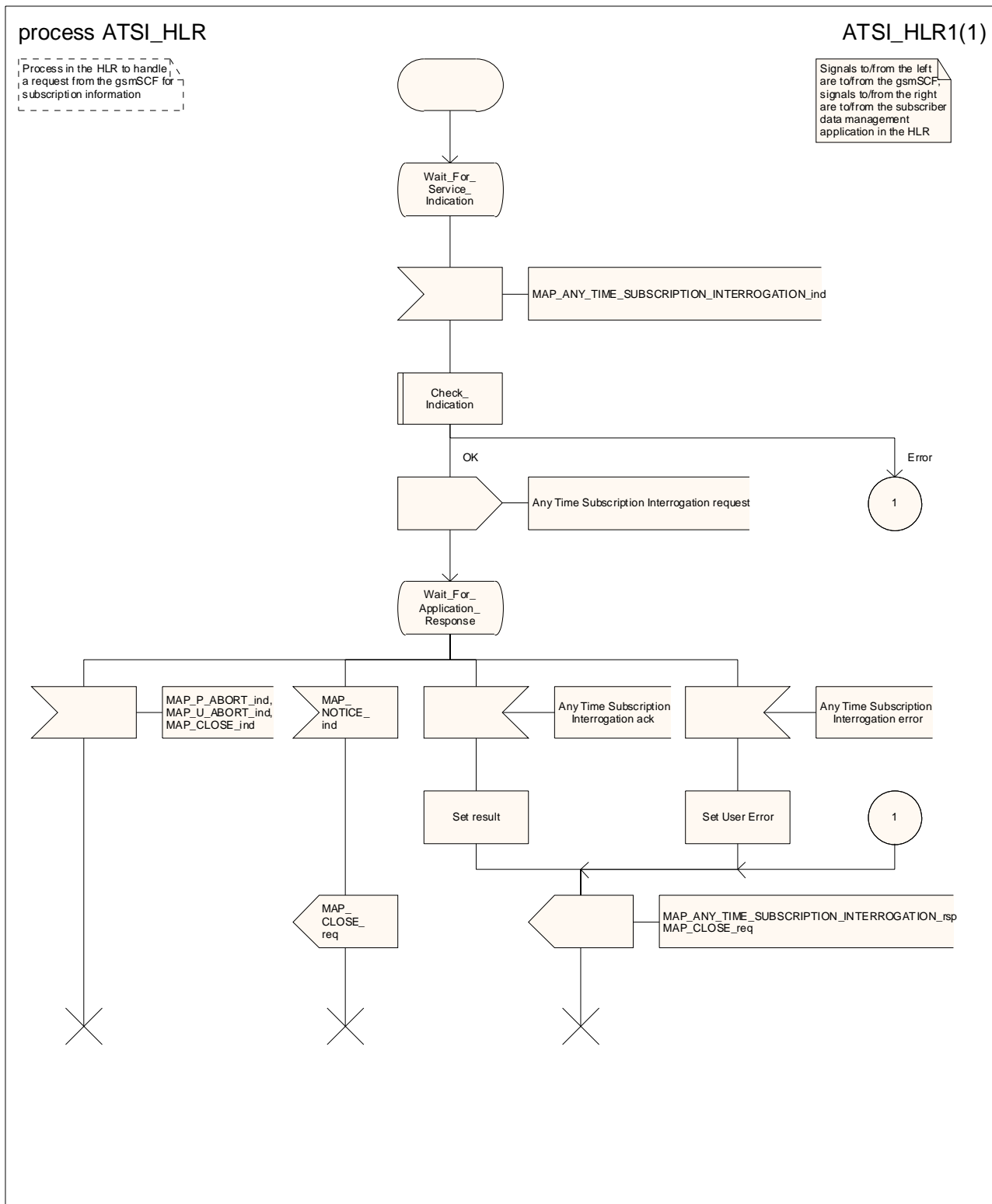

Figure 24A.2/3: Process ATSI_HLR

24A.3 Any Time Modification procedure

24A.3.1 General

The message flow for successful modification of subscription information related to an any time modification request from the CAMEL server is shown in figure 24A.3/1

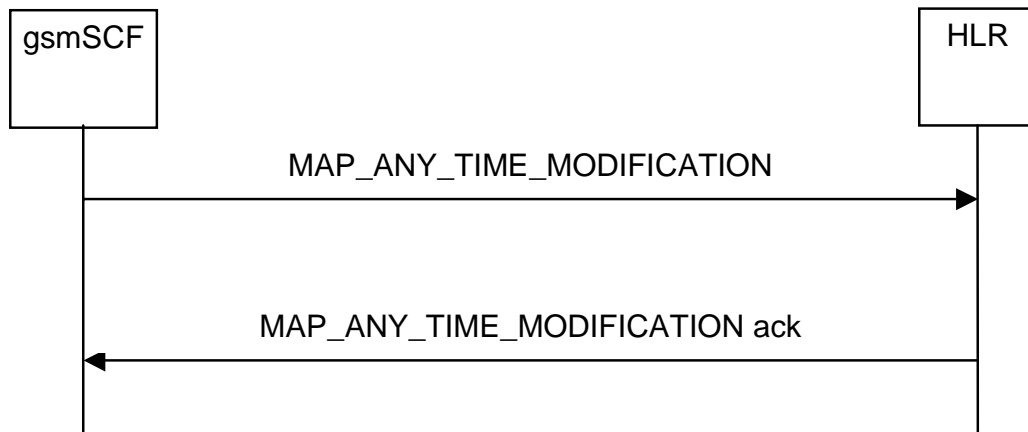

Figure 24A.3/1: Message flow for any time modification

The following MAP service is used to modify subscription information:

MAP_ANY_TIME_MODIFICATION see subclause 8.11.4.

24A.3.2 Process in the gsmSCF

The MAP process in the gsmSCF to modify subscription information in response to a request from the application process in the gsmSCF is shown in figure 24A.3/2. The MAP process invokes macros not defined in this clause; the definitions of these macros can be found as follows:

Receive_Open_Cnf see subclause 25.1.2;

Check_Confirmation see subclause 25.2.2

24A.3.3 Process in the HLR

The MAP process in the HLR to modify subscriber information in response to a modification request from the CAMEL server is shown in figure 24A.3/3. The MAP process invokes a macro and a process not defined in this clause; the definitions of the macro and process can be found as follows:

Check_Indication see subclause 25.2.2;

Insert_Subs_Data_Stand_Alone_HLR see subclause 25.7.3;

If the MAP_ANY_TIME_MODIFICATION service response cannot be carried in a single TC-Result component, it is carried in one or more TC-Result-NL components (each sent in a TC-CONTINUE), followed by a TC-Result-L component in a TC-END message.

If the serving node (VLR or SGSN) is to be updated after the modification, the MAP process creates an instance of the appropriate process (Insert_Subs_Data_Stand_Alone_HLR for VLR update, Insert_GPRS_Subs_Data_Stand_Alone_HLR for SGSN update).

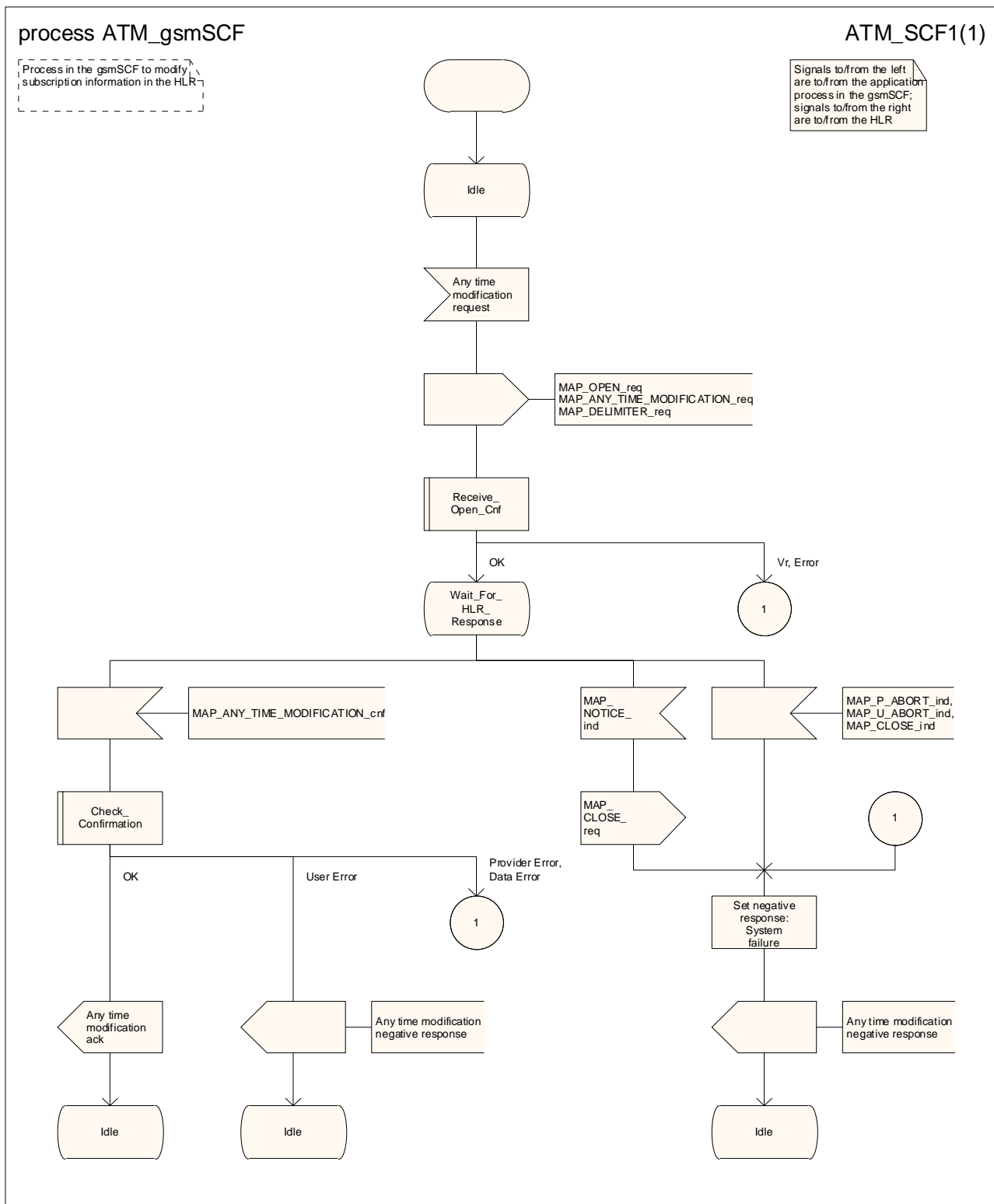

Figure 24A.3/2: Process ATM_gsmSCF

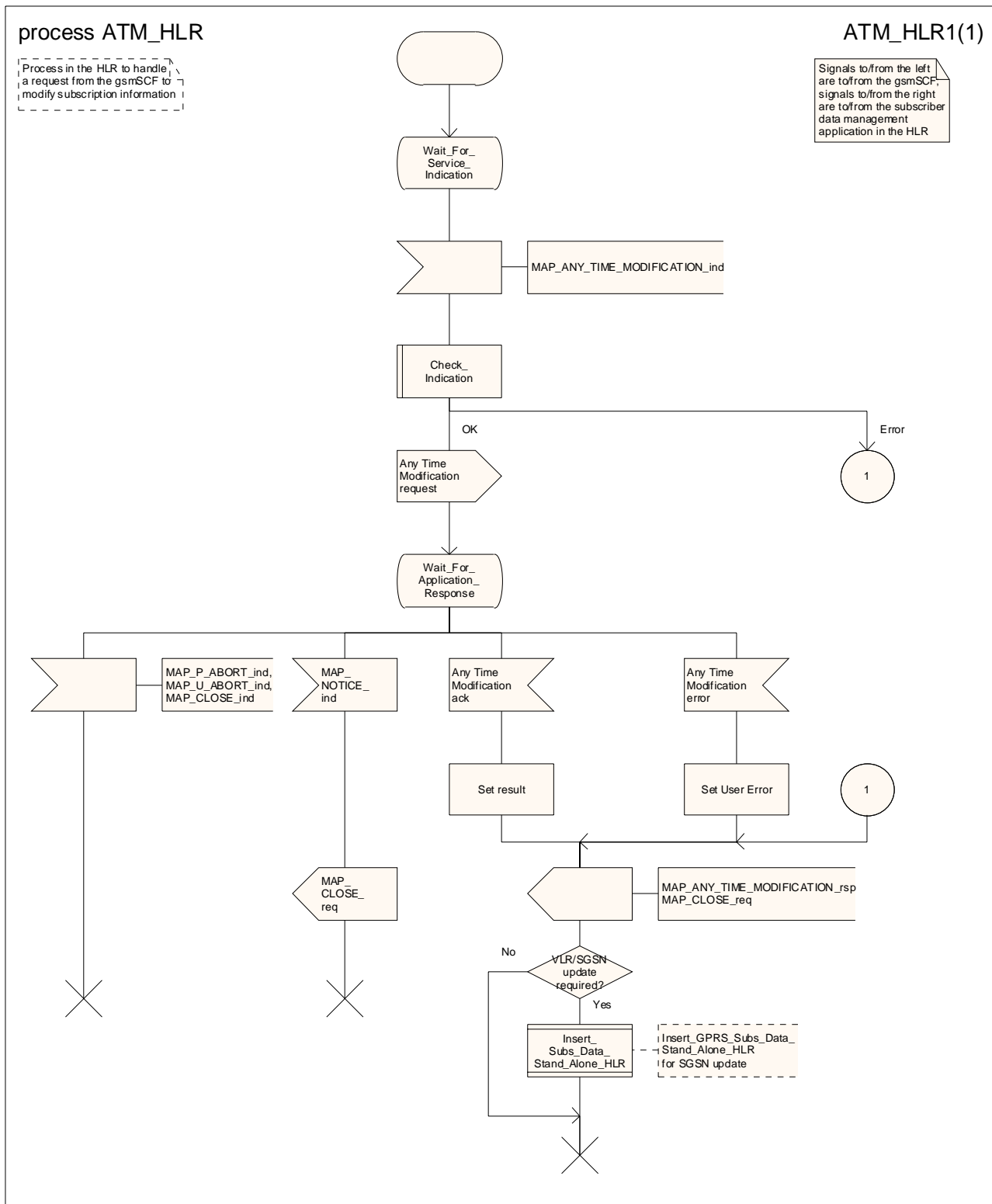

Figure 24A.3/3: Process ATM_HLR

24A.4 Subscriber Data Modification Notification procedure

24A.4.1 General

The Subscriber Data Modification Notification procedure is used to notify a gsmSCF about the modification of subscriber data. In an IP Multimedia Core Network, an IM-SSF can take on the role of a gsmSCF for this procedure.

The stage 2 specification for Subscriber Data Modification Notification is in 3GPP TS 23.078 [98] and 3GPP TS 23.278 [125]. The interworking between the MAP signalling procedures and the Subscriber Data Modification Notification procedures for each entity (HLR, gsmSCF) is shown by the transfer of signals between these processes.

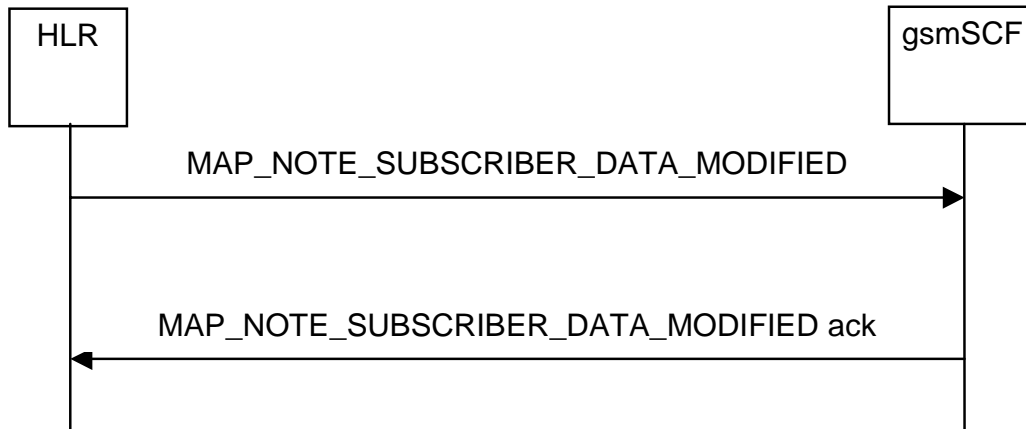

Figure 24A.4/1: Message flow for subscriber data modification notification

The following MAP service is used to send the notification to the gsmSCF:

MAP_NOTE_SUBSCRIBER_DATA_MODIFIED see subclause 8.11.5.

24A.4.2 Process in the HLR

The MAP process in the HLR to send modified data to the gsmSCF is shown in figure 24A.4/2. The MAP process invokes macros not defined in this clause; the definitions of these macros can be found as follows:

Receive_Open_Cnf see subclause 25.1.2;

Check_Confirmation see subclause 25.2.2.

If the required information cannot be carried in a single MAP_NOTE_SUBSCRIBER_DATA_MODIFIED service request, the HLR segments the information into two or more requests. The "All Information Sent" parameter is omitted from each request except the last.

Sheet 2: If the MAP_NOTE_SUBSCRIBER_DATA_MODIFIED service request contained the "All Information Sent" parameter, the test "All information sent" takes the "Yes" exit.

24A.4.3. Process in the gsmSCF

The MAP process in the gsmSCF to handle a notification to the gsmSCF of change of subscriber data is shown in figure 24A.4/3. The MAP process invokes macros not defined in this clause; the definitions of these macros can be found as follows:

Receive_Open_Ind see subclause 25.1.1;

Check_Indication see subclause 25.2.1

If the MAP_NOTE_SUBSCRIBER_DATA_MODIFIED service indication contained the "All Information Sent" parameter, the test "All information sent" takes the "Yes" exit.

If the test "All information sent" takes the "No" exit, the MAP process stores the data received in the MAP_NOTE_SUBSCRIBER_DATA_MODIFIED service indication. If the test "All information sent" takes the "Yes" exit, the MAP process assembles the data received in all the MAP_NOTE_SUBSCRIBER_DATA_MODIFIED service indications received in the dialogue and sends the assembled data to the application process in the gsmSCF.

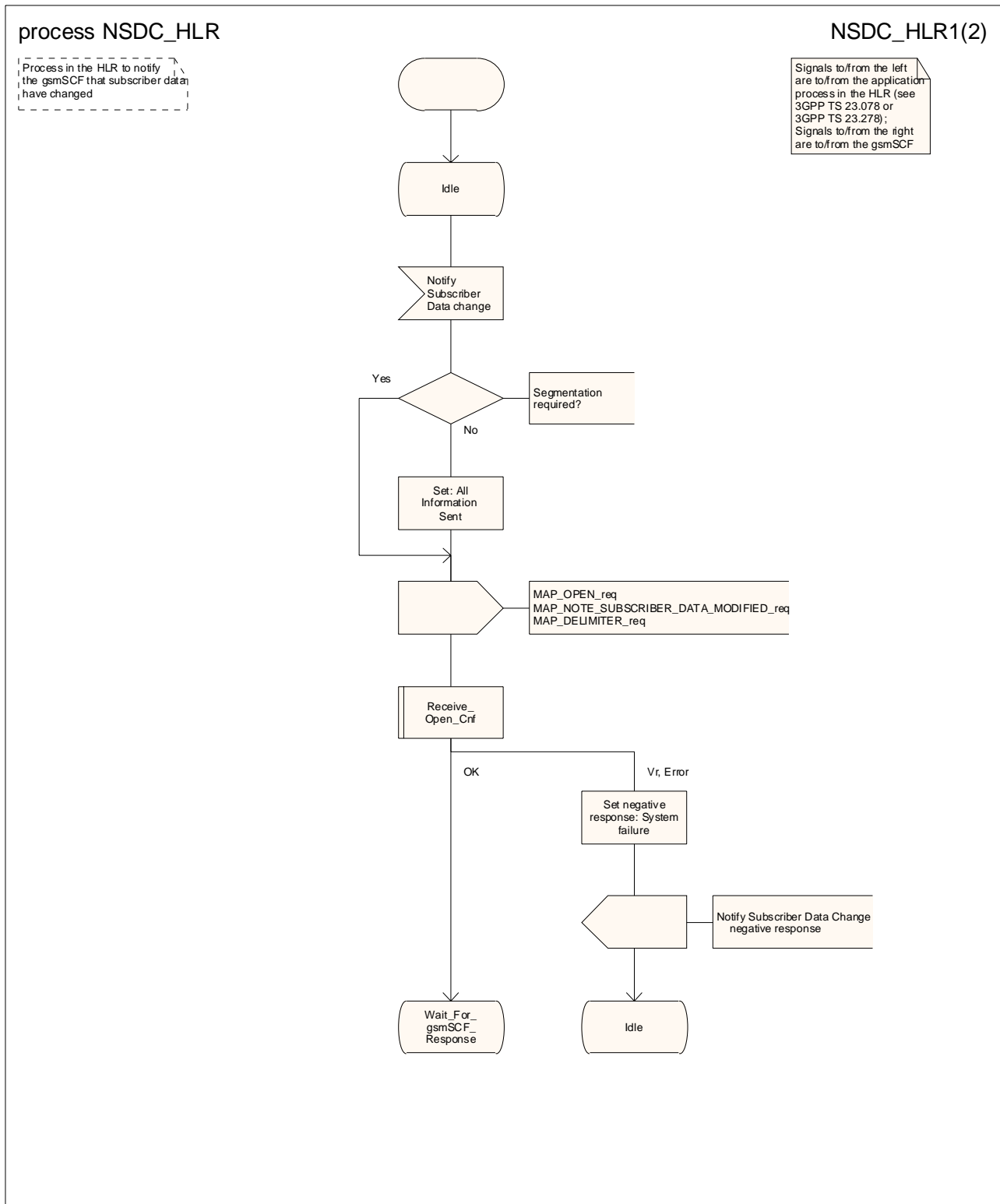

Figure 24A.4/2 (sheet 1 of 2): Process NSDC_HLR

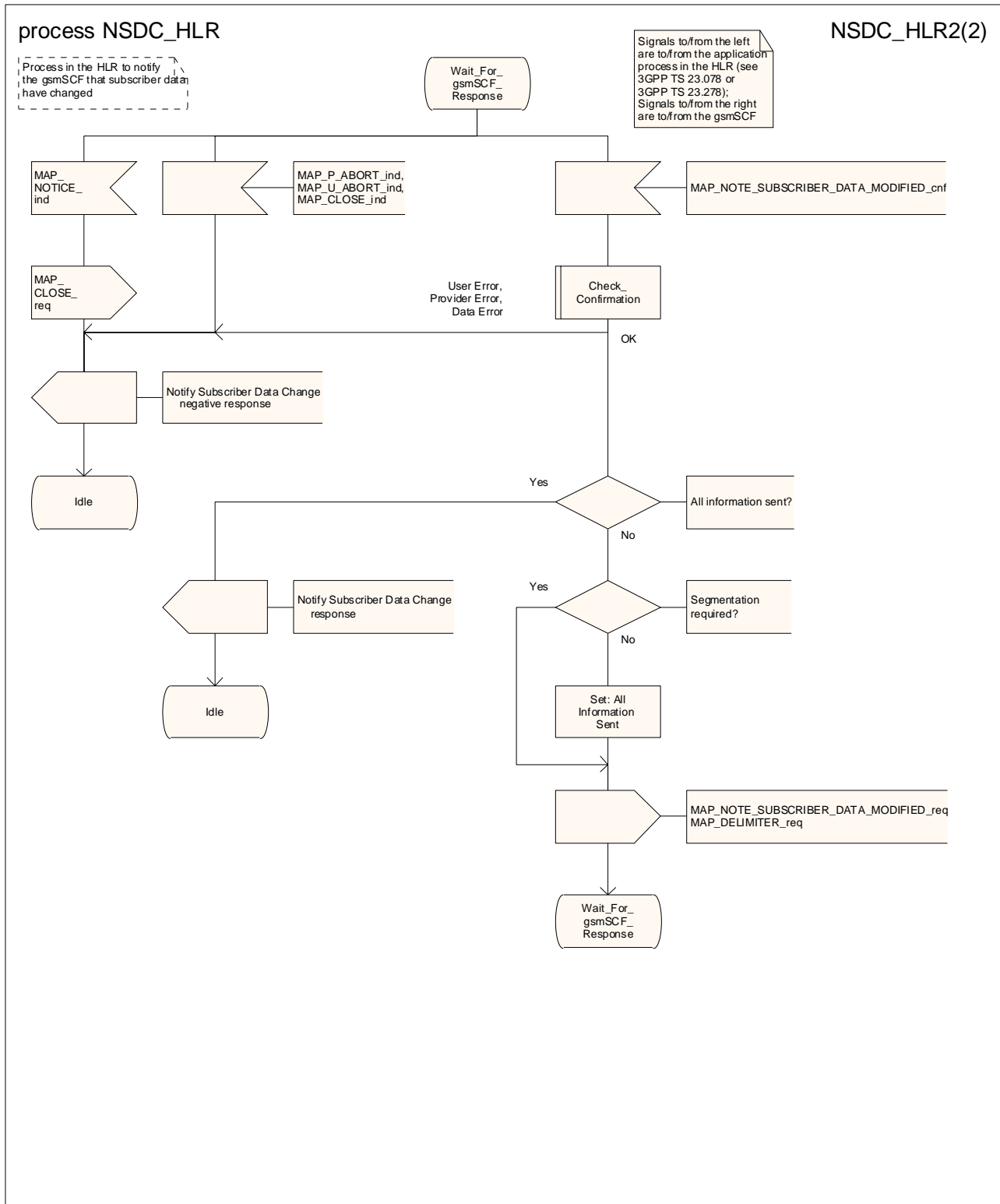

Figure 24A.4/2 (sheet 2 of 2): Process NSDC_HLR

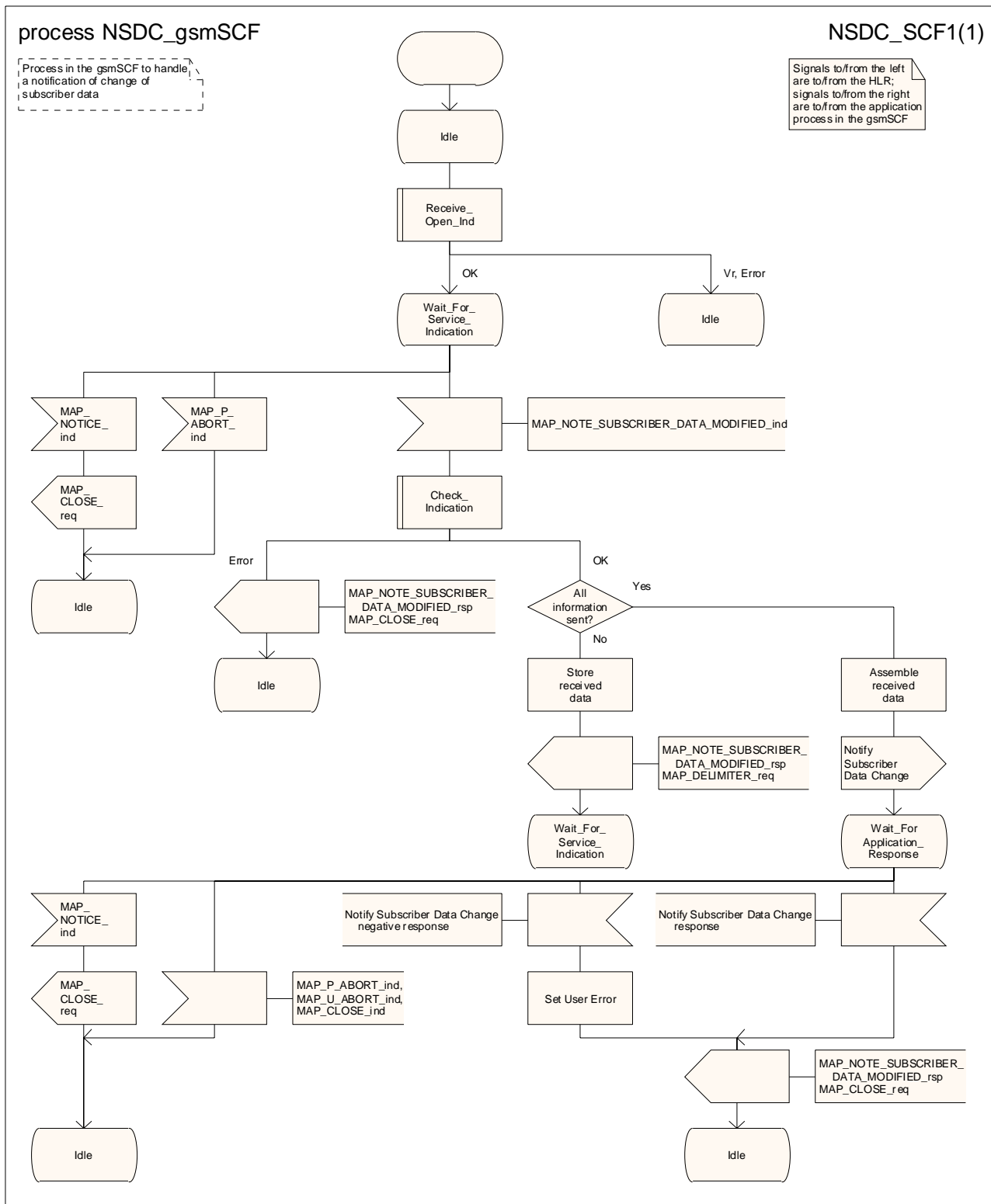
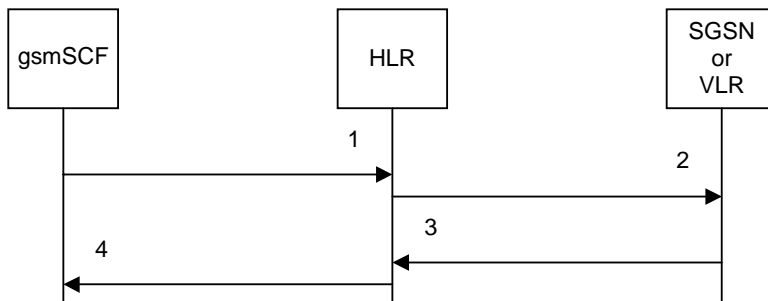

Figure 24A.4/3: Process NSDC_gsmSCF

24A.5 Any Time Interrogation procedure

The message flows for successful retrieval of subscriber information related to an any time interrogation from the CAMEL server are shown in figure 24A.5/1 for interrogation directed to an HLR and figure 24A.5/2 for interrogation directed to a GMLC.



- 1) MAP_ANY_TIME_INTERROGATION_req/ind
- 2) MAP_PROVIDE_SUBSCRIBER_INFO_req/ind
- 3) MAP_PROVIDE_SUBSCRIBER_INFO_rsp/cnf
- 4) MAP_ANY_TIME_INTERROGATION_rsp/cnf

Figure 24A.5/1: Message flow for any time interrogation (gsmSCF to HLR)

The following MAP services are used to retrieve information about the status and/or location of a subscriber:

MAP_ANY_TIME_INTERROGATION see subclause 8.11.1;

MAP_PROVIDE_SUBSCRIBER_INFO see subclause 8.11.2.

The HLR sends the MAP_PROVIDE_SUBSCRIBER_INFO request to the SGSN or the VLR, according to the domain for which the gsmSCF requested the information.

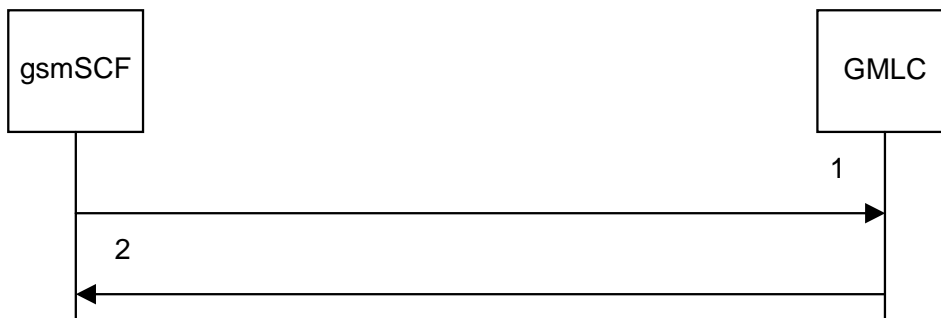

- 1) MAP_ANY_TIME_INTERROGATION_req/ind
- 2) MAP_ANY_TIME_INTERROGATION_rsp/cnf

Figure 24A.5/2: Message flow for any time interrogation (gsmSCF to GMLC)

The following MAP service is used to retrieve location information from a GMLC:

MAP_ANY_TIME_INTERROGATION see subclause 8.11.1;

In addition, the GMLC may use MAP Services specific to Location Services.

24A.5.2 Procedure in the gsmSCF

The process in the gsmSCF to request information about the location and/or state of a subscriber from the HLR is shown in figure 24A.5/3. The MAP process invokes macros not defined in this clause; the definitions of these macros can be found as follows:

Receive_Open_Cnf see subclause 25.1.2;

Check_Confirmation see subclause 25.2.2.

The process in the gsmSCF to request location information from the GMLC is shown in figure 24A.5/4. The MAP process invokes macros not defined in this clause; the definitions of these macros can be found as follows:

Receive_Open_Cnf see subclause 25.1.2;

Check_Confirmation see subclause 25.2.2.

24A.5/3 Procedure in the HLR

The MAP process in the HLR to provide subscriber information in response to an interrogation from the CAMEL server is shown in figure 24A.5/5. The MAP process invokes macros not defined in this clause; the definitions of these macros can be found as follows:

Receive_Open_Ind see subclause 25.1.1;

Receive_Open_Cnf see subclause 25.1.2;

Check_Confirmation see subclause 25.2.2.

24A.5.4 Procedure in the GMLC

The MAP process in the GMLC to provide location information in response to a request from the gsmSCF is shown in figure 24A.5/6. The MAP process invokes a macro not defined in this clause; the definition of this macro can be found as follows:

Receive_Open_Ind see subclause 25.1.1.

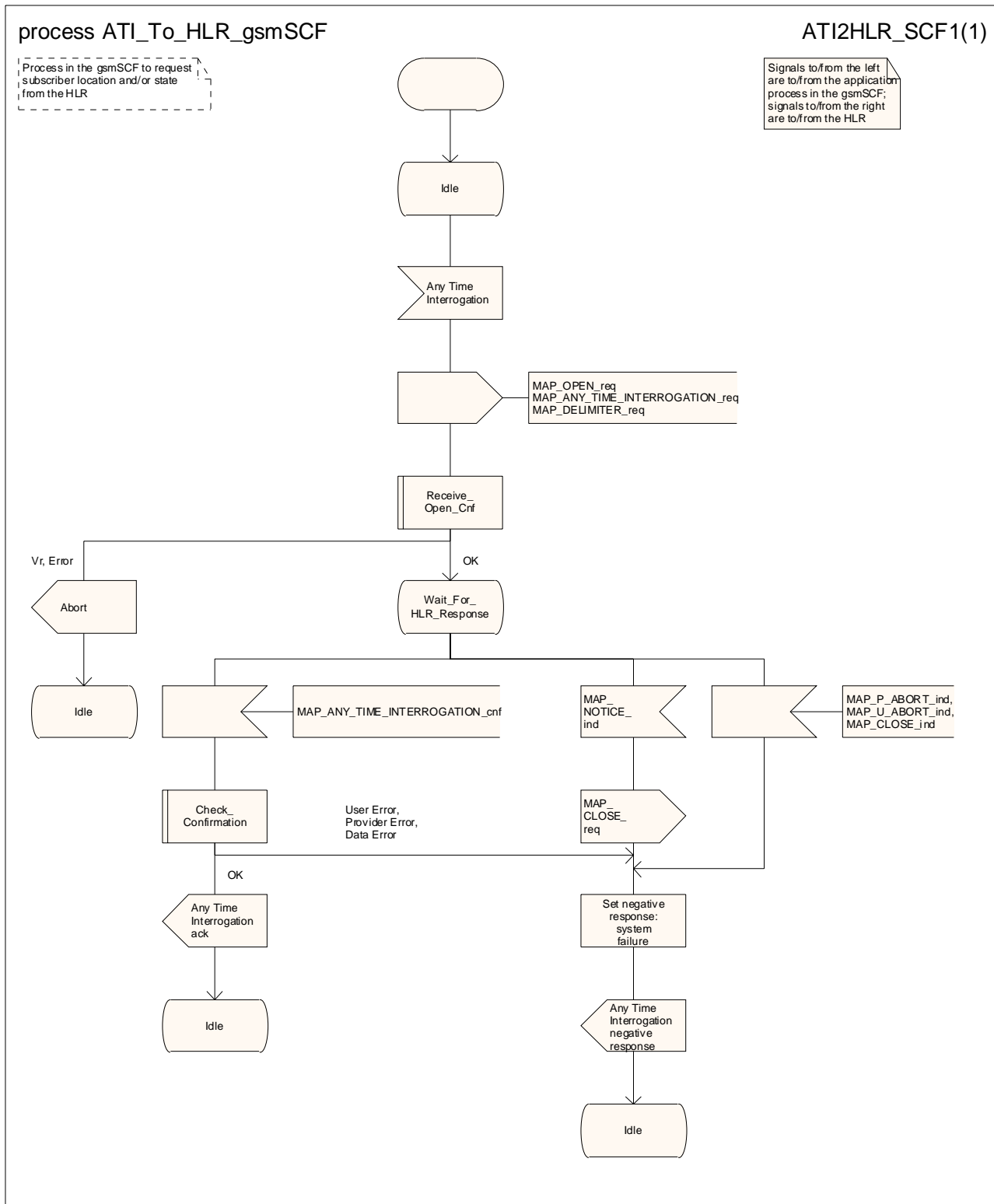

Figure 24A.5/3: Process ATI_To_HLR_gsmSCF

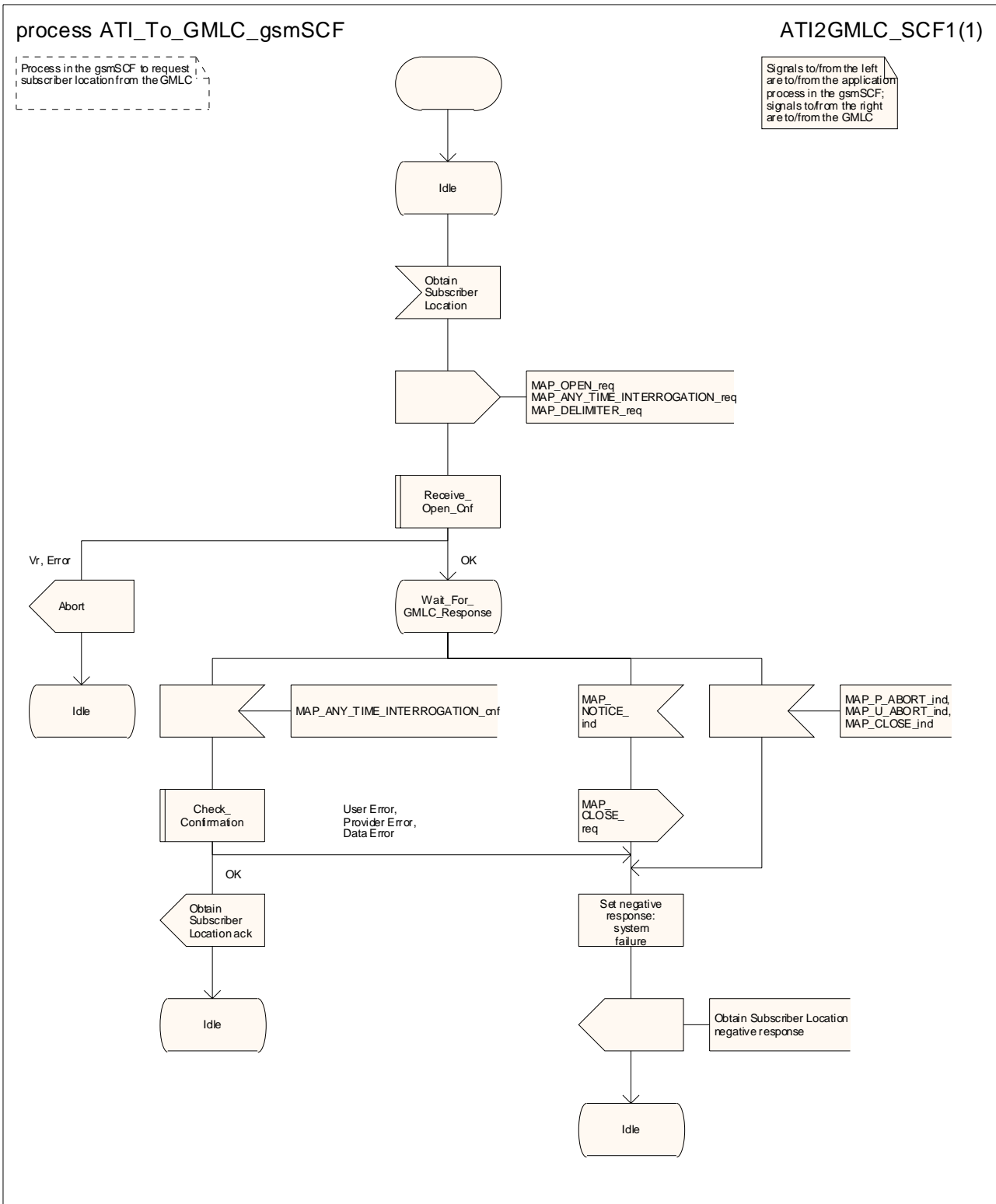

Figure 24A.5/4: Process ATI_To_GMLC_gsmSCF

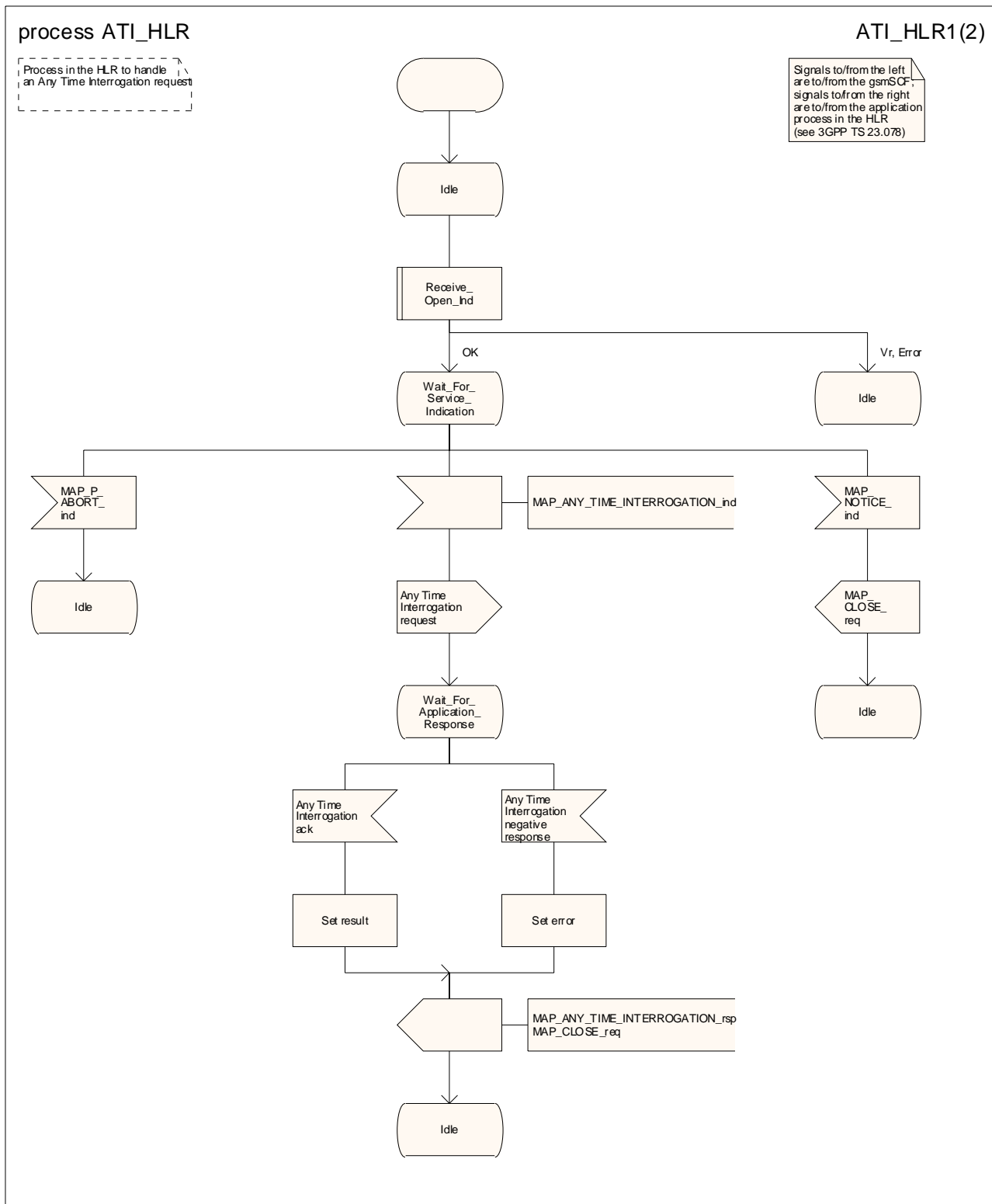

Figure 24A.5/5 (sheet 1 of 2): Process ATI_HLR

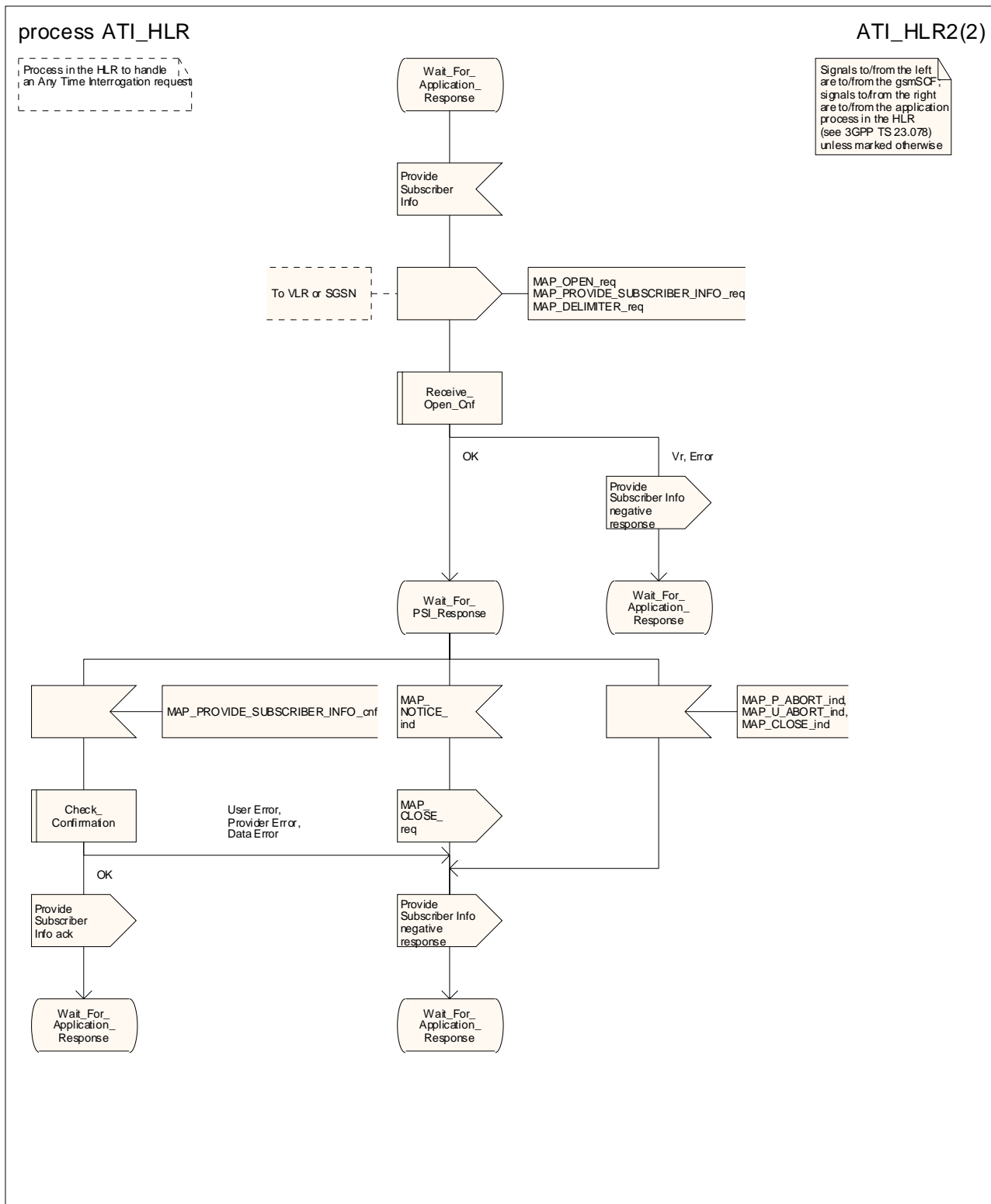

Figure 24A.5/5 (sheet 2 of 2): Process ATI_HLR

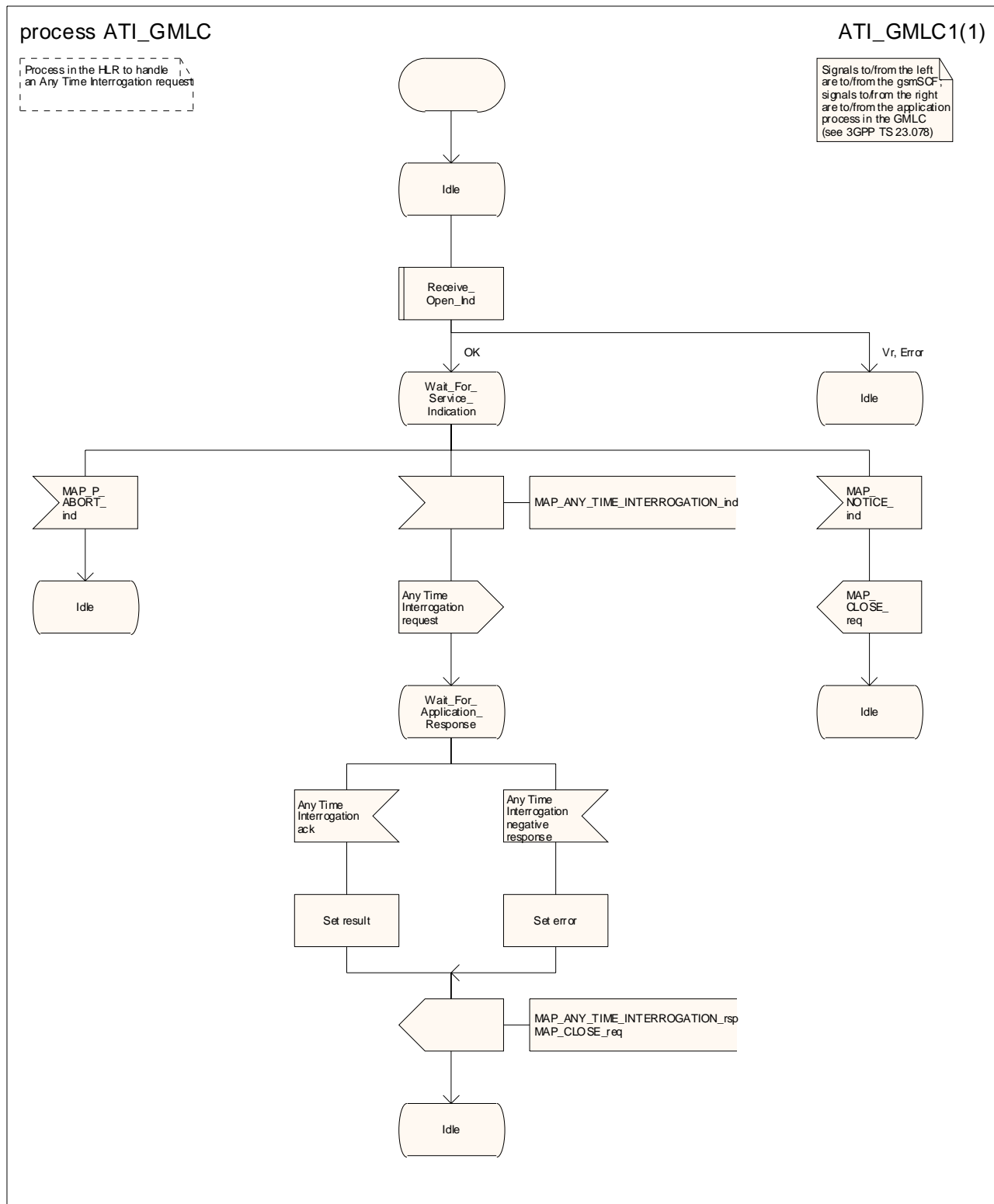

Figure 24A.5/6: Process ATI_GMLC

24B Location Services process description

24B.1 Routeing information retrieval procedure for LCS

24B.1.1 General

The message flow for successful retrieval of routeing information related to location services is shown in figure 24B.1/1.

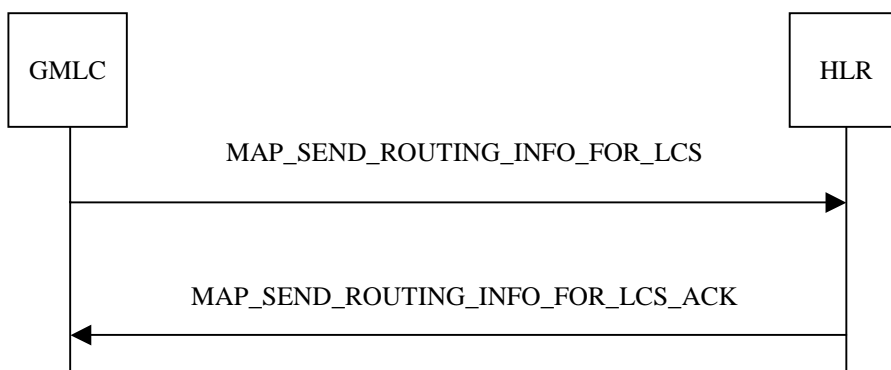

Figure 24B.1/1: Message flow for retrieval of routeing information for LCS

The following MAP service is used to retrieve routeing information:

MAP_SEND_ROUTING_INFO_FOR_LCS see subclause 13A.1.

24B.1.2 Process in the GMLC

The MAP process in the GMLC to request routeing information for LCS is shown in figure 24B.1/2. The MAP process invokes macros not defined in this clause; the definitions of these macros can be found as follows:

Receive_Open_Cnf see subclause 25.1.2;

Check_Confirmation see subclause 25.2.2.

24B.1.3 Process in the HLR

The MAP process in the HLR to handle a request for routeing information for LCS is shown in figure 24B.1/3. The MAP process invokes macros not defined in this clause; the definitions of these macros can be found as follows:

Receive_Open_Ind see subclause 25.1.1;

Check_Indication see subclause 25.2.1.

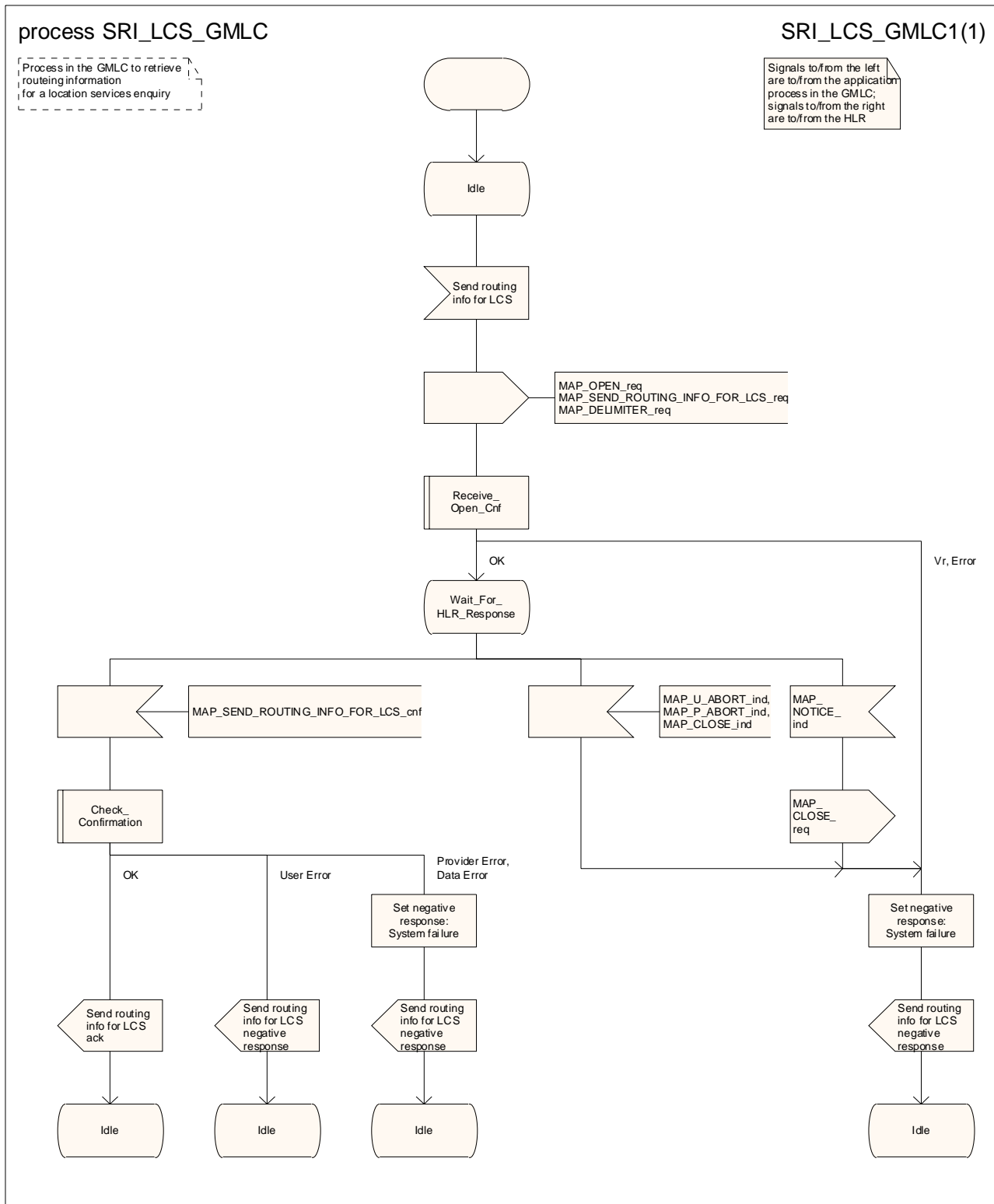

Figure 24B.1/2: Process SRI_LCS_GMLC

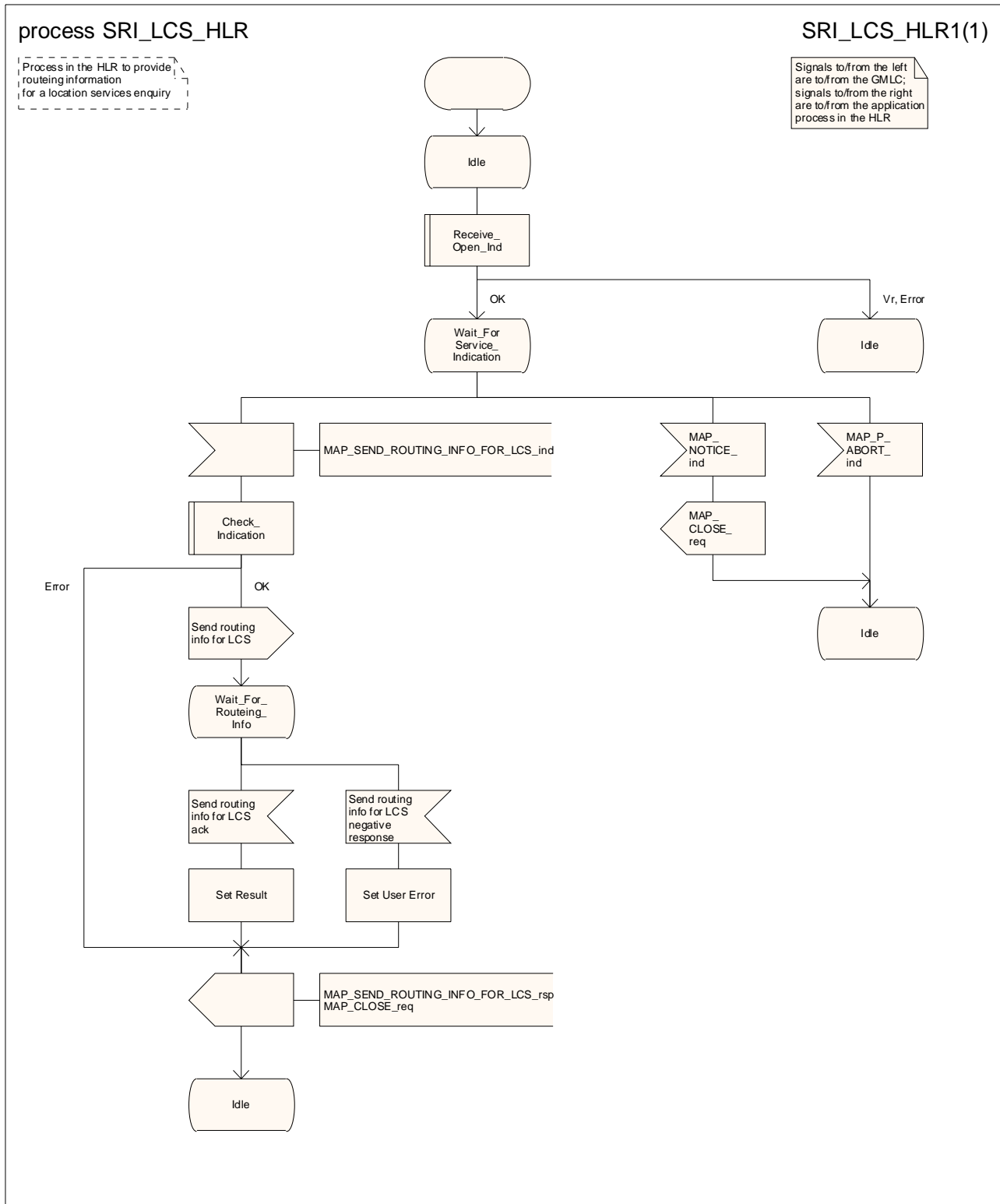

Figure 24B.1/3: Process SRI_LCS_HLR

24B.2 Provide Subscriber Location procedure

24B.2.1 General

The message flow for successful retrieval of the location information of a target MS related to location services is shown in figure 24B.1/1.

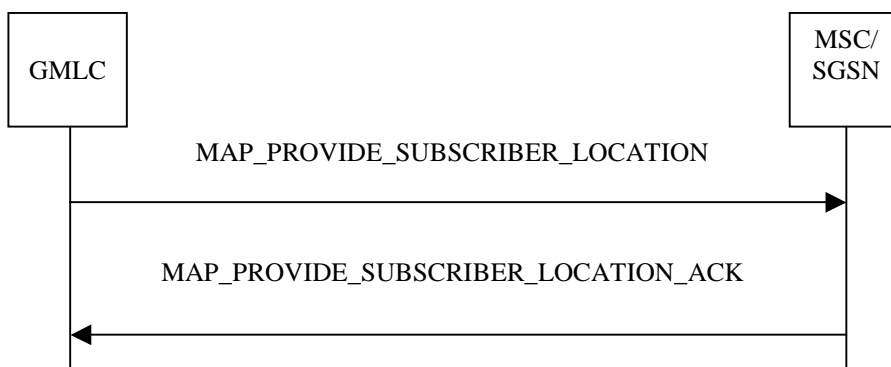

Figure 24B.2/1: Message flow for retrieval of location information

The following MAP service is used to retrieve location information:

MAP_PROVIDE_SUBSCRIBER_LOCATION see subclause 13A.2.

24B.2.2 Process in the GMLC

The MAP process in the GMLC to request location information from an MSC or an SGSN is shown in figure 24B.2/2. The MAP process invokes macros not defined in this clause; the definitions of these macros can be found as follows:

Receive_Open_Cnf see subclause 25.1.2;

Check_Confirmation see subclause 25.2.2.

24B.2.3 Process in the MSC

The MAP process in the MSC to handle a request for location information from a GMLC is shown in figure 24B.2/3. The MAP process invokes macros not defined in this clause; the definitions of these macros can be found as follows:

Receive_Open_Ind see subclause 25.1.1;

Check_Indication see subclause 25.2.1.

24B.2.4 Process in the SGSN

The MAP process in the SGSN to handle a request for location information from a GMLC is shown in figure 24B.2/4. The MAP process invokes macros not defined in this clause; the definitions of these macros can be found as follows:

Receive_Open_Ind see subclause 25.1.1;

Check_Indication see subclause 25.2.1.

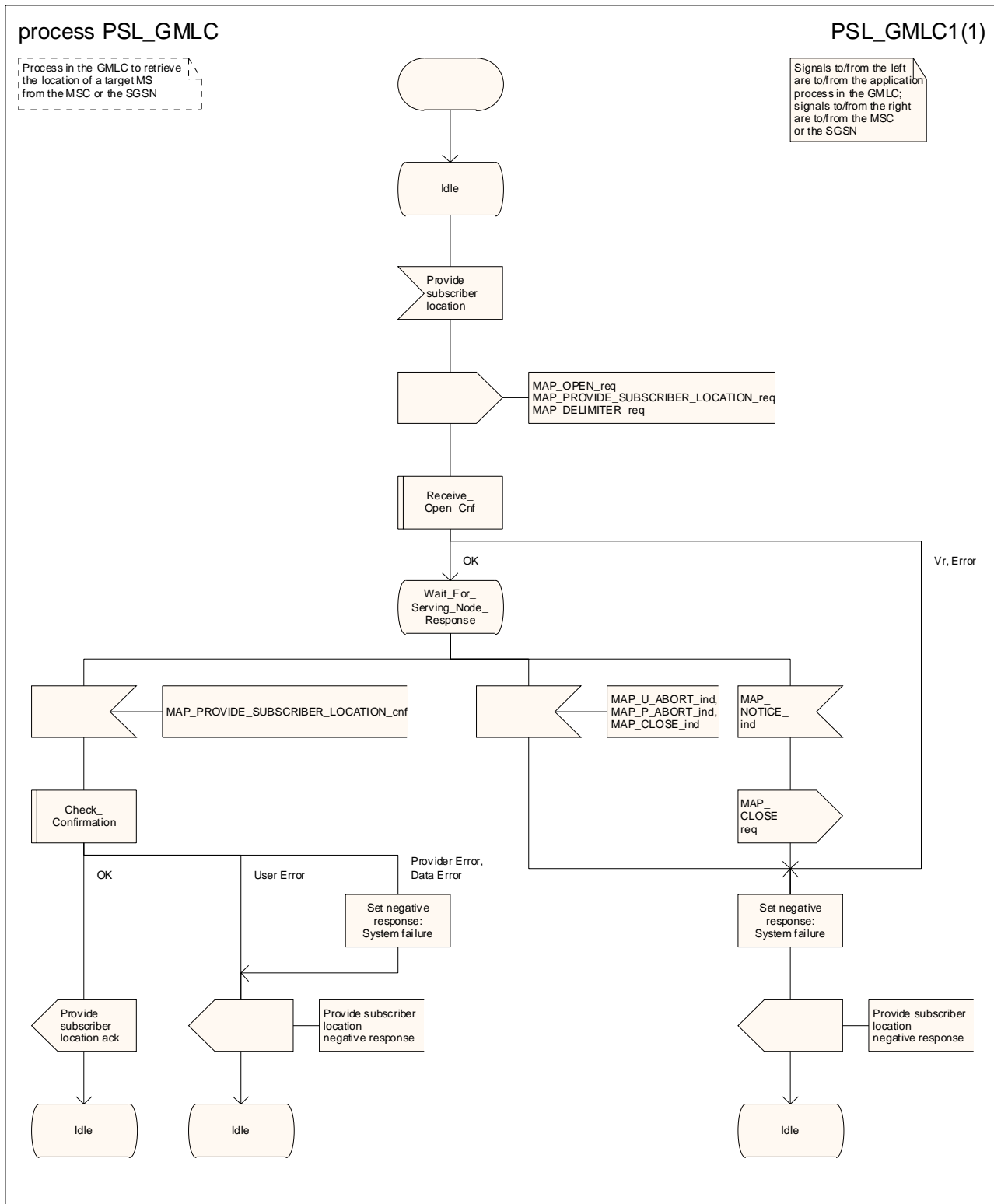

Figure 24B.2/2: Process PSL_GMLC

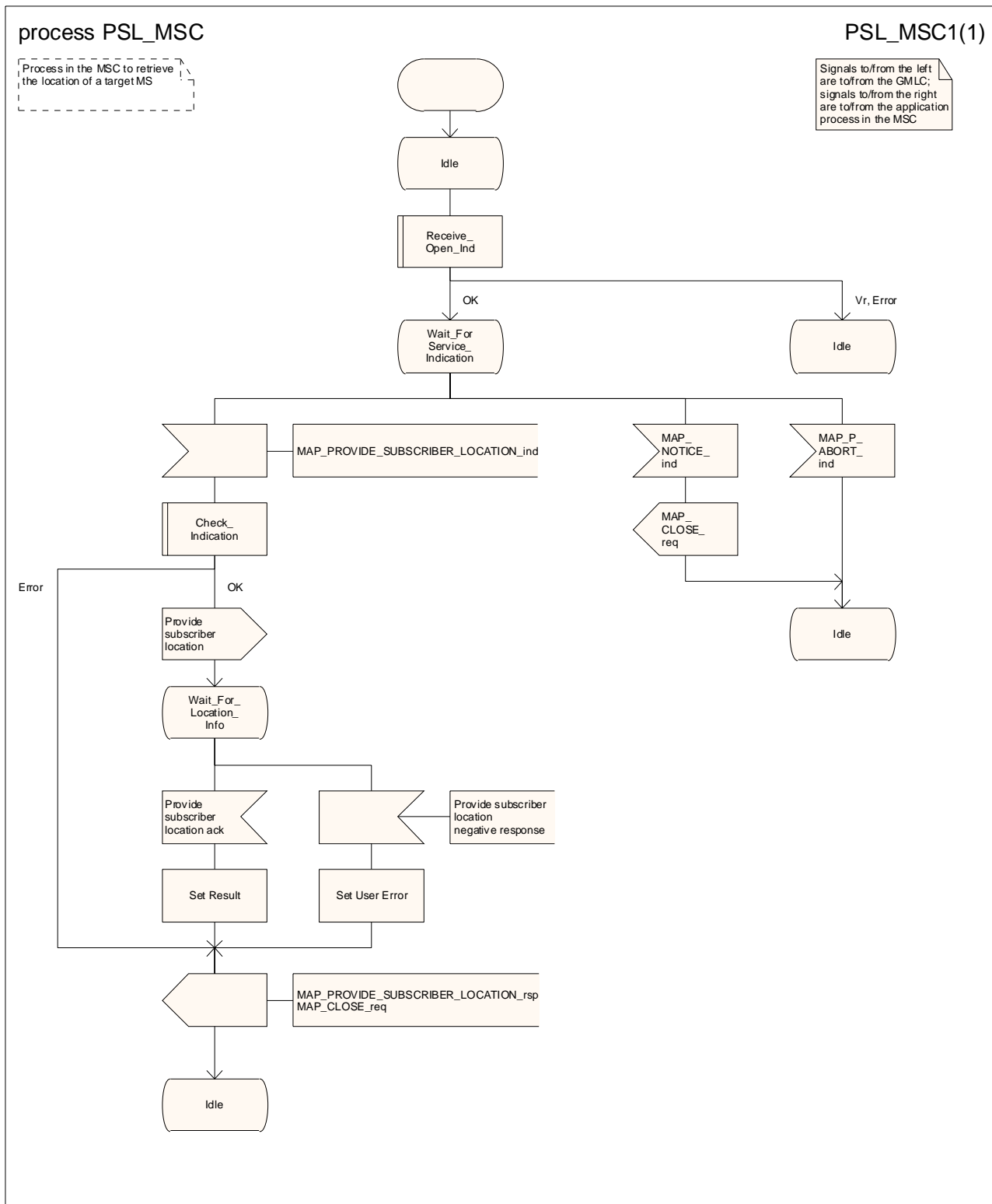

Figure 24B.2/3: Process PSL_MSC

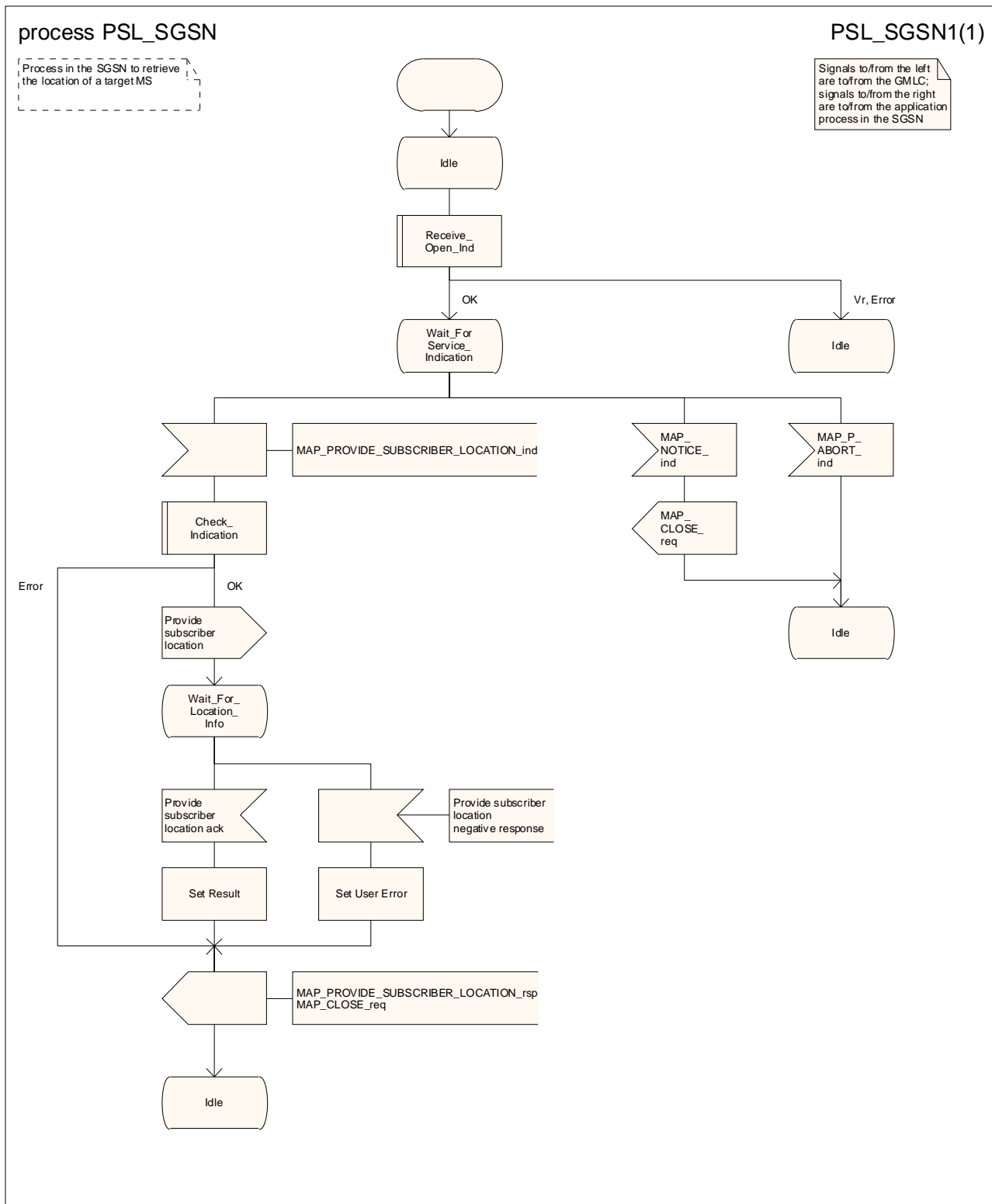

Figure 24B.2/4: Process PSL_SGSN

24B.3 Subscriber Location Report procedure

24B.3.1 General

The message flow for successful report of the location information of a target MS related to location services is shown in figure 24B.3/1.

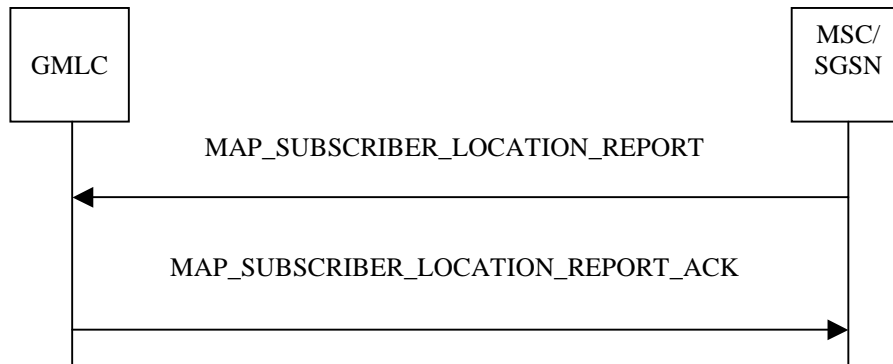

Figure 24B.3/1: Message flow for report of location information

The following MAP service is used to report location information:

MAP_SUBSCRIBER_LOCATION_REPORT see subclause 13A.3.

24B.3.2 Process in the MSC

The MAP process in the MSC to send a subscriber location report to the GMLC is shown in figure 24B.3/2. The MAP process invokes macros not defined in this clause; the definitions of these macros can be found as follows:

Receive_Open_Cnf see subclause 25.1.2;

Check_Confirmation see subclause 25.2.2.

24B.3.3 Process in the SGSN

The MAP process in the SGSN to send a subscriber location report to the GMLC is shown in figure 24B.3/3. The MAP process invokes macros not defined in this clause; the definitions of these macros can be found as follows:

Receive_Open_Cnf see subclause 25.1.2;

Check_Confirmation see subclause 25.2.2.

24B.3.4 Process in the GMLC

The MAP process in the GMLC to handle a subscriber location report is shown in figure 24B.3/4. The MAP process invokes macros not defined in this clause; the definitions of these macros can be found as follows:

Receive_Open_Ind see subclause 25.1.1;

Check_Indication see subclause 25.2.1.

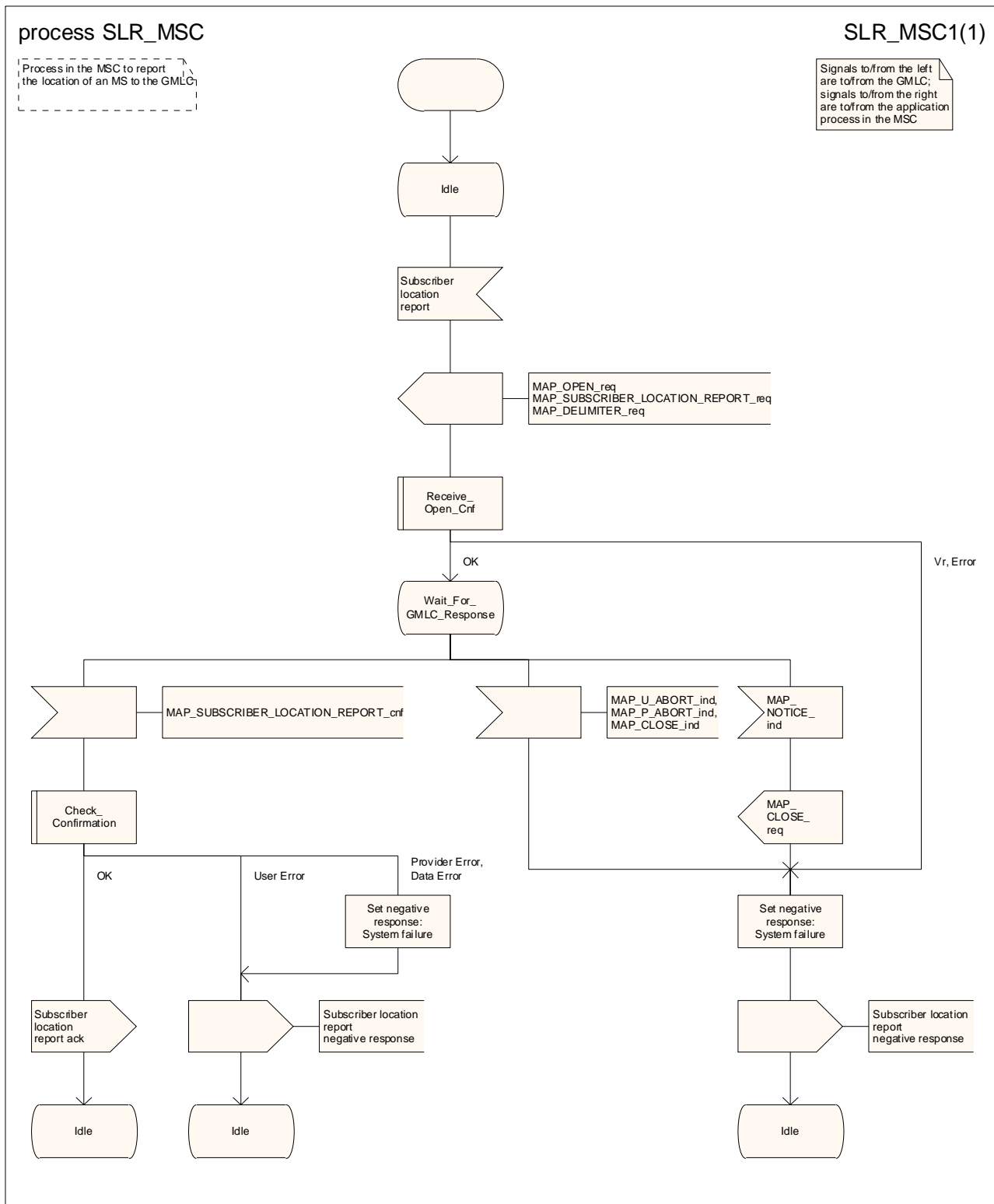

Figure 24B.3/2: Process SLR_MSC

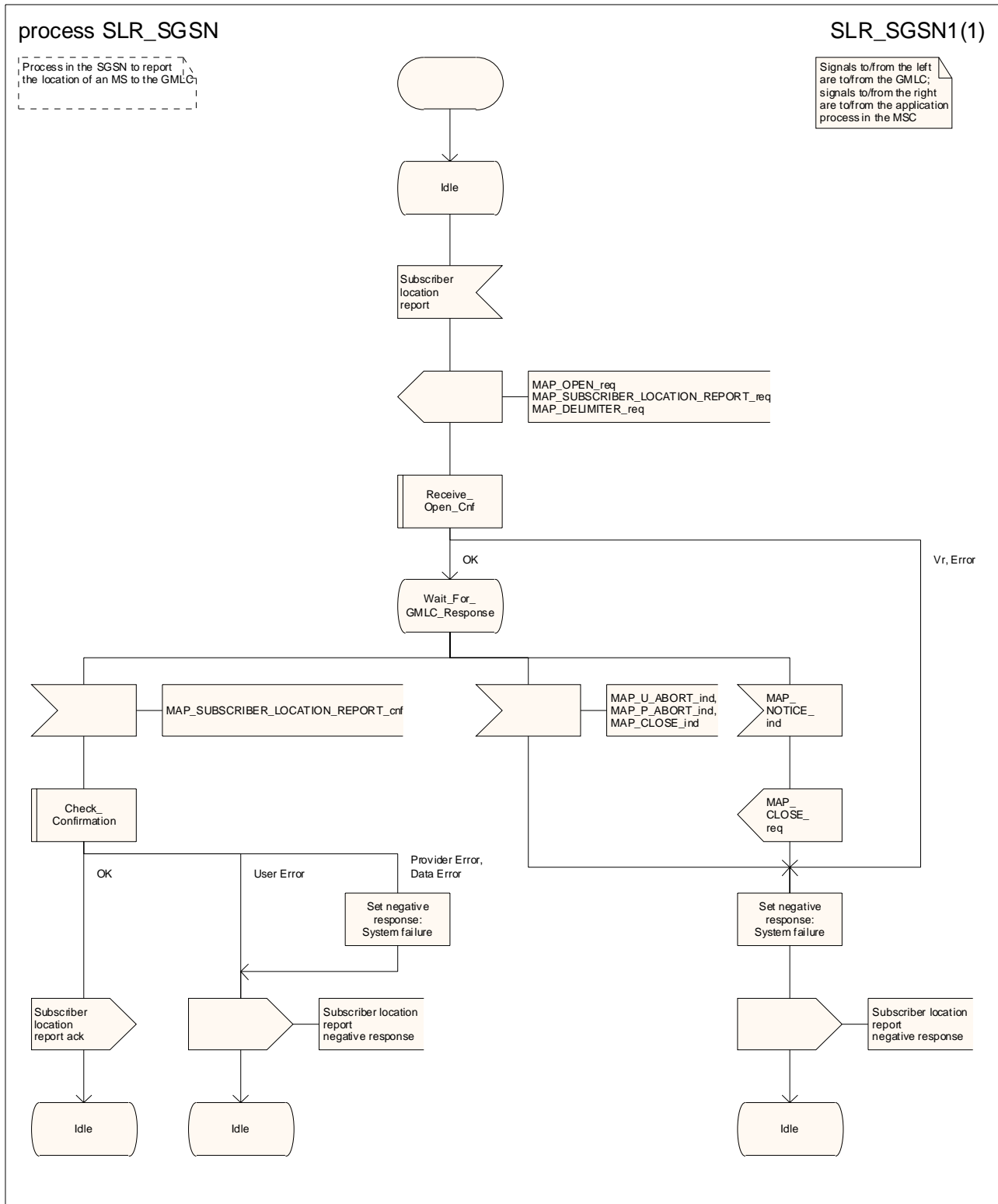

Figure 24B.3/3: Process SLR_SGSN

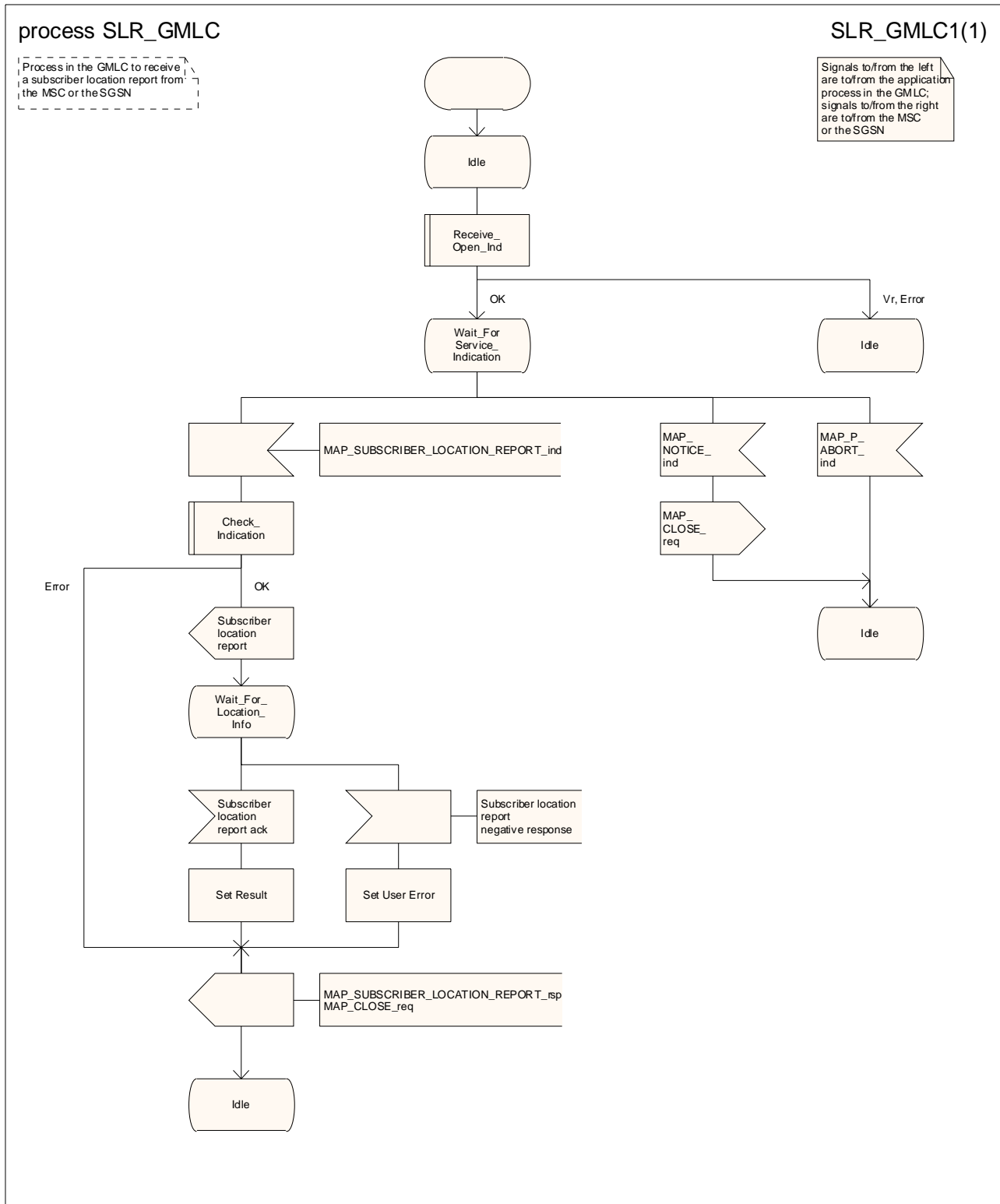

Figure 24B.3/4: Process SLR_GMLC

25 General macro description

25.1 MAP_OPEN handling macros

25.1.1 Macro Receive_Open_Ind

This macro is used by a MAP service-user procedure when a peer entity requests opening of a dialogue.

25.1.2 Macro Receive_Open_Cnf

This macro is used by a user procedure after it has requested opening of a dialogue towards a peer entity.

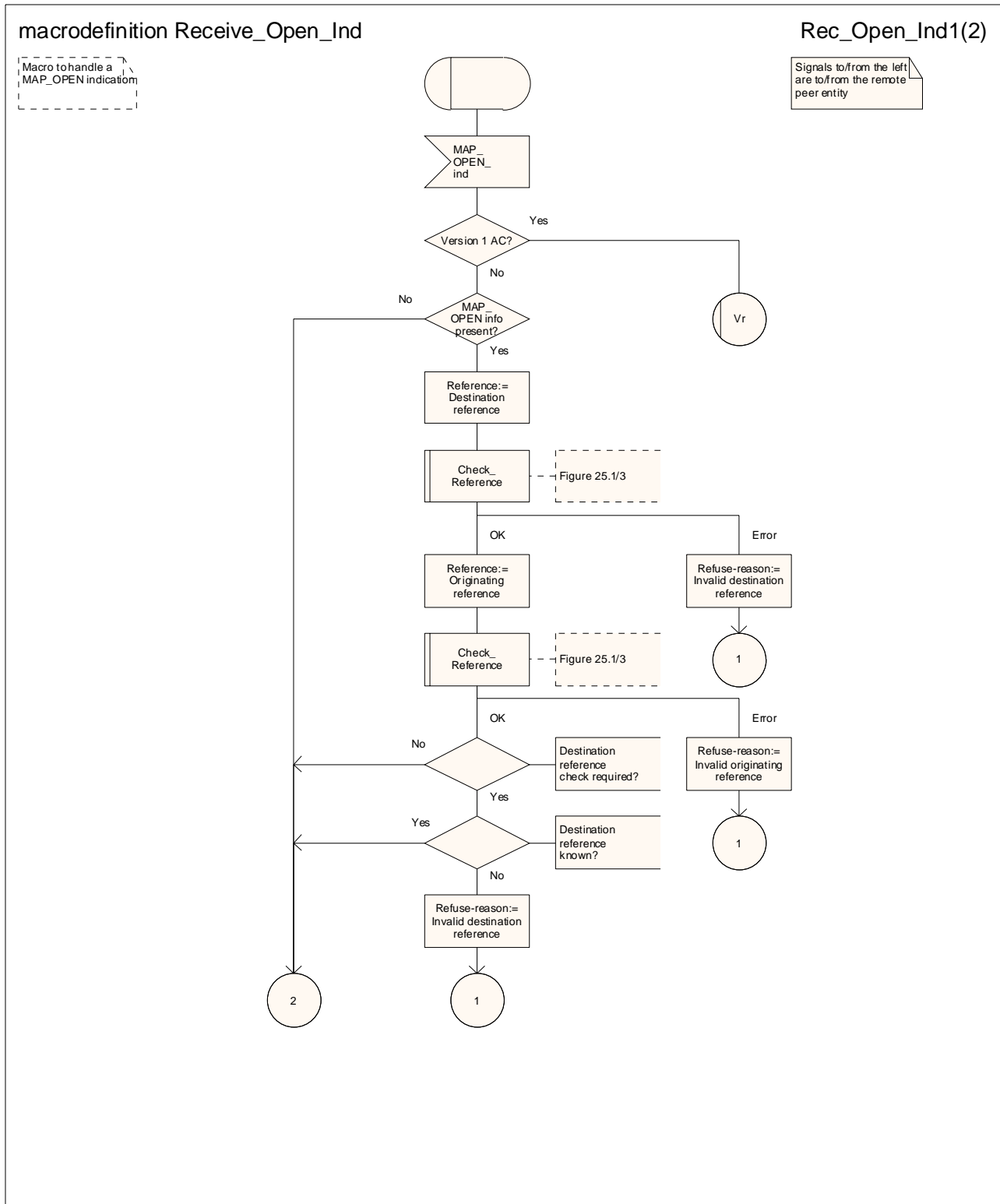

Figure 25.1/1 (sheet 1 of 2): Macro Receive_Open_Ind

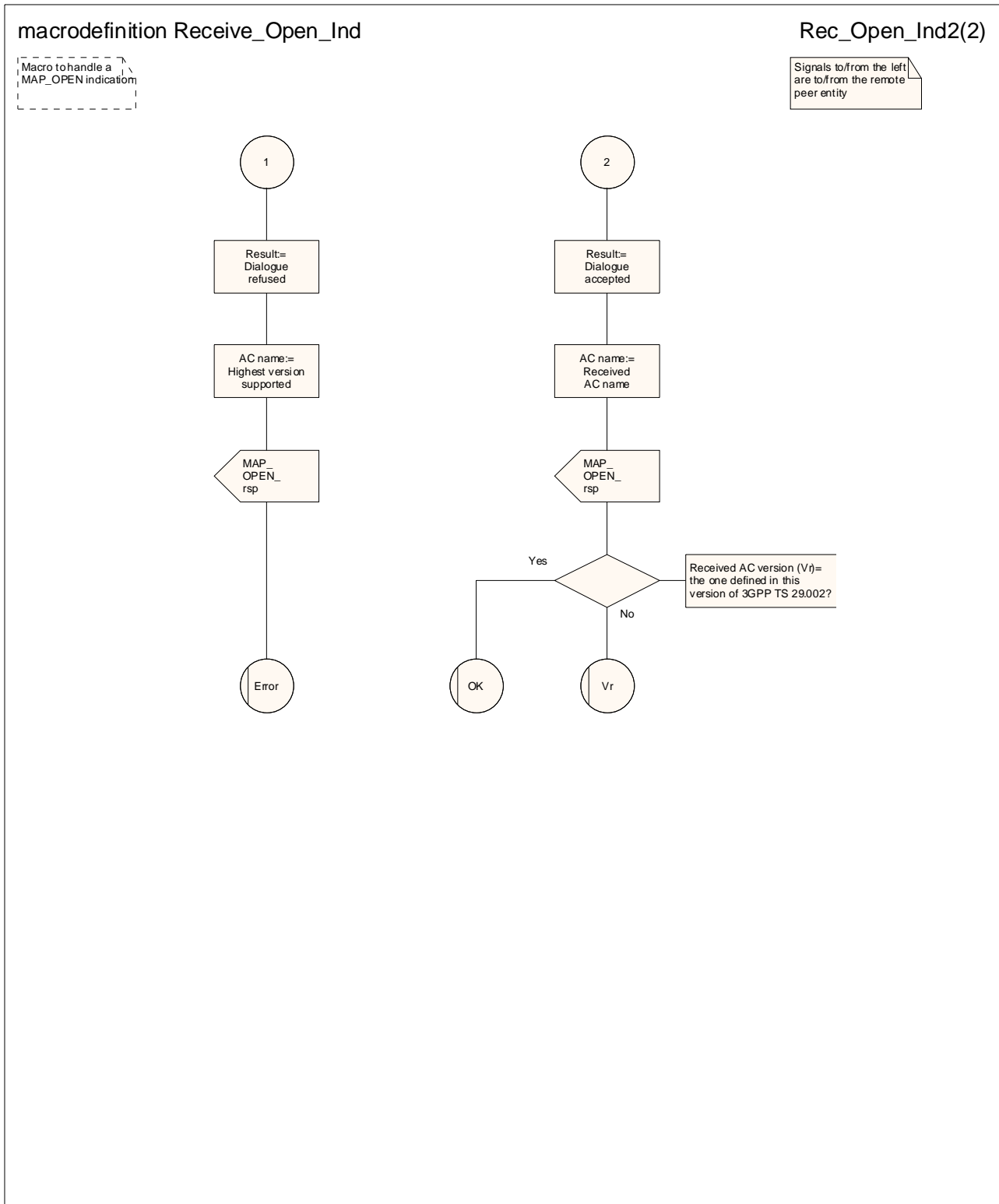

Figure 25.1/1 (sheet 2 of 2): Macro Receive_Open_Ind

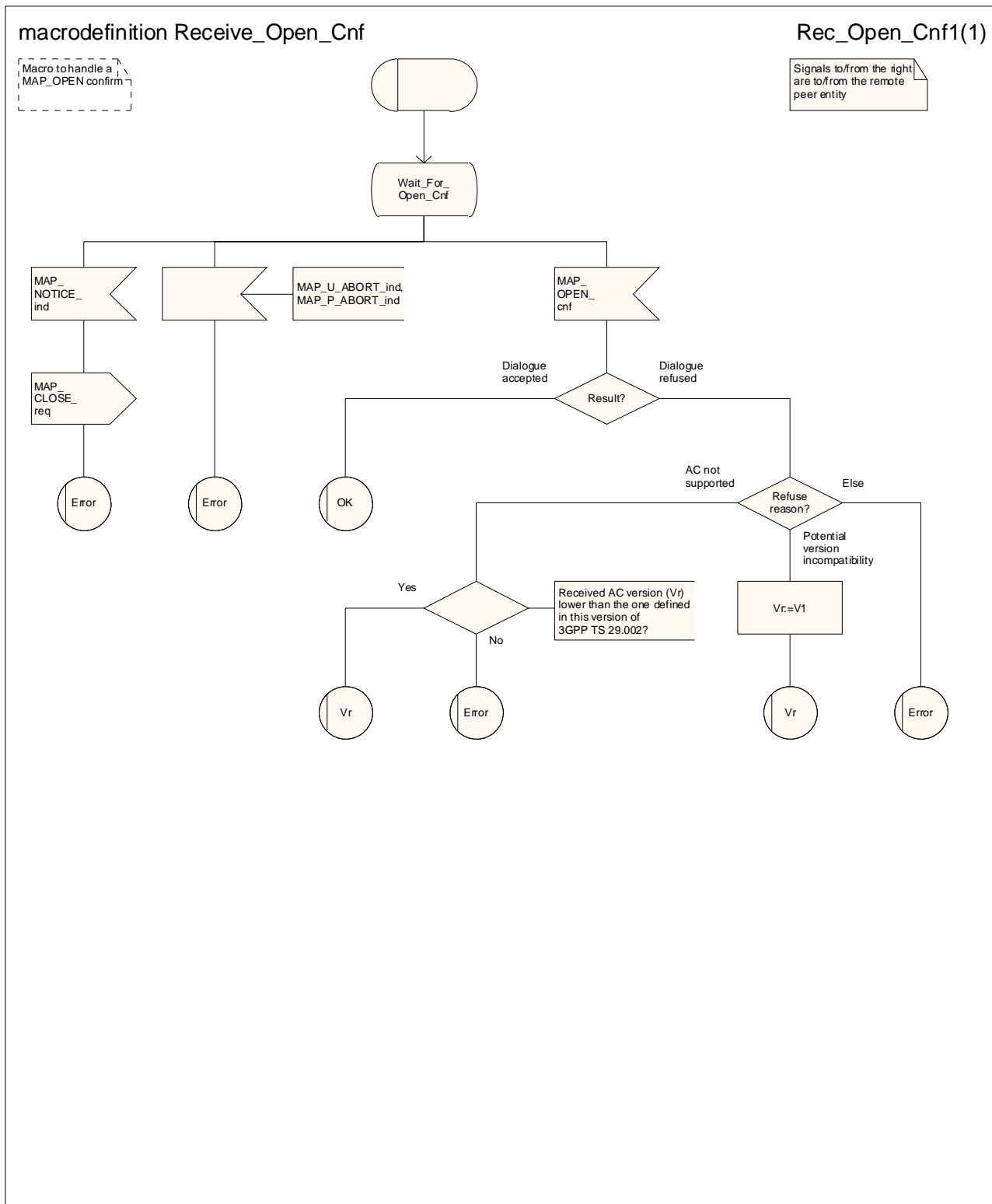

Figure 25.1/2: Macro Receive_Open_Cnf

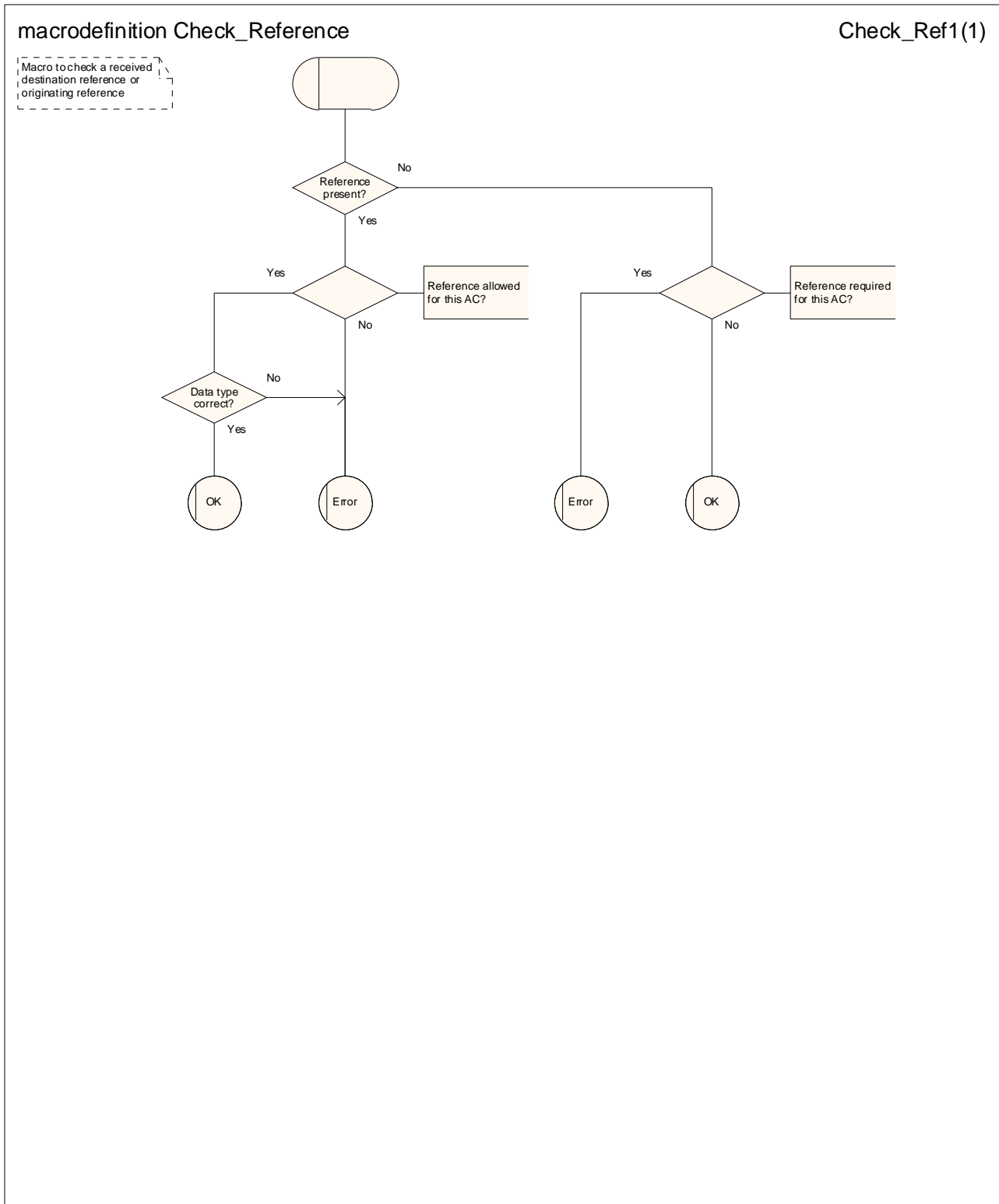

Figure 25.1/3: Macro Check_Reference

25.2 Macros to check the content of indication and confirmation primitives

25.2.1 Macro Check_Indication

This macro checks that an indication includes all the parameters required by the application, no more and no less, and that the parameters are all within the correct range. It does not handle syntax checking; that is part of the function of the MAP protocol machine.

25.2.2 Macro Check_Confirmation

This macro checks whether a confirmation contains an error or a result, and if it contains a result whether the result is correctly formed.

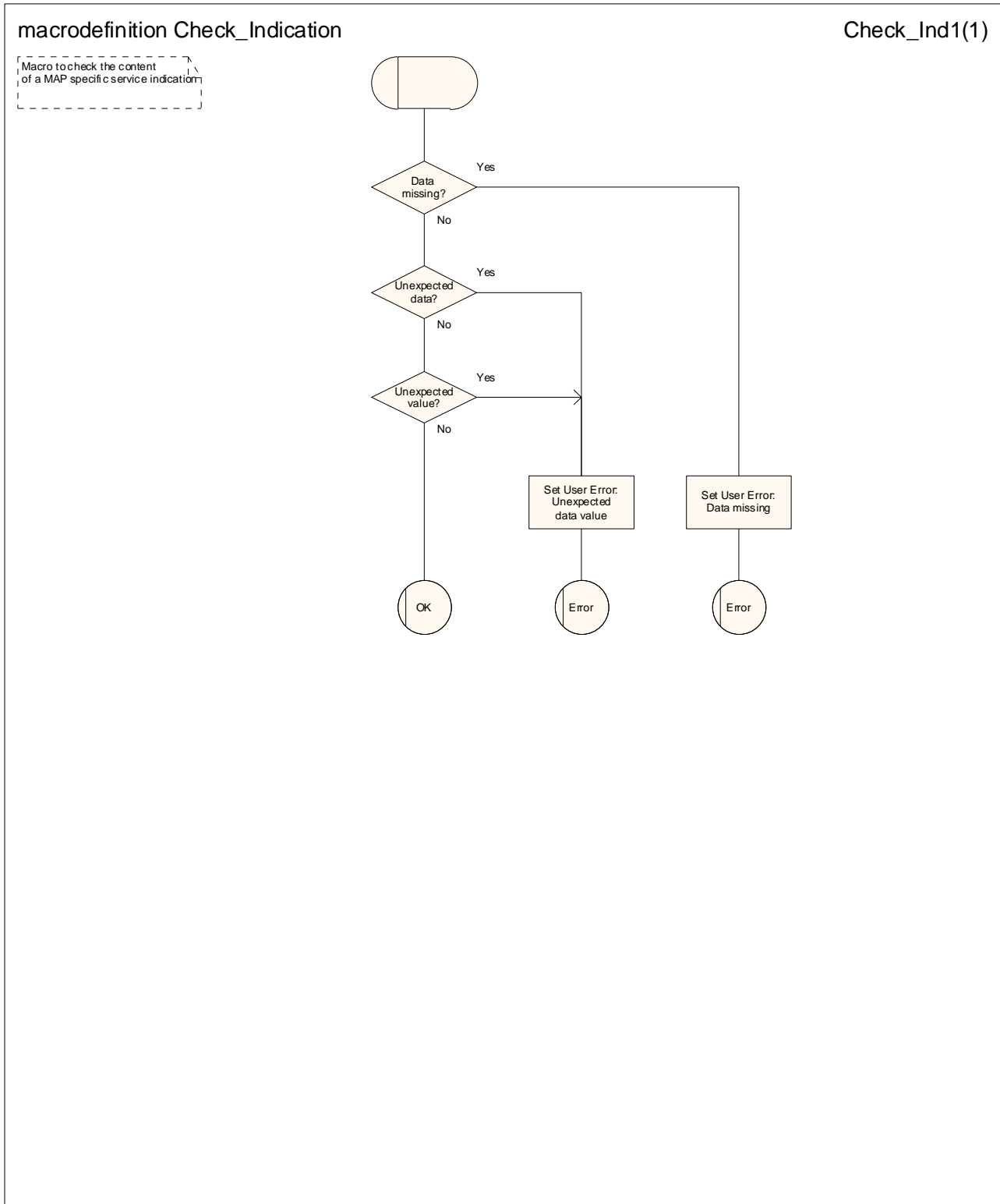

Figure 25.2/1: Macro Check_Indication

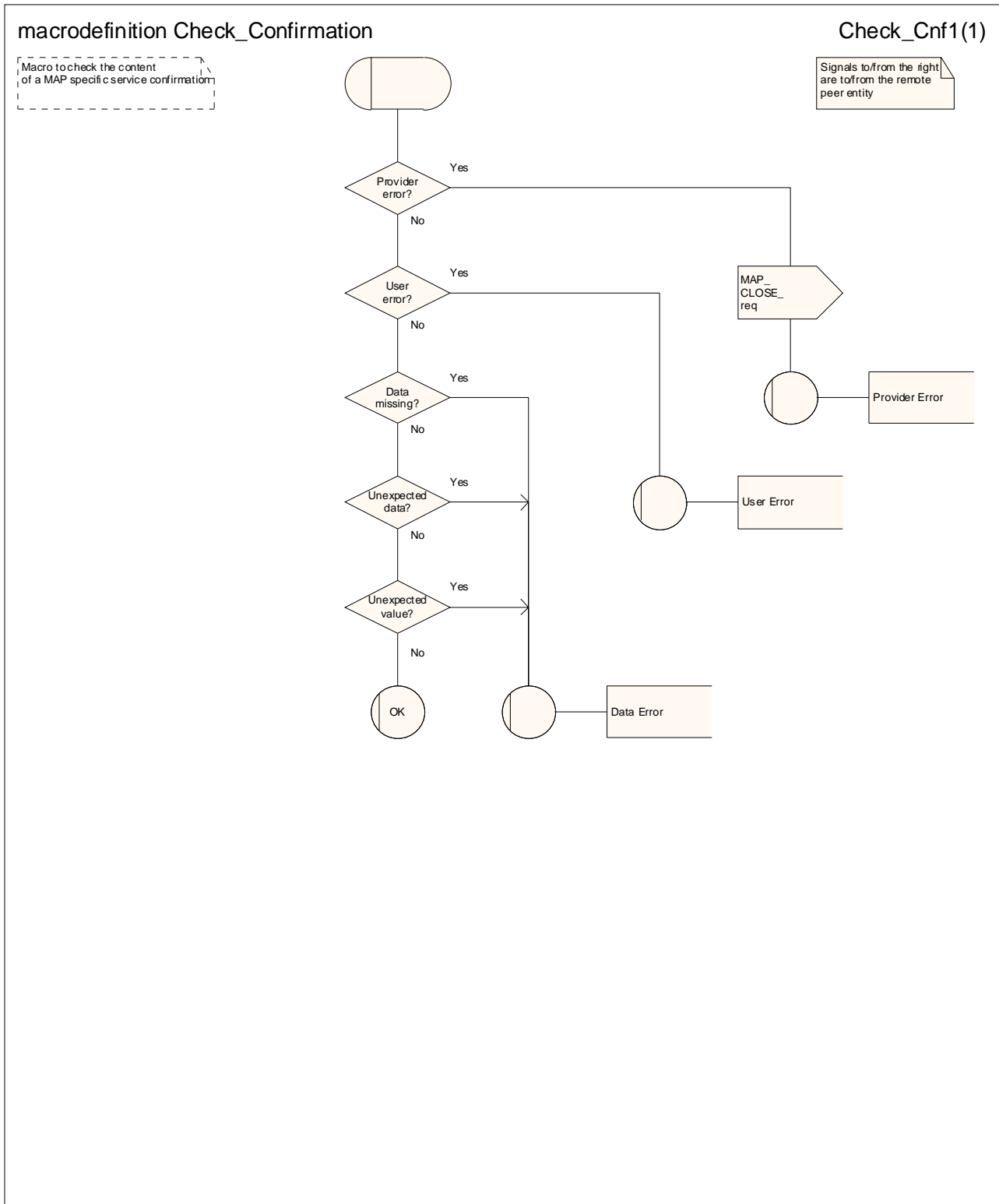

Figure 25.2/2: Macro Check_Confirmation

25.3 The page and search macros

25.3.1 Macro Page_MSC

This macro is called if an unstructured SS notification, a network-initiated unstructured SS request or a mobile terminating short message is to be delivered to the MS and the current location area identity of the MS is known in the VLR.

If an MM-connection over the radio link already exists for the given IMSI, the MSC sets the access connection status according to the characteristics of the existing connection (i.e. RR-connection established, ciphering mode on/off, MM-connection existing and authenticated or not).

If the MSC pages the MS and the VLR provided the TMSI, the MSC uses it to identify the MS at the radio interface; otherwise the MSC uses the IMSI. The MSC also uses the IMSI to determine the page group (see 3GPP TS 24.008 [35]).

If the MS responds with a channel request containing an establishment cause which is not "answer to paging" the MSC sends a MAP_PAGE response primitive with user error Busy Subscriber. This gives priority to the mobile originating request. Alternatively, as an implementation option, the MSC may treat this as a response to paging, which gives priority to the mobile terminating request.

If the paging is for MT SMS delivery and the VLR aborts the transaction before the MSC receives a response from the MS, the MSC aborts the transaction with the SMS-GMSC.

25.3.2 Macro Search_For_MS_MSC

This macro is called if an unstructured SS notification, a network-initiated unstructured SS request or a mobile terminating short message is to be delivered to the MS and the current location area identity of the MS is not known in VLR.

If an MM-connection over the radio link already exists for the given IMSI, the MSC returns a MAP_SEARCH_FOR_MS response containing the IMSI and current location area identification of the called MS to the VLR and sets the access connection status according to the characteristics of the existing connection (i.e. RR-connection established, ciphering mode on/off, MM-connection existing and authenticated or not).

If the MSC pages the MS, the MSC uses the IMSI to identify the subscriber and the page group (see 3GPP TS 24.008 [35]).

If the MS responds with a channel request containing an establishment cause which is not "answer to paging" the MSC sends a MAP_SEARCH_FOR_MS response with user error Busy Subscriber. This gives priority to the mobile originating request. Alternatively, as an implementation option, the MSC may treat this as a response to paging, which gives priority to the mobile terminating request.

If the paging is for MT SMS delivery and the VLR aborts the transaction before the MSC receives a response from the MS, the MSC aborts the transaction with the SMS-GMSC.

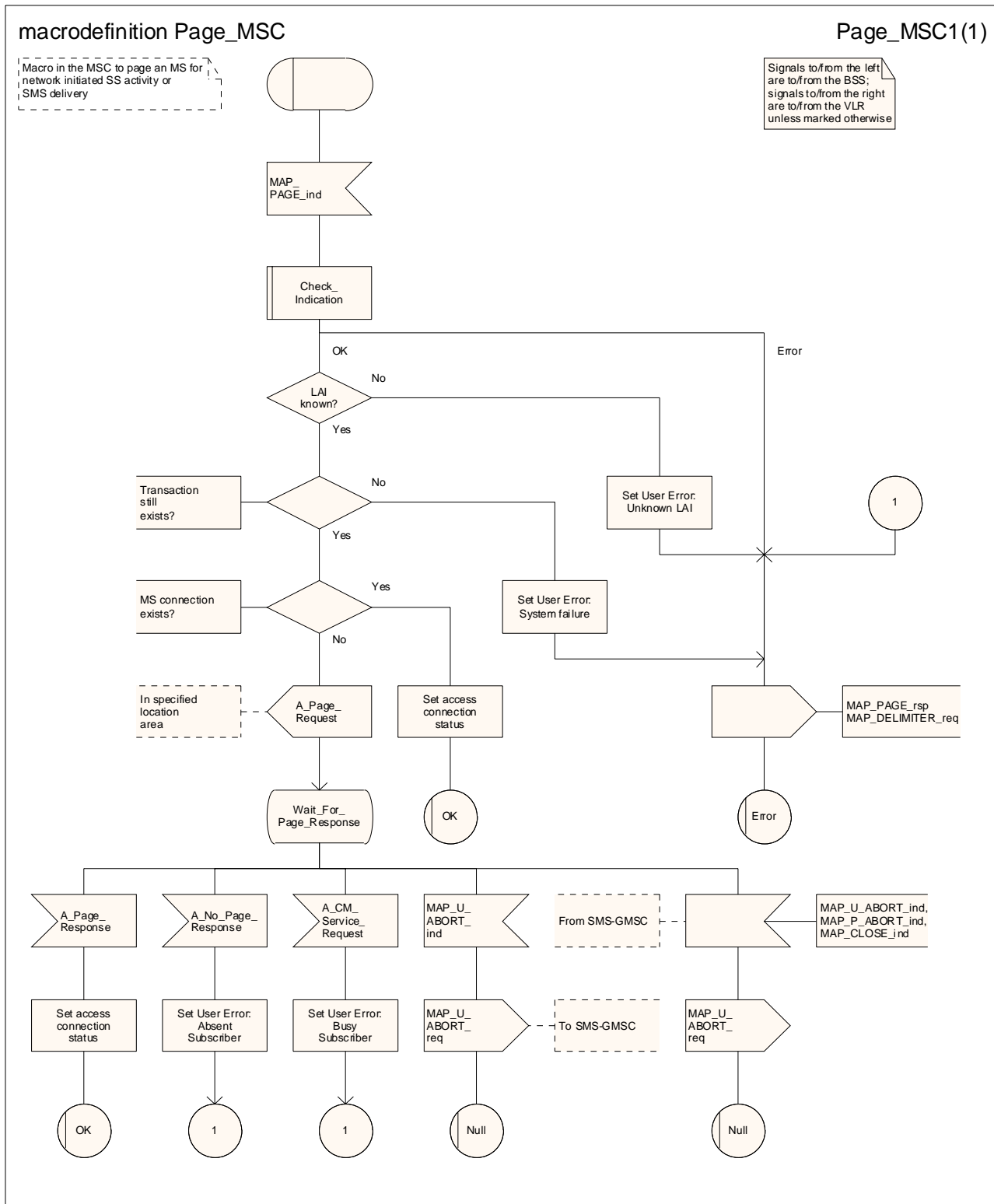

Figure 25.3/1: Macro Page_MSC

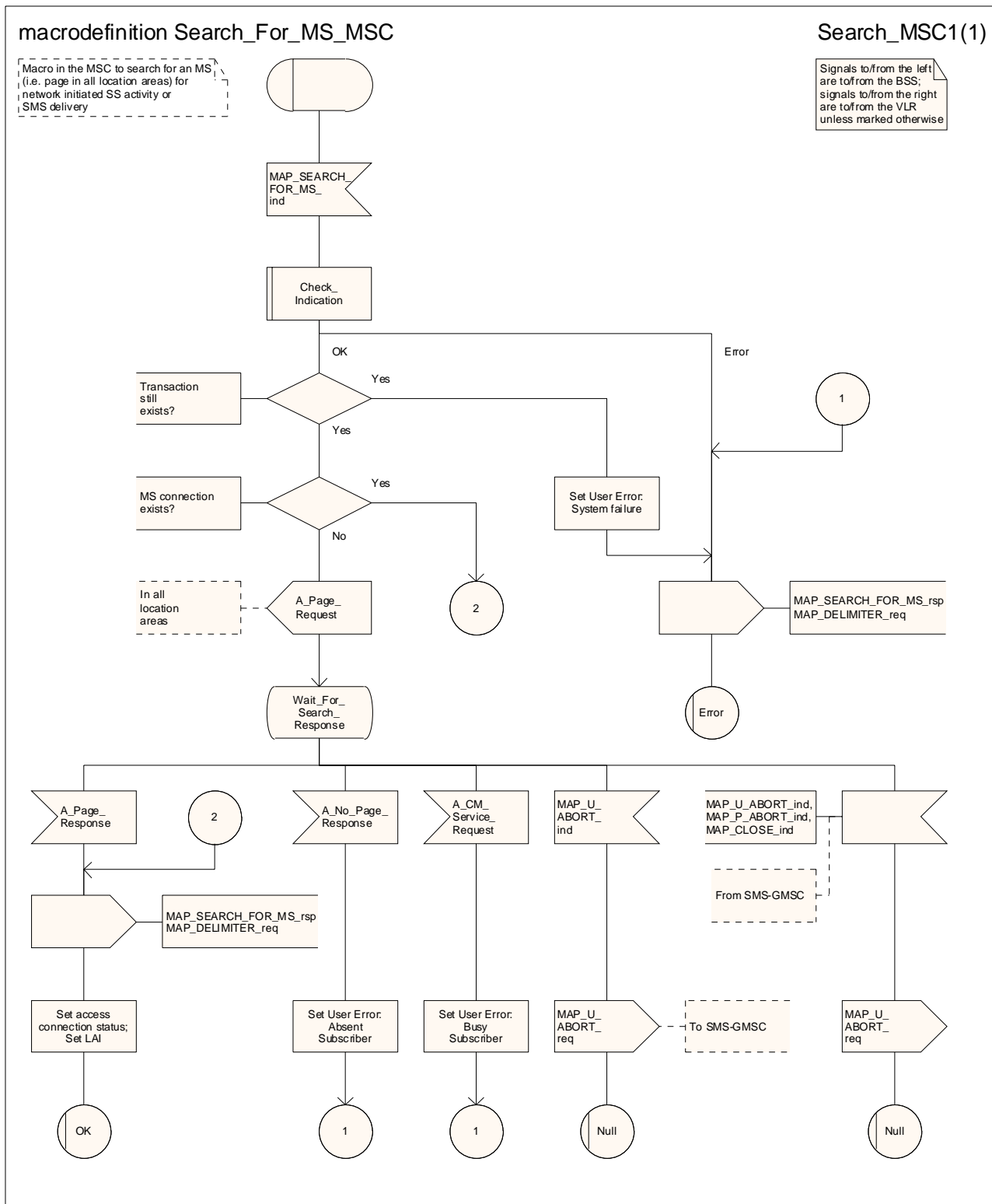

Figure 25.3/2: Macro Search_for_MS_MSC

25.4 Macros for handling an Access Request

These macros are invoked when an MS accesses the network, e.g. to submit an MO short message or when responding to paging. The macros handle identification and authentication of the mobile subscriber as well as invocation of security related features (see 3GPP TS 42.009 [6]).

25.4.1 Macro Process_Access_Request_MSC

Sheet 1: The MAP_PROCESS_ACCESS_REQUEST request includes the following parameters:

- the received subscriber identification (IMSI, TMSI);
- the CM service type, indicating the type of request;
- the status of the access connection, i.e. whether a connection to this MS already exists and if so, whether it is already authenticated and ciphered;
- the current location area id of the MS; and
- the CKSN received from the MS.

Sheet 2, sheet 3: If the MSC receives an A_SETUP indication while it is waiting for further instructions from the VLR or for the acknowledgment of TMSI reallocation from the MS, the MSC saves the setup request for processing after control has returned from the macro Process_Access_Request_MSC to the calling process.

Sheet 3: When the MSC is waiting for a possible instruction to allocate a new TMSI, a MAP_DELIMITER indication indicates that TMSI reallocation is not required.

Sheet 3: If the MS sends a TMSI reallocation failure in response to the TMSI reallocation command, the MSC takes the OK exit; the VLR treats the lack of response as a provider error (see macro Process_Access_Request_VLR).

25.4.2 Macro Process_Access_Request_VLR

Sheet 3: If the MSC does not send a positive response to the MAP_FORWARD_NEW_TMSI request, this is treated as a MAP_FORWARD_NEW_TMSI confirmation containing a provider error. The Macro takes the Error exit. If TMSI reallocation does not succeed, the old TMSI is frozen, to prevent it from being reallocated. In this case, both old and new TMSIs are regarded as valid.

25.4.3 Macro Obtain_Identity_VLR

This macro is invoked by the macro Process_Access_Request_VLR if the subscriber's identity is not known in the VLR.

It is an operator option to allow or prevent retrieval of the IMSI without encryption.

25.4.4 Process Update Location VLR

This process is started when the subscriber successfully accesses the network, e.g. for mobile originated short message submission, response to paging or supplementary services handling.

The procedure Notify_gsmSCF is specified in 3GPP TS 23.078.

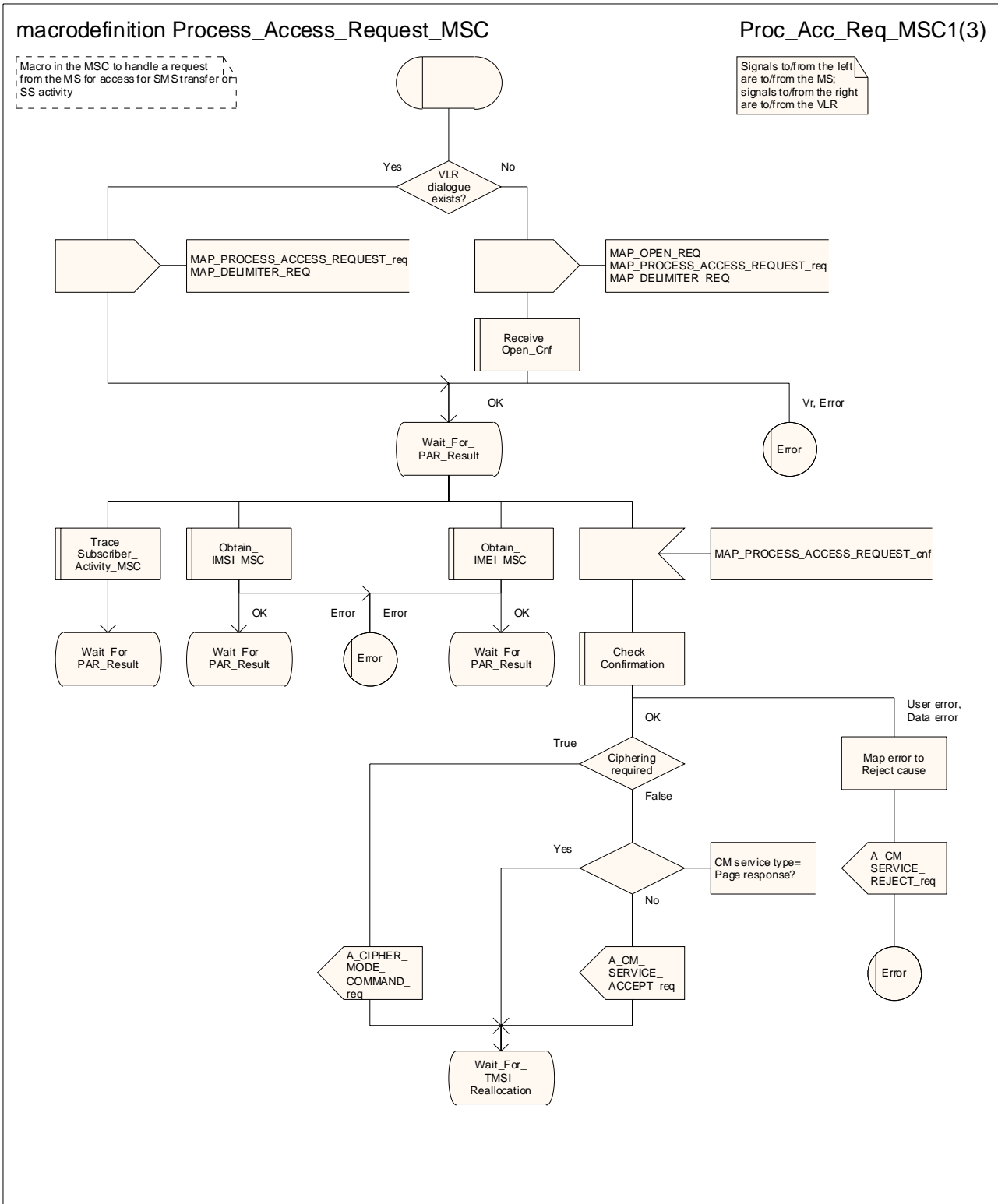

Figure 25.4/1 (sheet 1 of 3): Macro Process_Access_Request_MSC

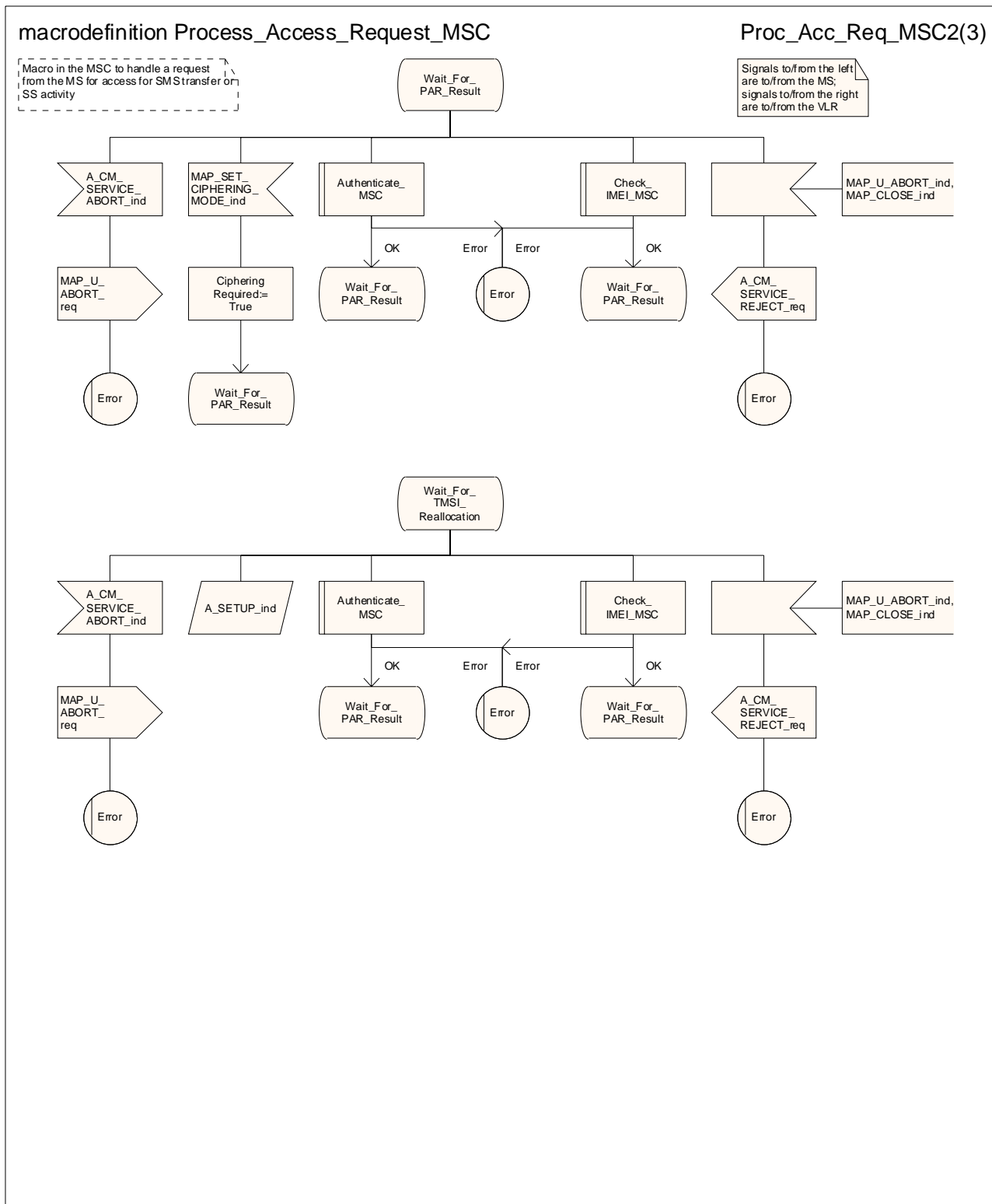

Figure 25.4/1 (sheet 2 of 3): Macro Process_Access_Request_MSC

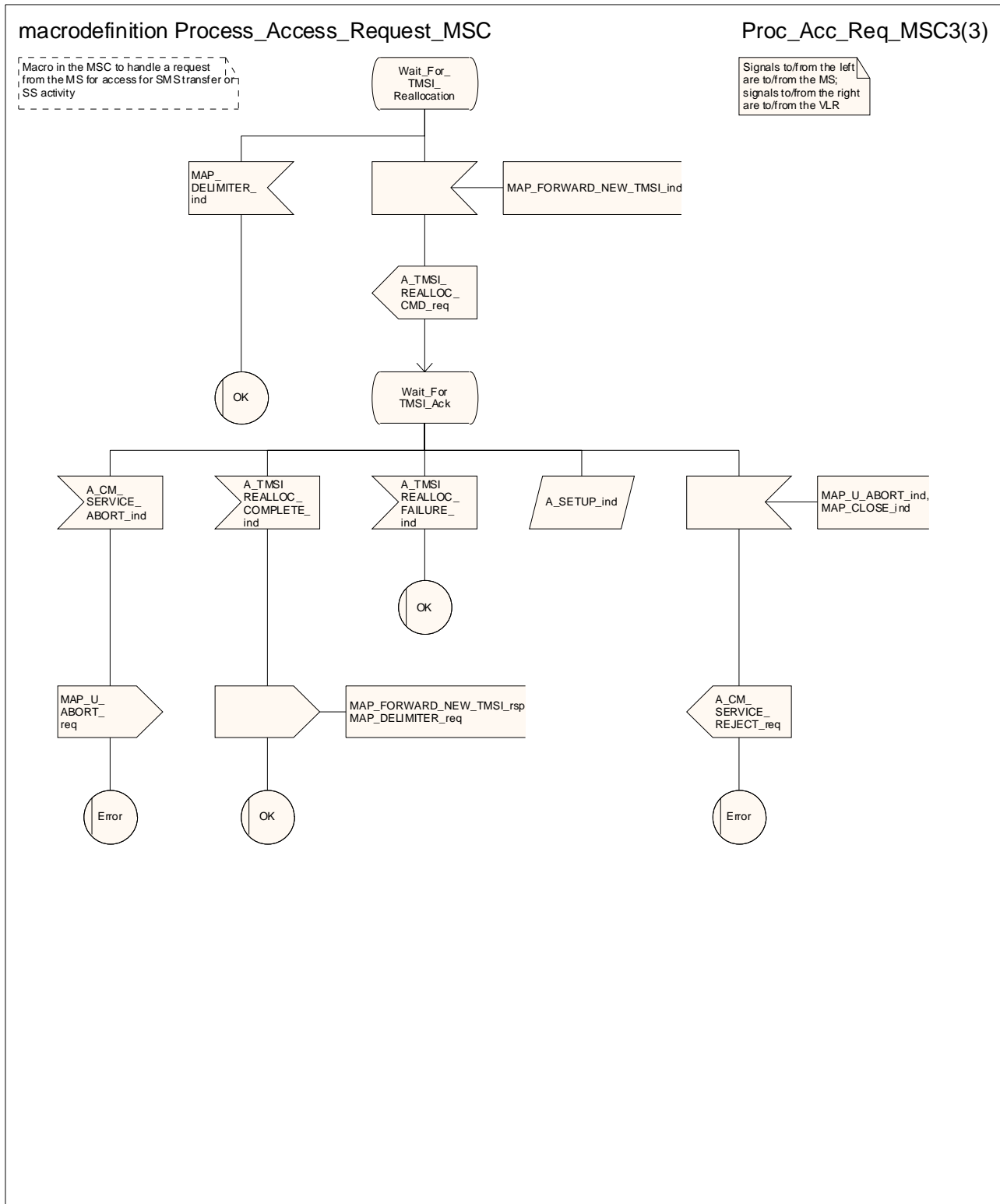

Figure 25.4/1 (sheet 3 of 3): Macro Process_Access_Request_MSC

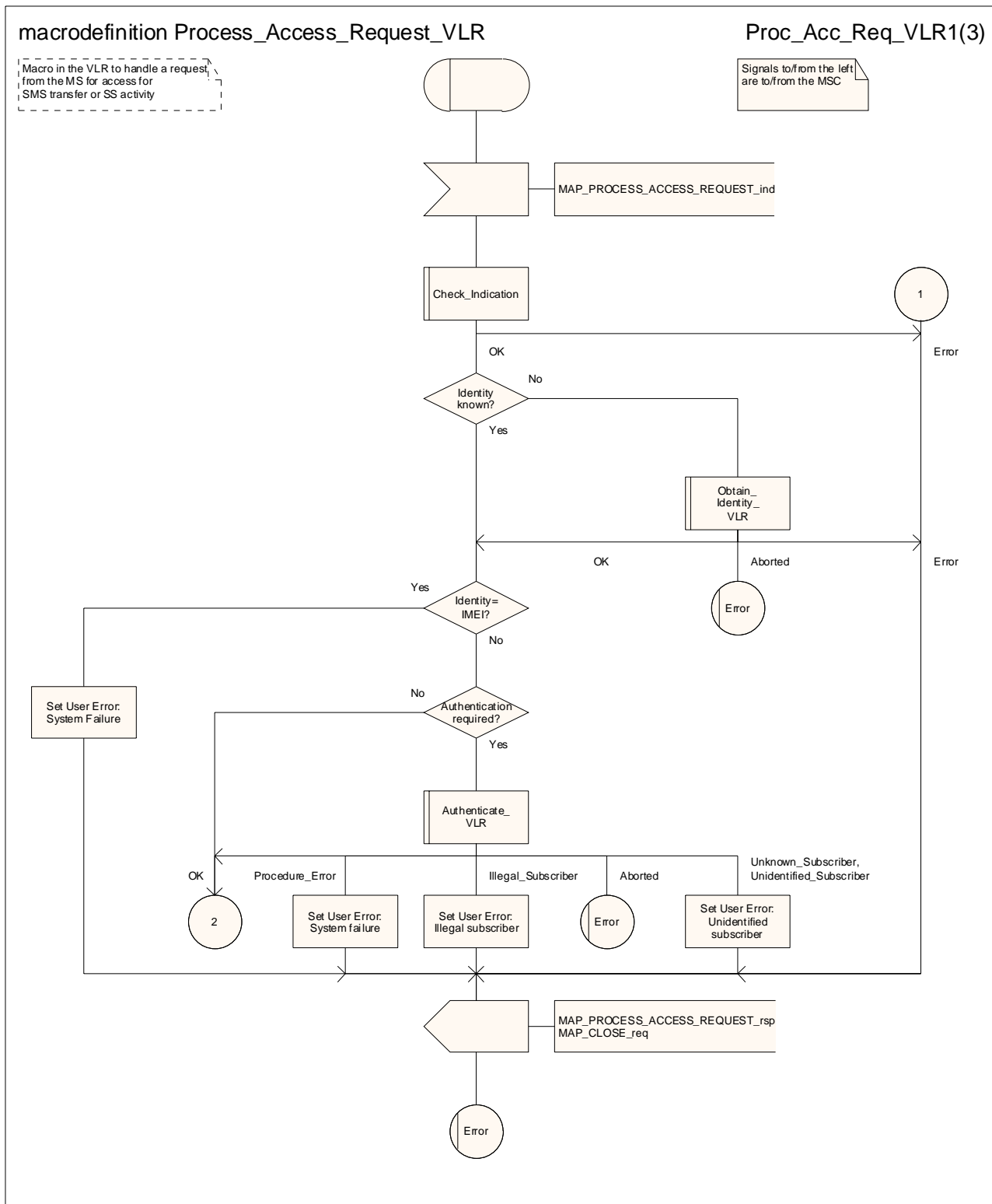

Figure 25.4/2 (sheet 1 of 3): Macro Process_Access_Request_VLR

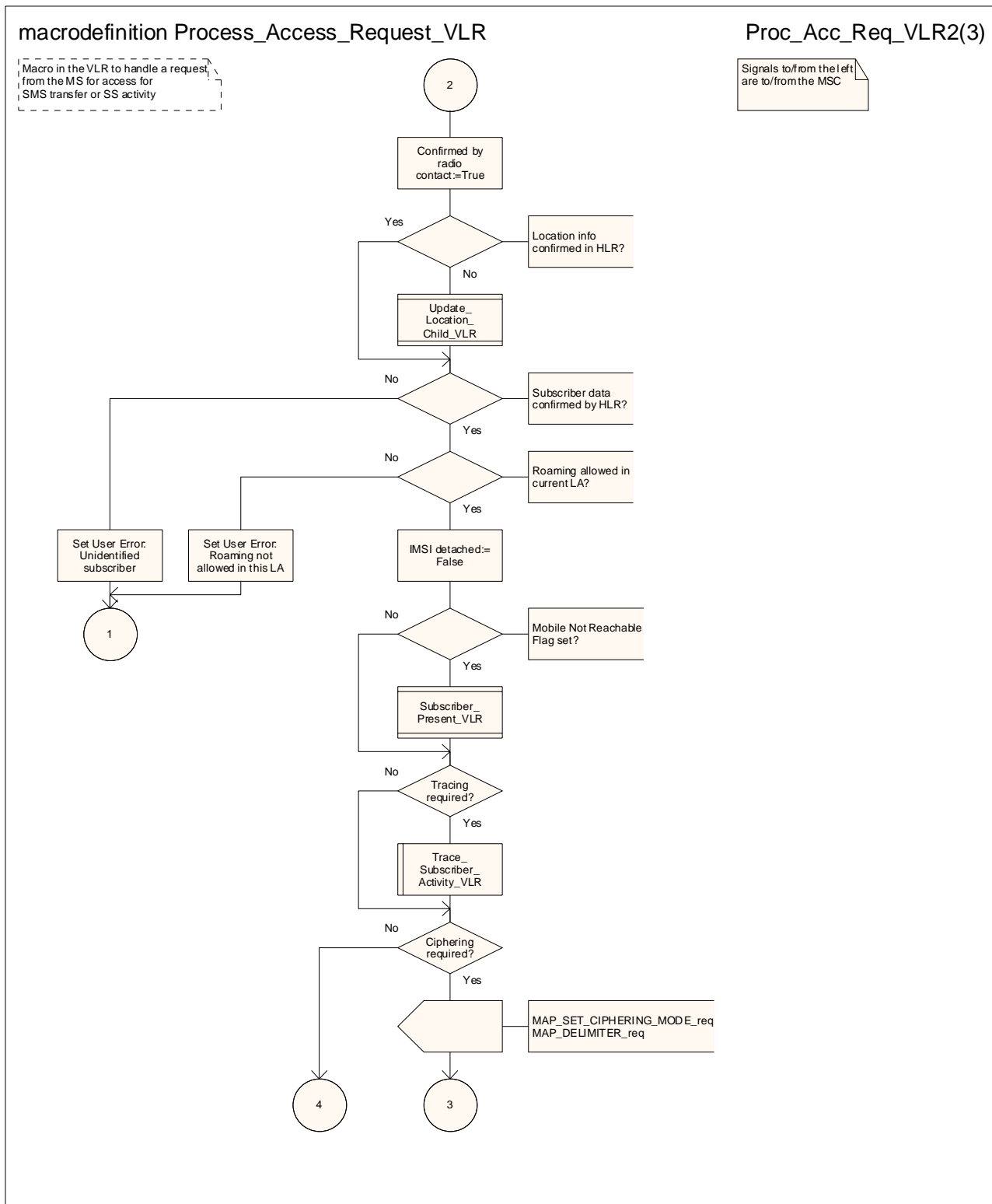

Figure 25.4/2 (sheet 2 of 3): Macro Process_Access_Request_VLR

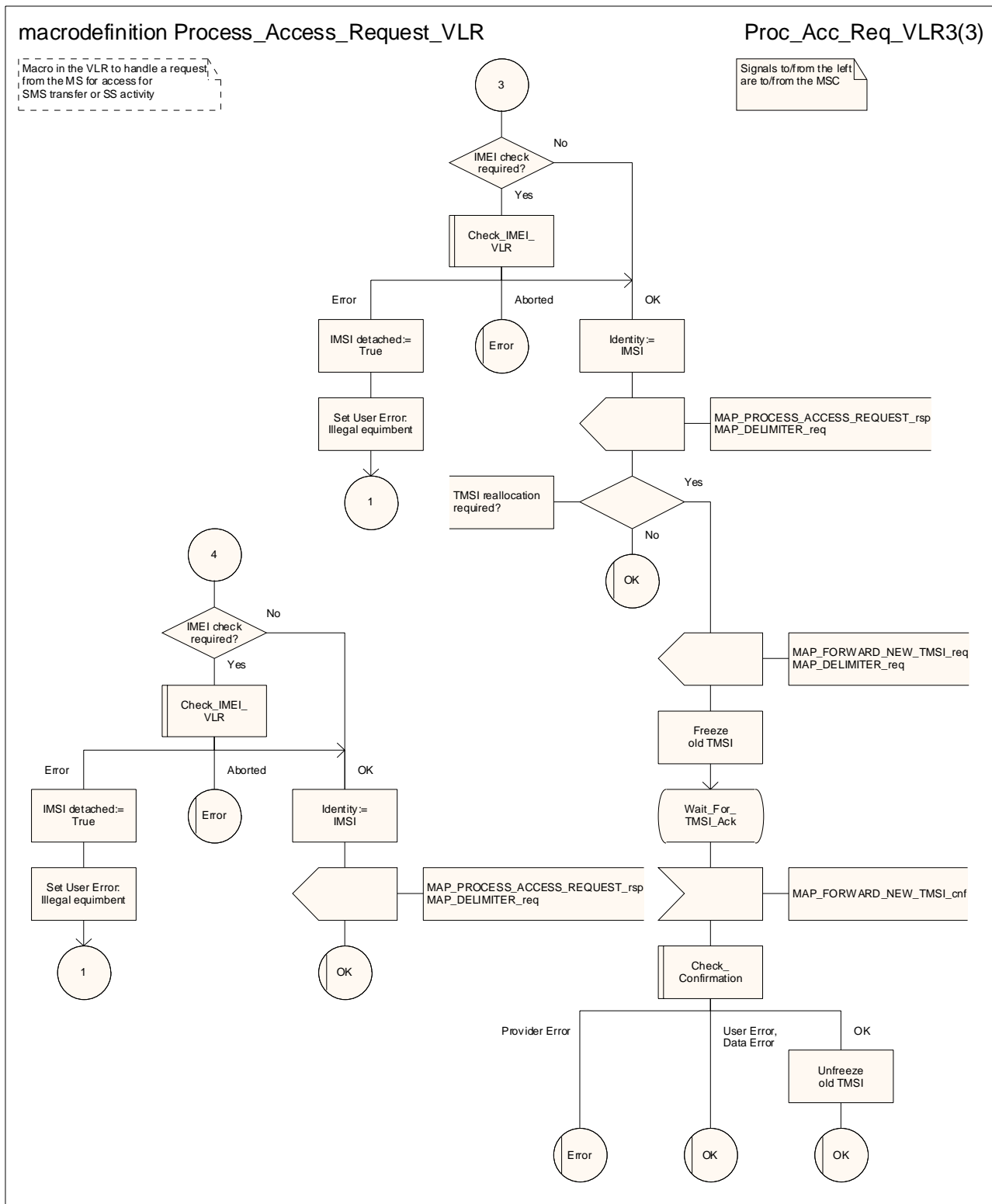

Figure 25.4/2 (sheet 3 of 3): Macro Process_Access_Request_VLR

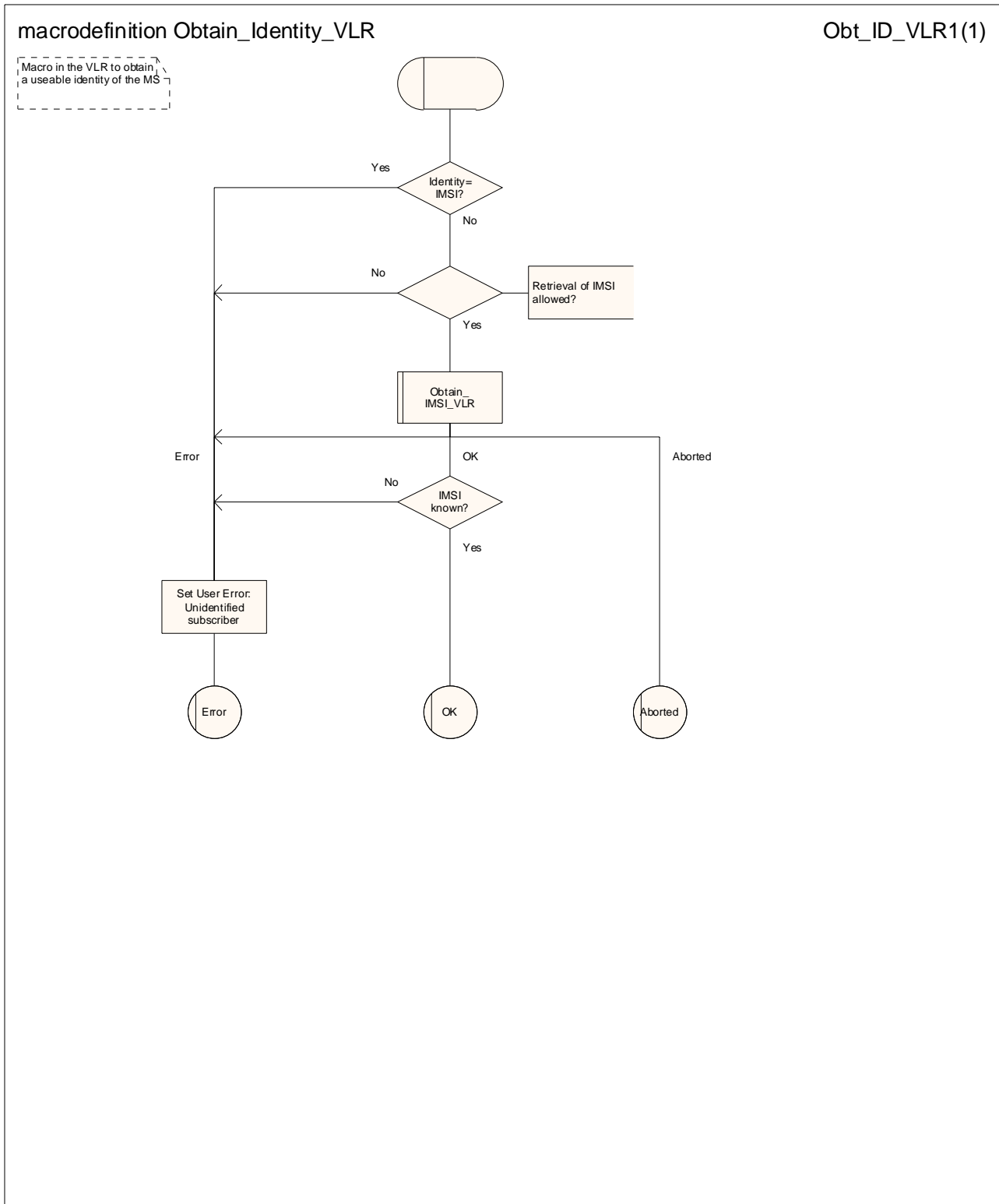

Figure 25.4/3: Macro Obtain_Identity_VLR

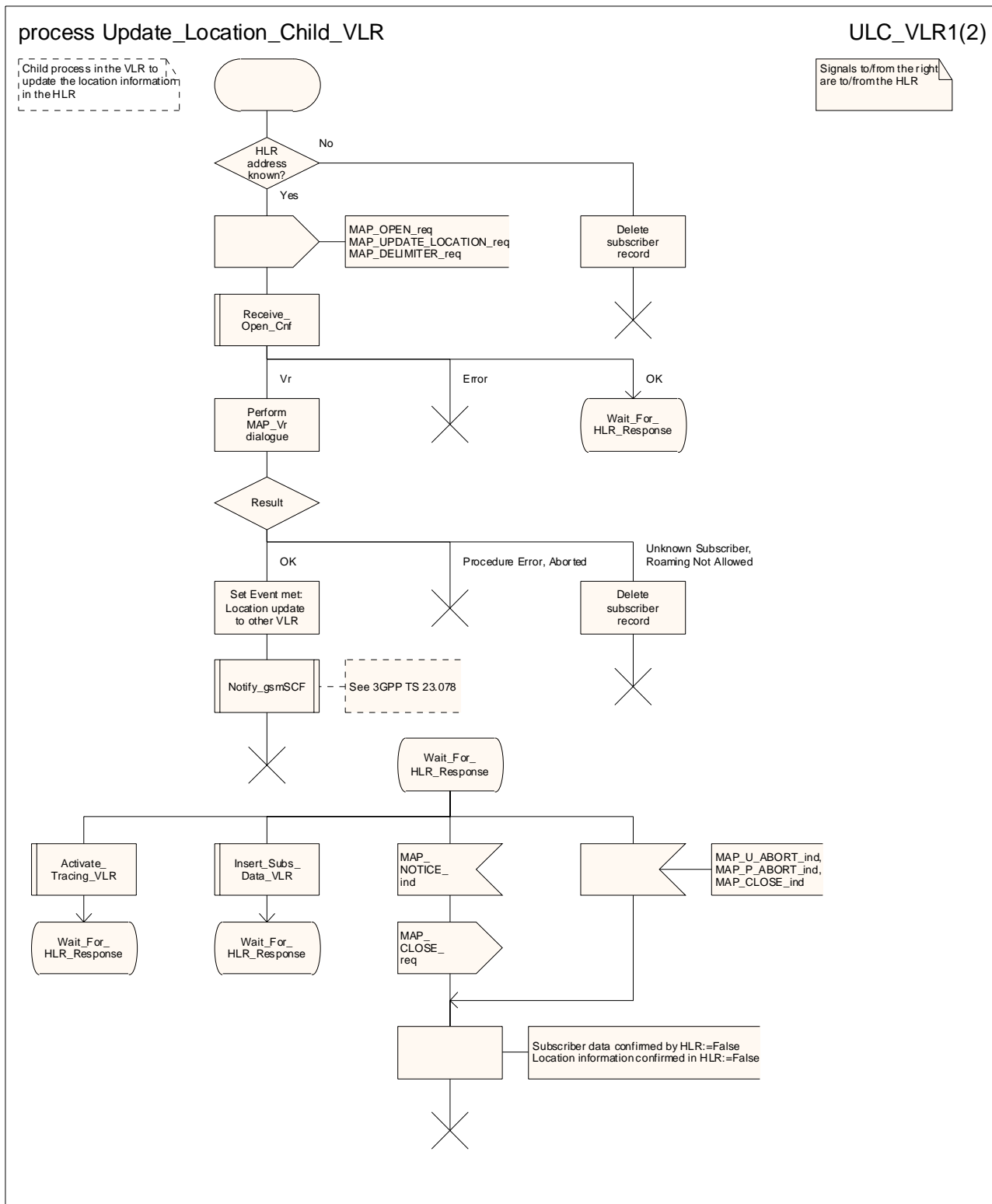

Figure 25.4/4 (sheet 1 of 2): Process Update_Location_Child_VLR

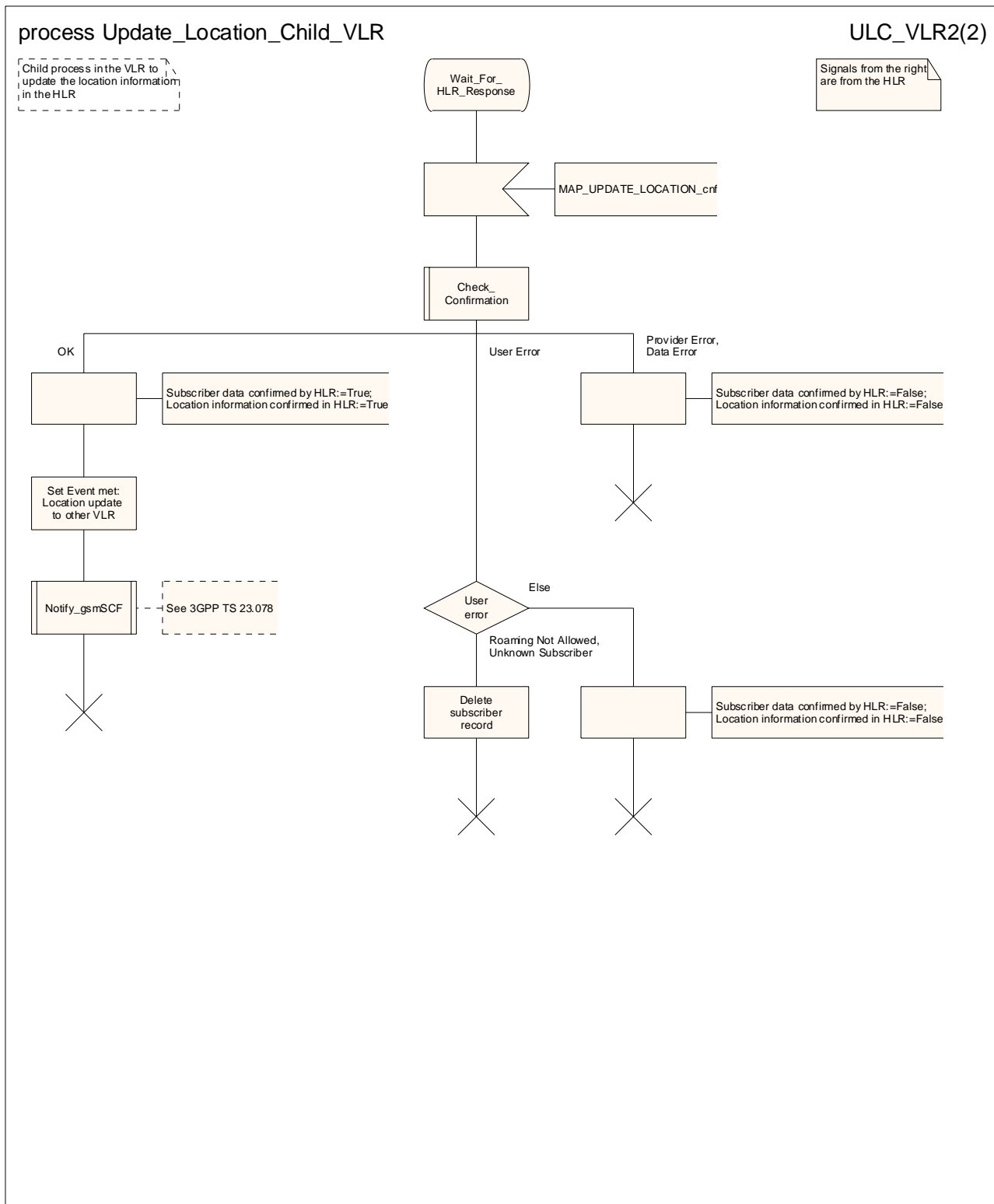

Figure 25.4/4 (sheet 2 of 2): Process Update_Location_Child_VLR

25.5 Authentication macros and processes

The following macros are used in the network in order to enable authentication of a mobile subscriber.

25.5.1 Macro Authenticate_MSC

This macro is used by the MSC to relay a request for authentication transparently from the VLR to the MS, wait for a response from the MS and to relay the response from the MS back to the VLR.

25.5.2 Macro Authenticate_VLR

This macro is used by the VLR to control the authentication of a subscriber.

Sheet 1: The test "Received SRES=Expected SRES" indicates:

- a comparison of the Signed RESult received from the MS with the Signed RESult received from the HLR, if GSM authentication is used (see 3GPP TS 43.020 [24]), or
- a comparison of the RESult received from the MS with the expected RESult received from the HLR, if UMTS authentication is used (see 3GPP TS 33.102).

25.5.3 Macro Obtain_Authent_Params_VLR

This macro is used by the VLR to request authentication vectors from the HLR.

Sheet 1, sheet 2, sheet 3: It is an operator option whether to allow the re-use of old authentication triplets.

Sheet 2, sheet 3: Old UMTS quintuplets shall not be re-used.

Sheet 2: if the VLR requests more authentication vectors in the same dialogue, the subsequent MAP_SEND_AUTHENTICATION_INFO request has no parameters.

25.5.4 Process Obtain_Authentication_Sets_VLR

This process is initiated by the VLR to fetch authentication vectors from a subscriber's HLR independently of any other processing.

25.5.5 Process Obtain_Authent_Sets_SGSN

The procedure for authentication when the serving node is an SGSN is described in 3GPP TS 23.060 [104] and 3GPP TS 24.008 [35].

This process is used by the SGSN to request authentication vectors from the HLR.

Sheet 1, sheet 2: It is an operator option whether to allow the re-use of old authentication triplets.

Sheet 2: Old UMTS quintuplets shall not be re-used.

25.5.6 Process Obtain_Auth_Sets_HLR

This process is used to provide authentication vectors (triplets or quintuplets) in response to a request from a VLR or an SGSN.

25.5.7 Authentication Failure Reporting

25.5.7.1 General

The Authentication Failure Report procedure is used to notify an HLR about the occurrence of an authentication failure in the SGSN or VLR.

The message flows for this procedure are shown in figures 25.5/7 & 25.5/8.

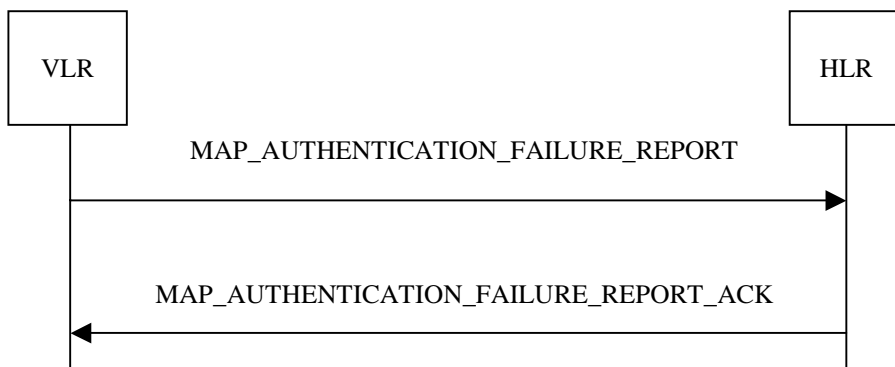

Figure 25.5/7: Message Flow for Authentication Failure Report– VLR to HLR

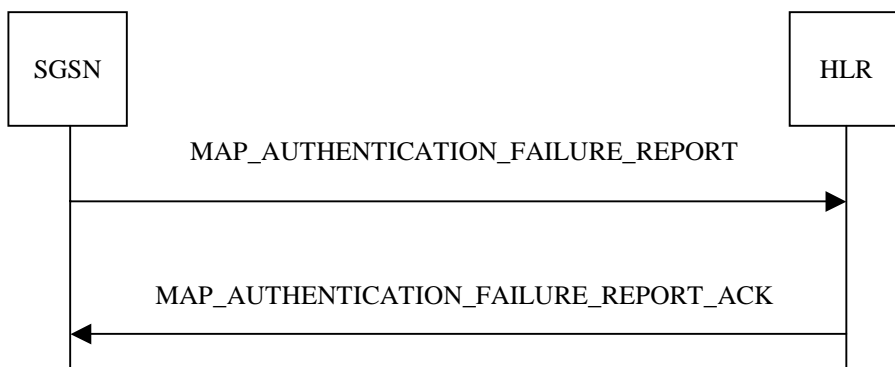

Figure 25.5/8: Message Flow for Authentication Failure Report – SGSN to HLR

25.5.7.2 Process in the VLR

25.5.7.3 Process in the SGSN

25.5.7.4 Process in the HLR

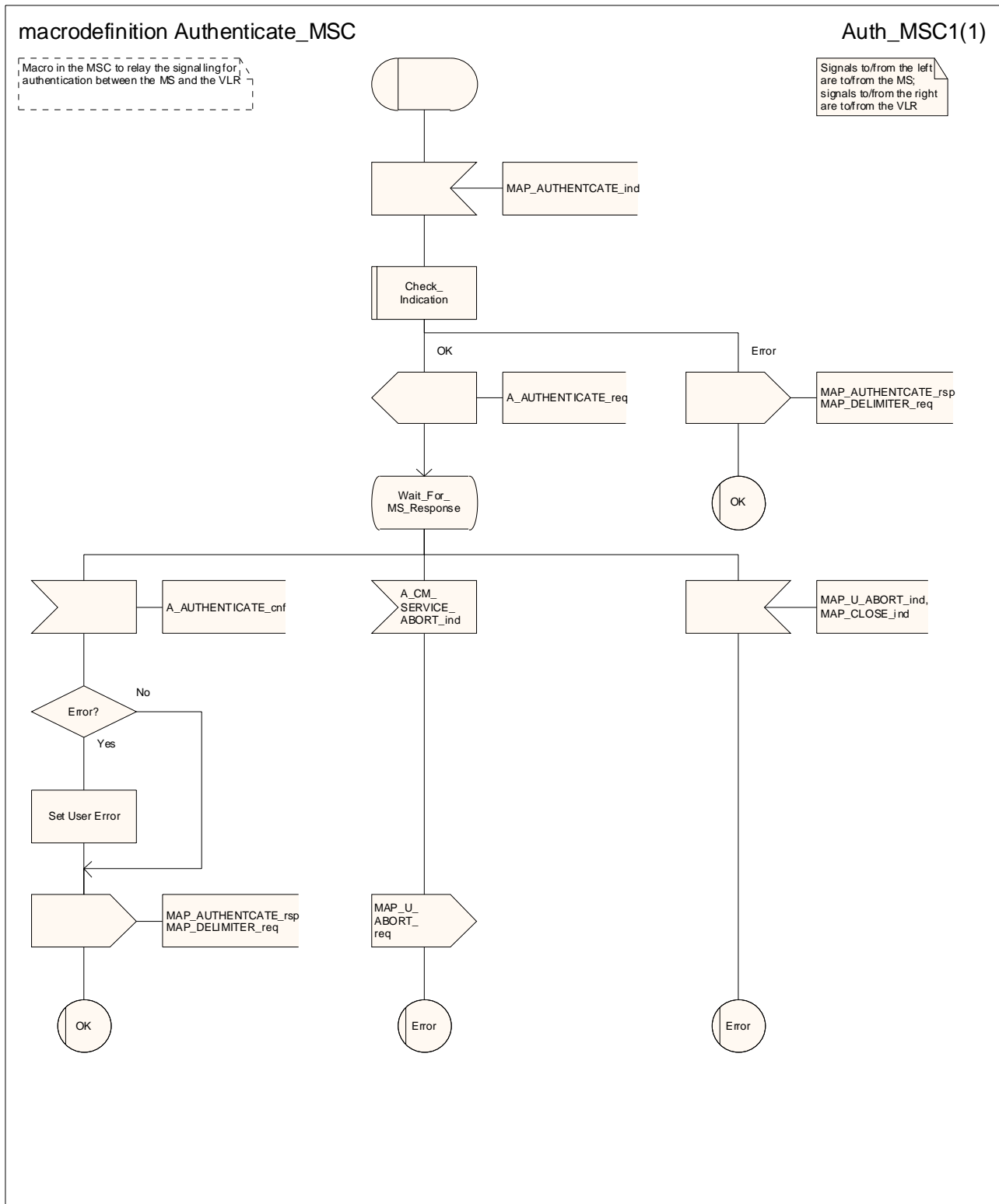

Figure 25.5/1: Macro Authenticate_MSC

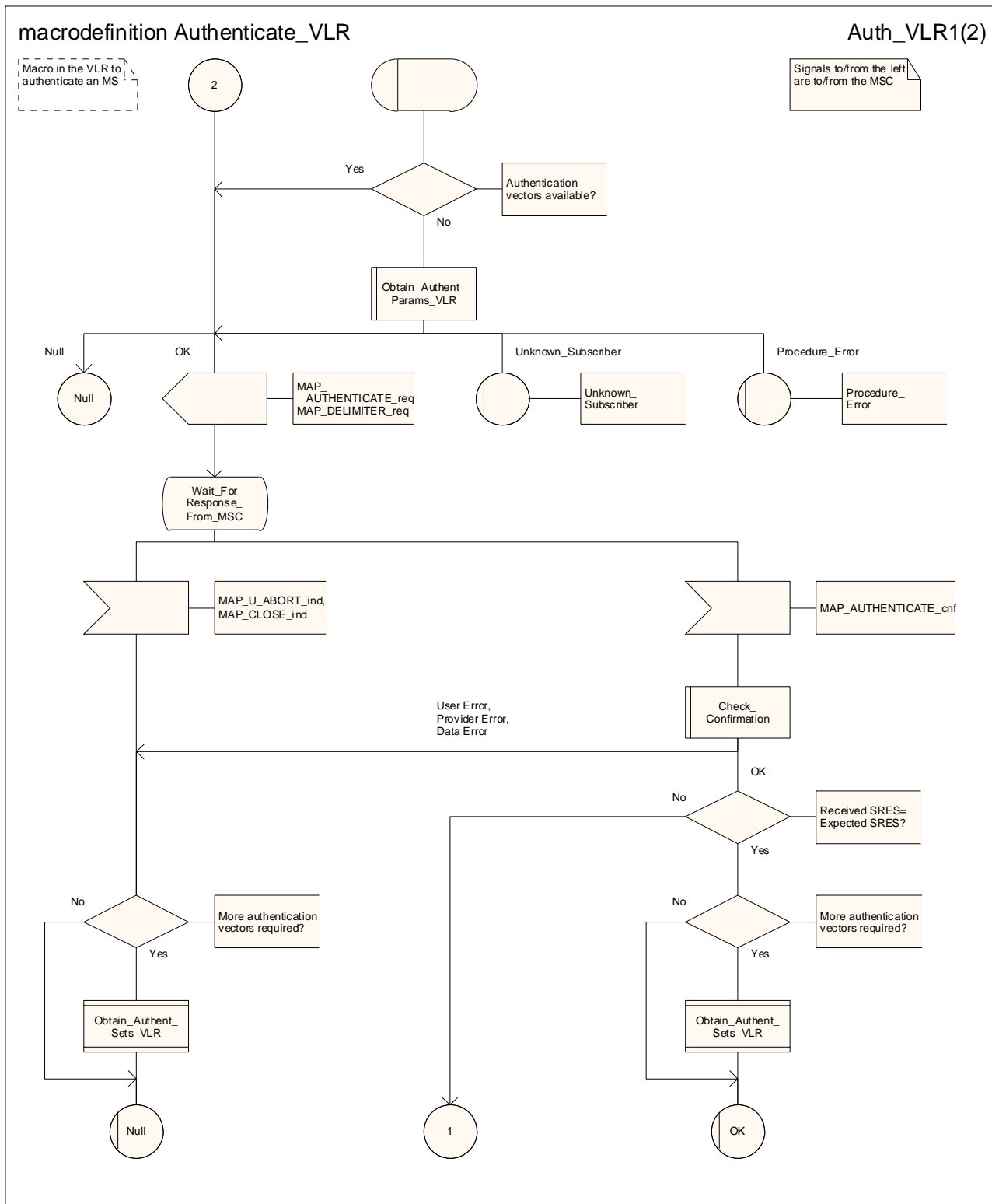

Figure 25.5/2 (sheet 1 of 2): Macro Authenticate_VLR

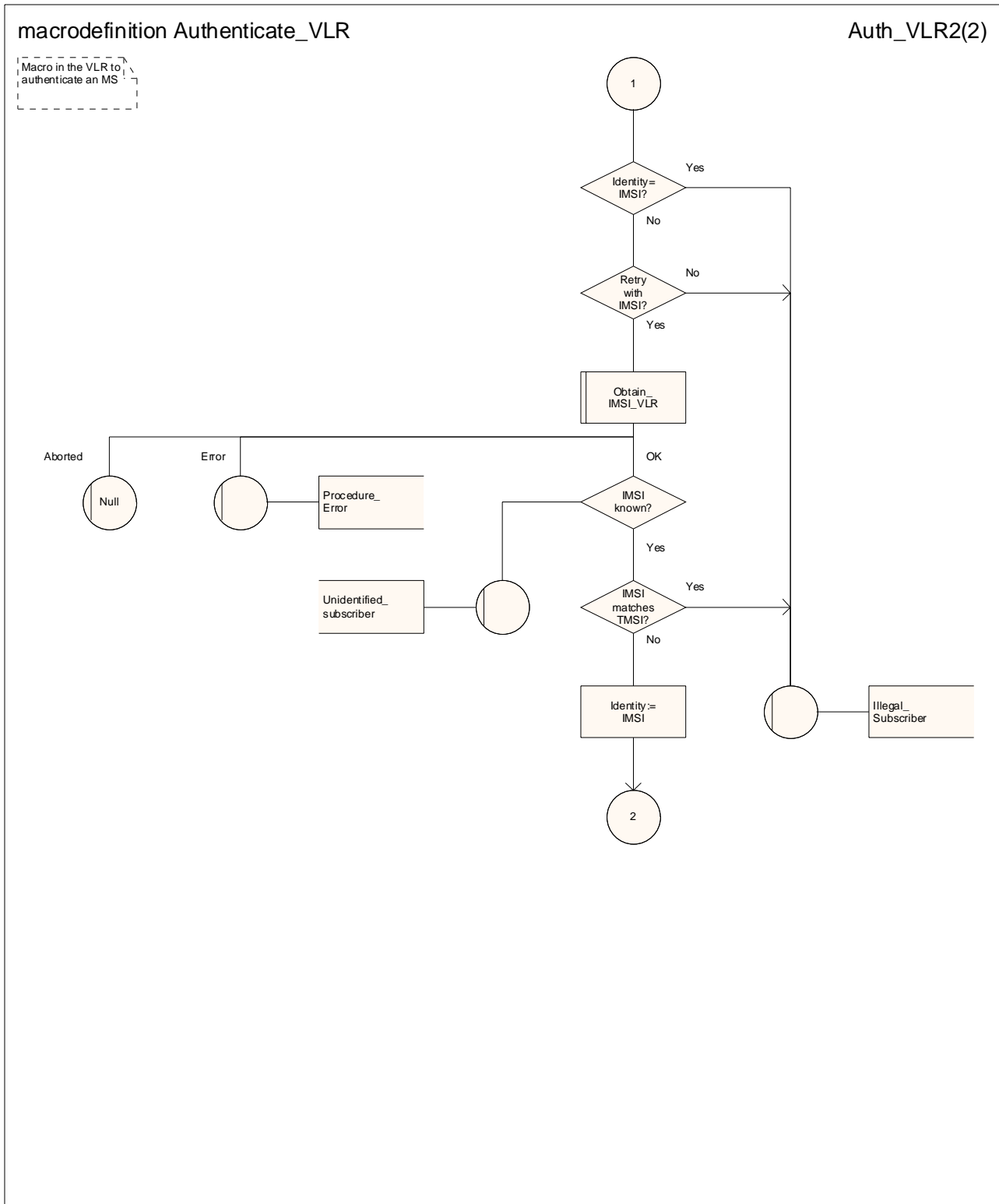

Figure 25.5/2 (sheet 2 of 2): Macro Authenticate_VLR

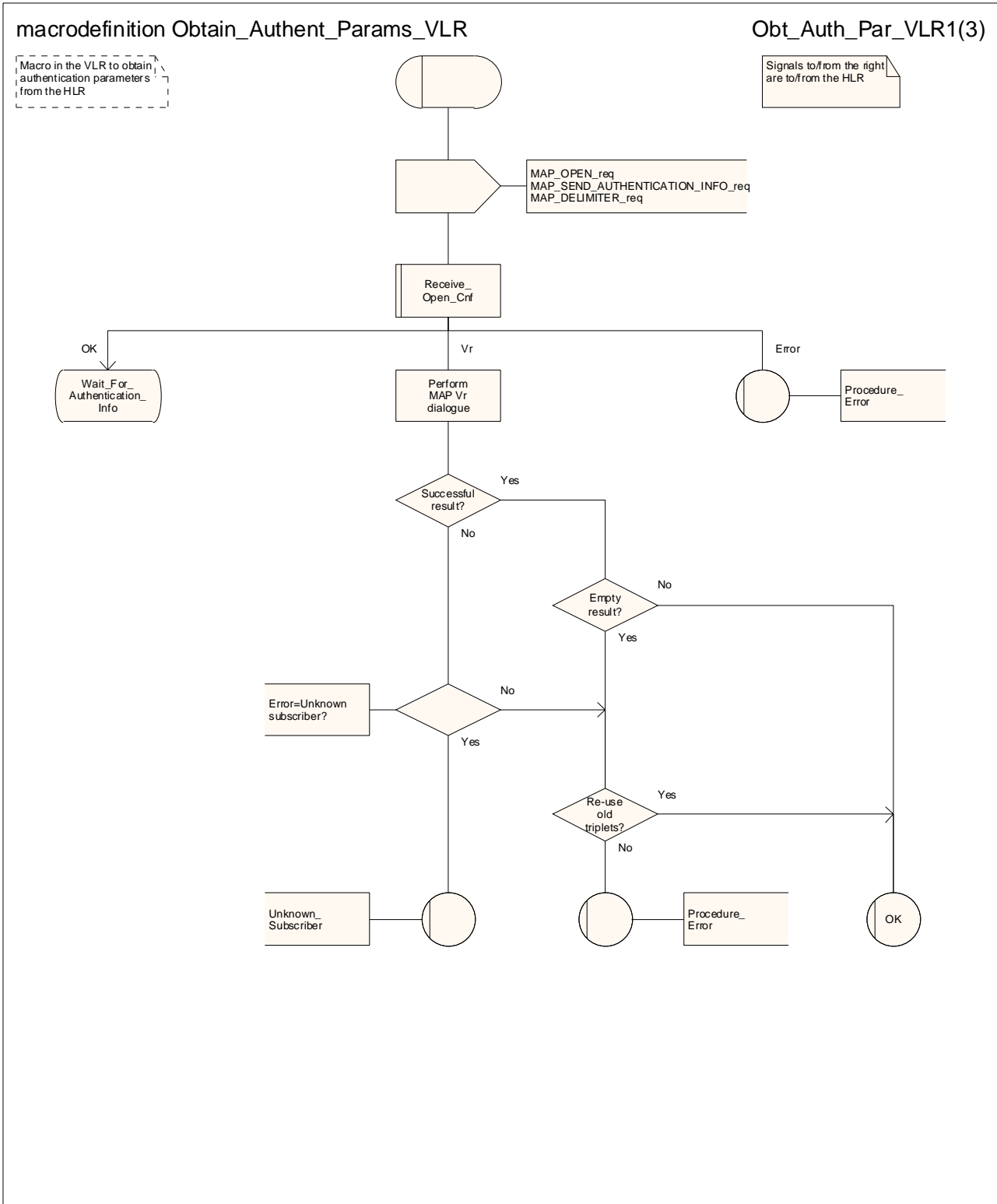

Figure 25.5/3 (sheet 1 of 3): Macro Obtain_Authent_Params_VLR

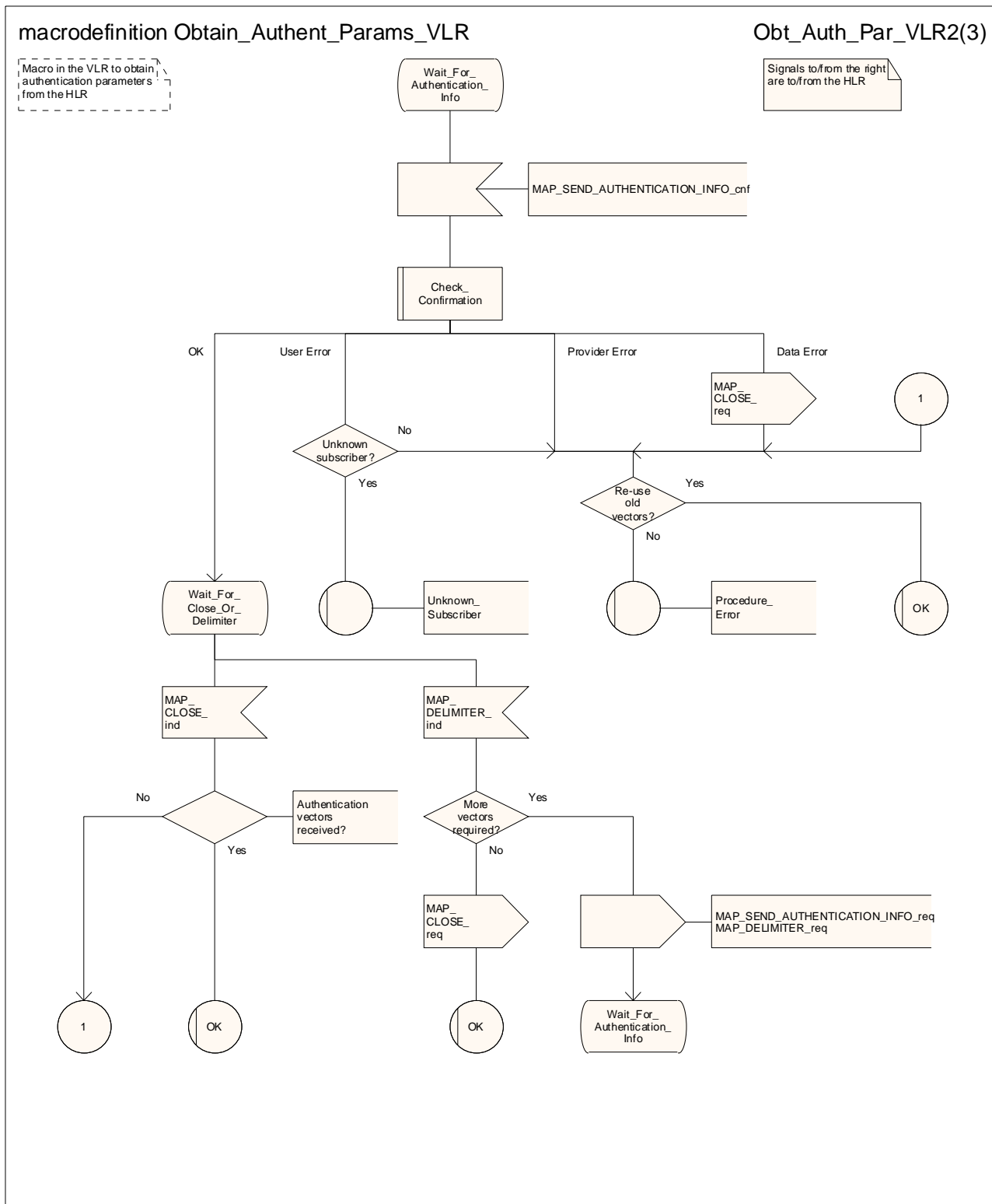

Figure 25.5/3 (sheet 2 of 3): Macro Obtain_Authent_Params_VLR

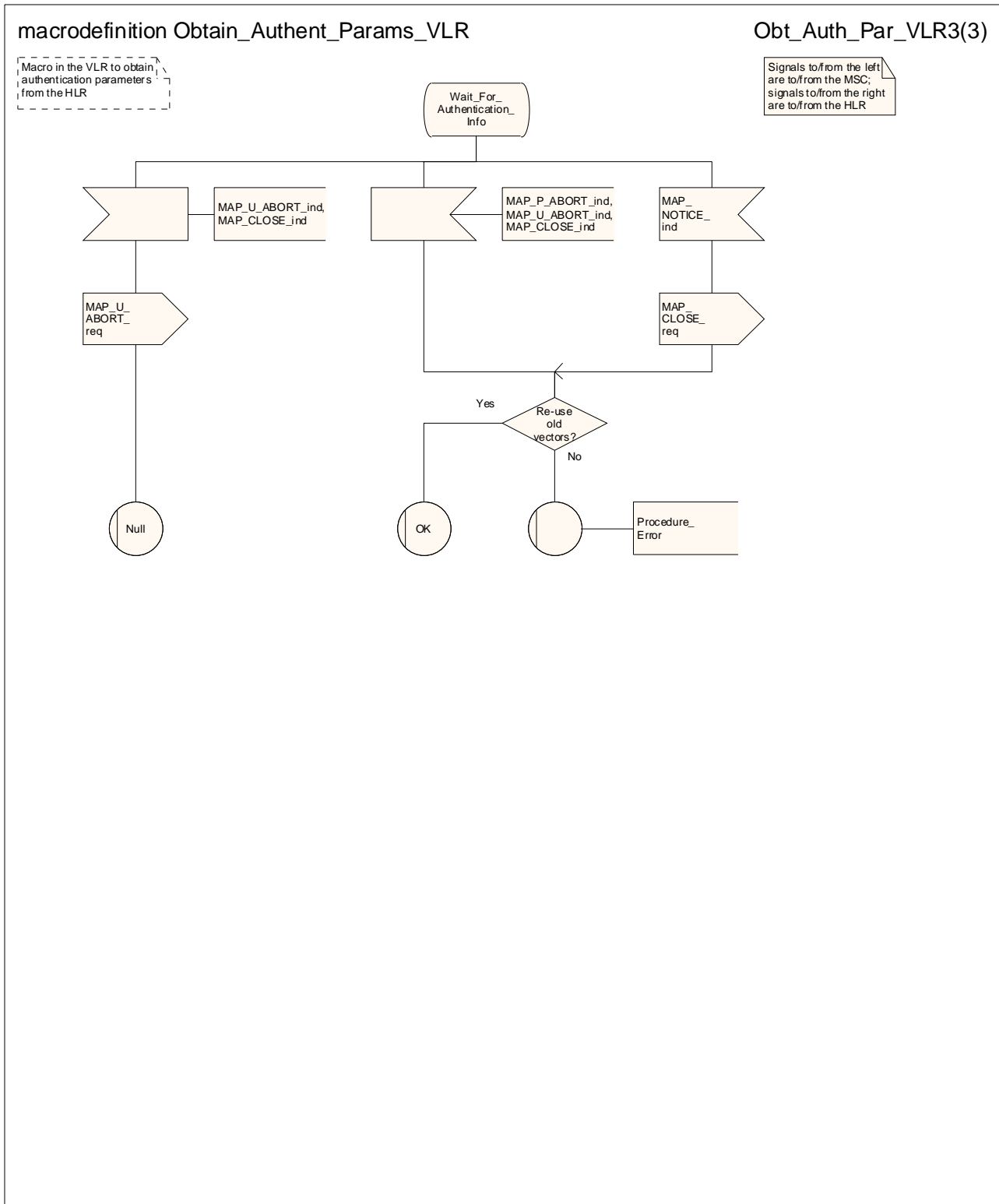

Figure 25.5/3 (sheet 3 of 3): Macro Obtain_Authent_Params_VLR

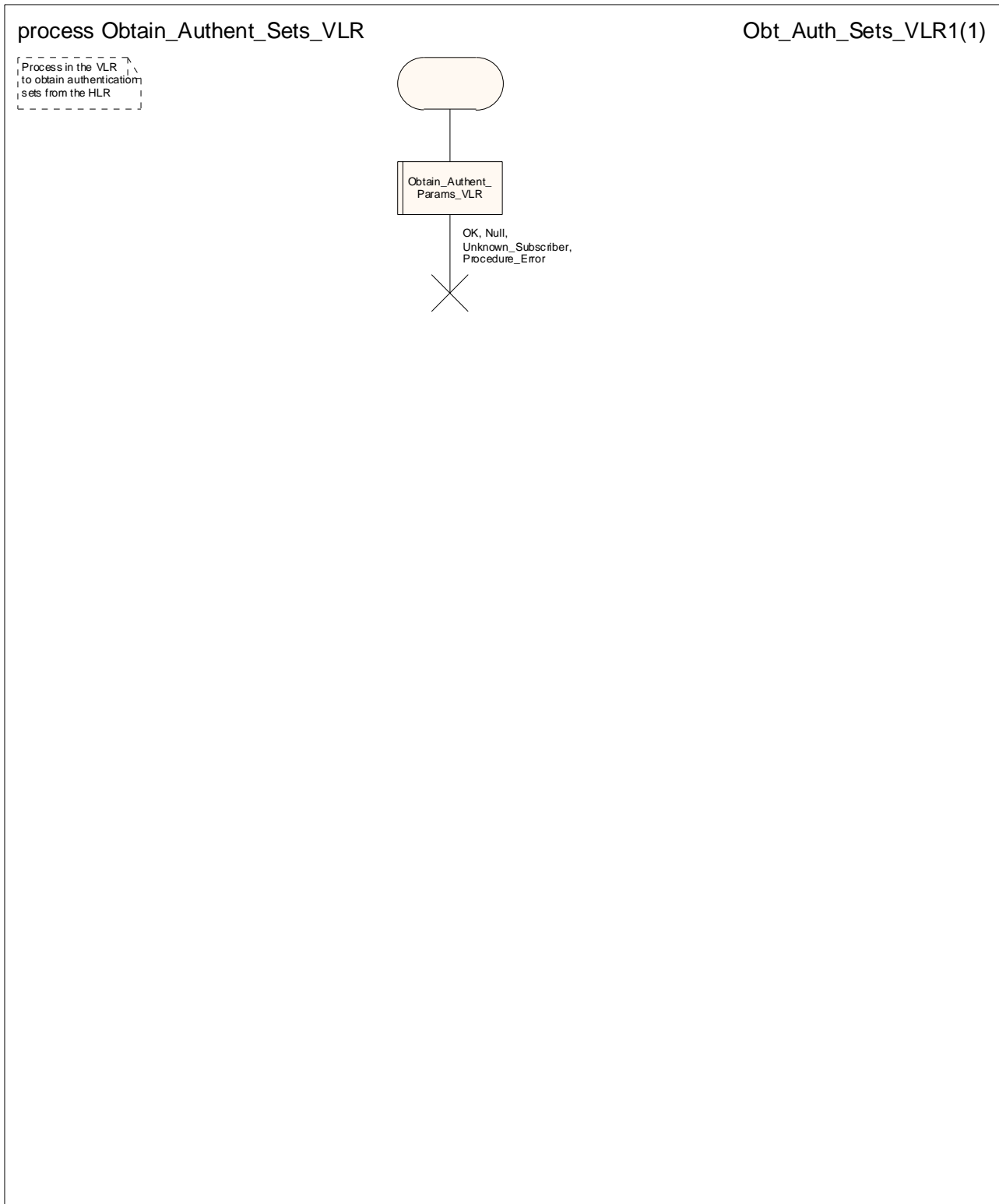

Figure 25.5/4: Process Obtain_Authentication_Sets_VLR

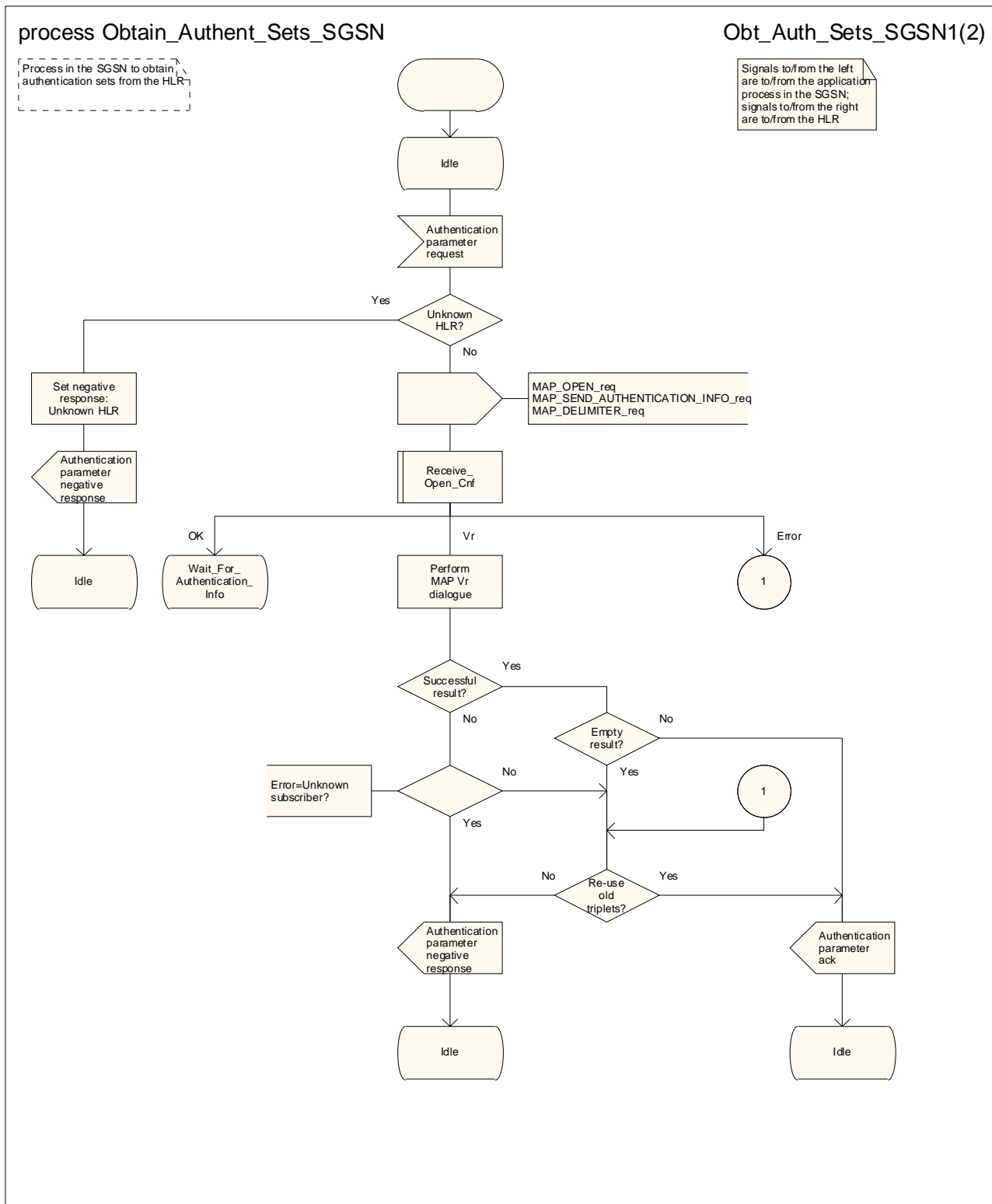

Figure 25.5/5 (sheet 1 of 2): Process Obtain_Authent_Sets_SGSN

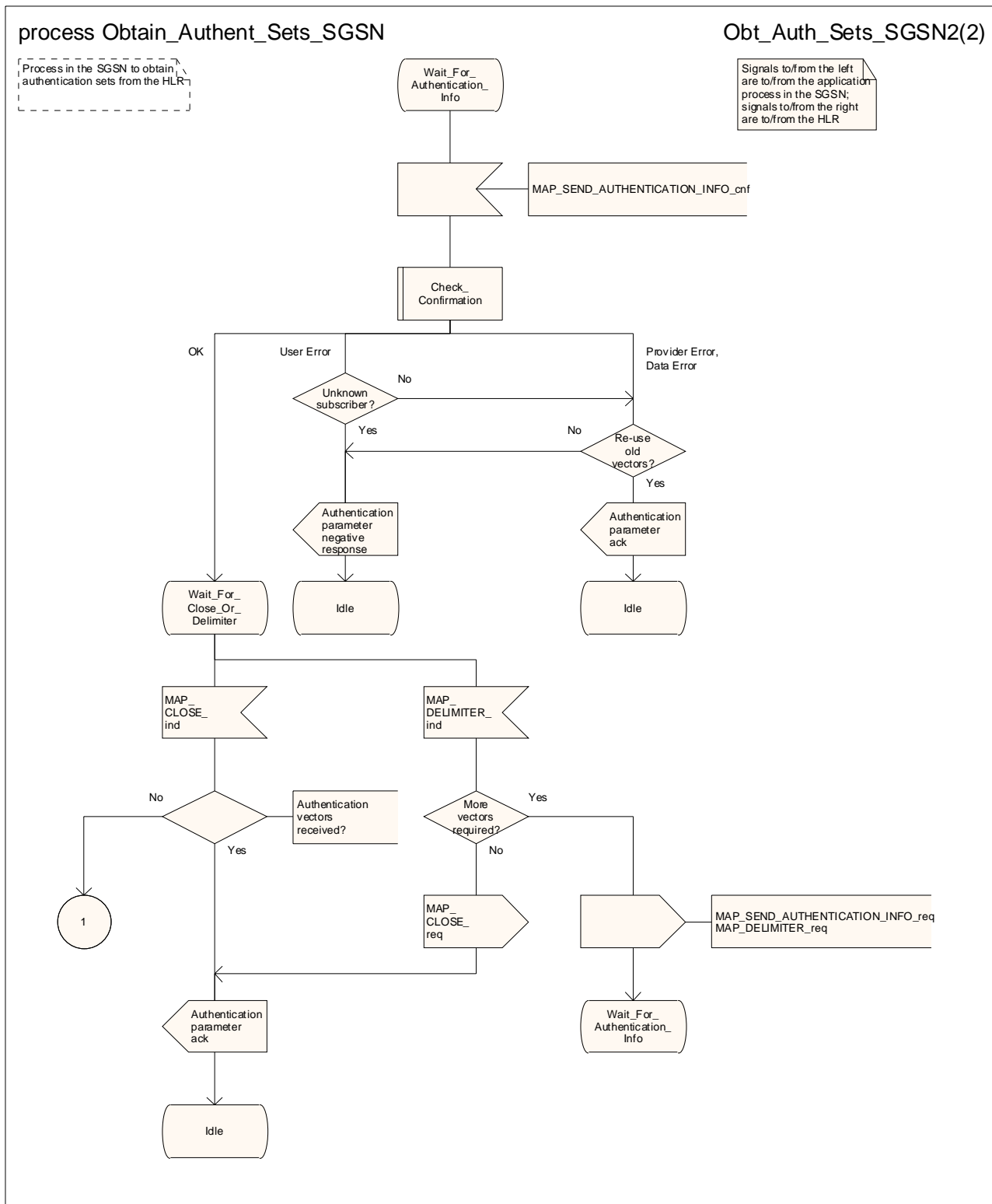

Figure 25.5/5 (sheet 2 of 2): Process Obtain_Authent_Sets_SGSN

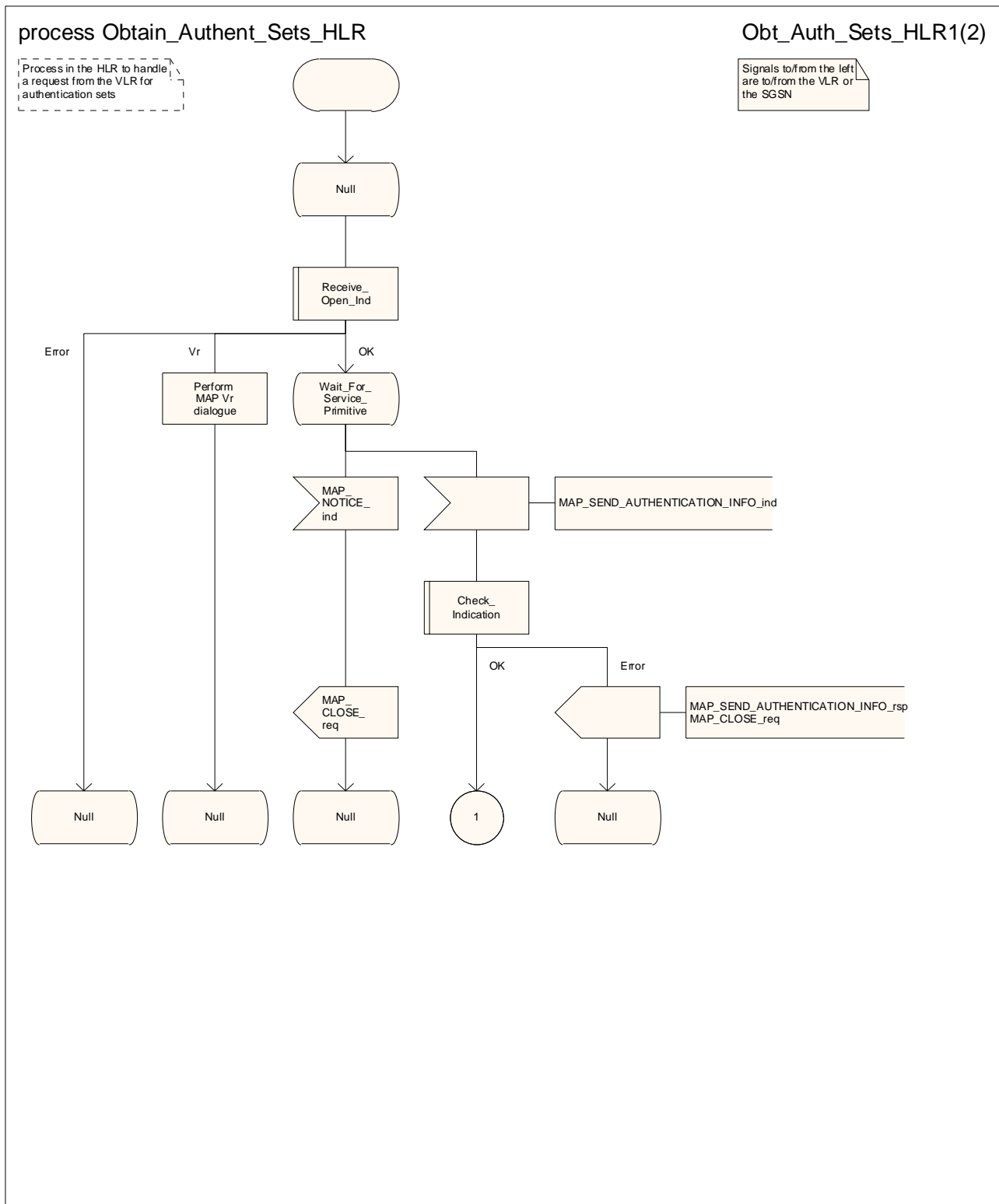

Figure 25.5/6 (sheet 1 of 2): Process Obtain_Authent_Sets_HLR

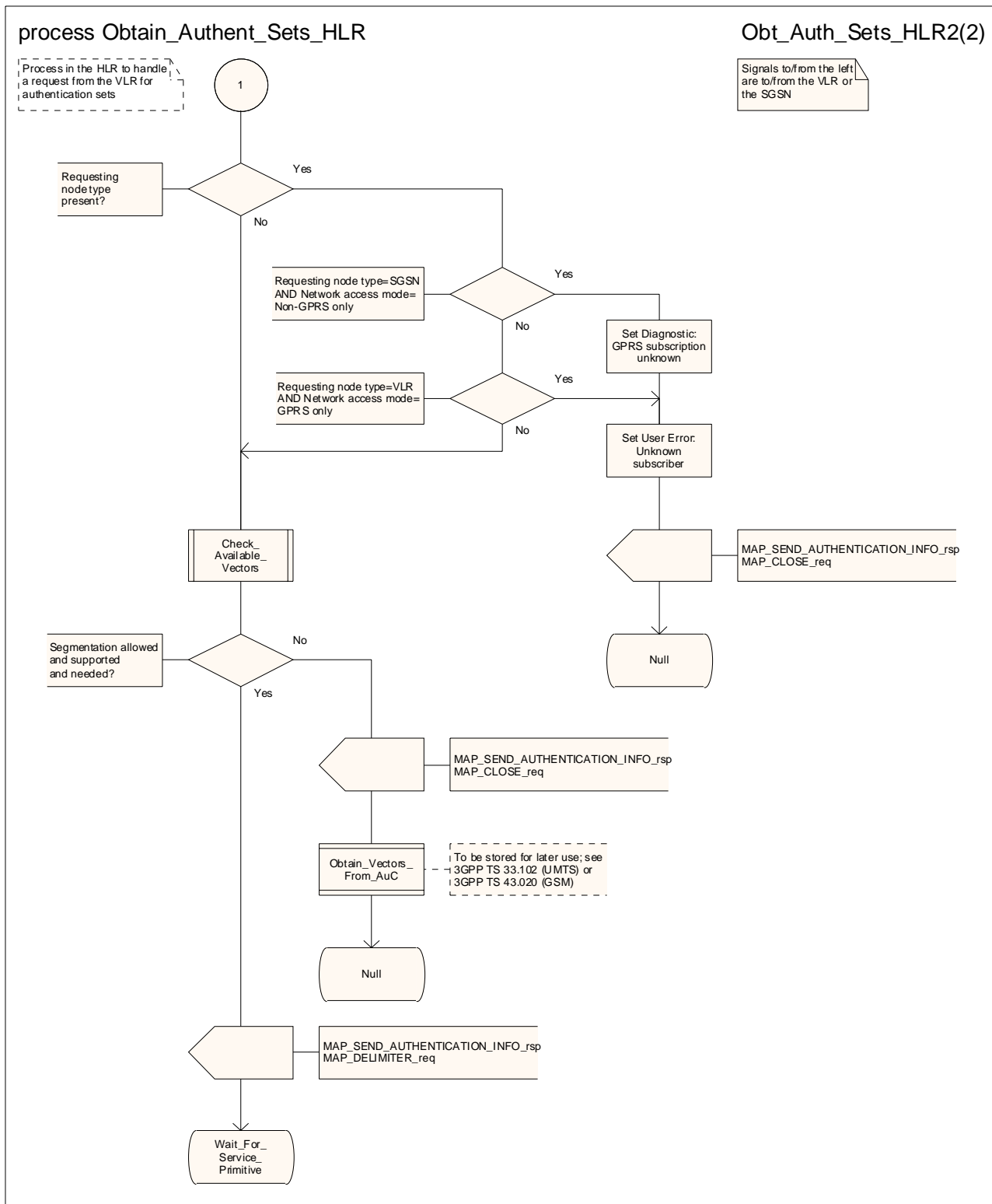

Figure 25.5/5 (sheet 2 of 2): Process Obtain_Authent_Sets_HLR

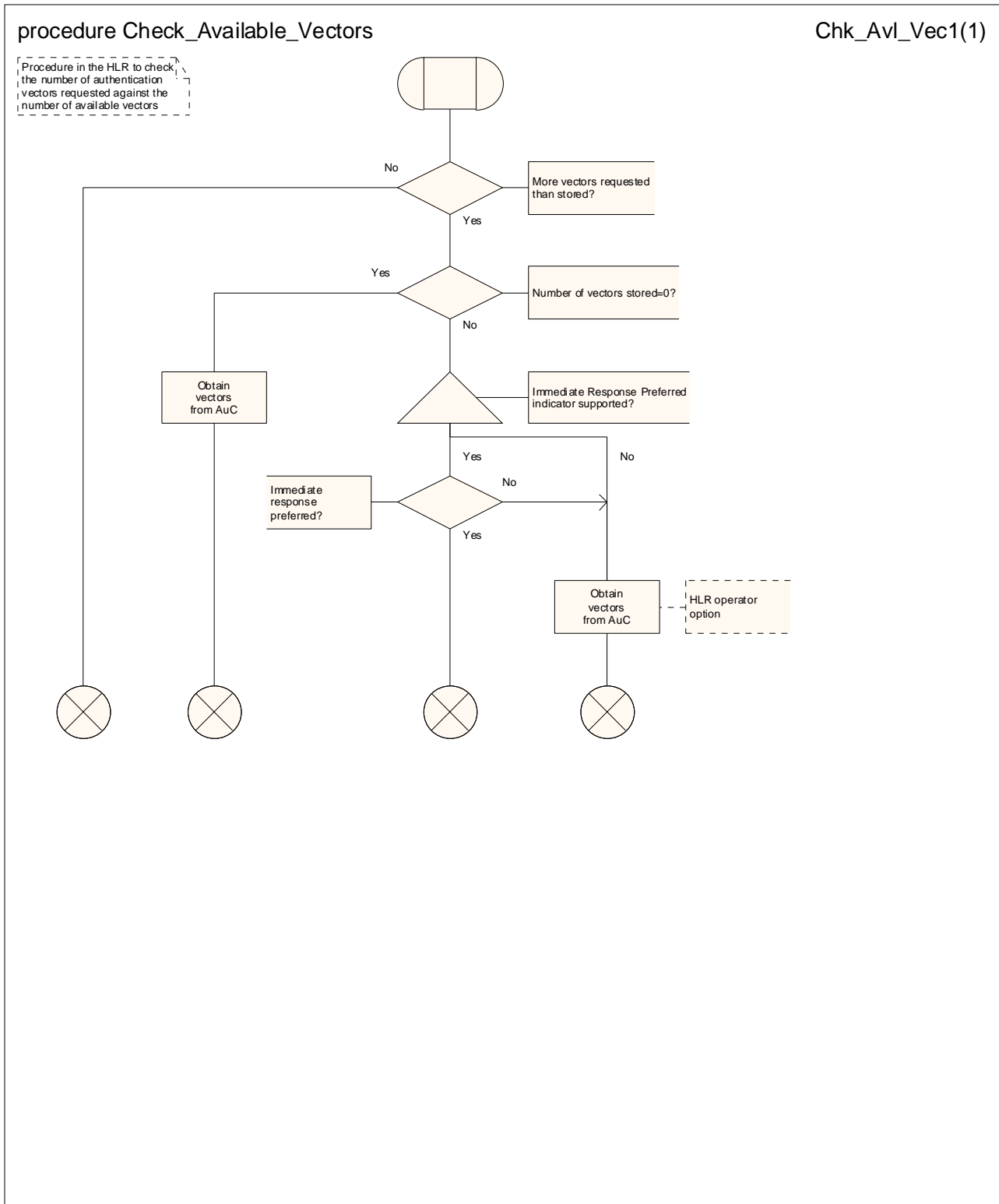

Figure 25.5/7: Procedure Check_Available_Vectors

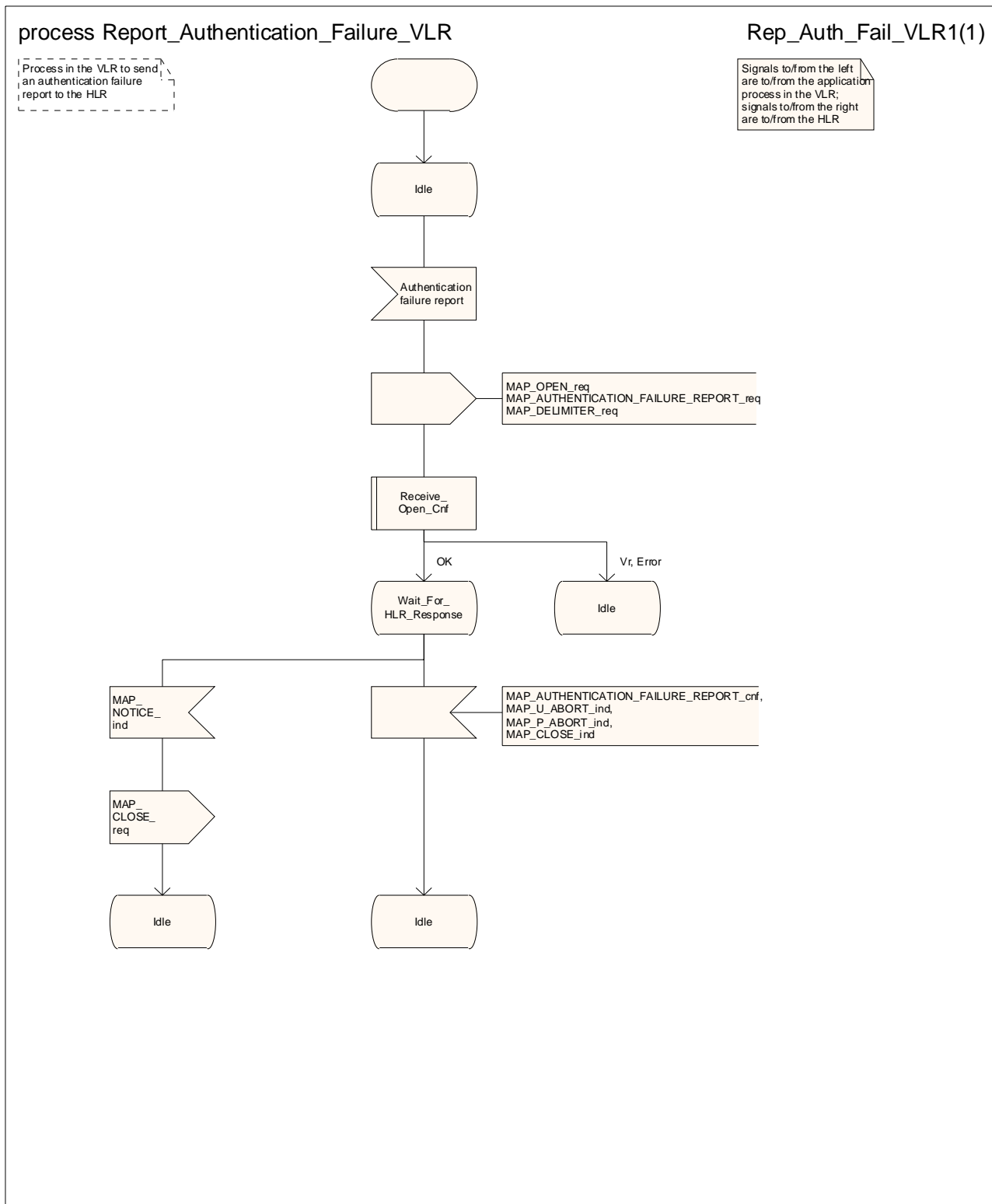

Figure 25.5/9: Process Report_Authentication_Failure_VLR

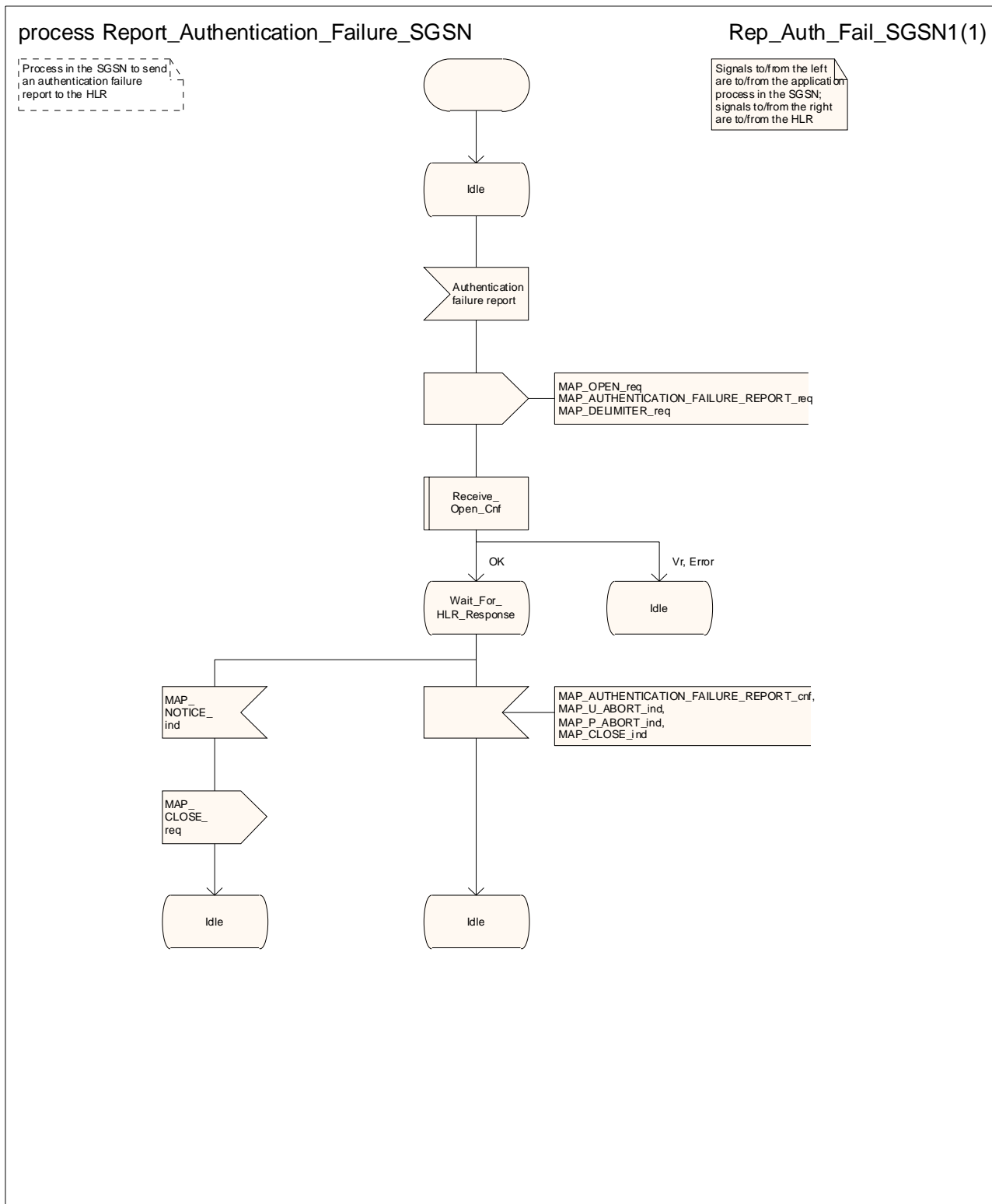

Figure 25.5/10: Process Report_Authentication_Failure_SGSN

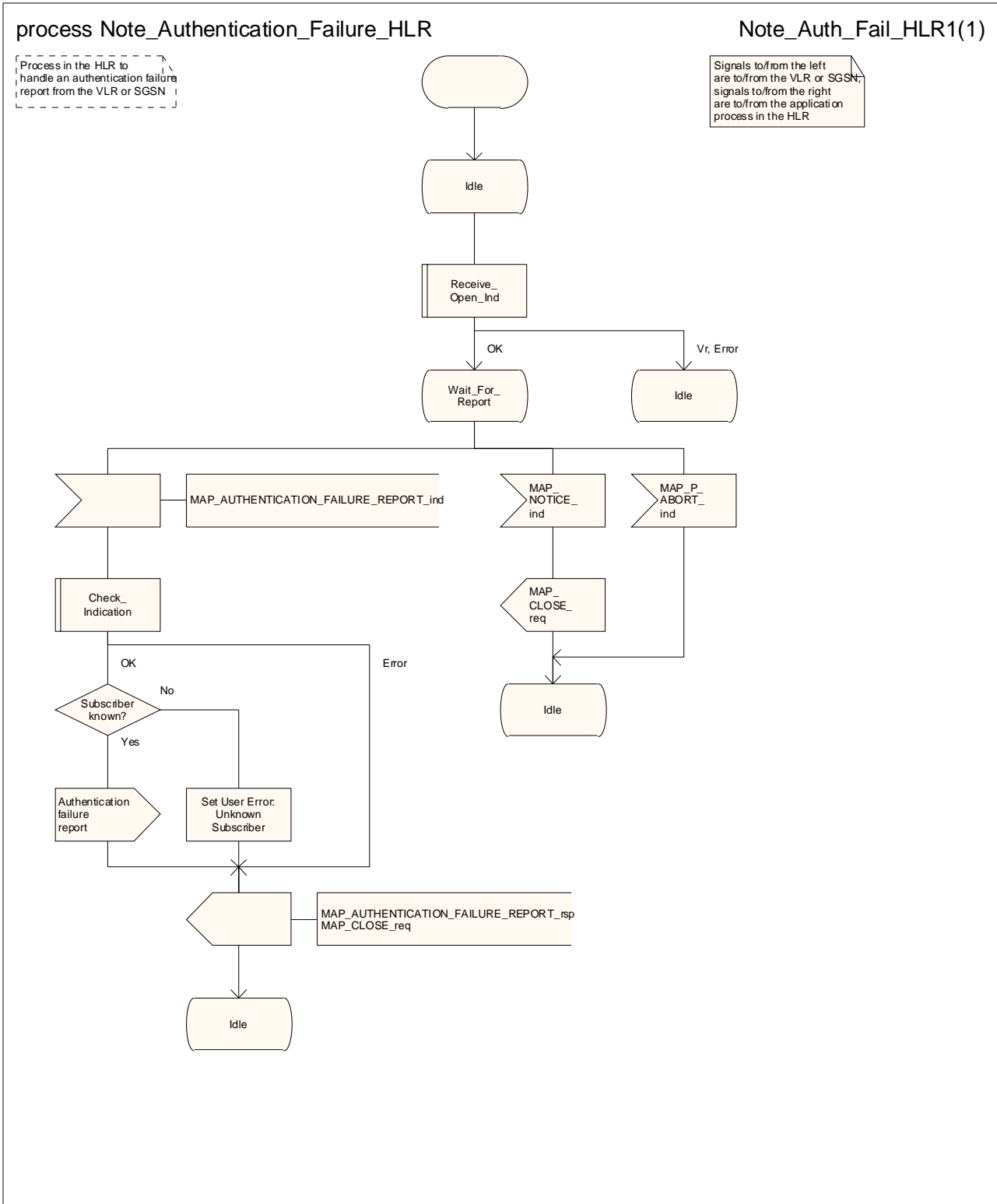

Figure 25.5/11: Process Note_Authentication_Failure_HLR

25.6 IMEI Handling macros and processes

The following macros and processes are used in the network to enable handling and checking of the mobile equipment identity.

25.6.1 Macro Check_IMEI_MSC

This macro is used by the MSC to receive a request from the VLR, relay it to the EIR, and pass the result from the EIR back to the VLR.

25.6.2 Macro Check_IMEI_VLR

This macro is used by the VLR to control the check of a mobile equipment's IMEI. It may also be used to request the BMUEF from the EIR.

25.6.3 Process Check_IMEI_SGSN

This process is used by the SGSN to control the check of a mobile equipment's IMEI. It may also be used to request the BMUEF from the EIR.

25.6.4 Process Check_IMEI_EIR

This process is used by the EIR to obtain the status of a mobile equipment, upon request from the MSC or from the SGSN. It may also be used to obtain the BMUEF.

25.6.5 Macro Obtain_IMEI_MSC

This macro is used by the MSC to respond to a request from the VLR to provide the IMEI.

25.6.5 Macro Obtain_IMEI_VLR

This macro is used by the VLR to obtain the IMEI from the MSC.

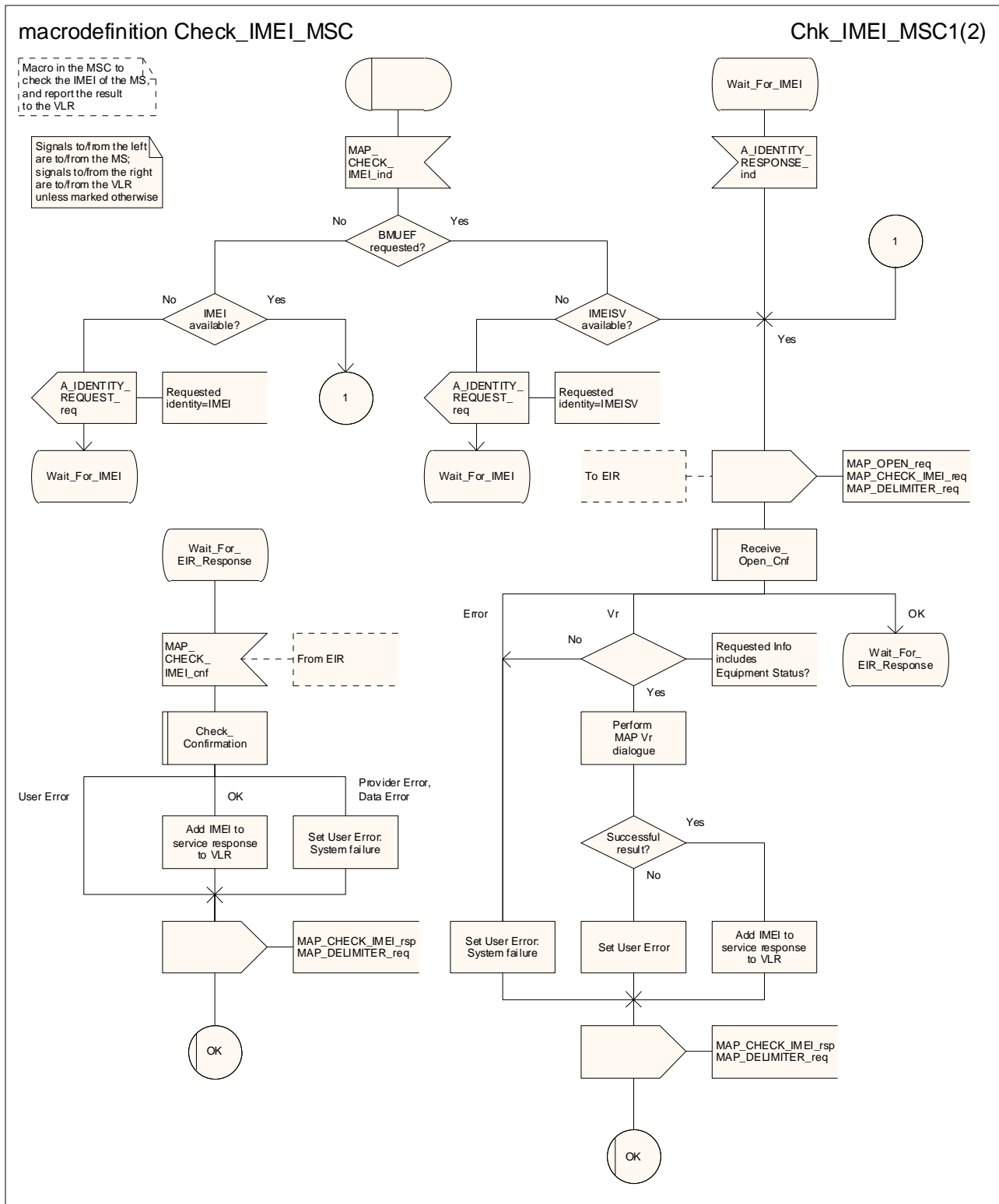

Figure 25.6/1 (sheet 1 of 2): Macro Check_IMEI_MSC

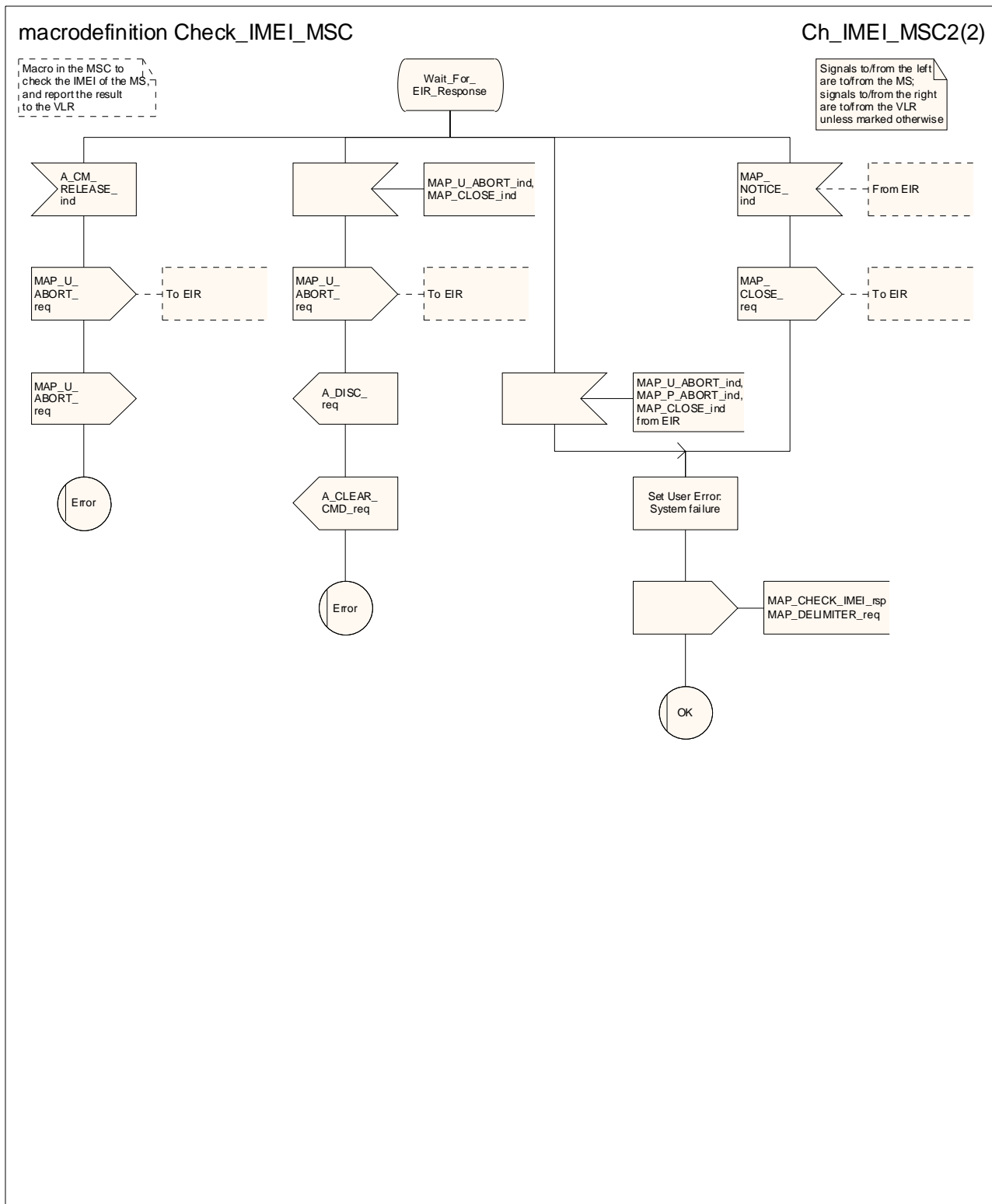

Figure 25.6/1 (sheet 2 of 2): Macro Check_IMEI_MSC

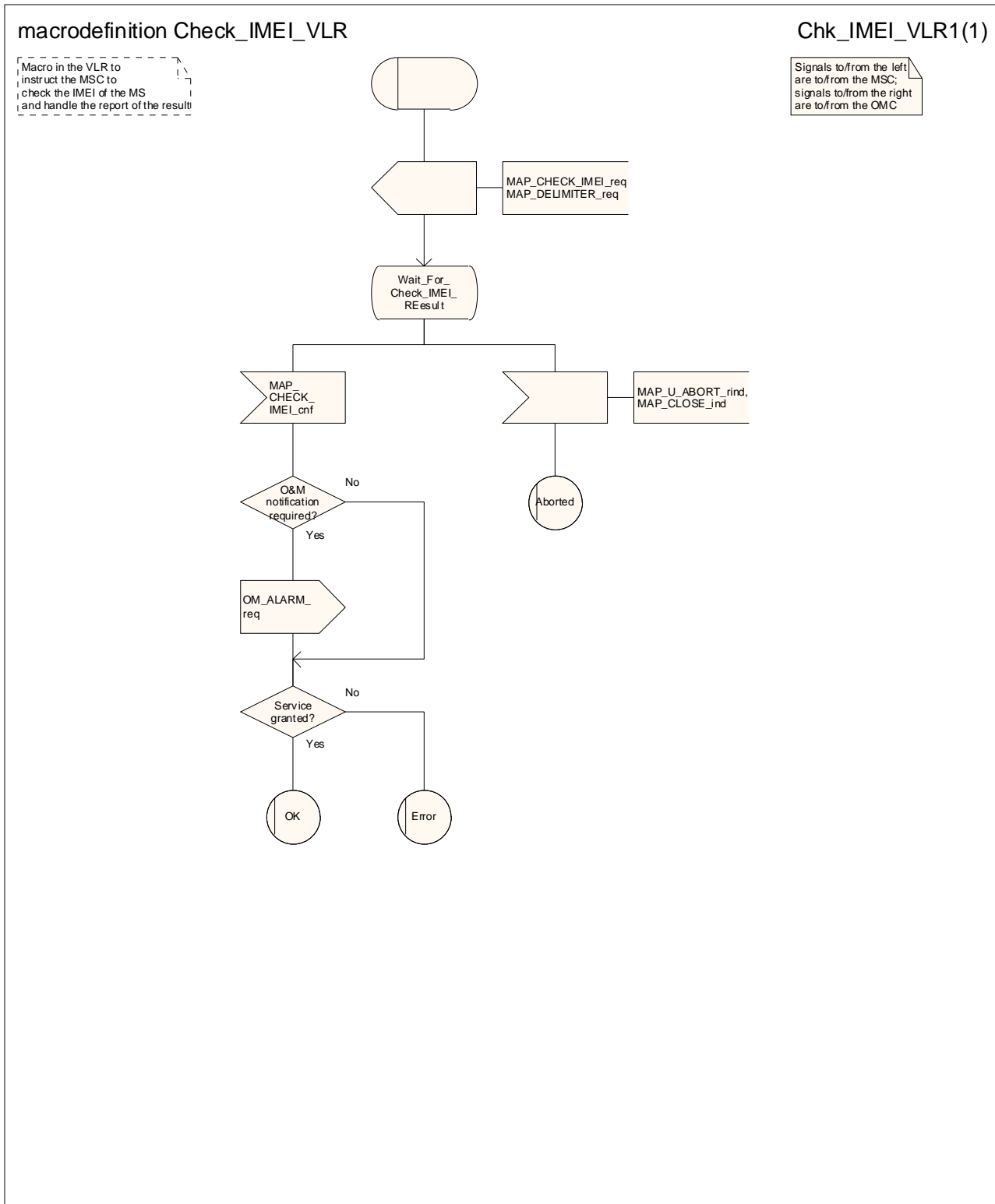

Figure 25.6/2: Macro Check_IMEI_VLR

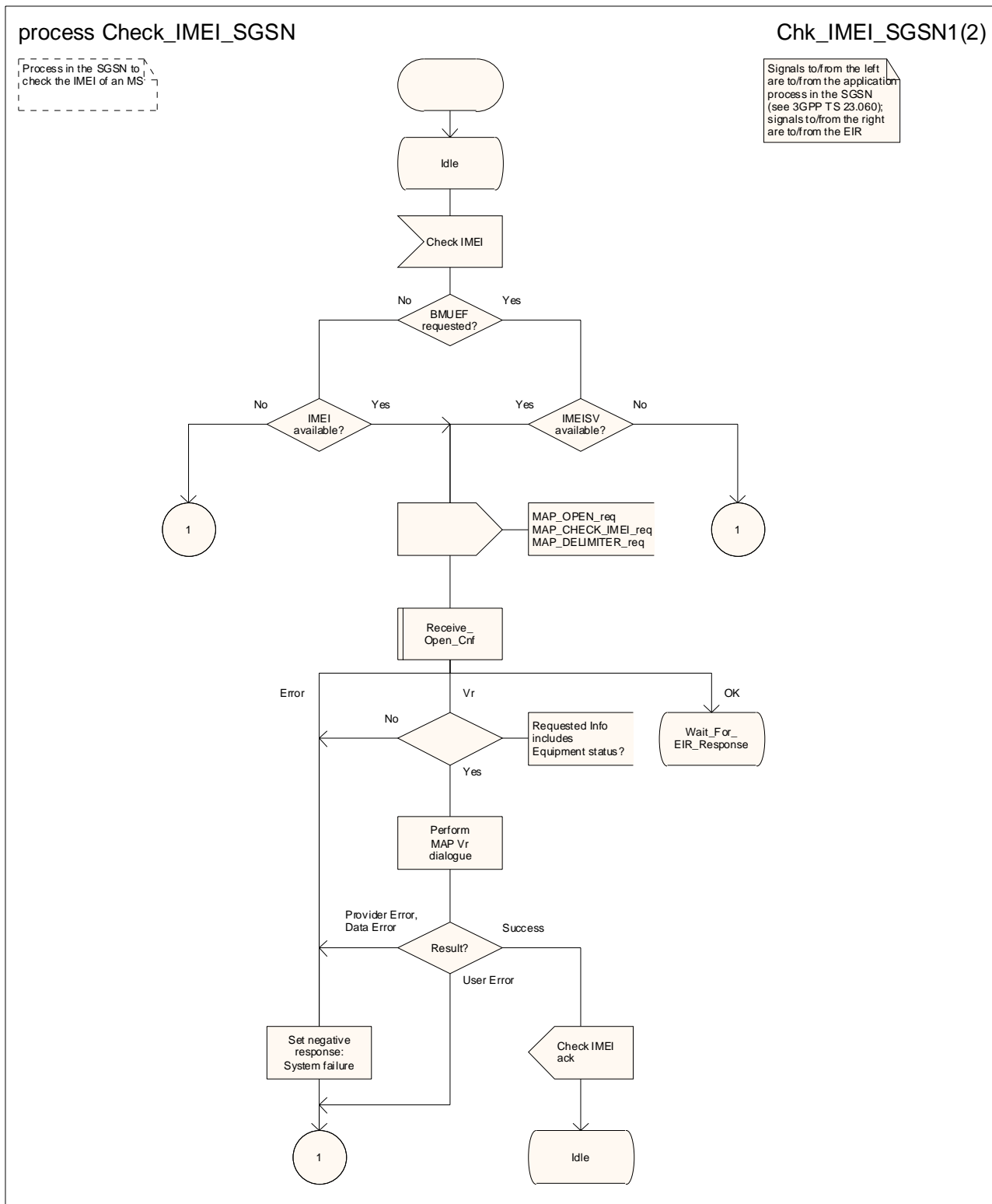

Figure 25.6/3 (sheet 1 of 2): Process Check_IMEI_SGSN

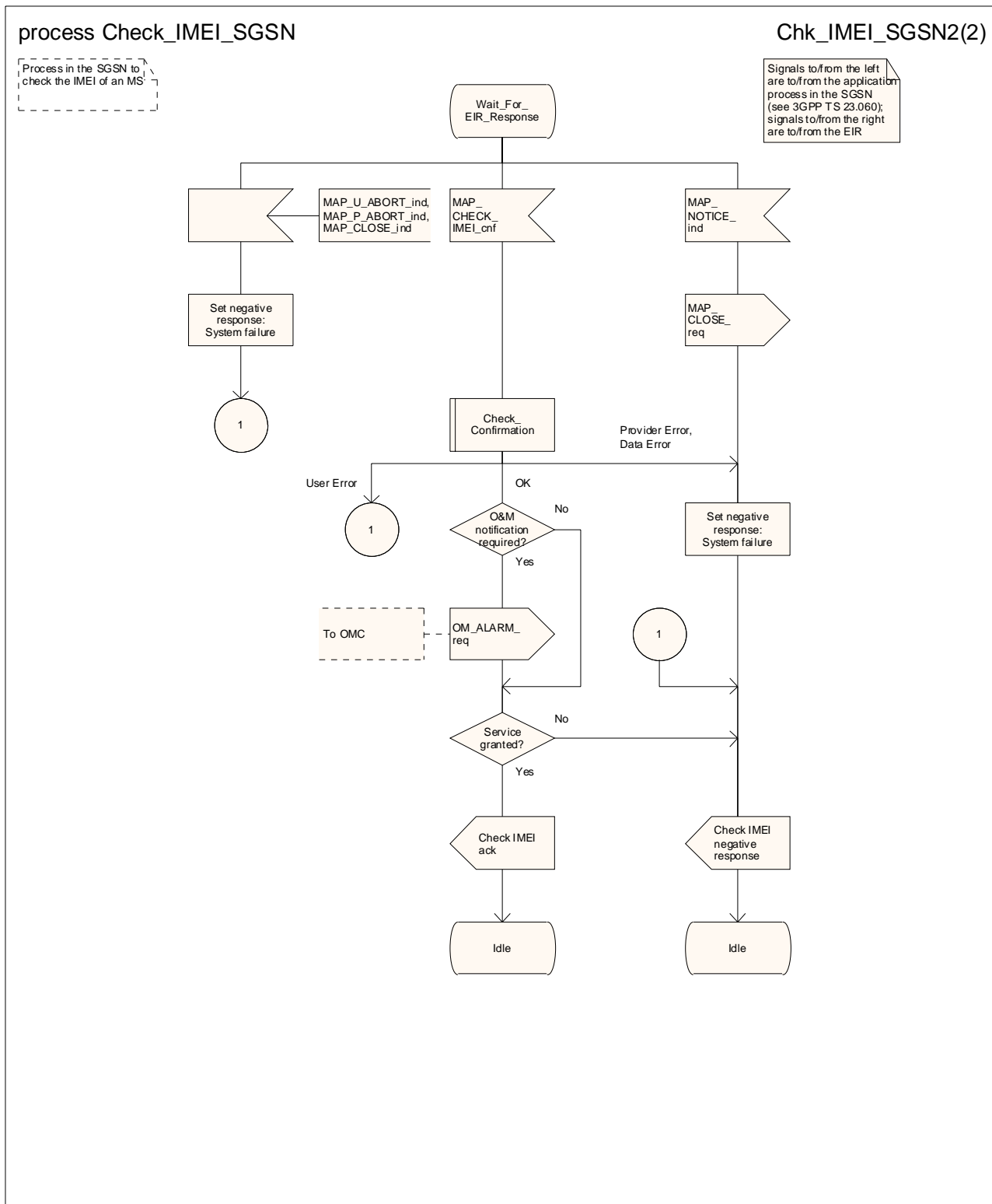

Figure 25.6/3 (sheet 2 of 2): Process Check_IMEI_SGSN

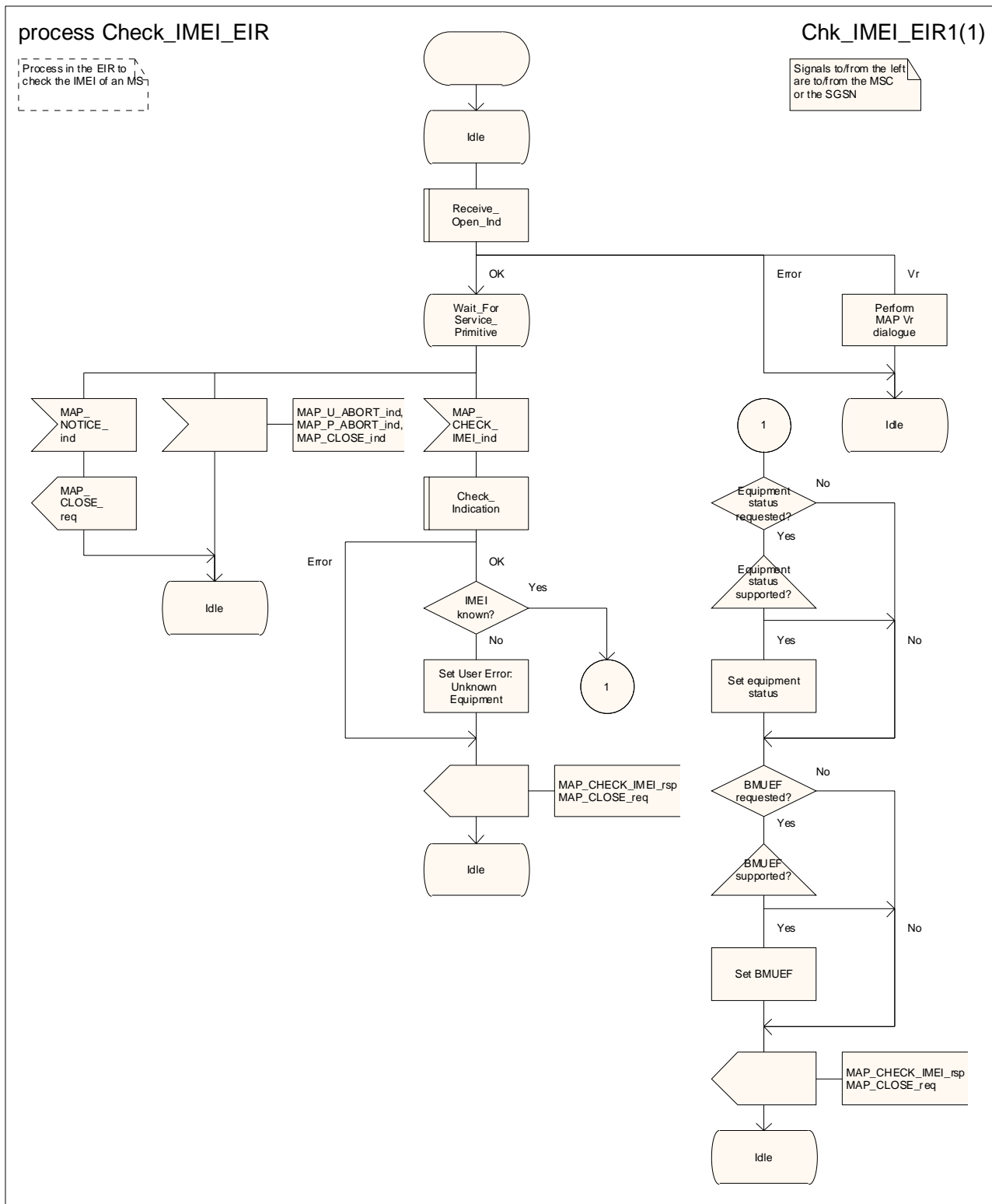

Figure 25.6/4: Process Check_IMEI_EIR

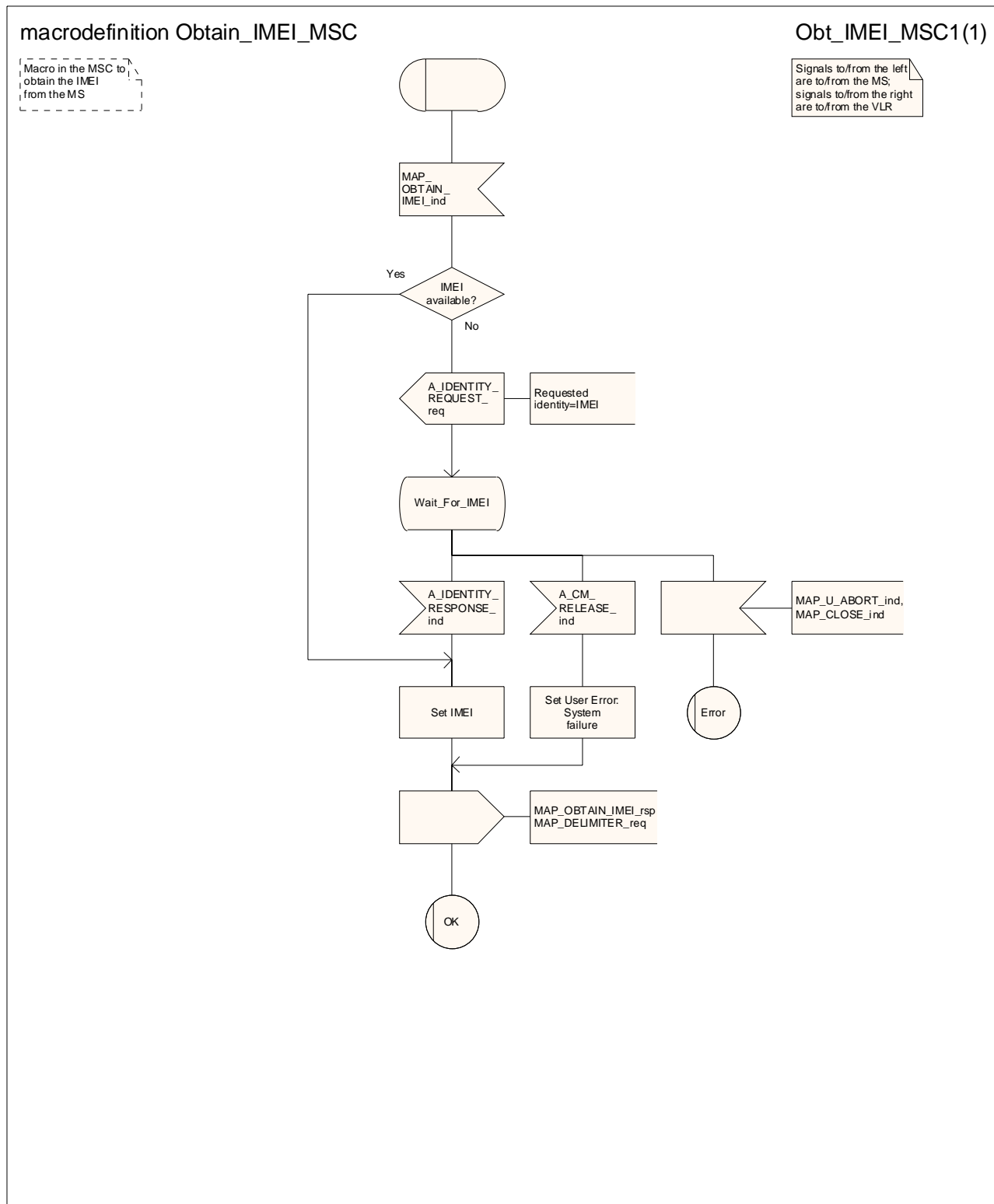

Figure 25.6/5: Macro Obtain_IMEI_MSC

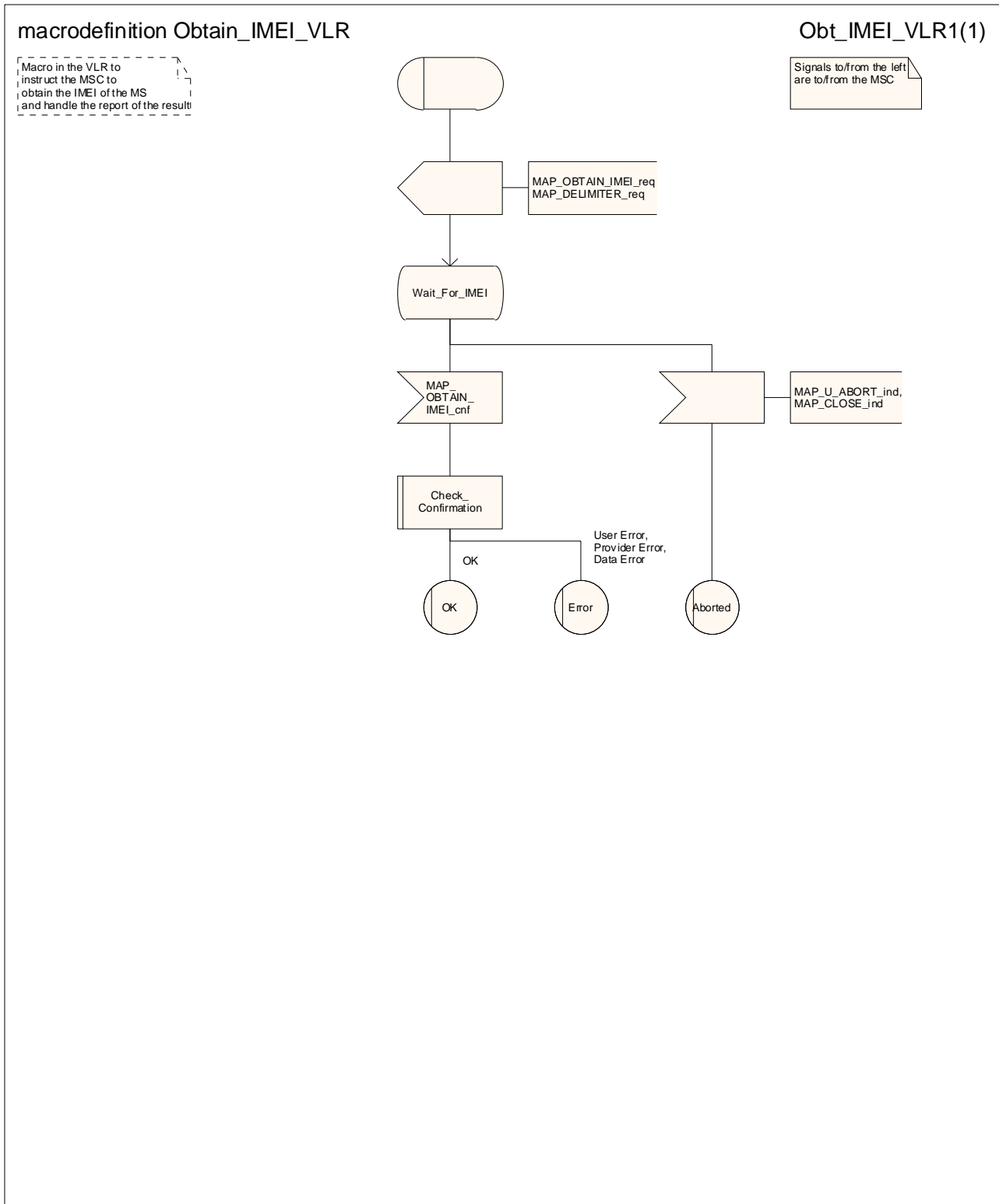

Figure 25.6/6: Process Obtain_IMEI_VLR

25.7 Insert Subscriber Data macros and processes

25.7.1 Macro Insert_Sub_Data_VLR

This macro is used by any procedure in the VLR that triggers the reception of subscriber data (e.g. Update Location or Restore Data).

25.7.2 Macro Insert_Sub_Data_SGSN

This macro is used by any procedure in the SGSN that triggers the reception of subscriber data (e.g. Update GPRS Location).

25.7.3 Process Insert_Sub_Data_Stand_Alone_HLR

This process is used by HLR to transfer subscriber data to VLR or to SGSN in a stand alone mode, i.e. in a separate dialogue. This is done whenever a change of subscriber data is performed either by the operator or by the subscriber and this change has to be reported to the VLR.

Sheet 1: The HLR may wait for each MAP_INSERT_SUBSCRIBER_DATA request to be acknowledged before it sends the next request, or it may handle the requests and the confirmations in parallel.

Sheet 1, sheet 2: If the VLR has indicated that it does not support a service or feature (e.g. Closed User Group or Advice Of Charge Charging Level) which the HLR operator regards as essential for the subscriber, the macro Wait_for_Insert_Sub_Data_Cnf takes the Replace_Service exit; the HLR sets the Roaming Restriction Due To Unsupported Feature flag to roaming restricted and sends Roaming Restriction Due To Unsupported Feature in a subsequent MAP_INSERT_SUBSCRIBER_DATA request.

Sheet 1, sheet 2: If the HLR operator does not regard the unsupported service or feature as essential for the subscriber but the macro Wait_for_Insert_Sub_Data_Cnf takes the Replace_Service exit, the HLR sends the data for a replacement service in a subsequent MAP_INSERT_SUBSCRIBER_DATA request.

Sheet 2: It is an operator option whether to repeat the download of subscriber data if the VLR returns an error response. The number of repeat attempts and the interval between them is also an operator option, depending on the error response from the VLR.

If subscriber data for CAMEL Phase 2 or later services are sent to a VLR which does not support the appropriate phase of CAMEL, the service behaviour may be unpredictable or incorrect. The HLR should therefore ensure that at the conclusion of a stand alone Insert Subscriber data procedure the data in the VLR do not require a capability that the VLR does not have. Possible mechanisms to ensure this are described in 3GPP TS 23.078 [98].

The HLR should send a Forwarded-to number which is not in E.164 international format to the VLR only when the HLR has ascertained that the VLR supports CAMEL Phase 2 or later. Thus, the ISD message containing the Forwarded-to number which is not in E.164 international format shall be sent to the VLR only if the HLR previously received confirmation from the VLR at Location Update that CAMEL Phase 2 or later is supported.

25.7.4 Process Insert_GPRS_Sub_Data_Stand_Alone_HLR

This process is used by the HLR to transfer subscriber data from the HLR to the SGSN in a stand alone mode, i.e. in a separate dialogue. This is done whenever a change of subscriber data is performed either by the operator or by the subscriber and this change has to be reported to the SGSN.

Sheet 1: The HLR may wait for each MAP_INSERT_SUBSCRIBER_DATA request to be acknowledged before it sends the next request, or it may handle the requests and the confirmations in parallel.

Sheet 1, sheet 2: If the SGSN has indicated that it does not support a service or feature which the HLR operator regards as essential for the subscriber, the macro Wait_for_Insert_GPRS_Sub_Data_Cnf takes the Replace_Service exit; the HLR sets the Roaming Restricted In SGSN Due To Unsupported Feature flag to roaming restricted and sends Roaming Restricted In SGSN Due To Unsupported Feature in a subsequent MAP_INSERT_SUBSCRIBER_DATA request.

Sheet 1, sheet 2: If the HLR operator does not regard the unsupported service or feature as essential for the subscriber but the macro `Wait_for_Insert_GPRS_Subscriber_Data_Cnf` takes the `Replace_Service` exit, the HLR sends the data for a replacement service in a subsequent `MAP_INSERT_SUBSCRIBER_DATA` request.

Sheet 2: It is an operator option whether to repeat the download of subscriber data if the SGSN returns an error response. The number of repeat attempts and the interval between them is also an operator option, depending on the error response from the SGSN.

25.7.5 Macro `Wait_for_Insert_Subscriber_Data_Cnf`

This macro is used by any process or macro that describes the handling in the HLR of the transfer of subscriber data to the VLR (e.g. Update Location or Restore Data).

25.7.6 Macro `Wait_for_Insert_GPRS_Subscriber_Data_Cnf`

This macro is used by any process or macro that describes the handling in the HLR of the transfer of subscriber data to the SGSN (e.g. Update GPRS Location).

25.7.7 Process `Send_Insert_Subscriber_Data_HLR`

This process is used by any process or macro in the HLR where a `MAP_INSERT_SUBSCRIBER_DATA` request is sent to the VLR or to the SGSN.

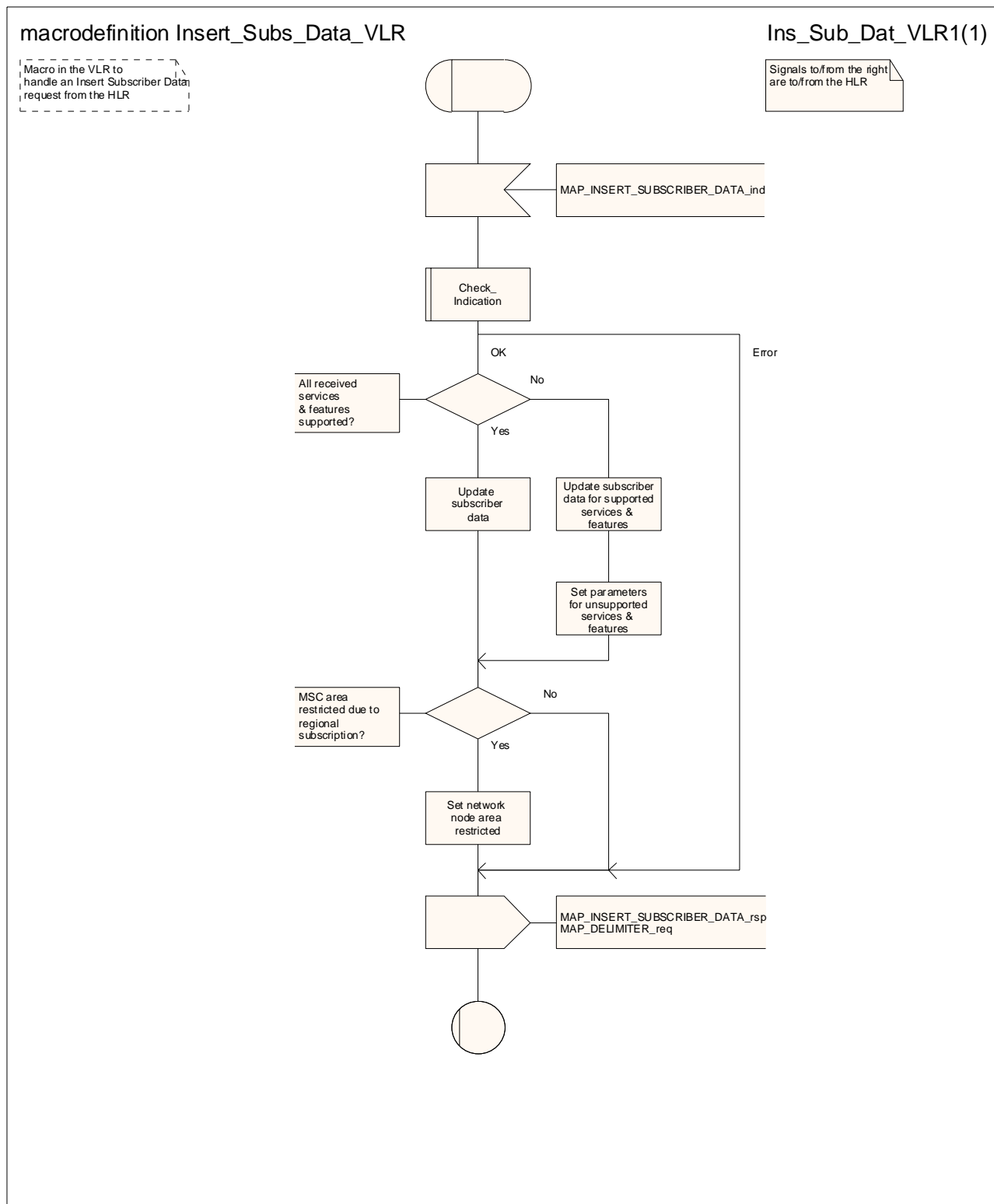

Figure 25.7/1: Macro Insert_Subscriber_Data_VLR

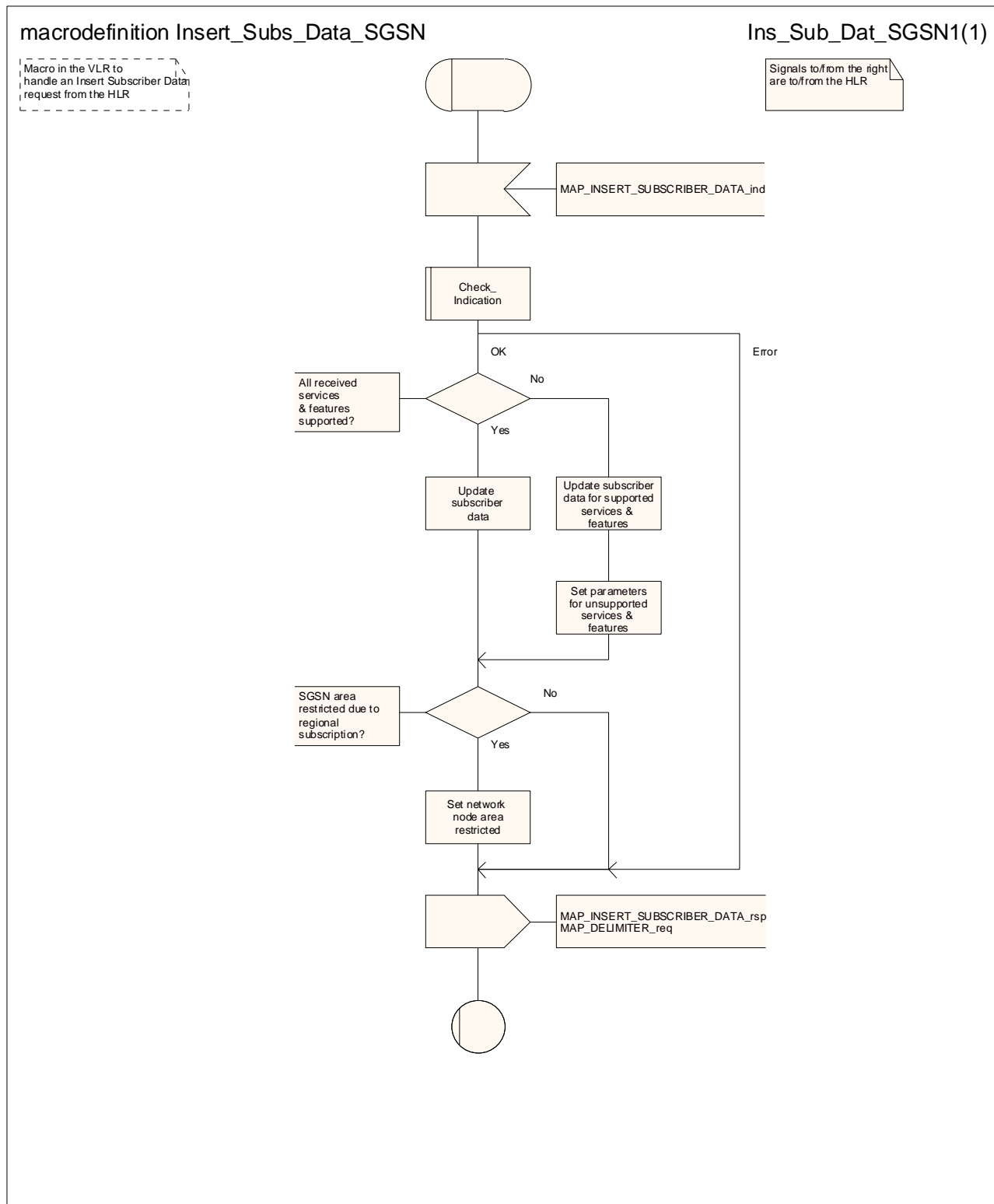

Figure 25.7/2: Macro Insert_Subscriber_Data_SGSN

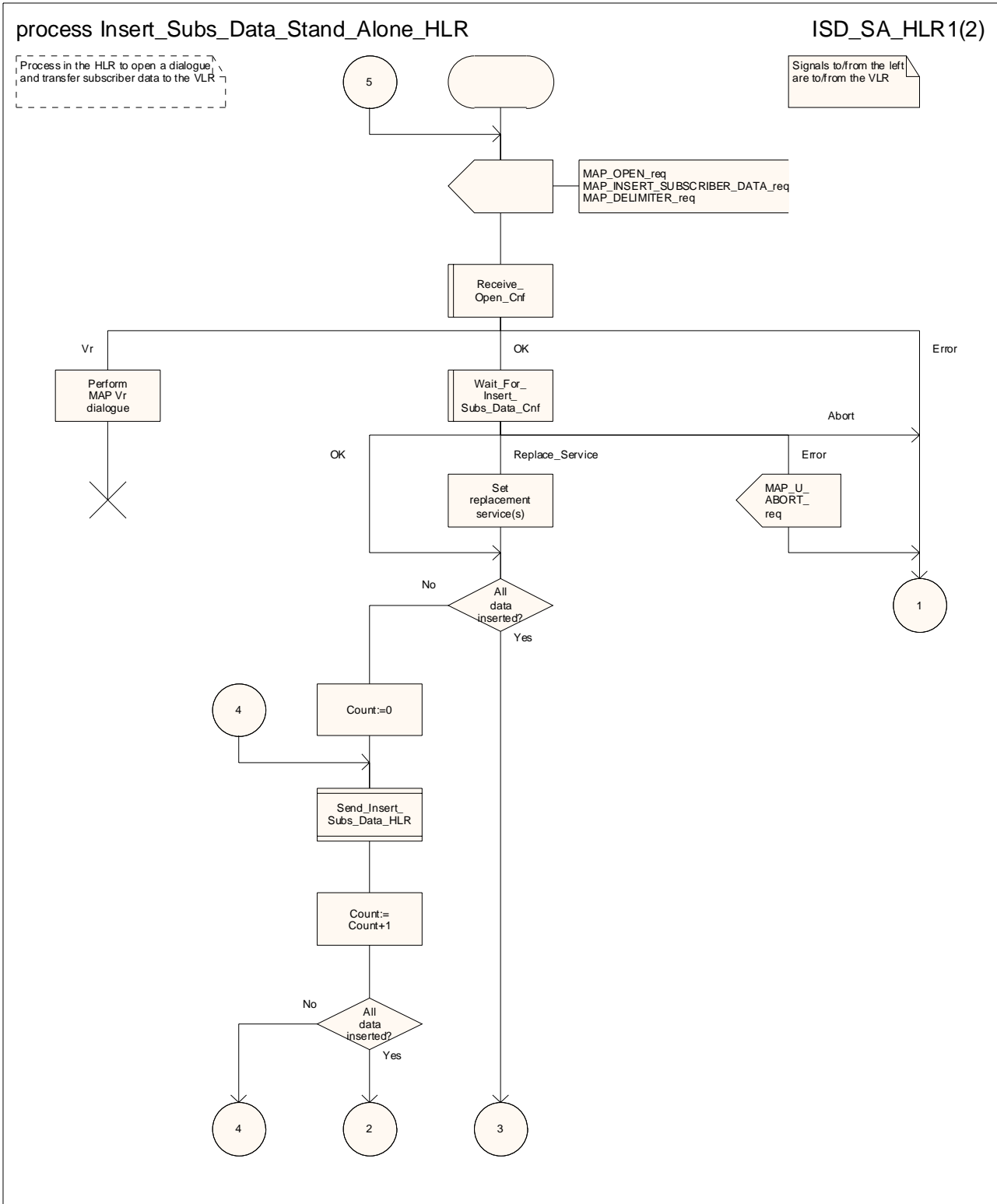

Figure 25.7/3 (sheet 1 of 2): Process Insert_Subs_Data_Stand_Alone_HLR

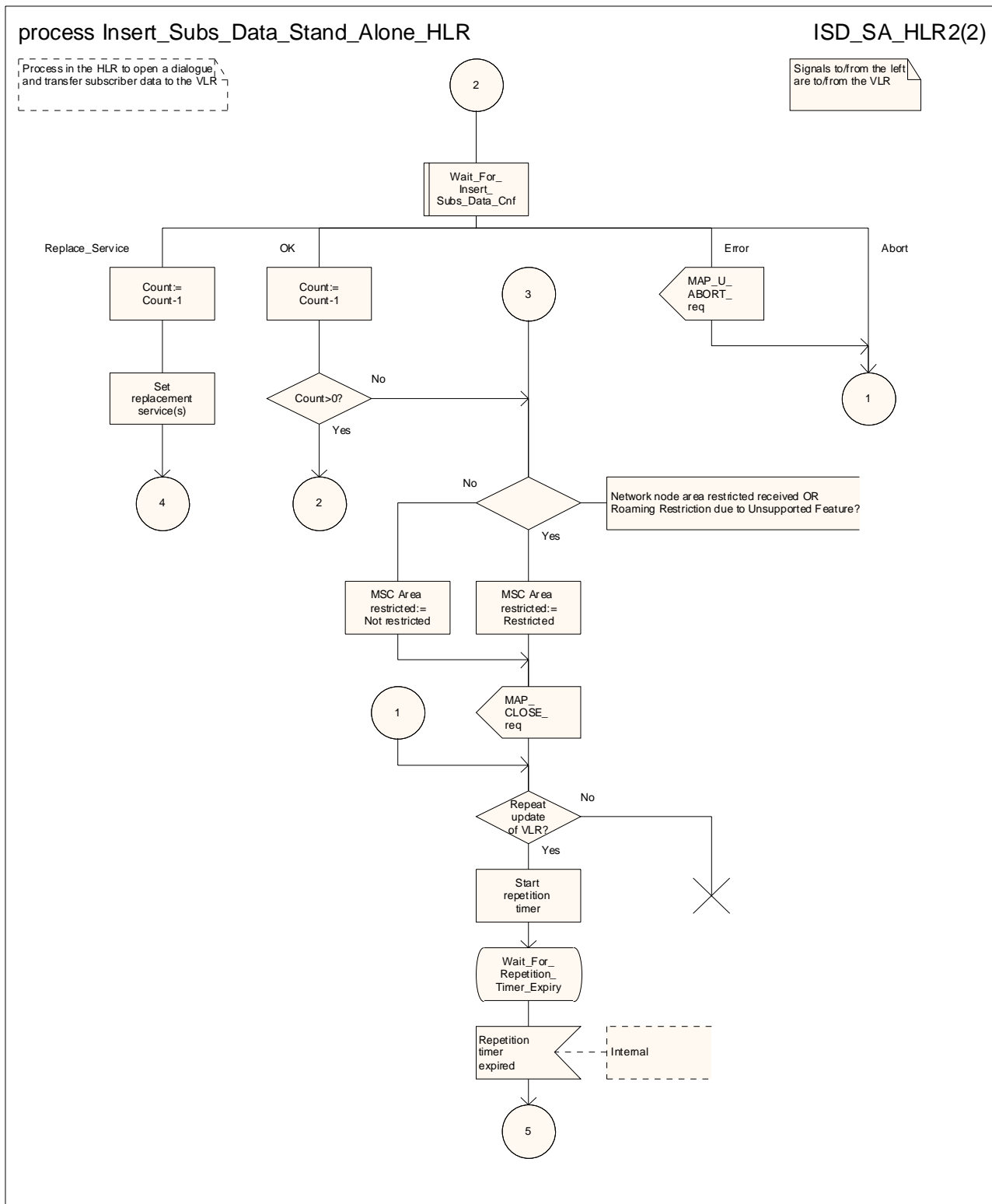

Figure 25.7/3 (sheet 2 of 2): Process Insert_Subs_Data_Stand_Alone_HLR

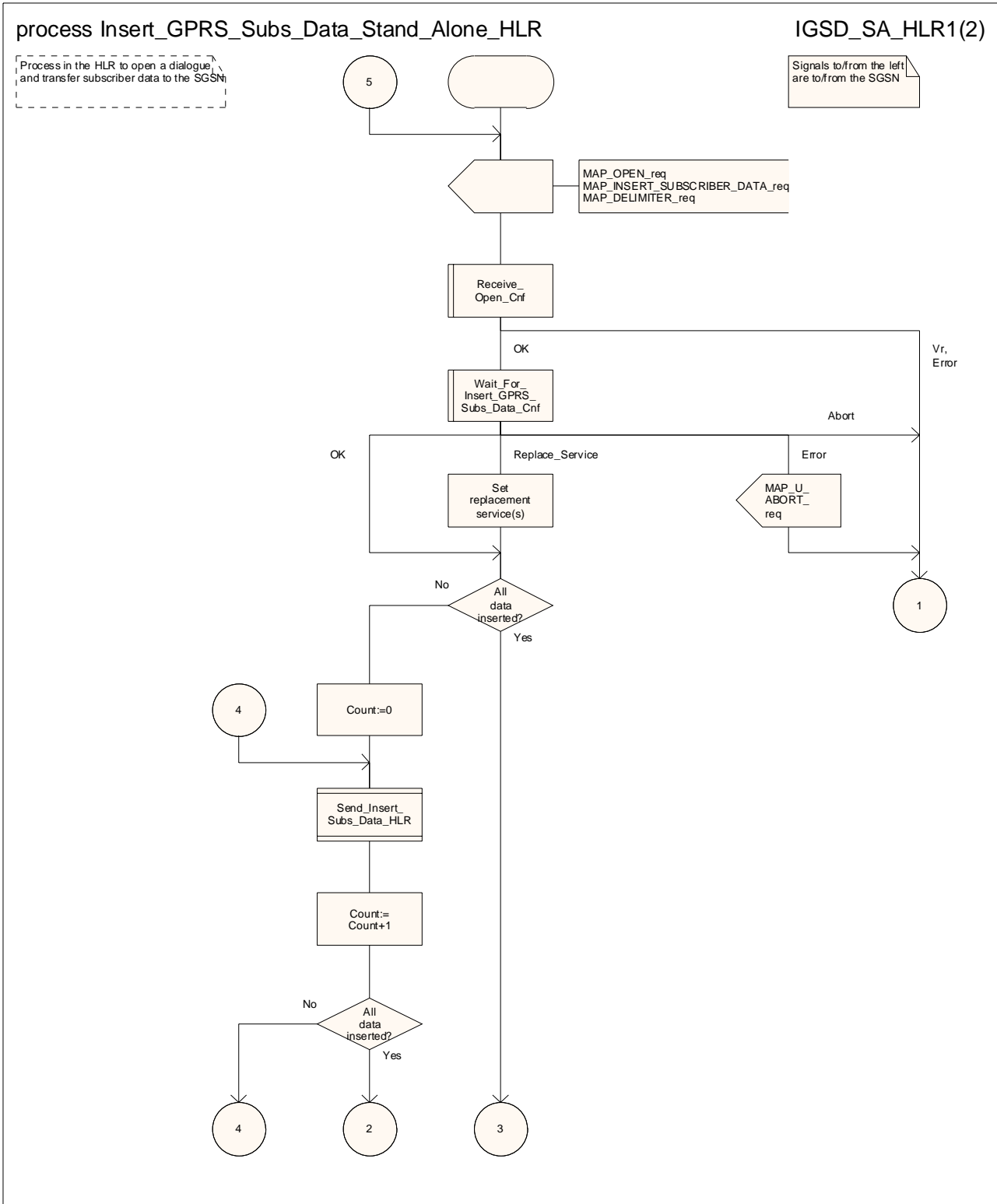

Figure 25.7/4 (sheet 1 of 2): Process Insert_GPRS_Subscriber_Data_Stand_Alone_HLR

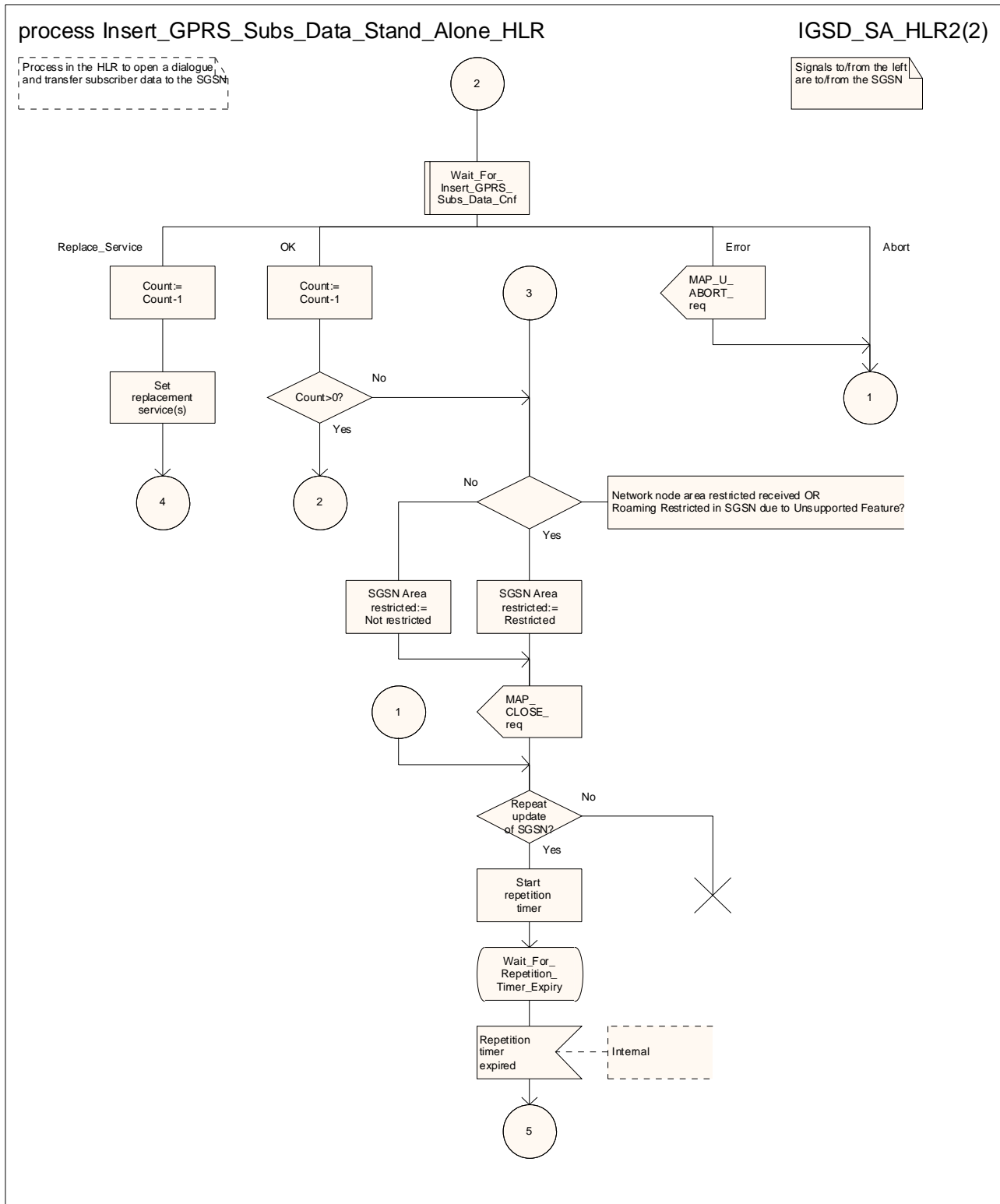

Figure 25.7/4 (sheet 2 of 2): Process Insert_GPRS_Subst_Data_Stand_Alone_HLR

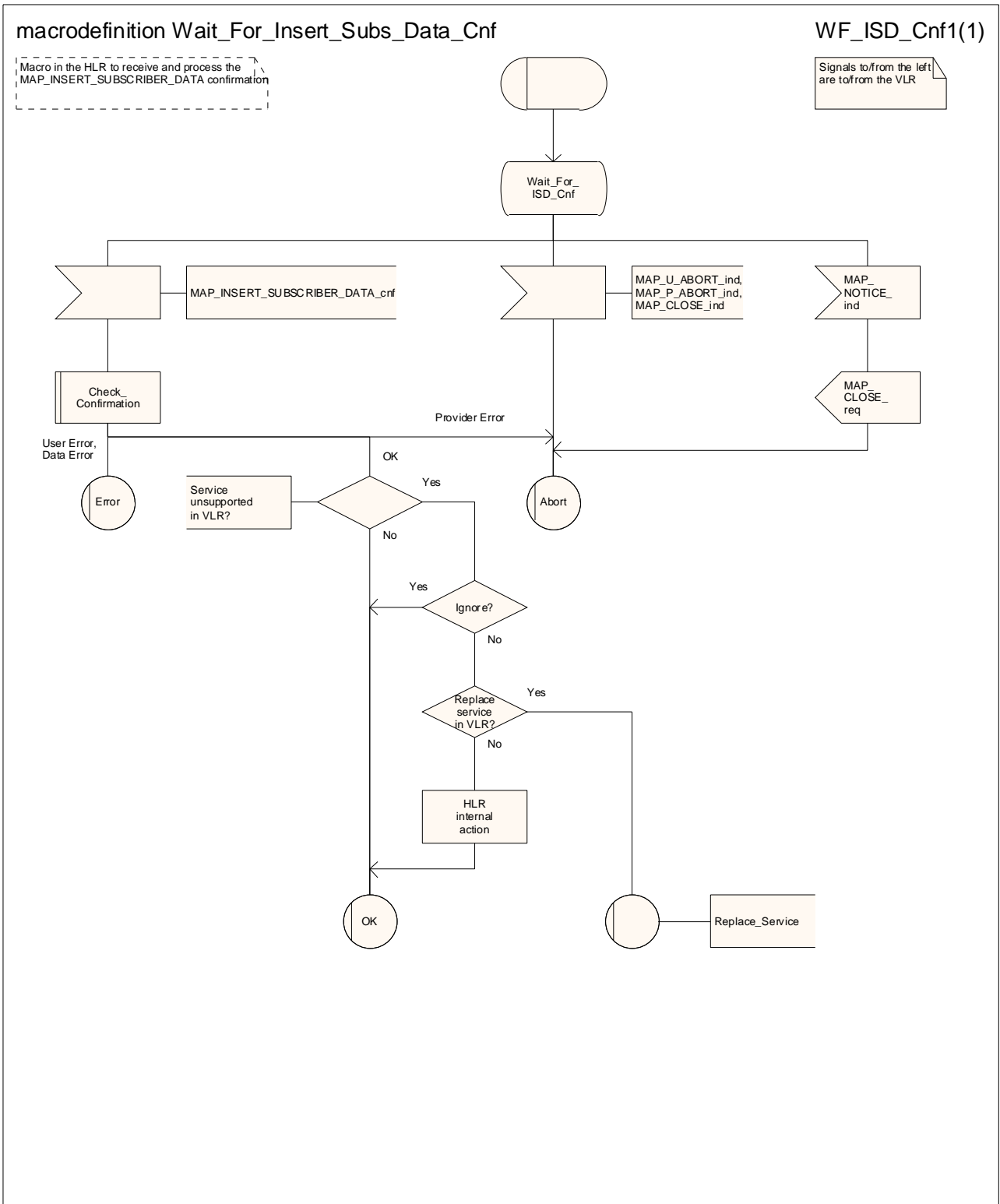

Figure 25.7/5: Macro Wait_for_Insert_Subscriber_Data_Cnf

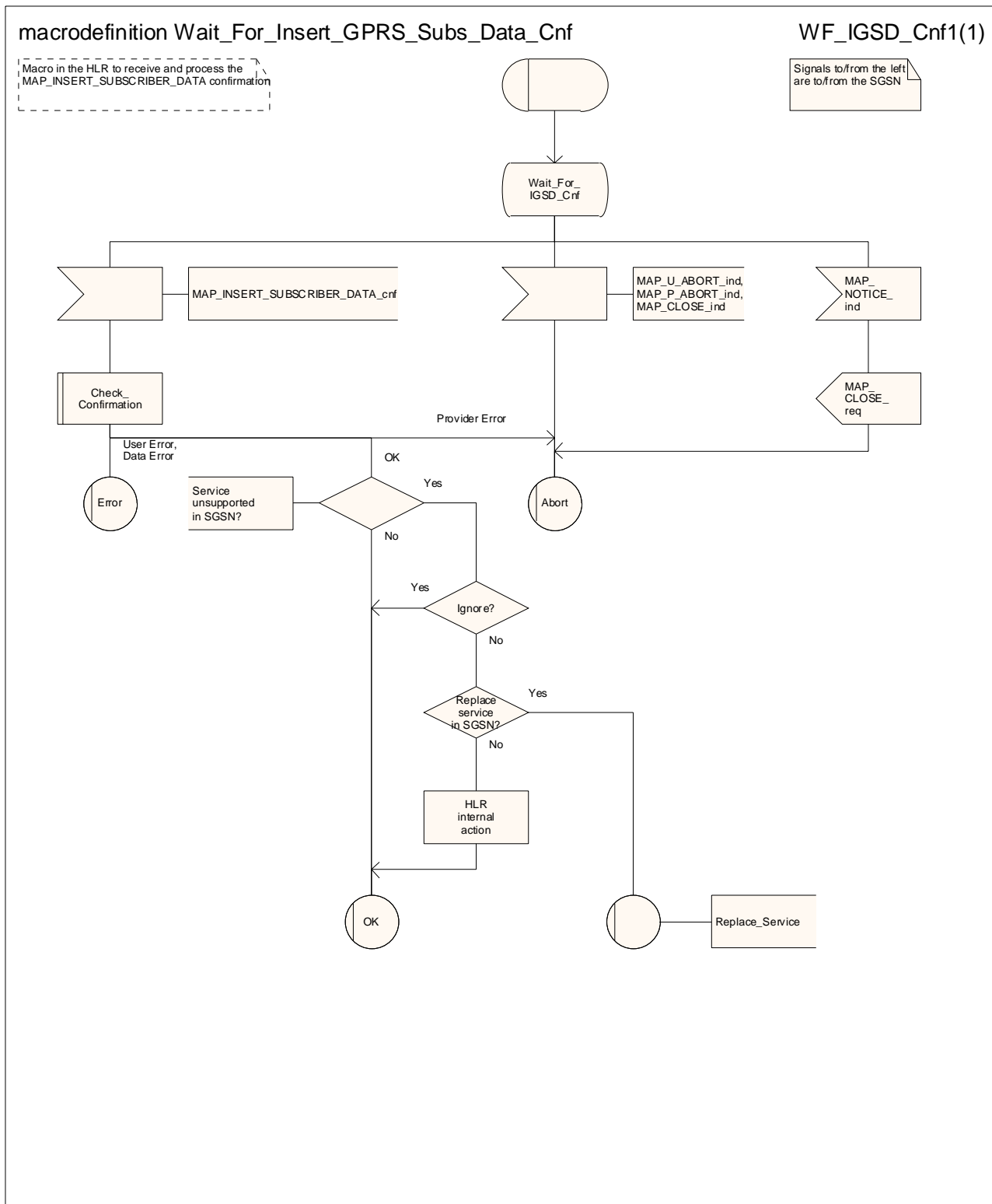

Figure 25.7/6: Macro Wait_for_Insert_GPRS_Subscriber_Data_Cnf

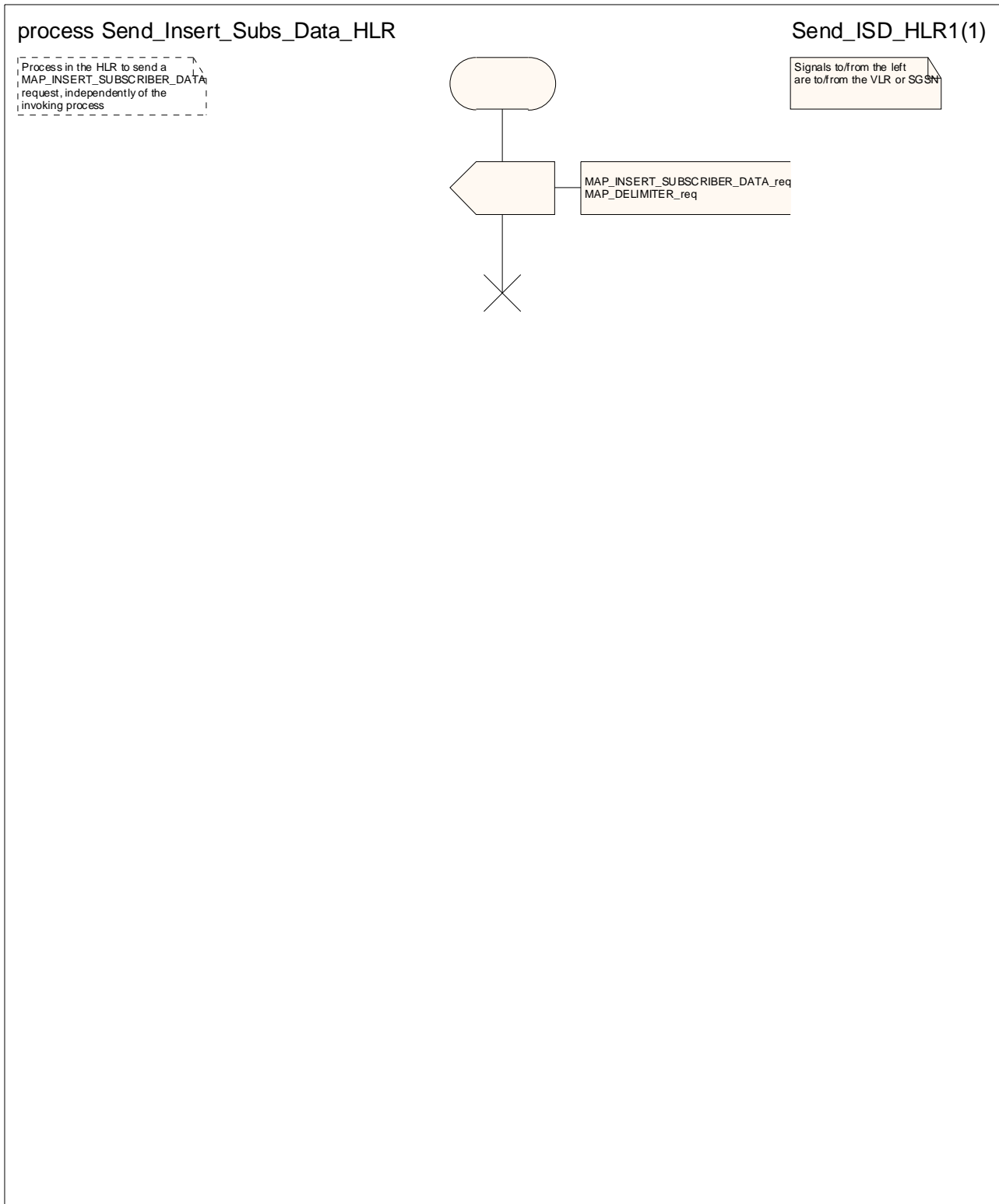

Figure 25.7/7: Process Send_Insert_Subscriber_Data_HLR

25.8 Request IMSI Macros

25.8.1 Macro Obtain_IMSI_MSC

This macro describes the handling of the request received from the VLR to provide the IMSI of a subscriber (e.g. at Location Updating).

25.8.2 Macro Obtain_IMSI_VLR

This macro describes the way VLR requests the MSC the IMSI of a subscriber (e.g. at Location Updating).

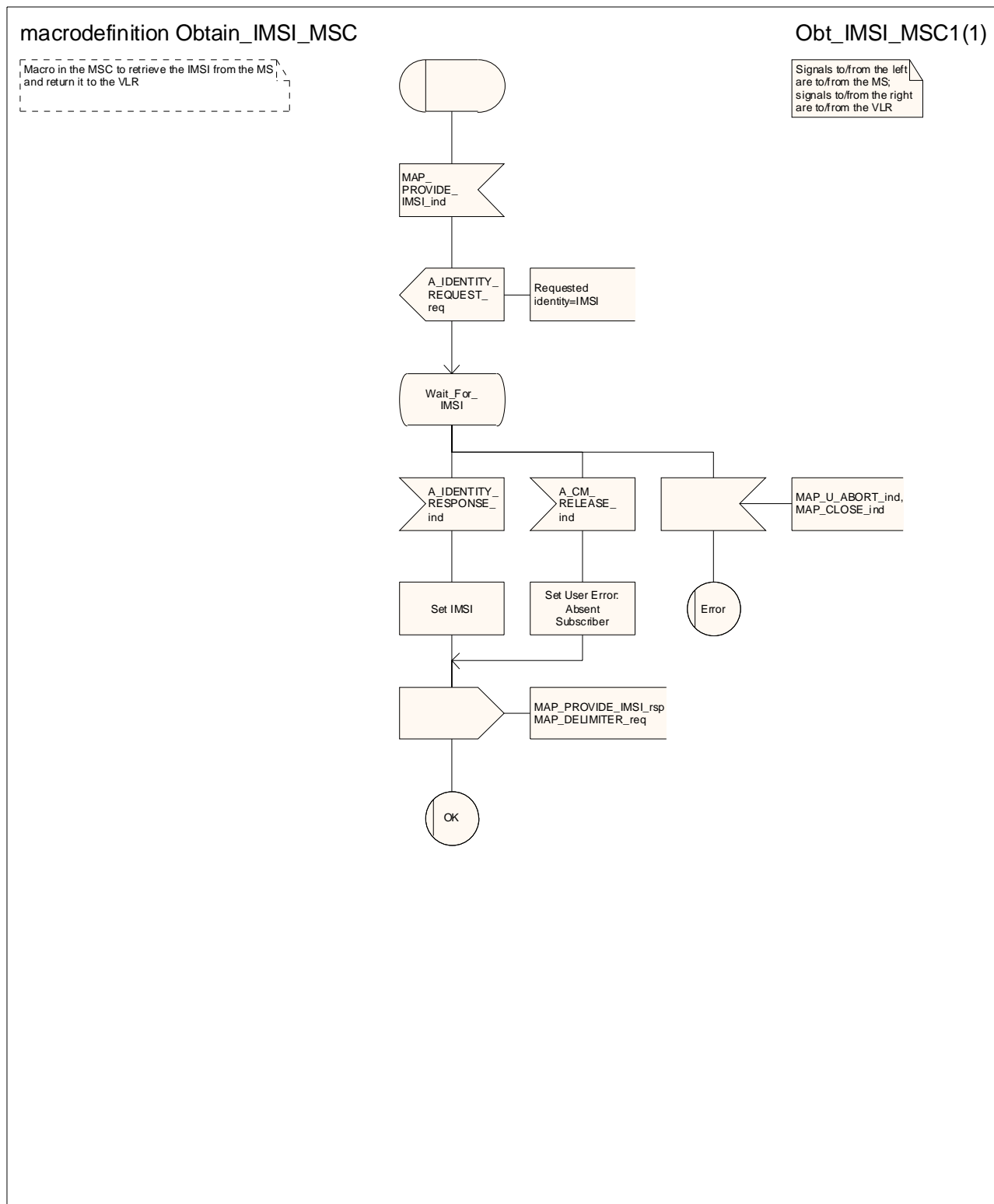

Figure 25.8/1: Macro Obtain_IMSI_MSC

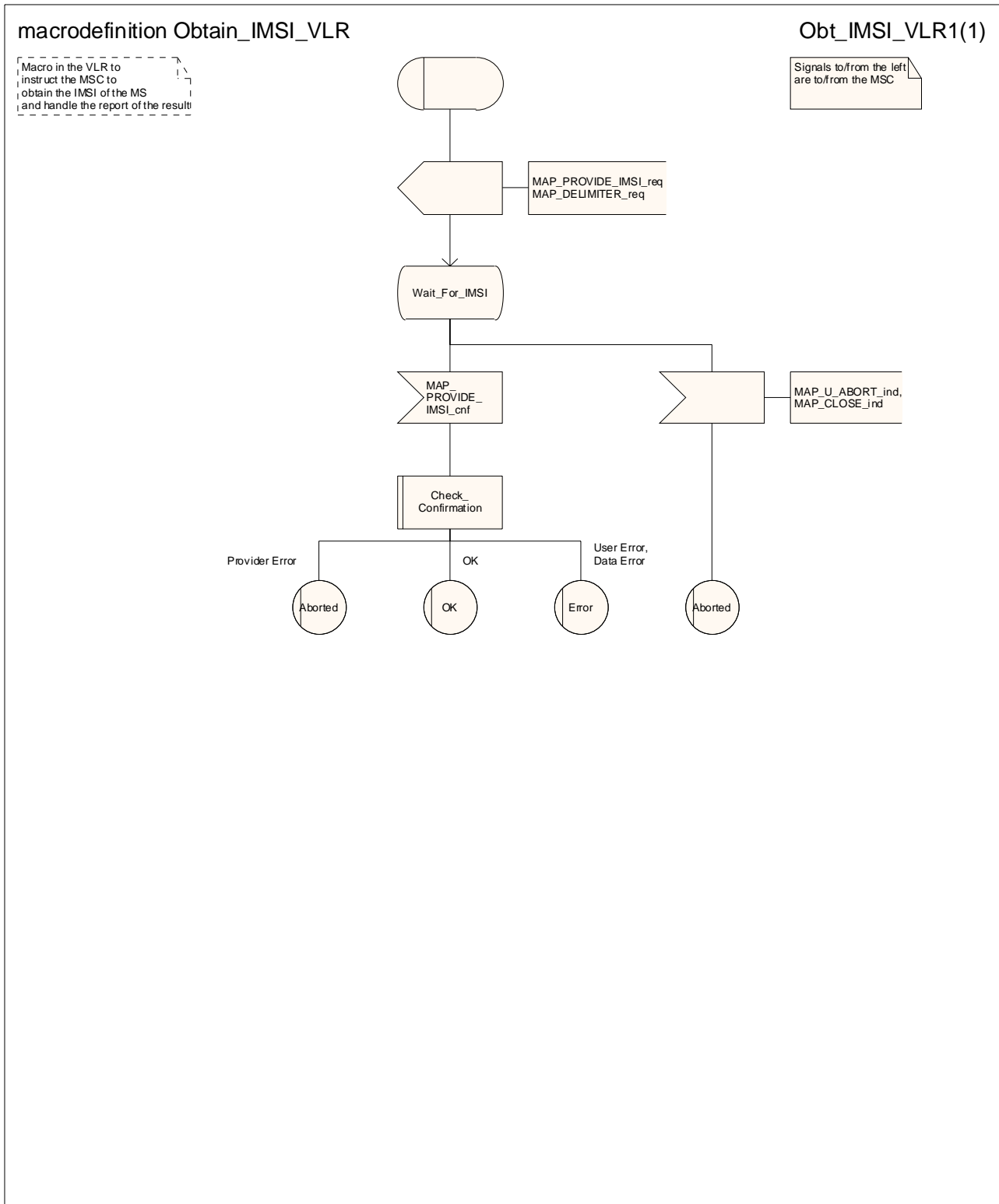

Figure 25.8/2: Macro Obtain_IMSI_VLR

25.9 Tracing macros

25.9.1 Macro Trace_Subscriber_Activity_MSC

This macro shows the handling in the MSC for a request from the VLR to trace the activity of a subscriber.

25.9.2 Macro Trace_Subscriber_Activity_VLR

This macro is called during the handling of subscriber activity in the VLR to activate tracing if necessary.

25.9.3 Macro Trace_Subscriber_Activity_SGSN

This macro is called during the handling of subscriber activity in the SGSN to activate tracing if necessary.

25.9.4 Macro Activate_Tracing_VLR

This macro shows the handling in the VLR for a request from the HLR to activate tracing for a subscriber.

25.9.5 Macro Activate_Tracing_SGSN

This macro shows the handling in the SGSN for a request from the HLR to activate tracing for a subscriber.

25.9.6 Macro Control_Tracing_With_VLR_HLR

This macro shows the handling in the HLR to activate tracing in the VLR if it is required during a dialogue between the VLR and the HLR

25.9.7 Macro Control_Tracing_With_SGSN_HLR

This macro shows the handling in the HLR to activate tracing in the SGSN if it is required during a dialogue between the SGSN and the HLR

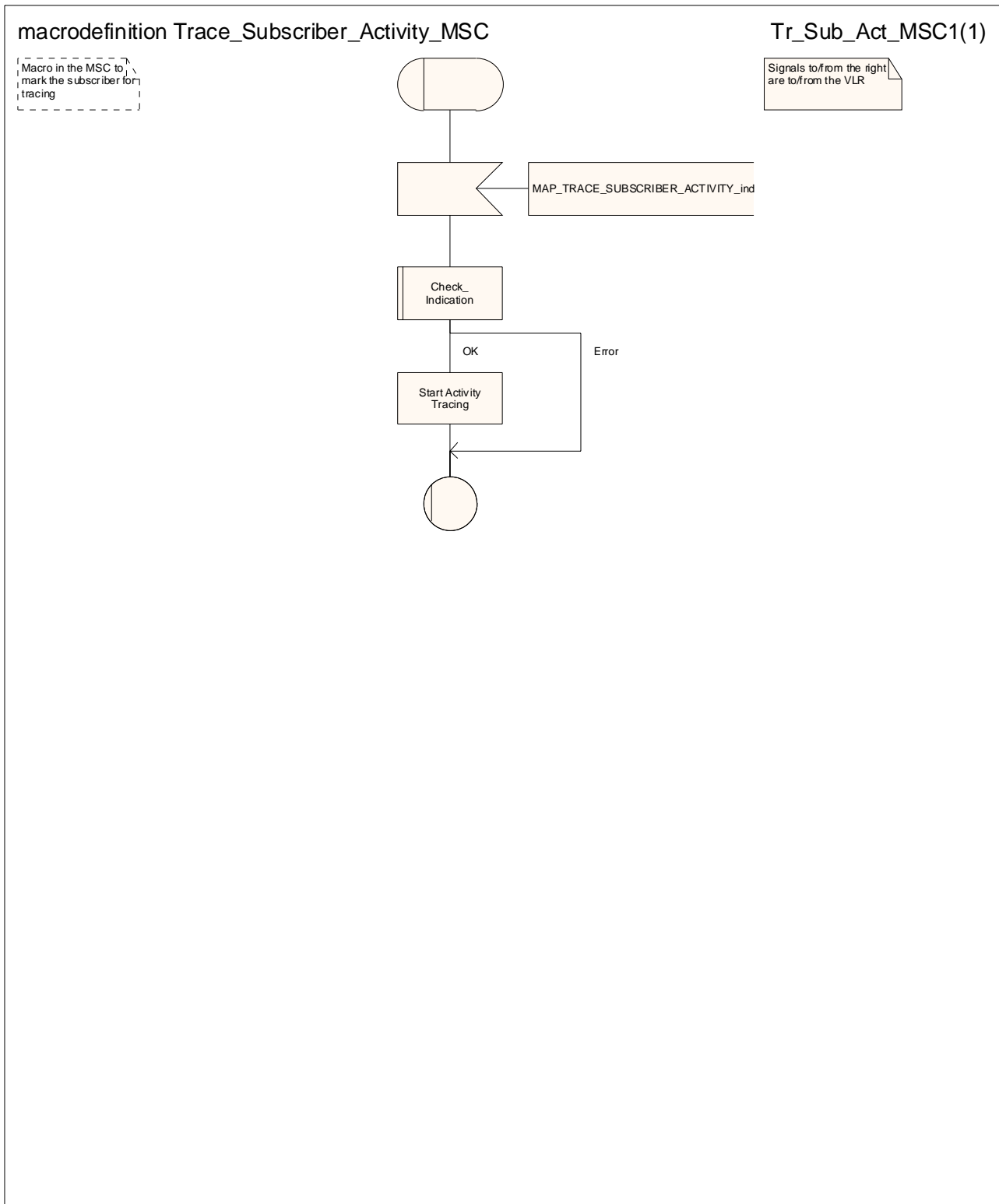

Figure 25.9/1: Macro Trace_Subscriber_Activity_MSC

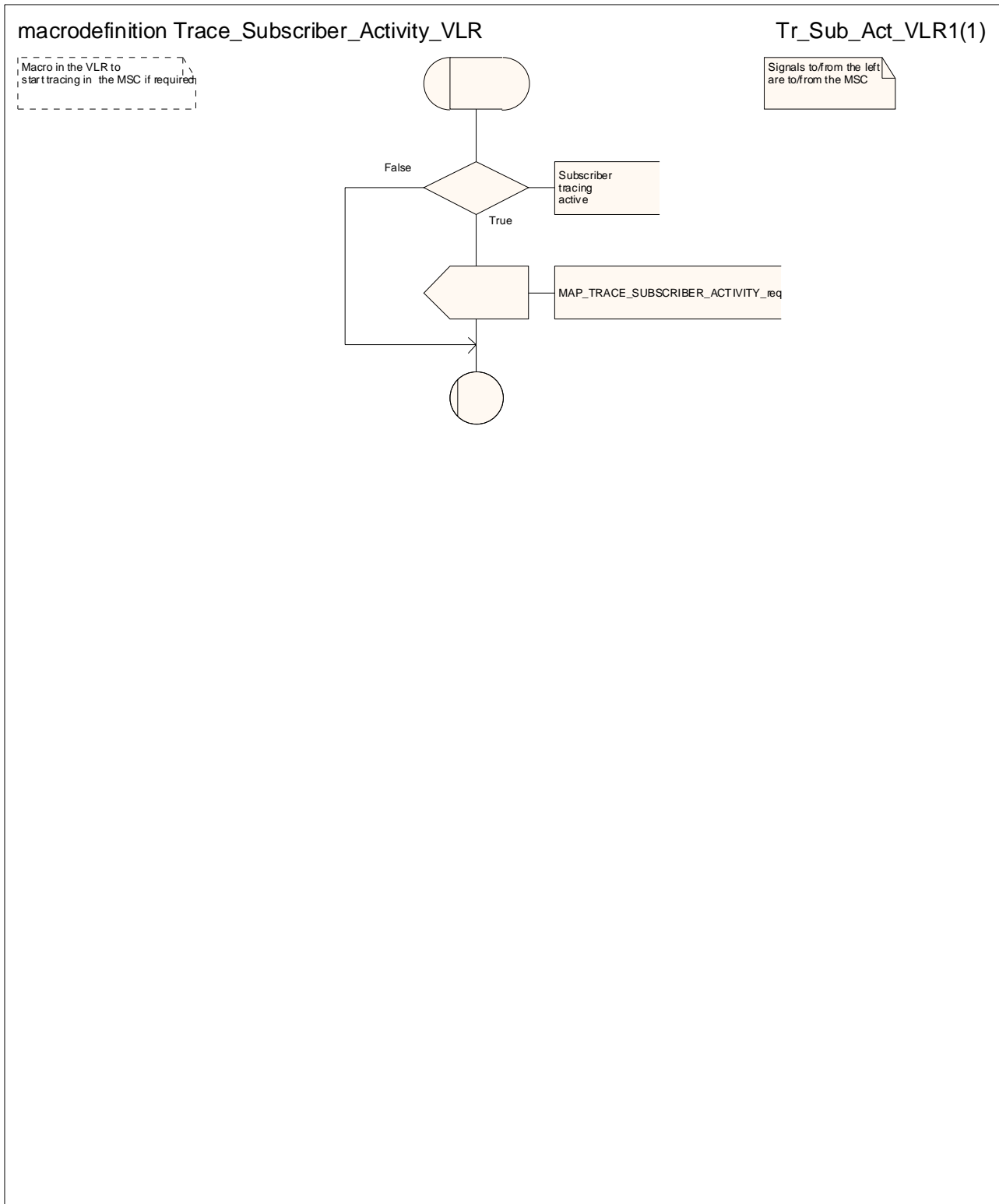

Figure 25.9/2: Macro Trace_Subscriber_Activity_VLR

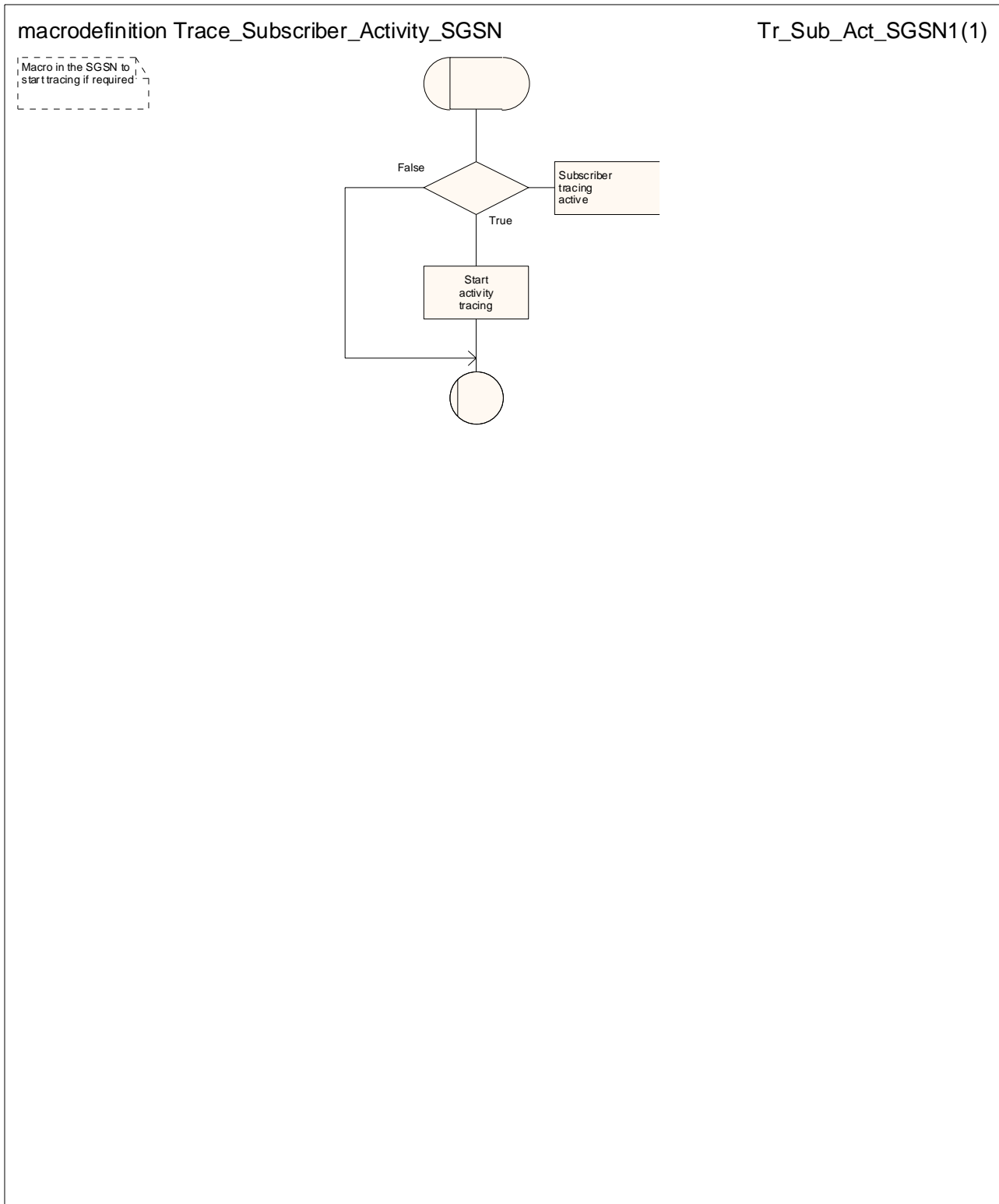

Figure 25.9/3: Macro Trace_Subscriber_Activity_SGSN

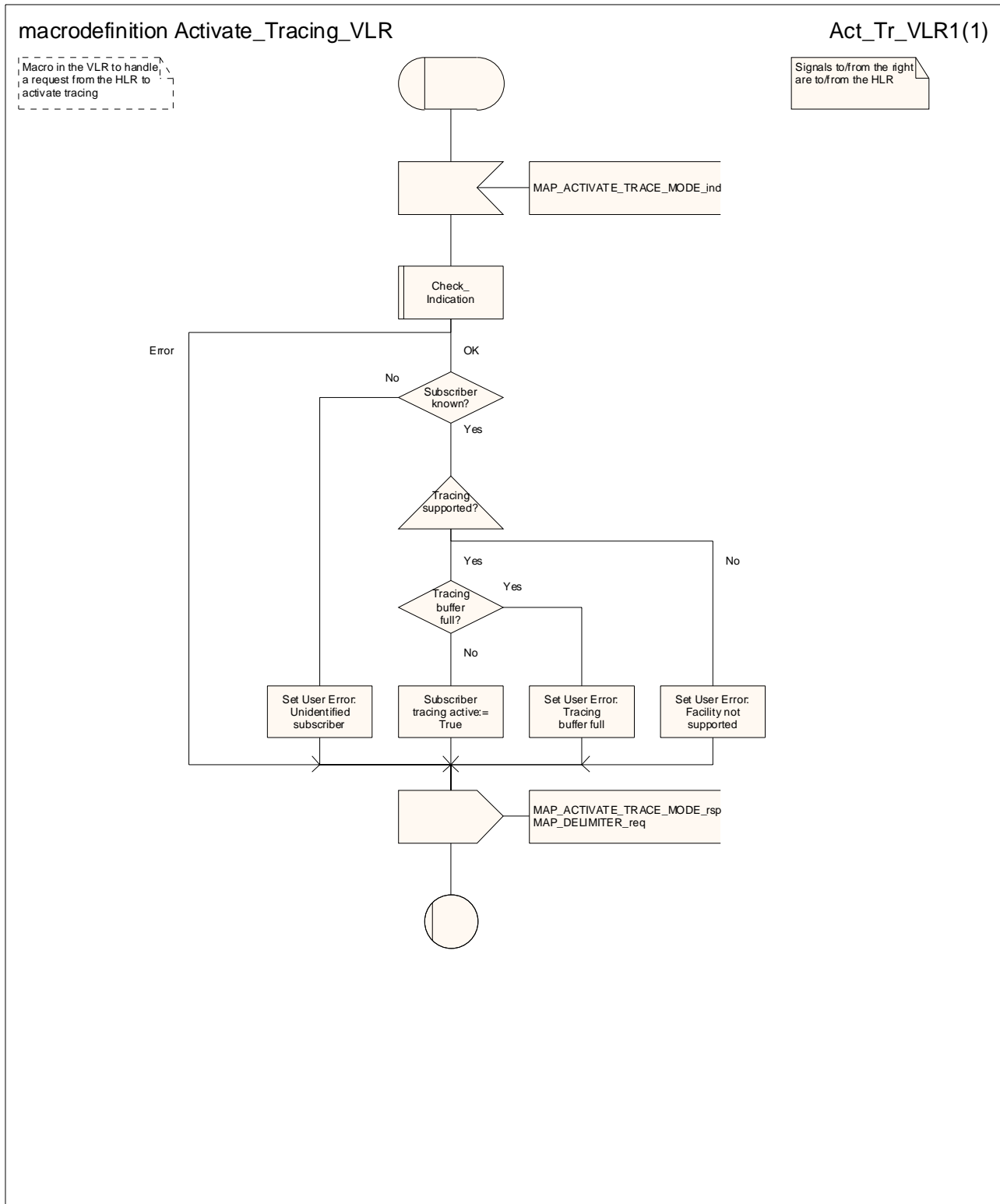

Figure 25.9/4: Macro Activate_Tracing_VLR

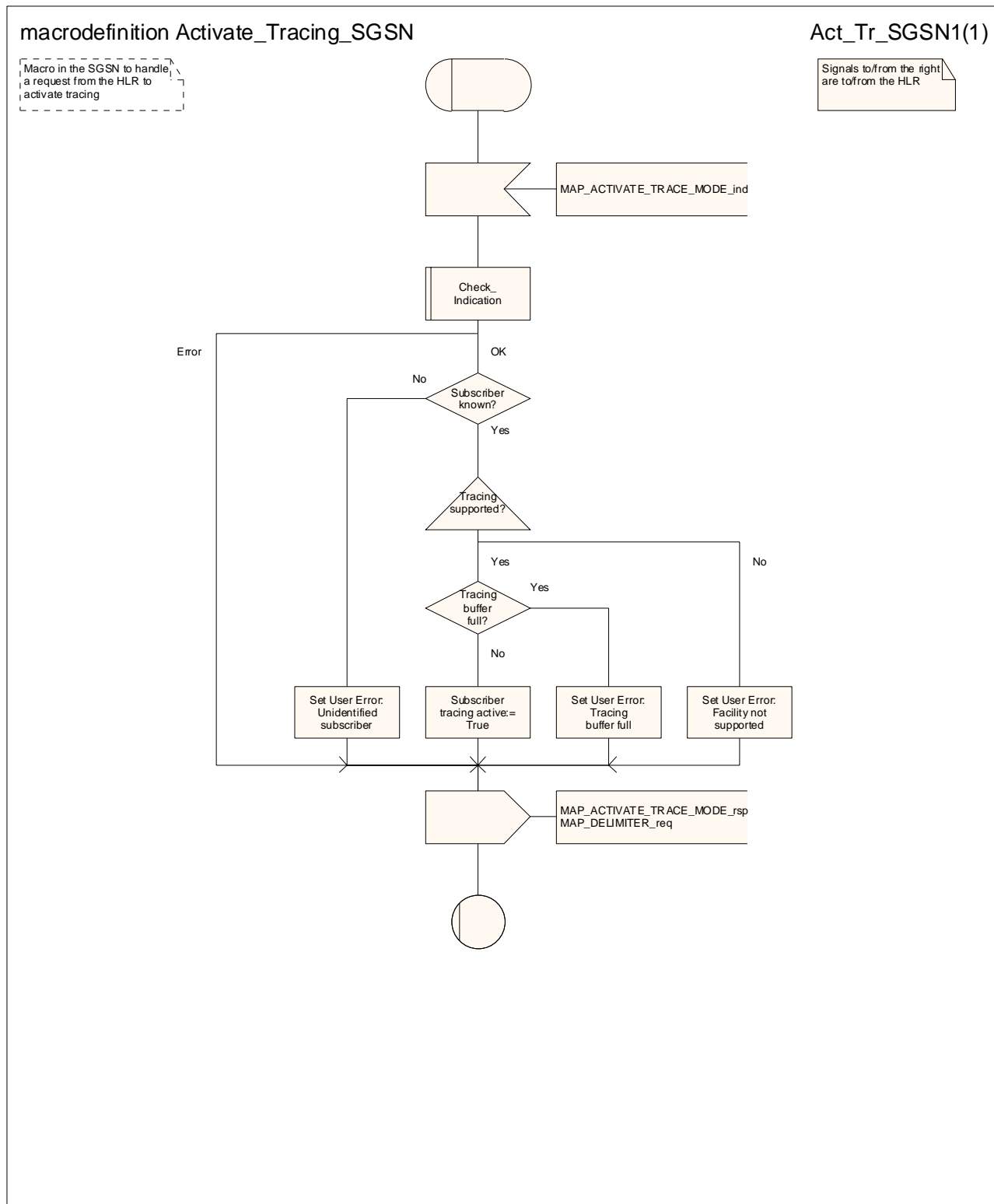

Figure 25.9/5: Macro Activate_Tracing_SGSN

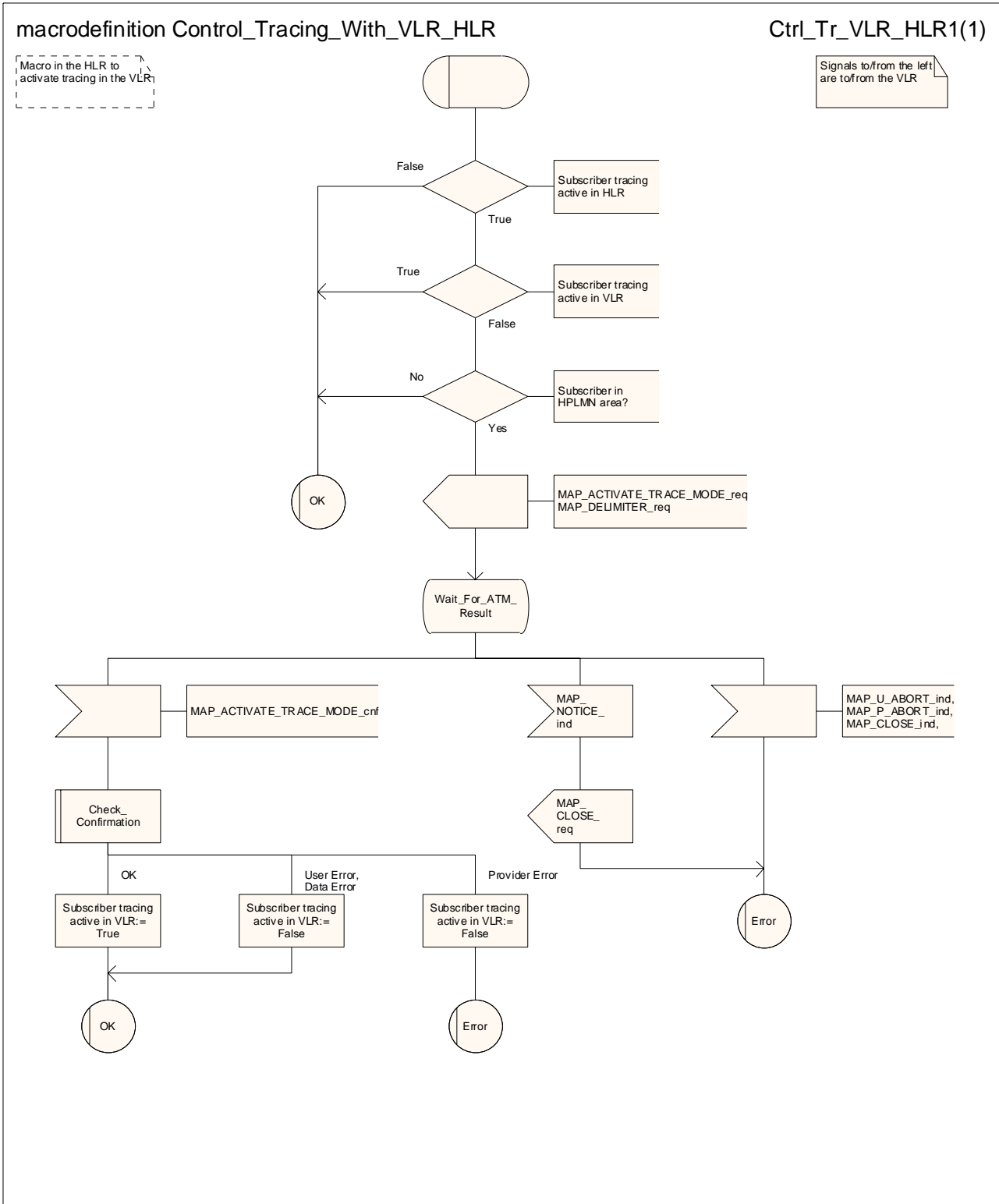

Figure 25.9/6: Macro Control_Tracing_With_VLR_HLR

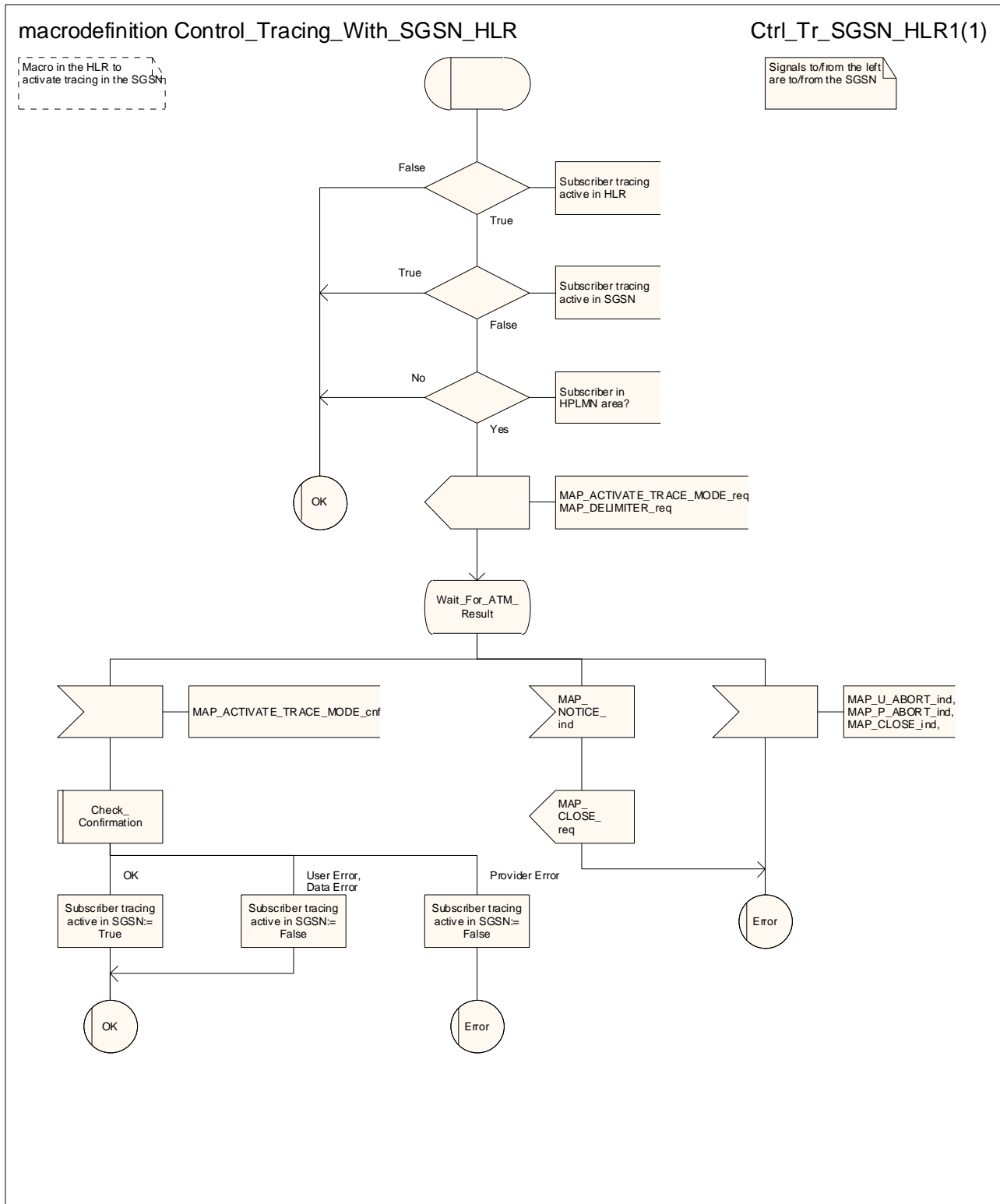

Figure 25.9/7: Macro Control_Tracing_With_SGSN_HLR

25.10 Short Message Alert procedures

25.10.1 Process Subscriber_Present_VLR

The VLR invokes the process Subscriber_Present_VLR when the mobile subscriber becomes active. The general description of the short message alert procedures is in subclause 23.4 of the present document.

25.10.2 Process Subscriber_Present_SGSN

The SGSN invokes the process Subscriber_Present_SGSN when it receives a Page response, a GPRS Attach request or a Routing area update request message (3GPP TS 24.008 [35]). The general description of the short message alert procedures is in subclause 23.4 of the present document.

25.10.3 Macro Alert_Service_Centre_HLR

The HLR invokes the macro Alert_Service_Centre_HLR when Service Centre(s) are to be alerted.

25.10.4 Process Alert_SC_HLR

It is an operator option to resend the MAP_ALERT_SERVICE_CENTRE request to the SMS-IW MSC if the alert is unsuccessful. The number of repeat attempts and the interval between them is also an operator option. The service centre address should be purged from the MWD list if the alert is consistently unsuccessful.

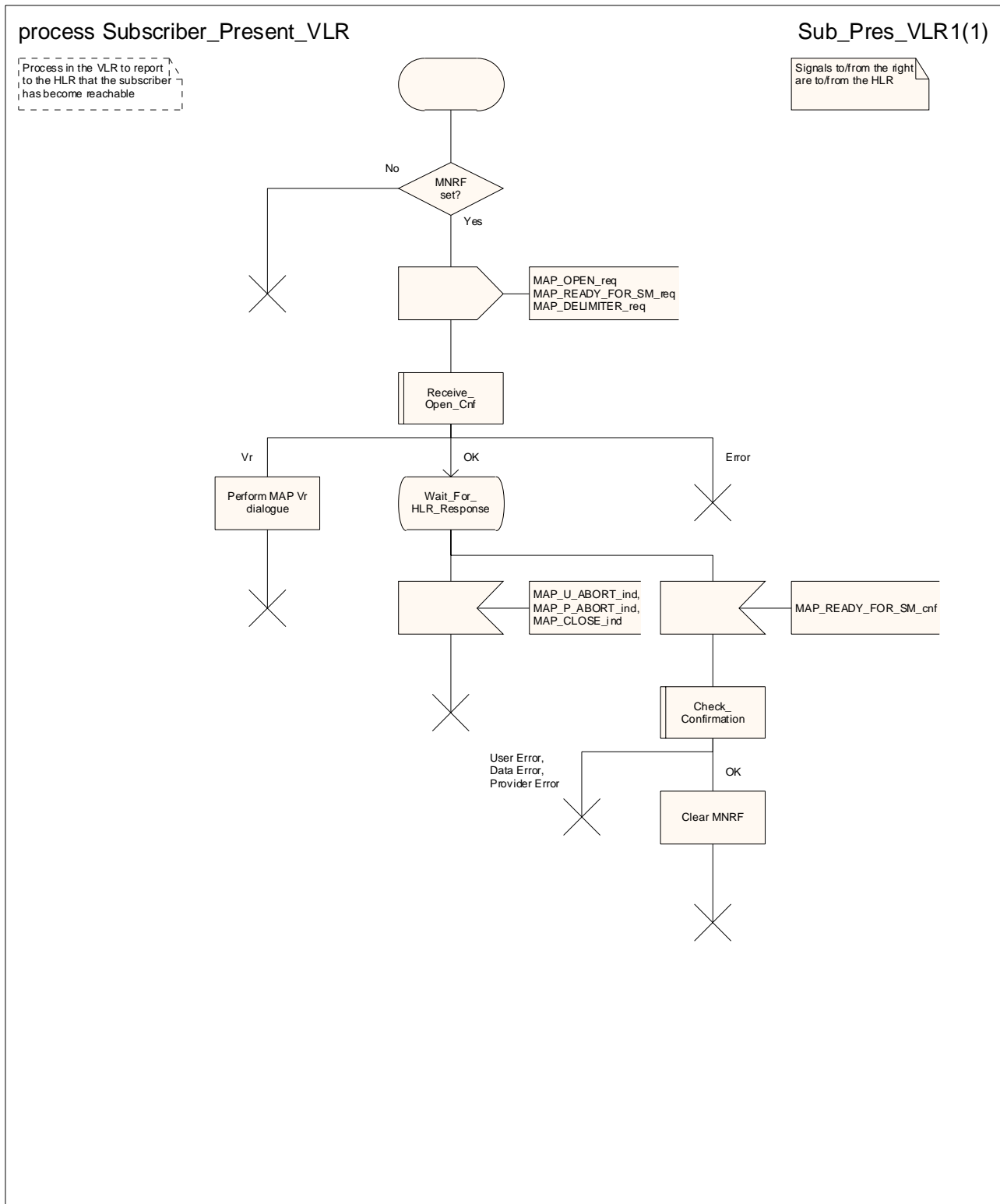

Figure 25.10/1: Process Subscriber_Present_VLR

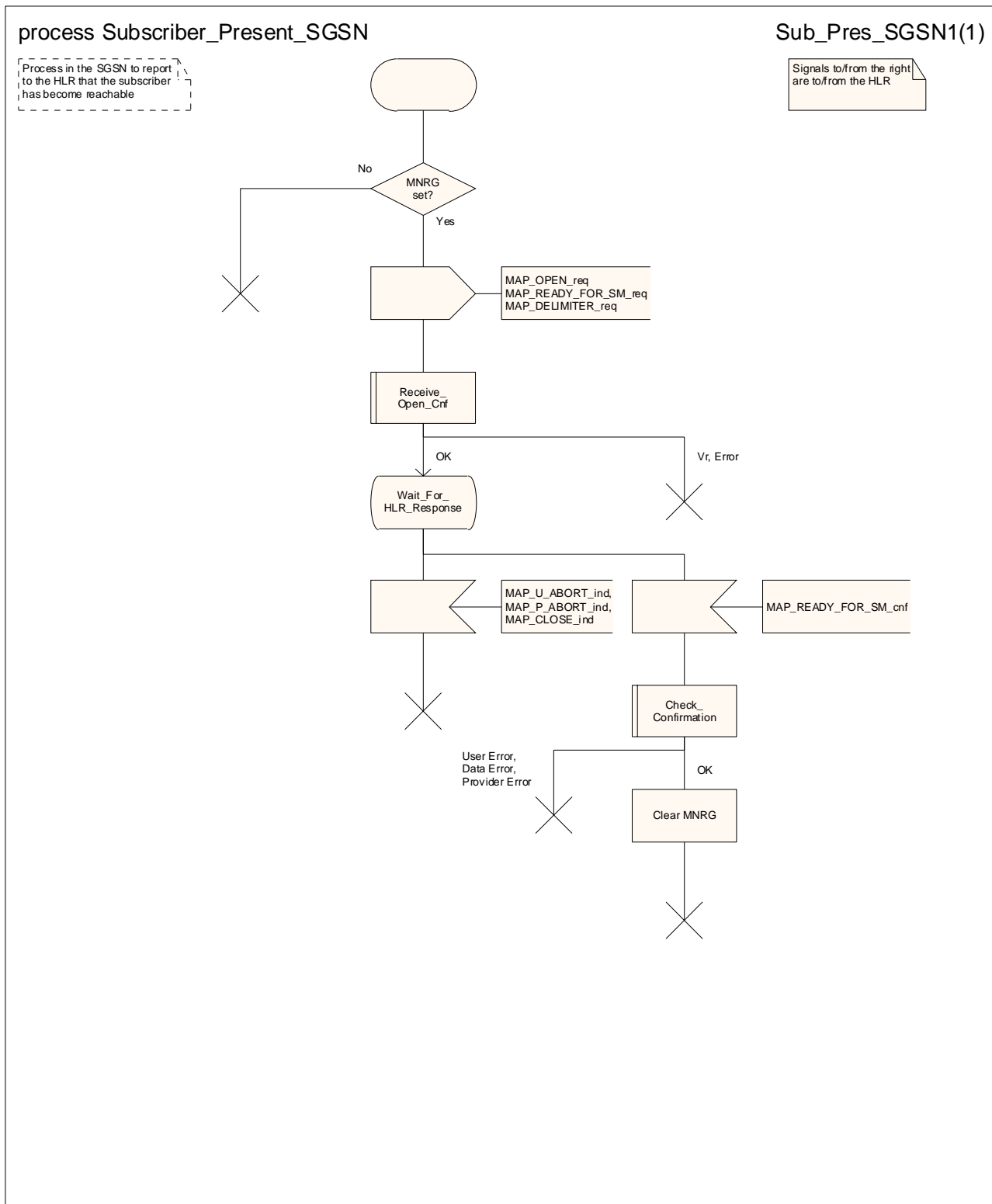

Figure 25.10/2: Process Subscriber_Present_SGSN

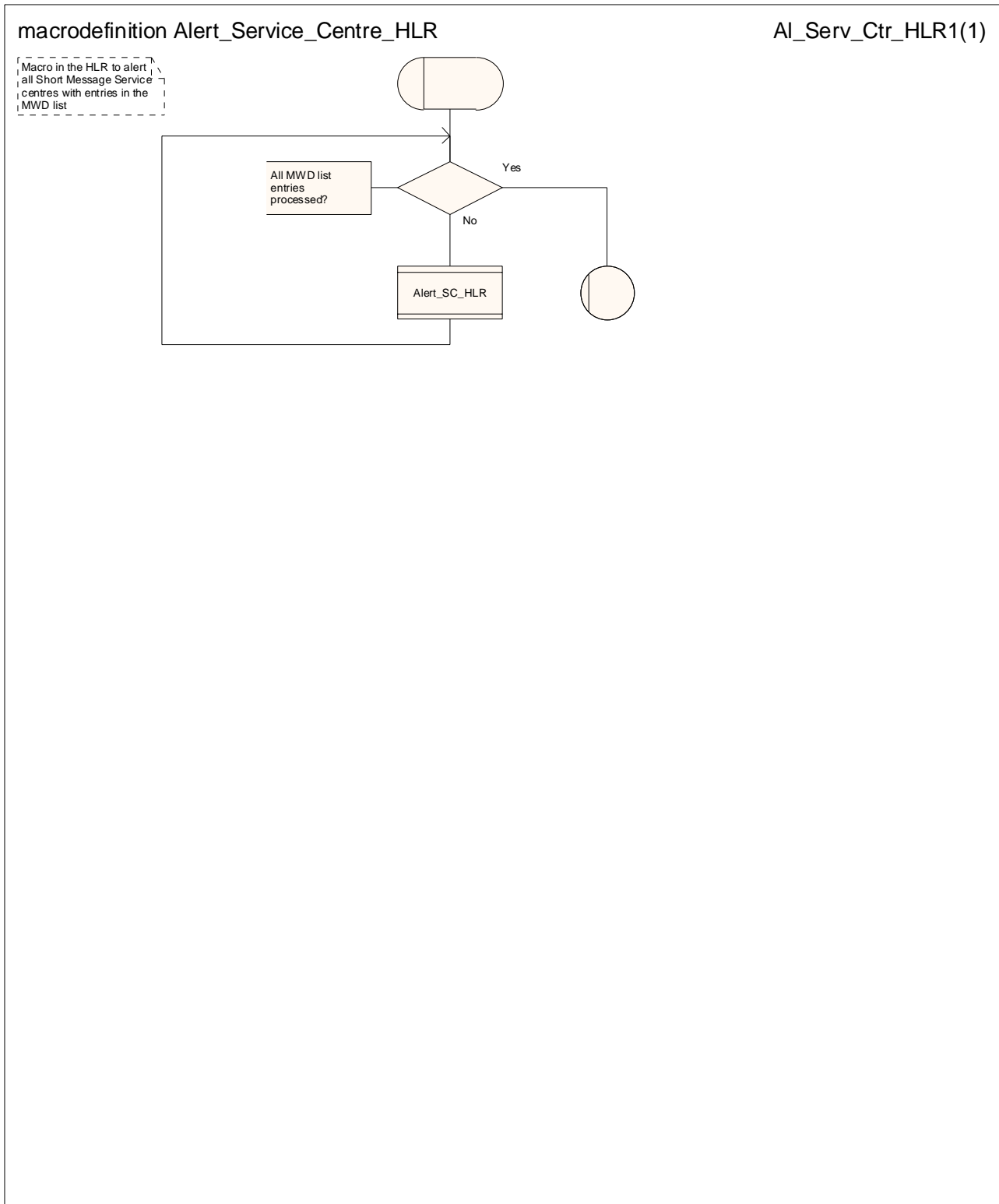

Figure 25.10/3: Macro Alert_Service_Centre_HLR

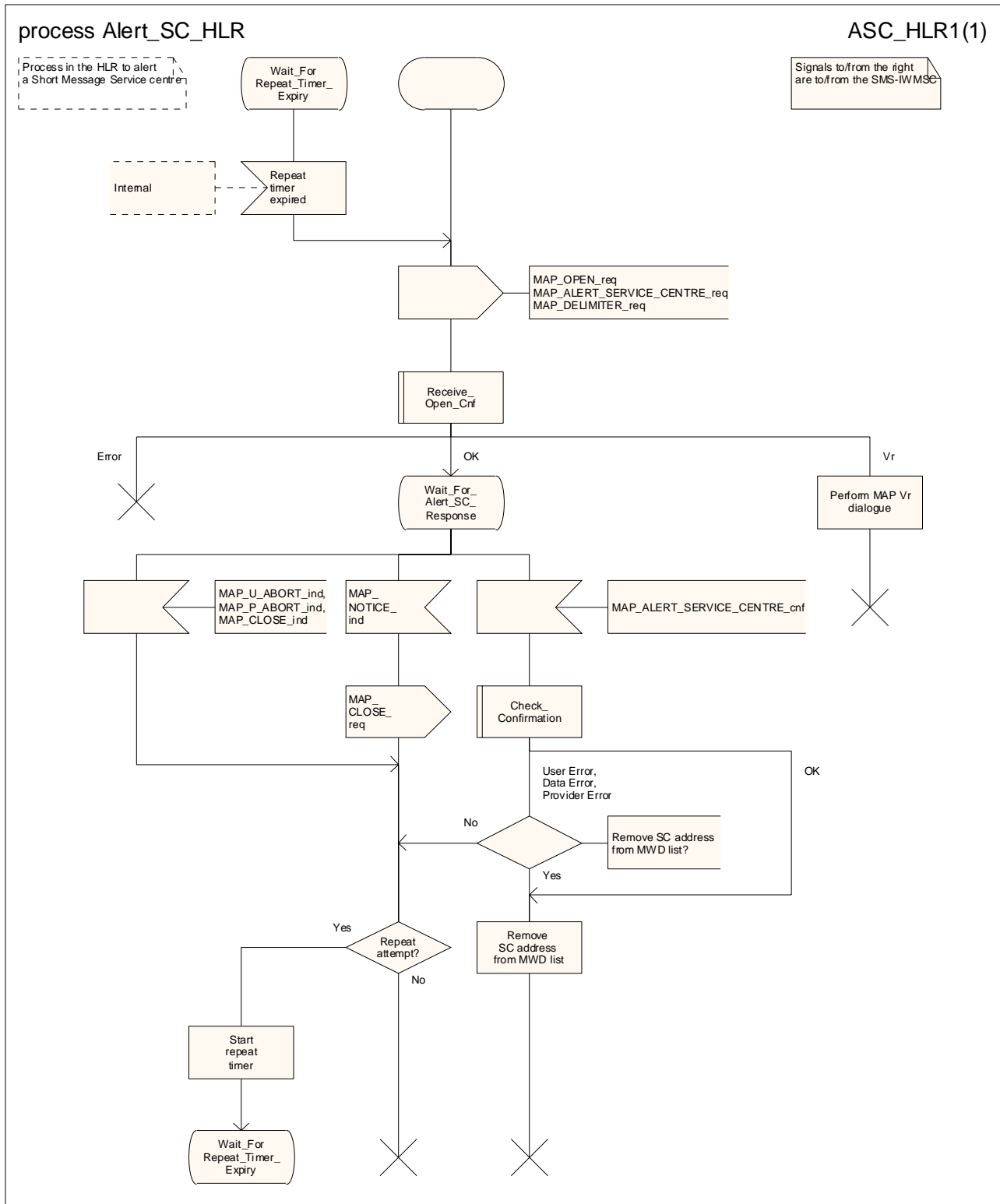

Figure 25.10/4: Process Alert_SC_HLR

Annex A (informative): Cross-reference for abstract syntaxes of MAP

Annex A is not part of the standard, it is included for information purposes only.

For every ASN.1 item such as identifier, type-reference or value-reference the cross-reference allows to locate all occurrences by means of module-name and line numbers. For that purpose line numbers are printed at the left margin in front of each ASN.1 source line starting with 1 for every module.

The items are sorted alphabetically in the cross-reference in a case-insensitive manner. Occurrences of an item are its definition and all its usages such as in exports, imports or within a type or value assignment.

For every item additional information is provided such as kind of item (identifier, value reference, type reference), and tag, associated type and value if applicable.

The cross-reference for a root module includes all modules referred to directly or indirectly via imports. The cross-references for the root modules MAP-Protocol/TCAPMessages and MAP-DialoguePDU are included.

TAG R6.0 Cross Reference Listing for MAP-Protocol 2006-06-08 15:10:26 PAGE 1

&alwaysReturns.....identifier of Fieldspec
DEFINED in Remote-Operations-Info : 22

&ArgumentType.....identifier of Fieldspec
DEFINED in Remote-Operations-Info : 14
USED in MAP-MobileServiceOpera : 175 188 199 211 223 237 249 264 282
304 319 332 339 344 349 363 381 395
408 420 434 442 456 472 487 501
USED in MAP-OperationAndMainte : 52 67 81
USED in MAP-CallHandlingOperat : 83 107 122 135 147 160 175 188 202
216
USED in MAP-SupplementaryServi : 89 107 125 146 166 182 195 212 227
245 252 264 282
USED in MAP-ShortMessageServic : 68 84 97 116 129 139 144
USED in MAP-Group-Call-Operati : 47 58 65 70
USED in MAP-LocationServiceOpe : 54 69 88

&argumentTypeOptional.....identifier of Fieldspec
DEFINED in Remote-Operations-Info : 15

&Both.....identifier of Fieldspec
DEFINED in Remote-Operations-Info : 56

&Consumer.....identifier of Fieldspec
DEFINED in Remote-Operations-Info : 57

&errorCode.....identifier of Fieldspec
DEFINED in Remote-Operations-Info : 46
USED in MAP-Errors : 169 176 183 190 196 202 211 217 220
227 230 238 245 252 259 266 272 275
281 289 298 305 312 318 324 330 336
342 348 356 363 369 375 385 391 398
405 411 414 417 422 425 428 434 440
448 453 459 465 473 481 487 493 499
505

&Errors.....identifier of Fieldspec
DEFINED in Remote-Operations-Info : 19
USED in MAP-MobileServiceOpera : 179 193 204 215 227 241 253 268 286
309 323 353 373 386 399 413 425 446
460 477 492 505
USED in MAP-OperationAndMainte : 57 72 85
USED in MAP-CallHandlingOperat : 87 111 127 139 152 165 180 192 207
221
USED in MAP-SupplementaryServi : 94 112 130 151 170 186 200 215 231
257 268 286
USED in MAP-ShortMessageServic : 72 89 102 121 132 149
USED in MAP-Group-Call-Operati : 51

USED in MAP-LocationServiceOpe : 58 73 92

&extensionId.....identifier of Fieldspec
 DEFINED in MAP-ExtensionDataTypes : 25
 USED in MAP-ExtensionDataTypes : 45

&ExtensionType.....identifier of Fieldspec
 DEFINED in MAP-ExtensionDataTypes : 24
 USED in MAP-ExtensionDataTypes : 47

&id.....identifier of Fieldspec
 DEFINED in Remote-Operations-Info : 59

&operationCode.....identifier of Fieldspec
 DEFINED in Remote-Operations-Info : 25
 USED in MAP-MobileServiceOpera : 185 196 208 218 232 244 259 279 299
 313 329 336 341 346 358 378 390 403
 417 429 436 439 451 467 482 497 510
 USED in MAP-OperationAndMainte : 64 78 89
 USED in MAP-CallHandlingOperat : 103 119 132 144 157 172 185 199 213
 227
 USED in MAP-SupplementaryServi : 104 122 143 163 179 192 209 224 242
 249 261 279 293
 USED in MAP-ShortMessageServic : 81 94 113 126 136 141 154
 USED in MAP-Group-Call-Operati : 55 62 67 72
 USED in MAP-LocationServiceOpe : 66 85 100

&ParameterType.....identifier of Fieldspec
 DEFINED in Remote-Operations-Info : 43
 USED in MAP-Errors : 166 172 179 186 193 199 207 214 223
 236 241 248 255 262 278 286 295 301
 309 315 321 327 333 339 345 353 360

TAG R6.0 Cross Reference Listing for MAP-Protocol 2006-06-08 15:10:26 PAGE 2

366 372 381 388 394 401 408 420 431
 437 445 451 456 462 470 478 484 490
 496 502

¶meterTypeOptional.....identifier of Fieldspec
 DEFINED in Remote-Operations-Info : 44

&ResultType.....identifier of Fieldspec
 DEFINED in Remote-Operations-Info : 17
 USED in MAP-MobileServiceOpera : 177 190 201 213 225 239 251 266 284
 306 321 334 351 370 383 397 410 422
 444 458 474 489 503
 USED in MAP-OperationAndMainte : 54 69 83
 USED in MAP-CallHandlingOperat : 85 109 124 137 149 162 177 190 204
 218
 USED in MAP-SupplementaryServi : 91 109 127 148 168 184 197 229 247
 254 266 284
 USED in MAP-ShortMessageServic : 70 86 99 118 146
 USED in MAP-Group-Call-Operati : 49 60
 USED in MAP-LocationServiceOpe : 56 71 90

&resultTypeOptional.....identifier of Fieldspec
 DEFINED in Remote-Operations-Info : 18

&returnResult.....identifier of Fieldspec
 DEFINED in Remote-Operations-Info : 16
 USED in MAP-SupplementaryServi : 214
 USED in MAP-ShortMessageServic : 131

&Supplier.....identifier of Fieldspec
 DEFINED in Remote-Operations-Info : 58

&synchronous.....identifier of Fieldspec
 DEFINED in Remote-Operations-Info : 21

absentSubscriber.....information object reference ERROR, Information Object
 DEFINED in MAP-Errors : 300
 USED in MAP-MobileServiceOpera : 94 461
 USED in MAP-CallHandlingOperat : 41 97 117 196
 USED in MAP-SupplementaryServi : 51 204 219
 USED in MAP-LocationServiceOpe : 29 64 81
 USED in MAP-Errors : 48

absentSubscriber.....identifier of Named Number, 3
 DEFINED in MAP-CH-DataTypes : 191

absentSubscriber.....identifier of Named Number, 1
 DEFINED in MAP-SM-DataTypes : 167

absentSubscriberDiagnosticSM.....identifier of [0] AbsentSubscriberDiagnosticSM
 DEFINED in MAP-SM-DataTypes : 146

absentSubscriberDiagnosticSM.....identifier of AbsentSubscriberDiagnosticSM
 DEFINED in MAP-SM-DataTypes : 186

absentSubscriberDiagnosticSM.....identifier of AbsentSubscriberDiagnosticSM
 DEFINED in MAP-ER-DataTypes : 156

AbsentSubscriberDiagnosticSM.....type reference INTEGER
 DEFINED in MAP-ER-DataTypes : 166
 USED in MAP-MS-DataTypes : 211 1883
 USED in MAP-SM-DataTypes : 41 146 159 186 187
 USED in MAP-ER-DataTypes : 43 156 161

AbsentSubscriberParam.....type reference SEQUENCE
 DEFINED in MAP-ER-DataTypes : 244
 USED in MAP-Errors : 125 302
 USED in MAP-ER-DataTypes : 34

absentSubscriberReason.....identifier of [0] AbsentSubscriberReason
 DEFINED in MAP-ER-DataTypes : 247

AbsentSubscriberReason.....type reference ENUMERATED
 DEFINED in MAP-ER-DataTypes : 249
 USED in MAP-ER-DataTypes : 247

absentSubscriberSM.....information object reference ERROR, Information Object
DEFINED in MAP-Errors : 461
USED in MAP-ShortMessageServic : 41 80 112
USED in MAP-Errors : 80

AbsentSubscriberSM-Param.....type reference SEQUENCE

TAG R6.0 Cross Reference Listing for MAP-Protocol 2006-06-08 15:10:26 PAGE 3

DEFINED in MAP-ER-DataTypes : 155
 USED in MAP-Errors : 135 463
 USED in MAP-ER-DataTypes : 42

accepted.....identifier of Named Number, 0
 DEFINED in MAP-CH-DataTypes : 431

accessNetworkProtocolId.....identifier of AccessNetworkProtocolId
 DEFINED in MAP-CommonDataTypes : 243

AccessNetworkProtocolId.....type reference ENUMERATED
 DEFINED in MAP-CommonDataTypes : 258
 USED in MAP-CommonDataTypes : 243

AccessNetworkSignalInfo.....type reference SEQUENCE
 DEFINED in MAP-CommonDataTypes : 242
 USED in MAP-MS-DataTypes : 181 458 521 579 628 636 641 688
 USED in MAP-CommonDataTypes : 23

accessOutsideLSAsAllowed.....identifier of Named Number, 0
 DEFINED in MAP-MS-DataTypes : 994

accessOutsideLSAsRestricted.....identifier of Named Number, 1
 DEFINED in MAP-MS-DataTypes : 995

accessType.....identifier of AccessType
 DEFINED in MAP-MS-DataTypes : 396

AccessType.....type reference ENUMERATED
 DEFINED in MAP-MS-DataTypes : 401
 USED in MAP-MS-DataTypes : 396

activate.....identifier of Named Number, 1
 DEFINED in MAP-MS-DataTypes : 2372

activateDeferredLocation.....identifier of Named Number, 3
 DEFINED in MAP-LCS-DataTypes : 124

activateSS.....information object reference OPERATION, Information Object
 DEFINED in MAP-SupplementaryServi : 124
 USED in MAP-Protocol : 75 132
 USED in MAP-SupplementaryServi : 15

activateTraceMode.....information object reference OPERATION, Information Object
 DEFINED in MAP-OperationAndMainte : 51
 USED in MAP-Protocol : 50 129
 USED in MAP-OperationAndMainte : 13

ActivateTraceModeArg.....type reference SEQUENCE
 DEFINED in MAP-OM-DataTypes : 36
 USED in MAP-OperationAndMainte : 35 53
 USED in MAP-OM-DataTypes : 14

ActivateTraceModeRes.....type reference SEQUENCE
 DEFINED in MAP-OM-DataTypes : 50
 USED in MAP-OperationAndMainte : 36 55
 USED in MAP-OM-DataTypes : 15

active.....identifier of Named Number, 2
 DEFINED in MAP-SS-DataTypes : 287

additionalAbsentSubscriberDiagnosticSM..identifier of [5] AbsentSubscriberDiagnosticSM
 DEFINED in MAP-SM-DataTypes : 159

additionalAbsentSubscriberDiagnosticSM..identifier of [0] AbsentSubscriberDiagnosticSM
 DEFINED in MAP-SM-DataTypes : 187

additionalAbsentSubscriberDiagnosticSM..identifier of [0] AbsentSubscriberDiagnosticSM
 DEFINED in MAP-ER-DataTypes : 161

additionalRequestedCAMEL-SubscriptionInfo..identifier of [7] AdditionalRequestedCAMEL-SubscriptionInfo
 DEFINED in MAP-MS-DataTypes : 2240

AdditionalRequestedCAMEL-SubscriptionInfo..type reference ENUMERATED
 DEFINED in MAP-MS-DataTypes : 2255

USED in MAP-MS-DataTypes : 2241 2365

additionalRequestedCAMEL-SubscriptionInfo identifier of [4] AdditionalRequestedCAMEL-SubscriptionInfo
DEFINED in MAP-MS-DataTypes : 2364

additionalSignalInfo.....identifier of [17] Ext-ExternalSignalInfo
DEFINED in MAP-CH-DataTypes : 113

TAG R6.0 Cross Reference Listing for MAP-Protocol 2006-06-08 15:10:26 PAGE 4

additionalSignalInfo.....identifier of [14] Ext-ExternalSignalInfo
 DEFINED in MAP-CH-DataTypes : 237

additionalSM-DeliveryOutcome.....identifier of [4] SM-DeliveryOutcome
 DEFINED in MAP-SM-DataTypes : 156

additional-Number.....identifier of [6] Additional-Number
 DEFINED in MAP-SM-DataTypes : 92

Additional-Number.....type reference CHOICE
 DEFINED in MAP-SM-DataTypes : 96
 USED in MAP-SM-DataTypes : 28 92
 USED in MAP-LCS-DataTypes : 61 89

additional-Number.....identifier of [3] Additional-Number
 DEFINED in MAP-LCS-DataTypes : 89

AddressString.....type reference OCTET STRING
 DEFINED in MAP-CommonDataTypes : 101
 USED in MAP-MS-DataTypes : 177 2335
 USED in MAP-OM-DataTypes : 21 40
 USED in MAP-CommonDataTypes : 16 145 151
 USED in MAP-SS-DataTypes : 44 74 300
 USED in MAP-SM-DataTypes : 32 56 134 139 144 178
 USED in MAP-LCS-DataTypes : 30 140

Add-GeographicalInformation.....type reference OCTET STRING
 DEFINED in MAP-LCS-DataTypes : 336
 USED in MAP-LCS-DataTypes : 24 244 370

add-Ics-PrivacyExceptionList.....identifier of [3] LCS-PrivacyExceptionList
 DEFINED in MAP-MS-DataTypes : 852

add-LocationEstimate.....identifier of [2] Add-GeographicalInformation
 DEFINED in MAP-LCS-DataTypes : 244

add-LocationEstimate.....identifier of [8] Add-GeographicalInformation
 DEFINED in MAP-LCS-DataTypes : 370

AgeIndicator.....type reference OCTET STRING
 DEFINED in MAP-MS-DataTypes : 248
 USED in MAP-MS-DataTypes : 246 832

ageOfLocationEstimate.....identifier of [0] AgeOfLocationInformation
 DEFINED in MAP-LCS-DataTypes : 241

ageOfLocationEstimate.....identifier of [6] AgeOfLocationInformation
 DEFINED in MAP-LCS-DataTypes : 367

ageOfLocationInformation.....identifier of AgeOfLocationInformation
 DEFINED in MAP-MS-DataTypes : 2062

ageOfLocationInformation.....identifier of [9] AgeOfLocationInformation
 DEFINED in MAP-MS-DataTypes : 2090

AgeOfLocationInformation.....type reference INTEGER
 DEFINED in MAP-CommonDataTypes : 512
 USED in MAP-MS-DataTypes : 195 2062 2090
 USED in MAP-CommonDataTypes : 58
 USED in MAP-LCS-DataTypes : 36 241 367

alertingCategory-1.....value reference AlertingPattern, '00000100'B
 DEFINED in MAP-CommonDataTypes : 286

alertingCategory-2.....value reference AlertingPattern, '00000101'B
 DEFINED in MAP-CommonDataTypes : 287

alertingCategory-3.....value reference AlertingPattern, '00000110'B
 DEFINED in MAP-CommonDataTypes : 288

alertingCategory-4.....value reference AlertingPattern, '00000111'B
 DEFINED in MAP-CommonDataTypes : 289

alertingCategory-5.....value reference AlertingPattern, '00001000'B

DEFINED in MAP-CommonDataTypes : 290

alertingDP.....identifier of Named Number, 9
DEFINED in MAP-MS-DataTypes : 1708

alertingLevel-0.....value reference AlertingPattern, '00000000'B
DEFINED in MAP-CommonDataTypes : 280

TAG R6.0 Cross Reference Listing for MAP-Protocol 2006-06-08 15:10:26 PAGE 5

alertingLevel-1.....value reference AlertingPattern, '0000001'B
 DEFINED in MAP-CommonDataTypes : 281

alertingLevel-2.....value reference AlertingPattern, '0000010'B
 DEFINED in MAP-CommonDataTypes : 282

AlertingPattern.....type reference OCTET STRING
 DEFINED in MAP-CommonDataTypes : 267
 USED in MAP-CommonDataTypes : 26 280 281 282 286 287 288 289 290
 USED in MAP-CH-DataTypes : 73 110 234 421
 USED in MAP-SS-DataTypes : 50 224

alertingPattern.....identifier of [14] AlertingPattern
 DEFINED in MAP-CH-DataTypes : 110

alertingPattern.....identifier of [12] AlertingPattern
 DEFINED in MAP-CH-DataTypes : 234

alertingPattern.....identifier of [5] AlertingPattern
 DEFINED in MAP-CH-DataTypes : 421

alertingPattern.....identifier of AlertingPattern
 DEFINED in MAP-SS-DataTypes : 224

alertReason.....identifier of AlertReason
 DEFINED in MAP-SM-DataTypes : 203

AlertReason.....type reference ENUMERATED
 DEFINED in MAP-SM-DataTypes : 215
 USED in MAP-SM-DataTypes : 27 203

alertReasonIndicator.....identifier of NULL
 DEFINED in MAP-SM-DataTypes : 204

alertServiceCentre.....information object reference OPERATION, Information Object
 DEFINED in MAP-ShortMessageServic : 128
 USED in MAP-Protocol : 95 136
 USED in MAP-ShortMessageServic : 17

AlertServiceCentreArg.....type reference SEQUENCE
 DEFINED in MAP-SM-DataTypes : 176
 USED in MAP-ShortMessageServic : 54 130
 USED in MAP-SM-DataTypes : 22

allAdditionalInfoTransferSS.....value reference SS-Code, '1000000'B
 DEFINED in MAP-SS-Code : 107

allAlternateSpeech-DataCDA.....value reference BearerServiceCode, '00110000'B
 DEFINED in MAP-BS-Code : 81

allAlternateSpeech-DataCDS.....value reference BearerServiceCode, '00111000'B
 DEFINED in MAP-BS-Code : 83

allAsynchronousServices.....value reference BearerServiceCode, '01100000'B
 DEFINED in MAP-BS-Code : 94

allBarringSS.....value reference SS-Code, '10010000'B
 DEFINED in MAP-SS-Code : 117

allBearerServices.....value reference BearerServiceCode, '00000000'B
 DEFINED in MAP-BS-Code : 48

allCallCompletionSS.....value reference SS-Code, '01000000'B
 DEFINED in MAP-SS-Code : 72

allCallOfferingSS.....value reference SS-Code, '00110000'B
 DEFINED in MAP-SS-Code : 63

allCallPrioritySS.....value reference SS-Code, '10100000'B
 DEFINED in MAP-SS-Code : 153

allChargingSS.....value reference SS-Code, '01110000'B
 DEFINED in MAP-SS-Code : 99

allCommunityOfInterest-SS.....value reference SS-Code, '01100000'B
DEFINED in MAP-SS-Code : 93

allCondForwardingSS.....value reference SS-Code, '00101000'B
DEFINED in MAP-SS-Code : 52

allDataCDA-Services.....value reference BearerServiceCode, '00010000'B

TAG R6.0 Cross Reference Listing for MAP-Protocol 2006-06-08 15:10:26 PAGE 6

DEFINED in MAP-BS-Code : 50

allDataCDS-Services.....value reference BearerServiceCode, '00011000'B
DEFINED in MAP-BS-Code : 59

allDataCircuitAsynchronous.....value reference BearerServiceCode, '01010000'B
DEFINED in MAP-BS-Code : 91

allDataCircuitSynchronous.....value reference BearerServiceCode, '01011000'B
DEFINED in MAP-BS-Code : 97

allDataPDS-Services.....value reference BearerServiceCode, '00101000'B
DEFINED in MAP-BS-Code : 75

allDataTeleservices.....value reference TeleserviceCode, '01110000'B
DEFINED in MAP-TS-Code : 55

allECT-Barred.....identifier of Named Number, 9
DEFINED in MAP-MS-DataTypes : 1076

allFacsimileTransmissionServices.....value reference TeleserviceCode, '01100000'B
DEFINED in MAP-TS-Code : 48

allForwardingSS.....value reference SS-Code, '00100000'B
DEFINED in MAP-SS-Code : 48

allGPRSDData.....identifier of NULL
DEFINED in MAP-MS-DataTypes : 1426

allIC-CallsBarred.....identifier of Named Number, 19
DEFINED in MAP-MS-DataTypes : 1086

allInformationSent.....identifier of [4] NULL
DEFINED in MAP-MS-DataTypes : 2383

allInformationSent.....identifier of [11] NULL
DEFINED in MAP-CH-DataTypes : 261

allLCSPrivacyException.....value reference SS-Code, '10110000'B
DEFINED in MAP-SS-Code : 159

allLineIdentificationSS.....value reference SS-Code, '00010000'B
DEFINED in MAP-SS-Code : 25

allLSAData.....identifier of NULL
DEFINED in MAP-MS-DataTypes : 1433

allMOLR-SS.....value reference SS-Code, '11000000'B
DEFINED in MAP-SS-Code : 173

allMultiPartySS.....value reference SS-Code, '01010000'B
DEFINED in MAP-SS-Code : 87

allNameIdentificationSS.....value reference SS-Code, '00011000'B
DEFINED in MAP-SS-Code : 40

allOG-CallsBarred.....identifier of Named Number, 0
DEFINED in MAP-MS-DataTypes : 1067

allowedGSM-Algorithms.....identifier of [4] AllowedGSM-Algorithms
DEFINED in MAP-MS-DataTypes : 462

AllowedGSM-Algorithms.....type reference OCTET STRING
DEFINED in MAP-MS-DataTypes : 476
USED in MAP-MS-DataTypes : 462 527

allowedGSM-Algorithms.....identifier of [9] AllowedGSM-Algorithms
DEFINED in MAP-MS-DataTypes : 527

allowedServices.....identifier of [20] AllowedServices
DEFINED in MAP-CH-DataTypes : 177

AllowedServices.....type reference BIT STRING
DEFINED in MAP-CH-DataTypes : 181
USED in MAP-CH-DataTypes : 177

allowedUMTS-Algorithms.....identifier of [5] AllowedUMTS-Algorithms
DEFINED in MAP-MS-DataTypes : 463

AllowedUMTS-Algorithms.....type reference SEQUENCE
DEFINED in MAP-MS-DataTypes : 481
USED in MAP-MS-DataTypes : 463 528

TAG R6.0 Cross Reference Listing for MAP-Protocol 2006-06-08 15:10:26 PAGE 7

allowedUMTS-Algorithms.....identifier of [10] AllowedUMTS-Algorithms
DEFINED in MAP-MS-DataTypes : 528

allPacketOrientedServicesBarred.....identifier of Named Number, 15
DEFINED in MAP-MS-DataTypes : 1082

allPadAccessCA-Services.....value reference BearerServiceCode, '00100000'B
DEFINED in MAP-BS-Code : 66

allPLMN-specificBS.....value reference BearerServiceCode, '11010000'B
DEFINED in MAP-BS-Code : 109

allPLMN-specificSS.....value reference SS-Code, '11110000'B
DEFINED in MAP-SS-Code : 136

allPLMN-specificTS.....value reference TeleserviceCode, '11010000'B
DEFINED in MAP-TS-Code : 71

allShortMessageServices.....value reference TeleserviceCode, '00100000'B
DEFINED in MAP-TS-Code : 44

allSpeechFollowedByDataCDA.....value reference BearerServiceCode, '01000000'B
DEFINED in MAP-BS-Code : 85

allSpeechFollowedByDataCDS.....value reference BearerServiceCode, '01001000'B
DEFINED in MAP-BS-Code : 87

allSpeechTransmissionServices.....value reference TeleserviceCode, '00010000'B
DEFINED in MAP-TS-Code : 40

allSS.....value reference SS-Code, '00000000'B
DEFINED in MAP-SS-Code : 21

allSynchronousServices.....value reference BearerServiceCode, '01101000'B
DEFINED in MAP-BS-Code : 100

allTeleservices.....value reference TeleserviceCode, '00000000'B
DEFINED in MAP-TS-Code : 38

allTeleservices-ExeptSMS.....value reference TeleserviceCode, '10000000'B
DEFINED in MAP-TS-Code : 58

allVoiceGroupCallServices.....value reference TeleserviceCode, '10010000'B
DEFINED in MAP-TS-Code : 67

anonymousLocation.....identifier of Named Number, 3
DEFINED in MAP-CommonDataTypes : 387

anyTimeInterrogation.....information object reference OPERATION, Information Object
DEFINED in MAP-MobileServiceOpera : 248
USED in MAP-Protocol : 35 127
USED in MAP-MobileServiceOpera : 27

AnyTimeInterrogationArg.....type reference SEQUENCE
DEFINED in MAP-MS-DataTypes : 2198
USED in MAP-MobileServiceOpera : 153 250
USED in MAP-MS-DataTypes : 117

AnyTimeInterrogationRes.....type reference SEQUENCE
DEFINED in MAP-MS-DataTypes : 2205
USED in MAP-MobileServiceOpera : 154 252
USED in MAP-MS-DataTypes : 118

anyTimeModification.....information object reference OPERATION, Information Object
DEFINED in MAP-MobileServiceOpera : 281
USED in MAP-Protocol : 37 127
USED in MAP-MobileServiceOpera : 31

AnyTimeModificationArg.....type reference SEQUENCE
DEFINED in MAP-MS-DataTypes : 2313
USED in MAP-MobileServiceOpera : 149 283
USED in MAP-MS-DataTypes : 123

AnyTimeModificationRes.....type reference SEQUENCE

DEFINED in MAP-MS-DataTypes : 2324
USED in MAP-MobileServiceOpera : 150 285
USED in MAP-MS-DataTypes : 124

anyTimeSubscriptionInterrogation.....information object reference OPERATION, Information Object
DEFINED in MAP-MobileServiceOpera : 263
USED in MAP-Protocol : 36 127

TAG R6.0 Cross Reference Listing for MAP-Protocol 2006-06-08 15:10:26 PAGE 8

USED in MAP-MobileServiceOpera : 30

AnyTimeSubscriptionInterrogationArg.....type reference SEQUENCE
 DEFINED in MAP-MS-DataTypes : 2212
 USED in MAP-MobileServiceOpera : 147 265
 USED in MAP-MS-DataTypes : 121

AnyTimeSubscriptionInterrogationRes.....type reference SEQUENCE
 DEFINED in MAP-MS-DataTypes : 2220
 USED in MAP-MobileServiceOpera : 148 267
 USED in MAP-MS-DataTypes : 122

an-APDU.....identifier of AccessNetworkSignalInfo
 DEFINED in MAP-MS-DataTypes : 458

an-APDU.....identifier of [2] AccessNetworkSignalInfo
 DEFINED in MAP-MS-DataTypes : 521

an-APDU.....identifier of [2] AccessNetworkSignalInfo
 DEFINED in MAP-MS-DataTypes : 579

an-APDU.....identifier of [3] AccessNetworkSignalInfo
 DEFINED in MAP-MS-DataTypes : 628

an-APDU.....identifier of AccessNetworkSignalInfo
 DEFINED in MAP-MS-DataTypes : 636

an-APDU.....identifier of AccessNetworkSignalInfo
 DEFINED in MAP-MS-DataTypes : 641

an-APDU.....identifier of AccessNetworkSignalInfo
 DEFINED in MAP-MS-DataTypes : 688

aocc.....value reference SS-Code, '01110010'B
 DEFINED in MAP-SS-Code : 104

aoci.....value reference SS-Code, '01110001'B
 DEFINED in MAP-SS-Code : 102

apn.....identifier of [20] APN
 DEFINED in MAP-MS-DataTypes : 885

APN.....type reference OCTET STRING
 DEFINED in MAP-MS-DataTypes : 961
 USED in MAP-MS-DataTypes : 92 885 2149 2150
 USED in MAP-LCS-DataTypes : 56 144

apn-InUse.....identifier of [5] APN
 DEFINED in MAP-MS-DataTypes : 2150

apn-Subscribed.....identifier of [4] APN
 DEFINED in MAP-MS-DataTypes : 2149

asciiCallReference.....identifier of [20] ASCII-CallReference
 DEFINED in MAP-MS-DataTypes : 536

asciiCallReference.....identifier of ASCII-CallReference
 DEFINED in MAP-GR-DataTypes : 51

ASCII-CallReference.....type reference TBCD-STRING
 DEFINED in MAP-CommonDataTypes : 310
 USED in MAP-MS-DataTypes : 200 536
 USED in MAP-CommonDataTypes : 41
 USED in MAP-GR-DataTypes : 26 51

assetManagement.....value reference LCSServiceTypeID, 4
 DEFINED in MAP-CommonDataTypes : 400

assumedIdle.....identifier of [0] NULL
 DEFINED in MAP-MS-DataTypes : 2127

ati-NotAllowed.....information object reference ERROR, Information Object
 DEFINED in MAP-Errors : 352
 USED in MAP-MobileServiceOpera : 91 255
 USED in MAP-Errors : 55

ATI-NotAllowedParam.....type reference SEQUENCE
DEFINED in MAP-ER-DataTypes : 280
USED in MAP-Errors : 132 354
USED in MAP-ER-DataTypes : 39

atm-NotAllowed.....information object reference ERROR, Information Object

TAG R6.0 Cross Reference Listing for MAP-Protocol 2006-06-08 15:10:26 PAGE 9

DEFINED in MAP-Errors : 365
 USED in MAP-MobileServiceOpera : 97 287
 USED in MAP-Errors : 59

ATM-NotAllowedParam.....type reference SEQUENCE

DEFINED in MAP-ER-DataTypes : 288
 USED in MAP-Errors : 147 367
 USED in MAP-ER-DataTypes : 55

atsi-NotAllowed.....information object reference ERROR, Information Object

DEFINED in MAP-Errors : 359
 USED in MAP-MobileServiceOpera : 96 269
 USED in MAP-Errors : 58

ATSI-NotAllowedParam.....type reference SEQUENCE

DEFINED in MAP-ER-DataTypes : 284
 USED in MAP-Errors : 146 361
 USED in MAP-ER-DataTypes : 54

attach.....identifier of Named Number, 1

DEFINED in MAP-MS-DataTypes : 950

attachChangeOfPosition.....identifier of Named Number, 2

DEFINED in MAP-MS-DataTypes : 951

authenticationFailureReport.....information object reference OPERATION, Information Object

DEFINED in MAP-MobileServiceOpera : 380
 USED in MAP-Protocol : 27 125
 USED in MAP-MobileServiceOpera : 46

AuthenticationFailureReportArg.....type reference SEQUENCE

DEFINED in MAP-MS-DataTypes : 390
 USED in MAP-MobileServiceOpera : 134 382
 USED in MAP-MS-DataTypes : 46

AuthenticationFailureReportRes.....type reference SEQUENCE

DEFINED in MAP-MS-DataTypes : 417
 USED in MAP-MobileServiceOpera : 135 384
 USED in MAP-MS-DataTypes : 47

AuthenticationQuintuplet.....type reference SEQUENCE

DEFINED in MAP-MS-DataTypes : 345
 USED in MAP-MS-DataTypes : 337

authenticationSetList.....identifier of AuthenticationSetList

DEFINED in MAP-MS-DataTypes : 322

AuthenticationSetList.....type reference CHOICE

DEFINED in MAP-MS-DataTypes : 329
 USED in MAP-MS-DataTypes : 322 767

authenticationSetList.....identifier of AuthenticationSetList

DEFINED in MAP-MS-DataTypes : 767

AuthenticationTriplet.....type reference SEQUENCE

DEFINED in MAP-MS-DataTypes : 339
 USED in MAP-MS-DataTypes : 334

autn.....identifier of AUTN

DEFINED in MAP-MS-DataTypes : 350

AUTN.....type reference OCTET STRING

DEFINED in MAP-MS-DataTypes : 380
 USED in MAP-MS-DataTypes : 350

automaticFacsimileGroup3.....value reference TeleserviceCode, '01100010'B

DEFINED in MAP-TS-Code : 50

autonomousSelfLocation.....value reference SS-Code, '11000010'B

DEFINED in MAP-SS-Code : 177

AUTS.....type reference OCTET STRING

DEFINED in MAP-MS-DataTypes : 382
 USED in MAP-MS-DataTypes : 763

auts.....identifier of AUTS
DEFINED in MAP-MS-DataTypes : 763

a-side.....identifier of Named Number, 0
DEFINED in MAP-CH-DataTypes : 394

baic.....value reference SS-Code, '10011010'B

TAG R6.0 Cross Reference Listing for MAP-Protocol 2006-06-08 15:10:26 PAGE 10

DEFINED in MAP-SS-Code : 130

baoc.....value reference SS-Code, '10010010'B
DEFINED in MAP-SS-Code : 121

barringOfIncomingCalls.....value reference SS-Code, '10011001'B
DEFINED in MAP-SS-Code : 128

barringOfOutgoingCalls.....value reference SS-Code, '10010001'B
DEFINED in MAP-SS-Code : 119

barringServiceActive.....identifier of Named Number, 0
DEFINED in MAP-ER-DataTypes : 108

basicCall.....identifier of Named Number, 0
DEFINED in MAP-CH-DataTypes : 128

basicSTSupported.....identifier of Named Number, 0
DEFINED in MAP-MS-DataTypes : 253

basicSelfLocation.....value reference SS-Code, '11000001'B
DEFINED in MAP-SS-Code : 175

basicService.....identifier of Ext-BasicServiceCode
DEFINED in MAP-MS-DataTypes : 1133

basicService.....identifier of Ext-BasicServiceCode
DEFINED in MAP-MS-DataTypes : 1192

basicService.....identifier of Ext-BasicServiceCode
DEFINED in MAP-MS-DataTypes : 1235

basicService.....identifier of [1] Ext-BasicServiceCode
DEFINED in MAP-MS-DataTypes : 2333

basicService.....identifier of [1] Ext-BasicServiceCode
DEFINED in MAP-MS-DataTypes : 2344

basicService.....identifier of [5] Ext-BasicServiceCode
DEFINED in MAP-CH-DataTypes : 161

basicService.....identifier of BasicServiceCode
DEFINED in MAP-SS-DataTypes : 73

basicService.....identifier of BasicServiceCode
DEFINED in MAP-SS-DataTypes : 99

basicService.....identifier of BasicServiceCode
DEFINED in MAP-SS-DataTypes : 156

basicService.....identifier of BasicServiceCode
DEFINED in MAP-SS-DataTypes : 185

basicService.....identifier of BasicServiceCode
DEFINED in MAP-ER-DataTypes : 130

basicService2.....identifier of [19] Ext-BasicServiceCode
DEFINED in MAP-CH-DataTypes : 176

BasicServiceCode.....type reference CHOICE
DEFINED in MAP-CommonDataTypes : 446
USED in MAP-CommonDataTypes : 48
USED in MAP-SS-DataTypes : 49 73 99 156 185 209 264
USED in MAP-ER-DataTypes : 72 130

basicServiceCriteria.....identifier of [1] BasicServiceCriteria
DEFINED in MAP-MS-DataTypes : 1601

basicServiceCriteria.....identifier of [0] BasicServiceCriteria
DEFINED in MAP-MS-DataTypes : 1609

BasicServiceCriteria.....type reference SEQUENCE OF
DEFINED in MAP-MS-DataTypes : 1629
USED in MAP-MS-DataTypes : 77 1601 1609

basicServiceGroup.....identifier of [9] Ext-BasicServiceCode
DEFINED in MAP-CH-DataTypes : 104

basicServiceGroup.....identifier of [1] Ext-BasicServiceCode
DEFINED in MAP-CH-DataTypes : 252

basicServiceGroup.....identifier of [3] BasicServiceCode

TAG R6.0 Cross Reference Listing for MAP-Protocol 2006-06-08 15:10:26 PAGE 11

DEFINED in MAP-SS-DataTypes : 209

basicServiceGroup2.....identifier of [25] Ext-BasicServiceCode
DEFINED in MAP-CH-DataTypes : 121

basicServiceGroup2.....identifier of [14] Ext-BasicServiceCode
DEFINED in MAP-CH-DataTypes : 265

basicServiceGroupList.....identifier of Ext-BasicServiceGroupList
DEFINED in MAP-MS-DataTypes : 1210

basicServiceGroupList.....identifier of Ext-BasicServiceGroupList
DEFINED in MAP-MS-DataTypes : 1255

basicServiceGroupList.....identifier of BasicServiceGroupList
DEFINED in MAP-SS-DataTypes : 164

basicServiceGroupList.....identifier of [2] BasicServiceGroupList
DEFINED in MAP-SS-DataTypes : 216

BasicServiceGroupList.....type reference SEQUENCE OF
DEFINED in MAP-SS-DataTypes : 263
USED in MAP-SS-DataTypes : 164 216

basicServiceList.....identifier of [1] BasicServiceList
DEFINED in MAP-MS-DataTypes : 1385

BasicServiceList.....type reference SEQUENCE OF
DEFINED in MAP-MS-DataTypes : 1439
USED in MAP-MS-DataTypes : 1385

bearerService.....identifier of [2] BearerServiceCode
DEFINED in MAP-CommonDataTypes : 447

BearerServiceCode.....type reference OCTET STRING
DEFINED in MAP-BS-Code : 11
USED in MAP-CommonDataTypes : 71 447
USED in MAP-BS-Code : 48 50 51 52 53 54 55 56 57
59 60 61 62 63 64 66 67 68
69 70 71 72 73 75 76 77 78
79 81 83 85 87 91 94 97 100
109 110 111 112 113 114 115 116 117
118 119 120 121 122 123 124

bearerServiceList.....identifier of [4] BearerServiceList
DEFINED in MAP-MS-DataTypes : 1028

BearerServiceList.....type reference SEQUENCE OF
DEFINED in MAP-MS-DataTypes : 1050
USED in MAP-MS-DataTypes : 1028 1368

bearerServiceList.....identifier of [2] BearerServiceList
DEFINED in MAP-MS-DataTypes : 1368

bearerServiceNotProvisioned.....information object reference ERROR, Information Object
DEFINED in MAP-Errors : 254
USED in MAP-MobileServiceOpera : 98 273 291
USED in MAP-CallHandlingOperat : 38 95
USED in MAP-SupplementaryServi : 38 98 116 134 155 174
USED in MAP-Errors : 32

bearerServiceNotProvisioned.....identifier of Named Number, 1
DEFINED in MAP-CH-DataTypes : 189

BearerServNotProvParam.....type reference SEQUENCE
DEFINED in MAP-ER-DataTypes : 228
USED in MAP-Errors : 120 256
USED in MAP-ER-DataTypes : 30

bicRoam.....value reference SS-Code, '10011011'B
DEFINED in MAP-SS-Code : 132

blackListed.....identifier of Named Number, 1
DEFINED in MAP-MS-DataTypes : 812

bmuef.....identifier of UESBI-Iu
DEFINED in MAP-MS-DataTypes : 789

bmuef.....identifier of Named Number, 1
DEFINED in MAP-MS-DataTypes : 795

boic.....value reference SS-Code, '10010011'B

TAG R6.0 Cross Reference Listing for MAP-Protocol 2006-06-08 15:10:26 PAGE 12

DEFINED in MAP-SS-Code : 123

boicExHC.....value reference SS-Code, '10010100'B
DEFINED in MAP-SS-Code : 125

bothMSCAndSGSN.....identifier of Named Number, 0
DEFINED in MAP-MS-DataTypes : 867

broadcastInitEntitlement.....identifier of NULL
DEFINED in MAP-MS-DataTypes : 1953

broadcastService.....identifier of Named Number, 0
DEFINED in MAP-CommonDataTypes : 384

bssmap-ServiceHandover.....identifier of [9] BSSMAP-ServiceHandover
DEFINED in MAP-MS-DataTypes : 468

bssmap-ServiceHandover.....identifier of [13] BSSMAP-ServiceHandover
DEFINED in MAP-MS-DataTypes : 533

bssmap-ServiceHandover.....identifier of BSSMAP-ServiceHandover
DEFINED in MAP-MS-DataTypes : 547

BSSMAP-ServiceHandover.....type reference OCTET STRING
DEFINED in MAP-MS-DataTypes : 554
USED in MAP-MS-DataTypes : 468 533 547

BSSMAP-ServiceHandoverInfo.....type reference SEQUENCE
DEFINED in MAP-MS-DataTypes : 546
USED in MAP-MS-DataTypes : 544

bssmap-ServiceHandoverList.....identifier of [10] BSSMAP-ServiceHandoverList
DEFINED in MAP-MS-DataTypes : 470

bssmap-ServiceHandoverList.....identifier of [15] BSSMAP-ServiceHandoverList
DEFINED in MAP-MS-DataTypes : 535

BSSMAP-ServiceHandoverList.....type reference SEQUENCE OF
DEFINED in MAP-MS-DataTypes : 543
USED in MAP-MS-DataTypes : 470 535

busy.....identifier of Named Number, 1
DEFINED in MAP-CH-DataTypes : 137

busy.....identifier of Named Number, 2
DEFINED in MAP-CH-DataTypes : 404

busySubscriber.....information object reference ERROR, Information Object
DEFINED in MAP-Errors : 308
USED in MAP-CallHandlingOperat : 42 98 198
USED in MAP-Errors : 46

busySubscriber.....identifier of Named Number, 4
DEFINED in MAP-CH-DataTypes : 192

BusySubscriberParam.....type reference SEQUENCE
DEFINED in MAP-ER-DataTypes : 262
USED in MAP-Errors : 126 310
USED in MAP-ER-DataTypes : 35

b-side.....identifier of Named Number, 1
DEFINED in MAP-CH-DataTypes : 395

b-subscriberNumber.....identifier of [1] ISDN-AddressString
DEFINED in MAP-SS-DataTypes : 207

b-subscriberNumber.....identifier of [5] ISDN-AddressString
DEFINED in MAP-SS-DataTypes : 280

b-subscriberSubaddress.....identifier of [2] ISDN-SubaddressString
DEFINED in MAP-SS-DataTypes : 208

b-Subscriber-Address.....identifier of [3] ISDN-AddressString
DEFINED in MAP-CH-DataTypes : 315

call.....identifier of Named Number, 0
DEFINED in MAP-MS-DataTypes : 402

callBarred.....information object reference ERROR, Information Object
DEFINED in MAP-Errors : 320
USED in MAP-MobileServiceOpera : 100 275 293 466
USED in MAP-CallHandlingOperat : 44 100

TAG R6.0 Cross Reference Listing for MAP-Protocol 2006-06-08 15:10:26 PAGE 13

USED in MAP-SupplementaryServi : 40 100 118 136 157 176 191 235 272
290
USED in MAP-ShortMessageServic : 37 79
USED in MAP-Errors : 49

callBarred.....identifier of Named Number, 5
DEFINED in MAP-CH-DataTypes : 193

CallBarredParam.....type reference CHOICE
DEFINED in MAP-ER-DataTypes : 100
USED in MAP-Errors : 128 322
USED in MAP-ER-DataTypes : 15

callBarringCause.....identifier of CallBarringCause
DEFINED in MAP-ER-DataTypes : 101

CallBarringCause.....type reference ENUMERATED
DEFINED in MAP-ER-DataTypes : 107
USED in MAP-ER-DataTypes : 101 112

callBarringCause.....identifier of CallBarringCause
DEFINED in MAP-ER-DataTypes : 112

callBarringData.....identifier of [2] CallBarringData
DEFINED in MAP-MS-DataTypes : 2222

CallBarringData.....type reference SEQUENCE
DEFINED in MAP-MS-DataTypes : 2270
USED in MAP-MS-DataTypes : 2222

CallBarringFeature.....type reference SEQUENCE
DEFINED in MAP-SS-DataTypes : 155
USED in MAP-SS-DataTypes : 153

callBarringFeatureList.....identifier of Ext-CallBarFeatureList
DEFINED in MAP-MS-DataTypes : 1184

callBarringFeatureList.....identifier of Ext-CallBarFeatureList
DEFINED in MAP-MS-DataTypes : 2271

callBarringFeatureList.....identifier of [1] Ext-CallBarFeatureList
DEFINED in MAP-MS-DataTypes : 2424

callBarringFeatureList.....identifier of CallBarringFeatureList
DEFINED in MAP-SS-DataTypes : 149

CallBarringFeatureList.....type reference SEQUENCE OF
DEFINED in MAP-SS-DataTypes : 152
USED in MAP-SS-DataTypes : 149

callBarringInfo.....identifier of [1] Ext-CallBarInfo
DEFINED in MAP-MS-DataTypes : 1118

callBarringInfo.....identifier of [1] CallBarringInfo
DEFINED in MAP-SS-DataTypes : 86

CallBarringInfo.....type reference SEQUENCE
DEFINED in MAP-SS-DataTypes : 147
USED in MAP-SS-DataTypes : 86

callBarringInfoFor-CSE.....identifier of [1] Ext-CallBarringInfoFor-CSE
DEFINED in MAP-MS-DataTypes : 2380

callBarringInfoFor-CSE.....identifier of [1] Ext-CallBarringInfoFor-CSE
DEFINED in MAP-MS-DataTypes : 2412

CallDirection.....type reference OCTET STRING
DEFINED in MAP-CH-DataTypes : 322
USED in MAP-CH-DataTypes : 314

callDiversionTreatmentIndicator.....identifier of [20] CallDiversionTreatmentIndicator
DEFINED in MAP-CH-DataTypes : 116

CallDiversionTreatmentIndicator.....type reference OCTET STRING
DEFINED in MAP-CH-DataTypes : 146

USED in MAP-CH-DataTypes : 116

calledPartySS-InteractionViolation.....identifier of Named Number, 7
DEFINED in MAP-ER-DataTypes : 126

callForwardingData.....identifier of [1] CallForwardingData
DEFINED in MAP-MS-DataTypes : 2221

TAG R6.0 Cross Reference Listing for MAP-Protocol 2006-06-08 15:10:26 PAGE 14

CallForwardingData.....type reference SEQUENCE
DEFINED in MAP-MS-DataTypes : 2264
USED in MAP-MS-DataTypes : 2221

callInfo.....identifier of [1] ExternalSignalInfo
DEFINED in MAP-CH-DataTypes : 417

callInfo.....identifier of [3] ExternalSignalInfo
DEFINED in MAP-SS-DataTypes : 313

callOriginator.....identifier of [8] NULL
DEFINED in MAP-GR-DataTypes : 118

callOutcome.....identifier of [1] CallOutcome
DEFINED in MAP-CH-DataTypes : 389

CallOutcome.....type reference ENUMERATED
DEFINED in MAP-CH-DataTypes : 401
USED in MAP-CH-DataTypes : 389

callReferenceNumber.....identifier of [7] CallReferenceNumber
DEFINED in MAP-CH-DataTypes : 102

CallReferenceNumber.....type reference OCTET STRING
DEFINED in MAP-CH-DataTypes : 133
USED in MAP-CH-DataTypes : 22 102 230 251

callReferenceNumber.....identifier of [9] CallReferenceNumber
DEFINED in MAP-CH-DataTypes : 230

callReferenceNumber.....identifier of [0] CallReferenceNumber
DEFINED in MAP-CH-DataTypes : 251

callReportdata.....identifier of [2] CallReportData
DEFINED in MAP-CH-DataTypes : 378

CallReportData.....type reference SEQUENCE
DEFINED in MAP-CH-DataTypes : 387
USED in MAP-CH-DataTypes : 378

callSessionRelated.....value reference SS-Code, '10110010'B
DEFINED in MAP-SS-Code : 163

callSessionUnrelated.....value reference SS-Code, '10110011'B
DEFINED in MAP-SS-Code : 166

callTerminationIndicator.....identifier of [2] CallTerminationIndicator
DEFINED in MAP-CH-DataTypes : 454

CallTerminationIndicator.....type reference ENUMERATED
DEFINED in MAP-CH-DataTypes : 467
USED in MAP-CH-DataTypes : 454

callToClientNotSetup.....identifier of Named Number, 2
DEFINED in MAP-ER-DataTypes : 349

callTypeCriteria.....identifier of [2] CallTypeCriteria
DEFINED in MAP-MS-DataTypes : 1602

CallTypeCriteria.....type reference ENUMERATED
DEFINED in MAP-MS-DataTypes : 1640
USED in MAP-MS-DataTypes : 1602

call-Direction.....identifier of [2] CallDirection
DEFINED in MAP-CH-DataTypes : 314

camelBusy.....identifier of [1] NULL
DEFINED in MAP-MS-DataTypes : 2128

camelCapabilityHandling.....identifier of [1] CamelCapabilityHandling
DEFINED in MAP-MS-DataTypes : 915

camelCapabilityHandling.....identifier of [1] CamelCapabilityHandling
DEFINED in MAP-MS-DataTypes : 1494

camelCapabilityHandling.....identifier of [0] CamelCapabilityHandling
DEFINED in MAP-MS-DataTypes : 1553

CamelCapabilityHandling.....type reference INTEGER
DEFINED in MAP-MS-DataTypes : 1670
USED in MAP-MS-DataTypes : 76 915 1494 1553 1721 1837

TAG R6.0 Cross Reference Listing for MAP-Protocol 2006-06-08 15:10:26 PAGE 15

camelCapabilityHandling.....identifier of [1] CamelCapabilityHandling
DEFINED in MAP-MS-DataTypes : 1721

camelCapabilityHandling.....identifier of [0] CamelCapabilityHandling
DEFINED in MAP-MS-DataTypes : 1837

camelInfo.....identifier of [11] CamelInfo
DEFINED in MAP-CH-DataTypes : 106

CamelInfo.....type reference SEQUENCE
DEFINED in MAP-CH-DataTypes : 285
USED in MAP-CH-DataTypes : 106

camelRoutingInfo.....identifier of [8] CamelRoutingInfo
DEFINED in MAP-CH-DataTypes : 294

CamelRoutingInfo.....type reference SEQUENCE
DEFINED in MAP-CH-DataTypes : 296
USED in MAP-CH-DataTypes : 294

camelSubscriptionInfoWithdraw.....identifier of [9] NULL
DEFINED in MAP-MS-DataTypes : 1393

camel-invoked.....identifier of Named Number, 1
DEFINED in MAP-SS-DataTypes : 319

camel-SubscriptionInfo.....identifier of [4] CAMEL-SubscriptionInfo
DEFINED in MAP-MS-DataTypes : 2224

CAMEL-SubscriptionInfo.....type reference SEQUENCE
DEFINED in MAP-MS-DataTypes : 2286
USED in MAP-MS-DataTypes : 2224 2326 2382

camel-SubscriptionInfo.....identifier of [1] CAMEL-SubscriptionInfo
DEFINED in MAP-MS-DataTypes : 2326

camel-SubscriptionInfo.....identifier of [3] CAMEL-SubscriptionInfo
DEFINED in MAP-MS-DataTypes : 2382

cancelDeferredLocation.....identifier of Named Number, 4
DEFINED in MAP-LCS-DataTypes : 125

cancellationType.....identifier of CancellationType
DEFINED in MAP-MS-DataTypes : 280

CancellationType.....type reference ENUMERATED
DEFINED in MAP-MS-DataTypes : 284
USED in MAP-MS-DataTypes : 280

cancelLocation.....information object reference OPERATION, Information Object
DEFINED in MAP-MobileServiceOpera : 187
USED in MAP-Protocol : 17 122
USED in MAP-MobileServiceOpera : 16

CancelLocationArg.....type reference [3] SEQUENCE
DEFINED in MAP-MS-DataTypes : 278
USED in MAP-MobileServiceOpera : 116 189
USED in MAP-MS-DataTypes : 18

CancelLocationRes.....type reference SEQUENCE
DEFINED in MAP-MS-DataTypes : 290
USED in MAP-MobileServiceOpera : 117 191
USED in MAP-MS-DataTypes : 19

category.....identifier of [2] Category
DEFINED in MAP-MS-DataTypes : 1026

Category.....type reference OCTET STRING
DEFINED in MAP-MS-DataTypes : 1043
USED in MAP-MS-DataTypes : 1026

CauseValue.....type reference OCTET STRING
DEFINED in MAP-MS-DataTypes : 1658
USED in MAP-MS-DataTypes : 1649 1652

ccbsIdle.....identifier of Named Number, 1
DEFINED in MAP-CH-DataTypes : 367

ccbsNotIdle.....identifier of Named Number, 0
DEFINED in MAP-CH-DataTypes : 366

TAG R6.0 Cross Reference Listing for MAP-Protocol 2006-06-08 15:10:26 PAGE 16

ccbsNotReachable.....identifier of Named Number, 2
DEFINED in MAP-CH-DataTypes : 368

ccbs-A.....value reference SS-Code, '01000011'B
DEFINED in MAP-SS-Code : 79

ccbs-B.....value reference SS-Code, '01000100'B
DEFINED in MAP-SS-Code : 81

ccbs-Busy.....identifier of [1] NULL
DEFINED in MAP-ER-DataTypes : 266

ccbs-Call.....identifier of [15] NULL
DEFINED in MAP-CH-DataTypes : 111

ccbs-Call.....identifier of [13] NULL
DEFINED in MAP-CH-DataTypes : 235

ccbs-Data.....identifier of [1] CCBS-Data
DEFINED in MAP-SS-DataTypes : 306

CCBS-Data.....type reference SEQUENCE
DEFINED in MAP-SS-DataTypes : 309
USED in MAP-SS-DataTypes : 306

ccbs-Feature.....identifier of [2] CCBS-Feature
DEFINED in MAP-CH-DataTypes : 418

CCBS-Feature.....type reference SEQUENCE
DEFINED in MAP-SS-DataTypes : 205
USED in MAP-CH-DataTypes : 60 418
USED in MAP-SS-DataTypes : 36 201 310 324

ccbs-Feature.....identifier of [0] CCBS-Feature
DEFINED in MAP-SS-DataTypes : 310

ccbs-Feature.....identifier of [0] CCBS-Feature
DEFINED in MAP-SS-DataTypes : 324

ccbs-FeatureList.....identifier of [2] CCBS-FeatureList
DEFINED in MAP-SS-DataTypes : 195

CCBS-FeatureList.....type reference SEQUENCE OF
DEFINED in MAP-SS-DataTypes : 200
USED in MAP-SS-DataTypes : 195

ccbs-Index.....identifier of [0] CCBS-Index
DEFINED in MAP-SS-DataTypes : 206

CCBS-Index.....type reference INTEGER
DEFINED in MAP-SS-DataTypes : 212
USED in MAP-SS-DataTypes : 206 329

ccbs-Index.....identifier of [1] CCBS-Index
DEFINED in MAP-SS-DataTypes : 329

ccbs-Indicators.....identifier of [11] CCBS-Indicators
DEFINED in MAP-CH-DataTypes : 168

CCBS-Indicators.....type reference SEQUENCE
DEFINED in MAP-CH-DataTypes : 200
USED in MAP-CH-DataTypes : 168

ccbs-Monitoring.....identifier of [2] ReportingState
DEFINED in MAP-CH-DataTypes : 348

ccbs-Possible.....identifier of [0] NULL
DEFINED in MAP-CH-DataTypes : 201

ccbs-Possible.....identifier of [8] NULL
DEFINED in MAP-CH-DataTypes : 258

ccbs-Possible.....identifier of [0] NULL
DEFINED in MAP-ER-DataTypes : 265

ccbs-RequestState.....identifier of [6] CCBS-RequestState
DEFINED in MAP-SS-DataTypes : 281

CCBS-RequestState.....type reference ENUMERATED
DEFINED in MAP-SS-DataTypes : 284
USED in MAP-SS-DataTypes : 281

TAG R6.0 Cross Reference Listing for MAP-Protocol 2006-06-08 15:10:26 PAGE 17

ccbs-SubscriberStatus.....identifier of [0] CCBS-SubscriberStatus
DEFINED in MAP-CH-DataTypes : 361

CCBS-SubscriberStatus.....type reference ENUMERATED
DEFINED in MAP-CH-DataTypes : 365
USED in MAP-CH-DataTypes : 361 383

ccbs-SubscriberStatus.....identifier of [0] CCBS-SubscriberStatus
DEFINED in MAP-CH-DataTypes : 383

cd.....value reference SS-Code, '00100100'B
DEFINED in MAP-SS-Code : 60

cellGlobalIdOrServiceAreaIdFixedLength..identifier of [0] CellGlobalIdOrServiceAreaIdFixedLength
DEFINED in MAP-CommonDataTypes : 413

CellGlobalIdOrServiceAreaIdFixedLength..type reference OCTET STRING
DEFINED in MAP-CommonDataTypes : 416
USED in MAP-CommonDataTypes : 413

cellGlobalIdOrServiceAreaIdOrLAI.....identifier of [3] CellGlobalIdOrServiceAreaIdOrLAI
DEFINED in MAP-MS-DataTypes : 2066

cellGlobalIdOrServiceAreaIdOrLAI.....identifier of [0] CellGlobalIdOrServiceAreaIdOrLAI
DEFINED in MAP-MS-DataTypes : 2080

CellGlobalIdOrServiceAreaIdOrLAI.....type reference CHOICE
DEFINED in MAP-CommonDataTypes : 412
USED in MAP-MS-DataTypes : 189 2066 2080
USED in MAP-CommonDataTypes : 45

cfb.....value reference SS-Code, '00101001'B
DEFINED in MAP-SS-Code : 54

cfnc.....value reference SS-Code, '00101011'B
DEFINED in MAP-SS-Code : 58

cfny.....value reference SS-Code, '00101010'B
DEFINED in MAP-SS-Code : 56

cfu.....value reference SS-Code, '00100001'B
DEFINED in MAP-SS-Code : 50

cf-Enhancements.....identifier of Named Number, 14
DEFINED in MAP-MS-DataTypes : 1713

changeOfPositionDP.....identifier of Named Number, 11
DEFINED in MAP-MS-DataTypes : 1710

channelType.....identifier of [0] ExternalSignalInfo
DEFINED in MAP-CH-DataTypes : 335

chargeableECT-Barred.....identifier of Named Number, 10
DEFINED in MAP-MS-DataTypes : 1077

chargingCharacteristics.....identifier of [18] ChargingCharacteristics
DEFINED in MAP-MS-DataTypes : 836

ChargingCharacteristics.....type reference OCTET STRING
DEFINED in MAP-MS-DataTypes : 990
USED in MAP-MS-DataTypes : 836 889 2160

chargingCharacteristics.....identifier of [15] ChargingCharacteristics
DEFINED in MAP-MS-DataTypes : 2160

chargingCharacteristicsWithdraw.....identifier of [16] NULL
DEFINED in MAP-MS-DataTypes : 1402

chargingId.....identifier of [14] GPRChargingID
DEFINED in MAP-MS-DataTypes : 2159

chargingIndicator.....identifier of Named Number, 8
DEFINED in MAP-MS-DataTypes : 1707

checkIMEI.....information object reference OPERATION, Information Object

DEFINED in MAP-MobileServiceOpera : 394
USED in MAP-Protocol : 28 125
USED in MAP-MobileServiceOpera : 49

CheckIMEI-Arg.....type reference SEQUENCE

DEFINED in MAP-MS-DataTypes : 781
USED in MAP-MobileServiceOpera : 136 396

TAG R6.0 Cross Reference Listing for MAP-Protocol 2006-06-08 15:10:26 PAGE 18

USED in MAP-MS-DataTypes : 53

CheckIMEI-Res.....type reference SEQUENCE
DEFINED in MAP-MS-DataTypes : 787
USED in MAP-MobileServiceOpera : 137 398
USED in MAP-MS-DataTypes : 54

chosenChannel.....identifier of [4] ExternalSignalInfo
DEFINED in MAP-CH-DataTypes : 316

chosenChannel.....identifier of [1] ExternalSignalInfo
DEFINED in MAP-CH-DataTypes : 336

chosenChannel.....identifier of [0] ExternalSignalInfo
DEFINED in MAP-CH-DataTypes : 341

chosenChannelInfo.....identifier of [0] ChosenChannelInfo
DEFINED in MAP-MS-DataTypes : 610

ChosenChannelInfo.....type reference OCTET STRING
DEFINED in MAP-MS-DataTypes : 615
USED in MAP-MS-DataTypes : 610

ChosenEncryptionAlgorithm.....type reference OCTET STRING
DEFINED in MAP-MS-DataTypes : 602
USED in MAP-MS-DataTypes : 591

ChosenIntegrityProtectionAlgorithm.....type reference OCTET STRING
DEFINED in MAP-MS-DataTypes : 595
USED in MAP-MS-DataTypes : 590

chosenRadioResourceInformation.....identifier of [6] ChosenRadioResourceInformation
DEFINED in MAP-MS-DataTypes : 583

ChosenRadioResourceInformation.....type reference SEQUENCE
DEFINED in MAP-MS-DataTypes : 609
USED in MAP-MS-DataTypes : 583 644

chosenRadioResourceInformation.....identifier of [3] ChosenRadioResourceInformation
DEFINED in MAP-MS-DataTypes : 644

chosenSpeechVersion.....identifier of [1] ChosenSpeechVersion
DEFINED in MAP-MS-DataTypes : 611

ChosenSpeechVersion.....type reference OCTET STRING
DEFINED in MAP-MS-DataTypes : 619
USED in MAP-MS-DataTypes : 611

cipheringAlgorithm.....identifier of CipheringAlgorithm
DEFINED in MAP-GR-DataTypes : 53

CipheringAlgorithm.....type reference OCTET STRING
DEFINED in MAP-GR-DataTypes : 99
USED in MAP-GR-DataTypes : 53

citySightseeing.....value reference LCSServiceTypeID, 9
DEFINED in MAP-CommonDataTypes : 405

ck.....identifier of CK
DEFINED in MAP-MS-DataTypes : 348

ck.....identifier of CK
DEFINED in MAP-MS-DataTypes : 363

CK.....type reference OCTET STRING
DEFINED in MAP-MS-DataTypes : 376
USED in MAP-MS-DataTypes : 348 363

cksn.....identifier of Cksn
DEFINED in MAP-MS-DataTypes : 359

Cksn.....type reference OCTET STRING
DEFINED in MAP-MS-DataTypes : 384
USED in MAP-MS-DataTypes : 359

clientIdentity.....identifier of LCSCClientExternalID
DEFINED in MAP-MS-DataTypes : 1307

clientNotInMSPrivacyExceptionList.....identifier of Named Number, 1
DEFINED in MAP-ER-DataTypes : 348

clip.....value reference SS-Code, '00010001'B

TAG R6.0 Cross Reference Listing for MAP-Protocol 2006-06-08 15:10:26 PAGE 19

DEFINED in MAP-SS-Code : 28
 clir.....value reference SS-Code, '00010010'B
 DEFINED in MAP-SS-Code : 30
 cliRestrictionOption.....identifier of [2] CliRestrictionOption
 DEFINED in MAP-SS-DataTypes : 171
 CliRestrictionOption.....type reference ENUMERATED
 DEFINED in MAP-SS-DataTypes : 174
 USED in MAP-SS-DataTypes : 29 171 191
 cliRestrictionOption.....identifier of CliRestrictionOption
 DEFINED in MAP-SS-DataTypes : 191
 clir-invoked.....identifier of Named Number, 0
 DEFINED in MAP-SS-DataTypes : 318
 cnap.....value reference SS-Code, '00011001'B
 DEFINED in MAP-SS-Code : 42
 Code.....type reference CHOICE
 DEFINED in Remote-Operations-Info : 114
 USED in Remote-Operations-Info : 25 46
 Codec.....type reference OCTET STRING
 DEFINED in MAP-MS-DataTypes : 671
 USED in MAP-MS-DataTypes : 471 474 538 586 648 659 660 661 662
 663 664 665 666
 codec1.....identifier of [1] Codec
 DEFINED in MAP-MS-DataTypes : 659
 codec2.....identifier of [2] Codec
 DEFINED in MAP-MS-DataTypes : 660
 codec3.....identifier of [3] Codec
 DEFINED in MAP-MS-DataTypes : 661
 codec4.....identifier of [4] Codec
 DEFINED in MAP-MS-DataTypes : 662
 codec5.....identifier of [5] Codec
 DEFINED in MAP-MS-DataTypes : 663
 codec6.....identifier of [6] Codec
 DEFINED in MAP-MS-DataTypes : 664
 codec7.....identifier of [7] Codec
 DEFINED in MAP-MS-DataTypes : 665
 codec8.....identifier of [8] Codec
 DEFINED in MAP-MS-DataTypes : 666
 CodecList.....type reference SEQUENCE
 DEFINED in MAP-MS-DataTypes : 658
 USED in MAP-MS-DataTypes : 587 649 652 653
 codec-Info.....identifier of CODEC-Info
 DEFINED in MAP-GR-DataTypes : 52
 CODEC-Info.....type reference OCTET STRING
 DEFINED in MAP-GR-DataTypes : 95
 USED in MAP-GR-DataTypes : 52
 collectedInfo.....identifier of Named Number, 2
 DEFINED in MAP-MS-DataTypes : 1581
 colp.....value reference SS-Code, '00010011'B
 DEFINED in MAP-SS-Code : 32
 colr.....value reference SS-Code, '00010100'B
 DEFINED in MAP-SS-Code : 34
 completed.....identifier of Named Number, 3

DEFINED in MAP-SS-DataTypes : 288

completeDataListIncluded.....identifier of NULL
DEFINED in MAP-MS-DataTypes : 896

completeDataListIncluded.....identifier of NULL
DEFINED in MAP-MS-DataTypes : 1010

TAG R6.0 Cross Reference Listing for MAP-Protocol 2006-06-08 15:10:26 PAGE 20

congestion.....identifier of Named Number, 3
DEFINED in MAP-LCS-DataTypes : 413

congestion.....identifier of Named Number, 0
DEFINED in MAP-ER-DataTypes : 365

ContextId.....type reference INTEGER
DEFINED in MAP-MS-DataTypes : 893
USED in MAP-MS-DataTypes : 880 1430 2145

contextIdList.....identifier of ContextIdList
DEFINED in MAP-MS-DataTypes : 1427

ContextIdList.....type reference SEQUENCE OF
DEFINED in MAP-MS-DataTypes : 1429
USED in MAP-MS-DataTypes : 1427

continueCall.....identifier of Named Number, 0
DEFINED in MAP-MS-DataTypes : 1663

continueTransaction.....identifier of Named Number, 0
DEFINED in MAP-MS-DataTypes : 942

continueTransaction.....identifier of Named Number, 0
DEFINED in MAP-MS-DataTypes : 1771

controllingMSC.....identifier of Named Number, 4
DEFINED in MAP-CommonDataTypes : 356

csiActive.....identifier of [2] NULL
DEFINED in MAP-MS-DataTypes : 1555

csi-Active.....identifier of [4] NULL
DEFINED in MAP-MS-DataTypes : 918

csi-Active.....identifier of [4] NULL
DEFINED in MAP-MS-DataTypes : 1497

csi-Active.....identifier of [1] NULL
DEFINED in MAP-MS-DataTypes : 1525

csi-Active.....identifier of [4] NULL
DEFINED in MAP-MS-DataTypes : 1724

csi-Active.....identifier of [3] NULL
DEFINED in MAP-MS-DataTypes : 1784

csi-Active.....identifier of [3] NULL
DEFINED in MAP-MS-DataTypes : 1795

csi-Active.....identifier of [2] NULL
DEFINED in MAP-MS-DataTypes : 1839

cs-AllocationRetentionPriority.....identifier of [29] CS-AllocationRetentionPriority
DEFINED in MAP-MS-DataTypes : 834

CS-AllocationRetentionPriority.....type reference OCTET STRING
DEFINED in MAP-MS-DataTypes : 841
USED in MAP-MS-DataTypes : 834

cs-Domain.....identifier of Named Number, 0
DEFINED in MAP-MS-DataTypes : 2055

cs-LCS-NotSupportedByUE.....identifier of [12] NULL
DEFINED in MAP-MS-DataTypes : 231

cug.....value reference SS-Code, '01100001'B
DEFINED in MAP-SS-Code : 96

cugIC-CallBarred.....identifier of Named Number, 1
DEFINED in MAP-MS-DataTypes : 1221

cugOG-CallBarred.....identifier of Named Number, 2
DEFINED in MAP-MS-DataTypes : 1222

cugSubscriptionFlag.....identifier of [6] NULL
DEFINED in MAP-CH-DataTypes : 158

CUG-CheckInfo.....type reference SEQUENCE
DEFINED in MAP-CH-DataTypes : 86
USED in MAP-CH-DataTypes : 96 157 255

TAG R6.0 Cross Reference Listing for MAP-Protocol 2006-06-08 15:10:26 PAGE 21

cug-CheckInfo.....identifier of [1] CUG-CheckInfo
 DEFINED in MAP-CH-DataTypes : 96

cug-CheckInfo.....identifier of [3] CUG-CheckInfo
 DEFINED in MAP-CH-DataTypes : 157

cug-CheckInfo.....identifier of [4] CUG-CheckInfo
 DEFINED in MAP-CH-DataTypes : 255

CUG-Feature.....type reference SEQUENCE
 DEFINED in MAP-MS-DataTypes : 1234
 USED in MAP-MS-DataTypes : 1227

cug-FeatureList.....identifier of CUG-FeatureList
 DEFINED in MAP-MS-DataTypes : 1199

CUG-FeatureList.....type reference SEQUENCE OF
 DEFINED in MAP-MS-DataTypes : 1226
 USED in MAP-MS-DataTypes : 1199

cug-Index.....identifier of CUG-Index
 DEFINED in MAP-MS-DataTypes : 1207

CUG-Index.....type reference INTEGER
 DEFINED in MAP-MS-DataTypes : 1214
 USED in MAP-MS-DataTypes : 82 1207 1236

cug-Info.....identifier of [2] CUG-Info
 DEFINED in MAP-MS-DataTypes : 1119

CUG-Info.....type reference SEQUENCE
 DEFINED in MAP-MS-DataTypes : 1197
 USED in MAP-MS-DataTypes : 83 1119

cug-Interlock.....identifier of CUG-Interlock
 DEFINED in MAP-MS-DataTypes : 1208

CUG-Interlock.....type reference OCTET STRING
 DEFINED in MAP-MS-DataTypes : 1217
 USED in MAP-MS-DataTypes : 84 1208
 USED in MAP-CH-DataTypes : 43 87

cug-Interlock.....identifier of CUG-Interlock
 DEFINED in MAP-CH-DataTypes : 87

cug-OutgoingAccess.....identifier of NULL
 DEFINED in MAP-CH-DataTypes : 88

cug-Reject.....information object reference ERROR, Information Object
 DEFINED in MAP-Errors : 338
 USED in MAP-CallHandlingOperat : 47 101
 USED in MAP-Errors : 52

cug-Reject.....identifier of Named Number, 6
 DEFINED in MAP-CH-DataTypes : 194

cug-RejectCause.....identifier of CUG-RejectCause
 DEFINED in MAP-ER-DataTypes : 118

CUG-RejectCause.....type reference ENUMERATED
 DEFINED in MAP-ER-DataTypes : 122
 USED in MAP-ER-DataTypes : 118

CUG-RejectParam.....type reference SEQUENCE
 DEFINED in MAP-ER-DataTypes : 117
 USED in MAP-Errors : 131 340
 USED in MAP-ER-DataTypes : 16

CUG-Subscription.....type reference SEQUENCE
 DEFINED in MAP-MS-DataTypes : 1206
 USED in MAP-MS-DataTypes : 1204

cug-SubscriptionList.....identifier of CUG-SubscriptionList
 DEFINED in MAP-MS-DataTypes : 1198

CUG-SubscriptionList.....type reference SEQUENCE OF
DEFINED in MAP-MS-DataTypes : 1203
USED in MAP-MS-DataTypes : 1198

currentLocation.....identifier of [3] NULL
DEFINED in MAP-MS-DataTypes : 2046

TAG R6.0 Cross Reference Listing for MAP-Protocol 2006-06-08 15:10:26 PAGE 22

currentLocation.....identifier of Named Number, 0
 DEFINED in MAP-LCS-DataTypes : 120

currentLocationRetrieved.....identifier of [8] NULL
 DEFINED in MAP-MS-DataTypes : 2072

currentLocationRetrieved.....identifier of [8] NULL
 DEFINED in MAP-MS-DataTypes : 2089

currentlyUsedCodec.....identifier of [11] Codec
 DEFINED in MAP-MS-DataTypes : 471

currentOrLastKnownLocation.....identifier of Named Number, 1
 DEFINED in MAP-LCS-DataTypes : 121

currentSecurityContext.....identifier of [2] CurrentSecurityContext
 DEFINED in MAP-MS-DataTypes : 323

CurrentSecurityContext.....type reference CHOICE
 DEFINED in MAP-MS-DataTypes : 353
 USED in MAP-MS-DataTypes : 323

cw.....value reference SS-Code, '01000001'B
 DEFINED in MAP-SS-Code : 75

dataCDA-1200bps.....value reference BearerServiceCode, '00010010'B
 DEFINED in MAP-BS-Code : 52

dataCDA-1200-75bps.....value reference BearerServiceCode, '00010011'B
 DEFINED in MAP-BS-Code : 53

dataCDA-2400bps.....value reference BearerServiceCode, '00010100'B
 DEFINED in MAP-BS-Code : 54

dataCDA-300bps.....value reference BearerServiceCode, '00010001'B
 DEFINED in MAP-BS-Code : 51

dataCDA-4800bps.....value reference BearerServiceCode, '00010101'B
 DEFINED in MAP-BS-Code : 55

dataCDA-9600bps.....value reference BearerServiceCode, '00010110'B
 DEFINED in MAP-BS-Code : 56

dataCDS-1200bps.....value reference BearerServiceCode, '00011010'B
 DEFINED in MAP-BS-Code : 60

dataCDS-2400bps.....value reference BearerServiceCode, '00011100'B
 DEFINED in MAP-BS-Code : 61

dataCDS-4800bps.....value reference BearerServiceCode, '00011101'B
 DEFINED in MAP-BS-Code : 62

dataCDS-9600bps.....value reference BearerServiceCode, '00011110'B
 DEFINED in MAP-BS-Code : 63

dataCodingScheme.....identifier of [0] USSD-DataCodingScheme
 DEFINED in MAP-LCS-DataTypes : 159

dataCodingScheme.....identifier of [0] USSD-DataCodingScheme
 DEFINED in MAP-LCS-DataTypes : 173

dataCodingScheme.....identifier of [0] USSD-DataCodingScheme
 DEFINED in MAP-LCS-DataTypes : 231

dataMissing.....information object reference ERROR, Information Object
 DEFINED in MAP-Errors : 171
 USED in MAP-MobileServiceOpera : 84 181 194 205 216 242 256 270 288
 310 325 355 375 401 414 426 448 463
 479 494 506
 USED in MAP-OperationAndMainte : 25 59 74 86
 USED in MAP-CallHandlingOperat : 32 89 113 131 141 154 169 184 194
 USED in MAP-SupplementaryServi : 35 96 114 132 153 172 188 202 217
 233 258 270 288
 USED in MAP-ShortMessageServic : 29 74 104 122 134 150

USED in MAP-LocationServiceOpe : 25 60 75 94
USED in MAP-Errors : 15

DataMissingParam.....type reference SEQUENCE
DEFINED in MAP-ER-DataTypes : 181
USED in MAP-Errors : 111 173
USED in MAP-ER-DataTypes : 21

TAG R6.0 Cross Reference Listing for MAP-Protocol 2006-06-08 15:10:26 PAGE 23

dataPDS-2400bps.....value reference BearerServiceCode, '00101100'B
DEFINED in MAP-BS-Code : 76

dataPDS-4800bps.....value reference BearerServiceCode, '00101101'B
DEFINED in MAP-BS-Code : 77

dataPDS-9600bps.....value reference BearerServiceCode, '00101110'B
DEFINED in MAP-BS-Code : 78

deactivate.....identifier of Named Number, 0
DEFINED in MAP-MS-DataTypes : 2371

deactivateSS.....information object reference OPERATION, Information Object
DEFINED in MAP-SupplementaryServi : 145
USED in MAP-Protocol : 76 132
USED in MAP-SupplementaryServi : 16

deactivateTraceMode.....information object reference OPERATION, Information Object
DEFINED in MAP-OperationAndMainte : 66
USED in MAP-Protocol : 51 129
USED in MAP-OperationAndMainte : 14

DeactivateTraceModeArg.....type reference SEQUENCE
DEFINED in MAP-OM-DataTypes : 54
USED in MAP-OperationAndMainte : 37 68
USED in MAP-OM-DataTypes : 16

DeactivateTraceModeRes.....type reference SEQUENCE
DEFINED in MAP-OM-DataTypes : 60
USED in MAP-OperationAndMainte : 38 70
USED in MAP-OM-DataTypes : 17

defaultCallHandling.....identifier of DefaultCallHandling
DEFINED in MAP-MS-DataTypes : 1516

defaultCallHandling.....identifier of [1] DefaultCallHandling
DEFINED in MAP-MS-DataTypes : 1573

DefaultCallHandling.....type reference ENUMERATED
DEFINED in MAP-MS-DataTypes : 1662
USED in MAP-MS-DataTypes : 75 1516 1573 1857

defaultCallHandling.....identifier of [1] DefaultCallHandling
DEFINED in MAP-MS-DataTypes : 1857

DefaultGPRS-Handling.....type reference ENUMERATED
DEFINED in MAP-MS-DataTypes : 941
USED in MAP-MS-DataTypes : 936

defaultPriority.....identifier of EMLPP-Priority
DEFINED in MAP-CommonDataTypes : 456

defaultPriority.....identifier of [7] EMLPP-Priority
DEFINED in MAP-SS-DataTypes : 78

defaultPriority.....identifier of EMLPP-Priority
DEFINED in MAP-SS-DataTypes : 166

defaultPriority.....identifier of [1] EMLPP-Priority
DEFINED in MAP-SS-DataTypes : 194

defaultSessionHandling.....identifier of [3] DefaultGPRS-Handling
DEFINED in MAP-MS-DataTypes : 936

defaultSMS-Handling.....identifier of [3] DefaultSMS-Handling
DEFINED in MAP-MS-DataTypes : 1743

DefaultSMS-Handling.....type reference ENUMERATED
DEFINED in MAP-MS-DataTypes : 1770
USED in MAP-MS-DataTypes : 1743

deferredLocationEventType.....identifier of [1] DeferredLocationEventType
DEFINED in MAP-LCS-DataTypes : 117

DeferredLocationEventType.....type reference BIT STRING

DEFINED in MAP-LCS-DataTypes : 130

USED in MAP-LCS-DataTypes : 117 392

deferredLocationEventType.....identifier of DeferredLocationEventType

DEFINED in MAP-LCS-DataTypes : 392

TAG R6.0 Cross Reference Listing for MAP-Protocol 2006-06-08 15:10:26 PAGE 24

deferredmt-IrData.....identifier of [9] Deferredmt-IrData
DEFINED in MAP-LCS-DataTypes : 371

Deferredmt-IrData.....type reference SEQUENCE
DEFINED in MAP-LCS-DataTypes : 391
USED in MAP-LCS-DataTypes : 371

deferredmt-IrResponse.....identifier of Named Number, 3
DEFINED in MAP-LCS-DataTypes : 404

deferredmt-IrResponseIndicator.....identifier of [3] NULL
DEFINED in MAP-LCS-DataTypes : 245

delaytolerant.....identifier of Named Number, 1
DEFINED in MAP-LCS-DataTypes : 212

deleted.....identifier of Named Number, 6
DEFINED in MAP-SS-DataTypes : 291

deleteSubscriberData.....information object reference OPERATION, Information Object
DEFINED in MAP-MobileServiceOpera : 419
USED in MAP-Protocol : 30 126
USED in MAP-MobileServiceOpera : 53

DeleteSubscriberDataArg.....type reference SEQUENCE
DEFINED in MAP-MS-DataTypes : 1383
USED in MAP-MobileServiceOpera : 140 421
USED in MAP-MS-DataTypes : 60

DeleteSubscriberDataRes.....type reference SEQUENCE
DEFINED in MAP-MS-DataTypes : 1444
USED in MAP-MobileServiceOpera : 141 423
USED in MAP-MS-DataTypes : 61

deliveryOutcomeIndicator.....identifier of [3] NULL
DEFINED in MAP-SM-DataTypes : 153

destinationNumberCriteria.....identifier of [0] DestinationNumberCriteria
DEFINED in MAP-MS-DataTypes : 1600

DestinationNumberCriteria.....type reference SEQUENCE
DEFINED in MAP-MS-DataTypes : 1613
USED in MAP-MS-DataTypes : 1600

destinationNumberLengthList.....identifier of [2] DestinationNumberLengthList
DEFINED in MAP-MS-DataTypes : 1616

DestinationNumberLengthList.....type reference SEQUENCE OF
DEFINED in MAP-MS-DataTypes : 1626
USED in MAP-MS-DataTypes : 1616

destinationNumberList.....identifier of [1] DestinationNumberList
DEFINED in MAP-MS-DataTypes : 1615

DestinationNumberList.....type reference SEQUENCE OF
DEFINED in MAP-MS-DataTypes : 1621
USED in MAP-MS-DataTypes : 1615

dfc-WithArgument.....identifier of Named Number, 5
DEFINED in MAP-MS-DataTypes : 1704

diagnosticInfo.....identifier of SignallInfo
DEFINED in MAP-ER-DataTypes : 151

dialledNumber.....identifier of ISDN-AddressString
DEFINED in MAP-MS-DataTypes : 1513

disallowedByLocalRegulatoryRequirements.identifier of Named Number, 4
DEFINED in MAP-ER-DataTypes : 351

disconnectLeg.....identifier of Named Number, 3
DEFINED in MAP-MS-DataTypes : 1702

DomainType.....type reference ENUMERATED
DEFINED in MAP-MS-DataTypes : 2054

USED in MAP-MS-DataTypes : 2047

doublyChargeableECT-Barred.....identifier of Named Number, 13
DEFINED in MAP-MS-DataTypes : 1080

downlinkAttached.....identifier of [5] NULL
DEFINED in MAP-GR-DataTypes : 115

TAG R6.0 Cross Reference Listing for MAP-Protocol 2006-06-08 15:10:26 PAGE 25

dp-AnalysedInfoCriteriaList.....identifier of [0] DP-AnalysedInfoCriteriaList
DEFINED in MAP-MS-DataTypes : 1493

DP-AnalysedInfoCriteriaList.....type reference SEQUENCE OF
DEFINED in MAP-MS-DataTypes : 1507
USED in MAP-MS-DataTypes : 1493

DP-AnalysedInfoCriterium.....type reference SEQUENCE
DEFINED in MAP-MS-DataTypes : 1512
USED in MAP-MS-DataTypes : 1508

dtmf-MidCall.....identifier of Named Number, 7
DEFINED in MAP-MS-DataTypes : 1706

dualCommunication.....identifier of [7] NULL
DEFINED in MAP-GR-DataTypes : 117

d-csi.....identifier of Named Number, 3
DEFINED in MAP-MS-DataTypes : 1408

d-CSI.....identifier of [9] D-CSI
DEFINED in MAP-MS-DataTypes : 1460

D-CSI.....type reference SEQUENCE
DEFINED in MAP-MS-DataTypes : 1492
USED in MAP-MS-DataTypes : 70 1460 2289 2308
USED in MAP-CH-DataTypes : 45 263 309

d-csi.....identifier of Named Number, 1
DEFINED in MAP-MS-DataTypes : 1687

d-csi.....identifier of Named Number, 8
DEFINED in MAP-MS-DataTypes : 2253

d-CSI.....identifier of [2] D-CSI
DEFINED in MAP-MS-DataTypes : 2289

d-csi.....identifier of [12] D-CSI
DEFINED in MAP-CH-DataTypes : 263

d-csi.....identifier of [5] D-CSI
DEFINED in MAP-CH-DataTypes : 309

d-IM-CSI.....identifier of Named Number, 12
DEFINED in MAP-MS-DataTypes : 1417

d-IM-CSI.....identifier of Named Number, 3
DEFINED in MAP-MS-DataTypes : 2259

d-IM-CSI.....identifier of [20] D-CSI
DEFINED in MAP-MS-DataTypes : 2308

ect.....value reference SS-Code, '00110001'B
DEFINED in MAP-SS-Code : 66

eir.....identifier of Named Number, 6
DEFINED in MAP-CommonDataTypes : 358

ellipsoidArc.....identifier of Named Number, 6
DEFINED in MAP-LCS-DataTypes : 224

ellipsoidPoint.....identifier of Named Number, 0
DEFINED in MAP-LCS-DataTypes : 218

ellipsoidPointWithAltitude.....identifier of Named Number, 4
DEFINED in MAP-LCS-DataTypes : 222

ellipsoidPointWithAltitudeAndUncertainty.....identifier of Named Number, 5
DEFINED in MAP-LCS-DataTypes : 223

ellipsoidPointWithUncertaintyCircle.....identifier of Named Number, 1
DEFINED in MAP-LCS-DataTypes : 219

ellipsoidPointWithUncertaintyEllipse.....identifier of Named Number, 2

DEFINED in MAP-LCS-DataTypes : 220

emergencyAlertServices.....value reference LCSServiceTypeID, 1
DEFINED in MAP-CommonDataTypes : 397

emergencyCall.....identifier of Named Number, 1
DEFINED in MAP-MS-DataTypes : 403

TAG R6.0 Cross Reference Listing for MAP-Protocol 2006-06-08 15:10:26 PAGE 26

emergencyCallOrigination.....identifier of Named Number, 0
 DEFINED in MAP-LCS-DataTypes : 400

emergencyCallRelease.....identifier of Named Number, 1
 DEFINED in MAP-LCS-DataTypes : 401

emergencyCalls.....value reference TeleserviceCode, '00010010'B
 DEFINED in MAP-TS-Code : 42

emergencyServices.....value reference LCSServiceTypeID, 0
 DEFINED in MAP-CommonDataTypes : 396

emergencyServices.....identifier of Named Number, 0
 DEFINED in MAP-LCS-DataTypes : 148

emlpp.....value reference SS-Code, '10100001'B
 DEFINED in MAP-SS-Code : 156

emlpp-Info.....identifier of [4] EMLPP-Info
 DEFINED in MAP-MS-DataTypes : 1121

EMLPP-Info.....type reference SEQUENCE
 DEFINED in MAP-CommonDataTypes : 454
 USED in MAP-MS-DataTypes : 192 1121
 USED in MAP-CommonDataTypes : 50

EMLPP-Priority.....type reference INTEGER
 DEFINED in MAP-CommonDataTypes : 460
 USED in MAP-CommonDataTypes : 51 455 456 466 467 468 469 470 471
 472
 USED in MAP-SS-DataTypes : 51 78 166 193 194
 USED in MAP-GR-DataTypes : 25 56

enabling.....identifier of Named Number, 1
 DEFINED in MAP-MS-DataTypes : 1646

encryptionAlgorithm.....identifier of [1] ChosenEncryptionAlgorithm
 DEFINED in MAP-MS-DataTypes : 591

encryptionAlgorithms.....identifier of [1] PermittedEncryptionAlgorithms
 DEFINED in MAP-MS-DataTypes : 483

encryptionInfo.....identifier of [1] EncryptionInformation
 DEFINED in MAP-MS-DataTypes : 460

encryptionInfo.....identifier of [6] EncryptionInformation
 DEFINED in MAP-MS-DataTypes : 525

EncryptionInformation.....type reference OCTET STRING
 DEFINED in MAP-MS-DataTypes : 738
 USED in MAP-MS-DataTypes : 460 525

enterNewPW.....identifier of Named Number, 1
 DEFINED in MAP-SS-DataTypes : 249

enterNewPW-Again.....identifier of Named Number, 2
 DEFINED in MAP-SS-DataTypes : 250

enterPW.....identifier of Named Number, 0
 DEFINED in MAP-SS-DataTypes : 248

entityReleased.....identifier of Named Number, 4
 DEFINED in MAP-MS-DataTypes : 1703

equipmentNotSM-Equipped.....identifier of Named Number, 2
 DEFINED in MAP-ER-DataTypes : 143

equipmentProtocolError.....identifier of Named Number, 1
 DEFINED in MAP-ER-DataTypes : 142

equipmentStatus.....identifier of EquipmentStatus
 DEFINED in MAP-MS-DataTypes : 788

equipmentStatus.....identifier of Named Number, 0

DEFINED in MAP-MS-DataTypes : 794

EquipmentStatus.....type reference ENUMERATED

DEFINED in MAP-MS-DataTypes : 810

USED in MAP-MS-DataTypes : 788

eraseCC-Entry.....information object reference OPERATION, Information Object

TAG R6.0 Cross Reference Listing for MAP-Protocol 2006-06-08 15:10:26 PAGE 27

DEFINED in MAP-SupplementaryServi : 281
 USED in MAP-Protocol : 85 134
 USED in MAP-SupplementaryServi : 25

EraseCC-EntryArg.....type reference SEQUENCE

DEFINED in MAP-SS-DataTypes : 327
 USED in MAP-SupplementaryServi : 73 283
 USED in MAP-SS-DataTypes : 39

EraseCC-EntryRes.....type reference SEQUENCE

DEFINED in MAP-SS-DataTypes : 332
 USED in MAP-SupplementaryServi : 74 285
 USED in MAP-SS-DataTypes : 40

eraseSS.....information object reference OPERATION, Information Object

DEFINED in MAP-SupplementaryServi : 106
 USED in MAP-Protocol : 74 132
 USED in MAP-SupplementaryServi : 14

ERROR.....information object class reference CLASS

DEFINED in Remote-Operations-Info : 42
 USED in Remote-Operations-Info : 19
 USED in MAP-Errors : 98 165 171 178 185 192 198 206 213
 219 222 229 235 240 247 254 261 271
 274 277 285 294 300 308 314 320 326
 332 338 344 352 359 365 371 380 387
 393 400 407 413 416 419 424 427 430
 436 444 450 455 461 469 477 483 489
 495 501

errorundefined.....identifier of Named Number, 1

DEFINED in MAP-LCS-DataTypes : 411

ets-300102-1.....identifier of Named Number, 4

DEFINED in MAP-CommonDataTypes : 223

ets-300356.....identifier of Named Number, 1

DEFINED in MAP-CommonDataTypes : 234

eventMet.....identifier of [0] MM-Code

DEFINED in MAP-MS-DataTypes : 2395

eventReportData.....identifier of [1] EventReportData

DEFINED in MAP-CH-DataTypes : 377

EventReportData.....type reference SEQUENCE

DEFINED in MAP-CH-DataTypes : 382
 USED in MAP-CH-DataTypes : 377

ext2-QoS-Subscribed.....identifier of [2] Ext2-QoS-Subscribed

DEFINED in MAP-MS-DataTypes : 890

Ext2-QoS-Subscribed.....type reference OCTET STRING

DEFINED in MAP-MS-DataTypes : 985
 USED in MAP-MS-DataTypes : 63 890 2164 2166 2168

extendedRoutingInfo.....identifier of ExtendedRoutingInfo

DEFINED in MAP-CH-DataTypes : 156

ExtendedRoutingInfo.....type reference CHOICE

DEFINED in MAP-CH-DataTypes : 292
 USED in MAP-CH-DataTypes : 156

extensibleCallBarredParam.....identifier of ExtensibleCallBarredParam

DEFINED in MAP-ER-DataTypes : 103

ExtensibleCallBarredParam.....type reference SEQUENCE

DEFINED in MAP-ER-DataTypes : 111
 USED in MAP-ER-DataTypes : 103

extensibleSystemFailureParam.....identifier of ExtensibleSystemFailureParam

DEFINED in MAP-ER-DataTypes : 172

ExtensibleSystemFailureParam.....type reference SEQUENCE

DEFINED in MAP-ER-DataTypes : 176

USED in MAP-ER-DataTypes : 172

extensionContainer.....identifier of ExtensionContainer
DEFINED in MAP-MS-DataTypes : 227

extensionContainer.....identifier of ExtensionContainer
DEFINED in MAP-MS-DataTypes : 235

TAG R6.0 Cross Reference Listing for MAP-Protocol 2006-06-08 15:10:26 PAGE 28

extensionContainer.....identifier of ExtensionContainer
DEFINED in MAP-MS-DataTypes : 275

extensionContainer.....identifier of ExtensionContainer
DEFINED in MAP-MS-DataTypes : 281

extensionContainer.....identifier of ExtensionContainer
DEFINED in MAP-MS-DataTypes : 291

extensionContainer.....identifier of ExtensionContainer
DEFINED in MAP-MS-DataTypes : 298

extensionContainer.....identifier of ExtensionContainer
DEFINED in MAP-MS-DataTypes : 304

extensionContainer.....identifier of ExtensionContainer
DEFINED in MAP-MS-DataTypes : 314

extensionContainer.....identifier of [3] ExtensionContainer
DEFINED in MAP-MS-DataTypes : 324

extensionContainer.....identifier of ExtensionContainer
DEFINED in MAP-MS-DataTypes : 393

extensionContainer.....identifier of ExtensionContainer
DEFINED in MAP-MS-DataTypes : 418

extensionContainer.....identifier of ExtensionContainer
DEFINED in MAP-MS-DataTypes : 431

extensionContainer.....identifier of [1] ExtensionContainer
DEFINED in MAP-MS-DataTypes : 439

extensionContainer.....identifier of ExtensionContainer
DEFINED in MAP-MS-DataTypes : 452

extensionContainer.....identifier of [3] ExtensionContainer
DEFINED in MAP-MS-DataTypes : 465

extensionContainer.....identifier of [2] ExtensionContainer
DEFINED in MAP-MS-DataTypes : 484

extensionContainer.....identifier of [8] ExtensionContainer
DEFINED in MAP-MS-DataTypes : 530

extensionContainer.....identifier of [4] ExtensionContainer
DEFINED in MAP-MS-DataTypes : 584

extensionContainer.....identifier of [2] ExtensionContainer
DEFINED in MAP-MS-DataTypes : 592

extensionContainer.....identifier of [5] ExtensionContainer
DEFINED in MAP-MS-DataTypes : 630

extensionContainer.....identifier of [0] ExtensionContainer
DEFINED in MAP-MS-DataTypes : 637

extensionContainer.....identifier of [0] ExtensionContainer
DEFINED in MAP-MS-DataTypes : 646

extensionContainer.....identifier of [2] ExtensionContainer
DEFINED in MAP-MS-DataTypes : 654

extensionContainer.....identifier of [9] ExtensionContainer
DEFINED in MAP-MS-DataTypes : 667

extensionContainer.....identifier of [0] ExtensionContainer
DEFINED in MAP-MS-DataTypes : 689

extensionContainer.....identifier of [0] ExtensionContainer
DEFINED in MAP-MS-DataTypes : 693

extensionContainer.....identifier of [2] ExtensionContainer
DEFINED in MAP-MS-DataTypes : 755

extensionContainer.....identifier of ExtensionContainer
DEFINED in MAP-MS-DataTypes : 768

extensionContainer.....identifier of ExtensionContainer
DEFINED in MAP-MS-DataTypes : 784

TAG R6.0 Cross Reference Listing for MAP-Protocol 2006-06-08 15:10:26 PAGE 29

extensionContainer.....identifier of [0] ExtensionContainer
DEFINED in MAP-MS-DataTypes : 790

extensionContainer.....identifier of [14] ExtensionContainer
DEFINED in MAP-MS-DataTypes : 820

extensionContainer.....identifier of [21] ExtensionContainer
DEFINED in MAP-MS-DataTypes : 886

extensionContainer.....identifier of [2] ExtensionContainer
DEFINED in MAP-MS-DataTypes : 900

extensionContainer.....identifier of [2] ExtensionContainer
DEFINED in MAP-MS-DataTypes : 906

extensionContainer.....identifier of [2] ExtensionContainer
DEFINED in MAP-MS-DataTypes : 916

extensionContainer.....identifier of [4] ExtensionContainer
DEFINED in MAP-MS-DataTypes : 937

extensionContainer.....identifier of [3] ExtensionContainer
DEFINED in MAP-MS-DataTypes : 1006

extensionContainer.....identifier of [3] ExtensionContainer
DEFINED in MAP-MS-DataTypes : 1015

extensionContainer.....identifier of ExtensionContainer
DEFINED in MAP-MS-DataTypes : 1063

extensionContainer.....identifier of [0] ExtensionContainer
DEFINED in MAP-MS-DataTypes : 1126

extensionContainer.....identifier of [9] ExtensionContainer
DEFINED in MAP-MS-DataTypes : 1142

extensionContainer.....identifier of ExtensionContainer
DEFINED in MAP-MS-DataTypes : 1185

extensionContainer.....identifier of ExtensionContainer
DEFINED in MAP-MS-DataTypes : 1194

extensionContainer.....identifier of [0] ExtensionContainer
DEFINED in MAP-MS-DataTypes : 1200

extensionContainer.....identifier of [0] ExtensionContainer
DEFINED in MAP-MS-DataTypes : 1211

extensionContainer.....identifier of ExtensionContainer
DEFINED in MAP-MS-DataTypes : 1238

extensionContainer.....identifier of [5] ExtensionContainer
DEFINED in MAP-MS-DataTypes : 1256

extensionContainer.....identifier of [3] ExtensionContainer
DEFINED in MAP-MS-DataTypes : 1279

extensionContainer.....identifier of [2] ExtensionContainer
DEFINED in MAP-MS-DataTypes : 1312

extensionContainer.....identifier of [2] ExtensionContainer
DEFINED in MAP-MS-DataTypes : 1344

extensionContainer.....identifier of [0] ExtensionContainer
DEFINED in MAP-MS-DataTypes : 1355

extensionContainer.....identifier of [7] ExtensionContainer
DEFINED in MAP-MS-DataTypes : 1373

extensionContainer.....identifier of [6] ExtensionContainer
DEFINED in MAP-MS-DataTypes : 1394

extensionContainer.....identifier of ExtensionContainer
DEFINED in MAP-MS-DataTypes : 1446

extensionContainer.....identifier of [1] ExtensionContainer
DEFINED in MAP-MS-DataTypes : 1451

extensionContainer.....identifier of [2] ExtensionContainer
DEFINED in MAP-MS-DataTypes : 1495

extensionContainer.....identifier of ExtensionContainer

TAG R6.0 Cross Reference Listing for MAP-Protocol 2006-06-08 15:10:26 PAGE 30

DEFINED in MAP-MS-DataTypes : 1517

extensionContainer.....identifier of ExtensionContainer
DEFINED in MAP-MS-DataTypes : 1522

extensionContainer.....identifier of [0] ExtensionContainer
DEFINED in MAP-MS-DataTypes : 1533

extensionContainer.....identifier of ExtensionContainer
DEFINED in MAP-MS-DataTypes : 1551

extensionContainer.....identifier of [2] ExtensionContainer
DEFINED in MAP-MS-DataTypes : 1574

extensionContainer.....identifier of [4] ExtensionContainer
DEFINED in MAP-MS-DataTypes : 1605

extensionContainer.....identifier of [2] ExtensionContainer
DEFINED in MAP-MS-DataTypes : 1722

extensionContainer.....identifier of [4] ExtensionContainer
DEFINED in MAP-MS-DataTypes : 1744

extensionContainer.....identifier of [1] ExtensionContainer
DEFINED in MAP-MS-DataTypes : 1782

extensionContainer.....identifier of [1] ExtensionContainer
DEFINED in MAP-MS-DataTypes : 1793

extensionContainer.....identifier of ExtensionContainer
DEFINED in MAP-MS-DataTypes : 1835

extensionContainer.....identifier of [2] ExtensionContainer
DEFINED in MAP-MS-DataTypes : 1858

extensionContainer.....identifier of [3] ExtensionContainer
DEFINED in MAP-MS-DataTypes : 1877

extensionContainer.....identifier of [3] ExtensionContainer
DEFINED in MAP-MS-DataTypes : 1884

extensionContainer.....identifier of [3] ExtensionContainer
DEFINED in MAP-MS-DataTypes : 1893

extensionContainer.....identifier of [1] ExtensionContainer
DEFINED in MAP-MS-DataTypes : 1898

extensionContainer.....identifier of [3] ExtensionContainer
DEFINED in MAP-MS-DataTypes : 1907

extensionContainer.....identifier of [0] ExtensionContainer
DEFINED in MAP-MS-DataTypes : 1911

extensionContainer.....identifier of ExtensionContainer
DEFINED in MAP-MS-DataTypes : 1924

extensionContainer.....identifier of ExtensionContainer
DEFINED in MAP-MS-DataTypes : 1931

extensionContainer.....identifier of ExtensionContainer
DEFINED in MAP-MS-DataTypes : 1948

extensionContainer.....identifier of ExtensionContainer
DEFINED in MAP-MS-DataTypes : 1954

extensionContainer.....identifier of [3] ExtensionContainer
DEFINED in MAP-MS-DataTypes : 1969

extensionContainer.....identifier of ExtensionContainer
DEFINED in MAP-MS-DataTypes : 1974

extensionContainer.....identifier of [2] ExtensionContainer
DEFINED in MAP-MS-DataTypes : 1980

extensionContainer.....identifier of [4] ExtensionContainer

DEFINED in MAP-MS-DataTypes : 1999

extensionContainer.....identifier of [2] ExtensionContainer
DEFINED in MAP-MS-DataTypes : 2044

extensionContainer.....identifier of [4] ExtensionContainer
DEFINED in MAP-MS-DataTypes : 2067

TAG R6.0 Cross Reference Listing for MAP-Protocol 2006-06-08 15:10:26 PAGE 31

extensionContainer.....identifier of [5] ExtensionContainer
DEFINED in MAP-MS-DataTypes : 2085

extensionContainer.....identifier of [17] ExtensionContainer
DEFINED in MAP-MS-DataTypes : 2162

extensionContainer.....identifier of [2] ExtensionContainer
DEFINED in MAP-MS-DataTypes : 2202

extensionContainer.....identifier of ExtensionContainer
DEFINED in MAP-MS-DataTypes : 2207

extensionContainer.....identifier of [3] ExtensionContainer
DEFINED in MAP-MS-DataTypes : 2216

extensionContainer.....identifier of [7] ExtensionContainer
DEFINED in MAP-MS-DataTypes : 2227

extensionContainer.....identifier of [6] ExtensionContainer
DEFINED in MAP-MS-DataTypes : 2238

extensionContainer.....identifier of [0] ExtensionContainer
DEFINED in MAP-MS-DataTypes : 2267

extensionContainer.....identifier of ExtensionContainer
DEFINED in MAP-MS-DataTypes : 2275

extensionContainer.....identifier of ExtensionContainer
DEFINED in MAP-MS-DataTypes : 2283

extensionContainer.....identifier of [13] ExtensionContainer
DEFINED in MAP-MS-DataTypes : 2300

extensionContainer.....identifier of [5] ExtensionContainer
DEFINED in MAP-MS-DataTypes : 2319

extensionContainer.....identifier of [2] ExtensionContainer
DEFINED in MAP-MS-DataTypes : 2327

extensionContainer.....identifier of [7] ExtensionContainer
DEFINED in MAP-MS-DataTypes : 2339

extensionContainer.....identifier of [6] ExtensionContainer
DEFINED in MAP-MS-DataTypes : 2349

extensionContainer.....identifier of [2] ExtensionContainer
DEFINED in MAP-MS-DataTypes : 2355

extensionContainer.....identifier of [3] ExtensionContainer
DEFINED in MAP-MS-DataTypes : 2362

extensionContainer.....identifier of ExtensionContainer
DEFINED in MAP-MS-DataTypes : 2384

extensionContainer.....identifier of ExtensionContainer
DEFINED in MAP-MS-DataTypes : 2388

extensionContainer.....identifier of [6] ExtensionContainer
DEFINED in MAP-MS-DataTypes : 2400

extensionContainer.....identifier of ExtensionContainer
DEFINED in MAP-MS-DataTypes : 2407

extensionContainer.....identifier of [3] ExtensionContainer
DEFINED in MAP-MS-DataTypes : 2419

extensionContainer.....identifier of [5] ExtensionContainer
DEFINED in MAP-MS-DataTypes : 2428

extensionContainer.....identifier of [4] ExtensionContainer
DEFINED in MAP-OM-DataTypes : 41

extensionContainer.....identifier of [0] ExtensionContainer
DEFINED in MAP-OM-DataTypes : 51

extensionContainer.....identifier of [2] ExtensionContainer
DEFINED in MAP-OM-DataTypes : 57

extensionContainer.....identifier of [0] ExtensionContainer
DEFINED in MAP-OM-DataTypes : 61

TAG R6.0 Cross Reference Listing for MAP-Protocol 2006-06-08 15:10:26 PAGE 32

extensionContainer.....identifier of ExtensionContainer
DEFINED in MAP-CommonDataTypes : 204

extensionContainer.....identifier of ExtensionContainer
DEFINED in MAP-CommonDataTypes : 230

extensionContainer.....identifier of ExtensionContainer
DEFINED in MAP-CommonDataTypes : 246

extensionContainer.....identifier of [1] ExtensionContainer
DEFINED in MAP-CommonDataTypes : 363

extensionContainer.....identifier of [1] ExtensionContainer
DEFINED in MAP-CommonDataTypes : 380

extensionContainer.....identifier of ExtensionContainer
DEFINED in MAP-CommonDataTypes : 457

extensionContainer.....identifier of [4] ExtensionContainer
DEFINED in MAP-CommonDataTypes : 479

extensionContainer.....identifier of ExtensionContainer
DEFINED in MAP-CH-DataTypes : 89

extensionContainer.....identifier of [13] ExtensionContainer
DEFINED in MAP-CH-DataTypes : 108

extensionContainer.....identifier of [0] ExtensionContainer
DEFINED in MAP-CH-DataTypes : 164

extensionContainer.....identifier of [2] ExtensionContainer
DEFINED in MAP-CH-DataTypes : 203

extensionContainer.....identifier of [7] ExtensionContainer
DEFINED in MAP-CH-DataTypes : 217

extensionContainer.....identifier of [11] ExtensionContainer
DEFINED in MAP-CH-DataTypes : 232

extensionContainer.....identifier of ExtensionContainer
DEFINED in MAP-CH-DataTypes : 247

extensionContainer.....identifier of [7] ExtensionContainer
DEFINED in MAP-CH-DataTypes : 257

extensionContainer.....identifier of [3] ExtensionContainer
DEFINED in MAP-CH-DataTypes : 272

extensionContainer.....identifier of ExtensionContainer
DEFINED in MAP-CH-DataTypes : 282

extensionContainer.....identifier of ExtensionContainer
DEFINED in MAP-CH-DataTypes : 288

extensionContainer.....identifier of [1] ExtensionContainer
DEFINED in MAP-CH-DataTypes : 299

extensionContainer.....identifier of [2] ExtensionContainer
DEFINED in MAP-CH-DataTypes : 305

extensionContainer.....identifier of [7] ExtensionContainer
DEFINED in MAP-CH-DataTypes : 319

extensionContainer.....identifier of [1] ExtensionContainer
DEFINED in MAP-CH-DataTypes : 331

extensionContainer.....identifier of [2] ExtensionContainer
DEFINED in MAP-CH-DataTypes : 337

extensionContainer.....identifier of [1] ExtensionContainer
DEFINED in MAP-CH-DataTypes : 342

extensionContainer.....identifier of [3] ExtensionContainer
DEFINED in MAP-CH-DataTypes : 349

extensionContainer.....identifier of [1] ExtensionContainer
DEFINED in MAP-CH-DataTypes : 362

extensionContainer.....identifier of [3] ExtensionContainer
DEFINED in MAP-CH-DataTypes : 379

extensionContainer.....identifier of [1] ExtensionContainer

TAG R6.0 Cross Reference Listing for MAP-Protocol 2006-06-08 15:10:26 PAGE 33

DEFINED in MAP-CH-DataTypes : 384

extensionContainer.....identifier of [2] ExtensionContainer
DEFINED in MAP-CH-DataTypes : 390

extensionContainer.....identifier of [0] ExtensionContainer
DEFINED in MAP-CH-DataTypes : 412

extensionContainer.....identifier of [6] ExtensionContainer
DEFINED in MAP-CH-DataTypes : 422

extensionContainer.....identifier of [1] ExtensionContainer
DEFINED in MAP-CH-DataTypes : 427

extensionContainer.....identifier of [1] ExtensionContainer
DEFINED in MAP-CH-DataTypes : 448

extensionContainer.....identifier of [3] ExtensionContainer
DEFINED in MAP-CH-DataTypes : 455

extensionContainer.....identifier of [1] ExtensionContainer
DEFINED in MAP-CH-DataTypes : 460

extensionContainer.....identifier of ExtensionContainer
DEFINED in MAP-CH-DataTypes : 464

extensionContainer.....identifier of [4] ExtensionContainer
DEFINED in MAP-SS-DataTypes : 278

extensionContainer.....identifier of ExtensionContainer
DEFINED in MAP-SS-DataTypes : 295

extensionContainer.....identifier of [6] ExtensionContainer
DEFINED in MAP-SM-DataTypes : 57

extensionContainer.....identifier of [4] ExtensionContainer
DEFINED in MAP-SM-DataTypes : 81

extensionContainer.....identifier of ExtensionContainer
DEFINED in MAP-SM-DataTypes : 87

extensionContainer.....identifier of ExtensionContainer
DEFINED in MAP-SM-DataTypes : 109

extensionContainer.....identifier of ExtensionContainer
DEFINED in MAP-SM-DataTypes : 115

extensionContainer.....identifier of ExtensionContainer
DEFINED in MAP-SM-DataTypes : 123

extensionContainer.....identifier of ExtensionContainer
DEFINED in MAP-SM-DataTypes : 128

extensionContainer.....identifier of [1] ExtensionContainer
DEFINED in MAP-SM-DataTypes : 148

extensionContainer.....identifier of ExtensionContainer
DEFINED in MAP-SM-DataTypes : 172

extensionContainer.....identifier of ExtensionContainer
DEFINED in MAP-SM-DataTypes : 184

extensionContainer.....identifier of ExtensionContainer
DEFINED in MAP-SM-DataTypes : 207

extensionContainer.....identifier of ExtensionContainer
DEFINED in MAP-SM-DataTypes : 211

extensionContainer.....identifier of [4] ExtensionContainer
DEFINED in MAP-GR-DataTypes : 58

extensionContainer.....identifier of ExtensionContainer
DEFINED in MAP-GR-DataTypes : 63

extensionContainer.....identifier of ExtensionContainer

DEFINED in MAP-GR-DataTypes : 68

extensionContainer.....identifier of ExtensionContainer
DEFINED in MAP-GR-DataTypes : 72

extensionContainer.....identifier of ExtensionContainer
DEFINED in MAP-GR-DataTypes : 82

TAG R6.0 Cross Reference Listing for MAP-Protocol 2006-06-08 15:10:26 PAGE 34

extensionContainer.....identifier of ExtensionContainer
DEFINED in MAP-GR-DataTypes : 90

extensionContainer.....identifier of [2] ExtensionContainer
DEFINED in MAP-LCS-DataTypes : 71

extensionContainer.....identifier of [2] ExtensionContainer
DEFINED in MAP-LCS-DataTypes : 77

extensionContainer.....identifier of [1] ExtensionContainer
DEFINED in MAP-LCS-DataTypes : 85

extensionContainer.....identifier of [8] ExtensionContainer
DEFINED in MAP-LCS-DataTypes : 103

extensionContainer.....identifier of [4] ExtensionContainer
DEFINED in MAP-LCS-DataTypes : 190

extensionContainer.....identifier of [1] ExtensionContainer
DEFINED in MAP-LCS-DataTypes : 242

extensionContainer.....identifier of ExtensionContainer
DEFINED in MAP-LCS-DataTypes : 427

extensionContainer.....identifier of ExtensionContainer
DEFINED in MAP-ER-DataTypes : 93

extensionContainer.....identifier of ExtensionContainer
DEFINED in MAP-ER-DataTypes : 113

extensionContainer.....identifier of ExtensionContainer
DEFINED in MAP-ER-DataTypes : 119

extensionContainer.....identifier of ExtensionContainer
DEFINED in MAP-ER-DataTypes : 152

extensionContainer.....identifier of ExtensionContainer
DEFINED in MAP-ER-DataTypes : 159

extensionContainer.....identifier of ExtensionContainer
DEFINED in MAP-ER-DataTypes : 178

extensionContainer.....identifier of ExtensionContainer
DEFINED in MAP-ER-DataTypes : 182

extensionContainer.....identifier of ExtensionContainer
DEFINED in MAP-ER-DataTypes : 186

extensionContainer.....identifier of ExtensionContainer
DEFINED in MAP-ER-DataTypes : 190

extensionContainer.....identifier of ExtensionContainer
DEFINED in MAP-ER-DataTypes : 196

extensionContainer.....identifier of ExtensionContainer
DEFINED in MAP-ER-DataTypes : 200

extensionContainer.....identifier of ExtensionContainer
DEFINED in MAP-ER-DataTypes : 213

extensionContainer.....identifier of ExtensionContainer
DEFINED in MAP-ER-DataTypes : 217

extensionContainer.....identifier of ExtensionContainer
DEFINED in MAP-ER-DataTypes : 221

extensionContainer.....identifier of ExtensionContainer
DEFINED in MAP-ER-DataTypes : 225

extensionContainer.....identifier of ExtensionContainer
DEFINED in MAP-ER-DataTypes : 229

extensionContainer.....identifier of ExtensionContainer
DEFINED in MAP-ER-DataTypes : 233

extensionContainer.....identifier of ExtensionContainer
DEFINED in MAP-ER-DataTypes : 237

extensionContainer.....identifier of ExtensionContainer
DEFINED in MAP-ER-DataTypes : 241

TAG R6.0 Cross Reference Listing for MAP-Protocol 2006-06-08 15:10:26 PAGE 35

extensionContainer.....identifier of ExtensionContainer
 DEFINED in MAP-ER-DataTypes : 245

extensionContainer.....identifier of ExtensionContainer
 DEFINED in MAP-ER-DataTypes : 263

extensionContainer.....identifier of ExtensionContainer
 DEFINED in MAP-ER-DataTypes : 269

extensionContainer.....identifier of ExtensionContainer
 DEFINED in MAP-ER-DataTypes : 273

extensionContainer.....identifier of ExtensionContainer
 DEFINED in MAP-ER-DataTypes : 277

extensionContainer.....identifier of ExtensionContainer
 DEFINED in MAP-ER-DataTypes : 281

extensionContainer.....identifier of ExtensionContainer
 DEFINED in MAP-ER-DataTypes : 285

extensionContainer.....identifier of ExtensionContainer
 DEFINED in MAP-ER-DataTypes : 289

extensionContainer.....identifier of ExtensionContainer
 DEFINED in MAP-ER-DataTypes : 293

extensionContainer.....identifier of ExtensionContainer
 DEFINED in MAP-ER-DataTypes : 297

extensionContainer.....identifier of ExtensionContainer
 DEFINED in MAP-ER-DataTypes : 301

extensionContainer.....identifier of ExtensionContainer
 DEFINED in MAP-ER-DataTypes : 305

extensionContainer.....identifier of ExtensionContainer
 DEFINED in MAP-ER-DataTypes : 309

extensionContainer.....identifier of ExtensionContainer
 DEFINED in MAP-ER-DataTypes : 316

extensionContainer.....identifier of ExtensionContainer
 DEFINED in MAP-ER-DataTypes : 320

extensionContainer.....identifier of ExtensionContainer
 DEFINED in MAP-ER-DataTypes : 324

extensionContainer.....identifier of ExtensionContainer
 DEFINED in MAP-ER-DataTypes : 328

extensionContainer.....identifier of ExtensionContainer
 DEFINED in MAP-ER-DataTypes : 338

extensionContainer.....identifier of [1] ExtensionContainer
 DEFINED in MAP-ER-DataTypes : 343

extensionContainer.....identifier of [1] ExtensionContainer
 DEFINED in MAP-ER-DataTypes : 361

extensionContainer.....identifier of ExtensionContainer
 DEFINED in MAP-ER-DataTypes : 379

extensionContainer.....identifier of ExtensionContainer
 DEFINED in MAP-ER-DataTypes : 383

extensionContainer.....identifier of ExtensionContainer
 DEFINED in MAP-ER-DataTypes : 387

ExtensionContainer.....type reference SEQUENCE
 DEFINED in MAP-ExtensionDataTypes : 31
 USED in MAP-MS-DataTypes : 206 227 235 275 281 291 298 304 314
 324 393 418 431 439 452 465 484 530
 584 592 630 637 646 654 667 689 693
 755 768 784 790 820 886 900 906 916

937 1006 1015 1063 1126 1142 1185 1194 1200
1211 1238 1256 1279 1312 1344 1355 1373 1394
1446 1451 1495 1517 1522 1533 1551 1574 1605
1722 1744 1782 1793 1835 1858 1877 1884 1893
1898 1907 1911 1924 1931 1948 1954 1969 1974
1980 1999 2044 2067 2085 2162 2202 2207 2216
2227 2238 2267 2275 2283 2300 2319 2327 2339

TAG R6.0 Cross Reference Listing for MAP-Protocol 2006-06-08 15:10:26 PAGE 36

2349 2355 2362 2384 2388 2400 2407 2419 2428
 USED in MAP-OM-DataTypes : 27 41 51 57 61
 USED in MAP-CommonDataTypes : 82 204 230 246 363 380 457 479
 USED in MAP-CH-DataTypes : 79 89 108 164 203 217 232 247 257
 272 282 288 299 305 319 331 337 342
 349 362 379 384 390 412 422 427 448
 455 460 464
 USED in MAP-SS-DataTypes : 59 278 295
 USED in MAP-SM-DataTypes : 46 57 81 87 109 115 123 128 148
 172 184 207 211
 USED in MAP-GR-DataTypes : 42 58 63 68 72 82 90
 USED in MAP-LCS-DataTypes : 44 71 77 85 103 190 242 427
 USED in MAP-ER-DataTypes : 85 93 113 119 152 159 178 182 186
 190 196 200 213 217 221 225 229 233
 237 241 245 263 269 273 277 281 285
 289 293 297 301 305 309 316 320 324
 328 338 343 361 379 383 387
 USED in MAP-ExtensionDataTypes : 16

ExtensionSet.....information object set reference MAP-EXTENSION, Information Object Set
 DEFINED in MAP-ExtensionDataTypes : 52
 USED in MAP-ExtensionDataTypes : 46 48

externalAddress.....identifier of [0] ISDN-AddressString
 DEFINED in MAP-CommonDataTypes : 379

ExternalClient.....type reference SEQUENCE
 DEFINED in MAP-MS-DataTypes : 1306
 USED in MAP-MS-DataTypes : 1292 1302

externalClientList.....identifier of [1] ExternalClientList
 DEFINED in MAP-MS-DataTypes : 1272

ExternalClientList.....type reference SEQUENCE OF
 DEFINED in MAP-MS-DataTypes : 1291
 USED in MAP-MS-DataTypes : 1272

ExternalSignalInfo.....type reference SEQUENCE
 DEFINED in MAP-CommonDataTypes : 199
 USED in MAP-CommonDataTypes : 21
 USED in MAP-CH-DataTypes : 68 105 122 226 227 312 313 316 317
 318 335 336 341 417
 USED in MAP-SS-DataTypes : 54 313 314

extId.....identifier of InformationObjectClassFieldType
 DEFINED in MAP-ExtensionDataTypes : 45

extType.....identifier of InformationObjectClassFieldType
 DEFINED in MAP-ExtensionDataTypes : 47

Ext-BasicServiceCode.....type reference CHOICE
 DEFINED in MAP-CommonDataTypes : 450
 USED in MAP-MS-DataTypes : 190 1133 1192 1230 1235 1440 1630 2333 2344
 USED in MAP-CommonDataTypes : 49
 USED in MAP-CH-DataTypes : 72 104 121 161 176 252 265

Ext-BasicServiceGroupList.....type reference SEQUENCE OF
 DEFINED in MAP-MS-DataTypes : 1229
 USED in MAP-MS-DataTypes : 1210 1255

ext-BearerService.....identifier of [2] Ext-BearerServiceCode
 DEFINED in MAP-CommonDataTypes : 451

Ext-BearerServiceCode.....type reference OCTET STRING
 DEFINED in MAP-BS-Code : 25
 USED in MAP-MS-DataTypes : 166 1051
 USED in MAP-CommonDataTypes : 72 451

Ext-CallBarFeatureList.....type reference SEQUENCE OF
 DEFINED in MAP-MS-DataTypes : 1188
 USED in MAP-MS-DataTypes : 1184 2271 2424

Ext-CallBarInfo.....type reference SEQUENCE
 DEFINED in MAP-MS-DataTypes : 1182
 USED in MAP-MS-DataTypes : 1118

Ext-CallBarringFeature.....type reference SEQUENCE
DEFINED in MAP-MS-DataTypes : 1191
USED in MAP-MS-DataTypes : 1189

Ext-CallBarringInfoFor-CSE.....type reference SEQUENCE
DEFINED in MAP-MS-DataTypes : 2422

TAG R6.0 Cross Reference Listing for MAP-Protocol 2006-06-08 15:10:26 PAGE 37

USED in MAP-MS-DataTypes : 2380 2412

ext-externalClientList.....identifier of [4] Ext-ExternalClientList
DEFINED in MAP-MS-DataTypes : 1281

Ext-ExternalClientList.....type reference SEQUENCE OF
DEFINED in MAP-MS-DataTypes : 1301
USED in MAP-MS-DataTypes : 1281

Ext-ExternalSignalInfo.....type reference SEQUENCE
DEFINED in MAP-CommonDataTypes : 225
USED in MAP-CommonDataTypes : 22
USED in MAP-CH-DataTypes : 69 113 237

Ext-ForwardingInfoFor-CSE.....type reference SEQUENCE
DEFINED in MAP-MS-DataTypes : 2415
USED in MAP-MS-DataTypes : 2379 2411

Ext-ForwFeature.....type reference SEQUENCE
DEFINED in MAP-MS-DataTypes : 1132
USED in MAP-MS-DataTypes : 1130

Ext-ForwFeatureList.....type reference SEQUENCE OF
DEFINED in MAP-MS-DataTypes : 1129
USED in MAP-MS-DataTypes : 1125 2265 2417

Ext-ForwInfo.....type reference SEQUENCE
DEFINED in MAP-MS-DataTypes : 1123
USED in MAP-MS-DataTypes : 1117

Ext-ForwOptions.....type reference OCTET STRING
DEFINED in MAP-MS-DataTypes : 1146
USED in MAP-MS-DataTypes : 1140

Ext-GeographicalInformation.....type reference OCTET STRING
DEFINED in MAP-LCS-DataTypes : 260
USED in MAP-LCS-DataTypes : 22 240 366

Ext-NoRepCondTime.....type reference INTEGER
DEFINED in MAP-MS-DataTypes : 1175
USED in MAP-MS-DataTypes : 1141 2337

ext-ProtocolId.....identifier of Ext-ProtocolId
DEFINED in MAP-CommonDataTypes : 226

Ext-ProtocolId.....type reference ENUMERATED
DEFINED in MAP-CommonDataTypes : 233
USED in MAP-CommonDataTypes : 226

ext-QoS-Subscribed.....identifier of [0] Ext-QoS-Subscribed
DEFINED in MAP-MS-DataTypes : 888

Ext-QoS-Subscribed.....type reference OCTET STRING
DEFINED in MAP-MS-DataTypes : 978
USED in MAP-MS-DataTypes : 62 888 2156 2157 2158

Ext-SS-Data.....type reference SEQUENCE
DEFINED in MAP-MS-DataTypes : 1251
USED in MAP-MS-DataTypes : 1120

Ext-SS-Info.....type reference CHOICE
DEFINED in MAP-MS-DataTypes : 1116
USED in MAP-MS-DataTypes : 1114

Ext-SS-InfoFor-CSE.....type reference CHOICE
DEFINED in MAP-MS-DataTypes : 2410
USED in MAP-MS-DataTypes : 2325

Ext-SS-InfoList.....type reference SEQUENCE OF
DEFINED in MAP-MS-DataTypes : 1113
USED in MAP-MS-DataTypes : 1034

Ext-SS-Status.....type reference OCTET STRING
DEFINED in MAP-CommonDataTypes : 488
USED in MAP-MS-DataTypes : 198 1134 1193 1253 1266 1354 2334 2345

USED in MAP-CommonDataTypes : 55 476

ext-Teleservice.....identifier of [3] Ext-TeleserviceCode
DEFINED in MAP-CommonDataTypes : 452

Ext-TeleserviceCode.....type reference OCTET STRING
DEFINED in MAP-TS-Code : 20

TAG R6.0 Cross Reference Listing for MAP-Protocol 2006-06-08 15:10:26 PAGE 38

USED in MAP-MS-DataTypes : 171 1056
 USED in MAP-CommonDataTypes : 66 452
 USED in MAP-GR-DataTypes : 31 50

FacilityNotSupParam.....type reference SEQUENCE
 DEFINED in MAP-ER-DataTypes : 189
 USED in MAP-Errors : 113 187
 USED in MAP-ER-DataTypes : 23

facilityNotSupported.....information object reference ERROR, Information Object
 DEFINED in MAP-Errors : 185
 USED in MAP-OperationAndMainte : 27 61 76
 USED in MAP-CallHandlingOperat : 34 91 115 171 212 226
 USED in MAP-SupplementaryServi : 56 278
 USED in MAP-ShortMessageServic : 31 76 92 106 152
 USED in MAP-LocationServiceOpe : 27 62 77
 USED in MAP-Errors : 17

facsimileGroup3AndAlterSpeech.....value reference TeleserviceCode, '01100001'B
 DEFINED in MAP-TS-Code : 49

facsimileGroup4.....value reference TeleserviceCode, '01100011'B
 DEFINED in MAP-TS-Code : 51

failure.....identifier of Named Number, 1
 DEFINED in MAP-CH-DataTypes : 403

failureCause.....identifier of FailureCause
 DEFINED in MAP-MS-DataTypes : 392

FailureCause.....type reference ENUMERATED
 DEFINED in MAP-MS-DataTypes : 421
 USED in MAP-MS-DataTypes : 392

failureReport.....information object reference OPERATION, Information Object
 DEFINED in MAP-MobileServiceOpera : 471
 USED in MAP-Protocol : 39 128
 USED in MAP-MobileServiceOpera : 64

FailureReportArg.....type reference SEQUENCE
 DEFINED in MAP-MS-DataTypes : 1889
 USED in MAP-MobileServiceOpera : 157 473
 USED in MAP-MS-DataTypes : 135

FailureReportRes.....type reference SEQUENCE
 DEFINED in MAP-MS-DataTypes : 1896
 USED in MAP-MobileServiceOpera : 158 475
 USED in MAP-MS-DataTypes : 136

firstServiceAllowed.....identifier of Named Number, 0
 DEFINED in MAP-CH-DataTypes : 182

fleetManagement.....value reference LCSServiceTypeID, 3
 DEFINED in MAP-CommonDataTypes : 399

foreignNumberPortedIn.....identifier of Named Number, 5
 DEFINED in MAP-MS-DataTypes : 2014

foreignNumberPortedToForeignNetwork.....identifier of Named Number, 2
 DEFINED in MAP-MS-DataTypes : 2011

forwardAccessSignalling.....information object reference OPERATION, Information Object
 DEFINED in MAP-MobileServiceOpera : 343
 USED in MAP-Protocol : 24 124
 USED in MAP-MobileServiceOpera : 41

ForwardAccessSignalling-Arg.....type reference [3] SEQUENCE
 DEFINED in MAP-MS-DataTypes : 457
 USED in MAP-MobileServiceOpera : 126 345
 USED in MAP-MS-DataTypes : 33

forwardCheckSS-Indication.....information object reference OPERATION, Information Object
 DEFINED in MAP-MobileServiceOpera : 438
 USED in MAP-Protocol : 32 126
 USED in MAP-MobileServiceOpera : 57

forwarded.....identifier of Named Number, 0
DEFINED in MAP-MS-DataTypes : 1641

forwardedToNumber.....identifier of [5] ISDN-AddressString
DEFINED in MAP-MS-DataTypes : 1135

TAG R6.0 Cross Reference Listing for MAP-Protocol 2006-06-08 15:10:26 PAGE 39

forwardedToNumber.....identifier of [3] AddressString
 DEFINED in MAP-MS-DataTypes : 2335

forwardedToNumber.....identifier of [5] ISDN-AddressString
 DEFINED in MAP-CH-DataTypes : 211

forwardedToNumber.....identifier of [4] AddressString
 DEFINED in MAP-SS-DataTypes : 74

forwardedToNumber.....identifier of [5] ISDN-AddressString
 DEFINED in MAP-SS-DataTypes : 101

forwardedToSubaddress.....identifier of [8] ISDN-SubaddressString
 DEFINED in MAP-MS-DataTypes : 1139

forwardedToSubaddress.....identifier of [4] ISDN-SubaddressString
 DEFINED in MAP-MS-DataTypes : 2336

forwardedToSubaddress.....identifier of [4] ISDN-SubaddressString
 DEFINED in MAP-CH-DataTypes : 215

forwardedToSubaddress.....identifier of [6] ISDN-SubaddressString
 DEFINED in MAP-SS-DataTypes : 75

forwardedToSubaddress.....identifier of [8] ISDN-SubaddressString
 DEFINED in MAP-SS-DataTypes : 102

forwardGroupCallSignalling.....information object reference OPERATION, Information Object
 DEFINED in MAP-Group-Call-Operati : 69
 USED in MAP-Protocol : 105 137
 USED in MAP-Group-Call-Operati : 15

ForwardGroupCallSignallingArg.....type reference SEQUENCE
 DEFINED in MAP-GR-DataTypes : 75
 USED in MAP-Group-Call-Operati : 36 71
 USED in MAP-GR-DataTypes : 18

forwarding.....identifier of Named Number, 1
 DEFINED in MAP-CH-DataTypes : 129

forwardingData.....identifier of ForwardingData
 DEFINED in MAP-CH-DataTypes : 208

ForwardingData.....type reference SEQUENCE
 DEFINED in MAP-CH-DataTypes : 210
 USED in MAP-CH-DataTypes : 208 253 297

forwardingData.....identifier of [2] ForwardingData
 DEFINED in MAP-CH-DataTypes : 253

forwardingData.....identifier of ForwardingData
 DEFINED in MAP-CH-DataTypes : 297

forwardingFailed.....information object reference ERROR, Information Object
 DEFINED in MAP-Errors : 332
 USED in MAP-CallHandlingOperat : 46 128
 USED in MAP-Errors : 51

ForwardingFailedParam.....type reference SEQUENCE
 DEFINED in MAP-ER-DataTypes : 276
 USED in MAP-Errors : 130 334
 USED in MAP-ER-DataTypes : 38

ForwardingFeature.....type reference SEQUENCE
 DEFINED in MAP-SS-DataTypes : 98
 USED in MAP-SS-DataTypes : 96

forwardingFeatureList.....identifier of Ext-ForwFeatureList
 DEFINED in MAP-MS-DataTypes : 1125

forwardingFeatureList.....identifier of Ext-ForwFeatureList
 DEFINED in MAP-MS-DataTypes : 2265

forwardingFeatureList.....identifier of [1] Ext-ForwFeatureList
 DEFINED in MAP-MS-DataTypes : 2417

forwardingFeatureList.....identifier of ForwardingFeatureList
DEFINED in MAP-SS-DataTypes : 91

ForwardingFeatureList.....type reference SEQUENCE OF
DEFINED in MAP-SS-DataTypes : 94
USED in MAP-SS-DataTypes : 91 217

TAG R6.0 Cross Reference Listing for MAP-Protocol 2006-06-08 15:10:26 PAGE 40

forwardingFeatureList.....identifier of [3] ForwardingFeatureList
 DEFINED in MAP-SS-DataTypes : 217

forwardingInfo.....identifier of [0] Ext-ForwInfo
 DEFINED in MAP-MS-DataTypes : 1117

forwardingInfo.....identifier of [0] ForwardingInfo
 DEFINED in MAP-SS-DataTypes : 85

ForwardingInfo.....type reference SEQUENCE
 DEFINED in MAP-SS-DataTypes : 89
 USED in MAP-SS-DataTypes : 85

forwardingInfoFor-CSE.....identifier of [0] Ext-ForwardingInfoFor-CSE
 DEFINED in MAP-MS-DataTypes : 2379

forwardingInfoFor-CSE.....identifier of [0] Ext-ForwardingInfoFor-CSE
 DEFINED in MAP-MS-DataTypes : 2411

forwardingInterrogationRequired.....identifier of [4] NULL
 DEFINED in MAP-CH-DataTypes : 162

forwardingOptions.....identifier of [6] Ext-ForwOptions
 DEFINED in MAP-MS-DataTypes : 1140

forwardingOptions.....identifier of [6] ForwardingOptions
 DEFINED in MAP-CH-DataTypes : 216

forwardingOptions.....identifier of [6] ForwardingOptions
 DEFINED in MAP-SS-DataTypes : 103

ForwardingOptions.....type reference OCTET STRING
 DEFINED in MAP-SS-DataTypes : 123
 USED in MAP-CH-DataTypes : 58 216
 USED in MAP-SS-DataTypes : 31 103

forwardingReason.....identifier of [8] ForwardingReason
 DEFINED in MAP-CH-DataTypes : 103

ForwardingReason.....type reference ENUMERATED
 DEFINED in MAP-CH-DataTypes : 135
 USED in MAP-CH-DataTypes : 103

forwardingViolation.....information object reference ERROR, Information Object
 DEFINED in MAP-Errors : 326
 USED in MAP-CallHandlingOperat : 45 102
 USED in MAP-Errors : 50

ForwardingViolationParam.....type reference SEQUENCE
 DEFINED in MAP-ER-DataTypes : 272
 USED in MAP-Errors : 129 328
 USED in MAP-ER-DataTypes : 37

freezeP-TMSI.....identifier of [1] NULL
 DEFINED in MAP-MS-DataTypes : 303

freezeTMSI.....identifier of [0] NULL
 DEFINED in MAP-MS-DataTypes : 302

frozen.....identifier of Named Number, 5
 DEFINED in MAP-SS-DataTypes : 290

FTN-AddressString.....type reference AddressString
 DEFINED in MAP-CommonDataTypes : 150
 USED in MAP-MS-DataTypes : 180 1144
 USED in MAP-CommonDataTypes : 19
 USED in MAP-CH-DataTypes : 67 219
 USED in MAP-SS-DataTypes : 47 106

general-dataCDA.....value reference BearerServiceCode, '00010111'B
 DEFINED in MAP-BS-Code : 57

general-dataCDS.....value reference BearerServiceCode, '00011111'B
 DEFINED in MAP-BS-Code : 64

general-dataPDS.....value reference BearerServiceCode, '00101111'B
DEFINED in MAP-BS-Code : 79

general-padAccessCA.....value reference BearerServiceCode, '00100111'B
DEFINED in MAP-BS-Code : 73

TAG R6.0 Cross Reference Listing for MAP-Protocol 2006-06-08 15:10:26 PAGE 41

GenericServiceInfo.....type reference SEQUENCE
DEFINED in MAP-SS-DataTypes : 189
USED in MAP-SS-DataTypes : 218

genericServiceInfo.....identifier of [4] GenericServiceInfo
DEFINED in MAP-SS-DataTypes : 218

geodeticInformation.....identifier of [7] GeodeticInformation
DEFINED in MAP-MS-DataTypes : 2071

geodeticInformation.....identifier of [7] GeodeticInformation
DEFINED in MAP-MS-DataTypes : 2088

GeodeticInformation.....type reference OCTET STRING
DEFINED in MAP-MS-DataTypes : 2111
USED in MAP-MS-DataTypes : 2071 2088

geographicalInformation.....identifier of [0] GeographicalInformation
DEFINED in MAP-MS-DataTypes : 2063

geographicalInformation.....identifier of [2] GeographicalInformation
DEFINED in MAP-MS-DataTypes : 2082

GeographicalInformation.....type reference OCTET STRING
DEFINED in MAP-MS-DataTypes : 2101
USED in MAP-MS-DataTypes : 100 2063 2082

geranCodecList.....identifier of [1] CodecList
DEFINED in MAP-MS-DataTypes : 653

geranPositioningData.....identifier of [4] PositioningDataInformation
DEFINED in MAP-LCS-DataTypes : 246

geranPositioningData.....identifier of [11] PositioningDataInformation
DEFINED in MAP-LCS-DataTypes : 373

geran-classmark.....identifier of [16] GERAN-Classmark
DEFINED in MAP-MS-DataTypes : 537

geran-classmark.....identifier of [6] GERAN-Classmark
DEFINED in MAP-MS-DataTypes : 632

GERAN-Classmark.....type reference OCTET STRING
DEFINED in MAP-MS-DataTypes : 679
USED in MAP-MS-DataTypes : 537 632

getPassword.....information object reference OPERATION, Information Object
DEFINED in MAP-SupplementaryServi : 244
USED in MAP-Protocol : 82 134
USED in MAP-SupplementaryServi : 22

ggsn-Address.....identifier of [1] GSN-Address
DEFINED in MAP-MS-DataTypes : 1875

ggsn-Address.....identifier of [1] GSN-Address
DEFINED in MAP-MS-DataTypes : 1882

ggsn-Address.....identifier of [2] GSN-Address
DEFINED in MAP-MS-DataTypes : 1892

ggsn-Address.....identifier of [0] GSN-Address
DEFINED in MAP-MS-DataTypes : 1897

ggsn-Address.....identifier of [2] GSN-Address
DEFINED in MAP-MS-DataTypes : 1906

ggsn-Address.....identifier of [10] GSN-Address
DEFINED in MAP-MS-DataTypes : 2155

ggsn-Number.....identifier of [2] ISDN-AddressString
DEFINED in MAP-MS-DataTypes : 1876

ggsn-Number.....identifier of [1] ISDN-AddressString
DEFINED in MAP-MS-DataTypes : 1891

global.....identifier of OBJECT IDENTIFIER
DEFINED in Remote-Operations-Info : 115

GlobalCellId.....type reference OCTET STRING
DEFINED in MAP-CommonDataTypes : 338
USED in MAP-MS-DataTypes : 188 518 625
USED in MAP-CommonDataTypes : 37

TAG R6.0 Cross Reference Listing for MAP-Protocol 2006-06-08 15:10:26 PAGE 42

gmlc-List.....identifier of [0] GMLC-List
DEFINED in MAP-MS-DataTypes : 848

GMLC-List.....type reference SEQUENCE OF
DEFINED in MAP-MS-DataTypes : 860
USED in MAP-MS-DataTypes : 848

gmlc-List.....identifier of Named Number, 0
DEFINED in MAP-MS-DataTypes : 1316

gmlc-ListWithdraw.....identifier of [13] NULL
DEFINED in MAP-MS-DataTypes : 1399

gmlc-Restriction.....identifier of [0] GMLC-Restriction
DEFINED in MAP-MS-DataTypes : 1308

GMLC-Restriction.....type reference ENUMERATED
DEFINED in MAP-MS-DataTypes : 1315
USED in MAP-MS-DataTypes : 1308 1340

gmlc-Restriction.....identifier of [0] GMLC-Restriction
DEFINED in MAP-MS-DataTypes : 1340

gmscCamelSubscriptionInfo.....identifier of [0] GmscCamelSubscriptionInfo
DEFINED in MAP-CH-DataTypes : 298

GmscCamelSubscriptionInfo.....type reference SEQUENCE
DEFINED in MAP-CH-DataTypes : 302
USED in MAP-CH-DataTypes : 298

gmsc-Address.....identifier of [8] ISDN-AddressString
DEFINED in MAP-CH-DataTypes : 229

gmsc-OrGsmSCF-Address.....identifier of [6] ISDN-AddressString
DEFINED in MAP-CH-DataTypes : 101

gprsAttach.....identifier of Named Number, 5
DEFINED in MAP-MS-DataTypes : 407

GPRChargingID.....type reference OCTET STRING
DEFINED in MAP-MS-DataTypes : 2185
USED in MAP-MS-DataTypes : 112 2159

gprsConnectionSuspended.....identifier of NULL
DEFINED in MAP-ER-DataTypes : 311

GPRSDataList.....type reference SEQUENCE OF
DEFINED in MAP-MS-DataTypes : 874
USED in MAP-MS-DataTypes : 899

gprsDataList.....identifier of [1] GPRSDataList
DEFINED in MAP-MS-DataTypes : 899

gprsDetach.....identifier of Named Number, 10
DEFINED in MAP-MS-DataTypes : 413

gprsEnhancementsSupportIndicator.....identifier of [3] NULL
DEFINED in MAP-MS-DataTypes : 442

GPRSMSCClass.....type reference SEQUENCE
DEFINED in MAP-MS-DataTypes : 2028
USED in MAP-MS-DataTypes : 102 1986

gprsNodeIndicator.....identifier of [5] NULL
DEFINED in MAP-SM-DataTypes : 89

gprsNodeIndicator.....identifier of [2] NULL
DEFINED in MAP-LCS-DataTypes : 87

gprsSubscriptionData.....identifier of [16] GPRSSubscriptionData
DEFINED in MAP-MS-DataTypes : 824

GPRSSubscriptionData.....type reference SEQUENCE
DEFINED in MAP-MS-DataTypes : 895

USED in MAP-MS-DataTypes : 824

gprsSubscriptionDataWithdraw.....identifier of [10] GPRSSubscriptionDataWithdraw
DEFINED in MAP-MS-DataTypes : 1396

GPRSSubscriptionDataWithdraw.....type reference CHOICE
DEFINED in MAP-MS-DataTypes : 1425

TAG R6.0 Cross Reference Listing for MAP-Protocol 2006-06-08 15:10:26 PAGE 43

USED in MAP-MS-DataTypes : 1396

gprsSubscriptionUnknown.....identifier of Named Number, 1
DEFINED in MAP-ER-DataTypes : 206

gprsSupportIndicator.....identifier of [7] NULL
DEFINED in MAP-SM-DataTypes : 59

gprsSupportIndicator.....identifier of [2] NULL
DEFINED in MAP-SM-DataTypes : 150

GPRS-CamelTDPData.....type reference SEQUENCE
DEFINED in MAP-MS-DataTypes : 932
USED in MAP-MS-DataTypes : 928

gprs-CamelTDPDataList.....identifier of [0] GPRS-CamelTDPDataList
DEFINED in MAP-MS-DataTypes : 914

GPRS-CamelTDPDataList.....type reference SEQUENCE OF
DEFINED in MAP-MS-DataTypes : 927
USED in MAP-MS-DataTypes : 914

gprs-CSI.....identifier of [0] GPRS-CSI
DEFINED in MAP-MS-DataTypes : 904

GPRS-CSI.....type reference SEQUENCE
DEFINED in MAP-MS-DataTypes : 913
USED in MAP-MS-DataTypes : 904 2296

gprs-csi.....identifier of Named Number, 7
DEFINED in MAP-MS-DataTypes : 1412

gprs-CSI.....identifier of Named Number, 4
DEFINED in MAP-MS-DataTypes : 2249

gprs-CSI.....identifier of [9] GPRS-CSI
DEFINED in MAP-MS-DataTypes : 2296

gprs-MS-Class.....identifier of [7] GPRSMSCClass
DEFINED in MAP-MS-DataTypes : 1986

gprs-TriggerDetectionPoint.....identifier of [0] GPRS-TriggerDetectionPoint
DEFINED in MAP-MS-DataTypes : 933

GPRS-TriggerDetectionPoint.....type reference ENUMERATED
DEFINED in MAP-MS-DataTypes : 949
USED in MAP-MS-DataTypes : 933

greyListed.....identifier of Named Number, 2
DEFINED in MAP-MS-DataTypes : 813

groupCallNumber.....identifier of ISDN-AddressString
DEFINED in MAP-GR-DataTypes : 62

groupId.....identifier of GroupId
DEFINED in MAP-MS-DataTypes : 1947

groupid.....identifier of GroupId
DEFINED in MAP-MS-DataTypes : 1952

GroupId.....type reference TBCD-STRING
DEFINED in MAP-MS-DataTypes : 1957
USED in MAP-MS-DataTypes : 1947 1952

groupKey.....identifier of [1] Kc
DEFINED in MAP-GR-DataTypes : 55

groupKeyNumber.....identifier of [0] GroupKeyNumber
DEFINED in MAP-GR-DataTypes : 54

GroupKeyNumber.....type reference INTEGER
DEFINED in MAP-GR-DataTypes : 93
USED in MAP-GR-DataTypes : 54

gsmSCF-Address.....identifier of [2] ISDN-AddressString

DEFINED in MAP-MS-DataTypes : 935

gsmSCF-Address.....identifier of ISDN-AddressString
DEFINED in MAP-MS-DataTypes : 1515

gsmSCF-Address.....identifier of ISDN-AddressString
DEFINED in MAP-MS-DataTypes : 1532

TAG R6.0 Cross Reference Listing for MAP-Protocol 2006-06-08 15:10:26 PAGE 44

gsmSCF-Address.....identifier of [0] ISDN-AddressString
 DEFINED in MAP-MS-DataTypes : 1572

gsmSCF-Address.....identifier of [2] ISDN-AddressString
 DEFINED in MAP-MS-DataTypes : 1742

gsmSCF-Address.....identifier of [0] ISDN-AddressString
 DEFINED in MAP-MS-DataTypes : 1781

gsmSCF-Address.....identifier of [0] ISDN-AddressString
 DEFINED in MAP-MS-DataTypes : 1792

gsmSCF-Address.....identifier of [0] ISDN-AddressString
 DEFINED in MAP-MS-DataTypes : 1856

gsmSCF-Address.....identifier of [3] ISDN-AddressString
 DEFINED in MAP-MS-DataTypes : 2201

gsmSCF-Address.....identifier of [2] ISDN-AddressString
 DEFINED in MAP-MS-DataTypes : 2215

gsmSCF-Address.....identifier of [1] ISDN-AddressString
 DEFINED in MAP-MS-DataTypes : 2315

gsmSCF-InitiatedCall.....identifier of [24] NULL
 DEFINED in MAP-CH-DataTypes : 120

gsm-0408.....identifier of Named Number, 1
 DEFINED in MAP-CommonDataTypes : 219

gsm-0806.....identifier of Named Number, 2
 DEFINED in MAP-CommonDataTypes : 220

gsm-BearerCapability.....identifier of [5] ExternalSignallInfo
 DEFINED in MAP-CH-DataTypes : 226

gsm-BearerCapability.....identifier of [0] ExternalSignallInfo
 DEFINED in MAP-CH-DataTypes : 312

gsm-BSSMAP.....identifier of Named Number, 3
 DEFINED in MAP-CommonDataTypes : 221

gsm-SecurityContextData.....identifier of [0] GSM-SecurityContextData
 DEFINED in MAP-MS-DataTypes : 354

GSM-SecurityContextData.....type reference SEQUENCE
 DEFINED in MAP-MS-DataTypes : 357
 USED in MAP-MS-DataTypes : 354

GSN-Address.....type reference OCTET STRING
 DEFINED in MAP-MS-DataTypes : 447
 USED in MAP-MS-DataTypes : 30 430 1875 1881 1882 1892 1897 1905 1906
 2155 2161

GuidanceInfo.....type reference ENUMERATED
 DEFINED in MAP-SS-DataTypes : 247
 USED in MAP-SupplementaryServi : 68 246
 USED in MAP-SS-DataTypes : 25

handoverNumber.....identifier of [0] ISDN-AddressString
 DEFINED in MAP-MS-DataTypes : 577

handoverNumber.....identifier of ISDN-AddressString
 DEFINED in MAP-MS-DataTypes : 714

highLayerCompatibility.....identifier of [6] ExternalSignallInfo
 DEFINED in MAP-CH-DataTypes : 318

hlr.....identifier of Named Number, 1
 DEFINED in MAP-CommonDataTypes : 353

HLR-Id.....type reference IMSI
 DEFINED in MAP-CommonDataTypes : 327
 USED in MAP-CommonDataTypes : 332

hlr-List.....identifier of HLR-List
DEFINED in MAP-MS-DataTypes : 1918

HLR-List.....type reference SEQUENCE OF
DEFINED in MAP-CommonDataTypes : 331
USED in MAP-MS-DataTypes : 185 1918

TAG R6.0 Cross Reference Listing for MAP-Protocol 2006-06-08 15:10:26 PAGE 45

USED in MAP-CommonDataTypes : 35

hlr-Number.....identifier of ISDN-AddressString
DEFINED in MAP-MS-DataTypes : 274

hlr-Number.....identifier of ISDN-AddressString
DEFINED in MAP-MS-DataTypes : 451

hlr-Number.....identifier of ISDN-AddressString
DEFINED in MAP-MS-DataTypes : 1917

hlr-Number.....identifier of ISDN-AddressString
DEFINED in MAP-MS-DataTypes : 1929

hold.....value reference SS-Code, '01000010'B
DEFINED in MAP-SS-Code : 77

home-Country.....identifier of Named Number, 1
DEFINED in MAP-MS-DataTypes : 1317

horizontal-accuracy.....identifier of [0] Horizontal-Accuracy
DEFINED in MAP-LCS-DataTypes : 187

Horizontal-Accuracy.....type reference OCTET STRING
DEFINED in MAP-LCS-DataTypes : 193
USED in MAP-LCS-DataTypes : 20 187

ho-NumberNotRequired.....identifier of NULL
DEFINED in MAP-MS-DataTypes : 519

identity.....identifier of Identity
DEFINED in MAP-MS-DataTypes : 279

Identity.....type reference CHOICE
DEFINED in MAP-CommonDataTypes : 300
USED in MAP-MS-DataTypes : 187 279
USED in MAP-CommonDataTypes : 32

ik.....identifier of IK
DEFINED in MAP-MS-DataTypes : 349

ik.....identifier of IK
DEFINED in MAP-MS-DataTypes : 364

IK.....type reference OCTET STRING
DEFINED in MAP-MS-DataTypes : 378
USED in MAP-MS-DataTypes : 349 364

illegalEquipment.....information object reference ERROR, Information Object
DEFINED in MAP-Errors : 247
USED in MAP-SupplementaryServi : 53 206 221
USED in MAP-ShortMessageServic : 35 109
USED in MAP-LocationServiceOpe : 36 80
USED in MAP-Errors : 31

IllegalEquipmentParam.....type reference SEQUENCE
DEFINED in MAP-ER-DataTypes : 224
USED in MAP-Errors : 119 249
USED in MAP-ER-DataTypes : 29

illegalSS-Operation.....information object reference ERROR, Information Object
DEFINED in MAP-Errors : 380
USED in MAP-MobileServiceOpera : 101 276 294
USED in MAP-SupplementaryServi : 41 101 119 137 158 177 273 291
USED in MAP-Errors : 63

IllegalSS-OperationParam.....type reference SEQUENCE
DEFINED in MAP-ER-DataTypes : 292
USED in MAP-Errors : 148 382
USED in MAP-ER-DataTypes : 56

illegalSubscriber.....information object reference ERROR, Information Object
DEFINED in MAP-Errors : 240
USED in MAP-SupplementaryServi : 52 205 220
USED in MAP-ShortMessageServic : 34 108

USED in MAP-LocationServiceOpe : 37 79
USED in MAP-Errors : 30

IllegalSubscriberParam.....type reference SEQUENCE
DEFINED in MAP-ER-DataTypes : 220
USED in MAP-Errors : 118 242
USED in MAP-ER-DataTypes : 28

imei.....identifier of IMEI
DEFINED in MAP-MS-DataTypes : 782

imei.....identifier of [5] IMEI
DEFINED in MAP-MS-DataTypes : 1984

imei.....identifier of [6] NULL
DEFINED in MAP-MS-DataTypes : 2048

IMEI.....type reference TBCD-STRING
DEFINED in MAP-CommonDataTypes : 320
USED in MAP-MS-DataTypes : 183 782 1984
USED in MAP-CommonDataTypes : 34
USED in MAP-LCS-DataTypes : 32 100 363

imei.....identifier of [5] IMEI
DEFINED in MAP-LCS-DataTypes : 100

imei.....identifier of [2] IMEI
DEFINED in MAP-LCS-DataTypes : 363

immediateResponsePreferred.....identifier of [1] NULL
DEFINED in MAP-MS-DataTypes : 753

imsi.....identifier of IMSI
DEFINED in MAP-MS-DataTypes : 223

imsi.....identifier of IMSI
DEFINED in MAP-MS-DataTypes : 295

imsi.....identifier of IMSI
DEFINED in MAP-MS-DataTypes : 318

imsi.....identifier of IMSI
DEFINED in MAP-MS-DataTypes : 391

imsi.....identifier of IMSI
DEFINED in MAP-MS-DataTypes : 428

imsi.....identifier of [4] IMSI
DEFINED in MAP-MS-DataTypes : 523

imsi.....identifier of [0] IMSI
DEFINED in MAP-MS-DataTypes : 750

imsi.....identifier of [0] IMSI
DEFINED in MAP-MS-DataTypes : 818

imsi.....identifier of [0] IMSI
DEFINED in MAP-MS-DataTypes : 1384

imsi.....identifier of [0] IMSI
DEFINED in MAP-MS-DataTypes : 1874

imsi.....identifier of [0] IMSI
DEFINED in MAP-MS-DataTypes : 1890

imsi.....identifier of [0] IMSI
DEFINED in MAP-MS-DataTypes : 1904

imsi.....identifier of IMSI
DEFINED in MAP-MS-DataTypes : 1922

imsi.....identifier of [0] IMSI
DEFINED in MAP-MS-DataTypes : 1966

imsi.....identifier of [1] IMSI
DEFINED in MAP-MS-DataTypes : 1996

imsi.....identifier of IMSI
DEFINED in MAP-MS-DataTypes : 2377

imsi.....identifier of [1] IMSI
DEFINED in MAP-MS-DataTypes : 2396

imsi.....identifier of [0] IMSI
DEFINED in MAP-OM-DataTypes : 37

imsi.....identifier of [0] IMSI
DEFINED in MAP-OM-DataTypes : 55

TAG R6.0 Cross Reference Listing for MAP-Protocol 2006-06-08 15:10:26 PAGE 47

IMSI.....type reference TBCD-STRING
 DEFINED in MAP-CommonDataTypes : 297
 USED in MAP-OperationAndMainte : 44 84
 USED in MAP-MS-DataTypes : 182 223 295 318 391 428 523 750 818
 1384 1874 1890 1904 1922 1966 1996 2377 2396
 USED in MAP-OM-DataTypes : 22 37 55
 USED in MAP-CommonDataTypes : 30 301 305 317 327 374
 USED in MAP-CH-DataTypes : 70 152 222 254 346 376 416 447 459
 USED in MAP-SS-DataTypes : 48 269
 USED in MAP-SM-DataTypes : 35 79 111 132 202
 USED in MAP-GR-DataTypes : 24 67 76
 USED in MAP-LCS-DataTypes : 33 97 362

imsi.....identifier of IMSI
 DEFINED in MAP-CommonDataTypes : 301

imsi.....identifier of IMSI
 DEFINED in MAP-CommonDataTypes : 305

imsi.....identifier of [0] IMSI
 DEFINED in MAP-CommonDataTypes : 317

imsi.....identifier of [0] IMSI
 DEFINED in MAP-CommonDataTypes : 374

imsi.....identifier of [9] IMSI
 DEFINED in MAP-CH-DataTypes : 152

imsi.....identifier of [0] IMSI
 DEFINED in MAP-CH-DataTypes : 222

imsi.....identifier of [3] IMSI
 DEFINED in MAP-CH-DataTypes : 254

imsi.....identifier of [0] IMSI
 DEFINED in MAP-CH-DataTypes : 346

imsi.....identifier of [0] IMSI
 DEFINED in MAP-CH-DataTypes : 376

imsi.....identifier of [0] IMSI
 DEFINED in MAP-CH-DataTypes : 416

imsi.....identifier of [0] IMSI
 DEFINED in MAP-CH-DataTypes : 447

imsi.....identifier of [0] IMSI
 DEFINED in MAP-CH-DataTypes : 459

imsi.....identifier of [0] IMSI
 DEFINED in MAP-SS-DataTypes : 269

imsi.....identifier of IMSI
 DEFINED in MAP-SM-DataTypes : 79

imsi.....identifier of IMSI
 DEFINED in MAP-SM-DataTypes : 111

imsi.....identifier of [0] IMSI
 DEFINED in MAP-SM-DataTypes : 132

imsi.....identifier of [0] IMSI
 DEFINED in MAP-SM-DataTypes : 202

imsi.....identifier of IMSI
 DEFINED in MAP-GR-DataTypes : 67

imsi.....identifier of IMSI
 DEFINED in MAP-GR-DataTypes : 76

imsi.....identifier of [2] IMSI
 DEFINED in MAP-LCS-DataTypes : 97

imsi.....identifier of [1] IMSI
 DEFINED in MAP-LCS-DataTypes : 362

imsiDetach.....identifier of Named Number, 0
DEFINED in MAP-ER-DataTypes : 250

imsiDetached.....identifier of Named Number, 1
DEFINED in MAP-MS-DataTypes : 2192

TAG R6.0 Cross Reference Listing for MAP-Protocol 2006-06-08 15:10:26 PAGE 48

imsiUnknown.....identifier of Named Number, 0
DEFINED in MAP-ER-DataTypes : 205

imsi-WithLMSI.....identifier of IMSI-WithLMSI
DEFINED in MAP-CommonDataTypes : 302

IMSI-WithLMSI.....type reference SEQUENCE
DEFINED in MAP-CommonDataTypes : 304
USED in MAP-CommonDataTypes : 302

incomingCallsBarredWithinCUG.....identifier of Named Number, 0
DEFINED in MAP-ER-DataTypes : 123

incompatibleTerminal.....information object reference ERROR, Information Object
DEFINED in MAP-Errors : 192
USED in MAP-CallHandlingOperat : 49 195
USED in MAP-Errors : 18

IncompatibleTerminalParam.....type reference SEQUENCE
DEFINED in MAP-ER-DataTypes : 327
USED in MAP-Errors : 138 194
USED in MAP-ER-DataTypes : 46

inconsistentMeasurementData.....identifier of Named Number, 3
DEFINED in MAP-ER-DataTypes : 368

informationNotAvailable.....information object reference ERROR, Information Object
DEFINED in MAP-Errors : 371
USED in MAP-MobileServiceOpera : 106 278 298
USED in MAP-Errors : 60

InformationNotAvailableParam.....type reference SEQUENCE
DEFINED in MAP-ER-DataTypes : 304
USED in MAP-Errors : 151 373
USED in MAP-ER-DataTypes : 59

informPreviousNetworkEntity.....identifier of [11] NULL
DEFINED in MAP-MS-DataTypes : 230

informPreviousNetworkEntity.....identifier of [1] NULL
DEFINED in MAP-MS-DataTypes : 434

informServiceCentre.....information object reference OPERATION, Information Object
DEFINED in MAP-ShortMessageServic : 138
USED in MAP-Protocol : 96 136
USED in MAP-ShortMessageServic : 18

InformServiceCentreArg.....type reference SEQUENCE
DEFINED in MAP-SM-DataTypes : 181
USED in MAP-ShortMessageServic : 55 140
USED in MAP-SM-DataTypes : 23

inhibiting.....identifier of Named Number, 0
DEFINED in MAP-MS-DataTypes : 1645

initialLocation.....identifier of Named Number, 2
DEFINED in MAP-LCS-DataTypes : 122

initiateCallAttempt.....identifier of Named Number, 0
DEFINED in MAP-MS-DataTypes : 1699

insertSubscriberData.....information object reference OPERATION, Information Object
DEFINED in MAP-MobileServiceOpera : 407
USED in MAP-Protocol : 29 125
USED in MAP-MobileServiceOpera : 52

InsertSubscriberDataArg.....type reference SEQUENCE
DEFINED in MAP-MS-DataTypes : 817
USED in MAP-MobileServiceOpera : 138 409
USED in MAP-MS-DataTypes : 57

InsertSubscriberDataRes.....type reference SEQUENCE
DEFINED in MAP-MS-DataTypes : 1366
USED in MAP-MobileServiceOpera : 139 411
USED in MAP-MS-DataTypes : 58

insufficientMeasurementData.....identifier of Named Number, 2
DEFINED in MAP-ER-DataTypes : 367

insufficientResources.....identifier of Named Number, 1
DEFINED in MAP-ER-DataTypes : 366

TAG R6.0 Cross Reference Listing for MAP-Protocol 2006-06-08 15:10:26 PAGE 49

integrityProtectionAlgorithm.....identifier of [0] ChosenIntegrityProtectionAlgorithm
DEFINED in MAP-MS-DataTypes : 590

integrityProtectionAlgorithms.....identifier of [0] PermittedIntegrityProtectionAlgorithms
DEFINED in MAP-MS-DataTypes : 482

integrityProtectionInfo.....identifier of [0] IntegrityProtectionInformation
DEFINED in MAP-MS-DataTypes : 459

integrityProtectionInfo.....identifier of [5] IntegrityProtectionInformation
DEFINED in MAP-MS-DataTypes : 524

IntegrityProtectionInformation.....type reference OCTET STRING
DEFINED in MAP-MS-DataTypes : 729
USED in MAP-MS-DataTypes : 459 524

interCUG-Restrictions.....identifier of InterCUG-Restrictions
DEFINED in MAP-MS-DataTypes : 1237

InterCUG-Restrictions.....type reference OCTET STRING
DEFINED in MAP-MS-DataTypes : 1241
USED in MAP-MS-DataTypes : 85 1237

internalTimeout.....identifier of Named Number, 2
DEFINED in MAP-LCS-DataTypes : 412

internationalECT-Barred.....identifier of Named Number, 11
DEFINED in MAP-MS-DataTypes : 1078

internationalOGCallsBarred.....identifier of Named Number, 1
DEFINED in MAP-MS-DataTypes : 1068

internationalOGCallsNotToHPLMN-CountryBaidentifier of Named Number, 2
DEFINED in MAP-MS-DataTypes : 1069

interrogateSS.....information object reference OPERATION, Information Object
DEFINED in MAP-SupplementaryServi : 165
USED in MAP-Protocol : 77 132
USED in MAP-SupplementaryServi : 17

InterrogateSS-Res.....type reference CHOICE
DEFINED in MAP-SS-DataTypes : 214
USED in MAP-SupplementaryServi : 64 169
USED in MAP-SS-DataTypes : 19

interrogationType.....identifier of [3] InterrogationType
DEFINED in MAP-CH-DataTypes : 98

InterrogationType.....type reference ENUMERATED
DEFINED in MAP-CH-DataTypes : 127
USED in MAP-CH-DataTypes : 98

interzonalECT-Barred.....identifier of Named Number, 12
DEFINED in MAP-MS-DataTypes : 1079

interzonalOGCallsAndInternationalOGCallsidentifier of Named Number, 8
DEFINED in MAP-MS-DataTypes : 1072

interzonalOGCallsBarred.....identifier of Named Number, 6
DEFINED in MAP-MS-DataTypes : 1070

interzonalOGCallsNotToHPLMN-CountryBarreidentifier of Named Number, 7
DEFINED in MAP-MS-DataTypes : 1071

intraCUG-Options.....identifier of IntraCUG-Options
DEFINED in MAP-MS-DataTypes : 1209

IntraCUG-Options.....type reference ENUMERATED
DEFINED in MAP-MS-DataTypes : 1219
USED in MAP-MS-DataTypes : 86 1209

invalidFormat.....identifier of Named Number, 1
DEFINED in MAP-ER-DataTypes : 136

invalidSME-Address.....identifier of Named Number, 5

DEFINED in MAP-ER-DataTypes : 146

ISDN-AddressString.....type reference AddressString

DEFINED in MAP-CommonDataTypes : 144

USED in MAP-OperationAndMainte : 43 82

USED in MAP-MS-DataTypes : 178 224 225 274 296 297 398 399 429
451 577 626 714 861 935 1025 1135 1513

TAG R6.0 Cross Reference Listing for MAP-Protocol 2006-06-08 15:10:26 PAGE 50

1515 1532 1572 1622 1742 1781 1792 1856 1876
 1891 1917 1929 1997 2064 2070 2083 2201 2215
 2315 2378 2397
 USED in MAP-CommonDataTypes : 17 375 379
 USED in MAP-CH-DataTypes : 65 95 101 163 169 207 211 223 224
 229 246 259 315 330 419
 USED in MAP-SS-DataTypes : 45 101 207 225 270 280 311
 USED in MAP-SM-DataTypes : 33 54 85 97 98 138 143 171 177
 182
 USED in MAP-GR-DataTypes : 23 62
 USED in MAP-LCS-DataTypes : 31 69 82 94 98 361 364 365 429

isdn-BearerCapability.....identifier of [1] ExternalSignalInfo
 DEFINED in MAP-CH-DataTypes : 313

ISDN-SubaddressString.....type reference OCTET STRING
 DEFINED in MAP-CommonDataTypes : 159
 USED in MAP-MS-DataTypes : 179 1139 2336
 USED in MAP-CommonDataTypes : 20
 USED in MAP-CH-DataTypes : 66 215
 USED in MAP-SS-DataTypes : 46 75 102 208

istAlertTimer.....identifier of [26] IST-AlertTimerValue
 DEFINED in MAP-MS-DataTypes : 831

istAlertTimer.....identifier of [14] IST-AlertTimerValue
 DEFINED in MAP-CH-DataTypes : 171

istAlertTimer.....identifier of [0] IST-AlertTimerValue
 DEFINED in MAP-CH-DataTypes : 452

istCommandSupported.....identifier of Named Number, 1
 DEFINED in MAP-MS-DataTypes : 254

istInformationWithdraw.....identifier of [14] NULL
 DEFINED in MAP-MS-DataTypes : 1400

istInformationWithdraw.....identifier of [1] NULL
 DEFINED in MAP-CH-DataTypes : 453

istSupportIndicator.....identifier of [1] IST-SupportIndicator
 DEFINED in MAP-MS-DataTypes : 238

istSupportIndicator.....identifier of [18] IST-SupportIndicator
 DEFINED in MAP-CH-DataTypes : 114

ist-Alert.....information object reference OPERATION, Information Object
 DEFINED in MAP-CallHandlingOperat : 201
 USED in MAP-Protocol : 66 131
 USED in MAP-CallHandlingOperat : 21

IST-AlertArg.....type reference SEQUENCE
 DEFINED in MAP-CH-DataTypes : 446
 USED in MAP-CallHandlingOperat : 71 203
 USED in MAP-CH-DataTypes : 33

IST-AlertRes.....type reference SEQUENCE
 DEFINED in MAP-CH-DataTypes : 451
 USED in MAP-CallHandlingOperat : 72 205
 USED in MAP-CH-DataTypes : 34

IST-AlertTimerValue.....type reference INTEGER
 DEFINED in MAP-MS-DataTypes : 845
 USED in MAP-MS-DataTypes : 89 831
 USED in MAP-CH-DataTypes : 49 171 452

ist-Command.....information object reference OPERATION, Information Object
 DEFINED in MAP-CallHandlingOperat : 215
 USED in MAP-Protocol : 67 132
 USED in MAP-CallHandlingOperat : 22

IST-CommandArg.....type reference SEQUENCE
 DEFINED in MAP-CH-DataTypes : 458
 USED in MAP-CallHandlingOperat : 73 217
 USED in MAP-CH-DataTypes : 35

IST-CommandRes.....type reference SEQUENCE
DEFINED in MAP-CH-DataTypes : 463
USED in MAP-CallHandlingOperat : 74 219
USED in MAP-CH-DataTypes : 36

IST-SupportIndicator.....type reference ENUMERATED

TAG R6.0 Cross Reference Listing for MAP-Protocol 2006-06-08 15:10:26 PAGE 51

DEFINED in MAP-MS-DataTypes : 252
USED in MAP-MS-DataTypes : 26 238
USED in MAP-CH-DataTypes : 48 114

iuAvailableCodecsList.....identifier of [8] CodecList
DEFINED in MAP-MS-DataTypes : 587

iuAvailableCodecsList.....identifier of [6] CodecList
DEFINED in MAP-MS-DataTypes : 649

iuCurrentlyUsedCodec.....identifier of [17] Codec
DEFINED in MAP-MS-DataTypes : 538

iuSelectedCodec.....identifier of [14] Codec
DEFINED in MAP-MS-DataTypes : 474

iuSelectedCodec.....identifier of [7] Codec
DEFINED in MAP-MS-DataTypes : 586

iUSelectedCodec.....identifier of [5] Codec
DEFINED in MAP-MS-DataTypes : 648

iuSupportedCodecsList.....identifier of [12] SupportedCodecsList
DEFINED in MAP-MS-DataTypes : 472

iuSupportedCodecsList.....identifier of [18] SupportedCodecsList
DEFINED in MAP-MS-DataTypes : 539

kc.....identifier of Kc
DEFINED in MAP-MS-DataTypes : 342

kc.....identifier of Kc
DEFINED in MAP-MS-DataTypes : 358

Kc.....type reference OCTET STRING
DEFINED in MAP-MS-DataTypes : 372
USED in MAP-MS-DataTypes : 50 342 358
USED in MAP-GR-DataTypes : 36 55

keepCCBS-CallIndicator.....identifier of [1] NULL
DEFINED in MAP-CH-DataTypes : 202

keyStatus.....identifier of [2] KeyStatus
DEFINED in MAP-MS-DataTypes : 461

KeyStatus.....type reference ENUMERATED
DEFINED in MAP-MS-DataTypes : 509
USED in MAP-MS-DataTypes : 461

ksi.....identifier of KSI
DEFINED in MAP-MS-DataTypes : 365

KSI.....type reference OCTET STRING
DEFINED in MAP-MS-DataTypes : 387
USED in MAP-MS-DataTypes : 365

laiFixedLength.....identifier of [1] LAIFixedLength
DEFINED in MAP-CommonDataTypes : 414

LAIFixedLength.....type reference OCTET STRING
DEFINED in MAP-CommonDataTypes : 432
USED in MAP-CommonDataTypes : 414

lawfulInterceptServices.....identifier of Named Number, 3
DEFINED in MAP-LCS-DataTypes : 151

lcsAPN.....identifier of [5] APN
DEFINED in MAP-LCS-DataTypes : 144

lcsCapabilitySet1.....identifier of Named Number, 0
DEFINED in MAP-MS-DataTypes : 260

lcsCapabilitySet2.....identifier of Named Number, 1
DEFINED in MAP-MS-DataTypes : 261

lcsCapabilitySet3.....identifier of Named Number, 2
DEFINED in MAP-MS-DataTypes : 262

lcsClientDialedByMS.....identifier of [2] AddressString
DEFINED in MAP-LCS-DataTypes : 140

LCSCClientExternalID.....type reference SEQUENCE

TAG R6.0 Cross Reference Listing for MAP-Protocol 2006-06-08 15:10:26 PAGE 52

DEFINED in MAP-CommonDataTypes : 378
 USED in MAP-MS-DataTypes : 196 1307
 USED in MAP-CommonDataTypes : 59
 USED in MAP-LCS-DataTypes : 37 139

lcsClientExternalID.....identifier of [1] LCSCClientExternalID
 DEFINED in MAP-LCS-DataTypes : 139

LCSCClientInternalID.....type reference ENUMERATED
 DEFINED in MAP-CommonDataTypes : 383
 USED in MAP-MS-DataTypes : 197 1297
 USED in MAP-CommonDataTypes : 60
 USED in MAP-LCS-DataTypes : 38 141

lcsClientInternalID.....identifier of [3] LCSCClientInternalID
 DEFINED in MAP-LCS-DataTypes : 141

lcsClientName.....identifier of [4] LCSCClientName
 DEFINED in MAP-LCS-DataTypes : 142

LCSCClientName.....type reference SEQUENCE
 DEFINED in MAP-LCS-DataTypes : 158
 USED in MAP-LCS-DataTypes : 18 142

lcsClientType.....identifier of [0] LCSCClientType
 DEFINED in MAP-LCS-DataTypes : 138

LCSCClientType.....type reference ENUMERATED
 DEFINED in MAP-LCS-DataTypes : 147
 USED in MAP-LCS-DataTypes : 138

lcsCodeword.....identifier of [12] LCSCodeword
 DEFINED in MAP-LCS-DataTypes : 108

LCSCodeword.....type reference SEQUENCE
 DEFINED in MAP-LCS-DataTypes : 230
 USED in MAP-LCS-DataTypes : 26 108

lcsCodewordString.....identifier of [1] LCSCodewordString
 DEFINED in MAP-LCS-DataTypes : 232

LCSCodewordString.....type reference USSD-String
 DEFINED in MAP-LCS-DataTypes : 235
 USED in MAP-LCS-DataTypes : 232

lcsInformation.....identifier of [22] LCSInformation
 DEFINED in MAP-MS-DataTypes : 830

LCSInformation.....type reference SEQUENCE
 DEFINED in MAP-MS-DataTypes : 847
 USED in MAP-MS-DataTypes : 830

lcsLocationInfo.....identifier of [1] LCSLocationInfo
 DEFINED in MAP-LCS-DataTypes : 76

LCSLocationInfo.....type reference SEQUENCE
 DEFINED in MAP-LCS-DataTypes : 81
 USED in MAP-LCS-DataTypes : 76 360 394

lcsLocationInfo.....identifier of LCSLocationInfo
 DEFINED in MAP-LCS-DataTypes : 360

lcsLocationInfo.....identifier of [1] LCSLocationInfo
 DEFINED in MAP-LCS-DataTypes : 394

lcsRequestorID.....identifier of [6] LCSRequestorID
 DEFINED in MAP-LCS-DataTypes : 145

LCSRequestorID.....type reference SEQUENCE
 DEFINED in MAP-LCS-DataTypes : 172
 USED in MAP-LCS-DataTypes : 25 145

LCSServiceTypeID.....type reference INTEGER
 DEFINED in MAP-CommonDataTypes : 392
 USED in MAP-MS-DataTypes : 199 1339

USED in MAP-CommonDataTypes : 61 396 397 398 399 400 401 402 403
404 405 406 407

USED in MAP-LCS-DataTypes : 39 107

lcsServiceTypeID.....identifier of [11] LCSServiceTypeID
DEFINED in MAP-LCS-DataTypes : 107

TAG R6.0 Cross Reference Listing for MAP-Protocol 2006-06-08 15:10:26 PAGE 53

lcs-ClientID.....identifier of [0] LCS-ClientID
 DEFINED in MAP-LCS-DataTypes : 95

LCS-ClientID.....type reference SEQUENCE
 DEFINED in MAP-LCS-DataTypes : 137
 USED in MAP-LCS-DataTypes : 95 359

lcs-ClientID.....identifier of LCS-ClientID
 DEFINED in MAP-LCS-DataTypes : 359

lcs-Event.....identifier of LCS-Event
 DEFINED in MAP-LCS-DataTypes : 358

LCS-Event.....type reference ENUMERATED
 DEFINED in MAP-LCS-DataTypes : 399
 USED in MAP-LCS-DataTypes : 358

lcs-Priority.....identifier of [6] LCS-Priority
 DEFINED in MAP-LCS-DataTypes : 101

LCS-Priority.....type reference OCTET STRING
 DEFINED in MAP-LCS-DataTypes : 181
 USED in MAP-LCS-DataTypes : 101

LCS-PrivacyClass.....type reference SEQUENCE
 DEFINED in MAP-MS-DataTypes : 1264
 USED in MAP-MS-DataTypes : 1260

lcs-PrivacyExceptionList.....identifier of [1] LCS-PrivacyExceptionList
 DEFINED in MAP-MS-DataTypes : 849

LCS-PrivacyExceptionList.....type reference SEQUENCE OF
 DEFINED in MAP-MS-DataTypes : 1259
 USED in MAP-MS-DataTypes : 849 852

lcs-QoS.....identifier of [7] LCS-QoS
 DEFINED in MAP-LCS-DataTypes : 102

LCS-QoS.....type reference SEQUENCE
 DEFINED in MAP-LCS-DataTypes : 186
 USED in MAP-LCS-DataTypes : 19 102

lcs-ReferenceNumber.....identifier of [10] LCS-ReferenceNumber
 DEFINED in MAP-LCS-DataTypes : 106

LCS-ReferenceNumber.....type reference OCTET STRING
 DEFINED in MAP-LCS-DataTypes : 228
 USED in MAP-LCS-DataTypes : 106 372

lcs-ReferenceNumber.....identifier of [10] LCS-ReferenceNumber
 DEFINED in MAP-LCS-DataTypes : 372

lmsi.....identifier of [10] LMSI
 DEFINED in MAP-MS-DataTypes : 226

lmsi.....identifier of LMSI
 DEFINED in MAP-MS-DataTypes : 1923

lmsi.....identifier of [1] LMSI
 DEFINED in MAP-MS-DataTypes : 1967

lmsi.....identifier of LMSI
 DEFINED in MAP-CommonDataTypes : 306

LMSI.....type reference OCTET STRING
 DEFINED in MAP-CommonDataTypes : 336
 USED in MAP-MS-DataTypes : 186 226 1923 1967
 USED in MAP-CommonDataTypes : 36 306
 USED in MAP-CH-DataTypes : 71 225 347
 USED in MAP-SM-DataTypes : 36 86 133
 USED in MAP-LCS-DataTypes : 34 84 99

lmsi.....identifier of [4] LMSI
 DEFINED in MAP-CH-DataTypes : 225

lmsi.....identifier of [1] LMSI
DEFINED in MAP-CH-DataTypes : 347

lmsi.....identifier of LMSI
DEFINED in MAP-SM-DataTypes : 86

lmsi.....identifier of [1] LMSI

TAG R6.0 Cross Reference Listing for MAP-Protocol 2006-06-08 15:10:26 PAGE 54

DEFINED in MAP-SM-DataTypes : 133

lmsi.....identifier of [0] LMSI
DEFINED in MAP-LCS-DataTypes : 84

lmsi.....identifier of [4] LMSI
DEFINED in MAP-LCS-DataTypes : 99

lmu-Indicator.....identifier of [21] NULL
DEFINED in MAP-MS-DataTypes : 829

local.....identifier of INTEGER
DEFINED in Remote-Operations-Info : 114
USED in MAP-MobileServiceOpera : 185 196 208 218 232 244 259 279 299
313 329 336 341 346 358 378 390 403
417 429 436 439 451 467 482 497 510
USED in MAP-OperationAndMainte : 64 78 89
USED in MAP-CallHandlingOperat : 103 119 132 144 157 172 185 199 213
227
USED in MAP-SupplementaryServi : 104 122 143 163 179 192 209 224 242
249 261 279 293
USED in MAP-ShortMessageServic : 81 94 113 126 136 141 154
USED in MAP-Group-Call-Operati : 55 62 67 72
USED in MAP-LocationServiceOpe : 66 85 100
USED in MAP-Errors : 169 176 183 190 196 202 211 217 220
227 230 238 245 252 259 266 272 275
281 289 298 305 312 318 324 330 336
342 348 356 363 369 375 385 391 398
405 411 414 417 422 425 428 434 440
448 453 459 465 473 481 487 493 499
505

localizedAdvertising.....value reference LCSServiceTypeID, 10
DEFINED in MAP-CommonDataTypes : 406

locationAtAlerting.....identifier of Named Number, 10
DEFINED in MAP-MS-DataTypes : 1709

locationEstimate.....identifier of Ext-GeographicalInformation
DEFINED in MAP-LCS-DataTypes : 240

locationEstimate.....identifier of [5] Ext-GeographicalInformation
DEFINED in MAP-LCS-DataTypes : 366

locationEstimateType.....identifier of [0] LocationEstimateType
DEFINED in MAP-LCS-DataTypes : 115

LocationEstimateType.....type reference ENUMERATED
DEFINED in MAP-LCS-DataTypes : 119
USED in MAP-LCS-DataTypes : 115

locationInformation.....identifier of [0] LocationInformation
DEFINED in MAP-MS-DataTypes : 1978

locationInformation.....identifier of [0] NULL
DEFINED in MAP-MS-DataTypes : 2042

LocationInformation.....type reference SEQUENCE
DEFINED in MAP-MS-DataTypes : 2061
USED in MAP-MS-DataTypes : 108 1978 2398

locationInformation.....identifier of [3] LocationInformation
DEFINED in MAP-MS-DataTypes : 2398

locationInformationGPRS.....identifier of [3] LocationInformationGPRS
DEFINED in MAP-MS-DataTypes : 1982

LocationInformationGPRS.....type reference SEQUENCE
DEFINED in MAP-MS-DataTypes : 2079
USED in MAP-MS-DataTypes : 109 1982 2402

locationInformationGPRS.....identifier of [7] LocationInformationGPRS
DEFINED in MAP-MS-DataTypes : 2402

locationInfoWithLMSI.....identifier of [0] LocationInfoWithLMSI

DEFINED in MAP-SM-DataTypes : 80

LocationInfoWithLMSI.....type reference SEQUENCE

DEFINED in MAP-SM-DataTypes : 84

USED in MAP-SM-DataTypes : 80

locationNotAllowed.....identifier of Named Number, 3

TAG R6.0 Cross Reference Listing for MAP-Protocol 2006-06-08 15:10:26 PAGE 55

DEFINED in MAP-MS-DataTypes : 1328

locationNumber.....identifier of [2] LocationNumber
DEFINED in MAP-MS-DataTypes : 2065

LocationNumber.....type reference OCTET STRING
DEFINED in MAP-MS-DataTypes : 2123
USED in MAP-MS-DataTypes : 2065

locationProcedureNotCompleted.....identifier of Named Number, 4
DEFINED in MAP-ER-DataTypes : 369

locationProcedureNotSupportedByTargetMS.identifier of Named Number, 5
DEFINED in MAP-ER-DataTypes : 370

locationType.....identifier of LocationType
DEFINED in MAP-LCS-DataTypes : 93

LocationType.....type reference SEQUENCE
DEFINED in MAP-LCS-DataTypes : 114
USED in MAP-LCS-DataTypes : 17 93

locationUpdating.....identifier of Named Number, 2
DEFINED in MAP-MS-DataTypes : 404

longForwardedToNumber.....identifier of [10] FTN-AddressString
DEFINED in MAP-MS-DataTypes : 1144

longForwardedToNumber.....identifier of [8] FTN-AddressString
DEFINED in MAP-CH-DataTypes : 219

longForwardedToNumber.....identifier of [9] FTN-AddressString
DEFINED in MAP-SS-DataTypes : 106

longFTN-Supported.....identifier of [4] NULL
DEFINED in MAP-MS-DataTypes : 240

longFTN-Supported.....identifier of [4] NULL
DEFINED in MAP-MS-DataTypes : 2217

longFTN-Supported.....identifier of [6] NULL
DEFINED in MAP-MS-DataTypes : 2320

longFTN-Supported.....identifier of [21] NULL
DEFINED in MAP-CH-DataTypes : 117

longFTN-Supported.....identifier of [18] NULL
DEFINED in MAP-CH-DataTypes : 240

longFTN-Supported.....identifier of [9] NULL
DEFINED in MAP-SS-DataTypes : 80

longFTN-Supported.....identifier of [4] NULL
DEFINED in MAP-SS-DataTypes : 187

LongSignalInfo.....type reference OCTET STRING
DEFINED in MAP-CommonDataTypes : 249
USED in MAP-CommonDataTypes : 244

longTermDenial.....information object reference ERROR, Information Object
DEFINED in MAP-Errors : 436
USED in MAP-SupplementaryServi : 55 277
USED in MAP-Errors : 74

LongTermDenialParam.....type reference SEQUENCE
DEFINED in MAP-ER-DataTypes : 334
USED in MAP-Errors : 140 438
USED in MAP-ER-DataTypes : 48

lowdelay.....identifier of Named Number, 0
DEFINED in MAP-LCS-DataTypes : 211

lowerLayerCompatibility.....identifier of [5] ExternalSignalInfo
DEFINED in MAP-CH-DataTypes : 317

IsaActiveModelIndicator.....identifier of [2] NULL
DEFINED in MAP-MS-DataTypes : 1005

IsaAttributes.....identifier of [1] LSAAttributes
DEFINED in MAP-MS-DataTypes : 1004

LSAAttributes.....type reference OCTET STRING

TAG R6.0 Cross Reference Listing for MAP-Protocol 2006-06-08 15:10:26 PAGE 56

DEFINED in MAP-MS-DataTypes : 1021
USED in MAP-MS-DataTypes : 1004

LSADData.....type reference SEQUENCE
DEFINED in MAP-MS-DataTypes : 1002
USED in MAP-MS-DataTypes : 998

LSADDataList.....type reference SEQUENCE OF
DEFINED in MAP-MS-DataTypes : 997
USED in MAP-MS-DataTypes : 1014

lsaDataList.....identifier of [2] LSADDataList
DEFINED in MAP-MS-DataTypes : 1014

lsaIdentity.....identifier of [0] lsaIdentity
DEFINED in MAP-MS-DataTypes : 1003

lsaIdentity.....type reference OCTET STRING
DEFINED in MAP-MS-DataTypes : 1018
USED in MAP-MS-DataTypes : 59 1003 1437 2069 2084

lsaIdentityList.....identifier of lsaIdentityList
DEFINED in MAP-MS-DataTypes : 1434

lsaIdentityList.....type reference SEQUENCE OF
DEFINED in MAP-MS-DataTypes : 1436
USED in MAP-MS-DataTypes : 1434

lsaInformation.....identifier of [25] lsaInformation
DEFINED in MAP-MS-DataTypes : 828

lsaInformation.....type reference SEQUENCE
DEFINED in MAP-MS-DataTypes : 1009
USED in MAP-MS-DataTypes : 828

lsaInformationWithdraw.....identifier of [12] lsaInformationWithdraw
DEFINED in MAP-MS-DataTypes : 1398

lsaInformationWithdraw.....type reference CHOICE
DEFINED in MAP-MS-DataTypes : 1432
USED in MAP-MS-DataTypes : 1398

lsaOnlyAccessIndicator.....type reference ENUMERATED
DEFINED in MAP-MS-DataTypes : 993
USED in MAP-MS-DataTypes : 1013

lsaOnlyAccessIndicator.....identifier of [1] lsaOnlyAccessIndicator
DEFINED in MAP-MS-DataTypes : 1013

mah.....value reference SS-Code, '00110010'B
DEFINED in MAP-SS-Code : 68

MAP-BS-Code.....module reference
DEFINED in MAP-BS-Code : 1
USED in MAP-MS-DataTypes : 167
USED in MAP-CommonDataTypes : 73

MAP-CallHandlingOperations.....module reference
DEFINED in MAP-CallHandlingOperat : 1
USED in MAP-Protocol : 68

MAP-CH-DataTypes.....module reference
DEFINED in MAP-CH-DataTypes : 1
USED in MAP-CallHandlingOperat : 75

MAP-CommonDataTypes.....module reference
DEFINED in MAP-CommonDataTypes : 1
USED in MAP-OperationAndMainte : 45
USED in MAP-MS-DataTypes : 202
USED in MAP-OM-DataTypes : 23
USED in MAP-CH-DataTypes : 75
USED in MAP-SS-DataTypes : 55
USED in MAP-SM-DataTypes : 37
USED in MAP-GR-DataTypes : 27
USED in MAP-LCS-DataTypes : 40

USED in MAP-ER-DataTypes : 74

MAP-Errors.....module reference

DEFINED in MAP-Errors : 1

USED in MAP-MobileServiceOpera : 110

USED in MAP-OperationAndMainte : 31

USED in MAP-CallHandlingOperat : 52

TAG R6.0 Cross Reference Listing for MAP-Protocol 2006-06-08 15:10:26 PAGE 57

USED in MAP-SupplementaryServ : 57
 USED in MAP-ShortMessageServ : 42
 USED in MAP-Group-Call-Operati : 28
 USED in MAP-LocationServiceOpe : 38

MAP-ER-DataTypes.....module reference
 DEFINED in MAP-ER-DataTypes : 1
 USED in MAP-Errors : 157
 USED in MAP-MS-DataTypes : 212
 USED in MAP-SM-DataTypes : 42

MAP-EXTENSION.....information object class reference CLASS
 DEFINED in MAP-ExtensionDataTypes : 23
 USED in MAP-ExtensionDataTypes : 45 47 52

MAP-ExtensionDataTypes.....module reference
 DEFINED in MAP-ExtensionDataTypes : 1
 USED in MAP-MS-DataTypes : 207
 USED in MAP-OM-DataTypes : 28
 USED in MAP-CommonDataTypes : 83
 USED in MAP-CH-DataTypes : 80
 USED in MAP-SS-DataTypes : 60
 USED in MAP-SM-DataTypes : 47
 USED in MAP-GR-DataTypes : 43
 USED in MAP-LCS-DataTypes : 46
 USED in MAP-ER-DataTypes : 86

MAP-Group-Call-Operations.....module reference
 DEFINED in MAP-Group-Call-Operati : 1
 USED in MAP-Protocol : 107

MAP-GR-DataTypes.....module reference
 DEFINED in MAP-GR-DataTypes : 1
 USED in MAP-Group-Call-Operati : 38

MAP-LCS-DataTypes.....module reference
 DEFINED in MAP-LCS-DataTypes : 1
 USED in MAP-LocationServiceOpe : 48

MAP-LocationServiceOperations.....module reference
 DEFINED in MAP-LocationServiceOpe : 1
 USED in MAP-Protocol : 115

MAP-MobileServiceOperations.....module reference
 DEFINED in MAP-MobileServiceOpera : 1
 USED in MAP-Protocol : 45

MAP-MS-DataTypes.....module reference
 DEFINED in MAP-MS-DataTypes : 1
 USED in MAP-MobileServiceOpera : 165
 USED in MAP-CH-DataTypes : 54
 USED in MAP-GR-DataTypes : 37
 USED in MAP-LCS-DataTypes : 57

MAP-OM-DataTypes.....module reference
 DEFINED in MAP-OM-DataTypes : 1
 USED in MAP-OperationAndMainte : 39

MAP-OperationAndMaintenanceOperations...module reference
 DEFINED in MAP-OperationAndMainte : 1
 USED in MAP-Protocol : 53

MAP-Protocol.....module reference
 DEFINED in MAP-Protocol : 1

MAP-ShortMessageServiceOperations.....module reference
 DEFINED in MAP-ShortMessageServ : 1
 USED in MAP-Protocol : 98

MAP-SM-DataTypes.....module reference
 DEFINED in MAP-SM-DataTypes : 1
 USED in MAP-ShortMessageServ : 58
 USED in MAP-LCS-DataTypes : 62

MAP-SS-Code.....module reference

DEFINED in MAP-SS-Code : 1
USED in MAP-SupplementaryServi : 80
USED in MAP-MS-DataTypes : 162
USED in MAP-CommonDataTypes : 78
USED in MAP-SS-DataTypes : 65
USED in MAP-ER-DataTypes : 81

TAG R6.0 Cross Reference Listing for MAP-Protocol 2006-06-08 15:10:26 PAGE 58

MAP-SS-DataTypes.....module reference
 DEFINED in MAP-SS-DataTypes : 1
 USED in MAP-SupplementaryServi : 75
 USED in MAP-Errors : 103
 USED in MAP-MS-DataTypes : 157
 USED in MAP-CH-DataTypes : 61
 USED in MAP-LCS-DataTypes : 52
 USED in MAP-ER-DataTypes : 67

MAP-SupplementaryServiceOperations.....module reference
 DEFINED in MAP-SupplementaryServi : 1
 USED in MAP-Protocol : 86

MAP-TS-Code.....module reference
 DEFINED in MAP-TS-Code : 1
 USED in MAP-MS-DataTypes : 172
 USED in MAP-CommonDataTypes : 67
 USED in MAP-GR-DataTypes : 32

matchType.....identifier of [0] MatchType
 DEFINED in MAP-MS-DataTypes : 1614

MatchType.....type reference ENUMERATED
 DEFINED in MAP-MS-DataTypes : 1644
 USED in MAP-MS-DataTypes : 1614

maxAddressLength.....value reference INTEGER, 20
 DEFINED in MAP-CommonDataTypes : 142
 USED in MAP-CommonDataTypes : 101

maxAdd-GeographicalInformation.....value reference INTEGER, 91
 DEFINED in MAP-LCS-DataTypes : 354
 USED in MAP-LCS-DataTypes : 336

maxEventSpecification.....value reference INTEGER, 2
 DEFINED in MAP-SS-DataTypes : 302
 USED in MAP-SS-DataTypes : 299

maxExt-GeographicalInformation.....value reference INTEGER, 20
 DEFINED in MAP-LCS-DataTypes : 316
 USED in MAP-LCS-DataTypes : 260

maxFTN-AddressLength.....value reference INTEGER, 15
 DEFINED in MAP-CommonDataTypes : 157
 USED in MAP-CommonDataTypes : 151

maximumentitledPriority.....identifier of EMLPP-Priority
 DEFINED in MAP-CommonDataTypes : 455

maximumEntitledPriority.....identifier of [0] EMLPP-Priority
 DEFINED in MAP-SS-DataTypes : 193

maxISDN-AddressLength.....value reference INTEGER, 9
 DEFINED in MAP-CommonDataTypes : 148
 USED in MAP-CommonDataTypes : 18 145

maxISDN-SubaddressLength.....value reference INTEGER, 21
 DEFINED in MAP-CommonDataTypes : 197
 USED in MAP-CommonDataTypes : 160

maxLCSCodewordStringLength.....value reference INTEGER, 20
 DEFINED in MAP-LCS-DataTypes : 237
 USED in MAP-LCS-DataTypes : 235

maxLongSignalInfoLength.....value reference INTEGER, 2560
 DEFINED in MAP-CommonDataTypes : 251
 USED in MAP-CommonDataTypes : 249

MaxMC-Bearers.....type reference INTEGER
 DEFINED in MAP-CommonDataTypes : 482
 USED in MAP-CommonDataTypes : 53 477
 USED in MAP-SS-DataTypes : 52 196

maxNameStringLength.....value reference INTEGER, 63
 DEFINED in MAP-LCS-DataTypes : 170

USED in MAP-LCS-DataTypes : 168

maxNrOfRABs.....value reference INTEGER, 255

DEFINED in MAP-MS-DataTypes : 721

USED in MAP-MS-DataTypes : 719

maxNumOfBasicServiceGroups.....value reference INTEGER, 13

TAG R6.0 Cross Reference Listing for MAP-Protocol 2006-06-08 15:10:26 PAGE 59

DEFINED in MAP-SS-DataTypes : 266
 USED in MAP-SS-DataTypes : 95 152 263

maxNumOfBasicServices.....value reference INTEGER, 70
 DEFINED in MAP-MS-DataTypes : 1442
 USED in MAP-MS-DataTypes : 1439

maxNumOfBearerServices.....value reference INTEGER, 50
 DEFINED in MAP-MS-DataTypes : 1053
 USED in MAP-MS-DataTypes : 1050

maxNumOfCamelBasicServiceCriteria.....value reference INTEGER, 5
 DEFINED in MAP-MS-DataTypes : 1638
 USED in MAP-MS-DataTypes : 1629

maxNumOfCamelDestinationNumberLengths...value reference INTEGER, 3
 DEFINED in MAP-MS-DataTypes : 1636
 USED in MAP-MS-DataTypes : 1626

maxNumOfCamelDestinationNumbers.....value reference INTEGER, 10
 DEFINED in MAP-MS-DataTypes : 1634
 USED in MAP-MS-DataTypes : 1621

maxNumOfCamelSSEvents.....value reference INTEGER, 10
 DEFINED in MAP-MS-DataTypes : 1547
 USED in MAP-MS-DataTypes : 1536

maxNumOfCamelTDPData.....value reference INTEGER, 10
 DEFINED in MAP-MS-DataTypes : 1567
 USED in MAP-MS-DataTypes : 81 927 1465 1560 1592 1595 1734 1845

maxNumOfCAMEL-O-CauseValueCriteria.....value reference INTEGER, 5
 DEFINED in MAP-MS-DataTypes : 1654
 USED in MAP-MS-DataTypes : 1648

maxNumOfCAMEL-T-CauseValueCriteria.....value reference INTEGER, 5
 DEFINED in MAP-MS-DataTypes : 1656
 USED in MAP-MS-DataTypes : 1651

maxNumOfCCBS-Requests.....value reference INTEGER, 5
 DEFINED in MAP-SS-DataTypes : 203
 USED in MAP-SS-DataTypes : 200 212

maxNumOfCUG.....value reference INTEGER, 10
 DEFINED in MAP-MS-DataTypes : 1224
 USED in MAP-MS-DataTypes : 1203

maxNumOfDP-AnalysedInfoCriteria.....value reference INTEGER, 10
 DEFINED in MAP-MS-DataTypes : 1510
 USED in MAP-MS-DataTypes : 1507

maxNumOfEncryptionInfo.....value reference INTEGER, 100
 DEFINED in MAP-MS-DataTypes : 745
 USED in MAP-MS-DataTypes : 738

maxNumOfExternalClient.....value reference INTEGER, 5
 DEFINED in MAP-MS-DataTypes : 1294
 USED in MAP-MS-DataTypes : 1291

maxNumOfExt-BasicServiceGroups.....value reference INTEGER, 32
 DEFINED in MAP-MS-DataTypes : 1232
 USED in MAP-MS-DataTypes : 1129 1188 1226 1229

maxNumOfExt-ExternalClient.....value reference INTEGER, 35
 DEFINED in MAP-MS-DataTypes : 1304
 USED in MAP-MS-DataTypes : 1301

maxNumOfGMLC.....value reference INTEGER, 5
 DEFINED in MAP-MS-DataTypes : 864
 USED in MAP-MS-DataTypes : 860

maxNumOfHLR-Id.....value reference INTEGER, 50
 DEFINED in MAP-CommonDataTypes : 334
 USED in MAP-CommonDataTypes : 331

maxNumOfIntegrityInfo.....value reference INTEGER, 100
DEFINED in MAP-MS-DataTypes : 736
USED in MAP-MS-DataTypes : 729

maxNumOfISDN-AddressDigits.....value reference INTEGER, 15
DEFINED in MAP-MS-DataTypes : 1632
USED in MAP-MS-DataTypes : 1627

TAG R6.0 Cross Reference Listing for MAP-Protocol 2006-06-08 15:10:26 PAGE 60

maxNumOfLSAs.....value reference INTEGER, 20
DEFINED in MAP-MS-DataTypes : 1000
USED in MAP-MS-DataTypes : 997 1436

maxNumOfMC-Bearers.....value reference INTEGER, 7
DEFINED in MAP-CommonDataTypes : 486
USED in MAP-CommonDataTypes : 482 484

maxNumOfMobilityTriggers.....value reference INTEGER, 10
DEFINED in MAP-MS-DataTypes : 1803
USED in MAP-MS-DataTypes : 1800

maxNumOfMOLR-Class.....value reference INTEGER, 3
DEFINED in MAP-MS-DataTypes : 1350
USED in MAP-MS-DataTypes : 1347

maxNumOfPDP-Contexts.....value reference INTEGER, 50
DEFINED in MAP-MS-DataTypes : 877
USED in MAP-MS-DataTypes : 874 893 1429 2141

maxNumOfPLMNCClient.....value reference INTEGER, 5
DEFINED in MAP-MS-DataTypes : 1299
USED in MAP-MS-DataTypes : 1296

maxNumOfPrivacyClass.....value reference INTEGER, 4
DEFINED in MAP-MS-DataTypes : 1262
USED in MAP-MS-DataTypes : 1259

maxNumOfPrivateExtensions.....value reference INTEGER, 10
DEFINED in MAP-ExtensionDataTypes : 50
USED in MAP-ExtensionDataTypes : 41

maxNumOfRadioResources.....value reference INTEGER, 7
DEFINED in MAP-MS-DataTypes : 574
USED in MAP-MS-DataTypes : 565

maxNumOfRelocationNumber.....value reference INTEGER, 7
DEFINED in MAP-MS-DataTypes : 723
USED in MAP-MS-DataTypes : 708 711

maxNumOfServiceHandovers.....value reference INTEGER, 7
DEFINED in MAP-MS-DataTypes : 552
USED in MAP-MS-DataTypes : 543

maxNumOfServiceType.....value reference INTEGER, 32
DEFINED in MAP-MS-DataTypes : 1336
USED in MAP-MS-DataTypes : 1333

maxNumOfSS.....value reference INTEGER, 30
DEFINED in MAP-SS-DataTypes : 258
USED in MAP-MS-DataTypes : 152 1113
USED in MAP-SS-DataTypes : 32 255 260

maxNumOfTeleservices.....value reference INTEGER, 20
DEFINED in MAP-MS-DataTypes : 1058
USED in MAP-MS-DataTypes : 1055

maxNumOfTPDUtypes.....value reference INTEGER, 5
DEFINED in MAP-MS-DataTypes : 1477
USED in MAP-MS-DataTypes : 1473

maxNumOfVBSGroupIds.....value reference INTEGER, 50
DEFINED in MAP-MS-DataTypes : 1942
USED in MAP-MS-DataTypes : 1936

maxNumOfVGCSGroupIds.....value reference INTEGER, 50
DEFINED in MAP-MS-DataTypes : 1944
USED in MAP-MS-DataTypes : 1939

maxNumOfZoneCodes.....value reference INTEGER, 10
DEFINED in MAP-MS-DataTypes : 1364
USED in MAP-MS-DataTypes : 68 1358

maxPermittedEncryptionAlgorithmsLength..value reference INTEGER, 9

DEFINED in MAP-MS-DataTypes : 507
USED in MAP-MS-DataTypes : 499

maxPermittedIntegrityProtectionAlgorithmvalue reference INTEGER, 9

DEFINED in MAP-MS-DataTypes : 496
USED in MAP-MS-DataTypes : 488

TAG R6.0 Cross Reference Listing for MAP-Protocol 2006-06-08 15:10:26 PAGE 61

maxPositioningDataInformation.....value reference INTEGER, 10
 DEFINED in MAP-LCS-DataTypes : 325
 USED in MAP-LCS-DataTypes : 320

maxRequestorIDStringLength.....value reference INTEGER, 63
 DEFINED in MAP-LCS-DataTypes : 179
 USED in MAP-LCS-DataTypes : 177

maxSignalInfoLength.....value reference INTEGER, 200
 DEFINED in MAP-CommonDataTypes : 210
 USED in MAP-CommonDataTypes : 25 208

maxUSSD-StringLength.....value reference INTEGER, 160
 DEFINED in MAP-SS-DataTypes : 241
 USED in MAP-SS-DataTypes : 237

maxUtranPositioningDataInfo.....value reference INTEGER, 11
 DEFINED in MAP-LCS-DataTypes : 333
 USED in MAP-LCS-DataTypes : 328

mc.....value reference SS-Code, '01000101'B
 DEFINED in MAP-SS-Code : 84

mcef-Set.....identifier of Named Number, 2
 DEFINED in MAP-SM-DataTypes : 196

mci.....value reference SS-Code, '00010101'B
 DEFINED in MAP-SS-Code : 36

MC-Bearers.....type reference INTEGER
 DEFINED in MAP-CommonDataTypes : 484
 USED in MAP-CommonDataTypes : 54 478
 USED in MAP-SS-DataTypes : 53 79 167 197 198

mc-SS-Info.....identifier of [28] MC-SS-Info
 DEFINED in MAP-MS-DataTypes : 833

MC-SS-Info.....type reference SEQUENCE
 DEFINED in MAP-CommonDataTypes : 474
 USED in MAP-MS-DataTypes : 193 833
 USED in MAP-CommonDataTypes : 52

memoryAvailable.....identifier of Named Number, 1
 DEFINED in MAP-SM-DataTypes : 217

memoryCapacityExceeded.....identifier of Named Number, 0
 DEFINED in MAP-SM-DataTypes : 166

memoryCapacityExceeded.....identifier of Named Number, 0
 DEFINED in MAP-ER-DataTypes : 141

messageWaitingListFull.....information object reference ERROR, Information Object
 DEFINED in MAP-Errors : 455
 USED in MAP-ShortMessageServic : 40 125
 USED in MAP-Errors : 79

MessageWaitListFullParam.....type reference SEQUENCE
 DEFINED in MAP-ER-DataTypes : 315
 USED in MAP-Errors : 134 457
 USED in MAP-ER-DataTypes : 41

mg-csi.....identifier of [5] MG-CSI
 DEFINED in MAP-MS-DataTypes : 910

mg-csi.....identifier of Named Number, 10
 DEFINED in MAP-MS-DataTypes : 1415

mg-csi.....identifier of Named Number, 5
 DEFINED in MAP-MS-DataTypes : 1691

MG-CSI.....type reference SEQUENCE
 DEFINED in MAP-MS-DataTypes : 1789
 USED in MAP-MS-DataTypes : 910 2305

mg-csi.....identifier of Named Number, 1

DEFINED in MAP-MS-DataTypes : 2257

mg-csi.....identifier of [17] MG-CSI
DEFINED in MAP-MS-DataTypes : 2305

mlcNumber.....identifier of [0] ISDN-AddressString
DEFINED in MAP-LCS-DataTypes : 69

TAG R6.0 Cross Reference Listing for MAP-Protocol 2006-06-08 15:10:26 PAGE 62

mlc-Number.....identifier of ISDN-AddressString
DEFINED in MAP-LCS-DataTypes : 94

MM-Code.....type reference OCTET STRING
DEFINED in MAP-MS-DataTypes : 1805
USED in MAP-MS-DataTypes : 1801 2395

mm-EventNotSupported.....information object reference ERROR, Information Object
DEFINED in MAP-Errors : 501
USED in MAP-MobileServiceOpera : 95 509
USED in MAP-Errors : 92

MM-EventNotSupported-Param.....type reference SEQUENCE
DEFINED in MAP-ER-DataTypes : 382
USED in MAP-Errors : 145 503
USED in MAP-ER-DataTypes : 53

mnpInfoRes.....identifier of [8] MNPInfoRes
DEFINED in MAP-MS-DataTypes : 1987

MNPInfoRes.....type reference SEQUENCE
DEFINED in MAP-MS-DataTypes : 1994
USED in MAP-MS-DataTypes : 113 1987

mnpRequestedInfo.....identifier of [7] NULL
DEFINED in MAP-MS-DataTypes : 2050

mnr-Set.....identifier of Named Number, 1
DEFINED in MAP-SM-DataTypes : 195

mnr-Set.....identifier of Named Number, 3
DEFINED in MAP-SM-DataTypes : 197

mobileNotReachableReason.....identifier of [2] AbsentSubscriberDiagnosticSM
DEFINED in MAP-MS-DataTypes : 1883

mobileYellowPages.....value reference LCSServiceTypeID, 11
DEFINED in MAP-CommonDataTypes : 407

mobilityTriggers.....identifier of MobilityTriggers
DEFINED in MAP-MS-DataTypes : 1779

mobilityTriggers.....identifier of MobilityTriggers
DEFINED in MAP-MS-DataTypes : 1790

MobilityTriggers.....type reference SEQUENCE OF
DEFINED in MAP-MS-DataTypes : 1800
USED in MAP-MS-DataTypes : 1779 1790

ModificationInstruction.....type reference ENUMERATED
DEFINED in MAP-MS-DataTypes : 2370
USED in MAP-MS-DataTypes : 2338 2348 2354 2360 2361

modificationRequestFor-CB-Info.....identifier of [3] ModificationRequestFor-CB-Info
DEFINED in MAP-MS-DataTypes : 2317

ModificationRequestFor-CB-Info.....type reference SEQUENCE
DEFINED in MAP-MS-DataTypes : 2342
USED in MAP-MS-DataTypes : 2317

modificationRequestFor-CF-Info.....identifier of [2] ModificationRequestFor-CF-Info
DEFINED in MAP-MS-DataTypes : 2316

ModificationRequestFor-CF-Info.....type reference SEQUENCE
DEFINED in MAP-MS-DataTypes : 2331
USED in MAP-MS-DataTypes : 2316

modificationRequestFor-CSI.....identifier of [4] ModificationRequestFor-CSI
DEFINED in MAP-MS-DataTypes : 2318

ModificationRequestFor-CSI.....type reference SEQUENCE
DEFINED in MAP-MS-DataTypes : 2358
USED in MAP-MS-DataTypes : 2318

modificationRequestFor-ODB-data.....identifier of [7] ModificationRequestFor-ODB-data
DEFINED in MAP-MS-DataTypes : 2322

ModificationRequestFor-ODB-data.....type reference SEQUENCE
DEFINED in MAP-MS-DataTypes : 2352
USED in MAP-MS-DataTypes : 2322

TAG R6.0 Cross Reference Listing for MAP-Protocol 2006-06-08 15:10:26 PAGE 63

modifyCSI-State.....identifier of [2] ModificationInstruction
DEFINED in MAP-MS-DataTypes : 2361

modifyNotificationToCSE.....identifier of [6] ModificationInstruction
DEFINED in MAP-MS-DataTypes : 2338

modifyNotificationToCSE.....identifier of [5] ModificationInstruction
DEFINED in MAP-MS-DataTypes : 2348

modifyNotificationToCSE.....identifier of [1] ModificationInstruction
DEFINED in MAP-MS-DataTypes : 2354

modifyNotificationToCSE.....identifier of [1] ModificationInstruction
DEFINED in MAP-MS-DataTypes : 2360

MOLR-Class.....type reference SEQUENCE
DEFINED in MAP-MS-DataTypes : 1352
USED in MAP-MS-DataTypes : 1348

molr-List.....identifier of [2] MOLR-List
DEFINED in MAP-MS-DataTypes : 850

MOLR-List.....type reference SEQUENCE OF
DEFINED in MAP-MS-DataTypes : 1347
USED in MAP-MS-DataTypes : 850

monitoringMode.....identifier of [0] MonitoringMode
DEFINED in MAP-CH-DataTypes : 388

MonitoringMode.....type reference ENUMERATED
DEFINED in MAP-CH-DataTypes : 393
USED in MAP-CH-DataTypes : 388

moreMessagesToSend.....identifier of NULL
DEFINED in MAP-SM-DataTypes : 122

moveLeg.....identifier of Named Number, 2
DEFINED in MAP-MS-DataTypes : 1701

mo-ForwardSM.....information object reference OPERATION, Information Object
DEFINED in MAP-ShortMessageService : 83
USED in MAP-Protocol : 92 135
USED in MAP-ShortMessageService : 14

MO-ForwardSM-Arg.....type reference SEQUENCE
DEFINED in MAP-SM-DataTypes : 105
USED in MAP-ShortMessageService : 48 85
USED in MAP-SM-DataTypes : 16

MO-ForwardSM-Res.....type reference SEQUENCE
DEFINED in MAP-SM-DataTypes : 113
USED in MAP-ShortMessageService : 49 87
USED in MAP-SM-DataTypes : 17

mo-lr.....identifier of Named Number, 2
DEFINED in MAP-LCS-DataTypes : 402

mo-sms-CSI.....identifier of [1] SMS-CSI
DEFINED in MAP-MS-DataTypes : 905

mo-sms-csi.....identifier of Named Number, 5
DEFINED in MAP-MS-DataTypes : 1410

mo-sms-CSI.....identifier of [6] SMS-CSI
DEFINED in MAP-MS-DataTypes : 1457

mo-sms-CSI.....identifier of Named Number, 5
DEFINED in MAP-MS-DataTypes : 2250

mo-sms-CSI.....identifier of [10] SMS-CSI
DEFINED in MAP-MS-DataTypes : 2297

msAvailable.....identifier of Named Number, 0
DEFINED in MAP-LCS-DataTypes : 131

msc-Number.....identifier of [1] ISDN-AddressString
DEFINED in MAP-MS-DataTypes : 224

msc-Number.....identifier of [6] ISDN-AddressString
DEFINED in MAP-MS-DataTypes : 2070

msc-Number.....identifier of [1] ISDN-AddressString

TAG R6.0 Cross Reference Listing for MAP-Protocol 2006-06-08 15:10:26 PAGE 64

DEFINED in MAP-CH-DataTypes : 223

msc-Number.....identifier of [0] ISDN-AddressString
DEFINED in MAP-SM-DataTypes : 97

msisdn.....identifier of [1] ISDN-AddressString
DEFINED in MAP-MS-DataTypes : 1025

msisdn.....identifier of [2] ISDN-AddressString
DEFINED in MAP-MS-DataTypes : 1997

msisdn.....identifier of ISDN-AddressString
DEFINED in MAP-MS-DataTypes : 2378

msisdn.....identifier of [2] ISDN-AddressString
DEFINED in MAP-MS-DataTypes : 2397

msisdn.....identifier of [1] ISDN-AddressString
DEFINED in MAP-CommonDataTypes : 375

msisdn.....identifier of [0] ISDN-AddressString
DEFINED in MAP-CH-DataTypes : 95

msisdn.....identifier of [12] ISDN-AddressString
DEFINED in MAP-CH-DataTypes : 169

msisdn.....identifier of [2] ISDN-AddressString
DEFINED in MAP-CH-DataTypes : 224

msisdn.....identifier of [9] ISDN-AddressString
DEFINED in MAP-CH-DataTypes : 259

msisdn.....identifier of [0] ISDN-AddressString
DEFINED in MAP-SS-DataTypes : 225

msisdn.....identifier of [1] ISDN-AddressString
DEFINED in MAP-SS-DataTypes : 270

msisdn.....identifier of [0] ISDN-AddressString
DEFINED in MAP-SM-DataTypes : 54

msisdn.....identifier of [2] ISDN-AddressString
DEFINED in MAP-SM-DataTypes : 138

msisdn.....identifier of ISDN-AddressString
DEFINED in MAP-SM-DataTypes : 143

msisdn.....identifier of ISDN-AddressString
DEFINED in MAP-SM-DataTypes : 177

msisdn.....identifier of [3] ISDN-AddressString
DEFINED in MAP-LCS-DataTypes : 98

msisdn.....identifier of [0] ISDN-AddressString
DEFINED in MAP-LCS-DataTypes : 361

mSNetworkCapability.....identifier of [0] MSNetworkCapability
DEFINED in MAP-MS-DataTypes : 2029

MSNetworkCapability.....type reference OCTET STRING
DEFINED in MAP-MS-DataTypes : 2033
USED in MAP-MS-DataTypes : 2029

msNotReachable.....identifier of NULL
DEFINED in MAP-MS-DataTypes : 1930

msPurged.....identifier of Named Number, 0
DEFINED in MAP-MS-DataTypes : 2191

mSRadioAccessCapability.....identifier of [1] MSRadioAccessCapability
DEFINED in MAP-MS-DataTypes : 2030

MSRadioAccessCapability.....type reference OCTET STRING
DEFINED in MAP-MS-DataTypes : 2037
USED in MAP-MS-DataTypes : 2030

ms-classmark.....identifier of [5] NULL
DEFINED in MAP-MS-DataTypes : 2049

ms-Classmark2.....identifier of [6] MS-Classmark2
DEFINED in MAP-MS-DataTypes : 1985

TAG R6.0 Cross Reference Listing for MAP-Protocol 2006-06-08 15:10:26 PAGE 65

MS-Classmark2.....type reference OCTET STRING
DEFINED in MAP-MS-DataTypes : 2024
USED in MAP-MS-DataTypes : 101 1985

ms-Present.....identifier of Named Number, 0
DEFINED in MAP-SM-DataTypes : 216

mt-ForwardSM.....information object reference OPERATION, Information Object
DEFINED in MAP-ShortMessageServ : 96
USED in MAP-Protocol : 93 135
USED in MAP-ShortMessageServ : 15

MT-ForwardSM-Arg.....type reference SEQUENCE
DEFINED in MAP-SM-DataTypes : 118
USED in MAP-ShortMessageServ : 50 98
USED in MAP-SM-DataTypes : 18

MT-ForwardSM-Res.....type reference SEQUENCE
DEFINED in MAP-SM-DataTypes : 126
USED in MAP-ShortMessageServ : 51 100
USED in MAP-SM-DataTypes : 19

mt-lrRestart.....identifier of Named Number, 4
DEFINED in MAP-LCS-DataTypes : 414

MT-smsCAMELTDP-Criteria.....type reference SEQUENCE
DEFINED in MAP-MS-DataTypes : 1468
USED in MAP-MS-DataTypes : 1466

mt-smsCAMELTDP-CriteriaList.....identifier of [4] MT-smsCAMELTDP-CriteriaList
DEFINED in MAP-MS-DataTypes : 909

mt-smsCAMELTDP-CriteriaList.....identifier of [11] MT-smsCAMELTDP-CriteriaList
DEFINED in MAP-MS-DataTypes : 1462

MT-smsCAMELTDP-CriteriaList.....type reference SEQUENCE OF
DEFINED in MAP-MS-DataTypes : 1465
USED in MAP-MS-DataTypes : 909 1462 2304

mt-smsCAMELTDP-CriteriaList.....identifier of [16] MT-smsCAMELTDP-CriteriaList
DEFINED in MAP-MS-DataTypes : 2304

mt-sms-CSl.....identifier of [3] SMS-CSl
DEFINED in MAP-MS-DataTypes : 908

mt-sms-csi.....identifier of Named Number, 9
DEFINED in MAP-MS-DataTypes : 1414

mt-sms-CSl.....identifier of [10] SMS-CSl
DEFINED in MAP-MS-DataTypes : 1461

mt-sms-csi.....identifier of Named Number, 4
DEFINED in MAP-MS-DataTypes : 1690

mt-sms-CSl.....identifier of Named Number, 0
DEFINED in MAP-MS-DataTypes : 2256

mt-sms-CSl.....identifier of [15] SMS-CSl
DEFINED in MAP-MS-DataTypes : 2303

MT-SMS-TPDU-Type.....type reference ENUMERATED
DEFINED in MAP-MS-DataTypes : 1479
USED in MAP-MS-DataTypes : 1474

multicallBearerInfo.....identifier of [3] MulticallBearerInfo
DEFINED in MAP-MS-DataTypes : 580

MulticallBearerInfo.....type reference INTEGER
DEFINED in MAP-MS-DataTypes : 711
USED in MAP-MS-DataTypes : 580

multipleBearerNotSupported.....identifier of NULL
DEFINED in MAP-MS-DataTypes : 581

multipleBearerRequested.....identifier of [3] NULL

DEFINED in MAP-MS-DataTypes : 522

multipleECT-Barred.....identifier of Named Number, 14
DEFINED in MAP-MS-DataTypes : 1081

multiPTY.....value reference SS-Code, '01010001'B
DEFINED in MAP-SS-Code : 90

TAG R6.0 Cross Reference Listing for MAP-Protocol 2006-06-08 15:10:26 PAGE 66

mw-Status.....identifier of MW-Status
DEFINED in MAP-SM-DataTypes : 183

MW-Status.....type reference BIT STRING
DEFINED in MAP-SM-DataTypes : 193
USED in MAP-SM-DataTypes : 183

m-csi.....identifier of Named Number, 6
DEFINED in MAP-MS-DataTypes : 1411

m-CSI.....identifier of [5] M-CSI
DEFINED in MAP-MS-DataTypes : 1456

M-CSI.....type reference SEQUENCE
DEFINED in MAP-MS-DataTypes : 1778
USED in MAP-MS-DataTypes : 1456 2299

m-CSI.....identifier of Named Number, 7
DEFINED in MAP-MS-DataTypes : 2252

m-CSI.....identifier of [12] M-CSI
DEFINED in MAP-MS-DataTypes : 2299

NAEA-CIC.....type reference OCTET STRING
DEFINED in MAP-CommonDataTypes : 366
USED in MAP-CommonDataTypes : 40 362

naea-PreferredCI.....identifier of [15] NAEA-PreferredCI
DEFINED in MAP-MS-DataTypes : 822

NAEA-PreferredCI.....type reference SEQUENCE
DEFINED in MAP-CommonDataTypes : 361
USED in MAP-MS-DataTypes : 191 822
USED in MAP-CommonDataTypes : 39
USED in MAP-CH-DataTypes : 74 166

naea-PreferredCI.....identifier of [10] NAEA-PreferredCI
DEFINED in MAP-CH-DataTypes : 166

naea-PreferredCIC.....identifier of [0] NAEA-CIC
DEFINED in MAP-CommonDataTypes : 362

nameString.....identifier of [2] NameString
DEFINED in MAP-LCS-DataTypes : 160

NameString.....type reference USSD-String
DEFINED in MAP-LCS-DataTypes : 168
USED in MAP-LCS-DataTypes : 160

navigation.....value reference LCSServiceTypeID, 8
DEFINED in MAP-CommonDataTypes : 404

na-ESRD.....identifier of [3] ISDN-AddressString
DEFINED in MAP-LCS-DataTypes : 364

na-ESRK.....identifier of [4] ISDN-AddressString
DEFINED in MAP-LCS-DataTypes : 365

na-ESRK.....identifier of [0] ISDN-AddressString
DEFINED in MAP-LCS-DataTypes : 429

na-ESRK-Request.....identifier of [0] NULL
DEFINED in MAP-ExtensionDataTypes : 63

nbrSB.....identifier of [2] MaxMC-Bearers
DEFINED in MAP-CommonDataTypes : 477

nbrSB.....identifier of [3] MaxMC-Bearers
DEFINED in MAP-SS-DataTypes : 196

nbrSN.....identifier of [5] MC-Bearers
DEFINED in MAP-SS-DataTypes : 198

nbrUser.....identifier of [3] MC-Bearers

DEFINED in MAP-CommonDataTypes : 478

nbrUser.....identifier of [8] MC-Bearers
DEFINED in MAP-SS-DataTypes : 79

nbrUser.....identifier of [5] MC-Bearers
DEFINED in MAP-SS-DataTypes : 167

TAG R6.0 Cross Reference Listing for MAP-Protocol 2006-06-08 15:10:26 PAGE 67

nbrUser.....identifier of [4] MC-Bearers
DEFINED in MAP-SS-DataTypes : 197

neededLcsCapabilityNotSupportedInServingidentifier of [1] NULL
DEFINED in MAP-ER-DataTypes : 193

negativePW-Check.....information object reference ERROR, Information Object
DEFINED in MAP-Errors : 424
USED in MAP-SupplementaryServi : 47 141 161 238
USED in MAP-Errors : 71

netDetNotReachable.....identifier of NotReachableReason
DEFINED in MAP-MS-DataTypes : 2129

netDetNotReachable.....identifier of NotReachableReason
DEFINED in MAP-MS-DataTypes : 2139

networkAccessMode.....identifier of [24] NetworkAccessMode
DEFINED in MAP-MS-DataTypes : 827

NetworkAccessMode.....type reference ENUMERATED
DEFINED in MAP-MS-DataTypes : 866
USED in MAP-MS-DataTypes : 827

networkNode-AreaRestricted.....identifier of Named Number, 0
DEFINED in MAP-MS-DataTypes : 1378

networkNode-Number.....identifier of [1] ISDN-AddressString
DEFINED in MAP-SM-DataTypes : 85

networkNode-Number.....identifier of ISDN-AddressString
DEFINED in MAP-LCS-DataTypes : 82

NetworkResource.....type reference ENUMERATED
DEFINED in MAP-CommonDataTypes : 351
USED in MAP-CommonDataTypes : 38
USED in MAP-ER-DataTypes : 73 170 177

networkResource.....identifier of NetworkResource
DEFINED in MAP-ER-DataTypes : 170

networkResource.....identifier of NetworkResource
DEFINED in MAP-ER-DataTypes : 177

networkSignalInfo.....identifier of [10] ExternalSignalInfo
DEFINED in MAP-CH-DataTypes : 105

networkSignalInfo.....identifier of [6] ExternalSignalInfo
DEFINED in MAP-CH-DataTypes : 227

networkSignalInfo.....identifier of [4] ExternalSignalInfo
DEFINED in MAP-SS-DataTypes : 314

networkSignalInfo2.....identifier of [26] ExternalSignalInfo
DEFINED in MAP-CH-DataTypes : 122

new.....identifier of Named Number, 1
DEFINED in MAP-MS-DataTypes : 511

newPasswordsMismatch.....identifier of Named Number, 2
DEFINED in MAP-ER-DataTypes : 137

noAdditionalInformation.....identifier of Named Number, 0
DEFINED in MAP-ER-DataTypes : 347

noCUG-Restrictions.....identifier of Named Number, 0
DEFINED in MAP-MS-DataTypes : 1220

NoGroupCallNbParam.....type reference SEQUENCE
DEFINED in MAP-ER-DataTypes : 323
USED in MAP-Errors : 137 471
USED in MAP-ER-DataTypes : 45

noGroupCallNumberAvailable.....information object reference ERROR, Information Object

DEFINED in MAP-Errors : 469
USED in MAP-Group-Call-Operati : 27 53
USED in MAP-Errors : 83

noHandoverNumberAvailable.....information object reference ERROR, Information Object
DEFINED in MAP-Errors : 271
USED in MAP-MobileServiceOpera : 92 327

TAG R6.0 Cross Reference Listing for MAP-Protocol 2006-06-08 15:10:26 PAGE 68

USED in MAP-Errors : 36

noPageResponse.....identifier of Named Number, 2
DEFINED in MAP-ER-DataTypes : 252

noReply.....identifier of Named Number, 2
DEFINED in MAP-CH-DataTypes : 138

noReplyConditionTime.....identifier of [7] Ext-NoRepCondTime
DEFINED in MAP-MS-DataTypes : 1141

noReplyConditionTime.....identifier of [5] Ext-NoRepCondTime
DEFINED in MAP-MS-DataTypes : 2337

noReplyConditionTime.....identifier of [5] NoReplyConditionTime
DEFINED in MAP-SS-DataTypes : 76

NoReplyConditionTime.....type reference INTEGER
DEFINED in MAP-SS-DataTypes : 82
USED in MAP-SS-DataTypes : 30 76 104

noReplyConditionTime.....identifier of [7] NoReplyConditionTime
DEFINED in MAP-SS-DataTypes : 104

noResponseFromBusyMS.....identifier of Named Number, 3
DEFINED in MAP-CH-DataTypes : 434

noResponseFromFreeMS.....identifier of Named Number, 2
DEFINED in MAP-CH-DataTypes : 433

normal.....identifier of Named Number, 0
DEFINED in MAP-LCS-DataTypes : 410

NoRoamingNbParam.....type reference SEQUENCE
DEFINED in MAP-ER-DataTypes : 240
USED in MAP-Errors : 123 296
USED in MAP-ER-DataTypes : 33

noRoamingNumberAvailable.....information object reference ERROR, Information Object
DEFINED in MAP-Errors : 294
USED in MAP-CallHandlingOperat : 40 118
USED in MAP-Errors : 45

noSM-RP-DA.....identifier of [5] NULL
DEFINED in MAP-SM-DataTypes : 135

noSM-RP-OA.....identifier of [5] NULL
DEFINED in MAP-SM-DataTypes : 140

noSubscriberReply.....information object reference ERROR, Information Object
DEFINED in MAP-Errors : 314
USED in MAP-CallHandlingOperat : 43 99
USED in MAP-Errors : 47

NoSubscriberReplyParam.....type reference SEQUENCE
DEFINED in MAP-ER-DataTypes : 268
USED in MAP-Errors : 127 316
USED in MAP-ER-DataTypes : 36

noteMM-Event.....information object reference OPERATION, Information Object
DEFINED in MAP-MobileServiceOpera : 500
USED in MAP-Protocol : 41 128
USED in MAP-MobileServiceOpera : 70

NoteMM-EventArg.....type reference SEQUENCE
DEFINED in MAP-MS-DataTypes : 2393
USED in MAP-MobileServiceOpera : 161 502
USED in MAP-MS-DataTypes : 143

NoteMM-EventRes.....type reference SEQUENCE
DEFINED in MAP-MS-DataTypes : 2406
USED in MAP-MobileServiceOpera : 162 504
USED in MAP-MS-DataTypes : 144

noteMsPresentForGprs.....information object reference OPERATION, Information Object

DEFINED in MAP-MobileServiceOpera : 486
USED in MAP-Protocol : 40 128
USED in MAP-MobileServiceOpera : 67

NoteMsPresentForGprsArg.....type reference SEQUENCE
DEFINED in MAP-MS-DataTypes : 1903
USED in MAP-MobileServiceOpera : 159 488

TAG R6.0 Cross Reference Listing for MAP-Protocol 2006-06-08 15:10:26 PAGE 69

USED in MAP-MS-DataTypes : 139

NoteMsPresentForGprsRes.....type reference SEQUENCE
DEFINED in MAP-MS-DataTypes : 1910
USED in MAP-MobileServiceOpera : 160 490
USED in MAP-MS-DataTypes : 140

noteSubscriberDataModified.....information object reference OPERATION, Information Object
DEFINED in MAP-MobileServiceOpera : 303
USED in MAP-Protocol : 42 129
USED in MAP-MobileServiceOpera : 34

NoteSubscriberDataModifiedArg.....type reference SEQUENCE
DEFINED in MAP-MS-DataTypes : 2376
USED in MAP-MobileServiceOpera : 151 305
USED in MAP-MS-DataTypes : 127

NoteSubscriberDataModifiedRes.....type reference SEQUENCE
DEFINED in MAP-MS-DataTypes : 2387
USED in MAP-MobileServiceOpera : 152 307
USED in MAP-MS-DataTypes : 128

notForwarded.....identifier of Named Number, 1
DEFINED in MAP-MS-DataTypes : 1642

notificationToCSE.....identifier of [3] NULL
DEFINED in MAP-MS-DataTypes : 917

notificationToCSE.....identifier of [3] NULL
DEFINED in MAP-MS-DataTypes : 1496

notificationToCSE.....identifier of [0] NULL
DEFINED in MAP-MS-DataTypes : 1524

notificationToCSE.....identifier of [1] NULL
DEFINED in MAP-MS-DataTypes : 1554

notificationToCSE.....identifier of [3] NULL
DEFINED in MAP-MS-DataTypes : 1723

notificationToCSE.....identifier of [2] NULL
DEFINED in MAP-MS-DataTypes : 1783

notificationToCSE.....identifier of [2] NULL
DEFINED in MAP-MS-DataTypes : 1794

notificationToCSE.....identifier of [1] NULL
DEFINED in MAP-MS-DataTypes : 1838

notificationToCSE.....identifier of NULL
DEFINED in MAP-MS-DataTypes : 2266

notificationToCSE.....identifier of NULL
DEFINED in MAP-MS-DataTypes : 2274

notificationToCSE.....identifier of NULL
DEFINED in MAP-MS-DataTypes : 2282

notificationToCSE.....identifier of [2] NULL
DEFINED in MAP-MS-DataTypes : 2418

notificationToCSE.....identifier of [4] NULL
DEFINED in MAP-MS-DataTypes : 2427

notificationToMSUser.....identifier of [0] NotificationToMSUser
DEFINED in MAP-MS-DataTypes : 1267

notificationToMSUser.....identifier of [1] NotificationToMSUser
DEFINED in MAP-MS-DataTypes : 1309

NotificationToMSUser.....type reference ENUMERATED
DEFINED in MAP-MS-DataTypes : 1323
USED in MAP-MS-DataTypes : 87 1267 1309 1341

notificationToMSUser.....identifier of [1] NotificationToMSUser

DEFINED in MAP-MS-DataTypes : 1341

notifyAndVerify-LocationAllowedIfNoRespoidentifier of Named Number, 1
DEFINED in MAP-MS-DataTypes : 1325

notifyAndVerify-LocationNotAllowedIfNoReidentifier of Named Number, 2
DEFINED in MAP-MS-DataTypes : 1326

TAG R6.0 Cross Reference Listing for MAP-Protocol 2006-06-08 15:10:26 PAGE 70

notifyLocationAllowed.....identifier of Named Number, 0
 DEFINED in MAP-MS-DataTypes : 1324

notKnownToBePorted.....identifier of Named Number, 0
 DEFINED in MAP-MS-DataTypes : 2009

notProvidedFromSGSN.....identifier of [0] NULL
 DEFINED in MAP-MS-DataTypes : 2133

notProvidedFromVLR.....identifier of [2] NULL
 DEFINED in MAP-MS-DataTypes : 2130

notReachable.....identifier of Named Number, 0
 DEFINED in MAP-CH-DataTypes : 136

NotReachableReason.....type reference ENUMERATED
 DEFINED in MAP-MS-DataTypes : 2190
 USED in MAP-MS-DataTypes : 2129 2139

notRegistered.....identifier of Named Number, 3
 DEFINED in MAP-MS-DataTypes : 2194

npdbMismatch.....identifier of Named Number, 2
 DEFINED in MAP-ER-DataTypes : 208

nsapi.....identifier of [6] NSAPI
 DEFINED in MAP-MS-DataTypes : 2151

NSAPI.....type reference INTEGER
 DEFINED in MAP-MS-DataTypes : 2172
 USED in MAP-MS-DataTypes : 2151

numberChanged.....information object reference ERROR, Information Object
 DEFINED in MAP-Errors : 213
 USED in MAP-CallHandlingOperat : 37 94
 USED in MAP-Errors : 23

NumberChangedParam.....type reference SEQUENCE
 DEFINED in MAP-ER-DataTypes : 212
 USED in MAP-Errors : 115 215
 USED in MAP-ER-DataTypes : 26

NumberOfForwarding.....type reference INTEGER
 DEFINED in MAP-CH-DataTypes : 92
 USED in MAP-CH-DataTypes : 20 97

numberOfForwarding.....identifier of [2] NumberOfForwarding
 DEFINED in MAP-CH-DataTypes : 97

numberOfPW-AttemptsViolation.....information object reference ERROR, Information Object
 DEFINED in MAP-Errors : 427
 USED in MAP-SupplementaryServi : 48 142 162 239
 USED in MAP-Errors : 72

numberOfRequestedVectors.....identifier of NumberOfRequestedVectors
 DEFINED in MAP-MS-DataTypes : 309

numberOfRequestedVectors.....identifier of NumberOfRequestedVectors
 DEFINED in MAP-MS-DataTypes : 751

NumberOfRequestedVectors.....type reference INTEGER
 DEFINED in MAP-MS-DataTypes : 759
 USED in MAP-MS-DataTypes : 309 751

numberPortabilityStatus.....identifier of [3] NumberPortabilityStatus
 DEFINED in MAP-MS-DataTypes : 1998

NumberPortabilityStatus.....type reference ENUMERATED
 DEFINED in MAP-MS-DataTypes : 2008
 USED in MAP-MS-DataTypes : 145 1998
 USED in MAP-CH-DataTypes : 51 170

numberPortabilityStatus.....identifier of [13] NumberPortabilityStatus
 DEFINED in MAP-CH-DataTypes : 170

odb.....identifier of [2] NULL
DEFINED in MAP-MS-DataTypes : 2234

odb-Data.....identifier of [8] ODB-Data
DEFINED in MAP-MS-DataTypes : 1035

TAG R6.0 Cross Reference Listing for MAP-Protocol 2006-06-08 15:10:26 PAGE 71

ODB-Data.....type reference SEQUENCE
DEFINED in MAP-MS-DataTypes : 1060
USED in MAP-MS-DataTypes : 65 1035 2281 2353

odb-Data.....identifier of ODB-Data
DEFINED in MAP-MS-DataTypes : 2281

odb-data.....identifier of [0] ODB-Data
DEFINED in MAP-MS-DataTypes : 2353

odb-GeneralData.....identifier of ODB-GeneralData
DEFINED in MAP-MS-DataTypes : 1061

ODB-GeneralData.....type reference BIT STRING
DEFINED in MAP-MS-DataTypes : 1066
USED in MAP-MS-DataTypes : 1061 1370

odb-GeneralData.....identifier of [4] ODB-GeneralData
DEFINED in MAP-MS-DataTypes : 1370

odb-HPLMN-Data.....identifier of ODB-HPLMN-Data
DEFINED in MAP-MS-DataTypes : 1062

ODB-HPLMN-Data.....type reference BIT STRING
DEFINED in MAP-MS-DataTypes : 1102
USED in MAP-MS-DataTypes : 1062

odb-Info.....identifier of [3] ODB-Info
DEFINED in MAP-MS-DataTypes : 2223

ODB-Info.....type reference SEQUENCE
DEFINED in MAP-MS-DataTypes : 2280
USED in MAP-MS-DataTypes : 2223 2329 2381

odb-Info.....identifier of [3] ODB-Info
DEFINED in MAP-MS-DataTypes : 2329

odb-Info.....identifier of [2] ODB-Info
DEFINED in MAP-MS-DataTypes : 2381

offeredCamel4CSIs.....identifier of [6] OfferedCamel4CSIs
DEFINED in MAP-MS-DataTypes : 242

offeredCamel4CSIs.....identifier of [6] OfferedCamel4CSIs
DEFINED in MAP-MS-DataTypes : 445

offeredCamel4CSIs.....identifier of [8] OfferedCamel4CSIs
DEFINED in MAP-MS-DataTypes : 1375

OfferedCamel4CSIs.....type reference BIT STRING
DEFINED in MAP-MS-DataTypes : 1685
USED in MAP-MS-DataTypes : 79 242 445 1375 2229 2230
USED in MAP-CH-DataTypes : 42 173 242 290

offeredCamel4CSIs.....identifier of [0] OfferedCamel4CSIs
DEFINED in MAP-CH-DataTypes : 290

offeredCamel4CSIsInInterrogatingNode.....identifier of [20] OfferedCamel4CSIs
DEFINED in MAP-CH-DataTypes : 242

offeredCamel4CSIsInSGSN.....identifier of [9] OfferedCamel4CSIs
DEFINED in MAP-MS-DataTypes : 2230

offeredCamel4CSIsInVLR.....identifier of [8] OfferedCamel4CSIs
DEFINED in MAP-MS-DataTypes : 2229

offeredCamel4CSIsInVMSC.....identifier of [16] OfferedCamel4CSIs
DEFINED in MAP-CH-DataTypes : 173

OfferedCamel4Functionalities.....type reference BIT STRING
DEFINED in MAP-MS-DataTypes : 1698
USED in MAP-MS-DataTypes : 80 2403

offeredCamel4Functionalities.....identifier of [8] OfferedCamel4Functionalities
DEFINED in MAP-MS-DataTypes : 2403

old.....identifier of Named Number, 0
DEFINED in MAP-MS-DataTypes : 510

omc-Id.....identifier of [3] AddressString
DEFINED in MAP-OM-DataTypes : 40

TAG R6.0 Cross Reference Listing for MAP-Protocol 2006-06-08 15:10:26 PAGE 72

onlyMSC.....identifier of Named Number, 1
 DEFINED in MAP-MS-DataTypes : 868

onlySGSN.....identifier of Named Number, 2
 DEFINED in MAP-MS-DataTypes : 869

OPERATION.....information object class reference CLASS
 DEFINED in Remote-Operations-Info : 13
 USED in MAP-Protocol : 12 122
 USED in Remote-Operations-Info : 56 57 58
 USED in MAP-MobileServiceOpera : 78 174 187 198 210 222 236 248 263
 281 303 318 331 338 343 348 362 380
 394 407 419 433 438 441 455 471 486
 500
 USED in MAP-OperationAndMainte : 19 51 66 80
 USED in MAP-CallHandlingOperat : 26 81 105 121 134 146 159 174 187
 201 215
 USED in MAP-SupplementaryServi : 29 88 106 124 145 165 181 194 211
 226 244 251 263 281
 USED in MAP-ShortMessageServic : 23 67 83 96 115 128 138 143
 USED in MAP-Group-Call-Operati : 20 46 57 64 69
 USED in MAP-LocationServiceOpe : 19 53 68 87

OPERATION-PACKAGE.....information object class reference CLASS
 DEFINED in Remote-Operations-Info : 55

operatorBarring.....identifier of Named Number, 1
 DEFINED in MAP-ER-DataTypes : 109

operatorDeterminedBarring.....identifier of Named Number, 1
 DEFINED in MAP-MS-DataTypes : 1048

operatorDeterminedBarring.....identifier of Named Number, 3
 DEFINED in MAP-ER-DataTypes : 98

orNotSupportedInGMSC.....identifier of [16] NULL
 DEFINED in MAP-CH-DataTypes : 238

or-Capability.....identifier of [5] OR-Phase
 DEFINED in MAP-CH-DataTypes : 100

or-Interactions.....identifier of Named Number, 12
 DEFINED in MAP-MS-DataTypes : 1711

or-Interrogation.....identifier of [4] NULL
 DEFINED in MAP-CH-DataTypes : 99

or-Interrogation.....identifier of [10] NULL
 DEFINED in MAP-CH-DataTypes : 231

or-NotAllowed.....information object reference ERROR, Information Object
 DEFINED in MAP-Errors : 344
 USED in MAP-CallHandlingOperat : 35 92 116 129
 USED in MAP-Errors : 44

OR-NotAllowedParam.....type reference SEQUENCE
 DEFINED in MAP-ER-DataTypes : 195
 USED in MAP-Errors : 124 346
 USED in MAP-ER-DataTypes : 24

OR-Phase.....type reference INTEGER
 DEFINED in MAP-CH-DataTypes : 131
 USED in MAP-CH-DataTypes : 100

overrideCategory.....identifier of [1] OverrideCategory
 DEFINED in MAP-SS-DataTypes : 172

OverrideCategory.....type reference ENUMERATED
 DEFINED in MAP-SS-DataTypes : 179
 USED in MAP-SS-DataTypes : 28 172

overrideDisabled.....identifier of Named Number, 1
 DEFINED in MAP-SS-DataTypes : 181

overrideEnabled.....identifier of Named Number, 0

DEFINED in MAP-SS-DataTypes : 180

ownNumberNotPortedOut.....identifier of Named Number, 4
DEFINED in MAP-MS-DataTypes : 2013

ownNumberPortedOut.....identifier of Named Number, 1
DEFINED in MAP-MS-DataTypes : 2010

TAG R6.0 Cross Reference Listing for MAP-Protocol 2006-06-08 15:10:26 PAGE 73

o-andM-HPLMN.....identifier of Named Number, 1
 DEFINED in MAP-CommonDataTypes : 385

o-andM-VPLMN.....identifier of Named Number, 2
 DEFINED in MAP-CommonDataTypes : 386

O-BcsmCamelTDPCriteriaList.....type reference SEQUENCE OF
 DEFINED in MAP-MS-DataTypes : 1592
 USED in MAP-MS-DataTypes : 71 1454 2288 2307
 USED in MAP-CH-DataTypes : 46 264 307

o-BcsmCamelTDPCriteriaList.....identifier of [13] O-BcsmCamelTDPCriteriaList
 DEFINED in MAP-CH-DataTypes : 264

O-BcsmCamelTDPData.....type reference SEQUENCE
 DEFINED in MAP-MS-DataTypes : 1569
 USED in MAP-MS-DataTypes : 1561

o-BcsmCamelTDPDataList.....identifier of O-BcsmCamelTDPDataList
 DEFINED in MAP-MS-DataTypes : 1550

O-BcsmCamelTDPDataList.....type reference SEQUENCE OF
 DEFINED in MAP-MS-DataTypes : 1560
 USED in MAP-MS-DataTypes : 1550

O-BcsmCamelTDP-Criteria.....type reference SEQUENCE
 DEFINED in MAP-MS-DataTypes : 1598
 USED in MAP-MS-DataTypes : 1593

o-BcsmCamelTDP-CriteriaList.....identifier of [4] O-BcsmCamelTDPCriteriaList
 DEFINED in MAP-MS-DataTypes : 1454

o-BcsmCamelTDP-CriteriaList.....identifier of [1] O-BcsmCamelTDPCriteriaList
 DEFINED in MAP-MS-DataTypes : 2288

o-BcsmCamelTDP-CriteriaList.....identifier of [3] O-BcsmCamelTDPCriteriaList
 DEFINED in MAP-CH-DataTypes : 307

o-BcsmTriggerDetectionPoint.....identifier of O-BcsmTriggerDetectionPoint
 DEFINED in MAP-MS-DataTypes : 1570

O-BcsmTriggerDetectionPoint.....type reference ENUMERATED
 DEFINED in MAP-MS-DataTypes : 1580
 USED in MAP-MS-DataTypes : 1570 1599

o-BcsmTriggerDetectionPoint.....identifier of O-BcsmTriggerDetectionPoint
 DEFINED in MAP-MS-DataTypes : 1599

o-CauseValueCriteria.....identifier of [3] O-CauseValueCriteria
 DEFINED in MAP-MS-DataTypes : 1604

O-CauseValueCriteria.....type reference SEQUENCE OF
 DEFINED in MAP-MS-DataTypes : 1648
 USED in MAP-MS-DataTypes : 1604

o-csi.....identifier of Named Number, 0
 DEFINED in MAP-MS-DataTypes : 1405

o-CSI.....identifier of [0] O-CSI
 DEFINED in MAP-MS-DataTypes : 1450

O-CSI.....type reference SEQUENCE
 DEFINED in MAP-MS-DataTypes : 1549
 USED in MAP-MS-DataTypes : 69 1450 2287 2306
 USED in MAP-CH-DataTypes : 44 256 304

o-csi.....identifier of Named Number, 0
 DEFINED in MAP-MS-DataTypes : 1686

o-CSI.....identifier of Named Number, 0
 DEFINED in MAP-MS-DataTypes : 2245

o-CSI.....identifier of [0] O-CSI
 DEFINED in MAP-MS-DataTypes : 2287

o-CSI.....identifier of [5] O-CSI
DEFINED in MAP-CH-DataTypes : 256

o-CSI.....identifier of [1] O-CSI
DEFINED in MAP-CH-DataTypes : 304

TAG R6.0 Cross Reference Listing for MAP-Protocol 2006-06-08 15:10:26 PAGE 74

o-IM-BcsmCamelITDP-CriteriaList.....identifier of [19] O-BcsmCamelITDPCriteriaList
DEFINED in MAP-MS-DataTypes : 2307

o-IM-CSI.....identifier of Named Number, 11
DEFINED in MAP-MS-DataTypes : 1416

o-IM-CSI.....identifier of Named Number, 2
DEFINED in MAP-MS-DataTypes : 2258

o-IM-CSI.....identifier of [18] O-CSI
DEFINED in MAP-MS-DataTypes : 2306

padAccessCA-1200bps.....value reference BearerServiceCode, '00100010'B
DEFINED in MAP-BS-Code : 68

padAccessCA-1200-75bps.....value reference BearerServiceCode, '00100011'B
DEFINED in MAP-BS-Code : 69

padAccessCA-2400bps.....value reference BearerServiceCode, '00100100'B
DEFINED in MAP-BS-Code : 70

padAccessCA-300bps.....value reference BearerServiceCode, '00100001'B
DEFINED in MAP-BS-Code : 67

padAccessCA-4800bps.....value reference BearerServiceCode, '00100101'B
DEFINED in MAP-BS-Code : 71

padAccessCA-9600bps.....value reference BearerServiceCode, '00100110'B
DEFINED in MAP-BS-Code : 72

password.....identifier of Password
DEFINED in MAP-MS-DataTypes : 2272

password.....identifier of [3] Password
DEFINED in MAP-MS-DataTypes : 2346

password.....identifier of [2] Password
DEFINED in MAP-MS-DataTypes : 2425

Password.....type reference NumericString
DEFINED in MAP-SS-DataTypes : 243
USED in MAP-SupplementaryServi : 67 230 248
USED in MAP-MS-DataTypes : 156 2272 2346 2425
USED in MAP-SS-DataTypes : 24

pcs-Extensions.....identifier of [1] PCS-Extensions
DEFINED in MAP-ExtensionDataTypes : 33

PCS-Extensions.....type reference SEQUENCE
DEFINED in MAP-ExtensionDataTypes : 58
USED in MAP-ExtensionDataTypes : 33

pdpContextActivation.....identifier of Named Number, 8
DEFINED in MAP-MS-DataTypes : 410

pdpContextDeactivation.....identifier of Named Number, 9
DEFINED in MAP-MS-DataTypes : 411

pdp-Address.....identifier of [17] PDP-Address
DEFINED in MAP-MS-DataTypes : 882

PDP-Address.....type reference OCTET STRING
DEFINED in MAP-MS-DataTypes : 967
USED in MAP-MS-DataTypes : 882 2148

pdp-Address.....identifier of [3] PDP-Address
DEFINED in MAP-MS-DataTypes : 2148

pdp-ChargingCharacteristics.....identifier of [1] ChargingCharacteristics
DEFINED in MAP-MS-DataTypes : 889

PDP-Context.....type reference SEQUENCE
DEFINED in MAP-MS-DataTypes : 879
USED in MAP-MS-DataTypes : 875

pdp-ContextActive.....identifier of [1] NULL
DEFINED in MAP-MS-DataTypes : 2146

pdp-ContextChangeOfPosition.....identifier of Named Number, 14
DEFINED in MAP-MS-DataTypes : 954

pdp-ContextEstablishment.....identifier of Named Number, 11

TAG R6.0 Cross Reference Listing for MAP-Protocol 2006-06-08 15:10:26 PAGE 75

DEFINED in MAP-MS-DataTypes : 952

pdp-ContextEstablishmentAcknowledgement.identifier of Named Number, 12
DEFINED in MAP-MS-DataTypes : 953

pdp-ContextId.....identifier of ContextId
DEFINED in MAP-MS-DataTypes : 880

pdp-ContextIdentifier.....identifier of [0] ContextId
DEFINED in MAP-MS-DataTypes : 2145

PDP-ContextInfo.....type reference SEQUENCE
DEFINED in MAP-MS-DataTypes : 2144
USED in MAP-MS-DataTypes : 2142

PDP-ContextInfoList.....type reference SEQUENCE OF
DEFINED in MAP-MS-DataTypes : 2141
USED in MAP-MS-DataTypes : 2137 2138

pdp-Type.....identifier of [16] PDP-Type
DEFINED in MAP-MS-DataTypes : 881

PDP-Type.....type reference OCTET STRING
DEFINED in MAP-MS-DataTypes : 964
USED in MAP-MS-DataTypes : 881 2147

pdp-Type.....identifier of [2] PDP-Type
DEFINED in MAP-MS-DataTypes : 2147

permanent.....identifier of Named Number, 0
DEFINED in MAP-SS-DataTypes : 175

PermittedEncryptionAlgorithms.....type reference OCTET STRING
DEFINED in MAP-MS-DataTypes : 498
USED in MAP-MS-DataTypes : 483

PermittedIntegrityProtectionAlgorithms..type reference OCTET STRING
DEFINED in MAP-MS-DataTypes : 487
USED in MAP-MS-DataTypes : 482

personTracking.....value reference LCSServiceTypeID, 2
DEFINED in MAP-CommonDataTypes : 398

phase1.....identifier of Named Number, 0
DEFINED in MAP-MS-DataTypes : 1678

phase2.....identifier of Named Number, 1
DEFINED in MAP-MS-DataTypes : 1679

phase3.....identifier of Named Number, 2
DEFINED in MAP-MS-DataTypes : 1680

phase4.....identifier of Named Number, 3
DEFINED in MAP-MS-DataTypes : 1681

playTone.....identifier of Named Number, 6
DEFINED in MAP-MS-DataTypes : 1705

plmn.....identifier of Named Number, 0
DEFINED in MAP-CommonDataTypes : 352

plmnClientList.....identifier of [2] PLMNClientList
DEFINED in MAP-MS-DataTypes : 1277

PLMNClientList.....type reference SEQUENCE OF
DEFINED in MAP-MS-DataTypes : 1296
USED in MAP-MS-DataTypes : 1277

plmnoperator.....value reference SS-Code, '10110100'B
DEFINED in MAP-SS-Code : 168

plmnOperatorServices.....identifier of Named Number, 2
DEFINED in MAP-LCS-DataTypes : 150

plmnRoamingNotAllowed.....identifier of Named Number, 0

DEFINED in MAP-ER-DataTypes : 97

plmn-SpecificBarringType1.....identifier of Named Number, 0
DEFINED in MAP-MS-DataTypes : 1103

plmn-SpecificBarringType2.....identifier of Named Number, 1
DEFINED in MAP-MS-DataTypes : 1104

TAG R6.0 Cross Reference Listing for MAP-Protocol 2006-06-08 15:10:26 PAGE 76

plmn-SpecificBarringType3.....identifier of Named Number, 2
DEFINED in MAP-MS-DataTypes : 1105

plmn-SpecificBarringType4.....identifier of Named Number, 3
DEFINED in MAP-MS-DataTypes : 1106

plmn-specificBS-1.....value reference BearerServiceCode, '11010001'B
DEFINED in MAP-BS-Code : 110

plmn-specificBS-2.....value reference BearerServiceCode, '11010010'B
DEFINED in MAP-BS-Code : 111

plmn-specificBS-3.....value reference BearerServiceCode, '11010011'B
DEFINED in MAP-BS-Code : 112

plmn-specificBS-4.....value reference BearerServiceCode, '11010100'B
DEFINED in MAP-BS-Code : 113

plmn-specificBS-5.....value reference BearerServiceCode, '11010101'B
DEFINED in MAP-BS-Code : 114

plmn-specificBS-6.....value reference BearerServiceCode, '11010110'B
DEFINED in MAP-BS-Code : 115

plmn-specificBS-7.....value reference BearerServiceCode, '11010111'B
DEFINED in MAP-BS-Code : 116

plmn-specificBS-8.....value reference BearerServiceCode, '11011000'B
DEFINED in MAP-BS-Code : 117

plmn-specificBS-9.....value reference BearerServiceCode, '11011001'B
DEFINED in MAP-BS-Code : 118

plmn-specificBS-A.....value reference BearerServiceCode, '11011010'B
DEFINED in MAP-BS-Code : 119

plmn-specificBS-B.....value reference BearerServiceCode, '11011011'B
DEFINED in MAP-BS-Code : 120

plmn-specificBS-C.....value reference BearerServiceCode, '11011100'B
DEFINED in MAP-BS-Code : 121

plmn-specificBS-D.....value reference BearerServiceCode, '11011101'B
DEFINED in MAP-BS-Code : 122

plmn-specificBS-E.....value reference BearerServiceCode, '11011110'B
DEFINED in MAP-BS-Code : 123

plmn-specificBS-F.....value reference BearerServiceCode, '11011111'B
DEFINED in MAP-BS-Code : 124

plmn-specificSS-1.....value reference SS-Code, '11110001'B
DEFINED in MAP-SS-Code : 137

plmn-specificSS-2.....value reference SS-Code, '11110010'B
DEFINED in MAP-SS-Code : 138

plmn-specificSS-3.....value reference SS-Code, '11110011'B
DEFINED in MAP-SS-Code : 139

plmn-specificSS-4.....value reference SS-Code, '11110100'B
DEFINED in MAP-SS-Code : 140

plmn-specificSS-5.....value reference SS-Code, '11110101'B
DEFINED in MAP-SS-Code : 141

plmn-specificSS-6.....value reference SS-Code, '11110110'B
DEFINED in MAP-SS-Code : 142

plmn-specificSS-7.....value reference SS-Code, '11110111'B
DEFINED in MAP-SS-Code : 143

plmn-specificSS-8.....value reference SS-Code, '11111000'B
DEFINED in MAP-SS-Code : 144

plmn-specificSS-9.....value reference SS-Code, '11111001'B
DEFINED in MAP-SS-Code : 145

plmn-specificSS-A.....value reference SS-Code, '11111010'B
DEFINED in MAP-SS-Code : 146

TAG R6.0 Cross Reference Listing for MAP-Protocol 2006-06-08 15:10:26 PAGE 77

plmn-specificSS-B.....value reference SS-Code, '11111011'B
DEFINED in MAP-SS-Code : 147

plmn-specificSS-C.....value reference SS-Code, '11111100'B
DEFINED in MAP-SS-Code : 148

plmn-specificSS-D.....value reference SS-Code, '11111101'B
DEFINED in MAP-SS-Code : 149

plmn-specificSS-E.....value reference SS-Code, '11111110'B
DEFINED in MAP-SS-Code : 150

plmn-specificSS-F.....value reference SS-Code, '11111111'B
DEFINED in MAP-SS-Code : 151

plmn-specificTS-1.....value reference TeleserviceCode, '11010001'B
DEFINED in MAP-TS-Code : 72

plmn-specificTS-2.....value reference TeleserviceCode, '11010010'B
DEFINED in MAP-TS-Code : 73

plmn-specificTS-3.....value reference TeleserviceCode, '11010011'B
DEFINED in MAP-TS-Code : 74

plmn-specificTS-4.....value reference TeleserviceCode, '11010100'B
DEFINED in MAP-TS-Code : 75

plmn-specificTS-5.....value reference TeleserviceCode, '11010101'B
DEFINED in MAP-TS-Code : 76

plmn-specificTS-6.....value reference TeleserviceCode, '11010110'B
DEFINED in MAP-TS-Code : 77

plmn-specificTS-7.....value reference TeleserviceCode, '11010111'B
DEFINED in MAP-TS-Code : 78

plmn-specificTS-8.....value reference TeleserviceCode, '11011000'B
DEFINED in MAP-TS-Code : 79

plmn-specificTS-9.....value reference TeleserviceCode, '11011001'B
DEFINED in MAP-TS-Code : 80

plmn-specificTS-A.....value reference TeleserviceCode, '11011010'B
DEFINED in MAP-TS-Code : 81

plmn-specificTS-B.....value reference TeleserviceCode, '11011011'B
DEFINED in MAP-TS-Code : 82

plmn-specificTS-C.....value reference TeleserviceCode, '11011100'B
DEFINED in MAP-TS-Code : 83

plmn-specificTS-D.....value reference TeleserviceCode, '11011101'B
DEFINED in MAP-TS-Code : 84

plmn-specificTS-E.....value reference TeleserviceCode, '11011110'B
DEFINED in MAP-TS-Code : 85

plmn-specificTS-F.....value reference TeleserviceCode, '11011111'B
DEFINED in MAP-TS-Code : 86

polygon.....identifier of Named Number, 3
DEFINED in MAP-LCS-DataTypes : 221

PositioningDataInformation.....type reference OCTET STRING
DEFINED in MAP-LCS-DataTypes : 320
USED in MAP-LCS-DataTypes : 246 373

positionMethodFailure.....information object reference ERROR, Information Object
DEFINED in MAP-Errors : 489
USED in MAP-LocationServiceOpe : 32 84
USED in MAP-Errors : 88

positionMethodFailure-Diagnostic.....identifier of [0] PositionMethodFailure-Diagnostic
DEFINED in MAP-ER-DataTypes : 360

PositionMethodFailure-Diagnostic.....type reference ENUMERATED

DEFINED in MAP-ER-DataTypes : 364

USED in MAP-ER-DataTypes : 360

PositionMethodFailure-Param.....type reference SEQUENCE

DEFINED in MAP-ER-DataTypes : 359

USED in MAP-Errors : 143 491

TAG R6.0 Cross Reference Listing for MAP-Protocol 2006-06-08 15:10:26 PAGE 78

USED in MAP-ER-DataTypes : 51

positionMethodNotAvailableInLocationAreaIdentifier of Named Number, 8
DEFINED in MAP-ER-DataTypes : 373

positionMethodNotAvailableInNetwork.....identifier of Named Number, 7
DEFINED in MAP-ER-DataTypes : 372

preferentialCUG-Indicator.....identifier of CUG-Index
DEFINED in MAP-MS-DataTypes : 1236

premiumRateEntertainmentOGCallsBarred..identifier of Named Number, 4
DEFINED in MAP-MS-DataTypes : 1074

premiumRateInformationOGCallsBarred.....identifier of Named Number, 3
DEFINED in MAP-MS-DataTypes : 1073

prepareGroupCall.....information object reference OPERATION, Information Object
DEFINED in MAP-Group-Call-Operati : 46
USED in MAP-Protocol : 103 136
USED in MAP-Group-Call-Operati : 13

PrepareGroupCallArg.....type reference SEQUENCE
DEFINED in MAP-GR-DataTypes : 49
USED in MAP-Group-Call-Operati : 32 48
USED in MAP-GR-DataTypes : 14

PrepareGroupCallRes.....type reference SEQUENCE
DEFINED in MAP-GR-DataTypes : 61
USED in MAP-Group-Call-Operati : 33 50
USED in MAP-GR-DataTypes : 15

prepareHandover.....information object reference OPERATION, Information Object
DEFINED in MAP-MobileServiceOpera : 318
USED in MAP-Protocol : 21 123
USED in MAP-MobileServiceOpera : 38

PrepareHO-Arg.....type reference [3] SEQUENCE
DEFINED in MAP-MS-DataTypes : 517
USED in MAP-MobileServiceOpera : 124 320
USED in MAP-MS-DataTypes : 34

PrepareHO-Res.....type reference [3] SEQUENCE
DEFINED in MAP-MS-DataTypes : 576
USED in MAP-MobileServiceOpera : 125 322
USED in MAP-MS-DataTypes : 35

prepareSubsequentHandover.....information object reference OPERATION, Information Object
DEFINED in MAP-MobileServiceOpera : 348
USED in MAP-Protocol : 25 124
USED in MAP-MobileServiceOpera : 42

PrepareSubsequentHO-Arg.....type reference [3] SEQUENCE
DEFINED in MAP-MS-DataTypes : 624
USED in MAP-MobileServiceOpera : 131 350
USED in MAP-MS-DataTypes : 36

PrepareSubsequentHO-Res.....type reference [3] SEQUENCE
DEFINED in MAP-MS-DataTypes : 635
USED in MAP-MobileServiceOpera : 130 352
USED in MAP-MS-DataTypes : 37

pre-pagingSupported.....identifier of [19] NULL
DEFINED in MAP-CH-DataTypes : 115

pre-pagingSupported.....identifier of [17] NULL
DEFINED in MAP-CH-DataTypes : 239

Priority.....type reference INTEGER
DEFINED in Remote-Operations-Info : 118

priority.....identifier of [2] EMLPP-Priority
DEFINED in MAP-GR-DataTypes : 56

priorityLevel0.....value reference EMLPP-Priority, 0

DEFINED in MAP-CommonDataTypes : 468

priorityLevel1.....value reference EMLPP-Priority, 1
DEFINED in MAP-CommonDataTypes : 469

priorityLevel2.....value reference EMLPP-Priority, 2
DEFINED in MAP-CommonDataTypes : 470

TAG R6.0 Cross Reference Listing for MAP-Protocol 2006-06-08 15:10:26 PAGE 79

priorityLevel3.....value reference EMLPP-Priority, 3
DEFINED in MAP-CommonDataTypes : 471

priorityLevel4.....value reference EMLPP-Priority, 4
DEFINED in MAP-CommonDataTypes : 472

priorityLevelA.....value reference EMLPP-Priority, 6
DEFINED in MAP-CommonDataTypes : 466

priorityLevelB.....value reference EMLPP-Priority, 5
DEFINED in MAP-CommonDataTypes : 467

privacyOverride.....identifier of [1] NULL
DEFINED in MAP-LCS-DataTypes : 96

privacyOverrideNotApplicable.....identifier of Named Number, 3
DEFINED in MAP-ER-DataTypes : 350

privacyViolation.....identifier of Named Number, 5
DEFINED in MAP-LCS-DataTypes : 415

PrivateExtension.....type reference SEQUENCE
DEFINED in MAP-ExtensionDataTypes : 44
USED in MAP-ExtensionDataTypes : 15 42

privateExtensionList.....identifier of [0] PrivateExtensionList
DEFINED in MAP-ExtensionDataTypes : 32

privateExtensionList.....identifier of [0] PrivateExtensionList
DEFINED in MAP-ExtensionDataTypes : 37

PrivateExtensionList.....type reference SEQUENCE OF
DEFINED in MAP-ExtensionDataTypes : 41
USED in MAP-ExtensionDataTypes : 32 37

processAccessSignalling.....information object reference OPERATION, Information Object
DEFINED in MAP-MobileServiceOpera : 338
USED in MAP-Protocol : 23 124
USED in MAP-MobileServiceOpera : 40

ProcessAccessSignalling-Arg.....type reference [3] SEQUENCE
DEFINED in MAP-MS-DataTypes : 640
USED in MAP-MobileServiceOpera : 127 340
USED in MAP-MS-DataTypes : 38

processGroupCallSignalling.....information object reference OPERATION, Information Object
DEFINED in MAP-Group-Call-Operati : 64
USED in MAP-Protocol : 104 137
USED in MAP-Group-Call-Operati : 16

ProcessGroupCallSignallingArg.....type reference SEQUENCE
DEFINED in MAP-GR-DataTypes : 86
USED in MAP-Group-Call-Operati : 37 66
USED in MAP-GR-DataTypes : 19

processUnstructuredSS-Request.....information object reference OPERATION, Information Object
DEFINED in MAP-SupplementaryServi : 181
USED in MAP-Protocol : 78 133
USED in MAP-SupplementaryServi : 18

protocoll.....identifier of Protocolld
DEFINED in MAP-CommonDataTypes : 200

Protocolld.....type reference ENUMERATED
DEFINED in MAP-CommonDataTypes : 218
USED in MAP-CommonDataTypes : 200

provideRoamingNumber.....information object reference OPERATION, Information Object
DEFINED in MAP-CallHandlingOperat : 105
USED in MAP-Protocol : 59 130
USED in MAP-CallHandlingOperat : 14

ProvideRoamingNumberArg.....type reference SEQUENCE
DEFINED in MAP-CH-DataTypes : 221

USED in MAP-CallHandlingOperat : 57 108
USED in MAP-CH-DataTypes : 16

ProvideRoamingNumberRes.....type reference SEQUENCE
DEFINED in MAP-CH-DataTypes : 245
USED in MAP-CallHandlingOperat : 58 110
USED in MAP-CH-DataTypes : 17

TAG R6.0 Cross Reference Listing for MAP-Protocol 2006-06-08 15:10:26 PAGE 80

provideSIWFSNumber.....information object reference OPERATION, Information Object
 DEFINED in MAP-CallHandlingOperat : 134
 USED in MAP-Protocol : 61 130
 USED in MAP-CallHandlingOperat : 16

ProvideSIWFSNumberArg.....type reference SEQUENCE
 DEFINED in MAP-CH-DataTypes : 311
 USED in MAP-CallHandlingOperat : 61 136
 USED in MAP-CH-DataTypes : 23

ProvideSIWFSNumberRes.....type reference SEQUENCE
 DEFINED in MAP-CH-DataTypes : 329
 USED in MAP-CallHandlingOperat : 62 138
 USED in MAP-CH-DataTypes : 24

provideSubscriberInfo.....information object reference OPERATION, Information Object
 DEFINED in MAP-MobileServiceOpera : 236
 USED in MAP-Protocol : 34 126
 USED in MAP-MobileServiceOpera : 24

ProvideSubscriberInfoArg.....type reference SEQUENCE
 DEFINED in MAP-MS-DataTypes : 1965
 USED in MAP-MobileServiceOpera : 145 238
 USED in MAP-MS-DataTypes : 105

ProvideSubscriberInfoRes.....type reference SEQUENCE
 DEFINED in MAP-MS-DataTypes : 1972
 USED in MAP-MobileServiceOpera : 146 240
 USED in MAP-MS-DataTypes : 106

provideSubscriberLocation.....information object reference OPERATION, Information Object
 DEFINED in MAP-LocationServiceOpe : 68
 USED in MAP-Protocol : 112 138
 USED in MAP-LocationServiceOpe : 13

ProvideSubscriberLocation-Arg.....type reference SEQUENCE
 DEFINED in MAP-LCS-DataTypes : 92
 USED in MAP-LocationServiceOpe : 44 70
 USED in MAP-LCS-DataTypes : 13

ProvideSubscriberLocation-Res.....type reference SEQUENCE
 DEFINED in MAP-LCS-DataTypes : 239
 USED in MAP-LocationServiceOpe : 45 72
 USED in MAP-LCS-DataTypes : 14

provisionedSS.....identifier of [7] Ext-SS-InfoList
 DEFINED in MAP-MS-DataTypes : 1034

psi-enhancements.....identifier of Named Number, 6
 DEFINED in MAP-MS-DataTypes : 1692

ps-AttachedNotReachableForPaging.....identifier of [2] NULL
 DEFINED in MAP-MS-DataTypes : 2135

ps-AttachedReachableForPaging.....identifier of [3] NULL
 DEFINED in MAP-MS-DataTypes : 2136

ps-Detached.....identifier of [1] NULL
 DEFINED in MAP-MS-DataTypes : 2134

ps-Domain.....identifier of Named Number, 1
 DEFINED in MAP-MS-DataTypes : 2056

ps-LCS-NotSupportedByUE.....identifier of [2] NULL
 DEFINED in MAP-MS-DataTypes : 435

ps-PDP-ActiveNotReachableForPaging.....identifier of [4] PDP-ContextInfoList
 DEFINED in MAP-MS-DataTypes : 2137

ps-PDP-ActiveReachableForPaging.....identifier of [5] PDP-ContextInfoList
 DEFINED in MAP-MS-DataTypes : 2138

ps-SubscriberState.....identifier of [4] PS-SubscriberState
 DEFINED in MAP-MS-DataTypes : 1983

PS-SubscriberState.....type reference CHOICE
DEFINED in MAP-MS-DataTypes : 2132
USED in MAP-MS-DataTypes : 1983

purgedMS.....identifier of Named Number, 3
DEFINED in MAP-ER-DataTypes : 254

TAG R6.0 Cross Reference Listing for MAP-Protocol 2006-06-08 15:10:26 PAGE 81

purgeMS.....information object reference OPERATION, Information Object

DEFINED in MAP-MobileServiceOpera : 198

USED in MAP-Protocol : 18 122

USED in MAP-MobileServiceOpera : 17

PurgeMS-Arg.....type reference [3] SEQUENCE

DEFINED in MAP-MS-DataTypes : 294

USED in MAP-MobileServiceOpera : 118 200

USED in MAP-MS-DataTypes : 20

PurgeMS-Res.....type reference SEQUENCE

DEFINED in MAP-MS-DataTypes : 301

USED in MAP-MobileServiceOpera : 119 202

USED in MAP-MS-DataTypes : 21

pvlr.....identifier of Named Number, 3

DEFINED in MAP-CommonDataTypes : 355

pw-RegistrationFailure.....information object reference ERROR, Information Object

DEFINED in MAP-Errors : 419

USED in MAP-SupplementaryServi : 46 237

USED in MAP-Errors : 70

PW-RegistrationFailureCause.....type reference ENUMERATED

DEFINED in MAP-ER-DataTypes : 134

USED in MAP-Errors : 108 421

USED in MAP-ER-DataTypes : 18

qos2-Negotiated.....identifier of [20] Ext2-QoS-Subscribed

DEFINED in MAP-MS-DataTypes : 2168

qos2-Requested.....identifier of [19] Ext2-QoS-Subscribed

DEFINED in MAP-MS-DataTypes : 2166

qos2-Subscribed.....identifier of [18] Ext2-QoS-Subscribed

DEFINED in MAP-MS-DataTypes : 2164

qoSNotAttainable.....identifier of Named Number, 6

DEFINED in MAP-ER-DataTypes : 371

qos-Negotiated.....identifier of [13] Ext-QoS-Subscribed

DEFINED in MAP-MS-DataTypes : 2158

qos-Requested.....identifier of [12] Ext-QoS-Subscribed

DEFINED in MAP-MS-DataTypes : 2157

qos-Subscribed.....identifier of [18] QoS-Subscribed

DEFINED in MAP-MS-DataTypes : 883

QoS-Subscribed.....type reference OCTET STRING

DEFINED in MAP-MS-DataTypes : 974

USED in MAP-MS-DataTypes : 88 883

qos-Subscribed.....identifier of [11] Ext-QoS-Subscribed

DEFINED in MAP-MS-DataTypes : 2156

quintupletList.....identifier of [1] QuintupletList

DEFINED in MAP-MS-DataTypes : 331

QuintupletList.....type reference SEQUENCE OF

DEFINED in MAP-MS-DataTypes : 336

USED in MAP-MS-DataTypes : 331

rab-ConfigurationIndicator.....identifier of [13] NULL

DEFINED in MAP-MS-DataTypes : 473

rab-ConfigurationIndicator.....identifier of [19] NULL

DEFINED in MAP-MS-DataTypes : 540

rab-ConfigurationIndicator.....identifier of [7] NULL

DEFINED in MAP-MS-DataTypes : 633

rab-Id.....identifier of [12] RAB-Id

DEFINED in MAP-MS-DataTypes : 532

rab-Id.....identifier of RAB-Id
DEFINED in MAP-MS-DataTypes : 548

rab-Id.....identifier of RAB-Id
DEFINED in MAP-MS-DataTypes : 570

TAG R6.0 Cross Reference Listing for MAP-Protocol 2006-06-08 15:10:26 PAGE 82

rab-Id.....identifier of RAB-Id
DEFINED in MAP-MS-DataTypes : 715

RAB-Id.....type reference INTEGER
DEFINED in MAP-MS-DataTypes : 719
USED in MAP-MS-DataTypes : 532 548 570 629 645 715

RadioResource.....type reference SEQUENCE
DEFINED in MAP-MS-DataTypes : 568
USED in MAP-MS-DataTypes : 566

radioResourceInformation.....identifier of [6] RadioResourceInformation
DEFINED in MAP-MS-DataTypes : 464

radioResourceInformation.....identifier of [7] RadioResourceInformation
DEFINED in MAP-MS-DataTypes : 526

radioResourceInformation.....identifier of RadioResourceInformation
DEFINED in MAP-MS-DataTypes : 569

RadioResourceInformation.....type reference OCTET STRING
DEFINED in MAP-MS-DataTypes : 725
USED in MAP-MS-DataTypes : 464 526 569

radioResourceList.....identifier of [7] RadioResourceList
DEFINED in MAP-MS-DataTypes : 467

radioResourceList.....identifier of [11] RadioResourceList
DEFINED in MAP-MS-DataTypes : 529

RadioResourceList.....type reference SEQUENCE OF
DEFINED in MAP-MS-DataTypes : 565
USED in MAP-MS-DataTypes : 467 529

RAIdentity.....type reference OCTET STRING
DEFINED in MAP-MS-DataTypes : 2096
USED in MAP-MS-DataTypes : 110 2081

ranap-ServiceHandover.....identifier of [8] RANAP-ServiceHandover
DEFINED in MAP-MS-DataTypes : 469

ranap-ServiceHandover.....identifier of [14] RANAP-ServiceHandover
DEFINED in MAP-MS-DataTypes : 534

RANAP-ServiceHandover.....type reference OCTET STRING
DEFINED in MAP-MS-DataTypes : 558
USED in MAP-MS-DataTypes : 469 534

rand.....identifier of RAND
DEFINED in MAP-MS-DataTypes : 340

rand.....identifier of RAND
DEFINED in MAP-MS-DataTypes : 346

RAND.....type reference OCTET STRING
DEFINED in MAP-MS-DataTypes : 368
USED in MAP-MS-DataTypes : 340 346 397 762

rand.....identifier of RAND
DEFINED in MAP-MS-DataTypes : 397

rand.....identifier of RAND
DEFINED in MAP-MS-DataTypes : 762

readyForSM.....information object reference OPERATION, Information Object
DEFINED in MAP-ShortMessageService : 143
USED in MAP-Protocol : 97 136
USED in MAP-ShortMessageService : 19

ReadyForSM-Arg.....type reference SEQUENCE
DEFINED in MAP-SM-DataTypes : 201
USED in MAP-ShortMessageService : 56 145
USED in MAP-SM-DataTypes : 24

ReadyForSM-Res.....type reference SEQUENCE

DEFINED in MAP-SM-DataTypes : 210
USED in MAP-ShortMessageService : 57 147
USED in MAP-SM-DataTypes : 25

recall.....identifier of Named Number, 1
DEFINED in MAP-SS-DataTypes : 286

TAG R6.0 Cross Reference Listing for MAP-Protocol 2006-06-08 15:10:26 PAGE 83

regionalSubscNotSupported.....identifier of Named Number, 3
 DEFINED in MAP-MS-DataTypes : 1381

regionalSubscriptionData.....identifier of [10] ZoneCodeList
 DEFINED in MAP-MS-DataTypes : 1037

regionalSubscriptionIdentifier.....identifier of [5] ZoneCode
 DEFINED in MAP-MS-DataTypes : 1390

regionalSubscriptionResponse.....identifier of [5] RegionalSubscriptionResponse
 DEFINED in MAP-MS-DataTypes : 1371

RegionalSubscriptionResponse.....type reference ENUMERATED
 DEFINED in MAP-MS-DataTypes : 1377
 USED in MAP-MS-DataTypes : 1371 1445

regionalSubscriptionResponse.....identifier of [0] RegionalSubscriptionResponse
 DEFINED in MAP-MS-DataTypes : 1445

registerCC-Entry.....information object reference OPERATION, Information Object
 DEFINED in MAP-SupplementaryServi : 263
 USED in MAP-Protocol : 84 134
 USED in MAP-SupplementaryServi : 24

RegisterCC-EntryArg.....type reference SEQUENCE
 DEFINED in MAP-SS-DataTypes : 304
 USED in MAP-SupplementaryServi : 71 265
 USED in MAP-SS-DataTypes : 37

RegisterCC-EntryRes.....type reference SEQUENCE
 DEFINED in MAP-SS-DataTypes : 323
 USED in MAP-SupplementaryServi : 72 267
 USED in MAP-SS-DataTypes : 38

registerPassword.....information object reference OPERATION, Information Object
 DEFINED in MAP-SupplementaryServi : 226
 USED in MAP-Protocol : 81 134
 USED in MAP-SupplementaryServi : 21

registerSS.....information object reference OPERATION, Information Object
 DEFINED in MAP-SupplementaryServi : 88
 USED in MAP-Protocol : 73 132
 USED in MAP-SupplementaryServi : 13

RegisterSS-Arg.....type reference SEQUENCE
 DEFINED in MAP-SS-DataTypes : 71
 USED in MAP-SupplementaryServi : 61 90
 USED in MAP-SS-DataTypes : 14

registrationAllCF-Barred.....identifier of Named Number, 24
 DEFINED in MAP-MS-DataTypes : 1091

registrationCFNotToHPLMN-Barred.....identifier of Named Number, 25
 DEFINED in MAP-MS-DataTypes : 1092

registrationInternationalCF-Barred.....identifier of Named Number, 28
 DEFINED in MAP-MS-DataTypes : 1095

registrationInterzonalCFNotToHPLMN-Barreidentifier of Named Number, 27
 DEFINED in MAP-MS-DataTypes : 1094

registrationInterzonalCF-Barred.....identifier of Named Number, 26
 DEFINED in MAP-MS-DataTypes : 1093

rejected.....identifier of Named Number, 1
 DEFINED in MAP-CH-DataTypes : 432

releaseCall.....identifier of Named Number, 1
 DEFINED in MAP-MS-DataTypes : 1664

releaseGroupCall.....identifier of [2] NULL
 DEFINED in MAP-GR-DataTypes : 89

releaseTransaction.....identifier of Named Number, 1
 DEFINED in MAP-MS-DataTypes : 943

releaseTransaction.....identifier of Named Number, 1
DEFINED in MAP-MS-DataTypes : 1772

RelocationNumber.....type reference SEQUENCE
DEFINED in MAP-MS-DataTypes : 713
USED in MAP-MS-DataTypes : 709

TAG R6.0 Cross Reference Listing for MAP-Protocol 2006-06-08 15:10:26 PAGE 84

relocationNumberList.....identifier of [1] RelocationNumberList
 DEFINED in MAP-MS-DataTypes : 578

RelocationNumberList.....type reference SEQUENCE OF
 DEFINED in MAP-MS-DataTypes : 708
 USED in MAP-MS-DataTypes : 578

remoteUserFree.....information object reference OPERATION, Information Object
 DEFINED in MAP-CallHandlingOperat : 187
 USED in MAP-Protocol : 65 131
 USED in MAP-CallHandlingOperat : 20

RemoteUserFreeArg.....type reference SEQUENCE
 DEFINED in MAP-CH-DataTypes : 415
 USED in MAP-CallHandlingOperat : 69 189
 USED in MAP-CH-DataTypes : 31

RemoteUserFreeRes.....type reference SEQUENCE
 DEFINED in MAP-CH-DataTypes : 425
 USED in MAP-CallHandlingOperat : 70 191
 USED in MAP-CH-DataTypes : 32

Remote-Operations-Information-Objects...module reference
 DEFINED in Remote-Operations-Info : 3
 USED in MAP-Protocol : 13
 USED in MAP-MobileServiceOpera : 79
 USED in MAP-OperationAndMainte : 20
 USED in MAP-CallHandlingOperat : 27
 USED in MAP-SupplementaryServi : 30
 USED in MAP-ShortMessageServic : 24
 USED in MAP-Group-Call-Operati : 21
 USED in MAP-LocationServiceOpe : 20
 USED in MAP-Errors : 99

replaceB-Number.....identifier of [4] NULL
 DEFINED in MAP-CH-DataTypes : 420

ReportingState.....type reference ENUMERATED
 DEFINED in MAP-CH-DataTypes : 352
 USED in MAP-CH-DataTypes : 348

reportSM-DeliveryStatus.....information object reference OPERATION, Information Object
 DEFINED in MAP-ShortMessageServic : 115
 USED in MAP-Protocol : 94 135
 USED in MAP-ShortMessageServic : 16

ReportSM-DeliveryStatusArg.....type reference SEQUENCE
 DEFINED in MAP-SM-DataTypes : 142
 USED in MAP-ShortMessageServic : 52 117
 USED in MAP-SM-DataTypes : 20

ReportSM-DeliveryStatusRes.....type reference SEQUENCE
 DEFINED in MAP-SM-DataTypes : 170
 USED in MAP-ShortMessageServic : 53 119
 USED in MAP-SM-DataTypes : 21

request.....identifier of Named Number, 0
 DEFINED in MAP-SS-DataTypes : 285

requestedBasicServiceViolatesCUG-Constraidentifier of Named Number, 5
 DEFINED in MAP-ER-DataTypes : 125

requestedCAMEL-SubscriptionInfo.....identifier of [3] RequestedCAMEL-SubscriptionInfo
 DEFINED in MAP-MS-DataTypes : 2235

RequestedCAMEL-SubscriptionInfo.....type reference ENUMERATED
 DEFINED in MAP-MS-DataTypes : 2244
 USED in MAP-MS-DataTypes : 2235 2359

requestedCamel-SubscriptionInfo.....identifier of [0] RequestedCAMEL-SubscriptionInfo
 DEFINED in MAP-MS-DataTypes : 2359

requestedDomain.....identifier of [4] DomainType
 DEFINED in MAP-MS-DataTypes : 2047

requestedEquipmentInfo.....identifier of RequestedEquipmentInfo
DEFINED in MAP-MS-DataTypes : 783

RequestedEquipmentInfo.....type reference BIT STRING
DEFINED in MAP-MS-DataTypes : 793
USED in MAP-MS-DataTypes : 783

TAG R6.0 Cross Reference Listing for MAP-Protocol 2006-06-08 15:10:26 PAGE 85

requestedInfo.....identifier of [2] RequestedInfo
 DEFINED in MAP-MS-DataTypes : 1968

RequestedInfo.....type reference SEQUENCE
 DEFINED in MAP-MS-DataTypes : 2041
 USED in MAP-MS-DataTypes : 1968 2200

requestedInfo.....identifier of [1] RequestedInfo
 DEFINED in MAP-MS-DataTypes : 2200

requestedSS-Info.....identifier of [1] SS-ForBS-Code
 DEFINED in MAP-MS-DataTypes : 2233

requestedSubscriptionInfo.....identifier of [1] RequestedSubscriptionInfo
 DEFINED in MAP-MS-DataTypes : 2214

RequestedSubscriptionInfo.....type reference SEQUENCE
 DEFINED in MAP-MS-DataTypes : 2232
 USED in MAP-MS-DataTypes : 2214

requestingNodeType.....identifier of [3] RequestingNodeType
 DEFINED in MAP-MS-DataTypes : 757

RequestingNodeType.....type reference ENUMERATED
 DEFINED in MAP-MS-DataTypes : 771
 USED in MAP-MS-DataTypes : 757

requestorIDString.....identifier of [1] RequestorIDString
 DEFINED in MAP-LCS-DataTypes : 174

RequestorIDString.....type reference USSD-String
 DEFINED in MAP-LCS-DataTypes : 177
 USED in MAP-LCS-DataTypes : 174

reset.....information object reference OPERATION, Information Object
 DEFINED in MAP-MobileServiceOpera : 433
 USED in MAP-Protocol : 31 126
 USED in MAP-MobileServiceOpera : 56

ResetArg.....type reference SEQUENCE
 DEFINED in MAP-MS-DataTypes : 1916
 USED in MAP-MobileServiceOpera : 142 435
 USED in MAP-MS-DataTypes : 95

resourceLimitation.....information object reference ERROR, Information Object
 DEFINED in MAP-Errors : 198
 USED in MAP-CallHandlingOperat : 48 140 153 170 209 223
 USED in MAP-LocationServiceOpe : 33 95
 USED in MAP-Errors : 19

ResourceLimitationParam.....type reference SEQUENCE
 DEFINED in MAP-ER-DataTypes : 319
 USED in MAP-Errors : 136 200
 USED in MAP-ER-DataTypes : 44

responseTime.....identifier of [3] ResponseTime
 DEFINED in MAP-LCS-DataTypes : 189

ResponseTime.....type reference SEQUENCE
 DEFINED in MAP-LCS-DataTypes : 205
 USED in MAP-LCS-DataTypes : 21 189

responseTimeCategory.....identifier of ResponseTimeCategory
 DEFINED in MAP-LCS-DataTypes : 206

ResponseTimeCategory.....type reference ENUMERATED
 DEFINED in MAP-LCS-DataTypes : 210
 USED in MAP-LCS-DataTypes : 206

restoreData.....information object reference OPERATION, Information Object
 DEFINED in MAP-MobileServiceOpera : 441
 USED in MAP-Protocol : 33 126
 USED in MAP-MobileServiceOpera : 58

RestoreDataArg.....type reference SEQUENCE
DEFINED in MAP-MS-DataTypes : 1921
USED in MAP-MobileServiceOpera : 143 443
USED in MAP-MS-DataTypes : 96

RestoreDataRes.....type reference SEQUENCE
DEFINED in MAP-MS-DataTypes : 1928

TAG R6.0 Cross Reference Listing for MAP-Protocol 2006-06-08 15:10:26 PAGE 86

USED in MAP-MobileServiceOpera : 144 445
USED in MAP-MS-DataTypes : 97

restrictedArea.....identifier of Named Number, 2
DEFINED in MAP-MS-DataTypes : 2193

restrictedArea.....identifier of Named Number, 1
DEFINED in MAP-ER-DataTypes : 251

resumeCallHandling.....information object reference OPERATION, Information Object
DEFINED in MAP-CallHandlingOperat : 121
USED in MAP-Protocol : 60 130
USED in MAP-CallHandlingOperat : 15

ResumeCallHandlingArg.....type reference SEQUENCE
DEFINED in MAP-CH-DataTypes : 250
USED in MAP-CallHandlingOperat : 59 123
USED in MAP-CH-DataTypes : 18

ResumeCallHandlingRes.....type reference SEQUENCE
DEFINED in MAP-CH-DataTypes : 281
USED in MAP-CallHandlingOperat : 60 125
USED in MAP-CH-DataTypes : 19

re-attempt.....identifier of BOOLEAN
DEFINED in MAP-MS-DataTypes : 395

re-synchronisationInfo.....identifier of Re-synchronisationInfo
DEFINED in MAP-MS-DataTypes : 754

Re-synchronisationInfo.....type reference SEQUENCE
DEFINED in MAP-MS-DataTypes : 761
USED in MAP-MS-DataTypes : 754

RNCId.....type reference OCTET STRING
DEFINED in MAP-MS-DataTypes : 696
USED in MAP-MS-DataTypes : 520 627

rnc-Address.....identifier of [16] GSN-Address
DEFINED in MAP-MS-DataTypes : 2161

roadsideAssistance.....value reference LCSServiceTypeID, 6
DEFINED in MAP-CommonDataTypes : 402

roamerAccessToHPLMN-AP-Barred.....identifier of Named Number, 16
DEFINED in MAP-MS-DataTypes : 1083

roamerAccessToVPLMN-AP-Barred.....identifier of Named Number, 17
DEFINED in MAP-MS-DataTypes : 1084

roamingNotAllowed.....information object reference ERROR, Information Object
DEFINED in MAP-Errors : 235
USED in MAP-MobileServiceOpera : 90 184 231
USED in MAP-Errors : 29

roamingNotAllowedCause.....identifier of RoamingNotAllowedCause
DEFINED in MAP-ER-DataTypes : 92

RoamingNotAllowedCause.....type reference ENUMERATED
DEFINED in MAP-ER-DataTypes : 96
USED in MAP-ER-DataTypes : 92

RoamingNotAllowedParam.....type reference SEQUENCE
DEFINED in MAP-ER-DataTypes : 91
USED in MAP-Errors : 117 237
USED in MAP-ER-DataTypes : 14

roamingNumber.....identifier of ISDN-AddressString
DEFINED in MAP-CH-DataTypes : 207

roamingNumber.....identifier of ISDN-AddressString
DEFINED in MAP-CH-DataTypes : 246

roamingOutsidePLMNCountryIC-CallsBarredidentifier of Named Number, 21
DEFINED in MAP-MS-DataTypes : 1088

roamingOutsidePLMNIC-CallsBarred.....identifier of Named Number, 20
DEFINED in MAP-MS-DataTypes : 1087

roamingOutsidePLMNOG-CallsBarred.....identifier of Named Number, 18
DEFINED in MAP-MS-DataTypes : 1085

TAG R6.0 Cross Reference Listing for MAP-Protocol 2006-06-08 15:10:26 PAGE 87

roamingOutsidePLMN-Barred.....identifier of Named Number, 22
 DEFINED in MAP-MS-DataTypes : 1089

roamingOutsidePLMN-CountryBarred.....identifier of Named Number, 23
 DEFINED in MAP-MS-DataTypes : 1090

roamingRestrictedInSgsnDueToUnsupportedFidentifier of [23] NULL
 DEFINED in MAP-MS-DataTypes : 825

roamingRestrictedInSgsnDueToUnsuppportedidentifier of [11] NULL
 DEFINED in MAP-MS-DataTypes : 1397

roamingRestrictionDueToUnsupportedFeaturidentifier of [9] NULL
 DEFINED in MAP-MS-DataTypes : 1036

roamingRestrictionDueToUnsupportedFeaturidentifier of [4] NULL
 DEFINED in MAP-MS-DataTypes : 1389

routeingAreaidentity.....identifier of [1] RAIdentity
 DEFINED in MAP-MS-DataTypes : 2081

routeingNumber.....identifier of [0] RouteingNumber
 DEFINED in MAP-MS-DataTypes : 1995

RouteingNumber.....type reference TBCD-STRING
 DEFINED in MAP-MS-DataTypes : 2005
 USED in MAP-MS-DataTypes : 114 1995

routeSelectFailure.....identifier of Named Number, 4
 DEFINED in MAP-MS-DataTypes : 1583

routingAreaUpdating.....identifier of Named Number, 6
 DEFINED in MAP-MS-DataTypes : 408

RoutingInfo.....type reference CHOICE
 DEFINED in MAP-CH-DataTypes : 206
 USED in MAP-CH-DataTypes : 174 293

routingInfo.....identifier of RoutingInfo
 DEFINED in MAP-CH-DataTypes : 293

routingInfo2.....identifier of [17] RoutingInfo
 DEFINED in MAP-CH-DataTypes : 174

RoutingInfoForLCS-Arg.....type reference SEQUENCE
 DEFINED in MAP-LCS-DataTypes : 68
 USED in MAP-LocationServiceOpe : 42 55
 USED in MAP-LCS-DataTypes : 11

RoutingInfoForLCS-Res.....type reference SEQUENCE
 DEFINED in MAP-LCS-DataTypes : 74
 USED in MAP-LocationServiceOpe : 43 57
 USED in MAP-LCS-DataTypes : 12

RoutingInfoForSM-Arg.....type reference SEQUENCE
 DEFINED in MAP-SM-DataTypes : 53
 USED in MAP-ShortMessageServic : 46 69
 USED in MAP-SM-DataTypes : 14

RoutingInfoForSM-Res.....type reference SEQUENCE
 DEFINED in MAP-SM-DataTypes : 78
 USED in MAP-ShortMessageServic : 47 71
 USED in MAP-SM-DataTypes : 15

routingToNearestCommercialEnterprise....value reference LCSServiceTypeID, 7
 DEFINED in MAP-CommonDataTypes : 403

rss.....identifier of Named Number, 7
 DEFINED in MAP-CommonDataTypes : 359

ruf-Outcome.....identifier of [0] RUF-Outcome
 DEFINED in MAP-CH-DataTypes : 426

RUF-Outcome.....type reference ENUMERATED
 DEFINED in MAP-CH-DataTypes : 430

USED in MAP-CH-DataTypes : 426

sai-Present.....identifier of [9] NULL
DEFINED in MAP-MS-DataTypes : 2073

sai-Present.....identifier of [6] NULL
DEFINED in MAP-MS-DataTypes : 2087

TAG R6.0 Cross Reference Listing for MAP-Protocol 2006-06-08 15:10:26 PAGE 88

sc-AddressNotIncluded.....identifier of Named Number, 0
 DEFINED in MAP-SM-DataTypes : 194

sc-Congestion.....identifier of Named Number, 4
 DEFINED in MAP-ER-DataTypes : 145

secondServiceAllowed.....identifier of Named Number, 1
 DEFINED in MAP-CH-DataTypes : 183

segmentationProhibited.....identifier of NULL
 DEFINED in MAP-MS-DataTypes : 313

segmentationProhibited.....identifier of NULL
 DEFINED in MAP-MS-DataTypes : 752

selectedGSM-Algorithm.....identifier of [2] SelectedGSM-Algorithm
 DEFINED in MAP-MS-DataTypes : 643

SelectedGSM-Algorithm.....type reference OCTET STRING
 DEFINED in MAP-MS-DataTypes : 682
 USED in MAP-MS-DataTypes : 643

selectedLSAIdentity.....identifier of [4] LSAIdentity
 DEFINED in MAP-MS-DataTypes : 2084

selectedLSA-Id.....identifier of [5] LSAIdentity
 DEFINED in MAP-MS-DataTypes : 2069

selectedRab-Id.....identifier of [4] RAB-Id
 DEFINED in MAP-MS-DataTypes : 629

selectedRab-Id.....identifier of [4] RAB-Id
 DEFINED in MAP-MS-DataTypes : 645

selectedUMTS-Algorithms.....identifier of [5] SelectedUMTS-Algorithms
 DEFINED in MAP-MS-DataTypes : 582

SelectedUMTS-Algorithms.....type reference SEQUENCE
 DEFINED in MAP-MS-DataTypes : 589
 USED in MAP-MS-DataTypes : 582 642

selectedUMTS-Algorithms.....identifier of [1] SelectedUMTS-Algorithms
 DEFINED in MAP-MS-DataTypes : 642

sendAuthenticationInfo.....information object reference OPERATION, Information Object
 DEFINED in MAP-MobileServiceOpera : 362
 USED in MAP-Protocol : 26 125
 USED in MAP-MobileServiceOpera : 45

SendAuthenticationInfoArg.....type reference SEQUENCE
 DEFINED in MAP-MS-DataTypes : 749
 USED in MAP-MobileServiceOpera : 132 364
 USED in MAP-MS-DataTypes : 44

SendAuthenticationInfoRes.....type reference [3] SEQUENCE
 DEFINED in MAP-MS-DataTypes : 766
 USED in MAP-MobileServiceOpera : 133 371
 USED in MAP-MS-DataTypes : 45

sendEndSignal.....information object reference OPERATION, Information Object
 DEFINED in MAP-MobileServiceOpera : 331
 USED in MAP-Protocol : 22 123
 USED in MAP-MobileServiceOpera : 39

SendEndSignal-Arg.....type reference [3] SEQUENCE
 DEFINED in MAP-MS-DataTypes : 687
 USED in MAP-MobileServiceOpera : 128 333
 USED in MAP-MS-DataTypes : 39

SendEndSignal-Res.....type reference SEQUENCE
 DEFINED in MAP-MS-DataTypes : 692
 USED in MAP-MobileServiceOpera : 129 335
 USED in MAP-MS-DataTypes : 40

sendGroupCallEndSignal.....information object reference OPERATION, Information Object
DEFINED in MAP-Group-Call-Operati : 57
USED in MAP-Protocol : 106 137
USED in MAP-Group-Call-Operati : 14

SendGroupCallEndSignalArg.....type reference SEQUENCE
DEFINED in MAP-GR-DataTypes : 66

TAG R6.0 Cross Reference Listing for MAP-Protocol 2006-06-08 15:10:26 PAGE 89

USED in MAP-Group-Call-Operati : 34 59
 USED in MAP-GR-DataTypes : 16

SendGroupCallEndSignalRes.....type reference SEQUENCE
 DEFINED in MAP-GR-DataTypes : 71
 USED in MAP-Group-Call-Operati : 35 61
 USED in MAP-GR-DataTypes : 17

sendIdentification.....information object reference OPERATION, Information Object
 DEFINED in MAP-MobileServiceOpera : 210
 USED in MAP-Protocol : 19 123
 USED in MAP-MobileServiceOpera : 18

SendIdentificationArg.....type reference SEQUENCE
 DEFINED in MAP-MS-DataTypes : 307
 USED in MAP-MobileServiceOpera : 120 212
 USED in MAP-MS-DataTypes : 22

SendIdentificationRes.....type reference [3] SEQUENCE
 DEFINED in MAP-MS-DataTypes : 317
 USED in MAP-MobileServiceOpera : 121 214
 USED in MAP-MS-DataTypes : 23

sendIMSI.....information object reference OPERATION, Information Object
 DEFINED in MAP-OperationAndMainte : 80
 USED in MAP-Protocol : 52 129
 USED in MAP-OperationAndMainte : 15

sendRoutingInfo.....information object reference OPERATION, Information Object
 DEFINED in MAP-CallHandlingOperat : 81
 USED in MAP-Protocol : 58 130
 USED in MAP-CallHandlingOperat : 13

SendRoutingInfoArg.....type reference SEQUENCE
 DEFINED in MAP-CH-DataTypes : 94
 USED in MAP-CallHandlingOperat : 55 84
 USED in MAP-CH-DataTypes : 14

sendRoutingInfoForGprs.....information object reference OPERATION, Information Object
 DEFINED in MAP-MobileServiceOpera : 455
 USED in MAP-Protocol : 38 128
 USED in MAP-MobileServiceOpera : 61

SendRoutingInfoForGprsArg.....type reference SEQUENCE
 DEFINED in MAP-MS-DataTypes : 1873
 USED in MAP-MobileServiceOpera : 155 457
 USED in MAP-MS-DataTypes : 131

SendRoutingInfoForGprsRes.....type reference SEQUENCE
 DEFINED in MAP-MS-DataTypes : 1880
 USED in MAP-MobileServiceOpera : 156 459
 USED in MAP-MS-DataTypes : 132

sendRoutingInfoForLCS.....information object reference OPERATION, Information Object
 DEFINED in MAP-LocationServiceOpe : 53
 USED in MAP-Protocol : 113 138
 USED in MAP-LocationServiceOpe : 14

sendRoutingInfoForSM.....information object reference OPERATION, Information Object
 DEFINED in MAP-ShortMessageServic : 67
 USED in MAP-Protocol : 91 135
 USED in MAP-ShortMessageServic : 13

SendRoutingInfoRes.....type reference [3] SEQUENCE
 DEFINED in MAP-CH-DataTypes : 151
 USED in MAP-CallHandlingOperat : 56 86
 USED in MAP-CH-DataTypes : 15

sendSubscriberData.....identifier of [0] NULL
 DEFINED in MAP-MS-DataTypes : 245

serviceCentreAddress.....identifier of [2] AddressString
 DEFINED in MAP-SM-DataTypes : 56

serviceCentreAddress.....identifier of AddressString

DEFINED in MAP-SM-DataTypes : 144

serviceCentreAddress.....identifier of AddressString
DEFINED in MAP-SM-DataTypes : 178

serviceCentreAddressDA.....identifier of [4] AddressString
DEFINED in MAP-SM-DataTypes : 134

TAG R6.0 Cross Reference Listing for MAP-Protocol 2006-06-08 15:10:26 PAGE 90

serviceCentreAddressOA.....identifier of [4] AddressString
 DEFINED in MAP-SM-DataTypes : 139

serviceGranted.....identifier of Named Number, 0
 DEFINED in MAP-MS-DataTypes : 1047

serviceIndicator.....identifier of [2] ServiceIndicator
 DEFINED in MAP-SS-DataTypes : 312

ServiceIndicator.....type reference BIT STRING
 DEFINED in MAP-SS-DataTypes : 317
 USED in MAP-SS-DataTypes : 312

serviceKey.....identifier of [1] ServiceKey
 DEFINED in MAP-MS-DataTypes : 934

serviceKey.....identifier of ServiceKey
 DEFINED in MAP-MS-DataTypes : 1514

serviceKey.....identifier of ServiceKey
 DEFINED in MAP-MS-DataTypes : 1571

ServiceKey.....type reference INTEGER
 DEFINED in MAP-MS-DataTypes : 1578
 USED in MAP-MS-DataTypes : 74 934 1514 1571 1741 1780 1791 1855 2394

serviceKey.....identifier of [1] ServiceKey
 DEFINED in MAP-MS-DataTypes : 1741

serviceKey.....identifier of ServiceKey
 DEFINED in MAP-MS-DataTypes : 1780

serviceKey.....identifier of ServiceKey
 DEFINED in MAP-MS-DataTypes : 1791

serviceKey.....identifier of ServiceKey
 DEFINED in MAP-MS-DataTypes : 1855

serviceKey.....identifier of ServiceKey
 DEFINED in MAP-MS-DataTypes : 2394

serviceRequest.....identifier of Named Number, 7
 DEFINED in MAP-MS-DataTypes : 409

ServiceType.....type reference SEQUENCE
 DEFINED in MAP-MS-DataTypes : 1338
 USED in MAP-MS-DataTypes : 1334

serviceType.....value reference SS-Code, '10110101'B
 DEFINED in MAP-SS-Code : 170

serviceTypeIdentity.....identifier of LCSServiceTypeID
 DEFINED in MAP-MS-DataTypes : 1339

serviceTypeList.....identifier of [5] ServiceTypeList
 DEFINED in MAP-MS-DataTypes : 1284

ServiceTypeList.....type reference SEQUENCE OF
 DEFINED in MAP-MS-DataTypes : 1333
 USED in MAP-MS-DataTypes : 1284

setReportingState.....information object reference OPERATION, Information Object
 DEFINED in MAP-CallHandlingOperat : 159
 USED in MAP-Protocol : 63 131
 USED in MAP-CallHandlingOperat : 18

SetReportingStateArg.....type reference SEQUENCE
 DEFINED in MAP-CH-DataTypes : 345
 USED in MAP-CallHandlingOperat : 65 161
 USED in MAP-CH-DataTypes : 27

SetReportingStateRes.....type reference SEQUENCE
 DEFINED in MAP-CH-DataTypes : 360
 USED in MAP-CallHandlingOperat : 66 163

USED in MAP-CH-DataTypes : 28

sgsn.....identifier of Named Number, 1
DEFINED in MAP-MS-DataTypes : 773

sgsn-Address.....identifier of GSN-Address
DEFINED in MAP-MS-DataTypes : 430

TAG R6.0 Cross Reference Listing for MAP-Protocol 2006-06-08 15:10:26 PAGE 91

sgsn-Address.....identifier of [0] GSN-Address
DEFINED in MAP-MS-DataTypes : 1881

sgsn-Address.....identifier of [1] GSN-Address
DEFINED in MAP-MS-DataTypes : 1905

sgsn-CAMEL-SubscriptionInfo.....identifier of [17] SGSN-CAMEL-SubscriptionInfo
DEFINED in MAP-MS-DataTypes : 835

SGSN-CAMEL-SubscriptionInfo.....type reference SEQUENCE
DEFINED in MAP-MS-DataTypes : 903
USED in MAP-MS-DataTypes : 835

sgsn-Capability.....identifier of [0] SGSN-Capability
DEFINED in MAP-MS-DataTypes : 433

SGSN-Capability.....type reference SEQUENCE
DEFINED in MAP-MS-DataTypes : 437
USED in MAP-MS-DataTypes : 433

sgsn-Number.....identifier of [1] ISDN-AddressString
DEFINED in MAP-MS-DataTypes : 297

sgsn-Number.....identifier of [1] ISDN-AddressString
DEFINED in MAP-MS-DataTypes : 399

sgsn-Number.....identifier of ISDN-AddressString
DEFINED in MAP-MS-DataTypes : 429

sgsn-Number.....identifier of [3] ISDN-AddressString
DEFINED in MAP-MS-DataTypes : 2083

sgsn-Number.....identifier of [1] ISDN-AddressString
DEFINED in MAP-SM-DataTypes : 98

shapeOfLocationEstimateNotSupported.....identifier of Named Number, 6
DEFINED in MAP-LCS-DataTypes : 417

shapeOfLocationEstimateNotSupported.....identifier of [0] NULL
DEFINED in MAP-ER-DataTypes : 192

shortMessage.....identifier of Named Number, 4
DEFINED in MAP-MS-DataTypes : 406

shortMessageMO-PP.....value reference TeleserviceCode, '00100010'B
DEFINED in MAP-TS-Code : 46

shortMessageMT-PP.....value reference TeleserviceCode, '00100001'B
DEFINED in MAP-TS-Code : 45

shortTermDenial.....information object reference ERROR, Information Object
DEFINED in MAP-Errors : 430
USED in MAP-SupplementaryServi : 54 276
USED in MAP-Errors : 73

ShortTermDenialParam.....type reference SEQUENCE
DEFINED in MAP-ER-DataTypes : 331
USED in MAP-Errors : 139 432
USED in MAP-ER-DataTypes : 47

signallInfo.....identifier of SignallInfo
DEFINED in MAP-CommonDataTypes : 201

SignallInfo.....type reference OCTET STRING
DEFINED in MAP-CommonDataTypes : 208
USED in MAP-CommonDataTypes : 24 201 227
USED in MAP-SM-DataTypes : 34 108 114 121 127
USED in MAP-ER-DataTypes : 71 151

signallInfo.....identifier of SignallInfo
DEFINED in MAP-CommonDataTypes : 227

signallInfo.....identifier of LongSignallInfo
DEFINED in MAP-CommonDataTypes : 244

sIWFSNumber.....identifier of [0] ISDN-AddressString
DEFINED in MAP-CH-DataTypes : 330

SIWFSSignallingModifyArg.....type reference SEQUENCE
DEFINED in MAP-CH-DataTypes : 334
USED in MAP-CallHandlingOperat : 63 148

TAG R6.0 Cross Reference Listing for MAP-Protocol 2006-06-08 15:10:26 PAGE 92

USED in MAP-CH-DataTypes : 25

SIWFSSignallingModifyRes.....type reference SEQUENCE
 DEFINED in MAP-CH-DataTypes : 340
 USED in MAP-CallHandlingOperat : 64 150
 USED in MAP-CH-DataTypes : 26

siwfs-SignallingModify.....information object reference OPERATION, Information Object
 DEFINED in MAP-CallHandlingOperat : 146
 USED in MAP-Protocol : 62 131
 USED in MAP-CallHandlingOperat : 17

slr-ArgExtensionContainer.....identifier of [7] SLR-ArgExtensionContainer
 DEFINED in MAP-LCS-DataTypes : 368

SLR-ArgExtensionContainer.....type reference SEQUENCE
 DEFINED in MAP-ExtensionDataTypes : 36
 USED in MAP-LCS-DataTypes : 45 368
 USED in MAP-ExtensionDataTypes : 17

slr-Arg-PCS-Extensions.....identifier of [1] SLR-Arg-PCS-Extensions
 DEFINED in MAP-ExtensionDataTypes : 38

SLR-Arg-PCS-Extensions.....type reference SEQUENCE
 DEFINED in MAP-ExtensionDataTypes : 61
 USED in MAP-ExtensionDataTypes : 38

SMS-CAMEL-TDP-Data.....type reference SEQUENCE
 DEFINED in MAP-MS-DataTypes : 1739
 USED in MAP-MS-DataTypes : 1735

sms-CAMEL-TDP-DataList.....identifier of [0] SMS-CAMEL-TDP-DataList
 DEFINED in MAP-MS-DataTypes : 1720

SMS-CAMEL-TDP-DataList.....type reference SEQUENCE OF
 DEFINED in MAP-MS-DataTypes : 1734
 USED in MAP-MS-DataTypes : 1720

sms-CollectedInfo.....identifier of Named Number, 1
 DEFINED in MAP-MS-DataTypes : 1749

SMS-CSI.....type reference SEQUENCE
 DEFINED in MAP-MS-DataTypes : 1719
 USED in MAP-MS-DataTypes : 905 908 1457 1461 2297 2303

sms-DELIVER.....identifier of Named Number, 0
 DEFINED in MAP-MS-DataTypes : 1480

sms-DeliveryRequest.....identifier of Named Number, 2
 DEFINED in MAP-MS-DataTypes : 1751

sms-STATUS-REPORT.....identifier of Named Number, 2
 DEFINED in MAP-MS-DataTypes : 1482

sms-SUBMIT-REPORT.....identifier of Named Number, 1
 DEFINED in MAP-MS-DataTypes : 1481

sms-TriggerDetectionPoint.....identifier of SMS-TriggerDetectionPoint
 DEFINED in MAP-MS-DataTypes : 1469

sms-TriggerDetectionPoint.....identifier of [0] SMS-TriggerDetectionPoint
 DEFINED in MAP-MS-DataTypes : 1740

SMS-TriggerDetectionPoint.....type reference ENUMERATED
 DEFINED in MAP-MS-DataTypes : 1748
 USED in MAP-MS-DataTypes : 1469 1740

sm-DeliveryFailure.....information object reference ERROR, Information Object
 DEFINED in MAP-Errors : 450
 USED in MAP-ShortMessageServic : 39 93 111
 USED in MAP-Errors : 78

SM-DeliveryFailureCause.....type reference SEQUENCE
 DEFINED in MAP-ER-DataTypes : 149
 USED in MAP-Errors : 109 452

USED in MAP-ER-DataTypes : 19

sm-DeliveryOutcome.....identifier of SM-DeliveryOutcome
DEFINED in MAP-SM-DataTypes : 145

SM-DeliveryOutcome.....type reference ENUMERATED
DEFINED in MAP-SM-DataTypes : 165

TAG R6.0 Cross Reference Listing for MAP-Protocol 2006-06-08 15:10:26 PAGE 93

USED in MAP-SM-DataTypes : 26 145 156

SM-EnumeratedDeliveryFailureCause.....type reference ENUMERATED
 DEFINED in MAP-ER-DataTypes : 140
 USED in MAP-ER-DataTypes : 150

sm-EnumeratedDeliveryFailureCause.....identifier of SM-EnumeratedDeliveryFailureCause
 DEFINED in MAP-ER-DataTypes : 150

sm-RP-DA.....identifier of SM-RP-DA
 DEFINED in MAP-SM-DataTypes : 106

sm-RP-DA.....identifier of SM-RP-DA
 DEFINED in MAP-SM-DataTypes : 119

SM-RP-DA.....type reference CHOICE
 DEFINED in MAP-SM-DataTypes : 131
 USED in MAP-SM-DataTypes : 106 119

sm-RP-MTI.....identifier of [8] SM-RP-MTI
 DEFINED in MAP-SM-DataTypes : 62

SM-RP-MTI.....type reference INTEGER
 DEFINED in MAP-SM-DataTypes : 65
 USED in MAP-SM-DataTypes : 62

sm-RP-OA.....identifier of SM-RP-OA
 DEFINED in MAP-SM-DataTypes : 107

sm-RP-OA.....identifier of SM-RP-OA
 DEFINED in MAP-SM-DataTypes : 120

SM-RP-OA.....type reference CHOICE
 DEFINED in MAP-SM-DataTypes : 137
 USED in MAP-SM-DataTypes : 107 120

sm-RP-PR1.....identifier of [1] BOOLEAN
 DEFINED in MAP-SM-DataTypes : 55

sm-RP-SMEA.....identifier of [9] SM-RP-SMEA
 DEFINED in MAP-SM-DataTypes : 63

SM-RP-SMEA.....type reference OCTET STRING
 DEFINED in MAP-SM-DataTypes : 71
 USED in MAP-SM-DataTypes : 63

sm-RP-UI.....identifier of SignallInfo
 DEFINED in MAP-SM-DataTypes : 108

sm-RP-UI.....identifier of SignallInfo
 DEFINED in MAP-SM-DataTypes : 114

sm-RP-UI.....identifier of SignallInfo
 DEFINED in MAP-SM-DataTypes : 121

sm-RP-UI.....identifier of SignallInfo
 DEFINED in MAP-SM-DataTypes : 127

solsaSupportIndicator.....identifier of [2] NULL
 DEFINED in MAP-MS-DataTypes : 237

solsaSupportIndicator.....identifier of NULL
 DEFINED in MAP-MS-DataTypes : 438

specificCSIDeletedList.....identifier of [14] SpecificCSI-Withdraw
 DEFINED in MAP-MS-DataTypes : 2302

specificCSI-Withdraw.....identifier of [15] SpecificCSI-Withdraw
 DEFINED in MAP-MS-DataTypes : 1401

SpecificCSI-Withdraw.....type reference BIT STRING
 DEFINED in MAP-MS-DataTypes : 1404
 USED in MAP-MS-DataTypes : 1401 2302

splitLeg.....identifier of Named Number, 1

DEFINED in MAP-MS-DataTypes : 1700

sres.....identifier of SRES
DEFINED in MAP-MS-DataTypes : 341

SRES.....type reference OCTET STRING
DEFINED in MAP-MS-DataTypes : 370

TAG R6.0 Cross Reference Listing for MAP-Protocol 2006-06-08 15:10:26 PAGE 94

USED in MAP-MS-DataTypes : 341

ss-AccessBarred.....identifier of Named Number, 5
DEFINED in MAP-MS-DataTypes : 1075

ss-CamelData.....identifier of SS-CamelData
DEFINED in MAP-MS-DataTypes : 1521

SS-CamelData.....type reference SEQUENCE
DEFINED in MAP-MS-DataTypes : 1530
USED in MAP-MS-DataTypes : 1521

ss-Code.....identifier of SS-Code
DEFINED in MAP-MS-DataTypes : 1124

ss-Code.....identifier of SS-Code
DEFINED in MAP-MS-DataTypes : 1183

ss-Code.....identifier of SS-Code
DEFINED in MAP-MS-DataTypes : 1252

ss-Code.....identifier of SS-Code
DEFINED in MAP-MS-DataTypes : 1265

ss-Code.....identifier of SS-Code
DEFINED in MAP-MS-DataTypes : 1353

ss-Code.....identifier of [0] SS-Code
DEFINED in MAP-MS-DataTypes : 2332

ss-Code.....identifier of [0] SS-Code
DEFINED in MAP-MS-DataTypes : 2343

ss-Code.....identifier of [0] SS-Code
DEFINED in MAP-MS-DataTypes : 2416

ss-Code.....identifier of [0] SS-Code
DEFINED in MAP-MS-DataTypes : 2423

ss-Code.....identifier of [0] SS-Code
DEFINED in MAP-CommonDataTypes : 475

ss-Code.....identifier of SS-Code
DEFINED in MAP-SS-DataTypes : 72

ss-Code.....identifier of SS-Code
DEFINED in MAP-SS-DataTypes : 90

ss-Code.....identifier of SS-Code
DEFINED in MAP-SS-DataTypes : 148

ss-Code.....identifier of SS-Code
DEFINED in MAP-SS-DataTypes : 161

ss-Code.....identifier of SS-Code
DEFINED in MAP-SS-DataTypes : 184

ss-Code.....identifier of [0] SS-Code
DEFINED in MAP-SS-DataTypes : 305

ss-Code.....identifier of [0] SS-Code
DEFINED in MAP-SS-DataTypes : 328

ss-Code.....identifier of [0] SS-Code
DEFINED in MAP-SS-DataTypes : 333

SS-Code.....type reference OCTET STRING
DEFINED in MAP-SS-Code : 11
USED in MAP-SupplementaryServi : 79 228
USED in MAP-MS-DataTypes : 161 1124 1183 1252 1265 1353 1536 2332 2343
2416 2423
USED in MAP-CommonDataTypes : 77 475
USED in MAP-SS-DataTypes : 64 72 90 148 161 184 256 271 305
328 333
USED in MAP-SS-Code : 21 25 28 30 32 34 36 40 42

48 50 52 54 56 58 60 63 66
68 72 75 77 79 81 84 87 90
93 96 99 102 104 107 110 112 114
117 119 121 123 125 128 130 132 136
137 138 139 140 141 142 143 144 145
146 147 148 149 150 151 153 156 159
161 163 166 168 170 173 175 177 180

TAG R6.0 Cross Reference Listing for MAP-Protocol 2006-06-08 15:10:26 PAGE 95

USED in MAP-ER-DataTypes : 80 129

ss-Code.....identifier of [1] SS-Code
DEFINED in MAP-ER-DataTypes : 129

ss-csi.....identifier of Named Number, 1
DEFINED in MAP-MS-DataTypes : 1406

ss-CSI.....identifier of [2] SS-CSI
DEFINED in MAP-MS-DataTypes : 1453

SS-CSI.....type reference SEQUENCE
DEFINED in MAP-MS-DataTypes : 1520
USED in MAP-MS-DataTypes : 73 1453 2298

ss-CSI.....identifier of Named Number, 6
DEFINED in MAP-MS-DataTypes : 2251

ss-CSI.....identifier of [11] SS-CSI
DEFINED in MAP-MS-DataTypes : 2298

ss-Data.....identifier of [3] Ext-SS-Data
DEFINED in MAP-MS-DataTypes : 1120

ss-Data.....identifier of [3] SS-Data
DEFINED in MAP-SS-DataTypes : 87

SS-Data.....type reference SEQUENCE
DEFINED in MAP-SS-DataTypes : 160
USED in MAP-SS-DataTypes : 33 87

ss-ErrorStatus.....information object reference ERROR, Information Object
DEFINED in MAP-Errors : 387
USED in MAP-MobileServiceOpera : 102 296
USED in MAP-SupplementaryServi : 42 102 120 138 159 274 292
USED in MAP-Errors : 64

ss-Event.....identifier of [2] SS-Code
DEFINED in MAP-SS-DataTypes : 271

ss-EventList.....identifier of SS-EventList
DEFINED in MAP-MS-DataTypes : 1531

SS-EventList.....type reference SEQUENCE OF
DEFINED in MAP-MS-DataTypes : 1536
USED in MAP-MS-DataTypes : 1531

ss-EventSpecification.....identifier of [3] SS-EventSpecification
DEFINED in MAP-SS-DataTypes : 277

SS-EventSpecification.....type reference SEQUENCE OF
DEFINED in MAP-SS-DataTypes : 299
USED in MAP-SS-DataTypes : 277

SS-ForBS-Code.....type reference SEQUENCE
DEFINED in MAP-SS-DataTypes : 183
USED in MAP-SupplementaryServi : 63 108 126 147 167
USED in MAP-MS-DataTypes : 155 2233
USED in MAP-SS-DataTypes : 18

ss-Incompatibility.....information object reference ERROR, Information Object
DEFINED in MAP-Errors : 407
USED in MAP-MobileServiceOpera : 104 297
USED in MAP-SupplementaryServi : 45 103 140 275
USED in MAP-Errors : 67

SS-IncompatibilityCause.....type reference SEQUENCE
DEFINED in MAP-ER-DataTypes : 128
USED in MAP-Errors : 107 409
USED in MAP-ER-DataTypes : 17

SS-Info.....type reference CHOICE
DEFINED in MAP-SS-DataTypes : 84
USED in MAP-SupplementaryServi : 62 92 110 128 149
USED in MAP-SS-DataTypes : 15 261

ss-InfoFor-CSE.....identifier of [0] Ext-SS-InfoFor-CSE
DEFINED in MAP-MS-DataTypes : 2325

SS-InfoList.....type reference SEQUENCE OF
DEFINED in MAP-SS-DataTypes : 260
USED in MAP-SS-DataTypes : 27

TAG R6.0 Cross Reference Listing for MAP-Protocol 2006-06-08 15:10:26 PAGE 96

ss-InvocationNotification.....information object reference OPERATION, Information Object

DEFINED in MAP-SupplementaryServi : 251

USED in MAP-Protocol : 83 134

USED in MAP-SupplementaryServi : 23

SS-InvocationNotificationArg.....type reference SEQUENCE

DEFINED in MAP-SS-DataTypes : 268

USED in MAP-SupplementaryServi : 69 253

USED in MAP-SS-DataTypes : 34

SS-InvocationNotificationRes.....type reference SEQUENCE

DEFINED in MAP-SS-DataTypes : 294

USED in MAP-SupplementaryServi : 70 255

USED in MAP-SS-DataTypes : 35

ss-List.....identifier of [3] SS-List

DEFINED in MAP-MS-DataTypes : 1369

ss-List.....identifier of [2] SS-List

DEFINED in MAP-MS-DataTypes : 1388

ss-List.....identifier of [1] SS-List

DEFINED in MAP-CH-DataTypes : 160

SS-List.....type reference SEQUENCE OF

DEFINED in MAP-SS-DataTypes : 255

USED in MAP-MS-DataTypes : 154 1369 1388

USED in MAP-CH-DataTypes : 59 160 175

USED in MAP-SS-DataTypes : 26

ss-List2.....identifier of [18] SS-List

DEFINED in MAP-CH-DataTypes : 175

ss-NotAvailable.....information object reference ERROR, Information Object

DEFINED in MAP-Errors : 393

USED in MAP-MobileServiceOpera : 103 277

USED in MAP-SupplementaryServi : 43 178

USED in MAP-Errors : 65

SS-NotAvailableParam.....type reference SEQUENCE

DEFINED in MAP-ER-DataTypes : 296

USED in MAP-Errors : 149 395

USED in MAP-ER-DataTypes : 57

ss-Status.....identifier of [4] Ext-SS-Status

DEFINED in MAP-MS-DataTypes : 1134

ss-Status.....identifier of [4] Ext-SS-Status

DEFINED in MAP-MS-DataTypes : 1193

ss-Status.....identifier of [4] Ext-SS-Status

DEFINED in MAP-MS-DataTypes : 1253

ss-Status.....identifier of Ext-SS-Status

DEFINED in MAP-MS-DataTypes : 1266

ss-Status.....identifier of Ext-SS-Status

DEFINED in MAP-MS-DataTypes : 1354

ss-Status.....identifier of [2] Ext-SS-Status

DEFINED in MAP-MS-DataTypes : 2334

ss-Status.....identifier of [2] Ext-SS-Status

DEFINED in MAP-MS-DataTypes : 2345

ss-Status.....identifier of [1] Ext-SS-Status

DEFINED in MAP-CommonDataTypes : 476

ss-Status.....identifier of [4] SS-Status

DEFINED in MAP-SS-DataTypes : 100

SS-Status.....type reference OCTET STRING

DEFINED in MAP-SS-DataTypes : 108

USED in MAP-Errors : 102 389

USED in MAP-SS-DataTypes : 16 100 157 162 190 215 334
USED in MAP-ER-DataTypes : 66 131

ss-Status.....identifier of [4] SS-Status
DEFINED in MAP-SS-DataTypes : 157

ss-Status.....identifier of [4] SS-Status

TAG R6.0 Cross Reference Listing for MAP-Protocol 2006-06-08 15:10:26 PAGE 97

DEFINED in MAP-SS-DataTypes : 162

ss-Status.....identifier of SS-Status
DEFINED in MAP-SS-DataTypes : 190

ss-Status.....identifier of [0] SS-Status
DEFINED in MAP-SS-DataTypes : 215

ss-Status.....identifier of [1] SS-Status
DEFINED in MAP-SS-DataTypes : 334

ss-Status.....identifier of [4] SS-Status
DEFINED in MAP-ER-DataTypes : 131

ss-SubscriptionOption.....identifier of SS-SubscriptionOption
DEFINED in MAP-MS-DataTypes : 1254

ss-SubscriptionOption.....identifier of SS-SubscriptionOption
DEFINED in MAP-SS-DataTypes : 163

SS-SubscriptionOption.....type reference CHOICE
DEFINED in MAP-SS-DataTypes : 170
USED in MAP-MS-DataTypes : 153 1254
USED in MAP-SS-DataTypes : 17 163

ss-SubscriptionViolation.....information object reference ERROR, Information Object
DEFINED in MAP-Errors : 400
USED in MAP-MobileServiceOpera : 105 295
USED in MAP-SupplementaryServi : 44 139 160 236
USED in MAP-Errors : 66

SS-SubscriptionViolationParam.....type reference SEQUENCE
DEFINED in MAP-ER-DataTypes : 300
USED in MAP-Errors : 150 402
USED in MAP-ER-DataTypes : 58

startMonitoring.....identifier of Named Number, 1
DEFINED in MAP-CH-DataTypes : 354

stateAttributes.....identifier of [5] StateAttributes
DEFINED in MAP-GR-DataTypes : 84

StateAttributes.....type reference SEQUENCE
DEFINED in MAP-GR-DataTypes : 114
USED in MAP-GR-DataTypes : 84

statusReport.....information object reference OPERATION, Information Object
DEFINED in MAP-CallHandlingOperat : 174
USED in MAP-Protocol : 64 131
USED in MAP-CallHandlingOperat : 19

StatusReportArg.....type reference SEQUENCE
DEFINED in MAP-CH-DataTypes : 375
USED in MAP-CallHandlingOperat : 67 176
USED in MAP-CH-DataTypes : 29

StatusReportRes.....type reference SEQUENCE
DEFINED in MAP-CH-DataTypes : 411
USED in MAP-CallHandlingOperat : 68 178
USED in MAP-CH-DataTypes : 30

stopMonitoring.....identifier of Named Number, 0
DEFINED in MAP-CH-DataTypes : 353

storedMSISDN.....identifier of ISDN-AddressString
DEFINED in MAP-SM-DataTypes : 171

storedMSISDN.....identifier of ISDN-AddressString
DEFINED in MAP-SM-DataTypes : 182

SubBusyForMT-SMS-Param.....type reference SEQUENCE
DEFINED in MAP-ER-DataTypes : 308
USED in MAP-Errors : 133 446
USED in MAP-ER-DataTypes : 40

subscriberBusyForMT-SMS.....information object reference ERROR, Information Object
DEFINED in MAP-Errors : 444
USED in MAP-ShortMessageServic : 38 110
USED in MAP-Errors : 77

SubscriberData.....type reference SEQUENCE
DEFINED in MAP-MS-DataTypes : 1024

TAG R6.0 Cross Reference Listing for MAP-Protocol 2006-06-08 15:10:26 PAGE 98

USED in MAP-MS-DataTypes : 64 819

subscriberDataStored.....identifier of [1] AgeIndicator
DEFINED in MAP-MS-DataTypes : 246

SubscriberId.....type reference CHOICE
DEFINED in MAP-CommonDataTypes : 316
USED in MAP-CommonDataTypes : 33

subscriberIdentity.....identifier of [0] SubscriberIdentity
DEFINED in MAP-MS-DataTypes : 2199

subscriberIdentity.....identifier of [0] SubscriberIdentity
DEFINED in MAP-MS-DataTypes : 2213

subscriberIdentity.....identifier of [0] SubscriberIdentity
DEFINED in MAP-MS-DataTypes : 2314

SubscriberIdentity.....type reference CHOICE
DEFINED in MAP-CommonDataTypes : 373
USED in MAP-MS-DataTypes : 194 2199 2213 2314
USED in MAP-CommonDataTypes : 42
USED in MAP-LCS-DataTypes : 35 70 75

subscriberInfo.....identifier of SubscriberInfo
DEFINED in MAP-MS-DataTypes : 1973

SubscriberInfo.....type reference SEQUENCE
DEFINED in MAP-MS-DataTypes : 1977
USED in MAP-MS-DataTypes : 107 1973 2206
USED in MAP-CH-DataTypes : 40 159

subscriberInfo.....identifier of SubscriberInfo
DEFINED in MAP-MS-DataTypes : 2206

subscriberInfo.....identifier of [7] SubscriberInfo
DEFINED in MAP-CH-DataTypes : 159

subscriberLocationReport.....information object reference OPERATION, Information Object
DEFINED in MAP-LocationServiceOpe : 87
USED in MAP-Protocol : 114 138
USED in MAP-LocationServiceOpe : 15

SubscriberLocationReport-Arg.....type reference SEQUENCE
DEFINED in MAP-LCS-DataTypes : 357
USED in MAP-LocationServiceOpe : 46 89
USED in MAP-LCS-DataTypes : 15

SubscriberLocationReport-Res.....type reference SEQUENCE
DEFINED in MAP-LCS-DataTypes : 426
USED in MAP-LocationServiceOpe : 47 91
USED in MAP-LCS-DataTypes : 16

subscriberNotMemberOfCUG.....identifier of Named Number, 1
DEFINED in MAP-ER-DataTypes : 124

subscriberNotSC-Subscriber.....identifier of Named Number, 6
DEFINED in MAP-ER-DataTypes : 147

subscriberState.....identifier of [1] SubscriberState
DEFINED in MAP-MS-DataTypes : 1979

subscriberState.....identifier of [1] NULL
DEFINED in MAP-MS-DataTypes : 2043

SubscriberState.....type reference CHOICE
DEFINED in MAP-MS-DataTypes : 2126
USED in MAP-MS-DataTypes : 111 1979

subscriberStatus.....identifier of [3] SubscriberStatus
DEFINED in MAP-MS-DataTypes : 1027

SubscriberStatus.....type reference ENUMERATED
DEFINED in MAP-MS-DataTypes : 1046
USED in MAP-MS-DataTypes : 66 1027

subscriptionWithdraw.....identifier of Named Number, 1
DEFINED in MAP-MS-DataTypes : 286

subsequentHandoverFailure.....information object reference ERROR, Information Object
DEFINED in MAP-Errors : 274
USED in MAP-MobileServiceOpera : 93 357

TAG R6.0 Cross Reference Listing for MAP-Protocol 2006-06-08 15:10:26 PAGE 99

USED in MAP-Errors : 37

success.....identifier of Named Number, 0
DEFINED in MAP-CH-DataTypes : 402

successfulTransfer.....identifier of Named Number, 2
DEFINED in MAP-SM-DataTypes : 168

SuperChargerInfo.....type reference CHOICE
DEFINED in MAP-MS-DataTypes : 244
USED in MAP-MS-DataTypes : 239 441

superChargerSupportedInHLR.....identifier of [27] AgeIndicator
DEFINED in MAP-MS-DataTypes : 832

superChargerSupportedInServingNetworkEntidentifier of [3] SuperChargerInfo
DEFINED in MAP-MS-DataTypes : 239

superChargerSupportedInServingNetworkEntidentifier of [2] SuperChargerInfo
DEFINED in MAP-MS-DataTypes : 441

supplementaryService.....identifier of Named Number, 3
DEFINED in MAP-MS-DataTypes : 405

supportedCamelPhases.....identifier of [0] SupportedCamelPhases
DEFINED in MAP-MS-DataTypes : 234

supportedCamelPhases.....identifier of [4] SupportedCamelPhases
DEFINED in MAP-MS-DataTypes : 443

supportedCamelPhases.....identifier of [6] SupportedCamelPhases
DEFINED in MAP-MS-DataTypes : 1372

SupportedCamelPhases.....type reference BIT STRING
DEFINED in MAP-MS-DataTypes : 1677
USED in MAP-MS-DataTypes : 78 234 443 1372 2225 2226 2399
USED in MAP-CH-DataTypes : 41 172 236 286

supportedCAMELPhases.....identifier of [5] SupportedCamelPhases
DEFINED in MAP-MS-DataTypes : 2399

supportedCamelPhases.....identifier of SupportedCamelPhases
DEFINED in MAP-CH-DataTypes : 286

supportedCamelPhasesInInterrogatingNode.identifier of [15] SupportedCamelPhases
DEFINED in MAP-CH-DataTypes : 236

supportedCamelPhasesInVMSC.....identifier of [15] SupportedCamelPhases
DEFINED in MAP-CH-DataTypes : 172

supportedCCBS-Phase.....identifier of [16] SupportedCCBS-Phase
DEFINED in MAP-CH-DataTypes : 112

SupportedCCBS-Phase.....type reference INTEGER
DEFINED in MAP-CH-DataTypes : 140
USED in MAP-CH-DataTypes : 112

SupportedCodecsList.....type reference SEQUENCE
DEFINED in MAP-MS-DataTypes : 651
USED in MAP-MS-DataTypes : 472 539

supportedGADShapes.....identifier of [9] SupportedGADShapes
DEFINED in MAP-LCS-DataTypes : 105

SupportedGADShapes.....type reference BIT STRING
DEFINED in MAP-LCS-DataTypes : 217
USED in MAP-LCS-DataTypes : 23 105

supportedLCS-CapabilitySets.....identifier of [5] SupportedLCS-CapabilitySets
DEFINED in MAP-MS-DataTypes : 241

SupportedLCS-CapabilitySets.....type reference BIT STRING
DEFINED in MAP-MS-DataTypes : 259
USED in MAP-MS-DataTypes : 27 241 444

supportedLCS-CapabilitySets.....identifier of [5] SupportedLCS-CapabilitySets
DEFINED in MAP-MS-DataTypes : 444

supportedSGSN-CAMEL-Phases.....identifier of [6] SupportedCamelPhases
DEFINED in MAP-MS-DataTypes : 2226

supportedSGSN-CAMEL-Phases.....identifier of [5] NULL

TAG R6.0 Cross Reference Listing for MAP-Protocol 2006-06-08 15:10:26 PAGE 100

DEFINED in MAP-MS-DataTypes : 2237

supportedVLR-CAMEL-Phases.....identifier of [5] SupportedCamelPhases
DEFINED in MAP-MS-DataTypes : 2225

supportedVLR-CAMEL-Phases.....identifier of [4] NULL
DEFINED in MAP-MS-DataTypes : 2236

Supported-MAP-Operations.....information object set reference OPERATION, Information Object Set
DEFINED in MAP-Protocol : 122

suppressIncomingCallBarring.....identifier of [23] NULL
DEFINED in MAP-CH-DataTypes : 119

suppressionOfAnnouncement.....identifier of [12] SuppressionOfAnnouncement
DEFINED in MAP-CH-DataTypes : 107

SuppressionOfAnnouncement.....type reference NULL
DEFINED in MAP-CH-DataTypes : 125
USED in MAP-CH-DataTypes : 21 107 228

suppressionOfAnnouncement.....identifier of [7] SuppressionOfAnnouncement
DEFINED in MAP-CH-DataTypes : 228

suppress-T-CSI.....identifier of NULL
DEFINED in MAP-CH-DataTypes : 287

suppress-VT-CSI.....identifier of [22] NULL
DEFINED in MAP-CH-DataTypes : 118

suppress-VT-CSI.....identifier of [19] NULL
DEFINED in MAP-CH-DataTypes : 241

suspended.....identifier of Named Number, 4
DEFINED in MAP-SS-DataTypes : 289

systemFailure.....information object reference ERROR, Information Object
DEFINED in MAP-Errors : 165
USED in MAP-MobileServiceOpera : 83 180 228 254 324 374 387 400 447
462 478 493
USED in MAP-OperationAndMainte : 24 58 73
USED in MAP-CallHandlingOperat : 31 88 112 143 156 166 182 197 211
225
USED in MAP-SupplementaryServi : 34 95 113 131 152 171 187 201 216
232 269 287
USED in MAP-ShortMessageServic : 28 73 90 103 133
USED in MAP-Group-Call-Operati : 25 52
USED in MAP-LocationServiceOpe : 24 59 74 93
USED in MAP-Errors : 14

SystemFailureParam.....type reference CHOICE
DEFINED in MAP-ER-DataTypes : 169
USED in MAP-Errors : 110 167
USED in MAP-ER-DataTypes : 20

targetCellId.....identifier of [0] GlobalCellId
DEFINED in MAP-MS-DataTypes : 518

targetCellId.....identifier of [0] GlobalCellId
DEFINED in MAP-MS-DataTypes : 625

TargetCellOutsideGCA-Param.....type reference SEQUENCE
DEFINED in MAP-ER-DataTypes : 386
USED in MAP-Errors : 152 279
USED in MAP-ER-DataTypes : 60

targetCellOutsideGroupCallArea.....information object reference ERROR, Information Object
DEFINED in MAP-Errors : 277
USED in MAP-MobileServiceOpera : 107 328
USED in MAP-Errors : 38

targetMS.....identifier of [1] SubscriberIdentity
DEFINED in MAP-LCS-DataTypes : 70

targetMS.....identifier of [0] SubscriberIdentity

DEFINED in MAP-LCS-DataTypes : 75

targetMSC-Number.....identifier of [1] ISDN-AddressString
DEFINED in MAP-MS-DataTypes : 626

targetMSsubscribedService.....identifier of Named Number, 4
DEFINED in MAP-CommonDataTypes : 388

TAG R6.0 Cross Reference Listing for MAP-Protocol 2006-06-08 15:10:26 PAGE 101

targetRNCId.....identifier of [1] RNCId
 DEFINED in MAP-MS-DataTypes : 520

targetRNCId.....identifier of [2] RNCId
 DEFINED in MAP-MS-DataTypes : 627

TBCD-STRING.....type reference OCTET STRING
 DEFINED in MAP-CommonDataTypes : 91
 USED in MAP-MS-DataTypes : 201 1957 2005
 USED in MAP-CommonDataTypes : 27 297 310 320

tBusy.....identifier of Named Number, 13
 DEFINED in MAP-MS-DataTypes : 1864

TEID.....type reference OCTET STRING
 DEFINED in MAP-MS-DataTypes : 2180
 USED in MAP-MS-DataTypes : 2153 2154

teid-ForGnAndGp.....identifier of [8] TEID
 DEFINED in MAP-MS-DataTypes : 2153

teid-ForLu.....identifier of [9] TEID
 DEFINED in MAP-MS-DataTypes : 2154

telephony.....value reference TeleserviceCode, '00010001'B
 DEFINED in MAP-TS-Code : 41

teleservice.....identifier of [3] TeleserviceCode
 DEFINED in MAP-CommonDataTypes : 448

teleservice.....identifier of Ext-TeleserviceCode
 DEFINED in MAP-GR-DataTypes : 50

TeleserviceCode.....type reference OCTET STRING
 DEFINED in MAP-TS-Code : 11
 USED in MAP-CommonDataTypes : 65 448
 USED in MAP-TS-Code : 38 40 41 42 44 45 46 48 49
 50 51 55 58 67 68 69 71 72
 73 74 75 76 77 78 79 80 81
 82 83 84 85 86

teleserviceList.....identifier of [6] TeleserviceList
 DEFINED in MAP-MS-DataTypes : 1031

TeleserviceList.....type reference SEQUENCE OF
 DEFINED in MAP-MS-DataTypes : 1055
 USED in MAP-MS-DataTypes : 1031 1367

teleserviceList.....identifier of [1] TeleserviceList
 DEFINED in MAP-MS-DataTypes : 1367

teleserviceNotProvisioned.....information object reference ERROR, Information Object
 DEFINED in MAP-Errors : 261
 USED in MAP-MobileServiceOpera : 99 274 292
 USED in MAP-CallHandlingOperat : 39 96
 USED in MAP-SupplementaryServi : 39 99 117 135 156 175
 USED in MAP-ShortMessageServic : 36 78
 USED in MAP-Errors : 33

teleserviceNotProvisioned.....identifier of Named Number, 2
 DEFINED in MAP-CH-DataTypes : 190

TeleservNotProvParam.....type reference SEQUENCE
 DEFINED in MAP-ER-DataTypes : 232
 USED in MAP-Errors : 121 263
 USED in MAP-ER-DataTypes : 31

temporaryDefaultAllowed.....identifier of Named Number, 2
 DEFINED in MAP-SS-DataTypes : 177

temporaryDefaultRestricted.....identifier of Named Number, 1
 DEFINED in MAP-SS-DataTypes : 176

termAttemptAuthorized.....identifier of Named Number, 12

DEFINED in MAP-MS-DataTypes : 1862

terminateAllCallActivities.....identifier of Named Number, 1
DEFINED in MAP-CH-DataTypes : 469

terminateCallActivityReferred.....identifier of Named Number, 0
DEFINED in MAP-CH-DataTypes : 468

TAG R6.0 Cross Reference Listing for MAP-Protocol 2006-06-08 15:10:26 PAGE 102

terminationCause.....identifier of [0] TerminationCause
DEFINED in MAP-LCS-DataTypes : 393

TerminationCause.....type reference ENUMERATED
DEFINED in MAP-LCS-DataTypes : 409
USED in MAP-LCS-DataTypes : 393

tif-csi.....identifier of Named Number, 2
DEFINED in MAP-MS-DataTypes : 1407

tif-CSI.....identifier of [3] NULL
DEFINED in MAP-MS-DataTypes : 1455

tif-CSI.....identifier of Named Number, 3
DEFINED in MAP-MS-DataTypes : 2248

tif-CSI.....identifier of [7] NULL
DEFINED in MAP-MS-DataTypes : 2294

tif-CSI-NotificationToCSE.....identifier of [8] NULL
DEFINED in MAP-MS-DataTypes : 2295

tmsi.....identifier of TMSI
DEFINED in MAP-MS-DataTypes : 308

TMSI.....type reference OCTET STRING
DEFINED in MAP-CommonDataTypes : 314
USED in MAP-MS-DataTypes : 184 308
USED in MAP-CommonDataTypes : 31 318

tmsi.....identifier of [1] TMSI
DEFINED in MAP-CommonDataTypes : 318

tNoAnswer.....identifier of Named Number, 14
DEFINED in MAP-MS-DataTypes : 1865

tooManyZoneCodes.....identifier of Named Number, 1
DEFINED in MAP-MS-DataTypes : 1379

tpdu-TypeCriterion.....identifier of [0] TPDU-TypeCriterion
DEFINED in MAP-MS-DataTypes : 1470

TPDU-TypeCriterion.....type reference SEQUENCE OF
DEFINED in MAP-MS-DataTypes : 1473
USED in MAP-MS-DataTypes : 1470

traceReference.....identifier of [1] TraceReference
DEFINED in MAP-OM-DataTypes : 38

TraceReference.....type reference OCTET STRING
DEFINED in MAP-OM-DataTypes : 44
USED in MAP-OM-DataTypes : 38 56

traceReference.....identifier of [1] TraceReference
DEFINED in MAP-OM-DataTypes : 56

traceType.....identifier of [2] TraceType
DEFINED in MAP-OM-DataTypes : 39

TraceType.....type reference INTEGER
DEFINED in MAP-OM-DataTypes : 46
USED in MAP-OM-DataTypes : 39

tracingBufferFull.....information object reference ERROR, Information Object
DEFINED in MAP-Errors : 285
USED in MAP-OperationAndMainte : 30 63
USED in MAP-Errors : 41

TracingBufferFullParam.....type reference SEQUENCE
DEFINED in MAP-ER-DataTypes : 236
USED in MAP-Errors : 122 287
USED in MAP-ER-DataTypes : 32

trafficCongestionReporting.....value reference LCSServiceTypeID, 5

DEFINED in MAP-CommonDataTypes : 401

transactionId.....identifier of [7] TransactionId
DEFINED in MAP-MS-DataTypes : 2152

TransactionId.....type reference OCTET STRING
DEFINED in MAP-MS-DataTypes : 2175

TAG R6.0 Cross Reference Listing for MAP-Protocol 2006-06-08 15:10:26 PAGE 103

USED in MAP-MS-DataTypes : 2152

transferToThirdParty.....value reference SS-Code, '11000011'B
DEFINED in MAP-SS-Code : 180

translatedB-Number.....identifier of [3] ISDN-AddressString
DEFINED in MAP-CH-DataTypes : 419

translatedB-Number.....identifier of [1] ISDN-AddressString
DEFINED in MAP-SS-DataTypes : 311

tripletList.....identifier of [0] TripletList
DEFINED in MAP-MS-DataTypes : 330

TripletList.....type reference SEQUENCE OF
DEFINED in MAP-MS-DataTypes : 333
USED in MAP-MS-DataTypes : 330

ts3G-25413.....identifier of Named Number, 2
DEFINED in MAP-CommonDataTypes : 260

ts3G-48006.....identifier of Named Number, 1
DEFINED in MAP-CommonDataTypes : 259

T-BcsmCamelTDPData.....type reference SEQUENCE
DEFINED in MAP-MS-DataTypes : 1853
USED in MAP-MS-DataTypes : 1846

t-BcsmCamelTDPDataList.....identifier of T-BcsmCamelTDPDataList
DEFINED in MAP-MS-DataTypes : 1834

T-BcsmCamelTDPDataList.....type reference SEQUENCE OF
DEFINED in MAP-MS-DataTypes : 1845
USED in MAP-MS-DataTypes : 1834

t-BcsmTriggerDetectionPoint.....identifier of T-BcsmTriggerDetectionPoint
DEFINED in MAP-MS-DataTypes : 1854

T-BcsmTriggerDetectionPoint.....type reference ENUMERATED
DEFINED in MAP-MS-DataTypes : 1861
USED in MAP-MS-DataTypes : 91 1608 1854

T-BCSM-CAMEL-TDP-Criteria.....type reference SEQUENCE
DEFINED in MAP-MS-DataTypes : 1607
USED in MAP-MS-DataTypes : 1596

t-BCSM-CAMEL-TDP-CriteriaList.....identifier of [8] T-BCSM-CAMEL-TDP-CriteriaList
DEFINED in MAP-MS-DataTypes : 1459

T-BCSM-CAMEL-TDP-CriteriaList.....type reference SEQUENCE OF
DEFINED in MAP-MS-DataTypes : 1595
USED in MAP-MS-DataTypes : 72 1459 2291 2293 2310
USED in MAP-CH-DataTypes : 47 308

t-BCSM-CAMEL-TDP-CriteriaList.....identifier of [4] T-BCSM-CAMEL-TDP-CriteriaList
DEFINED in MAP-MS-DataTypes : 2291

t-BCSM-CAMEL-TDP-CriteriaList.....identifier of [4] T-BCSM-CAMEL-TDP-CriteriaList
DEFINED in MAP-CH-DataTypes : 308

t-BCSM-TriggerDetectionPoint.....identifier of T-BcsmTriggerDetectionPoint
DEFINED in MAP-MS-DataTypes : 1608

t-CauseValueCriteria.....identifier of [1] T-CauseValueCriteria
DEFINED in MAP-MS-DataTypes : 1610

T-CauseValueCriteria.....type reference SEQUENCE OF
DEFINED in MAP-MS-DataTypes : 1651
USED in MAP-MS-DataTypes : 1610

t-csi.....identifier of Named Number, 8
DEFINED in MAP-MS-DataTypes : 1413

t-csi.....identifier of Named Number, 3
DEFINED in MAP-MS-DataTypes : 1689

T-CSI.....type reference SEQUENCE
DEFINED in MAP-MS-DataTypes : 1833
USED in MAP-MS-DataTypes : 90 1458 2290 2292 2309
USED in MAP-CH-DataTypes : 50 303

t-CSI.....identifier of Named Number, 1

TAG R6.0 Cross Reference Listing for MAP-Protocol 2006-06-08 15:10:26 PAGE 104

DEFINED in MAP-MS-DataTypes : 2246

t-CSI.....identifier of [3] T-CSI
DEFINED in MAP-MS-DataTypes : 2290

t-CSI.....identifier of [0] T-CSI
DEFINED in MAP-CH-DataTypes : 303

udubFromBusyMS.....identifier of Named Number, 5
DEFINED in MAP-CH-DataTypes : 436

udubFromFreeMS.....identifier of Named Number, 4
DEFINED in MAP-CH-DataTypes : 435

uesbi-lu.....identifier of [21] UESBI-lu
DEFINED in MAP-MS-DataTypes : 541

UESBI-lu.....type reference SEQUENCE
DEFINED in MAP-MS-DataTypes : 799
USED in MAP-MS-DataTypes : 541 789

uesbi-luA.....identifier of [0] UESBI-luA
DEFINED in MAP-MS-DataTypes : 800

UESBI-luA.....type reference BIT STRING
DEFINED in MAP-MS-DataTypes : 804
USED in MAP-MS-DataTypes : 800

uesbi-luB.....identifier of [1] UESBI-luB
DEFINED in MAP-MS-DataTypes : 801

UESBI-luB.....type reference BIT STRING
DEFINED in MAP-MS-DataTypes : 807
USED in MAP-MS-DataTypes : 801

umts-SecurityContextData.....identifier of [1] UMTS-SecurityContextData
DEFINED in MAP-MS-DataTypes : 355

UMTS-SecurityContextData.....type reference SEQUENCE
DEFINED in MAP-MS-DataTypes : 362
USED in MAP-MS-DataTypes : 355

unauthorisedMessageOriginator.....identifier of [1] NULL
DEFINED in MAP-ER-DataTypes : 115

unauthorizedCallSessionRelatedExternalClidentifier of Named Number, 7
DEFINED in MAP-ER-DataTypes : 355

unauthorizedCallSessionUnrelatedExternalidentifier of Named Number, 6
DEFINED in MAP-ER-DataTypes : 354

unauthorizedLCSCClient.....information object reference ERROR, Information Object
DEFINED in MAP-Errors : 483
USED in MAP-LocationServiceOpe : 31 83
USED in MAP-Errors : 87

unauthorizedLCSCClient-Diagnostic.....identifier of [0] UnauthorizedLCSCClient-Diagnostic
DEFINED in MAP-ER-DataTypes : 342

UnauthorizedLCSCClient-Diagnostic.....type reference ENUMERATED
DEFINED in MAP-ER-DataTypes : 346
USED in MAP-ER-DataTypes : 342

UnauthorizedLCSCClient-Param.....type reference SEQUENCE
DEFINED in MAP-ER-DataTypes : 341
USED in MAP-Errors : 142 485
USED in MAP-ER-DataTypes : 50

unauthorizedPrivacyClass.....identifier of Named Number, 5
DEFINED in MAP-ER-DataTypes : 353

unauthorizedRequestingNetwork.....information object reference ERROR, Information Object
DEFINED in MAP-Errors : 477
USED in MAP-LocationServiceOpe : 30 65 82 98
USED in MAP-Errors : 86

UnauthorizedRequestingNetwork-Param.....type reference SEQUENCE
DEFINED in MAP-ER-DataTypes : 337
USED in MAP-Errors : 141 479
USED in MAP-ER-DataTypes : 49

unavailabilityCause.....identifier of [21] UnavailabilityCause

TAG R6.0 Cross Reference Listing for MAP-Protocol 2006-06-08 15:10:26 PAGE 105

DEFINED in MAP-CH-DataTypes : 178

UnavailabilityCause.....type reference ENUMERATED
 DEFINED in MAP-CH-DataTypes : 188
 USED in MAP-CH-DataTypes : 178

undetermined.....identifier of Named Number, 0
 DEFINED in MAP-ER-DataTypes : 135

UnexpectedDataParam.....type reference SEQUENCE
 DEFINED in MAP-ER-DataTypes : 185
 USED in MAP-Errors : 112 180
 USED in MAP-ER-DataTypes : 22

unexpectedDataValue.....information object reference ERROR, Information Object
 DEFINED in MAP-Errors : 178
 USED in MAP-MobileServiceOpera : 85 182 195 206 229 243 257 271 289
 311 326 354 376 388 415 427 449 464
 480 495 507
 USED in MAP-OperationAndMainte : 26 60 75 87
 USED in MAP-CallHandlingOperat : 33 90 114 130 142 155 168 183 193
 208 222
 USED in MAP-SupplementaryServi : 36 97 115 133 154 173 189 203 218
 234 259 271 289
 USED in MAP-ShortMessageServic : 30 75 91 105 123 135 151
 USED in MAP-Group-Call-Operati : 26 54
 USED in MAP-LocationServiceOpe : 26 61 76 96
 USED in MAP-Errors : 16

UnidentifiedSubParam.....type reference SEQUENCE
 DEFINED in MAP-ER-DataTypes : 216
 USED in MAP-Errors : 116 224
 USED in MAP-ER-DataTypes : 27

unidentifiedSubscriber.....information object reference ERROR, Information Object
 DEFINED in MAP-Errors : 222
 USED in MAP-MobileServiceOpera : 88 217 416 428
 USED in MAP-OperationAndMainte : 29 62 77
 USED in MAP-CallHandlingOperat : 50 167
 USED in MAP-ShortMessageServic : 33 107
 USED in MAP-LocationServiceOpe : 35 78
 USED in MAP-Errors : 25

universal.....value reference SS-Code, '10110001'B
 DEFINED in MAP-SS-Code : 161

unknownAlphabet.....information object reference ERROR, Information Object
 DEFINED in MAP-Errors : 413
 USED in MAP-SupplementaryServi : 49 190 207 222
 USED in MAP-Errors : 68

unknownEquipment.....information object reference ERROR, Information Object
 DEFINED in MAP-Errors : 229
 USED in MAP-MobileServiceOpera : 89 402
 USED in MAP-Errors : 26

unknownMSC.....information object reference ERROR, Information Object
 DEFINED in MAP-Errors : 219
 USED in MAP-MobileServiceOpera : 87 356
 USED in MAP-Errors : 24

unknownOrUnreachableLCSCClient.....information object reference ERROR, Information Object
 DEFINED in MAP-Errors : 495
 USED in MAP-LocationServiceOpe : 34 99
 USED in MAP-Errors : 89

UnknownOrUnreachableLCSCClient-Param....type reference SEQUENCE
 DEFINED in MAP-ER-DataTypes : 378
 USED in MAP-Errors : 144 497
 USED in MAP-ER-DataTypes : 52

unknownServiceCentre.....identifier of Named Number, 3
 DEFINED in MAP-ER-DataTypes : 144

unknownSubscriber.....information object reference ERROR, Information Object

DEFINED in MAP-Errors : 206
USED in MAP-MobileServiceOpera : 86 183 207 230 258 272 290 312 377
389 450 465 481 496 508
USED in MAP-OperationAndMainte : 28 88
USED in MAP-CallHandlingOperat : 36 93 181 210 224
USED in MAP-SupplementaryServi : 37 260
USED in MAP-ShortMessageServic : 32 77 124 153

TAG R6.0 Cross Reference Listing for MAP-Protocol 2006-06-08 15:10:26 PAGE 106

USED in MAP-LocationServiceOpe : 28 63 97
 USED in MAP-Errors : 22

unknownSubscriberDiagnostic.....identifier of UnknownSubscriberDiagnostic
 DEFINED in MAP-ER-DataTypes : 202

UnknownSubscriberDiagnostic.....type reference ENUMERATED
 DEFINED in MAP-ER-DataTypes : 204
 USED in MAP-ER-DataTypes : 202

UnknownSubscriberParam.....type reference SEQUENCE
 DEFINED in MAP-ER-DataTypes : 199
 USED in MAP-Errors : 114 208
 USED in MAP-ER-DataTypes : 25

unstructuredSS-Notify.....information object reference OPERATION, Information Object
 DEFINED in MAP-SupplementaryServi : 211
 USED in MAP-Protocol : 80 133
 USED in MAP-SupplementaryServi : 20

unstructuredSS-Request.....information object reference OPERATION, Information Object
 DEFINED in MAP-SupplementaryServi : 194
 USED in MAP-Protocol : 79 133
 USED in MAP-SupplementaryServi : 19

updateGprsLocation.....information object reference OPERATION, Information Object
 DEFINED in MAP-MobileServiceOpera : 222
 USED in MAP-Protocol : 20 123
 USED in MAP-MobileServiceOpera : 21

UpdateGprsLocationArg.....type reference SEQUENCE
 DEFINED in MAP-MS-DataTypes : 427
 USED in MAP-MobileServiceOpera : 122 224
 USED in MAP-MS-DataTypes : 24

UpdateGprsLocationRes.....type reference SEQUENCE
 DEFINED in MAP-MS-DataTypes : 450
 USED in MAP-MobileServiceOpera : 123 226
 USED in MAP-MS-DataTypes : 25

updateLocation.....information object reference OPERATION, Information Object
 DEFINED in MAP-MobileServiceOpera : 174
 USED in MAP-Protocol : 16 122
 USED in MAP-MobileServiceOpera : 15

UpdateLocationArg.....type reference SEQUENCE
 DEFINED in MAP-MS-DataTypes : 222
 USED in MAP-MobileServiceOpera : 114 176
 USED in MAP-MS-DataTypes : 16

UpdateLocationRes.....type reference SEQUENCE
 DEFINED in MAP-MS-DataTypes : 273
 USED in MAP-MobileServiceOpera : 115 178
 USED in MAP-MS-DataTypes : 17

updateProcedure.....identifier of Named Number, 0
 DEFINED in MAP-MS-DataTypes : 285

uplinkAttached.....identifier of [6] NULL
 DEFINED in MAP-GR-DataTypes : 116

uplinkFree.....identifier of [3] NULL
 DEFINED in MAP-GR-DataTypes : 57

uplinkRejectCommand.....identifier of [2] NULL
 DEFINED in MAP-GR-DataTypes : 79

uplinkReleaseCommand.....identifier of [4] NULL
 DEFINED in MAP-GR-DataTypes : 81

uplinkReleaseIndication.....identifier of [1] NULL
 DEFINED in MAP-GR-DataTypes : 78

uplinkReleaseIndication.....identifier of [1] NULL
 DEFINED in MAP-GR-DataTypes : 88

uplinkRequest.....identifier of [0] NULL
DEFINED in MAP-GR-DataTypes : 87

uplinkRequestAck.....identifier of [0] NULL
DEFINED in MAP-GR-DataTypes : 77

TAG R6.0 Cross Reference Listing for MAP-Protocol 2006-06-08 15:10:26 PAGE 107

uplinkSeizedCommand.....identifier of [3] NULL
DEFINED in MAP-GR-DataTypes : 80

USSD-Arg.....type reference SEQUENCE
DEFINED in MAP-SS-DataTypes : 220
USED in MAP-SupplementaryServi : 65 183 196 213
USED in MAP-SS-DataTypes : 20

ussd-Busy.....information object reference ERROR, Information Object
DEFINED in MAP-Errors : 416
USED in MAP-SupplementaryServi : 50 208 223
USED in MAP-Errors : 69

ussd-DataCodingScheme.....identifier of USSD-DataCodingScheme
DEFINED in MAP-SS-DataTypes : 221

ussd-DataCodingScheme.....identifier of USSD-DataCodingScheme
DEFINED in MAP-SS-DataTypes : 228

USSD-DataCodingScheme.....type reference OCTET STRING
DEFINED in MAP-SS-DataTypes : 232
USED in MAP-SS-DataTypes : 22 221 228
USED in MAP-LCS-DataTypes : 50 159 173 231

USSD-Res.....type reference SEQUENCE
DEFINED in MAP-SS-DataTypes : 227
USED in MAP-SupplementaryServi : 66 185 198
USED in MAP-SS-DataTypes : 21

ussd-String.....identifier of USSD-String
DEFINED in MAP-SS-DataTypes : 222

ussd-String.....identifier of USSD-String
DEFINED in MAP-SS-DataTypes : 229

USSD-String.....type reference OCTET STRING
DEFINED in MAP-SS-DataTypes : 237
USED in MAP-SS-DataTypes : 23 222 229
USED in MAP-LCS-DataTypes : 51 168 177 235

utranCodecList.....identifier of [0] CodecList
DEFINED in MAP-MS-DataTypes : 652

utranPositioningData.....identifier of [5] UtranPositioningDataInfo
DEFINED in MAP-LCS-DataTypes : 247

utranPositioningData.....identifier of [12] UtranPositioningDataInfo
DEFINED in MAP-LCS-DataTypes : 374

UtranPositioningDataInfo.....type reference OCTET STRING
DEFINED in MAP-LCS-DataTypes : 328
USED in MAP-LCS-DataTypes : 247 374

uui.....identifier of [1] UUI
DEFINED in MAP-CH-DataTypes : 270

UUI.....type reference OCTET STRING
DEFINED in MAP-CH-DataTypes : 278
USED in MAP-CH-DataTypes : 270

uuiIndicator.....identifier of [0] UUIIndicator
DEFINED in MAP-CH-DataTypes : 269

UUIIndicator.....type reference OCTET STRING
DEFINED in MAP-CH-DataTypes : 275
USED in MAP-CH-DataTypes : 269

uus1.....value reference SS-Code, '10000001'B
DEFINED in MAP-SS-Code : 110

uus2.....value reference SS-Code, '10000010'B
DEFINED in MAP-SS-Code : 112

uus3.....value reference SS-Code, '10000011'B
DEFINED in MAP-SS-Code : 114

uusCFInteraction.....identifier of [2] NULL
DEFINED in MAP-CH-DataTypes : 271

uu-Data.....identifier of [10] UU-Data
DEFINED in MAP-CH-DataTypes : 260

TAG R6.0 Cross Reference Listing for MAP-Protocol 2006-06-08 15:10:26 PAGE 108

UU-Data.....type reference SEQUENCE
DEFINED in MAP-CH-DataTypes : 268
USED in MAP-CH-DataTypes : 260

valueAddedServices.....identifier of Named Number, 1
DEFINED in MAP-LCS-DataTypes : 149

VBSDDataList.....type reference SEQUENCE OF
DEFINED in MAP-MS-DataTypes : 1936
USED in MAP-MS-DataTypes : 1038

vbsGroupIndication.....identifier of [7] NULL
DEFINED in MAP-MS-DataTypes : 1391

vbsSubscriptionData.....identifier of [11] VBSDDataList
DEFINED in MAP-MS-DataTypes : 1038

verticalCoordinateRequest.....identifier of [1] NULL
DEFINED in MAP-LCS-DataTypes : 188

vertical-accuracy.....identifier of [2] Vertical-Accuracy
DEFINED in MAP-LCS-DataTypes : 189

Vertical-Accuracy.....type reference OCTET STRING
DEFINED in MAP-LCS-DataTypes : 199
USED in MAP-LCS-DataTypes : 189

VGCSDataList.....type reference SEQUENCE OF
DEFINED in MAP-MS-DataTypes : 1939
USED in MAP-MS-DataTypes : 1039

vgcsGroupIndication.....identifier of [8] NULL
DEFINED in MAP-MS-DataTypes : 1392

vgcsSubscriptionData.....identifier of [12] VGCSDataList
DEFINED in MAP-MS-DataTypes : 1039

vlr.....identifier of Named Number, 0
DEFINED in MAP-MS-DataTypes : 772

vlr.....identifier of Named Number, 2
DEFINED in MAP-CommonDataTypes : 354

vlrCamelSubscriptionInfo.....identifier of [13] VlrCamelSubscriptionInfo
DEFINED in MAP-MS-DataTypes : 1040

VlrCamelSubscriptionInfo.....type reference SEQUENCE
DEFINED in MAP-MS-DataTypes : 1449
USED in MAP-MS-DataTypes : 1040

vlr-Capability.....identifier of [6] VLR-Capability
DEFINED in MAP-MS-DataTypes : 229

VLR-Capability.....type reference SEQUENCE
DEFINED in MAP-MS-DataTypes : 233
USED in MAP-MS-DataTypes : 229 1926

vlr-Capability.....identifier of [6] VLR-Capability
DEFINED in MAP-MS-DataTypes : 1926

vlr-Number.....identifier of ISDN-AddressString
DEFINED in MAP-MS-DataTypes : 225

vlr-Number.....identifier of [0] ISDN-AddressString
DEFINED in MAP-MS-DataTypes : 296

vlr-Number.....identifier of [0] ISDN-AddressString
DEFINED in MAP-MS-DataTypes : 398

vlr-number.....identifier of [1] ISDN-AddressString
DEFINED in MAP-MS-DataTypes : 2064

vmsc.....identifier of Named Number, 5
DEFINED in MAP-CommonDataTypes : 357

vmsc-Address.....identifier of [2] ISDN-AddressString
DEFINED in MAP-CH-DataTypes : 163

voiceBroadcastCall.....value reference TeleserviceCode, '10010010'B
DEFINED in MAP-TS-Code : 69

VoiceBroadcastData.....type reference SEQUENCE

TAG R6.0 Cross Reference Listing for MAP-Protocol 2006-06-08 15:10:26 PAGE 109

DEFINED in MAP-MS-DataTypes : 1951
USED in MAP-MS-DataTypes : 1937

voiceGroupCall.....value reference TeleserviceCode, '10010001'B
DEFINED in MAP-TS-Code : 68

VoiceGroupCallData.....type reference SEQUENCE
DEFINED in MAP-MS-DataTypes : 1946
USED in MAP-MS-DataTypes : 1940

vplmnAddressAllowed.....identifier of [19] NULL
DEFINED in MAP-MS-DataTypes : 884

vt-BCSM-CAMEL-TDP-CriteriaList.....identifier of [6] T-BCSM-CAMEL-TDP-CriteriaList
DEFINED in MAP-MS-DataTypes : 2293

vt-csi.....identifier of Named Number, 4
DEFINED in MAP-MS-DataTypes : 1409

vt-CSI.....identifier of [7] T-CSI
DEFINED in MAP-MS-DataTypes : 1458

vt-csi.....identifier of Named Number, 2
DEFINED in MAP-MS-DataTypes : 1688

vt-CSI.....identifier of Named Number, 2
DEFINED in MAP-MS-DataTypes : 2247

vt-CSI.....identifier of [5] T-CSI
DEFINED in MAP-MS-DataTypes : 2292

vt-IM-BCSM-CAMEL-TDP-CriteriaList.....identifier of [22] T-BCSM-CAMEL-TDP-CriteriaList
DEFINED in MAP-MS-DataTypes : 2310

vt-IM-CSI.....identifier of Named Number, 13
DEFINED in MAP-MS-DataTypes : 1418

vt-IM-CSI.....identifier of Named Number, 4
DEFINED in MAP-MS-DataTypes : 2260

vt-IM-CSI.....identifier of [21] T-CSI
DEFINED in MAP-MS-DataTypes : 2309

warningToneEnhancements.....identifier of Named Number, 13
DEFINED in MAP-MS-DataTypes : 1712

whiteListed.....identifier of Named Number, 0
DEFINED in MAP-MS-DataTypes : 811

wrongNetworkSignature.....identifier of Named Number, 1
DEFINED in MAP-MS-DataTypes : 423

wrongPasswordAttemptsCounter.....identifier of WrongPasswordAttemptsCounter
DEFINED in MAP-MS-DataTypes : 2273

WrongPasswordAttemptsCounter.....type reference INTEGER
DEFINED in MAP-MS-DataTypes : 2278
USED in MAP-MS-DataTypes : 2273 2347 2426

wrongPasswordAttemptsCounter.....identifier of [4] WrongPasswordAttemptsCounter
DEFINED in MAP-MS-DataTypes : 2347

wrongPasswordAttemptsCounter.....identifier of [3] WrongPasswordAttemptsCounter
DEFINED in MAP-MS-DataTypes : 2426

wrongUserResponse.....identifier of Named Number, 0
DEFINED in MAP-MS-DataTypes : 422

xres.....identifier of XRES
DEFINED in MAP-MS-DataTypes : 347

XRES.....type reference OCTET STRING
DEFINED in MAP-MS-DataTypes : 374
USED in MAP-MS-DataTypes : 347

ZoneCode.....type reference OCTET STRING
DEFINED in MAP-MS-DataTypes : 1361
USED in MAP-MS-DataTypes : 1359 1390

ZoneCodeList.....type reference SEQUENCE OF
DEFINED in MAP-MS-DataTypes : 1358
USED in MAP-MS-DataTypes : 67 1037

zoneCodesConflict.....identifier of Named Number, 2
DEFINED in MAP-MS-DataTypes : 1380

Annex B (informative): Fully expanded ASN.1 sources for abstract syntaxes of MAP

Annex B is not part of the standard, it is included for information purposes only.

For every (Value)Assignment in the root ASN.1 module all the used defined types and defined values, which are defined within the ASN.1 module or imported from ASN.1 modules, are replaced by the constructs this type or value is composed of.

The fully expanded ASN.1 root module is itself a correct and equivalent representation of the MAP-Protocol.

It allows to see at all the parameters, including all nested ones for a specific operationcode or errorcode at once.

Note that for those operations which use a result without parameters the word 'RESULT' is not shown. Empty results are only defined in the ASN.1 description in clause 17.

B.1 Fully Expanded ASN.1 Source of MAP- Protocol/TCAPMessages

```
-- Expanded ASN1 Module 'MAP-MobileServiceOperations'
--SIEMENS ASN.1 Compiler      R6.0 (Production_6.0)
--      Date: 2006-06-08 Time: 15:10:45
```

```
MAP-MobileServiceOperations{ 0 identified-organization (4) etsi (0) mobileDomain (0) gsm-Network (1) modules (3) map-
MobileServiceOperations (5) version8 (8) }
```

DEFINITIONS

```
::=
```

BEGIN

EXPORTS

```
updateLocation,
cancelLocation,
purgeMS,
sendIdentification,
updateGprsLocation,
provideSubscriberInfo,
anyTimeInterrogation,
anyTimeSubscriptionInterrogation,
anyTimeModification,
noteSubscriberDataModified,
prepareHandover,
sendEndSignal,
processAccessSignalling,
forwardAccessSignalling,
prepareSubsequentHandover,
sendAuthenticationInfo,
authenticationFailureReport,
checkIMEI,
insertSubscriberData,
deleteSubscriberData,
reset,
forwardCheckSS-Indication,
restoreData,
sendRoutingInfoForGprs,
failureReport,
noteMsPresentForGprs,
noteMM-Event;
```

```
updateLocation OPERATION ::= {
```



```

ARGUMENT SEQUENCE {
imsi OCTET STRING ( SIZE( 3 .. 8 ) ),
msc-Number [1] IMPLICIT OCTET STRING ( SIZE( 1 .. 20 ) ) ( SIZE( 1 .. 9 ) ),
vlr-Number OCTET STRING ( SIZE( 1 .. 20 ) ) ( SIZE( 1 .. 9 ) ),
lmsi [10] IMPLICIT OCTET STRING ( SIZE( 4 ) ) OPTIONAL,
extensionContainer SEQUENCE {
privateExtensionList [0] IMPLICIT SEQUENCE ( SIZE( 1 .. 10 ) ) OF
SEQUENCE {
extId MAP-EXTENSION .&extensionId ( {
'
...} ),
extType MAP-EXTENSION .&ExtensionType ( {
'
...} { @extId } ) OPTIONAL} OPTIONAL,
pcs-Extensions [1] IMPLICIT SEQUENCE {
... } OPTIONAL,
... } OPTIONAL,
... ,
vlr-Capability [6] IMPLICIT SEQUENCE {
supportedCamelPhases [0] IMPLICIT BIT STRING {
phase1 ( 0 ),
phase2 ( 1 ),
phase3 ( 2 ),
phase4 ( 3 ) } ( SIZE( 1 .. 16 ) ) OPTIONAL,
extensionContainer SEQUENCE {
privateExtensionList [0] IMPLICIT SEQUENCE ( SIZE( 1 .. 10 ) ) OF
SEQUENCE {
extId MAP-EXTENSION .&extensionId ( {
'
...} ),
extType MAP-EXTENSION .&ExtensionType ( {
'
...} { @extId } ) OPTIONAL} OPTIONAL,
pcs-Extensions [1] IMPLICIT SEQUENCE {
... } OPTIONAL,
... } OPTIONAL,
... ,
solsaSupportIndicator [2] IMPLICIT NULL OPTIONAL,
istSupportIndicator [1] IMPLICIT ENUMERATED {
basicSTSupported ( 0 ),
istCommandSupported ( 1 ),
... } OPTIONAL,
superChargerSupportedInServingNetworkEntity [3] CHOICE {
sendSubscriberData [0] IMPLICIT NULL,
subscriberDataStored [1] IMPLICIT OCTET STRING ( SIZE( 1 .. 6 ) ) OPTIONAL,
longFTN-Supported [4] IMPLICIT NULL OPTIONAL,
supportedLCS-CapabilitySets [5] IMPLICIT BIT STRING {
lcsCapabilitySet1 ( 0 ),
lcsCapabilitySet2 ( 1 ),
lcsCapabilitySet3 ( 2 ) } ( SIZE( 2 .. 16 ) ) OPTIONAL,
offeredCamel4CSIs [6] IMPLICIT BIT STRING {
o-csi ( 0 ),
d-csi ( 1 ),
vt-csi ( 2 ),
t-csi ( 3 ),
mt-sms-csi ( 4 ),
mg-csi ( 5 ),
psi-enhancements ( 6 ) } ( SIZE( 7 .. 16 ) ) OPTIONAL,
informPreviousNetworkEntity [11] IMPLICIT NULL OPTIONAL,
cs-LCS-NotSupportedByUE [12] IMPLICIT NULL OPTIONAL}
RESULT SEQUENCE {
hlr-Number OCTET STRING ( SIZE( 1 .. 20 ) ) ( SIZE( 1 .. 9 ) ),
extensionContainer SEQUENCE {
privateExtensionList [0] IMPLICIT SEQUENCE ( SIZE( 1 .. 10 ) ) OF
SEQUENCE {
extId MAP-EXTENSION .&extensionId ( {
'
...} ),
extType MAP-EXTENSION .&ExtensionType ( {
'
...} { @extId } ) OPTIONAL} OPTIONAL,
pcs-Extensions [1] IMPLICIT SEQUENCE {
... } OPTIONAL,
... } OPTIONAL,
... }
ERRORS {
systemFailure |

```

```

dataMissing |
unexpectedDataValue |
unknownSubscriber |
roamingNotAllowed }
CODE local :2
}

```

```

cancelLocation OPERATION ::= {
ARGUMENT [3] IMPLICIT SEQUENCE {
identity CHOICE {
imsi OCTET STRING ( SIZE( 3 .. 8 ) ),
imsi-WithLMSI SEQUENCE {
imsi OCTET STRING ( SIZE( 3 .. 8 ) ),
lmsi OCTET STRING ( SIZE( 4 ) ),
... }},
cancellationType ENUMERATED {
updateProcedure ( 0 ),
subscriptionWithdraw ( 1 ),
... } OPTIONAL,
extensionContainer SEQUENCE {
privateExtensionList [0] IMPLICIT SEQUENCE ( SIZE( 1 .. 10 ) ) OF
SEQUENCE {
extId MAP-EXTENSION .&extensionId ( {
'
...} ),
extType MAP-EXTENSION .&ExtensionType ( {
'
...}{ @extId } ) OPTIONAL} OPTIONAL,
pcs-Extensions [1] IMPLICIT SEQUENCE {
... } OPTIONAL,
... } OPTIONAL,
... }
RESULT SEQUENCE {
extensionContainer SEQUENCE {
privateExtensionList [0] IMPLICIT SEQUENCE ( SIZE( 1 .. 10 ) ) OF
SEQUENCE {
extId MAP-EXTENSION .&extensionId ( {
'
...} ),
extType MAP-EXTENSION .&ExtensionType ( {
'
...}{ @extId } ) OPTIONAL} OPTIONAL,
pcs-Extensions [1] IMPLICIT SEQUENCE {
... } OPTIONAL,
... } OPTIONAL,
... }
ERRORS {
dataMissing |
unexpectedDataValue }
CODE local :3
}

```

```

purgeMS OPERATION ::= {
ARGUMENT [3] IMPLICIT SEQUENCE {
imsi OCTET STRING ( SIZE( 3 .. 8 ) ),
vlr-Number [0] IMPLICIT OCTET STRING ( SIZE( 1 .. 20 ) ) ( SIZE( 1 .. 9 ) ) OPTIONAL,
sgsn-Number [1] IMPLICIT OCTET STRING ( SIZE( 1 .. 20 ) ) ( SIZE( 1 .. 9 ) ) OPTIONAL,
extensionContainer SEQUENCE {
privateExtensionList [0] IMPLICIT SEQUENCE ( SIZE( 1 .. 10 ) ) OF
SEQUENCE {
extId MAP-EXTENSION .&extensionId ( {
'
...} ),
extType MAP-EXTENSION .&ExtensionType ( {
'
...}{ @extId } ) OPTIONAL} OPTIONAL,
pcs-Extensions [1] IMPLICIT SEQUENCE {
... } OPTIONAL,
... } OPTIONAL,
... }
RESULT SEQUENCE {
freezeTMSI [0] IMPLICIT NULL OPTIONAL,
freezeP-TMSI [1] IMPLICIT NULL OPTIONAL,
extensionContainer SEQUENCE {
privateExtensionList [0] IMPLICIT SEQUENCE ( SIZE( 1 .. 10 ) ) OF
SEQUENCE {
extId MAP-EXTENSION .&extensionId ( {

```

```

    ...}),
    extType MAP-EXTENSION .&ExtensionType ( {
        ...}{ @extId } ) OPTIONAL} OPTIONAL,
    pcs-Extensions [1] IMPLICIT SEQUENCE {
        ... } OPTIONAL,
    ... } OPTIONAL,
    ... }
}
ERRORS {
    dataMissing |
    unexpectedDataValue |
    unknownSubscriber }
CODE local : 67
}

sendIdentification OPERATION ::= {
    ARGUMENT SEQUENCE {
        tmsi OCTET STRING ( SIZE( 1 .. 4 ) ),
        numberOfRequestedVectors INTEGER ( 1 .. 5 ) OPTIONAL,
        segmentationProhibited NULL OPTIONAL,
        extensionContainer SEQUENCE {
            privateExtensionList [0] IMPLICIT SEQUENCE ( SIZE( 1 .. 10 ) ) OF
                SEQUENCE {
                    extId MAP-EXTENSION .&extensionId ( {
                        ...}),
                    extType MAP-EXTENSION .&ExtensionType ( {
                        ...}{ @extId } ) OPTIONAL} OPTIONAL,
                    pcs-Extensions [1] IMPLICIT SEQUENCE {
                        ... } OPTIONAL,
                    ... } OPTIONAL,
                    ... }
                }
            }
        RESULT [3] IMPLICIT SEQUENCE {
            imsi OCTET STRING ( SIZE( 3 .. 8 ) ) OPTIONAL,
            authenticationSetList CHOICE {
                tripletList [0] IMPLICIT SEQUENCE ( SIZE( 1 .. 5 ) ) OF
                    SEQUENCE {
                        rand OCTET STRING ( SIZE( 16 ) ),
                        sres OCTET STRING ( SIZE( 4 ) ),
                        kc OCTET STRING ( SIZE( 8 ) ),
                        ... },
                quintupletList [1] IMPLICIT SEQUENCE ( SIZE( 1 .. 5 ) ) OF
                    SEQUENCE {
                        rand OCTET STRING ( SIZE( 16 ) ),
                        xres OCTET STRING ( SIZE( 4 .. 16 ) ),
                        ck OCTET STRING ( SIZE( 16 ) ),
                        ik OCTET STRING ( SIZE( 16 ) ),
                        autn OCTET STRING ( SIZE( 16 ) ),
                        ... } } OPTIONAL,
            currentSecurityContext [2] CHOICE {
                gsm-SecurityContextData [0] IMPLICIT SEQUENCE {
                    kc OCTET STRING ( SIZE( 8 ) ),
                    cksn OCTET STRING ( SIZE( 1 ) ),
                    ... },
                umts-SecurityContextData [1] IMPLICIT SEQUENCE {
                    ck OCTET STRING ( SIZE( 16 ) ),
                    ik OCTET STRING ( SIZE( 16 ) ),
                    ksi OCTET STRING ( SIZE( 1 ) ),
                    ... } } OPTIONAL,
            extensionContainer [3] IMPLICIT SEQUENCE {
                privateExtensionList [0] IMPLICIT SEQUENCE ( SIZE( 1 .. 10 ) ) OF
                    SEQUENCE {
                        extId MAP-EXTENSION .&extensionId ( {
                            ...}),
                            extType MAP-EXTENSION .&ExtensionType ( {
                                ...}{ @extId } ) OPTIONAL} OPTIONAL,
                                pcs-Extensions [1] IMPLICIT SEQUENCE {
                                    ... } OPTIONAL,
                                    ... } OPTIONAL,
                                    ... }
                    }
                }
            }
        ERRORS {
            dataMissing |
            unidentifiedSubscriber }
    }
}

```

```
CODE local :55
}
```

```
updateGprsLocation OPERATION ::= {
  ARGUMENT SEQUENCE {
    imsi OCTET STRING ( SIZE( 3 .. 8 ) ),
    sgsn-Number OCTET STRING ( SIZE( 1 .. 20 ) ) ( SIZE( 1 .. 9 ) ),
    sgsn-Address OCTET STRING ( SIZE( 5 .. 17 ) ),
    extensionContainer SEQUENCE {
      privateExtensionList [0] IMPLICIT SEQUENCE ( SIZE( 1 .. 10 ) ) OF
        SEQUENCE {
          extId MAP-EXTENSION .&extensionId ( {
            '
            ... } ),
          extType MAP-EXTENSION .&ExtensionType ( {
            '
            ... } { @extId } ) OPTIONAL } OPTIONAL,
      pcs-Extensions [1] IMPLICIT SEQUENCE {
        ... } OPTIONAL,
      ... } OPTIONAL,
    ... ,
    sgsn-Capability [0] IMPLICIT SEQUENCE {
      solsaSupportIndicator NULL OPTIONAL,
      extensionContainer [1] IMPLICIT SEQUENCE {
        privateExtensionList [0] IMPLICIT SEQUENCE ( SIZE( 1 .. 10 ) ) OF
          SEQUENCE {
            extId MAP-EXTENSION .&extensionId ( {
              '
              ... } ),
            extType MAP-EXTENSION .&ExtensionType ( {
              '
              ... } { @extId } ) OPTIONAL } OPTIONAL,
        pcs-Extensions [1] IMPLICIT SEQUENCE {
          ... } OPTIONAL,
        ... } OPTIONAL,
      ... ,
      superChargerSupportedInServingNetworkEntity [2] CHOICE {
        sendSubscriberData [0] IMPLICIT NULL,
        subscriberDataStored [1] IMPLICIT OCTET STRING ( SIZE( 1 .. 6 ) ) OPTIONAL,
        gprsEnhancementsSupportIndicator [3] IMPLICIT NULL OPTIONAL,
        supportedCamelPhases [4] IMPLICIT BIT STRING {
          phase1 ( 0 ),
          phase2 ( 1 ),
          phase3 ( 2 ),
          phase4 ( 3 ) } ( SIZE( 1 .. 16 ) ) OPTIONAL,
        supportedLCS-CapabilitySets [5] IMPLICIT BIT STRING {
          lcsCapabilitySet1 ( 0 ),
          lcsCapabilitySet2 ( 1 ),
          lcsCapabilitySet3 ( 2 ) } ( SIZE( 2 .. 16 ) ) OPTIONAL,
        offeredCamel4CSIs [6] IMPLICIT BIT STRING {
          o-csi ( 0 ),
          d-csi ( 1 ),
          vt-csi ( 2 ),
          t-csi ( 3 ),
          mt-sms-csi ( 4 ),
          mg-csi ( 5 ),
          psi-enhancements ( 6 ) } ( SIZE( 7 .. 16 ) ) OPTIONAL } OPTIONAL,
        informPreviousNetworkEntity [1] IMPLICIT NULL OPTIONAL,
        ps-LCS-NotSupportedByUE [2] IMPLICIT NULL OPTIONAL }
    RESULT SEQUENCE {
      hlr-Number OCTET STRING ( SIZE( 1 .. 20 ) ) ( SIZE( 1 .. 9 ) ),
      extensionContainer SEQUENCE {
        privateExtensionList [0] IMPLICIT SEQUENCE ( SIZE( 1 .. 10 ) ) OF
          SEQUENCE {
            extId MAP-EXTENSION .&extensionId ( {
              '
              ... } ),
            extType MAP-EXTENSION .&ExtensionType ( {
              '
              ... } { @extId } ) OPTIONAL } OPTIONAL,
        pcs-Extensions [1] IMPLICIT SEQUENCE {
          ... } OPTIONAL,
        ... } OPTIONAL,
      ... }
    ERRORS {
      systemFailure |
      unexpectedDataValue |

```

```

    unknownSubscriber |
    roamingNotAllowed }
CODE local : 23
}

```

```

provideSubscriberInfo OPERATION ::= {
  ARGUMENT SEQUENCE {
    imsi [0] IMPLICIT OCTET STRING ( SIZE( 3 .. 8 ) ),
    lmsi [1] IMPLICIT OCTET STRING ( SIZE( 4 ) ) OPTIONAL,
    requestedInfo [2] IMPLICIT SEQUENCE {
      locationInformation [0] IMPLICIT NULL OPTIONAL,
      subscriberState [1] IMPLICIT NULL OPTIONAL,
      extensionContainer [2] IMPLICIT SEQUENCE {
        privateExtensionList [0] IMPLICIT SEQUENCE ( SIZE( 1 .. 10 ) ) OF
          SEQUENCE {
            extId MAP-EXTENSION .&extensionId ( {
              '
              ... } ),
            extType MAP-EXTENSION .&ExtensionType ( {
              '
              ... } { @extId } ) OPTIONAL } OPTIONAL,
            pcs-Extensions [1] IMPLICIT SEQUENCE {
              ... } OPTIONAL,
              ... } OPTIONAL,
            ... ,
            currentLocation [3] IMPLICIT NULL OPTIONAL,
            requestedDomain [4] IMPLICIT ENUMERATED {
              cs-Domain ( 0 ),
              ps-Domain ( 1 ),
              ... } OPTIONAL,
            imei [6] IMPLICIT NULL OPTIONAL,
            ms-classmark [5] IMPLICIT NULL OPTIONAL,
            mnpRequestedInfo [7] IMPLICIT NULL OPTIONAL,
            extensionContainer [3] IMPLICIT SEQUENCE {
              privateExtensionList [0] IMPLICIT SEQUENCE ( SIZE( 1 .. 10 ) ) OF
                SEQUENCE {
                  extId MAP-EXTENSION .&extensionId ( {
                    '
                    ... } ),
                  extType MAP-EXTENSION .&ExtensionType ( {
                    '
                    ... } { @extId } ) OPTIONAL } OPTIONAL,
                  pcs-Extensions [1] IMPLICIT SEQUENCE {
                    ... } OPTIONAL,
                    ... } OPTIONAL,
                  ... }
            ... }
          RESULT SEQUENCE {
            subscriberInfo SEQUENCE {
              locationInformation [0] IMPLICIT SEQUENCE {
                ageOfLocationInformation INTEGER ( 0 .. 32767 ) OPTIONAL,
                geographicalInformation [0] IMPLICIT OCTET STRING ( SIZE( 8 ) ) OPTIONAL,
                vlr-number [1] IMPLICIT OCTET STRING ( SIZE( 1 .. 20 ) ) ( SIZE( 1 .. 9 ) ) OPTIONAL,
                locationNumber [2] IMPLICIT OCTET STRING ( SIZE( 2 .. 10 ) ) OPTIONAL,
                cellGlobalIdOrServiceAreaIdOrLAI [3] CHOICE {
                  cellGlobalIdOrServiceAreaIdFixedLength [0] IMPLICIT OCTET STRING ( SIZE( 7 ) ),
                  laiFixedLength [1] IMPLICIT OCTET STRING ( SIZE( 5 ) ) } OPTIONAL,
                extensionContainer [4] IMPLICIT SEQUENCE {
                  privateExtensionList [0] IMPLICIT SEQUENCE ( SIZE( 1 .. 10 ) ) OF
                    SEQUENCE {
                      extId MAP-EXTENSION .&extensionId ( {
                        '
                        ... } ),
                      extType MAP-EXTENSION .&ExtensionType ( {
                        '
                        ... } { @extId } ) OPTIONAL } OPTIONAL,
                      pcs-Extensions [1] IMPLICIT SEQUENCE {
                        ... } OPTIONAL,
                        ... } OPTIONAL,
                      ... ,
                      selectedLSA-Id [5] IMPLICIT OCTET STRING ( SIZE( 3 ) ) OPTIONAL,
                      msc-Number [6] IMPLICIT OCTET STRING ( SIZE( 1 .. 20 ) ) ( SIZE( 1 .. 9 ) ) OPTIONAL,
                      geodeticInformation [7] IMPLICIT OCTET STRING ( SIZE( 10 ) ) OPTIONAL,
                      currentLocationRetrieved [8] IMPLICIT NULL OPTIONAL,
                      sai-Present [9] IMPLICIT NULL OPTIONAL } OPTIONAL,
                subscriberState [1] CHOICE {
                  assumedIdle [0] IMPLICIT NULL,
                  camelBusy [1] IMPLICIT NULL,

```



```

pcs-Extensions      [1] IMPLICIT SEQUENCE {
  ... } OPTIONAL,
  ... } OPTIONAL,
... ,
qos2-Subscribed     [18] IMPLICIT OCTET STRING ( SIZE( 1 .. 3 ) ) OPTIONAL,
qos2-Requested      [19] IMPLICIT OCTET STRING ( SIZE( 1 .. 3 ) ) OPTIONAL,
qos2-Negotiated     [20] IMPLICIT OCTET STRING ( SIZE( 1 .. 3 ) ) OPTIONAL},
ps-PDP-ActiveReachableForPaging [5] IMPLICIT SEQUENCE ( SIZE( 1 .. 50 ) ) OF
SEQUENCE {
  pdp-ContextIdentifier [0] IMPLICIT INTEGER ( 1 .. 50 ),
  pdp-ContextActive     [1] IMPLICIT NULL OPTIONAL,
  pdp-Type              [2] IMPLICIT OCTET STRING ( SIZE( 2 ) ),
  pdp-Address           [3] IMPLICIT OCTET STRING ( SIZE( 1 .. 16 ) ) OPTIONAL,
  apn-Subscribed        [4] IMPLICIT OCTET STRING ( SIZE( 2 .. 63 ) ) OPTIONAL,
  apn-InUse             [5] IMPLICIT OCTET STRING ( SIZE( 2 .. 63 ) ) OPTIONAL,
  nsapi                 [6] IMPLICIT INTEGER ( 0 .. 15 ) OPTIONAL,
  transactionId        [7] IMPLICIT OCTET STRING ( SIZE( 1 .. 2 ) ) OPTIONAL,
  teid-ForGnAndGp      [8] IMPLICIT OCTET STRING ( SIZE( 4 ) ) OPTIONAL,
  teid-ForLu           [9] IMPLICIT OCTET STRING ( SIZE( 4 ) ) OPTIONAL,
  ggsn-Address         [10] IMPLICIT OCTET STRING ( SIZE( 5 .. 17 ) ) OPTIONAL,
  qos-Subscribed       [11] IMPLICIT OCTET STRING ( SIZE( 1 .. 9 ) ) OPTIONAL,
  qos-Requested        [12] IMPLICIT OCTET STRING ( SIZE( 1 .. 9 ) ) OPTIONAL,
  qos-Negotiated       [13] IMPLICIT OCTET STRING ( SIZE( 1 .. 9 ) ) OPTIONAL,
  chargingId           [14] IMPLICIT OCTET STRING ( SIZE( 4 ) ) OPTIONAL,
  chargingCharacteristics [15] IMPLICIT OCTET STRING ( SIZE( 2 ) ) OPTIONAL,
  rnc-Address          [16] IMPLICIT OCTET STRING ( SIZE( 5 .. 17 ) ) OPTIONAL,
  extensionContainer   [17] IMPLICIT SEQUENCE {
    privateExtensionList [0] IMPLICIT SEQUENCE ( SIZE( 1 .. 10 ) ) OF
    SEQUENCE {
      extId  MAP-EXTENSION .&extensionId ( {
        '
        ... } ),
      extType  MAP-EXTENSION .&ExtensionType ( {
        '
        ... } { @extId } ) OPTIONAL } OPTIONAL,
    pcs-Extensions [1] IMPLICIT SEQUENCE {
      ... } OPTIONAL,
      ... } OPTIONAL,
    ... ,
    qos2-Subscribed [18] IMPLICIT OCTET STRING ( SIZE( 1 .. 3 ) ) OPTIONAL,
    qos2-Requested  [19] IMPLICIT OCTET STRING ( SIZE( 1 .. 3 ) ) OPTIONAL,
    qos2-Negotiated [20] IMPLICIT OCTET STRING ( SIZE( 1 .. 3 ) ) OPTIONAL},
    netDetNotReachable
    ENUMERATED {
      msPurged      ( 0 ),
      imsiDetached  ( 1 ),
      restrictedArea ( 2 ),
      notRegistered ( 3 ) } } OPTIONAL,
    imei [5] IMPLICIT OCTET STRING ( SIZE( 8 ) ) OPTIONAL,
    ms-Classmark2 [6] IMPLICIT OCTET STRING ( SIZE( 3 ) ) OPTIONAL,
    gprs-MS-Class [7] IMPLICIT SEQUENCE {
      mSNetworkCapability [0] IMPLICIT OCTET STRING ( SIZE( 1 .. 8 ) ),
      mSRadioAccessCapability [1] IMPLICIT OCTET STRING ( SIZE( 1 .. 50 ) ) OPTIONAL } OPTIONAL,
    mnpInfoRes [8] IMPLICIT SEQUENCE {
      routingNumber [0] IMPLICIT OCTET STRING ( SIZE( 1 .. 5 ) ) OPTIONAL,
      imsi [1] IMPLICIT OCTET STRING ( SIZE( 3 .. 8 ) ) OPTIONAL,
      msisdN [2] IMPLICIT OCTET STRING ( SIZE( 1 .. 20 ) ) ( SIZE( 1 .. 9 ) ) OPTIONAL,
      numberPortabilityStatus [3] IMPLICIT ENUMERATED {
        notKnownToBePorted ( 0 ),
        ownNumberPortedOut ( 1 ),
        foreignNumberPortedToForeignNetwork ( 2 ),
        ... ,
        ownNumberNotPortedOut ( 4 ),
        foreignNumberPortedIn ( 5 ) } OPTIONAL,
    extensionContainer [4] IMPLICIT SEQUENCE {
      privateExtensionList [0] IMPLICIT SEQUENCE ( SIZE( 1 .. 10 ) ) OF
      SEQUENCE {
        extId  MAP-EXTENSION .&extensionId ( {
          '
          ... } ),
        extType  MAP-EXTENSION .&ExtensionType ( {
          '
          ... } { @extId } ) OPTIONAL } OPTIONAL,
      pcs-Extensions [1] IMPLICIT SEQUENCE {
        ... } OPTIONAL,
        ... } OPTIONAL,
        ... } OPTIONAL,
        ... } OPTIONAL},
    extensionContainer SEQUENCE {

```

```

privateExtensionList [0] IMPLICIT SEQUENCE ( SIZE( 1 .. 10 ) ) OF
SEQUENCE {
  extId MAP-EXTENSION .&extensionId ( {
    '
    ... } ),
  extType MAP-EXTENSION .&ExtensionType ( {
    '
    ... } { @extId } ) OPTIONAL} OPTIONAL,
pcs-Extensions [1] IMPLICIT SEQUENCE {
  ... } OPTIONAL,
  ... } OPTIONAL,
... }
ERRORS {
  dataMissing |
  unexpectedDataValue }
CODE local :70
}

anyTimeInterrogation OPERATION ::= {
ARGUMENT SEQUENCE {
  subscriberIdentity [0] CHOICE {
    imsi [0] IMPLICIT OCTET STRING ( SIZE( 3 .. 8 ) ),
    msisdn [1] IMPLICIT OCTET STRING ( SIZE( 1 .. 20 ) ) ( SIZE( 1 .. 9 ) ) },
  requestedInfo [1] IMPLICIT SEQUENCE {
    locationInformation [0] IMPLICIT NULL OPTIONAL,
    subscriberState [1] IMPLICIT NULL OPTIONAL,
    extensionContainer [2] IMPLICIT SEQUENCE {
      privateExtensionList [0] IMPLICIT SEQUENCE ( SIZE( 1 .. 10 ) ) OF
      SEQUENCE {
        extId MAP-EXTENSION .&extensionId ( {
          '
          ... } ),
        extType MAP-EXTENSION .&ExtensionType ( {
          '
          ... } { @extId } ) OPTIONAL} OPTIONAL,
        pcs-Extensions [1] IMPLICIT SEQUENCE {
          ... } OPTIONAL,
          ... } OPTIONAL,
        ... ,
        currentLocation [3] IMPLICIT NULL OPTIONAL,
        requestedDomain [4] IMPLICIT ENUMERATED {
          cs-Domain ( 0 ),
          ps-Domain ( 1 ),
          ... } OPTIONAL,
        imei [6] IMPLICIT NULL OPTIONAL,
        ms-classmark [5] IMPLICIT NULL OPTIONAL,
        mnpRequestedInfo [7] IMPLICIT NULL OPTIONAL,
        gsmSCF-Address [3] IMPLICIT OCTET STRING ( SIZE( 1 .. 20 ) ) ( SIZE( 1 .. 9 ) ),
        extensionContainer [2] IMPLICIT SEQUENCE {
          privateExtensionList [0] IMPLICIT SEQUENCE ( SIZE( 1 .. 10 ) ) OF
          SEQUENCE {
            extId MAP-EXTENSION .&extensionId ( {
              '
              ... } ),
            extType MAP-EXTENSION .&ExtensionType ( {
              '
              ... } { @extId } ) OPTIONAL} OPTIONAL,
            pcs-Extensions [1] IMPLICIT SEQUENCE {
              ... } OPTIONAL,
              ... } OPTIONAL,
            ... }
          }
        }
      }
    }
  }
RESULT SEQUENCE {
  subscriberInfo SEQUENCE {
    locationInformation [0] IMPLICIT SEQUENCE {
      ageOfLocationInformation INTEGER ( 0 .. 32767 ) OPTIONAL,
      geographicalInformation [0] IMPLICIT OCTET STRING ( SIZE( 8 ) ) OPTIONAL,
      vlr-number [1] IMPLICIT OCTET STRING ( SIZE( 1 .. 20 ) ) ( SIZE( 1 .. 9 ) ) OPTIONAL,
      locationNumber [2] IMPLICIT OCTET STRING ( SIZE( 2 .. 10 ) ) OPTIONAL,
      cellGlobalIdOrServiceAreaIdOrLAI [3] CHOICE {
        cellGlobalIdOrServiceAreaIdFixedLength [0] IMPLICIT OCTET STRING ( SIZE( 7 ) ),
        laiFixedLength [1] IMPLICIT OCTET STRING ( SIZE( 5 ) ) } OPTIONAL,
      extensionContainer [4] IMPLICIT SEQUENCE {
        privateExtensionList [0] IMPLICIT SEQUENCE ( SIZE( 1 .. 10 ) ) OF
        SEQUENCE {
          extId MAP-EXTENSION .&extensionId ( {
            '
            ... } ),
          ... }
        }
      }
    }
  }
}

```



```

    extType MAP-EXTENSION .&ExtensionType ( {
        '
        ... } { @extId } ) OPTIONAL} OPTIONAL,
    pcs-Extensions [1] IMPLICIT SEQUENCE {
        ... } OPTIONAL,
    ... } OPTIONAL,
    ... ,
    selectedLSA-Id [5] IMPLICIT OCTET STRING ( SIZE( 3 ) ) OPTIONAL,
    msc-Number [6] IMPLICIT OCTET STRING ( SIZE( 1 .. 20 ) ) ( SIZE( 1 .. 9 ) ) OPTIONAL,
    geodeticInformation [7] IMPLICIT OCTET STRING ( SIZE( 10 ) ) OPTIONAL,
    currentLocationRetrieved [8] IMPLICIT NULL OPTIONAL,
    sai-Present [9] IMPLICIT NULL OPTIONAL} OPTIONAL,
subscriberState [1] CHOICE {
    assumedIdle [0] IMPLICIT NULL,
    camelBusy [1] IMPLICIT NULL,
    netDetNotReachable ENUMERATED {
        msPurged ( 0 ),
        imsiDetached ( 1 ),
        restrictedArea ( 2 ),
        notRegistered ( 3 ) },
    notProvidedFromVLR [2] IMPLICIT NULL} OPTIONAL,
extensionContainer [2] IMPLICIT SEQUENCE {
    privateExtensionList [0] IMPLICIT SEQUENCE ( SIZE( 1 .. 10 ) ) OF
        SEQUENCE {
            extId MAP-EXTENSION .&extensionId ( {
                '
                ... } ),
            extType MAP-EXTENSION .&ExtensionType ( {
                '
                ... } { @extId } ) OPTIONAL} OPTIONAL,
            pcs-Extensions [1] IMPLICIT SEQUENCE {
                ... } OPTIONAL,
            ... } OPTIONAL,
            ... ,
locationInformationGPRS [3] IMPLICIT SEQUENCE {
    cellGlobalIdOrServiceAreaIdOrLAI [0] CHOICE {
        cellGlobalIdOrServiceAreaIdFixedLength [0] IMPLICIT OCTET STRING ( SIZE( 7 ) ),
        laiFixedLength [1] IMPLICIT OCTET STRING ( SIZE( 5 ) )} OPTIONAL,
    routingAreaId [1] IMPLICIT OCTET STRING ( SIZE( 6 ) ) OPTIONAL,
    geographicalInformation [2] IMPLICIT OCTET STRING ( SIZE( 8 ) ) OPTIONAL,
    sgsn-Number [3] IMPLICIT OCTET STRING ( SIZE( 1 .. 20 ) ) ( SIZE( 1 .. 9 ) ) OPTIONAL,
    selectedLSAId [4] IMPLICIT OCTET STRING ( SIZE( 3 ) ) OPTIONAL,
    extensionContainer [5] IMPLICIT SEQUENCE {
        privateExtensionList [0] IMPLICIT SEQUENCE ( SIZE( 1 .. 10 ) ) OF
            SEQUENCE {
                extId MAP-EXTENSION .&extensionId ( {
                    '
                    ... } ),
                extType MAP-EXTENSION .&ExtensionType ( {
                    '
                    ... } { @extId } ) OPTIONAL} OPTIONAL,
                pcs-Extensions [1] IMPLICIT SEQUENCE {
                    ... } OPTIONAL,
                ... } OPTIONAL,
                ... ,
            sai-Present [6] IMPLICIT NULL OPTIONAL,
            geodeticInformation [7] IMPLICIT OCTET STRING ( SIZE( 10 ) ) OPTIONAL,
            currentLocationRetrieved [8] IMPLICIT NULL OPTIONAL,
            ageOfLocationInformation [9] IMPLICIT INTEGER ( 0 .. 32767 ) OPTIONAL} OPTIONAL,
ps-SubscriberState [4] CHOICE {
    notProvidedFromSGSN [0] IMPLICIT NULL,
    ps-Detached [1] IMPLICIT NULL,
    ps-AttachedNotReachableForPaging [2] IMPLICIT NULL,
    ps-AttachedReachableForPaging [3] IMPLICIT NULL,
    ps-PDP-ActiveNotReachableForPaging [4] IMPLICIT SEQUENCE ( SIZE( 1 .. 50 ) ) OF
        SEQUENCE {
            pdp-ContextIdentifier [0] IMPLICIT INTEGER ( 1 .. 50 ),
            pdp-ContextActive [1] IMPLICIT NULL OPTIONAL,
            pdp-Type [2] IMPLICIT OCTET STRING ( SIZE( 2 ) ),
            pdp-Address [3] IMPLICIT OCTET STRING ( SIZE( 1 .. 16 ) ) OPTIONAL,
            apn-Subscribed [4] IMPLICIT OCTET STRING ( SIZE( 2 .. 63 ) ) OPTIONAL,
            apn-InUse [5] IMPLICIT OCTET STRING ( SIZE( 2 .. 63 ) ) OPTIONAL,
            nsapi [6] IMPLICIT INTEGER ( 0 .. 15 ) OPTIONAL,
            transactionId [7] IMPLICIT OCTET STRING ( SIZE( 1 .. 2 ) ) OPTIONAL,
            teid-ForGnAndGp [8] IMPLICIT OCTET STRING ( SIZE( 4 ) ) OPTIONAL,
            teid-ForLu [9] IMPLICIT OCTET STRING ( SIZE( 4 ) ) OPTIONAL,
            ggsn-Address [10] IMPLICIT OCTET STRING ( SIZE( 5 .. 17 ) ) OPTIONAL,

```

```

qos-Subscribed      [11] IMPLICIT OCTET STRING ( SIZE( 1 .. 9 ) ) OPTIONAL,
qos-Requested      [12] IMPLICIT OCTET STRING ( SIZE( 1 .. 9 ) ) OPTIONAL,
qos-Negotiated     [13] IMPLICIT OCTET STRING ( SIZE( 1 .. 9 ) ) OPTIONAL,
chargingId         [14] IMPLICIT OCTET STRING ( SIZE( 4 ) ) OPTIONAL,
chargingCharacteristics [15] IMPLICIT OCTET STRING ( SIZE( 2 ) ) OPTIONAL,
rnc-Address        [16] IMPLICIT OCTET STRING ( SIZE( 5 .. 17 ) ) OPTIONAL,
extensionContainer [17] IMPLICIT SEQUENCE {
  privateExtensionList [0] IMPLICIT SEQUENCE ( SIZE( 1 .. 10 ) ) OF
    SEQUENCE {
      extId  MAP-EXTENSION .&extensionId ( {
        '
        ... } ),
      extType  MAP-EXTENSION .&ExtensionType ( {
        '
        ... } { @extId } ) OPTIONAL } OPTIONAL,
  pcs-Extensions [1] IMPLICIT SEQUENCE {
    ... } OPTIONAL,
  ... } OPTIONAL,
... ,
qos2-Subscribed    [18] IMPLICIT OCTET STRING ( SIZE( 1 .. 3 ) ) OPTIONAL,
qos2-Requested     [19] IMPLICIT OCTET STRING ( SIZE( 1 .. 3 ) ) OPTIONAL,
qos2-Negotiated    [20] IMPLICIT OCTET STRING ( SIZE( 1 .. 3 ) ) OPTIONAL,
ps-PDP-ActiveReachableForPaging [5] IMPLICIT SEQUENCE ( SIZE( 1 .. 50 ) ) OF
  SEQUENCE {
    pdp-ContextIdentifier [0] IMPLICIT INTEGER ( 1 .. 50 ),
    pdp-ContextActive     [1] IMPLICIT NULL OPTIONAL,
    pdp-Type              [2] IMPLICIT OCTET STRING ( SIZE( 2 ) ),
    pdp-Address           [3] IMPLICIT OCTET STRING ( SIZE( 1 .. 16 ) ) OPTIONAL,
    apn-Subscribed        [4] IMPLICIT OCTET STRING ( SIZE( 2 .. 63 ) ) OPTIONAL,
    apn-InUse             [5] IMPLICIT OCTET STRING ( SIZE( 2 .. 63 ) ) OPTIONAL,
    nsapi                 [6] IMPLICIT INTEGER ( 0 .. 15 ) OPTIONAL,
    transactionId        [7] IMPLICIT OCTET STRING ( SIZE( 1 .. 2 ) ) OPTIONAL,
    teid-ForGnAndGp      [8] IMPLICIT OCTET STRING ( SIZE( 4 ) ) OPTIONAL,
    teid-ForLu           [9] IMPLICIT OCTET STRING ( SIZE( 4 ) ) OPTIONAL,
    ggsn-Address         [10] IMPLICIT OCTET STRING ( SIZE( 5 .. 17 ) ) OPTIONAL,
    qos-Subscribed       [11] IMPLICIT OCTET STRING ( SIZE( 1 .. 9 ) ) OPTIONAL,
    qos-Requested        [12] IMPLICIT OCTET STRING ( SIZE( 1 .. 9 ) ) OPTIONAL,
    qos-Negotiated       [13] IMPLICIT OCTET STRING ( SIZE( 1 .. 9 ) ) OPTIONAL,
    chargingId           [14] IMPLICIT OCTET STRING ( SIZE( 4 ) ) OPTIONAL,
    chargingCharacteristics [15] IMPLICIT OCTET STRING ( SIZE( 2 ) ) OPTIONAL,
    rnc-Address          [16] IMPLICIT OCTET STRING ( SIZE( 5 .. 17 ) ) OPTIONAL,
    extensionContainer   [17] IMPLICIT SEQUENCE {
      privateExtensionList [0] IMPLICIT SEQUENCE ( SIZE( 1 .. 10 ) ) OF
        SEQUENCE {
          extId  MAP-EXTENSION .&extensionId ( {
            '
            ... } ),
          extType  MAP-EXTENSION .&ExtensionType ( {
            '
            ... } { @extId } ) OPTIONAL } OPTIONAL,
      pcs-Extensions [1] IMPLICIT SEQUENCE {
        ... } OPTIONAL,
      ... } OPTIONAL,
    ... ,
    qos2-Subscribed    [18] IMPLICIT OCTET STRING ( SIZE( 1 .. 3 ) ) OPTIONAL,
    qos2-Requested     [19] IMPLICIT OCTET STRING ( SIZE( 1 .. 3 ) ) OPTIONAL,
    qos2-Negotiated    [20] IMPLICIT OCTET STRING ( SIZE( 1 .. 3 ) ) OPTIONAL,
  netDetNotReachable  ENUMERATED {
    msPurged      ( 0 ),
    imsiDetached  ( 1 ),
    restrictedArea ( 2 ),
    notRegistered ( 3 ) } OPTIONAL,
  imei            [5] IMPLICIT OCTET STRING ( SIZE( 8 ) ) OPTIONAL,
  ms-Classmark2   [6] IMPLICIT OCTET STRING ( SIZE( 3 ) ) OPTIONAL,
  gprs-MS-Class   [7] IMPLICIT SEQUENCE {
    mSNetworkCapability [0] IMPLICIT OCTET STRING ( SIZE( 1 .. 8 ) ),
    mSRadioAccessCapability [1] IMPLICIT OCTET STRING ( SIZE( 1 .. 50 ) ) OPTIONAL } OPTIONAL,
  mnpInfoRes      [8] IMPLICIT SEQUENCE {
    routingNumber [0] IMPLICIT OCTET STRING ( SIZE( 1 .. 5 ) ) OPTIONAL,
    imsi          [1] IMPLICIT OCTET STRING ( SIZE( 3 .. 8 ) ) OPTIONAL,
    msisdn        [2] IMPLICIT OCTET STRING ( SIZE( 1 .. 20 ) ) ( SIZE( 1 .. 9 ) ) OPTIONAL,
    numberPortabilityStatus [3] IMPLICIT ENUMERATED {
      notKnownToBePorted ( 0 ),
      ownNumberPortedOut ( 1 ),
      foreignNumberPortedToForeignNetwork ( 2 ),
      ... ,
      ownNumberNotPortedOut ( 4 ),

```

```

foreignNumberPortedIn      ( 5 ) } OPTIONAL,
extensionContainer         [4] IMPLICIT SEQUENCE {
  privateExtensionList [0] IMPLICIT SEQUENCE ( SIZE( 1 .. 10 ) ) OF
  SEQUENCE {
    extId   MAP-EXTENSION .&extensionId ( {
      '
      ... } ),
    extType MAP-EXTENSION .&ExtensionType ( {
      '
      ... } { @extId } ) OPTIONAL } OPTIONAL,
  pcs-Extensions [1] IMPLICIT SEQUENCE {
    ... } OPTIONAL,
    ... } OPTIONAL,
    ... } OPTIONAL,
  }
extensionContainer SEQUENCE {
  privateExtensionList [0] IMPLICIT SEQUENCE ( SIZE( 1 .. 10 ) ) OF
  SEQUENCE {
    extId   MAP-EXTENSION .&extensionId ( {
      '
      ... } ),
    extType MAP-EXTENSION .&ExtensionType ( {
      '
      ... } { @extId } ) OPTIONAL } OPTIONAL,
  pcs-Extensions [1] IMPLICIT SEQUENCE {
    ... } OPTIONAL,
    ... } OPTIONAL,
    ... } OPTIONAL,
  }
ERRORS {
  systemFailure |
  ati-NotAllowed |
  dataMissing |
  unexpectedDataValue |
  unknownSubscriber }
CODE local : 71
}

```

```

anyTimeSubscriptionInterrogation OPERATION ::= {
  ARGUMENT SEQUENCE {
    subscriberIdentity [0] CHOICE {
      imsi [0] IMPLICIT OCTET STRING ( SIZE( 3 .. 8 ) ),
      msisdn [1] IMPLICIT OCTET STRING ( SIZE( 1 .. 20 ) ) ( SIZE( 1 .. 9 ) ) },
    requestedSubscriptionInfo [1] IMPLICIT SEQUENCE {
      requestedSS-Info [1] IMPLICIT SEQUENCE {
        ss-Code OCTET STRING ( SIZE( 1 ) ),
        basicService CHOICE {
          bearerService [2] IMPLICIT OCTET STRING ( SIZE( 1 ) ),
          teleservice [3] IMPLICIT OCTET STRING ( SIZE( 1 ) ) } OPTIONAL,
        ... ,
        longFTN-Supported [4] IMPLICIT NULL OPTIONAL } OPTIONAL,
      odb [2] IMPLICIT NULL OPTIONAL,
      requestedCAMEL-SubscriptionInfo [3] IMPLICIT ENUMERATED {
        o-CSI ( 0 ),
        t-CSI ( 1 ),
        vt-CSI ( 2 ),
        tif-CSI ( 3 ),
        gprs-CSI ( 4 ),
        mo-sms-CSI ( 5 ),
        ss-CSI ( 6 ),
        m-CSI ( 7 ),
        d-csi ( 8 ) } OPTIONAL,
      supportedVLR-CAMEL-Phases [4] IMPLICIT NULL OPTIONAL,
      supportedSGSN-CAMEL-Phases [5] IMPLICIT NULL OPTIONAL,
      extensionContainer [6] IMPLICIT SEQUENCE {
        privateExtensionList [0] IMPLICIT SEQUENCE ( SIZE( 1 .. 10 ) ) OF
        SEQUENCE {
          extId   MAP-EXTENSION .&extensionId ( {
            '
            ... } ),
          extType MAP-EXTENSION .&ExtensionType ( {
            '
            ... } { @extId } ) OPTIONAL } OPTIONAL,
        pcs-Extensions [1] IMPLICIT SEQUENCE {
          ... } OPTIONAL,
          ... } OPTIONAL,
        ... ,
        additionalRequestedCAMEL-SubscriptionInfo [7] IMPLICIT ENUMERATED {
          mt-sms-CSI ( 0 ),

```

```

    mg-csi      ( 1 ),
    o-IM-CSI   ( 2 ),
    d-IM-CSI   ( 3 ),
    vt-IM-CSI  ( 4 ),
    ... } OPTIONAL},
gsmSCF-Address [2] IMPLICIT OCTET STRING ( SIZE( 1 .. 20 ) ) ( SIZE( 1 .. 9 ) ),
extensionContainer [3] IMPLICIT SEQUENCE {
  privateExtensionList [0] IMPLICIT SEQUENCE ( SIZE( 1 .. 10 ) ) OF
  SEQUENCE {
    extId  MAP-EXTENSION .&extensionId ( {
      '
      ... } ),
    extType  MAP-EXTENSION .&ExtensionType ( {
      '
      ... } { @extId } ) OPTIONAL} OPTIONAL,
  pcs-Extensions [1] IMPLICIT SEQUENCE {
    ... } OPTIONAL,
  ... } OPTIONAL,
longFTN-Supported [4] IMPLICIT NULL OPTIONAL,
... }
RESULT SEQUENCE {
  callForwardingData [1] IMPLICIT SEQUENCE {
    forwardingFeatureList SEQUENCE ( SIZE( 1 .. 32 ) ) OF
    SEQUENCE {
      basicService CHOICE {
        ext-BearerService [2] IMPLICIT OCTET STRING ( SIZE( 1 .. 5 ) ),
        ext-Teleservice [3] IMPLICIT OCTET STRING ( SIZE( 1 .. 5 ) )} OPTIONAL,
        ss-Status [4] IMPLICIT OCTET STRING ( SIZE( 1 .. 5 ) ),
        forwardedToNumber [5] IMPLICIT OCTET STRING ( SIZE( 1 .. 20 ) ) ( SIZE( 1 .. 9 ) ) OPTIONAL,
        forwardedToSubaddress [8] IMPLICIT OCTET STRING ( SIZE( 1 .. 21 ) ) OPTIONAL,
        forwardingOptions [6] IMPLICIT OCTET STRING ( SIZE( 1 .. 5 ) ) OPTIONAL,
        noReplyConditionTime [7] IMPLICIT INTEGER ( 1 .. 100 ) OPTIONAL,
        extensionContainer [9] IMPLICIT SEQUENCE {
          privateExtensionList [0] IMPLICIT SEQUENCE ( SIZE( 1 .. 10 ) ) OF
          SEQUENCE {
            extId  MAP-EXTENSION .&extensionId ( {
              '
              ... } ),
            extType  MAP-EXTENSION .&ExtensionType ( {
              '
              ... } { @extId } ) OPTIONAL} OPTIONAL,
          pcs-Extensions [1] IMPLICIT SEQUENCE {
            ... } OPTIONAL,
          ... } OPTIONAL,
          ... },
        longForwardedToNumber [10] IMPLICIT OCTET STRING ( SIZE( 1 .. 20 ) ) ( SIZE( 1 .. 15 ) ) OPTIONAL,
        notificationToCSE NULL OPTIONAL,
        extensionContainer [0] IMPLICIT SEQUENCE {
          privateExtensionList [0] IMPLICIT SEQUENCE ( SIZE( 1 .. 10 ) ) OF
          SEQUENCE {
            extId  MAP-EXTENSION .&extensionId ( {
              '
              ... } ),
            extType  MAP-EXTENSION .&ExtensionType ( {
              '
              ... } { @extId } ) OPTIONAL} OPTIONAL,
          pcs-Extensions [1] IMPLICIT SEQUENCE {
            ... } OPTIONAL,
          ... } OPTIONAL,
          ... } OPTIONAL,
        callBarringData [2] IMPLICIT SEQUENCE {
          callBarringFeatureList SEQUENCE ( SIZE( 1 .. 32 ) ) OF
          SEQUENCE {
            basicService CHOICE {
              ext-BearerService [2] IMPLICIT OCTET STRING ( SIZE( 1 .. 5 ) ),
              ext-Teleservice [3] IMPLICIT OCTET STRING ( SIZE( 1 .. 5 ) )} OPTIONAL,
              ss-Status [4] IMPLICIT OCTET STRING ( SIZE( 1 .. 5 ) ),
              extensionContainer SEQUENCE {
                privateExtensionList [0] IMPLICIT SEQUENCE ( SIZE( 1 .. 10 ) ) OF
                SEQUENCE {
                  extId  MAP-EXTENSION .&extensionId ( {
                    '
                    ... } ),
                  extType  MAP-EXTENSION .&ExtensionType ( {
                    '
                    ... } { @extId } ) OPTIONAL} OPTIONAL,
                pcs-Extensions [1] IMPLICIT SEQUENCE {

```

```

... } OPTIONAL,
... } OPTIONAL,
... },
password          NumericString ( FROM ("0"|"1"|"2"|"3"|"4"|"5"|"6"|"7"|"8"|"9" )) (SIZE( 4 ) ) OPTIONAL,
wrongPasswordAttemptsCounter INTEGER ( 0 .. 4 ) OPTIONAL,
notificationToCSE NULL OPTIONAL,
extensionContainer SEQUENCE {
  privateExtensionList [0] IMPLICIT SEQUENCE ( SIZE( 1 .. 10 ) ) OF
  SEQUENCE {
    extId  MAP-EXTENSION .&extensionId ( {
      '
      ...} ),
    extType  MAP-EXTENSION .&ExtensionType ( {
      '
      ...} { @extId } ) OPTIONAL } OPTIONAL,
  pcs-Extensions [1] IMPLICIT SEQUENCE {
    ... } OPTIONAL,
    ... } OPTIONAL,
    ... } OPTIONAL,
  } OPTIONAL,
odbc-Info [3] IMPLICIT SEQUENCE {
  odbc-Data SEQUENCE {
    odbc-GeneralData BIT STRING {
      allOG-CallsBarred ( 0 ),
      internationalOGCallsBarred ( 1 ),
      internationalOGCallsNotToHPLMN-CountryBarred ( 2 ),
      interzonalOGCallsBarred ( 6 ),
      interzonalOGCallsNotToHPLMN-CountryBarred ( 7 ),
      interzonalOGCallsAndInternationalOGCallsNotToHPLMN-CountryBarred ( 8 ),
      premiumRateInformationOGCallsBarred ( 3 ),
      premiumRateEntertainmentOGCallsBarred ( 4 ),
      ss-AccessBarred ( 5 ),
      allECT-Barred ( 9 ),
      chargeableECT-Barred ( 10 ),
      internationalECT-Barred ( 11 ),
      interzonalECT-Barred ( 12 ),
      doublyChargeableECT-Barred ( 13 ),
      multipleECT-Barred ( 14 ),
      allPacketOrientedServicesBarred ( 15 ),
      roamerAccessToHPLMN-AP-Barred ( 16 ),
      roamerAccessToVPLMN-AP-Barred ( 17 ),
      roamingOutsidePLMNOG-CallsBarred ( 18 ),
      allIC-CallsBarred ( 19 ),
      roamingOutsidePLMNIC-CallsBarred ( 20 ),
      roamingOutsidePLMNICCountryIC-CallsBarred ( 21 ),
      roamingOutsidePLMN-Barred ( 22 ),
      roamingOutsidePLMN-CountryBarred ( 23 ),
      registrationAllCF-Barred ( 24 ),
      registrationCFNotToHPLMN-Barred ( 25 ),
      registrationInterzonalCF-Barred ( 26 ),
      registrationInterzonalCFNotToHPLMN-Barred ( 27 ),
      registrationInternationalCF-Barred ( 28 ) } ( SIZE( 15 .. 32 ) ),
    odbc-HPLMN-Data BIT STRING {
      plmn-SpecificBarringType1 ( 0 ),
      plmn-SpecificBarringType2 ( 1 ),
      plmn-SpecificBarringType3 ( 2 ),
      plmn-SpecificBarringType4 ( 3 ) } ( SIZE( 4 .. 32 ) ) OPTIONAL,
    extensionContainer SEQUENCE {
      privateExtensionList [0] IMPLICIT SEQUENCE ( SIZE( 1 .. 10 ) ) OF
      SEQUENCE {
        extId  MAP-EXTENSION .&extensionId ( {
          '
          ...} ),
        extType  MAP-EXTENSION .&ExtensionType ( {
          '
          ...} { @extId } ) OPTIONAL } OPTIONAL,
      pcs-Extensions [1] IMPLICIT SEQUENCE {
        ... } OPTIONAL,
        ... } OPTIONAL,
        ... } OPTIONAL,
      } OPTIONAL,
    notificationToCSE NULL OPTIONAL,
    extensionContainer SEQUENCE {
      privateExtensionList [0] IMPLICIT SEQUENCE ( SIZE( 1 .. 10 ) ) OF
      SEQUENCE {
        extId  MAP-EXTENSION .&extensionId ( {
          '
          ...} ),
        extType  MAP-EXTENSION .&ExtensionType ( {

```

```

    ... } { @extId } ) OPTIONAL } OPTIONAL,
    pcs-Extensions [1] IMPLICIT SEQUENCE {
    ... } OPTIONAL,
    ... } OPTIONAL,
    ... } OPTIONAL,
camel-SubscriptionInfo [4] IMPLICIT SEQUENCE {
o-CSI [0] IMPLICIT SEQUENCE {
o-BcsmCamelTDPDataList SEQUENCE ( SIZE( 1 .. 10 ) ) OF
SEQUENCE {
o-BcsmTriggerDetectionPoint ENUMERATED {
collectedInfo ( 2 ),
... ,
routeSelectFailure ( 4 ) },
serviceKey INTEGER ( 0 .. 2147483647 ),
gsmSCF-Address [0] IMPLICIT OCTET STRING ( SIZE( 1 .. 20 ) ) ( SIZE( 1 .. 9 ) ),
defaultCallHandling [1] IMPLICIT ENUMERATED {
continueCall ( 0 ),
releaseCall ( 1 ),
... },
extensionContainer [2] IMPLICIT SEQUENCE {
privateExtensionList [0] IMPLICIT SEQUENCE ( SIZE( 1 .. 10 ) ) OF
SEQUENCE {
extId MAP-EXTENSION .&extensionId ( {
'
... } ),
extType MAP-EXTENSION .&ExtensionType ( {
'
... } { @extId } ) OPTIONAL } OPTIONAL,
pcs-Extensions [1] IMPLICIT SEQUENCE {
... } OPTIONAL,
... } OPTIONAL,
... },
extensionContainer SEQUENCE {
privateExtensionList [0] IMPLICIT SEQUENCE ( SIZE( 1 .. 10 ) ) OF
SEQUENCE {
extId MAP-EXTENSION .&extensionId ( {
'
... } ),
extType MAP-EXTENSION .&ExtensionType ( {
'
... } { @extId } ) OPTIONAL } OPTIONAL,
pcs-Extensions [1] IMPLICIT SEQUENCE {
... } OPTIONAL,
... } OPTIONAL,
... },
camelCapabilityHandling [0] IMPLICIT INTEGER ( 1 .. 16 ) OPTIONAL,
notificationToCSE [1] IMPLICIT NULL OPTIONAL,
csiActive [2] IMPLICIT NULL OPTIONAL } OPTIONAL,
o-BcsmCamelTDP-CriteriaList [1] IMPLICIT SEQUENCE ( SIZE( 1 .. 10 ) ) OF
SEQUENCE {
o-BcsmTriggerDetectionPoint ENUMERATED {
collectedInfo ( 2 ),
... ,
routeSelectFailure ( 4 ) },
destinationNumberCriteria [0] IMPLICIT SEQUENCE {
matchType [0] IMPLICIT ENUMERATED {
inhibiting ( 0 ),
enabling ( 1 ) },
destinationNumberList [1] IMPLICIT SEQUENCE ( SIZE( 1 .. 10 ) ) OF
OCTET STRING ( SIZE( 1 .. 20 ) ) ( SIZE( 1 .. 9 ) ) OPTIONAL,
destinationNumberLengthList [2] IMPLICIT SEQUENCE ( SIZE( 1 .. 3 ) ) OF
INTEGER ( 1 .. 15 ) OPTIONAL,
... } OPTIONAL,
basicServiceCriteria [1] IMPLICIT SEQUENCE ( SIZE( 1 .. 5 ) ) OF
CHOICE {
ext-BearerService [2] IMPLICIT OCTET STRING ( SIZE( 1 .. 5 ) ),
ext-Teleservice [3] IMPLICIT OCTET STRING ( SIZE( 1 .. 5 ) ) } OPTIONAL,
callTypeCriteria [2] IMPLICIT ENUMERATED {
forwarded ( 0 ),
notForwarded ( 1 ) } OPTIONAL,
... ,
o-CauseValueCriteria [3] IMPLICIT SEQUENCE ( SIZE( 1 .. 5 ) ) OF
OCTET STRING ( SIZE( 1 ) ) OPTIONAL,
extensionContainer [4] IMPLICIT SEQUENCE {
privateExtensionList [0] IMPLICIT SEQUENCE ( SIZE( 1 .. 10 ) ) OF
SEQUENCE {

```

```

    extId    MAP-EXTENSION .&extensionId ( {
        '
        ... } ),
    extType  MAP-EXTENSION .&ExtensionType ( {
        '
        ... } { @extId } ) OPTIONAL} OPTIONAL,
    pcs-Extensions    [1] IMPLICIT SEQUENCE {
    ... } OPTIONAL,
    ... } OPTIONAL} OPTIONAL,
d-CSI                [2] IMPLICIT SEQUENCE {
    dp-AnalysedInfoCriteriaList [0] IMPLICIT SEQUENCE ( SIZE( 1 .. 10 ) ) OF
    SEQUENCE {
        dialledNumber    OCTET STRING ( SIZE( 1 .. 20 ) ) ( SIZE( 1 .. 9 ) ),
        serviceKey       INTEGER ( 0 .. 2147483647 ),
        gsmSCF-Address   OCTET STRING ( SIZE( 1 .. 20 ) ) ( SIZE( 1 .. 9 ) ),
        defaultCallHandling    ENUMERATED {
            continueCall ( 0 ),
            releaseCall ( 1 ),
            ... },
        extensionContainer    SEQUENCE {
            privateExtensionList [0] IMPLICIT SEQUENCE ( SIZE( 1 .. 10 ) ) OF
            SEQUENCE {
                extId    MAP-EXTENSION .&extensionId ( {
                    '
                    ... } ),
                extType  MAP-EXTENSION .&ExtensionType ( {
                    '
                    ... } { @extId } ) OPTIONAL} OPTIONAL,
                pcs-Extensions    [1] IMPLICIT SEQUENCE {
                ... } OPTIONAL,
                ... } OPTIONAL,
                ... } OPTIONAL,
            camelCapabilityHandling    [1] IMPLICIT INTEGER ( 1 .. 16 ) OPTIONAL,
            extensionContainer    [2] IMPLICIT SEQUENCE {
            privateExtensionList [0] IMPLICIT SEQUENCE ( SIZE( 1 .. 10 ) ) OF
            SEQUENCE {
                extId    MAP-EXTENSION .&extensionId ( {
                    '
                    ... } ),
                extType  MAP-EXTENSION .&ExtensionType ( {
                    '
                    ... } { @extId } ) OPTIONAL} OPTIONAL,
                pcs-Extensions    [1] IMPLICIT SEQUENCE {
                ... } OPTIONAL,
                ... } OPTIONAL,
            notificationToCSE        [3] IMPLICIT NULL OPTIONAL,
            csi-Active                [4] IMPLICIT NULL OPTIONAL,
            ... } OPTIONAL,
t-CSI                [3] IMPLICIT SEQUENCE {
    t-BcsmCamelTDPDataList    SEQUENCE ( SIZE( 1 .. 10 ) ) OF
    SEQUENCE {
        t-BcsmTriggerDetectionPoint    ENUMERATED {
            termAttemptAuthorized ( 12 ),
            ... ,
            tBusy ( 13 ),
            tNoAnswer ( 14 ) },
        serviceKey    INTEGER ( 0 .. 2147483647 ),
        gsmSCF-Address    [0] IMPLICIT OCTET STRING ( SIZE( 1 .. 20 ) ) ( SIZE( 1 .. 9 ) ),
        defaultCallHandling    [1] IMPLICIT ENUMERATED {
            continueCall ( 0 ),
            releaseCall ( 1 ),
            ... },
        extensionContainer    [2] IMPLICIT SEQUENCE {
            privateExtensionList [0] IMPLICIT SEQUENCE ( SIZE( 1 .. 10 ) ) OF
            SEQUENCE {
                extId    MAP-EXTENSION .&extensionId ( {
                    '
                    ... } ),
                extType  MAP-EXTENSION .&ExtensionType ( {
                    '
                    ... } { @extId } ) OPTIONAL} OPTIONAL,
                pcs-Extensions    [1] IMPLICIT SEQUENCE {
                ... } OPTIONAL,
                ... } OPTIONAL,
                ... },
            extensionContainer    SEQUENCE {
            privateExtensionList [0] IMPLICIT SEQUENCE ( SIZE( 1 .. 10 ) ) OF

```

```

SEQUENCE {
  extId  MAP-EXTENSION .&extensionId ( {
    '
    ... } ),
  extType  MAP-EXTENSION .&ExtensionType ( {
    '
    ... } { @extId } ) OPTIONAL } OPTIONAL,
  pcs-Extensions  [1] IMPLICIT SEQUENCE {
    ... } OPTIONAL,
  ... } OPTIONAL,
... ,
camelCapabilityHandling  [0] IMPLICIT INTEGER ( 1 .. 16 ) OPTIONAL,
notificationToCSE  [1] IMPLICIT NULL OPTIONAL,
csi-Active  [2] IMPLICIT NULL OPTIONAL } OPTIONAL,
t-BCSM-CAMEL-TDP-CriteriaList  [4] IMPLICIT SEQUENCE ( SIZE( 1 .. 10 ) ) OF
SEQUENCE {
  t-BCSM-TriggerDetectionPoint  ENUMERATED {
    termAttemptAuthorized  ( 12 ),
    ... ,
    tBusy  ( 13 ),
    tNoAnswer  ( 14 ) },
  basicServiceCriteria  [0] IMPLICIT SEQUENCE ( SIZE( 1 .. 5 ) ) OF
  CHOICE {
    ext-BearerService  [2] IMPLICIT OCTET STRING ( SIZE( 1 .. 5 ) ),
    ext-Teleservice  [3] IMPLICIT OCTET STRING ( SIZE( 1 .. 5 ) ) } OPTIONAL,
  t-CauseValueCriteria  [1] IMPLICIT SEQUENCE ( SIZE( 1 .. 5 ) ) OF
  OCTET STRING ( SIZE( 1 ) ) OPTIONAL,
  ... } OPTIONAL,
vt-CSI  [5] IMPLICIT SEQUENCE {
  t-BcsmCamelTDPDataList  SEQUENCE ( SIZE( 1 .. 10 ) ) OF
  SEQUENCE {
    t-BcsmTriggerDetectionPoint  ENUMERATED {
      termAttemptAuthorized  ( 12 ),
      ... ,
      tBusy  ( 13 ),
      tNoAnswer  ( 14 ) },
    serviceKey  INTEGER ( 0 .. 2147483647 ),
    gsmSCF-Address  [0] IMPLICIT OCTET STRING ( SIZE( 1 .. 20 ) ) ( SIZE( 1 .. 9 ) ),
    defaultCallHandling  [1] IMPLICIT ENUMERATED {
      continueCall  ( 0 ),
      releaseCall  ( 1 ),
      ... },
    extensionContainer  [2] IMPLICIT SEQUENCE {
      privateExtensionList  [0] IMPLICIT SEQUENCE ( SIZE( 1 .. 10 ) ) OF
      SEQUENCE {
        extId  MAP-EXTENSION .&extensionId ( {
          '
          ... } ),
        extType  MAP-EXTENSION .&ExtensionType ( {
          '
          ... } { @extId } ) OPTIONAL } OPTIONAL,
        pcs-Extensions  [1] IMPLICIT SEQUENCE {
          ... } OPTIONAL,
          ... } OPTIONAL,
        ... },
      extensionContainer  SEQUENCE {
        privateExtensionList  [0] IMPLICIT SEQUENCE ( SIZE( 1 .. 10 ) ) OF
        SEQUENCE {
          extId  MAP-EXTENSION .&extensionId ( {
            '
            ... } ),
            extType  MAP-EXTENSION .&ExtensionType ( {
              '
              ... } { @extId } ) OPTIONAL } OPTIONAL,
            pcs-Extensions  [1] IMPLICIT SEQUENCE {
              ... } OPTIONAL,
              ... } OPTIONAL,
            ... },
          camelCapabilityHandling  [0] IMPLICIT INTEGER ( 1 .. 16 ) OPTIONAL,
          notificationToCSE  [1] IMPLICIT NULL OPTIONAL,
          csi-Active  [2] IMPLICIT NULL OPTIONAL } OPTIONAL,
          vt-BCSM-CAMEL-TDP-CriteriaList  [6] IMPLICIT SEQUENCE ( SIZE( 1 .. 10 ) ) OF
          SEQUENCE {
            t-BCSM-TriggerDetectionPoint  ENUMERATED {
              termAttemptAuthorized  ( 12 ),
              ... ,
              tBusy  ( 13 ),

```



```

    tNoAnswer          ( 14 ) },
    basicServiceCriteria [0] IMPLICIT SEQUENCE ( SIZE( 1 .. 5 ) ) OF
    CHOICE {
        ext-BearerService [2] IMPLICIT OCTET STRING ( SIZE( 1 .. 5 ) ),
        ext-Teleservice   [3] IMPLICIT OCTET STRING ( SIZE( 1 .. 5 ) ) } OPTIONAL,
    t-CauseValueCriteria [1] IMPLICIT SEQUENCE ( SIZE( 1 .. 5 ) ) OF
    OCTET STRING ( SIZE( 1 ) ) OPTIONAL,
    ... } OPTIONAL,
tif-CSI [7] IMPLICIT NULL OPTIONAL,
tif-CSI-NotificationToCSE [8] IMPLICIT NULL OPTIONAL,
gprs-CSI [9] IMPLICIT SEQUENCE {
    gprs-CamelTDPDataList [0] IMPLICIT SEQUENCE ( SIZE( 1 .. 10 ) ) OF
    SEQUENCE {
        gprs-TriggerDetectionPoint [0] IMPLICIT ENUMERATED {
            attach ( 1 ),
            attachChangeOfPosition ( 2 ),
            pdp-ContextEstablishment ( 11 ),
            pdp-ContextEstablishmentAcknowledgement ( 12 ),
            pdp-ContextChangeOfPosition ( 14 ),
            ... },
        serviceKey [1] IMPLICIT INTEGER ( 0 .. 2147483647 ),
        gsmSCF-Address [2] IMPLICIT OCTET STRING ( SIZE( 1 .. 20 ) ) ( SIZE( 1 .. 9 ) ),
        defaultSessionHandling [3] IMPLICIT ENUMERATED {
            continueTransaction ( 0 ),
            releaseTransaction ( 1 ),
            ... },
        extensionContainer [4] IMPLICIT SEQUENCE {
            privateExtensionList [0] IMPLICIT SEQUENCE ( SIZE( 1 .. 10 ) ) OF
            SEQUENCE {
                extId MAP-EXTENSION .&extensionId ( {
                    '
                    ... } ),
                extType MAP-EXTENSION .&ExtensionType ( {
                    '
                    ... } { @extId } ) OPTIONAL } OPTIONAL,
            pcs-Extensions [1] IMPLICIT SEQUENCE {
                ... } OPTIONAL,
                ... } OPTIONAL,
                ... } OPTIONAL,
            camelCapabilityHandling [1] IMPLICIT INTEGER ( 1 .. 16 ) OPTIONAL,
            extensionContainer [2] IMPLICIT SEQUENCE {
                privateExtensionList [0] IMPLICIT SEQUENCE ( SIZE( 1 .. 10 ) ) OF
                SEQUENCE {
                    extId MAP-EXTENSION .&extensionId ( {
                        '
                        ... } ),
                    extType MAP-EXTENSION .&ExtensionType ( {
                        '
                        ... } { @extId } ) OPTIONAL } OPTIONAL,
                pcs-Extensions [1] IMPLICIT SEQUENCE {
                    ... } OPTIONAL,
                    ... } OPTIONAL,
                notificationToCSE [3] IMPLICIT NULL OPTIONAL,
                csi-Active [4] IMPLICIT NULL OPTIONAL,
                ... } OPTIONAL,
            mo-sms-CSI [10] IMPLICIT SEQUENCE {
                sms-CAMEL-TDP-DataList [0] IMPLICIT SEQUENCE ( SIZE( 1 .. 10 ) ) OF
                SEQUENCE {
                    sms-TriggerDetectionPoint [0] IMPLICIT ENUMERATED {
                        sms-CollectedInfo ( 1 ),
                        ... ,
                        sms-DeliveryRequest ( 2 ) },
                    serviceKey [1] IMPLICIT INTEGER ( 0 .. 2147483647 ),
                    gsmSCF-Address [2] IMPLICIT OCTET STRING ( SIZE( 1 .. 20 ) ) ( SIZE( 1 .. 9 ) ),
                    defaultSMS-Handling [3] IMPLICIT ENUMERATED {
                        continueTransaction ( 0 ),
                        releaseTransaction ( 1 ),
                        ... },
                    extensionContainer [4] IMPLICIT SEQUENCE {
                        privateExtensionList [0] IMPLICIT SEQUENCE ( SIZE( 1 .. 10 ) ) OF
                        SEQUENCE {
                            extId MAP-EXTENSION .&extensionId ( {
                                '
                                ... } ),
                            extType MAP-EXTENSION .&ExtensionType ( {
                                '
                                ... } { @extId } ) OPTIONAL } OPTIONAL,

```

```

    pcs-Extensions      [1] IMPLICIT SEQUENCE {
      ... } OPTIONAL,
      ... } OPTIONAL,
      ... } OPTIONAL,
camelCapabilityHandling [1] IMPLICIT INTEGER ( 1 .. 16 ) OPTIONAL,
extensionContainer     [2] IMPLICIT SEQUENCE {
  privateExtensionList [0] IMPLICIT SEQUENCE ( SIZE( 1 .. 10 ) ) OF
  SEQUENCE {
    extId  MAP-EXTENSION .&extensionId ( {
      '
      ... } ),
    extType MAP-EXTENSION .&ExtensionType ( {
      '
      ... } { @extId } ) OPTIONAL } OPTIONAL,
  pcs-Extensions      [1] IMPLICIT SEQUENCE {
    ... } OPTIONAL,
    ... } OPTIONAL,
  notificationToCSE   [3] IMPLICIT NULL OPTIONAL,
  csi-Active          [4] IMPLICIT NULL OPTIONAL,
  ... } OPTIONAL,
ss-CSI                [11] IMPLICIT SEQUENCE {
  ss-CamelData        SEQUENCE {
    ss-EventList      SEQUENCE ( SIZE( 1 .. 10 ) ) OF
    OCTET STRING ( SIZE( 1 ) ),
    gsmSCF-Address    OCTET STRING ( SIZE( 1 .. 20 ) ) ( SIZE( 1 .. 9 ) ),
    extensionContainer [0] IMPLICIT SEQUENCE {
      privateExtensionList [0] IMPLICIT SEQUENCE ( SIZE( 1 .. 10 ) ) OF
      SEQUENCE {
        extId  MAP-EXTENSION .&extensionId ( {
          '
          ... } ),
        extType MAP-EXTENSION .&ExtensionType ( {
          '
          ... } { @extId } ) OPTIONAL } OPTIONAL,
      pcs-Extensions      [1] IMPLICIT SEQUENCE {
        ... } OPTIONAL,
        ... } OPTIONAL,
      ... },
    extensionContainer SEQUENCE {
      privateExtensionList [0] IMPLICIT SEQUENCE ( SIZE( 1 .. 10 ) ) OF
      SEQUENCE {
        extId  MAP-EXTENSION .&extensionId ( {
          '
          ... } ),
        extType MAP-EXTENSION .&ExtensionType ( {
          '
          ... } { @extId } ) OPTIONAL } OPTIONAL,
      pcs-Extensions      [1] IMPLICIT SEQUENCE {
        ... } OPTIONAL,
        ... } OPTIONAL,
      ... },
    notificationToCSE [0] IMPLICIT NULL OPTIONAL,
    csi-Active        [1] IMPLICIT NULL OPTIONAL } OPTIONAL,
  m-CSI              [12] IMPLICIT SEQUENCE {
    mobilityTriggers  SEQUENCE ( SIZE( 1 .. 10 ) ) OF
    OCTET STRING ( SIZE( 1 ) ),
    serviceKey        INTEGER ( 0 .. 2147483647 ),
    gsmSCF-Address    [0] IMPLICIT OCTET STRING ( SIZE( 1 .. 20 ) ) ( SIZE( 1 .. 9 ) ),
    extensionContainer [1] IMPLICIT SEQUENCE {
      privateExtensionList [0] IMPLICIT SEQUENCE ( SIZE( 1 .. 10 ) ) OF
      SEQUENCE {
        extId  MAP-EXTENSION .&extensionId ( {
          '
          ... } ),
        extType MAP-EXTENSION .&ExtensionType ( {
          '
          ... } { @extId } ) OPTIONAL } OPTIONAL,
      pcs-Extensions      [1] IMPLICIT SEQUENCE {
        ... } OPTIONAL,
        ... } OPTIONAL,
      notificationToCSE [2] IMPLICIT NULL OPTIONAL,
      csi-Active        [3] IMPLICIT NULL OPTIONAL,
      ... } OPTIONAL,
    extensionContainer [13] IMPLICIT SEQUENCE {
      privateExtensionList [0] IMPLICIT SEQUENCE ( SIZE( 1 .. 10 ) ) OF
      SEQUENCE {
        extId  MAP-EXTENSION .&extensionId ( {

```

```

    ...}),
    extType MAP-EXTENSION .&ExtensionType ( {
        ...}{ @extId } ) OPTIONAL} OPTIONAL,
    pcs-Extensions [1] IMPLICIT SEQUENCE {
        ... } OPTIONAL,
    ... } OPTIONAL,
... ,
specificCSIDeletedList [14] IMPLICIT BIT STRING {
    o-csi ( 0 ),
    ss-csi ( 1 ),
    tif-csi ( 2 ),
    d-csi ( 3 ),
    vt-csi ( 4 ),
    mo-sms-csi ( 5 ),
    m-csi ( 6 ),
    gprs-csi ( 7 ),
    t-csi ( 8 ),
    mt-sms-csi ( 9 ),
    mg-csi ( 10 ),
    o-IM-CSI ( 11 ),
    d-IM-CSI ( 12 ),
    vt-IM-CSI ( 13 )} ( SIZE( 8 .. 32 ) ) OPTIONAL,
mt-sms-CSI [15] IMPLICIT SEQUENCE {
    sms-CAMEL-TDP-DataList [0] IMPLICIT SEQUENCE ( SIZE( 1 .. 10 ) ) OF
    SEQUENCE {
        sms-TriggerDetectionPoint [0] IMPLICIT ENUMERATED {
            sms-CollectedInfo ( 1 ),
            ... ,
            sms-DeliveryRequest ( 2 )},
        serviceKey [1] IMPLICIT INTEGER ( 0 .. 2147483647 ),
        gsmSCF-Address [2] IMPLICIT OCTET STRING ( SIZE( 1 .. 20 ) ) ( SIZE( 1 .. 9 ) ),
        defaultSMS-Handling [3] IMPLICIT ENUMERATED {
            continueTransaction ( 0 ),
            releaseTransaction ( 1 ),
            ... },
        extensionContainer [4] IMPLICIT SEQUENCE {
            privateExtensionList [0] IMPLICIT SEQUENCE ( SIZE( 1 .. 10 ) ) OF
            SEQUENCE {
                extId MAP-EXTENSION .&extensionId ( {
                    ...}),
                extType MAP-EXTENSION .&ExtensionType ( {
                    ...}{ @extId } ) OPTIONAL} OPTIONAL,
                pcs-Extensions [1] IMPLICIT SEQUENCE {
                    ... } OPTIONAL,
                ... } OPTIONAL,
                ... } OPTIONAL,
                ... } OPTIONAL,
            camelCapabilityHandling [1] IMPLICIT INTEGER ( 1 .. 16 ) OPTIONAL,
            extensionContainer [2] IMPLICIT SEQUENCE {
                privateExtensionList [0] IMPLICIT SEQUENCE ( SIZE( 1 .. 10 ) ) OF
                SEQUENCE {
                    extId MAP-EXTENSION .&extensionId ( {
                        ...}),
                    extType MAP-EXTENSION .&ExtensionType ( {
                        ...}{ @extId } ) OPTIONAL} OPTIONAL,
                    pcs-Extensions [1] IMPLICIT SEQUENCE {
                        ... } OPTIONAL,
                        ... } OPTIONAL,
                        ... } OPTIONAL,
                    notificationToCSE [3] IMPLICIT NULL OPTIONAL,
                    csi-Active [4] IMPLICIT NULL OPTIONAL,
                    ... } OPTIONAL,
            mt-smsCAMELTDP-CriteriaList [16] IMPLICIT SEQUENCE ( SIZE( 1 .. 10 ) ) OF
            SEQUENCE {
                sms-TriggerDetectionPoint ENUMERATED {
                    sms-CollectedInfo ( 1 ),
                    ... ,
                    sms-DeliveryRequest ( 2 )},
                tpdu-TypeCriterion [0] IMPLICIT SEQUENCE ( SIZE( 1 .. 5 ) ) OF
                ENUMERATED {
                    sms-DELIVER ( 0 ),
                    sms-SUBMIT-REPORT ( 1 ),
                    sms-STATUS-REPORT ( 2 ),

```

```

... } OPTIONAL,
... } OPTIONAL,
mg-csi [17] IMPLICIT SEQUENCE {
  mobilityTriggers SEQUENCE ( SIZE( 1 .. 10 )) OF
    OCTET STRING ( SIZE( 1 ) ),
  serviceKey INTEGER ( 0 .. 2147483647 ),
  gsmSCF-Address [0] IMPLICIT OCTET STRING ( SIZE( 1 .. 20 )) ( SIZE( 1 .. 9 ) ),
  extensionContainer [1] IMPLICIT SEQUENCE {
    privateExtensionList [0] IMPLICIT SEQUENCE ( SIZE( 1 .. 10 )) OF
      SEQUENCE {
        extId MAP-EXTENSION .&extensionId ( {
          '
          ... } ),
        extType MAP-EXTENSION .&ExtensionType ( {
          '
          ... } { @extId } ) OPTIONAL } OPTIONAL,
        pcs-Extensions [1] IMPLICIT SEQUENCE {
          ... } OPTIONAL,
          ... } OPTIONAL,
          ... } OPTIONAL,
notificationToCSE [2] IMPLICIT NULL OPTIONAL,
csi-Active [3] IMPLICIT NULL OPTIONAL,
... } OPTIONAL,
o-IM-CSI [18] IMPLICIT SEQUENCE {
  o-BcsmCamelTDPDataList SEQUENCE ( SIZE( 1 .. 10 )) OF
    SEQUENCE {
      o-BcsmTriggerDetectionPoint ENUMERATED {
        collectedInfo ( 2 ),
        ... ,
        routeSelectFailure ( 4 ) },
      serviceKey INTEGER ( 0 .. 2147483647 ),
      gsmSCF-Address [0] IMPLICIT OCTET STRING ( SIZE( 1 .. 20 )) ( SIZE( 1 .. 9 ) ),
      defaultCallHandling [1] IMPLICIT ENUMERATED {
        continueCall ( 0 ),
        releaseCall ( 1 ),
        ... },
      extensionContainer [2] IMPLICIT SEQUENCE {
        privateExtensionList [0] IMPLICIT SEQUENCE ( SIZE( 1 .. 10 )) OF
          SEQUENCE {
            extId MAP-EXTENSION .&extensionId ( {
              '
              ... } ),
            extType MAP-EXTENSION .&ExtensionType ( {
              '
              ... } { @extId } ) OPTIONAL } OPTIONAL,
            pcs-Extensions [1] IMPLICIT SEQUENCE {
              ... } OPTIONAL,
              ... } OPTIONAL,
              ... } OPTIONAL,
              ... },
      extensionContainer SEQUENCE {
        privateExtensionList [0] IMPLICIT SEQUENCE ( SIZE( 1 .. 10 )) OF
          SEQUENCE {
            extId MAP-EXTENSION .&extensionId ( {
              '
              ... } ),
            extType MAP-EXTENSION .&ExtensionType ( {
              '
              ... } { @extId } ) OPTIONAL } OPTIONAL,
            pcs-Extensions [1] IMPLICIT SEQUENCE {
              ... } OPTIONAL,
              ... } OPTIONAL,
              ... } OPTIONAL,
              ... },
      camelCapabilityHandling [0] IMPLICIT INTEGER ( 1 .. 16 ) OPTIONAL,
      notificationToCSE [1] IMPLICIT NULL OPTIONAL,
      csiActive [2] IMPLICIT NULL OPTIONAL } OPTIONAL,
o-IM-BcsmCamelTDP-CriteriaList [19] IMPLICIT SEQUENCE ( SIZE( 1 .. 10 )) OF
  SEQUENCE {
    o-BcsmTriggerDetectionPoint ENUMERATED {
      collectedInfo ( 2 ),
      ... ,
      routeSelectFailure ( 4 ) },
    destinationNumberCriteria [0] IMPLICIT SEQUENCE {
      matchType [0] IMPLICIT ENUMERATED {
        inhibiting ( 0 ),
        enabling ( 1 ) },
      destinationNumberList [1] IMPLICIT SEQUENCE ( SIZE( 1 .. 10 )) OF
        OCTET STRING ( SIZE( 1 .. 20 )) ( SIZE( 1 .. 9 ) ) OPTIONAL,
      destinationNumberLengthList [2] IMPLICIT SEQUENCE ( SIZE( 1 .. 3 ) ) OF

```

```

    INTEGER ( 1 .. 15 ) OPTIONAL,
    ... } OPTIONAL,
basicServiceCriteria    [1] IMPLICIT SEQUENCE ( SIZE( 1 .. 5 ) ) OF
CHOICE {
    ext-BearerService    [2] IMPLICIT OCTET STRING ( SIZE( 1 .. 5 ) ),
    ext-Teleservice      [3] IMPLICIT OCTET STRING ( SIZE( 1 .. 5 ) ) } OPTIONAL,
callTypeCriteria       [2] IMPLICIT ENUMERATED {
    forwarded    ( 0 ),
    notForwarded ( 1 ) } OPTIONAL,
... ,
o-CauseValueCriteria   [3] IMPLICIT SEQUENCE ( SIZE( 1 .. 5 ) ) OF
OCTET STRING ( SIZE( 1 ) ) OPTIONAL,
extensionContainer      [4] IMPLICIT SEQUENCE {
    privateExtensionList [0] IMPLICIT SEQUENCE ( SIZE( 1 .. 10 ) ) OF
    SEQUENCE {
        extId    MAP-EXTENSION .&extensionId ( {
            '
            ... } ),
        extType  MAP-EXTENSION .&ExtensionType ( {
            '
            ... } { @extId } ) OPTIONAL } OPTIONAL,
    pcs-Extensions [1] IMPLICIT SEQUENCE {
        ... } OPTIONAL,
        ... } OPTIONAL } OPTIONAL,
d-IM-CSI              [20] IMPLICIT SEQUENCE {
dp-AnalysedInfoCriteriaList [0] IMPLICIT SEQUENCE ( SIZE( 1 .. 10 ) ) OF
SEQUENCE {
    dialledNumber    OCTET STRING ( SIZE( 1 .. 20 ) ) ( SIZE( 1 .. 9 ) ),
    serviceKey       INTEGER ( 0 .. 2147483647 ),
    gsmSCF-Address   OCTET STRING ( SIZE( 1 .. 20 ) ) ( SIZE( 1 .. 9 ) ),
    defaultCallHandling ENUMERATED {
        continueCall ( 0 ),
        releaseCall  ( 1 ),
        ... },
    extensionContainer SEQUENCE {
        privateExtensionList [0] IMPLICIT SEQUENCE ( SIZE( 1 .. 10 ) ) OF
        SEQUENCE {
            extId    MAP-EXTENSION .&extensionId ( {
                '
                ... } ),
            extType  MAP-EXTENSION .&ExtensionType ( {
                '
                ... } { @extId } ) OPTIONAL } OPTIONAL,
        pcs-Extensions [1] IMPLICIT SEQUENCE {
            ... } OPTIONAL,
            ... } OPTIONAL,
            ... } OPTIONAL,
        camelCapabilityHandling [1] IMPLICIT INTEGER ( 1 .. 16 ) OPTIONAL,
        extensionContainer [2] IMPLICIT SEQUENCE {
            privateExtensionList [0] IMPLICIT SEQUENCE ( SIZE( 1 .. 10 ) ) OF
            SEQUENCE {
                extId    MAP-EXTENSION .&extensionId ( {
                    '
                    ... } ),
                extType  MAP-EXTENSION .&ExtensionType ( {
                    '
                    ... } { @extId } ) OPTIONAL } OPTIONAL,
            pcs-Extensions [1] IMPLICIT SEQUENCE {
                ... } OPTIONAL,
                ... } OPTIONAL,
                ... } OPTIONAL,
            notificationToCSE [3] IMPLICIT NULL OPTIONAL,
            csi-Active [4] IMPLICIT NULL OPTIONAL,
            ... } OPTIONAL,
vt-IM-CSI              [21] IMPLICIT SEQUENCE {
t-BcsmCamelTDPDataList SEQUENCE ( SIZE( 1 .. 10 ) ) OF
SEQUENCE {
    t-BcsmTriggerDetectionPoint ENUMERATED {
        termAttemptAuthorized ( 12 ),
        ... ,
        tBusy ( 13 ),
        tNoAnswer ( 14 ) },
    serviceKey    INTEGER ( 0 .. 2147483647 ),
    gsmSCF-Address [0] IMPLICIT OCTET STRING ( SIZE( 1 .. 20 ) ) ( SIZE( 1 .. 9 ) ),
    defaultCallHandling [1] IMPLICIT ENUMERATED {
        continueCall ( 0 ),
        releaseCall  ( 1 ),
        ... },

```

```

extensionContainer      [2] IMPLICIT SEQUENCE {
  privateExtensionList [0] IMPLICIT SEQUENCE ( SIZE( 1 .. 10 )) OF
  SEQUENCE {
    extId   MAP-EXTENSION .&extensionId ( {
      '
      ... } ),
    extType MAP-EXTENSION .&ExtensionType ( {
      '
      ... } { @extId } ) OPTIONAL } OPTIONAL,
  pcs-Extensions [1] IMPLICIT SEQUENCE {
    ... } OPTIONAL,
  ... } OPTIONAL,
  ... },
extensionContainer      SEQUENCE {
  privateExtensionList [0] IMPLICIT SEQUENCE ( SIZE( 1 .. 10 )) OF
  SEQUENCE {
    extId   MAP-EXTENSION .&extensionId ( {
      '
      ... } ),
    extType MAP-EXTENSION .&ExtensionType ( {
      '
      ... } { @extId } ) OPTIONAL } OPTIONAL,
  pcs-Extensions [1] IMPLICIT SEQUENCE {
    ... } OPTIONAL,
  ... } OPTIONAL,
  ... },
camelCapabilityHandling [0] IMPLICIT INTEGER ( 1 .. 16 ) OPTIONAL,
notificationToCSE      [1] IMPLICIT NULL OPTIONAL,
csi-Active              [2] IMPLICIT NULL OPTIONAL } OPTIONAL,
vt-IM-BCSM-CAMEL-TDP-CriteriaList [22] IMPLICIT SEQUENCE ( SIZE( 1 .. 10 )) OF
SEQUENCE {
  t-BCSM-TriggerDetectionPoint ENUMERATED {
    termAttemptAuthorized ( 12 ),
    ... ,
    tBusy ( 13 ),
    tNoAnswer ( 14 ) },
  basicServiceCriteria [0] IMPLICIT SEQUENCE ( SIZE( 1 .. 5 )) OF
  CHOICE {
    ext-BearerService [2] IMPLICIT OCTET STRING ( SIZE( 1 .. 5 )),
    ext-Teleservice [3] IMPLICIT OCTET STRING ( SIZE( 1 .. 5 )) } OPTIONAL,
  t-CauseValueCriteria [1] IMPLICIT SEQUENCE ( SIZE( 1 .. 5 )) OF
  OCTET STRING ( SIZE( 1 )) OPTIONAL,
  ... } OPTIONAL } OPTIONAL,
supportedVLR-CAMEL-Phases [5] IMPLICIT BIT STRING {
  phase1 ( 0 ),
  phase2 ( 1 ),
  phase3 ( 2 ),
  phase4 ( 3 ) } ( SIZE( 1 .. 16 )) OPTIONAL,
supportedSGSN-CAMEL-Phases [6] IMPLICIT BIT STRING {
  phase1 ( 0 ),
  phase2 ( 1 ),
  phase3 ( 2 ),
  phase4 ( 3 ) } ( SIZE( 1 .. 16 )) OPTIONAL,
extensionContainer      [7] IMPLICIT SEQUENCE {
  privateExtensionList [0] IMPLICIT SEQUENCE ( SIZE( 1 .. 10 )) OF
  SEQUENCE {
    extId   MAP-EXTENSION .&extensionId ( {
      '
      ... } ),
    extType MAP-EXTENSION .&ExtensionType ( {
      '
      ... } { @extId } ) OPTIONAL } OPTIONAL,
  pcs-Extensions [1] IMPLICIT SEQUENCE {
    ... } OPTIONAL,
  ... } OPTIONAL,
  ... },
offeredCamel4CSIsInVLR [8] IMPLICIT BIT STRING {
  o-csi ( 0 ),
  d-csi ( 1 ),
  vt-csi ( 2 ),
  t-csi ( 3 ),
  mt-sms-csi ( 4 ),
  mg-csi ( 5 ),
  psi-enhancements ( 6 ) } ( SIZE( 7 .. 16 )) OPTIONAL,
offeredCamel4CSIsInSGSN [9] IMPLICIT BIT STRING {
  o-csi ( 0 ),
  d-csi ( 1 ),

```

```

vt-csi ( 2 ),
t-csi ( 3 ),
mt-sms-csi ( 4 ),
mg-csi ( 5 ),
psi-enhancements ( 6 )) ( SIZE( 7 .. 16 ) ) OPTIONAL

```

```

ERRORS {
  atsi-NotAllowed |
  dataMissing |
  unexpectedDataValue |
  unknownSubscriber |
  bearerServiceNotProvisioned |
  teleserviceNotProvisioned |
  callBarred |
  illegalSS-Operation |
  ss-NotAvailable |
  informationNotAvailable }
CODE local : 62
}

```

```

anyTimeModification OPERATION ::= {
  ARGUMENT SEQUENCE {
    subscriberIdentity [0] CHOICE {
      imsi [0] IMPLICIT OCTET STRING ( SIZE( 3 .. 8 ) ),
      msisdn [1] IMPLICIT OCTET STRING ( SIZE( 1 .. 20 ) ) ( SIZE( 1 .. 9 ) ) },
    gsmSCF-Address [1] IMPLICIT OCTET STRING ( SIZE( 1 .. 20 ) ) ( SIZE( 1 .. 9 ) ),
    modificationRequestFor-CF-Info [2] IMPLICIT SEQUENCE {
      ss-Code [0] IMPLICIT OCTET STRING ( SIZE( 1 ) ),
      basicService [1] CHOICE {
        ext-BearerService [2] IMPLICIT OCTET STRING ( SIZE( 1 .. 5 ) ),
        ext-Teleservice [3] IMPLICIT OCTET STRING ( SIZE( 1 .. 5 ) ) } OPTIONAL,
      ss-Status [2] IMPLICIT OCTET STRING ( SIZE( 1 .. 5 ) ) OPTIONAL,
      forwardedToNumber [3] IMPLICIT OCTET STRING ( SIZE( 1 .. 20 ) ) OPTIONAL,
      forwardedToSubaddress [4] IMPLICIT OCTET STRING ( SIZE( 1 .. 21 ) ) OPTIONAL,
      noReplyConditionTime [5] IMPLICIT INTEGER ( 1 .. 100 ) OPTIONAL,
      modifyNotificationToCSE [6] IMPLICIT ENUMERATED {
        deactivate ( 0 ),
        activate ( 1 ) } OPTIONAL,
      extensionContainer [7] IMPLICIT SEQUENCE {
        privateExtensionList [0] IMPLICIT SEQUENCE ( SIZE( 1 .. 10 ) ) OF
          SEQUENCE {
            extId MAP-EXTENSION .&extensionId ( {
              '
              ... } ),
            extType MAP-EXTENSION .&ExtensionType ( {
              '
              ... } { @extId } ) OPTIONAL } OPTIONAL,
        pcs-Extensions [1] IMPLICIT SEQUENCE {
          ... } OPTIONAL,
          ... } OPTIONAL,
          ... } OPTIONAL,
        modificationRequestFor-CB-Info [3] IMPLICIT SEQUENCE {
          ss-Code [0] IMPLICIT OCTET STRING ( SIZE( 1 ) ),
          basicService [1] CHOICE {
            ext-BearerService [2] IMPLICIT OCTET STRING ( SIZE( 1 .. 5 ) ),
            ext-Teleservice [3] IMPLICIT OCTET STRING ( SIZE( 1 .. 5 ) ) } OPTIONAL,
          ss-Status [2] IMPLICIT OCTET STRING ( SIZE( 1 .. 5 ) ) OPTIONAL,
          password [3] IMPLICIT NumericString ( FROM ("0"|"1"|"2"|"3"|"4"|"5"|"6"|"7"|"8"|"9" ) ) ( SIZE( 4 ) ) OPTIONAL,
          wrongPasswordAttemptsCounter [4] IMPLICIT INTEGER ( 0 .. 4 ) OPTIONAL,
          modifyNotificationToCSE [5] IMPLICIT ENUMERATED {
            deactivate ( 0 ),
            activate ( 1 ) } OPTIONAL,
          extensionContainer [6] IMPLICIT SEQUENCE {
            privateExtensionList [0] IMPLICIT SEQUENCE ( SIZE( 1 .. 10 ) ) OF
              SEQUENCE {
                extId MAP-EXTENSION .&extensionId ( {
                  '
                  ... } ),
                extType MAP-EXTENSION .&ExtensionType ( {
                  '
                  ... } { @extId } ) OPTIONAL } OPTIONAL,
            pcs-Extensions [1] IMPLICIT SEQUENCE {
              ... } OPTIONAL,
              ... } OPTIONAL,
              ... } OPTIONAL,
            modificationRequestFor-CSI [4] IMPLICIT SEQUENCE {
              requestedCamel-SubscriptionInfo [0] IMPLICIT ENUMERATED {
                o-CSI ( 0 ),

```

```

t-CSI      ( 1 ),
vt-CSI     ( 2 ),
tif-CSI    ( 3 ),
gprs-CSI   ( 4 ),
mo-sms-CSI ( 5 ),
ss-CSI     ( 6 ),
m-CSI      ( 7 ),
d-csi      ( 8 ),
modifyNotificationToCSE      [1] IMPLICIT ENUMERATED {
  deactivate ( 0 ),
  activate   ( 1 ) } OPTIONAL,
modifyCSI-State              [2] IMPLICIT ENUMERATED {
  deactivate ( 0 ),
  activate   ( 1 ) } OPTIONAL,
extensionContainer           [3] IMPLICIT SEQUENCE {
  privateExtensionList [0] IMPLICIT SEQUENCE ( SIZE( 1 .. 10 ) ) OF
  SEQUENCE {
    extId  MAP-EXTENSION .&extensionId ( {
      '
      ... } ),
    extType MAP-EXTENSION .&ExtensionType ( {
      '
      ... } { @extId } ) OPTIONAL } OPTIONAL,
  pcs-Extensions [1] IMPLICIT SEQUENCE {
    ... } OPTIONAL,
  ... } OPTIONAL,
... ,
additionalRequestedCAMEL-SubscriptionInfo [4] IMPLICIT ENUMERATED {
  mt-sms-CSI ( 0 ),
  mg-csi     ( 1 ),
  o-IM-CSI   ( 2 ),
  d-IM-CSI   ( 3 ),
  vt-IM-CSI  ( 4 ),
  ... } OPTIONAL } OPTIONAL,
extensionContainer           [5] IMPLICIT SEQUENCE {
  privateExtensionList [0] IMPLICIT SEQUENCE ( SIZE( 1 .. 10 ) ) OF
  SEQUENCE {
    extId  MAP-EXTENSION .&extensionId ( {
      '
      ... } ),
    extType MAP-EXTENSION .&ExtensionType ( {
      '
      ... } { @extId } ) OPTIONAL } OPTIONAL,
  pcs-Extensions [1] IMPLICIT SEQUENCE {
    ... } OPTIONAL,
  ... } OPTIONAL,
longFTN-Supported           [6] IMPLICIT NULL OPTIONAL,
... ,
modificationRequestFor-ODB-data [7] IMPLICIT SEQUENCE {
  odb-data [0] IMPLICIT SEQUENCE {
    odb-GeneralData BIT STRING {
      allOG-CallsBarred ( 0 ),
      internationalOGCallsBarred ( 1 ),
      internationalOGCallsNotToHPLMN-CountryBarred ( 2 ),
      interzonalOGCallsBarred ( 6 ),
      interzonalOGCallsNotToHPLMN-CountryBarred ( 7 ),
      interzonalOGCallsAndInternationalOGCallsNotToHPLMN-CountryBarred ( 8 ),
      premiumRateInformationOGCallsBarred ( 3 ),
      premiumRateEntertainmentOGCallsBarred ( 4 ),
      ss-AccessBarred ( 5 ),
      allECT-Barred ( 9 ),
      chargeableECT-Barred ( 10 ),
      internationalECT-Barred ( 11 ),
      interzonalECT-Barred ( 12 ),
      doublyChargeableECT-Barred ( 13 ),
      multipleECT-Barred ( 14 ),
      allPacketOrientedServicesBarred ( 15 ),
      roamerAccessToHPLMN-AP-Barred ( 16 ),
      roamerAccessToVPLMN-AP-Barred ( 17 ),
      roamingOutsidePLMNOG-CallsBarred ( 18 ),
      allIC-CallsBarred ( 19 ),
      roamingOutsidePLMNIC-CallsBarred ( 20 ),
      roamingOutsidePLMNICountryIC-CallsBarred ( 21 ),
      roamingOutsidePLMN-Barred ( 22 ),
      roamingOutsidePLMN-CountryBarred ( 23 ),
      registrationAllCF-Barred ( 24 ),
      registrationCFNotToHPLMN-Barred ( 25 ),

```



```

... } OPTIONAL,
... },
callBarringInfoFor-CSE [1] IMPLICIT SEQUENCE {
  ss-Code [0] IMPLICIT OCTET STRING ( SIZE( 1 ) ),
  callBarringFeatureList [1] IMPLICIT SEQUENCE ( SIZE( 1 .. 32 ) ) OF
  SEQUENCE {
    basicService CHOICE {
      ext-BearerService [2] IMPLICIT OCTET STRING ( SIZE( 1 .. 5 ) ),
      ext-Teleservice [3] IMPLICIT OCTET STRING ( SIZE( 1 .. 5 ) ); OPTIONAL,
      ss-Status [4] IMPLICIT OCTET STRING ( SIZE( 1 .. 5 ) ),
    }
    extensionContainer SEQUENCE {
      privateExtensionList [0] IMPLICIT SEQUENCE ( SIZE( 1 .. 10 ) ) OF
      SEQUENCE {
        extId MAP-EXTENSION .&extensionId ( {
          '
          ... } ),
        extType MAP-EXTENSION .&ExtensionType ( {
          '
          ... } { @extId } ) OPTIONAL } OPTIONAL,
      pcs-Extensions [1] IMPLICIT SEQUENCE {
        ... } OPTIONAL,
        ... } OPTIONAL,
      ... },
password [2] IMPLICIT NumericString ( FROM ("0"|"1"|"2"|"3"|"4"|"5"|"6"|"7"|"8"|"9" ) ) (SIZE( 4 ) ) OPTIONAL,
wrongPasswordAttemptsCounter [3] IMPLICIT INTEGER ( 0 .. 4 ) OPTIONAL,
notificationToCSE [4] IMPLICIT NULL OPTIONAL,
extensionContainer [5] IMPLICIT SEQUENCE {
  privateExtensionList [0] IMPLICIT SEQUENCE ( SIZE( 1 .. 10 ) ) OF
  SEQUENCE {
    extId MAP-EXTENSION .&extensionId ( {
      '
      ... } ),
    extType MAP-EXTENSION .&ExtensionType ( {
      '
      ... } { @extId } ) OPTIONAL } OPTIONAL,
  pcs-Extensions [1] IMPLICIT SEQUENCE {
    ... } OPTIONAL,
    ... } OPTIONAL,
    ... } OPTIONAL,
  ... } OPTIONAL,
camel-SubscriptionInfo [1] IMPLICIT SEQUENCE {
  o-CSI [0] IMPLICIT SEQUENCE {
  o-BcsmCamelTDPDataList SEQUENCE ( SIZE( 1 .. 10 ) ) OF
  SEQUENCE {
    o-BcsmTriggerDetectionPoint ENUMERATED {
      collectedInfo ( 2 ),
      ... ,
      routeSelectFailure ( 4 ) },
    serviceKey INTEGER ( 0 .. 2147483647 ),
    gsmSCF-Address [0] IMPLICIT OCTET STRING ( SIZE( 1 .. 20 ) ) ( SIZE( 1 .. 9 ) ),
    defaultCallHandling [1] IMPLICIT ENUMERATED {
      continueCall ( 0 ),
      releaseCall ( 1 ),
      ... },
    extensionContainer [2] IMPLICIT SEQUENCE {
      privateExtensionList [0] IMPLICIT SEQUENCE ( SIZE( 1 .. 10 ) ) OF
      SEQUENCE {
        extId MAP-EXTENSION .&extensionId ( {
          '
          ... } ),
        extType MAP-EXTENSION .&ExtensionType ( {
          '
          ... } { @extId } ) OPTIONAL } OPTIONAL,
      pcs-Extensions [1] IMPLICIT SEQUENCE {
        ... } OPTIONAL,
        ... } OPTIONAL,
      ... },
    extensionContainer SEQUENCE {
      privateExtensionList [0] IMPLICIT SEQUENCE ( SIZE( 1 .. 10 ) ) OF
      SEQUENCE {
        extId MAP-EXTENSION .&extensionId ( {
          '
          ... } ),
        extType MAP-EXTENSION .&ExtensionType ( {
          '
          ... } { @extId } ) OPTIONAL } OPTIONAL,
      pcs-Extensions [1] IMPLICIT SEQUENCE {
        ... } OPTIONAL,

```

```

... } OPTIONAL,
... ,
camelCapabilityHandling [0] IMPLICIT INTEGER ( 1 .. 16 ) OPTIONAL,
notificationToCSE [1] IMPLICIT NULL OPTIONAL,
csiActive [2] IMPLICIT NULL OPTIONAL } OPTIONAL,
o-BcsmCamelTDP-CriteriaList [1] IMPLICIT SEQUENCE ( SIZE( 1 .. 10 ) ) OF
SEQUENCE {
  o-BcsmTriggerDetectionPoint ENUMERATED {
    collectedInfo ( 2 ),
    ... ,
    routeSelectFailure ( 4 ) },
  destinationNumberCriteria [0] IMPLICIT SEQUENCE {
    matchType [0] IMPLICIT ENUMERATED {
      inhibiting ( 0 ),
      enabling ( 1 ) },
    destinationNumberList [1] IMPLICIT SEQUENCE ( SIZE( 1 .. 10 ) ) OF
      OCTET STRING ( SIZE( 1 .. 20 ) ) ( SIZE( 1 .. 9 ) ) OPTIONAL,
    destinationNumberLengthList [2] IMPLICIT SEQUENCE ( SIZE( 1 .. 3 ) ) OF
      INTEGER ( 1 .. 15 ) OPTIONAL,
    ... } OPTIONAL,
  basicServiceCriteria [1] IMPLICIT SEQUENCE ( SIZE( 1 .. 5 ) ) OF
    CHOICE {
      ext-BearerService [2] IMPLICIT OCTET STRING ( SIZE( 1 .. 5 ) ),
      ext-Teleservice [3] IMPLICIT OCTET STRING ( SIZE( 1 .. 5 ) ) } OPTIONAL,
  callTypeCriteria [2] IMPLICIT ENUMERATED {
    forwarded ( 0 ),
    notForwarded ( 1 ) } OPTIONAL,
  ... ,
  o-CauseValueCriteria [3] IMPLICIT SEQUENCE ( SIZE( 1 .. 5 ) ) OF
    OCTET STRING ( SIZE( 1 ) ) OPTIONAL,
  extensionContainer [4] IMPLICIT SEQUENCE {
    privateExtensionList [0] IMPLICIT SEQUENCE ( SIZE( 1 .. 10 ) ) OF
      SEQUENCE {
        extId MAP-EXTENSION .&extensionId ( {
          '
          ... } ),
        extType MAP-EXTENSION .&ExtensionType ( {
          '
          ... } { @extId } ) OPTIONAL } OPTIONAL,
    pcs-Extensions [1] IMPLICIT SEQUENCE {
      ... } OPTIONAL,
    ... } OPTIONAL } OPTIONAL,
d-CSI [2] IMPLICIT SEQUENCE {
  dp-AnalysedInfoCriteriaList [0] IMPLICIT SEQUENCE ( SIZE( 1 .. 10 ) ) OF
    SEQUENCE {
      dialledNumber OCTET STRING ( SIZE( 1 .. 20 ) ) ( SIZE( 1 .. 9 ) ),
      serviceKey INTEGER ( 0 .. 2147483647 ),
      gsmSCF-Address OCTET STRING ( SIZE( 1 .. 20 ) ) ( SIZE( 1 .. 9 ) ),
      defaultCallHandling ENUMERATED {
        continueCall ( 0 ),
        releaseCall ( 1 ),
        ... },
      extensionContainer SEQUENCE {
        privateExtensionList [0] IMPLICIT SEQUENCE ( SIZE( 1 .. 10 ) ) OF
          SEQUENCE {
            extId MAP-EXTENSION .&extensionId ( {
              '
              ... } ),
            extType MAP-EXTENSION .&ExtensionType ( {
              '
              ... } { @extId } ) OPTIONAL } OPTIONAL,
        pcs-Extensions [1] IMPLICIT SEQUENCE {
          ... } OPTIONAL,
          ... } OPTIONAL,
          ... } OPTIONAL,
        camelCapabilityHandling [1] IMPLICIT INTEGER ( 1 .. 16 ) OPTIONAL,
        extensionContainer [2] IMPLICIT SEQUENCE {
          privateExtensionList [0] IMPLICIT SEQUENCE ( SIZE( 1 .. 10 ) ) OF
            SEQUENCE {
              extId MAP-EXTENSION .&extensionId ( {
                '
                ... } ),
              extType MAP-EXTENSION .&ExtensionType ( {
                '
                ... } { @extId } ) OPTIONAL } OPTIONAL,
          pcs-Extensions [1] IMPLICIT SEQUENCE {
            ... } OPTIONAL,

```

```

... } OPTIONAL,
notificationToCSE [3] IMPLICIT NULL OPTIONAL,
csi-Active [4] IMPLICIT NULL OPTIONAL,
... } OPTIONAL,
t-CSI [3] IMPLICIT SEQUENCE {
t-BcsmCamelTDPDataList SEQUENCE ( SIZE( 1 .. 10 ) ) OF
SEQUENCE {
t-BcsmTriggerDetectionPoint ENUMERATED {
termAttemptAuthorized ( 12 ),
... ,
tBusy ( 13 ),
tNoAnswer ( 14 ) },
serviceKey INTEGER ( 0 .. 2147483647 ),
gsmSCF-Address [0] IMPLICIT OCTET STRING ( SIZE( 1 .. 20 ) ) ( SIZE( 1 .. 9 ) ),
defaultCallHandling [1] IMPLICIT ENUMERATED {
continueCall ( 0 ),
releaseCall ( 1 ),
... },
extensionContainer [2] IMPLICIT SEQUENCE {
privateExtensionList [0] IMPLICIT SEQUENCE ( SIZE( 1 .. 10 ) ) OF
SEQUENCE {
extId MAP-EXTENSION .&extensionId ( {
'
...} ),
extType MAP-EXTENSION .&ExtensionType ( {
'
...} { @extId } ) OPTIONAL} OPTIONAL,
pcs-Extensions [1] IMPLICIT SEQUENCE {
... } OPTIONAL,
... } OPTIONAL,
... },
extensionContainer SEQUENCE {
privateExtensionList [0] IMPLICIT SEQUENCE ( SIZE( 1 .. 10 ) ) OF
SEQUENCE {
extId MAP-EXTENSION .&extensionId ( {
'
...} ),
extType MAP-EXTENSION .&ExtensionType ( {
'
...} { @extId } ) OPTIONAL} OPTIONAL,
pcs-Extensions [1] IMPLICIT SEQUENCE {
... } OPTIONAL,
... } OPTIONAL,
... ,
camelCapabilityHandling [0] IMPLICIT INTEGER ( 1 .. 16 ) OPTIONAL,
notificationToCSE [1] IMPLICIT NULL OPTIONAL,
csi-Active [2] IMPLICIT NULL OPTIONAL} OPTIONAL,
t-BCSM-CAMEL-TDP-CriteriaList [4] IMPLICIT SEQUENCE ( SIZE( 1 .. 10 ) ) OF
SEQUENCE {
t-BCSM-TriggerDetectionPoint ENUMERATED {
termAttemptAuthorized ( 12 ),
... ,
tBusy ( 13 ),
tNoAnswer ( 14 ) },
basicServiceCriteria [0] IMPLICIT SEQUENCE ( SIZE( 1 .. 5 ) ) OF
CHOICE {
ext-BearerService [2] IMPLICIT OCTET STRING ( SIZE( 1 .. 5 ) ),
ext-Teleservice [3] IMPLICIT OCTET STRING ( SIZE( 1 .. 5 ) )} OPTIONAL,
t-CauseValueCriteria [1] IMPLICIT SEQUENCE ( SIZE( 1 .. 5 ) ) OF
OCTET STRING ( SIZE( 1 ) ) OPTIONAL,
... } OPTIONAL,
vt-CSI [5] IMPLICIT SEQUENCE {
t-BcsmCamelTDPDataList SEQUENCE ( SIZE( 1 .. 10 ) ) OF
SEQUENCE {
t-BcsmTriggerDetectionPoint ENUMERATED {
termAttemptAuthorized ( 12 ),
... ,
tBusy ( 13 ),
tNoAnswer ( 14 ) },
serviceKey INTEGER ( 0 .. 2147483647 ),
gsmSCF-Address [0] IMPLICIT OCTET STRING ( SIZE( 1 .. 20 ) ) ( SIZE( 1 .. 9 ) ),
defaultCallHandling [1] IMPLICIT ENUMERATED {
continueCall ( 0 ),
releaseCall ( 1 ),
... },
extensionContainer [2] IMPLICIT SEQUENCE {
privateExtensionList [0] IMPLICIT SEQUENCE ( SIZE( 1 .. 10 ) ) OF

```

```

SEQUENCE {
    extId    MAP-EXTENSION.&extensionId ( {
        '
        ... } ),
    extType  MAP-EXTENSION.&ExtensionType ( {
        '
        ... } { @extId } ) OPTIONAL } OPTIONAL,
    pcs-Extensions    [1] IMPLICIT SEQUENCE {
        ... } OPTIONAL,
    ... } OPTIONAL,
    ... },
extensionContainer    SEQUENCE {
    privateExtensionList [0] IMPLICIT SEQUENCE ( SIZE( 1 .. 10 ) ) OF
    SEQUENCE {
        extId    MAP-EXTENSION.&extensionId ( {
            '
            ... } ),
        extType  MAP-EXTENSION.&ExtensionType ( {
            '
            ... } { @extId } ) OPTIONAL } OPTIONAL,
        pcs-Extensions    [1] IMPLICIT SEQUENCE {
            ... } OPTIONAL,
            ... } OPTIONAL,
            ... } OPTIONAL,
            ... },
camelCapabilityHandling [0] IMPLICIT INTEGER ( 1 .. 16 ) OPTIONAL,
notificationToCSE      [1] IMPLICIT NULL OPTIONAL,
csi-Active              [2] IMPLICIT NULL OPTIONAL } OPTIONAL,
vt-BCSM-CAMEL-TDP-CriteriaList [6] IMPLICIT SEQUENCE ( SIZE( 1 .. 10 ) ) OF
SEQUENCE {
    t-BCSM-TriggerDetectionPoint    ENUMERATED {
        termAttemptAuthorized ( 12 ),
        ... ,
        tBusy ( 13 ),
        tNoAnswer ( 14 ) },
    basicServiceCriteria [0] IMPLICIT SEQUENCE ( SIZE( 1 .. 5 ) ) OF
    CHOICE {
        ext-BearerService [2] IMPLICIT OCTET STRING ( SIZE( 1 .. 5 ) ),
        ext-Teleservice [3] IMPLICIT OCTET STRING ( SIZE( 1 .. 5 ) ) } OPTIONAL,
    t-CauseValueCriteria [1] IMPLICIT SEQUENCE ( SIZE( 1 .. 5 ) ) OF
    OCTET STRING ( SIZE( 1 ) ) OPTIONAL,
    ... } OPTIONAL,
    ... },
tif-CSI [7] IMPLICIT NULL OPTIONAL,
tif-CSI-NotificationToCSE [8] IMPLICIT NULL OPTIONAL,
gprs-CSI [9] IMPLICIT SEQUENCE {
    gprs-CamelTDPDataList [0] IMPLICIT SEQUENCE ( SIZE( 1 .. 10 ) ) OF
    SEQUENCE {
        gprs-TriggerDetectionPoint [0] IMPLICIT ENUMERATED {
            attach ( 1 ),
            attachChangeOfPosition ( 2 ),
            pdp-ContextEstablishment ( 11 ),
            pdp-ContextEstablishmentAcknowledgement ( 12 ),
            pdp-ContextChangeOfPosition ( 14 ),
            ... },
        serviceKey [1] IMPLICIT INTEGER ( 0 .. 2147483647 ),
        gsmSCF-Address [2] IMPLICIT OCTET STRING ( SIZE( 1 .. 20 ) ) ( SIZE( 1 .. 9 ) ),
        defaultSessionHandling [3] IMPLICIT ENUMERATED {
            continueTransaction ( 0 ),
            releaseTransaction ( 1 ),
            ... },
        extensionContainer [4] IMPLICIT SEQUENCE {
            privateExtensionList [0] IMPLICIT SEQUENCE ( SIZE( 1 .. 10 ) ) OF
            SEQUENCE {
                extId    MAP-EXTENSION.&extensionId ( {
                    '
                    ... } ),
                extType  MAP-EXTENSION.&ExtensionType ( {
                    '
                    ... } { @extId } ) OPTIONAL } OPTIONAL,
                pcs-Extensions    [1] IMPLICIT SEQUENCE {
                    ... } OPTIONAL,
                    ... } OPTIONAL,
                    ... } OPTIONAL,
                    ... },
            camelCapabilityHandling [1] IMPLICIT INTEGER ( 1 .. 16 ) OPTIONAL,
            extensionContainer [2] IMPLICIT SEQUENCE {
                privateExtensionList [0] IMPLICIT SEQUENCE ( SIZE( 1 .. 10 ) ) OF
                SEQUENCE {
                    extId    MAP-EXTENSION.&extensionId ( {

```



```

    extType MAP-EXTENSION .&ExtensionType ( {
        '
        ... } { @extId } ) OPTIONAL} OPTIONAL,
    pcs-Extensions [1] IMPLICIT SEQUENCE {
        ... } OPTIONAL,
        ... } OPTIONAL,
    ... ,
    notificationToCSE [0] IMPLICIT NULL OPTIONAL,
    csi-Active [1] IMPLICIT NULL OPTIONAL} OPTIONAL,
    m-CSI [12] IMPLICIT SEQUENCE {
    mobilityTriggers SEQUENCE ( SIZE( 1 .. 10 ) ) OF
        OCTET STRING ( SIZE( 1 ) ),
    serviceKey INTEGER ( 0 .. 2147483647 ),
    gsmSCF-Address [0] IMPLICIT OCTET STRING ( SIZE( 1 .. 20 ) ) ( SIZE( 1 .. 9 ) ),
    extensionContainer [1] IMPLICIT SEQUENCE {
        privateExtensionList [0] IMPLICIT SEQUENCE ( SIZE( 1 .. 10 ) ) OF
            SEQUENCE {
                extId MAP-EXTENSION .&extensionId ( {
                    '
                    ... } ),
                extType MAP-EXTENSION .&ExtensionType ( {
                    '
                    ... } { @extId } ) OPTIONAL} OPTIONAL,
                    pcs-Extensions [1] IMPLICIT SEQUENCE {
                        ... } OPTIONAL,
                        ... } OPTIONAL,
                    notificationToCSE [2] IMPLICIT NULL OPTIONAL,
                    csi-Active [3] IMPLICIT NULL OPTIONAL,
                    ... } OPTIONAL,
                    extensionContainer [13] IMPLICIT SEQUENCE {
                        privateExtensionList [0] IMPLICIT SEQUENCE ( SIZE( 1 .. 10 ) ) OF
                            SEQUENCE {
                                extId MAP-EXTENSION .&extensionId ( {
                                    '
                                    ... } ),
                                extType MAP-EXTENSION .&ExtensionType ( {
                                    '
                                    ... } { @extId } ) OPTIONAL} OPTIONAL,
                                    pcs-Extensions [1] IMPLICIT SEQUENCE {
                                        ... } OPTIONAL,
                                        ... } OPTIONAL,
                                    ... ,
                                specificCSIDeletedList [14] IMPLICIT BIT STRING {
                                    o-csi ( 0 ),
                                    ss-csi ( 1 ),
                                    tif-csi ( 2 ),
                                    d-csi ( 3 ),
                                    vt-csi ( 4 ),
                                    mo-sms-csi ( 5 ),
                                    m-csi ( 6 ),
                                    gprs-csi ( 7 ),
                                    t-csi ( 8 ),
                                    mt-sms-csi ( 9 ),
                                    mg-csi ( 10 ),
                                    o-IM-CSI ( 11 ),
                                    d-IM-CSI ( 12 ),
                                    vt-IM-CSI ( 13 ) } ( SIZE( 8 .. 32 ) ) OPTIONAL,
                                    mt-sms-CSI [15] IMPLICIT SEQUENCE {
                                        sms-CAMEL-TDP-DataList [0] IMPLICIT SEQUENCE ( SIZE( 1 .. 10 ) ) OF
                                            SEQUENCE {
                                                sms-TriggerDetectionPoint [0] IMPLICIT ENUMERATED {
                                                    sms-CollectedInfo ( 1 ),
                                                    ... ,
                                                    sms-DeliveryRequest ( 2 ) },
                                                serviceKey [1] IMPLICIT INTEGER ( 0 .. 2147483647 ),
                                                gsmSCF-Address [2] IMPLICIT OCTET STRING ( SIZE( 1 .. 20 ) ) ( SIZE( 1 .. 9 ) ),
                                                defaultSMS-Handling [3] IMPLICIT ENUMERATED {
                                                    continueTransaction ( 0 ),
                                                    releaseTransaction ( 1 ),
                                                    ... },
                                                extensionContainer [4] IMPLICIT SEQUENCE {
                                                    privateExtensionList [0] IMPLICIT SEQUENCE ( SIZE( 1 .. 10 ) ) OF
                                                        SEQUENCE {
                                                            extId MAP-EXTENSION .&extensionId ( {
                                                                '
                                                                ... } ),
                                                            extType MAP-EXTENSION .&ExtensionType ( {

```

```

        ... } { @extId } ) OPTIONAL} OPTIONAL,
    pcs-Extensions [1] IMPLICIT SEQUENCE {
        ... } OPTIONAL,
        ... } OPTIONAL,
        ... } OPTIONAL,
    camelCapabilityHandling [1] IMPLICIT INTEGER ( 1 .. 16 ) OPTIONAL,
    extensionContainer [2] IMPLICIT SEQUENCE {
        privateExtensionList [0] IMPLICIT SEQUENCE ( SIZE( 1 .. 10 ) ) OF
        SEQUENCE {
            extId MAP-EXTENSION .&extensionId ( {
                '
                ... } ),
            extType MAP-EXTENSION .&ExtensionType ( {
                '
                ... } { @extId } ) OPTIONAL} OPTIONAL,
        pcs-Extensions [1] IMPLICIT SEQUENCE {
            ... } OPTIONAL,
            ... } OPTIONAL,
            ... } OPTIONAL,
        notificationToCSE [3] IMPLICIT NULL OPTIONAL,
        csi-Active [4] IMPLICIT NULL OPTIONAL,
        ... } OPTIONAL,
    mt-smsCAMELTDP-CriteriaList [16] IMPLICIT SEQUENCE ( SIZE( 1 .. 10 ) ) OF
    SEQUENCE {
        sms-TriggerDetectionPoint ENUMERATED {
            sms-CollectedInfo ( 1 ),
            ... ,
            sms-DeliveryRequest ( 2 ) },
        tpdu-TypeCriterion [0] IMPLICIT SEQUENCE ( SIZE( 1 .. 5 ) ) OF
        ENUMERATED {
            sms-DELIVER ( 0 ),
            sms-SUBMIT-REPORT ( 1 ),
            sms-STATUS-REPORT ( 2 ),
            ... } OPTIONAL,
        ... } OPTIONAL,
    mg-csi [17] IMPLICIT SEQUENCE {
        mobilityTriggers SEQUENCE ( SIZE( 1 .. 10 ) ) OF
        OCTET STRING ( SIZE( 1 ) ),
        serviceKey INTEGER ( 0 .. 2147483647 ),
        gsmSCF-Address [0] IMPLICIT OCTET STRING ( SIZE( 1 .. 20 ) ) ( SIZE( 1 .. 9 ) ),
        extensionContainer [1] IMPLICIT SEQUENCE {
            privateExtensionList [0] IMPLICIT SEQUENCE ( SIZE( 1 .. 10 ) ) OF
            SEQUENCE {
                extId MAP-EXTENSION .&extensionId ( {
                    '
                    ... } ),
                extType MAP-EXTENSION .&ExtensionType ( {
                    '
                    ... } { @extId } ) OPTIONAL} OPTIONAL,
            pcs-Extensions [1] IMPLICIT SEQUENCE {
                ... } OPTIONAL,
                ... } OPTIONAL,
                ... } OPTIONAL,
            notificationToCSE [2] IMPLICIT NULL OPTIONAL,
            csi-Active [3] IMPLICIT NULL OPTIONAL,
            ... } OPTIONAL,
    o-IM-CSI [18] IMPLICIT SEQUENCE {
        o-BcsmCamelTDPDataList SEQUENCE ( SIZE( 1 .. 10 ) ) OF
        SEQUENCE {
            o-BcsmTriggerDetectionPoint ENUMERATED {
                collectedInfo ( 2 ),
                ... ,
                routeSelectFailure ( 4 ) },
            serviceKey INTEGER ( 0 .. 2147483647 ),
            gsmSCF-Address [0] IMPLICIT OCTET STRING ( SIZE( 1 .. 20 ) ) ( SIZE( 1 .. 9 ) ),
            defaultCallHandling [1] IMPLICIT ENUMERATED {
                continueCall ( 0 ),
                releaseCall ( 1 ),
                ... },
            extensionContainer [2] IMPLICIT SEQUENCE {
                privateExtensionList [0] IMPLICIT SEQUENCE ( SIZE( 1 .. 10 ) ) OF
                SEQUENCE {
                    extId MAP-EXTENSION .&extensionId ( {
                        '
                        ... } ),
                    extType MAP-EXTENSION .&ExtensionType ( {
                        '
                        ... } { @extId } ) OPTIONAL} OPTIONAL,

```



```

    pcs-Extensions      [1] IMPLICIT SEQUENCE {
      ... } OPTIONAL,
      ... } OPTIONAL,
    ... },
  extensionContainer  SEQUENCE {
    privateExtensionList [0] IMPLICIT SEQUENCE ( SIZE( 1 .. 10 )) OF
      SEQUENCE {
        extId  MAP-EXTENSION .&extensionId ( {
          '
          ... } ),
        extType  MAP-EXTENSION .&ExtensionType ( {
          '
          ... } { @extId } ) OPTIONAL } OPTIONAL,
    pcs-Extensions      [1] IMPLICIT SEQUENCE {
      ... } OPTIONAL,
      ... } OPTIONAL,
    ... ,
  camelCapabilityHandling [0] IMPLICIT INTEGER ( 1 .. 16 ) OPTIONAL,
  notificationToCSE      [1] IMPLICIT NULL OPTIONAL,
  csiActive               [2] IMPLICIT NULL OPTIONAL } OPTIONAL,
o-IM-BcsmCamelITDP-CriteriaList [19] IMPLICIT SEQUENCE ( SIZE( 1 .. 10 )) OF
  SEQUENCE {
    o-BcsmTriggerDetectionPoint  ENUMERATED {
      collectedInfo      ( 2 ),
      ... ,
      routeSelectFailure  ( 4 ) },
    destinationNumberCriteria [0] IMPLICIT SEQUENCE {
      matchType          [0] IMPLICIT ENUMERATED {
        inhibiting      ( 0 ),
        enabling        ( 1 ) },
      destinationNumberList [1] IMPLICIT SEQUENCE ( SIZE( 1 .. 10 )) OF
        OCTET STRING ( SIZE( 1 .. 20 )) ( SIZE( 1 .. 9 )) OPTIONAL,
      destinationNumberLengthList [2] IMPLICIT SEQUENCE ( SIZE( 1 .. 3 )) OF
        INTEGER ( 1 .. 15 ) OPTIONAL,
      ... } OPTIONAL,
    basicServiceCriteria [1] IMPLICIT SEQUENCE ( SIZE( 1 .. 5 )) OF
      CHOICE {
        ext-BearerService [2] IMPLICIT OCTET STRING ( SIZE( 1 .. 5 )),
        ext-Teleservice [3] IMPLICIT OCTET STRING ( SIZE( 1 .. 5 )) } OPTIONAL,
    callTypeCriteria [2] IMPLICIT ENUMERATED {
      forwarded      ( 0 ),
      notForwarded  ( 1 ) } OPTIONAL,
    ... ,
    o-CauseValueCriteria [3] IMPLICIT SEQUENCE ( SIZE( 1 .. 5 )) OF
      OCTET STRING ( SIZE( 1 )) OPTIONAL,
    extensionContainer [4] IMPLICIT SEQUENCE {
      privateExtensionList [0] IMPLICIT SEQUENCE ( SIZE( 1 .. 10 )) OF
        SEQUENCE {
          extId  MAP-EXTENSION .&extensionId ( {
            '
            ... } ),
          extType  MAP-EXTENSION .&ExtensionType ( {
            '
            ... } { @extId } ) OPTIONAL } OPTIONAL,
      pcs-Extensions      [1] IMPLICIT SEQUENCE {
        ... } OPTIONAL,
        ... } OPTIONAL } OPTIONAL,
  d-IM-CSI [20] IMPLICIT SEQUENCE {
    dp-AnalysedInfoCriteriaList [0] IMPLICIT SEQUENCE ( SIZE( 1 .. 10 )) OF
      SEQUENCE {
        dialledNumber  OCTET STRING ( SIZE( 1 .. 20 )) ( SIZE( 1 .. 9 )),
        serviceKey     INTEGER ( 0 .. 2147483647 ),
        gsmSCF-Address  OCTET STRING ( SIZE( 1 .. 20 )) ( SIZE( 1 .. 9 )),
        defaultCallHandling  ENUMERATED {
          continueCall  ( 0 ),
          releaseCall   ( 1 ),
          ... },
        extensionContainer  SEQUENCE {
          privateExtensionList [0] IMPLICIT SEQUENCE ( SIZE( 1 .. 10 )) OF
            SEQUENCE {
              extId  MAP-EXTENSION .&extensionId ( {
                '
                ... } ),
              extType  MAP-EXTENSION .&ExtensionType ( {
                '
                ... } { @extId } ) OPTIONAL } OPTIONAL,
          pcs-Extensions      [1] IMPLICIT SEQUENCE {

```

```

... } OPTIONAL,
... } OPTIONAL,
... } OPTIONAL,
camelCapabilityHandling [1] IMPLICIT INTEGER ( 1 .. 16 ) OPTIONAL,
extensionContainer [2] IMPLICIT SEQUENCE {
  privateExtensionList [0] IMPLICIT SEQUENCE ( SIZE( 1 .. 10 ) ) OF
  SEQUENCE {
    extId MAP-EXTENSION .&extensionId ( {
      '
      ... } ),
    extType MAP-EXTENSION .&ExtensionType ( {
      '
      ... } { @extId } ) OPTIONAL } OPTIONAL,
  pcs-Extensions [1] IMPLICIT SEQUENCE {
    ... } OPTIONAL,
    ... } OPTIONAL,
notificationToCSE [3] IMPLICIT NULL OPTIONAL,
csi-Active [4] IMPLICIT NULL OPTIONAL,
... } OPTIONAL,
vt-IM-CSI [21] IMPLICIT SEQUENCE {
  t-BcsmCamelTDPDataList SEQUENCE ( SIZE( 1 .. 10 ) ) OF
  SEQUENCE {
    t-BcsmTriggerDetectionPoint ENUMERATED {
      termAttemptAuthorized ( 12 ),
      ... ,
      tBusy ( 13 ),
      tNoAnswer ( 14 ) },
    serviceKey INTEGER ( 0 .. 2147483647 ),
    gsmSCF-Address [0] IMPLICIT OCTET STRING ( SIZE( 1 .. 20 ) ) ( SIZE( 1 .. 9 ) ),
    defaultCallHandling [1] IMPLICIT ENUMERATED {
      continueCall ( 0 ),
      releaseCall ( 1 ),
      ... },
    extensionContainer [2] IMPLICIT SEQUENCE {
      privateExtensionList [0] IMPLICIT SEQUENCE ( SIZE( 1 .. 10 ) ) OF
      SEQUENCE {
        extId MAP-EXTENSION .&extensionId ( {
          '
          ... } ),
        extType MAP-EXTENSION .&ExtensionType ( {
          '
          ... } { @extId } ) OPTIONAL } OPTIONAL,
      pcs-Extensions [1] IMPLICIT SEQUENCE {
        ... } OPTIONAL,
        ... } OPTIONAL,
      ... },
    extensionContainer SEQUENCE {
      privateExtensionList [0] IMPLICIT SEQUENCE ( SIZE( 1 .. 10 ) ) OF
      SEQUENCE {
        extId MAP-EXTENSION .&extensionId ( {
          '
          ... } ),
        extType MAP-EXTENSION .&ExtensionType ( {
          '
          ... } { @extId } ) OPTIONAL } OPTIONAL,
      pcs-Extensions [1] IMPLICIT SEQUENCE {
        ... } OPTIONAL,
        ... } OPTIONAL,
      ... },
    camelCapabilityHandling [0] IMPLICIT INTEGER ( 1 .. 16 ) OPTIONAL,
    notificationToCSE [1] IMPLICIT NULL OPTIONAL,
    csi-Active [2] IMPLICIT NULL OPTIONAL } OPTIONAL,
vt-IM-BCSM-CAMEL-TDP-CriteriaList [22] IMPLICIT SEQUENCE ( SIZE( 1 .. 10 ) ) OF
SEQUENCE {
  t-BCSM-TriggerDetectionPoint ENUMERATED {
    termAttemptAuthorized ( 12 ),
    ... ,
    tBusy ( 13 ),
    tNoAnswer ( 14 ) },
  basicServiceCriteria [0] IMPLICIT SEQUENCE ( SIZE( 1 .. 5 ) ) OF
  CHOICE {
    ext-BearerService [2] IMPLICIT OCTET STRING ( SIZE( 1 .. 5 ) ),
    ext-Teleservice [3] IMPLICIT OCTET STRING ( SIZE( 1 .. 5 ) ) } OPTIONAL,
  t-CauseValueCriteria [1] IMPLICIT SEQUENCE ( SIZE( 1 .. 5 ) ) OF
  OCTET STRING ( SIZE( 1 ) ) OPTIONAL,
  ... } OPTIONAL } OPTIONAL,
extensionContainer [2] IMPLICIT SEQUENCE {

```

```

privateExtensionList [0] IMPLICIT SEQUENCE ( SIZE( 1 .. 10 ) ) OF
SEQUENCE {
  extId  MAP-EXTENSION .&extensionId ( {
    '
    ... } ),
  extType  MAP-EXTENSION .&ExtensionType ( {
    '
    ... } { @extId } ) OPTIONAL} OPTIONAL,
pcs-Extensions [1] IMPLICIT SEQUENCE {
  ... } OPTIONAL,
... } OPTIONAL,
... ,
odb-Info [3] IMPLICIT SEQUENCE {
  odb-Data SEQUENCE {
    odb-GeneralData BIT STRING {
      allOG-CallsBarred ( 0 ),
      internationalOGCallsBarred ( 1 ),
      internationalOGCallsNotToHPLMN-CountryBarred ( 2 ),
      interzonalOGCallsBarred ( 6 ),
      interzonalOGCallsNotToHPLMN-CountryBarred ( 7 ),
      interzonalOGCallsAndInternationalOGCallsNotToHPLMN-CountryBarred ( 8 ),
      premiumRateInformationOGCallsBarred ( 3 ),
      premiumRateEntertainmentOGCallsBarred ( 4 ),
      ss-AccessBarred ( 5 ),
      allECT-Barred ( 9 ),
      chargeableECT-Barred ( 10 ),
      internationalECT-Barred ( 11 ),
      interzonalECT-Barred ( 12 ),
      doublyChargeableECT-Barred ( 13 ),
      multipleECT-Barred ( 14 ),
      allPacketOrientedServicesBarred ( 15 ),
      roamerAccessToHPLMN-AP-Barred ( 16 ),
      roamerAccessToVPLMN-AP-Barred ( 17 ),
      roamingOutsidePLMNOG-CallsBarred ( 18 ),
      allIC-CallsBarred ( 19 ),
      roamingOutsidePLMNIC-CallsBarred ( 20 ),
      roamingOutsidePLMNICountryIC-CallsBarred ( 21 ),
      roamingOutsidePLMN-Barred ( 22 ),
      roamingOutsidePLMN-CountryBarred ( 23 ),
      registrationAllCF-Barred ( 24 ),
      registrationCFNotToHPLMN-Barred ( 25 ),
      registrationInterzonalCF-Barred ( 26 ),
      registrationInterzonalCFNotToHPLMN-Barred ( 27 ),
      registrationInternationalCF-Barred ( 28 ) } ( SIZE( 15 .. 32 ) ),
    odb-HPLMN-Data BIT STRING {
      plmn-SpecificBarringType1 ( 0 ),
      plmn-SpecificBarringType2 ( 1 ),
      plmn-SpecificBarringType3 ( 2 ),
      plmn-SpecificBarringType4 ( 3 ) } ( SIZE( 4 .. 32 ) ) OPTIONAL,
    extensionContainer SEQUENCE {
      privateExtensionList [0] IMPLICIT SEQUENCE ( SIZE( 1 .. 10 ) ) OF
      SEQUENCE {
        extId  MAP-EXTENSION .&extensionId ( {
          '
          ... } ),
        extType  MAP-EXTENSION .&ExtensionType ( {
          '
          ... } { @extId } ) OPTIONAL} OPTIONAL,
      pcs-Extensions [1] IMPLICIT SEQUENCE {
        ... } OPTIONAL,
      ... } OPTIONAL,
      ... },
    notificationToCSE NULL OPTIONAL,
  }
  extensionContainer SEQUENCE {
    privateExtensionList [0] IMPLICIT SEQUENCE ( SIZE( 1 .. 10 ) ) OF
    SEQUENCE {
      extId  MAP-EXTENSION .&extensionId ( {
        '
        ... } ),
      extType  MAP-EXTENSION .&ExtensionType ( {
        '
        ... } { @extId } ) OPTIONAL} OPTIONAL,
    pcs-Extensions [1] IMPLICIT SEQUENCE {
      ... } OPTIONAL,
      ... } OPTIONAL,
      ... } OPTIONAL}
  ERRORS {

```

```

atm-NotAllowed |
dataMissing |
unexpectedDataValue |
unknownSubscriber |
bearerServiceNotProvisioned |
teleserviceNotProvisioned |
callBarred |
illegalSS-Operation |
ss-SubscriptionViolation |
ss-ErrorStatus |
ss-Incompatibility |
informationNotAvailable }
CODE local : 65
}

```

```

noteSubscriberDataModified OPERATION ::= {
ARGUMENT SEQUENCE {
imsi OCTET STRING ( SIZE( 3 .. 8 ) ),
msisdn OCTET STRING ( SIZE( 1 .. 20 ) ) ( SIZE( 1 .. 9 ) ),
forwardingInfoFor-CSE [0] IMPLICIT SEQUENCE {
ss-Code [0] IMPLICIT OCTET STRING ( SIZE( 1 ) ),
forwardingFeatureList [1] IMPLICIT SEQUENCE ( SIZE( 1 .. 32 ) ) OF
SEQUENCE {
basicService CHOICE {
ext-BearerService [2] IMPLICIT OCTET STRING ( SIZE( 1 .. 5 ) ),
ext-Teleservice [3] IMPLICIT OCTET STRING ( SIZE( 1 .. 5 ) ) } OPTIONAL,
ss-Status [4] IMPLICIT OCTET STRING ( SIZE( 1 .. 5 ) ),
forwardedToNumber [5] IMPLICIT OCTET STRING ( SIZE( 1 .. 20 ) ) ( SIZE( 1 .. 9 ) ) OPTIONAL,
forwardedToSubaddress [8] IMPLICIT OCTET STRING ( SIZE( 1 .. 21 ) ) OPTIONAL,
forwardingOptions [6] IMPLICIT OCTET STRING ( SIZE( 1 .. 5 ) ) OPTIONAL,
noReplyConditionTime [7] IMPLICIT INTEGER ( 1 .. 100 ) OPTIONAL,
extensionContainer [9] IMPLICIT SEQUENCE {
privateExtensionList [0] IMPLICIT SEQUENCE ( SIZE( 1 .. 10 ) ) OF
SEQUENCE {
extId MAP-EXTENSION .&extensionId ( {
'
... } ),
extType MAP-EXTENSION .&ExtensionType ( {
'
... } { @extId } ) OPTIONAL } OPTIONAL,
pcs-Extensions [1] IMPLICIT SEQUENCE {
... } OPTIONAL,
... } OPTIONAL,
... ,
longForwardedToNumber [10] IMPLICIT OCTET STRING ( SIZE( 1 .. 20 ) ) ( SIZE( 1 .. 15 ) ) OPTIONAL,
notificationToCSE [2] IMPLICIT NULL OPTIONAL,
extensionContainer [3] IMPLICIT SEQUENCE {
privateExtensionList [0] IMPLICIT SEQUENCE ( SIZE( 1 .. 10 ) ) OF
SEQUENCE {
extId MAP-EXTENSION .&extensionId ( {
'
... } ),
extType MAP-EXTENSION .&ExtensionType ( {
'
... } { @extId } ) OPTIONAL } OPTIONAL,
pcs-Extensions [1] IMPLICIT SEQUENCE {
... } OPTIONAL,
... } OPTIONAL,
... } OPTIONAL,
callBarringInfoFor-CSE [1] IMPLICIT SEQUENCE {
ss-Code [0] IMPLICIT OCTET STRING ( SIZE( 1 ) ),
callBarringFeatureList [1] IMPLICIT SEQUENCE ( SIZE( 1 .. 32 ) ) OF
SEQUENCE {
basicService CHOICE {
ext-BearerService [2] IMPLICIT OCTET STRING ( SIZE( 1 .. 5 ) ),
ext-Teleservice [3] IMPLICIT OCTET STRING ( SIZE( 1 .. 5 ) ) } OPTIONAL,
ss-Status [4] IMPLICIT OCTET STRING ( SIZE( 1 .. 5 ) ),
extensionContainer SEQUENCE {
privateExtensionList [0] IMPLICIT SEQUENCE ( SIZE( 1 .. 10 ) ) OF
SEQUENCE {
extId MAP-EXTENSION .&extensionId ( {
'
... } ),
extType MAP-EXTENSION .&ExtensionType ( {
'
... } { @extId } ) OPTIONAL } OPTIONAL,
pcs-Extensions [1] IMPLICIT SEQUENCE {

```

```

... } OPTIONAL,
... } OPTIONAL,
... },
password [2] IMPLICIT NumericString ( FROM ("0"|"1"|"2"|"3"|"4"|"5"|"6"|"7"|"8"|"9" )) (SIZE( 4 ) ) OPTIONAL,
wrongPasswordAttemptsCounter [3] IMPLICIT INTEGER ( 0 .. 4 ) OPTIONAL,
notificationToCSE [4] IMPLICIT NULL OPTIONAL,
extensionContainer [5] IMPLICIT SEQUENCE {
  privateExtensionList [0] IMPLICIT SEQUENCE ( SIZE( 1 .. 10 ) ) OF
  SEQUENCE {
    extId MAP-EXTENSION .&extensionId ( {
      '
      ... } ),
    extType MAP-EXTENSION .&ExtensionType ( {
      '
      ... } { @extId } ) OPTIONAL } OPTIONAL,
  pcs-Extensions [1] IMPLICIT SEQUENCE {
    ... } OPTIONAL,
    ... } OPTIONAL,
    ... } OPTIONAL,
  }
oddb-Info [2] IMPLICIT SEQUENCE {
  oddb-Data SEQUENCE {
    oddb-GeneralData BIT STRING {
      allOG-CallsBarred ( 0 ),
      internationalOGCallsBarred ( 1 ),
      internationalOGCallsNotToHPLMN-CountryBarred ( 2 ),
      interzonalOGCallsBarred ( 6 ),
      interzonalOGCallsNotToHPLMN-CountryBarred ( 7 ),
      interzonalOGCallsAndInternationalOGCallsNotToHPLMN-CountryBarred ( 8 ),
      premiumRateInformationOGCallsBarred ( 3 ),
      premiumRateEntertainmentOGCallsBarred ( 4 ),
      ss-AccessBarred ( 5 ),
      allECT-Barred ( 9 ),
      chargeableECT-Barred ( 10 ),
      internationalECT-Barred ( 11 ),
      interzonalECT-Barred ( 12 ),
      doublyChargeableECT-Barred ( 13 ),
      multipleECT-Barred ( 14 ),
      allPacketOrientedServicesBarred ( 15 ),
      roamerAccessToHPLMN-AP-Barred ( 16 ),
      roamerAccessToVPLMN-AP-Barred ( 17 ),
      roamingOutsidePLMNOG-CallsBarred ( 18 ),
      allIC-CallsBarred ( 19 ),
      roamingOutsidePLMNIC-CallsBarred ( 20 ),
      roamingOutsidePLMNICCountryIC-CallsBarred ( 21 ),
      roamingOutsidePLMN-Barred ( 22 ),
      roamingOutsidePLMN-CountryBarred ( 23 ),
      registrationAllCF-Barred ( 24 ),
      registrationCFNotToHPLMN-Barred ( 25 ),
      registrationInterzonalCF-Barred ( 26 ),
      registrationInterzonalCFNotToHPLMN-Barred ( 27 ),
      registrationInternationalCF-Barred ( 28 ) } ( SIZE( 15 .. 32 ) ),
    oddb-HPLMN-Data BIT STRING {
      plmn-SpecificBarringType1 ( 0 ),
      plmn-SpecificBarringType2 ( 1 ),
      plmn-SpecificBarringType3 ( 2 ),
      plmn-SpecificBarringType4 ( 3 ) } ( SIZE( 4 .. 32 ) ) OPTIONAL,
    extensionContainer SEQUENCE {
      privateExtensionList [0] IMPLICIT SEQUENCE ( SIZE( 1 .. 10 ) ) OF
      SEQUENCE {
        extId MAP-EXTENSION .&extensionId ( {
          '
          ... } ),
        extType MAP-EXTENSION .&ExtensionType ( {
          '
          ... } { @extId } ) OPTIONAL } OPTIONAL,
      pcs-Extensions [1] IMPLICIT SEQUENCE {
        ... } OPTIONAL,
        ... } OPTIONAL,
      }
    },
  notificationToCSE NULL OPTIONAL,
  extensionContainer SEQUENCE {
    privateExtensionList [0] IMPLICIT SEQUENCE ( SIZE( 1 .. 10 ) ) OF
    SEQUENCE {
      extId MAP-EXTENSION .&extensionId ( {
        '
        ... } ),
      extType MAP-EXTENSION .&ExtensionType ( {

```

```

    ... } { @extId } ) OPTIONAL } OPTIONAL,
    pcs-Extensions [1] IMPLICIT SEQUENCE {
    ... } OPTIONAL,
    ... } OPTIONAL,
    ... } OPTIONAL,
camel-SubscriptionInfo [3] IMPLICIT SEQUENCE {
  o-CSI [0] IMPLICIT SEQUENCE {
    o-BcsmCamelTDPDataList SEQUENCE ( SIZE( 1 .. 10 ) ) OF
    SEQUENCE {
      o-BcsmTriggerDetectionPoint ENUMERATED {
        collectedInfo ( 2 ),
        ... ,
        routeSelectFailure ( 4 ) },
      serviceKey INTEGER ( 0 .. 2147483647 ),
      gsmSCF-Address [0] IMPLICIT OCTET STRING ( SIZE( 1 .. 20 ) ) ( SIZE( 1 .. 9 ) ),
      defaultCallHandling [1] IMPLICIT ENUMERATED {
        continueCall ( 0 ),
        releaseCall ( 1 ),
        ... },
      extensionContainer [2] IMPLICIT SEQUENCE {
        privateExtensionList [0] IMPLICIT SEQUENCE ( SIZE( 1 .. 10 ) ) OF
        SEQUENCE {
          extId MAP-EXTENSION .&extensionId ( {
            '
            ... } ),
          extType MAP-EXTENSION .&ExtensionType ( {
            '
            ... } { @extId } ) OPTIONAL } OPTIONAL,
          pcs-Extensions [1] IMPLICIT SEQUENCE {
            ... } OPTIONAL,
            ... } OPTIONAL,
            ... },
        extensionContainer SEQUENCE {
          privateExtensionList [0] IMPLICIT SEQUENCE ( SIZE( 1 .. 10 ) ) OF
          SEQUENCE {
            extId MAP-EXTENSION .&extensionId ( {
              '
              ... } ),
            extType MAP-EXTENSION .&ExtensionType ( {
              '
              ... } { @extId } ) OPTIONAL } OPTIONAL,
            pcs-Extensions [1] IMPLICIT SEQUENCE {
              ... } OPTIONAL,
              ... } OPTIONAL,
              ... },
          camelCapabilityHandling [0] IMPLICIT INTEGER ( 1 .. 16 ) OPTIONAL,
          notificationToCSE [1] IMPLICIT NULL OPTIONAL,
          csiActive [2] IMPLICIT NULL OPTIONAL } OPTIONAL,
        o-BcsmCamelTDP-CriteriaList [1] IMPLICIT SEQUENCE ( SIZE( 1 .. 10 ) ) OF
        SEQUENCE {
          o-BcsmTriggerDetectionPoint ENUMERATED {
            collectedInfo ( 2 ),
            ... ,
            routeSelectFailure ( 4 ) },
          destinationNumberCriteria [0] IMPLICIT SEQUENCE {
            matchType [0] IMPLICIT ENUMERATED {
              inhibiting ( 0 ),
              enabling ( 1 ) },
            destinationNumberList [1] IMPLICIT SEQUENCE ( SIZE( 1 .. 10 ) ) OF
            OCTET STRING ( SIZE( 1 .. 20 ) ) ( SIZE( 1 .. 9 ) ) OPTIONAL,
            destinationNumberLengthList [2] IMPLICIT SEQUENCE ( SIZE( 1 .. 3 ) ) OF
            INTEGER ( 1 .. 15 ) OPTIONAL,
            ... } OPTIONAL,
          basicServiceCriteria [1] IMPLICIT SEQUENCE ( SIZE( 1 .. 5 ) ) OF
          CHOICE {
            ext-BearerService [2] IMPLICIT OCTET STRING ( SIZE( 1 .. 5 ) ),
            ext-Teleservice [3] IMPLICIT OCTET STRING ( SIZE( 1 .. 5 ) ) } OPTIONAL,
          callTypeCriteria [2] IMPLICIT ENUMERATED {
            forwarded ( 0 ),
            notForwarded ( 1 ) } OPTIONAL,
          ... ,
          o-CauseValueCriteria [3] IMPLICIT SEQUENCE ( SIZE( 1 .. 5 ) ) OF
          OCTET STRING ( SIZE( 1 ) ) OPTIONAL,
          extensionContainer [4] IMPLICIT SEQUENCE {
            privateExtensionList [0] IMPLICIT SEQUENCE ( SIZE( 1 .. 10 ) ) OF
            SEQUENCE {

```

```

    extId    MAP-EXTENSION .&extensionId ( {
        '
        ... } ),
    extType  MAP-EXTENSION .&ExtensionType ( {
        '
        ... } { @extId } ) OPTIONAL} OPTIONAL,
    pcs-Extensions    [1] IMPLICIT SEQUENCE {
    ... } OPTIONAL,
    ... } OPTIONAL} OPTIONAL,
d-CSI                [2] IMPLICIT SEQUENCE {
    dp-AnalysedInfoCriteriaList [0] IMPLICIT SEQUENCE ( SIZE( 1 .. 10 ) ) OF
    SEQUENCE {
        dialledNumber    OCTET STRING ( SIZE( 1 .. 20 ) ) ( SIZE( 1 .. 9 ) ),
        serviceKey       INTEGER ( 0 .. 2147483647 ),
        gsmSCF-Address   OCTET STRING ( SIZE( 1 .. 20 ) ) ( SIZE( 1 .. 9 ) ),
        defaultCallHandling    ENUMERATED {
            continueCall ( 0 ),
            releaseCall ( 1 ),
            ... },
        extensionContainer SEQUENCE {
            privateExtensionList [0] IMPLICIT SEQUENCE ( SIZE( 1 .. 10 ) ) OF
            SEQUENCE {
                extId    MAP-EXTENSION .&extensionId ( {
                    '
                    ... } ),
                extType  MAP-EXTENSION .&ExtensionType ( {
                    '
                    ... } { @extId } ) OPTIONAL} OPTIONAL,
                pcs-Extensions    [1] IMPLICIT SEQUENCE {
                ... } OPTIONAL,
                ... } OPTIONAL,
                ... } OPTIONAL,
            camelCapabilityHandling [1] IMPLICIT INTEGER ( 1 .. 16 ) OPTIONAL,
            extensionContainer [2] IMPLICIT SEQUENCE {
            privateExtensionList [0] IMPLICIT SEQUENCE ( SIZE( 1 .. 10 ) ) OF
            SEQUENCE {
                extId    MAP-EXTENSION .&extensionId ( {
                    '
                    ... } ),
                extType  MAP-EXTENSION .&ExtensionType ( {
                    '
                    ... } { @extId } ) OPTIONAL} OPTIONAL,
                pcs-Extensions    [1] IMPLICIT SEQUENCE {
                ... } OPTIONAL,
                ... } OPTIONAL,
            notificationToCSE [3] IMPLICIT NULL OPTIONAL,
            csi-Active [4] IMPLICIT NULL OPTIONAL,
            ... } OPTIONAL,
t-CSI                [3] IMPLICIT SEQUENCE {
    t-BcsmCamelTDPDataList SEQUENCE ( SIZE( 1 .. 10 ) ) OF
    SEQUENCE {
        t-BcsmTriggerDetectionPoint    ENUMERATED {
            termAttemptAuthorized ( 12 ),
            ... ,
            tBusy ( 13 ),
            tNoAnswer ( 14 ) },
        serviceKey    INTEGER ( 0 .. 2147483647 ),
        gsmSCF-Address [0] IMPLICIT OCTET STRING ( SIZE( 1 .. 20 ) ) ( SIZE( 1 .. 9 ) ),
        defaultCallHandling [1] IMPLICIT ENUMERATED {
            continueCall ( 0 ),
            releaseCall ( 1 ),
            ... },
        extensionContainer [2] IMPLICIT SEQUENCE {
            privateExtensionList [0] IMPLICIT SEQUENCE ( SIZE( 1 .. 10 ) ) OF
            SEQUENCE {
                extId    MAP-EXTENSION .&extensionId ( {
                    '
                    ... } ),
                extType  MAP-EXTENSION .&ExtensionType ( {
                    '
                    ... } { @extId } ) OPTIONAL} OPTIONAL,
                pcs-Extensions    [1] IMPLICIT SEQUENCE {
                ... } OPTIONAL,
                ... } OPTIONAL,
                ... },
            extensionContainer SEQUENCE {
            privateExtensionList [0] IMPLICIT SEQUENCE ( SIZE( 1 .. 10 ) ) OF

```

```

SEQUENCE {
  extId  MAP-EXTENSION .&extensionId ( {
    '
    ... } ),
  extType  MAP-EXTENSION .&ExtensionType ( {
    '
    ... } { @extId } ) OPTIONAL } OPTIONAL,
  pcs-Extensions  [1] IMPLICIT SEQUENCE {
    ... } OPTIONAL,
  ... } OPTIONAL,
... ,
camelCapabilityHandling  [0] IMPLICIT INTEGER ( 1 .. 16 ) OPTIONAL,
notificationToCSE  [1] IMPLICIT NULL OPTIONAL,
csi-Active  [2] IMPLICIT NULL OPTIONAL } OPTIONAL,
t-BCSM-CAMEL-TDP-CriteriaList  [4] IMPLICIT SEQUENCE ( SIZE( 1 .. 10 ) ) OF
SEQUENCE {
  t-BCSM-TriggerDetectionPoint  ENUMERATED {
    termAttemptAuthorized  ( 12 ),
    ... ,
    tBusy  ( 13 ),
    tNoAnswer  ( 14 ) },
  basicServiceCriteria  [0] IMPLICIT SEQUENCE ( SIZE( 1 .. 5 ) ) OF
  CHOICE {
    ext-BearerService  [2] IMPLICIT OCTET STRING ( SIZE( 1 .. 5 ) ),
    ext-Teleservice  [3] IMPLICIT OCTET STRING ( SIZE( 1 .. 5 ) ) } OPTIONAL,
  t-CauseValueCriteria  [1] IMPLICIT SEQUENCE ( SIZE( 1 .. 5 ) ) OF
  OCTET STRING ( SIZE( 1 ) ) OPTIONAL,
  ... } OPTIONAL,
vt-CSI  [5] IMPLICIT SEQUENCE {
  t-BcsmCamelTDPDataList  SEQUENCE ( SIZE( 1 .. 10 ) ) OF
  SEQUENCE {
    t-BcsmTriggerDetectionPoint  ENUMERATED {
      termAttemptAuthorized  ( 12 ),
      ... ,
      tBusy  ( 13 ),
      tNoAnswer  ( 14 ) },
    serviceKey  INTEGER ( 0 .. 2147483647 ),
    gsmSCF-Address  [0] IMPLICIT OCTET STRING ( SIZE( 1 .. 20 ) ) ( SIZE( 1 .. 9 ) ),
    defaultCallHandling  [1] IMPLICIT ENUMERATED {
      continueCall  ( 0 ),
      releaseCall  ( 1 ),
      ... },
    extensionContainer  [2] IMPLICIT SEQUENCE {
      privateExtensionList  [0] IMPLICIT SEQUENCE ( SIZE( 1 .. 10 ) ) OF
      SEQUENCE {
        extId  MAP-EXTENSION .&extensionId ( {
          '
          ... } ),
        extType  MAP-EXTENSION .&ExtensionType ( {
          '
          ... } { @extId } ) OPTIONAL } OPTIONAL,
        pcs-Extensions  [1] IMPLICIT SEQUENCE {
          ... } OPTIONAL,
          ... } OPTIONAL,
        ... },
      extensionContainer  SEQUENCE {
        privateExtensionList  [0] IMPLICIT SEQUENCE ( SIZE( 1 .. 10 ) ) OF
        SEQUENCE {
          extId  MAP-EXTENSION .&extensionId ( {
            '
            ... } ),
            extType  MAP-EXTENSION .&ExtensionType ( {
              '
              ... } { @extId } ) OPTIONAL } OPTIONAL,
            pcs-Extensions  [1] IMPLICIT SEQUENCE {
              ... } OPTIONAL,
              ... } OPTIONAL,
            ... },
          camelCapabilityHandling  [0] IMPLICIT INTEGER ( 1 .. 16 ) OPTIONAL,
          notificationToCSE  [1] IMPLICIT NULL OPTIONAL,
          csi-Active  [2] IMPLICIT NULL OPTIONAL } OPTIONAL,
          vt-BCSM-CAMEL-TDP-CriteriaList  [6] IMPLICIT SEQUENCE ( SIZE( 1 .. 10 ) ) OF
          SEQUENCE {
            t-BCSM-TriggerDetectionPoint  ENUMERATED {
              termAttemptAuthorized  ( 12 ),
              ... ,
              tBusy  ( 13 ),

```



```

    tNoAnswer          ( 14 ) },
    basicServiceCriteria [0] IMPLICIT SEQUENCE ( SIZE( 1 .. 5 ) ) OF
    CHOICE {
        ext-BearerService [2] IMPLICIT OCTET STRING ( SIZE( 1 .. 5 ) ),
        ext-Teleservice   [3] IMPLICIT OCTET STRING ( SIZE( 1 .. 5 ) ) } OPTIONAL,
    t-CauseValueCriteria [1] IMPLICIT SEQUENCE ( SIZE( 1 .. 5 ) ) OF
    OCTET STRING ( SIZE( 1 ) ) OPTIONAL,
    ... } OPTIONAL,
tif-CSI [7] IMPLICIT NULL OPTIONAL,
tif-CSI-NotificationToCSE [8] IMPLICIT NULL OPTIONAL,
gprs-CSI [9] IMPLICIT SEQUENCE {
    gprs-CamelTDPDataList [0] IMPLICIT SEQUENCE ( SIZE( 1 .. 10 ) ) OF
    SEQUENCE {
        gprs-TriggerDetectionPoint [0] IMPLICIT ENUMERATED {
            attach ( 1 ),
            attachChangeOfPosition ( 2 ),
            pdp-ContextEstablishment ( 11 ),
            pdp-ContextEstablishmentAcknowledgement ( 12 ),
            pdp-ContextChangeOfPosition ( 14 ),
            ... },
        serviceKey [1] IMPLICIT INTEGER ( 0 .. 2147483647 ),
        gsmSCF-Address [2] IMPLICIT OCTET STRING ( SIZE( 1 .. 20 ) ) ( SIZE( 1 .. 9 ) ),
        defaultSessionHandling [3] IMPLICIT ENUMERATED {
            continueTransaction ( 0 ),
            releaseTransaction ( 1 ),
            ... },
        extensionContainer [4] IMPLICIT SEQUENCE {
            privateExtensionList [0] IMPLICIT SEQUENCE ( SIZE( 1 .. 10 ) ) OF
            SEQUENCE {
                extId MAP-EXTENSION .&extensionId ( {
                    '
                    ... } ),
                extType MAP-EXTENSION .&ExtensionType ( {
                    '
                    ... } { @extId } ) OPTIONAL } OPTIONAL,
            pcs-Extensions [1] IMPLICIT SEQUENCE {
                ... } OPTIONAL,
                ... } OPTIONAL,
                ... } OPTIONAL,
            camelCapabilityHandling [1] IMPLICIT INTEGER ( 1 .. 16 ) OPTIONAL,
            extensionContainer [2] IMPLICIT SEQUENCE {
                privateExtensionList [0] IMPLICIT SEQUENCE ( SIZE( 1 .. 10 ) ) OF
                SEQUENCE {
                    extId MAP-EXTENSION .&extensionId ( {
                        '
                        ... } ),
                    extType MAP-EXTENSION .&ExtensionType ( {
                        '
                        ... } { @extId } ) OPTIONAL } OPTIONAL,
                pcs-Extensions [1] IMPLICIT SEQUENCE {
                    ... } OPTIONAL,
                    ... } OPTIONAL,
                notificationToCSE [3] IMPLICIT NULL OPTIONAL,
                csi-Active [4] IMPLICIT NULL OPTIONAL,
                ... } OPTIONAL,
            mo-sms-CSI [10] IMPLICIT SEQUENCE {
                sms-CAMEL-TDP-DataList [0] IMPLICIT SEQUENCE ( SIZE( 1 .. 10 ) ) OF
                SEQUENCE {
                    sms-TriggerDetectionPoint [0] IMPLICIT ENUMERATED {
                        sms-CollectedInfo ( 1 ),
                        ... ,
                        sms-DeliveryRequest ( 2 ) },
                    serviceKey [1] IMPLICIT INTEGER ( 0 .. 2147483647 ),
                    gsmSCF-Address [2] IMPLICIT OCTET STRING ( SIZE( 1 .. 20 ) ) ( SIZE( 1 .. 9 ) ),
                    defaultSMS-Handling [3] IMPLICIT ENUMERATED {
                        continueTransaction ( 0 ),
                        releaseTransaction ( 1 ),
                        ... },
                    extensionContainer [4] IMPLICIT SEQUENCE {
                        privateExtensionList [0] IMPLICIT SEQUENCE ( SIZE( 1 .. 10 ) ) OF
                        SEQUENCE {
                            extId MAP-EXTENSION .&extensionId ( {
                                '
                                ... } ),
                            extType MAP-EXTENSION .&ExtensionType ( {
                                '
                                ... } { @extId } ) OPTIONAL } OPTIONAL,

```

```

    pcs-Extensions      [1] IMPLICIT SEQUENCE {
      ... } OPTIONAL,
      ... } OPTIONAL,
      ... } OPTIONAL,
camelCapabilityHandling [1] IMPLICIT INTEGER ( 1 .. 16 ) OPTIONAL,
extensionContainer     [2] IMPLICIT SEQUENCE {
  privateExtensionList [0] IMPLICIT SEQUENCE ( SIZE( 1 .. 10 ) ) OF
  SEQUENCE {
    extId  MAP-EXTENSION .&extensionId ( {
      '
      ... } ),
    extType MAP-EXTENSION .&ExtensionType ( {
      '
      ... } { @extId } ) OPTIONAL } OPTIONAL,
  pcs-Extensions      [1] IMPLICIT SEQUENCE {
    ... } OPTIONAL,
    ... } OPTIONAL,
  notificationToCSE   [3] IMPLICIT NULL OPTIONAL,
  csi-Active          [4] IMPLICIT NULL OPTIONAL,
  ... } OPTIONAL,
ss-CSI                [11] IMPLICIT SEQUENCE {
  ss-CamelData        SEQUENCE {
    ss-EventList      SEQUENCE ( SIZE( 1 .. 10 ) ) OF
    OCTET STRING ( SIZE( 1 ) ),
    gsmSCF-Address    OCTET STRING ( SIZE( 1 .. 20 ) ) ( SIZE( 1 .. 9 ) ),
    extensionContainer [0] IMPLICIT SEQUENCE {
      privateExtensionList [0] IMPLICIT SEQUENCE ( SIZE( 1 .. 10 ) ) OF
      SEQUENCE {
        extId  MAP-EXTENSION .&extensionId ( {
          '
          ... } ),
        extType MAP-EXTENSION .&ExtensionType ( {
          '
          ... } { @extId } ) OPTIONAL } OPTIONAL,
      pcs-Extensions      [1] IMPLICIT SEQUENCE {
        ... } OPTIONAL,
        ... } OPTIONAL,
      ... },
    extensionContainer SEQUENCE {
      privateExtensionList [0] IMPLICIT SEQUENCE ( SIZE( 1 .. 10 ) ) OF
      SEQUENCE {
        extId  MAP-EXTENSION .&extensionId ( {
          '
          ... } ),
        extType MAP-EXTENSION .&ExtensionType ( {
          '
          ... } { @extId } ) OPTIONAL } OPTIONAL,
      pcs-Extensions      [1] IMPLICIT SEQUENCE {
        ... } OPTIONAL,
        ... } OPTIONAL,
      ... },
    notificationToCSE [0] IMPLICIT NULL OPTIONAL,
    csi-Active        [1] IMPLICIT NULL OPTIONAL } OPTIONAL,
  m-CSI              [12] IMPLICIT SEQUENCE {
    mobilityTriggers  SEQUENCE ( SIZE( 1 .. 10 ) ) OF
    OCTET STRING ( SIZE( 1 ) ),
    serviceKey        INTEGER ( 0 .. 2147483647 ),
    gsmSCF-Address    [0] IMPLICIT OCTET STRING ( SIZE( 1 .. 20 ) ) ( SIZE( 1 .. 9 ) ),
    extensionContainer [1] IMPLICIT SEQUENCE {
      privateExtensionList [0] IMPLICIT SEQUENCE ( SIZE( 1 .. 10 ) ) OF
      SEQUENCE {
        extId  MAP-EXTENSION .&extensionId ( {
          '
          ... } ),
        extType MAP-EXTENSION .&ExtensionType ( {
          '
          ... } { @extId } ) OPTIONAL } OPTIONAL,
      pcs-Extensions      [1] IMPLICIT SEQUENCE {
        ... } OPTIONAL,
        ... } OPTIONAL,
      notificationToCSE [2] IMPLICIT NULL OPTIONAL,
      csi-Active        [3] IMPLICIT NULL OPTIONAL,
      ... } OPTIONAL,
    extensionContainer [13] IMPLICIT SEQUENCE {
      privateExtensionList [0] IMPLICIT SEQUENCE ( SIZE( 1 .. 10 ) ) OF
      SEQUENCE {
        extId  MAP-EXTENSION .&extensionId ( {

```

```

    ...}),
    extType MAP-EXTENSION .&ExtensionType ( {
        ...}{ @extId } ) OPTIONAL} OPTIONAL,
    pcs-Extensions [1] IMPLICIT SEQUENCE {
        ... } OPTIONAL,
    ... } OPTIONAL,
... ,
specificCSIDeletedList [14] IMPLICIT BIT STRING {
    o-csi ( 0 ),
    ss-csi ( 1 ),
    tif-csi ( 2 ),
    d-csi ( 3 ),
    vt-csi ( 4 ),
    mo-sms-csi ( 5 ),
    m-csi ( 6 ),
    gprs-csi ( 7 ),
    t-csi ( 8 ),
    mt-sms-csi ( 9 ),
    mg-csi ( 10 ),
    o-IM-CSI ( 11 ),
    d-IM-CSI ( 12 ),
    vt-IM-CSI ( 13 )} ( SIZE( 8 .. 32 ) ) OPTIONAL,
mt-sms-CSI [15] IMPLICIT SEQUENCE {
    sms-CAMEL-TDP-DataList [0] IMPLICIT SEQUENCE ( SIZE( 1 .. 10 ) ) OF
    SEQUENCE {
        sms-TriggerDetectionPoint [0] IMPLICIT ENUMERATED {
            sms-CollectedInfo ( 1 ),
            ... ,
            sms-DeliveryRequest ( 2 )},
        serviceKey [1] IMPLICIT INTEGER ( 0 .. 2147483647 ),
        gsmSCF-Address [2] IMPLICIT OCTET STRING ( SIZE( 1 .. 20 ) ) ( SIZE( 1 .. 9 ) ),
        defaultSMS-Handling [3] IMPLICIT ENUMERATED {
            continueTransaction ( 0 ),
            releaseTransaction ( 1 ),
            ... },
        extensionContainer [4] IMPLICIT SEQUENCE {
            privateExtensionList [0] IMPLICIT SEQUENCE ( SIZE( 1 .. 10 ) ) OF
            SEQUENCE {
                extId MAP-EXTENSION .&extensionId ( {
                    ...}),
                extType MAP-EXTENSION .&ExtensionType ( {
                    ...}{ @extId } ) OPTIONAL} OPTIONAL,
                pcs-Extensions [1] IMPLICIT SEQUENCE {
                    ... } OPTIONAL,
                ... } OPTIONAL,
                ... } OPTIONAL,
                ... } OPTIONAL,
            camelCapabilityHandling [1] IMPLICIT INTEGER ( 1 .. 16 ) OPTIONAL,
            extensionContainer [2] IMPLICIT SEQUENCE {
                privateExtensionList [0] IMPLICIT SEQUENCE ( SIZE( 1 .. 10 ) ) OF
                SEQUENCE {
                    extId MAP-EXTENSION .&extensionId ( {
                        ...}),
                    extType MAP-EXTENSION .&ExtensionType ( {
                        ...}{ @extId } ) OPTIONAL} OPTIONAL,
                    pcs-Extensions [1] IMPLICIT SEQUENCE {
                        ... } OPTIONAL,
                        ... } OPTIONAL,
                        ... } OPTIONAL,
                    notificationToCSE [3] IMPLICIT NULL OPTIONAL,
                    csi-Active [4] IMPLICIT NULL OPTIONAL,
                    ... } OPTIONAL,
            mt-smsCAMELTDP-CriteriaList [16] IMPLICIT SEQUENCE ( SIZE( 1 .. 10 ) ) OF
            SEQUENCE {
                sms-TriggerDetectionPoint ENUMERATED {
                    sms-CollectedInfo ( 1 ),
                    ... ,
                    sms-DeliveryRequest ( 2 )},
                tpdu-TypeCriterion [0] IMPLICIT SEQUENCE ( SIZE( 1 .. 5 ) ) OF
                ENUMERATED {
                    sms-DELIVER ( 0 ),
                    sms-SUBMIT-REPORT ( 1 ),
                    sms-STATUS-REPORT ( 2 ),

```

```

... } OPTIONAL,
... } OPTIONAL,
mg-csi [17] IMPLICIT SEQUENCE {
  mobilityTriggers SEQUENCE ( SIZE( 1 .. 10 )) OF
    OCTET STRING ( SIZE( 1 ) ),
  serviceKey INTEGER ( 0 .. 2147483647 ),
  gsmSCF-Address [0] IMPLICIT OCTET STRING ( SIZE( 1 .. 20 )) ( SIZE( 1 .. 9 ) ),
  extensionContainer [1] IMPLICIT SEQUENCE {
    privateExtensionList [0] IMPLICIT SEQUENCE ( SIZE( 1 .. 10 )) OF
      SEQUENCE {
        extId MAP-EXTENSION .&extensionId ( {
          '
          ... } ),
        extType MAP-EXTENSION .&ExtensionType ( {
          '
          ... } { @extId } ) OPTIONAL } OPTIONAL,
        pcs-Extensions [1] IMPLICIT SEQUENCE {
          ... } OPTIONAL,
          ... } OPTIONAL,
          ... } OPTIONAL,
notificationToCSE [2] IMPLICIT NULL OPTIONAL,
csi-Active [3] IMPLICIT NULL OPTIONAL,
... } OPTIONAL,
o-IM-CSI [18] IMPLICIT SEQUENCE {
  o-BcmCamelTDPDataList SEQUENCE ( SIZE( 1 .. 10 )) OF
    SEQUENCE {
      o-BcmTriggerDetectionPoint ENUMERATED {
        collectedInfo ( 2 ),
        ... ,
        routeSelectFailure ( 4 ) },
      serviceKey INTEGER ( 0 .. 2147483647 ),
      gsmSCF-Address [0] IMPLICIT OCTET STRING ( SIZE( 1 .. 20 )) ( SIZE( 1 .. 9 ) ),
      defaultCallHandling [1] IMPLICIT ENUMERATED {
        continueCall ( 0 ),
        releaseCall ( 1 ),
        ... },
      extensionContainer [2] IMPLICIT SEQUENCE {
        privateExtensionList [0] IMPLICIT SEQUENCE ( SIZE( 1 .. 10 )) OF
          SEQUENCE {
            extId MAP-EXTENSION .&extensionId ( {
              '
              ... } ),
            extType MAP-EXTENSION .&ExtensionType ( {
              '
              ... } { @extId } ) OPTIONAL } OPTIONAL,
            pcs-Extensions [1] IMPLICIT SEQUENCE {
              ... } OPTIONAL,
              ... } OPTIONAL,
              ... } OPTIONAL,
              ... },
      extensionContainer SEQUENCE {
        privateExtensionList [0] IMPLICIT SEQUENCE ( SIZE( 1 .. 10 )) OF
          SEQUENCE {
            extId MAP-EXTENSION .&extensionId ( {
              '
              ... } ),
            extType MAP-EXTENSION .&ExtensionType ( {
              '
              ... } { @extId } ) OPTIONAL } OPTIONAL,
            pcs-Extensions [1] IMPLICIT SEQUENCE {
              ... } OPTIONAL,
              ... } OPTIONAL,
              ... } OPTIONAL,
              ... },
      camelCapabilityHandling [0] IMPLICIT INTEGER ( 1 .. 16 ) OPTIONAL,
      notificationToCSE [1] IMPLICIT NULL OPTIONAL,
      csiActive [2] IMPLICIT NULL OPTIONAL } OPTIONAL,
o-IM-BcmCamelTDP-CriteriaList [19] IMPLICIT SEQUENCE ( SIZE( 1 .. 10 )) OF
  SEQUENCE {
    o-BcmTriggerDetectionPoint ENUMERATED {
      collectedInfo ( 2 ),
      ... ,
      routeSelectFailure ( 4 ) },
    destinationNumberCriteria [0] IMPLICIT SEQUENCE {
      matchType [0] IMPLICIT ENUMERATED {
        inhibiting ( 0 ),
        enabling ( 1 ) },
      destinationNumberList [1] IMPLICIT SEQUENCE ( SIZE( 1 .. 10 )) OF
        OCTET STRING ( SIZE( 1 .. 20 )) ( SIZE( 1 .. 9 ) ) OPTIONAL,
      destinationNumberLengthList [2] IMPLICIT SEQUENCE ( SIZE( 1 .. 3 ) ) OF

```

```

    INTEGER ( 1 .. 15 ) OPTIONAL,
    ... } OPTIONAL,
    basicServiceCriteria    [1] IMPLICIT SEQUENCE ( SIZE( 1 .. 5 ) ) OF
    CHOICE {
        ext-BearerService    [2] IMPLICIT OCTET STRING ( SIZE( 1 .. 5 ) ),
        ext-Teleservice      [3] IMPLICIT OCTET STRING ( SIZE( 1 .. 5 ) ) } OPTIONAL,
    callTypeCriteria      [2] IMPLICIT ENUMERATED {
        forwarded    ( 0 ),
        notForwarded ( 1 ) } OPTIONAL,
    ... ,
    o-CauseValueCriteria    [3] IMPLICIT SEQUENCE ( SIZE( 1 .. 5 ) ) OF
    OCTET STRING ( SIZE( 1 ) ) OPTIONAL,
    extensionContainer      [4] IMPLICIT SEQUENCE {
        privateExtensionList [0] IMPLICIT SEQUENCE ( SIZE( 1 .. 10 ) ) OF
        SEQUENCE {
            extId    MAP-EXTENSION .&extensionId ( {
                '
                ... } ),
            extType  MAP-EXTENSION .&ExtensionType ( {
                '
                ... } { @extId } ) OPTIONAL } OPTIONAL,
        pcs-Extensions [1] IMPLICIT SEQUENCE {
            ... } OPTIONAL,
            ... } OPTIONAL } OPTIONAL,
    d-IM-CSI                [20] IMPLICIT SEQUENCE {
    dp-AnalysedInfoCriteriaList [0] IMPLICIT SEQUENCE ( SIZE( 1 .. 10 ) ) OF
    SEQUENCE {
        dialledNumber    OCTET STRING ( SIZE( 1 .. 20 ) ) ( SIZE( 1 .. 9 ) ),
        serviceKey       INTEGER ( 0 .. 2147483647 ),
        gsmSCF-Address   OCTET STRING ( SIZE( 1 .. 20 ) ) ( SIZE( 1 .. 9 ) ),
        defaultCallHandling ENUMERATED {
            continueCall ( 0 ),
            releaseCall  ( 1 ),
            ... },
        extensionContainer SEQUENCE {
            privateExtensionList [0] IMPLICIT SEQUENCE ( SIZE( 1 .. 10 ) ) OF
            SEQUENCE {
                extId    MAP-EXTENSION .&extensionId ( {
                    '
                    ... } ),
                extType  MAP-EXTENSION .&ExtensionType ( {
                    '
                    ... } { @extId } ) OPTIONAL } OPTIONAL,
            pcs-Extensions [1] IMPLICIT SEQUENCE {
                ... } OPTIONAL,
                ... } OPTIONAL,
                ... } OPTIONAL,
            camelCapabilityHandling [1] IMPLICIT INTEGER ( 1 .. 16 ) OPTIONAL,
            extensionContainer [2] IMPLICIT SEQUENCE {
                privateExtensionList [0] IMPLICIT SEQUENCE ( SIZE( 1 .. 10 ) ) OF
                SEQUENCE {
                    extId    MAP-EXTENSION .&extensionId ( {
                        '
                        ... } ),
                    extType  MAP-EXTENSION .&ExtensionType ( {
                        '
                        ... } { @extId } ) OPTIONAL } OPTIONAL,
                pcs-Extensions [1] IMPLICIT SEQUENCE {
                    ... } OPTIONAL,
                    ... } OPTIONAL,
                    ... } OPTIONAL,
                notificationToCSE [3] IMPLICIT NULL OPTIONAL,
                csi-Active [4] IMPLICIT NULL OPTIONAL,
                ... } OPTIONAL,
            vt-IM-CSI [21] IMPLICIT SEQUENCE {
            t-BcsmCamelTDPDataList SEQUENCE ( SIZE( 1 .. 10 ) ) OF
            SEQUENCE {
                t-BcsmTriggerDetectionPoint ENUMERATED {
                    termAttemptAuthorized ( 12 ),
                    ... ,
                    tBusy ( 13 ),
                    tNoAnswer ( 14 ) },
                serviceKey    INTEGER ( 0 .. 2147483647 ),
                gsmSCF-Address [0] IMPLICIT OCTET STRING ( SIZE( 1 .. 20 ) ) ( SIZE( 1 .. 9 ) ),
                defaultCallHandling [1] IMPLICIT ENUMERATED {
                    continueCall ( 0 ),
                    releaseCall  ( 1 ),
                    ... },

```

```

extensionContainer [2] IMPLICIT SEQUENCE {
  privateExtensionList [0] IMPLICIT SEQUENCE ( SIZE( 1 .. 10 )) OF
  SEQUENCE {
    extId MAP-EXTENSION .&extensionId ( {
      '
      ... } ),
    extType MAP-EXTENSION .&ExtensionType ( {
      '
      ... } { @extId } ) OPTIONAL } OPTIONAL,
  pcs-Extensions [1] IMPLICIT SEQUENCE {
    ... } OPTIONAL,
  ... } OPTIONAL,
  ... },
extensionContainer SEQUENCE {
  privateExtensionList [0] IMPLICIT SEQUENCE ( SIZE( 1 .. 10 )) OF
  SEQUENCE {
    extId MAP-EXTENSION .&extensionId ( {
      '
      ... } ),
    extType MAP-EXTENSION .&ExtensionType ( {
      '
      ... } { @extId } ) OPTIONAL } OPTIONAL,
  pcs-Extensions [1] IMPLICIT SEQUENCE {
    ... } OPTIONAL,
  ... } OPTIONAL,
  ... },
camelCapabilityHandling [0] IMPLICIT INTEGER ( 1 .. 16 ) OPTIONAL,
notificationToCSE [1] IMPLICIT NULL OPTIONAL,
csi-Active [2] IMPLICIT NULL OPTIONAL } OPTIONAL,
vt-IM-BCSM-CAMEL-TDP-CriteriaList [22] IMPLICIT SEQUENCE ( SIZE( 1 .. 10 )) OF
SEQUENCE {
  t-BCSM-TriggerDetectionPoint ENUMERATED {
    termAttemptAuthorized ( 12 ),
    ... ,
    tBusy ( 13 ),
    tNoAnswer ( 14 ) },
  basicServiceCriteria [0] IMPLICIT SEQUENCE ( SIZE( 1 .. 5 )) OF
  CHOICE {
    ext-BearerService [2] IMPLICIT OCTET STRING ( SIZE( 1 .. 5 )),
    ext-Teleservice [3] IMPLICIT OCTET STRING ( SIZE( 1 .. 5 )) } OPTIONAL,
  t-CauseValueCriteria [1] IMPLICIT SEQUENCE ( SIZE( 1 .. 5 )) OF
  OCTET STRING ( SIZE( 1 )) OPTIONAL,
  ... } OPTIONAL } OPTIONAL,
allInformationSent [4] IMPLICIT NULL OPTIONAL,
extensionContainer SEQUENCE {
  privateExtensionList [0] IMPLICIT SEQUENCE ( SIZE( 1 .. 10 )) OF
  SEQUENCE {
    extId MAP-EXTENSION .&extensionId ( {
      '
      ... } ),
    extType MAP-EXTENSION .&ExtensionType ( {
      '
      ... } { @extId } ) OPTIONAL } OPTIONAL,
  pcs-Extensions [1] IMPLICIT SEQUENCE {
    ... } OPTIONAL,
  ... } OPTIONAL,
  ... }
RESULT SEQUENCE {
  extensionContainer SEQUENCE {
    privateExtensionList [0] IMPLICIT SEQUENCE ( SIZE( 1 .. 10 )) OF
    SEQUENCE {
      extId MAP-EXTENSION .&extensionId ( {
        '
        ... } ),
      extType MAP-EXTENSION .&ExtensionType ( {
        '
        ... } { @extId } ) OPTIONAL } OPTIONAL,
    pcs-Extensions [1] IMPLICIT SEQUENCE {
      ... } OPTIONAL,
      ... } OPTIONAL,
      ... }
  ... }
ERRORS {
  dataMissing |
  unexpectedDataValue |
  unknownSubscriber }
CODE local :5
}

```

```

prepareHandover OPERATION ::= {
  ARGUMENT [3] IMPLICIT SEQUENCE {
    targetCellId [0] IMPLICIT OCTET STRING ( SIZE( 5 .. 7 ) ) OPTIONAL,
    ho-NumberNotRequired NULL OPTIONAL,
    targetRNCId [1] IMPLICIT OCTET STRING ( SIZE( 7 ) ) OPTIONAL,
    an-APDU [2] IMPLICIT SEQUENCE {
      accessNetworkProtocolId ENUMERATED {
        ts3G-48006 ( 1 ),
        ts3G-25413 ( 2 ),
        ... },
      signalInfo OCTET STRING ( SIZE( 1 .. 2560 ) ),
      extensionContainer SEQUENCE {
        privateExtensionList [0] IMPLICIT SEQUENCE ( SIZE( 1 .. 10 ) ) OF
          SEQUENCE {
            extId MAP-EXTENSION .&extensionId ( {
              '
              ... } ),
            extType MAP-EXTENSION .&ExtensionType ( {
              '
              ... } { @extId } ) OPTIONAL } OPTIONAL,
            pcs-Extensions [1] IMPLICIT SEQUENCE {
              ... } OPTIONAL,
              ... } OPTIONAL,
              ... } OPTIONAL,
            multipleBearerRequested [3] IMPLICIT NULL OPTIONAL,
            imsi [4] IMPLICIT OCTET STRING ( SIZE( 3 .. 8 ) ) OPTIONAL,
            integrityProtectionInfo [5] IMPLICIT OCTET STRING ( SIZE( 18 .. 100 ) ) OPTIONAL,
            encryptionInfo [6] IMPLICIT OCTET STRING ( SIZE( 18 .. 100 ) ) OPTIONAL,
            radioResourceInformation [7] IMPLICIT OCTET STRING ( SIZE( 3 .. 13 ) ) OPTIONAL,
            allowedGSM-Algorithms [9] IMPLICIT OCTET STRING ( SIZE( 1 ) ) OPTIONAL,
            allowedUMTS-Algorithms [10] IMPLICIT SEQUENCE {
              integrityProtectionAlgorithms [0] IMPLICIT OCTET STRING ( SIZE( 1 .. 9 ) ) OPTIONAL,
              encryptionAlgorithms [1] IMPLICIT OCTET STRING ( SIZE( 1 .. 9 ) ) OPTIONAL,
              extensionContainer [2] IMPLICIT SEQUENCE {
                privateExtensionList [0] IMPLICIT SEQUENCE ( SIZE( 1 .. 10 ) ) OF
                  SEQUENCE {
                    extId MAP-EXTENSION .&extensionId ( {
                      '
                      ... } ),
                    extType MAP-EXTENSION .&ExtensionType ( {
                      '
                      ... } { @extId } ) OPTIONAL } OPTIONAL,
                    pcs-Extensions [1] IMPLICIT SEQUENCE {
                      ... } OPTIONAL,
                      ... } OPTIONAL,
                      ... } OPTIONAL,
                    radioResourceList [11] IMPLICIT SEQUENCE ( SIZE( 1 .. 7 ) ) OF
                      SEQUENCE {
                        radioResourceInformation OCTET STRING ( SIZE( 3 .. 13 ) ),
                        rab-Id INTEGER ( 1 .. 255 ),
                        ... } OPTIONAL,
                    extensionContainer [8] IMPLICIT SEQUENCE {
                      privateExtensionList [0] IMPLICIT SEQUENCE ( SIZE( 1 .. 10 ) ) OF
                        SEQUENCE {
                          extId MAP-EXTENSION .&extensionId ( {
                            '
                            ... } ),
                          extType MAP-EXTENSION .&ExtensionType ( {
                            '
                            ... } { @extId } ) OPTIONAL } OPTIONAL,
                          pcs-Extensions [1] IMPLICIT SEQUENCE {
                            ... } OPTIONAL,
                            ... } OPTIONAL,
                            ... } OPTIONAL,
                          rab-Id [12] IMPLICIT INTEGER ( 1 .. 255 ) OPTIONAL,
                          bssmap-ServiceHandover [13] IMPLICIT OCTET STRING ( SIZE( 1 ) ) OPTIONAL,
                          ranap-ServiceHandover [14] IMPLICIT OCTET STRING ( SIZE( 1 ) ) OPTIONAL,
                          bssmap-ServiceHandoverList [15] IMPLICIT SEQUENCE ( SIZE( 1 .. 7 ) ) OF
                            SEQUENCE {
                              bssmap-ServiceHandover OCTET STRING ( SIZE( 1 ) ),
                              rab-Id INTEGER ( 1 .. 255 ),
                              ... } OPTIONAL,
                              ascIcallReference [20] IMPLICIT OCTET STRING ( SIZE( 1 .. 8 ) ) OPTIONAL,
                              geran-classmark [16] IMPLICIT OCTET STRING ( SIZE( 2 .. 87 ) ) OPTIONAL,
                              iuCurrentlyUsedCodec [17] IMPLICIT OCTET STRING ( SIZE( 1 .. 4 ) ) OPTIONAL,
                              iuSupportedCodecsList [18] IMPLICIT SEQUENCE {

```

```

utranCodecList [0] IMPLICIT SEQUENCE {
  codec1 [1] IMPLICIT OCTET STRING ( SIZE( 1 .. 4 ) ),
  codec2 [2] IMPLICIT OCTET STRING ( SIZE( 1 .. 4 ) ) OPTIONAL,
  codec3 [3] IMPLICIT OCTET STRING ( SIZE( 1 .. 4 ) ) OPTIONAL,
  codec4 [4] IMPLICIT OCTET STRING ( SIZE( 1 .. 4 ) ) OPTIONAL,
  codec5 [5] IMPLICIT OCTET STRING ( SIZE( 1 .. 4 ) ) OPTIONAL,
  codec6 [6] IMPLICIT OCTET STRING ( SIZE( 1 .. 4 ) ) OPTIONAL,
  codec7 [7] IMPLICIT OCTET STRING ( SIZE( 1 .. 4 ) ) OPTIONAL,
  codec8 [8] IMPLICIT OCTET STRING ( SIZE( 1 .. 4 ) ) OPTIONAL,
  extensionContainer [9] IMPLICIT SEQUENCE {
    privateExtensionList [0] IMPLICIT SEQUENCE ( SIZE( 1 .. 10 ) ) OF
      SEQUENCE {
        extId MAP-EXTENSION .&extensionId ( {
          '
          ... } ),
        extType MAP-EXTENSION .&ExtensionType ( {
          '
          ... } { @extId } ) OPTIONAL } OPTIONAL,
        pcs-Extensions [1] IMPLICIT SEQUENCE {
          ... } OPTIONAL,
          ... } OPTIONAL,
          ... } OPTIONAL,
          ... } OPTIONAL,
geranCodecList [1] IMPLICIT SEQUENCE {
  codec1 [1] IMPLICIT OCTET STRING ( SIZE( 1 .. 4 ) ),
  codec2 [2] IMPLICIT OCTET STRING ( SIZE( 1 .. 4 ) ) OPTIONAL,
  codec3 [3] IMPLICIT OCTET STRING ( SIZE( 1 .. 4 ) ) OPTIONAL,
  codec4 [4] IMPLICIT OCTET STRING ( SIZE( 1 .. 4 ) ) OPTIONAL,
  codec5 [5] IMPLICIT OCTET STRING ( SIZE( 1 .. 4 ) ) OPTIONAL,
  codec6 [6] IMPLICIT OCTET STRING ( SIZE( 1 .. 4 ) ) OPTIONAL,
  codec7 [7] IMPLICIT OCTET STRING ( SIZE( 1 .. 4 ) ) OPTIONAL,
  codec8 [8] IMPLICIT OCTET STRING ( SIZE( 1 .. 4 ) ) OPTIONAL,
  extensionContainer [9] IMPLICIT SEQUENCE {
    privateExtensionList [0] IMPLICIT SEQUENCE ( SIZE( 1 .. 10 ) ) OF
      SEQUENCE {
        extId MAP-EXTENSION .&extensionId ( {
          '
          ... } ),
        extType MAP-EXTENSION .&ExtensionType ( {
          '
          ... } { @extId } ) OPTIONAL } OPTIONAL,
        pcs-Extensions [1] IMPLICIT SEQUENCE {
          ... } OPTIONAL,
          ... } OPTIONAL,
          ... } OPTIONAL,
          ... } OPTIONAL,
extensionContainer [2] IMPLICIT SEQUENCE {
  privateExtensionList [0] IMPLICIT SEQUENCE ( SIZE( 1 .. 10 ) ) OF
    SEQUENCE {
      extId MAP-EXTENSION .&extensionId ( {
        '
        ... } ),
      extType MAP-EXTENSION .&ExtensionType ( {
        '
        ... } { @extId } ) OPTIONAL } OPTIONAL,
      pcs-Extensions [1] IMPLICIT SEQUENCE {
        ... } OPTIONAL,
        ... } OPTIONAL,
        ... } OPTIONAL,
        ... } OPTIONAL,
rab-ConfigurationIndicator [19] IMPLICIT NULL OPTIONAL,
uesbi-lu [21] IMPLICIT SEQUENCE {
  uesbi-luA [0] IMPLICIT BIT STRING ( SIZE( 1 .. 128 ) ) OPTIONAL,
  uesbi-luB [1] IMPLICIT BIT STRING ( SIZE( 1 .. 128 ) ) OPTIONAL,
  ... } OPTIONAL }
RESULT [3] IMPLICIT SEQUENCE {
  handoverNumber [0] IMPLICIT OCTET STRING ( SIZE( 1 .. 20 ) ) ( SIZE( 1 .. 9 ) ) OPTIONAL,
  relocationNumberList [1] IMPLICIT SEQUENCE ( SIZE( 1 .. 7 ) ) OF
    SEQUENCE {
      handoverNumber OCTET STRING ( SIZE( 1 .. 20 ) ) ( SIZE( 1 .. 9 ) ),
      rab-Id INTEGER ( 1 .. 255 ),
      ... } OPTIONAL,
an-APDU [2] IMPLICIT SEQUENCE {
  accessNetworkProtocolId ENUMERATED {
    ts3G-48006 ( 1 ),
    ts3G-25413 ( 2 ),
    ... },
  signalInfo OCTET STRING ( SIZE( 1 .. 2560 ) ),
  extensionContainer SEQUENCE {
    privateExtensionList [0] IMPLICIT SEQUENCE ( SIZE( 1 .. 10 ) ) OF

```



```

sendEndSignal OPERATION ::= {
  ARGUMENT [3] IMPLICIT SEQUENCE {
    an-APDU SEQUENCE {
      accessNetworkProtocolId ENUMERATED {
        ts3G-48006 (1),
        ts3G-25413 (2),
        ...
      },
      signalInfo OCTET STRING ( SIZE( 1 .. 2560 ) ),
      extensionContainer SEQUENCE {
        privateExtensionList [0] IMPLICIT SEQUENCE ( SIZE( 1 .. 10 ) ) OF
          SEQUENCE {
            extId MAP-EXTENSION .&extensionId ( {
              '
              ...
            } ),
            extType MAP-EXTENSION .&ExtensionType ( {
              '
              ... { @extId } ) OPTIONAL } OPTIONAL,
            pcs-Extensions [1] IMPLICIT SEQUENCE {
              ... } OPTIONAL,
            ... } OPTIONAL,
            ...
          },
        extensionContainer [0] IMPLICIT SEQUENCE {
          privateExtensionList [0] IMPLICIT SEQUENCE ( SIZE( 1 .. 10 ) ) OF
            SEQUENCE {
              extId MAP-EXTENSION .&extensionId ( {
                '
                ...
              } ),
              extType MAP-EXTENSION .&ExtensionType ( {
                '
                ... { @extId } ) OPTIONAL } OPTIONAL,
              pcs-Extensions [1] IMPLICIT SEQUENCE {
                ... } OPTIONAL,
              ... } OPTIONAL,
              ...
            }
          },
        RESULT SEQUENCE {
          extensionContainer [0] IMPLICIT SEQUENCE {
            privateExtensionList [0] IMPLICIT SEQUENCE ( SIZE( 1 .. 10 ) ) OF
              SEQUENCE {
                extId MAP-EXTENSION .&extensionId ( {
                  '
                  ...
                } ),
                extType MAP-EXTENSION .&ExtensionType ( {
                  '
                  ... { @extId } ) OPTIONAL } OPTIONAL,
                pcs-Extensions [1] IMPLICIT SEQUENCE {
                  ... } OPTIONAL,
                ... } OPTIONAL,
                ...
              }
            },
          CODE local : 29
        }
      }
    }
  }
}

processAccessSignalling OPERATION ::= {
  ARGUMENT [3] IMPLICIT SEQUENCE {
    an-APDU SEQUENCE {
      accessNetworkProtocolId ENUMERATED {
        ts3G-48006 (1),
        ts3G-25413 (2),
        ...
      },
      signalInfo OCTET STRING ( SIZE( 1 .. 2560 ) ),
      extensionContainer SEQUENCE {
        privateExtensionList [0] IMPLICIT SEQUENCE ( SIZE( 1 .. 10 ) ) OF
          SEQUENCE {
            extId MAP-EXTENSION .&extensionId ( {
              '
              ...
            } ),
            extType MAP-EXTENSION .&ExtensionType ( {
              '
              ... { @extId } ) OPTIONAL } OPTIONAL,
            pcs-Extensions [1] IMPLICIT SEQUENCE {
              ... } OPTIONAL,
            ... } OPTIONAL,
            ...
          },
        selectedUMTS-Algorithms [1] IMPLICIT SEQUENCE {
          integrityProtectionAlgorithm [0] IMPLICIT OCTET STRING ( SIZE( 1 ) ) OPTIONAL,
          encryptionAlgorithm [1] IMPLICIT OCTET STRING ( SIZE( 1 ) ) OPTIONAL,
          extensionContainer [2] IMPLICIT SEQUENCE {

```

```

privateExtensionList [0] IMPLICIT SEQUENCE ( SIZE( 1 .. 10 ) ) OF
SEQUENCE {
  extId MAP-EXTENSION .&extensionId ( {
    '
    ... } ),
  extType MAP-EXTENSION .&ExtensionType ( {
    '
    ... } { @extId } ) OPTIONAL } OPTIONAL,
  pcs-Extensions [1] IMPLICIT SEQUENCE {
    ... } OPTIONAL,
  ... } OPTIONAL,
  ... } OPTIONAL,
selectedGSM-Algorithm [2] IMPLICIT OCTET STRING ( SIZE( 1 ) ) OPTIONAL,
chosenRadioResourceInformation [3] IMPLICIT SEQUENCE {
  chosenChannelInfo [0] IMPLICIT OCTET STRING ( SIZE( 1 ) ) OPTIONAL,
  chosenSpeechVersion [1] IMPLICIT OCTET STRING ( SIZE( 1 ) ) OPTIONAL,
  ... } OPTIONAL,
selectedRab-Id [4] IMPLICIT INTEGER ( 1 .. 255 ) OPTIONAL,
extensionContainer [0] IMPLICIT SEQUENCE {
  privateExtensionList [0] IMPLICIT SEQUENCE ( SIZE( 1 .. 10 ) ) OF
SEQUENCE {
  extId MAP-EXTENSION .&extensionId ( {
    '
    ... } ),
  extType MAP-EXTENSION .&ExtensionType ( {
    '
    ... } { @extId } ) OPTIONAL } OPTIONAL,
  pcs-Extensions [1] IMPLICIT SEQUENCE {
    ... } OPTIONAL,
  ... } OPTIONAL,
  ... } OPTIONAL,
  ... },
iuSelectedCodec [5] IMPLICIT OCTET STRING ( SIZE( 1 .. 4 ) ) OPTIONAL,
iuAvailableCodecsList [6] IMPLICIT SEQUENCE {
  codec1 [1] IMPLICIT OCTET STRING ( SIZE( 1 .. 4 ) ),
  codec2 [2] IMPLICIT OCTET STRING ( SIZE( 1 .. 4 ) ) OPTIONAL,
  codec3 [3] IMPLICIT OCTET STRING ( SIZE( 1 .. 4 ) ) OPTIONAL,
  codec4 [4] IMPLICIT OCTET STRING ( SIZE( 1 .. 4 ) ) OPTIONAL,
  codec5 [5] IMPLICIT OCTET STRING ( SIZE( 1 .. 4 ) ) OPTIONAL,
  codec6 [6] IMPLICIT OCTET STRING ( SIZE( 1 .. 4 ) ) OPTIONAL,
  codec7 [7] IMPLICIT OCTET STRING ( SIZE( 1 .. 4 ) ) OPTIONAL,
  codec8 [8] IMPLICIT OCTET STRING ( SIZE( 1 .. 4 ) ) OPTIONAL,
  extensionContainer [9] IMPLICIT SEQUENCE {
  privateExtensionList [0] IMPLICIT SEQUENCE ( SIZE( 1 .. 10 ) ) OF
SEQUENCE {
  extId MAP-EXTENSION .&extensionId ( {
    '
    ... } ),
  extType MAP-EXTENSION .&ExtensionType ( {
    '
    ... } { @extId } ) OPTIONAL } OPTIONAL,
  pcs-Extensions [1] IMPLICIT SEQUENCE {
    ... } OPTIONAL,
  ... } OPTIONAL,
  ... } OPTIONAL }
CODE local : 33
}

```

```

forwardAccessSignalling OPERATION ::= {
  ARGUMENT [3] IMPLICIT SEQUENCE {
    an-APDU SEQUENCE {
      accessNetworkProtocolId ENUMERATED {
        ts3G-48006 ( 1 ),
        ts3G-25413 ( 2 ),
        ... },
      signalInfo OCTET STRING ( SIZE( 1 .. 2560 ) ),
      extensionContainer SEQUENCE {
        privateExtensionList [0] IMPLICIT SEQUENCE ( SIZE( 1 .. 10 ) ) OF
SEQUENCE {
  extId MAP-EXTENSION .&extensionId ( {
    '
    ... } ),
  extType MAP-EXTENSION .&ExtensionType ( {
    '
    ... } { @extId } ) OPTIONAL } OPTIONAL,
  pcs-Extensions [1] IMPLICIT SEQUENCE {
    ... } OPTIONAL,
  ... } OPTIONAL,
  ... } OPTIONAL,
  ... }
}

```

```

... },
integrityProtectionInfo [0] IMPLICIT OCTET STRING ( SIZE( 18 .. 100 ) ) OPTIONAL,
encryptionInfo [1] IMPLICIT OCTET STRING ( SIZE( 18 .. 100 ) ) OPTIONAL,
keyStatus [2] IMPLICIT ENUMERATED {
  old ( 0 ),
  new ( 1 ),
... } OPTIONAL,
allowedGSM-Algorithms [4] IMPLICIT OCTET STRING ( SIZE( 1 ) ) OPTIONAL,
allowedUMTS-Algorithms [5] IMPLICIT SEQUENCE {
  integrityProtectionAlgorithms [0] IMPLICIT OCTET STRING ( SIZE( 1 .. 9 ) ) OPTIONAL,
  encryptionAlgorithms [1] IMPLICIT OCTET STRING ( SIZE( 1 .. 9 ) ) OPTIONAL,
  extensionContainer [2] IMPLICIT SEQUENCE {
    privateExtensionList [0] IMPLICIT SEQUENCE ( SIZE( 1 .. 10 ) ) OF
    SEQUENCE {
      extId MAP-EXTENSION .&extensionId ( {
        '
        ... } ),
      extType MAP-EXTENSION .&ExtensionType ( {
        '
        ... } { @extId } ) OPTIONAL } OPTIONAL,
    pcs-Extensions [1] IMPLICIT SEQUENCE {
      ... } OPTIONAL,
      ... } OPTIONAL,
      ... } OPTIONAL,
    radioResourceInformation [6] IMPLICIT OCTET STRING ( SIZE( 3 .. 13 ) ) OPTIONAL,
  extensionContainer [3] IMPLICIT SEQUENCE {
    privateExtensionList [0] IMPLICIT SEQUENCE ( SIZE( 1 .. 10 ) ) OF
    SEQUENCE {
      extId MAP-EXTENSION .&extensionId ( {
        '
        ... } ),
      extType MAP-EXTENSION .&ExtensionType ( {
        '
        ... } { @extId } ) OPTIONAL } OPTIONAL,
    pcs-Extensions [1] IMPLICIT SEQUENCE {
      ... } OPTIONAL,
      ... } OPTIONAL,
      ... } OPTIONAL,
    ... },
  radioResourceList [7] IMPLICIT SEQUENCE ( SIZE( 1 .. 7 ) ) OF
  SEQUENCE {
    radioResourceInformation OCTET STRING ( SIZE( 3 .. 13 ) ),
    rab-Id INTEGER ( 1 .. 255 ),
    ... } OPTIONAL,
  bssmap-ServiceHandover [9] IMPLICIT OCTET STRING ( SIZE( 1 ) ) OPTIONAL,
  ranap-ServiceHandover [8] IMPLICIT OCTET STRING ( SIZE( 1 ) ) OPTIONAL,
  bssmap-ServiceHandoverList [10] IMPLICIT SEQUENCE ( SIZE( 1 .. 7 ) ) OF
  SEQUENCE {
    bssmap-ServiceHandover OCTET STRING ( SIZE( 1 ) ),
    rab-Id INTEGER ( 1 .. 255 ),
    ... } OPTIONAL,
  currentlyUsedCodec [11] IMPLICIT OCTET STRING ( SIZE( 1 .. 4 ) ) OPTIONAL,
  iuSupportedCodecsList [12] IMPLICIT SEQUENCE {
    utranCodecList [0] IMPLICIT SEQUENCE {
      codec1 [1] IMPLICIT OCTET STRING ( SIZE( 1 .. 4 ) ),
      codec2 [2] IMPLICIT OCTET STRING ( SIZE( 1 .. 4 ) ) OPTIONAL,
      codec3 [3] IMPLICIT OCTET STRING ( SIZE( 1 .. 4 ) ) OPTIONAL,
      codec4 [4] IMPLICIT OCTET STRING ( SIZE( 1 .. 4 ) ) OPTIONAL,
      codec5 [5] IMPLICIT OCTET STRING ( SIZE( 1 .. 4 ) ) OPTIONAL,
      codec6 [6] IMPLICIT OCTET STRING ( SIZE( 1 .. 4 ) ) OPTIONAL,
      codec7 [7] IMPLICIT OCTET STRING ( SIZE( 1 .. 4 ) ) OPTIONAL,
      codec8 [8] IMPLICIT OCTET STRING ( SIZE( 1 .. 4 ) ) OPTIONAL,
    extensionContainer [9] IMPLICIT SEQUENCE {
      privateExtensionList [0] IMPLICIT SEQUENCE ( SIZE( 1 .. 10 ) ) OF
      SEQUENCE {
        extId MAP-EXTENSION .&extensionId ( {
          '
          ... } ),
        extType MAP-EXTENSION .&ExtensionType ( {
          '
          ... } { @extId } ) OPTIONAL } OPTIONAL,
      pcs-Extensions [1] IMPLICIT SEQUENCE {
        ... } OPTIONAL,
        ... } OPTIONAL,
        ... } OPTIONAL,
      ... } OPTIONAL,
      geranCodecList [1] IMPLICIT SEQUENCE {
        codec1 [1] IMPLICIT OCTET STRING ( SIZE( 1 .. 4 ) ),
        codec2 [2] IMPLICIT OCTET STRING ( SIZE( 1 .. 4 ) ) OPTIONAL,

```

```

codec3      [3] IMPLICIT OCTET STRING ( SIZE( 1 .. 4 ) ) OPTIONAL,
codec4      [4] IMPLICIT OCTET STRING ( SIZE( 1 .. 4 ) ) OPTIONAL,
codec5      [5] IMPLICIT OCTET STRING ( SIZE( 1 .. 4 ) ) OPTIONAL,
codec6      [6] IMPLICIT OCTET STRING ( SIZE( 1 .. 4 ) ) OPTIONAL,
codec7      [7] IMPLICIT OCTET STRING ( SIZE( 1 .. 4 ) ) OPTIONAL,
codec8      [8] IMPLICIT OCTET STRING ( SIZE( 1 .. 4 ) ) OPTIONAL,
extensionContainer [9] IMPLICIT SEQUENCE {
  privateExtensionList [0] IMPLICIT SEQUENCE ( SIZE( 1 .. 10 ) ) OF
  SEQUENCE {
    extId  MAP-EXTENSION .&extensionId ( {
      '
      ... } ),
    extType  MAP-EXTENSION .&ExtensionType ( {
      '
      ... } { @extId } ) OPTIONAL} OPTIONAL,
  pcs-Extensions [1] IMPLICIT SEQUENCE {
    ... } OPTIONAL,
  ... } OPTIONAL,
  ... } OPTIONAL,
extensionContainer [2] IMPLICIT SEQUENCE {
  privateExtensionList [0] IMPLICIT SEQUENCE ( SIZE( 1 .. 10 ) ) OF
  SEQUENCE {
    extId  MAP-EXTENSION .&extensionId ( {
      '
      ... } ),
    extType  MAP-EXTENSION .&ExtensionType ( {
      '
      ... } { @extId } ) OPTIONAL} OPTIONAL,
  pcs-Extensions [1] IMPLICIT SEQUENCE {
    ... } OPTIONAL,
  ... } OPTIONAL,
  ... } OPTIONAL,
  rab-ConfigurationIndicator [13] IMPLICIT NULL OPTIONAL,
iuSelectedCodec [14] IMPLICIT OCTET STRING ( SIZE( 1 .. 4 ) ) OPTIONAL}
CODE local : 34
}

```

```

prepareSubsequentHandover OPERATION ::= {
  ARGUMENT [3] IMPLICIT SEQUENCE {
    targetCellId [0] IMPLICIT OCTET STRING ( SIZE( 5 .. 7 ) ) OPTIONAL,
    targetMSC-Number [1] IMPLICIT OCTET STRING ( SIZE( 1 .. 20 ) ) ( SIZE( 1 .. 9 ) ),
    targetRNCId [2] IMPLICIT OCTET STRING ( SIZE( 7 ) ) OPTIONAL,
    an-APDU [3] IMPLICIT SEQUENCE {
      accessNetworkProtocolId ENUMERATED {
        ts3G-48006 ( 1 ),
        ts3G-25413 ( 2 ),
        ... },
      signalInfo OCTET STRING ( SIZE( 1 .. 2560 ) ),
      extensionContainer SEQUENCE {
        privateExtensionList [0] IMPLICIT SEQUENCE ( SIZE( 1 .. 10 ) ) OF
        SEQUENCE {
          extId  MAP-EXTENSION .&extensionId ( {
            '
            ... } ),
          extType  MAP-EXTENSION .&ExtensionType ( {
            '
            ... } { @extId } ) OPTIONAL} OPTIONAL,
        pcs-Extensions [1] IMPLICIT SEQUENCE {
          ... } OPTIONAL,
          ... } OPTIONAL,
          ... } OPTIONAL,
        selectedRab-Id [4] IMPLICIT INTEGER ( 1 .. 255 ) OPTIONAL,
        extensionContainer [5] IMPLICIT SEQUENCE {
          privateExtensionList [0] IMPLICIT SEQUENCE ( SIZE( 1 .. 10 ) ) OF
          SEQUENCE {
            extId  MAP-EXTENSION .&extensionId ( {
              '
              ... } ),
            extType  MAP-EXTENSION .&ExtensionType ( {
              '
              ... } { @extId } ) OPTIONAL} OPTIONAL,
          pcs-Extensions [1] IMPLICIT SEQUENCE {
            ... } OPTIONAL,
            ... } OPTIONAL,
            ... } OPTIONAL,
          geran-classmark [6] IMPLICIT OCTET STRING ( SIZE( 2 .. 87 ) ) OPTIONAL,
          rab-ConfigurationIndicator [7] IMPLICIT NULL OPTIONAL}

```

```

RESULT [3] IMPLICIT SEQUENCE {
  an-APDU SEQUENCE {
    accessNetworkProtocolId ENUMERATED {
      ts3G-48006 ( 1 ),
      ts3G-25413 ( 2 ),
      ... },
    signalInfo OCTET STRING ( SIZE( 1 .. 2560 ) ),
    extensionContainer SEQUENCE {
      privateExtensionList [0] IMPLICIT SEQUENCE ( SIZE( 1 .. 10 ) ) OF
      SEQUENCE {
        extId MAP-EXTENSION .&extensionId ( {
          '
          ... } ),
        extType MAP-EXTENSION .&ExtensionType ( {
          '
          ... } { @extId } ) OPTIONAL } OPTIONAL,
        pcs-Extensions [1] IMPLICIT SEQUENCE {
          ... } OPTIONAL,
          ... } OPTIONAL,
          ... },
      extensionContainer [0] IMPLICIT SEQUENCE {
        privateExtensionList [0] IMPLICIT SEQUENCE ( SIZE( 1 .. 10 ) ) OF
        SEQUENCE {
          extId MAP-EXTENSION .&extensionId ( {
            '
            ... } ),
          extType MAP-EXTENSION .&ExtensionType ( {
            '
            ... } { @extId } ) OPTIONAL } OPTIONAL,
          pcs-Extensions [1] IMPLICIT SEQUENCE {
            ... } OPTIONAL,
            ... } OPTIONAL,
            ... }
      }
    }
  }
  ERRORS {
    unexpectedDataValue |
    dataMissing |
    unknownMSC |
    subsequentHandoverFailure }
  CODE local : 69
}

```

```

sendAuthenticationInfo OPERATION ::= {
  ARGUMENT SEQUENCE {
    imsi [0] IMPLICIT OCTET STRING ( SIZE( 3 .. 8 ) ),
    numberOfRequestedVectors INTEGER ( 1 .. 5 ),
    segmentationProhibited NULL OPTIONAL,
    immediateResponsePreferred [1] IMPLICIT NULL OPTIONAL,
    re-synchronisationInfo SEQUENCE {
      rand OCTET STRING ( SIZE( 16 ) ),
      auts OCTET STRING ( SIZE( 14 ) ),
      ... } OPTIONAL,
    extensionContainer [2] IMPLICIT SEQUENCE {
      privateExtensionList [0] IMPLICIT SEQUENCE ( SIZE( 1 .. 10 ) ) OF
      SEQUENCE {
        extId MAP-EXTENSION .&extensionId ( {
          '
          ... } ),
        extType MAP-EXTENSION .&ExtensionType ( {
          '
          ... } { @extId } ) OPTIONAL } OPTIONAL,
        pcs-Extensions [1] IMPLICIT SEQUENCE {
          ... } OPTIONAL,
          ... } OPTIONAL,
          ... },
      requestingNodeType [3] IMPLICIT ENUMERATED {
        vlr ( 0 ),
        sgsn ( 1 ),
        ... } OPTIONAL }
  }
  RESULT [3] IMPLICIT SEQUENCE {
    authenticationSetList CHOICE {
      tripletList [0] IMPLICIT SEQUENCE ( SIZE( 1 .. 5 ) ) OF
      SEQUENCE {
        rand OCTET STRING ( SIZE( 16 ) ),
        sres OCTET STRING ( SIZE( 4 ) ),
        kc OCTET STRING ( SIZE( 8 ) ),
        ... },
      quintupletList [1] IMPLICIT SEQUENCE ( SIZE( 1 .. 5 ) ) OF

```



```

... }
ERRORS {
  systemFailure |
  unexpectedDataValue |
  unknownSubscriber }
CODE local : 15
}

checkIMEI OPERATION ::= {
  ARGUMENT SEQUENCE {
    imei OCTET STRING ( SIZE( 8 ) ),
    requestedEquipmentInfo BIT STRING {
      equipmentStatus ( 0 ),
      bmuef ( 1 ) ( SIZE( 2 .. 8 ) ),
    }
    extensionContainer SEQUENCE {
      privateExtensionList [0] IMPLICIT SEQUENCE ( SIZE( 1 .. 10 ) ) OF
        SEQUENCE {
          extId MAP-EXTENSION .&extensionId ( {
            '
            ... } ),
          extType MAP-EXTENSION .&ExtensionType ( {
            '
            ... } { @extId } ) OPTIONAL } OPTIONAL,
          pcs-Extensions [1] IMPLICIT SEQUENCE {
            ... } OPTIONAL,
            ... } OPTIONAL,
            ... }
        }
    RESULT SEQUENCE {
      equipmentStatus ENUMERATED {
        whiteListed ( 0 ),
        blackListed ( 1 ),
        greyListed ( 2 ) } OPTIONAL,
      bmuef SEQUENCE {
        uesbi-luA [0] IMPLICIT BIT STRING ( SIZE( 1 .. 128 ) ) OPTIONAL,
        uesbi-luB [1] IMPLICIT BIT STRING ( SIZE( 1 .. 128 ) ) OPTIONAL,
        ... } OPTIONAL,
      extensionContainer [0] IMPLICIT SEQUENCE {
        privateExtensionList [0] IMPLICIT SEQUENCE ( SIZE( 1 .. 10 ) ) OF
          SEQUENCE {
            extId MAP-EXTENSION .&extensionId ( {
              '
              ... } ),
            extType MAP-EXTENSION .&ExtensionType ( {
              '
              ... } { @extId } ) OPTIONAL } OPTIONAL,
            pcs-Extensions [1] IMPLICIT SEQUENCE {
              ... } OPTIONAL,
              ... } OPTIONAL,
              ... }
          }
      ERRORS {
        systemFailure |
        dataMissing |
        unknownEquipment }
      CODE local : 43
    }

insertSubscriberData OPERATION ::= {
  ARGUMENT SEQUENCE {
    imsi [0] IMPLICIT OCTET STRING ( SIZE( 3 .. 8 ) ) OPTIONAL,
    msisdn [1] IMPLICIT OCTET STRING ( SIZE( 1 .. 20 ) ) ( SIZE( 1 .. 9 ) ) OPTIONAL,
    category [2] IMPLICIT OCTET STRING ( SIZE( 1 ) ) OPTIONAL,
    subscriberStatus [3] IMPLICIT ENUMERATED {
      serviceGranted ( 0 ),
      operatorDeterminedBarring ( 1 ) } OPTIONAL,
    bearerServiceList [4] IMPLICIT SEQUENCE ( SIZE( 1 .. 50 ) ) OF
      OCTET STRING ( SIZE( 1 .. 5 ) ) OPTIONAL,
    teleserviceList [6] IMPLICIT SEQUENCE ( SIZE( 1 .. 20 ) ) OF
      OCTET STRING ( SIZE( 1 .. 5 ) ) OPTIONAL,
    provisionedSS [7] IMPLICIT SEQUENCE ( SIZE( 1 .. 30 ) ) OF
      CHOICE {
        forwardingInfo [0] IMPLICIT SEQUENCE {
          ss-Code OCTET STRING ( SIZE( 1 ) ),
          forwardingFeatureList SEQUENCE ( SIZE( 1 .. 32 ) ) OF
            SEQUENCE {
              basicService CHOICE {
                ext-BearerService [2] IMPLICIT OCTET STRING ( SIZE( 1 .. 5 ) ),
                ext-Teleservice [3] IMPLICIT OCTET STRING ( SIZE( 1 .. 5 ) ) } OPTIONAL,

```



```

ss-Status          [4] IMPLICIT OCTET STRING ( SIZE( 1 .. 5 ) ),
forwardedToNumber  [5] IMPLICIT OCTET STRING ( SIZE( 1 .. 20 ) ) ( SIZE( 1 .. 9 ) ) OPTIONAL,
forwardedToSubaddress [8] IMPLICIT OCTET STRING ( SIZE( 1 .. 21 ) ) OPTIONAL,
forwardingOptions  [6] IMPLICIT OCTET STRING ( SIZE( 1 .. 5 ) ) OPTIONAL,
noReplyConditionTime [7] IMPLICIT INTEGER ( 1 .. 100 ) OPTIONAL,
extensionContainer [9] IMPLICIT SEQUENCE {
  privateExtensionList [0] IMPLICIT SEQUENCE ( SIZE( 1 .. 10 ) ) OF
  SEQUENCE {
    extId  MAP-EXTENSION .&extensionId ( {
      '
      ... } ),
    extType  MAP-EXTENSION .&ExtensionType ( {
      '
      ... } { @extId } ) OPTIONAL} OPTIONAL,
  pcs-Extensions [1] IMPLICIT SEQUENCE {
    ... } OPTIONAL,
  ... } OPTIONAL,
  ... },
longForwardedToNumber [10] IMPLICIT OCTET STRING ( SIZE( 1 .. 20 ) ) ( SIZE( 1 .. 15 ) ) OPTIONAL,
extensionContainer [0] IMPLICIT SEQUENCE {
  privateExtensionList [0] IMPLICIT SEQUENCE ( SIZE( 1 .. 10 ) ) OF
  SEQUENCE {
    extId  MAP-EXTENSION .&extensionId ( {
      '
      ... } ),
    extType  MAP-EXTENSION .&ExtensionType ( {
      '
      ... } { @extId } ) OPTIONAL} OPTIONAL,
  pcs-Extensions [1] IMPLICIT SEQUENCE {
    ... } OPTIONAL,
  ... } OPTIONAL,
  ... },
callBarringInfo [1] IMPLICIT SEQUENCE {
  ss-Code          OCTET STRING ( SIZE( 1 ) ),
  callBarringFeatureList SEQUENCE ( SIZE( 1 .. 32 ) ) OF
  SEQUENCE {
    basicService CHOICE {
      ext-BearerService [2] IMPLICIT OCTET STRING ( SIZE( 1 .. 5 ) ),
      ext-Teleservice [3] IMPLICIT OCTET STRING ( SIZE( 1 .. 5 ) ) OPTIONAL,
    }
    ss-Status [4] IMPLICIT OCTET STRING ( SIZE( 1 .. 5 ) ),
    extensionContainer SEQUENCE {
      privateExtensionList [0] IMPLICIT SEQUENCE ( SIZE( 1 .. 10 ) ) OF
      SEQUENCE {
        extId  MAP-EXTENSION .&extensionId ( {
          '
          ... } ),
        extType  MAP-EXTENSION .&ExtensionType ( {
          '
          ... } { @extId } ) OPTIONAL} OPTIONAL,
      pcs-Extensions [1] IMPLICIT SEQUENCE {
        ... } OPTIONAL,
      ... } OPTIONAL,
      ... },
    extensionContainer SEQUENCE {
      privateExtensionList [0] IMPLICIT SEQUENCE ( SIZE( 1 .. 10 ) ) OF
      SEQUENCE {
        extId  MAP-EXTENSION .&extensionId ( {
          '
          ... } ),
        extType  MAP-EXTENSION .&ExtensionType ( {
          '
          ... } { @extId } ) OPTIONAL} OPTIONAL,
      pcs-Extensions [1] IMPLICIT SEQUENCE {
        ... } OPTIONAL,
      ... } OPTIONAL,
      ... },
    cug-Info [2] IMPLICIT SEQUENCE {
      cug-SubscriptionList SEQUENCE ( SIZE( 0 .. 10 ) ) OF
      SEQUENCE {
        cug-Index          INTEGER ( 0 .. 32767 ),
        cug-Interlock      OCTET STRING ( SIZE( 4 ) ),
        intraCUG-Options  ENUMERATED {
          noCUG-Restrictions ( 0 ),
          cugIC-CallBarred ( 1 ),
          cugOG-CallBarred ( 2 ) },
        basicServiceGroupList SEQUENCE ( SIZE( 1 .. 32 ) ) OF
        CHOICE {

```

```

    ext-BearerService [2] IMPLICIT OCTET STRING ( SIZE( 1 .. 5 ) ),
    ext-Teleservice [3] IMPLICIT OCTET STRING ( SIZE( 1 .. 5 ) ) OPTIONAL,
    extensionContainer [0] IMPLICIT SEQUENCE {
    privateExtensionList [0] IMPLICIT SEQUENCE ( SIZE( 1 .. 10 ) ) OF
    SEQUENCE {
        extId MAP-EXTENSION .&extensionId ( {
            '
            ... } ),
        extType MAP-EXTENSION .&ExtensionType ( {
            '
            ... } { @extId } ) OPTIONAL} OPTIONAL,
    pcs-Extensions [1] IMPLICIT SEQUENCE {
        ... } OPTIONAL,
    ... } OPTIONAL,
    ... },
    cug-FeatureList SEQUENCE ( SIZE( 1 .. 32 ) ) OF
    SEQUENCE {
        basicService CHOICE {
            ext-BearerService [2] IMPLICIT OCTET STRING ( SIZE( 1 .. 5 ) ),
            ext-Teleservice [3] IMPLICIT OCTET STRING ( SIZE( 1 .. 5 ) ) OPTIONAL,
            preferentialCUG-Indicator INTEGER ( 0 .. 32767 ) OPTIONAL,
            interCUG-Restrictions OCTET STRING ( SIZE( 1 ) ),
            extensionContainer SEQUENCE {
                privateExtensionList [0] IMPLICIT SEQUENCE ( SIZE( 1 .. 10 ) ) OF
                SEQUENCE {
                    extId MAP-EXTENSION .&extensionId ( {
                        '
                        ... } ),
                    extType MAP-EXTENSION .&ExtensionType ( {
                        '
                        ... } { @extId } ) OPTIONAL} OPTIONAL,
                pcs-Extensions [1] IMPLICIT SEQUENCE {
                    ... } OPTIONAL,
                ... } OPTIONAL,
                ... } OPTIONAL,
            extensionContainer [0] IMPLICIT SEQUENCE {
                privateExtensionList [0] IMPLICIT SEQUENCE ( SIZE( 1 .. 10 ) ) OF
                SEQUENCE {
                    extId MAP-EXTENSION .&extensionId ( {
                        '
                        ... } ),
                    extType MAP-EXTENSION .&ExtensionType ( {
                        '
                        ... } { @extId } ) OPTIONAL} OPTIONAL,
                pcs-Extensions [1] IMPLICIT SEQUENCE {
                    ... } OPTIONAL,
                ... } OPTIONAL,
                ... } OPTIONAL,
            ... },
            ss-Data [3] IMPLICIT SEQUENCE {
                ss-Code OCTET STRING ( SIZE( 1 ) ),
                ss-Status [4] IMPLICIT OCTET STRING ( SIZE( 1 .. 5 ) ),
                ss-SubscriptionOption CHOICE {
                    cliRestrictionOption [2] IMPLICIT ENUMERATED {
                        permanent ( 0 ),
                        temporaryDefaultRestricted ( 1 ),
                        temporaryDefaultAllowed ( 2 ) },
                    overrideCategory [1] IMPLICIT ENUMERATED {
                        overrideEnabled ( 0 ),
                        overrideDisabled ( 1 ) } OPTIONAL,
                basicServiceGroupList SEQUENCE ( SIZE( 1 .. 32 ) ) OF
                CHOICE {
                    ext-BearerService [2] IMPLICIT OCTET STRING ( SIZE( 1 .. 5 ) ),
                    ext-Teleservice [3] IMPLICIT OCTET STRING ( SIZE( 1 .. 5 ) ) OPTIONAL,
                extensionContainer [5] IMPLICIT SEQUENCE {
                    privateExtensionList [0] IMPLICIT SEQUENCE ( SIZE( 1 .. 10 ) ) OF
                    SEQUENCE {
                        extId MAP-EXTENSION .&extensionId ( {
                            '
                            ... } ),
                        extType MAP-EXTENSION .&ExtensionType ( {
                            '
                            ... } { @extId } ) OPTIONAL} OPTIONAL,
                    pcs-Extensions [1] IMPLICIT SEQUENCE {
                        ... } OPTIONAL,
                    ... } OPTIONAL,
                    ... },
                emlpp-Info [4] IMPLICIT SEQUENCE {

```

```

maximumentitledPriority INTEGER ( 0 .. 15 ),
defaultPriority INTEGER ( 0 .. 15 ),
extensionContainer SEQUENCE {
  privateExtensionList [0] IMPLICIT SEQUENCE ( SIZE( 1 .. 10 ) ) OF
  SEQUENCE {
    extId MAP-EXTENSION .&extensionId ( {
      '
      ... } ),
    extType MAP-EXTENSION .&ExtensionType ( {
      '
      ... } { @extId } ) OPTIONAL } OPTIONAL,
  pcs-Extensions [1] IMPLICIT SEQUENCE {
    ... } OPTIONAL,
    ... } OPTIONAL,
    ... } OPTIONAL,
  } OPTIONAL,
odbc-Data [8] IMPLICIT SEQUENCE {
  odbc-GeneralData BIT STRING {
    allOG-CallsBarred ( 0 ),
    internationalOGCallsBarred ( 1 ),
    internationalOGCallsNotToHPLMN-CountryBarred ( 2 ),
    interzonalOGCallsBarred ( 6 ),
    interzonalOGCallsNotToHPLMN-CountryBarred ( 7 ),
    interzonalOGCallsAndInternationalOGCallsNotToHPLMN-CountryBarred ( 8 ),
    premiumRateInformationOGCallsBarred ( 3 ),
    premiumRateEntertainmentOGCallsBarred ( 4 ),
    ss-AccessBarred ( 5 ),
    allECT-Barred ( 9 ),
    chargeableECT-Barred ( 10 ),
    internationalECT-Barred ( 11 ),
    interzonalECT-Barred ( 12 ),
    doublyChargeableECT-Barred ( 13 ),
    multipleECT-Barred ( 14 ),
    allPacketOrientedServicesBarred ( 15 ),
    roamerAccessToHPLMN-AP-Barred ( 16 ),
    roamerAccessToVPLMN-AP-Barred ( 17 ),
    roamingOutsidePLMNOG-CallsBarred ( 18 ),
    allIC-CallsBarred ( 19 ),
    roamingOutsidePLMNIC-CallsBarred ( 20 ),
    roamingOutsidePLMNICountryIC-CallsBarred ( 21 ),
    roamingOutsidePLMN-Barred ( 22 ),
    roamingOutsidePLMN-CountryBarred ( 23 ),
    registrationAllCF-Barred ( 24 ),
    registrationCFNotToHPLMN-Barred ( 25 ),
    registrationInterzonalCF-Barred ( 26 ),
    registrationInterzonalCFNotToHPLMN-Barred ( 27 ),
    registrationInternationalCF-Barred ( 28 ) } ( SIZE( 15 .. 32 ) ),
  odbc-HPLMN-Data BIT STRING {
    plmn-SpecificBarringType1 ( 0 ),
    plmn-SpecificBarringType2 ( 1 ),
    plmn-SpecificBarringType3 ( 2 ),
    plmn-SpecificBarringType4 ( 3 ) } ( SIZE( 4 .. 32 ) ) OPTIONAL,
  extensionContainer SEQUENCE {
    privateExtensionList [0] IMPLICIT SEQUENCE ( SIZE( 1 .. 10 ) ) OF
    SEQUENCE {
      extId MAP-EXTENSION .&extensionId ( {
        '
        ... } ),
      extType MAP-EXTENSION .&ExtensionType ( {
        '
        ... } { @extId } ) OPTIONAL } OPTIONAL,
    pcs-Extensions [1] IMPLICIT SEQUENCE {
      ... } OPTIONAL,
      ... } OPTIONAL,
      ... } OPTIONAL,
    ... } OPTIONAL,
  } OPTIONAL,
  roamingRestrictionDueToUnsupportedFeature [9] IMPLICIT NULL OPTIONAL,
  regionalSubscriptionData [10] IMPLICIT SEQUENCE ( SIZE( 1 .. 10 ) ) OF
  OCTET STRING ( SIZE( 2 ) ) OPTIONAL,
  vbsSubscriptionData [11] IMPLICIT SEQUENCE ( SIZE( 1 .. 50 ) ) OF
  SEQUENCE {
    groupid OCTET STRING ( SIZE( 3 ) ),
    broadcastInitEntitlement NULL OPTIONAL,
    extensionContainer SEQUENCE {
      privateExtensionList [0] IMPLICIT SEQUENCE ( SIZE( 1 .. 10 ) ) OF
      SEQUENCE {
        extId MAP-EXTENSION .&extensionId ( {
          '
          ... } ),

```



```

... } OPTIONAL,
... ,
ss-CSI [2] IMPLICIT SEQUENCE {
ss-CamelData SEQUENCE {
ss-EventList SEQUENCE ( SIZE( 1 .. 10 ) ) OF
OCTET STRING ( SIZE( 1 ) ),
gsmSCF-Address OCTET STRING ( SIZE( 1 .. 20 ) ) ( SIZE( 1 .. 9 ) ),
extensionContainer [0] IMPLICIT SEQUENCE {
privateExtensionList [0] IMPLICIT SEQUENCE ( SIZE( 1 .. 10 ) ) OF
SEQUENCE {
extId MAP-EXTENSION .&extensionId ( {
'
...} ),
extType MAP-EXTENSION .&ExtensionType ( {
'
...} { @extId } ) OPTIONAL} OPTIONAL,
pcs-Extensions [1] IMPLICIT SEQUENCE {
... } OPTIONAL,
... } OPTIONAL,
... },
extensionContainer SEQUENCE {
privateExtensionList [0] IMPLICIT SEQUENCE ( SIZE( 1 .. 10 ) ) OF
SEQUENCE {
extId MAP-EXTENSION .&extensionId ( {
'
...} ),
extType MAP-EXTENSION .&ExtensionType ( {
'
...} { @extId } ) OPTIONAL} OPTIONAL,
pcs-Extensions [1] IMPLICIT SEQUENCE {
... } OPTIONAL,
... } OPTIONAL,
... },
notificationToCSE [0] IMPLICIT NULL OPTIONAL,
csi-Active [1] IMPLICIT NULL OPTIONAL} OPTIONAL,
o-BcsmCamelTDP-CriteriaList [4] IMPLICIT SEQUENCE ( SIZE( 1 .. 10 ) ) OF
SEQUENCE {
o-BcsmTriggerDetectionPoint ENUMERATED {
collectedInfo ( 2 ),
... ,
routeSelectFailure ( 4 ) },
destinationNumberCriteria [0] IMPLICIT SEQUENCE {
matchType [0] IMPLICIT ENUMERATED {
inhibiting ( 0 ),
enabling ( 1 ) },
destinationNumberList [1] IMPLICIT SEQUENCE ( SIZE( 1 .. 10 ) ) OF
OCTET STRING ( SIZE( 1 .. 20 ) ) ( SIZE( 1 .. 9 ) ) OPTIONAL,
destinationNumberLengthList [2] IMPLICIT SEQUENCE ( SIZE( 1 .. 3 ) ) OF
INTEGER ( 1 .. 15 ) OPTIONAL,
... } OPTIONAL,
basicServiceCriteria [1] IMPLICIT SEQUENCE ( SIZE( 1 .. 5 ) ) OF
CHOICE {
ext-BearerService [2] IMPLICIT OCTET STRING ( SIZE( 1 .. 5 ) ),
ext-Teleservice [3] IMPLICIT OCTET STRING ( SIZE( 1 .. 5 ) )} OPTIONAL,
callTypeCriteria [2] IMPLICIT ENUMERATED {
forwarded ( 0 ),
notForwarded ( 1 ) } OPTIONAL,
... ,
o-CauseValueCriteria [3] IMPLICIT SEQUENCE ( SIZE( 1 .. 5 ) ) OF
OCTET STRING ( SIZE( 1 ) ) OPTIONAL,
extensionContainer [4] IMPLICIT SEQUENCE {
privateExtensionList [0] IMPLICIT SEQUENCE ( SIZE( 1 .. 10 ) ) OF
SEQUENCE {
extId MAP-EXTENSION .&extensionId ( {
'
...} ),
extType MAP-EXTENSION .&ExtensionType ( {
'
...} { @extId } ) OPTIONAL} OPTIONAL,
pcs-Extensions [1] IMPLICIT SEQUENCE {
... } OPTIONAL,
... } OPTIONAL} OPTIONAL,
tif-CSI [3] IMPLICIT NULL OPTIONAL,
m-CSI [5] IMPLICIT SEQUENCE {
mobilityTriggers SEQUENCE ( SIZE( 1 .. 10 ) ) OF
OCTET STRING ( SIZE( 1 ) ),
serviceKey INTEGER ( 0 .. 2147483647 ),

```



```

    ... } ),
    extType MAP-EXTENSION .&ExtensionType ( {
        '
        ... } { @extId } ) OPTIONAL } OPTIONAL,
    pcs-Extensions [1] IMPLICIT SEQUENCE {
        ... } OPTIONAL,
    ... } OPTIONAL,
    ... },
extensionContainer SEQUENCE {
    privateExtensionList [0] IMPLICIT SEQUENCE ( SIZE( 1 .. 10 ) ) OF
    SEQUENCE {
        extId MAP-EXTENSION .&extensionId ( {
            '
            ... } ),
        extType MAP-EXTENSION .&ExtensionType ( {
            '
            ... } { @extId } ) OPTIONAL } OPTIONAL,
        pcs-Extensions [1] IMPLICIT SEQUENCE {
            ... } OPTIONAL,
            ... } OPTIONAL,
            ... } OPTIONAL,
            ... },
camelCapabilityHandling [0] IMPLICIT INTEGER ( 1 .. 16 ) OPTIONAL,
notificationToCSE [1] IMPLICIT NULL OPTIONAL,
csi-Active [2] IMPLICIT NULL OPTIONAL } OPTIONAL,
t-BCSM-CAMEL-TDP-CriteriaList [8] IMPLICIT SEQUENCE ( SIZE( 1 .. 10 ) ) OF
SEQUENCE {
    t-BCSM-TriggerDetectionPoint ENUMERATED {
        termAttemptAuthorized ( 12 ),
        ... },
    tBusy ( 13 ),
    tNoAnswer ( 14 ) },
    basicServiceCriteria [0] IMPLICIT SEQUENCE ( SIZE( 1 .. 5 ) ) OF
    CHOICE {
        ext-BearerService [2] IMPLICIT OCTET STRING ( SIZE( 1 .. 5 ) ),
        ext-Teleservice [3] IMPLICIT OCTET STRING ( SIZE( 1 .. 5 ) ) } OPTIONAL,
    t-CauseValueCriteria [1] IMPLICIT SEQUENCE ( SIZE( 1 .. 5 ) ) OF
    OCTET STRING ( SIZE( 1 ) ) OPTIONAL,
    ... } OPTIONAL,
d-CSI [9] IMPLICIT SEQUENCE {
    dp-AnalysedInfoCriteriaList [0] IMPLICIT SEQUENCE ( SIZE( 1 .. 10 ) ) OF
    SEQUENCE {
        dialledNumber OCTET STRING ( SIZE( 1 .. 20 ) ) ( SIZE( 1 .. 9 ) ),
        serviceKey INTEGER ( 0 .. 2147483647 ),
        gsmSCF-Address OCTET STRING ( SIZE( 1 .. 20 ) ) ( SIZE( 1 .. 9 ) ),
        defaultCallHandling ENUMERATED {
            continueCall ( 0 ),
            releaseCall ( 1 ),
            ... },
        extensionContainer SEQUENCE {
            privateExtensionList [0] IMPLICIT SEQUENCE ( SIZE( 1 .. 10 ) ) OF
            SEQUENCE {
                extId MAP-EXTENSION .&extensionId ( {
                    '
                    ... } ),
                extType MAP-EXTENSION .&ExtensionType ( {
                    '
                    ... } { @extId } ) OPTIONAL } OPTIONAL,
                    pcs-Extensions [1] IMPLICIT SEQUENCE {
                        ... } OPTIONAL,
                        ... } OPTIONAL,
                        ... } OPTIONAL,
                        ... },
                    camelCapabilityHandling [1] IMPLICIT INTEGER ( 1 .. 16 ) OPTIONAL,
                    extensionContainer [2] IMPLICIT SEQUENCE {
                        privateExtensionList [0] IMPLICIT SEQUENCE ( SIZE( 1 .. 10 ) ) OF
                        SEQUENCE {
                            extId MAP-EXTENSION .&extensionId ( {
                                '
                                ... } ),
                                extType MAP-EXTENSION .&ExtensionType ( {
                                    '
                                    ... } { @extId } ) OPTIONAL } OPTIONAL,
                                    pcs-Extensions [1] IMPLICIT SEQUENCE {
                                        ... } OPTIONAL,
                                        ... } OPTIONAL,
                                        ... } OPTIONAL,
                                        notificationToCSE [3] IMPLICIT NULL OPTIONAL,
                                        csi-Active [4] IMPLICIT NULL OPTIONAL,
                                        ... } OPTIONAL,

```

```

mt-sms-CSI [10] IMPLICIT SEQUENCE {
  sms-CAMEL-TDP-DataList [0] IMPLICIT SEQUENCE ( SIZE( 1 .. 10 ) ) OF
  SEQUENCE {
    sms-TriggerDetectionPoint [0] IMPLICIT ENUMERATED {
      sms-CollectedInfo ( 1 ),
      ... ,
      sms-DeliveryRequest ( 2 ) },
    serviceKey [1] IMPLICIT INTEGER ( 0 .. 2147483647 ),
    gsmSCF-Address [2] IMPLICIT OCTET STRING ( SIZE( 1 .. 20 ) ) ( SIZE( 1 .. 9 ) ),
    defaultSMS-Handling [3] IMPLICIT ENUMERATED {
      continueTransaction ( 0 ),
      releaseTransaction ( 1 ),
      ... },
    extensionContainer [4] IMPLICIT SEQUENCE {
      privateExtensionList [0] IMPLICIT SEQUENCE ( SIZE( 1 .. 10 ) ) OF
      SEQUENCE {
        extId MAP-EXTENSION .&extensionId ( {
          '
          ... } ),
        extType MAP-EXTENSION .&ExtensionType ( {
          '
          ... } { @extId } ) OPTIONAL } OPTIONAL,
        pcs-Extensions [1] IMPLICIT SEQUENCE {
          ... } OPTIONAL,
          ... } OPTIONAL,
          ... } OPTIONAL,
        camelCapabilityHandling [1] IMPLICIT INTEGER ( 1 .. 16 ) OPTIONAL,
        extensionContainer [2] IMPLICIT SEQUENCE {
          privateExtensionList [0] IMPLICIT SEQUENCE ( SIZE( 1 .. 10 ) ) OF
          SEQUENCE {
            extId MAP-EXTENSION .&extensionId ( {
              '
              ... } ),
            extType MAP-EXTENSION .&ExtensionType ( {
              '
              ... } { @extId } ) OPTIONAL } OPTIONAL,
            pcs-Extensions [1] IMPLICIT SEQUENCE {
              ... } OPTIONAL,
              ... } OPTIONAL,
            notificationToCSE [3] IMPLICIT NULL OPTIONAL,
            csi-Active [4] IMPLICIT NULL OPTIONAL,
            ... } OPTIONAL,
          mt-smsCAMELTDP-CriteriaList [11] IMPLICIT SEQUENCE ( SIZE( 1 .. 10 ) ) OF
          SEQUENCE {
            sms-TriggerDetectionPoint ENUMERATED {
              sms-CollectedInfo ( 1 ),
              ... ,
              sms-DeliveryRequest ( 2 ) },
            tpdu-TypeCriterion [0] IMPLICIT SEQUENCE ( SIZE( 1 .. 5 ) ) OF
            ENUMERATED {
              sms-DELIVER ( 0 ),
              sms-SUBMIT-REPORT ( 1 ),
              sms-STATUS-REPORT ( 2 ),
              ... } OPTIONAL,
            ... } OPTIONAL } OPTIONAL,
          extensionContainer [14] IMPLICIT SEQUENCE {
            privateExtensionList [0] IMPLICIT SEQUENCE ( SIZE( 1 .. 10 ) ) OF
            SEQUENCE {
              extId MAP-EXTENSION .&extensionId ( {
                '
                ... } ),
              extType MAP-EXTENSION .&ExtensionType ( {
                '
                ... } { @extId } ) OPTIONAL } OPTIONAL,
              pcs-Extensions [1] IMPLICIT SEQUENCE {
                ... } OPTIONAL,
                ... } OPTIONAL,
              ... ,
            naea-PreferredCI [15] IMPLICIT SEQUENCE {
              naea-PreferredCIC [0] IMPLICIT OCTET STRING ( SIZE( 3 ) ),
              extensionContainer [1] IMPLICIT SEQUENCE {
                privateExtensionList [0] IMPLICIT SEQUENCE ( SIZE( 1 .. 10 ) ) OF
                SEQUENCE {
                  extId MAP-EXTENSION .&extensionId ( {
                    '
                    ... } ),
                  extType MAP-EXTENSION .&ExtensionType ( {

```



```

    ... } { @extId } ) OPTIONAL } OPTIONAL,
    pcs-Extensions [1] IMPLICIT SEQUENCE {
    ... } OPTIONAL,
    ... } OPTIONAL,
    ... } OPTIONAL,
    gprsSubscriptionData [16] IMPLICIT SEQUENCE {
    completeDataListIncluded NULL OPTIONAL,
    gprsDataList [1] IMPLICIT SEQUENCE ( SIZE( 1 .. 50 ) ) OF
    SEQUENCE {
    pdp-ContextId INTEGER ( 1 .. 50 ),
    pdp-Type [16] IMPLICIT OCTET STRING ( SIZE( 2 ) ),
    pdp-Address [17] IMPLICIT OCTET STRING ( SIZE( 1 .. 16 ) ) OPTIONAL,
    qos-Subscribed [18] IMPLICIT OCTET STRING ( SIZE( 3 ) ),
    vplmnAddressAllowed [19] IMPLICIT NULL OPTIONAL,
    apn [20] IMPLICIT OCTET STRING ( SIZE( 2 .. 63 ) ),
    extensionContainer [21] IMPLICIT SEQUENCE {
    privateExtensionList [0] IMPLICIT SEQUENCE ( SIZE( 1 .. 10 ) ) OF
    SEQUENCE {
    extId MAP-EXTENSION .&extensionId ( {
    '
    ... } ),
    extType MAP-EXTENSION .&ExtensionType ( {
    '
    ... } { @extId } ) OPTIONAL } OPTIONAL,
    pcs-Extensions [1] IMPLICIT SEQUENCE {
    ... } OPTIONAL,
    ... } OPTIONAL,
    ... } OPTIONAL,
    ... ,
    ext-QoS-Subscribed [0] IMPLICIT OCTET STRING ( SIZE( 1 .. 9 ) ) OPTIONAL,
    pdp-ChargingCharacteristics [1] IMPLICIT OCTET STRING ( SIZE( 2 ) ) OPTIONAL,
    ext2-QoS-Subscribed [2] IMPLICIT OCTET STRING ( SIZE( 1 .. 3 ) ) OPTIONAL,
    extensionContainer [2] IMPLICIT SEQUENCE {
    privateExtensionList [0] IMPLICIT SEQUENCE ( SIZE( 1 .. 10 ) ) OF
    SEQUENCE {
    extId MAP-EXTENSION .&extensionId ( {
    '
    ... } ),
    extType MAP-EXTENSION .&ExtensionType ( {
    '
    ... } { @extId } ) OPTIONAL } OPTIONAL,
    pcs-Extensions [1] IMPLICIT SEQUENCE {
    ... } OPTIONAL,
    ... } OPTIONAL,
    ... } OPTIONAL,
    roamingRestrictedInSgsnDueToUnsupportedFeature [23] IMPLICIT NULL OPTIONAL,
    networkAccessMode [24] IMPLICIT ENUMERATED {
    bothMSCAndSGSN ( 0 ),
    onlyMSC ( 1 ),
    onlySGSN ( 2 ),
    ... } OPTIONAL,
    lsaInformation [25] IMPLICIT SEQUENCE {
    completeDataListIncluded NULL OPTIONAL,
    lsaOnlyAccessIndicator [1] IMPLICIT ENUMERATED {
    accessOutsideLSAsAllowed ( 0 ),
    accessOutsideLSAsRestricted ( 1 ) } OPTIONAL,
    lsaDataList [2] IMPLICIT SEQUENCE ( SIZE( 1 .. 20 ) ) OF
    SEQUENCE {
    lsaIdentity [0] IMPLICIT OCTET STRING ( SIZE( 3 ) ),
    lsaAttributes [1] IMPLICIT OCTET STRING ( SIZE( 1 ) ),
    lsaActiveModelIndicator [2] IMPLICIT NULL OPTIONAL,
    extensionContainer [3] IMPLICIT SEQUENCE {
    privateExtensionList [0] IMPLICIT SEQUENCE ( SIZE( 1 .. 10 ) ) OF
    SEQUENCE {
    extId MAP-EXTENSION .&extensionId ( {
    '
    ... } ),
    extType MAP-EXTENSION .&ExtensionType ( {
    '
    ... } { @extId } ) OPTIONAL } OPTIONAL,
    pcs-Extensions [1] IMPLICIT SEQUENCE {
    ... } OPTIONAL,
    ... } OPTIONAL,
    ... } OPTIONAL,
    extensionContainer [3] IMPLICIT SEQUENCE {
    privateExtensionList [0] IMPLICIT SEQUENCE ( SIZE( 1 .. 10 ) ) OF
    SEQUENCE {

```

```

extId  MAP-EXTENSION .&extensionId ( {
    '
    ... } ),
extType  MAP-EXTENSION .&ExtensionType ( {
    '
    ... } { @extId } ) OPTIONAL } OPTIONAL,
pcs-Extensions  [1] IMPLICIT SEQUENCE {
    ... } OPTIONAL,
    ... } OPTIONAL,
    ... } OPTIONAL,
Imu-Indicator  [21] IMPLICIT NULL OPTIONAL,
lcsInformation  [22] IMPLICIT SEQUENCE {
gmlc-List  [0] IMPLICIT SEQUENCE ( SIZE( 1 .. 5 ) ) OF
    OCTET STRING ( SIZE( 1 .. 20 ) ) ( SIZE( 1 .. 9 ) ) OPTIONAL,
lcs-PrivacyExceptionList  [1] IMPLICIT SEQUENCE ( SIZE( 1 .. 4 ) ) OF
    SEQUENCE {
    ss-Code  OCTET STRING ( SIZE( 1 ) ),
    ss-Status  OCTET STRING ( SIZE( 1 .. 5 ) ),
    notificationToMSUser  [0] IMPLICIT ENUMERATED {
        notifyLocationAllowed  ( 0 ),
        notifyAndVerify-LocationAllowedIfNoResponse  ( 1 ),
        notifyAndVerify-LocationNotAllowedIfNoResponse  ( 2 ),
        ... ,
        locationNotAllowed  ( 3 ) } OPTIONAL,
    externalClientList  [1] IMPLICIT SEQUENCE ( SIZE( 0 .. 5 ) ) OF
        SEQUENCE {
        clientIdentity  SEQUENCE {
            externalAddress  [0] IMPLICIT OCTET STRING ( SIZE( 1 .. 20 ) ) ( SIZE( 1 .. 9 ) ) OPTIONAL,
            extensionContainer  [1] IMPLICIT SEQUENCE {
                privateExtensionList  [0] IMPLICIT SEQUENCE ( SIZE( 1 .. 10 ) ) OF
                    SEQUENCE {
                    extId  MAP-EXTENSION .&extensionId ( {
                        '
                        ... } ),
                    extType  MAP-EXTENSION .&ExtensionType ( {
                        '
                        ... } { @extId } ) OPTIONAL } OPTIONAL,
                    pcs-Extensions  [1] IMPLICIT SEQUENCE {
                        ... } OPTIONAL,
                        ... } OPTIONAL,
                        ... },
                    gmlc-Restriction  [0] IMPLICIT ENUMERATED {
                        gmlc-List  ( 0 ),
                        home-Country  ( 1 ),
                        ... } OPTIONAL,
                    notificationToMSUser  [1] IMPLICIT ENUMERATED {
                        notifyLocationAllowed  ( 0 ),
                        notifyAndVerify-LocationAllowedIfNoResponse  ( 1 ),
                        notifyAndVerify-LocationNotAllowedIfNoResponse  ( 2 ),
                        ... ,
                        locationNotAllowed  ( 3 ) } OPTIONAL,
                    extensionContainer  [2] IMPLICIT SEQUENCE {
                        privateExtensionList  [0] IMPLICIT SEQUENCE ( SIZE( 1 .. 10 ) ) OF
                            SEQUENCE {
                            extId  MAP-EXTENSION .&extensionId ( {
                                '
                                ... } ),
                            extType  MAP-EXTENSION .&ExtensionType ( {
                                '
                                ... } { @extId } ) OPTIONAL } OPTIONAL,
                            pcs-Extensions  [1] IMPLICIT SEQUENCE {
                                ... } OPTIONAL,
                                ... } OPTIONAL,
                                ... } OPTIONAL,
                                ... } OPTIONAL,
                                plmnClientList  [2] IMPLICIT SEQUENCE ( SIZE( 1 .. 5 ) ) OF
                                    ENUMERATED {
                                    broadcastService  ( 0 ),
                                    o-andM-HPLMN  ( 1 ),
                                    o-andM-VPLMN  ( 2 ),
                                    anonymousLocation  ( 3 ),
                                    targetMSsubscribedService  ( 4 ),
                                    ... } OPTIONAL,
                                    extensionContainer  [3] IMPLICIT SEQUENCE {
                                        privateExtensionList  [0] IMPLICIT SEQUENCE ( SIZE( 1 .. 10 ) ) OF
                                            SEQUENCE {
                                            extId  MAP-EXTENSION .&extensionId ( {
                                                '

```

```

...} ),
extType MAP-EXTENSION .&ExtensionType ( {
    '
    ...} { @extId } ) OPTIONAL} OPTIONAL,
pcs-Extensions [1] IMPLICIT SEQUENCE {
    ... } OPTIONAL,
    ... } OPTIONAL,
... ,
ext-externalClientList [4] IMPLICIT SEQUENCE ( SIZE( 1 .. 35 ) ) OF
SEQUENCE {
    clientIdentity SEQUENCE {
        externalAddress [0] IMPLICIT OCTET STRING ( SIZE( 1 .. 20 ) ) ( SIZE( 1 .. 9 ) ) OPTIONAL,
        extensionContainer [1] IMPLICIT SEQUENCE {
            privateExtensionList [0] IMPLICIT SEQUENCE ( SIZE( 1 .. 10 ) ) OF
            SEQUENCE {
                extId MAP-EXTENSION .&extensionId ( {
                    '
                    ...} ),
                extType MAP-EXTENSION .&ExtensionType ( {
                    '
                    ...} { @extId } ) OPTIONAL} OPTIONAL,
                pcs-Extensions [1] IMPLICIT SEQUENCE {
                    ... } OPTIONAL,
                    ... } OPTIONAL,
                    ... } OPTIONAL,
                ... },
            gmlc-Restriction [0] IMPLICIT ENUMERATED {
                gmlc-List ( 0 ),
                home-Country ( 1 ),
                ... } OPTIONAL,
            notificationToMSUser [1] IMPLICIT ENUMERATED {
                notifyLocationAllowed ( 0 ),
                notifyAndVerify-LocationAllowedIfNoResponse ( 1 ),
                notifyAndVerify-LocationNotAllowedIfNoResponse ( 2 ),
                ... ,
                locationNotAllowed ( 3 ) } OPTIONAL,
            extensionContainer [2] IMPLICIT SEQUENCE {
                privateExtensionList [0] IMPLICIT SEQUENCE ( SIZE( 1 .. 10 ) ) OF
                SEQUENCE {
                    extId MAP-EXTENSION .&extensionId ( {
                        '
                        ...} ),
                    extType MAP-EXTENSION .&ExtensionType ( {
                        '
                        ...} { @extId } ) OPTIONAL} OPTIONAL,
                    pcs-Extensions [1] IMPLICIT SEQUENCE {
                        ... } OPTIONAL,
                        ... } OPTIONAL,
                        ... } OPTIONAL,
                    ... } OPTIONAL,
                serviceTypeList [5] IMPLICIT SEQUENCE ( SIZE( 1 .. 32 ) ) OF
                SEQUENCE {
                    serviceTypeIdentity INTEGER ( 0 .. 127 ),
                    gmlc-Restriction [0] IMPLICIT ENUMERATED {
                        gmlc-List ( 0 ),
                        home-Country ( 1 ),
                        ... } OPTIONAL,
                    notificationToMSUser [1] IMPLICIT ENUMERATED {
                        notifyLocationAllowed ( 0 ),
                        notifyAndVerify-LocationAllowedIfNoResponse ( 1 ),
                        notifyAndVerify-LocationNotAllowedIfNoResponse ( 2 ),
                        ... ,
                        locationNotAllowed ( 3 ) } OPTIONAL,
                    extensionContainer [2] IMPLICIT SEQUENCE {
                        privateExtensionList [0] IMPLICIT SEQUENCE ( SIZE( 1 .. 10 ) ) OF
                        SEQUENCE {
                            extId MAP-EXTENSION .&extensionId ( {
                                '
                                ...} ),
                            extType MAP-EXTENSION .&ExtensionType ( {
                                '
                                ...} { @extId } ) OPTIONAL} OPTIONAL,
                                pcs-Extensions [1] IMPLICIT SEQUENCE {
                                    ... } OPTIONAL,
                                    ... } OPTIONAL,
                                    ... } OPTIONAL,
                                ... } OPTIONAL,
                            molr-List [2] IMPLICIT SEQUENCE ( SIZE( 1 .. 3 ) ) OF
                            SEQUENCE {
                                ss-Code OCTET STRING ( SIZE( 1 ) ),

```

```

ss-Status      OCTET STRING ( SIZE( 1 .. 5 ) ),
extensionContainer [0] IMPLICIT SEQUENCE {
  privateExtensionList [0] IMPLICIT SEQUENCE ( SIZE( 1 .. 10 ) ) OF
  SEQUENCE {
    extId  MAP-EXTENSION .&extensionId ( {
      '
      ... } ),
    extType  MAP-EXTENSION .&ExtensionType ( {
      '
      ... } { @extId } ) OPTIONAL } OPTIONAL,
  pcs-Extensions [1] IMPLICIT SEQUENCE {
    ... } OPTIONAL,
    ... } OPTIONAL,
    ... } OPTIONAL,
  ... } OPTIONAL,
... ,
add-Ics-PrivacyExceptionList [3] IMPLICIT SEQUENCE ( SIZE( 1 .. 4 ) ) OF
SEQUENCE {
  ss-Code      OCTET STRING ( SIZE( 1 ) ),
  ss-Status    OCTET STRING ( SIZE( 1 .. 5 ) ),
  notificationToMSUser [0] IMPLICIT ENUMERATED {
    notifyLocationAllowed ( 0 ),
    notifyAndVerify-LocationAllowedIfNoResponse ( 1 ),
    notifyAndVerify-LocationNotAllowedIfNoResponse ( 2 ),
    ... ,
    locationNotAllowed ( 3 ) } OPTIONAL,
  externalClientList [1] IMPLICIT SEQUENCE ( SIZE( 0 .. 5 ) ) OF
  SEQUENCE {
    clientIdentity SEQUENCE {
      externalAddress [0] IMPLICIT OCTET STRING ( SIZE( 1 .. 20 ) ) ( SIZE( 1 .. 9 ) ) OPTIONAL,
      extensionContainer [1] IMPLICIT SEQUENCE {
        privateExtensionList [0] IMPLICIT SEQUENCE ( SIZE( 1 .. 10 ) ) OF
        SEQUENCE {
          extId  MAP-EXTENSION .&extensionId ( {
            '
            ... } ),
          extType  MAP-EXTENSION .&ExtensionType ( {
            '
            ... } { @extId } ) OPTIONAL } OPTIONAL,
          pcs-Extensions [1] IMPLICIT SEQUENCE {
            ... } OPTIONAL,
            ... } OPTIONAL,
            ... } OPTIONAL,
          ... },
        gmlc-Restriction [0] IMPLICIT ENUMERATED {
          gmlc-List ( 0 ),
          home-Country ( 1 ),
          ... } OPTIONAL,
        notificationToMSUser [1] IMPLICIT ENUMERATED {
          notifyLocationAllowed ( 0 ),
          notifyAndVerify-LocationAllowedIfNoResponse ( 1 ),
          notifyAndVerify-LocationNotAllowedIfNoResponse ( 2 ),
          ... ,
          locationNotAllowed ( 3 ) } OPTIONAL,
        extensionContainer [2] IMPLICIT SEQUENCE {
          privateExtensionList [0] IMPLICIT SEQUENCE ( SIZE( 1 .. 10 ) ) OF
          SEQUENCE {
            extId  MAP-EXTENSION .&extensionId ( {
              '
              ... } ),
            extType  MAP-EXTENSION .&ExtensionType ( {
              '
              ... } { @extId } ) OPTIONAL } OPTIONAL,
            pcs-Extensions [1] IMPLICIT SEQUENCE {
              ... } OPTIONAL,
              ... } OPTIONAL,
              ... } OPTIONAL,
            ... } OPTIONAL,
          plmnClientList [2] IMPLICIT SEQUENCE ( SIZE( 1 .. 5 ) ) OF
          ENUMERATED {
            broadcastService ( 0 ),
            o-andM-HPLMN ( 1 ),
            o-andM-VPLMN ( 2 ),
            anonymousLocation ( 3 ),
            targetMSsubscribedService ( 4 ),
            ... } OPTIONAL,
          extensionContainer [3] IMPLICIT SEQUENCE {
            privateExtensionList [0] IMPLICIT SEQUENCE ( SIZE( 1 .. 10 ) ) OF
            SEQUENCE {
              extId  MAP-EXTENSION .&extensionId ( {

```

```

    ... } ),
    extType MAP-EXTENSION .&ExtensionType ( {
        '
        ... } { @extId } ) OPTIONAL } OPTIONAL,
    pcs-Extensions [1] IMPLICIT SEQUENCE {
        ... } OPTIONAL,
        ... } OPTIONAL,
    ... ,
    ext-externalClientList [4] IMPLICIT SEQUENCE ( SIZE( 1 .. 35 ) ) OF
    SEQUENCE {
        clientIdentity SEQUENCE {
            externalAddress [0] IMPLICIT OCTET STRING ( SIZE( 1 .. 20 ) ) ( SIZE( 1 .. 9 ) ) OPTIONAL,
            extensionContainer [1] IMPLICIT SEQUENCE {
                privateExtensionList [0] IMPLICIT SEQUENCE ( SIZE( 1 .. 10 ) ) OF
                SEQUENCE {
                    extId MAP-EXTENSION .&extensionId ( {
                        '
                        ... } ),
                    extType MAP-EXTENSION .&ExtensionType ( {
                        '
                        ... } { @extId } ) OPTIONAL } OPTIONAL,
                        pcs-Extensions [1] IMPLICIT SEQUENCE {
                            ... } OPTIONAL,
                            ... } OPTIONAL,
                        ... } OPTIONAL,
                    ... },
                    gmlc-Restriction [0] IMPLICIT ENUMERATED {
                        gmlc-List ( 0 ),
                        home-Country ( 1 ),
                        ... } OPTIONAL,
                    notificationToMSUser [1] IMPLICIT ENUMERATED {
                        notifyLocationAllowed ( 0 ),
                        notifyAndVerify-LocationAllowedIfNoResponse ( 1 ),
                        notifyAndVerify-LocationNotAllowedIfNoResponse ( 2 ),
                        ... ,
                        locationNotAllowed ( 3 ) } OPTIONAL,
                    extensionContainer [2] IMPLICIT SEQUENCE {
                        privateExtensionList [0] IMPLICIT SEQUENCE ( SIZE( 1 .. 10 ) ) OF
                        SEQUENCE {
                            extId MAP-EXTENSION .&extensionId ( {
                                '
                                ... } ),
                            extType MAP-EXTENSION .&ExtensionType ( {
                                '
                                ... } { @extId } ) OPTIONAL } OPTIONAL,
                            pcs-Extensions [1] IMPLICIT SEQUENCE {
                                ... } OPTIONAL,
                                ... } OPTIONAL,
                                ... } OPTIONAL,
                            ... } OPTIONAL,
                        serviceTypeList [5] IMPLICIT SEQUENCE ( SIZE( 1 .. 32 ) ) OF
                        SEQUENCE {
                            serviceTypeIdentity INTEGER ( 0 .. 127 ),
                            gmlc-Restriction [0] IMPLICIT ENUMERATED {
                                gmlc-List ( 0 ),
                                home-Country ( 1 ),
                                ... } OPTIONAL,
                            notificationToMSUser [1] IMPLICIT ENUMERATED {
                                notifyLocationAllowed ( 0 ),
                                notifyAndVerify-LocationAllowedIfNoResponse ( 1 ),
                                notifyAndVerify-LocationNotAllowedIfNoResponse ( 2 ),
                                ... ,
                                locationNotAllowed ( 3 ) } OPTIONAL,
                            extensionContainer [2] IMPLICIT SEQUENCE {
                                privateExtensionList [0] IMPLICIT SEQUENCE ( SIZE( 1 .. 10 ) ) OF
                                SEQUENCE {
                                    extId MAP-EXTENSION .&extensionId ( {
                                        '
                                        ... } ),
                                    extType MAP-EXTENSION .&ExtensionType ( {
                                        '
                                        ... } { @extId } ) OPTIONAL } OPTIONAL,
                                    pcs-Extensions [1] IMPLICIT SEQUENCE {
                                        ... } OPTIONAL,
                                        ... } OPTIONAL,
                                        ... } OPTIONAL,
                                    ... } OPTIONAL } OPTIONAL,
                                istAlertTimer [26] IMPLICIT INTEGER ( 15 .. 255 ) OPTIONAL,
                                superChargerSupportedInHLR [27] IMPLICIT OCTET STRING ( SIZE( 1 .. 6 ) ) OPTIONAL,

```

```

mc-SS-Info [28] IMPLICIT SEQUENCE {
  ss-Code [0] IMPLICIT OCTET STRING ( SIZE( 1 ) ),
  ss-Status [1] IMPLICIT OCTET STRING ( SIZE( 1 .. 5 ) ),
  nbrSB [2] IMPLICIT INTEGER ( 2 .. 7 ),
  nbrUser [3] IMPLICIT INTEGER ( 1 .. 7 ),
  extensionContainer [4] IMPLICIT SEQUENCE {
    privateExtensionList [0] IMPLICIT SEQUENCE ( SIZE( 1 .. 10 ) ) OF
      SEQUENCE {
        extId MAP-EXTENSION .&extensionId ( {
          '
          ... } ),
        extType MAP-EXTENSION .&ExtensionType ( {
          '
          ... } { @extId } ) OPTIONAL } OPTIONAL,
    pcs-Extensions [1] IMPLICIT SEQUENCE {
      ... } OPTIONAL,
      ... } OPTIONAL,
      ... } OPTIONAL,
      ... } OPTIONAL,
  cs-AllocationRetentionPriority [29] IMPLICIT OCTET STRING ( SIZE( 1 ) ) OPTIONAL,
  sgsn-CAMEL-SubscriptionInfo [17] IMPLICIT SEQUENCE {
    gprs-CSI [0] IMPLICIT SEQUENCE {
      gprs-CamelTDPDataList [0] IMPLICIT SEQUENCE ( SIZE( 1 .. 10 ) ) OF
        SEQUENCE {
          gprs-TriggerDetectionPoint [0] IMPLICIT ENUMERATED {
            attach ( 1 ),
            attachChangeOfPosition ( 2 ),
            pdp-ContextEstablishment ( 11 ),
            pdp-ContextEstablishmentAcknowledgement ( 12 ),
            pdp-ContextChangeOfPosition ( 14 ),
            ... },
          serviceKey [1] IMPLICIT INTEGER ( 0 .. 2147483647 ),
          gsmSCF-Address [2] IMPLICIT OCTET STRING ( SIZE( 1 .. 20 ) ) ( SIZE( 1 .. 9 ) ),
          defaultSessionHandling [3] IMPLICIT ENUMERATED {
            continueTransaction ( 0 ),
            releaseTransaction ( 1 ),
            ... },
          extensionContainer [4] IMPLICIT SEQUENCE {
            privateExtensionList [0] IMPLICIT SEQUENCE ( SIZE( 1 .. 10 ) ) OF
              SEQUENCE {
                extId MAP-EXTENSION .&extensionId ( {
                  '
                  ... } ),
                extType MAP-EXTENSION .&ExtensionType ( {
                  '
                  ... } { @extId } ) OPTIONAL } OPTIONAL,
            pcs-Extensions [1] IMPLICIT SEQUENCE {
              ... } OPTIONAL,
              ... } OPTIONAL,
              ... } OPTIONAL,
              ... } OPTIONAL,
            camelCapabilityHandling [1] IMPLICIT INTEGER ( 1 .. 16 ) OPTIONAL,
            extensionContainer [2] IMPLICIT SEQUENCE {
              privateExtensionList [0] IMPLICIT SEQUENCE ( SIZE( 1 .. 10 ) ) OF
                SEQUENCE {
                  extId MAP-EXTENSION .&extensionId ( {
                    '
                    ... } ),
                  extType MAP-EXTENSION .&ExtensionType ( {
                    '
                    ... } { @extId } ) OPTIONAL } OPTIONAL,
              pcs-Extensions [1] IMPLICIT SEQUENCE {
                ... } OPTIONAL,
                ... } OPTIONAL,
                ... } OPTIONAL,
                notificationToCSE [3] IMPLICIT NULL OPTIONAL,
                csi-Active [4] IMPLICIT NULL OPTIONAL,
                ... } OPTIONAL,
            mo-sms-CSI [1] IMPLICIT SEQUENCE {
              sms-CAMEL-TDP-DataList [0] IMPLICIT SEQUENCE ( SIZE( 1 .. 10 ) ) OF
                SEQUENCE {
                  sms-TriggerDetectionPoint [0] IMPLICIT ENUMERATED {
                    sms-CollectedInfo ( 1 ),
                    ... ,
                    sms-DeliveryRequest ( 2 ) },
                  serviceKey [1] IMPLICIT INTEGER ( 0 .. 2147483647 ),
                  gsmSCF-Address [2] IMPLICIT OCTET STRING ( SIZE( 1 .. 20 ) ) ( SIZE( 1 .. 9 ) ),
                  defaultSMS-Handling [3] IMPLICIT ENUMERATED {
                    continueTransaction ( 0 ),
                    releaseTransaction ( 1 ),

```

```

... },
extensionContainer [4] IMPLICIT SEQUENCE {
  privateExtensionList [0] IMPLICIT SEQUENCE ( SIZE( 1 .. 10 )) OF
  SEQUENCE {
    extId MAP-EXTENSION .&extensionId ( {
      '
      ... } ),
    extType MAP-EXTENSION .&ExtensionType ( {
      '
      ... } { @extId } ) OPTIONAL } OPTIONAL,
  pcs-Extensions [1] IMPLICIT SEQUENCE {
    ... } OPTIONAL,
    ... } OPTIONAL,
    ... } OPTIONAL,
camelCapabilityHandling [1] IMPLICIT INTEGER ( 1 .. 16 ) OPTIONAL,
extensionContainer [2] IMPLICIT SEQUENCE {
  privateExtensionList [0] IMPLICIT SEQUENCE ( SIZE( 1 .. 10 )) OF
  SEQUENCE {
    extId MAP-EXTENSION .&extensionId ( {
      '
      ... } ),
    extType MAP-EXTENSION .&ExtensionType ( {
      '
      ... } { @extId } ) OPTIONAL } OPTIONAL,
  pcs-Extensions [1] IMPLICIT SEQUENCE {
    ... } OPTIONAL,
    ... } OPTIONAL,
notificationToCSE [3] IMPLICIT NULL OPTIONAL,
csi-Active [4] IMPLICIT NULL OPTIONAL,
... } OPTIONAL,
extensionContainer [2] IMPLICIT SEQUENCE {
  privateExtensionList [0] IMPLICIT SEQUENCE ( SIZE( 1 .. 10 )) OF
  SEQUENCE {
    extId MAP-EXTENSION .&extensionId ( {
      '
      ... } ),
    extType MAP-EXTENSION .&ExtensionType ( {
      '
      ... } { @extId } ) OPTIONAL } OPTIONAL,
  pcs-Extensions [1] IMPLICIT SEQUENCE {
    ... } OPTIONAL,
    ... } OPTIONAL,
    ... } OPTIONAL,
... ,
mt-sms-CSI [3] IMPLICIT SEQUENCE {
  sms-CAMEL-TDP-DataList [0] IMPLICIT SEQUENCE ( SIZE( 1 .. 10 )) OF
  SEQUENCE {
    sms-TriggerDetectionPoint [0] IMPLICIT ENUMERATED {
      sms-CollectedInfo ( 1 ),
      ... ,
      sms-DeliveryRequest ( 2 ) },
    serviceKey [1] IMPLICIT INTEGER ( 0 .. 2147483647 ),
    gsmSCF-Address [2] IMPLICIT OCTET STRING ( SIZE( 1 .. 20 )) ( SIZE( 1 .. 9 ) ),
    defaultSMS-Handling [3] IMPLICIT ENUMERATED {
      continueTransaction ( 0 ),
      releaseTransaction ( 1 ),
      ... },
    extensionContainer [4] IMPLICIT SEQUENCE {
      privateExtensionList [0] IMPLICIT SEQUENCE ( SIZE( 1 .. 10 )) OF
      SEQUENCE {
        extId MAP-EXTENSION .&extensionId ( {
          '
          ... } ),
        extType MAP-EXTENSION .&ExtensionType ( {
          '
          ... } { @extId } ) OPTIONAL } OPTIONAL,
      pcs-Extensions [1] IMPLICIT SEQUENCE {
        ... } OPTIONAL,
        ... } OPTIONAL,
        ... } OPTIONAL,
      camelCapabilityHandling [1] IMPLICIT INTEGER ( 1 .. 16 ) OPTIONAL,
      extensionContainer [2] IMPLICIT SEQUENCE {
        privateExtensionList [0] IMPLICIT SEQUENCE ( SIZE( 1 .. 10 )) OF
        SEQUENCE {
          extId MAP-EXTENSION .&extensionId ( {
            '
            ... } ),
          extType MAP-EXTENSION .&ExtensionType ( {

```

```

    ... } { @extId } ) OPTIONAL} OPTIONAL,
    pcs-Extensions [1] IMPLICIT SEQUENCE {
    ... } OPTIONAL,
    ... } OPTIONAL,
    notificationToCSE [3] IMPLICIT NULL OPTIONAL,
    csi-Active [4] IMPLICIT NULL OPTIONAL,
    ... } OPTIONAL,
    mt-smsCAMELTDP-CriteriaList [4] IMPLICIT SEQUENCE ( SIZE( 1 .. 10 ) ) OF
    SEQUENCE {
    sms-TriggerDetectionPoint ENUMERATED {
    sms-CollectedInfo ( 1 ),
    ... ,
    sms-DeliveryRequest ( 2 ) },
    tpdu-TypeCriterion [0] IMPLICIT SEQUENCE ( SIZE( 1 .. 5 ) ) OF
    ENUMERATED {
    sms-DELIVER ( 0 ),
    sms-SUBMIT-REPORT ( 1 ),
    sms-STATUS-REPORT ( 2 ),
    ... } OPTIONAL,
    ... } OPTIONAL,
    mg-csi [5] IMPLICIT SEQUENCE {
    mobilityTriggers SEQUENCE ( SIZE( 1 .. 10 ) ) OF
    OCTET STRING ( SIZE( 1 ) ),
    serviceKey INTEGER ( 0 .. 2147483647 ),
    gsmSCF-Address [0] IMPLICIT OCTET STRING ( SIZE( 1 .. 20 ) ) ( SIZE( 1 .. 9 ) ),
    extensionContainer [1] IMPLICIT SEQUENCE {
    privateExtensionList [0] IMPLICIT SEQUENCE ( SIZE( 1 .. 10 ) ) OF
    SEQUENCE {
    extId MAP-EXTENSION .&extensionId ( {
    ... } ),
    extType MAP-EXTENSION .&ExtensionType ( {
    ... } { @extId } ) OPTIONAL} OPTIONAL,
    pcs-Extensions [1] IMPLICIT SEQUENCE {
    ... } OPTIONAL,
    ... } OPTIONAL,
    notificationToCSE [2] IMPLICIT NULL OPTIONAL,
    csi-Active [3] IMPLICIT NULL OPTIONAL,
    ... } OPTIONAL} OPTIONAL,
    chargingCharacteristics [18] IMPLICIT OCTET STRING ( SIZE( 2 ) ) OPTIONAL}
RESULT SEQUENCE {
    teleserviceList [1] IMPLICIT SEQUENCE ( SIZE( 1 .. 20 ) ) OF
    OCTET STRING ( SIZE( 1 .. 5 ) ) OPTIONAL,
    bearerServiceList [2] IMPLICIT SEQUENCE ( SIZE( 1 .. 50 ) ) OF
    OCTET STRING ( SIZE( 1 .. 5 ) ) OPTIONAL,
    ss-List [3] IMPLICIT SEQUENCE ( SIZE( 1 .. 30 ) ) OF
    OCTET STRING ( SIZE( 1 ) ) OPTIONAL,
    odb-GeneralData [4] IMPLICIT BIT STRING {
    allOG-CallsBarred ( 0 ),
    internationalOGCallsBarred ( 1 ),
    internationalOGCallsNotToHPLMN-CountryBarred ( 2 ),
    interzonalOGCallsBarred ( 6 ),
    interzonalOGCallsNotToHPLMN-CountryBarred ( 7 ),
    interzonalOGCallsAndInternationalOGCallsNotToHPLMN-CountryBarred ( 8 ),
    premiumRateInformationOGCallsBarred ( 3 ),
    premiumRateEntertainmentOGCallsBarred ( 4 ),
    ss-AccessBarred ( 5 ),
    allECT-Barred ( 9 ),
    chargeableECT-Barred ( 10 ),
    internationalECT-Barred ( 11 ),
    interzonalECT-Barred ( 12 ),
    doublyChargeableECT-Barred ( 13 ),
    multipleECT-Barred ( 14 ),
    allPacketOrientedServicesBarred ( 15 ),
    roamerAccessToHPLMN-AP-Barred ( 16 ),
    roamerAccessToVPLMN-AP-Barred ( 17 ),
    roamingOutsidePLMNOG-CallsBarred ( 18 ),
    allIC-CallsBarred ( 19 ),
    roamingOutsidePLMNIC-CallsBarred ( 20 ),
    roamingOutsidePLMNICountryIC-CallsBarred ( 21 ),
    roamingOutsidePLMN-Barred ( 22 ),
    roamingOutsidePLMN-CountryBarred ( 23 ),
    registrationAllICF-Barred ( 24 ),
    registrationCFNotToHPLMN-Barred ( 25 ),
    registrationInterzonalCF-Barred ( 26 ),

```



```

    registrationInterzonalCFNotToHPLMN-Barred (27),
    registrationInternationalCF-Barred (28) ( SIZE( 15 .. 32 ) ) OPTIONAL,
    regionalSubscriptionResponse [5] IMPLICIT ENUMERATED {
    networkNode-AreaRestricted (0),
    tooManyZoneCodes (1),
    zoneCodesConflict (2),
    regionalSubscNotSupported (3) } OPTIONAL,
    supportedCamelPhases [6] IMPLICIT BIT STRING {
    phase1 (0),
    phase2 (1),
    phase3 (2),
    phase4 (3) } ( SIZE( 1 .. 16 ) ) OPTIONAL,
    extensionContainer [7] IMPLICIT SEQUENCE {
    privateExtensionList [0] IMPLICIT SEQUENCE ( SIZE( 1 .. 10 ) ) OF
    SEQUENCE {
    extId MAP-EXTENSION .&extensionId ( {
    '
    ... } ),
    extType MAP-EXTENSION .&ExtensionType ( {
    '
    ... } { @extId } ) OPTIONAL } OPTIONAL,
    pcs-Extensions [1] IMPLICIT SEQUENCE {
    ... } OPTIONAL,
    ... } OPTIONAL,
    ... ,
    offeredCamel4CSIs [8] IMPLICIT BIT STRING {
    o-csi (0),
    d-csi (1),
    vt-csi (2),
    t-csi (3),
    mt-sms-csi (4),
    mg-csi (5),
    psi-enhancements (6) } ( SIZE( 7 .. 16 ) ) OPTIONAL
    ERRORS {
    dataMissing |
    unexpectedDataValue |
    unidentifiedSubscriber }
    CODE local :7
    }

```

```

deleteSubscriberData OPERATION ::= {
    ARGUMENT SEQUENCE {
    imsi [0] IMPLICIT OCTET STRING ( SIZE( 3 .. 8 ) ),
    basicServiceList [1] IMPLICIT SEQUENCE ( SIZE( 1 .. 70 ) ) OF
    CHOICE {
    ext-BearerService [2] IMPLICIT OCTET STRING ( SIZE( 1 .. 5 ) ),
    ext-Teleservice [3] IMPLICIT OCTET STRING ( SIZE( 1 .. 5 ) ) } OPTIONAL,
    ss-List [2] IMPLICIT SEQUENCE ( SIZE( 1 .. 30 ) ) OF
    OCTET STRING ( SIZE( 1 ) ) OPTIONAL,
    roamingRestrictionDueToUnsupportedFeature [4] IMPLICIT NULL OPTIONAL,
    regionalSubscriptionIdentifier [5] IMPLICIT OCTET STRING ( SIZE( 2 ) ) OPTIONAL,
    vbsGroupIndication [7] IMPLICIT NULL OPTIONAL,
    vgcsGroupIndication [8] IMPLICIT NULL OPTIONAL,
    camelSubscriptionInfoWithdraw [9] IMPLICIT NULL OPTIONAL,
    extensionContainer [6] IMPLICIT SEQUENCE {
    privateExtensionList [0] IMPLICIT SEQUENCE ( SIZE( 1 .. 10 ) ) OF
    SEQUENCE {
    extId MAP-EXTENSION .&extensionId ( {
    '
    ... } ),
    extType MAP-EXTENSION .&ExtensionType ( {
    '
    ... } { @extId } ) OPTIONAL } OPTIONAL,
    pcs-Extensions [1] IMPLICIT SEQUENCE {
    ... } OPTIONAL,
    ... } OPTIONAL,
    ... ,
    gprsSubscriptionDataWithdraw [10] CHOICE {
    allGPRSDData NULL,
    contextIdList SEQUENCE ( SIZE( 1 .. 50 ) ) OF
    INTEGER ( 1 .. 50 ) } OPTIONAL,
    roamingRestrictedInSgsnDueToUnsupportedFeature [11] IMPLICIT NULL OPTIONAL,
    lsInformationWithdraw [12] CHOICE {
    allLSaData NULL,
    lsIdentityList SEQUENCE ( SIZE( 1 .. 20 ) ) OF
    OCTET STRING ( SIZE( 3 ) ) } OPTIONAL,
    gmlc-ListWithdraw [13] IMPLICIT NULL OPTIONAL,

```

```

istInformationWithdraw          [14] IMPLICIT NULL OPTIONAL,
specificCSI-Withdraw          [15] IMPLICIT BIT STRING {
  o-csi (0),
  ss-csi (1),
  tif-csi (2),
  d-csi (3),
  vt-csi (4),
  mo-sms-csi (5),
  m-csi (6),
  gprs-csi (7),
  t-csi (8),
  mt-sms-csi (9),
  mg-csi (10),
  o-IM-CSI (11),
  d-IM-CSI (12),
  vt-IM-CSI (13)} ( SIZE( 8 .. 32 ) ) OPTIONAL,
chargingCharacteristicsWithdraw [16] IMPLICIT NULL OPTIONAL}
RESULT SEQUENCE {
  regionalSubscriptionResponse [0] IMPLICIT ENUMERATED {
    networkNode-AreaRestricted (0),
    tooManyZoneCodes (1),
    zoneCodesConflict (2),
    regionalSubscNotSupported (3)} OPTIONAL,
  extensionContainer SEQUENCE {
    privateExtensionList [0] IMPLICIT SEQUENCE ( SIZE( 1 .. 10 ) ) OF
      SEQUENCE {
        extId MAP-EXTENSION .&extensionId ( {
          '
          ... } ),
        extType MAP-EXTENSION .&ExtensionType ( {
          '
          ... } { @extId } ) OPTIONAL} OPTIONAL,
    pcs-Extensions [1] IMPLICIT SEQUENCE {
      ... } OPTIONAL,
    ... } OPTIONAL,
    ... }
  ERRORS {
    dataMissing |
    unexpectedDataValue |
    unidentifiedSubscriber }
  CODE local : 8
}

reset OPERATION ::= {
  ARGUMENT SEQUENCE {
    hlr-Number OCTET STRING ( SIZE( 1 .. 20 ) ) ( SIZE( 1 .. 9 ) ),
    hlr-List SEQUENCE ( SIZE( 1 .. 50 ) ) OF
      OCTET STRING ( SIZE( 3 .. 8 ) ) OPTIONAL,
    ... }
  CODE local : 37
}

forwardCheckSS-Indication OPERATION ::= {
  CODE local : 38
}

restoreData OPERATION ::= {
  ARGUMENT SEQUENCE {
    imsi OCTET STRING ( SIZE( 3 .. 8 ) ),
    lmsi OCTET STRING ( SIZE( 4 ) ) OPTIONAL,
    extensionContainer SEQUENCE {
      privateExtensionList [0] IMPLICIT SEQUENCE ( SIZE( 1 .. 10 ) ) OF
        SEQUENCE {
          extId MAP-EXTENSION .&extensionId ( {
            '
            ... } ),
          extType MAP-EXTENSION .&ExtensionType ( {
            '
            ... } { @extId } ) OPTIONAL} OPTIONAL,
      pcs-Extensions [1] IMPLICIT SEQUENCE {
        ... } OPTIONAL,
      ... } OPTIONAL,
      ... ,
      vlr-Capability [6] IMPLICIT SEQUENCE {
        supportedCamelPhases [0] IMPLICIT BIT STRING {
          phase1 (0),
          phase2 (1),

```

```

    phase3 (2),
    phase4 (3)} ( SIZE( 1 .. 16 ) ) OPTIONAL,
extensionContainer SEQUENCE {
  privateExtensionList [0] IMPLICIT SEQUENCE ( SIZE( 1 .. 10 ) ) OF
  SEQUENCE {
    extId MAP-EXTENSION .&extensionId ( {
      '
      ...} ),
    extType MAP-EXTENSION .&ExtensionType ( {
      '
      ...}{ @extId } ) OPTIONAL} OPTIONAL,
  pcs-Extensions [1] IMPLICIT SEQUENCE {
    ... } OPTIONAL,
  ... } OPTIONAL,
... ,
solsaSupportIndicator [2] IMPLICIT NULL OPTIONAL,
istSupportIndicator [1] IMPLICIT ENUMERATED {
  basicSTSupported (0),
  istCommandSupported (1),
  ... } OPTIONAL,
superChargerSupportedInServingNetworkEntity [3] CHOICE {
  sendSubscriberData [0] IMPLICIT NULL,
  subscriberDataStored [1] IMPLICIT OCTET STRING ( SIZE( 1 .. 6 ) ) OPTIONAL,
  longFTN-Supported [4] IMPLICIT NULL OPTIONAL,
  supportedLCS-CapabilitySets [5] IMPLICIT BIT STRING {
    lcsCapabilitySet1 (0),
    lcsCapabilitySet2 (1),
    lcsCapabilitySet3 (2)} ( SIZE( 2 .. 16 ) ) OPTIONAL,
  offeredCamel4CSIs [6] IMPLICIT BIT STRING {
    o-csi (0),
    d-csi (1),
    vt-csi (2),
    t-csi (3),
    mt-sms-csi (4),
    mg-csi (5),
    psi-enhancements (6)} ( SIZE( 7 .. 16 ) ) OPTIONAL} OPTIONAL}
RESULT SEQUENCE {
  hlr-Number OCTET STRING ( SIZE( 1 .. 20 ) ) ( SIZE( 1 .. 9 ) ),
  msNotReachable NULL OPTIONAL,
  extensionContainer SEQUENCE {
    privateExtensionList [0] IMPLICIT SEQUENCE ( SIZE( 1 .. 10 ) ) OF
    SEQUENCE {
      extId MAP-EXTENSION .&extensionId ( {
        '
        ...} ),
      extType MAP-EXTENSION .&ExtensionType ( {
        '
        ...}{ @extId } ) OPTIONAL} OPTIONAL,
    pcs-Extensions [1] IMPLICIT SEQUENCE {
      ... } OPTIONAL,
    ... } OPTIONAL,
  ... }
ERRORS {
  systemFailure |
  dataMissing |
  unexpectedDataValue |
  unknownSubscriber }
CODE local : 57
}

sendRoutingInfoForGprs OPERATION ::= {
  ARGUMENT SEQUENCE {
    imsi [0] IMPLICIT OCTET STRING ( SIZE( 3 .. 8 ) ),
    ggsn-Address [1] IMPLICIT OCTET STRING ( SIZE( 5 .. 17 ) ) OPTIONAL,
    ggsn-Number [2] IMPLICIT OCTET STRING ( SIZE( 1 .. 20 ) ) ( SIZE( 1 .. 9 ) ),
    extensionContainer [3] IMPLICIT SEQUENCE {
      privateExtensionList [0] IMPLICIT SEQUENCE ( SIZE( 1 .. 10 ) ) OF
      SEQUENCE {
        extId MAP-EXTENSION .&extensionId ( {
          '
          ...} ),
        extType MAP-EXTENSION .&ExtensionType ( {
          '
          ...}{ @extId } ) OPTIONAL} OPTIONAL,
      pcs-Extensions [1] IMPLICIT SEQUENCE {
        ... } OPTIONAL,
      ... } OPTIONAL,
    ... }

```

```

... }
RESULT SEQUENCE {
sgsn-Address      [0] IMPLICIT OCTET STRING ( SIZE( 5 .. 17 ) ),
ggsn-Address      [1] IMPLICIT OCTET STRING ( SIZE( 5 .. 17 ) ) OPTIONAL,
mobileNotReachableReason [2] IMPLICIT INTEGER ( 0 .. 255 ) OPTIONAL,
extensionContainer [3] IMPLICIT SEQUENCE {
  privateExtensionList [0] IMPLICIT SEQUENCE ( SIZE( 1 .. 10 ) ) OF
  SEQUENCE {
    extId  MAP-EXTENSION .&extensionId ( {
      '
      ... } ),
    extType  MAP-EXTENSION .&ExtensionType ( {
      '
      ... } { @extId } ) OPTIONAL} OPTIONAL,
  pcs-Extensions [1] IMPLICIT SEQUENCE {
    ... } OPTIONAL,
    ... } OPTIONAL,
  ... }
}
ERRORS {
  absentSubscriber |
  systemFailure |
  dataMissing |
  unexpectedDataValue |
  unknownSubscriber |
  callBarred }
CODE local :24
}

failureReport OPERATION ::= {
ARGUMENT SEQUENCE {
  imsi [0] IMPLICIT OCTET STRING ( SIZE( 3 .. 8 ) ),
  ggsn-Number [1] IMPLICIT OCTET STRING ( SIZE( 1 .. 20 ) ) ( SIZE( 1 .. 9 ) ),
  ggsn-Address [2] IMPLICIT OCTET STRING ( SIZE( 5 .. 17 ) ) OPTIONAL,
  extensionContainer [3] IMPLICIT SEQUENCE {
    privateExtensionList [0] IMPLICIT SEQUENCE ( SIZE( 1 .. 10 ) ) OF
    SEQUENCE {
      extId  MAP-EXTENSION .&extensionId ( {
        '
        ... } ),
      extType  MAP-EXTENSION .&ExtensionType ( {
        '
        ... } { @extId } ) OPTIONAL} OPTIONAL,
    pcs-Extensions [1] IMPLICIT SEQUENCE {
      ... } OPTIONAL,
      ... } OPTIONAL,
    ... }
  ... }
RESULT SEQUENCE {
  ggsn-Address [0] IMPLICIT OCTET STRING ( SIZE( 5 .. 17 ) ) OPTIONAL,
  extensionContainer [1] IMPLICIT SEQUENCE {
    privateExtensionList [0] IMPLICIT SEQUENCE ( SIZE( 1 .. 10 ) ) OF
    SEQUENCE {
      extId  MAP-EXTENSION .&extensionId ( {
        '
        ... } ),
      extType  MAP-EXTENSION .&ExtensionType ( {
        '
        ... } { @extId } ) OPTIONAL} OPTIONAL,
    pcs-Extensions [1] IMPLICIT SEQUENCE {
      ... } OPTIONAL,
      ... } OPTIONAL,
    ... }
  ... }
ERRORS {
  systemFailure |
  dataMissing |
  unexpectedDataValue |
  unknownSubscriber }
CODE local :25
}

noteMsPresentForGprs OPERATION ::= {
ARGUMENT SEQUENCE {
  imsi [0] IMPLICIT OCTET STRING ( SIZE( 3 .. 8 ) ),
  sgsn-Address [1] IMPLICIT OCTET STRING ( SIZE( 5 .. 17 ) ),
  ggsn-Address [2] IMPLICIT OCTET STRING ( SIZE( 5 .. 17 ) ) OPTIONAL,
  extensionContainer [3] IMPLICIT SEQUENCE {
    privateExtensionList [0] IMPLICIT SEQUENCE ( SIZE( 1 .. 10 ) ) OF
    SEQUENCE {

```

```

    extId    MAP-EXTENSION .&extensionId ( {
        '
        ... } ),
    extType  MAP-EXTENSION .&ExtensionType ( {
        '
        ... } { @extId } ) OPTIONAL } OPTIONAL,
    pcs-Extensions [1] IMPLICIT SEQUENCE {
        ... } OPTIONAL,
    ... } OPTIONAL,
    ... }
RESULT SEQUENCE {
extensionContainer [0] IMPLICIT SEQUENCE {
    privateExtensionList [0] IMPLICIT SEQUENCE ( SIZE( 1 .. 10 ) ) OF
        SEQUENCE {
            extId    MAP-EXTENSION .&extensionId ( {
                '
                ... } ),
            extType  MAP-EXTENSION .&ExtensionType ( {
                '
                ... } { @extId } ) OPTIONAL } OPTIONAL,
            pcs-Extensions [1] IMPLICIT SEQUENCE {
                ... } OPTIONAL,
            ... } OPTIONAL,
            ... }
ERRORS {
    systemFailure |
    dataMissing |
    unexpectedDataValue |
    unknownSubscriber }
CODE local :26
}

noteMM-Event OPERATION ::= {
ARGUMENT SEQUENCE {
    serviceKey          INTEGER ( 0 .. 2147483647 ),
    eventMet            [0] IMPLICIT OCTET STRING ( SIZE( 1 ) ),
    imsi                [1] IMPLICIT OCTET STRING ( SIZE( 3 .. 8 ) ),
    msisdn              [2] IMPLICIT OCTET STRING ( SIZE( 1 .. 20 ) ) ( SIZE( 1 .. 9 ) ),
    locationInformation [3] IMPLICIT SEQUENCE {
        ageOfLocationInformation INTEGER ( 0 .. 32767 ) OPTIONAL,
        geographicalInformation  [0] IMPLICIT OCTET STRING ( SIZE( 8 ) ) OPTIONAL,
        vlr-number              [1] IMPLICIT OCTET STRING ( SIZE( 1 .. 20 ) ) ( SIZE( 1 .. 9 ) ) OPTIONAL,
        locationNumber          [2] IMPLICIT OCTET STRING ( SIZE( 2 .. 10 ) ) OPTIONAL,
        cellGlobalIdOrServiceAreaIdOrLAI [3] CHOICE {
            cellGlobalIdOrServiceAreaIdFixedLength [0] IMPLICIT OCTET STRING ( SIZE( 7 ) ),
            laiFixedLength [1] IMPLICIT OCTET STRING ( SIZE( 5 ) ) } OPTIONAL,
        extensionContainer [4] IMPLICIT SEQUENCE {
            privateExtensionList [0] IMPLICIT SEQUENCE ( SIZE( 1 .. 10 ) ) OF
                SEQUENCE {
                    extId    MAP-EXTENSION .&extensionId ( {
                        '
                        ... } ),
                    extType  MAP-EXTENSION .&ExtensionType ( {
                        '
                        ... } { @extId } ) OPTIONAL } OPTIONAL,
                    pcs-Extensions [1] IMPLICIT SEQUENCE {
                        ... } OPTIONAL,
                    ... } OPTIONAL,
                    ... ,
                    selectedLSA-Id [5] IMPLICIT OCTET STRING ( SIZE( 3 ) ) OPTIONAL,
                    msc-Number [6] IMPLICIT OCTET STRING ( SIZE( 1 .. 20 ) ) ( SIZE( 1 .. 9 ) ) OPTIONAL,
                    geodeticInformation [7] IMPLICIT OCTET STRING ( SIZE( 10 ) ) OPTIONAL,
                    currentLocationRetrieved [8] IMPLICIT NULL OPTIONAL,
                    sai-Present [9] IMPLICIT NULL OPTIONAL } OPTIONAL,
                supportedCAMELPhases [5] IMPLICIT BIT STRING {
                    phase1 ( 0 ),
                    phase2 ( 1 ),
                    phase3 ( 2 ),
                    phase4 ( 3 ) } ( SIZE( 1 .. 16 ) ) OPTIONAL,
            extensionContainer [6] IMPLICIT SEQUENCE {
                privateExtensionList [0] IMPLICIT SEQUENCE ( SIZE( 1 .. 10 ) ) OF
                    SEQUENCE {
                        extId    MAP-EXTENSION .&extensionId ( {
                            '
                            ... } ),
                        extType  MAP-EXTENSION .&ExtensionType ( {
                            '

```

```

...}{ @extId } ) OPTIONAL} OPTIONAL,
pcs-Extensions [1] IMPLICIT SEQUENCE {
... } OPTIONAL,
... } OPTIONAL,
... ,
locationInformationGPRS [7] IMPLICIT SEQUENCE {
  cellGlobalIdOrServiceAreaIdOrLAI [0] CHOICE {
    cellGlobalIdOrServiceAreaIdFixedLength [0] IMPLICIT OCTET STRING ( SIZE( 7 ) ),
    laiFixedLength [1] IMPLICIT OCTET STRING ( SIZE( 5 ) )} OPTIONAL,
  routingAreaIdentity [1] IMPLICIT OCTET STRING ( SIZE( 6 ) ) OPTIONAL,
  geographicalInformation [2] IMPLICIT OCTET STRING ( SIZE( 8 ) ) OPTIONAL,
  sgsn-Number [3] IMPLICIT OCTET STRING ( SIZE( 1 .. 20 ) ) ( SIZE( 1 .. 9 ) ) OPTIONAL,
  selectedLSAidentity [4] IMPLICIT OCTET STRING ( SIZE( 3 ) ) OPTIONAL,
  extensionContainer [5] IMPLICIT SEQUENCE {
    privateExtensionList [0] IMPLICIT SEQUENCE ( SIZE( 1 .. 10 ) ) OF
      SEQUENCE {
        extId MAP-EXTENSION .&extensionId ( {
          '
          ...} ),
        extType MAP-EXTENSION .&ExtensionType ( {
          '
          ...}{ @extId } ) OPTIONAL} OPTIONAL,
        pcs-Extensions [1] IMPLICIT SEQUENCE {
          ... } OPTIONAL,
          ... } OPTIONAL,
          ... ,
sai-Present [6] IMPLICIT NULL OPTIONAL,
geodeticInformation [7] IMPLICIT OCTET STRING ( SIZE( 10 ) ) OPTIONAL,
currentLocationRetrieved [8] IMPLICIT NULL OPTIONAL,
ageOfLocationInformation [9] IMPLICIT INTEGER ( 0 .. 32767 ) OPTIONAL} OPTIONAL,
offeredCamel4Functionalities [8] IMPLICIT BIT STRING {
  initiateCallAttempt ( 0 ),
  splitLeg ( 1 ),
  moveLeg ( 2 ),
  disconnectLeg ( 3 ),
  entityReleased ( 4 ),
  dfc-WithArgument ( 5 ),
  playTone ( 6 ),
  dtmf-MidCall ( 7 ),
  chargingIndicator ( 8 ),
  alertingDP ( 9 ),
  locationAtAlerting ( 10 ),
  changeOfPositionDP ( 11 ),
  or-Interactions ( 12 ),
  warningToneEnhancements ( 13 ),
  cf-Enhancements ( 14 )} ( SIZE( 15 .. 64 ) ) OPTIONAL}
RESULT SEQUENCE {
  extensionContainer SEQUENCE {
    privateExtensionList [0] IMPLICIT SEQUENCE ( SIZE( 1 .. 10 ) ) OF
      SEQUENCE {
        extId MAP-EXTENSION .&extensionId ( {
          '
          ...} ),
        extType MAP-EXTENSION .&ExtensionType ( {
          '
          ...}{ @extId } ) OPTIONAL} OPTIONAL,
        pcs-Extensions [1] IMPLICIT SEQUENCE {
          ... } OPTIONAL,
          ... } OPTIONAL,
          ... }
ERRORS {
  dataMissing |
  unexpectedDataValue |
  unknownSubscriber |
  mm-EventNotSupported }
CODE local : 89
}

```

END

```

--Expanded ASN1 Module 'MAP-OperationAndMaintenanceOperations'
--SIEMENS ASN.1 Compiler R6.0 (Production_6.0)
-- Date: 2006-06-08 Time: 15:10:56

```

```

MAP-OperationAndMaintenanceOperations{ 0 identified-organization (4) etsi (0) mobileDomain (0) gsm-Network (1) modules (3) map-
OperationAndMaintenanceOperations (6) version8 (8) }

```

DEFINITIONS

::=

BEGIN

EXPORTS

```
activateTraceMode,
deactivateTraceMode,
sendIMSI;
```

```
activateTraceMode OPERATION ::= {
  ARGUMENT SEQUENCE {
    imsi [0] IMPLICIT OCTET STRING ( SIZE( 3 .. 8 ) ) OPTIONAL,
    traceReference [1] IMPLICIT OCTET STRING ( SIZE( 1 .. 2 ) ),
    traceType [2] IMPLICIT INTEGER ( 0 .. 255 ),
    omc-Id [3] IMPLICIT OCTET STRING ( SIZE( 1 .. 20 ) ) OPTIONAL,
    extensionContainer [4] IMPLICIT SEQUENCE {
      privateExtensionList [0] IMPLICIT SEQUENCE ( SIZE( 1 .. 10 ) ) OF
        SEQUENCE {
          extId MAP-EXTENSION .&extensionId ( {
            '
            ... } ),
          extType MAP-EXTENSION .&ExtensionType ( {
            '
            ... } { @extId } ) OPTIONAL } OPTIONAL,
          pcs-Extensions [1] IMPLICIT SEQUENCE {
            ... } OPTIONAL,
          ... } OPTIONAL,
          ... }
    }
  RESULT SEQUENCE {
    extensionContainer [0] IMPLICIT SEQUENCE {
      privateExtensionList [0] IMPLICIT SEQUENCE ( SIZE( 1 .. 10 ) ) OF
        SEQUENCE {
          extId MAP-EXTENSION .&extensionId ( {
            '
            ... } ),
          extType MAP-EXTENSION .&ExtensionType ( {
            '
            ... } { @extId } ) OPTIONAL } OPTIONAL,
          pcs-Extensions [1] IMPLICIT SEQUENCE {
            ... } OPTIONAL,
          ... } OPTIONAL,
          ... }
    }
  ERRORS {
    systemFailure |
    dataMissing |
    unexpectedDataValue |
    facilityNotSupported |
    unidentifiedSubscriber |
    tracingBufferFull }
  CODE local :50
}
```

```
deactivateTraceMode OPERATION ::= {
  ARGUMENT SEQUENCE {
    imsi [0] IMPLICIT OCTET STRING ( SIZE( 3 .. 8 ) ) OPTIONAL,
    traceReference [1] IMPLICIT OCTET STRING ( SIZE( 1 .. 2 ) ),
    extensionContainer [2] IMPLICIT SEQUENCE {
      privateExtensionList [0] IMPLICIT SEQUENCE ( SIZE( 1 .. 10 ) ) OF
        SEQUENCE {
          extId MAP-EXTENSION .&extensionId ( {
            '
            ... } ),
          extType MAP-EXTENSION .&ExtensionType ( {
            '
            ... } { @extId } ) OPTIONAL } OPTIONAL,
          pcs-Extensions [1] IMPLICIT SEQUENCE {
            ... } OPTIONAL,
          ... } OPTIONAL,
          ... }
    }
  RESULT SEQUENCE {
    extensionContainer [0] IMPLICIT SEQUENCE {
      privateExtensionList [0] IMPLICIT SEQUENCE ( SIZE( 1 .. 10 ) ) OF
        SEQUENCE {
```

```

    extId  MAP-EXTENSION .&extensionId ( {
        '
        ... } ),
    extType MAP-EXTENSION .&ExtensionType ( {
        '
        ... } { @extId } ) OPTIONAL } OPTIONAL,
    pcs-Extensions [1] IMPLICIT SEQUENCE {
        ... } OPTIONAL,
    ... } OPTIONAL,
    ... }
}
ERRORS {
    systemFailure |
    dataMissing |
    unexpectedDataValue |
    facilityNotSupported |
    unidentifiedSubscriber }
CODE local : 51
}

sendIMSI OPERATION ::= {
    ARGUMENT  OCTET STRING ( SIZE( 1 .. 20 ) ) ( SIZE( 1 .. 9 ) )
    RESULT  OCTET STRING ( SIZE( 3 .. 8 ) )
    ERRORS {
        dataMissing |
        unexpectedDataValue |
        unknownSubscriber }
    CODE local : 58
}

END

-- Expanded ASN1 Module 'MAP-CallHandlingOperations'
--SIEMENS ASN.1 Compiler R6.0 (Production_6.0)
-- Date: 2006-06-08 Time: 15:11:07

MAP-CallHandlingOperations{ 0 identified-organization (4) etsi (0) mobileDomain (0) gsm-Network (1) modules (3) map-
CallHandlingOperations (7) version8 (8) }

DEFINITIONS

::=

BEGIN

EXPORTS
    sendRoutingInfo,
    provideRoamingNumber,
    resumeCallHandling,
    provideSIWFSNumber,
    siwfs-SignallingModify,
    setReportingState,
    statusReport,
    remoteUserFree,
    ist-Alert,
    ist-Command;

sendRoutingInfo OPERATION ::= {
    ARGUMENT  SEQUENCE {
        msisdn [0] IMPLICIT OCTET STRING ( SIZE( 1 .. 20 ) ) ( SIZE( 1 .. 9 ) ),
        cug-CheckInfo [1] IMPLICIT SEQUENCE {
            cug-Interlock OCTET STRING ( SIZE( 4 ) ),
            cug-OutgoingAccess NULL OPTIONAL,
            extensionContainer SEQUENCE {
                privateExtensionList [0] IMPLICIT SEQUENCE ( SIZE( 1 .. 10 ) ) OF
                SEQUENCE {
                    extId  MAP-EXTENSION .&extensionId ( {
                        '
                        ... } ),
                    extType MAP-EXTENSION .&ExtensionType ( {
                        '
                        ... } { @extId } ) OPTIONAL } OPTIONAL,
                pcs-Extensions [1] IMPLICIT SEQUENCE {
                    ... } OPTIONAL,
                ... } OPTIONAL,
                ... } OPTIONAL,
                ... } OPTIONAL,
            }
        }
    }
}

```



```

numberOfForwarding          [2] IMPLICIT INTEGER ( 1 .. 5 ) OPTIONAL,
interrogationType          [3] IMPLICIT ENUMERATED {
  basicCall ( 0 ),
  forwarding ( 1 ) },
or-Interrogation           [4] IMPLICIT NULL OPTIONAL,
or-Capability              [5] IMPLICIT INTEGER ( 1 .. 127 ) OPTIONAL,
gmsc-OrGsmSCF-Address     [6] IMPLICIT OCTET STRING ( SIZE( 1 .. 20 ) ) ( SIZE( 1 .. 9 ) ),
callReferenceNumber        [7] IMPLICIT OCTET STRING ( SIZE( 1 .. 8 ) ) OPTIONAL,
forwardingReason           [8] IMPLICIT ENUMERATED {
  notReachable ( 0 ),
  busy ( 1 ),
  noReply ( 2 ) } OPTIONAL,
basicServiceGroup          [9] CHOICE {
  ext-BearerService [2] IMPLICIT OCTET STRING ( SIZE( 1 .. 5 ) ),
  ext-Teleservice [3] IMPLICIT OCTET STRING ( SIZE( 1 .. 5 ) ) } OPTIONAL,
networkSignallInfo        [10] IMPLICIT SEQUENCE {
  protocolId      ENUMERATED {
    gsm-0408 ( 1 ),
    gsm-0806 ( 2 ),
    gsm-BSSMAP ( 3 ),
    ets-300102-1 ( 4 ) },
  signallInfo     OCTET STRING ( SIZE( 1 .. 200 ) ),
  extensionContainer SEQUENCE {
    privateExtensionList [0] IMPLICIT SEQUENCE ( SIZE( 1 .. 10 ) ) OF
      SEQUENCE {
        extId  MAP-EXTENSION .&extensionId ( {
          '
          ... } ),
        extType  MAP-EXTENSION .&ExtensionType ( {
          '
          ... } { @extId } ) OPTIONAL } OPTIONAL,
    pcs-Extensions [1] IMPLICIT SEQUENCE {
      ... } OPTIONAL,
      ... } OPTIONAL,
      ... } OPTIONAL,
  ... } OPTIONAL,
  camellInfo [11] IMPLICIT SEQUENCE {
    supportedCamelPhases BIT STRING {
      phase1 ( 0 ),
      phase2 ( 1 ),
      phase3 ( 2 ),
      phase4 ( 3 ) } ( SIZE( 1 .. 16 ) ),
    suppress-T-CSI NULL OPTIONAL,
    extensionContainer SEQUENCE {
      privateExtensionList [0] IMPLICIT SEQUENCE ( SIZE( 1 .. 10 ) ) OF
        SEQUENCE {
          extId  MAP-EXTENSION .&extensionId ( {
            '
            ... } ),
          extType  MAP-EXTENSION .&ExtensionType ( {
            '
            ... } { @extId } ) OPTIONAL } OPTIONAL,
      pcs-Extensions [1] IMPLICIT SEQUENCE {
        ... } OPTIONAL,
        ... } OPTIONAL,
      ... } OPTIONAL,
    ... ,
    offeredCamel4CSIs [0] IMPLICIT BIT STRING {
      o-csi ( 0 ),
      d-csi ( 1 ),
      vt-csi ( 2 ),
      t-csi ( 3 ),
      mt-sms-csi ( 4 ),
      mg-csi ( 5 ),
      psi-enhancements ( 6 ) } ( SIZE( 7 .. 16 ) ) OPTIONAL } OPTIONAL,
    suppressionOfAnnouncement [12] IMPLICIT NULL OPTIONAL,
    extensionContainer [13] IMPLICIT SEQUENCE {
      privateExtensionList [0] IMPLICIT SEQUENCE ( SIZE( 1 .. 10 ) ) OF
        SEQUENCE {
          extId  MAP-EXTENSION .&extensionId ( {
            '
            ... } ),
          extType  MAP-EXTENSION .&ExtensionType ( {
            '
            ... } { @extId } ) OPTIONAL } OPTIONAL,
      pcs-Extensions [1] IMPLICIT SEQUENCE {
        ... } OPTIONAL,
        ... } OPTIONAL,
        ... } OPTIONAL,
      ... ,

```

```

alertingPattern          [14] IMPLICIT OCTET STRING ( SIZE( 1 ) ) OPTIONAL,
ccbs-Call                [15] IMPLICIT NULL OPTIONAL,
supportedCCBS-Phase     [16] IMPLICIT INTEGER ( 1 .. 127 ) OPTIONAL,
additionalSignalInfo    [17] IMPLICIT SEQUENCE {
  ext-ProtocolId        ENUMERATED {
    ets-300356 ( 1 ),
    ... },
  signalInfo            OCTET STRING ( SIZE( 1 .. 200 ) ),
  extensionContainer    SEQUENCE {
    privateExtensionList [0] IMPLICIT SEQUENCE ( SIZE( 1 .. 10 ) ) OF
      SEQUENCE {
        extId           MAP-EXTENSION .&extensionId ( {
          '
          ... } ),
        extType         MAP-EXTENSION .&ExtensionType ( {
          '
          ... } { @extId } ) OPTIONAL } OPTIONAL,
        pcs-Extensions [1] IMPLICIT SEQUENCE {
          ... } OPTIONAL,
          ... } OPTIONAL,
          ... } OPTIONAL,
          ... } OPTIONAL,
        istSupportIndicator [18] IMPLICIT ENUMERATED {
          basicSTSupported ( 0 ),
          istCommandSupported ( 1 ),
          ... } OPTIONAL,
        pre-pagingSupported [19] IMPLICIT NULL OPTIONAL,
        callDiversionTreatmentIndicator [20] IMPLICIT OCTET STRING ( SIZE( 1 ) ) OPTIONAL,
        longFTN-Supported [21] IMPLICIT NULL OPTIONAL,
        suppress-VT-CSt [22] IMPLICIT NULL OPTIONAL,
        suppressIncomingCallBarring [23] IMPLICIT NULL OPTIONAL,
        gsmSCF-InitiatedCall [24] IMPLICIT NULL OPTIONAL,
        basicServiceGroup2 [25] CHOICE {
          ext-BearerService [2] IMPLICIT OCTET STRING ( SIZE( 1 .. 5 ) ),
          ext-Teleservice [3] IMPLICIT OCTET STRING ( SIZE( 1 .. 5 ) ) } OPTIONAL,
        networkSignalInfo2 [26] IMPLICIT SEQUENCE {
          protocolId      ENUMERATED {
            gsm-0408 ( 1 ),
            gsm-0806 ( 2 ),
            gsm-BSSMAP ( 3 ),
            ets-300102-1 ( 4 ) },
          signalInfo      OCTET STRING ( SIZE( 1 .. 200 ) ),
          extensionContainer SEQUENCE {
            privateExtensionList [0] IMPLICIT SEQUENCE ( SIZE( 1 .. 10 ) ) OF
              SEQUENCE {
                extId           MAP-EXTENSION .&extensionId ( {
                  '
                  ... } ),
                extType         MAP-EXTENSION .&ExtensionType ( {
                  '
                  ... } { @extId } ) OPTIONAL } OPTIONAL,
                pcs-Extensions [1] IMPLICIT SEQUENCE {
                  ... } OPTIONAL,
                  ... } OPTIONAL,
                  ... } OPTIONAL,
                  ... } OPTIONAL,
                RESULT [3] IMPLICIT SEQUENCE {
                  imsi [9] IMPLICIT OCTET STRING ( SIZE( 3 .. 8 ) ) OPTIONAL,
                  extendedRoutingInfo CHOICE {
                    routingInfo CHOICE {
                      roamingNumber OCTET STRING ( SIZE( 1 .. 20 ) ) ( SIZE( 1 .. 9 ) ),
                      forwardingData SEQUENCE {
                        forwardedToNumber [5] IMPLICIT OCTET STRING ( SIZE( 1 .. 20 ) ) ( SIZE( 1 .. 9 ) ) OPTIONAL,
                        forwardedToSubaddress [4] IMPLICIT OCTET STRING ( SIZE( 1 .. 21 ) ) OPTIONAL,
                        forwardingOptions [6] IMPLICIT OCTET STRING ( SIZE( 1 ) ) OPTIONAL,
                        extensionContainer [7] IMPLICIT SEQUENCE {
                          privateExtensionList [0] IMPLICIT SEQUENCE ( SIZE( 1 .. 10 ) ) OF
                            SEQUENCE {
                              extId           MAP-EXTENSION .&extensionId ( {
                                '
                                ... } ),
                              extType         MAP-EXTENSION .&ExtensionType ( {
                                '
                                ... } { @extId } ) OPTIONAL } OPTIONAL,
                              pcs-Extensions [1] IMPLICIT SEQUENCE {
                                ... } OPTIONAL,
                                ... } OPTIONAL,
                                ... } OPTIONAL,
                                ... },
                              longForwardedToNumber [8] IMPLICIT OCTET STRING ( SIZE( 1 .. 20 ) ) ( SIZE( 1 .. 15 ) ) OPTIONAL}},

```

```

camelRoutingInfo [8] IMPLICIT SEQUENCE {
  forwardingData SEQUENCE {
    forwardedToNumber [5] IMPLICIT OCTET STRING ( SIZE( 1 .. 20 ) ) ( SIZE( 1 .. 9 ) ) OPTIONAL,
    forwardedToSubaddress [4] IMPLICIT OCTET STRING ( SIZE( 1 .. 21 ) ) OPTIONAL,
    forwardingOptions [6] IMPLICIT OCTET STRING ( SIZE( 1 ) ) OPTIONAL,
    extensionContainer [7] IMPLICIT SEQUENCE {
      privateExtensionList [0] IMPLICIT SEQUENCE ( SIZE( 1 .. 10 ) ) OF
        SEQUENCE {
          extId MAP-EXTENSION .&extensionId ( {
            '
            ... } ),
          extType MAP-EXTENSION .&ExtensionType ( {
            '
            ... } { @extId } ) OPTIONAL } OPTIONAL,
      pcs-Extensions [1] IMPLICIT SEQUENCE {
        ... } OPTIONAL,
        ... } OPTIONAL,
    ... },
  longForwardedToNumber [8] IMPLICIT OCTET STRING ( SIZE( 1 .. 20 ) ) ( SIZE( 1 .. 15 ) ) OPTIONAL } OPTIONAL,
gsmcCamelSubscriptionInfo [0] IMPLICIT SEQUENCE {
  t-CSI [0] IMPLICIT SEQUENCE {
    t-BcsmCamelTDPDataList SEQUENCE ( SIZE( 1 .. 10 ) ) OF
      SEQUENCE {
        t-BcsmTriggerDetectionPoint ENUMERATED {
          termAttemptAuthorized ( 12 ),
          ... ,
          tBusy ( 13 ),
          tNoAnswer ( 14 ) },
        serviceKey INTEGER ( 0 .. 2147483647 ),
        gsmSCF-Address [0] IMPLICIT OCTET STRING ( SIZE( 1 .. 20 ) ) ( SIZE( 1 .. 9 ) ),
        defaultCallHandling [1] IMPLICIT ENUMERATED {
          continueCall ( 0 ),
          releaseCall ( 1 ),
          ... },
        extensionContainer [2] IMPLICIT SEQUENCE {
          privateExtensionList [0] IMPLICIT SEQUENCE ( SIZE( 1 .. 10 ) ) OF
            SEQUENCE {
              extId MAP-EXTENSION .&extensionId ( {
                '
                ... } ),
              extType MAP-EXTENSION .&ExtensionType ( {
                '
                ... } { @extId } ) OPTIONAL } OPTIONAL,
            pcs-Extensions [1] IMPLICIT SEQUENCE {
              ... } OPTIONAL,
              ... } OPTIONAL,
            ... },
          extensionContainer SEQUENCE {
            privateExtensionList [0] IMPLICIT SEQUENCE ( SIZE( 1 .. 10 ) ) OF
              SEQUENCE {
                extId MAP-EXTENSION .&extensionId ( {
                  '
                  ... } ),
                extType MAP-EXTENSION .&ExtensionType ( {
                  '
                  ... } { @extId } ) OPTIONAL } OPTIONAL,
            pcs-Extensions [1] IMPLICIT SEQUENCE {
              ... } OPTIONAL,
              ... } OPTIONAL,
            ... },
          camelCapabilityHandling [0] IMPLICIT INTEGER ( 1 .. 16 ) OPTIONAL,
          notificationToCSE [1] IMPLICIT NULL OPTIONAL,
          csi-Active [2] IMPLICIT NULL OPTIONAL } OPTIONAL,
        o-CSI [1] IMPLICIT SEQUENCE {
          o-BcsmCamelTDPDataList SEQUENCE ( SIZE( 1 .. 10 ) ) OF
            SEQUENCE {
              o-BcsmTriggerDetectionPoint ENUMERATED {
                collectedInfo ( 2 ),
                ... ,
                routeSelectFailure ( 4 ) },
              serviceKey INTEGER ( 0 .. 2147483647 ),
              gsmSCF-Address [0] IMPLICIT OCTET STRING ( SIZE( 1 .. 20 ) ) ( SIZE( 1 .. 9 ) ),
              defaultCallHandling [1] IMPLICIT ENUMERATED {
                continueCall ( 0 ),
                releaseCall ( 1 ),
                ... },
              extensionContainer [2] IMPLICIT SEQUENCE {

```

```

privateExtensionList [0] IMPLICIT SEQUENCE ( SIZE( 1 .. 10 ) ) OF
SEQUENCE {
  extId MAP-EXTENSION .&extensionId ( {
    '
    ... } ),
  extType MAP-EXTENSION .&ExtensionType ( {
    '
    ... } { @extId } ) OPTIONAL } OPTIONAL,
pcs-Extensions [1] IMPLICIT SEQUENCE {
  ... } OPTIONAL,
... } OPTIONAL,
... };
extensionContainer SEQUENCE {
privateExtensionList [0] IMPLICIT SEQUENCE ( SIZE( 1 .. 10 ) ) OF
SEQUENCE {
  extId MAP-EXTENSION .&extensionId ( {
    '
    ... } ),
  extType MAP-EXTENSION .&ExtensionType ( {
    '
    ... } { @extId } ) OPTIONAL } OPTIONAL,
pcs-Extensions [1] IMPLICIT SEQUENCE {
  ... } OPTIONAL,
... } OPTIONAL,
... ;
camelCapabilityHandling [0] IMPLICIT INTEGER ( 1 .. 16 ) OPTIONAL,
notificationToCSE [1] IMPLICIT NULL OPTIONAL,
csiActive [2] IMPLICIT NULL OPTIONAL } OPTIONAL,
extensionContainer [2] IMPLICIT SEQUENCE {
privateExtensionList [0] IMPLICIT SEQUENCE ( SIZE( 1 .. 10 ) ) OF
SEQUENCE {
  extId MAP-EXTENSION .&extensionId ( {
    '
    ... } ),
  extType MAP-EXTENSION .&ExtensionType ( {
    '
    ... } { @extId } ) OPTIONAL } OPTIONAL,
pcs-Extensions [1] IMPLICIT SEQUENCE {
  ... } OPTIONAL,
... } OPTIONAL,
... ;
o-BcsmCamelTDP-CriteriaList [3] IMPLICIT SEQUENCE ( SIZE( 1 .. 10 ) ) OF
SEQUENCE {
  o-BcsmTriggerDetectionPoint ENUMERATED {
    collectedInfo ( 2 ),
    ... ,
    routeSelectFailure ( 4 ) },
  destinationNumberCriteria [0] IMPLICIT SEQUENCE {
    matchType [0] IMPLICIT ENUMERATED {
      inhibiting ( 0 ),
      enabling ( 1 ) },
    destinationNumberList [1] IMPLICIT SEQUENCE ( SIZE( 1 .. 10 ) ) OF
    OCTET STRING ( SIZE( 1 .. 20 ) ) ( SIZE( 1 .. 9 ) ) OPTIONAL,
    destinationNumberLengthList [2] IMPLICIT SEQUENCE ( SIZE( 1 .. 3 ) ) OF
    INTEGER ( 1 .. 15 ) OPTIONAL,
    ... } OPTIONAL,
  basicServiceCriteria [1] IMPLICIT SEQUENCE ( SIZE( 1 .. 5 ) ) OF
  CHOICE {
    ext-BearerService [2] IMPLICIT OCTET STRING ( SIZE( 1 .. 5 ) ),
    ext-Teleservice [3] IMPLICIT OCTET STRING ( SIZE( 1 .. 5 ) ) } OPTIONAL,
  callTypeCriteria [2] IMPLICIT ENUMERATED {
    forwarded ( 0 ),
    notForwarded ( 1 ) } OPTIONAL,
  ... ;
  o-CauseValueCriteria [3] IMPLICIT SEQUENCE ( SIZE( 1 .. 5 ) ) OF
  OCTET STRING ( SIZE( 1 ) ) OPTIONAL,
  extensionContainer [4] IMPLICIT SEQUENCE {
  privateExtensionList [0] IMPLICIT SEQUENCE ( SIZE( 1 .. 10 ) ) OF
  SEQUENCE {
    extId MAP-EXTENSION .&extensionId ( {
      '
      ... } ),
    extType MAP-EXTENSION .&ExtensionType ( {
      '
      ... } { @extId } ) OPTIONAL } OPTIONAL,
  pcs-Extensions [1] IMPLICIT SEQUENCE {
    ... } OPTIONAL,

```



```

    ... } { @extId } ) OPTIONAL } OPTIONAL,
    pcs-Extensions [1] IMPLICIT SEQUENCE {
    ... } OPTIONAL,
    ... } OPTIONAL,
    ... } OPTIONAL,
    cugSubscriptionFlag [6] IMPLICIT NULL OPTIONAL,
    subscriberInfo [7] IMPLICIT SEQUENCE {
    locationInformation [0] IMPLICIT SEQUENCE {
    ageOfLocationInformation INTEGER ( 0 .. 32767 ) OPTIONAL,
    geographicalInformation [0] IMPLICIT OCTET STRING ( SIZE( 8 ) ) OPTIONAL,
    vlr-number [1] IMPLICIT OCTET STRING ( SIZE( 1 .. 20 ) ) ( SIZE( 1 .. 9 ) ) OPTIONAL,
    locationNumber [2] IMPLICIT OCTET STRING ( SIZE( 2 .. 10 ) ) OPTIONAL,
    cellGlobalIdOrServiceAreaIdOrLAI [3] CHOICE {
    cellGlobalIdOrServiceAreaIdFixedLength [0] IMPLICIT OCTET STRING ( SIZE( 7 ) ),
    laiFixedLength [1] IMPLICIT OCTET STRING ( SIZE( 5 ) ) } OPTIONAL,
    extensionContainer [4] IMPLICIT SEQUENCE {
    privateExtensionList [0] IMPLICIT SEQUENCE ( SIZE( 1 .. 10 ) ) OF
    SEQUENCE {
    extId MAP-EXTENSION .&extensionId ( {
    ... } ),
    extType MAP-EXTENSION .&ExtensionType ( {
    ... } { @extId } ) OPTIONAL } OPTIONAL,
    pcs-Extensions [1] IMPLICIT SEQUENCE {
    ... } OPTIONAL,
    ... } OPTIONAL,
    ... ,
    selectedLSA-Id [5] IMPLICIT OCTET STRING ( SIZE( 3 ) ) OPTIONAL,
    msc-Number [6] IMPLICIT OCTET STRING ( SIZE( 1 .. 20 ) ) ( SIZE( 1 .. 9 ) ) OPTIONAL,
    geodeticInformation [7] IMPLICIT OCTET STRING ( SIZE( 10 ) ) OPTIONAL,
    currentLocationRetrieved [8] IMPLICIT NULL OPTIONAL,
    sai-Present [9] IMPLICIT NULL OPTIONAL } OPTIONAL,
    subscriberState [1] CHOICE {
    assumedIdle [0] IMPLICIT NULL,
    camelBusy [1] IMPLICIT NULL,
    netDetNotReachable ENUMERATED {
    msPurged ( 0 ),
    imsiDetached ( 1 ),
    restrictedArea ( 2 ),
    notRegistered ( 3 ) },
    notProvidedFromVLR [2] IMPLICIT NULL } OPTIONAL,
    extensionContainer [2] IMPLICIT SEQUENCE {
    privateExtensionList [0] IMPLICIT SEQUENCE ( SIZE( 1 .. 10 ) ) OF
    SEQUENCE {
    extId MAP-EXTENSION .&extensionId ( {
    ... } ),
    extType MAP-EXTENSION .&ExtensionType ( {
    ... } { @extId } ) OPTIONAL } OPTIONAL,
    pcs-Extensions [1] IMPLICIT SEQUENCE {
    ... } OPTIONAL,
    ... } OPTIONAL,
    ... ,
    locationInformationGPRS [3] IMPLICIT SEQUENCE {
    cellGlobalIdOrServiceAreaIdOrLAI [0] CHOICE {
    cellGlobalIdOrServiceAreaIdFixedLength [0] IMPLICIT OCTET STRING ( SIZE( 7 ) ),
    laiFixedLength [1] IMPLICIT OCTET STRING ( SIZE( 5 ) ) } OPTIONAL,
    routingAreaIdentity [1] IMPLICIT OCTET STRING ( SIZE( 6 ) ) OPTIONAL,
    geographicalInformation [2] IMPLICIT OCTET STRING ( SIZE( 8 ) ) OPTIONAL,
    sgsn-Number [3] IMPLICIT OCTET STRING ( SIZE( 1 .. 20 ) ) ( SIZE( 1 .. 9 ) ) OPTIONAL,
    selectedLSAIdentity [4] IMPLICIT OCTET STRING ( SIZE( 3 ) ) OPTIONAL,
    extensionContainer [5] IMPLICIT SEQUENCE {
    privateExtensionList [0] IMPLICIT SEQUENCE ( SIZE( 1 .. 10 ) ) OF
    SEQUENCE {
    extId MAP-EXTENSION .&extensionId ( {
    ... } ),
    extType MAP-EXTENSION .&ExtensionType ( {
    ... } { @extId } ) OPTIONAL } OPTIONAL,
    pcs-Extensions [1] IMPLICIT SEQUENCE {
    ... } OPTIONAL,
    ... } OPTIONAL,
    ... ,

```

```

sai-Present [6] IMPLICIT NULL OPTIONAL,
geodeticInformation [7] IMPLICIT OCTET STRING ( SIZE( 10 ) ) OPTIONAL,
currentLocationRetrieved [8] IMPLICIT NULL OPTIONAL,
ageOfLocationInformation [9] IMPLICIT INTEGER ( 0 .. 32767 ) OPTIONAL} OPTIONAL,
ps-SubscriberState [4] CHOICE {
notProvidedFromSGSN [0] IMPLICIT NULL,
ps-Detached [1] IMPLICIT NULL,
ps-AttachedNotReachableForPaging [2] IMPLICIT NULL,
ps-AttachedReachableForPaging [3] IMPLICIT NULL,
ps-PDP-ActiveNotReachableForPaging [4] IMPLICIT SEQUENCE ( SIZE( 1 .. 50 ) ) OF
SEQUENCE {
pdp-ContextIdentifier [0] IMPLICIT INTEGER ( 1 .. 50 ),
pdp-ContextActive [1] IMPLICIT NULL OPTIONAL,
pdp-Type [2] IMPLICIT OCTET STRING ( SIZE( 2 ) ),
pdp-Address [3] IMPLICIT OCTET STRING ( SIZE( 1 .. 16 ) ) OPTIONAL,
apn-Subscribed [4] IMPLICIT OCTET STRING ( SIZE( 2 .. 63 ) ) OPTIONAL,
apn-InUse [5] IMPLICIT OCTET STRING ( SIZE( 2 .. 63 ) ) OPTIONAL,
nsapi [6] IMPLICIT INTEGER ( 0 .. 15 ) OPTIONAL,
transactionId [7] IMPLICIT OCTET STRING ( SIZE( 1 .. 2 ) ) OPTIONAL,
teid-ForGnAndGp [8] IMPLICIT OCTET STRING ( SIZE( 4 ) ) OPTIONAL,
teid-ForLu [9] IMPLICIT OCTET STRING ( SIZE( 4 ) ) OPTIONAL,
ggsn-Address [10] IMPLICIT OCTET STRING ( SIZE( 5 .. 17 ) ) OPTIONAL,
qos-Subscribed [11] IMPLICIT OCTET STRING ( SIZE( 1 .. 9 ) ) OPTIONAL,
qos-Requested [12] IMPLICIT OCTET STRING ( SIZE( 1 .. 9 ) ) OPTIONAL,
qos-Negotiated [13] IMPLICIT OCTET STRING ( SIZE( 1 .. 9 ) ) OPTIONAL,
chargingId [14] IMPLICIT OCTET STRING ( SIZE( 4 ) ) OPTIONAL,
chargingCharacteristics [15] IMPLICIT OCTET STRING ( SIZE( 2 ) ) OPTIONAL,
rnc-Address [16] IMPLICIT OCTET STRING ( SIZE( 5 .. 17 ) ) OPTIONAL,
extensionContainer [17] IMPLICIT SEQUENCE {
privateExtensionList [0] IMPLICIT SEQUENCE ( SIZE( 1 .. 10 ) ) OF
SEQUENCE {
extId MAP-EXTENSION .&extensionId ( {
'
...} ),
extType MAP-EXTENSION .&ExtensionType ( {
'
...} { @extId } ) OPTIONAL} OPTIONAL,
pcs-Extensions [1] IMPLICIT SEQUENCE {
... } OPTIONAL,
... } OPTIONAL,
... ,
qos2-Subscribed [18] IMPLICIT OCTET STRING ( SIZE( 1 .. 3 ) ) OPTIONAL,
qos2-Requested [19] IMPLICIT OCTET STRING ( SIZE( 1 .. 3 ) ) OPTIONAL,
qos2-Negotiated [20] IMPLICIT OCTET STRING ( SIZE( 1 .. 3 ) ) OPTIONAL},
ps-PDP-ActiveReachableForPaging [5] IMPLICIT SEQUENCE ( SIZE( 1 .. 50 ) ) OF
SEQUENCE {
pdp-ContextIdentifier [0] IMPLICIT INTEGER ( 1 .. 50 ),
pdp-ContextActive [1] IMPLICIT NULL OPTIONAL,
pdp-Type [2] IMPLICIT OCTET STRING ( SIZE( 2 ) ),
pdp-Address [3] IMPLICIT OCTET STRING ( SIZE( 1 .. 16 ) ) OPTIONAL,
apn-Subscribed [4] IMPLICIT OCTET STRING ( SIZE( 2 .. 63 ) ) OPTIONAL,
apn-InUse [5] IMPLICIT OCTET STRING ( SIZE( 2 .. 63 ) ) OPTIONAL,
nsapi [6] IMPLICIT INTEGER ( 0 .. 15 ) OPTIONAL,
transactionId [7] IMPLICIT OCTET STRING ( SIZE( 1 .. 2 ) ) OPTIONAL,
teid-ForGnAndGp [8] IMPLICIT OCTET STRING ( SIZE( 4 ) ) OPTIONAL,
teid-ForLu [9] IMPLICIT OCTET STRING ( SIZE( 4 ) ) OPTIONAL,
ggsn-Address [10] IMPLICIT OCTET STRING ( SIZE( 5 .. 17 ) ) OPTIONAL,
qos-Subscribed [11] IMPLICIT OCTET STRING ( SIZE( 1 .. 9 ) ) OPTIONAL,
qos-Requested [12] IMPLICIT OCTET STRING ( SIZE( 1 .. 9 ) ) OPTIONAL,
qos-Negotiated [13] IMPLICIT OCTET STRING ( SIZE( 1 .. 9 ) ) OPTIONAL,
chargingId [14] IMPLICIT OCTET STRING ( SIZE( 4 ) ) OPTIONAL,
chargingCharacteristics [15] IMPLICIT OCTET STRING ( SIZE( 2 ) ) OPTIONAL,
rnc-Address [16] IMPLICIT OCTET STRING ( SIZE( 5 .. 17 ) ) OPTIONAL,
extensionContainer [17] IMPLICIT SEQUENCE {
privateExtensionList [0] IMPLICIT SEQUENCE ( SIZE( 1 .. 10 ) ) OF
SEQUENCE {
extId MAP-EXTENSION .&extensionId ( {
'
...} ),
extType MAP-EXTENSION .&ExtensionType ( {
'
...} { @extId } ) OPTIONAL} OPTIONAL,
pcs-Extensions [1] IMPLICIT SEQUENCE {
... } OPTIONAL,
... } OPTIONAL,
... ,
qos2-Subscribed [18] IMPLICIT OCTET STRING ( SIZE( 1 .. 3 ) ) OPTIONAL,

```

```

    qos2-Requested      [19] IMPLICIT OCTET STRING ( SIZE( 1 .. 3 ) ) OPTIONAL,
    qos2-Negotiated    [20] IMPLICIT OCTET STRING ( SIZE( 1 .. 3 ) ) OPTIONAL,
    netDetNotReachable ENUMERATED {
    msPurged           ( 0 ),
    imsiDetached      ( 1 ),
    restrictedArea     ( 2 ),
    notRegistered     ( 3 ) } OPTIONAL,
    imei               [5] IMPLICIT OCTET STRING ( SIZE( 8 ) ) OPTIONAL,
    ms-Classmark2      [6] IMPLICIT OCTET STRING ( SIZE( 3 ) ) OPTIONAL,
    gprs-MS-Class      [7] IMPLICIT SEQUENCE {
    mSNetworkCapability [0] IMPLICIT OCTET STRING ( SIZE( 1 .. 8 ) ),
    mSRadioAccessCapability [1] IMPLICIT OCTET STRING ( SIZE( 1 .. 50 ) ) OPTIONAL} OPTIONAL,
    mnpInfoRes         [8] IMPLICIT SEQUENCE {
    routingNumber       [0] IMPLICIT OCTET STRING ( SIZE( 1 .. 5 ) ) OPTIONAL,
    imsi                [1] IMPLICIT OCTET STRING ( SIZE( 3 .. 8 ) ) OPTIONAL,
    msisdn              [2] IMPLICIT OCTET STRING ( SIZE( 1 .. 20 ) ) ( SIZE( 1 .. 9 ) ) OPTIONAL,
    numberPortabilityStatus [3] IMPLICIT ENUMERATED {
    notKnownToBePorted ( 0 ),
    ownNumberPortedOut ( 1 ),
    foreignNumberPortedToForeignNetwork ( 2 ),
    ... ,
    ownNumberNotPortedOut ( 4 ),
    foreignNumberPortedIn ( 5 ) } OPTIONAL,
    extensionContainer [4] IMPLICIT SEQUENCE {
    privateExtensionList [0] IMPLICIT SEQUENCE ( SIZE( 1 .. 10 ) ) OF
    SEQUENCE {
    extId  MAP-EXTENSION .&extensionId ( {
    '
    ... } ),
    extType  MAP-EXTENSION .&ExtensionType ( {
    '
    ... } { @extId } ) OPTIONAL} OPTIONAL,
    pcs-Extensions [1] IMPLICIT SEQUENCE {
    ... } OPTIONAL,
    ... } OPTIONAL,
    ... } OPTIONAL} OPTIONAL,
    ss-List          [1] IMPLICIT SEQUENCE ( SIZE( 1 .. 30 ) ) OF
    OCTET STRING ( SIZE( 1 ) ) OPTIONAL,
    basicService     [5] CHOICE {
    ext-BearerService [2] IMPLICIT OCTET STRING ( SIZE( 1 .. 5 ) ),
    ext-Teleservice [3] IMPLICIT OCTET STRING ( SIZE( 1 .. 5 ) ) OPTIONAL,
    forwardingInterrogationRequired [4] IMPLICIT NULL OPTIONAL,
    vmsc-Address      [2] IMPLICIT OCTET STRING ( SIZE( 1 .. 20 ) ) ( SIZE( 1 .. 9 ) ) OPTIONAL,
    extensionContainer [0] IMPLICIT SEQUENCE {
    privateExtensionList [0] IMPLICIT SEQUENCE ( SIZE( 1 .. 10 ) ) OF
    SEQUENCE {
    extId  MAP-EXTENSION .&extensionId ( {
    '
    ... } ),
    extType  MAP-EXTENSION .&ExtensionType ( {
    '
    ... } { @extId } ) OPTIONAL} OPTIONAL,
    pcs-Extensions [1] IMPLICIT SEQUENCE {
    ... } OPTIONAL,
    ... } OPTIONAL,
    ... } OPTIONAL,
    ... ,
    naea-PreferredCI [10] IMPLICIT SEQUENCE {
    naea-PreferredCIC [0] IMPLICIT OCTET STRING ( SIZE( 3 ) ),
    extensionContainer [1] IMPLICIT SEQUENCE {
    privateExtensionList [0] IMPLICIT SEQUENCE ( SIZE( 1 .. 10 ) ) OF
    SEQUENCE {
    extId  MAP-EXTENSION .&extensionId ( {
    '
    ... } ),
    extType  MAP-EXTENSION .&ExtensionType ( {
    '
    ... } { @extId } ) OPTIONAL} OPTIONAL,
    pcs-Extensions [1] IMPLICIT SEQUENCE {
    ... } OPTIONAL,
    ... } OPTIONAL,
    ... } OPTIONAL,
    ... } OPTIONAL,
    ccbs-Indicators [11] IMPLICIT SEQUENCE {
    ccbs-Possible [0] IMPLICIT NULL OPTIONAL,
    keepCCBS-CallIndicator [1] IMPLICIT NULL OPTIONAL,
    extensionContainer [2] IMPLICIT SEQUENCE {
    privateExtensionList [0] IMPLICIT SEQUENCE ( SIZE( 1 .. 10 ) ) OF
    SEQUENCE {

```



```

    extId    MAP-EXTENSION .&extensionId ( {
        '
        ... } ),
    extType  MAP-EXTENSION .&ExtensionType ( {
        '
        ... } { @extId } ) OPTIONAL} OPTIONAL,
    pcs-Extensions    [1] IMPLICIT SEQUENCE {
        ... } OPTIONAL,
    ... } OPTIONAL,
    ... } OPTIONAL,
msisdn          [12] IMPLICIT OCTET STRING ( SIZE( 1 .. 20 ) ) ( SIZE( 1 .. 9 ) ) OPTIONAL,
numberPortabilityStatus    [13] IMPLICIT ENUMERATED {
    notKnownToBePorted      ( 0 ),
    ownNumberPortedOut      ( 1 ),
    foreignNumberPortedToForeignNetwork    ( 2 ),
    ... ,
    ownNumberNotPortedOut    ( 4 ),
    foreignNumberPortedIn    ( 5 ) } OPTIONAL,
istAlertTimer    [14] IMPLICIT INTEGER ( 15 .. 255 ) OPTIONAL,
supportedCamelPhasesInVMSC    [15] IMPLICIT BIT STRING {
    phase1 ( 0 ),
    phase2 ( 1 ),
    phase3 ( 2 ),
    phase4 ( 3 ) } ( SIZE( 1 .. 16 ) ) OPTIONAL,
offeredCamel4CSIsInVMSC    [16] IMPLICIT BIT STRING {
    o-csi ( 0 ),
    d-csi ( 1 ),
    vt-csi ( 2 ),
    t-csi ( 3 ),
    mt-sms-csi ( 4 ),
    mg-csi ( 5 ),
    psi-enhancements ( 6 ) } ( SIZE( 7 .. 16 ) ) OPTIONAL,
routingInfo2    [17] CHOICE {
    roamingNumber    OCTET STRING ( SIZE( 1 .. 20 ) ) ( SIZE( 1 .. 9 ) ),
    forwardingData    SEQUENCE {
        forwardedToNumber    [5] IMPLICIT OCTET STRING ( SIZE( 1 .. 20 ) ) ( SIZE( 1 .. 9 ) ) OPTIONAL,
        forwardedToSubaddress    [4] IMPLICIT OCTET STRING ( SIZE( 1 .. 21 ) ) OPTIONAL,
        forwardingOptions    [6] IMPLICIT OCTET STRING ( SIZE( 1 ) ) OPTIONAL,
        extensionContainer    [7] IMPLICIT SEQUENCE {
            privateExtensionList    [0] IMPLICIT SEQUENCE ( SIZE( 1 .. 10 ) ) OF
                SEQUENCE {
                    extId    MAP-EXTENSION .&extensionId ( {
                        '
                        ... } ),
                    extType  MAP-EXTENSION .&ExtensionType ( {
                        '
                        ... } { @extId } ) OPTIONAL} OPTIONAL,
                    pcs-Extensions    [1] IMPLICIT SEQUENCE {
                        ... } OPTIONAL,
                    ... } OPTIONAL,
                ... ,
                longForwardedToNumber    [8] IMPLICIT OCTET STRING ( SIZE( 1 .. 20 ) ) ( SIZE( 1 .. 15 ) ) OPTIONAL} OPTIONAL,
            ss-List2    [18] IMPLICIT SEQUENCE ( SIZE( 1 .. 30 ) ) OF
                OCTET STRING ( SIZE( 1 ) ) OPTIONAL,
            basicService2    [19] CHOICE {
                ext-BearerService    [2] IMPLICIT OCTET STRING ( SIZE( 1 .. 5 ) ),
                ext-Teleservice    [3] IMPLICIT OCTET STRING ( SIZE( 1 .. 5 ) ) OPTIONAL,
            allowedServices    [20] IMPLICIT BIT STRING {
                firstServiceAllowed ( 0 ),
                secondServiceAllowed ( 1 ) } ( SIZE( 2 .. 8 ) ) OPTIONAL,
            unavailabilityCause    [21] IMPLICIT ENUMERATED {
                bearerServiceNotProvisioned    ( 1 ),
                teleserviceNotProvisioned    ( 2 ),
                absentSubscriber    ( 3 ),
                busySubscriber    ( 4 ),
                callBarred    ( 5 ),
                cug-Reject    ( 6 ),
                ... } OPTIONAL}
        }
    }
}
ERRORS {
    systemFailure |
    dataMissing |
    unexpectedDataValue |
    facilityNotSupported |
    or-NotAllowed |
    unknownSubscriber |
    numberChanged |
    bearerServiceNotProvisioned |

```

```

teleserviceNotProvisioned |
absentSubscriber |
busySubscriber |
noSubscriberReply |
callBarred |
cug-Reject |
forwardingViolation }
CODE local :22
}

```

```

provideRoamingNumber OPERATION ::= {
ARGUMENT SEQUENCE {
imsi [0] IMPLICIT OCTET STRING ( SIZE( 3 .. 8 ) ),
msc-Number [1] IMPLICIT OCTET STRING ( SIZE( 1 .. 20 ) ) ( SIZE( 1 .. 9 ) ),
msisdn [2] IMPLICIT OCTET STRING ( SIZE( 1 .. 20 ) ) ( SIZE( 1 .. 9 ) ) OPTIONAL,
lmsi [4] IMPLICIT OCTET STRING ( SIZE( 4 ) ) OPTIONAL,
gsm-BearerCapability [5] IMPLICIT SEQUENCE {
protocolId ENUMERATED {
gsm-0408 ( 1 ),
gsm-0806 ( 2 ),
gsm-BSSMAP ( 3 ),
ets-300102-1 ( 4 ) },
signallInfo OCTET STRING ( SIZE( 1 .. 200 ) ),
extensionContainer SEQUENCE {
privateExtensionList [0] IMPLICIT SEQUENCE ( SIZE( 1 .. 10 ) ) OF
SEQUENCE {
extId MAP-EXTENSION .&extensionId ( {
'
...} ),
extType MAP-EXTENSION .&ExtensionType ( {
'
...}{ @extId } ) OPTIONAL} OPTIONAL,
pcs-Extensions [1] IMPLICIT SEQUENCE {
... } OPTIONAL,
... } OPTIONAL,
... } OPTIONAL,
networkSignallInfo [6] IMPLICIT SEQUENCE {
protocolId ENUMERATED {
gsm-0408 ( 1 ),
gsm-0806 ( 2 ),
gsm-BSSMAP ( 3 ),
ets-300102-1 ( 4 ) },
signallInfo OCTET STRING ( SIZE( 1 .. 200 ) ),
extensionContainer SEQUENCE {
privateExtensionList [0] IMPLICIT SEQUENCE ( SIZE( 1 .. 10 ) ) OF
SEQUENCE {
extId MAP-EXTENSION .&extensionId ( {
'
...} ),
extType MAP-EXTENSION .&ExtensionType ( {
'
...}{ @extId } ) OPTIONAL} OPTIONAL,
pcs-Extensions [1] IMPLICIT SEQUENCE {
... } OPTIONAL,
... } OPTIONAL,
... } OPTIONAL,
suppressionOfAnnouncement [7] IMPLICIT NULL OPTIONAL,
gsmc-Address [8] IMPLICIT OCTET STRING ( SIZE( 1 .. 20 ) ) ( SIZE( 1 .. 9 ) ) OPTIONAL,
callReferenceNumber [9] IMPLICIT OCTET STRING ( SIZE( 1 .. 8 ) ) OPTIONAL,
or-Interrogation [10] IMPLICIT NULL OPTIONAL,
extensionContainer [11] IMPLICIT SEQUENCE {
privateExtensionList [0] IMPLICIT SEQUENCE ( SIZE( 1 .. 10 ) ) OF
SEQUENCE {
extId MAP-EXTENSION .&extensionId ( {
'
...} ),
extType MAP-EXTENSION .&ExtensionType ( {
'
...}{ @extId } ) OPTIONAL} OPTIONAL,
pcs-Extensions [1] IMPLICIT SEQUENCE {
... } OPTIONAL,
... } OPTIONAL,
... },
alertingPattern [12] IMPLICIT OCTET STRING ( SIZE( 1 ) ) OPTIONAL,
ccbs-Call [13] IMPLICIT NULL OPTIONAL,
supportedCamelPhasesInInterrogatingNode [15] IMPLICIT BIT STRING {
phase1 ( 0 ),

```

```

    phase2 ( 1 ),
    phase3 ( 2 ),
    phase4 ( 3 ) ( SIZE( 1 .. 16 ) ) OPTIONAL,
additionalSignalInfo [14] IMPLICIT SEQUENCE {
    ext-ProtocolId  ENUMERATED {
        ets-300356 ( 1 ),
        ... },
    signalInfo      OCTET STRING ( SIZE( 1 .. 200 ) ),
    extensionContainer SEQUENCE {
        privateExtensionList [0] IMPLICIT SEQUENCE ( SIZE( 1 .. 10 ) ) OF
        SEQUENCE {
            extId  MAP-EXTENSION .&extensionId ( {
                '
                ... } ),
            extType  MAP-EXTENSION .&ExtensionType ( {
                '
                ... } { @extId } ) OPTIONAL } OPTIONAL,
        pcs-Extensions [1] IMPLICIT SEQUENCE {
            ... } OPTIONAL,
        ... } OPTIONAL,
        ... } OPTIONAL,
    orNotSupportedInGMSC [16] IMPLICIT NULL OPTIONAL,
    pre-pagingSupported [17] IMPLICIT NULL OPTIONAL,
    longFTN-Supported [18] IMPLICIT NULL OPTIONAL,
    suppress-VT-CSI [19] IMPLICIT NULL OPTIONAL,
    offeredCamel4CSIsInInterrogatingNode [20] IMPLICIT BIT STRING {
        o-csi ( 0 ),
        d-csi ( 1 ),
        vt-csi ( 2 ),
        t-csi ( 3 ),
        mt-sms-csi ( 4 ),
        mg-csi ( 5 ),
        psi-enhancements ( 6 ) ( SIZE( 7 .. 16 ) ) OPTIONAL }
RESULT SEQUENCE {
    roamingNumber  OCTET STRING ( SIZE( 1 .. 20 ) ) ( SIZE( 1 .. 9 ) ),
    extensionContainer SEQUENCE {
        privateExtensionList [0] IMPLICIT SEQUENCE ( SIZE( 1 .. 10 ) ) OF
        SEQUENCE {
            extId  MAP-EXTENSION .&extensionId ( {
                '
                ... } ),
            extType  MAP-EXTENSION .&ExtensionType ( {
                '
                ... } { @extId } ) OPTIONAL } OPTIONAL,
        pcs-Extensions [1] IMPLICIT SEQUENCE {
            ... } OPTIONAL,
        ... } OPTIONAL,
        ... }
ERRORS {
    systemFailure |
    dataMissing |
    unexpectedDataValue |
    facilityNotSupported |
    or-NotAllowed |
    absentSubscriber |
    noRoamingNumberAvailable }
CODE local : 4
}

resumeCallHandling OPERATION ::= {
ARGUMENT SEQUENCE {
    callReferenceNumber [0] IMPLICIT OCTET STRING ( SIZE( 1 .. 8 ) ) OPTIONAL,
    basicServiceGroup [1] CHOICE {
        ext-BearerService [2] IMPLICIT OCTET STRING ( SIZE( 1 .. 5 ) ),
        ext-Teleservice [3] IMPLICIT OCTET STRING ( SIZE( 1 .. 5 ) ) } OPTIONAL,
    forwardingData [2] IMPLICIT SEQUENCE {
        forwardedToNumber [5] IMPLICIT OCTET STRING ( SIZE( 1 .. 20 ) ) ( SIZE( 1 .. 9 ) ) OPTIONAL,
        forwardedToSubaddress [4] IMPLICIT OCTET STRING ( SIZE( 1 .. 21 ) ) OPTIONAL,
        forwardingOptions [6] IMPLICIT OCTET STRING ( SIZE( 1 ) ) OPTIONAL,
        extensionContainer [7] IMPLICIT SEQUENCE {
            privateExtensionList [0] IMPLICIT SEQUENCE ( SIZE( 1 .. 10 ) ) OF
            SEQUENCE {
                extId  MAP-EXTENSION .&extensionId ( {
                    '
                    ... } ),
                extType  MAP-EXTENSION .&ExtensionType ( {
                    '

```

```

...}{ @extId } ) OPTIONAL} OPTIONAL,
pcs-Extensions [1] IMPLICIT SEQUENCE {
... } OPTIONAL,
... } OPTIONAL,
... ,
longForwardedToNumber [8] IMPLICIT OCTET STRING ( SIZE( 1 .. 20 ) ) ( SIZE( 1 .. 15 ) ) OPTIONAL} OPTIONAL,
imsi [3] IMPLICIT OCTET STRING ( SIZE( 3 .. 8 ) ) OPTIONAL,
cug-CheckInfo [4] IMPLICIT SEQUENCE {
cug-Interlock OCTET STRING ( SIZE( 4 ) ),
cug-OutgoingAccess NULL OPTIONAL,
extensionContainer SEQUENCE {
privateExtensionList [0] IMPLICIT SEQUENCE ( SIZE( 1 .. 10 ) ) OF
SEQUENCE {
extId MAP-EXTENSION .&extensionId ( {
'
...} ) ,
extType MAP-EXTENSION .&ExtensionType ( {
'
...}{ @extId } ) OPTIONAL} OPTIONAL,
pcs-Extensions [1] IMPLICIT SEQUENCE {
... } OPTIONAL,
... } OPTIONAL,
... } OPTIONAL,
o-CSI [5] IMPLICIT SEQUENCE {
o-BcsmCamelTDPDataList SEQUENCE ( SIZE( 1 .. 10 ) ) OF
SEQUENCE {
o-BcsmTriggerDetectionPoint ENUMERATED {
collectedInfo ( 2 ),
... ,
routeSelectFailure ( 4 ) },
serviceKey INTEGER ( 0 .. 2147483647 ),
gsmSCF-Address [0] IMPLICIT OCTET STRING ( SIZE( 1 .. 20 ) ) ( SIZE( 1 .. 9 ) ),
defaultCallHandling [1] IMPLICIT ENUMERATED {
continueCall ( 0 ),
releaseCall ( 1 ),
... },
extensionContainer [2] IMPLICIT SEQUENCE {
privateExtensionList [0] IMPLICIT SEQUENCE ( SIZE( 1 .. 10 ) ) OF
SEQUENCE {
extId MAP-EXTENSION .&extensionId ( {
'
...} ) ,
extType MAP-EXTENSION .&ExtensionType ( {
'
...}{ @extId } ) OPTIONAL} OPTIONAL,
pcs-Extensions [1] IMPLICIT SEQUENCE {
... } OPTIONAL,
... } OPTIONAL,
... },
extensionContainer SEQUENCE {
privateExtensionList [0] IMPLICIT SEQUENCE ( SIZE( 1 .. 10 ) ) OF
SEQUENCE {
extId MAP-EXTENSION .&extensionId ( {
'
...} ) ,
extType MAP-EXTENSION .&ExtensionType ( {
'
...}{ @extId } ) OPTIONAL} OPTIONAL,
pcs-Extensions [1] IMPLICIT SEQUENCE {
... } OPTIONAL,
... } OPTIONAL,
... ,
camelCapabilityHandling [0] IMPLICIT INTEGER ( 1 .. 16 ) OPTIONAL,
notificationToCSE [1] IMPLICIT NULL OPTIONAL,
csiActive [2] IMPLICIT NULL OPTIONAL} OPTIONAL,
extensionContainer [7] IMPLICIT SEQUENCE {
privateExtensionList [0] IMPLICIT SEQUENCE ( SIZE( 1 .. 10 ) ) OF
SEQUENCE {
extId MAP-EXTENSION .&extensionId ( {
'
...} ) ,
extType MAP-EXTENSION .&ExtensionType ( {
'
...}{ @extId } ) OPTIONAL} OPTIONAL,
pcs-Extensions [1] IMPLICIT SEQUENCE {
... } OPTIONAL,
... } OPTIONAL,
... } OPTIONAL,

```

```

ccbs-Possible          [8] IMPLICIT NULL OPTIONAL,
msisdn                 [9] IMPLICIT OCTET STRING ( SIZE( 1 .. 20 ) ) ( SIZE( 1 .. 9 ) ) OPTIONAL,
uu-Data                [10] IMPLICIT SEQUENCE {
  uuIndicator          [0] IMPLICIT OCTET STRING ( SIZE( 1 ) ) OPTIONAL,
  uui                  [1] IMPLICIT OCTET STRING ( SIZE( 1 .. 131 ) ) OPTIONAL,
  uusCFInteraction     [2] IMPLICIT NULL OPTIONAL,
  extensionContainer   [3] IMPLICIT SEQUENCE {
    privateExtensionList [0] IMPLICIT SEQUENCE ( SIZE( 1 .. 10 ) ) OF
      SEQUENCE {
        extId    MAP-EXTENSION .&extensionId ( {
          '
          ... } ),
        extType  MAP-EXTENSION .&ExtensionType ( {
          '
          ... } { @extId } ) OPTIONAL } OPTIONAL,
    pcs-Extensions [1] IMPLICIT SEQUENCE {
      ... } OPTIONAL,
      ... } OPTIONAL,
      ... } OPTIONAL,
  } OPTIONAL,
allInformationSent     [11] IMPLICIT NULL OPTIONAL,
... ,
d-csi                  [12] IMPLICIT SEQUENCE {
  dp-AnalysedInfoCriteriaList [0] IMPLICIT SEQUENCE ( SIZE( 1 .. 10 ) ) OF
    SEQUENCE {
      dialledNumber    OCTET STRING ( SIZE( 1 .. 20 ) ) ( SIZE( 1 .. 9 ) ),
      serviceKey       INTEGER ( 0 .. 2147483647 ),
      gsmSCF-Address   OCTET STRING ( SIZE( 1 .. 20 ) ) ( SIZE( 1 .. 9 ) ),
      defaultCallHandling ENUMERATED {
        continueCall ( 0 ),
        releaseCall ( 1 ),
        ... },
      extensionContainer SEQUENCE {
        privateExtensionList [0] IMPLICIT SEQUENCE ( SIZE( 1 .. 10 ) ) OF
          SEQUENCE {
            extId    MAP-EXTENSION .&extensionId ( {
              '
              ... } ),
            extType  MAP-EXTENSION .&ExtensionType ( {
              '
              ... } { @extId } ) OPTIONAL } OPTIONAL,
          pcs-Extensions [1] IMPLICIT SEQUENCE {
            ... } OPTIONAL,
            ... } OPTIONAL,
            ... } OPTIONAL,
          } OPTIONAL,
        camelCapabilityHandling [1] IMPLICIT INTEGER ( 1 .. 16 ) OPTIONAL,
        extensionContainer [2] IMPLICIT SEQUENCE {
          privateExtensionList [0] IMPLICIT SEQUENCE ( SIZE( 1 .. 10 ) ) OF
            SEQUENCE {
              extId    MAP-EXTENSION .&extensionId ( {
                '
                ... } ),
              extType  MAP-EXTENSION .&ExtensionType ( {
                '
                ... } { @extId } ) OPTIONAL } OPTIONAL,
            pcs-Extensions [1] IMPLICIT SEQUENCE {
              ... } OPTIONAL,
              ... } OPTIONAL,
              ... } OPTIONAL,
            notificationToCSE [3] IMPLICIT NULL OPTIONAL,
            csi-Active [4] IMPLICIT NULL OPTIONAL,
            ... } OPTIONAL,
          } OPTIONAL,
        o-BcsmCamelTDPCriteriaList [13] IMPLICIT SEQUENCE ( SIZE( 1 .. 10 ) ) OF
          SEQUENCE {
            o-BcsmTriggerDetectionPoint ENUMERATED {
              collectedInfo ( 2 ),
              ... ,
              routeSelectFailure ( 4 ) },
            destinationNumberCriteria [0] IMPLICIT SEQUENCE {
              matchType [0] IMPLICIT ENUMERATED {
                inhibiting ( 0 ),
                enabling ( 1 ) },
              destinationNumberList [1] IMPLICIT SEQUENCE ( SIZE( 1 .. 10 ) ) OF
                OCTET STRING ( SIZE( 1 .. 20 ) ) ( SIZE( 1 .. 9 ) ) OPTIONAL,
              destinationNumberLengthList [2] IMPLICIT SEQUENCE ( SIZE( 1 .. 3 ) ) OF
                INTEGER ( 1 .. 15 ) OPTIONAL,
              ... } OPTIONAL,
            basicServiceCriteria [1] IMPLICIT SEQUENCE ( SIZE( 1 .. 5 ) ) OF
              CHOICE {

```

```

    ext-BearerService [2] IMPLICIT OCTET STRING ( SIZE( 1 .. 5 ) ),
    ext-Teleservice [3] IMPLICIT OCTET STRING ( SIZE( 1 .. 5 ) )} OPTIONAL,
callTypeCriteria [2] IMPLICIT ENUMERATED {
    forwarded ( 0 ),
    notForwarded ( 1 ) } OPTIONAL,
... ,
o-CauseValueCriteria [3] IMPLICIT SEQUENCE ( SIZE( 1 .. 5 ) ) OF
OCTET STRING ( SIZE( 1 ) ) OPTIONAL,
extensionContainer [4] IMPLICIT SEQUENCE {
    privateExtensionList [0] IMPLICIT SEQUENCE ( SIZE( 1 .. 10 ) ) OF
SEQUENCE {
    extId MAP-EXTENSION .&extensionId ( {
        '
        ... } ),
    extType MAP-EXTENSION .&ExtensionType ( {
        '
        ... } { @extId } ) OPTIONAL} OPTIONAL,
    pcs-Extensions [1] IMPLICIT SEQUENCE {
    ... } OPTIONAL,
    ... } OPTIONAL} OPTIONAL,
basicServiceGroup2 [14] CHOICE {
    ext-BearerService [2] IMPLICIT OCTET STRING ( SIZE( 1 .. 5 ) ),
    ext-Teleservice [3] IMPLICIT OCTET STRING ( SIZE( 1 .. 5 ) )} OPTIONAL}
RESULT SEQUENCE {
    extensionContainer SEQUENCE {
    privateExtensionList [0] IMPLICIT SEQUENCE ( SIZE( 1 .. 10 ) ) OF
SEQUENCE {
    extId MAP-EXTENSION .&extensionId ( {
        '
        ... } ),
    extType MAP-EXTENSION .&ExtensionType ( {
        '
        ... } { @extId } ) OPTIONAL} OPTIONAL,
    pcs-Extensions [1] IMPLICIT SEQUENCE {
    ... } OPTIONAL,
    ... } OPTIONAL,
    ... }
ERRORS {
    forwardingFailed |
    or-NotAllowed |
    unexpectedDataValue |
    dataMissing }
CODE local :6
}

```

```

provideSIWFsNumber OPERATION ::= {
    ARGUMENT SEQUENCE {
    gsm-BearerCapability [0] IMPLICIT SEQUENCE {
    protocolId ENUMERATED {
    gsm-0408 ( 1 ),
    gsm-0806 ( 2 ),
    gsm-BSSMAP ( 3 ),
    ets-300102-1 ( 4 ) },
    signalInfo OCTET STRING ( SIZE( 1 .. 200 ) ),
    extensionContainer SEQUENCE {
    privateExtensionList [0] IMPLICIT SEQUENCE ( SIZE( 1 .. 10 ) ) OF
SEQUENCE {
    extId MAP-EXTENSION .&extensionId ( {
        '
        ... } ),
    extType MAP-EXTENSION .&ExtensionType ( {
        '
        ... } { @extId } ) OPTIONAL} OPTIONAL,
    pcs-Extensions [1] IMPLICIT SEQUENCE {
    ... } OPTIONAL,
    ... } OPTIONAL,
    ... },
    isdn-BearerCapability [1] IMPLICIT SEQUENCE {
    protocolId ENUMERATED {
    gsm-0408 ( 1 ),
    gsm-0806 ( 2 ),
    gsm-BSSMAP ( 3 ),
    ets-300102-1 ( 4 ) },
    signalInfo OCTET STRING ( SIZE( 1 .. 200 ) ),
    extensionContainer SEQUENCE {
    privateExtensionList [0] IMPLICIT SEQUENCE ( SIZE( 1 .. 10 ) ) OF
SEQUENCE {

```

```

    extId    MAP-EXTENSION .&extensionId ( {
        '
        ... } ),
    extType  MAP-EXTENSION .&ExtensionType ( {
        '
        ... } { @extId } ) OPTIONAL } OPTIONAL,
    pcs-Extensions [1] IMPLICIT SEQUENCE {
        ... } OPTIONAL,
    ... } OPTIONAL,
    ... },
call-Direction [2] IMPLICIT OCTET STRING ( SIZE( 1 ) ),
b-Subscriber-Address [3] IMPLICIT OCTET STRING ( SIZE( 1 .. 20 ) ) ( SIZE( 1 .. 9 ) ),
chosenChannel [4] IMPLICIT SEQUENCE {
    protocolId    ENUMERATED {
        gsm-0408    ( 1 ),
        gsm-0806    ( 2 ),
        gsm-BSSMAP ( 3 ),
        ets-300102-1 ( 4 ) },
    signalInfo    OCTET STRING ( SIZE( 1 .. 200 ) ),
    extensionContainer SEQUENCE {
        privateExtensionList [0] IMPLICIT SEQUENCE ( SIZE( 1 .. 10 ) ) OF
        SEQUENCE {
            extId    MAP-EXTENSION .&extensionId ( {
                '
                ... } ),
            extType  MAP-EXTENSION .&ExtensionType ( {
                '
                ... } { @extId } ) OPTIONAL } OPTIONAL,
            pcs-Extensions [1] IMPLICIT SEQUENCE {
                ... } OPTIONAL,
            ... } OPTIONAL,
            ... },
lowerLayerCompatibility [5] IMPLICIT SEQUENCE {
    protocolId    ENUMERATED {
        gsm-0408    ( 1 ),
        gsm-0806    ( 2 ),
        gsm-BSSMAP ( 3 ),
        ets-300102-1 ( 4 ) },
    signalInfo    OCTET STRING ( SIZE( 1 .. 200 ) ),
    extensionContainer SEQUENCE {
        privateExtensionList [0] IMPLICIT SEQUENCE ( SIZE( 1 .. 10 ) ) OF
        SEQUENCE {
            extId    MAP-EXTENSION .&extensionId ( {
                '
                ... } ),
            extType  MAP-EXTENSION .&ExtensionType ( {
                '
                ... } { @extId } ) OPTIONAL } OPTIONAL,
            pcs-Extensions [1] IMPLICIT SEQUENCE {
                ... } OPTIONAL,
                ... } OPTIONAL,
                ... },
highLayerCompatibility [6] IMPLICIT SEQUENCE {
    protocolId    ENUMERATED {
        gsm-0408    ( 1 ),
        gsm-0806    ( 2 ),
        gsm-BSSMAP ( 3 ),
        ets-300102-1 ( 4 ) },
    signalInfo    OCTET STRING ( SIZE( 1 .. 200 ) ),
    extensionContainer SEQUENCE {
        privateExtensionList [0] IMPLICIT SEQUENCE ( SIZE( 1 .. 10 ) ) OF
        SEQUENCE {
            extId    MAP-EXTENSION .&extensionId ( {
                '
                ... } ),
            extType  MAP-EXTENSION .&ExtensionType ( {
                '
                ... } { @extId } ) OPTIONAL } OPTIONAL,
            pcs-Extensions [1] IMPLICIT SEQUENCE {
                ... } OPTIONAL,
                ... } OPTIONAL,
                ... },
extensionContainer [7] IMPLICIT SEQUENCE {
    privateExtensionList [0] IMPLICIT SEQUENCE ( SIZE( 1 .. 10 ) ) OF
    SEQUENCE {
        extId    MAP-EXTENSION .&extensionId ( {
            '

```

```

        ...}),
        extType MAP-EXTENSION .&ExtensionType ( {
            '...}{ @extId } ) OPTIONAL} OPTIONAL,
        pcs-Extensions [1] IMPLICIT SEQUENCE {
            ... } OPTIONAL,
            ... } OPTIONAL,
        ... }
    }
RESULT SEQUENCE {
    siWFSNumber [0] IMPLICIT OCTET STRING ( SIZE( 1 .. 20 ) ) ( SIZE( 1 .. 9 ) ),
    extensionContainer [1] IMPLICIT SEQUENCE {
        privateExtensionList [0] IMPLICIT SEQUENCE ( SIZE( 1 .. 10 ) ) OF
        SEQUENCE {
            extId MAP-EXTENSION .&extensionId ( {
                '...}),
                extType MAP-EXTENSION .&ExtensionType ( {
                    '...}{ @extId } ) OPTIONAL} OPTIONAL,
                    pcs-Extensions [1] IMPLICIT SEQUENCE {
                        ... } OPTIONAL,
                        ... } OPTIONAL,
                    ... }
                }
    }
ERRORS {
    resourceLimitation |
    dataMissing |
    unexpectedDataValue |
    systemFailure }
CODE local : 31
}

siwfs-SignallingModify OPERATION ::= {
    ARGUMENT SEQUENCE {
        channelType [0] IMPLICIT SEQUENCE {
            protocolId ENUMERATED {
                gsm-0408 ( 1 ),
                gsm-0806 ( 2 ),
                gsm-BSSMAP ( 3 ),
                ets-300102-1 ( 4 ) },
            signalInfo OCTET STRING ( SIZE( 1 .. 200 ) ),
            extensionContainer SEQUENCE {
                privateExtensionList [0] IMPLICIT SEQUENCE ( SIZE( 1 .. 10 ) ) OF
                SEQUENCE {
                    extId MAP-EXTENSION .&extensionId ( {
                        '...}),
                        extType MAP-EXTENSION .&ExtensionType ( {
                            '...}{ @extId } ) OPTIONAL} OPTIONAL,
                            pcs-Extensions [1] IMPLICIT SEQUENCE {
                                ... } OPTIONAL,
                                ... } OPTIONAL,
                            ... } OPTIONAL,
                        }
                    }
                }
            }
        }
        chosenChannel [1] IMPLICIT SEQUENCE {
            protocolId ENUMERATED {
                gsm-0408 ( 1 ),
                gsm-0806 ( 2 ),
                gsm-BSSMAP ( 3 ),
                ets-300102-1 ( 4 ) },
            signalInfo OCTET STRING ( SIZE( 1 .. 200 ) ),
            extensionContainer SEQUENCE {
                privateExtensionList [0] IMPLICIT SEQUENCE ( SIZE( 1 .. 10 ) ) OF
                SEQUENCE {
                    extId MAP-EXTENSION .&extensionId ( {
                        '...}),
                        extType MAP-EXTENSION .&ExtensionType ( {
                            '...}{ @extId } ) OPTIONAL} OPTIONAL,
                            pcs-Extensions [1] IMPLICIT SEQUENCE {
                                ... } OPTIONAL,
                                ... } OPTIONAL,
                            ... } OPTIONAL,
                        }
                    }
                }
            }
        }
        extensionContainer [2] IMPLICIT SEQUENCE {
            privateExtensionList [0] IMPLICIT SEQUENCE ( SIZE( 1 .. 10 ) ) OF
            SEQUENCE {
                extId MAP-EXTENSION .&extensionId ( {

```



```

        ...}),
        extType MAP-EXTENSION .&ExtensionType ( {
            ...}{ @extId } ) OPTIONAL} OPTIONAL,
        pcs-Extensions [1] IMPLICIT SEQUENCE {
            ... } OPTIONAL,
        ... } OPTIONAL,
    ... }
}
RESULT SEQUENCE {
    chosenChannel [0] IMPLICIT SEQUENCE {
        protocolId ENUMERATED {
            gsm-0408 ( 1 ),
            gsm-0806 ( 2 ),
            gsm-BSSMAP ( 3 ),
            ets-300102-1 ( 4 )},
        signalInfo OCTET STRING ( SIZE( 1 .. 200 ) ),
        extensionContainer SEQUENCE {
            privateExtensionList [0] IMPLICIT SEQUENCE ( SIZE( 1 .. 10 ) ) OF
                SEQUENCE {
                    extId MAP-EXTENSION .&extensionId ( {
                        ...}),
                    extType MAP-EXTENSION .&ExtensionType ( {
                        ...}{ @extId } ) OPTIONAL} OPTIONAL,
                    pcs-Extensions [1] IMPLICIT SEQUENCE {
                        ... } OPTIONAL,
                    ... } OPTIONAL,
                ... } OPTIONAL,
            extensionContainer [1] IMPLICIT SEQUENCE {
                privateExtensionList [0] IMPLICIT SEQUENCE ( SIZE( 1 .. 10 ) ) OF
                    SEQUENCE {
                        extId MAP-EXTENSION .&extensionId ( {
                            ...}),
                        extType MAP-EXTENSION .&ExtensionType ( {
                            ...}{ @extId } ) OPTIONAL} OPTIONAL,
                        pcs-Extensions [1] IMPLICIT SEQUENCE {
                            ... } OPTIONAL,
                        ... } OPTIONAL,
                    ... }
                }
            ERRORS {
                resourceLimitation |
                dataMissing |
                unexpectedDataValue |
                systemFailure }
            CODE local : 32
        }
    }
}

setReportingState OPERATION ::= {
    ARGUMENT SEQUENCE {
        imsi [0] IMPLICIT OCTET STRING ( SIZE( 3 .. 8 ) ) OPTIONAL,
        lmsi [1] IMPLICIT OCTET STRING ( SIZE( 4 ) ) OPTIONAL,
        ccbs-Monitoring [2] IMPLICIT ENUMERATED {
            stopMonitoring ( 0 ),
            startMonitoring ( 1 ),
            ... } OPTIONAL,
        extensionContainer [3] IMPLICIT SEQUENCE {
            privateExtensionList [0] IMPLICIT SEQUENCE ( SIZE( 1 .. 10 ) ) OF
                SEQUENCE {
                    extId MAP-EXTENSION .&extensionId ( {
                        ...}),
                    extType MAP-EXTENSION .&ExtensionType ( {
                        ...}{ @extId } ) OPTIONAL} OPTIONAL,
                    pcs-Extensions [1] IMPLICIT SEQUENCE {
                        ... } OPTIONAL,
                    ... } OPTIONAL,
                ... }
            }
        }
    }
    RESULT SEQUENCE {
        ccbs-SubscriberStatus [0] IMPLICIT ENUMERATED {
            ccbsNotIdle ( 0 ),
            ccbsIdle ( 1 ),
            ccbsNotReachable ( 2 ),

```

```

... } OPTIONAL,
extensionContainer [1] IMPLICIT SEQUENCE {
  privateExtensionList [0] IMPLICIT SEQUENCE ( SIZE( 1 .. 10 ) ) OF
  SEQUENCE {
    extId MAP-EXTENSION .&extensionId ( {
      '
      ... } ),
    extType MAP-EXTENSION .&ExtensionType ( {
      '
      ... } { @extId } ) OPTIONAL } OPTIONAL,
  pcs-Extensions [1] IMPLICIT SEQUENCE {
    ... } OPTIONAL,
    ... } OPTIONAL,
    ... } OPTIONAL,
  ... }
ERRORS {
  systemFailure |
  unidentifiedSubscriber |
  unexpectedDataValue |
  dataMissing |
  resourceLimitation |
  facilityNotSupported }
CODE local : 73
}

statusReport OPERATION ::= {
  ARGUMENT SEQUENCE {
    imsi [0] IMPLICIT OCTET STRING ( SIZE( 3 .. 8 ) ),
    eventReportData [1] IMPLICIT SEQUENCE {
      ccbs-SubscriberStatus [0] IMPLICIT ENUMERATED {
        ccbsNotIdle ( 0 ),
        ccbsIdle ( 1 ),
        ccbsNotReachable ( 2 ),
        ... } OPTIONAL,
      extensionContainer [1] IMPLICIT SEQUENCE {
        privateExtensionList [0] IMPLICIT SEQUENCE ( SIZE( 1 .. 10 ) ) OF
        SEQUENCE {
          extId MAP-EXTENSION .&extensionId ( {
            '
            ... } ),
          extType MAP-EXTENSION .&ExtensionType ( {
            '
            ... } { @extId } ) OPTIONAL } OPTIONAL,
        pcs-Extensions [1] IMPLICIT SEQUENCE {
          ... } OPTIONAL,
          ... } OPTIONAL,
          ... } OPTIONAL,
          ... } OPTIONAL,
        callReportdata [2] IMPLICIT SEQUENCE {
          monitoringMode [0] IMPLICIT ENUMERATED {
            a-side ( 0 ),
            b-side ( 1 ),
            ... } OPTIONAL,
          callOutcome [1] IMPLICIT ENUMERATED {
            success ( 0 ),
            failure ( 1 ),
            busy ( 2 ),
            ... } OPTIONAL,
          extensionContainer [2] IMPLICIT SEQUENCE {
            privateExtensionList [0] IMPLICIT SEQUENCE ( SIZE( 1 .. 10 ) ) OF
            SEQUENCE {
              extId MAP-EXTENSION .&extensionId ( {
                '
                ... } ),
              extType MAP-EXTENSION .&ExtensionType ( {
                '
                ... } { @extId } ) OPTIONAL } OPTIONAL,
            pcs-Extensions [1] IMPLICIT SEQUENCE {
              ... } OPTIONAL,
              ... } OPTIONAL,
              ... } OPTIONAL,
              ... } OPTIONAL,
            extensionContainer [3] IMPLICIT SEQUENCE {
              privateExtensionList [0] IMPLICIT SEQUENCE ( SIZE( 1 .. 10 ) ) OF
              SEQUENCE {
                extId MAP-EXTENSION .&extensionId ( {
                  '
                  ... } ),
                extType MAP-EXTENSION .&ExtensionType ( {
                  '

```

```

        ...}{ @extId } ) OPTIONAL} OPTIONAL,
    pcs-Extensions [1] IMPLICIT SEQUENCE {
        ... } OPTIONAL,
        ... } OPTIONAL,
        ... }
RESULT SEQUENCE {
    extensionContainer [0] IMPLICIT SEQUENCE {
        privateExtensionList [0] IMPLICIT SEQUENCE ( SIZE( 1 .. 10 ) ) OF
        SEQUENCE {
            extId MAP-EXTENSION .&extensionId ( {
                '
                ...} ),
            extType MAP-EXTENSION .&ExtensionType ( {
                '
                ...}{ @extId } ) OPTIONAL} OPTIONAL,
            pcs-Extensions [1] IMPLICIT SEQUENCE {
                ... } OPTIONAL,
                ... } OPTIONAL,
                ... }
ERRORS {
    unknownSubscriber |
    systemFailure |
    unexpectedDataValue |
    dataMissing }
CODE local : 74
}

remoteUserFree OPERATION ::= {
    ARGUMENT SEQUENCE {
        imsi [0] IMPLICIT OCTET STRING ( SIZE( 3 .. 8 ) ),
        callInfo [1] IMPLICIT SEQUENCE {
            protocolId ENUMERATED {
                gsm-0408 ( 1 ),
                gsm-0806 ( 2 ),
                gsm-BSSMAP ( 3 ),
                ets-300102-1 ( 4 ) },
            signalInfo OCTET STRING ( SIZE( 1 .. 200 ) ),
            extensionContainer SEQUENCE {
                privateExtensionList [0] IMPLICIT SEQUENCE ( SIZE( 1 .. 10 ) ) OF
                SEQUENCE {
                    extId MAP-EXTENSION .&extensionId ( {
                        '
                        ...} ),
                    extType MAP-EXTENSION .&ExtensionType ( {
                        '
                        ...}{ @extId } ) OPTIONAL} OPTIONAL,
                    pcs-Extensions [1] IMPLICIT SEQUENCE {
                        ... } OPTIONAL,
                        ... } OPTIONAL,
                        ... } },
            ccbs-Feature [2] IMPLICIT SEQUENCE {
                ccbs-Index [0] IMPLICIT INTEGER ( 1 .. 5 ) OPTIONAL,
                b-subscriberNumber [1] IMPLICIT OCTET STRING ( SIZE( 1 .. 20 ) ) ( SIZE( 1 .. 9 ) ) OPTIONAL,
                b-subscriberSubaddress [2] IMPLICIT OCTET STRING ( SIZE( 1 .. 21 ) ) OPTIONAL,
                basicServiceGroup [3] CHOICE {
                    bearerService [2] IMPLICIT OCTET STRING ( SIZE( 1 ) ),
                    teleservice [3] IMPLICIT OCTET STRING ( SIZE( 1 ) ) } OPTIONAL,
                    ... },
                translatedB-Number [3] IMPLICIT OCTET STRING ( SIZE( 1 .. 20 ) ) ( SIZE( 1 .. 9 ) ),
                replaceB-Number [4] IMPLICIT NULL OPTIONAL,
                alertingPattern [5] IMPLICIT OCTET STRING ( SIZE( 1 ) ) OPTIONAL,
                extensionContainer [6] IMPLICIT SEQUENCE {
                    privateExtensionList [0] IMPLICIT SEQUENCE ( SIZE( 1 .. 10 ) ) OF
                    SEQUENCE {
                        extId MAP-EXTENSION .&extensionId ( {
                            '
                            ...} ),
                        extType MAP-EXTENSION .&ExtensionType ( {
                            '
                            ...}{ @extId } ) OPTIONAL} OPTIONAL,
                        pcs-Extensions [1] IMPLICIT SEQUENCE {
                            ... } OPTIONAL,
                            ... } OPTIONAL,
                            ... }
                RESULT SEQUENCE {
                    ruf-Outcome [0] IMPLICIT ENUMERATED {
                        accepted ( 0 ),

```

```

rejected          ( 1 ),
noResponseFromFreeMS ( 2 ),
noResponseFromBusyMS ( 3 ),
udubFromFreeMS     ( 4 ),
udubFromBusyMS     ( 5 ),
... },
extensionContainer [1] IMPLICIT SEQUENCE {
  privateExtensionList [0] IMPLICIT SEQUENCE ( SIZE ( 1 .. 10 ) ) OF
  SEQUENCE {
    extId  MAP-EXTENSION .&extensionId ( {
      '
      ... } ),
    extType  MAP-EXTENSION .&ExtensionType ( {
      '
      ... } { @extId } ) OPTIONAL } OPTIONAL,
  pcs-Extensions [1] IMPLICIT SEQUENCE {
    ... } OPTIONAL,
    ... } OPTIONAL,
    ... }
ERRORS {
  unexpectedDataValue |
  dataMissing |
  incompatibleTerminal |
  absentSubscriber |
  systemFailure |
  busySubscriber }
CODE local : 75
}

```

```

ist-Alert OPERATION ::= {
  ARGUMENT SEQUENCE {
    imsi [0] IMPLICIT OCTET STRING ( SIZE ( 3 .. 8 ) ),
    extensionContainer [1] IMPLICIT SEQUENCE {
      privateExtensionList [0] IMPLICIT SEQUENCE ( SIZE ( 1 .. 10 ) ) OF
      SEQUENCE {
        extId  MAP-EXTENSION .&extensionId ( {
          '
          ... } ),
        extType  MAP-EXTENSION .&ExtensionType ( {
          '
          ... } { @extId } ) OPTIONAL } OPTIONAL,
        pcs-Extensions [1] IMPLICIT SEQUENCE {
          ... } OPTIONAL,
          ... } OPTIONAL,
          ... }
      RESULT SEQUENCE {
        istAlertTimer [0] IMPLICIT INTEGER ( 15 .. 255 ) OPTIONAL,
        istInformationWithdraw [1] IMPLICIT NULL OPTIONAL,
        callTerminationIndicator [2] IMPLICIT ENUMERATED {
          terminateCallActivityReferred ( 0 ),
          terminateAllCallActivities ( 1 ),
          ... } OPTIONAL,
        extensionContainer [3] IMPLICIT SEQUENCE {
          privateExtensionList [0] IMPLICIT SEQUENCE ( SIZE ( 1 .. 10 ) ) OF
          SEQUENCE {
            extId  MAP-EXTENSION .&extensionId ( {
              '
              ... } ),
            extType  MAP-EXTENSION .&ExtensionType ( {
              '
              ... } { @extId } ) OPTIONAL } OPTIONAL,
            pcs-Extensions [1] IMPLICIT SEQUENCE {
              ... } OPTIONAL,
              ... } OPTIONAL,
              ... }
          ERRORS {
            unexpectedDataValue |
            resourceLimitation |
            unknownSubscriber |
            systemFailure |
            facilityNotSupported }
          CODE local : 87
          }
}

```

```

ist-Command OPERATION ::= {
  ARGUMENT SEQUENCE {
    imsi [0] IMPLICIT OCTET STRING ( SIZE ( 3 .. 8 ) ),

```

```

extensionContainer [1] IMPLICIT SEQUENCE {
  privateExtensionList [0] IMPLICIT SEQUENCE ( SIZE( 1 .. 10 ) ) OF
  SEQUENCE {
    extId    MAP-EXTENSION .&extensionId ( {
      '
      ... } ),
    extType  MAP-EXTENSION .&ExtensionType ( {
      '
      ... } { @extId } ) OPTIONAL } OPTIONAL,
  pcs-Extensions [1] IMPLICIT SEQUENCE {
    ... } OPTIONAL,
  ... } OPTIONAL,
  ... }
RESULT SEQUENCE {
  extensionContainer SEQUENCE {
    privateExtensionList [0] IMPLICIT SEQUENCE ( SIZE( 1 .. 10 ) ) OF
    SEQUENCE {
      extId    MAP-EXTENSION .&extensionId ( {
        '
        ... } ),
      extType  MAP-EXTENSION .&ExtensionType ( {
        '
        ... } { @extId } ) OPTIONAL } OPTIONAL,
    pcs-Extensions [1] IMPLICIT SEQUENCE {
      ... } OPTIONAL,
    ... } OPTIONAL,
    ... }
  ... }
ERRORS {
  unexpectedDataValue |
  resourceLimitation |
  unknownSubscriber |
  systemFailure |
  facilityNotSupported }
CODE local : 88
}

```

END

```

--Expanded ASN1 Module 'MAP-SupplementaryServiceOperations'
--SIEMENS ASN.1 Compiler R6.0 (Production_6.0)
-- Date: 2006-06-08 Time: 15:11:16

```

MAP-SupplementaryServiceOperations{ 0 identified-organization (4) etsi (0) mobileDomain (0) gsm-Network (1) modules (3) map-SupplementaryServiceOperations (8) version8 (8) }

DEFINITIONS

::=

BEGIN

EXPORTS

```

registerSS,
eraseSS,
activateSS,
deactivateSS,
interrogateSS,
processUnstructuredSS-Request,
unstructuredSS-Request,
unstructuredSS-Notify,
registerPassword,
getPassword,
ss-InvocationNotification,
registerCC-Entry,
eraseCC-Entry;

```

```

registerSS OPERATION ::= {
  ARGUMENT SEQUENCE {
    ss-Code      OCTET STRING ( SIZE( 1 ) ),
    basicService CHOICE {
      bearerService [2] IMPLICIT OCTET STRING ( SIZE( 1 ) ),
      teleservice [3] IMPLICIT OCTET STRING ( SIZE( 1 ) ) } OPTIONAL,
    forwardedToNumber [4] IMPLICIT OCTET STRING ( SIZE( 1 .. 20 ) ) OPTIONAL,
    forwardedToSubaddress [6] IMPLICIT OCTET STRING ( SIZE( 1 .. 21 ) ) OPTIONAL,
    noReplyConditionTime [5] IMPLICIT INTEGER ( 5 .. 30 ) OPTIONAL,

```

```

... ,
defaultPriority [7] IMPLICIT INTEGER ( 0 .. 15 ) OPTIONAL,
nbrUser [8] IMPLICIT INTEGER ( 1 .. 7 ) OPTIONAL,
longFTN-Supported [9] IMPLICIT NULL OPTIONAL}
RESULT CHOICE {
forwardingInfo [0] IMPLICIT SEQUENCE {
ss-Code OCTET STRING ( SIZE( 1 ) ) OPTIONAL,
forwardingFeatureList SEQUENCE ( SIZE( 1 .. 13 ) ) OF
SEQUENCE {
basicService CHOICE {
bearerService [2] IMPLICIT OCTET STRING ( SIZE( 1 ) ),
teleservice [3] IMPLICIT OCTET STRING ( SIZE( 1 ) )} OPTIONAL,
ss-Status [4] IMPLICIT OCTET STRING ( SIZE( 1 ) ) OPTIONAL,
forwardedToNumber [5] IMPLICIT OCTET STRING ( SIZE( 1 .. 20 ) ) ( SIZE( 1 .. 9 ) ) OPTIONAL,
forwardedToSubaddress [8] IMPLICIT OCTET STRING ( SIZE( 1 .. 21 ) ) OPTIONAL,
forwardingOptions [6] IMPLICIT OCTET STRING ( SIZE( 1 ) ) OPTIONAL,
noReplyConditionTime [7] IMPLICIT INTEGER ( 5 .. 30 ) OPTIONAL,
... ,
longForwardedToNumber [9] IMPLICIT OCTET STRING ( SIZE( 1 .. 20 ) ) ( SIZE( 1 .. 15 ) ) OPTIONAL},
... },
callBarringInfo [1] IMPLICIT SEQUENCE {
ss-Code OCTET STRING ( SIZE( 1 ) ) OPTIONAL,
callBarringFeatureList SEQUENCE ( SIZE( 1 .. 13 ) ) OF
SEQUENCE {
basicService CHOICE {
bearerService [2] IMPLICIT OCTET STRING ( SIZE( 1 ) ),
teleservice [3] IMPLICIT OCTET STRING ( SIZE( 1 ) )} OPTIONAL,
ss-Status [4] IMPLICIT OCTET STRING ( SIZE( 1 ) ) OPTIONAL,
... },
... },
ss-Data [3] IMPLICIT SEQUENCE {
ss-Code OCTET STRING ( SIZE( 1 ) ) OPTIONAL,
ss-Status [4] IMPLICIT OCTET STRING ( SIZE( 1 ) ) OPTIONAL,
ss-SubscriptionOption CHOICE {
cliRestrictionOption [2] IMPLICIT ENUMERATED {
permanent ( 0 ),
temporaryDefaultRestricted ( 1 ),
temporaryDefaultAllowed ( 2 )},
overrideCategory [1] IMPLICIT ENUMERATED {
overrideEnabled ( 0 ),
overrideDisabled ( 1 )} OPTIONAL,
basicServiceGroupList SEQUENCE ( SIZE( 1 .. 13 ) ) OF
CHOICE {
bearerService [2] IMPLICIT OCTET STRING ( SIZE( 1 ) ),
teleservice [3] IMPLICIT OCTET STRING ( SIZE( 1 ) )} OPTIONAL,
... ,
defaultPriority INTEGER ( 0 .. 15 ) OPTIONAL,
nbrUser [5] IMPLICIT INTEGER ( 1 .. 7 ) OPTIONAL}}
ERRORS {
systemFailure |
dataMissing |
unexpectedDataValue |
bearerServiceNotProvisioned |
teleserviceNotProvisioned |
callBarred |
illegalSS-Operation |
ss-ErrorStatus |
ss-Incompatibility }
CODE local : 10
}

```

```

eraseSS OPERATION ::= {
ARGUMENT SEQUENCE {
ss-Code OCTET STRING ( SIZE( 1 ) ),
basicService CHOICE {
bearerService [2] IMPLICIT OCTET STRING ( SIZE( 1 ) ),
teleservice [3] IMPLICIT OCTET STRING ( SIZE( 1 ) )} OPTIONAL,
... ,
longFTN-Supported [4] IMPLICIT NULL OPTIONAL}
RESULT CHOICE {
forwardingInfo [0] IMPLICIT SEQUENCE {
ss-Code OCTET STRING ( SIZE( 1 ) ) OPTIONAL,
forwardingFeatureList SEQUENCE ( SIZE( 1 .. 13 ) ) OF
SEQUENCE {
basicService CHOICE {
bearerService [2] IMPLICIT OCTET STRING ( SIZE( 1 ) ),
teleservice [3] IMPLICIT OCTET STRING ( SIZE( 1 ) )} OPTIONAL,

```

```

    ss-Status          [4] IMPLICIT OCTET STRING ( SIZE( 1 ) ) OPTIONAL,
    forwardedToNumber [5] IMPLICIT OCTET STRING ( SIZE( 1 .. 20 ) ) ( SIZE( 1 .. 9 ) ) OPTIONAL,
    forwardedToSubaddress [8] IMPLICIT OCTET STRING ( SIZE( 1 .. 21 ) ) OPTIONAL,
    forwardingOptions  [6] IMPLICIT OCTET STRING ( SIZE( 1 ) ) OPTIONAL,
    noReplyConditionTime [7] IMPLICIT INTEGER ( 5 .. 30 ) OPTIONAL,
    ... ,
    longForwardedToNumber [9] IMPLICIT OCTET STRING ( SIZE( 1 .. 20 ) ) ( SIZE( 1 .. 15 ) ) OPTIONAL,
    ... },
callBarringInfo [1] IMPLICIT SEQUENCE {
    ss-Code          OCTET STRING ( SIZE( 1 ) ) OPTIONAL,
    callBarringFeatureList SEQUENCE ( SIZE( 1 .. 13 ) ) OF
    SEQUENCE {
        basicService CHOICE {
            bearerService [2] IMPLICIT OCTET STRING ( SIZE( 1 ) ),
            teleservice [3] IMPLICIT OCTET STRING ( SIZE( 1 ) ) } OPTIONAL,
            ss-Status [4] IMPLICIT OCTET STRING ( SIZE( 1 ) ) OPTIONAL,
            ... },
        ... },
ss-Data [3] IMPLICIT SEQUENCE {
    ss-Code          OCTET STRING ( SIZE( 1 ) ) OPTIONAL,
    ss-Status        [4] IMPLICIT OCTET STRING ( SIZE( 1 ) ) OPTIONAL,
    ss-SubscriptionOption CHOICE {
        cliRestrictionOption [2] IMPLICIT ENUMERATED {
            permanent ( 0 ),
            temporaryDefaultRestricted ( 1 ),
            temporaryDefaultAllowed ( 2 ) },
        overrideCategory [1] IMPLICIT ENUMERATED {
            overrideEnabled ( 0 ),
            overrideDisabled ( 1 ) } } OPTIONAL,
        basicServiceGroupList SEQUENCE ( SIZE( 1 .. 13 ) ) OF
        CHOICE {
            bearerService [2] IMPLICIT OCTET STRING ( SIZE( 1 ) ),
            teleservice [3] IMPLICIT OCTET STRING ( SIZE( 1 ) ) } OPTIONAL,
        ... ,
        defaultPriority INTEGER ( 0 .. 15 ) OPTIONAL,
        nbrUser [5] IMPLICIT INTEGER ( 1 .. 7 ) OPTIONAL } }
ERRORS {
    systemFailure |
    dataMissing |
    unexpectedDataValue |
    bearerServiceNotProvisioned |
    teleserviceNotProvisioned |
    callBarred |
    illegalSS-Operation |
    ss-ErrorStatus }
CODE local : 11
}

activateSS OPERATION ::= {
    ARGUMENT SEQUENCE {
        ss-Code          OCTET STRING ( SIZE( 1 ) ),
        basicService    CHOICE {
            bearerService [2] IMPLICIT OCTET STRING ( SIZE( 1 ) ),
            teleservice [3] IMPLICIT OCTET STRING ( SIZE( 1 ) ) } OPTIONAL,
        ... ,
        longFTN-Supported [4] IMPLICIT NULL OPTIONAL }
    RESULT CHOICE {
        forwardingInfo [0] IMPLICIT SEQUENCE {
            ss-Code          OCTET STRING ( SIZE( 1 ) ) OPTIONAL,
            forwardingFeatureList SEQUENCE ( SIZE( 1 .. 13 ) ) OF
            SEQUENCE {
                basicService CHOICE {
                    bearerService [2] IMPLICIT OCTET STRING ( SIZE( 1 ) ),
                    teleservice [3] IMPLICIT OCTET STRING ( SIZE( 1 ) ) } OPTIONAL,
                    ss-Status [4] IMPLICIT OCTET STRING ( SIZE( 1 ) ) OPTIONAL,
                    forwardedToNumber [5] IMPLICIT OCTET STRING ( SIZE( 1 .. 20 ) ) ( SIZE( 1 .. 9 ) ) OPTIONAL,
                    forwardedToSubaddress [8] IMPLICIT OCTET STRING ( SIZE( 1 .. 21 ) ) OPTIONAL,
                    forwardingOptions [6] IMPLICIT OCTET STRING ( SIZE( 1 ) ) OPTIONAL,
                    noReplyConditionTime [7] IMPLICIT INTEGER ( 5 .. 30 ) OPTIONAL,
                    ... ,
                    longForwardedToNumber [9] IMPLICIT OCTET STRING ( SIZE( 1 .. 20 ) ) ( SIZE( 1 .. 15 ) ) OPTIONAL,
                    ... },
            callBarringInfo [1] IMPLICIT SEQUENCE {
                ss-Code          OCTET STRING ( SIZE( 1 ) ) OPTIONAL,
                callBarringFeatureList SEQUENCE ( SIZE( 1 .. 13 ) ) OF
                SEQUENCE {
                    basicService CHOICE {

```

```

        bearerService [2] IMPLICIT OCTET STRING ( SIZE( 1 ) ),
        teleservice [3] IMPLICIT OCTET STRING ( SIZE( 1 ) )} OPTIONAL,
        ss-Status [4] IMPLICIT OCTET STRING ( SIZE( 1 ) ) OPTIONAL,
        ... },
    ... },
    ss-Data [3] IMPLICIT SEQUENCE {
        ss-Code OCTET STRING ( SIZE( 1 ) ) OPTIONAL,
        ss-Status [4] IMPLICIT OCTET STRING ( SIZE( 1 ) ) OPTIONAL,
        ss-SubscriptionOption CHOICE {
            cliRestrictionOption [2] IMPLICIT ENUMERATED {
                permanent ( 0 ),
                temporaryDefaultRestricted ( 1 ),
                temporaryDefaultAllowed ( 2 ) },
            overrideCategory [1] IMPLICIT ENUMERATED {
                overrideEnabled ( 0 ),
                overrideDisabled ( 1 ) } } OPTIONAL,
        basicServiceGroupList SEQUENCE ( SIZE( 1 .. 13 ) ) OF
            CHOICE {
                bearerService [2] IMPLICIT OCTET STRING ( SIZE( 1 ) ),
                teleservice [3] IMPLICIT OCTET STRING ( SIZE( 1 ) )} OPTIONAL,
            ... ,
        defaultPriority INTEGER ( 0 .. 15 ) OPTIONAL,
        nbrUser [5] IMPLICIT INTEGER ( 1 .. 7 ) OPTIONAL} }
ERRORS {
    systemFailure |
    dataMissing |
    unexpectedDataValue |
    bearerServiceNotProvisioned |
    teleserviceNotProvisioned |
    callBarred |
    illegalSS-Operation |
    ss-ErrorStatus |
    ss-SubscriptionViolation |
    ss-Incompatibility |
    negativePW-Check |
    numberOfPW-AttemptsViolation }
CODE local : 12
}

deactivateSS OPERATION ::= {
    ARGUMENT SEQUENCE {
        ss-Code OCTET STRING ( SIZE( 1 ) ),
        basicService CHOICE {
            bearerService [2] IMPLICIT OCTET STRING ( SIZE( 1 ) ),
            teleservice [3] IMPLICIT OCTET STRING ( SIZE( 1 ) )} OPTIONAL,
            ... ,
        longFTN-Supported [4] IMPLICIT NULL OPTIONAL}
    RESULT CHOICE {
        forwardingInfo [0] IMPLICIT SEQUENCE {
            ss-Code OCTET STRING ( SIZE( 1 ) ) OPTIONAL,
            forwardingFeatureList SEQUENCE ( SIZE( 1 .. 13 ) ) OF
                SEQUENCE {
                    basicService CHOICE {
                        bearerService [2] IMPLICIT OCTET STRING ( SIZE( 1 ) ),
                        teleservice [3] IMPLICIT OCTET STRING ( SIZE( 1 ) )} OPTIONAL,
                    ss-Status [4] IMPLICIT OCTET STRING ( SIZE( 1 ) ) OPTIONAL,
                    forwardedToNumber [5] IMPLICIT OCTET STRING ( SIZE( 1 .. 20 ) ) ( SIZE( 1 .. 9 ) ) OPTIONAL,
                    forwardedToSubaddress [8] IMPLICIT OCTET STRING ( SIZE( 1 .. 21 ) ) OPTIONAL,
                    forwardingOptions [6] IMPLICIT OCTET STRING ( SIZE( 1 ) ) OPTIONAL,
                    noReplyConditionTime [7] IMPLICIT INTEGER ( 5 .. 30 ) OPTIONAL,
                    ... ,
                    longForwardedToNumber [9] IMPLICIT OCTET STRING ( SIZE( 1 .. 20 ) ) ( SIZE( 1 .. 15 ) ) OPTIONAL},
                ... },
            callBarringInfo [1] IMPLICIT SEQUENCE {
                ss-Code OCTET STRING ( SIZE( 1 ) ) OPTIONAL,
                callBarringFeatureList SEQUENCE ( SIZE( 1 .. 13 ) ) OF
                    SEQUENCE {
                        basicService CHOICE {
                            bearerService [2] IMPLICIT OCTET STRING ( SIZE( 1 ) ),
                            teleservice [3] IMPLICIT OCTET STRING ( SIZE( 1 ) )} OPTIONAL,
                            ss-Status [4] IMPLICIT OCTET STRING ( SIZE( 1 ) ) OPTIONAL,
                            ... },
                        ... },
                ss-Data [3] IMPLICIT SEQUENCE {
                    ss-Code OCTET STRING ( SIZE( 1 ) ) OPTIONAL,
                    ss-Status [4] IMPLICIT OCTET STRING ( SIZE( 1 ) ) OPTIONAL,
                    ss-SubscriptionOption CHOICE {

```



```

cliRestrictionOption [2] IMPLICIT ENUMERATED {
    permanent (0),
    temporaryDefaultRestricted (1),
    temporaryDefaultAllowed (2)},
overrideCategory [1] IMPLICIT ENUMERATED {
    overrideEnabled (0),
    overrideDisabled (1)} OPTIONAL,
basicServiceGroupList SEQUENCE (SIZE(1..13)) OF
    CHOICE {
        bearerService [2] IMPLICIT OCTET STRING (SIZE(1)),
        teleservice [3] IMPLICIT OCTET STRING (SIZE(1))} OPTIONAL,
... ,
defaultPriority INTEGER (0..15) OPTIONAL,
nbrUser [5] IMPLICIT INTEGER (1..7) OPTIONAL}}
ERRORS {
    systemFailure |
    dataMissing |
    unexpectedDataValue |
    bearerServiceNotProvisioned |
    teleserviceNotProvisioned |
    callBarred |
    illegalSS-Operation |
    ss-ErrorStatus |
    ss-SubscriptionViolation |
    negativePW-Check |
    numberOfPW-AttemptsViolation }
CODE local :13
}

interrogateSS OPERATION ::= {
    ARGUMENT SEQUENCE {
        ss-Code OCTET STRING (SIZE(1)),
        basicService CHOICE {
            bearerService [2] IMPLICIT OCTET STRING (SIZE(1)),
            teleservice [3] IMPLICIT OCTET STRING (SIZE(1))} OPTIONAL,
        ... ,
        longFTN-Supported [4] IMPLICIT NULL OPTIONAL}
    RESULT CHOICE {
        ss-Status [0] IMPLICIT OCTET STRING (SIZE(1)),
        basicServiceGroupList [2] IMPLICIT SEQUENCE (SIZE(1..13)) OF
            CHOICE {
                bearerService [2] IMPLICIT OCTET STRING (SIZE(1)),
                teleservice [3] IMPLICIT OCTET STRING (SIZE(1))},
        forwardingFeatureList [3] IMPLICIT SEQUENCE (SIZE(1..13)) OF
            SEQUENCE {
                basicService CHOICE {
                    bearerService [2] IMPLICIT OCTET STRING (SIZE(1)),
                    teleservice [3] IMPLICIT OCTET STRING (SIZE(1))} OPTIONAL,
                ss-Status [4] IMPLICIT OCTET STRING (SIZE(1)) OPTIONAL,
                forwardedToNumber [5] IMPLICIT OCTET STRING (SIZE(1..20)) (SIZE(1..9)) OPTIONAL,
                forwardedToSubaddress [8] IMPLICIT OCTET STRING (SIZE(1..21)) OPTIONAL,
                forwardingOptions [6] IMPLICIT OCTET STRING (SIZE(1)) OPTIONAL,
                noReplyConditionTime [7] IMPLICIT INTEGER (5..30) OPTIONAL,
                ... ,
                longForwardedToNumber [9] IMPLICIT OCTET STRING (SIZE(1..20)) (SIZE(1..15)) OPTIONAL},
        genericServiceInfo [4] IMPLICIT SEQUENCE {
            ss-Status OCTET STRING (SIZE(1)),
            cliRestrictionOption ENUMERATED {
                permanent (0),
                temporaryDefaultRestricted (1),
                temporaryDefaultAllowed (2)} OPTIONAL,
            ... ,
            maximumEntitledPriority [0] IMPLICIT INTEGER (0..15) OPTIONAL,
            defaultPriority [1] IMPLICIT INTEGER (0..15) OPTIONAL,
            ccbs-FeatureList [2] IMPLICIT SEQUENCE (SIZE(1..5)) OF
                SEQUENCE {
                    ccbs-Index [0] IMPLICIT INTEGER (1..5) OPTIONAL,
                    b-subscriberNumber [1] IMPLICIT OCTET STRING (SIZE(1..20)) (SIZE(1..9)) OPTIONAL,
                    b-subscriberSubaddress [2] IMPLICIT OCTET STRING (SIZE(1..21)) OPTIONAL,
                    basicServiceGroup [3] CHOICE {
                        bearerService [2] IMPLICIT OCTET STRING (SIZE(1)),
                        teleservice [3] IMPLICIT OCTET STRING (SIZE(1))} OPTIONAL,
                    ... } OPTIONAL,
            nbrSB [3] IMPLICIT INTEGER (2..7) OPTIONAL,
            nbrUser [4] IMPLICIT INTEGER (1..7) OPTIONAL,
            nbrSN [5] IMPLICIT INTEGER (1..7) OPTIONAL}}
    ERRORS {

```

```

systemFailure |
dataMissing |
unexpectedDataValue |
bearerServiceNotProvisioned |
teleserviceNotProvisioned |
callBarred |
illegalSS-Operation |
ss-NotAvailable }
CODE local : 14
}

```

```

processUnstructuredSS-Request OPERATION ::= {
ARGUMENT SEQUENCE {
ussd-DataCodingScheme OCTET STRING ( SIZE( 1 ) ),
ussd-String OCTET STRING ( SIZE( 1 .. 160 ) ),
... ,
alertingPattern OCTET STRING ( SIZE( 1 ) ) OPTIONAL,
msisdn [0] IMPLICIT OCTET STRING ( SIZE( 1 .. 20 ) ) ( SIZE( 1 .. 9 ) ) OPTIONAL}
RESULT SEQUENCE {
ussd-DataCodingScheme OCTET STRING ( SIZE( 1 ) ),
ussd-String OCTET STRING ( SIZE( 1 .. 160 ) ),
... }
ERRORS {
systemFailure |
dataMissing |
unexpectedDataValue |
unknownAlphabet |
callBarred }
CODE local : 59
}

```

```

unstructuredSS-Request OPERATION ::= {
ARGUMENT SEQUENCE {
ussd-DataCodingScheme OCTET STRING ( SIZE( 1 ) ),
ussd-String OCTET STRING ( SIZE( 1 .. 160 ) ),
... ,
alertingPattern OCTET STRING ( SIZE( 1 ) ) OPTIONAL,
msisdn [0] IMPLICIT OCTET STRING ( SIZE( 1 .. 20 ) ) ( SIZE( 1 .. 9 ) ) OPTIONAL}
RESULT SEQUENCE {
ussd-DataCodingScheme OCTET STRING ( SIZE( 1 ) ),
ussd-String OCTET STRING ( SIZE( 1 .. 160 ) ),
... }
ERRORS {
systemFailure |
dataMissing |
unexpectedDataValue |
absentSubscriber |
illegalSubscriber |
illegalEquipment |
unknownAlphabet |
ussd-Busy }
CODE local : 60
}

```

```

unstructuredSS-Notify OPERATION ::= {
ARGUMENT SEQUENCE {
ussd-DataCodingScheme OCTET STRING ( SIZE( 1 ) ),
ussd-String OCTET STRING ( SIZE( 1 .. 160 ) ),
... ,
alertingPattern OCTET STRING ( SIZE( 1 ) ) OPTIONAL,
msisdn [0] IMPLICIT OCTET STRING ( SIZE( 1 .. 20 ) ) ( SIZE( 1 .. 9 ) ) OPTIONAL}
RETURN RESULT TRUE
ERRORS {
systemFailure |
dataMissing |
unexpectedDataValue |
absentSubscriber |
illegalSubscriber |
illegalEquipment |
unknownAlphabet |
ussd-Busy }
CODE local : 61
}

```

```

registerPassword OPERATION ::= {
ARGUMENT OCTET STRING ( SIZE( 1 ) )
RESULT NumericString ( FROM ("0"|"1"|"2"|"3"|"4"|"5"|"6"|"7"|"8"|"9" ) ) ( SIZE( 4 ) )
}

```

```

ERRORS {
  systemFailure |
  dataMissing |
  unexpectedDataValue |
  callBarred |
  ss-SubscriptionViolation |
  pw-RegistrationFailure |
  negativePW-Check |
  numberOfPW-AttemptsViolation }
CODE local :17
}

getPassword OPERATION ::= {
  ARGUMENT ENUMERATED {
    enterPW ( 0 ),
    enterNewPW ( 1 ),
    enterNewPW-Again ( 2 ) }
  RESULT NumericString ( FROM ("0"|"1"|"2"|"3"|"4"|"5"|"6"|"7"|"8"|"9" ) ) (SIZE( 4 ) )
  CODE local : 18
}

ss-InvocationNotification OPERATION ::= {
  ARGUMENT SEQUENCE {
    imsi [0] IMPLICIT OCTET STRING ( SIZE( 3 .. 8 ) ),
    msisdn [1] IMPLICIT OCTET STRING ( SIZE( 1 .. 20 ) ) ( SIZE( 1 .. 9 ) ),
    ss-Event [2] IMPLICIT OCTET STRING ( SIZE( 1 ) ),
    ss-EventSpecification [3] IMPLICIT SEQUENCE ( SIZE( 1 .. 2 ) ) OF
      OCTET STRING ( SIZE( 1 .. 20 ) ) OPTIONAL,
    extensionContainer [4] IMPLICIT SEQUENCE {
      privateExtensionList [0] IMPLICIT SEQUENCE ( SIZE( 1 .. 10 ) ) OF
        SEQUENCE {
          extId MAP-EXTENSION .&extensionId ( {
            '
            ... } ),
          extType MAP-EXTENSION .&ExtensionType ( {
            '
            ... } { @extId } ) OPTIONAL } OPTIONAL,
      pcs-Extensions [1] IMPLICIT SEQUENCE {
        ... } OPTIONAL,
      ... } OPTIONAL,
    ... ,
    b-subscriberNumber [5] IMPLICIT OCTET STRING ( SIZE( 1 .. 20 ) ) ( SIZE( 1 .. 9 ) ) OPTIONAL,
    ccbs-RequestState [6] IMPLICIT ENUMERATED {
      request ( 0 ),
      recall ( 1 ),
      active ( 2 ),
      completed ( 3 ),
      suspended ( 4 ),
      frozen ( 5 ),
      deleted ( 6 ) } OPTIONAL }
  RESULT SEQUENCE {
    extensionContainer SEQUENCE {
      privateExtensionList [0] IMPLICIT SEQUENCE ( SIZE( 1 .. 10 ) ) OF
        SEQUENCE {
          extId MAP-EXTENSION .&extensionId ( {
            '
            ... } ),
          extType MAP-EXTENSION .&ExtensionType ( {
            '
            ... } { @extId } ) OPTIONAL } OPTIONAL,
      pcs-Extensions [1] IMPLICIT SEQUENCE {
        ... } OPTIONAL,
      ... } OPTIONAL,
    ... }
  ERRORS {
    dataMissing |
    unexpectedDataValue |
    unknownSubscriber }
  CODE local : 72
}

registerCC-Entry OPERATION ::= {
  ARGUMENT SEQUENCE {
    ss-Code [0] IMPLICIT OCTET STRING ( SIZE( 1 ) ),
    ccbs-Data [1] IMPLICIT SEQUENCE {
      ccbs-Feature [0] IMPLICIT SEQUENCE {
        ccbs-Index [0] IMPLICIT INTEGER ( 1 .. 5 ) OPTIONAL,

```

```

b-subscriberNumber [1] IMPLICIT OCTET STRING ( SIZE( 1 .. 20 ) ) ( SIZE( 1 .. 9 ) ) OPTIONAL,
b-subscriberSubaddress [2] IMPLICIT OCTET STRING ( SIZE( 1 .. 21 ) ) OPTIONAL,
basicServiceGroup [3] CHOICE {
  bearerService [2] IMPLICIT OCTET STRING ( SIZE( 1 ) ),
  teleservice [3] IMPLICIT OCTET STRING ( SIZE( 1 ) ) } OPTIONAL,
... },
translatedB-Number [1] IMPLICIT OCTET STRING ( SIZE( 1 .. 20 ) ) ( SIZE( 1 .. 9 ) ),
serviceIndicator [2] IMPLICIT BIT STRING {
  clir-invoked ( 0 ),
  camel-invoked ( 1 ) } ( SIZE( 2 .. 32 ) ) OPTIONAL,
callInfo [3] IMPLICIT SEQUENCE {
  protocolId ENUMERATED {
    gsm-0408 ( 1 ),
    gsm-0806 ( 2 ),
    gsm-BSSMAP ( 3 ),
    ets-300102-1 ( 4 ) },
  signalInfo OCTET STRING ( SIZE( 1 .. 200 ) ),
  extensionContainer SEQUENCE {
    privateExtensionList [0] IMPLICIT SEQUENCE ( SIZE( 1 .. 10 ) ) OF
      SEQUENCE {
        extId MAP-EXTENSION .&extensionId ( {
          '
          ... } ),
        extType MAP-EXTENSION .&ExtensionType ( {
          '
          ... } { @extId } ) OPTIONAL } OPTIONAL,
    pcs-Extensions [1] IMPLICIT SEQUENCE {
      ... } OPTIONAL,
    ... } OPTIONAL,
  ... },
networkSignalInfo [4] IMPLICIT SEQUENCE {
  protocolId ENUMERATED {
    gsm-0408 ( 1 ),
    gsm-0806 ( 2 ),
    gsm-BSSMAP ( 3 ),
    ets-300102-1 ( 4 ) },
  signalInfo OCTET STRING ( SIZE( 1 .. 200 ) ),
  extensionContainer SEQUENCE {
    privateExtensionList [0] IMPLICIT SEQUENCE ( SIZE( 1 .. 10 ) ) OF
      SEQUENCE {
        extId MAP-EXTENSION .&extensionId ( {
          '
          ... } ),
        extType MAP-EXTENSION .&ExtensionType ( {
          '
          ... } { @extId } ) OPTIONAL } OPTIONAL,
    pcs-Extensions [1] IMPLICIT SEQUENCE {
      ... } OPTIONAL,
    ... } OPTIONAL,
  ... },
... } OPTIONAL,
... }
RESULT SEQUENCE {
  ccbs-Feature [0] IMPLICIT SEQUENCE {
    ccbs-Index [0] IMPLICIT INTEGER ( 1 .. 5 ) OPTIONAL,
    b-subscriberNumber [1] IMPLICIT OCTET STRING ( SIZE( 1 .. 20 ) ) ( SIZE( 1 .. 9 ) ) OPTIONAL,
    b-subscriberSubaddress [2] IMPLICIT OCTET STRING ( SIZE( 1 .. 21 ) ) OPTIONAL,
    basicServiceGroup [3] CHOICE {
      bearerService [2] IMPLICIT OCTET STRING ( SIZE( 1 ) ),
      teleservice [3] IMPLICIT OCTET STRING ( SIZE( 1 ) ) } OPTIONAL,
    ... } OPTIONAL,
  ... }
ERRORS {
  systemFailure |
  dataMissing |
  unexpectedDataValue |
  callBarred |
  illegalSS-Operation |
  ss-ErrorStatus |
  ss-Incompatibility |
  shortTermDenial |
  longTermDenial |
  facilityNotSupported }
CODE local : 76
}
eraseCC-Entry OPERATION ::= {

```

```

ARGUMENT SEQUENCE {
  ss-Code [0] IMPLICIT OCTET STRING ( SIZE( 1 ) ),
  ccbs-Index [1] IMPLICIT INTEGER ( 1 .. 5 ) OPTIONAL,
  ... }
RESULT SEQUENCE {
  ss-Code [0] IMPLICIT OCTET STRING ( SIZE( 1 ) ),
  ss-Status [1] IMPLICIT OCTET STRING ( SIZE( 1 ) ) OPTIONAL,
  ... }
ERRORS {
  systemFailure |
  dataMissing |
  unexpectedDataValue |
  callBarred |
  illegalSS-Operation |
  ss-ErrorStatus }
CODE local : 77
}

```

END

```

--Expanded ASN1 Module 'MAP-ShortMessageServiceOperations'
--SIEMENS ASN.1 Compiler R6.0 (Production_6.0)
-- Date: 2006-06-08 Time: 15:11:22

```

```

MAP-ShortMessageServiceOperations { 0 identified-organization (4) etsi (0) mobileDomain (0) gsm-Network (1) modules (3) map-ShortMessageServiceOperations (9) version8 (8) }

```

DEFINITIONS

::=

BEGIN

EXPORTS

```

sendRoutingInfoForSM,
mo-ForwardSM,
mt-ForwardSM,
reportSM-DeliveryStatus,
alertServiceCentre,
informServiceCentre,
readyForSM;

```

```

sendRoutingInfoForSM OPERATION ::= {
  ARGUMENT SEQUENCE {
    msisdn [0] IMPLICIT OCTET STRING ( SIZE( 1 .. 20 ) ) ( SIZE( 1 .. 9 ) ),
    sm-RP-PRI [1] IMPLICIT BOOLEAN,
    serviceCentreAddress [2] IMPLICIT OCTET STRING ( SIZE( 1 .. 20 ) ),
    extensionContainer [6] IMPLICIT SEQUENCE {
      privateExtensionList [0] IMPLICIT SEQUENCE ( SIZE( 1 .. 10 ) ) OF
        SEQUENCE {
          extId MAP-EXTENSION .&extensionId ( {
            '
            ... } ),
          extType MAP-EXTENSION .&ExtensionType ( {
            '
            ... } { @extId } ) OPTIONAL } OPTIONAL,
      pcs-Extensions [1] IMPLICIT SEQUENCE {
        ... } OPTIONAL,
      ... } OPTIONAL,
    ... ,
    gprsSupportIndicator [7] IMPLICIT NULL OPTIONAL,
    sm-RP-MTI [8] IMPLICIT INTEGER ( 0 .. 10 ) OPTIONAL,
    sm-RP-SMEA [9] IMPLICIT OCTET STRING ( SIZE( 1 .. 12 ) ) OPTIONAL }
  RESULT SEQUENCE {
    imsi OCTET STRING ( SIZE( 3 .. 8 ) ),
    locationInfoWithLMSI [0] IMPLICIT SEQUENCE {
      networkNode-Number [1] IMPLICIT OCTET STRING ( SIZE( 1 .. 20 ) ) ( SIZE( 1 .. 9 ) ),
      lmsi OCTET STRING ( SIZE( 4 ) ) OPTIONAL,
      extensionContainer SEQUENCE {
        privateExtensionList [0] IMPLICIT SEQUENCE ( SIZE( 1 .. 10 ) ) OF
          SEQUENCE {
            extId MAP-EXTENSION .&extensionId ( {
              '
              ... } ),
            extType MAP-EXTENSION .&ExtensionType ( {

```

```

        ...}{ @extId } ) OPTIONAL} OPTIONAL,
    pcs-Extensions [1] IMPLICIT SEQUENCE {
        ... } OPTIONAL,
    ... } OPTIONAL,
    ... ,
    gprsNodeIndicator [5] IMPLICIT NULL OPTIONAL,
    additional-Number [6] CHOICE {
        msc-Number [0] IMPLICIT OCTET STRING ( SIZE( 1 .. 20 ) ) ( SIZE( 1 .. 9 ) ),
        sgsn-Number [1] IMPLICIT OCTET STRING ( SIZE( 1 .. 20 ) ) ( SIZE( 1 .. 9 ) ) } OPTIONAL,
    extensionContainer [4] IMPLICIT SEQUENCE {
        privateExtensionList [0] IMPLICIT SEQUENCE ( SIZE( 1 .. 10 ) ) OF
        SEQUENCE {
            extId MAP-EXTENSION .&extensionId ( {
                '
                ...} ),
            extType MAP-EXTENSION .&ExtensionType ( {
                '
                ...}{ @extId } ) OPTIONAL} OPTIONAL,
        pcs-Extensions [1] IMPLICIT SEQUENCE {
            ... } OPTIONAL,
        ... } OPTIONAL,
    ... }
    ERRORS {
        systemFailure |
        dataMissing |
        unexpectedDataValue |
        facilityNotSupported |
        unknownSubscriber |
        teleserviceNotProvisioned |
        callBarred |
        absentSubscriberSM }
    CODE local : 45
}

mo-ForwardSM OPERATION ::= {
    ARGUMENT SEQUENCE {
        sm-RP-DA CHOICE {
            imsi [0] IMPLICIT OCTET STRING ( SIZE( 3 .. 8 ) ),
            lmsi [1] IMPLICIT OCTET STRING ( SIZE( 4 ) ),
            serviceCentreAddressDA [4] IMPLICIT OCTET STRING ( SIZE( 1 .. 20 ) ),
            noSM-RP-DA [5] IMPLICIT NULL,
        }
        sm-RP-OA CHOICE {
            msisdn [2] IMPLICIT OCTET STRING ( SIZE( 1 .. 20 ) ) ( SIZE( 1 .. 9 ) ),
            serviceCentreAddressOA [4] IMPLICIT OCTET STRING ( SIZE( 1 .. 20 ) ),
            noSM-RP-OA [5] IMPLICIT NULL,
        }
        sm-RP-UI OCTET STRING ( SIZE( 1 .. 200 ) ),
        extensionContainer SEQUENCE {
            privateExtensionList [0] IMPLICIT SEQUENCE ( SIZE( 1 .. 10 ) ) OF
            SEQUENCE {
                extId MAP-EXTENSION .&extensionId ( {
                    '
                    ...} ),
                extType MAP-EXTENSION .&ExtensionType ( {
                    '
                    ...}{ @extId } ) OPTIONAL} OPTIONAL,
            pcs-Extensions [1] IMPLICIT SEQUENCE {
                ... } OPTIONAL,
            ... } OPTIONAL,
        }
        ... ,
        imsi OCTET STRING ( SIZE( 3 .. 8 ) ) OPTIONAL
    }
    RESULT SEQUENCE {
        sm-RP-UI OCTET STRING ( SIZE( 1 .. 200 ) ) OPTIONAL,
        extensionContainer SEQUENCE {
            privateExtensionList [0] IMPLICIT SEQUENCE ( SIZE( 1 .. 10 ) ) OF
            SEQUENCE {
                extId MAP-EXTENSION .&extensionId ( {
                    '
                    ...} ),
                extType MAP-EXTENSION .&ExtensionType ( {
                    '
                    ...}{ @extId } ) OPTIONAL} OPTIONAL,
            pcs-Extensions [1] IMPLICIT SEQUENCE {
                ... } OPTIONAL,
            ... } OPTIONAL,
        }
        ... }
    ERRORS {

```

```

systemFailure |
unexpectedDataValue |
facilityNotSupported |
sm-DeliveryFailure }
CODE local : 46
}

mt-ForwardSM OPERATION ::= {
ARGUMENT SEQUENCE {
sm-RP-DA CHOICE {
imsi [0] IMPLICIT OCTET STRING ( SIZE( 3 .. 8 ) ),
imsi [1] IMPLICIT OCTET STRING ( SIZE( 4 ) ),
serviceCentreAddressDA [4] IMPLICIT OCTET STRING ( SIZE( 1 .. 20 ) ),
noSM-RP-DA [5] IMPLICIT NULL},
sm-RP-OA CHOICE {
msisdn [2] IMPLICIT OCTET STRING ( SIZE( 1 .. 20 ) ) ( SIZE( 1 .. 9 ) ),
serviceCentreAddressOA [4] IMPLICIT OCTET STRING ( SIZE( 1 .. 20 ) ),
noSM-RP-OA [5] IMPLICIT NULL},
sm-RP-UI OCTET STRING ( SIZE( 1 .. 200 ) ),
moreMessagesToSend NULL OPTIONAL,
extensionContainer SEQUENCE {
privateExtensionList [0] IMPLICIT SEQUENCE ( SIZE( 1 .. 10 ) ) OF
SEQUENCE {
extld MAP-EXTENSION .&extensionId ( {
'
...} ),
extType MAP-EXTENSION .&ExtensionType ( {
'
...} { @extld } ) OPTIONAL} OPTIONAL,
pcs-Extensions [1] IMPLICIT SEQUENCE {
... } OPTIONAL,
... } OPTIONAL,
... }
}
RESULT SEQUENCE {
sm-RP-UI OCTET STRING ( SIZE( 1 .. 200 ) ) OPTIONAL,
extensionContainer SEQUENCE {
privateExtensionList [0] IMPLICIT SEQUENCE ( SIZE( 1 .. 10 ) ) OF
SEQUENCE {
extld MAP-EXTENSION .&extensionId ( {
'
...} ),
extType MAP-EXTENSION .&ExtensionType ( {
'
...} { @extld } ) OPTIONAL} OPTIONAL,
pcs-Extensions [1] IMPLICIT SEQUENCE {
... } OPTIONAL,
... } OPTIONAL,
... }
}
ERRORS {
systemFailure |
dataMissing |
unexpectedDataValue |
facilityNotSupported |
unidentifiedSubscriber |
illegalSubscriber |
illegalEquipment |
subscriberBusyForMT-SMS |
sm-DeliveryFailure |
absentSubscriberSM }
CODE local : 44
}

reportSM-DeliveryStatus OPERATION ::= {
ARGUMENT SEQUENCE {
msisdn OCTET STRING ( SIZE( 1 .. 20 ) ) ( SIZE( 1 .. 9 ) ),
serviceCentreAddress OCTET STRING ( SIZE( 1 .. 20 ) ),
sm-DeliveryOutcome ENUMERATED {
memoryCapacityExceeded ( 0 ),
absentSubscriber ( 1 ),
successfulTransfer ( 2 ) },
absentSubscriberDiagnosticSM [0] IMPLICIT INTEGER ( 0 .. 255 ) OPTIONAL,
extensionContainer [1] IMPLICIT SEQUENCE {
privateExtensionList [0] IMPLICIT SEQUENCE ( SIZE( 1 .. 10 ) ) OF
SEQUENCE {
extld MAP-EXTENSION .&extensionId ( {
'
...} ),

```

```

    extType MAP-EXTENSION .&ExtensionType ( {
        '
        ... } { @extId } ) OPTIONAL } OPTIONAL,
    pcs-Extensions [1] IMPLICIT SEQUENCE {
        ... } OPTIONAL,
    ... } OPTIONAL,
    ...,
    gprsSupportIndicator [2] IMPLICIT NULL OPTIONAL,
    deliveryOutcomeIndicator [3] IMPLICIT NULL OPTIONAL,
    additionalSM-DeliveryOutcome [4] IMPLICIT ENUMERATED {
        memoryCapacityExceeded ( 0 ),
        absentSubscriber ( 1 ),
        successfulTransfer ( 2 ) } OPTIONAL,
    additionalAbsentSubscriberDiagnosticSM [5] IMPLICIT INTEGER ( 0 .. 255 ) OPTIONAL
RESULT SEQUENCE {
    storedMSISDN OCTET STRING ( SIZE( 1 .. 20 ) ) ( SIZE( 1 .. 9 ) ) OPTIONAL,
    extensionContainer SEQUENCE {
        privateExtensionList [0] IMPLICIT SEQUENCE ( SIZE( 1 .. 10 ) ) OF
        SEQUENCE {
            extId MAP-EXTENSION .&extensionId ( {
                '
                ... } ),
            extType MAP-EXTENSION .&ExtensionType ( {
                '
                ... } { @extId } ) OPTIONAL } OPTIONAL,
            pcs-Extensions [1] IMPLICIT SEQUENCE {
                ... } OPTIONAL,
            ... } OPTIONAL,
            ... }
ERRORS {
    dataMissing |
    unexpectedDataValue |
    unknownSubscriber |
    messageWaitingListFull }
CODE local : 47
}

alertServiceCentre OPERATION ::= {
    ARGUMENT SEQUENCE {
        msisdn OCTET STRING ( SIZE( 1 .. 20 ) ) ( SIZE( 1 .. 9 ) ),
        serviceCentreAddress OCTET STRING ( SIZE( 1 .. 20 ) ),
        ... }
    RETURN RESULT TRUE
    ERRORS {
        systemFailure |
        dataMissing |
        unexpectedDataValue }
    CODE local : 64
}

informServiceCentre OPERATION ::= {
    ARGUMENT SEQUENCE {
        storedMSISDN OCTET STRING ( SIZE( 1 .. 20 ) ) ( SIZE( 1 .. 9 ) ) OPTIONAL,
        mw-Status BIT STRING {
            sc-AddressNotIncluded ( 0 ),
            mnrf-Set ( 1 ),
            mcef-Set ( 2 ),
            mnrg-Set ( 3 ) } ( SIZE( 6 .. 16 ) ) OPTIONAL,
        extensionContainer SEQUENCE {
            privateExtensionList [0] IMPLICIT SEQUENCE ( SIZE( 1 .. 10 ) ) OF
            SEQUENCE {
                extId MAP-EXTENSION .&extensionId ( {
                    '
                    ... } ),
                extType MAP-EXTENSION .&ExtensionType ( {
                    '
                    ... } { @extId } ) OPTIONAL } OPTIONAL,
                pcs-Extensions [1] IMPLICIT SEQUENCE {
                    ... } OPTIONAL,
                ... } OPTIONAL,
                ... }
            absentSubscriberDiagnosticSM INTEGER ( 0 .. 255 ) OPTIONAL,
            additionalAbsentSubscriberDiagnosticSM [0] IMPLICIT INTEGER ( 0 .. 255 ) OPTIONAL
    CODE local : 63
}

readyForSM OPERATION ::= {

```



```

ARGUMENT SEQUENCE {
  imsi [0] IMPLICIT OCTET STRING ( SIZE( 3 .. 8 ) ),
  alertReason ENUMERATED {
    ms-Present ( 0 ),
    memoryAvailable ( 1 ) },
  alertReasonIndicator NULL OPTIONAL,
  extensionContainer SEQUENCE {
    privateExtensionList [0] IMPLICIT SEQUENCE ( SIZE( 1 .. 10 ) ) OF
      SEQUENCE {
        extId MAP-EXTENSION .&extensionId ( {
          '
          ... } ),
        extType MAP-EXTENSION .&ExtensionType ( {
          '
          ... } { @extId } ) OPTIONAL } OPTIONAL,
    pcs-Extensions [1] IMPLICIT SEQUENCE {
      ... } OPTIONAL,
    ... } OPTIONAL,
    ... }
RESULT SEQUENCE {
  extensionContainer SEQUENCE {
    privateExtensionList [0] IMPLICIT SEQUENCE ( SIZE( 1 .. 10 ) ) OF
      SEQUENCE {
        extId MAP-EXTENSION .&extensionId ( {
          '
          ... } ),
        extType MAP-EXTENSION .&ExtensionType ( {
          '
          ... } { @extId } ) OPTIONAL } OPTIONAL,
    pcs-Extensions [1] IMPLICIT SEQUENCE {
      ... } OPTIONAL,
    ... } OPTIONAL,
    ... }
ERRORS {
  dataMissing |
  unexpectedDataValue |
  facilityNotSupported |
  unknownSubscriber }
CODE local : 66
}

```

END

```

-- Expanded ASN1 Module 'MAP-Group-Call-Operations'
--SIEMENS ASN.1 Compiler R6.0 (Production_6.0)
-- Date: 2006-06-08 Time: 15:11:30

```

MAP-Group-Call-Operations{ 0 identified-organization (4) etsi (0) mobileDomain (0) gsm-Network (1) modules (3) map-Group-Call-Operations (22) version8 (8) }

DEFINITIONS

::=

BEGIN

EXPORTS

```

prepareGroupCall,
sendGroupCallEndSignal,
forwardGroupCallSignalling,
processGroupCallSignalling;

```

prepareGroupCall OPERATION ::= {

```

ARGUMENT SEQUENCE {
  teleservice OCTET STRING ( SIZE( 1 .. 5 ) ),
  asciiCallReference OCTET STRING ( SIZE( 1 .. 8 ) ),
  codec-Info OCTET STRING ( SIZE( 5 .. 10 ) ),
  cipheringAlgorithm OCTET STRING ( SIZE( 1 ) ),
  groupKeyNumber [0] IMPLICIT INTEGER ( 0 .. 15 ) OPTIONAL,
  groupKey [1] IMPLICIT OCTET STRING ( SIZE( 8 ) ) OPTIONAL,
  priority [2] IMPLICIT INTEGER ( 0 .. 15 ) OPTIONAL,
  uplinkFree [3] IMPLICIT NULL OPTIONAL,
  extensionContainer [4] IMPLICIT SEQUENCE {
    privateExtensionList [0] IMPLICIT SEQUENCE ( SIZE( 1 .. 10 ) ) OF
      SEQUENCE {

```

```

    extId    MAP-EXTENSION .&extensionId ( {
        '
        ... } ),
    extType  MAP-EXTENSION .&ExtensionType ( {
        '
        ... } { @extId } ) OPTIONAL } OPTIONAL,
    pcs-Extensions [1] IMPLICIT SEQUENCE {
        ... } OPTIONAL,
    ... } OPTIONAL,
    ... }
RESULT SEQUENCE {
    groupCallNumber OCTET STRING ( SIZE( 1 .. 20 ) ) ( SIZE( 1 .. 9 ) ),
    extensionContainer SEQUENCE {
        privateExtensionList [0] IMPLICIT SEQUENCE ( SIZE( 1 .. 10 ) ) OF
        SEQUENCE {
            extId    MAP-EXTENSION .&extensionId ( {
                '
                ... } ),
            extType  MAP-EXTENSION .&ExtensionType ( {
                '
                ... } { @extId } ) OPTIONAL } OPTIONAL,
            pcs-Extensions [1] IMPLICIT SEQUENCE {
                ... } OPTIONAL,
            ... } OPTIONAL,
            ... }
        }
    }
ERRORS {
    systemFailure |
    noGroupCallNumberAvailable |
    unexpectedDataValue }
CODE local : 39
}

sendGroupCallEndSignal OPERATION ::= {
    ARGUMENT SEQUENCE {
        imsi          OCTET STRING ( SIZE( 3 .. 8 ) ) OPTIONAL,
        extensionContainer SEQUENCE {
            privateExtensionList [0] IMPLICIT SEQUENCE ( SIZE( 1 .. 10 ) ) OF
            SEQUENCE {
                extId    MAP-EXTENSION .&extensionId ( {
                    '
                    ... } ),
                extType  MAP-EXTENSION .&ExtensionType ( {
                    '
                    ... } { @extId } ) OPTIONAL } OPTIONAL,
                pcs-Extensions [1] IMPLICIT SEQUENCE {
                    ... } OPTIONAL,
                ... } OPTIONAL,
                ... }
            }
        }
    }
    RESULT SEQUENCE {
        extensionContainer SEQUENCE {
            privateExtensionList [0] IMPLICIT SEQUENCE ( SIZE( 1 .. 10 ) ) OF
            SEQUENCE {
                extId    MAP-EXTENSION .&extensionId ( {
                    '
                    ... } ),
                extType  MAP-EXTENSION .&ExtensionType ( {
                    '
                    ... } { @extId } ) OPTIONAL } OPTIONAL,
                pcs-Extensions [1] IMPLICIT SEQUENCE {
                    ... } OPTIONAL,
                ... } OPTIONAL,
                ... }
            }
        }
    }
    CODE local : 40
}

processGroupCallSignalling OPERATION ::= {
    ARGUMENT SEQUENCE {
        uplinkRequest [0] IMPLICIT NULL OPTIONAL,
        uplinkReleaseIndication [1] IMPLICIT NULL OPTIONAL,
        releaseGroupCall [2] IMPLICIT NULL OPTIONAL,
        extensionContainer SEQUENCE {
            privateExtensionList [0] IMPLICIT SEQUENCE ( SIZE( 1 .. 10 ) ) OF
            SEQUENCE {
                extId    MAP-EXTENSION .&extensionId ( {
                    '
                    ... } ),
                extType  MAP-EXTENSION .&ExtensionType ( {

```

```

    ...}{ @extId } ) OPTIONAL} OPTIONAL,
    pcs-Extensions [1] IMPLICIT SEQUENCE {
    ... } OPTIONAL,
    ... } OPTIONAL,
    ... }
CODE local :41
}

```

```

forwardGroupCallSignalling OPERATION ::= {
  ARGUMENT SEQUENCE {
    imsi OCTET STRING ( SIZE( 3 .. 8 ) ) OPTIONAL,
    uplinkRequestAck [0] IMPLICIT NULL OPTIONAL,
    uplinkReleaseIndication [1] IMPLICIT NULL OPTIONAL,
    uplinkRejectCommand [2] IMPLICIT NULL OPTIONAL,
    uplinkSeizedCommand [3] IMPLICIT NULL OPTIONAL,
    uplinkReleaseCommand [4] IMPLICIT NULL OPTIONAL,
    extensionContainer SEQUENCE {
      privateExtensionList [0] IMPLICIT SEQUENCE ( SIZE( 1 .. 10 ) ) OF
        SEQUENCE {
          extId MAP-EXTENSION .&extensionId ( {
            '
            ...} ),
          extType MAP-EXTENSION .&ExtensionType ( {
            '
            ...}{ @extId } ) OPTIONAL} OPTIONAL,
          pcs-Extensions [1] IMPLICIT SEQUENCE {
            ... } OPTIONAL,
            ... } OPTIONAL,
            ... ,
            stateAttributes [5] IMPLICIT SEQUENCE {
              downlinkAttached [5] IMPLICIT NULL OPTIONAL,
              uplinkAttached [6] IMPLICIT NULL OPTIONAL,
              dualCommunication [7] IMPLICIT NULL OPTIONAL,
              callOriginator [8] IMPLICIT NULL OPTIONAL} OPTIONAL}
CODE local :42
}

```

END

```

-- Expanded ASN1 Module 'MAP-LocationServiceOperations'
--SIEMENS ASN.1 Compiler R6.0 (Production_6.0)
-- Date: 2006-06-08 Time: 15:11:37

```

```

MAP-LocationServiceOperations{ 0 identified-organization (4) etsi (0) mobileDomain (0) gsm-Network (1) modules (3) map-
LocationServiceOperations (24) version8 (8) }

```

DEFINITIONS

::=

BEGIN

EXPORTS

```

provideSubscriberLocation,
sendRoutingInfoForLCS,
subscriberLocationReport;

```

```

sendRoutingInfoForLCS OPERATION ::= {
  ARGUMENT SEQUENCE {
    mlcNumber [0] IMPLICIT OCTET STRING ( SIZE( 1 .. 20 ) ) ( SIZE( 1 .. 9 ) ),
    targetMS [1] CHOICE {
      imsi [0] IMPLICIT OCTET STRING ( SIZE( 3 .. 8 ) ),
      msisdn [1] IMPLICIT OCTET STRING ( SIZE( 1 .. 20 ) ) ( SIZE( 1 .. 9 ) )},
    extensionContainer [2] IMPLICIT SEQUENCE {
      privateExtensionList [0] IMPLICIT SEQUENCE ( SIZE( 1 .. 10 ) ) OF
        SEQUENCE {
          extId MAP-EXTENSION .&extensionId ( {
            '
            ...} ),
          extType MAP-EXTENSION .&ExtensionType ( {
            '
            ...}{ @extId } ) OPTIONAL} OPTIONAL,
          pcs-Extensions [1] IMPLICIT SEQUENCE {
            ... } OPTIONAL,

```

```

... } OPTIONAL,
... }
RESULT SEQUENCE {
targetMS [0] CHOICE {
imsi [0] IMPLICIT OCTET STRING ( SIZE( 3 .. 8 ) ),
msisdn [1] IMPLICIT OCTET STRING ( SIZE( 1 .. 20 ) ) ( SIZE( 1 .. 9 ) ),
lcsLocationInfo [1] IMPLICIT SEQUENCE {
networkNode-Number OCTET STRING ( SIZE( 1 .. 20 ) ) ( SIZE( 1 .. 9 ) ),
lmsi [0] IMPLICIT OCTET STRING ( SIZE( 4 ) ) OPTIONAL,
extensionContainer [1] IMPLICIT SEQUENCE {
privateExtensionList [0] IMPLICIT SEQUENCE ( SIZE( 1 .. 10 ) ) OF
SEQUENCE {
extld MAP-EXTENSION .&extensionId ( {
'
...} ),
extType MAP-EXTENSION .&ExtensionType ( {
'
...} { @extld } ) OPTIONAL} OPTIONAL,
pcs-Extensions [1] IMPLICIT SEQUENCE {
... } OPTIONAL,
... } OPTIONAL,
... ,
gprsNodeIndicator [2] IMPLICIT NULL OPTIONAL,
additional-Number [3] CHOICE {
msc-Number [0] IMPLICIT OCTET STRING ( SIZE( 1 .. 20 ) ) ( SIZE( 1 .. 9 ) ),
sgsn-Number [1] IMPLICIT OCTET STRING ( SIZE( 1 .. 20 ) ) ( SIZE( 1 .. 9 ) ) OPTIONAL},
extensionContainer [2] IMPLICIT SEQUENCE {
privateExtensionList [0] IMPLICIT SEQUENCE ( SIZE( 1 .. 10 ) ) OF
SEQUENCE {
extld MAP-EXTENSION .&extensionId ( {
'
...} ),
extType MAP-EXTENSION .&ExtensionType ( {
'
...} { @extld } ) OPTIONAL} OPTIONAL,
pcs-Extensions [1] IMPLICIT SEQUENCE {
... } OPTIONAL,
... } OPTIONAL,
... }
}
ERRORS {
systemFailure |
dataMissing |
unexpectedDataValue |
facilityNotSupported |
unknownSubscriber |
absentSubscriber |
unauthorizedRequestingNetwork }
CODE local : 85
}

provideSubscriberLocation OPERATION ::= {
ARGUMENT SEQUENCE {
locationType SEQUENCE {
locationEstimateType [0] IMPLICIT ENUMERATED {
currentLocation ( 0 ),
currentOrLastKnownLocation ( 1 ),
initialLocation ( 2 ),
... ,
activateDeferredLocation ( 3 ),
cancelDeferredLocation ( 4 ) },
... ,
deferredLocationEventType [1] IMPLICIT BIT STRING {
msAvailable ( 0 ) } ( SIZE( 1 .. 16 ) ) OPTIONAL},
mlc-Number OCTET STRING ( SIZE( 1 .. 20 ) ) ( SIZE( 1 .. 9 ) ),
lcs-ClientID [0] IMPLICIT SEQUENCE {
lcsClientType [0] IMPLICIT ENUMERATED {
emergencyServices ( 0 ),
valueAddedServices ( 1 ),
plmnOperatorServices ( 2 ),
lawfullInterceptServices ( 3 ),
... },
lcsClientExternalID [1] IMPLICIT SEQUENCE {
externalAddress [0] IMPLICIT OCTET STRING ( SIZE( 1 .. 20 ) ) ( SIZE( 1 .. 9 ) ) OPTIONAL,
extensionContainer [1] IMPLICIT SEQUENCE {
privateExtensionList [0] IMPLICIT SEQUENCE ( SIZE( 1 .. 10 ) ) OF
SEQUENCE {
extld MAP-EXTENSION .&extensionId ( {

```

```

    ...}),
    extType MAP-EXTENSION .&ExtensionType ( {
        ...}{ @extId } ) OPTIONAL} OPTIONAL,
    pcs-Extensions [1] IMPLICIT SEQUENCE {
        ... } OPTIONAL,
        ... } OPTIONAL,
        ... } OPTIONAL,
    lcsClientDialedByMS [2] IMPLICIT OCTET STRING ( SIZE( 1 .. 20 ) ) OPTIONAL,
    lcsClientInternalID [3] IMPLICIT ENUMERATED {
        broadcastService ( 0 ),
        o-andM-HPLMN ( 1 ),
        o-andM-VPLMN ( 2 ),
        anonymousLocation ( 3 ),
        targetMSsubscribedService ( 4 ),
        ... } OPTIONAL,
    lcsClientName [4] IMPLICIT SEQUENCE {
        dataCodingScheme [0] IMPLICIT OCTET STRING ( SIZE( 1 ) ),
        nameString [2] IMPLICIT OCTET STRING ( SIZE( 1 .. 160 ) ) ( SIZE( 1 .. 63 ) ),
        ... } OPTIONAL,
    ... ,
    lcsAPN [5] IMPLICIT OCTET STRING ( SIZE( 2 .. 63 ) ) OPTIONAL,
    lcsRequestorID [6] IMPLICIT SEQUENCE {
        dataCodingScheme [0] IMPLICIT OCTET STRING ( SIZE( 1 ) ),
        requestorIDString [1] IMPLICIT OCTET STRING ( SIZE( 1 .. 160 ) ) ( SIZE( 1 .. 63 ) ),
        ... } OPTIONAL} OPTIONAL,
    privacyOverride [1] IMPLICIT NULL OPTIONAL,
    imsi [2] IMPLICIT OCTET STRING ( SIZE( 3 .. 8 ) ) OPTIONAL,
    msisdn [3] IMPLICIT OCTET STRING ( SIZE( 1 .. 20 ) ) ( SIZE( 1 .. 9 ) ) OPTIONAL,
    lmsi [4] IMPLICIT OCTET STRING ( SIZE( 4 ) ) OPTIONAL,
    imei [5] IMPLICIT OCTET STRING ( SIZE( 8 ) ) OPTIONAL,
    lcs-Priority [6] IMPLICIT OCTET STRING ( SIZE( 1 ) ) OPTIONAL,
    lcs-QoS [7] IMPLICIT SEQUENCE {
        horizontal-accuracy [0] IMPLICIT OCTET STRING ( SIZE( 1 ) ) OPTIONAL,
        verticalCoordinateRequest [1] IMPLICIT NULL OPTIONAL,
        vertical-accuracy [2] IMPLICIT OCTET STRING ( SIZE( 1 ) ) OPTIONAL,
        responseTime [3] IMPLICIT SEQUENCE {
            responseTimeCategory ENUMERATED {
                lowdelay ( 0 ),
                delaytolerant ( 1 ),
                ... },
            ... } OPTIONAL,
        ... } OPTIONAL,
    extensionContainer [4] IMPLICIT SEQUENCE {
        privateExtensionList [0] IMPLICIT SEQUENCE ( SIZE( 1 .. 10 ) ) OF
        SEQUENCE {
            extId MAP-EXTENSION .&extensionId ( {
                ...}),
            extType MAP-EXTENSION .&ExtensionType ( {
                ...}{ @extId } ) OPTIONAL} OPTIONAL,
            pcs-Extensions [1] IMPLICIT SEQUENCE {
                ... } OPTIONAL,
                ... } OPTIONAL,
                ... } OPTIONAL,
            ... } OPTIONAL,
        extensionContainer [8] IMPLICIT SEQUENCE {
            privateExtensionList [0] IMPLICIT SEQUENCE ( SIZE( 1 .. 10 ) ) OF
            SEQUENCE {
                extId MAP-EXTENSION .&extensionId ( {
                    ...}),
                    ...}),
                extType MAP-EXTENSION .&ExtensionType ( {
                    ...}{ @extId } ) OPTIONAL} OPTIONAL,
                    pcs-Extensions [1] IMPLICIT SEQUENCE {
                        ... } OPTIONAL,
                        ... } OPTIONAL,
                        ... } OPTIONAL,
                    ... } OPTIONAL,
                supportedGADShapes [9] IMPLICIT BIT STRING {
                    ellipsoidPoint ( 0 ),
                    ellipsoidPointWithUncertaintyCircle ( 1 ),
                    ellipsoidPointWithUncertaintyEllipse ( 2 ),
                    polygon ( 3 ),
                    ellipsoidPointWithAltitude ( 4 ),
                    ellipsoidPointWithAltitudeAndUncertaintyElipsoid ( 5 ),
                    ellipsoidArc ( 6 ) } ( SIZE( 7 .. 16 ) ) OPTIONAL,

```

```

Ics-ReferenceNumber [10] IMPLICIT OCTET STRING ( SIZE( 1 ) ) OPTIONAL,
IcsServiceTypeID [11] IMPLICIT INTEGER ( 0 .. 127 ) OPTIONAL,
IcsCodeword [12] IMPLICIT SEQUENCE {
  dataCodingScheme [0] IMPLICIT OCTET STRING ( SIZE( 1 ) ),
  IcsCodewordString [1] IMPLICIT OCTET STRING ( SIZE( 1 .. 160 ) ) ( SIZE( 1 .. 20 ) ),
  ... } OPTIONAL}
RESULT SEQUENCE {
  locationEstimate OCTET STRING ( SIZE( 1 .. 20 ) ),
  ageOfLocationEstimate [0] IMPLICIT INTEGER ( 0 .. 32767 ) OPTIONAL,
  extensionContainer [1] IMPLICIT SEQUENCE {
    privateExtensionList [0] IMPLICIT SEQUENCE ( SIZE( 1 .. 10 ) ) OF
      SEQUENCE {
        extId MAP-EXTENSION .&extensionId ( {
          '
          ... } ),
        extType MAP-EXTENSION .&ExtensionType ( {
          '
          ... } { @extId } ) OPTIONAL} OPTIONAL,
    pcs-Extensions [1] IMPLICIT SEQUENCE {
      ... } OPTIONAL,
    ... } OPTIONAL,
  ... },
  add-LocationEstimate [2] IMPLICIT OCTET STRING ( SIZE( 1 .. 91 ) ) OPTIONAL,
  deferredmt-IrResponseIndicator [3] IMPLICIT NULL OPTIONAL,
  geranPositioningData [4] IMPLICIT OCTET STRING ( SIZE( 2 .. 10 ) ) OPTIONAL,
  utranPositioningData [5] IMPLICIT OCTET STRING ( SIZE( 3 .. 11 ) ) OPTIONAL}
ERRORS {
  systemFailure |
  dataMissing |
  unexpectedDataValue |
  facilityNotSupported |
  unidentifiedSubscriber |
  illegalSubscriber |
  illegalEquipment |
  absentSubscriber |
  unauthorizedRequestingNetwork |
  unauthorizedLCSClient |
  positionMethodFailure }
CODE local : 83
}

subscriberLocationReport OPERATION ::= {
  ARGUMENT SEQUENCE {
    Ics-Event ENUMERATED {
      emergencyCallOrigination ( 0 ),
      emergencyCallRelease ( 1 ),
      mo-Ir ( 2 ),
      ... ,
      deferredmt-IrResponse ( 3 ) },
    Ics-ClientID SEQUENCE {
      IcsClientType [0] IMPLICIT ENUMERATED {
        emergencyServices ( 0 ),
        valueAddedServices ( 1 ),
        plmnOperatorServices ( 2 ),
        lawfulInterceptServices ( 3 ),
        ... },
      IcsClientExternalID [1] IMPLICIT SEQUENCE {
        externalAddress [0] IMPLICIT OCTET STRING ( SIZE( 1 .. 20 ) ) ( SIZE( 1 .. 9 ) ) OPTIONAL,
        extensionContainer [1] IMPLICIT SEQUENCE {
          privateExtensionList [0] IMPLICIT SEQUENCE ( SIZE( 1 .. 10 ) ) OF
            SEQUENCE {
              extId MAP-EXTENSION .&extensionId ( {
                '
                ... } ),
              extType MAP-EXTENSION .&ExtensionType ( {
                '
                ... } { @extId } ) OPTIONAL} OPTIONAL,
          pcs-Extensions [1] IMPLICIT SEQUENCE {
            ... } OPTIONAL,
          ... } OPTIONAL,
          ... } OPTIONAL,
        IcsClientDialedByMS [2] IMPLICIT OCTET STRING ( SIZE( 1 .. 20 ) ) OPTIONAL,
        IcsClientInternalID [3] IMPLICIT ENUMERATED {
          broadcastService ( 0 ),
          o-andM-HPLMN ( 1 ),
          o-andM-VPLMN ( 2 ),
          anonymousLocation ( 3 ),

```

```

    targetMSsubscribedService ( 4 ),
    ... } OPTIONAL,
lcsClientName [4] IMPLICIT SEQUENCE {
    dataCodingScheme [0] IMPLICIT OCTET STRING ( SIZE( 1 ) ),
    nameString [2] IMPLICIT OCTET STRING ( SIZE( 1 .. 160 ) ) ( SIZE( 1 .. 63 ) ),
    ... } OPTIONAL,
... ,
lcsAPN [5] IMPLICIT OCTET STRING ( SIZE( 2 .. 63 ) ) OPTIONAL,
lcsRequestorID [6] IMPLICIT SEQUENCE {
    dataCodingScheme [0] IMPLICIT OCTET STRING ( SIZE( 1 ) ),
    requestorIDString [1] IMPLICIT OCTET STRING ( SIZE( 1 .. 160 ) ) ( SIZE( 1 .. 63 ) ),
    ... } OPTIONAL,
lcsLocationInfo SEQUENCE {
    networkNode-Number OCTET STRING ( SIZE( 1 .. 20 ) ) ( SIZE( 1 .. 9 ) ),
    lmsi [0] IMPLICIT OCTET STRING ( SIZE( 4 ) ) OPTIONAL,
    extensionContainer [1] IMPLICIT SEQUENCE {
        privateExtensionList [0] IMPLICIT SEQUENCE ( SIZE( 1 .. 10 ) ) OF
        SEQUENCE {
            extId MAP-EXTENSION .&extensionId ( {
                '
                ... } ),
            extType MAP-EXTENSION .&ExtensionType ( {
                '
                ... } { @extId } ) OPTIONAL } OPTIONAL,
        pcs-Extensions [1] IMPLICIT SEQUENCE {
            ... } OPTIONAL,
        ... } OPTIONAL,
    ... ,
    gprsNodeIndicator [2] IMPLICIT NULL OPTIONAL,
    additional-Number [3] CHOICE {
        msc-Number [0] IMPLICIT OCTET STRING ( SIZE( 1 .. 20 ) ) ( SIZE( 1 .. 9 ) ),
        sgsn-Number [1] IMPLICIT OCTET STRING ( SIZE( 1 .. 20 ) ) ( SIZE( 1 .. 9 ) ) } OPTIONAL,
    msisdn [0] IMPLICIT OCTET STRING ( SIZE( 1 .. 20 ) ) ( SIZE( 1 .. 9 ) ) OPTIONAL,
    imsi [1] IMPLICIT OCTET STRING ( SIZE( 3 .. 8 ) ) OPTIONAL,
    imei [2] IMPLICIT OCTET STRING ( SIZE( 8 ) ) OPTIONAL,
    na-ESRD [3] IMPLICIT OCTET STRING ( SIZE( 1 .. 20 ) ) ( SIZE( 1 .. 9 ) ) OPTIONAL,
    na-ESRK [4] IMPLICIT OCTET STRING ( SIZE( 1 .. 20 ) ) ( SIZE( 1 .. 9 ) ) OPTIONAL,
    locationEstimate [5] IMPLICIT OCTET STRING ( SIZE( 1 .. 20 ) ) OPTIONAL,
    ageOfLocationEstimate [6] IMPLICIT INTEGER ( 0 .. 32767 ) OPTIONAL,
    slr-ArgExtensionContainer [7] IMPLICIT SEQUENCE {
        privateExtensionList [0] IMPLICIT SEQUENCE ( SIZE( 1 .. 10 ) ) OF
        SEQUENCE {
            extId MAP-EXTENSION .&extensionId ( {
                '
                ... } ),
            extType MAP-EXTENSION .&ExtensionType ( {
                '
                ... } { @extId } ) OPTIONAL } OPTIONAL,
        slr-Arg-PCS-Extensions [1] IMPLICIT SEQUENCE {
            ... ,
            na-ESRK-Request [0] IMPLICIT NULL OPTIONAL } OPTIONAL,
        ... } OPTIONAL,
    ... ,
    add-LocationEstimate [8] IMPLICIT OCTET STRING ( SIZE( 1 .. 91 ) ) OPTIONAL,
    deferredmt-lrData [9] IMPLICIT SEQUENCE {
        deferredLocationEventType BIT STRING {
            msAvailable ( 0 ) } ( SIZE( 1 .. 16 ) ),
        terminationCause [0] IMPLICIT ENUMERATED {
            normal ( 0 ),
            errorundefined ( 1 ),
            internalTimeout ( 2 ),
            congestion ( 3 ),
            mt-lrRestart ( 4 ),
            privacyViolation ( 5 ),
            ... ,
            shapeOfLocationEstimateNotSupported ( 6 ) } OPTIONAL,
    lcsLocationInfo [1] IMPLICIT SEQUENCE {
        networkNode-Number OCTET STRING ( SIZE( 1 .. 20 ) ) ( SIZE( 1 .. 9 ) ),
        lmsi [0] IMPLICIT OCTET STRING ( SIZE( 4 ) ) OPTIONAL,
        extensionContainer [1] IMPLICIT SEQUENCE {
            privateExtensionList [0] IMPLICIT SEQUENCE ( SIZE( 1 .. 10 ) ) OF
            SEQUENCE {
                extId MAP-EXTENSION .&extensionId ( {
                    '
                    ... } ),
                extType MAP-EXTENSION .&ExtensionType ( {
                    '

```

```

        ...} { @extId } ) OPTIONAL} OPTIONAL,
    pcs-Extensions [1] IMPLICIT SEQUENCE {
        ... } OPTIONAL,
    ... } OPTIONAL,
    ... ,
    gprsNodeIndicator [2] IMPLICIT NULL OPTIONAL,
    additional-Number [3] CHOICE {
        msc-Number [0] IMPLICIT OCTET STRING ( SIZE( 1 .. 20 ) ) ( SIZE( 1 .. 9 ) ),
        sgsn-Number [1] IMPLICIT OCTET STRING ( SIZE( 1 .. 20 ) ) ( SIZE( 1 .. 9 ) ) } OPTIONAL} OPTIONAL,
    ... } OPTIONAL,
    lcs-ReferenceNumber [10] IMPLICIT OCTET STRING ( SIZE( 1 ) ) OPTIONAL,
    geranPositioningData [11] IMPLICIT OCTET STRING ( SIZE( 2 .. 10 ) ) OPTIONAL,
    utranPositioningData [12] IMPLICIT OCTET STRING ( SIZE( 3 .. 11 ) ) OPTIONAL}
RESULT SEQUENCE {
    extensionContainer SEQUENCE {
        privateExtensionList [0] IMPLICIT SEQUENCE ( SIZE( 1 .. 10 ) ) OF
        SEQUENCE {
            extId MAP-EXTENSION .&extensionId ( {
                '
                ... } ),
            extType MAP-EXTENSION .&ExtensionType ( {
                '
                ...} { @extId } ) OPTIONAL} OPTIONAL,
        pcs-Extensions [1] IMPLICIT SEQUENCE {
            ... } OPTIONAL,
        ... } OPTIONAL,
        ... ,
        na-ESRK [0] IMPLICIT OCTET STRING ( SIZE( 1 .. 20 ) ) ( SIZE( 1 .. 9 ) ) OPTIONAL}
ERRORS {
    systemFailure |
    dataMissing |
    resourceLimitation |
    unexpectedDataValue |
    unknownSubscriber |
    unauthorizedRequestingNetwork |
    unknownOrUnreachableLCSClient }
CODE local : 86
}

```

END

```

-- Expanded ASN1 Module 'MAP-Errors'
--SIEMENS ASN.1 Compiler R6.0 (Production_6.0)
-- Date: 2006-06-08 Time: 15:11:54

```

MAP-Errors{ 0 identified-organization (4) etsi (0) mobileDomain (0) gsm-Network (1) modules (3) map-Errors (10) version8 (8) }

DEFINITIONS

::=

BEGIN

EXPORTS

```

systemFailure,
dataMissing,
unexpectedDataValue,
facilityNotSupported,
incompatibleTerminal,
resourceLimitation,
unknownSubscriber,
numberChanged,
unknownMSC,
unidentifiedSubscriber,
unknownEquipment,
roamingNotAllowed,
illegalSubscriber,
illegalEquipment,
bearerServiceNotProvisioned,
teleserviceNotProvisioned,
noHandoverNumberAvailable,
subsequentHandoverFailure,
targetCellOutsideGroupCallArea,
tracingBufferFull,
or-NotAllowed,
noRoamingNumberAvailable,

```

busySubscriber,
 noSubscriberReply,
 absentSubscriber,
 callBarred,
 forwardingViolation,
 forwardingFailed,
 cug-Reject,
 ati-NotAllowed,
 atsi-NotAllowed,
 atm-NotAllowed,
 informationNotAvailable,
 illegalSS-Operation,
 ss-ErrorStatus,
 ss-NotAvailable,
 ss-SubscriptionViolation,
 ss-Incompatibility,
 unknownAlphabet,
 ussd-Busy,
 pw-RegistrationFailure,
 negativePW-Check,
 numberOfPW-AttemptsViolation,
 shortTermDenial,
 longTermDenial,
 subscriberBusyForMT-SMS,
 sm-DeliveryFailure,
 messageWaitingListFull,
 absentSubscriberSM,
 noGroupCallNumberAvailable,
 unauthorizedRequestingNetwork,
 unauthorizedLCSCClient,
 positionMethodFailure,
 unknownOrUnreachableLCSCClient,
 mm-EventNotSupported;

```

systemFailure ERROR ::= {
  PARAMETER CHOICE {
    networkResource      ENUMERATED {
      plmn      ( 0 ),
      hlr      ( 1 ),
      vlr      ( 2 ),
      pvlr     ( 3 ),
      controllingMSC ( 4 ),
      vmsc     ( 5 ),
      eir      ( 6 ),
      rss      ( 7 )},
    extensibleSystemFailureParam SEQUENCE {
      networkResource  ENUMERATED {
        plmn      ( 0 ),
        hlr      ( 1 ),
        vlr      ( 2 ),
        pvlr     ( 3 ),
        controllingMSC ( 4 ),
        vmsc     ( 5 ),
        eir      ( 6 ),
        rss      ( 7 )} OPTIONAL,
      extensionContainer SEQUENCE {
        privateExtensionList [0] IMPLICIT SEQUENCE ( SIZE( 1 .. 10 ) ) OF
          SEQUENCE {
            extId  MAP-EXTENSION .&extensionId ( {
              ... } ),
            extType  MAP-EXTENSION .&ExtensionType ( {
              ... } { @extId } ) OPTIONAL} OPTIONAL,
        pcs-Extensions [1] IMPLICIT SEQUENCE {
          ... } OPTIONAL,
          ... } OPTIONAL,
          ... } }
  }
  CODE local : 34
}
  
```

```

dataMissing ERROR ::= {
  PARAMETER SEQUENCE {
    extensionContainer SEQUENCE {
      privateExtensionList [0] IMPLICIT SEQUENCE ( SIZE( 1 .. 10 ) ) OF
        SEQUENCE {
  
```

```

    extId    MAP-EXTENSION .&extensionId ( {
        '
        ... } ),
    extType  MAP-EXTENSION .&ExtensionType ( {
        '
        ... } { @extId } ) OPTIONAL } OPTIONAL,
    pcs-Extensions [1] IMPLICIT SEQUENCE {
        ... } OPTIONAL,
    ... } OPTIONAL,
    ... }
CODE local : 35
}

unexpectedDataValue ERROR ::= {
PARAMETER SEQUENCE {
    extensionContainer SEQUENCE {
        privateExtensionList [0] IMPLICIT SEQUENCE ( SIZE( 1 .. 10 ) ) OF
        SEQUENCE {
            extId    MAP-EXTENSION .&extensionId ( {
                '
                ... } ),
            extType  MAP-EXTENSION .&ExtensionType ( {
                '
                ... } { @extId } ) OPTIONAL } OPTIONAL,
            pcs-Extensions [1] IMPLICIT SEQUENCE {
                ... } OPTIONAL,
            ... } OPTIONAL,
            ... }
CODE local : 36
}

facilityNotSupported ERROR ::= {
PARAMETER SEQUENCE {
    extensionContainer SEQUENCE {
        privateExtensionList [0] IMPLICIT SEQUENCE ( SIZE( 1 .. 10 ) ) OF
        SEQUENCE {
            extId    MAP-EXTENSION .&extensionId ( {
                '
                ... } ),
            extType  MAP-EXTENSION .&ExtensionType ( {
                '
                ... } { @extId } ) OPTIONAL } OPTIONAL,
            pcs-Extensions [1] IMPLICIT SEQUENCE {
                ... } OPTIONAL,
            ... } OPTIONAL,
            ... ,
            shapeOfLocationEstimateNotSupported [0] IMPLICIT NULL OPTIONAL,
            neededLcsCapabilityNotSupportedInServingNode [1] IMPLICIT NULL OPTIONAL }
CODE local : 21
}

incompatibleTerminal ERROR ::= {
PARAMETER SEQUENCE {
    extensionContainer SEQUENCE {
        privateExtensionList [0] IMPLICIT SEQUENCE ( SIZE( 1 .. 10 ) ) OF
        SEQUENCE {
            extId    MAP-EXTENSION .&extensionId ( {
                '
                ... } ),
            extType  MAP-EXTENSION .&ExtensionType ( {
                '
                ... } { @extId } ) OPTIONAL } OPTIONAL,
            pcs-Extensions [1] IMPLICIT SEQUENCE {
                ... } OPTIONAL,
            ... } OPTIONAL,
            ... }
CODE local : 28
}

resourceLimitation ERROR ::= {
PARAMETER SEQUENCE {
    extensionContainer SEQUENCE {
        privateExtensionList [0] IMPLICIT SEQUENCE ( SIZE( 1 .. 10 ) ) OF
        SEQUENCE {
            extId    MAP-EXTENSION .&extensionId ( {
                '
                ... } ),

```

```

        extType MAP-EXTENSION .&ExtensionType ( {
            '
            ...}{ @extId } ) OPTIONAL} OPTIONAL,
        pcs-Extensions [1] IMPLICIT SEQUENCE {
            ... } OPTIONAL,
        ... } OPTIONAL,
        ... }
    CODE local : 51
}

unknownSubscriber ERROR ::= {
    PARAMETER SEQUENCE {
        extensionContainer SEQUENCE {
            privateExtensionList [0] IMPLICIT SEQUENCE ( SIZE( 1 .. 10 ) ) OF
                SEQUENCE {
                    extId MAP-EXTENSION .&extensionId ( {
                        '
                        ...} ),
                    extType MAP-EXTENSION .&ExtensionType ( {
                        '
                        ...}{ @extId } ) OPTIONAL} OPTIONAL,
                    pcs-Extensions [1] IMPLICIT SEQUENCE {
                        ... } OPTIONAL,
                    ... } OPTIONAL,
                    ... ,
                    unknownSubscriberDiagnostic ENUMERATED {
                        imsiUnknown ( 0 ),
                        gprsSubscriptionUnknown ( 1 ),
                        ... ,
                        npdbMismatch ( 2 ) } OPTIONAL}
    CODE local : 1
}

numberChanged ERROR ::= {
    PARAMETER SEQUENCE {
        extensionContainer SEQUENCE {
            privateExtensionList [0] IMPLICIT SEQUENCE ( SIZE( 1 .. 10 ) ) OF
                SEQUENCE {
                    extId MAP-EXTENSION .&extensionId ( {
                        '
                        ...} ),
                    extType MAP-EXTENSION .&ExtensionType ( {
                        '
                        ...}{ @extId } ) OPTIONAL} OPTIONAL,
                    pcs-Extensions [1] IMPLICIT SEQUENCE {
                        ... } OPTIONAL,
                    ... } OPTIONAL,
                    ... }
    CODE local : 44
}

unknownMSC ERROR ::= {
    CODE local : 3
}

unidentifiedSubscriber ERROR ::= {
    PARAMETER SEQUENCE {
        extensionContainer SEQUENCE {
            privateExtensionList [0] IMPLICIT SEQUENCE ( SIZE( 1 .. 10 ) ) OF
                SEQUENCE {
                    extId MAP-EXTENSION .&extensionId ( {
                        '
                        ...} ),
                    extType MAP-EXTENSION .&ExtensionType ( {
                        '
                        ...}{ @extId } ) OPTIONAL} OPTIONAL,
                    pcs-Extensions [1] IMPLICIT SEQUENCE {
                        ... } OPTIONAL,
                    ... } OPTIONAL,
                    ... }
    CODE local : 5
}

unknownEquipment ERROR ::= {
    CODE local : 7
}

```

```

roamingNotAllowed ERROR ::= {
  PARAMETER SEQUENCE {
    roamingNotAllowedCause ENUMERATED {
      plmnRoamingNotAllowed (0),
      operatorDeterminedBarring (3)},
    extensionContainer SEQUENCE {
      privateExtensionList [0] IMPLICIT SEQUENCE (SIZE(1..10)) OF
        SEQUENCE {
          extId MAP-EXTENSION .&extensionId ({
            '
            ...}),
          extType MAP-EXTENSION .&ExtensionType ({
            '
            ...}{ @extId } ) OPTIONAL} OPTIONAL,
      pcs-Extensions [1] IMPLICIT SEQUENCE {
        ... } OPTIONAL,
        ... } OPTIONAL,
        ... }
    }
  CODE local :8
}

```

```

illegalSubscriber ERROR ::= {
  PARAMETER SEQUENCE {
    extensionContainer SEQUENCE {
      privateExtensionList [0] IMPLICIT SEQUENCE (SIZE(1..10)) OF
        SEQUENCE {
          extId MAP-EXTENSION .&extensionId ({
            '
            ...}),
          extType MAP-EXTENSION .&ExtensionType ({
            '
            ...}{ @extId } ) OPTIONAL} OPTIONAL,
      pcs-Extensions [1] IMPLICIT SEQUENCE {
        ... } OPTIONAL,
        ... } OPTIONAL,
        ... }
    }
  CODE local :9
}

```

```

illegalEquipment ERROR ::= {
  PARAMETER SEQUENCE {
    extensionContainer SEQUENCE {
      privateExtensionList [0] IMPLICIT SEQUENCE (SIZE(1..10)) OF
        SEQUENCE {
          extId MAP-EXTENSION .&extensionId ({
            '
            ...}),
          extType MAP-EXTENSION .&ExtensionType ({
            '
            ...}{ @extId } ) OPTIONAL} OPTIONAL,
      pcs-Extensions [1] IMPLICIT SEQUENCE {
        ... } OPTIONAL,
        ... } OPTIONAL,
        ... }
    }
  CODE local :12
}

```

```

bearerServiceNotProvisioned ERROR ::= {
  PARAMETER SEQUENCE {
    extensionContainer SEQUENCE {
      privateExtensionList [0] IMPLICIT SEQUENCE (SIZE(1..10)) OF
        SEQUENCE {
          extId MAP-EXTENSION .&extensionId ({
            '
            ...}),
          extType MAP-EXTENSION .&ExtensionType ({
            '
            ...}{ @extId } ) OPTIONAL} OPTIONAL,
      pcs-Extensions [1] IMPLICIT SEQUENCE {
        ... } OPTIONAL,
        ... } OPTIONAL,
        ... }
    }
  CODE local :10
}

```

```

teleserviceNotProvisioned ERROR ::= {
  PARAMETER SEQUENCE {

```

```

extensionContainer SEQUENCE {
  privateExtensionList [0] IMPLICIT SEQUENCE ( SIZE( 1 .. 10 ) ) OF
  SEQUENCE {
    extId MAP-EXTENSION .&extensionId ( {
      '
      ... } ),
    extType MAP-EXTENSION .&ExtensionType ( {
      '
      ... } { @extId } ) OPTIONAL } OPTIONAL,
  pcs-Extensions [1] IMPLICIT SEQUENCE {
    ... } OPTIONAL,
  ... } OPTIONAL,
  ... }
CODE local : 11
}

noHandoverNumberAvailable ERROR ::= {
  CODE local : 25
}

subsequentHandoverFailure ERROR ::= {
  CODE local : 26
}

targetCellOutsideGroupCallArea ERROR ::= {
  PARAMETER SEQUENCE {
    extensionContainer SEQUENCE {
      privateExtensionList [0] IMPLICIT SEQUENCE ( SIZE( 1 .. 10 ) ) OF
      SEQUENCE {
        extId MAP-EXTENSION .&extensionId ( {
          '
          ... } ),
        extType MAP-EXTENSION .&ExtensionType ( {
          '
          ... } { @extId } ) OPTIONAL } OPTIONAL,
        pcs-Extensions [1] IMPLICIT SEQUENCE {
          ... } OPTIONAL,
          ... } OPTIONAL,
          ... } OPTIONAL,
          ... }
CODE local : 42
}

tracingBufferFull ERROR ::= {
  PARAMETER SEQUENCE {
    extensionContainer SEQUENCE {
      privateExtensionList [0] IMPLICIT SEQUENCE ( SIZE( 1 .. 10 ) ) OF
      SEQUENCE {
        extId MAP-EXTENSION .&extensionId ( {
          '
          ... } ),
        extType MAP-EXTENSION .&ExtensionType ( {
          '
          ... } { @extId } ) OPTIONAL } OPTIONAL,
        pcs-Extensions [1] IMPLICIT SEQUENCE {
          ... } OPTIONAL,
          ... } OPTIONAL,
          ... }
CODE local : 40
}

noRoamingNumberAvailable ERROR ::= {
  PARAMETER SEQUENCE {
    extensionContainer SEQUENCE {
      privateExtensionList [0] IMPLICIT SEQUENCE ( SIZE( 1 .. 10 ) ) OF
      SEQUENCE {
        extId MAP-EXTENSION .&extensionId ( {
          '
          ... } ),
        extType MAP-EXTENSION .&ExtensionType ( {
          '
          ... } { @extId } ) OPTIONAL } OPTIONAL,
        pcs-Extensions [1] IMPLICIT SEQUENCE {
          ... } OPTIONAL,
          ... } OPTIONAL,
          ... }
CODE local : 39
}

```

```

absentSubscriber ERROR ::= {
  PARAMETER SEQUENCE {
    extensionContainer SEQUENCE {
      privateExtensionList [0] IMPLICIT SEQUENCE ( SIZE( 1 .. 10 ) ) OF
        SEQUENCE {
          extId MAP-EXTENSION .&extensionId ( {
            '
            ... } ),
          extType MAP-EXTENSION .&ExtensionType ( {
            '
            ... } { @extId } ) OPTIONAL } OPTIONAL,
          pcs-Extensions [1] IMPLICIT SEQUENCE {
            ... } OPTIONAL,
          ... } OPTIONAL,
        ... ,
      absentSubscriberReason [0] IMPLICIT ENUMERATED {
        imsiDetach ( 0 ),
        restrictedArea ( 1 ),
        noPageResponse ( 2 ),
        ... ,
        purgedMS ( 3 ) } OPTIONAL }
    CODE local : 27
  }

```

```

busySubscriber ERROR ::= {
  PARAMETER SEQUENCE {
    extensionContainer SEQUENCE {
      privateExtensionList [0] IMPLICIT SEQUENCE ( SIZE( 1 .. 10 ) ) OF
        SEQUENCE {
          extId MAP-EXTENSION .&extensionId ( {
            '
            ... } ),
          extType MAP-EXTENSION .&ExtensionType ( {
            '
            ... } { @extId } ) OPTIONAL } OPTIONAL,
          pcs-Extensions [1] IMPLICIT SEQUENCE {
            ... } OPTIONAL,
          ... } OPTIONAL,
        ... ,
      ccbs-Possible [0] IMPLICIT NULL OPTIONAL,
      ccbs-Busy [1] IMPLICIT NULL OPTIONAL }
    CODE local : 45
  }

```

```

noSubscriberReply ERROR ::= {
  PARAMETER SEQUENCE {
    extensionContainer SEQUENCE {
      privateExtensionList [0] IMPLICIT SEQUENCE ( SIZE( 1 .. 10 ) ) OF
        SEQUENCE {
          extId MAP-EXTENSION .&extensionId ( {
            '
            ... } ),
          extType MAP-EXTENSION .&ExtensionType ( {
            '
            ... } { @extId } ) OPTIONAL } OPTIONAL,
          pcs-Extensions [1] IMPLICIT SEQUENCE {
            ... } OPTIONAL,
          ... } OPTIONAL,
        ... }
    CODE local : 46
  }

```

```

callBarred ERROR ::= {
  PARAMETER CHOICE {
    callBarringCause ENUMERATED {
      barringServiceActive ( 0 ),
      operatorBarring ( 1 ) },
    extensibleCallBarredParam SEQUENCE {
      callBarringCause ENUMERATED {
        barringServiceActive ( 0 ),
        operatorBarring ( 1 ) } OPTIONAL,
      extensionContainer SEQUENCE {
        privateExtensionList [0] IMPLICIT SEQUENCE ( SIZE( 1 .. 10 ) ) OF
          SEQUENCE {
            extId MAP-EXTENSION .&extensionId ( {
              '
              ... } ),
            extType MAP-EXTENSION .&ExtensionType ( {
              '
              ... } { @extId } ) OPTIONAL } OPTIONAL,
            pcs-Extensions [1] IMPLICIT SEQUENCE {
              ... } OPTIONAL,
            ... } OPTIONAL,
          ... ,
        absentSubscriberReason [0] IMPLICIT ENUMERATED {
          imsiDetach ( 0 ),
          restrictedArea ( 1 ),
          noPageResponse ( 2 ),
          ... ,
          purgedMS ( 3 ) } OPTIONAL }
      CODE local : 47
    }
  }

```

```

        ...}),
        extType MAP-EXTENSION .&ExtensionType ({
            '
            ...}{ @extId } ) OPTIONAL} OPTIONAL,
        pcs-Extensions [1] IMPLICIT SEQUENCE {
            ... } OPTIONAL,
            ... } OPTIONAL,
        ... ,
        unauthorisedMessageOriginator [1] IMPLICIT NULL OPTIONAL}}
CODE local : 13
}

forwardingViolation ERROR ::= {
PARAMETER SEQUENCE {
    extensionContainer SEQUENCE {
        privateExtensionList [0] IMPLICIT SEQUENCE ( SIZE( 1 .. 10 ) ) OF
        SEQUENCE {
            extId MAP-EXTENSION .&extensionId ({
                '
                ...}),
            extType MAP-EXTENSION .&ExtensionType ({
                '
                ...}{ @extId } ) OPTIONAL} OPTIONAL,
            pcs-Extensions [1] IMPLICIT SEQUENCE {
                ... } OPTIONAL,
                ... } OPTIONAL,
            ... } OPTIONAL,
            ... }
CODE local : 14
}

forwardingFailed ERROR ::= {
PARAMETER SEQUENCE {
    extensionContainer SEQUENCE {
        privateExtensionList [0] IMPLICIT SEQUENCE ( SIZE( 1 .. 10 ) ) OF
        SEQUENCE {
            extId MAP-EXTENSION .&extensionId ({
                '
                ...}),
            extType MAP-EXTENSION .&ExtensionType ({
                '
                ...}{ @extId } ) OPTIONAL} OPTIONAL,
            pcs-Extensions [1] IMPLICIT SEQUENCE {
                ... } OPTIONAL,
                ... } OPTIONAL,
            ... }
CODE local : 47
}

cug-Reject ERROR ::= {
PARAMETER SEQUENCE {
    cug-RejectCause ENUMERATED{
        incomingCallsBarredWithinCUG ( 0 ),
        subscriberNotMemberOfCUG ( 1 ),
        requestedBasicServiceViolatesCUG-Constraints ( 5 ),
        calledPartySS-InteractionViolation ( 7 )} OPTIONAL,
    extensionContainer SEQUENCE {
        privateExtensionList [0] IMPLICIT SEQUENCE ( SIZE( 1 .. 10 ) ) OF
        SEQUENCE {
            extId MAP-EXTENSION .&extensionId ({
                '
                ...}),
            extType MAP-EXTENSION .&ExtensionType ({
                '
                ...}{ @extId } ) OPTIONAL} OPTIONAL,
            pcs-Extensions [1] IMPLICIT SEQUENCE {
                ... } OPTIONAL,
                ... } OPTIONAL,
            ... }
CODE local : 15
}

or-NotAllowed ERROR ::= {
PARAMETER SEQUENCE {
    extensionContainer SEQUENCE {
        privateExtensionList [0] IMPLICIT SEQUENCE ( SIZE( 1 .. 10 ) ) OF
        SEQUENCE {
            extId MAP-EXTENSION .&extensionId ({

```

```

        ...}),
        extType MAP-EXTENSION .&ExtensionType ( {
            ...}{ @extId } ) OPTIONAL} OPTIONAL,
        pcs-Extensions [1] IMPLICIT SEQUENCE {
            ... } OPTIONAL,
        ... } OPTIONAL,
        ... }
CODE local : 48
}

ati-NotAllowed ERROR ::= {
PARAMETER SEQUENCE {
    extensionContainer SEQUENCE {
        privateExtensionList [0] IMPLICIT SEQUENCE ( SIZE( 1 .. 10 ) ) OF
        SEQUENCE {
            extId MAP-EXTENSION .&extensionId ( {
                ...}),
            extType MAP-EXTENSION .&ExtensionType ( {
                ...}{ @extId } ) OPTIONAL} OPTIONAL,
            pcs-Extensions [1] IMPLICIT SEQUENCE {
                ... } OPTIONAL,
            ... } OPTIONAL,
            ... } OPTIONAL,
            ... }
CODE local : 49
}

atsi-NotAllowed ERROR ::= {
PARAMETER SEQUENCE {
    extensionContainer SEQUENCE {
        privateExtensionList [0] IMPLICIT SEQUENCE ( SIZE( 1 .. 10 ) ) OF
        SEQUENCE {
            extId MAP-EXTENSION .&extensionId ( {
                ...}),
            extType MAP-EXTENSION .&ExtensionType ( {
                ...}{ @extId } ) OPTIONAL} OPTIONAL,
            pcs-Extensions [1] IMPLICIT SEQUENCE {
                ... } OPTIONAL,
            ... } OPTIONAL,
            ... } OPTIONAL,
            ... }
CODE local : 60
}

atm-NotAllowed ERROR ::= {
PARAMETER SEQUENCE {
    extensionContainer SEQUENCE {
        privateExtensionList [0] IMPLICIT SEQUENCE ( SIZE( 1 .. 10 ) ) OF
        SEQUENCE {
            extId MAP-EXTENSION .&extensionId ( {
                ...}),
            extType MAP-EXTENSION .&ExtensionType ( {
                ...}{ @extId } ) OPTIONAL} OPTIONAL,
            pcs-Extensions [1] IMPLICIT SEQUENCE {
                ... } OPTIONAL,
            ... } OPTIONAL,
            ... }
CODE local : 61
}

informationNotAvailable ERROR ::= {
PARAMETER SEQUENCE {
    extensionContainer SEQUENCE {
        privateExtensionList [0] IMPLICIT SEQUENCE ( SIZE( 1 .. 10 ) ) OF
        SEQUENCE {
            extId MAP-EXTENSION .&extensionId ( {
                ...}),
            extType MAP-EXTENSION .&ExtensionType ( {
                ...}{ @extId } ) OPTIONAL} OPTIONAL,

```



```

    pcs-Extensions    [1] IMPLICIT SEQUENCE {
      ... } OPTIONAL,
      ... } OPTIONAL,
    ... }
CODE    local    : 62
}

illegalSS-Operation ERROR ::= {
PARAMETER SEQUENCE {
  extensionContainer SEQUENCE {
    privateExtensionList [0] IMPLICIT SEQUENCE ( SIZE( 1 .. 10 ) ) OF
    SEQUENCE {
      extId    MAP-EXTENSION .&extensionId ( {
        '
        ... } ),
      extType  MAP-EXTENSION .&ExtensionType ( {
        '
        ... } { @extId } ) OPTIONAL } OPTIONAL,
      pcs-Extensions    [1] IMPLICIT SEQUENCE {
        ... } OPTIONAL,
        ... } OPTIONAL,
      ... }
CODE    local    : 16
}

ss-ErrorStatus ERROR ::= {
PARAMETER OCTET STRING ( SIZE( 1 ) )
CODE    local    : 17
}

ss-NotAvailable ERROR ::= {
PARAMETER SEQUENCE {
  extensionContainer SEQUENCE {
    privateExtensionList [0] IMPLICIT SEQUENCE ( SIZE( 1 .. 10 ) ) OF
    SEQUENCE {
      extId    MAP-EXTENSION .&extensionId ( {
        '
        ... } ),
      extType  MAP-EXTENSION .&ExtensionType ( {
        '
        ... } { @extId } ) OPTIONAL } OPTIONAL,
      pcs-Extensions    [1] IMPLICIT SEQUENCE {
        ... } OPTIONAL,
        ... } OPTIONAL,
      ... }
CODE    local    : 18
}

ss-SubscriptionViolation ERROR ::= {
PARAMETER SEQUENCE {
  extensionContainer SEQUENCE {
    privateExtensionList [0] IMPLICIT SEQUENCE ( SIZE( 1 .. 10 ) ) OF
    SEQUENCE {
      extId    MAP-EXTENSION .&extensionId ( {
        '
        ... } ),
      extType  MAP-EXTENSION .&ExtensionType ( {
        '
        ... } { @extId } ) OPTIONAL } OPTIONAL,
      pcs-Extensions    [1] IMPLICIT SEQUENCE {
        ... } OPTIONAL,
        ... } OPTIONAL,
      ... }
CODE    local    : 19
}

ss-Incompatibility ERROR ::= {
PARAMETER SEQUENCE {
  ss-Code    [1] IMPLICIT OCTET STRING ( SIZE( 1 ) ) OPTIONAL,
  basicService CHOICE {
    bearerService [2] IMPLICIT OCTET STRING ( SIZE( 1 ) ),
    teleservice [3] IMPLICIT OCTET STRING ( SIZE( 1 ) ) } OPTIONAL,
  ss-Status [4] IMPLICIT OCTET STRING ( SIZE( 1 ) ) OPTIONAL,
  ... }
CODE    local    : 20
}

```

```

unknownAlphabet ERROR ::= {
  CODE local : 71
}

ussd-Busy ERROR ::= {
  CODE local : 72
}

pw-RegistrationFailure ERROR ::= {
  PARAMETER ENUMERATED {
    undetermined ( 0 ),
    invalidFormat ( 1 ),
    newPasswordsMismatch ( 2 ) }
  CODE local : 37
}

negativePW-Check ERROR ::= {
  CODE local : 38
}

numberOfPW-AttemptsViolation ERROR ::= {
  CODE local : 43
}

shortTermDenial ERROR ::= {
  PARAMETER SEQUENCE {
    ... }
  CODE local : 29
}

longTermDenial ERROR ::= {
  PARAMETER SEQUENCE {
    ... }
  CODE local : 30
}

subscriberBusyForMT-SMS ERROR ::= {
  PARAMETER SEQUENCE {
    extensionContainer SEQUENCE {
      privateExtensionList [0] IMPLICIT SEQUENCE ( SIZE( 1 .. 10 ) ) OF
        SEQUENCE {
          extId MAP-EXTENSION .&extensionId ( {
            '
            ... } ),
          extType MAP-EXTENSION .&ExtensionType ( {
            '
            ... } { @extId } ) OPTIONAL } OPTIONAL,
          pcs-Extensions [1] IMPLICIT SEQUENCE {
            ... } OPTIONAL,
            ... } OPTIONAL,
            ... ,
            gprsConnectionSuspended NULL OPTIONAL }
  CODE local : 31
}

sm-DeliveryFailure ERROR ::= {
  PARAMETER SEQUENCE {
    sm-EnumeratedDeliveryFailureCause ENUMERATED {
      memoryCapacityExceeded ( 0 ),
      equipmentProtocolError ( 1 ),
      equipmentNotSM-Equipped ( 2 ),
      unknownServiceCentre ( 3 ),
      sc-Congestion ( 4 ),
      invalidSME-Address ( 5 ),
      subscriberNotSC-Subscriber ( 6 ) },
    diagnosticInfo OCTET STRING ( SIZE( 1 .. 200 ) ) OPTIONAL,
    extensionContainer SEQUENCE {
      privateExtensionList [0] IMPLICIT SEQUENCE ( SIZE( 1 .. 10 ) ) OF
        SEQUENCE {
          extId MAP-EXTENSION .&extensionId ( {
            '
            ... } ),
          extType MAP-EXTENSION .&ExtensionType ( {
            '
            ... } { @extId } ) OPTIONAL } OPTIONAL,
          pcs-Extensions [1] IMPLICIT SEQUENCE {
            ... } OPTIONAL,

```

```

    ... } OPTIONAL,
    ... }
CODE local : 32
}

messageWaitingListFull ERROR ::= {
PARAMETER SEQUENCE {
extensionContainer SEQUENCE {
privateExtensionList [0] IMPLICIT SEQUENCE ( SIZE( 1 .. 10 ) ) OF
SEQUENCE {
extId MAP-EXTENSION .&extensionId ( {
'
...} ),
extType MAP-EXTENSION .&ExtensionType ( {
'
...}{ @extId } ) OPTIONAL} OPTIONAL,
pcs-Extensions [1] IMPLICIT SEQUENCE {
... } OPTIONAL,
... } OPTIONAL,
... }
CODE local : 33
}

absentSubscriberSM ERROR ::= {
PARAMETER SEQUENCE {
absentSubscriberDiagnosticSM INTEGER ( 0 .. 255 ) OPTIONAL,
extensionContainer SEQUENCE {
privateExtensionList [0] IMPLICIT SEQUENCE ( SIZE( 1 .. 10 ) ) OF
SEQUENCE {
extId MAP-EXTENSION .&extensionId ( {
'
...} ),
extType MAP-EXTENSION .&ExtensionType ( {
'
...}{ @extId } ) OPTIONAL} OPTIONAL,
pcs-Extensions [1] IMPLICIT SEQUENCE {
... } OPTIONAL,
... } OPTIONAL,
... },
additionalAbsentSubscriberDiagnosticSM [0] IMPLICIT INTEGER ( 0 .. 255 ) OPTIONAL}
CODE local : 6
}

noGroupCallNumberAvailable ERROR ::= {
PARAMETER SEQUENCE {
extensionContainer SEQUENCE {
privateExtensionList [0] IMPLICIT SEQUENCE ( SIZE( 1 .. 10 ) ) OF
SEQUENCE {
extId MAP-EXTENSION .&extensionId ( {
'
...} ),
extType MAP-EXTENSION .&ExtensionType ( {
'
...}{ @extId } ) OPTIONAL} OPTIONAL,
pcs-Extensions [1] IMPLICIT SEQUENCE {
... } OPTIONAL,
... } OPTIONAL,
... }
CODE local : 50
}

unauthorizedRequestingNetwork ERROR ::= {
PARAMETER SEQUENCE {
extensionContainer SEQUENCE {
privateExtensionList [0] IMPLICIT SEQUENCE ( SIZE( 1 .. 10 ) ) OF
SEQUENCE {
extId MAP-EXTENSION .&extensionId ( {
'
...} ),
extType MAP-EXTENSION .&ExtensionType ( {
'
...}{ @extId } ) OPTIONAL} OPTIONAL,
pcs-Extensions [1] IMPLICIT SEQUENCE {
... } OPTIONAL,
... } OPTIONAL,
... }
CODE local : 52
}

```

```

}

unauthorizedLCSCClient ERROR ::= {
  PARAMETER SEQUENCE {
    unauthorizedLCSCClient-Diagnostic [0] IMPLICIT ENUMERATED {
      noAdditionalInformation (0),
      clientNotInMSPrivacyExceptionList (1),
      callToClientNotSetup (2),
      privacyOverrideNotApplicable (3),
      disallowedByLocalRegulatoryRequirements (4),
      ... ,
      unauthorizedPrivacyClass (5),
      unauthorizedCallSessionUnrelatedExternalClient (6),
      unauthorizedCallSessionRelatedExternalClient (7) } OPTIONAL,
    extensionContainer [1] IMPLICIT SEQUENCE {
      privateExtensionList [0] IMPLICIT SEQUENCE ( SIZE( 1 .. 10 ) ) OF
        SEQUENCE {
          extId MAP-EXTENSION .&extensionId ( {
            '
            ... } ),
          extType MAP-EXTENSION .&ExtensionType ( {
            '
            ... } { @extId } ) OPTIONAL } OPTIONAL,
      pcs-Extensions [1] IMPLICIT SEQUENCE {
        ... } OPTIONAL,
        ... } OPTIONAL,
        ... }
    }
  }
  CODE local : 53
}

```

```

positionMethodFailure ERROR ::= {
  PARAMETER SEQUENCE {
    positionMethodFailure-Diagnostic [0] IMPLICIT ENUMERATED {
      congestion (0),
      insufficientResources (1),
      insufficientMeasurementData (2),
      inconsistentMeasurementData (3),
      locationProcedureNotCompleted (4),
      locationProcedureNotSupportedByTargetMS (5),
      qosNotAttainable (6),
      positionMethodNotAvailableInNetwork (7),
      positionMethodNotAvailableInLocationArea (8),
      ... } OPTIONAL,
    extensionContainer [1] IMPLICIT SEQUENCE {
      privateExtensionList [0] IMPLICIT SEQUENCE ( SIZE( 1 .. 10 ) ) OF
        SEQUENCE {
          extId MAP-EXTENSION .&extensionId ( {
            '
            ... } ),
          extType MAP-EXTENSION .&ExtensionType ( {
            '
            ... } { @extId } ) OPTIONAL } OPTIONAL,
      pcs-Extensions [1] IMPLICIT SEQUENCE {
        ... } OPTIONAL,
        ... } OPTIONAL,
        ... }
    }
  }
  CODE local : 54
}

```

```

unknownOrUnreachableLCSCClient ERROR ::= {
  PARAMETER SEQUENCE {
    extensionContainer SEQUENCE {
      privateExtensionList [0] IMPLICIT SEQUENCE ( SIZE( 1 .. 10 ) ) OF
        SEQUENCE {
          extId MAP-EXTENSION .&extensionId ( {
            '
            ... } ),
          extType MAP-EXTENSION .&ExtensionType ( {
            '
            ... } { @extId } ) OPTIONAL } OPTIONAL,
      pcs-Extensions [1] IMPLICIT SEQUENCE {
        ... } OPTIONAL,
        ... } OPTIONAL,
        ... }
    }
  }
  CODE local : 58
}

```

```
mm-EventNotSupported ERROR ::= {
  PARAMETER SEQUENCE {
    extensionContainer SEQUENCE {
      privateExtensionList [0] IMPLICIT SEQUENCE ( SIZE( 1 .. 10 ) ) OF
        SEQUENCE {
          extId MAP-EXTENSION .&extensionId ( {
            '
            ... } ),
          extType MAP-EXTENSION .&ExtensionType ( {
            '
            ... } { @extId } ) OPTIONAL } OPTIONAL,
          pcs-Extensions [1] IMPLICIT SEQUENCE {
            ... } OPTIONAL,
            ... } OPTIONAL,
            ... }
        }
  }
  CODE local : 59
}
```

END

B.2 Fully Expanded ASN.1 Source of MAP-DialogueInformation

```

-- Expanded ASN1 Module 'MAP-DialogueInformation'
--SIEMENS ASN.1 Compiler R6.0 (Production_6.0)
-- Date: 2006-06-08 Time: 15:12:01

MAP-DialogueInformation{ 0 identified-organization (4) etsi (0) mobileDomain (0) gsm-Network (1) modules (3) map-
DialogueInformation (3) version8 (8) }

DEFINITIONS

 ::=

BEGIN

EXPORTS
  map-DialogueAS,
  MAP-DialoguePDU;

map-DialogueAS OBJECT IDENTIFIER ::= { ccitt (0) identified-organization (4) etsi (0) mobileDomain (0) gsm-Network (1) 1 map-
DialoguePDU (1) version1 (1) }

MAP-DialoguePDU ::= CHOICE {
  map-open [0] IMPLICIT SEQUENCE {
    destinationReference [0] IMPLICIT OCTET STRING ( SIZE( 1 .. 20 ) ) OPTIONAL,
    originationReference [1] IMPLICIT OCTET STRING ( SIZE( 1 .. 20 ) ) OPTIONAL,
    ...,
    extensionContainer SEQUENCE {
      privateExtensionList [0] IMPLICIT SEQUENCE ( SIZE( 1 .. 10 ) ) OF
        SEQUENCE {
          extId MAP-EXTENSION .&extensionId ( {
            '
            ... } ),
          extType MAP-EXTENSION .&ExtensionType ( {
            '
            ... } { @extId } ) OPTIONAL } OPTIONAL,
      pcs-Extensions [1] IMPLICIT SEQUENCE {
        ... } OPTIONAL,
        ... } OPTIONAL },
  map-accept [1] IMPLICIT SEQUENCE {
    ...,
    extensionContainer SEQUENCE {
      privateExtensionList [0] IMPLICIT SEQUENCE ( SIZE( 1 .. 10 ) ) OF
        SEQUENCE {
          extId MAP-EXTENSION .&extensionId ( {
            '
            ... } ),
          extType MAP-EXTENSION .&ExtensionType ( {
            '
            ... } { @extId } ) OPTIONAL } OPTIONAL,
      pcs-Extensions [1] IMPLICIT SEQUENCE {
        ... } OPTIONAL,
        ... } OPTIONAL },
  map-close [2] IMPLICIT SEQUENCE {
    ...,
    extensionContainer SEQUENCE {
      privateExtensionList [0] IMPLICIT SEQUENCE ( SIZE( 1 .. 10 ) ) OF
        SEQUENCE {
          extId MAP-EXTENSION .&extensionId ( {
            '
            ... } ),
          extType MAP-EXTENSION .&ExtensionType ( {
            '
            ... } { @extId } ) OPTIONAL } OPTIONAL,
      pcs-Extensions [1] IMPLICIT SEQUENCE {
        ... } OPTIONAL,
        ... } OPTIONAL },
  map-refuse [3] IMPLICIT SEQUENCE {
    reason ENUMERATED {
      noReasonGiven ( 0 ),

```

```

invalidDestinationReference ( 1 ),
invalidOriginatingReference ( 2 ) },
... ,
extensionContainer SEQUENCE {
  privateExtensionList [0] IMPLICIT SEQUENCE ( SIZE( 1 .. 10 ) ) OF
  SEQUENCE {
    extId MAP-EXTENSION .&extensionId ( {
      '
      ... } ),
    extType MAP-EXTENSION .&ExtensionType ( {
      '
      ... } { @extId } ) OPTIONAL } OPTIONAL,
  pcs-Extensions [1] IMPLICIT SEQUENCE {
    ... } OPTIONAL,
  ... } OPTIONAL,
  alternativeApplicationContext OBJECT IDENTIFIER OPTIONAL },
map-userAbort [4] IMPLICIT SEQUENCE {
  map-UserAbortChoice CHOICE {
    userSpecificReason [0] IMPLICIT NULL,
    userResourceLimitation [1] IMPLICIT NULL,
    resourceUnavailable [2] IMPLICIT ENUMERATED {
      shortTermResourceLimitation ( 0 ),
      longTermResourceLimitation ( 1 ) },
    applicationProcedureCancellation [3] IMPLICIT ENUMERATED {
      handoverCancellation ( 0 ),
      radioChannelRelease ( 1 ),
      networkPathRelease ( 2 ),
      callRelease ( 3 ),
      associatedProcedureFailure ( 4 ),
      tandemDialogueRelease ( 5 ),
      remoteOperationsFailure ( 6 ) },
  ... ,
  extensionContainer SEQUENCE {
    privateExtensionList [0] IMPLICIT SEQUENCE ( SIZE( 1 .. 10 ) ) OF
    SEQUENCE {
      extId MAP-EXTENSION .&extensionId ( {
        '
        ... } ),
      extType MAP-EXTENSION .&ExtensionType ( {
        '
        ... } { @extId } ) OPTIONAL } OPTIONAL,
    pcs-Extensions [1] IMPLICIT SEQUENCE {
      ... } OPTIONAL,
    ... } OPTIONAL },
  map-providerAbort [5] IMPLICIT SEQUENCE {
    map-ProviderAbortReason ENUMERATED {
      abnormalDialogue ( 0 ),
      invalidPDU ( 1 ) },
  ... ,
  extensionContainer SEQUENCE {
    privateExtensionList [0] IMPLICIT SEQUENCE ( SIZE( 1 .. 10 ) ) OF
    SEQUENCE {
      extId MAP-EXTENSION .&extensionId ( {
        '
        ... } ),
      extType MAP-EXTENSION .&ExtensionType ( {
        '
        ... } { @extId } ) OPTIONAL } OPTIONAL,
    pcs-Extensions [1] IMPLICIT SEQUENCE {
      ... } OPTIONAL,
    ... } OPTIONAL } }
MAP-OpenInfo ::= SEQUENCE {
  destinationReference [0] IMPLICIT OCTET STRING ( SIZE( 1 .. 20 ) ) OPTIONAL,
  originationReference [1] IMPLICIT OCTET STRING ( SIZE( 1 .. 20 ) ) OPTIONAL,
  ... ,
  extensionContainer SEQUENCE {
    privateExtensionList [0] IMPLICIT SEQUENCE ( SIZE( 1 .. 10 ) ) OF
    SEQUENCE {
      extId MAP-EXTENSION .&extensionId ( {
        '
        ... } ),
      extType MAP-EXTENSION .&ExtensionType ( {
        '
        ... } { @extId } ) OPTIONAL } OPTIONAL,
    pcs-Extensions [1] IMPLICIT SEQUENCE {
      ... } OPTIONAL,
  ... } OPTIONAL,

```

... } OPTIONAL}

```
MAP-AcceptInfo ::= SEQUENCE {
  ...,
  extensionContainer SEQUENCE {
    privateExtensionList [0] IMPLICIT SEQUENCE ( SIZE( 1 .. 10 )) OF
      SEQUENCE {
        extId MAP-EXTENSION .&extensionId ( {
          '
          ... } ),
        extType MAP-EXTENSION .&ExtensionType ( {
          '
          ... } { @extId } ) OPTIONAL } OPTIONAL,
    pcs-Extensions [1] IMPLICIT SEQUENCE {
      ... } OPTIONAL,
    ... } OPTIONAL}

```

```
MAP-CloseInfo ::= SEQUENCE {
  ...,
  extensionContainer SEQUENCE {
    privateExtensionList [0] IMPLICIT SEQUENCE ( SIZE( 1 .. 10 )) OF
      SEQUENCE {
        extId MAP-EXTENSION .&extensionId ( {
          '
          ... } ),
        extType MAP-EXTENSION .&ExtensionType ( {
          '
          ... } { @extId } ) OPTIONAL } OPTIONAL,
    pcs-Extensions [1] IMPLICIT SEQUENCE {
      ... } OPTIONAL,
    ... } OPTIONAL}

```

```
MAP-RefuseInfo ::= SEQUENCE {
  reason ENUMERATED {
    noReasonGiven ( 0 ),
    invalidDestinationReference ( 1 ),
    invalidOriginatingReference ( 2 ) },
  ...,
  extensionContainer SEQUENCE {
    privateExtensionList [0] IMPLICIT SEQUENCE ( SIZE( 1 .. 10 )) OF
      SEQUENCE {
        extId MAP-EXTENSION .&extensionId ( {
          '
          ... } ),
        extType MAP-EXTENSION .&ExtensionType ( {
          '
          ... } { @extId } ) OPTIONAL } OPTIONAL,
    pcs-Extensions [1] IMPLICIT SEQUENCE {
      ... } OPTIONAL,
    ... } OPTIONAL,
  alternativeApplicationContext OBJECT IDENTIFIER OPTIONAL}

```

```
Reason ::= ENUMERATED {
  noReasonGiven ( 0 ),
  invalidDestinationReference ( 1 ),
  invalidOriginatingReference ( 2 ) }

```

```
MAP-UserAbortInfo ::= SEQUENCE {
  map-UserAbortChoice CHOICE {
    userSpecificReason [0] IMPLICIT NULL,
    userResourceLimitation [1] IMPLICIT NULL,
    resourceUnavailable [2] IMPLICIT ENUMERATED {
      shortTermResourceLimitation ( 0 ),
      longTermResourceLimitation ( 1 ) },
    applicationProcedureCancellation [3] IMPLICIT ENUMERATED {
      handoverCancellation ( 0 ),
      radioChannelRelease ( 1 ),
      networkPathRelease ( 2 ),
      callRelease ( 3 ),
      associatedProcedureFailure ( 4 ),
      tandemDialogueRelease ( 5 ),
      remoteOperationsFailure ( 6 ) } },
  ...,
  extensionContainer SEQUENCE {
    privateExtensionList [0] IMPLICIT SEQUENCE ( SIZE( 1 .. 10 )) OF
      SEQUENCE {
        extId MAP-EXTENSION .&extensionId ( {

```



```

    ...}),
    extType MAP-EXTENSION .&ExtensionType ( {
        ...}{ @extId } ) OPTIONAL} OPTIONAL,
    pcs-Extensions [1] IMPLICIT SEQUENCE {
        ... } OPTIONAL,
    ... } OPTIONAL}

MAP-UserAbortChoice ::= CHOICE {
    userSpecificReason [0] IMPLICIT NULL,
    userResourceLimitation [1] IMPLICIT NULL,
    resourceUnavailable [2] IMPLICIT ENUMERATED {
        shortTermResourceLimitation ( 0 ),
        longTermResourceLimitation ( 1 )},
    applicationProcedureCancellation [3] IMPLICIT ENUMERATED {
        handoverCancellation ( 0 ),
        radioChannelRelease ( 1 ),
        networkPathRelease ( 2 ),
        callRelease ( 3 ),
        associatedProcedureFailure ( 4 ),
        tandemDialogueRelease ( 5 ),
        remoteOperationsFailure ( 6 )}}

ResourceUnavailableReason ::= ENUMERATED {
    shortTermResourceLimitation ( 0 ),
    longTermResourceLimitation ( 1 )}

ProcedureCancellationReason ::= ENUMERATED {
    handoverCancellation ( 0 ),
    radioChannelRelease ( 1 ),
    networkPathRelease ( 2 ),
    callRelease ( 3 ),
    associatedProcedureFailure ( 4 ),
    tandemDialogueRelease ( 5 ),
    remoteOperationsFailure ( 6 )}

MAP-ProviderAbortInfo ::= SEQUENCE {
    map-ProviderAbortReason ENUMERATED {
        abnormalDialogue ( 0 ),
        invalidPDU ( 1 )},
    ... ,
    extensionContainer SEQUENCE {
        privateExtensionList [0] IMPLICIT SEQUENCE ( SIZE( 1 .. 10 ) ) OF
            SEQUENCE {
                extId MAP-EXTENSION .&extensionId ( {
                    ...}),
                extType MAP-EXTENSION .&ExtensionType ( {
                    ...}{ @extId } ) OPTIONAL} OPTIONAL,
                pcs-Extensions [1] IMPLICIT SEQUENCE {
                    ... } OPTIONAL,
                ... } OPTIONAL}

MAP-ProviderAbortReason ::= ENUMERATED {
    abnormalDialogue ( 0 ),
    invalidPDU ( 1 )}

END

```

Annex C :
Void

Annex D (informative): Clause mapping table

D.1 Mapping of Clause numbers

The clause numbers have been modified according to table D.1.

Table D.1: Clause mapping from Version 5.9.0 to Version 6.0.0

Old Clause No (V5.9.0)	New Clause No (V6.0.0)	Old Clause No (V5.9.0)	New Clause No (V6.0.0)
1.1	2	17.*	20.*
1.2	3	18.*	21.*
2.*	4.*	19.*	22.*
3.*	5.*	19.0.*	22.1.*
4.*	6.*	19.1.*	22.2.*
5.*	7.*	19.2.*	22.3.*
6.*	8.*	19.3.*	22.4.*
7.*	9.*	19.4.*	22.5.*
8.*	10.*	19.5.*	22.6.*
9.*	11.*	19.6.*	22.7.*
10.*	12.*	19.7.*	22.8.*
new11.*	13.*	19.8.*	22.9.*
old11.*	14.*	19.9.*	22.10.*
12.*	15.*	19.10.*	22.11.*
13.*	16.*	19.11.*	22.12.*
14.*	17.*	20.*	23.*
15.*	18.*	new22.*	24.*
16.*	19.*	old21.*	25.*

Annex E (informative): Change History

CN#	TDoc	SPEC	VERS	CR	REV	PHAS E	CAT	SUBJECT	NEW_VERS	WORKITEM
04	N2-99227	29.002	3.0.0	A002	3	R98	A	Use of E interface	3.1.0	
04	N2-99578	29.002	3.0.0	A003		R98	B	Introduction of TIF-CSI for Call Deflection	3.1.0	
04	N2-99233	29.002	3.0.0	A004		R98	A	Clarification in ASN.1 encoding of O-CSI and T-CSI	3.1.0	
04	N2-99269	29.002	3.0.0	A005		R98	C	Introduction of MSISDN in USSD operation	3.1.0	
04	N2-99650	29.002	3.0.0	A006		R98	A	Modification of the O-CSI ASN.1 structure	3.1.0	
04	N2-99250	29.002	3.0.0	A007		R98	A	Adding of MAP_DELIMITER_req to the Status report operation	3.1.0	
04	N2-99628	29.002	3.0.0	A008		R98	A	Correction to the Purge MS "Detailed procedure in the HLR"	3.1.0	
04	N2-99677	29.002	3.0.0	A009		R98	A	Adding of MNP-indicator to the SRI ack	3.1.0	
04	N2-99228	29.002	3.0.0	A010		R98	F	New subscription options for call forwarding	3.1.0	
04	N2-99585	29.002	3.0.0	A011		R98	C	Adding the support of ANSI SCCP which is required in North America (World Zone 1)	3.1.0	
04	N2-99515	29.002	3.0.0	A012		R98	A	Introduction of 3-digit MNCs correction	3.1.0	
04	N2-99520	29.002	3.0.0	A013		R98	F	Export of NAEA-CIC	3.1.0	
04	N2-99548	29.002	3.0.0	A014		R98	D	Clarification to text to identify how the LSA data relevant in the current VPLMN can be determined	3.1.0	
04	3C99-468	29.002	3.0.0	A015		R97	F	Alignment with 04.80	3.1.0	
04	N2-99519	29.002	3.0.0	A016		R98	A	VBS data	3.1.0	
04	N2-99461	29.002	3.0.0	A017		R98	F	Introduction of Data Missing error to the Resume Call Handling	3.1.0	
04	N2-99583	29.002	3.0.0	A018		R97	F	Removal of 3-digit MNCs	3.1.0	
04	N2-99676	29.002	3.0.0	A019		R98	A	Corrections of mapping from MAP service to TC service	3.1.0	
04	3C99-206	29.002	3.0.0	A020		R98	B	Introduction of UUS service to Resume Call Handling	3.1.0	
05	N2-99906	29.002	3.1.0	021		R99	A	Clarification on VLR CAMEL Subscription Info	3.2.0	CAMEL Phase 2
05	N2-99908	29.002	3.1.0	022		R99	A	Clarification on DestinationNumberCriteria	3.2.0	CAMEL Phase 2
05	N2-99910	29.002	3.1.0	023		R99	A	Removal of TDP-Criteria from RCH	3.2.0	CAMEL Phase 2
05	N2-99934	29.002	3.1.0	025		R99	A	Various corrections related to GGSN-HLR Interface.	3.2.0	GPRS
05	N2-99936	29.002	3.1.0	034		R99	A	Update Location handling for GPRS-only subscription	3.2.0	GPRS
05	N2-99938	29.002	3.1.0	035		R99	A	Correction of OP & AC definitions for NoteMS-PresentForGPRS	3.2.0	GPRS
05	N2-99952	29.002	3.1.0	036		R99	A	Removal of redundant information from RCH	3.2.0	UUS
05	N2-99956	29.002	3.1.0	026		R99	A	OR capability IE in PRN	3.2.0	TEI
05	N2-99964	29.002	3.1.0	024	1	R99	A	GMSC-CAMEL phase 2 support IE in PRN	3.2.0	CAMEL Phase 2
05	N2-99A19	29.002	3.1.0	028		R99	A	Alignment of 29.002 with 02.67	3.2.0	eMLPP
05	N2-99A45	29.002	3.1.0	029	1	R99	B	Non-CAMEL IST implementation	3.2.0	IST
05	N2-99B57	29.002	3.1.0	027	2	R99	B	Addition of the information elements and the ASN.1 definitions for Pre-paging	3.2.0	Pre-Paging
05	N2-99C27	29.002	3.1.0	042		R99	A	Clarification on 'Supported CAMEL Phases' in ISD ack	3.2.0	CAMEL Phase 2
05	N2-99C78	29.002	3.1.0	044		R99	A	Editing error correction on VLR capabilities	3.2.0	SoLSA
05	N2-99D06	29.002	3.1.0	043	1	R99	A	Addition of exception handling to the CancellationType	3.2.0	GPRS
05	N2-99D33	29.002	3.1.0	046		R99	A	Clarification of LR-REJECT cause corresponding to RoamingRestrictionDueTo UnsupportedFeature	3.2.0	TEI

CN#	TDoc	SPEC	VERS	CR	REV	PHASE	CAT	SUBJECT	NEW_VERS	WORKITEM
05	N2-99D35	29.002	3.1.0	047		R99		Clarification of returning the MSISDN in SRLack	3.2.0	MNP
06	N2-99G06	29.002	3.2.0	033	3	R99	C	Introduction of the Super-Charger Concept in TS 29.002	3.3.0	Super Charger
06	N2-99G18	29.002	3.2.0	032	2	R99	C	Introduction of White Book SCCP in MAP	3.3.0	TEI
06	N2-99G50	29.002	3.2.0	070		R99	A	Addition of GGSN number for the SRIforGPRS	3.3.0	GPRS
06	N2-99J88	29.002	3.2.0	075	1	R99	B	Introduction of Follow Me	3.3.0	Follow Me
06	N2-99K12	29.002	3.2.0	077		R99	A	Use of SSN for GPRS	3.3.0	GPRS
06	N2-99K24	29.002	3.2.0	069		R99	A	Correction of the USSD procedure in the HLR.	3.3.0	USSD & Follow Me
06	N2-99K52	29.002	3.2.0	060	1	R99	C	MAP Impacts for Location Services (LCS)	3.3.0	Location Services
06	N2-99K58	29.002	3.2.0	045	4	R99	B	Authentication Enhancements	3.3.0	Security
06	N2-99K60	29.002	3.2.0	050	5	R99	C	QoS-Subscribed field modification	3.3.0	QoS enhancements
06	N2-99L20	29.002	3.2.0	073	1	R99	C	Introduction of CAMEL Phase 3 in 3GPP TS 29.002	3.3.0	CAMEL Phase 3
06	N2-99J52	29.002	3.2.0	074		R99	D	Restructuring of MAP Location Management Procedures for the Circuit Switched Domain	3.3.0	TEI
06	N2-99J92	29.002	3.2.0	068		R99	B	Update of SDLs to support Super-Charger	3.3.0	Super-Charger
			3.3.0					New version created to fix a CR implementation error	3.3.1	
07	N2B000436	29.002	3.3.1	048	5	R99	B	Introduction of Multicall	3.4.0	Multicall
07	N2B000319	29.002	3.3.1	059	1	R99	B	Alternative solution for ALR	3.4.0	CAMEL phase 3
07	N2B000461	29.002	3.3.1	063	4	R99	B	MNP Database Mismatch	3.4.0	MNP
07	N2B000375	29.002	3.3.1	066	5	R99	B	Addition of the FTN-AddressString	3.4.0	Call Forwarding Enhancements
07	N2B000456	29.002	3.3.1	079	4	R99	C	Correction of SS Invocation Notification for CCBS	3.4.0	CAMEL Phase 3
07	N2A000023	29.002	3.3.1	080		R99	F	Corrections to ATSI, ATM, NCSD	3.4.0	CAMEL Phase 3
07	N2B000046	29.002	3.3.1	083		R99	A	Privacy notification/verification for call related privacy class	3.4.0	Location Services (LCS)
07	N2B000142	29.002	3.3.1	084	2	R99	B	Addition of CS Allocation/retention priority	3.4.0	QoS enhancements
07	N2B000144	29.022	3.3.1	086	1	R99	D	Editorial cleanup of 29.002	3.4.0	TEI
07	N2B000100	29.002	3.3.1	087		R99	A	Correction of LSA information	3.4.0	SoLSA
07	N2B000067	29.002	3.3.1	089		R99	F	Security interworking between release 99 and pre-99 MSC/VLRs	3.4.0	Security
07	N2B000113	29.002	3.3.1	090	1	R99	B	Improving GPRS charging efficiency	3.4.0	GPRS
07	N2B000120	29.002	3.3.1	094	2	R99	C	QoS-Subscribed field enhancements	3.4.0	QoS enhancements
07	N2B000322	29.002	3.3.1	095	1	R99	C	RANAP support on the E-interface	3.4.0	Handover
07	N2B000191	29.002	3.3.1	099		R99	B	UMTS Authentication	3.4.0	Security
07	N2B000466	29.002	3.3.1	100	5	R99	C	Support of 3G Handover, including Multicall	3.4.0	Multicall
07	N2B000372	29.002	3.3.1	101	1	R99	B	Introduction of Service Area Identification	3.4.0	TEI
07	N2B000380	29.002	3.3.1	102	2	R99	F	Clarification on Authentication Info Retrieval	3.4.0	Security
07	N2B000330	29.002	3.3.1	103	1	R99	B	Addition of UMTS security to MAP B interface	3.4.0	Security
07	N2B000244	29.002	3.3.1	104		R99	F	Re-Synchronisation Info	3.4.0	UMTS Security
07	N2B000324	29.002	3.3.1	105	1	R99	C	Introduction of additional service parameters for inter-system handover	3.4.0	Handover
07	N2B000281	29.002	3.3.1	107		R99	D	Removal of architectural information from clause 4	3.4.0	TEI

CN#	TDoc	SPEC	VERS	CR	REV	PHAS E	CAT	SUBJECT	NEW_VERS	WORKITEM
07	N2-000454	29.002	3.3.1	110	1	R99	B	Introduction of Authentication Failure Report	3.4.0	Security
07	N2B000357	29.002	3.3.1	111		R99	B	Use of MAP private extensions to implement region-specific requirements	3.4.0	TEI
07	N2B000470	29.002	3.3.1	112		R99	A	Prioritisation of MAP application context related to VGCS/VBS	3.4.0	ASCI Phase 2
07	N2B000472	29.002	3.3.1	113		R99	F	Correction of SS-Codes for LCS	3.4.0	LCS
08	N4-000098	29.002	3.4.0	115	1	R99	F	Minor corrections to CAMEL3 NSDC/ATM/ATSI information flows	3.5.0	CAMEL Phase 3
08	N4-000094	29.002	3.4.0	117	1	R99	A	Using DSD to delete CCBS-B from the subscriber	3.5.0	CCBS
08	N4-000089	29.002	3.4.0	118	1	R99	F	Indication in PRN of support of Long FTNs	3.5.0	CF enhancements
08	N4-000073	29.002	3.4.0	120	1	R99	F	QoS-Subscribed field enhancements	3.5.0	QoS enhancements
08	N4-000050	29.002	3.4.0	121		R99	F	Correction of introduction of additional service parameters for inter-system handover	3.5.0	Handover/Relocation
08	N4-000100	29.002	3.4.0	122	2	R99	C	Proposed information flow on NSDC	3.5.0	CAMEL Phase 3
08	N4-000321	29.002	3.4.0	124	3	R99	C	CAMEL Subscription Info	3.5.0	CAMEL Phase 3
08	N4-000068	29.002	3.4.0	125		R99	A	Clarification to GMLC List definition	3.5.0	LCS
08	N4-000320	29.002	3.4.0	127	1	R99	F	Optionality of parameters in d-csi and in sms-csi	3.5.0	CAMEL Phase 3
08	N4-000209	29.002	3.4.0	130		R99	F	Version 3 tags for handover messages	3.5.0	Handover
08	N4-000211	29.002	3.4.0	132		R99	A	Correction of version handling at dialogue establishment	3.5.0	TEI
08	N4-000357	29.002	3.4.0	133	1	R99	F	Various corrections and/or cleanup to 29.002	3.5.0	TEI
08	N4-000217	29.002	3.4.0	134		R99	A	Correction of errors in Figure 25.1/1: Macro Receive_Open_Ind	3.5.0	TEI
08	N4-000326	29.002	3.4.0	135	1	R99	B	Addition of charging characteristics per PDP context	3.5.0	TEI
08	N4-000264	29.002	3.4.0	138		R99	F	Clarification of SAI-ack segmentation procedure	3.5.0	Security
08	N4-000392	29.002	3.4.0	139	1	R99	A	Indication of unsupported position method	3.5.0	LCS
08	N4-000276	29.002	3.4.0	141		R99	A	Clarification for ReportSM-DeliveryStatus operation	3.5.0	GPRS
08	N4-000349	29.002	3.4.0	142	1	R99	C	Addition of a parameter in the subsequent Handover from UMTS to GSM with Multicall	3.5.0	Multicall
08	N4-000278	29.002	3.4.0	143		R99	D	Editorial correction to MSC-A handover SDLs	3.5.0	Multicall
08	N4-000378	29.002	3.4.0	144	1	R99	A	Use of NAM parameter with MAP-INSERT-SUBSCRIBER-DATA service between HLR and SGSN	3.5.0	GPRS
08	N4-000293	29.002	3.4.0	145		R99	F	Addition of state attributes in Forward group call signalling	3.5.0	ASCI
08	N4-000294	29.002	3.4.0	146		R99	F	New user error "target cell outside group call area" in MAP Prepare Handover message	3.5.0	ASCI
08	N4-000374	29.002	3.4.0	149		R99	A	Correction to the description of MAP-MO-Forward-Short-Message service	3.5.0	TEI
08	N4-000407	29.002	3.5.0	148	4	R00	B	Changes to MAP for secure transport of MAP messages	4.0.0	Security
08		29.002	4.0.0			R00		Version 4.0.1 created to allow inclusion of automatic update of Annexes A and B and of section 17	4.0.1	
09	N4-000543	29.002	4.0.1	152	1	R00	F	Clarifications for secure MAP transport	4.1.0	Core Network Security
09	N4-000539	29.002	4.0.1	153	1	R00	D	Generalization of version handling text in clause 18.2.4	4.1.0	TEI
09	N4-000491	29.002	4.0.1	158		R00	A	Deletion of informative Annexe C	4.1.0	TEI
09	N4-000540	29.002	4.0.1	159		R00	A	Aligning 29.002 with 25.413 (UTRAN lu Interface RANAP Signalling)	4.1.0	Handover

CN#	TDoc	SPEC	VERS	CR	REV	PHAS E	CAT	SUBJECT	NEW_VERS	WORKITEM
09	N4-000541	29.002	4.0.1	160		R00	A	AUTS and AUTN parameter length	4.1.0	Security
09	N4-000744	29.002	4.0.1	161	2	R00	A	Clarification on Authentication Failure Report ack	4.1.0	Security
09	N4-000666	29.002	4.0.1	163	1	R00	A	Correction on Location Information	4.1.0	CAMEL phase 3
09	N4-000777	29.002	4.0.1	174	2	R00	A	Optionality of parameters in GPRS-CSI	4.1.0	CAMEL phase 3
09	N4-000788	29.002	4.0.1	176	1	R00	A	Correction to QoS indication	4.1.0	LCS
09	N4-000747	29.002	4.0.1	178	1	R00	A	Clarification of use of Radio Resource Information	4.1.0	Handover
09	N4-000750	29.002	4.0.1	180	2	R00	A	Correction to MSC-A handover SDLs	4.1.0	TEI
09	N4-000736	29.002	4.0.1	182		R00	A	Removal of LSAIdentity from NoteMM-EventArg	4.1.0	CAMEL phase 3
09	N4-000772	29.002	4.0.1	184		R00	A	LCS Support for CAMEL Phase 3	4.1.0	LCS
09	N4-000751	29.002	4.0.1	186	1	R00	A	Correction to MSC-A handover SDLs	4.1.0	TEI
09	N4-000779	29.002	4.0.1	188		R00	A	Clarification for segmentation of D-CSI and SMS-CSI	4.1.0	CAMEL phase 3
10	N4-000912	29.002	4.0.1	166	3	Rel-4	A	Corrections and clarifications for USSD procedures on the HLR - gsmSCF interface	4.2.0	USSD
10	N4-000908	29.002	4.1.0	191	1	Rel-4	A	Corrections of ISD data structure for CAMEL phase 3	4.2.0	CAMEL phase 3
10	N4-001069	29.002	4.1.0	193	2	Rel-4	A	USSD Corrections for Follow Me	4.2.0	USSD
10	N4-001071	29.002	4.1.0	196	1	Rel-4	A	GSM to 3G Handover: MAP parameter Target Cell ID	4.2.0	Handover
10	N4-000921	29.002	4.1.0	198		Rel-4	A	ASN.1 description of targetCellId	4.2.0	Handover
10	N4-001073	29.002	4.1.0	200	1	Rel-4	A	IMSI in MAP_PREPARE_HANDOVER	4.2.0	Handover
10	N4-001076	29.002	4.1.0	208	1	Rel-4	A	Alignment of the Target RNC-ID	4.2.0	Handover
10	N4-001089	29.002	4.1.0	211	1	Rel-4	A	Export of GSN-Address data type	4.2.0	CAMEL phase 3
10	N4-001095	29.002	4.1.0	212		Rel-4	A	Transport of long RANAP messages on MAP-E interface	4.2.0	Handover
-	-	29.002	4.2.0	-	-	Rel-4	-	Automatic update of annexes A and B	4.2.1	-
11	N4-010036	29.002	4.2.1	206	1	Rel-4	A	Correction to LCS application context	4.3.0	LCS
11	N4-010276	29.002	4.2.1	215	2	Rel-4	B	Add parameters to ISD and SRI for GPRS to handle ODB for PS	4.3.0	ODB enhancements
11	N4-010033	29.002	4.2.1	217		Rel-4	A	Correction to maximum number of RAB's	4.3.0	Multicall
11	N4-010198	29.002	4.2.1	222	2	Rel-4	B	PS domain support for LCS Release 4	4.3.0	LCS
11	N4-010058	29.002	4.2.1	224		Rel-4	A	Failure of Update GPRS Location when HLR is not reachable	4.3.0	GPRS R97
11	N4-010287	29.002	4.2.1	231	1	Rel-4	B	Extension of call related privacy class for LCS Release 4	4.3.0	LCS
11	N4-010375	29.002	4.2.1	232	2	Rel4	B	Maximum number of LCS Clients	4.3.0	LCS
11	N4-010261	29.002	4.2.1	234		Rel-4	B	MAP over IP according to SIGTRAN	4.3.0	SS7IP
11	N4-010465	29.002	4.2.1	236	1	Rel-4	B	Requesting node type in authentication set request	4.3.0	SEC1-EHCS
11	N4-010360	29.002	4.2.1	246		Rel-4	A	Adding EXPORT definition for LSAIdentity	4.3.0	Camel 3

CN#	TDoc	SPEC	VERS	CR	REV	PHASE	CAT	SUBJECT	NEW_VERS	WORKITEM
11	N4-010361	29.002	4.2.1	247		Rel-4	A	Removing duplicate parameters from ss-CSI	4.3.0	CAMEL 3
11	N4-010362	29.002	4.2.1	248		Rel-4	A	Correction to description of SS-CSI in HLR to VLR information flow	4.3.0	CAMEL 3
11	N4-010365	29.002	4.2.1	250		Rel-4	A	GSM to UMTS handover: addition of MAP parameter RNC ID	4.3.0	Handover
11	N4-010393	29.002	4.2.1	252		Rel-4	A	Clarification of the use of multicall bearer information	4.3.0	Multicall
11	N4-010428	29.002	4.2.1	258		Rel-4	A	Adding EXPORT definition for GeographicalInformation	4.3.0	Camel 3
11	N4-010446	29.002	4.2.1	260		Rel-4	A	Failure of Authentication Parameter GPRS when HLR is not reachable	4.3.0	GPRS R97
11	N4-010484	29.002	4.2.1	262	1	Rel-4	A	Correction to D-CSI	4.3.0	CAMEL 3
12	N4-010728	29.002	4.3.0	239	4	Rel-4	A	Addition of selected UMTS algorithm indication to the handover procedures	4.4.0	Handover
12	N4-010730	29.002	4.3.0	241	4	Rel-4	A	Addition of allowed GSM algorithms indication to the handover procedures	4.4.0	Handover
12	N4-010733	29.002	4.3.0	244	4	Rel-4	A	Addition of allowed UMTS algorithm indication to the handover procedures	4.4.0	Handover
12	N4-010735	29.002	4.3.0	245	4	Rel-4	A	Addition of selected GSM algorithm indication to the handover procedures	4.4.0	Handover
12	N4-010739	29.002	4.3.0	254	2	Rel-4	A	Addition of radio resource list to the handover procedures	4.4.0	Multicall
12	NP-010247	29.002	4.3.0	256	3	Rel-4	A	Addition of GSM channel type and GSM chosen channel indications to handover procedures	4.4.0	Handover
12	N4-010787	29.002	4.3.0	264	3	Rel-4	A	Add support in MAP for all shapes defined in 23.032	4.4.0	LCS
12	N4-010633	29.002	4.3.0	270	1	Rel-4	A	Correction to description of RNCid parameter	4.4.0	Handover
12	N4-010635	29.002	4.3.0	272	1	Rel-4	A	Correction to Encryption Information and Integrity Protection parameters	4.4.0	Handover
12	N4-010767	29.002	4.3.0	279	3	Rel-4	A	Essential drawbacks on services due to introduction of Super-Charger function	4.4.0	TEI
12	N4-010741	29.002	4.3.0	283	1	Rel-4	A	Introduction of selected Rab-id to the Process Access Signalling operation	4.4.0	Multicall
12	N4-010673	29.002	4.3.0	285		Rel-4	A	Mistake in the definition of Authentication Failure Report Application Context	4.4.0	SEC
12	N4-010551	29.002	4.3.0	266		Rel-4	A	Add support in MAP for Ellipsoid Point	4.4.0	LCS
12	N4-010778	29.002	4.3.0	168	5	Rel-4	C	Security Header modification	4.4.0	Security
12	N4-010785	29.002	4.3.0	267	3	Rel-4	C	Additional Parameters in Authentication Failure Report	4.4.0	SEC1 - EHCS
12	N4-010783	29.002	4.3.0	268	3	Rel-4	F	MS presence notification procedure for LCS	4.4.0	LCS1

CN#	TDoc	SPEC	VERS	CR	REV	PHAS E	CAT	SUBJECT	NEW_VERS	WORKITEM
12	N4-010790	29.002	4.3.0	289	2	Rel-4	F	Component level granularity of protection	4.4.0	SEC1
		29.002	4.4.0			Rel-4		Corrupted headers fixed	4.4.1	
13	N4-010840	29.002	4.4.1	290		Rel-4	F	Clarifications on long forwarded-to numbers	4.5.0	TEI4
13	N4-010929	29.002	4.4.1	291	1	Rel-4	F	Corrections for Deferred MT-LR	4.5.0	LCS1
13	N4-010930	29.002	4.4.1	292	2	Rel-4	F	Clarifications on SupportedLCS-CapabilitySets	4.5.0	LCS1
13	N4-010958	29.002	4.4.1	295	2	Rel4	F	Corrections on the introduction of LCS for PS domain	4.5.0	LCS1
13	N4-010970	29.002	4.4.1	302	2	Rel-4	F	Additional SGSN related values to Access Type	4.5.0	SEC1-EHCS
13	N4-010976	29.002	4.4.1	306		Rel-4	A	Addition of data type definitions to EXPORT statements for the usage in CAP	4.5.0	CAMEL3
13	N4-011017	29.002	4.4.1	307	2	Rel-4	A	Minimum MAP application context for intersystem MSC handover from GSM to UMTS	4.5.0	Handover
13	N4-011019	29.002	4.4.1	309	2	Rel-4	A	Minimum MAP application context for intersystem MSC handover from UMTS to GSM	4.5.0	Handover
13	N4-010845	29.002	4.4.1	277	1	Rel4	F	Correction on the SDL of NW initiated USSD operations	4.5.0	TEI
13		29.002	4.4.1			Rel-4		Editorial Clean up	4.5.0	
14	N4-011031	29.002	4.5.0	313		Rel-4	A	Clarification on LCS parameters in MAP	4.6.0	LCS1
14	N4-011043	29.002	4.5.0	314		Rel-4	F	Handling of linked operations in the MAP protocol machine	4.6.0	TEI4
14	N4-011285	29.002	4.5.0	316		Rel-4	F	Corrections on the SDL diagrams for LCS	4.6.0	LCS1
14	N4-011198	29.002	4.5.0	318	1	Rel-4	A	Indication of deletion of CSI in Notify Subscriber Data Change	4.6.0	CAMEL3
14	N4-011074	29.002	4.5.0	320		Rel-4	A	Correct length of Add-GeographicalInformation	4.6.0	LCS
14	N4-011091	29.002	4.5.0	322		Rel-4	A	Clarify encoding of RNC Id	4.6.0	Handover
14	N4-011094	29.002	4.5.0	324		Rel-4	A	Clarify encoding of RANAP parameters in MAP	4.6.0	Handover
14	N4-011097	29.002	4.5.0	325		Rel-4	F	Clarifications on long forwarded-to numbers	4.6.0	TEI4
14	N4-011227	29.002	4.5.0	331	1	Rel-4	A	Clarification of methodology for maintaining data consistency in Supercharger	4.6.0	TEI
14	N4-011173	29.002	4.5.0	334		Rel-4	A	Addition of RAB ID to Prepare Handover procedure	4.6.0	Multicall
14	N4-011175	29.002	4.5.0	336		Rel-4	A	Correction to the Allowed GSM Algorithms parameter	4.6.0	Handover
14	N4-011177	29.002	4.5.0	337	1	Rel-4	F	Correction of references	4.6.0	TEI4
14	N4-011190	29.002	4.5.0	339		Rel-4	A	CUG-Info is not exported from 29.002	4.6.0	CAMEL3
14	N4-011209	29.002	4.5.0	341		Rel-4	A	Clarification on NSCD when data is withdrawn	4.6.0	CAMEL phase 3
14	N4-011211	29.002	4.5.0	343		Rel-4	A	Clarification of sending CAMEL information in stand alone ISD case	4.6.0	CAMEL phase 3
14	N4-011262	29.002	4.5.0	344		Rel-4	F	Correction of the priority for 'SRI for LCS'	4.6.0	LCS1

CN#	TDoc	SPEC	VERS	CR	REV	PHAS E	CAT	SUBJECT	NEW_VERS	WORKITEM
14	N4-011273	29.002	4.5.0	347		Rel-4	A	ASN.1 correction	4.6.0	CAMEL
14	N4-011437	29.002	4.5.0	349	2	Rel-4	F	Handling of MNRR in the HLR & SMS-GMSC	4.6.0	TEI4
14	N4-011433	29.002	4.5.0	354	1	Rel-4	A	Minimum MAP application context for G2G inter-MSC handover	4.6.0	Handover
14	N4-011439	29.002	4.5.0	359	2	Rel-4	A	Alignment of parameter lengths with those prescribed in 08.08	4.6.0	TEI
14	N4-011423	29.002	4.5.0	360	1	Rel-4	F	Aligning the security header elements with TS33.200	4.6.0	TEI-4
14	N4-011394	29.002	4.5.0	364		Rel-4	A	Syntax error in the ATM result and ATSI result	4.6.0	CAMEL phase 3
14	N4-011381	29.002	4.6.0	355	1	Rel-5	B	LCS Capability Handling for UE"s	5.0.0	TEI5
15	N4-020300	29.002	5.0.0	368	4	Rel-5	B	Collective CAMEL Phase 4 CR	5.1.0	CAMEL4
15	N4-020013	29.002	5.0.0	373		Rel-5	A	Inclusion of complete ODB data in ATSI and NSDC	5.1.0	CAMEL3
15	N4-020266	29.002	5.0.0	381	2	Rel-5	B	Introduction of the 'Requestor ID'	5.1.0	LCS1
15	N4-020068	29.002	5.0.0	386		Rel-5	A	Correction to AC version of gprsLocationInfoRetrievalContext	5.1.0	TEI4
15	N4-020248	29.002	5.0.0	390	1	Rel-5	A	Incomplete description of Restore Data parameters	5.1.0	TEI4
15	N4-020183	29.002	5.0.0	403		Rel-5	A	Clarification on CODEC-Info	5.1.0	TEI
15	N4-020250	29.002	5.0.0	407	1	Rel-5	A	ODB alignment	5.1.0	TEI4
16	N4-020530	29.002	5.1.0	428	2	Rel-5	A	LCS: error handling if shape not supported by GMLC	5.2.0	LCS1
16	N4-020622	29.002	5.1.0	453		Rel-5	A	Addition of Radio Resource List to the Forward Access Signalling operation	5.2.0	Multicall
16	N4-020641	29.002	5.1.0	460		Rel-5	A	Clarification on Resume Call Handling	5.2.0	TEI
16	N4-020746	29.002	5.1.0	440	2	Rel-5	A	Clarification on SendAuthenticationInfo	5.2.0	TEI
16	N4-020750	29.002	5.1.0	446	1	Rel-5	A	Addition of Service Handover parameters to MAP Handover messages	5.2.0	Handover
16	N4-020318	29.002	5.1.0	398		Rel-5	C	Check of NAM and Requesting Node Type on receipt of SendAuthenticationInfo	5.2.0	TEI4
16	N4-020333	29.002	5.1.0	410		Rel-5	A	Handling the MNRR flag in the HLR & SMS-GMSC	5.2.0	TEI4
16	N4-020499	29.002	5.1.0	420	1	Rel-5	A	Clarification of introducing Session related and unrelated class	5.2.0	LCS1-PS
16	N4-020511	29.002	5.1.0	430	1	Rel-5	A	Corrections on the introduction of LCS for PS domain	5.2.0	LCS
16	N4-020743	29.002	5.1.0	448	1	Rel-5	A	Corrections in SS-code chapter	5.2.0	TEI
16	N4-020408	29.002	5.1.0	423		Rel-5	C	Clarification of handling of MT-SMS-TPDU-Type and SMS-TDP	5.2.0	CAMEL4
16	N4-020410	29.002	5.1.0	425		Rel-5	A	Clarify conditions to trigger restart of MTLR-Deferred procedure	5.2.0	LCS1
16	N4-020468	29.002	5.1.0	414	1	Rel-5	F	Corrections to the handling of Any Time Interrogation and Provide Subscriber Info	5.2.0	CAMEL4

CN#	TDoc	SPEC	VERS	CR	REV	PHASE	CAT	SUBJECT	NEW_VERS	WORKITEM
16	N4-020476	29.002	5.1.0	435	1	Rel-5	D	Change PS-connected in PS-PDPactive	5.2.0	CAMEL4
16	N4-020483	29.002	5.1.0	422	1	Rel-5	F	Triggering of gsmSCF for MT-SMS-CSI	5.2.0	CAMEL4
16	N4-020485	29.002	5.1.0	408	2	Rel-5	C	Transferring the MS classmark & IMEI to the gsmSCF	5.2.0	CAMEL4
16	N4-020543	29.002	5.1.0	441		Rel-5	F	Correction of Object Identifiers for ASN.1 modules	5.2.0	TEI
16	N4-020608	29.002	5.1.0	450		Rel-5	C	Enhancement to LCS in the PS domain	5.2.0	LCS
16	N4-020623	29.002	5.1.0	454		Rel-5	F	Addition of Location Information GPRS to Note MM Event operation	5.2.0	CAMEL4-NMM
16	N4-020703	29.002	5.1.0	421	4	Rel-5	B	LCS: Codeword and Service Type	5.2.0	LCS1
16	N4-020756	29.002	5.1.0	436	2	Rel-5	B	Splitting of CAMEL phase 4	5.2.0	CAMEL4
17	N4-021001	29.002	5.2.0	437	3	Rel-5	F	Compatible upgrade to ASN.1:1997 of 29.002	5.3.0	TEI
17	NP-020399	29.002	5.2.0	462	2	Rel-5	F	Introduction of GERAN classmark	5.3.0	TEI
17	N4-020841	29.002	5.2.0	465		Rel-5	F	Clarification on Call Deflection	5.3.0	Call Deflection
17	N4-021040	29.002	5.2.0	470	1	Rel-5	F	Correction to the usage of "Roaming not allowed" error	5.3.0	TEI5
17	N4-021041	29.002	5.2.0	471	1	Rel-5	A	Clarifications on Send Identification	5.3.0	TEI
17	N4-021094	29.002	5.2.0	479	2	Rel-5	C	Handling of partial implementations of CAMEL phase 4	5.3.0	CAMEL4
17	N4-021047	29.002	5.2.0	480		Rel-5	C	Removal of ChargingNotification feature	5.3.0	CAMEL4
17	N4-020810	29.002	5.2.0	481		Rel-5	B	CR29.002-443 (rel5) on extensions to ATM for CAMEL control of IMS	5.3.0	IMS-CAMEL
17	N4-020809	29.002	5.2.0	482		Rel-5	B	CR to 29.002 for the support of the MAP Si interface	5.3.0	IMS-CAMEL
18	N4-021290	29.002	5.3.0	499		Rel-5	A	Correction to segmentation of O-CSI and T-CSI	5.4.0	CAMEL3
18	N4-021418	29.002	5.3.0	508		Rel-5	A	ODB correction	5.4.0	CAMEL3
18	N4-021563	29.002	5.3.0	511	1	Rel-5	A	Addition of reference number to deferred location request procedure	5.4.0	LCS1
18	N4-021573	29.002	5.3.0	516	2	Rel-5	A	Correction to the Service Handover parameters	5.4.0	Multicall
18	N4-021299	29.002	5.3.0	442	3	Rel-5	F	Description of MT SM delivery via two serving nodes	5.4.0	TEI5
18	N4-021294	29.002	5.3.0	474	2	Rel-5	F	Correction of handling of MT-SMS in the SGSN	5.4.0	CAMEL4
18	N4-021124	29.002	5.3.0	475		Rel-5	F	ODB and CB for SMS	5.4.0	TEI5
18	N4-021153	29.002	5.3.0	486		Rel-5	F	Correction of IMEI check for SGSN	5.4.0	TEI5
18	N4-021467	29.002	5.3.0	489	5	Rel-5	F	Available codecs list and selected codec indication	5.4.0	TEI5
18	N4-021194	29.002	5.3.0	490		Rel-5	F	Clarification of the use of Requested CAMEL Subscription Info parameters	5.4.0	CAMEL4

CN#	TDoc	SPEC	VERS	CR	REV	PHASE	CAT	SUBJECT	NEW_VERS	WORKITEM
18	N4-021252	29.002	5.3.0	495		Rel-5	F	Correction to RCH – adding O-CSI trigger criteria	5.4.0	CAMEL4
18	N4-021264	29.002	5.3.0	496		Rel-5	F	Additional MM-Code for MG-CSI	5.4.0	CAMEL4
18	N4-021296	29.002	5.3.0	497	1	Rel-5	F	Additional handling of partial implementations of CAMEL phase 4	5.4.0	CAMEL4
18	N4-021383	29.002	5.3.0	512		Rel-5	F	Correcion of Codeword Handling	5.4.0	LCS1-PS
18	N4-021443	29.002	5.3.0	513		Rel-5	F	Reference to TS 23.078 in TS 29.002 regarding handling of VMSC address is missing	5.4.0	CAMEL4
18	N4-021524	29.002	5.3.0	521	1	Rel-5	F	Editorial clean-up	5.4.0	TEI5
18	N4-021531	29.002	5.3.0	522		Rel-5	F	Introduction of the CHOICE element 'netDetNotReachable' for PS-SubscriberState	5.4.0	CAMEL4
19	N4-030324	29.002	5.4.0	523	3	Rel-5	F	Clean-up of SMS procedures chapter	5.5.0	TEI5
19	NP-030068	29.002	5.4.0	544	2	Rel-5	A	Correction to interactions between CAMEL control of MO SMS and barring	5.5.0	CAMEL3
19	N4-030062	29.002	5.4.0	527		Rel-5	F	LCS diagnostic alignment	5.5.0	LCS1
19	N4-030300	29.002	5.4.0	532	1	Rel-5	A	Correction to the definitions of Radio Resource List and BSSMAP Service Handover List	5.5.0	Multicall
19	N4-030304	29.002	5.4.0	540	2	Rel-5	A	Handover of Group Calls where MSC-B has bearer established	5.5.0	TEI
19	N4-030286	29.002	5.4.0	550	1	Rel-5	A	Change of SS-Code List description for Insert Subscriber Data	5.5.0	TEI
19	N4-030288	29.002	5.4.0	558	1	Rel-5	F	Missing of 'Continue Monitoring message' in SDL 21.7_3.2	5.5.0	TEI5
19	N4-030296	29.002	5.4.0	562	1	Rel-5	F	Alignment of TS 29.002 with TS 23.107 regarding QoS subscribed data	5.5.0	TEI5
20	N4-030657	29.002	5.5.0	500	5	Rel-5	F	Addition of Positioning Data IE to Provide Subscriber Location and Send Location Report	5.6.0	LCS
20	N4-030691	29.002	5.5.0	535	2	Rel-5	A	Additional SGSN Related Access Type – Detach	5.6.0	SEC1-EHCS
20	N4-030438	29.002	5.5.0	598		Rel-5	F	LCS Client external ID	5.6.0	LCS
20	N4-030681	29.002	5.5.0	606	1	Rel-5	F	Provision of SDL diagrams and removal of redundant text in chapter 22	5.6.0	TEI5
20	N4-030646	29.002	5.5.0	611	1	Rel-5	F	Enhancement of the CheckIMEI operation to retrieve the BMUEF	5.6.0	Late UE
20	N4-030513	29.002	5.5.0	617		Rel-5	F	Formal correction to the ASN.1 syntax of SendIdentificationRes	5.6.0	TEI5
20	N4-030677	29.002	5.5.0	618	1	Rel-5	F	Correction to naming of PRN parameter	5.6.0	CAMEL4
20	N4-030683	29.002	5.5.0	634		Rel-5	F	Provision of SDL diagrams and removal of redundant text in chapter 25	5.6.0	TEI5
20	N4-030684	29.002	5.5.0	635		Rel-5	F	Removal of redundant text from 29.002 Chapter 23	5.6.0	TEI6
20	N4-030641	29.002	5.5.0	609	1	Rel-5	F	Transfer of UE-specific behaviour bitmap at handover	5.6.0	Late UE

CN#	TDoc	SPEC	VERS	CR	REV	PHAS E	CAT	SUBJECT	NEW_VERS	WORKITEM
20	N4-030639	29.002	5.5.0	578	1	Rel-5	F	Provision of SDL diagrams and removal of redundant text in chapter 24A	5.6.0	TEI5
20	N4-030391	29.002	5.5.0	580		Rel-5	F	Provision of SDL diagrams in chapter 24B	5.6.0	TEI5
20	N4-030670	29.002	5.5.0	593	2	Rel-5	F	Provision of SDL diagrams and removal of redundant text in chapter 24	5.6.0	TEI5
20	N4-030600	29.002	5.5.0	632		Rel-5	A	Missing SMSs over MSC even if the MS is capable of such sending	5.6.0	TEI5
July 2003		29.002	5.6.0			Rel-5		Small editorial corrections and SDL source file added	5.6.1	
July 2003		29.002	5.6.1			Rel-5		History table updated to show that the CRs 578r1, 580, 593r2 and 632 were implemented. Note that these were implemented in v5.6.0 but were omitted from this table.	5.6.2	
21	N4-030952	29.002	5.6.2	636	2	Rel-5	F	Provision of SDL diagrams and removal of redundant text in chapter 19	5.7.0	TEI5
21	N4-030744	29.002	5.6.2	638		Rel-5	F	Provision of SDL diagrams and removal of redundant text in chapter 20	5.7.0	TEI5
21	N4-030746	29.002	5.6.2	640		Rel-5	F	Provision of SDL diagrams and removal of redundant text in chapter 21	5.7.0	TEI5
21	N4-031042	29.002	5.6.2	583	2	Rel-5	A	Correction to MAP Process Secure_MAP_DSM SDLs	5.7.0	MAP Security
21	N4-031052	29.002	5.6.2	663	1	Rel-5	A	Correction of encoding description of Group-Id	5.7.0	ASCI
21	N4-030826	29.002	5.6.2	656		Rel-5	F	Reduce maximum length of 'LCS Requestor ID' and 'LCS Codeword'.	5.7.0	LCS1
21	N4-030921	29.002	5.6.2	646	1	Rel-5	F	UESBI-Iu format	5.7.0	LATE UE
21	N4-031068	29.002	5.6.2	615	3	Rel-5	F	Incorrect Charging with MNP	5.7.0	CAMEL4
21	N4-031056	29.002	5.6.2	659	2	Rel-5	F	Notification of the 2 nd BSG in case of Late CF with OR	5.7.0	SCUDIF
21	N4-031058	29.002	5.6.2	613	3	Rel-5	F	HLR Interrogation for SCUDIF calls	5.7.0	SCUDIF
22	N4-031131	29.002	5.7.0	685		Rel-5	F	More spare bits for CAMEL4 enhancements	5.8.0	CAMEL4
22	N4-031162	29.002	5.7.0	691		Rel-5	F	Clarification on D-CSI segmentation	5.8.0	CAMEL4
22	N4-031341	29.002	5.7.0	675	2	Rel-5	F	MNP correction for prepaid charging	5.8.0	MNP
22	N4-031337	29.002	5.7.0	694	1	Rel-5	F	Remove redundant option for retrieval of routing information in figure 21.2.3	5.8.0	TEI5
22	N4-031316	29.002	5.7.0	688	2	Rel-5	F	HSDPA impacts to MAP	5.8.0	HSDPA
23	N4-040332	29.002	5.8.0	707	2	Rel-5	F	Correction to Insert Subscriber Data message for LCS SS	5.9.0	LCS
23	N4-040309	29.002	5.8.0	667	4	Rel-5	F	Codec Modification/ Mid-Call Codec Negotiation after Inter-MSC Relocation	5.9.0	OoBTC
23	N4-040192	29.002	5.8.0	669	3	Rel-5	F	Correction of Inter-MSC SRSN Relocation procedure	5.9.0	OoBTC

CN#	TDoc	SPEC	VERS	CR	REV	PHAS E	CAT	SUBJECT	NEW_VERS	WORKITEM
23	N4-040326	29.002	5.8.0	710	2	Rel-5	F	Inclusion of UTRAN Positioning Data parameter	5.9.0	LCS2
23	N4-040339	29.002	5.8.0	719	2	Rel-5	F	Add new Unavailability cause for SCUDIF	5.9.0	SCUDIF
24	N4-040519	29.002	5.9.0	714	1	Rel-5	A	Introduction of North American Interim Location Based Routing of Emergency Call	5.10.0	LCS
29	C4-051331	29.002	5.10.0	775	1	Rel-5	A	Subscribed Charging Characteristics	5.11.0	TEI
31	C4-060704	29.002	5.11.0	0816		Rel-5	A	Removal of MAPsec material	5.12.0	SEC7-TCAP

History

Document history		
V5.1.0	March 2002	Publication
V5.2.0	June 2002	Publication
V5.3.0	September 2002	Publication
V5.4.0	December 2002	Publication
V5.5.0	March 2003	Publication
V5.6.1	July 2003	Publication
V5.6.2	July 2003	Publication
V5.7.0	September 2003	Publication
V5.8.0	December 2003	Publication
V5.9.0	March 2004	Publication
V5.10.0	June 2004	Publication
V5.11.0	September 2005	Publication
V5.12.0	June 2006	Publication