

ETSI TS 129 002 V5.2.0 (2002-06)

Technical Specification

**Digital cellular telecommunications system (Phase 2+);
Universal Mobile Telecommunications System (UMTS);
Mobile Application Part (MAP) specification
(3GPP TS 29.002 version 5.2.0 Release 5)**



Reference

RTS/TSGN-0429002v520

Keywords

GSM, UMTS

ETSI

650 Route des Lucioles
F-06921 Sophia Antipolis Cedex - FRANCE

Tel.: +33 4 92 94 42 00 Fax: +33 4 93 65 47 16

Siret N° 348 623 562 00017 - NAF 742 C
Association à but non lucratif enregistrée à la
Sous-Préfecture de Grasse (06) N° 7803/88

Important notice

Individual copies of the present document can be downloaded from:

<http://www.etsi.org>

The present document may be made available in more than one electronic version or in print. In any case of existing or perceived difference in contents between such versions, the reference version is the Portable Document Format (PDF). In case of dispute, the reference shall be the printing on ETSI printers of the PDF version kept on a specific network drive within ETSI Secretariat.

Users of the present document should be aware that the document may be subject to revision or change of status. Information on the current status of this and other ETSI documents is available at

<http://portal.etsi.org/tb/status/status.asp>

If you find errors in the present document, send your comment to:

editor@etsi.fr

Copyright Notification

No part may be reproduced except as authorized by written permission.
The copyright and the foregoing restriction extend to reproduction in all media.

© European Telecommunications Standards Institute 2002.
All rights reserved.

DECTTM, **PLUGTESTS**TM and **UMTS**TM are Trade Marks of ETSI registered for the benefit of its Members.
TIPHONTM and the **TIPHON logo** are Trade Marks currently being registered by ETSI for the benefit of its Members.
3GPPTM is a Trade Mark of ETSI registered for the benefit of its Members and of the 3GPP Organizational Partners.

Intellectual Property Rights

IPRs essential or potentially essential to the present document may have been declared to ETSI. The information pertaining to these essential IPRs, if any, is publicly available for **ETSI members and non-members**, and can be found in ETSI SR 000 314: "*Intellectual Property Rights (IPRs); Essential, or potentially Essential, IPRs notified to ETSI in respect of ETSI standards*", which is available from the ETSI Secretariat. Latest updates are available on the ETSI Web server (<http://webapp.etsi.org/IPR/home.asp>).

Pursuant to the ETSI IPR Policy, no investigation, including IPR searches, has been carried out by ETSI. No guarantee can be given as to the existence of other IPRs not referenced in ETSI SR 000 314 (or the updates on the ETSI Web server) which are, or may be, or may become, essential to the present document.

Foreword

This Technical Specification (TS) has been produced by ETSI 3rd Generation Partnership Project (3GPP).

The present document may refer to technical specifications or reports using their 3GPP identities, UMTS identities or GSM identities. These should be interpreted as being references to the corresponding ETSI deliverables.

The cross reference between GSM, UMTS, 3GPP and ETSI identities can be found under www.etsi.org/key.

Contents

Intellectual Property Rights	2
Foreword.....	2
Foreword.....	25
1 Scope	26
2 References	26
3 Abbreviations	31
4 Void.....	31
5 Overload and compatibility overview	31
5.1 Overload control.....	31
5.1.1 Overload control for MSC (outside MAP)	31
5.1.2 Overload control for MAP entities	32
5.1.3 Congestion control for Signalling System No. 7	36
5.2 Compatibility.....	36
5.2.1 General.....	36
5.2.2 Strategy for selecting the Application Context (AC) version	36
5.2.2.1 Proposed method.....	36
5.2.2.2 Managing the version look-up table.....	37
5.2.2.3 Optimising the method.....	38
6 Requirements concerning the use of SCCP and TC	38
6.1 Use of SCCP.....	38
6.1.1 SCCP Class	38
6.1.2 Sub-System Number (SSN)	38
6.1.3 SCCP addressing	39
6.1.3.1 Introduction	39
6.1.3.2 The Mobile-services Switching Centre (MSC)	41
6.1.3.2.1 MSC interaction during handover or relocation	41
6.1.3.2.2 MSC for short message routing	41
6.1.3.2.3 MSC for location request routing	41
6.1.3.2.4 MSC for LMU Control	41
6.1.3.3 The Home Location Register (HLR).....	41
6.1.3.3.1 During call set-up	41
6.1.3.3.2 Before location updating completion.....	42
6.1.3.3.3 After location updating completion.....	42
6.1.3.3.4 VLR restoration	43
6.1.3.3.5 During Network-Requested PDP Context Activation	43
6.1.3.3.6 Before GPRS location updating completion.....	43
6.1.3.3.7 After GPRS location updating completion	44
6.1.3.3.8 Query for a Location Request.....	44
6.1.3.4 The Visitor Location Register (VLR)	44
6.1.3.4.1 Inter-VLR information retrieval	44
6.1.3.4.2 HLR request	44
6.1.3.5 The Interworking MSC (IWMSC) for Short Message Service	44
6.1.3.6 The Equipment Identity Register (EIR)	44
6.1.3.7 The Shared Inter Working Function (SIWF)	45
6.1.3.8 The Serving GPRS Support Node (SGSN)	45
6.1.3.9 The Gateway GPRS Support Node (GGSN).....	45
6.1.3.10 The Gateway MSC (GMSC) for Short Message Service	45
6.1.3.10A Void.....	45
6.1.3.10A.1 Void.....	45
6.1.3.10A.2 Void.....	45
6.1.3.10B The Gateway Mobile Location Centre (GMLC)	45
6.1.3.11 Summary table	45

6.2	Use of TC	48
7	General on MAP services.....	48
7.1	Terminology and definitions	48
7.2	Modelling principles.....	48
7.3	Common MAP services.....	49
7.3.1	MAP-OPEN service.....	50
7.3.2	MAP-CLOSE service	53
7.3.3	MAP-DELIMITER service.....	53
7.3.4	MAP-U-ABORT service	53
7.3.5	MAP-P-ABORT service	54
7.3.6	MAP-NOTICE service	55
7.3.7	MAP-SECURE-TRANSPORT-CLASS-1 service	55
7.3.8	MAP-SECURE-TRANSPORT-CLASS-2 service	56
7.3.9	MAP-SECURE-TRANSPORT-CLASS-3 service	56
7.3.10	MAP-SECURE-TRANSPORT-CLASS-4 service	57
7.4	Sequencing of services	57
7.5	General rules for mapping of services onto TC.....	59
7.5.1	Mapping of common services.....	59
7.5.2	Mapping of user specific services.....	60
7.6	Definition of parameters.....	60
7.6.1	Common parameters	63
7.6.1.1	Invoke Id	63
7.6.1.2	Linked Id	63
7.6.1.3	Provider error	63
7.6.1.4	User error	63
7.6.2	Numbering and identification parameters.....	67
7.6.2.1	IMSI	67
7.6.2.2	TMSI.....	67
7.6.2.3	IMEI.....	67
7.6.2.4	Previous location area Id.....	67
7.6.2.5	Stored location area Id	67
7.6.2.6	Current location area Id.....	67
7.6.2.7	Target location area Id	67
7.6.2.8	Target cell Id	67
7.6.2.8A	Target RNC Id.....	67
7.6.2.9	Void.....	67
7.6.2.10	Originating entity number	67
7.6.2.11	MSC number	68
7.6.2.12	Target MSC number.....	68
7.6.2.13	HLR number	68
7.6.2.14	VLR number	68
7.6.2.15	HLR Id	68
7.6.2.16	LMSI.....	68
7.6.2.17	MS ISDN	68
7.6.2.18	OMC Id	68
7.6.2.19	Roaming number.....	68
7.6.2.19A	Relocation Number List	68
7.6.2.20	Void.....	68
7.6.2.21	Handover number.....	68
7.6.2.22	Forwarded-to number	68
7.6.2.22A	Long forwarded-to number	68
7.6.2.22B	Long FTN Supported	69
7.6.2.23	Forwarded-to subaddress	69
7.6.2.24	Called number	69
7.6.2.25	Calling number.....	69
7.6.2.26	Originally dialled number	69
7.6.2.27	Service centre address	69
7.6.2.28	Zone Code	69
7.6.2.29	MSISdn-Alert	69
7.6.2.30	Location Information	69
7.6.2.30a	Location Information for GPRS.....	69

7.6.2.31	GMSC Address	69
7.6.2.32	VMSC Address	69
7.6.2.33	Group Id	69
7.6.2.34	North American Equal Access preferred Carrier Id	70
7.6.2.35	SIWFS Number	70
7.6.2.36	B-subscriber address	70
7.6.2.37	Serving cell Id	70
7.6.2.38	SGSN number	70
7.6.2.39	SGSN address	70
7.6.2.40	GGSN address	70
7.6.2.41	GGSN number	70
7.6.2.42	APN	70
7.6.2.43	Network Node number	70
7.6.2.44	PDP-Type	70
7.6.2.45	PDP-Address	70
7.6.2.46	Additional number	71
7.6.2.47	P-TMSI	71
7.6.2.48	B-subscriber number	71
7.6.2.49	B-subscriber subaddress	71
7.6.2.50	LMU Number	71
7.6.2.51	MLC Number	71
7.6.2.52	Multicall Bearer Information	71
7.6.2.53	Multiple Bearer Requested	71
7.6.2.54	Multiple Bearer Not Supported	71
7.6.2.55	PDP-Charging Characteristics	71
7.6.2.56	Selected RAB ID	71
7.6.2.57	RAB ID	71
7.6.3	Subscriber management parameters	71
7.6.3.1	Category	71
7.6.3.2	Equipment status	72
7.6.3.3	Extensible Bearer service	72
7.6.3.4	Extensible Teleservice	72
7.6.3.5	Extensible Basic Service Group	72
7.6.3.6	GSM bearer capability	72
7.6.3.7	Subscriber Status	72
7.6.3.8	CUG Outgoing Access indicator	72
7.6.3.9	Operator Determined Barring General Data	72
7.6.3.10	ODB HPLMN Specific Data	74
7.6.3.11	Regional Subscription Data	75
7.6.3.12	Regional Subscription Response	75
7.6.3.13	Roaming Restriction Due To Unsupported Feature	75
7.6.3.14	Extensible SS-Info	75
7.6.3.15	Extensible forwarding information	75
7.6.3.16	Extensible forwarding feature	75
7.6.3.17	Extensible SS-Status	76
7.6.3.18	Extensible Forwarding Options	76
7.6.3.19	Extensible No reply condition timer	76
7.6.3.20	Extensible Call barring information	76
7.6.3.21	Extensible Call barring feature	76
7.6.3.22	CUG info	76
7.6.3.23	CUG subscription	77
7.6.3.24	CUG interlock	77
7.6.3.25	CUG index	77
7.6.3.26	CUG feature	77
7.6.3.27	Inter CUG options	77
7.6.3.28	Intra CUG restrictions	77
7.6.3.29	Extensible SS-Data	78
7.6.3.30	Subscriber State	78
7.6.3.31	Requested Info	78
7.6.3.31A	Requested Domain	78
7.6.3.32	Suppression of Announcement	78
7.6.3.33	Suppress T-CSI	78

7.6.3.34	GMSC CAMEL Subscription Info.....	78
7.6.3.35	VLR CAMEL Subscription Info	78
7.6.3.36	Supported CAMEL Phases in the VLR.....	78
7.6.3.36A	Supported CAMEL Phases in the SGSN	78
7.6.3.36B	Supported CAMEL4 Subsets in the VLR	78
7.6.3.36C	Supported CAMEL4 Subsets in the SGSN	79
7.6.3.36D	Supported CAMEL4 Subsets	79
7.6.3.36E	Supported CAMEL4 Subsets in GMSC.....	79
7.6.3.36F	Supported CAMEL4 Subsets in VMSC.....	79
7.6.3.37	CUG Subscription Flag.....	79
7.6.3.38	CAMEL Subscription Info Withdraw	79
7.6.3.39	Voice Group Call Service (VGCS) Data.....	79
7.6.3.40	Voice Broadcast Service (VBS) Data	79
7.6.3.41	ISDN bearer capability.....	79
7.6.3.42	Lower layer Compatibility	79
7.6.3.43	High Layer Compatibility	79
7.6.3.44	Alerting Pattern	79
7.6.3.45	GPRS Subscription Data Withdraw	79
7.6.3.46	GPRS Subscription Data	79
7.6.3.47	QoS-Subscribed	80
7.6.3.48	VPLMN address allowed	80
7.6.3.49	Roaming Restricted In SGSN Due To Unsupported Feature	80
7.6.3.50	Network Access Mode	80
7.6.3.51	Mobile Not Reachable Reason.....	80
7.6.3.52	Cancellation Type	80
7.6.3.53	All GPRS Data.....	80
7.6.3.54	Complete Data List Included.....	80
7.6.3.55	PDP Context Identifier	80
7.6.3.56	LSA Information	80
7.6.3.57	SoLSA support indicator.....	80
7.6.3.58	LSA Information Withdraw	80
7.6.3.59	LMU Indicator	80
7.6.3.60	LCS Information	81
7.6.3.61	GMLC List.....	81
7.6.3.62	LCS Privacy Exception List.....	81
7.6.3.62A	Additional LCS Privacy Exception List.....	81
7.6.3.63	LCS Privacy Exception Parameters	81
7.6.3.64	External Client List	81
7.6.3.65	Internal Client List	82
7.6.3.65A	MO-LR List.....	82
7.6.3.65B	Privacy Notification to MS User.....	82
7.6.3.65C	GMLC List Withdraw	82
7.6.3.65D	Service Type List	82
7.6.3.66	IST Alert Timer.....	82
7.6.3.67	Call Termination Indicator.....	82
7.6.3.68	IST Information Withdraw.....	82
7.6.3.69	IST Support Indicator.....	82
7.6.3.70	Super-Charger Supported In HLR.....	83
7.6.3.71	Super-Charger Supported In Serving Network Entity.....	83
7.6.3.72	Age Indicator.....	83
7.6.3.73	GPRS enhancements support indicator	83
7.6.3.74	Extensible QoS-Subscribed.....	83
7.6.3.75	SGSN CAMEL Subscription Info	83
7.6.3.76	MO-SMS-CSI	83
7.6.3.76a	MT-SMS-CSI.....	83
7.6.3.77	GPRS-CSI	83
7.6.3.78	CAMEL subscription info.....	83
7.6.3.83	Call Barring Data	84
7.6.3.84	Call Forwarding Data.....	84
7.6.3.85	ODB Data.....	84
7.6.3.86	Requested Subscription Info	84
7.6.3.87	CS Allocation/Retention priority	84

7.6.3.88	ODB Info	84
7.6.3.89	Suppress VT-CSI	84
7.6.3.90	Suppress Incoming Call Barring	84
7.6.3.91	gsmSCF Initiated Call	85
7.6.4	Supplementary services parameters	85
7.6.4.1	SS-Code	85
7.6.4.2	SS-Status	85
7.6.4.3	SS-Data	85
7.6.4.4	Override Category	86
7.6.4.5	CLI Restriction Option	86
7.6.4.6	Forwarding Options	86
7.6.4.7	No reply condition timer	86
7.6.4.8 - 7.6.4.14	Void	86
7.6.4.15	Forwarding information	86
7.6.4.16	Forwarding feature	86
7.6.4.17	Void	87
7.6.4.18	Call barring information	87
7.6.4.19	Call barring feature	87
7.6.4.20	New password	87
7.6.4.21	Current password	87
7.6.4.22	Guidance information	87
7.6.4.23	Void	88
7.6.4.24	SS-Info	88
7.6.4.25 - 7.6.4.35	Void	88
7.6.4.36	USSD Data Coding Scheme	88
7.6.4.37	USSD String	88
7.6.4.38	Bearer service	88
7.6.4.39	Teleservice	88
7.6.4.40	Basic Service Group	88
7.6.4.41	eMLPP information	88
7.6.4.42	SS-event	89
7.6.4.43	SS-event data	89
7.6.4.44	LCS Privacy Exceptions	89
7.6.4.45	Mobile Originating Location Request (MO-LR)	89
7.6.4.46	NbrUser	89
7.6.4.47	MC Subscription Data	89
7.6.4.48	MC Information	90
7.6.4.49	CCBS Request State	90
7.6.5	Call parameters	90
7.6.5.1	Call reference number	90
7.6.5.2	Interrogation type	90
7.6.5.3	OR interrogation	90
7.6.5.4	OR capability	90
7.6.5.5	Forwarding reason	90
7.6.5.6	Forwarding interrogation required	91
7.6.5.7	O-CSI	91
7.6.5.7A	D-CSI	91
7.6.5.7B	T-CSI	91
7.6.5.7C	VT-CSI	91
7.6.5.8	Call Direction	91
7.6.5.9	Channel Type	91
7.6.5.10	Chosen Channel	91
7.6.5.11	CCBS Feature	91
7.6.5.12	UU Data	92
7.6.5.14	Number Portability Status	92
7.6.5.15	Pre-paging supported	92
7.6.6	Radio parameters	92
7.6.6.1 - 7.6.6.4	Void	92
7.6.6.5	BSSMAP Service Handover	92
7.6.6.6	RANAP Service Handover	92
7.6.6.7	HO-Number Not Required	92
7.6.6.8	Integrity Protection Information	92

7.6.6.9	Encryption Information	92
7.6.6.10	Radio Resource Information	92
7.6.6.10A	Radio Resource List	92
7.6.6.10B	Chosen Radio Resource Information	92
7.6.6.11	Key Status	92
7.6.6.12	Selected UMTS Algorithms	93
7.6.6.13	Allowed GSM Algorithms	93
7.6.6.14	Allowed UMTS Algorithms	93
7.6.6.15	Selected GSM Algorithm	93
7.6.7	Authentication parameters	93
7.6.7.1	Authentication set list	93
7.6.7.2	Rand	93
7.6.7.3	Sres	93
7.6.7.4	Kc	93
7.6.7.5	Xres	93
7.6.7.5A	Ck	93
7.6.7.5B	Ik	93
7.6.7.5C	Autn	93
7.6.7.6	Cksn	94
7.6.7.6A	Ksi	94
7.6.7.6B	Auts	94
7.6.7.7	Ciphering mode	94
7.6.7.8	Current Security Context	94
7.6.7.9	Failure cause	94
7.6.7.10	Re-attempt	94
7.6.7.11	Access Type	94
7.6.8	Short message parameters	94
7.6.8.1	SM-RP-DA	94
7.6.8.2	SM-RP-OA	95
7.6.8.3	MWD status	95
7.6.8.4	SM-RP-UI	95
7.6.8.5	SM-RP-PRI	95
7.6.8.6	SM Delivery Outcome	95
7.6.8.7	More Messages To Send	95
7.6.8.8	Alert Reason	95
7.6.8.9	Absent Subscriber Diagnostic SM	95
7.6.8.10	Alert Reason Indicator	95
7.6.8.11	Additional SM Delivery Outcome	95
7.6.8.12	Additional Absent Subscriber Diagnostic SM	96
7.6.8.13	Delivery Outcome Indicator	96
7.6.8.14	GPRS Node Indicator	96
7.6.8.15	GPRS Support Indicator	96
7.6.8.16	SM-RP-MTI	96
7.6.8.17	SM-RP-SMEA	96
7.6.9	Access and signalling system related parameters	96
7.6.9.1	AN-apdu	96
7.6.9.2	CM service type	96
7.6.9.3	Access connection status	97
7.6.9.4	External Signal Information	97
7.6.9.5	Access signalling information	97
7.6.9.6	Location update type	97
7.6.9.7	Protocol ID	97
7.6.9.8	Network signal information	97
7.6.9.9	Call Info	98
7.6.9.10	Additional signal info	98
7.6.10	System operations parameters	98
7.6.10.1	Network resources	98
7.6.10.2	Trace reference	99
7.6.10.3	Trace type	99
7.6.11	Location Service Parameters	99
7.6.11.1	Age of Location Estimate	99
7.6.11.2	Deferred MT-LR Response Indicator	99

7.6.11.3	Deferred MT-LR Data.....	99
7.6.11.4	LCS Client ID	99
7.6.11.5	LCS Event.....	99
7.6.11.7	LCS Priority	99
7.6.11.8	LCS QoS	99
7.6.11.9	CS LCS Not Supported by UE.....	100
7.6.11.10	PS LCS Not Supported by UE	100
7.6.11.11	Location Estimate	100
7.6.11.12	Location Type	100
7.6.11.13	NA-ESRD	100
7.6.11.14	NA-ESRK	101
7.6.11.15	LCS Service Type Id.....	101
7.6.11.16	Privacy Override	101
7.6.11.17	Supported LCS Capability Sets.....	101
7.6.11.18	LCS Codeword.....	101
7.6.11.19	LCS Codeword Applicability.....	101
7.6.11.20	Supported GAD Shapes	101
7.6.11.21	Additional Location Estimate.....	101
7.6.11.22	LCS Codeword Notification.....	101
7.6.12	Secure Transport Parameters	101
7.6.12.1	Security Header.....	101
7.7	Representation of a list of a basic parameter in service-primitives	102
8	Mobility services	103
8.1	Location management services.....	103
8.1.1	Void	103
8.1.1.1	Void.....	103
8.1.1.2	Void.....	103
8.1.1.3	Void.....	103
8.1.2	MAP_UPDATE_LOCATION service	103
8.1.2.1	Definition	103
8.1.2.2	Service primitives	103
8.1.2.3	Parameter definitions and use	103
8.1.3	MAP_CANCEL_LOCATION service	105
8.1.3.1	Definition	105
8.1.3.2	Service primitives	105
8.1.3.3	Parameter definitions and use	105
8.1.4	MAP_SEND_IDENTIFICATION service	106
8.1.4.1	Definition	106
8.1.4.2	Service primitives	106
8.1.4.3	Parameter definitions and use	106
8.1.5	Void.....	107
8.1.5.1	Void.....	107
8.1.5.2	Void.....	107
8.1.5.3	Void.....	107
8.1.6	MAP_PURGE_MS service.....	107
8.1.6.1	Definition	107
8.1.6.2	Service primitives	108
8.1.6.3	Parameter definitions and use	108
8.1.7	MAP_UPDATE_GPRS_LOCATION service	108
8.1.7.1	Definition	108
8.1.7.2	Service primitives	109
8.1.7.3	Parameter definitions and use	109
8.1.8	MAP-NOTE-MM-EVENT	110
8.1.8.1	Definition	110
8.1.8.2	Service primitives	110
8.1.8.3	Parameter use	111
8.2	Paging and search.....	112
8.2.1	MAP_PAGE service	112
8.2.1.1	Definition	112
8.2.1.2	Service primitives	112
8.2.1.3	Parameter definitions and use	112

8.2.2	MAP_SEARCH_FOR_MS service	113
8.2.2.1	Definition	113
8.2.2.2	Service primitives	113
8.2.2.3	Parameter definitions and use	113
8.3	Access management services	114
8.3.1	MAP_PROCESS_ACCESS_REQUEST service	114
8.3.1.1	Definition	114
8.3.1.2	Service primitives	114
8.3.1.3	Parameter definitions and use	115
8.4	Handover services	116
8.4.1	MAP_PREPARE_HANOVER service.....	116
8.4.1.1	Definition	116
8.4.1.2	Service primitives	116
8.4.1.3	Parameter use	117
8.4.2	MAP_SEND_END_SIGNAL service	119
8.4.2.1	Definition	119
8.4.2.2	Service primitives	119
8.4.2.3	Parameter use	119
8.4.3	MAP_PROCESS_ACCESS_SIGNALLING service	119
8.4.3.1	Definition	119
8.4.3.2	Service primitives	120
8.4.3.3	Parameter use	120
8.4.4	MAP_FORWARD_ACCESS_SIGNALLING service	120
8.4.4.1	Definition	120
8.4.4.2	Service primitives	120
8.4.4.3	Parameter use	121
8.4.5	MAP_PREPARE_SUBSEQUENT_HANOVER service.....	122
8.4.5.1	Definition	122
8.4.5.2	Service primitives	122
8.4.5.3	Parameter use	122
8.4.6	MAP_ALLOCATE_HANOVER_NUMBER service	123
8.4.6.1	Definition	123
8.4.6.2	Service primitives	123
8.4.6.3	Parameter use	123
8.4.7	MAP_SEND_HANOVER_REPORT service.....	123
8.4.7.1	Definition	123
8.4.7.2	Service primitives	124
8.4.7.3	Parameter use	124
8.5	Authentication management services	124
8.5.1	MAP_AUTHENTICATE service.....	124
8.5.1.1	Definition	124
8.5.1.2	Service primitives	124
8.5.1.3	Parameter use	125
8.5.2	MAP_SEND_AUTHENTICATION_INFO service.....	125
8.5.2.1	Definition	125
8.5.2.2	Service primitives	125
8.5.2.3	Parameter use	126
8.5.3	MAP_AUTHENTICATION_FAILURE_REPORT service	127
8.5.3.1	Definition	127
8.5.3.2	Service primitives	127
8.5.3.3	Parameter use	127
8.6	Security management services	128
8.6.1	MAP_SET_CIPHERING_MODE service	128
8.6.1.1	Definitions.....	128
8.6.1.2	Service primitives	128
8.6.1.3	Parameter use	128
8.7	International mobile equipment identities management services	129
8.7.1	MAP_CHECK_IMEI service	129
8.7.1.1	Definition	129
8.7.1.2	Service primitives	129
8.7.1.3	Parameter use	129
8.7.2	MAP_OBTAIN_IMEI service.....	130

8.7.2.1	Definition	130
8.7.2.2	Service primitives	130
8.7.2.3	Parameter use	130
8.8	Subscriber management services	130
8.8.1	MAP-INSERT-SUBSCRIBER-DATA service	130
8.8.1.1	Definition	130
8.8.1.2	Service primitives	131
8.8.1.3	Parameter use	132
8.8.1.4	Basic service information related to supplementary services	140
8.8.2	MAP-DELETE-SUBSCRIBER-DATA service	141
8.8.2.1	Definition	141
8.8.2.2	Service primitives	141
8.8.2.3	Parameter use	142
8.9	Identity management services	144
8.9.1	MAP-PROVIDE-IMSI service	144
8.9.1.1	Definition	144
8.9.1.2	Service primitives	144
8.9.1.3	Parameter use	144
8.9.2	MAP-FORWARD-NEW-TMSI service	145
8.9.2.1	Definition	145
8.9.2.2	Service primitives	145
8.9.2.3	Parameter use	145
8.10	Fault recovery services	145
8.10.1	MAP_RESET service	145
8.10.1.1	Definition	145
8.10.1.2	Service primitives	145
8.10.1.3	Parameter definition and use	145
8.10.2	MAP_FORWARD_CHECK_SS_INDICATION service	146
8.10.2.1	Definition	146
8.10.2.2	Service primitives	146
8.10.2.3	Parameter definition and use	146
8.10.3	MAP_RESTORE_DATA service	146
8.10.3.1	Definition	146
8.10.3.2	Service primitives	146
8.10.3.3	Parameter definitions and use	147
8.11	Subscriber Information services	148
8.11.1	MAP-ANY-TIME-INTERROGATION service	148
8.11.1.1	Definition	148
8.11.1.2	Service primitives	148
8.11.1.3	Parameter definition and use	149
8.11.2	MAP-PROVIDE-SUBSCRIBER-INFO service	149
8.11.2.1	Definition	149
8.11.2.2	Service primitives	150
8.11.2.3	Parameter definition and use	150
8.11.3	MAP-ANY-TIME-SUBSCRIPTION-INTERROGATION service	150
8.11.3.1	Definition	150
8.11.3.2	Service primitives	150
8.11.3.3	Parameter definition and use	151
8.11.4	MAP-ANY-TIME-MODIFICATION service	151
8.11.4.1	Definition	151
8.11.4.2	Service primitives	151
8.11.4.3	Parameter definition and use	152
8.11.5	MAP-NOTE-SUBSCRIBER-DATA-MODIFIED service	152
8.11.5.1	Definition	152
8.11.5.2	Service primitives	152
8.11.5.3	Parameter definition and use	153
9	Operation and maintenance services	154
9.1	Subscriber tracing services	154
9.1.1	MAP-ACTIVATE-TRACE-MODE service	154
9.1.1.1	Definition	154
9.1.1.2	Service primitives	154

9.1.1.3	Parameter use	154
9.1.2	MAP-DEACTIVATE-TRACE-MODE service.....	155
9.1.2.1	Definition	155
9.1.2.2	Service primitives	155
9.1.2.3	Parameter use	155
9.1.3	MAP-TRACE-SUBSCRIBER-ACTIVITY service	156
9.1.3.1	Definition	156
9.1.3.2	Service primitives	156
9.1.3.3	Parameter use	156
9.2	Other operation and maintenance services	156
9.2.1	MAP-SEND-IMSI service	156
9.2.1.1	Definition	156
9.2.1.2	Service primitives	157
9.2.1.3	Parameter use	157
10	Call handling services	157
10.1	MAP_SEND_ROUTING_INFORMATION service	157
10.1.1	Definition.....	157
10.1.2	Service primitives	157
10.1.3	Parameter use.....	158
10.2	MAP_PROVIDE_ROAMING_NUMBER service.....	163
10.2.1	Definition.....	163
10.2.2	Service primitives	163
10.2.3	Parameter use.....	163
10.3	MAP_RESUME_CALL_HANDLING service.....	165
10.3.1	Definition.....	165
10.3.2	Service primitives	165
10.3.3	Parameter use.....	166
10.4	MAP_PREPARE_GROUP_CALL service.....	167
10.4.1	Definition.....	167
10.4.2	Service primitives	167
10.4.3	Parameter definitions and use	167
10.5	MAP_PROCESS_GROUP_CALL_SIGNALLING service	168
10.5.1	Definitions	168
10.5.2	Service primitives	168
10.5.3	Parameter definitions and use	169
10.6	MAP_FORWARD_GROUP_CALL_SIGNALLING service	169
10.6.1	Definitions	169
10.6.2	Service primitives	169
10.6.3	Parameter definitions and use	169
10.7	MAP_SEND_GROUP_CALL_END_SIGNAL service	170
10.7.1	Definitions	170
10.7.2	Service primitives	170
10.7.3	Parameter definitions and use	170
10.8	MAP_Provide_SIWFS_Number	171
10.8.1	Definition.....	171
10.8.2	Service primitive.....	171
10.8.3	Parameter use.....	171
10.9	MAP_SIWFS_Signalling_Modify	172
10.9.1	Definition.....	172
10.9.2	Service primitive.....	172
10.9.3	Parameter use.....	172
10.10	MAP_SET_REPORTING_STATE service	173
10.10.1	Definition.....	173
10.10.2	Service primitives	173
10.10.3	Parameter use.....	173
10.11	MAP_STATUS_REPORT service.....	174
10.11.1	Definition.....	174
10.11.2	Service primitives	174
10.11.3	Parameter use.....	174
10.12	MAP_REMOTE_USER_FREE service.....	175
10.12.1	Definition.....	175

10.12.2	Service primitives	175
10.12.3	Parameter use.....	175
10.13	MAP_IST_ALERT service	176
10.13.1	Definition.....	176
10.13.2	Service primitives	176
10.13.3	Parameter use.....	176
10.14	MAP_IST_COMMAND service.....	177
10.14.1	Definition.....	177
10.14.2	Service primitives	177
10.14.3	Parameter use.....	177
11	Supplementary services related services	178
11.1	MAP_REGISTER_SS service.....	178
11.1.1	Definition.....	178
11.1.2	Service primitives	178
11.1.3	Parameter use.....	178
11.2	MAP_ERASE_SS service.....	179
11.2.1	Definition.....	179
11.2.2	Service primitives	179
11.2.3	Parameter use.....	180
11.3	MAP_ACTIVATE_SS service.....	180
11.3.1	Definition.....	180
11.3.2	Service primitives	180
11.3.3	Parameter use.....	181
11.4	MAP_DEACTIVATE_SS service	182
11.4.1	Definitions	182
11.4.2	Service primitives	182
11.4.3	Parameter use.....	182
11.5	MAP_INTERROGATE_SS service.....	183
11.5.1	Definitions	183
11.5.2	Service primitives	183
11.5.3	Parameter use.....	184
11.6	MAP_INVOKE_SS service	185
11.6.1	Definitions	185
11.6.2	Service primitives	185
11.6.3	Parameter use.....	186
11.7	MAP_REGISTER_PASSWORD service	186
11.7.1	Definitions	186
11.7.2	Service primitives	186
11.7.3	Parameter use.....	187
11.8	MAP_GET_PASSWORD service.....	187
11.8.1	Definitions	187
11.8.2	Service primitives	187
11.8.3	Parameter use.....	188
11.9	MAP_PROCESS_UNSTRUCTURED_SS_REQUEST service.....	188
11.9.1	Definitions	188
11.9.2	Service primitives	188
11.9.3	Parameter use.....	188
11.10	MAP_UNSTRUCTURED_SS_REQUEST service.....	189
11.10.1	Definitions	189
11.10.2	Service primitives	189
11.10.3	Parameter use.....	189
11.11	MAP_UNSTRUCTURED_SS_NOTIFY service	190
11.11.1	Definitions	190
11.11.2	Service primitives	191
11.11.3	Parameter use.....	191
11.12	MAP_SS_INVOCATION_NOTIFY	192
11.12.1	Definition.....	192
11.12.2	Service primitives	192
11.12.3	Parameter use.....	192
11.13	MAP_REGISTER_CC_ENTRY service	192
11.13.1	Definition.....	192

11.13.2	Service primitives	193
11.13.3	Parameter use.....	193
11.14	MAP_ERASE_CC_ENTRY service.....	194
11.14.1	Definition.....	194
11.14.2	Service primitives	194
11.14.3	Parameter use.....	194
12	Short message service management services	195
12.1	MAP-SEND-ROUTING-INFO-FOR-SM service	195
12.1.1	Definition.....	195
12.1.2	Service primitives	195
12.1.3	Parameter use.....	195
12.2	MAP-MO-FORWARD-SHORT-MESSAGE service.....	197
12.2.1	Definition.....	197
12.2.2	Service primitives	197
12.2.3	Parameter use.....	197
12.3	MAP-REPORT-SM-DELIVERY-STATUS service.....	198
12.3.1	Definition.....	198
12.3.2	Service primitives	198
12.3.3	Parameter use.....	198
12.4	MAP-READY-FOR-SM service.....	199
12.4.1	Definition.....	199
12.4.2	Service primitives	200
12.4.3	Parameter use.....	200
12.5	MAP-ALERT-SERVICE-CENTRE service	200
12.5.1	Definition.....	200
12.5.2	Service primitives	201
12.5.3	Parameter use.....	201
12.6	MAP-INFORM-SERVICE-CENTRE service.....	201
12.6.1	Definition.....	201
12.6.2	Service primitives	202
12.6.3	Parameter use.....	202
12.7	MAP-SEND-INFO-FOR-MT-SMS service.....	202
12.7.1	Definition.....	202
12.7.2	Service primitives	202
12.7.3	Parameter use.....	203
12.8	MAP-SEND-INFO-FOR-MO-SMS service.....	203
12.8.1	Definition.....	203
12.8.2	Service primitives	203
12.8.3	Parameter use.....	204
12.9	MAP-MT-FORWARD-SHORT-MESSAGE service	204
12.9.1	Definition.....	204
12.9.2	Service primitives	204
12.9.3	Parameter use.....	204
13	Network-Requested PDP Context Activation services	206
13.1	MAP_SEND_ROUTING_INFO_FOR_GPRS service.....	206
13.1.1	Definition.....	206
13.1.2	Service primitives	206
13.1.3	Parameter definition and use.....	206
13.2	MAP_FAILURE_REPORT service.....	207
13.2.1	Definition.....	207
13.2.2	Service primitives	207
13.2.3	Parameter definition and use.....	207
13.3	MAP_NOTE_MS_PRESENT_FOR_GPRS service.....	208
13.3.1	Definition.....	208
13.3.2	Service primitives	208
13.3.3	Parameter definition and use.....	208
13A	Location Service Management Services	209
13A.1	MAP-SEND-ROUTING-INFO-FOR-LCS Service	209
13A.1.1	Definition.....	209
13A.1.2	Service Primitives.....	209

13A.1.3	Parameter Use	209
13A.2	MAP-PROVIDE-SUBSCRIBER-LOCATION Service.....	210
13A.2.1	Definition.....	210
13A.2.2	Service Primitives.....	210
13A.2.3	Parameter Definition and Use.....	211
13A.3	MAP-SUBSCRIBER-LOCATION-REPORT Service.....	212
13A.3.1	Definition.....	212
13A.3.2	Service Primitives.....	213
13A.3.3	Parameter Definition and Use.....	213
13A.4	Void.....	215
13A.4.1	Void	215
13A.4.2	Void	215
13A.4.3	Void	215
13A.5	Void.....	215
13A.5.1	Void	215
13A.5.2	Void	215
13A.5.3	Void	215
13A.6	Void.....	215
13A.6.1	Void	215
13A.6.2	Void	215
13A.6.3	Void	215
13A.7	Void.....	215
13A.7.1	Void	215
13A.7.2	Void	215
13A.7.3	Void	215
13A.8	Void.....	215
13A.8.1	Void	215
13A.8.2	Void	215
13A.8.3	Void	215
13A.9	Void.....	215
13A.9.1	Void	215
13A.9.2	Void	216
13A.9.3	Void	216
14	General	216
14.1	Overview	216
14.2	Underlying services.....	216
14.3	Model	216
14.4	Conventions.....	216
15	Elements of procedure.....	217
15.1	Handling of unknown operations	217
15.2	Dialogue establishment	217
15.2.1	Behaviour at the initiating side	218
15.2.2	Behaviour at the responding side.....	219
15.3	Dialogue continuation	220
15.4	Load control	220
15.5	Procedures for MAP specific services.....	221
15.5.1	Service invocation for unsecured dialogues.....	221
15.5.2	Service invocation for secured dialogues.....	221
15.5.3	Service invocation receipt for unsecured dialogues.....	221
15.5.4	Service invocation receipt for secured dialogues.....	222
15.5.5	Handling of components received from TC.....	222
15.6	SDL descriptions	222
16	Mapping on to TC services	261
16.1	Dialogue control.....	261
16.1.1	Directly mapped parameters	261
16.1.2	Use of other parameters of dialogue handling primitives	261
16.1.2.1	Dialogue Id.....	261
16.1.2.2	Application-context-name	261
16.1.2.3	User information	261
16.1.2.4	Component present.....	261

16.1.2.5	Termination	261
16.1.2.6	P-Abort-Cause	261
16.1.2.7	Quality of service	261
16.2	Service specific procedures	262
16.2.1	Directly mapped parameters	262
16.2.2	Use of other parameters of component handling primitives	262
16.2.2.1	Dialogue Id	262
16.2.2.2	Class	262
16.2.2.3	Linked Id	262
16.2.2.4	Operation	263
16.2.2.5	Error	264
16.2.2.6	Parameters	264
16.2.2.7	Time out	264
16.2.2.8	Last component	264
16.2.2.9	Problem code	264
16.2.2.9.1	Mapping to MAP User Error	264
16.2.2.9.2	Mapping to MAP Provider Error parameter	265
16.2.2.9.3	Mapping to diagnostic parameter	265
17	Abstract syntax of the MAP protocol	266
17.1	General	266
17.1.1	Encoding rules	266
17.1.2	Use of TC	266
17.1.2.1	Use of Global Operation and Error codes defined outside MAP	267
17.1.3	Use of information elements defined outside MAP	267
17.1.4	Compatibility considerations	268
17.1.5	Structure of the Abstract Syntax of MAP	268
17.1.6	Application Contexts	270
17.2	Operation packages	272
17.2.1	General aspects	272
17.2.2	Packages specifications	272
17.2.2.1	Location updating	272
17.2.2.2	Location cancellation	273
17.2.2.3	Roaming number enquiry	273
17.2.2.4	Information retrieval	273
17.2.2.5	Inter-VLR information retrieval	273
17.2.2.6	IMSI retrieval	274
17.2.2.7	Call control transfer	274
17.2.2.8	Secure transport	274
17.2.2.9	Void	274
17.2.2.10	Interrogation	274
17.2.2.11	Void	275
17.2.2.12	Handover Control	275
17.2.2.13	Subscriber Data management stand alone	275
17.2.2.14	Equipment management	275
17.2.2.15	Subscriber data management	275
17.2.2.16	Location register restart	276
17.2.2.17	Tracing stand-alone	276
17.2.2.18	Functional SS handling	276
17.2.2.19	Tracing	276
17.2.2.20	Binding	276
17.2.2.21	Unstructured SS handling	277
17.2.2.22	MO Short message relay services	277
17.2.2.23	Short message gateway services	277
17.2.2.24	MT Short message relay services	278
17.2.2.25	Void	278
17.2.2.26	Message waiting data management	278
17.2.2.27	Alerting	278
17.2.2.28	Data restoration	278
17.2.2.29	Purging	279
17.2.2.30	Subscriber information enquiry	279
17.2.2.31	Any time information enquiry	279

17.2.2.32	Group Call Control.....	279
17.2.2.33	Provide SIWFS number	279
17.2.2.34	SIWFS Signalling Modify.....	280
17.2.2.35	Gprs location updating	280
17.2.2.36	Gprs Interrogation	280
17.2.2.37	Failure reporting	280
17.2.2.38	GPRS notifying	281
17.2.2.39	Supplementary Service invocation notification.....	281
17.2.2.40	Set Reporting State.....	281
17.2.2.41	Status Report	281
17.2.2.42	Remote User Free.....	281
17.2.2.43	Call Completion	282
17.2.2.44	Location service gateway services	282
17.2.2.45	Location service enquiry	282
17.2.2.45A	Location service reporting.....	282
17.2.2.46	Void.....	283
17.2.2.47	Void.....	283
17.2.2.48	Void.....	283
17.2.2.49	IST Alerting	283
17.2.2.50	Service Termination	283
17.2.2.51	Mobility Management event notification	283
17.2.2.53	Subscriber Data modification notification	284
17.2.2.54	Authentication Failure Report.....	284
17.3	Application contexts.....	284
17.3.1	General aspects	284
17.3.2	Application context definitions.....	285
17.3.2.1	Void.....	285
17.3.2.2	Location Updating.....	285
17.3.2.3	Location Cancellation	285
17.3.2.4	Roaming number enquiry.....	286
17.3.2.5	Void.....	286
17.3.2.6	Location Information Retrieval.....	286
17.3.2.7	Call control transfer.....	286
17.3.2.8	Secure transport.....	286
17.3.2.9 - 17.3.2.10	Void.....	287
17.3.2.11	Location registers restart	287
17.3.2.12	Handover control.....	287
17.3.2.13	IMSI Retrieval.....	287
17.3.2.14	Equipment Management	287
17.3.2.15	Information retrieval	288
17.3.2.16	Inter-VLR information retrieval.....	288
17.3.2.17	Stand Alone Subscriber Data Management.....	288
17.3.2.18	Tracing	289
17.3.2.19	Network functional SS handling	289
17.3.2.20	Network unstructured SS handling	289
17.3.2.21	Short Message Gateway.....	289
17.3.2.22	Mobile originating Short Message Relay	290
17.3.2.23	Void.....	290
17.3.2.24	Short message alert	290
17.3.2.25	Short message waiting data management.....	290
17.3.2.26	Mobile terminating Short Message Relay	291
17.3.2.27	MS purging	291
17.3.2.28	Subscriber information enquiry.....	291
17.3.2.29	Any time information enquiry.....	291
17.3.2.30	Group Call Control.....	292
17.3.2.31	Provide SIWFS Number	292
17.3.2.32	Gprs Location Updating.....	292
17.3.2.33	Gprs Location Information Retrieval	292
17.3.2.34	Failure Reporting	292
17.3.2.35	GPRS Notifying	293
17.3.2.36	Supplementary Service invocation notification.....	293
17.3.2.37	Reporting.....	293

17.3.2.38	Call Completion	293
17.3.2.39	Location Service Gateway	293
17.3.2.40	Location Service Enquiry	294
17.3.2.41	Void.....	294
17.3.2.42	Void.....	294
17.3.2.43	Void.....	294
17.3.2.44	IST Alerting	294
17.3.2.45	Service Termination	294
17.3.2.46	Mobility Management event notification	294
17.3.2.48	Subscriber Data modification notification	295
17.3.2.49	Authentication Failure Report.....	295
17.3.3	ASN.1 Module for application-context-names	295
17.4	MAP Dialogue Information.....	298
17.5	MAP operation and error codes.....	300
17.6	MAP operation and error types	306
17.6.1	Mobile Service Operations	306
17.6.2	Operation and Maintenance Operations.....	313
17.6.3	Call Handling Operations	314
17.6.4	Supplementary service operations	317
17.6.5	Short message service operations	321
17.6.6	Errors	323
17.6.7	Group Call operations	329
17.6.8	Location service operations	330
17.6.9	Secure transport operations.....	331
17.7	MAP constants and data types.....	332
17.7.1	Mobile Service data types.....	332
17.7.2	Operation and maintenance data types.....	364
17.7.3	Call handling data types.....	365
17.7.4	Supplementary service data types.....	371
17.7.5	Supplementary service codes.....	376
17.7.6	Short message data types	378
17.7.7	Error data types.....	382
17.7.8	Common data types	387
17.7.9	Teleservice Codes.....	394
17.7.10	Bearer Service Codes.....	396
17.7.11	Extension data types	398
17.7.12	Group Call data types	398
17.7.13	Location service data types.....	400
17.7.14	Secure transport data types	406
18	General on MAP user procedures	408
18.1	Introduction	408
18.2	Common aspects of user procedure descriptions.....	408
18.2.1	General conventions	408
18.2.2	Naming conventions	409
18.2.3	Convention on primitives parameters	410
18.2.3.1	Open service.....	410
18.2.3.2	Close service	410
18.2.4	Version handling at dialogue establishment	410
18.2.4.1	Behaviour at the initiating side.....	410
18.2.4.2	Behaviour at the responding side	410
18.2.5	Abort Handling	410
18.2.6	SDL conventions	411
18.3	Interaction between MAP Provider and MAP Users.....	411
19	Mobility procedures	411
19.1	Location management Procedures.....	411
19.1.1	Location updating	414
19.1.1.1	General	414
19.1.1.3	Detailed procedure in the VLR	419
19.1.1.4	Detailed procedure in the HLR	428
19.1.1.5	Send Identification	435

19.1.1.5.1	General	435
19.1.1.5.2	Detailed procedure in the VLR.....	435
19.1.1.5.3	Detailed procedure in the PVLR	435
19.1.1.6	Process Update Location VLR.....	440
19.1.1.8	Detailed procedure in the SGSN	442
19.1.2	Location Cancellation.....	445
19.1.2.1	General.....	445
19.1.2.2	Detailed procedure in the HLR	445
19.1.2.3	Detailed procedure in the VLR	446
19.1.2.4	Detailed procedure in the SGSN	448
19.1.3	Void	452
19.1.3.1	Void.....	452
19.1.3.2	Void.....	452
19.1.3.3	Void.....	452
19.1.4	Purge MS	452
19.1.4.1	General.....	452
19.1.4.2	Void.....	452
19.1.4.3	Void.....	452
19.1.4.4	Detailed procedure in the SGSN	452
19.2	Handover procedure	457
19.2.1	General.....	458
19.2.2	Handover procedure in MSC-A	461
19.2.2.1	Basic handover	461
19.2.2.2	Handling of access signalling.....	461
19.2.2.3	Other procedures in stable handover situation	462
19.2.2.4	Subsequent handover	462
19.2.2.5	SDL Diagrams.....	462
19.2.3	Handover procedure in MSC-B	475
19.2.3.1	Basic handover	476
19.2.3.2	Allocation of handover number.....	476
19.2.3.3	Handling of access signalling.....	476
19.2.3.4	Other procedures in stable handover situation	476
19.2.3.5	Subsequent handover	476
19.2.3.6	SDL Diagrams.....	476
19.2.4	Handover error handling macro	488
19.2.5	Handover procedure in VLR.....	490
19.2.5.1	Allocation of handover number.....	490
19.2.5.2	SDL Diagrams.....	490
19.3	Fault recovery procedures	493
19.3.1	VLR fault recovery procedures.....	493
19.3.2	HLR fault recovery procedures.....	495
19.3.3	VLR restoration: the restore data procedure in the HLR	503
19.4	Macro Insert_Sub_Data_Framed_HLR	505
19.5	Mobility Management Event notification procedure.....	508
19.5.1	General.....	508
19.5.2	Process in the VLR/SGSN.....	508
19.5.3	Process in the gsmSCF	510
20	Operation and maintenance procedures.....	512
20.1	General	512
20.1.1	Tracing Co-ordinator for the VLR.....	512
20.1.2	Subscriber Data Management Co-ordinator for the VLR	514
20.1.3	Tracing Co-ordinator for the SGSN.....	516
20.1.4	Subscriber Data Management Co-ordinator for the SGSN.....	518
20.2	Tracing procedures	520
20.2.1	Procedures in the HLR.....	522
20.2.1.1	Subscriber tracing activation procedure.....	522
20.2.1.2	Subscriber tracing deactivation procedure	527
20.2.2	Procedures in the VLR.....	532
20.2.2.1	Subscriber tracing activation procedure.....	532
20.2.2.2	Subscriber tracing deactivation procedure	534
20.2.2.3	Subscriber tracing procedure.....	536

20.2.3	Procedures in the MSC	536
20.2.3.1	Subscriber tracing procedure.....	536
20.2.4	Procedures in the SGSN	536
20.2.4.1	Subscriber tracing activation procedure	536
20.2.4.2	Subscriber tracing deactivation procedure in SGSN	536
20.3	Subscriber data management procedures	539
20.3.1	Procedures in the HLR.....	540
20.3.1.1	Subscriber deletion procedure.....	540
20.3.1.2	Subscriber data modification procedure.....	542
20.3.2	Procedures in the VLR.....	547
20.3.2.1	Subscriber deletion procedure.....	547
20.3.2.2	Subscriber data modification procedure.....	547
20.3.3	Procedures in the SGSN	550
20.3.3.1	Subscriber deletion procedure.....	550
20.3.3.2	Subscriber data modification procedure.....	550
20.4	Subscriber Identity procedure.....	553
20.4.1	Subscriber identity procedure in the HLR	553
20.4.2	Subscriber identity procedure in the VLR	555
21	Call handling procedures.....	557
21.1	General	557
21.2	Retrieval of routing information.....	557
21.2.1	General.....	557
21.2.2	Process in the GMSC.....	560
21.2.3	Procedures in the HLR.....	564
21.2.4	Process in the VLR to provide a roaming number	569
21.2.5	Process in the VLR to restore subscriber data	571
21.2.6	Process in the VLR to provide subscriber information	573
21.2.7	Process in the HLR for Any Time Interrogation.....	575
21.2.7.1	Process in the gsmSCF.....	575
21.2.7.2	Process in the HLR.....	575
21.2.8	Process in the GMLC for Any Time Interrogation	579
21.2.8.1	Process in the gsmSCF.....	579
21.2.8.2	Process in the GMLC.....	579
21.2.9	Process in the gsmSCF	582
21.3	Transfer of call handling	583
21.3.1	General.....	583
21.3.2	Process in the VMSC.....	583
21.3.3	Process in the GMSC.....	586
21.4	Inter MSC Group Call Procedures	588
21.4.1	General.....	588
21.4.2	Process in the Anchor MSC.....	588
21.4.3	Process in the Relay MSC	594
21.5	Allocation and modifications of resources in an SIWFS.....	599
21.5.1	General.....	599
21.5.2	Process in the VMSC.....	602
21.5.2.1	Allocation of SIWFS resources.....	602
21.5.2.2	Modification of SIWFS resources initiated by the user	603
21.5.2.3	Modification of SIWFS resources initiated by the SIWFS	603
21.5.3	Process in the SIWFS	611
21.5.3.1	Procedures for allocation of SIWFS resources.....	611
21.5.3.2	Process for modification of SIWFS resources initiated by the user	612
21.5.3.3	Process for modification of SIWFS resources initiated by the SIWFS	612
21.6	Setting of Reporting State	618
21.6.1	General.....	618
21.6.2	Process in the HLR for Set Reporting State stand-alone	618
21.6.3	Reporting co-ordinator process in the VLR.....	621
21.6.4	Process in the VLR to set the reporting state	623
21.7	Status Reporting	626
21.7.1	General.....	626
21.7.2	Process in the VLR for Status Reporting	626
21.7.3	Process in the HLR for Status Reporting	630

21.8	Remote User Free.....	635
21.8.1	General.....	635
21.8.2	Process in the HLR for Remote User Free.....	635
21.8.3	Process in the VLR for Remote User Free.....	638
21.9	IST Alert.....	641
21.9.1	General.....	641
21.9.2	Procedure in the MSC.....	641
21.9.3	Procedure in the HLR.....	643
21.10	IST Command.....	645
21.10.1	General.....	645
21.10.2	Procedure in the HLR.....	645
21.10.3	Procedure in the MSC.....	647
22	Supplementary services procedures.....	649
22.1	Functional supplementary service processes.....	649
22.1.1	Functional supplementary service process co-ordinator for MSC.....	649
22.1.2	Functional supplementary service process co-ordinator for VLR.....	651
22.1.3	Functional supplementary service process co-ordinator for HLR.....	653
22.1.4	Call completion supplementary service process co-ordinator for HLR.....	655
22.2	Registration procedure.....	657
22.2.1	General.....	657
22.2.2	Procedures in the MSC.....	657
22.2.3	Procedures in the VLR.....	660
22.2.4	Procedures in the HLR.....	662
22.3	Erasure procedure.....	665
22.3.1	General.....	665
22.3.2	Procedures in the MSC.....	665
22.3.3	Procedures in the VLR.....	666
22.3.4	Procedures in the HLR.....	666
22.4	Activation procedure.....	666
22.4.1	General.....	666
22.4.2	Procedures in the MSC.....	667
22.4.3	Procedures in the VLR.....	669
22.4.4	Procedures in the HLR.....	672
22.5	Deactivation procedure.....	674
22.5.1	General.....	674
22.5.2	Procedures in the MSC.....	675
22.5.3	Procedures in the VLR.....	675
22.5.4	Procedures in the HLR.....	675
22.6	Interrogation procedure.....	675
22.6.1	General.....	675
22.6.2	Procedures in the MSC.....	676
22.6.3	Procedures in the VLR.....	676
22.6.4	Procedures in the HLR.....	681
22.7	Invocation procedure.....	683
22.7.1	General.....	683
22.7.2	Procedures in the MSC.....	683
22.7.3	Procedures in the VLR.....	687
22.8	Password registration procedure.....	689
22.8.1	General.....	689
22.8.2	Procedures in the MSC.....	690
22.8.3	Procedures in the VLR.....	690
22.8.4	Procedures in the HLR.....	690
22.9	Mobile Initiated USSD procedure.....	693
22.9.1	General.....	693
22.9.2	Procedures in the MSC.....	693
22.9.3	Procedures in the VLR.....	697
22.9.4	Procedures in the HLR.....	702
22.9.5	Procedures in the gsmSCF/secondary HLR.....	706
22.10	Network initiated USSD procedure.....	709
22.10.1	General.....	709
22.10.2	Procedure in the MSC.....	709

22.10.3	Procedure in the VLR	714
22.10.4	Procedure in the HLR	721
22.10.5	Procedure in the gsmSCF and secondary HLR	727
22.11	Common macros for clause 22	731
22.11.1	SS Password handling macros	731
22.11.2	SS Error handling macros	734
22.12	Supplementary Service Invocation Notification procedure	740
22.12.1	General	740
22.12.2	Procedures in the MSC	740
22.12.3	Procedures in the gsmSCF	742
22.13	Activation of a CCBS request	744
22.13.1	General	744
22.13.2	Procedure in the VLR	744
22.13.3	Procedure in the HLR	746
22.14	Deactivation of a CCBS request	748
22.14.1	General	748
22.14.2	Procedure in the VLR	748
22.14.3	Procedure in the HLR	750
23	Short message service procedures	752
23.1	General	752
23.1.1	Mobile originated short message service Co-ordinator for the MSC	752
23.1.2	Short message Gateway Co-ordinator for the HLR	754
23.1.3	Mobile originated short message service Co-ordinator for the SGSN	756
23.2	The mobile originated short message transfer procedure	758
23.2.1	Procedure in the servicing MSC	758
23.2.2	Procedure in the VLR	764
23.2.3	Procedure in the interworking MSC	766
23.2.4	Procedure in the servicing SGSN	768
23.3	The mobile terminated short message transfer procedure	772
23.3.1	Procedure in the Servicing MSC	774
23.3.2	Procedures in the VLR	787
23.3.3	Procedures in the HLR	791
23.3.4	Procedures in the gateway MSC	800
23.3.5	Procedure in the Servicing SGSN	810
23.4	The Short Message Alert procedure	822
23.4.1	Procedures in the Servicing MSC	824
23.4.2	Procedures in the VLR	826
23.4.2.1	The Mobile Subscriber is present	826
23.4.2.2	The Mobile Equipment has memory available	826
23.4.3	Procedures in the HLR	828
23.4.4	Procedures in the Interworking MSC	831
23.4.5	Procedures in the Servicing SGSN	833
23.4.5.1	The Mobile Subscriber is present	833
23.4.5.2	The Mobile Equipment has memory available	833
23.5	The SM delivery status report procedure	835
23.5.1	Procedures in the HLR	835
23.5.2	Procedures in the gateway MSC	837
23.6	Common procedures for the short message clause	839
23.6.1	The macro Report_SM_Delivery_Stat_HLR	839
24	GPRS process description	841
24.1	General	841
24.1.1	Process in the HLR for Send Routing Information for GPRS	841
24.1.2	Process in the GGSN for Send Routing Information for GPRS	843
24.2.1	Process in the HLR for Failure Report	845
24.2.2	Process in the GGSN for Failure Report	847
24.3.1	Process in the GGSN for Note Ms Present For Gprs	849
24.3.2	Process in the HLR for Note Ms Present For Gprs	851
24A	CSE control of subscriber data	853
24A.1	Any Time Subscription Interrogation procedure	853
24A.1.1	General	853

24A.1.2	Process in the gsmSCF	853
24A.1.3	Process in the HLR	853
24A.2	Any Time Modification procedure	856
24A.2.1	General.....	856
24A.2.2	Process in the gsmSCF	856
24A.2.3	Process in the HLR	856
24A.3	Subscriber Data Modification Notification procedure.....	859
24A.3.1	General.....	859
24A.3.2	Processes in the MAP Entities	859
24A.3.2.1	Process in the HLR.....	859
24A.3.2.2	Process in the gsmSCF.....	862
24B	Location Service process description	864
24B.1	Routeing information retrieval procedure for LCS	864
24B.1.1	General.....	864
24B.1.2	Process in the GMLC.....	865
24B.1.3	Process in the HLR	866
24B.2	Provide Subscriber Location procedure	867
24B.2.1	General.....	867
24B.2.2	Process in the GMLC.....	868
24B.2.3	Process in the MSC.....	869
24B.2.4	Process in the SGSN	870
24B.3	Subscriber Location Report procedure	871
24B.3.1	General.....	871
24B.3.2	Process in the GMLC.....	872
24B.3.3	Process in the MSC.....	873
24B.3.4	Process in the SGSN	874
25	General macro description.....	875
25.1	MAP open macros	875
25.1.1	Macro Receive_Open_Ind	875
25.1.2	Macro Receive_Open_Cnf	875
25.2	Macros to check the content of indication and confirmation primitives.....	880
25.2.1	Macro Check_Indication.....	880
25.2.2	Macro Check_Confirmation	880
25.3	The page and search macros.....	883
25.3.1	Macro PAGE_MSC	883
25.3.2	Macro Search_For_MS_MSC	884
25.4	Macros for handling an Access Request.....	887
25.4.1	Macro Process_Access_Request_MSC	887
25.4.2	Macro Process_Access_Request_VLR.....	892
25.4.3	Macro Identification Procedure	894
25.5	Authentication macros and processes.....	899
25.5.1	Macro Authenticate_MSC	899
25.5.2	Macro Authenticate_VLR.....	899
25.5.3	Process Obtain_Authentication_Sets_VLR	899
25.5.4	Macro Obtain_Authent_Para_VLR	899
25.5.5	Process Obtain_Auth_Sets_HLR	900
25.5.6	Process Obtain_Authent_Para_SGSN	910
25.5.7	Process Authentication_Failure_Report	915
25.5.7.1	General	915
25.5.7.2	Process in the VLR.....	916
25.5.7.3	Process in the SGSN	917
25.5.7.4	Process in the HLR.....	918
25.6	IMEI Handling Macros	919
25.6.1	Macro Check_IMEI_MSC.....	919
25.6.2	Macro Check_IMEI_VLR	919
25.6.3	Process Check_IMEI_EIR.....	920
25.6.4	Macro Obtain_IMEI_MSC	920
25.6.5	Macro Obtain_IMEI_VLR	920
25.6.6	Process Check_IMEI_SGSN	927
25.7	Insert Subscriber Data Macros	930

25.7.1	Macro Insert_Subst_Data_VLR.....	930
25.7.2	Process Insert_Subst_Data_Stand_Alone_HLR	932
25.7.3	Macro Wait_for_Insert_Subst_Data_Cnf	938
25.7.4	Process Send_Insert_Subst_Data	940
25.7.5	Macro Insert_Subst_Data_SGSN	940
25.7.6	Macro Wait_for_Insert_GPRS_Subst_Data_Cnf	942
25.8	Request IMSI Macros.....	944
25.8.1	Macro Obtain_IMSI_MSC	944
25.8.2	Macro Obtain_IMSI_VLR.....	944
25.9	Tracing macros	946
25.9.1	Macro Trace_Subscriber_Activity_MSC	946
25.9.2	Macro Trace_Subscriber_Activity_VLR.....	946
25.9.3	Macro Activate_Tracing_VLR.....	947
25.9.4	Macro Control_Tracing_HLR	949
25.9.5	Macro Trace_Subscriber_Activity_SGSN.....	952
25.9.6	Macro Activate_Tracing_SGSN.....	952
25.10	Short Message Alert procedures.....	954
25.10.1	Subscriber_Present_VLR process.....	954
25.10.2	Macro Alert_Service_Centre_HLR	956
25.10.3	The Mobile Subscriber is present	958
Annex A (informative): Cross-reference for abstract syntaxes of MAP		960
Annex B (informative): Fully expanded ASN.1 sources for abstract syntaxes of MAP.....		1197
B.1	Fully Expanded ASN.1 Source of MAP-Protocol/TCAPMessages	1197
B.2	Fully Expanded ASN.1 Source of MAP-DialogueInformation.....	1314
Annex C : Void		1319
Annex D (informative): Clause mapping table		1320
D.1	Mapping of Clause numbers.....	1320
Annex E (informative): Change History		1321
History		1329

Foreword

This Technical Specification (TS) has been produced by the 3rd Generation Partnership Project (3GPP).

The present document specifies the Mobile Application Part (MAP), the requirements for the signalling system and procedures within the 3GPP system at application level.

The contents of the present document are subject to continuing work within the TSG and may change following formal TSG approval. Should the TSG modify the contents of the present document, it will be re-released by the TSG with an identifying change of release date and an increase in version number as follows:

Version x.y.z

where:

- x the first digit:
 - 1 presented to TSG for information;
 - 2 presented to TSG for approval;
 - 3 or greater indicates TSG approved document under change control.
- y the second digit is incremented for all changes of substance, i.e. technical enhancements, corrections, updates, etc.
- z the third digit is incremented when editorial only changes have been incorporated in the document.

1 Scope

It is necessary to transfer between entities of a Public Land Mobile Network (PLMN) information specific to the PLMN in order to deal with the specific behaviour of roaming Mobile Stations (MS)s. The Signalling System No. 7 specified by CCITT is used to transfer this information.

The present document describes the requirements for the signalling system and the procedures needed at the application level in order to fulfil these signalling needs.

Clauses 1 to 6 are related to general aspects such as terminology, mobile network configuration and other protocols required by MAP.

MAP consists of a set of MAP services that are provided to MAP service-users by a MAP service-provider.

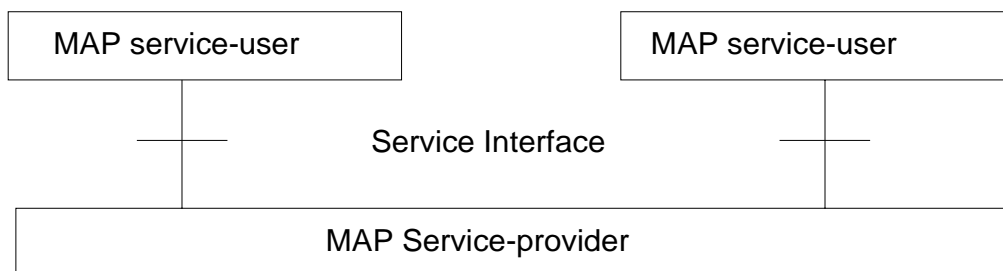

Figure 1.1/1: Modelling principles

Clauses 7 to 13A of the present document describe the MAP services.

Clauses 14 to 17 define the MAP protocol specification and the behaviour of service provider (protocol elements to be used to provide MAP services, mapping on to TC service primitives, abstract syntaxes, etc.).

Clauses 18 to 25 describe the MAP user procedures that make use of MAP services.

2 References

The following documents contain provisions which, through reference in this text, constitute provisions of the present document.

- References are either specific (identified by date of publication, edition number, version number, etc.) or non-specific.
- For a specific reference, subsequent revisions do not apply.
- For a non-specific reference, the latest version applies. In the case of a reference to a 3GPP document (including a GSM document), a non-specific reference implicitly refers to the latest version of that document *in the same Release as the present document*.

- [1] 3G TS 21.905: "3G Vocabulary".
- [2] 3GPP TS 22.001: "Digital cellular telecommunications system (Phase 2+); Principles of telecommunication services supported by a Public Land Mobile Network (PLMN)".
- [3] 3G TS 22.002: "Bearer Services Supported by a Public Land Mobile Network (PLMN)".
- [4] 3GPP TS 22.003: "Circuit Teleservices Supported by a Public Land Mobile Network (PLMN)".
- [5] 3G TS 22.004: "General on Supplementary Services".
- [6] 3GPP TS 42.009: "Digital cellular telecommunications system (Phase 2+); Security aspects".
- [7] 3G TS 22.016: "International Mobile station Equipment Identities (IMEI)".

- [8] 3G TS 22.041: "Operator Determined Barring".
- [9] 3G TS 22.081: "Line identification supplementary services - Stage 1".
- [10] 3G TS 22.082: "Call Forwarding (CF) supplementary services - Stage 1".
- [11] 3G TS 22.083: "Call Waiting (CW) and Call Hold (HOLD) Supplementary Services - Stage 1".
- [12] 3G TS 22.084: "Multi Party (MPTY) Supplementary Services - Stage 1".
- [13] 3G TS 22.085: "Closed User Group (CUG) supplementary services - Stage 1".
- [14] 3G TS 22.086: "Advice of charge (AoC) Supplementary Services - Stage 1".
- [15] 3G TS 22.088: "Call Barring (CB) supplementary services - Stage 1".
- [16] 3G TS 22.090: "Unstructured Supplementary Service Data (USSD); - Stage 1".
- [17] 3G TS 23.003: "Numbering, addressing and identification".
- [18] GSM 03.04: "Digital cellular telecommunications system (Phase 2+); Signalling requirements relating to routing of calls to mobile subscribers".
- [19] 3G TS 23.007: "Restoration procedures".
- [20] 3G TS 23.008: "Organisation of subscriber data".
- [21] 3G TS 23.009: "Handover procedures".
- [22] 3G TS 23.011: "Technical realization of Supplementary Services - General Aspects".
- [23] 3G TS 23.012: "Location registration procedures".
- [24] 3GPP TS 43.020: "Security related network functions".
- [25] 3G TS 23.038: "Alphabets and language".
- [26] 3G TS 23.040: "Technical realization of the Short Message Service (SMS) Point to Point (PP)".
- [26a] 3G TS 23.271: "Functional stage2 description of LCS".
- [27] 3G TS 23.081: "Line Identification Supplementary Services - Stage 2".
- [28] 3G TS 23.082: "Call Forwarding (CF) Supplementary Services - Stage 2".
- [29] 3G TS 23.083: "Call Waiting (CW) and Call Hold (HOLD) Supplementary Services - Stage 2".
- [30] 3G TS 23.084: "Multi Party (MPTY) Supplementary Services - Stage 2".
- [31] 3G TS 23.085: "Closed User Group (CUG) Supplementary Services - Stage 2".
- [32] 3G TS 23.086: "Advice of Charge (AoC) Supplementary Services - Stage 2".
- [33] 3G TS 23.088: "Call Barring (CB) Supplementary Services - Stage 2".
- [34] 3G TS 23.090: "Unstructured Supplementary Services Data (USSD) - Stage 2".
- [34a] 3G TS 33.200: "3G Security; Network domain security; MAP application layer security".
- [35] 3G TS 24.008: "Mobile Radio Interface Layer 3 specification; Core Network Protocols - Stage 3".
- [36] 3G TS 24.010: "Mobile radio interface layer 3 Supplementary Services specification - General aspects".
- [37] 3G TS 24.011: "Point-to-Point (PP) Short Message Service (SMS) support on mobile radio interface".
- [37a] 3GPP TS 44.071: "Location Services (LCS) – stage 3".

- [38] 3G TS 24.080: "Mobile radio interface layer 3 supplementary services specification - Formats and coding".
- [39] 3G TS 24.081: "Line identification supplementary services - Stage 3".
- [40] 3G TS 24.082: "Call Forwarding (CF) Supplementary Services - Stage 3".
- [41] 3G TS 24.083: "Call Waiting (CW) and Call Hold (HOLD) supplementary services - Stage 3".
- [42] 3G TS 24.084: "Multi Party (MPTY) Supplementary Services - Stage 3".
- [43] 3G TS 24.085: "Closed User Group (CUG) Supplementary Services - Stage 3".
- [44] 3G TS 24.086: "Advice of Charge (AoC) Supplementary Services - Stage 3".
- [45] 3G TS 24.088: "Call Barring (CB) Supplementary Services - Stage 3".
- [46] 3G TS 24.090: "Unstructured Supplementary Services Data - Stage 3".
- [47] 3GPP TS 48.002: " Base Station System - Mobile-services Switching Centre (BSS - MSC) interface principles".
- [48] 3GPP TS 48.006: "Signalling transport mechanism specification for the Base Station System - Mobile-services Switching Centre (BSS - MSC) interface".
- [49] 3G TS 48.008: "Mobile Switching Centre - Base Station System (MSC - BSS) interface; Layer 3 specification".
- [49a1] 3GPP TS 48.031: "Location Services (LCS); Serving Mobile Location Centre (SMLC) – Serving Mobile Location Centre (SMLC); SMLC Peer Protocol (SMLCPP)".
- [49b] 3GPP TS 48.071: "Location Services (LCS); Serving Mobile Location Centre - Base Station System (SMLC - BSS) interface Layer 3 specification".
- [50] 3GPP TS 49.001: "General network interworking scenarios".
- [51] 3G TS 29.002: "Mobile Application Part (MAP) specification".
- [52] GSM 09.03: "Digital cellular telecommunications system (Phase 2+); Signalling requirements on interworking between the Integrated Services Digital Network (ISDN) or Public Switched Telephone Network (PSTN) and the Public Land Mobile Network (PLMN)".
- [53] GSM 09.04: "Digital cellular telecommunications system (Phase 2+); Interworking between the Public Land Mobile Network (PLMN) and the Circuit Switched Public Data Network (CSPDN)".
- [54] GSM 09.05: "Digital cellular telecommunications system (Phase 2+); Interworking between the Public Land Mobile Network (PLMN) and the Packet Switched Public Data Network (PSPDN) for Packet Assembly/Disassembly facility (PAD) access".
- [55] 3G TS 29.006: "Interworking between a Public Land Mobile Network (PLMN) and a Packet Switched Public Data Network/Integrated Services Digital Network (PSPDN/ISDN) for the support of Packet Switched data transmission services".
- [56] 3G TS 29.007: "General requirements on interworking between the Public Land Mobile Network (PLMN) and the Integrated Services Digital Network (ISDN) or Public Switched Telephone Network (PSTN)".
- [57] 3GPP TS 29.008: "Application of the Base Station System Application Part (BSSAP) on the E-interface".
- [58] 3G TS 29.010: "Information element mapping between Mobile Station - Base Station System and BSS - Mobile-services Switching Centre (MS - BSS - MSC) Signalling procedures and the Mobile Application Part (MAP)".
- [59] 3G TS 29.011: "Signalling interworking for Supplementary Services".

- [59a] 3GPP TS 49.031: "Digital cellular telecommunications system (Phase 2+); Location Services (LCS); Base Station System Application Part LCS Extension (BSSAP-LE)".
- [60] GSM 09.90: "Digital cellular telecommunications system (Phase 2+); Interworking between Phase 1 infrastructure and Phase 2 Mobile Stations (MS)".
- [61] GSM 12.08: "Digital cellular telecommunications system (Phase 2); Subscriber and Equipment Trace".
- [62] ETS 300 102-1 (1990): "Integrated Services Digital Network (ISDN); User-network interface layer 3 specifications for basic call control".
- [63] ETS 300 136 (1992): "Integrated Services Digital Network (ISDN); Closed User Group (CUG) supplementary service description".
- [64] ETS 300 138 (1992): "Integrated Services Digital Network (ISDN); Closed User Group (CUG) supplementary service Digital Subscriber Signalling System No.one (DSS1) protocol".
- [65] ETS 300 287: "Integrated Services Digital Network (ISDN); Signalling System No.7; Transaction Capabilities (TC) version 2".
- [66] ETR 060: "Signalling Protocols and Switching (SPS); Guide-lines for using Abstract Syntax Notation One (ASN.1) in telecommunication application protocols".
- [67] ITU-T Recommendation E.164: "Numbering plan for the ISDN era".
- [68] ITU-T Recommendation E.212: "Identification plan for land mobile stations".
- [69] ITU-T Recommendation E.213: "Telephone and ISDN numbering plan for land mobile stations".
- [70] ITU-T Recommendation E.214: "Structuring of the land mobile global title for the signalling connection control part".
- [71] CCITT Recommendation Q.699: "Interworking between the Digital Subscriber Signalling System Layer 3 protocol and the Signalling System No.7 ISDN User part".
- [72] ITU-T Recommendation Q.711: "Specifications of Signalling System No.7; Functional description of the Signalling Connection Control Part".
- [73] ITU-T Recommendation Q.712: "Definition and function of SCCP messages".
- [74] ITU-T Recommendation Q.713: "Specifications of Signalling System No.7; SCCP formats and codes".
- [75] ITU-T Recommendation Q.714: "Specifications of Signalling System No.7; Signalling Connection Control Part procedures".
- [76] ITU-T Recommendation Q.716: "Specifications of Signalling System No.7; Signalling connection control part (SCCP) performances".
- [77] ITU-T Recommendation Q.721 (1988): "Specifications of Signalling System No.7; Functional description of the Signalling System No.7 Telephone user part".
- [78] ITU-T Recommendation Q.722 (1988): "Specifications of Signalling System No.7; General function of Telephone messages and signals".
- [79] ITU-T Recommendation Q.723 (1988): "Specifications of Signalling System No.7; Formats and codes".
- [80] ITU-T Recommendation Q.724 (1988): "Specifications of Signalling System No.7; Signalling procedures".
- [81] ITU-T Recommendation Q.725 (1988): "Specifications of Signalling System No.7; Signalling performance in the telephone application".
- [82] ITU-T Recommendation Q.761 (1988): "Specifications of Signalling System No.7; Functional description of the ISDN user part of Signalling System No.7".

- [83] ITU-T Recommendation Q.762 (1988): "Specifications of Signalling System No.7; General function of messages and signals".
- [84] ITU-T Recommendation Q.763 (1988): "Specifications of Signalling System No.7; Formats and codes".
- [85] ITU-T Recommendation Q.764 (1988): "Specifications of Signalling System No.7; Signalling procedures".
- [86] ITU-T Recommendation Q.767: "Specifications of Signalling System No.7; Application of the ISDN user part of CCITT signalling System No.7 for international ISDN interconnections".
- [87] ITU-T Recommendation Q.771: "Specifications of Signalling System No.7; Functional description of transaction capabilities".
- [88] ITU-T Recommendation Q.772: "Specifications of Signalling System No.7; Transaction capabilities information element definitions".
- [89] ITU-T Recommendation Q.773: "Specifications of Signalling System No.7; Transaction capabilities formats and encoding".
- [90] ITU-T Recommendation Q.774: "Specifications of Signalling System No.7; Transaction capabilities procedures".
- [91] ITU-T Recommendation Q.775: "Specifications of Signalling System No.7; Guide-lines for using transaction capabilities".
- [92] ITU-T Recommendation X.200: "Reference Model of Open systems interconnection for CCITT Applications".
- [93] ITU-T Recommendation X.208 (1988): "Specification of Abstract Syntax Notation One (ASN.1)".
- [94] ITU-T Recommendation X.209 (1988): "Specification of basic encoding rules for Abstract Syntax Notation One (ASN.1)".
- [95] ITU-T Recommendation X.210: "Open systems interconnection layer service definition conventions".
- [97] 3G TS 23.018: "Basic Call Handling".
- [98] 3G TS 23.078: "Customised Applications for Mobile network Enhanced Logic (CAMEL) Phase 3 - Stage 2".
- [99] 3G TS 23.079: "Support of Optimal Routeing (SOR) - Stage 2".
- [100] 3GPP TS 43.068: "Voice Group Call Service (VGCS) - Stage 2".
- [101] 3GPP TS 43.069: "Voice Broadcast service (VBS) - Stage 2".
- [102] ANSI T1.113: "Signaling System No. 7 (SS7) - ISDN User Part".
- [103] GSM 03.54 "Shared Inter Working Function (SIWF) - Stage 2".
- [104] 3G TS 23.060: "General Packet Radio Service (GPRS) Description; Stage 2".
- [105] 3G TS 29.060: "General Packet Radio Service (GPRS); GPRS Tunnelling Protocol (GTP) across the Gn and Gp Interface".
- [106] 3G TS 29.018: "General Packet Radio Service (GPRS); Serving GPRS Support Node (SGSN) - Visitors Location Register (VLR); Gs interface layer 3 specification".
- [107] 3G TS 23.093: "Technical Realization of Completion of Calls to Busy Subscriber (CCBS); Stage 2".
- [108] 3G TS 23.066: "Support of Mobile Number Portability (MNP); Technical Realisation Stage 2".

- [109] ANSI T1.112 (1996): "Telecommunication – Signalling No. 7 - Signaling Connection Control Part (SCCP)".
- [110] 3G TS 23.116: "Super-Charger Technical Realisation; Stage 2."
- [111] ITU-T Recommendation Q.711: "Specifications of Signalling System No.7; Signalling System No. 7 – Functional Description of the Signalling Connection Control Part".
- [112] ITU-T Recommendation Q.712: "Specifications of Signalling System No.7; Signalling System No. 7 – Definition and Function of SCCP Messages".
- [113] ITU-T Recommendation Q.713: "Specifications of Signalling System No.7; Signalling System No. 7 – SCCP formats and codes".
- [114] ITU-T Recommendation Q.714: "Specifications of Signalling System No.7; Signalling System No. 7 – Signalling Connection Control Part Procedures".
- [115] ITU-T Recommendation Q.716: "Specifications of Signalling System No.7; Signalling System No. 7 – Signalling Connection Control Part (SCCP) Performance".
- [116] ITU-T Q.850, May 1998: "Usage of cause and location in the Digital Subscriber Signalling System No. 1 and the Signalling System No. 7 ISDN User Part".
- [117] 3G TS 22.135: "Multicall; Service description; Stage 1".
- [118] 3G TS 23.135: "Multicall supplementary service; Stage 2".
- [119] 3G TS 24.135: "Multicall supplementary service; Stage 3".
- [120] 3G TS 25.413: "UTRAN Iu Interface RANAP Signalling".
- [121] 3G TS 29.202: "SS7 signalling transport in core network"
- [122] 3G TS 23.032: "Universal Geographical Area Description (GAD)"
- [123] 3G TS 22.071: " Location Services (LCS); Service description, Stage 1"

3 Abbreviations

Abbreviations used in the present document are listed in 3G TS 21.905.

4 Void

5 Overload and compatibility overview

5.1 Overload control

There is a requirement for an overload/congestion control for all entities of the Public Land Mobile Network and the underlying Signalling System No. 7.

5.1.1 Overload control for MSC (outside MAP)

For the entity MSC the following two procedures (outside MAP) may be applied to control the processor load:

- ISDN
CCITT Recommendation Q.764 (Automatic Congestion Control), applicable to reduce the mobile terminating traffic;
- BSSAP
3GPP TS 48.008 [49] (A-interface Flow Control), applicable to reduce the mobile originating traffic.

5.1.2 Overload control for MAP entities

For all MAP entities, especially the HLR, the following overload control method is applied.

If overload of a MAP entity is detected requests for certain MAP operations (see tables 5.1/1, 5.1/2, 5.1/3 and 5.1/4) may be ignored by the responder. The decision as to which MAP Operations may be ignored is made by the MAP service provider and is based upon the priority of the application context.

Since most of the affected MAP operations are supervised in the originating entity by TC timers (medium) an additional delay effect is achieved for the incoming traffic.

If overload levels are applicable in the Location Registers the MAP operations should be discarded taking into account the priority of their application context (see table 5.1/1 for HLR, table 5.1/2 for MSC/VLR, table 5.1/3 for the SGSN and table 5.1/4 for the SMLC; the lowest priority is discarded first).

The ranking of priorities given in the tables 5.1/1, 5.1/2, 5.1/3 and 5.1/4 is not normative. The tables can only be seen as a proposal that might be changed due to network operator/implementation matters.

If secure transport is used, the encapsulated application context for the requested dialogue determines the priority for discarding the received MAP operation.

Table 5.1/1: Priorities of Application Contexts for HLR as Responder

	Responder = HLR	Initiating Entity	
Priority high	<u>Mobility Management</u>		
	networkLocUp (updateLocation), (restoreData/v2), (sendParameters/v1)	VLR	
	gprsLocationUpdate (updateGPRSLocation/v3),	SGSN	
	infoRetrieval (sendAuthenticationInfo/v2/v3), (sendParameters/v1)	VLR/SGSN	
	istAlerting (istAlert/v3) (purgeMS/v2/v3)	MSC msPurging	VLR
	msPurging (purgeMS/v3)	SGSN	
	<u>Short Message Service</u>		
	shortMsgGateway (sendRoutingInfoforSM), (reportSM-DeliveryStatus)	GMSC	
	mwdMngt VLR/SGSN (readyForSM/v2/v3), (noteSubscriberPresent/v1)		
	<u>Mobile Terminating Traffic</u>		
	locInfoRetrieval (sendRoutingInfo)	GMSC	
	anyTimeEnquiry (anyTimeInterrogation/v3)	gsmSCF	
	reporting (statusReport)	VLR	
	<u>Location Services</u>		
	locationSvcGateway (sendRoutingInfoforLCS/v3)	GMLC	
	<u>Subscriber Controlled Inputs (Supplementary Services)</u>		
	networkFunctionalSs (registerSS), (eraseSS), (activateSS), (deactivateSS), (interrogateSS), (registerPassword), (processUnstructuredSS-Data/v1), (beginSubscriberActivity/v1)	VLR	
	callCompletion (registerCCEnter), (eraseCCEnter)	VLR	
	networkUnstructuredSs (processUnstructuredSS-Request/v2)	VLR	
	imsiRetrieval (sendIMSI/v2)	VLR	
	gprsLocationInfoRetrieval (sendRoutingInfoForGprs/v3/v4)	GGSN/SGSN	
	failureReport (failureReport/v3)	GGSN/SGSN	
	authenticationFailureReport (authenticationFailureReport/v3)	VLR/SGSN	
	Priority low		

NOTE: The application context name is the last component but one of the object identifier.
Operation names are given in brackets for information with "/vn" appended to vn only operations.

Table 5.1/3: Priorities of Application Contexts for SGSN as Responder

Responder = SGSN	Initiating Entity
Priority high	
<u>Mobility and Location Register Management</u>	
locationCancel (cancelLocation v3)	HLR
reset (reset)	HLR
subscriberDataMngt (insertSubscriberData v3), (deleteSubscriberData v3)	HLR
tracing (activateTraceMode), (deactivateTraceMode)	HLR
<u>Short Message Service</u>	
shortMsgMT-Relay (MT-ForwardSM v3), (forwardSM v1/v2)	MSC
<u>Location Services</u>	
locationSvcEnquiry (provideSubscriberLocation v3)	GMLC
<u>Network-Requested PDP context activation</u>	
gprsNotify (noteMsPresentForGprs v3),	HLR
<u>(Subscriber Location & State retrieval)</u>	
subscriberInfoEnquiry (provideSubscriberInformation/v3)	HLR
Priority low	

NOTE: The application context name is the last component but one of the object identifier.
Operation names are given in brackets for information with "/vn" appended to vn.

Table 5.1/2: Priorities of Application Contexts for MSC/VLR as Responder

Responder = MSC/VLR	Initiating Entity
<i>Priority high</i>	
<u>Handover</u>	
handoverControl (prepareHandover/v2/v3), (performHandover/v1)	MSC
<u>Group call and Broadcast call</u>	
groupCallControl (prepareGroupCall/v3)	MSC
<u>Mobility and Location Register Management</u>	
locationCancel (cancelLocation)	HLR
reset (reset)	HLR
immediateTermination (istCommand/v3)	HLR
interVlrInfoRetrieval (sendIdentification/v2/v3), (sendParameters/v1)	VLR
subscriberDataMngt (insertSubscriberData), (deleteSubscriberData)	HLR
tracing (activateTraceMode), (deactivateTraceMode)	HLR
<u>Short Message Service</u>	
shortMsgMO-Relay (MO-ForwardSM v3), (forwardSM v1/v2)	MSC/SGSN
shortMsgMT-Relay (MT-ForwardSM v3), (forwardSM v1/v2)	MSC
shortMsgAlert (alertServiceCentre/v2), (alertServiceCentreWithoutResult/v1)	HLR
<u>Mobile Terminating Traffic</u>	
roamingNbEnquiry (provideRoamingNumber)	HLR
callControlTransfer (resumeCallHandling)	MSC
subscriberInfoEnquiry (provideSubscriberInformation/v3)	HLR
reporting (remoteUserFree), (SetReportingState)	HLR
<u>Location Services</u>	
locationSvcEnquiry (provideSubscriberLocation/v3)	GMLC
<u>Network-Initiated USSD</u>	
networkUnstructuredSs (unstructuredSS-Request/v2), (unstructuredSS-Notify/v2)	HLR
<i>Priority low</i>	

NOTE: The application context name is the last component but one of the object identifier.
Operation names are given in brackets for information with "/vn" appended to vn only operations.

5.1.3 Congestion control for Signalling System No. 7

The requirements of SS7 Congestion control have to be taken into account as far as possible.

Means that could be applied to achieve the required traffic reductions are described in clauses 5.1.1 and 5.1.2.

5.2 Compatibility

5.2.1 General

The present document of the Mobile Application Part is designed in such a way that an implementation which conforms to it can also conform to the Mobile Application Part operational version 1 specifications, except on the MSC-VLR interface.

A version negotiation mechanism based on the use of an application-context-name is used to negotiate the protocol version used between two entities for supporting a MAP-user signalling procedure.

When starting a signalling procedure, the MAP-user supplies an application-context-name to the MAP-provider. This name refers to the set of application layer communication capabilities required for this dialogue. This refers to the required TC facilities (e.g. version 1 or 2) and the list of operation packages (i.e. set of operations) from which operations can be invoked during the dialogue.

A version one application-context-name may only be transferred to the peer user in a MAP-U-ABORT to an entity of version two or higher (i.e. to trigger a dialogue which involves only communication capabilities defined for MAP operational version 1).

If the proposed application-context-name can be supported by the responding entity the dialogue continues on this basis otherwise the dialogue is refused and the initiating user needs to start a new dialogue, which involves another application-context-name which requires less communication capabilities but provides similar functionality (if possible).

When a signalling procedure can be supported by several application contexts that differ by their version number, the MAP-User needs to select a name. It can either select the name that corresponds to the highest version it supports or follow a more specific strategy so that the number of protocol fallbacks due to version compatibility problems is minimised.

5.2.2 Strategy for selecting the Application Context (AC) version

A method should be used to minimise the number of protocol fall-backs which would occur sometimes if the highest supported AC-Name were always the one selected by GSM entities when initiating a dialogue. The following method is an example that can be used mainly at transitory phase stage when the network is one of mixed phase entities.

5.2.2.1 Proposed method

A table (table 1) may be set up by administrative action to define the highest application context (AC) version supported by each destination; a destination may be another node within the same or a different PLMN, or another PLMN considered as a single entity. The destination may be defined by an E.164 number or an E.214 number derived from an IMSI or in North America (World Zone 1) by an E.164 number or an IMSI (E.212 number). The table also includes the date when each destination is expected to be able to handle at least one AC of the latest version of the MAP protocol. When this date is reached, the application context supported by the node is marked as "unknown", which will trigger the use of table 2.

A second table (table 2) contains an entry for each destination that has an entry in table 1. For a given entity, the entry in table 2 may be a single application context version or a vector of different versions applying to different application contexts for that entity. Table 2 is managed as described in clause 5.2.2.2.

The data for each destination will go through the following states:

- a) the version shown in table 1 is "version n-1", where 'n' is the highest version existing in this specification; table 2 is not used;

- b) the version shown in table 1 is "unknown"; table 2 is used, and maintained as described in clause 5.2.2.2;
- c) when the PLMN operator declares that an entity (single node or entire PLMN) has been upgraded to support all the MAP version n ACs defined for the relevant interface, the version shown in table 1 is set to "version n" by administrative action; table 2 is no longer used, and the storage space may be recovered.

5.2.2.2 Managing the version look-up table

WHEN it receives a MAP-OPEN and the MAP-User determines the originating entity number either using the originating address parameter or the originating reference parameter or retrieving it from the subscriber data using the IMSI or the MSISDN.

IF the entity number is known:

THEN

It updates (if required) the associated list of highest supported ACs.

ELSE

It creates an entry for this entity and includes the received AC-name in the list of highest supported ACs.

WHEN starting a procedure, the originating MAP-user looks up its version control table.

IF the destination address is known and not timed-out.

THEN

It retrieves the appropriate AC-name and uses it

IF the dialogue is accepted by the peer

THEN

It does not modify the version control table

ELSE (this should never occur)

It starts a new dialogue with the common highest version supported (based on information implicitly or explicitly provided by the peer).

It replaces the old AC-name by the new one in the list of associated highest AC supported.

ELSE

It uses the AC-name that corresponds to the highest version it supports.

IF the dialogue is accepted by the peer.

THEN

It adds the destination node in its version control table and includes the AC-Name in the list of associated highest AC supported.

ELSE

It starts a new dialogue with the common highest version supported (based on information implicitly or explicitly provided by the peer).

IF the destination node was not known

THEN

It adds the destination node in its version control table and includes the new AC-Name in the list of associated highest AC supported.

ELSE

It replaces the old AC-name by the new one in the list of highest supported AC and reset the timer.

5.2.2.3 Optimising the method

A table look-up may be avoided in some cases if both the HLR and the VLR or both the HLR and the SGSN store for each subscriber the version of the AC-name used at location updating. Then:

- for procedures which make use of the same application-context, the same AC-name (thus the same version) can be selected (without any table look-up) when the procedure is triggered;
- for procedures which make use of a different application-context but which includes one of the packages used by the location updating AC, the same version can be selected (without any table look-up) when the procedure is triggered;

for HLR:

- Subscriber data modification (stand alone);

for VLR:

- Data Restoration.

6 Requirements concerning the use of SCCP and TC

6.1 Use of SCCP

The Mobile Application Part (MAP) makes use of the services offered by the Signalling Connection Control Part (SCCP).

MAP supports the following SCCP versions:

- Signalling Connection Control Part, Signalling System no. 7 CCITT ('Blue Book SCCP');
- Signalling Connection Control Part, Signalling System no. 7 ITU-T Recommendation (07/96) Q.711 to Q.716 ('White Book SCCP'). Support of White Book SCCP at the receiving side shall be mandated from 00:01hrs, 1st July 2002(UTC). However, for signalling over the MAP E-interface to support inter-MSC handover/relocation, the support of White Book SCCP shall be mandated with immediate effect.

A White Book SCCP message will fail if any signalling point used in the transfer of the message does not support White Book SCCP. Therefore it is recommended that the originator of the White Book SCCP message supports a drop back mechanism or route capability determination mechanism to interwork with signalling points that are beyond the control of GSM/UMTS network operators.

In North America (World Zone 1) the national version of SCCP is used as specified in ANSI T1.112. Interworking between a PLMN in North America and a PLMN outside North America will involve an STP to translate between ANSI SCCP and ITU-T/CCITT SCCP.

The SCCP is identified as an MTP3-user and the transport of SCCP messages between two entities shall be accomplished according to the 3GPP TS 29.202 [121].

6.1.1 SCCP Class

MAP will only make use of the connectionless classes (0 or 1) of the SCCP.

6.1.2 Sub-System Number (SSN)

The Application Entities (AEs) defined for MAP consist of several Application Service Elements (ASEs) and are addressed by sub-system numbers (SSNs). The SSNs for MAP are specified in 3GPP TS 23.003 [17].

When the SGSN emulates MSC behaviour for processing messages (MAP-MO-FORWARD-SHORT-MESSAGE, MAP_CHECK_IMEI, MAP_SUBSCRIBER_LOCATION_REPORT) towards entities which do not support interworking to SGSNs, it shall use the MSC SSN in the calling party address instead of the SGSN SSN.

6.1.3 SCCP addressing

6.1.3.1 Introduction

Within the GSM System there will be a need to communicate between entities within the same PLMN and in different PLMNs. Using the Mobile Application Part (MAP) for this function implies the use of Transaction Capabilities (TC) and the Signalling Connection Control Part (SCCP) of CCITT Signalling System No. 7.

Only the entities that should be addressed are described below. If the CCITT or ITU-T SCCP is used, the format and coding of address parameters carried by the SCCP for that purpose shall comply with CCITT Recommendation Q.713 with the following restrictions:

1) Intra-PLMN addressing

For communication between entities within the same PLMN, a MAP SSN shall always be included in the called and calling party addresses. All other aspects of SCCP addressing are network specific.

2) Inter-PLMN addressing

a) Called Party Address

- SSN indicator = 1 (MAP SSN always included);
- Global title indicator = 0100 (Global title includes translation type, numbering plan, encoding scheme and nature of address indicator);
- the translation type field will be coded "00000000" (Not used). For call related messages for non-optimal routed calls (as described in 3GPP TS 23.066 [108]) directed to another PLMN the translation type field may be coded "10000000" (CRMNP);
- Routing indicator = 0 (Routing on global title);

b) Calling Party Address

- SSN indicator = 1 (MAP SSNs always included);
- Point code indicator = 0;
- Global title indicator = 0100 (Global title includes translation type, numbering plan, encoding scheme and nature of address indicator);
- Numbering Plan = 0001 (ISDN Numbering Plan, E.164; In Case of Inter-PLMN Signalling, the dialogue initiating entity and dialogue responding entity shall always include its own E.164 Global Title as Calling Party Address);
- the translation type field will be coded "00000000" (Not used);
- Routing indicator = 0 (Routing on Global Title).

If ANSI T1.112 SCCP is used, the format and coding of address parameters carried by the SCCP for that purpose shall comply with ANSI specification T1.112 with the following restrictions:

1) Intra-PLMN addressing

For communication between entities within the same PLMN, a MAP SSN shall always be included in the called and calling party addresses. All other aspects of SCCP addressing are network specific.

2) Inter-PLMN addressing

a) Called Party Address

- SSN indicator = 1 (MAP SSN always included);
- Global title indicator = 0010 (Global title includes translation type);
- the Translation Type (TT) field will be coded as follows:
 - TT = 9, if IMSI is included;
 - TT = 14, if MSISDN is included;
 - Or TT = 10, if Network Element is included. (If TT=10, then Number Portability GTT is not invoked, if TT=14, then Number Portability GTT may be invoked).
- Routing indicator = 0 (Routing on global title);

b) Calling Party Address

- SSN indicator = 1 (MAP SSNs always included);
- Point code indicator = 0;
- Global Title indicator = 0010 (Global title includes translation type);
 - TT = 9, if IMSI is included;
 - TT = 14, if MSISDN is included;
 - Or TT = 10, if Network Element is included. (If TT=10, then Number Portability GTT is not invoked, if TT=14, then Number Portability GTT may be invoked).

Routing indicator = 0 (Routing on Global Title).

If a Global Title translation is required for obtaining routing information, one of the numbering plans E.164, E.212 and E.214 is applicable.

- E.212 numbering plan.

When CCITT or ITU-T SCCP is used, an E.212 number must not be included as Global Title in an SCCP UNITDATA message. The translation of an E.212 number into a Mobile Global Title is applicable in a dialogue initiating VLR, SGSN or GGSN if the routing information towards the HLR is derived from the subscriber's IMSI. In World Zone 1 when ANSI SCCP is used, the IMSI (E.212 number) is used as a Global Title to address the HLR. When an MS moves from one VLR service area to another, the new VLR may derive the address of the previous VLR from the Location Area Identification provided by the MS in the location registration request. The PLMN where the previous VLR is located is identified by the E.212 numbering plan elements of the Location Area Identification, i.e. the Mobile Country Code (MCC) and the Mobile Network Code (MNC).

- E.214 and E.164 numbering plans.

When CCITT or ITU-T SCCP is used, only address information belonging to either E.214 or E.164 numbering plan is allowed to be included as Global Title in the Called and Calling Party Address. In World Zone 1 when ANSI SCCP is used, the IMSI (E.212 number) is used as a Global Title to address the HLR.

If the Calling Party Address associated with the dialogue initiating message contains a Global Title, the sending network entity shall include its E.164 entity number.

When receiving an SCCP UNITDATA message, SCCP shall accept either of the valid numbering plans in the Called Party Address and in the Calling Party Address.

When CCITT or ITU-T SCCP is used and an N-UNITDATA-REQUEST primitive from TC is received, SCCP shall accept an E.164 number or an E.214 number in the Called Address and in the Calling Address. In World Zone 1 when ANSI SCCP is used, the IMSI (E.212 number) is used instead of E.214 number.

The following clauses describe the method of SCCP addressing appropriate for each entity both for the simple intra-PLMN case and where an inter-PLMN communication is required. The following entities are considered:

- the Mobile-services Switching Centre (MSC);

- the Home location Register (HLR);
- the Visitor Location Register (VLR);
- the Gateway Mobile-services Switching Centre (GMSC);
- the GSM Service Control Function (gsmSCF);
- the Interworking Mobile-services Switching Centre (IWMSC);
- the Shared Inter Working Function (SIWF);
- the Serving GPRS Support Node (SGSN);
- the Gateway GPRS Support Node (GGSN);
- the Gateway Mobile Location Centre (GMLC).

6.1.3.2 The Mobile-services Switching Centre (MSC)

There are several cases where it is necessary to address the MSC.

6.1.3.2.1 MSC interaction during handover or relocation

The address is derived from the target Cell id or from the target RNC id.

6.1.3.2.2 MSC for short message routing

When a short message has to be routed to an MS, the GMSC addresses the VMSC by an MSC identity received from the HLR that complies with E.164 rules.

For MS originating short message, the IWMSC address is derived from the Service Centre address.

6.1.3.2.3 MSC for location request routing

When a location request for a particular MS needs to be sent to the MS's VMSC, the GMLC addresses the VMSC using an E.164 address received from the MS's HLR.

6.1.3.2.4 MSC for LMU Control

When a control message has to be routed to an LMU from an SMLC, the SMLC addresses the serving MSC for the LMU using an E.164 address.

6.1.3.3 The Home Location Register (HLR)

There are several cases where the HLR has to be addressed.

6.1.3.3.1 During call set-up

When a call is initiated the HLR of the called mobile subscriber will be interrogated to discover the whereabouts of the MS. The addressing required by the SCCP will be derived from the MSISDN dialled by the calling subscriber. The dialled number will be translated into either an SPC, in the case of communications within a PLMN, or a Global Title if other networks are involved (i.e. if the communication is across a PLMN boundary).

If the calling subscriber is a fixed network subscriber, the interrogation can be initiated from the Gateway MSC of the home PLMN in the general case. If the topology of the network allows it, the interrogation could be initiated from any Signalling Point that has MAP capabilities, e.g. local exchange, outgoing International Switching Centre (ISC), etc.

6.1.3.3.2 Before location updating completion

When an MS registers for the first time in a VLR, the VLR has to initiate the update location dialogue with the MS's HLR and a preceding dialogue for authentication information retrieval if the authentication information must be retrieved from the HLR. When initiating either of these dialogues, the only data for addressing the HLR that the VLR has available is contained in the IMSI, and addressing information for SCCP must be derived from it. When continuing the established update location dialogue (as with any other dialogue), the VLR must derive the routing information towards the HLR from the Calling Party Address received with the first responding CONTINUE message until the dialogue terminating message is received. This means that the VLR must be able to address the HLR based on:

- an E.214 Mobile Global Title originally derived by the VLR from the IMSI (when CCITT or ITU-T SCCP is used), or an E.212 number originally derived from IMSI (when ANSI SCCP is used, an IMSI); or
- an E.164 HLR address; or
- in the case of intra-PLMN signalling, an SPC.

When answering with Global Title to the VLR, the HLR shall insert its E.164 address in the Calling Party Address of the SCCP message containing the first responding CONTINUE message.

If the HLR is in the same PLMN as the VLR, local translation tables may exist to derive an SPC. For authentication information retrieval and location updating via the international PSTN/ISDN signalling network that requires the use of CCITT or ITU-T SCCP, the Global Title must be derived from the IMSI, using the principles contained in CCITT Recommendation E.214 and the Numbering Plan Indicator (NPI) value referenced by the SCCP Specifications. In World Zone 1 where the ANSI SCCP is used, IMSI (E.212 number) is used as Global Title. A summary of the translation from the IMSI (CCITT Recommendation E.212) to Mobile Global Title (described in CCITT Recommendation E.214) is shown below:

- E.212 Mobile Country Code translates to E.164 Country Code;
- E.212 Mobile Network Code translates to E.164 National Destination Code;
- E.212 Mobile Subscriber Identification Number (MSIN) is carried unchanged if within the E.164 number maximum length (15 digits). If the Mobile Global Title is more than 15 digits the number is truncated to 15 by deleting the least significant digits.

This translation will be done either at the application or at SCCP level in the VLR. The Mobile Global Title thus derived will be used to address the HLR.

If location updating is triggered by an MS that roams from one MSC Area into a different MSC Area served by the same VLR, the VLR shall address the HLR in the same way as if the MS registers for the first time in the VLR.

6.1.3.3.3 After location updating completion

In this case, the subscriber's basic MSISDN has been received from the HLR during the subscriber data retrieval procedure as well as the HLR number constituting a parameter of the MAP message indicating successful completion of the update location dialogue. From either of these E.164 numbers the address information for initiating dialogues with the roaming subscriber's HLR can be derived. Also the subscriber's IMSI may be used for establishing the routing information towards the HLR. This may apply in particular if the dialogue with the HLR is triggered by subscriber controlled input.

Thus the SCCP address of the roaming subscriber's HLR may be an SPC, or it may be a Global title consisting of the E.164 MSISDN or the E.164 number allocated to the HLR or either the E.214 Mobile Global Title derived from the IMSI if CCITT or ITU-T SCCP is used, or the IMSI if ANSI SCCP is used (ANSI SCCP is used in World Zone 1).

6.1.3.3.4 VLR restoration

If a roaming number is requested by the HLR for an IMSI that has no data record in the interrogated VLR, the VLR provides the roaming number in the dialogue terminating message. Subsequently the VLR must retrieve the authentication data from the MS's HLR, if required, and must then trigger the restore data procedure. For this purpose, the VLR has to initiate in succession two independent dialogues with the MS's HLR. The MTP and SCCP address information needed for routing towards the HLR can be derived from the IMSI received as a parameter of the MAP message requesting the roaming number. In this case, the IMSI received from the HLR in the roaming number request shall be processed in the same way as the IMSI that is received from an MS that registers for the first time within a VLR. Alternatively to the IMSI, the Calling Party Address associated with the roaming number request may be used to obtain the routing information towards the HLR.

6.1.3.3.5 During Network-Requested PDP Context Activation

When receiving a PDP PDU the GGSN may interrogate the HLR of the MS for information retrieval. When initiating such a dialogue, the only data for addressing the HLR that the GGSN has available is contained in the IMSI, and addressing information must be derived from it. The IMSI is obtained from the IP address or the X.25 address in the incoming IP message by means of a translation table. This means that the GGSN shall be able to address the HLR based on an E.214, (if CCITT or ITU-T SCCP is used), or E.212 (if ANSI SCCP is used), Mobile Global Title originally derived by the GGSN from the IMSI in the case of inter-PLMN signalling. In the case of intra-PLMN signalling, an SPC may also be used.

If the HLR is in the same PLMN as the GGSN, local translation tables may exist to derive an SPC. For information retrieval via the international PSTN/ISDN signalling network, the Global title must be derived from the IMSI, using the principles contained in CCITT Recommendation E.214 and the Numbering Plan Indicator (NPI) value referenced by the SCCP Specifications. A summary of the translation from the IMSI (CCITT Recommendation E.212) to Mobile Global Title (described in CCITT Recommendation E.214) is shown below:

- E.212 Mobile Country Code translates to E.164 Country Code;
- E.212 Mobile Network Code translates to E.164 National Destination Code;
- E.212 Mobile Subscriber Identification Number (MSIN) is carried unchanged if within the E.164 number maximum length (15 digits). If the Mobile Global Title is more than 15 digits the number is truncated to 15 by deleting the least significant digits.

This translation will be done either at the application or at SCCP level in the GGSN. The Mobile Global Title thus derived will be used to address the HLR.

6.1.3.3.6 Before GPRS location updating completion

When an MS registers for the first time in an SGSN, the SGSN has to initiate the update location dialogue with the MS's HLR and a preceding dialogue for authentication information retrieval if the authentication information must be retrieved from the HLR. When initiating either of these dialogues, the only data for addressing the HLR that the SGSN has available is contained in the IMSI, and addressing information for SCCP must be derived from it. When continuing the established update location dialogue (as with any other dialogue), the SGSN must derive the routing information towards the HLR from the Calling Party Address received with the first responding CONTINUE message until the dialogue terminating message is received. This means that the SGSN must be able to address the HLR based on:

- an E.214 (if CCITT or ITU-T SCCP is used) or E.212 (if ANSI SCCP is used) Mobile Global Title originally derived by the SGSN from the IMSI; or
- an E.164 HLR address; or
- in the case of intra-PLMN signalling, an SPC.

If the HLR is in the same PLMN as the SGSN, local translation tables may exist to derive an SPC. For authentication information retrieval and location updating via the international PSTN/ISDN signalling network, the Global title must be derived from the IMSI, using the principles contained in CCITT Recommendation E.214 and the Numbering Plan Indicator (NPI) value referenced by the SCCP Specifications. A summary of the translation from the IMSI (CCITT Recommendation E.212) to Mobile Global Title (described in CCITT Recommendation E.214) is shown below:

- E.212 Mobile Country Code translates to E.164 Country Code;

- E.212 Mobile Network Code translates to E.164 National Destination Code;
- E.212 Mobile Subscriber Identification Number (MSIN) is carried unchanged if within the E.164 number maximum length (15 digits). If the Mobile Global Title is more than 15 digits the number is truncated to 15 by deleting the least significant digits.

This translation will be done either at the application or at SCCP level in the SGSN. The Mobile Global Title thus derived will be used to address the HLR.

6.1.3.3.7 After GPRS location updating completion

In this case, the subscriber's Basic MSISDN has been received from the HLR during the subscriber data retrieval procedure as well as the HLR number constituting a parameter of the MAP message indicating successful completion of the update location dialogue. From either of these E.164 numbers the address information for initiating dialogues with the roaming subscriber's HLR can be derived. Also the subscriber's IMSI may be used for establishing the routing information towards the HLR.

Thus the SCCP address of the roaming subscriber's HLR may be an SPC, or it may be a Global title consisting of the E.164 MSISDN or the E.164 number allocated to the HLR or the E.214 Mobile Global Title derived from the IMSI.

6.1.3.3.8 Query for a Location Request

For a location request from an external client, the GMLC needs to address the home HLR of the target MS to obtain the address of the target MS's serving MSC. The GMLC uses either the international E.164 MSISDN, the international E.214 number (if CCITT or ITU-T SCCP is used) or the international E.212 number (if ANSI SCCP is used) of the MS as means to route a query to the HLR.

6.1.3.4 The Visitor Location Register (VLR)

There are several cases when the VLR needs to be addressed.

6.1.3.4.1 Inter-VLR information retrieval

When an MS moves from one VLR service area to another, the new VLR may request the IMSI and authentication sets from the previous VLR. The new VLR derives the address of the previous VLR from the Location Area Identification provided by the MS in the location registration request.

6.1.3.4.2 HLR request

The HLR will only request information from a VLR if it is aware that one of its subscribers is in the VLR service area. This means that a location updating dialogue initiated by the VLR has been successfully completed, i.e. the HLR has indicated successful completion of the update location procedure to the VLR.

When initiating dialogues towards the VLR after successful completion of location updating, the routing information used by the HLR is derived from the E.164 VLR number received as a parameter of the MAP message initiating the update location dialogue. If the VLR is in the same PLMN as the HLR, the VLR may be addressed directly by an SPC derived from the E.164 VLR number. For dialogues via the international PSTN/ISDN signalling network, presence of the E.164 VLR number in the Called Party Address is required.

6.1.3.5 The Interworking MSC (IWMSC) for Short Message Service

The IWMSC is the interface between the mobile network and the network to access to the Short Message Service Centre. This exchange has an E.164 address known in the SGSN or in the MSC.

6.1.3.6 The Equipment Identity Register (EIR)

The EIR address is either unique or could be derived from the IMEI. The type of address is not defined.

6.1.3.7 The Shared Inter Working Function (SIWF)

When the Visited MSC detects a data or fax call and the IWF in the V-MSC cannot handle the required service an SIWF can be invoked. The SIWF is addressed with an E.164 number.

6.1.3.8 The Serving GPRS Support Node (SGSN)

The HLR will initiate dialogues towards the SGSN if it is aware that one of its subscribers is in the SGSN serving area. This means that a GPRS location updating has been successfully completed, i.e., the HLR has indicated successful completion of the GPRS location update to the SGSN. The routing information used by the HLR is derived from the E.164 SGSN number received as parameter of the MAP message initiating the GPRS update location procedure. If the SGSN is in the same PLMN as the HLR, the SGSN may be addressed directly by an SPC derived from the E.164 SGSN number. For dialogues via the international PSTN/ISDN signalling network, the presence of the E.164 SGSN number in the Called Party Address is required.

When the GMSC initiates dialogues towards the SGSN the SGSN (MAP) SSN (See 3GPP TS 23.003 [17]) shall be included in the called party address. The routing information used by the GMSC is derived from the E.164 SGSN number received as a parameter of the MAP message initiating the forward short message procedure. If the GMSC does not support the GPRS functionality the MSC (MAP) SSN value shall be included in the called party address.

NOTE: Every VMSC and SGSN shall have uniquely identifiable application using E.164 numbers, for the purpose of SMS over GPRS when the GMSC does not support the GPRS functionality.

6.1.3.9 The Gateway GPRS Support Node (GGSN)

The GGSN provides interworking with external packet-switched networks, network screens and routing of the Network-Requested PDP Context activation. If a Network-Requested PDP Context activation fails, the HLR will alert the GGSN when the subscriber becomes reachable. The HLR will use the E.164 GGSN number received as parameter of the MAP message reporting the failure.

6.1.3.10 The Gateway MSC (GMSC) for Short Message Service

The GMSC provides interworking with the network to access the Short Message Service Centre, the mobile network and routing of Send Routing Info For SM. The GMSC has an E.164 address known in the HLR, SGSN or MSC.

6.1.3.10A Void

6.1.3.10A.1 Void

6.1.3.10A.2 Void

6.1.3.10B The Gateway Mobile Location Centre (GMLC)

The GMLC initiates location requests on behalf of external clients. The E.164 address of the GMLC is provided to an HLR when the GMLC requests a serving MSC address or SGSN address from the HLR for a target MS. The E.164 address of the GMLC is also provided to a serving MSC or SGSN when the GMLC requests the location of a target MS served by this MSC or SGSN.

6.1.3.11 Summary table

The following tables summarise the SCCP address used for invoke operations. As a principle, within a PLMN either an SPC or a GT may be used (network operation option), whereas when addressing an entity outside the PLMN the GT must be used. The address type mentioned in the table (e.g. MSISDN) is used as GT or to derive the SPC.

For a response, the originating address passed in the invoke is used as SCCP Called Party Address. For extra-PLMN addressing the own E.164 entity address is used as SCCP Calling Party Address; for intra-PLMN addressing an SPC derived from the entity number may be used instead. When using an SPC, the SPC may be taken directly from MTP.

Table 6.1/1

to from	fixed net work	HLR	VLR	MSC	EIR	gsmSCF	SIWF	SGSN	GGSN
fixed network	---	E:GT T:MSISDN	---	---	---	---	---	---	---
Home Location Register	---	---	I:SPC/GT E:GT T:VLR NUMBER	---	---	I:SPC/GT E:GT T:gsmSCF NUMBER	---	I:SPC/GT E:GT T:SGSN NUMBER	I:SPC/GT E:GT T:GGSN NUMBER
Visitor Location Register	---	I:SPC/GT E:GT T:MGT (outside World Zone 1)/MSISDN (World Zone 1)/HLR NUMBER (note)	I:SPC/GT E:GT T:VLR NUMBER	---	---	I:SPC/GT E:GT T:gsmSCF NUMBER	---	---	---
mobile-services switching centre	---	I:SPC/GT E:GT T:MSISDN	I:SPC/GT E:GT T:VLR NUMBER	I:SPC/GT E:GT T:MSC NUMBER	I:SPC/GT E:GT T:EIR NUMBER	I:SPC/GT E:GT T:gsmSCF NUMBER	I:SPC/GT E:GT T:SIWF NUMBER	I:SPC/GT E:GT T:SGSN NUMBER	---
gsm Service Control Function	---	I:SPC/GT E:GT T:MSISDN	---	---	---	---	---	---	---
Shared Inter Working Function	---	---	---	I:SPC/GT E:GT T:MSC NUMBER	---	---	---	---	---
Serving GPRS Support Node	---	I:SPC/GT E:GT T:MGT/ MSISDN/HL R NUMBER	---	I:SPC/GT E:GT T:MSC NUMBER	I:SPC/GT E:GT T:EIR NUMBER	I:SPC/GT E:GT T:gsmSCF NUMBER	---	---	---
Gateway GPRS Support Node	---	I:SPC/GT E:GT T:MGT	---	---	---	---	---	---	---
Gateway Mobile Location Centre	---	I:SPC/GT E:GT T:MSISDN, MGT (outside World Zone 1) or IMSI (World Zone 1) (note)	---	I:SPC/GT E:GT T:MSC NUMBER	---	---	---	I:SPC/GT E:GT T:SGSN NUMBER	---

I: Intra-PLMN.
 E: Extra (Inter)-PLMN.
 T: Address Type.
 GT: Global Title.
 MGT: E.214 Mobile Global Title.
 SPC: Signalling Point Code.
 NOTE: For initiating the location updating procedure and an authentication information retrieval from the HLR preceding it, the VLR has to derive the HLR address from the IMSI of the MS. The result can be an SPC or an E.214 Mobile Global Title if CCITT or ITU-T SCCP is used, or IMSI itself if ANSI SCCP is used (ANSI SCCP is used in World Zone 1). When continuing the established update location dialogue (as with any other dialogue) the VLR must derive the routing information towards the HLR from the Calling Party Address received with the first responding CONTINUE message until the dialogue terminating message is received.
 For transactions invoked by the VLR after update location completion, the VLR may derive the information for addressing the HLR from addresses received in the course of the update location procedure (MSISDN or HLR number) or from the IMSI.
 When invoking the Restore Data procedure and an authentication information retrieval from the HLR preceding it, the VLR must derive the information for addressing the HLR from the address information received in association with the roaming number request. This may be either the IMSI received as a parameter of the MAP message requesting the Roaming Number or the Calling Party Address associated with the MAP message requesting the Roaming Number.
 The gsmSCF shall be addressed using more than one Global Title number. The first Global Title number is used to address a gsmSCF for MAP. The second Global Title number is used to address a gsmSCF for CAP.
 For querying the HLR to obtain the VMSC address to support location services, the GMLC has to derive the HLR address from either the MSISDN or IMSI of the target MS. When using the IMSI, the result can be an SPC or an E.214 Mobile Global Title if CCITT or ITU-T SCCP is used, or IMSI itself if ANSI SCCP is used (ANSI SCCP is used in World Zone 1).

Table 6.1/2

to from		GMLC
fixed network		---
Home Location Register		---
Visitor Location Register		---
Mobile-services Switching Centre		I:SPC/GT E:GT T:MLC Number
gsm Service Control Function		I:SPC/GT E:GT T:MSISDN
Shared Inter Working Function		---
Serving GPRS Support Node		I:SPC/GT E:GT T:MLC Number
Gateway GPRS Support Node		---
Gateway Mobile Location Centre		
I: Intra-PLMN. E: Extra (Inter)-PLMN. T: Address Type. GT: Global Title. MGT: E.214 Mobile Global Title. SPC: Signalling Point Code.		

6.2 Use of TC

The Mobile Application part makes use of the services offered by the Transaction Capabilities (TC) of Signalling System No. 7. ETS 300 287, which is based on CCITT White Book Recommendations Q.771 to Q.775, should be consulted for the full specification of TC.

The MAP uses all the services provided by TC except the ones related to the unstructured dialogue facility.

From a modelling perspective, the MAP is viewed as a single Application Service Element. Further structuring of it is for further study.

Transaction Capabilities refers to a protocol structure above the network layer interface (i.e., the SCCP service interface) up to the application layer including common application service elements but not the specific application service elements using them.

TC is structured as a Component sub-layer above a Transaction sub-layer.

The Component sub-layer provides two types of application services: services for the control of end-to-end dialogues and services for Remote Operation handling. These services are accessed using the TC-Dialogue handling primitives and TC-Component handling primitives respectively.

Services for dialogue control include the ability to exchange information related to application-context negotiation as well as initialisation data.

Services for Remote Operation handling provide for the exchange of protocol data units invoking tasks (operations), and reporting their outcomes (results or errors) plus any non-application-specific protocol errors detected by the component sub-layer. The reporting of application-specific protocol errors by the TC user, as distinct from application process errors, is also provided. The Transaction sub-layer provides a simple end-to-end connection association service over which several related protocol data units (i.e. built by the Component Sub-Layer) can be exchanged. A Transaction termination can be prearranged (no indication provided to the TC user) or basic (indication provided).

7 General on MAP services

7.1 Terminology and definitions

The term service is used in clauses 7 to 12 as defined in CCITT Recommendation X.200. The service definition conventions of CCITT Recommendation X.210 are also used.

7.2 Modelling principles

MAP provides its users with a specified set of services and can be viewed by its users as a "black box" or abstract machine representing the MAP service-provider. The service interface can then be depicted as shown in figure 7.2/1.

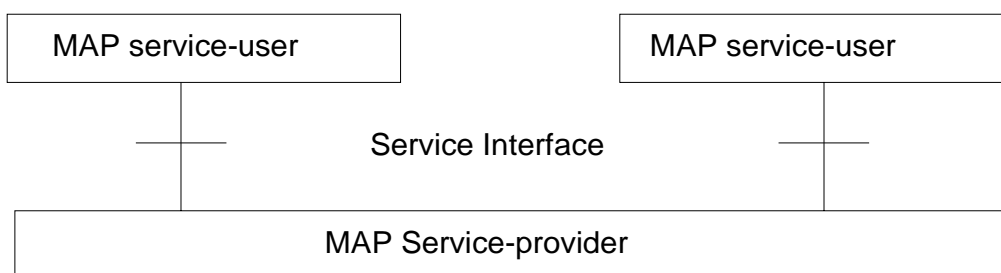

Figure 7.2/1: Modelling principles

The MAP service-users interact with the MAP service-provider by issuing or receiving MAP service-primitives at the service interface.

A MAP service-user may receive services from several instances of the MAP service-provider at the same time. In such cases the overall procedure is synchronised by the service-user.

The MAP service-primitives are named using the following notation:

MAP-ServicePrimitiveName type

where **type** can be any of: request (req), indication (ind), response (rsp) or confirm (cnf). (In the user arrow diagrams type is not indicated in the case of req/ind and indicated as "ack" in the case of rsp/cnf).

The services are further classified as unconfirmed-service, confirmed-service and provider-initiated-service where the first two categories refer to whether or not the service is confirmed by the service-provider. The confirmation may or may not correspond to a response provided by the other service-user.

MAP services are also classified as common MAP services that are available to all MAP service-users, and MAP service-user specific services, which are services available to one or several, but not all, MAP service-users.

A MAP dialogue is defined as an exchange of information between two MAP users in order to perform a common task. A MAP dialogue will consist of one or several MAP services.

7.3 Common MAP services

All MAP service-users require access to services for performing basic application layer functions:

- for establishing and clearing MAP dialogues between peer MAP service-users;
- for accessing functions supported by layers below the applications layer;
- for reporting abnormal situations;
- for handling of different MAP versions;
- for testing whether or not a persistent MAP dialogue is still active at each side.

For these purposes the following common services are defined:

- MAP-OPEN service;
- MAP-CLOSE service;
- MAP-DELIMITER service;
- MAP-U-ABORT service;
- MAP-P-ABORT service;
- MAP-NOTICE service;
- MAP-SECURE-TRANSPORT-CLASS-1 service;
- MAP-SECURE-TRANSPORT-CLASS-2 service;
- MAP-SECURE-TRANSPORT-CLASS-3 service;
- MAP-SECURE-TRANSPORT-CLASS-4 service.

In defining the service-primitives the following convention is used for categorising parameters:

- M** the inclusion of the parameter is mandatory. The M category can be used for any primitive type and specifies that the corresponding parameter must be present in the indicated primitive type;
- O** the inclusion of the parameter is a service-provider option. The O category can be used in indication and confirm type primitives and is used for parameters that may optionally be included by the service-provider;
- U** the inclusion of the parameter is a service-user option. The U category can be used in request and response type primitives. The inclusion of the corresponding parameter is the choice of the service-user;

- C the inclusion of the parameter is conditional. The C category can be used for the following purposes:
- to indicate that if the parameter is received from another entity it must be included for the service being considered;
 - to indicate that the service user must decide whether to include the parameter, based on the context on which the service is used;
 - to indicate that one of a number of mutually exclusive parameters must be included (e.g. parameters indicating a positive result versus parameters indicating a negative result);
 - to indicate that a service user optional parameter (marked "U") or a conditional parameter (marked "C") presented by the service user in a request or response type primitive is to be presented to the service user in the corresponding indication or confirm type primitive;
- (=) when appended to one of the above, this symbol means that the parameter takes the same value as the parameter appearing immediately to its left;

blank the parameter is not present.

A primitive type may also be without parameters, i.e. no parameter is required with the primitive type; in this case the corresponding column of the table is empty.

7.3.1 MAP-OPEN service

This service is used for establishing a MAP dialogue between two MAP service-users. The service is a confirmed service with service primitives as shown in table 7.3/1.

Table 7.3/1: Service-primitives for the MAP-OPEN service

Parameters	Request	Indication	Response	Confirm
Application context name	M	M(=)	U	C(=)
Destination address	M	M(=)		
Destination reference	U	C(=)		
Originating address	U	O		
Originating reference	U	C(=)		
Specific information	U	C(=)	U	C(=)
Responding address			U	C(=)
Result			M	M(=)
Refuse-reason			C	C(=)
Provider error				O

Application context name:

This parameter identifies the type of application context being established. If the dialogue is accepted the received application context name shall be echoed. In case of refusal of dialogue this parameter shall indicate the highest version supported.

Destination address:

A valid SCCP address identifying the destination peer entity (see also clause 6). As an implementation option, this parameter may also, in the indication, be implicitly associated with the service access point at which the primitive is issued.

Destination-reference:

This parameter is a reference that refines the identification of the called process. It may be identical to Destination address but its value is to be carried at MAP level. Table 7.3/2 describes the MAP services using this parameter. Only these services are allowed to use it.

Table 7.3/2: Use of the destination reference

MAP service	Reference type	Use of the parameter
MAP-REGISTER-SS	IMSI	Subscriber identity
MAP-ERASE-SS	IMSI	Subscriber identity
MAP-ACTIVATE-SS	IMSI	Subscriber identity
MAP-DEACTIVATE-SS	IMSI	Subscriber identity
MAP-INTERROGATE-SS	IMSI	Subscriber identity
MAP-REGISTER-PASSWORD	IMSI	Subscriber identity
MAP-PROCESS-UNSTRUCTURED-SS-REQUEST	IMSI (note 1)	Subscriber identity
MAP-UNSTRUCTURED-SS-REQUEST	IMSI (note 2)	Subscriber identity
MAP-UNSTRUCTURED-SS-NOTIFY	IMSI (note 2)	Subscriber identity
MAP-FORWARD-SHORT-MESSAGE	IMSI (note 3)	Subscriber identity
MAP-REGISTER-CC-ENTRY	IMSI	Subscriber identity
MAP-ERASE-CC-ENTRY	IMSI	Subscriber identity

NOTE 1: On the HLR - HLR interface and on the HLR - gsmSCF interface the Destination reference shall be either IMSI or MSISDN.

NOTE 2: On the gsmSCF - HLR interface and on the HLR - HLR interface the Destination reference shall be either IMSI or MSISDN.

NOTE 3: Only when the IMSI and the LMSI are received together from the HLR in the mobile terminated short message transfer.

Originating address:

A valid SCCP address identifying the requestor of a MAP dialogue (see also clause 6). As an implementation option, this parameter may also, in the request, be implicitly associated with the service access point at which the primitive is issued.

Originating-reference:

This parameter is a reference that refines the identification of the calling process. It may be identical to the Originating address but its value is to be carried at MAP level. Table 7.3/3 describes the MAP services using the parameter. Only these services are allowed to use it. Processing of the Originating-reference shall be performed according to the supplementary service descriptions and other service descriptions, e.g. operator determined barring. Furthermore the receiving entity may be able to use the value of the Originating-reference to screen the service indication.

Table 7.3/3: Use of the originating reference

MAP service	Reference type	Use of the parameter
MAP-REGISTER-SS	ISDN-Address-String	Originated entity address
MAP-ERASE-SS	ISDN-Address-String	Originated entity address
MAP-ACTIVATE-SS	ISDN-Address-String	Originated entity address
MAP-DEACTIVATE-SS	ISDN-Address-String	Originated entity address
MAP-INTERROGATE-SS	ISDN-Address-String	Originated entity address
MAP-REGISTER-PASSWORD	ISDN-Address-String	Originated entity address
MAP-PROCESS-UNSTRUCTURED-SS-REQUEST	ISDN-Address-String	Originated entity address
MAP-UNSTRUCTURED-SS-REQUEST	ISDN-Address-String (note)	Originated entity address
MAP-UNSTRUCTURED-SS-NOTIFY	ISDN-Address-String (note)	Originated entity address
MAP-REGISTER-CC-ENTRY	ISDN-Address-String	Originated entity address
MAP-ERASE-CC-ENTRY	ISDN-Address-String	Originated entity address

NOTE: The Originating reference may be omitted.

Specific information:

This parameter may be used for passing any user specific information. Establishment and processing of the Specific information is not specified by GSM and shall be performed according to operator specific requirements.

Responding address:

An address identifying the responding entity. The responding address is included if required by the context (e.g. if it is different from the destination address).

Result:

This parameter indicates whether the peer accepts the dialogue.

Refuse reason:

This parameter is present only if the Result parameter indicates that the dialogue is refused. It takes one of the following values:

- Application-context-not-supported;
- Invalid-destination-reference;
- Invalid-originating-reference;
- No-reason-given;
- Remote node not reachable;
- Potential version incompatibility;
- Secured transport not possible;

- Transport protection not adequate.

7.3.2 MAP-CLOSE service

This service is used for releasing a previously established MAP dialogue. The service may be invoked by either MAP service-user depending on rules defined within the service-user. The service is an unconfirmed service with parameters as shown in table 7.3/4.

Table 7.3/4: Service-primitives for the MAP-CLOSE service

Parameters	Request	Indication
Release method	M	
Specific Information	U	C(=)

Release method:

This parameter can take the following two values:

- normal release; in this case the primitive is mapped onto the protocol and sent to the peer;
- prearranged end; in this case the primitive is not mapped onto the protocol. Prearranged end is managed independently by the two users, i.e. only the request type primitive is required in this case.

Specific information:

This parameter may be used for passing any user specific information. Establishment and processing of the Specific information is not specified by GSM GSM and shall be performed according to operator specific requirements.

7.3.3 MAP-DELIMITER service

This service is used to explicitly request the transfer of the MAP protocol data units to the peer entities.

See also clause 7.4 and 7.5 for the detailed use of the MAP-DELIMITER service.

The service is an unconfirmed service with service-primitives as shown in table 7.3/5.

Table 7.3/5: Service-primitives for the MAP-DELIMITER service

Parameters	Request	Indication

7.3.4 MAP-U-ABORT service

This service enables the service-user to request the MAP dialogue to be aborted. The service is an unconfirmed service with service-primitives as shown in table 7.3/6.

Table 7.3/6: Service-primitives for the MAP-U-ABORT service

Parameters	Request	Indication
User reason	M	M(=)
Diagnostic information	U	C(=)
Specific information	U	C(=)

User reason:

This parameter can take the following values:

- resource limitation (congestion);
the requested user resource is unavailable due to congestion;

- resource unavailable;
the requested user resource is unavailable for reasons other than congestion;
- application procedure cancellation;
the procedure is cancelled for reasons detailed in the diagnostic information parameter;
- procedure error;
processing of the procedure is terminated for procedural reasons.

Diagnostic information:

This parameter may be used to give additional information for some of the values of the user-reason parameter:

Table 7.3/7: User reason and diagnostic information

User reason	Diagnostic information
Resource limitation (congestion)	-
Resource unavailable	Short term/long term problem
Application procedure cancellation	Handover cancellation/ Radio Channel release/ Network path release/ Call release/ Associated procedure failure/ Tandem dialogue released/ Remote operations failure
Procedure error	-

Specific information:

This parameter may be used for passing any user specific information. Establishment and processing of the Specific information is not specified by GSM and shall be performed according to operator specific requirements.

7.3.5 MAP-P-ABORT service

This service enables the MAP service-provider to abort a MAP dialogue. The service is a provider-initiated service with service-primitives as shown in table 7.3/8.

Table 7.3/8: Service-primitives for the MAP-P-ABORT service

Parameters		Indication
Provider reason		M
Source		M

Provider reason:

This parameter indicates the reason for aborting the MAP dialogue:

- provider malfunction;
- supporting dialogue/transaction released;
- resource limitation;
- maintenance activity;
- version incompatibility;
- abnormal MAP dialogue.

Source:

This parameter indicates the source of the abort. For Transaction Capabilities (TC) applications the parameter may take the following values:

- MAP problem;
- TC problem;
- network service problem.

Table 7.3/9: Values of provider reason and source parameters and examples of corresponding events

Provider reason	Source	Corresponding event
Provider malfunction	MAP	Malfunction at MAP level at peer entity
	TC	"Unrecognised message type" or "Badly formatted transaction portion" or "Incorrect transaction portion" received in TC-P-ABORT "Abnormal dialogue"
	Network service	Malfunction at network service level at peer entity
Supporting dialogue/transaction released	TC	"Unrecognised transaction ID" received in TC-ABORT
Resource limitation	MAP	Congestion towards MAP peer service-user
	TC	"Resource limitation" received in TC-P-ABORT
Maintenance activity	MAP	Maintenance at MAP peer service-user
	Network service	Maintenance at network peer service level
Abnormal MAP dialogue	MAP	MAP dialogue is not in accordance with specified application context
Version incompatibility	TC	A Provider Abort indicating "No common dialogue portion" is received in the dialogue initiated state

7.3.6 MAP-NOTICE service

This service is used to notify the MAP service-user about protocol problems related to a MAP dialogue not affecting the state of the protocol machines.

The service is a provider-initiated service with service-primitive as shown in table 7.3/10.

Table 7.3/10: Service-primitive for the MAP-NOTICE service

Parameters	Indication
Problem diagnostic	M

Problem diagnostic:

This parameter can take one of the following values:

- abnormal event detected by the peer;
- response rejected by the peer;
- abnormal event received from the peer;
- message cannot be delivered to the peer.

7.3.7 MAP-SECURE-TRANSPORT-CLASS-1 service

This service is used for secure transport of a specific confirmed MAP service which is mapped on to a TCAP class 1 operation (i.e. one which can return a result or an error). The service is a confirmed service with service primitives as shown in table 7.3/11.

Table 7.3/11: Service-primitives for the MAP-SECURE-TRANSPORT-CLASS-1 service

Parameters	Request	Indication	Response	Confirm
Security header	M	M(=)	M	M(=)
Protected payload	C	C(=)	U	C(=)
User error			U	C(=)
Provider error				O

Security header:

This parameter carries the security header information required for secure transport of MAP messages. The details of this parameter are given in clause 7.6.12.

Protected payload:

This parameter represents in protected mode the complete Request, Indication, Response or Confirm primitive of the service which makes use of the MAP-SECURE-TRANSPORT-CLASS-1 service.

User error:

If the application at the responding entity returns an error to be carried in the secure transport envelope, this parameter contains the Secure transport error defined in clause 7.6.1.

Provider error

For the definition of provider errors see clause 7.6.1.

7.3.8 MAP-SECURE-TRANSPORT-CLASS-2 service

This service is used for secure transport of a specific confirmed MAP service which is mapped on to a TCAP class 2 operation (i.e. one which can return an error but no result). The service is a confirmed service with service primitives as shown in table 7.3/12.

Table 7.3/12: Service-primitives for the MAP-SECURE-TRANSPORT-CLASS-2 service

Parameters	Request	Indication	Response	Confirm
Security header	M	M(=)	M	M(=)
Protected payload	C	C(=)		
User error			U	C(=)
Provider error				O

Security header:

This parameter carries the security header information required for secure transport of MAP messages. The details of this parameter are given in clause 7.6.12.

Protected payload:

This parameter represents in protected mode the complete Request, Indication, Response or Confirm primitive of the service which makes use of the MAP-SECURE-TRANSPORT-CLASS-2 service.

User error:

If the application at the responding entity returns an error to be carried in the secure transport envelope, this parameter contains the Secure transport error defined in clause 7.6.1.

Provider error

For the definition of provider errors see clause 7.6.1.

7.3.9 MAP-SECURE-TRANSPORT-CLASS-3 service

This service is used for secure transport of a specific confirmed MAP service which is mapped on to a TCAP class 3 operation (i.e. one which can return a result but no error). The service is a confirmed service with service primitives as shown in table 7.3/13.

Table 7.3/13: Service-primitives for the MAP-SECURE-TRANSPORT-CLASS-3 service

Parameters	Request	Indication	Response	Confirm
Security header	M	M(=)	M	M(=)
Protected payload	C	C(=)	U	C(=)
Provider error				O

Security header:

This parameter carries the security header information required for secure transport of MAP messages. The details of this parameter are given in clause 7.6.12.

Protected payload:

This parameter represents in protected mode the complete Request, Indication, Response or Confirm primitive of the service which makes use of the MAP-SECURE-TRANSPORT-CLASS-3 service.

Provider error

For the definition of provider errors see clause 7.6.1.

7.3.10 MAP-SECURE-TRANSPORT-CLASS-4 service

This service is used for secure transport of a specific unconfirmed MAP service which is mapped on to a TCAP class 4 operation (i.e. one which can return neither a result nor an error). The service is an unconfirmed service with service primitives as shown in table 7.3/14.

Table 7.3/14: Service-primitives for the MAP-SECURE-TRANSPORT-CLASS-4 service

Parameters	Request	Indication
Security header	M	M(=)
Protected payload	C	C(=)

Security header:

This parameter carries the security header information required for secure transport of MAP messages. The details of this parameter are given in clause 7.6.12.

Protected payload:

This parameter represents in protected mode the complete Request or Indication primitive of the service which makes use of the MAP-SECURE-TRANSPORT-CLASS-4 service.

7.4 Sequencing of services

The sequencing of services is shown in figure 7.4/1 and is as follows:

Opening:

The MAP-OPEN service is invoked before any user specific service-primitive is accepted. The sequence may contain none, one or several user specific service-primitives. If no user specific service-primitive is contained between the MAP-OPEN and the MAP-DELIMITER primitives, then this will correspond to sending an empty Begin message in TC. If more than one user specific service-primitive is included, all are to be sent in the same Begin message. The sequence ends with a MAP-DELIMITER primitive.

Continuing:

This sequence may not be present in some MAP dialogues. If it is present, it ends with a MAP-DELIMITER primitive. If more than one user specific service-primitive is included, all are to be included in the same Continue message.

Closing:

The sequence can only appear after an opening sequence or a continuing sequence. The sequence may contain none, one or several user specific service-primitives if the MAP-CLOSE primitive specifies normal release. If no user specific service-primitive is included, then this will correspond to sending an empty End message in TC. If more than one user specific service-primitive is included, all are to be sent in the same End message. If prearranged end is specified, the sequence cannot contain any user specific service-primitive. The MAP-CLOSE primitive must be sent after all user specific service-primitives have been delivered to the MAP service-provider.

Aborting:

A MAP service-user can issue a MAP-U-ABORT primitive at any time after the MAP dialogue has been opened or as a response to an attempt to open a MAP dialogue.

The MAP service-provider may issue at any time a MAP-P-ABORT primitive towards a MAP service-user for which a MAP dialogue exists.

MAP-U-ABORT primitives and MAP-P-ABORT primitives terminate the MAP dialogue.

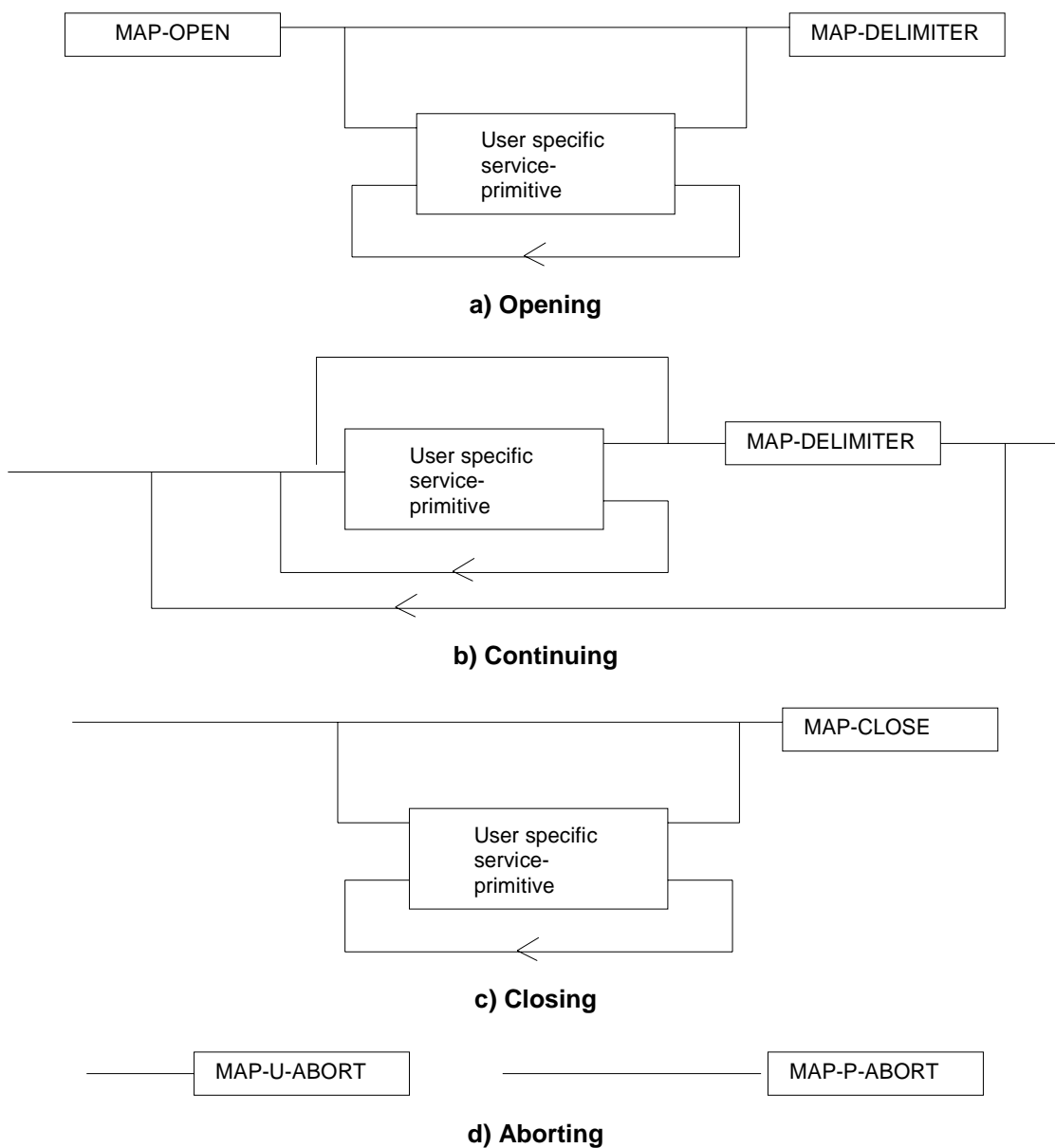

Figure 7.4/1: Sequencing of services

If the reason "resource unavailable (short term problem)" is indicated in the MAP-U-ABORT indication primitive, the MAP service-user may decide to attempt a new MAP dialogue establishment immediately.

Sequencing of user specific service-primitives is done by the MAP service-user and based on rules applicable for each MAP service-user instance.

A MAP-NOTICE indication primitive may be received at any time during the active period of a MAP dialogue.

7.5 General rules for mapping of services onto TC

7.5.1 Mapping of common services

Table 7.5/1 gives an overview of the mapping rules for mapping of common services onto TC-services. Table 7.5/2 gives the mapping rules for mapping of TC-services onto common services.

Protocol machine description is given in clauses 14 to 17.

Table 7.5/1: Mapping of common services onto TC services

MAP service-primitive	TC service-primitive
MAP-OPEN request (+ any user specific service primitives) + MAP-DELIMITER request	TC-BEGIN request (+ component handling primitives)
MAP-OPEN response (+ any user specific service primitives) + MAP-DELIMITER request	TC-CONTINUE request (note) (+ component handling primitives)
(any user specific service primitives) + MAP-DELIMITER request	TC-CONTINUE request (+ component handling primitives)
(any user specific service primitives) + MAP-CLOSE request	TC-END request (+ component handling primitives)
MAP-U-ABORT request	TC-U-ABORT request
NOTE: Or TC-END if the MAP-CLOSE request has been received before the MAP-DELIMITER request.	

Table 7.5/2: Mapping of TC services onto common service

TC service-primitive	MAP service-primitive
TC-BEGIN indication (+ component handling primitives)	MAP-OPEN indication (+ user specific service primitives) + MAP-DELIMITER indication (note 1)
TC-CONTINUE indication (+ component handling primitives)	First time: MAP-OPEN confirm (+ user specific service primitives) + MAP-DELIMITER indication (note 1) Subsequent times: (user specific service primitives) + MAP-DELIMITER indication (note 1)
TC-END indication (+ component handling primitives)	MAP-OPEN confirm (note 6) (user specific service primitives) + MAP-CLOSE indication
TC-U-ABORT indication	MAP-U-ABORT indication or MAP-P-ABORT indication (note 2) MAP-OPEN confirmation (note 3)
TC-P-ABORT indication	MAP-P-ABORT indication (note 4) MAP-OPEN confirmation (note 5)

NOTE 1:	It may not be necessary to present this primitive to the user for MAP version 2 applications.
NOTE 2:	The mapping depends on whether the TC-U-ABORT indication primitive contains a MAP-abort-PDU from the remote MAP service-provider or a MAP-user-abort-PDU from the remote MAP service-user.
NOTE 3:	Only if the opening sequence is pending and if the "Abort Reason" in the TC-U-ABORT indication is set to "Application Context Not Supported".
NOTE 4:	If the "Abort Reason" in the TC-P-ABORT indication is set to a value different from "Incorrect Transaction Portion".
NOTE 5:	Only if the opening sequence is pending and if the "Abort Reason" in the TC-P-ABORT indication is set to "Incorrect Transaction Portion".
NOTE 6:	Only if opening sequence is pending.

7.5.2 Mapping of user specific services

Table 7.5/3 gives the general mapping rules which apply to mapping of MAP user specific services onto TC services and table 7.5/4 gives the similar rules for mapping of TC services onto MAP user specific services. Detailed mapping is given in clauses 14 to 17.

Table 7.5/3: Mapping of MAP user specific services onto TC services

MAP service-primitive	TC-service-primitive
MAP-xx request	TC-INVOKE request
MAP-xx response (note 1)	TC-RESULT-L request TC-U-ERROR request TC-U-REJECT request TC-INVOKE request (note 2)

Table 7.5/4: Mapping of TC services onto MAP user specific services

TC-service-primitive	MAP service-primitive
TC-INVOKE indication	MAP-xx indication
TC-RESULT-L indication (note 4) TC-U-ERROR indication TC-INVOKE indication (note 2) TC-L-CANCEL indication	MAP-xx confirm
TC-U-REJECT indication TC-L-REJECT indication TC-R-REJECT indication	MAP-xx confirm or MAP-NOTICE indication (note 3)

Notes to tables 7.5/3 and 7.5/4:

NOTE 1: The mapping is determined by parameters contained in the MAP-xx response primitive.

NOTE 2: This applies only to TC class 4 operations where the operation is used to pass a result of another class 2 or class 4 operation.

NOTE 3: The detailed mapping rules are given in clause 16.

NOTE 4: If RESULT-NL components are present they are mapped onto the same MAP-xx confirm.

7.6 Definition of parameters

Following is an alphabetic list of parameters used in the common MAP-services in clause 7.3:

Application context name	7.3.1	Refuse reason	7.3.1
Destination address	7.3.1	Release method	7.3.2
Destination reference	7.3.1	Responding address	7.3.1
Diagnostic information	7.3.4	Result	7.3.1
Originating address	7.3.1	Source	7.3.5

Originating reference	7.3.1	Specific information	7.3.1/7.3.2/7.3.4
Problem diagnostic	7.3.6	User reason	7.3.4
Provider reason	7.3.5		

Following is an alphabetic list of parameters contained in this clause:

Absent Subscriber Diagnostic SM	7.6.8.9	Invoke Id	7.6.1.1
Access connection status	7.6.9.3	ISDN Bearer Capability	7.6.3.41
		IST Alert Timer	7.6.3.66
		IST Information Withdrawn	7.6.3.68
		IST Support Indicator	7.6.3.69
		LCS Codeword	7.6.11.18
		LCS Codeword Applicability	7.6.11.19
		LCS Information	7.6.3.60
		LCS Service Type Id	7.6.11.15
		LCS Codeword Notification	7.6.11.22
Access signalling information	7.6.9.5	Kc	7.6.7.4
Additional Absent Subscriber Diagnostic SM	7.6.8.12	Linked Id	7.6.1.2
Additional Location Estimate	7.6.11.21	LMSI	7.6.2.16
Additional number	7.6.2.46	Location Information	7.6.2.30
		Location Information for GPRS	7.6.2.30a
Additional signal info	7.6.9.10	Location update type	7.6.9.6
Additional SM Delivery Outcome	7.6.8.11	Long Forwarded-to Number	7.6.2.22A
		Long FTN Supported	7.6.2.22B
Age Indicator	7.6.3.72	Lower Layer Compatibility	7.6.3.42
		LSA Information	7.6.3.56
		LSA Information Withdraw	7.6.3.58
Alert Reason	7.6.8.8	MC Information	7.6.4.48
Alert Reason Indicator	7.6.8.10	MC Subscription Data	7.6.4.47
Alerting Pattern	7.6.3.44	Mobile Not Reachable Reason	7.6.3.51
All GPRS Data	7.6.3.53	Modification request for CSI	7.6.3.81
All Information Sent	7.6.1.5	Modification request for SS Information	7.6.3.82
AN-apdu	7.6.9.1	More Messages To Send	7.6.8.7
APN	7.6.2.42	MS ISDN	7.6.2.17
Authentication set list	7.6.7.1	MSC number	7.6.2.11
B-subscriber Address	7.6.2.36	MSISdn-Alert	7.6.2.29
B subscriber Number	7.6.2.48	Multicall Bearer Information	7.6.2.52
B subscriber subaddress	7.6.2.49	Multiple Bearer Requested	7.6.2.53
Basic Service Group	7.6.4.40	Multiple Bearer Not Supported	7.6.2.54
Bearer service	7.6.4.38	MWD status	7.6.8.3
BSSMAP Service Handover	7.6.6.5		
Call Barring Data	7.6.3.83	NbrUser	7.6.4.45
Call barring feature	7.6.4.19	Network Access Mode	7.6.3.50
Call barring information	7.6.4.18	Network node number	7.6.2.43
Call Direction	7.6.5.8	Network resources	7.6.10.1
Call Forwarding Data	7.6.3.84	Network signal information	7.6.9.8
Call Info	7.6.9.9	New password	7.6.4.20
Call reference	7.6.5.1	No reply condition timer	7.6.4.7
Call Termination Indicator	7.6.3.67		
Called number	7.6.2.24	North American Equal Access preferred Carrier Id	7.6.2.34
		Number Portability Status	7.6.5.14
Calling number	7.6.2.25	ODB Data	7.6.3.85
CAMEL Subscription Info	7.6.3.78	ODB General Data	7.6.3.9
CAMEL Subscription Info Withdraw	7.6.3.38	ODB HPLMN Specific Data	7.6.3.10
Cancellation Type	7.6.3.52	OMC Id	7.6.2.18
Category	7.6.3.1	Originally dialled number	7.6.2.26
CCBS Feature	7.6.5.8	Originating entity number	7.6.2.10
CCBS Request State	7.6.4.49	Override Category	7.6.4.4
Channel Type	7.6.5.9	P-TMSI	7.6.2.47
Chosen Channel	7.6.5.10	PDP-Address	7.6.2.45
Chosen Radio Resource Information	7.6.6.10B	PDP-Context identifier	7.6.3.55
Ciphering mode	7.6.7.7	PDP-Type	7.6.2.44
Cksn	7.6.7.5	Pre-paging supported	7.6.5.15
CLI Restriction	7.6.4.5		

CM service type	7.6.9.2	Previous location area Id	7.6.2.4
Complete Data List Included	7.6.3.54	Protocol Id	7.6.9.7
CS Allocation Retention priority	7.6.3.87	Provider error	7.6.1.3
CS LCS Not Supported by UE	7.6.11.9	PS LCS Not Supported by UE	7.6.11.10
CUG feature	7.6.3.26	QoS-Subscribed	7.6.3.47
CUG index	7.6.3.25	Radio Resource Information	7.6.6.10
CUG info	7.6.3.22	Radio Resource List	7.6.6.10A
		RANAP Service Handover	7.6.6.6
CUG interlock	7.6.3.24	Rand	7.6.7.2
CUG Outgoing Access indicator	7.6.3.8	Regional Subscription Data	7.6.3.11
CUG subscription	7.6.3.23	Regional Subscription Response	7.6.3.12
CUG Subscription Flag	7.6.3.37	Relocation Number List	7.6.2.19A
Current location area Id	7.6.2.6	Requested Info	7.6.3.31
		Requested Subscription Info	7.6.3.86
Current password	7.6.4.21	Roaming number	7.6.2.19
		Roaming Restricted In SGSN Due To Unsupported Feature	7.6.3.49
Deferred MT-LR Data	7.6.11.3	Roaming Restriction Due To Unsupported Feature	7.6.3.13
Deferred MT-LR Response Indicator	7.6.11.2	Current Security Context	7.6.7.8
eMLPP Information	7.6.4.41	Selected RAB ID	7.6.2.56
Encryption Information	7.6.6.9	Service centre address	7.6.2.27
Equipment status	7.6.3.2	Serving Cell Id	7.6.2.37
Extensible Basic Service Group	7.6.3.5	SGSN address	7.6.2.39
Extensible Bearer service	7.6.3.3	SGSN CAMEL Subscription Info	7.6.3.75
Extensible Call barring feature	7.6.3.21	SGSN number	7.6.2.38
Extensible Call barring information	7.6.3.20	SIWF Number	7.6.2.35
		SoLSA Support Indicator	7.6.3.57
Extensible Call barring information for CSE	7.6.3.79	SM Delivery Outcome	7.6.8.6
Extensible Forwarding feature	7.6.3.16	SM-RP-DA	7.6.8.1
Extensible Forwarding info	7.6.3.15	SM-RP-MTI	7.6.8.16
Extensible Forwarding information for CSE	7.6.3.80	SM-RP-OA	7.6.8.2
Extensible Forwarding Options	7.6.3.18	SM-RP-PRI	7.6.8.5
Extensible No reply condition timer	7.6.3.19	SM-RP-SMEA	7.6.8.17
Extensible QoS-Subscribed	7.6.3.74	SM-RP-UI	7.6.8.4
Extensible SS-Data	7.6.3.29	Sres	7.6.7.3
Extensible SS-Info	7.6.3.14	SS-Code	7.6.4.1
Extensible SS-Status	7.6.3.17	SS-Data	7.6.4.3
Extensible Teleservice	7.6.3.4	SS-Event	7.6.4.42
External Signal Information	7.6.9.4	SS-Event-Data	7.6.4.43
Failure Cause	7.6.7.9	SS-Info	7.6.4.24
Forwarded-to number	7.6.2.22	SS-Status	7.6.4.2
Forwarded-to subaddress	7.6.2.23	Stored location area Id	7.6.2.5
Forwarding feature	7.6.4.16	Subscriber State	7.6.3.30
Forwarding information	7.6.4.15	Subscriber Status	7.6.3.7
Forwarding Options	7.6.4.6	Super-Charger Supported in HLR	7.6.3.70
GGSN address	7.6.2.40	Super-Charger Supported in Serving Network Entity	7.6.3.71
		Supported Camel4 Subsets	7.6.3.36D
GGSN number	7.6.2.41	Supported Camel4 Subsets in GMSC	7.6.3.36E
GMSC CAMEL Subscription Info	7.6.3.34	Supported Camel4 Subsets in VMSC	7.6.3.36F
GPRS enhancements support indicator	7.6.3.73	Supported Camel4 Subsets in VLR	7.6.3.36B
GPRS Node Indicator	7.6.8.14	Supported Camel4 Subsets in SGSN	7.6.3.36C
		Supported CAMEL Phases in VLR	7.6.3.36
GPRS Subscription Data	7.6.3.46	Supported CAMEL Phases in SGSN	7.6.3.36A
GPRS Subscription Data Withdraw	7.6.3.45	Supported GAD Shapes	7.6.11.20
GPRS Support Indicator	7.6.8.15	Supported LCS Capability Sets	7.6.11.17
Group Id	7.6.2.33	Suppress Incoming Call Barring	7.6.3.b
GSM bearer capability	7.6.3.6	Suppress T-CSI	7.6.3.33
gsmSCF Address	7.6.2.58	Suppress VT-CSI	7.6.3.a
gsmSCF Initiated Call	7.6.3.c	Suppression of Announcement	7.6.3.32
Guidance information	7.6.4.22	Target cell Id	7.6.2.8
		Target location area Id	7.6.2.7
		Target RNC Id	7.6.2.8A
		Target MSC number	7.6.2.12

Handover number	7.6.2.21	Teleservice	7.6.4.39
High Layer Compatibility	7.6.3.43	TMSI	7.6.2.2
HLR Id	7.6.2.15	Trace reference	7.6.10.2
HLR number	7.6.2.13	Trace type	7.6.10.3
HO-Number Not Required	7.6.6.7	User error	7.6.1.4
IMEI	7.6.2.3	USSD Data Coding Scheme	7.6.4.36
IMSI	7.6.2.1	USSD String	7.6.4.37
Integrity Protection Information	7.6.6.8	UU Data	7.6.5.12
Inter CUG options	7.6.3.27	UUS CF Interaction	7.6.5.13
Intra CUG restrictions	7.6.3.28	VBS Data	7.6.3.40
		VGCS Data	7.6.3.39
		VLR CAMEL Subscription Info	7.6.3.35
		VLR number	7.6.2.14
		VPLMN address allowed	7.6.3.48
		Zone Code	7.6.2.28

7.6.1 Common parameters

The following set of parameters is used in several MAP service-primitives.

7.6.1.1 Invoke Id

This parameter identifies corresponding service primitives. The parameter is supplied by the MAP service-user and must be unique over each service-user/service-provider interface.

7.6.1.2 Linked Id

This parameter is used for linked services and it takes the value of the invoke Id of the service linked to.

7.6.1.3 Provider error

This parameter is used to indicate a protocol related type of error:

- duplicated invoke Id;
- not supported service;
- mistyped parameter;
- resource limitation;
- initiating release, i.e. the peer has already initiated release of the dialogue and the service has to be released;
- unexpected response from the peer;
- service completion failure;
- no response from the peer;
- invalid response received.

7.6.1.4 User error

This parameter can take values as follows:

NOTE: The values are grouped in order to improve readability; the grouping has no other significance.

a) Generic error:

- system failure, i.e. a task cannot be performed because of a problem in another entity. The type of entity or network resource may be indicated by use of the network resource parameter;
- data missing, i.e. an optional parameter required by the context is missing;
- unexpected data value, i.e. the data type is formally correct but its value or presence is unexpected in the current context;
- resource limitation;
- initiating release, i.e. the receiving entity has started the release procedure;
- facility not supported, i.e. the requested facility is not supported by the PLMN with detailed reasons as follows:
 - Shape of location estimate not supported;
 - Needed LCS capability not supported in serving node;
- incompatible terminal, i.e. the requested facility is not supported by the terminal.

b) Identification or numbering problem:

- unknown subscriber, i.e. no such subscription exists;
- number changed, i.e. the subscription does not exist for that number any more;
- unknown MSC;
- unidentified subscriber, i.e. if the subscriber is not contained in the database and it has not or cannot be established whether or not a subscription exists;
- unallocated roaming number;
- unknown equipment;
- unknown location area.

c) Subscription problem:

- roaming not allowed, i.e. a location updating attempt is made in an area not covered by the subscription;
- illegal subscriber, i.e. illegality of the access has been established by use of authentication procedure;
- bearer service not provisioned;
- teleservice not provisioned;
- illegal equipment, i.e. the IMEI check procedure has shown that the IMEI is blacklisted or not whitelisted.

d) Handover problem:

- no handover number available, i.e. the VLR cannot allocate a number for handover or cannot allocate the required amount of numbers for relocation;
- subsequent handover failure, i.e. handover to a third MSC failed for some reason;
- target cell outside group call area.

e) Operation and maintenance problem:

- tracing buffer full, i.e. tracing cannot be performed because the tracing capacity is exceeded.

f) Call set-up problem:

- no roaming number available, i.e. a roaming number cannot be allocated because all available numbers are in use;
- absent subscriber, i.e. the subscriber has activated the detach service or the system detects the absence condition. This error may be qualified to indicate whether the subscriber was IMSI detached, in a restricted area or did not respond to paging;
- busy subscriber. This error may be qualified to indicate that the subscriber was busy due to CCBS and that CCBS is possible;
- no subscriber reply;
- forwarding violation, i.e. the call has already been forwarded the maximum number of times that is allowed;
- CUG reject, i.e. the call does not pass a CUG check; additional information may also be given in order to indicate rejection due to e.g. incoming call barred or non-CUG membership;
- call barred. Optionally, additional information may be included for indicating either that the call meets a barring condition set by the subscriber or that the call is barred for operator reasons. In the case of barring of Mobile Terminating Short Message, the additional information may indicate a barring condition due to "Unauthorised Message Originator";
- optimal routing not allowed, i.e. the entity which sends the error does not support optimal routing, or the HLR will not accept an optimal routing interrogation from the GMSC, or the call cannot be optimally routed because it would contravene optimal routing constraints;
- forwarding failed, i.e. the GMSC interrogated the HLR for forwarding information but the HLR returned an error.

g) Supplementary services problem:

- call barred;
- illegal SS operation;
- SS error status;
- SS not available;
- SS subscription violation;
- SS incompatibility;
- negative password check;
- password registration failure;
- Number of Password Attempts;
- USSD Busy;
- Unknown Alphabet;
- short term denial;
- long term denial.

For definition of these errors see 3GPP TS 24.080 [38].

h) Short message problem:

- SM delivery failure with detailed reason as follows:
 - memory capacity exceeded;
 - MS protocol error;
 - MS not equipped;

- unknown service centre (SC);
 - SC congestion;
 - invalid SME address;
 - subscriber is not an SC subscriber;
 - and possibly detailed diagnostic information, coded as specified in 3GPP TS 23.140, under SMS-SUBMIT-REPORT and SMS-DELIVERY-REPORT. If the SM entity that returns the SM Delivery Failure error includes detailed diagnostic information, it shall be forwarded in the MAP_MO_FORWARD_SHORT_MESSAGE and in the MAP_MT_FORWARD_SHORT_MESSAGE response.
 - message waiting list full, i.e. no further SC address can be added to the message waiting list.
 - Subscriber busy for MT SMS, i.e. the mobile terminated short message transfer cannot be completed because:
 - another mobile terminated short message transfer is going on and the delivery node does not support message buffering; or
 - another mobile terminated short message transfer is going on and it is not possible to buffer the message for later delivery; or
 - the message was buffered but it is not possible to deliver the message before the expiry of the buffering time defined in 3GPP TS 23.140;
 - Absent Subscriber SM, i.e. the mobile terminated short message transfer cannot be completed because the network cannot contact the subscriber. Diagnostic information regarding the reason for the subscriber's absence may be included with this error.
- i) Location services problem:
- Unauthorised Requesting Network
 - Unauthorised LCS Client with detailed reasons as follows:
 - Unauthorised Privacy Class
 - Unauthorised Call/Session Unrelated External Client
 - Unauthorised Call/Session Related External Client
 - Privacy override not applicable
 - Position method failure with detailed reasons as follows:
 - Congestion
 - Insufficient resources
 - Insufficient Measurement Data
 - Inconsistent Measurement Data
 - Location procedure not completed
 - QoS not attainable
 - Position Method Not Available in Network
 - Position Method Not Available in Location Area
 - Unknown or unreachable LCS Client.

j) Problem detected by an application using secure transport:

- Secure transport error. This error indicates that the application using secure transport returned an error. The parameter of the error indicates:
 - The protected payload, which carries the result of applying the protection function specified in 3G TS 33.200 to the encoding of the parameter of the original error.

7.6.1.5 All Information Sent

This parameter indicates to the receiving entity when the sending entity has sent all necessary information.

7.6.2 Numbering and identification parameters

7.6.2.1 IMSI

This parameter is the International Mobile Subscriber Identity defined in 3GPP TS 23.003 [17].

7.6.2.2 TMSI

This parameter is the Temporary Mobile Subscriber Identity defined in 3GPP TS 23.003 [17].

7.6.2.3 IMEI

This parameter is the International Mobile Equipment Identity defined in 3GPP TS 23.003 [17].

7.6.2.4 Previous location area Id

This parameter refers to the identity of the location area from which the subscriber has roamed.

7.6.2.5 Stored location area Id

This parameter refers to the location area where the subscriber is assumed to be located.

7.6.2.6 Current location area Id

This parameter is used to indicate the location area in which the subscriber is currently located.

7.6.2.7 Target location area Id

This parameter refers to the location area into which the subscriber intends to roam.

7.6.2.8 Target cell Id

This parameter refers to the identity of the cell to which a call has to be handed over.

7.6.2.8A Target RNC Id

This parameter refers to the identity of the RNC to which a call has to be relocated.

7.6.2.9 Void

7.6.2.10 Originating entity number

This parameter refers to an application layer identification of a system component in terms of its associated ISDN number.

7.6.2.11 MSC number

This parameter refers to the ISDN number of an MSC.

7.6.2.12 Target MSC number

This parameter refers to the ISDN number of an MSC to which a call has to be handed over.

7.6.2.13 HLR number

This parameter refers to the ISDN number of an HLR.

7.6.2.14 VLR number

This parameter refers to the ISDN number of a VLR.

7.6.2.15 HLR Id

This parameter refers to the identity of an HLR derived from the IMSI defined in CCITT Recommendation E.212.

7.6.2.16 LMSI

This parameter refers to a local identity allocated by the VLR to a given subscriber for internal management of data in the VLR. LMSI shall not be sent to the SGSN.

7.6.2.17 MS ISDN

This parameter refers to one of the ISDN numbers assigned to a mobile subscriber in accordance with CCITT Recommendation E.213.

7.6.2.18 OMC Id

This parameter refers to the identity of an Operation and Maintenance Centre.

7.6.2.19 Roaming number

This parameter refers to the roaming number as defined in CCITT Recommendation E.213.

7.6.2.19A Relocation Number List

This parameter refers to the number(s) used for routing one call or several calls between MSCs during relocation.

7.6.2.20 Void

7.6.2.21 Handover number

This parameter refers to the number used for routing a call between MSCs during handover.

7.6.2.22 Forwarded-to number

This parameter refers to the address to which a call is to be forwarded. A subaddress may be appended. For subscribers having an originating CAMEL Phase 2 or higher subscription, this address need not be in E.164 international format.

7.6.2.22A Long forwarded-to number

This parameter refers to the address to which a call is to be forwarded. A subaddress may be appended. For subscribers having an originating CAMEL Phase 2 or higher subscription this address need not be in international format.

7.6.2.22B Long FTN Supported

This parameter indicates that the sending entity supports Long Forwarded-to Numbers.

7.6.2.23 Forwarded-to subaddress

This parameter refers to the sub-address attached to the address to which a call is to be forwarded.

7.6.2.24 Called number

This parameter refers to a called party number as defined in CCITT Recommendation Q.767.

7.6.2.25 Calling number

This parameter refers to a calling party number as defined in CCITT Recommendation Q.767.

7.6.2.26 Originally dialled number

This parameter refers to the number dialled by the calling party in order to reach a mobile subscriber.

7.6.2.27 Service centre address

This parameter represents the address of a Short Message Service Centre.

7.6.2.28 Zone Code

This parameter is used to define location areas into which the subscriber is allowed or not allowed to roam (regional subscription). With a complete list of Zone Codes the VLR or the SGSN is able to determine for all its location areas whether roaming is allowed or not.

7.6.2.29 MSISdn-Alert

This parameter refers to the MSISDN stored in a Message Waiting Data File in the HLR. It is used to alert the Service Centre when the MS is again attainable.

7.6.2.30 Location Information

This parameter indicates the location of the served subscriber as defined in 3GPP TS 23.018 [97].

7.6.2.30a Location Information for GPRS

This parameter indicates the location of the served subscriber as defined in 3GPP TS 23.078 [98].

7.6.2.31 GMSC Address

This parameter refers to the E.164 address of a GMSC.

7.6.2.32 VMSC Address

This parameter refers to the E.164 address of a VMSC.

7.6.2.33 Group Id

This parameter is used to describe groups a subscriber can be a member of. A subscriber can partake in all group calls (VBS/VGCS) where he subscribed to the respective groups.

7.6.2.34 North American Equal Access preferred Carrier Id

This parameter refers to the carrier identity preferred by the subscriber for calls requiring routing via an inter-exchange carrier. This identity is used at:

- outgoing calls: when the subscriber does not specify at call set-up a carrier identity;
- forwarded calls: when a call is forwarded by the subscriber;
- incoming calls: applicable to the roaming leg of the call.

7.6.2.35 SIWFS Number

This parameter refers to the number used for routing a call between the MSC and the SIWFS (used by ISUP).

7.6.2.36 B-subscriber address

This parameter refers to the address used by the SIWFS to route the outgoing call from the SIWFS to either the B-subscriber in case of the non-loop method or back to the VMSC in case of the loop method.

7.6.2.37 Serving cell Id

This parameter indicates the cell currently being used by the served subscriber.

7.6.2.38 SGSN number

This parameter refers to the ISDN number of a SGSN.

7.6.2.39 SGSN address

This parameter refers to the IP-address of a SGSN. This parameter is defined in 3GPP TS 23.003 [17].

7.6.2.40 GGSN address

This parameter refers to the IP-address of a GGSN. This parameter is defined in 3GPP TS 23.003 [17].

7.6.2.41 GGSN number

This parameter refers to the ISDN number of a GGSN or the ISDN number of the protocol-converter if a protocol-converting GSN is used between the GGSN and the HLR.

7.6.2.42 APN

This parameter refers to the DNS name of a GGSN. This parameter is defined in 3GPP TS 23.060 [104].

7.6.2.43 Network Node number

This parameter refers either to the ISDN number of SGSN or to the ISDN number of MSC.

7.6.2.44 PDP-Type

This parameter indicates which type of protocol is used by the MS as defined in 3GPP TS 23.060 [104].

7.6.2.45 PDP-Address

This parameter indicates the address of the data protocol as defined in 3GPP TS 23.060 [104].

7.6.2.46 Additional number

This parameter can refer either to the SGSN number or to the MSC number.

7.6.2.47 P-TMSI

This parameter is the Packet Temporary Mobile Subscriber Identity defined in 3GPP TS 23.003 [17].

7.6.2.48 B-subscriber number

This parameter refers to the number of the destination B dialled by the A user. This may include a subaddress.

7.6.2.49 B-subscriber subaddress

This parameter refers to the sub-address attached to the destination B dialled by the A user.

7.6.2.50 LMU Number

This parameter refers to a local number assigned to an LMU by an SMLC.

7.6.2.51 MLC Number

This parameter refers to the ISDN (E.164) number of an MLC.

7.6.2.52 Multicall Bearer Information

This parameter refers to the number of simultaneous bearers supported per user by the serving network.

7.6.2.53 Multiple Bearer Requested

This parameter indicates whether multiple bearers are requested for a relocation.

7.6.2.54 Multiple Bearer Not Supported

This parameter indicates whether multiple bearers are supported.

7.6.2.55 PDP-Charging Characteristics

This parameter indicates the charging characteristics associated with a specific PDP context as defined in 3G TS 32.015.

7.6.2.56 Selected RAB ID

The selected radio access bearer to be kept at subsequent inter-MSC handover from UMTS to GSM.

7.6.2.57 RAB ID

This parameter indicates the radio access bearer identifier as defined in 3G TS 25.413. This parameter is used to relate the radio resources with the radio access bearers.

7.6.3 Subscriber management parameters

7.6.3.1 Category

This parameter refers to the calling party category as defined in CCITT Recommendation Q.767.

7.6.3.2 Equipment status

This parameter refers to the status of the mobile equipment as defined in 3GPP TS 22.016 [7].

7.6.3.3 Extensible Bearer service

This parameter may refer to a single bearer service, a set of bearer services or to all bearer services as defined in 3GPP TS 22.002 [3]. This parameter is used only for subscriber profile management. Extensible Bearer service values include all values defined for a Bearer service parameter (7.6.4.38).

7.6.3.4 Extensible Teleservice

This parameter may refer to a single teleservice, a set of teleservices or to all teleservices as defined in 3GPP TS 22.003 [4]. This parameter is used only for subscriber profile management. Extensible Teleservice values include all values defined for a Teleservice parameter (7.6.4.39).

7.6.3.5 Extensible Basic Service Group

This parameter refers to the Basic Service Group either as an extensible bearer service (see clause 7.6.3.3) or an extensible teleservice (see clause 7.6.3.4). This parameter is used only for subscriber profile management. The null value (i.e. neither extensible bearer service nor extensible teleservice) is used to denote the group containing all extensible bearer services and all extensible teleservices.

7.6.3.6 GSM bearer capability

This parameter refers to the GSM bearer capability information element defined in 3GPP TS 24.008 [35].

7.6.3.7 Subscriber Status

This parameter refers to the barring status of the subscriber:

- service granted;
- Operator Determined Barring.

7.6.3.8 CUG Outgoing Access indicator

This parameter represents the Outgoing Access as defined in ETS 300 136.

7.6.3.9 Operator Determined Barring General Data

This parameter refers to the set of subscriber features that the network operator or the service provider can regulate. This set only includes those limitations that can be

- a) controlled in the VLR,
- b) controlled in the SGSN,
- c) controlled in the SGSN applied for short message transfer only,
- d) interrogated or modified by the gsmSCF:

ODB category	Controlled in the VLR	Controlled in the SGSN	Controlled in the SGSN applied for short message transfer only	Interrogatable and modifyable by the gsmSCF
All outgoing calls barred	X		X	X
International outgoing	X		X	X

calls barred				
International outgoing calls except those to the home PLMN country barred	X		X	X
Interzonal outgoing calls barred	X		X	X
Interzonal outgoing calls except those to the home PLMN country barred	X		X	X
Interzonal outgoing calls AND international outgoing calls except those directed to the home PLMN country barred	X		X	X
Premium rate (information) outgoing calls barred	X			X
Premium rate (entertainment) outgoing calls barred	X			X
Supplementary service access barred	X			X
Invocation of call transfer barred	X			X
Invocation of chargeable call transfer barred	X			X
Invocation of internationally chargeable call transfer barred	X			X
Invocation of interzonally chargeable call transfer barred	X			X
Invocation of call transfer where both legs are chargeable barred	X			X
Invocation of call transfer if there is already an ongoing transferred call for the served subscriber in the serving MSC/VLR barred	X			X
All packet Oriented Services barred		X		X

Roamer Access to HPLMN-AP barred		X		X
Roamer Access to VPLMN-AP barred		X		X
Outgoing calls when roaming outside the home PLMN country				X
All incoming calls				X
Incoming calls when roaming outside the home PLMN country				X
Incoming calls when roaming outside the zone of the home PLMN country				X
Roaming outside the home PLMN				X
Roaming outside the home PLMN country				X
Registration of any call forwarded-to number				X
Registration of any international call forwarded-to number				X
Registration of any international call forwarded-to number except to a number within the HPLMN country				X
Registration of any inter-zone call forwarded-to number				X
Registration of any inter-zone call forwarded-to number except to a number within the HPLMN country				X

7.6.3.10 ODB HPLMN Specific Data

This parameter refers to the set of subscriber features that the network operator or the service provider can regulate only when the subscriber is registered in the HPLMN. This set only includes those limitations that can be controlled in the VLR or in the SGSN:

- Operator Determined Barring Type 1;

- Operator Determined Barring Type 2;
- Operator Determined Barring Type 3;
- Operator Determined Barring Type 4.

7.6.3.11 Regional Subscription Data

This parameter defines the regional subscription area in which the subscriber is allowed to roam. It consists of a list of Zone Codes (see clause 7.6.2.28).

7.6.3.12 Regional Subscription Response

This parameter indicates either that the regional subscription data cannot be handled or that the current MSC or SGSN area is entirely restricted because of regional subscription.

7.6.3.13 Roaming Restriction Due To Unsupported Feature

This parameter defines that a subscriber is not allowed to roam in the current MSC area. It may be used by the HLR if a feature or service is indicated as unsupported by the VLR.

7.6.3.14 Extensible SS-Info

This parameter refers to all the information related to a supplementary service and is a choice between:

- extensible forwarding information (see clause 7.6.3.15);
- extensible call barring information (see clause 7.6.3.20);
- CUG info (see clause 7.6.3.22);
- extensible SS-Data (see clause 7.6.3.29).

7.6.3.15 Extensible forwarding information

This parameter represents the information related to each call forwarding service:

- the SS-Code of the relevant call forwarding service (see clause 7.6.4.1);
- if required, a list of extensible forwarding feature parameters (see clause 7.6.3.16).

The list may contain one item per Basic Service Group.

7.6.3.16 Extensible forwarding feature

This parameter applies to each combination of call forwarding service and Basic Service Group and contains the following information, as required:

- extensible Basic Service Group (see clause 7.6.3.5);
- extensible SS-Status (see clause 7.6.3.17);
- forwarded-to number (see clause 7.6.2.22);
- forwarded-to subaddress (see clause 7.6.2.23);
- extensible forwarding options (see clause 7.6.3.18);
- extensible no reply condition timer (see clause 7.6.4.19);
- long forwarded-to number (see clause 7.6.2.22A).

If a number is required to define the forwarded-to destination then:

- If the VLR supports Long Forwarded-to Numbers then the long forwarded-to number shall be present and the forwarded-to number shall be absent;
- If the VLR does not support Long Forwarded-to Numbers then the forwarded-to number shall be present and the long forwarded-to number shall be absent.

7.6.3.17 Extensible SS-Status

This parameter refers to the state information of individual supplementary services as defined in 3GPP TS 23.011 [22].

7.6.3.18 Extensible Forwarding Options

This parameter refers to a set of forwarding options attached to a supplementary service. It contains the following information:

- notification to forwarding party (see 3GPP TS 22.082 [10] for the meaning of this parameter);
- redirection notification to the forwarded-to party (see 3GPP TS 22.082 [10] for the meaning of this parameter);
- notification to calling party (see 3GPP TS 22.082 [10] for the meaning of this parameter);
- redirecting presentation (see 3GPP TS 22.082 [10] for the meaning of this parameter);
- forwarding reason (see 3GPP TS 22.082 [10] for the meaning of this parameter).

7.6.3.19 Extensible No reply condition timer

This parameter refers to the extensible no reply condition timer for call forwarding on no reply.

7.6.3.20 Extensible Call barring information

This parameter contains for each call barring service:

- SS-Code (see clause 7.6.4.1);
- a list of extensible call barring feature parameters (see clause 7.6.3.21).

The list may contain one item per Basic Service Group.

7.6.3.21 Extensible Call barring feature

This parameter gives the status of call barring services as applicable to each Basic Service Group. The parameter contains the following information:

- Extensible Basic Service Group (see clause 7.6.3.5);
- provisioned SS-Status (see clause 7.6.3.17).

7.6.3.22 CUG info

This parameter refers to the overall information required for operation for each CUG:

- CUG subscriptionList;
- CUG featureList.

7.6.3.23 CUG subscription

This parameter refers to the set of basic information for each CUG defined in that subscription. The following information is stored:

- CUG index;
- CUG interlock;
- Intra CUG restrictions;
- Basic Service Group List.

7.6.3.24 CUG interlock

This parameter represents the CUG interlock code defined in ETS 300 138.

7.6.3.25 CUG index

This parameter represents the CUG index defined in ETS 300 138.

7.6.3.26 CUG feature

This parameter contains two parameters that are associated with the Basic Service Group. If the Basic Service Group Code is not present the feature applies to all Basic Services. The following parameters are included:

- Preferential CUG indicator:
 - indicates which CUG index is to be used at outgoing call set-up using the associated Basic Service Group;
- Inter CUG Option:
 - describes whether it for the associated Basic Service Group is allowed to make calls outside the CUG and whether incoming calls are allowed;
- Basic Service Group.

See 3GPP TS 22.085 [13] for meaning of this parameter.

7.6.3.27 Inter CUG options

This parameter indicates the subscribers' ability to make and receive calls outside a specific closed user group. It takes any of the following values:

- CUG only facility (only calls within CUG are allowed);
- CUG with outgoing access (calls outside CUG allowed);
- CUG with incoming access (calls from outside CUG into CUG allowed);
- CUG with both incoming and outgoing access (all calls allowed).

7.6.3.28 Intra CUG restrictions

This parameter describes whether or not the subscriber is allowed to originate calls to or to receive calls from within the CUG. It can take any of the following values:

- no CUG restrictions;
- CUG incoming calls barred;
- CUG outgoing calls barred.

7.6.3.29 Extensible SS-Data

This parameter refers to the necessary set of information required in order to characterise one supplementary service:

- SS-Code (see clause 7.6.4.1);
- Extensible SS-Status (if applicable) (see clause 7.6.3.17);
- Extensible Override subscription option (if applicable) (see clause 7.6.3.30);
- Extensible CLI Restriction (if applicable) (see clause 7.6.3.31);
- Extensible Basic Service Group Code (see clause 7.6.3.5).

7.6.3.30 Subscriber State

This parameter indicates the state of the MS as defined in 3GPP TS 23.018 [97].

7.6.3.31 Requested Info

This parameter indicates the subscriber information being requested as defined in 3GPP TS 23.018 [97] and 3GPP TS 23.078 [98].

7.6.3.31A Requested Domain

This parameter indicates the domain (circuit switched, i.e. from the MSC/VLR, or packet switched, i.e. from the SGSN) from which the requested information should be retrieved.

7.6.3.32 Suppression of Announcement

This parameter indicates if the announcement or tones shall be suppressed as defined in 3GPP TS 23.078 [98].

7.6.3.33 Suppress T-CSI

This parameter is used to suppress the invocation of terminating CAMEL services.

7.6.3.34 GMSC CAMEL Subscription Info

This parameter contains CAMEL subscription information, i.e. O-CSI and/or D-CSI and/or T-CSI, which indicates to the GMSC that originating and/or terminating CAMEL services shall be invoked for the incoming call.

7.6.3.35 VLR CAMEL Subscription Info

This parameter identifies the subscriber as having CAMEL services that are invoked in the MSC or VLR.

7.6.3.36 Supported CAMEL Phases in the VLR

This parameter indicates which phases of CAMEL are supported in the VLR.

7.6.3.36A Supported CAMEL Phases in the SGSN

This parameter indicates which phases of CAMEL are supported in the SGSN.

7.6.3.36B Supported CAMEL4 Subsets in the VLR

This parameter indicates which subsets of CAMEL phase 4 are supported in the VLR as defined in 3GPP TS 23.078.

7.6.3.36C Supported CAMEL4 Subsets in the SGSN

This parameter indicates which subsets of CAMEL phase 4 are supported in the SGSN as defined in 3GPP TS 23.078.

7.6.3.36D Supported CAMEL4 Subsets

This parameter indicates which subsets of CAMEL phase 4 are supported as defined in 3GPP TS 23.078.

7.6.3.36E Supported CAMEL4 Subsets in GMSC

This parameter indicates which subsets of CAMEL phase 4 are supported in the GMSC as defined in 3GPP TS 23.078.

7.6.3.36F Supported CAMEL4 Subsets in VMSC

This parameter indicates which subsets of CAMEL phase 4 are supported in the VMSC as defined in 3GPP TS 23.078.

7.6.3.37 CUG Subscription Flag

This parameter indicates a that a subscriber with a T-CSI also has a CUG subscription. It is defined in 3GPP TS 23.078.

7.6.3.38 CAMEL Subscription Info Withdraw

This parameter indicates that CAMEL Subscription Info shall be deleted from the VLR or SGSN.

7.6.3.39 Voice Group Call Service (VGCS) Data

This parameter refers to one or more groups a subscriber may be a member of for voice group calls.

7.6.3.40 Voice Broadcast Service (VBS) Data

This parameter refers to one or more groups a subscriber may be a member of for the voice broadcast service. Per group it is further indicated whether the subscriber is only allowed to listen to respective group calls or whether he is in addition entitled to initiate respective voice broadcast calls.

7.6.3.41 ISDN bearer capability

This parameter refers to the ISDN bearer capability information element defined in 3GPP TS 29.007 [56].

7.6.3.42 Lower layer Compatibility

This parameter refers to the lower layer compatibility information element defined in 3GPP TS 24.008 [35].

7.6.3.43 High Layer Compatibility

This parameter refers to the high layer compatibility information element defined in 3GPP TS 24.008 [35].

7.6.3.44 Alerting Pattern

This parameter is an indication that can be used by the MS to alert the user in a specific manner in case of mobile terminating traffic (switched call or USSD). That indication can be an alerting level or an alerting category.

7.6.3.45 GPRS Subscription Data Withdraw

This parameter indicates that GPRS Subscription Data shall be deleted from the SGSN.

7.6.3.46 GPRS Subscription Data

This parameter refers to the list of PDP-Contexts that subscriber has subscribed to.

7.6.3.47 QoS-Subscribed

This parameter indicates the quality of service subscribed for a certain service. It is defined in 3GPP TS 23.060 [104].

7.6.3.48 VPLMN address allowed

This parameter specifies whether the MS is allowed to use a dynamic address allocated in the VPLMN. It is defined in 3GPP TS 23.060 [104].

7.6.3.49 Roaming Restricted In SGSN Due To Unsupported Feature

This parameter defines that a subscriber is not allowed to roam in the current SGSN area. It may be used by the HLR if a feature or service is indicated as unsupported by the SGSN.

7.6.3.50 Network Access Mode

This parameter is defined in 3GPP TS 23.108.

7.6.3.51 Mobile Not Reachable Reason

This parameter stores the reason for the MS being absent when an attempt to deliver a short message to an MS fails at the MSC, SGSN or both. It is defined in 3GPP TS 23.140.

7.6.3.52 Cancellation Type

This parameter indicates the reason of location cancellation. It is defined in 3GPP TS 23.060 [104].

7.6.3.53 All GPRS Data

This parameter indicates to the SGSN that all GPRS Subscription Data shall be deleted for the subscriber.

7.6.3.54 Complete Data List Included

This parameter indicates to the SGSN that the complete GPRS Subscription Data stored for the Subscriber shall be replaced with the GPRS Subscription Data received.

7.6.3.55 PDP Context Identifier

This parameter is used to identify a PDP context for the subscriber.

7.6.3.56 LSA Information

This parameter refers to one or more localised service areas a subscriber may be a member of, together with the priority, the preferential access indicator, the active mode support indicator and active mode indication of each localised service area. The access right outside these localised service areas is also indicated.

7.6.3.57 SoLSA support indicator

This parameter indicates that the VLR or the SGSN supports SoLSA subscription.

7.6.3.58 LSA Information Withdraw

This parameter indicates that LSA information shall be deleted from the VLR or the SGSN.

7.6.3.59 LMU Indicator

This parameter indicates the presence of an LMU.

7.6.3.60 LCS Information

This parameter defines the LCS related information for an MS subscriber and contains the following components:

- GMLC List (see clause 7.6.3.61).
- LCS Privacy Exception List (see clause 7.6.3.62).
- MO-LR List (see clause 7.6.3.65A).
- Additional LCS Privacy Exception List (see clause 7.6.3.62A).

7.6.3.61 GMLC List

This parameter contains the addresses of all GMLCs that are permitted to issue a call/session unrelated or call/session related MT-LR location request for this MS. Usage of this parameter is defined in 3G TS 23.271.

7.6.3.62 LCS Privacy Exception List

This parameter defines the classes of LCS Client that are allowed to locate any target MS. For each class, the following information is provided:

- SS-Code (see clause 7.6.4.1);
- a list of LCS privacy exception parameters (see clause 7.6.3.63).

7.6.3.62A Additional LCS Privacy Exception List

This parameter defines the classes of LCS Client that are allowed to locate any target MS. For each class, the following information is provided:

- SS-Code (see clause 7.6.4.1);
- a list of LCS privacy exception parameters (see clause 7.6.3.63).

The Additional LCS Privacy Exception List shall be present only if the LCS Privacy Exception List is present and contains LCS privacy exception parameters for 4 privacy exception classes.

7.6.3.63 LCS Privacy Exception Parameters

This parameter gives the status of each LCS privacy exception class and any additional parameters relevant to this class. The parameter contains the following information:

- provisioned SS-Status (see clause 7.6.3.17);
- privacy notification to MS user (see clause 7.6.3.65B);
- external client List (see clause 7.6.3.64);
- internal client List (see clause 7.6.3.65).
- service type List (see clause 7.6.3.65D);

7.6.3.64 External Client List

This parameter is only applicable to the call/session unrelated privacy class and call/session related privacy class, and gives the identities of the external clients that are allowed to locate a target MS for a MT-LR. Each identity is an international (e.g.E.164) address. For each identified external client, GMLC restrictions may be defined. It may also be indicated if the MS shall be notified of a non-restricted MT-LR from each identified LCS client and, if so, whether

notification only or notification with privacy verification shall apply. Usage of this parameter is defined in 3G TS 23.271.

7.6.3.65 Internal Client List

This parameter is only applicable to the PLMN operator privacy class and gives the identities of the internal PLMN operator clients that are allowed to locate a target MS for an NI-LR or MT-LR. Usage of this parameter is defined in 3G TS 23.271.

7.6.3.65A MO-LR List

This parameter defines the classes of MO-LR for which a subscription exists for a particular MS. For each class, the following information is provided:

- SS-Code (see clause 7.6.4.1).

7.6.3.65B Privacy Notification to MS User

This parameter is applicable to the call/session unrelated privacy class and call/session related privacy class. For non-call/call related privacy class it indicates whether the MS user shall be notified for that class MT-LR from any value added LCS client when the MT-LR is restricted and be enabled to accept or override the restriction. Usage of this parameter is defined in 3G TS 23.271.

7.6.3.65C GMLC List Withdraw

This parameter indicates whether the subscriber's LCS GMLC list shall be deleted from the VLR or SGSN.

7.6.3.65D Service Type List

This parameter is only applicable to the Service type privacy class and gives the identities of the service type of the clients that are allowed to locate a target MS for an MT-LR. Usage of this parameter is defined in 3G TS 23.271.

7.6.3.66 IST Alert Timer

This parameter indicates the IST Alert Timer value that must be used in the MSC to inform the HLR about the call activities that the subscriber performs. Units are minutes.

7.6.3.67 Call Termination Indicator

This parameter indicates whether the MSC shall terminate a specific ongoing call, or all the call activities related to a specified subscriber.

7.6.3.68 IST Information Withdraw

This parameter indicates that IST information shall be deleted from the VMSC.

7.6.3.69 IST Support Indicator

This parameter indicates the degree of IST functionality supported by the MSC (Visited MSC or Gateway MSC). It can take one of the following values:

- Basic IST functionality;
- IST command service (in addition to the basic IST functionality and including the ability to terminate all calls being carried for the identified subscriber).

7.6.3.70 Super-Charger Supported In HLR

This parameter is used by the HLR to indicate support of the Super-Charger functionality and an indication of the age of the subscription data stored in the HLR.

7.6.3.71 Super-Charger Supported In Serving Network Entity

This parameter is used to indicate support of the Super-Charger functionality by the originating entity and to indicate either that subscription data is required or the date and time of the last know subscriber data modification.

7.6.3.72 Age Indicator

This parameter is used by the HLR to determine the validity of the subscription data retained by the serving network entity in a Super-Charged network.

7.6.3.73 GPRS enhancements support indicator

This parameter indicates to the HLR that the SGSN supports GPRS enhancements.

7.6.3.74 Extensible QoS-Subscribed

This parameter indicates the enhanced QoS subscribed for a certain service. It is defined in 3G TS 23.060. This parameter is an extension to QoS-Subscribed.

7.6.3.75 SGSN CAMEL Subscription Info

This parameter identifies the subscriber as having CAMEL services that are invoked in the SGSN.

7.6.3.76 MO-SMS-CSI

This parameter identifies the subscriber as having mobile originating SMS CAMEL services as defined in 3GPP TS 23.078. For the CAMEL phase 3 the MO-SMS-CSI is the same as the SMS-CSI.

7.6.3.76a MT-SMS-CSI

This parameter identifies the subscriber as having mobile terminating SMS CAMEL services as defined in 3GPP TS 23.078.

7.6.3.77 GPRS-CSI

This parameter identifies the subscriber as having GPRS CAMEL services as defined in 3GPP TS 23.078.

7.6.3.78 CAMEL subscription info

This parameter indicates the CSI that can be controlled by CSE.

7.6.3.79 Extensible Call barring information for CSE

This parameter contains for each call barring service for CSE:

- SS-Code;
- a list of extensible call barring feature parameters.

The list may contain one item per Basic Service Group.

- password;
- wrong password attempt counter;

- notification-to-CSE flag.

7.6.3.80 Extensible Forwarding information for CSE

This parameter represents the information for CSE related to each call forwarding service:

- the SS-Code of the relevant call forwarding service;
- if required, a list of extensible forwarding feature parameters;
- the list may contain one item per Basic Service Group;
- notification-to-CSE flag.

7.6.3.81 Modification Request for CSI

This parameter indicates the CAMEL subscription information to be modified by CSE.

7.6.3.81a Modification Request for ODB data

This parameter indicates the operator determined barring data to be modified by CSE.

7.6.3.82 Modification Request for SS Information

This parameter indicates the call forwarding and call barring supplementary service data to be modified by CSE.

7.6.3.83 Call Barring Data

This parameter contains the extensible call barring feature list (see clause 7.6.3.21) and Notification to CSE flag.

7.6.3.84 Call Forwarding Data

This parameter contains the extensible call forwarding feature list (see clause 7.6.3.16) and Notification to CSE flag.

7.6.3.85 ODB Data

This parameter contains the ODB general data, ODB HPLMN specific data.

7.6.3.86 Requested Subscription Info

This parameter indicates the subscription information being requested.

7.6.3.87 CS Allocation/Retention priority

This parameter indicates the allocation/retention priority for Circuit Switched (CS). It corresponds to the allocation/retention priority that is defined in 3G TS 23.107.

7.6.3.88 ODB Info

This parameter contains the ODB data and Notification to CSE flag.

7.6.3.89 Suppress VT-CSI

This parameter is used to suppress the invocation of terminating CAMEL services at the VMSC.

7.6.3.90 Suppress Incoming Call Barring

This parameter is used to suppress the invocation of Incoming Call Barrings.

7.6.3.91 gsmSCF Initiated Call

This parameter is used to indicate that the call was initiated by the gsmSCF.

7.6.4 Supplementary services parameters

7.6.4.1 SS-Code

This parameter may refer to one supplementary service or a set of supplementary services as defined in 3G TS 22.004. For MAP this includes:

- Calling Line Identification Presentation service (CLIP);
- Calling Line Identification Restriction service (CLIR);
- Connected Line Identification Presentation service (COLP);
- Connected Line Identification Restriction service (COLR);
- Calling Name Presentation (CNAP);
- All Call Forwarding services;
- Call Waiting (CW);
- Call Hold (HOLD);
- Multi-Party service (MPTY);
- Closed User Group (CUG);
- All Charging services;
- All Call Restriction services;
- Explicit Call Transfer service (ECT);
- enhanced Multi-Level Precedence and Pre-emption service (eMLPP);
- Completion of Calls to Busy Subscriber, originating side (CCBS-A);
- Completion of Calls to Busy Subscriber, destination side (CCBS-B);
- All LCS privacy exceptions (see clause 7.6.4.44);
- Mobile Originating Location Request (MO-LR) (see clause 7.6.4.45);
- Multicall (MC).

7.6.4.2 SS-Status

This parameter refers to the state information of individual supplementary services as defined in 3G TS 23.011.

7.6.4.3 SS-Data

This parameter refers to the necessary set of information required in order to characterise one supplementary service:

- SS-Code (see clause 7.6.4.1);
- SS-Status (if applicable) (see clause 7.6.4.2);
- Override subscription option (see clause 7.6.4.4);

- CLI Restriction (see clause 7.6.4.5);
- Basic Service Group Code (see clause 7.6.4.40).

7.6.4.4 Override Category

This parameter refers to the subscription option Override Category attached to a supplementary service. It can take the following two values:

- Enabled;
- Disabled.

7.6.4.5 CLI Restriction Option

This parameter refers to the subscription option Restriction mode attached to the CLIR supplementary service. It can take the following three values:

- Permanent;
- Temporary (Default Restricted);
- Temporary (Default Allowed).

7.6.4.6 Forwarding Options

This parameter refers to a forwarding option attached to a supplementary service. It can take one of the following values:

- notification to forwarding party (see 3GPP TS 22.082 [10] for the meaning of this parameter);
- notification to calling party (see 3GPP TS 22.082 [10] for the meaning of this parameter);
- redirecting presentation (see 3GPP TS 22.082 [10] for the meaning of this parameter);
- Forwarding reason (see 3GPP TS 22.082 [10] for the meaning of this parameter).

7.6.4.7 No reply condition timer

This parameter refers to the no reply condition timer for call forwarding on no reply.

7.6.4.8 - 7.6.4.14 Void

7.6.4.15 Forwarding information

This parameter represents the information related to each call forwarding service:

- the SS-Code of the relevant call forwarding service (see clause 7.6.4.1);
- if required, a list of forwarding feature parameters (see clause 7.6.4.16).
the list may contain one item per Basic Service Group.

7.6.4.16 Forwarding feature

This parameter applies to each combination of call forwarding service and Basic Service Group and contains the following information, as required:

- Basic Service Group (see clause 7.6.4.40);
- SS-Status (see clause 7.6.4.2);
- forwarded-to number (see clause 7.6.2.22);

- forwarded-to subaddress (see clause 7.6.2.23);
- forwarding options (see clause 7.6.4.6);
- no reply condition timer (see clause 7.6.4.7);
- long forwarded-to number (see clause 7.6.2.22A).

If a number is required to define the forwarded-to destination then:

- If the VLR supports Long Forwarded-to Numbers then the long forwarded-to number shall be present and the forwarded-to number shall be absent.
- If the VLR does not support Long Forwarded-to Numbers then the forwarded-to number shall be present and the long forwarded-to number shall be absent.

7.6.4.17 Void

7.6.4.18 Call barring information

This parameter contains for each call barring service:

- SS-Code (see clause 7.6.4.1);
- a list of call barring feature parameters (see clause 7.6.4.19).

The list may contain one item per Basic Service Group.

7.6.4.19 Call barring feature

This parameter gives the status of call barring services as applicable to each Basic Service Group. The parameter contains the following information:

- Basic Service Group (see clause 7.6.4.40);
- SS-Status (see clause 7.6.4.2).

7.6.4.20 New password

This parameter refers to the password which the subscriber just registered in the network.

This parameter refers to a password used by the subscriber for supplementary service control.

7.6.4.21 Current password

This parameter refers to a password used by the subscriber for supplementary service control.

7.6.4.22 Guidance information

This parameter refers to guidance information given to a subscriber who is requested to provide a password. One of the following information may be given:

- "enter password";
this information is used for checking of the old password;
- "enter new password";
this information is used during password registration for the request of the first new password;
- "enter new password again";
this information is used during password registration for the request of the new password again for verification.

7.6.4.23 Void

7.6.4.24 SS-Info

This parameter refers to all the information related to a supplementary service and is a choice between:

- forwarding information (see clause 7.6.4.15);
- call barring information (see clause 7.6.4.18);
- CUG info (see clause 7.6.4.8);
- SS-Data (see clause 7.6.4.3).
- eMLPP information (see clause 7.6.4.41).

7.6.4.25 - 7.6.4.35 Void

7.6.4.36 USSD Data Coding Scheme

This parameter contains the information of the alphabet and the language used for the unstructured information in an Unstructured Supplementary Service Data operation. The coding of this parameter is according to the Cell Broadcast Data Coding Scheme as specified in 3GPP TS 23.038 [25].

7.6.4.37 USSD String

This parameter contains a string of unstructured information in an Unstructured Supplementary Service Data operation. The string is sent either by the mobile user or the network. The contents of a string sent by the MS are interpreted by the network as specified in 3GPP TS 22.090 [16].

7.6.4.38 Bearer service

This parameter may refer to a single bearer service, a set of bearer services or to all bearer services as defined in 3GPP TS 22.002 [3]. This parameter is used only for supplementary service management.

7.6.4.39 Teleservice

This parameter may refer to a single teleservice, a set of teleservices or to all teleservices as defined in 3GPP TS 22.003 [4]. This parameter is used only for supplementary service management.

7.6.4.40 Basic Service Group

This parameter refers to the Basic Service Group either as a bearer service (see clause 7.6.4.38) or a teleservice (see clause 7.6.4.39). This parameter is used only for supplementary service management. The null value (i.e. neither bearer service nor teleservice) is used to denote the group containing all bearer services and all teleservices.

7.6.4.41 eMLPP information

This parameter contains two parameters which are associated with the eMLPP service. The following two parameters are included:

- maximum entitled priority:
 - indicates the highest priority level the subscriber is allowed to apply for an outgoing call set-up;
- default priority:
 - defines the priority level which shall be assigned to a call if no explicit priority is indicated during call set-up.

7.6.4.42 SS-event

This parameter indicates the Supplementary Service for which an invocation notification is sent towards the gsmSCF. It can indicate one of the following services:

- Explicit Call Transfer (ECT)
- Call Deflection (CD)
- Multi-Party call (MPTY)
- Completion of Calls to Busy Subscriber (CCBS)

7.6.4.43 SS-event data

This parameter contains additional information related to Supplementary Service invocation. Depending on the service invoked it can contain the following information:

- ECT A list with all Called Party Numbers involved.
- CD The called Party number involved.

7.6.4.44 LCS Privacy Exceptions

Distinct SS codes are assigned to the following classes of LCS client in a target MS subscriber's privacy exception list.

- Universal Class;
- Call/session related value added class;
- Call/session unrelated value added class;
- PLMN operator class.
- Service type class.

7.6.4.45 Mobile Originating Location Request (MO-LR)

Distinct SS codes are assigned to the following classes of MO-LR:

- Basic Self Location;
- Autonomous Self Location;
- Transfer to Third Party.

7.6.4.46 NbrUser

This parameter indicates the maximum number of parallel bearers that may be used as defined by the user at registration of the MC SS.

7.6.4.47 MC Subscription Data

This parameter contains two parameters which are associated with the MC service. The following two parameters are included:

- NbrUser:
indicates the maximum number of parallel bearers that may be used as defined by the user at registration of the MC SS
- NbrSB:

indicates the maximum number of parallel bearers that may be used as defined by the user's subscription.

7.6.4.48 MC Information

This parameter contains three parameters which are associated with the MC service. The following parameters are included:

- NbrSB;
- NbrUser;
- NbrSN.

Definitions of these parameters are provided in 3G TS 23.135.

7.6.4.49 CCBS Request State

This parameter indicates the current state of the CCBS request. It can take one of seven values:

- request;
- recall;
- active;
- completed;
- suspended;
- frozen;
- deleted.

7.6.5 Call parameters

7.6.5.1 Call reference number

This parameter refers to a call reference number allocated by a call control MSC.

7.6.5.2 Interrogation type

This parameter refers to the type of interrogation for routing information which is sent from a GMSC to an HLR. It can take either of two values:

- basic call (for information to route a call before the call has been extended to the VMSC of the called party);
- forwarding (for information to route the call to the forwarded-to destination after the VMSC of the forwarding party has requested the GMSC to resume handling of the call).

7.6.5.3 OR interrogation

This parameter indicates that the GMSC which interrogated the HLR for routing information is not in the same PLMN as the HLR, and therefore that the call will potentially be optimally routed.

7.6.5.4 OR capability

This parameter indicates the phase of OR which the GMSC supports.

7.6.5.5 Forwarding reason

This parameter indicates the reason for which the call is to be forwarded. It can take one of three values:

- busy subscriber;
- mobile subscriber not reachable;
- no subscriber reply.

7.6.5.6 Forwarding interrogation required

This parameter indicates that if the VMSC of the forwarding subscriber requests the GMSC to resume handling of the call the GMSC shall interrogate the HLR for forwarding information.

7.6.5.7 O-CSI

This parameter identifies the subscriber as having originating CAMEL services as defined in 3GPP TS 23.078.

7.6.5.7A D-CSI

This parameter identifies the subscriber as having originating CAMEL dialled services as defined in 3GPP TS 23.078.

7.6.5.7B T-CSI

This parameter identifies the subscriber as having terminating CAMEL services in the GMSC, as defined in 3GPP TS 23.078.

7.6.5.7C VT-CSI

This parameter identifies the subscriber as having terminating CAMEL services in the VMSC, as defined in 3GPP TS 23.078.

7.6.5.8 Call Direction

This parameter is used to indicate the direction of the call.

7.6.5.9 Channel Type

This parameter is the result of a Channel Mode Modification for TS 61/62. It contains the changed Air Interface User Rate. The information is sent from the SIWFS to the MSC to assign the correct radio resource. This parameter is defined in 3GPP TS 48.008 [49].

7.6.5.10 Chosen Channel

This parameter is sent from the MSC to the SIWFS to adjust the interworking unit to the assigned radio resources. This parameter is defined in 3GPP TS 48.008 [49].

7.6.5.11 CCBS Feature

This parameter corresponds to the 'CCBS Description' parameter in 3G TS 23.093. It refers to the necessary set of information required in order to characterise a certain CCBS request. The parameter may contain the following information:

- CCBS Index (see 3G TS 23.093 for the use of this parameter);
- B-subscriber number (see clause 7.6.2.48);
- B-subscriber subaddress (see clause 7.6.2.49);
- Basic Service Group Code (see clause 7.6.4.40).

7.6.5.12 UU Data

This parameter includes User-To-User Data. It is defined in 3GPP TS 23.087.

7.6.5.13 UUS CF Interaction

This parameter indicates if the call forwarding or call deflection has been activated after UUS1 request has been accepted . It is defined in 3GPP TS 23.087.

7.6.5.14 Number Portability Status

This parameter indicates the number portability status of subscriber. See 3GPP TS 23.066 [108].

7.6.5.15 Pre-paging supported

This parameter indicates that the entity which sent it supports pre-paging.

7.6.6 Radio parameters

7.6.6.1 - 7.6.6.4 Void

7.6.6.5 BSSMAP Service Handover

This parameter refers to the Service Handover information element defined in 3GPP TS 48.008

7.6.6.6 RANAP Service Handover

This parameter refers to the Service Handover information element defined in 3GPP TS 25.413.

7.6.6.7 HO-Number Not Required

This parameter indicates that no handover or relocation number allocation is necessary.

7.6.6.8 Integrity Protection Information

This parameter refers to the Integrity Protection Information element defined in 3G TS 25.413.

7.6.6.9 Encryption Information

This parameter refers to the Encryption Information element defined in 3G TS 25.413.

7.6.6.10 Radio Resource Information

This parameter refers to the Channel Type information element defined in 3GPP TS 48.008 [49].

7.6.6.10A Radio Resource List

This parameter refers to list of RAB-id's and their associated Channel Type information elements defined in 3G TS 48.008.

7.6.6.10B Chosen Radio Resource Information

This parameter refers to the Chosen Channel and Speech Version information elements defined in 3G TS 48.008.

7.6.6.11 Key Status

This parameter refers to the Key Status element defined in 3G TS 25.413.

7.6.6.12 Selected UMTS Algorithms

This parameters identifies the UMTS integrity and optionally encryption algorithms selected by MSC-B. Coding of this parameter is defined in 3G TS 25.413.

7.6.6.13 Allowed GSM Algorithms

This parameters identifies the allowed GSM algorithms in MSC-B. Coding of this parameter is defined in 3G TS 48.008.

7.6.6.14 Allowed UMTS Algorithms

This parameters identifies the allowed UMTS algorithms in MSC-B. Coding of this parameter is defined in 3G TS 25.413.

7.6.6.15 Selected GSM Algorithm

This parameter identifies the GSM algorithm selected by GSM BSC controlled by MSC-B. Coding of this parameter is defined in 3G TS 48.008.

7.6.7 Authentication parameters

7.6.7.1 Authentication set list

This parameter represents a list of sets of authentication parameters for a given subscriber.

The list either contains Authentication Triplets (Rand, Sres, Kc) or Authentication Quintuplets (Rand, Xres, Ck, Ik, Autn). If the list contains Authentication Quintuplets, the order of sequence in this list is chronological, the first quintuplet in the list is the oldest one.

7.6.7.2 Rand

This parameter represents a random number used for authentication.

7.6.7.3 Sres

This parameter represents the response to an authentication request.

7.6.7.4 Kc

This parameter refers to a key used for ciphering purposes.

7.6.7.5 Xres

This parameter represents the response to an UMTS authentication request.

7.6.7.5A Ck

This parameter refers to a key used for UMTS ciphering purposes.

7.6.7.5B Ik

This parameter refers to the Integrity Key.

7.6.7.5C Autn

This parameter refers to the Authentication Token.

7.6.7.6 Cksn

This parameter refers to a ciphering key sequence number.

7.6.7.6A Ksi

This parameter refers to a key set identifier.

7.6.7.6B Auts

This parameter refers to the resynchronisation token.

7.6.7.7 Ciphering mode

This parameter refers to the ciphering mode which is associated with a radio channel. It may take values as follows:

- no encryption;
- identification of specific ciphering algorithm.

7.6.7.8 Current Security Context

This parameter represents a list of security context parameters for a given subscriber.

The list either contains GSM Security Context data (Kc, Cksn) or UMTS Security Context Data (Ck, Ik, Ksi).

7.6.7.9 Failure cause

This parameter refers to an authentication failure which has occurred. It may take values as follows:

- wrong user response;
- wrong network signature.

7.6.7.10 Re-attempt

It indicates whether the failure occurred in a normal authentication attempt or in an authentication reattempt (there was a previous unsuccessful authentication).

7.6.7.11 Access Type

It indicates whether the authentication procedure was initiated due to a call, an emergency call, a location updating, a supplementary service procedure, a short message transfer, a GPRS attach procedure, a routing area updating, a service request, a PDP context activation or a PDP context deactivation procedure.

7.6.8 Short message parameters

7.6.8.1 SM-RP-DA

This parameter represents the destination address used by the short message service relay sub-layer protocol. It can be either of the following:

- IMSI (see clause 7.6.2.1);
- LMSI (see clause 7.6.2.16);
- MS-ISDN (see clause 7.6.2.17);
- roaming number (see clause 7.6.2.19);
- service centre address (see clause 7.6.2.27).

7.6.8.2 SM-RP-OA

This parameter refers to the originating address used by the short message service relay sub-layer protocol. It can be either of the following:

- MS-ISDN (see clause 7.6.2.17);
- service centre address (see clause 7.6.2.27).

7.6.8.3 MWD status

This parameter indicates whether or not the address of the originator service centre is already contained in the Message Waiting Data file. In addition, it contains the status of the Memory Capacity Exceeded Flag (MCEF), the status of the Mobile subscriber Not Reachable Flag (MNRF) and the status of the Mobile station Not Reachable for GPRS flag (MNRG).

7.6.8.4 SM-RP-UI

This parameter represents the user data field carried by the short message service relay sub-layer protocol.

7.6.8.5 SM-RP-PRI

This parameter is used to indicate whether or not delivery of the short message shall be attempted when a service centre address is already contained in the Message Waiting Data file.

7.6.8.6 SM Delivery Outcome

This parameter indicates the cause for setting the message waiting data. It can take one of the following values:

- Absent subscriber;
- MS memory capacity exceeded;
- Successful transfer.

7.6.8.7 More Messages To Send

This parameter is used to indicate whether or not the service centre has more short messages to send.

7.6.8.8 Alert Reason

This parameter is used to indicate the reason why the service centre is alerted. It can take one of the following values:

- MS present;
- Memory Available.

7.6.8.9 Absent Subscriber Diagnostic SM

This parameter is used to indicate the reason why the subscriber is absent. For the values for this parameter see 3GPP TS 23.140.

7.6.8.10 Alert Reason Indicator

This parameter indicates that the alert reason is sent to the HLR due to GPRS activity.

7.6.8.11 Additional SM Delivery Outcome

This parameter is used to indicate the GPRS delivery outcome in case a combination between delivery outcome for GPRS and non-GPRS are sent to the HLR.

7.6.8.12 Additional Absent Subscriber Diagnostic SM

This parameter indicates the reason of the additional SM Delivery Outcome.

7.6.8.13 Delivery Outcome Indicator

This parameter indicates that the delivery outcome sent to the HLR is for GPRS.

7.6.8.14 GPRS Node Indicator

This parameter indicates that the Network Node Number sent by the HLR is the SGSN number.

7.6.8.15 GPRS Support Indicator

This parameter indicates that the SMS-GMSC supports GPRS specific procedure of combine delivery of Short Message via MSC and/or via the SGSN.

7.6.8.16 SM-RP-MTI

This parameter represents the RP-Message Type Indicator of the Short Message. It is used to distinguish a SM sent to the mobile station in order to acknowledge an MO-SM initiated by the mobile from a normal MT-SM. This parameter is formatted according to the formatting rules of address fields as described in 3GPP TS 23.140.

7.6.8.17 SM-RP-SMEA

This parameter represents the RP-Originating SME-address of the Short Message Entity that has originated the SM. This parameter is used by the short message service relay sub-layer protocol and is formatted according to the formatting rules of address fields as described in 3GPP TS 23.140.

7.6.9 Access and signalling system related parameters

7.6.9.1 AN-apdu

This parameter includes one or two concatenated complete 3G TS 25.413 or 3GPP TS 48.006 [48] messages, as described in 3G TS 23.009 and 3G TS 29.010. The access network protocol ID indicates that the message or messages are according to either 3GPP TS 48.006 [48] or 3G TS 25.413. For the coding of the messages see 3G TS 25.413, 3GPP TS 48.006 [48] and 3GPP TS 48.008 [49].

7.6.9.2 CM service type

This parameter identifies the service category being requested by the subscriber:

- mobile originating call;
- emergency call establishment;
- short message service;
- mobile originating call re-establishment;
- mobile terminating call;
- SS request;
- Voice group call set-up;
- Voice broadcast set-up.

7.6.9.3 Access connection status

This parameter represents the following access connection status information:

- RR-connection status (established/not established);
- ciphering mode (on/off);
- authentication status (authenticated/not authenticated).

7.6.9.4 External Signal Information

This parameter contains concatenated information elements (including tag and length) which are defined by a common protocol version, preceded by the associated protocol ID. It is used to transport information of the indicated protocol via MAP interfaces.

7.6.9.5 Access signalling information

This parameter refers to any set of information elements imported from 3GPP TS 24.008 [35].

7.6.9.6 Location update type

This parameter refers to the location update type (normal, periodic or IMSI attach) contained in the 3GPP TS 24.008 [35] LOCATION REGISTRATION REQUEST message.

7.6.9.7 Protocol ID

This parameter refers to the protocol to which the coding of the content of the associated External Signal Information conforms.

The following values are defined:

- 04.08;
- 08.06;
- ETS 300 102-1.

This value indicates the protocol defined by ETS 300 102-1 (EDSS1).

7.6.9.8 Network signal information

This parameter is transported as external signal information. The protocol ID shall be set to "ETS 300 102-1".

The network signal information may include the following information elements as defined in 3GPP TS 29.007 [56]:

- ISDN BC; the tag and length are defined by ETS 300 102-1.
For the content, see 3GPP TS 29.007 [56].
- HLC; the tag and length are defined by ETS 300 102-1.
For the content, see 3GPP TS 29.007 [56].
- LLC; the tag and length are defined by ETS 300 102-1.
For the content, see 3GPP TS 29.007 [56].

They are contained in the Signal Information parameter according to figure 7.6/1 (irrespective of the order):

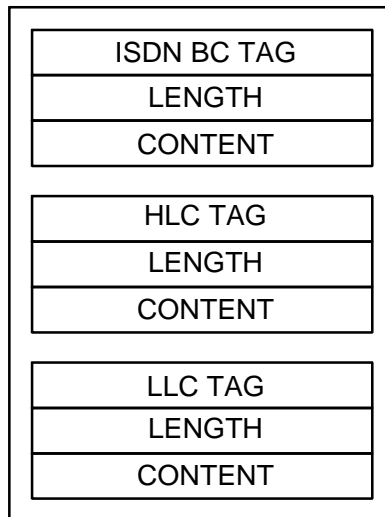

Figure 7.6/1: Network signal information parameter

7.6.9.9 Call Info

This parameter is transported as external signal information. The protocol ID shall be set to "3GPP TS 24.008 [35]".

The Call Info includes the set of information elements from the original SETUP message and is imported from 3GPP TS 24.008 [35].

7.6.9.10 Additional signal info

This parameter is transported as external signal information. The protocol ID shall be set to "ETS 300 356".

The additional signal information may include the following information elements:

- Calling Party Number as defined by ETS 300 356.
- Generic Number as defined by ETS 300 356.

They are contained in the Signal Information parameter according to figure 7.6/2 (irrespective of the order):

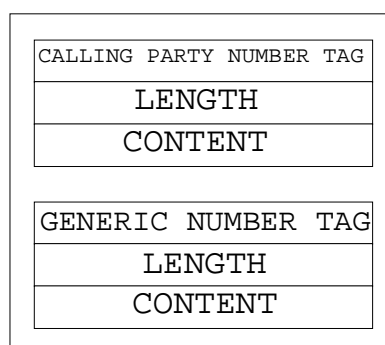

Figure 7.6/2: Additional signal information parameter

7.6.10 System operations parameters

7.6.10.1 Network resources

This parameter refers to a class or type of network resource:

- PLMN;
- HLR;

- VLR (current or previous);
- MSC (controlling or current);
- EIR;
- radio sub-system.

7.6.10.2 Trace reference

This parameter represents a reference associated with a tracing request. The parameter is managed by OMC.

7.6.10.3 Trace type

This parameter identifies the type of trace. Trace types are fully defined in GSM 12.08.

7.6.11 Location Service Parameters

7.6.11.1 Age of Location Estimate

This parameter indicates how long ago the location estimate was obtained.

7.6.11.2 Deferred MT-LR Response Indicator

This parameter shows that this is a response to a deferred mt-lr request.

7.6.11.3 Deferred MT-LR Data

This parameter is used to report the deferred location event type, the location information and reason why the serving node aborted monitoring the event to the GMLC. The termination cause mt-lrRestart shall be used to trigger the GMLC to restart the location procedure in all the cases where the sending node detects that the location procedure cannot be successfully performed anymore by the sending node and that it could be successfully performed by another node (as for example when. Cancel Location or Send Identification has been received). The location information shall be included only if the termination cause is mt-lrRestart. The network node number contained in the location information refers to the node where the MS/UE has moved to and shall be included if available, like in case Send Identification has been received.

7.6.11.4 LCS Client ID

This parameter provides information related to the identity of an LCS client.

7.6.11.5 LCS Event

This parameter identifies an event associated with the triggering of a location estimate.

7.6.11.6 Void

7.6.11.7 LCS Priority

This parameter gives the priority of the location request.

7.6.11.8 LCS QoS

This parameter defines the Quality of Service (QoS) for any location request. It is composed of the following elements.

1) Response Time

Indicates the category of response time – “low delay” or “delay tolerant”.

2) Horizontal Accuracy

Indicates the required horizontal accuracy of the location estimate.

3) Vertical Coordinate

Indicates if a vertical coordinate is required (in addition to horizontal coordinates).

4) Vertical Accuracy

Indicates the required vertical accuracy of the location estimate (inclusion is optional).

7.6.11.9 CS LCS Not Supported by UE

This parameter is used by the VLR to indicate to the HLR that the UE does not support neither UE Based nor UE Assisted positioning methods for Circuit Switched Location Services. VLR defines the presence of this parameter on the basis of the Classmark 3 information.

7.6.11.10 PS LCS Not Supported by UE

This parameter is used by the SGSN to indicate to the HLR that the UE does not support neither UE Based nor UE Assisted positioning methods for Packet Switched Location Services. SGSN defines the presence of this parameter on the basis of the UE capability information.

7.6.11.11 Location Estimate

This parameter gives an estimate of the location of an MS in universal coordinates and the accuracy of the estimate. The estimate is expressed in terms of the geographical shapes defined by 3G TS 23.032, and is composed of the type of shape plus the encoding of the shape itself. Any type of shape defined in 3G TS 23.032 can be filled in in the Location Estimate parameter, but only the encoding of the following shapes shall be carried by Location Estimate:

- Ellipsoid point with uncertainty circle
- Ellipsoid point with uncertainty ellipse
- Ellipsoid point with altitude and uncertainty ellipsoid
- Ellipsoid arc
- Ellipsoid point

The encoding for the remaining types of shape, defined in the 3G TS 23.032, shall be filled in in the Additional Location Estimate parameter.

7.6.11.12 Location Type

This parameter indicates the type of location estimate required by the LCS client. Possible location estimate types include:

- current location;
- current or last known location;
- initial location for an emergency services call;
- deferred location event type.

7.6.11.13 NA-ESRD

This parameter only applies to location for an emergency services call in North America and gives the North American Emergency Services Routing Digits.

7.6.11.14 NA-ESRK

This parameter only applies to location for an emergency services call in North America and gives the North American Emergency Services Routing Key.

7.6.11.15 LCS Service Type Id

This parameter defines the LCS Service Type of the current positioning request. The possible values are defined in 3G TS 22.071 [123]

7.6.11.16 Privacy Override

This parameter indicates if MS privacy is overridden by the LCS client when the GMLC and VMSC/SGSN for an MT-LR are in the same country.

7.6.11.17 Supported LCS Capability Sets

This parameter indicates which capability sets of LCS are supported in the VLR or SGSN.

7.6.11.18 LCS Codeword

This parameter contains the codeword associated to current positioning request as described in 3G TS 23.271 [26a].

7.6.11.19 LCS Codeword Applicability

This parameter indicates if codeword checks are applicable as described in 3G TS 23.271 [26a].

7.6.11.20 Supported GAD Shapes

This parameter indicates which of the shapes defined in 3G TS 23.032 are supported. If the parameter is not provided then the receiving node shall assume that the sending entity supports the following shapes:

- Ellipsoid point with uncertainty circle
- Ellipsoid point with uncertainty ellipse
- Ellipsoid point with altitude and uncertainty ellipsoid
- Ellipsoid arc
- Ellipsoid point

7.6.11.21 Additional Location Estimate

This parameter gives an estimate of the location of an MS/UE in universal coordinates and the accuracy of the estimate. This parameter allows the location estimate to be expressed in any of the geographical shapes defined in 3G TS 23.032

7.6.11.22 LCS Codeword Notification

This parameter indicates if codeword shall be sent to the subscriber as described in 3G TS 23.271 [26a]

7.6.12 Secure Transport Parameters

7.6.12.1 Security Header

This parameter carries the security header information, which is required by a receiving entity in order to extract the protected information from a securely transported MAP message. The components of the security header are shown in table 7.6.12/1.

See 3GPP TS 33.200 for the use of these parameters.

Table 7.6.12/1: Components of the Security Header

Component name	Presence requirement	Description
Security Parameters Index	M	Identifies the Security Association for the component.
Original component identifier	M	Identifies the type of component to be securely transported – one of: <ul style="list-style-type: none"> - Operation, identified by the operation code; - Error, defined by the error code; - User information.
TVP	O	A parameter based on time that is used to ensure the current message is fresh. This is only present if required for the current Protection Mode.
NE-Id	O	The identity of the Network Element sending the message. This is only present if required for the current Protection Mode.
Prop	O	Bytes used to ensure the IV is unique for a given TVP and NE-Id. This is only present if required for the current Protection Mode.

7.7 Representation of a list of a basic parameter in service-primitives

In some service-primitives several instances of a basic parameter of clause 7.6 are required. In the service descriptions such cases will be represented as



in the tables where ParameterName refers to one of the parameters defined in clause 7.6. This corresponds to the following construction rule:

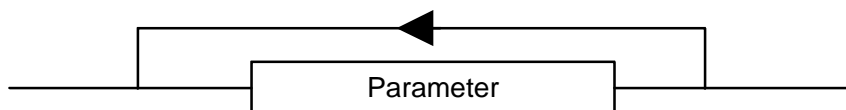

Figure 7.7/1: Construction of Lists

8 Mobility services

8.1 Location management services

8.1.1 Void

8.1.1.1 Void

8.1.1.2 Void

8.1.1.3 Void

8.1.2 MAP_UPDATE_LOCATION service

8.1.2.1 Definition

This service is used by the VLR to update the location information stored in the HLR.

The MAP_UPDATE_LOCATION service is a confirmed service using the service primitives given in table 8.1/2.

8.1.2.2 Service primitives

Table 8.1/2: MAP_UPDATE_LOCATION

Parameter name	Request	Indication	Response	Confirm
Invoke Id	M	M(=)	M(=)	M(=)
IMSI	M	M(=)		
MSC Address	M	M(=)		
VLR number	M	M(=)		
LMSI	U	C(=)		
Supported CAMEL Phases	C	C(=)		
SoLSA Support Indicator	C	C(=)		
IST Support Indicator	C	C(=)		
Super-Charger Supported in Serving Network Entity	C	C(=)		
Long FTN Supported	C	C(=)		
Supported LCS Capability Sets	C	C(=)		
Supported CAMEL 4 Subsets	C	C(=)		
Inform Previous Network Entity	C	C(=)		
CS LCS Not Supported by UE	C	C(=)		
HLR number			C	C(=)
User error			C	C(=)
Provider error				O

8.1.2.3 Parameter definitions and use

Invoke Id

See definition in clause 7.6.1.

IMSI

See definition in clause 7.6.2.

MSC Address

See definition for MSC number in clause 7.6.2. The MSC address is used for short message delivery only and for each incoming call set-up attempt the MSRN will be requested from the VLR.

VLR number

See definition in clause 7.6.2.

LMSI

See definition in clause 7.6.2. It is an operator option to provide the LMSI from the VLR; it is mandatory for the HLR to support the LMSI handling procedures.

Supported CAMEL Phases

This parameter indicates which phases of CAMEL are supported. Must be present if a CAMEL phase different from phase 1 is supported. Otherwise may be absent.

HLR number

See definition in clause 7.6.2. The presence of this parameter is mandatory in case of successful HLR updating.

SoLSA Support Indicator

This parameter is used by the VLR to indicate to the HLR in the Update Location indication that SoLSA is supported. If this parameter is not included in the Update Location indication and the Subscriber is marked as only allowed to roam in Subscribed LSAs, then the HLR shall reject the roaming and indicate to the VLR that roaming is not allowed to that Subscriber in the VLR.

This SoLSA Support Indicator shall be stored by the HLR per VLR where there are Subscribers roaming. If a Subscriber is marked as only allowed to roam in Subscribed LSAs while roaming in a VLR and no SoLSA Support indicator is stored for that VLR, the location status of that Subscriber shall be set to Restricted.

IST Support Indicator

This parameter is used to indicate to the HLR that the VMSC supports basic IST functionality, that is, the VMSC is able to terminate the Subscriber Call Activity that originated the IST Alert when it receives the IST alert response indicating that the call(s) shall be terminated. If this parameter is not included in the Update Location indication and the Subscriber is marked as an IST Subscriber, then the HLR may limit the service for the subscriber (by inducing an Operator Determined barring of Roaming, Incoming or Outgoing calls), or allow service assuming the associated risk of not having the basic IST mechanism available.

This parameter can also indicate that the VMSC supports the IST Command service, including the ability to terminate all calls being carried for the identified subscriber by using the IMSI as a key. If this additional capability is not included in the Update Location indication and the HLR supports the IST Command capability, then the HLR may limit the service for the subscriber (by inducing an Operator Determined barring of Roaming, Incoming or Outgoing calls), or allow service assuming the associated risk of not having the IST Command mechanism available.

Long FTN Supported

This parameter indicates that the VLR supports Long Forwarded-to Numbers.

Super-Charger Supported in Serving Network Entity

This parameter is used by the VLR to indicate to the HLR that the VLR supports the Super-Charger functionality and whether subscription data has been retained by the VLR. If subscription data has been retained by the VLR the age indicator shall be included. Otherwise the VLR shall indicate that subscriber data is required.

If this parameter is absent then the VLR does not support the Super-Charger functionality.

Supported LCS Capability Sets

This parameter indicates, if present, the capability sets of LCS which are supported. If the parameter is sent but no capability set is marked as supported then the VLR does not support LCS at all.

If this parameter is absent then the VLR may support at most LCS capability set 1, that is LCS Release98 or Release99 version.

Supported CAMEL 4 Subsets

This parameter indicates the CAMEL phase 4 subsets supported in the VMSC/VLR (see clause 7.6.3.36D).

Inform Previous Network Entity

This parameter is used by the VLR to ask the HLR to inform the previous network entity about the update by sending the previous network entity a Cancel Location message. It is used in case Super-Charger is supported in the network and the serving network entity has not been able to inform the previous network entity that MS has moved, that is if it has not sent Send Identification to the previous serving entity.

CS LCS Not Supported by UE

See definition in clause 7.6.11.

User error

In case of unsuccessful updating, an error cause shall be returned by the HLR. The following error causes defined in clause 7.6.1 may be used, depending on the nature of the fault:

- unknown subscriber;
- roaming not allowed;

This cause will be sent if the MS is not allowed to roam into the PLMN indicated by the VLR number. The cause is qualified by the roaming restriction reason "PLMN Not Allowed" or "Operator Determined Barring". If no qualification is received (HLR with MAP Version 1), "PLMN Not Allowed" is taken as default.

- system failure;
- unexpected data value.

Provider error

For definition of provider errors see clause 7.6.1.

8.1.3 MAP_CANCEL_LOCATION service

8.1.3.1 Definition

This service is used between HLR and VLR to delete a subscriber record from the VLR. It may be invoked automatically when an MS moves from one VLR area to another, to remove the subscriber record from the old VLR, or by the HLR operator to enforce a location updating from the VLR to the HLR, e.g. on withdrawal of a subscription.

Also this service is used between HLR and SGSN to delete a subscriber record from the SGSN. It may be invoked automatically when an MS moves from one SGSN area to another, to remove the subscriber record from the old SGSN, or by the HLR operator to enforce a location updating from the SGSN to the HLR.

The MAP_CANCEL_LOCATION service is a confirmed service using the primitives defined in table 8.1/3.

8.1.3.2 Service primitives

Table 8.1/3: MAP_CANCEL_LOCATION

Parameter name	Request	Indication	Response	Confirm
Invoke Id	M	M(=)	M(=)	M(=)
IMSI	M	M(=)		
LMSI	C	C(=)		
Cancellation Type	C	C(=)		
User error			C	C(=)
Provider error				O

8.1.3.3 Parameter definitions and use

Invoke Id

See definition in clause 7.6.1.

IMSI

See definition in clause 7.6.2.

LMSI

See definition in clause 7.6.2. The LMSI shall be included if it has been received from VLR. LMSI is not applicable between SGSN and HLR.

Value 0000 0000 can be used to indicate that the LMSI is not in use.

Cancellation Type

See definition in clause 7.6.3. The presence of this parameter is mandatory when the Cancel Location is sent to the SGSN. If the VLR receives this parameter and do not understand it the VLR shall ignore it.

User error

If the cancellation fails, an error cause is to be returned by the VLR or by the SGSN. One of the following error causes defined in clause 7.6.1 shall be used:

- unexpected data value;
- data missing.

Provider error

For definition of provider errors see clause 7.6.1.

8.1.4 MAP_SEND_IDENTIFICATION service

8.1.4.1 Definition

The MAP_SEND_IDENTIFICATION service is used between a VLR and a previous VLR to retrieve IMSI and authentication data for a subscriber registering afresh in that VLR.

The MAP_SEND_IDENTIFICATION service is a confirmed service using the service primitives defined in table 8.1/4.

8.1.4.2 Service primitives

Table 8.1/4: MAP_SEND_IDENTIFICATION

Parameter name	Request	Indication	Response	Confirm
Invoke Id	M	M(=)	M(=)	M(=)
TMSI	M	M(=)		
Number of requested vectors	M	M(=)		
Segmentation prohibited indicator	C	C(=)		
IMSI			C	C(=)
Authentication set			U	C(=)
Current Security Context			U	C(=)
User error			C	C(=)
Provider error				O

8.1.4.3 Parameter definitions and use

Invoke Id

See definition in clause 7.6.1.

TMSI

See definition in clause 7.6.2.

Number of requested vectors

A number indicating how many authentication vectors the new VLR is prepared to receive. The previous VLR shall not return more vectors than indicated by this parameter.

Segmentation prohibited indicator

This parameter indicates if the new VLR or SGSN allows message segmentation.

IMSI

See definition in clause 7.6.2. The IMSI is to be returned if the service succeeds.

Authentication set

See definition in clause 7.6.7. If the service succeeds a list of up to five authentication sets is returned, if there are any available.

Current Security Context

See definition in clause 7.6.7. If the service succeeds, a list of either GSM or UMTS Security Context parameters can be returned.

User error

This parameter is mandatory if the service fails. The following error cause defined in clause 7.6.1 may be used, depending on the nature of the fault:

- unidentified subscriber.

Provider error

For definition of provider errors see clause 7.6.1.

8.1.5 Void

8.1.5.1 Void

8.1.5.2 Void

8.1.5.3 Void

8.1.6 MAP_PURGE_MS service

8.1.6.1 Definition

This service is used between the VLR and the HLR to cause the HLR to mark its data for an MS so that any request for routing information for a mobile terminated call or a mobile terminated short message will be treated as if the MS is not reachable. It is invoked when the subscriber record for the MS is to be deleted in the VLR, either by MMI interaction or automatically, e.g. because the MS has been inactive for several days. This service shall not be used if both the VLR and HLR support the Super-Charger functionality.

Also this service is used between the SGSN and the HLR to cause the HLR to mark its data for an MS so that any request for routing information for a mobile terminated short message or a network requested PDP-context activation will be treated as if the MS is not reachable. It is invoked when the subscriber record for the MS is to be deleted in the SGSN, either by MMI interaction or automatically, e.g. because the MS has been inactive for several days. This service shall not be used if both the SGSN and HLR support the Super-Charger functionality.

The MAP_PURGE_MS service is a confirmed service using the primitives defined in table 8.1/6.

8.1.6.2 Service primitives

Table 8.1/6: MAP_PURGE_MS

Parameter name	Request	Indication	Response	Confirm
Invoke Id	M	M(=)	M(=)	M(=)
IMSI	M	M(=)		
VLR number	C	C(=)		
Freeze TMSI			C	C(=)
Freeze P-TMSI			C	C(=)
SGSN number	C	C(=)		
User error			C	C(=)
Provider error				O

8.1.6.3 Parameter definitions and use

Invoke ID

See definition in clause 7.6.1.

IMSI

See definition in clause 7.6.2.

VLR number

Shall be present if the sender is VLR. See definition in clause 7.6.2.

SGSN number

Shall be present if the sender is SGSN. See definition in clause 7.6.2.

Freeze TMSI

This parameter is sent to the VLR to indicate that the TMSI has to be frozen. It shall be present if the received VLR number matches the stored VLR number.

Freeze P-TMSI

This parameter is sent to the SGSN to indicate that the P-TMSI has to be frozen. It shall be present if the received SGSN number matches the stored SGSN number.

User error

This parameter is sent by the responder when an error is detected and if present, takes one of the following values:

- Data Missing;
- Unexpected Data Value;
- Unknown Subscriber.

Provider error

See definition of provider errors in clause 7.6.1.

8.1.7 MAP_UPDATE_GPRS_LOCATION service

8.1.7.1 Definition

This service is used by the SGSN to update the location information stored in the HLR.

The MAP_UPDATE_GPRS_LOCATION service is a confirmed service using the service primitives given in table 8.1/7.

8.1.7.2 Service primitives

Table 8.1/7: MAP_UPDATE_GPRS_LOCATION

Parameter name	Request	Indication	Response	Confirm
Invoke Id	M	M(=)	M(=)	M(=)
IMSI	M	M(=)		
SGSN number	M	M(=)		
SGSN address	M	M(=)		
Supported CAMEL Phases	C	C(=)		
SoLSA Support Indicator	C	C(=)		
Super-Charger Supported in Serving Network Entity	C	C(=)		
GPRS enhancements support indicator	C	C(=)		
Supported LCS Capability Sets	C	C(=)		
Supported CAMEL 4 Subsets	C	C(=)		
Inform Previous Network Entity	C	C(=)		
PS LCS Not Supported by UE	C	C(=)		
HLR number			C	C(=)
User error			C	C(=)
Provider error				O

8.1.7.3 Parameter definitions and use

Invoke Id

See definition in clause 7.6.1.

IMSI

See definition in clause 7.6.2.

SGSN number

See definition in clause 7.6.2.

SGSN address

See definition in clause 7.6.2.

Supported CAMEL Phases

This parameter indicates which phases of CAMEL are supported. The SGSN can only support CAMEL phase 3 or greater.

SoLSA Support Indicator

This parameter is used by the SGSN to indicate to the HLR in the Update GPRS Location indication that SoLSA is supported. If this parameter is not included in the Update GPRS Location indication and the Subscriber is marked as only allowed to roam in Subscribed LSAs, then the HLR shall reject the roaming and indicate to the SGSN that roaming is not allowed to that Subscriber in the SGSN.

This SoLSA Support Indicator shall be stored by the HLR per SGSN where there are Subscribers roaming. If a Subscriber is marked as only allowed to roam in Subscribed LSAs while roaming in a SGSN and no SoLSA Support indicator is stored for that SGSN, the location status of that Subscriber has to be set to Restricted.

Super-Charger Supported in Serving Network Entity

This parameter is used by the SGSN to indicate to the HLR that the SGSN supports the Super-Charger functionality and whether subscription data has been retained by the SGSN. If subscription data has been retained by the SGSN the age indicator shall be included. Otherwise the SGSN shall indicate that subscriber data is required.

If this parameter is absent then the SGSN does not support the Super-Charger functionality.

GPRS enhancements support indicator

This parameter is used by the SGSN to indicate to the HLR in the Update GPRS Location indication that GPRS enhancements are supported. If this parameter is included in the Update GPRS Location indication the HLR may send the extensible QoS in the PDP contexts to the SGSN.

HLR number

See definition in clause 7.6.2. The presence of this parameter is mandatory in case of successful HLR updating.

Supported LCS Capability Sets

This parameter indicates, if present, the capability sets of LCS which are supported. If the parameter is sent but no capability set is marked as supported then the SGSN does not support LCS at all.

The SGSN is not allowed to indicate support for LCS capability set 1.

If this parameter is absent then the SGSN does not support LCS at all.

Supported CAMEL 4 Subsets

This parameter indicates the CAMEL phase 4 subsets supported in the SGSN (see clause 7.6.3.36D).

Inform Previous Network Entity

This parameter is used by the SGSN to ask the HLR to inform the previous network entity about the update by sending the previous network entity a Cancel Location message. It is used in case Super-Charger is supported in the network and the serving network entity has not been able to inform the previous network entity that MS has moved, that is if it has not sent SGSN Context Request to the previous serving entity.

PS LCS Not Supported by UE

See definition in clause 7.6.11.

User error

In case of unsuccessful updating, an error cause shall be returned by the HLR. The following error causes defined in clause 7.6.1 may be used, depending on the nature of the fault:

- unknown subscriber;
- roaming not allowed.

This cause will be sent if the MS is not allowed to roam into the PLMN indicated by the SGSN number. The cause is qualified by the roaming restriction reason "PLMN Not Allowed" or "Operator Determined Barring".

- system failure;
- unexpected data value.

The diagnostic in the Unknown Subscriber may indicate "Imsi Unknown" or "Gprs Subscription Unknown".

Provider error

For definition of provider errors see clause 7.6.1.

8.1.8 MAP-NOTE-MM-EVENT

8.1.8.1 Definition

This service is used between the VLR and the gsmSCF or between the SGSN and the gsmSCF when a mobility management event for a subscriber has been processed successfully, that subscriber is provisioned with M-CSI or MG-CSI and the relevant mobility management event is marked for reporting.

8.1.8.2 Service primitives

The service primitives are shown in table 8.1/8.

Table 8.1/8: MAP_NOTE_MM_EVENT parameters

Parameter name	Request	Indication	Response	Confirm
Invoke id	M	M(=)	M(=)	M(=)
Event Met	M	M(=)		
Service Key	M	M(=)		
IMSI	M	M(=)		
Basic MSISDN	M	M(=)		
Location Information for GPRS	C	C(=)		
Location Information	C	C(=)		
LSA Identity	C	C(=)		
Supported CAMEL Phases	M	M(=)		
Supported CAMEL 4 Subsets	C	C(=)		
User error			C	C(=)
Provider error				O

8.1.8.3 Parameter use

Event Met

This parameter indicates the mobility management event that has lead to the notification. It shall have one of the following values for a mobility management event reported by the VLR:

- Location update in the same VLR service area;
- Location update to another VLR service area;
- IMSI attach;
- MS initiated IMSI detach (explicit detach);
- Network initiated IMSI detach (implicit detach).

It shall have one of the following values for a mobility management event reported by the SGSN:

- Routeing area update in the same SGSN service area;
- Routeing area update to another SGSN service area;
- GPRS attach;
- MS initiated GPRS detach;
- Network initiated GPRS detach;
- Network initiated transfer to the "not reachable for paging" state.

Service Key

See clause 7.6.x.

IMSI

See clause 7.6.x.

Basic MSISDN

See clause 7.6.x.

Location Information

See clause 7.6.2.30. This information shall be sent when the event is reported by a VLR, if available.

Location Information for GPRS

See clause 7.6.2.30a. This information shall be sent when the event is reported by an SGSN, if available.

LSA Identity

See clause 7.6.x. This information shall be sent, if available.

Supported CAMEL Phases

See clause 7.6.x. This information shall always be sent.

Supported CAMEL 4 Subsets

This parameter indicates the CAMEL phase 4 subsets supported by the sending entity, VMSC/VLR or SGSN (see clause 7.6.3.36D).

User error

This parameter is sent by the receiving entity when an error is detected. It shall have one of the following values:

- Data Missing;
- Unexpected Data Value;
- Unknown Subscriber;
- MM-EventNotSupported.

Provider error

This is defined in clause 7.6.1.

8.2 Paging and search

8.2.1 MAP_PAGE service

8.2.1.1 Definition

This service is used between VLR and MSC to initiate paging of an MS for mobile terminated call set-up, mobile terminated short message or unstructured SS notification.

The MAP_PAGE service is a confirmed service using the primitives from table 8.2/1.

8.2.1.2 Service primitives

Table 8.2/1: MAP_PAGE

Parameter name	Request	Indication	Response	Confirm
Invoke Id	M	M(=)	M(=)	M(=)
IMSI	M	M(=)		
Stored location area Id	M	M(=)		
TMSI	U	C(=)		
User error			C	C(=)
Provider error				O

8.2.1.3 Parameter definitions and use

Invoke Id

See definition in clause 7.6.1.

IMSI

See definition in clause 7.6.2. The IMSI is used to define the paging subgroup. If the TMSI is not supplied, paging on the radio path uses the IMSI as an identifier.

Stored location area Id

See definition in clause 7.6.2.

TMSI

See definition in clause 7.6.2. The TMSI is included if paging on the radio channel is to use the TMSI as an identifier.

User error

The following error causes defined in clause 7.6.1 may be sent by the user in case of a paging error, depending on the failure reason:

- absent subscriber;
- unknown location area;
- busy subscriber;
- system failure;
- this corresponds to the case where there is no call associated with the MAP_PAGE service, i.e. if the call has been released but the dialogue to the VLR has not been aborted;
- unexpected data value.

Provider error

See definition in clause 7.6.1.

8.2.2 MAP_SEARCH_FOR_MS service

8.2.2.1 Definition

This service is used between VLR and MSC to initiate paging of an MS in all location areas of that VLR. It is used if the VLR does not hold location area information confirmed by radio contact.

The MAP_SEARCH_FOR_MS service is a confirmed service using the primitives from table 8.2/2.

8.2.2.2 Service primitives

Table 8.2/2: MAP_SEARCH_FOR_MS

Parameter name	Request	Indication	Response	Confirm
Invoke Id	M	M(=)	M(=)	M(=)
IMSI	M	M(=)		
Current location area Id			C	C(=)
User error			C	C(=)
Provider error				O

8.2.2.3 Parameter definitions and use

Invoke Id

See definition in clause 7.6.1.

IMSI

See definition in clause 7.6.2. The IMSI is used to identify the subscriber when paging on the radio path.

Current location area Id

See definition in clause 7.6.2. In case of successful outcome of the service, i.e. if the MS responds to paging, the Location Area Id of the area in which the MS responded is given in the response.

User error

The following error causes defined in clause 7.6.1 shall be sent by the user if the search procedure fails, depending on the failure reason:

- absent subscriber;
this error cause is returned by the MSC if the MS does not respond to the paging request;
- system failure;
- this corresponds to the case where there is no call associated with the MAP_SEARCH_FOR_MS service, i.e. if the call has been released but the dialogue to the VLR has not been aborted;
- busy subscriber;
- unexpected data value.

Provider error

See definition in clause 7.6.1.

8.3 Access management services

8.3.1 MAP_PROCESS_ACCESS_REQUEST service

8.3.1.1 Definition

This service is used between MSC and VLR to initiate processing of an MS access to the network, e.g. in case of mobile originated call set-up or after being paged by the network.

The MAP_PROCESS_ACCESS_REQUEST service is a confirmed service using the primitives from table 8.3/1.

8.3.1.2 Service primitives

Table 8.3/1: MAP_PROCESS_ACCESS_REQUEST

Parameter name	Request	Indication	Response	Confirm
Invoke Id	M	M(=)	M(=)	M(=)
CM service type	M	M(=)		
Access connection status	M	M(=)		
Current Location Area Id	M	M(=)		
Serving cell Id	M	M(=)		
TMSI	C	C(=)		
Cksn	C	C(=)		
IMSI	C	C(=)	C	C(=)
IMEI	C	C(=)	C	C(=)
MSISDN			U	C(=)
User error			C	C(=)
Provider error				O

8.3.1.3 Parameter definitions and use

Invoke Id

See definition in clause 7.6.1.

CM service type

See definition in clause 7.6.9.

Access connection status

See definition in clause 7.6.9.

Current Location Area Id

See definition in clause 7.6.2. This parameter is used to update the VLR in case of previous VLR failure.

Serving cell Id

See definition in clause 7.6.2.

TMSI

See definition in clause 7.6.2. Either TMSI or IMSI as received from the MS are included in the Request/Indication, but one shall be present. In case of CM Service Type "Emergency Call Establishment", the IMEI may replace IMSI/TMSI.

Cksn

See definition in clause 7.6.7. In case of access with TMSI, the Cksn shall be present.

IMSI

See definition in clause 7.6.2. Either TMSI or IMSI as received from the MS are included in the Request/Indication, but one shall be present. In case of CM Service Type "Emergency Call Establishment", the IMEI may replace IMSI/TMSI.

In the Response/Confirmation, the IMSI is to be sent in case of successful outcome of the service. In case of CM Service Type "Emergency Call Establishment", IMEI may replace IMSI.

IMEI

See definition in clause 7.6.2. The IMEI may replace IMSI/TMSI in the Request/Indication and IMSI in the Response/Confirmation only in case the CM Service Type indicates "Emergency Call Establishment".

MSISDN

See definition in clause 7.6.2. The MSISDN is included in case of successful outcome of the service as an operator option, e.g. if it is needed at the MSC for charging purposes in case of call forwarding.

User error

One of the following error causes defined in clause 7.6.1 shall be sent by the user if the access request fails, depending on the failure reason:

- unidentified subscriber;
- illegal subscriber;
this error is sent if a correlated authentication procedure has not authenticated the subscriber;
- illegal equipment;
this error is sent if an IMEI check failed, i.e. the IMEI is blacklisted or not white-listed;
- roaming not allowed;

- this cause is used after VLR restart if the subscriber has no subscription for the current location area, e.g. due to regional subscription. The cause will be qualified by "location area not allowed" or "national roaming not allowed", respectively;
- unknown location area;
- system failure;
- unexpected data value.

Provider error

For definition of provider errors see clause 7.6.1.

8.4 Handover services

It should be noted that the handover services used on the B-interface have not been updated for Release 99. The B-interface is not fully operational specified. It is strongly recommended not to implement the B-interface as an external interface.

8.4.1 MAP_PREPARE_HANDOVER service

8.4.1.1 Definition

This service is used between MSC-A and MSC-B (E-interface) when a call is to be handed over or relocated from MSC-A to MSC-B.

The MAP_PREPARE_HANDOVER service is a confirmed service using the primitives from table 8.4/1.

8.4.1.2 Service primitives

Table 8.4/1: MAP_PREPARE_HANDOVER

Parameter name	Request	Indication	Response	Confirm
Invoke Id	M	M(=)	M(=)	M(=)
Target Cell Id	C	C(=)		
Target RNC Id	C	C(=)		
HO-NumberNotRequired	C	C(=)		
IMSI	C	C(=)		
Integrity Protection Information	C	C(=)		
Encryption Information	C	C(=)		
Radio Resource Information	C	C(=)		
AN-APDU	C	C(=)	C	C(=)
Allowed GSM Algorithms	C	C(=)		
Allowed UMTS Algorithms	C	C(=)		
Radio Resource List	C	C(=)		
RAB ID	C	C(=)		
BSSMAP Service Handover	C	C(=)		
RANAP Service Handover	C	C(=)		
Handover Number			C	C(=)
Relocation Number List			C	C(=)
Multicall Bearer Information			C	C(=)
Multiple Bearer Requested	C	C(=)		
Multiple Bearer Not Supported			C	C(=)
Selected UMTS Algorithms			C	C(=)
Chosen Radio Resource Information			C	C(=)
User error			C	C(=)
Provider error				O

8.4.1.3 Parameter use

Invoke Id

For definition of this parameter see clause 7.6.1.

Target Cell Id

For definition of this parameter see clause 7.6.2. This parameter is only included if the service is not in an ongoing transaction. This parameter shall also be excluded if the service is a part of the Inter-MSC SRNS Relocation procedure or the inter-system handover GSM to UMTS procedure described in 3G TS 23.009.

Target RNC Id

For definition of this parameter see clause 7.6.2. This parameter shall be included if the service is a part of the Inter-MSC SRNS Relocation procedure or the inter-system handover GSM to UMTS procedure described in 3G TS 23.009.

HO-Number Not Required

For definition of this parameter see clause 7.6.6.

IMSI

For definition of this parameter see clause 7.6.2. This UMTS parameter shall be included if:

- available and
- if the access network protocol is BSSAP and
- there is an indication that the MS also supports UMTS.

Integrity Protection Information

For definition of this parameter see clause 7.6.6. This UMTS parameter shall be included if available and if the access network protocol is BSSAP.

Encryption Information

For definition of this parameter see clause 7.6.6. This UMTS parameter shall be included if available and if the access network protocol is BSSAP.

Radio Resource Information

For definition of this parameter see clause 7.6.6. This GSM parameter shall be included if the access network protocol is RANAP and there is an indication that the UE also supports GSM. If the parameter Radio Resource List is sent, the parameter Radio Resource Information shall not be sent.

AN-APDU

For definition of this parameter see clause 7.6.9.

Allowed GSM Algorithms

For definition of this parameter see clause 7.6.6. This parameter includes allowed GSM algorithms. This GSM parameter shall be included if:

- the service is a part of the Inter-MSC SRNS Relocation procedure and
- Ciphering or Security Mode Setting procedure has been performed, and
- there is an indication that the UE also supports GSM.

Allowed UMTS Algorithms

For definition of this parameter see clause 7.6.6. This UMTS parameter shall be included if all of the following conditions apply:

- access network protocol is BSSAP and
- Integrity Protection Information and Encryption Information are not available and

Ciphering or Security Mode Setting procedure has been performed.

Radio Resource List

For definition of this parameter see clause 7.6.6. This parameter shall be included if the access network protocol is RANAP and there is an indication that the UE also supports GSM. This parameter shall be sent when MSC-A requests multiple bearers to MSC-B. If the parameter Radio Resource Information is sent, the parameter Radio Resource List shall not be sent.

RAB ID

For definition of this parameter see subclause 7.6.2. This parameter shall be included when MSC-A supports multiple bearers and access network protocol is BSSAP and the RAB ID has a value other than 1.

BSSMAP Service Handover

For definition of this parameter see clause 7.6.6. It shall be present if it is available.

RANAP Service Handover

For definition of this parameter see clause 7.6.6. It shall be present if it is available.

Handover Number

For definition of this parameter see clause 7.6.2. This parameter shall be returned at handover, unless the parameter HO-NumberNotRequired is sent. If the parameter Handover Number is returned, the parameter Relocation Number List shall not be returned.

Relocation Number List

For definition of this parameter see clause 7.6.2. This parameter shall be returned at relocation, unless the parameter HO-NumberNotRequired is sent. If the parameter Relocation Number List is returned, the parameter Handover Number shall not be returned.

Multicall Bearer Information

For a definition of this parameter see clause 7.6.2. This parameter shall be returned at relocation in the case that MSC-B supports multiple bearers.

Multiple Bearer Requested

For a definition of this parameter see clause 7.6.2. This parameter shall be sent when MSC-A requests multiple bearers to MSC-B.

Multiple Bearer Not Supported

For a definition of this parameter see clause 7.6.2. This parameter shall be returned at relocation when MSC-B receives Multiple Bearer Requested parameter and MSC-B does not support multiple bearers.

Selected UMTS Algorithms

For definition of this parameter see clause 7.6.6. This parameter includes the UMTS integrity and optionally encryption algorithms selected by RNC under the control of MSC-B. This UMTS parameter shall be included if the service is a part of the inter MSC inter system handover from GSM to UMTS.

Chosen Radio Resource Information

For definition of this parameter see clause 7.6.6. This parameter shall be returned at relocation if the encapsulated PDU is RANAP RAB Assignment Response and MS is in GSM access.

User error

For definition of this parameter see clause 7.6.1. The following errors defined in clause 7.6.1 may be used, depending on the nature of the fault:

- No handover number available.
- Target cell outside group call area;
- System failure.
- Unexpected data value.
- Data Missing.

Provider error

See definition of provider errors in clause 7.6.1.

8.4.2 MAP_SEND_END_SIGNAL service

8.4.2.1 Definition

This service is used between MSC-B and MSC-A (E-interface) indicating that the radio path has been established by MSC-B to the MS. MSC-A retains then the main control of the call until it clears.

The response is used by MSC-A to inform MSC-B that all resources for the call can be released in MSC-B, either because the call has been released in MSC-A or because the call has been successfully handed over or relocated from MSC-B to another MSC.

The MAP_SEND_END_SIGNAL service is a confirmed service using the primitives from table 8.4/2.

8.4.2.2 Service primitives

Table 8.4/2: MAP_SEND_END_SIGNAL

Parameter name	Request	Indication	Response	Confirm
Invoke Id	M	M(=)	M(=)	M(=)
AN-APDU	M	M(=)		
Provider error				O

8.4.2.3 Parameter use

Invoke Id

For definition of this parameter see clause 7.6.1.

AN-APDU

For definition of this parameter see clause 7.6.9.

Provider error

For definition of this parameter see clause 7.6.1.

8.4.3 MAP_PROCESS_ACCESS_SIGNALLING service

8.4.3.1 Definition

This service is used between MSC-B and MSC-A (E-interface) to pass information received on the A-interface or Iu-interface in MSC-B to MSC-A.

The MAP_PROCESS_ACCESS_SIGNALLING service is a non-confirmed service using the primitives from table 8.4/3.

8.4.3.2 Service primitives

Table 8.4/3: MAP_PROCESS_ACCESS_SIGNALLING

Parameter name	Request	Indication
Invoke Id	M	M(=)
AN-APDU	M	M(=)
Selected GSM Algorithm	C	C(=)
Selected UMTS Algorithms	C	C(=)
Chosen Radio Resource Information	C	C(=)
Selected RAB id	C	C(=)

8.4.3.3 Parameter use

Invoke Id

For definition of this parameter see clause 7.6.1.

AN-APDU

For definition of this parameter see clause 7.6.9.

Selected GSM algorithm

For definition of this parameter see clause 7.6.6. This parameter shall be present if the encapsulated PDU is Security Mode Complete and MS is in GSM access.

Selected UMTS Algorithms

For definition of this parameter see clause 7.6.6. This parameters includes the UMTS integrity and optionally encryption algorithms selected by RNC under the control of MSC-B. This UMTS parameter shall be included if the encapsulated PDU is BSSMAP Cipher Mode Complete and the MS is in UMTS, or an interystem handover to UMTS is performed in MSC-B, or in the case of intra MSC-B intra UMTS relocation.

Chosen Radio Resource Information

For definition of this parameter see clause 7.6.6. This parameter shall be sent if the encapsulated PDU is RANAP RAB Assignment Response and MS is in GSM access.

Selected RAB ID

The selected radio access bearer that was kept at subsequent intra-MSC handover from UMTS to GSM after multiple bearers were used.

8.4.4 MAP_FORWARD_ACCESS_SIGNALLING service

8.4.4.1 Definition

This service is used between MSC-A and MSC-B (E-interface) to pass information to be forwarded to the A-interface or Iu-interface of MSC-B.

The MAP_FORWARD_ACCESS_SIGNALLING service is a non-confirmed service using the primitives from table 8.4/4.

8.4.4.2 Service primitives

Table 8.4/4: MAP_FORWARD_ACCESS_SIGNALLING

Parameter name	Request	Indication
Invoke Id	M	M(=)
Integrity Protection Information	C	C(=)
Encryption Information	C	C(=)
Key Status	C	C(=)
AN-APDU	M	M(=)
Allowed GSM Algorithms	C	C(=)
Allowed UMTS Algorithms	C	C(=)
Radio Resource Information	C	C(=)
Radio Resource List	C	C(=)
BSSMAP Service Handover	C	C(=)
RANAP Service Handover	C	C(=)

8.4.4.3 Parameter use

For the definition and use of all parameters and errors, see clause 7.6.1.

Invoke Id

For definition of this parameter see clause 7.6.1.

Integrity Protection Information

For definition of this parameter see clause 7.6.6. This UMTS parameter shall be included if available and if the encapsulated PDU is BSSMAP Cipher Mode Command.

Encryption Information

For definition of this parameter see clause 7.6.6. This UMTS parameter shall be included if available and if the encapsulated PDU is BSSMAP Cipher Mode Command.

Key Status

For definition of this parameter see clause 7.6.6. This UMTS parameter shall be included if available and if the encapsulated PDU is BSSMAP Cipher Mode Command.

AN-APDU

For definition of this parameter see clause 7.6.9.

Allowed GSM Algorithms

This parameters includes allowed GSM algorithms. This GSM parameter shall be included if the encapsulated PDU is RANAP Security Mode Command and there is an indication that the UE also supports GSM.

Allowed UMTS Algorithms

For definition of this parameter see clause 7.6.6. This UMTS parameter shall be included if Integrity Protection Information and Encryption Information are not available and the encapsulated PDU is BSSMAP Cipher Mode Command.

Radio Resource Information

For definition of this parameter see clause 7.6.6. This parameter shall be sent if the encapsulated PDU is RANAP RAB Assignment Request. If the parameter Radio Resource List is sent, the parameter Radio Resource Information shall not be sent.

Radio Resource List

For definition of this parameter see clause 7.6.6. This parameter shall be sent if the encapsulated PDU is RANAP RAB Assignment Request and MSC-A requests modification of multiple bearers. If the parameter Radio Resource Information is sent, the parameter Radio Resource List shall not be sent.

BSSMAP Service Handover

For definition of this parameter see clause 7.6.6. It shall be present if it is available and the encapsulated PDU is RANAP RAB Assignment Request or BSSMAP Assignment Request.

RANAP Service Handover

For definition of this parameter see clause 7.6.6.. It shall be present if it is available and the encapsulated PDU is BSSMAP Assignment Request or RANAP RAB Assignment Request.

8.4.5 MAP_PREPARE_SUBSEQUENT_HANOVER service

8.4.5.1 Definition

This service is used between MSC-B and MSC-A (E-interface) to inform MSC-A that it has been decided that a handover or relocation to either MSC-A or a third MSC (MSC-B') is required.

The MAP_PREPARE_SUBSEQUENT_HANOVER service is a confirmed service using the primitives from table 8.4/5.

8.4.5.2 Service primitives

Table 8.4/5: MAP_PREPARE_SUBSEQUENT_HANOVER

Parameter name	Request	Indication	Response	Confirm
Invoke Id	M	M(=)	M(=)	M(=)
Target Cell Id	C	C(=)		
Target RNC Id	C	C(=)		
Target MSC Number	M	M(=)		
Selected RAB ID	C	C(=)		
AN-APDU	M	M(=)	C	C(=)
User error			C	C(=)
Provider error				O

8.4.5.3 Parameter use

Invoke Id

For definition of this parameter see clause 7.6.1.

Target Cell Id

For definition of this parameter see clause 7.6.2. This parameter shall be excluded if the service is a part of the Inter-MSC SRNS Relocation procedure or the inter-system handover GSM to UMTS procedure described in 3G TS 23.009.

Target RNC Id

For definition of this parameter see clause 7.6.2. This parameter shall be included if the service is a part of the Inter-MSC SRNS Relocation procedure or the inter-system handover GSM to UMTS procedure described in 3G TS 23.009.

Target MSC Number

For definition of this parameter see clause 7.6.2.

Selected RAB ID

For definition of this parameter see clause 7.6.2.

AN-APDU

For definition of this parameter see clause 7.6.9.

User error

For definition of this parameter see clause 7.6.1. The following error causes defined in clause 7.6.1 may be used, depending on the nature of the fault:

- Unknown MSC;
- Subsequent handover failure;
- Unexpected data value;
- Data Missing.

Provider error

For definition of this parameter see clause 7.6.1.

8.4.6 MAP_ALLOCATE_HANOVER_NUMBER service

8.4.6.1 Definition

This service is used between MSC and VLR (B-interface) to request a handover number.

The MAP_ALLOCATE_HANOVER_NUMBER service is a confirmed service using the primitives from table 8.4/6.

8.4.6.2 Service primitives

Table 8.4/6: MAP_ALLOCATE_HANOVER_NUMBER

Parameter name	Request	Indication	Response	Confirm
Invoke Id	M	M(=)	M(=)	M(=)
User error			C	C(=)
Provider error				O

8.4.6.3 Parameter use

Invoke Id

For definition of this parameter see clause 7.6.1.

User error

For definition of this parameter see clause 7.6.1. The following errors defined in clause 7.6.1 may be used, depending on the nature of the fault:

- No handover number available.

Provider error

For definition of this parameter see clause 7.6.1.

8.4.7 MAP_SEND_HANOVER_REPORT service

8.4.7.1 Definition

This service is used between VLR and MSC-B (B-interface) to transfer the handover number to be forwarded to and used by MSC-A.

The MAP_SEND_HANOVER_REPORT service is a confirmed service using the primitives from table 8.4/7.

8.4.7.2 Service primitives

Table 8.4/7: MAP_SEND_HANOVER_REPORT

Parameter name	Request	Indication	Response	Confirm
Invoke Id	M	M(=)	M(=)	M(=)
Handover Number	M	M(=)		
Linked Id	M	M(=)		
Provider error				O

8.4.7.3 Parameter use

Invoke Id

For definition of this parameter see clause 7.6.1.

Handover Number

For definition of this parameter see clause 7.6.2.

Linked Id

For definition of this parameter see clause 7.6.1. This service is linked with MAP_ALLOCATE_HANOVER_NUMBER.

Provider error

For definition of this parameter see clause 7.6.1.

8.5 Authentication management services

8.5.1 MAP_AUTHENTICATE service

The MAP_AUTHENTICATE service is used on the MAP B interface. This interface is not fully operational specified. It is strongly recommended not to implement the B-interface as an external interface.

8.5.1.1 Definition

This service is used between the VLR and the MSC when the VLR receives a MAP service indication from the MSC concerning a location registration, call set-up, operation on a supplementary service or a request from the MSC to initiate authentication.

The service is a confirmed service and consists of four service primitives.

8.5.1.2 Service primitives

The service primitives are shown in table 8.5/1.

Table 8.5/1: MAP_AUTHENTICATE parameters

Parameter name	Request	Indication	Response	Confirm
Invoke id	M	M(=)	M(=)	M(=)
RAND	M	M(=)		
CKSN	M	M(=)		
SRES			M	M(=)
Provider error				O

8.5.1.3 Parameter use

Invoke id

See clause 7.6.1 for the use of this parameter.

RAND

See clause 7.6.7 for the use of this parameter.

CKSN

See clause 7.6.7 for the use of this parameter.

SRES

See clause 7.6.7 for the use of this parameter.

Provider error

See clause 7.6.1 for the use of this parameter.

8.5.2 MAP_SEND_AUTHENTICATION_INFO service

8.5.2.1 Definition

This service is used between the VLR and the HLR for the VLR to retrieve authentication information from the HLR. The VLR requests up to five authentication vectors.

Also this service is used between the SGSN and the HLR for the SGSN to retrieve authentication information from the HLR. The SGSN requests up to five authentication vectors.

If the user is a UMTS subscriber, the HLR shall return authentication quintuplets. If the user is a GSM subscriber, the HLR shall return authentication triplets.

If the HLR cannot provide the VLR or the SGSN with triplets, an empty response is returned. The VLR or the SGSN may then re-use old authentication triplets, except where this is forbidden under the conditions specified in 3GPP TS 43.020 [24].

If the HLR cannot provide the VLR or the SGSN with quintuplets, an empty response is returned. The VLR or the SGSN shall not re-use old authentication quintuplets.

If the VLR or SGSN receives a MAP_SEND_AUTHENTICATION_INFO response containing a User Error parameter as part of the handling of an authentication procedure, the authentication procedure in the VLR or SGSN shall fail.

Security related network functions are further described in 3GPP TS 43.020 [24] and 3G TS 33.200.

The service is a confirmed service and consists of four service primitives.

8.5.2.2 Service primitives

The service primitives are shown in table 8.5/2.

Table 8.5/2: MAP_SEND_AUTHENTICATION_INFO parameters

Parameter name	Request	Indication	Response	Confirm
Invoke id	M	M(=)	M(=)	M(=)
IMSI	C	C(=)		
Number of requested vectors	C	C(=)		
Requesting node type	C	C(=)		
Re-synchronisation Info	C	C(=)		
Segmentation prohibited indicator	C	C(=)		
Immediate response preferred indicator	U	C(=)		
AuthenticationSetList			C	C(=)
User error			C	C(=)

Provider error				O
----------------	--	--	--	---

8.5.2.3 Parameter use

Invoke id

See clause 7.6.1 for the use of this parameter.

IMSI

See clause 7.6.2 for the use of this parameter.

This parameter shall be present in the first (or only) request of the dialogue. If multiple service requests are present in a dialogue then this parameter shall not be present in any service request other than the first one.

Number of requested vectors

A number indicating how many authentication vectors the VLR or SGSN is prepared to receive. The HLR shall not return more vectors than indicated by this parameter.

This parameter shall be present in the first (or only) request of the dialogue. If multiple service requests are present in a dialogue then this parameter shall not be present in any service request other than the first one.

Requesting node type

The type of the requesting node (SGSN or VLR).

This parameter shall be present in the first (or only) request of the dialogue. If multiple service requests are present in a dialogue then this parameter shall not be present in any service request other than the first one.

Re-synchronisation Info

For definition and use of this parameter see 3G TS 33.200.

If multiple service requests are present in a dialogue then this parameter shall not be present in any service request other than the first one..

Segmentation prohibited indicator

This parameter indicates if the VLR or SGSN allows segmentation of the response at application level.

This parameter may be present only in the first request of the dialogue.

Immediate response preferred indicator

This parameter indicates that one of the requested authentication vectors is requested for immediate use in the VLR or SGSN. It may be used by the HLR together with the number of requested vectors and the number of vectors stored in the HLR to determine the number of vectors to be obtained from the AuC. It shall be ignored if the number of available vectors is greater than the number of requested vectors.

If multiple service requests are present in a dialogue then this parameter shall not be present in any service request other than the first one.

AuthenticationSetList

A set of one to five authentication vectors are transferred from the HLR to the VLR or from the HLR to the SGSN, if the outcome of the service was successful.

User error

One of the following error causes defined in clause 7.6.1 shall be sent by the user in case of unsuccessful outcome of the service, depending on the respective failure reason:

- unknown subscriber;
- unexpected data value;

- system failure;
- data missing.

Provider error

See clause 7.6.1 for the use of this parameter.

8.5.3 MAP_AUTHENTICATION_FAILURE_REPORT service

8.5.3.1 Definition

This service is used between the VLR and the HLR or between the SGSN or HLR for reporting of authentication failures.

8.5.3.2 Service primitives

The service primitives are shown in table 8.5/3.

Table 8.5/3: MAP_AUTHENTICATION_FAILURE_REPORT parameters

Parameter name	Request	Indication	Response	Confirm
Invoke id	M	M(=)	M(=)	M(=)
IMSI	M	M(=)		
Failure cause	M	M(=)		
Re-attempt	M	M(=)		
Access Type	M	M(=)		
Rand	M	M(=)		
VLR number	C	C(=)		
SGSN number	C	C(=)		
User error			C	C(=)
Provider error				O

8.5.3.3 Parameter use

Invoke id

See clause 7.6.1 for the use of this parameter.

IMSI

See clause 7.6.2 for the use of this parameter.

Failure Cause

See clause 7.6.7 for use of this parameter.

Re-attempt

See clause 7.6.7 for use of this parameter.

Access Type

See clause 7.6.7 for use of this parameter.

Rand

This parameter identifies the specific AV that failed authentication.

See clause 7.6.7 for use of this parameter.

VLR number

Shall be present if the sender is VLR. See definition in clause 7.6.2.

SGSN number

Shall be present if the sender is SGSN. See definition in clause 7.6.2.

User error

This parameter is sent by the responder upon unsuccessful outcome of the service, and then takes one of the following values defined in clause 7.6.1:

- Unknown Subscriber;
- System Failure;
- Unexpected Data Value.

Provider error

These are defined in clause 7.6.

8.6 Security management services

8.6.1 MAP_SET_CIPHERING_MODE service

8.6.1.1 Definitions

This service is used between the VLR and the MSC to set the ciphering mode and to start ciphering if applicable. It is called when another service requires that information is to be sent on the radio path in encrypted form.

The service is a non-confirmed service and consists of two service primitives.

8.6.1.2 Service primitives

The service primitives are shown in table 8.6/1.

Table 8.6/1: MAP_SET_CIPHERING_MODE parameters

Parameter name	Request	Indication
Invoke id	M	M(=)
Ciphering mode	M	M(=)
Kc	C	C(=)

8.6.1.3 Parameter use

Invoke id

See clause 7.6.1 for the use of this parameter.

Ciphering mode

See clause 7.6.7 for the use of this parameter.

Kc

The Kc parameter should be included when the ciphering mode parameter indicates that ciphering must be performed.

8.7 International mobile equipment identities management services

8.7.1 MAP_CHECK_IMEI service

8.7.1.1 Definition

This service is used between the VLR and the MSC and between the MSC and the EIR and between the SGSN and EIR to request check of IMEI. If the IMEI is not available in the MSC or in the SGSN, it is requested from the MS and transferred to the EIR in the service request.

The service is a confirmed service and consists of four service primitives.

8.7.1.2 Service primitives

The service primitives are shown in table 8.7/1.

Table 8.7/1: MAP_CHECK_IMEI parameters

Parameter name	Request	Indication	Response	Confirm
Invoke id	M	M(=)	M(=)	M(=)
IMEI	C	C(=)	C	C(=)
Equipment status			C	C(=)
User error			C	C(=)
Provider error				O

8.7.1.3 Parameter use

Invoke id

See clause 7.6.1 for the use of this parameter.

IMEI

See clause 7.6.2 for the use of this parameter. The parameter shall not be included in the service request between the VLR and the MSC, but is mandatory in the service request from the MSC to the EIR and from the SGSN to the EIR. It is not included in the service response from the EIR to the MSC or to the SGSN, but is mandatory in the service response from the MSC to the VLR on successful outcome.

Equipment status

See clause 7.6.4 for the use of this parameter. This parameter is sent by the responder in case of successful outcome of the service.

User error

One of the following error causes defined in clause 7.6.1 shall be sent by the user in case of unsuccessful outcome of the service, depending on the respective failure reason:

- unknown equipment;
this error is returned by the responder when the IMEI is not known in the EIR;
- system failure;
- unexpected data value.

Provider error

See clause 7.6.1 for the use of this parameter.

8.7.2 MAP_OBTAIN_IMEI service

8.7.2.1 Definition

This service is used between the VLR and the MSC to request the IMEI. If the IMEI is not available in the MSC, it is requested from the MS.

The service is a confirmed service and consists of four service primitives.

8.7.2.2 Service primitives

The service primitives are shown in table 8.7/2.

Table 8.7/2: MAP_OBTAIN_IMEI parameters

Parameter name	Request	Indication	Response	Confirm
Invoke id	M	M(=)	M(=)	M(=)
IMEI			C	C(=)
User error			C	C(=)
Provider error				O

8.7.2.3 Parameter use

Invoke id

See clause 7.6.1 for the use of this parameter.

IMEI

See clause 7.6.2 for the use of this parameter. The parameter is included in the service response from the MSC to the VLR on successful outcome of the service.

User error

If the service fails, the VLR sends the user error System Failure (see clause 7.6.1) to the MSC.

Provider error

See clause 7.6.1 for the use of this parameter.

8.8 Subscriber management services

8.8.1 MAP-INSERT-SUBSCRIBER-DATA service

8.8.1.1 Definition

This service is used by an HLR to update a VLR with certain subscriber data in the following occasions:

- the operator has changed the subscription of one or more supplementary services, basic services or data of a subscriber. Note that in case of withdrawal of a Basic or Supplementary service this primitive shall not be used;
- the operator has applied, changed or removed Operator Determined Barring;
- the subscriber has changed data concerning one or more supplementary services by using a subscriber procedure;
- the HLR provides the VLR with subscriber parameters at location updating of a subscriber or at restoration. In this case, this service is used to indicate explicitly that a supplementary service is not provisioned, if the supplementary service specification requires it. The only supplementary services which have this requirement are the CLIR and COLR services. Network access mode is provided only in restoration. If the Super-Charger

functionality is supported the HLR may not need to provide the VLR with subscriber parameters at location updating of a subscriber. See TS 23.116.

Also this service is used by an HLR to update an SGSN with certain subscriber data in the following occasions:

- if the GPRS subscription has changed;
- if the network access mode is changed;
- the operator has applied, changed or removed Operator Determined Barring;
- the subscriber has changed data concerning one or more supplementary services by using a subscriber procedure;
- the HLR provides the SGSN with subscriber parameters at GPRS location updating of a subscriber. If the Super-Charger functionality is supported the HLR may not need to provide the SGSN with subscriber parameters. See 3G TS 23.116.

It is a confirmed service and consists of the primitives shown in table 8.8/1.

8.8.1.2 Service primitives

Table 8.8/1: MAP-INSERT-SUBSCRIBER-DATA

Parameter name	Request	Indication	Response	Confirm
Invoke Id	M	M(=)	M(=)	M(=)
IMSI	C	C(=)		
MSISDN	C	C(=)		
Category	C	C(=)		
Subscriber Status	C	C(=)		
Bearer service List	C	C(=)	C	C(=)
Teleservice List	C	C(=)	C	C(=)
Forwarding information List	C	C(=)		
Call barring information List	C	C(=)		
CUG information List	C	C(=)		
SS-Data List	C	C(=)		
eMLPP Subscription Data	C	C(=)		
MC-Subscription Data	C	C(=)		
Operator Determined Barring General data	C	C(=)	C	C(=)
Operator Determined Barring HPLMN data	C	C(=)		
Roaming Restriction Due To Unsupported Feature	C	C(=)		
Regional Subscription Data	C	C(=)		
VLR CAMEL Subscription Info	C	C(=)		
Voice Broadcast Data	C	C(=)		
Voice Group Call Data	C	C(=)		
Network access mode	C	C(=)		
GPRS Subscription Data	C	C(=)		
Roaming Restricted In SGSN Due To Unsupported Feature	C	C(=)		
North American Equal Access preferred Carrier Id List	U	C(=)		
SGSN CAMEL Subscription Info	C	C(=)		
LSA Information	C	C(=)		
IST Alert Timer	C	C(=)		
SS-Code List			C	C(=)
LMU Identifier	C	C(=)		
LCS Information	C	C(=)		
CS Allocation/Retention priority	C	C(=)		
Super-Charger Supported In HLR	C	C(=)		
Regional Subscription Response			C	C(=)
Supported CAMEL Phases			C	C(=)
Supported CAMEL 4 Subsets			C	C(=)
User error			U	C(=)
Provider error				O

8.8.1.3 Parameter use

All parameters are described in clause 7.6. The following clarifications are applicable:

Network access mode

This parameter defines if the subscriber has access to MSC/VLR and/or to SGSN. This parameter is used by SGSN and MSC/VLR. In VLR, the parameter is used only as part of Restore Data Procedure and the parameter is not stored in the VLR. This parameter shall always be sent to the SGSN as part of the GPRS subscriber data at GPRS location updating. It shall be sent to the SGSN if it is changed as a result of administrative action.

IMSI

It is only included if the service is not used in an ongoing transaction (e.g. location updating). This parameter is used by the VLR and the SGSN.

MSISDN

It is included either at location updating or when it is changed. The MSISDN sent shall be the basic MSISDN. This parameter is used by the VLR and the SGSN.

Category

It is included either at location updating or when it is changed. This parameter is used only by the VLR and if the SGSN receives this parameter it shall ignore it.

Subscriber Status

It is included either at location updating or when it is changed.

To apply, remove or update Operator Determined Barring Categories the Subscriber Status is set to Operator Determined Barring. In this case ODB General Data shall also be present. If the Operator Determined Barring applies and the subscriber is registered in the HPLMN and HPLMN specific Operator Determined Barring applies then ODB HPLMN Specific Data shall also be present.

To remove all Operator Determined Barring Categories the Subscriber Status shall be set to "Service Granted". This parameter is used by the VLR and the SGSN.

Bearer service List

A list of Extensible Bearer service parameters (Extensible Bearer service is defined in clause 7.6). An Extensible Bearer service parameter must be the code for an individual Bearer service, except in the cases described below.

The codes for the Bearer service groups "allAlternateSpeech-DataCDA" and "allAlternateSpeech-DataCDS" shall, if applicable, be sent from the HLR to the VLR as a pair. The codes for the Bearer service groups "allSpeechFollowedByDataCDA" and "allSpeechFollowedByDataCDS" shall, if applicable, be sent from the HLR to the VLR as a pair.

If it is included in the Request/Indication, it includes either all Extensible Bearer services subscribed (at location updating or at restoration) or only the ones added (at subscriber data modification).

If the VLR receives an Indication containing any Extensible Bearer service parameters which it does not support/allocate it returns them in the response to the HLR and discards the unsupported Extensible Bearer services (no error is sent back), except in the cases described below.

If the VLR receives the codes for the Bearer service groups "allSpeechFollowedByDataCDA" and "allSpeechFollowedByDataCDS" and supports one or more of the circuit-switched synchronous or asynchronous data rates specified for simple data bearer services, it shall accept the bearer service codes, and not return them in the response to the HLR. If the VLR does not support any of the circuit-switched synchronous or asynchronous data rates specified for simple data bearer services, and receives the pair of codes for "allAlternateSpeech-DataCDA" and "allAlternateSpeech-DataCDS" or the pair of codes for "allSpeechFollowedByDataCDA" and "allSpeechFollowedByDataCDS", it shall reject the pair of codes by returning them in the response to the HLR. This parameter is used only by the VLR and if the SGSN receives this parameter it shall ignore it.

Teleservice List

A list of Extensible Teleservice parameters (Extensible Teleservice is defined in clause 7.6). An Extensible Teleservice parameter must be the code for an individual Teleservice.

If it is included in the Request/Indication, it contains either all Extensible Teleservices subscribed (at location updating or at restoration) or the ones added (at subscriber data modification). Only the Extensible Teleservices that are relevant to the node at which the message is received should be included in the Teleservice List.

If the VLR or the SGSN receives an Indication containing any Extensible Teleservice parameters which it does not support/allocate it returns them in the response to the HLR and discards the unsupported Extensible Teleservices (no error is sent back). This parameter is used by the VLR and the SGSN.

Forwarding information List

A list of Extensible Forwarding information parameters (Extensible Forwarding information is defined in clause 7.6). It includes Call Forwarding services either at location updating or at restoration or when they are changed. Each Extensible Forwarding information parameter shall be treated independently of all other parameters in the primitive.

The Extensible Forwarding information shall include the SS-Code for an individual call forwarding supplementary service. The Extensible Forwarding information shall contain one or more Extensible Forwarding Features (Extensible Forwarding Feature is defined in clause 7.6).

The Extensible Forwarding Feature may include an Extensible Basic Service Group. This shall be interpreted according to the rules in clause 8.8.1.4.

The Extensible Forwarding Feature shall contain an Extensible SS-Status parameter.

If the Extensible SS-Status indicates that call forwarding is registered then (except for call forwarding unconditional) the Extensible Forwarding Feature shall contain a number to define the forwarded-to destination and, if available, the forwarded-to subaddress. In other states the forwarded-to number and, if applicable, the forwarded-to subaddress shall not be included. For call forwarding unconditional the forwarded-to number and, if applicable, the forwarded-to subaddress shall not be included. If the VLR does not receive a forwarded-to subaddress then it shall assume that a forwarded-to subaddress has not been registered.

The Extensible Forwarding Feature shall contain the extensible forwarding options (except for call forwarding unconditional where the extensible forwarding options shall not be included). Bits 3 and 4 of the extensible forwarding options shall be ignored by the VLR, and may be set to any value by the HLR.

For call forwarding on no reply: If the extensible SS-Status indicates that call forwarding is registered then the Extensible Forwarding Feature shall contain an extensible no reply condition timer. In other states the no reply condition timer shall not be included.

For call forwarding services other than call forwarding on no reply: The Extensible Forwarding Feature shall not contain a no reply condition timer.

If the VLR receives an Indication containing any Call Forwarding service codes which it does not support/allocate it returns them to the HLR in the parameter SS-Code List and discards the unsupported Call Forwarding service codes (no error is sent back). This parameter is used only by the VLR and if the SGSN receives this parameter it shall ignore it.

Call barring information List

A list of Extensible Call barring information parameters (Extensible Call barring information is defined in clause 7.6). It includes Call Barring services either at location updating or at restoration or when they are changed. Each Extensible Call barring information parameter shall be treated independently of all other parameters in the primitive.

The Extensible Call barring information shall include the SS-Code for an individual call barring supplementary service. The Extensible Call barring information shall contain one or more Extensible Call Barring Features (Extensible Call Barring Feature is defined in clause 7.6).

The Extensible Call Barring Feature may include an Extensible Basic Service Group. This shall be interpreted according to the rules in clause 8.8.1.4.

The Extensible Call Barring Feature shall contain an extensible SS-Status parameter.

If the VLR receives an Indication containing any Extensible Call Barring service codes which it does not support/allocate it returns them to the HLR in the parameter SS-Code List and discards the unsupported Extensible Call

Barring service codes (no error is sent back). This parameter is used only by the VLR and if the SGSN receives this parameter it shall ignore it.

CUG information List

A list of CUG information list parameters (CUG information is defined in clause 7.6). It includes CUG information either at location updating or at restoration or when it is changed.

At location updating, restoration or when there is a change in CUG data, the HLR shall include the complete CUG-SubscriptionList and, if there are options per basic group, it shall also include the complete CUG-FeatureList. If there are not options per extensible basic service group the CUG-FeatureList shall not be included.

In any dialogue, the first insertSubscriberData message which contains CUG information shall include a non-empty CUG-SubscriptionList.

When the VLR receives CUG data it shall replace the stored CUG data with the received data set.

If CUG-FeatureList is omitted in the Insert Subscriber Data operation VLR shall interpret that no options per extensible basic service group exist, and then it shall apply the default values i.e. no outgoing access, no incoming access, no preferential CUG exists.

If CUG-Feature is received without preferential CUG, the VLR shall interpret that no preferential CUG applies.

If the VLR detects that there is overlapping in the information received within a dialogue, it shall send the error Unexpected Data Value.

Note that data consistency between CUG subscription data and CUG feature data is the responsibility of the HLR.

If the VLR does not support the CUG service it returns its code to the HLR in the parameter SS-Code List and discards the received information (no error is sent back). This parameter is used only by the VLR and if the SGSN receives this parameter it shall ignore it.

SS-Data List

A list of Extensible SS-Data parameters (Extensible SS-Data is defined in clause 7.6). It is sent for any other supplementary service than Call Forwarding, Call Barring, CUG and eMLPP either at location updating or at restoration or when they are changed. Each SS-Data parameter shall be treated independently of all other parameters in the primitive.

The Extensible SS-Data shall include the SS-Code for an individual supplementary service.

The Extensible SS-Data shall contain an Extensible SS-Status parameter and any subscription options that are applicable to the service defined by the SS-Code.

The SS-Data may include a Basic Service Group List. This shall be interpreted according to the rules in clause 8.8.1.4.

If the VLR receives an Indication containing any supplementary service codes which it does not support/allocate it returns them to the HLR in the parameter SS-Code List and therefore discards the unsupported service codes received (no error is sent back)

This parameter is used by the SGSN only for LCS. If the SGSN receives an Indication containing any LCS related supplementary service codes which it does not support/allocate it returns them to the HLR in the parameter SS-Code List and therefore discards the unsupported service codes received (no error is sent back). SS-codes not related to the supported LCS capability set shall be discarded.

Operator Determined Barring General data

If it is included in a Request/Indication, it includes all the Operator Determined Barring categories that may be applied to a subscriber registered in any PLMN. This parameter is only included in a Request/Indication when the parameter Subscriber Status is set to the value Operator Determined Barring. Note that all General Operator Determined Barring Categories shall be set to their actual status.

If the VLR or the SGSN receives an Indication containing Operator Determined Barring General Data which shows that the subscriber is subject to barring not supported / not allocated by the VLR or by the SGSN, it returns Operator Determined Barring General Data in the response to the HLR to show the barring categories which are not supported / not allocated by the VLR or by the SGSN. This parameter is used by the VLR and the SGSN.

Operator Determined Barring HPLMN data

It includes all the Operator Determined Barring categories that may be applied only to a subscriber registered in the HPLMN. Therefore, it shall only be transferred to the VLR or to the SGSN when the subscriber is roaming into the HPLMN and when the parameter Subscriber Status is set to the value Operator Determined Barring. Note that all HPLMN Operator Determined Barring Categories shall be set to their actual status.

If Subscriber Status is set to the value Operator Determined Barring and no Operator Determined Barring HPLMN data is present then the VLR or the SGSN shall not apply any HPLMN specific ODB services to the subscriber. This parameter is used by the VLR and the SGSN.

eMLPP Subscription Data

If included in the Insert Subscriber Data request this parameter defines the priorities the subscriber might apply for a call (as defined in clause 7.6). It contains both subparameters of eMLPP.

If the VLR does not support the eMLPP service it returns its code to the HLR in the parameter SS-Code List and therefore discards the received information (no error is sent back).

eMLPP subscription data that have been stored previously in a subscriber data record in the VLR are completely replaced by the new eMLPP subscription data received in a MAP_INSERT_SUBSCRIBER_DATA during either an Update Location or Restore Data procedure or a stand alone Insert Subscriber data procedure. This parameter is used only by the VLR and if the SGSN receives this parameter it shall ignore it.

MC Subscription Data

If included in the Insert Subscriber Data request, this parameter provides the MC Subscription Data as defined in clause 7.6.

If the VLR does not support the MC service, it returns its code to the HLR in the parameter SS-Code List and therefore discards the received information (no error is sent back).

MC subscription data that have been stored previously in a subscriber data record in the VLR are completely replaced by the new MC subscription data received in a MAP_INSERT_SUBSCRIBER_DATA during either an Update Location or Restore Data procedure or a stand alone Insert Subscriber data procedure. This parameter is used only by the VLR and if the SGSN receives this parameter it shall ignore it.

Roaming Restriction Due To Unsupported Feature

The HLR may decide to include this parameter in the request if certain services or features are indicated as not supported by the MSC/VLR (e.g. Advice of Charge Charging Level).

If this parameter is sent to the VLR the MSC area is restricted by the HLR and the VLR. This parameter is used only by the VLR and if the SGSN receives this parameter it shall ignore it.

Regional Subscription Data

If included in the Insert Subscriber Data request this parameter defines the subscriber's subscription area for the addressed VLR or for the addressed SGSN (as defined in clause 7.6). It contains the complete list of up to 10 Zone Codes that apply to a subscriber in the currently visited PLMN. The HLR shall send only those Zone Codes which are stored against the CC and NDC of the VLR or the CC and NDC of the SGSN to be updated.

NOTE: Support of this parameter is a network operator option and it will not be sent to networks which do not support Regional Subscription.

Regional subscription data that have been stored previously in a subscriber data record in the VLR or in the SGSN are completely replaced by the regional subscription data received in an Insert Subscriber Data indication during either an Update Location or Restore Data procedure or a stand alone Insert Subscriber data procedure.

After the regional subscription data are inserted the VLR or the SGSN shall derive whether its location areas are allowed or not. If the whole MSC or SGSN area is restricted it will be reported to HLR by returning the Regional Subscription Response.

The VLR or the SGSN returns a Regional Subscription Response indicating that a problem with the Zone Code has been detected in one of the following cases:

- Too Many Zone Codes: more than 10 Zone Codes are to be stored in the VLR or in the SGSN.
- Regional Subscription Not Supported by the VLR or the SGSN.
- Zone Codes Conflict: the VLR or the SGSN detects that the zone codes indicate conflicting service permission for a location area.

Zone codes which have no mapping to location areas shall be ignored.

If a sequence of MAP_INSERT_SUBSCRIBER_DATA services is used during a dialogue, Regional Subscription Data shall be accepted only in one service. Regional Subscription Data received in a subsequent service shall be rejected with the error Unexpected Data Value.

If Regional Subscription Data are not included in any MAP_INSERT_SUBSCRIBER_DATA service, there is no restriction of roaming due to Regional Subscription. This parameter is used by the VLR and the SGSN.

Voice Broadcast Data

This parameter contains a list of group id's a user might have subscribed to; (VBS-Data is defined in clause 7.6). It includes VBS information either at location updating or at restoration or when it is changed.

At location updating, restoration or when there is a change in VBS data, the HLR shall include the complete VBS-Data.

When the VLR receives VBS-Data within a dialogue it shall replace the stored VBS-data with the received data set. All subsequent VBS-data received within this dialogue shall be interpreted as add-on data.

If VBS-data is omitted in the Insert Subscriber Data operation the VLR shall keep the previously stored VBS data.

If the VLR detects that there is overlapping in the information received within a dialogue, it shall send the error Unexpected Data Value. This parameter is used only by the VLR and if the SGSN receives this parameter it shall ignore it.

Voice Group Call Data

This parameter contains a list of group id's a user might have subscribed to; see clause 7.6.

At location updating, restoration or when there is a change in VGCS data, the HLR shall include the complete VGCS-Data.

When the VLR receives VGCS-Data within a dialogue it shall replace the stored VGCS-Data with the received data set. All VGCS-Data received within this dialogue shall be interpreted as add-on data.

If VGCS-Data is omitted in the Insert Subscriber Data operation the VLR shall keep the previously stored VGCS-Data.

If the VLR detects that there is overlapping in the information received within a dialogue, it shall send the error Unexpected Data Value. This parameter is used only by the VLR and if the SGSN receives this parameter it shall ignore it.

North American Equal Access preferred Carrier Id List

A list of the preferred carrier identity codes that are subscribed to.

When the VLR receives this parameter from the HLR, it shall replace the previously stored preferred carrier identity codes with the received ones. It is not possible to delete all the preferred carrier identity codes from the VLR using this service. To delete all the preferred carrier identity codes from the VLR, the HLR shall use the MAP_CANCEL_LOCATION service.

LSA Information

If included in the ISD request, this parameter contains a list of localised service area identities a user might have subscribed to together with the priority, the preferential access indicator, the active mode support indicator and active mode indication of each localised service area; see clause 7.6. The access right outside these localised service areas is also indicated. In all cases mentioned below, the LSA information shall only include LSA Data applicable to the VPLMN where the Subscriber is located. The VLR number, received in the MAP-UPDATE_LOCATION primitive, or the SGSN number, received in the MAP_UPDATE_GPRS_LOCATION primitive, can be used, alongside data stored in the HLR, to determine the LSA Data applicable to the VPLMN.

At restoration, location updating or GPRS location updating the HLR shall include the complete set of applicable LSA Information.

When there is a change in LSA data the HLR shall include at least the new and/or modified LSA data.

When there is a change in the access right outside the localised service areas the HLR shall include the LSA only access indicator.

When the SGSN or the VLR receives LSA information within a dialogue it shall check if the received data has to be considered as the entire LSA information. If so, it shall replace the stored LSA information with the received data set, otherwise it shall replace the data only for the modified LSA data (if any) and/or access right, and add the new LSA data (if any) to the stored LSA Information.

If the entire LSA information is received, it shall always include the LSA only access indicator value together with the LSA data applicable for the PLMN (if any).

If LSA Information is omitted in the Insert Subscriber Data operation the SGSN or the VLR shall keep the previously stored LSA Information.

If the SGSN or the VLR detects that there is overlapping in the information received within a dialogue, it shall send the error Unexpected Data Value. This parameter is used by the VLR and the SGSN.

IST Alert Timer

This parameter contains the IST Alert timer value that must be used to inform the HLR about the call activities that the subscriber performs.

At Location Updating, restoration, or when there is a change in the IST data defined for the Subscriber, the HLR shall include the IST Alert timer.

LMU Identifier

This parameter indicates the presence of an LMU. This parameter is used only by the VLR and shall be ignored if received by an SGSN.

LCS Information

This parameter provides the following LCS related information for an MS subscriber:

- list of GMLCs in the HPLMN;
- privacy exception list;
- MO-LR list.

At restoration and location updating, the HLR shall include the complete LCS data of the subscriber.

When there is a change in LCS subscriber data the HLR shall include at least the new and/or modified LCS data. LCS data that is not modified need not be included.

The VLR/SGSN shall keep any previously stored LCS Information that is not included in an Insert Subscriber Data operation.

If the VLR/SGSN detects that there is overlapping in the LCS information received within a dialogue, it shall send the error Unexpected Data Value.

Super-Charger Supported In HLR

This parameter is used by the HLR to indicate support for the Super-Charger functionality. If this parameter is present it shall include an indication of the age of the subscription data stored in the HLR.

If this parameter is absent then the HLR does not support the Super-Charger functionality.

SS-Code List

The list of SS-Code parameters that are provided to a subscriber but are not supported/allocated by the VLR (SS-Code is defined in clause 7.6). The list can only include individual SS-Codes that were sent in the service request. This parameter is used by only the VLR.

Regional Subscription Response

If included in the response this parameter indicates one of:

- MSC Area Restricted entirely because of regional subscription;
- SGSN Area Restricted entirely because of regional subscription;
- Too Many Zone Codes to be inserted;
- Zone Codes Conflict;
- Regional Subscription not Supported by the VLR or by the SGSN.

If the VLR determines after insertion of Regional Subscription Data that the entire MSC area is restricted, the VLR shall respond with a Regional Subscription Response indicating MSC Area Restricted. Otherwise MSC Area Restricted is not sent. The HLR shall check whether the current MSC area is no longer restricted.

If the SGSN determines after insertion of Regional Subscription Data that the entire SGSN area is restricted, the SGSN shall respond with a Regional Subscription Response indicating SGSN Area Restricted. Otherwise SGSN Area Restricted is not sent. The HLR shall check whether the current SGSN area is no longer restricted. This parameter is used by the VLR and by the SGSN.

VLR CAMEL Subscription Info

This parameter is sent for subscribers who have CAMEL services which are invoked in the MSC.

- In CAMEL phase 1, this parameter contains only the O-CSI.
- In CAMEL Phase 2, this parameter may contain O-CSI, SS-CSI and TIF-CSI. In CAMEL Phase 2 and onwards, TDP-Criteria for O-CSI may be associated with O-CSI.
- In CAMEL Phase 3, this parameter may contain O-CSI, D-CSI, SS-CSI, VT-CSI, MO-SMS-CSI, M-CSI and TIF-CSI. In CAMEL Phase 3 and onwards, TDP-Criteria for VT-CSI may be associated with VT-CSI.
- In CAMEL Phase 4, this parameter may contain O-CSI, D-CSI, SS-CSI, VT-CSI, MO-SMS-CSI, MT-SMS-CSI, M-CSI and TIF-CSI. In CAMEL Phase 4, TDP-Criteria for MT-SMS-CSI may be associated with MT-SMS-CSI.

The VLR CAMEL Subscription Info is sent at location updating or when any information in the applicable CAMEL Subscription Info in the HLR has been changed.

At location updating, the complete set of VLR CAMEL Subscription Info is sent in one dialogue.

When CAMEL Subscription Information is changed in the HLR and changed data have to be sent to the VLR, then:

- for CAMEL Phase 1 and CAMEL Phase 2, the complete set of VLR CAMEL Subscription Info is sent in one dialogue;
- for CAMEL Phase 3 or higher, one or more specific elements of VLR CAMEL Subscription Info are sent in one dialogue.

When the VLR receives a specific element of VLR CAMEL Subscription Info, it shall overwrite the corresponding specific element of VLR CAMEL Subscription Info (if any) which it has stored for that subscriber.

For CAMEL Phase 1 and CAMEL Phase 2, the VLR CAMEL Subscription Info consists of any one or more of:

- O-CSI (irrespective of the value of the “CAMEL Capability Handling” inside O-CSI), TDP-Criteria for O-CSI, SS-CSI and TIF-CSI.

(The complete set of above shall be sent even if only one CSI has changed in case of stand alone ISD. The omitted elements of above list will be withdrawn in the VLR.)

From CAMEL phase 3 onwards, the specific elements of VLR CAMEL Subscription Info which may be sent are:

- O-CSI (irrespective of the value of the “CAMEL Capability Handling” inside O-CSI), TDP criteria for O-CSI, SS-CSI and TIF-CSI;

(The complete set of above shall be sent even if only one CSI has changed in case of stand alone ISD. The omitted elements of above list will be withdrawn in the VLR.)

- D-CSI;
- VT-CSI;
- TDP-Criteria for VT-CSI;
- MO-SMS-CSI;
- MT-SMS-CSI;
- TDP-Criteria for MT-SMS-CSI;
- M-CSI.

If the VLR CAMEL Subscription Info is omitted in the Insert Subscriber Data operation the VLR shall keep the previously stored VLR CAMEL Subscription Info. Within one dialogue subsequent received data are interpreted as add-on data. If the VLR detects that there is overlapping in the information received within a dialogue, it shall send the error Unexpected Data Value. This parameter is used only by the VLR and if the SGSN receives this parameter it shall ignore it.

The VLR CAMEL Subscription Info may contain the TIF-CSI (Translation Information Flag) for CAMEL Phase 2 and higher. See 3G TS 23.072 for the use of this parameter and the conditions for its presence.

Supported CAMEL Phases

The use of this parameter and the requirements for its presence are specified in 3GPP TS 23.078. This parameter is used by the VLR and SGSN.

A VLR or SGSN not supporting any CAMEL Phase may omit this parameter.

GPRS Subscription Data

This parameter contains a list of PDP-contexts a user has subscribed to; see clause 7.6.

At GPRS location updating the HLR shall include the complete GPRS Subscription Data.

When there is a change in GPRS subscriber data the HLR shall include only the new and/or modified PDP contexts.

When the SGSN receives GPRS Subscription Data within a dialogue it shall check if the received data has to be considered as the entire GPRS subscription data. If so, it shall replace the stored GPRS Subscription Data with the received data set, otherwise it shall replace the data only for the modified PDP contexts (if any) and add the new PDP contexts (if any) to the stored GPRS Subscription Data.

If GPRS Subscription Data is omitted in the Insert Subscriber Data operation the SGSN shall keep the previously stored GPRS Subscription Data.

If the SGSN detects that there is overlapping in the information received within a dialogue, it shall send the error Unexpected Data Value. This parameter is used only by the SGSN and if the VLR receives this parameter it shall ignore it.

SGSN CAMEL Subscription Info

The SGSN CAMEL Subscription Info is sent at GPRS location updating or when any information in the applicable SGSN CAMEL Subscription Info in the HLR has been changed.

- In CAMEL Phase 3, this parameter may contain one or both of GPRS-CSI and MO-SMS-CSI.
- In CAMEL Phase 4, this parameter may contain GPRS-CSI, MO-SMS-CSI and MT-SMS-CSI and TDP-Criteria for MT-SMS-CSI.

At GPRS location updating the complete set of SGSN CAMEL Subscription Info is sent.

When CAMEL Subscription Information is changed in the HLR and changed data have to be sent to the SGSN, then one or more specific elements of SGSN CAMEL Subscription Info are sent in one dialogue.

When the SGSN receives a specific element of SGSN CAMEL Subscription Info, it shall overwrite the corresponding specific element of SGSN CAMEL Subscription Info (if any) which it has stored for that subscriber.

The specific elements of SGSN CAMEL Subscription Info which may be sent are:

- MO-SMS-CSI;
- MT-SMS-CSI;
- TDP-Criteria for MT-SMS-CSI;
- GPRS-CSI;
- MC-CSI.

This parameter is used only by the SGSN and if the VLR receives this parameter it shall ignore it.

Roaming Restricted In SGSN Due To Unsupported Feature

The HLR may decide to include this parameter in the request if certain services or features are indicated as not supported by the SGSN. This parameter is used only by the SGSN and if the VLR receives this parameter it shall ignore it.

CS Allocation/Retention priority

The CS Allocation/Retention priority is used only for Circuit Switched (CS). This parameter specifies relative importance to compare with other bearers about allocation and retention of bearer. This parameter is used only by the VLR and if the SGSN receives this parameter it shall ignore it.

Supported CAMEL 4 Subsets

This parameter indicates the CAMEL phase 4 subsets supported in the VMSC/VLR (see clause 7.6.3.36D).

User error

Only one of the following values is applicable:

- Unidentified subscriber;
- Data missing;
- Unexpected data value.

8.8.1.4 Basic service information related to supplementary services

A number of parameters that relate to supplementary services can be qualified by a Basic Service Group (or a Basic Service Group List). This clause explains how this information is to be interpreted. Supplementary service parameters to which this clause is applicable only apply to the basic service groups described in this clause, and only those basic service groups shall be overwritten at the VLR.

The Basic Service Group (or Basic Service Group List) is optional.

If present the Basic Service Group (or the elements of the Basic Service Group List) shall be one of:

- an Elementary Basic Service Group for which the supplementary service is applicable to at least one basic service in the group; and to which the subscriber has a subscription to at least one basic service in the group;
- the group "All Teleservices" provided that the service is applicable to at least one teleservice and that the subscriber has a subscription to at least one teleservice that is in the same Elementary Basic Service Group as a teleservice to which the service is applicable;
- the group "All Bearer Services" provided that the service is applicable to at least one bearer service and that the subscriber has a subscription to at least one bearer service that is in the same Elementary Basic Service Group as a basic service to which the service is applicable.

If the Basic Service Group (or Basic Service Group List) is not present then the parameter shall apply to all Basic Service Groups.

If the basic service information is not a single Elementary Basic Service Group then the parameter shall be taken as applying individually to all the Elementary Basic Service Groups for which:

- the supplementary service is applicable to at least one basic service in the Basic Service Group; and
- the subscriber has a subscription to at least one basic service in the Basic Service Group.

The VLR is not required to store supplementary services data for Basic Service Groups that are not supported at the VLR.

8.8.2 MAP-DELETE-SUBSCRIBER-DATA service

8.8.2.1 Definition

This service is used by an HLR to remove certain subscriber data from a VLR if the subscription of one or more supplementary services or basic services is withdrawn. Note that this service is not used in case of erasure or deactivation of supplementary services.

Also this service is used by an HLR to remove GPRS subscription data from a SGSN.

It is a confirmed service and consists of the primitives shown in table 8.8/2.

8.8.2.2 Service primitives

Table 8.8/2: MAP-DELETE-SUBSCRIBER-DATA

Parameter name	Request	Indication	Response	Confirm
Invoke Id	M	M(=)	M(=)	M(=)
IMSI	M	M(=)		
Basic service List	C	C(=)		
SS-Code List	C	C(=)		
Roaming Restriction Due To				
Unsupported Feature	C	C(=)		
Camel Subscription Info Withdraw	C	C(=)		
Specific CSI Withdraw	C	C(=)		
Regional Subscription Data	C	C(=)		
VBS Group Indication	C	C(=)		
VGCS Group Indication	C	C(=)		
GPRS Subscription Data Withdraw	C	C(=)		
Roaming Restricted In SGSN Due To	C	C(=)		
Unsupported Feature				
LSA Information Withdraw	C	C(=)		
IST Information Withdraw	C	C(=)		
Regional Subscription Response			C	C(=)
GMLC List Withdraw	C	C(=)		
User error			C	C(=)
Provider error				O

8.8.2.3 Parameter use

All parameters are described in clause 7.6. The following clarifications are applicable:

Basic service List

A list of Extensible Basic service parameters (Extensible Basic service is defined in clause 7.6). It is used when one, several or all basic services are to be withdrawn from the subscriber. If the VLR or the SGSN receives a value for an Extensible Basic Service which it does not support, it shall ignore that value. This parameter is used by the VLR and by the SGSN.

SS-Code List

A list of SS-Code parameters (SS-Code is defined in clause 7.6). It is used when several or all supplementary services are to be withdrawn from the subscriber.

There are three possible options:

- deletion of basic service(s);
The parameter Basic service List is only included.
- deletion of supplementary service(s);
The parameter SS-Code List is only included.
- deletion of basic and supplementary services;
Both Basic service List and SS-Code List are included.

This parameter is used by the VLR and SGSN for LCS. Otherwise, this parameter is used only by the VLR and if the SGSN receives this parameter it shall ignore it.

Roaming Restriction Due To Unsupported Feature

This parameter is used if Roaming Restriction Due To Unsupported Feature is deleted from the subscriber data. This may occur if unsupported features or services are removed from the subscriber data in the HLR.

If this parameter is sent the VLR shall check if the current Location Area is possibly allowed now. This parameter is used only by the VLR and if the SGSN receives this parameter it shall ignore it.

CAMEL Subscription Info Withdraw

This parameter is used to indicate that CAMEL Subscription Info shall be deleted from the VLR or from the SGSN. All CAMEL Subscription Info for the subscriber shall be deleted. This parameter is used by the VLR and by the SGSN. This parameter should not be sent in the same message as the Specific CSI Withdraw parameter.

Specific CSI Withdraw

This parameter is used to indicate that one or more specific elements of CAMEL Subscription Info shall be deleted from the VLR or from the SGSN.

The specific elements of CAMEL Subscription Info which may be withdrawn are:

- O-CSI with TDP criteria for O-CSI;
- SS-CSI;
- TIF-CSI;
- D-CSI;
- VT-CSI with TDP criteria for VT-CSI;
- MO-SMS-CSI;
- MT-SMS-CSI with TDP-Criteria for MT-SMS-CSI;

- M-CSI;
- MG-CSI;
- GPRS-CSI.

This parameter is used by the VLR and by the SGSN. It shall not be sent to VLRs that do not support CAMEL phase 3 or higher. This parameter should not be sent in the same message as the CAMEL Subscription Info Withdraw parameter.

Regional Subscription Identifier

Contains one single Zone Code (as defined in clause 7.6) and is used if all Zone Codes shall be deleted from the subscriber data. When all the Zone Codes are deleted, the VLR or the SGSN shall check for its location areas whether they are allowed or not. If the whole MSC area is restricted, VLR will report it to HLR by returning the Regional Subscription Response "MSC Area Restricted". If the whole SGSN area is restricted, SGSN will report it to HLR by returning the Regional Subscription Response "SGSN Area Restricted".

The binary coding of the Zone Code value received in a Delete Subscriber Data request shall not be checked by the VLR or by the SGSN.

Note that support of this parameter is a network operator option and it shall not be sent to networks which do not support Regional Subscription.

If Regional Subscription is not supported by the VLR or by the SGSN, the request for deletion of Zone Codes is refused by sending the Regional Subscription Response "Regional Subscription Not Supported" to the HLR.

If no Zone Codes are stored in the respective subscriber data record, the request for deleting all Zone Code information shall be ignored and no Regional Subscription Response shall be returned. This parameter is used by the VLR and by the SGSN.

VBS Group Indication

Contains an indication (flag) which is used if all Group Ids shall be deleted from the subscriber data for the Voice Broadcast teleservice.

If VBS is not supported in the VLR or no Group Ids are stored for VBS in the respective subscriber record, the request for deletion of all Group Ids shall be ignored. This parameter is used only by the VLR and if the SGSN receives this parameter it shall ignore it.

VGCS Group Indication

Contains an indication (flag) which is used if all Group Id's shall be deleted from the subscriber data for the Voice Group Call teleservice. This parameter is used only by the VLR and if the SGSN receives this parameter it shall ignore it.

If VGCS is not supported in the VLR or no Group Ids are stored for VGCS in the respective subscriber record, the request for deletion of all Group Ids shall be ignored.

GPRS Subscription Data Withdraw

This parameter is used to indicate whether all GPRS Subscription Data for the subscriber shall be deleted or if only a subset of the stored GPRS Subscription Data for the subscriber shall be deleted. In the latter case only those PDP contexts whose identifiers are included in the subsequent identifier list will be deleted. This parameter is used only by the SGSN and if the VLR receives this parameter it shall ignore it.

Roaming Restricted In SGSN Due To Unsupported Feature

This parameter is used if Roaming Restricted In SGSN Due To Unsupported Feature is deleted from the GPRS subscriber data. This may occur if unsupported features or services are removed from the GPRS subscriber data in the HLR.

If this parameter is sent the SGSN shall check if the current Location Area is possibly allowed now. This parameter is used only by the SGSN and if the VLR receives this parameter it shall ignore it.

LSA Information Withdraw

This parameter is used to indicate whether all LSA Information for the subscriber shall be deleted or if only a subset of the stored LSA Information for the subscriber shall be deleted. In the latter case only the LSA data whose LSA identities are included in the subsequent LSA data list will be deleted. This parameter is used by the VLR and the SGSN.

IST Information Withdraw

This parameter is used to indicate that the IST condition has been removed for the subscriber. See 3GPP TS 43.035 for the use of this parameter.

Regional Subscription Response

If included in the Delete Subscriber Data response this parameter indicates one of:

- MSC Area Restricted;
- SGSN Area Restricted;
- Regional Subscription Not Supported.

This parameter is used by the VLR and by the SGSN.

GMLC List Withdraw

This parameter indicates that the subscriber's LCS GMLC List shall be deleted from the VLR or SGSN.

User error

Only one of the following values is applicable:

- Unidentified subscriber;
- Data missing;
- Unexpected data value.

8.9 Identity management services

8.9.1 MAP-PROVIDE-IMSI service

8.9.1.1 Definition

This service is used by a VLR in order to get, via the MSC, the IMSI of a subscriber (e.g. when a subscriber has identified itself with a TMSI not allocated to any subscriber in the VLR).

It is a confirmed service and consists of the primitives shown in table 8.9/1.

8.9.1.2 Service primitives

Table 8.9/1: MAP-PROVIDE-IMSI

Parameter name	Request	Indication	Response	Confirm
Invoke Id	M	M(=)	M(=)	M(=)
IMSI			C	C(=)
User error			C	C(=)
Provider error				O

8.9.1.3 Parameter use

All parameters are described in clause 7.6. The following clarifications are applicable:

IMSI

This parameter is received when the request is successfully carried out. It contains the requested IMSI.

User error

Only one of the following values is applicable:

- Absent subscriber.

8.9.2 MAP-FORWARD-NEW-TMSI service

8.9.2.1 Definition

This service is used by a VLR to allocate, via MSC, a new TMSI to a subscriber during an ongoing transaction (e.g. call set-up, location updating or supplementary services operation).

It is a confirmed service and consists of the primitives shown in table 8.9/2.

8.9.2.2 Service primitives

Table 8.9/2: MAP-FORWARD-NEW-TMSI

Parameter name	Request	Indication	Response	Confirm
Invoke Id	M	M(=)	M(=)	M(=)
TMSI	M	M(=)		
Provider error				O

8.9.2.3 Parameter use

The parameter TMSI is described in clause 7.6.

8.10 Fault recovery services

8.10.1 MAP_RESET service

8.10.1.1 Definition

This service is used by the HLR, after a restart, to indicate to a list of VLRs or SGSNs that a failure occurred.

The MAP_RESET service is a non-confirmed service using the service primitives defined in table 8.10/1.

8.10.1.2 Service primitives

Table 8.10/1: MAP_RESET

Parameter name	Request	Indication
Invoke Id	M	M(=)
HLR number	M	M(=)
HLR Id LIST	U	C(=)

8.10.1.3 Parameter definition and use

Invoke Id

See definition in clause 7.6.1.

HLR number

See definition in clause 7.6.2.

HLR Id LIST

The HLR Id List is a list of HLR Ids. If the parameter is present in the indication, the VLR or SGSN may base the retrieval of subscribers to be restored on their IMSI: the subscribers affected by the reset are those whose IMSI leading digits are equal to one of these numbers. If the parameter is absent, subscribers to be restored are those for which the OriginatingEntityNumber received at location updating time matches the equivalent parameter of the Reset Indication.

8.10.2 MAP_FORWARD_CHECK_SS_INDICATION service**8.10.2.1 Definition**

This service may be used by an HLR as an implementation option, to indicate to a mobile subscriber that supplementary services parameters may have been altered, e.g. due to a restart. If received from the HLR, the VLR shall forward this indication to the MSC, which in turn forwards it to the MS. The HLR only sends this indication after successful completion of the subscriber data retrieval from HLR to VLR that ran embedded in a MAP_UPDATE_LOCATION procedure.

The MAP_FORWARD_CHECK_SS_INDICATION service is a non-confirmed service using the service primitives defined in table 8.10/2.

8.10.2.2 Service primitives**Table 8.10/2: MAP_FORWARD_CHECK_SS_INDICATION**

Parameter name	Request	Indication
Invoke Id	M	M(=)

8.10.2.3 Parameter definition and useInvoke Id

See definition in clause 7.6.1.

8.10.3 MAP_RESTORE_DATA service**8.10.3.1 Definition**

This service is invoked by the VLR on receipt of a MAP_PROVIDE_ROAMING_NUMBER indication for an unknown IMSI, or for a known IMSI with the indicator "Confirmed by HLR" set to "Not confirmed". The service is used to update the LMSI in the HLR, if provided, and to request the HLR to send all data to the VLR that are to be stored in the subscriber's IMSI record.

The MAP_RESTORE_DATA service is a confirmed service using the service primitives defined in table 8.10/3.

8.10.3.2 Service primitives**Table 8.10/3: MAP_RESTORE_DATA**

Parameter name	Request	Indication	Response	Confirm
Invoke Id	M	M(=)	M(=)	M(=)
IMSI	M	M(=)		
LMSI	U	C(=)		
Supported CAMEL phases	C	C(=)		
SoLSA Support Indicator	C	C(=)		
IST Support Indicator	C	C(=)		
Super-Charger Supported in Serving Network Entity	C	C(=)		
Long FTN Supported	C	C(=)		
Supported LCS Capability	C	C(=)		

Sets				
HLR number			C	C(=)
Supported CAMEL 4 Subsets	C	C(=)		
MS Not Reachable Flag			C	C(=)
User error			C	C(=)
Provider error				O

8.10.3.3 Parameter definitions and use

Invoke Id

See definition in clause 7.6.1.

IMSI

See definition in clause 7.6.2.

LMSI

See definition in clause 7.6.2. It is an operator option to provide the LMSI from the VLR; it is mandatory for the HLR to support the LMSI handling procedures.

Supported CAMEL Phases

This parameter indicates which phases of CAMEL are supported. Must be present if a CAMEL phase different from phase 1 is supported. Otherwise may be absent.

SoLSA Support Indicator

This parameter is used by the VLR to indicate to the HLR in the Restore Data indication that SoLSA is supported. If this parameter is not included in the Restore Data indication then the HLR shall not perform any specific error handling.

This SoLSA Support Indicator shall be stored by the HLR per VLR where there are Subscribers roaming. If a Subscriber is marked as only allowed to roam in Subscribed LSAs while roaming in a VLR and no SoLSA Support indicator is stored for that VLR, the location status of that Subscriber shall be set to Restricted.

IST Support Indicator

This parameter is used to indicate to the HLR that the VMSC supports basic IST functionality, that is, the VMSC is able to terminate the Subscriber Call Activity that originated the IST Alert when it receives the IST alert response indicating that the call(s) shall be terminated. If this parameter is not included in the Restore Data indication and the Subscriber is marked as an IST Subscriber, then the HLR may limit the service for the subscriber (by inducing an Operator Determined barring of Outgoing calls), or allow service assuming the associated risk of not having the basic IST mechanism available.

This parameter can also indicate that the VMSC supports the IST Command service, including the ability to terminate all calls being carried for the identified subscriber by using the IMSI as a key. If this additional capability is not included in the Restore Data indication and the HLR supports the IST Command capability, then the HLR may limit the service for the subscriber (by inducing an Operator Determined barring of Outgoing calls), or allow service assuming the associated risk of not having the IST Command mechanism available.

Long FTN Supported

This parameter indicates that the VLR supports Long Forwarded-to Numbers.

Super-Charger Supported in Serving Network Entity

This parameter is used by the VLR to indicate to the HLR that the VLR supports the Super-Charger functionality and that subscriber data is required.

If this parameter is absent then the VLR does not support the Super-Charger functionality.

Supported LCS Capability Sets

This parameter indicates, if present, the capability sets of LCS which are supported. If the parameter is sent but no capability set is marked as supported then the VLR does not support LCS at all.

If this parameter is absent then the VLR may support at most LCS capability set 1, that is LCS Release98 or Release99 version.

Supported CAMEL 4 Subsets

This parameter indicates the CAMEL phase 4 subsets supported in the VMSC/VLR (see clause 7.6.3.36D).

HLR number

See definition in clause 7.6.2. The presence of this parameter is mandatory in case of successful outcome of the service.

MS Not Reachable Flag

See definition in clause 7.6.8. This parameter shall be present in case of successful outcome of the service, if the "MS Not Reachable flag" was set in the HLR.

User error

In case of unsuccessful outcome of the service, an error cause shall be returned by the HLR. The following error causes defined in clause 7.6.1 may be used, depending on the nature of the fault:

- unknown subscriber;
- system failure;
- unexpected data value;
- data missing.

Provider error

For definition of provider errors see clause 7.6.1.

8.11 Subscriber Information services

8.11.1 MAP-ANY-TIME-INTERROGATION service

8.11.1.1 Definition

This service is used by the gsmSCF, to request information (e.g. subscriber state and location) from the HLR or the GMLC at any time.

When this service is used to the HLR, the subscriber state or location may be requested.

When this service is used to the GMLC, only the location may be requested.

The MAP-ANY-TIME-INTERROGATION service is a confirmed service using the service primitives defined in table 8.11/1.

8.11.1.2 Service primitives

Table 8.11/1: Any_Time_Interrogation

Parameter name	Request	Indication	Response	Confirm
Invoke id	M	M(=)	M(=)	M(=)
Requested Info	M	M(=)		
Requested domain	C	C(=)		
gsmSCF-Address	M	M(=)		
IMSI	C	C(=)		
MSISDN	C	C(=)		

Location Information			C	C(=)
Location Information for GPRS			C	C(=)
Subscriber State			C	C(=)
PS Subscriber State			C	C(=)
IMEI			C	C(=)
MS Classmark 2			C	C(=)
GPRS MS Class			C	C(=)
User error			C	C(=)
Provider error				O

8.11.1.3 Parameter definition and use

All parameters are described in clause 7.6. The use of these parameters and the requirements for their presence are specified in 3GPP TS 23.018 [97] and 3GPP TS 23.078 [98].

The HLR or GMLC may be able to use the value of the parameter gsmSCF-address to screen a MAP_Any_Time_Interrogation indication.

The use of the parameters and the requirements for their presence are specified in 3GPP TS 23.078.

User error

This parameter is sent by the responder when an error is detected and if present, takes one of the following values:

- System Failure;
- Any Time Interrogation Not Allowed;
- Data Missing;
- Unexpected Data Value;
- Unknown Subscriber.

Provider error

These are defined in clause 7.6.1.

8.11.2 MAP-PROVIDE-SUBSCRIBER-INFO service

8.11.2.1 Definition

This service is used to request information (e.g. subscriber state and location) from the VLR or SGSN at any time.

The MAP-PROVIDE-SUBSCRIBER-INFO service is a confirmed service using the primitives defined in table 8.11/2.

8.11.2.2 Service primitives

Table 8.11/2: Provide_Subscriber_Information

Parameter name	Request	Indication	Response	Confirm
Invoke id	M	M(=)	M(=)	M(=)
Requested Info	M	M(=)		
IMSI	M	M(=)		
LMSI	U	O		
Location Information			C	C(=)
Location Information for GPRS			C	C(=)
Subscriber State			C	C(=)
PS Subscriber State			C	C(=)
IMEI			C	C(=)
MS Classmark 2			C	C(=)
GPRS MS Class			C	C(=)
User error			C	C(=)
Provider error				O

8.11.2.3 Parameter definition and use

All parameters are defined in clause 7.6. The use of these parameters and the requirements for their presence are specified in 3GPP TS 23.018 [97] and 3GPP TS 23.078 [98].

User error

This parameter is sent by the responder when an error is detected and if present, takes one of the following values:

- Data Missing;
- Unexpected Data Value.

Provider error

These are defined in clause 7.6.1.

8.11.3 MAP-ANY-TIME-SUBSCRIPTION-INTERROGATION service

8.11.3.1 Definition

This service is used by the gsmSCF, to request subscription information (e.g. call forwarding supplementary service data or CSI) from the HLR at any time.

8.11.3.2 Service primitives

Table 8.11/3: Any_Time_Subscription_Interrogation

Parameter name	Request	Indication	Response	Confirm
Invoke id	M	M(=)	M(=)	M(=)
Requested Subscription Info	M	M(=)		
GsmSCF-Address	M	M(=)		
IMSI	C	C(=)		
MSISDN	C	C(=)		
Long FTN Supported	C	C(=)		
Call Forwarding Data			C	C(=)
Call Barring Data			C	C(=)
ODB Info			C	C(=)
CAMEL Subscription Info			C	C(=)
Supported CAMEL phases in VLR			C	C(=)
Supported CAMEL phases in SGSN			C	C(=)
Supported CAMEL 4 Subsets in VLR			C	C(=)

Supported CAMEL 4 Subsets in SGSN			C	C(=)
User error			C	C(=)
Provider error				O

8.11.3.3 Parameter definition and use

All parameters are described in clause 7.6.

The HLR may be able to use the value of the parameter gsmSCF-address to screen a MAP_Any_Time_Subscription_Interrogation indication.

The use of the parameters and the requirements for their presence are specified in 3GPP TS 23.078.

User error

This parameter is sent by the responder when an error is detected and if present, takes one of the following values:

- Unexpected Data Value;
- Unknown Subscriber;
- BearerServiceNotProvisioned;
- TeleserviceNotProvisioned;
- CallBarred;
- IllegalSS-Operation;
- SS-NotAvailable;
- InformationNotAvailable;
- Any Time Subscription Interrogation Not Allowed;
- Data Missing.

Provider error

These are defined in clause 7.6.1.

8.11.4 MAP-ANY-TIME-MODIFICATION service

8.11.4.1 Definition

This service is used by the gsmSCF, to modify information of the HLR at any time.

8.11.4.2 Service primitives

Table 8.11/4: Any_Time_Modification

Parameter name	Request	Indication	Response	Confirm
Invoke id	M	M(=)	M(=)	M(=)
gsmSCF-Address	M	M(=)		
IMSI	C	C(=)		
MSISDN	C	C(=)		
Modification request for ODB data	C	C(=)		
Modification request for SS information	C	C(=)		
Modification request for CSI	C	C(=)		
Long FTN Supported	C	C(=)		
Ext Forwarding information-for-CSE			C	C(=)
Ext Call barring information-for-CSE			C	C(=)
ODB Info			C	C(=)

CAMEL subscription info			C	C(=)
User error			C	C(=)
Provider error				O

8.11.4.3 Parameter definition and use

All parameters are described in clause 7.6.

The HLR may be able to use the value of the parameter gsmSCF-address to screen a MAP_Any_Time_Modification indication.

The use of these parameters and the requirements for their presence are specified in 3GPP TS 23.078.

User error

This parameter is sent by the responder when an error is detected and if present, takes one of the following values:

- Any Time Modification Not Allowed;
- Data Missing;
- Unexpected Data Value;
- Unknown Subscriber;
- Bearer service not provisioned;

This error is returned only if not even a subset of the requested bearer service group has been subscribed to;

- Teleservice not provisioned;

This error is returned only if not even a subset of the requested teleservice group has been subscribed to;

- Call Barred;
- Illegal SS operation;
- SS error status;
- SS incompatibility;
- SS subscription violation;
- Information Not Available.

Provider error

These are defined in clause 7.6.1.

8.11.5 MAP-NOTE-SUBSCRIBER-DATA-MODIFIED service

8.11.5.1 Definition

This service is used by the HLR to inform the gsmSCF that subscriber data have been modified.

8.11.5.2 Service primitives

Table 8.11/5: Note_Subscriber_Data_Modified

Parameter name	Request	Indication	Response	Confirm
Invoke id	M	M(=)	M(=)	M(=)
IMSI	M	M(=)		
MSISDN	M	M(=)		

Parameter name	Request	Indication	Response	Confirm
Ext Forwarding information-for-CSE	C	C(=)		
Ext Call barring information-for-CSE	C	C(=)		
ODB Info	C	C(=)		
CAMEL subscription info	C	C(=)		
All Information Sent	C	C(=)		
User error			C	C(=)
Provider error				O

8.11.5.3 Parameter definition and use

Invoke id

See clause 7.6.1 for the use of this parameter.

IMSI

See clause 7.6.2 for the use of this parameter.

MSISDN

See clause 7.6.2 for the use of this parameter.

Ext Forwarding information-for-CSE

See clause 7.6.3 for the use of this parameter. The use of this parameter and the requirements for their presence are specified in 3GPP TS 23.078.

Ext Call barring information-for-CSE

See clause 7.6.3 for the use of this parameter. The use of this parameter and the requirements for their presence are specified in 3GPP TS 23.078.

ODB Info

See clause 7.6.3 for the use of this parameter. The use of this parameter and the requirements for their presence are specified in 3GPP TS 23.078.

CAMEL subscription info

See clause 7.6.3 for the use of this parameter. The use of this parameter and the requirements for their presence are specified in 3GPP TS 23.078.

All Information Sent

This parameter is set when the HLR has sent all information to gsmSCF.

User error

This parameter is sent by the responder when an error is detected and if present, takes one of the following values:

- Data Missing;
- Unexpected Data Value;
- Unknown Subscriber.

Provider error

These are defined in clause 7.6.1.

The use of the parameters and the requirements for their presence are specified in 3GPP TS 23.078.

9 Operation and maintenance services

9.1 Subscriber tracing services

9.1.1 MAP-ACTIVATE-TRACE-MODE service

9.1.1.1 Definition

This service is used between the HLR and the VLR to activate subscriber tracing in the VLR.

Also this service is used between the HLR and the SGSN to activate subscriber tracing in the SGSN.

The MAP-ACTIVATE-TRACE-MODE service is a confirmed service using the primitives from table 9.1/1.

9.1.1.2 Service primitives

Table 9.1/1: MAP-ACTIVATE-TRACE-MODE

Parameter name	Request	Indication	Response	Confirm
Invoke id	M	M(=)	M(=)	M(=)
IMSI	C	C(=)		
Trace reference	M	M(=)		
Trace type	M	M(=)		
OMC Id	U	C(=)		
User error			C	C(=)
Provider error				O

9.1.1.3 Parameter use

Invoke id

See definition in clause 7.6.1.

IMSI

See definition in clause 7.6.2. The IMSI is a mandatory parameter in a stand-alone operation.

Trace reference

See definition in clause 7.6.10.

Trace type

See definition in clause 7.6.10.

OMC Id

See definition in clause 7.6.2. The use of this parameter is an operator option.

User error

The following errors defined in clause 7.6.1 may be used, depending on the nature of the fault:

- Unidentified Subscriber;
- Facility Not Supported;
- Tracing Buffer Full;
- System Failure;

- Unexpected Data Value;
- Data missing.

Provider error

For definition of provider errors see clause 7.6.1.

9.1.2 MAP-DEACTIVATE-TRACE-MODE service

9.1.2.1 Definition

This service is used between the VLR and the HLR for deactivating subscriber tracing in the VLR.

Also this service is used between the SGSN and the HLR for deactivating subscriber tracing in the SGSN.

The MAP-DEACTIVATE-TRACE-MODE service is a confirmed service using the primitives from table 9.1/2.

9.1.2.2 Service primitives

Table 9.1/2: MAP-DEACTIVATE-TRACE-MODE

Parameter name	Request	Indication	Response	Confirm
Invoke id	M	M(=)	M(=)	M(=)
IMSI	C	C(=)		
Trace reference	M	M(=)		
User error			C	C(=)
Provider error				O

9.1.2.3 Parameter use

Invoke id

See definition in clause 7.6.1.

IMSI

See definition in clause 7.6.2. The IMSI is a mandatory parameter in a stand-alone operation.

Trace reference

See definition in clause 7.6.10.

User error

The following errors defined in clause 7.6.1 may be used, depending on the nature of the fault:

- Unidentified Subscriber;
- Facility Not Supported;
- System Failure;
- Unexpected Data Value;
- Data missing.

Provider error

For definition of provider errors see clause 7.6.1.

9.1.3 MAP-TRACE-SUBSCRIBER-ACTIVITY service

9.1.3.1 Definition

This service is used between the VLR and the MSC to activate the subscriber tracing in the MSC.

The MAP-TRACE-SUBSCRIBER-ACTIVITY service is a non-confirmed service using the primitives from table 9.1/3.

9.1.3.2 Service primitives

Table 9.1/3: MAP-TRACE-SUBSCRIBER-ACTIVITY

Parameter name	Request	Indication
Invoke id	M	M(=)
IMSI	C	C(=)
Trace reference	M	M(=)
Trace type	M	M(=)
OMC Id	U	C(=)

9.1.3.3 Parameter use

Invoke id

See definition in clause 7.6.1.

IMSI

See definition in clause 7.6.2. The controlling MSC shall provide either the IMSI or the IMEI to the servicing MSC.

Trace reference

See definition in clause 7.6.10.

Trace type

See definition in clause 7.6.10.

OMC Id

See definition in clause 7.6.2. The use of this parameter is an operator option.

9.2 Other operation and maintenance services

9.2.1 MAP-SEND-IMSI service

9.2.1.1 Definition

This service is used by a VLR in order to fetch the IMSI of a subscriber in case of some Operation & Maintenance procedure where subscriber data are needed in the Visited PLMN and MSISDN is the only subscriber's identity known.

It is a confirmed service and consists of the primitives shown in table 9.2/1.

9.2.1.2 Service primitives

Table 9.2/1: MAP-SEND-IMSI

Parameter name	Request	Indication	Response	Confirm
Invoke Id	M	M(=)	M(=)	M(=)
MSISDN	M	M(=)		
IMSI			C	C(=)
User error			C	C(=)
Provider error				O

9.2.1.3 Parameter use

All parameters are described in clause 7.6. The following clarifications are applicable.

User error

Only one of the following values is applicable:

- Unknown subscriber;
- Unexpected data value;
- Data missing.

10 Call handling services

10.1 MAP_SEND_ROUTING_INFORMATION service

10.1.1 Definition

This service is used between the Gateway MSC and the HLR. The service is invoked by the Gateway MSC to perform the interrogation of the HLR in order to route a call towards the called MS.

This is a confirmed service using the primitives listed in table 10.1/1.

This service is also used between the GMSC and the NPLR and between the gsmSCF and the HLR.

10.1.2 Service primitives

Table 10.1/1: MAP_SEND_ROUTING_INFORMATION parameters

Parameter name	Request	Indication	Response	Confirm
Invoke Id	M	M(=)	M(=)	M(=)
Interrogation Type	M	M(=)		
GMSC or gsmSCF Address	M	M(=)		
MSISDN	M	M(=)	C	C(=)
OR Interrogation	C	C(=)		
OR Capability	C	C(=)		
CUG Interlock	C	C(=)	C	C(=)
CUG Outgoing Access	C	C(=)	C	C(=)
Number of Forwarding	C	C(=)		
Network Signal Info	C	C(=)		
Supported CAMEL Phases	C	C(=)	C	C(=)
Suppress T-CSI	C	C(=)		
Supported CAMEL 4 Subsets	C	C(=)		
Suppression of Announcement	C	C(=)		
Call Reference Number	C	C(=)		
Forwarding Reason	C	C(=)		
Basic Service Group	C	C(=)		

Parameter name	Request	Indication	Response	Confirm
Alerting Pattern	C	C(=)		
CCBS Call	C	C(=)		
Supported CCBS Phase	C	C(=)		
Additional Signal Info	C	C(=)		
IST Support Indicator	C	C(=)		
Pre-paging supported	C	C(=)		
Call Diversion Treatment Indicator	C	C(=)		
Long FTN Supported	C	C(=)		
Suppress VT-CSI	C	C(=)		
Suppress Incoming Call Barring	C	C(=)		
gsmSCF Initiated Call	C	C(=)		
IMSI			C	C(=)
MSRN			C	C(=)
Forwarding Data			C	C(=)
Forwarding Interrogation Required			C	C(=)
VMSC address			C	C(=)
GMSC Camel Subscription Info			C	C(=)
Location Information			C	C(=)
Subscriber State			C	C(=)
Basic Service Code			C	C(=)
CUG Subscription Flag			C	C(=)
North American Equal Access preferred			U	C(=)
Carrier Id				
User error			C	C(=)
SS-List			U	C(=)
CCBS Target			C	C(=)
Keep CCBS Call Indicator			C	C(=)
IST Alert Timer			C	C(=)
Number Portability Status			U	C(=)
Supported CAMEL Phases in VMSC			C	
Supported CAMEL 4 Subsets in VMSC			C	C(=)
Provider error				O

10.1.3 Parameter use

See clause 7.6 for a definition of the parameters used in addition to the following. Note that:

- a conditional parameter whose use is defined only in 3GPP TS 23.078 shall be absent if the sending entity does not support CAMEL;
- a conditional parameter whose use is defined only in 3GPP TS 23.079 [99] shall be absent if the sending entity does not support optimal routing;
- a conditional parameter whose use is defined only in 3GPP TS 23.078 & 3GPP TS 23.079 [99] shall be absent if the sending entity supports neither CAMEL nor optimal routing.

Interrogation Type

See 3GPP TS 23.079 [99] for the use of this parameter.

GMSC or gsmSCF address

The E.164 address of the GMSC or the gsmSCF. This parameter contains the a gsmSCF address if the gsmSCF initiated call parameter is present, otherwise it is the GMSC address.

MSISDN

This is the Mobile Subscriber ISDN number assigned to the called subscriber. In the Request & Indication it is the number received by the GMSC in the IAM. If the call is to be forwarded and the HLR supports determination of the redirecting number, the HLR inserts the basic MSISDN in the Response.

See 3GPP TS 23.066 [108] for the use of this parameter and the conditions for its presence in the response.

OR Interrogation

See 3GPP TS 23.079 [99] for the use of this parameter and the conditions for its presence.

OR Capability

See 3GPP TS 23.079 [99] for the use of this parameter and the conditions for its presence.

CUG Interlock

See 3GPP TS 23.018 [97] for the use of this parameter and the conditions for its presence.

CUG Outgoing Access

See 3GPP TS 23.018 [97] for the use of this parameter and the conditions for its presence.

Number of Forwarding

See 3GPP TS 23.018 [97] for the use of this parameter and the conditions for its presence.

Network Signal Info

See 3GPP TS 23.018 [97] for the conditions for the presence of the components of this parameter.

Supported CAMEL Phases

The use of this parameter and the requirements for its presence are specified in 3GPP TS 23.078.

T-CSI Suppression

The use of this parameter and the requirements for its presence are specified in 3GPP TS 23.078.

Supported CAMEL 4 Subsets

This parameter indicates the CAMEL phase 4 subsets supported in the GMSC/VLR (see clause 7.6.3.36D).

Suppression Of Announcement

The use of this parameter and the requirements for its presence are specified in 3GPP TS 23.078.

Call Reference Number

The use of this parameter and the conditions for its presence are specified in 3GPP TS 23.078 [98] and 3GPP TS 23.079 [99].

Forwarding Reason

See 3GPP TS 23.079 [99] for the use of this parameter and the conditions for its presence.

Basic Service Group

See 3GPP TS 23.079 [99] for the use of this parameter and the conditions for its presence.

Alerting Pattern

See 3GPP TS 23.018 [97] for the use of this parameter and the conditions for its presence.

CCBS Call

See 3G TS 23.093 [107] for the use of this parameter and the conditions for its presence.

Supported CCBS Phase

This parameter indicates by its presence that CCBS is supported and the phase of CCBS which is supported.

Additional Signal Info

See 3G TS 23.081 [27] for the conditions for the presence of the components of this parameter.

IST Support Indicator

This parameter is used to indicate to the HLR that the GMSC supports basic IST functionality, that is, the GMSC is able to terminate the subscriber call activity that originated the IST Alert when it receives the IST Alert response indicating that the call(s) shall be terminated. If this parameter is not included in the Send Routing Information indication and the subscriber is marked as an IST subscriber, then the HLR may limit the service for the call (by barring the incoming call if it is not subject to forwarding, or suppressing Call Forwarding from the GMSC), or allow the call assuming the associated risk of not having the basic IST mechanism available.

This parameter can also indicate that the GMSC supports the IST Command, including the ability to terminate all calls being carried for the identified subscriber by using the IMSI as a key. If this additional capability is not included in the Send Routing Information indication and the subscriber is marked as an IST subscriber, then the HLR may limit the service for the subscriber (by barring the incoming calls if they are not subject to forwarding, or suppressing Call Forwarding from the GMSC), or allow the incoming calls assuming the associated risk of not having the IST Command mechanism available.

Pre-paging supported

See 3G TS 23.018 for the use of this parameter and the conditions for its presence.

Call Diversion Treatment Indicator

This parameter indicates whether or not call diversion is allowed.

IMSI

See 3GPP TS 23.018 [97] and 3GPP TS 23.066 [108] for the use of this parameter and the conditions for its presence.

MSRN

See 3GPP TS 23.018 [97], 3GPP TS 23.066 [108] and 3GPP TS 23.079 [99] for the use of this parameter and the conditions for its presence. If the NPLR returns only the MSISDN-number without Routeing Number to the GMSC, the MSISDN-number shall be returned as MSRN.

Forwarding Data

This parameter includes a number to define the forwarded-to destination, the forwarding reason and the forwarding options Notification to calling party and Redirecting presentation, and can include the forwarded-to subaddress. See 3GPP TS 23.018 [97] and 3GPP TS 23.079 [99] for the conditions for the presence of its components.

Forwarding Interrogation Required

See 3GPP TS 23.079 [99] for the use of this parameter and the conditions for its presence.

Long FTN Supported

This parameter indicates that the GMSC supports Long Forwarded-to Numbers.

Suppress VT-CSI

The use of this parameter and the requirements for its presence are specified in 3GPP TS 23.078.

Suppress Incoming Call Barring

The use of this parameter and the requirements for its presence are specified in 3GPP TS 23.078.

gsmSCF Initiated Call

The use of this parameter and the requirements for its presence are specified in 3GPP TS 23.078.

VMSC address

See 3GPP TS 23.079 [99] for the use of this parameter and the conditions for its presence.

GMSC CAMEL Subscription Info

The use of this parameter and the requirements for its presence are specified in 3GPP TS 23.078.

Location Information

The use of this parameter and the requirements for its presence are specified in 3GPP TS 23.078.

Subscriber State

The use of this parameter and the requirements for its presence are specified in 3GPP TS 23.078.

CUG Subscription Flag

The use of this parameter and the requirements for its presence are specified in 3GPP TS 23.078.

North American Equal Access preferred Carrier Id

This parameter is returned to indicate the preferred carrier identity to be used to set-up the call (i.e. forwarding the call or establishing the roaming leg).

SS-List

This parameter includes SS-codes and will be returned as an operator option. The HLR shall not send PLMN-specific SS-codes across PLMN boundaries. However if the GMSC receives PLMN-specific SS-codes from a foreign PLMN's HLR the GMSC may ignore it. If the GMSC attempts to process the PLMN-specific SS-codes, this may lead to unpredictable behaviour but the GMSC shall continue call processing.

Basic Service Code

The use of this parameter and the requirements for its presence are specified in 3GPP TS 23.078.

If the CAMEL service is not involved, this parameter includes the basic service code and will be returned as an operator option. The HLR shall not send a PLMN-specific Basic Service Code across PLMN boundaries. However if the GMSC receives a PLMN-specific Basic Service Code from a foreign PLMN's HLR the GMSC may ignore it. If the GMSC attempts to process the PLMN specific Basic Service codes, this may lead to unpredictable behaviour but the GMSC shall continue call processing.

CCBS Target

See 3GPP TS 23.093 [107] for the use of this parameter and the conditions for its presence.

Keep CCBS Call Indicator

See 3GPP TS 23.093 [107] for the use of this parameter and the conditions for its presence.

IST Alert Timer

It includes the IST Alert timer value that must be used to inform the HLR about the call activities that the subscriber performs. This parameter is only sent to the GMSC in response to a Send Routing Information request which indicates the the GMSC supports IST.

Number Portability Status

This parameter indicates the number portability status of the subscriber. This parameter may be present if the sender of SRIack is NPLR.

Supported CAMEL Phases in VMSC

The use of this parameter and the requirements for its presence are specified in 3GPP TS 23.078.

Supported CAMEL 4 Subsets in VMSC

This parameter is defined in clause 7.6.3.36F.

User error

This parameter is sent by the responder when an error is detected and if present, takes one of the following values:

- Unknown Subscriber;

The diagnostic for the Unknown Subscriber error may indicate “NPDB Mismatch”.

- Number changed;
- Call Barred;

This error will indicate that either incoming calls are barred for this MS or that calls are barred due to Operator Determined Barring (see 3GPP TS 22.041 [8] for a definition of this network feature);

- CUG Reject;

The value of this error cause will indicate the reason for CUG Reject;

- Bearer Service Not Provisioned;
- Teleservice Not Provisioned;

A subscription check has been performed and the call has not passed the check due to incompatibility with regard to the requested service. Depending on the nature of the incompatibility, either of these messages will be returned;

- Facility Not Supported;
- Absent Subscriber;

This indicates that the location of the MS is not known (either the station is not registered and there is no location information available or the Provide Roaming Number procedure fails due to IMSI detached flag being set), or the GMSC requested forwarding information with a forwarding reason of not reachable, and the call forwarding on MS not reachable service is not active;

- Busy Subscriber;

This indicates that Call Forwarding on Busy was not active for the specified basic service group when the GMSC requested forwarding information with a forwarding reason of busy;

The error may also indicate that the subscriber is busy due to an outstanding CCBS recall. In the error data it may then be specified that CCBS is possible for the busy encountered call;

- No Subscriber Reply;

This indicates that Call Forwarding on No Reply was not active for the specified basic service group when the GMSC requested forwarding information with a forwarding reason of no reply;

- OR Not Allowed;

This indicates that the HLR is not prepared to accept an OR interrogation from the GMSC, or that calls to the specified subscriber are not allowed to be optimally routed;

- Forwarding Violation;
- System Failure;
- Data Missing;
- Unexpected Data Value.

See clause 7.6 for a definition of these errors.

Provider error

These are defined in clause 7.6.

10.2 MAP_PROVIDE_ROAMING_NUMBER service

10.2.1 Definition

This service is used between the HLR and VLR. The service is invoked by the HLR to request a VLR to send back a roaming number to enable the HLR to instruct the GMSC to route an incoming call to the called MS.

This is a confirmed service which uses the primitives described in table 10.2/1.

10.2.2 Service primitives

Table 10.2/1: MAP_PROVIDE_ROAMING_NUMBER parameters

Parameter name	Request	Indication	Response	Confirm
Invoke Id	M	M(=)	M(=)	M(=)
IMSI	M	M(=)		
MSC Number	M	M(=)		
MSISDN	U	C(=)		
LMSI	C	C(=)		
GSM Bearer Capability	C	C(=)		
Network Signal Info	C	C(=)		
Suppression Of Announcement	C	C(=)		
Call Reference Number	C	C(=)		
GMSC Address	C	C(=)		
OR Interrogation	C	C(=)		
OR Not Supported in GMSC	C	C(=)		
Alerting Pattern	C	C(=)		
CCBS Call	C	C(=)		
Supported CAMEL Phases in GMSC	C	C(=)		
Additional Signal Info	C	C(=)		
Pre-paging supported	C	C(=)		
Long FTN Supported	C	C(=)		
Suppress VT-CSI	C	C(=)		
Roaming Number			C	C(=)
Supported CAMEL 4 Subsets in GMSC	C	C(=)		
User error			C	C(=)
Provider error				O

10.2.3 Parameter use

See clause 7.6 for a definition of the parameters used, in addition to the following. Note that:

- a conditional parameter whose use is defined only in 3GPP TS 23.078 [98] shall be absent if the sending entity does not support CAMEL;
- a conditional parameter whose use is defined only in 3GPP TS 23.079 [99] shall be absent if the sending entity does not support optimal routing;
- a conditional parameter whose use is defined only in 3GPP TS 23.078 [98] & 3GPP TS 23.079 [99] shall be absent if the sending entity supports neither CAMEL nor optimal routing.

IMSI

This is the IMSI of the called Subscriber.

MSC Number

This is the ISDN number assigned to the MSC currently serving the MS. The MSC number will have been stored in the HLR as provided at location updating.

MSISDN

See 3GPP TS 23.018 [97] for the use of this parameter and the conditions for its presence.

LMSI

See 3GPP TS 23.018 [97] for the use of this parameter and the conditions for its presence.

GSM Bearer Capability

See 3GPP TS 23.018 [97] for the use of this parameter and the conditions for its presence.

This information is passed according to the rules specified in TS 3GPP TS 29.007 [56].

There may be two GSM Bearer Capabilities supplied.

Network Signal Info

See 3GPP TS 23.018 [97] for the conditions for the presence of the components of this parameter.

Suppression Of Announcement

The use of this parameter and the requirements for its presence are specified in 3GPP TS 23.078 [98].

Call Reference Number

The use of this parameter and the conditions for its presence are specified in 3GPP TS 23.078 [98] and 3GPP TS 23.079 [99].

GMSC Address

The use of this parameter and the conditions for its presence are specified in 3GPP TS 23.078 [98] and 3GPP TS 23.079 [99].

OR Interrogation

See 3GPP TS 23.079 [99] for the use of this parameter and the conditions for its presence.

OR Not Supported in GMSC

See 3GPP TS 23.079 [99] for the use of this parameter and the conditions for its presence.

Supported CAMEL Phases in GMSC

See 3GPP TS 23.078 [98] for the use of this parameter and the conditions for its presence.

Alerting Pattern

See 3GPP TS 23.078 [98] for the use of this parameter and the conditions for its presence.

CCBS Call

See 3GPP TS 23.093 [107] for the use of this parameter and the conditions for its presence.

Additional Signal Info

See 3GPP TS 23.081 [27] for the conditions for the presence of the components of this parameter.

Pre-paging supported

See 3G TS 23.018 for the use of this parameter and the conditions for its presence.

Long FTN supported

See 3G TS 23.082 for the use of this parameter and the conditions for its presence.

Suppress VT-CSI

See 3GPP TS 23.078 for the use of this parameter and the conditions for its presence.

Supported CAMEL 4 Subsets in GMSC

This parameter is defined in clause 7.6.3.36E.

Roaming Number

See 3GPP TS 23.018 [97] for the use of this parameter and the conditions for its presence.

User error

This parameter is sent by the responder when an error is detected and if present, takes one of the following values:

- Absent Subscriber;
This error will be returned if the IMSI detach flag is set.
- No Roaming Number Available;
- OR Not Allowed;
This indicates that the MAP_PROVIDE_ROAMING_NUMBER indication included the OR interrogation indicator, but the VLR does not support optimal routing.
- Facility Not Supported;
- System Failure;
- Data Missing;
- Unexpected Data Value.

See clause 7.6 for a definition of these reasons.

Provider error

These are defined in clause 7.6.

10.3 MAP_RESUME_CALL_HANDLING service

10.3.1 Definition

This service is used between the terminating VMSC and the GMSC. The service is invoked by the terminating VMSC to request the GMSC to resume handling the call and forward it to the specified destination.

This is a confirmed service which uses the Primitives listed in table 10.3/1.

10.3.2 Service primitives

Table 10.3/1: MAP_RESUME_CALL_HANDLING parameters

Parameter name	Request	Indication	Response	Confirm
Invoke Id	M	M(=)	M(=)	M(=)
Call Reference Number	C	C(=)		
Basic Service Group	C	C(=)		
IMSI	C	C(=)		
Forwarding Data	C	C(=)		
CUG Interlock	C	C(=)		
CUG Outgoing Access	C	C(=)		
O-CSI	C	C(=)		
D-CSI	C	C(=)		
CCBS Target	C	C(=)		
UU Data	C	C(=)		
UUS CF Interaction	C	C(=)		
All Information Sent	C	C(=)		

MSISDN	C	C(=)		
User error			C	C(=)
Provider error				O

10.3.3 Parameter use

Information received in subsequent segment of a segmented dialogue shall not overwrite information received in an earlier segment.

See clause 7.6 for a definition of the parameters used, in addition to the following.

Call Reference Number

See 3GPP TS 23.079 [99] for the use of this parameter. This parameter shall be present in a first segment of the dialogue.

Basic Service Group

See 3GPP TS 23.079 [99] for the use of this parameter. This parameter shall be present in a first segment of the dialogue.

IMSI

This is the IMSI of the forwarding Subscriber. This parameter shall be present in a first segment of the dialogue.

Forwarding Data

This parameter includes a number to define the forwarded-to destination, the forwarding reason and the forwarding options Notification to calling party and Redirecting presentation, and can include the forwarded-to subaddress. See 3GPP TS 23.079 [99] for the conditions for the presence of its components. This parameter shall be present in a first segment of the dialogue.

CUG Interlock

See 3GPP TS 23.079 [99] for the use of this parameter and the conditions for its presence.

CUG Outgoing Access

See 3GPP TS 23.079 [99] for the use of this parameter and the conditions for its presence.

O-CSI

See 3GPP TS 23.078 for the use of this parameter and the conditions for its presence.

For CAMEL phases 1 & 2, the O-CSI shall contain only one set of O-BCSM TDP data.

D-CSI

The Dialed Services-CSI.

See 3GPP TS 23.078 for the use of this parameter and the conditions for its presence.

CCBS Target

See 3GPP TS 23.093 [107] for the use of this parameter and the conditions for its presence.

UU Data

See 3GPP TS 23.087 for the use of this parameter and the conditions for its presence.

UUS CF Interaction

See 3GPP TS 23.087 for the use of this parameter and the conditions for its presence.

All Information Sent

This parameter is set when the VMSC has sent all information to GMSC.

MSISDN

This parameter is the basic MSISDN of the forwarding subscriber. It shall be present if the VMSC supports determination of the redirecting number.

User error

This parameter is sent by the responder when an error is detected and if present, takes one of the following values:

- Optimal Routeing not allowed;
- Forwarding failed;
- Unexpected Data Value;
- Data Missing.

Provider error

These are defined in clause 7.6.

10.4 MAP_PREPARE_GROUP_CALL service

10.4.1 Definition

This service is used by the Anchor_MSC to inform the Relay_MSC about a group call set-up.

The MAP_PREPARE_GROUP_CALL service is a confirmed service using the service primitives given in table 10.4/1.

10.4.2 Service primitives

Table 10.4/1: MAP_PREPARE_GROUP_CALL service

Parameter name	Request	Indication	Response	Confirm
Invoke Id	M	M(=)	M(=)	M(=)
Teleservice	M	M(=)		
ASCI Call Reference	M	M(=)		
Ciphering Algorithm	M	M(=)		
Group Key Number	C	C(=)		
Group Key	C	C(=)		
Priority	C	C(=)		
CODEC-Information	M	M(=)		
Uplink Free Indicator	M	M(=)		
Group Call Number			M	M(=)
User Error			C	C(=)
Provider Error				O

10.4.3 Parameter definitions and use

Invoke Id

See definition in clause 7.6.1.

Teleservice

Voice Broadcast Service or Voice Group Call Service.

ASCI Call Reference

Broadcast call reference or group call reference. This item is used to access the VBS-GCR or VGCS-GCR within the Relay_MSC.

Ciphering Algorithm

The ciphering algorithm to be used for the group call.

Group Key Number

This number has to be broadcasted and is used by the mobile station to select the chosen group key.

Shall be present if the ciphering applies.

Group Key

This key is used for ciphering on the radio interface.

Shall be present if the ciphering applies.

Priority

Default priority level related to the call if eMLPP applies.

CODEC-Information

Information on the codecs allowed for this call.

Uplink Free Indicator

A flag indicating whether the call is initiated from a dispatcher.

Group Call Number

This temporary allocated E.164 number is used for routing the call from the Anchor MSC to the Relay MSC.

User Error

For definition of this parameter see clause 7.6.1 The following errors defined in clause 7.6.1 may be used, depending on the nature of the fault:

- No Group Call Number available;
- System Failure;
- Unexpected Data Value.

Provider Error

See definition of provider error in clause 7.6.1.

10.5 MAP_PROCESS_GROUP_CALL_SIGNALLING service

10.5.1 Definitions

This service is used between Relay MSC and Anchor MSC for transmission of Group Call notifications.

The MAP_PROCESS_GROUP_CALL_SIGNALLING service is a non-confirmed service using the service primitives given in table 10.5/1.

10.5.2 Service primitives

Table 10.5/1: MAP_PROCESS_GROUP_CALL_SIGNALLING service

Parameter name	Request	Indication
Invoke Id	M	M(=)

Uplink Request	C	C(=)
Uplink Release Indication	C	C(=)
Release Group Call	C	C(=)

10.5.3 Parameter definitions and use

Invoke Id

See definition in clause 7.6.1

Uplink Request

This information element indicates to the anchor MSC that a service subscriber roaming in the relay MSC area requests access to the uplink.

Uplink Release Indication

This information element if included by the Relay MSC indicates to the Anchor MSC that the uplink has become free.

Release Group Call

This information element if included by the Relay MSC indicates to the Anchor MSC that the service subscriber who has initiated the call and who currently has access to the uplink terminates the call.

10.6 MAP_FORWARD_GROUP_CALL_SIGNALLING service

10.6.1 Definitions

This service is used between Anchor MSC and Relay MSC for transmission of Group Call notifications.

The MAP_FORWARD_GROUP_CALL_SIGNALLING service is a non-confirmed service using the service primitives given in table 10.6/1.

10.6.2 Service primitives

Table 10.6/1: MAP_FORWARD_GROUP_CALL_SIGNALLING service

Parameter name	Request	Indication
Invoke Id	M	M(=)
IMSI	C	C(=)
Uplink Request Acknowledgement	C	C(=)
Uplink Release Indication	C	C(=)
Uplink Reject Command	C	C(=)
Uplink Seized Command	C	C(=)
Uplink Release Command	C	C(=)
State Attributes	C	C(=)

10.6.3 Parameter definitions and use

IMSI

Identity of the service subscriber who has established the call and who is allowed to terminate the call.

Invoke Id

See definition in clause 7.6.1.

Uplink Request Acknowledgement

This information element is used for positive acknowledgement of an uplink request.

Uplink Release Indication

This information element if included by the Anchor MSC indicates to the Relay MSC that the uplink has become free.

Uplink Reject Command

This information element is used for negative acknowledgement of an uplink request.

Uplink Seized Command

This information element if included by the Anchor MSC indicates to the Relay MSC that the uplink is no longer free.

Uplink Release Command

This information element if included by the Anchor MSC indicates to the Relay MSC that the uplink which is granted to a MS in the relay MSC area shall be released.

State Attributes

This information element is used to allow service logic running in an Anchor MSC to mute a VGCS talker even when the talker is served on a Relay MSC. The IE is used to build a GCC message that provides a mechanism to induce the VGCS talker terminal to mute/unmute the downlink at the Anchor MSC, as defined in 3GPP TS 44.068.

10.7 MAP_SEND_GROUP_CALL_END_SIGNAL service

10.7.1 Definitions

This service is used between the Relay MSC and the Anchor MSC indicating that VGCS / VBS channels have been established in the Relay MSC area. The response is used by the Anchor MSC to inform the Relay MSC that all resources for the call can be released in the Relay MSC because the call has been released in the Anchor MSC.

The MAP_SEND_GROUP_CALL_END_SIGNAL service is a confirmed service using the service primitives given in table 10.7/1.

10.7.2 Service primitives

Table 10.7/1: MAP_SEND_GROUP_CALL_END_SIGNAL service

Parameter name	Request	Indication	Response	Confirm
Invoke Id	M	M(=)	M(=)	M(=)
IMSI	C	C(=)		
Provider Error				O

10.7.3 Parameter definitions and use

IMSI

Identity of the service subscriber who has established the call and who is allowed to terminate the call.

Shall be present if the call was established by a service subscriber roaming in the relay MSC area.

Invoke Id

See definition in clause 7.6.1

Provider Error

See definition of provider error in clause 7.6.1.

10.8 MAP_Provide_SIWFS_Number

10.8.1 Definition

This service is used between an MSC and SIWFS. It is invoked by an MSC receiving an incoming call (call to or from MS) to request the SIWFS to allocate IWU resources. The service is defined in GSM 03.54.

This is a confirmed service using the primitives described in table 10.8/1.

10.8.2 Service primitive

Table 10.8/1: MAP_Provide_SIWFS_Number service

Parameter name	Request	Indication	Response	Confirm
Invoke ID	M	M(=)	M(=)	M(=)
GSM Bearer Capability	M	M(=)		
ISDN Bearer Capability	M	M(=)		
Call Direction	M	M(=)		
B-subscriber address	M	M(=)		
Chosen Channel	M	M(=)		
Lower Layer Compatibility	C	C(=)		
High Layer Compatibility	C	C(=)		
SIWFS number			C	C(=)
User error			C	C(=)
Provider error				O

10.8.3 Parameter use

See clause 7.6 for a definition of the parameters used, in addition to the following.

GSM Bearer Capability

This information is the result from the negotiation with the mobile station. The information is sent from the MSC to the SIWFS to allocate the correct IWU.

ISDN Bearer Capability

This parameter refers to the ISDN Bearer Capability information element. For the MTC this parameter is received in the ISUP User Service Information parameter. For the MOC call this parameter is mapped from the GSM BC parameter according to 3GPP TS 29.007 [56]. The parameter is used by the SIWFS to route the call and to allocate the outgoing circuit.

Call Direction

This parameter indicates the direction of the call (mobile originated or mobile terminated) at call set-up.

B-subscriber address

This parameter is sent from the MSC to the SIWFS to inform the SIWFS where to route the call i.e. where to send the IAM. If the loop method is used this parameter will indicate the address to the VMSC. This address is allocated by the VMSC in the same way as a MSRN and is used to correlate the incoming IAM to the corresponding MAP dialogue. If the non-loop method is used this parameter will indicate the address to the B-subscriber.

Chosen Channel

This parameter is sent from the MSC to the SIWFS to adjust the interworking unit to the assigned radio resources. This parameter is defined in 3GPP TS 48.008 [49].

Lower Layer Compatibility

This parameter is sent from the MSC to the SIWF to allow the interworking unit to perform a compatibility check. This parameter is handled as specified in 3GPP TS 29.007 [56]. This parameter is defined in 3GPP TS 24.008 [35].

High Layer Compatibility

This parameter is sent from the MSC to the SIWF to allow the interworking unit to perform a compatibility check. This parameter is handled as specified in 3GPP TS 29.007 [56]. This parameter is defined in 3GPP TS 24.008 [35].

SIWFS number

This parameter is sent from the SIWFS to the MSC. This address is used by the visited MSC to route the call, i.e. the IAM to the SIWFS (similar to MSRN) and will be used by the SIWFS to correlate the incoming IAM to the corresponding MAP message. This parameter must always be sent from the SIWFS when a successful allocation of SIWFS resources has been made.

User error

This parameter is sent by the responder when an error is detected and if present, takes one of the following values:

- Resource limitation;
- Facility Not Supported;
- Unexpected Data Value;
- System Failure.

See clause 7.6 for a definition of these reasons.

Provider error

These are defined in clause 7.6.

10.9 MAP_SIWFS_Signalling_Modify

10.9.1 Definition

This service is used to transport signalling information between an MSC and an SIWFS in the case of a request to modify the configuration (e.g. HSCSD). It is invoked either by an MSC or by the SIWFS. The service is defined in GSM 03.54.

This is a confirmed service using the primitives described in table 10.9/1.

10.9.2 Service primitive

Table 10.9/1: MAP_SIWFS_Signalling_Modify service

Parameter name	Request	Indication	Response	Confirm
Invoke ID	M	M(=)	M(=)	M(=)
Channel Type	C	C(=)		
Chosen Channel	C	C(=)	C(=)	C(=)
User error			C	C(=)
Provider error				O

10.9.3 Parameter use

See clause 7.6 for a definition of the parameter used, in addition to the following.

Channel Type

This parameter is the result of a Channel Mode Modification for TS61/62. It contains the changed Air Interface User Rate. The information is sent from the SIWFS to the MSC to assign the correct radio resource. This parameter is defined in 3GPP TS 48.008 [49].

Chosen Channel

This parameter is sent from the MSC to the SIWFS to adjust the interworking unit to the assigned radio resources. This parameter is defined in 3GPP TS 48.008 [49].

User error

This parameter is sent by the responder when an error is detected and if present , takes one of the following values:

- Resource limitation;
- Facility Not Supported;
- Data Missing;
- Unexpected Data Value;
- System Failure.

See clause 7.6 for a definition of these reasons.

Provider error

These are defined in clause 7.6.

10.10 MAP_SET_REPORTING_STATE service

10.10.1 Definition

This service is used between the HLR and the VLR to set the reporting state for a requested service. It is a confirmed service using the service primitives shown in table 10.10/1.

10.10.2 Service primitives

Table 10.10/1: MAP_SET_REPORTING_STATE parameters

Parameter name	Request	Indication	Response	Confirm
Invoke id	M	M(=)	M(=)	M(=)
IMSI	C	C(=)		
LMSI	C	C(=)		
CCBS Monitoring	C	C(=)		
CCBS Subscriber Status			C	C(=)
User error			C	C(=)
Provider error				O

10.10.3 Parameter use

See clause 7.6 for a definition of the parameters used, in addition to the following.

IMSI

The IMSI is a mandatory parameter if the service is used as the only one in a dialogue.

CCBS Monitoring

This parameter indicates whether monitoring for CCBS shall be started or stopped. If it indicates that monitoring shall be started this service corresponds to the message 'Start Reporting' in 3GPP TS 23.093 [107]; if it indicates that monitoring shall be stopped this service corresponds to the message 'Stop Reporting' in 3GPP TS 23.093 [107].

CCBS Subscriber Status

See 3GPP TS 23.093 [107] for the use of this parameter and the conditions for its presence.

User error

This parameter is sent by the responder upon unsuccessful outcome of the service, and then takes one of the following values defined in clause 7.6.1:

- System Failure;
- Unidentified Subscriber;
- Unexpected Data Value;
- Data Missing;
- Resource Limitation;
- Facility Not Supported.

NOTE: This error is reserved for future use.

Provider error

These are defined in clause 7.6.

10.11 MAP_STATUS_REPORT service

10.11.1 Definition

This service is used by the VLR to report an event or call outcome to the HLR. It is a confirmed service using the service primitives shown in table 10.11/1.

10.11.2 Service primitives

Table 10.11/1: MAP_STATUS_REPORT parameters

Parameter name	Request	Indication	Response	Confirm
Invoke id	M	M(=)	M(=)	M(=)
IMSI	M	M(=)		
CCBS Subscriber Status	C	C(=)		
Monitoring Mode	C	C(=)		
Call Outcome	C	C(=)		
User error			C	C(=)
Provider error				O

10.11.3 Parameter use

See clause 7.6 for a definition of the parameters used, in addition to the following.

CCBS Subscriber Status

If this parameter is present without Monitoring Mode and Call Outcome this service corresponds to the message 'Event Report' in 3GPP TS 23.093 [107]. See 3GPP TS 23.093 [107] for the use of this parameter and the conditions for its presence.

Monitoring Mode

If this parameter is present with CCBS Call Outcome this service corresponds to the message 'CCBS Call Report' in 3GPP TS 23.093 [107]. See 3GPP TS 23.093 [107] for the use of this parameter and the conditions for its presence.

Call Outcome

See 3GPP TS 23.093 [107] for the use of this parameter and the conditions for its presence.

User error

This parameter is sent by the responder upon unsuccessful outcome of the service, and then takes one of the following values defined in clause 7.6.1:

- Unknown Subscriber;
- System Failure;
- Unexpected Data Value;
- Data Missing.

Provider error

These are defined in clause 7.6.

10.12 MAP_REMOTE_USER_FREE service

10.12.1 Definition

This service is used between the HLR and the VLR to report that the B subscriber is now idle and that the A subscriber can be notified. It is a confirmed service using the service primitives shown in table 10.12/1.

10.12.2 Service primitives

Table 10.12/1: MAP_REMOTE_USER_FREE parameters

Parameter name	Request	Indication	Response	Confirm
Invoke id	M	M(=)	M(=)	M(=)
IMSI	M	M(=)		
Call Info	M	M(=)		
CCBS Feature	M	M(=)		
Translated B Number	M	M(=)		
Replace B Number	C	C(=)		
Alerting Pattern	C	C(=)		
RUF Outcome			C	C(=)
User error			C	C(=)
Provider error				O

10.12.3 Parameter use

See clause 7.6 for a definition of the parameters used, in addition to the following.

Call Info

See 3GPP TS 23.093 [107] for the use of this parameter.

CCBS Feature

See 3GPP TS 23.093 [107] for the conditions for the presence of the parameters included in the CCBS feature.

Translated B Number

See 3GPP TS 23.093 [107] for the use of this parameter.

Replace B Number

See 3GPP TS 23.093 [107] for the use of this parameter and the conditions for its presence.

Alerting Pattern

See 3GPP TS 23.093 [107] for the use of this parameter and the conditions for its presence.

RUF Outcome

See 3GPP TS 23.093 [107] for the use of this parameter and the conditions for its presence.

User error

This parameter is sent by the responder upon unsuccessful outcome of the service, and then takes one of the following values defined in clause 7.6.1:

- Unexpected Data Value;
- Data Missing;
- Incompatible Terminal;
- This error is returned by the responder when the terminal used for CCBS activation is not compatible with the terminal used for the CCBS recall. For details refer to 3GPP TS 24.008 [35];
- Absent Subscriber (IMSI Detach; Restricted Area; No Page Response);
- System Failure;
- Busy Subscriber (CCBS Busy).

Provider error

These are defined in clause 7.6.

10.13 MAP_IST_ALERT service

10.13.1 Definition

This service is used between the MSC (Visited MSC or Gateway MSC) and the HLR, to report that the IST timer running for a call for the Subscriber has expired. It is a confirmed service using the service primitives shown in table 10.13/1.

10.13.2 Service primitives

Table 10.13/1: MAP_IST_ALERT parameters

Parameter name	Request	Indication	Response	Confirm
Invoke Id	M	M(=)	M(=)	M(=)
IMSI	M	M(=)		
IST Alert Timer			C	C(=)
IST Information Withdraw			C	C(=)
Call termination Indicator			C	C(=)
User error			C	C(=)
Provider error				O

10.13.3 Parameter use

All parameters are described in clause 7.6. The following clarifications are applicable:

IST Alert Timer

If included in the IST Alert response, it includes the new IST Alert timer value that must be used to inform the HLR about the call activities that the subscriber performs.

IST Information Withdraw

If included in the IST Alert response, this parameter is used to indicate that the IST condition has been removed for the subscriber. When the MSC receives this parameter, IST control for that call shall be terminated.

Call termination Indicator

If included in the IST Alert response, this parameter is used to indicate whether the MSC shall terminate the call activity that had previously triggered the IST Alert procedure, or it shall also release all other call activities for the specified subscriber (outgoing call activities if the IST Alert is initiated by the VMSC, or incoming call activities if the IST Alert is initiated by the GMSC). Release of all other call activities is possible only if the MSC has the capability to link the call activities for the Subscriber by using the IMSI as key.

User error

This parameter is sent by the responder when an error is detected and if present, takes one of the following values:

- System Failure;
- Unexpected Data Value;
- Resource Limitation;
- Facility Not Supported;
- Unknown Subscriber.

10.14 MAP_IST_COMMAND service

10.14.1 Definition

This service is used by the HLR to instruct the MSC (Visited MSC or Gateway MSC) to terminate ongoing call activities for a specific subscriber. It is a confirmed service using the service primitives shown in table 10.14/1.

10.14.2 Service primitives

Table 10.14/1: MAP_IST_COMMAND parameters

Parameter name	Request	Indication	Response	Confirm
Invoke Id	M	M(=)	M(=)	M(=)
IMSI	M	M(=)		
User error			C	C(=)
Provider error				O

10.14.3 Parameter use

All parameters are described in clause 7.6. The following clarifications are applicable:

User error

This parameter is sent by the responder when an error is detected and if present, takes one of the following values:

- System Failure;
- Unexpected Data Value;
- Resource Limitation;
- Facility Not Supported;
- Unknown Subscriber.

11 Supplementary services related services

11.1 MAP_REGISTER_SS service

11.1.1 Definition

This service is used between the MSC and the VLR and between the VLR and the HLR to register data related to a supplementary service. The VLR will relay the message to the HLR.

The service is a confirmed service and uses the service primitives shown in table 11.1./1.

11.1.2 Service primitives

Table 11.1/1: MAP_REGISTER_SS parameters

Parameter name	Request	Indication	Response	Confirm
Invoke id	M	M(=)	M(=)	M(=)
SS-Code	M	M(=)		
Basic service	C	C(=)		
Forwarded-to number with subaddress	C	C(=)		
No reply condition time	C	C(=)		
EMLPP default priority	C	C(=)	C	C(=)
Long FTN Supported	C	C(=)		
NbrUser	C	C(=)	C	C(=)
Forwarding information			C	C(=)
User error			C	C(=)
Provider error				O

11.1.3 Parameter use

Invoke id

See clause 7.6.1 for the use of this parameter.

SS-Code

This parameter indicates the supplementary service which the mobile subscriber wants to register.

Basic service

This parameter indicates for which basic service group the supplementary service is to be registered. If it is not included, the registration request applies to all basic services.

Forwarded-to number with subaddress

This parameter is obligatory if the registration applies to one or more call forwarding supplementary services. It can optionally include a sub-address.

No reply condition time

This parameter is included if the registration applies to the Call Forwarding on No Reply supplementary service (or a superset of this service) and the mobile subscriber supplies a value for this time.

EMLPP default priority

This parameter is sent by the initiator to register the eMLPP default priority level and is returned by the responder at successful outcome of the service.

Long FTN Supported

This parameter indicates that the mobile station supports Long Forwarded-to Numbers.

NbrUser

This parameter is sent by the initiator to register the MC maximum number of user defined circuit switched bearers to be used.

Forwarding information

This parameter is returned by the responder at successful outcome of the service, if the registration request concerned one or a group of Call Forwarding supplementary services.

User error

This parameter is sent by the responder upon unsuccessful outcome of the service, and then takes one of the following values defined in clause 7.6.1:

- System failure;
- Data missing;
- Unexpected data value;
- Call Barred;
- Bearer service not provisioned;
- This error is returned only if not even a subset of the requested bearer service group has been subscribed to;
- Teleservice not provisioned;

This error is returned only if not even a subset of the requested teleservice group has been subscribed to;

- Illegal SS operation;
- SS error status;
- SS incompatibility.

Provider error

See clause 7.6.1 for the use of this parameter.

11.2 MAP_ERASE_SS service

11.2.1 Definition

This service is used between the MSC and the VLR and between the VLR and the HLR to erase data related to a supplementary service. The VLR will relay the message to the HLR.

The service is a confirmed service and uses the service primitives shown in table 11.2/1.

11.2.2 Service primitives

Table 11.2/1: MAP_ERASE_SS parameters

Parameter name	Request	Indication	Response	Confirm
Invoke id	M	M(=)	M(=)	M(=)
SS-Code	M	M(=)		
Basic service	C	C(=)		
Forwarding information			C	C(=)
User error			C	C(=)
Provider error				O

11.2.3 Parameter use

Invoke id

See clause 7.6.1 for the use of this parameter.

SS-Code

This parameter indicates the supplementary service which the mobile subscriber wants to erase.

Basic service

This parameter indicates for which basic service group the supplementary service should be erased. If it is not included, the erasure request applies to all basic services.

Forwarding information

This parameter is returned by the responder at successful outcome of the service, if the erasure request concerned one or a group of Call Forwarding supplementary services.

User error

This parameter is sent by the responder upon unsuccessful outcome of the service, and then takes one of the following values, defined in clause 7.6.1:

- System failure;
- Data Missing;
- Unexpected data value;
- Bearer service not provisioned;

This error is returned only if not even a subset of the requested bearer service group has been subscribed to;

- Teleservice not provisioned;

This error is returned only if not even a subset of the requested teleservice group has been subscribed to;

- Call Barred;
- Illegal SS operation;
- SS error status.

Provider error

See clause 7.6.1 for the use of this parameter.

11.3 MAP_ACTIVATE_SS service

11.3.1 Definition

This service is used between the MSC and the VLR and between the VLR and the HLR to activate a supplementary service. The VLR will relay the message to the HLR.

The service is a confirmed service and uses the service primitives shown in table 11.3/1.

11.3.2 Service primitives

Table 11.3/1: MAP_ACTIVATE_SS parameters

Parameter name	Request	Indication	Response	Confirm
Invoke id	M	M(=)	M(=)	M(=)

SS-Code	M	M(=)		
Long FTN Supported	C	C(=)		
Basic service	C	C(=)		
Forwarding information			C	C(=)
Call barring information			C	C(=)
SS-Data			C	C(=)
User error			C	C(=)
Provider error				O

11.3.3 Parameter use

Invoke id

See clause 7.6.1 for the use of this parameter.

SS-Code

This parameter indicates the supplementary service which the mobile subscriber wants to activate.

Basic service

This parameter indicates for which basic service groups the requested supplementary service(s) should be activated. If it is not included, the activation request applies to all basic services.

Forwarding information

This parameter is returned by the responder at successful outcome of the service, if the activation request concerned Call Forwarding.

Long FTN Supported

This parameter indicates that the mobile station supports Long Forwarded-to Numbers.

Call barring information

This parameter is returned by the responder at successful outcome of the service, if the activation request concerned Call Barring.

SS-Data

This parameter is returned by the responder at successful outcome of the service, if the activation request concerned for example Call Waiting.

User error

This parameter is sent by the responder upon unsuccessful outcome of the service, and then takes one of the following values, defined in clause 7.6.1:

- System failure;
- Data Missing;
- Unexpected data value;
- Bearer service not provisioned;
- This error is returned only if not even a subset of the requested bearer service group has been subscribed to.
- Teleservice not provisioned;
- This error is returned only if not even a subset of the requested teleservice group has been subscribed to.
- Call Barred;
- Illegal SS operation;

- SS error status;
- SS subscription violation;
- SS incompatibility;
- Negative PW check;
- Number Of PW Attempts Violation.

Provider error

See clause 7.6.1 for the use of this parameter.

11.4 MAP_DEACTIVATE_SS service

11.4.1 Definitions

This service is used between the MSC and the VLR and between the VLR and the HLR to deactivate a supplementary service. The VLR will relay the message to the HLR.

The service is a confirmed service and uses the service primitives shown in table 11.4/1.

11.4.2 Service primitives

Table 11.4/1: MAP_DEACTIVATE_SS parameters

Parameter name	Request	Indication	Response	Confirm
Invoke id	M	M(=)	M(=)	M(=)
SS-Code	M	M(=)		
Basic service	C	C(=)		
Forwarding information			C	C(=)
Call barring information			C	C(=)
SS-Data			C	C(=)
User error			C	C(=)
Provider error				O

11.4.3 Parameter use

Invoke id

See clause 7.6.1 for the use of this parameter.

SS-Code

This parameter indicates the supplementary service which the mobile subscriber wants to deactivate.

Basic service

This parameter indicates for which basic service group the requested supplementary service(s) should be deactivated. If it is not included the deactivation request applies to all basic services.

Forwarding information

This parameter is returned by the responder at successful outcome of the service, if the deactivation request concerned one or a group of Call Forwarding supplementary services.

Call barring information

This parameter is returned by the responder at successful outcome of the service, if the activation request concerned one or a group of Call Barring supplementary services.

SS-Data

This parameter is returned by the responder at successful outcome of the service, for example if the deactivation request concerned the Call Waiting supplementary service.

User error

This parameter is sent by the responder upon unsuccessful outcome of the service, and then takes one of the following values, defined in clause 7.6.1:

- System failure;
- Data Missing;
- Unexpected data value;
- Bearer service not provisioned;

This error is returned only if not even a subset of the requested bearer service group has been subscribed to;

- Teleservice not provisioned;

This error is returned only if not even a subset of the requested teleservice group has been subscribed to;

- Call Barred;
- Illegal SS operation;
- SS error status;
- SS subscription violation;
- Negative PW check;
- Number Of PW Attempts Violation.

Provider error

See clause 7.6.1 for the use of this parameter.

11.5 MAP_INTERROGATE_SS service

11.5.1 Definitions

This service is used between the MSC and the VLR and between the VLR and the HLR to retrieve information related to a supplementary service. The VLR will relay the message to the HLR if necessary.

The service is a confirmed service and consists of four service primitives.

11.5.2 Service primitives

The service primitives are shown in table 11.5/1.

Table 11.5/1: MAP_INTERROGATE_SS parameters

Parameter name	Request	Indication	Response	Confirm
Invoke id	M	M(=)	M(=)	M(=)
SS-Code	M	M(=)		
Basic service	C	C(=)		
Long FTN Supported	C	C(=)		
SS-Status			C	C(=)
Basic service Group LIST			C	C(=)
Forwarding feature LIST			C	C(=)
CLI restriction Info			C	C(=)

EMLPP Info			C	C(=)
MC Information			C	C(=)
CCBS Feature LIST			C	C(=)
User error			C	C(=)
Provider error				O

11.5.3 Parameter use

For additional information on parameter use refer to the GSM 04.8x and 04.9x-series of technical specifications.

Invoke id

See clause 7.6.1 for the use of this parameter.

SS-Code

The mobile subscriber can only interrogate a single supplementary service per service request.

Basic service

This parameter indicates for which basic service group the given supplementary service is interrogated. If it is not included, the interrogation request applies to all basic services.

SS-Status

This parameter is included by the responder if:

- the interrogated supplementary service can only be subscribed for all applicable basic services simultaneously;
or
- the interrogated supplementary service is not active for any of the interrogated basic services, or
- the interrogation was for the CCBS supplementary service and no CCBS request is active or the service is not provisioned.

Basic service group LIST

This parameter LIST is used to include one or a series of basic service groups for which the interrogated supplementary service is active. If the interrogated supplementary service is not active for any of the interrogated (and provisioned) basic service groups, the SS-Status parameter is returned.

Long FTN Supported

This parameter indicates that the mobile station supports Long Forwarded-to Numbers.

Forwarding feature LIST

The forwarding feature parameter is described in clause 7.6.4. A list of one or more forwarding features is returned by the responder when the interrogation request applied to Call Forwarding supplementary service.

If no basic service code parameter is provided within this sequence, the forwarding feature parameter applies to all provisioned basic services.

CLI restriction Info

The CLI-RestrictionInfo parameter is returned by the responder when the interrogation request applies to the CLIR supplementary service.

EMLPP Info

The eMLPP info (maximum entitled priority and default priority) is returned by the responder if the interrogation request applies to the eMLPP supplementary service.

MC Information

The MC information (NbrSB, NbrUser and NbrSN) is returned by the responder if the interrogation request applies to the MC supplementary service. For a definition of these 3 components, refer to 3G TS 23.135 and 3G TS 24.135.

CCBS Feature LIST

The CCBS feature parameter is described in clause 7.6. A list of one or more CCBS features is returned by the responder when the interrogation request applied to the CCBS supplementary service. See 3GPP TS 23.093 [107] for the conditions for the presence of the parameters included in the CCBS feature.

User error

This error is sent by the responder upon unsuccessful outcome of the interrogation service, and then takes one of the following values, defined in clause 7.6.1:

- System failure;
- Data Missing;
- Unexpected data value;
- Bearer Service not provisioned;

This error is returned only if not even a subset of the interrogated bearer services are provided;

- Teleservice not provisioned;

This error is returned only if not even a subset of the interrogated teleservices are provided;

- Call Barred;
- Illegal SS operation;
- SS not available.

Provider error

See clause 7.6.1 for the use of this parameter.

11.6 MAP_INVOKE_SS service

11.6.1 Definitions

This service is used between the MSC and the VLR to check the subscriber's subscription to a given supplementary service in the VLR, in connection with in-call invocation of that supplementary service, i.e. after the call set-up phase is finished. For supplementary service invocation during call set-up phase, please refer to the call handling descriptions.

The service is a confirmed service and consists of four service primitives.

11.6.2 Service primitives

The service primitives are shown in table 11.6/1.

Table 11.6/1: MAP_INVOKE_SS parameters

Parameter name	Request	Indication	Response	Confirm
Invoke id	M	M(=)	M(=)	M(=)
SS-Code	M	M(=)		
Basic service	C	C(=)		
User error			C	C(=)
Provider error				O

11.6.3 Parameter use

Invoke id

See clause 7.6.1 for the use of this parameter.

SS-Code

This SS-Code can only refer to a single supplementary service, e.g. the Call Hold or Multi Party supplementary services.

Basic service

This parameter indicates for which basic service the supplementary service invocation is required.

User error

This parameter is sent by the responder upon unsuccessful outcome of the service, and then takes one of the following values:

- System Failure;
- Data Missing;
- Unexpected data value;
- Call Barred;
- Illegal SS operation;
- SS error status;
- SS not available.

Provider error

See clause 7.6.1 for the use of this parameter.

11.7 MAP_REGISTER_PASSWORD service

11.7.1 Definitions

This service is used between the MSC and the VLR and between the VLR and the HLR if the mobile subscriber requests to register a new password. The VLR will relay the message to the HLR.

The service is a confirmed service and consists of four service primitives.

11.7.2 Service primitives

The service primitives are shown in table 11.7/1.

Table 11.7/1: MAP_REGISTER_PASSWORD parameters

Parameter name	Request	Indication	Response	Confirm
Invoke id	M	M(=)	M(=)	M(=)
SS-Code	M	M(=)		
New password			C	C(=)
User error			C	C(=)
Provider error				O

11.7.3 Parameter use

Invoke id

See clause 7.6.1 for the use of this parameter.

SS-Code

This parameter indicates for which supplementary service(s) the password should be registered.

New Password

See clause 7.6.4 for the use of this parameter.

User error

This parameter is sent by the responder upon unsuccessful outcome of the service, and then takes one of the following values, defined in clause 7.6.1:

- System failure;
- Data Missing;
- Unexpected data value;
- Call Barred;
- SS subscription violation;
- Password registration failure;
- Negative PW check;
- Number Of PW Attempts Violation.

Provider error

See clause 7.6.1 for the use of this parameter.

11.8 MAP_GET_PASSWORD service

11.8.1 Definitions

This service is used between the HLR and the VLR and between the VLR and the MSC when the HLR receives a request from the mobile subscriber for an operation on a supplementary service which requires a password from the subscriber. The VLR will relay the message to the MSC.

The service is a confirmed service and uses the service primitives shown in table 11.8/1.

11.8.2 Service primitives

Table 11.8/1: MAP_GET_PASSWORD parameters

Parameter name	Request	Indication	Response	Confirm
Invoke id	M	M(=)	M(=)	M(=)
Linked id	C	C(=)		
Guidance info	M	M(=)		
Current password			M	M(=)
Provider error				O

11.8.3 Parameter use

Invoke id

See clause 7.6.1 for the use of this parameter.

Linked Id

See clause 7.6.1 for the use of this parameter. If the MAP_GET_PASSWORD service is used in conjunction with the MAP_REGISTER_PASSWORD service, this parameter must be present; otherwise it must be absent.

Guidance info

See clause 7.6.4 for the use of this parameter.

Current password

See clause 7.6.4 for the use of this parameter.

Provider error

See clause 7.6.1 for the use of this parameter.

11.9 MAP_PROCESS_UNSTRUCTURED_SS_REQUEST service

11.9.1 Definitions

This service is used between the MSC and the VLR, between the VLR and the HLR, between the HLR and gsmSCF and between the HLR and HLR to relay information in order to allow unstructured supplementary service operation.

The MAP_PROCESS_UNSTRUCTURED_SS_REQUEST service is a confirmed service using the primitives from table 11.9/1.

11.9.2 Service primitives

Table 11.9/1: MAP_PROCESS_UNSTRUCTURED_SS_REQUEST parameters

Parameter name	Request	Indication	Response	Confirm
Invoke id	M	M(=)	M(=)	M(=)
USSD Data Coding Scheme	M	M(=)	C	C(=)
USSD String	M	M(=)	C	C(=)
MSISDN	U	C(=)		
User error			C	C(=)
Provider error				O

11.9.3 Parameter use

Invoke id

See clause 7.6.1 for the use of this parameter.

USSD Data Coding Scheme

See clause 7.6.4 for the use of this parameter. The presence of the parameter in the response is dependent on the unstructured supplementary service application. If this parameter is present, then the USSD String parameter has to be present.

USSD String

See clause 7.6.1 for the use of this parameter. The presence of the parameter in the response is dependent on the unstructured supplementary service application. If this parameter is present, then the USSD Data Coding Scheme parameter has to be present.

MSISDN

The subscriber's basic MSISDN.

See definition in clause 7.6.2. The MSISDN is included as an operator option, e.g. to allow addressing the subscriber's data in the gsmSCF with the MSISDN.

User error

This parameter is sent by the responder upon unsuccessful outcome of the service, and then takes one of the following values defined in clause 7.6.1:

- System failure;
- Data missing;
- Unexpected data value;

This error is returned by the responder if it is not able to deal with the contents of the USSD string.

- Call Barred;
- Unknown Alphabet.

Provider error

See clause 7.6.1 for the use of this parameter.

11.10 MAP_UNSTRUCTURED_SS_REQUEST service

11.10.1 Definitions

This service is used between the gsmSCF and the HLR, the HLR and the VLR and between the VLR and the MSC when the invoking entity requires information from the mobile user, in connection with unstructured supplementary service handling.

The MAP_UNSTRUCTURED_SS_REQUEST service is a confirmed service using the primitives from table 11.10/1.

11.10.2 Service primitives

Table 11.10/1: MAP_UNSTRUCTURED_SS_REQUEST parameters

Parameter name	Request	Indication	Response	Confirm
Invoke id	M	M(=)	M(=)	M(=)
USSD Data Coding Scheme	M	M(=)	C	C(=)
USSD String	M	M(=)	C	C(=)
Alerting Pattern	C	C(=)		
User error			C	C(=)
Provider error				O

11.10.3 Parameter use

Invoke id

See clause 7.6.1 for the use of this parameter.

USSD Data Coding Scheme

See clause 7.6.4 for the use of this parameter. The presence of the parameter in the response is dependent on the mobile user's MMI input. If this parameter is present, then the USSD String parameter has to be present.

USSD String

See clause 7.6.1 for the use of this parameter. The presence of the parameter in the response is dependent on the mobile user's MMI input. If this parameter is present, then the USSD Data Coding Scheme parameter has to be present.

Alerting Pattern

See clause 7.6.3 for the use of this parameter.

User error

This parameter is sent by the responder upon unsuccessful outcome of the service, and then takes one of the following values defined in clause 7.6.1:

- System failure;
- Data missing;
- Unexpected data value;

This error is returned by the responder if it is not able to deal with the contents of the USSD string;

- Absent Subscriber;
- Illegal Subscriber;

This error indicates that delivery of the unstructured supplementary service data failed because the MS failed authentication;

- Illegal Equipment;
- USSD Busy;
- Unknown Alphabet.

Provider error

See clause 7.6.1 for the use of this parameter.

11.11 MAP_UNSTRUCTURED_SS_NOTIFY service

11.11.1 Definitions

This service is used between the gsmSCF and the HLR, the HLR and the VLR and between the VLR and the MSC when the invoking entity requires a notification to be sent to the mobile user, in connection with unstructured supplementary services handling.

The MAP_UNSTRUCTURED_SS_NOTIFY service is a confirmed service using the primitives from table 11.11/1.

11.11.2 Service primitives

Table 11.11/1: MAP_UNSTRUCTURED_SS_NOTIFY parameters

Parameter name	Request	Indication	Response	Confirm
Invoke id	M	M(=)	M(=)	M(=)
USSD Data Coding Scheme	M	M(=)		
USSD String	M	M(=)		
Alerting Pattern	C	C(=)		
User error			C	C(=)
Provider error				O

11.11.3 Parameter use

Invoke id

See clause 7.6.1 for the use of this parameter.

USSD Data Coding Scheme:

See clause 7.6.4 for the use of this parameter.

USSD String:

See clause 7.6.1 for the use of this parameter.

Alerting Pattern

See clause 7.6.3 for the use of this parameter.

User error

This parameter is sent by the responder upon unsuccessful outcome of the service, and then takes one of the following values defined in clause 7.6.1:

- System failure;
- Data missing;
- Unexpected data value;

This error is returned by the responder if it is not able to deal with the contents of the USSD string.

- Absent Subscriber;
- Illegal Subscriber;

This error indicates that delivery of the unstructured supplementary service data failed because the MS failed authentication.

- Illegal Equipment;
- USSD Busy;
- Unknown Alphabet.

Provider error

See clause 7.6.1 for the use of this parameter.

11.12 MAP_SS_INVOCATION_NOTIFY

11.12.1 Definition

This service is used between the MSC and the gsmSCF when the subscriber invokes one of the following supplementary services; Call Deflection (CD), Explicit Call Transfer (ECT) or Multi Party (MPTY).

This service is used between the HLR and the gsmSCF when the subscriber invokes the CCBS supplementary service.

11.12.2 Service primitives

The service primitives are shown in table 11.12/1.

Table 11.12/1: SS_INVOCATION_NOTIFY parameters

Parameter name	Request	Indication	Response	Confirm
Invoke id	M	M(=)	M(=)	M(=)
MSISDN	M	M(=)		
IMSI	M	M(=)		
SS- event	M	M(=)		
SS- event data	C	C(=)		
B-subscriber Number	C	C(=)		
CCBS Request State	C	C(=)		
User error			C	C(=)
Provider error				O

11.12.3 Parameter use

All parameters are described in clause 7.6. The use of these parameters and the requirements for their presence are specified in 3GPP TS 23.078.

User error

This parameter is sent by the responder when an error is detected and if present, takes one of the following values:

- Data Missing;
- Unexpected Data Value;
- Unknown Subscriber.

Provider error

This is defined in clause 7.6.1.

11.13 MAP_REGISTER_CC_ENTRY service

11.13.1 Definition

This service is used between the MSC and the VLR and between the VLR and the HLR to register data for a requested call completion supplementary service. The VLR will relay the message to the HLR.

The service is a confirmed service and uses the service primitives shown in table 11.13/1.

11.13.2 Service primitives

Table 11.13/1: MAP_REGISTER_CC_ENTRY parameters

Parameter name	Request	Indication	Response	Confirm
Invoke id	M	M(=)	M(=)	M(=)
SS Code	M	M(=)		
CCBS Feature	C	C(=)	C	C(=)
Translated B number	C	C(=)		
Service Indicator	C	C(=)		
Call Info	C	C(=)		
Network Signal Info	C	C(=)		
User error			C	C(=)
Provider error				O

11.13.3 Parameter use

See clause 7.6 for a definition of the parameters used, in addition to the following.

SS-Code

This parameter indicates the call completion supplementary service for which the mobile subscriber wants to register an entry.

CCBS Feature

See 3GPP TS 23.093 [107] for the conditions for the presence of the parameters included in the CCBS feature.

Translated B Number

See 3GPP TS 23.093 [107] for the use of this parameter and the conditions for its presence.

Service Indicator

This parameter corresponds to the parameters 'Presentation Indicator' and 'CAMEL Invoked' in 3GPP TS 23.093 [107]. It indicates which services have been invoked for the original call (e.g. CLIR, CAMEL). See 3GPP TS 23.093 [107] for the use of this parameter and the conditions for its presence.

Call Info

See 3GPP TS 23.093 [107] for the use of this parameter and the conditions for its presence.

Network Signal Info

See 3GPP TS 23.093 [107] for the use of this parameter and the conditions for its presence.

User error

This parameter is sent by the responder upon unsuccessful outcome of the service, and then takes one of the following values, defined in clause 7.6.1:

- System failure;
- Data missing;
- Unexpected data value;
- Call Barred;
- Illegal SS operation;
- SS error status;
- SS incompatibility.

- Short Term Denial;
- Long Term Denial;
- Facility Not Supported;

NOTE: This error is reserved for future use.

Private Extensions shall not be sent with these user errors for this operation.

Provider error

See clause 7.6.1 for the use of this parameter.

11.14 MAP_ERASE_CC_ENTRY service

11.14.1 Definition

This service is used between the MSC and the VLR and between the VLR and the HLR to erase data related to a call completion supplementary service. The VLR will relay the message to the HLR.

The service is a confirmed service and uses the service primitives shown in table 11.14/1.

11.14.2 Service primitives

Table 11.14/1: MAP_ERASE_CC_ENTRY parameters

Parameter name	Request	Indication	Response	Confirm
Invoke id	M	M(=)	M(=)	M(=)
SS-Code	M	M(=)	C(=)	C(=)
CCBS Index	C	C(=)		
SS-Status			C	C(=)
User error			C	C(=)
Provider error				O

11.14.3 Parameter use

See clause 7.6 for a definition of the parameters used, in addition to the following.

SS-Code

This parameter indicates the call completion supplementary service for which the mobile subscriber wants to erase an entry/entries.

CCBS Index

See 3GPP TS 23.093 [107] for the use of this parameter and the condition for its presence.

SS-Status

Depending on the outcome of the service request this parameter may indicate either provisioned and active or not provisioned.

User error

This parameter is sent by the responder upon unsuccessful outcome of the service, and then takes one of the following values, defined in clause 7.6.1:

- System failure;
- Data Missing;

- Unexpected data value;
- Call Barred;
- Illegal SS operation;
- SS error status.

Private Extensions shall not be sent with these user errors for this operation.

Provider error

See clause 7.6.1 for the use of this parameter.

12 Short message service management services

12.1 MAP-SEND-ROUTING-INFO-FOR-SM service

12.1.1 Definition

This service is used between the gateway MSC and the HLR to retrieve the routing information needed for routing the short message to the servicing MSC.

The MAP-SEND-ROUTING-INFO-FOR-SM is a confirmed service using the primitives from table 12.1/1.

12.1.2 Service primitives

Table 12.1/1: MAP-SEND-ROUTING-INFO-FOR-SM

Parameter name	Request	Indication	Response	Confirm
Invoke Id	M	M(=)	M(=)	M(=)
MSISDN	M	M(=)		
SM-RP-PRI	M	M(=)		
Service Centre Address	M	M(=)		
SM-RP-MTI	C	C(=)		
SM-RP-SMEA	C	C(=)		
GPRS Support Indicator	C	C(=)		
IMSI			C	C(=)
Network Node Number			C	C(=)
LMSI			C	C(=)
GPRS Node Indicator			C	C(=)
Additional Number			C	C(=)
User error			C	C(=)
Provider error				O

12.1.3 Parameter use

Invoke id

See definition in clause 7.6.1.

MSISDN

See definition in clause 7.6.2.

SM-RP-PRI

See definition in clause 7.6.8.

Service Centre Address

See definition in clause 7.6.2.

SM-RP-MTI

See definition in clause 7.6.8. This parameter shall be present when the feature « SM filtering by the HPLMN » is supported by the SMS-GMSC and when the equivalent parameter is received from the short message service relay sub-layer protocol.

SM-RP-SMEA

See definition in clause 7.6.8. This parameter shall be present when the feature « SM filtering by the HPLMN » is supported by the SMS-GMSC and when the equivalent parameter is received from the short message service relay sub-layer protocol.

GPRS Support Indicator

See definition in clause 7.6.8. The presence of this parameter is mandatory if the SMS-GMSC supports receiving of the two numbers from the HLR.

IMSI

See definition in clause 7.6.2. The presence of this parameter is mandatory in a successful case.

Network Node Number

See definition in clause 7.6.2. This parameter is provided in a successful response.

LMSI

See definition in clause 7.6.2. It is an operator option to provide this parameter from the VLR; it is mandatory for the HLR to include the LMSI in a successful response, if the VLR has used the LMSI.

GPRS Node Indicator

See definition in clause 7.6.8. The presence of this parameter is mandatory if only the SGSN number is sent in the Network Node Number.

Additional Number

See definition in clause 7.6.2. This parameter is provided in a successful response.

User error

The following errors defined in clause 7.6.1 may be used, depending on the nature of the fault:

- Unknown subscriber;
- Call Barred;
- Teleservice Not Provisioned;
- Absent Subscriber_SM;
- Facility Not Supported;
- System failure;
- Unexpected Data Value;
- Data missing.

Provider error

For definition of provider errors see clause 7.6.1.

12.2 MAP-MO-FORWARD-SHORT-MESSAGE service

12.2.1 Definition

This service is used between the serving MSC or the SGSN and the SMS Interworking MSC to forward mobile originated short messages.

The MAP-MO-FORWARD-SHORT-MESSAGE service is a confirmed service using the service primitives given in table 12.2/1.

12.2.2 Service primitives

Table 12.2/1: MAP-MO-FORWARD-SHORT-MESSAGE

Parameter name	Request	Indication	Response	Confirm
Invoke Id	M	M(=)	M(=)	M(=)
SM RP DA	M	M(=)		
SM RP OA	M	M(=)		
SM RP UI	M	M(=)	C	C(=)
IMSI	C	C(=)		
User error			C	C(=)
Provider error				O

12.2.3 Parameter use

Invoke id

See definition in clause 7.6.1.

SM RP DA

See definition in clause 7.6.8.

In the mobile originated SM transfer this parameter contains the Service Centre address received from the mobile station.

SM RP OA

See definition in clause 7.6.8.

The MSISDN received from the VLR or from the SGSN is inserted in this parameter in the mobile originated SM transfer.

SM RP UI

See definition in clause 7.6.8. The short message transfer protocol data unit received from the Service Centre is inserted in this parameter.

IMSI

See definition in clause 7.6.2.1. The IMSI of the originating subscriber is inserted in this parameter in the mobile originated SM transfer.

This parameter shall be included if the sending entity, whether MSC or SGSN, supports mobile number portability.

User error

The following errors defined in clause 7.6.1 may be used, depending on the nature of the fault:

- Facility Not Supported;
- System Failure;

- SM Delivery Failure;
 - The reason of the SM Delivery Failure can be one of the following in the mobile originated SM:
 - unknown Service Centre address;
 - Service Centre congestion;
 - invalid Short Message Entity address;
 - subscriber not Service Centre subscriber;
 - protocol error.
- Unexpected Data Value

Provider error

For definition of provider errors see clause 7.6.1.

12.3 MAP-REPORT-SM-DELIVERY-STATUS service

12.3.1 Definition

This service is used between the gateway MSC and the HLR. The MAP-REPORT-SM-DELIVERY-STATUS service is used to set the Message Waiting Data into the HLR or to inform the HLR of successful SM transfer after polling. This service is invoked by the gateway MSC.

The MAP-REPORT-SM-DELIVERY-STATUS service is a confirmed service using the service primitives given in table 12.3/1.

12.3.2 Service primitives

Table 12.3/1: MAP-REPORT-SM-DELIVERY-STATUS

Parameter name	Request	Indication	Response	Confirm
Invoke Id	M	M(=)	M(=)	M(=)
MSISDN	M	M(=)		
Service Centre Address	M	M(=)		
SM Delivery Outcome	M	M(=)		
Absent Subscriber Diagnostic SM	C	C(=)		
GPRS Support Indicator	C	C(=)		
Delivery Outcome Indicator	C	C(=)		
Additional SM Delivery Outcome	C	C(=)		
Additional Absent Subscriber Diagnostic SM	C	C(=)		
MSISdn-Alert			C	C(=)
User error			C	C(=)
Provider error				O

12.3.3 Parameter use

Invoke id

See definition in clause 7.6.1.

MSISDN

See definition in clause 7.6.2.

Service Centre Address

See definition in clause 7.6.2.

SM Delivery Outcome

See definition in clause 7.6.8. This parameter indicates the status of the mobile terminated SM delivery.

Absent Subscriber Diagnostic SM

See definition in clause 7.6.8.

GPRS Support Indicator

See definition in clause 7.6.8. The presence of this parameter is mandatory if the SMS-GMSC supports handling of two delivery outcomes.

Delivery Outcome Indicator

See definition in clause 7.6.8.

Additional SM Delivery Outcome

See definition in clause 7.6.8.

Additional Absent Subscriber Diagnostic SM

See definition in clause 7.6.8.

MSISdn-Alert

See definition in clause 7.6.2. This parameter shall be present in case of unsuccessful delivery, when the MSISDN received in the operation is different from the stored MSISdn-Alert; the stored MSISdn-Alert is the value that is returned to the gateway MSC.

User error

The following errors defined in clause 7.6.1 may be used, depending on the nature of the fault:

- Unknown Subscriber;
- Message Waiting List Full;
- Unexpected Data Value;
- Data missing.

Provider error

For definition of provider errors see clause 7.6.1.

12.4 MAP-READY-FOR-SM service

12.4.1 Definition

This service is used between the MSC and VLR as well as between the VLR and the HLR. The MSC initiates this service if a subscriber indicates memory available situation. The VLR uses the service to indicate this to the HLR.

The VLR initiates this service if a subscriber, whose message waiting flag is active in the VLR, has radio contact in the MSC.

Also this service is used between the SGSN and the HLR. The SGSN initiates this service if a subscriber indicates memory available situation. The SGSN uses the service to indicate this to the HLR.

The SGSN initiates this service if a subscriber, whose message waiting flag is active in the SGSN, has radio contact in the GPRS.

The MAP-READY-FOR-SM service is a confirmed service using the primitives from table 12.4/1.

12.4.2 Service primitives

Table 12.4/1: MAP-READY-FOR-SM

Parameter name	Request	Indication	Response	Confirm
Invoke Id	M	M(=)	M(=)	M(=)
IMSI	C	C(=)		
TMSI	C	C(=)		
Alert Reason	M	M(=)		
Alert Reason Indicator	C	C(=)		
User error			C	C(=)
Provider error				O

12.4.3 Parameter use

Invoke id

See definition in clause 7.6.1.

IMSI

See definition in clause 7.6.2. The IMSI is used always between the VLR and the HLR and between the SGSN and the HLR. Between the MSC and the VLR the identification can be either IMSI or TMSI.

TMSI

See definition in clause 7.6.2. The identification can be either IMSI or TMSI between MSC and VLR.

Alert Reason

See definition in clause 7.6.8. This parameter indicates if the mobile subscriber is present or the MS has memory available.

Alert Reason Indicator

See definition in clause 7.6.8.

User error

The following errors defined in clause 7.6.1 may be used, depending on the nature of the fault:

- Unknown Subscriber;
- Facility Not Supported;
- System Failure;
- Unexpected Data Value;
- Data missing.

Provider error

For definition of provider errors see clause 7.6.1.

12.5 MAP-ALERT-SERVICE-CENTRE service

12.5.1 Definition

This service is used between the HLR and the interworking MSC. The HLR initiates this service, if the HLR detects that a subscriber, whose MSISDN is in the Message Waiting Data file, is active or the MS has memory available.

The MAP-ALERT-SERVICE-CENTRE service is a confirmed service using the primitives from table 12.5/1.

12.5.2 Service primitives

Table 12.5/1: MAP-ALERT-SERVICE-CENTRE

Parameter name	Request	Indication	Response	Confirm
Invoke Id	M	M(=)	M(=)	M(=)
MSIsdn-Alert	M	M(=)		
Service Centre Address	M	M(=)		
User error			C	C(=)
Provider error				O

12.5.3 Parameter use

Invoke id

See definition in clause 7.6.1.

MSIsdn-Alert

See definition in clause 7.6.2. The provided MSISDN shall be the one which is stored in the Message Waiting Data file.

Service Centre Address

See definition in clause 7.6.2.

User error

The following errors defined in clause 7.6.1 may be used, depending on the nature of the fault:

- System Failure;
- Unexpected Data Value;
- Data missing.

Provider error

For definition of provider errors see clause 7.6.1.

12.6 MAP-INFORM-SERVICE-CENTRE service

12.6.1 Definition

This service is used between the HLR and the gateway MSC to inform the Service Centre which MSISDN number is stored in the Message Waiting Data file. If the stored MSISDN number is not the same as the one received from the gateway MSC in the MAP-SEND-ROUTING-INFO-FOR-SM service primitive the stored MSISDN number is included in the message.

Additionally the status of MCEF, MNRF and MNRG flags and the inclusion of the particular Service Centre address in the Message Waiting Data list is informed to the gateway MSC when appropriate.

If the HLR has stored a single MNRR, the value is included in the Absent Subscriber Diagnostic SM parameter.

If the HLR has stored a second MNRR, the value of the MNRR for the MSC is included in the Absent Subscriber Diagnostic SM parameter and the value of the MNRR for the SGSN is included in the Additional Absent Subscriber Diagnostic SM parameter.

The MAP-INFORM-SERVICE-CENTRE service is a non-confirmed service using the primitives from table 12.6/1.

12.6.2 Service primitives

Table 12.6/1: MAP-INFORM-SERVICE-CENTRE

Parameter name	Request	Indication
Invoke Id	M	M(=)
MSIsdn-Alert	C	C(=)
MWD Status	C	C(=)
Absent Subscriber Diagnostic SM	C	C(=)
Additional Absent Subscriber Diagnostic SM	C	C(=)

12.6.3 Parameter use

Invoke id

See definition in clause 7.6.1.

MSIsdn-Alert

See definition in clause 7.6.2. This parameter refers to the MSISDN stored in a Message Waiting Data file in the HLR.

MWD Status

See definition in clause 7.6.8. This parameter indicates the status of the MCEF, MNRF and MNRG flags and the status of the particular SC address presence in the Message Waiting Data list.

Absent Subscriber Diagnostic SM

See definition in clause 7.6.8.

Additional Absent Subscriber Diagnostic SM

See definition in clause 7.6.8.

12.7 MAP-SEND-INFO-FOR-MT-SMS service

12.7.1 Definition

This service is used between the MSC and the VLR. The service is invoked by the MSC receiving an mobile terminated short message to request subscriber related information from the VLR.

The MAP-SEND-INFO-FOR-MT-SMS service is a confirmed service using the primitives from table 12.7/1.

12.7.2 Service primitives

Table 12.7/1: MAP-SEND-INFO-FOR-MT-SMS

Parameter name	Request	Indication	Response	Confirm
Invoke Id	M	M(=)	M(=)	M(=)
SM RP DA	M	M(=)		
MSISDN			C	C(=)
User error			C	C(=)
Provider error				O

12.7.3 Parameter use

Invoke id

See definition in clause 7.6.1.

SM RP DA

See definition in clause 7.6.8. This parameter shall contain either an IMSI or a LMSI.

MSISDN

See definition in clause 7.6.2.

User error

The following errors defined in clause 7.6.1 may be used, depending on the nature of the fault:

- Unknown subscriber;
- Unidentified Subscriber;
- Absent subscriber;
- Unexpected Data Value;
- Data Missing;
- Illegal subscriber;
- Illegal equipment;
- Subscriber busy for MT SMS;
- System Failure.

Provider error

For definition of provider errors see clause 7.6.1.

12.8 MAP-SEND-INFO-FOR-MO-SMS service

12.8.1 Definition

This service is used between the MSC and the VLR. The service is invoked by the MSC which has to handle a mobile originated short message request to request the subscriber related information from the VLR.

The MAP-SEND-INFO-FOR-MO-SMS service is a confirmed service using the primitives from table 12.8/1.

12.8.2 Service primitives

Table 12.8/1: MAP-SEND-INFO-FOR-MO-SMS

Parameter name	Request	Indication	Response	Confirm
Invoke Id	M	M(=)	M(=)	M(=)
Service Centre Address	M	M(=)		
MSISDN			C	C(=)
User error			C	C(=)
Provider error				O

12.8.3 Parameter use

Invoke id

See definition in clause 7.6.1.

Service Centre Address

See definition in clause 7.6.2.

MSISDN

See definition in clause 7.6.2.

User error

The following errors defined in clause 7.6.1 may be used, depending on the nature of the fault:

- Teleservice Not Provisioned;
- Call Barred;
- Unexpected Data Value;
- Data Missing.

Provider error

For definition of provider errors see clause 7.6.1.

12.9 MAP-MT-FORWARD-SHORT-MESSAGE service

12.9.1 Definition

This service is used between the gateway MSC and the servicing MSC or the SGSN to forward mobile terminated short messages.

The MAP-MT-FORWARD-SHORT-MESSAGE service is a confirmed service using the service primitives given in table 12.9/1.

12.9.2 Service primitives

Table 12.9/1: MAP-MT-FORWARD-SHORT-MESSAGE

Parameter name	Request	Indication	Response	Confirm
Invoke Id	M	M(=)	M(=)	M(=)
SM RP DA	M	M(=)		
SM RP OA	M	M(=)		
SM RP UI	M	M(=)	C	C(=)
More Messages To Send	C	C(=)		
User error			C	C(=)
Provider error				O

12.9.3 Parameter use

Invoke id

See definition in clause 7.6.1.

SM RP DA

See definition in clause 7.6.8. This parameter can contain either an IMSI or a LMSI. The use of the LMSI is an operator option. The LMSI can be provided if it is received from the HLR. The IMSI is used if the use of the LMSI is not available.

This parameter is omitted in the mobile terminated subsequent SM transfers.

SM RP OA

See definition in clause 7.6.8. The Service Centre address received from the originating Service Centre is inserted in this parameter.

This parameter is omitted in the mobile terminated subsequent SM transfers.

SM RP UI

See definition in clause 7.6.8. The short message transfer protocol data unit received from the Service Centre is inserted in this parameter. A short message transfer protocol data unit may also be inserted in this parameter in the message delivery acknowledgement from the MSC or from the SGSN to the Service Centre.

More Messages To Send

See definition in clause 7.6.8. The information from the MMS indication received from the Service Centre is inserted in this parameter.

User error

The following errors defined in clause 7.6.1 may be used, depending on the nature of the fault:

- Unidentified subscriber;
- Absent Subscriber_SM;
- Subscriber busy for MT SMS;
- Facility Not Supported;
- Illegal Subscriber indicates that delivery of the mobile terminated short message failed because the mobile station failed authentication;
- Illegal equipment indicates that delivery of the mobile terminated short message failed because an IMEI check failed, i.e. the IMEI was blacklisted or not white-listed;
- System Failure;
- SM Delivery Failure:
 - The reason of the SM Delivery Failure can be one of the following in the mobile terminated SM:
 - memory capacity exceeded in the mobile equipment;
 - protocol error;
 - mobile equipment does not support the mobile terminated short message service.
- Unexpected Data Value;
- Data Missing.

Provider error

For definition of provider errors see clause 7.6.1.

13 Network-Requested PDP Context Activation services

13.1 MAP_SEND_ROUTING_INFO_FOR_GPRS service

13.1.1 Definition

This service is used by the GGSN to request GPRS routing information from the HLR.

13.1.2 Service primitives

Table 13.1/1: MAP_SEND_ROUTING_INFO_FOR_GPRS

Parameter name	Request	Indication	Response	Confirm
Invoke id	M	M(=)	M(=)	M(=)
IMSI	M	M(=)		
GGSN address	C	C(=)	C	C(=)
GGSN number	M	M(=)		
SGSN address			C	C(=)
Mobile Not Reachable Reason			C	C(=)
User error			C	C(=)
Provider error				O

13.1.3 Parameter definition and use

Invoke Id

See definition in clause 7.6.1.

IMSI

See definition in clause 7.6.2.

GGSN address

This parameter shall be present if the protocol-converting GSN is used between the GGSN and the HLR.

GGSN number

See definition in clause 7.6.2.

SGSN address

This parameter shall be present if the outcome of the Send Routing Info For GPRS request to the GPRS application process in the HLR is positive.

Mobile Not Reachable Reason

This parameter shall be present if the outcome of the Send Routing Info For GPRS request to the GPRS application process in the HLR is positive and the MNRG flag in the HLR is set. See definition in clause 7.6.3.51.

User error

This parameter is sent by the responder when an error is detected and if present, takes one of the following values:

- Absent Subscriber;
- System Failure;
- Data Missing;
- Unexpected Data Value;

- Unknown Subscriber.

The diagnostic in the Unknown Subscriber may indicate “Imsi Unknown” or “Gprs Subscription Unknown”.

- Call Barred;

This error will indicate that the received PDP PDUs in the GGSN shall be barred for this MS due to Operator Determined Barring. (The CallBarringCause must be the operatorBarring.)

Provider error

These are defined in clause 7.6.1.

13.2 MAP_FAILURE_REPORT service

13.2.1 Definition

This service is used by the GGSN to inform the HLR that network requested PDP-context activation has failed.

13.2.2 Service primitives

Table 13.2/1: MAP_FAILURE_REPORT

Parameter name	Request	Indication	Response	Confirm
Invoke id	M	M(=)	M(=)	M(=)
IMSI	M	M(=)		
GGSN address	C	C(=)	C	C(=)
GGSN number	M	M(=)		
User error			C	C(=)
Provider error				O

13.2.3 Parameter definition and use

Invoke Id

See definition in clause 7.6.1.

IMSI

See definition in clause 7.6.2.

GGSN address

This parameter shall be present if the protocol-converting GSN is used between the GGSN and the HLR.

GGSN number

See definition in clause 7.6.2.

User error

This parameter is sent by the responder when an error is detected and if present, takes one of the following values:

- System Failure;
- Data Missing;
- Unexpected Data Value;
- Unknown Subscriber.

Provider error

These are defined in clause 7.6.1.

13.3 MAP_NOTE_MS_PRESENT_FOR_GPRS service

13.3.1 Definition

This service is used by the HLR to inform the GGSN that the MS is present for GPRS again.

13.3.2 Service primitives

Table 13.3/1: MAP_NOTE_MS_PRESENT_FOR_GPRS

Parameter name	Request	Indication	Response	Confirm
Invoke id	M	M(=)	M(=)	M(=)
IMSI	M	M(=)		
GGSN address	C	C(=)		
SGSN address	M	M(=)		
User error			C	C(=)
Provider error				O

13.3.3 Parameter definition and use

Invoke Id

See definition in clause 7.6.1.

IMSI

See definition in clause 7.6.2.

GGSN address

This parameter shall be present if the protocol-converting GSN is used between the GGSN and the HLR.

SGSN address

See definition in clause 7.6.2.

User error

This parameter is sent by the responder when an error is detected and if present, takes one of the following values:

- System Failure;
- Data Missing;
- Unexpected Data Value;
- Unknown Subscriber.

Provider error

These are defined in clause 7.6.1.

13A Location Service Management Services

13A.1 MAP-SEND-ROUTING-INFO-FOR-LCS Service

13A.1.1 Definition

This service is used between the GMLC and the HLR to retrieve the routing information needed for routing a location service request to the servicing VMSC or SGSN. The MAP-SEND-ROUTING-INFO-FOR-LCS is a confirmed service using the primitives from table 13A.1/1.

13A.1.2 Service Primitives

Table 13A.1/1: MAP-SEND-ROUTING-INFO-FOR-LCS

Parameter name	Request	Indication	Response	Confirm
Invoke Id	M	M(=)	M(=)	M(=)
MLC Number	M	M(=)		
MSISDN	C	C(=)	C	C(=)
IMSI	C	C(=)	C	C(=)
LCS Codeword Applicability	C	C(=)		
LMSI			C	C(=)
Network Node Number			C	C(=)
GPRS Node Indicator			C	C(=)
Additional Number			C	C(=)
LCS Codeword Notification			C	C(=)
User error			C	C(=)
Provider error				O

13A.1.3 Parameter Use

Invoke id

See definition in clause 7.6.1.

MLC Number

See definition in clause 7.6.2.

MSISDN

See definition in clause 7.6.2. The request shall carry either the IMSI or MSISDN. The response shall carry whichever of these was not included in the request (see 3G TS 23.271 for details).

IMSI

See definition in clause 7.6.2.

LCS Codeword Applicability

See definition in clause 7.6.11.19.

LMSI

See definition in clause 7.6.2. It is an operator option to provide this parameter from the VLR; it is mandatory for the HLR to include the LMSI in a successful response, if the VLR has used the LMSI.

Network Node Number

See definition in clause 7.6.2. This parameter is provided in a successful response. If the "Network Node Number" and "Additional Number" are received in the GMLC, the "Network Node Number" is used in preference to the "Additional Number".

GPRS Node Indicator

See definition in clause 7.6.8. The presence of this parameter is mandatory only if the SGSN number is sent in the Network Node Number.

Additional Number

See definition in clause 7.6.2. This parameter is provided in a successful response. If the "Network Node Number" and "Additional Number" are received in the GMLC, the "Network Node Number" is used in preference to the "Additional Number".

LCS Codeword Notification

See definition in clause 7.6.11.22. The presence of this parameter indicates that codeword shall be sent to the subscriber. HLR may include this parameter in the response only if codeword checks had been indicated as applicable in the request.

User error

The following errors defined in clause 7.6.1 may be used, depending on the nature of the fault:

- Unknown subscriber;
- Absent Subscriber;
- Facility Not Supported;
- System failure;
- Unexpected Data Value;
- Data missing;
- Unauthorised requesting network.

Provider error

For definition of provider errors see clause 7.6.1.

13A.2 MAP-PROVIDE-SUBSCRIBER-LOCATION Service

13A.2.1 Definition

This service is used by a GMLC to request the location of a target MS from the visited MSC or SGSN at any time. This is a confirmed service using the primitives from table 13A.2/1.

13A.2.2 Service Primitives

Table 13A.2/1: Provide_Subscriber_Location

Parameter name	Request	Indication	Response	Confirm
Invoke id	M	M(=)	M(=)	M(=)
Location Type	M	M(=)		
MLC Number	M	M(=)		
LCS Client ID	M	M(=)		
Privacy Override	U	C(=)		
IMSI	C	C(=)		
MSISDN	C	C(=)		
LMSI	C	C(=)		

LCS Priority	C	C(=)		
LCS QoS	C	C(=)		
IMEI	U	C(=)		
Supported GAD Shapes	C	C(=)		
LCS Codeword	C	C(=)		
LCS Service Type Id	C	C(=)		
Location Estimate			M	M(=)
Age of Location Estimate			C	C(=)
Additional Location Estimate			C	C(=)
Deferred MT-LR Response Indicator			C	C(=)
User error			C	C(=)
Provider error				O

13A.2.3 Parameter Definition and Use

All parameters are defined in clause 7.6. The use of these parameters and the requirements for their presence are specified in. 3G TS 23.271

Location Type

This parameter identifies the type of location information requested.

MLC Number

This is the E.164 number of the requesting GMLC.

LCS Client ID

This parameter provides information related to the identity of an LCS client.

Privacy Override

This parameter indicates if MS privacy is overridden by the LCS client when the GMLC and VMSC or SGSN for an MT-LR are in the same country.

IMSI

The IMSI is provided to identify the target MS. At least one of the IMSI or MSISDN is mandatory.

MSISDN

The MSISDN is provided to identify the target MS. At least one of the IMSI or MSISDN is mandatory.

LMSI

The LMSI shall be provided if previously supplied by the HLR. This parameter is only used in the case of the MT-LR for CS domain.

LCS Priority

This parameter indicates the priority of the location request.

LCS QoS

This parameter indicates the required quality of service in terms of response time and accuracy.

IMEI

Inclusion of the IMEI is optional.

Supported GAD Shapes

This parameter indicates which of the shapes defined in 3G TS 23.032 are supported.

LCS Codeword

See definition in clause 7.6.11.18. The requirements for its presence are specified in 3G TS 23.271.

LCS Service Type Id

See definition in clause 7.6.11.15. The requirements for its presence are specified in 3G TS 23.271.

Location Estimate

This parameter provides the location estimate if this is encoded in one of the supported geographical shapes. Otherwise this parameter shall consist of one octet, which shall be discarded by the receiving node.

Age of Location Estimate

This parameter indicates how long ago the location estimate was obtained.

Additional Location Estimate

This parameter provides the location estimate when not provided by the Location Estimate parameter. It may be sent only if the parameter Supported GAD Shapes has been received in the Provide Subscriber Location indication and the shape to be included is supported by the GMLC.

Deferred MT-LR Response Indicator

See definition in clause 7.6.11.2.

User error

This parameter is sent by the responder when the location request has failed or cannot proceed and if present, takes one of the following values defined in clause 7.6.1.

- System Failure;
- Data Missing;
- Unexpected Data Value;
- Facility Not Supported;
- Unidentified Subscriber;
- Illegal Subscriber;
- Illegal Equipment;
- Absent Subscriber (diagnostic information may also be provided);
- Unauthorised requesting network;
- Unauthorised LCS Client with detailed reason;
- Position method failure with detailed reason.

Provider error

These are defined in clause 7.6.1.

13A.3 MAP-SUBSCRIBER-LOCATION-REPORT Service

13A.3.1 Definition

This service is used by a VMSC or SGSN to provide the location of a target MS to a GMLC when a request for location is either implicitly administered or made at some earlier time. This is a confirmed service using the primitives from table 13A.3/1.

13A.3.2 Service Primitives

Table 13A.3/1: Subscriber_Location_Report

Parameter name	Request	Indication	Response	Confirm
Invoke id	M	M(=)	M(=)	M(=)
LCS Event	M	M(=)		
LCS Client ID	M	M(=)		
Network Node Number	M	M(=)		
IMSI	C	C(=)		
MSISDN	C	C(=)		
NA-ESRD	C	C(=)		
NA-ESRK	C	C(=)		
IMEI	U	C(=)		
Location Estimate	C	C(=)		
Age of Location Estimate	C	C(=)		
LMSI	U	C(=)		
GPRS Node Indicator	C	C(=)		
Additional Location Estimate	C	C(=)		
Deferred MT-LR Data	C	C(=)		
User error			C	C(=)
Provider error				O

13A.3.3 Parameter Definition and Use

All parameters are defined in clause 7.6. The use of these parameters and the requirements for their presence are specified in 3G TS 23.271

LCS Event

This parameter indicates the event that triggered the Subscriber Location Report.

LCS Client ID

This parameter provides information related to the identity of the recipient LCS client.

Network Node Number

See definition in clause 7.6.2. This parameter provides the address of the sending node.

IMSI

The IMSI shall be provided if available to the VMSC or SGSN.

MSISDN

The MSISDN shall be provided if available to the VMSC or SGSN.

NA-ESRD

If the target MS has originated an emergency service call in North America, the NA-ESRD shall be provided by the VMSC if available.

NA-ESRK

If the target MS has originated an emergency service call in North America, the NA-ESRK shall be provided by the VMSC if assigned.

IMEI

Inclusion of the IMEI is optional.

Location Estimate

This parameter provides the location estimate. The absence of this parameter implies that a location estimate was not available or could not be successfully obtained. If the obtained location estimate is not encoded in one of the supported geographical shapes then this parameter shall consist of one octet, which shall be discarded by the receiving node.

Age of Location Estimate

This parameter indicates how long ago the location estimate was obtained.

LMSI

The LMSI may be provided if assigned by the VLR.

GPRS Node Indicator

See definition in clause 7.6.8. This presence of this parameter is mandatory only if the SGSN number is sent in the Network Node Number.

Additional Location Estimate

This parameter provides the location estimate when not provided by the Location Estimate parameter..

Deferred MT-LR Data

See definition in clause 7.6.11.3.

User error

This parameter is sent by the responder when the received message contains an error, cannot be forwarded or stored for an LCS client or cannot be accepted for some other reason and if present, takes one of the following values defined in clause 7.6.1.

- System Failure;
- Data Missing;
- Unexpected Data Value;
- Resource Limitation;
- Unknown Subscriber;
- Unauthorised requesting network;
- Unknown or unreachable LCS Client.

Provider error

These are defined in clause 7.6.1.

13A.4 Void

13A.4.1 Void

13A.4.2 Void

13A.4.3 Void

13A.5 Void

13A.5.1 Void

13A.5.2 Void

13A.5.3 Void

13A.6 Void

13A.6.1 Void

13A.6.2 Void

13A.6.3 Void

13A.7 Void

13A.7.1 Void

13A.7.2 Void

13A.7.3 Void

13A.8 Void

13A.8.1 Void

13A.8.2 Void

13A.8.3 Void

13A.9 Void

13A.9.1 Void

13A.9.2 Void

13A.9.3 Void

14 General

14.1 Overview

Clauses 14 to 17 specify the protocol elements to be used to provide the MAP services described in clause 7.

Clause 15 specifies the elements of procedures for the MAP protocol. Clause 16 specifies the mapping onto TC service primitives. Clause 17 specifies the application contexts, operation packages and abstract syntaxes for the MAP protocol as well as the encoding rules to be applied.

14.2 Underlying services

The MAP protocol relies on the services provided by the Transaction Capabilities (TC) of Signalling System Number No. 7, as referenced in clause 6.

14.3 Model

The MAP Protocol Machine (MAP PM) can be modelled as a collection of service state machines (SSMs) - one per MAP specific service invoked - coordinated by a MAP dialogue control function with its one state machine: MAP dialogue state machine (DSM). There are two types of Service State Machines: Requesting Service State Machines (RSM) and Performing Service State Machines (PSM).

A new invocation of a MAP PM is employed on the receipt of a MAP-OPEN request primitive or a TC-BEGIN indication primitive. Each invocation controls exactly one MAP dialogue. For each MAP specific service invoked during a dialogue, a MAP RSM is created at the requestor's side and a MAP PSM is created at the performer's side.

This modelling is used only to facilitate understanding and the MAP behaviour descriptions and is not intended to suggest any implementation. SDL descriptions are organised according to this model.

How the MAP-service-user and the MAP refer to a MAP dialogue (i.e. a MAP PM invocation) is a local implementation matter.

How TC dialogue identifiers are assigned to a MAP PM invocation is also a local implementation matter.

14.4 Conventions

The behaviour of the MAP PM depends on the application-context-name associated with the dialogue. One major difference is that the MAP requests the transfer of the application-context-name by TC only for those contexts which do not belong to the so-called "version one context set".

The "version one context set" is a set of application-contexts which model the behaviour of a MAP V1 implementation according to the latest phase 1 version of GSM 09.02. This set is defined in clause 15.

The procedures described in clause 15 are used when the application-context-name does not refer to a dialogue between an MSC and its VLR. When the application-context-name refers to a dialogue between an MSC and its VLR the MAP PM procedures are a local implementation matter.

15 Elements of procedure

15.1 Handling of unknown operations

Unknown operations (i.e. a standard operation introduced in a later version of the MAP specification, or a private operation) can be introduced into MAP in a backwards compatible way. This means that the receiver of an unknown operation shall, if the dialogue state allows it, send a TC-REJECT component to the sender of the operation indicating 'unrecognised operation' and continue with the processing of further components or messages exchanged within the dialogue as if the unknown operation had not been received.

The standardised structure of a MAP dialogue shall not be affected by the invocation of unknown operations, i.e. if a dialogue uses only a TC-BEGIN message which is acknowledged by a TC-END message, a TC-CONTINUE message shall not be used to invoke an unknown operation. However the standardised structure of a MAP dialogue may be affected by the rejection of unknown operations, i.e. if a dialogue uses only a TC-BEGIN message which is acknowledged by a TC-END message, a TC-CONTINUE message followed by a TC-END message may be used to carry the rejection of an unknown operation and the response to the standardised operation. The entity which initiated a dialogue whose standardised structure is a TC-BEGIN message which is acknowledged by a TC-END message shall not send any messages in that dialogue after the TC-BEGIN. Note that if the dialogue structure is affected as described in this paragraph the TC-CONTINUE shall include the dialogue portion required to confirm the acceptance of the dialogue.

Unknown operations may be invoked in the following types of message (there is no restriction as to how many unknown operations can be invoked in a message):

- TC-BEGIN: the component to invoke the unknown operation shall follow the component of the standard operation which is included in this message.
- TC-CONTINUE: the component to invoke the unknown operation may be transported as the only component in a stand-alone message or may be grouped with existing operations. In the latter case a specific sequencing of components is not required.
- TC-END: if the component to invoke the unknown operation is grouped with an existing operation a specific sequencing of components is not required

The TC-REJECT component may be sent in the following messages:

- TC-CONTINUE or TC-END: either as the only component of the message or grouped with an existing component. The choice is up to the MAP-Service User.

If the received message contains only unknown operations the MAP-Service User shall send the TC-REJECT components in a TC-CONTINUE message to the peer entity, if the dialogue state allows it.

If the received message contains unknown operations and standard operations and the standardised structure of the dialogue requires the response to the standard operation to be sent within a TC-END message, then the MAP-Service User may send the response to the standard operations and the TC-REJECT components for the unknown operations in a TC-CONTINUE message followed by a TC-END message. Neither a specific distribution of the components to the TC messages nor a specific sequencing of components is required.

Note that the SDL diagrams of clauses 19 - 25 do not show the report to the MAP-Service User about the reception of the unknown operation. This has been done for simplicity of description; the MAP PM may inform the MAP-Service User.

The sender of the unknown operation shall ensure that there is enough room in the used message for the unknown operation.

15.2 Dialogue establishment

The establishment of a MAP dialogue involves two MAP-service-users: the dialogue-initiator and the dialogue-responder.

This procedure is driven by the following signals:

- a MAP-OPEN request primitive from the dialogue-initiator;
- a TC-BEGIN indication primitive occurring at the responding side;
- a MAP-OPEN response primitive from the dialogue-responder;
- the first TC-CONTINUE indication primitive occurring at the initiating side;

and under specific conditions:

- a TC-END indication primitive occurring at the initiating side;
- a TC-U-ABORT indication primitive occurring at the initiating side;
- a TC-P-ABORT indication primitive occurring at the initiating side.

One instance of the MAP dialogue state machine runs at the initiating side, and one at the responding side.

15.2.1 Behaviour at the initiating side

The behaviour of the MAP dialogue state machine at the initiating side is defined in sheets 1 – 9 of the process `Secure_MAP_DSM`.

Sheet 1: The MAP protocol machine decides according to the application context name received in the MAP-OPEN request and the identity of the responder whether secure transport of the MAP dialogue is required, and if so what level of protection is required. This decision is based on bilateral agreements between the operators of the network entities concerned; it requires the dialogue initiating entity to store configuration information on which the decision is based. Secure transport of a MAP dialogue is required if any of the operation components (invoke, result or error) used in the application context for the dialogue requires secure transport, as shown in 3GPP TS 33.200. If a dialogue uses secure transport then MAP secure transport services shall be used with a protection mode of "No protection" to produce the same functional effect as unsecured transport for those components which do not need protection. If secure transport is required, the MAP protocol machine builds a protected dialogue portion (including the AC name and any user information received in the MAP-OPEN request, encoded as user information for the TC-BEGIN) for the TC-BEGIN; otherwise it builds a normal dialogue portion using the application context name and any user data included in the MAP-OPEN request.

Sheet 2: If secure transport is used, each MAP specific service request is stored in case drop-back to unsecured transport is to be invoked.

Sheet 2: If secure transport is required, each MAP specific service request triggers the creation of an instance of the `Secure_Requesting_MAP_SSM` to handle the secure transport of the request. If secure transport is not required, each MAP specific service request triggers the creation of an instance of the `Requesting_MAP_SSM` to handle the transport of the request.

Sheet 3: When the MAP dialogue state machine at the initiating side is waiting for a response from the responding side, a TC-END indication which echoes the AC name which was sent in the TC-BEGIN indicates acceptance of the dialogue. If secure transport is required, acceptance of the dialogue opening request which was transported in the secure dialogue opening request is indicated by the encapsulated AC name transported in the user information of the TC-END being equal to the encapsulated AC which was included in the user information of the TC-BEGIN. Mismatch of either the AC name or the encapsulated AC name indicates failure of the dialogue opening.

Sheet 3: If the dialogue opening is accepted, any components included in the TC-END are processed and passed to the MAP-Service User. The dialogue is closed by sending a MAP-CLOSE to the MAP-Service User.

Sheet 3, sheet 4, sheet 5, sheet 6, sheet 7, sheet 8, sheet 9: when a dialogue is terminated, the MAP dialogue state machine terminates all instances of the `Requesting_MAP_SSM` or `Secure_Requesting_MAP_SSM` which are active for this dialogue.

Sheet 4, sheet 5: It is a matter for agreement between the operators of the network entities involved whether fallback to unsecured transport is acceptable if secure transport is not possible. This requires the dialogue initiating entity to store configuration information on which this decision is based.

Sheet 4: A TC-P-ABORT with an abort parameter `Incorrect_Transaction_Portion` indicates that the responding side does not support a MAP version higher than 1. If secure transport is not required, this triggers a MAP-OPEN confirm indicating that the dialogue is refused, with a refuse reason potential version incompatibility. The MAP-Service User

may then decide to retry the dialogue at MAP version 1. If secure transport is required and fallback to unsecured transport is acceptable, the dialogue machine retries the dialogue with unsecured transport. If secure transport is required and fallback to unsecured transport is not acceptable, this triggers a MAP-OPEN confirm indicating that the dialogue is refused, with a refuse reason secured transport not possible. No retry of the dialogue with a lower version is allowed.

Sheet 5: If the initiating side receives a TC-U-ABORT with an abort reason AC not supported and secure transport is required, then secured transport is not possible. If fallback to unsecured transport is acceptable, the dialogue machine retries the dialogue with unsecured transport. If fallback to unsecured transport is not acceptable, this triggers a MAP-OPEN confirm indicating that the dialogue is refused, with a refuse reason secured transport not possible. No retry of the dialogue with a lower version is allowed.

Sheet 7: A TC-U-ABORT with a user-specific abort reason leads to a check of the user information. User information carrying a MAP-Refuse PDU with a refuse reason encapsulated AC not supported means that the responding entity supports the secure transport AC, but not the AC required for the protected request. This triggers a MAP-OPEN confirm indicating that the dialogue is refused, with a refuse reason AC not supported. The MAP-Service User may then decide to retry the dialogue with a lower AC version; this will again use secure transport. User information carrying a MAP-Refuse PDU with a refuse reason transport protection not adequate means that the responding entity is not prepared to accept a dialogue with the protection mode offered by the initiating entity: either unsecured transport or secured transport with an inadequate protection mode.

Sheet 9: When the MAP dialogue state machine at the initiating side is waiting for a response from the responding side, a TC-CONTINUE indication which echoes the AC name which was sent in the TC-BEGIN indicates acceptance of the dialogue. If secure transport is required, acceptance of the dialogue opening request which was transported in the secure dialogue opening request is indicated by the encapsulated AC name transported in the user information of the TC-CONTINUE being equal to the encapsulated AC which was included in the user information of the TC-BEGIN. Mismatch of either the AC name or the encapsulated AC name indicates failure of the dialogue opening.

Sheet 9: If the dialogue opening is accepted, any components included in the TC-CONTINUE are processed and passed to the MAP-Service User. The dialogue has then reached the established state.

15.2.2 Behaviour at the responding side

The behaviour of the MAP dialogue state machine at the responding side is defined in sheets 10 – 14 of the process Secure_MAP_DSM.

Sheet 10: If no application context information is included in the TC-BEGIN indication, this implies a MAP version 1 dialogue. An explicit application context indicating version 1 is treated as abnormal behaviour.

Sheet 10, sheet 11: The test "Unsecured_Transport_Permitted" takes the "True" exit if there is an agreement between the operators of the dialogue initiating entity and the dialogue responding entity to allow unsecured transport for the application context for the requested dialogue. This requires the dialogue responding entity to store configuration information on which this decision is based.

Sheet 10: The task "Extract_User_Information" includes decryption of the protected user information if confidentiality protection has been applied.

Sheet 10: The test "Protection mode correct" takes the "yes" exit if the protection mode is acceptable to the receiving entity, based on the identity of the sending entity and the encapsulated application context for the requested dialogue.

Sheet 11: The v1 application context name which corresponds to a v1 operation is derived using the information in table 15.2/1.

Table 15.2/1: Mapping of V1 operation codes on to application-context-names

Operation	Application-context-name (note 1)
updateLocation	networkLocUpContext-v1
cancelLocation	locationCancellationContext-v1
provideRoamingNumber	roamingNumberEnquiryContext-v1
insertSubscriberData	subscriberDataMngtContext-v1
deleteSubscriberData	subscriberDataMngtContext-v1
sendParameters	infoRetrievalContext-v1 networkLocUpContext-v1 (note 2)
beginSubscriberActivity	networkFunctionalSsContext-v1
sendRoutingInfo	locationInfoRetrievalContext-v1
performHandover	handoverControlContext-v1
reset	resetContext-v1
activateTraceMode	tracingContext-v1
deactivateTraceMode	tracingContext-v1
sendRoutingInfoForSM	shortMsgGatewayContext-v1
forwardSM	shortMsgRelayContext-v1
reportSM-deliveryStatus	shortMsgGatewayContext-v1
noteSubscriberPresent	mwdMngtContext-v1
alertServiceCentreWithoutResult	shortMsgAlertContext-v1
checkIMEI	EquipmentMngtContext-v1

NOTE 1: These symbolic names refer to the object identifier value defined in clause 17 and allocated to each application-context used for the MAP.

NOTE 2: The choice between the application contexts is based on the parameters received in the operation.

Sheet 12: If the AC name received in the TC-BEGIN indicated that secure transport is required, the MAP dialogue state machine checks whether the encapsulated application context name is supported. If it is supported, the dialogue can be accepted. If the encapsulated AC name is not supported, the MAP dialogue machine indicates this by sending a TC-U-ABORT with a user-specific abort reason and user information indicating that the encapsulated AC name is not supported.

Sheet 12: If the dialogue is accepted, each component present in the TC-BEGIN is forwarded to an instance of a Performing_MAP_SSM or Secure_Performing_MAP_SSM, by executing the procedure Process_Components.

Sheet 13: If the MAP dialogue state machine receives a MAP-OPEN confirm with a result accepted, it waits for any MAP specific service request or response primitives or a MAP-DELIMITER request.

Sheet 14: A MAP-DELIMITER request triggers a TC-CONTINUE request to accept the dialogue. The dialogue has then reached the established state.

Sheet 13, sheet 14: When a dialogue is terminated, the MAP dialogue state machine terminates all instances of the Requesting_MAP_SSM, Secure_Requesting_MAP_SSM, Performing_MAP_SSM or Secure_Performing_MAP_SSM which are active for this dialogue.

15.3 Dialogue continuation

Once established the dialogue is said to be in a continuation phase. The behaviour of the MAP dialogue state machine in this phase is defined in sheets 15 – 17 of the process Secure_MAP_DSM.

Both MAP users can request the transfer of MAP APDUs until one of them requests the termination of the dialogue.

Normal closure of an established dialogue is shown on sheet 16; abnormal termination is shown on sheet 17.

15.4 Load control

If an entity which should respond to a MAP dialogue opening request is overloaded, it uses the AC of the request to determine whether to discard the request. If the AC of the request is secure transport, the encapsulated AC (i.e. the AC of the dialogue for which secure transport is required) is used to determine whether the request is discarded.

The priority level allocated to each application-context is described in clause 5, tables 5.1/1 and 5.1/2.

15.5 Procedures for MAP specific services

This clause describes the MAP procedures for MAP specific services. These procedures are driven by the following types of event:

- a MAP specific request or a MAP specific response primitive;
- a component handling primitive from TC.

A Service State Machine is activated when one of the following signals is received:

- a MAP request primitive, which activates a requesting SSM;
- a TC-INVOKE indication primitive without a linked identifier, which activates a performing SSM.

For component handling primitives there are two types of event:

- events which activate a Service State Machine or which can be related to an existing one;
- events which cannot be related to a Service State Machine.

15.5.1 Service invocation for unsecured dialogues

The behaviour of the requesting SSM which handles a service for an unsecured dialogue is defined by the SDL for the process `Requesting_MAP_SSM`. The requesting SSM receives a MAP service request from the MAP-Service User via the MAP dialogue state machine and sends a TC-INVOKE request to TCAP. When a confirm is received from TCAP via the MAP dialogue state machine, the requesting SSM forwards a MAP service confirm to the MAP-Service User.

The response to a MAP service invocation may come in the form of a linked request. If the linked request corresponds to a class 4 operation, this is handled by the requesting SSM. If the linked request corresponds to a class 1, 2 or 3 operation, the MAP dialogue state machine sends a notification to the requesting SSM and creates an instance of a performing SSM to handle the linked request. The test "Linked_Operation_Allowed" on sheet 3 of the process `Requesting_MAP_SSM` takes the (TRUE) exit if the definition of the parent operation includes the received linked operation as a permitted linked operation; otherwise the test takes the (FALSE) exit.

The mapping of MAP specific services on to remote operations is given in table 16.2/1.

15.5.2 Service invocation for secured dialogues

The behaviour of the requesting SSMs which handle a service for a secured dialogue is defined by the SDL for the processes `Secure_Requesting_MAP_SSM` and `Requesting_MAP_SSM`. The secure requesting SSM receives a MAP service request from the MAP-Service User via the MAP dialogue state machine and constructs the corresponding MAP secure transport service request. It then creates an instance of the requesting SSM and sends the MAP secure transport service request to it. The requesting SSM sends a TC-INVOKE request to TCAP. When the MAP dialogue state machine receives a confirm from TCAP, it forwards it to the secure requesting SSM, which unpacks the MAP service confirm from the MAP secure transport service confirm and sends it to the requesting SSM. The requesting SSM forwards the MAP service confirm to the MAP-Service User.

The response to a MAP service invocation which was carried in a secure dialogue may come in the form of a linked request. This linked request is carried in a MAP secure transport service request of the class corresponding to the operation; however the MAP secure transport service request is not linked to another MAP secure transport service request. If the linked request which is carried in the MAP secure transport service corresponds to a class 4 operation, this is handled by the secure requesting service state machine, which unpacks the linked request and sends it to the requesting SSM. If the linked request which is carried in the MAP secure transport service corresponds to a class 1, 2 or 3 operation, the MAP dialogue state machine sends a notification to the secure requesting SSM (which passes the notification to the requesting SSM) and creates an instance of a secure performing SSM to handle the linked request.

15.5.3 Service invocation receipt for unsecured dialogues

The behaviour of the performing SSM which handles a service for an unsecured dialogue is defined by the SDL for the process `Performing_MAP_SSM`. The performing SSM receives a TC-INVOKE component from TCAP via the MAP dialogue state machine and sends a MAP service indication to the MAP-Service User. When a MAP service response is

received from the MAP-Service User via the MAP dialogue state machine, the performing SSM forwards a TC-RESULT or TC-U-ERROR component to TCAP.

15.5.4 Service invocation receipt for secured dialogues

The behaviour of the performing SSMs which handle a service for a secured dialogue is defined by the SDL for the processes `Secure_Performing_MAP_SSM` and `Performing_MAP_SSM`. The secure performing SSM receives a TC-INVOKE component containing a secure MAP transport service from TCAP via the MAP dialogue state machine and unpacks the MAP service indication from it. It then creates an instance of the performing SSM and sends the MAP service indication to it. The performing SSM forwards the MAP service indication to the MAP-Service User. When the MAP dialogue state machine receives a MAP service response from the MAP-Service User it forwards it to the secure performing SSM. The secure performing SSM constructs a MAP secure transport service response and sends it to the performing SSM, which forwards a TC-RESULT or TC-U-ERROR component to TCAP.

15.5.5 Handling of components received from TC

The procedure `Process_Components` shows the handling of components received in a TC-BEGIN, TC-CONTINUE or TC-END message.

Sheet 1: If a linked invoke component is transported securely, the linked invoke ID is carried as part of the security header, so that it can be checked without the need to unpack the protected component.

Sheet 2: If a linked invoke component corresponds to a class 4 operation, the MAP dialogue state machine sends it to the requesting SSM instance identified by the linked invoke ID. If a linked invoke component corresponds to any other class of operation, the MAP dialogue state machine sends a notification to the requesting SSM instance identified by the linked invoke ID, creates an instance of a performing SSM and sends the invoke component to it.

15.6 SDL descriptions

The following SDL specification describes a system which includes three blocks: MAP-user, MAP-provider and TC.

Such a system resides in each network component supporting MAP and communicates with its peers via the lower layers of the signalling network which are part of the environment.

Only the MAP-provider is fully described in this clause. The various types of processes which form the MAP-User block and the TC block are described respectively in clauses 18 to 25 of the present document and in CCITT Recommendation Q.774.

The MAP-Provider block communicates with the MAP_USER via two channels U1 and U2. Via U1 the MAP-provider receives the MAP request and response primitives. Via U2 it sends the MAP indication and confirm primitives.

The MAP-Provider block communicates with TC via two channels P1 and P2. Via P1 the MAP-Provider sends all the TC request primitives. Via P2 it receives all the TC indication primitives.

The MAP-Provider block is composed of the six following types of process:

- a) `Secure_MAP_DSM`: This type of process handles a dialogue for both secured and unsecured transport of MAP messages. There exists one process instance per MAP dialogue.
- b) `Load_Ctrl`: This type of process is in charge of load control. There is only one instance of this process in each system.
- c) `Requesting_MAP_SSM`: This type of process handles a MAP service requested during a dialogue. For unsecured transport of MAP messages, an instance of this process is created by the instance of the `Secure_MAP_DSM` process for each requested MAP service. For secured transport of MAP messages, an instance of this process is created by the instance of the `Secure_Requesting_MAP_SSM` process for each requested MAP-Secure-Transport-service.
- d) `Secure_Requesting_MAP_SSM`: This type of process handles a MAP service requested during a dialogue for secured transport of MAP messages. An instance of this process is created by the `Secure_MAP_DSM` process for each requested MAP service.

- e) `Performing_MAP_SSM`: This type of process handles a MAP service performed during a dialogue. For unsecured transport of MAP messages, an instance of this process is created by the instance of the `Secure_MAP_DSM` process for each MAP service to be performed. For secured transport of MAP messages, an instance of this process is created by the instance of the `Secure_Performing_MAP_SSM` process for each MAP-Secure-Transport-service to be performed.
- f) `Secure_Performing_MAP_SSM`: This type of process handles a MAP service performed during a dialogue for secured transport of MAP messages. An instance of this process is created by the `Secure_MAP_DSM` process for each MAP service to be performed.

A process `Secure_MAP_DSM` exchanges external signals with other blocks as well as internal signals with the other processes of the MAP-Provider block. The external signals are either MAP service primitives or TC service primitives.

The signal routes used by the various processes are organised as follows:

- a) A process `Secure_MAP_DSM` receives and sends events from/to the `MAP_user` via signal route `User1/User2`. These routes use channels `U1` and `U2` respectively.
- b) A process `Secure_MAP_DSM` receives and sends events from/to the `TCAP` via signal route `TC1/TC2`. These routes use channels `P1` and `P2` respectively.
- c) A process `Secure_MAP_DSM` receives and sends events from/to the `LOAD_CTRL` process via signal route `Load1/Load2`. These routes are internal.
- d) A process `Secure_MAP_DSM` sends events to the `Performing_MAP_SSM` processes via signal route `Intern1`. This route is internal.
- e) A process `Secure_MAP_DSM` sends events to the `Requesting_MAP_SSM` processes via signal route `Intern2`. This route is internal.
- f) A process `Secure_MAP_DSM` sends events to the `Secure_Performing_MAP_SSM` processes via signal route `Intern3`. This route is internal.
- g) A process `Secure_MAP_DSM` sends events to the `Secure_Requesting_MAP_SSM` processes via signal route `Intern4`. This route is internal.
- h) A process `Performing_MAP_SSM` sends events to the `MAP_USER` via signal route `User3`. This route uses channel `U2`.
- i) A process `Performing_MAP_SSM` sends events to the `TCAP` via signal route `TC3`. This route uses channel `P1`.
- j) A process `Requesting_MAP_SSM` sends events to the `MAP_USER` via signal route `User4`. This route uses channel `U2`.
- k) A process `Requesting_MAP_SSM` sends events to the `TCAP` via signal route `TC4`. This route uses channel `P1`.
- l) A process `Secure_Performing_MAP_SSM` sends events to the `MAP_USER` via signal route `User5`. This route uses channel `U2`.
- m) A process `Secure_Performing_MAP_SSM` sends events to the `TCAP` via signal route `TC5`. This route uses channel `P1`.
- n) A process `Secure_Performing_MAP_SSM` sends events to the corresponding `Performing_MAP_SSM` process via signal route `Intern5`. This route is internal.
- o) A process `Secure_Requesting_MAP_SSM` sends events to the `MAP_USER` via signal route `User6`. This route uses channel `U2`.
- p) A process `Secure_Requesting_MAP_SSM` sends events to the `TCAP` via signal route `TC6`. This route uses channel `P1`.
- q) A process `Secure_Requesting_MAP_SSM` sends events to the corresponding `Requesting_MAP_SSM` process via signal route `Intern6`. This route is internal.

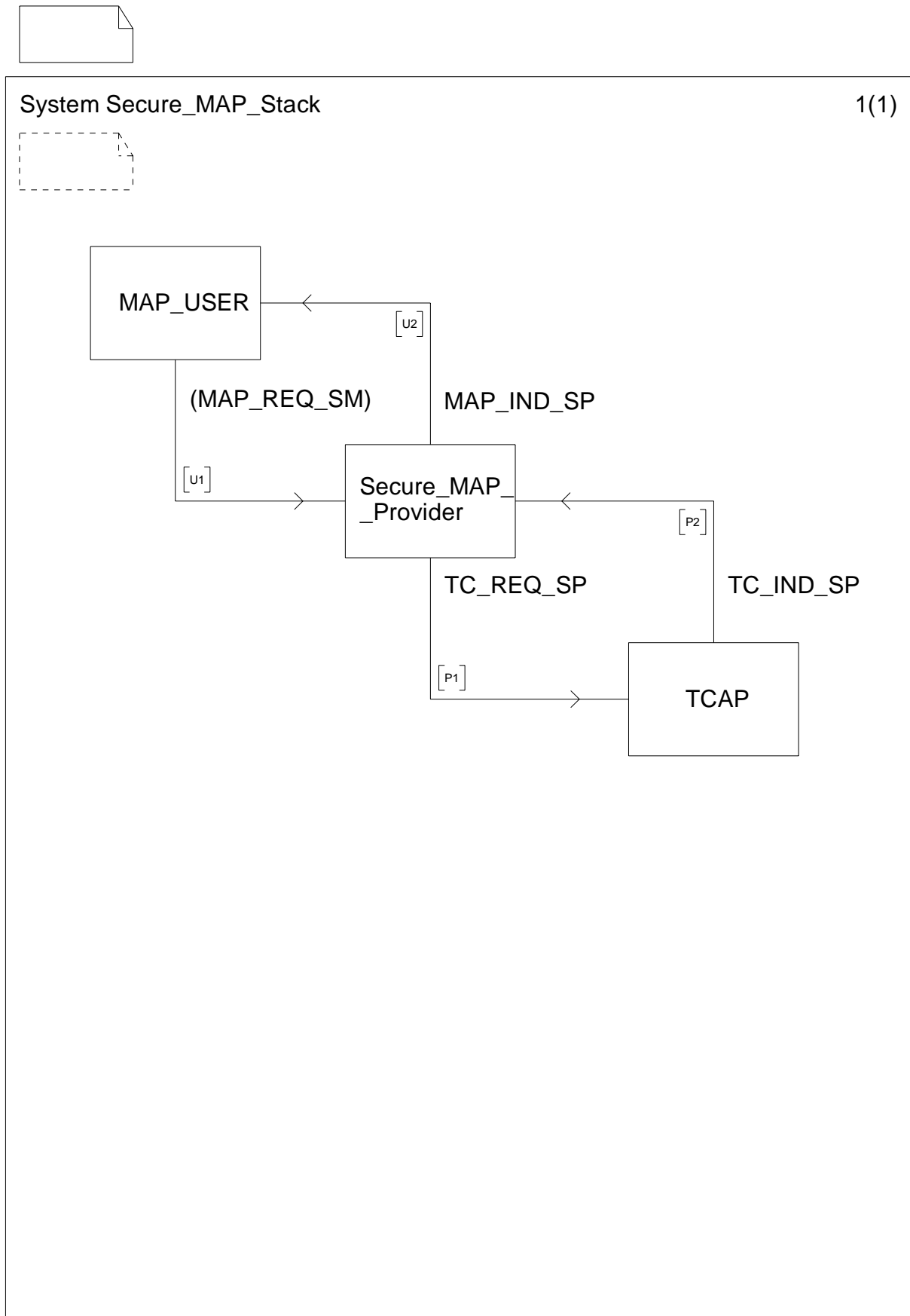

Figure 15.6/1: System Secure_MAP_Stack

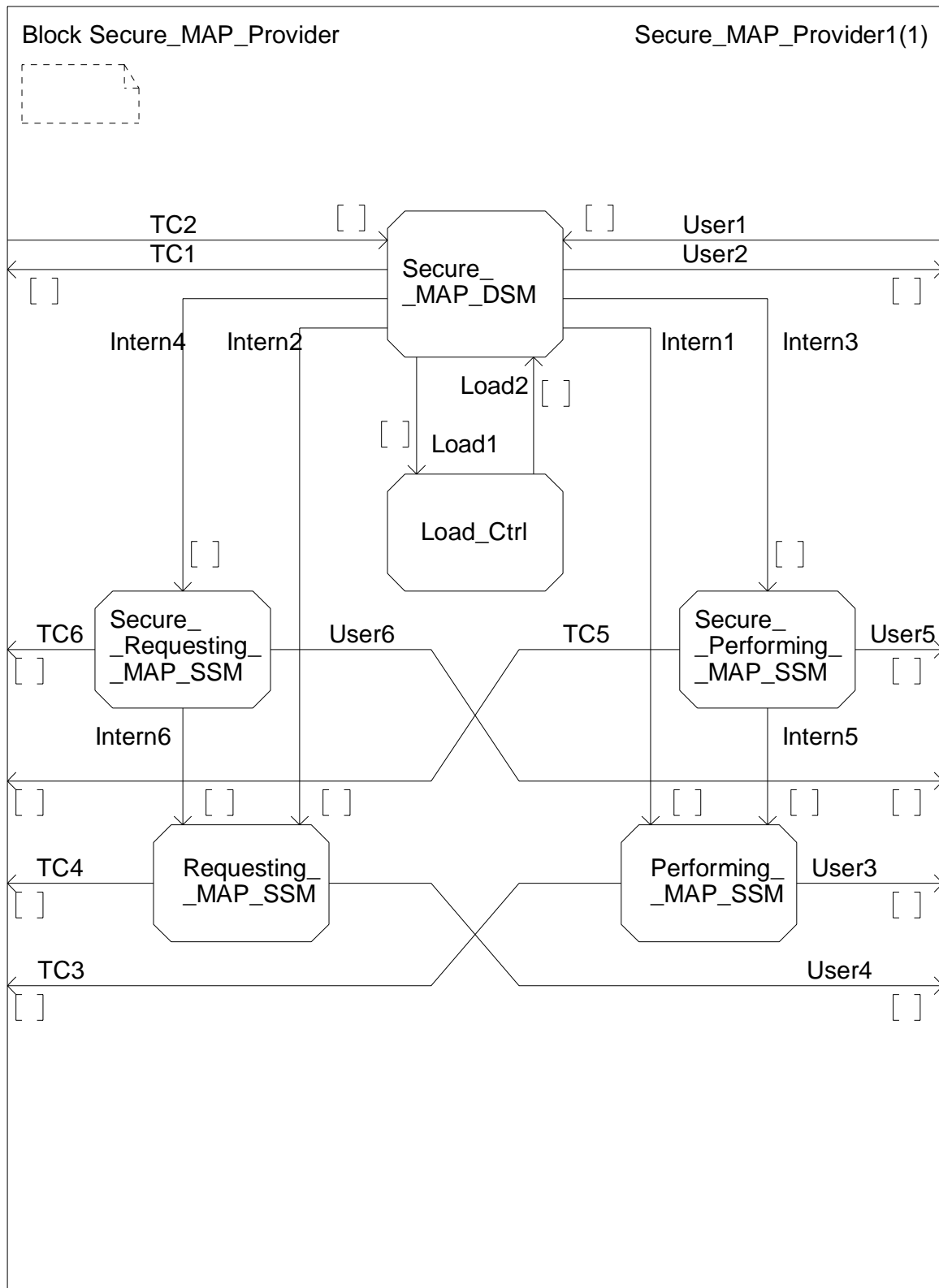

Figure 15.6/2: Block Secure_MAP_Provider

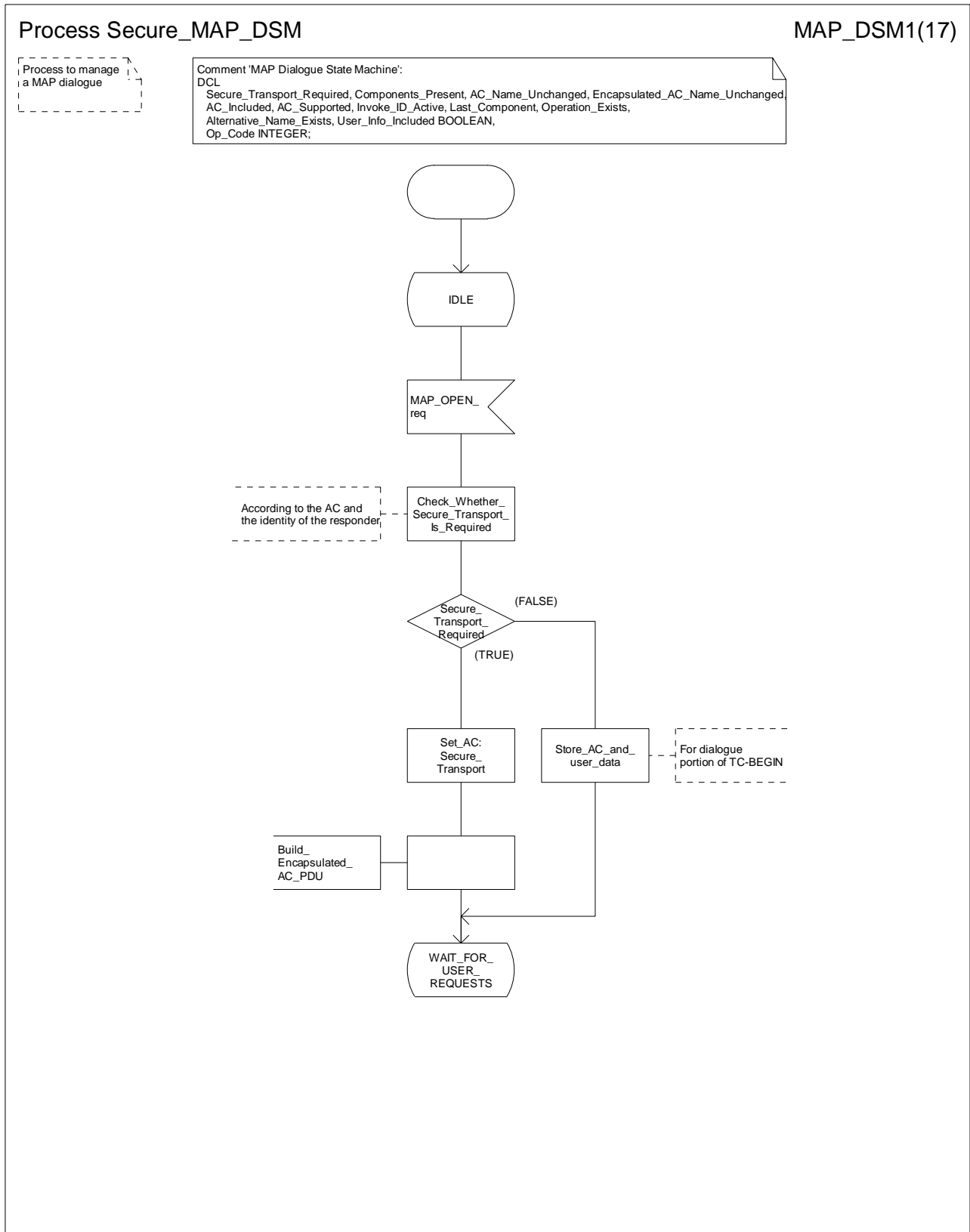

Figure 15.6/3a: Process Secure_MAP_DSM (sheet 1)

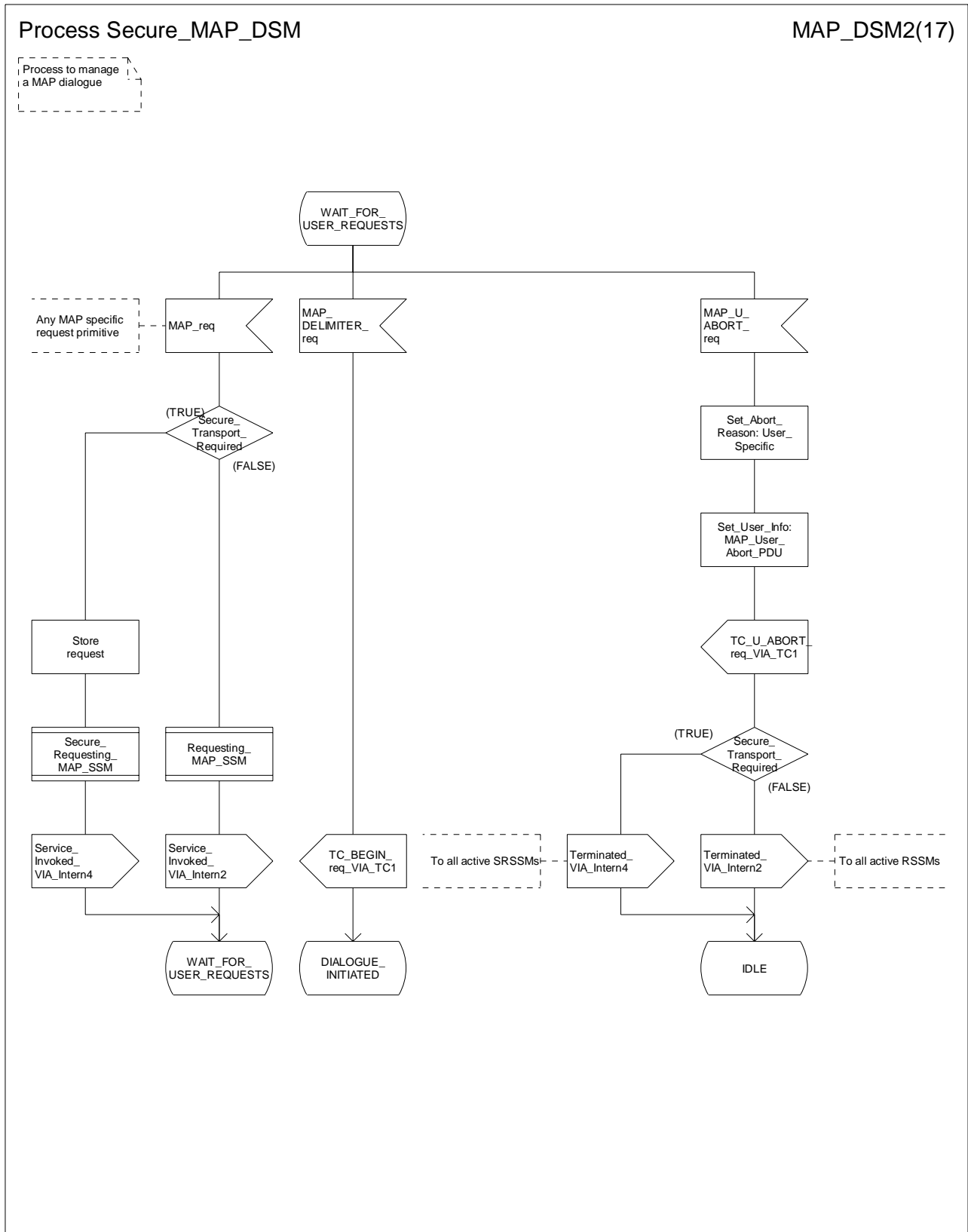

Figure 15.6/3b: Process Secure_MAP_DSM (sheet 2)

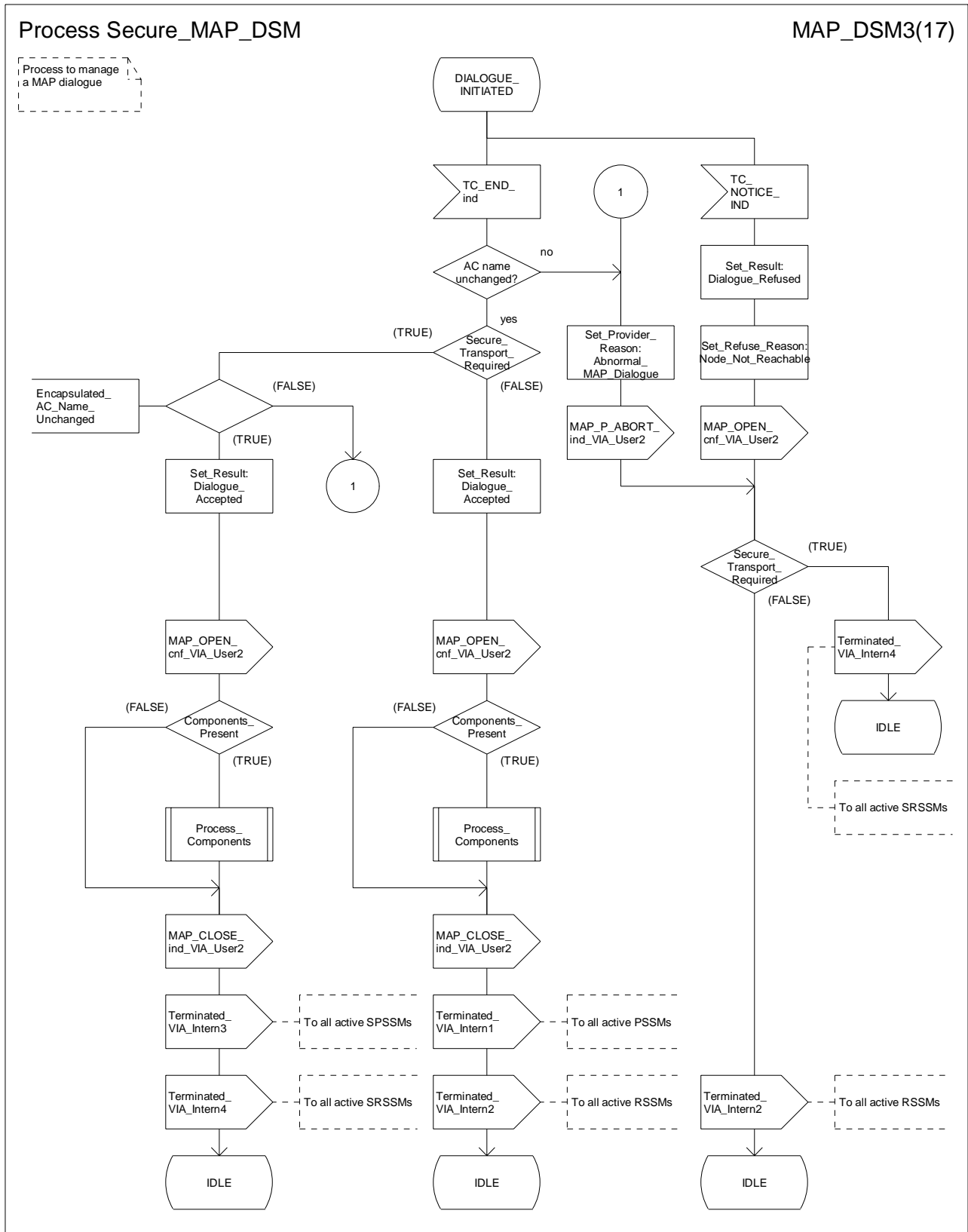

Figure 15.6/3c: Process Secure_MAP_DSM (sheet 3)

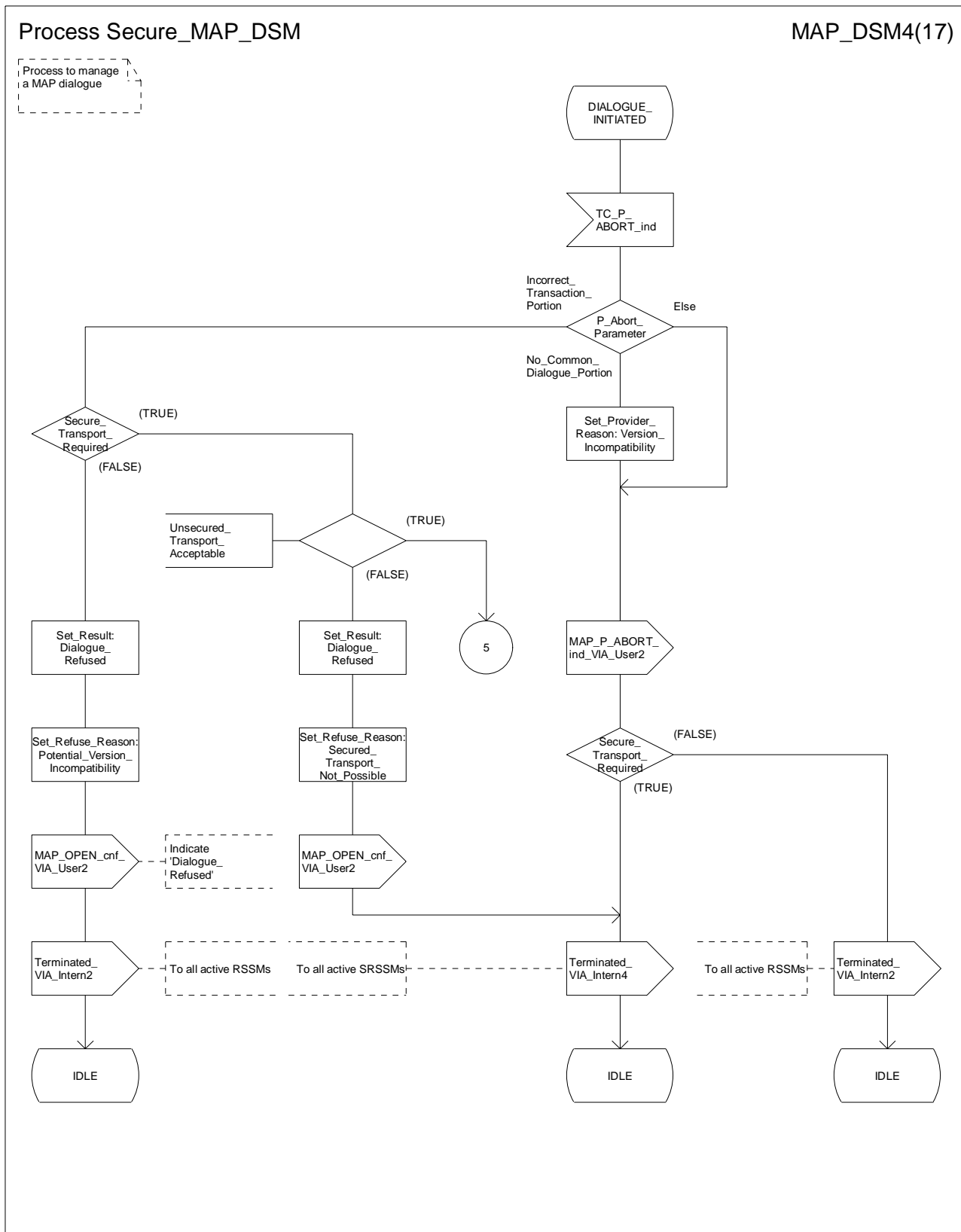

Figure 15.6/3d: Process Secure_MAP_DSM (sheet 4)

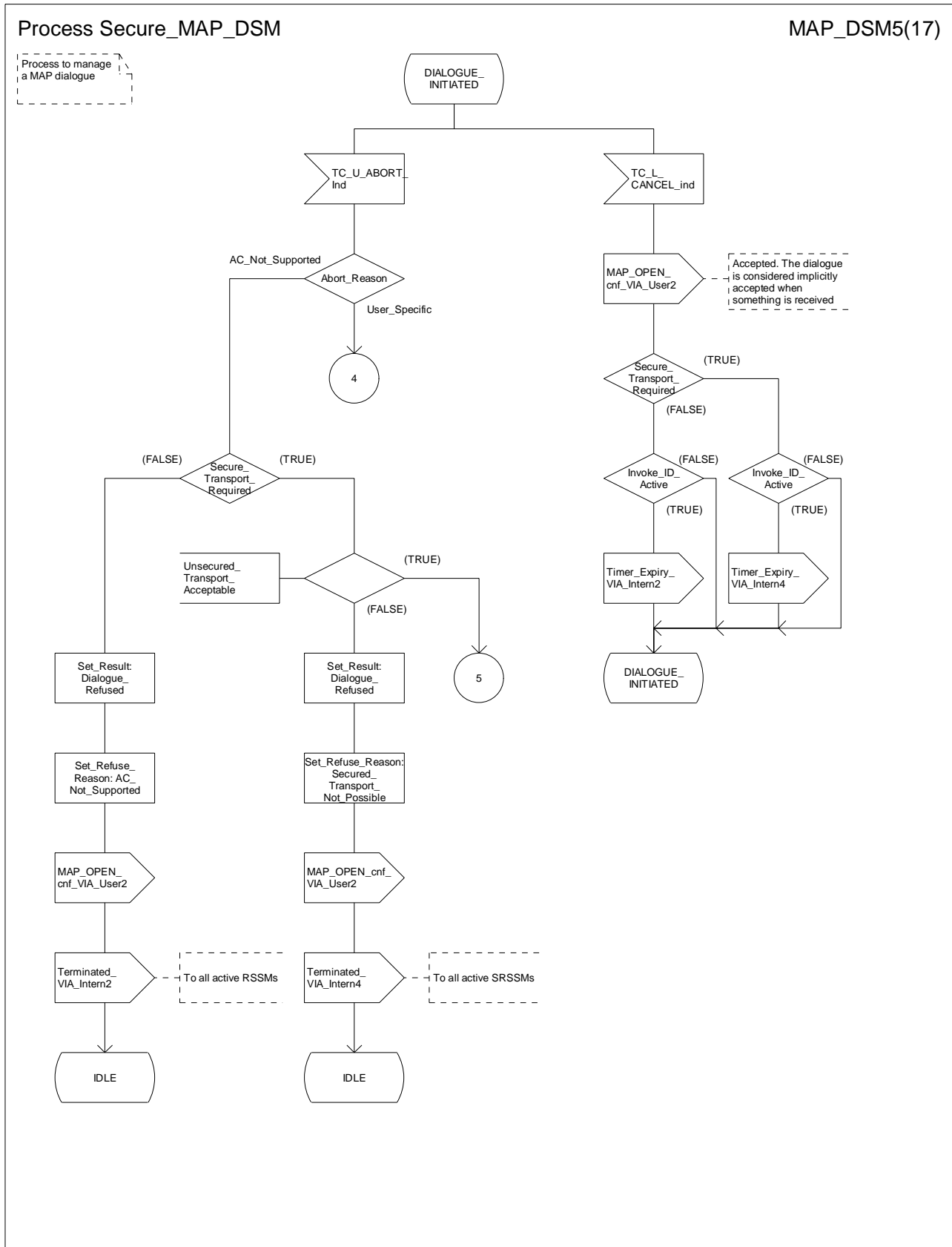

Figure 15.6/3e: Process Secure_MAP_DSM (sheet 5)

Process Secure_MAP_DSM

MAP_DSM6(17)

Process to manage a MAP dialogue

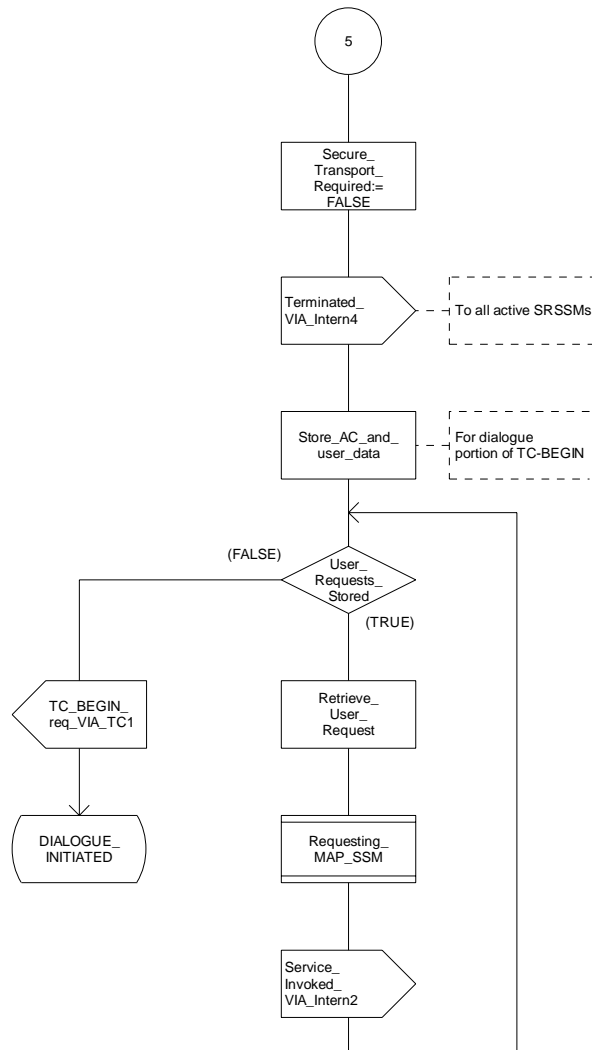

Figure 15.6/3f: Process Secure_MAP_DSM (sheet 6)

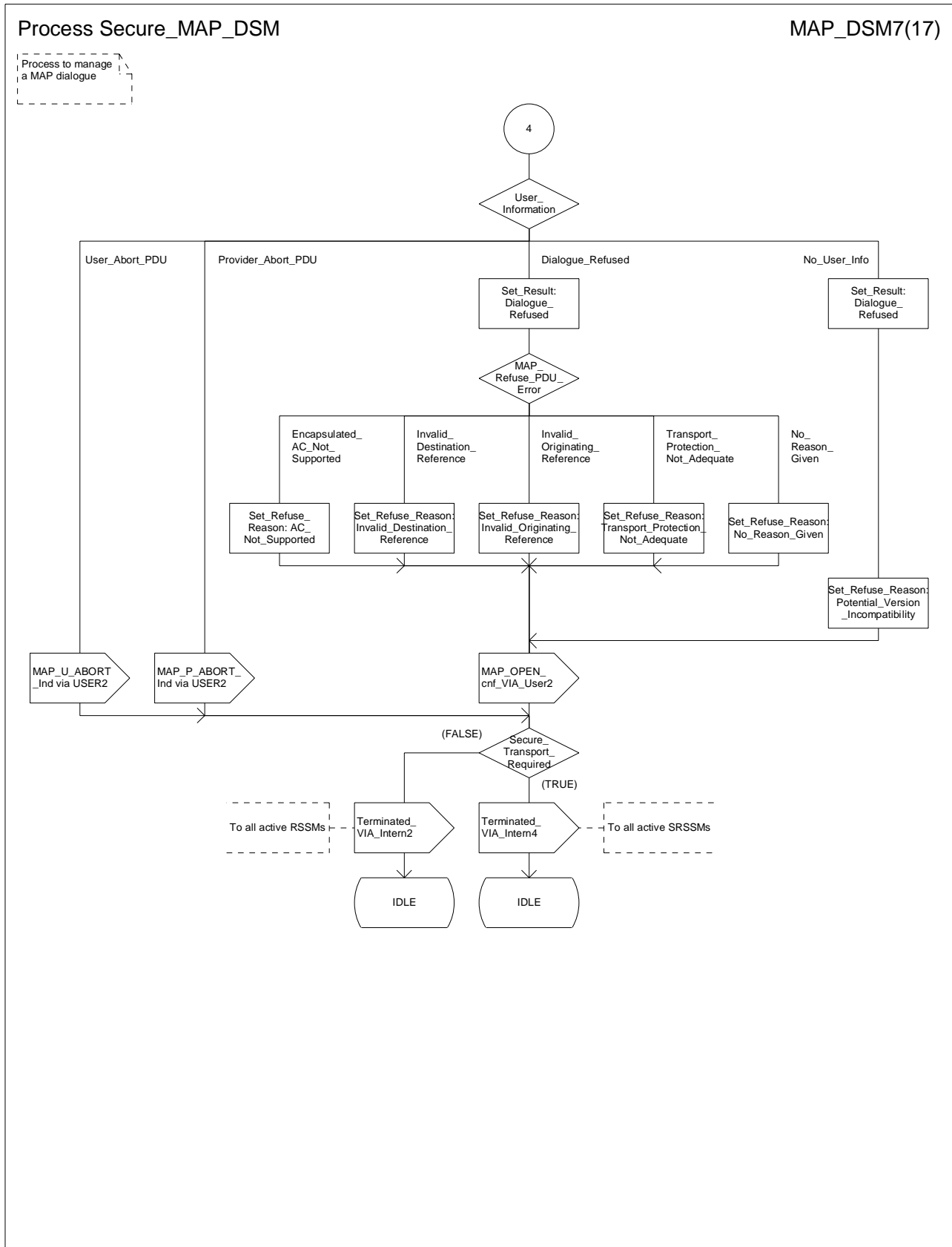

Figure 15.6/3g: Process Secure_MAP_DSM (sheet 7)

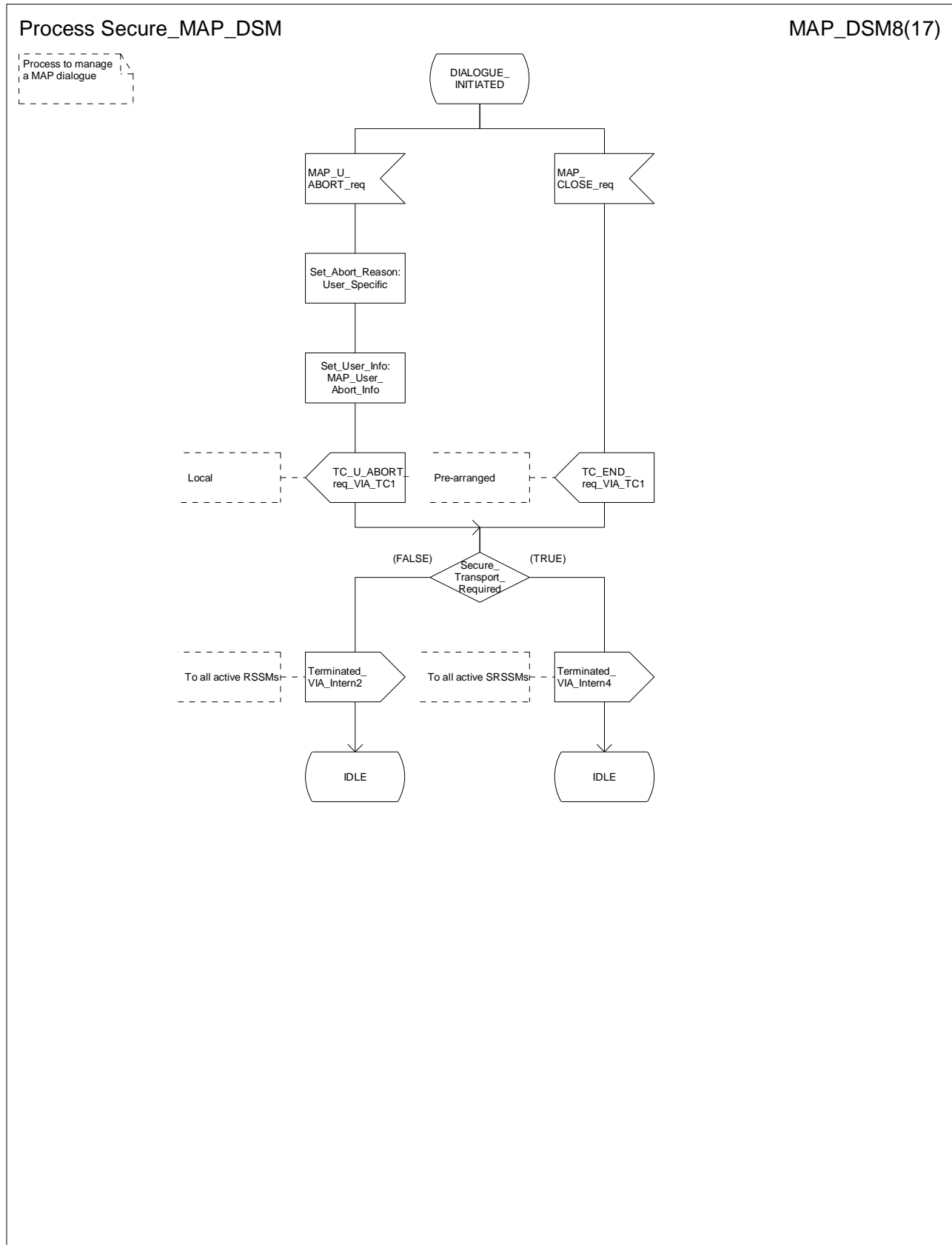

Figure 15.6/3h: Process Secure_MAP_DSM (sheet 8)

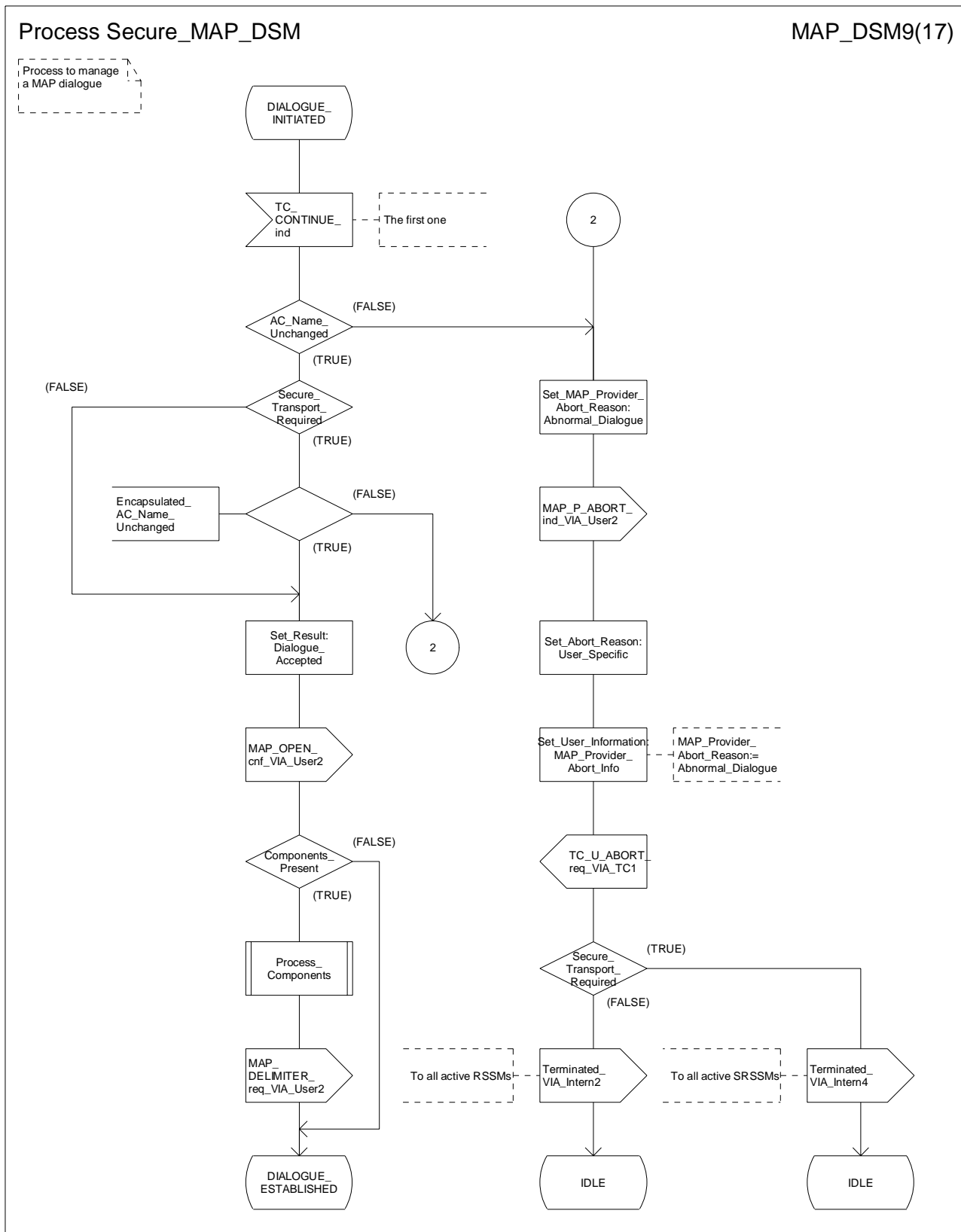

Figure 15.6/3i: Process Secure_MAP_DSM (sheet 9)

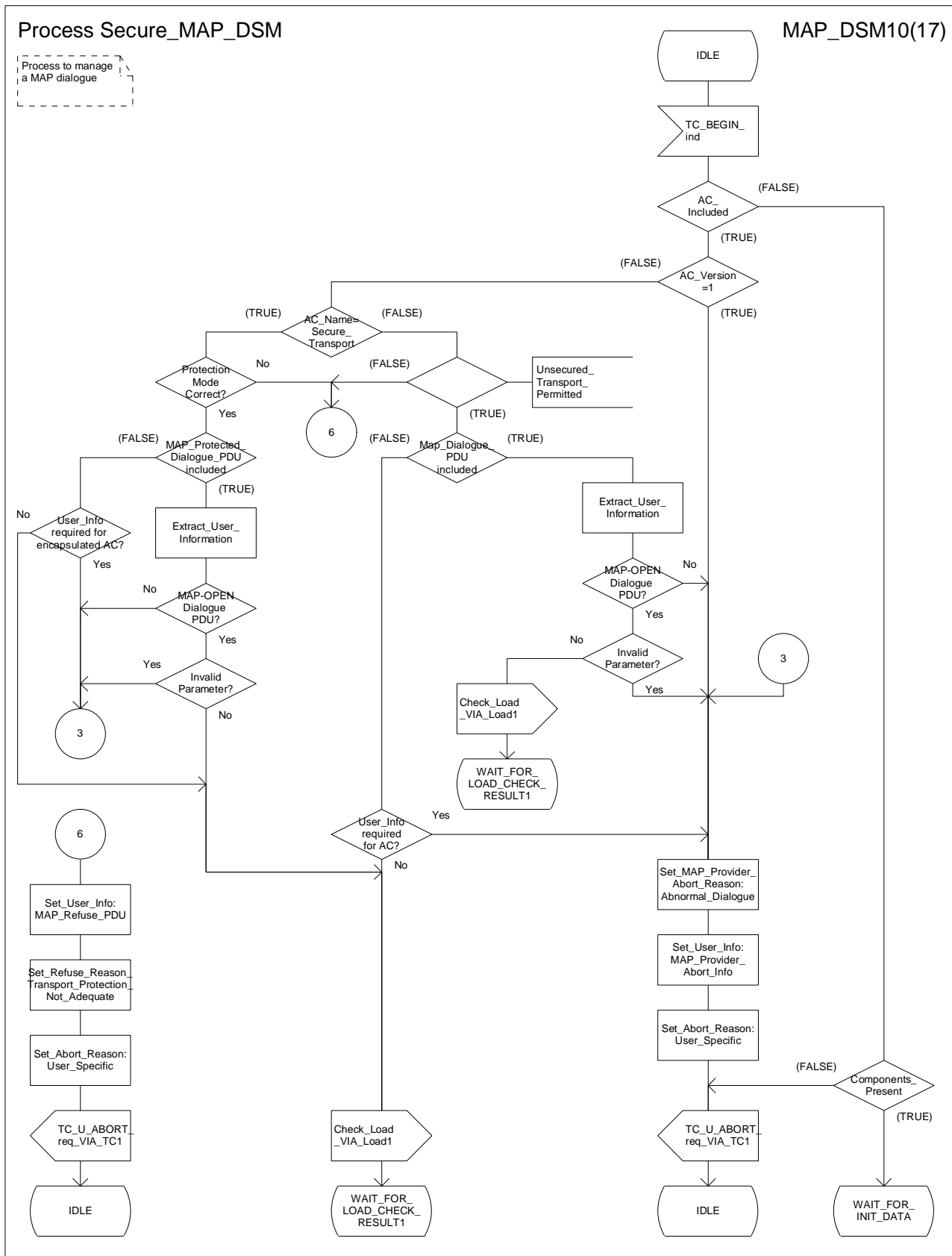

Figure 15.6/3j: Process Secure_MAP_DSM (sheet 10)

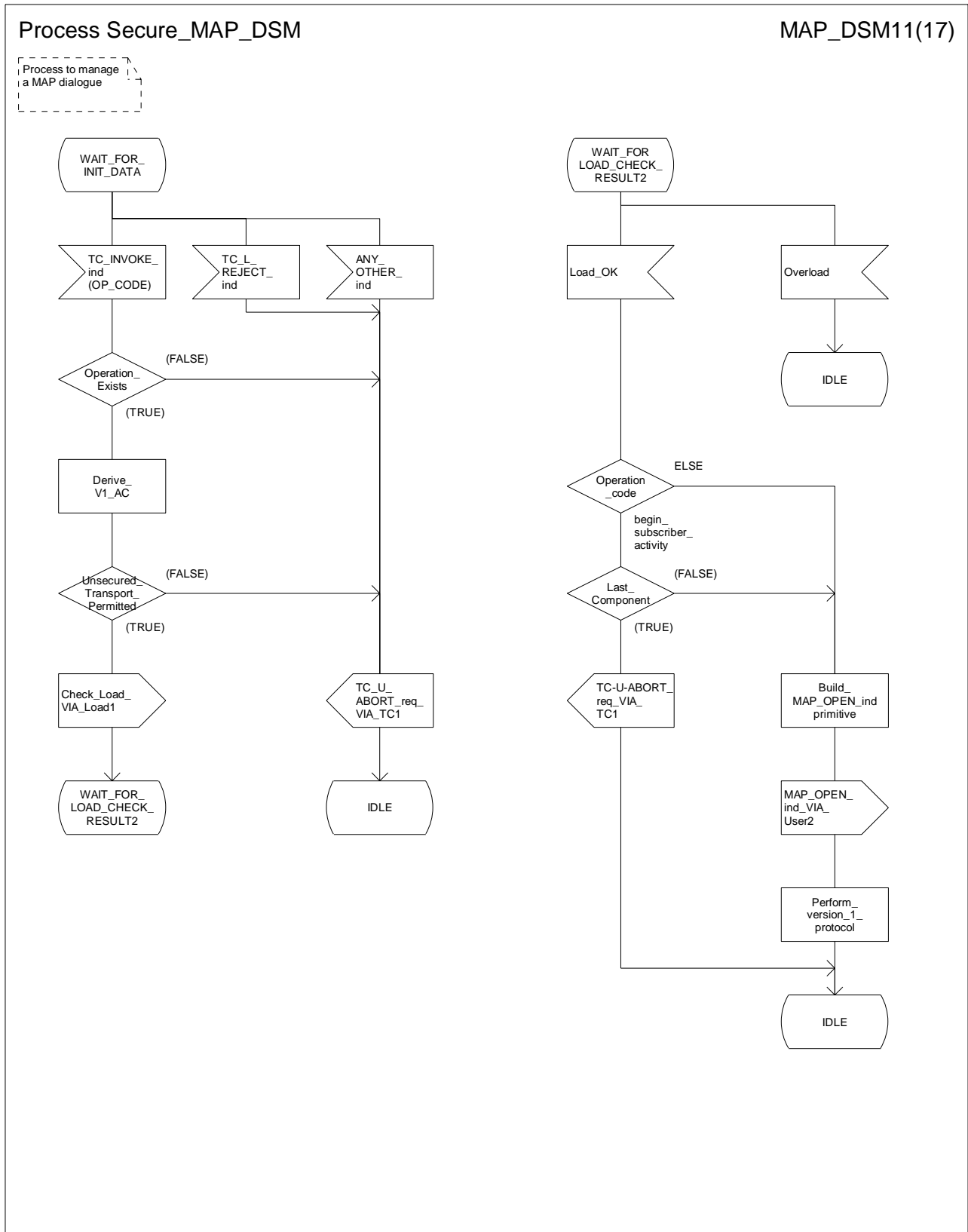

Figure 15.6/3k: Process Secure_MAP_DSM (sheet 11)

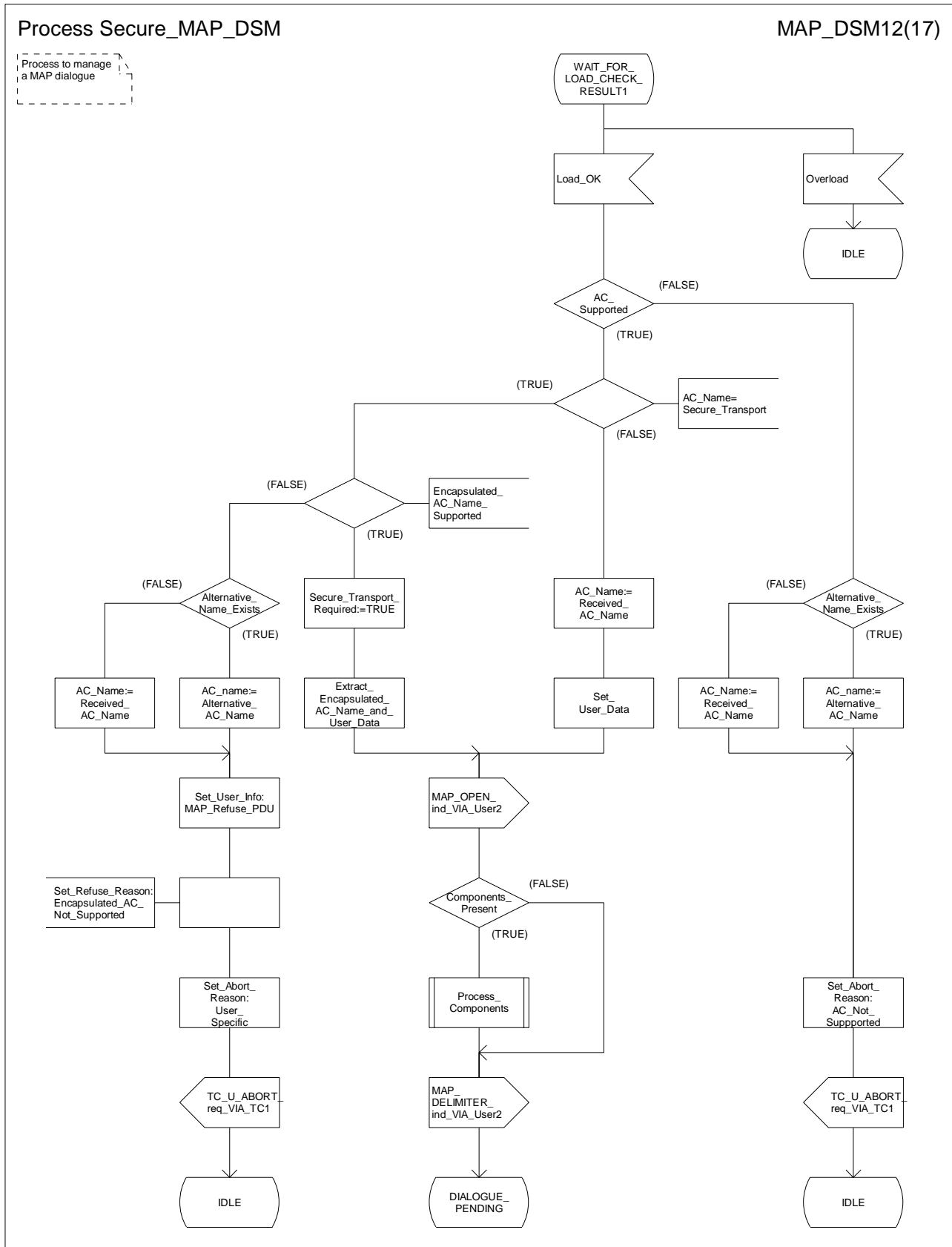

Figure 15.6/3l: Process Secure_MAP_DSM (sheet 12)

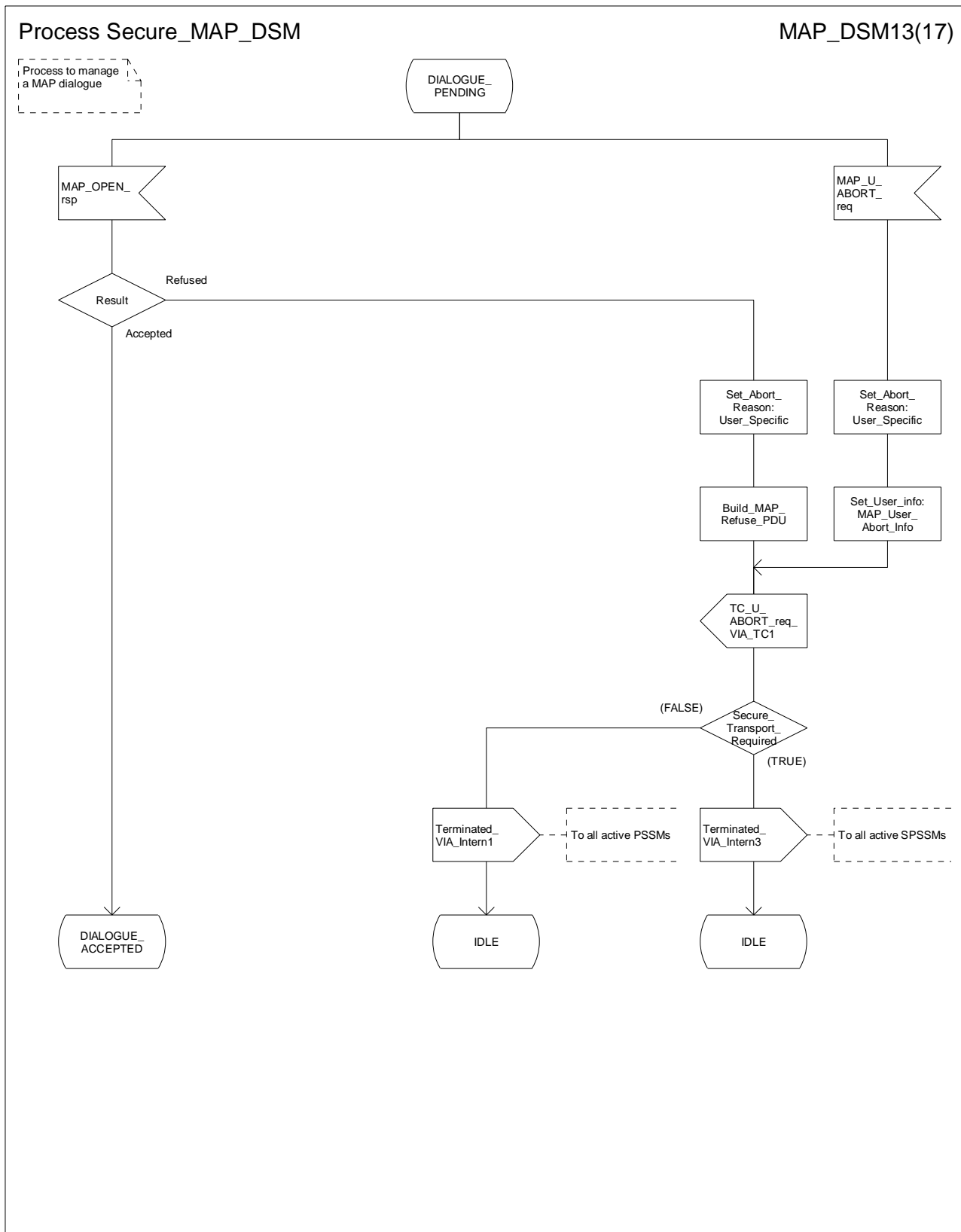

Figure 15.6/3m: Process Secure_MAP_DSM (sheet 13)

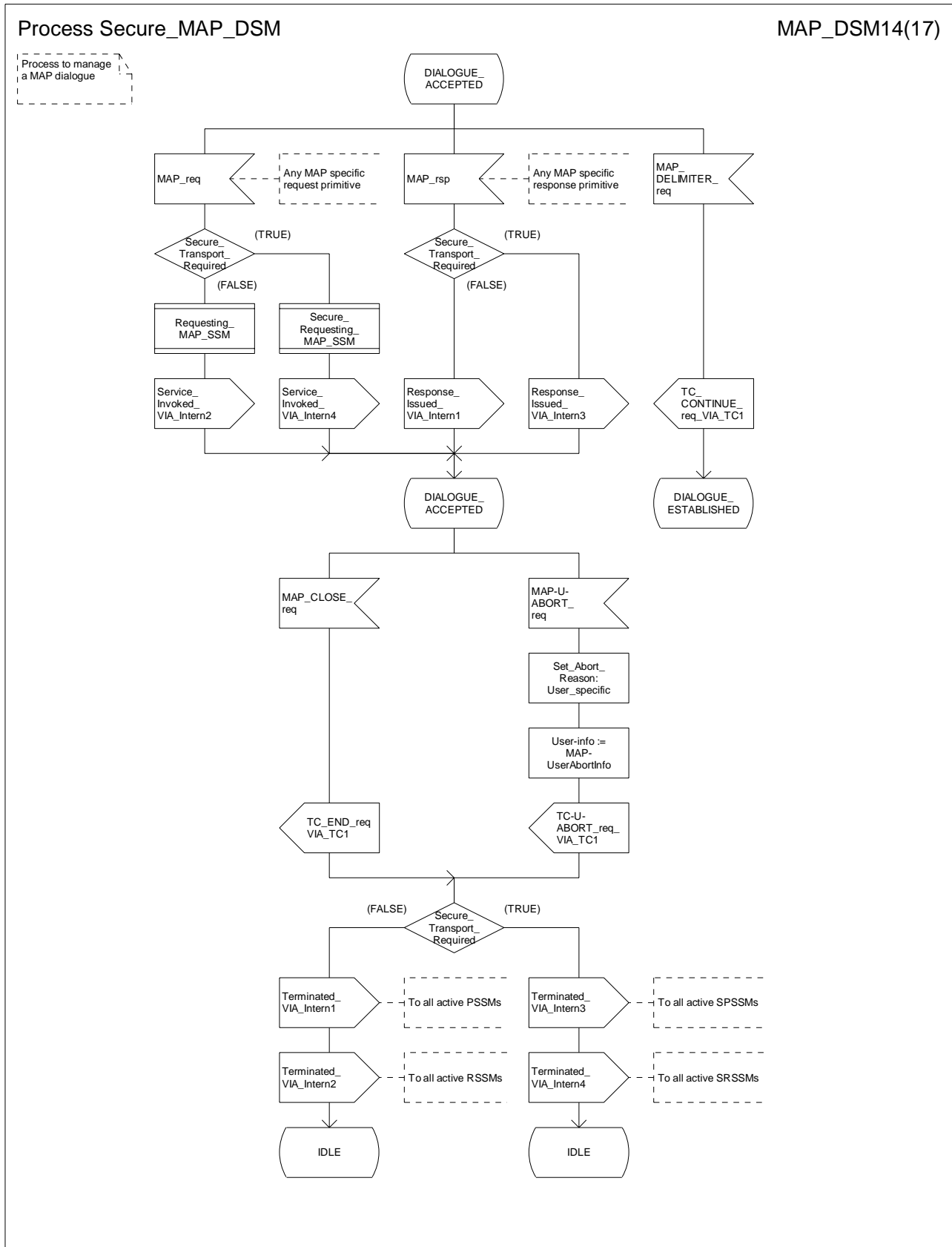

Figure 15.6/3n: Process Secure_MAP_DSM (sheet 14)

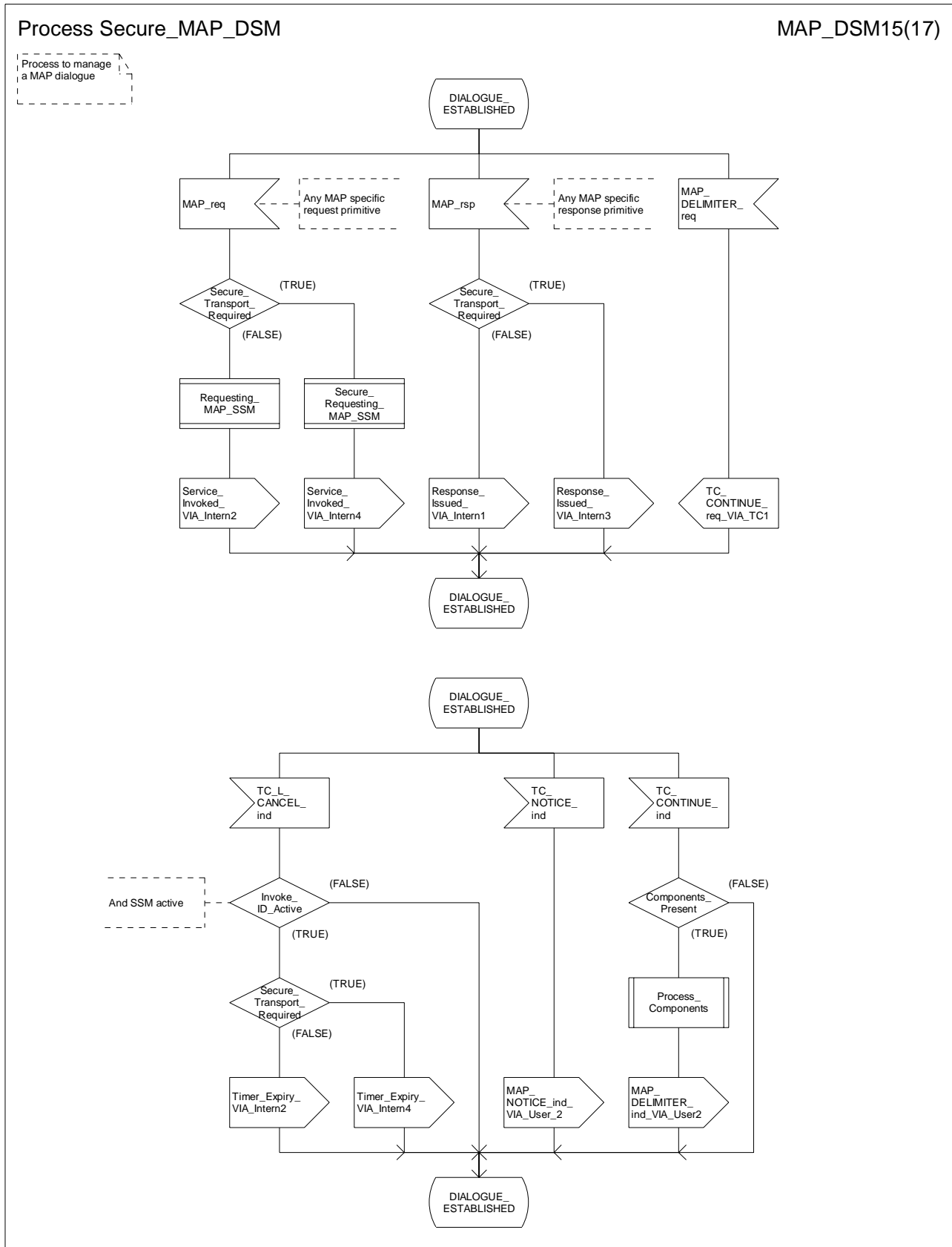

Figure 15.6/3o: Process Secure_MAP_DSM (sheet 15)

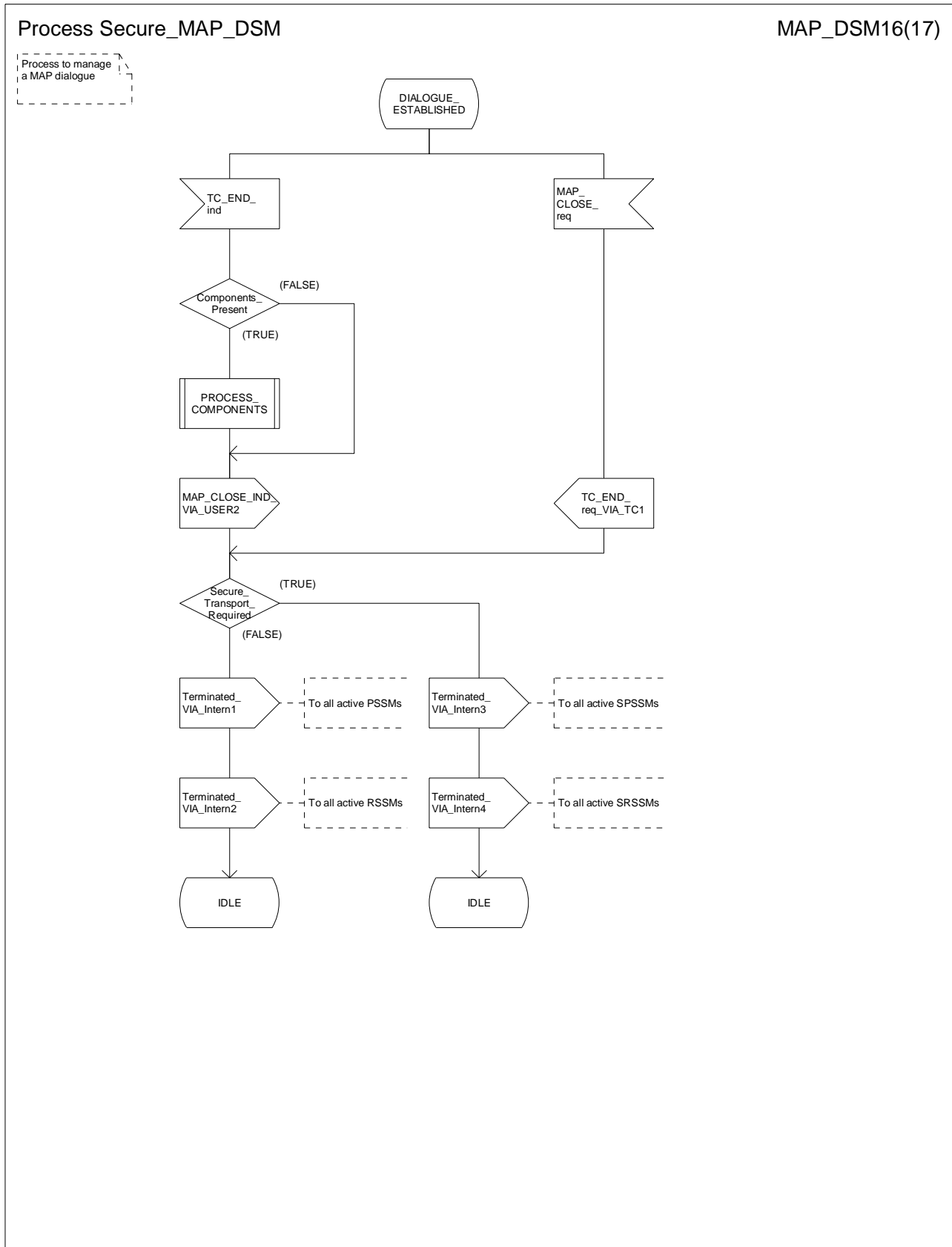

Figure 15.6/3p: Process Secure_MAP_DSM (sheet 16)

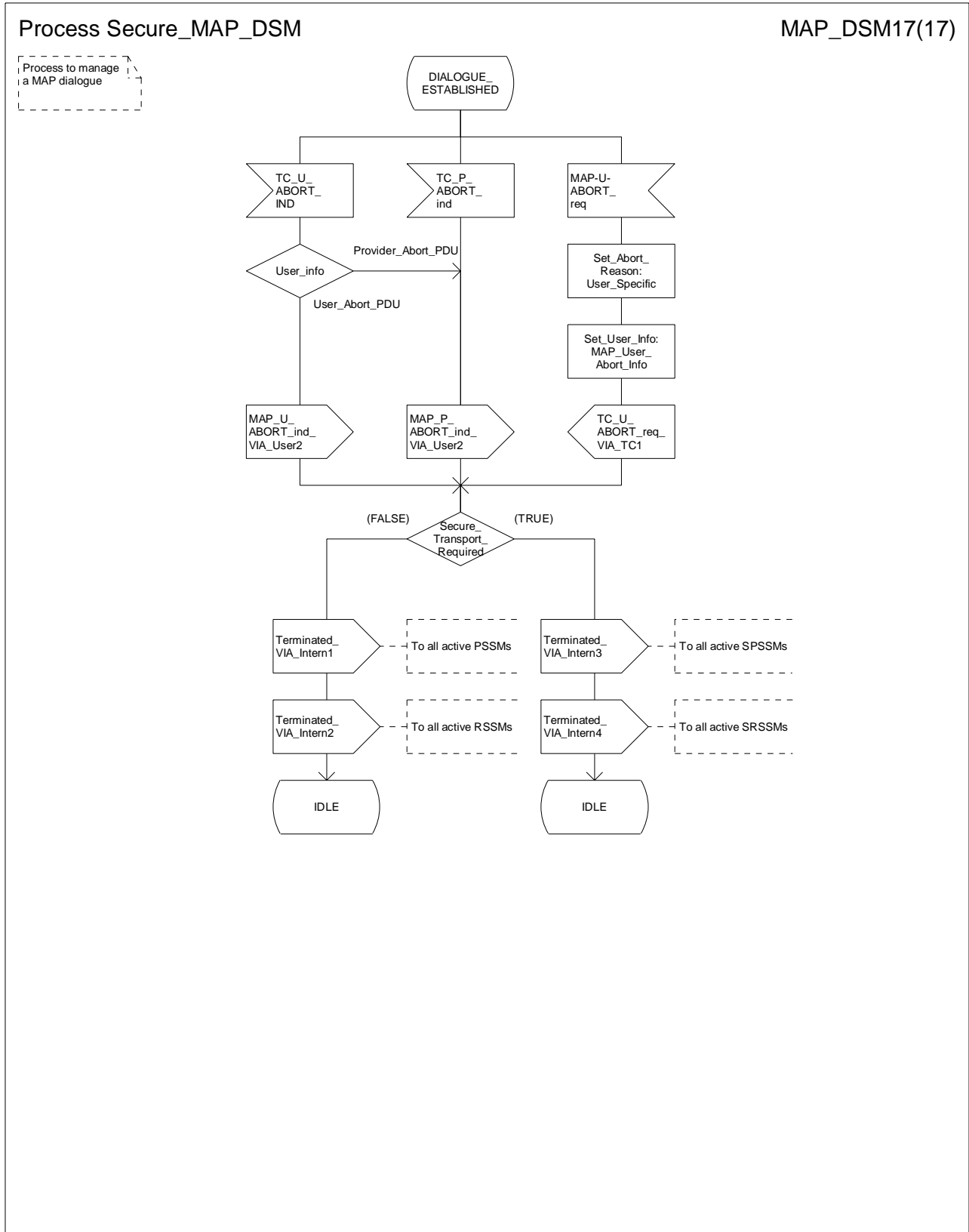

Figure 15.6/3q: Process Secure_MAP_DSM (sheet 17)

Procedure Process_Components

Proc_Comp1(5)

Procedure to process components received in a TC message

Comments: Components from TCAP:
 DCL
 Op_Code, Operation_Class INTEGER,
 Operation_Exists, Last_Component, Invoke_ID_Present, Invoke_ID_Assigned, Secure_Transport_Required,
 Linked_ID_Present, Encapsulator_Linked_ID_Present, Linked_ID_Assigned, Encapsulated_Linked_ID_Assigned,
 Linked_Operation_Allowed, v3_Or_Higher_Dialogue BOOLEAN;

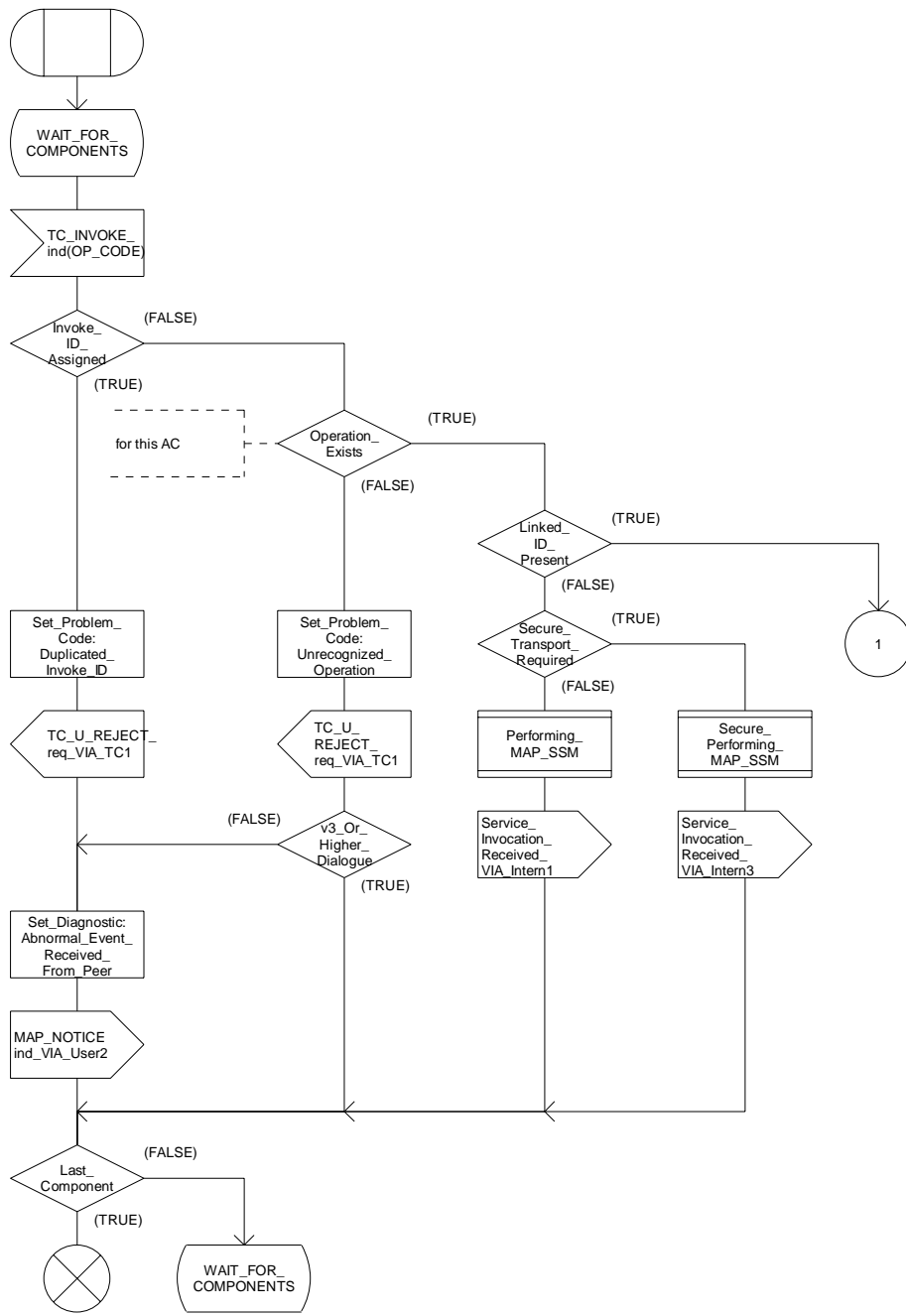

Figure 15.6/4a: Procedure Process_Components (sheet 1)

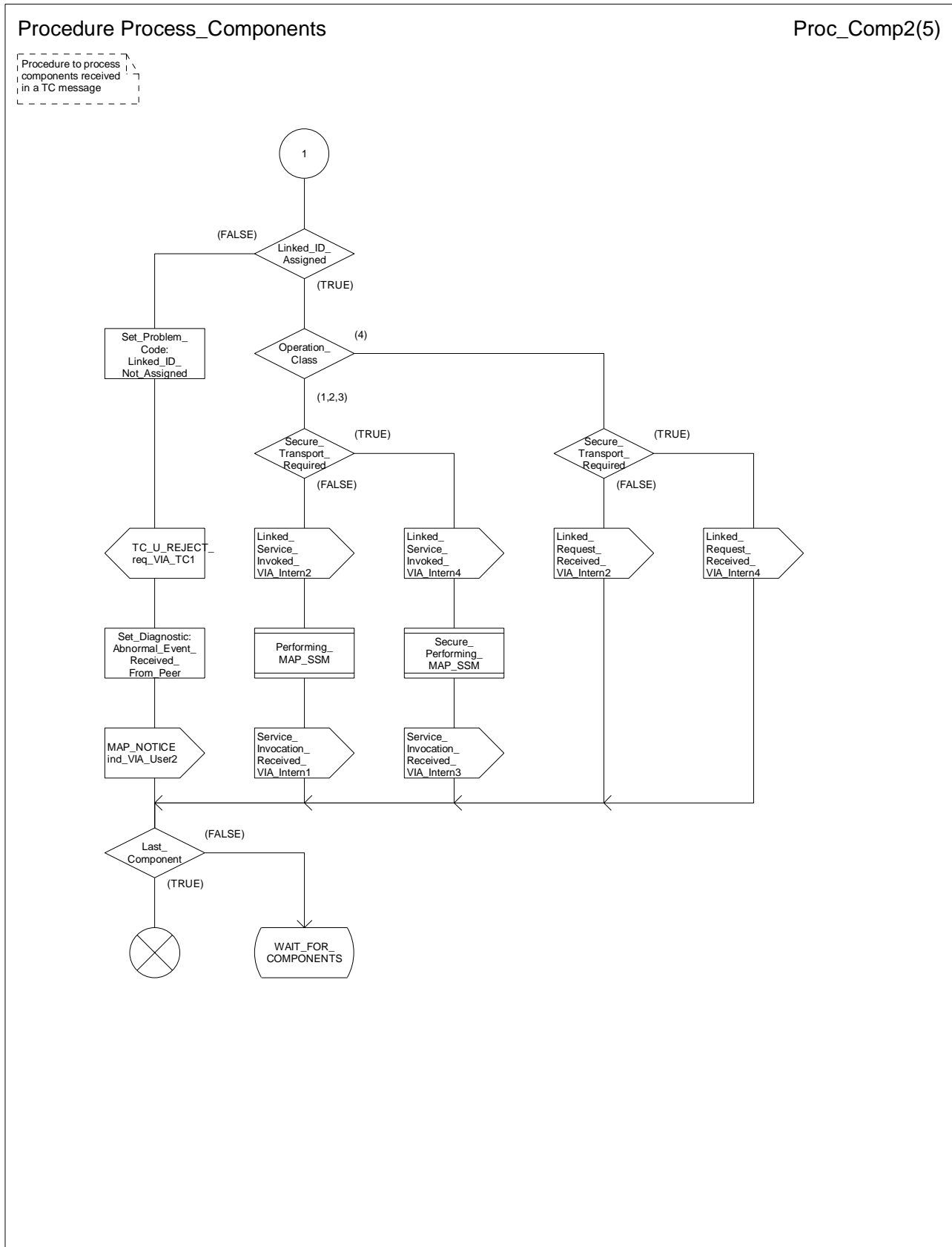

Figure 15.6/4b: Procedure Process_Components (sheet 2)

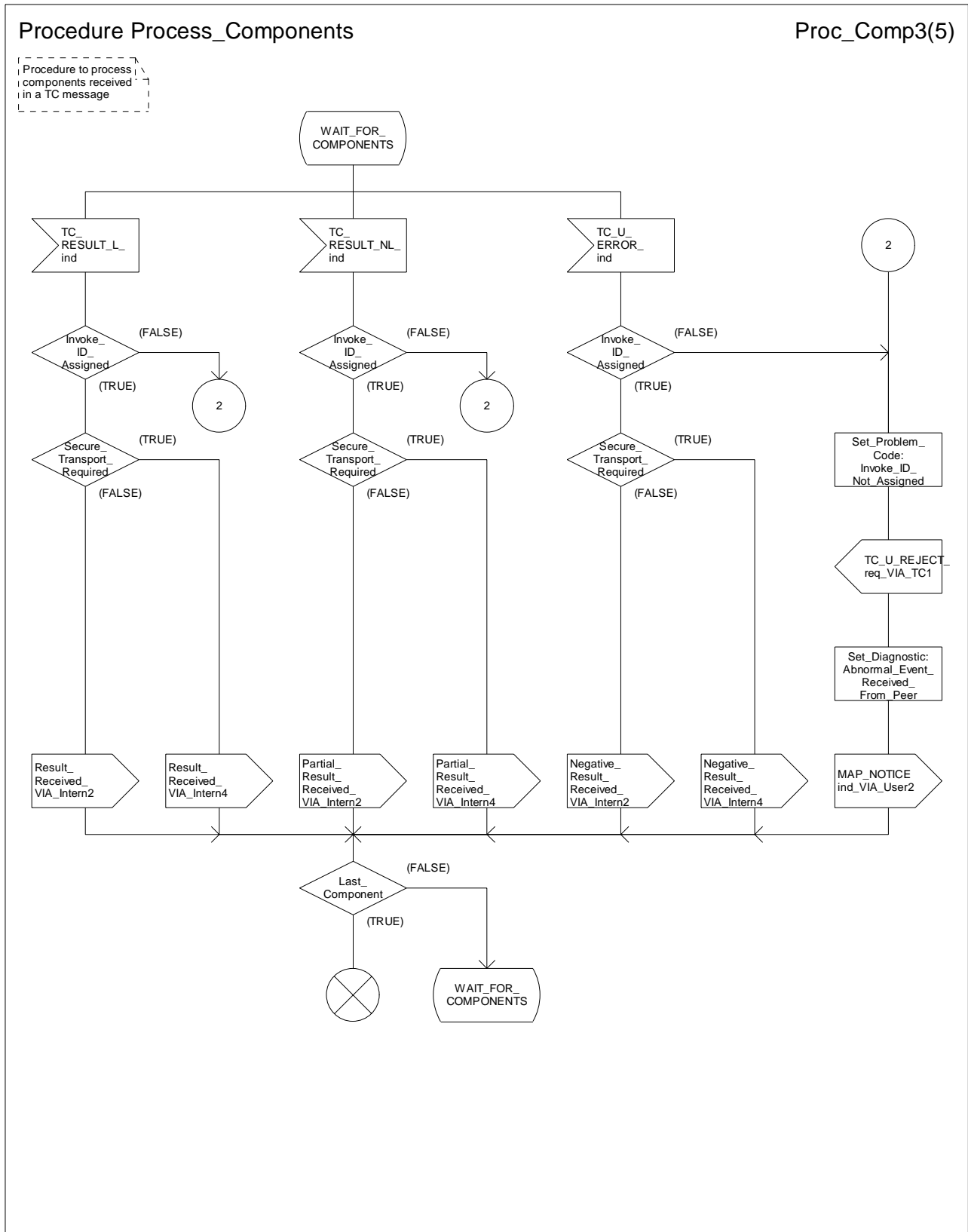

Figure 15.6/4c: Procedure Process_Components (sheet 3)

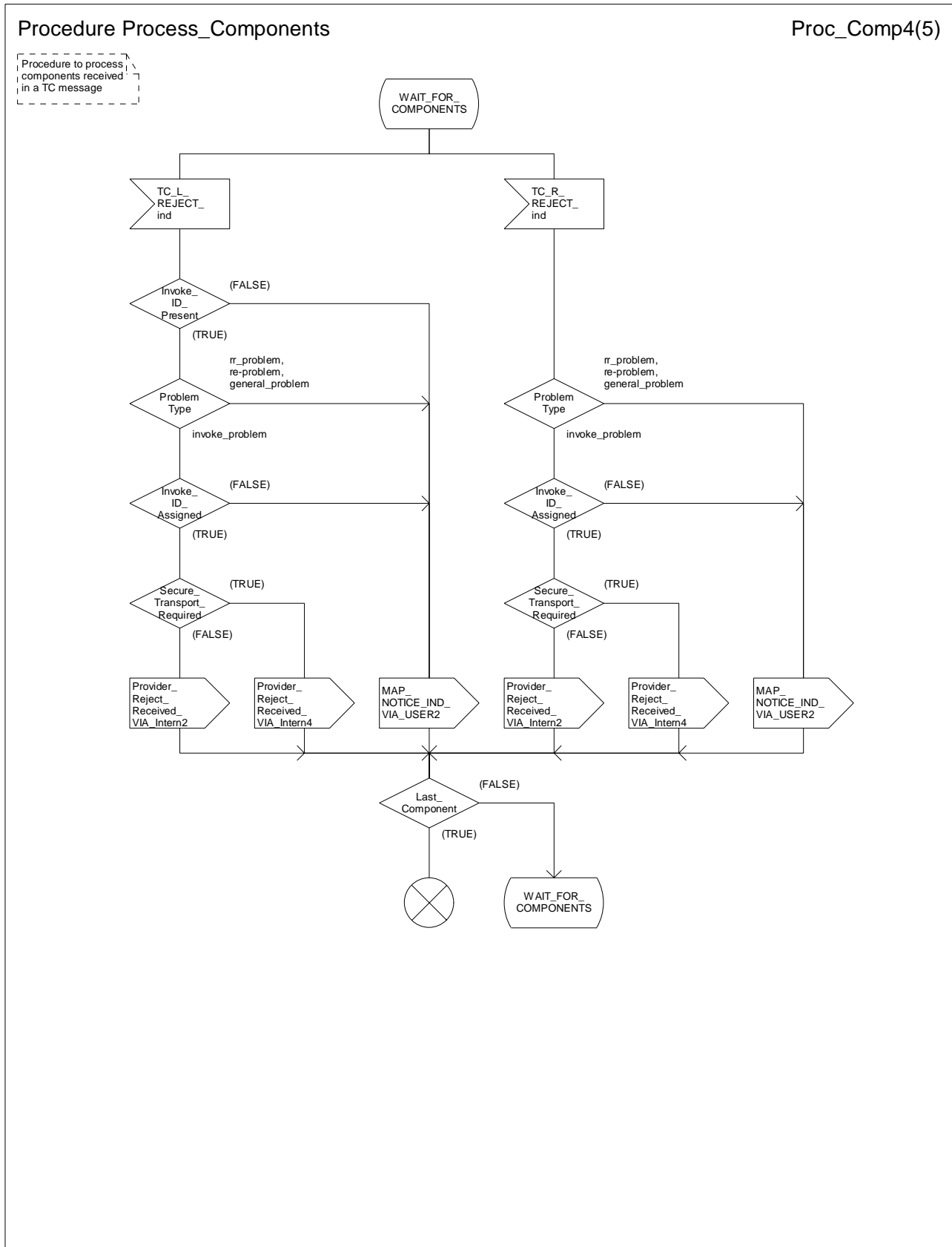

Figure 15.6/4d: Procedure Process_Components (sheet 4)

Procedure Process_Components

Proc_Comp5(5)

Procedure to process components received in a TC message

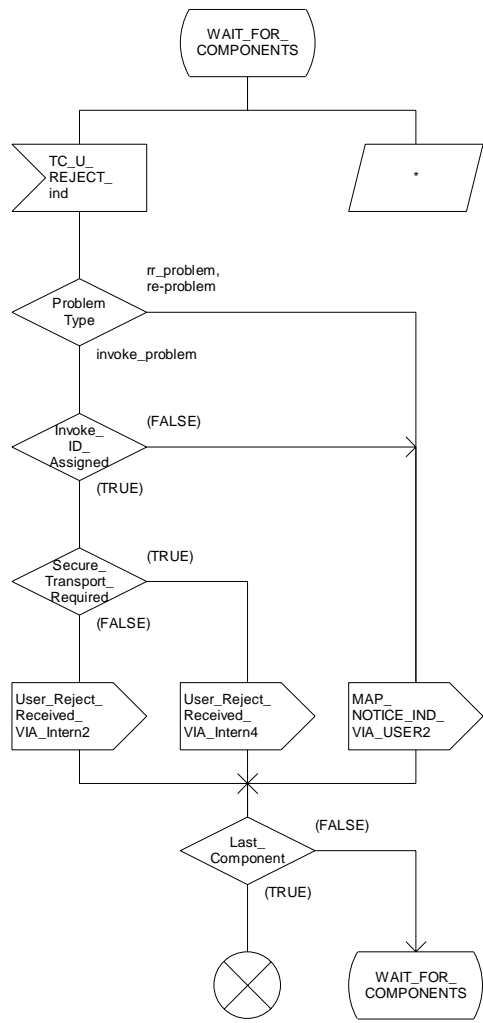

Figure 15.6/4e: Procedure Process_Components (sheet 5)

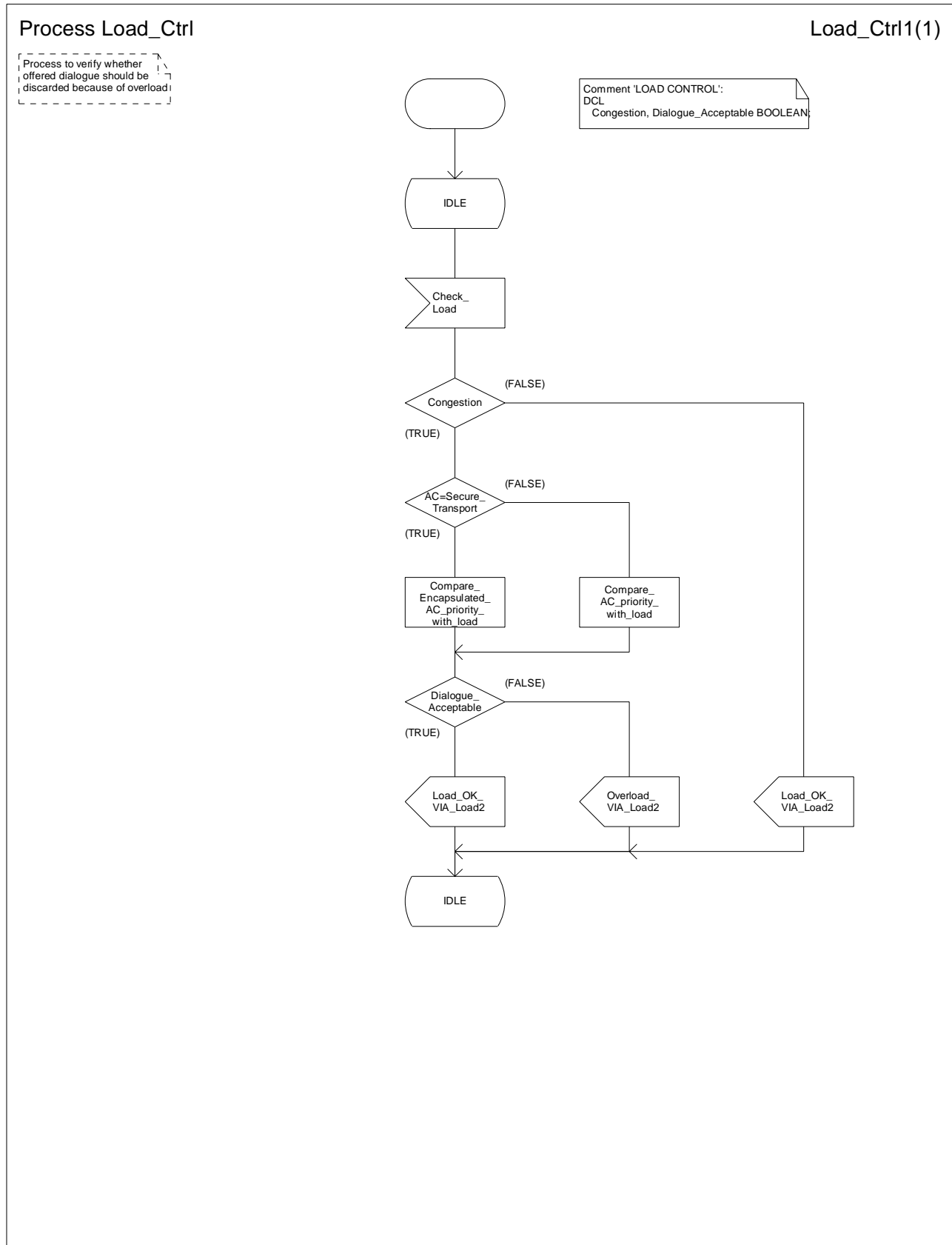

Figure 15.6/5: Process Load_Ctrl

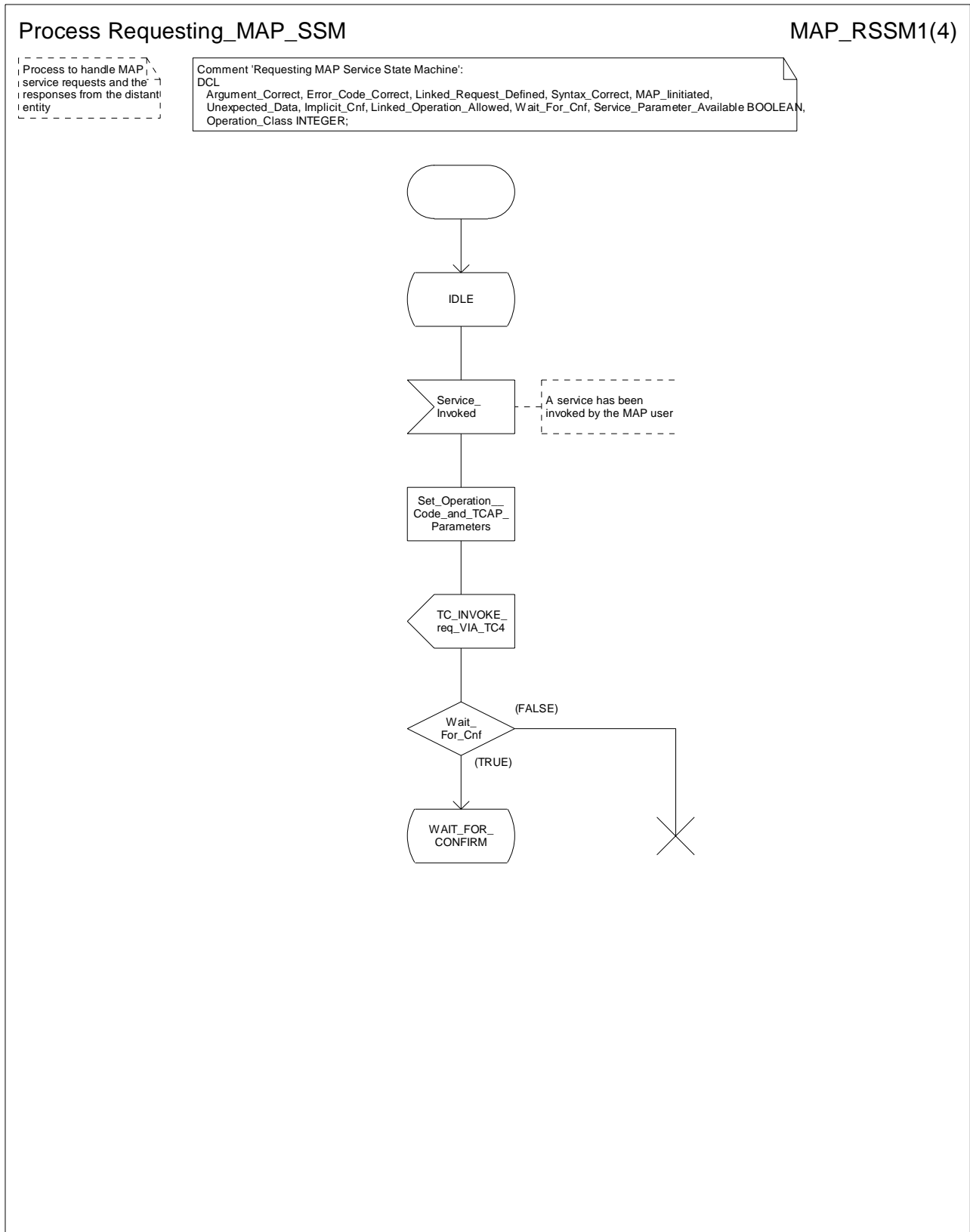

Figure 15.6/6a: Process Requesting_MAP_SSM (sheet 1)

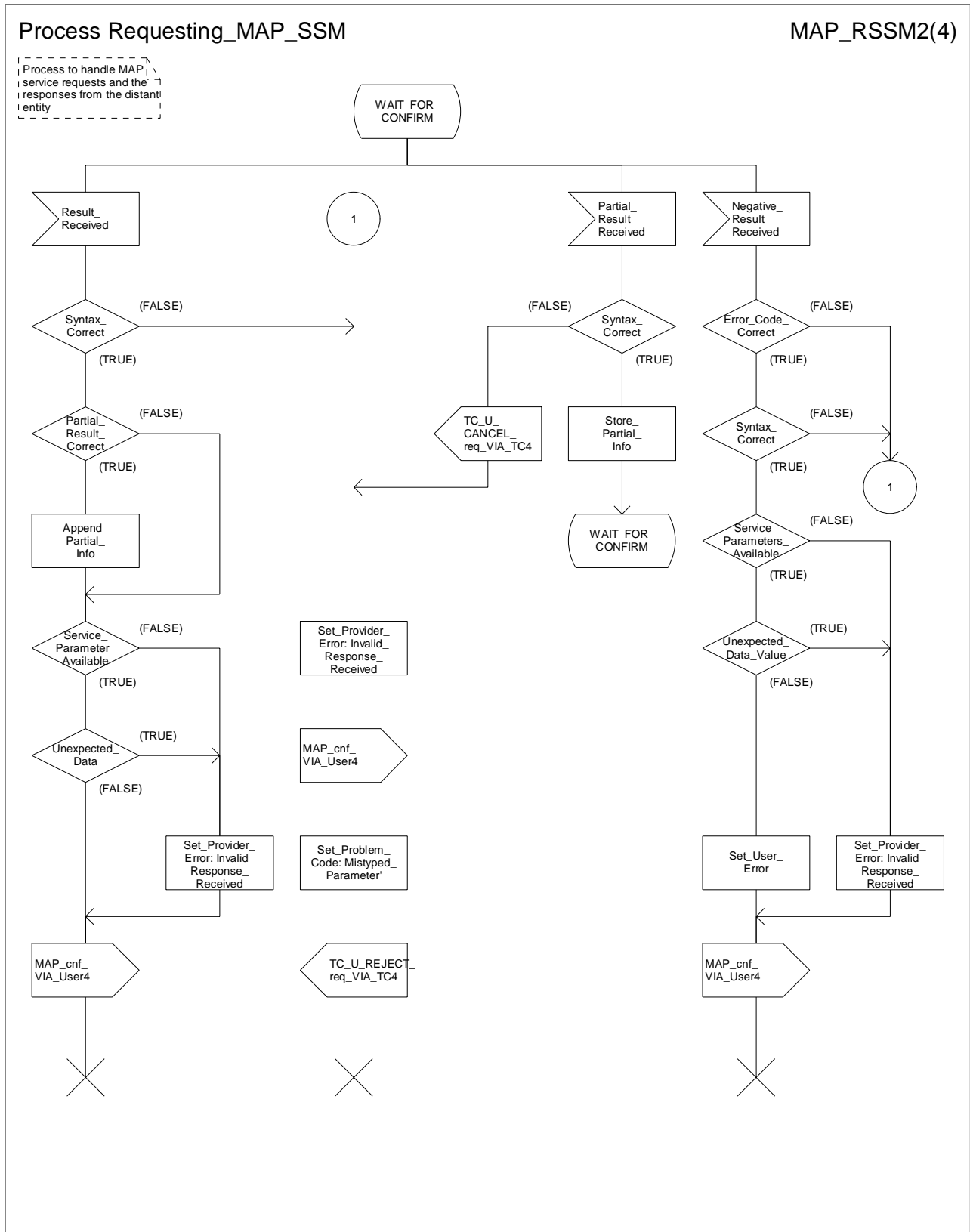

Figure 15.6/6b: Process Requesting_MAP_SSM (sheet 2)

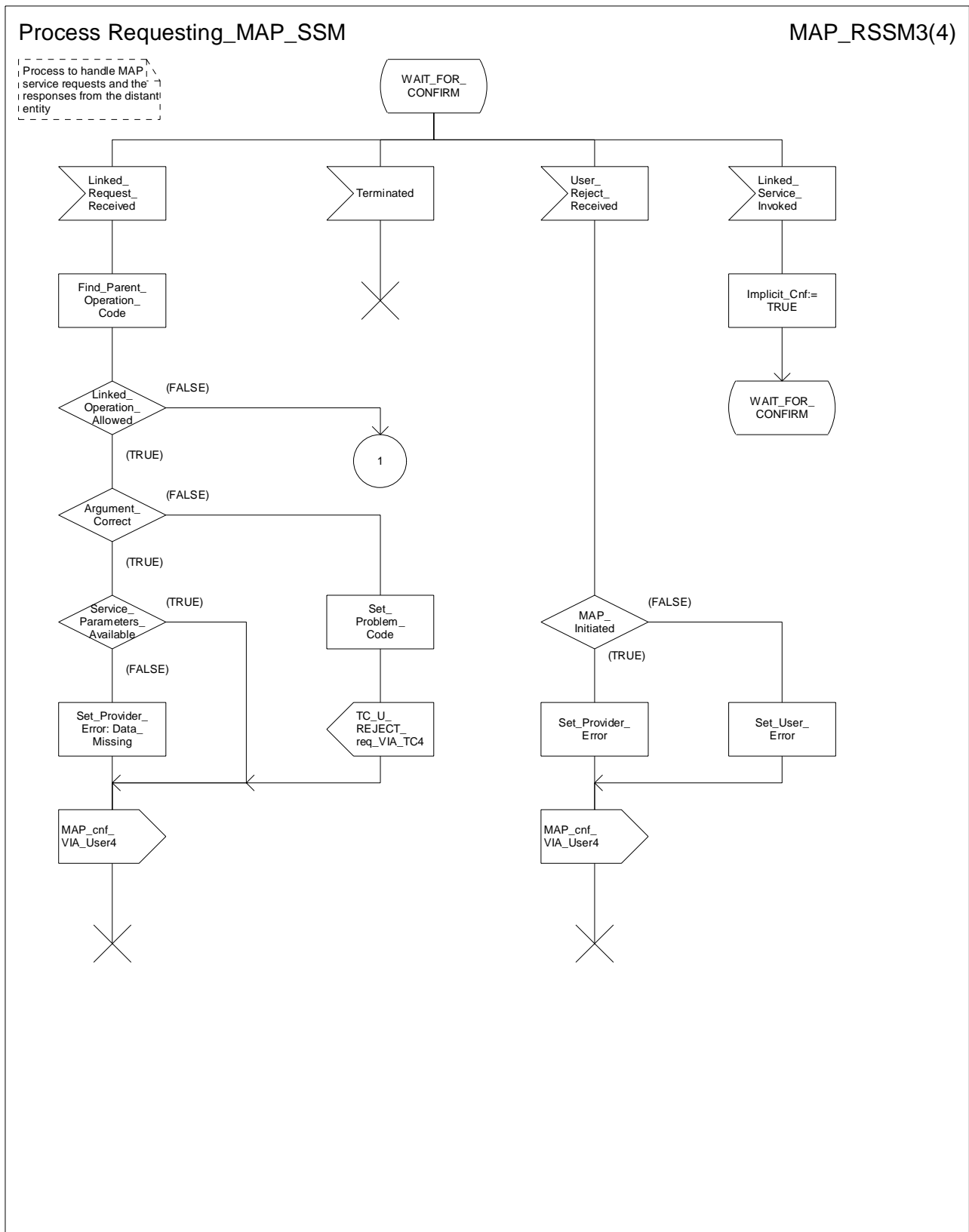

Figure 15.6/6c: Process Requesting_MAP_SSM (sheet 3)

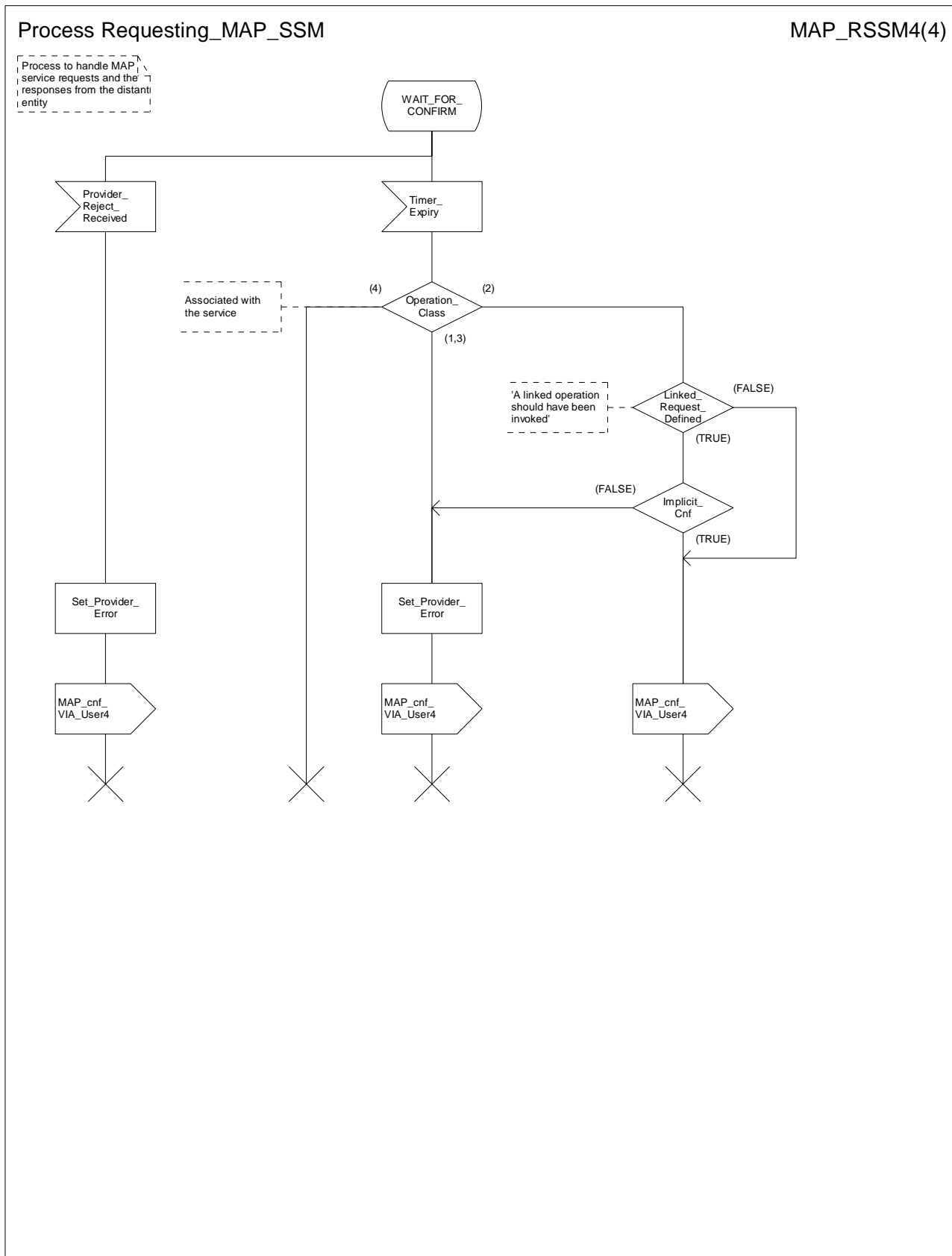

Figure 15.6/6d: Process Requesting_MAP_SSM (sheet 4)

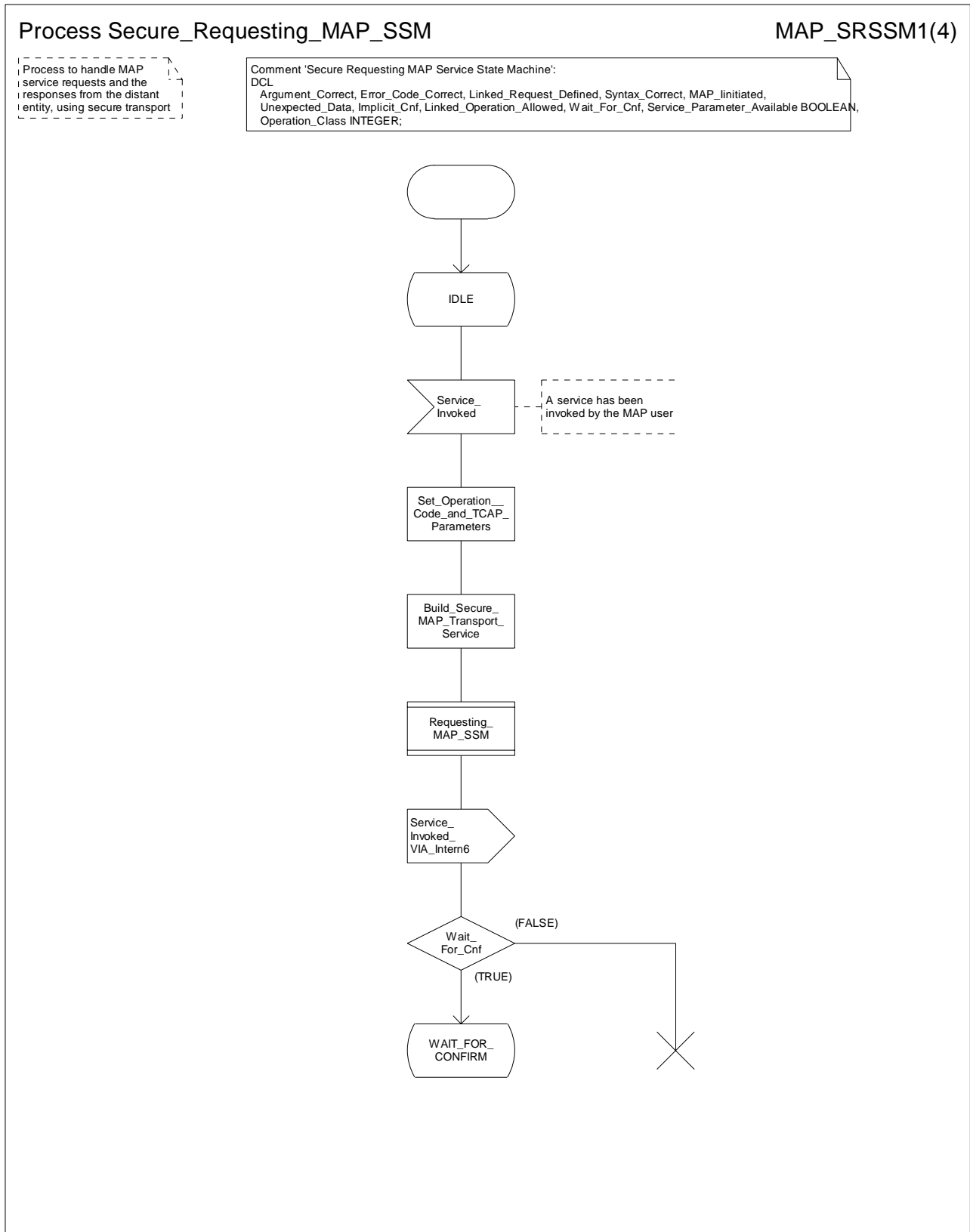

Figure 15.6/7a: Process Secure_Requesting_MAP_SSM (sheet 1)

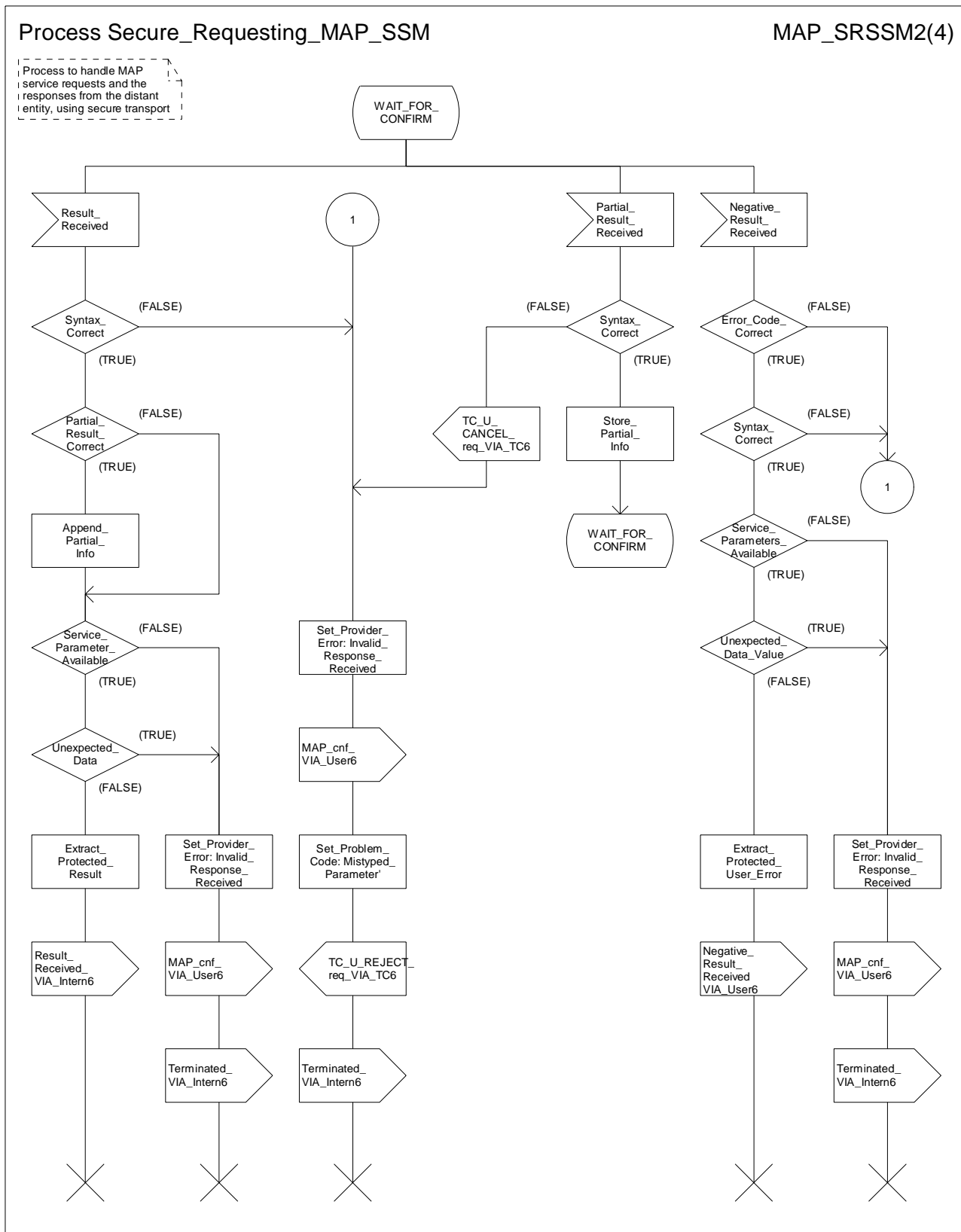

Figure 15.6/7b: Process Secure_Requesting_MAP_SSM (sheet 2)

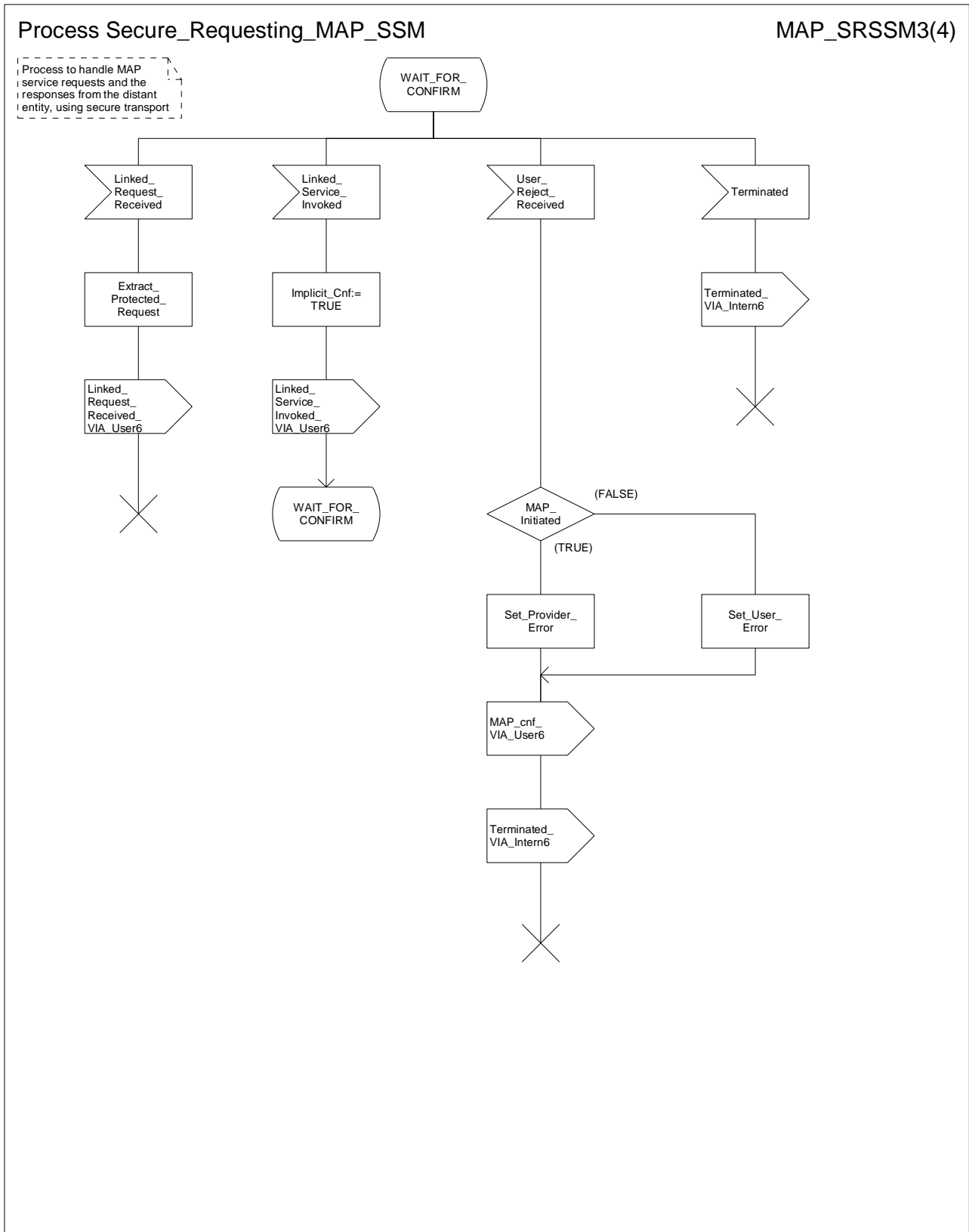

Figure 15.6/7c: Process Secure_Requesting_MAP_SSM (sheet 3)

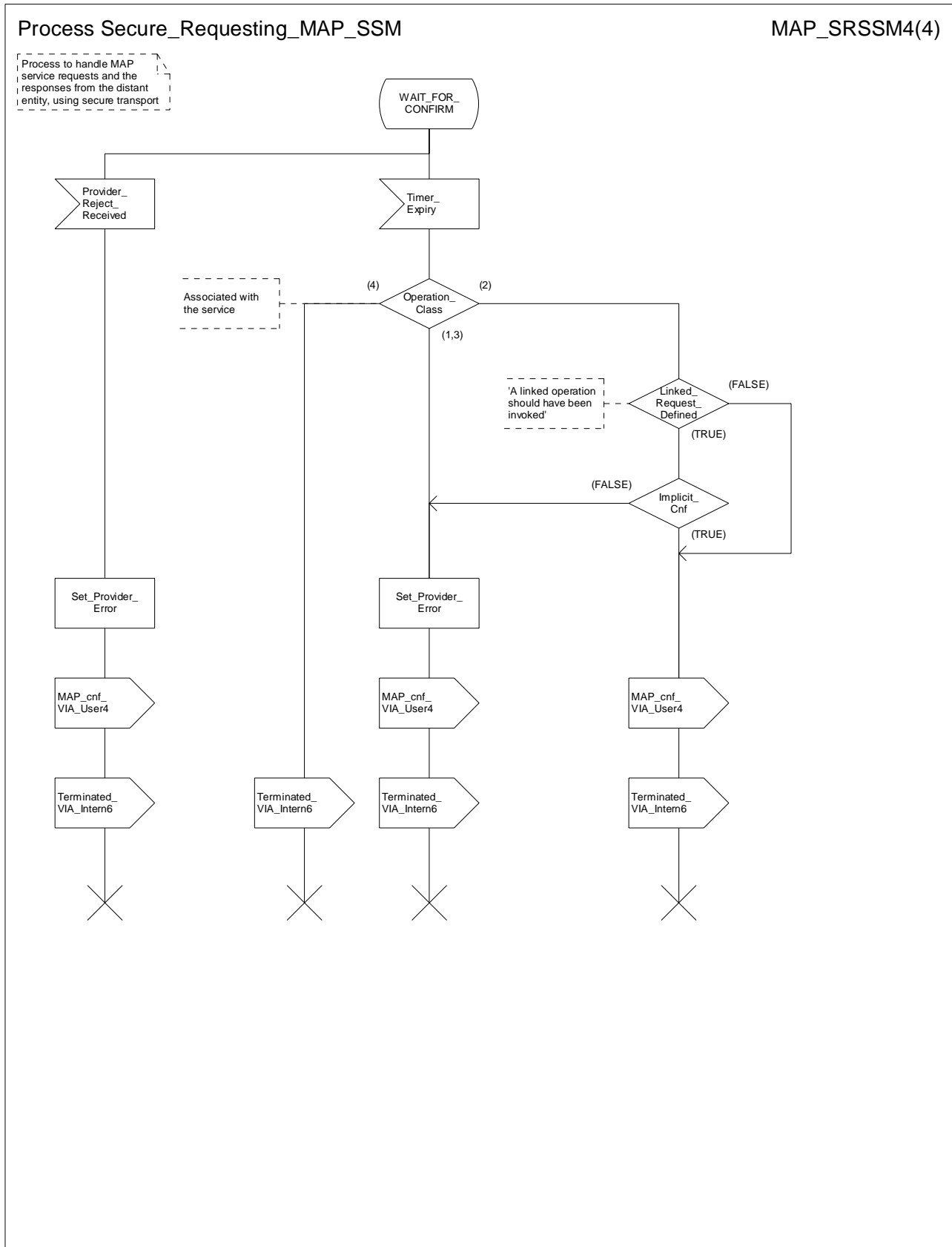

Figure 15.6/7d: Process Secure_Requesting_MAP_SSM (sheet 4)

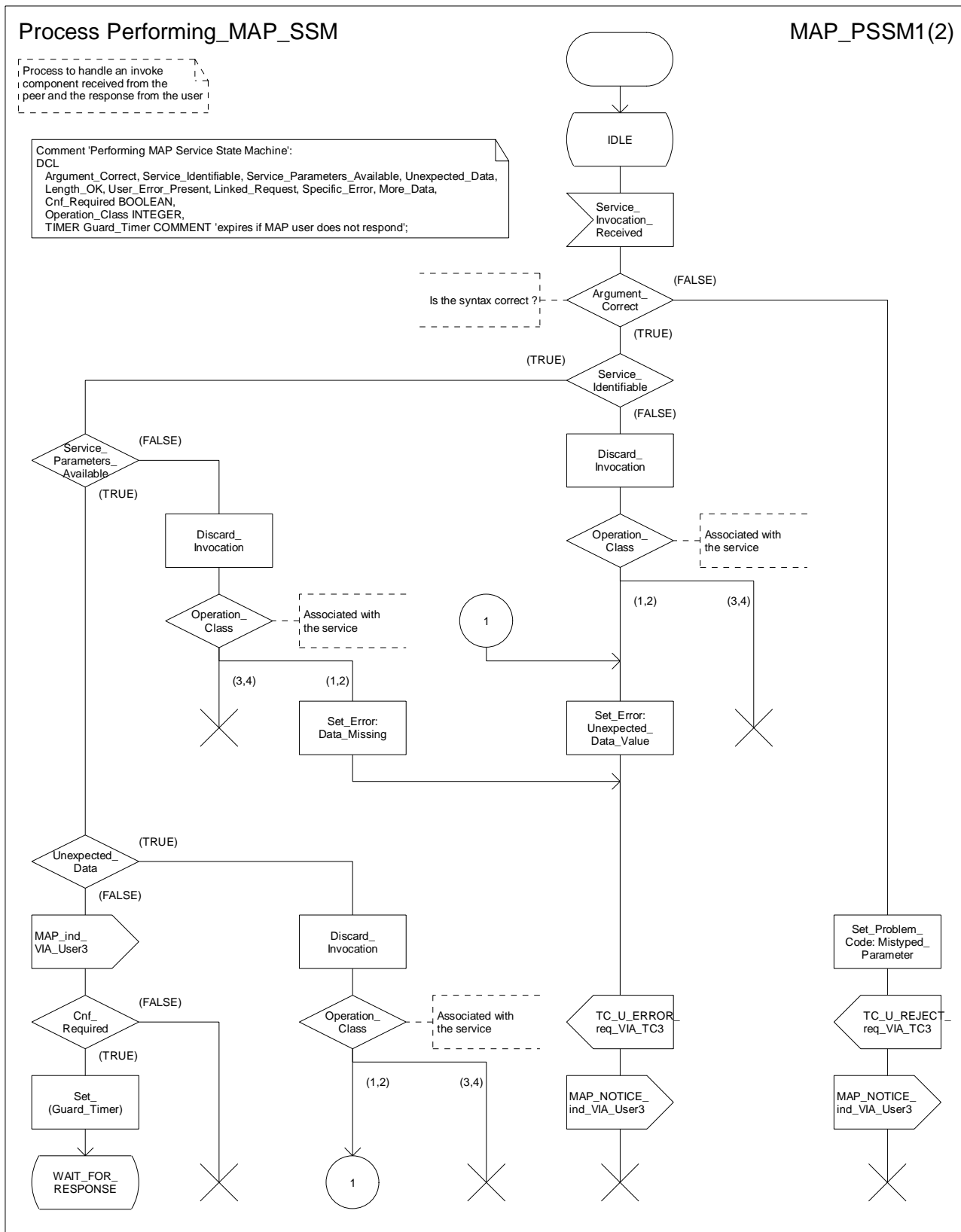

Figure 15.6/8a: Process Performing_MAP_SSM (sheet 1)

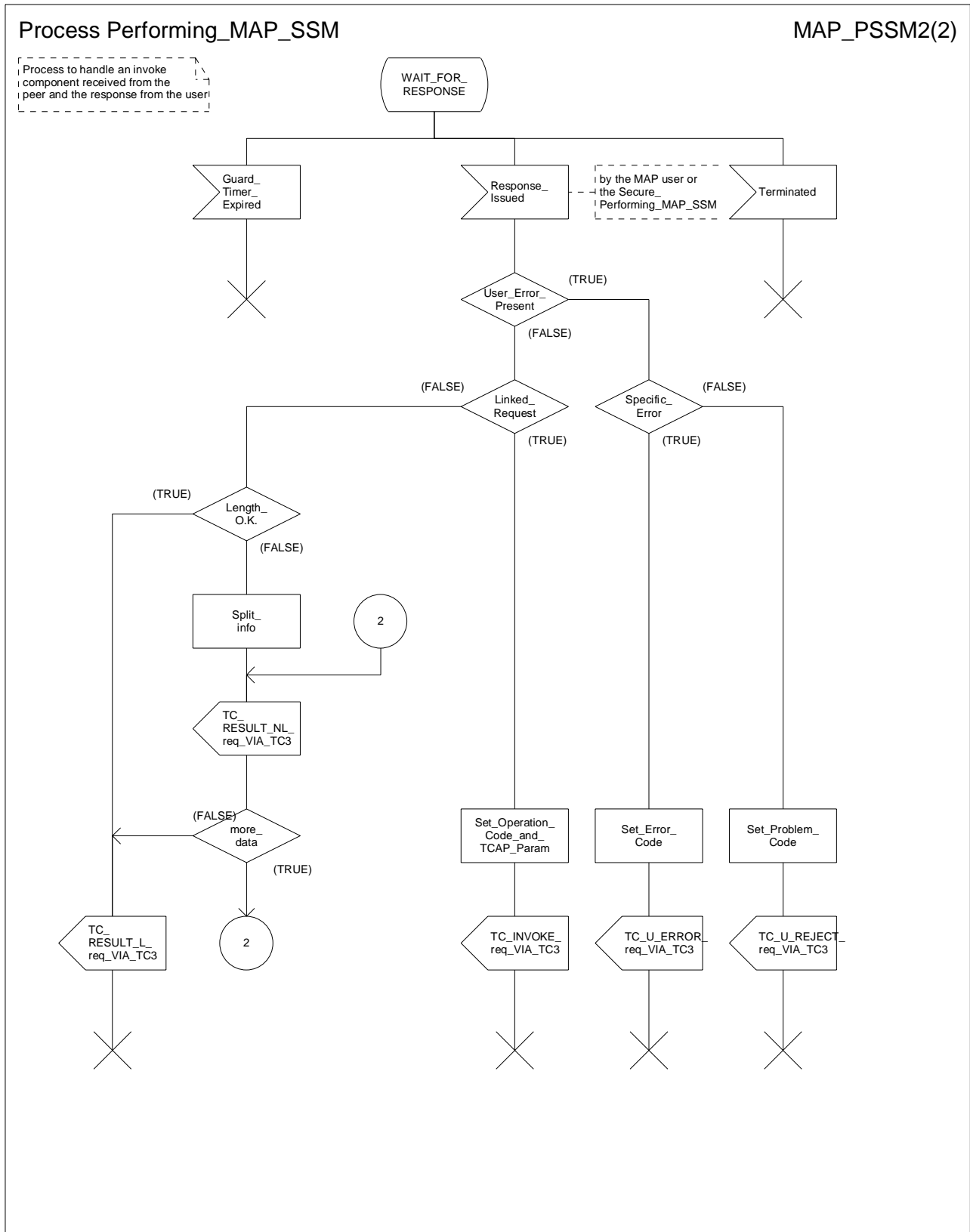

Figure 15.6/8b: Process Performing_MAP_SSM (sheet 2)

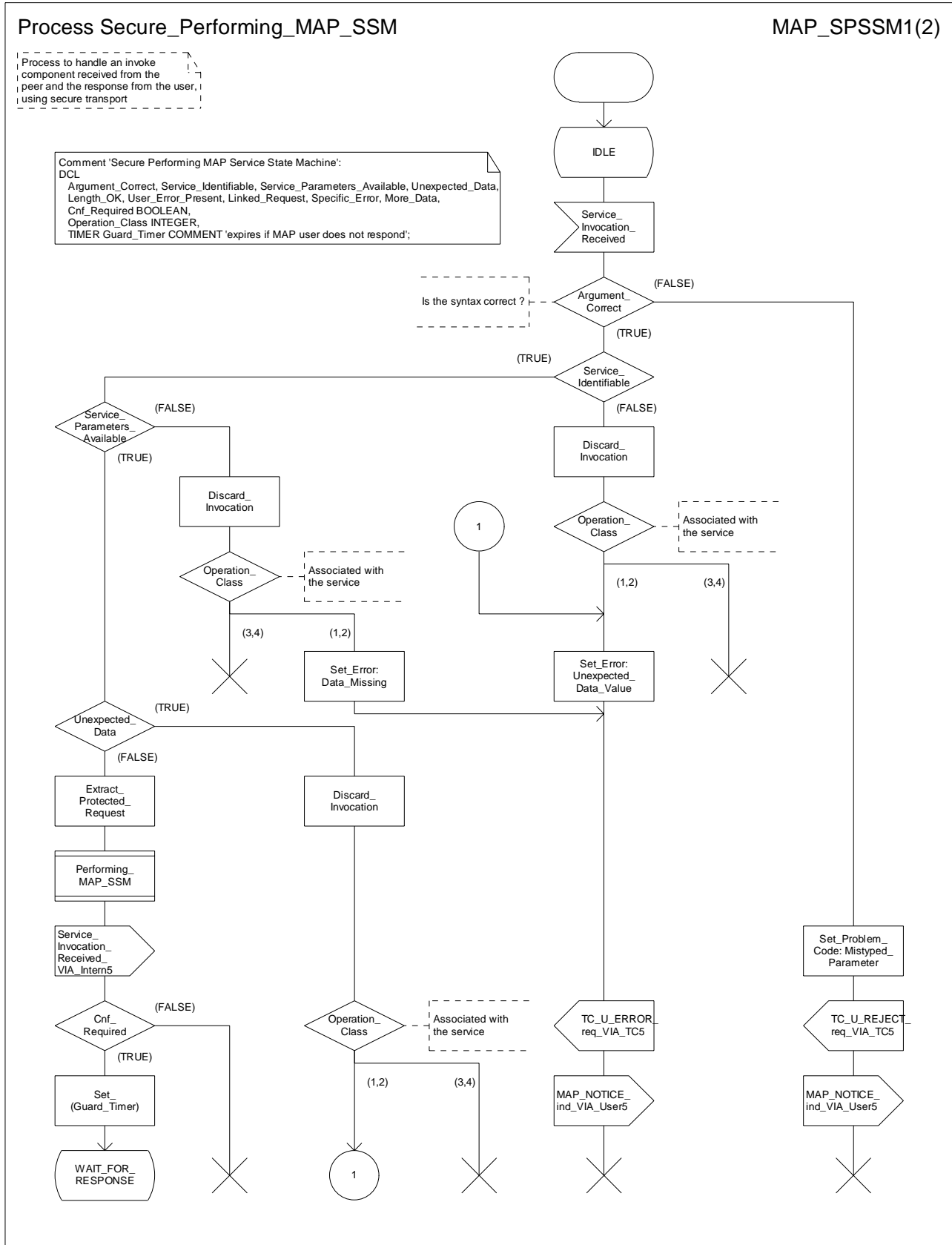

Figure 15.6/9a: Process Secure_Performing_MAP_SSM (sheet 1)

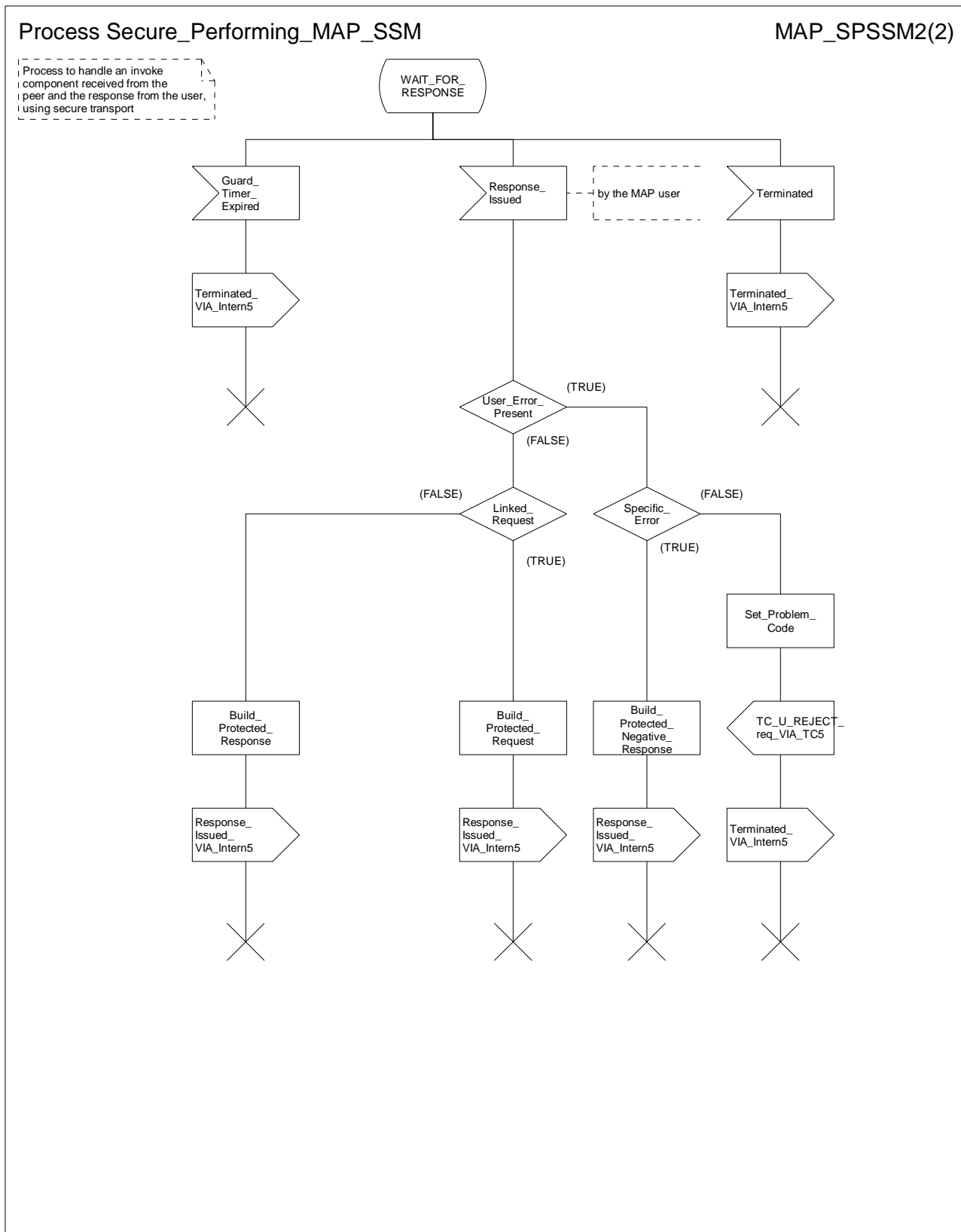

Figure 15.6/9b: Process Secure_Performing_MAP_SSM (sheet 2)

16 Mapping on to TC services

16.1 Dialogue control

Dialogue control services are mapped to TC dialogue handling services. The TC-UNI service is not used by the MAP PM.

16.1.1 Directly mapped parameters

The following parameters of the MAP-OPEN request and indication primitives are directly mapped on to the corresponding parameters of the TC-BEGIN primitives:

- destination address;
- originating address.

16.1.2 Use of other parameters of dialogue handling primitives

16.1.2.1 Dialogue Id

The value of this parameter is associated with the MAP PM invocation in an implementation dependent manner.

16.1.2.2 Application-context-name

The application-context-name parameter of a MAP primitive is mapped to the application-context-name parameter of TC dialogue handling primitives according to the rules described in clause 15.1.

16.1.2.3 User information

The user information parameter of TC dialogue primitives is used to carry the MAP dialogue APDUs.

16.1.2.4 Component present

This parameter is used by the MAP PM as described in CCITT Recommendation Q.771. It is not visible to the MAP user.

16.1.2.5 Termination

The value of this parameter of the TC-END request primitive is set by the MAP PM on the basis of the release method parameter of the MAP-CLOSE request primitive, except when the dialogue state machine is in the state DIALOGUE INITIATED, in which case the Termination parameter shall always indicate "pre-arranged end".

16.1.2.6 P-Abort-Cause

Values of the P-abort-cause parameter are mapped to the values of the provider-reason parameter of the MAP-P-ABORT indication primitive according to table 16.1/1, except in the dialogue initiated phase for the "incorrectTransactionPortion" and "noCommonDialoguePortion" values which are mapped to the "potential incompatibility problem" value of the refuse-reason parameter of the MAP-OPEN cnf primitive. The source parameter in the MAP-P-ABORT ind takes the value "TC problem".

16.1.2.7 Quality of service

The quality of service of TC request primitives is set by the MAP as shown below.

- Return option: "Return message on error" or "Discard message on error" as required by the network operator;

- Sequence control: "Sequence guaranteed" or "Sequence result not guaranteed" as required by the network operator;
- "Sequence guaranteed" shall be used when a segmented result is to be transferred (e.g. subscriber data in response to SendParameters). It may also be appropriate to use Sequence guaranteed when a series of InsertSubscriberData, ProcessAccessSignalling or ForwardAccessSignalling operations is used.

It is essential that the TC message which indicates acceptance of a dialogue opening request is received by the dialogue initiator before any subsequent message in that dialogue; otherwise the dialogue opening will fail. The dialogue responder shall ensure that this requirement is met by:

- Sending the dialogue acceptance message in a TC-END, if the dialogue structure requires it; or
- Using "Sequence guaranteed", if the dialogue acceptance message is sent in a TC-CONTINUE; or
- Waiting until the dialogue acceptance message has been acknowledged by the dialogue initiator before sending a subsequent message, if the dialogue acceptance message is sent in a TC-CONTINUE.

Table 16.1/1: Mapping of P-Abort cause in TC-P-ABORT indication on to provider-reason in MAP-P-ABORT indication

TC P-Abort cause	MAP provider-reason
unrecognised message type	provider malfunction
unrecognised transaction Id	supporting dialogue released
badlyFormattedTransactionPortion	provider malfunction
incorrectTransactionPortion	provider malfunction (note)
resourceLimitation	resource limitation
abnormalDialogue	provider malfunction
noCommonDialoguePortion	version incompatibility
NOTE: Or version incompatibility in the dialogue initiated phase.	

16.2 Service specific procedures

Specific services are mapped to TC component handling services.

16.2.1 Directly mapped parameters

The Invoke Id parameter of the MAP request and indication primitive is directly mapped on to the Invoke Id parameter of the component handling primitives.

16.2.2 Use of other parameters of component handling primitives

16.2.2.1 Dialogue Id

The value of this parameter is associated with the MAP PM invocation in an implementation dependent manner.

16.2.2.2 Class

The value of this parameter is set by the MAP PM according to the type of the operation to be invoked.

16.2.2.3 Linked Id

When a service response is mapped to a class 4 operation, the value of this parameter is set by the MAP PM and corresponds to the value assigned by the user to the initial service request (i.e. the value of the invoke ID parameter of the request primitive). Otherwise if such a parameter is included in MAP request/indication primitives it is directly mapped to the linked ID parameter of the associated TC-INVOKE request/indication primitives.

16.2.2.4 Operation

When mapping a request primitive on to a Remote Operations PDU (invoke), the MAP PM shall set the operation code according to the mapping described in table 16.2/1.

When mapping a response primitive on to a Remote Operations service, the MAP PM shall set the operation code of the TC-RESULT-L/NL primitive (if required) to the same value as the one received at invocation time.

Table 16.2/1: Mapping of MAP specific services on to MAP operations

MAP-SERVICE	operation
MAP-ACTIVATE-SS	activateSS
MAP-ACTIVATE-TRACE-MODE	activateTraceMode
MAP-ALERT-SERVICE-CENTRE	alertServiceCentre
MAP-ANY-TIME-INTERROGATION	anyTimeInterrogation
MAP_AUTHENTICATION_FAILURE_REPORT	authenticationFailureReport
MAP-ANY-TIME-MODIFICATION	anyTimeModification
MAP-ANY-TIME-SUBSCRIPTION-INTERROGATION	anyTimeSubscriptionInterrogation
MAP-CANCEL-LOCATION	cancelLocation
MAP-CHECK-IMEI	checkIMEI
MAP-DEACTIVATE-SS	deactivateSS
MAP-DEACTIVATE-TRACE-MODE	deactivateTraceMode
MAP-DELETE-SUBSCRIBER-DATA	deleteSubscriberData
MAP-ERASE-CC-ENTRY	eraseCC-Entry
MAP-ERASE-SS	eraseSS
MAP-FAILURE-REPORT	failureReport
MAP-FORWARD-ACCESS-SIGNALLING	forwardAccessSignalling
MAP-FORWARD-CHECK-SS-INDICATION	forwardCheckSsIndication
MAP-FORWARD-GROUP-CALL-SIGNALLING	forwardGroupCallSignalling
MAP-MT-FORWARD-SHORT-MESSAGE	mt-forwardSM
MAP-MO-FORWARD-SHORT-MESSAGE	mo-forwardSM
MAP-GET-PASSWORD	getPassword
MAP-INFORM-SERVICE-CENTRE	informServiceCentre
MAP-INSERT-SUBSCRIBER-DATA	insertSubscriberData
MAP-INTERROGATE-SS	interrogateSs
MAP-IST-ALERT	istAlert
MAP-IST-COMMAND	istCommand
MAP-NOTE-MS-PRESENT-FOR-GPRS	noteMsPresentForGprs
MAP-NOTE-SUBSCRIBER-DATA-MODIFIED	noteSubscriberDataModified
MAP-PREPARE-GROUP-CALL	prepareGroupCall
MAP-PREPARE-HANDOVER	prepareHandover
MAP-PREPARE-SUBSEQUENT-HANDOVER	prepareSubsequentHandover
MAP-PROCESS-ACCESS-SIGNALLING	processAccessSignalling
MAP-PROCESS-GROUP-CALL-SIGNALLING	processGroupCallSignalling
MAP-PROCESS-UNSTRUCTURED-SS-REQUEST	processUnstructuredSS-Request
MAP-PROVIDE-ROAMING-NUMBER	provideRoamingNumber
MAP-PROVIDE-SIWFS-NUMBER	provideSIWFSNumber
MAP-PROVIDE-SUBSCRIBER-LOCATION	provideSubscriberLocation
MAP-PROVIDE-SUBSCRIBER-INFO	provideSubscriberInfo
MAP-PURGE-MS	purgeMS
MAP-READY-FOR-SM	readyForSM
MAP-REGISTER-CC-ENTRY	registerCC-Entry
MAP-REGISTER-PASSWORD	registerPassword
MAP-REGISTER-SS	registerSS
MAP-REMOTE-USER-FREE	remoteUserFree
MAP-REPORT-SM-DELIVERY-STATUS	reportSmDeliveryStatus
MAP-RESET	reset
MAP-RESTORE-DATA	restoreData
MAP-SECURE-TRANSPORT-CLASS-1	secureTransportClass1
MAP-SECURE-TRANSPORT-CLASS-2	secureTransportClass2
MAP-SECURE-TRANSPORT-CLASS-3	secureTransportClass3
MAP-SECURE-TRANSPORT-CLASS-4	secureTransportClass4
MAP-SEND_GROUP_CALL_END_SIGNAL	sendGroupCallEndSignal
MAP-SEND-END-SIGNAL	sendEndSignal

MAP-SEND-AUTHENTICATION-INFO	sendAuthenticationInfo
MAP-SEND-IMSI	sendIMSI
MAP-SEND-IDENTIFICATION	sendIdentification
MAP-SEND-ROUTING-INFO-FOR-SM	sendRoutingInfoForSM
MAP-SEND-ROUTING-INFO-FOR-GPRS	sendRoutingInfoForGprs
MAP-SEND-ROUTING-INFO-FOR-LCS	sendRoutingInfoForLCS
MAP-SEND-ROUTING-INFORMATION	sendRoutingInfo
MAP-SET-REPORTING-STATE	setReportingState
MAP-SIWFS-SIGNALING-MODIFY	SIWFSSignallingModify
MAP-STATUS-REPORT	statusReport
MAP-SUBSCRIBER-LOCATION-REPORT	subscriberLocationReport
MAP-SUPPLEMENTARY-SERVICE-INVOCATION-NOTIFICATION	ss-Invocation-Notification
MAP-UNSTRUCTURED-SS-NOTIFY	unstructuredSS-Notify
MAP-UNSTRUCTURED-SS-REQUEST	unstructuredSS-Request
MAP-UPDATE-GPRS-LOCATION	updateGprsLocation
MAP-UPDATE-LOCATION	updateLocation
MAP-NOTE-MM-EVENT	NoteMM-Event

16.2.2.5 Error

The error parameter in a TC-U-ERROR indication primitive is mapped to the user error parameter in the MAP confirm primitive of the service associated with the operation to which the error is attached.

The user error parameter in MAP response primitives is mapped to the error parameter of the TC-U-ERROR request primitive, except for "initiating-release" and "resource-limitation" which are mapped to the problem code parameter of the TC-U-REJECT request primitive.

16.2.2.6 Parameters

The parameters of MAP specific request and indication primitives are mapped to the argument parameter of TC-INVOKE primitives.

The parameters of MAP specific response and confirm primitives are mapped to the result parameter of TC-RESULT-L primitives, the parameter of TC-U-ERROR primitives or the argument of TC-INVOKE primitives when mapping on linked class 4 operations is used.

16.2.2.7 Time out

The value of this parameter is set by the MAP PM according to the type of operation invoked.

16.2.2.8 Last component

This parameter is used by the MAP PM as described in CCITT Recommendation Q.711. It is not visible from the MAP user.

16.2.2.9 Problem code

16.2.2.9.1 Mapping to MAP User Error

The following values of the user error parameter are mapped as follows to values of the TC problem code parameter. These values are generated by the MAP user. This mapping is valid from the TC-U-REJECT indication primitive to the MAP confirm service primitive and from the MAP response service primitive to the TC-U-REJECT request primitive.

Table 16.2/2: Mapping of MAP User Error parameter on to TC problem code in TC-U-REJECT primitives

MAP User Error	TC problem code
resource limitation	resource limitation
initiating release	initiating release

16.2.2.9.2 Mapping to MAP Provider Error parameter

The following values of the TC problem code parameter of the TC-U-REJECT indication primitive are mapped as follows to values of the MAP Provider Error parameter of the MAP confirm primitive.

Table 16.2/3: Mapping of TC problem code in TC-U-REJECT on to MAP Provider Error parameter

TC problem code	MAP Provider Error
duplicated invoke Id	duplicated invoke id
unrecognised operation	service not supported
mistyped parameter	mistyped parameter

The following values of the problem code parameters of the TC-L-REJECT primitive are mapped to values of the provider error parameter of the MAP confirm primitive as follows.

Table 16.2/4: Mapping of TC problem code in TC-L-REJECT on to MAP Provider Error parameter

TC problem code	MAP Provider Error
return result unexpected	unexpected response from the peer
return error unexpected	unexpected response from the peer

16.2.2.9.3 Mapping to diagnostic parameter

The following values of the problem code parameter of the TC-R-REJECT and TC-U-REJECT primitive are mapped to values of the diagnostic parameter of the MAP-NOTICE indication primitive as follows:

Table 16.2/5: Mapping of TC problem code of TC-R-REJECT and TC-U-REJECT on to diagnostic parameter

TC problem code	MAP diagnostic
General problem	- abnormal event detected by the peer
Invoke problem	
- unrecognised linked ID	- abnormal event detected by the peer
- linked response unexpected	- response rejected by the peer
- unexpected linked operation	- response rejected by the peer
Return result problem	
- unrecognised invoke ID	- response rejected by the peer
- return result unexpected	- response rejected by the peer
- mistyped parameter	- response rejected by the peer
Return error problem	
- unrecognised invoke ID	- response rejected by the peer
- return error unexpected	- response rejected by the peer
- unrecognised error	- response rejected by the peer
- unexpected error	- response rejected by the peer
- mistyped parameter	- response rejected by the peer

The following values of the problem code parameter of the TC-L-REJECT primitive are mapped to values of the diagnostic parameter of the MAP-NOTICE indication primitive as follows.

Table 16.2/6: Mapping of TC problem code of TC-L-REJECT on to diagnostic parameter

TC problem code	MAP diagnostic
General problems	- abnormal event received from the peer
Invoke problem	
- unrecognised linked ID	- abnormal event received from the peer
Return result problem	
- unrecognised invoke ID	- abnormal event received from the peer
Return error problem	
- unrecognised invoke ID	- abnormal event received from the peer

17 Abstract syntax of the MAP protocol

17.1 General

This clause specifies the Abstract Syntaxes for the Mobile Application Part as well as the associated set of Operations and Errors, using the Abstract Syntax Notation One (ASN.1), defined in CCITT Recommendation X.208 (1988) or X.680 (1994) with additions as defined in clause 17.1.4 on Compatibility Considerations and the OPERATION and ERROR external MACROs, defined in CCITT Recommendation Q.773.

The Abstract Syntax is defined for all interfaces specified in clause 4.4 except for the A- and B-interfaces.

The Mobile Application Part protocol is defined by two Abstract Syntaxes:

- one Abstract Syntax which encompass all Operations; and
- Errors identified by the various MAP subsystem numbers.

This Abstract Syntax represents the set of values each of which is a value of the ASN.1 type TCAPMessages.MessageType as defined in CCITT Recommendation Q.773 with the ANY DEFINED BY sections resolved by the operation and error codes included in the ASN.1 module MAP-Protocol. However, only the subset of this abstract syntax which is required by the procedures defined for an entity needs to be supported:

- one Abstract Syntax identified by the OBJECT IDENTIFIER value MAP-DialogueInformation.map-DialogueAS.

This Abstract Syntax represents the set of values each of which is a value of the ASN.1 type MAP-DialogueInformation.MAP-DialoguePDU. Such a value of the ASN.1 single-ASN.1-type element is contained within the user-information element of the TCAPMessages.DialoguePortion ASN.1 type. This Abstract Syntax name is to be used as a direct reference.

17.1.1 Encoding rules

The encoding rules which are applicable to the defined Abstract Syntaxes are the Basic Encoding Rules for Abstract Syntax Notation One, defined in CCITT Recommendation X.690 with the same exceptions as in CCITT Recommendation Q.773 clause 4 Message Representation.

When the definite form is used for length encoding, a data value of length less than 128 octets must have the length encoded in the short form.

When the long form is employed to code a length, the minimum number of octets shall be used to code the length field.

OCTET STRING values and BIT STRING values must be encoded in a primitive form.

There is no restriction to the use of empty constructors (e.g. an empty SEQUENCE type). That is, the encoding of the content of any data value shall consist of zero, one or more octets.

17.1.2 Use of TC

The mapping of OPERATION and ERROR to TC components is defined in ETS 300 287 (version 2) which is based on CCITT Recommendation Q.773 (1992).

NOTE 1: The class of an operation is not stated explicitly but is specified as well in the ASN.1 operation type definition.

Class 1: RESULT and ERROR appear in ASN.1 operation type definition.

Class 2: only ERROR appears in ASN.1 operation type definition.

Class 3: only RESULT appears in ASN.1 operation type definition.

Class 4: both RESULT and ERROR do not appear in ASN.1 operation type definition.

The ASN.1 data type which follows the keywords "ARGUMENT", "PARAMETER" or "RESULT" (for OPERATION and ERROR) is always optional from a syntactic point of view. However, except when specifically mentioned with the ASN.1 comment «-- optional», the «parameter» part of a component has to be considered as mandatory from a semantic point of view.

When an optional element is missing in an invoke component or in an inner data structure while it is required by the context, an error component is returned if specified in the operation type; the associated type of error is DataMissing. This holds also when the entire parameter of an invoke component is missing while it is required by the context.

NOTE 2: When a mandatory element is missing in the parameter or inner data structure of any component, a reject component is returned (if the dialogue still exists). The problem code to be used is "Mistyped parameter".

The Timer Values used in the operation type definitions are indicated as ASN.1 comments. The Timer Value Ranges are:

s = from 3 seconds to 10 seconds;

m = from 15 seconds to 30 seconds;

ml = from 1 minute to 10 minutes;

l = from 28 hours to 38 hours.

17.1.2.1 Use of Global Operation and Error codes defined outside MAP

An entity supporting an application context greater than 2 shall be capable of receiving an operation or error code, within an application context defined in GSM 09.02, encoded as either an Object Identifier (as defined in CCITT Recommendation X.690 (1994)) or an integer value (as defined in clause 17.5). Related restrictions regarding the use of Object Identifiers are as follows:

- The length of the Object Identifier shall not exceed 16 octets and the number of components of the Object Identifier shall not exceed 16.
- Object Identifiers shall be used only for operations or errors defined outside of GSM 09.02.
- Global error codes may be sent only in response to a global operation. If a standard operation is received then a global error code shall not be sent in response.

Handling of an unknown operation codes by the receiving entity is defined in clause 15.1.1.

17.1.3 Use of information elements defined outside MAP

An information element or a set of information elements (messages) transparently carried in the Mobile Application Part but defined in other recommendations/technical specifications are handled in one of the following ways:

- i) The contents of each information element (without the octets encoding the identifier and the length in the recommendation/technical specification where it is defined unless explicitly stated otherwise) is carried as the value of an ASN.1 NamedType derived from the OCTET STRING data type. Additionally, the internal structure may be explained by means of comments. In case of misalignment the referred to recommendation/technical specification takes precedence.
- ii) The complete information element (including the octets encoding the identifier and the length in the recommendation/technical specification where it is defined) or set of information elements and the identity of the associated protocol are carried as the value of the ExternalSignalInfo data type defined in the present document. Where more than one information element is carried, the information elements are sent contiguously with no filler octets between them.

17.1.4 Compatibility considerations

The following ASN.1 modules conform to CCITT Recommendation X.208 (1988) or X.680 (1994) (the only module which makes use of X.680 is MAP-ExtensionDataTypes), but in addition Ellipsis Notation ("..." - notation) is used as described in ITU-T Recommendation X.680 Amendment 1 (1995) wherever future protocol extensions are foreseen.

The "..." construct applies only to SEQUENCE and ENUMERATED data types. An entity supporting a version greater than 1 shall not reject an unsupported extension following "..." of that SEQUENCE or ENUMERATED data type. The Encoding Rules from clause 17.1.1 apply to every element of the whole Transfer Syntax especially to the ASN.1 type EXTERNAL.

The extension container "privateExtensionList" is defined in this specification in order to carry extensions which are defined outside this specification. Private extensions can be defined by, for example, network operators, manufacturers, and regional standardisation bodies.

Private extensions shall:

- 1) if included in operations of an AC of V2, follow the extension marker and be tagged using PRIVATE tags up to and including 29.

NOTE: This type of extension is in most cases used only within a PLMN.

- 2) if included in operations of an AC of V3 or higher: be included only in the Private Extension Container that is defined in the specification.

NOTE: This type of extension can be used between PLMNs.

Private extensions shall not be included in v2 supplementary service operations.

Private extensions shall not be included within user error for RegisterCCEnter and EraseCCEnter operations.

PCS extensions shall be included in the PCS Extension Container that is defined in this specification.

In order to improve extensibility, a few error parameters have been defined as a CHOICE between the version 2 description and a SEQUENCE including the version 2 description and an extension container. Operations used in a v2-application-context must consider only the first alternative while operations used in a vn-application-context (n>2) must consider only the second alternative.

17.1.5 Structure of the Abstract Syntax of MAP

For each MAP parameter which has to be transferred by a MAP Protocol Data Unit (MAP message), there is a PDU field (an ASN.1 NamedType) whose ASN.1 identifier has the same name as the corresponding parameter, except for the differences required by the ASN.1 notation (blanks between words are removed or replaced by hyphen, the first letter of the first word is lower-case and the first letter of the following words are capitalised, e.g. "no reply condition time" is mapped to "noReplyConditionTime"). Additionally some words may be abbreviated as follows:

bs basic service
ch call handling
cug closed user group
ho handover
ic incoming call
id identity
info information
mm mobility management
lcs location services
ms mobile service
oc outgoing call

om operation & maintenance
pw Password
sm short message service
ss supplementary service
st secure transport

The MAP protocol is composed of several ASN.1 modules dealing with either operations, errors, data types, and, if applicable, split into those dealing with mobile services, call handling services, supplementary services and short message services. For operations and errors no values are assigned, but only the operation and error types in order to allow use of the defined types also by other protocols (e.g. 3GPP TS 24.080 [38]). The values (operation codes and error codes) are defined in a separate module. The ASN.1 source lines are preceded by line-numbers at the left margin in order to enable the usage of the cross-reference in annex A.

The module containing the definition of the operation packages for MAP is:

1. MAP-OperationPackages.

The module containing the definition of the application contexts for MAP is:

2. MAP-ApplicationContexts.

The module containing the data types for the Abstract Syntax to be used for TCAPMessages.DialoguePortion for MAP is:

3. MAP-DialogueInformation.

The module containing the operation codes and error codes for MAP is:

4. MAP-Protocol.

The modules containing all operation type definitions for MAP are:

5. MAP-MobileServiceOperations;
6. MAP-OperationAndMaintenanceOperations;
7. MAP-CallHandlingOperations;
8. MAP-SupplementaryServiceOperations;
9. MAP-ShortMessageServiceOperations;
10. MAP-Group-Call-Operations;
11. MAP-LocationServiceOperations;
12. MAP-SecureTransportOperations.

The module containing all error type definitions for MAP is:

13. MAP-Errors.

Modules containing all data type definitions for MAP are:

14. MAP-MS-DataTypes;
15. MAP-OM-DataTypes;
16. MAP-CH-DataTypes;
17. MAP-SS-DataTypes;
18. MAP-SS-Code;
19. MAP-SM-DataTypes;

- 20. MAP-ER-DataTypes;
- 21. MAP-CommonDataTypes;
- 22. MAP-TS-Code;
- 23. MAP-BS-Code;
- 24. MAP-ExtensionDataTypes;
- 25. MAP-GR-DataTypes;
- 26. MAP-LCS-DataTypes;
- 27. MAP-ST-DataTypes.

References are made also to modules defined outside of the present document. They are defined in the technical specification Mobile Services Domain and technical specification Transaction Capability respectively:

- MobileDomainDefinitions;
- TCAPMessages;
- DialoguePDUs.

17.1.6 Application Contexts

The following informative table lists the latest versions of the Application Contexts used in this specification, with the operations used by them and, where applicable, whether or not the operation description is exactly the same as for previous versions. Information in 17.6 & 17.7 relates only to the ACs in this table.

AC Name	AC Version	Operations Used	Comments
locationCancellationContext	v3	cancelLocation	
equipmentMngtContext	v2	checkIMEI	
imsiRetrievalContext	v2	sendIMSI	
infoRetrievalContext	v3	sendAuthenticationInfo	
interVlrInfoRetrievalContext	v3	sendIdentification	
handoverControlContext	v3	prepareHandover forwardAccessSignalling sendEndSignal processAccessSignalling prepareSubsequentHandover	the syntax of this operation has been extended in comparison with release 98 version
mwdMngtContext	v3	readyForSM	
msPurgingContext	v3	purgeMS	
shortMsgAlertContext	v2	alertServiceCentre	
resetContext	v2	reset	
networkUnstructuredSsContext	v2	processUnstructuredSS-Request unstructuredSS-Request unstructuredSS-Notify	
tracingContext	v3	activateTraceMode deactivateTraceMode	
networkFunctionalSsContext	v2	registerSS eraseSS activateSS deactivateSS registerPassword interrogateSS getPassword	
shortMsgMO-RelayContext	v3	mo-forwardSM	
shortMsgMT-RelayContext	v3	mt-forwardSM	
shortMsgGatewayContext	v3	sendRoutingInfoForSM reportSM-DeliveryStatus InformServiceCentre	the syntax of this operation has been extended in

AC Name	AC Version	Operations Used	Comments
			comparison with release 96 version
networkLocUpContext	v3	updateLocation forwardCheckSs-Indication restoreData insertSubscriberData activateTraceMode	the syntax is the same in v1 & v2
gprsLocationUpdateContext	v3	updateGprsLocation insertSubscriberData activateTraceMode	
subscriberDataMngtContext	v3	insertSubscriberData deleteSubscriberData	
roamingNumberEnquiryContext	v3	provideRoamingNumber	
locationInfoRetrievalContext	v3	sendRoutingInfo	
gprsNotifyContext	v3	noteMsPresentForGprs	
gprsLocationInfoRetrievalContext	v4	sendRoutingInfoForGprs	
failureReportContext	v3	failureReport	
callControlTransferContext	v4	resumeCallHandling	
subscriberInfoEnquiryContext	v3	provideSubscriberInfo	
anyTimeEnquiryContext	v3	anyTimeInterrogation	
anyTimeInfoHandlingContext	v3	anyTimeSubscriptionInterrogation anyTimeModification	
ss-InvocationNotificationContext	v3	ss-InvocationNotification	
sIWFSAllocationContext	v3	provideSIWFSSNumber sIWFSsignallingModify	
groupCallControlContext	v3	prepareGroupCall processGroupCallSignalling forwardGroupCallSignalling sendGroupCallEndSignal	
reportingContext	v3	setReportingState statusReport remoteUserFree	
callCompletionContext	v3	registerCC-Entry eraseCC-Entry	
istAlertingContext	v3	istAlert	
ImmediateTerminationContext	v3	istCommand	
locationSvcEnquiryContext	v3	provideSubscriberLocation subscriberLocationReport	
locationSvcGatewayContext	v3	sendRoutingInfoForLCS	
mm-EventReportingContext	v3	noteMM-Event	
subscriberDataModificationNotificationContext	v3	noteSubscriberDataModified	
authenticationFailureReportContext	v3	authenticationFailureReport	
secureTransportHandlingContext	v3	secureTransportClass1 secureTransportClass2 secureTransportClass3 secureTransportClass4	

NOTE (*): The syntax of the operations is not the same as in previous versions unless explicitly stated

17.2 Operation packages

17.2.1 General aspects

This clause describes the operation-packages which are used to build the application-contexts defined in clause 17.3.

Each operation-package is a specification of the roles of a pair of communicating objects (i.e. a pair of MAP-Providers), in terms of operations which they can invoke of each other.

The grouping of operations into one or several packages does not necessarily imply any grouping in terms of Application Service Elements.

The following ASN.1 MACRO is used to describe operation-packages in this clause:

```
OPERATION-PACKAGE MACRO ::=
BEGIN
TYPE NOTATION ::= Symmetric | ConsumerInvokes SupplierInvokes |
empty
VALUE NOTATION ::= value(VALUE OBJECT IDENTIFIER)
Symmetric ::= "OPERATIONS" "{" OperationList "}"
ConsumerInvokes ::= "CONSUMER INVOKES" "{" OperationList "}"
SupplierInvokes ::= "SUPPLIER INVOKES" "{" OperationList "}" | empty
OperationList ::= Operation | OperationList "," Operation
Operation ::= value(OPERATION)
END
```

Since the application-context definitions provided in clause 17.3 use only an informal description technique, only the type notation is used in the following clauses to define operation-packages.

The following definitions are used throughout this clause ($n \geq 2$):

- v1-only operation: An operation which shall be used only in v1 application-contexts;
- vn-only operation: An operation which shall be used only in vn application-contexts;
- v(n-1)-operation: An operation whose specification has not been modified since the MAP v(n-1) specifications or if the modifications are considered as not affecting v(n-1) implementations;
- v(n-1)-equivalent operation: The version of an operation which excludes all the information elements and errors which have been added since the MAP v(n-1) specification;
- vn-only package: An operation package which contains only vn-only operations;
- v(n-1)-package: An operation package which contains only v(n-1)- operations.

The names of vn-packages are suffixed by "-vn" where $n \geq 2$.

For each operation package which is not vn-only ($n \geq 2$) and which does not include only v(n-1)-operations, there is a v(n-1)-equivalent package. Except when a definition is explicitly provided in the following clauses, the v(n-1)-equivalent package includes the v(n-1)-equivalent operations of the operations which belong to this package.

17.2.2 Packages specifications

17.2.2.1 Location updating

This operation package includes the operations required for location management procedures between HLR and VLR.

```

LocationUpdatingPackage-v3 ::= OPERATION-PACKAGE
  -- Supplier is HLR if Consumer is VLR
  CONSUMER INVOKES {
    updateLocation}
  SUPPLIER INVOKES {
    forwardCheckSs-Indication}

```

The v1-equivalent and v2-equivalent packages can be determined according to the rules described in clause 17.2.1.

17.2.2.2 Location cancellation

This operation package includes the operations required for location cancellation and MS purging procedures between HLR and VLR and between HLR and SGSN.

```

LocationCancellationPackage-v3 ::= OPERATION-PACKAGE
  -- Supplier is VLR or SGSN if Consumer is HLR
  CONSUMER INVOKES {
    cancelLocation}

```

The v1-equivalent and v2-equivalent packages can be determined according to the rules described in clause 17.2.1.

17.2.2.3 Roaming number enquiry

This operation package includes the operations required for roaming number enquiry procedures between HLR and VLR.

```

RoamingNumberEnquiryPackage-v3 ::= OPERATION-PACKAGE
  -- Supplier is VLR if Consumer is HLR
  CONSUMER INVOKES {
    provideRoamingNumber}

```

The v1-equivalent and v2-equivalent packages can be determined according to the rules described in clause 17.2.1.

17.2.2.4 Information retrieval

This operation package includes the operation required for the authentication information retrieval procedure between HLR and VLR and between HLR and SGSN.

```

InfoRetrievalPackage-v3 ::= OPERATION-PACKAGE
  -- Supplier is HLR if Consumer is VLR
  -- Supplier is HLR if Consumer is SGSN
  CONSUMER INVOKES {
    sendAuthenticationInfo}

```

The v2-equivalent package is defined as follows:

```

InfoRetrievalPackage-v2 ::= OPERATION-PACKAGE
  -- Supplier is HLR if Consumer is VLR
  -- Supplier is HLR if Consumer is SGSN
  CONSUMER INVOKES {
    sendAuthenticationInfo}

```

The v1-equivalent package is defined as follows:

```

InfoRetrievalPackage-v1 ::= OPERATION-PACKAGE
  -- Supplier is HLR or VLR if Consumer is VLR
  -- Supplier is HLR if Consumer is SGSN
  CONSUMER INVOKES {
    sendParameters}

```

17.2.2.5 Inter-VLR information retrieval

This operation package includes the operations required for inter VLR information retrieval procedures.

```

InterVlrInfoRetrievalPackage-v3 ::= OPERATION-PACKAGE
  -- Supplier is VLR if Consumer is VLR
  CONSUMER INVOKES {
    sendIdentification}

```

The v2-equivalent package is defined as follows:

```

InterVlrInfoRetrievalPackage-v2 ::= OPERATION-PACKAGE
  -- Supplier is VLR if Consumer is VLR
  CONSUMER INVOKES {
    sendIdentification}

```

The v1-equivalent package is : InfoRetrievalPackage-v1.

17.2.2.6 IMSI retrieval

This operation package includes the operation required for the IMSI retrieval procedure between HLR and VLR.

```

IMSIRetrievalPackage-v2 ::= OPERATION-PACKAGE
  -- Supplier is HLR if Consumer is VLR
  CONSUMER INVOKES {
    sendIMSI}

```

This package is v2 only.

17.2.2.7 Call control transfer

This operation package includes the operation required for the call control transfer procedure between VMSC and GMSC.

```

CallControlTransferPackage-v4 ::= OPERATION-PACKAGE
  -- Supplier is GMSC if Consumer is VMSC
  CONSUMER INVOKES {
    resumeCallHandling}

```

The v3-equivalent package can be determined according to the rules described in clause 17.2.1.

17.2.2.8 Secure transport

This operation package includes the operations required for the secure transport of MAP messages between any MAP entities.

```

SecureTransportHandlingPackage-v3 ::= OPERATION-PACKAGE
  CONSUMER INVOKES {
    SecureTransportClass1,      -- to be used if the original operation is a
                                -- TCAP class 1 operation
    SecureTransportClass2,      -- to be used if the original operation is a
                                -- TCAP class 2 operation
    SecureTransportClass3,      -- to be used if the original operation is a
                                -- TCAP class 3 operation
    SecureTransportClass4}      -- to be used if the original operation is a
                                -- TCAP class 4 operation

```

This package is v3 only.

17.2.2.9 Void

17.2.2.10 Interrogation

This operation package includes the operations required for interrogation procedures between MSC and HLR or NPLR or between HLR and gsmSCF.

```

InterrogationPackage-v3 ::= OPERATION-PACKAGE
  -- Supplier is HLR or NPLR if Consumer is MSC
  -- Supplier is HLR if Consumer is gsmSCF
  CONSUMER INVOKES {
    sendRoutingInfo}

```

The v1-equivalent and v2-equivalent packages can be determined according to the rules described in clause 17.2.1.

17.2.2.11 Void

17.2.2.12 Handover Control

This operation package includes the operations required for handover procedures between MSCs.

```

HandoverControlPackage-v3 ::= OPERATION-PACKAGE
-- Supplier is MSCB if Consumer is MSCA
CONSUMER INVOKES {
    prepareHandover,
    forwardAccessSignalling}
SUPPLIER INVOKES {
    sendEndSignal,
    processAccessSignalling,
    prepareSubsequentHandover}

```

The v2-equivalent package can be determined according to the rules described in clause 17.2.1.

The v1-equivalent package is defined as follows.

```

HandoverControlPackage-v1 ::= OPERATION-PACKAGE
-- Supplier is MSCB if Consumer is MSCA
CONSUMER INVOKES {
    performHandover,
    forwardAccessSignalling,
    traceSubscriberActivity}
SUPPLIER INVOKES {
    sendEndSignal,
    noteInternalHandover,
    processAccessSignalling,
    performSubsequentHandover}

```

17.2.2.13 Subscriber Data management stand alone

This operation package includes the operations required for stand alone subscriber data management procedures between HLR and VLR or between HLR and SGSN.

```

SubscriberDataMngtStandAlonePackage-v3 ::= OPERATION-PACKAGE
-- Supplier is VLR or SGSN if Consumer is HLR
CONSUMER INVOKES {
    insertSubscriberData,
    deleteSubscriberData}

```

The v1-equivalent and v2-equivalent packages can be determined according to the rules described in clause 17.2.1.

17.2.2.14 Equipment management

This operation package includes the operations required for equipment management procedures between EIR and MSC or between EIR and SGSN.

```

EquipmentMngtPackage-v2 ::= OPERATION-PACKAGE
-- Supplier is EIR if Consumer is MSC
-- Supplier is EIR if Consumer is SGSN
CONSUMER INVOKES {
    checkIMEI}

```

The v1-equivalent package can be determined according to the rules described in clause 17.2.1.

17.2.2.15 Subscriber data management

This operation package includes the operations required for subscriber data management procedures between HLR and VLR or between HLR and SGSN.

```

SubscriberDataMngtPackage-v3 ::= OPERATION-PACKAGE
-- Supplier is VLR or SGSN if Consumer is HLR
CONSUMER INVOKES {
    insertSubscriberData}

```

The v1-equivalent and v2-equivalent packages can be determined according to the rules described in clause 17.2.1.

17.2.2.16 Location register restart

This operation package includes the operations required for location register restart procedures between HLR and VLR or between HLR and SGSN.

```
ResetPackage-v2 ::= OPERATION-PACKAGE
-- Supplier is VLR or SGSN if Consumer is HLR
CONSUMER INVOKES {
    reset}
```

The v1-equivalent package can be determined according to the rules described in clause 17.2.1.

17.2.2.17 Tracing stand-alone

This operation package includes the operations required for stand alone tracing procedures between HLR and VLR or between HLR and SGSN.

```
TracingStandAlonePackage-v3 ::= OPERATION-PACKAGE
-- Supplier is VLR or SGSN if Consumer is HLR
CONSUMER INVOKES {
    activateTraceMode,
    deactivateTraceMode}
```

The v1-equivalent and v2-equivalent packages can be determined according to the rules described in clause 17.2.1.

17.2.2.18 Functional SS handling

This operation package includes the operations required for functional supplementary services procedures between VLR and HLR.

```
FunctionalSsPackage-v2 ::= OPERATION-PACKAGE
-- Supplier is HLR if Consumer is VLR
CONSUMER INVOKES {
    registerSS,
    eraseSS,
    activateSS,
    deactivateSS,
    registerPassword,
    interrogateSS}
SUPPLIER INVOKES {
    getPassword}
```

The v1-equivalent package can be determined according to the rules described in clause 17.2.1.

17.2.2.19 Tracing

This operation package includes the operations required for tracing procedures between HLR and VLR or between HLR and SGSN.

```
TracingPackage-v3 ::= OPERATION-PACKAGE
-- Supplier is VLR or SGSN if Consumer is HLR
CONSUMER INVOKES {
    activateTraceMode}
```

The v1-equivalent and v2-equivalent packages can be determined according to the rules described in clause 17.2.1.

17.2.2.20 Binding

This operation package includes the operation required to initialise a supplementary service procedure between VLR and HLR or between gsmSCF and HLR.

```
BindingPackage-v1 ::= OPERATION-PACKAGE
-- Supplier is HLR if Consumer is VLR
-- Supplier is gsmSCF if Consumer is HLR
CONSUMER INVOKES {
    beginSubscriberActivity}
```

This package is v1 only.

17.2.2.21 Unstructured SS handling

This operation package includes the operations required for unstructured supplementary services procedures between VLR and HLR, between the HLR and the gsmSCF, and between HLR and HLR.

```

UnstructuredSsPackage-v2 ::= OPERATION-PACKAGE
  -- Supplier is HLR if Consumer is VLR
  -- Supplier is gsmSCF or HLR if Consumer is HLR
  CONSUMER INVOKES {
    processUnstructuredSS-Request}
  SUPPLIER INVOKES {
    unstructuredSS-Request,
    unstructuredSS-Notify}

```

The v1-equivalent package is defined as follows:

```

UnstructuredSsPackage-v1 ::= OPERATION-PACKAGE
  -- Supplier is HLR if Consumer is VLR
  -- Supplier is gsmSCF if Consumer is HLR
  CONSUMER INVOKES {
    processUnstructuredSS-Data}

```

17.2.2.22 MO Short message relay services

This operation package includes the operations required for short message relay service procedures between IWMSC and VMSC or between GMSC and MSC or between SGSN and IWMSC.

```

MOShortMsgRelayPackage-v3 ::= OPERATION-PACKAGE
  -- Supplier is IWMSC if Consumer is MSC
  -- Supplier is IWMSC if Consumer is SGSN
  CONSUMER INVOKES {
    MO-forwardSM}

```

The v2-equivalent package is defined as follows:

```

ShortMsgRelayPackage-v2 ::= OPERATION-PACKAGE
  -- Supplier is IWMSC if Consumer is MSC
  -- Supplier is MSC or SGSN if Consumer is GMSC
  -- Supplier is IWMSC if Consumer is SGSN
  CONSUMER INVOKES {
    forwardSM}

```

The v1-equivalent package can be determined according to the rules described in clause 17.2.1.

17.2.2.23 Short message gateway services

This operation package includes the operations required for short message service gateway procedures between MSC and HLR.

```

ShortMsgGatewayPackage-v3 ::= OPERATION-PACKAGE
  -- Supplier is HLR if Consumer is GMSC
  CONSUMER INVOKES {
    sendRoutingInfoForSM,
    reportSM-DeliveryStatus}
  SUPPLIER INVOKES {
    informServiceCentre}

```

The v2-equivalent package can be determined according to the rules described in clause 17.2.1.

The v1-equivalent package is defined as follows:

```

ShortMsgGatewayPackage-v1 ::= OPERATION-PACKAGE
  -- Supplier is HLR if Consumer is GMSC
  CONSUMER INVOKES {
    sendRoutingInfoForSM,
    reportSMDeliveryStatus}

```

17.2.2.24 MT Short message relay services

This operation package includes the operations required for short message relay service procedures between GMSC and MSC or between GMSC and SGSN.

```

MTShortMsgRelayPackage-v3 ::= OPERATION-PACKAGE
  -- Supplier is MSC or SGSN if Consumer is GMSC
  CONSUMER INVOKES {
    MT-forwardSM}

```

The v2-equivalent package is: **ShortMsgRelayPackage-v2**

17.2.2.25 Void

17.2.2.26 Message waiting data management

This operation package includes the operations required for short message waiting data procedures between HLR and VLR, between HLR and SGSN.

```

MwdMngtPackage-v3 ::= OPERATION-PACKAGE
  -- Supplier is HLR if Consumer is SGSN
  -- Supplier is HLR if Consumer is VLR
  CONSUMER INVOKES {
    readyForSM}

```

The v2-equivalent package can be determined according to the rules described in clause 17.2.1.

The v1-equivalent package is defined as follows:

```

MwdMngtPackage-v1 ::= OPERATION-PACKAGE
  -- Supplier is HLR if Consumer is VLR
  CONSUMER INVOKES {
    noteSubscriberPresent}

```

17.2.2.27 Alerting

This operation package includes the operations required for alerting between HLR and IWMSC.

```

AlertingPackage-v2 ::= OPERATION-PACKAGE
  -- Supplier is IWMSC if Consumer is HLR
  CONSUMER INVOKES {
    alertServiceCentre}

```

The v1-equivalent package is defined as follows.

```

AlertingPackage-v1 ::= OPERATION-PACKAGE
  -- Supplier is IWMSC if Consumer is HLR
  CONSUMER INVOKES {
    alertServiceCentreWithoutResult}

```

17.2.2.28 Data restoration

This operation package includes the operations required for VLR data restoration between HLR and VLR.

```

DataRestorationPackage-v3 ::= OPERATION-PACKAGE
  -- Supplier is HLR if Consumer is VLR
  CONSUMER INVOKES {
    restoreData}

```

The v2-equivalent package can be determined according to the rules described in clause 17.2.1.

The v1-equivalent package is: **InfoRetrievalPackage-v1**

17.2.2.29 Purging

This operation package includes the operations required for purging between HLR and VLR or between HLR and SGSN.

```
PurgingPackage-v3 ::= OPERATION-PACKAGE
-- Supplier is HLR if Consumer is VLR
-- Supplier is HLR if Consumer is SGSN
CONSUMER INVOKES {
    purgeMS}
```

The v2-equivalent package can be determined according to the rules described in clause 17.2.1.

17.2.2.30 Subscriber information enquiry

This operation package includes the operations required for subscriber information enquiry procedures between HLR and VLR or between HLR and SGSN.

```
SubscriberInformationEnquiryPackage-v3 ::= OPERATION-PACKAGE
-- Supplier is VLR or SGSN if Consumer is HLR
CONSUMER INVOKES {
    provideSubscriberInfo}
```

This package is v3 only.

17.2.2.31 Any time information enquiry

This operation package includes the operations required for any time information enquiry procedures between gsmSCF and HLR or between gsmSCF and GMLC.

```
AnyTimeInformationEnquiryPackage-v3 ::= OPERATION-PACKAGE
-- Supplier is HLR or GMLC if Consumer is gsmSCF
CONSUMER INVOKES {
    anyTimeInterrogation}
```

This package is v3 only.

17.2.2.32 Group Call Control

This operation package includes the operations required for group call and broadcast call procedures between MSCs.

```
GroupCallControlPackage-v3 ::= OPERATION-PACKAGE
-- Supplier is relay MSC if Consumer is anchor MSC
CONSUMER INVOKES {
    prepareGroupCall,
    forwardGroupCallSignalling}
SUPPLIER INVOKES {
    sendGroupCallEndSignal,
    processGroupCallSignalling}
```

This package is v3 only.

17.2.2.33 Provide SIWFS number

This operation package includes the operations required between VMSC and SIWF for requesting resources from an SIWF.

```
ProvidesIWFSNumberPackage-v3 ::= OPERATION-PACKAGE
-- Supplier is SIWF if Consumer is VMSC
CONSUMER INVOKES {
    provideSIWFSNumber}
```

This package is v3 only.

17.2.2.34 SIWFS Signalling Modify

This operation package includes the operations required for the modification of the resources in an SIWF between the VMSC and SIWF.

```
SIWFSSignallingModifyPackage-v3 ::= OPERATION-PACKAGE
-- Supplier is SIWF if Consumer is VMSC
CONSUMER INVOKES {
    siWFSSignallingModify}
```

This package is v3 only.

17.2.2.35 Gprs location updating

This operation package includes the operations required for the gprs location management procedures between HLR and SGSN.

```
GprsLocationUpdatingPackage-v3 ::= OPERATION-PACKAGE
-- Supplier is HLR if Consumer is SGSN
CONSUMER INVOKES {
    updateGprsLocation}
```

This package is v3 only.

17.2.2.36 Gprs Interrogation

This operation package includes the operations required for interrogation procedures between HLR and GGSN.

```
GprsInterrogationPackage-v4 ::= OPERATION-PACKAGE
-- Supplier is HLR if Consumer is GGSN
CONSUMER INVOKES {
    sendRoutingInfoForGprs}
```

The v3-equivalent package is defined as follows.

```
GprsInterrogationPackage-v3 ::= OPERATION-PACKAGE
-- Supplier is HLR if Consumer is GGSN
CONSUMER INVOKES {
    sendRoutingInfoForGprs}
```

17.2.2.37 Failure reporting

This operation package includes the operations required for failure reporting between HLR and GGSN.

```
FailureReportingPackage-v3 ::= OPERATION-PACKAGE
-- Supplier is HLR if Consumer is GGSN
CONSUMER INVOKES {
    failureReport}
```

This package is v3 only.

17.2.2.38 GPRS notifying

This operation package includes the operations required for notifying that GPRS subscriber is present between HLR and GGSN.

```
GprsNotifyingPackage-v3 ::= OPERATION-PACKAGE
-- Supplier is GGSN if Consumer is HLR
CONSUMER INVOKES {
    noteMsPresentForGprs}
```

This package is v3 only.

17.2.2.39 Supplementary Service invocation notification

This operation package includes the operations required for Supplementary Service invocation notification procedures between the MSC and the gsmSCF and between the HLR and the gsmSCF.

```
SS-InvocationNotificationPackage-v3 ::= OPERATION-PACKAGE
-- Supplier is gsmSCF if Consumer is MSC
-- Supplier is gsmSCF if Consumer is HLR
CONSUMER INVOKES {
    ss-InvocationNotification}
```

This package is v3 only.

17.2.2.40 Set Reporting State

This operation package includes the operation required for procedures between HLR and VLR to set the reporting state.

```
SetReportingStatePackage-v3 ::= OPERATION-PACKAGE
-- Supplier is VLR if Consumer is HLR
CONSUMER INVOKES {
    setReportingState}
```

This package is v3 only.

17.2.2.41 Status Report

This operation package includes the operation required for procedures between VLR and HLR to report call results and events.

```
StatusReportPackage-v3 ::= OPERATION-PACKAGE
-- Supplier is HLR if Consumer is VLR
CONSUMER INVOKES {
    statusReport}
```

This package is v3 only.

17.2.2.42 Remote User Free

This operation package includes the operation required by the HLR to indicate to the VLR that the remote user is free.

```
RemoteUserFreePackage-v3 ::= OPERATION-PACKAGE
-- Supplier is VLR if Consumer is HLR
CONSUMER INVOKES {
    remoteUserFree}
```

This package is v3 only.

17.2.2.43 Call Completion

This operation package includes the operations required for procedures between VLR and HLR for subscriber control of call completion services.

```
CallCompletionPackage-v3 ::= OPERATION-PACKAGE
-- Supplier is HLR if Consumer is VLR
CONSUMER INVOKES {
    registerCC-Entry,
    eraseCC-Entry}
```

This package is v3 only.

17.2.2.44 Location service gateway services

This operation package includes the operations required for location service gateway procedures between GMLC and HLR.

```
LocationSvcGatewayPackage-v3 ::= OPERATION-PACKAGE
-- Supplier is HLR if Consumer is GMLC
CONSUMER INVOKES {
    sendRoutingInfoForLCS}
```

This package is v3 only.

17.2.2.45 Location service enquiry

This operation package includes the operations required for the location service enquiry procedures between GMLC and MSC and between GMLC and SGSN.

```
LocationSvcEnquiryPackage-v3 ::= OPERATION-PACKAGE
-- Supplier is MSC or SGSN if Consumer is GMLC
CONSUMER INVOKES {
    provideSubscriberLocation}
```

This package is v3 only.

17.2.2.45A Location service reporting

This operation package includes the operations required for the location service enquiry procedures between MSC and GMLC and between SGSN and GMLC.

```
LocationSvcReportingPackage-v3 ::= OPERATION-PACKAGE
-- Supplier is GMLC if Consumer is MSC
-- Supplier is GMLC if Consumer is SGSN
CONSUMER INVOKES {
    subscriberLocationReport}
```

17.2.2.46 Void

17.2.2.47 Void

17.2.2.48 Void

17.2.2.49 IST Alerting

This operation package includes the operation required for alerting procedures between the MSC (Visited MSC or Gateway MSC) and HLR.

```

IST-AlertingPackage-v3 ::= OPERATION-PACKAGE
  -- Supplier is HLR if Consumer is VMSC
  -- Supplier is HLR if Consumer is GMSC
  CONSUMER INVOKES {
    istAlert}

```

This package is v3 only.

17.2.2.50 Service Termination

This operation package includes the operation required for immediate service termination procedures between the HLR and the Visited MSC or between the HLR and the Gateway MSC.

```

ServiceTerminationPackage-v3 ::= OPERATION-PACKAGE
  -- Supplier is VMSC or GMSC if Consumer is HLR
  CONSUMER INVOKES {
    istCommand}

```

This package is v3 only.

17.2.2.51 Mobility Management event notification

This operation package includes the operations required for Mobility Management event notification procedures between VLR and gsmSCF.

```

MM-EventReportingPackage-v3 ::= OPERATION-PACKAGE
  -- Supplier is gsmSCF if Consumer is VLR
  CONSUMER INVOKES {
    noteMM-Event}

```

This package is v3 only.

17.2.2.52 Any time information handling

This operation package includes the operations required for any time information handling procedures between gsmSCF and HLR.

```

AnyTimeInformationHandlingPackage-v3 ::= OPERATION-PACKAGE
  -- Supplier is HLR if Consumer is gsmSCF
  CONSUMER INVOKES {
    anyTimeSubscriptionInterrogation,
    anyTimeModification}

```

This package is v3 only.

17.2.2.53 Subscriber Data modification notification

This operation package includes the operations required for Subscriber Data modification notification procedures between HLR and gsmSCF.

```
SubscriberDataModificationNotificationPackage-v3 ::= OPERATION-PACKAGE
-- Supplier is gsmSCF if Consumer is HLR
CONSUMER INVOKES {
    noteSubscriberDataModified}
```

This package is v3 only.

17.2.2.54 Authentication Failure Report

This operation package includes the operation required for procedures between VLR and HLR or the SGSN and the HLR for reporting of authentication failures.

```
AuthenticationFailureReportPackage-v3 ::= OPERATION-PACKAGE
-- Supplier is HLR if Consumer is VLR
-- Supplier is HLR if Consumer is SGSN
CONSUMER INVOKES {
    authenticationFailureReport}
```

This package is v3 only.

17.3 Application contexts

17.3.1 General aspects

An application-context is assigned for each dialogue established by a MAP-user. In the present document each application-context is assigned a name which is supplied in the MAP-OPEN Req primitive by the MAP-User and transmitted to the peer under certain circumstances.

The following ASN.1 MACRO is used to describe the main aspects of application-contexts in the following clauses:

```
APPLICATION-CONTEXT MACRO ::=
BEGIN
TYPE NOTATION ::= Symmetric | InitiatorConsumerOf
ResponderConsumerOf | empty
VALUE NOTATION ::= value(VALUE OBJECT IDENTIFIER)
Symmetric ::= "OPERATIONS OF" "{" PackageList "}"
InitiatorConsumerOf ::= "INITIATOR CONSUMER OF" "{" PackageList "}"
ResponderConsumerOf ::= "RESPONDER CONSUMER OF" "{" PackageList "}"
| empty
PackageList ::= Package | PackageList "," Package
Package ::= value(OPERATION-PACKAGE)
| type -- shall reference a package type
END
```

The following definitions are used throughout this clause:

- v1-application-context: An application-context which contains only v1-packages and uses only TC v1 facilities;
- v1 context set: the set of v1-application-contexts defined in the present document.
- vn-application-context (n>=2): An application-context which contains only vn-packages;

The names of v1-application-contexts are suffixed by "-v1" while other names are suffixed by "-vn" where n>=2.

Application-contexts which do not belong to the v1 context set use v2 TC facilities.

The last component of each application-context-name (i.e. the last component of the object identifier value) assigned to an application-context which belongs to the v1 context set indicates explicitly "version1".

For each application-context which does not belong to the "v1 context set" there is a v1-equivalent application context. This is a v1-application-context which includes the v1-equivalents of the packages included in the original context.

Each application-context uses the abstract-syntax associated with the operation-packages it includes and uses the transfer-syntax derived from it by applying the encoding rules defined in clause 17.1.1.

ACs which do not belong to the v1 context set require the support of the abstract-syntax identified by the object identifier value: MAP-DialogueInformation.map-Dialogue-AS defined in clause 17.4.

17.3.2 Application context definitions

17.3.2.1 Void

17.3.2.2 Location Updating

This application context is used between HLR and VLR for location updating procedures.

```
networkLocUpContext-v3 APPLICATION-CONTEXT
-- Responder is HLR if Initiator is VLR
INITIATOR CONSUMER OF {
    LocationUpdatingPackage-v3,
    DataRestorationPackage-v3}
RESPONDER CONSUMER OF {
    SubscriberDataMngtPackage-v3
    TracingPackage-v3}
 ::= {map-ac networkLocUp(1) version3(3)}
```

The following application-context-name is assigned to the v2-equivalent application-context:

```
{map-ac networkLocUp(1) version2(2)}
```

The following application-context-name is assigned to the v1-equivalent application-context:

```
{map-ac networkLocUp(1) version1(1)}
```

17.3.2.3 Location Cancellation

This application context is used between HLR and VLR or between HLR and SGSN for location cancellation procedures. For the HLR - SGSN interface only version 3 of this application context is applicable.

```
locationCancellationContext-v3 APPLICATION-CONTEXT
-- Responder is VLR or SGSN if Initiator is HLR
INITIATOR CONSUMER OF {
    LocationCancellationPackage-v3}
 ::= {map-ac locationCancel(2) version3(3)}
```

The following application-context-name is assigned to the v2-equivalent application-context:

```
map-ac locationCancel(2) version2(2)
```

The following application-context-name is assigned to the v1-equivalent application-context:

```
map-ac locationCancel(2) version1(1)
```

17.3.2.4 Roaming number enquiry

This application context is used between HLR and VLR for roaming number enquiry procedures.

```

roamingNumberEnquiryContext-v3 APPLICATION-CONTEXT
  -- Responder is VLR if Initiator is HLR
  INITIATOR CONSUMER OF {
    RoamingNumberEnquiryPackage-v3
  }
  ::= {map-ac roamingNbEnquiry(3) version3(3)}

```

The following application-context-name is assigned to the v2-equivalent application-context:

```
{map-ac roamingNbEnquiry(3) version2(2)}
```

The following application-context-name is assigned to the v1-equivalent application-context:

```
{map-ac roamingNbEnquiry(3) version1(1)}
```

17.3.2.5 Void

17.3.2.6 Location Information Retrieval

This application-context is used between GMSC and HLR or between GMSC and NPLR or between gsmSCF and HLR when retrieving location information. For the GMSC - NPLR interface version 1, version 2 and version 3 of this application context are applicable.

```

locationInfoRetrievalContext-v3 APPLICATION-CONTEXT
  -- Responder is HLR or NPLR if Initiator is GMSC
  -- Responder is HLR if Initiator is gsmSCF
  INITIATOR CONSUMER OF {
    InterrogationPackage-v3
  }
  ::= {map-ac locInfoRetrieval(5) version3(3)}

```

The following application-context-name is assigned to the v2-equivalent application-context:

```
{map-ac locInfoRetrieval(5) version2(2)}
```

The following application-context-name is assigned to the v1-equivalent application-context:

```
{map-ac locInfoRetrieval(5) version1(1)}
```

17.3.2.7 Call control transfer

This application context is used for the call control transfer procedure between the VMSC and the GMSC.

```

callControlTransferContext-v4 APPLICATION-CONTEXT
  -- Responder is GMSC if Initiator is VMSC
  INITIATOR CONSUMER OF {
    CallControlTransferPackage-v4
  }
  ::= {map-ac callControlTransfer(6) version4(4)}

```

The following application-context-name is assigned to the v3-equivalent application-context:

```
{map-ac callControlTransfer(6) version3(3)}
```

17.3.2.8 Secure transport

This application context is used for the secure transport of MAP messages between any MAP entities.

```

SecureTransportHandlingContext-v3 APPLICATION-CONTEXT
  INITIATOR CONSUMER OF {
    SecureTransportHandlingPackage-v3
  }
  ::= {map-ac secureTransportHandling(40) version3(3)}

```

This application-context is v3 only.

17.3.2.9 - 17.3.2.10 Void

17.3.2.11 Location registers restart

This application context is used between HLR and VLR or between HLR and SGSN for location register restart procedures. For the HLR - SGSN interface version 1 and version 2 of this application context are applicable.

```
resetContext-v2 APPLICATION-CONTEXT
-- Responder is VLR or SGSN if Initiator is HLR
INITIATOR CONSUMER OF {
  ResetPackage-v2}
 ::= {map-ac reset(10) version2(2)}
```

The following application-context-name is assigned to the v1-equivalent application-context:

```
{map-ac reset(10) version1(1)}
```

17.3.2.12 Handover control

This application context is used for handover procedures between MSCs.

```
handoverControlContext-v3 APPLICATION-CONTEXT
-- Responder is MSCB if Initiator is MSCA
INITIATOR CONSUMER OF {
  HandoverControlPackage-v3}
 ::= {map-ac handoverControl(11) version3(3)}
```

The following application-context-name is assigned to the v2-equivalent application-context:

```
{map-ac handoverControl(11) version2(2)}
```

The following application-context-name is assigned to the v1-equivalent application-context:

```
{map-ac handoverControl(11) version1(1)}
```

17.3.2.13 IMSI Retrieval

This application context is used for IMSI retrieval between HLR and VLR.

```
imsiRetrievalContext-v2 APPLICATION-CONTEXT
-- Responder is HLR if Initiator is VLR
INITIATOR CONSUMER OF {
  IMSIRetrievalPackage-v2}
 ::= {map-ac imsiRetrieval(26) version2(2)}
```

This application-context is v2 only.

17.3.2.14 Equipment Management

This application context is used for equipment checking between MSC and EIR or between SGSN and EIR. For the SGSN - EIR interface version 1 and version 2 of this application context are applicable:

```
equipmentMngtContext-v2 APPLICATION-CONTEXT
-- Responder is EIR if Initiator is MSC
-- Responder is EIR if Initiator is SGSN
INITIATOR CONSUMER OF {
  EquipmentMngtPackage-v2}
 ::= {map-ac equipmentMngt(13) version2(2)}
```

The following application-context-name is assigned to the v1-equivalent application-context:

```
{map-ac equipmentMngt(13) version1(1)}
```

17.3.2.15 Information retrieval

This application context is used for authentication information retrieval between HLR and VLR or between HLR and SGSN. For the HLR - SGSN interface version 1 and version 2 and version 3 of this application context are applicable.

```
infoRetrievalContext-v3 APPLICATION-CONTEXT
-- Responder is HLR if Initiator is VLR
-- Responder is HLR if Initiator is SGSN
INITIATOR CONSUMER OF {
    InfoRetrievalPackage-v3}
 ::= {map-ac infoRetrieval(14) version3(3)}
```

The following application-context-name is assigned to the v2-equivalent application-context:

```
infoRetrievalContext-v2 APPLICATION-CONTEXT
-- Responder is HLR if Initiator is VLR
-- Responder is HLR if Initiator is SGSN
INITIATOR CONSUMER OF {
    InfoRetrievalPackage-v2}
 ::= {map-ac infoRetrieval(14) version2(2)}
```

The following application-context-name is assigned to the v1-equivalent application-context:

```
{map-ac infoRetrieval(14) version1(1)}
```

17.3.2.16 Inter-VLR information retrieval

This application context is used for information retrieval between VLRs.

```
interVlrInfoRetrievalContext-v3 APPLICATION-CONTEXT
-- Responder is VLR if Initiator is VLR
INITIATOR CONSUMER OF {
    InterVlrInfoRetrievalPackage-v3}
 ::= {map-ac interVlrInfoRetrieval(15) version3(3)}
```

The v2-equivalent application-context is:

```
interVlrInfoRetrievalContext-v2 APPLICATION-CONTEXT
-- Responder is VLR if Initiator is VLR
INITIATOR CONSUMER OF {
    InterVlrInfoRetrievalPackage-v2}
 ::= {map-ac interVlrInfoRetrieval(15) version2(2)}
```

The v1-equivalent application-context is:

```
{map-ac infoRetrieval(14) version1(1)}
```

17.3.2.17 Stand Alone Subscriber Data Management

This application context is used for stand alone subscriber data management between HLR and VLR or between HLR and SGSN. For the HLR - SGSN interface only version 3 of this application context is applicable:

```
subscriberDataMngtContext-v3 APPLICATION-CONTEXT
-- Responder is VLR or SGSN if Initiator is HLR
INITIATOR CONSUMER OF {
    SubscriberDataMngtStandAlonePackage-v3}
 ::= {map-ac subscriberDataMngt(16) version3(3)}
```

The following application-context-name is assigned to the v2-equivalent application-context:

```
{map-ac subscriberDataMngt(16) version2(2)}
```

The following application-context-name is assigned to the v1-equivalent application-context:

```
{map-ac subscriberDataMngt(16) version1(1)}
```

17.3.2.18 Tracing

This application context is used between HLR and VLR or between HLR and SGSN for stand alone tracing control procedures. For the HLR - SGSN interface version 1, version 2 and version 3 of this application context are applicable.

```
tracingContext-v3 APPLICATION-CONTEXT
-- Responder is VLR or SGSN if Initiator is HLR
INITIATOR CONSUMER OF {
    TracingStandAlonePackage-v3}
 ::= {map-ac tracing(17) version3(3)}
```

The following application-context-name is assigned to the v2-equivalent application-context:

```
{map-ac tracing(17) version2(2)}
```

The following application-context-name is assigned to the v1-equivalent application-context:

```
{map-ac tracing(17) version1(1)}
```

17.3.2.19 Network functional SS handling

This application context is used for functional-like SS handling procedures between VLR and HLR.

```
networkFunctionalSsContext-v2 APPLICATION-CONTEXT
-- Responder is HLR, Initiator is VLR
INITIATOR CONSUMER OF {
    FunctionalSsPackage-v2}
 ::= {map-ac networkFunctionalSs(18) version2(2)}
```

The v1-equivalent application-context is defined as follows:

```
networkFunctionalSsContext-v1 APPLICATION-CONTEXT
-- Responder is HLR, Initiator is VLR
INITIATOR CONSUMER OF {
    FunctionalSsPackage-v1,
    UnstructuredSsPackage-v1,
    BindingPackage-v1}
 ::= {map-ac networkFunctionalSs(18) version1(1)}
```

17.3.2.20 Network unstructured SS handling

This application context is used for handling stimuli-like procedures between HLR and VLR, between the HLR and gsmSCF, and between HLR and HLR.

```
networkUnstructuredSsContext-v2 APPLICATION-CONTEXT
-- Responder is HLR, Initiator is VLR
-- Responder is VLR, Initiator is HLR
-- Responder is gsmSCF, Initiator is HLR
-- Responder is HLR, Initiator is gsmSCF
-- Responder is HLR, Initiator is HLR
OPERATIONS OF {
    UnstructuredSsPackage-v2}
 ::= {map-ac networkUnstructuredSs(19) version2(2)}
```

The following application-context-name is assigned to the v1-equivalent application-context:

```
{map-ac networkFunctionalSs(18) version1(1)}
```

17.3.2.21 Short Message Gateway

This application context is used for short message gateway procedures.

```
shortMsgGatewayContext-v3 APPLICATION-CONTEXT
-- Responder is HLR if Initiator is GMSC
INITIATOR CONSUMER OF {
    ShortMsgGatewayPackage-v3}
 ::= {map-ac shortMsgGateway(20) version3(3)}
```

The following application-context-name is assigned to the v2-equivalent application-context:

```
{map-ac shortMsgGateway(20) version2(2)}
```

The following application-context-name is assigned to the v1-equivalent application-context:

```
{map-ac shortMsgGateway(20) version1(1)}
```

17.3.2.22 Mobile originating Short Message Relay

This application context is used between MSC and IWMSC or between SGSN and IWMSC for mobile originating short message relay procedures. For the SGSN - IWMSC interface version 1, version 2 and version 3 of this application context are applicable.

```
shortMsgMO-RelayContext-v3 APPLICATION-CONTEXT
-- Responder is IWMSC if Initiator is MSC
-- Responder is IWMSC if Initiator is SGSN
INITIATOR CONSUMER OF {
    MShortMsgRelayPackage-v3}
::= {map-ac shortMsgMO-Relay(21) version3(3)}
```

The following application-context-name is assigned to the v2-equivalent application-context:

```
{map-ac shortMsgMO-Relay(21) version2(2)}
```

The following application-context-name is assigned to the v1-equivalent application-context:

```
{map-ac shortMsg-Relay(21) version1(1)}
```

17.3.2.23 Void

17.3.2.24 Short message alert

This application context is used for short message alerting procedures.

```
shortMsgAlertContext-v2 APPLICATION-CONTEXT
-- Responder is IWMSC if Initiator is HLR
INITIATOR CONSUMER OF {
    AlertingPackage-v2}
::= {map-ac shortMsgAlert(23) version2(2)}
```

The following application-context-name is symbolically assigned to the v1-equivalent application-context:

```
{map-ac shortMsgAlert(23) version1(1)}
```

17.3.2.25 Short message waiting data management

This application context is used between VLR and HLR or between SGSN and HLR for short message waiting data management procedures. For the SGSN - HLR interface only version 3 of this application context is applicable.

```
mwdMngtContext-v3 APPLICATION-CONTEXT
-- Responder is HLR if Initiator is SGSN
-- Responder is HLR if Initiator is VLR
INITIATOR CONSUMER OF {
    MwdMngtPackage-v3}
::= {map-ac mwdMngt(24) version3(3)}
```

The following application-context-name is assigned to the v2-equivalent application-context:

```
{map-ac mwdMngt(24) version2(2)}
```

The following application-context-name is assigned to the v1-equivalent application-context:

```
{map-ac mwdMngt(24) version1(1)}
```

17.3.2.26 Mobile terminating Short Message Relay

This application context is used between GMSC and MSC or between GMSC and SGSN for mobile terminating short message relay procedures. For the GMSC - SGSN interface version 2 and version 3 of this application context and the equivalent version 1 application context are applicable.

```
shortMsgMT-RelayContext-v3 APPLICATION-CONTEXT
-- Responder is MSC or SGSN if Initiator is GMSC
INITIATOR CONSUMER OF {
    MTShortMsgRelayPackage-v3}
 ::= {map-ac shortMsgMT-Relay(25) version3(3)}
```

The following application-context-name is assigned to the v2-equivalent application-context:

```
{map-ac shortMsgMT-Relay(25) version2(2)}
```

The following application-context-name is assigned to the v1-equivalent application-context:

```
{map-ac shortMsgMO-Relay(21) version1(1)}
```

17.3.2.27 MS purging

This application context is used between HLR and VLR or between HLR and SGSN for MS purging procedures. For the SGSN - HLR interface only version 3 of this application context is applicable.

```
msPurgingContext-v3 APPLICATION-CONTEXT
-- Responder is HLR if Initiator is VLR
-- Responder is HLR if Initiator is SGSN
INITIATOR CONSUMER OF {
    purgingPackage-v3}
 ::= {map-ac msPurging(27) version3(3)}
```

The following application-context-name is assigned to the v2-equivalent application-context:

```
{map-ac msPurging(27) version2(2)}
```

17.3.2.28 Subscriber information enquiry

This application context is used between HLR and VLR or between HLR and SGSN for subscriber information enquiry procedures.

```
subscriberInfoEnquiryContext-v3 APPLICATION-CONTEXT
-- Responder is VLR or SGSN if Initiator is HLR
INITIATOR CONSUMER OF {
    SubscriberInformationEnquiryPackage-v3}
 ::= {map-ac subscriberInfoEnquiry(28) version3(3)}
```

This application-context is v3 only.

17.3.2.29 Any time information enquiry

This application context is used between gsmSCF and HLR or between gsmSCF and GMLC for any time information enquiry procedures.

```
anyTimeInfoEnquiryContext-v3 APPLICATION-CONTEXT
-- Responder is HLR or GMLC if Initiator is gsmSCF
INITIATOR CONSUMER OF {
    AnyTimeInformationEnquiryPackage-v3}
 ::= {map-ac anyTimeInfoEnquiry(29) version3(3)}
```

This application-context is v3 only.

17.3.2.30 Group Call Control

This application context is used between anchor MSC and relay MSC for group call and broadcast call procedures.

```
groupCallControlContext-v3 APPLICATION-CONTEXT
-- Responder is relay MSC if Initiator is anchor MSC
INITIATOR CONSUMER OF {
    GroupCallControlPackage-v3}
 ::= {map-ac groupCallControl(31) version3(3)}
```

This application-context is v3 only.

17.3.2.31 Provide SIWFS Number

This application context is used for activation or modification of SIWF resources.

```
sIWFSAllocationContext-v3 APPLICATION-CONTEXT
-- Responder is SIWF if Initiator is VMSC
INITIATOR CONSUMER OF {
    ProvideSIWFSNumberPackage-v3,
    SIWFSSignallingModifyPackage-v3}
 ::= {map-ac sIWFSAllocation (12) version3(3)}
```

This application-context is v3 only.

17.3.2.32 Gprs Location Updating

This application context is used between HLR and SGSN for gprs location updating procedures.

```
gprsLocationUpdateContext-v3 APPLICATION-CONTEXT
-- Responder is HLR if Initiator is SGSN
INITIATOR CONSUMER OF {
    GprsLocationUpdatingPackage-v3}
RESPONDER CONSUMER OF {
    SubscriberDataMngtPackage-v3
    TracingPackage-v3}
 ::= {map-ac gprsLocationUpdate(32) version3(3)}
```

This application-context is v3 only.

17.3.2.33 Gprs Location Information Retrieval

This application context is used between HLR and GGSN when retrieving gprs location information.

```
gprsLocationInfoRetrievalContext-v4 APPLICATION-CONTEXT
-- Responder is HLR if Initiator is GGSN
INITIATOR CONSUMER OF {
    GprsInterrogationPackage-v4}
 ::= {map-ac gprsLocationInfoRetrieval(33) version4(4)}
```

The following application-context-name is assigned to the v3-equivalent application-context:

```
{map-ac gprsLocationInfoRetrieval(33) version3(3)}
```

17.3.2.34 Failure Reporting

This application context is used between HLR and GGSN to inform that network requested PDP-context activation has failed.

```
failureReportContext-v3 APPLICATION-CONTEXT
-- Responder is HLR if Initiator is GGSN
INITIATOR CONSUMER OF {
    FailureReportingPackage-v3}
 ::= {map-ac failureReport(34) version3(3)}
```

This application-context is v3 only.

17.3.2.35 GPRS Notifying

This application context is used between HLR and GGSN for notifying that GPRS subscriber is present again.

```

gprsNotifyContext-v3 APPLICATION-CONTEXT
  -- Responder is GGSN if Initiator is HLR
  INITIATOR CONSUMER OF {
    GprsNotifyingPackage-v3}
  ::= {map-ac gprsNotify(35) version3(3)}

```

This application-context is v3 only.

17.3.2.36 Supplementary Service invocation notification

This application context is used between the MSC and the gsmSCF and between the HLR and the gsmSCF for Supplementary Service invocation notification procedures.

```

ss-InvocationNotificationContext-v3 APPLICATION-CONTEXT
  -- Responder is gsmSCF, Initiator is MSC
  -- Responder is gsmSCF, Initiator is HLR
  INITIATOR CONSUMER OF {
    SS-InvocationNotificationPackage-v3}
  ::= {map-ac ss-InvocationNotification(36) version3(3)}

```

This application-context is v3 only.

17.3.2.37 Reporting

This application context is used between HLR and VLR for reporting procedures.

```

reportingContext-v3 APPLICATION-CONTEXT
  -- Responder is VLR if Initiator is HLR
  -- Responder is HLR if Initiator is VLR
  INITIATOR CONSUMER OF {
    SetReportingStatePackage-v3,
    StatusReportPackage-v3,
    RemoteUserFreePackage-v3}
  RESPONDER CONSUMER OF {
    SetReportingStatePackage-v3,
    StatusReportPackage-v3}
  ::= {map-ac reporting(7) version3(3)}

```

This application-context is v3 only.

17.3.2.38 Call Completion

This application context is used between VLR and the HLR for subscriber control of call completion services.

```

callCompletionContext-v3 APPLICATION-CONTEXT
  -- Responder is HLR if Initiator is VLR
  INITIATOR CONSUMER OF {
    CallCompletionPackage-v3}
  ::= {map-ac callCompletion(8) version3(3)}

```

This application-context is v3 only.

17.3.2.39 Location Service Gateway

This application context is used for location service gateway procedures.

```

locationSvcGatewayContext-v3 APPLICATION-CONTEXT
  -- Responder is HLR if Initiator is GMLC
  INITIATOR CONSUMER OF {
    locationSvcGatewayPackage-v3}
  ::= {map-ac locationSvcGateway(37) version3(3)}

```

17.3.2.40 Location Service Enquiry

This application context is used for location service enquiry procedures.

```
locationSvcEnquiryContext-v3 APPLICATION-CONTEXT
-- Responder is MSC or SGSN if Initiator is GMLC
-- Responder is GMLC if Initiator is MSC
-- Responder is GMLC if Initiator is SGSN
INITIATOR CONSUMER OF {
    locationSvcEnquiryPackage-v3,
    locationSvcReportingPackage-v3}
 ::= {map-ac locationSvcEnquiry(38) version3 (3)}
```

17.3.2.41 Void

17.3.2.42 Void

17.3.2.43 Void

17.3.2.44 IST Alerting

This application context is used between MSC (Visited MSC or Gateway MSC) and HLR for alerting services within IST procedures.

```
istAlertingContext-v3 APPLICATION-CONTEXT
-- Responder is HLR if Initiator is VMSC
-- Responder is HLR if Initiator is GMSC
INITIATOR CONSUMER OF {
    IST-AlertingPackage-v3}
 ::= {map-ac alerting(4) version3(3)}
```

This application-context is v3 only.

17.3.2.45 Service Termination

This application context is used between HLR and MSC (Visited MSC or Gateway MSC) for service termination services within IST procedures.

```
serviceTerminationContext-v3 APPLICATION-CONTEXT
-- Responder is VMSC or GMSC if Initiator is HLR
INITIATOR CONSUMER OF {
    ServiceTerminationPackage-v3}
 ::= {map-ac serviceTermination(9) version3(3)}
```

This application-context is v3 only.

17.3.2.46 Mobility Management event notification

This application context is used between VLR and gsmSCF for Mobility Management event notification procedures.

```
mm-EventReportingContext-v3 APPLICATION-CONTEXT
-- Responder is gsmSCF, Initiator is VLR
INITIATOR CONSUMER OF {
    MM-EventReportingPackage-v3}
 ::= {map-ac mm-EventReporting(42) version3(3)}
```

This application-context is v3 only.

17.3.2.47 Any time information handling

This application context is used between gsmSCF and HLR for any time information handling procedures.

```
anyTimeInfohandlingContext-v3 APPLICATION-CONTEXT
-- Responder is HLR if Initiator is gsmSCF
INITIATOR CONSUMER OF {
    AnyTimeInformationHandlingPackage-v3}
 ::= {map-ac anyTimeInfoHandling(43) version3(3)}
```

This application-context is v3 only.

17.3.2.48 Subscriber Data modification notification

This application context is used between HLR and gsmSCF for Subscriber Data modification notification procedures.

```
subscriberDataModificationNotificationContext-v3 APPLICATION-CONTEXT
-- Responder is gsmSCF, Initiator is HLR
INITIATOR CONSUMER OF {
    SubscriberDataModificationNotificationPackage-v3}
 ::= {map-ac subscriberDataModificationNotification(22) version3(3)}
```

This application-context is v3 only.

17.3.2.49 Authentication Failure Report

This application context is used between VLR and HLR or SGSN and HLR for reporting of authentication failures.

```
authenticationFailureReportContext-v3 APPLICATION-CONTEXT
-- Responder is HLR if Initiator is VLR
-- Responder is HLR if Initiator is SGSN
INITIATOR CONSUMER OF {
    AuthenticationFailureReportPackage-v3 }
 ::= {map-ac authenticationFailureReport(39) version3(3)}
```

This application-context is v3 only.

17.3.3 ASN.1 Module for application-context-names

The following ASN.1 module summarises the application-context-name assigned to MAP application-contexts.

```
MAP-ApplicationContexts {
    ccitt identified-organization (4) etsi (0) mobileDomain (0)
    gsm-Network (1) modules (3) map-ApplicationContexts (2) version8 (8)}
```

DEFINITIONS

::=

BEGIN

-- EXPORTS everything

IMPORTS

gsm-NetworkId,
ac-Id

```
FROM MobileDomainDefinitions {
    ccitt (0) identified-organization (4) etsi (0) mobileDomain (0)
    mobileDomainDefinitions (0) version1 (1)}
;
```

-- application-context-names

```
map-ac OBJECT IDENTIFIER ::= {gsm-NetworkId ac-Id}
```

```
networkLocUpContext-v3 OBJECT IDENTIFIER ::=
    {map-ac networkLocUp(1) version3(3)}
```



```
locationCancellationContext-v3 OBJECT IDENTIFIER ::=
  {map-ac locationCancel(2) version3(3)}
```

```
roamingNumberEnquiryContext-v3 OBJECT IDENTIFIER ::=
  {map-ac roamingNbEnquiry(3) version3(3)}
```

```
authenticationFailureReportContext-v3 OBJECT IDENTIFIER ::=
  {map-ac authenticationFailureReport(39) version3(3)}
```

```
locationInfoRetrievalContext-v3 OBJECT IDENTIFIER ::=
  {map-ac locInfoRetrieval(5) version3(3)}
```

```
resetContext-v2 OBJECT IDENTIFIER ::=
  {map-ac reset(10) version2(2)}
```

```
handoverControlContext-v3 OBJECT IDENTIFIER ::=
  {map-ac handoverControl(11) version3(3)}
```

```
equipmentMngtContext-v2 OBJECT IDENTIFIER ::=
  {map-ac equipmentMngt(13) version2(2)}
```

```
infoRetrievalContext-v3 OBJECT IDENTIFIER ::=
  {map-ac infoRetrieval(14) version3(3)}
```

```
interVlrInfoRetrievalContext-v3 OBJECT IDENTIFIER ::=
  {map-ac interVlrInfoRetrieval(15) version3(3)}
```

```
subscriberDataMngtContext-v3 OBJECT IDENTIFIER ::=
  {map-ac subscriberDataMngt(16) version3(3)}
```

```
tracingContext-v3 OBJECT IDENTIFIER ::=
  {map-ac tracing(17) version3(3)}
```

```
networkFunctionalSsContext-v2 OBJECT IDENTIFIER ::=
  {map-ac networkFunctionalSs(18) version2(2)}
```

```
networkUnstructuredSsContext-v2 OBJECT IDENTIFIER ::=
  {map-ac networkUnstructuredSs(19) version2(2)}
```

```
shortMsgGatewayContext-v3 OBJECT IDENTIFIER ::=
  {map-ac shortMsgGateway(20) version3(3)}
```

```
shortMsgMO-RelayContext-v3 OBJECT IDENTIFIER ::=
  {map-ac shortMsgMO-Relay(21) version3(3)}
```

```
shortMsgAlertContext-v2 OBJECT IDENTIFIER ::=
  {map-ac shortMsgAlert(23) version2(2)}
```

```
mwdMngtContext-v3 OBJECT IDENTIFIER ::=
  {map-ac mwdMngt(24) version3(3)}
```

```
shortMsgMT-RelayContext-v3 OBJECT IDENTIFIER ::=
  {map-ac shortMsgMT-Relay(25) version3(3)}
```

```
imsiRetrievalContext-v2 OBJECT IDENTIFIER ::=
  {map-ac imsiRetrieval(26) version2(2)}
```

```
msPurgingContext-v3 OBJECT IDENTIFIER ::=
  {map-ac msPurging(27) version3(3)}
```

```
subscriberInfoEnquiryContext-v3 OBJECT IDENTIFIER ::=
  {map-ac subscriberInfoEnquiry(28) version3(3)}
```

```
anyTimeInfoEnquiryContext-v3 OBJECT IDENTIFIER ::=
  {map-ac anyTimeInfoEnquiry(29) version3(3)}
```

```
callControlTransferContext-v4 OBJECT IDENTIFIER ::=
  {map-ac callControlTransfer(6) version4(4)}
```

```
ss-InvocationNotificationContext-v3 OBJECT IDENTIFIER ::=
  {map-ac ss-InvocationNotification(36) version3(3)}
```

```
sIWFSAllocationContext-v3 OBJECT IDENTIFIER ::=
  {map-ac sIWFSAllocation(12) version3(3)}
```

```
groupCallControlContext-v3 OBJECT IDENTIFIER ::=
  {map-ac groupCallControl(31) version3(3)}
```

```
gprsLocationUpdateContext-v3 OBJECT IDENTIFIER ::=
  {map-ac gprsLocationUpdate(32) version3(3)}
```

```
gprsLocationInfoRetrievalContext-v4 OBJECT IDENTIFIER ::=
  {map-ac gprsLocationInfoRetrieval(33) version4(4)}
```

```
failureReportContext-v3 OBJECT IDENTIFIER ::=
  {map-ac failureReport(34) version3(3)}
```

```
gprsNotifyContext-v3 OBJECT IDENTIFIER ::=
  {map-ac gprsNotify(35) version3(3)}
```

```
reportingContext-v3 OBJECT IDENTIFIER ::=
  {map-ac reporting(7) version3(3)}
```

```
callCompletionContext-v3 OBJECT IDENTIFIER ::=
  {map-ac callCompletion(8) version3(3)}
```

```
istAlertingContext-v3 OBJECT IDENTIFIER ::=
  {map-ac istAlerting(4) version3(3)}
```

```
serviceTerminationContext-v3 OBJECT IDENTIFIER ::=
  {map-ac immediateTermination(9) version3(3)}
```

```
locationSvcGatewayContext-v3 OBJECT IDENTIFIER ::=
  {map-ac locationSvcGateway(37) version3(3)}
```

```
locationSvcEnquiryContext-v3 OBJECT IDENTIFIER ::=
  {map-ac locationSvcEnquiry(38) version3(3)}
```

```
mm-EventReportingContext-v3 OBJECT IDENTIFIER ::=
  {map-ac mm-EventReporting(42) version3(3)}
```

```
anyTimeInfoHandlingContext-v3 OBJECT IDENTIFIER ::=
  {map-ac anyTimeInfoHandling(43) version3(3)}
```

```
subscriberDataModificationNotificationContext-v3 OBJECT IDENTIFIER ::=
  {map-ac subscriberDataModificationNotification(22) version3(3)}
```

```
secureTransportHandlingContext-v3 OBJECT IDENTIFIER ::=
  {map-ac secureTransportHandling(40) version3(3)}
```

```
-- The following Object Identifiers are reserved for application-
-- contexts existing in previous versions of the protocol
```

AC Name & Version	Object Identifier
-- networkLocUpContext-v1	map-ac networkLocUp (1) version1 (1)
-- networkLocUpContext-v2	map-ac networkLocUp (1) version2 (2)
-- locationCancellationContext-v1	map-ac locationCancellation (2) version1 (1)
-- locationCancellationContext-v2	map-ac locationCancellation (2) version2 (2)
-- roamingNumberEnquiryContext-v1	map-ac roamingNumberEnquiry (3) version1 (1)
-- roamingNumberEnquiryContext-v2	map-ac roamingNumberEnquiry (3) version2 (2)
-- locationInfoRetrievalContext-v1	map-ac locationInfoRetrieval (5) version1 (1)
-- locationInfoRetrievalContext-v2	map-ac locationInfoRetrieval (5) version2 (2)
-- resetContext-v1	map-ac reset (10) version1 (1)
-- handoverControlContext-v1	map-ac handoverControl (11) version1 (1)
-- handoverControlContext-v2	map-ac handoverControl (11) version2 (2)
-- equipmentMngtContext-v1	map-ac equipmentMngt (13) version1 (1)
-- infoRetrievalContext-v1	map-ac infoRetrieval (14) version1 (1)
-- infoRetrievalContext-v2	map-ac infoRetrieval (14) version2 (2)
-- interVlInfoRetrievalContext-v2	map-ac interVlInfoRetrieval (15) version2 (2)
-- subscriberDataMngtContext-v1	map-ac subscriberDataMngt (16) version1 (1)
-- subscriberDataMngtContext-v2	map-ac subscriberDataMngt (16) version2 (2)
-- tracingContext-v1	map-ac tracing (17) version1 (1)
-- tracingContext-v2	map-ac tracing (17) version2 (2)
-- networkFunctionalSsContext-v1	map-ac networkFunctionalSs (18) version1 (1)
-- shortMsgGatewayContext-v1	map-ac shortMsgGateway (20) version1 (1)
-- shortMsgGatewayContext-v2	map-ac shortMsgGateway (20) version2 (2)
-- shortMsgRelayContext-v1	map-ac shortMsgRelay (21) version1 (1)
-- shortMsgAlertContext-v1	map-ac shortMsgAlert (23) version1 (1)
-- mwdMngtContext-v1	map-ac mwdMngt (24) version1 (1)
-- mwdMngtContext-v2	map-ac mwdMngt (24) version2 (2)
-- shortMsgMT-RelayContext-v2	map-ac shortMsgMT-Relay (25) version2 (2)
-- msPurgingContext-v2	map-ac msPurging (27) version2 (2)
-- callControlTransferContext-v3	map-ac callControlTransferContext (6) version3 (3)
-- gprsLocationInfoRetrievalContext-v3	map-ac gprsLocationInfoRetrievalContext (33) version3 (3)

END

17.4 MAP Dialogue Information

```
MAP-DialogueInformation {
    ccitt identified-organization (4) etsi (0) mobileDomain (0)
    gsm-Network (1) modules (3) map-DialogueInformation (3) version8 (8)}
```

DEFINITIONS

IMPLICIT TAGS

::=

BEGIN

EXPORTS

```
map-DialogueAS,
MAP-DialoguePDU,
map-ProtectedDialogueAS,
MAP-ProtectedDialoguePDU
```

;

IMPORTS

```
gsm-NetworkId,
as-Id
```

FROM MobileDomainDefinitions {

```
ccitt (0) identified-organization (4) etsi (0) mobileDomain (0)
mobileDomainDefinitions (0) version1 (1)}
```

AddressString

FROM MAP-CommonDataTypes {

```
ccitt identified-organization (4) etsi (0) mobileDomain (0)
gsm-Network(1) modules (3) map-CommonDataTypes (18) version8 (8)}
```

ExtensionContainer

FROM MAP-ExtensionDataTypes {

```
ccitt identified-organization (4) etsi (0) mobileDomain (0)
gsm-Network (1) modules (3) map-ExtensionDataTypes (21) version8 (8)}
```

```
SecurityHeader,
ProtectedPayload
```

```

FROM MAP-ST-DataTypes {
  ccitt identified-organization (4) etsi (0) mobileDomain (0)
  gsm-Network (1) modules (3) map-ST-DataTypes (27) version8 (8)}
;

```

-- abstract syntax name for MAP-DialoguePDU

```

map-DialogueAS OBJECT IDENTIFIER ::=
  {gsm-NetworkId as-Id map-DialoguePDU (1) version1 (1)}

```

```

MAP-DialoguePDU ::= CHOICE {
  map-open [0] MAP-OpenInfo,
  map-accept [1] MAP-AcceptInfo,
  map-close [2] MAP-CloseInfo,
  map-refuse [3] MAP-RefuseInfo,
  map-userAbort [4] MAP-UserAbortInfo,
  map-providerAbort [5] MAP-ProviderAbortInfo}

```

```

MAP-OpenInfo ::= SEQUENCE {
  destinationReference [0] AddressString OPTIONAL,
  originationReference [1] AddressString OPTIONAL,
  ...,
  extensionContainer ExtensionContainer OPTIONAL
  -- extensionContainer must not be used in version 2
}

```

```

MAP-AcceptInfo ::= SEQUENCE {
  ...,
  extensionContainer ExtensionContainer OPTIONAL
  -- extensionContainer must not be used in version 2
}

```

```

MAP-CloseInfo ::= SEQUENCE {
  ...,
  extensionContainer ExtensionContainer OPTIONAL
  -- extensionContainer must not be used in version 2
}

```

```

MAP-RefuseInfo ::= SEQUENCE {
  reason Reason,
  ...,
  extensionContainer ExtensionContainer OPTIONAL,
  -- extensionContainer must not be used in version 2
  alternativeApplicationContext OBJECT IDENTIFIER OPTIONAL
  -- alternativeApplicationContext must not be used in version 2
}

```

```

Reason ::= ENUMERATED {
  noReasonGiven (0),
  invalidDestinationReference (1),
  invalidOriginatingReference (2),
  encapsulatedAC-NotSupported (3),
  transportProtectionNotAdequate (4)}
  -- encapsulatedAC-NotSupported and transportProtectionNotAdequate must not be used in
  -- dialogues with an AC different from secureTransportHandling

```

```

MAP-UserAbortInfo ::= SEQUENCE {
  map-UserAbortChoice MAP-UserAbortChoice,
  ...,
  extensionContainer ExtensionContainer OPTIONAL
  -- extensionContainer must not be used in version 2
}

```

```

MAP-UserAbortChoice ::= CHOICE {
  userSpecificReason [0] NULL,
  userResourceLimitation [1] NULL,
  resourceUnavailable [2] ResourceUnavailableReason,
  applicationProcedureCancellation [3] ProcedureCancellationReason}

```

```

ResourceUnavailableReason ::= ENUMERATED {
  shortTermResourceLimitation (0),
  longTermResourceLimitation (1)}

```

```

ProcedureCancellationReason ::= ENUMERATED {
    handoverCancellation (0),
    radioChannelRelease (1),
    networkPathRelease (2),
    callRelease (3),
    associatedProcedureFailure (4),
    tandemDialogueRelease (5),
    remoteOperationsFailure (6)}

```

```

MAP-ProviderAbortInfo ::= SEQUENCE {
    map-ProviderAbortReason          MAP-ProviderAbortReason,
    ...,
    extensionContainer              ExtensionContainer          OPTIONAL
    -- extensionContainer must not be used in version 2
}

```

```

MAP-ProviderAbortReason ::= ENUMERATED {
    abnormalDialogue (0),
    invalidPDU (1)}

```

-- abstract syntax name for MAP-ProtectedDialoguePDU

```

map-ProtectedDialogueAS OBJECT IDENTIFIER ::=
    {gsm-NetworkId as-Id map-ProtectedDialoguePDU (3) version1 (1)}

```

```

MAP-ProtectedDialoguePDU ::= SEQUENCE {
    encapsulatedAC                OBJECT IDENTIFIER,
    securityHeader                SecurityHeader              OPTIONAL,
    protectedPayload              ProtectedPayload            OPTIONAL,
    ...}
    -- The protectedPayload carries the result of applying the security function
    -- defined in 3G TS 33.200 to the encoding of the securely transported
    -- MAP-DialoguePDU

```

END

17.5 MAP operation and error codes

```

MAP-Protocol {
    ccitt identified-organization (4) etsi (0) mobileDomain (0)
    gsm-Network (1) modules (3) map-Protocol (4) version8 (8)}

```

DEFINITIONS

::=

BEGIN

IMPORTS

```

    UpdateLocation,
    CancelLocation,
    PurgeMS,
    SendIdentification,
    UpdateGprsLocation,
    PrepareHandover,
    SendEndSignal,
    ProcessAccessSignalling,
    ForwardAccessSignalling,
    PrepareSubsequentHandover,
    SendAuthenticationInfo,
    AuthenticationFailureReport,
    CheckIMEI,
    InsertSubscriberData,
    DeleteSubscriberData,
    Reset,
    ForwardCheckSS-Indication,
    RestoreData,
    ProvideSubscriberInfo,
    AnyTimeInterrogation,
    AnyTimeSubscriptionInterrogation,
    AnyTimeModification,
    SendRoutingInfoForGprs,
    FailureReport,
    NoteMsPresentForGprs,
    NoteMM-Event,
    NoteSubscriberDataModified

```

```
FROM MAP-MobileServiceOperations {
  ccitt identified-organization (4) etsi (0) mobileDomain (0)
  gsm-Network (1) modules (3) map-MobileServiceOperations (5)
  version8 (8)}

  ActivateTraceMode,
  DeactivateTraceMode,
  SendIMSI
FROM MAP-OperationAndMaintenanceOperations {
  ccitt identified-organization (4) etsi (0) mobileDomain (0)
  gsm-Network (1) modules (3) map-OperationAndMaintenanceOperations (6)
  version8 (8)}

  SendRoutingInfo,
  ProvideRoamingNumber,
  ResumeCallHandling,
  ProvideSIWFSNumber,
  SIWFSSignallingModify,
  SetReportingState,
  StatusReport,
  RemoteUserFree,
  IST-Alert,
  IST-Command
FROM MAP-CallHandlingOperations {
  ccitt identified-organization (4) etsi (0) mobileDomain (0)
  gsm-Network (1) modules (3) map-CallHandlingOperations (7)
  version8 (8)}

  RegisterSS,
  EraseSS,
  ActivateSS,
  DeactivateSS,
  InterrogateSS,
  ProcessUnstructuredSS-Request,
  UnstructuredSS-Request,
  UnstructuredSS-Notify,
  RegisterPassword,
  GetPassword,
  SS-InvocationNotification,
  RegisterCC-Entry,
  EraseCC-Entry
FROM MAP-SupplementaryServiceOperations {
  ccitt identified-organization (4) etsi (0) mobileDomain (0)
  gsm-Network (1) modules (3) map-SupplementaryServiceOperations (8)
  version8 (8)}

  SendRoutingInfoForSM,
  MO-ForwardSM,
  MT-ForwardSM,
  ReportSM-DeliveryStatus,
  AlertServiceCentre,
  InformServiceCentre,
  ReadyForSM
FROM MAP-ShortMessageServiceOperations {
  ccitt identified-organization (4) etsi (0) mobileDomain (0)
  gsm-Network (1) modules (3) map-ShortMessageServiceOperations (9)
  version8 (8)}

  PrepareGroupCall,
  ProcessGroupCallSignalling,
  ForwardGroupCallSignalling,
  SendGroupCallEndSignal
FROM MAP-Group-Call-Operations {
  ccitt identified-organization (4) etsi (0) mobileDomain (0)
  gsm-Network (1) modules (3) map-Group-Call-Operations (22)
  version8 (8)}

  ProvideSubscriberLocation,
  SendRoutingInfoForLCS,
  SubscriberLocationReport
FROM MAP-LocationServiceOperations {
  ccitt identified-organization (4) etsi (0) mobileDomain (0)
  gsm-Network (1) modules (3) map-LocationServiceOperations (24)
  version8 (8)}

  SecureTransportClass1,
  SecureTransportClass2,
  SecureTransportClass3,
```

SecureTransportClass4

```
FROM MAP-SecureTransportOperations {
  ccitt identified-organization (4) etsi (0) mobileDomain (0)
  gsm-Network (1) modules (3) map-SecureTransportOperations (26)
  version8 (8)}
```

```
SystemFailure,
DataMissing,
UnexpectedDataValue,
FacilityNotSupported,
UnknownSubscriber,
NumberChanged,
UnknownMSC,
UnidentifiedSubscriber,
UnknownEquipment,
RoamingNotAllowed,
IllegalSubscriber,
IllegalEquipment,
BearerServiceNotProvisioned,
TeleserviceNotProvisioned,
NoHandoverNumberAvailable,
SubsequentHandoverFailure,
TracingBufferFull,
OR-NotAllowed,
NoRoamingNumberAvailable,
AbsentSubscriber,
BusySubscriber,
NoSubscriberReply,
CallBarred,
ForwardingViolation,
ForwardingFailed,
CUG-Reject,
ATI-NotAllowed,
IllegalSS-Operation,
SS-ErrorStatus,
SS-NotAvailable,
SS-SubscriptionViolation,
SS-Incompatibility,
UnknownAlphabet,
USSD-Busy,
PW-RegistrationFailure,
NegativePW-Check,
NumberOfPW-AttemptsViolation,
SubscriberBusyForMT-SMS,
SM-DeliveryFailure,
MessageWaitingListFull,
AbsentSubscriberSM,
ResourceLimitation,
NoGroupCallNumberAvailable,
ShortTermDenial,
LongTermDenial,
IncompatibleTerminal,
UnauthorizedRequestingNetwork,
UnauthorizedLCSCClient,
PositionMethodFailure,
UnknownOrUnreachableLCSCClient,
ATSI-NotAllowed,
ATM-NotAllowed,
InformationNotAvailable,
MM-EventNotSupported,
TargetCellOutsideGroupCallArea,
SecureTransportError
```

```
FROM MAP-Errors {
  ccitt identified-organization (4) etsi (0) mobileDomain (0)
  gsm-Network (1) modules (3) map-Errors (10) version8 (8)}
;
```

-- location registration operation codes

updateLocation	UpdateLocation ::= localValue 2
cancelLocation	CancelLocation ::= localValue 3
purgeMS	PurgeMS ::= localValue 67
sendIdentification	SendIdentification ::= localValue 55

-- handover operation codes

```
prepareHandover PrepareHandover ::= localValue 68
sendEndSignal SendEndSignal ::= localValue 29
processAccessSignalling ProcessAccessSignalling ::= localValue 33
forwardAccessSignalling ForwardAccessSignalling ::= localValue 34
prepareSubsequentHandover PrepareSubsequentHandover ::=
    localValue 69
```

-- authentication operation codes

```
sendAuthenticationInfo SendAuthenticationInfo ::= localValue 56
authenticationFailureReport AuthenticationFailureReport ::= localValue 15
```

-- IMEI MANAGEMENT operation codes

```
checkIMEI CheckIMEI ::= localValue 43
```

-- subscriber management operation codes

```
insertSubscriberData InsertSubscriberData ::= localValue 7
deleteSubscriberData DeleteSubscriberData ::= localValue 8
```

-- fault recovery operation codes

```
reset Reset ::= localValue 37
forwardCheckSS-Indication ForwardCheckSS-Indication ::=
    localValue 38
restoreData RestoreData ::= localValue 57
```

-- operation and maintenance operation codes

```
activateTraceMode ActivateTraceMode ::= localValue 50
deactivateTraceMode DeactivateTraceMode ::= localValue 51
sendIMSI SendIMSI ::= localValue 58
```

-- call handling operation codes

```
sendRoutingInfo SendRoutingInfo ::= localValue 22
provideRoamingNumber ProvideRoamingNumber ::= localValue 4
resumeCallHandling ResumeCallHandling ::= localValue 6
provideSIWFSNumber ProvideSIWFSNumber ::= localValue 31
SIWFSSignallingModify SIWFSSignallingModify ::= localValue 32
setReportingState SetReportingState ::= localValue 73
statusReport StatusReport ::= localValue 74
remoteUserFree RemoteUserFree ::= localValue 75
istAlert IST-Alert ::= localValue 87
istCommand IST-Command ::= localValue 88
```

-- supplementary service handling operation codes

```
registerSS RegisterSS ::= localValue 10
eraseSS EraseSS ::= localValue 11
activateSS ActivateSS ::= localValue 12
deactivateSS DeactivateSS ::= localValue 13
interrogateSS InterrogateSS ::= localValue 14
processUnstructuredSS-Request ProcessUnstructuredSS-Request ::=
    localValue 59
unstructuredSS-Request UnstructuredSS-Request ::= localValue 60
unstructuredSS-Notify UnstructuredSS-Notify ::= localValue 61
registerPassword RegisterPassword ::= localValue 17
getPassword GetPassword ::= localValue 18
registerCC-Entry RegisterCC-Entry ::= localValue 76
eraseCC-Entry EraseCC-Entry ::= localValue 77
```

-- short message service operation codes

```
sendRoutingInfoForSM SendRoutingInfoForSM ::= localValue 45
mo-forwardSM MO-ForwardSM ::= localValue 46
mt-forwardSM MT-ForwardSM ::= localValue 44
reportSM-DeliveryStatus ReportSM-DeliveryStatus ::= localValue 47
informServiceCentre InformServiceCentre ::= localValue 63
alertServiceCentre AlertServiceCentre ::= localValue 64
readyForSM ReadyForSM ::= localValue 66
```

-- provide subscriber info operation codes

```
provideSubscriberInfo ProvideSubscriberInfo ::= localValue 70
```

-- any time interrogation operation codes

```
anyTimeInterrogation AnyTimeInterrogation ::= localValue 71
```

-- any time information handling operation codes

```
anyTimeSubscriptionInterrogation AnyTimeSubscriptionInterrogation ::= localValue 62
anyTimeModification AnyTimeModification ::= localValue 65
```

-- subscriber data modification notification operation codes

```
noteSubscriberDataModified NoteSubscriberDataModified ::= localValue 5
```

-- supplementary service invocation notification operation codes

```
ss-InvocationNotification SS-InvocationNotification ::= localValue 72
```

--Group Call operation codes

```
prepareGroupCall PrepareGroupCall ::= localValue 39
sendGroupCallEndSignal SendGroupCallEndSignal ::= localValue 40
processGroupCallSignalling ProcessGroupCallSignalling ::= localValue 41
forwardGroupCallSignalling ForwardGroupCallSignalling ::= localValue 42
```

-- gprs location updating operation codes

```
updateGprsLocation UpdateGprsLocation ::= localValue 23
```

-- gprs location information retrieval operation codes

```
sendRoutingInfoForGprs SendRoutingInfoForGprs ::= localValue 24
```

-- failure reporting operation codes

```
failureReport FailureReport ::= localValue 25
```

-- GPRS notification operation codes

```
noteMsPresentForGprs NoteMsPresentForGprs ::= localValue 26
```

-- Location service operation codes

```
provideSubscriberLocation ProvideSubscriberLocation ::= localValue 83
sendRoutingInfoForLCS SendRoutingInfoForLCS ::= localValue 85
subscriberLocationReport SubscriberLocationReport ::= localValue 86
```

-- Mobility Management operation codes

```
noteMM-Event NoteMM-Event ::= localValue 89
```

-- Secure transport operation codes

```
secureTransportClass1 SecureTransportClass1 ::= localValue 78
secureTransportClass2 SecureTransportClass2 ::= localValue 79
secureTransportClass3 SecureTransportClass3 ::= localValue 80
secureTransportClass4 SecureTransportClass4 ::= localValue 81
```

-- generic error codes

```
systemFailure SystemFailure ::= localValue 34
dataMissing DataMissing ::= localValue 35
unexpectedDataValue UnexpectedDataValue ::= localValue 36
facilityNotSupported FacilityNotSupported ::= localValue 21
incompatibleTerminal IncompatibleTerminal ::= localValue 28
resourceLimitation ResourceLimitation ::= localValue 51
```

-- identification and numbering error codes

```
unknownSubscriber UnknownSubscriber ::= localValue 1
numberChanged NumberChanged ::= localValue 44
unknownMSC UnknownMSC ::= localValue 3
unidentifiedSubscriber UnidentifiedSubscriber ::= localValue 5
unknownEquipment UnknownEquipment ::= localValue 7
```

-- subscription error codes

```
roamingNotAllowed RoamingNotAllowed ::= localValue 8
illegalSubscriber IllegalSubscriber ::= localValue 9
illegalEquipment IllegalEquipment ::= localValue 12
bearerServiceNotProvisioned BearerServiceNotProvisioned ::=
    localValue 10
teleserviceNotProvisioned TeleserviceNotProvisioned ::=
    localValue 11
```

-- handover error codes

```
noHandoverNumberAvailable NoHandoverNumberAvailable ::=
    localValue 25
subsequentHandoverFailure SubsequentHandoverFailure ::=
    localValue 26
targetCellOutsideGroupCallArea TargetCellOutsideGroupCallArea ::=
    localValue 42
```

-- operation and maintenance error codes

```
tracingBufferFull TracingBufferFull ::= localValue 40
```

-- call handling error codes

```
noRoamingNumberAvailable NoRoamingNumberAvailable ::= localValue 39
absentSubscriber AbsentSubscriber ::= localValue 27
busySubscriber BusySubscriber ::= localValue 45
noSubscriberReply NoSubscriberReply ::= localValue 46
callBarred CallBarred ::= localValue 13
forwardingFailed ForwardingFailed ::= localValue 47
or-NotAllowed OR-NotAllowed ::= localValue 48
forwardingViolation ForwardingViolation ::= localValue 14
cug-Reject CUG-Reject ::= localValue 15
```

-- any time interrogation error codes

```
ati-NotAllowed ATI-NotAllowed ::= localValue 49
```

-- any time information handling error codes

```
atsi-NotAllowed ATSI-NotAllowed ::= localValue 60
atm-NotAllowed ATM-NotAllowed ::= localValue 61
informationNotAvailable InformationNotAvailable ::= localValue 62
```

-- Group Call error codes

```
noGroupCallNumberAvailable NoGroupCallNumberAvailable ::= localValue 50
```

-- supplementary service error codes

```

illegalSS-Operation IllegalSS-Operation ::= localValue 16
ss-ErrorStatus SS-ErrorStatus ::= localValue 17
ss-NotAvailable SS-NotAvailable ::= localValue 18
ss-SubscriptionViolation SS-SubscriptionViolation ::= localValue 19
ss-Incompatibility SS-Incompatibility ::= localValue 20
unknownAlphabet UnknownAlphabet ::= localValue 71
ussd-Busy USSD-Busy ::= localValue 72
pw-RegistrationFailure PW-RegistrationFailure ::= localValue 37
negativePW-Check NegativePW-Check ::= localValue 38
numberOfPW-AttemptsViolation NumberOfPW-AttemptsViolation ::=
    localValue 43
shortTermDenial ShortTermDenial ::= localValue 29
longTermDenial LongTermDenial ::= localValue 30

```

-- short message service error codes

```

subscriberBusyForMT-SMS SubscriberBusyForMT-SMS ::= localValue 31
sm-DeliveryFailure SM-DeliveryFailure ::= localValue 32
messageWaitingListFull MessageWaitingListFull ::= localValue 33
absentSubscriberSM AbsentSubscriberSM ::= localValue 6

```

-- location service error codes

```

unauthorizedRequestingNetwork UnauthorizedRequestingNetwork ::= localValue 52
unauthorizedLCSClient UnauthorizedLCSClient ::= localValue 53
positionMethodFailure PositionMethodFailure ::= localValue 54
unknownOrUnreachableLCSClient UnknownOrUnreachableLCSClient ::= localValue 58

```

-- Mobility Management error codes

```

mm-EventNotSupported MM-EventNotSupported ::= localValue 59

```

-- Secure transport error codes

```

secureTransportError SecureTransportError ::= localValue 4

```

-- The following operation codes are reserved for operations
existing in previous versions of the protocol

Operation Name	AC used	Oper. Code
-- sendParameters	map-ac infoRetrieval (14) version1 (1)	localValue 9
-- processUnstructuredSS-Data	map-ac networkFunctionalSs (18) version1 (1)	localValue 19
-- performHandover	map-ac handoverControl (11) version1 (1)	localValue 28
-- performSubsequentHandover	map-ac handoverControl (11) version1 (1)	localValue 30
-- noteInternalHandover	map-ac handoverControl (11) version1 (1)	localValue 35
-- noteSubscriberPresent	map-ac mwdMngt (24) version1 (1)	localValue 48
-- alertServiceCentreWithoutResult	map-ac shortMsgAlert (23) version1 (1)	localValue 49
-- traceSubscriberActivity	map-ac handoverControl (11) version1 (1)	localValue 52
-- beginSubscriberActivity	map-ac networkFunctionalSs (18) version1 (1)	localValue 54

-- The following error codes are reserved for errors
existing in previous versions of the protocol

Error Name	AC used	Error Code
-- unknownBaseStation	map-ac handoverControl (11) version1 (1)	localValue 2
-- invalidTargetBaseStation	map-ac handoverControl (11) version1 (1)	localValue 23
-- noRadioResourceAvailable	map-ac handoverControl (11) version1 (1)	localValue 24

END

17.6 MAP operation and error types

17.6.1 Mobile Service Operations

```

MAP-MobileServiceOperations {
    ccitt identified-organization (4) etsi (0) mobileDomain (0)
    gsm-Network (1) modules (3) map-MobileServiceOperations (5)
    version8 (8)}

```

DEFINITIONS

::=

BEGIN

EXPORTS

```
-- location registration operations
UpdateLocation,
CancelLocation,
PurgeMS,
SendIdentification,

-- gprs location registration operations
UpdateGprsLocation,

-- subscriber information enquiry operations
ProvideSubscriberInfo,

-- any time information enquiry operations
AnyTimeInterrogation,

-- any time information handling operations
AnyTimeSubscriptionInterrogation,
AnyTimeModification,

-- subscriber data modification notification operations
NoteSubscriberDataModified,

-- handover operations
PrepareHandover,
SendEndSignal,
ProcessAccessSignalling,
ForwardAccessSignalling,
PrepareSubsequentHandover,

-- authentication management operations
SendAuthenticationInfo,
AuthenticationFailureReport,

-- IMEI management operations
CheckIMEI,

-- subscriber management operations
InsertSubscriberData,
DeleteSubscriberData,

-- fault recovery operations
Reset,
ForwardCheckSS-Indication,
RestoreData,

-- gprs location information retrieval operations
SendRoutingInfoForGprs,

-- failure reporting operations
FailureReport,

-- gprs notification operations
NoteMsPresentForGprs,

-- Mobility Management operations
NoteMM-Event
```

;

IMPORTS

OPERATION

```
FROM TCAPMessages {
  ccitt recommendation q 773 modules (2) messages (1) version2 (2)}
```

```
SystemFailure,
DataMissing,
UnexpectedDataValue,
```

UnknownSubscriber,
 UnknownMSC,
 UnidentifiedSubscriber,
 UnknownEquipment,
 RoamingNotAllowed,
 ATI-NotAllowed,
 NoHandoverNumberAvailable,
 SubsequentHandoverFailure,
 AbsentSubscriber,
 MM-EventNotSupported,
 ATSI-NotAllowed,
 ATM-NotAllowed,
 BearerServiceNotProvisioned,
 TeleserviceNotProvisioned,
 CallBarred,
 IllegalSS-Operation,
 SS-ErrorStatus,
 SS-NotAvailable,
 SS-Incompatibility,
 SS-SubscriptionViolation,
 InformationNotAvailable,
 TargetCellOutsideGroupCallArea

```

FROM MAP-Errors {
  ccitt identified-organization (4) etsi (0) mobileDomain (0)
  gsm-Network (1) modules (3) map-Errors (10) version8 (8)}
  
```

UpdateLocationArg,
 UpdateLocationRes,
 CancelLocationArg,
 CancelLocationRes,
 PurgeMS-Arg,
 PurgeMS-Res,
 SendIdentificationArg,
 SendIdentificationRes,
 UpdateGprsLocationArg,
 UpdateGprsLocationRes,
 PrepareHO-Arg,
 PrepareHO-Res,
 ForwardAccessSignalling-Arg,
 ProcessAccessSignalling-Arg,
 SendEndSignal-Arg,
 SendEndSignal-Res,
 PrepareSubsequentHO-Res,
 PrepareSubsequentHO-Arg,
 SendAuthenticationInfoArg,
 SendAuthenticationInfoRes,
 AuthenticationFailureReportArg,
 AuthenticationFailureReportRes,
 EquipmentStatus,
 InsertSubscriberDataArg,
 InsertSubscriberDataRes,
 DeleteSubscriberDataArg,
 DeleteSubscriberDataRes,
 ResetArg,
 RestoreDataArg,
 RestoreDataRes,
 ProvideSubscriberInfoArg,
 ProvideSubscriberInfoRes,
 AnyTimeSubscriptionInterrogationArg,
 AnyTimeSubscriptionInterrogationRes,
 AnyTimeModificationArg,
 AnyTimeModificationRes,
 NoteSubscriberDataModifiedArg,
 NoteSubscriberDataModifiedRes,
 AnyTimeInterrogationArg,
 AnyTimeInterrogationRes,
 SendRoutingInfoForGprsArg,
 SendRoutingInfoForGprsRes,
 FailureReportArg,
 FailureReportRes,
 NoteMsPresentForGprsArg,
 NoteMsPresentForGprsRes,
 NoteMM-EventArg,
 NoteMM-EventRes

```

FROM MAP-MS-DataTypes {
  
```

```
ccitt identified-organization (4) etsi (0) mobileDomain (0)
gsm-Network (1) modules (3) map-MS-DataTypes (11) version8 (8)}
```

```
IMEI
```

```
FROM MAP-CommonDataTypes {
  ccitt identified-organization (4) etsi (0) mobileDomain (0)
  gsm-Network (1) modules (3) map-CommonDataTypes (18) version8 (8)}
;
```

```
-- location registration operations
```

<pre>UpdateLocation ::= OPERATION ARGUMENT updateLocationArg UpdateLocationArg RESULT updateLocationRes UpdateLocationRes ERRORS { SystemFailure, DataMissing, UnexpectedDataValue, UnknownSubscriber, RoamingNotAllowed}</pre>	--Timer m
--	-----------

<pre>CancelLocation ::= OPERATION ARGUMENT cancelLocationArg CancelLocationArg RESULT cancelLocationRes CancelLocationRes -- optional ERRORS { DataMissing, UnexpectedDataValue}</pre>	--Timer m
---	-----------

<pre>PurgeMS ::= OPERATION ARGUMENT purgeMS-Arg PurgeMS-Arg RESULT purgeMS-Res PurgeMS-Res -- optional ERRORS{ DataMissing, UnexpectedDataValue, UnknownSubscriber}</pre>	--Timer m
--	-----------

<pre>SendIdentification ::= OPERATION ARGUMENT sendIdentificationArg SendIdentificationArg RESULT sendIdentificationRes SendIdentificationRes ERRORS { DataMissing, UnidentifiedSubscriber}</pre>	--Timer s
--	-----------

```
-- gprs location registration operations
```

<pre>UpdateGprsLocation ::= OPERATION ARGUMENT updateGprsLocationArg UpdateGprsLocationArg RESULT updateGprsLocationRes UpdateGprsLocationRes ERRORS { SystemFailure, UnexpectedDataValue, UnknownSubscriber, RoamingNotAllowed}</pre>	--Timer m
---	-----------

```
-- subscriber information enquiry operations
```

```

ProvideSubscriberInfo ::= OPERATION --Timer m
  ARGUMENT
    provideSubscriberInfoArg      ProvideSubscriberInfoArg
  RESULT
    provideSubscriberInfoRes      ProvideSubscriberInfoRes
  ERRORS {
    DataMissing,
    UnexpectedDataValue}

```

-- any time information enquiry operations

```

AnyTimeInterrogation ::= OPERATION --Timer m
  ARGUMENT
    anyTimeInterrogationArg      AnyTimeInterrogationArg
  RESULT
    anyTimeInterrogationRes      AnyTimeInterrogationRes
  ERRORS {
    SystemFailure,
    ATI-NotAllowed,
    DataMissing,
    UnexpectedDataValue,
    UnknownSubscriber}

```

-- any time information handling operations

```

AnyTimeSubscriptionInterrogation ::= OPERATION --Timer m
  ARGUMENT
    anyTimeSubscriptionInterrogationArg AnyTimeSubscriptionInterrogationArg
  RESULT
    anyTimeSubscriptionInterrogationRes AnyTimeSubscriptionInterrogationRes
  ERRORS {
    ATSI-NotAllowed,
    DataMissing,
    UnexpectedDataValue,
    UnknownSubscriber,
    BearerServiceNotProvisioned,
    TeleserviceNotProvisioned,
    CallBarred,
    IllegalSS-Operation,
    SS-NotAvailable,
    InformationNotAvailable}

```

```

AnyTimeModification ::= OPERATION --Timer m
  ARGUMENT
    anyTimeModificationArg      AnyTimeModificationArg
  RESULT
    anyTimeModificationRes      AnyTimeModificationRes
  ERRORS {
    ATM-NotAllowed,
    DataMissing,
    UnexpectedDataValue,
    UnknownSubscriber,
    BearerServiceNotProvisioned,
    TeleserviceNotProvisioned,
    CallBarred,
    IllegalSS-Operation,
    SS-SubscriptionViolation,
    SS-ErrorStatus,
    SS-Incompatibility,
    InformationNotAvailable}

```

-- subscriber data modification notification operations

```

NoteSubscriberDataModified ::= OPERATION --Timer m
  ARGUMENT
    noteSubscriberDataModifiedArg NoteSubscriberDataModifiedArg
  RESULT
    noteSubscriberDataModifiedRes NoteSubscriberDataModifiedRes
    -- optional
  ERRORS {
    DataMissing,
    UnexpectedDataValue,
    UnknownSubscriber}

```

-- handover operations

```

PrepareHandover ::= OPERATION --Timer m
  ARGUMENT
    prepareHO-Arg          PrepareHO-Arg
  RESULT
    prepareHO-Res          PrepareHO-Res
  ERRORS {
    SystemFailure,
    DataMissing,
    UnexpectedDataValue,
    NoHandoverNumberAvailable,
    TargetCellOutsideGroupCallArea }

```

```

SendEndSignal ::= OPERATION --Timer l
  ARGUMENT
    sendEndSignal-Arg      SendEndSignal-Arg
  RESULT
    sendEndSignal-Res      SendEndSignal-Res

```

```

ProcessAccessSignalling ::= OPERATION --Timer s
  ARGUMENT
    processAccessSignalling-Arg ProcessAccessSignalling-Arg

```

```

ForwardAccessSignalling ::= OPERATION --Timer s
  ARGUMENT
    forwardAccessSignalling-Arg ForwardAccessSignalling-Arg

```

```

PrepareSubsequentHandover ::= OPERATION --Timer m
  ARGUMENT
    prepareSubsequentHO-Arg PrepareSubsequentHO-Arg
  RESULT
    prepareSubsequentHO-Res PrepareSubsequentHO-Res
  ERRORS {
    UnexpectedDataValue,
    DataMissing,
    UnknownMSC,
    SubsequentHandoverFailure}

```

-- authentication management operations

```

SendAuthenticationInfo ::= OPERATION --Timer m
  ARGUMENT
    sendAuthenticationInfoArg SendAuthenticationInfoArg
    -- optional
    -- within a dialogue sendAuthenticationInfoArg shall not be present in
    -- subsequent invoke components. If received in a subsequent invoke component
    -- it shall be discarded.
  RESULT
    sendAuthenticationInfoRes SendAuthenticationInfoRes
    -- optional
  ERRORS {
    SystemFailure,
    DataMissing,
    UnexpectedDataValue,
    UnknownSubscriber}

```

```

AuthenticationFailureReport ::= OPERATION --Timer m
  ARGUMENT
    authenticationFailureReportArg AuthenticationFailureReportArg
  RESULT
    authenticationFailureReportRes AuthenticationFailureReportRes
    -- optional
  ERRORS {
    SystemFailure,
    UnexpectedDataValue,
    UnknownSubscriber}

```

-- IMEI management operations

CheckIMEI ::= OPERATION		--Timer m
ARGUMENT		
imei	IMEI	
RESULT		
equipmentStatus	EquipmentStatus	
ERRORS {		
SystemFailure,		
DataMissing,		
UnknownEquipment}		

-- subscriber management operations

InsertSubscriberData ::= OPERATION		--Timer m
ARGUMENT		
insertSubscriberDataArg	InsertSubscriberDataArg	
RESULT		
insertSubscriberDataRes	InsertSubscriberDataRes	
-- optional		
ERRORS {		
DataMissing,		
UnexpectedDataValue,		
UnidentifiedSubscriber}		

DeleteSubscriberData ::= OPERATION		--Timer m
ARGUMENT		
deleteSubscriberDataArg	DeleteSubscriberDataArg	
RESULT		
deleteSubscriberDataRes	DeleteSubscriberDataRes	
-- optional		
ERRORS {		
DataMissing,		
UnexpectedDataValue,		
UnidentifiedSubscriber}		

-- fault recovery operations

Reset ::= OPERATION		--Timer m
ARGUMENT		
resetArg	ResetArg	

ForwardCheckSS-Indication ::= OPERATION		--Timer s
--	--	-----------

RestoreData ::= OPERATION		--Timer m
ARGUMENT		
restoreDataArg	RestoreDataArg	
RESULT		
restoreDataRes	RestoreDataRes	
ERRORS {		
SystemFailure,		
DataMissing,		
UnexpectedDataValue,		
UnknownSubscriber}		

-- gprs location information retrieval operations

SendRoutingInfoForGprs ::= OPERATION		--Timer m
ARGUMENT		
sendRoutingInfoForGprsArg	SendRoutingInfoForGprsArg	
RESULT		
sendRoutingInfoForGprsRes	SendRoutingInfoForGprsRes	
ERRORS {		
AbsentSubscriber,		
SystemFailure,		
DataMissing,		
UnexpectedDataValue,		
UnknownSubscriber,		
CallBarred }		

-- failure reporting operations

```

FailureReport ::= OPERATION --Timer m
  ARGUMENT
    failureReportArg          FailureReportArg
  RESULT
    failureReportRes          FailureReportRes
    -- optional
  ERRORS {
    SystemFailure,
    DataMissing,
    UnexpectedDataValue,
    UnknownSubscriber}

```

-- gprs notification operations

```

NoteMsPresentForGprs ::= OPERATION --Timer m
  ARGUMENT
    noteMsPresentForGprsArg    NoteMsPresentForGprsArg
  RESULT
    noteMsPresentForGprsRes    NoteMsPresentForGprsRes
    -- optional
  ERRORS {
    SystemFailure,
    DataMissing,
    UnexpectedDataValue,
    UnknownSubscriber}

```

```

NoteMM-Event ::= OPERATION --Timer m
  ARGUMENT
    noteMM-EventArg           NoteMM-EventArg
  RESULT
    noteMM-EventRes           NoteMM-EventRes
  ERRORS {
    DataMissing,
    UnexpectedDataValue,
    UnknownSubscriber,
    MM-EventNotSupported}

```

END

17.6.2 Operation and Maintenance Operations

```

MAP-OperationAndMaintenanceOperations {
  ccitt identified-organization (4) etsi (0) mobileDomain (0)
  gsm-Network (1) modules (3) map-OperationAndMaintenanceOperations (6)
  version8 (8)}

```

DEFINITIONS

::=

BEGIN

EXPORTS

```

  ActivateTraceMode,
  DeactivateTraceMode,
  SendIMSI

```

;

IMPORTS

OPERATION

```

FROM TCAPMessages {
  ccitt recommendation q 773 modules (2) messages (1) version2 (2)}

```

```

  SystemFailure,
  DataMissing,
  UnexpectedDataValue,
  FacilityNotSupported,
  UnknownSubscriber,
  UnidentifiedSubscriber,
  TracingBufferFull

```

```

FROM MAP-Errors {
  ccitt identified-organization (4) etsi (0) mobileDomain (0)
  gsm-Network (1) modules (3) map-Errors (10) version8 (8)}

```

```

  ActivateTraceModeArg,
  ActivateTraceModeRes,
  DeactivateTraceModeArg,

```

```

    DeactivateTraceModeRes
FROM MAP-OM-DataTypes {
    ccitt identified-organization (4) etsi (0) mobileDomain (0)
    gsm-Network (1) modules (3) map-OM-DataTypes (12) version8 (8)}

    ISDN-AddressString,
    IMSI
FROM MAP-CommonDataTypes {
    ccitt identified-organization (4) etsi (0) mobileDomain (0)
    gsm-Network (1) modules (3) map-CommonDataTypes (18) version8 (8)}
;

```

```

ActivateTraceMode ::= OPERATION --Timer m
    ARGUMENT
        activateTraceModeArg          ActivateTraceModeArg
    RESULT
        activateTraceModeRes          ActivateTraceModeRes
        -- optional
    ERRORS {
        SystemFailure,
        DataMissing,
        UnexpectedDataValue,
        FacilityNotSupported,
        UnidentifiedSubscriber,
        TracingBufferFull}

```

```

DeactivateTraceMode ::= OPERATION --Timer m
    ARGUMENT
        deactivateTraceModeArg        DeactivateTraceModeArg
    RESULT
        deactivateTraceModeRes        DeactivateTraceModeRes
        -- optional
    ERRORS {
        SystemFailure,
        DataMissing,
        UnexpectedDataValue,
        FacilityNotSupported,
        UnidentifiedSubscriber}

```

```

SendIMSI ::= OPERATION --Timer m
    ARGUMENT
        msisdn                        ISDN-AddressString
    RESULT
        imsi                          IMSI
    ERRORS {
        DataMissing,
        UnexpectedDataValue,
        UnknownSubscriber}

```

END

17.6.3 Call Handling Operations

```

MAP-CallHandlingOperations {
    ccitt identified-organization (4) etsi (0) mobileDomain (0)
    gsm-Network (1) modules (3) map-CallHandlingOperations (7)
    version8 (8)}

```

DEFINITIONS

::=

BEGIN

EXPORTS

```

    SendRoutingInfo,
    ProvideRoamingNumber,
    ResumeCallHandling,
    ProvideSIWFSNumber,
    SIWFSSignallingModify,
    SetReportingState,
    StatusReport,
    RemoteUserFree,
    IST-Alert,
    IST-Command
;

```

```

IMPORTS
  OPERATION
FROM TCAPMessages {
  ccitt recommendation q 773 modules (2) messages (1) version2 (2)}

  SystemFailure,
  DataMissing,
  UnexpectedDataValue,
  FacilityNotSupported,
  OR-NotAllowed,
  UnknownSubscriber,
  NumberChanged,
  BearerServiceNotProvisioned,
  TeleserviceNotProvisioned,
  NoRoamingNumberAvailable,
  AbsentSubscriber,
  BusySubscriber,
  NoSubscriberReply,
  CallBarred,
  ForwardingViolation,
  ForwardingFailed,
  CUG-Reject,
  ResourceLimitation,
  IncompatibleTerminal,
  UnidentifiedSubscriber

FROM MAP-Errors {
  ccitt identified-organization (4) etsi (0) mobileDomain (0)
  gsm-Network (1) modules (3) map-Errors (10) version8 (8)}
  SendRoutingInfoArg,
  SendRoutingInfoRes,
  ProvideRoamingNumberArg,
  ProvideRoamingNumberRes,
  ResumeCallHandlingArg,
  ResumeCallHandlingRes,
  ProvideSIWFSNumberArg,
  ProvideSIWFSNumberRes,
  SIWFSSignallingModifyArg,
  SIWFSSignallingModifyRes,
  SetReportingStateArg,
  SetReportingStateRes,
  StatusReportArg,
  StatusReportRes,
  RemoteUserFreeArg,
  RemoteUserFreeRes,
  IST-AlertArg,
  IST-AlertRes,
  IST-CommandArg,
  IST-CommandRes
FROM MAP-CH-DataTypes {
  ccitt identified-organization (4) etsi (0) mobileDomain (0)
  gsm-Network (1) modules (3) map-CH-DataTypes (13) version8 (8)}

;

```

<pre> SendRoutingInfo ::= OPERATION -- The timer is set to the upper limit of the range if the GMSC supports pre-paging. ARGUMENT sendRoutingInfoArg SendRoutingInfoArg RESULT sendRoutingInfoRes SendRoutingInfoRes ERRORS { SystemFailure, DataMissing, UnexpectedDataValue, FacilityNotSupported, OR-NotAllowed, UnknownSubscriber, NumberChanged, BearerServiceNotProvisioned, TeleserviceNotProvisioned, AbsentSubscriber, BusySubscriber, NoSubscriberReply, CallBarred, CUG-Reject, ForwardingViolation} </pre>	<pre> --Timer m </pre>
---	------------------------

```

ProvideRoamingNumber ::= OPERATION --Timer m
-- The timer is set to the upper limit of the range if the HLR supports pre-paging.
  ARGUMENT
    provideRoamingNumberArg      ProvideRoamingNumberArg
  RESULT
    provideRoamingNumberRes      ProvideRoamingNumberRes
  ERRORS {
    SystemFailure,
    DataMissing,
    UnexpectedDataValue,
    FacilityNotSupported,
    OR-NotAllowed,
    AbsentSubscriber,
    NoRoamingNumberAvailable}

```

```

ResumeCallHandling ::= OPERATION --Timer m
  ARGUMENT
    resumeCallHandlingArg        ResumeCallHandlingArg
  RESULT
    resumeCallHandlingRes        ResumeCallHandlingRes
    -- optional
  ERRORS {
    ForwardingFailed,
    OR-NotAllowed,
    UnexpectedDataValue,
    DataMissing }

```

```

ProvidesIWFSNumber ::= OPERATION --Timer m
  ARGUMENT
    providesIWFSNumberArg        ProvideSIWFSNumberArg
  RESULT
    providesIWFSNumberRes        ProvideSIWFSNumberRes
  ERRORS {
    ResourceLimitation,
    DataMissing,
    UnexpectedDataValue,
    SystemFailure}

```

```

SIWFSSignallingModify ::= OPERATION --Timer m
  ARGUMENT
    siWFSSignallingModifyArg      SIWFSSignallingModifyArg
  RESULT
    siWFSSignallingModifyRes      SIWFSSignallingModifyRes
    -- optional
  ERRORS {
    ResourceLimitation,
    DataMissing,
    UnexpectedDataValue,
    SystemFailure}

```

```

SetReportingState ::= OPERATION --Timer m
  ARGUMENT
    setReportingStateArg          SetReportingStateArg
  RESULT
    setReportingStateRes          SetReportingStateRes
    -- optional
  ERRORS {
    SystemFailure,
    UnidentifiedSubscriber,
    UnexpectedDataValue,
    DataMissing,
    ResourceLimitation,
    FacilityNotSupported}

```

```

StatusReport ::= OPERATION --Timer m
  ARGUMENT
    statusReportArg              StatusReportArg
  RESULT
    statusReportRes              StatusReportRes
    -- optional
  ERRORS {
    UnknownSubscriber,
    SystemFailure,
    UnexpectedDataValue,
    DataMissing}

```

```

RemoteUserFree ::= OPERATION --Timer ml
  ARGUMENT
    remoteUserFreeArg RemoteUserFreeArg
  RESULT
    remoteUserFreeRes RemoteUserFreeRes
  ERRORS {
    UnexpectedDataValue,
    DataMissing,
    IncompatibleTerminal,
    AbsentSubscriber,
    SystemFailure,
    BusySubscriber}

```

```

IST-Alert ::= OPERATION --Timer m
  ARGUMENT
    istAlertArg IST-AlertArg
  RESULT
    istAlertRes IST-AlertRes
    -- optional
  ERRORS {
    UnexpectedDataValue,
    ResourceLimitation,
    UnknownSubscriber,
    SystemFailure,
    FacilityNotSupported}

```

```

IST-Command ::= OPERATION --Timer m
  ARGUMENT
    istCommandArg IST-CommandArg
  RESULT
    istCommandRes IST-CommandRes
    -- optional
  ERRORS {
    UnexpectedDataValue,
    ResourceLimitation,
    UnknownSubscriber,
    SystemFailure,
    FacilityNotSupported}

```

END

17.6.4 Supplementary service operations

```

MAP-SupplementaryServiceOperations {
  ccitt identified-organization (4) etsi (0) mobileDomain (0)
  gsm-Network (1) modules (3) map-SupplementaryServiceOperations (8)
  version8 (8)}

```

DEFINITIONS

::=

BEGIN

EXPORTS

```

  RegisterSS,
  EraseSS,
  ActivateSS,
  DeactivateSS,
  InterrogateSS,
  ProcessUnstructuredSS-Request,
  UnstructuredSS-Request,
  UnstructuredSS-Notify,
  RegisterPassword,
  GetPassword,
  SS-InvocationNotification,
  RegisterCC-Entry,
  EraseCC-Entry
;

```

IMPORTS

```

  OPERATION
  FROM TCAPMessages {
    ccitt recommendation q 773 modules (2) messages (1) version2 (2)}

  SystemFailure,
  DataMissing,
  UnexpectedDataValue,

```

```

UnknownSubscriber,
BearerServiceNotProvisioned,
TeleserviceNotProvisioned,
CallBarred,
IllegalSS-Operation,
SS-ErrorStatus,
SS-NotAvailable,
SS-SubscriptionViolation,
SS-Incompatibility,
PW-RegistrationFailure,
NegativePW-Check,
NumberOfPW-AttemptsViolation,
UnknownAlphabet,
USSD-Busy,
AbsentSubscriber,
IllegalSubscriber,
IllegalEquipment,
ShortTermDenial,
LongTermDenial,
FacilityNotSupported
FROM MAP-Errors {
  ccitt identified-organization (4) etsi (0) mobileDomain (0)
  gsm-Network (1) modules (3) map-Errors (10) version8 (8)}

RegisterSS-Arg,
SS-Info,
SS-ForBS-Code,
InterrogateSS-Res,
USSD-Arg,
USSD-Res,
Password,
GuidanceInfo,
SS-InvocationNotificationArg,
SS-InvocationNotificationRes,
RegisterCC-EntryArg,
RegisterCC-EntryRes,
EraseCC-EntryArg,
EraseCC-EntryRes
FROM MAP-SS-DataTypes {
  ccitt identified-organization (4) etsi (0) mobileDomain (0)
  gsm-Network (1) modules (3) map-SS-DataTypes (14) version8 (8)}

SS-Code
FROM MAP-SS-Code {
  ccitt identified-organization (4) etsi (0) mobileDomain (0)
  gsm-Network (1) modules (3) map-SS-Code (15) version8 (8)}
;

-- supplementary service handling operations

```

RegisterSS ::= OPERATION	--Timer m
ARGUMENT	
registerSS-Arg	RegisterSS-Arg
RESULT	
ss-Info	SS-Info
-- optional	
ERRORS {	
SystemFailure,	
DataMissing,	
UnexpectedDataValue,	
BearerServiceNotProvisioned,	
TeleserviceNotProvisioned,	
CallBarred,	
IllegalSS-Operation,	
SS-ErrorStatus,	
SS-Incompatibility}	

```

EraseSS ::= OPERATION --Timer m
  ARGUMENT
    ss-ForBS SS-ForBS-Code
  RESULT
    ss-Info SS-Info
    -- optional
  ERRORS {
    SystemFailure,
    DataMissing,
    UnexpectedDataValue,
    BearerServiceNotProvisioned,
    TeleserviceNotProvisioned,
    CallBarred,
    IllegalSS-Operation,
    SS-ErrorStatus
  }

```

```

ActivateSS ::= OPERATION --Timer m
  ARGUMENT
    ss-ForBS SS-ForBS-Code
  RESULT
    ss-Info SS-Info
    -- optional
  ERRORS {
    SystemFailure,
    DataMissing,
    UnexpectedDataValue,
    BearerServiceNotProvisioned,
    TeleserviceNotProvisioned,
    CallBarred,
    IllegalSS-Operation,
    SS-ErrorStatus,
    SS-SubscriptionViolation,
    SS-Incompatibility,
    NegativePW-Check,
    NumberOfPW-AttemptsViolation}

```

```

DeactivateSS ::= OPERATION --Timer m
  ARGUMENT
    ss-ForBS SS-ForBS-Code
  RESULT
    ss-Info SS-Info
    -- optional
  ERRORS {
    SystemFailure,
    DataMissing,
    UnexpectedDataValue,
    BearerServiceNotProvisioned,
    TeleserviceNotProvisioned,
    CallBarred,
    IllegalSS-Operation,
    SS-ErrorStatus,
    SS-SubscriptionViolation,
    NegativePW-Check,
    NumberOfPW-AttemptsViolation}

```

```

InterrogateSS ::= OPERATION --Timer m
  ARGUMENT
    ss-ForBS SS-ForBS-Code
  RESULT
    interrogateSS-Res InterrogateSS-Res
  ERRORS {
    SystemFailure,
    DataMissing,
    UnexpectedDataValue,
    BearerServiceNotProvisioned,
    TeleserviceNotProvisioned,
    CallBarred,
    IllegalSS-Operation,
    SS-NotAvailable}

```



```

ProcessUnstructuredSS-Request ::= OPERATION --Timer 10 minutes
  ARGUMENT
    ussd-Arg          USSD-Arg
  RESULT
    ussd-Res          USSD-Res
  ERRORS {
    SystemFailure,
    DataMissing,
    UnexpectedDataValue,
    UnknownAlphabet,
    CallBarred}

```

```

UnstructuredSS-Request ::= OPERATION --Timer m1
  ARGUMENT
    ussd-Arg          USSD-Arg
  RESULT
    ussd-Res          USSD-Res
    -- optional
  ERRORS {
    SystemFailure,
    DataMissing,
    UnexpectedDataValue,
    AbsentSubscriber,
    IllegalSubscriber,
    IllegalEquipment,
    UnknownAlphabet,
    USSD-Busy}

```

```

UnstructuredSS-Notify ::= OPERATION --Timer m1
  ARGUMENT
    ussd-Arg          USSD-Arg
  RESULT
  ERRORS {
    SystemFailure,
    DataMissing,
    UnexpectedDataValue,
    AbsentSubscriber,
    IllegalSubscriber,
    IllegalEquipment,
    UnknownAlphabet,
    USSD-Busy}

```

```

RegisterPassword ::= OPERATION --Timer m1
  ARGUMENT
    ss-Code           SS-Code
  RESULT
    newPassword        Password
  ERRORS {
    SystemFailure,
    DataMissing,
    UnexpectedDataValue,
    CallBarred,
    SS-SubscriptionViolation,
    PW-RegistrationFailure,
    NegativePW-Check,
    NumberOfPW-AttemptsViolation}
  LINKED {
    GetPassword}

```

```

GetPassword ::= OPERATION --Timer m
  ARGUMENT
    guidanceInfo       GuidanceInfo
  RESULT
    currentPassword     Password

```

```

SS-InvocationNotification ::= OPERATION --Timer m
  ARGUMENT
    ss-InvocationNotificationArg  SS-InvocationNotificationArg
  RESULT
    ss-InvocationNotificationRes  SS-InvocationNotificationRes
    -- optional
  ERRORS {
    DataMissing,
    UnexpectedDataValue,
    UnknownSubscriber}

```

```

RegisterCC-Entry ::= OPERATION --Timer m
  ARGUMENT
    registerCC-EntryArg          RegisterCC-EntryArg
  RESULT
    registerCC-EntryRes         RegisterCC-EntryRes
  ERRORS {
    SystemFailure,
    DataMissing,
    UnexpectedDataValue,
    CallBarred,
    IllegalSS-Operation,
    SS-ErrorStatus,
    SS-Incompatibility,
    ShortTermDenial,
    LongTermDenial,
    FacilityNotSupported}

```

```

EraseCC-Entry ::= OPERATION --Timer m
  ARGUMENT
    eraseCC-EntryArg           EraseCC-EntryArg
  RESULT
    eraseCC-EntryRes          EraseCC-EntryRes
  ERRORS {
    SystemFailure,
    DataMissing,
    UnexpectedDataValue,
    CallBarred,
    IllegalSS-Operation,
    SS-ErrorStatus}

```

END

17.6.5 Short message service operations

```

MAP-ShortMessageServiceOperations {
  ccitt identified-organization (4) etsi (0) mobileDomain (0)
  gsm-Network (1) modules (3) map-ShortMessageServiceOperations (9)
  version8 (8)}

```

DEFINITIONS

::=

BEGIN

EXPORTS

```

  SendRoutingInfoForSM,
  MO-ForwardSM,
  MT-ForwardSM,
  ReportSM-DeliveryStatus,
  AlertServiceCentre,
  InformServiceCentre,
  ReadyForSM
;

```

IMPORTS

OPERATION

FROM TCAPMessages {

```

  ccitt recommendation q 773 modules (2) messages (1) version2 (2)}

```

```

  SystemFailure,
  DataMissing,
  UnexpectedDataValue,
  FacilityNotSupported,
  UnknownSubscriber,
  UnidentifiedSubscriber,
  IllegalSubscriber,
  IllegalEquipment,
  TeleserviceNotProvisioned,
  CallBarred,
  SubscriberBusyForMT-SMS,
  SM-DeliveryFailure,
  MessageWaitingListFull,
  AbsentSubscriberSM

```

FROM MAP-Errors {

```

  ccitt identified-organization (4) etsi (0) mobileDomain (0)
  gsm-Network (1) modules (3) map-Errors (10) version8 (8)}

```

```

RoutingInfoForSM-Arg,
RoutingInfoForSM-Res,
MO-ForwardSM-Arg,
MO-ForwardSM-Res,
MT-ForwardSM-Arg,
MT-ForwardSM-Res,
ReportSM-DeliveryStatusArg,
ReportSM-DeliveryStatusRes,
AlertServiceCentreArg,
InformServiceCentreArg,
ReadyForSM-Arg,
ReadyForSM-Res
FROM MAP-SM-DataTypes {
  ccitt identified-organization (4) etsi (0) mobileDomain (0)
  gsm-Network (1) modules (3) map-SM-DataTypes (16) version8 (8)}
;

```

```

SendRoutingInfoForSM ::= OPERATION --Timer m
  ARGUMENT
    routingInfoForSM-Arg          RoutingInfoForSM-Arg
  RESULT
    routingInfoForSM-Res          RoutingInfoForSM-Res
  ERRORS {
    SystemFailure,
    DataMissing,
    UnexpectedDataValue,
    FacilityNotSupported,
    UnknownSubscriber,
    TeleserviceNotProvisioned,
    CallBarred,
    AbsentSubscriberSM}

```

```

MO-ForwardSM ::= OPERATION --Timer m1
  ARGUMENT
    mo-forwardSM-Arg              MO-ForwardSM-Arg
  RESULT
    mo-forwardSM-Res              MO-ForwardSM-Res
    -- optional
  ERRORS {
    SystemFailure,
    UnexpectedDataValue,
    FacilityNotSupported,
    SM-DeliveryFailure}

```

```

MT-ForwardSM ::= OPERATION --Timer m1
  ARGUMENT
    mt-forwardSM-Arg              MT-ForwardSM-Arg
  RESULT
    mt-forwardSM-Res              MT-ForwardSM-Res
    -- optional
  ERRORS {
    SystemFailure,
    DataMissing,
    UnexpectedDataValue,
    FacilityNotSupported,
    UnidentifiedSubscriber,
    IllegalSubscriber,
    IllegalEquipment,
    SubscriberBusyForMT-SMS,
    SM-DeliveryFailure,
    AbsentSubscriberSM}

```

```

ReportSM-DeliveryStatus ::= OPERATION --Timer s
  ARGUMENT
    reportSM-DeliveryStatusArg     ReportSM-DeliveryStatusArg
  RESULT
    reportSM-DeliveryStatusRes     ReportSM-DeliveryStatusRes
    -- optional
  ERRORS {
    DataMissing,
    UnexpectedDataValue,
    UnknownSubscriber,
    MessageWaitingListFull}

```

```

AlertServiceCentre ::= OPERATION --Timer s
  ARGUMENT
    alertServiceCentreArg          AlertServiceCentreArg
  RESULT
  ERRORS {
    SystemFailure,
    DataMissing,
    UnexpectedDataValue}

```

```

InformServiceCentre ::= OPERATION --Timer s
  ARGUMENT
    informServiceCentreArg        InformServiceCentreArg

```

```

ReadyForSM ::= OPERATION --Timer m
  ARGUMENT
    readyForSM-Arg                ReadyForSM-Arg
  RESULT
    readyForSM-Res                ReadyForSM-Res
    -- optional
  ERRORS {
    DataMissing,
    UnexpectedDataValue,
    FacilityNotSupported,
    UnknownSubscriber}

```

END

17.6.6 Errors

```

MAP-Errors {
  ccitt identified-organization (4) etsi (0) mobileDomain (0)
  gsm-Network (1) modules (3) map-Errors (10) version8 (8)}

```

DEFINITIONS

::=

BEGIN

EXPORTS

```

-- generic errors
SystemFailure,
DataMissing,
UnexpectedDataValue,
FacilityNotSupported,
IncompatibleTerminal,
ResourceLimitation,

-- identification and numbering errors
UnknownSubscriber,
NumberChanged,
UnknownMSC,
UnidentifiedSubscriber,
UnknownEquipment,

-- subscription errors
RoamingNotAllowed,
IllegalSubscriber,
IllegalEquipment,
BearerServiceNotProvisioned,
TeleserviceNotProvisioned,

-- handover errors
NoHandoverNumberAvailable,
SubsequentHandoverFailure,
TargetCellOutsideGroupCallArea,

-- operation and maintenance errors
TracingBufferFull,

-- call handling errors
OR-NotAllowed,
NoRoamingNumberAvailable,
BusySubscriber,
NoSubscriberReply,
AbsentSubscriber,
CallBarred,

```

```
ForwardingViolation,
ForwardingFailed,
CUG-Reject,

-- any time interrogation errors
ATI-NotAllowed,

-- any time information handling errors
ATSI-NotAllowed,
ATM-NotAllowed,
InformationNotAvailable,

-- supplementary service errors
IllegalSS-Operation,
SS-ErrorStatus,
SS-NotAvailable,
SS-SubscriptionViolation,
SS-Incompatibility,
UnknownAlphabet,
USSD-Busy,
PW-RegistrationFailure,
NegativePW-Check,
NumberOfPW-AttemptsViolation,
ShortTermDenial,
LongTermDenial,

-- short message service errors
SubscriberBusyForMT-SMS,
SM-DeliveryFailure,
MessageWaitingListFull,
AbsentSubscriberSM,

-- Group Call errors
NoGroupCallNumberAvailable,

-- location service errors
UnauthorizedRequestingNetwork,
UnauthorizedLCSCClient,
PositionMethodFailure,
UnknownOrUnreachableLCSCClient,

-- Mobility Management errors
MM-EventNotSupported,

-- Secure transport errors
SecureTransportError

;

IMPORTS
  ERROR
FROM TCAPMessages {
  ccitt recommendation q 773 modules (2) messages (1) version2 (2)}

  SS-Status
FROM MAP-SS-DataTypes {
  ccitt identified-organization (4) etsi (0) mobileDomain (0)
  gsm-Network (1) modules (3) map-SS-DataTypes (14) version8 (8)}

  SS-IncompatibilityCause,
  PW-RegistrationFailureCause,
  SM-DeliveryFailureCause,
  SystemFailureParam,
  DataMissingParam,
  UnexpectedDataParam,
  FacilityNotSupParam,
  UnknownSubscriberParam,
  NumberChangedParam,
  UnidentifiedSubParam,
  RoamingNotAllowedParam,
  IllegalSubscriberParam,
  IllegalEquipmentParam,
  BearerServNotProvParam,
  TeleservNotProvParam,
  TracingBufferFullParam,
  NoRoamingNbParam,
  OR-NotAllowedParam,
  AbsentSubscriberParam,
```

```

BusySubscriberParam,
NoSubscriberReplyParam,
CallBarredParam,
ForwardingViolationParam,
ForwardingFailedParam,
CUG-RejectParam,
ATI-NotAllowedParam,
SubBusyForMT-SMS-Param,
MessageWaitListFullParam,
AbsentSubscriberSM-Param,
ResourceLimitationParam,
NoGroupCallNbParam,
IncompatibleTerminalParam,
ShortTermDenialParam,
LongTermDenialParam,
UnauthorizedRequestingNetwork-Param,
UnauthorizedLCSCClient-Param,
PositionMethodFailure-Param,
UnknownOrUnreachableLCSCClient-Param,
MM-EventNotSupported-Param,
ATSI-NotAllowedParam,
ATM-NotAllowedParam,
IllegalSS-OperationParam,
SS-NotAvailableParam,
SS-SubscriptionViolationParam,
InformationNotAvailableParam,
TargetCellOutsideGCA-Param,
SecureTransportErrorParam

```

```

FROM MAP-ER-DataTypes {
  ccitt identified-organization (4) etsi (0) mobileDomain (0)
  gsm-Network (1) modules (3) map-ER-DataTypes (17) version8 (8)}
;

```

```
-- generic errors
```

```

SystemFailure ::= ERROR
  PARAMETER
    systemFailureParam          SystemFailureParam
  -- optional

```

```

DataMissing ::= ERROR
  PARAMETER
    dataMissingParam           DataMissingParam
  -- optional
  -- dataMissingParam must not be used in version <3

```

```

UnexpectedDataValue ::= ERROR
  PARAMETER
    unexpectedDataParam        UnexpectedDataParam
  -- optional
  -- unexpectedDataParam must not be used in version <3

```

```

FacilityNotSupported ::= ERROR
  PARAMETER
    facilityNotSupParam        FacilityNotSupParam
  -- optional
  -- facilityNotSupParam must not be used in version <3

```

```

IncompatibleTerminal ::= ERROR
  PARAMETER
    incompatibleTerminalParam   IncompatibleTerminalParam
  -- optional

```

```

ResourceLimitation ::= ERROR
  PARAMETER
    resourceLimitationParam     ResourceLimitationParam
  -- optional

```

```
-- identification and numbering errors
```

```

UnknownSubscriber ::= ERROR
  PARAMETER
    unknownSubscriberParam          UnknownSubscriberParam
    -- optional
    -- unknownSubscriberParam must not be used in version <3

```

```

NumberChanged ::= ERROR
  PARAMETER
    numberChangedParam              NumberChangedParam
    -- optional

```

```

UnknownMSC ::= ERROR

```

```

UnidentifiedSubscriber ::= ERROR
  PARAMETER
    unidentifiedSubParam            UnidentifiedSubParam
    -- optional
    -- unidentifiedSubParam must not be used in version <3

```

```

UnknownEquipment ::= ERROR

```

```

-- subscription errors

```

```

RoamingNotAllowed ::= ERROR
  PARAMETER
    roamingNotAllowedParam          RoamingNotAllowedParam

```

```

IllegalSubscriber ::= ERROR
  PARAMETER
    illegalSubscriberParam          IllegalSubscriberParam
    -- optional
    -- illegalSubscriberParam must not be used in version <3

```

```

IllegalEquipment ::= ERROR
  PARAMETER
    illegalEquipmentParam           IllegalEquipmentParam
    -- optional
    -- illegalEquipmentParam must not be used in version <3

```

```

BearerServiceNotProvisioned ::= ERROR
  PARAMETER
    bearerServNotProvParam          BearerServNotProvParam
    -- optional
    -- bearerServNotProvParam must not be used in version <3

```

```

TeleserviceNotProvisioned ::= ERROR
  PARAMETER
    teleservNotProvParam            TeleservNotProvParam
    -- optional
    -- teleservNotProvParam must not be used in version <3

```

```

-- handover errors

```

```

NoHandoverNumberAvailable ::= ERROR

```

```

SubsequentHandoverFailure ::= ERROR

```

```

TargetCellOutsideGroupCallArea ::= ERROR
  PARAMETER
    targetCellOutsideGCA-Param      TargetCellOutsideGCA-Param
    -- optional

```

```

-- operation and maintenance errors

```

```

TracingBufferFull ::= ERROR
  PARAMETER
    tracingBufferFullParam           TracingBufferFullParam
    -- optional

```

```

-- call handling errors

```

```

NoRoamingNumberAvailable ::= ERROR
  PARAMETER
    noRoamingNbParam          NoRoamingNbParam
    -- optional

```

```

AbsentSubscriber ::= ERROR
  PARAMETER
    absentSubscriberParam      AbsentSubscriberParam
    -- optional
    -- absentSubscriberParam must not be used in version <3

```

```

BusySubscriber ::= ERROR
  PARAMETER
    busySubscriberParam        BusySubscriberParam
    -- optional

```

```

NoSubscriberReply ::= ERROR
  PARAMETER
    noSubscriberReplyParam     NoSubscriberReplyParam
    -- optional

```

```

CallBarred ::= ERROR
  PARAMETER
    callBarredParam            CallBarredParam
    -- optional

```

```

ForwardingViolation ::= ERROR
  PARAMETER
    forwardingViolationParam    ForwardingViolationParam
    -- optional

```

```

ForwardingFailed ::= ERROR
  PARAMETER
    forwardingFailedParam       ForwardingFailedParam
    -- optional

```

```

CUG-Reject ::= ERROR
  PARAMETER
    cug-RejectParam            CUG-RejectParam
    -- optional

```

```

OR-NotAllowed ::= ERROR
  PARAMETER
    or-NotAllowedParam         OR-NotAllowedParam
    -- optional

```

-- any time interrogation errors

```

ATI-NotAllowed ::= ERROR
  PARAMETER
    ati-NotAllowedParam        ATI-NotAllowedParam
    -- optional

```

-- any time information handling errors

```

ATSI-NotAllowed ::= ERROR
  PARAMETER
    atsi-NotAllowedParam       ATSI-NotAllowedParam
    -- optional

```

```

ATM-NotAllowed ::= ERROR
  PARAMETER
    atm-NotAllowedParam        ATM-NotAllowedParam
    -- optional

```

```

InformationNotAvailable ::= ERROR
  PARAMETER
    informationNotAvailableParam InformationNotAvailableParam
    -- optional

```

-- supplementary service errors

```

IllegalSS-Operation ::= ERROR
  PARAMETER
    illegalSS-OperationParam    IllegalSS-OperationParam
    -- optional

```

-- illegalSS-OperationParam must not be used in version <3

SS-ErrorStatus ::= ERROR
 PARAMETER
 ss-Status SS-Status
 -- optional

SS-NotAvailable ::= ERROR
 PARAMETER
 ss-NotAvailableParam SS-NotAvailableParam
 -- optional
 -- ss-NotAvailableParam must not be used in version <3

SS-SubscriptionViolation ::= ERROR
 PARAMETER
 ss-SubscriptionViolationParam SS-SubscriptionViolationParam
 -- optional
 -- ss-NotAvailableParam must not be used in version <3

SS-Incompatibility ::= ERROR
 PARAMETER
 ss-IncompatibilityCause SS-IncompatibilityCause
 -- optional

UnknownAlphabet ::= ERROR

USSD-Busy ::= ERROR

PW-RegistrationFailure ::= ERROR
 PARAMETER
 pw-RegistrationFailureCause PW-RegistrationFailureCause

NegativePW-Check ::= ERROR

NumberOfPW-AttemptsViolation ::= ERROR

ShortTermDenial ::= ERROR
 PARAMETER
 shortTermDenialParam ShortTermDenialParam
 -- optional

LongTermDenial ::= ERROR
 PARAMETER
 longTermDenialParam LongTermDenialParam
 -- optional

-- short message service errors

SubscriberBusyForMT-SMS ::= ERROR
 PARAMETER
 subBusyForMT-SMS-Param SubBusyForMT-SMS-Param
 -- optional

SM-DeliveryFailure ::= ERROR
 PARAMETER
 sm-DeliveryFailureCause SM-DeliveryFailureCause

MessageWaitingListFull ::= ERROR
 PARAMETER
 messageWaitListFullParam MessageWaitListFullParam
 -- optional

AbsentSubscriberSM ::= ERROR
 PARAMETER
 absentSubscriberSM-Param AbsentSubscriberSM-Param
 -- optional

-- Group Call errors

NoGroupCallNumberAvailable ::= ERROR
 PARAMETER
 noGroupCallNbParam NoGroupCallNbParam
 -- optional

-- location service errors

```

UnauthorizedRequestingNetwork ::= ERROR
  PARAMETER
    unauthorizedRequestingNetwork-Param  UnauthorizedRequestingNetwork-Param
    -- optional

UnauthorizedLCSCClient ::= ERROR
  PARAMETER
    unauthorizedLCSCClient-Param      UnauthorizedLCSCClient-Param
    -- optional

PositionMethodFailure ::= ERROR
  PARAMETER
    positionMethodFailure-Param      PositionMethodFailure-Param
    -- optional

UnknownOrUnreachableLCSCClient ::= ERROR
  PARAMETER
    unknownOrUnreachableLCSCClient-Param  UnknownOrUnreachableLCSCClient-Param
    -- optional

MM-EventNotSupported ::= ERROR
  PARAMETER
    mm-EventNotSupported-Param      MM-EventNotSupported-Param
    -- optional

-- Secure transport errors

SecureTransportError ::= ERROR
  PARAMETER
    secureTransportErrorParam      SecureTransportErrorParam

```

END

17.6.7 Group Call operations

```

MAP-Group-Call-Operations {
  ccitt identified-organization (4) etsi (0) mobileDomain (0)
  gsm-Network (1) modules (3) map-Group-Call-Operations (22)
  version8 (8)}

DEFINITIONS

 ::=

BEGIN

EXPORTS
  PrepareGroupCall,
  SendGroupCallEndSignal,
  ForwardGroupCallSignalling,
  ProcessGroupCallSignalling
;

IMPORTS
  OPERATION
FROM TCAPMessages {
  ccitt recommendation q 773 modules (2) messages (1) version2 (2)}

  SystemFailure,
  UnexpectedDataValue,
  NoGroupCallNumberAvailable
FROM MAP-Errors {
  ccitt identified-organization (4) etsi (0) mobileDomain (0)
  gsm-Network (1) modules (3) map-Errors (10) version8 (8)}

  PrepareGroupCallArg,
  PrepareGroupCallRes,
  SendGroupCallEndSignalArg,
  SendGroupCallEndSignalRes,
  ForwardGroupCallSignallingArg,
  ProcessGroupCallSignallingArg
FROM MAP-GR-DataTypes {
  ccitt identified-organization (4) etsi (0) mobileDomain (0)
  gsm-Network (1) modules (3) map-GR-DataTypes (23) version8 (8)}

```

;

PrepareGroupCall ::= OPERATION	--Timer m
ARGUMENT	
prepareGroupCallArg	PrepareGroupCallArg
RESULT	
prepareGroupCallRes	PrepareGroupCallRes
ERRORS {	
SystemFailure,	
NoGroupCallNumberAvailable,	
UnexpectedDataValue}	

SendGroupCallEndSignal ::= OPERATION	--Timer l
ARGUMENT	
sendGroupCallEndSignalArg	SendGroupCallEndSignalArg
RESULT	
sendGroupCallEndSignalRes	SendGroupCallEndSignalRes

ProcessGroupCallSignalling ::= OPERATION	--Timer s
ARGUMENT	
processGroupCallSignallingArg	ProcessGroupCallSignallingArg

ForwardGroupCallSignalling ::= OPERATION	--Timer s
ARGUMENT	
forwardGroupCallSignallingArg	ForwardGroupCallSignallingArg

END

17.6.8 Location service operations

```

1  MAP-LocationServiceOperations {
2    ccitt identified-organization (4) etsi (0) mobileDomain (0)
3    gsm-Network (1) modules (3) map-LocationServiceOperations (24)
4    version8 (8)}
5
6  DEFINITIONS
7
8  ::=
9
10 BEGIN
11
12 EXPORTS
13   ProvideSubscriberLocation,
14   SendRoutingInfoForLCS,
15   SubscriberLocationReport
16 ;
17
18 IMPORTS
19   OPERATION
20 FROM TCAPMessages {
21   ccitt recommendation q 773 modules (2) messages (1) version2 (2)}
22
23   SystemFailure,
24   DataMissing,
25   UnexpectedDataValue,
26   FacilityNotSupported,
27   UnknownSubscriber,
28   AbsentSubscriber,
29   UnauthorizedRequestingNetwork,
30   UnauthorizedLCSCClient,
31   PositionMethodFailure,
32   ResourceLimitation,
33   UnknownOrUnreachableLCSCClient,
34   UnidentifiedSubscriber,
35   IllegalEquipment,
36   IllegalSubscriber
37 FROM MAP-Errors {
38   ccitt identified-organization (4) etsi (0) mobileDomain (0)
39   gsm-Network (1) modules (3) map-Errors (10) version8 (8)}
40
41   RoutingInfoForLCS-Arg,
42   RoutingInfoForLCS-Res,
43   ProvideSubscriberLocation-Arg,
44   ProvideSubscriberLocation-Res,

```

```

45     SubscriberLocationReport-Arg,
46     SubscriberLocationReport-Res
47 FROM MAP-LCS-DataTypes {
48     ccitt identified-organization (4) etsi (0) mobileDomain (0)
49     gsm-Network (1) modules (3) map-LCS-DataTypes (25) version8 (8)}
50 ;
51
52 SendRoutingInfoForLCS ::= OPERATION --Timer m
53     ARGUMENT
54         routingInfoForLCS-Arg         RoutingInfoForLCS-Arg
55     RESULT
56         routingInfoForLCS-Res         RoutingInfoForLCS-Res
57     ERRORS {
58         SystemFailure,
59         DataMissing,
60         UnexpectedDataValue,
61         FacilityNotSupported,
62         UnknownSubscriber,
63         AbsentSubscriber,
64         UnauthorizedRequestingNetwork }
65
66 ProvideSubscriberLocation ::= OPERATION --Timer ml
67     ARGUMENT
68         provideSubscriberLocation-Arg ProvideSubscriberLocation-Arg
69     RESULT
70         provideSubscriberLocation-Res ProvideSubscriberLocation-Res
71     ERRORS {
72         SystemFailure,
73         DataMissing,
74         UnexpectedDataValue,
75         FacilityNotSupported,
76         UnidentifiedSubscriber,
77         IllegalSubscriber,
78         IllegalEquipment,
79         AbsentSubscriber,
80         UnauthorizedRequestingNetwork,
81         UnauthorizedLCSCClient,
82         PositionMethodFailure }
83
84 SubscriberLocationReport ::= OPERATION --Timer m
85     ARGUMENT
86         subscriberLocationReport-Arg SubscriberLocationReport-Arg
87     RESULT
88         subscriberLocationReport-Res SubscriberLocationReport-Res
89     ERRORS {
90         SystemFailure,
91         DataMissing,
92         ResourceLimitation,
93         UnexpectedDataValue,
94         UnknownSubscriber,
95         UnauthorizedRequestingNetwork,
96         UnknownOrUnreachableLCSCClient}
97
98
99 END
1

```

2 17.6.9 Secure transport operations

```

MAP-SecureTransportOperations {
    ccitt identified-organization (4) etsi (0) mobileDomain (0)
    gsm-Network (1) modules (3) map-SecureTransportOperations (26)
    version8 (8)}

```

DEFINITIONS

::=

BEGIN

EXPORTS

```

    SecureTransportClass1,
    SecureTransportClass2,
    SecureTransportClass3,
    SecureTransportClass4

```

;

```

IMPORTS
  OPERATION
FROM TCAPMessages {
  ccitt recommendation q 773 modules (2) messages (1) version2 (2)}

  DataMissing,
  SecureTransportError,
  UnexpectedDataValue

FROM MAP-Errors {
  ccitt identified-organization (4) etsi (0) mobileDomain (0)
  gsm-Network (1) modules (3) map-Errors (10) version8 (8)}

  SecureTransportArg,
  SecureTransportRes

FROM MAP-ST-DataTypes {
  ccitt identified-organization (4) etsi (0) mobileDomain (0)
  gsm-Network (1) modules (3) map-ST-DataTypes (27) version8 (8)}
;

```

<pre> SecureTransportClass1 ::= OPERATION --Timer shall be the same as for the --securely transported operation ARGUMENT secureTransportArg SecureTransportArg RESULT secureTransportRes SecureTransportRes ERRORS { SecureTransportError, DataMissing, UnexpectedDataValue} </pre>

<pre> SecureTransportClass2 ::= OPERATION --Timer shall be the same as for the --securely transported operation ARGUMENT secureTransportArg SecureTransportArg ERRORS { SecureTransportError, DataMissing, UnexpectedDataValue} </pre>

<pre> SecureTransportClass3 ::= OPERATION --Timer shall be the same as for the --securely transported operation ARGUMENT secureTransportArg SecureTransportArg RESULT secureTransportRes SecureTransportRes </pre>
--

<pre> SecureTransportClass4 ::= OPERATION --Timer shall be the same as for the --securely transported operation ARGUMENT secureTransportArg SecureTransportArg </pre>
--

END

17.7 MAP constants and data types

17.7.1 Mobile Service data types

```

MAP-MS-DataTypes {
  ccitt identified-organization (4) etsi (0) mobileDomain (0)
  gsm-Network (1) modules (3) map-MS-DataTypes (11) version8 (8)}

```

DEFINITIONS

IMPLICIT TAGS

::=

BEGIN

EXPORTS

```
-- location registration types
UpdateLocationArg,
UpdateLocationRes,
CancelLocationArg,
CancelLocationRes,
PurgeMS-Arg,
PurgeMS-Res,
SendIdentificationArg,
SendIdentificationRes,
UpdateGprsLocationArg,
UpdateGprsLocationRes,
IST-SupportIndicator,
SupportedLCS-CapabilitySets,

-- gprs location registration types
GSN-Address,

-- handover types
ForwardAccessSignalling-Arg,
PrepareHO-Arg,
PrepareHO-Res,
PrepareSubsequentHO-Arg,
PrepareSubsequentHO-Res,
ProcessAccessSignalling-Arg,
SendEndSignal-Arg,
SendEndSignal-Res,

-- authentication management types
SendAuthenticationInfoArg,
SendAuthenticationInfoRes,
AuthenticationFailureReportArg,
AuthenticationFailureReportRes,

-- security management types
EquipmentStatus,
Kc,

-- subscriber management types
InsertSubscriberDataArg,
InsertSubscriberDataRes,
LSAIdentity,
DeleteSubscriberDataArg,
DeleteSubscriberDataRes,
Ext-QoS-Subscribed,
SubscriberData,
ODB-Data,
SubscriberStatus,
ZoneCodeList,
maxNumOfZoneCodes,
O-CSI,
D-CSI,
O-BcsmCamelTDPCriteriaList,
T-BCSM-CAMEL-TDP-CriteriaList,
SS-CSI,
ServiceKey,
DefaultCallHandling,
CamelCapabilityHandling,
BasicServiceCriteria,
SupportedCamelPhases,
SupportedCamel4Subsets,
maxNumOfCamelTDPData,
CUG-Index,
CUG-Info,
CUG-Interlock,
InterCUG-Restrictions,
IntraCUG-Options,
NotificationToMSUser,
QoS-Subscribed,
IST-AlertTimerValue,
T-CSI,
T-BcsmTriggerDetectionPoint,
APN,

-- fault recovery types
ResetArg,
RestoreDataArg,
RestoreDataRes,
```

```
-- provide subscriber info types
GeographicalInformation,
MS-Classmark2,
GPRSMSCClass,

-- subscriber information enquiry types
ProvideSubscriberInfoArg,
ProvideSubscriberInfoRes,
SubscriberInfo,
LocationInformation,
LocationInformationGPRS,
RAIdentity,
SubscriberState,
GPRSChargingID,

-- any time information enquiry types
AnyTimeInterrogationArg,
AnyTimeInterrogationRes,

-- any time information handling types
AnyTimeSubscriptionInterrogationArg,
AnyTimeSubscriptionInterrogationRes,
AnyTimeModificationArg,
AnyTimeModificationRes,

-- subscriber data modification notification types
NoteSubscriberDataModifiedArg,
NoteSubscriberDataModifiedRes,

-- gprs location information retrieval types
SendRoutingInfoForGprsArg,
SendRoutingInfoForGprsRes,

-- failure reporting types
FailureReportArg,
FailureReportRes,

-- gprs notification types
NoteMsPresentForGprsArg,
NoteMsPresentForGprsRes,

-- Mobility Management types
NoteMM-EventArg,
NoteMM-EventRes

;

IMPORTS
maxNumOfSS,
SS-SubscriptionOption,
SS-List,
SS-ForBS-Code,
Password
FROM MAP-SS-DataTypes {
ccitt identified-organization (4) etsi (0) mobileDomain (0)
gsm-Network (1) modules (3) map-SS-DataTypes (14) version8 (8)}

SS-Code
FROM MAP-SS-Code {
ccitt identified-organization (4) etsi (0) mobileDomain (0)
gsm-Network (1) modules (3) map-SS-Code (15) version8 (8)}

Ext-BearerServiceCode
FROM MAP-BS-Code {
ccitt identified-organization (4) etsi (0) mobileDomain (0)
gsm-Network (1) modules (3) map-BS-Code (20) version8 (8)}

Ext-TeleserviceCode
FROM MAP-TS-Code {
ccitt identified-organization (4) etsi (0) mobileDomain (0)
gsm-Network (1) modules (3) map-TS-Code (19) version8 (8)}

AddressString,
ISDN-AddressString,
ISDN-SubaddressString,
FTN-AddressString,
```

```

AccessNetworkSignalInfo,
IMSI,
IMEI,
TMSI,
HLR-List,
LMSI,
Identity,
GlobalCellId,
CellGlobalIdOrServiceAreaIdOrLAI,
Ext-BasicServiceCode,
NAEA-PreferredCI,
EMLPP-Info,
MC-SS-Info,
SubscriberIdentity,
AgeOfLocationInformation,
LCSCClientExternalID,
LCSCClientInternalID,
Ext-SS-Status,
LCSServiceTypeID

```

```

FROM MAP-CommonDataTypes {
  ccitt identified-organization (4) etsi (0) mobileDomain (0)
  gsm-Network (1) modules (3) map-CommonDataTypes (18) version8 (8)}

```

ExtensionContainer

```

FROM MAP-ExtensionDataTypes {
  ccitt identified-organization (4) etsi (0) mobileDomain (0)
  gsm-Network (1) modules (3) map-ExtensionDataTypes (21) version8 (8)}

```

AbsentSubscriberDiagnosticSM

```

FROM MAP-ER-DataTypes {
  ccitt identified-organization (4) etsi (0) mobileDomain (0)
  gsm-Network (1) modules (3) map-ER-DataTypes (17) version8 (8)}

```

;

-- location registration types

UpdateLocationArg ::= SEQUENCE {		
imsi	IMSI,	
msc-Number	[1] ISDN-AddressString,	
vlr-Number	ISDN-AddressString,	
lmsi	[10] LMSI OPTIONAL,	
extensionContainer	ExtensionContainer	OPTIONAL,
...		
vlr-Capability	[6] VLR-Capability	OPTIONAL,
informPreviousNetworkEntity	[11] NULL	OPTIONAL,
cs-LCS-NotSupportedByUE	[12] NULL	OPTIONAL }

VLR-Capability ::= SEQUENCE{		
supportedCamelPhases	[0] SupportedCamelPhases	OPTIONAL,
extensionContainer	ExtensionContainer	OPTIONAL,
...		
solsaSupportIndicator	[2] NULL	OPTIONAL,
istSupportIndicator	[1] IST-SupportIndicator	OPTIONAL,
superChargerSupportedInServingNetworkEntity	[3] SuperChargerInfo	OPTIONAL,
longFTN-Supported	[4] NULL	OPTIONAL,
supportedLCS-CapabilitySets	[5] SupportedLCS-CapabilitySets	OPTIONAL,
supportedCamel4Subsets	[6] SupportedCamel4Subsets	OPTIONAL }

SuperChargerInfo ::= CHOICE {		
sendSubscriberData	[0] NULL,	
subscriberDataStored	[1] AgeIndicator }	

AgeIndicator ::= OCTET STRING (SIZE (1..6))		
-- The internal structure of this parameter is implementation specific.		

```

IST-SupportIndicator ::= ENUMERATED {
    basicISTSupported          (0),
    istCommandSupported        (1),
    ...}
-- exception handling:
-- reception of values > 1 shall be mapped to ' istCommandSupported '

```

```

SupportedLCS-CapabilitySets ::= BIT STRING {
    lcsCapabilitySet1 (0),
    lcsCapabilitySet2 (1),
    lcsCapabilitySet3 (2) } (SIZE (2..16))
-- Core network signalling capability set1 indicates LCS Release98 or Release99 version.
-- Core network signalling capability set2 indicates LCS Release4.
-- Core network signalling capability set3 indicates LCS Release5 or later version.
-- A node shall mark in the BIT STRING all LCS capability sets it supports.
-- If no bit is set then the sending node does not support LCS.
-- If the parameter is not sent by an VLR then the VLR may support at most capability set1.
-- If the parameter is not sent by an SGSN then no support for LCS is assumed.
-- An SGSN is not allowed to indicate support of capability set1.
-- Other bits than listed above shall be discarded.

```

```

UpdateLocationRes ::= SEQUENCE {
    hlr-Number          ISDN-AddressString,
    extensionContainer  ExtensionContainer          OPTIONAL,
    ... }

```

```

CancelLocationArg ::= [3] SEQUENCE {
    identity              Identity,
    cancellationType      CancellationType          OPTIONAL,
    extensionContainer    ExtensionContainer          OPTIONAL,
    ...}

```

```

CancellationType ::= ENUMERATED {
    updateProcedure      (0),
    subscriptionWithdraw (1),
    ...}
-- The HLR shall not send values other than listed above

```

```

CancelLocationRes ::= SEQUENCE {
    extensionContainer  ExtensionContainer          OPTIONAL,
    ...}

```

```

PurgeMS-Arg ::= [3] SEQUENCE {
    imsi                IMSI,
    vlr-Number          [0] ISDN-AddressString    OPTIONAL,
    sgsn-Number         [1] ISDN-AddressString    OPTIONAL,
    extensionContainer  ExtensionContainer          OPTIONAL,
    ...}

```

```

PurgeMS-Res ::= SEQUENCE {
    freezeTMSI          [0] NULL                  OPTIONAL,
    freezeP-TMSI        [1] NULL                  OPTIONAL,
    extensionContainer  ExtensionContainer          OPTIONAL,
    ...}

```

```

SendIdentificationArg ::= SEQUENCE {
    tmsi                TMSI,
    numberOfRequestedVectors  NumberOfRequestedVectors    OPTIONAL,
    -- if segmentation is used, numberOfRequestedVectors shall be present in
    -- the first segment and shall not be present in subsequent segments. If received
    -- in a subsequent segment it shall be discarded.
    segmentationProhibited  NULL                      OPTIONAL,
    -- if segmentation is prohibited the previous VLR shall not send the result
    -- within a TC-CONTINUE message.
    extensionContainer  ExtensionContainer          OPTIONAL,
    ...}

```

```

SendIdentificationRes ::= [3] SEQUENCE {
    imsi                IMSI                OPTIONAL,
    -- IMSI must be present if SendIdentificationRes is not segmented.
    -- If the TC-Continue segmentation option is taken the IMSI must be
    -- present in one segmented transmission of SendIdentificationRes.
    authenticationSetList AuthenticationSetList OPTIONAL,
    currentSecurityContext [2]CurrentSecurityContext OPTIONAL,
    extensionContainer    [3] ExtensionContainer OPTIONAL,
    ...}

```

-- authentication management types

```

AuthenticationSetList ::= CHOICE {
    tripletList          [0] TripletList,
    quintupletList      [1] QuintupletList }

```

```

TripletList ::= SEQUENCE SIZE (1..5) OF
    AuthenticationTriplet

```

```

QuintupletList ::= SEQUENCE SIZE (1..5) OF
    AuthenticationQuintuplet

```

```

AuthenticationTriplet ::= SEQUENCE {
    rand                RAND,
    sres                SRES,
    kc                  Kc,
    ...}

```

```

AuthenticationQuintuplet ::= SEQUENCE {
    rand                RAND,
    xres                XRES,
    ck                  CK,
    ik                  IK,
    autn                AUTN,
    ...}

```

```

CurrentSecurityContext ::= CHOICE {
    gsm-SecurityContextData [0] GSM-SecurityContextData,
    umts-SecurityContextData [1] UMTS-SecurityContextData }

```

```

GSM-SecurityContextData ::= SEQUENCE {
    kc                  Kc,
    cksn                Cksn,
    ... }

```

```

UMTS-SecurityContextData ::= SEQUENCE {
    ck                  CK,
    ik                  IK,
    ksi                 KSI,
    ... }

```

```

RAND ::= OCTET STRING (SIZE (16))

```

```

SRES ::= OCTET STRING (SIZE (4))

```

```

Kc ::= OCTET STRING (SIZE (8))

```

```

XRES ::= OCTET STRING (SIZE (4..16))

```

```

CK ::= OCTET STRING (SIZE (16))

```

```

IK ::= OCTET STRING (SIZE (16))

```

```

AUTN ::= OCTET STRING (SIZE (16))

```

```

AUTS ::= OCTET STRING (SIZE (14))

```

```

Cksn ::= OCTET STRING (SIZE (1))
    -- The internal structure is defined in 3G TS 24.008

```

```

KSI ::= OCTET STRING (SIZE (1))
    -- The internal structure is defined in 3G TS 24.008

```

```

AuthenticationFailureReportArg ::= SEQUENCE {
    imsi                IMSI,
    failureCause        FailureCause,
    extensionContainer  ExtensionContainer          OPTIONAL,
    ... ,
    re-attempt          BOOLEAN                   OPTIONAL,
    accessType          AccessType                OPTIONAL,
    rand                RAND                      OPTIONAL,
    vlr-Number          [0] ISDN-AddressString    OPTIONAL,
    sgsn-Number         [1] ISDN-AddressString    OPTIONAL }

```

```

AccessType ::= ENUMERATED {
    call (0),
    emergencyCall (1),
    locationUpdating (2),
    supplementaryService (3),
    shortMessage (4),
    gprsAttach (5),
    routingAreaUpdating (6),
    serviceRequest (7),
    pdpContextActivation (8),
    pdpContextDeactivation (9),
    ...}
-- exception handling:
-- received values greater than 9 shall be ignored.

```

```

AuthenticationFailureReportRes ::= SEQUENCE {
    extensionContainer  ExtensionContainer          OPTIONAL,
    ...}

```

```

FailureCause ::= ENUMERATED {
    wrongUserResponse (0),
    wrongNetworkSignature (1)}

```

-- gprs location registration types

```

UpdateGprsLocationArg ::= SEQUENCE {
    imsi                IMSI,
    sgsn-Number         ISDN-AddressString,
    sgsn-Address        GSN-Address,
    extensionContainer  ExtensionContainer          OPTIONAL,
    ... ,
    sgsn-Capability     [0] SGSN-Capability        OPTIONAL,
    informPreviousNetworkEntity [1] NULL           OPTIONAL,
    ps-LCS-NotSupportedByUE [2] NULL             OPTIONAL }

```

```

SGSN-Capability ::= SEQUENCE{
    solsaSupportIndicator  NULL                   OPTIONAL,
    extensionContainer     [1] ExtensionContainer  OPTIONAL,
    ... ,
    superChargerSupportedInServingNetworkEntity [2] SuperChargerInfo  OPTIONAL ,
    gprsEnhancementsSupportIndicator [3] NULL      OPTIONAL,
    supportedCamelPhases   [4] SupportedCamelPhases  OPTIONAL,
    supportedLCS-CapabilitySets [5] SupportedLCS-CapabilitySets  OPTIONAL,
    supportedCamel4Subsets [6] SupportedCamel4Subsets  OPTIONAL }

```

```

GSN-Address ::= OCTET STRING (SIZE (5..17))
-- Octets are coded according to TS 3GPP TS 23.003 [17]

```

```

UpdateGprsLocationRes ::= SEQUENCE {
    hlr-Number          ISDN-AddressString,
    extensionContainer  ExtensionContainer          OPTIONAL,
    ...}

```

-- handover types

```

ForwardAccessSignalling-Arg ::= [3] SEQUENCE {
    an-APDU              AccessNetworkSignalInfo,
    integrityProtectionInfo [0] IntegrityProtectionInformation  OPTIONAL,
    encryptionInfo       [1] EncryptionInformation              OPTIONAL,
    keyStatus             [2] KeyStatus                          OPTIONAL,
    allowedGSM-Algorithms [4] AllowedGSM-Algorithms              OPTIONAL,

```

allowedUMTS-Algorithms	[5]	AllowedUMTS-Algorithms	OPTIONAL,
radioResourceInformation	[6]	RadioResourceInformation	OPTIONAL,
extensionContainer	[3]	ExtensionContainer	OPTIONAL,
...			
radioResourceList	[7]	RadioResourceList	OPTIONAL,
bssmap-ServiceHandover	[9]	BSSMAP-ServiceHandover	OPTIONAL,
ranap-ServiceHandover	[8]	RANAP-ServiceHandover	OPTIONAL }

```

AllowedGSM-Algorithms ::= OCTET STRING (SIZE (1))
-- internal structure is coded as Algorithm identifier octet from
-- Permitted Algorithms defined in 3G TS 48.008
-- A node shall mark all GSM algorithms that are allowed in MSC-B

```

```

AllowedUMTS-Algorithms ::= SEQUENCE {
  integrityProtectionAlgorithms [0] PermittedIntegrityProtectionAlgorithms
  OPTIONAL,
  encryptionAlgorithms [1] PermittedEncryptionAlgorithms OPTIONAL,
  extensionContainer [2] ExtensionContainer OPTIONAL,
  ...}

```

```

PermittedIntegrityProtectionAlgorithms ::=
  OCTET STRING (SIZE (1..maxPermittedIntegrityProtectionAlgorithmsLength))
-- Octets contain a complete PermittedIntegrityProtectionAlgorithms data type
-- as defined in 3G TS 25.413, encoded according to the encoding scheme
-- mandated by 3G TS 25.413.
-- Padding bits are included, if needed, in the least significant bits of the
-- last octet of the octet string.

```

```

maxPermittedIntegrityProtectionAlgorithmsLength INTEGER ::= 9

```

```

PermittedEncryptionAlgorithms ::=
  OCTET STRING (SIZE (1..maxPermittedEncryptionAlgorithmsLength))
-- Octets contain a complete PermittedEncryptionAlgorithms data type
-- as defined in 3G TS 25.413, encoded according to the encoding scheme
-- mandated by 3G TS 25.413
-- Padding bits are included, if needed, in the least significant bits of the
-- last octet of the octet string.

```

```

maxPermittedEncryptionAlgorithmsLength INTEGER ::= 9

```

```

KeyStatus ::= ENUMERATED {
  old (0),
  new (1),
  ...}
-- exception handling:
-- received values in range 2-31 shall be treated as "old"
-- received values greater than 31 shall be treated as "new"

```

```

PrepareHO-Arg ::= [3] SEQUENCE {
  targetCellId [0] GlobalCellId OPTIONAL,
  ho-NumberNotRequired NULL OPTIONAL,
  targetRNCId [1] RNCId OPTIONAL,
  an-APDU [2] AccessNetworkSignalInfo OPTIONAL,
  multipleBearerRequested [3] NULL OPTIONAL,
  imsi [4] IMSI OPTIONAL,
  integrityProtectionInfo [5] IntegrityProtectionInformation OPTIONAL,
  encryptionInfo [6] EncryptionInformation OPTIONAL,
  radioResourceInformation [7] RadioResourceInformation OPTIONAL,
  allowedGSM-Algorithms [9] AllowedGSM-Algorithms OPTIONAL,
  allowedUMTS-Algorithms [10] AllowedUMTS-Algorithms OPTIONAL,
  radioResourceList [11] RadioResourceList OPTIONAL,
  extensionContainer [8] ExtensionContainer OPTIONAL,
  ... ,
  rab-Id [12] RAB-Id OPTIONAL,
  bssmap-ServiceHandover [13] BSSMAP-ServiceHandover OPTIONAL,
  ranap-ServiceHandover [14] RANAP-ServiceHandover OPTIONAL
}

```

```

BSSMAP-ServiceHandover ::= OCTET STRING (SIZE (1))
-- Octets are coded according the Service Handover information element in
-- 3G TS 48.008.

```

```

RANAP-ServiceHandover ::= OCTET STRING (SIZE (1))
  -- Octet contains a complete Service-Handover data type
  -- as defined in 3G TS 25.413, encoded according to the encoding scheme
  -- mandated by 3G TS 25.413
  -- Padding bits are included in the least significant bits.

```

```

RadioResourceList ::= SEQUENCE SIZE (2.. maxNumOfRadioResources) OF
  RadioResource

```

```

RadioResource ::= SEQUENCE {
  radioResourceInformation      RadioResourceInformation,
  rab-Id                        RAB-Id,
  -- RAB Identity is needed to relate the radio resources with the radio access bearers.
  ...}

```

```

maxNumOfRadioResources INTEGER ::= 7

```

```

PrepareHO-Res ::= [3] SEQUENCE {
  handoverNumber                [0] ISDN-AddressString      OPTIONAL,
  relocationNumberList           [1] RelocationNumberList    OPTIONAL,
  an-APDU                        [2] AccessNetworkSignalInfo OPTIONAL,
  multicallBearerInfo           [3] MulticallBearerInfo      OPTIONAL,
  multipleBearerNotSupported     NULL                      OPTIONAL,
  selectedUMTS-Algorithms        [5] SelectedUMTS-Algorithms OPTIONAL,
  chosenRadioResourceInformation [6] ChosenRadioResourceInformation OPTIONAL,
  extensionContainer             [4] ExtensionContainer       OPTIONAL,
  ...}

```

```

SelectedUMTS-Algorithms ::= SEQUENCE {
  integrityProtectionAlgorithm  [0] ChosenIntegrityProtectionAlgorithm OPTIONAL,
  encryptionAlgorithm           [1] ChosenEncryptionAlgorithm OPTIONAL,
  extensionContainer            [2] ExtensionContainer       OPTIONAL,
  ...}

```

```

ChosenIntegrityProtectionAlgorithm ::= OCTET STRING (SIZE (1))
  -- Octet contains a complete IntegrityProtectionAlgorithm data type
  -- as defined in 3G TS 25.413, encoded according to the encoding scheme
  -- mandated by 3G TS 25.413
  -- Padding bits are included in the least significant bits.

```

```

ChosenEncryptionAlgorithm ::= OCTET STRING (SIZE (1))
  -- Octet contains a complete EncryptionAlgorithm data type
  -- as defined in 3G TS 25.413, encoded according to the encoding scheme
  -- mandated by 3G TS 25.413
  -- Padding bits are included in the least significant bits.

```

```

ChosenRadioResourceInformation ::= SEQUENCE {
  chosenChannelInfo              [0] ChosenChannelInfo      OPTIONAL,
  chosenSpeechVersion            [1] ChosenSpeechVersion     OPTIONAL,
  ...}

```

```

ChosenChannelInfo ::= OCTET STRING (SIZE (1))
  -- Octets are coded according the Chosen Channel information element in 3G TS 48.008

```

```

ChosenSpeechVersion ::= OCTET STRING (SIZE (1))
  -- Octets are coded according the Speech Version (chosen) information element in 3G TS
  -- 48.008

```

```

PrepareSubsequentHO-Arg ::= [3] SEQUENCE {
  targetCellId                  [0] GlobalCellId            OPTIONAL,
  targetMSC-Number              [1] ISDN-AddressString,
  targetRNCId                   [2] RNCId                   OPTIONAL,
  an-APDU                       [3] AccessNetworkSignalInfo OPTIONAL,
  selectedRab-Id                [4] RAB-Id                  OPTIONAL,
  extensionContainer             [5] ExtensionContainer       OPTIONAL,
  ...}

```

```

PrepareSubsequentHO-Res ::= [3] SEQUENCE {
  an-APDU                               AccessNetworkSignalInfo,
  extensionContainer                     [0] ExtensionContainer      OPTIONAL,
  ...}

```

```

ProcessAccessSignalling-Arg ::= [3] SEQUENCE {
  an-APDU                               AccessNetworkSignalInfo,
  selectedUMTS-Algorithms                [1] SelectedUMTS-Algorithms    OPTIONAL,
  selectedGSM-Algorithm                  [2] SelectedGSM-Algorithm      OPTIONAL,
  chosenRadioResourceInformation          [3] ChosenRadioResourceInformation OPTIONAL,
  selectedRab-Id                         [4] RAB-Id                    OPTIONAL,
  extensionContainer                     [0] ExtensionContainer      OPTIONAL,
  ...}

```

```

SelectedGSM-Algorithm ::= OCTET STRING (SIZE (1))
  -- internal structure is coded as Algorithm identifier octet from Chosen Encryption
  -- Algorithm defined in 3G TS 48.008
  -- A node shall mark only the selected GSM algorithm

```

```

SendEndSignal-Arg ::= [3] SEQUENCE {
  an-APDU                               AccessNetworkSignalInfo,
  extensionContainer                     [0] ExtensionContainer      OPTIONAL,
  ...}

```

```

SendEndSignal-Res ::= SEQUENCE {
  extensionContainer                     [0] ExtensionContainer      OPTIONAL,
  ...}

```

```

RNCId ::= OCTET STRING (SIZE (7))
  -- The internal structure is defined as follows:
  -- octet 1 bits 4321      Mobile Country Code 1st digit
  -- bits 8765             Mobile Country Code 2nd digit
  -- octet 2 bits 4321      Mobile Country Code 3rd digit
  -- bits 8765             Mobile Network Code 3rd digit
  --                       or filler (1111) for 2 digit MNCs
  -- octet 3 bits 4321      Mobile Network Code 1st digit
  -- bits 8765             Mobile Network Code 2nd digit
  -- octets 4 and 5        Location Area Code according to 3G TS 24.008
  -- octets 6 and 7        RNC Id value according to 3G TS 25.413

```

```

RelocationNumberList ::= SEQUENCE SIZE (1..maxNumOfRelocationNumber) OF
  RelocationNumber

```

```

MulticallBearerInfo ::= INTEGER (1..maxNumOfRelocationNumber)

```

```

RelocationNumber ::= SEQUENCE {
  handoverNumber                       ISDN-AddressString,
  rab-Id                                RAB-Id,
  -- RAB Identity is needed to relate the calls with the radio access bearers.
  ...}

```

```

RAB-Id ::= INTEGER (1..maxNrOfRABs)

```

```

maxNrOfRABs INTEGER ::= 255

```

```

maxNumOfRelocationNumber INTEGER ::= 7

```

```

RadioResourceInformation ::= OCTET STRING (SIZE (3..13))
  -- Octets are coded according the Channel Type information element in 3G TS 48.008

```

```

IntegrityProtectionInformation ::= OCTET STRING (SIZE (18..maxNumOfIntegrityInfo))
  -- Octets contain a complete IntegrityProtectionInformation data type
  -- as defined in 3G TS 25.413, encoded according to the encoding scheme
  -- mandated by 3G TS 25.413
  -- Padding bits are included, if needed, in the least significant bits of the
  -- last octet of the octet string.

```

```

maxNumOfIntegrityInfo INTEGER ::= 100

```

```

EncryptionInformation ::= OCTET STRING (SIZE (18..maxNumOfEncryptionInfo))
-- Octets contain a complete EncryptionInformation data type
-- as defined in 3G TS 25.413, encoded according to the encoding scheme
-- mandated by 3G TS 25.413
-- Padding bits are included, if needed, in the least significant bits of the
-- last octet of the octet string.

```

```

maxNumOfEncryptionInfo INTEGER ::= 100

```

-- authentication management types

```

SendAuthenticationInfoArg ::= SEQUENCE {
    imsi [0] IMSI,
    numberOfRequestedVectors      NumberOfRequestedVectors,
    segmentationProhibited        NULL OPTIONAL,
-- if segmentation is prohibited the HLR shall not send the result within
-- a TC-CONTINUE message.
    immediateResponsePreferred    [1] NULL OPTIONAL,
-- if present, the HLR may send an immediate response with the available authentication
-- vectors (see § 8.5.2 for more information).
    re-synchronisationInfo        Re-synchronisationInfo OPTIONAL,
    extensionContainer            [2] ExtensionContainer OPTIONAL,
    ...,
    requestingNodeType            [3] RequestingNodeType OPTIONAL}

```

```

NumberOfRequestedVectors ::= INTEGER (1..5)

```

```

Re-synchronisationInfo ::= SEQUENCE {
    rand          RAND,
    auts          AUTS,
    ...}

```

```

SendAuthenticationInfoRes ::= [3] SEQUENCE {
    authenticationSetList      AuthenticationSetList      OPTIONAL,
    extensionContainer          ExtensionContainer        OPTIONAL,
    ...}

```

```

RequestingNodeType ::= ENUMERATED {
    vlr (0),
    sgsn (1),
    ...}
-- exception handling:
-- received values in the range 2-15 shall be treated as "vlr"
-- received values greater than 15 shall be treated as "sgsn"

```

-- security management types

```

EquipmentStatus ::= ENUMERATED {
    whiteListed (0),
    blackListed (1),
    greyListed (2)}

```

-- subscriber management types

```

InsertSubscriberDataArg ::= SEQUENCE {
    imsi                               [0] IMSI                               OPTIONAL,
    COMPONENTS OF                      SubscriberData,
    extensionContainer                  [14] ExtensionContainer           OPTIONAL,
    ... ,
    naea-PreferredCI                   [15] NAEA-PreferredCI           OPTIONAL,
    -- naea-PreferredCI is included at the discretion of the HLR operator.
    gprsSubscriptionData                [16] GPRSSubscriptionData       OPTIONAL,
    roamingRestrictedInSgsnDueToUnsupportedFeature [23]                NULL
                                                                OPTIONAL,
    networkAccessMode                  [24] NetworkAccessMode         OPTIONAL,
    lsaInformation                      [25] LSAInformation           OPTIONAL,
    lmu-Indicator                       [21] NULL                       OPTIONAL,
    lcsInformation                      [22] LCSInformation           OPTIONAL,
    istAlertTimer                      [26] IST-AlertTimerValue       OPTIONAL,
    superChargerSupportedInHLR         [27] AgeIndicator             OPTIONAL,
    mc-SS-Info                          [28] MC-SS-Info             OPTIONAL,
    cs-AllocationRetentionPriority      [29] CS-AllocationRetentionPriority OPTIONAL,
    sgsn-CAMEL-SubscriptionInfo        [17] SGSN-CAMEL-SubscriptionInfo OPTIONAL,
    chargingCharacteristics             [18] ChargingCharacteristics   OPTIONAL
}
-- If the Network Access Mode parameter is sent, it shall be present only in
-- the first sequence if segmentation is used

```

```

CS-AllocationRetentionPriority ::= OCTET STRING (SIZE (1))
-- This data type encodes each priority level defined in TS 23.107 as the binary value
-- of the priority level.

```

```

IST-AlertTimerValue ::= INTEGER (15..255)

```

```

LCSInformation ::= SEQUENCE {
    gmlc-List [0] GMLC-List OPTIONAL,
    lcs-PrivacyExceptionList [1] LCS-PrivacyExceptionList OPTIONAL,
    molr-List [2] MOLR-List OPTIONAL,
    ... ,
    add-lcs-PrivacyExceptionList [3] LCS-PrivacyExceptionList OPTIONAL }
-- add-lcs-PrivacyExceptionList may be sent only if lcs-PrivacyExceptionList is
-- present and contains four instances of LCS-PrivacyClass. If the mentioned condition
-- is not satisfied the receiving node shall discard add-lcs-PrivacyExceptionList.
-- If an LCS-PrivacyClass is received both in lcs-PrivacyExceptionList and in
-- add-lcs-PrivacyExceptionList with the same SS-Code, then the error unexpected
-- data value shall be returned.

```

```

GMLC-List ::= SEQUENCE SIZE (1..maxNumOfGMLC) OF
                ISDN-AddressString
-- if segmentation is used, the complete GMLC-List shall be sent in one segment

```

```

maxNumOfGMLC INTEGER ::= 5

```

```

NetworkAccessMode ::= ENUMERATED {
    bothMSCAndSGSN (0),
    onlyMSC (1),
    onlySGSN (2),
    ... }
-- if unknown values are received in NetworkAccessMode
-- they shall be discarded.

```

```

GPRSDataList ::= SEQUENCE SIZE (1..maxNumOfPDP-Contexts) OF
                PDP-Context

```

```

maxNumOfPDP-Contexts INTEGER ::= 50

```

```

PDP-Context ::= SEQUENCE {
    pdp-ContextId ContextId,
    pdp-Type [16] PDP-Type,
    pdp-Address [17] PDP-Address OPTIONAL,
    qos-Subscribed [18] QoS-Subscribed,
    vplmnAddressAllowed [19] NULL OPTIONAL,
    apn [20] APN,
    extensionContainer [21] ExtensionContainer OPTIONAL,
    ... ,
    ext-QoS-Subscribed [0] Ext-QoS-Subscribed OPTIONAL,
    pdp-ChargingCharacteristics [1] ChargingCharacteristics OPTIONAL }
-- qos-Subscribed shall be discarded if ext-QoS-Subscribed is received and supported

```

```

ContextId ::= INTEGER (1..maxNumOfPDP-Contexts)

```



```

GPRSSubscriptionData ::= SEQUENCE {
  completeDataListIncluded          NULL          OPTIONAL,
  -- If segmentation is used, completeDataListIncluded may only be present in the
  -- first segment.
  gprsDataList                      [1] GPRSDataList,
  extensionContainer                 [2] ExtensionContainer OPTIONAL,
  ... }

```

```

SGSN-CAMEL-SubscriptionInfo ::= SEQUENCE {
  gprs-CSI                          [0] GPRS-CSI          OPTIONAL,
  mo-sms-CSI                        [1] SMS-CSI            OPTIONAL,
  extensionContainer                 [2] ExtensionContainer OPTIONAL,
  ...,
  mt-sms-CSI                        [3] SMS-CSI            OPTIONAL,
  mt-smsCAMELTDP-CriteriaList       [4] MT-smsCAMELTDP-CriteriaList OPTIONAL,
  mg-csi                            [5] MG-CSI            OPTIONAL
}

```

```

GPRS-CSI ::= SEQUENCE {
  gprs-CamelTDPDataList             [0] GPRS-CamelTDPDataList OPTIONAL,
  camelCapabilityHandling           [1] CamelCapabilityHandling OPTIONAL,
  extensionContainer                 [2] ExtensionContainer OPTIONAL,
  notificationToCSE                 [3] NULL              OPTIONAL,
  csi-Active                        [4] NULL              OPTIONAL,
  ...}
-- notificationToCSE and csi-Active shall not be present when GPRS-CSI is sent to SGSN.
-- They may only be included in ATSI/ATM ack/NSDC message.
-- GPRS-CamelTDPData and camelCapabilityHandling shall be present in
-- the GPRS-CSI sequence.
-- If GPRS-CSI is segmented, gprs-CamelTDPDataList and camelCapabilityHandling shall be
-- present in the first segment

```

```

GPRS-CamelTDPDataList ::= SEQUENCE SIZE (1..maxNumOfCamelTDPData) OF
  GPRS-CamelTDPData
-- GPRS-CamelTDPDataList shall not contain more than one instance of
-- GPRS-CamelTDPData containing the same value for gprs-TriggerDetectionPoint.

```

```

GPRS-CamelTDPData ::= SEQUENCE {
  gprs-TriggerDetectionPoint        [0] GPRS-TriggerDetectionPoint,
  serviceKey                        [1] ServiceKey,
  gsmSCF-Address                   [2] ISDN-AddressString,
  defaultSessionHandling            [3] DefaultGPRS-Handling,
  extensionContainer                 [4] ExtensionContainer OPTIONAL,
  ...
}

```

```

DefaultGPRS-Handling ::= ENUMERATED {
  continueTransaction (0) ,
  releaseTransaction (1) ,
  ...}
-- exception handling:
-- reception of values in range 2-31 shall be treated as "continueTransaction"
-- reception of values greater than 31 shall be treated as "releaseTransaction"

```

```

GPRS-TriggerDetectionPoint ::= ENUMERATED {
  attach                            (1),
  attachChangeOfPosition            (2),
  pdp-ContextEstablishment          (11),
  pdp-ContextEstablishmentAcknowledgement (12),
  pdp-ContextChangeOfPosition       (14),
  ... }
-- exception handling:
-- For GPRS-CamelTDPData sequences containing this parameter with any
-- other value than the ones listed the receiver shall ignore the whole
-- GPRS-CamelTDPData sequence.

```

```

APN ::= OCTET STRING (SIZE (2..63))
-- Octets are coded according to TS 3GPP TS 23.003 [17]

```

```

PDP-Type ::= OCTET STRING (SIZE (2))
-- Octets are coded according to TS 3GPP TS 29.060 [105]

```

```

PDP-Address ::= OCTET STRING (SIZE (1..16))
  -- Octets are coded according to TS 3GPP TS 29.060 [105]

  -- The possible size values are:
  -- 1-7 octets X.25 address type
  -- 4 octets IPv4 address type
  -- 16 octets Ipv6 address type

```

```

QoS-Subscribed ::= OCTET STRING (SIZE (3))
  -- Octets are coded according to TS 3GPP TS 24.008 [35].

```

```

Ext-QoS-Subscribed ::= OCTET STRING (SIZE (1..9))
  -- OCTET 1:
  -- Allocation/Retention Priority (This octet encodes each priority level defined in
  -- 23.107 as the binary value of the priority level, declaration in 29.060)
  -- Octets 2-9 are coded according to 3G TS 24.008 Quality of Service Octets
  -- 6-13.

```

```

ChargingCharacteristics ::= OCTET STRING (SIZE (2))
  -- Octets are coded according to 3G TS 32.015.

```

```

LSAOnlyAccessIndicator ::= ENUMERATED {
  accessOutsideLSAsAllowed (0),
  accessOutsideLSAsRestricted (1)}

```

```

LSADataList ::= SEQUENCE SIZE (1..maxNumOfLSAs) OF
  LSAData

```

```

maxNumOfLSAs INTEGER ::= 20

```

```

LSAData ::= SEQUENCE {
  lsaIdentity [0] LSAIdentity,
  lsaAttributes [1] LSAAttributes,
  lsaActiveModeIndicator [2] NULL OPTIONAL,
  extensionContainer [3] ExtensionContainer OPTIONAL,
  ...}

```

```

LSAInformation ::= SEQUENCE {
  completedDataListIncluded NULL OPTIONAL,
  -- If segmentation is used, completeDataListIncluded may only be present in the
  -- first segment.
  lsaOnlyAccessIndicator [1] LSAOnlyAccessIndicator OPTIONAL,
  lsaDataList [2] LSADataList OPTIONAL,
  extensionContainer [3] ExtensionContainer OPTIONAL,
  ...}

```

```

LSAIdentity ::= OCTET STRING (SIZE (3))
  -- Octets are coded according to TS 3GPP TS 23.003 [17]

```

```

LSAAttributes ::= OCTET STRING (SIZE (1))
  -- Octets are coded according to TS 3GPP TS 48.008 [49]

```

```

SubscriberData ::= SEQUENCE {
  msisdn [1] ISDN-AddressString OPTIONAL,
  category [2] Category OPTIONAL,
  subscriberStatus [3] SubscriberStatus OPTIONAL,
  bearerServiceList [4] BearerServiceList OPTIONAL,
  -- The exception handling for reception of unsupported / not allocated
  -- bearerServiceCodes is defined in section 8.8.1
  teleserviceList [6] TeleserviceList OPTIONAL,
  -- The exception handling for reception of unsupported / not allocated
  -- teleserviceCodes is defined in section 8.8.1
  provisionedSS [7] Ext-SS-InfoList OPTIONAL,
  odb-Data [8] ODB-Data OPTIONAL,
  roamingRestrictionDueToUnsupportedFeature [9] NULL OPTIONAL,
  regionalSubscriptionData [10] ZoneCodeList OPTIONAL,
  vbsSubscriptionData [11] VBSDDataList OPTIONAL,
  vgcsSubscriptionData [12] VGCSDataList OPTIONAL,
  vlrCamelSubscriptionInfo [13] VlrCamelSubscriptionInfo OPTIONAL
}

```

```
Category ::= OCTET STRING (SIZE (1))
-- The internal structure is defined in CCITT Rec Q.763.
```

```
SubscriberStatus ::= ENUMERATED {
    serviceGranted (0),
    operatorDeterminedBarring (1)}
```

```
BearerServiceList ::= SEQUENCE SIZE (1..maxNumOfBearerServices) OF
    Ext-BearerServiceCode
```

```
maxNumOfBearerServices INTEGER ::= 50
```

```
TeleserviceList ::= SEQUENCE SIZE (1..maxNumOfTeleservices) OF
    Ext-TeleserviceCode
```

```
maxNumOfTeleservices INTEGER ::= 20
```

```
ODB-Data ::= SEQUENCE {
    odb-GeneralData                ODB-GeneralData,
    odb-HPLMN-Data                 ODB-HPLMN-Data          OPTIONAL,
    extensionContainer              ExtensionContainer        OPTIONAL,
    ...}
```

```
ODB-GeneralData ::= BIT STRING {
    allOG-CallsBarred (0),
    internationalOGCallsBarred (1),
    internationalOGCallsNotToHPLMN-CountryBarred (2),
    interzonalOGCallsBarred (6),
    interzonalOGCallsNotToHPLMN-CountryBarred (7),
    interzonalOGCallsAndInternationalOGCallsNotToHPLMN-CountryBarred (8),
    premiumRateInformationOGCallsBarred (3),
    premiumRateEntertainmentOGCallsBarred (4),
    ss-AccessBarred (5),
    allECT-Barred (9),
    chargeableECT-Barred (10),
    internationalECT-Barred (11),
    interzonalECT-Barred (12),
    doublyChargeableECT-Barred (13),
    multipleECT-Barred (14),
    allPacketOrientedServicesBarred (15),
    roamerAccessToHPLMN-AP-Barred (16),
    roamerAccessToVPLMN-AP-Barred (17),
    roamingOutsidePLMNOG-CallsBarred (18),
    allIC-CallsBarred (19),
    roamingOutsidePLMNIC-CallsBarred (20),
    roamingOutsidePLMNICountryIC-CallsBarred (21),
    roamingOutsidePLMN-Barred (22),
    roamingOutsidePLMN-CountryBarred (23),
    registrationAllCF-Barred (24),
    registrationCFNotToHPLMN-Barred (25),
    registrationInterzonalCF-Barred (26),
    registrationInterzonalCFNotToHPLMN-Barred (27)} (SIZE (15..32))
-- exception handling: reception of unknown bit assignments in the
-- ODB-GeneralData type shall be treated like unsupported ODB-GeneralData
-- When the ODB-GeneralData type is removed from the HLR for a given subscriber,
-- in NoteSubscriberDataModified operation sent toward the gsmSCF
-- all bits shall be set to "0".
```

```
ODB-HPLMN-Data ::= BIT STRING {
    plmn-SpecificBarringType1 (0),
    plmn-SpecificBarringType2 (1),
    plmn-SpecificBarringType3 (2),
    plmn-SpecificBarringType4 (3)} (SIZE (4..32))
-- exception handling: reception of unknown bit assignments in the
-- ODB-HPLMN-Data type shall be treated like unsupported ODB-HPLMN-Data
-- When the ODB-HPLMN-Data type is removed from the HLR for a given subscriber,
-- in NoteSubscriberDataModified operation sent toward the gsmSCF
-- all bits shall be set to "0".
```

```
Ext-SS-InfoList ::= SEQUENCE SIZE (1..maxNumOfSS) OF
    Ext-SS-Info
```

```

Ext-SS-Info ::= CHOICE {
    forwardingInfo           [0] Ext-ForwInfo,
    callBarringInfo         [1] Ext-CallBarInfo,
    cug-Info                 [2] CUG-Info,
    ss-Data                  [3] Ext-SS-Data,
    emlpp-Info              [4] EMLPP-Info}

```

```

Ext-ForwInfo ::= SEQUENCE {
    ss-Code                  SS-Code,
    forwardingFeatureList    Ext-ForwFeatureList,
    extensionContainer       [0] ExtensionContainer OPTIONAL,
    ...}

```

```

Ext-ForwFeatureList ::= SEQUENCE SIZE (1..maxNumOfExt-BasicServiceGroups) OF
    Ext-ForwFeature

```

```

Ext-ForwFeature ::= SEQUENCE {
    basicService             Ext-BasicServiceCode OPTIONAL,
    ss-Status                [4] Ext-SS-Status,
    forwardedToNumber        [5] ISDN-AddressString OPTIONAL,
    -- When this data type is sent from an HLR which supports CAMEL Phase 2
    -- to a VLR that supports CAMEL Phase 2 the VLR shall not check the
    -- format of the number
    forwardedToSubaddress    [8] ISDN-SubaddressString OPTIONAL,
    forwardingOptions         [6] Ext-ForwOptions OPTIONAL,
    noReplyConditionTime     [7] Ext-NoRepCondTime OPTIONAL,
    extensionContainer        [9] ExtensionContainer OPTIONAL,
    ...,
    longForwardedToNumber    [10] FTN-AddressString OPTIONAL }

```

```

Ext-ForwOptions ::= OCTET STRING (SIZE (1..5))

    -- OCTET 1:

    -- bit 8: notification to forwarding party
    -- 0 no notification
    -- 1 notification

    -- bit 7: redirecting presentation
    -- 0 no presentation
    -- 1 presentation

    -- bit 6: notification to calling party
    -- 0 no notification
    -- 1 notification

    -- bit 5: 0 (unused)

    -- bits 4:3: forwarding reason
    -- 00 ms not reachable
    -- 01 ms busy
    -- 10 no reply
    -- 11 unconditional

    -- bits 2:1: 00 (unused)

    -- OCTETS 2-5: reserved for future use. They shall be discarded if
    -- received and not understood.

```

```

Ext-NoRepCondTime ::= INTEGER (1..100)
    -- Only values 5-30 are used.
    -- Values in the ranges 1-4 and 31-100 are reserved for future use
    -- If received:
    --     values 1-4 shall be mapped on to value 5
    --     values 31-100 shall be mapped on to value 30

```

```

Ext-CallBarInfo ::= SEQUENCE {
    ss-Code                  SS-Code,
    callBarringFeatureList   Ext-CallBarFeatureList,
    extensionContainer        ExtensionContainer OPTIONAL,
    ...}

```

```

Ext-CallBarFeatureList ::= SEQUENCE SIZE (1..maxNumOfExt-BasicServiceGroups) OF
    Ext-CallBarringFeature

```

```

Ext-CallBarringFeature ::= SEQUENCE {
    basicService                Ext-BasicServiceCode                OPTIONAL,
    ss-Status                    [4] Ext-SS-Status,
    extensionContainer           ExtensionContainer                 OPTIONAL,
    ...}

```

```

CUG-Info ::= SEQUENCE {
    cug-SubscriptionList        CUG-SubscriptionList,
    cug-FeatureList             CUG-FeatureList                OPTIONAL,
    extensionContainer           [0] ExtensionContainer             OPTIONAL,
    ...}

```

```

CUG-SubscriptionList ::= SEQUENCE SIZE (0..maxNumOfCUG) OF
    CUG-Subscription

```

```

CUG-Subscription ::= SEQUENCE {
    cug-Index CUG-Index,
    cug-Interlock                CUG-Interlock,
    intraCUG-Options             IntraCUG-Options,
    basicServiceGroupList        Ext-BasicServiceGroupList    OPTIONAL,
    extensionContainer           [0] ExtensionContainer             OPTIONAL,
    ...}

```

```

CUG-Index ::= INTEGER (0..32767)
-- The internal structure is defined in ETS 300 138.

```

```

CUG-Interlock ::= OCTET STRING (SIZE (4))

```

```

IntraCUG-Options ::= ENUMERATED {
    noCUG-Restrictions (0),
    cugIC-CallBarred (1),
    cugOG-CallBarred (2)}

```

```

maxNumOfCUG INTEGER ::= 10

```

```

CUG-FeatureList ::= SEQUENCE SIZE (1..maxNumOfExt-BasicServiceGroups) OF
    CUG-Feature

```

```

Ext-BasicServiceGroupList ::= SEQUENCE SIZE (1..maxNumOfExt-BasicServiceGroups) OF
    Ext-BasicServiceCode

```

```

maxNumOfExt-BasicServiceGroups INTEGER ::= 32

```

```

CUG-Feature ::= SEQUENCE {
    basicService                Ext-BasicServiceCode                OPTIONAL,
    preferentialCUG-Indicator    CUG-Index OPTIONAL,
    interCUG-Restrictions        InterCUG-Restrictions,
    extensionContainer           ExtensionContainer                 OPTIONAL,
    ...}

```

```

InterCUG-Restrictions ::= OCTET STRING (SIZE (1))

-- bits 876543: 000000 (unused)
-- Exception handling:
-- bits 876543 shall be ignored if received and not understood

-- bits 21
-- 00 CUG only facilities
-- 01 CUG with outgoing access
-- 10 CUG with incoming access
-- 11 CUG with both outgoing and incoming access

```

```

Ext-SS-Data ::= SEQUENCE {
    ss-Code                    SS-Code,
    ss-Status [4] Ext-SS-Status,
    ss-SubscriptionOption      SS-SubscriptionOption        OPTIONAL,
    basicServiceGroupList      Ext-BasicServiceGroupList    OPTIONAL,
    extensionContainer           [5] ExtensionContainer             OPTIONAL,
    ...}

```

```

LCS-PrivacyExceptionList ::= SEQUENCE SIZE (1..maxNumOfPrivacyClass) OF
    LCS-PrivacyClass

```

```

maxNumOfPrivacyClass INTEGER ::= 4

```

```

LCS-PrivacyClass ::= SEQUENCE {
    ss-Code                SS-Code,
    ss-Status              Ext-SS-Status,
    notificationToMSUser  [0] NotificationToMSUser    OPTIONAL,
    -- notificationToMSUser may be sent only for SS-codes callSessionRelated
    -- and callSessionUnrelated. If not received for SS-codes callSessionRelated
    -- and callSessionUnrelated,
    -- the default values according to 3G TS 23.271 shall be assumed.
    externalClientList    [1] ExternalClientList      OPTIONAL,
    -- externalClientList may be sent only for SS-code callSessionUnrelated to a
    -- visited node that does not support LCS Release 4 or later versions.
    -- externalClientList may be sent only for SS-codes callSessionUnrelated and
    -- callSessionRelated to a visited node that supports LCS Release 4 or later versions.
    plmnClientList        [2] PLMNClientList          OPTIONAL,
    -- plmnClientList may be sent only for SS-code plmnoperator.
    extensionContainer     [3] ExtensionContainer      OPTIONAL,
    ...,
    ext-externalClientList [4] Ext-ExternalClientList  OPTIONAL,
    -- Ext-externalClientList may be sent only if the visited node supports LCS Release 4 or
    -- later versions, the user did specify more than 5 clients, and White Book SCCP is used.
    serviceTypeList       [5] ServiceTypeList        OPTIONAL
    -- serviceTypeList may be sent only for SS-code serviceType and if the visited node
    -- supports LCS Release 5 or later versions.
    --
    -- if segmentation is used, the complete LCS-PrivacyClass shall be sent in one segment
}

```

```

ExternalClientList ::= SEQUENCE SIZE (0..maxNumOfExternalClient) OF
    ExternalClient

```

```

maxNumOfExternalClient  INTEGER ::= 5

```

```

PLMNClientList ::= SEQUENCE SIZE (1..maxNumOfPLMNClient) OF
    LCSCClientInternalID

```

```

maxNumOfPLMNClient    INTEGER ::= 5

```

```

Ext-ExternalClientList ::= SEQUENCE SIZE (1..maxNumOfExt-ExternalClient) OF
    ExternalClient

```

```

maxNumOfExt-ExternalClient  INTEGER ::= 35

```

```

ExternalClient ::= SEQUENCE {
    clientIdentity          LCSCClientExternalID,
    gmlc-Restriction       [0] GMLC-Restriction      OPTIONAL,
    notificationToMSUser  [1] NotificationToMSUser    OPTIONAL,
    -- If notificationToMSUser is not received, the default value according to
    -- 3G TS 23.271 shall be assumed.
    extensionContainer     [2] ExtensionContainer      OPTIONAL,
    ... }

```

```

GMLC-Restriction ::= ENUMERATED {
    gmlc-List              (0),
    home-Country           (1),
    ... }
-- exception handling:
-- At reception of any other value than the ones listed the receiver shall ignore
-- GMLC-Restriction.

```

```

NotificationToMSUser ::= ENUMERATED {
    notifyLocationAllowed (0),
    notifyAndVerify-LocationAllowedIfNoResponse (1),
    notifyAndVerify-LocationNotAllowedIfNoResponse (2),
    ...,
    locationNotAllowed (3) }
-- exception handling:
-- At reception of any other value than the ones listed the receiver shall ignore
-- NotificationToMSUser.

```

```

ServiceTypeList ::= SEQUENCE SIZE (1..maxNumOfServiceType) OF
    ServiceType

```

```

maxNumOfServiceType    INTEGER ::= 32

```

```

ServiceType ::= SEQUENCE {
    serviceTypeIdentity          LCSServiceTypeID,
    gmlc-Restriction             [0] GMLC-Restriction           OPTIONAL,
    notificationToMSUser        [1] NotificationToMSUser       OPTIONAL,
    -- If notificationToMSUser is not received, the default value according to
    -- 3G TS 23.271 shall be assumed.
    extensionContainer           [2] ExtensionContainer          OPTIONAL,
    ... }

```

```

MOLR-List ::= SEQUENCE SIZE (1..maxNumOfMOLR-Class) OF
    MOLR-Class

```

```

maxNumOfMOLR-Class INTEGER ::= 3

```

```

MOLR-Class ::= SEQUENCE {
    ss-Code                     SS-Code,
    ss-Status                   Ext-SS-Status,
    extensionContainer           [0] ExtensionContainer          OPTIONAL,
    ... }

```

```

ZoneCodeList ::= SEQUENCE SIZE (1..maxNumOfZoneCodes)
    OF ZoneCode

```

```

ZoneCode ::= OCTET STRING (SIZE (2))
    -- internal structure is defined in TS 3GPP TS 23.003 [17]

```

```

maxNumOfZoneCodes INTEGER ::= 10

```

```

InsertSubscriberDataRes ::= SEQUENCE {
    teleserviceList             [1] TeleserviceList           OPTIONAL,
    bearerServiceList           [2] BearerServiceList         OPTIONAL,
    ss-List                     [3] SS-List                   OPTIONAL,
    odb-GeneralData             [4] ODB-GeneralData           OPTIONAL,
    regionalSubscriptionResponse [5] RegionalSubscriptionResponse OPTIONAL,
    supportedCamelPhases        [6] SupportedCamelPhases       OPTIONAL,
    extensionContainer           [7] ExtensionContainer          OPTIONAL,
    ... ,
    supportedCamel4Subsets      [8] SupportedCamel4Subsets     OPTIONAL }

```

```

RegionalSubscriptionResponse ::= ENUMERATED {
    networkNode-AreaRestricted (0),
    tooManyZoneCodes          (1),
    zoneCodesConflict         (2),
    regionalSubscNotSupported (3)}

```

```

DeleteSubscriberDataArg ::= SEQUENCE {
    imsi                       [0] IMSI,
    basicServiceList           [1] BasicServiceList           OPTIONAL,
    -- The exception handling for reception of unsupported/not allocated
    -- basicServiceCodes is defined in section 6.8.2
    ss-List                    [2] SS-List                   OPTIONAL,
    roamingRestrictionDueToUnsupportedFeature [4] NULL           OPTIONAL,
    regionalSubscriptionIdentifier [5] ZoneCode                OPTIONAL,
    vbsGroupIndication         [7] NULL                       OPTIONAL,
    vgcsGroupIndication        [8] NULL OPTIONAL,
    camelSubscriptionInfoWithdraw [9] NULL OPTIONAL,
    extensionContainer          [6] ExtensionContainer          OPTIONAL,
    ... ,
    gprsSubscriptionDataWithdraw [10] GPRSSubscriptionDataWithdraw OPTIONAL,
    roamingRestrictedInSgsnDueToUnsupportedFeature [11] NULL     OPTIONAL,
    lsaInformationWithdraw      [12] LSAInformationWithdraw    OPTIONAL,
    gmlc-ListWithdraw           [13] NULL                       OPTIONAL,
    istInformationWithdraw       [14] NULL                       OPTIONAL,
    specificCSI-Withdraw        [15] SpecificCSI-Withdraw      OPTIONAL }

```

```

SpecificCSI-Withdraw ::= BIT STRING {
  o-csi (0),
  ss-csi (1),
  tif-csi (2),
  d-csi (3),
  vt-csi (4),
  mo-sms-csi (5),
  m-csi (6),
  gprs-csi (7),
  t-csi (8),
  mt-sms-csi (9),
  mg-csi (10)} (SIZE(8..32))
-- exception handling:
-- bits 11 to 31 shall be ignored if received.
-- Bit 8 is only applicable for the NoteSubscriberDataModified operation.

```

```

GPRSSubscriptionDataWithdraw ::= CHOICE {
  allGPRSData                NULL,
  contextIdList              ContextIdList}

```

```

ContextIdList ::= SEQUENCE SIZE (1..maxNumOfPDP-Contexts) OF
  ContextId

```

```

LSAInformationWithdraw ::= CHOICE {
  allLSAData                NULL,
  lsaIdentityList           LSAIdentityList }

```

```

LSAIdentityList ::= SEQUENCE SIZE (1..maxNumOfLSAs) OF
  LSAIdentity

```

```

BasicServiceList ::= SEQUENCE SIZE (1..maxNumOfBasicServices) OF
  Ext-BasicServiceCode

```

```

maxNumOfBasicServices INTEGER ::= 70

```

```

DeleteSubscriberDataRes ::= SEQUENCE {
  regionalSubscriptionResponse [0] RegionalSubscriptionResponse OPTIONAL,
  extensionContainer           ExtensionContainer                OPTIONAL,
  ...}

```

```

VlrCamelSubscriptionInfo ::= SEQUENCE {
  o-CSI [0] O-CSI OPTIONAL,
  extensionContainer [1] ExtensionContainer OPTIONAL,
  ...,
  ss-CSI [2] SS-CSI OPTIONAL,
  o-BcsmCamelTDP-CriteriaList [4] O-BcsmCamelTDPCriteriaList OPTIONAL,
  tif-CSI [3] NULL OPTIONAL,
  m-CSI [5] M-CSI OPTIONAL,
  mo-sms-CSI [6] SMS-CSI OPTIONAL,
  vt-CSI [7] T-CSI OPTIONAL,
  t-BCSM-CAMEL-TDP-CriteriaList [8] T-BCSM-CAMEL-TDP-CriteriaList OPTIONAL,
  d-CSI [9] D-CSI OPTIONAL,
  mt-sms-CSI [10] SMS-CSI OPTIONAL,
  mt-smsCAMELTDP-CriteriaList [11] MT-smsCAMELTDP-CriteriaList OPTIONAL
}

```

```

MT-smsCAMELTDP-CriteriaList ::= SEQUENCE SIZE (1.. maxNumOfCamelTDPData) OF
  MT-smsCAMELTDP-Criteria

```

```

MT-smsCAMELTDP-Criteria ::= SEQUENCE {
  sms-TriggerDetectionPoint SMS-TriggerDetectionPoint,
  tpdu-TypeCriterion [0] TPDU-TypeCriterion OPTIONAL,
  ... }

```

```

TPDU-TypeCriterion ::= SEQUENCE SIZE (1..maxNumOfTPDUTypes) OF
  MT-SMS-TPDU-Type

```

```

maxNumOfTPDUTypes INTEGER ::= 5

```



```

MT-SMS-TPDU-Type ::= ENUMERATED {
    sms-DELIVER                (0),
    sms-SUBMIT-REPORT          (1),
    sms-STATUS-REPORT          (2),
    ... }

-- exception handling:
-- For TPDU-TypeCriterion sequences containing this parameter with any
-- other value than the ones listed above the receiver shall ignore
-- the whole TPDU-TypeCriterion sequence.
-- In CAMEL phase 4, sms-SUBMIT-REPORT shall not be used and a received TPDU-TypeCriterion
-- sequence containing sms-SUBMIT-REPORT shall be wholly ignored.

```

```

D-CSI ::= SEQUENCE {
    dp-AnalysedInfoCriteriaList [0] DP-AnalysedInfoCriteriaList OPTIONAL,
    camelCapabilityHandling      [1] CamelCapabilityHandling    OPTIONAL,
    extensionContainer           [2] ExtensionContainer          OPTIONAL,
    notificationToCSE            [3] NULL                       OPTIONAL,
    csi-Active                   [4] NULL                       OPTIONAL,
    ...}
-- notificationToCSE and csi-Active shall not be present when D-CSI is sent to VLR/GMSC.
-- They may only be included in ATSI/ATM ack/NSDC message.
-- DP-AnalysedInfoCriteria and camelCapabilityHandling shall be present in
-- the D-CSI sequence.
-- If D-CSI is segmented, dp-AnalysedInfoCriteriaList and camelCapabilityHandling shall be
-- present in the first segment

```

```

DP-AnalysedInfoCriteriaList ::= SEQUENCE SIZE (1..maxNumOfDP-AnalysedInfoCriteria) OF
    DP-AnalysedInfoCriterion

```

```

maxNumOfDP-AnalysedInfoCriteria INTEGER ::= 10

```

```

DP-AnalysedInfoCriterion ::= SEQUENCE {
    dialledNumber                ISDN-AddressString,
    serviceKey                   ServiceKey,
    gsmSCF-Address               ISDN-AddressString,
    defaultCallHandling          DefaultCallHandling,
    extensionContainer            ExtensionContainer          OPTIONAL,
    ...}

```

```

SS-CSI ::= SEQUENCE {
    ss-CamelData                 SS-CamelData,
    extensionContainer            ExtensionContainer          OPTIONAL,
    ...,
    notificationToCSE            [0] NULL                   OPTIONAL,
    csi-Active                   [1] NULL                   OPTIONAL
-- notificationToCSE and csi-Active shall not be present when SS-CSI is sent to VLR.
-- They may only be included in ATSI/ATM ack/NSDC message.
}

```

```

SS-CamelData ::= SEQUENCE {
    ss-EventList                 SS-EventList,
    gsmSCF-Address               ISDN-AddressString,
    extensionContainer            [0] ExtensionContainer    OPTIONAL,
    ...}

```

```

SS-EventList ::= SEQUENCE SIZE (1..maxNumOfCamelSSEvents) OF SS-Code
-- Actions for the following SS-Code values are defined in CAMEL Phase 3:
-- ect                SS-Code ::= '00110001'B
-- multiPTY           SS-Code ::= '01010001'B
-- cd                 SS-Code ::= '00100100'B
-- ccbs               SS-Code ::= '01000100'B
-- all other SS codes shall be ignored
-- When SS-CSI is sent to the VLR, it shall not contain a marking for ccbs.
-- If the VLR receives SS-CSI containing a marking for ccbs, the VLR shall discard the
-- ccbs marking in SS-CSI.

```

```

maxNumOfCamelSSEvents INTEGER ::= 10

```

```

O-CSI ::= SEQUENCE {
  o-BcsmCamelTDPDataList          O-BcsmCamelTDPDataList,
  extensionContainer                ExtensionContainer                OPTIONAL,
  ...,
  camelCapabilityHandling          [0] CamelCapabilityHandling    OPTIONAL,
  notificationToCSE                [1] NULL                      OPTIONAL,
  csiActive                        [2] NULL                      OPTIONAL}
-- notificationtoCSE and csiActive shall not be present when O-CSI is sent to VLR/GMSC.
-- They may only be included in ATSI/ATM ack/NSDC message.

```

```

O-BcsmCamelTDPDataList ::= SEQUENCE SIZE (1..maxNumOfCamelTDPData) OF
  O-BcsmCamelTDPData
-- O-BcsmCamelTDPDataList shall not contain more than one instance of
-- O-BcsmCamelTDPData containing the same value for o-BcsmTriggerDetectionPoint.
-- For CAMEL Phase 2, this means that only one instance of O-BcsmCamelTDPData is allowed
-- with o-BcsmTriggerDetectionPoint being equal to DP2.

```

```

maxNumOfCamelTDPData INTEGER ::= 10

```

```

O-BcsmCamelTDPData ::= SEQUENCE {
  o-BcsmTriggerDetectionPoint      O-BcsmTriggerDetectionPoint,
  serviceKey                       ServiceKey,
  gsmSCF-Address                   [0] ISDN-AddressString,
  defaultCallHandling              [1] DefaultCallHandling,
  extensionContainer                [2] ExtensionContainer                OPTIONAL,
  ...
}

```

```

ServiceKey ::= INTEGER (0..2147483647)

```

```

O-BcsmTriggerDetectionPoint ::= ENUMERATED {
  collectedInfo (2),
  ...,
  routeSelectFailure (4) }
-- exception handling:
-- For O-BcsmCamelTDPData sequences containing this parameter with any
-- other value than the ones listed the receiver shall ignore the whole
-- O-BcsmCamelTDPData sequence.
-- For O-BcsmCamelTDP-Criteria sequences containing this parameter with any
-- other value than the ones listed the receiver shall ignore the whole
-- O-BcsmCamelTDP-Criteria sequence.

```

```

O-BcsmCamelTDPCriteriaList ::= SEQUENCE SIZE (1..maxNumOfCamelTDPData) OF
  O-BcsmCamelTDP-Criteria

```

```

T-BCSM-CAMEL-TDP-CriteriaList ::= SEQUENCE SIZE (1..maxNumOfCamelTDPData) OF
  T-BCSM-CAMEL-TDP-Criteria

```

```

O-BcsmCamelTDP-Criteria ::= SEQUENCE {
  o-BcsmTriggerDetectionPoint      O-BcsmTriggerDetectionPoint,
  destinationNumberCriteria        [0] DestinationNumberCriteria    OPTIONAL,
  basicServiceCriteria             [1] BasicServiceCriteria          OPTIONAL,
  callTypeCriteria                 [2] CallTypeCriteria              OPTIONAL,
  ...,
  o-CauseValueCriteria             [3] O-CauseValueCriteria          OPTIONAL,
  extensionContainer               [4] ExtensionContainer            OPTIONAL }

```

```

T-BCSM-CAMEL-TDP-Criteria ::= SEQUENCE {
  t-BCSM-TriggerDetectionPoint      T-BcsmTriggerDetectionPoint,
  basicServiceCriteria              [0] BasicServiceCriteria          OPTIONAL,
  t-CauseValueCriteria              [1] T-CauseValueCriteria          OPTIONAL,
  ...
}

```

```

DestinationNumberCriteria ::= SEQUENCE {
  matchType                        [0] MatchType,
  destinationNumberList            [1] DestinationNumberList          OPTIONAL,
  destinationNumberLengthList     [2] DestinationNumberLengthList    OPTIONAL,
-- one or both of destinationNumberList and destinationNumberLengthList
-- shall be present
...}

```

```

DestinationNumberList ::= SEQUENCE SIZE (1..maxNumOfCamelDestinationNumbers) OF
  ISDN-AddressString
-- The receiving entity shall not check the format of a number in
-- the dialled number list

```

```

DestinationNumberLengthList ::= SEQUENCE SIZE (1..maxNumOfCamelDestinationNumberLengths)
OF
                                INTEGER(1..maxNumOfISDN-AddressDigits)

```

```

BasicServiceCriteria ::= SEQUENCE SIZE(1..maxNumOfCamelBasicServiceCriteria) OF
Ext-BasicServiceCode

```

```

maxNumOfISDN-AddressDigits INTEGER ::= 15

```

```

maxNumOfCamelDestinationNumbers INTEGER ::= 10

```

```

maxNumOfCamelDestinationNumberLengths INTEGER ::= 3

```

```

maxNumOfCamelBasicServiceCriteria INTEGER ::= 5

```

```

CallTypeCriteria ::= ENUMERATED {
    forwarded (0),
    notForwarded (1)}

```

```

MatchType ::= ENUMERATED {
    inhibiting (0),
    enabling (1)}

```

```

O-CauseValueCriteria ::= SEQUENCE SIZE(1..maxNumOfCAMEL-O-CauseValueCriteria) OF
CauseValue

```

```

T-CauseValueCriteria ::= SEQUENCE SIZE(1..maxNumOfCAMEL-T-CauseValueCriteria) OF
CauseValue

```

```

maxNumOfCAMEL-O-CauseValueCriteria INTEGER ::= 5

```

```

maxNumOfCAMEL-T-CauseValueCriteria INTEGER ::= 5

```

```

CauseValue ::= OCTET STRING (SIZE(1))
-- Type extracted from Cause parameter in ITU-T Recommendation Q.763.
-- For the use of cause value refer to ITU-T Recommendation Q.850.

```

```

DefaultCallHandling ::= ENUMERATED {
    continueCall (0) ,
    releaseCall (1) ,
    ...}
-- exception handling:
-- reception of values in range 2-31 shall be treated as "continueCall"
-- reception of values greater than 31 shall be treated as "releaseCall"

```

```

CamelCapabilityHandling ::= INTEGER(1..16)
-- value 1 = CAMEL phase 1,
-- value 2 = CAMEL phase 2,
-- value 3 = CAMEL Phase 3,
-- value 4 = CAMEL phase 4:
-- reception of values greater than 4 shall be treated as CAMEL phase 4.

```

```

SupportedCamelPhases ::= BIT STRING {
    phase1 (0),
    phase2 (1),
    phase3 (2),
    phase4 (3)} (SIZE (1..16))
-- A node shall mark in the BIT STRING all CAMEL Phases it supports.
-- Other values than listed above shall be discarded.

```

```

SupportedCamel4Subsets ::= BIT STRING {
    cs-CallHandling (0),
    chargingNotification (1),
    cAMELControlOver-MT-SMS (2),
    gprs-MobilityManagement (3),
    gprs-AnyTimeInterrogation (4)
} (SIZE (5..16))
-- A node supporting Camel phase 4 shall mark in the BIT STRING all Camel4 subsets
-- it supports.
-- Other values than listed above shall be discarded.

```

```

SMS-CSI ::= SEQUENCE {
  sms-CAMEL-TDP-DataList          [0] SMS-CAMEL-TDP-DataList          OPTIONAL,
  camelCapabilityHandling         [1] CamelCapabilityHandling         OPTIONAL,
  extensionContainer              [2] ExtensionContainer              OPTIONAL,
  notificationToCSE               [3] NULL                          OPTIONAL,
  csi-Active                      [4] NULL                          OPTIONAL,
  ...}
-- notificationToCSE and csi-Active shall not be present
-- when MO-SMS-CSI or MT-SMS-CSI is sent to VLR or SGSN.
-- They may only be included in ATSI/ATM ack/NSDC message.
-- SMS-CAMEL-TDP-Data and camelCapabilityHandling shall be present in
-- the SMS-CSI sequence.
-- If SMS-CSI is segmented, sms-CAMEL-TDP-DataList and camelCapabilityHandling shall be
-- present in the first segment

```

```

SMS-CAMEL-TDP-DataList ::= SEQUENCE SIZE (1..maxNumOfCamelTDPData) OF
  SMS-CAMEL-TDP-Data
-- SMS-CAMEL-TDP-DataList shall not contain more than one instance of
-- SMS-CAMEL-TDP-Data containing the same value for sms-TriggerDetectionPoint.

```

```

SMS-CAMEL-TDP-Data ::= SEQUENCE {
  sms-TriggerDetectionPoint      [0] SMS-TriggerDetectionPoint,
  serviceKey                    [1] ServiceKey,
  gsmSCF-Address                [2] ISDN-AddressString,
  defaultSMS-Handling           [3] DefaultSMS-Handling,
  extensionContainer             [4] ExtensionContainer              OPTIONAL,
  ...
}

```

```

SMS-TriggerDetectionPoint ::= ENUMERATED {
  sms-CollectedInfo (1),
  ...,
  sms-DeliveryRequest (2)
}
-- exception handling:
-- For SMS-CAMEL-TDP-Data and MT-smsCAMELTDP-Criteria sequences containing this
-- parameter with any other value than the ones listed the receiver shall ignore
-- the whole sequence.
--
-- If this parameter is received with any other value than sms-CollectedInfo
-- in an SMS-CAMEL-TDP-Data sequence contained in mo-sms-CSI, then the receiver shall
-- ignore the whole SMS-CAMEL-TDP-Data sequence.
--
-- If this parameter is received with any other value than sms-DeliveryRequest
-- in an SMS-CAMEL-TDP-Data sequence contained in mt-sms-CSI then the receiver shall
-- ignore the whole SMS-CAMEL-TDP-Data sequence.
--
-- If this parameter is received with any other value than sms-DeliveryRequest
-- in an MT-smsCAMELTDP-Criteria sequence then the receiver shall
-- ignore the whole MT-smsCAMELTDP-Criteria sequence.

```

```

DefaultSMS-Handling ::= ENUMERATED {
  continueTransaction (0) ,
  releaseTransaction (1) ,
  ...}
-- exception handling:
-- reception of values in range 2-31 shall be treated as "continueTransaction"
-- reception of values greater than 31 shall be treated as "releaseTransaction"

```

```

M-CSI ::= SEQUENCE {
  mobilityTriggers              MobilityTriggers,
  serviceKey                   ServiceKey,
  gsmSCF-Address               [0] ISDN-AddressString,
  extensionContainer            [1] ExtensionContainer              OPTIONAL,
  notificationToCSE            [2] NULL                          OPTIONAL,
  csi-Active                   [3] NULL                          OPTIONAL,
  ...}
-- notificationToCSE and csi-Active shall not be present when M-CSI is sent to VLR.
-- They may only be included in ATSI/ATM ack/NSDC message.

```

```

MG-CSI ::= SEQUENCE {
    mobilityTriggers           MobilityTriggers,
    serviceKey                 ServiceKey,
    gsmSCF-Address             [0] ISDN-AddressString,
    extensionContainer         [1] ExtensionContainer           OPTIONAL,
    notificationToCSE         [2] NULL                       OPTIONAL,
    csi-Active                 [3] NULL                       OPTIONAL,
    ...}
-- notificationToCSE and csi-Active shall not be present when MG-CSI is sent to SGSN.
-- They may only be included in ATSI/ATM ack/NSDC message.

```

```

MobilityTriggers ::= SEQUENCE SIZE (1..maxNumOfMobilityTriggers) OF
    MM-Code

```

```

maxNumOfMobilityTriggers INTEGER ::= 10

```

```

MM-Code ::= OCTET STRING (SIZE (1))
-- This type is used to indicate a Mobility Management event.
-- Actions for the following MM-Code values are defined in CAMEL Phase 4:
--
-- CS domain MM events:
-- Location-update-in-same-VLR           MM-Code ::= '00000000'B
-- Location-update-to-other-VLR        MM-Code ::= '00000001'B
-- IMSI-Attach                          MM-Code ::= '00000010'B
-- MS-initiated-IMSI-Detach            MM-Code ::= '00000011'B
-- Network-initiated-IMSI-Detach       MM-Code ::= '00000100'B
--
-- PS domain MM events:
-- Routeing-Area-update-in-same-SGSN    MM-Code ::= '10000000'B
-- Routeing-Area-update-to-other-SGSN  MM-Code ::= '10000001'B
-- GPRS-Attach                          MM-Code ::= '10000010'B
-- MS-initiated-GPRS-Detach             MM-Code ::= '10000011'B
-- Network-initiated-GPRS-Detach       MM-Code ::= '10000100'B
-- Network-initiated-transfer-to-MS-not-reachable-for-paging
--                                     MM-Code ::= '10000101'B
--
-- If the MSC receives any other MM-code than the ones listed above for the
-- CS domain, then the MSC shall ignore that MM-code.
-- If the SGSN receives any other MM-code than the ones listed above for the
-- PS domain, then the SGSN shall ignore that MM-code.

```

```

T-CSI ::= SEQUENCE {
    t-BcsmCamelTDPDataList      T-BcsmCamelTDPDataList,
    extensionContainer          ExtensionContainer           OPTIONAL,
    ...,
    camelCapabilityHandling     [0] CamelCapabilityHandling  OPTIONAL,
    notificationToCSE          [1] NULL                       OPTIONAL,
    csi-Active                  [2] NULL                       OPTIONAL}
-- notificationToCSE and csi-Active shall not be present when VT-CSI/T-CSI is sent
-- to VLR/GMSC.
-- They may only be included in ATSI/ATM ack/NSDC message.

```

```

T-BcsmCamelTDPDataList ::= SEQUENCE SIZE (1..maxNumOfCamelTDPData) OF
    T-BcsmCamelTDPData
--- T-BcsmCamelTDPDataList shall not contain more than one instance of
--- T-BcsmCamelTDPData containing the same value for t-BcsmTriggerDetectionPoint.
--- For CAMEL Phase 2, this means that only one instance of T-BcsmCamelTDPData is
allowed
--- with t-BcsmTriggerDetectionPoint being equal to DP12.
--- For CAMEL Phase 3, more TDP's are allowed.

```

```

T-BcsmCamelTDPData ::= SEQUENCE {
    t-BcsmTriggerDetectionPoint  T-BcsmTriggerDetectionPoint,
    serviceKey                   ServiceKey,
    gsmSCF-Address               [0] ISDN-AddressString,
    defaultCallHandling          [1] DefaultCallHandling,
    extensionContainer           [2] ExtensionContainer           OPTIONAL,
    ...}

```

```

T-BcsmTriggerDetectionPoint ::= ENUMERATED {
    termAttemptAuthorized (12),
    ... ,
    tBusy (13),
    tNoAnswer (14)}
-- exception handling:
-- For T-BcsmCamelTDPData sequences containing this parameter with any other
-- value than the ones listed above, the receiver shall ignore the whole
-- T-BcsmCamelTDPData sequence.

```

-- gprs location information retrieval types

```

SendRoutingInfoForGprsArg ::= SEQUENCE {
    imsi
    ggsn-Address [0] IMSI,
    ggsn-Number [1] GSN-Address OPTIONAL,
    extensionContainer [2] ISDN-AddressString,
    ... } [3] ExtensionContainer OPTIONAL,

```

```

SendRoutingInfoForGprsRes ::= SEQUENCE {
    sgsn-Address [0] GSN-Address,
    ggsn-Address [1] GSN-Address OPTIONAL,
    mobileNotReachableReason [2] AbsentSubscriberDiagnosticSM OPTIONAL,
    extensionContainer [3] ExtensionContainer OPTIONAL,
    ... }

```

-- failure report types

```

FailureReportArg ::= SEQUENCE {
    imsi [0] IMSI,
    ggsn-Number [1] ISDN-AddressString ,
    ggsn-Address [2] GSN-Address OPTIONAL,
    extensionContainer [3] ExtensionContainer OPTIONAL,
    ... }

```

```

FailureReportRes ::= SEQUENCE {
    ggsn-Address [0] GSN-Address OPTIONAL,
    extensionContainer [1] ExtensionContainer OPTIONAL,
    ... }

```

-- gprs notification types

```

NoteMsPresentForGprsArg ::= SEQUENCE {
    imsi [0] IMSI,
    sgsn-Address [1] GSN-Address,
    ggsn-Address [2] GSN-Address OPTIONAL,
    extensionContainer [3] ExtensionContainer OPTIONAL,
    ... }

```

```

NoteMsPresentForGprsRes ::= SEQUENCE {
    extensionContainer [0] ExtensionContainer OPTIONAL,
    ... }

```

-- fault recovery types

```

ResetArg ::= SEQUENCE {
    hlr-Number ISDN-AddressString,
    hlr-List HLR-List OPTIONAL,
    ... }

```

```

RestoreDataArg ::= SEQUENCE {
    imsi IMSI,
    lmsi LMSI OPTIONAL,
    extensionContainer ExtensionContainer OPTIONAL,
    ... ,
    vlr-Capability [6] VLR-Capability OPTIONAL }

```

```

RestoreDataRes ::= SEQUENCE {
    hlr-Number ISDN-AddressString,
    msNotReachable NULL OPTIONAL,
    extensionContainer ExtensionContainer OPTIONAL,
    ... }

```

-- VBS/VGCS types

```
VBSDataList ::= SEQUENCE SIZE (1..maxNumOfVBGroupIds) OF
    VoiceBroadcastData
```

```
VGCSDataList ::= SEQUENCE SIZE (1..maxNumOfVGCSGroupIds) OF
    VoiceGroupCallData
```

```
maxNumOfVBGroupIds INTEGER ::= 50
```

```
maxNumOfVGCSGroupIds INTEGER ::= 50
```

```
VoiceGroupCallData ::= SEQUENCE {
    groupId                GroupId,
    extensionContainer     ExtensionContainer          OPTIONAL,
    ...}

```

```
VoiceBroadcastData ::= SEQUENCE {
    groupid                GroupId,
    broadcastInitEntitlement NULL                    OPTIONAL,
    extensionContainer     ExtensionContainer          OPTIONAL,
    ...}

```

```
GroupId ::= OCTET STRING (SIZE (3))
-- Refers to the Group Identification as specified in GSM TS 03.03
-- and 03.68/ 03.69
```

-- provide subscriber info types

```
ProvideSubscriberInfoArg ::= SEQUENCE {
    imsi        [0] IMSI,
    lmsi        [1] LMSI          OPTIONAL,
    requestedInfo [2] RequestedInfo,
    extensionContainer [3] ExtensionContainer          OPTIONAL,
    ...}

```

```
ProvideSubscriberInfoRes ::= SEQUENCE {
    subscriberInfo    SubscriberInfo,
    extensionContainer ExtensionContainer          OPTIONAL,
    ...}

```

```
SubscriberInfo ::= SEQUENCE {
    locationInformation    [0] LocationInformation          OPTIONAL,
    subscriberState       [1] SubscriberState              OPTIONAL,
    extensionContainer     [2] ExtensionContainer          OPTIONAL,
    ... ,
    locationInformationGPRS [3] LocationInformationGPRS    OPTIONAL,
    ps-SubscriberState    [4] PS-SubscriberState          OPTIONAL,
    imei                  [5] IMEI                        OPTIONAL,
    ms-Classmark2         [6] MS-Classmark2                OPTIONAL,
    gprs-MS-Class         [7] GPRSMSClass                 OPTIONAL}
-- If the HLR receives locationInformation, subscriberState or ms-Classmark2 from an SGSN
-- it shall discard them.
-- If the HLR receives locationInformationGPRS, ps-SubscriberState or gprs-MS-Class from
-- a VLR it shall discard them.
-- If the HLR receives parameters which it has not requested, it shall discard them.
```

```
MS-Classmark2 ::= OCTET STRING (SIZE (3))
-- This parameter carries the value part of the MS Classmark 2 IE defined in
-- 3GPP TS 24.008 [35].
```

```
GPRSMSClass ::= SEQUENCE {
    mSNetworkCapability [0] MSNetworkCapability,
    mSRadioAccessCapability [1] MSRadioAccessCapability    OPTIONAL
}

```

```
MSNetworkCapability ::= OCTET STRING (SIZE (1..8))
-- This parameter carries the value part of the MS Network Capability IE defined in
-- 3GPP TS 24.008 [35].
```

```
MSRadioAccessCapability ::= OCTET STRING (SIZE (1..50))
-- This parameter carries the value part of the MS Radio Access Capability IE defined in
-- 3GPP TS 24.008 [35].
```

```

RequestedInfo ::= SEQUENCE {
    locationInformation          [0] NULL                OPTIONAL,
    subscriberState             [1] NULL                OPTIONAL,
    extensionContainer          [2] ExtensionContainer  OPTIONAL,
    ...,
    currentLocation            [3] NULL                OPTIONAL,
    requestedDomain             [4] DomainType          OPTIONAL,
    imei                        [6] NULL                OPTIONAL,
    ms-classmark                [5] NULL                OPTIONAL }

-- currentLocation shall be absent if locationInformation is absent

```

```

DomainType ::= ENUMERATED {
    cs-Domain                    (0),
    ps-Domain                    (1),
    ...}
-- exception handling:
-- reception of values > 1 shall be mapped to 'cs-Domain'

```

```

LocationInformation ::= SEQUENCE {
    ageOfLocationInformation    AgeOfLocationInformation  OPTIONAL,
    geographicalInformation     [0] GeographicalInformation  OPTIONAL,
    vlr-number                  [1] ISDN-AddressString      OPTIONAL,
    locationNumber              [2] LocationNumber          OPTIONAL,
    cellGlobalIdOrServiceAreaIdOrLAI [3] CellGlobalIdOrServiceAreaIdOrLAI  OPTIONAL,
    extensionContainer          [4] ExtensionContainer      OPTIONAL,
    ...,
    selectedLSA-Id              [5] LSAIdentity            OPTIONAL,
    msc-Number                  [6] ISDN-AddressString      OPTIONAL,
    geodeticInformation         [7] GeodeticInformation     OPTIONAL,
    currentLocationRetrieved     [8] NULL                  OPTIONAL,
    sai-Present                 [9] NULL                  OPTIONAL }
-- sai-Present indicates that the cellGlobalIdOrServiceAreaIdOrLAI parameter contains
-- a Service Area Identity.
-- currentLocationRetrieved shall be present
-- if the location information were retrieved after a successful paging.

```

```

LocationInformationGPRS ::= SEQUENCE {
    cellGlobalIdOrServiceAreaIdOrLAI [0] CellGlobalIdOrServiceAreaIdOrLAI  OPTIONAL,
    routeingAreaIdentity            [1] RAIdentity            OPTIONAL,
    geographicalInformation          [2] GeographicalInformation  OPTIONAL,
    sgsn-Number                     [3] ISDN-AddressString      OPTIONAL,
    selectedLSAIdentity              [4] LSAIdentity            OPTIONAL,
    extensionContainer               [5] ExtensionContainer      OPTIONAL,
    ...,
    sai-Present                     [6] NULL                  OPTIONAL,
    geodeticInformation              [7] GeodeticInformation     OPTIONAL,
    currentLocationRetrieved         [8] NULL                  OPTIONAL,
    ageOfLocationInformation         [9] AgeOfLocationInformation  OPTIONAL }
-- sai-Present indicates that the cellGlobalIdOrServiceAreaIdOrLAI parameter contains
-- a Service Area Identity.
-- currentLocationRetrieved shall be present if the location information
-- was retrieved after successful paging.

```

```

RAIdentity ::= OCTET STRING (SIZE (6))
-- Routing Area Identity is coded in accordance with 3GPP TS 29.060 [105].
-- It shall contain the value part defined in 3GPP TS 29.060 only. I.e. the 3GPP TS 29.060
-- type identifier octet shall not be included.

```

```

GeographicalInformation ::= OCTET STRING (SIZE (8))
-- Refers to geographical Information defined in 3GPP TS 23.032.
-- Only the description of an ellipsoid point with uncertainty circle
-- as specified in 3GPP TS 23.032 is allowed to be used
-- The internal structure according to 3GPP TS 23.032 is as follows:
--   Type of shape (ellipsoid point with uncertainty circle)          1 octet
--   Degrees of Latitude                                               3 octets
--   Degrees of Longitude                                              3 octets
--   Uncertainty code                                                  1 octet

```



```

GeodeticInformation ::= OCTET STRING (SIZE (10))
-- Refers to Calling Geodetic Location defined in Q.763 (1999).
-- Only the description of an ellipsoid point with uncertainty circle
-- as specified in Q.763 (1999) is allowed to be used
-- The internal structure according to Q.763 (1999) is as follows:
--   Screening and presentation indicators           1 octet
--   Type of shape (ellipsoid point with uncertainty circle) 1 octet
--   Degrees of Latitude                           3 octets
--   Degrees of Longitude                         3 octets
--   Uncertainty code                             1 octet
--   Confidence                                   1 octet

```

```

LocationNumber ::= OCTET STRING (SIZE (2..10))
-- the internal structure is defined in CCITT Rec Q.763

```

```

SubscriberState ::= CHOICE {
    assumedIdle           [0] NULL,
    camelBusy             [1] NULL,
    netDetNotReachable   NotReachableReason,
    notProvidedFromVLR   [2] NULL}

```

```

PS-SubscriberState ::= CHOICE {
    notProvidedFromSGSN   [0] NULL,
    ps-Detached           [1] NULL,
    ps-AttachedNotReachableForPaging [2] NULL,
    ps-AttachedReachableForPaging [3] NULL,
    ps-PDP-ActiveNotReachableForPaging [4] PDP-ContextInfoList,
    ps-PDP-ActiveReachableForPaging [5] PDP-ContextInfoList}

```

```

PDP-ContextInfoList ::= SEQUENCE SIZE (1..maxNumOfPDP-Contexts) OF
    PDP-ContextInfo

```

```

PDP-ContextInfo ::= SEQUENCE {
    pdp-ContextIdentifier [0] ContextId,
    pdp-ContextActive     [1] NULL OPTIONAL,
    pdp-Type              [2] PDP-Type,
    pdp-Address           [3] PDP-Address OPTIONAL,
    apn-Subscribed        [4] APN OPTIONAL,
    apn-InUse             [5] APN OPTIONAL,
    nsapi                 [6] NSAPI OPTIONAL,
    transactionId         [7] TransactionId OPTIONAL,
    teid-ForGnAndGp       [8] TEID OPTIONAL,
    teid-ForIu            [9] TEID OPTIONAL,
    ggsn-Address          [10] GSN-Address OPTIONAL,
    qos-Subscribed        [11] Ext-QoS-Subscribed OPTIONAL,
    qos-Requested         [12] Ext-QoS-Subscribed OPTIONAL,
    qos-Negotiated        [13] Ext-QoS-Subscribed OPTIONAL,
    chargingId            [14] GPRSChargingID OPTIONAL,
    chargingCharacteristics [15] ChargingCharacteristics OPTIONAL,
    rnc-Address           [16] GSN-Address OPTIONAL,
    extensionContainer    [17] ExtensionContainer OPTIONAL,
    ...}

```

```

NSAPI ::= INTEGER (0..15)
-- This type is used to indicate the Network layer Service Access Point

```

```

TransactionId ::= OCTET STRING (SIZE (1..2))
-- This type carries the value part of the transaction identifier which is used in the
-- session management messages on the access interface. The encoding is defined in
-- 3GPP TS 24.008

```

```

TEID ::= OCTET STRING (SIZE (4))
-- This type carries the value part of the Tunnel Endpoint Identifier which is used to
-- distinguish between different tunnels between the same pair of entities which communicate
-- using the GPRS Tunnelling Protocol The encoding is defined in 3GPP TS 29.060.

```

```

GPRSChargingID ::= OCTET STRING (SIZE (4))
-- The Charging ID is a unique four octet value generated by the GGSN when
-- a PDP Context is activated. A Charging ID is generated for each activated context.
-- The encoding is defined in 3GPP TS 29.060.

```

```

NotReachableReason ::= ENUMERATED {
    msPurged (0),
    imsiDetached (1),
    restrictedArea (2),
    notRegistered (3)}

```

-- any time interrogation info types

```

AnyTimeInterrogationArg ::= SEQUENCE {
    subscriberIdentity [0] SubscriberIdentity,
    requestedInfo [1] RequestedInfo,
    gsmSCF-Address [3] ISDN-AddressString,
    extensionContainer [2] ExtensionContainer OPTIONAL,
    ...}

```

```

AnyTimeInterrogationRes ::= SEQUENCE {
    subscriberInfo SubscriberInfo,
    extensionContainer ExtensionContainer OPTIONAL,
    ...}

```

-- any time information handling types

```

AnyTimeSubscriptionInterrogationArg ::= SEQUENCE {
    subscriberIdentity [0] SubscriberIdentity,
    requestedSubscriptionInfo [1] RequestedSubscriptionInfo,
    gsmSCF-Address [2] ISDN-AddressString,
    extensionContainer [3] ExtensionContainer OPTIONAL,
    longFTN-Supported [4] NULL OPTIONAL,
    ...}

```

```

AnyTimeSubscriptionInterrogationRes ::= SEQUENCE {
    callForwardingData [1] CallForwardingData OPTIONAL,
    callBarringData [2] CallBarringData OPTIONAL,
    odb-Info [3] ODB-Info OPTIONAL,
    camel-SubscriptionInfo [4] CAMEL-SubscriptionInfo OPTIONAL,
    supportedVLR-CAMEL-Phases [5] SupportedCamelPhases OPTIONAL,
    supportedSGSN-CAMEL-Phases [6] SupportedCamelPhases OPTIONAL,
    extensionContainer [7] ExtensionContainer OPTIONAL,
    ... ,
    supportedCamel4SubsetsInVLR [8] SupportedCamel4Subsets OPTIONAL,
    supportedCamel4SubsetsInSGSN [9] SupportedCamel4Subsets OPTIONAL }

```

```

RequestedSubscriptionInfo ::= SEQUENCE {
    requestedSS-Info [1] SS-ForBS-Code OPTIONAL,
    odb [2] NULL OPTIONAL,
    requestedCAMEL-SubscriptionInfo [3] RequestedCAMEL-SubscriptionInfo OPTIONAL,
    supportedVLR-CAMEL-Phases [4] NULL OPTIONAL,
    supportedSGSN-CAMEL-Phases [5] NULL OPTIONAL,
    extensionContainer [6] ExtensionContainer OPTIONAL,
    ... ,
    additionalRequestedCAMEL-SubscriptionInfo [7] AdditionalRequestedCAMEL-SubscriptionInfo OPTIONAL }

```

```

RequestedCAMEL-SubscriptionInfo ::= ENUMERATED {
    o-CSI (0),
    t-CSI (1),
    vt-CSI (2),
    tif-CSI (3),
    gprs-CSI (4),
    mo-sms-CSI (5),
    ss-CSI (6),
    m-CSI (7),
    d-csi (8)}

```

```

AdditionalRequestedCAMEL-SubscriptionInfo ::= ENUMERATED {
    mt-sms-CSI (0),
    mg-csi (1),
    ...}

```

-- exception handling: unknown values shall be discarded by the receiver.

CallForwardingData ::= SEQUENCE {		
forwardingFeatureList	Ext-ForwFeatureList,	
notificationToCSE	NULL	OPTIONAL,
extensionContainer	[0] ExtensionContainer	OPTIONAL,
...		

CallBarringData ::= SEQUENCE {		
callBarringFeatureList	Ext-CallBarFeatureList,	
password	Password	OPTIONAL,
wrongPasswordAttemptsCounter	WrongPasswordAttemptsCounter	OPTIONAL,
notificationToCSE	NULL	OPTIONAL,
extensionContainer	ExtensionContainer	OPTIONAL,
...		

WrongPasswordAttemptsCounter ::= INTEGER (0..4)
--

ODB-Info ::= SEQUENCE {		
odb-Data	ODB-Data,	
notificationToCSE	NULL	OPTIONAL,
extensionContainer	ExtensionContainer	OPTIONAL,
...		

CAMEL-SubscriptionInfo ::= SEQUENCE {		
o-CSI	[0] O-CSI	OPTIONAL,
o-BcsmCamelTDP-CriteriaList	[1] O-BcsmCamelTDPCriteriaList	OPTIONAL,
d-CSI	[2] D-CSI	OPTIONAL,
t-CSI	[3] T-CSI	OPTIONAL,
t-BCSM-CAMEL-TDP-CriteriaList	[4] T-BCSM-CAMEL-TDP-CriteriaList	OPTIONAL,
vt-CSI	[5] T-CSI	OPTIONAL,
vt-BCSM-CAMEL-TDP-CriteriaList	[6] T-BCSM-CAMEL-TDP-CriteriaList	OPTIONAL,
tif-CSI	[7] NULL	OPTIONAL,
tif-CSI-NotificationToCSE	[8] NULL	OPTIONAL,
gprs-CSI	[9] GPRS-CSI	OPTIONAL,
mo-sms-CSI	[10] SMS-CSI	OPTIONAL,
ss-CSI	[11] SS-CSI	OPTIONAL,
m-CSI	[12] M-CSI	OPTIONAL,
extensionContainer	[13] ExtensionContainer	OPTIONAL,
...		
specificCSIDeletedList	[14] SpecificCSI-Withdraw	OPTIONAL,
mt-sms-CSI	[15] SMS-CSI	OPTIONAL,
mt-smsCAMELTDP-CriteriaList	[16] MT-smsCAMELTDP-CriteriaList	OPTIONAL,
mg-csi	[17] MG-CSI	OPTIONAL
}		

AnyTimeModificationArg ::= SEQUENCE {		
subscriberIdentity	[0] SubscriberIdentity,	
gsmSCF-Address	[1] ISDN-AddressString,	
modificationRequestFor-CF-Info	[2] ModificationRequestFor-CF-Info	OPTIONAL,
modificationRequestFor-CB-Info	[3] ModificationRequestFor-CB-Info	OPTIONAL,
modificationRequestFor-CSI	[4] ModificationRequestFor-CSI	OPTIONAL,
extensionContainer	[5] ExtensionContainer	OPTIONAL,
longFTN-Supported	[6] NULL	OPTIONAL,
...		
modificationRequestFor-ODB-data	[7] ModificationRequestFor-ODB-data	OPTIONAL }

AnyTimeModificationRes ::= SEQUENCE {		
ss-InfoFor-CSE	[0] Ext-SS-InfoFor-CSE	OPTIONAL,
camel-SubscriptionInfo	[1] CAMEL-SubscriptionInfo	OPTIONAL,
extensionContainer	[2] ExtensionContainer	OPTIONAL,
...		
odb-Info	[3] ODB-Info	OPTIONAL }

ModificationRequestFor-CF-Info ::= SEQUENCE {		
ss-Code	[0] SS-Code,	
basicService	[1] Ext-BasicServiceCode	OPTIONAL,
ss-Status	[2] Ext-SS-Status	OPTIONAL,
forwardedToNumber	[3] AddressString	OPTIONAL,
forwardedToSubaddress	[4] ISDN-SubaddressString	OPTIONAL,
noReplyConditionTime	[5] Ext-NoRepCondTime	OPTIONAL,
modifyNotificationToCSE	[6] ModificationInstruction	OPTIONAL,
extensionContainer	[7] ExtensionContainer	OPTIONAL,
...		

```

ModificationRequestFor-CB-Info ::= SEQUENCE {
  ss-Code [0] SS-Code,
  basicService [1] Ext-BasicServiceCode OPTIONAL,
  ss-Status [2] Ext-SS-Status OPTIONAL,
  password [3] Password OPTIONAL,
  wrongPasswordAttemptsCounter [4] WrongPasswordAttemptsCounter OPTIONAL,
  modifyNotificationToCSE [5] ModificationInstruction OPTIONAL,
  extensionContainer [6] ExtensionContainer OPTIONAL,
  ...}

```

```

ModificationRequestFor-ODB-data ::= SEQUENCE {
  odb-data [0] ODB-Data OPTIONAL,
  modifyNotificationToCSE [1] ModificationInstruction OPTIONAL,
  extensionContainer [2] ExtensionContainer OPTIONAL,
  ...}

```

```

ModificationRequestFor-CSI ::= SEQUENCE {
  requestedCamel-SubscriptionInfo [0] RequestedCAMEL-SubscriptionInfo,
  modifyNotificationToCSE [1] ModificationInstruction OPTIONAL,
  modifyCSI-State [2] ModificationInstruction OPTIONAL,
  extensionContainer [3] ExtensionContainer OPTIONAL,
  ...,
  additionalRequestedCAMEL-SubscriptionInfo [4] AdditionalRequestedCAMEL-SubscriptionInfo OPTIONAL }

```

```

ModificationInstruction ::= ENUMERATED {
  deactivate (0),
  activate (1)}

```

-- subscriber data modification notification types

```

NoteSubscriberDataModifiedArg ::= SEQUENCE {
  imsi IMSI,
  msisdn ISDN-AddressString,
  forwardingInfoFor-CSE [0] Ext-ForwardingInfoFor-CSE OPTIONAL,
  callBarringInfoFor-CSE [1] Ext-CallBarringInfoFor-CSE OPTIONAL,
  odb-Info [2] ODB-Info OPTIONAL,
  camel-SubscriptionInfo [3] CAMEL-SubscriptionInfo OPTIONAL,
  allInformationSent [4] NULL OPTIONAL,
  extensionContainer ExtensionContainer OPTIONAL,
  ...}

```

```

NoteSubscriberDataModifiedRes ::= SEQUENCE {
  extensionContainer ExtensionContainer OPTIONAL,
  ...}

```

-- mobility management event notification info types

```

NoteMM-EventArg ::= SEQUENCE {
  serviceKey ServiceKey,
  eventMet [0] MM-Code,
  imsi [1] IMSI,
  msisdn [2] ISDN-AddressString,
  locationInformation [3] LocationInformation OPTIONAL,
  supportedCAMELPhases [5] SupportedCamelPhases OPTIONAL,
  extensionContainer [6] ExtensionContainer OPTIONAL,
  ...,
  locationInformationGPRS [7] LocationInformationGPRS OPTIONAL,
  supportedCamel4Subsets [8] SupportedCamel4Subsets OPTIONAL
}

```

```

NoteMM-EventRes ::= SEQUENCE {
  extensionContainer ExtensionContainer OPTIONAL,
  ...}

```

```

Ext-SS-InfoFor-CSE ::= CHOICE {
  forwardingInfoFor-CSE [0] Ext-ForwardingInfoFor-CSE,
  callBarringInfoFor-CSE [1] Ext-CallBarringInfoFor-CSE
}

```

```

Ext-ForwardingInfoFor-CSE ::= SEQUENCE {
    ss-Code [0] SS-Code,
    forwardingFeatureList [1] Ext-ForwFeatureList,
    notificationToCSE [2] NULL OPTIONAL,
    extensionContainer [3] ExtensionContainer OPTIONAL,
    ...}

```

```

Ext-CallBarringInfoFor-CSE ::= SEQUENCE {
    ss-Code [0] SS-Code,
    callBarringFeatureList [1] Ext-CallBarFeatureList,
    password [2] Password OPTIONAL,
    wrongPasswordAttemptsCounter [3] WrongPasswordAttemptsCounter OPTIONAL,
    notificationToCSE [4] NULL OPTIONAL,
    extensionContainer [5] ExtensionContainer OPTIONAL,
    ...}

```

END

17.7.2 Operation and maintenance data types

```

MAP-OM-DataTypes {
    ccitt identified-organization (4) etsi (0) mobileDomain (0)
    gsm-Network (1) modules (3) map-OM-DataTypes (12) version8 (8)}

```

DEFINITIONS

IMPLICIT TAGS

::=

BEGIN

EXPORTS

```

    ActivateTraceModeArg,
    ActivateTraceModeRes,
    DeactivateTraceModeArg,
    DeactivateTraceModeRes

```

;

IMPORTS

```

    AddressString,
    IMSI

```

FROM MAP-CommonDataTypes {

```

    ccitt identified-organization (4) etsi (0) mobileDomain (0)
    gsm-Network (1) modules (3) map-CommonDataTypes (18) version8 (8)}

```

ExtensionContainer

FROM MAP-ExtensionDataTypes {

```

    ccitt identified-organization (4) etsi (0) mobileDomain (0)
    gsm-Network (1) modules (3) map-ExtensionDataTypes (21) version8 (8)}

```

;

```

ActivateTraceModeArg ::= SEQUENCE {
    imsi [0] IMSI OPTIONAL,
    traceReference [1] TraceReference,
    traceType [2] TraceType,
    omc-Id [3] AddressString OPTIONAL,
    extensionContainer [4] ExtensionContainer OPTIONAL,
    ...}

```

```

TraceReference ::= OCTET STRING (SIZE (1..2))

```

```

TraceType ::= INTEGER
    (0..255)
    -- Trace types are fully defined in TS GSM 12.08.

```

```

ActivateTraceModeRes ::= SEQUENCE {
    extensionContainer [0] ExtensionContainer OPTIONAL,
    ...}

```

DeactivateTraceModeArg ::= SEQUENCE {		
imsi	[0] IMSI	OPTIONAL,
traceReference	[1] TraceReference,	
extensionContainer	[2] ExtensionContainer	OPTIONAL,
...}		

DeactivateTraceModeRes ::= SEQUENCE {		
extensionContainer	[0] ExtensionContainer	OPTIONAL,
...}		

END

17.7.3 Call handling data types

```
MAP-CH-DataTypes {
  ccitt identified-organization (4) etsi (0) mobileDomain (0)
  gsm-Network (1) modules (3) map-CH-DataTypes (13) version8 (8)}
```

DEFINITIONS

IMPLICIT TAGS

::=

BEGIN

EXPORTS

```
SendRoutingInfoArg,
SendRoutingInfoRes,
ProvideRoamingNumberArg,
ProvideRoamingNumberRes,
ResumeCallHandlingArg,
ResumeCallHandlingRes,
NumberOfForwarding,
SuppressionOfAnnouncement,
CallReferenceNumber,
ProvideSIWFSNumberArg,
ProvideSIWFSNumberRes,
SIWFSSignallingModifyArg,
SIWFSSignallingModifyRes,
SetReportingStateArg,
SetReportingStateRes,
StatusReportArg,
StatusReportRes,
RemoteUserFreeArg,
RemoteUserFreeRes,
IST-AlertArg,
IST-AlertRes,
IST-CommandArg,
IST-CommandRes
```

;

IMPORTS

```
SubscriberInfo,
SupportedCamelPhases,
SupportedCamel4Subsets,
CUG-Interlock,
O-CSI,
D-CSI,
O-BcsmCamelTDPCriteriaList,
T-BCSM-CAMEL-TDP-CriteriaList,
IST-SupportIndicator,
IST-AlertTimerValue,
T-CSI
```

```
FROM MAP-MS-DataTypes {
  ccitt identified-organization (4) etsi (0) mobileDomain (0)
  gsm-Network (1) modules (3) map-MS-DataTypes (11) version8 (8)}
```

```
ForwardingOptions,
SS-List,
CCBS-Feature
```

```
FROM MAP-SS-DataTypes {
  ccitt identified-organization (4) etsi (0) mobileDomain (0)
  gsm-Network (1) modules (3) map-SS-DataTypes (14) version8 (8)}
```

```
ISDN-AddressString,
```

```

ISDN-SubaddressString,
FTN-AddressString,
ExternalSignalInfo,
Ext-ExternalSignalInfo,
IMSI,
LMSI,
Ext-BasicServiceCode,
AlertingPattern,
NAEA-PreferredCI

```

```

FROM MAP-CommonDataTypes {
  ccitt identified-organization (4) etsi (0) mobileDomain (0)
  gsm-Network (1) modules (3) map-CommonDataTypes (18) version8 (8)}

ExtensionContainer
FROM MAP-ExtensionDataTypes {
  ccitt identified-organization (4) etsi (0) mobileDomain (0)
  gsm-Network (1) modules (3) map-ExtensionDataTypes (21) version8 (8)}
;

```

CUG-CheckInfo ::= SEQUENCE {		
cug-Interlock	CUG-Interlock,	
cug-OutgoingAccess	NULL	OPTIONAL,
extensionContainer	ExtensionContainer	OPTIONAL,
...		

NumberOfForwarding ::= INTEGER (1..5)
--

SendRoutingInfoArg ::= SEQUENCE {		
msisdN	[0] ISDN-AddressString,	
cug-CheckInfo	[1] CUG-CheckInfo	OPTIONAL,
numberOfForwarding	[2] NumberOfForwarding	OPTIONAL,
interrogationType	[3] InterrogationType,	
or-Interrogation	[4] NULL	OPTIONAL,
or-Capability	[5] OR-Phase	OPTIONAL,
gsmc-OrGsmSCF-Address	[6] ISDN-AddressString,	
callReferenceNumber	[7] CallReferenceNumber	OPTIONAL,
forwardingReason	[8] ForwardingReason	OPTIONAL,
basicServiceGroup	[9] Ext-BasicServiceCode	OPTIONAL,
networkSignalInfo	[10] ExternalSignalInfo	OPTIONAL,
camelInfo	[11] CamelInfo	OPTIONAL,
suppressionOfAnnouncement	[12] SuppressionOfAnnouncement	OPTIONAL,
extensionContainer	[13] ExtensionContainer	OPTIONAL,
...		
alertingPattern	[14] AlertingPattern	OPTIONAL,
ccbs-Call	[15] NULL	OPTIONAL,
supportedCCBS-Phase	[16] SupportedCCBS-Phase	OPTIONAL,
additionalSignalInfo	[17] Ext-ExternalSignalInfo	OPTIONAL,
istSupportIndicator	[18] IST-SupportIndicator	OPTIONAL,
pre-pagingSupported	[19] NULL	OPTIONAL,
callDiversionTreatmentIndicator	[20] CallDiversionTreatmentIndicator	OPTIONAL,
longFTN-Supported	[21] NULL	OPTIONAL,
suppress-VT-CSI	[22] NULL	OPTIONAL,
suppressIncomingCallBarring	[23] NULL	OPTIONAL,
gsmSCF-InitiatedCall	[24] NULL	OPTIONAL,
}		

SuppressionOfAnnouncement ::= NULL

InterrogationType ::= ENUMERATED {
basicCall (0),
forwarding (1)}

OR-Phase ::= INTEGER (1..127)

CallReferenceNumber ::= OCTET STRING (SIZE (1..8))

ForwardingReason ::= ENUMERATED {
notReachable (0),
busy (1),
noReply (2)}

```
SupportedCCBS-Phase ::= INTEGER (1..127)
-- exception handling:
-- Only value 1 is used.
-- Values in the ranges 2-127 are reserved for future use.
-- If received values 2-127 shall be mapped on to value 1.
```

```
CallDiversionTreatmentIndicator ::= OCTET STRING (SIZE(1))
-- callDiversionAllowed (xxxx xx01)
-- callDiversionNotAllowed (xxxx xx10)
-- network default is call diversion allowed
```

```
SendRoutingInfoRes ::= [3] SEQUENCE {
  imsi [9] IMSI OPTIONAL,
  -- IMSI must be present if SendRoutingInfoRes is not segmented.
  -- If the TC-Result-NL segmentation option is taken the IMSI must be
  -- present in one segmented transmission of SendRoutingInfoRes.
  extendedRoutingInfo ExtendedRoutingInfo OPTIONAL,
  cug-CheckInfo [3] CUG-CheckInfo OPTIONAL,
  cugSubscriptionFlag [6] NULL OPTIONAL,
  subscriberInfo [7] SubscriberInfo OPTIONAL,
  ss-List [1] SS-List OPTIONAL,
  basicService [5] Ext-BasicServiceCode OPTIONAL,
  forwardingInterrogationRequired [4] NULL OPTIONAL,
  vmsc-Address [2] ISDN-AddressString OPTIONAL,
  extensionContainer [0] ExtensionContainer OPTIONAL,
  ... ,
  naea-PreferredCI [10] NAEA-PreferredCI OPTIONAL,
  -- naea-PreferredCI is included at the discretion of the HLR operator.
  ccbs-Indicators [11] CCBS-Indicators OPTIONAL,
  msisdN [12] ISDN-AddressString OPTIONAL,
  numberPortabilityStatus [13] NumberPortabilityStatus OPTIONAL,
  istAlertTimer [14] IST-AlertTimerValue OPTIONAL,
  supportedCamelPhasesInVMSC [15] SupportedCamelPhases OPTIONAL,
  supportedCamel4SubsetsInVMSC [16] SupportedCamel4Subsets OPTIONAL
}
```

```
NumberPortabilityStatus ::= ENUMERATED {
  notKnownToBePorted (0),
  ownNumberPortedOut (1),
  foreignNumberPortedToForeignNetwork (2),
  ...}
-- exception handling:
-- reception of other values than the ones listed the receiver shall ignore the
-- whole NumberPortabilityStatus
```

```
CCBS-Indicators ::= SEQUENCE {
  ccbs-Possible [0] NULL OPTIONAL,
  keepCCBS-CallIndicator [1] NULL OPTIONAL,
  extensionContainer [2] ExtensionContainer OPTIONAL,
  ...}
```

```
RoutingInfo ::= CHOICE {
  roamingNumber ISDN-AddressString,
  forwardingData ForwardingData}
```

```
ForwardingData ::= SEQUENCE {
  forwardedToNumber [5] ISDN-AddressString OPTIONAL,
  -- When this datatype is sent from an HLR which supports CAMEL Phase 2
  -- to a GMSC which supports CAMEL Phase 2 the GMSC shall not check the
  -- format of the number
  forwardedToSubaddress [4] ISDN-SubaddressString OPTIONAL,
  forwardingOptions [6] ForwardingOptions OPTIONAL,
  extensionContainer [7] ExtensionContainer OPTIONAL,
  ... ,
  longForwardedToNumber [8] FTN-AddressString OPTIONAL}
```



```

ProvideRoamingNumberArg ::= SEQUENCE {
    imsi [0] IMSI,
    msc-Number [1] ISDN-AddressString,
    msisdn [2] ISDN-AddressString OPTIONAL,
    lmsi [4] LMSI OPTIONAL,
    gsm-BearerCapability [5] ExternalSignalInfo OPTIONAL,
    networkSignalInfo [6] ExternalSignalInfo OPTIONAL,
    suppressionOfAnnouncement [7] SuppressionOfAnnouncement OPTIONAL,
    gmsc-Address [8] ISDN-AddressString OPTIONAL,
    callReferenceNumber [9] CallReferenceNumber OPTIONAL,
    or-Interrogation [10] NULL OPTIONAL,
    extensionContainer [11] ExtensionContainer OPTIONAL,
    ... ,
    alertingPattern [12] AlertingPattern OPTIONAL,
    ccbs-Call [13] NULL OPTIONAL,
    supportedCamelPhasesInGMSC [15] SupportedCamelPhases OPTIONAL,
    additionalSignalInfo [14] Ext-ExternalSignalInfo OPTIONAL,
    orNotSupportedInGMSC [16] NULL OPTIONAL,
    pre-pagingSupported [17] NULL OPTIONAL,
    longFTN-Supported [18] NULL OPTIONAL,
    suppress-VT-CSI [19] NULL OPTIONAL,
    supportedCamel4SubsetsInGMSC [20] SupportedCamel4Subsets OPTIONAL
}

```

```

ProvideRoamingNumberRes ::= SEQUENCE {
    roamingNumber ISDN-AddressString,
    extensionContainer ExtensionContainer OPTIONAL,
    ...}

```

```

ResumeCallHandlingArg ::= SEQUENCE {
    callReferenceNumber [0] CallReferenceNumber OPTIONAL,
    basicServiceGroup [1] Ext-BasicServiceCode OPTIONAL,
    forwardingData [2] ForwardingData OPTIONAL,
    imsi [3] IMSI OPTIONAL,
    cug-CheckInfo [4] CUG-CheckInfo OPTIONAL,
    o-CSI [5] O-CSI OPTIONAL,
    extensionContainer [7] ExtensionContainer OPTIONAL,
    ccbs-Possible [8] NULL OPTIONAL,
    msisdn [9] ISDN-AddressString OPTIONAL,
    uu-Data [10] UU-Data OPTIONAL,
    allInformationSent [11] NULL OPTIONAL,
    ... ,
    d-csi [12] D-CSI OPTIONAL}

```

```

UU-Data ::= SEQUENCE {
    uuIndicator [0] UUIndicator OPTIONAL,
    uui [1] UUI OPTIONAL,
    uusCFInteraction [2] NULL OPTIONAL,
    extensionContainer [3] ExtensionContainer OPTIONAL,
    ...}

```

```

UUIndicator ::= OCTET STRING (SIZE (1))
-- Octets are coded according to ETS 300 356

```

```

UUI ::= OCTET STRING (SIZE (1..131))
-- Octets are coded according to ETS 300 356

```

```

ResumeCallHandlingRes ::= SEQUENCE {
    extensionContainer ExtensionContainer OPTIONAL,
    ...}

```

```

CamelInfo ::= SEQUENCE {
    supportedCamelPhases SupportedCamelPhases,
    suppress-T-CSI NULL OPTIONAL,
    extensionContainer ExtensionContainer OPTIONAL,
    ... ,
    supportedCamel4Subsets [0] SupportedCamel4Subsets OPTIONAL }

```

```

ExtendedRoutingInfo ::= CHOICE {
    routingInfo RoutingInfo,
    camelRoutingInfo [8] CamelRoutingInfo}

```

```

CamelRoutingInfo ::= SEQUENCE {
    forwardingData          ForwardingData          OPTIONAL,
    gsmcCamelSubscriptionInfo [0] GsmcCamelSubscriptionInfo,
    extensionContainer      [1] ExtensionContainer    OPTIONAL,
    ...}

```

```

GsmcCamelSubscriptionInfo ::= SEQUENCE {
    t-CSI [0] T-CSI OPTIONAL,
    o-CSI [1] O-CSI OPTIONAL,
    extensionContainer [2] ExtensionContainer OPTIONAL,
    ...,
    o-BcsmCamelTDP-CriteriaList [3] O-BcsmCamelTDPCriteriaList OPTIONAL,
    t-BCSM-CAMEL-TDP-CriteriaList [4] T-BCSM-CAMEL-TDP-CriteriaList OPTIONAL,
    d-csi [5] D-CSI OPTIONAL}

```

```

ProvidesIWFSNumberArg ::= SEQUENCE {
    gsm-BearerCapability [0] ExternalSignalInfo,
    isdn-BearerCapability [1] ExternalSignalInfo,
    call-Direction [2] CallDirection,
    b-Subscriber-Address [3] ISDN-AddressString,
    chosenChannel [4] ExternalSignalInfo,
    lowerLayerCompatibility [5] ExternalSignalInfo OPTIONAL,
    highLayerCompatibility [6] ExternalSignalInfo OPTIONAL,
    extensionContainer [7] ExtensionContainer OPTIONAL,
    ...}

```

```

CallDirection ::= OCTET STRING (SIZE (1))
    -- OCTET 1

    -- bit 1 (direction of call)
    -- 0 Mobile Originated Call (MOC)
    -- 1 Mobile Terminated Call (MTC)

```

```

ProvidesIWFSNumberRes ::= SEQUENCE {
    sIWFSNumber [0] ISDN-AddressString,
    extensionContainer [1] ExtensionContainer OPTIONAL,
    ...}

```

```

SIWFSSignallingModifyArg ::= SEQUENCE {
    channelType [0] ExternalSignalInfo OPTIONAL,
    chosenChannel [1] ExternalSignalInfo OPTIONAL,
    extensionContainer [2] ExtensionContainer OPTIONAL,
    ...}

```

```

SIWFSSignallingModifyRes ::= SEQUENCE {
    chosenChannel [0] ExternalSignalInfo OPTIONAL,
    extensionContainer [1] ExtensionContainer OPTIONAL,
    ...}

```

```

SetReportingStateArg ::= SEQUENCE {
    imsi [0] IMSI OPTIONAL,
    lmsi [1] LMSI OPTIONAL,
    ccbs-Monitoring [2] ReportingState OPTIONAL,
    extensionContainer [3] ExtensionContainer OPTIONAL,
    ...}

```

```

ReportingState ::= ENUMERATED {
    stopMonitoring (0),
    startMonitoring (1),
    ...}
    -- exception handling:
    -- reception of values 2-10 shall be mapped to 'stopMonitoring'
    -- reception of values > 10 shall be mapped to 'startMonitoring'

```

```

SetReportingStateRes ::= SEQUENCE{
    ccbs-SubscriberStatus [0] CCBS-SubscriberStatus OPTIONAL,
    extensionContainer [1] ExtensionContainer OPTIONAL,
    ...}

```

```

CCBS-SubscriberStatus ::= ENUMERATED {
  ccbsNotIdle           (0),
  ccbsIdle              (1),
  ccbsNotReachable     (2),
  ...}
-- exception handling:
-- reception of values 3-10 shall be mapped to 'ccbsNotIdle'
-- reception of values 11-20 shall be mapped to 'ccbsIdle'
-- reception of values > 20 shall be mapped to 'ccbsNotReachable'

```

```

StatusReportArg ::= SEQUENCE{
  imsi                    [0] IMSI,
  eventReportData        [1] EventReportData           OPTIONAL,
  callReportdata         [2] CallReportData             OPTIONAL,
  extensionContainer     [3] ExtensionContainer         OPTIONAL,
  ...}

```

```

EventReportData ::= SEQUENCE{
  ccbs-SubscriberStatus [0] CCBS-SubscriberStatus     OPTIONAL,
  extensionContainer     [1] ExtensionContainer         OPTIONAL,
  ...}

```

```

CallReportData ::= SEQUENCE{
  monitoringMode         [0] MonitoringMode           OPTIONAL,
  callOutcome           [1] CallOutcome              OPTIONAL,
  extensionContainer     [2] ExtensionContainer         OPTIONAL,
  ...}

```

```

MonitoringMode ::= ENUMERATED {
  a-side                (0),
  b-side                (1),
  ...}
-- exception handling:
-- reception of values 2-10 shall be mapped 'a-side'
-- reception of values > 10 shall be mapped to 'b-side'

```

```

CallOutcome ::= ENUMERATED {
  success                (0),
  failure                (1),
  busy                  (2),
  ...}
-- exception handling:
-- reception of values 3-10 shall be mapped to 'success'
-- reception of values 11-20 shall be mapped to 'failure'
-- reception of values > 20 shall be mapped to 'busy'

```

```

StatusReportRes ::= SEQUENCE {
  extensionContainer     [0] ExtensionContainer         OPTIONAL,
  ...}

```

```

RemoteUserFreeArg ::= SEQUENCE{
  imsi                    [0] IMSI,
  callInfo                [1] ExternalSignalInfo,
  ccbs-Feature            [2] CCBS-Feature,
  translatedB-Number     [3] ISDN-AddressString,
  replaceB-Number        [4] NULL                     OPTIONAL,
  alertingPattern        [5] AlertingPattern           OPTIONAL,
  extensionContainer     [6] ExtensionContainer         OPTIONAL,
  ...}

```

```

RemoteUserFreeRes ::= SEQUENCE{
  ruf-Outcome            [0] RUF-Outcome,
  extensionContainer     [1] ExtensionContainer         OPTIONAL,
  ...}

```

```

RUF-Outcome ::= ENUMERATED{
  accepted (0),
  rejected (1),
  noResponseFromFreeMS (2), -- T4 Expiry
  noResponseFromBusyMS (3), -- T10 Expiry
  udubFromFreeMS (4),
  udubFromBusyMS (5),
  ...}
-- exception handling:
-- reception of values 6-20 shall be mapped to 'accepted'
-- reception of values 21-30 shall be mapped to 'rejected'
-- reception of values 31-40 shall be mapped to 'noResponseFromFreeMS'
-- reception of values 41-50 shall be mapped to 'noResponseFromBusyMS'
-- reception of values 51-60 shall be mapped to 'udubFromFreeMS'
-- reception of values > 60 shall be mapped to 'udubFromBusyMS'

```

```

IST-AlertArg ::= SEQUENCE{
  imsi [0] IMSI,
  extensionContainer [1] ExtensionContainer OPTIONAL,
  ...}

```

```

IST-AlertRes ::= SEQUENCE{
  istAlertTimer [0] IST-AlertTimerValue OPTIONAL,
  istInformationWithdraw [1] NULL OPTIONAL,
  callTerminationIndicator [2] CallTerminationIndicator OPTIONAL,
  extensionContainer [3] ExtensionContainer OPTIONAL,
  ...}

```

```

IST-CommandArg ::= SEQUENCE{
  imsi [0] IMSI,
  extensionContainer [1] ExtensionContainer OPTIONAL,
  ...}

```

```

IST-CommandRes ::= SEQUENCE{
  extensionContainer ExtensionContainer OPTIONAL,
  ...}

```

```

CallTerminationIndicator ::= ENUMERATED {
  terminateCallActivityReferred (0),
  terminateAllCallActivities (1),
  ...}
-- exception handling:
-- reception of values 2-10 shall be mapped to ' terminateCallActivityReferred '
-- reception of values > 10 shall be mapped to ' terminateAllCallActivities '

-- In MSCs not supporting linkage of all call activities, any value received shall
-- be interpreted as ' terminateCallActivityReferred '

```

END

17.7.4 Supplementary service data types

```

MAP-SS-DataTypes {
  ccitt-identified-organization (4) etsi (0) mobileDomain (0)
  gsm-Network (1) modules (3) map-SS-DataTypes (14) version8 (8)}

```

DEFINITIONS

IMPLICIT TAGS

::=

BEGIN

EXPORTS

```

  RegisterSS-Arg,
  SS-Info,
  SS-Status,
  SS-SubscriptionOption,
  SS-ForBS-Code,
  InterrogateSS-Res,
  USSD-Arg,
  USSD-Res,
  USSD-DataCodingScheme,
  USSD-String,
  Password,
  GuidanceInfo,

```

```

SS-List,
SS-InfoList,
OverrideCategory,
CliRestrictionOption,
NoReplyConditionTime,
ForwardingOptions,
maxNumOfSS,
SS-Data,
SS-InvocationNotificationArg,
SS-InvocationNotificationRes,
CCBS-Feature,
RegisterCC-EntryArg,
RegisterCC-EntryRes,
EraseCC-EntryArg,
EraseCC-EntryRes
;

IMPORTS
  AddressString,
  ISDN-AddressString,
  ISDN-SubaddressString,
  FTN-AddressString,
  IMSI,
  BasicServiceCode,
  AlertingPattern,
  EMLPP-Priority,
  MaxMC-Bearers,
  MC-Bearers,
  ExternalSignalInfo

FROM MAP-CommonDataTypes {
  ccitt identified-organization (4) etsi (0) mobileDomain (0)
  gsm-Network (1) modules (3) map-CommonDataTypes (18) version8 (8)}

  ExtensionContainer
FROM MAP-ExtensionDataTypes {
  ccitt identified-organization (4) etsi (0) mobileDomain (0)
  gsm-Network (1) modules (3) map-ExtensionDataTypes (21) version8 (8)}

  SS-Code
FROM MAP-SS-Code {
  ccitt identified-organization (4) etsi (0) mobileDomain (0)
  gsm-Network (1) modules (3) map-SS-Code (15) version8 (8)}
;

```

RegisterSS-Arg ::= SEQUENCE {		
ss-Code	SS-Code,	
basicService	BasicServiceCode	OPTIONAL,
forwardedToNumber	[4] AddressString	OPTIONAL,
forwardedToSubaddress	[6] ISDN-SubaddressString	OPTIONAL,
noReplyConditionTime	[5] NoReplyConditionTime	OPTIONAL,
...		
defaultPriority	[7] EMLPP-Priority	OPTIONAL,
nbrUser	[8] MC-Bearers	OPTIONAL,
longFTN-Supported	[9] NULL	OPTIONAL }

NoReplyConditionTime ::= INTEGER (5..30)

SS-Info ::= CHOICE {		
forwardingInfo	[0] ForwardingInfo,	
callBarringInfo	[1] CallBarringInfo,	
ss-Data	[3] SS-Data}	

ForwardingInfo ::= SEQUENCE {		
ss-Code	SS-Code	OPTIONAL,
forwardingFeatureList	ForwardingFeatureList,	
...		

ForwardingFeatureList ::=		
SEQUENCE SIZE (1..maxNumOfBasicServiceGroups) OF		
ForwardingFeature		

ForwardingFeature ::= SEQUENCE {		
basicService	BasicServiceCode	OPTIONAL,
ss-Status	[4] SS-Status	OPTIONAL,
forwardedToNumber	[5] ISDN-AddressString	OPTIONAL,
forwardedToSubaddress	[8] ISDN-SubaddressString	OPTIONAL,
forwardingOptions	[6] ForwardingOptions	OPTIONAL,
noReplyConditionTime	[7] NoReplyConditionTime	OPTIONAL,
...		
longForwardedToNumber	[9] FTN-AddressString	OPTIONAL }

SS-Status ::= OCTET STRING (SIZE (1))		
-- bits 8765: 0000 (unused)		
-- bits 4321: Used to convey the "P bit", "R bit", "A bit" and "Q bit",		
-- representing supplementary service state information		
-- as defined in TS 3GPP TS 23.011 [22]		
-- bit 4: "Q bit"		
-- bit 3: "P bit"		
-- bit 2: "R bit"		
-- bit 1: "A bit"		

ForwardingOptions ::= OCTET STRING (SIZE (1))		
-- bit 8: notification to forwarding party		
-- 0 no notification		
-- 1 notification		
-- bit 7: redirecting presentation		
-- 0 no presentation		
-- 1 presentation		
-- bit 6: notification to calling party		
-- 0 no notification		
-- 1 notification		
-- bit 5: 0 (unused)		
-- bits 43: forwarding reason		
-- 00 ms not reachable		
-- 01 ms busy		
-- 10 no reply		
-- 11 unconditional when used in a SRI Result,		
-- or call deflection when used in a RCH Argument		
-- bits 21: 00 (unused)		

CallBarringInfo ::= SEQUENCE {		
ss-Code	SS-Code	OPTIONAL,
callBarringFeatureList	CallBarringFeatureList,	
...		

CallBarringFeatureList ::= SEQUENCE SIZE (1..maxNumOfBasicServiceGroups) OF		
CallBarringFeature		

CallBarringFeature ::= SEQUENCE {		
basicService	BasicServiceCode	OPTIONAL,
ss-Status [4] SS-Status	OPTIONAL,	
...		

SS-Data ::= SEQUENCE {		
ss-Code	SS-Code	OPTIONAL,
ss-Status	[4] SS-Status	OPTIONAL,
ss-SubscriptionOption	SS-SubscriptionOption	OPTIONAL,
basicServiceGroupList	BasicServiceGroupList	OPTIONAL,
...		
defaultPriority	EMLPP-Priority	OPTIONAL,
nbrUser	[5] MC-Bearers	OPTIONAL
}		

SS-SubscriptionOption ::= CHOICE {		
cliRestrictionOption	[2] CliRestrictionOption,	
overrideCategory	[1] OverrideCategory}	

```

CliRestrictionOption ::= ENUMERATED {
    permanent (0),
    temporaryDefaultRestricted (1),
    temporaryDefaultAllowed (2)}

```

```

OverrideCategory ::= ENUMERATED {
    overrideEnabled (0),
    overrideDisabled (1)}

```

```

SS-ForBS-Code ::= SEQUENCE {
    ss-Code                               SS-Code,
    basicService                           BasicServiceCode           OPTIONAL,
    ...,
    longFTN-Supported                       [4] NULL                       OPTIONAL }

```

```

GenericServiceInfo ::= SEQUENCE {
    ss-Status SS-Status,
    cliRestrictionOption                   CliRestrictionOption         OPTIONAL,
    ...,
    maximumEntitledPriority                 [0] EMLPP-Priority           OPTIONAL,
    defaultPriority                         [1] EMLPP-Priority           OPTIONAL,
    ccbs-FeatureList                       [2] CCBS-FeatureList         OPTIONAL,
    nbrSB                                   [3] MaxMC-Bearers            OPTIONAL,
    nbrUser                                 [4] MC-Bearers                OPTIONAL,
    nbrSN                                   [5] MC-Bearers                OPTIONAL }

```

```

CCBS-FeatureList ::= SEQUENCE SIZE (1..maxNumOfCCBS-Requests) OF
    CCBS-Feature

```

```

maxNumOfCCBS-Requests INTEGER ::= 5

```

```

CCBS-Feature ::= SEQUENCE {
    ccbs-Index                             [0] CCBS-Index               OPTIONAL,
    b-subscriberNumber                     [1] ISDN-AddressString       OPTIONAL,
    b-subscriberSubaddress                 [2] ISDN-SubaddressString    OPTIONAL,
    basicServiceGroup                      [3] BasicServiceCode         OPTIONAL,
    ...}

```

```

CCBS-Index ::= INTEGER (1..maxNumOfCCBS-Requests)

```

```

InterrogateSS-Res ::= CHOICE {
    ss-Status                               [0] SS-Status,
    basicServiceGroupList                   [2] BasicServiceGroupList,
    forwardingFeatureList                   [3] ForwardingFeatureList,
    genericServiceInfo                     [4] GenericServiceInfo }

```

```

USSD-Arg ::= SEQUENCE {
    ussd-DataCodingScheme                   USSD-DataCodingScheme,
    ussd-String                             USSD-String,
    ...,
    alertingPattern                         AlertingPattern              OPTIONAL,
    msisdn                                  [0] ISDN-AddressString       OPTIONAL }

```

```

USSD-Res ::= SEQUENCE {
    ussd-DataCodingScheme                   USSD-DataCodingScheme,
    ussd-String                             USSD-String,
    ...}

```

```

USSD-DataCodingScheme ::= OCTET STRING (SIZE (1))
    -- The structure of the USSD-DataCodingScheme is defined by
    -- the Cell Broadcast Data Coding Scheme as described in
    -- TS 3GPP TS 23.038 [25]

```

```

USSD-String ::= OCTET STRING (SIZE (1..maxUSSD-StringLength))
    -- The structure of the contents of the USSD-String is dependent
    -- on the USSD-DataCodingScheme as described in TS 3GPP TS 23.038 [25].

```

```

maxUSSD-StringLength INTEGER ::= 160

```

```

Password ::= NumericString
    (FROM ("0"|"1"|"2"|"3"|"4"|"5"|"6"|"7"|"8"|"9"))
    (SIZE (4))

```

```

GuidanceInfo ::= ENUMERATED {
    enterPW (0),
    enterNewPW (1),
    enterNewPW-Again (2)}
    -- How this information is really delivered to the subscriber
    -- (display, announcement, ...) is not part of this
    -- specification.

```

```

SS-List ::= SEQUENCE SIZE (1..maxNumOfSS) OF
    SS-Code

```

```

maxNumOfSS INTEGER ::= 30

```

```

SS-InfoList ::= SEQUENCE SIZE (1..maxNumOfSS) OF
    SS-Info

```

```

BasicServiceGroupList ::= SEQUENCE SIZE (1..maxNumOfBasicServiceGroups) OF
    BasicServiceCode

```

```

maxNumOfBasicServiceGroups INTEGER ::= 13

```

```

SS-InvocationNotificationArg ::= SEQUENCE {
    imsi [0] IMSI,
    msisdn [1] ISDN-AddressString,
    ss-Event [2] SS-Code,
    -- The following SS-Code values are allowed :
    -- ect SS-Code ::= '00110001'B
    -- multiPTY SS-Code ::= '01010001'B
    -- cd SS-Code ::= '00100100'B
    -- ccbs SS-Code ::= '01000100'B
    ss-EventSpecification [3] SS-EventSpecification OPTIONAL,
    extensionContainer [4] ExtensionContainer OPTIONAL,
    ...,
    b-subscriberNumber [5] ISDN-AddressString OPTIONAL,
    ccbs-RequestState [6] CCBS-RequestState OPTIONAL
}

```

```

CCBS-RequestState ::= ENUMERATED {
    request (0),
    recall (1),
    active (2),
    completed (3),
    suspended (4),
    frozen (5),
    deleted (6)
}

```

```

SS-InvocationNotificationRes ::= SEQUENCE {
    extensionContainer ExtensionContainer OPTIONAL,
    ...
}

```

```

SS-EventSpecification ::= SEQUENCE SIZE (1..maxEventSpecification) OF
    AddressString

```

```

maxEventSpecification INTEGER ::= 2

```

```

RegisterCC-EntryArg ::= SEQUENCE {
    ss-Code [0] SS-Code,
    ccbs-Data [1] CCBS-Data OPTIONAL,
    ...
}

```

```

CCBS-Data ::= SEQUENCE {
    ccbs-Feature [0] CCBS-Feature,
    translatedB-Number [1] ISDN-AddressString,
    serviceIndicator [2] ServiceIndicator OPTIONAL,
    callInfo [3] ExternalSignalInfo,
    networkSignalInfo [4] ExternalSignalInfo,
    ...
}

```

```

ServiceIndicator ::= BIT STRING {
    clir-invoked (0),
    camel-invoked (1)} (SIZE(2..32))
    -- exception handling:
    -- bits 2 to 31 shall be ignored if received and not understood

```



```
RegisterCC-EntryRes ::= SEQUENCE {
    ccbs-Feature          [0] CCBS-Feature          OPTIONAL,
    ...}

```

```
EraseCC-EntryArg ::= SEQUENCE {
    ss-Code              [0] SS-Code,
    ccbs-Index          [1] CCBS-Index          OPTIONAL,
    ...}

```

```
EraseCC-EntryRes ::= SEQUENCE {
    ss-Code              [0] SS-Code,
    ss-Status           [1] SS-Status          OPTIONAL,
    ...}

```

END

17.7.5 Supplementary service codes

```
MAP-SS-Code {
    ccitt identified-organization (4) etsi (0) mobileDomain (0)
    gsm-Network (1) modules (3) map-SS-Code (15) version8 (8)}

```

DEFINITIONS

::=

BEGIN

```
SS-Code ::= OCTET STRING (SIZE (1))
-- This type is used to represent the code identifying a single
-- supplementary service, a group of supplementary services, or
-- all supplementary services. The services and abbreviations
-- used are defined in TS 3GPP TS 22.004 [5]. The internal structure is
-- defined as follows:
--
-- bits 87654321: group (bits 8765), and specific service
-- (bits 4321)

```

```
allSS          SS-Code ::= '00000000'B
-- reserved for possible future use
-- all SS

```

```
allLineIdentificationSS  SS-Code ::= '00010000'B
-- reserved for possible future use
-- all line identification SS
clip          SS-Code ::= '00010001'B
-- calling line identification presentation
clir          SS-Code ::= '00010010'B
-- calling line identification restriction
colp          SS-Code ::= '00010011'B
-- connected line identification presentation
colr          SS-Code ::= '00010100'B
-- connected line identification restriction
mci          SS-Code ::= '00010101'B
-- reserved for possible future use
-- malicious call identification

allNameIdentificationSS  SS-Code ::= '00011000'B
-- all name identification SS
cnap          SS-Code ::= '00011001'B
-- calling name presentation

-- SS-Codes '00011010'B to '00011111'B are reserved for future
-- NameIdentification Supplementary Service use.

```

allForwardingSS	SS-Code ::= '00100000'B
<i>-- all forwarding SS</i>	
cfu	SS-Code ::= '00100001'B
<i>-- call forwarding unconditional</i>	
allCondForwardingSS	SS-Code ::= '00101000'B
<i>-- all conditional forwarding SS</i>	
cfb	SS-Code ::= '00101001'B
<i>-- call forwarding on mobile subscriber busy</i>	
cfnry	SS-Code ::= '00101010'B
<i>-- call forwarding on no reply</i>	
cfnrc	SS-Code ::= '00101011'B
<i>-- call forwarding on mobile subscriber not reachable</i>	
cd	SS-Code ::= '00100100'B
<i>-- call deflection</i>	

allCallOfferingSS	SS-Code ::= '00110000'B
<i>-- reserved for possible future use</i>	
<i>-- all call offering SS includes also all forwarding SS</i>	
ect	SS-Code ::= '00110001'B
<i>-- explicit call transfer</i>	
mah	SS-Code ::= '00110010'B
<i>-- reserved for possible future use</i>	
<i>-- mobile access hunting</i>	

allCallCompletionSS	SS-Code ::= '01000000'B
<i>-- reserved for possible future use</i>	
<i>-- all Call completion SS</i>	
cw	SS-Code ::= '01000001'B
<i>-- call waiting</i>	
hold	SS-Code ::= '01000010'B
<i>-- call hold</i>	
ccbs-A	SS-Code ::= '01000011'B
<i>-- completion of call to busy subscribers, originating side</i>	
ccbs-B	SS-Code ::= '01000100'B
<i>-- completion of call to busy subscribers, destination side</i>	
<i>-- this SS-Code is used only in InsertSubscriberData and DeleteSubscriberData</i>	
mc	SS-Code ::= '01000101'B
<i>-- multicall</i>	

allMultiPartySS	SS-Code ::= '01010000'B
<i>-- reserved for possible future use</i>	
<i>-- all multiparty SS</i>	
multiPTY	SS-Code ::= '01010001'B
<i>-- multiparty</i>	

allCommunityOfInterest-SS	SS-Code ::= '01100000'B
<i>-- reserved for possible future use</i>	
<i>-- all community of interest SS</i>	
cug	SS-Code ::= '01100001'B
<i>-- closed user group</i>	

allChargingSS	SS-Code ::= '01110000'B
<i>-- reserved for possible future use</i>	
<i>-- all charging SS</i>	
aoci	SS-Code ::= '01110001'B
<i>-- advice of charge information</i>	
aocc	SS-Code ::= '01110010'B
<i>-- advice of charge charging</i>	

allAdditionalInfoTransferSS	SS-Code ::= '10000000'B
<i>-- reserved for possible future use</i>	
<i>-- all additional information transfer SS</i>	
uus1	SS-Code ::= '10000001'B
<i>-- UUS1 user-to-user signalling</i>	
uus2	SS-Code ::= '10000010'B
<i>-- UUS2 user-to-user signalling</i>	
uus3	SS-Code ::= '10000011'B
<i>-- UUS3 user-to-user signalling</i>	

allBarringSS	SS-Code ::= '10010000'B
-- all barring SS	
barringOfOutgoingCalls	SS-Code ::= '10010001'B
-- barring of outgoing calls	
baoc	SS-Code ::= '10010010'B
-- barring of all outgoing calls	
boic	SS-Code ::= '10010011'B
-- barring of outgoing international calls	
boicExHC	SS-Code ::= '10010100'B
-- barring of outgoing international calls except those directed to the home PLMN	
barringOfIncomingCalls	SS-Code ::= '10011001'B
-- barring of incoming calls	
baic	SS-Code ::= '10011010'B
-- barring of all incoming calls	
bicRoam	SS-Code ::= '10011011'B
-- barring of incoming calls when roaming outside home PLMN Country	

allPLMN-specificSS	SS-Code ::= '11110000'B
plmn-specificSS-1	SS-Code ::= '11110001'B
plmn-specificSS-2	SS-Code ::= '11110010'B
plmn-specificSS-3	SS-Code ::= '11110011'B
plmn-specificSS-4	SS-Code ::= '11110100'B
plmn-specificSS-5	SS-Code ::= '11110101'B
plmn-specificSS-6	SS-Code ::= '11110110'B
plmn-specificSS-7	SS-Code ::= '11110111'B
plmn-specificSS-8	SS-Code ::= '11111000'B
plmn-specificSS-9	SS-Code ::= '11111001'B
plmn-specificSS-A	SS-Code ::= '11111010'B
plmn-specificSS-B	SS-Code ::= '11111011'B
plmn-specificSS-C	SS-Code ::= '11111100'B
plmn-specificSS-D	SS-Code ::= '11111101'B
plmn-specificSS-E	SS-Code ::= '11111110'B
plmn-specificSS-F	SS-Code ::= '11111111'B

allCallPrioritySS	SS-Code ::= '10100000'B
-- reserved for possible future use	
-- all call priority SS	
emlpp	SS-Code ::= '10100001'B
-- enhanced Multilevel Precedence Pre-emption (EMLPP) service	

allLCSPrivacyException	SS-Code ::= '10110000'B
-- all LCS Privacy Exception Classes	
universal	SS-Code ::= '10110001'B
-- allow location by any LCS client	
callSessionRelated	SS-Code ::= '10110010'B
-- allow location by any value added LCS client to which a call/session is established from the target MS	
callSessionUnrelated	SS-Code ::= '10110011'B
-- allow location by designated external value added LCS clients	
plmnooperator	SS-Code ::= '10110100'B
-- allow location by designated PLMN operator LCS clients	
serviceType	SS-Code ::= '10110101'B
-- allow location by LCS clients of a designated LCS service type	

allMOLR-SS	SS-Code ::= '11000000'B
-- all Mobile Originating Location Request Classes	
basicSelfLocation	SS-Code ::= '11000001'B
-- allow an MS to request its own location	
autonomousSelfLocation	SS-Code ::= '11000010'B
-- allow an MS to perform self location without interaction with the PLMN for a predetermined period of time	
transferToThirdParty	SS-Code ::= '11000011'B
-- allow an MS to request transfer of its location to another LCS client	

END

17.7.6 Short message data types

```
MAP-SM-DataTypes {
  ccitt identified-organization (4) etsi (0) mobileDomain (0)
  gsm-Network (1) modules (3) map-SM-DataTypes (16) version8 (8)}
```

DEFINITIONS

IMPLICIT TAGS

```
 ::=
```

```
 BEGIN
```

```
 EXPORTS
```

```
 RoutingInfoForSM-Arg,
 RoutingInfoForSM-Res,
 MO-ForwardSM-Arg,
 MO-ForwardSM-Res,
 MT-ForwardSM-Arg,
 MT-ForwardSM-Res,
 ReportSM-DeliveryStatusArg,
 ReportSM-DeliveryStatusRes,
 AlertServiceCentreArg,
 InformServiceCentreArg,
 ReadyForSM-Arg,
 ReadyForSM-Res,
 SM-DeliveryOutcome,
 AlertReason,
 Additional-Number
```

```
 ;
```

```
 IMPORTS
```

```
 AddressString,
 ISDN-AddressString,
 SignalInfo,
 IMSI,
 LMSI
```

```
 FROM MAP-CommonDataTypes {
 ccitt identified-organization (4) etsi (0) mobileDomain (0)
 gsm-Network (1) modules (3) map-CommonDataTypes (18) version8 (8)}
```

```
 AbsentSubscriberDiagnosticSM
```

```
 FROM MAP-ER-DataTypes {
 ccitt identified-organization (4) etsi (0) mobileDomain (0)
 gsm-Network (1) modules (3) map-ER-DataTypes (17) version8 (8)}
```

```
 ExtensionContainer
```

```
 FROM MAP-ExtensionDataTypes {
 ccitt identified-organization (4) etsi (0) mobileDomain (0)
 gsm-Network (1) modules (3) map-ExtensionDataTypes (21) version8 (8)}
```

```
 ;
```

```
 RoutingInfoForSM-Arg ::= SEQUENCE {
    msisdn                [0] ISDN-AddressString,
    sm-RP-PRI             [1] BOOLEAN,
    serviceCentreAddress  [2] AddressString,
    extensionContainer    [6] ExtensionContainer OPTIONAL,
    ... ,
    gprsSupportIndicator  [7] NULL OPTIONAL,
    -- gprsSupportIndicator is set only if the SMS-GMSC supports
    -- receiving of two numbers from the HLR
    sm-RP-MTI             [8] SM-RP-MTI OPTIONAL,
    sm-RP-SMEA            [9] SM-RP-SMEA  OPTIONAL }
```

```
 SM-RP-MTI ::= INTEGER (0..10)
    -- 0 SMS Deliver
    -- 1 SMS Status Report
    -- other values are reserved for future use and shall be discarded if
    -- received
```

```
 SM-RP-SMEA ::= OCTET STRING (SIZE (1..12))
    -- this parameter contains an address field which is encoded
    -- as defined in 3GPP TS 23.140. An address field contains 3 elements :
    --     address-length
    --     type-of-address
    --     address-value
```

```
 RoutingInfoForSM-Res ::= SEQUENCE {
    imsi                IMSI,
    locationInfoWithLMSI [0] LocationInfoWithLMSI,
    extensionContainer  [4] ExtensionContainer OPTIONAL,
    ... }
```

```

LocationInfoWithLMSI ::= SEQUENCE {
    networkNode-Number          [1] ISDN-AddressString,
    lmsi                        LMSI                                OPTIONAL,
    extensionContainer          ExtensionContainer                OPTIONAL,
    ...,
    gprsNodeIndicator          [5] NULL                          OPTIONAL,
    -- gprsNodeIndicator is set only if the SGSN number is sent as the
    -- Network Node Number
    additional-Number          [6] Additional-Number              OPTIONAL
    -- NetworkNode-number can be either msc-number or sgsn-number
}

```

```

Additional-Number ::= CHOICE {
    msc-Number                  [0] ISDN-AddressString,
    sgsn-Number                  [1] ISDN-AddressString}
    -- additional-number can be either msc-number or sgsn-number
    -- if received networkNode-number is msc-number then the
    -- additional number is sgsn-number
    -- if received networkNode-number is sgsn-number then the
    -- additional number is msc-number

```

```

MO-ForwardSM-Arg ::= SEQUENCE {
    sm-RP-DA                    SM-RP-DA,
    sm-RP-OA                    SM-RP-OA,
    sm-RP-UI                    SignalInfo,
    extensionContainer          ExtensionContainer                OPTIONAL,
    ... ,
    imsi                        IMSI                             OPTIONAL }

```

```

MO-ForwardSM-Res ::= SEQUENCE {
    sm-RP-UI                    SignalInfo                        OPTIONAL,
    extensionContainer          ExtensionContainer                OPTIONAL,
    ...}

```

```

MT-ForwardSM-Arg ::= SEQUENCE {
    sm-RP-DA                    SM-RP-DA,
    sm-RP-OA                    SM-RP-OA,
    sm-RP-UI                    SignalInfo,
    moreMessagesToSend         NULL                            OPTIONAL,
    extensionContainer          ExtensionContainer                OPTIONAL,
    ...}

```

```

MT-ForwardSM-Res ::= SEQUENCE {
    sm-RP-UI                    SignalInfo                        OPTIONAL,
    extensionContainer          ExtensionContainer                OPTIONAL,
    ...}

```

```

SM-RP-DA ::= CHOICE {
    imsi                        [0] IMSI,
    lmsi                        [1] LMSI,
    serviceCentreAddressDA     [4] AddressString,
    noSM-RP-DA                 [5] NULL}

```

```

SM-RP-OA ::= CHOICE {
    msisdn                      [2] ISDN-AddressString,
    serviceCentreAddressOA     [4] AddressString,
    noSM-RP-OA                 [5] NULL}

```

```

ReportSM-DeliveryStatusArg ::= SEQUENCE {
    msisdn                ISDN-AddressString,
    serviceCentreAddress  AddressString,
    sm-DeliveryOutcome    SM-DeliveryOutcome,
    absentSubscriberDiagnosticSM [0] AbsentSubscriberDiagnosticSM
                                OPTIONAL,
    extensionContainer    [1] ExtensionContainer    OPTIONAL,
    ...,
    gprsSupportIndicator  [2] NULL                  OPTIONAL,
    -- gprsSupportIndicator is set only if the SMS-GMSC supports
    -- handling of two delivery outcomes
    deliveryOutcomeIndicator [3] NULL              OPTIONAL,
    -- DeliveryOutcomeIndicator is set when the SM-DeliveryOutcome
    -- is for GPRS
    additionalSM-DeliveryOutcome [4] SM-DeliveryOutcome    OPTIONAL,
    -- If received, additionalSM-DeliveryOutcome is for GPRS
    -- If DeliveryOutcomeIndicator is set, then AdditionalSM-DeliveryOutcome shall be absent
    additionalAbsentSubscriberDiagnosticSM [5] AbsentSubscriberDiagnosticSM OPTIONAL
    -- If received additionalAbsentSubscriberDiagnosticSM is for GPRS
    -- If DeliveryOutcomeIndicator is set, then AdditionalAbsentSubscriberDiagnosticSM
    -- shall be absent
}

```

```

SM-DeliveryOutcome ::= ENUMERATED {
    memoryCapacityExceeded (0),
    absentSubscriber (1),
    successfulTransfer (2)}

```

```

ReportSM-DeliveryStatusRes ::= SEQUENCE {
    storedMSISDN          ISDN-AddressString    OPTIONAL,
    extensionContainer    ExtensionContainer    OPTIONAL,
    ...}

```

```

AlertServiceCentreArg ::= SEQUENCE {
    msisdn                ISDN-AddressString,
    serviceCentreAddress  AddressString,
    ...}

```

```

InformServiceCentreArg ::= SEQUENCE {
    storedMSISDN          ISDN-AddressString    OPTIONAL,
    mw-Status MW-Status  OPTIONAL,
    extensionContainer    ExtensionContainer    OPTIONAL,
    ...,
    absentSubscriberDiagnosticSM AbsentSubscriberDiagnosticSM OPTIONAL,
    additionalAbsentSubscriberDiagnosticSM [0] AbsentSubscriberDiagnosticSM OPTIONAL }
    -- additionalAbsentSubscriberDiagnosticSM may be present only if
    -- absentSubscriberDiagnosticSM is present.
    -- if included, additionalAbsentSubscriberDiagnosticSM is for GPRS and
    -- absentSubscriberDiagnosticSM is for non-GPRS

```

```

MW-Status ::= BIT STRING {
    sc-AddressNotIncluded (0),
    mnrf-Set (1),
    mcef-Set (2),
    mnrg-Set (3)} (SIZE (6..16))
    -- exception handling:
    -- bits 4 to 15 shall be ignored if received and not understood

```

```

ReadyForSM-Arg ::= SEQUENCE {
    imsi                [0] IMSI,
    alertReason         AlertReason,
    alertReasonIndicator NULL                OPTIONAL,
    -- alertReasonIndicator is set only when the alertReason
    -- sent to HLR is for GPRS
    extensionContainer  ExtensionContainer    OPTIONAL,
    ...}

```

```

ReadyForSM-Res ::= SEQUENCE {
    extensionContainer  ExtensionContainer    OPTIONAL,
    ...}

```

```

AlertReason ::= ENUMERATED {
    ms-Present (0),
    memoryAvailable (1)}

```

END

17.7.7 Error data types

```
MAP-ER-DataTypes {
  ccitt identified-organization (4) etsi (0) mobileDomain (0)
  gsm-Network (1) modules (3) map-ER-DataTypes (17) version8 (8)}
```

DEFINITIONS

IMPLICIT TAGS

::=

BEGIN

EXPORTS

```
RoamingNotAllowedParam,
CallBarredParam,
CUG-RejectParam,
SS-IncompatibilityCause,
PW-RegistrationFailureCause,
SM-DeliveryFailureCause,
SystemFailureParam,
DataMissingParam,
UnexpectedDataParam,
FacilityNotSupParam,
OR-NotAllowedParam,
UnknownSubscriberParam,
NumberChangedParam,
UnidentifiedSubParam,
IllegalSubscriberParam,
IllegalEquipmentParam,
BearerServNotProvParam,
TeleservNotProvParam,
TracingBufferFullParam,
NoRoamingNbParam,
AbsentSubscriberParam,
BusySubscriberParam,
NoSubscriberReplyParam,
ForwardingViolationParam,
ForwardingFailedParam,
ATI-NotAllowedParam,
SubBusyForMT-SMS-Param,
MessageWaitListFullParam,
AbsentSubscriberSM-Param,
AbsentSubscriberDiagnosticSM,
ResourceLimitationParam,
NoGroupCallNbParam,
IncompatibleTerminalParam,
ShortTermDenialParam,
LongTermDenialParam,
UnauthorizedRequestingNetwork-Param,
UnauthorizedLCSCClient-Param,
PositionMethodFailure-Param,
UnknownOrUnreachableLCSCClient-Param,
MM-EventNotSupported-Param,
SecureTransportErrorParam,
ATSI-NotAllowedParam,
ATM-NotAllowedParam,
IllegalSS-OperationParam,
SS-NotAvailableParam,
SS-SubscriptionViolationParam,
InformationNotAvailableParam,
TargetCellOutsideGCA-Param
```

;

IMPORTS

```
SS-Status
```

```
FROM MAP-SS-DataTypes {
  ccitt identified-organization (4) etsi (0) mobileDomain (0)
  gsm-Network (1) modules (3) map-SS-DataTypes (14) version8 (8)}
```

```
SignalInfo,
```

```

BasicServiceCode,
NetworkResource
FROM MAP-CommonDataTypes {
  ccitt identified-organization (4) etsi (0) mobileDomain (0)
  gsm-Network (1) modules (3) map-CommonDataTypes (18) version8 (8)}

SecurityHeader,
ProtectedPayload
FROM MAP-ST-DataTypes {
  ccitt identified-organization (4) etsi (0) mobileDomain (0)
  gsm-Network (1) modules (3) map-ST-DataTypes (27) version8 (8)}

SS-Code
FROM MAP-SS-Code {
  ccitt identified-organization (4) etsi (0) mobileDomain (0)
  gsm-Network (1) modules (3) map-SS-Code (15) version8 (8)}

ExtensionContainer
FROM MAP-ExtensionDataTypes {
  ccitt identified-organization (4) etsi (0) mobileDomain (0)
  gsm-Network (1) modules (3) map-ExtensionDataTypes (21) version8 (8)}
;

```

```

RoamingNotAllowedParam ::= SEQUENCE {
  roamingNotAllowedCause          RoamingNotAllowedCause,
  extensionContainer              ExtensionContainer          OPTIONAL,
  ...}

```

```

RoamingNotAllowedCause ::= ENUMERATED {
  plmnRoamingNotAllowed (0),
  operatorDeterminedBarring (3)}

```

```

CallBarredParam ::= CHOICE {
  callBarringCause          CallBarringCause,
  -- call BarringCause must not be used in version 3 and higher
  extensibleCallBarredParam ExtensibleCallBarredParam
  -- extensibleCallBarredParam must not be used in version <3
}

```

```

CallBarringCause ::= ENUMERATED {
  barringServiceActive (0),
  operatorBarring (1)}

```

```

ExtensibleCallBarredParam ::= SEQUENCE {
  callBarringCause          CallBarringCause          OPTIONAL,
  extensionContainer        ExtensionContainer          OPTIONAL,
  ... ,
  unauthorisedMessageOriginator [1] NULL              OPTIONAL }

```

```

CUG-RejectParam ::= SEQUENCE {
  cug-RejectCause          CUG-RejectCause          OPTIONAL,
  extensionContainer        ExtensionContainer          OPTIONAL,
  ...}

```

```

CUG-RejectCause ::= ENUMERATED {
  incomingCallsBarredWithinCUG (0),
  subscriberNotMemberOfCUG (1),
  requestedBasicServiceViolatesCUG-Constraints (5),
  calledPartySS-InteractionViolation (7)}

```

```

SS-IncompatibilityCause ::= SEQUENCE {
  ss-Code                  [1] SS-Code              OPTIONAL,
  basicService              BasicServiceCode          OPTIONAL,
  ss-Status                 [4] SS-Status            OPTIONAL,
  ...}

```

```

PW-RegistrationFailureCause ::= ENUMERATED {
  undetermined (0),
  invalidFormat (1),
  newPasswordsMismatch (2)}

```



```

SM-EnumeratedDeliveryFailureCause ::= ENUMERATED {
    memoryCapacityExceeded (0),
    equipmentProtocolError (1),
    equipmentNotSM-Equipped (2),
    unknownServiceCentre (3),
    sc-Congestion (4),
    invalidSME-Address (5),
    subscriberNotSC-Subscriber (6)}

```

```

SM-DeliveryFailureCause ::= SEQUENCE {
    sm-EnumeratedDeliveryFailureCause SM-EnumeratedDeliveryFailureCause,
    diagnosticInfo SignalInfo OPTIONAL,
    extensionContainer ExtensionContainer OPTIONAL,
    ...}

```

```

AbsentSubscriberSM-Param ::= SEQUENCE {
    absentSubscriberDiagnosticSM AbsentSubscriberDiagnosticSM OPTIONAL,
    -- AbsentSubscriberDiagnosticSM can be either for non-GPRS
    -- or for GPRS
    extensionContainer ExtensionContainer OPTIONAL,
    ...,
    additionalAbsentSubscriberDiagnosticSM [0] AbsentSubscriberDiagnosticSM OPTIONAL }
    -- if received, additionalAbsentSubscriberDiagnosticSM
    -- is for GPRS and absentSubscriberDiagnosticSM is
    -- for non-GPRS

```

```

AbsentSubscriberDiagnosticSM ::= INTEGER (0..255)
    -- AbsentSubscriberDiagnosticSM values are defined in ETS 300 536 (3GPP TS 23.140)

```

```

SystemFailureParam ::= CHOICE {
    networkResource NetworkResource,
    -- networkResource must not be used in version 3
    extensibleSystemFailureParam ExtensibleSystemFailureParam
    -- extensibleSystemFailureParam must not be used in version <3
}

```

```

ExtensibleSystemFailureParam ::= SEQUENCE {
    networkResource NetworkResource OPTIONAL,
    extensionContainer ExtensionContainer OPTIONAL,
    ...}

```

```

DataMissingParam ::= SEQUENCE {
    extensionContainer ExtensionContainer OPTIONAL,
    ...}

```

```

UnexpectedDataParam ::= SEQUENCE {
    extensionContainer ExtensionContainer OPTIONAL,
    ...}

```

```

FacilityNotSupParam ::= SEQUENCE {
    extensionContainer ExtensionContainer OPTIONAL,
    ...,
    shapeOfLocationEstimateNotSupported [0] NULL OPTIONAL,
    neededLcsCapabilityNotSupportedInServingNode [1] NULL OPTIONAL }

```

```

OR-NotAllowedParam ::= SEQUENCE {
    extensionContainer ExtensionContainer OPTIONAL,
    ...}

```

```

UnknownSubscriberParam ::= SEQUENCE {
    extensionContainer ExtensionContainer OPTIONAL,
    ...,
    unknownSubscriberDiagnostic UnknownSubscriberDiagnostic OPTIONAL}

```

```

UnknownSubscriberDiagnostic ::= ENUMERATED {
    imsiUnknown (0),
    gprsSubscriptionUnknown (1),
    ...,
    npdbMismatch (2)}
    -- if unknown values are received in
    -- unknownSubscriberDiagnostic they shall be discarded

```

```

NumberChangedParam ::= SEQUENCE {
    extensionContainer ExtensionContainer OPTIONAL,
    ...}

```

UnidentifiedSubParam ::= SEQUENCE { extensionContainer ...}	ExtensionContainer	OPTIONAL,
IllegalSubscriberParam ::= SEQUENCE { extensionContainer ...}	ExtensionContainer	OPTIONAL,
IllegalEquipmentParam ::= SEQUENCE { extensionContainer ...}	ExtensionContainer	OPTIONAL,
BearerServNotProvParam ::= SEQUENCE { extensionContainer ...}	ExtensionContainer	OPTIONAL,
TeleservNotProvParam ::= SEQUENCE { extensionContainer ...}	ExtensionContainer	OPTIONAL,
TracingBufferFullParam ::= SEQUENCE { extensionContainer ...}	ExtensionContainer	OPTIONAL,
NoRoamingNbParam ::= SEQUENCE { extensionContainer ...}	ExtensionContainer	OPTIONAL,
AbsentSubscriberParam ::= SEQUENCE { extensionContainer ..., absentSubscriberReason	ExtensionContainer [0] AbsentSubscriberReason	OPTIONAL, OPTIONAL}
AbsentSubscriberReason ::= ENUMERATED { imsiDetach (0), restrictedArea (1), noPageResponse (2), ... , purgedMS (3)} -- exception handling: at reception of other values than the ones listed the -- AbsentSubscriberReason shall be ignored. -- The AbsentSubscriberReason: purgedMS is defined for the Super-Charger feature -- (see TS 23.116). If this value is received in a Provide Roaming Number response -- it shall be mapped to the AbsentSubscriberReason: imsiDetach in the Send Routing -- Information response		
BusySubscriberParam ::= SEQUENCE { extensionContainer ..., ccbs-Possible ccbs-Busy	ExtensionContainer [0] NULL [1] NULL	OPTIONAL, OPTIONAL, OPTIONAL}
NoSubscriberReplyParam ::= SEQUENCE { extensionContainer ...}	ExtensionContainer	OPTIONAL,
ForwardingViolationParam ::= SEQUENCE { extensionContainer ...}	ExtensionContainer	OPTIONAL,
ForwardingFailedParam ::= SEQUENCE { extensionContainer ...}	ExtensionContainer	OPTIONAL,
ATI-NotAllowedParam ::= SEQUENCE { extensionContainer ...}	ExtensionContainer	OPTIONAL,
ATSI-NotAllowedParam ::= SEQUENCE { extensionContainer ...}	ExtensionContainer	OPTIONAL,

ATM-NotAllowedParam ::= SEQUENCE { extensionContainer ExtensionContainer OPTIONAL, ... }
IllegalSS-OperationParam ::= SEQUENCE { extensionContainer ExtensionContainer OPTIONAL, ... }
SS-NotAvailableParam ::= SEQUENCE { extensionContainer ExtensionContainer OPTIONAL, ... }
SS-SubscriptionViolationParam ::= SEQUENCE { extensionContainer ExtensionContainer OPTIONAL, ... }
InformationNotAvailableParam ::= SEQUENCE { extensionContainer ExtensionContainer OPTIONAL, ... }
SubBusyForMT-SMS-Param ::= SEQUENCE { extensionContainer ExtensionContainer OPTIONAL, ... , gprsConnectionSuspended NULL OPTIONAL } -- If GprsConnectionSuspended is not understood it shall -- be discarded
MessageWaitListFullParam ::= SEQUENCE { extensionContainer ExtensionContainer OPTIONAL, ... }
ResourceLimitationParam ::= SEQUENCE { extensionContainer ExtensionContainer OPTIONAL, ... }
NoGroupCallNbParam ::= SEQUENCE { extensionContainer ExtensionContainer OPTIONAL, ... }
IncompatibleTerminalParam ::= SEQUENCE { extensionContainer ExtensionContainer OPTIONAL, ... }
ShortTermDenialParam ::= SEQUENCE { ... }
LongTermDenialParam ::= SEQUENCE { ... }
UnauthorizedRequestingNetwork-Param ::= SEQUENCE { extensionContainer ExtensionContainer OPTIONAL, ... }
UnauthorizedLCSCClient-Param ::= SEQUENCE { unauthorizedLCSCClient-Diagnostic [0] UnauthorizedLCSCClient-Diagnostic OPTIONAL, extensionContainer [1] ExtensionContainer OPTIONAL, ... }
UnauthorizedLCSCClient-Diagnostic ::= ENUMERATED { noAdditionalInformation (0), clientNotInMSPrivacyExceptionList (1), callToClientNotSetup (2), privacyOverrideNotApplicable (3), disallowedByLocalRegulatoryRequirements (4), ... } -- exception handling: -- any unrecognized value shall be ignored
PositionMethodFailure-Param ::= SEQUENCE { positionMethodFailure-Diagnostic [0] PositionMethodFailure-Diagnostic OPTIONAL, extensionContainer [1] ExtensionContainer OPTIONAL, ... }

```

PositionMethodFailure-Diagnostic ::= ENUMERATED {
  congestion (0),
  insufficientResources (1),
  insufficientMeasurementData (2),
  inconsistentMeasurementData (3),
  locationProcedureNotCompleted (4),
  locationProcedureNotSupportedByTargetMS (5),
  qosNotAttainable (6),
  positionMethodNotAvailableInNetwork (7),
  positionMethodNotAvailableInLocationArea (8),
  ... }
-- exception handling:
-- any unrecognized value shall be ignored

```

```

UnknownOrUnreachableLCSClient-Param ::= SEQUENCE {
  extensionContainer          ExtensionContainer          OPTIONAL,
  ...}

```

```

MM-EventNotSupported-Param ::= SEQUENCE {
  extensionContainer          ExtensionContainer          OPTIONAL,
  ...}

```

```

TargetCellOutsideGCA-Param ::= SEQUENCE {
  extensionContainer          ExtensionContainer          OPTIONAL,
  ...}

```

```

SecureTransportErrorParam ::= SEQUENCE {
  securityHeader              SecurityHeader,
  protectedPayload            ProtectedPayload            OPTIONAL
  }
-- The protectedPayload carries the result of applying the security function
-- defined in 3G TS 33.200 to the encoding of the securely transported error
-- parameter

```

END

17.7.8 Common data types

```

MAP-CommonDataTypes {
  ccitt-identified-organization (4) etsi (0) mobileDomain (0)
  gsm-Network (1) modules (3) map-CommonDataTypes (18) version8 (8)}

```

DEFINITIONS

IMPLICIT TAGS

::=

BEGIN

EXPORTS

```

-- general data types and values
AddressString,
ISDN-AddressString,
maxISDN-AddressLength,
FTN-AddressString,
ISDN-SubaddressString,
ExternalSignalInfo,
Ext-ExternalSignalInfo,
AccessNetworkSignalInfo,
SignalInfo,
maxSignalInfoLength,
AlertingPattern,

-- data types for numbering and identification
IMSI,
TMSI,
Identity,
SubscriberId,
IMEI,
HLR-List,
LMSI,
GlobalCellId,
NetworkResource,

```

```

NAEA-PreferredCI,
NAEA-CIC,
ASCI-CallReference,
SubscriberIdentity,

-- data types for CAMEL
CellGlobalIdOrServiceAreaIdOrLAI,

-- data types for subscriber management
BasicServiceCode,
Ext-BasicServiceCode,
EMLPP-Info,
EMLPP-Priority,
MC-SS-Info,
MaxMC-Bearers,
MC-Bearers,
Ext-SS-Status,

-- data types for geographic location
AgeOfLocationInformation,
LCSCClientExternalID,
LCSCClientInternalID,
LCSServiceTypeID
;

IMPORTS
  TeleserviceCode,
  Ext-TeleserviceCode
FROM MAP-TS-Code {
  ccitt identified-organization (4) etsi (0) mobileDomain (0)
  gsm-Network (1) modules (3) map-TS-Code (19) version8 (8)}

  BearerServiceCode,
  Ext-BearerServiceCode
FROM MAP-BS-Code {
  ccitt identified-organization (4) etsi (0) mobileDomain (0)
  gsm-Network (1) modules (3) map-BS-Code (20) version8 (8)}

  SS-Code
FROM MAP-SS-Code {
  ccitt identified-organization (4) etsi (0) mobileDomain (0)
  gsm-Network (1) modules (3) map-SS-Code (15) version8 (8)}

  ExtensionContainer
FROM MAP-ExtensionDataTypes {
  ccitt identified-organization (4) etsi (0) mobileDomain (0)
  gsm-Network (1) modules (3) map-ExtensionDataTypes (21) version8 (8)}
;

-- general data types

```

<pre> TBCD-STRING ::= OCTET STRING -- This type (Telephony Binary Coded Decimal String) is used to -- represent several digits from 0 through 9, *, #, a, b, c, two -- digits per octet, each digit encoded 0000 to 1001 (0 to 9), -- 1010 (*), 1011 (#), 1100 (a), 1101 (b) or 1110 (c); 1111 used -- as filler when there is an odd number of digits. -- bits 8765 of octet n encoding digit 2n -- bits 4321 of octet n encoding digit 2(n-1) +1 </pre>

```

AddressString ::= OCTET STRING (SIZE (1..maxAddressLength))
-- This type is used to represent a number for addressing
-- purposes. It is composed of
-- a) one octet for nature of address, and numbering plan
-- indicator.
-- b) digits of an address encoded as TBCD-String.

-- a) The first octet includes a one bit extension indicator, a
-- 3 bits nature of address indicator and a 4 bits numbering
-- plan indicator, encoded as follows:

-- bit 8: 1 (no extension)

-- bits 765: nature of address indicator
-- 000 unknown
-- 001 international number
-- 010 national significant number
-- 011 network specific number
-- 100 subscriber number
-- 101 reserved
-- 110 abbreviated number
-- 111 reserved for extension

-- bits 4321: numbering plan indicator
-- 0000 unknown
-- 0001 ISDN/Telephony Numbering Plan (Rec CCITT E.164)
-- 0010 spare
-- 0011 data numbering plan (CCITT Rec X.121)
-- 0100 telex numbering plan (CCITT Rec F.69)
-- 0101 spare
-- 0110 land mobile numbering plan (CCITT Rec E.212)
-- 0111 spare
-- 1000 national numbering plan
-- 1001 private numbering plan
-- 1111 reserved for extension

-- all other values are reserved.

-- b) The following octets representing digits of an address
-- encoded as a TBCD-STRING.

```

```

maxAddressLength INTEGER ::= 20

```

```

ISDN-AddressString ::=
    AddressString (SIZE (1..maxISDN-AddressLength))
-- This type is used to represent ISDN numbers.

```

```

maxISDN-AddressLength INTEGER ::= 9

```

```

FTN-AddressString ::=
    AddressString (SIZE (1..maxFTN-AddressLength))
-- This type is used to represent forwarded-to numbers.
-- For long forwarded-to numbers (longer than 15 digits) NPI shall be unknown;
-- if NAI = international the first digits represent the country code (CC)
-- and the network destination code (NDC) as for E.164.

```

```

maxFTN-AddressLength INTEGER ::= 15

```

```

ISDN-SubaddressString ::=
    OCTET STRING (SIZE (1..maxISDN-SubaddressLength))
    -- This type is used to represent ISDN subaddresses.
    -- It is composed of
    -- a) one octet for type of subaddress and odd/even indicator.
    -- b) 20 octets for subaddress information.

    -- a) The first octet includes a one bit extension indicator, a
    --     3 bits type of subaddress and a one bit odd/even indicator,
    --     encoded as follows:

    -- bit 8: 1 (no extension)

    -- bits 765: type of subaddress
    --     000 NSAP (X.213/ISO 8348 AD2)
    --     010 User Specified
    --     All other values are reserved

    -- bit 4: odd/even indicator
    --     0 even number of address signals
    --     1 odd number of address signals
    --     The odd/even indicator is used when the type of subaddress
    --     is "user specified" and the coding is BCD.

    -- bits 321: 000 (unused)

    -- b) Subaddress information.
    -- The NSAP X.213/ISO8348AD2 address shall be formatted as specified
    -- by octet 4 which contains the Authority and Format Identifier
    -- (AFI). The encoding is made according to the "preferred binary
    -- encoding" as defined in X.213/ISO834AD2. For the definition
    -- of this type of subaddress, see CCITT Rec I.334.

    -- For User-specific subaddress, this field is encoded according
    -- to the user specification, subject to a maximum length of 20
    -- octets. When interworking with X.25 networks BCD coding should
    -- be applied.

```

```

maxISDN-SubaddressLength INTEGER ::= 21

```

```

ExternalSignalInfo ::= SEQUENCE {
    protocolId          ProtocolId,
    signalInfo          SignalInfo,
    -- Information about the internal structure is given in
    -- clause 7.6.9.
    extensionContainer  ExtensionContainer OPTIONAL,
    -- extensionContainer must not be used in version 2
    ...}

```

```

SignalInfo ::= OCTET STRING (SIZE (1..maxSignalInfoLength))

```

```

maxSignalInfoLength INTEGER ::= 200
    -- This NamedValue represents the theoretical maximum number of octets which is
    -- available to carry a single instance of the SignalInfo data type,
    -- without requiring segmentation to cope with the network layer service.
    -- However, the actual maximum size available for an instance of the data
    -- type may be lower, especially when other information elements
    -- have to be included in the same component.

```

```

ProtocolId ::= ENUMERATED {
    gsm-0408 (1),
    gsm-0806 (2),
    gsm-BSSMAP (3),
    -- Value 3 is reserved and must not be used
    ets-300102-1 (4)}

```

```

Ext-ExternalSignalInfo ::= SEQUENCE {
    ext-ProtocolId      Ext-ProtocolId,
    signalInfo          SignalInfo,
    -- Information about the internal structure is given in
    -- clause 7.6.9.10
    extensionContainer  ExtensionContainer OPTIONAL,
    ...}

```

```

Ext-ProtocolId ::= ENUMERATED {
    ets-300356 (1),
    ...
}
-- exception handling:
-- For Ext-ExternalSignalInfo sequences containing this parameter with any
-- other value than the ones listed the receiver shall ignore the whole
-- Ext-ExternalSignalInfo sequence.

```

```

AccessNetworkSignalInfo ::= SEQUENCE {
    accessNetworkProtocolId      AccessNetworkProtocolId,
    signalInfo                   LongSignalInfo,
    -- Information about the internal structure is given in clause 7.6.9.1

    extensionContainer           ExtensionContainer           OPTIONAL,
    ...}

```

```

LongSignalInfo ::= OCTET STRING (SIZE (1..maxLongSignalInfoLength))

```

```

maxLongSignalInfoLength INTEGER ::= 2560
-- This Named Value represents the maximum number of octets which is available
-- to carry a single instance of the LongSignalInfo data type using
-- White Book SCCP with the maximum number of segments.
-- It takes account of the octets used by the lower layers of the protocol, and
-- other information elements which may be included in the same component.

```

```

AccessNetworkProtocolId ::= ENUMERATED {
    ts3G-48006 (1),
    ts3G-25413 (2),
    ...}
-- exception handling:
-- For AccessNetworkSignalInfo sequences containing this parameter with any
-- other value than the ones listed the receiver shall ignore the whole
-- AccessNetworkSignalInfo sequence.

```

```

AlertingPattern ::= OCTET STRING (SIZE (1) )
-- This type is used to represent Alerting Pattern

-- bits 8765 : 0000 (unused)

-- bits 43 : type of Pattern
-- 00 level
-- 01 category
-- 10 category
-- all other values are reserved.

-- bits 21 : type of alerting

alertingLevel-0 AlertingPattern ::= '00000000'B
alertingLevel-1 AlertingPattern ::= '00000001'B
alertingLevel-2 AlertingPattern ::= '00000010'B
-- all other values of Alerting level are reserved
-- Alerting Levels are defined in GSM 02.07

alertingCategory-1 AlertingPattern ::= '00000100'B
alertingCategory-2 AlertingPattern ::= '00000101'B
alertingCategory-3 AlertingPattern ::= '00000110'B
alertingCategory-4 AlertingPattern ::= '00000111'B
alertingCategory-5 AlertingPattern ::= '00001000'B
-- all other values of Alerting Category are reserved
-- Alerting categories are defined in GSM 02.07

```

```

-- data types for numbering and identification

```

```

IMSI ::= TBCD-STRING (SIZE (3..8))
-- digits of MCC, MNC, MSIN are concatenated in this order.

```

```

Identity ::= CHOICE {
    imsi                               IMSI,
    imsi-WithLMSI                     IMSI-WithLMSI}

```



```

IMSI-WithLMSI ::= SEQUENCE {
    imsi                               IMSI,
    lmsi                               LMSI,
    -- a special value 00000000 indicates that the LMSI is not in use
    ...}

```

```

ASCII-CallReference ::= TBCD-STRING (SIZE (1..8))
    -- digits of VGCS/VBC-area,Group-ID are concatenated in this order.

```

```

TMSI ::= OCTET STRING (SIZE (1..4))

```

```

SubscriberId ::= CHOICE {
    imsi                               [0] IMSI,
    tmsi                               [1] TMSI}

```

```

IMEI ::= TBCD-STRING (SIZE (8))
    -- Refers to International Mobile Station Equipment Identity
    -- and Software Version Number (SVN) defined in TS 3GPP TS 23.003 [17].
    -- If the SVN is not present the last octet shall contain the
    -- digit 0 and a filler.
    -- If present the SVN shall be included in the last octet.

```

```

HLR-Id ::= IMSI
    -- leading digits of IMSI, i.e. (MCC, MNC, leading digits of
    -- MSIN) forming HLR Id defined in TS 3GPP TS 23.003 [17].

```

```

HLR-List ::= SEQUENCE SIZE (1..maxNumOfHLR-Id) OF
    HLR-Id

```

```

maxNumOfHLR-Id INTEGER ::= 50

```

```

LMSI ::= OCTET STRING (SIZE (4))

```

```

GlobalCellId ::= OCTET STRING (SIZE (5..7))
    -- Refers to Cell Global Identification defined in TS 3GPP TS 23.003 [17].
    -- The internal structure is defined as follows:
    -- octet 1 bits 4321      Mobile Country Code 1st digit
    --           bits 8765      Mobile Country Code 2nd digit
    -- octet 2 bits 4321      Mobile Country Code 3rd digit
    --           bits 8765      Mobile Network Code 3rd digit
    --                               or filler (1111) for 2 digit MNCs
    -- octet 3 bits 4321      Mobile Network Code 1st digit
    --           bits 8765      Mobile Network Code 2nd digit
    -- octets 4 and 5        Location Area Code according to TS 3GPP TS 24.008
[35]
    -- octets 6 and 7        Cell Identity (CI) according to TS 3GPP TS 24.008
[35]

```

```

NetworkResource ::= ENUMERATED {
    plmn (0),
    hlr (1),
    vlr (2),
    pvlr (3),
    controllingMSC (4),
    vmsc (5),
    eir (6),
    rss (7)}

```

```

NAEA-PreferredCI ::= SEQUENCE {
    naea-PreferredCIC                [0] NAEA-CIC,
    extensionContainer                [1] ExtensionContainer OPTIONAL,
    ...}

```

```

NAEA-CIC ::= OCTET STRING (SIZE (3))
    -- The internal structure is defined by the Carrier Identification
    -- parameter in ANSI T1.113.3. Carrier codes between "000" and "999" may
    -- be encoded as 3 digits using "000" to "999" or as 4 digits using
    -- "0000" to "0999". Carrier codes between "1000" and "9999" are encoded
    -- using 4 digits.

```

```

SubscriberIdentity ::= CHOICE {
    imsi                               [0] IMSI,
    msisdn                             [1] ISDN-AddressString
}

```

```

LCSCClientExternalID ::= SEQUENCE {
    externalAddress          [0] AddressString          OPTIONAL,
    extensionContainer       [1] ExtensionContainer       OPTIONAL,
    ... }

```

```

LCSCClientInternalID ::= ENUMERATED {
    broadcastService        (0),
    o-andM-HPLMN           (1),
    o-andM-VPLMN           (2),
    anonymousLocation       (3),
    targetMSSubscribedService (4),
    ... }
-- for a CAMEL phase 3 PLMN operator client, the value targetMSSubscribedService shall be used

```

```

LCSServiceTypeID ::= INTEGER (0..127)
-- the integer values 0-63 are reserved for Standard LCS service types
-- the integer values 64-127 are reserved for Non Standard LCS service types

```

```

emergencyServices           LCSServiceTypeID ::= 0
emergencyAlertServices     LCSServiceTypeID ::= 1
personTracking             LCSServiceTypeID ::= 2
fleetManagement           LCSServiceTypeID ::= 3
assetManagement           LCSServiceTypeID ::= 4
trafficCongestionReporting LCSServiceTypeID ::= 5
roadsideAssistance        LCSServiceTypeID ::= 6
routingToNearestCommercialEnterprise LCSServiceTypeID ::= 7
navigation                 LCSServiceTypeID ::= 8
citySightseeing           LCSServiceTypeID ::= 9
localizedAdvertising      LCSServiceTypeID ::= 10
mobileYellowPages         LCSServiceTypeID ::= 11
-- The values of LCSServiceTypeID are defined according to 3G TS 22.071.

```

-- data types for CAMEL

```

CellGlobalIdOrServiceAreaIdOrLAI ::= CHOICE {
    cellGlobalIdOrServiceAreaIdFixedLength [0] CellGlobalIdOrServiceAreaIdFixedLength,
    laiFixedLength [1] LAIFixedLength}

```

```

CellGlobalIdOrServiceAreaIdFixedLength ::= OCTET STRING (SIZE (7))
-- Refers to Cell Global Identification or Service Area Identification
-- defined in 3G TS 23.003.
-- The internal structure is defined as follows:
-- octet 1 bits 4321      Mobile Country Code 1st digit
--          bits 8765      Mobile Country Code 2nd digit
-- octet 2 bits 4321      Mobile Country Code 3rd digit
--          bits 8765      Mobile Network Code 3rd digit
--                               or filler (1111) for 2 digit MNCs
-- octet 3 bits 4321      Mobile Network Code 1st digit
--          bits 8765      Mobile Network Code 2nd digit
-- octets 4 and 5        Location Area Code according to 3G TS 24.008
-- octets 6 and 7        Cell Identity (CI) value or
--                               Service Area Code (SAC) value
--                               according to 3G TS 23.003

```

```

LAIFixedLength ::= OCTET STRING (SIZE (5))
-- Refers to Location Area Identification defined in TS 3GPP TS 23.003 [17].
-- The internal structure is defined as follows:
-- octet 1 bits 4321      Mobile Country Code 1st digit
--          bits 8765      Mobile Country Code 2nd digit
-- octet 2 bits 4321      Mobile Country Code 3rd digit
--          bits 8765      Mobile Network Code 3rd digit
--                               or filler (1111) for 2 digit MNCs
-- octet 3 bits 4321      Mobile Network Code 1st digit
--          bits 8765      Mobile Network Code 2nd digit
-- octets 4 and 5        Location Area Code according to TS 3GPP TS 24.008
[35]

```

-- data types for subscriber management

```

BasicServiceCode ::= CHOICE {
    bearerService          [2] BearerServiceCode,
    teleservice            [3] TeleserviceCode}

```

```

Ext-BasicServiceCode ::= CHOICE {
    ext-BearerService           [2] Ext-BearerServiceCode,
    ext-Teleservice             [3] Ext-TeleserviceCode}

```

```

EMLPP-Info ::= SEQUENCE {
    maximumentitledPriority      EMLPP-Priority,
    defaultPriority              EMLPP-Priority,
    extensionContainer           ExtensionContainer           OPTIONAL,
    ...}

```

```

EMLPP-Priority ::= INTEGER (0..15)
-- The mapping from the values A,B,0,1,2,3,4 to the integer-value is
-- specified as follows where A is the highest and 4 is the lowest
-- priority level
-- the integer values 7-15 are spare and shall be mapped to value 4

```

```

priorityLevelA           EMLPP-Priority ::= 6
priorityLevelB           EMLPP-Priority ::= 5
priorityLevel0           EMLPP-Priority ::= 0
priorityLevel1           EMLPP-Priority ::= 1
priorityLevel2           EMLPP-Priority ::= 2
priorityLevel3           EMLPP-Priority ::= 3
priorityLevel4           EMLPP-Priority ::= 4

```

```

MC-SS-Info ::= SEQUENCE {
    ss-Code                     [0] SS-Code,
    ss-Status                   [1] Ext-SS-Status,
    nbrSB                       [2] MaxMC-Bearers,
    nbrUser                     [3] MC-Bearers,
    extensionContainer           [4] ExtensionContainer           OPTIONAL,
    ...}

```

```

MaxMC-Bearers ::= INTEGER (2..maxNumOfMC-Bearers)

```

```

MC-Bearers ::= INTEGER (1..maxNumOfMC-Bearers)

```

```

maxNumOfMC-Bearers INTEGER ::= 7

```

```

Ext-SS-Status ::= OCTET STRING (SIZE (1..5))

-- OCTET 1:
--
-- bits 8765: 0000 (unused)
-- bits 4321: Used to convey the "P bit", "R bit", "A bit" and "Q bit",
--             representing supplementary service state information
--             as defined in TS 3GPP TS 23.011 [22]

-- bit 4: "Q bit"

-- bit 3: "P bit"

-- bit 2: "R bit"

-- bit 1: "A bit"

-- OCTETS 2-5: reserved for future use. They shall be discarded if
-- received and not understood.

```

```

-- data types for geographic location

```

```

AgeOfLocationInformation ::= INTEGER (0..32767)
-- the value represents the elapsed time in minutes since the last
-- network contact of the mobile station (i.e. the actuality of the
-- location information).
-- value "0" indicates that the MS is currently in contact with the
-- network
-- value "32767" indicates that the location information is at least
-- 32767 minutes old

```

END

17.7.9 Teleservice Codes

```
MAP-TS-Code {
  ccitt identified-organization (4) etsi (0) mobileDomain (0)
  gsm-Network (1) modules (3) map-TS-Code (19) version8 (8)}
```

DEFINITIONS

::=

BEGIN

```
TeleserviceCode ::= OCTET STRING (SIZE (1))
  -- This type is used to represent the code identifying a single
  -- teleservice, a group of teleservices, or all teleservices. The
  -- services are defined in TS GSM 22.003 [4].
  -- The internal structure is defined as follows:

  -- bits 87654321: group (bits 8765) and specific service
  -- (bits 4321)
```

```
Ext-TeleserviceCode ::= OCTET STRING (SIZE (1..5))
  -- This type is used to represent the code identifying a single
  -- teleservice, a group of teleservices, or all teleservices. The
  -- services are defined in TS GSM 22.003 [4].
  -- The internal structure is defined as follows:

  -- OCTET 1:
  -- bits 87654321: group (bits 8765) and specific service
  -- (bits 4321)

  -- OCTETS 2-5: reserved for future use. If received the
  -- Ext-TeleserviceCode shall be
  -- treated according to the exception handling defined for the
  -- operation that uses this type.

  -- Ext-TeleserviceCode includes all values defined for TeleserviceCode.
```

```
allTeleservices TeleserviceCode ::= '00000000'B
```

```
allSpeechTransmissionServices TeleserviceCode ::= '00010000'B
telephony TeleserviceCode ::= '00010001'B
emergencyCalls TeleserviceCode ::= '00010010'B
```

```
allShortMessageServices TeleserviceCode ::= '00100000'B
shortMessageMT-PP TeleserviceCode ::= '00100001'B
shortMessageMO-PP TeleserviceCode ::= '00100010'B
```

```
allFacsimileTransmissionServices TeleserviceCode ::= '01100000'B
facsimileGroup3AndAlterSpeech TeleserviceCode ::= '01100001'B
automaticFacsimileGroup3 TeleserviceCode ::= '01100010'B
facsimileGroup4 TeleserviceCode ::= '01100011'B
```

```
-- The following non-hierarchical Compound Teleservice Groups
-- are defined in TS 3GPP TS 22.030:
allDataTeleservices TeleserviceCode ::= '01110000'B
  -- covers Teleservice Groups 'allFacsimileTransmissionServices'
  -- and 'allShortMessageServices'
allTeleservices-ExeptSMS TeleserviceCode ::= '10000000'B
  -- covers Teleservice Groups 'allSpeechTransmissionServices' and
  -- 'allFacsimileTransmissionServices'
--
-- Compound Teleservice Group Codes are only used in call
-- independent supplementary service operations, i.e. they
-- are not used in InsertSubscriberData or in
-- DeleteSubscriberData messages.
```

```
allVoiceGroupCallServices TeleserviceCode ::= '10010000'B
voiceGroupCall TeleserviceCode ::= '10010001'B
voiceBroadcastCall TeleserviceCode ::= '10010010'B
```

allPLMN-specificTS	TeleserviceCode ::= '11010000'B
plmn-specificTS-1	TeleserviceCode ::= '11010001'B
plmn-specificTS-2	TeleserviceCode ::= '11010010'B
plmn-specificTS-3	TeleserviceCode ::= '11010011'B
plmn-specificTS-4	TeleserviceCode ::= '11010100'B
plmn-specificTS-5	TeleserviceCode ::= '11010101'B
plmn-specificTS-6	TeleserviceCode ::= '11010110'B
plmn-specificTS-7	TeleserviceCode ::= '11010111'B
plmn-specificTS-8	TeleserviceCode ::= '11011000'B
plmn-specificTS-9	TeleserviceCode ::= '11011001'B
plmn-specificTS-A	TeleserviceCode ::= '11011010'B
plmn-specificTS-B	TeleserviceCode ::= '11011011'B
plmn-specificTS-C	TeleserviceCode ::= '11011100'B
plmn-specificTS-D	TeleserviceCode ::= '11011101'B
plmn-specificTS-E	TeleserviceCode ::= '11011110'B
plmn-specificTS-F	TeleserviceCode ::= '11011111'B

END

17.7.10 Bearer Service Codes

MAP-BS-Code {
 ccitt identified-organization (4) etsi (0) mobileDomain (0)
 gsm-Network (1) modules (3) map-BS-Code (20) version8 (8)}

DEFINITIONS

::=

BEGIN

<p>BearerServiceCode ::= OCTET STRING (SIZE (1))</p> <p>-- This type is used to represent the code identifying a single -- bearer service, a group of bearer services, or all bearer -- services. The services are defined in TS 3GPP TS 22.002 [3]. -- The internal structure is defined as follows: -- -- plmn-specific bearer services: -- bits 87654321: defined by the HPLMN operator</p> <p>-- rest of bearer services: -- bit 8: 0 (unused) -- bits 7654321: group (bits 7654), and rate, if applicable -- (bits 321)</p>
--

<p>Ext-BearerServiceCode ::= OCTET STRING (SIZE (1..5))</p> <p>-- This type is used to represent the code identifying a single -- bearer service, a group of bearer services, or all bearer -- services. The services are defined in TS 3GPP TS 22.002 [3]. -- The internal structure is defined as follows: -- -- OCTET 1: -- plmn-specific bearer services: -- bits 87654321: defined by the HPLMN operator</p> <p>-- rest of bearer services: -- bit 8: 0 (unused) -- bits 7654321: group (bits 7654), and rate, if applicable -- (bits 321)</p> <p>-- OCTETS 2-5: reserved for future use. If received the -- Ext-TeleserviceCode shall be -- treated according to the exception handling defined for the -- operation that uses this type.</p> <p>-- Ext-BearerServiceCode includes all values defined for BearerServiceCode.</p>
--

allBearerServices	BearerServiceCode ::= '00000000'B
--------------------------	-----------------------------------

allDataCDA-Services	BearerServiceCode ::= '00010000'B
dataCDA-300bps	BearerServiceCode ::= '00010001'B
dataCDA-1200bps	BearerServiceCode ::= '00010010'B
dataCDA-1200-75bps	BearerServiceCode ::= '00010011'B
dataCDA-2400bps	BearerServiceCode ::= '00010100'B
dataCDA-4800bps	BearerServiceCode ::= '00010101'B
dataCDA-9600bps	BearerServiceCode ::= '00010110'B
general-dataCDA	BearerServiceCode ::= '00010111'B

allDataCDS-Services	BearerServiceCode ::= '00011000'B
dataCDS-1200bps	BearerServiceCode ::= '00011010'B
dataCDS-2400bps	BearerServiceCode ::= '00011100'B
dataCDS-4800bps	BearerServiceCode ::= '00011101'B
dataCDS-9600bps	BearerServiceCode ::= '00011110'B
general-dataCDS	BearerServiceCode ::= '00011111'B

allPadAccessCA-Services	BearerServiceCode ::= '00100000'B
padAccessCA-300bps	BearerServiceCode ::= '00100001'B
padAccessCA-1200bps	BearerServiceCode ::= '00100010'B
padAccessCA-1200-75bps	BearerServiceCode ::= '00100011'B
padAccessCA-2400bps	BearerServiceCode ::= '00100100'B
padAccessCA-4800bps	BearerServiceCode ::= '00100101'B
padAccessCA-9600bps	BearerServiceCode ::= '00100110'B
general-padAccessCA	BearerServiceCode ::= '00100111'B

allDataPDS-Services	BearerServiceCode ::= '00101000'B
dataPDS-2400bps	BearerServiceCode ::= '00101100'B
dataPDS-4800bps	BearerServiceCode ::= '00101101'B
dataPDS-9600bps	BearerServiceCode ::= '00101110'B
general-dataPDS	BearerServiceCode ::= '00101111'B

allAlternateSpeech-DataCDA	BearerServiceCode ::= '00110000'B
-----------------------------------	-----------------------------------

allAlternateSpeech-DataCDS	BearerServiceCode ::= '00111000'B
-----------------------------------	-----------------------------------

allSpeechFollowedByDataCDA	BearerServiceCode ::= '01000000'B
-----------------------------------	-----------------------------------

allSpeechFollowedByDataCDS	BearerServiceCode ::= '01001000'B
-----------------------------------	-----------------------------------

<i>-- The following non-hierarchical Compound Bearer Service</i>	
<i>-- Groups are defined in TS 3GPP TS 22.030:</i>	
allDataCircuitAsynchronous	BearerServiceCode ::= '01010000'B
<i>-- covers "allDataCDA-Services", "allAlternateSpeech-DataCDA" and</i>	
<i>-- "allSpeechFollowedByDataCDA"</i>	
allAsynchronousServices	BearerServiceCode ::= '01100000'B
<i>-- covers "allDataCDA-Services", "allAlternateSpeech-DataCDA",</i>	
<i>-- "allSpeechFollowedByDataCDA" and "allPadAccessCDA-Services"</i>	
allDataCircuitSynchronous	BearerServiceCode ::= '01011000'B
<i>-- covers "allDataCDS-Services", "allAlternateSpeech-DataCDS" and</i>	
<i>-- "allSpeechFollowedByDataCDS"</i>	
allSynchronousServices	BearerServiceCode ::= '01101000'B
<i>-- covers "allDataCDS-Services", "allAlternateSpeech-DataCDS",</i>	
<i>-- "allSpeechFollowedByDataCDS" and "allDataPDS-Services"</i>	
<i>--</i>	
<i>-- Compound Bearer Service Group Codes are only used in call</i>	
<i>-- independent supplementary service operations, i.e. they</i>	
<i>-- are not used in InsertSubscriberData or in</i>	
<i>-- DeleteSubscriberData messages.</i>	

allPLMN-specificBS	BearerServiceCode ::= '11010000'B
plmn-specificBS-1	BearerServiceCode ::= '11010001'B
plmn-specificBS-2	BearerServiceCode ::= '11010010'B
plmn-specificBS-3	BearerServiceCode ::= '11010011'B
plmn-specificBS-4	BearerServiceCode ::= '11010100'B
plmn-specificBS-5	BearerServiceCode ::= '11010101'B
plmn-specificBS-6	BearerServiceCode ::= '11010110'B
plmn-specificBS-7	BearerServiceCode ::= '11010111'B
plmn-specificBS-8	BearerServiceCode ::= '11011000'B
plmn-specificBS-9	BearerServiceCode ::= '11011001'B
plmn-specificBS-A	BearerServiceCode ::= '11011010'B
plmn-specificBS-B	BearerServiceCode ::= '11011011'B
plmn-specificBS-C	BearerServiceCode ::= '11011100'B
plmn-specificBS-D	BearerServiceCode ::= '11011101'B
plmn-specificBS-E	BearerServiceCode ::= '11011110'B
plmn-specificBS-F	BearerServiceCode ::= '11011111'B

END

17.7.11 Extension data types

```
MAP-ExtensionDataTypes {
    ccitt identified-organization (4) etsi (0) mobileDomain (0)
    gsm-Network (1) modules (3) map-ExtensionDataTypes (21) version8 (8)}
```

DEFINITIONS

IMPLICIT TAGS

::=

BEGIN

EXPORTS

```
PrivateExtension,
ExtensionContainer;
```

-- IOC for private MAP extensions

<pre>MAP-EXTENSION ::= CLASS { &ExtensionType OPTIONAL, &extensionId OBJECT IDENTIFIER } -- The length of the Object Identifier shall not exceed 16 octets and the -- number of components of the Object Identifier shall not exceed 16</pre>

-- data types

<pre>ExtensionContainer ::= SEQUENCE { privateExtensionList [0]PrivateExtensionList OPTIONAL, pcs-Extensions [1]PCS-Extensions OPTIONAL, ...}</pre>

<pre>PrivateExtensionList ::= SEQUENCE SIZE (1..maxNumOfPrivateExtensions) OF PrivateExtension</pre>
--

<pre>PrivateExtension ::= SEQUENCE { extId MAP-EXTENSION.&extensionId ({ExtensionSet}), extType MAP-EXTENSION.&ExtensionType ({ExtensionSet}@extId) OPTIONAL}</pre>

<pre>maxNumOfPrivateExtensions INTEGER ::= 10</pre>

<pre>ExtensionSet MAP-EXTENSION ::= {... -- ExtensionSet is the set of all defined private extensions } -- Unsupported private extensions shall be discarded if received.</pre>
--

<pre>PCS-Extensions ::= SEQUENCE { ...}</pre>

END

17.7.12 Group Call data types

```
MAP-GR-DataTypes {
    ccitt identified-organization (4) etsi (0) mobileDomain (0)
    gsm-Network (1) modules (3) map-GR-DataTypes (23) version8 (8)}
```

DEFINITIONS

IMPLICIT TAGS

::=

BEGIN

EXPORTS

```

PrepareGroupCallArg,
PrepareGroupCallRes,
SendGroupCallEndSignalArg,
SendGroupCallEndSignalRes,
ForwardGroupCallSignallingArg,
ProcessGroupCallSignallingArg
;

```

IMPORTS

```

ISDN-AddressString,
IMSI,
EMLPP-Priority,
ASCII-CallReference
FROM MAP-CommonDataTypes {
  ccitt identified-organization (4) etsi (0) mobileDomain (0)
  gsm-Network (1) modules (3) map-CommonDataTypes (18) version8 (8)}

  Ext-TeleserviceCode
FROM MAP-TS-Code {
  ccitt identified-organization (4) etsi (0) mobileDomain (0)
  gsm-Network (1) modules (3) map-TS-Code (19) version8 (8)}

  Kc
FROM MAP-MS-DataTypes {
  ccitt identified-organization (4) etsi (0) mobileDomain (0)
  gsm-Network (1) modules (3) map-MS-DataTypes (11) version8 (8)}

  ExtensionContainer
FROM MAP-ExtensionDataTypes {
  ccitt identified-organization (4) etsi (0) mobileDomain (0)
  gsm-Network (1) modules (3) map-ExtensionDataTypes (21) version8 (8)}
;

```

PrepareGroupCallArg ::= SEQUENCE {		
teleservice	Ext-TeleserviceCode,	
asciiCallReference	ASCII-CallReference,	
codec-Info	CODEC-Info,	
cipheringAlgorithm	CipheringAlgorithm,	
groupKeyNumber	[0] GroupKeyNumber	OPTIONAL,
groupKey	[1] Kc	OPTIONAL,
priority	[2] EMLPP-Priority	OPTIONAL,
uplinkFree	[3] NULL	OPTIONAL,
extensionContainer	[4] ExtensionContainer	OPTIONAL,
...		

PrepareGroupCallRes ::= SEQUENCE {		
groupCallNumber	ISDN-AddressString,	
extensionContainer	ExtensionContainer	OPTIONAL,
...		

SendGroupCallEndSignalArg ::= SEQUENCE {		
imsi	IMSI	OPTIONAL,
extensionContainer	ExtensionContainer	OPTIONAL,
...		

SendGroupCallEndSignalRes ::= SEQUENCE {		
extensionContainer	ExtensionContainer	OPTIONAL,
...		

ForwardGroupCallSignallingArg ::= SEQUENCE {		
imsi	IMSI	OPTIONAL,
uplinkRequestAck	[0] NULL	OPTIONAL,
uplinkReleaseIndication	[1] NULL	OPTIONAL,
uplinkRejectCommand	[2] NULL	OPTIONAL,
uplinkSeizedCommand	[3] NULL	OPTIONAL,
uplinkReleaseCommand	[4] NULL	OPTIONAL,
extensionContainer	ExtensionContainer	OPTIONAL,
...		
stateAttributes	[5] StateAttributes	OPTIONAL }

```

ProcessGroupCallSignallingArg ::= SEQUENCE {
    uplinkRequest                [0] NULL                OPTIONAL,
    uplinkReleaseIndication      [1] NULL                OPTIONAL,
    releaseGroupCall             [2] NULL                OPTIONAL,
    extensionContainer            ExtensionContainer        OPTIONAL,
    ...}

```

```

GroupKeyNumber ::= INTEGER (0..15)

```

```

CODEC-Info ::= OCTET STRING (SIZE (5..10))
-- Refers to channel type
-- coded according to 3GPP TS 48.008 [49] and including Element identifier and Length

```

```

CipheringAlgorithm ::= OCTET STRING (SIZE (1))
-- Refers to 'permitted algorithms' in 'encryption information'
-- coded according to 3GPP TS 48.008 [49]:

-- Bits 8-1
-- 8765 4321
-- 0000 0001                No encryption
-- 0000 0010                GSM A5/1
-- 0000 0100                GSM A5/2
-- 0000 1000                GSM A5/3
-- 0001 0000                GSM A5/4
-- 0010 0000                GSM A5/5
-- 0100 0000                GSM A5/6
-- 1000 0000                GSM A5/7

```

```

StateAttributes ::= SEQUENCE {
    downlinkAttached             [5] NULL                OPTIONAL,
    uplinkAttached               [6] NULL                OPTIONAL,
    dualCommunication            [7] NULL                OPTIONAL,
    callOriginator               [8] NULL                OPTIONAL }
-- Refers to 3GPP TS 44.068 for definitions of StateAttributes fields.

```

END

17.7.13 Location service data types

```

1  MAP-LCS-DataTypes {
2    ccitt identified-organization (4) etsi (0) mobileDomain (0)
3    gsm-Network (1) modules (3) map-LCS-DataTypes (25) version8 (8)}
4
5  DEFINITIONS
6  IMPLICIT TAGS
7  ::=
8  BEGIN
9
10  EXPORTS
11    RoutingInfoForLCS-Arg,
12    RoutingInfoForLCS-Res,
13    ProvideSubscriberLocation-Arg,
14    ProvideSubscriberLocation-Res,
15    SubscriberLocationReport-Arg,
16    SubscriberLocationReport-Res,
17    LocationType,
18    LCSClientName,
19    LCS-QoS,
20    Horizontal-Accuracy,
21    ResponseTime,
22    Ext-GeographicalInformation,
23    SupportedGADShapes,
24    Add-GeographicalInformation,
25    LCSRequestorID,
26    LCSCodeword
27 ;
28

```

```

29 IMPORTS
30   AddressString,
31   ISDN-AddressString,
32   IMEI,
33   IMSI,
34   LMSI,
35   SubscriberIdentity,
36   AgeOfLocationInformation,
37   LCSCClientExternalID,
38   LCSCClientInternalID,
39   LCSServiceTypeID
40 FROM MAP-CommonDataTypes {
41   ccitt identified-organization (4) etsi (0) mobileDomain (0)
42   gsm-Network (1) modules (3) map-CommonDataTypes (18) version8 (8)}
43
44   ExtensionContainer
45 FROM MAP-ExtensionDataTypes {
46   ccitt identified-organization (4) etsi (0) mobileDomain (0)
47   gsm-Network (1) modules (3) map-ExtensionDataTypes (21) version8 (8)}
48
49   USSD-DataCodingScheme,
50   USSD-String
51 FROM MAP-SS-DataTypes {
52   ccitt identified-organization (4) etsi (0) mobileDomain (0) gsm-Network (1) modules (3)
53   map-SS-DataTypes (14) version8 (8)}
54
55   APN
56 FROM MAP-MS-DataTypes {
57   ccitt identified-organization (4) etsi (0) mobileDomain (0)
58   gsm-Network (1) modules (3) map-MS-DataTypes (11) version8 (8)}
59
60   Additional-Number
61 FROM MAP-SM-DataTypes {
62   ccitt identified-organization (4) etsi (0) mobileDomain (0)
63   gsm-Network (1) modules (3) map-SM-DataTypes (16) version8 (8)}
64 ;

```

```

67 RoutingInfoForLCS-Arg ::= SEQUENCE {
68   mlcNumber [0] ISDN-AddressString,
69   targetMS [1] SubscriberIdentity,
70   extensionContainer [2] ExtensionContainer OPTIONAL,
71   ...,
72   lcsCodewordApplicability [3] LCSCodewordApplicability OPTIONAL }

```

```

74 LCSCodewordApplicability ::= ENUMERATED {
75   codewordCheckApplicable (0),
76   codewordCheckNotApplicable (1),
77   ...}
78 -- exception handling:
79 -- unrecognized values shall be ignored by the receiver.

```

```

81 RoutingInfoForLCS-Res ::= SEQUENCE {
82   targetMS [0] SubscriberIdentity,
83   lcsLocationInfo [1] LCSLocationInfo,
84   extensionContainer [2] ExtensionContainer OPTIONAL,
85   ...,
86   lcsCodewordNotification [3] NULL OPTIONAL
87   -- lcsCodewordNotification may be present only if
88   -- lcsCodewordApplicability was present in RoutingInfoForLCS-Arg.
89   -- If received when lcsCodewordApplicability was not present in
90   -- RoutingInfoForLCS-Arg then lcsCodewordNotification shall be ignored.
91 }

```

```

93 LCSLocationInfo ::= SEQUENCE {
94   networkNode-Number ISDN-AddressString,
95   -- NetworkNode-number can be either msc-number or sgsn-number
96   lmsi [0] LMSI OPTIONAL,
97   extensionContainer [1] ExtensionContainer OPTIONAL,
98   ...,
99   gprsNodeIndicator [2] NULL OPTIONAL,
100  -- gprsNodeIndicator is set only if the SGSN number is sent as the Network Node Number
101  additional-Number [3] Additional-Number OPTIONAL
102 }

```

103

```

104 ProvideSubscriberLocation-Arg ::= SEQUENCE {
105     locationType                LocationType,
106     lmc-Number                  ISDN-AddressString,
107     lcs-ClientID                [0] LCS-ClientID                OPTIONAL,
108     privacyOverride             [1] NULL                    OPTIONAL,
109     imsi                        [2] IMSI                    OPTIONAL,
110     msisdn                      [3] ISDN-AddressString        OPTIONAL,
111     lmsi                        [4] LMSI                    OPTIONAL,
112     imei                        [5] IMEI                    OPTIONAL,
113     lcs-Priority                [6] LCS-Priority                OPTIONAL,
114     lcs-QoS                     [7] LCS-QoS                    OPTIONAL,
115     extensionContainer          [8] ExtensionContainer        OPTIONAL,
116     ... ,
117     supportedGADShapes          [9] SupportedGADShapes        OPTIONAL,
118     lcsServiceTypeID            [10] LCSServiceTypeID        OPTIONAL,
119     lcsCodeword                 [11] LCSCodeword                OPTIONAL }
120
121     -- one of imsi or msisdn is mandatory
122
123 LocationType ::= SEQUENCE {
124     locationEstimateType        [0] LocationEstimateType,
125     ... ,
126     deferredLocationEventType   [1] DeferredLocationEventType OPTIONAL }
127
128 LocationEstimateType ::= ENUMERATED {
129     currentLocation              (0),
130     currentOrLastKnownLocation   (1),
131     initialLocation              (2),
132     ... ,
133     activateDeferredLocation     (3),
134     cancelDeferredLocation       (4) }
135 -- exception handling:
136 -- a ProvideSubscriberLocation-Arg containing an unrecognized LocationEstimateType
137 -- shall be rejected by the receiver with a return error cause of unexpected data value
138
139 DeferredLocationEventType ::= BIT STRING {
140     msAvailable                  (0) } (SIZE (1..16))
141 -- exception handling
142 -- a ProvideSubscriberLocation-Arg containing other values than listed above in
143 -- DeferredLocationEventType shall be rejected by the receiver with a return error cause of
144 -- unexpected data value.
145
146 LCS-ClientID ::= SEQUENCE {
147     lcsClientType                [0] LCSClientType,
148     lcsClientExternalID          [1] LCSClientExternalID        OPTIONAL,
149     lcsClientDialedByMS         [2] AddressString                OPTIONAL,
150     lcsClientInternalID         [3] LCSClientInternalID        OPTIONAL,
151     lcsClientName               [4] LCSClientName                OPTIONAL,
152     ... ,
153     lcsAPN                      [5] APN                        OPTIONAL,
154     lcsRequestorID              [6] LCSRequestorID            OPTIONAL }
155
156 LCSClientType ::= ENUMERATED {
157     emergencyServices            (0),
158     valueAddedServices           (1),
159     plmnOperatorServices        (2),
160     lawfulInterceptServices     (3),
161     ... }
162 -- exception handling:
163 -- unrecognized values may be ignored if the LCS client uses the privacy override
164 -- otherwise, an unrecognized value shall be treated as unexpected data by a receiver
165 -- a return error shall then be returned if received in a MAP invoke
166
167 LCSClientName ::= SEQUENCE {
168     dataCodingScheme             [0] USSD-DataCodingScheme,
169     nameString                   [2] NameString,
170     ... }
171
172 -- The USSD-DataCodingScheme shall indicate use of the default alphabet through the
173 -- following encoding
174 -- bit 7 6 5 4 3 2 1 0
175 --      0 0 0 0 1 1 1 1
176
177 NameString ::= USSD-String (SIZE (1..maxNameStringLength))
178
179 maxNameStringLength INTEGER ::= 63
180

```

```

181 LCSRequestorID ::= SEQUENCE {
182     dataCodingScheme          [0] USSD-DataCodingScheme,
183     requestorIDString        [1] RequestorIDString,
184     ... }
185
186 RequestorIDString ::= USSD-String (SIZE (0..maxRequestorIDStringLength))
187
188 maxRequestorIDStringLength INTEGER ::= 127
189
190 LCS-Priority ::= OCTET STRING (SIZE (1))
191     -- 0 = highest priority
192     -- 1 = normal priority
193     -- all other values treated as 1
194
195 LCS-QoS ::= SEQUENCE {
196     horizontal-accuracy      [0] Horizontal-Accuracy          OPTIONAL,
197     verticalCoordinateRequest [1] NULL                      OPTIONAL,
198     vertical-accuracy        [2] Vertical-Accuracy            OPTIONAL,
199     responseTime              [3] ResponseTime                OPTIONAL,
200     extensionContainer        [4] ExtensionContainer           OPTIONAL,
201     ... }
202
203 Horizontal-Accuracy ::= OCTET STRING (SIZE (1))
204     -- bit 8 = 0
205     -- bits 7-1 = 7 bit Uncertainty Code defined in 3G TS 23.032. The horizontal location
206     -- error should be less than the error indicated by the uncertainty code with 67%
207     -- confidence.
208
209 Vertical-Accuracy ::= OCTET STRING (SIZE (1))
210     -- bit 8 = 0
211     -- bits 7-1 = 7 bit Vertical Uncertainty Code defined in 3G TS 23.032.
212     -- The vertical location error should be less than the error indicated
213     -- by the uncertainty code with 67% confidence.
214
215 ResponseTime ::= SEQUENCE {
216     responseTimeCategory      ResponseTimeCategory,
217     ... }
218 -- note: an expandable SEQUENCE simplifies later addition of a numeric response time.
219
220 ResponseTimeCategory ::= ENUMERATED {
221     lowdelay (0),
222     delaytolerant (1),
223     ... }
224 -- exception handling:
225 -- an unrecognized value shall be treated the same as value 1 (delaytolerant)
226
227 SupportedGADShapes ::= BIT STRING {
228     ellipsoidPoint (0),
229     ellipsoidPointWithUncertaintyCircle (1),
230     ellipsoidPointWithUncertaintyEllipse (2),
231     polygon (3),
232     ellipsoidPointWithAltitude (4),
233     ellipsoidPointWithAltitudeAndUncertaintyElipsoid (5),
234     ellipsoidArc (6) } (SIZE (7..16))
235 -- A node shall mark in the BIT STRING all Shapes defined in 3G TS 23.032 it supports.
236 -- exception handling: bits 7 to 15 shall be ignored if received.
237
238 LCSCodeword ::= SEQUENCE {
239     dataCodingScheme          [0] USSD-DataCodingScheme,
240     lcsCodewordString         [1] LCSCodewordString,
241     ... }
242
243 LCSCodewordString ::= USSD-String (SIZE (1..maxLCSCodewordStringLength))
244
245 maxLCSCodewordStringLength INTEGER ::= 127
246

```

```

247 ProvideSubscriberLocation-Res ::= SEQUENCE {
248     locationEstimate           Ext-GeographicalInformation,
249     ageOfLocationEstimate     [0] AgeOfLocationInformation    OPTIONAL,
250     extensionContainer        [1] ExtensionContainer            OPTIONAL,
251     ... ,
252     add-LocationEstimate      [2] Add-GeographicalInformation    OPTIONAL,
253     deferredmt-lrResponseIndicator [3] NULL                    OPTIONAL }
254
255 -- if deferredmt-lrResponseIndicator is set, locationEstimate is ignored.
256
257 -- the add-LocationEstimate parameter shall not be sent to a node that did not indicate the
258 -- geographic shapes supported in the ProvideSubscriberLocation-Arg
259 -- The locationEstimate and the add-locationEstimate parameters shall not be sent if
260 -- the supportedGADShapes parameter has been received in ProvideSubscriberLocation-Arg
261 -- and the shape encoded in locationEstimate or add-LocationEstimate is not marked
262 -- as supported in supportedGADShapes. In such a case ProvideSubscriberLocation
263 -- shall be rejected with error FacilityNotSupported with additional indication
264 -- shapeOfLocationEstimateNotSupported
265
266 Ext-GeographicalInformation ::= OCTET STRING (SIZE (1..maxExt-GeographicalInformation))
267 -- Refers to geographical Information defined in 3G TS 23.032.
268 -- This is composed of 1 or more octets with an internal structure according to
269 -- 3G TS 23.032
270 -- Octet 1: Type of shape, only the following shapes in 3G TS 23.032 are allowed:
271 --     (a) Ellipsoid point with uncertainty circle
272 --     (b) Ellipsoid point with uncertainty ellipse
273 --     (c) Ellipsoid point with altitude and uncertainty ellipsoid
274 --     (d) Ellipsoid Arc
275 --     (e) Ellipsoid Point
276 -- Any other value in octet 1 shall be treated as invalid
277 -- Octets 2 to 8 for case (a) - Ellipsoid point with uncertainty circle
278 --     Degrees of Latitude           3 octets
279 --     Degrees of Longitude         3 octets
280 --     Uncertainty code              1 octet
281 -- Octets 2 to 11 for case (b) - Ellipsoid point with uncertainty ellipse:
282 --     Degrees of Latitude           3 octets
283 --     Degrees of Longitude         3 octets
284 --     Uncertainty semi-major axis   1 octet
285 --     Uncertainty semi-minor axis   1 octet
286 --     Angle of major axis           1 octet
287 --     Confidence                     1 octet
288 -- Octets 2 to 14 for case (c) - Ellipsoid point with altitude and uncertainty ellipsoid
289 --     Degrees of Latitude           3 octets
290 --     Degrees of Longitude         3 octets
291 --     Altitude                       2 octets
292 --     Uncertainty semi-major axis   1 octet
293 --     Uncertainty semi-minor axis   1 octet
294 --     Angle of major axis           1 octet
295 --     Uncertainty altitude          1 octet
296 --     Confidence                     1 octet
297 -- Octets 2 to 13 for case (d) - Ellipsoid Arc
298 --     Degrees of Latitude           3 octets
299 --     Degrees of Longitude         3 octets
300 --     Inner radius                  2 octets
301 --     Uncertainty radius            1 octet
302 --     Offset angle                  1 octet
303 --     Included angle                1 octet
304 --     Confidence                     1 octet
305 -- Octets 2 to 7 for case (e) - Ellipsoid Point
306 --     Degrees of Latitude           3 octets
307 --     Degrees of Longitude         3 octets
308
309 --
310 -- An Ext-GeographicalInformation parameter comprising more than one octet and
311 -- containing any other shape or an incorrect number of octets or coding according
312 -- to 3G TS 23.032 shall be treated as invalid data by a receiver.
313 --
314 -- An Ext-GeographicalInformation parameter comprising one octet shall be discarded
315 -- by the receiver if an Add-GeographicalInformation parameter is received
316 -- in the same message.
317 --
318 -- An Ext-GeographicalInformation parameter comprising one octet shall be treated as
319 -- invalid data by the receiver if an Add-GeographicalInformation parameter is not
320 -- received in the same message.
321

```

```

322 maxExt-GeographicalInformation INTEGER ::= 20
323 -- the maximum length allows for further shapes in 3G TS 23.032 to be included in later
324 -- versions of 3G TS 29.002
325
326 Add-GeographicalInformation ::= OCTET STRING (SIZE (1..maxAdd-GeographicalInformation))
327 -- Refers to geographical Information defined in 3G TS 23.032.
328 -- This is composed of 1 or more octets with an internal structure according to
329 -- 3G TS 23.032
330 -- Octet 1: Type of shape, all the shapes defined in 3G TS 23.032 are allowed:
331 -- Octets 2 to n (where n is the total number of octets necessary to encode the shape
332 -- according to 3G TS 23.032) are used to encode the shape itself in accordance with the
333 -- encoding defined in 3G TS 23.032
334 --
335 -- An Add-GeographicalInformation parameter, whether valid or invalid, received
336 -- together with a valid Ext-GeographicalInformation parameter in the same message
337 -- shall be discarded.
338 --
339 -- An Add-GeographicalInformation parameter containing any shape not defined in
340 -- 3G TS 23.032 or an incorrect number of octets or coding according to
341 -- 3G TS 23.032 shall be treated as invalid data by a receiver if not received
342 -- together with a valid Ext-GeographicalInformation parameter in the same message.
343
344 maxAdd-GeographicalInformation INTEGER ::= 91
345 -- the maximum length allows support for all the shapes currently defined in 3G TS 23.032
346
347 SubscriberLocationReport-Arg ::= SEQUENCE {
348     lcs-Event                LCS-Event,
349     lcs-ClientID             LCS-ClientID,
350     lcsLocationInfo         LCSLocationInfo,
351     msisdn                   [0] ISDN-AddressString           OPTIONAL,
352     imsi                     [1] IMSI                       OPTIONAL,
353     imei                     [2] IMEI                       OPTIONAL,
354     na-ESRD                  [3] ISDN-AddressString           OPTIONAL,
355     na-ESRK                  [4] ISDN-AddressString           OPTIONAL,
356     locationEstimate         [5] Ext-GeographicalInformation  OPTIONAL,
357     ageOfLocationEstimate    [6] AgeOfLocationInformation    OPTIONAL,
358     extensionContainer       [7] ExtensionContainer           OPTIONAL,
359     ... ,
360     add-LocationEstimate     [8] Add-GeographicalInformation  OPTIONAL,
361     deferredmt-lrData       [9] Deferredmt-lrData            OPTIONAL }
362
363 -- one of msisdn or imsi is mandatory
364 -- a location estimate that is valid for the locationEstimate parameter should
365 -- be transferred in this parameter in preference to the add-LocationEstimate.
366 -- the deferredmt-lrData parameter shall be included if and only if the lcs-Event
367 -- indicates a deferredmt-lrResponse.
368 -- if the lcs-Event indicates a deferredmt-lrResponse then the locationEstimate
369 -- and the add-locationEstimate parameters shall not be sent if the
370 -- supportedGADShapes parameter had been received in ProvideSubscriberLocation-Arg
371 -- and the shape encoded in locationEstimate or add-LocationEstimate was not marked
372 -- as supported in supportedGADShapes. In such a case terminationCause
373 -- in deferredmt-lrData shall be present with value
374 -- shapeOfLocationEstimateNotSupported.
375
376
377 Deferredmt-lrData ::= SEQUENCE {
378     deferredLocationEventType DeferredLocationEventType,
379     terminationCause         [0] TerminationCause           OPTIONAL,
380     lcsLocationInfo         [1] LCSLocationInfo             OPTIONAL,
381     ... }
382 -- lcsLocationInfo may be included only if a terminationCause is present
383 -- indicating mt-lrRestart.
384
385 LCS-Event ::= ENUMERATED {
386     emergencyCallOrigination (0),
387     emergencyCallRelease (1),
388     mo-lr (2),
389     ... ,
390     deferredmt-lrResponse (3) }
391 -- exception handling:
392 -- a SubscriberLocationReport-Arg containing an unrecognized LCS-Event
393 -- shall be rejected by a receiver with a return error cause of unexpected data value
394

```

```
395 TerminationCause ::= ENUMERATED {
396     normal (0),
397     errorundefined (1),
398     internalTimeout (2),
399     congestion (3),
400     mt-lrRestart (4),
401     privacyViolation (5),
402     ...,
403     shapeOfLocationEstimateNotSupported (6) }
404 -- mt-lrRestart shall be used to trigger the GMLC to restart the location procedure,
405 -- either because the sending node knows that the terminal has moved under coverage
406 -- of another MSC or SGSN (e.g. Send Identification received), or because the subscriber
407 -- has been deregistered due to a Cancel Location received from HLR.
408 --
409 -- exception handling
410 -- an unrecognized value shall be treated the same as value 1 (errorundefined)
411
412 SubscriberLocationReport-Res ::= SEQUENCE {
413     extensionContainer          ExtensionContainer          OPTIONAL,
414     ...}
415
416
417
418 END
419
```

1 17.7.14 Secure transport data types

```

MAP-ST-DataTypes {
  ccitt identified-organization (4) etsi (0) mobileDomain (0)
  gsm-Network (1) modules (3) map-ST-DataTypes (27) version8 (8)}

DEFINITIONS
IMPLICIT TAGS
 ::=
BEGIN

EXPORTS
  SecureTransportArg,
  SecureTransportRes,
  SecurityHeader,
  ProtectedPayload
;

IMPORTS
  IMSI

FROM MAP-CommonDataTypes {
  ccitt identified-organization (4) etsi (0) mobileDomain (0)
  gsm-Network (1) modules (3) map-CommonDataTypes (18) version8 (8)}
;

```

```

SecureTransportArg ::= SEQUENCE {
  securityHeader          SecurityHeader,
  protectedPayload        ProtectedPayload          OPTIONAL
}
-- The protectedPayload carries the result of applying the security function
-- defined in 3G TS 33.200 to the encoding of the argument of the securely
-- transported operation

```

```

SecureTransportRes ::= SEQUENCE {
  securityHeader          SecurityHeader,
  protectedPayload        ProtectedPayload          OPTIONAL
}
-- The protectedPayload carries the result of applying the security function
-- defined in 3G TS 33.200 to the encoding of the result of the securely
-- transported operation

```

```

SecurityHeader ::= SEQUENCE {
  securityParametersIndex SecurityParametersIndex,
  originalComponentIdentifier OriginalComponentIdentifier,
  initialisationVector     InitialisationVector          OPTIONAL,
  ...}

```

```

ProtectedPayload ::= OCTET STRING(SIZE(1.. 3438))
-- In protection mode 0 (noProtection) the ProtectedPayload carries the transfer
-- syntax value of the component parameter identified by the
-- originalComponentIdentifier.
-- In protection mode 1 (integrityAuthenticity) the protectedPayload carries
-- the transfer syntax value of the component
-- parameter identified by the originalComponentIdentifier, followed by
-- the 32 bit integrity check value.
-- The integrity check value is the result of applying the hash algorithm
-- to the concatenation of the transfer syntax value of the SecurityHeader,
-- and the transfer syntax value of the component parameter.
-- In protection mode 2 (confidentialityIntegrityAuthenticity) the protected
-- payload carries the encrypted transfer syntax
-- value of the component parameter identified by the
-- originalComponentIdentifier, followed by the 32 bit integrity check value.
-- The integrity check value is the result of applying the hash algorithm
-- to the concatenation of the transfer syntax value of the SecurityHeader,
-- and the encrypted transfer syntax value of the component parameter.
-- See 33.200.
-- The length of the protectedPayload is adjusted according to the capabilities of
-- the lower protocol layers

```

```

SecurityParametersIndex ::= OCTET STRING (SIZE(4))

```



```

InitialisationVector ::= OCTET STRING (SIZE(14))
-- the internal structure is defined as follows:
-- Octets 1 to 4 : TVP. The TVP is a 32 bit time stamp. Its value is binary coded
-- and indicates the number of intervals of 100 milliseconds
-- elapsed since 1st January 2002, 0:00:00 UTC
-- Octets 5 to 10: NE-Id. The NE-Id uniquely identifies the sending network entity
-- within the PLMN. It is the entity's E.164 number without CC and
-- NDC. It is TBCD-coded, padded with zeros.
-- Octets 11 to 14: PROP. This 32 bit value is used to make the
-- InitialisationVector unique within the same TVP period.
-- The content is not standardized.

```

```

OriginalComponentIdentifier ::= CHOICE {
  operationCode      [0] OperationCode,
  errorCode          [1] ErrorCode,
  userInfo           [2] NULL}

```

```

OperationCode ::= CHOICE {
  localValue         INTEGER,
  globalValue        OBJECT IDENTIFIER}

```

```

ErrorCode ::= CHOICE {
  localValue         INTEGER,
  globalValue        OBJECT IDENTIFIER}

```

END

18 General on MAP user procedures

18.1 Introduction

Clauses 18 to 25 describe the use of MAP services for GSM signalling procedures. GSM signalling procedures may involve one or several interfaces running one or several application protocols. The present document addresses only the signalling procedures which require at least the use of one MAP service.

When a signalling procedure takes place in the network, an application process invocation is created in each system component involved. Part of the application process invocation acts as a MAP user and handles one or several MAP dialogues. For each dialogue it employs an instance of the MAP service provider. It may also use other communication services to exchange information on other interfaces, but detailed description of these aspects is outside the scope of the present document.

18.2 Common aspects of user procedure descriptions

18.2.1 General conventions

For each signalling procedure the present document provides a brief textual overview accompanied by a flow diagram which represent the functional interactions between system components. Functional interactions are labelled using the MAP service name when the interaction results from a service request or by this service name followed by the symbol "ack" when this interaction results from a service response.

For each of the system components involved, the present document also provides a detailed textual description of the application process behaviour as well as an SDL diagram. SDL diagrams describe the sequence of events, as seen by the MAP-User, which occurs at MAP service provider boundaries as well as external events which occur at other interfaces and which impact on the previous sequence.

External events do not necessarily correspond to the messages of other protocols used in the system component. The MAP-user procedures are described as if a set of interworking functions (IWF) between the MAP-user and the other protocol entities was implemented (see figure 18.2/1). Such interworking functions are assumed to perform either an identity mapping or some processing or translation as required to eliminate information irrelevant to the MAP-user.

The mapping of service primitives on to protocol elements is described in clauses 14 to 17.

GSM signalling procedures are built from one or more sub-procedures (e.g. authentication, ciphering, ...). Sub-procedures from which signalling procedures are built are represented using SDL MACRO descriptions.

In case of any discrepancy between the textual descriptions and the SDL descriptions, the latter take precedence.

18.2.2 Naming conventions

Events related to MAP are represented by MAP service primitives. The signal names used in the SDL diagrams are derived from the service primitive names defined in clauses 7 to 12, with some lexical transformations for readability and parsability purposes (blanks between words are replaced by underscores, the first letter of each word is capitalised).

Events received and sent on other interfaces are named by appending the message or signal name to a symbol representing the interface type, with some lexical transformations for readability and parsability purposes (blanks between words are replaced by underscores, the first letter of each word is capitalised).

The following symbols are used to represent the interface types:

- "I": For interfaces to the fixed network. "I" stands for ISUP interface.
- "A": For interfaces to BSS (i.e. A-interfaces);
- "OM": For network management interfaces (communication with OMC, MML interface, ...);
- "SC": For interfaces to a Service Centre;
- "HO_CA": For internal interfaces to the Handover Control Application.
- "US": For a local USSD application.

These naming conventions can be summarised by the following BNF description:

```

<Event_Name> ::= <MAP_Primitive> | <External_Event>
<MAP_Primitive> ::= <MAP_Open> | <MAP_Close> | <MAP_U_Abort> | <MAP_P_Abort> |
<MAP_Specific> | <MAP_Notice>
<MAP_Open> ::= MAP_Open_Req | MAP_Open_Ind | MAP_Open_Rsp | MAP_Open_Cnf
<MAP_Close> ::= MAP_Close_Req | MAP_Close_Ind
<MAP_U_Abort> ::= MAP_U_Abort_Req | MAP_U_Abort_Ind
<MAP_P_Abort> ::= MAP_P_Abort_Ind
<MAP_Notice> ::= MAP_Notice_Ind
<MAP_Specific> ::= <MAP_Req> | <MAP_Ind> | <MAP_Rsp> | <MAP_Cnf>
<MAP_Req> ::= MAP_<Service_Name>_Req
<MAP_Ind> ::= MAP_<Service_Name>_Ind
<MAP_Rsp> ::= MAP_<Service_Name>_Rsp
<MAP_Cnf> ::= MAP_<Service_Name>_Cnf
<External_Event> ::= <Interface_Type>_<External_Signal>
<Interface_Type> ::= I | A | OM | SC | HO AC | US
<External_Signal> ::= <Lexical_Unit>
<Service_Name> ::= <Lexical_Unit>

```

```

<Lexical_Unit> ::= <Lexical_Component> | <Lexical_Unit>_ <Lexical_Component>
<Lexical_Component> ::= <Upper_Case_Letter><Letter_Or_Digit_List>
<Letter_Or_Digit_List> ::= <Letter_Or_Digit> | <Letter_Or_Digit_List><Letter_Or_Digit>
<Letter_Or_Digit> ::= <Letter> | <Digit>
<Letter> ::= <Lower_Case_Letter> | <Upper_Case_Letter>
<Upper_Case_Letter> ::= A|B|C|D|E|F|G|H|I|J|K|L|M|N|O|P|Q|R|S|T|U|V|W|X|Y|Z
<Lower_Case_Letter> ::= a|b|c|d|e|f|g|h|i|j|k|l|m|n|o|p|q|r|s|t|u|v|w|x|y|z
<Digit> ::= 1|2|3|4|5|6|7|8|9|0

```

Figure 18.2/1: Interfaces applicable to the MAP-User

18.2.3 Convention on primitives parameters

18.2.3.1 Open service

When the originating and destination reference parameters shall be included in the MAP-OPEN request primitive, their value are indicated as a comment to the signal which represents this primitive.

18.2.3.2 Close service

When a pre-arranged released is requested, a comment is attached to the signal which represents the MAP-CLOSE request primitive. In the absence of comment, a normal release is assumed.

18.2.4 Version handling at dialogue establishment

Unless explicitly indicated in subsequent clauses, the following principles regarding version handling procedures at dialogue establishment are applied by the MAP-user.

18.2.4.1 Behaviour at the initiating side

When a MAP user signalling procedure has to be executed, the MAP-user issues a MAP-OPEN request primitive with an appropriate application-context-name. If several names are supported (i.e. several versions) a suitable one is selected using the procedures described in clause 5.

If version n is selected (where $1 < n \leq$ highest existing version) and a MAP-OPEN Confirm primitive is received in response to the MAP-OPEN request with a result parameter set to "refused" and a diagnostic parameter indicating "application context not supported" or "potential version incompatibility problem", the MAP-User issues a new MAP-OPEN request primitive with the equivalent version y context (where $1 \leq y < n$). This is informally represented in the SDL diagrams by task symbols indicating "Perform Vr procedure".

18.2.4.2 Behaviour at the responding side

On receipt of a MAP-OPEN indication primitive, the MAP-User analyses the application-context-name and executes the procedure associated with the requested version context. For example, if it refers to a version one context, the associated V1 procedure is executed; if it refers to a version two context, the associated V2 procedure is executed; etc.

18.2.5 Abort Handling

Unless explicitly indicated in subsequent clauses, the following principles are applied by the MAP-user regarding abort handling procedures:

On receipt of a MAP-P-ABORT indication or MAP-U-ABORT Indication primitive from any MAP-provider invocation, the MAP-User issues a MAP-U-ABORT Request primitive to each MAP-provider invocation associated with the same user procedure.

If applicable a decision is made to decide if the affected user procedure has to be retried or not.

18.2.6 SDL conventions

The MAP SDLs make use of a number of SDL concepts and conventions, where not all of them may be widely known. Therefore, this clause outlines the use of a few concepts and conventions to improve understanding of the MAP SDLs.

The MAP User SDLs make use of SDL Processes, Procedures and Macros. Processes are independent from each other even if one process starts another one: The actions of both of them have no ordering in time. SDL Procedures and Macros are just used to ease writing of the specification: They contain parts of a behaviour used in several places, and the corresponding Procedure/Macro definition has to be expanded at the position of the Procedure/Macro call.

All Processes are started at system initialisation and live forever, unless process creation/termination is indicated explicitly (i.e. a process is created by some other process).

The direction of Input/Output Signals in the SDL graphs is used to indicate the entity to which/from which communication is directed. If a process A communicates in parallel with processes B and C, all Inputs/Outputs to/from B are directed to one side, whereas communication with C is directed to the other side. However, there has been no formal convention used that communication to a certain entity (e.g. a HLR) will always be directed to a certain side (e.g. right).

In each state all those Input Signals are listed, which result in an action and/or state change. If an Input Signal is not listed in a state, receipt of this input should lead to an implicit consumption without any action or state change (according to the SDL rules). This implicit consumption is mainly used for receipt of the MAP DELIMITER indication and for receipt of a MAP CLOSE indication, except for a premature MAP CLOSE.

18.3 Interaction between MAP Provider and MAP Users

Each MAP User is defined by at least one SDL process. On the dialogue initiating side, the MAP User will create a new instance of a MAP Provider implicit by issuing a MAP-OPEN request. This instance corresponds to a TC Dialogue and lives as long as the dialogue exists (see also clause 14.3). There is a fixed relation between MAP User and this Provider instance, i.e. all MAP service primitives from the MAP User for this dialogue are sent to this instance and all TC components received by this MAP Provider are mapped onto service primitives sent to this MAP User.

On the receiving side a MAP Provider instance is created implicit by receipt of a TC BEGIN indication. The corresponding MAP User is determined by the Application Context name included in this primitive, i.e. each Application Context is associated with one and only one MAP User. An instance of this User will be created implicitly by receiving a MAP-OPEN indication. Note that in some cases there exist several SDL Processes for one MAP User (Application Context), e.g. the processes Register_SS_HLR, Erase_SS_HLR, Activate_SS_HLR, Deactivate_SS_HLR, Interrogate_SS_HLR, and Register_Password for the AC Network_Functional_SS_Handling. In these cases, a coordinator process is introduced acting as a MAP User, which in turn starts a sub-process depending on the first MAP service primitive received.

19 Mobility procedures

19.1 Location management Procedures

For non-GPRS subscribers, this clause comprises a number of processes to handle the mobile nature of the subscriber. The processes will be addressed by SCCP Sub-System Number (MSC, VLR or HLR) and the Application Context. The following processes are defined in this clause:

Process Update Location Area:

Update_Location_Area_VLR, clause 19.1.1.3;

Process Update Location:

Initiator: Update_Location_Area_VLR, clause 19.1.1.3;

Responder: Update_Location_HLR, clause 19.1.1.4;

Process Send Identification:

Initiator: Send_Identification_VLR, clause 19.1.1.x;

Responder: Send_Identification_PVLR, clause 19.1.1.5;

Process Cancel Location:

Initiator: Cancel_Location_HLR, clause 19.1.2.2;

Responder: Cancel_Location_VLR, clause 19.1.2.3;

Process Purge MS:

Initiator: Purge_MS_VLR, clause 19.1.4.2;

Responder: Purge_MS_HLR, clause 19.1.4.3.

For GPRS subscribers, this clause comprises a number of other processes to handle the mobile nature of the subscriber. The processes will be addressed by SCCP Sub-System Number (SGSN or HLR) and the Application Context. The following processes are defined in this clause:

Process GPRS Update Location:

Initiator: GPRS_Update_Location_Area_VLR, clause 19.1.1.3, or

SGSN_Update_HLR, clause 19.1.1.8,

Responder: Update_GPRS_Location_HLR, clause 19.1.1.4;

Process Cancel Location:

Initiator: Cancel_GPRS_Location_HLR, clause 19.1.2.2;

Responder: Cancel_Location_SGSN, clause 19.1.2.4;

Process Purge MS:

Initiator: Purge_MS_SGSN, clause 19.1.4.4;

Responder: Purge_MS_HLR, clause 19.1.4.3.

The following existing process is also used for GPRS subscribers :

Process Subscriber Present HLR:

Initiator: Subscriber_Present_HLR, clause 19.1.1.7;

Responder: Short_Message_Alert_IWMSC, clause 23.4.3;

Location Management Coordinator HLR

Sheet 1: After creation of the user process the service primitive received from the MAP service-provider is passed to the user process. Henceforth, the coordinator will relay all service primitives from MAP service-provider to the MAP service-user and vice versa, until a request or indication for dialogue termination is received. This last primitive will be relayed, too, before the Coordinator process returns to idle state.

Process Location_Management_Coordinator_HLR

19.1_3(1)

Figure 19.1/3
Location management coordination process in the HLR

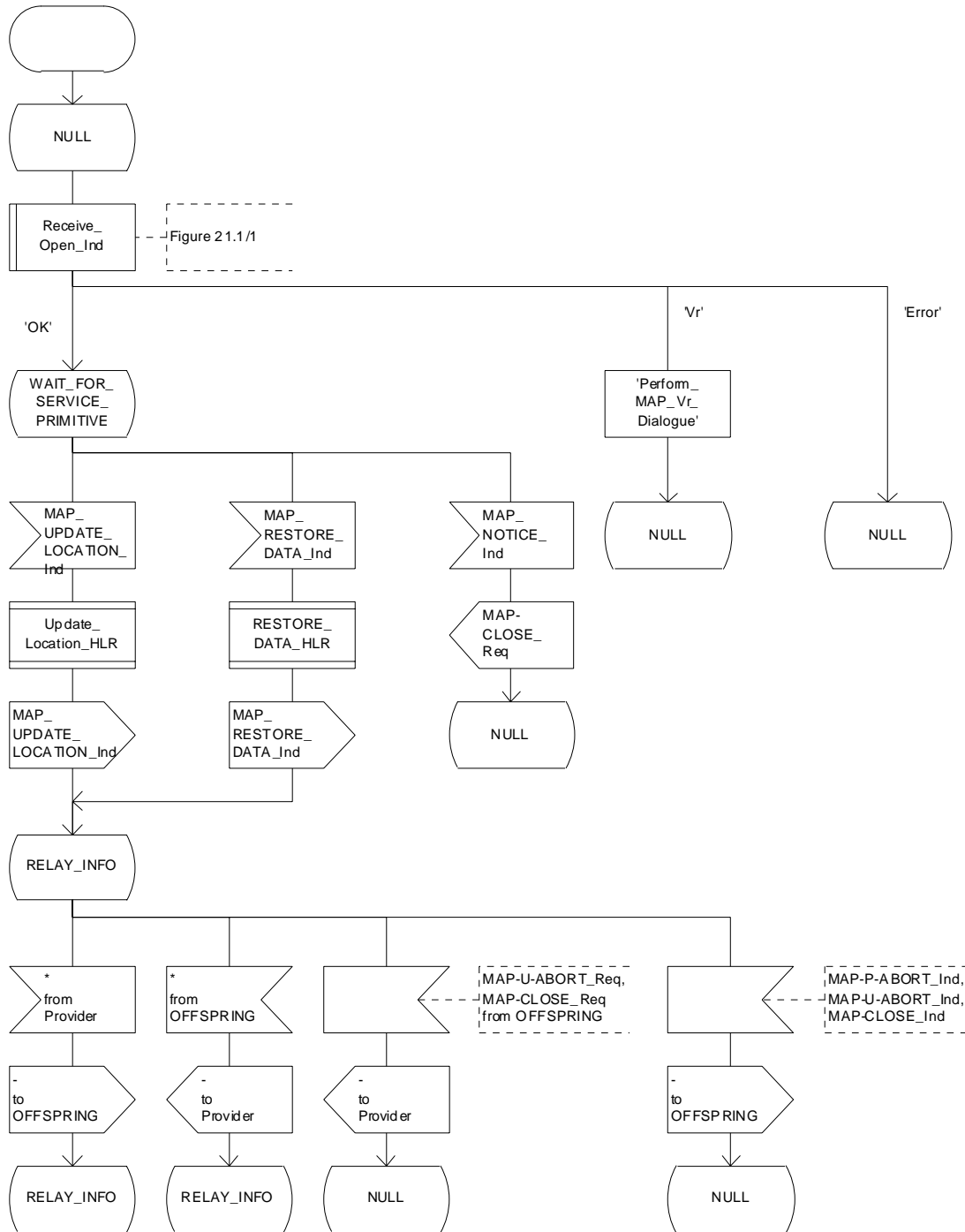

Figure 19.1/3: Process Location_Management_Coordinator_HLR

19.1.1 Location updating

19.1.1.1 General

The location updating procedure is used to update the location information held in the network. For GPRS subscribers, this procedure describes also updating of the SGSN and, if Gs interface is installed, updating of the VLR in combination with an attach/routing area updating in the SGSN. This location information is used to route incoming calls, packet data, short messages and unstructured supplementary service data to the roaming subscriber. Additionally, this procedure is used to provide the VLR and/or the SGSN with the information that a subscriber already registered, but being detached, is reachable again (IMSI Attach and/or GPRS Attach, see 3GPP TS 23.012 [23] and 3GPP TS 23.060 [104]). The use of the IMSI Detach / Attach feature is optional for the network operator.

To minimise the updates of the subscriber's HLR, the HLR holds only information about the VLR and MSC the subscriber is attached to and, for GPRS subscribers, the SGSN the subscriber is attached to. The VLR and the SGSN contain more detailed location information, i.e. the location area the subscriber is actually roaming in (for the VLR) and the routing area (RA) where the GPRS subscriber is located (for SGSN). Therefore, the VLR needs to be updated at each location area change (see figure 19.1.1/1 for this procedure) and the SGSN needs to be updated at each routing area change. The HLR needs updating only in the following cases:

- when the subscriber registers in a new VLR or SGSN, i.e. the VLR or SGSN has no data for that subscriber;
- when the subscriber registers in a new location area of the same VLR and new routing information is to be provided to the HLR (change of MSC area);
- if the indicator "Confirmed by HLR" or the indicator "Location Information Confirmed in HLR" is set to "Not Confirmed" because of HLR, VLR or SGSN restoration, and the VLR or SGSN receives an indication that the subscriber is present.

If a mobile subscriber registers in a visitor location register (VLR) not holding any information about this subscriber and is identified by a temporary mobile subscriber identity (TMSI) allocated by a previous visitor location register (PVLR), if the PVLR identity can be derived from LAI the new VLR must obtain the IMSI from PVLR to identify the HLR to be updated (see figure 19.1.1/2). If the IMSI cannot be retrieved from PVLR, it is requested from the MS (see figure 19.1.1/3).

The stage 2 specification for GPRS is in 3GPP TS 23.060 [104]. The interworking between the MAP signalling procedures and the GPRS procedures in the SGSN is shown by the transfer of signals between these procedures (see clause 19.1.1.8).

The message flow for successful GPRS Attach/ RA update procedure (with Gs interface not installed) is shown in figure 19.1.1/4.

The message flow for successful GPRS Attach/ RA update procedure combined with a successful VLR location updating (Gs interface installed) is shown in figure 19.1.1/5.

The following MAP services are invoked by the location update procedure:

MAP_UPDATE_LOCATION_AREA	(see clause 8.1);(**)
MAP_UPDATE_LOCATION	(see clause 8.1);(**)
MAP_UPDATE_GPRS_LOCATION	(see clause 8.1) (*);
MAP_CANCEL_LOCATION	(see clause 8.1);
MAP_INSERT_SUBSCRIBER_DATA	(see clause 8.8);
MAP_SEND_IDENTIFICATION	(see clause 8.1) (**);
MAP_PROVIDE_IMSI	(see clause 8.9) (**);
MAP_AUTHENTICATE	(see clause 8.5) (**);
MAP_SET_CIPHERING_MODE	(see clause 8.6) (**);
MAP_FORWARD_NEW_TMSI	(see clause 8.9) (**);

MAP_CHECK_IMEI (see clause 8.7) (**);
 MAP_ACTIVATE_TRACE_MODE (see clause 9.2);
 MAP_TRACE_SUBSCRIBER_ACTIVITY (see clause 9.2) (**).

(*): only used in SGSN and HLR for GPRS
 (**): not used in SGSN

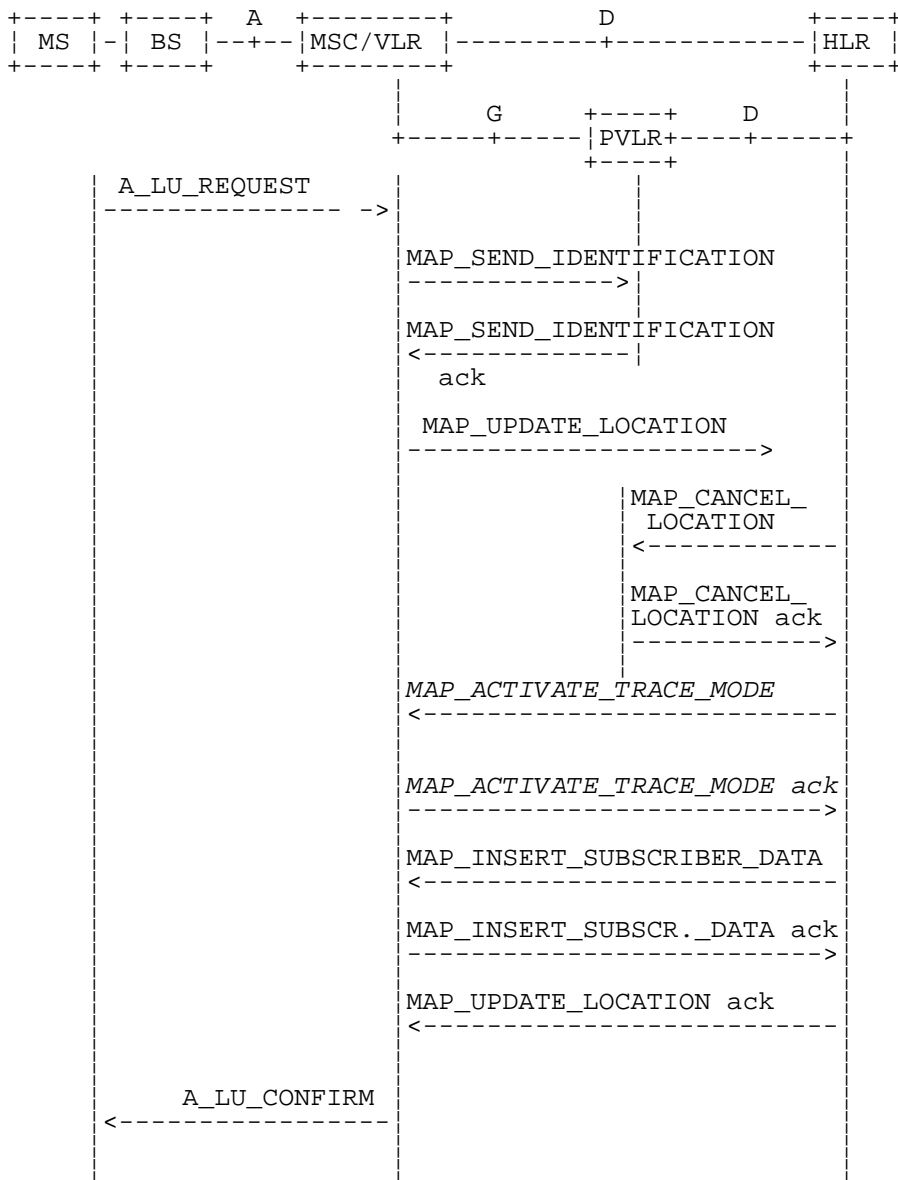

NOTE: Procedures shown in italics are optional.

Figure 19.1.1/2: Interface and services for location updating when changing the VLR area

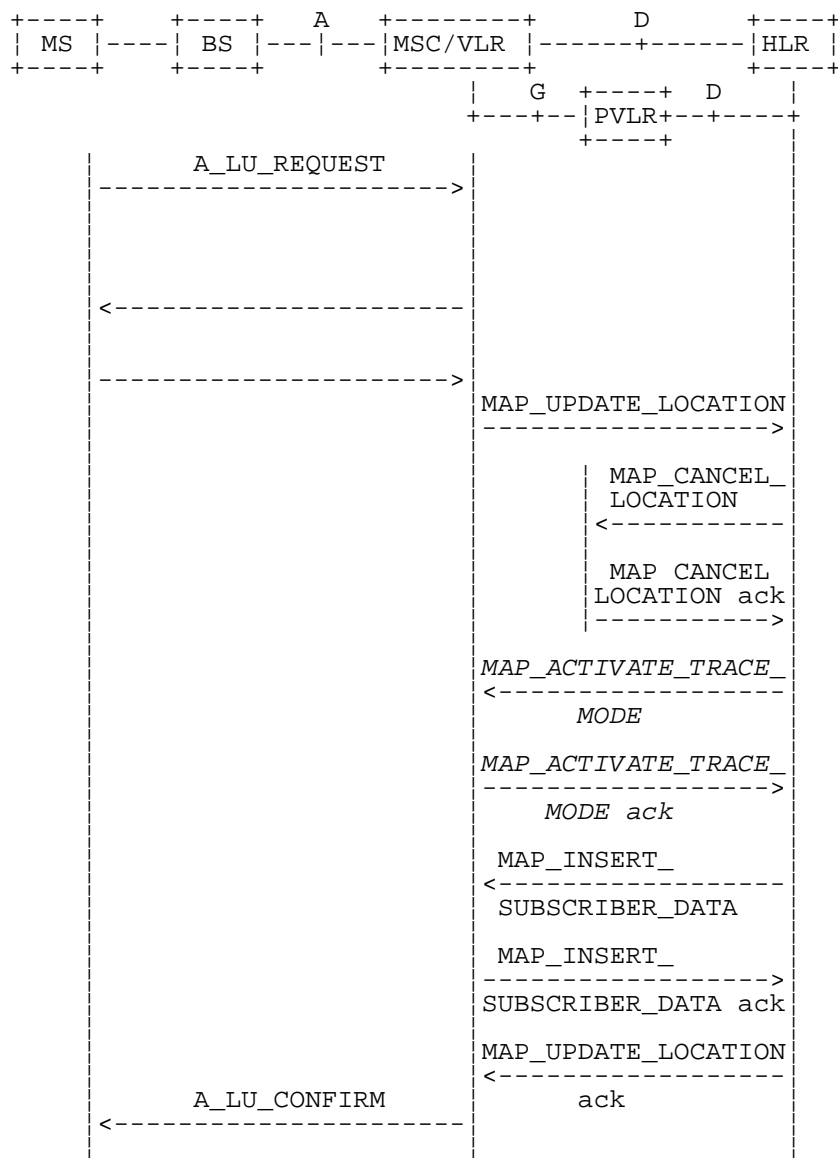

NOTE: Procedures shown in italics are optional.

Figure 19.1.1/3: Interface and services for location updating involving both a VLR and an HLR, when IMSI can not be retrieved from the previous VLR

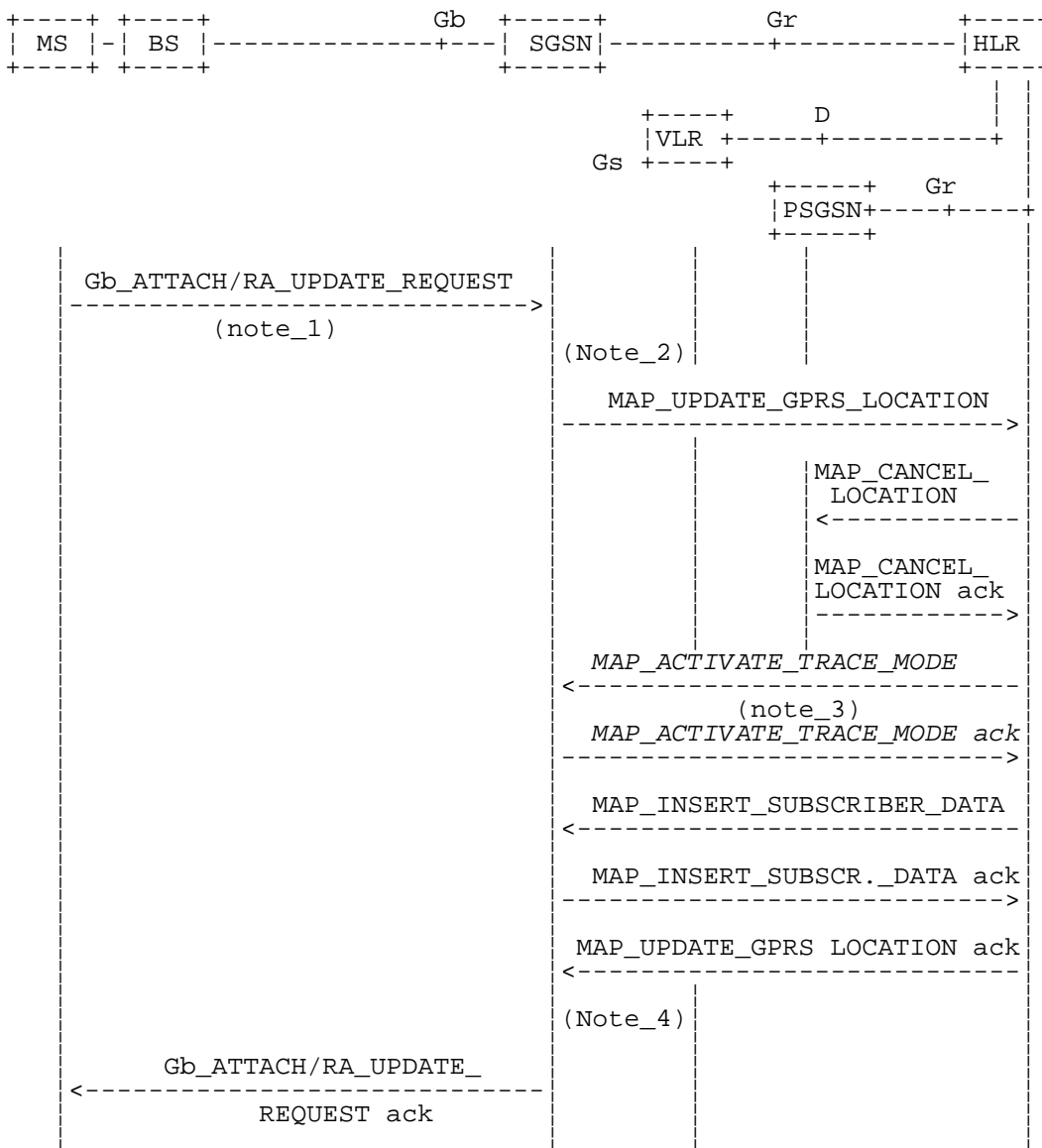

PSGSN = Previous SGSN

- NOTE 1: For details of the procedure on the radio path, see 3GPP TS 48.018. The services shown in dotted lines indicate the trigger provided by the signalling on the radio path, and the signalling triggered on the radio path.
- NOTE 2: For security functions (authentication, ciphering, IMEI check) triggering refer to 3GPP TS 23.060 [104]. MAP processes invoked for those procedures are described in section 25.
- NOTE 3: Optional services are printed in *italics*.
- NOTE 4: Refer to 3GPP TS 23.060 [104] for termination of the procedure and triggering of the signalling on the Gb interface.

Figure 19.1.1/4: Interface and services for GPRS location updating (Gs-interface not installed)

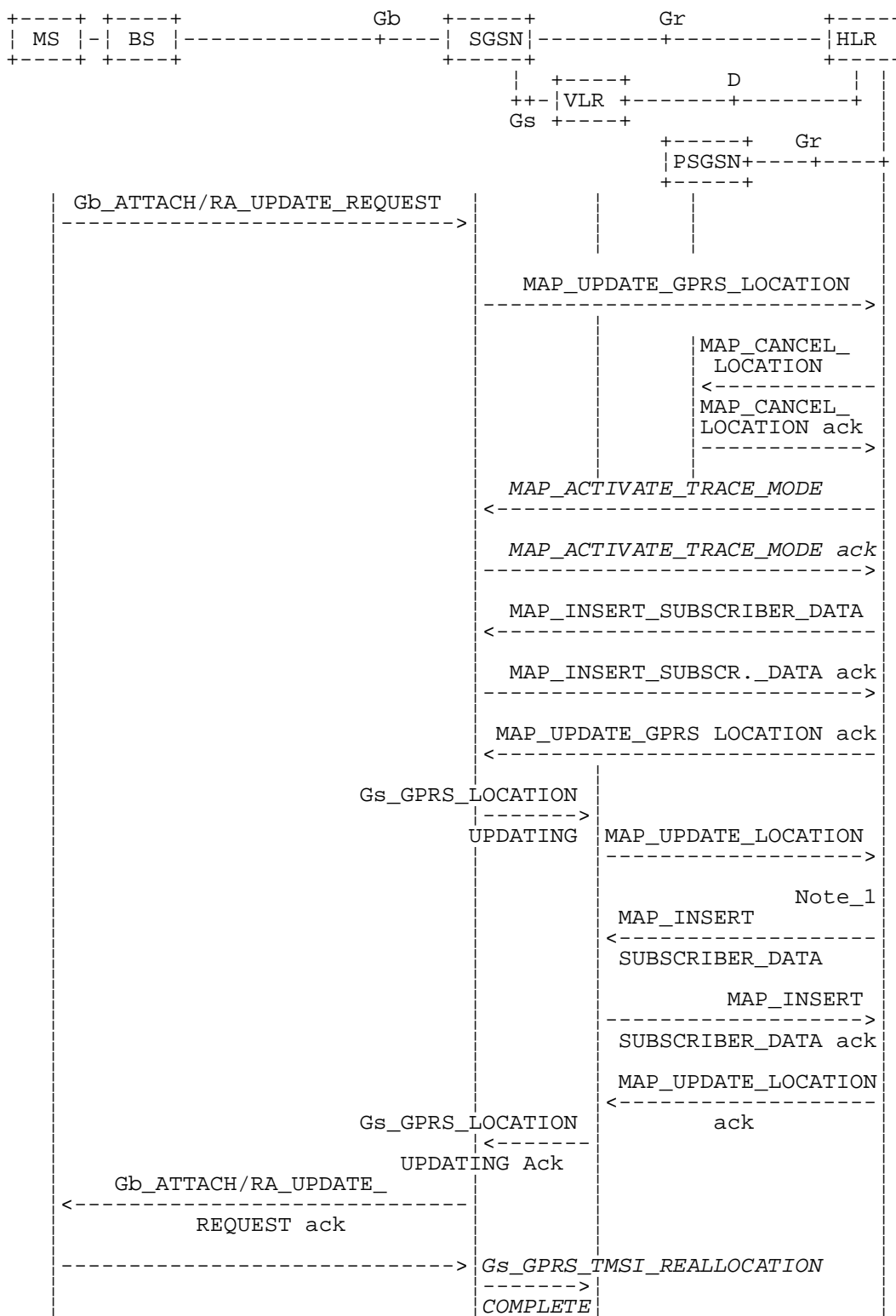

NOTE 1: The optional procedures in figure 19.1.1/14 apply here respectively. For details of the procedure on the Gs-interface, see 3GPP TS 29.018 [106].

NOTE 2: Location Cancellation procedure toward the old VLR and optional tracing activation toward the new VLR are not represented on this figure.

Figure 19.1.1/5: Interface and services for GPRS location updating (Gs-interface installed)

19.1.1.3 Detailed procedure in the VLR

Updating request via the Gs interface (optional for GPRS)

If Gs-interface is installed, the VLR may receive the Gs_GPRS_LOCATION_UPDATING_Request message from the SGSN for triggering an IMSI Attach or Location Updating procedure (see 3GPP TS 23.060 [104] and 09.18).

Figure 19.1.1/16 shows the process for handling this Gs interface message.

The process specific macro

« GPRS_Location_Update_Completion_VLR » for optional initiation of TMSI reallocation as for acknowledgement of the Gs_GPRS_LOCATION_UPDATING_Request message (see figure 19.1.1/17),

and the optional process specific macro

« VLR_Update_GPRS_HLR » to update the HLR and download subscriber data from there (see figure 19.1.1/18), are invoked by this process.

On receipt of the Gs_GPRS_LOCATION_UPDATING_Request message, the VLR checks whether the subscriber is unknown (i.e. no IMSI record). If so, the indicator "Location Information Confirmed in HLR" is set to "Not Confirmed" to initiate HLR updating later on. The indicator "Confirmed by Radio Contact" is set to "Confirmed" and the location information held in the register is updated. If no VLR/SGSN association exists it is created (storage of SGSN address received) otherwise it is updated.

If the HLR is to be updated, the VLR_Update_GPRS_HLR macro described below is performed, with one of the following results (see sheet 2 of figure 19.1.1/18):

- OK, if HLR updating has been completed successfully. The response will contain the HLR number as parameter. Next, the GPRS_Location_Update_Completion VLR macro is invoked (checking amongst others the roaming restrictions and regional subscription data), and upon successful outcome of this macro the register is updated and the process terminates.
- Roaming Not Allowed, qualified by PLMN Roaming Not Allowed if the location information indicates a PLMN for which the subscriber has no subscription or if the subscribers HLR cannot be reached (e.g. SS7 links to the subscribers HPLMN do not yet exist). In this case, the appropriate error (see 3GPP TS 29.018 [106]) is sent to the SGSN in the Gs_GPRS_LOCATION_UPDATING Reject. The Subscriber Data are deleted in the VLR.
- if Roaming Not Allowed was qualified by the parameter Operator Determined Barring, the appropriate error (see 3GPP TS 29.018 [106]) is sent in the Gs_GPRS_LOCATION_UPDATING Reject to the SGSN. The subscriber data are deleted in the VLR.
- Unknown Subscriber, if the subscriber is not known in the HLR. In this case, the subscriber data are deleted in the VLR, and the appropriate error (see 3GPP TS 29.018 [106]) is sent in the Gs_GPRS_LOCATION_UPDATING Reject.
- Procedure error, if there occurs some other error during HLR updating (e.g. abort of the connection to HLR). In this case the appropriate error (see 3GPP TS 29.018 [106]) is sent in the Gs_GPRS_LOCATION_UPDATING Reject.

The macro GPRS Location Update Completion VLR

This macro completes the VLR updating process. First, the VLR checks whether there is a roaming restriction for the subscriber (see figure 19.1.1/17):

- if the target LA is not allowed for the subscriber due to national roaming restrictions, the appropriate error (see 3GPP TS 29.018 [106]) is sent in the Gs_GPRS_LOCATION_UPDATING Reject towards the SGSN.

The subscriber data are not deleted from VLR, to avoid unnecessary HLR updating when roaming into other LAs of the same MSC/VLR. An indication that the subscriber is not allowed to roam is set in the VLR (LA Not Allowed Flag set to not allowed). As a consequence the subscriber is not reachable (checked for MTC, SMS and MT USSD) and cannot perform outgoing actions (checked in Access Management).

- if the target LA is not allowed for the subscriber because of regional subscription data (Zone Code List) or Roaming Restriction Due To Unsupported Feature stored in the VLR, the appropriate error (see 3GPP TS 29.018 [106]) is returned to the SGSN in the Gs_GPRS_LOCATION_UPDATING Reject.

Also in this case the subscriber data are not deleted from VLR, to avoid unnecessary HLR updating when roaming into other LAs of the same MSC. The LA Not Allowed Flag is set to not allowed in the VLR.

- if, after check of possible roaming restrictions, the subscriber is allowed to roam in the target LA, the LA Not Allowed Flag is set to allowed (if necessary), the IMSI Detached Flag is set to attached and the process SUBSCRIBER_PRESENT_VLR is started; this may inform the HLR that the subscriber is present again to retry an SMS delivery (see clause 19.1.1.7). Thereafter, the VLR checks whether TMSI reallocation is required.
- if so, the VLR sends the TMSI within the Gs_GPRS_LOCATION_UPDATING Accept message and Gs_GPRS_TMSI_REALLOCATION_Complete is expected.
- if TMSI reallocation is not required, the VLR sends the Gs_GPRS_LOCATION_UPDATING Accept message to the SGSN.

The macro VLR Update GPRS HLR

This macro is invoked by the VLR process for location updating (see 3GPP TS 23.060 [104]). If the VLR does not know the subscribers HLR (e.g. no IMSI translation exists as there are not yet any SS7 links to the subscribers HPLMN), the error Roaming Not Allowed with cause PLMN Roaming Not Allowed is returned.

If the subscribers HLR can be reached, the VLR opens a dialogue towards the HLR (see figure 19.1.1/18) by sending a MAP_OPEN request without any user specific parameters, together with a MAP_UPDATE_LOCATION request containing the parameters

- IMSI, identifying the subscriber;
- Location Info, containing the MSC number;
- VLR Number, the E.164 address of the VLR, to be used by the HLR when addressing the VLR henceforth (e.g. when requesting an MSRN);
- the LMSI as an VLR operator option; this is a subscriber identification local to the VLR, used for fast data base access.

In case the HLR rejects dialogue opening (see clause 25.1), the VLR will terminate the procedure indicating Procedure error. If the HLR indicates version Vr protocol to be used, the VLR will revert to the version Vr procedure concerning the dialogue with the HLR, with outcomes as for the current MAP version procedure.

If the HLR accepts the dialogue, the HLR will respond with:

- a MAP_INSERT_SUBSCRIBER_DATA indication, handled by the macro Insert_Subs_Data_VLR defined in clause 25.7;

NOTE: The HLR may repeat this service several times depending on the amount of data to be transferred to the VLR and to replace subscription data in case they are not supported by the VLR.

- a MAP_ACTIVATE_TRACE_MODE indication, handled by the macro Activate_Tracing_VLR defined in clause 25.9;
- a MAP_FORWARD_CHECK_SS_INDICATION_ind. This indication will not be relayed to the SGSN.
- the MAP_UPDATE_LOCATION confirmation:
 - if this confirmation contains the HLR Number, this indicates that the HLR has passed all information and that updating has been successfully completed. The VLR is updated using the parameters provided in the service and needed by the VLR. If certain parameters are not needed in the VLR, e.g. because some service is not supported, the corresponding data may be discarded. The VLR sets the "Confirmed by HLR" and "Location information confirmed in HLR" indicators to "Confirmed" to indicate successful subscriber data updating;
 - if the confirmation contains an User error cause (Unknown Subscriber, Roaming Not Allowed or some other), the process calling the macro continues accordingly. In the last case, the subscriber data are marked as incomplete by setting the indicators "Confirmed by HLR" and "Location information confirmed in HLR" to "Not Confirmed". The same holds if there is a Provider error or a Data error in the confirmation;
- a MAP_P_ABORT, MAP_U_ABORT, or MAP_CLOSE indication. In these cases, the subscriber data are marked to be incomplete and the process continues as in the case of an error reported by the HLR;

- a MAP_NOTICE indication. Then, the dialogue towards the HLR is terminated, the subscriber data are marked to be incomplete and the process continues as in the case of an error reported by the HLR.

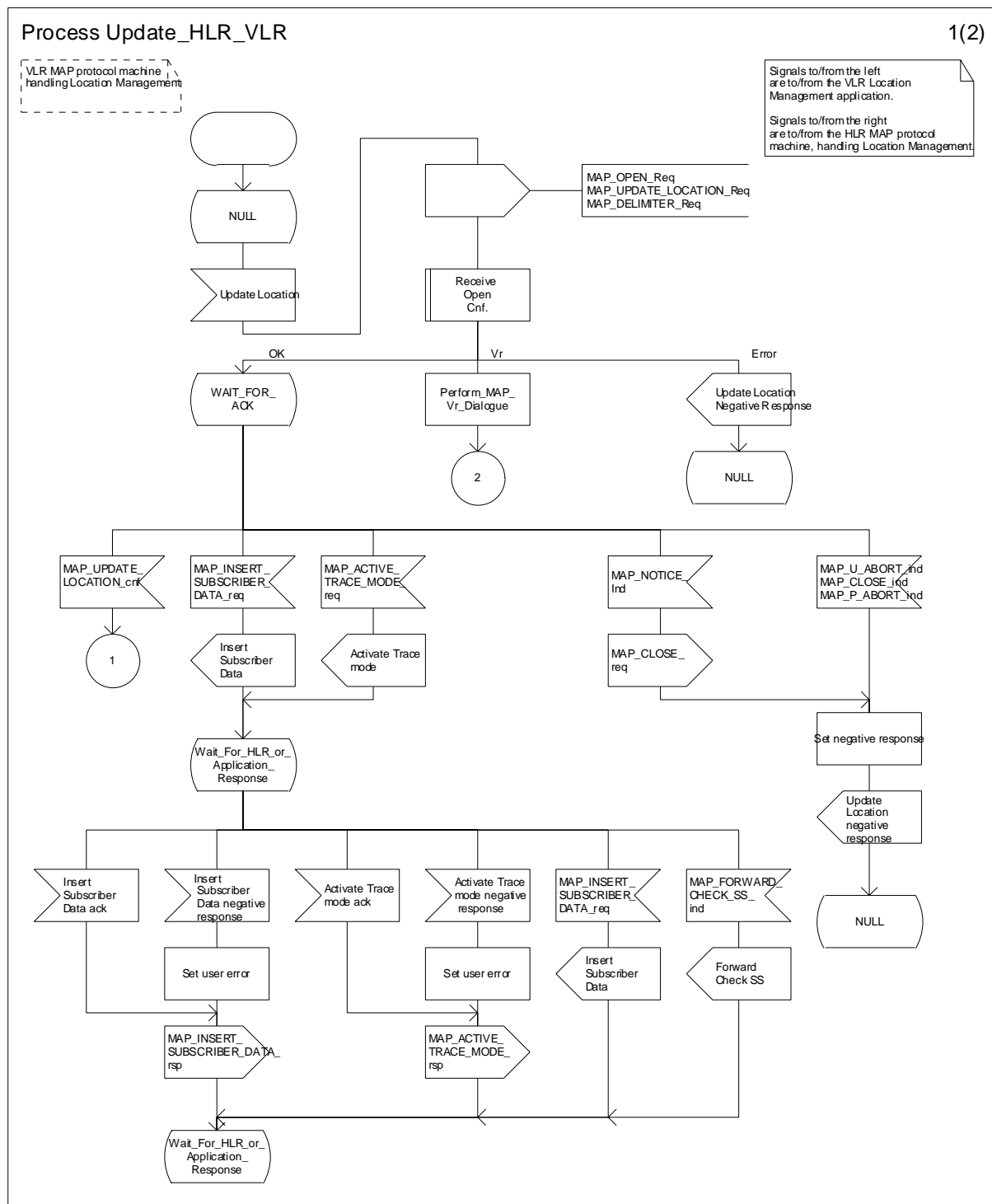

Figure 19.1.1/6 (sheet 1 of 2): Process Update_HLR_VLR

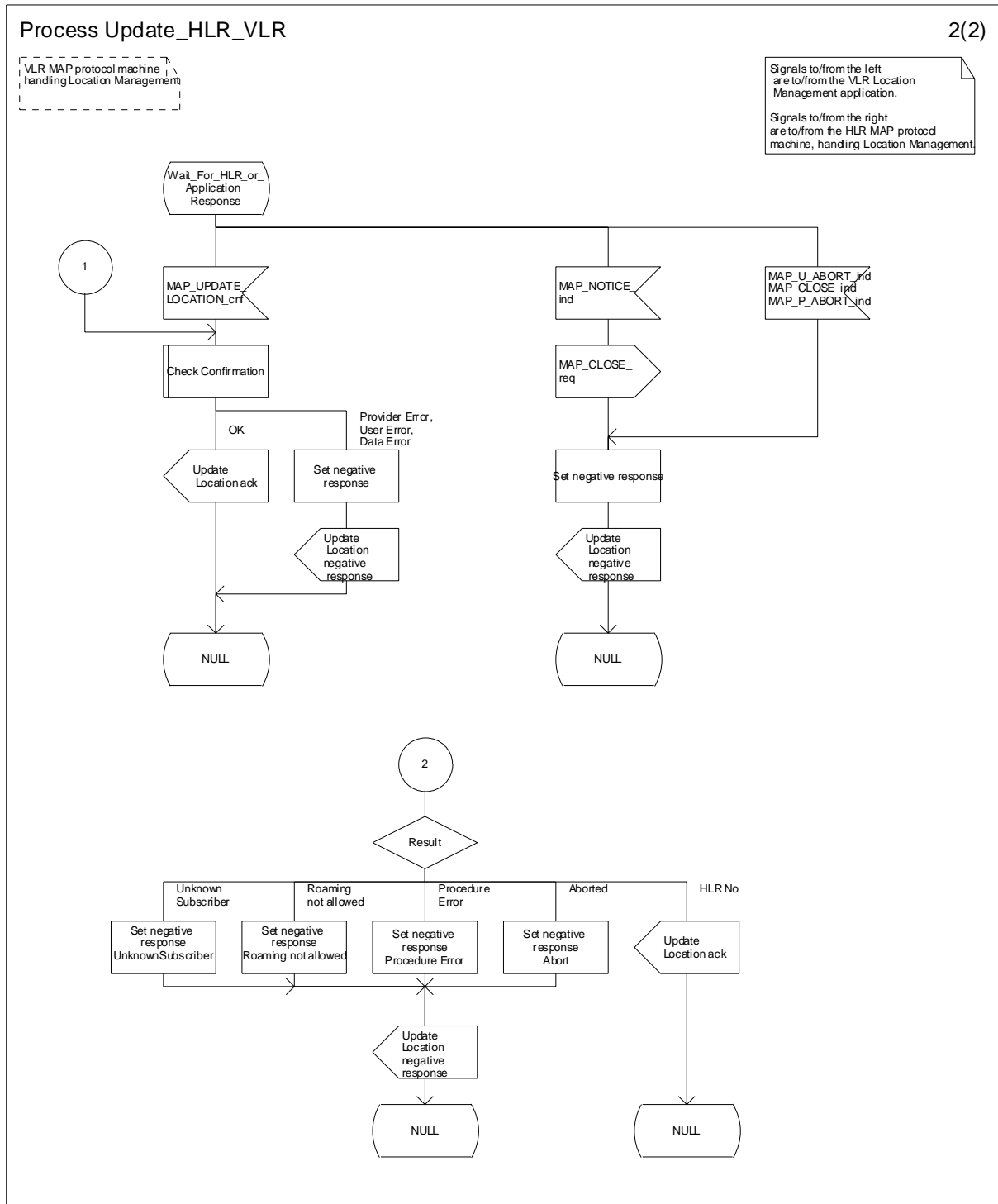

Figure 19.1.1/6 (sheet 2 of 2): Process Update_HLR_VLR

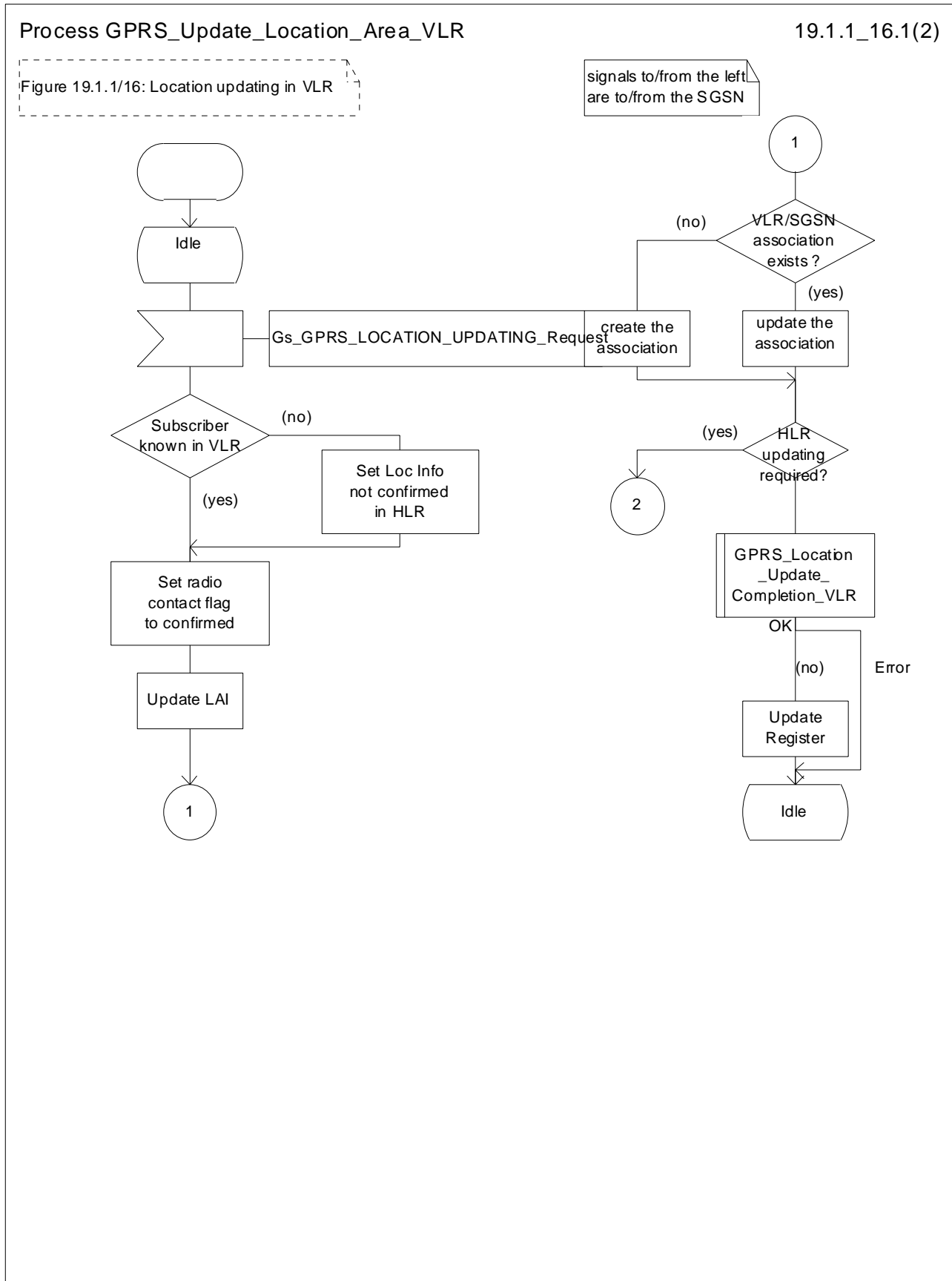

Figure 19.1.1/16 (sheet 1 of 2): Process GPRS_Update_Location_Area_VLR

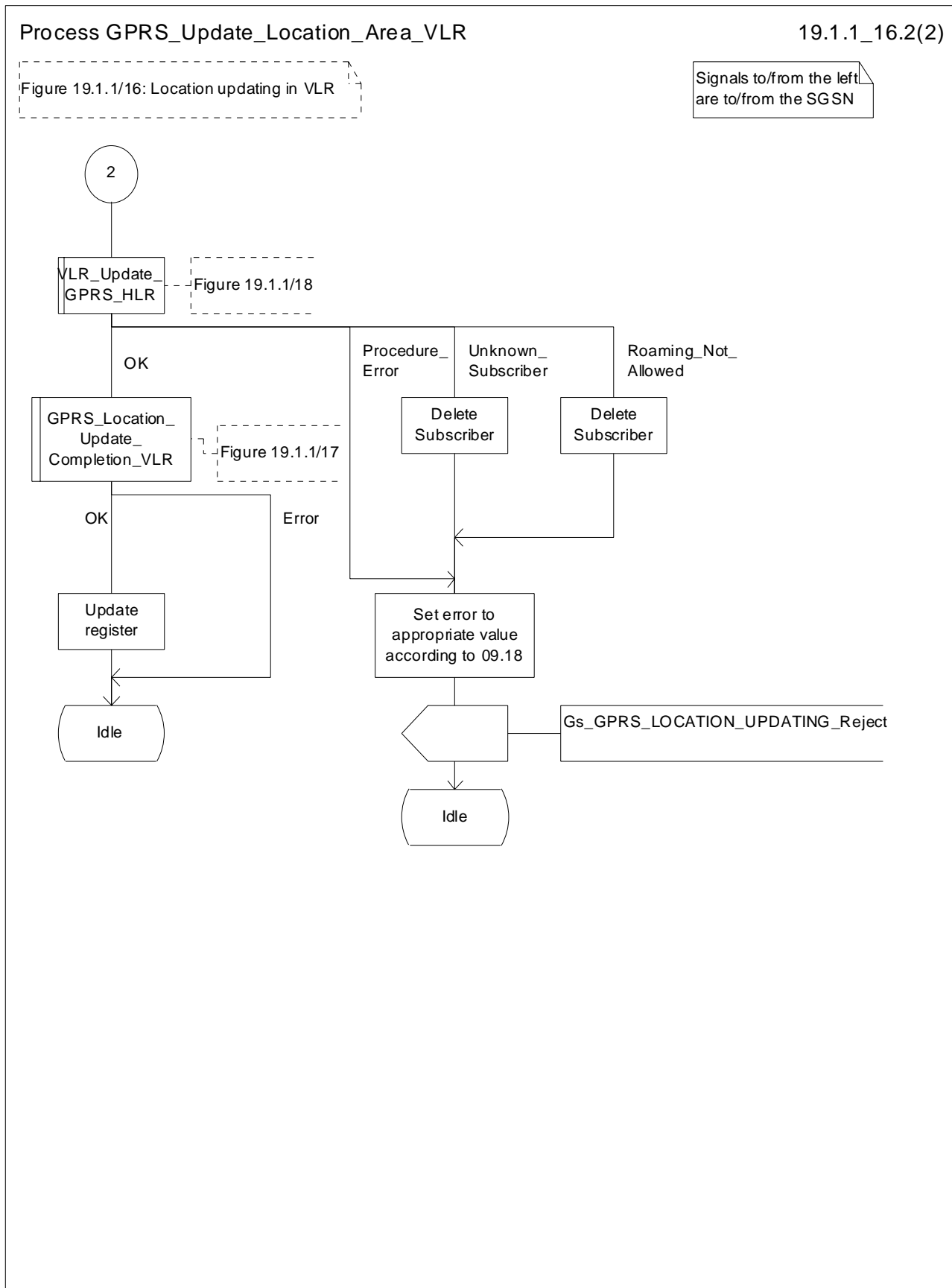

Figure 19.1.1/16 (sheet 2 of 2): Process GPRS_Update_Location_Area_VLR

Macrodefinition GPRS_Location_Update_Completion_VLR

19.1.1_17(1)

Figure 19.1.1/17:
Location updating in VLR for GPRS;
closing sequence

Signals to/from the left
are to/from the SGSN

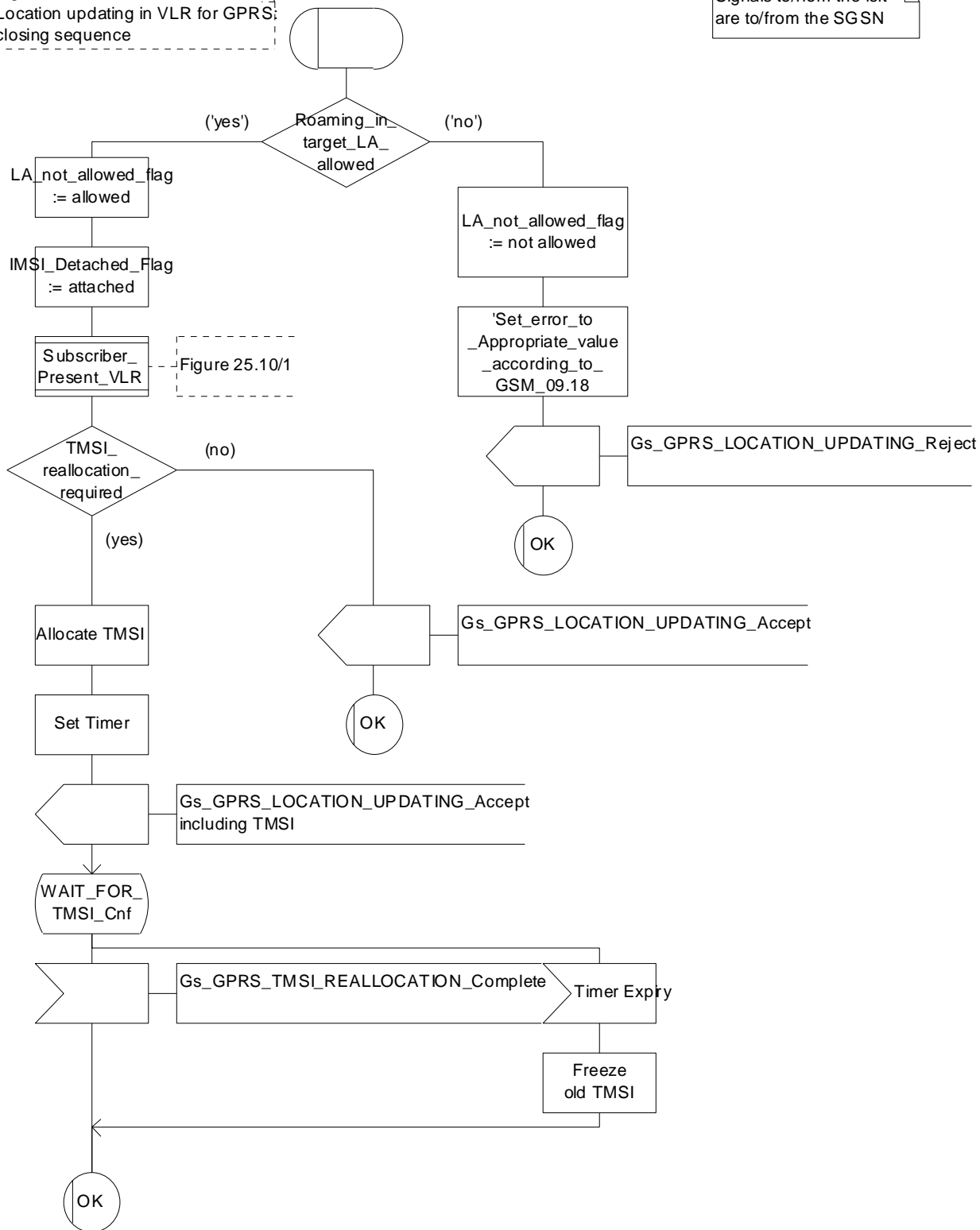

Figure 19.1.1/17: Macro GPRS_Location_Update_Completion_VLR

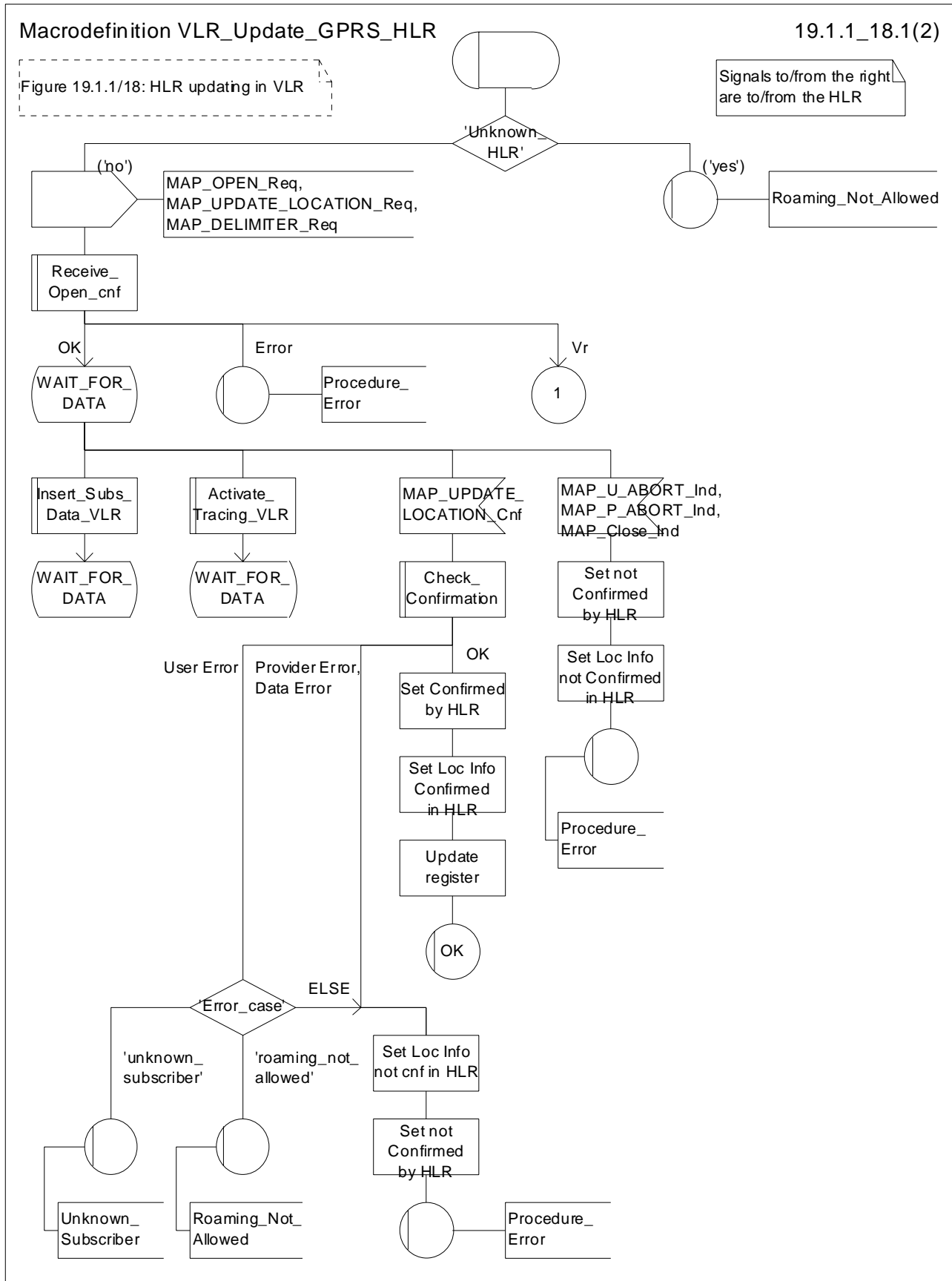

Figure 19.1.1/18 (sheet 1 of 2): Macro VLR_Update_GPRS_HLR

Macrodefinition VLR_Update_GPRS_HLR

19.1.1_18.2(2)

Figure 19.1.1/18: HLR updating in VLR

Signals to/from the right are to/from the HLR

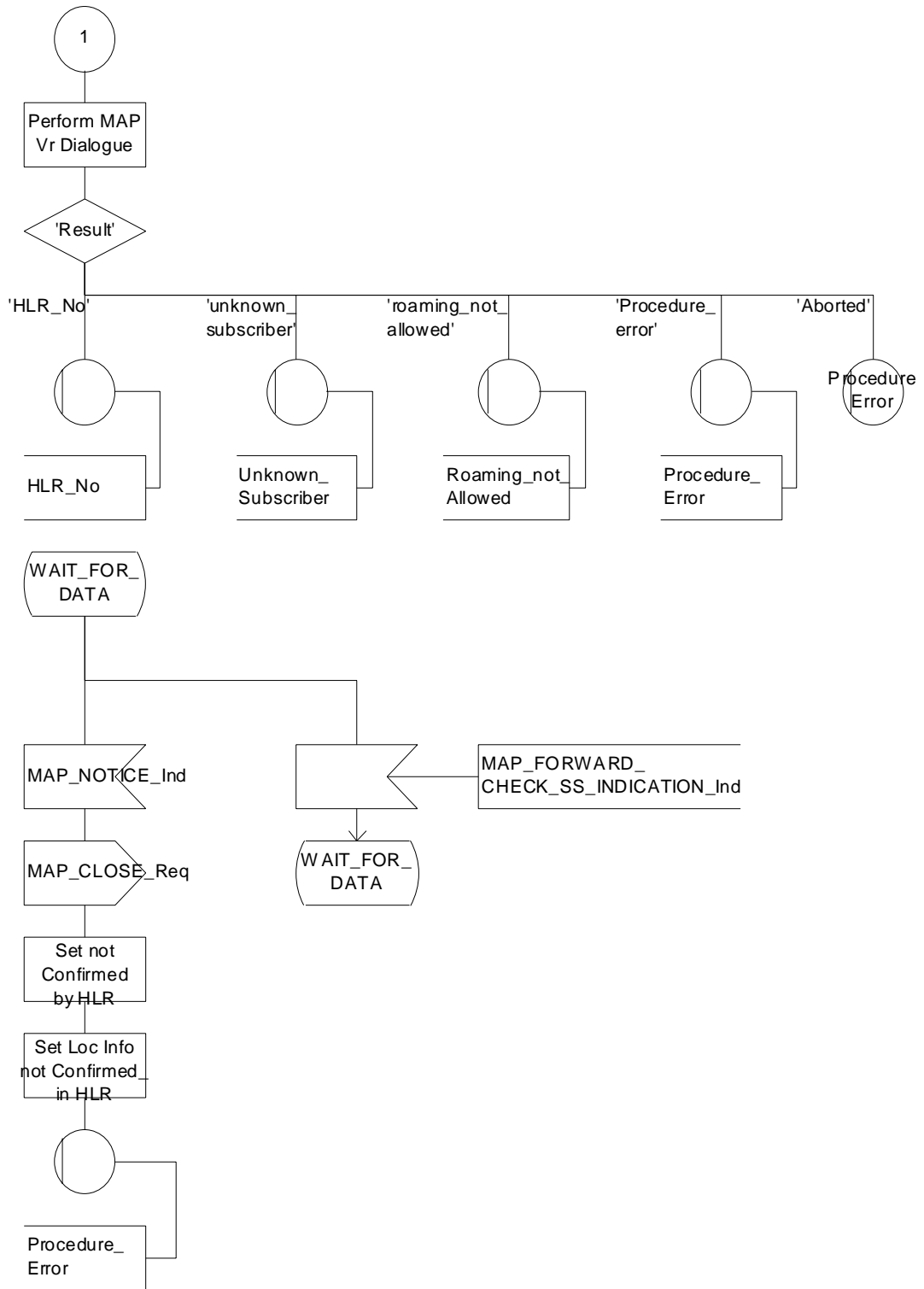

Figure 19.1.1/18 (sheet 2 of 2): Macro VLR_Update_GPRS_HLR

19.1.1.4 Detailed procedure in the HLR

Sheet 1: The procedure Super_Charged_Cancel_Location_HLR is specific to Super-Charger; it is specified in TS 23.116 [110]. If the previous SGSN and the originating HLR support the Super-Charger functionality, processing continues from the "Yes" exit of the test "Result=Pass?".

Sheet 2: The procedure Super_Charged_Location_Updating_HLR is specific to Super-Charger; it is specified in TS 23.116 [110]. If subscription data needs to be sent to the SGSN, processing continues from the "No" exit of the test "Result=Pass?".

When addressed by the SGSN, the following macros are used by the process Update_GPRS_Location_HLR:

- Receive_Open_indication, defined in clause 25.1;
- Check_indication, defined in clause 25.2;
- Insert_SubData_In_SGSN_Framed_HLR, described in clause 19.4;
- Control_Tracing_HLR_with_SGSN, described in clause 25.9;

and the processes Cancel_Location_HLR (see clause 19.1.2) and Subscriber_Present_HLR (see clause 19.1.1.7) are invoked.

The location updating process in the HLR is activated by receipt of a MAP_UPDATE_GPRS_LOCATION indication (see figure 19.1.1/19):

- if there is a parameter problem in the indication, the error Unexpected Data Value is returned in the MAP_UPDATE_LOCATION response (see Check_indication macro defined in clause 25.2); if the subscriber is not known in the HLR, the error Unknown Subscriber (with diagnostic value set to "Imsi Unknown") is returned in the response. In either case the process terminates;
- if Network Access Mode is set to "non-GPRS only" the error Unknown Subscriber (with diagnostic value set to "Gprs Subscription Unknown") is returned in the response. The process terminates;
- tracing shall be set to deactivate in the SGSN.
- if the SGSN number received in the MAP_UPDATE_GPRS_LOCATION indication differs from the one actually stored against the subscriber, the Cancel_Location_HLR process is started to cancel the subscriber data in the stored SGSN (see clause 19.1.2).

The next action will be to check whether the subscriber is allowed to roam into the PLMN indicated by the SGSN Number given in the MAP_UPDATE_GPRS_LOCATION indication:

- if the subscriber is not allowed to roam into the PLMN, the error Roaming not Allowed with cause PLMN Roaming Not Allowed or 'Operator determined Barring', depending on the case, is returned in the MAP_UPDATE_GPRS_LOCATION response, and the routing information stored (SGSN number) is deleted (deregistration);
- otherwise the HLR database will be updated with information received in the indication. The HLR sets the "MS purged for GPRS" flag to False and checks whether tracing is required for that subscriber. This is handled by the macro Control_Tracing_HLR-with_SGSN described in clause 25.9.

Thereafter, the macro Insert_SubData_In_SGSN_Framed_HLR described in clause 19.4 is invoked. The outcome of this macro may be:

- aborted, in which case the process terminates;
- error, in which case the error System Failure is returned in the MAP_UPDATE_GPRS_LOCATION response and the process terminates;
- OK, indicating successful outcome of downloading the subscriber data to the SGSN.

The SUBSCRIBER_PRESENT_HLR process is then started to alert the Short Message Service Centre, if required (see clause 19.1.7).

Finally the HLR number is returned in the MAP_UPDATE_GPRS_LOCATION response.

In all cases where the HLR sends a MAP_UPDATE_GPRS_LOCATION response to the SGSN, the dialogue towards the SGSN is terminated by a MAP_CLOSE request with parameter Release Method indicating Normal Release.

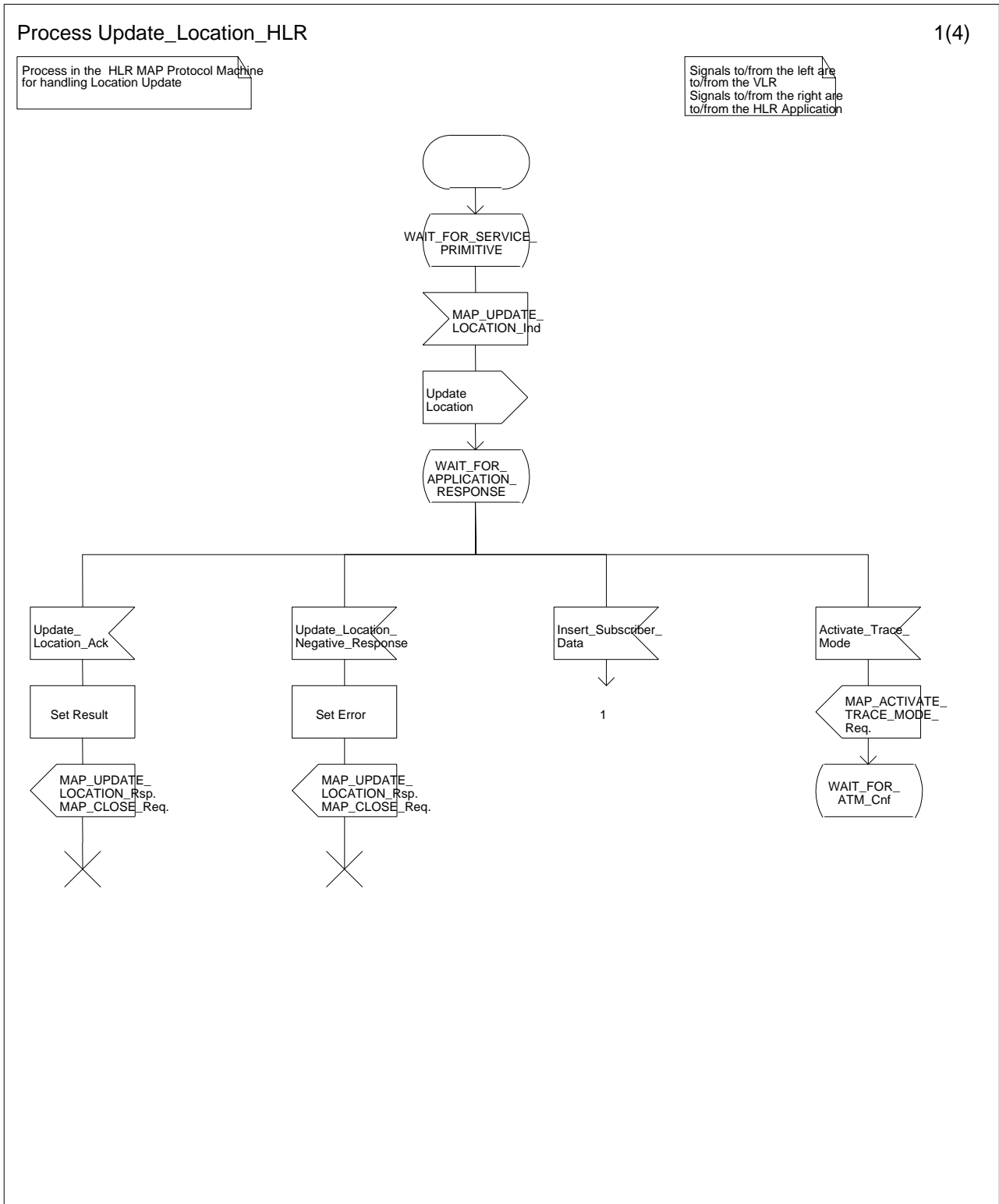

Figure 19.1.1/9 (sheet 1 of 4): Process Update_Location_HLR

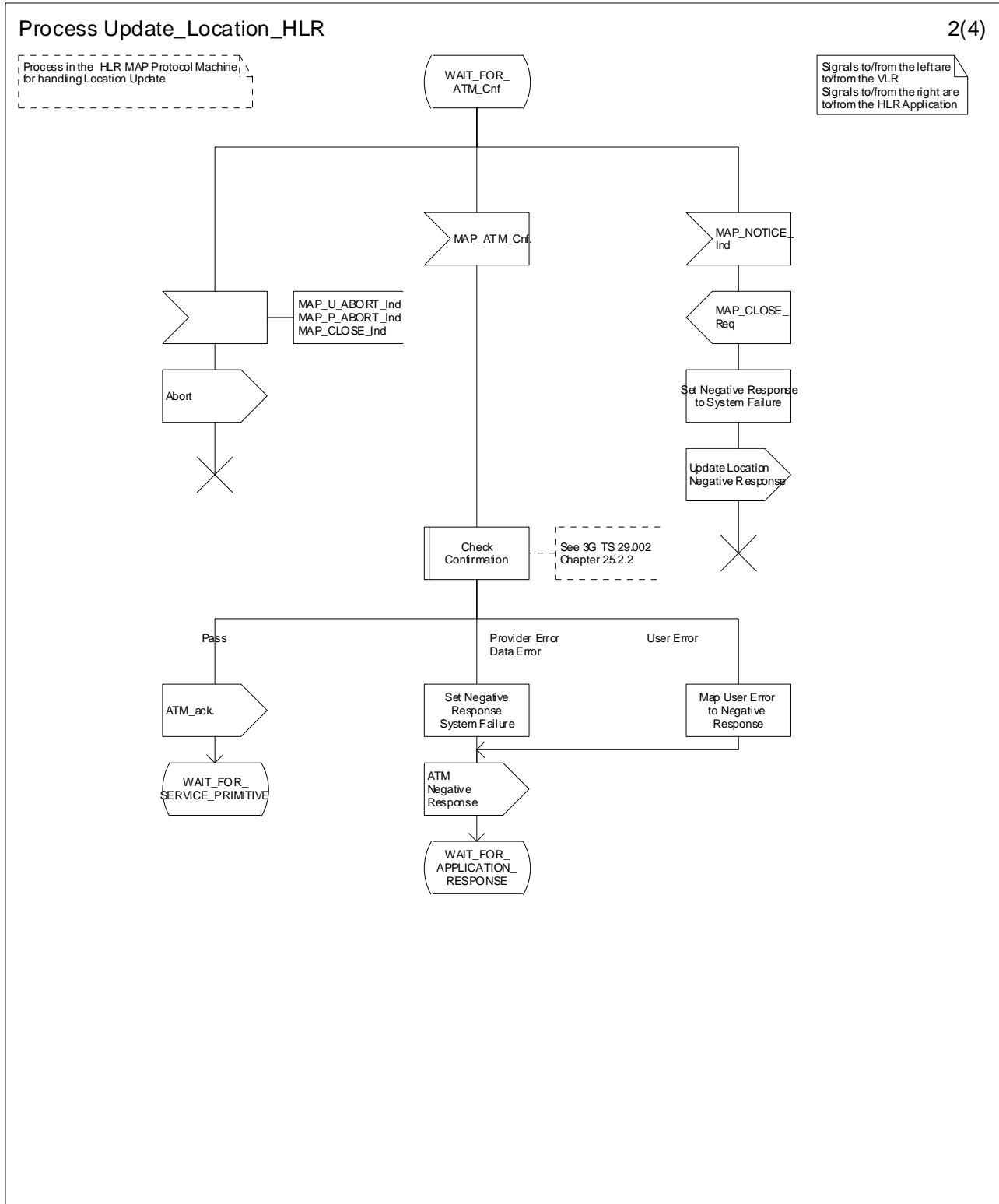

Figure 19.1.1/9 (sheet 2 of 4): Process Update_Location_HLR

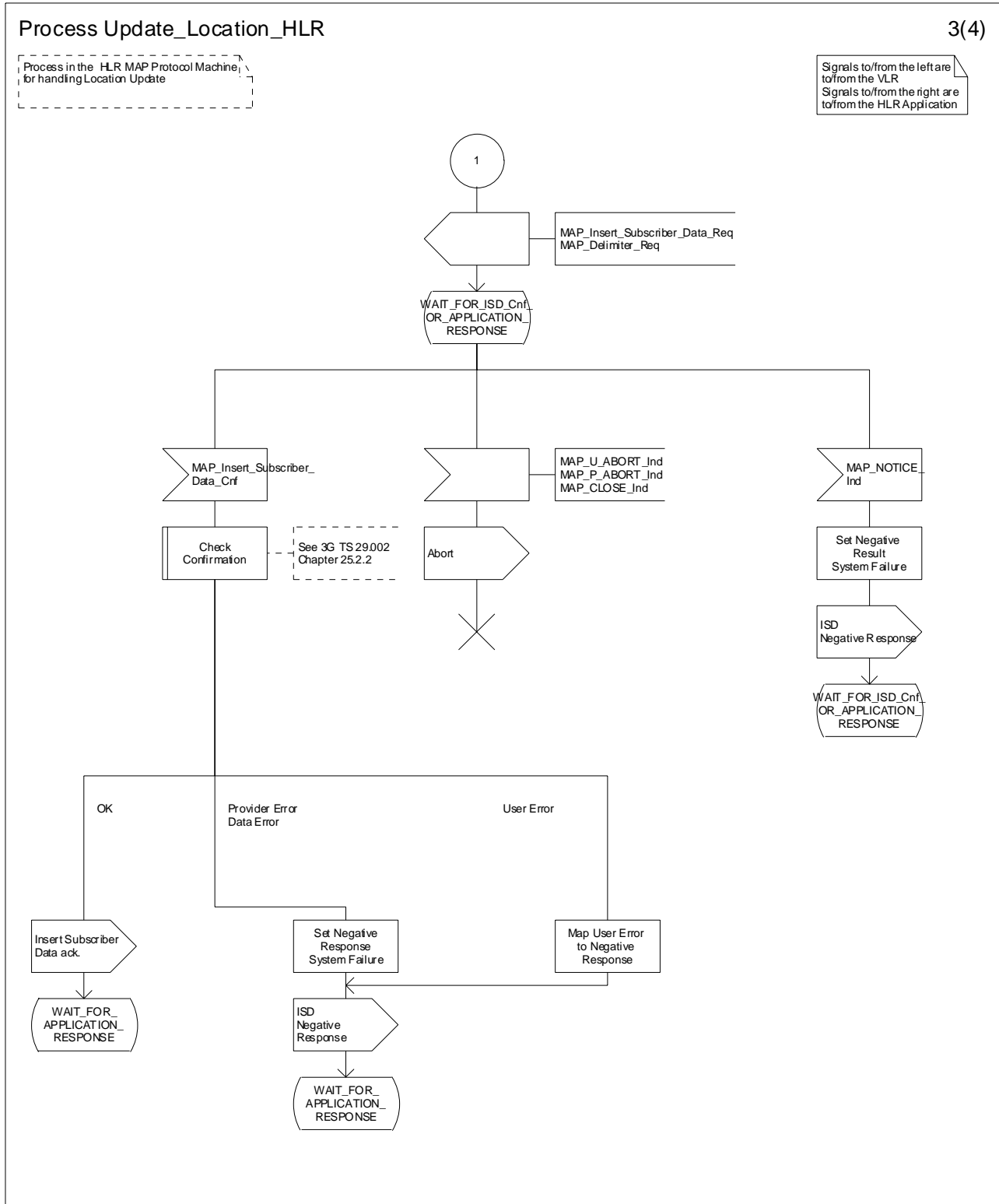

Figure 19.1.1/9 (sheet 3 of 4): Process Update_Location_HLR

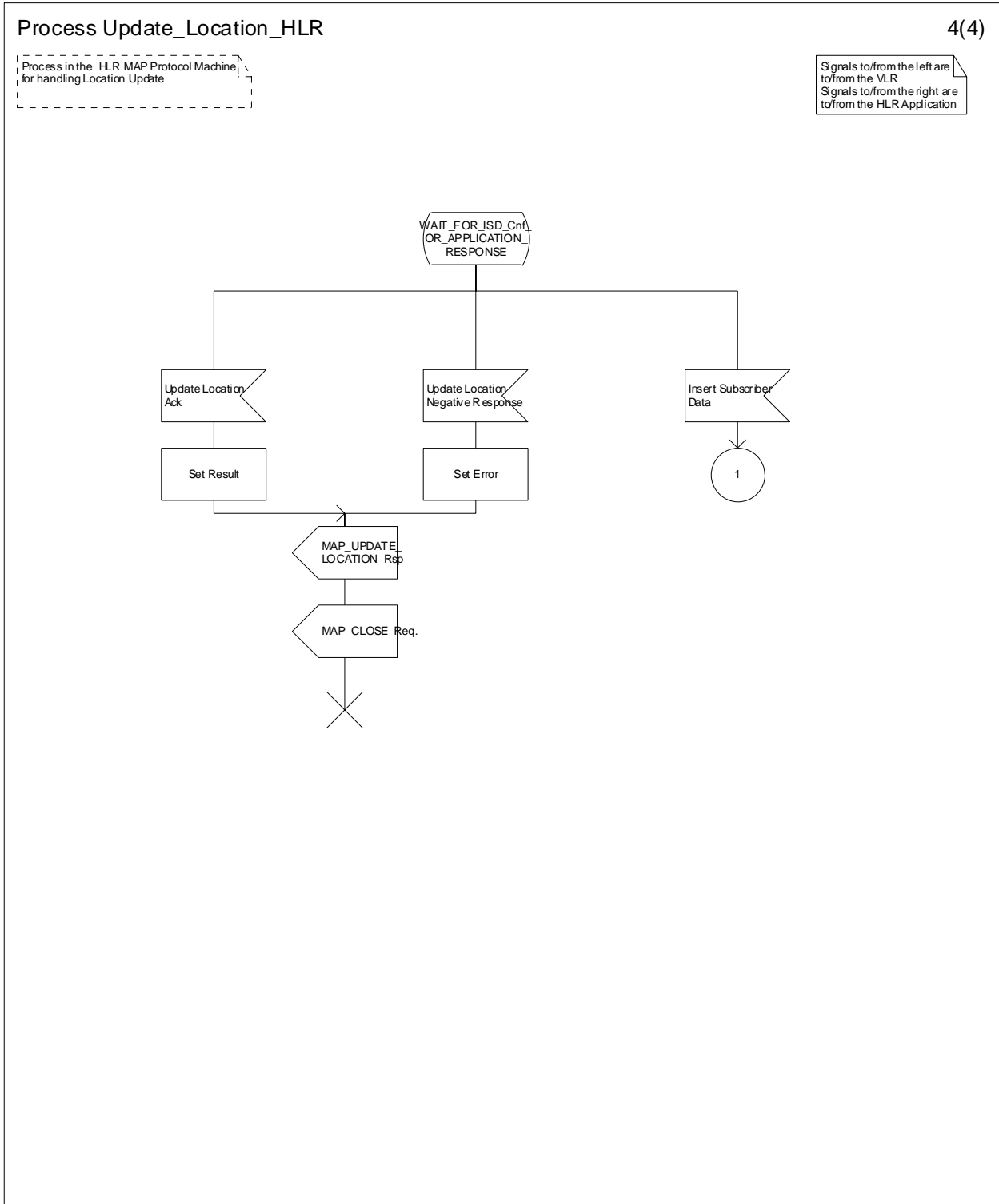

Figure 19.1.1/9 (sheet 4 of 4): Process Update_Location_HLR

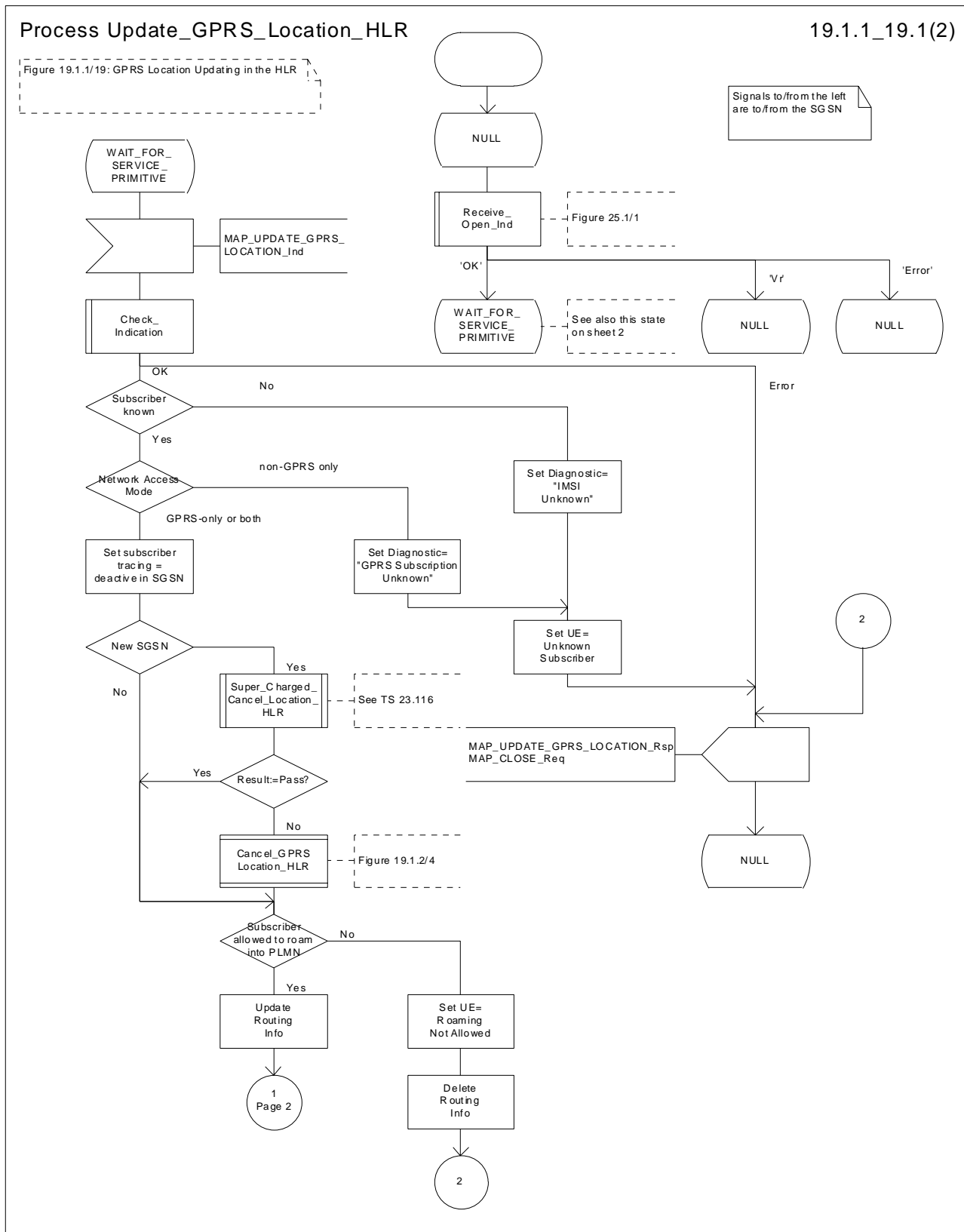

Figure 19.1.1/19 (sheet 1 of 2): Process Update_GPRS_Location_HLR

Process Update_GPRS_Location_HLR

19.1.1_19.2(2)

Figure 19.1.1/19: GPRS Location Updating in the HLR

Signals to/from the left are to/from the HLR

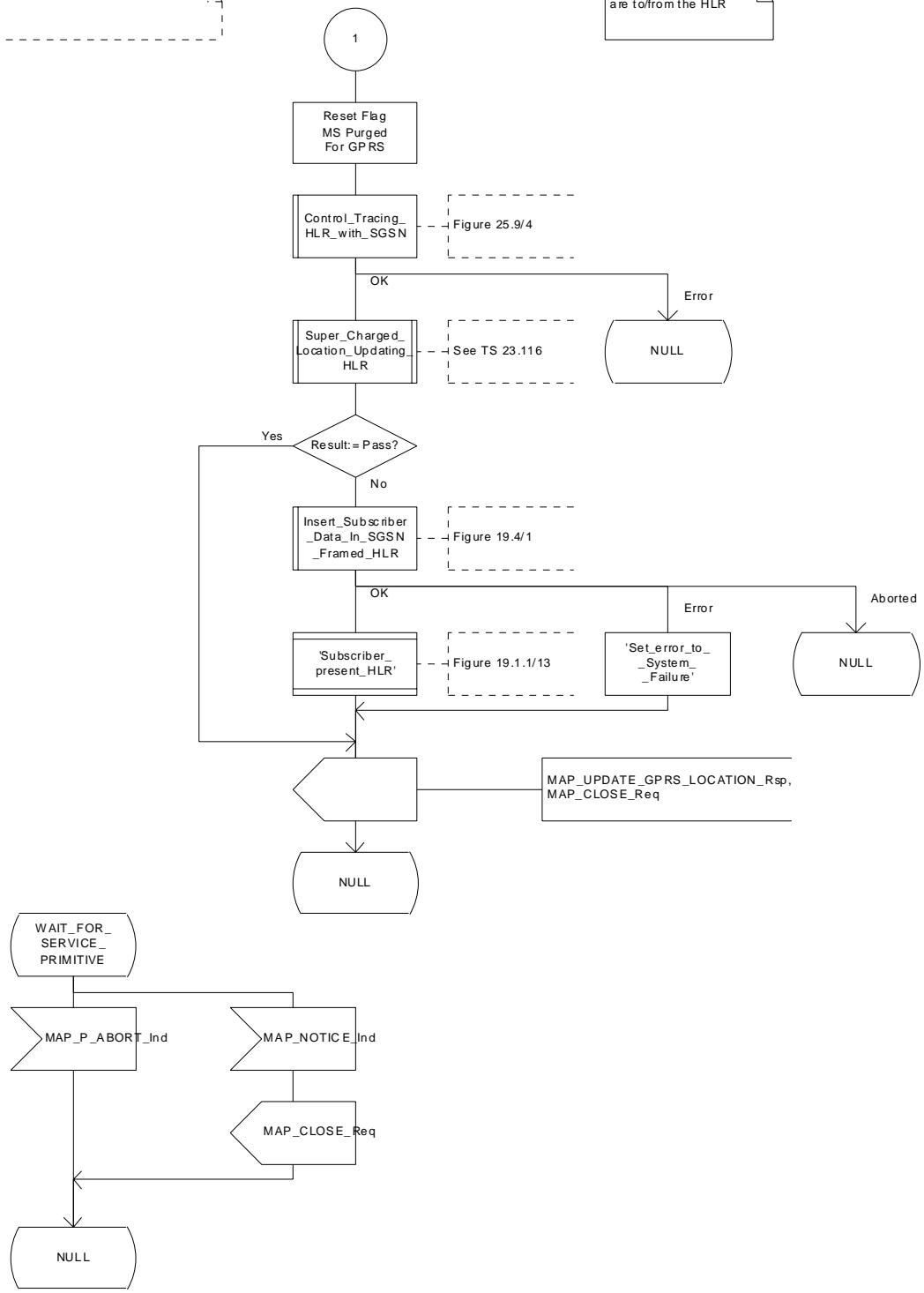

Figure 19.1.1/19 (sheet 2 of 2): Process Update_GPRS_Location_HLR

19.1.1.5 Send Identification

19.1.1.5.1 General

This service is invoked by the VLR when it receives Update location from the MSC indicating that the subscriber was registered in a different VLR (henceforth called the Previous VLR, PVLR). If the identity of the PVLR is derivable for the VLR (usually if both are within the same network), the IMSI and authentication sets are requested from the PVLR (see clause 19.1.1.3), using the service described in clause 8.1.4.

If the version negotiation between R99 VLR and pre-R99 PVLR leads to the MAP version 1 or 2, the VLR shall request authentication sets from the HLR.

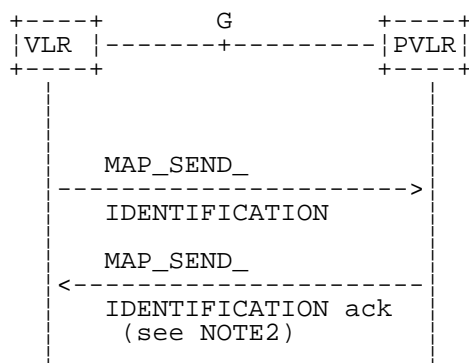

NOTE1: The service shown in dotted lines indicates the trigger provided by other MAP signalling.

NOTE2: Several MAP_SEND_IDENTIFICATION request/response may be used if message segmentation is required.

Figure 19.1.1/10: Interface and services for Send Identification

19.1.1.5.2 Detailed procedure in the VLR

The VLR procedure is part of the location area updating process described in clause 19.1.1.X.

19.1.1.5.3 Detailed procedure in the PVLR

On receipt of a dialogue request for the Send Identification procedure, (see Receive_Open_Ind macro in clause 25.1), the PVLR will:

- terminate the procedure in case of parameter problems;
- revert to the MAP version Vr procedure in case the VLR indicated version Vr protocol; or
- continue as below, if the dialogue is accepted.

If the PVLR process receives a MAP_NOTICE indication, it terminates the dialogue by sending a MAP_CLOSE request.

If the PVLR process receives a MAP_SEND_IDENTIFICATION indication from the VLR (see figure 19.1.1/11), it checks whether the subscriber identity provided is known:

- if so, the IMSI and - if available - authentication parameters for the subscriber are returned in the MAP_SEND_IDENTIFICATION response;
- if not, the error Unidentified Subscriber is returned in the MAP_SEND_IDENTIFICATION response.

In all cases where the PVLR sends a MAP_SEND_IDENTIFICATION response to the VLR, the dialogue towards the VLR is terminated by a MAP_CLOSE request with parameter Release Method indicating Normal Release.

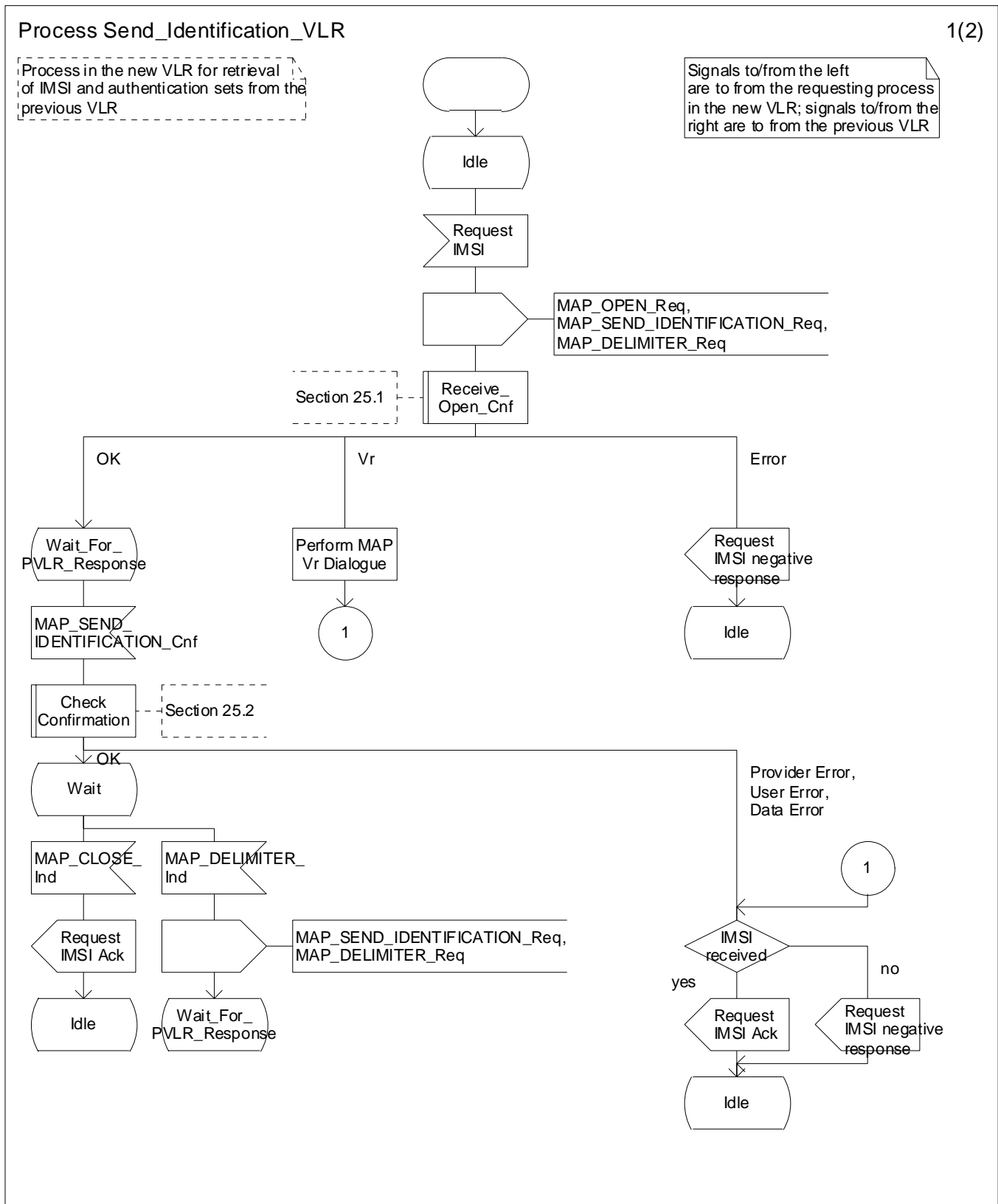

Figure 19.1.1/XX (sheet 1 of 2): Process Send_Identification_VLR

Process Send_Identification_VLR

2(2)

Process in the new VLR for retrieval of IMSI and authentication sets from the previous VLR

Signals to/from the left are to from the requesting process in the new VLR; signals to/from the right are to from the previous VLR

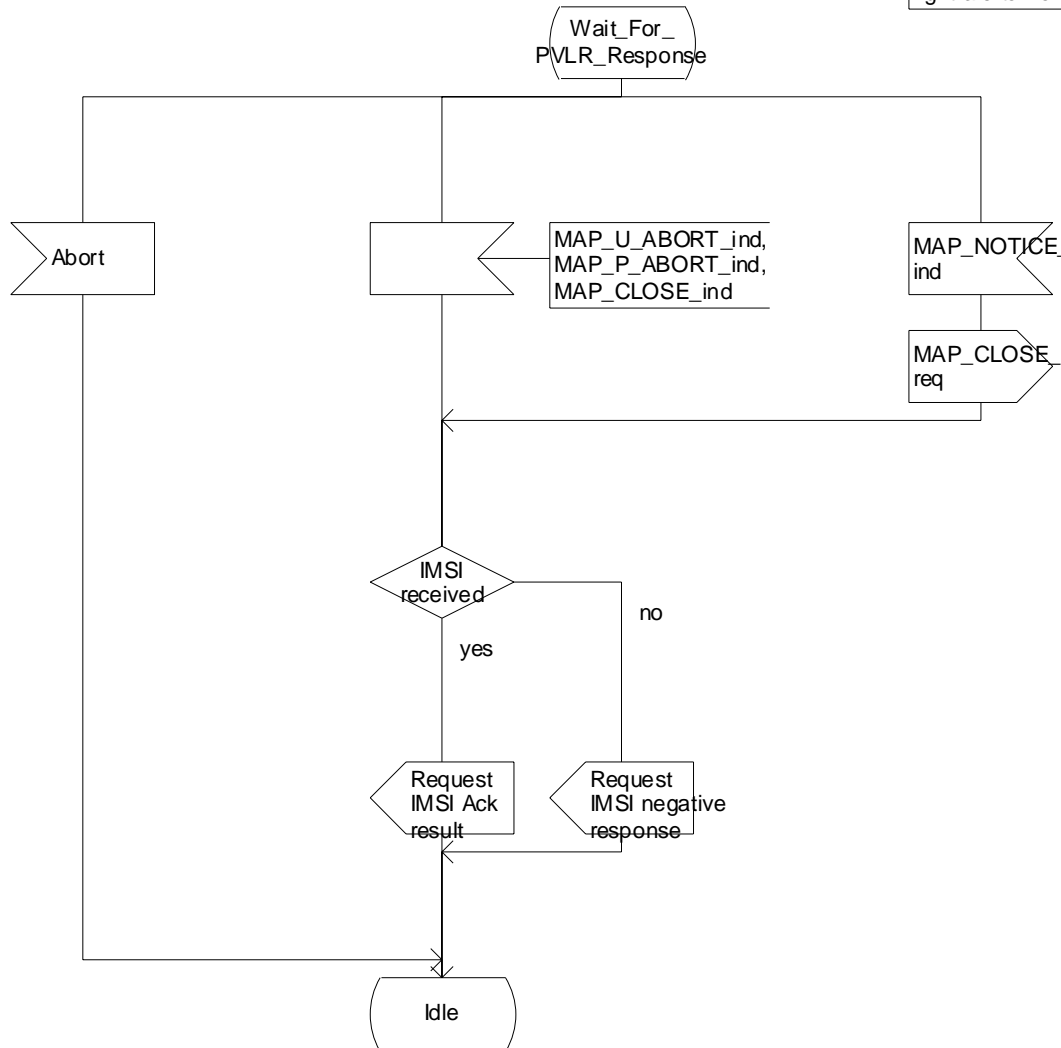

Figure 19.1.1/XX (sheet 2 of 2): Process Send_Identification_VLR

Process Send_Identification_PVLR

1(2)

Figure 19.1/11: Process in the Previous VLR to handle an identification request

Signals to/from the left are to from the new VLR.
Signals to/from the right are to/from the PVLR Location Management application

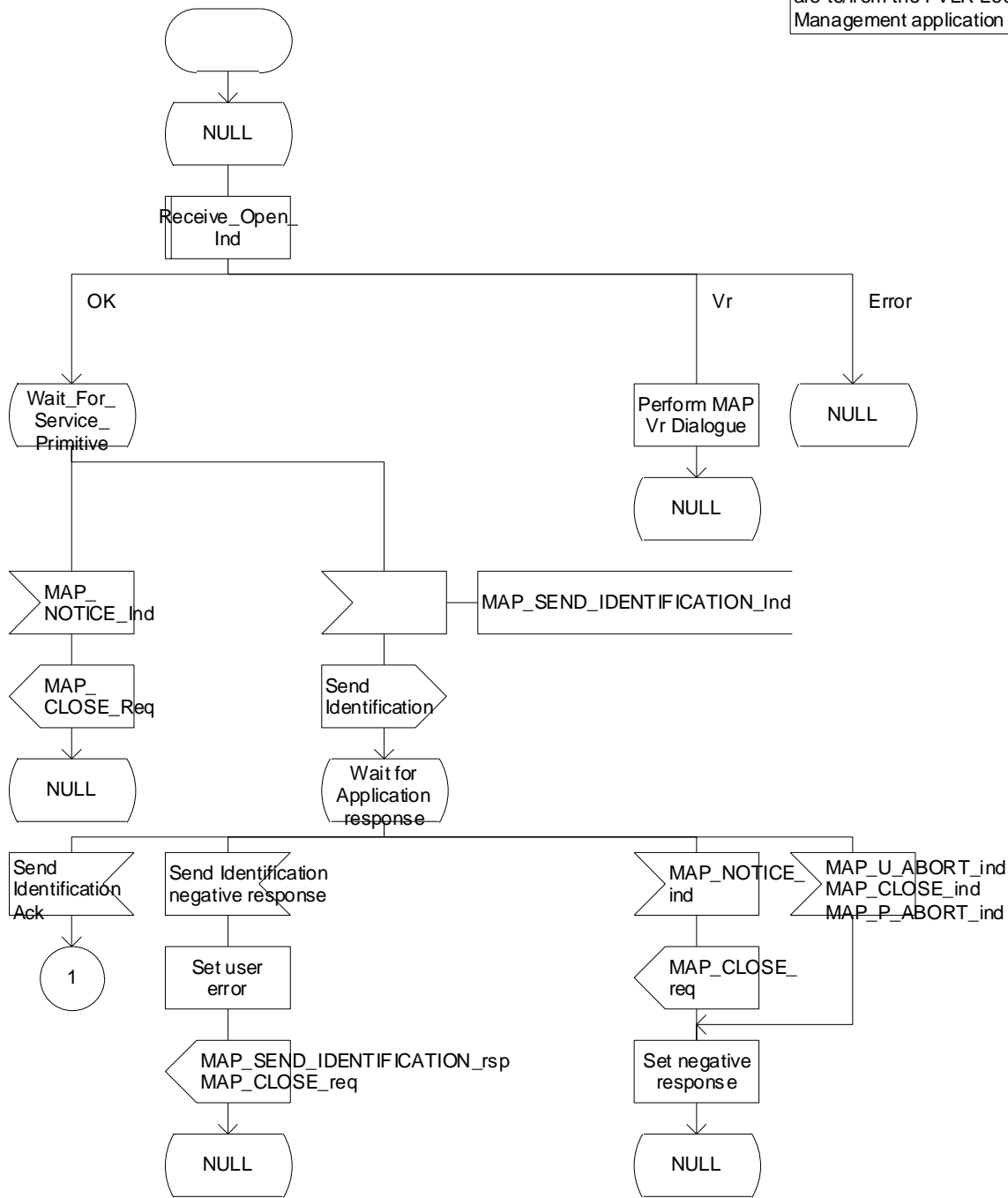

Figure 19.1/XX (sheet 1 of 2): Process Send_Identification_PVLR

Process Send_Identification_PVLR

2(2)

Figure 19.1/11: Process in the Previous VLR to handle an identification request

Signals to/from the left are to/from the new VLR

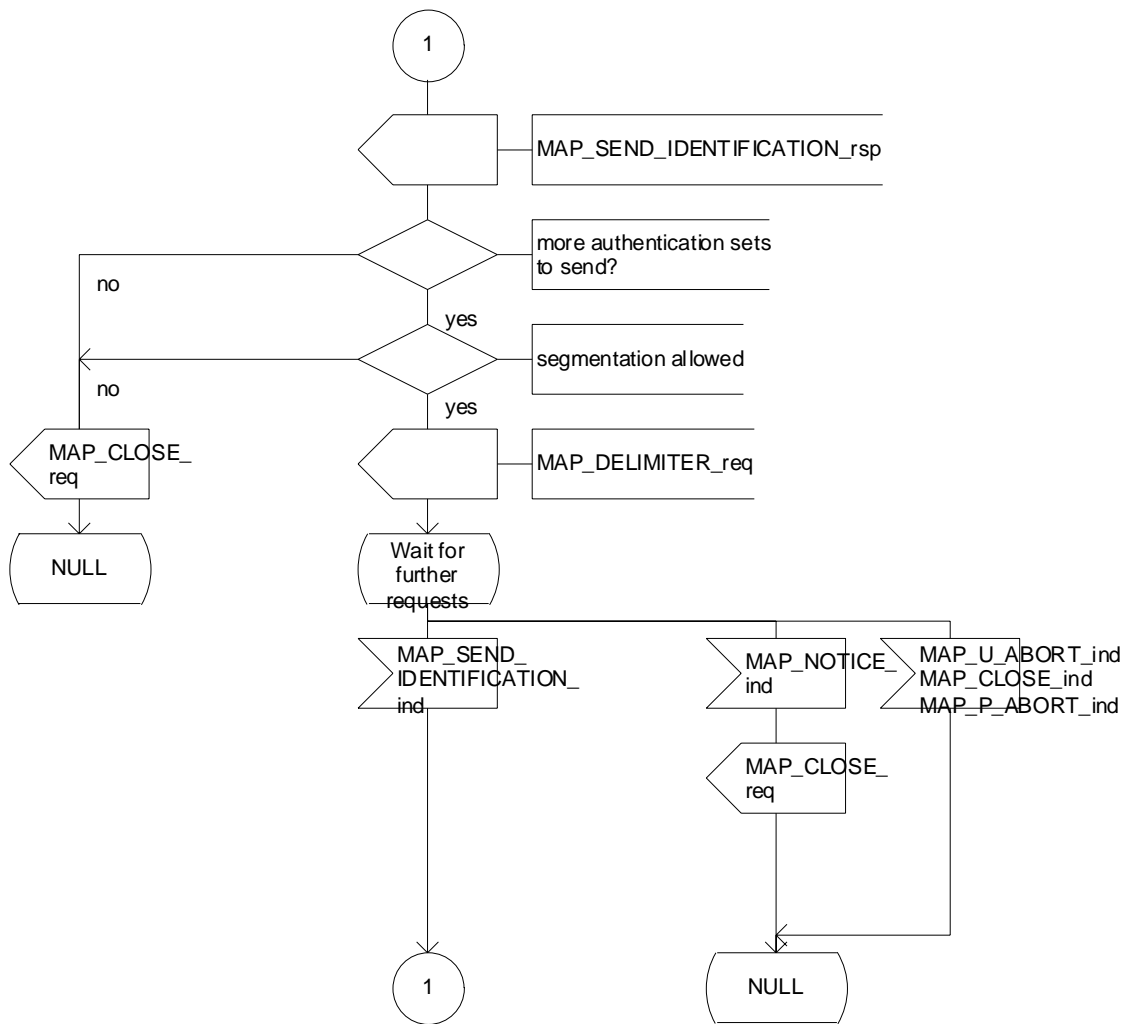

Figure 19.1.1/XX (sheet 2 of 2): Process Send_Identification_PVLR

19.1.1.6 Process Update Location VLR

This process is started by some other MAP user process in the case the HLR need to be updated due to previous network failure. It is invoked when the subscriber accesses the network, e.g. for mobile originated call set-up, response to paging or supplementary services handling. Here, location updating consists only of invoking the macro VLR_Update_HLR described above (see clause 19.1.1.3), which performs HLR updating and downloading of subscriber data.

If updating is successful (OK), the HLR Number is received in the MAP_UPDATE_LOCATION confirm primitive; the register will be updated and the SCP will be informed about the Mobility Management event. The process then terminates.

In the above case, the notification sent to the gsmSCF shall be '*Location Update to new VLR Service Area*'.

If one of the errors Roaming not Allowed or Unknown Subscriber is received instead, all subscriber data are deleted from the VLR before the process terminates.

In the case some other error occurs during HLR updating, the process simply terminates. Note, in all error cases the initiating restoration flags in VLR remain false, therefore a new HLR updating attempt will be started later on.

NOTE 1: This process will be performed independent from the calling process, no coordination is required.

NOTE 2: The procedure Notify_gsmSCF is specified in 3GPP TS 23.078.

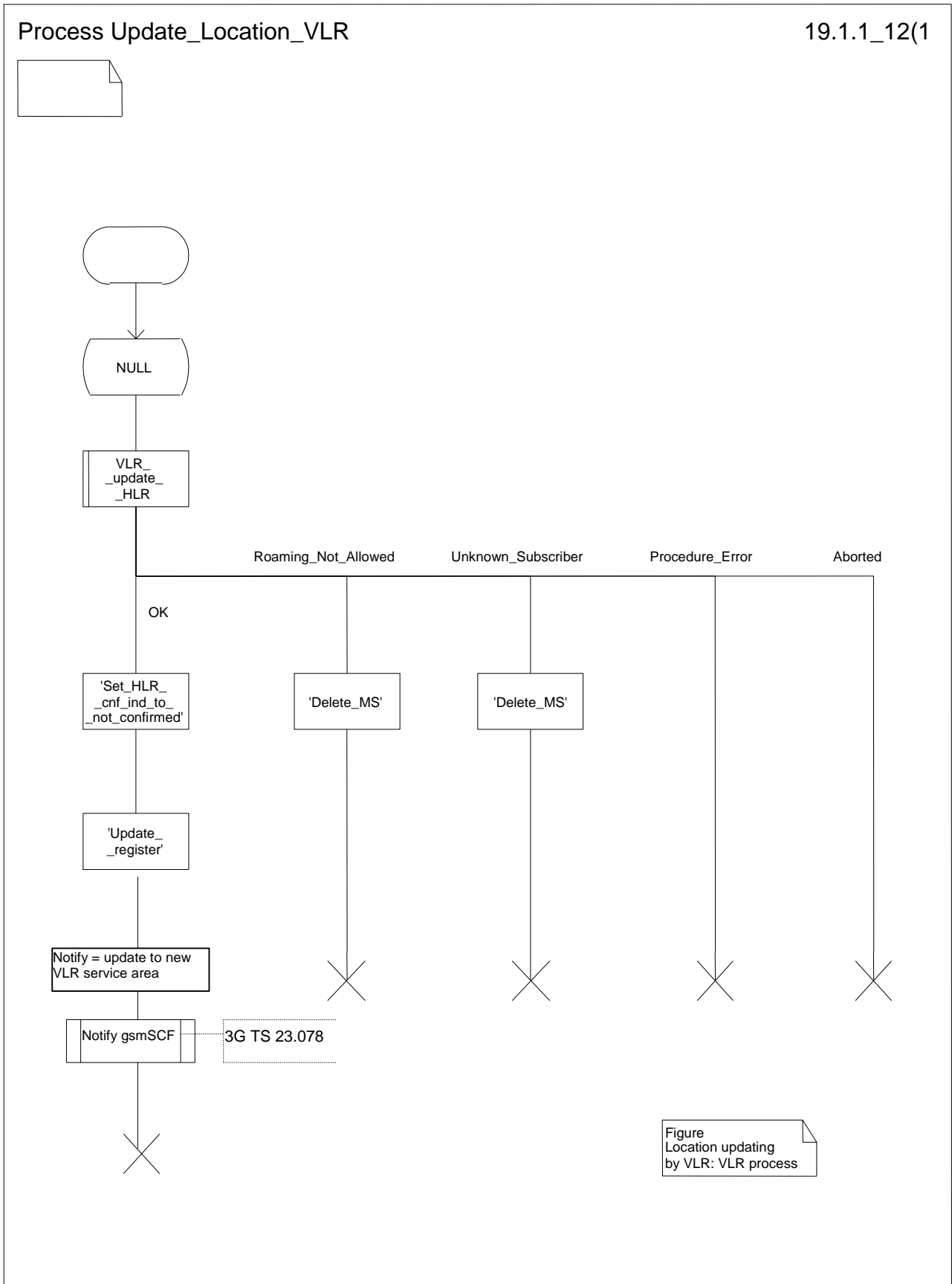

Figure 19.1.1/12: Process UL_VLR

19.1.1.8 Detailed procedure in the SGSN

Figure 19.1.1/20 shows the MAP process for updating of the SGSN. The following general macros are used:

Receive_Open_Cnf	clause 25.1;
Insert_Subscriber_Data_SGSN	clause 25.7;
Activate_Tracing_SGSN	clause 25.9;

Sheet 2: The procedure Check_User_Error_In_Serving_Network_Entity is specific to Super-Charger; it is specified in 3G TS 23.116 [110].

The location updating process

The MAP process receives an « Update HLR request » from the relevant process in the SGSN (see 3GPP TS 23.060 [104]) to perform HLR updating. If the SGSN does not know the subscribers HLR (e.g. no IMSI translation exists as there are not yet any SS7 links to the subscribers HPLMN), the « Update HLR negative response » with error Unknown HLR is returned to the requesting process.

If the subscribers HLR can be reached, the SGSN opens a dialogue towards the HLR by sending a MAP_OPEN request without any user specific parameters, together with a MAP_UPDATE_GPRS_LOCATION request containing the parameters

- IMSI, identifying the subscriber;
- SGSN Address and SGSN number.

In case the HLR rejects dialogue opening (see clause 25.1) or indicates version Vr protocol to be used, the SGSN will terminate the process indicating « Update HLR negative response » to the requesting process.

If the HLR accepts the dialogue, the HLR will respond with:

- a MAP_INSERT_SUBSCRIBER_DATA indication, handled by the macro Insert_Subs_Data_SGSN defined in clause 25.7;

NOTE: The HLR may repeat this service several times depending on the amount of data to be transferred to the SGSN and to replace subscription data in case they are not supported by the SGSN.

- a MAP_ACTIVATE_TRACE_MODE indication, handled by the macro Activate_Tracing_SGSN defined in clause 25.9;
- the MAP_UPDATE_GPRS_LOCATION confirmation:
 - if this confirmation contains the HLR Number, this indicates that the HLR has passed all information and that updating has been successfully completed. The « Update HLR response » message is returned to the requesting process for completion of the SGSN updating (see 3GPP TS 23.060 [104]).
 - if the confirmation contains an User error cause (Unknown Subscriber, Roaming Not Allowed or some other), the corresponding error is returned to the requesting process in the « Update HLR negative response ».
- a MAP_P_ABORT, MAP_U_ABORT, or MAP_CLOSE indication. In these cases, the corresponding error is returned to the requesting process in the « Update HLR negative response ».
- a MAP_NOTICE indication. Then, the dialogue towards the HLR is terminated, and the « HLR Update negative response » with the appropriate error is returned to the requesting process.

Process SGSN_Update_HLR

19.1.1_20.1(2)

Figure 19.1.1/20: HLR updating in SGSN

Signals from/to the left are from/to requesting process in SGSN
 Signals to/from the right are to/from the HLR

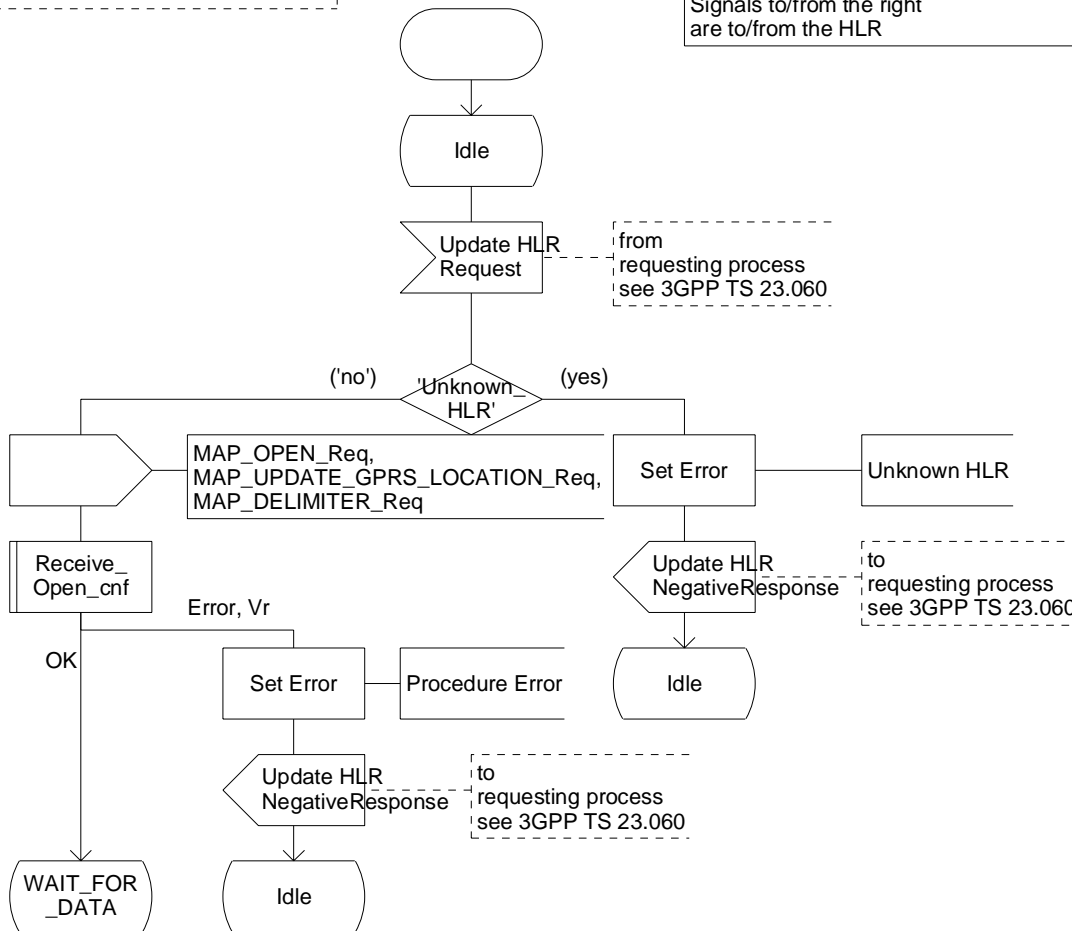

Figure 19.1.1/20 (sheet 1 of 2): Process SGSN_Update_HLR

Process SGSN_Update_HLR

19.1.1_20.2(2)

Figure 19.1.1/20: HLR updating in SGSN

Signal from/to the left are from/to requesting process in SGSN
Signals to/from the right are to/from the HLR

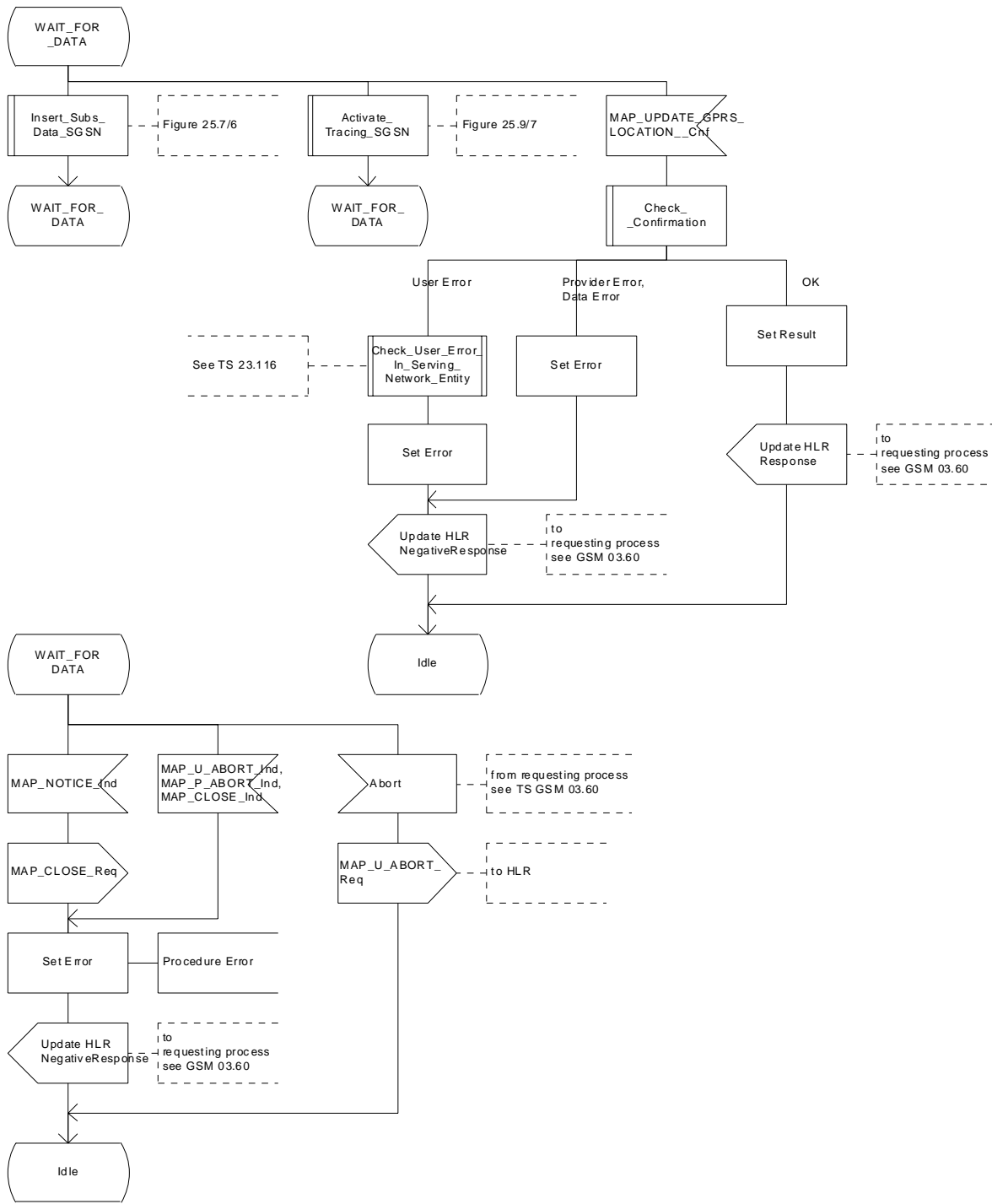

Figure 19.1.1/20 (sheet 2 of 2): Process SGSN_Update_HLR

19.1.2 Location Cancellation

19.1.2.1 General

The purpose of this process is to delete a subscriber's record from a previous visitor location register after she has registered with a new visitor location register. Also this process is used to delete a subscriber's record from a old SGSN after she has registered with a SGSN. The procedure may also be used if the subscriber's record is to be deleted for other operator determined purposes, e.g. withdrawal of subscription, imposition of roaming restrictions or modifications to the subscription which result in roaming restrictions. Location cancellation can be used to enforce location updating including updating of subscriber data in the VLR or in the SGSN at the next subscriber access.

In all cases, the process is performed independently of the invoking process (e.g. Location Updating).

The service as described in clause 8.1.3 is invoked when an HLR receives a MAP_UPDATE_LOCATION indication from a VLR other than that stored in its table for this subscriber. Also the MAP_CANCEL_LOCATION service is invoked when the HLR receives a MAP_UPDATE_GPRS_LOCATION indication from a SGSN other than stored in its table for this subscriber. Additionally the service may be invoked by operator intervention. The MAP_CANCEL_LOCATION service is in any case invoked towards the VLR or the SGSN whose identity is contained in the HLR table.

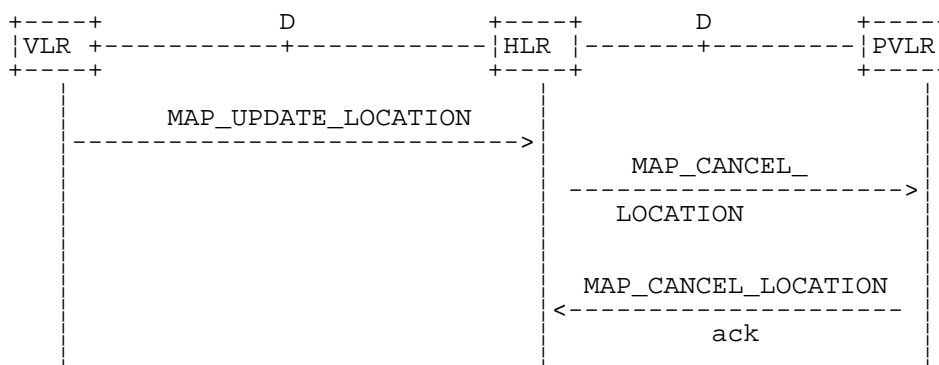

NOTE: The service shown in dotted lines indicates the trigger provided by other MAP signalling.

Figure 19.1.2/1: Interface and services for Location Cancellation

19.1.2.2 Detailed procedure in the HLR

The location cancellation process is started by an external process as stated above. The HLR opens a dialogue with the VLR or with the SGSN whose identity is contained in the HLR table (MAP_OPEN request without any user specific parameters), sending the MAP_CANCEL_LOCATION request primitive (see figures 19.1.2/2 and 19.1.2/4), containing the parameters:

- IMSI, to identify the subscriber to be deleted from that VLR or SGSN;
- LMSI, which is included if available in the HLR. LMSI is not applicable between HLR and SGSN;
- Cancellation Type if the Cancel Location is sent to SGSN. Cancellation Type is not applicable between HLR and VLR. If the VLR receives this parameter and does not understand it, this parameter shall be ignored.

19.1.2.3 Detailed procedure in the VLR

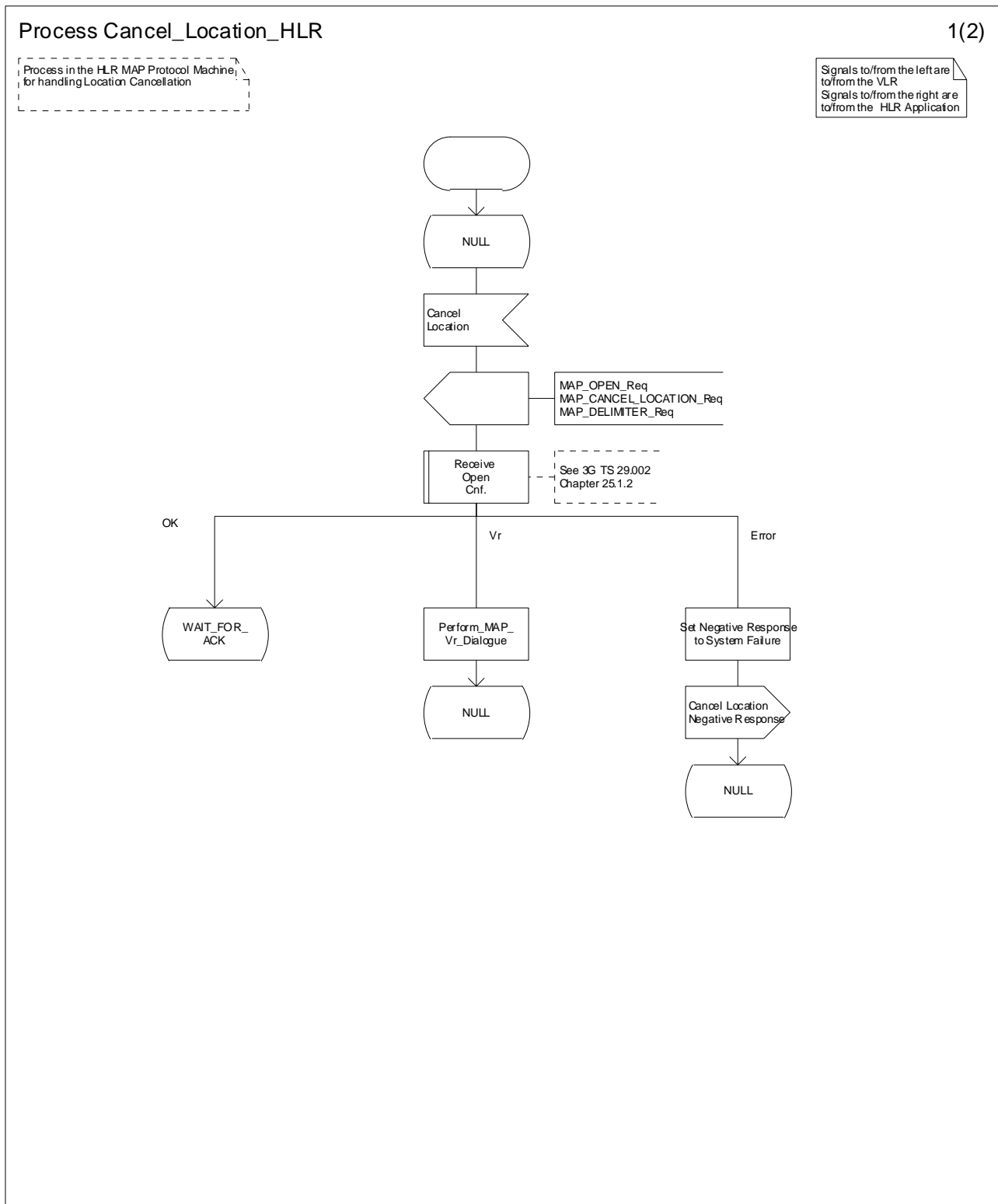

Figure 19.1.2/2 (Sheet 1 of 2): Process Cancel_Location_HLR

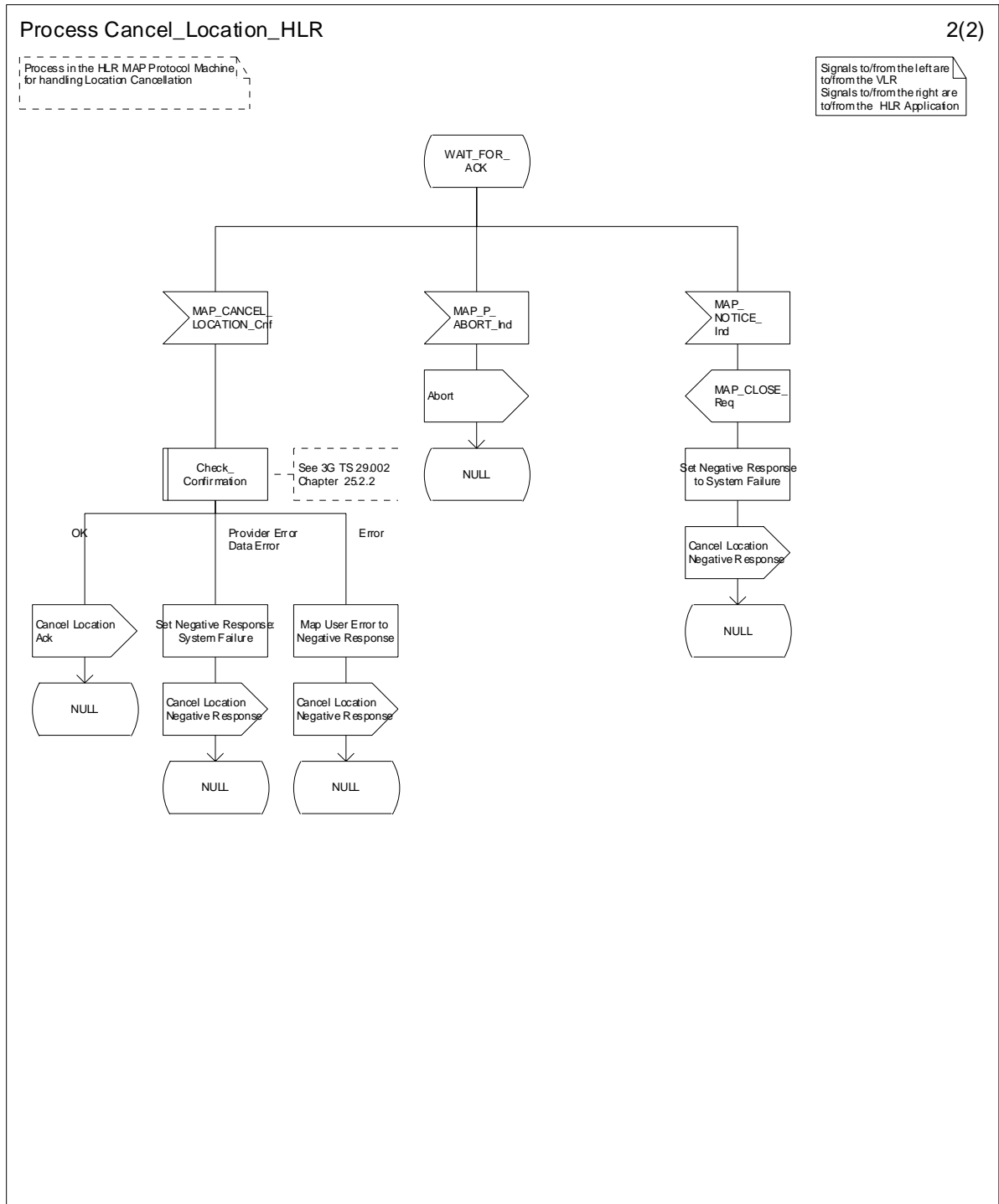

Figure 19.1.2/2 (Sheet 2 of 2): Process Cancel_Location_HLR

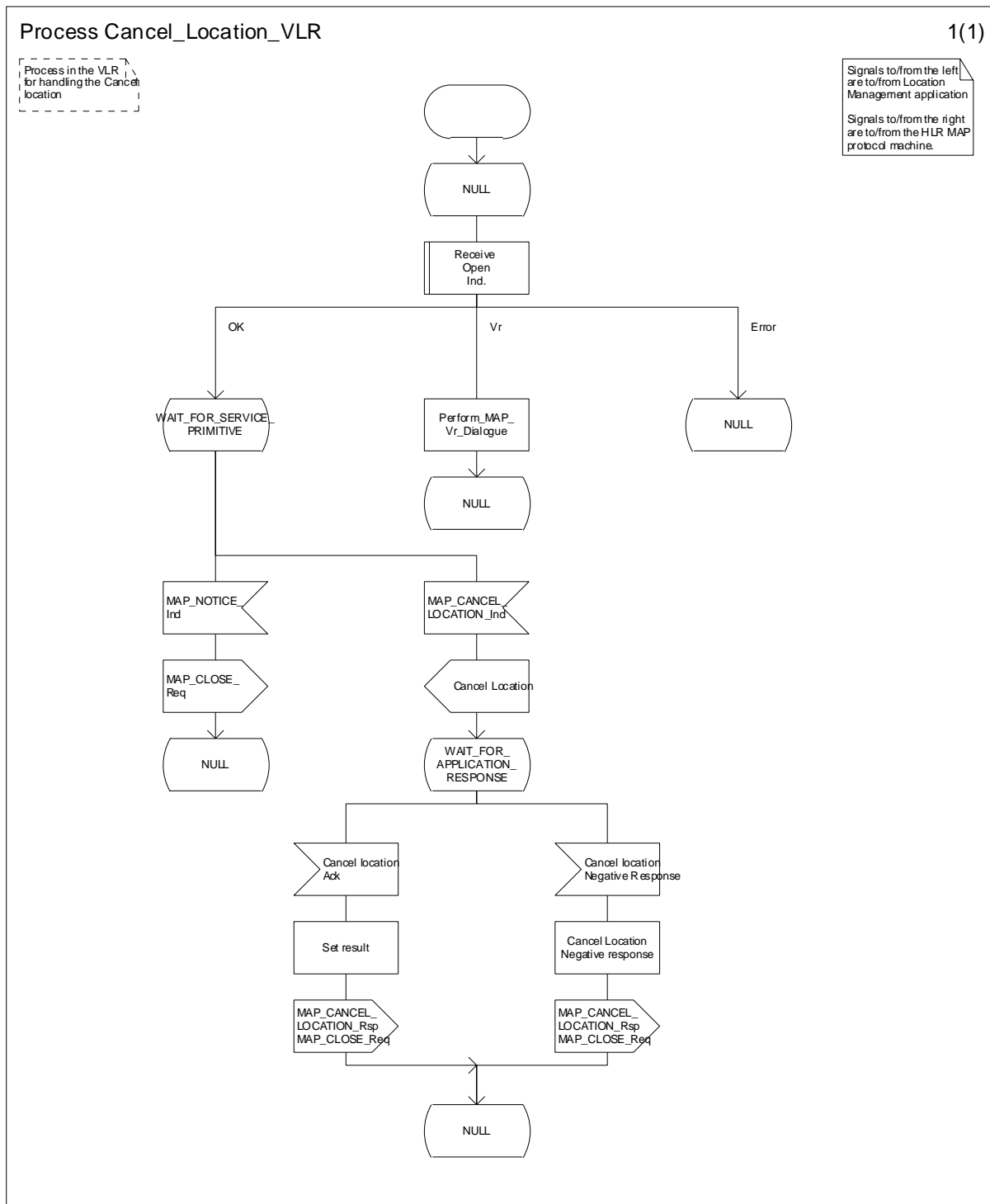

Figure 19.1.2/3: Process Cancel_Location_VLR

19.1.2.4 Detailed procedure in the SGSN

Opening of the dialogue is described in the macro Receive_Open_Ind in clause 25.1, with outcomes:

- procedure termination; or
- dialogue acceptance, with processing as below.

If the SGSN process receives a MAP_NOTICE indication, it terminates the dialogue by sending a MAP_CLOSE request.

If the SGSN process receives a MAP_CANCEL_LOCATION indication from the HLR (see figure 19.1.2/4), the parameters are checked first (macro Check_Indication, see clause 25.2). In case of parameter problems the appropriate error is sent in the MAP_CANCEL_LOCATION response.

Thereafter the SGSN checks whether the subscriber identity provided is known in the SGSN:

- if so, the data of the subscriber are deleted from SGSN table and a MAP_CANCEL_LOCATION response is returned without any parameters;
- if not, location cancellation is regarded as being successful, too, and the MAP_CANCEL_LOCATION response is returned without any parameters.

In either case, after sending the MAP_CANCEL_LOCATION response the SGSN process releases any P-TMSI which may be associated with the IMSI of the subscriber, terminates the dialogue (MAP_CLOSE with Release Method Normal Release) and returns to the idle state.

Process Cancel_GPRS_Location_HLR

19.1.2_4(1)

Figure 19.1.2/4: Location Cancellation in the HLR for GPRS

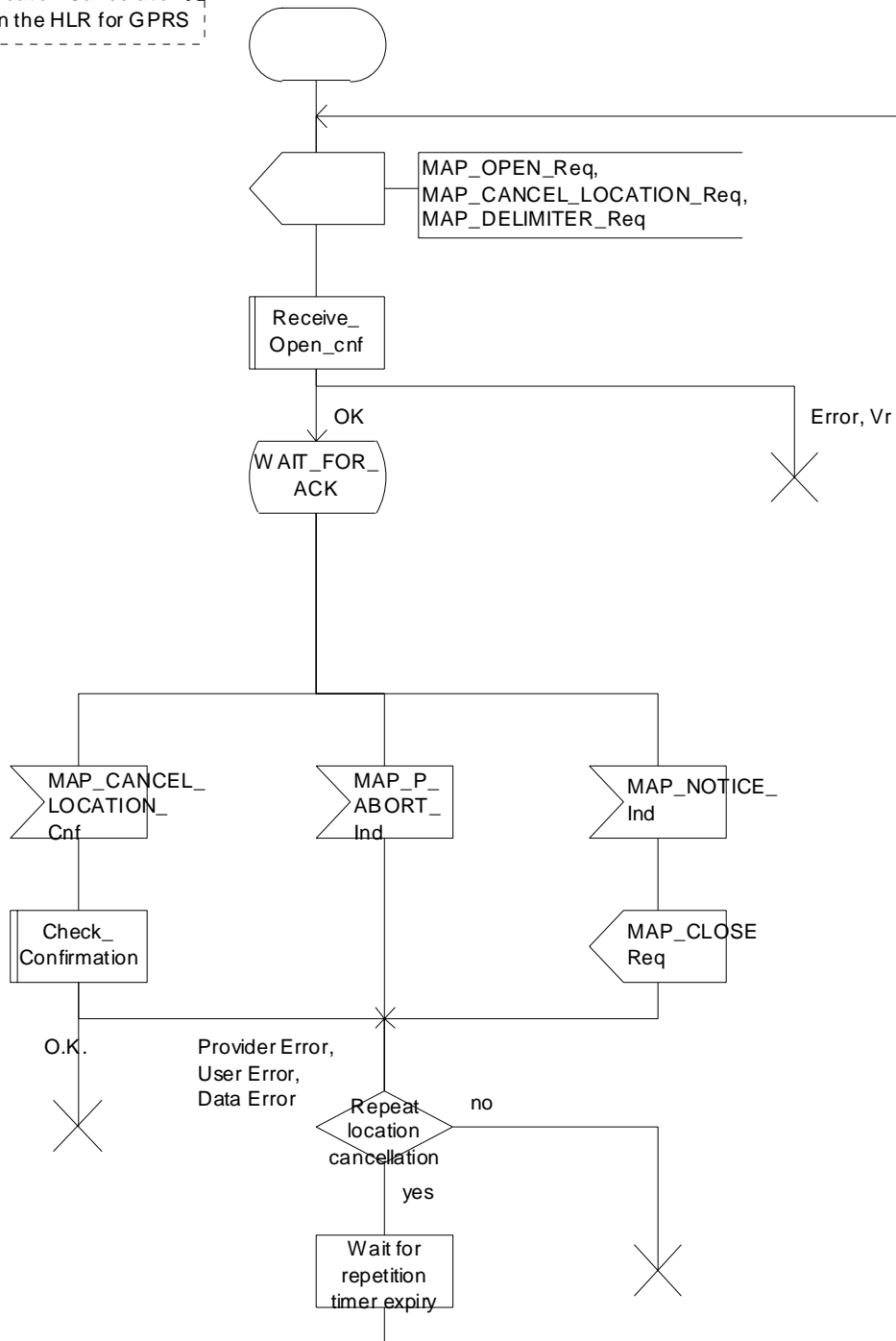

Figure 19.1.2/4: Process Cancel_GPRS_Location_HLR

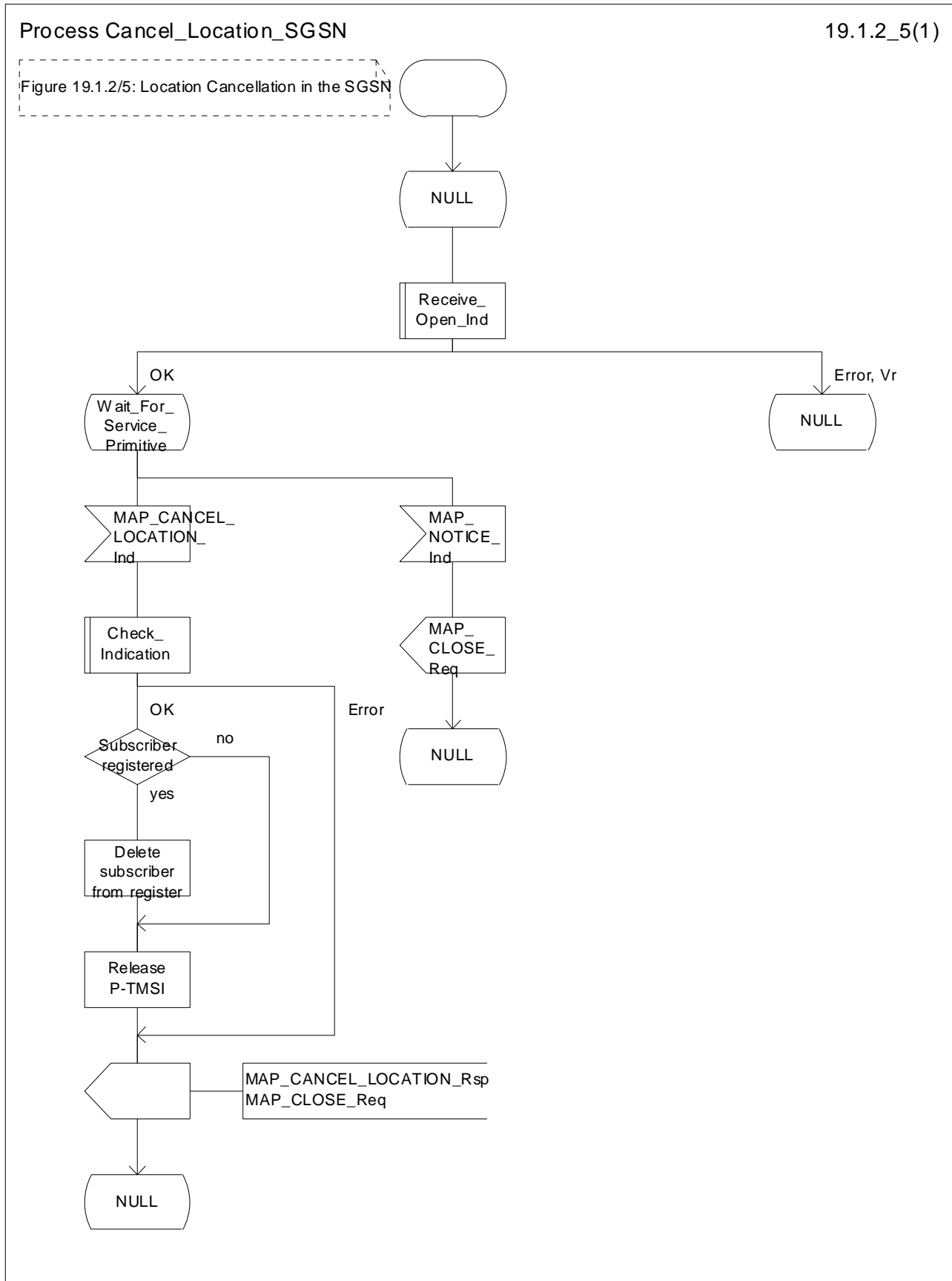

Figure 19.1.2/5: Process Cancel_Location_SGSN

19.1.3 Void

19.1.3.1 Void

19.1.3.2 Void

19.1.3.3 Void

19.1.4 Purge MS

19.1.4.1 General

When the VLR or the SGSN receives an indication on the O&M interface that the MS record is to be purged (either because of administrative action or because the MS has been inactive for an extended period), this procedure invokes the MAP_PURGE_MS service described in clause 8.1.6 to request the HLR to set the "MS purged for non-GPRS" or the "MS purged for GPRS" flag for the MS so that any request for routing information for a mobile terminated call or a mobile terminated short message will be treated as if the MS is not reachable. The message flows are shown in figures 19.1.4/1 and 19.1.4/5.

It is optional for the network operator to delete MS records from the VLR or from the SGSN, but if the option is used the VLR or the SGSN shall notify the HLR when a record has been deleted.

The O&M process in the VLR or in the SGSN must ensure that during the MS purging procedure any other attempt to access the MS record is blocked, to maintain consistency of data.

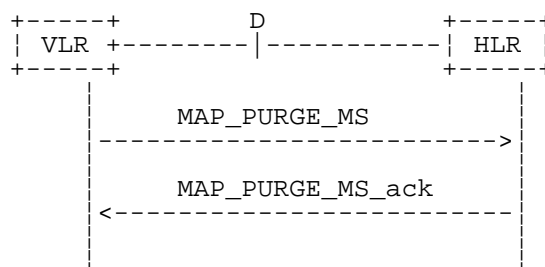

Figure 19.1.4/1: MAP-D Interface and services for MAP_PURGE_MS

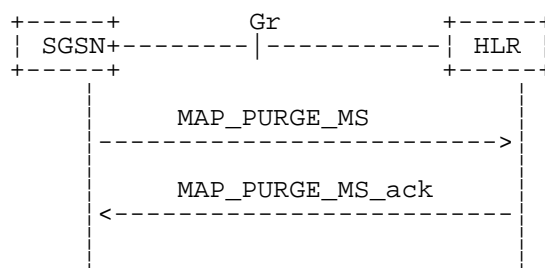

Figure 19.1.4/5: Gr Interface and services for MAP_PURGE_MS

19.1.4.2 Void

19.1.4.3 Void

19.1.4.4 Detailed procedure in the SGSN

Figure 19.1.4/4 shows the MAP process in the SGSN to notify the HLR that an MS record has been purged. The following general macro is used:

Receive_Open_Cnf clause 25.1;

Sheet 1: The procedure Purge_MS_In_Serving_Network_Entity is specific to Super-Charger; it is specified in 3G TS 23.116 [110]. If the SGSN and the originating HLR support the Super-Charger functionality, processing continues from the "Yes" exit of the test "Result=Pass?".

When the SGSN receives an indication from O&M that an MS record is to be purged, it invokes the MAP_PURGE_MS service.

The SGSN opens the dialogue to the HLR with a MAP_OPEN request containing no user specific parameters. The MAP_PURGE_MS request contains the IMSI of the MS which is to be purged and the SGSN number.

The SGSN then waits for the MAP_OPEN confirmation indicating one of:

- rejection of the dialogue (process terminates);
- reversion to Vr (process terminates);
- dialogue acceptance.

If the HLR accepts the dialogue it returns a MAP_PURGE_MS confirmation, containing no parameter, indicating successful outcome of the procedure.

If a MAP_PURGE_MS confirmation containing a provider error, data error or user error, or a MAP_P_ABORT, MAP_NOTICE or premature MAP_CLOSE indication, has been received, the failure is reported to the O&M interface. Successful outcome of the procedure leads to deletion of the subscriber data and freezing of the P-TMSI if so requested by the HLR, and is reported to the O&M interface.

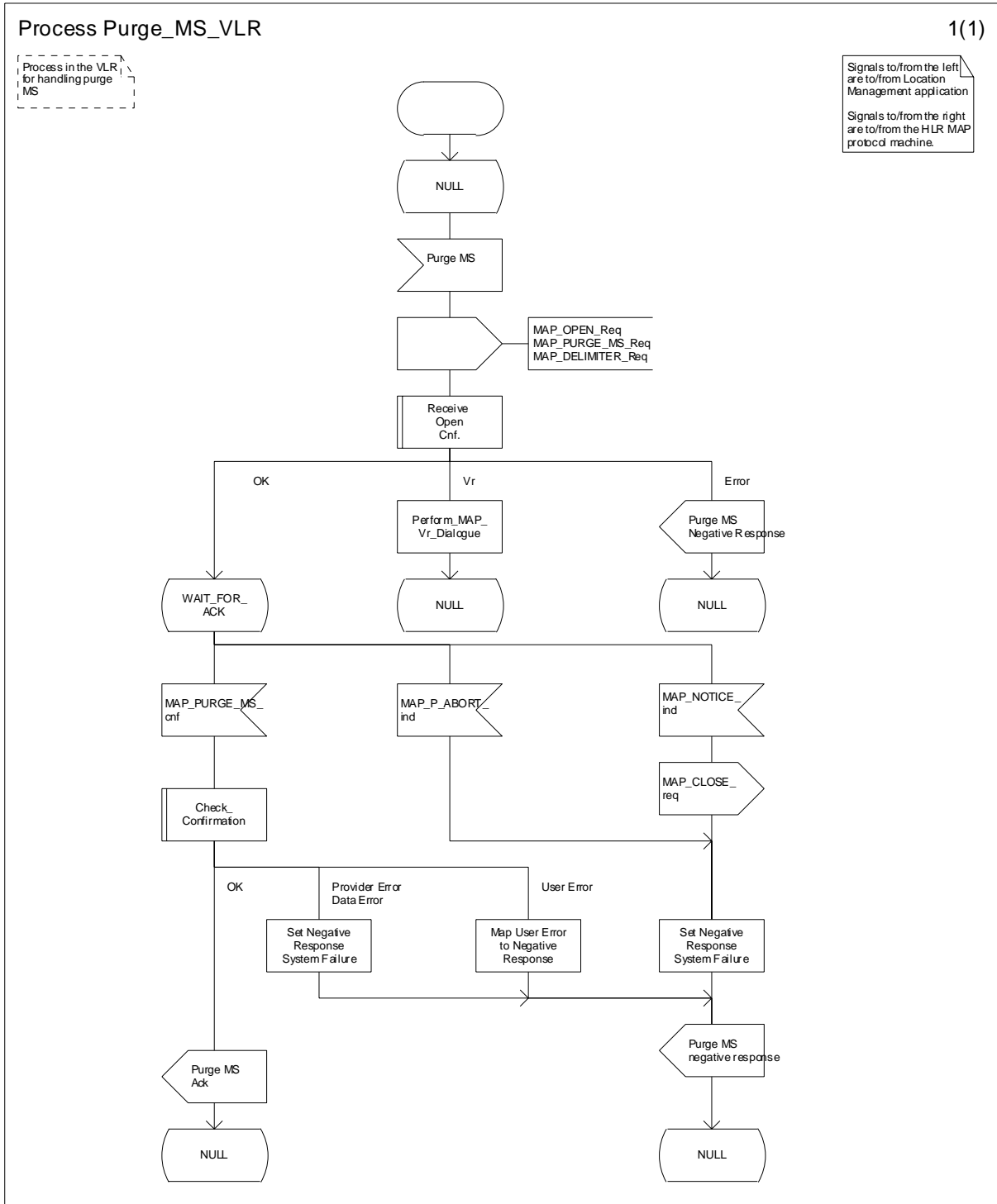

Figure 19.1.4/2: Process Purge_MS_VLR

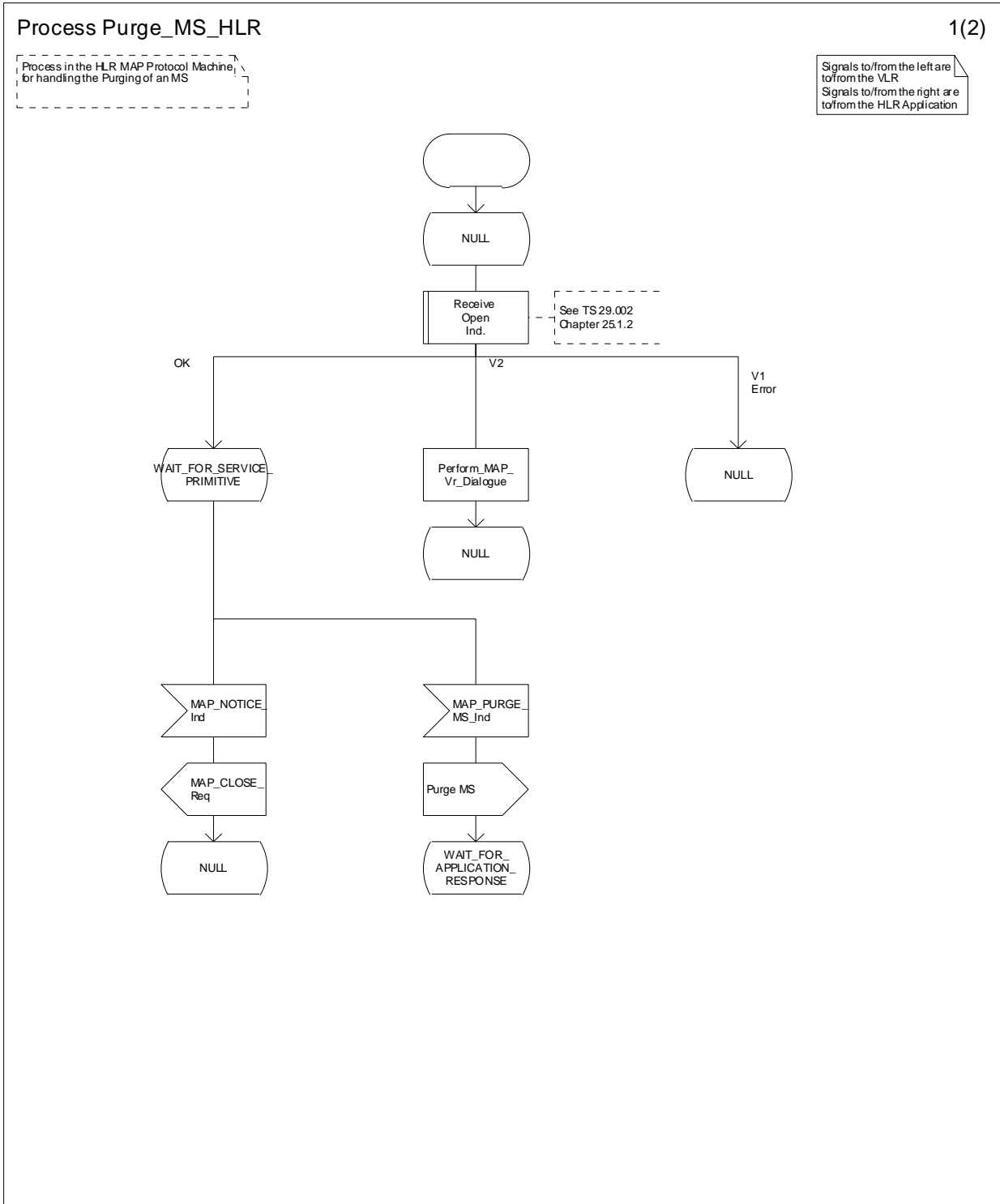

Figure 19.1.4/3 (Sheet 1 of 2): Process Purge_MS_HLR

Process Purge_MS_HLR

2(2)

Process in the HLR MAP Protocol Machine for handling the Purging of an MS

Signals to/from the left are to/from the VLR
Signals to/from the right are to/from the HLR Application

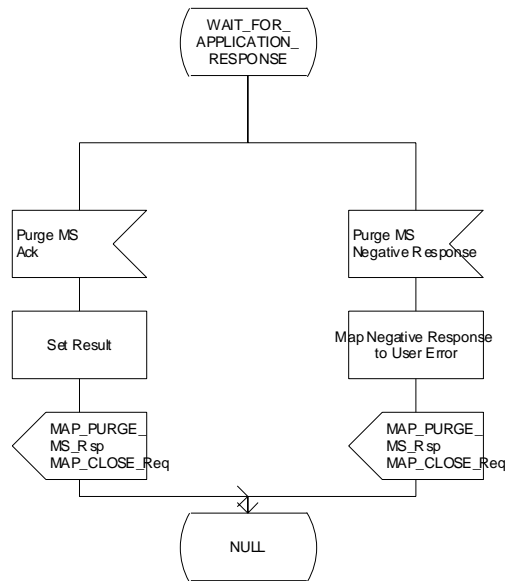

Figure 19.1.4/3 (Sheet 2 of 2): Process Purge_MS_HLR

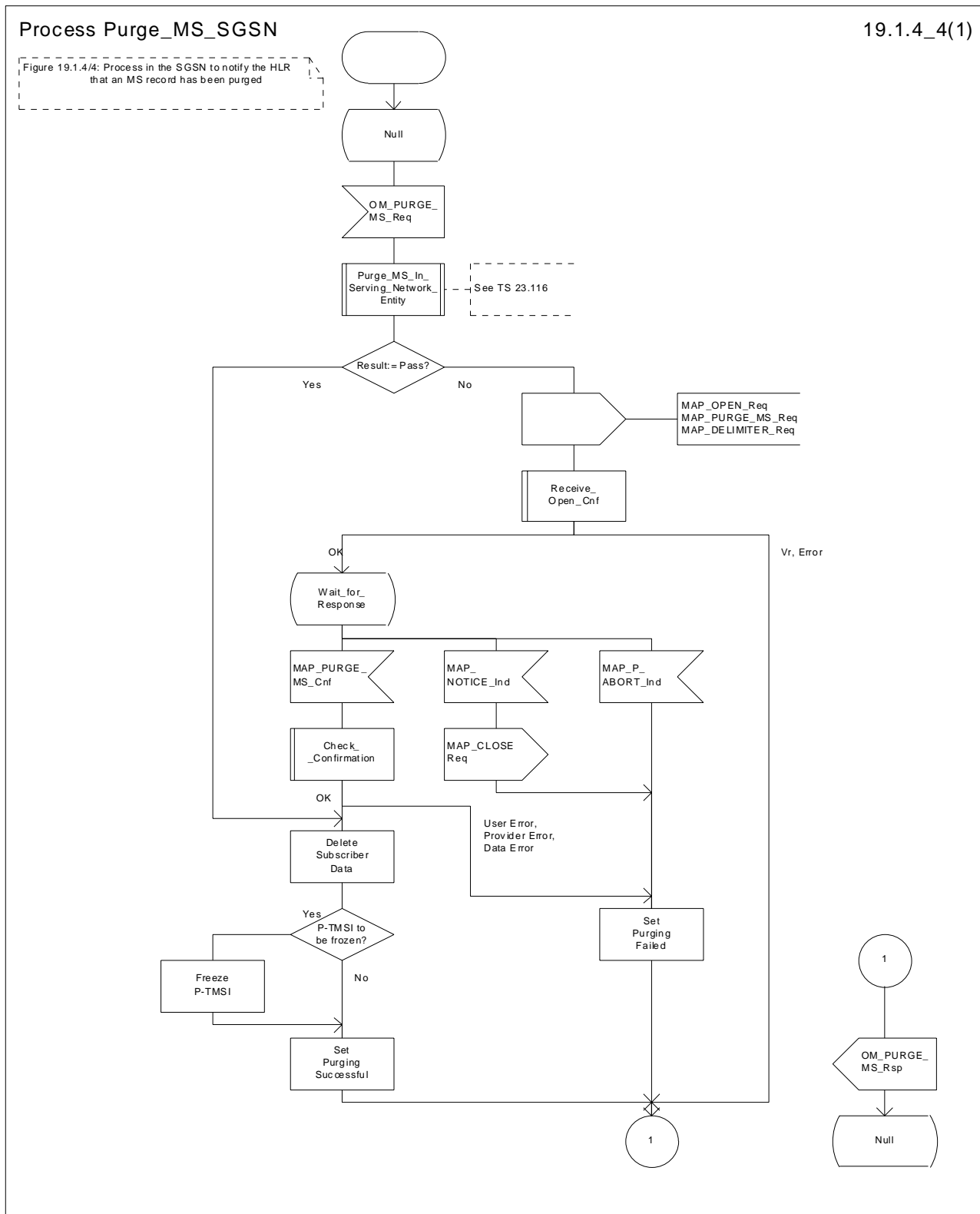

Figure 19.1.4/4: Process Purge_MS_SGSN

19.2 Handover procedure

It should be noted that procedures related to the B-interface have not been updated for Release 99. The B-interface is not fully operational specified. It is strongly recommended not to implement the B-interface as an external interface.

19.2.1 General

The handover or relocation between different MSCs is called Inter-MSC handover. The interfaces involved for Inter-MSC handover are shown in figure 19.2/1. Following two Inter-MSC handover procedures apply:

1) Basic Inter-MSC handover:

The call is handed over from the controlling MSC, called MSC-A to another MSC, called MSC-B (figure 19.2/1a).

Figure 19.2/2 shows a successful handover between MSC-A and MSC-B including a request for handover number allocation by MSC-B to VLR-B.

2) Subsequent Inter-MSC handover:

After the call has been handed over from MSC-A to MSC-B, a handover to either MSC-A (figure 19.2/1a) or to a third MSC (MSC-B') (figure 19.2/1b) is necessary in order to continue the connection.

Figure 19.2/3 shows a successful subsequent handover.

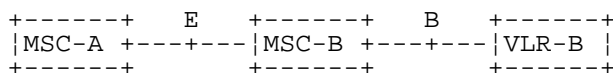

a) Basic handover procedure MSC-A to MSC-B and subsequent handover procedure MSC-B to MSC-A.

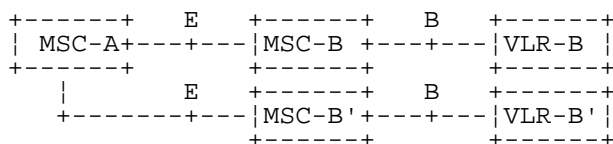

b) Subsequent handover procedure MSC-B to MSC-B'.

Figure 19.2/1: Interface structure for handover

The MAP handover procedures achieve the functionality required to set up an MSC-MSC dialogue, to optionally allocate a handover number or one or several relocation numbers and to transport BSSAP or RANAP messages.

Minimum applicable MAP AC for intersystem inter-MSC GSM BSS to UTRAN handover shall be MAP handover AC version 3.

Minimum applicable MAP AC for intersystem inter-MSC UTRAN to GSM BSS handover shall be MAP handover AC version 2.

Note: If MAP AC version 2 is used, subsequent handover to UTRAN is not possible.

Minimum applicable MAP AC for inter-MSC GSM BSS to GSM BSS handover should be MAP handover AC version 2.

NOTE: If MAP AC version 2 or lower is used, subsequent handover to UTRAN is not possible.

The transported BSSAP or RANAP messages are controlled and handled by the Handover Control Application in the MSCs. This information will be transparent to the MAP protocol. If the MSC receives via the MAP protocol BSSAP or RANAP messages, this information will be forwarded to the Handover Control Application (shown in the handover SDL diagrams with the internal HO_CA signalling, it is an internal process in the MSC) and vice versa if the Handover Control Application requires the sending of BSSAP or RANAP messages via the MAP protocol.

For detailed interworking between the A-interface and MAP procedures or the Iu-interface and MAP procedures, see 3G TS 23.009 and 3G TS 29.010.

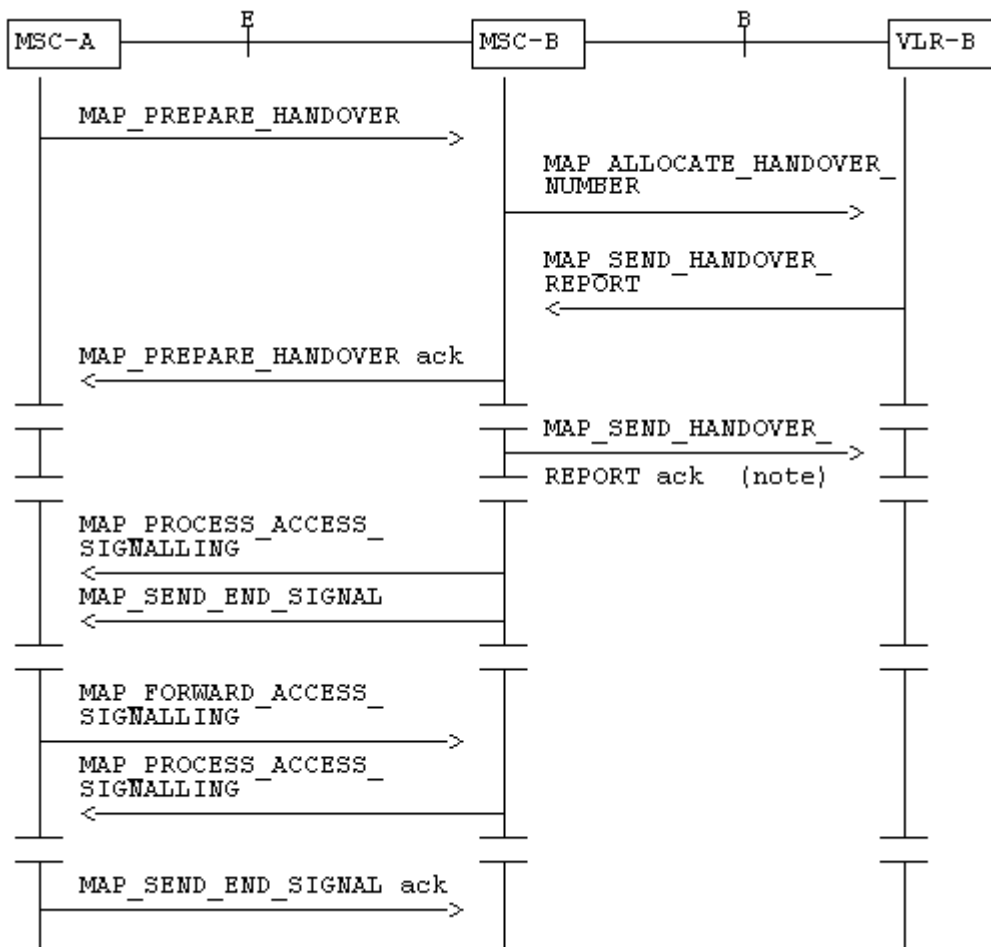

NOTE: This can be sent at any time after the connection between MSC-A and MSC-B is established.

Figure 19.2/2: Example of a successful basic handover procedure to MSC-B

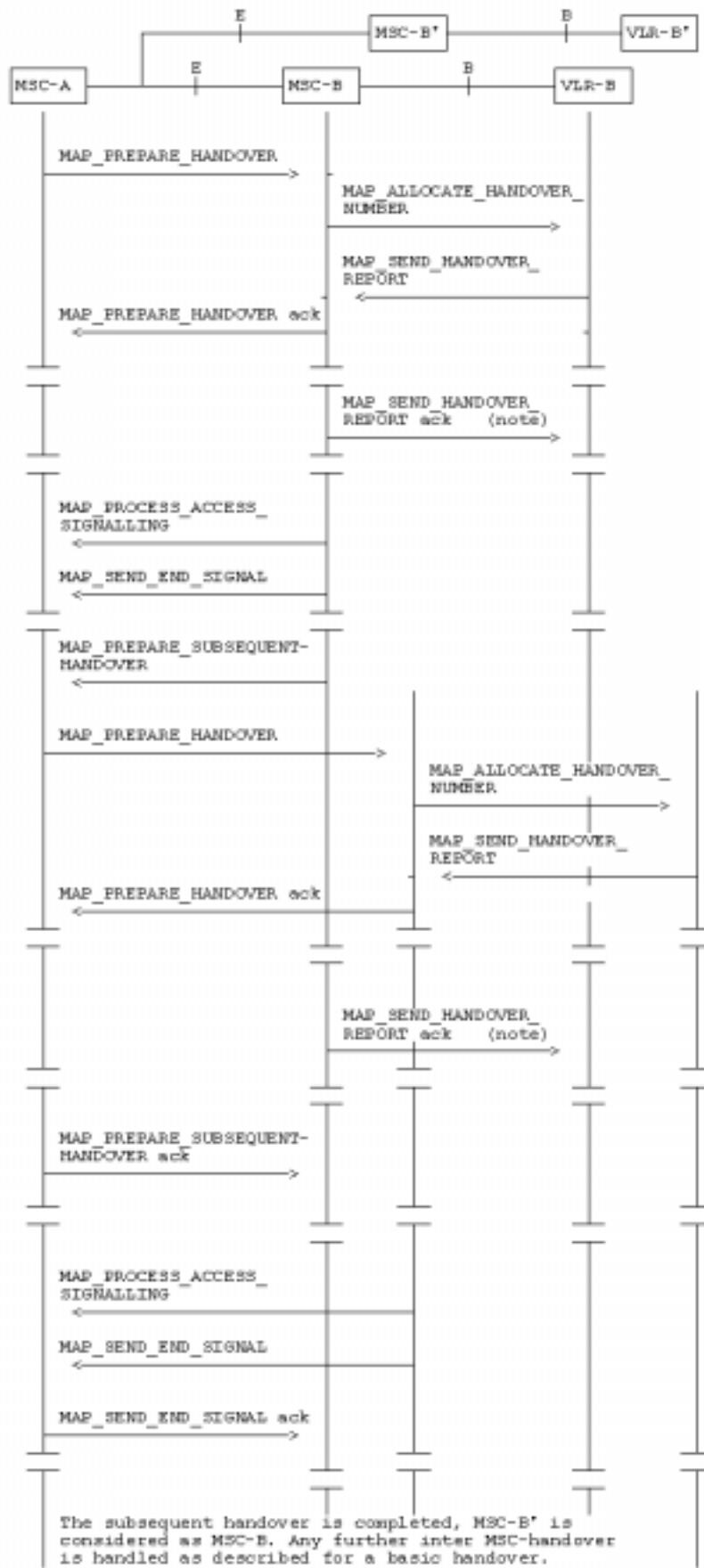

NOTE: This can be sent at any time after the connection between MSC-A and MSC-B is established.

Figure 19.2/3: Example of a handover towards a third MSC

19.2.2 Handover procedure in MSC-A

This clause describes the handover or relocation procedure in MSC-A, including the request for a basic handover or relocation to another MSC (MSC-B), subsequent handover or relocation to a third MSC (MSC-B') or back to the controlling MSC (MSC-A).

19.2.2.1 Basic handover

When MSC-A has decided that a call has to be handed over or relocated to MSC-B, the Handover Control Application in MSC-A requests the MAP application to initiate the MAP_PREPARE_HANOVER request to MSC-B.

MSC-A opens the dialogue to MSC-B with a MAP_OPEN request containing no user specific parameters and sends a MAP_PREPARE_HANOVER request. This request shall contain all the information required by MSC-B to allocate the necessary radio resources. In addition, it may optionally contain:

- an indication that a handover number allocation is not required;
- the targetCellId, for compatibility reasons in the case of handover or inter-system handover to GSM ;
- the targetRNCId, in case of SRNS relocation or inter-system handover from GSM to UMTS;
- the IMSI;
- UMTS encryption information and UMTS integrity protection information, which are necessary parameters for inter-system handover from GSM to UMTS;
- GSM radio resource information (channel type) shall be included at inter-MSC relocation to prepare for a possible subsequent intra-MSC handover from UMTS to GSM in MSC-B.

The conditions when these parameters shall be included and the processing of them in MSC-B (3G_MSC-B) are described in detail in 3G TS 29.010 and 23.009.

If MSC-B accepts the dialogue, it returns a MAP_PREPARE_HANOVER confirmation containing a handover number or one or several relocation numbers, unless the request has included the HO-NumberNotRequired parameter, and BSSAP or RANAP information which is forwarded to and handled by the Handover Control Application in MSC-A.

Optionally MSC-A can receive, after a MAP_PREPARE_HANOVER confirmation, a MAP_PROCESS_ACCESS_SIGNALLING indication containing BSSAP or RANAP information.

When the connection has been established between the MS and MSC-B, MSC-A will be informed by a MAP_SEND_END_SIGNAL indication.

When MSC-A wants to clear the connection with BSS-B, an indication from the Handover Control Application is received in the Map Application to send the MAP_SEND_END-SIGNAL response to MSC-B to close the MAP dialogue.

MSC-A may abort the handover or relocation procedure at any time (e.g. if the call is cleared).

19.2.2.2 Handling of access signalling

If required, the Handover Control Application in MSC-A requests the MAP application to invoke the MAP_FORWARD_ACCESS_SIGNALLING request containing the information to be transferred to the A-interface or the Iu-interface of MSC-B (e.g. call control information).

MAP_FORWARD_ACCESS_SIGNALLING is a non-confirmed service.

MSC-B will then forward the required information to the Handover Control Application. The MAP_FORWARD_ACCESS_SIGNALLING is composed in such a way that the information can be passed transparently to the A-interface or the Iu-interface for call control and mobility management information. Any response received in MSC-B from the A-interface or the Iu-interface that should be brought to MSC-A will require a new independent request from the Handover Control Application in MSC-B to MSC-A by invoking a MAP_PROCESS_ACCESS_SIGNALLING request.

19.2.2.3 Other procedures in stable handover situation

During a call and after handover or relocation, a number of procedures between MSC-A and BSS-B or RNS-B controlled by or reported to MSC-A may be initiated in both directions by invoking a MAP_FORWARD_ACCESS_SIGNALLING request and reception of a MAP_PROCESS_ACCESS_SIGNALLING indication.

19.2.2.4 Subsequent handover

When MSC-A receives a MAP_PREPARE_SUBSEQUENT_HANDOVER request, it will start the procedure of handing or relocating the call over to a third MSC (MSC-B'), or back to the controlling MSC (MSC-A). If the new handover or relocation procedure towards MSC-B' or MSC-A is successful, the handover control application in MSC-A will request the release of the dialogue towards MSC-B by sending the MAP_SEND_END_SIGNAL confirmation.

19.2.2.5 SDL Diagrams

The SDL diagrams on the following pages describe the user processes in MSC-A for the procedures described in this clause.

The services used are defined in clause 8.4.

NOTE: The message primitives HO_CA_MESSAGE used in the SDL-Diagrams are used to show the internal co-ordination between the MAP application and the Handover Control Application. For a detailed description of the co-ordination between the applications for the handover or relocation procedure, see 3G TS 23.009.

Note that in case of reception of errors from the MSCs (see the Handover error handling macro), the MAP user reports them to the Handover Control Application and does not take any action except in cases explicitly mentioned in the SDL diagrams.

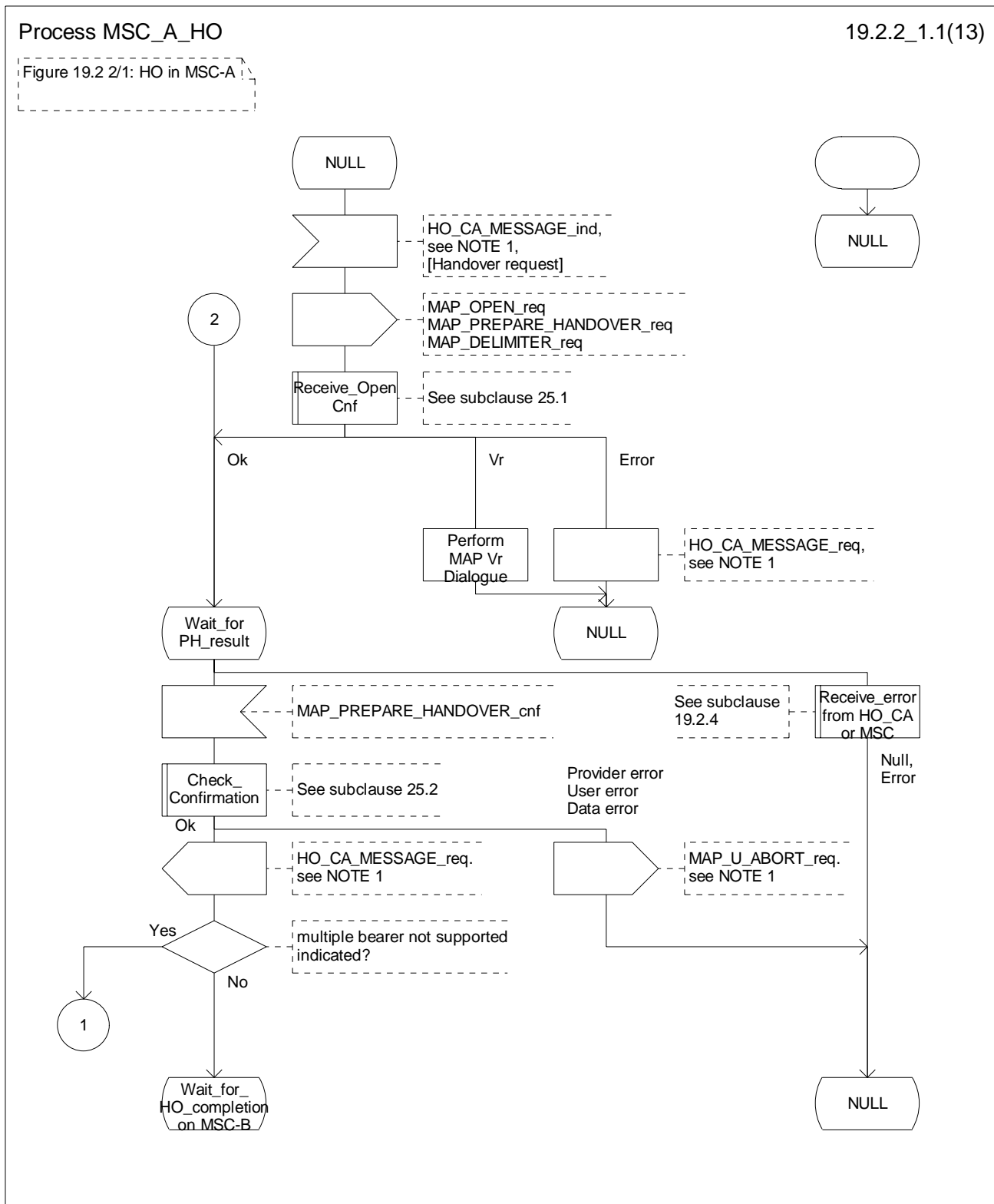

Figure 19.2.2/1 (sheet 1 of 13): Process MSC_A_HO

Process MSC_A_HO

19.2.2_1.2(13)

Figure 19.2 2/1: HO in MSC-A

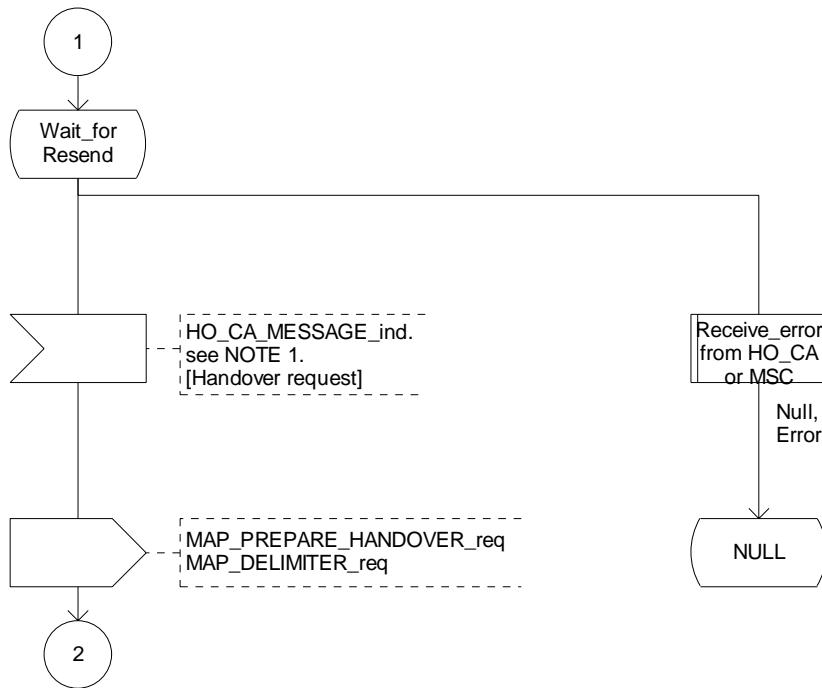

Figure 19.2.2/1 (sheet 2 of 13): Process MSC_A_HO

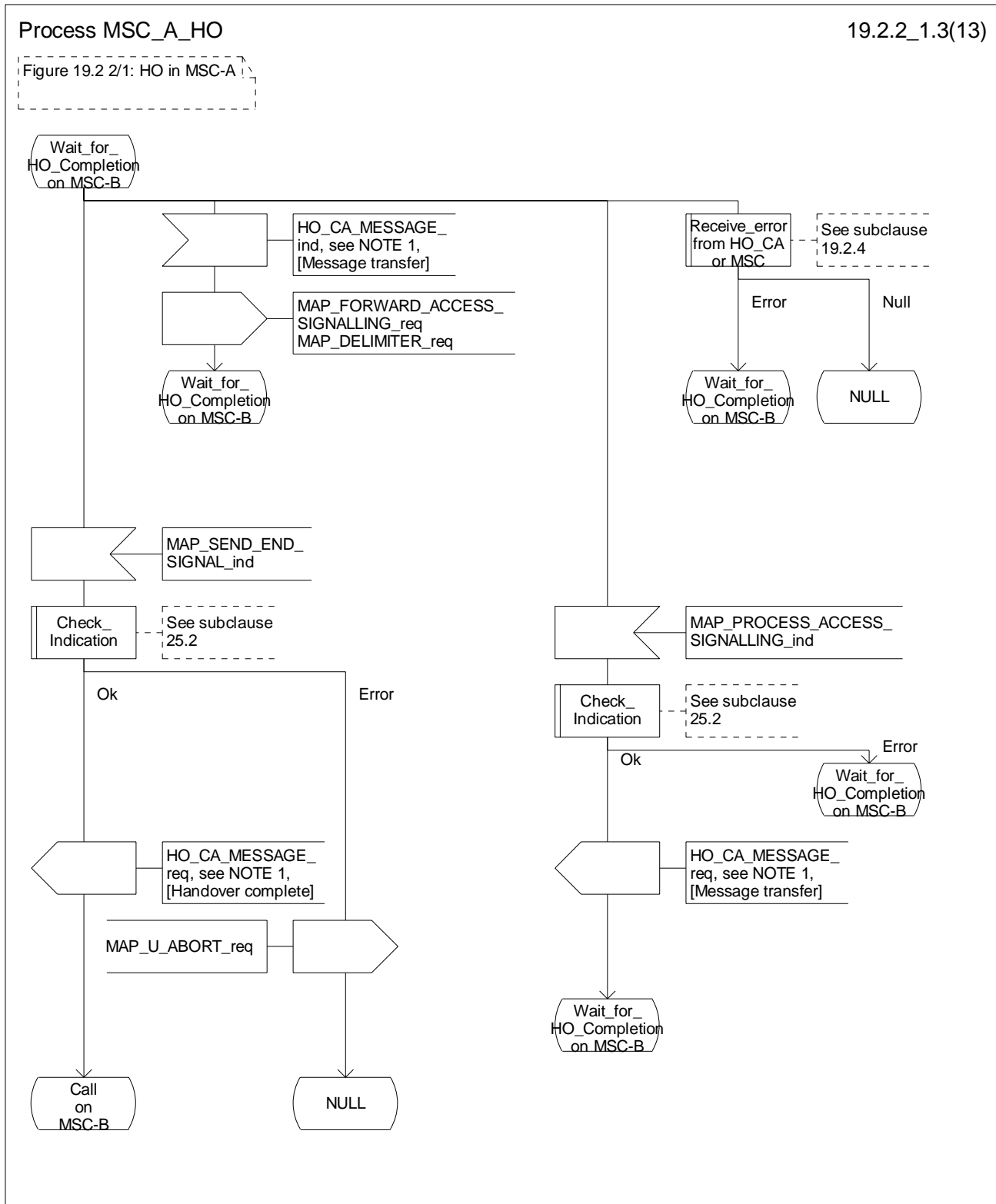

Figure 19.2.2/1 (sheet 3 of 13): Process MSC_A_HO

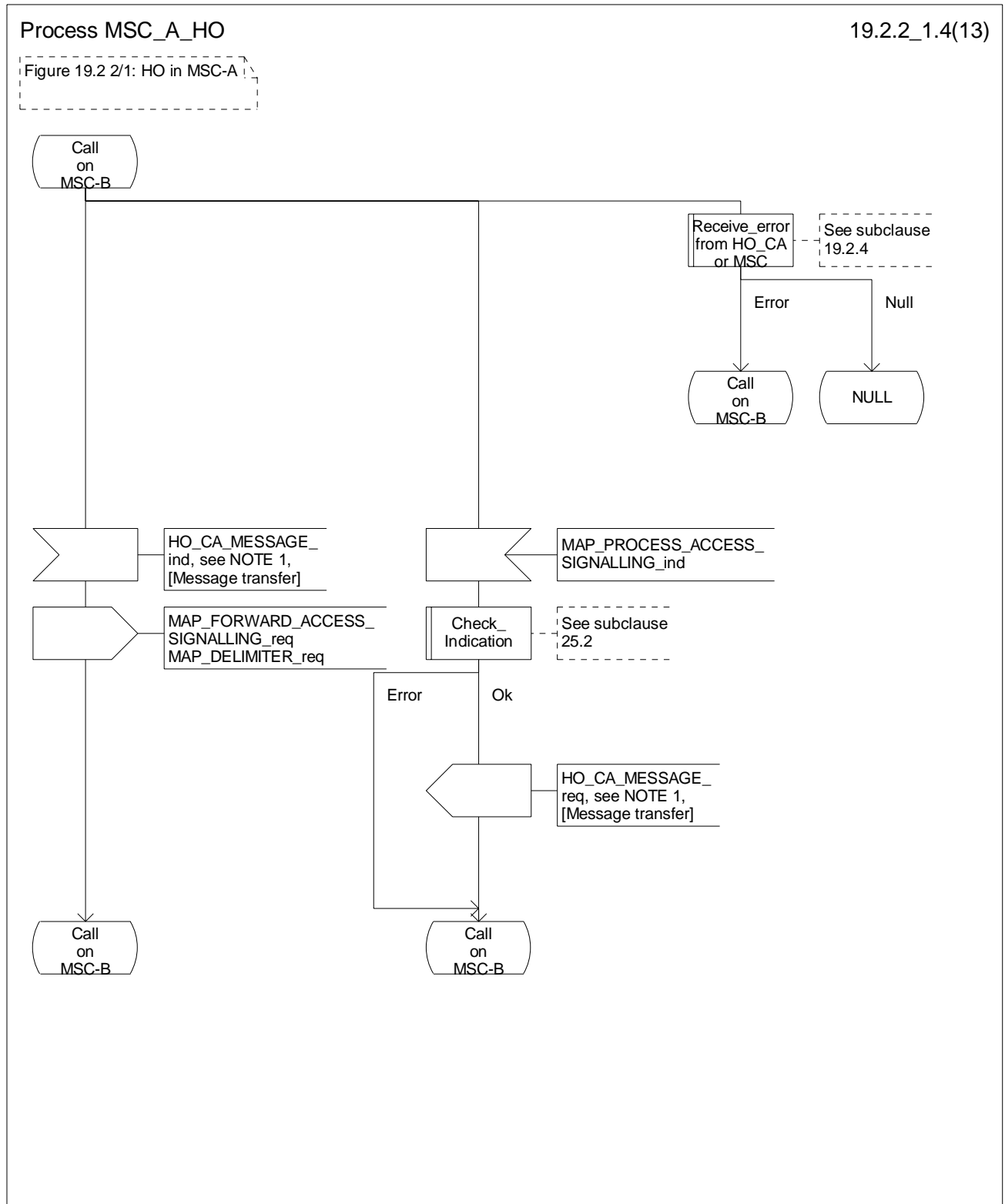

Figure 19.2.2/1 (sheet 4 of 13): Process MSC_A_HO

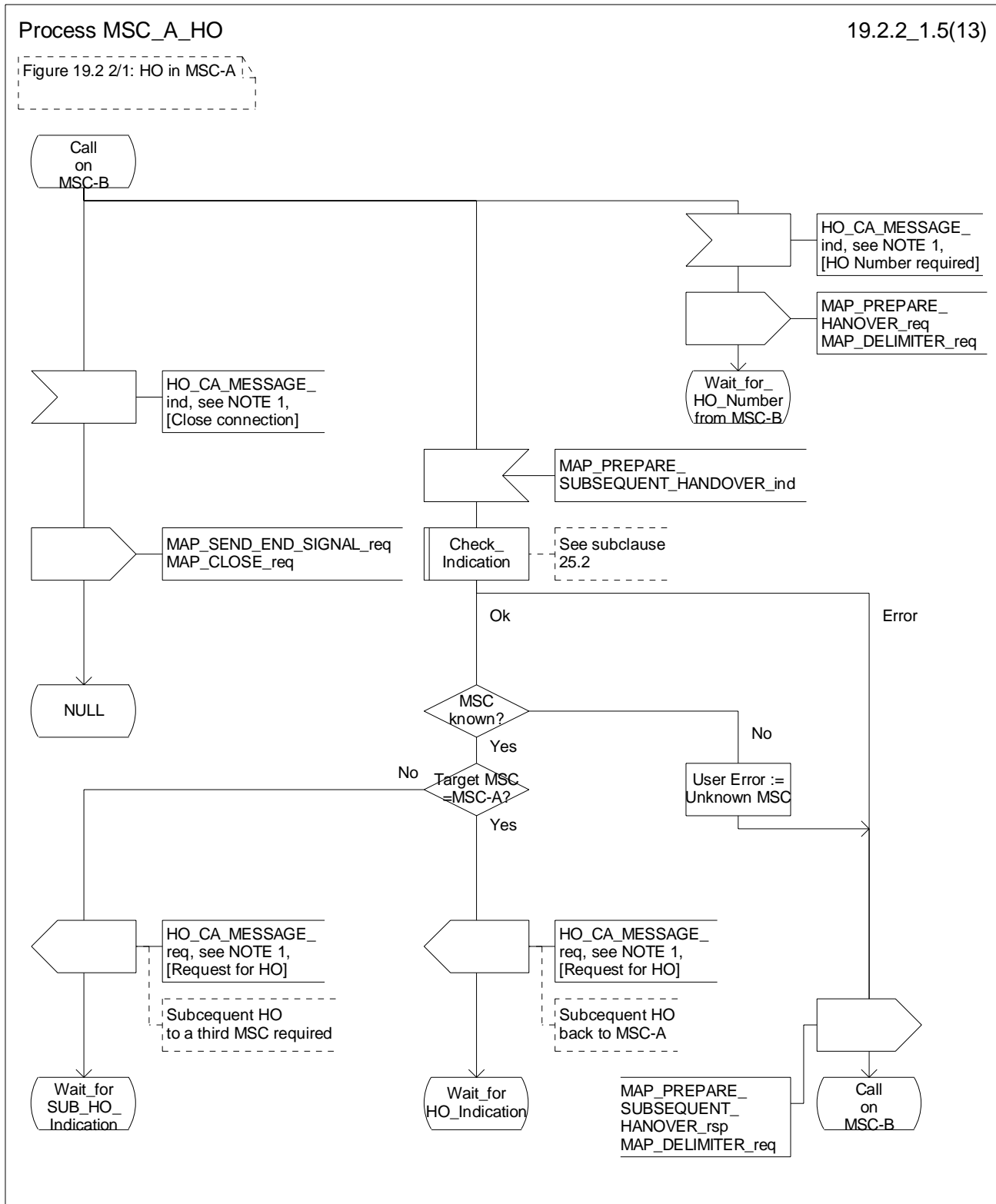

Figure 19.2.2/1 (sheet 5 of 13): Process MSC_A_HO

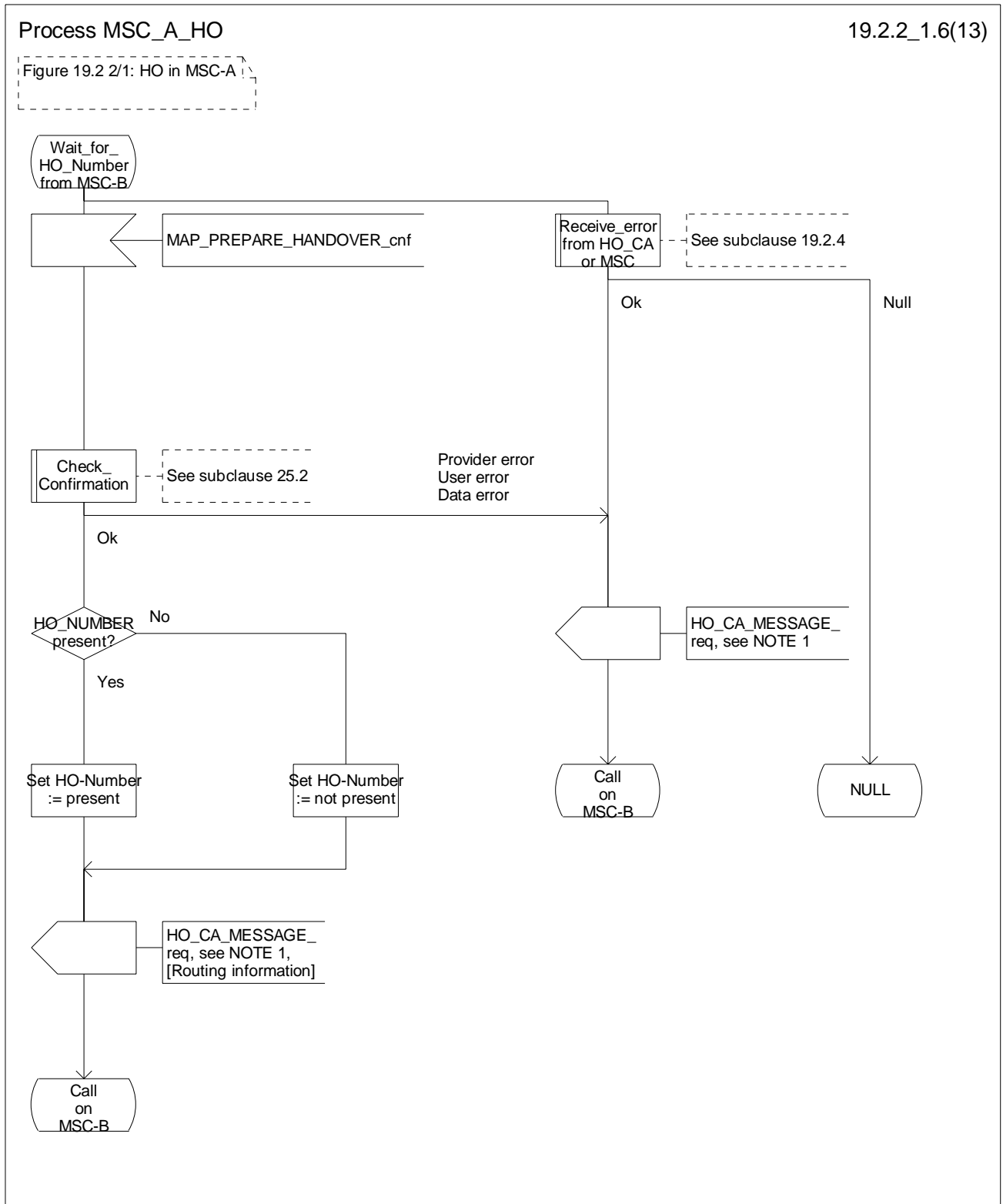

Figure 19.2.2/1 (sheet 6 of 13): Process MSC_A_HO

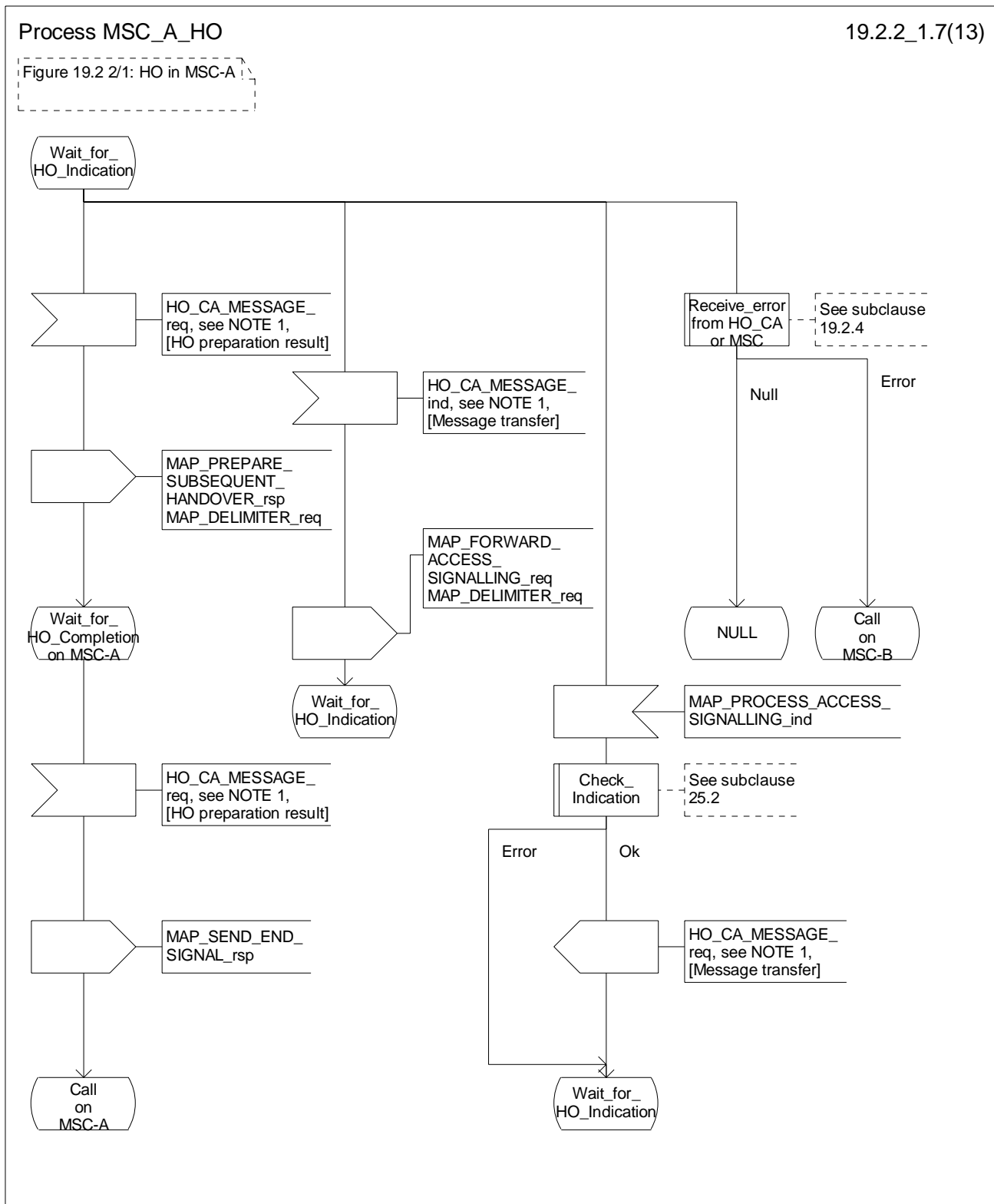

Figure 19.2.2/1 (sheet 7 of 13): Process MSC_A_HO

Process MSC_A_HO

19.2.2_1.8(13)

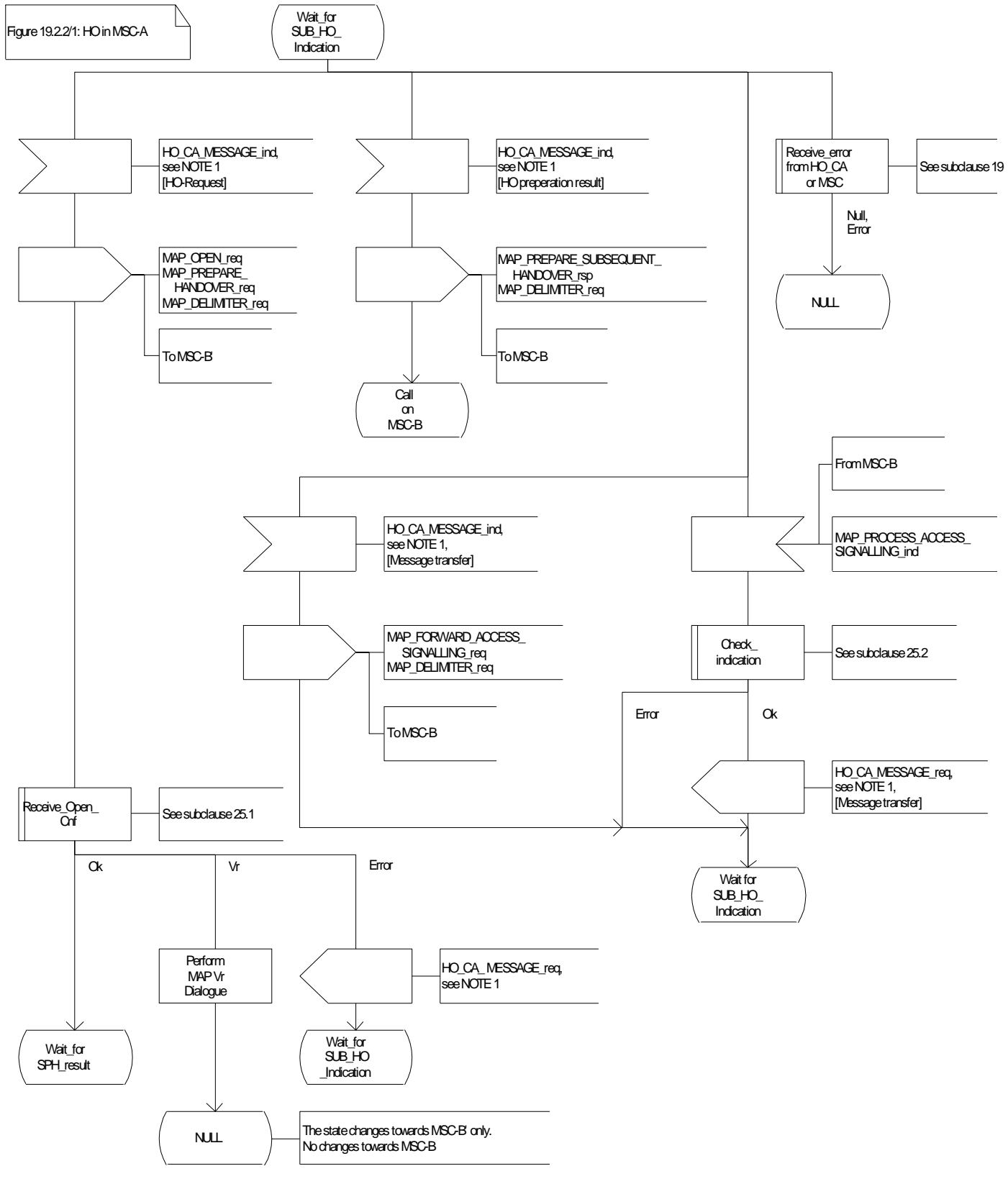

Figure 19.2.2/1 (sheet 8 of 13): Process MSC_A_HO

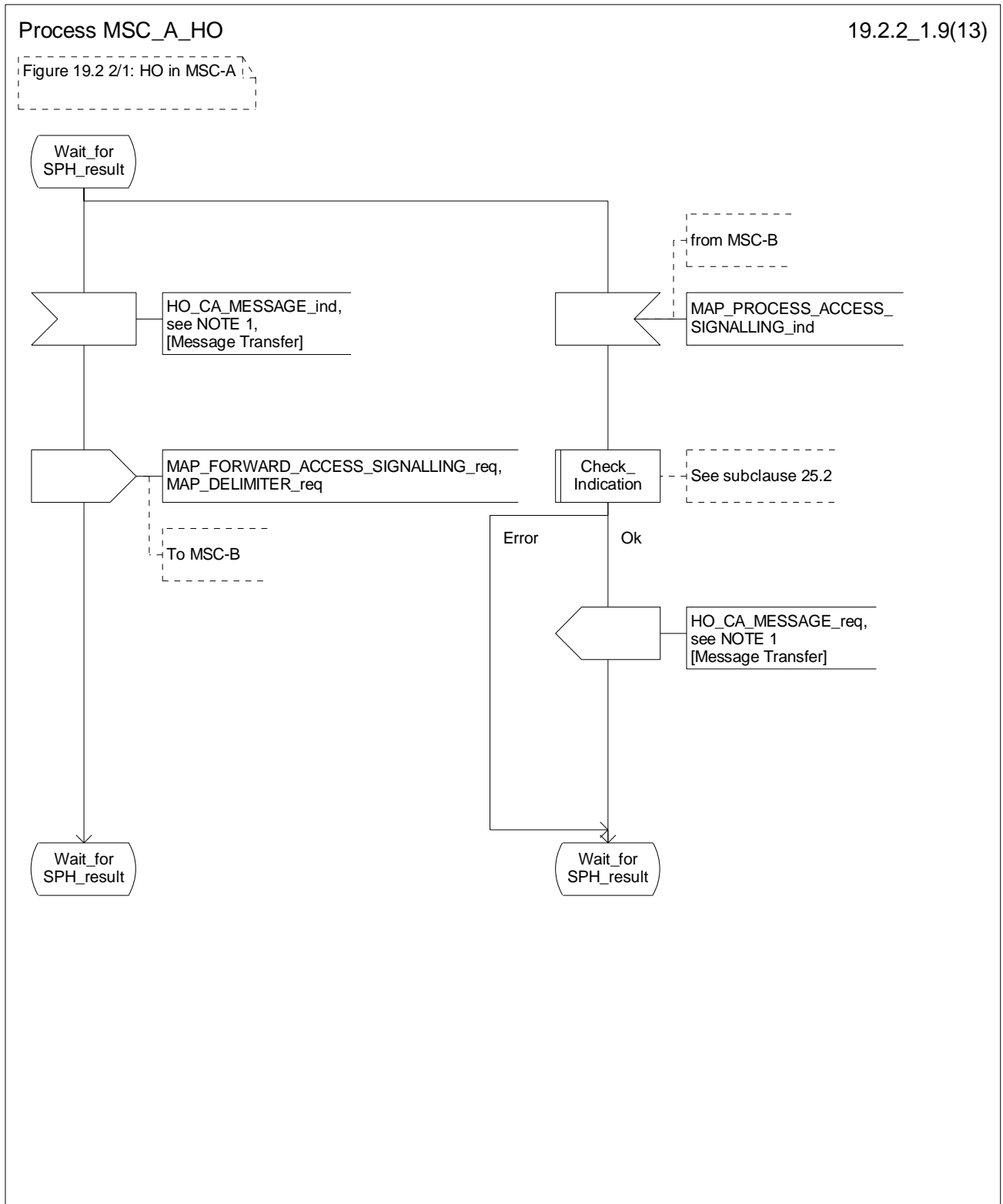

Figure 19.2.2/1 (sheet 9 of 13): Process MSC_A_HO

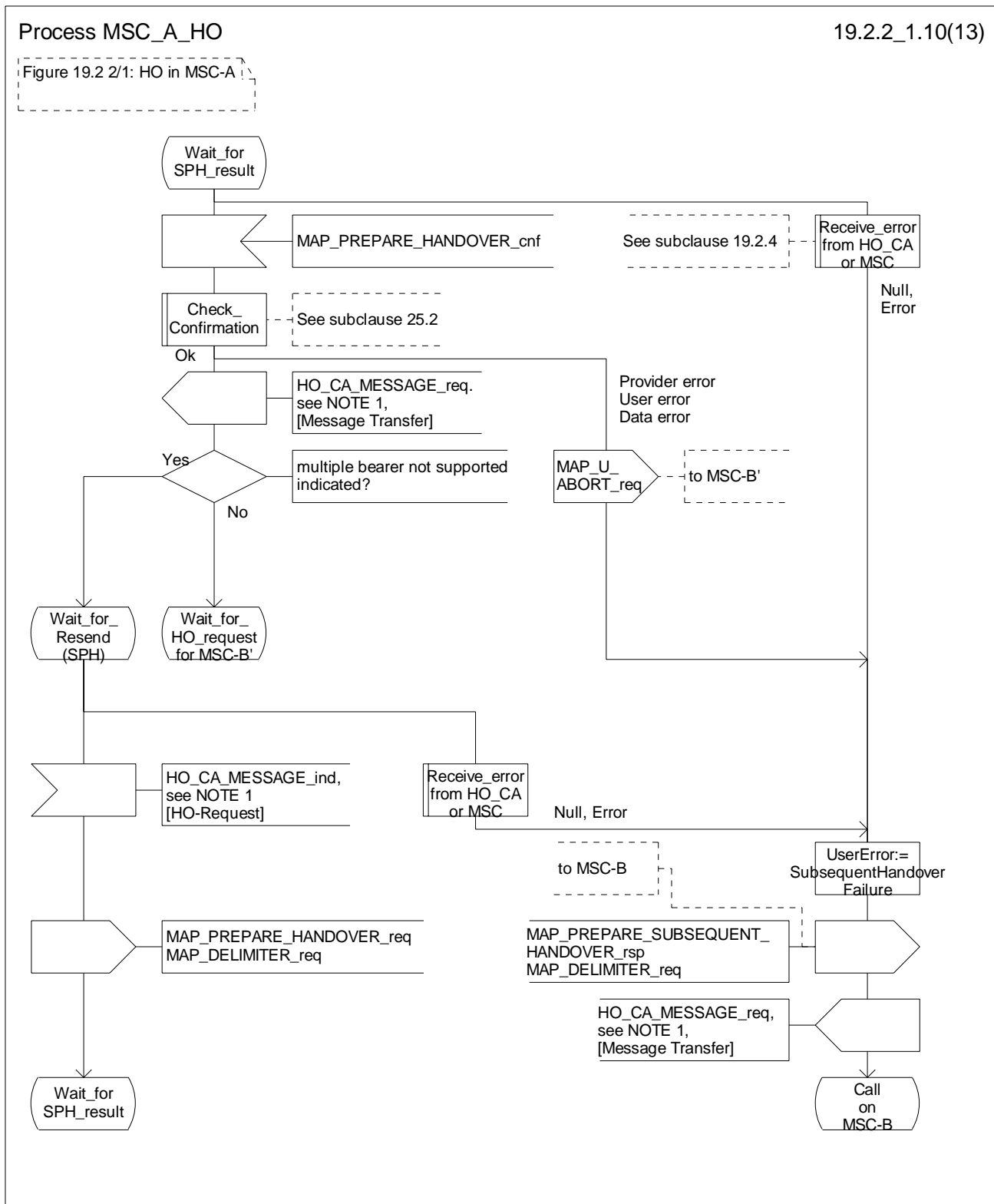

Figure 19.2.2/1 (sheet 10 of 13): Process MSC_A_HO

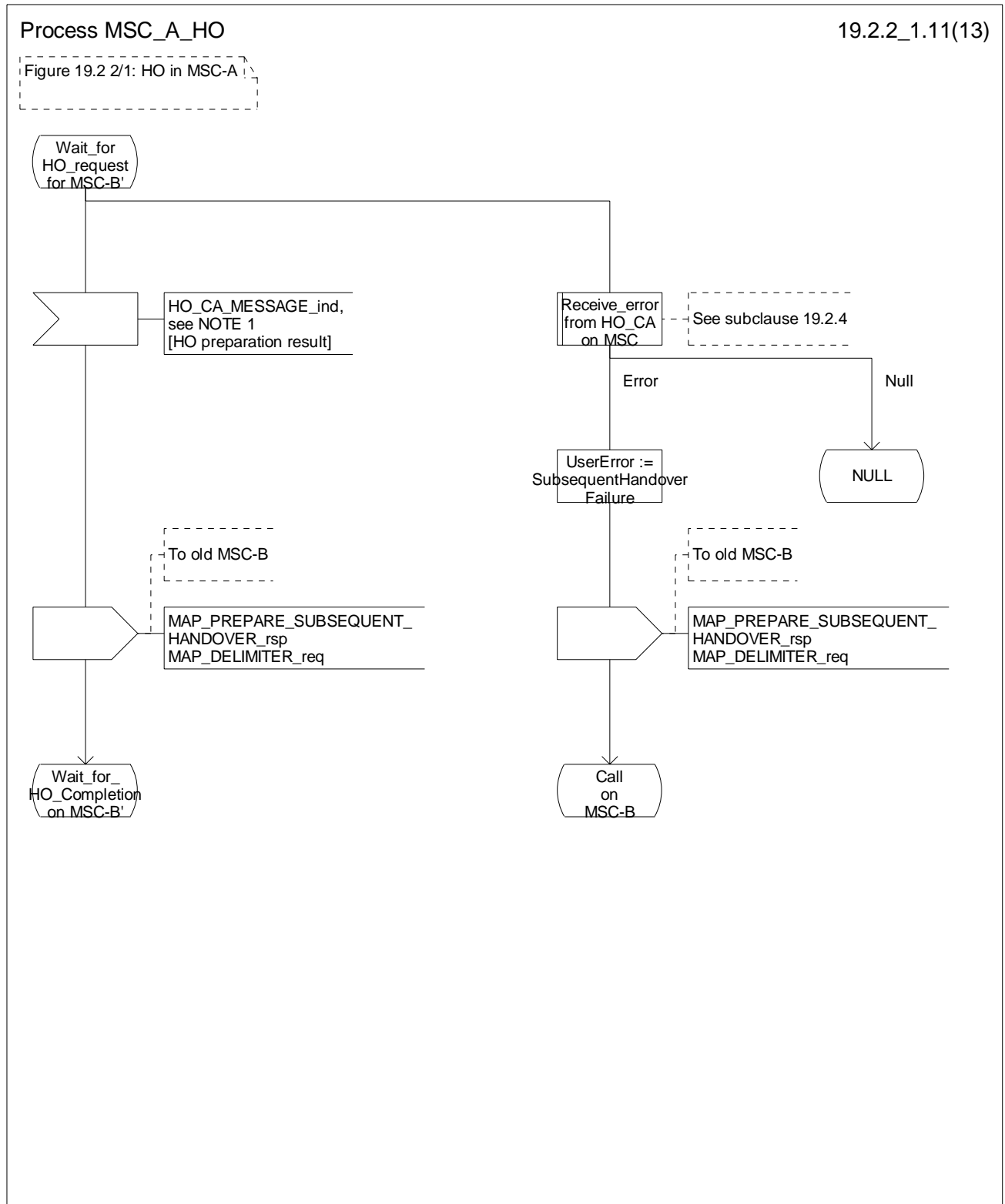

Figure 19.2.2/1 (sheet 11 of 13): Process MSC_A_HO

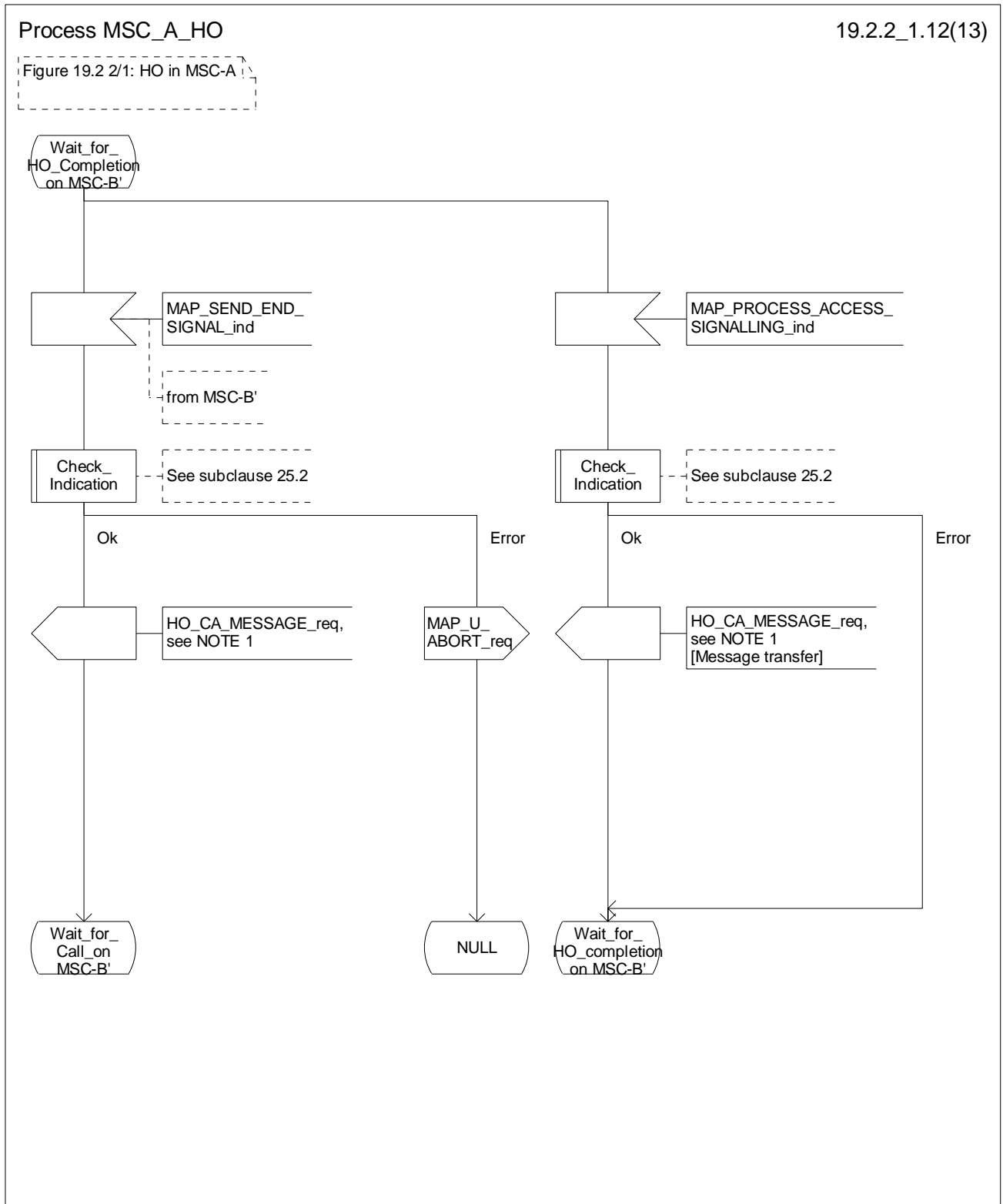

Figure 19.2.2/1 (sheet 12 of 13): Process MSC_A_HO

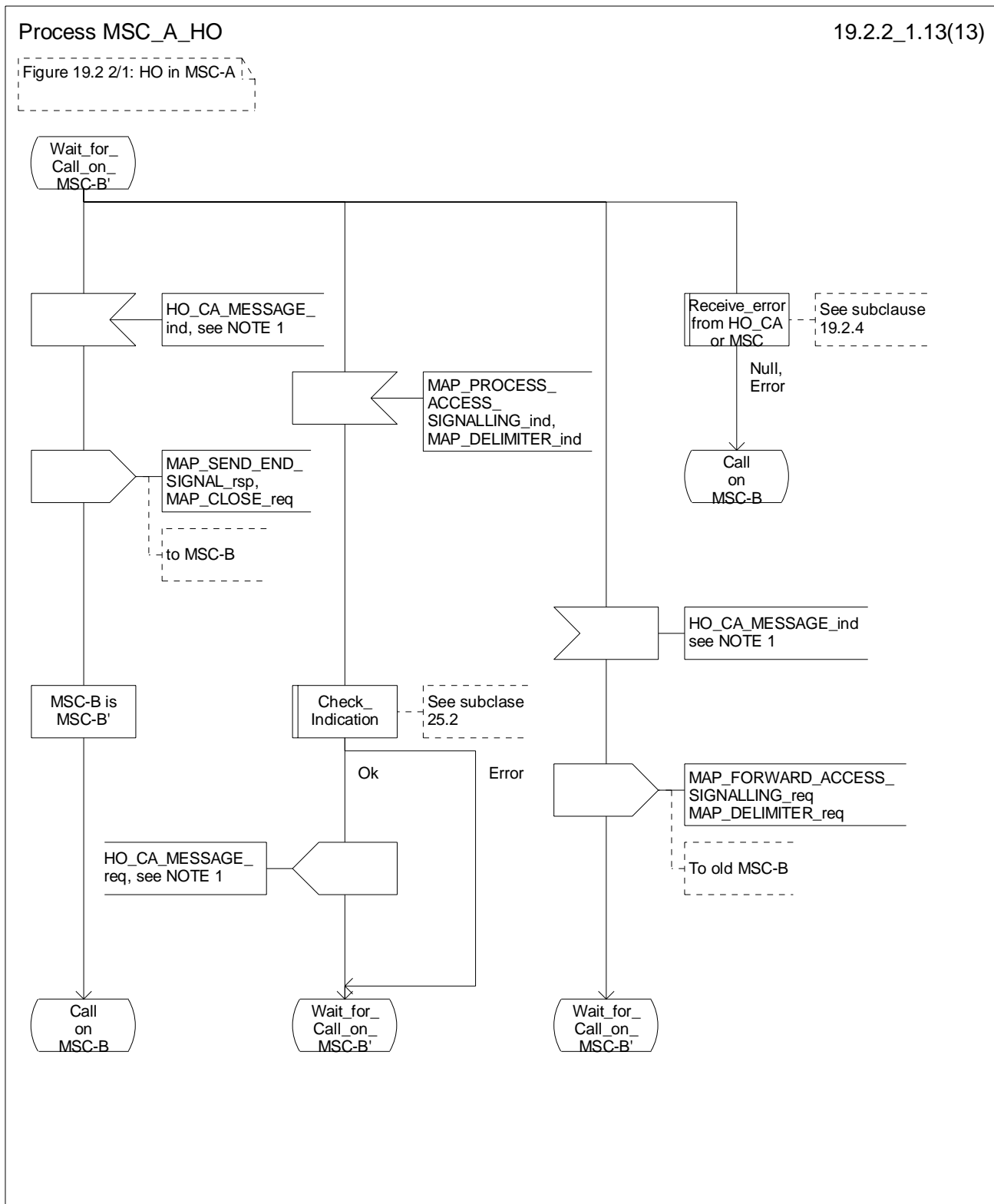

Figure 19.2.2/1 (sheet 13 of 13): Process MSC_A_HO

19.2.3 Handover procedure in MSC-B

This clause describes the handover or relocation procedure in MSC-B, including the request for a handover or relocation from another MSC (MSC-A), subsequent handover or relocation to a third MSC (MSC-B') or back to the controlling MSC (MSC-A).

19.2.3.1 Basic handover

Opening of the dialogue is described in the macro `Receive_Open_Ind` in clause 25.1.

When MSC-B process receives a `MAP_PREPARE_HANOVER` indication from MSC-A, MSC-B requests its associated VLR to provide a handover number, unless the parameter `HO-NumberNotRequired` is received in the indication.

When the connection between the MS and MSC-B is established on MSC-B, the Handover Control Application will request the MAP application to indicate this event to MSC-A by invoking the `MAP_SEND_END_SIGNAL` request. When a call is released, MSC-A will inform MSC-B by `MAP_SEND_END_SIGNAL` response and the MAP dialogue between MSC-A and MSC-B is closed.

19.2.3.2 Allocation of handover number

When a handover number is required, a `MAP_ALLOCATE_HANOVER_NUMBER` request will be sent to the VLR. The handover number is received in the `MAP_SEND_HANOVER_REPORT` request, and will be included in the `MAP_PREPARE_HANOVER` response to MSC-A.

When relocation numbers are required, one or several `MAP_ALLOCATE_HANOVER_NUMBER` requests will be sent to the VLR. Each relocation number is received in a `MAP_SEND_HANOVER_REPORT` request, and the collected relocation numbers will be included in the `MAP_PREPARE_HANOVER` response to MSC-A.

As soon as the call from MSC-A using the handover number arrives in MSC-B, MSC-B shall release the handover number in the VLR using the `MAP_SEND_HANOVER_REPORT` response.

As soon as a call from MSC-A using a relocation number arrives in MSC-B, MSC-B shall release the relocation number in the VLR using the `MAP_SEND_HANOVER_REPORT` response.

19.2.3.3 Handling of access signalling

If required by the Handover Control Application, MSC-B invokes the `MAP_PROCESS_ACCESS_SIGNALLING` request containing the information received on the A-interface or the Iu-interface that should be transferred to MSC-A (e.g. call control information).

`MAP_PROCESS_ACCESS_SIGNALLING` is a non-confirmed service and any response from MSC-A will require a `MAP_FORWARD_ACCESS_SIGNALLING` request.

19.2.3.4 Other procedures in stable handover situation

During a call and after handover or relocation, a number of procedures between MSC-A and BSS-B or RNS-B controlled by or reported to MSC-A may be initiated by involving access signalling transfer in both directions.

19.2.3.5 Subsequent handover

The procedure is used when the Handover Control Application in MSC-B has decided that a call is to be handed over or relocated to another MSC (either back to the controlling MSC (MSC-A) or to a third MSC (MSC-B)).

After the `MAP_PREPARE_SUBSEQUENT_HANOVER` response is received from MSC-A, MSC-B will await the disconnection of the call. Once the disconnect is complete, MSC-B will inform its VLR by invoking the `MAP_SEND_HANOVER_REPORT` confirmation. VLR-B will then release the allocated handover number.

The subsequent handover procedure is shown in figure 19.2/3.

19.2.3.6 SDL Diagrams

The SDL diagrams on the following pages describe the user process in MSC-B for the procedures described in this clause.

The services used are defined in clause 8.4.

NOTE 1: The message primitives HO_CA_MESSAGE in the SDL-diagrams are used to show the internal co-ordination between the MAP application and the Handover Control Application. For a detailed description of the co-ordination between the applications for the handover procedure, see 3G TS 23.009.

NOTE 2: The order in the SDL diagrams to allocate first the handover number and then the radio resources is not binding.

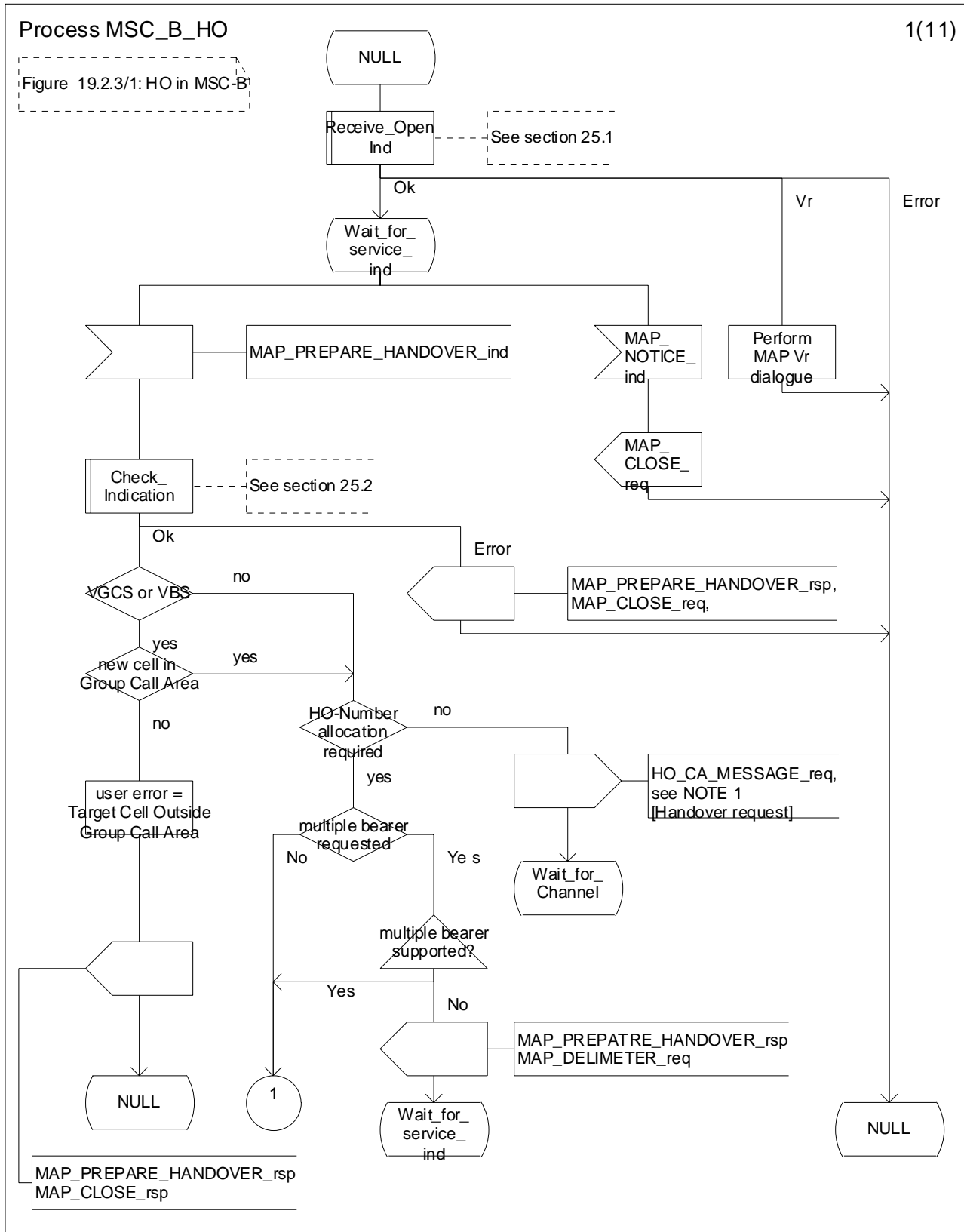

Figure 19.2.3/1 (sheet 1 of 11): Process MSC_B_HO

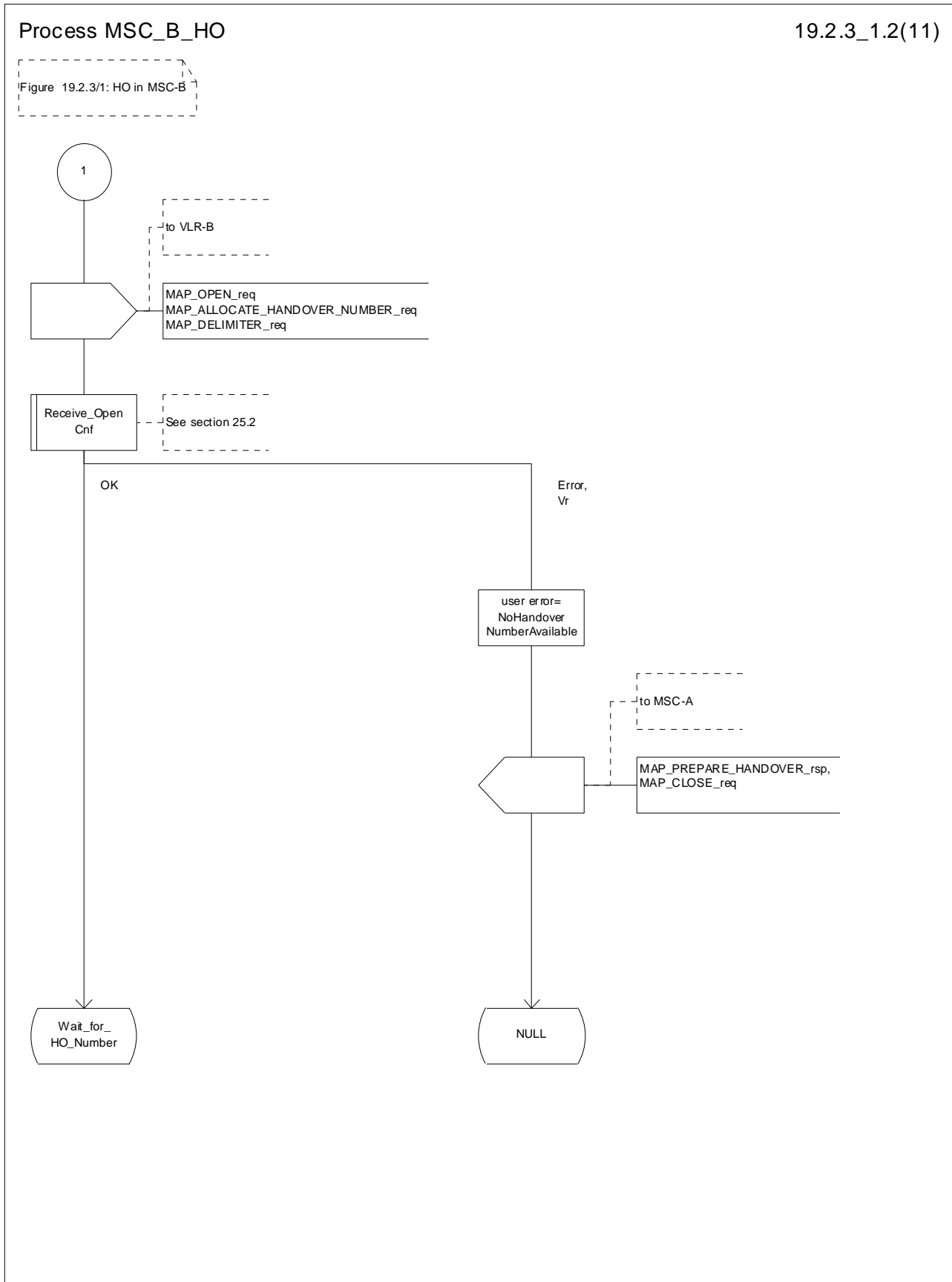

Figure 19.2.3/1 (sheet 2 of 11): Process MSC_B_HO

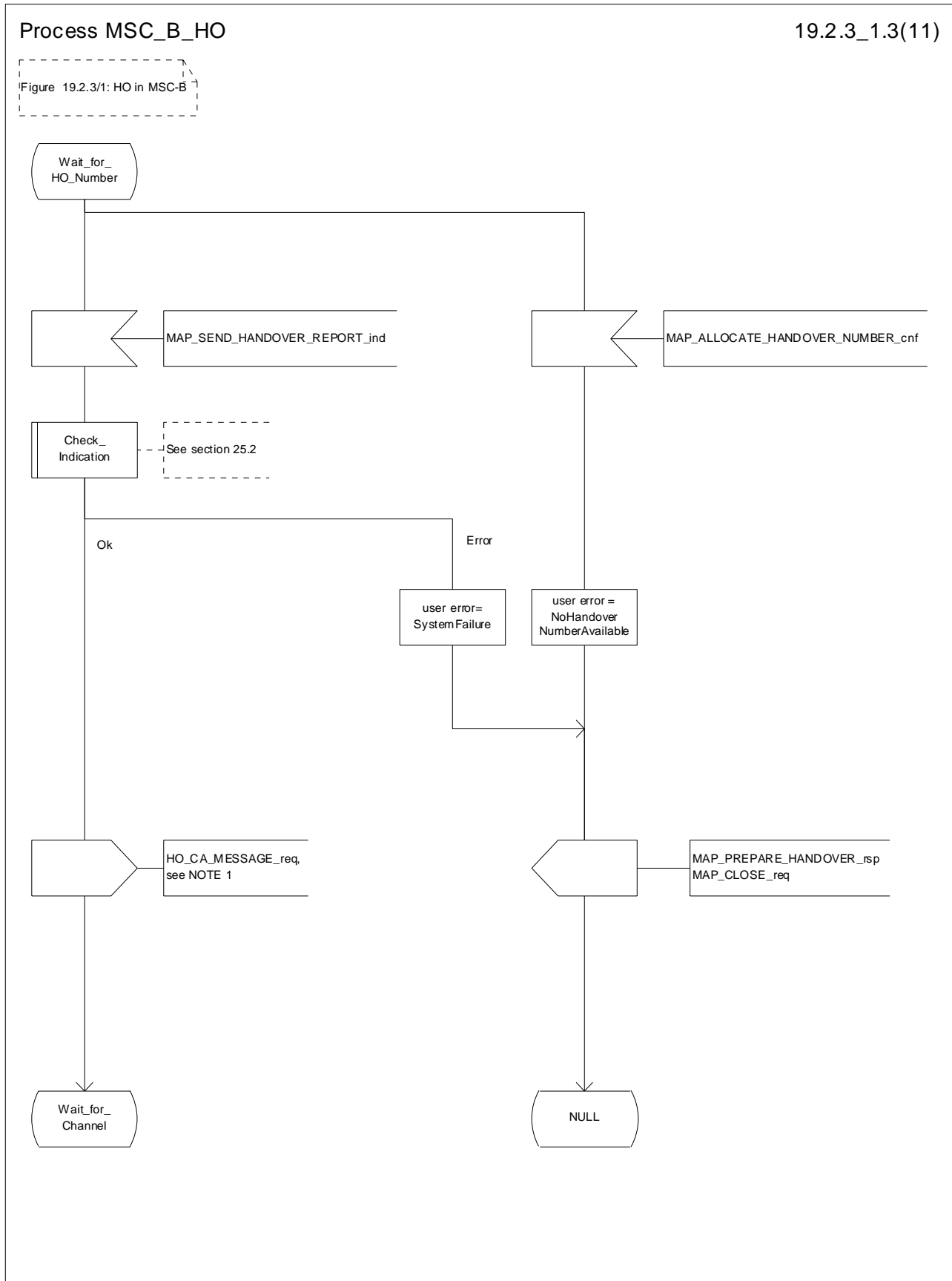

Figure 19.2.3/1 (sheet 3 of 11): Process MSC_B_HO

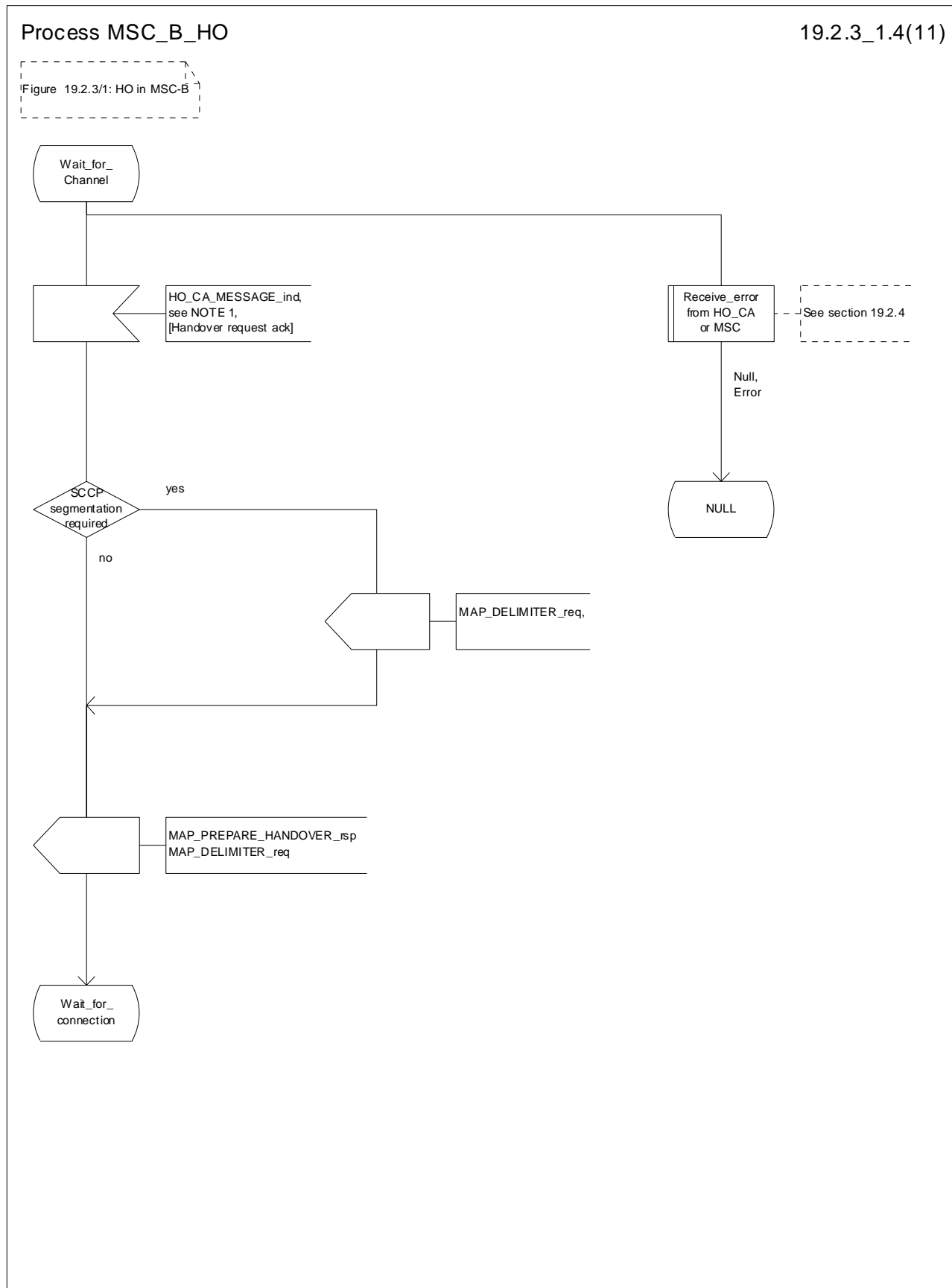

Figure 19.2.3/1 (sheet 4 of 11): Process MSC_B_HO

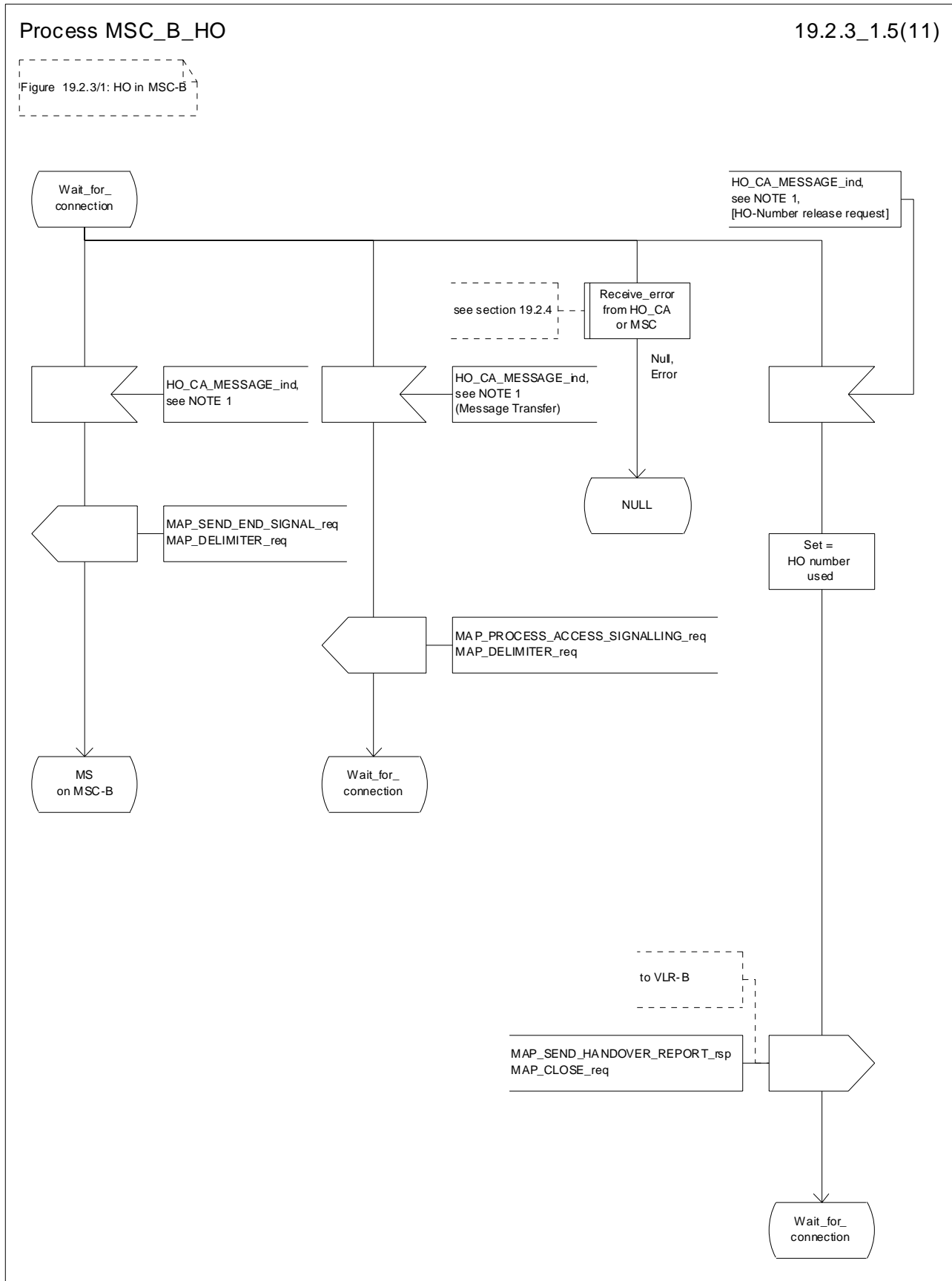

Figure 19.2.3/1 (sheet 5 of 11): Process MSC_B_HO

Process MSC_B_HO

19.2.3_1.6(11)

Figure 19.2.3/1: HO in MSC-B

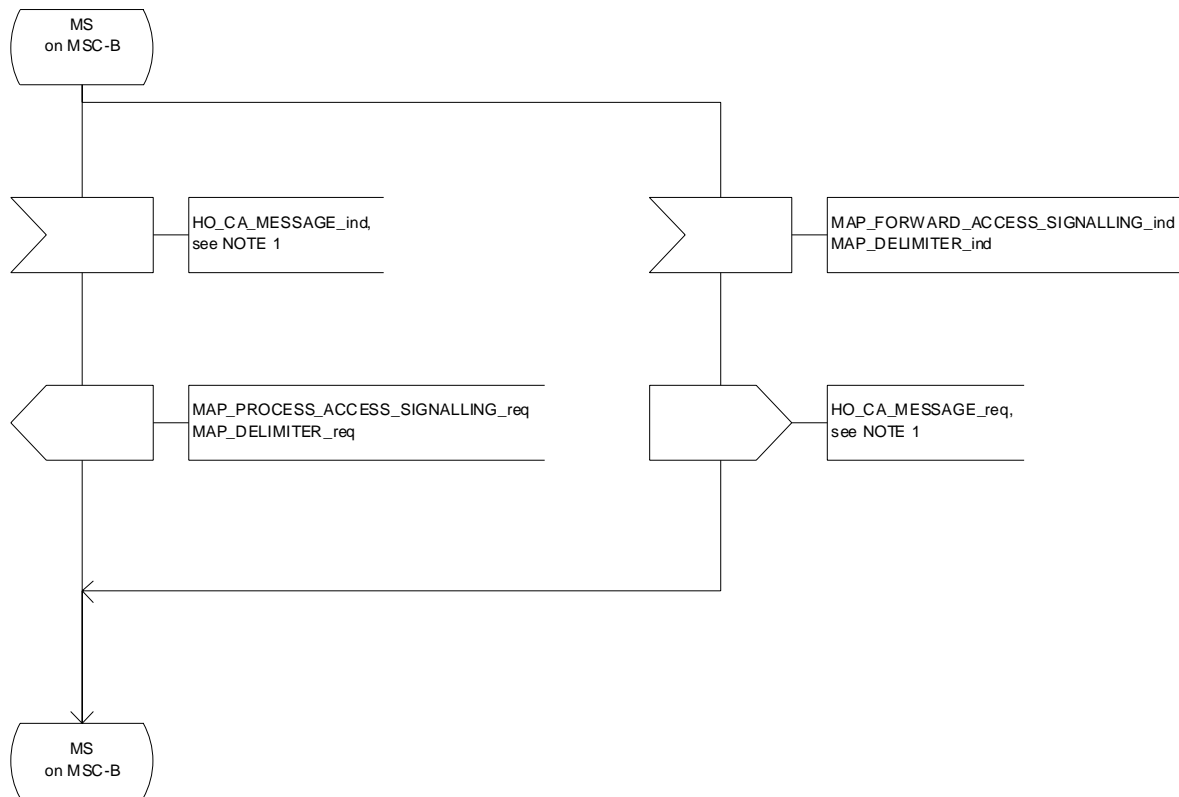

Figure 19.2.3/1 (sheet 6 of 11): Process MSC_B_HO

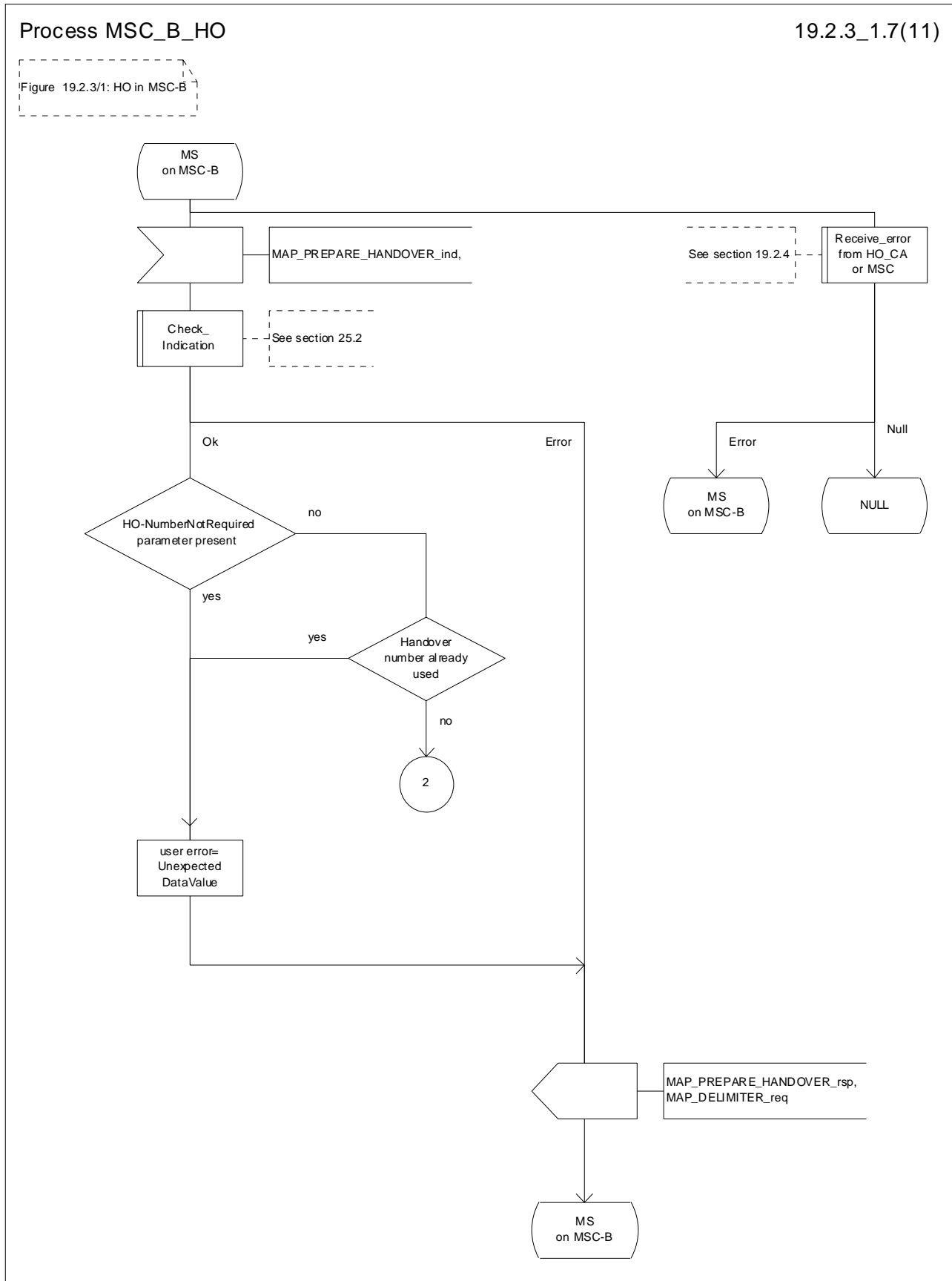

Figure 19.2.3/1 (sheet 7 of 11): Process MSC_B_HO

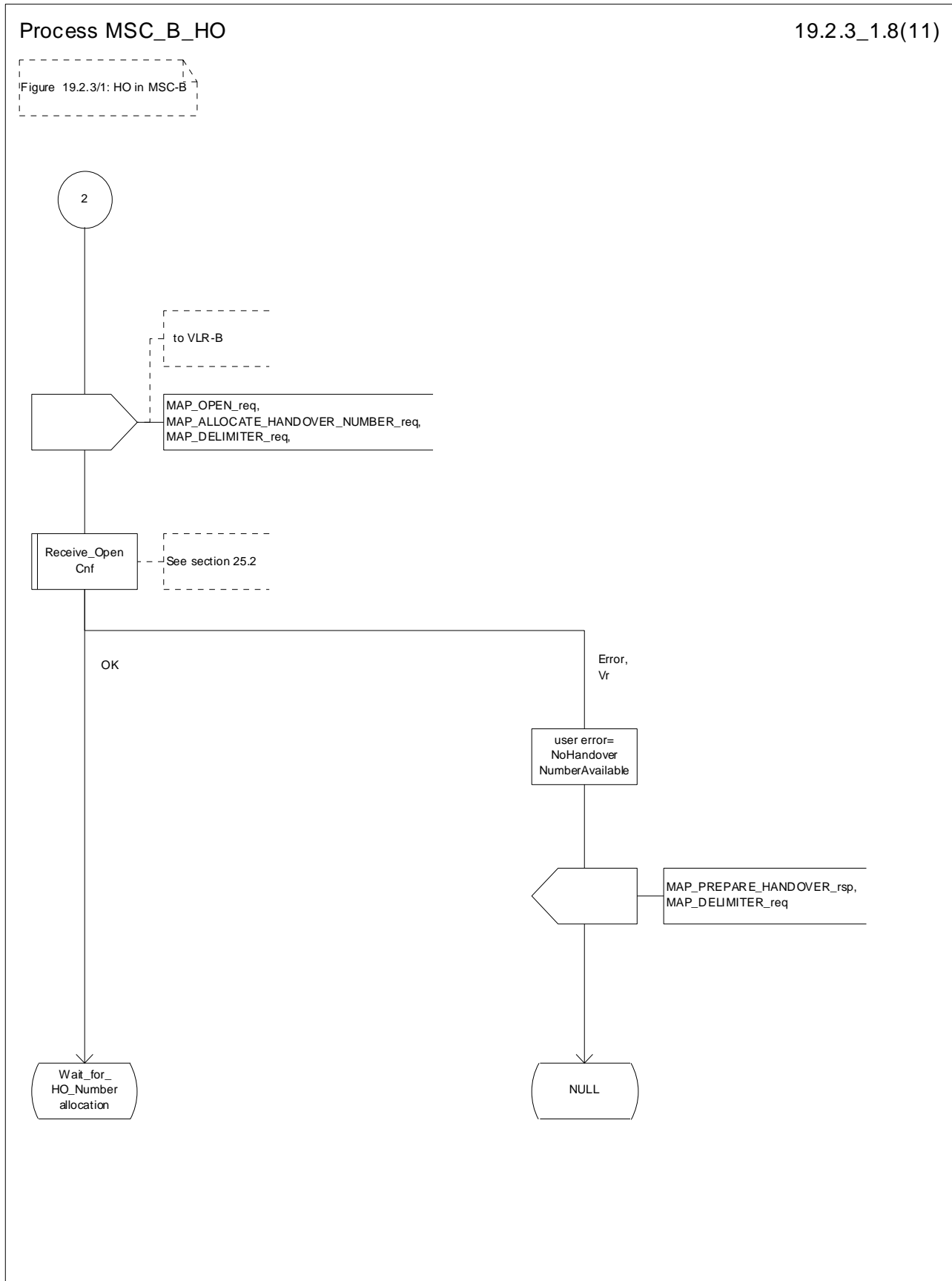

Figure 19.2.3/1 (sheet 8 of 11): Process MSC_B_HO

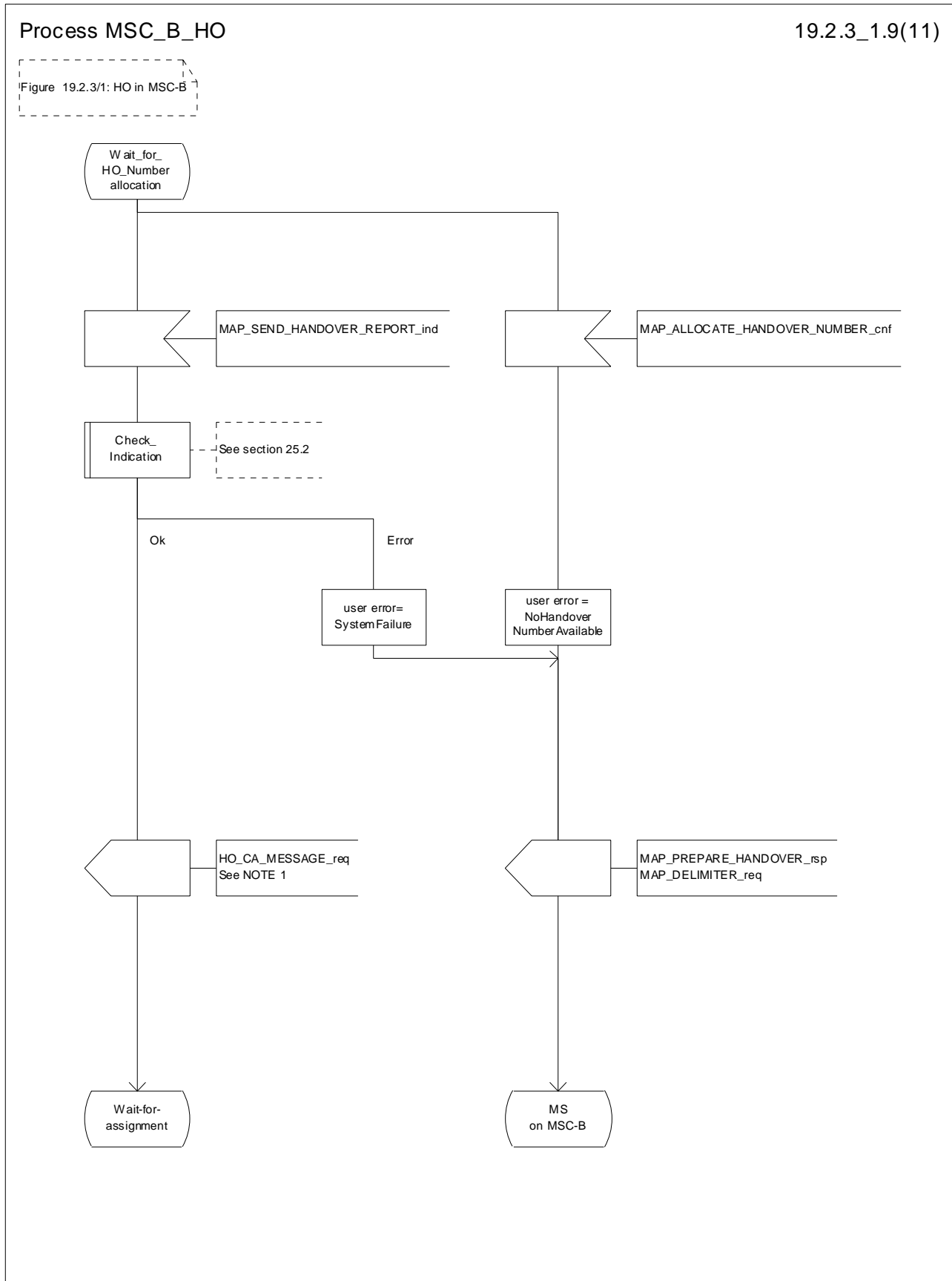

Figure 19.2.3/1 (sheet 9 of 11): Process MSC_B_HO

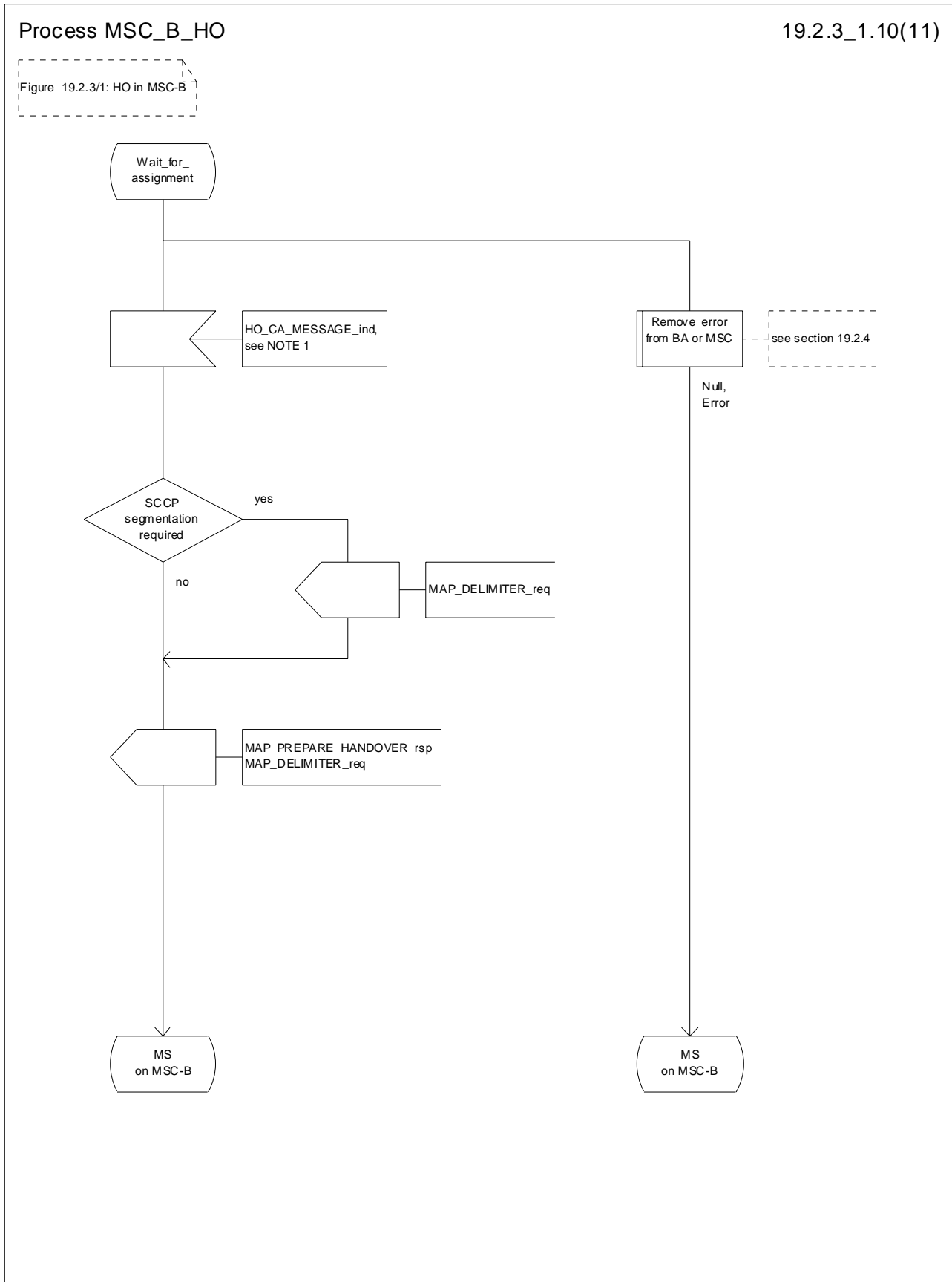

Figure 19.2.3/1 (sheet 10 of 11): Process MSC_B_HO

Process MSC_B_HO

19.2.3_1.11(11)

Figure 19.2.3/1: HO in MSC-B

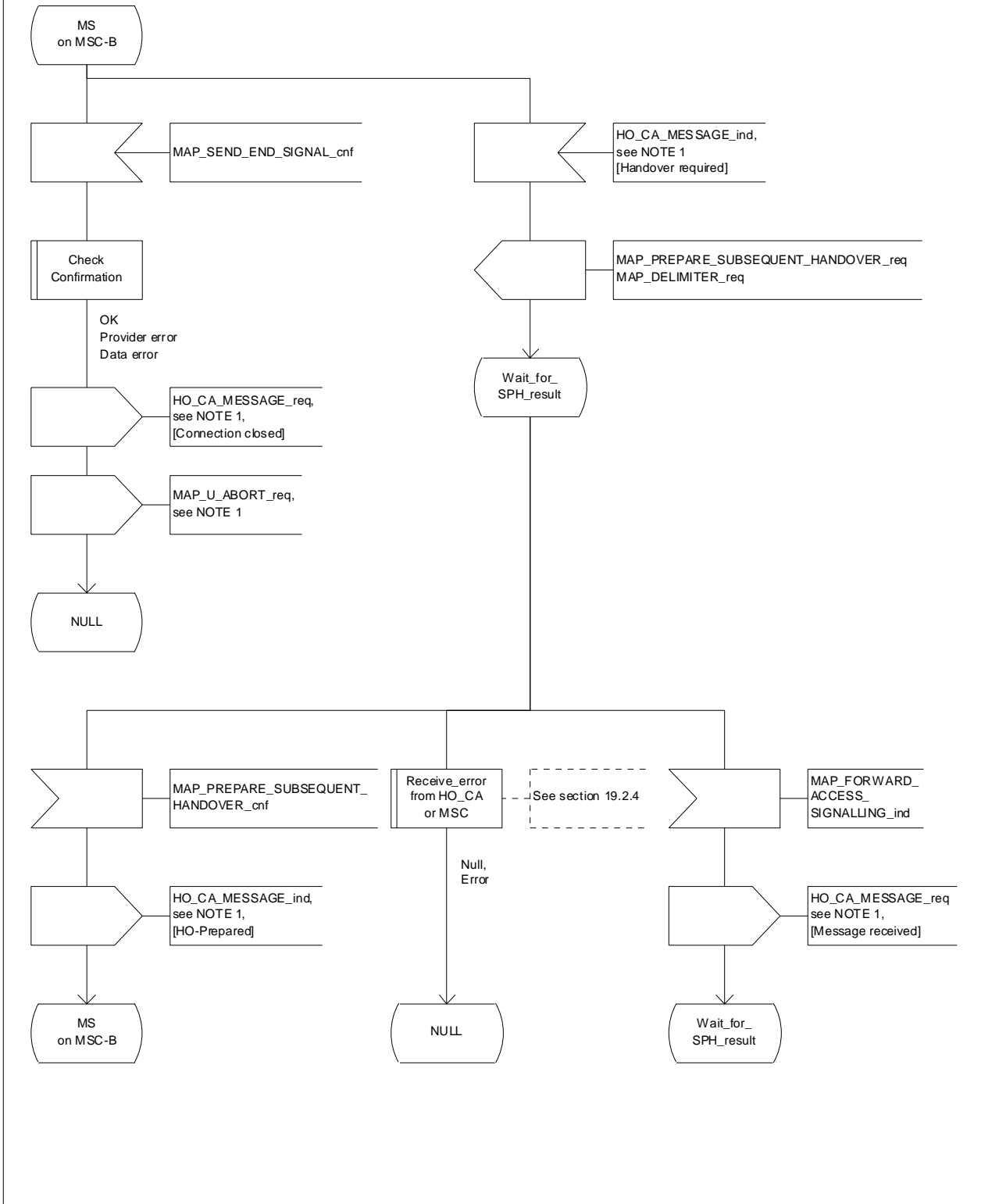

Figure 19.2.3/1 (sheet 11 of 11): Process MSC_B_HO

19.2.4 Handover error handling macro

This macro is used for the handover procedures to receive errors from the MSCs and from the Handover Control Application at any state of a handover process.

If a MAP_NOTICE indication is received, the Handover Control Application is informed and the actual situation is kept and the Handover Control Application decides how the handover or relocation process should continue. In all other cases the MSC is returned to a "NULL" state.

Macrodefinition Receive_error_from_HO_CA_or_MSC

19.2.4_1(1)

Figure 19.2.4/1: Macro Receive_error_from_HO_CA_or_MSC

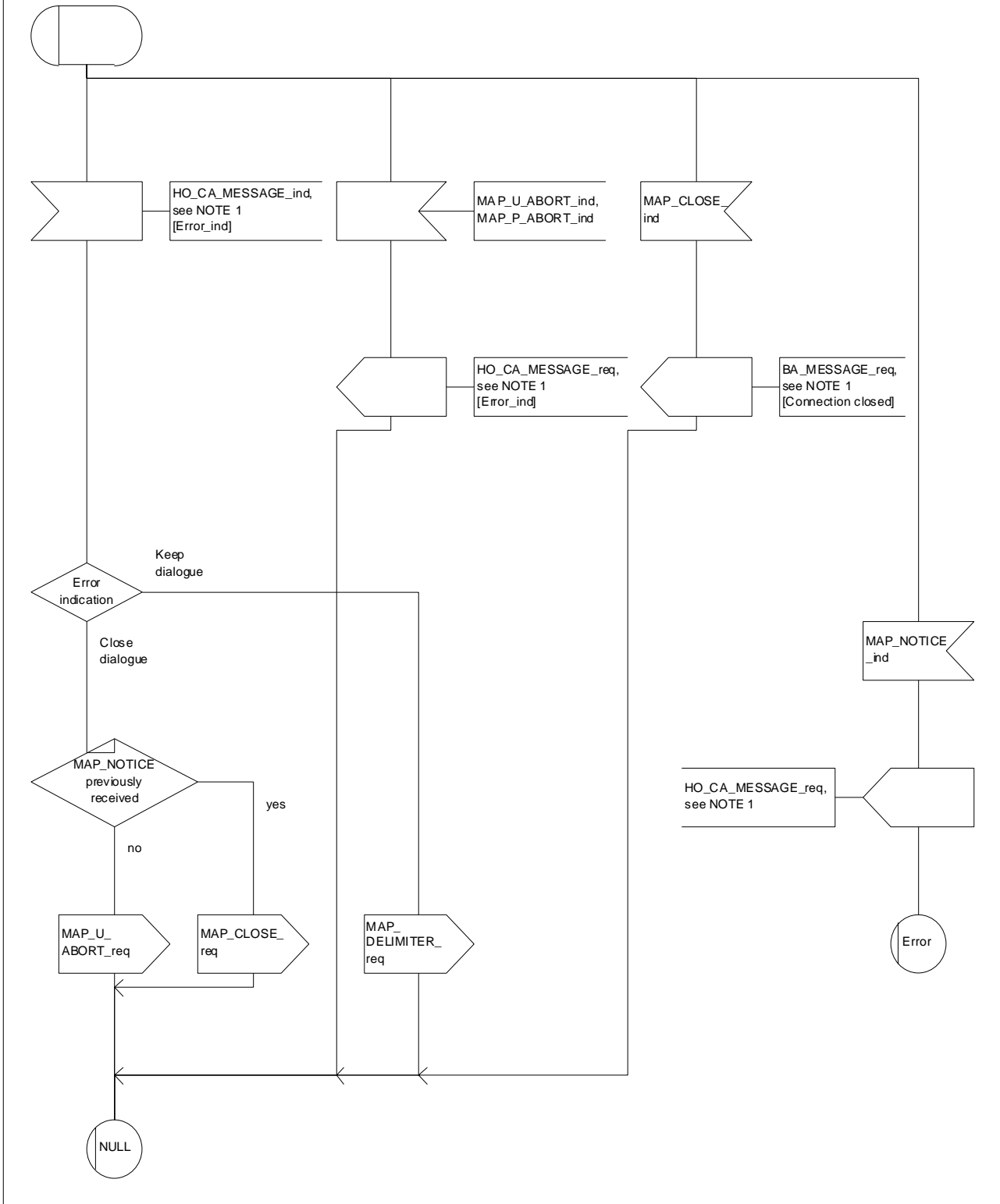

Figure 19.2.4/1: Macro Receive_error_from_HO_CA_or_MSC

19.2.5 Handover procedure in VLR

19.2.5.1 Allocation of handover number

When receiving the MAP_ALLOCATE_HANOVER_NUMBER indication, the VLR will determine whether a handover number is available. If no handover number is available, this will be indicated by a MAP_ALLOCATE_HANOVER_NUMBER response with the appropriate error.

The handover number allocated will otherwise be returned to MSC-B in the MAP_SEND_HANOVER_REPORT request.

The handover number will be reserved until a MAP_SEND_HANOVER_REPORT confirmation is received from MSC-B.

19.2.5.2 SDL Diagrams

The SDL diagrams on the following pages describe the user processes in VLR for the procedures described in this clause.

The services used are defined in clause 8.4.

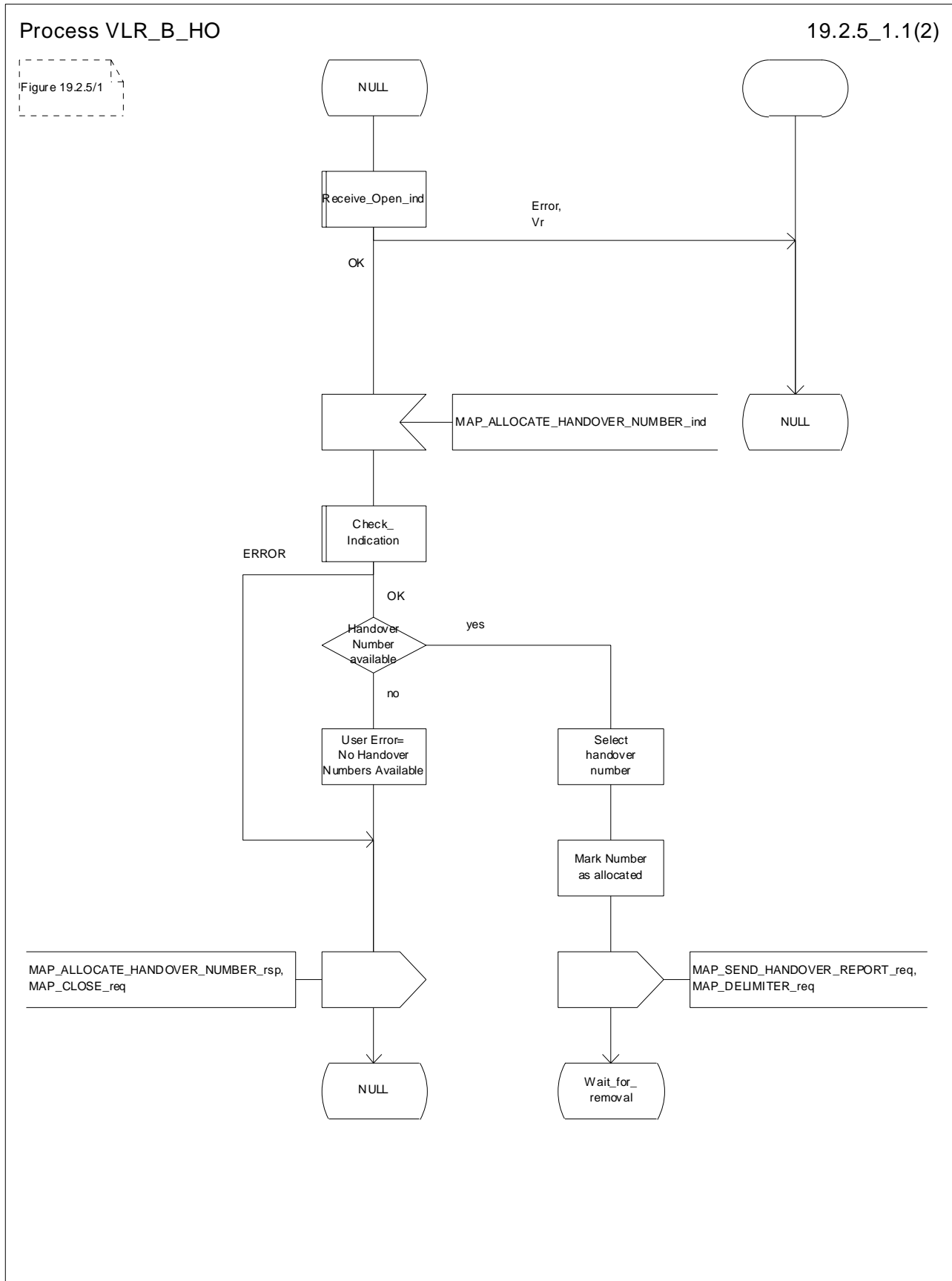

Figure 19.2.5/1 (sheet 1 of 2): Process VLR_B_HO

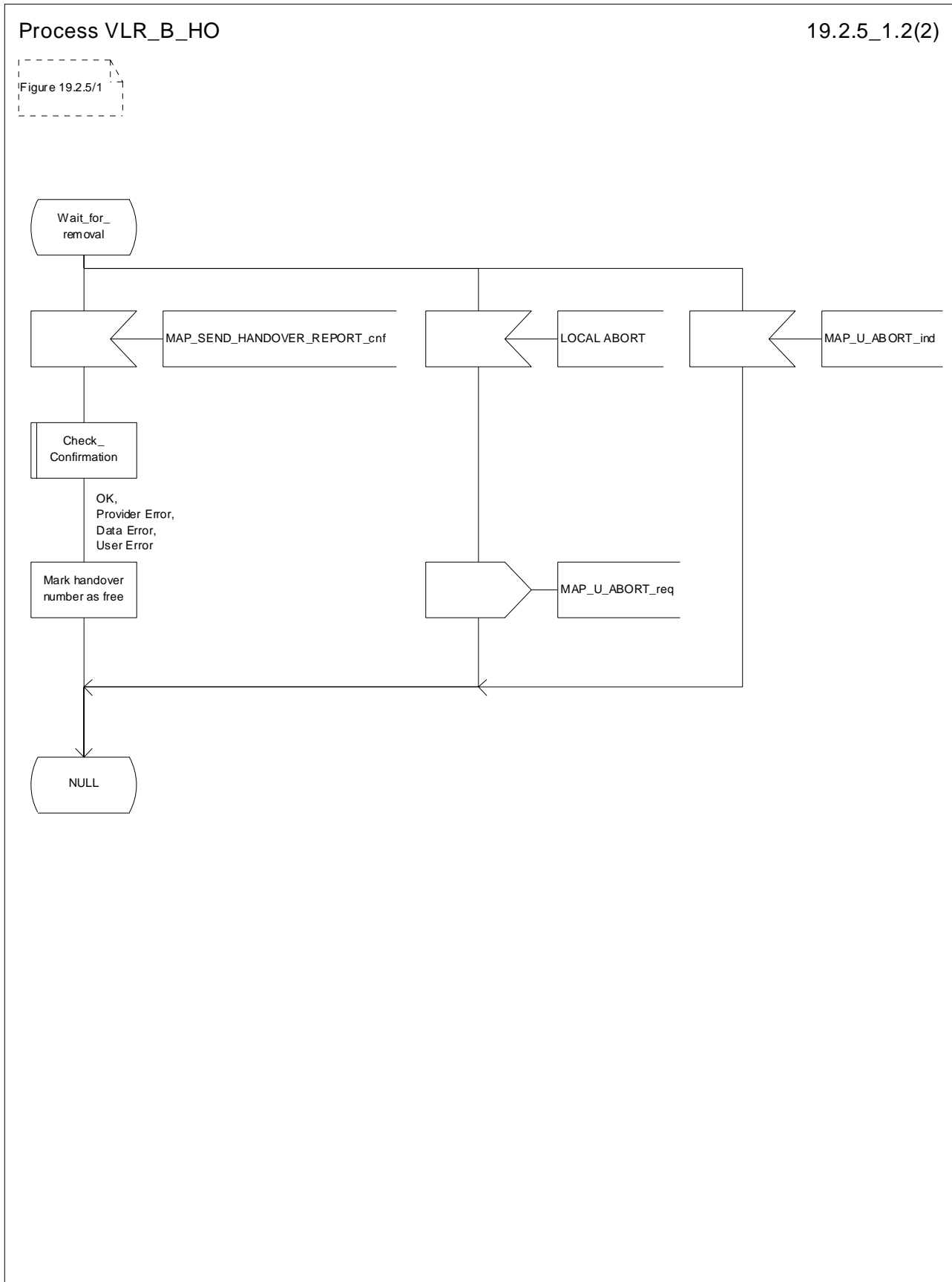

Figure 19.2.5/1 (sheet 2 of 2): Process VLR_B_HO

19.3 Fault recovery procedures

After a fault of a location register, the fault recovery procedures ensure that the subscriber data in the VLR or in the SGSN become consistent with the subscriber data that are stored in the HLR for the MS concerned and that the location information in HLR, VLR and SGSN reflect accurately the current location of the MS.

The detailed specification of fault recovery procedures of location registers is given in 3GPP TS 23.007 [19].

19.3.1 VLR fault recovery procedures

The following processes are involved with the restoration of one IMSI record in the VLR:

- In case of a location registration request from the MS:
 - Update_Location_Area_VLR clause 19.1.1.3;
 - Update_Location_HLR clause 19.1.1.4.
- In case of a mobile terminated call:
 - PRN_VLR clause 21.2.4;
 - RESTORE_DATA_VLR clause 21.2.4;
 - RESTORE_DATA_HLR clause 19.3.3;
 - ICS_VLR clause 21.3.3.

After a restart, the VLR shall erase all IMSI records affected by the failure and shall cause all affected TMSIs and all affected LMSIs to become invalid. There will be no subscriber data or location information stored for an affected MS until after the VLR has received either a MAP_PROVIDE_ROAMING_NUMBER indication or a MAP_UPDATE_LOCATION_AREA indication for that MS. Restoration of subscriber data in the VLR is triggered individually for each IMSI record by receipt of either of these indications.

Reception of either a MAP_UPDATE_LOCATION_AREA indication or a MAP_PROVIDE_ROAMING_NUMBER indication with an IMSI that is unknown in the VLR causes creation of a skeleton IMSI record that is marked as:

- not confirmed by radio contact by the indicator "Confirmed by Radio Contact" (The function of this indicator is described in 3GPP TS 23.007 [19]); and
- not confirmed by HLR by the indicator "Confirmed by HLR" (The function of this indicator is described in 3GPP TS 23.007 [19]).

A third indicator "Location Information Confirmed in HLR" is allocated to each IMSI record in the VLR (The function of this indicator is described in 3GPP TS 23.007 [19]).

The indicator "Location Information Confirmed in HLR" shall be checked whenever authenticated radio contact with an MS has been established. The status "Not Confirmed" of this indicator shall force the VLR to invoke the MAP_UPDATE_LOCATION service but it shall never cause rejection of a mobile originated request. The status is changed from "Not Confirmed" to "Confirmed" only after successful completion of a MAP_UPDATE_LOCATION procedure for the MS concerned.

If the VLR serves only one MSC, the indicator "Location Information Confirmed in HLR" is only relevant to the HLR restoration procedure and an initial value must be assigned when an IMSI record is created in the VLR:

- if the IMSI record was created due to a roaming number request, the initial value must be set to "Confirmed";
- if reception of a MAP_UPDATE_LOCATION_AREA indication causes creation of the IMSI record, the initial value must be "Not Confirmed".

If the VLR serves more than one MSC, the indicator "Location Information Confirmed in HLR" is used in the VLR restoration procedure as well as in the HLR restoration procedure. When an IMSI record is created in the VLR, the indicator must be set to "Not Confirmed".

VLR restoration triggered by a location registration request

Upon receipt of a MAP_UPDATE_LOCATION_AREA indication, the VLR retrieves authentication data from the HLR by using the MAP_SEND_AUTHENTICATION_INFO service if authentication is required and if no authentication data are available in the VLR for the IMSI concerned (see figure 19.1.1/6).

Receipt of a MAP_UPDATE_LOCATION_AREA indication for an MS whose IMSI is unknown in the VLR or whose data stored in the VLR are marked as "Not Confirmed" by the indicator "Confirmed by HLR" and/or by the indicator "Location Information Confirmed in HLR" forces the VLR to invoke the MAP_UPDATE_LOCATION service after successful authentication, if required. The location updating procedure is performed as described in clause 19.1.

Any other mobile originated request from an MS whose IMSI is unknown in the VLR or whose subscriber data stored in the VLR are marked as "Not Confirmed" by the indicator "Confirmed by HLR" shall be rejected with error cause "Unidentified Subscriber". This causes the MS to trigger the location registration procedure.

After successful completion of the MAP_UPDATE_LOCATION procedure, the indicators "Confirmed by HLR" and "Location Information Confirmed in HLR" are set to "Confirmed".

The indicator "Confirmed by Radio Contact" is set to "Confirmed" when the radio contact with the MS is authenticated.

VLR restoration triggered by a roaming number request

Figure 19.3/1 illustrates the signalling sequence for restoration of an IMSI record in the VLR triggered by a mobile terminating call set-up.

Upon receipt of a MAP_PROVIDE_ROAMING_NUMBER indication for an IMSI that is unknown in the VLR and for which authentication is required, the VLR retrieves authentication data from the HLR by using the MAP_SEND_AUTHENTICATION_INFO service after an MSRN has been sent to the HLR in the MAP_PROVIDE_ROAMING_NUMBER response.

Receipt of a MAP_PROVIDE_ROAMING_NUMBER indication for an MS whose IMSI is unknown in the VLR or whose data record in the VLR is marked as "Not Confirmed" by the indicator "Confirmed by HLR" forces the VLR to request subscriber data from the HLR by sending a MAP_RESTORE_DATA request which triggers one or more INSERT_SUBSCRIBER_DATA operations from the HLR. The MAP_RESTORE_DATA request may also be used to send the LMSI to the HLR.

The MAP_RESTORE_DATA process in the VLR is described in clause 21.2.4.

The MAP_RESTORE_DATA process in the HLR is described in clause 19.3.3.

After successful completion of the MAP_RESTORE_DATA procedure, the indicator "Confirmed by HLR" is set to "Confirmed".

If restoration of an IMSI record was triggered by a MAP_PROVIDE_ROAMING_NUMBER indication (i.e. by a mobile terminating call), the VLR has no valid Location Area Identity information for the MS concerned before successful establishment of the first authenticated radio contact. Upon receipt of a MAP_SEND_INFO_FOR_INCOMING_CALL indication from the MSC (see 5 in figure 19.3/1) for an MS whose subscriber data are marked as "Confirmed" by the indicator "Confirmed by HLR" but not confirmed by radio contact, the VLR shall invoke a "MAP_SEARCH_FOR_MS" instead of a "MAP_PAGE".

A MAP_SEARCH_FOR_MS shall also be performed if the VLR receives a MAP_SEND_INFO_FOR_MT_SMS indication from the MSC for an MS whose IMSI record is marked as "Confirmed" by the indicator "Confirmed by HLR" but not confirmed by radio contact.

The indicator "Confirmed by Radio Contact" is set to "Confirmed" when authenticated radio contact caused by a mobile originated or a mobile terminated activity is established.

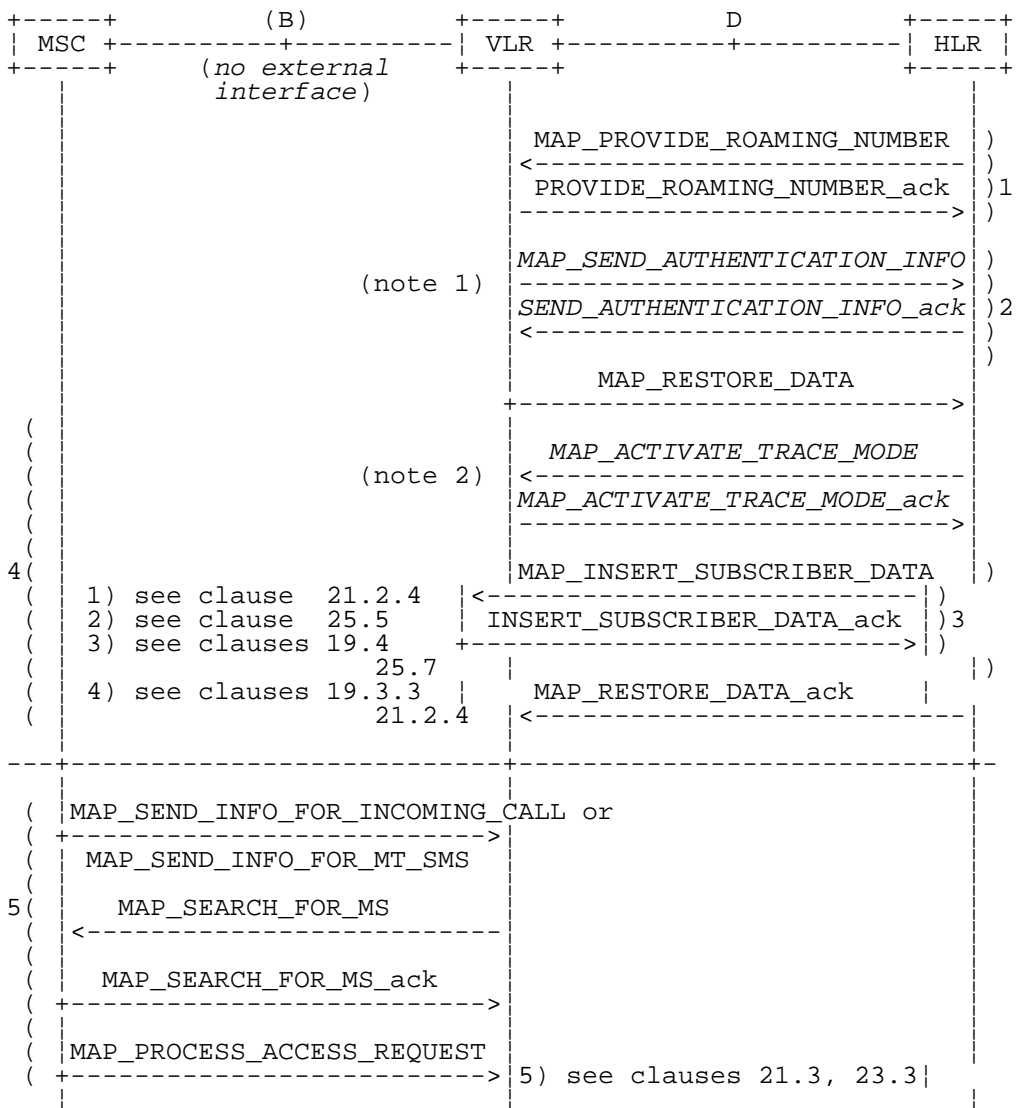

NOTE 1: If authentication required.
 NOTE 2: If subscriber tracing active in HLR.

Figure 19.3/1: Procedures related to restoration of VLR in case of mobile terminated call set-up

19.3.2 HLR fault recovery procedures

The following processes are involved with the restart of the HLR:

- HLR_RESTART clause 19.3.2;
- REC_RESET_IN_VLR clause 19.3.2;
- REC_RESET_IN_SGSN clause 19.3.2.

In the case of a location registration request from the MS, the following processes are involved with the HLR restoration procedure:

- Update_Location_Area_VLR clause 19.1.1.3;
- Update_Location_HLR clause 19.1.1.4;
- Update_GPRS_Location_HLR clause 19.1.1.4;
- GPRS_Update_Location_Area_VLR clause 19.1.1.3;

- SGSN_Update_HLR clause 19.1.1.8.

In the case of a mobile originated service request, the

- Macro Process_Access_Request_VLR clause 25.4.2; and the
- Process Update_Location_HLR clause 19.1.1.4,

are involved with the HLR restoration procedure.

For the HLR, periodic back-up of data to non-volatile memory is mandatory.

Data that have been changed in the period of time after the last back-up storage and before the restart of the HLR cannot be recovered by reload from the non-volatile memory. Therefore, a restoration procedure is triggered individually for each IMSI record that has been affected by the HLR fault at the first authenticated radio contact that is established with the MS concerned.

The HLR restoration procedure forces updating of MSC number, VLR number, SGSN number and, if provided by the VLR, LMSI in the HLR. Consistency of subscriber data that are stored in the VLR or in the SGSN for an MS that has been affected by a HLR fault with the subscriber data stored in the HLR for this MS will be achieved.

As an implementation option, a notification can be forwarded to the MS to alert the subscriber to check the parameters for supplementary services that allow subscriber controlled input (MAP_FORWARD_CHECK_SS_INDICATION service). If the VLR receives this notification from the HLR it shall forward the notification to the MS. If the Gs-interface is present the VLR shall not forward this notification.

Figures 19.3/2 and 19.3/9 illustrates the signalling sequence for HLR restoration.

After a restart, the home location register performs the following actions for the subscriber data records that have been affected by the HLR fault (see figure 19.3/3):

- reload all data from the non-volatile back-up;
- if the MAP_FORWARD_CHECK_SS_INDICATION service is implemented, mark each subscriber record "SS Check Required" by setting the "Check SS" indicator;
- set subscriber tracing deactive in the VLR for each of its Mss;
- reset the "MS Purged" flag for each of its MSs;
- send a MAP_RESET request to the VLRs where its MSs are located (see figure 19.3/4).
- send a MAP_RESET request to the SGSNs where its MSs are located (see figure 19.3/7).

The MAP_RESET request contains the HLR number and optionally the HLR Identity List.

When receiving a MAP_RESET indication, the VLR or the SGSN will derive all involved MSs of that HLR either from the HLR Identity List (if present), or from the HLR number. The VLR or the SGSN will then mark these MSs with the indicator "Location Information Confirmed in HLR" set to "Not Confirmed" and will deactivate all subscriber tracings for these Mss (see figures 19.3/5 and 19.3/8).

The status "Not Confirmed" of the indicator "Location Information Confirmed in HLR" forces the VLR to invoke the MAP_UPDATE_LOCATION service after establishment of authenticated radio contact with the MS concerned.

Also the status "Not Confirmed" of the indicator "Location Information Confirmed in HLR" forces the SGSN to invoke the MAP_UPDATE_GPRS_LOCATION service after establishment of authenticated radio contact with the MS concerned.

The MAP_UPDATE_LOCATION procedure is performed as described in clause 19.1.

After receipt of the MAP_UPDATE_LOCATION or the MAP_UPDATE_GPRS_LOCATION acknowledgement containing the HLR number, the status of the indicator "Location Information Confirmed in HLR" is changed to "Confirmed".

If the MAP_UPDATE_LOCATION procedure is unsuccessful for any reason, the status of the indicator "Location Information Confirmed in HLR" remains unchanged except for the case that the IMSI record in the VLR is deleted because either of the errors "Unknown Subscriber" or "Roaming Not Allowed" has been received from the HLR in response to a MAP_UPDATE_LOCATION request.

If the MAP_UPDATE_GPRS_LOCATION procedure is unsuccessful for any reason, the status of the indicator "Location Information Confirmed in HLR" remains unchanged except for the case that the IMSI record in the SGSN is deleted because either of the errors "Unknown Subscriber" or "Roaming Not Allowed" has been received from the HLR in response to a MAP_UPDATE_GPRS_LOCATION request.

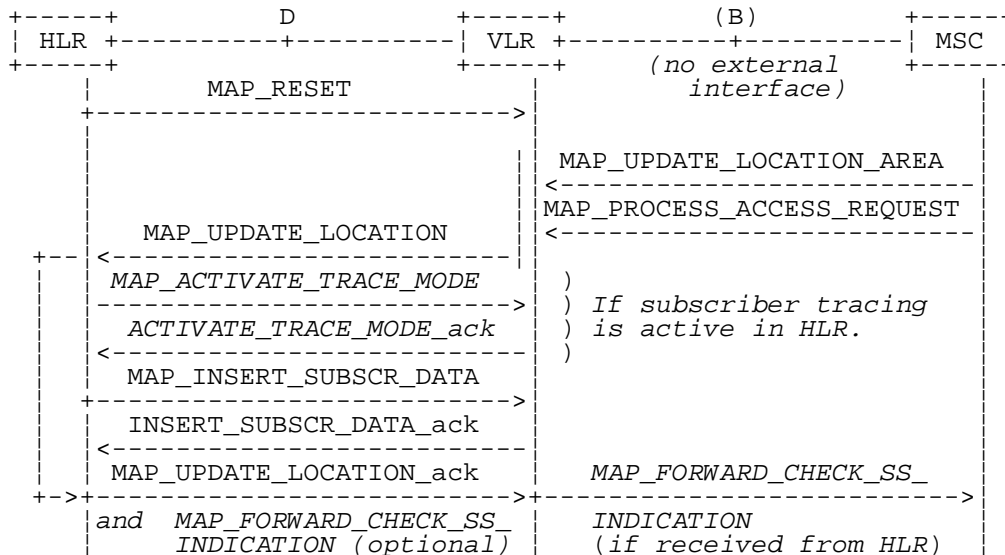

Figure 19.3/2: Procedures related to restoration of HLR

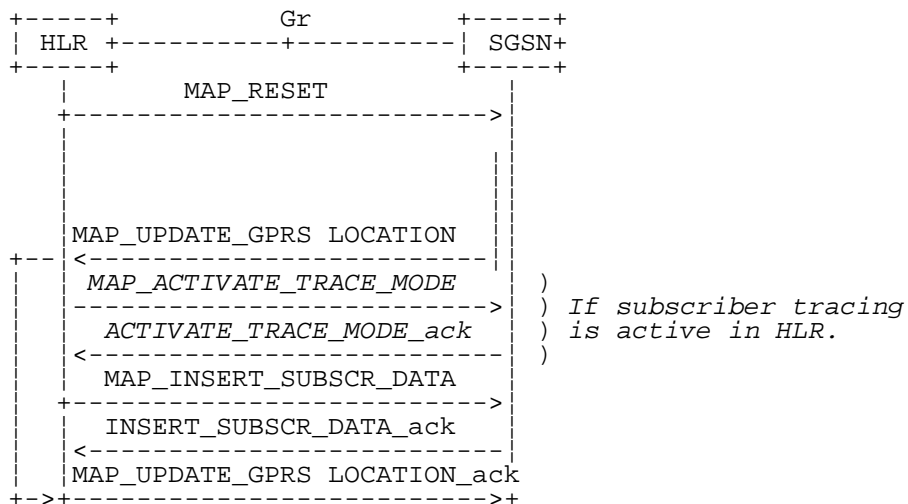

Figure 19.3/9: Procedures related to restoration of HLR for GPRS

Process HLR_RESTART

19.3_3(1)

Figure 19.3/3 Restoration of the HLR
Application process in the HLR for HLR Restart

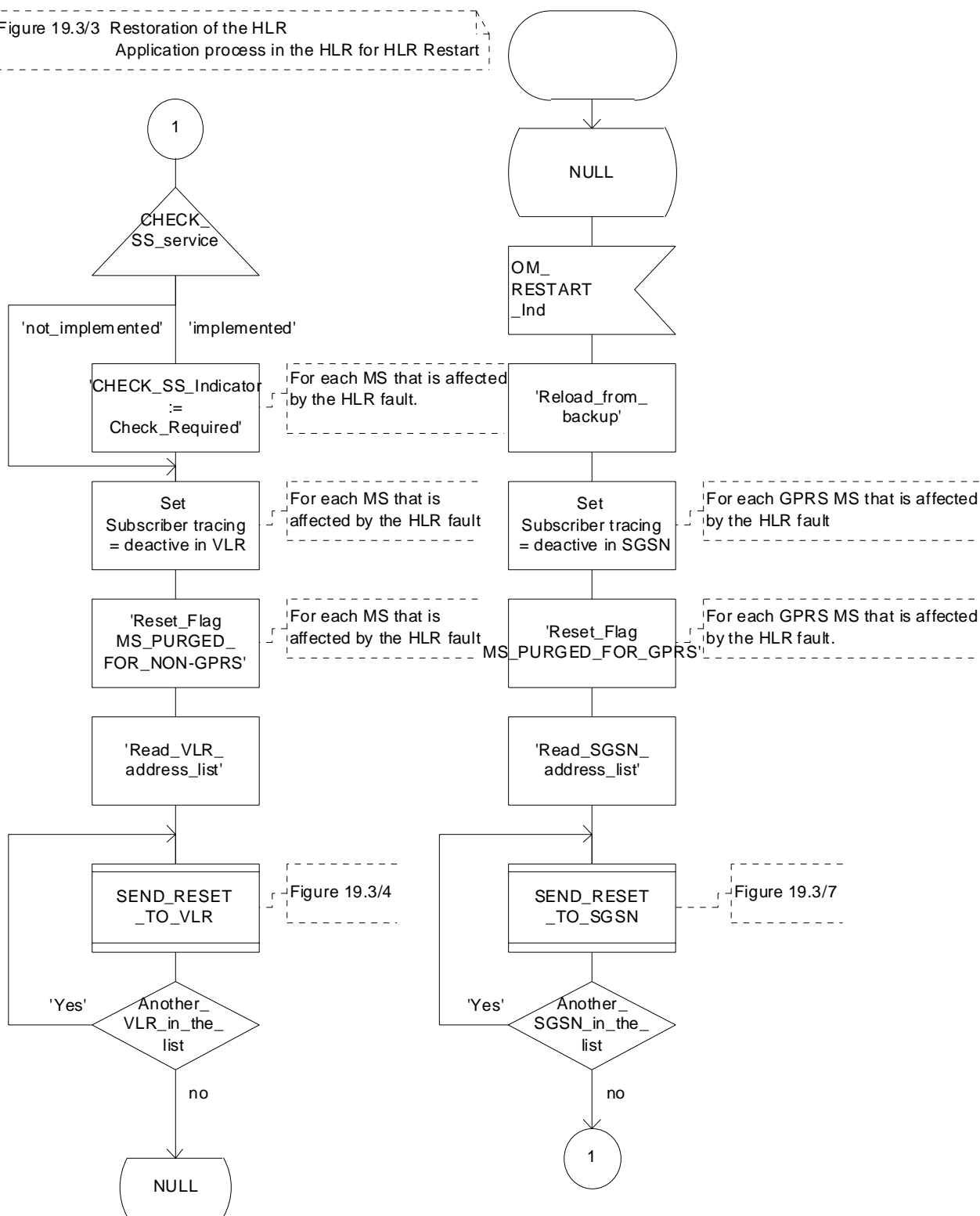

Figure 19.3/3: Process HLR_RESTART

Process SEND_RESET_TO_VLR

19.3_4(1)

Figure 19.3/4 Restoration of the HLR
Process for sending the RESET message
from HLR to VLR

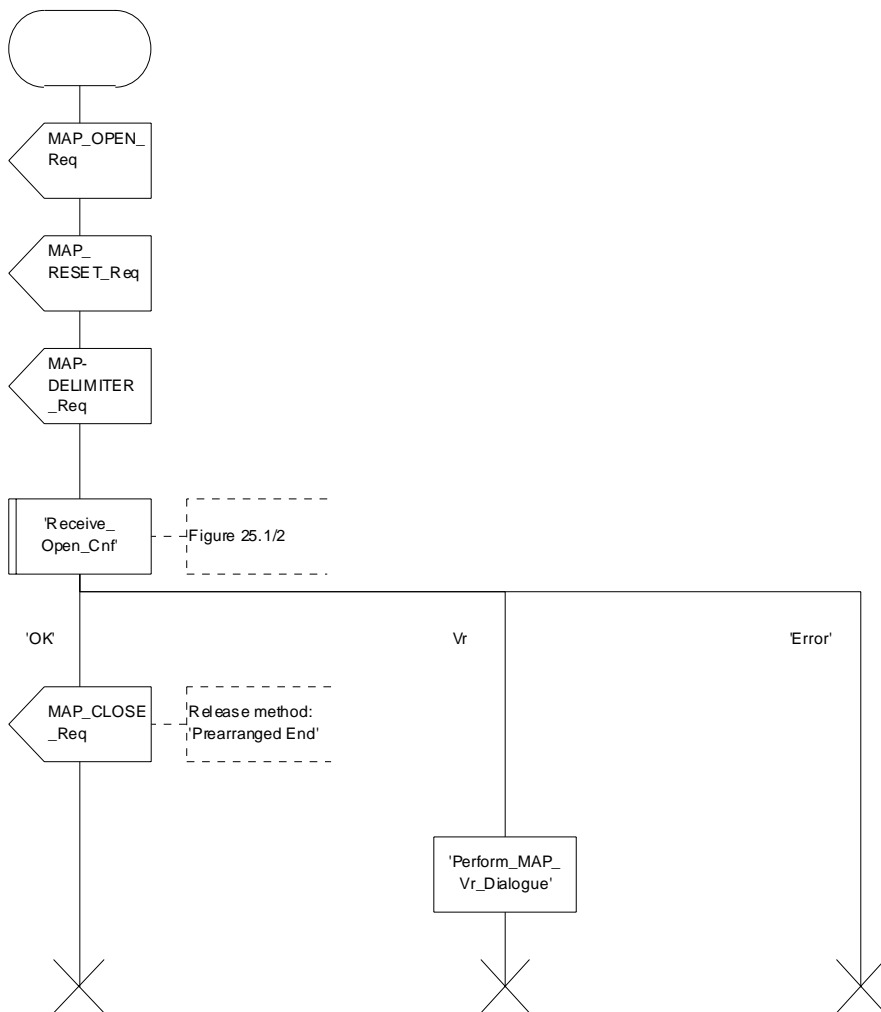

Figure 19.3/4: Process SEND_RESET_TO_VLR

Process REC_RESET_IN_VLR

19.3_5(1)

Figure 19.3/5 Restoration of the HLR - Application process in the VLR for reception of the RESET message from HLR

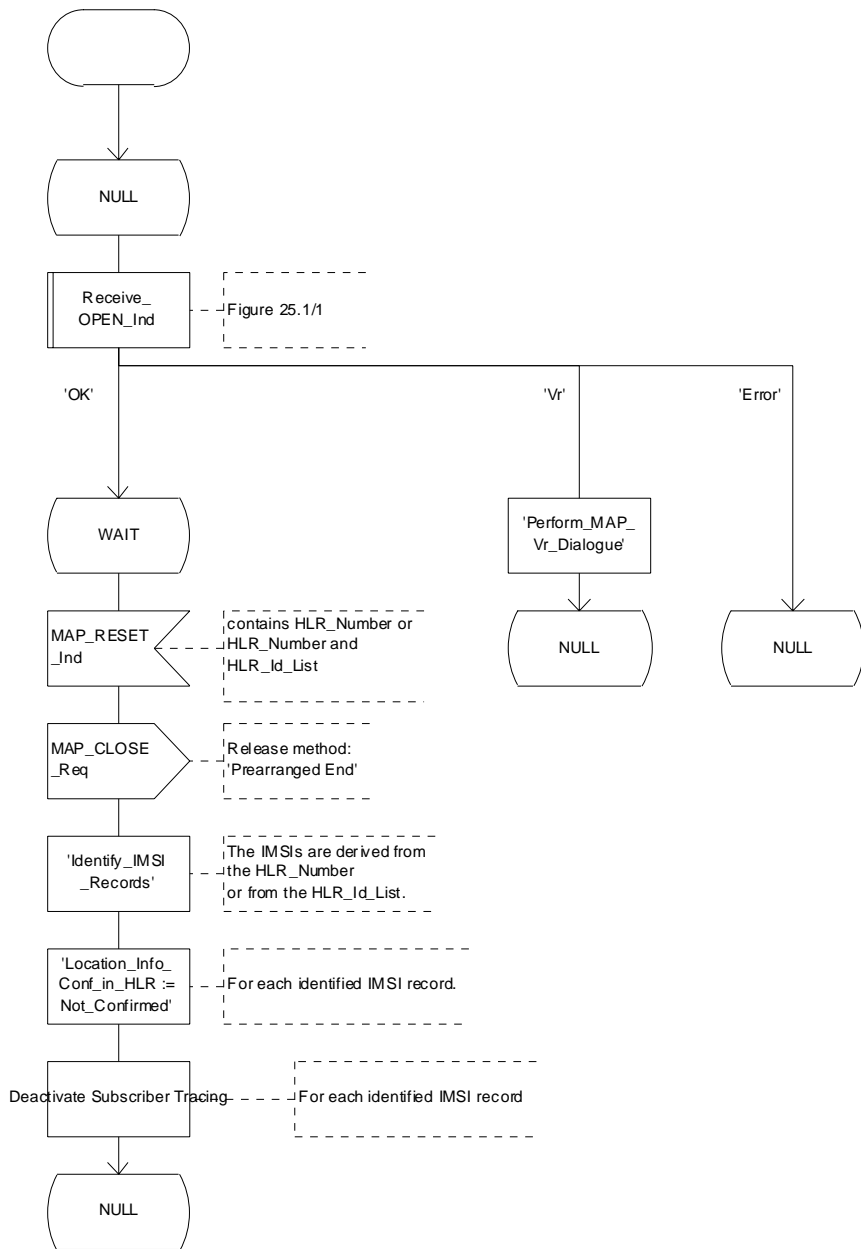

Figure 19.3/5: Process REC_RESET_IN_VLR

Process SEND_RESET_TO_SGSN

19.3_7(1)

Figure 19.3/7: Restoration of the HLR
Process for sending the RESET message
from HLR to SGSN

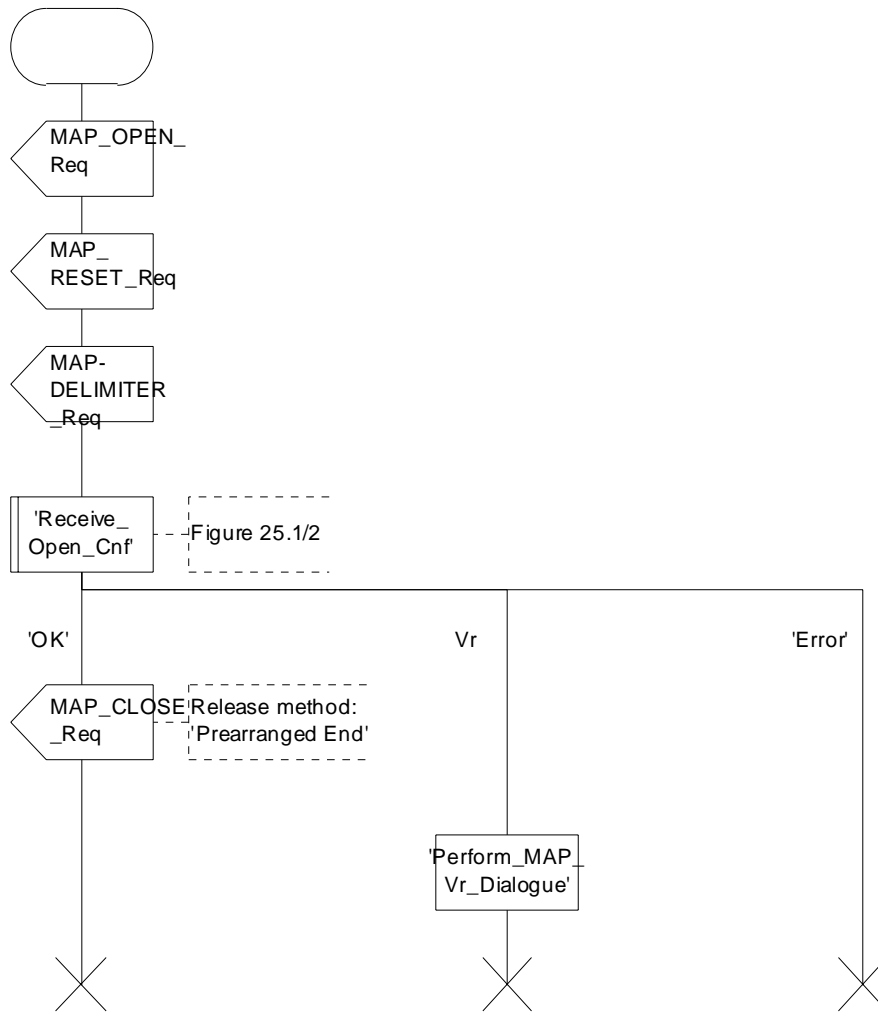

Figure 19.3/7: Process SEND_RESET_TO_SGSN

Process REC_RESET_IN_SGSN

19.3_8(1)

Figure 19.3/8: Restoration of the HLR - Application process in the SGSN for reception of the RESET message from HLR

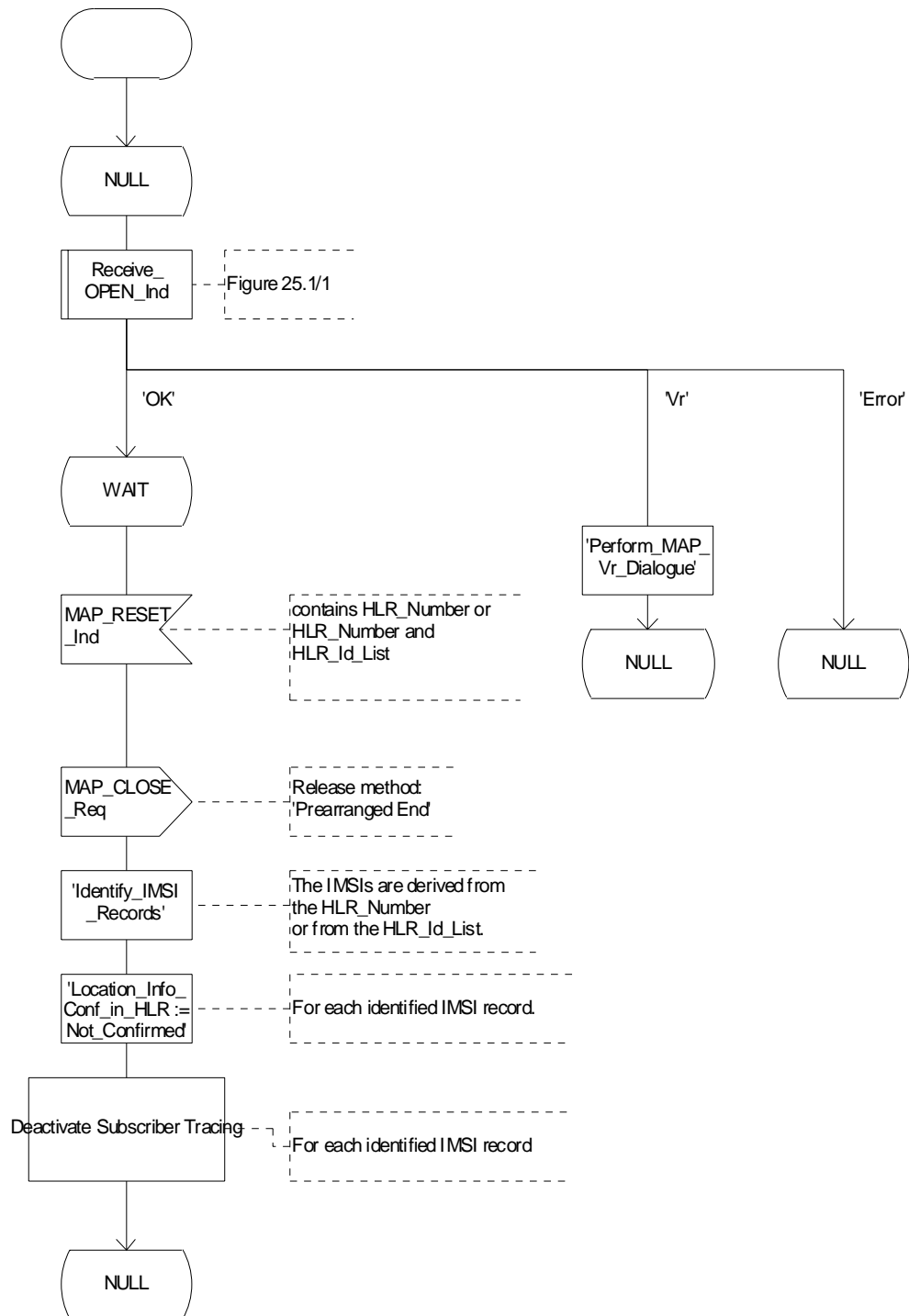

Figure 19.3/8: Process REC_RESET_IN_SGSN

19.3.3 VLR restoration: the restore data procedure in the HLR

The MAP_RESTORE_DATA procedure in the HLR (Process RESTORE_DATA_HLR) is described in this clause; the corresponding procedure in the VLR (RESTORE_DATA_VLR) is described in clause 21.2.4.

The process RESTORE_DATA_HLR makes use of the following macros:

- Receive_Open_Ind clause 25.1.1;
- Check_Indication clause 25.2.1;
- Insert_Sub_Data_Framed_HLR clause 19.4.

The MAP_RESTORE_DATA service is invoked by the VLR after provision of a roaming number in response to a MAP_PROVIDE_ROAMING_NUMBER indication for an unidentified MS (i.e. IMSI unknown in VLR), or for a known MS whose IMSI record is marked as "Not Confirmed" by the indicator "Confirmed by HLR" (see 4 in figure 19.3/1). The process RESTORE_DATA_VLR is shown in figure 21.2/6.

The restore data process in the HLR is activated by receipt of a MAP_RESTORE_DATA indication from the VLR (see figure 19.3/6). If there is a parameter problem in the indication, either of the errors "Unexpected Data Value" or "Data Missing" is returned in the MAP_RESTORE_DATA response; if the subscriber is not known in the HLR, the error "Unknown Subscriber" is returned in the MAP_RESTORE_DATA response. In all of these cases the process in the HLR terminates.

If the MAP_RESTORE_DATA indication is accepted and if the LMSI is received, the HLR updates the LMSI for the IMSI received in the MAP_RESTORE_DATA indication. For this IMSI the HLR sets "subscriber-tracing-not-active-in-VLR" and checks whether tracing is required. This check is handled by the macro "Control_Tracing_HLR" that is described in clause 25.9. Thereafter, the macro "Insert_Sub_Data_Framed_HLR" that is described in clause 19.4 is invoked. The outcome of the macro Insert_Sub_Data_Framed_HLR is one of:

- abort, in which case the process terminates;
- error, in which case the HLR returns the error "System Failure" in the MAP_RESTORE_DATA response, and the process terminates;
- OK, indicating successful outcome of downloading the subscriber data to the VLR.

After successful completion of the framed MAP_INSERT_SUBSCRIBER_DATA procedure, the HLR Number and, if applicable, the "MS Not Reachable Flag" which is used for SMS, are provided in the MAP_RESTORE_DATA response.

Upon receipt of the MAP_RESTORE_DATA confirmation, the VLR behaves as described in clause 21.2.4, figure 21.2/6.

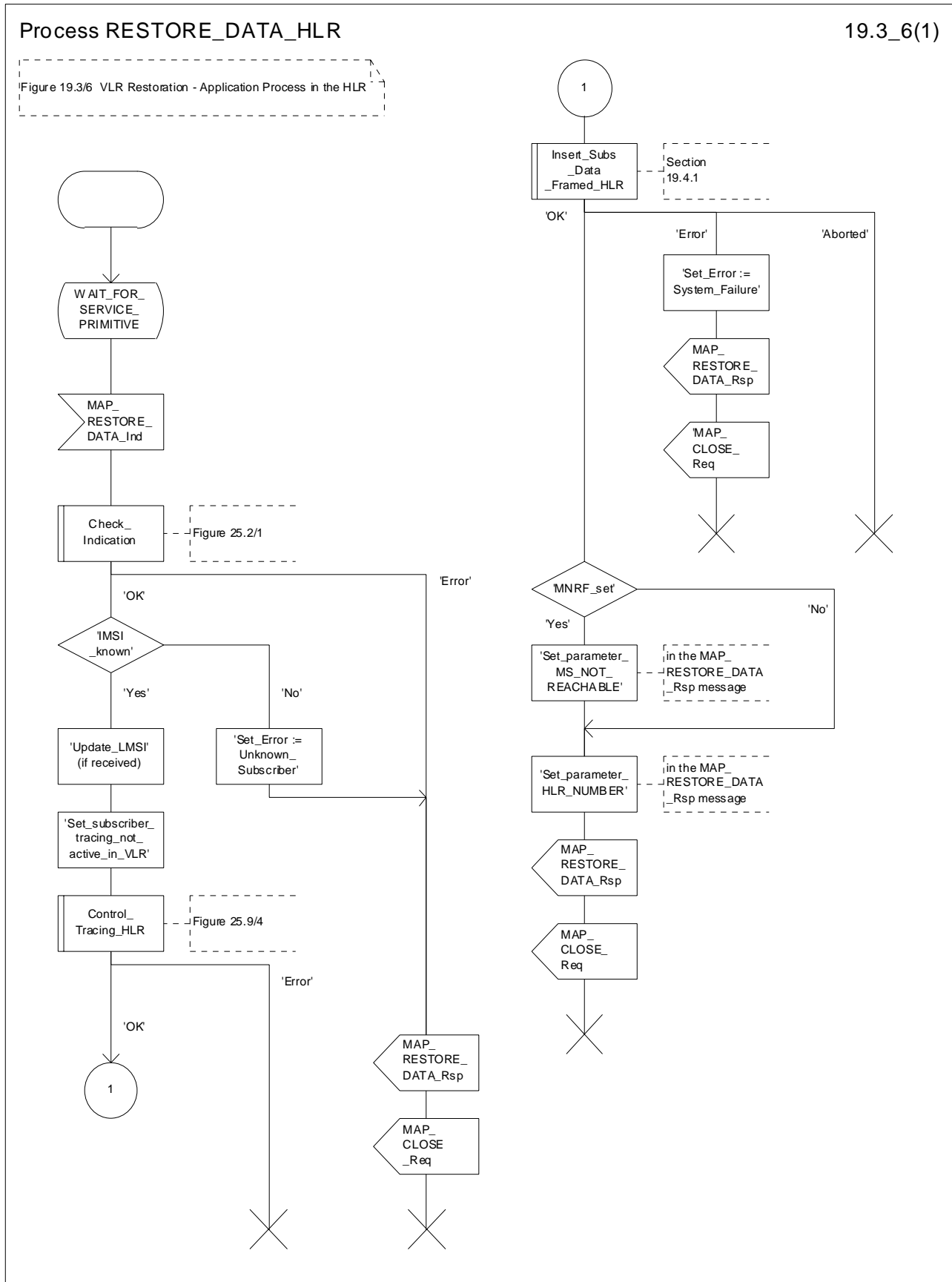

Figure 19.3/6: Process RESTORE_DATA_HLR

19.4 Macro Insert_Subscriber_Data_Framed_HLR

This macro is used by any procedure invoked in HLR which requires the transfer of subscriber data by means of the InsertSubscriberData operation (e.g. Update Location or Restore Data).

The invocation of the operation is done in a dialogue already opened by the framing procedure. Therefore the latter is the one that handles the reception of the open indication and sends the dialogue close request.

The macro calls the process "Send_Insert_Subscriber_Data" (see clause 25.7.4) as many times as it is needed for transferring all subscriber data. This process call is meant to describe two possible behaviours of HLR to handle service requests and confirmations:

- either the HLR handles requests and confirmations in parallel; or
- the HLR sends the next request only after receiving the confirmation to the previous one.

Another call is done to the macro "Wait_for_Insert_Subscriber_Data" (see clause 25.7.3). There the reception and handling of the service confirmations is described.

If certain services required for a subscriber are not supported by the VLR or by the SGSN (e.g. Advice of Charge Charging Level), this may result in one of the following outcomes:

- The HLR stores and sends "Roaming Restriction Due To Unsupported Feature" in a subsequent MAP_INSERT_SUBSCRIBER_DATA service. If "Roaming Restriction Due To Unsupported Feature" is stored in the HLR, the "MSC Area Restricted Flag" shall be set to "restricted". This will prevent MT calls, MT SM and MT USSD from being forwarded to the MSC/VLR;
- The HLR stores and sends other induced subscriber data (e.g. a specific barring program) in a subsequent MAP_INSERT_SUBSCRIBER_DATA service. This will cause rejection of mobile originated service requests, except emergency calls.
- The HLR stores and sends "Roaming Restricted in the SGSN Due To Unsupported Feature" in a subsequent MAP_INSERT_SUBSCRIBER_DATA service. If "Roaming Restricted In SGSN Due To Unsupported Feature" is stored in the HLR, the "SGSN Area Restricted Flag" shall be set to "restricted". This will prevent MT SM from being forwarded to the SGSN and Network Requested PDP-Context Activation;

When the VLR receives regional subscription data (Zone Code List) it may respond with "MSC Area Restricted" in the MAP_INSERT_SUBSCRIBER_DATA response. In this case the "MSC Area Restricted Flag" shall be set to "restricted" in the HLR. This will prevent MT calls, MT SM and MT USSD from being forwarded to the MSC/VLR.

If the HLR neither stores "Roaming Restriction Due To Unsupported Feature" nor receives "MSC Area Restricted" in the MAP_INSERT_SUBSCRIBER_DATA response, the "MSC Area Restricted Flag" in the HLR shall be set to "not restricted".

If subscriber data for CAMEL Phase 2 or 3 services are sent to a VLR which does not support CAMEL Phase 2 or 3, the service behaviour may be unpredictable or incorrect. The HLR therefore needs to ensure that at the conclusion of a location updating dialogue the data in the VLR do not require a capability that the VLR does not have. Possible mechanisms to ensure this are described in 3GPP TS 23.078.

The HLR should send a Forwarded-to number which is not in E.164 international format to the VLR only when the HLR has ascertained that the VLR supports CAMEL Phase 2 or higher. Thus, the ISD message containing the Forwarded-to number which is not in E.164 international format shall be sent to the VLR only after the HLR receives confirmation in the first ISD message result that CAMEL Phase 2 or higher is supported.

A Forwarded-to number non-international E.164 format shall only be sent from an HLR to a VLR if the VLR supports CAMEL Phase 2, or a subsequent phase of CAMEL.

When the SGSN receives regional subscription data (Zone Code List) it may respond with "SGSN Area Restricted" in the MAP_INSERT_SUBSCRIBER_DATA response. In this case the "SGSN Area Restricted Flag" shall be set to "restricted" in the HLR. This will prevent MT SM from being forwarded to the SGSN and Network Requested PDP-Context Activation.

If the HLR neither stores "Roaming Restricted In SGSN Due To Unsupported Feature" nor receives "SGSN Area Restricted" in the MAP_INSERT_SUBSCRIBER_DATA response, the "SGSN Area Restricted Flag" in the HLR shall be set to "not restricted".

The SDL diagrams are shown in figures 19.4/1 and 19.4/2.

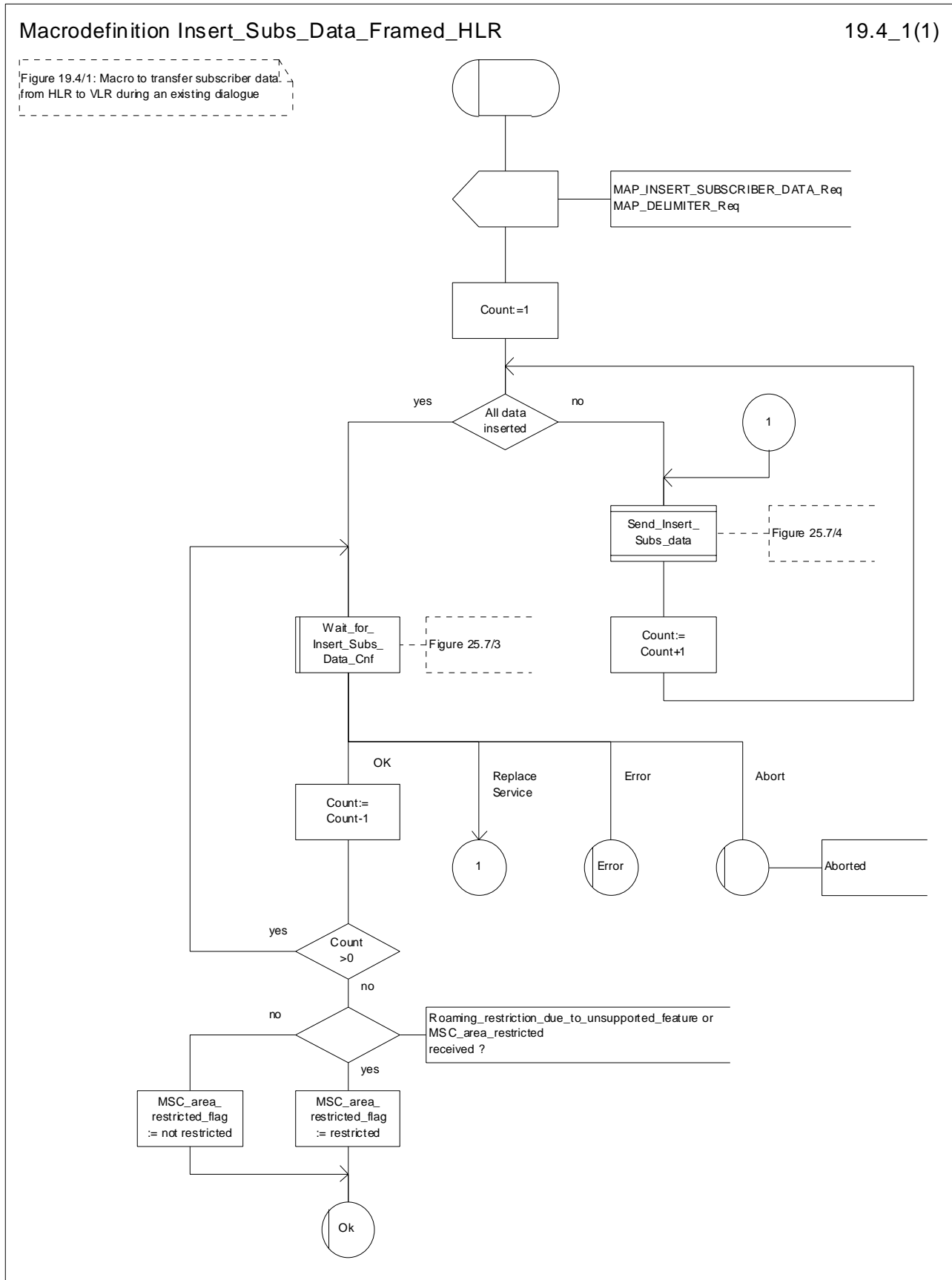

Figure 19.4/1: Macro Insert_Subs_Data_Framed_HLR

Macrodefinition Insert_Subs_Data_In_SGSN_Framed_HLR

19.4_2(1)

Figure 19.4/2: Macro to transfer subscriber data from HLR to SGSN during an existing dialogue

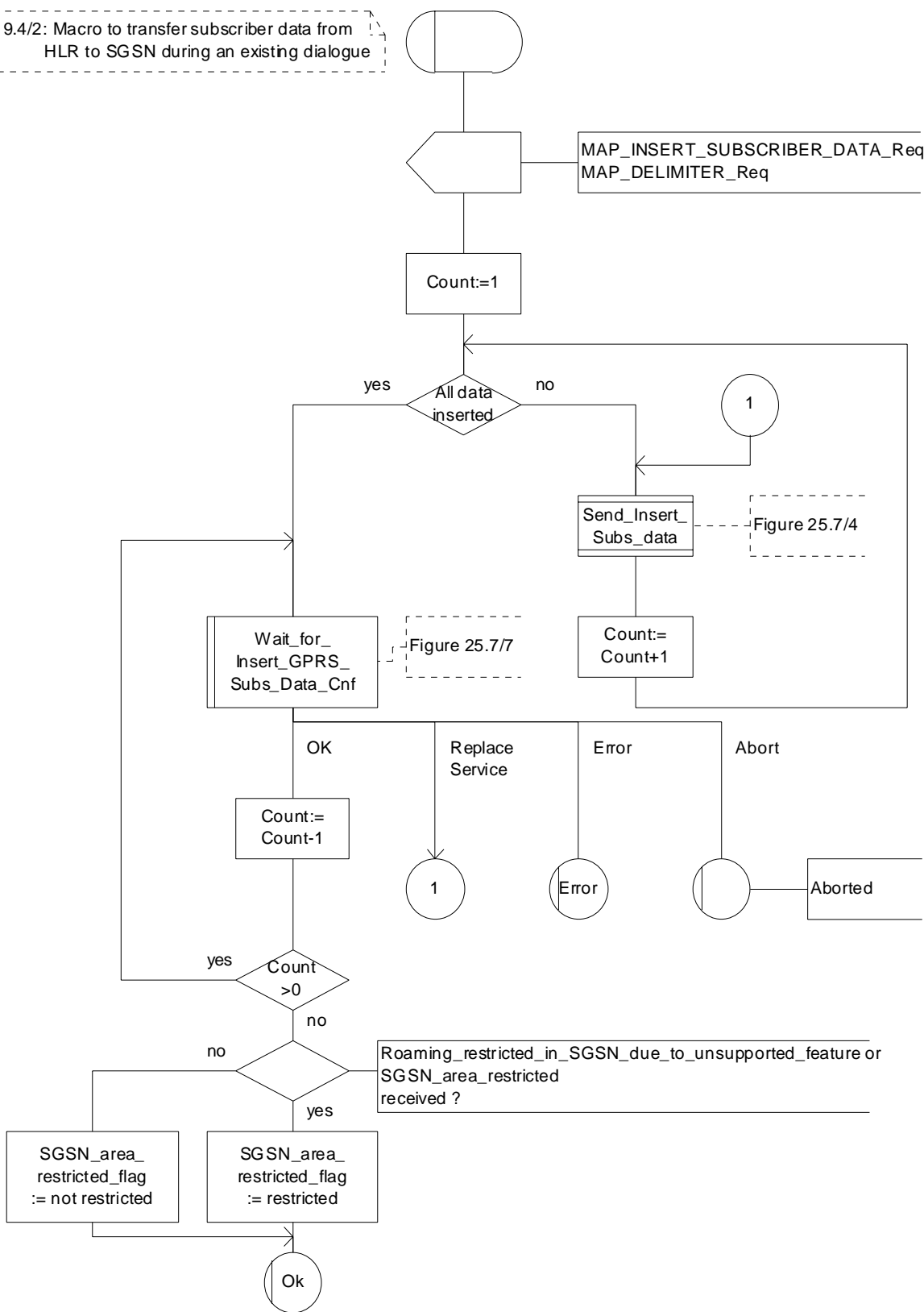

Figure 19.4/2: Macro Insert_Subs_Data_In_SGSN_Framed_HLR

19.5 Mobility Management Event notification procedure

19.5.1 General

The Mobility Management Event Notification VLR process (MMEN_VLR) is used to notify a gsmSCF about the successful completion of a Mobility Management event.

Figure 19.5/1. depicts the MAP signalling used for the event notification.

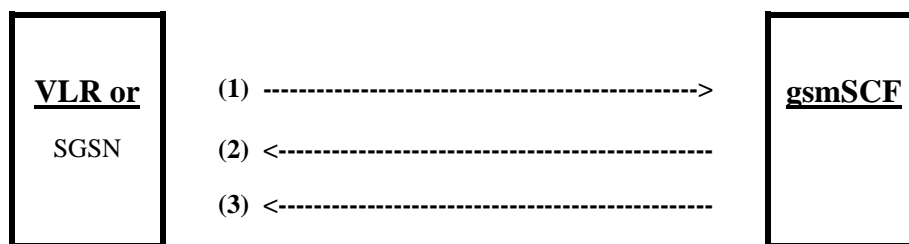

- (1) Report Mobility Management Event (VLR or SGSN to gsmSCF).
- (2) Report Mobility Management Event Result (gsmSCF to VLR or SGSN).
- (3) Report Mobility Management Event Error (gsmSCF to VLR or SGSN).

Figure 19.5/1: Interfaces and MAP Messages for Mobility Management Event notifications

19.5.2 Process in the VLR/SGSN

The Mobility Management event notification procedure in the VLR/SGSN is triggered when the following conditions are fulfilled:

1. the VLR/SGSN has successfully completed a Mobility Management event;
2. the subscriber has a subscription to Mobility Management event notifications;
3. the Mobility Management event is marked for reporting.

The VLR/SGSN notifies the gsmSCF of a mobility management event with the ReportMMEvent MAP message. This message is sent in a TCAP TC-BEGIN primitive. The VLR/SGSN then awaits a positive result (RESULT) or a negative result (ERROR). This is received in a TCAP TC-END primitive. The Basic End procedure is used.

When the VLR/SGSN has received the RESULT or ERROR, the relationship between the VLR/SGSN and the gsmSCF is terminated. The relationship, if existing, is also terminated when the VLR/SGSN sends a TCAP P-ABORT primitive to the calling procedure or when the VLR/SGSN receives a TCAP P-ABORT or a TCAP-U-ABORT primitive from the gsmSCF.

The sending process shall indicate to the MMEN_VLR process, which Mobility Management event shall be reported to the gsmSCF.

The MMEN_VLR process is illustrated in figure 19.5/2.

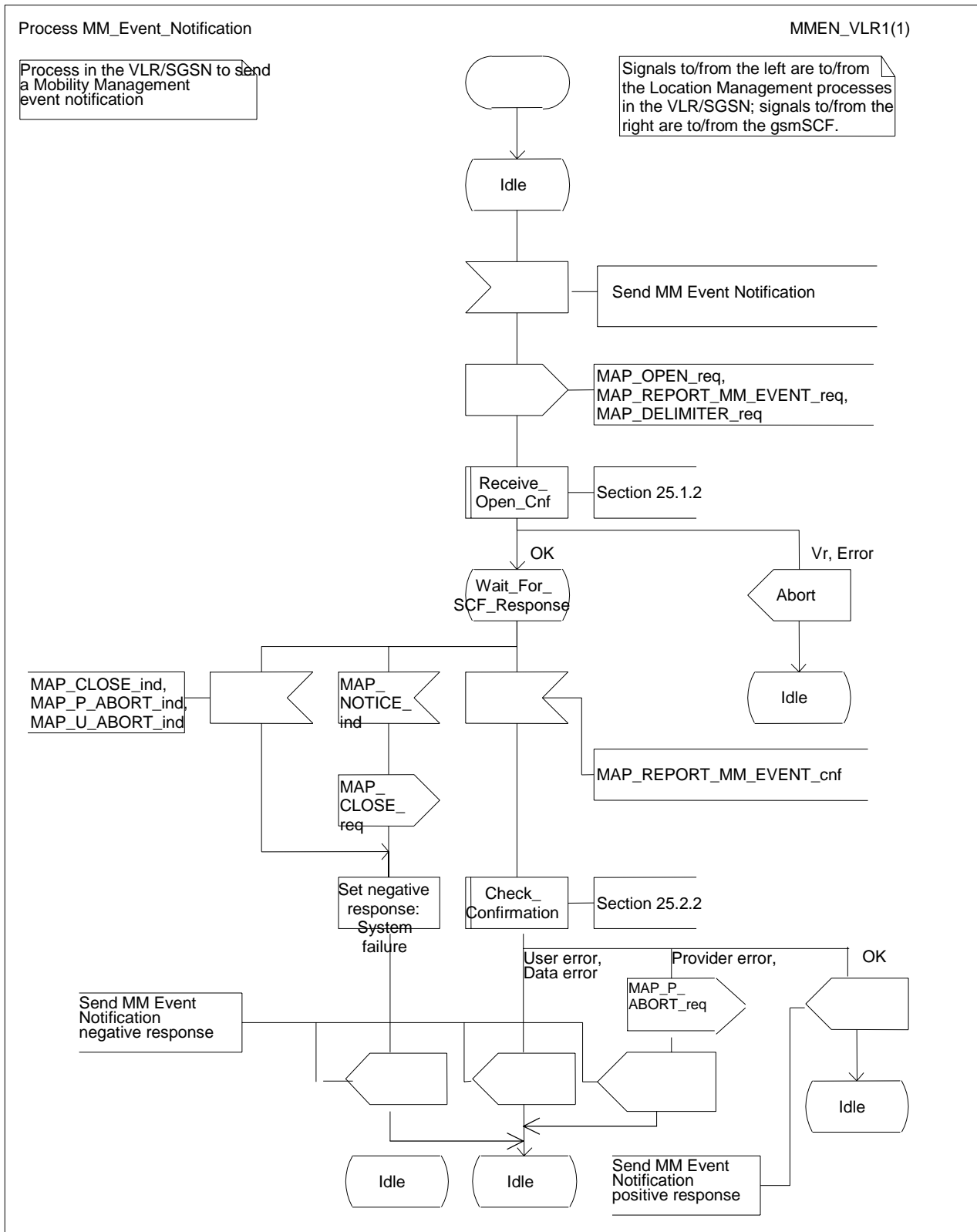

Figure 19.5/2: Process MM_Event_Notification_VLR (sheet 1 of 1)

19.5.3 Process in the gsmSCF

When the gsmSCF receives the ReportMMEvent MAP Message (in a TCAP TC-BEGIN primitive), the MM_Event_Notification_gsmSCF' (MMEN_SCF) process is started.

If the gsmSCF has validated the information it has received in the ReportMMEvent MAP Message, then it informs the Service Logic in the SCP and awaits a response.

If a positive response is received from the Service Logic, then a REPORT_MM_EVENT_RESULT is sent to the VLR/SGSN.

If a negative response is received from the Service Logic, then a REPORT_MM_EVENT_ERROR is sent to the VLR/SGSN.

Both RESULT and ERROR are sent in a TCAP TC-END primitive. The Basic End procedure is used.

If the Service Logic returns a User Error, then a MAP U-ABORT primitive is sent to the VLR/SGSN.

The gsmSCF TCAP service may choose to abort the relationship with the VLR/SGSN by sending a TCAP P-ABORT primitive to the VLR/SGSN.

When the gsmSCF receives a TCAP P-ABORT primitive from the VLR/SGSN, it shall immediately terminate the mobility management process.

This is illustrated in figure 19.5/3.

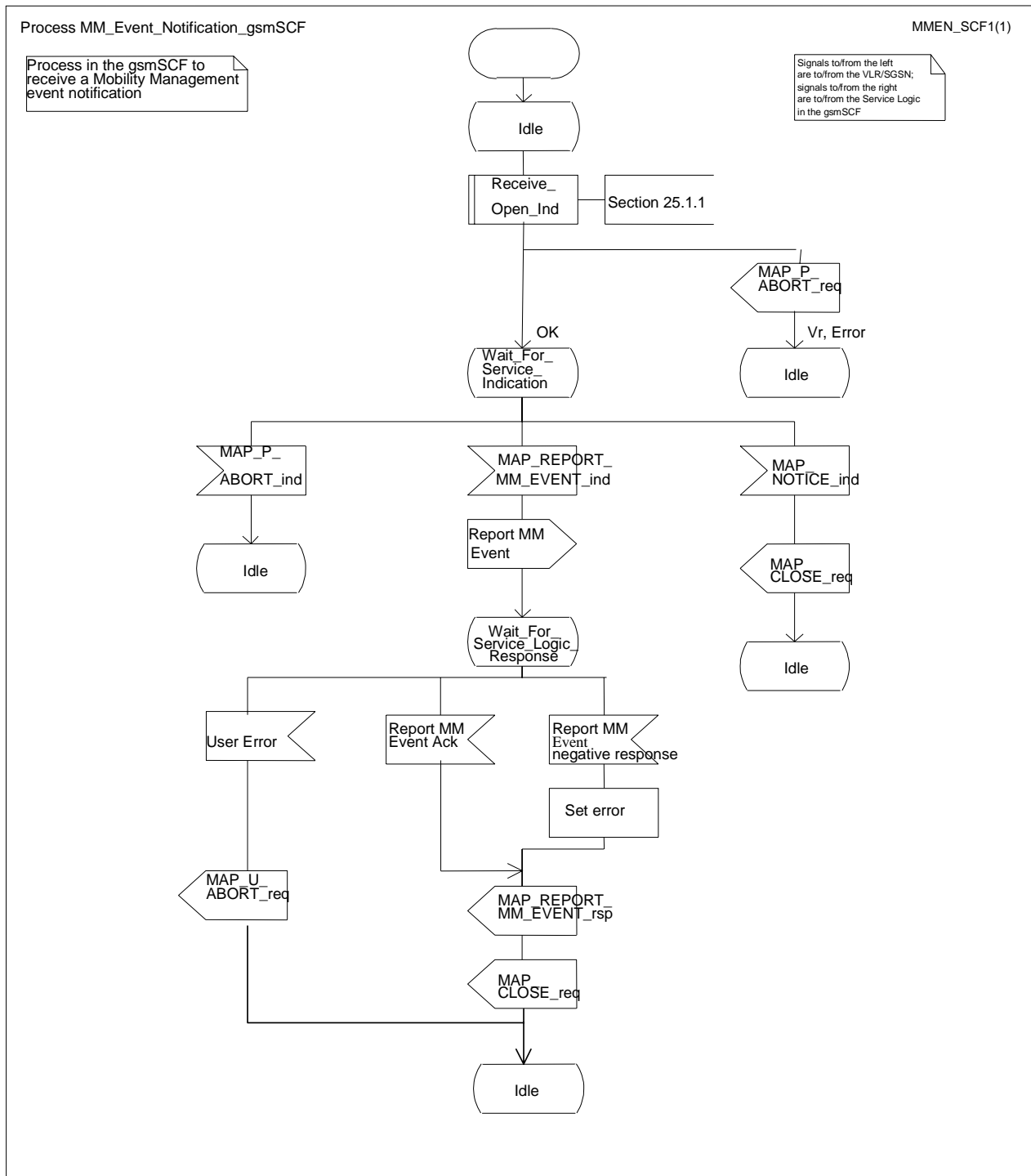

Figure 19.5/3: Process MM_Event_Notification_gsmSCF (sheet 1 of 1)

20 Operation and maintenance procedures

20.1 General

The Operation and Maintenance procedures are needed for operating and maintaining the GSM PLMN network.

The following procedures exist for operation and maintenance purposes:

- i) Tracing procedures;
- ii) Subscriber Data Management procedures;
- iii) Subscriber Identity procedures.

The following application contexts refer to complex MAP Users consisting of several processes:

- subscriberDataManagementContext;
- tracingContext.

These two application contexts need a co-ordinating process in the VLR or in the SGSN as described in the following clauses.

20.1.1 Tracing Co-ordinator for the VLR

The MAP_OPEN indication opens the dialogue for the stand-alone tracing procedure when the application context tracingContext is received. If that service is successful, the Co-ordinator can receive the first service primitive from the MAP_PM. Depending on the received primitive, the user process is created as follows:

- if the MAP_ACTIVATE_TRACE_MODE indication is received, the process ATM_VLR_Standalone is created;
- if the MAP_DEACTIVATE_TRACE_MODE indication is received, the process DTM_VLR_Standalone is created.

After creation of the user process the Co-ordinator relays the messages between the MAP_PM and the invoked process until a request or an indication for dialogue termination is received.

The Tracing Co-ordinator is shown in the figure 20.1/1.

Process Co_Tracing_VLR

20.1_1(1)

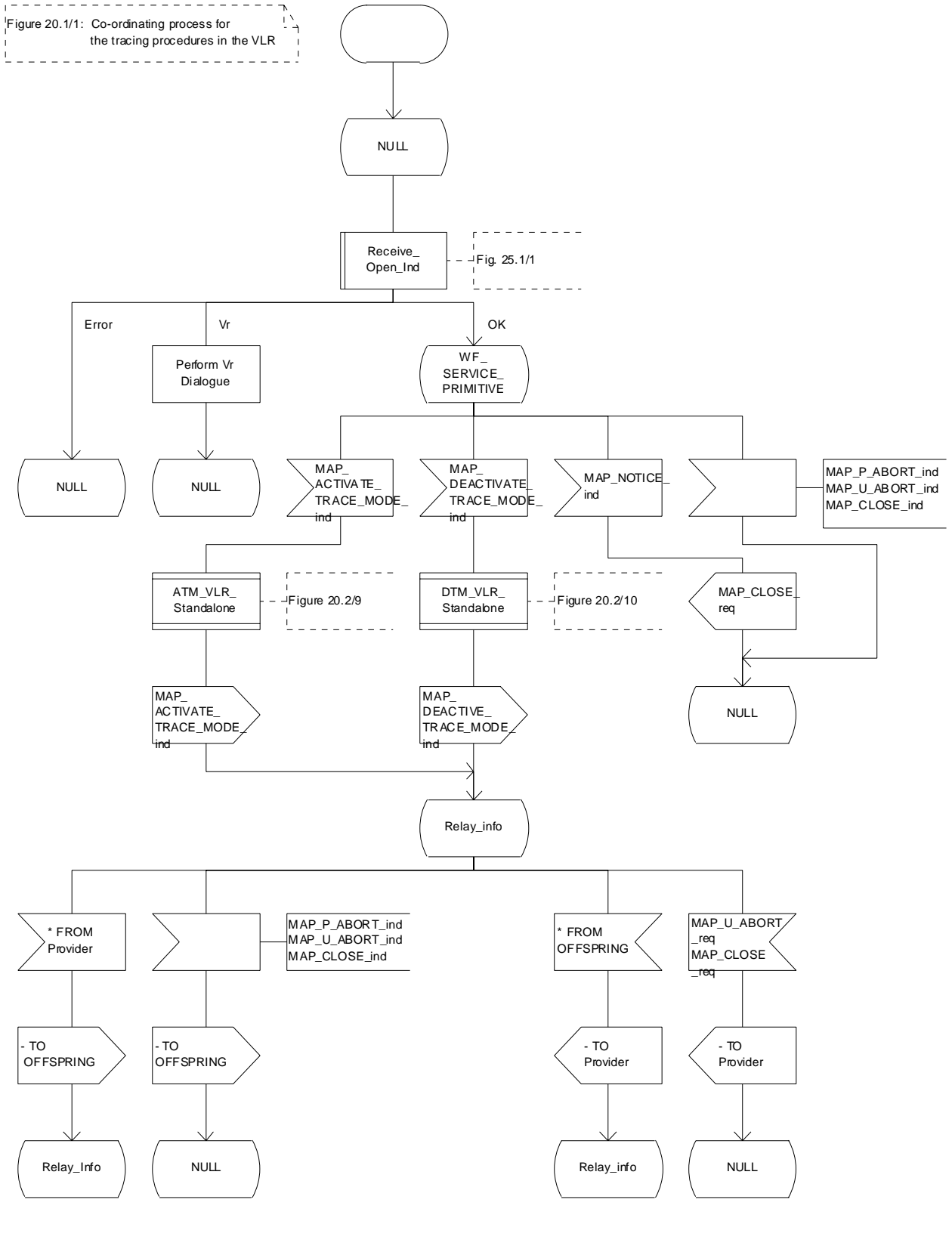

Figure 20.1/1: Process Co_Tracing_VLR

20.1.2 Subscriber Data Management Co-ordinator for the VLR

The MAP_OPEN indication opens the dialogue for the stand-alone subscriber data management procedure when the application context subscriberDataManagementContex is received. If that service is successful, the Co-ordinator can receive the first service primitive from the MAP_PM. Depending on the received primitive, the user process is created as follows:

- if the MAP_INSERT_SUBSCRIBER_DATA indication is received, the process INS_SUBS_DATA_VLR is created;
- if the MAP_DELETE_SUBSCRIBER_DATA indication is received, the process Delete_Subscriber_Data_VLR is created.

After creation of the user process the Co-ordinator relays the messages between the MAP_PM and the invoked process until a request or an indication for dialogue termination is received.

The Subscriber_Data_Management Co-ordinator is shown in the figure 20.1/2.

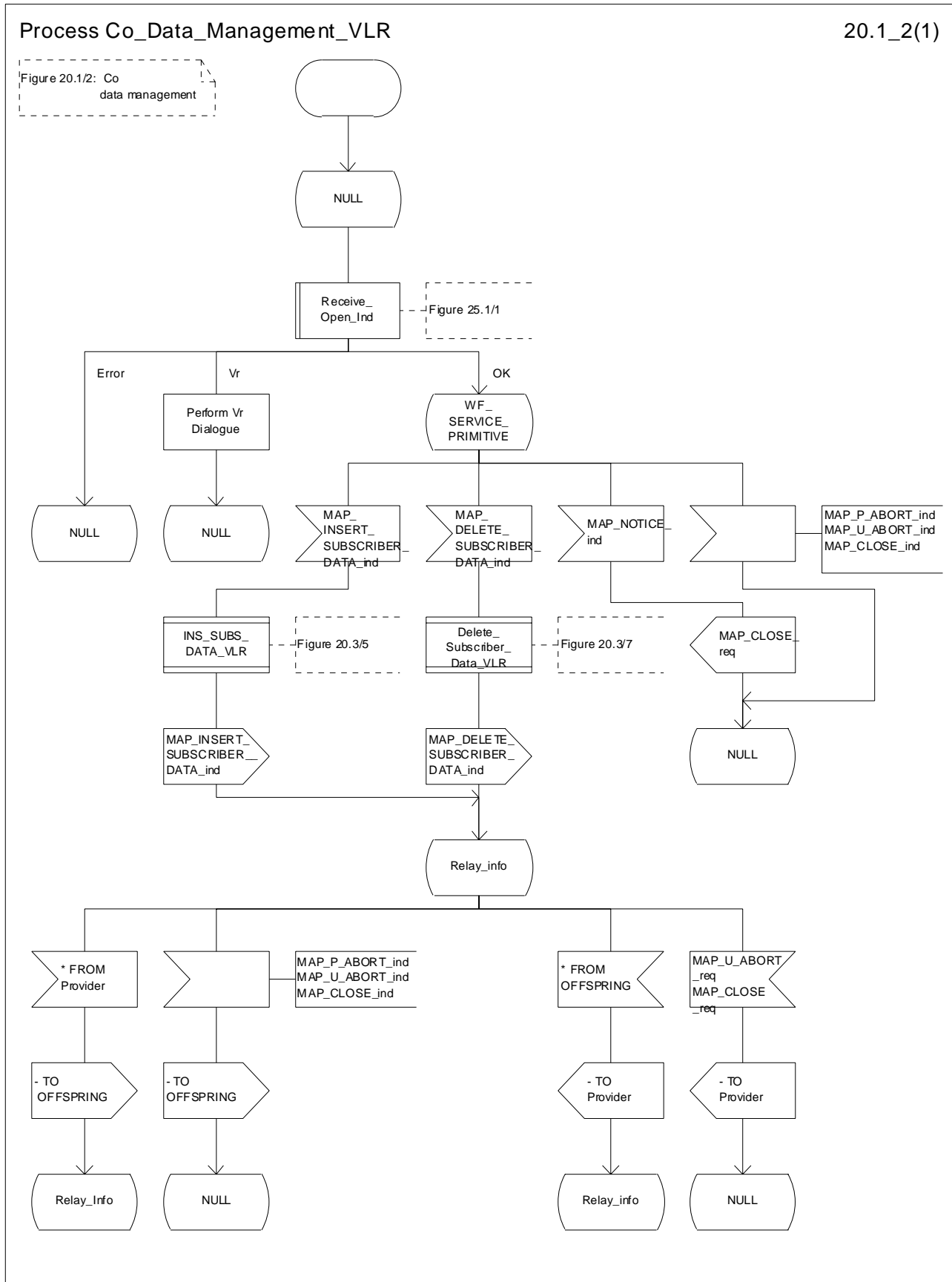

Figure 20.1/2: Process Co_Data_Management_VLR

20.1.3 Tracing Co-ordinator for the SGSN

The MAP_OPEN indication opens the dialogue for the stand-alone tracing procedure when the application context tracingContext is received. If that service is successful, the Co-ordinator can receive the first service primitive from the MAP_PM. Depending on the received primitive, the user process is created as follows:

- if the MAP_ACTIVATE_TRACE_MODE indication is received, the process ATM_SGSN_Standalone is created;
- if the MAP_DEACTIVATE_TRACE_MODE indication is received, the process DTM_SGSN_Standalone is created.

After creation of the user process the Co-ordinator relays the messages between the MAP_PM and the invoked process until a request or an indication for dialogue termination is received.

The Tracing Co-ordinator for the SGSN is shown in the figure 20.1/3.

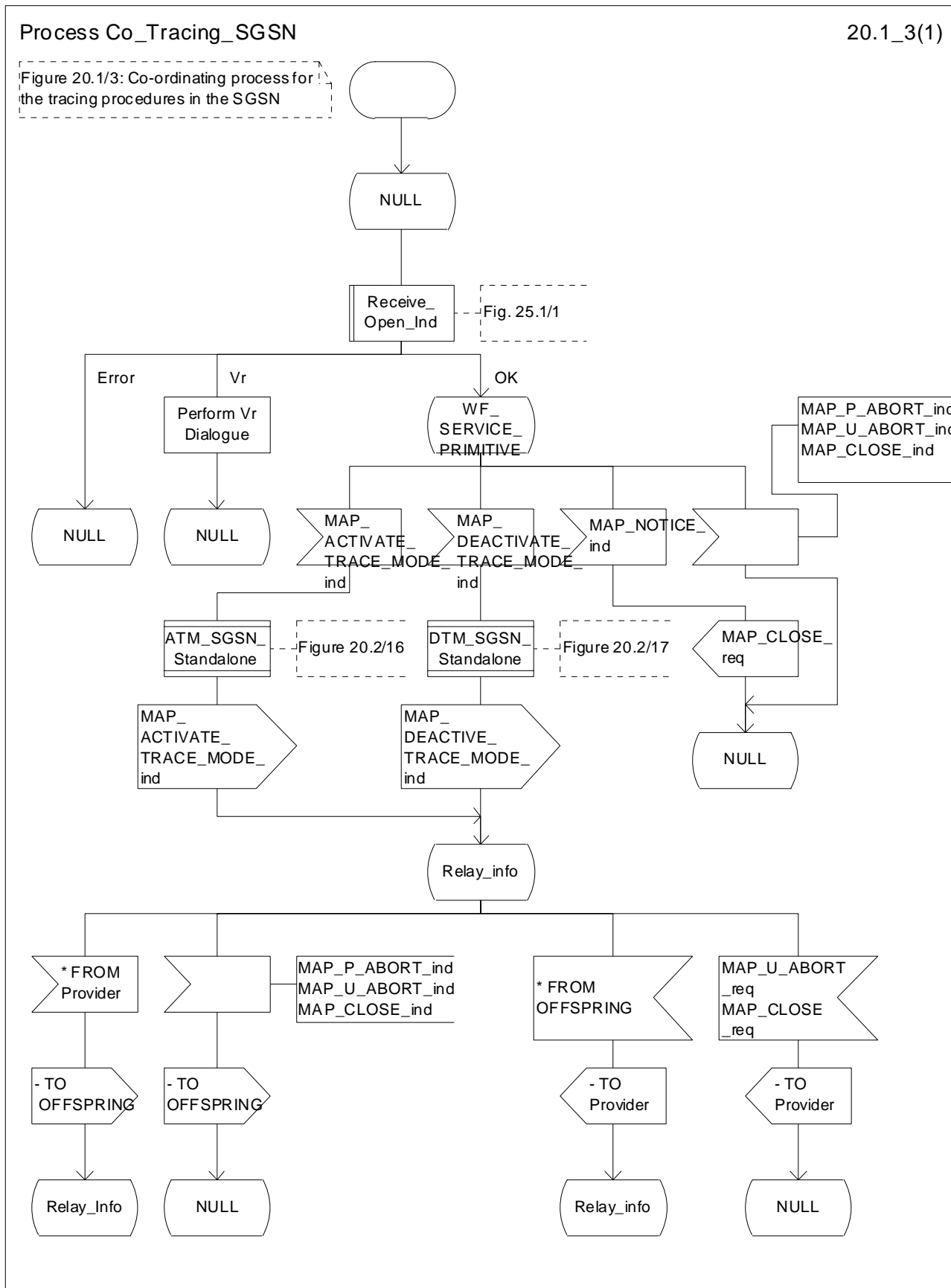

Figure 20.1/3: Process Co_Tracing_SGSN

20.1.4 Subscriber Data Management Co-ordinator for the SGSN

The MAP_OPEN indication opens the dialogue for the stand-alone subscriber data management procedure when the application context subscriberDataManagementContext is received. If that service is successful, the Co-ordinator can receive the first service primitive from the MAP_PM. Depending on the received primitive, the user process is created as follows:

- if the MAP_INSERT_SUBSCRIBER_DATA indication is received, the process INS_SUBS_DATA_SGSN is created;
- if the MAP_DELETE_SUBSCRIBER_DATA indication is received, the process Delete_Subscriber_Data_SGSN is created.

After creation of the user process the Co-ordinator relays the messages between the MAP_PM and the invoked process until a request or an indication for dialogue termination is received.

The Subscriber_Data_Management Co-ordinator is shown in the figure 20.1/4.

Process Co_Data_Management_SGSN

20.1_4(1)

Figure 20.1/4: Co-ordinating process for the subscriber data management procedures in the SGSN

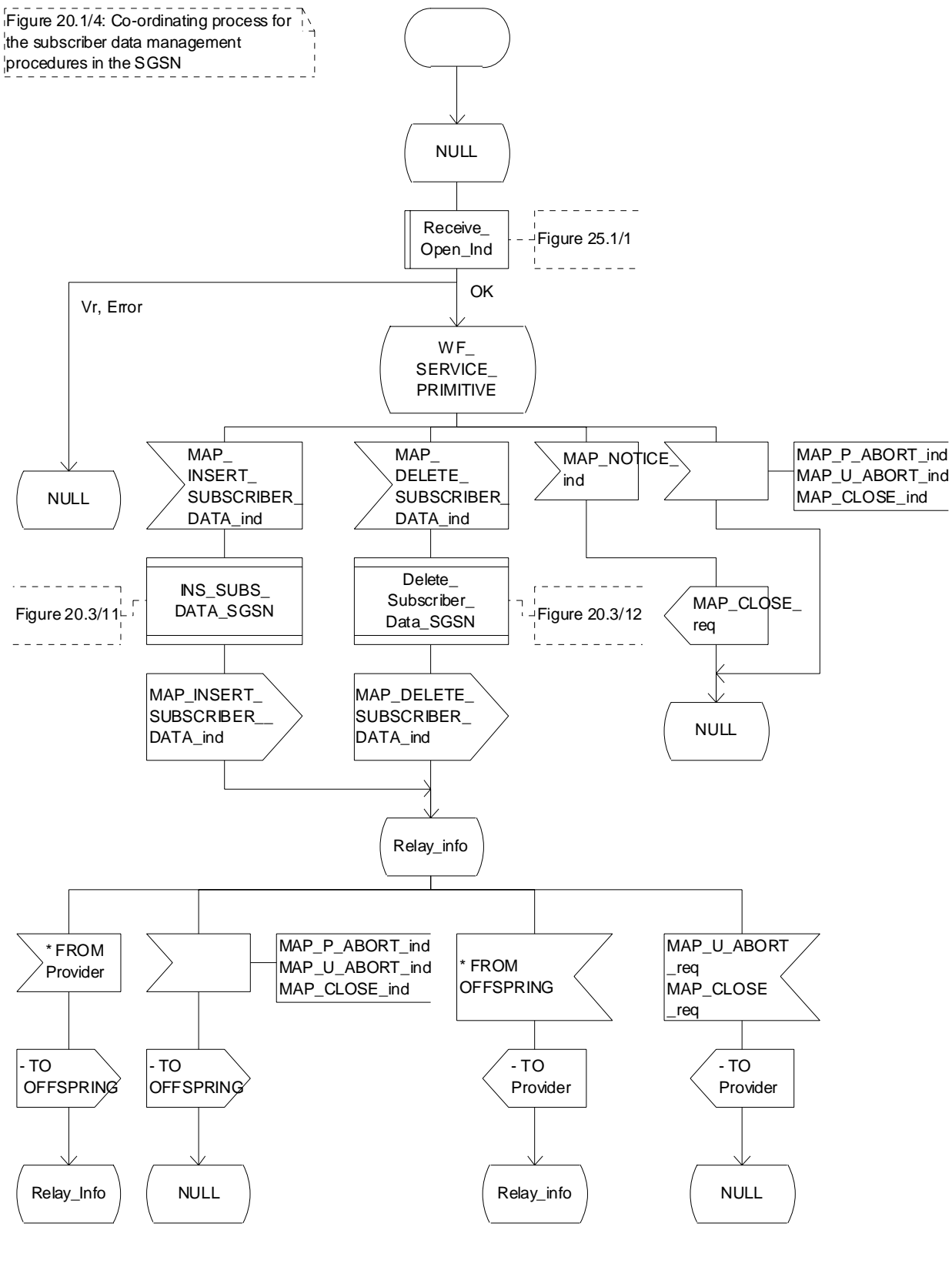

Figure 20.1/4: Process Co_Data_Management_SGSN

20.2 Tracing procedures

Three types of tracing procedures exist:

- i) Subscriber tracing management procedures;
- ii) Subscriber tracing procedures;
- iii) Event tracing procedures.

The subscriber tracing management procedures are used for management of the status and the type of the tracing. The subscriber tracing activation procedure is used at location updating or data restoration when the trace mode of a subscriber is set active in the HLR or, as a stand alone procedure, when the subscriber is already registered and the trace mode becomes active in the HLR. The procedures for providing a trace request to the VLR are shown in figures 20.2/1 and 20.2/2. The procedures for providing a trace request to the SGSN are shown in figures 20.2/11 and 20.2/12.

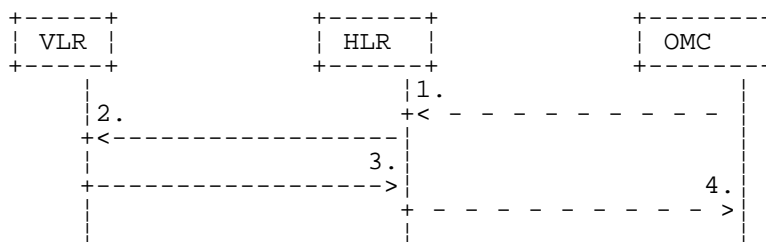

- 1) Subscriber Tracing Activation.
- 2) MAP_ACTIVATE_TRACE_MODE.
- 3) MAP_ACTIVATE_TRACE_MODE_ACK.
- 4) Subscriber Tracing Activation Accepted.

Figure 20.2/1: Stand alone subscriber tracing activation procedure

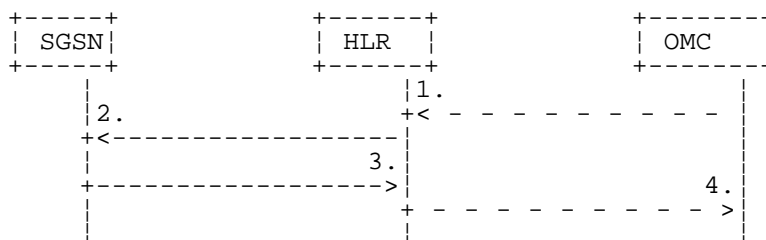

- 1) Subscriber Tracing Activation.
- 2) MAP_ACTIVATE_TRACE_MODE.
- 3) MAP_ACTIVATE_TRACE_MODE_ACK.
- 4) Subscriber Tracing Activation Accepted.

Figure 20.2/11: Stand alone subscriber tracing activation procedure for GPRS

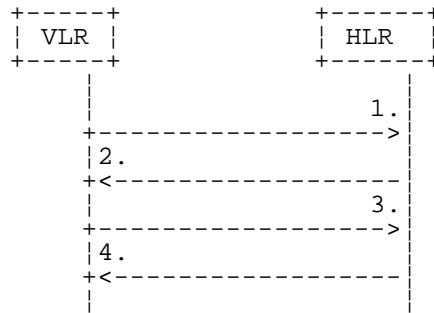

- 1) MAP_UPDATE_LOCATION or MAP_RESTORE_DATA.
- 2) MAP_ACTIVATE_TRACE_MODE.
- 3) MAP_ACTIVATE_TRACE_MODE_ACK.
- 4) MAP_UPDATE_LOCATION_ACK or MAP_RESTORE_DATA_ACK.

Figure 20.2/2: Subscriber tracing activation procedure at location updating or data restoration

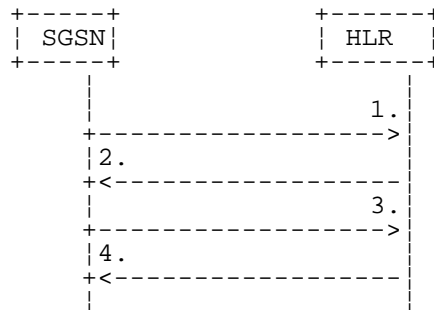

- 1) MAP_UPDATE_GPRS_LOCATION.
- 2) MAP_ACTIVATE_TRACE_MODE.
- 3) MAP_ACTIVATE_TRACE_MODE_ACK.
- 4) MAP_UPDATE_GPRS_LOCATION_ACK.

Figure 20.2/12: Subscriber tracing activation procedure at GPRS location updating

The HLR sends the trace request (IMSI, trace reference, trace type and identity of the OMC) to the VLR or to the SGSN in a MAP_ACTIVATE_TRACE_MODE request. The receipt of this primitive is acknowledged. The acknowledge primitive will indicate that the trace request is accepted by the VLR or by the SGSN. If the request is not accepted, the reason will be reported to the HLR.

The subscriber tracing deactivation procedure is used when the trace request of a subscriber is to be cancelled in the VLR or in the SGSN. The procedures is shown in figures 20.2/3 and 20.2/13.

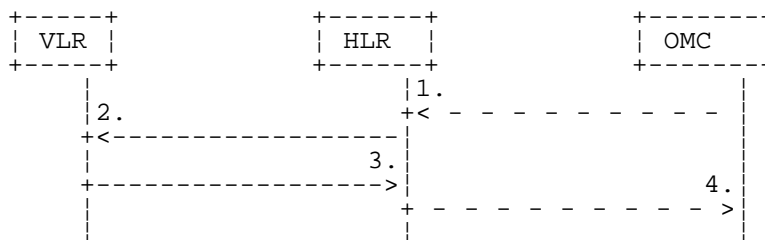

- 1) Subscriber Tracing Deactivation.
- 2) MAP_DEACTIVATE_TRACE_MODE.
- 3) MAP_DEACTIVATE_TRACE_MODE_ACK.
- 4) Subscriber Tracing Deactivation Accepted.

Figure 20.2/3: Subscriber tracing deactivation procedure

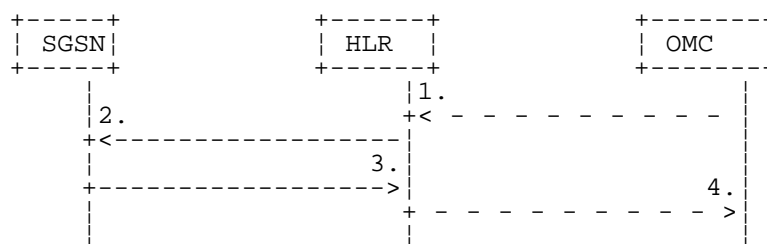

- 1) Subscriber Tracing Deactivation.
- 2) MAP_DEACTIVATE_TRACE_MODE.
- 3) MAP_DEACTIVATE_TRACE_MODE_ACK.
- 4) Subscriber Tracing Deactivation Accepted.

Figure 20.2/13: Subscriber tracing deactivation procedure for GPRS

The HLR sends a MAP_DEACTIVATE_TRACE_MODE request to the VLR or to the SGSN. The VLR or the SGSN will acknowledge the deactivation. The acknowledge primitive will indicate that the trace request has been deleted by the VLR or by the SGSN. If the deactivation is not accepted, the reason will be reported to the HLR.

The subscriber tracing procedures are used when the VLR detects any subscriber related activity for which the trace mode is activated, e.g. receives the MAP_PROCESS_ACCESS_REQUEST indication. The procedure is shown in figure 20.2/4.

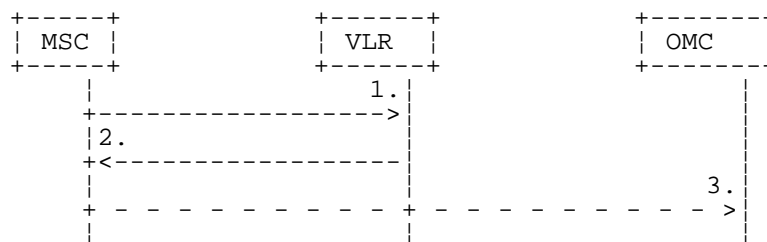

- 1) MAP_PROCESS_ACCESS_REQUEST, MAP_UPDATE_LOCATION_AREA.
- 2) MAP_TRACE_SUBSCRIBER_ACTIVITY.
- 3) Subscriber tracing information.

Figure 20.2/4: Subscriber tracing procedure in the servicing MSC

The VLR will generate the MAP_TRACE_SUBSCRIBER_ACTIVITY indication. The receiving MSC will send the trace record to the OMC.

[Figure numbers 20.2/5 and 20.2/6 are spare.]

20.2.1 Procedures in the HLR

20.2.1.1 Subscriber tracing activation procedure

When receiving the subscriber tracing mode activation command for a subscriber from the OMC, the HLR will activate tracing, if the subscriber is known and registered in the HLR and the subscriber is roaming in the home PLMN area. The MAP_ACTIVATE_TRACE_MODE request is sent to the VLR or to the SGSN where the subscriber is registered.

If the MAP_ACTIVATE_TRACE_MODE confirmation is received indicating an error situation, the errors are mapped to the OMC interface. The activation request may also be repeated; the number of repeat attempts and the time in between are HLR operator options, depending on the error returned by the VLR or the SGSN.

If the subscriber is known in the HLR, but is deregistered or roaming outside the home PLMN area, the subscriber tracing status is activated in the HLR, but the VLR or the SGSN is not updated.

When receiving a request for location updating or data restoration while the subscriber trace mode is active, the macro Control_Tracing_HLR (see figure 25.9/4) shall be initiated by the location updating process in the HLR.

The subscriber tracing activation process in the HLR with VLR is shown in figure 20.2/7.

The subscriber tracing activation process in the HLR with SGSN is shown in figure 20.2/14.

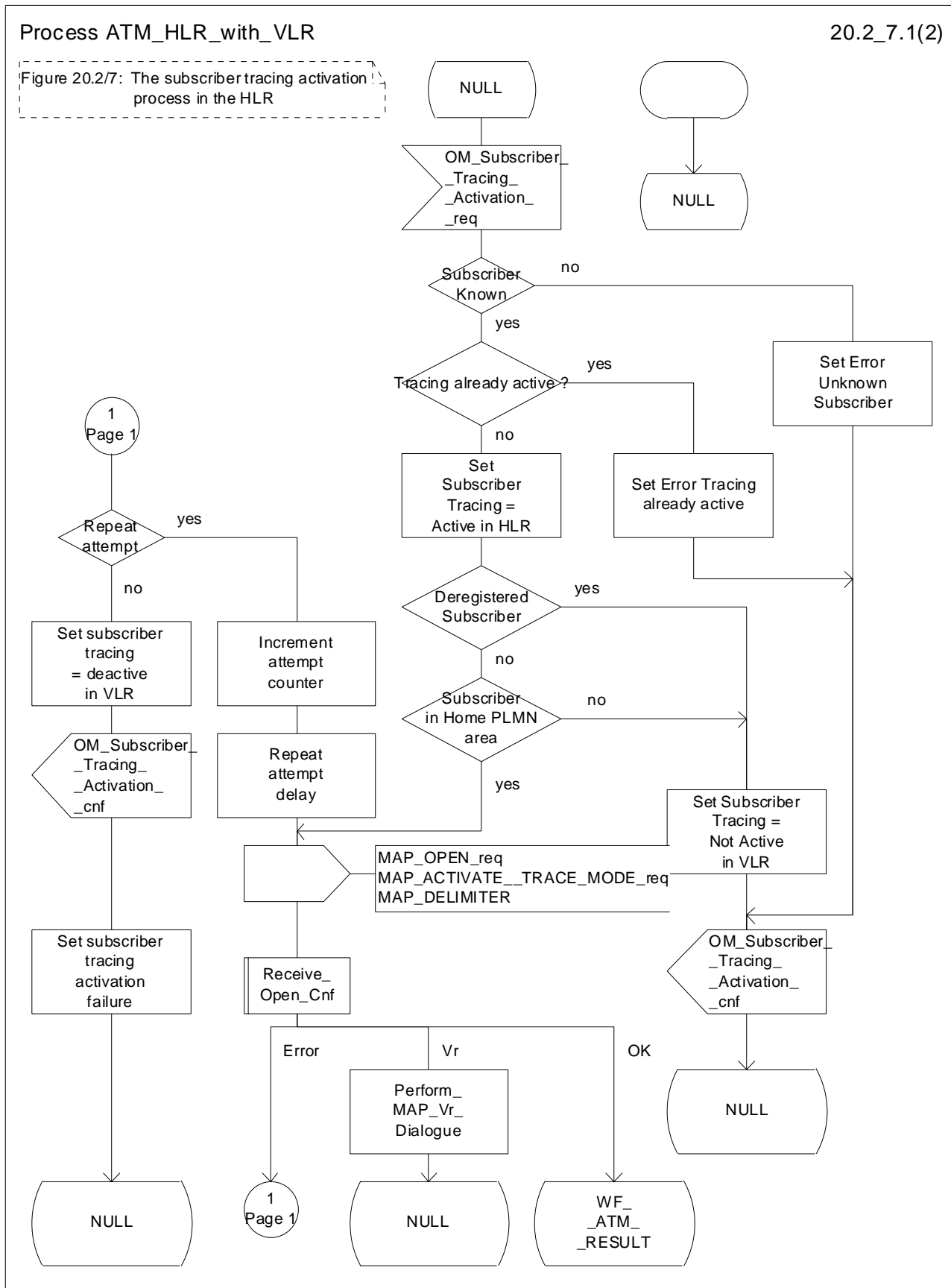

Figure 20.2/7 (sheet 1 of 2): Process ATM_HLR_with_VLR

Process ATM_HLR_with_VLR

20.2_7.2(2)

Figure 20.2/7: The subscriber tracing activation process in the HLR

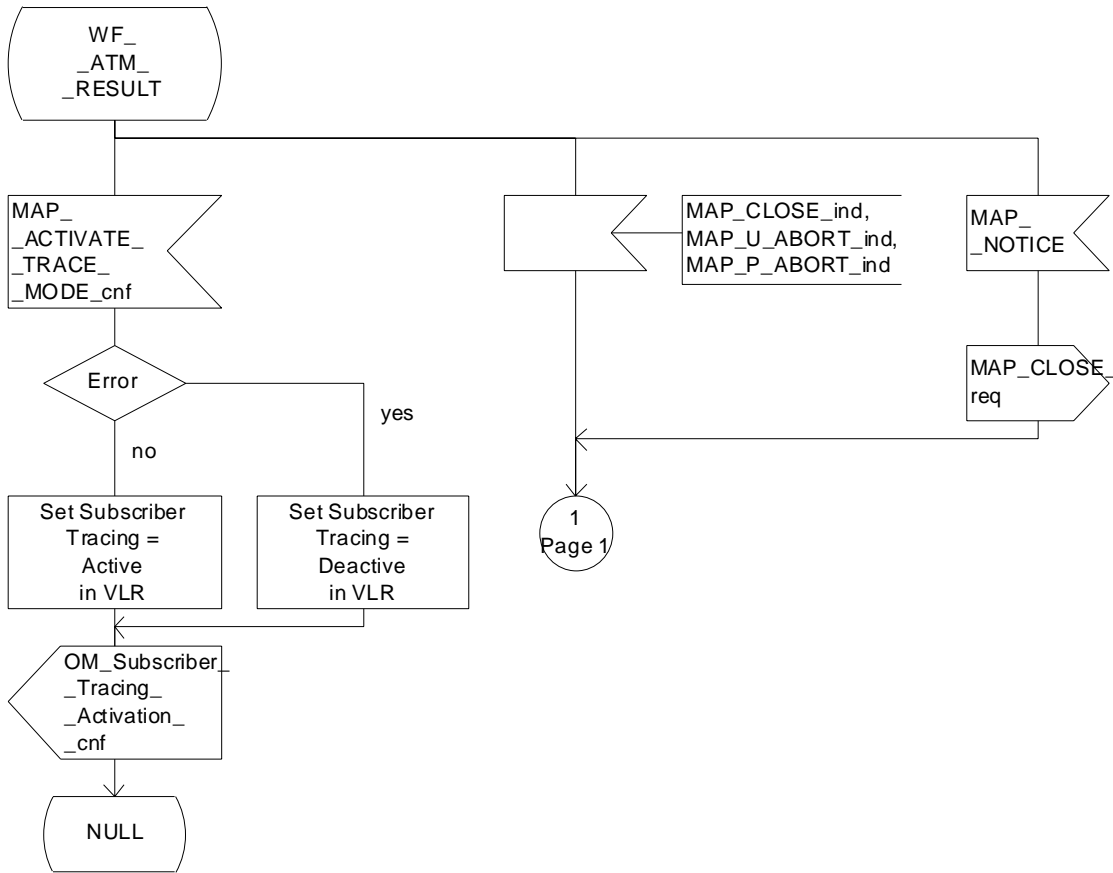

Figure 20.2/7 (sheet 2 of 2): Process ATM_HLR_with_VLR

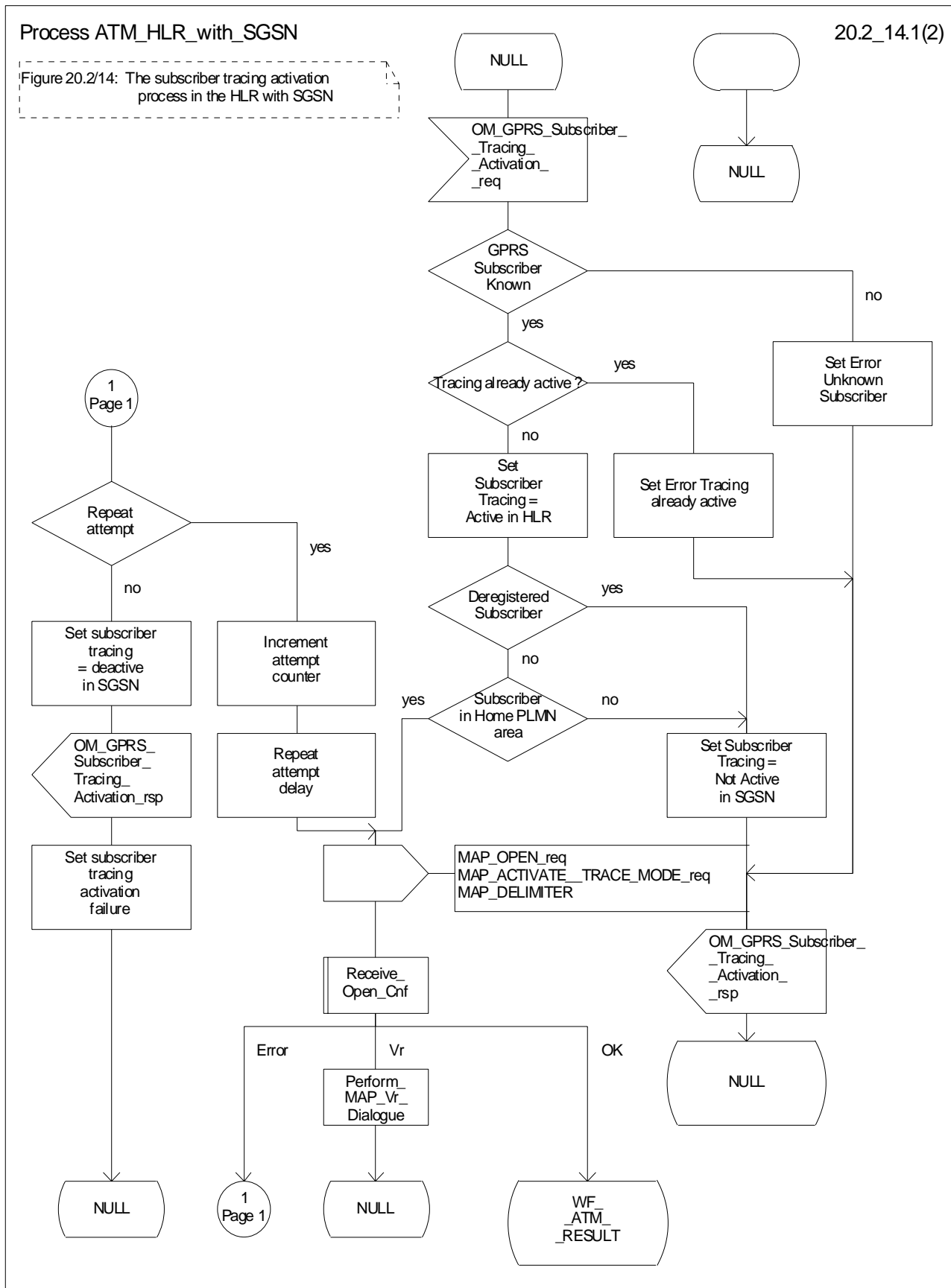

Figure 20.2/14 (sheet 1 of 2): Process ATM_HLR_with_SGSN

Process ATM_HLR_with_SGSN

20.2_14.2(2)

Figure 20.2/14: The subscriber tracing activation process in the HLR with SGSN

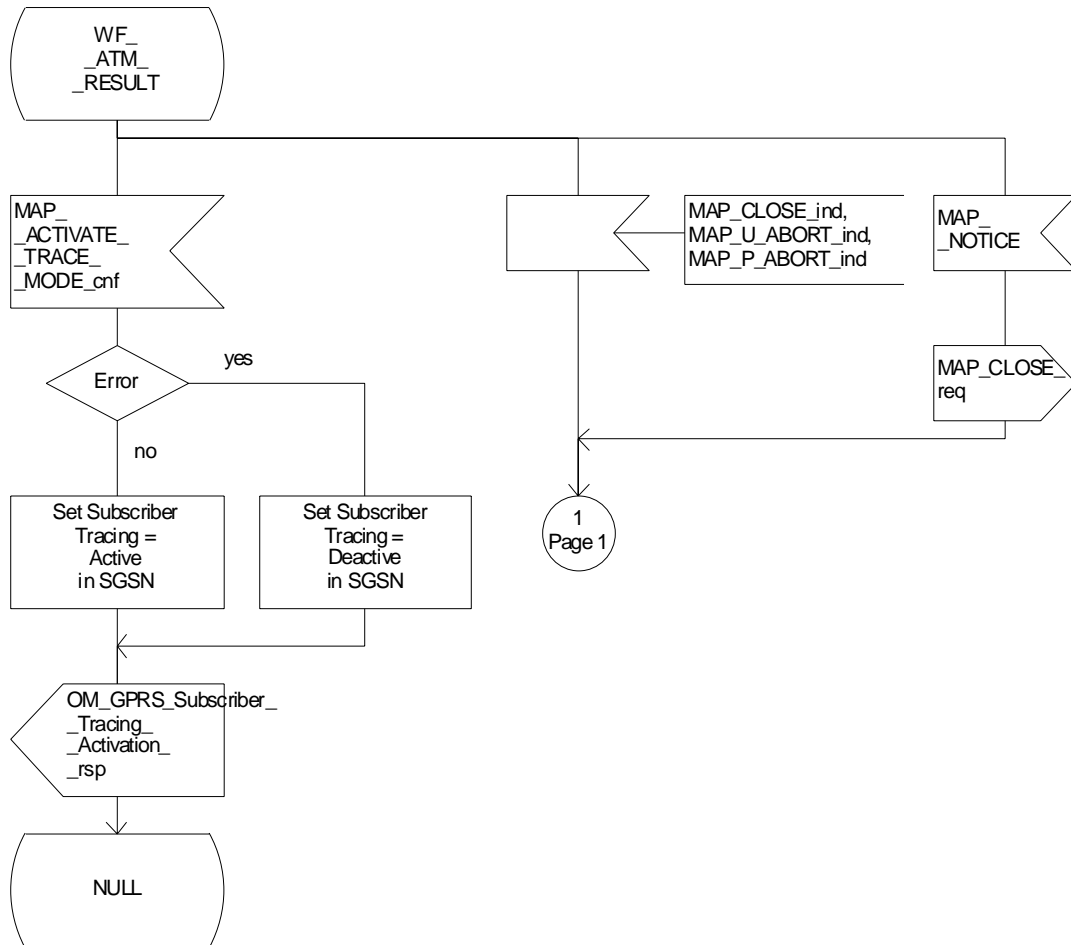

Figure 20.2/14 (sheet 2 of 2): Process ATM_HLR_with_SGSN

20.2.1.2 Subscriber tracing deactivation procedure

When receiving the subscriber trace mode deactivation command for a subscriber from the OMC, the HLR will send the MAP_DEACTIVATE_TRACE_MODE request to the VLR or to the SGSN where the subscriber is registered, if the trace mode activation has been carried out. The subscriber tracing in HLR is set to a deactive state.

If the operation is successful, the HLR will set the subscriber tracing in VLR or in SGSN to a deactive state.

If the MAP_DEACTIVATE_TRACE_MODE confirmation is received indicating an error situation, the errors are mapped to the OMC interface. The deactivation request may be also repeated; the number of repeat attempts and the time in between are HLR operator options, depending on the error returned by the VLR or by the SGSN.

The subscriber tracing deactivation procedure with VLR is shown in figure 20.2/8.

The subscriber tracing deactivation procedure with SGSN is shown in figure 20.2/15.

Process DTM_HLR_with_VLR

20.2_8.1(2)

Figure 20.2/8: The subscriber tracing deactivation process in the HLR

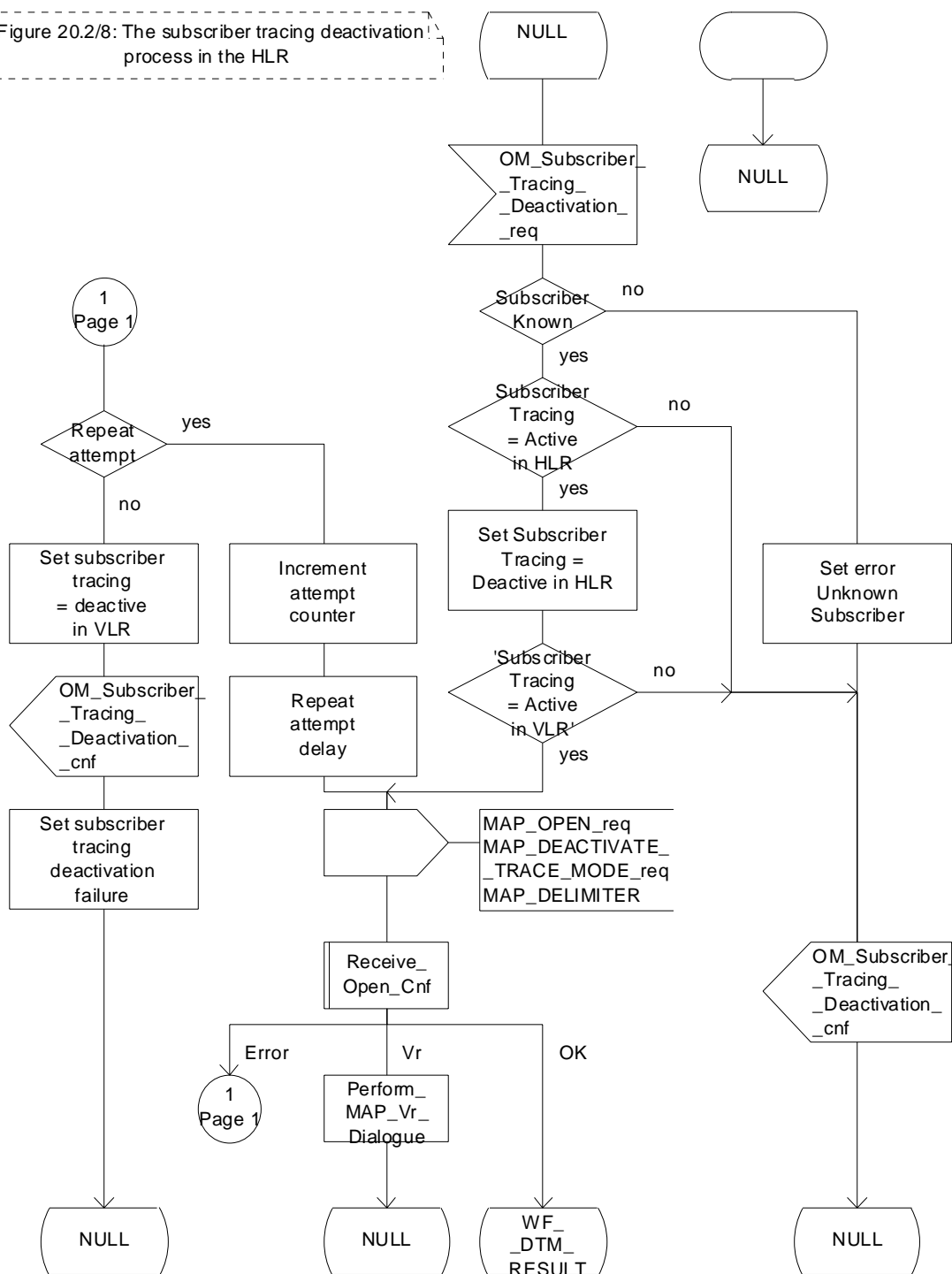

Figure 20.2/8 (sheet 1 of 2): Process DTM_HLR_with_VLR

Process DTM_HLR_with_VLR

20.2_8.2(2)

Figure 20.2/8: The subscriber tracing deactivation process in the HLR

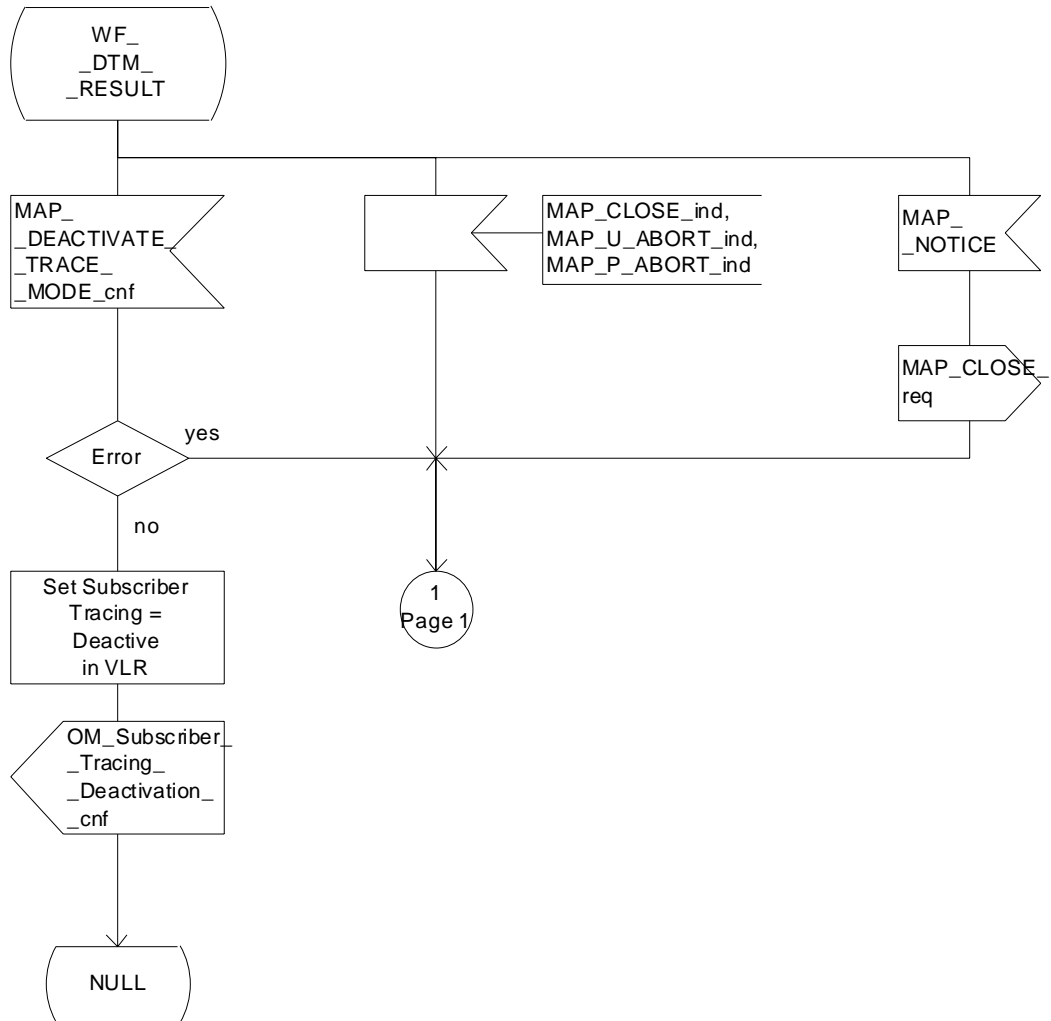

Figure 20.2/8 (sheet 2 of 2): Process DTM_HLR_with_VLR

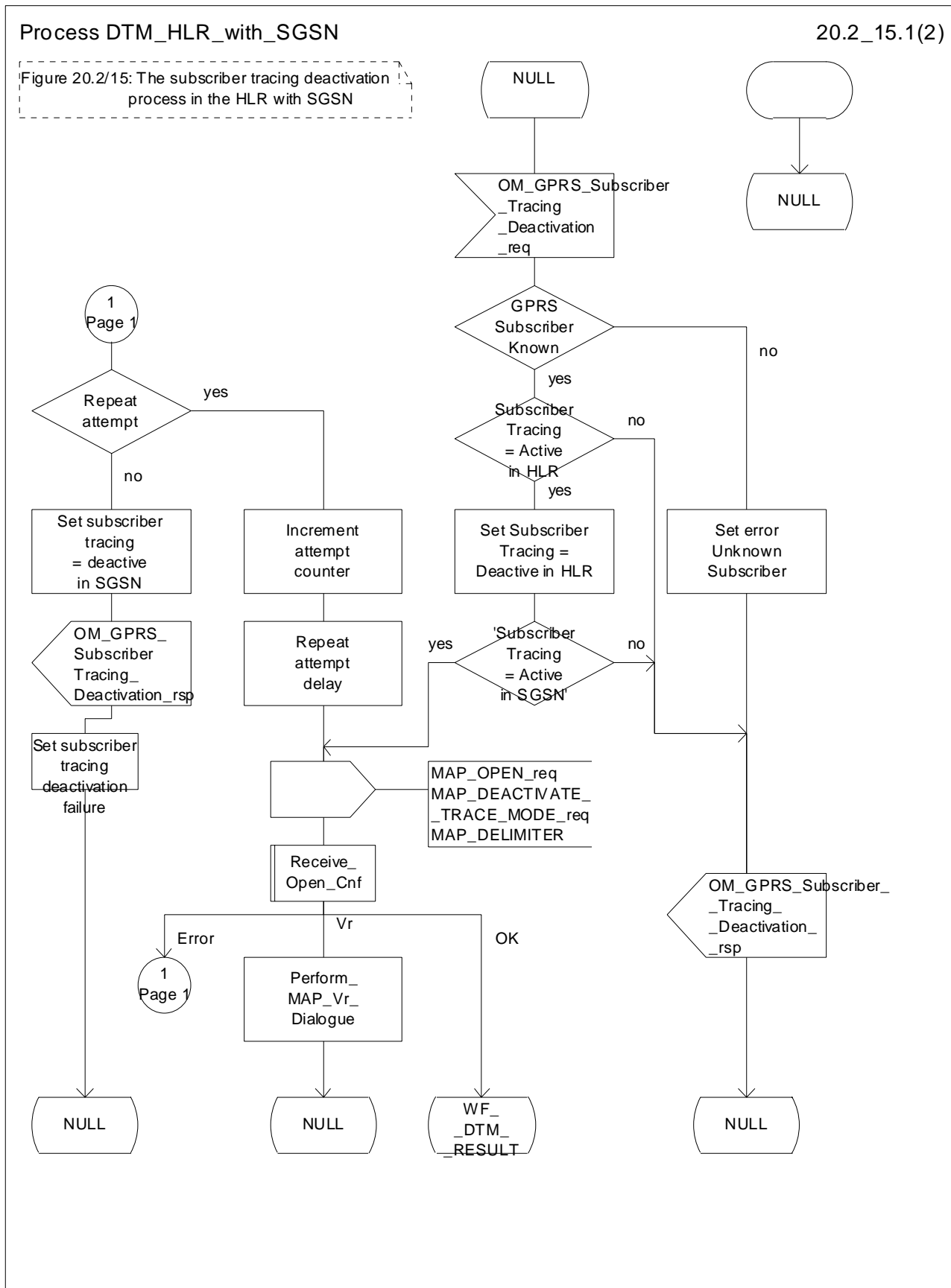

Figure 20.2/15 (sheet 1 of 2): Process DTM_HLR_with_SGSN

Process DTM_HLR_with_SGSN

20.2_15.2(2)

Figure 20.2/15: The subscriber tracing deactivation process in the HLR with SGSN

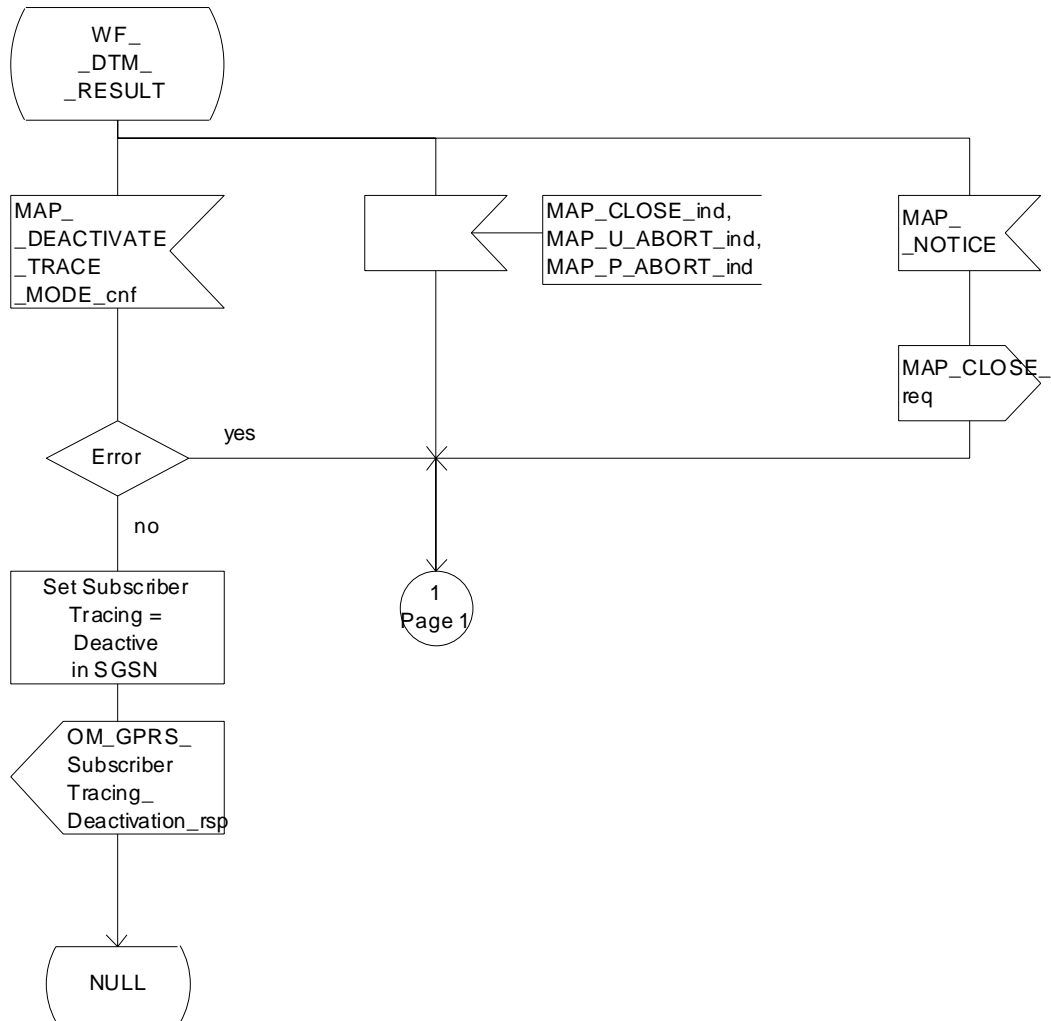

Figure 20.2/15 (sheet 2 of 2): Process DTM_HLR_with_SGSN

20.2.2 Procedures in the VLR

The VLR is involved in the following tracing procedures:

- i) Subscriber tracing activation procedure;
- ii) Subscriber tracing deactivation procedure;
- iii) Subscriber tracing procedure.

20.2.2.1 Subscriber tracing activation procedure

When receiving a MAP_ACTIVATE_TRACE_MODE indication, the VLR will check the parameters and data in the primitive. Data errors are reported as an unexpected data value error or as a data missing error depending on the nature of the error.

If the subscriber is known, the tracing facility is supported and the tracing capacity is not exceeded, the successful report is sent in the MAP_ACTIVATE_TRACE_MODE response primitive.

The MAP_ACTIVATE_TRACE_MODE indication primitive may be received during a location updating or data restoration procedure, so the location updating or restore data process shall use the macro Activate_Tracing_VLR (see figure 25.9/3).

The subscriber tracing activation process in the VLR is shown in figure 20.2/9.

Process ATM_VLR_Standalone

20.2_9(1)

FIGURE 20.2/9 The subscriber tracing activation process for standalone operation in the VLR

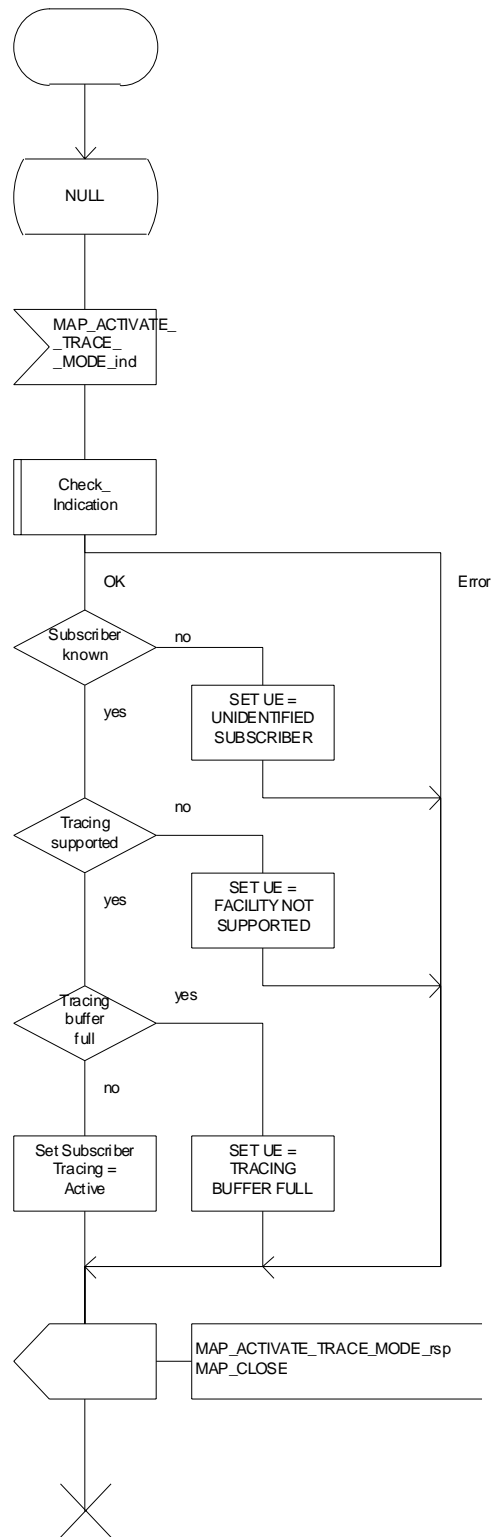

Figure 20.2/9: Process ATM_VLR_Standalone

20.2.2.2 Subscriber tracing deactivation procedure

When receiving a MAP_DEACTIVATE_TRACE_MODE indication, the VLR will check the parameters and data in the primitive. Data errors are reported as an unexpected data value error or as a data missing error depending on the nature of the error.

If the subscriber is known and the tracing facility is supported, the successful report is sent in the MAP_DEACTIVATE_TRACE_MODE response primitive.

The subscriber tracing deactivation procedure in the VLR is shown in figure 20.2/10.

Process DTM_VLR_Standalone

20.2_10(1)

Figure 20.2/10: The subscriber tracing deactivation process in the VLR

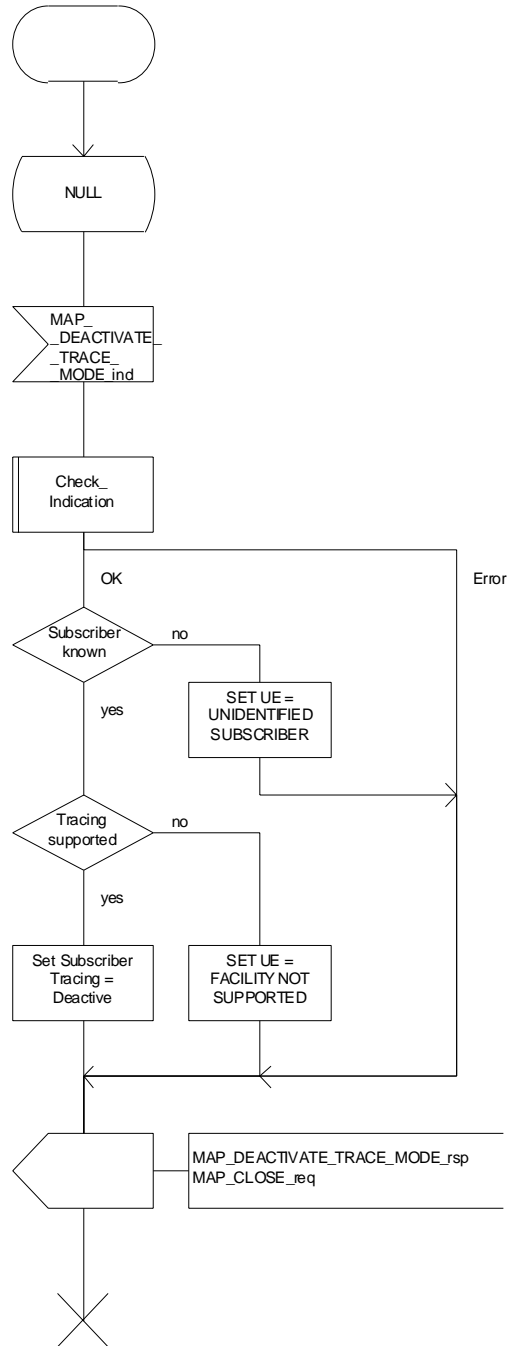

Figure 20.2/10: Process DTM_VLR_Standalone

20.2.2.3 Subscriber tracing procedure

When the VLR receives a MAP_PROCESS_ACCESS_REQUEST or MAP_UPDATE_LOCATION_AREA indication related to any subscriber activity from the MSC, the subscriber tracing procedure may be carried out. The macro Trace_Subscriber_Activity_VLR is shown in figure 25.9/2.

20.2.3 Procedures in the MSC

The MSC is involved in the following tracing procedure:

- i) Subscriber tracing procedure.

20.2.3.1 Subscriber tracing procedure

When receiving the MAP_TRACE_SUBSCRIBER_ACTIVITY indication from the VLR, the MSC stores trace reference, trace type and the identity of the OMC in charge of the trace, and the MSC starts to collect the trace information. The MSC will send the trace record to the OMC.

The macro Trace_Subscriber_Activity_MSC is shown in figure 25.9/1.

20.2.4 Procedures in the SGSN

The SGSN is involved in the following tracing procedures:

- i) Subscriber tracing activation procedure;
- ii) Subscriber tracing deactivation procedure.

20.2.4.1 Subscriber tracing activation procedure

When receiving a MAP_ACTIVATE_TRACE_MODE indication, the SGSN will check the parameters and data in the primitive. Data errors are reported as an unexpected data value error or as a data missing error depending on the nature of the error.

If the subscriber is known, the tracing facility is supported and the tracing capacity is not exceeded, the successful report is sent in the MAP_ACTIVATE_TRACE_MODE response primitive.

The MAP_ACTIVATE_TRACE_MODE indication primitive may be received during a location updating or data restoration procedure, so the location updating or restore data process shall use the macro Activate_Tracing_SGSN (see figure 25.9/7).

The subscriber tracing activation process in the SGSN is shown in figure 20.2/16.

20.2.4.2 Subscriber tracing deactivation procedure in SGSN

When receiving a MAP_DEACTIVATE_TRACE_MODE indication, the SGSN will check the parameters and data in the primitive. Data errors are reported as an unexpected data value error or as a data missing error depending on the nature of the error.

If the subscriber is known and the tracing facility is supported, the successful report is sent in the MAP_DEACTIVATE_TRACE_MODE response primitive.

The subscriber tracing deactivation procedure in the SGSN is shown in figure 20.2/17.

Process ATM_SGSN_Standalone

20.2_16(1)

FIGURE 20.2/16: The subscriber tracing activation process for standalone operation in the SGSN

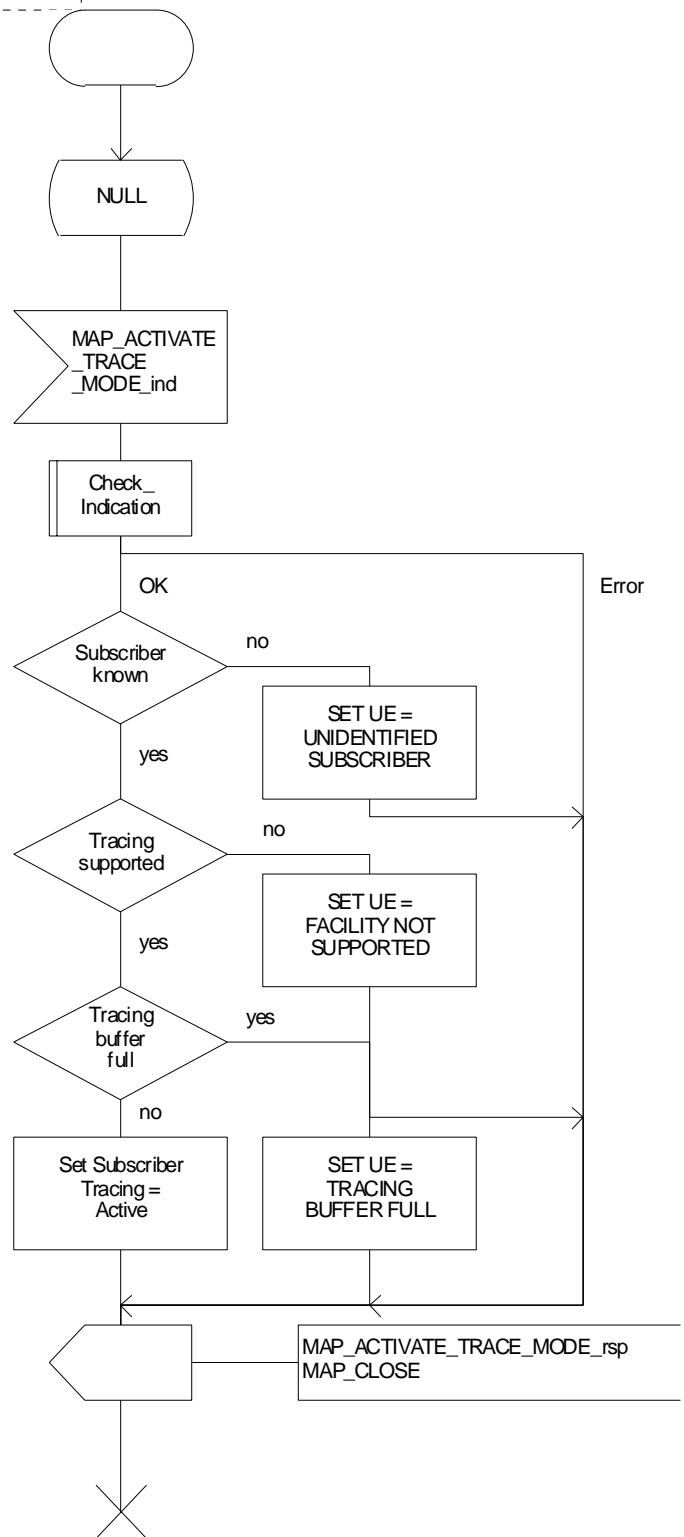

Figure 20.2/16: Process ATM_SGSN_Standalone

Process DTM_SGSN_Standalone

20.2_17(1)

Figure 20.2/17: The subscriber tracing deactivation process in the SGSN

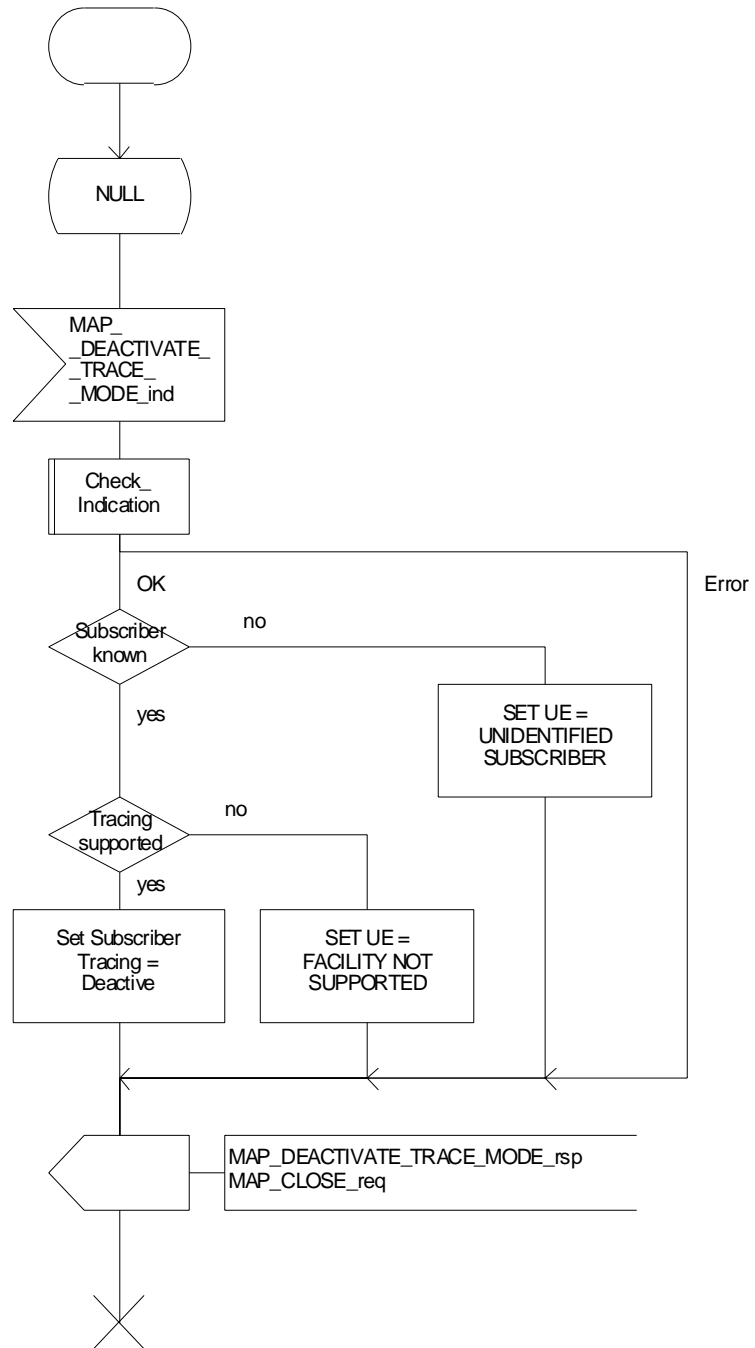

Figure 20.2/17: Process DTM_SGSN_Standalone

20.3 Subscriber data management procedures

Two types of subscriber data management procedures exist in the Mobile Application Part

- i) Subscriber Deletion;
- ii) Subscriber Data Modification.

No requirements have been identified for the Subscriber creation and subscriber data interrogation procedures.

The subscriber deletion and subscriber data modification procedures are initiated by the OMC (see figures 20.3/1 , 20.3/2, 20.3/8 and 20.3/9).

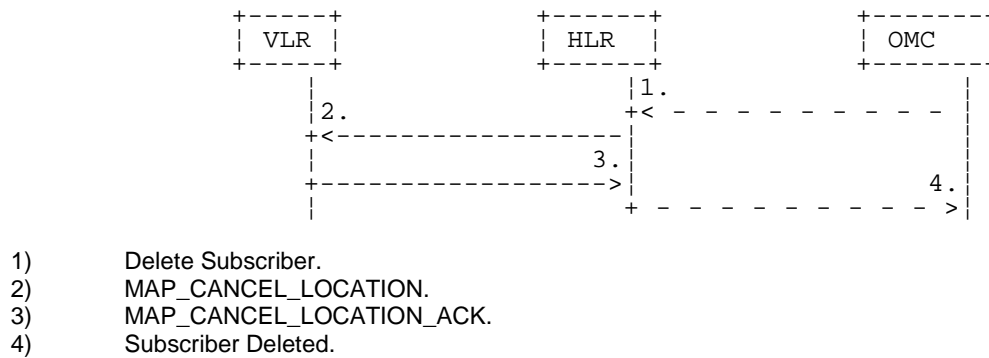

Figure 20.3/1: Subscriber deletion procedure

In the subscriber deletion procedure the subscriber data should be removed from the VLR and from the HLR. The HLR uses the MAP_CANCEL_LOCATION service.

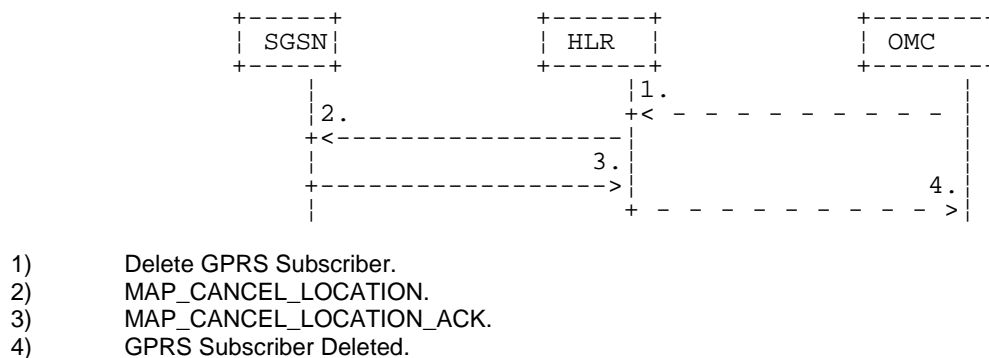

Figure 20.3/8: Subscriber deletion procedure for GPRS

In the subscriber deletion procedure the subscriber data should be removed from the SGSN and from the HLR. The HLR uses the MAP_CANCEL_LOCATION service.

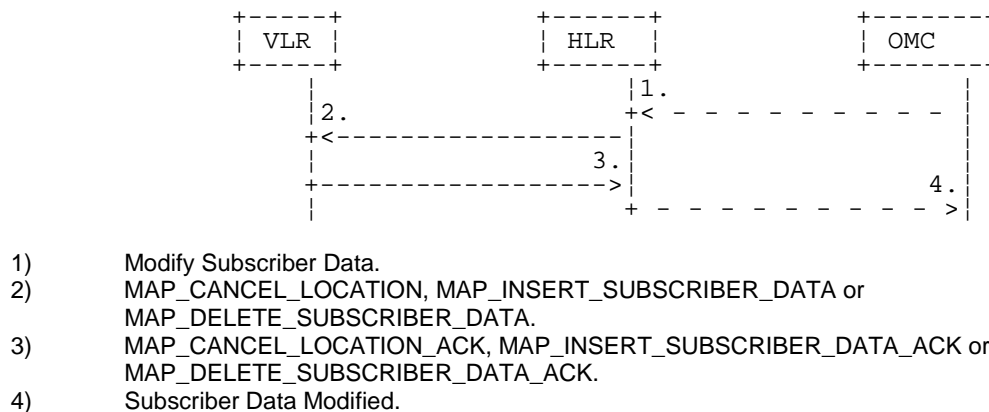
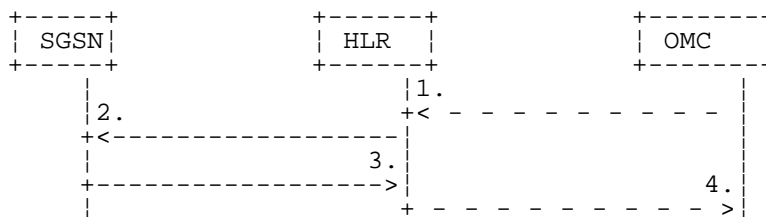

Figure 20.3/2: Subscriber data modification procedure



- 1) Modify Subscriber Data.
- 2) MAP_CANCEL_LOCATION, MAP_INSERT_SUBSCRIBER_DATA or MAP_DELETE_SUBSCRIBER_DATA.
- 3) MAP_CANCEL_LOCATION_ACK, MAP_INSERT_SUBSCRIBER_DATA_ACK or MAP_DELETE_SUBSCRIBER_DATA_ACK.
- 4) Subscriber Data Modified.

Figure 20.3/9: Subscriber data modification procedure for GPRS

In the subscriber data modification procedure the subscriber data is modified in the HLR and when necessary also in the VLR or in the SGSN. The HLR initiates either the MAP_INSERT_SUBSCRIBER_DATA, MAP_DELETE_SUBSCRIBER_DATA or MAP_CANCEL_LOCATION service depending on the modified data.

20.3.1 Procedures in the HLR

20.3.1.1 Subscriber deletion procedure

When the subscriber deletion request is received from the OMC, the HLR shall delete the subscriber data from the HLR and initiate the MAP_CANCEL_LOCATION request to the VLR or to the SGSN where the subscriber is registered.

The subscriber deletion procedure in the HLR is shown in the figure 20.3/3.

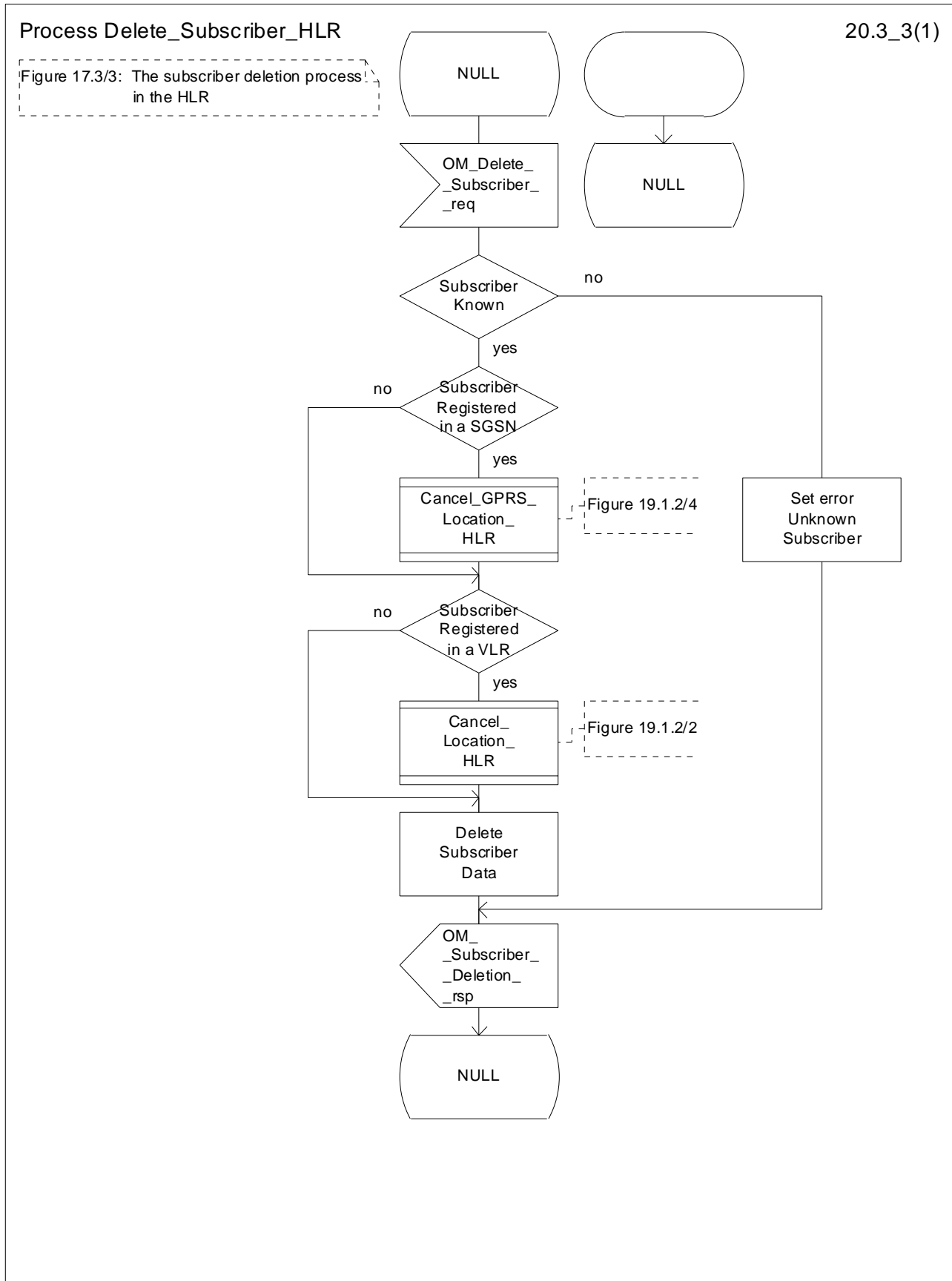

Figure 20.3/3: Process Delete_Subscriber_HLR

20.3.1.2 Subscriber data modification procedure

The OMC can modify the subscriber data in several different ways. The modifications can be categorised in following groups:

- a) no effect in the VLR;
- b) data shall be modified in both the HLR and the VLR;
- c) withdrawal of a basic service or a supplementary service requiring change to VLR data;
- d) modification affects on the roaming of the subscriber and the subscriber shall be removed from the VLR data base;
- e) authentication algorithm or authentication key of the subscriber is modified;
- f) no effect in the SGSN;
- g) data shall be modified in both the HLR and the SGSN;
- h) withdrawal of a GPRS subscription data or a basic service or both requiring change to SGSN data;
- i) modification affects on the roaming of the subscriber and the subscriber shall be removed from the SGSN data base;
- j) withdrawal of GPRS Subscription related to Network Access Mode;
- k) withdrawal of non-GPRS Subscription related to Network Access Mode;

In case "b" and "g" the MAP_INSERT_SUBSCRIBER_DATA service is initiated in the HLR.

In case "c" and "h" the MAP_DELETE_SUBSCRIBER_DATA service is initiated in the HLR.

In cases "d", "e", "i", "j" and "k" the MAP_CANCEL_LOCATION service is initiated in the HLR.

If the result of a primitive received from the VLR or from the SGSN is unsuccessful, the HLR may initiate re-attempts; the number of repeat attempts and the time in between are HLR operator options, depending on the error returned by the VLR or by the SGSN.

The subscriber data modification procedure in the HLR is shown in the figures 20.3/4, 20.3/5 and 25.7/2.

Process Modify_Data_HLR

20.3_4.1(2)

Figure 20.3/4: The subscriber data modification process in the HLR

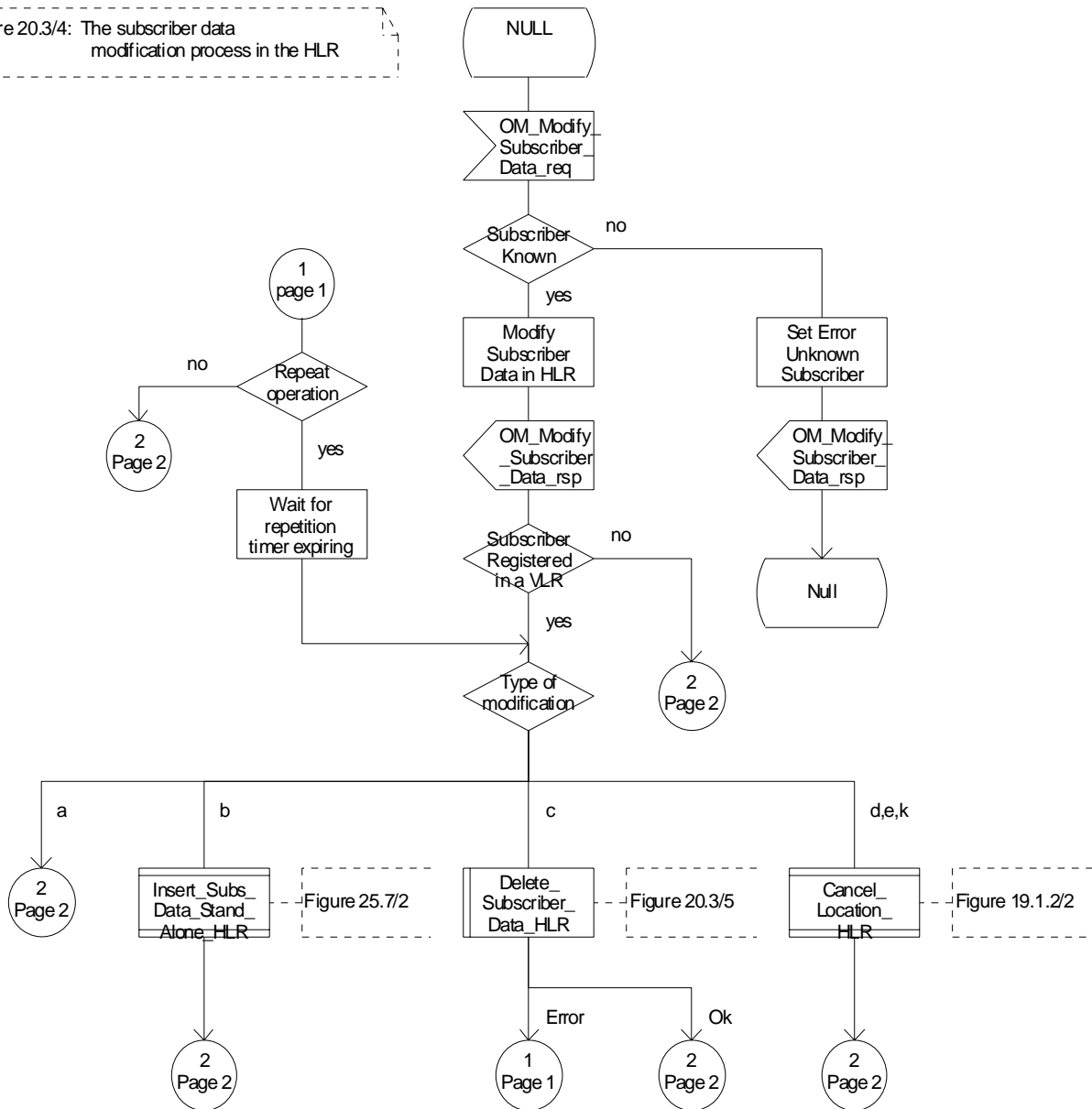

Figure 20.3/4 (sheet 1 of 2): Process Modify_Data_HLR

Process Modify_Data_HLR

20.3_4.2(2)

Figure 20.3/4: The subscriber data modification process in the HLR

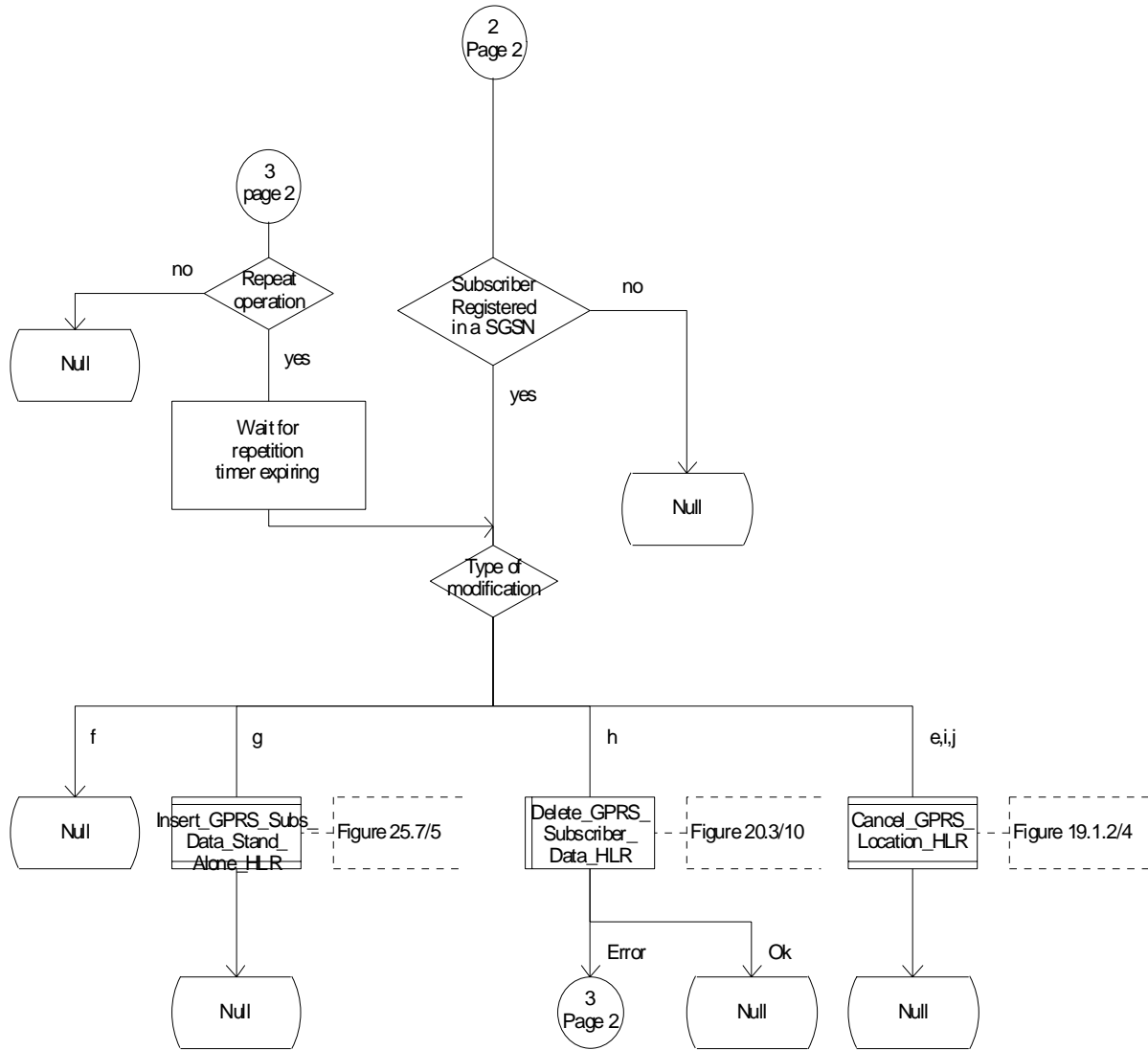

Figure 20.3/4 (sheet 2 of 2): Process Modify_Data_HLR

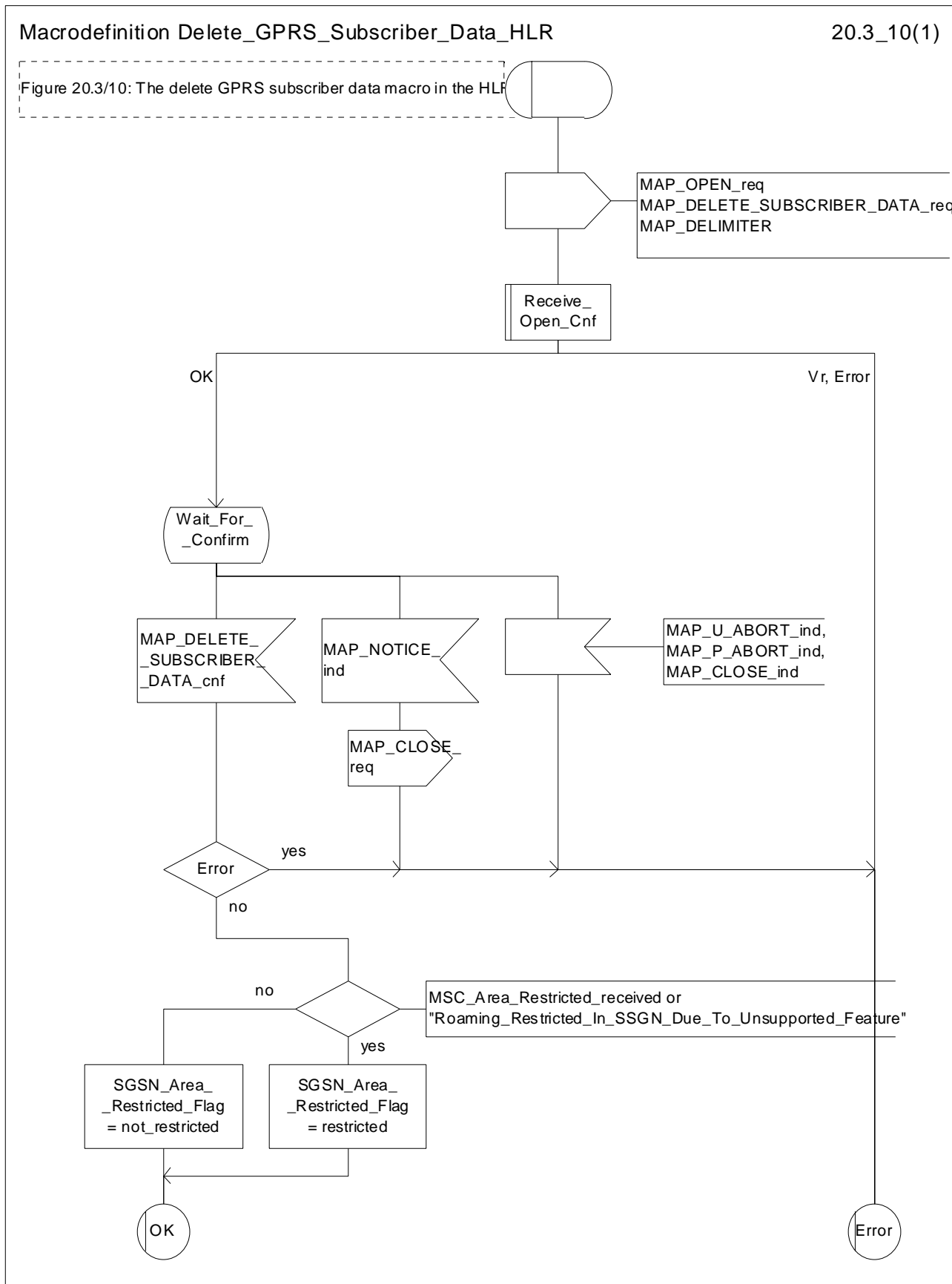

Figure 20.3/10: Macro Delete_GPRS_Subscriber_Data_HLR

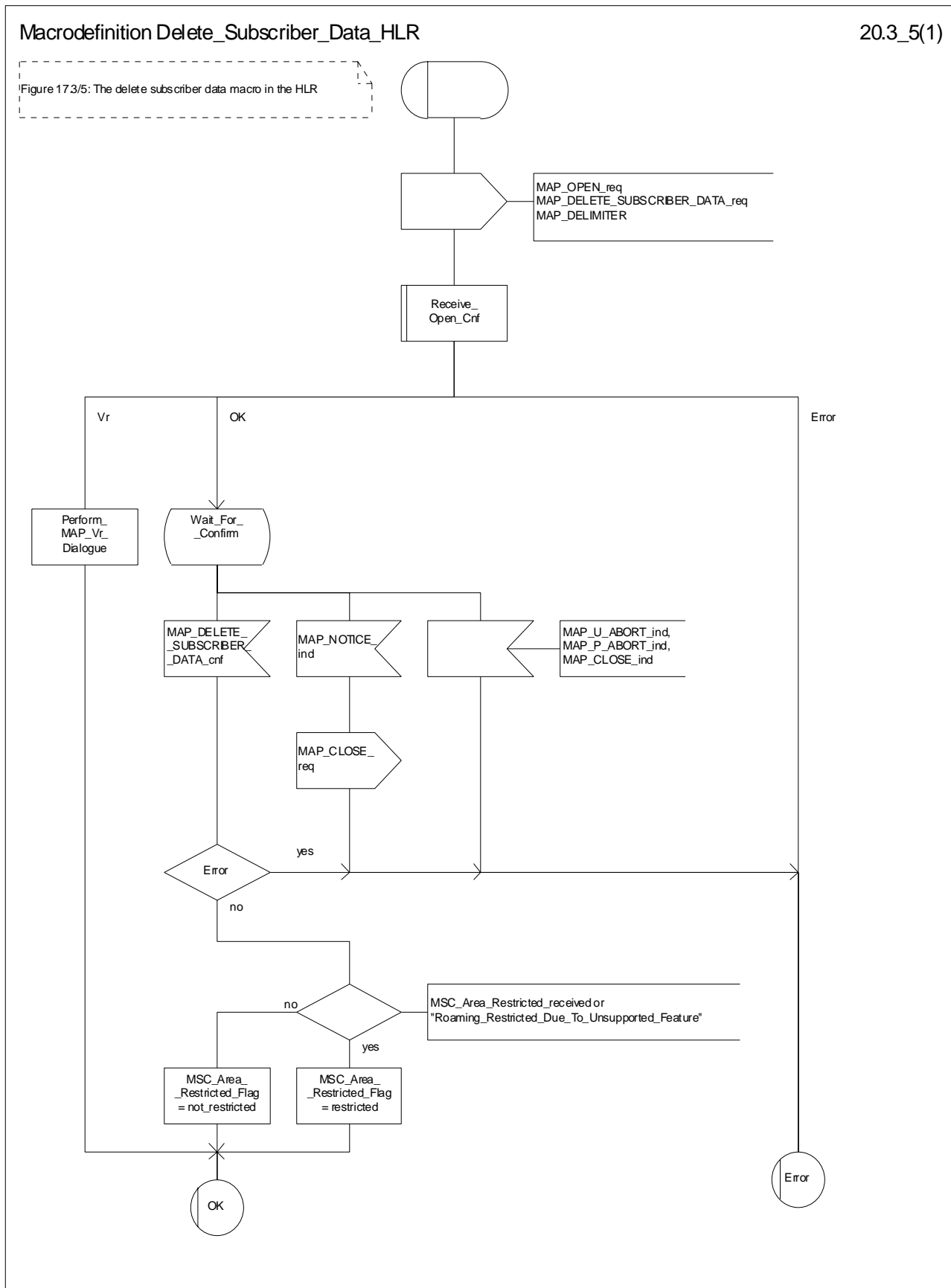

Figure 20.3/5: Macro Delete_Subscriber_Data_HLR

20.3.2 Procedures in the VLR

20.3.2.1 Subscriber deletion procedure

The subscriber deletion procedure in the VLR is described in the clause 19.1.

20.3.2.2 Subscriber data modification procedure

When receiving either the MAP_INSERT_SUBSCRIBER_DATA indication or the MAP_DELETE_SUBSCRIBER_DATA indication, the VLR checks the parameters and data in the primitive. Data errors are reported as an unexpected data value error or a data missing error depending on the nature of the error.

After receiving the first MAP_INSERT_SUBSCRIBER_DATA indication, the VLR will check the IMSI that is included in the primitive. If the IMSI is unknown, the error "Unidentified subscriber" is returned.

If the VLR does not support received basic or supplementary services or the network feature Operator Determined Barring, or there is a problem with Regional Subscription Data then it reports it to the HLR.

If the entire MSC area is restricted due to regional subscription, this is reported to the HLR.

If the updating of the subscriber data is not possible, the VLR will initiate the MAP_U_ABORT request primitive. If the updating is successful, the MAP_CLOSE indication is received from the HLR.

The subscriber data modification procedure in the VLR is shown in the figures 20.3/6, 20.3/7 and 25.7/1.

Process INS_SUBS_DATA_VLR

20.3_6(1)

Figure 20.3/6: The insert subscriber data process in the VLR

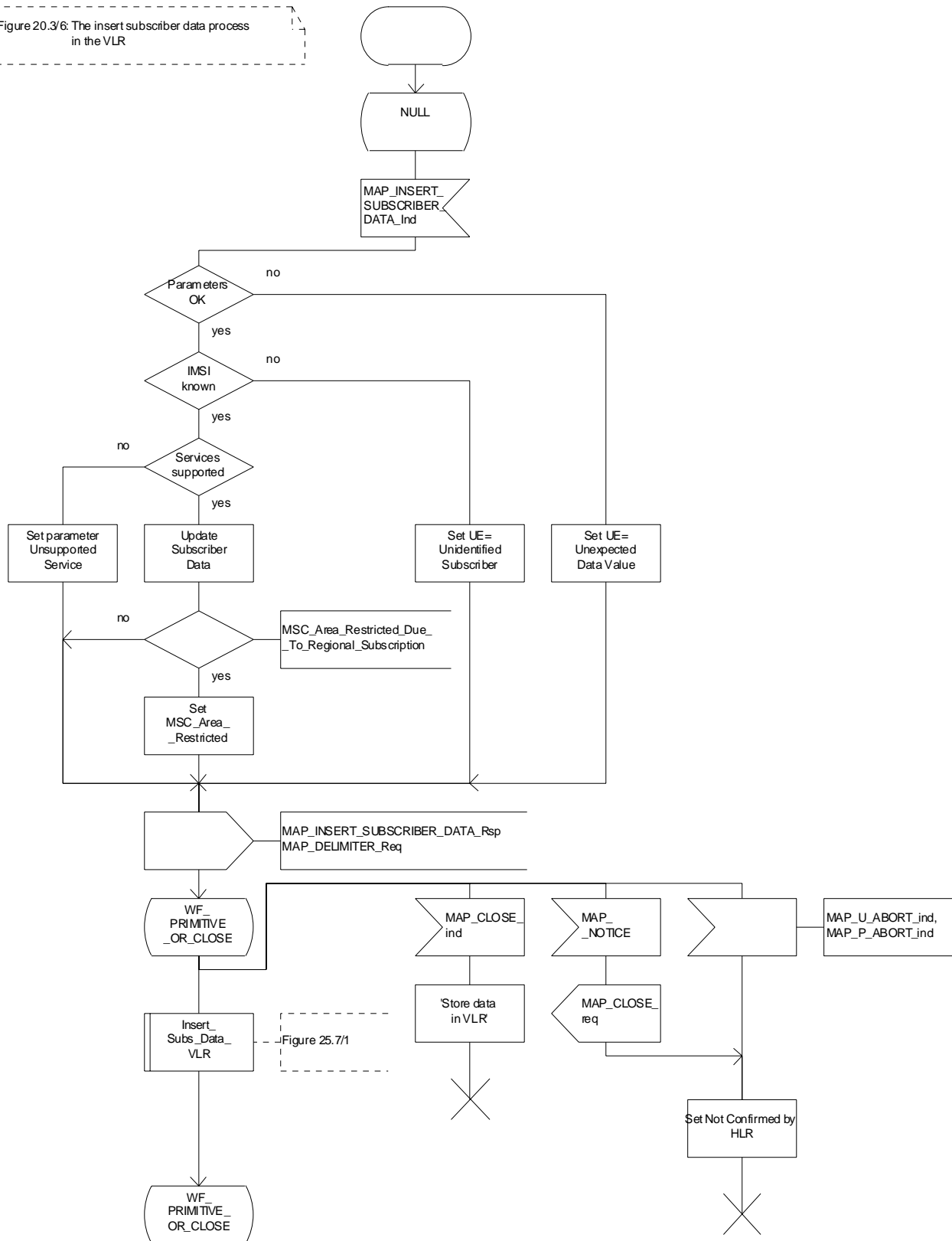

Figure 20.3/6: Process INS_SUBS_DATA_VLR

Process Delete_Subscriber_Data_VLR

20.3_7(1)

Figure 20.3/7: The delete subscriber data process in the VLR

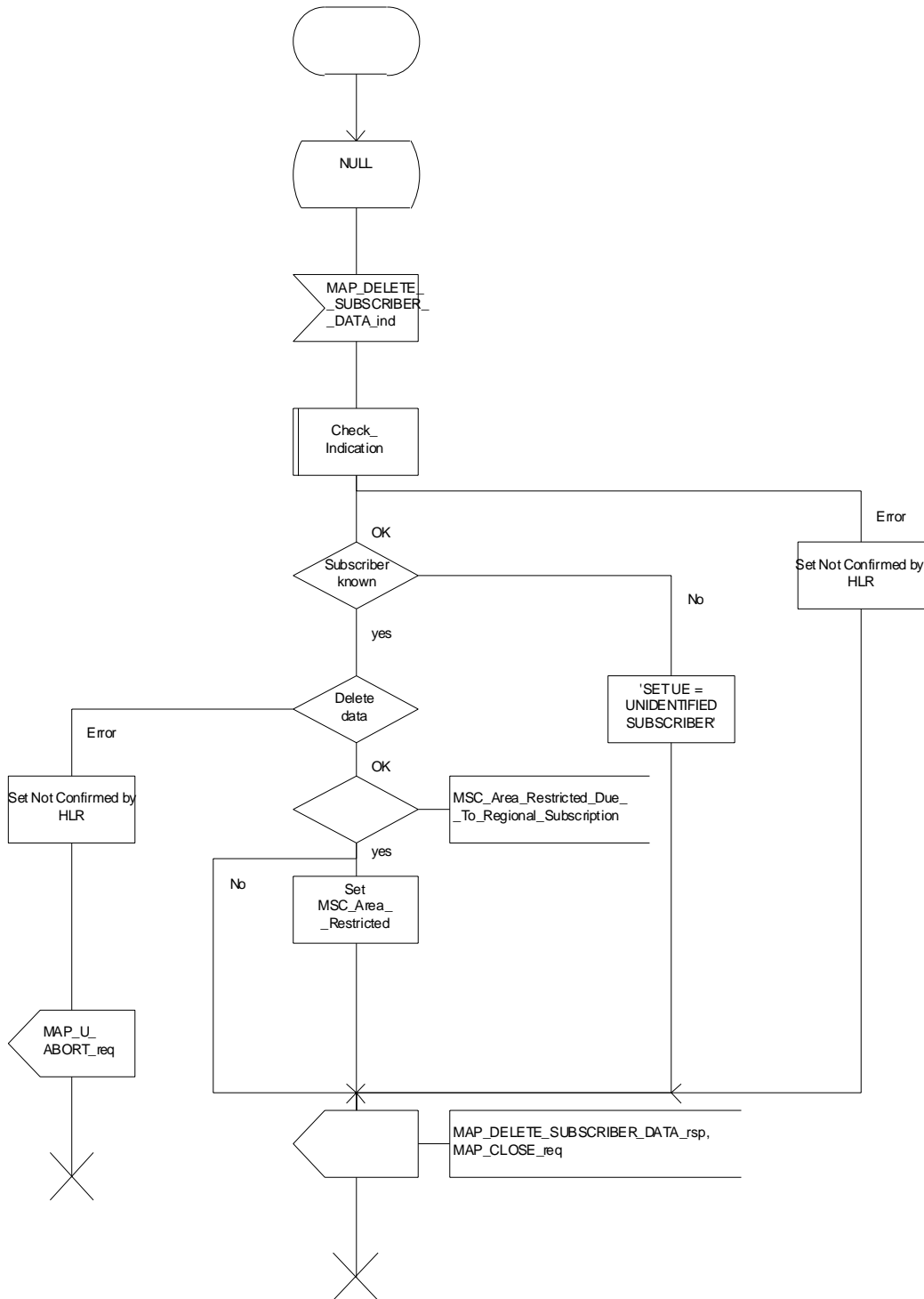

Figure 20.3/7: Process Delete_Subscriber_Data_VLR

20.3.3 Procedures in the SGSN

20.3.3.1 Subscriber deletion procedure

The subscriber deletion procedure in the SGSN is described in the clause 19.1.

20.3.3.2 Subscriber data modification procedure

When receiving either the MAP_INSERT_SUBSCRIBER_DATA indication or the MAP_DELETE_SUBSCRIBER_DATA indication, the SGSN checks the parameters and data in the primitive. Data errors are reported as an unexpected data value error or a data missing error depending on the nature of the error.

After receiving the first MAP_INSERT_SUBSCRIBER_DATA indication, the SGSN will check the IMSI that is included in the primitive. If the IMSI is unknown, the error "Unidentified subscriber" is returned.

If the SGSN does not support received basic services or the network feature Operator Determined Barring, or there is a problem with Regional Subscription Data then it reports it to the HLR.

If the entire SGSN area is restricted due to regional subscription, this is reported to the HLR.

If the updating of the subscriber data is not possible, the SGSN will initiate the MAP_U_ABORT request primitive. If the updating is successful, the MAP_CLOSE indication is received from the HLR.

The subscriber data modification procedure in the SGSN is shown in the figures 20.3/11, 20.3/12 and 25.7/5.

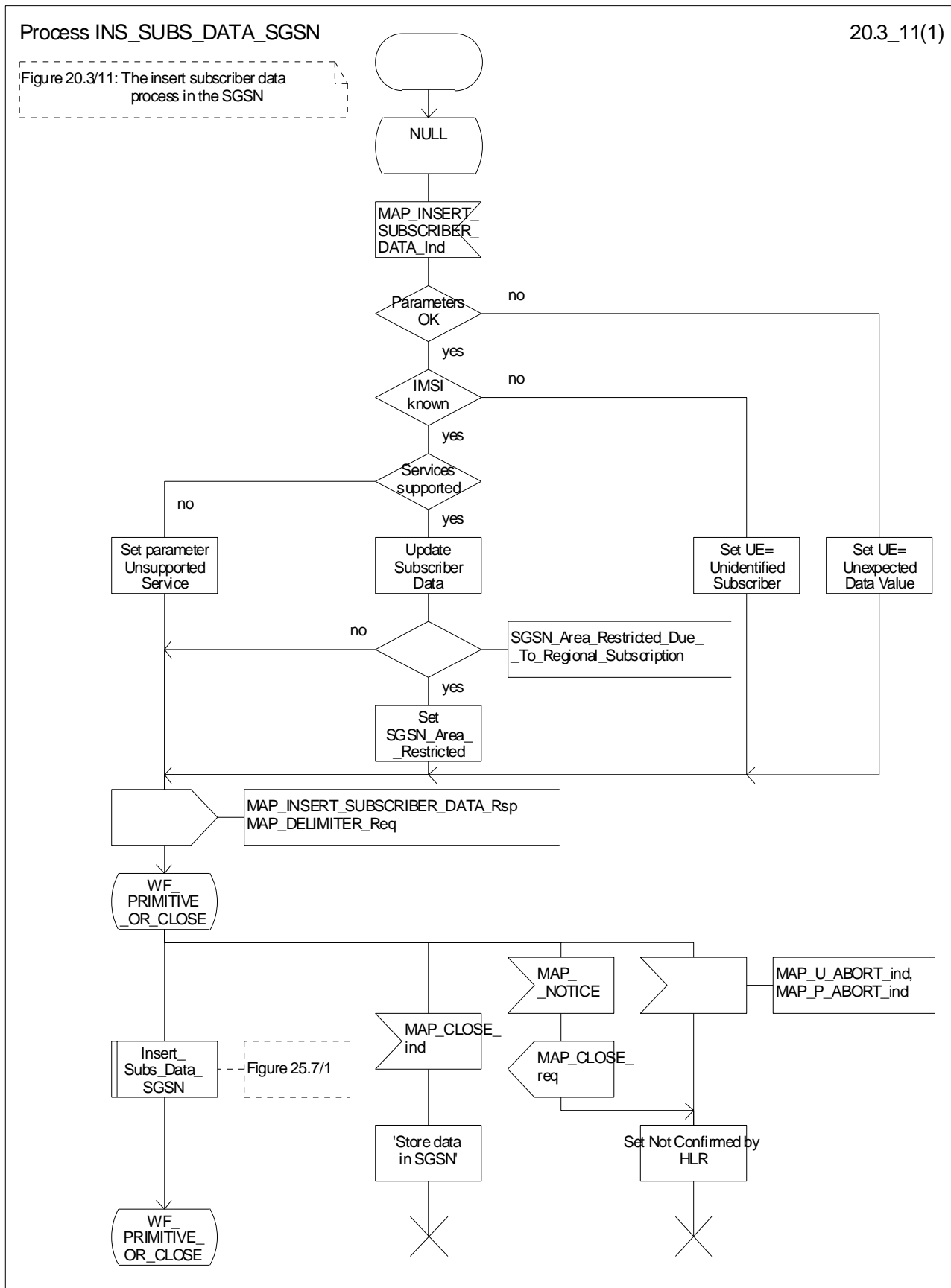

Figure 20.3/11: Process INS_SUBS_DATA_SGSN

Process Delete_Subscriber_Data_SGSN

20.3_12(1)

Figure 20.3/12: The delete subscriber data process in the SGSN

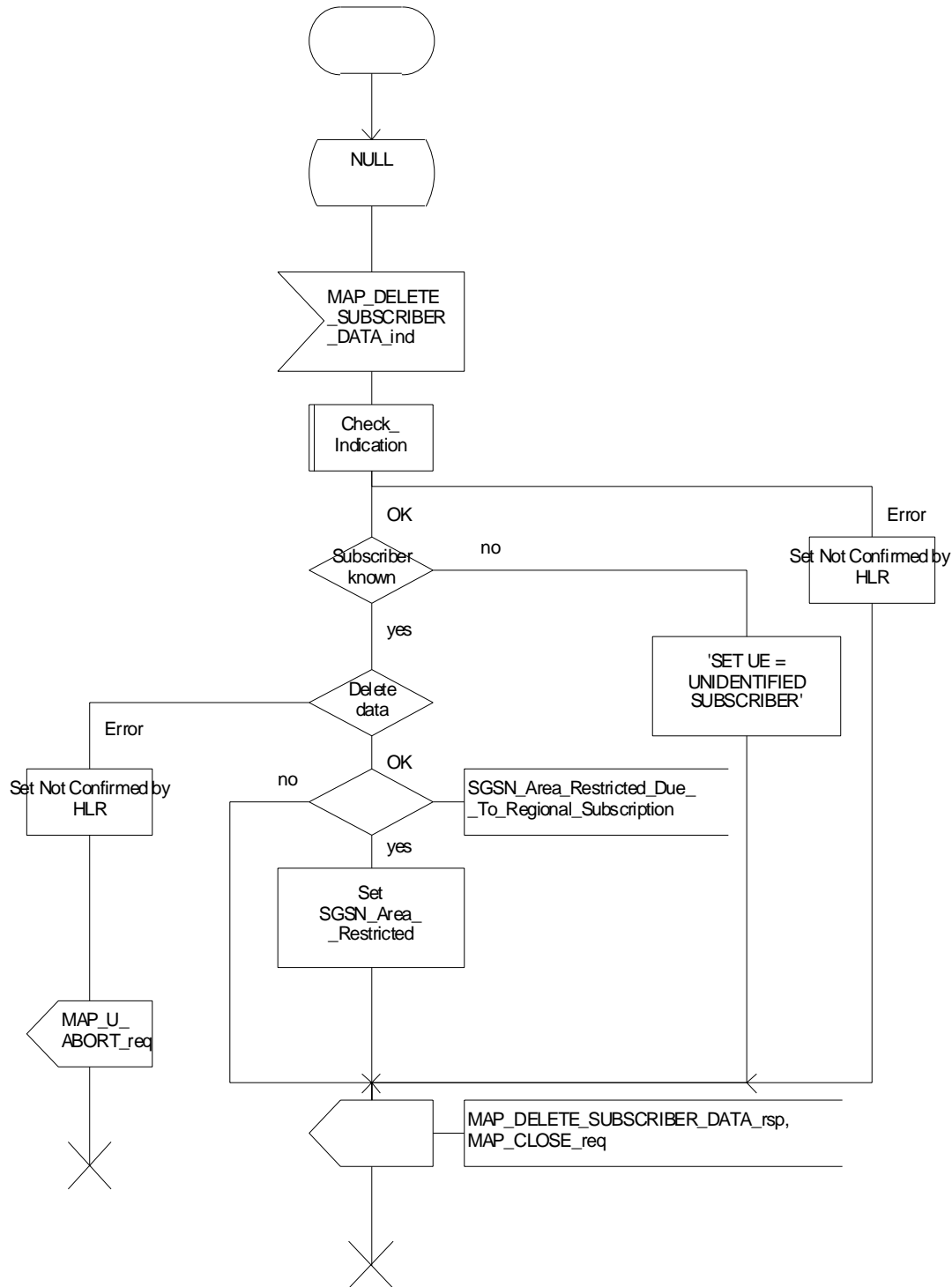
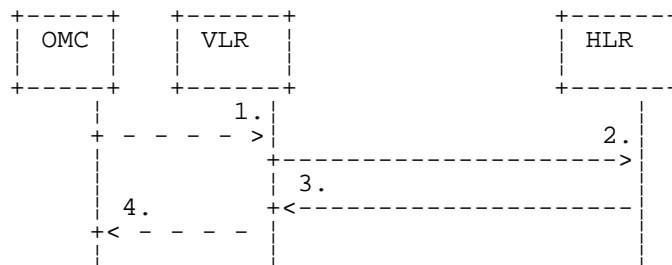

Figure 20.3/12: Process Delete_Subscriber_Data_SGSN

20.4 Subscriber Identity procedure

In the subscriber identity procedure the IMSI of the subscriber is retrieved from the HLR. The procedure is shown in figure 20.4/1.



- 1) Identity request.
- 2) MAP_SEND_IMSI.
- 3) MAP_SEND_IMSI_ACK.
- 4) Identity confirm.

Figure 20.4/1: The subscriber identity procedure

20.4.1 Subscriber identity procedure in the HLR

Opening of the dialogue is described in the macro Receive_Open_Ind in clause 25.1, with outcomes:

- procedure termination; or
- dialogue acceptance, with proceeding as below.

When receiving the MAP_SEND_IMSI indication, the HLR will check the parameters and data in the primitive. Data errors are reported as an unexpected data value error or a data missing error depending on the nature of the error.

If the subscriber is known in the HLR, the IMSI is fetched from the database and sent to the VLR. If the MSISDN cannot be identified, unknown subscriber indication is passed to the VLR.

The subscriber identity procedure in the HLR is shown in figure 20.4/2.

Process Send_IMSI_HLR

20.4_2(1)

Figure 20.4/2: The send IMSI process in the HLR

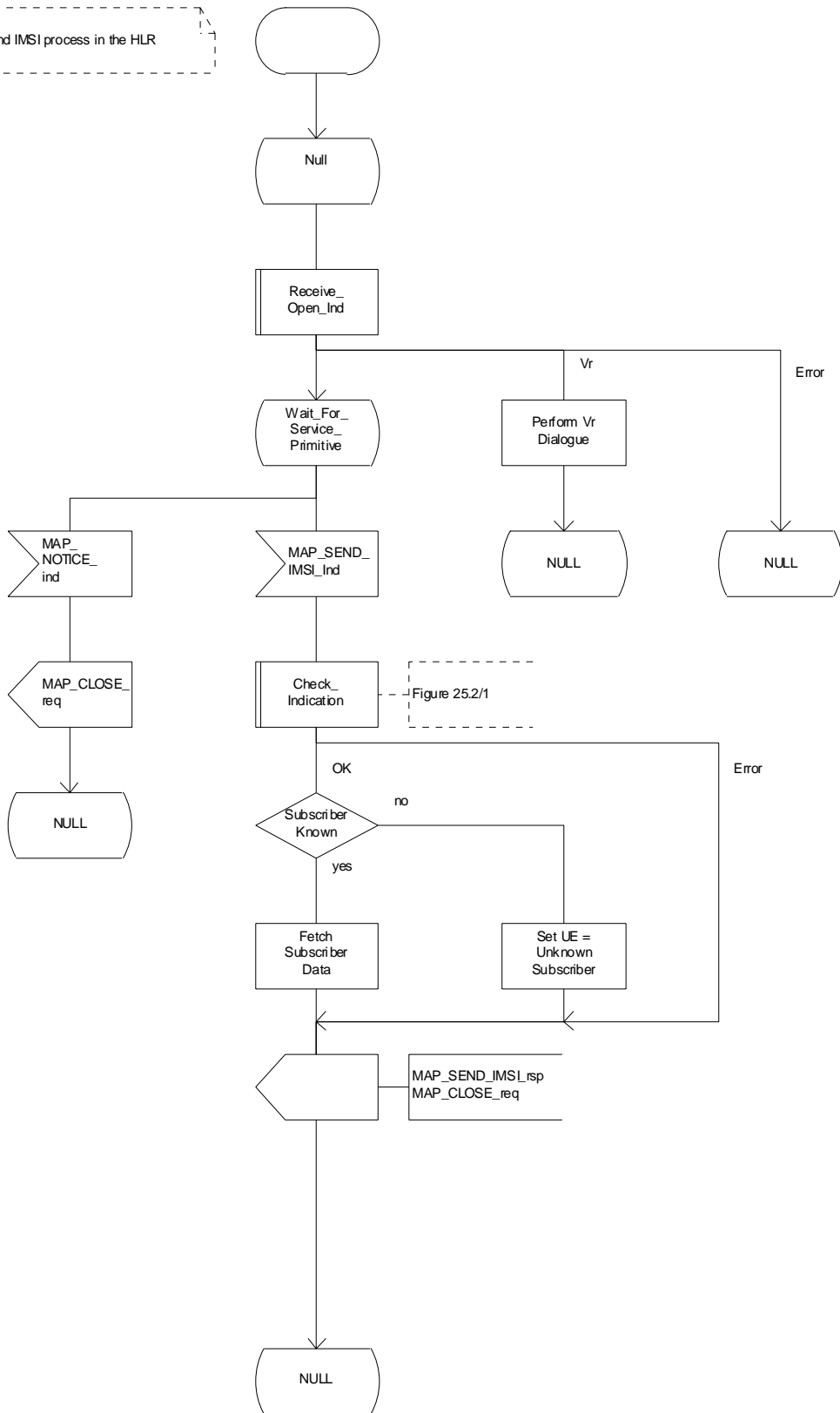

Figure 20.4/2: Process Send_IMSI_HLR

20.4.2 Subscriber identity procedure in the VLR

When the IMSI request is received from the OMC, the VLR will send the MAP_SEND_IMSI request to the HLR. The contents of the response are sent to the OMC.

The subscriber identity procedure in the VLR is shown in figure 20.4/3.

Process Send_IMSI_VLR

20.4_3(1)

Figure 20.4/3: The send IMSI process in the VLR

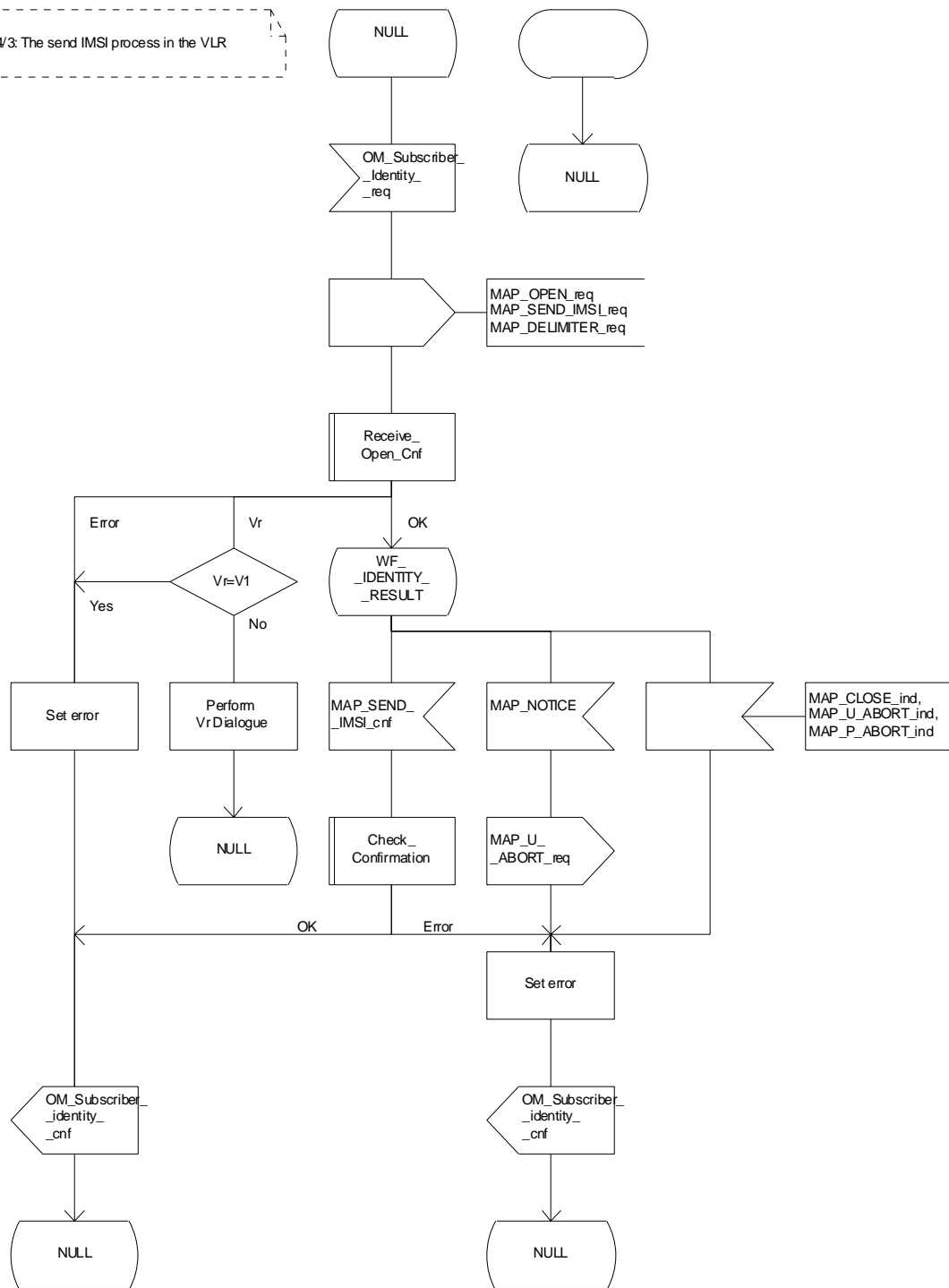

Figure 20.4/3: Process Send_IMSI_VLR

21 Call handling procedures

21.1 General

The MAP call handling procedures are used:

- to retrieve routing information to handle a mobile terminating call;
- to transfer control of a call back to the GMSC if the call is to be forwarded;
- to retrieve and transfer information between anchor MSC and relay MSC for inter MSC group calls / broadcast calls;
- to allocate resources in an SIWFS;
- to handle the reporting of MS status for call completion services;
- to handle the notification of remote user free for CCBS;
- to handle the alerting and termination of ongoing call activities for a specific subscriber.

The procedures to handle a mobile originating call and a mobile terminating call after the call has arrived at the destination MSC do not require any signalling over a MAP interface. These procedures are specified in 3GPP TS 23.018 [97].

The stage 2 specification for the retrieval of routing information to handle a mobile terminating call is in 3GPP TS 23.018 [97]; modifications to this procedure for CAMEL are specified in 3GPP TS 23.078 [98], for optimal routing of a basic mobile-to-mobile call in 3GPP TS 23.079 [99] and for CCBS in 3GPP TS 23.093 [107]. The interworking between the MAP signalling procedures and the call handling procedures for each entity (GMSC, HLR and VLR) is shown by the transfer of signals between these procedures.

The stage 2 specification for the transfer of control of a call back to the GMSC if the call is to be forwarded is in 3GPP TS 23.079 [99]. The interworking between the MAP signalling procedures and the call handling procedures for each entity (VMSC and GMSC) is shown by the transfer of signals between these procedures.

The stage 2 specifications for inter MSC group calls / broadcast calls are in 3GPP TS 43.068 [100] and 3GPP TS 43.069 [101]. The interworking between the MAP signalling procedures and the group call /broadcast call procedures for each entity (Anchor MSC and Relay MSC) is shown by the transfer of signals between these procedures.

The stage 2 specification for the allocation of resources in an SIWFS is in GSM 03.54. The interworking between the MAP signalling procedures and the call handling procedures for each entity (VMSC and SIWFS) is shown by the transfer of signals between these procedures.

The interworking between the call handling procedures and signalling protocols other than MAP are shown in 3GPP TS 23.018, 3GPP TS 23.078 and 3GPP TS 23.079 [99].

The stage 2 specification for the handling of reporting of MS status for call completion services and notification of remote user free for CCBS is in 3GPP TS 23.093 [107].

21.2 Retrieval of routing information

21.2.1 General

The message flows for successful retrieval of routing information for a mobile terminating call are shown in figure 21.2/1 (mobile terminating call which has not been optimally routed) and 21.2/2 (mobile-to-mobile call which has been optimally routed). The message flow for successful retrieval of routing information for a gsmSCF initiated call is shown in figure 21.2/x.

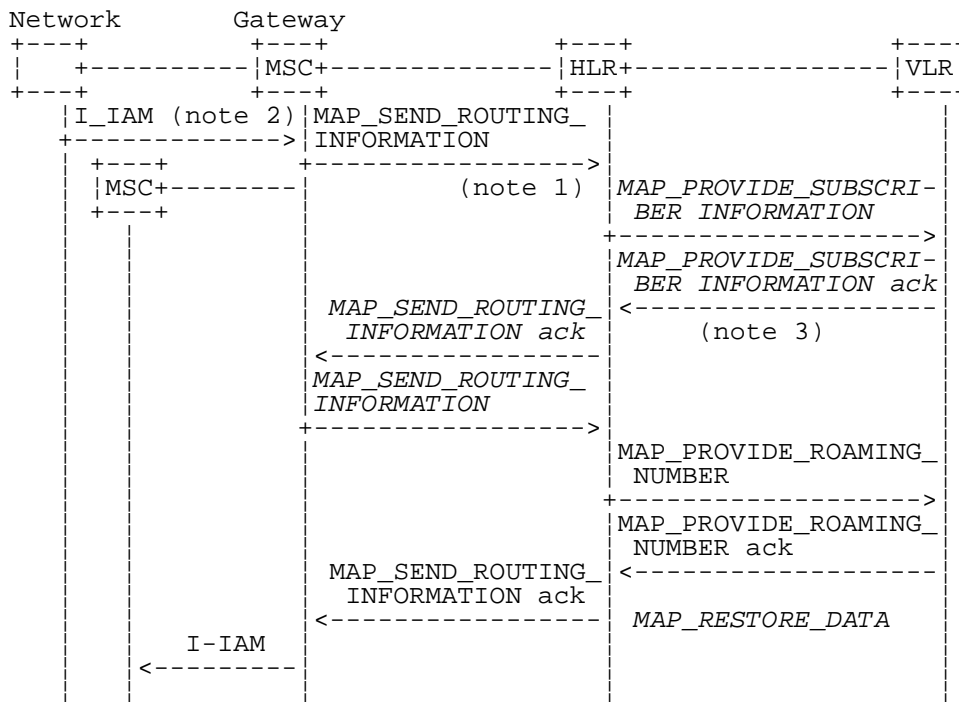

xxx = Optional Procedure

NOTE 1: This service may also be used by an ISDN exchange for obtaining routing information from the HLR.

NOTE 2: TUP or ISUP may be used in signalling between MSCs, depending on the network type between the MSCs. For further details on the TUP and ISUP procedures refer to the following ITU-T Recommendations and ETSI specification:

- Q.721-725 - Telephone User Part (TUP);
- ETS 300 356-1 - Integrated Services Digital Network (ISDN); Signalling System No.7; ISDN User Part (ISUP) version 2 for the international interface; Part 1: Basic services.

NOTE 3: As a network operator option, the HLR sends MAP_PROVIDE_SUBSCRIBER_INFORMATION to the VLR. For further details on the CAMEL procedures refer to 3GPP TS 23.078 [98].

Figure 21.2/1: Message flow for retrieval of routeing information (non-optimally routed call)

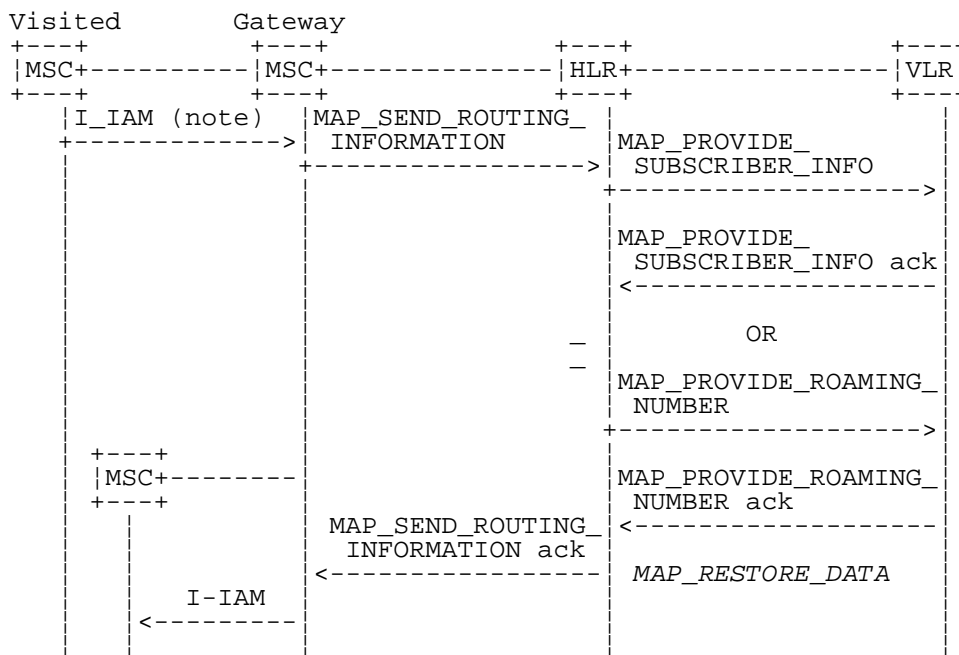

xxx = Optional Procedure

NOTE 1: For Optimal Routing phase 1, only one of the information flows for Provide Subscriber Info and Provide Roaming Number is used. For later phases of Optimal Routing, the HLR may return a MAP_SEND_ROUTEING_INFORMATION ack after the Provide Subscriber Info information flow, and the GMSC may send a second MAP_SEND_ROUTEING_INFORMATION, which will trigger the Provide Roaming Number information flow.

NOTE 2: TUP or ISUP may be used in signalling between MSCs, depending on the network type between the MSCs. For further details on the TUP and ISUP procedures refer to the following CCITT

Recommendations & ETSI specification:

- Q.721-725 - Telephone User Part (TUP);
- ETS 300 356-1 - Integrated Services Digital Network (ISDN); Signalling System No.7; ISDN User Part (ISUP) version 2 for the international interface; Part 1: Basic services.

Figure 21.2/2: Message flow for retrieval of routing information (optimally routed call)

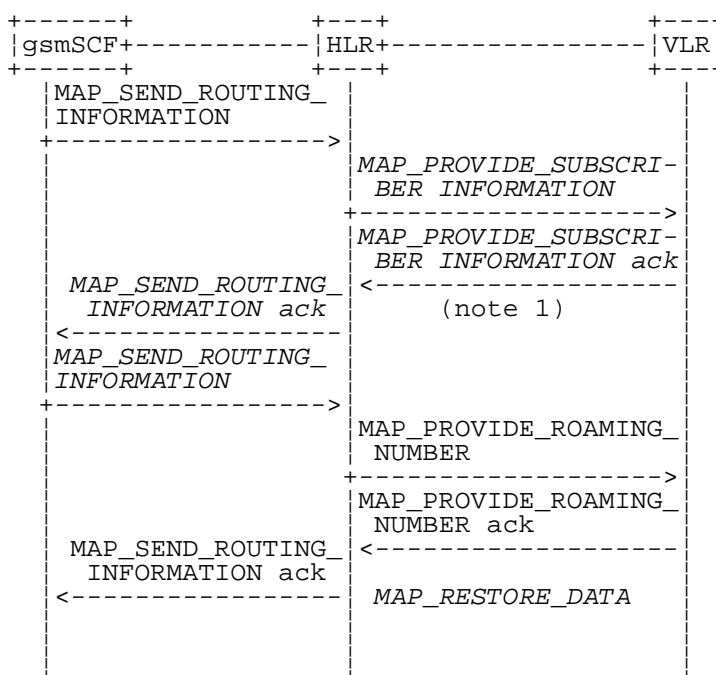

xxx = Optional Procedure

NOTE 1: As a network operator option, the HLR sends MAP_PROVIDE_SUBSCRIBER_INFORMATION to the VLR. For further details on the CAMEL procedures refer to 3GPP TS 23.078 [98].

Figure 21.2/x: Message flow for retrieval of routing information for a gsmSCF initiated call

The following MAP services are used to retrieve routing information:

MAP_SEND_ROUTING_INFORMATION	see clause 10.1;
MAP_PROVIDE_ROAMING_NUMBER	see clause 10.2;
MAP_PROVIDE_SUBSCRIBER_INFO	see clause 8.11.2;
MAP_RESTORE_DATA	see clause 8.10.3.

21.2.2 Process in the GMSC

The MAP process in the GMSC to retrieve routing information for a mobile terminating call is shown in figure 21.2/3. The MAP process invokes macros not defined in this clause; the definitions of these macros can be found as follows:

Receive_Open_Cnf	see clause 25.1.2;
Check_Confirmation	see clause 25.2.2.

Successful Outcome

When the MAP process receives a Send Routeing Info request from the call handling process in the GMSC, it requests a dialogue with the HLR whose identity is contained in the Send Routeing Info request by sending a MAP_OPEN service request, requests routing information using a MAP_SEND_ROUTING_INFORMATION service request and invokes the macro Receive_Open_Cnf to wait for the response to the dialogue opening request. If the dialogue opening is successful, the MAP process waits for a response from the HLR.

If the MAP process receives a MAP_SEND_ROUTING_INFORMATION service confirm from the HLR, the MAP process invokes the macro Check_Confirmation to check the content of the confirm. If the MAP_SEND_ROUTING_INFORMATION confirm from the HLR cannot be carried in a single TC-Result component, it is carried in one or more TC-Result-NL components (each sent in a TC-CONTINUE), followed by a TC-Result-L component in a TC-END message.

If the macro Check_Confirmation takes the OK exit, the MAP process sends a Send Routeing Info ack containing the routing information received from the HLR to the call handling process in the GMSC and returns to the idle state.

Earlier version MAP dialogue with the HLR

If the macro Receive_Open_Cnf takes the Vr exit, the MAP process checks whether this is an OR interrogation (indicated by the inclusion of the OR interrogation parameter in the MAP_SEND_ROUTING_INFORMATION service request).

If this is not an OR interrogation, the GMSC performs the earlier version MAP dialogue as specified in [51] and the process returns to the idle state.

If this is an OR interrogation, the MAP process sends a Send Routeing Info negative response indicating OR not allowed to the call handling process in the GMSC and returns to the idle state.

Dialogue opening failure

If the macro Receive_Open_Cnf indicates that the dialogue with the HLR could not be opened, the MAP process sends an Abort to the call handling process in the GMSC and returns to the idle state.

Error in MAP_SEND_ROUTING_INFORMATION confirm

If the MAP_SEND_ROUTING_INFORMATION service confirm contains a user error or a provider error, or the macro Check_Confirmation indicates that there is a data error, the MAP process sends a Send Routeing Info negative response to the call handling process in the GMSC and returns to the idle state.

Call release

If the call handling process in the GMSC indicates that the call has been aborted (i.e. prematurely released by the calling subscriber), the MAP process returns to the idle state. Any response from the HLR will be discarded.

Abort of HLR dialogue

After the dialogue with the HLR has been established, the MAP service provider may abort the dialogue by issuing a MAP_P_ABORT indication, or the HLR may send a MAP_U_ABORT indication or a MAP_CLOSE indication. In any of these cases, the MAP process sends a Send Routeing Info negative response to the call handling process in the GMSC and returns to the idle state.

If the MAP provider indicates a protocol problem by sending a MAP_NOTICE indication, the MAP process closes the dialogue with the HLR, sends a Send Routeing Info negative response indicating system failure to the call handling process in the GMSC and returns to the idle state.

Process SRI_GMSC

21.2_3.1(2)

Figure 21.2/3: Process in the GMSC for retrieval of routing information

Signals to/from the left are to/from the GMSC call handling process; signals to/from the right are to/from the HLR

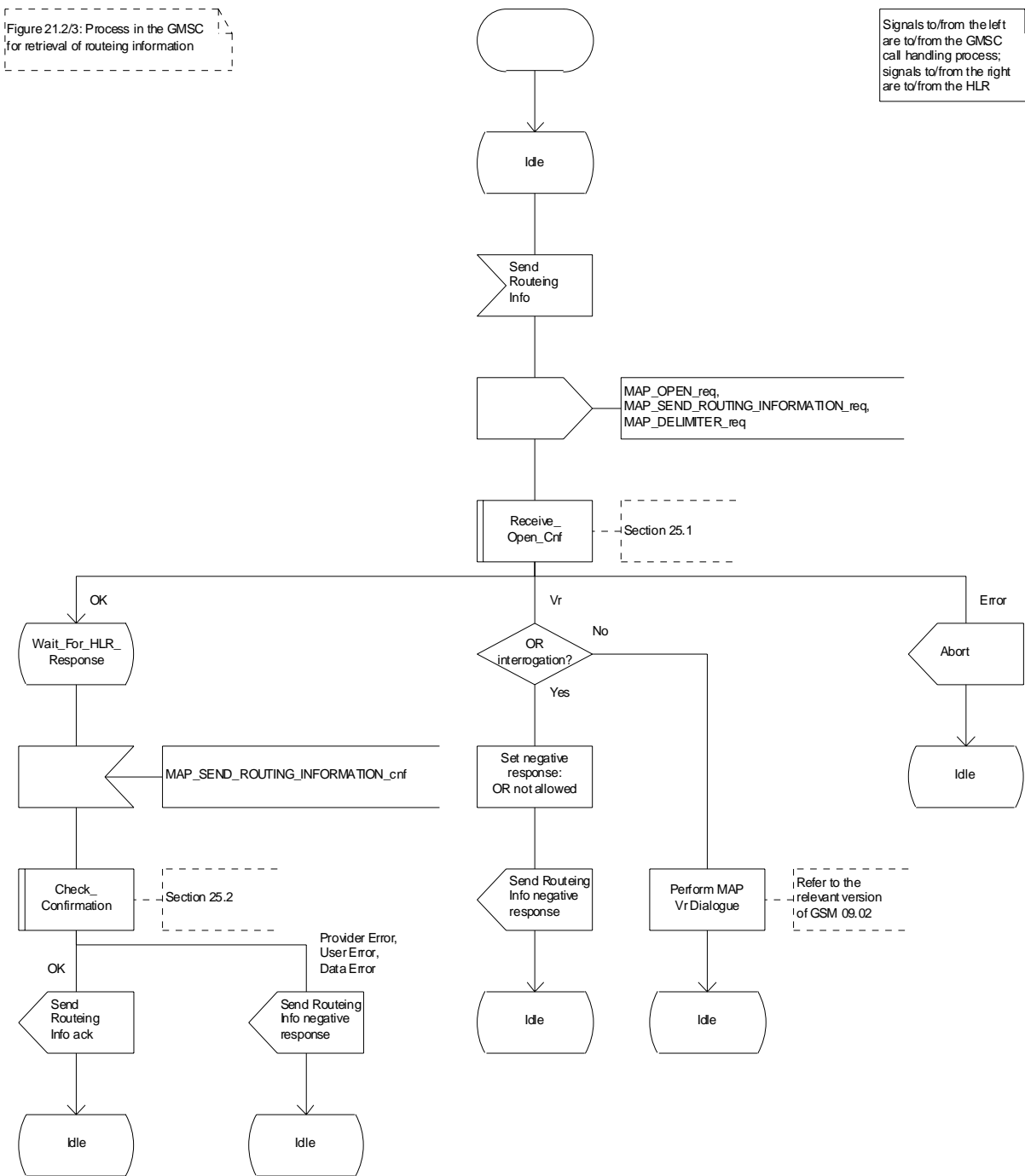

Figure 21.2/3 (sheet 1 of 2): Process SRI_GMSC

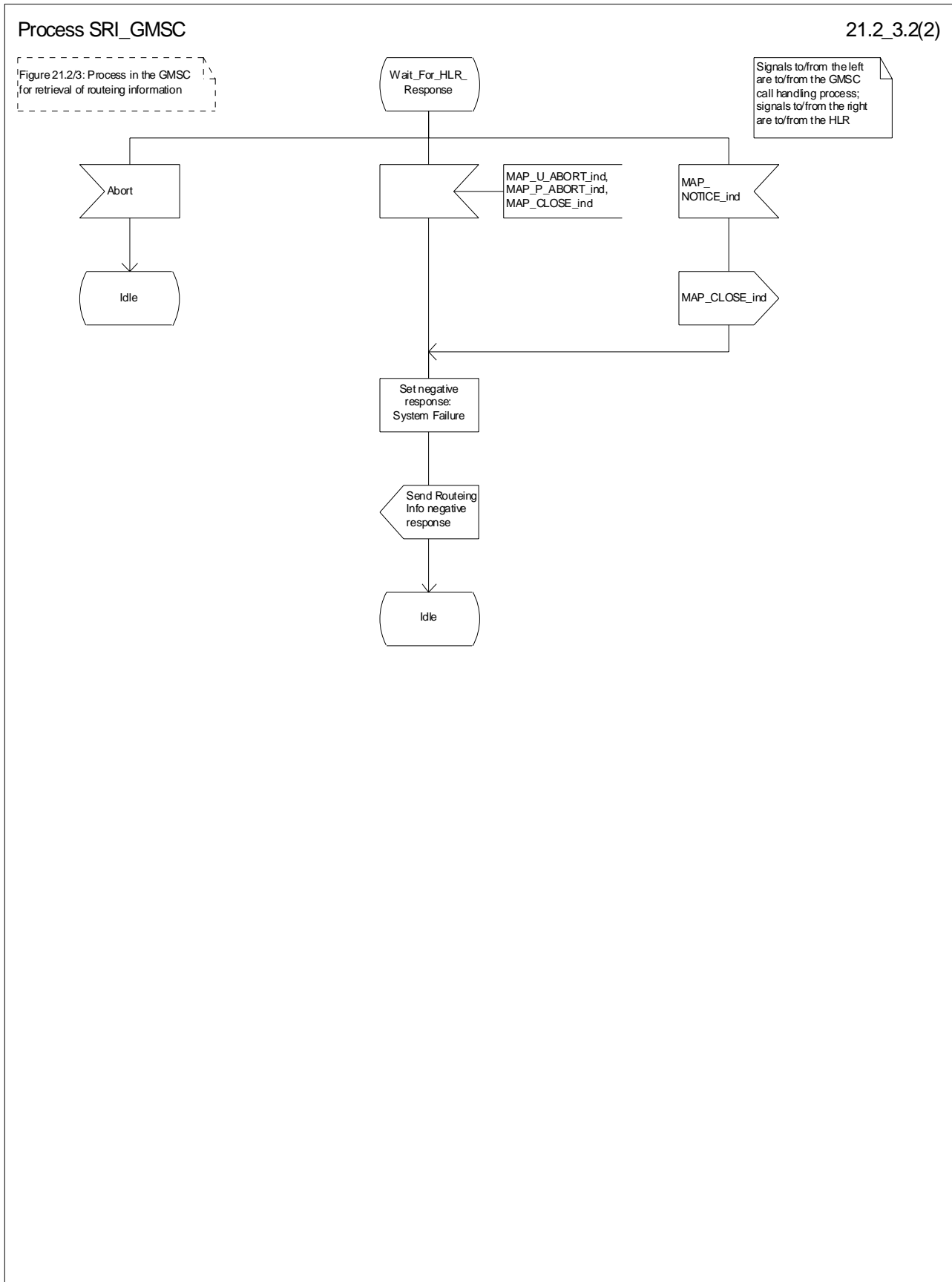

Figure 21.2/3 (sheet 2 of 2): Process SRI_GMSC

21.2.3 Procedures in the HLR

The MAP process in the HLR to retrieve routing information for a mobile terminating call is shown in figure 21.2/4. The MAP process invokes macros not defined in this clause; the definitions of these macros can be found as follows:

Receive_Open_Ind	see clause 25.1.1;
Receive_Open_Cnf	see clause 25.1.2;
Check_Confirmation	see clause 25.2.2.

Successful outcome

When the MAP process receives a MAP_OPEN indication with the application context locInfoRetrieval, it checks it by invoking the macro Receive_Open_Ind.

If the macro takes the OK exit, the MAP process waits for a service indication.

If a MAP_SEND_ROUTING_INFORMATION service indication is received, the MAP process sends a Send Routing Info request to the call handling process in the HLR, and waits for a response. The Send Routing Info request contains the parameters received in the MAP_SEND_ROUTING_INFORMATION service indication.

If the call handling process in the HLR returns a Send Routing Info ack, the MAP process constructs a MAP_SEND_ROUTING_INFORMATION service response containing the routing information contained in the Send Routing Info ack, constructs a MAP_CLOSE service request, sends them to the GMSC and returns to the idle state. If the MAP_SEND_ROUTING_INFORMATION response cannot be carried in a single TC-Result component, it is carried in one or more TC-Result-NL components (each sent in a TC-CONTINUE), followed by a TC-Result-L component in a TC-END message.

If the call handling process in the HLR returns a Provide Subscriber Info request, the MAP process requests a dialogue with the VLR whose identity is contained in the Provide Subscriber Info request by sending a MAP_OPEN service request, requests the subscriber status using a MAP_PROVIDE_SUBSCRIBER_INFO service request, and invokes the macro Receive_Open_Cnf to wait for the response to the dialogue opening request.

If the macro takes the OK exit, the MAP process waits for the response from the VLR.

If the MAP process receives a MAP_PROVIDE_SUBSCRIBER_INFO service confirm, it invokes the macro Check_Confirmation to check the content of the confirm.

If the Check_Confirmation macro takes the OK exit, the MAP process sends a Provide Subscriber Info ack containing the information received in the MAP_PROVIDE_SUBSCRIBER_INFO service confirm to the call handling process in the HLR, and waits for a response. The handling of the response from the call handling process in the HLR is described above.

If the MAP_PROVIDE_SUBSCRIBER_INFO service confirm contains a provider error or a data error, the MAP process sends a Provide Subscriber Info negative response indicating the type of error to the call handling process in the HLR, and waits for a response. The handling of the response from the call handling process in the HLR is described above.

NOTE: The 'User Error' exit from the macro Check_Confirmation is shown for formal completeness; the MAP_PROVIDE_SUBSCRIBER_INFO_cnf primitive cannot contain a user error.

If the call handling process in the HLR returns a Provide Roaming Number request, the MAP process requests a dialogue with the VLR whose identity is contained in the Provide Roaming Number request by sending a MAP_OPEN service request, requests a roaming number using a MAP_PROVIDE_ROAMING_NUMBER service request, and invokes the macro Receive_Open_Cnf to wait for the response to the dialogue opening request.

If the macro takes the OK exit, the MAP process waits for the response from the VLR.

If the MAP process receives a MAP_PROVIDE_ROAMING_NUMBER service confirm, it invokes the macro Check_Confirmation to check the content of the confirm.

If the Check_Confirmation macro takes the OK exit, the MAP process sends a Provide Roaming Number ack containing the MSRN received in the MAP_PROVIDE_ROAMING_NUMBER service confirm to the call handling process in the HLR, and waits for a response. The handling of the response from the call handling process in the HLR is described above.

If the MAP_PROVIDE_ROAMING_NUMBER service confirm contains a user error or a provider error, or the macro Check_Confirmation indicates that there is a data error, the MAP process sends a Provide Roaming Number negative response indicating the type of error to the call handling process in the HLR, and waits for a response. The handling of the response from the call handling process in the HLR is described above.

Negative response from HLR call handling process

If the call handling process in the HLR returns a negative response, either before or after a dialogue with the VLR to obtain a roaming number, the MAP process constructs a MAP_SEND_ROUTING_INFORMATION service response containing the appropriate error, constructs a MAP_CLOSE service request, sends them to the GMSC and returns to the idle state.

Earlier version MAP Provide Roaming Number dialogue with the VLR

If the macro Receive_Open_Cnf takes the Vr exit after the MAP process has requested opening of a Provide Roaming Number dialogue with the VLR, the MAP process checks whether this is an OR interrogation (indicated by the inclusion of the OR interrogation parameter in the MAP_PROVIDE_ROAMING_NUMBER service request).

If this is not an OR interrogation, the HLR performs the earlier version MAP dialogue as specified in [51], relays the result of the dialogue to the HLR call handling process, and waits for a response. The handling of the response from the call handling process in the HLR is described above.

If this is an OR interrogation, the MAP process sends a Provide Roaming Number negative response indicating OR not allowed to the call handling process in the HLR and waits for a response. The handling of the response from the call handling process in the HLR is described above.

Failure of Provide Subscriber Info dialogue with the VLR

If the Receive_Open_Cnf macro takes the Vr exit or the Error exit after the MAP process has requested opening of a Provide Subscriber Info dialogue with the VLR, the MAP process sends a Provide Subscriber Info negative response indicating system failure to the call handling process in the HLR, and waits for a response. The handling of the response from the call handling process in the HLR is described above.

Failure of Provide Roaming Number dialogue with the VLR

If the Receive_Open_Cnf macro takes the Error exit after the MAP process has requested opening of a Provide Roaming Number dialogue with the VLR, the MAP process sends a Provide Roaming Number negative response indicating system failure to the call handling process in the HLR, and waits for a response. The handling of the response from the call handling process in the HLR is described above.

If the MAP process receives a MAP_U_ABORT, a MAP_P_ABORT or a premature MAP_CLOSE from the MAP provider, it sends a Provide Roaming Number negative response indicating system failure to the call handling process in the HLR, and waits for a response. The handling of the response from the call handling process in the HLR is described above.

If the MAP process receives a MAP_NOTICE from the MAP provider, it returns a MAP_CLOSE request to the MAP provider, sends a Provide Roaming Number negative response indicating system failure to the call handling process in the HLR, and waits for a response. The handling of the response from the call handling process in the HLR is described above.

Earlier version MAP dialogue with the GMSC

If the macro Receive_Open_Ind takes the Vr exit, the HLR performs the earlier version MAP dialogue as specified in [51] and the process returns to the idle state.

Failure of dialogue opening with the GMSC

If the macro Receive_Open_Ind takes the Error exit, the MAP process returns to the idle state.

If the MAP provider sends a MAP_P_ABORT while the MAP process is waiting for a service indication, the MAP process returns to the idle state.

If the MAP provider sends a MAP_NOTICE while the MAP process is waiting for a service indication, the MAP process sends a MAP_CLOSE request to terminate the dialogue and returns to the idle state.

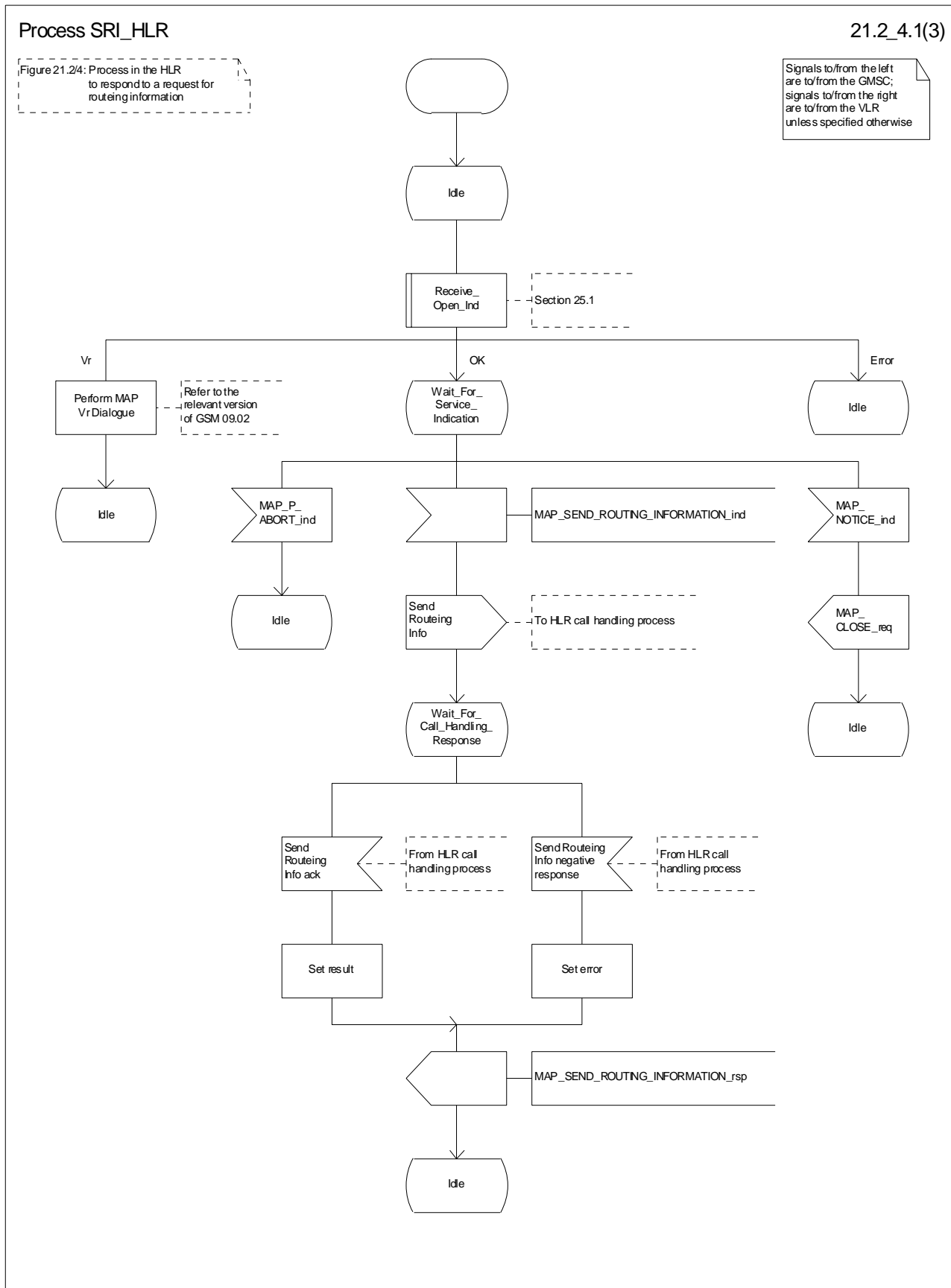

Figure 21.2/4 (sheet 1 of 3): Process SRI_HLR

Process SRI_HLR

21.2_4.2(3)

Figure 21.2/4: Process in the HLR to respond to a request for routing information

Signals to/from the left are to/from the GMSC; signals to/from the right are to/from the VLR unless specified otherwise

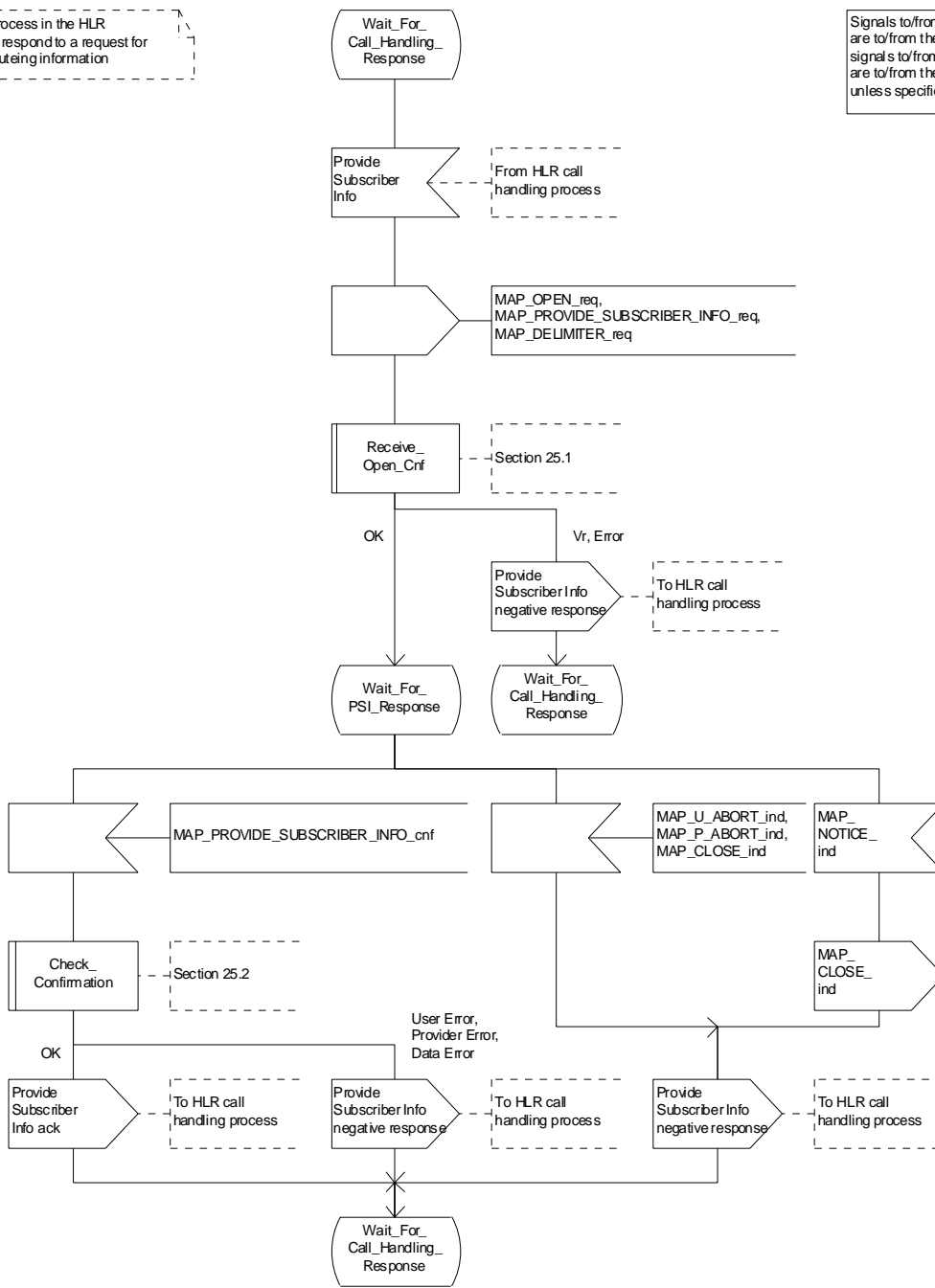

Figure 21.2/4 (sheet 2 of 3): Process SRI_HLR

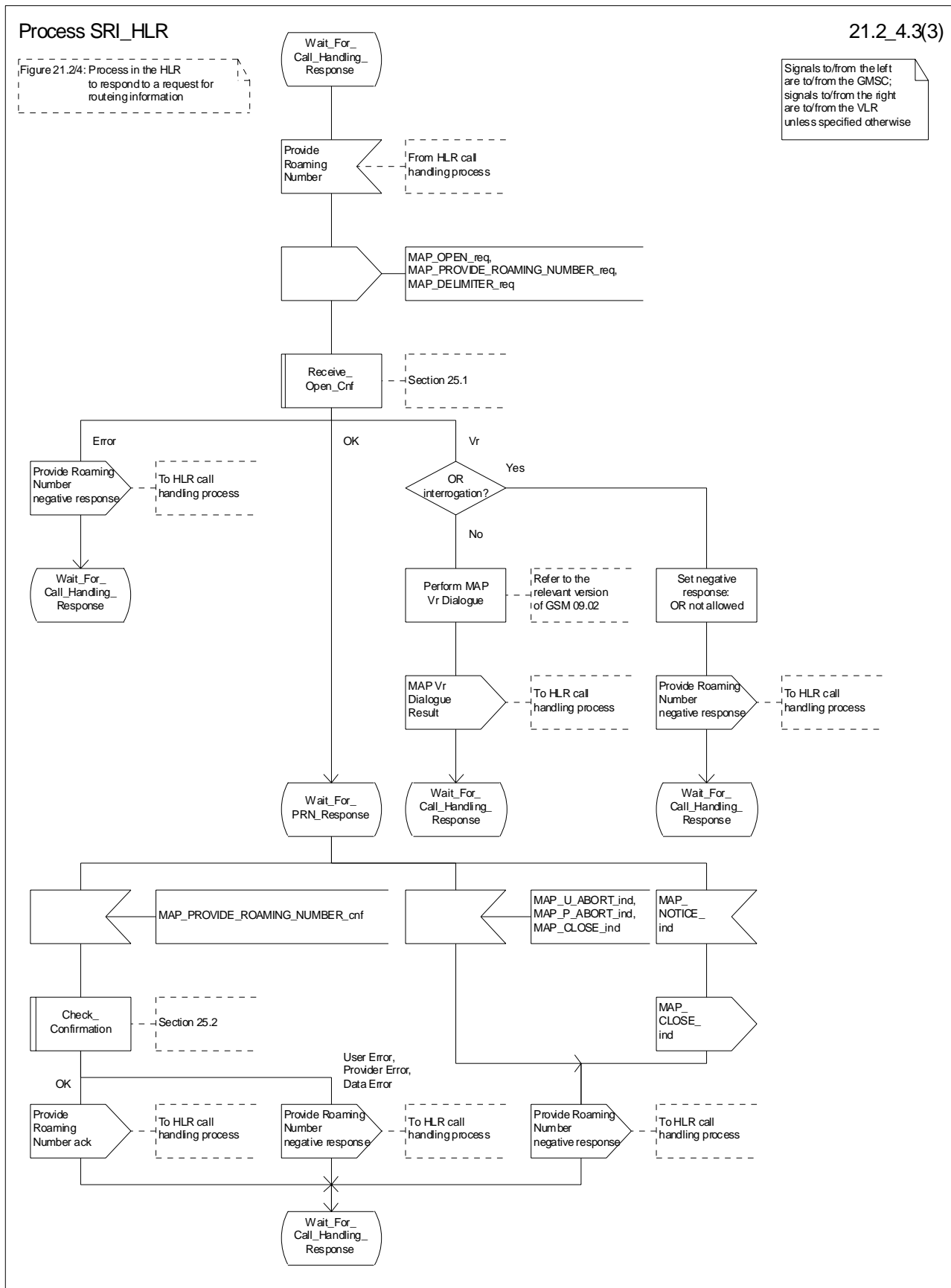

Figure 21.2/4 (sheet 3 of 3): Process SRI_HLR

21.2.4 Process in the VLR to provide a roaming number

The MAP process in the VLR to provide a roaming number for a mobile terminating call is shown in figure 21.2/5. The MAP process invokes a macro not defined in this clause; the definition of this macro can be found as follows:

Receive_Open_Ind see clause 25.1.1;

Successful outcome

When the MAP process receives a MAP_OPEN indication with the application context roamingNbEnquiry, it checks it by invoking the macro Receive_Open_Ind.

If the macro takes the OK exit, the MAP process waits for a service indication.

If a MAP_PROVIDE_ROAMING_NUMBER service indication is received, the MAP process sends a Provide Roaming Number request to the call handling process in the VLR, and waits for a response. The Provide Roaming Number request contains the parameters received in the MAP_PROVIDE_ROAMING_NUMBER service indication.

If the call handling process in the VLR returns a Provide Roaming Number ack, the MAP process constructs a MAP_PROVIDE_ROAMING_NUMBER service response containing the roaming number contained in the Send Routeing Info ack, constructs a MAP_CLOSE service request, sends them to the HLR and returns to the idle state.

Earlier version MAP dialogue with the HLR

If the macro Receive_Open_Ind takes the Vr exit, the VLR performs the earlier version MAP dialogue as specified in [51] and the process returns to the idle state.

Failure of dialogue opening with the HLR

If the macro Receive_Open_Ind takes the Error exit, the MAP process returns to the idle state.

If the MAP provider sends a MAP_P_ABORT while the MAP process is waiting for a service indication, the MAP process returns to the idle state.

If the MAP provider sends a MAP_NOTICE while the MAP process is waiting for a service indication, the MAP process sends a MAP_CLOSE request to terminate the dialogue and returns to the idle state.

Negative response from VLR call handling process

If the call handling process in the HLR returns a negative response, the MAP process constructs a MAP_PROVIDE_ROAMING_NUMBER service response containing the appropriate error, constructs a MAP_CLOSE service request, sends them to the HLR and returns to the idle state.

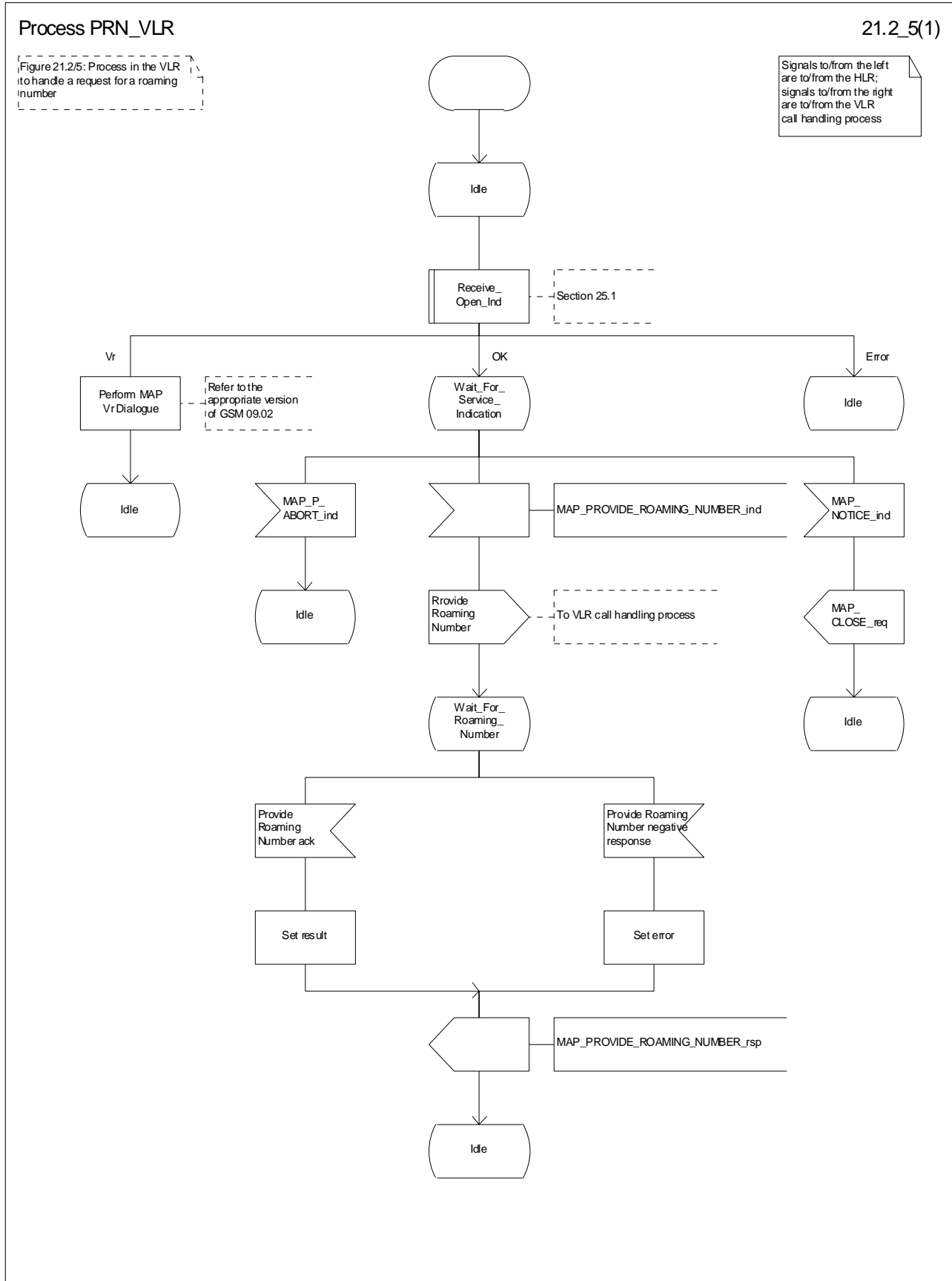

Figure 21.2/5: Process PRN_VLR

21.2.5 Process in the VLR to restore subscriber data

The MAP process in the HLR to restore subscriber data is shown in figure 21.2/6. The MAP process invokes macros not defined in this clause; the definitions of these macros can be found as follows:

Receive_Open_Cnf	see clause 25.1.2;
Check_Confirmation	see clause 25.2.2;
Insert_Subscriber_Data_VLR	see clause 25.7.1;
Activate_Tracing_VLR	see clause 25.9.3.

Successful outcome

When the MAP process receives a Restore Data request from the data restoration process in the VLR, it requests a dialogue with the HLR whose identity is contained in the Restore Data request by sending a MAP_OPEN service request, requests data restoration using a MAP_RESTORE_DATA service request and invokes the macro Receive_Open_Cnf to wait for the response to the dialogue opening request. If the dialogue opening is successful, the MAP process waits for a response from the HLR.

The VLR may receive a MAP_INSERT_SUBSCRIBER_DATA service indication from the HLR; this is handled by the macro Insert_Subscriber_Data_VLR as described in clause 25.7.1, and the MAP process waits for a further response from the HLR.

The VLR may receive a MAP_ACTIVATE_TRACE_MODE service indication from the HLR; this is handled by the macro Activate_Tracing_VLR as described in clause 25.9.3, and the MAP process waits for a further response from the HLR.

If the MAP process receives a MAP_RESTORE_DATA service confirm, it invokes the macro Check_Confirmation to check the content of the confirm.

If the Check_Confirmation macro takes the OK exit, the MAP process sends a Restore Data ack containing the information received from the HLR to the data restoration process in the VLR and returns to the idle state.

Error in MAP_RESTORE_DATA confirm

If the MAP_RESTORE_DATA service confirm contains a user error or a provider error, or the macro Check_Confirmation indicates that there is a data error, the MAP process sends a Restore Data negative response indicating the type of error to the call handling process in the HLR, and returns to the idle state.

Earlier version MAP dialogue with the HLR

If the macro Receive_Open_Cnf takes the Vr exit, the VLR performs the earlier MAP version dialogue as specified in [51] and the process terminates.

Dialogue opening failure

If the macro Receive_Open_Cnf indicates that the dialogue with the HLR could not be opened, the MAP process sends a negative response indicating system failure to the data restoration process in the GMSC and returns to the idle state.

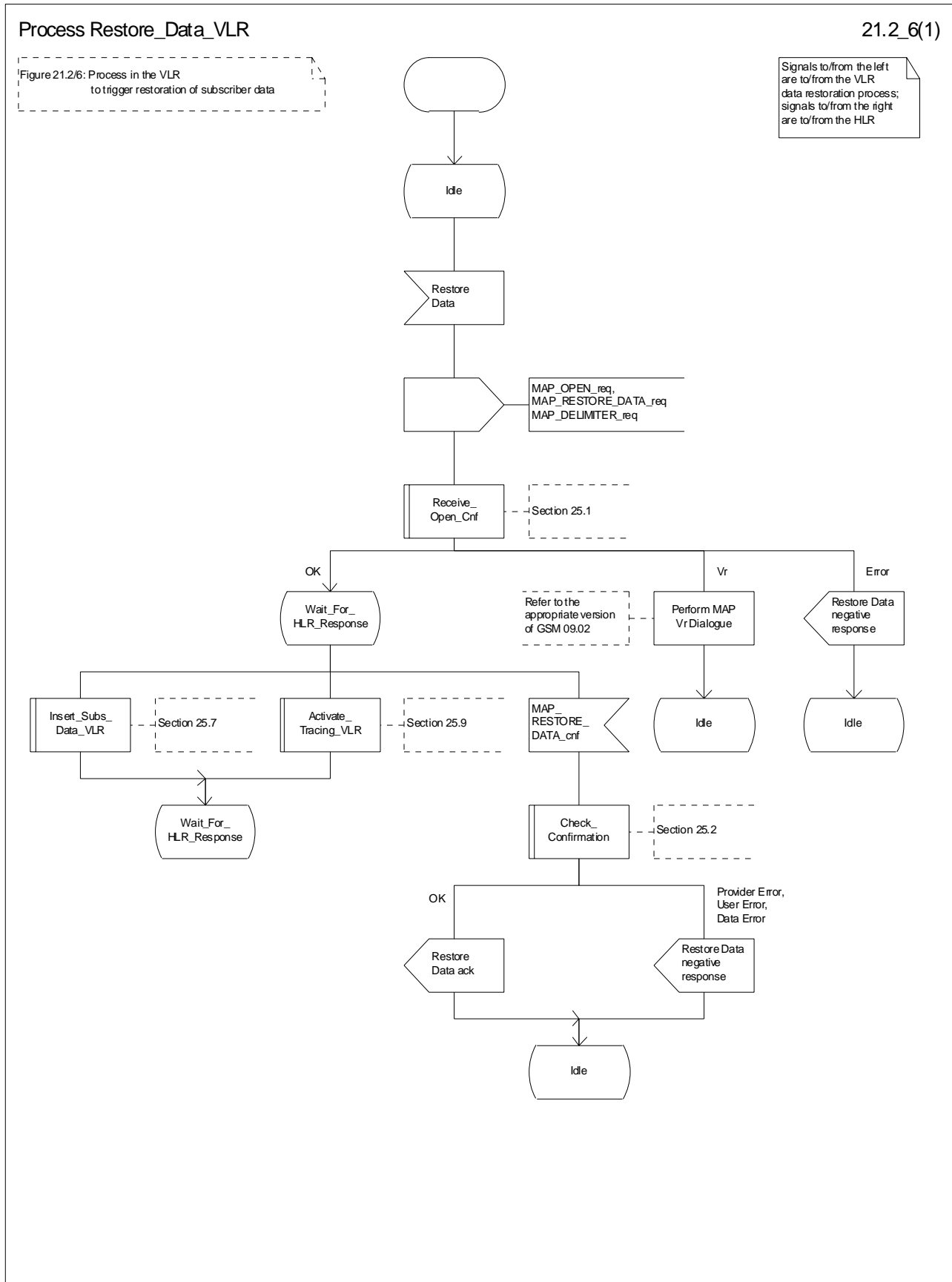

Figure 21.2/6: Process Restore_Data_VLR

21.2.6 Process in the VLR to provide subscriber information

The MAP process in the VLR to provide subscriber information for a mobile terminating call subject to CAMEL invocation is shown in figure 21.2/6. The MAP process invokes a macro not defined in this clause; the definition of this macro can be found as follows:

Receive_Open_Ind see clause 25.1.1;

Successful outcome

When the MAP process receives a MAP_OPEN indication with the application context subscriberInfoEnquiry, it checks it by invoking the macro Receive_Open_Ind.

If the macro takes the OK exit, the MAP process waits for a service indication.

If a MAP_PROVIDE_SUBSCRIBER_INFO service indication is received, the MAP process sends a Provide Subscriber Info request to the subscriber information request process in the VLR, and waits for a response. The Provide Subscriber Info request contains the parameters received in the MAP_PROVIDE_SUBSCRIBER_INFO service indication.

If the subscriber information request process in the VLR returns a Provide Subscriber Info ack, the MAP process constructs a MAP_PROVIDE_SUBSCRIBER_INFO service response containing the information contained in the Provide Subscriber Info ack, constructs a MAP_CLOSE service request, sends them to the HLR and returns to the idle state.

Failure of dialogue opening with the HLR

If the macro Receive_Open_Ind takes the Vr exit or the Error exit, the MAP process returns to the idle state.

If the MAP provider sends a MAP_P_ABORT while the MAP process is waiting for a service indication, the MAP process returns to the idle state.

If the MAP provider sends a MAP_NOTICE while the MAP process is waiting for a service indication, the MAP process sends a MAP_CLOSE request to terminate the dialogue and returns to the idle state.

Process PSI_VLR

21.2_7(1)

Figure 21.2/7: Process in the VLR to handle a request for subscriber information

Signals to/from the left are to/from the HLR; signals to/from the right are to/from the VLR subscriber information request process

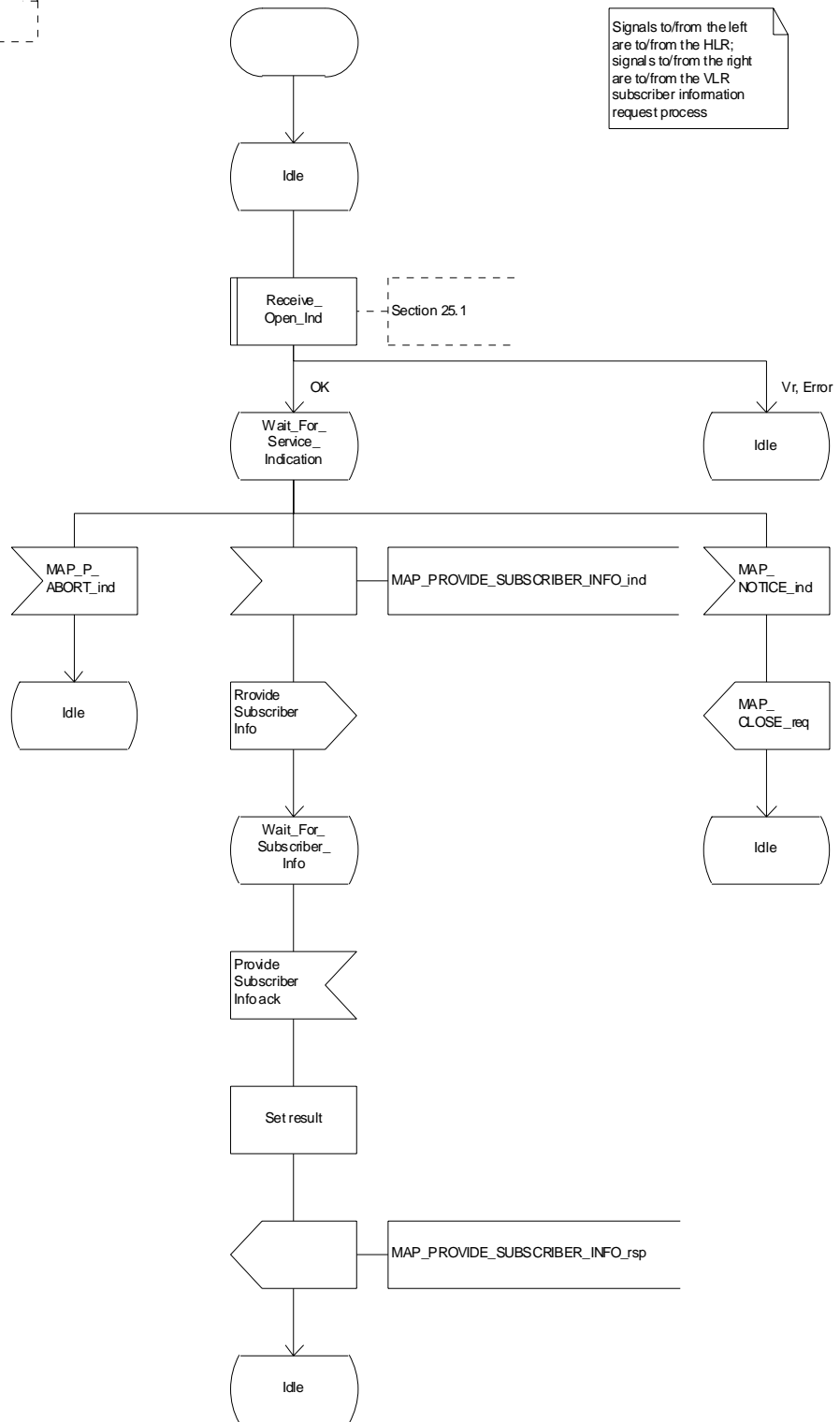

Figure 21.2/7: Process PSI_VLR

21.2.7 Process in the HLR for Any Time Interrogation

The message flows for successful retrieval of subscriber information related to an any time interrogation from the CAMEL server are shown in figure 21.2/8.

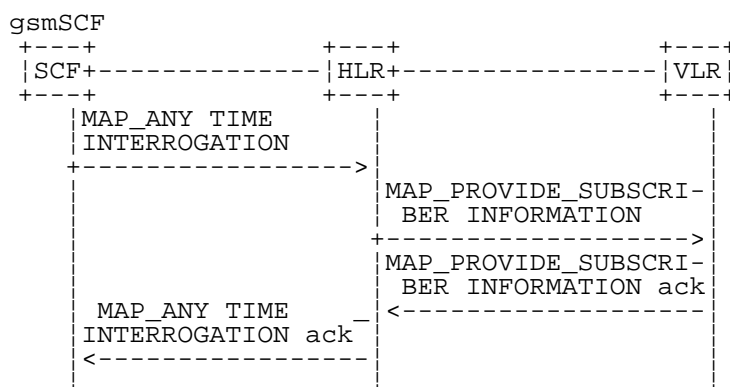

Figure 21.2/8: Message flow for any time interrogation

The following MAP services are used to retrieve routing information:

MAP_ANY_TIME_INTERROGATION see clause 8.11.1;

MAP_PROVIDE_SUBSCRIBER_INFO see clause 8.11.2.

21.2.7.1 Process in the gsmSCF

Out of the scope of the MAP specification.

21.2.7.2 Process in the HLR

The MAP process in the HLR to provide subscriber information in response to an interrogation from the CAMEL server is shown in figure 21.2/8. The MAP process invokes macros not defined in this clause; the definitions of these macros can be found as follows:

Receive_Open_Ind see clause 25.1.1;

Receive_Open_Cnf see clause 25.1.2;

Check_Confirmation see clause 25.2.2.

Successful outcome

When the MAP process receives a MAP_OPEN indication with the application context anyTimeInterrogationEnquiry, it checks it by invoking the macro Receive_Open_Ind.

If the macro takes the OK exit, the MAP process waits for a service indication.

If a MAP_ANY_TIME_INTERROGATION service indication is received, the MAP process sends an Any Time Interrogation request to the call handling process in the HLR (described in 3GPP TS 23.078), and waits for a response. The Any Time Interrogation request contains the parameters received in the MAP_ANY_TIME_INTERROGATION service indication.

If the call handling process in the HLR returns an Any Time Interrogation response, the MAP process constructs a MAP_ANY_TIME_INTERROGATION service response containing the subscriber information contained in the Any Time Interrogation response, constructs a MAP_CLOSE service request, sends them to the CAMEL server and returns to the idle state.

If the call handling process in the HLR returns a Provide Subscriber Info request, the MAP process requests a dialogue with the VLR whose identity is contained in the Provide Subscriber Info request by sending a MAP_OPEN service request, requests the subscriber status using a MAP_PROVIDE_SUBSCRIBER_INFO service request, and invokes the macro Receive_Open_Cnf to wait for the response to the dialogue opening request.

If the macro takes the OK exit, the MAP process waits for the response from the VLR.

If the MAP process receives a MAP_PROVIDE_SUBSCRIBER_INFO service confirm, it invokes the macro Check_Confirmation to check the content of the confirm.

If the Check_Confirmation macro takes the OK exit, the MAP process sends a Provide Subscriber Info ack containing the information received in the MAP_PROVIDE_SUBSCRIBER_INFO service confirm to the call handling process in the HLR, and waits for a response. The handling of the response from the call handling process in the HLR is described above.

If the MAP_PROVIDE_SUBSCRIBER_INFO service confirm contains a provider error or a data error, the MAP process sends a Provide Subscriber Info negative response indicating the type of error to the call handling process in the HLR, and waits for a response. The handling of the response from the call handling process in the HLR is described above.

NOTE: The 'User Error' exit from the macro Check_Confirmation is shown for formal completeness; the MAP_PROVIDE_SUBSCRIBER_INFO_cnf primitive cannot contain a user error.

Negative response from HLR call handling process

If the call handling process in the HLR returns a negative response, either before or after a dialogue with the VLR to obtain subscriber information, the MAP process constructs a MAP_ANY_TIME_INTERROGATION service response containing the appropriate error, constructs a MAP_CLOSE service request, sends them to the CAMEL server and returns to the idle state.

Failure of Provide Subscriber Info dialogue with the VLR

If the Receive_Open_Cnf macro takes the Vr exit or the Error exit after the MAP process has requested opening of a Provide Subscriber Info dialogue with the VLR, the MAP process sends a Provide Subscriber Info negative response indicating system failure to the call handling process in the HLR, and waits for a response. The handling of the response from the call handling process in the HLR is described above.

Failure of dialogue opening with the CAMEL server

If the macro Receive_Open_Ind takes the Vr or Error exit, the MAP process returns to the idle state.

If the MAP provider sends a MAP_P_ABORT while the MAP process is waiting for a service indication, the MAP process returns to the idle state.

If the MAP provider sends a MAP_NOTICE while the MAP process is waiting for a service indication, the MAP process sends a MAP_CLOSE request to terminate the dialogue and returns to the idle state.

Process ATI_HLR

21.2_9.1(2)

Figure 21.2/9: Process in the HLR to respond to a request for any time interrogation

Signals to/from the left are to/from the gsmSCF; signals to/from the right are to/from the VLR unless specified otherwise

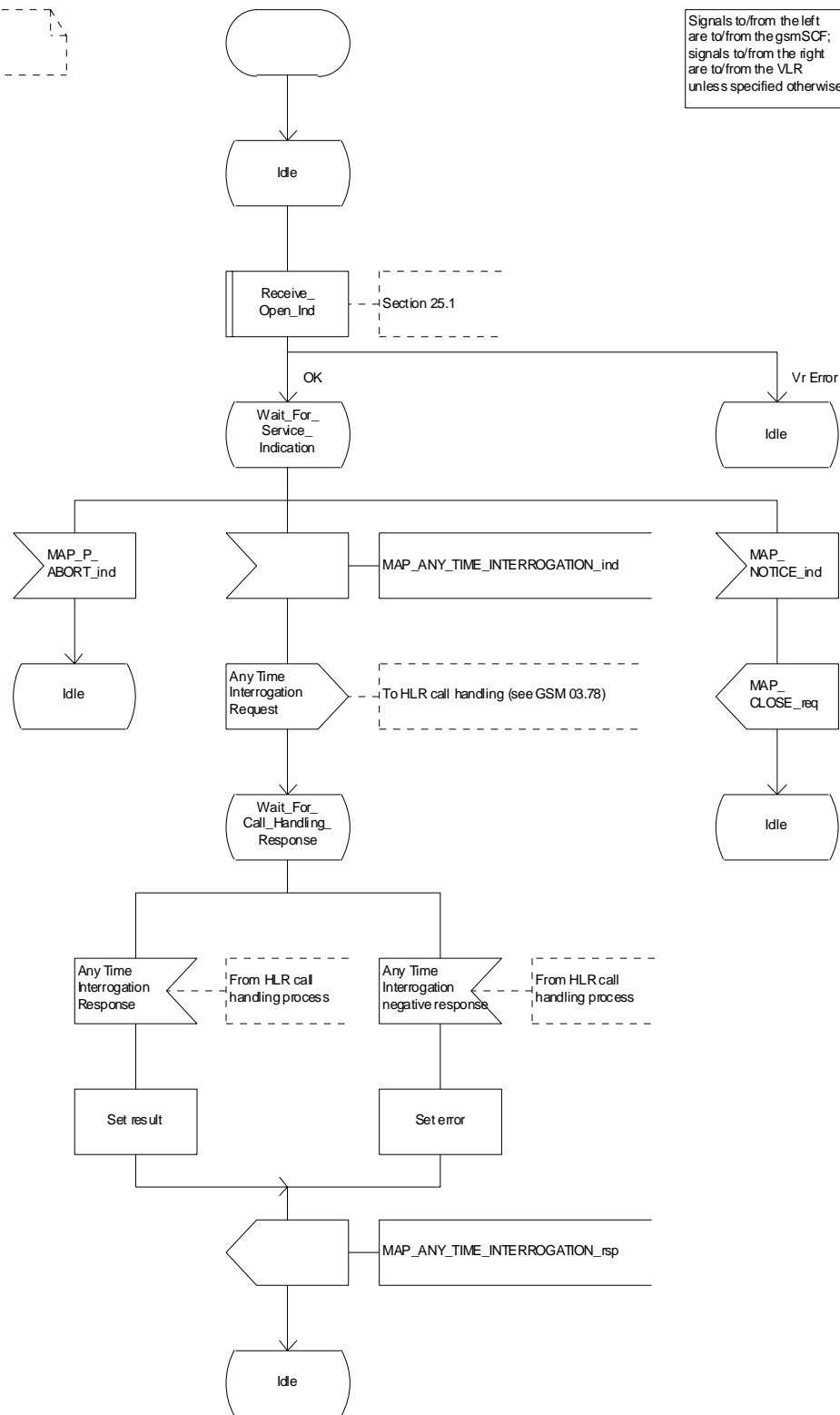

Figure 21.2/9 (sheet 1 of 2): Process ATI_HLR (New)

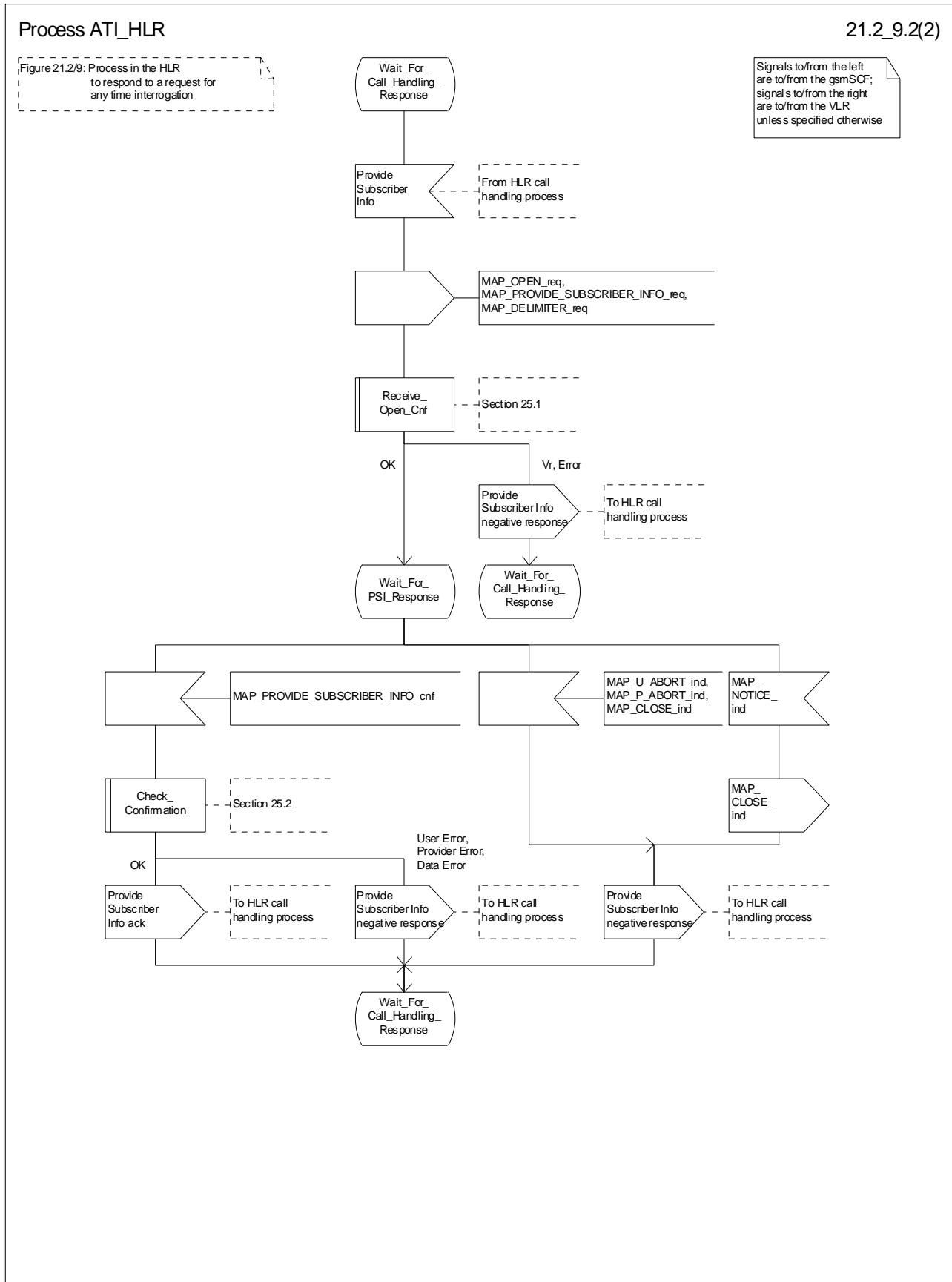
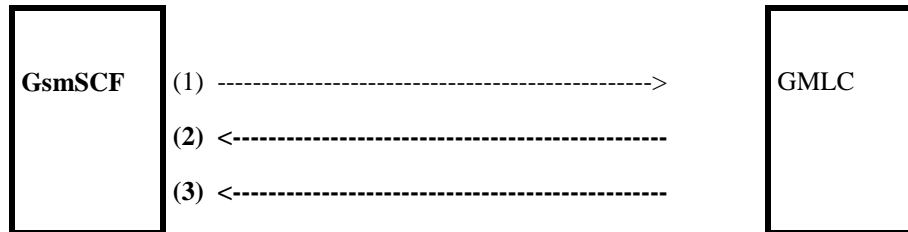

Figure 21.2/9 (sheet 2 of 2): Process ATI_HLR (New)

21.2.8 Process in the GMLC for Any Time Interrogation

The message flows for successful retrieval of subscriber information related to an any time interrogation from the CAMEL server are shown in figure 21.2.8/1.



- (1) Any Time Interrogation (gsmSCF to GMLC).
- (2) Any Time Interrogation Result (GMLC to gsmSCF).
- (3) Any Time Interrogation Error (GMLC to gsmSCF)The following MAP services are used to retrieve routing information:
 - MAP_ANY_TIME_INTERROGATION see clause 8.11.1;

Figure 21.2.8/1

In addition, the GMLC may use Location Services specific MAP Services.

21.2.8.1 Process in the gsmSCF

The process in the gsmSCF to request location information from the GMLC is shown in figure 21.2.8/2.

The process is started with internal signal Request_Subscriber_Info_GMLC. This signal is sent by the Service Logic in the gsmSCF.

The process responds with 'Request_Subscriber_Info_GMLC positive response' or 'Request_Subscriber_Info_GMLC negative response'.

21.2.8.2 Process in the GMLC

The MAP process in the GMLC to provide location information in response to a request from the gsmSCF is shown in figure 21.2.8/3.

Successful outcome

When the GMLC has successfully received the MAP Any_Time_Interrogation MAP Message, it will send an internal signal to the Location Service process in the GMLC to obtain the subscriber's Location Information. The result received from that process is sent back to the gsmSCF, in the Any_Time_Interrogation Result MAP Message.

Unsuccessful outcome

In the case of a Provider Error received, the process will terminate.

When a User error is received from the Location Services process in the GMLC, then a User Abort is sent to the gsmSCF.

If a negative response is received from the Location Services process in the GMLC, then this response is forwarded to the gsmSCF.

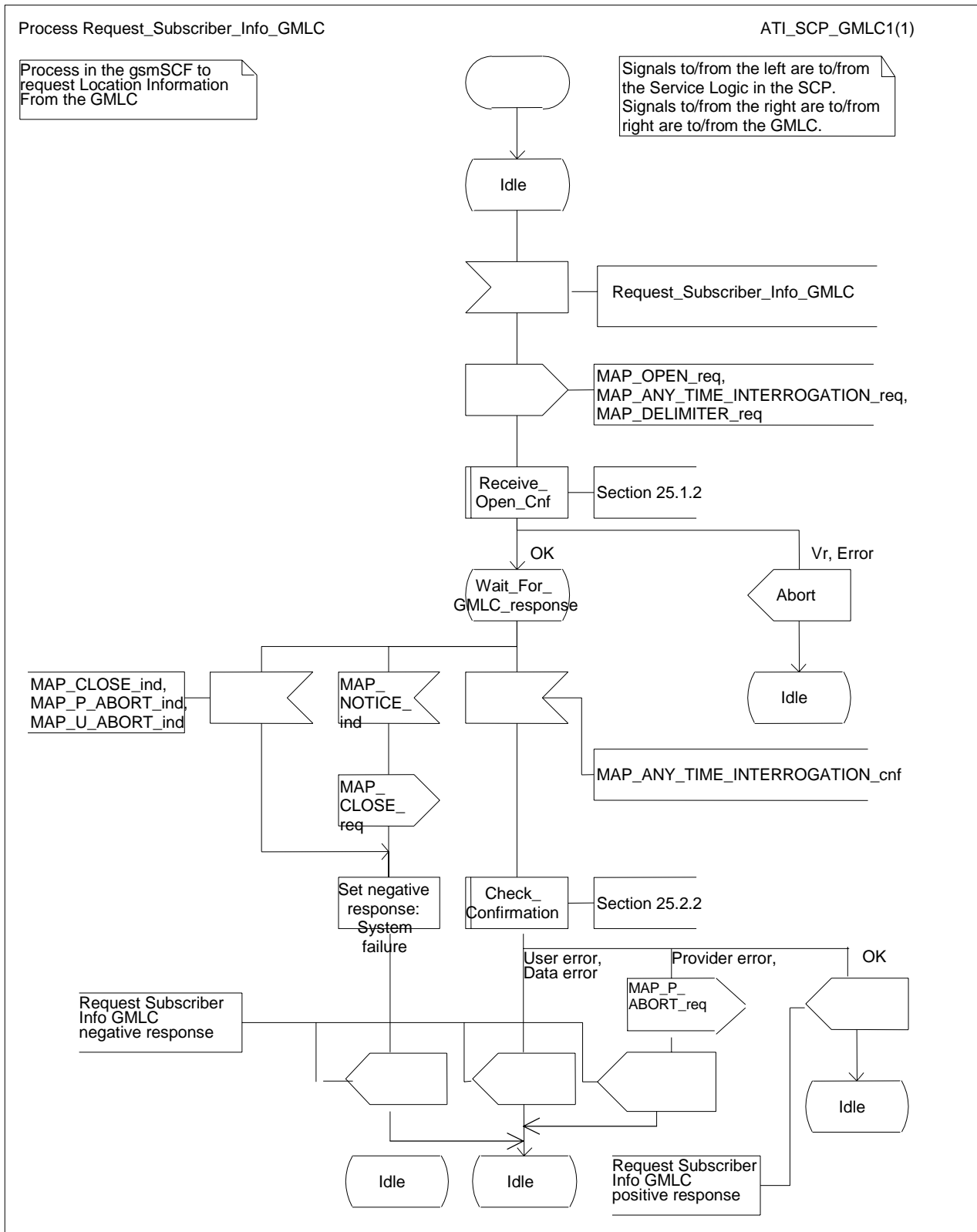

Figure 21.2.8/2: Process Request_Subscriber_Info_GMLC



Figure 21.2.8/3: Process ATI_GMLC

21.2.9 Process in the gsmSCF

For the purposes of retrieving routing information from the HLR, the gsmSCF takes the role of the GMSC and follows the process specified in subclause 21.2.2.

21.3 Transfer of call handling

21.3.1 General

The message flow for successful transfer of call handling to forward a call is shown in figure 21.3/1.

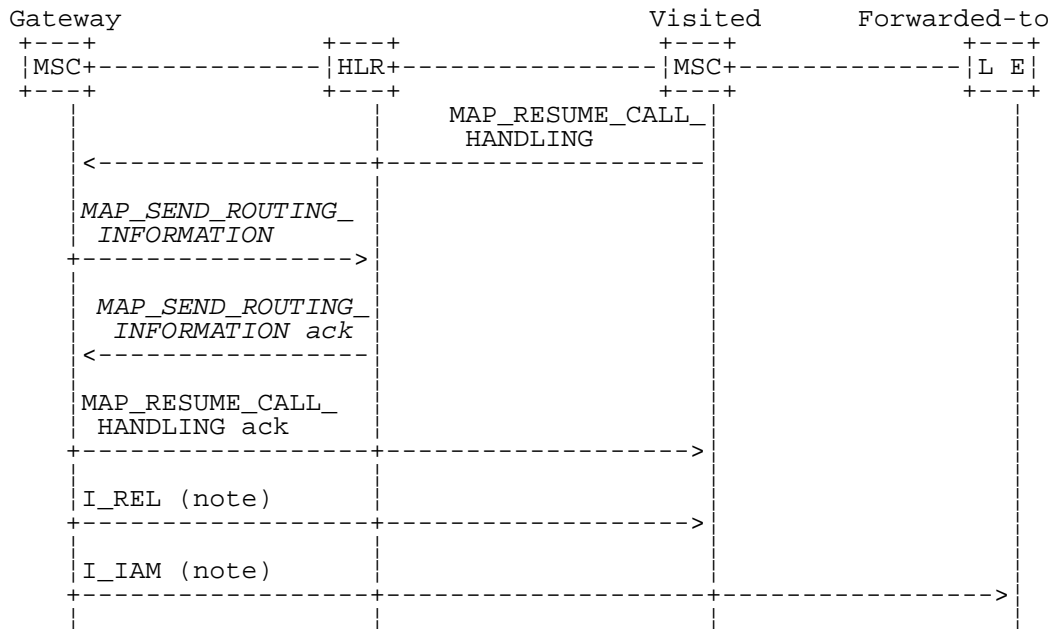

xxx = *Optional Procedure*

NOTE: TUP or ISUP may be used in signalling between MSCs, depending on the network type between the MSCs. For further details on the TUP and ISUP procedures refer to the following CCITT Recommendations & ETSI specification:

- Q.721-725 - Telephone User Part (TUP);
- ETS 300 356-1 - Integrated Services Digital Network (ISDN); Signalling System No.7; ISDN User Part (ISUP) version 2 for the international interface; Part 1: Basic services.

Figure 21.3/1: Message flow for transfer of call handling

If the HLR indicated in the response to the original request for routing information that forwarding interrogation is required, the GMSC executes the Send Routing Information procedure with the HLR to obtain forwarding information; otherwise the GMSC uses the forwarding data which were sent in the MAP_RESUME_CALL_HANDLING req/ind.

21.3.2 Process in the VMSC

The MAP process in the VMSC to retrieve routing information for a mobile terminating call is shown in figure 21.3/2. The MAP process invokes macros not defined in this clause; the definitions of these macros can be found as follows:

- Receive_Open_Cnf see clause 25.1.2;
- Check_Confirmation see clause 25.2.2.

Successful Outcome

When the MAP process receives a Resume Call Handling request from the call handling process in the VMSC, it requests a dialogue with the GMSC whose identity is contained in the Resume Call Handling request by sending a MAP_OPEN service request, requests routing information using a MAP_RESUME_CALL_HANDLING service request and invokes the macro Receive_Open_Cnf to wait for the response to the dialogue opening request. If the dialogue opening is successful, the MAP process waits for a response from the GMSC. VMSC shall not send any duplicate data to the GMSC.

If the VMSC notices after receiving a Resume Call Handling request that the segmentation is needed the VMSC does not set the “All Information Sent” indicator. Otherwise the indicator is set and the process returns to the Wait For GMSC Response state.

If the MAP process receives a MAP_RESUME_CALL_HANDLING service confirm from the GMSC, the MAP process invokes the macro Check_Confirmation to check the content of the confirm.

If the macro Check_Confirmation takes the OK exit, the MAP process checks if the “All Information Sent” indicator is set. If it is set the MAP process sends a Resume Call Handling ack to the call handling process in the VMSC and returns to the idle state. If the “All Information Sent” indicator is not set the MAP process checks if further segmentation is needed. If segmentation is needed the VMSC does not set the indicator and sends MAP_RESUME_CALL_HANDLING service request to the GMSC. Otherwise the indicator is set and the MAP_RESUME_CALL_HANDLING service request is sent to the GMSC.

Dialogue opening failure

If the macro Receive_Open_Cnf indicates that the dialogue with the GMSC could not be opened or that the dialogue can be opened only at an earlier version, the MAP process sends an Resume Call Handling negative response indicating system failure to the call handling process in the VMSC and returns to the idle state.

Error in MAP_RESUME_CALL_HANDLING confirm

If the MAP_RESUME_CALL_HANDLING service confirm contains a user error or a provider error, the MAP process sends a Resume Call Handling negative response to the call handling process in the VMSC and returns to the idle state.

NOTE: the 'Data Error' exit from the macro Check_Confirmation is shown for formal completeness; the result is empty, so the MAP_PROVIDE_SUBSCRIBER_INFO_cnf primitive cannot contain a data error.

Abort of GMSC dialogue

After the dialogue with the GMSC has been established, the MAP service provider may abort the dialogue by issuing a MAP_P_ABORT indication, or the GMSC may send a MAP_CLOSE indication. In either of these cases, the MAP process sends a Resume Call Handling negative response to the call handling process in the GMSC and returns to the idle state.

If the MAP provider indicates a protocol problem by sending a MAP_NOTICE indication, the MAP process closes the dialogue with the GMSC, sends a Resume Call Handling negative response indicating system failure to the call handling process in the VMSC and returns to the idle state.

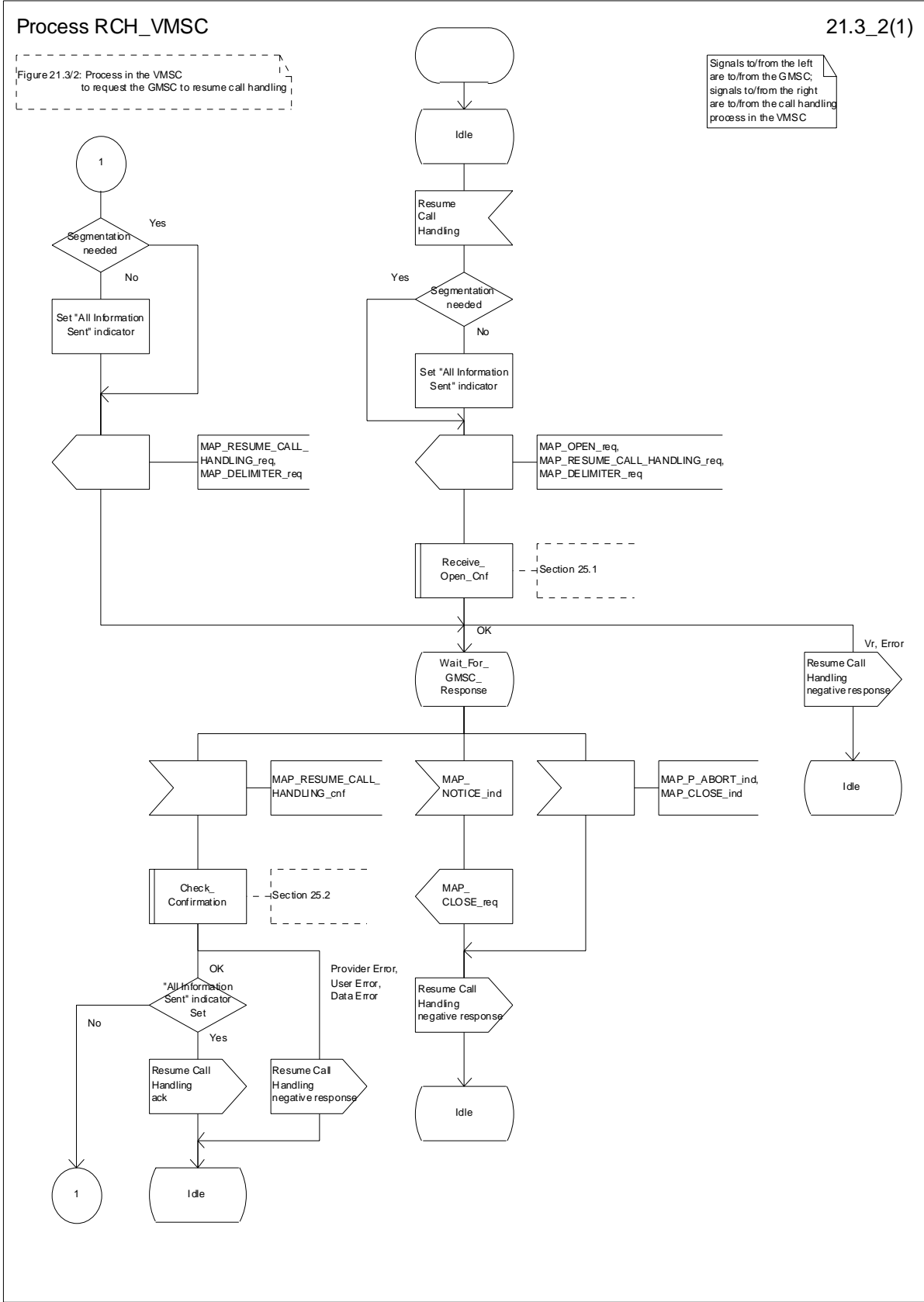

Figure 21.3/2: Process RCH_VMSC

21.3.3 Process in the GMSC

The MAP process in the GMSC to handle a request for the GMSC to resume call handling is shown in figure 21.3/3. The MAP process invokes a macro not defined in this clause; the definition of this macro can be found as follows:

Receive_Open_Ind see clause 25.1.1;

Successful outcome

When the MAP process receives a MAP_OPEN indication with the application context callControlTransfer, it checks it by invoking the macro Receive_Open_Ind.

If the macro takes the OK exit, the MAP process waits for a service indication.

If a MAP_RESUME_CALL_HANDLING service indication is received, the MAP process checks if the “All Information Sent” indicator is set and if so it sends a Resume Call Handling request including all the stored data to the call handling process in the GMSC, and waits for a response. The Resume Call Handling request contains the parameters received in the MAP_RESUME_CALL_HANDLING service indication. If the “All Information Sent” indicator is not set, the received data is stored and the MAP process constructs an empty MAP_RESUME_CALL_HANDLING service response, sends it to the VMSC and returns to the Wait For Service Indication state.

If the call handling process in the GMSC returns a Resume Call Handling ack, the MAP process constructs a MAP_RESUME_CALL_HANDLING service response, constructs a MAP_CLOSE service request, sends them to the VMSC and returns to the idle state.

Failure of dialogue opening with the VMSC

If the macro Receive_Open_Ind takes the Vr exit or the Error exit, the MAP process returns to the idle state.

If the MAP provider sends a MAP_P_ABORT while the MAP process is waiting for a service indication, the MAP process returns to the idle state.

If the MAP provider sends a MAP_NOTICE while the MAP process is waiting for a service indication, the MAP process sends a MAP_CLOSE request to terminate the dialogue and returns to the idle state.

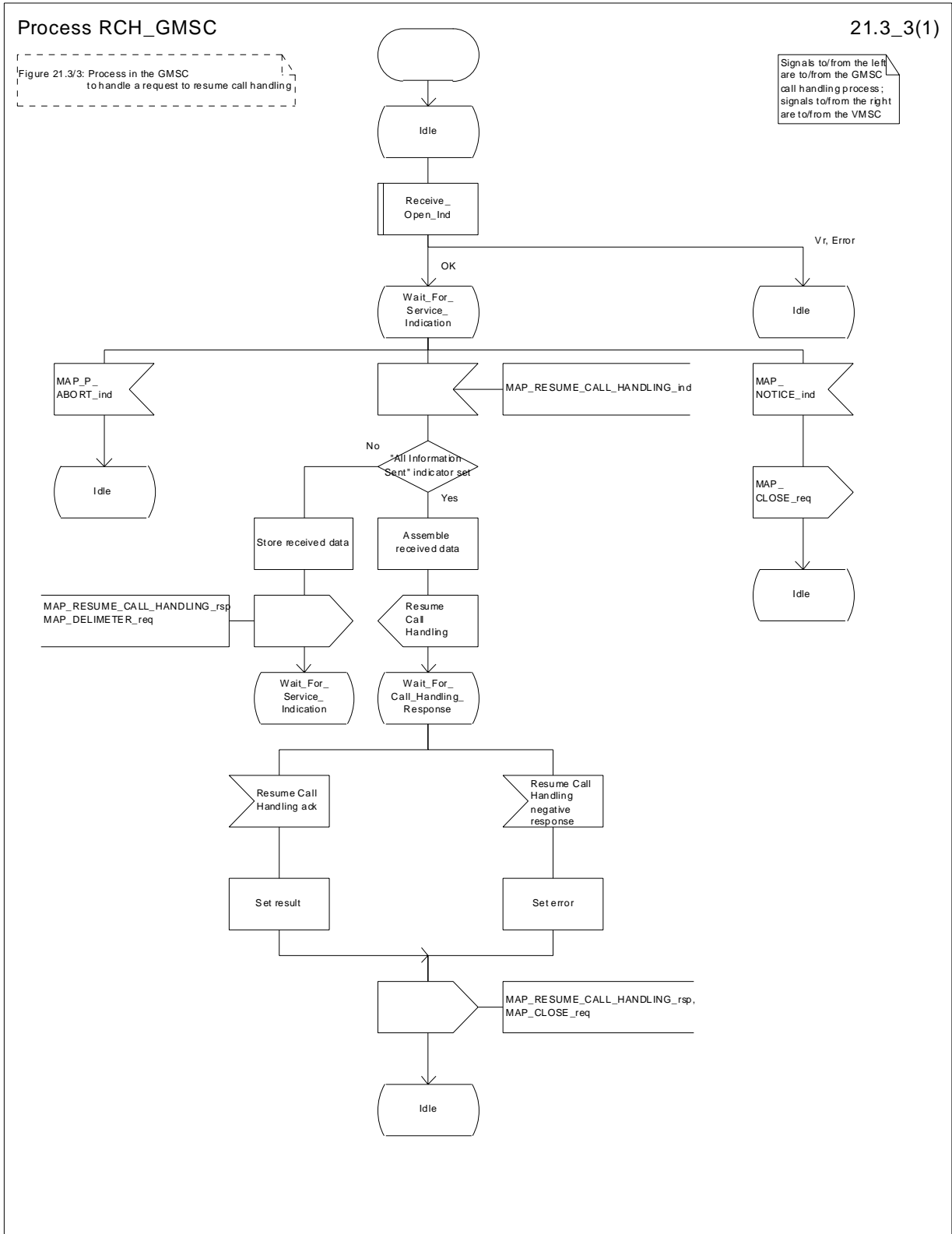
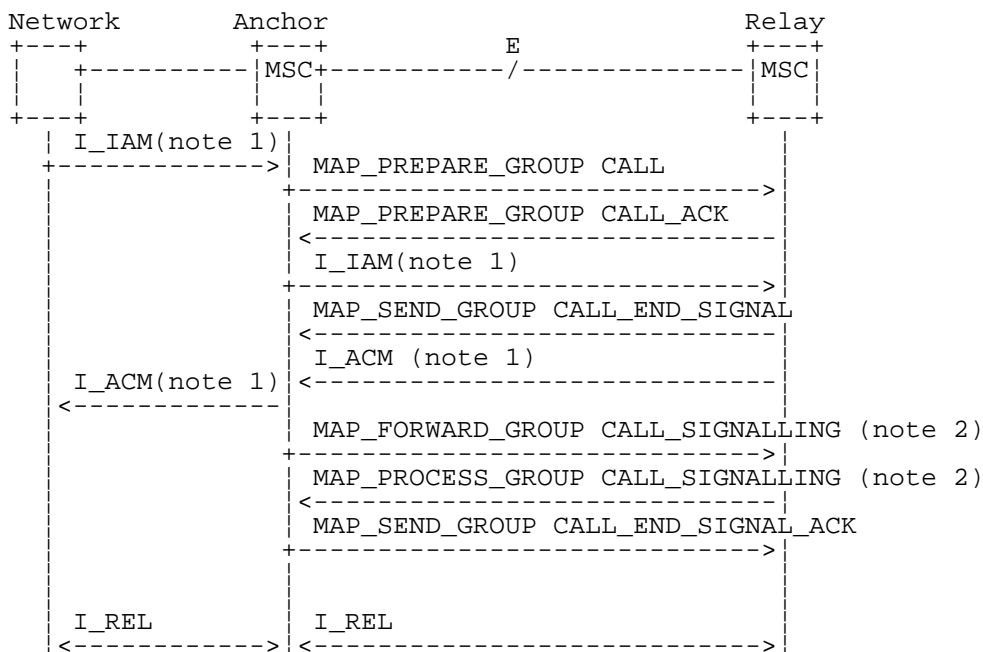

Figure 21.3/3: Process RCH_GMSC

21.4 Inter MSC Group Call Procedures

21.4.1 General

The message flows for successful inter MSC group call / broadcast call set-up is shown in figure 21.4/1.



NOTE 1: TUP or ISUP may be used in signalling between MSCs, depending on the network type between the MSCs. For further details on the TUP and ISUP procedures refer to the following ITU-T Recommendations and ETSI specification:

- Q.721-725 - Telephone User Part (TUP);
- ETS 300 356-1 - Integrated Services Digital Network (ISDN); Signalling System No.7; ISDN User Part (ISUP) version 2 for the international interface; Part 1: Basic services.

NOTE 2: The MAP_FORWARD_GROUP_CALL_SIGNALLING and MAP_PROCESS_GROUP_CALL_SIGNALLING services are not applicable for voice broadcast calls.

Figure 21.4/1: Message flow for inter MSC group call / broadcast call

21.4.2 Process in the Anchor MSC

The MAP process in the Anchor MSC to retrieve and transfer information from / to the Relay MSC for VBS and VGCS calls is shown in figure 21.4/2. The MAP process invokes macros not defined in this clause; the definitions of these macros can be found as follows:

Receive_Open_Cnf	see clause 25.1.2;
Check_Indication	see clause 25.2.1;
Check_Confirmation	see clause 25.2.2.

Successful Outcome

When the MAP process receives a Prepare Group Call request from the ASCII handling process in the anchor MSC, it requests a dialogue with the relay MSC whose identity is contained in the Prepare Group Call request by sending a MAP_OPEN service request, requests a Group Call number by using a MAP_PREPARE_GROUP_CALL service request and invokes the macro Receive_Open_Cnf to wait for the response to the dialogue opening request. If the dialogue opening is successful, the MAP process waits for a response from the relay MSC.

If the MAP process receives a MAP_PREPARE_GROUP_CALL service confirm from the relay MSC, the MAP process invokes the macro Check_Confirmation to check the content of the confirm.

If the macro Check_Confirmation takes the OK exit, the MAP process sends a Prepare Group Call ack containing the Group Call number received from the relay MSC to the ASCI handling process in the anchor MSC and waits for completion of call set-up in the relay MSC.

On receipt of a MAP_SEND_GROUP_CALL_END_SIGNAL service indication from the relay MSC the MAP process invokes the macro Check_Indication to check the content of the indication.

If the macro Check_Indication takes the OK exit, the MAP process sends a Send Group Call End Signal to the ASCI handling process in the anchor MSC and waits for uplink management signals. In this state the following events are processed:

- Reception of a Send Group Call End Signal ack from the ASCI handling process in the anchor MSC;
- Reception of a Forward Group Call Signalling request from the ASCI handling process in the anchor MSC;
- Reception of a MAP_PROCESS_GROUP_CALL_SIGNALLING service indication from the relay MSC.

On reception of a Send Group Call End Signal ack from the ASCI handling process in the anchor MSC, the MAP process constructs a MAP_SEND_GROUP_CALL_END_SIGNAL service response, constructs a MAP_CLOSE service request, sends them to the relay MSC and returns to the idle state.

On reception of a Forward Group Call Signalling request from the ASCI handling process in the anchor MSC, the MAP process constructs a MAP_FORWARD_GROUP_CALL_SIGNALLING service request, sends it to the relay MSC and returns to the uplink management state.

On reception of a MAP_PROCESS_GROUP_CALL_SIGNALLING service indication from the relay MSC, the MAP process invokes the macro Check_Indication to check the content of the indication.

If the macro Check_Indication takes the OK exit, the MAP process sends a Process Group Call Signalling to the ASCI handling process in the anchor MSC and returns to the uplink management state.

Dialogue opening failure

If the macro Receive_Open_Cnf indicates that the dialogue with the relay MSC could not be opened, the MAP process sends an Abort to the ASCI handling process and returns to the idle state.

Error in MAP_PREPARE_GROUP_CALL confirm

If the MAP_PREPARE_GROUP_CALL service confirm contains a user error or a provider error, or the macro Check_Confirmation indicates that there is a data error, the MAP process sends a Prepare Group Call negative response to the ASCI handling process in the anchor MSC, sends a MAP_U_ABORT request to the relay MSC and returns to the idle state.

Abort of MAP dialogue

After the dialogue with the relay MSC has been established, the MAP service provider may abort the dialogue by issuing a MAP_P_ABORT indication, or the relay MSC may send a MAP_U_ABORT indication or a MAP_CLOSE indication. In any of these cases, the MAP process sends an Abort to the ASCI handling process in the anchor MSC and returns to the idle state.

If the MAP provider indicates a protocol problem by sending a MAP_NOTICE indication, the MAP process closes the dialogue with the relay MSC, sends an Abort to the ASCI handling process in the anchor MSC and returns to the idle state.

Process ASCI_Anchor_MSC

21.4_2.1(4)

Figure 21.4/2: Process in the Anchor MSC for ASCI call handling

Signals to/from the left are to/from the A-MSC ASCI process; signals to/from the right are to/from the R-MSC

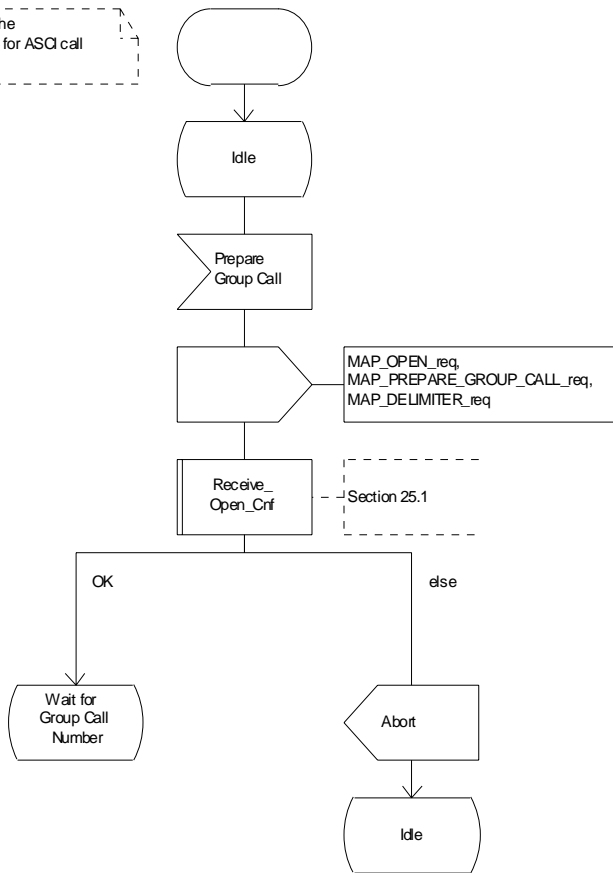

Figure 21.4/2 (sheet 1 of 4): Process ASCI_Anchor_MSC

Process ASCI_Anchor_MSC

21.4_2.2(4)

Figure 21.4/2: Process in the Anchor MSC for ASCI call handling

Signals to/from the left are to/from the A-MSC ASCI process; signals to/from the right are to/from the R-MSC

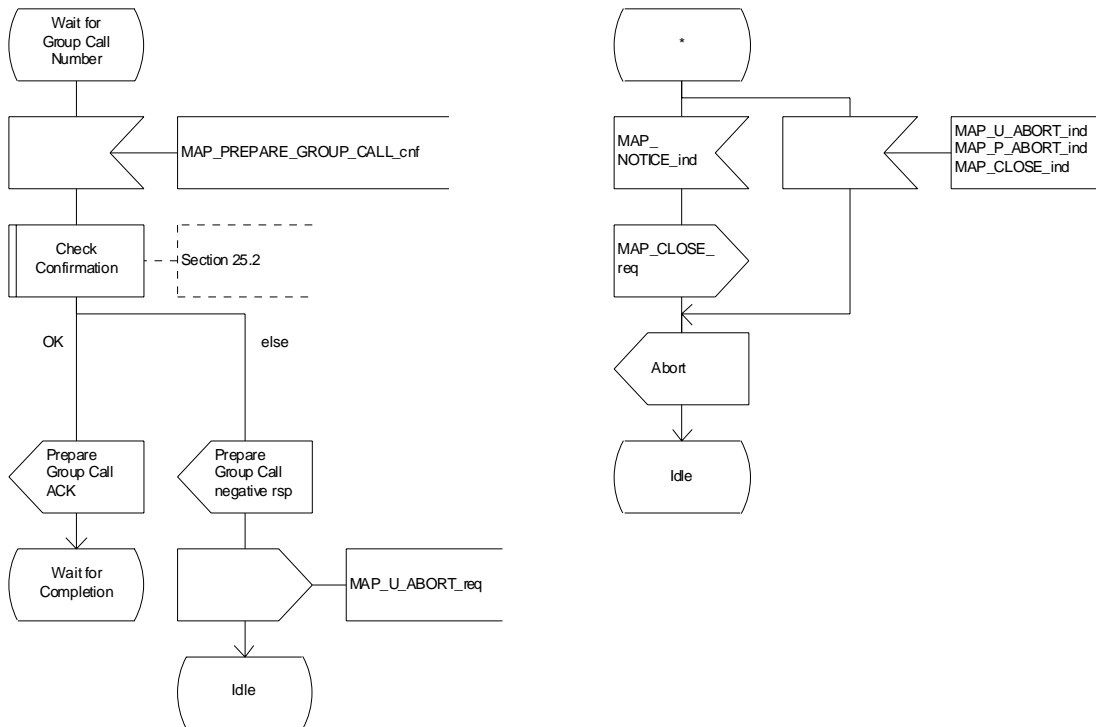

Figure 21.4/2 (sheet 2 of 4): Process ASCI_Anchor_MSC

Process ASCI_Anchor_MSC

21.4_2.3(4)

Figure 21.4/2: Process in the Anchor MSC for ASCI call handling

Signals to/from the left are to/from the A-MSC/ASCI process; signals to/from the right are to/from the R-MSC

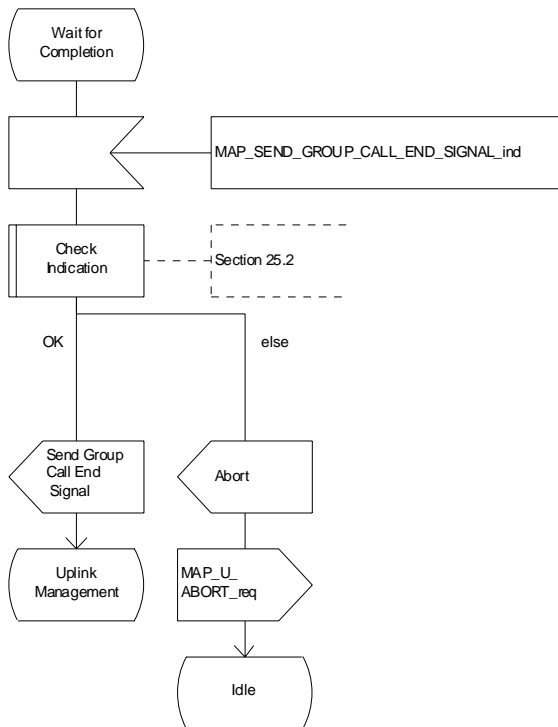

Figure 21.4/2 (sheet 3 of 4): Process ASCI_Anchor_MSC

Process ASCI_Anchor_MSC

21.4_2.4(4)

Figure 21.4/2: Process in the Anchor MSC for ASCI call handling

Signals to/from the left are to/from the A-MSC ASCI process; signals to/from the right are to/from the R-MSC

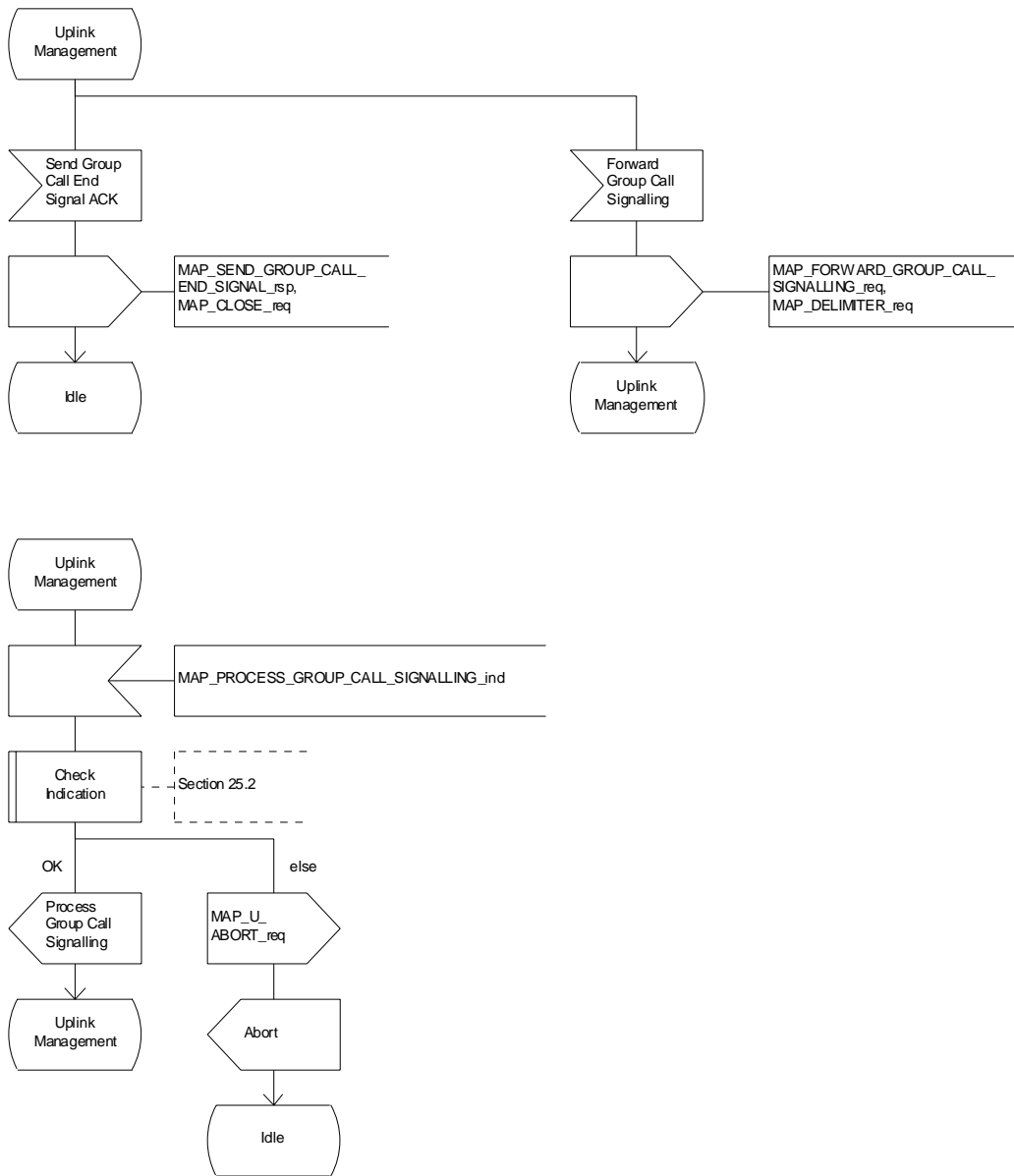

Figure 21.4/2 (sheet 4 of 4): Process ASCI_Anchor_MSC

21.4.3 Process in the Relay MSC

The MAP process in the Relay MSC to receive and transfer information from / to the Anchor MSC for VBS and VGCS calls is shown in figure 21.4/3. The MAP process invokes macros not defined in this clause; the definitions of these macros can be found as follows:

Receive_Open_Ind	see clause 25.1.2;
Check_Indication	see clause 25.2.1.

Successful Outcome

When the MAP process receives a MAP_OPEN indication with the application context groupCallControl, it checks it by invoking the macro Receive_Open_Ind.

If the macro takes the OK exit, the MAP process waits for a service indication.

If a MAP_PREPARE_GROUP_CALL service indication is received, the MAP process invokes the macro Check_Indication.

If the macro takes the OK exit, the MAP process sends a Prepare Group Call request to the ASCI handling process in the relay MSC and waits for a response. The Prepare Group Call request contains the parameters received in the MAP_PREPARE_GROUP_CALL service indication.

If the ASCI handling process in the relay MSC returns a Prepare Group Call ack, the MAP process constructs a MAP_PREPARE_GROUP_CALL service response containing the information contained in the Prepare Group Call ack, constructs a MAP_DELIMITER service request, sends them to the anchor MSC and waits for the GROUP CALL END SIGNAL.

If the ASCI handling process in the relay MSC sends a Send Group Call End Signal request to the MAP process, the MAP process constructs a MAP_SEND_GROUP_CALL_END_SIGNAL service request containing the information contained in the SEND GROUP CALL End Signal request, constructs a MAP_DELIMITER service request, sends them to the anchor MSC and waits for uplink management signals. In this state the following events are processed:

- Reception of a MAP_SEND_GROUP_CALL_END_SIGNAL service confirmation from the anchor MSC;
- Reception of a MAP_FORWARD_GROUP_CALL_SIGNALLING service indication from the anchor MSC;
- Reception of a Process Group Call Signalling request from the ASCI handling process in the relay MSC.

On reception of a MAP_SEND_GROUP_CALL_END_SIGNAL service confirmation from the anchor MSC, the MAP process returns to the idle state.

On reception of a MAP_FORWARD_GROUP_CALL_SIGNALLING service indication from the anchor MSC, the MAP process invokes the macro Check Indication. If the macro takes the OK exit, the MAP process sends a Forward Group Call Signalling request to the ASCI handling process in the relay MSC and waits for further uplink management signals.

On reception of a Process Group Call Signalling request from the ASCI handling process in the relay MSC, the MAP process constructs a MAP_PROCESS_GROUP_CALL_SIGNALLING service request containing the information received in the Process Group Call Signalling request, constructs a MAP_DELIMITER service request, sends them to the anchor MSC and waits for further uplink management signals.

Failure of dialogue opening with the anchor MSC

If the macro Receive_Open_Ind takes the Error exit, the MAP process returns to the idle state.

If the MAP provider sends a MAP_P_ABORT while the MAP process is waiting for a service indication, the MAP process returns to the idle state.

If the MAP provider sends a MAP_NOTICE while the MAP process is waiting for a service indication, the MAP process sends a MAP_CLOSE request to terminate the dialogue and returns to the idle state.

Error in MAP_PREPARE_GROUP_CALL indication

If the macro Check Indication takes the Error exit, the MAP process sends a MAP_U_ABORT request to the anchor MSC and returns to the idle state.

Negative response received from the ASCI handling process

If the ASCI handling process in the relay MSC returns a negative response to the Prepare Group Call request, the MAP process constructs a MAP_PREPARE_GROUP_CALL service response containing the appropriate error, constructs a MAP_CLOSE service request, sends them to the anchor MSC and returns to the idle state.

Error in MAP_FORWARD_GROUP_CALL_SIGNALLING indication

If the macro Check Indication takes the Error exit, the MAP process sends a MAP_U_ABORT request to the anchor MSC, sends an Abort to the ASCI handling process in the relay MSC and returns to the idle state.

Abort of MAP dialogue

After the dialogue with the anchor MSC has been established, the MAP service provider may abort the dialogue by issuing a MAP_P_ABORT indication, or the anchor MSC may send a MAP_U_ABORT indication or a MAP_CLOSE indication. In any of these cases, the MAP process sends an Abort to the ASCI handling process in the relay MSC and returns to the idle state.

If the MAP provider indicates a protocol problem by sending a MAP_NOTICE indication, the MAP process closes the dialogue with the anchor MSC, sends an Abort to the ASCI handling process in the anchor MSC and returns to the idle state.

Process ASCI_Relay_MSC

21.4_3.1(3)

Figure 21.4/3: Process in the Relay MSC for ASCI call handling

Signals to/from the left are to/from the A-MSC; Signals to/from the right are to/from the R-MSC ASCI process

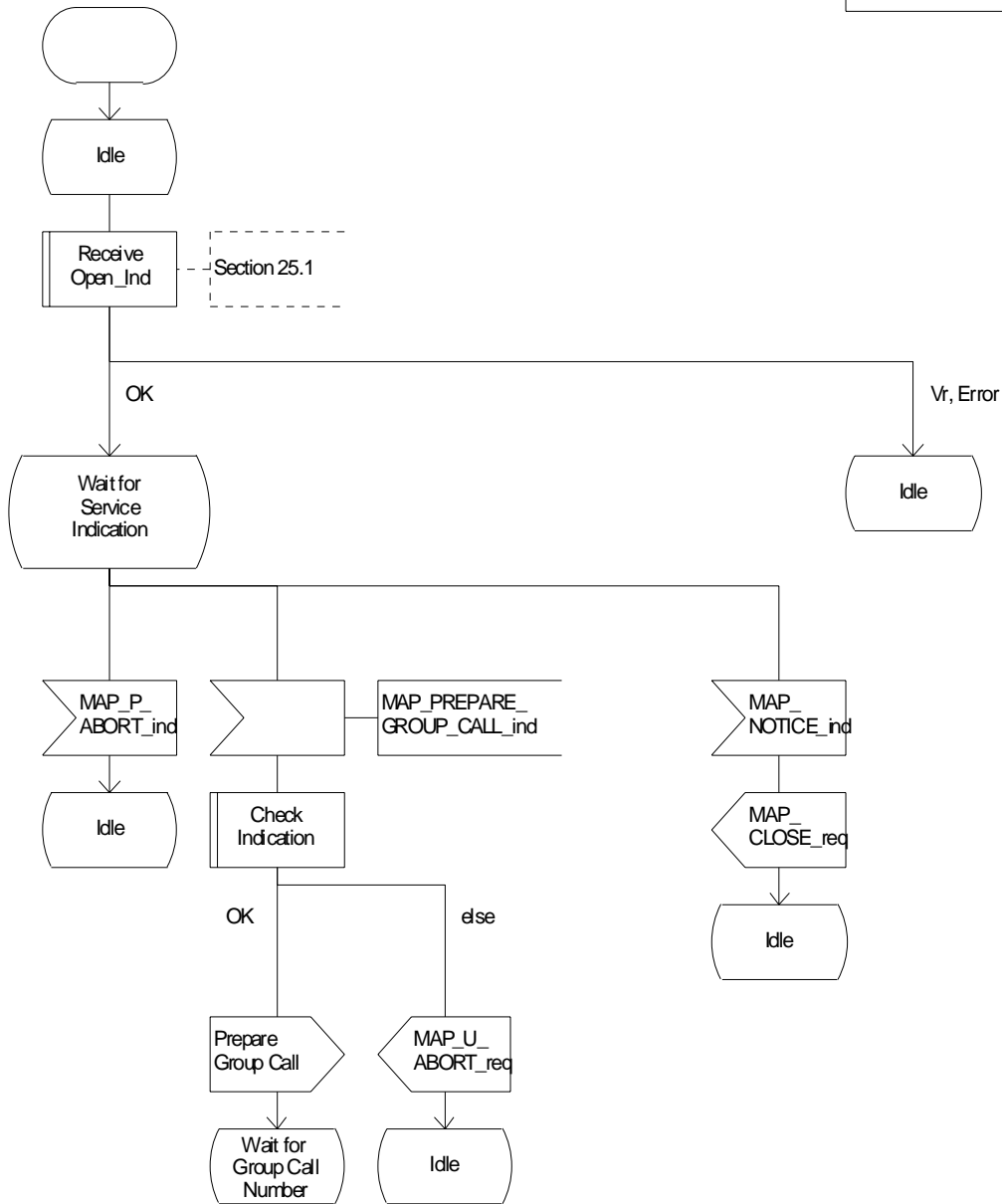

Figure 21.4/3 (sheet 1 of 3): Process ASCI_Relay_MSC

Process ASCII_Relay_MSC

21.4_3.2(3)

Figure 21.4/3: Process in the Relay MSC for ASCII call handling

Signals to/from the left are to/from the A-MSC; Signals to/from the right are to/from the R-MSC ASCII process

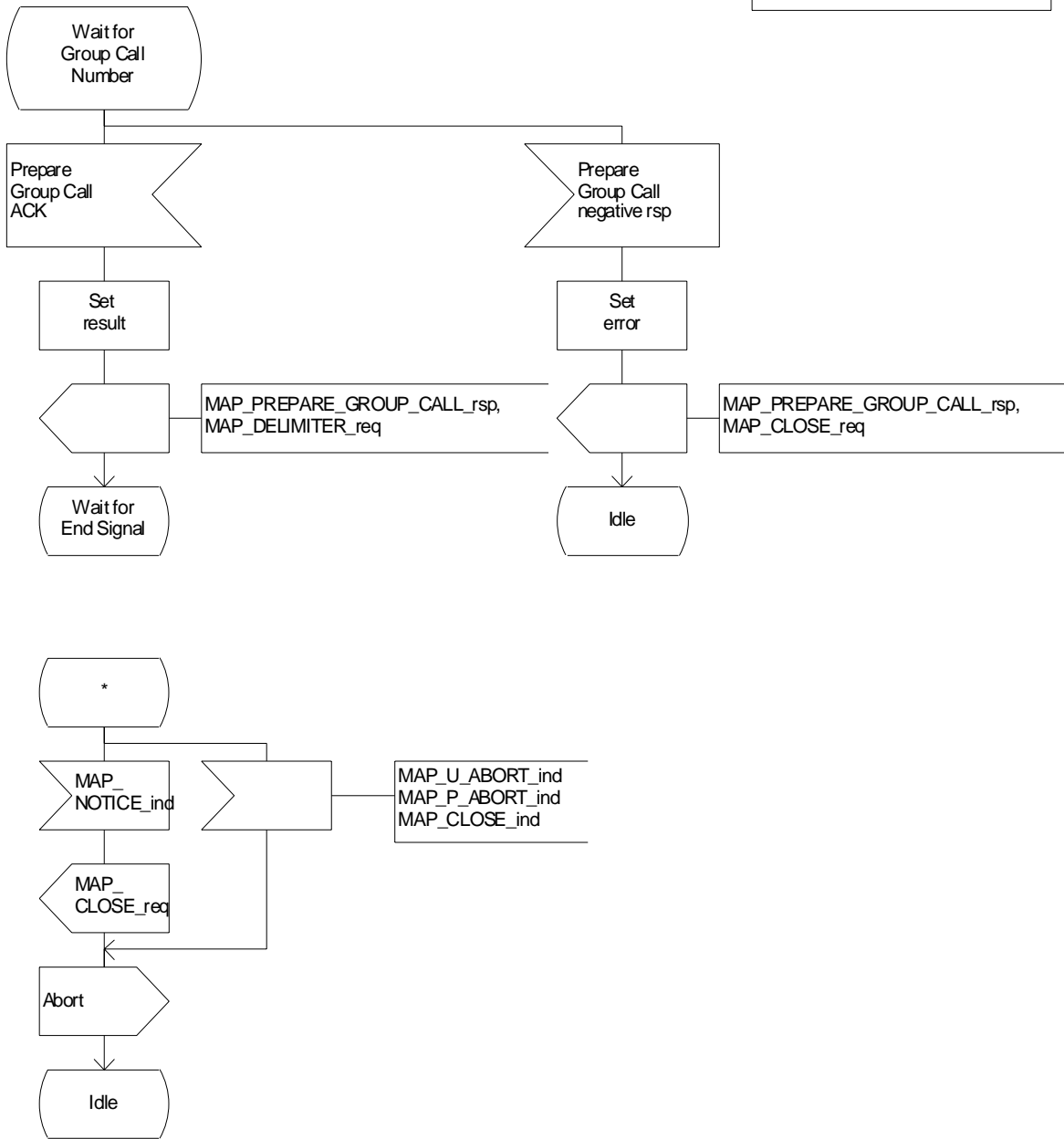

Figure 21.4/3 (sheet 2 of 3): Process ASCII_Relay_MSC

Process ASCI_Relay_MSC

21.4_3.3(3)

Figure 21.4/3: Process in the Relay MSC for ASCI call handling

Signals to/from the left are to/from the A-MSC; Signals to/from the right are to/from the R-MSC ASCI process

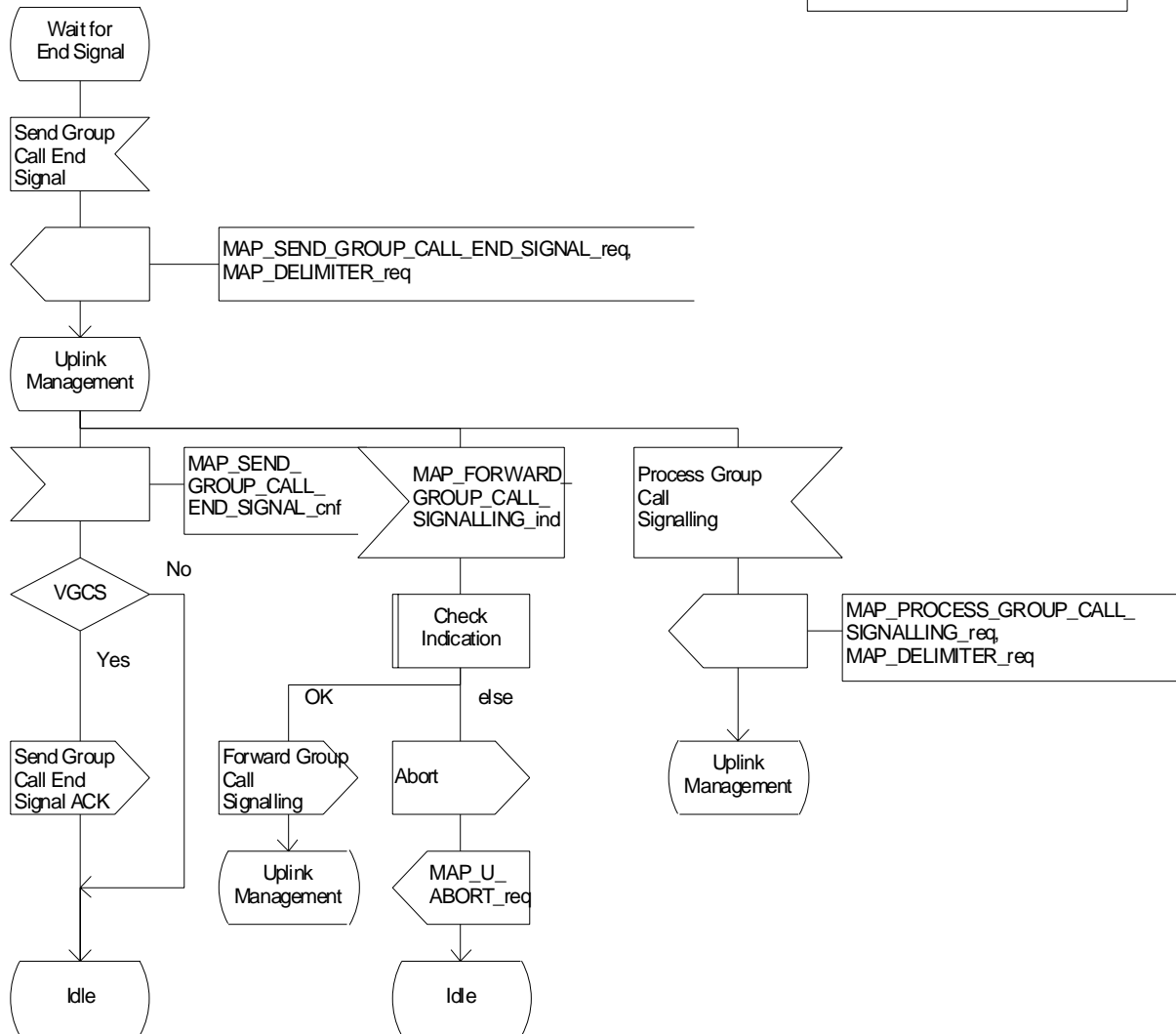
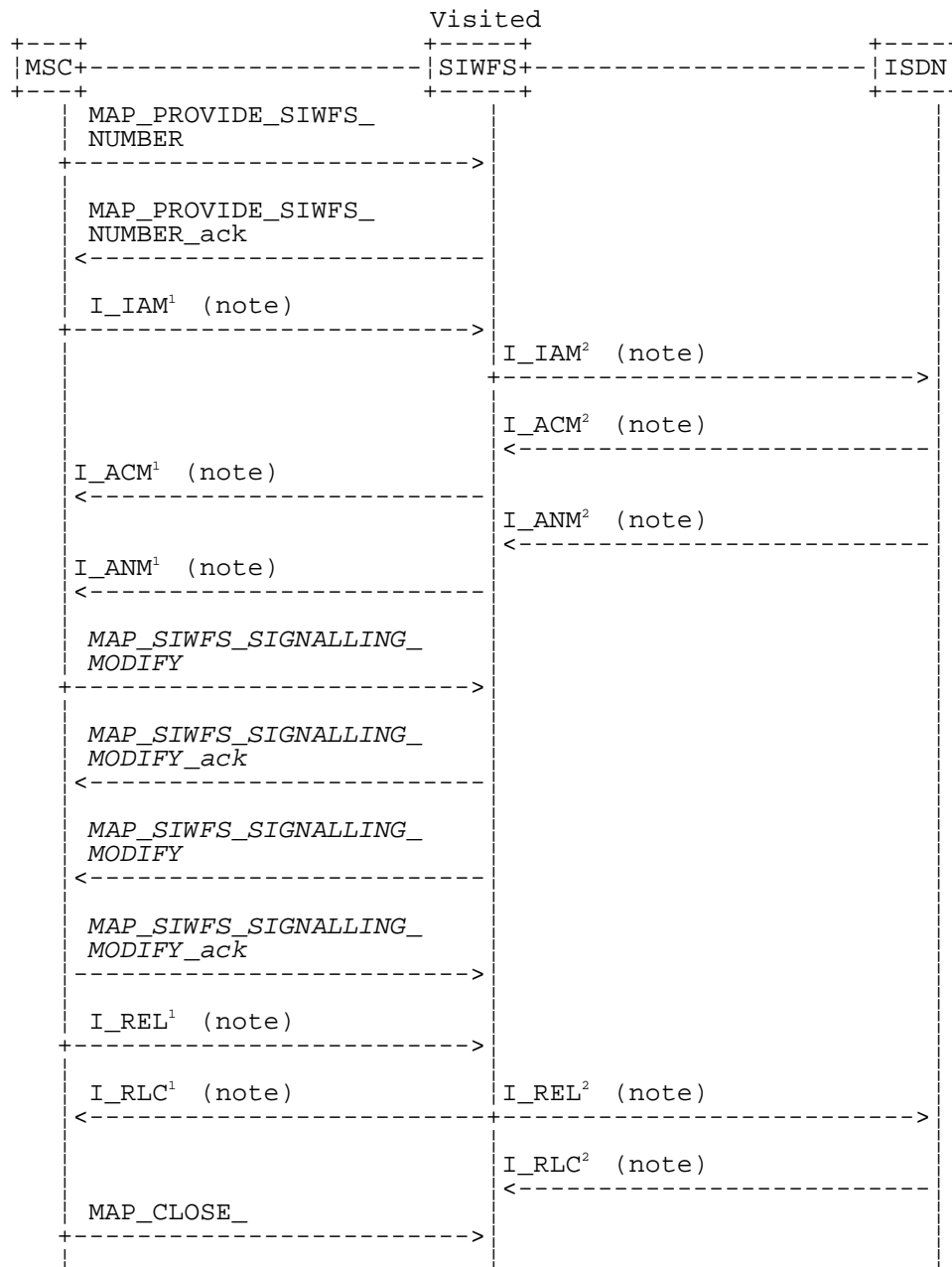

Figure 21.4/3 (sheet 3 of 3): Process ASCI_Relay_MSC

21.5 Allocation and modifications of resources in an SIWFS

21.5.1 General

The message flow for successful allocation and modification of resources in an SIWFS is shown in figure 21.5/1 (mobile originating call non-loop method), 21.5/2 (mobile originating call loop method) and 21.5/3 (mobile terminating call loop method).



xxx = Optional Procedure

- NOTE 1: TUP or ISUP may be used in signalling between MSCs, depending on the network type between the MSCs. The Release message can be initiated either by the calling or called subscriber. For further details on the TUP and ISUP procedures refer to the following CCITT Recommendations & ETSI specification:
- Q.721-725 - Telephone User Part (TUP);
 - ETS 300 356-1 - Integrated Services Digital Network (ISDN); Signalling System No.7; ISDN User Part (ISUP) version 2 for the international interface; Part 1: Basic services.

NOTE 2: The number on the ISUP messages have been added to link the messages to respective signalling sequence.

NOTE 3: The modification of SIWF resources could be initiated any time during the call either by the VMSC or the SIWFS.

Figure 21.5/1: Message flow for mobile originating call non-loop method

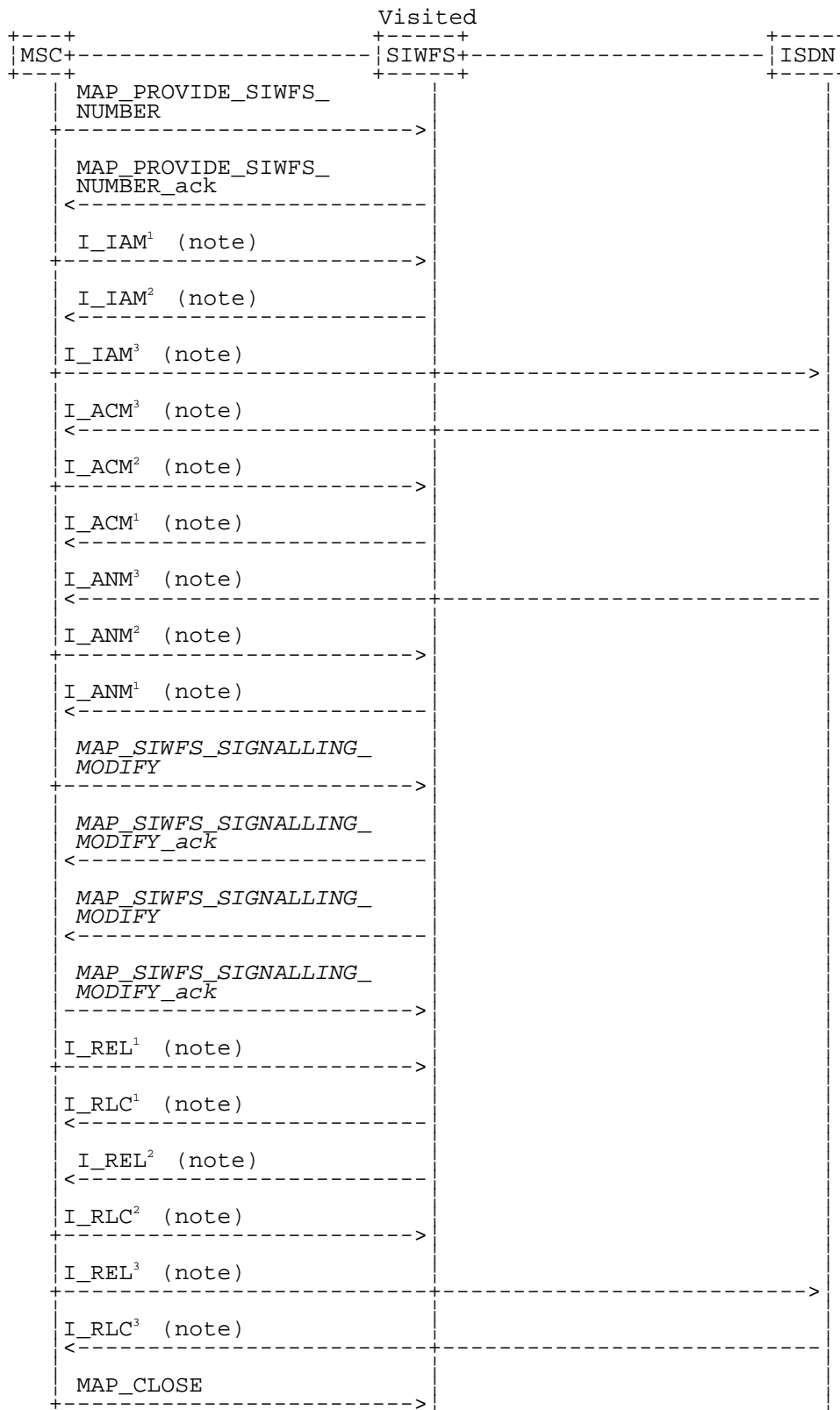

xxx = Optional Procedure

NOTE 1: TUP or ISUP may be used in signalling between MSCs, depending on the network type between the MSCs. The Release message can be initiated either by calling or called subscriber. For further details on the TUP and ISUP procedures refer to the following CCITT Recommendations & ETSI specification:

- Q.721-725 - Telephone User Part (TUP);
- ETS 300 356-1 - Integrated Services Digital Network (ISDN); Signalling System No.7; ISDN User Part (ISUP) version 2 for the international interface; Part 1: Basic services.

NOTE 2: The number on the ISUP messages have been added to link the messages to respective signalling sequence.

NOTE 3: The modification of SIWF resources could be initiated any time during the call either by the VMSC or the SIWFS.

Figure 21.5/2: Message flow for mobile originating call loop method

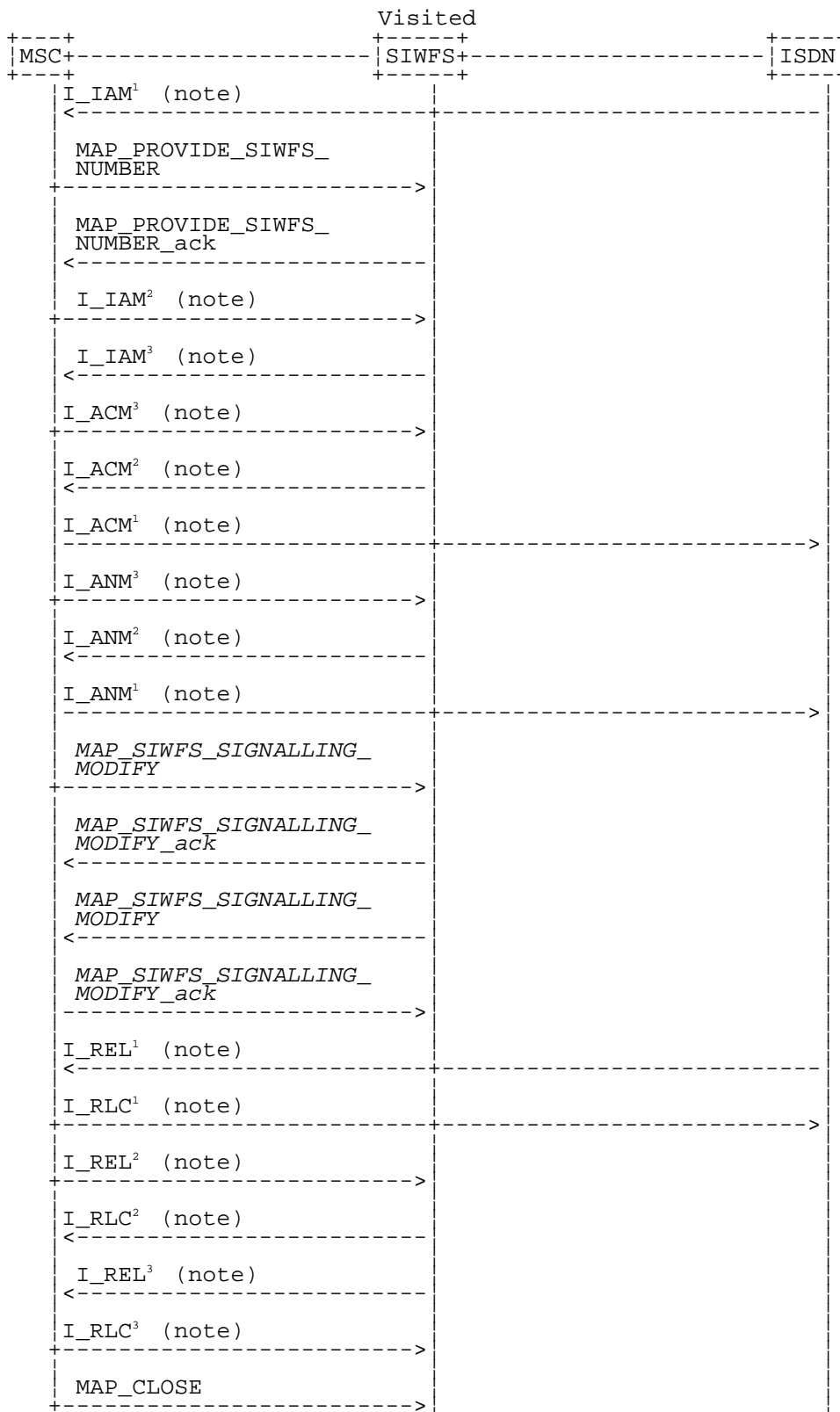

xxx = Optional Procedure

NOTE 1: TUP or ISUP may be used in signalling between MSCs, depending on the network type between the MSCs. The Release message can be initiated either by calling or called subscriber. For further details on the TUP and ISUP procedures refer to the following CCITT Recommendations & ETSI specification:

- Q.721-725 - Telephone User Part (TUP);

- ETS 300 356-1 - Integrated Services Digital Network (ISDN); Signalling System No.7; ISDN User Part (ISUP) version 2 for the international interface; Part 1: Basic services.

NOTE 2: The number on the ISUP messages have been added to link the messages to respective signalling sequence.

NOTE 3: The modification of SIWF resources could be initiated any time during the call either by the VMSC or the SIWFS.

Figure 21.5/3: Message flow for mobile terminating call loop method

The following MAP services are used to allocate resources in an SIWFS:

MAP_PROVIDE_SIWFS_NUMBER see clause 10.8.

The following MAP services are used to modify resources in an SIWFS:

MAP_SIWFS_SIGNALLING_MODIFY see clause 10.9.

21.5.2 Process in the VMSC

The MAP process in the VMSC to allocate and modify resources in an SIWFS for a mobile call is shown in figure 21.5/4. The MAP process invokes macros not defined in this clause; the definitions of these macros can be found as follows:

Receive_Open_Cnf see clause 25.1.2;

Check_Confirmation see clause 25.2.2.

21.5.2.1 Allocation of SIWFS resources

Successful Outcome

When the MAP process receives a Provide SIWFS Number request from the call handling process in the VMSC, it requests a dialogue with the SIWF whose identity is contained in the Provide SIWFS Number request by sending a MAP_OPEN service request, requests resources in the SIWFS using a MAP_PROVIDE_SIWFS_NUMBER service request and invokes the macro Receive_Open_Cnf to wait for the response to the dialogue opening request. If the dialogue opening is successful, the MAP process waits for a response from the SIWFS.

If the MAP process receives a MAP_PROVIDE_SIWFS_NUMBER service confirm from the SIWFS, the MAP process invokes the macro Check_Confirmation to check the content of the confirm.

If the macro Check_Confirmation takes the OK exit, the MAP process sends a Provide SIWFS Number ack containing the SIWFS Number received from the SIWFS to the call handling process in the VMSC and go to Wait_For_Modification state.

Earlier version MAP dialogue with the SIWFS

If the macro Receive_Open_Cnf takes the Vr exit, the MAP process sends an Abort to the call handling process in the VMSC and returns to the idle state.

Dialogue opening failure

If the macro Receive_Open_Cnf indicates that the dialogue with the SIWFS could not be opened, the MAP process sends an Abort to the call handling process in the VMSC and returns to the idle state.

Error in MAP_PROVIDE_SIWFS_NUMBER confirm

If the MAP_PROVIDE_SIWFS_NUMBER service confirm contains a user error or a provider error, or the macro Check_Confirmation indicates that there is a data error, the MAP process sends a Provide SIWFS number negative response to the call handling process in the VMSC and returns to the idle state.

Call release

If the call handling process in the VMSC indicates that the call has been aborted, the MAP process returns to the idle state. Any response from the SIWFS will be discarded.

If the call handling process in the VMSC indicates that the traffic channel has been released (i.e. call released by a user) a MAP_CLOSE_req is sent and the process is returned to the idle state.

Abort of SIWFS dialogue

During the time an answer is expected from the SIWFS, the MAP service provider may abort the dialogue by issuing a MAP_P_ABORT indication, or the SIWFS may send a MAP_U_ABORT indication or a MAP_CLOSE indication. In any of these cases, the MAP process sends a Provide SIWFS number negative response to the call handling process in the VMSC and returns to the idle state.

If the MAP provider indicates a protocol problem by sending a MAP_NOTICE indication, the MAP process closes the dialogue with the SIWFS, sends a Provide SIWFS number negative response indicating system failure to the call handling process in the VMSC and returns to the idle state.

After the dialogue with the SIWFS has been established, the MAP service provider may abort the dialogue by issuing a MAP_P_ABORT indication, or the SIWFS may send a MAP_U_ABORT indication or a MAP_CLOSE indication. In any of these cases, the MAP process returns to the idle state.

If the MAP provider indicates a protocol problem by sending a MAP_NOTICE indication, the MAP process closes the dialogue with the SIWFS, and returns to the idle state.

21.5.2.2 Modification of SIWFS resources initiated by the user

Successful Outcome

When the MAP process receives an SIWFS Signalling Modify request from the call handling process in the VMSC, it requests a dialogue with the SIWFS whose identity is contained in the SIWFS Signalling Modify request by sending a MAP_SIWFS_SIGNALLING_MODIFY service request and waits for a response from the SIWFS.

If the MAP process receives a MAP_SIWFS_SIGNALLING_MODIFY service confirm from the SIWFS, the MAP process invokes the macro Check_Confirmation to check the content of the confirm.

If the macro Check_Confirmation takes the OK exit, the MAP process sends an SIWFS Signalling Modify ack containing the response received from the SIWFS to the call handling process in the VMSC and go to Wait_For_Modification state.

Error in MAP_SIWFS_SIGNALLING_MODIFY confirm

If the MAP_SIWFS_SIGNALLING_MODIFY service confirm contains a user error or a provider error, or the macro Check_Confirmation indicates that there is a data error, the MAP process sends an SIWFS Signalling Modify negative response to the call handling process in the VMSC and go to Wait_For_Modification state.

Abort of SIWFS dialogue

During the time an answer is expected from the SIWFS, the MAP service provider may abort the dialogue by issuing a MAP_P_ABORT indication, or the SIWFS may send a MAP_U_ABORT indication or a MAP_CLOSE indication. In any of these cases, the MAP process sends an SIWFS Signalling Modify negative response to the call handling process in the VMSC and returns to the idle state.

If the MAP provider indicates a protocol problem by sending a MAP_NOTICE indication, the MAP process closes the dialogue with the SIWFS, sends an SIWFS Signalling Modify negative response indicating system failure to the call handling process in the VMSC and returns to the idle state.

21.5.2.3 Modification of SIWFS resources initiated by the SIWFS

Successful outcome

If a MAP_SIWFS_SIGNALLING_MODIFY service indication is received, the MAP process sends an SIWFS signalling modify Info request to the call handling process in the VMSC, and waits for a response. The SIWFS signalling modify request contains the parameters received in the MAP_SIWFS_SIGNALLING_MODIFY service indication.

If the call handling process in the VMSC returns an SIWFS signalling modify ack, the MAP process constructs a MAP_SIWFS_SIGNALLING_MODIFY service response contained in the Provide SIWFS Number ack, send it to the SIWFS and go to Wait_For_Modification state.

Negative response from VMSC call handling process

If the call handling process in the VMSC returns a negative response the MAP process constructs a MAP_SIWFS_SIGNALLING_MODIFY service response containing the appropriate error, send it to the SIWFS and go to Wait_For_Modification state.

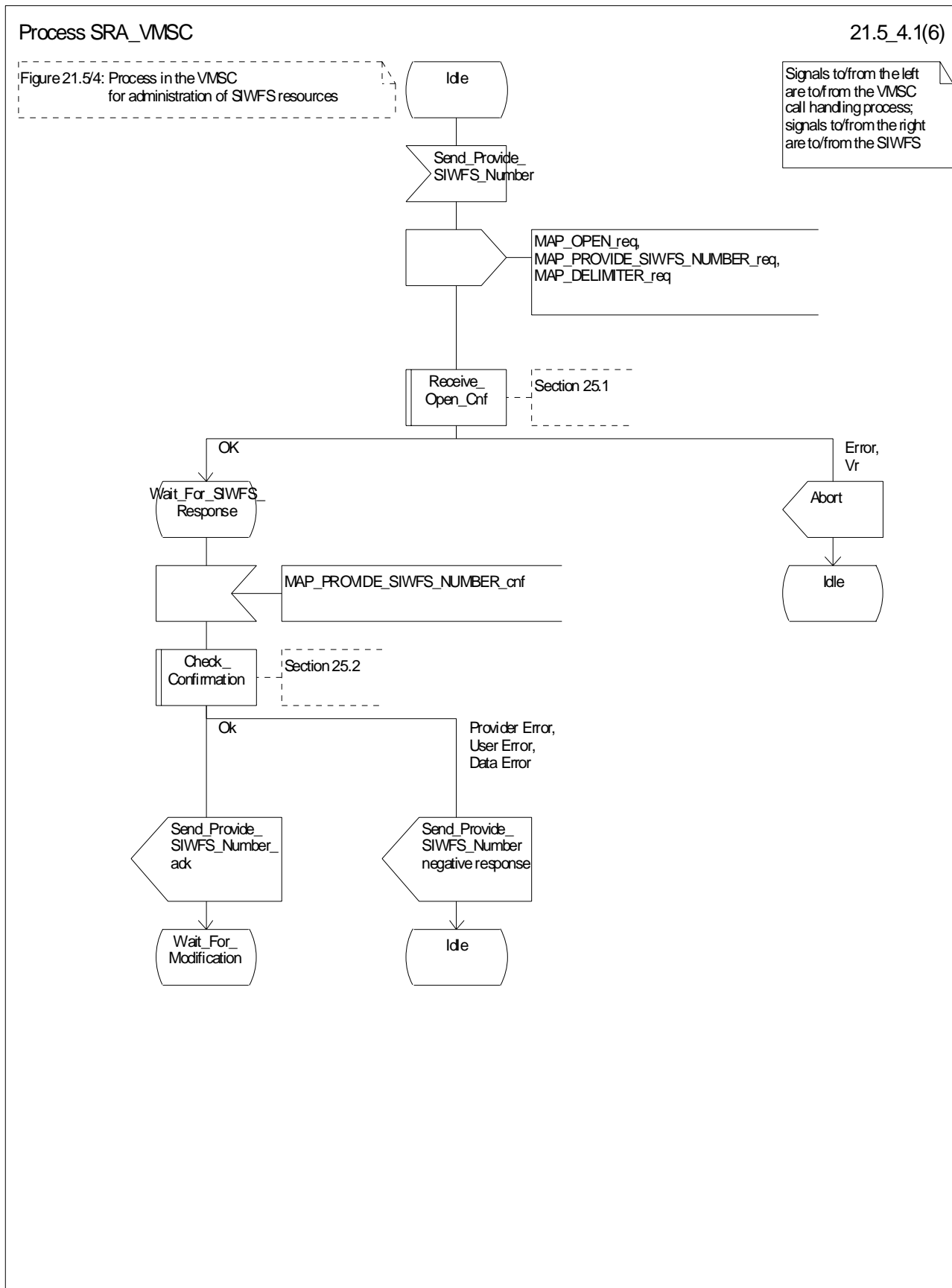

Figure 21.5/4 (sheet 1 of 6): Process SRA (SIWFS_RESOURCE_ADMINISTRATION)_VMSC

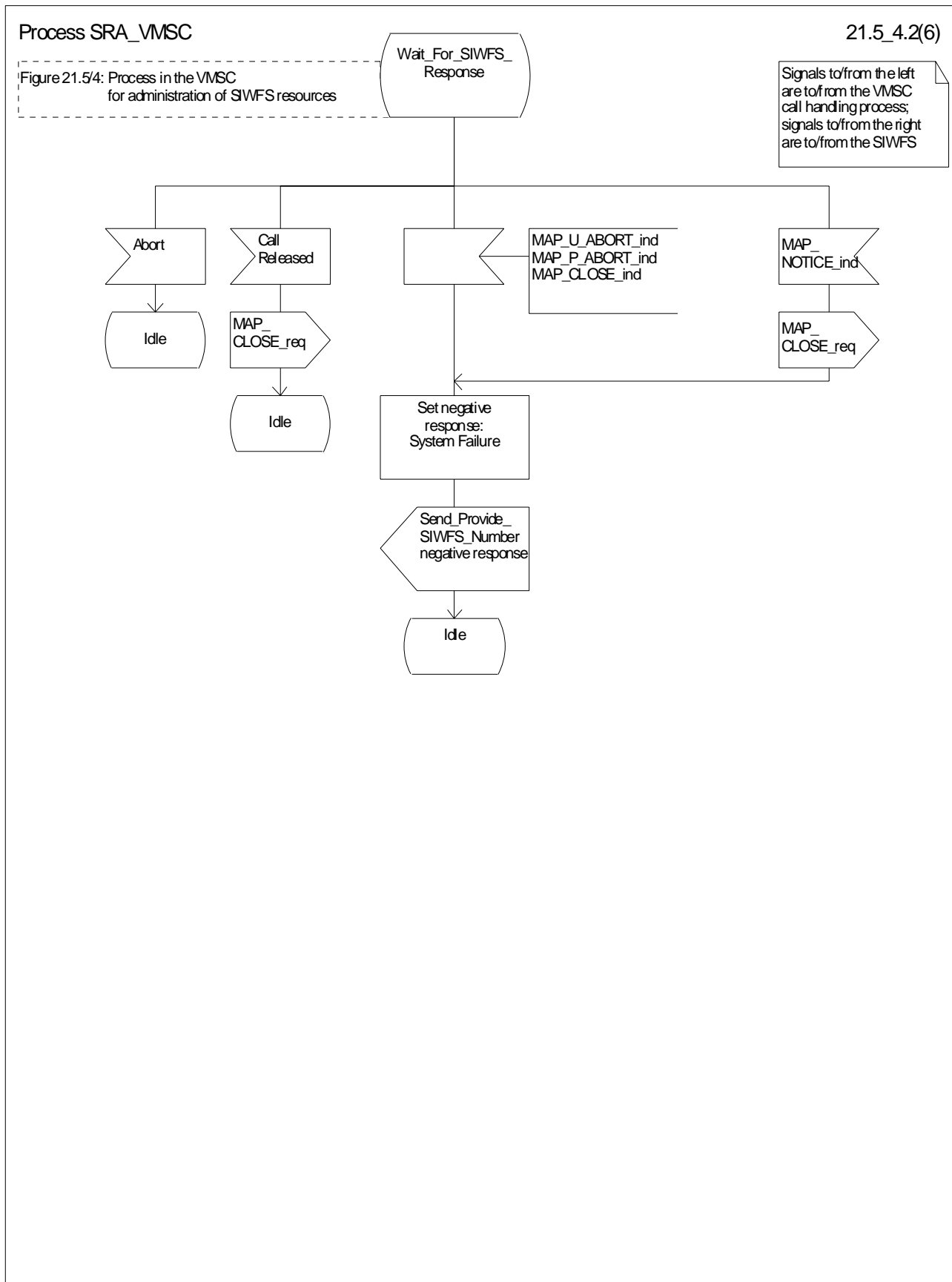

Figure 21.5/4 (sheet 2 of 6): Process SRA_VMSC

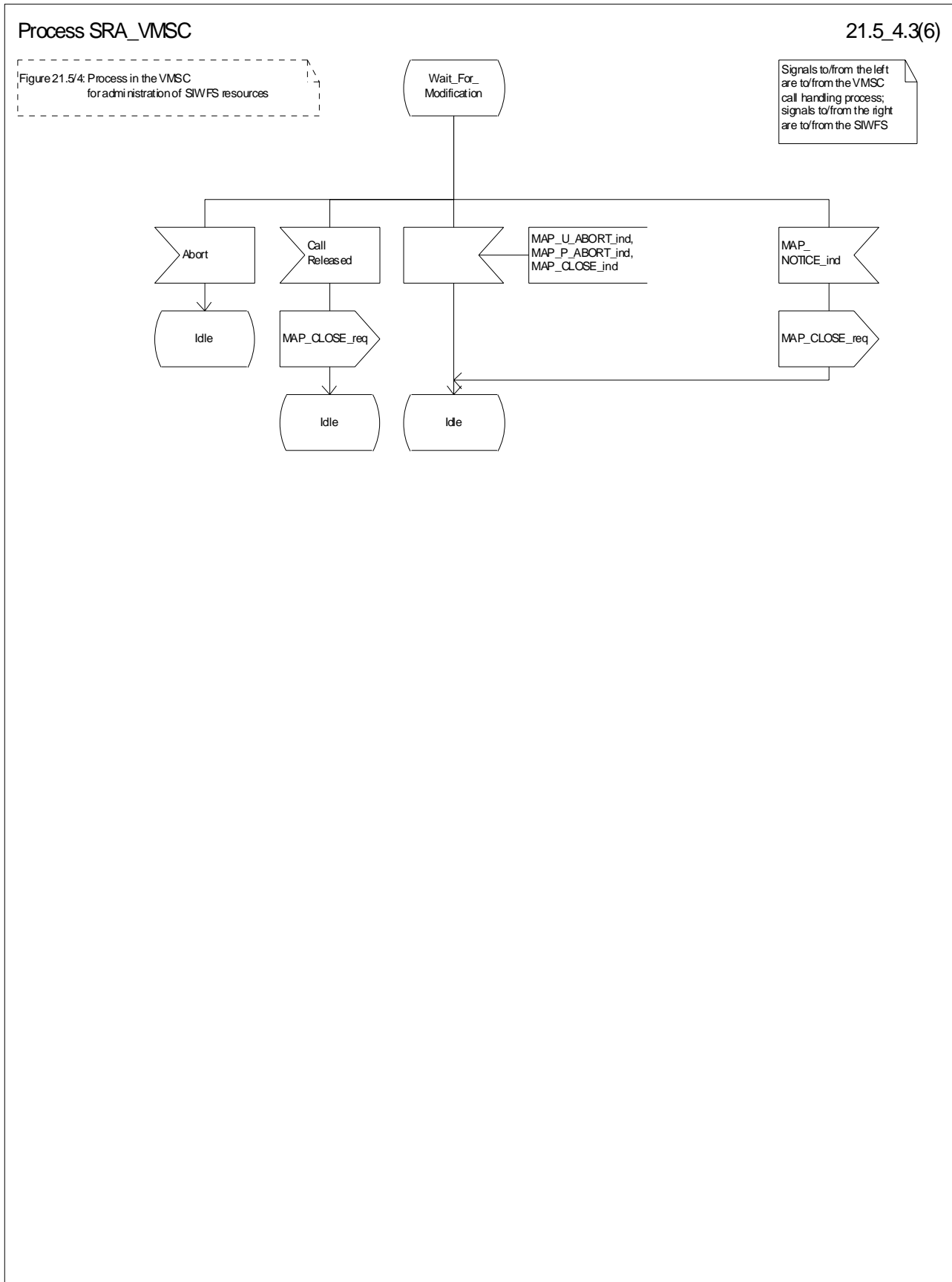

Figure 21.5/4 (sheet 3 of 6): Process SRA_VMSC

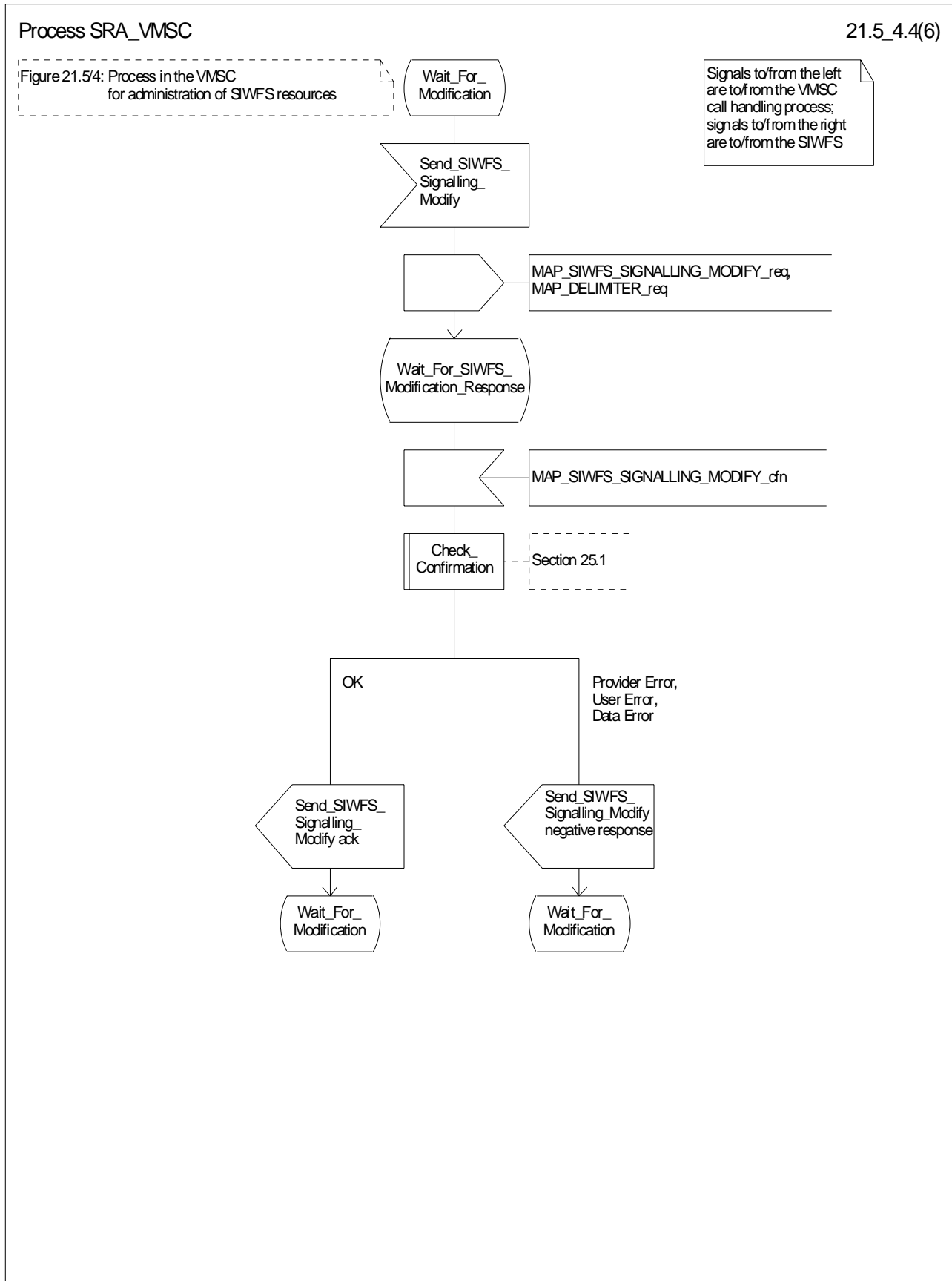

Figure 21.5/4 (sheet 4 of 6): Process SRA_VMSC

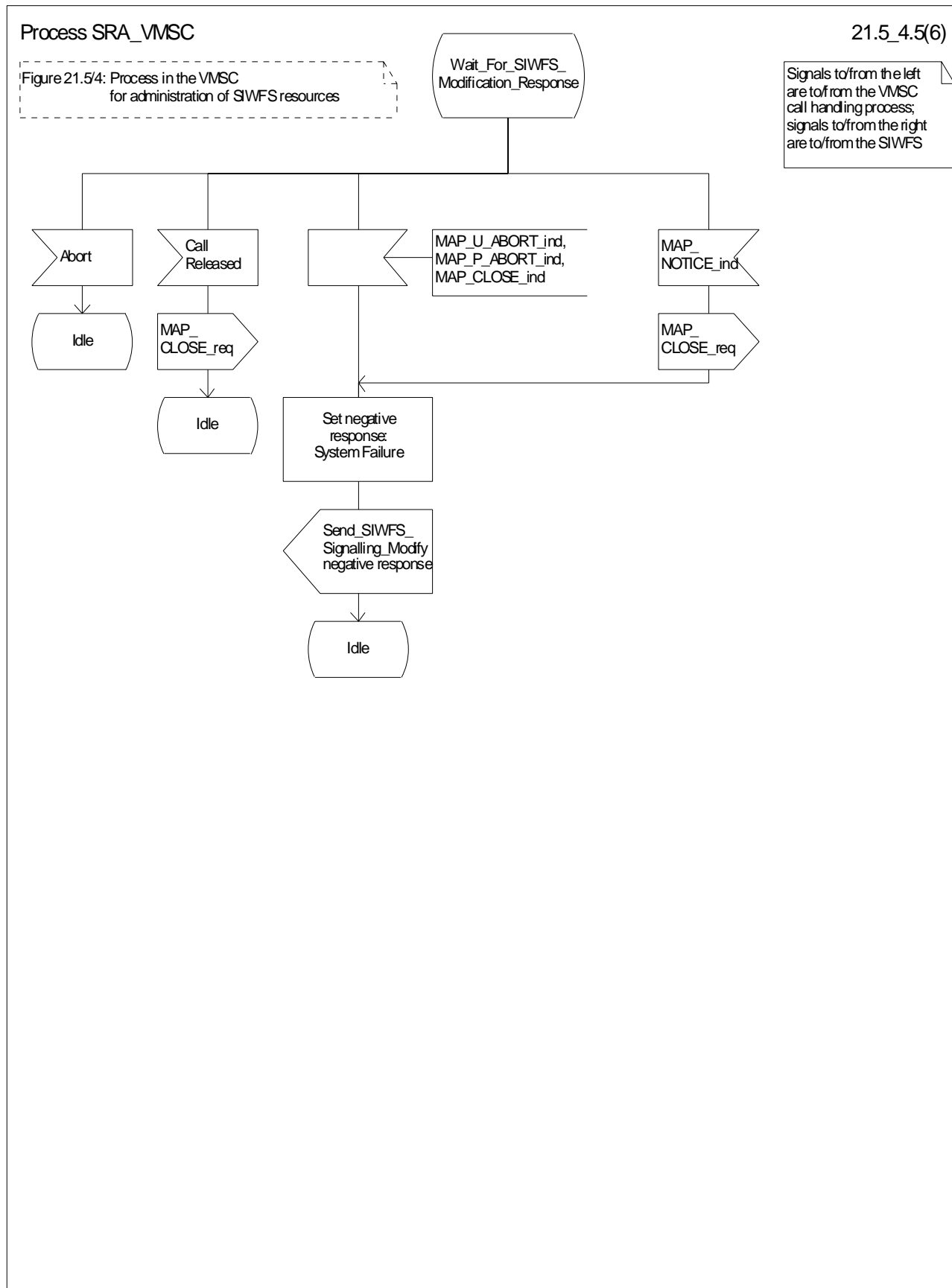

Figure 21.5/4 (sheet 5 of 6): Process SRA_VMSC

Process SRA_VMSC

21.5_4.6(6)

Figure 21.5/4: Process in the VMSC for administration of SIWFS resources

Signals to/from the left are to/from the VMSC call handling process; signals to/from the right are to/from the SIWFS

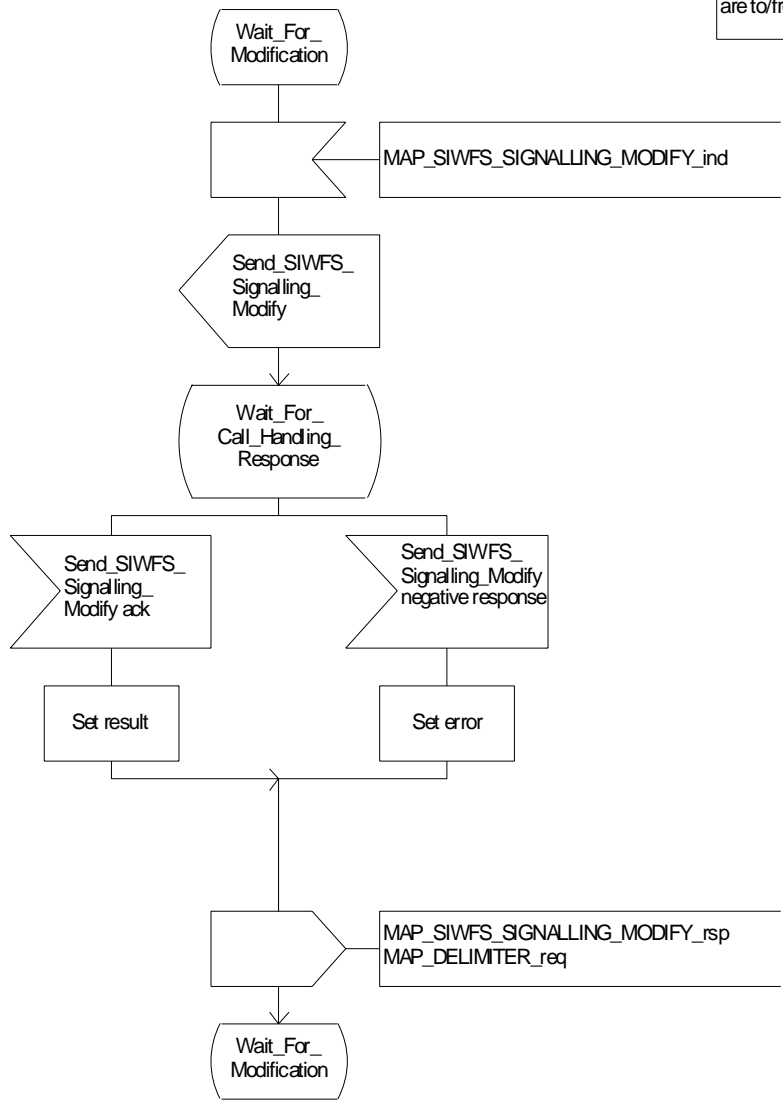

Figure 21.5/4 (sheet 6 of 6): Process SRA_VMSC

21.5.3 Process in the SIWFS

The MAP process in the SIWFS to allocate and modify SIWFS resources for a mobile call is shown in figure 21.5/5. The MAP process invokes macros not defined in this clause; the definitions of these macros can be found as follows:

Receive_Open_Ind	see clause 25.1.1.
Check_Confirmation	see clause 25.2.2.

21.5.3.1 Procedures for allocation of SIWFS resources

Successful outcome

When the MAP process receives a MAP_OPEN indication with the application context locInfoRetrieval, it checks it by invoking the macro Receive_Open_Ind.

If the macro takes the OK exit, the MAP process waits for a service indication.

If a MAP_PROVIDE_SIWFS_NUMBER service indication is received, the MAP process sends a Provide SIWFS number Info request to the call handling process in the SIWFS, and waits for a response. The Provide SIWFS number request contains the parameters received in the MAP_PROVIDE_SIWFS_NUMBER service indication.

If the call handling process in the SIWFS returns a Provide SIWFS number ack, the MAP process constructs a MAP_PROVIDE_SIWFS_NUMBER service response containing the routing information contained in the Provide SIWFS Number ack, constructs a MAP_DELIMITER service request, sends them to the VMSC and go to Wait_For_Modification state.

Earlier version MAP dialogue with the VMSC

If the macro Receive_Open_Ind takes the Vr exit, the MAP process returns to the idle state.

Dialogue opening failure

If the macro Receive_Open_Ind takes the Error exit, the MAP process returns to the idle state.

If the MAP provider sends a MAP_P_ABORT while the MAP process is waiting for a service indication, the MAP process returns to the idle state.

If the MAP provider sends a MAP_NOTICE while the MAP process is waiting for a service indication, the MAP process sends a MAP_CLOSE request to terminate the dialogue and returns to the idle state.

Negative response from SIWFS call handling process

If the call handling process in the SIWFS returns a negative response the MAP process constructs a MAP_PROVIDE_SIWFS_NUMBER service response containing the appropriate error, constructs a MAP_CLOSE service request, sends them to the VMSC and returns to the idle state.

Call release

If the call handling process in the SIWFS indicates that the call has been aborted, the MAP process returns to the idle state. Any response from the VMSC will be discarded.

If the call handling process in the SIWFS indicates that the traffic channel has been released (i.e. call released by a user) a MAP_CLOSE_req is sent and the process is returned to the idle state.

Abort of VMSC dialogue

After the dialogue with the VMSC has been established, the MAP service provider may abort the dialogue by issuing a MAP_P_ABORT indication, or the VMSC may send a MAP_U_ABORT indication or a MAP_CLOSE indication. In any of these cases, the MAP process returns to the idle state.

If the MAP provider indicates a protocol problem by sending a MAP_NOTICE indication, the MAP process closes the dialogue with the VMSC, and returns to the idle state.

21.5.3.2 Process for modification of SIWFS resources initiated by the user

Successful outcome

If a MAP_SIWFS_SIGNALLING_MODIFY service indication is received, the MAP process sends an SIWFS signalling modify Info request to the call handling process in the SIWFS, and waits for a response. The SIWFS signalling modify request contains the parameters received in the MAP_SIWFS_SIGNALLING_MODIFY service indication.

If the call handling process in the SIWFS returns an SIWFS signalling modify ack, the MAP process constructs a MAP_SIWFS_SIGNALLING_MODIFY service response contained in the Provide SIWFS Number ack, send it to the VMSC and go to Wait_For_Modification state.

Negative response from SIWFS call handling process

If the call handling process in the SIWFS returns a negative response the MAP process constructs a MAP_SIWFS_SIGNALLING_MODIFY service response containing the appropriate error, send it to the VMSC and go to Wait_For_Modification state.

21.5.3.3 Process for modification of SIWFS resources initiated by the SIWFS

Successful Outcome

When the MAP process receives an SIWFS Signalling Modify request from the call handling process in the SIWF, it requests a dialogue with the VMSC whose identity is contained in the VMSC Signalling Modify request by sending a MAP_DELIMITER service request, requests resources in the VMSC using a MAP_SIWFS_SIGNALLING_MODIFY service request, the MAP process waits for a response from the VMSC.

If the MAP process receives a MAP_SIWFS_SIGNALLING_MODIFY service confirm from the VMSC, the MAP process invokes the macro Check_Confirmation to check the content of the confirm.

If the macro Check_Confirmation takes the OK exit, the MAP process sends an SIWFS Signalling Modify ack containing the response received from the VMSC to the call handling process in the SIWF and go to Wait_For_Modification state.

Error in MAP_SIWFS_SIGNALLING_MODIFY confirm

If the MAP_SIWFS_SIGNALLING_MODIFY service confirm contains a user error or a provider error, or the macro Check_Confirmation indicates that there is a data error, the MAP process sends an SIWFS Signalling Modify negative response to the call handling process in the SIWFS and go to Wait_For_Modification state.

Abort of SIWFS dialogue

During the time an answer is expected from the VMSC, the MAP service provider may abort the dialogue by issuing a MAP_P_ABORT indication, or the VMSC may send a MAP_U_ABORT indication or a MAP_CLOSE indication. In any of these cases, the MAP process sends an SIWFS Signalling Modify negative response to the call handling process in the SIWFS and returns to the idle state.

If the MAP provider indicates a protocol problem by sending a MAP_NOTICE indication, the MAP process closes the dialogue with the VMSC, sends an SIWFS Signalling Modify negative response indicating system failure to the call handling process in the SIWFS and returns to the idle state.

Process SRA_SIWFS

21.5_5.1(5)

Figure 21.5/5: Process in the SIWFS for administration of SIWFS resources

Signals to/from the left are to/from the SIWFS call handling process; signals to/from the right are to/from the VMSC

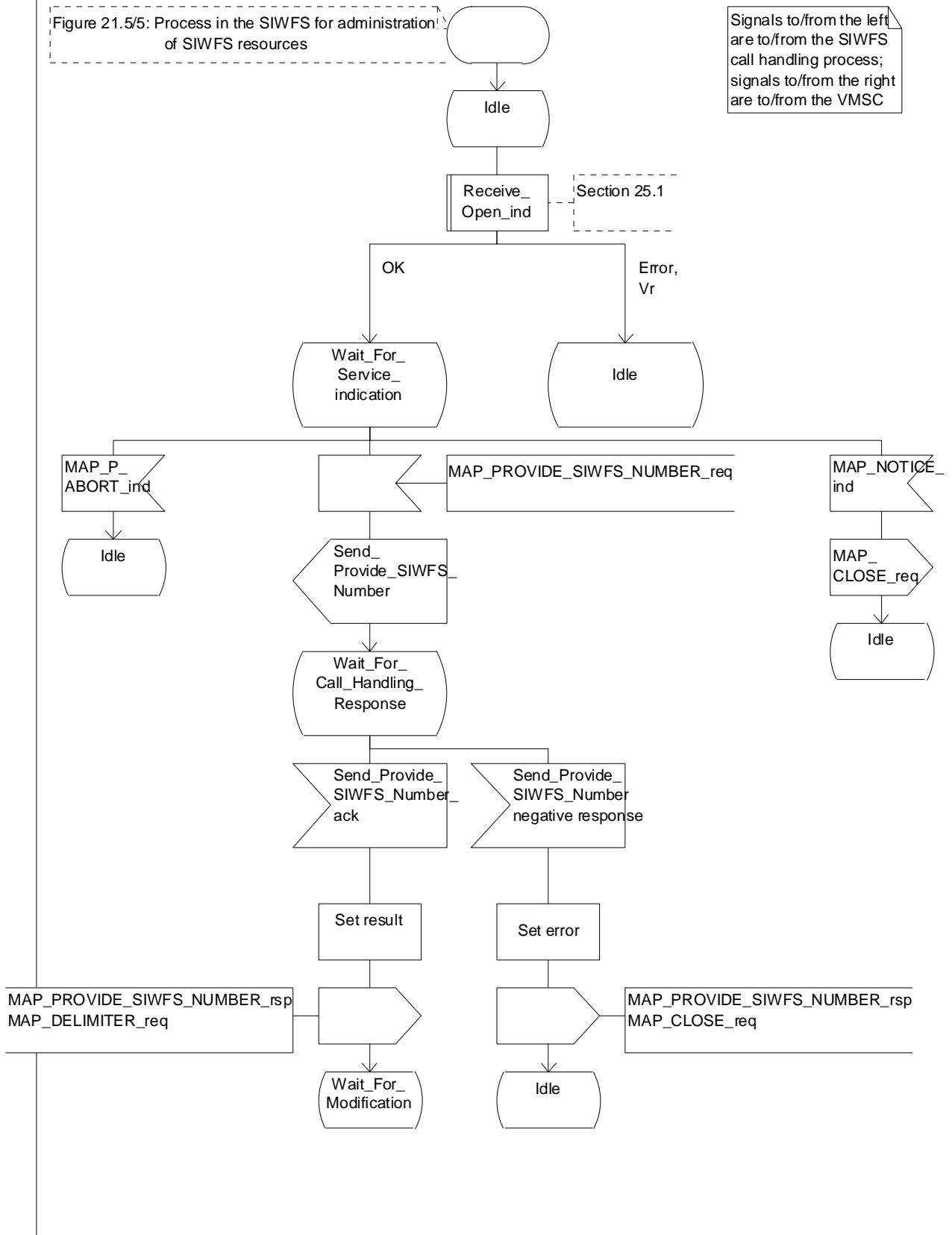

Figure 21.5/5 (sheet 1 of 5): Process SRA_SIWFS

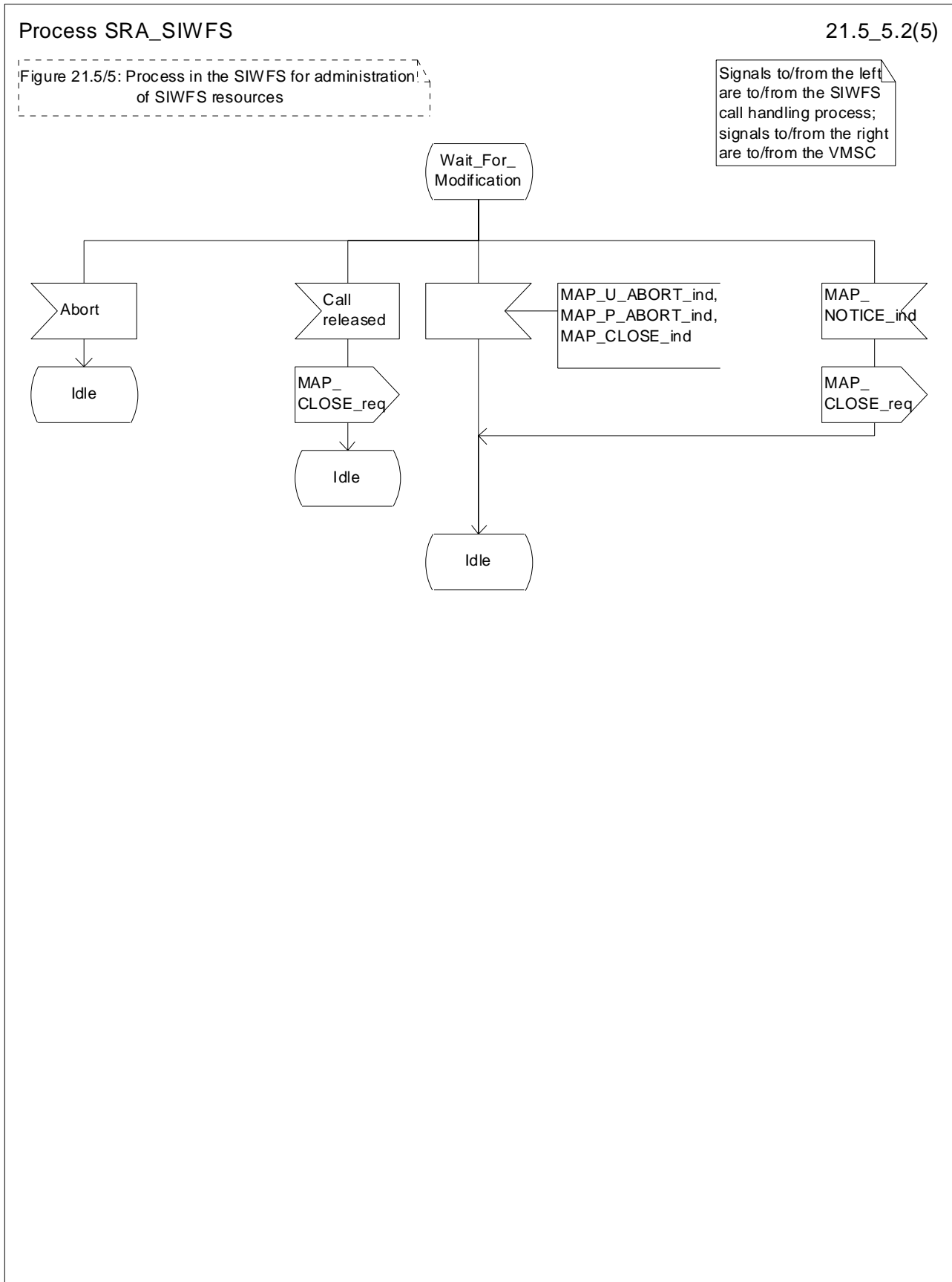

Figure 21.5/5 (sheet 2 of 5): Process SRA_SIWFS

Process SRA_SIWFS

21.5_5.3(5)

Figure 21.5/5: Process in the SIWFS for administration of SIWFS resources

Signals to/from the left are to/from the SIWFS call handling process; signals to/from the right are to/from the VMSC

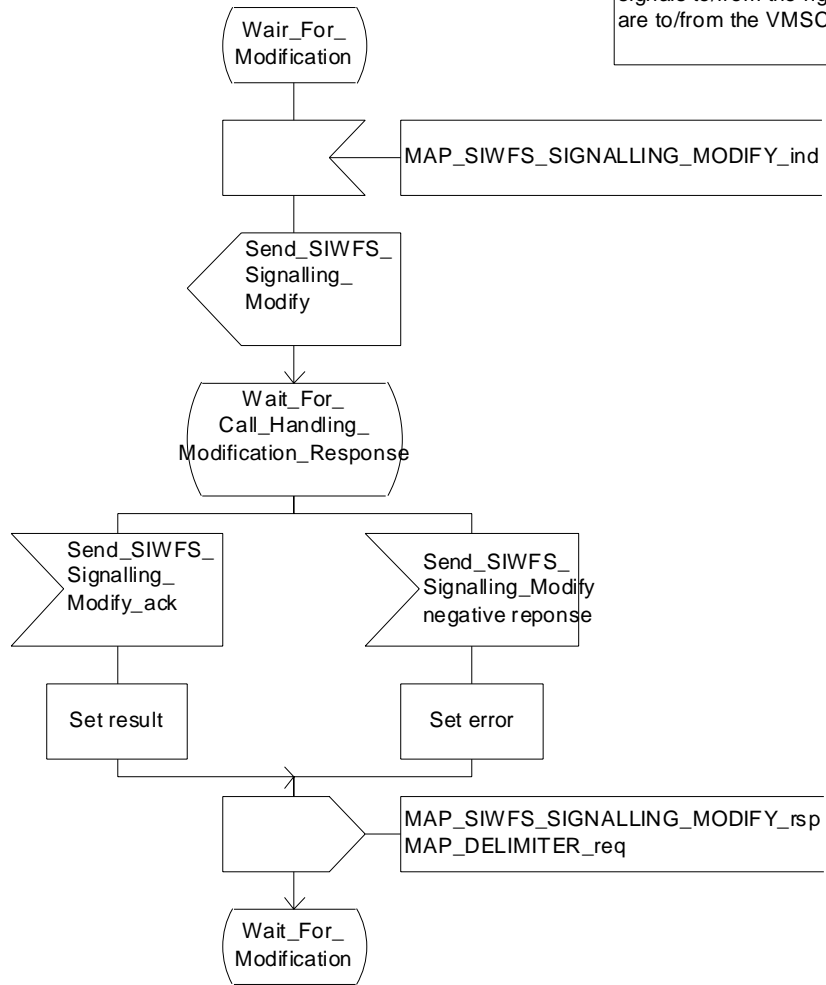

Figure 21.5/5 (sheet 3 of 5): Process SRA_SIWFS

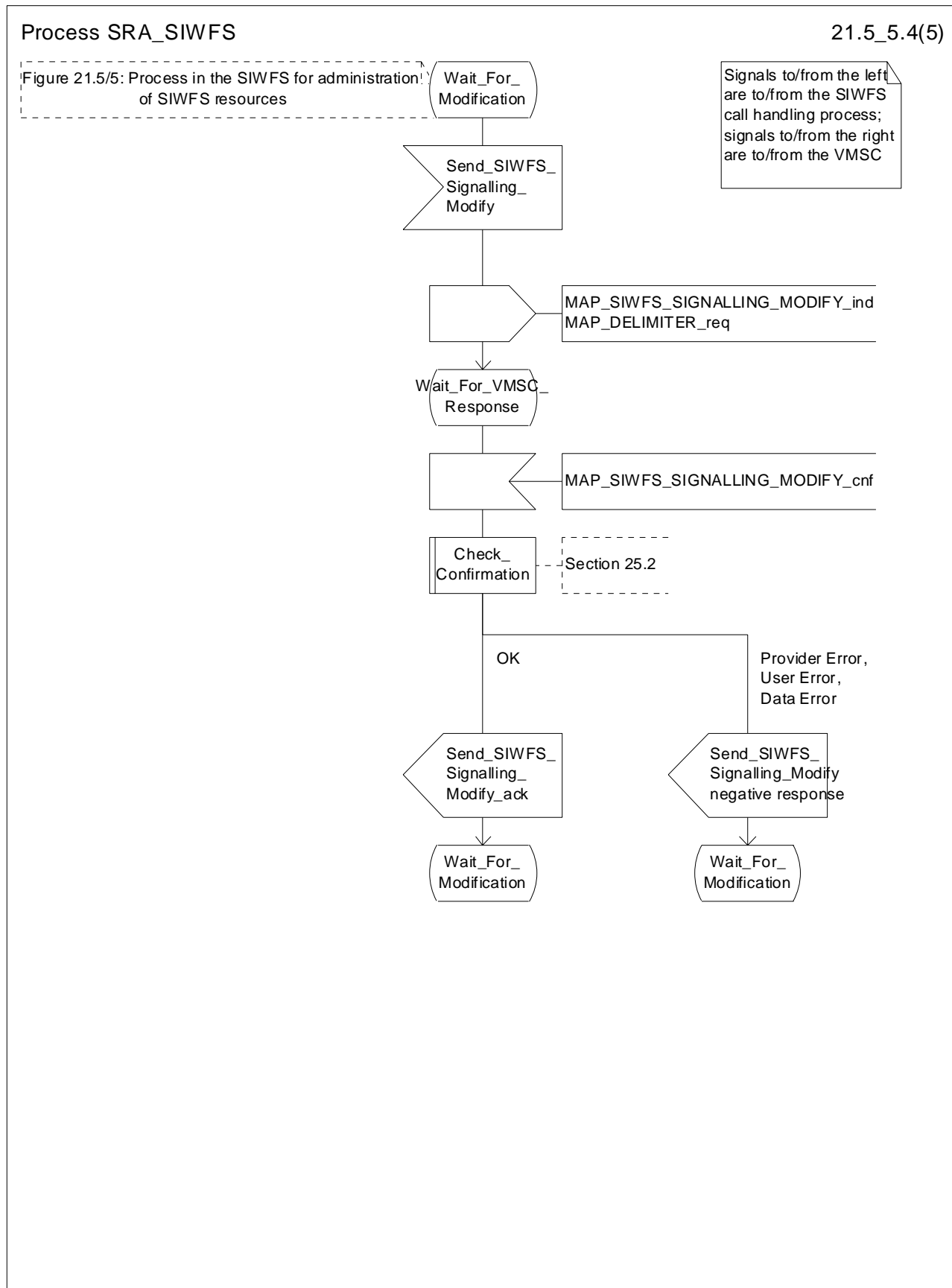

Figure 21.5/5 (sheet 4 of 5): Process SRA_SIWFS

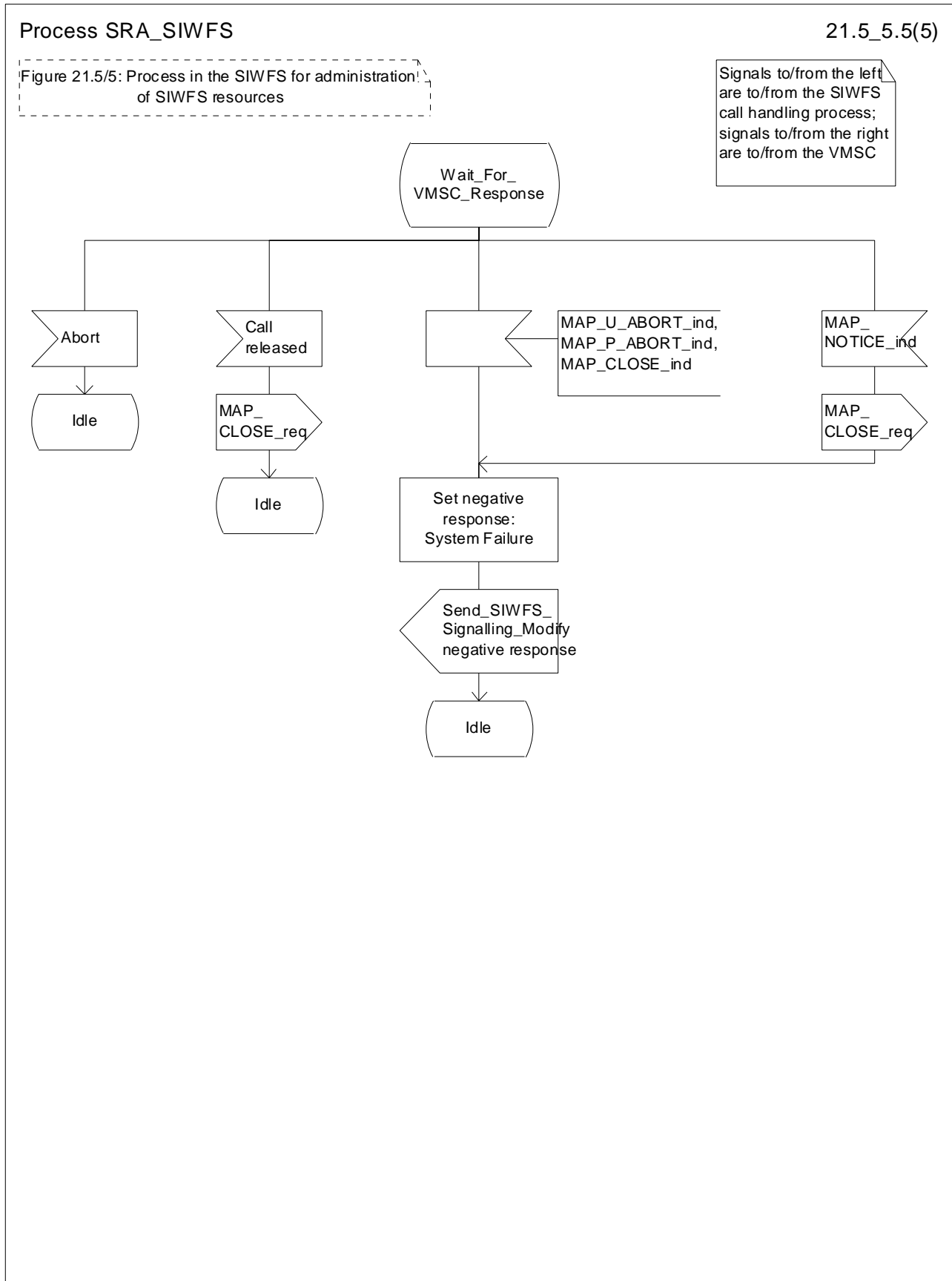

Figure 21.5/5 (sheet 5 of 5): Process SRA_SIWFS

21.6 Setting of Reporting State

21.6.1 General

The message flow for setting the reporting state in a stand-alone dialogue is shown in figure 21.6.1/1.

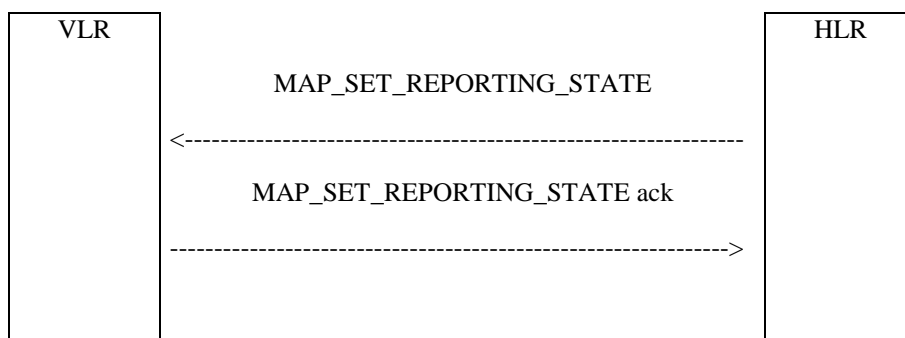

Figure 21.6/1: Message Flow for Setting the Reporting State

In Set Reporting State, the HLR can request a start or a stop of monitoring in the VLR.

21.6.2 Process in the HLR for Set Reporting State stand-alone

The MAP process in the HLR to set the reporting state in the VLR in a separate stand-alone dialogue is shown in figure 21.6/2. The MAP process invokes macros not defined in this clause; the definitions of these macros can be found as follows:

Receive_Open_Cnf see clause 25.1.2;

Check_Confirmation see clause 25.2.2.

Successful Outcome

When the MAP process receives a Start Reporting or Stop Reporting request from the CCBS application process in the HLR, it requests a dialogue with the VLR whose identity is contained in the request by sending a MAP_OPEN service request and sending the necessary information using a MAP_SET_REPORTING_STATE service request. The HLR then invokes the macro Receive_Open_Cnf to wait for the response to the dialogue opening request. If the dialogue opening is successful, the MAP process waits for a response from the VLR.

If the MAP process receives a MAP_SET_REPORTING_STATE service confirm from the VLR, the MAP process invokes the macro Check_Confirmation to check the content of the confirm.

If the macro Check_Confirmation takes the OK exit and the request was for Start Reporting, the MAP process sends a positive acknowledgement containing the information received from the VLR to the CCBS application process in the HLR and returns to the idle state. In the case of Stop Reporting the CCBS application process returns to the idle state.

Failure of dialogue opening with the VLR

If the macro Receive_Open_Cnf takes the Vr exit or the Error exit, the MAP process sends (in the case of Start Reporting) a negative response to the CCBS application process in the HLR and returns to the idle state. In the case of Stop Reporting the process returns to the idle state.

Error in MAP_SET_REPORTING_STATE confirm

If the MAP_SET_REPORTING_STATE service confirm contains a user error or a provider error, or the macro Check_Confirmation indicates that there is a data error, the MAP process sends a negative response (in the case of Start Reporting) to the CCBS application process in the HLR and returns to the idle state. In the case of Stop Reporting the CCBS application process returns to the idle state.

Abort of VLR dialogue

After the dialogue with the VLR has been established, the MAP service provider may abort the dialogue by issuing a MAP_P_ABORT or a MAP_U_ABORT indication. If the request was for the Start Reporting, the MAP process sends a Start Reporting negative response to the CCBS application process in the HLR and returns to the idle state.

If the MAP provider indicates a protocol problem by sending a MAP_NOTICE indication, the MAP process closes the dialogue with the VLR, sends a negative response (in the case of the Start Reporting) indicating system failure to the CCBS application process in the HLR and returns to the idle state. In the case of Stop Reporting the CCBS application process returns to the idle state.

21.6.3 Reporting co-ordinator process in the VLR

The MAP co-ordinating process in the VLR to handle a dialogue opened with the reporting application context is shown in figure 21.6/3. The MAP process invokes a macro not defined in this clause; the definition of this macro can be found as follows:

Receive_Open_Ind see clause 25.1.1.

Any reporting process in the VLR starts by the VLR receiving a MAP-OPEN service indication. If that service is successful, the VLR can handle reporting indications from the HLR. Table 21.6/1 shows the co-ordinating process' reaction on receipt of specific reporting indications from the HLR. After the relevant process is invoked, the received service indication is sent to that process.

Table 21.6/1: Relationship between received service indication and invoked process in the VLR

Service indication received	Process invoked
MAP_REMOTE_USER_FREE_ind	REMOTE_USER_FREE_VLR
MAP_SET_REPORTING_STATE_ind	SET_REPORTING_STATE_VLR

After creation of the user process the co-ordinator relays the messages between the MAP protocol machine and the invoked process until a request or an indication for dialogue termination is received.

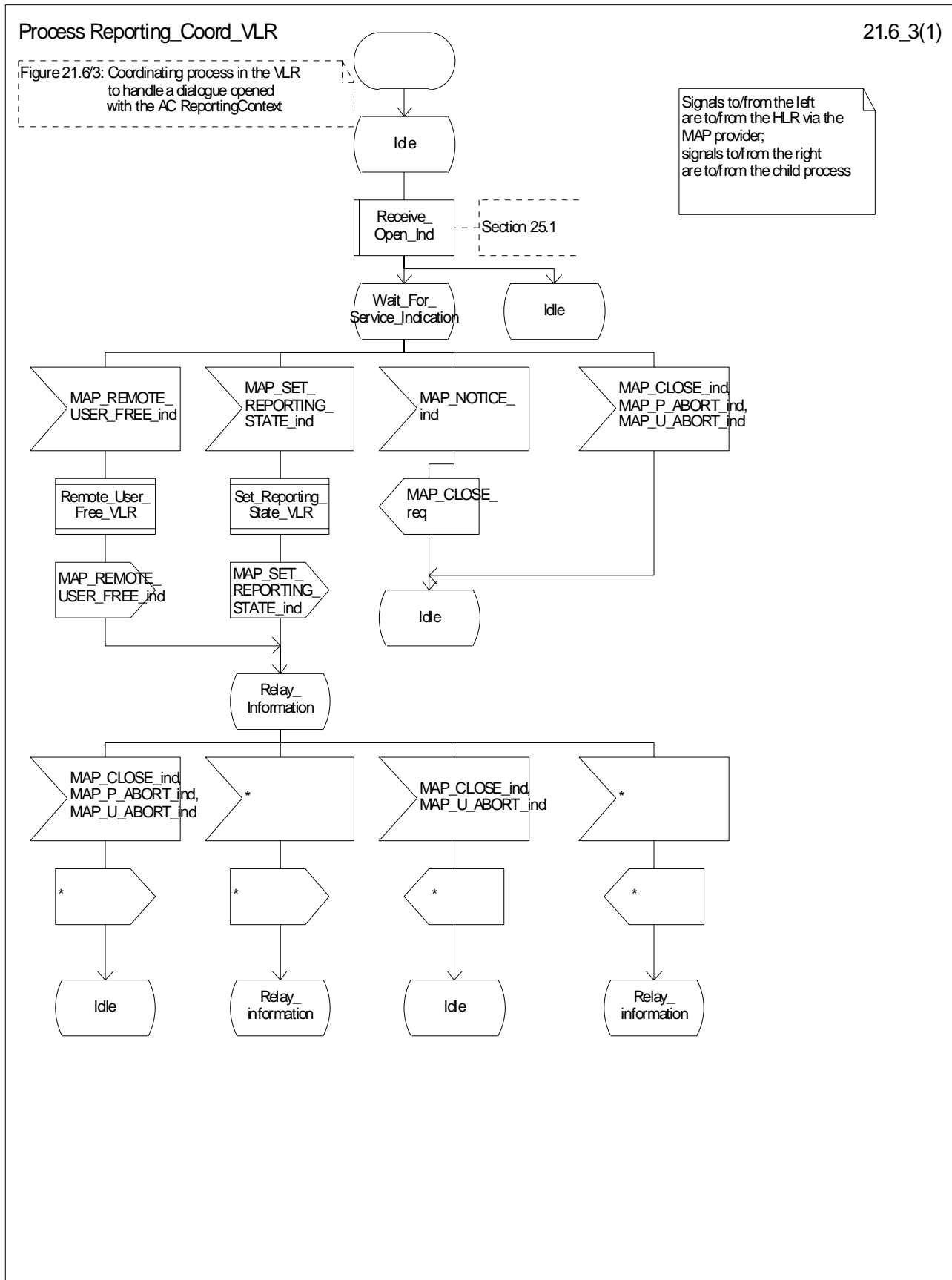

Figure 21.6/3: Process Reporting_Coord_VLR

21.6.4 Process in the VLR to set the reporting state

The MAP process in the VLR to set the reporting state is shown in figure 21.6/4.

The co-ordinator opens the process. The macro `Receive_Set_Reporting_State_VLR` handles the receipt of the request from the HLR, and the possible response from the CCBS application process in the VLR. When the macro exits, a MAP `CLOSE` is sent to the HLR and the process terminates.

The macro `Set_Reporting_State_VLR` is defined in figure 21.6/5.

When the VLR receives a `MAP_SET_REPORTING_STATE` service indication, it checks whether the required monitoring state is stopped.

If the required monitoring state is stopped, the MAP process sends a Stop Reporting message to the CCBS application in the VLR, sends a `MAP_SET_REPORTING_STATE` response to the HLR and exits from the macro.

If the required monitoring state is started, the MAP process sends a Start Reporting message to the CCBS application in the VLR and waits for a response.

If the CCBS application sends a Start Reporting ack, the MAP process sends a `MAP_SET_REPORTING_STATE` response to the HLR and exits from the macro.

If the CCBS application sends a Start Reporting negative response, the MAP process translates the negative response into a MAP user error, sends a `MAP_SET_REPORTING_STATE` response to the HLR and exits from the macro.

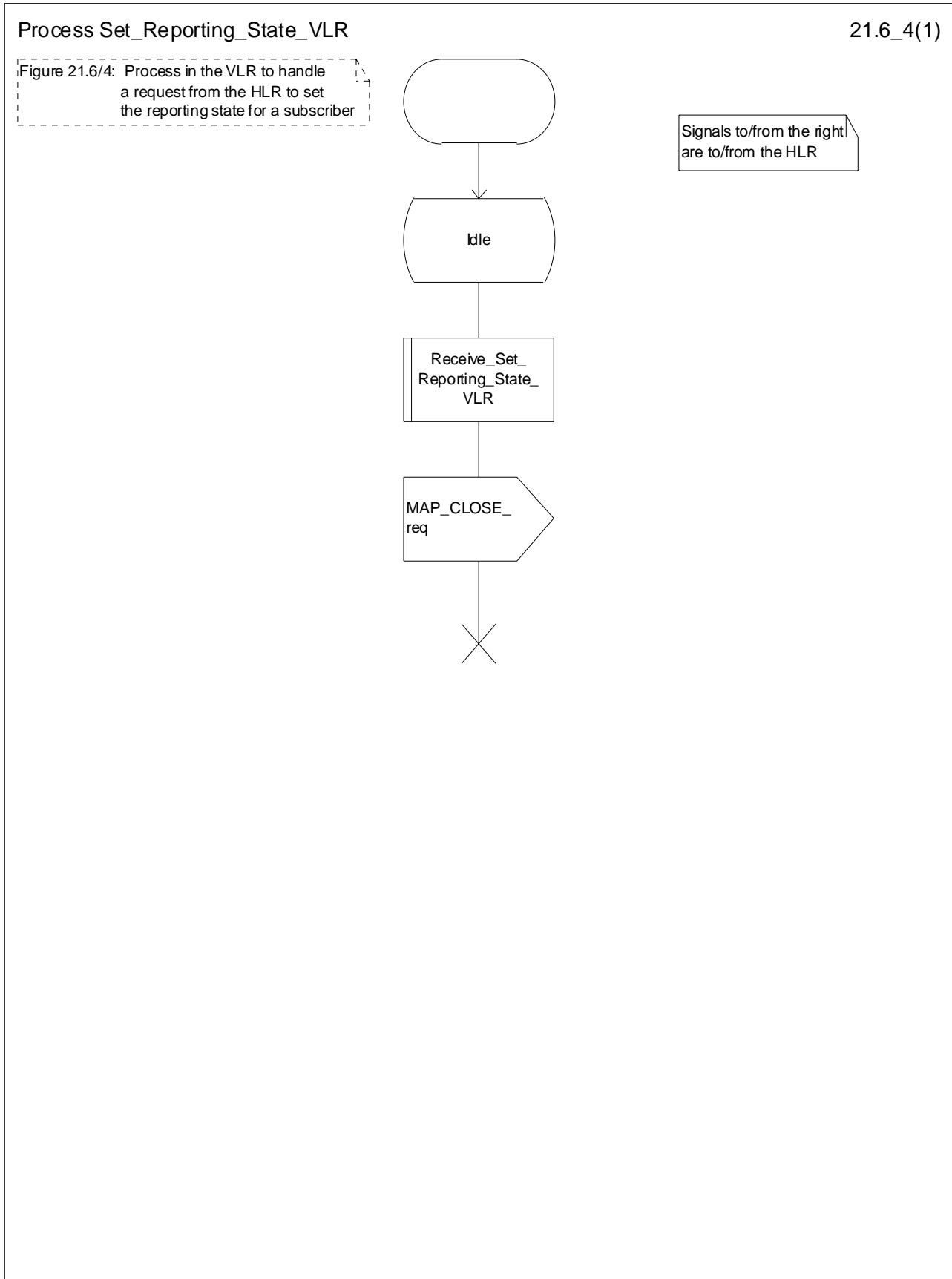

Figure 21.6/4: Process Set_Reporting_State_VLR

Macrodefinition Receive_Set_Reporting_State_VLR

21.6_5(1)

Figure 21.6/5: Macro in the VLR to handle a Set Reporting State instruction from the HLR

Signals to/from the left are to/from the CCBS application process in the VLR; signals to/from the right are to/from the HLR

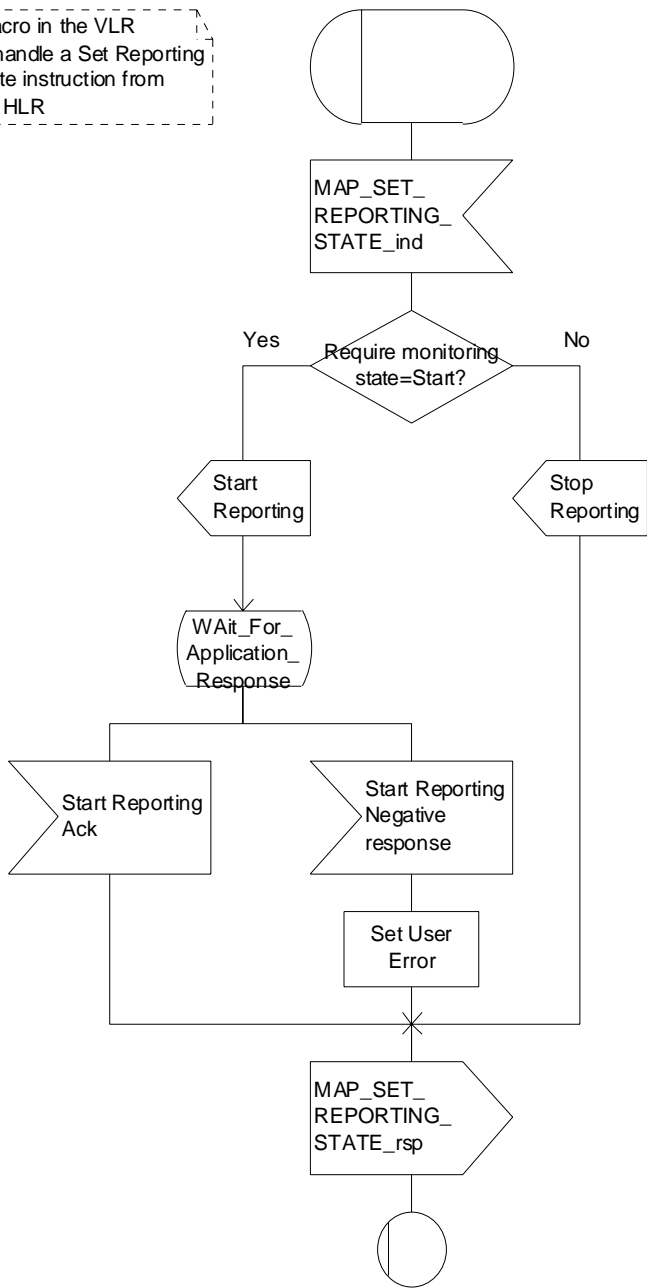

Figure 21.6/5: Macro Receive_Set_Reporting_State_VLR

21.7 Status Reporting

21.7.1 General

The message flows for reporting the status of a subscriber are shown in figures 21.7/1 and 21.7/2.

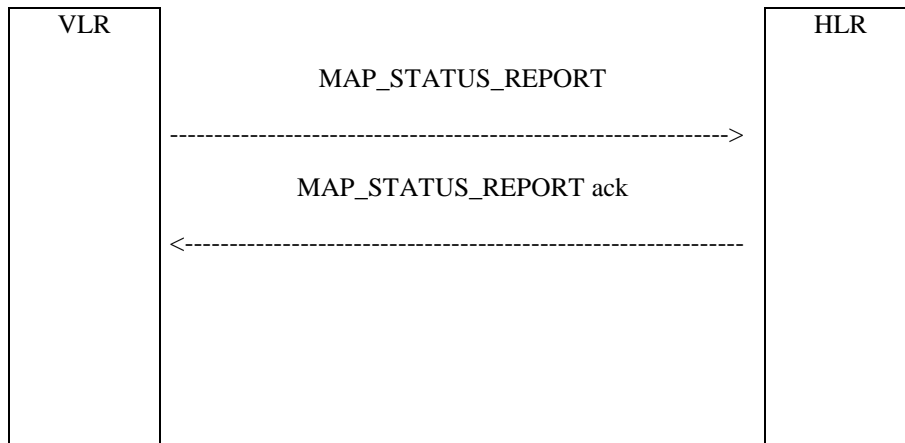

Figure 21.7/1: Status reporting, when monitoring continues in the VLR

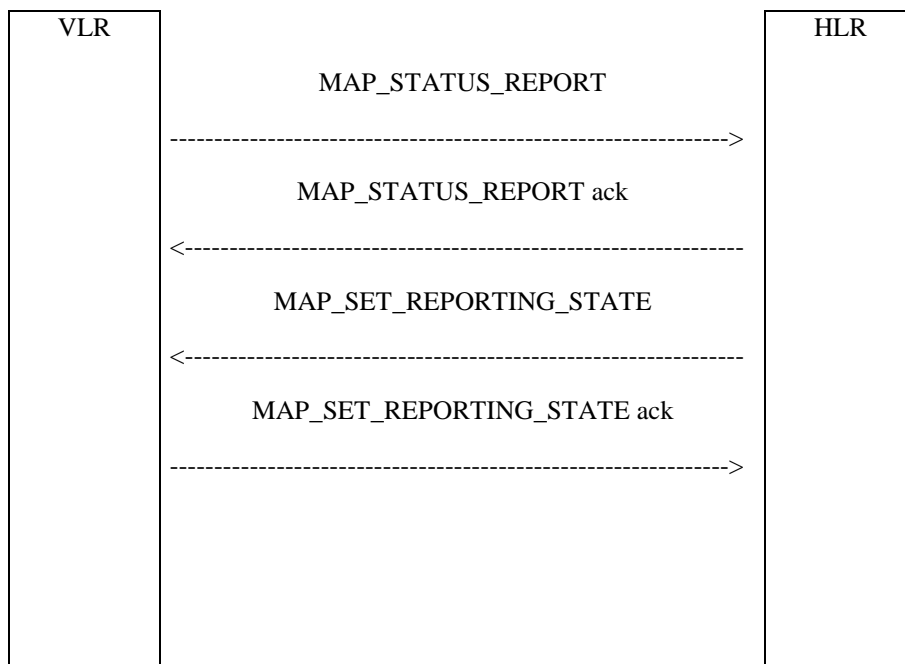

Figure 21.7/2: Status reporting, when monitoring stops

When the HLR sends a MAP_SET_REPORTING_STATE, it requests the stop of monitoring in the VLR.

21.7.2 Process in the VLR for Status Reporting

The MAP process in the VLR to send a status report to the HLR is shown in figure 21.7/3. The MAP process invokes macros not defined in this clause; the definitions of these macros can be found as follows:

- Receive_Open_Cnf see clause 25.1.2;
- Check_Confirmation see clause 25.2.2.

Successful Outcome

When the MAP process receives a Event Report or CCBS Call Report from the CCBS application process in the VLR, it requests a dialogue with the HLR whose identity is contained in the request by sending a MAP_OPEN service request, and requests status report using a MAP_STATUS_REPORT service request. The VLR then invokes the macro Receive_Open_Cnf to wait for the response to the dialogue opening request. If the dialogue opening is successful, the MAP process waits for a response from the HLR.

If the MAP process receives a MAP_STATUS_REPORT service confirm from the HLR, the MAP process invokes the macro Check_Confirmation to check the content of the confirm.

If the macro Check_Confirmation takes the OK exit, the MAP process sends an Event Report ack or a CCBS Call Report ack containing the information received from the HLR to the CCBS application process in the VLR and waits for a possible instruction from the HLR to set the reporting state.

If the HLR requests the VLR to set a reporting state (in the macro Receive_Set_Reporting_State_VLR), the VLR closes the dialogue with the HLR by sending a MAP_CLOSE to the HLR.

If the HLR requires monitoring in the VLR to continue, it closes the dialogue by sending a MAP_CLOSE, and the MAP process in the VLR sends Continue Monitoring message to the CCBS application process in the VLR and returns to the idle state.

Failure of dialogue opening with the HLR

If the macro Receive_Open_Cnf takes the Vr exit or the Error exit, the MAP process sends a Event Report negative response or CCBS Call Report negative response to the CCBS application process in the VLR and returns to the idle state.

Error in MAP_STATUS_REPORT confirm

If the MAP_STATUS_REPORT service confirm contains a user error or a provider error, or the macro Check_Confirmation indicates that there is a data error, the MAP process sends an Event Report negative response or CCBS Call Report negative response to the CCBS application process in the VLR and returns to the idle state.

Abort of HLR dialogue in State Wait_For_HLR_Response

After the dialogue with the HLR has been established, the MAP service provider may abort the dialogue by issuing a MAP_P_ABORT or a MAP_U_ABORT indication. In this case, the MAP process sends a Event Report or CCBS Call Report negative response to the CCBS application process in the VLR and returns to the idle state.

If the MAP provider indicates a protocol problem by sending a MAP_NOTICE indication, the MAP process closes the dialogue with the HLR. The VLR sends an Event Report negative response or CCBS Call Report negative response indicating system failure to the CCBS application process in the VLR and returns to the idle state.

Abort of HLR dialogue in State Wait_For_Set_Reporting

After the dialogue with the HLR has been established, the MAP service provider may abort the dialogue by issuing a MAP_P_ABORT or a MAP_U_ABORT indication. In this case, the VLR returns to the idle state.

If the MAP provider indicates a protocol problem by sending a MAP_NOTICE indication, the MAP process closes the dialogue with the HLR and returns to the idle state.

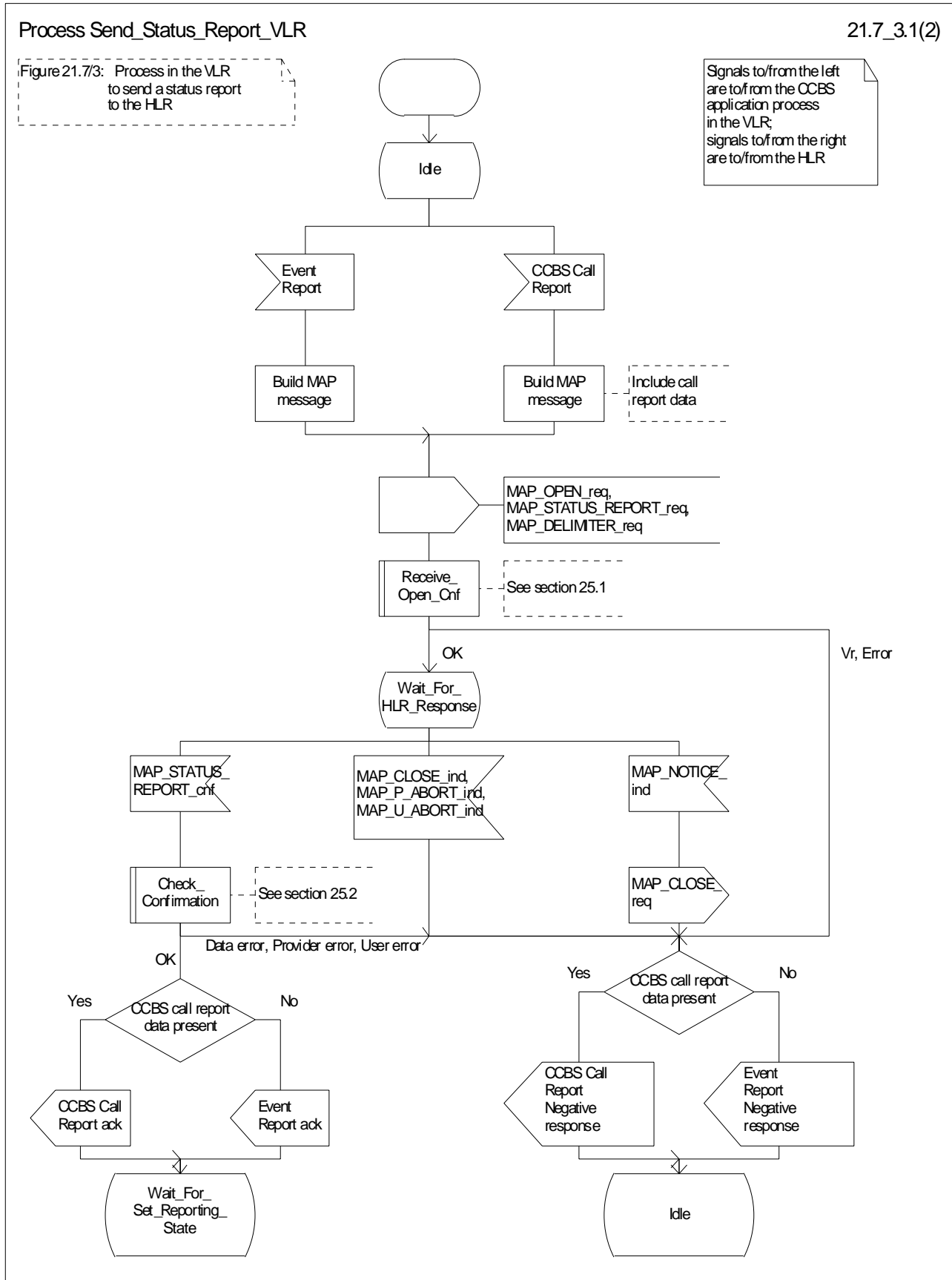

Figure 21.7/3 (sheet 1 of 2): Process Send_Status_Report_VLR

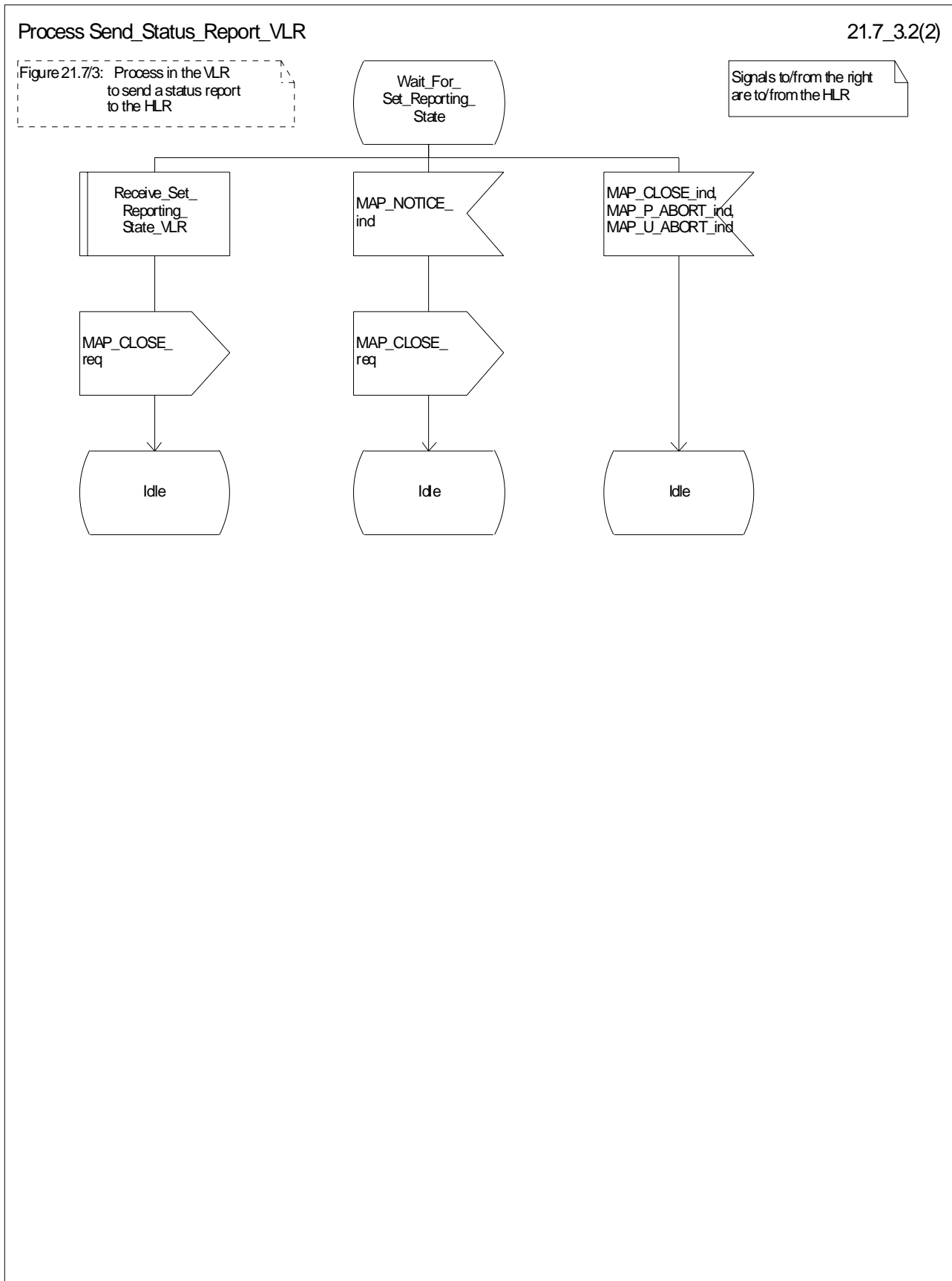

Figure 21.7/3 (sheet 2 of 2): Process Send_Status_Report_VLR

21.7.3 Process in the HLR for Status Reporting

The MAP process in the HLR to handle a status report is shown in figure 21.7/4. The MAP process invokes macros not defined in this clause; the definitions of these macros can be found as follows:

Receive_Open_Ind	see clause 25.1.1;
Check_Confirmation	see clause 25.2.2.

Successful outcome

When the MAP process receives a MAP_OPEN indication with the application context reporting, it checks it by invoking the macro Receive_Open_Ind.

If the macro takes the OK exit, the MAP process waits for a service indication.

The MAP process invokes the macro Receive_Status_Report_HLR to handle a MAP_STATUS_REPORT service indication; this macro is defined in figure 21.7/5. The MAP process then waits for a response from the CCBS application in the HLR.

If the MAP process receives a Stop Reporting message from the CCBS process, it sets the required monitoring state to stop, and may send a MAP_DELIMITER service request to the VLR. The HLR then invokes the macro Set_Reporting_State_HLR. After exiting the macro, the MAP process returns to the idle state.

If the MAP process receives a Continue Reporting from the CCBS process, it sends a MAP_CLOSE Request to VLR and returns to the idle state.

Failure of dialogue opening with the VLR

If the macro Receive_Open_Ind takes the Vr exit or the Error exit, the MAP process returns to the idle state.

Abort of VLR dialogue in State Wait_For_Service_Indication

After the dialogue with the HLR has been established, the MAP service provider may abort the dialogue by issuing a MAP_P_ABORT indication. In this case, the MAP process returns to the idle state.

If the MAP provider indicates a protocol problem by sending a MAP_NOTICE indication, the MAP process closes the dialogue with the VLR and returns to the idle state.

Macro Receive_Status_Report_HLR

The macro Receive_Status_Report_HLR is shown in figure 21.7/5.

When a MAP_STATUS_REPORT service indication is received, the HLR checks whether call report data are present.

If call report data are present, the MAP process sends a CCBS Call Report message to the CCBS application process in the HLR and waits for a response; otherwise it sends an Event Report message to the CCBS application process in the HLR and waits for a response.

If the MAP process receives a CCBS Call Report ack or Event Report ack from the CCBS application process in the HLR, it sends a MAP_STATUS_REPORT service confirm to the VLR and exits from the macro.

If the MAP process receives a CCBS Call Report negative response or Event Report negative response from the CCBS application process in the HLR, it sets the User Error according to the negative response, sends a MAP_STATUS_REPORT service confirm to the VLR and exits from the macro.

Macro Set_Reporting_State_HLR

The macro Set_Reporting_State_HLR is shown in figure 21.7/6.

The MAP process in the HLR sends a MAP_SET_REPORTING_STATE service request to the VLR and waits for a response.

If the MAP process receives a MAP_SET_REPORTING_STATE service confirm from the VLR, it invokes the macro Check_Confirmation to check the content of the confirm.

If the macro Check_Confirmation takes the OK exit, the macro Set_Reporting_State_HLR takes the OK exit.

If the macro Check_Confirmation takes the Data error, Provider error or User error exit, the macro Set_Reporting_State_HLR takes the Error exit.

While the MAP process is waiting for a response from the VLR, the MAP provider may terminate the dialogue by sending a MAP_CLOSE, MAP_P_ABORT or MAP_U_ABORT. In this case the macro takes the Aborted exit.

If the MAP provider indicates a protocol problem by sending a MAP_NOTICE indication, the MAP process closes the dialogue with the VLR and the macro takes the Aborted exit.

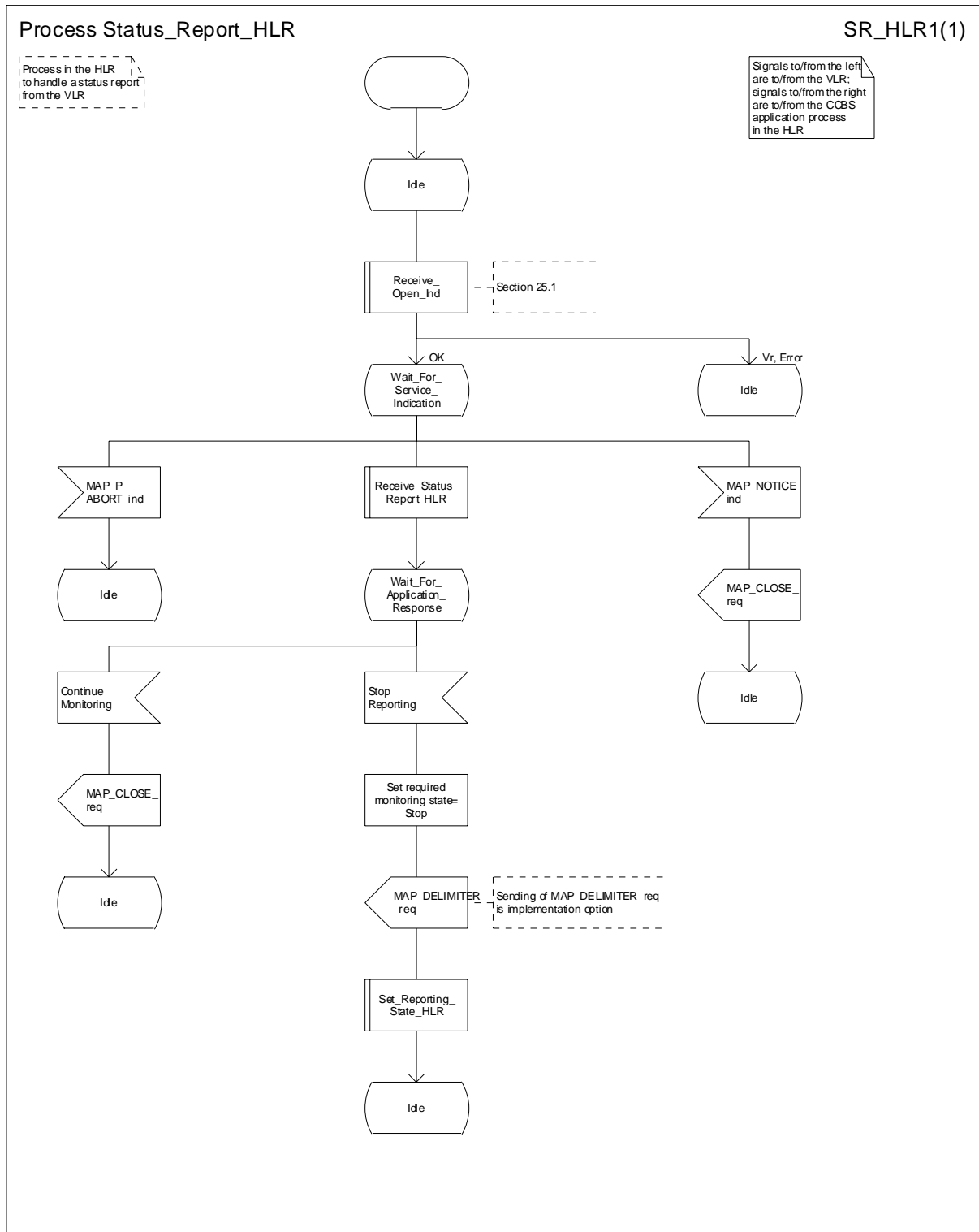

Figure 21.7/4: Process Status_Report_HLR

Macrodefinition Receive_Status_Report_HLR

21.7_5(1)

Figure 21.7/5: Macro in the HLR to receive a status report from the VLR

Signals to/from the left are to/from the VLR; signals to/from the right are to/from the CCBS application process in the HLR

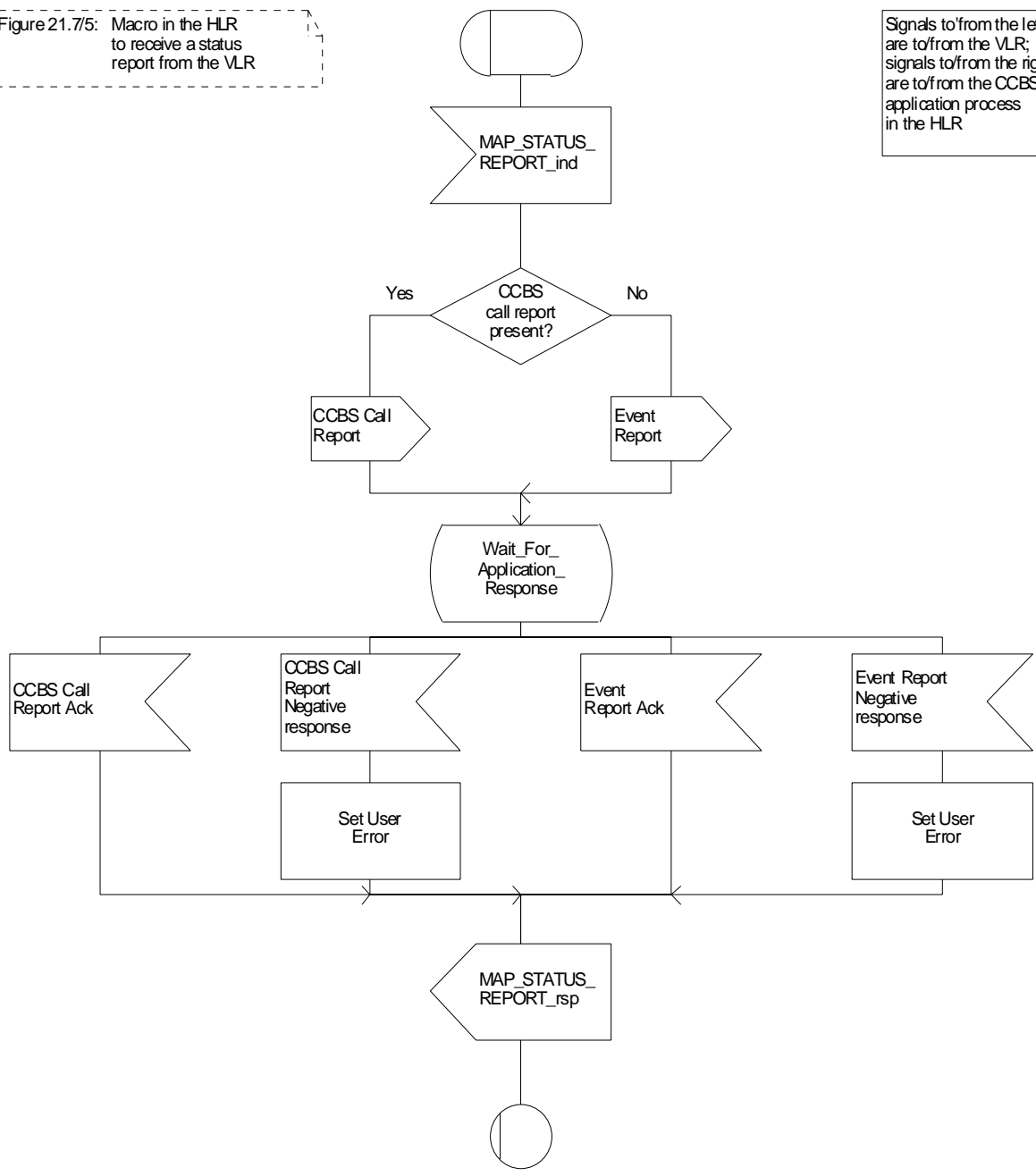

Figure 21.7/5: Macro Receive_Status_Report_HLR

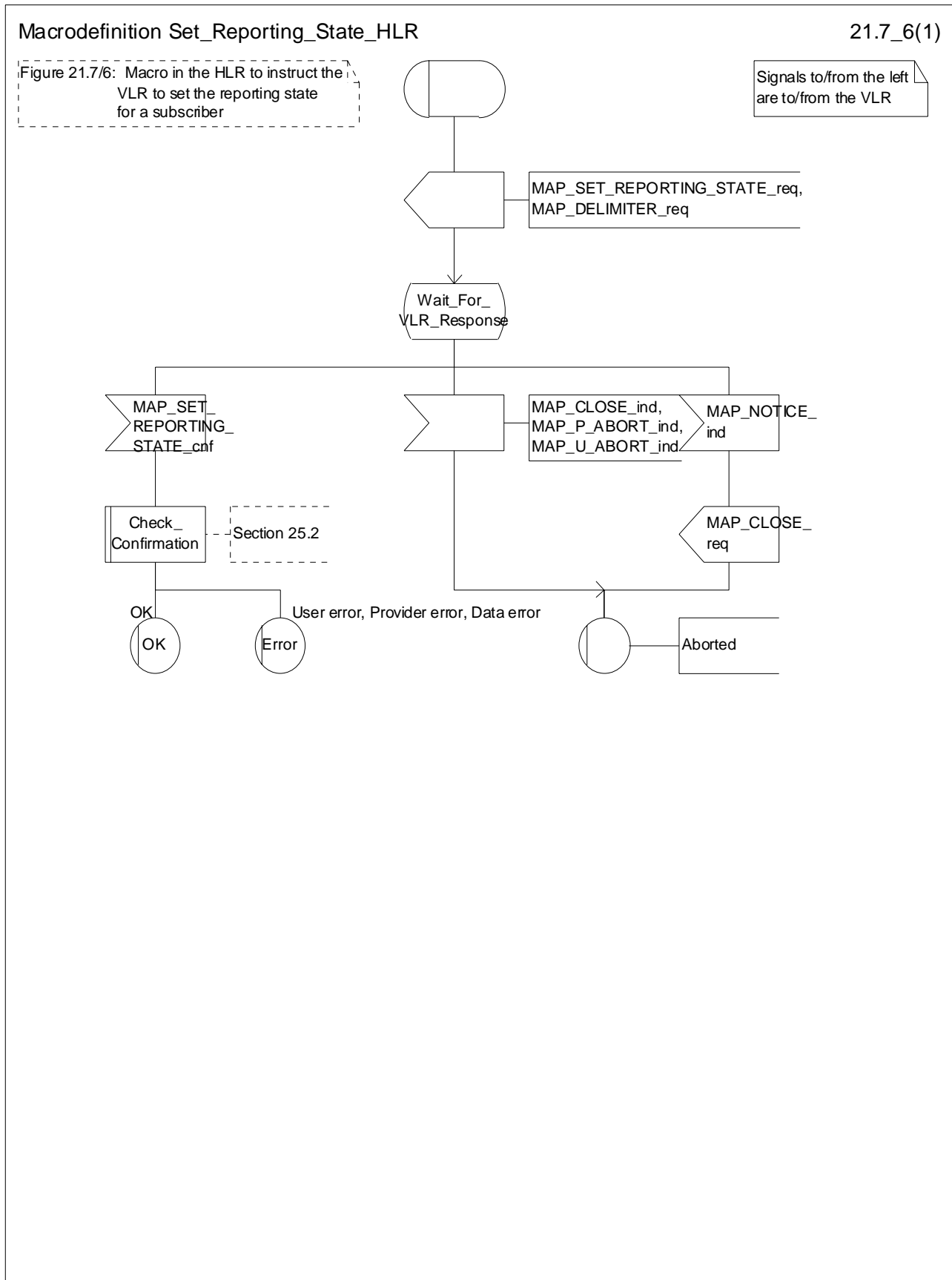

Figure 21.7/6: Macro Set_Reporting_State_HLR

21.8 Remote User Free

21.8.1 General

The message flows for handling remote user free are shown in figures 21.8/1 and 21.8/2.

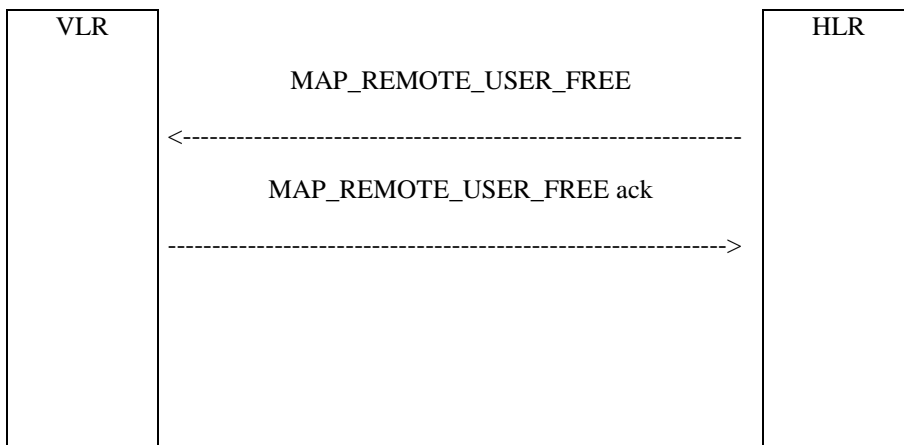

Figure 21.8/1: Remote User Free: recall not accepted

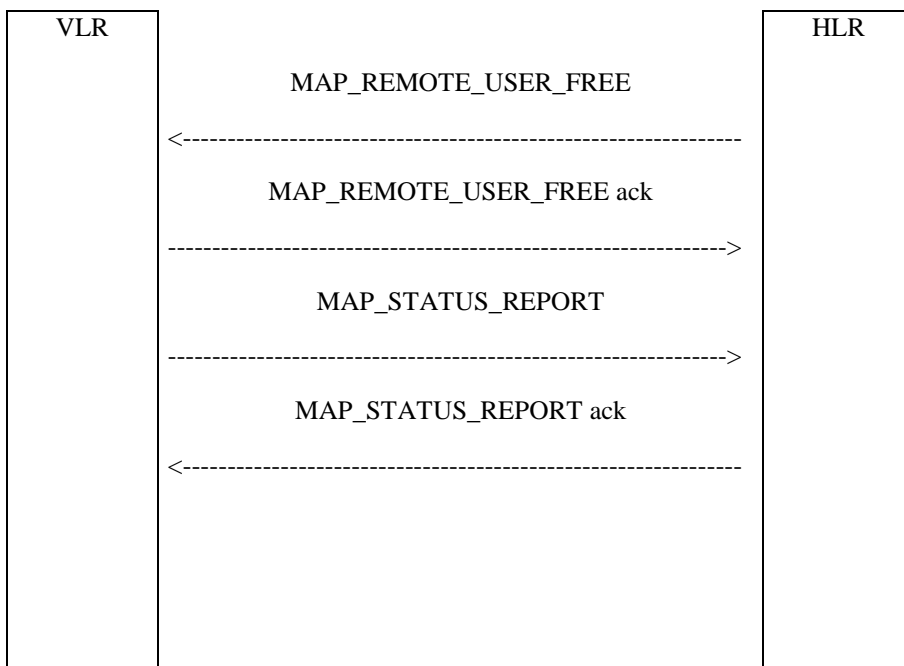

Figure 21.8/2: Remote User Free: recall accepted

21.8.2 Process in the HLR for Remote User Free

The MAP process in the HLR to handle Remote User Free is shown in figure 21.8/3. The MAP process invokes macros not defined in this clause; the definitions of these macros can be found as follows:

Receive_Open_Cnf see clause 25.1.2;

Check_Confirmation see clause 25.2.2.

Successful Outcome

When the MAP process receives a CCBS RUF request from the CCBS application process in the HLR, it requests a dialogue with the VLR whose identity is contained in the request by sending a MAP_OPEN service request and sending the necessary information using a MAP_REMOTE_USER_FREE service request. The HLR then invokes the macro Receive_Open_Cnf to wait for the response to the dialogue opening request. If the dialogue opening is successful, the MAP process waits for a response from the VLR.

If the MAP process receives a MAP_REMOTE_USER_FREE service confirm from the VLR, the MAP process invokes the macro Check_Confirmation to check the content of the confirm.

If the macro Check_Confirmation takes the OK exit, the MAP process sends a CCBS RUF ack containing the information received from the VLR to the CCBS application process in the HLR and waits for a MAP_STATUS_REPORT service indication from the VLR. If in this state a MAP_CLOSE service indication is received, the MAP process returns to the idle state. If in this state a MAP_STATUS_REPORT service indication is received, further processing is described by the macro Receive_Status_Report_HLR (described in clause 21.7.3). When the macro exits, the MAP process constructs a MAP_CLOSE service request, sends it to the VLR and returns to the idle state.

Failure of dialogue opening with the VLR

If the macro Receive_Open_Cnf takes the Vr exit or the Error exit, the MAP process sends a negative response to the CCBS application process in the HLR and returns to the idle state.

Error in MAP_REMOTE_USER_FREE confirm

If the MAP_REMOTE_USER_FREE service confirm contains a user error or a provider error, or the macro Check_Confirmation indicates that there is a data error, the MAP process sends a CCBS RUF negative response to the CCBS application process in the HLR and returns to the idle state.

Abort of VLR dialogue

When the MAP process is waiting for a VLR response to the MAP_REMOTE_USER_FREE, the MAP service provider may abort the dialogue by issuing a MAP_CLOSE, a MAP_P_ABORT or a MAP_U_ABORT indication. In this case, the MAP process sends a CCBS RUF negative response to the CCBS application process in the HLR and returns to the idle state.

If the MAP provider indicates a protocol problem by sending a MAP_NOTICE indication when the MAP process is waiting for a VLR response to the MAP_REMOTE_USER_FREE, the MAP process closes the dialogue with the VLR, sends a CCBS RUF negative response indicating system failure to the CCBS application process in the HLR and returns to the idle state.

When the MAP process is waiting for a possible MAP_STATUS_REPORT from the VLR, the MAP service provider may abort the dialogue by issuing a MAP_P_ABORT or a MAP_U_ABORT indication. In this case, the MAP process returns to the idle state.

If the MAP provider indicates a protocol problem by sending a MAP_NOTICE indication when the MAP process is waiting for a possible MAP_STATUS_REPORT from the VLR, the MAP process closes the dialogue with the VLR and returns to the idle state.

If the CCBS application in the HLR decides to abort the dialogue, it sends an Abort message to the MAP process, which closes the dialogue with the VLR and returns to the idle state.

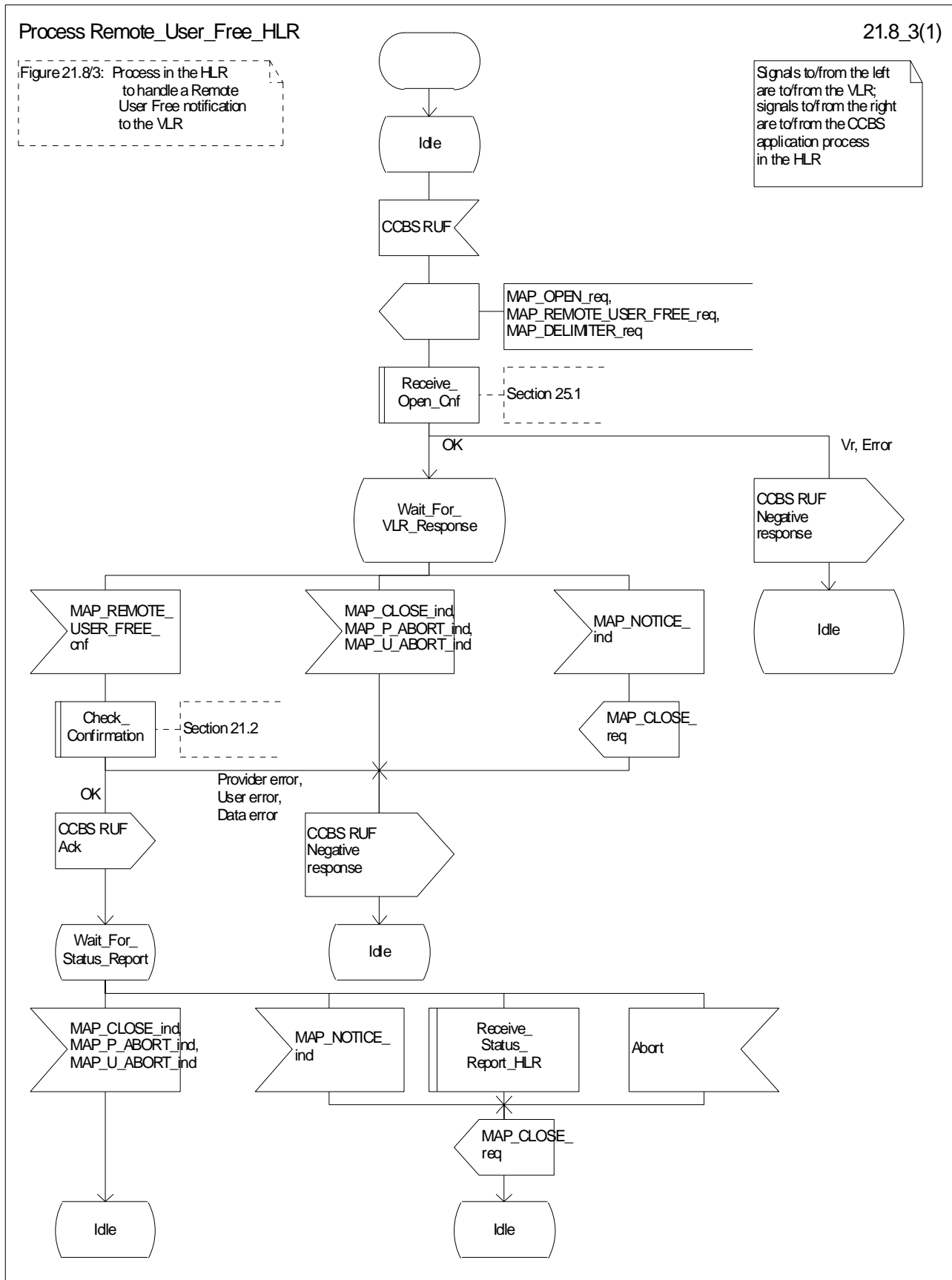

Figure 21.8/3: Process Remote_User_Free_HLR

21.8.3 Process in the VLR for Remote User Free

The MAP process in the VLR to handle Remote User Free is shown in figure 21.8/4. The MAP process invokes a macro not defined in this clause; the definitions of this macro can be found as follows:

Check_Confirmation see clause 25.2.2.

Successful outcome (Recall accepted)

When the MAP process receives a MAP_REMOTE_USER_FREE service indication, the VLR sends a CCBS RUF request to the CCBS application process in the VLR, and waits for a response. The request contains the parameters received in the MAP_REMOTE_USER_FREE service indication.

If the CCBS application process in the VLR returns a positive response indicating "recall accepted", the MAP process constructs a MAP_REMOTE_USER_FREE service response and a MAP_DELIMITER service request, sends them to the VLR and waits for a CCBS Call Report message from the CCBS application process in the VLR. When the MAP process receives the CCBS Call Report from the CCBS application process in the VLR, it constructs a MAP_STATUS_REPORT service request and a MAP_DELIMITER service request, sends them to the HLR and waits for a response. If the MAP process receives a MAP_STATUS_REPORT service confirm, the VLR calls the macro Check_Confirmation. If this macro takes the OK exit, the MAP process sends a CCBS Call Report ack to the CCBS application process in the VLR and the MAP process terminates.

Successful outcome (Recall not accepted)

If the CCBS application process in the VLR returns a positive response indicating "recall not accepted", the MAP process constructs a MAP_REMOTE_USER_FREE service response and a MAP_CLOSE service request, sends them to the HLR and terminates.

Negative response from VLR CCBS application process

If the CCBS application process in the VLR returns a negative response, the MAP process constructs a MAP_REMOTE_USER_FREE service response containing the appropriate error and a MAP_CLOSE service request, sends them to the HLR and terminates.

Failure of dialogue with the HLR

When waiting for a response or a call result from the CCBS application process in the VLR, the MAP process may receive a MAP_CLOSE service indication, a MAP_U_ABORT service indication or a MAP_P_ABORT service indication from the co-ordinating process, in which case the MAP process terminates.

When waiting for a call result from the CCBS application process in the VLR, the MAP process may receive a MAP_NOTICE indication from the co-ordinating process, in which case the MAP process constructs a MAP_CLOSE service request, sends it to the co-ordinating process and terminates.

When waiting for a response from the HLR, the MAP process may receive a MAP_CLOSE indication, a MAP_U_ABORT indication or a MAP_P_ABORT indication from the co-ordinating process, in which case the MAP process sends a CCBS Call Report negative response to the CCBS application process in the VLR and terminates.

When waiting for a response from the HLR, the MAP process may receive a MAP_NOTICE indication from the co-ordinating process, in which case the MAP process constructs a MAP_CLOSE service request, sends it to the co-ordinating process, sends a CCBS Call Report negative response to the CCBS application process in the VLR and terminates.

Error in MAP_STATUS_REPORT confirm

If the MAP_STATUS_REPORT service confirm contains a user error or a provider error, the MAP process sends a CCBS Call Report negative response to the CCBS application process in the VLR and terminates.

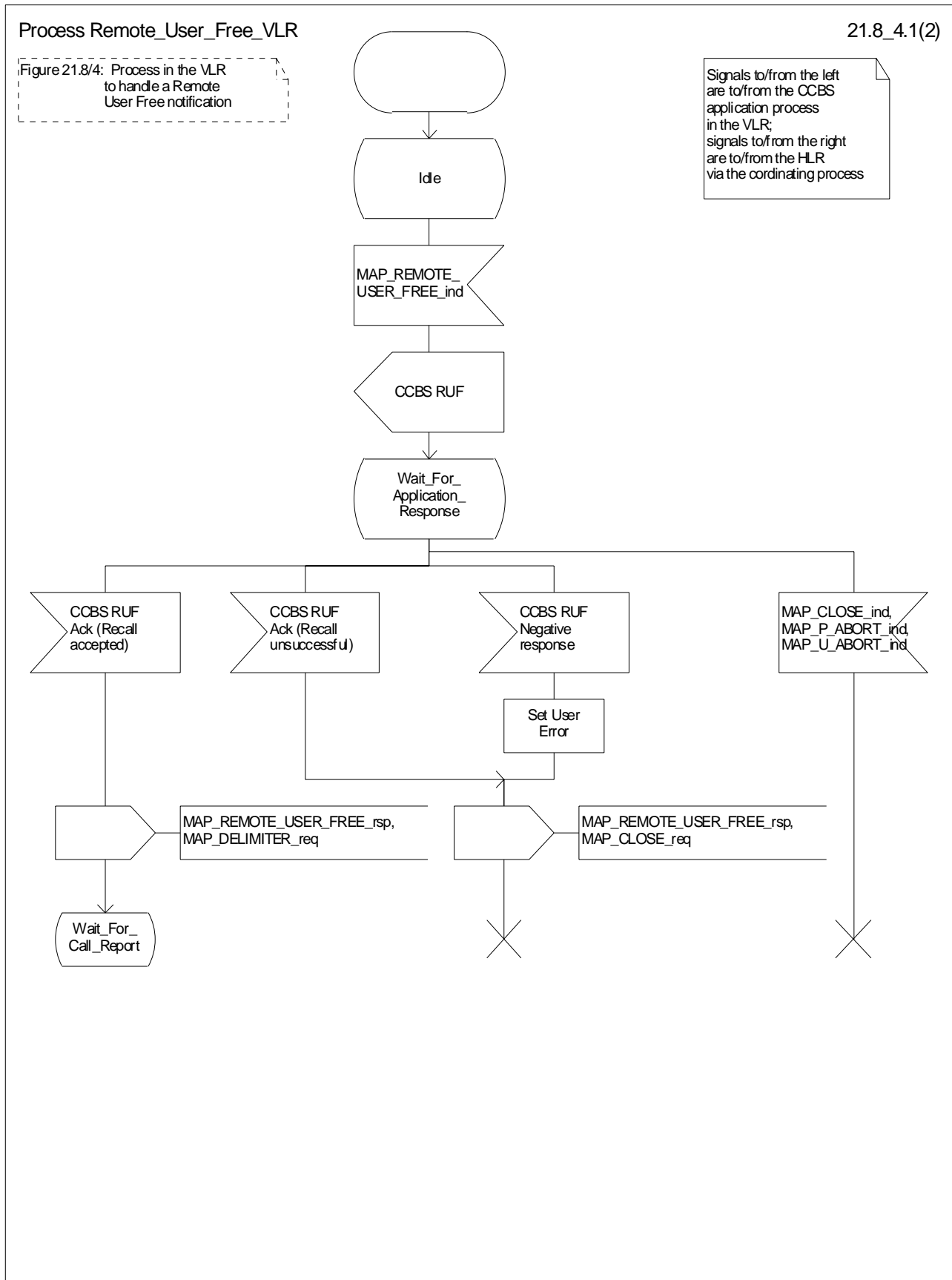

Figure 21.8/4 (sheet 1 of 2): Process Remote_User_Free_VLR

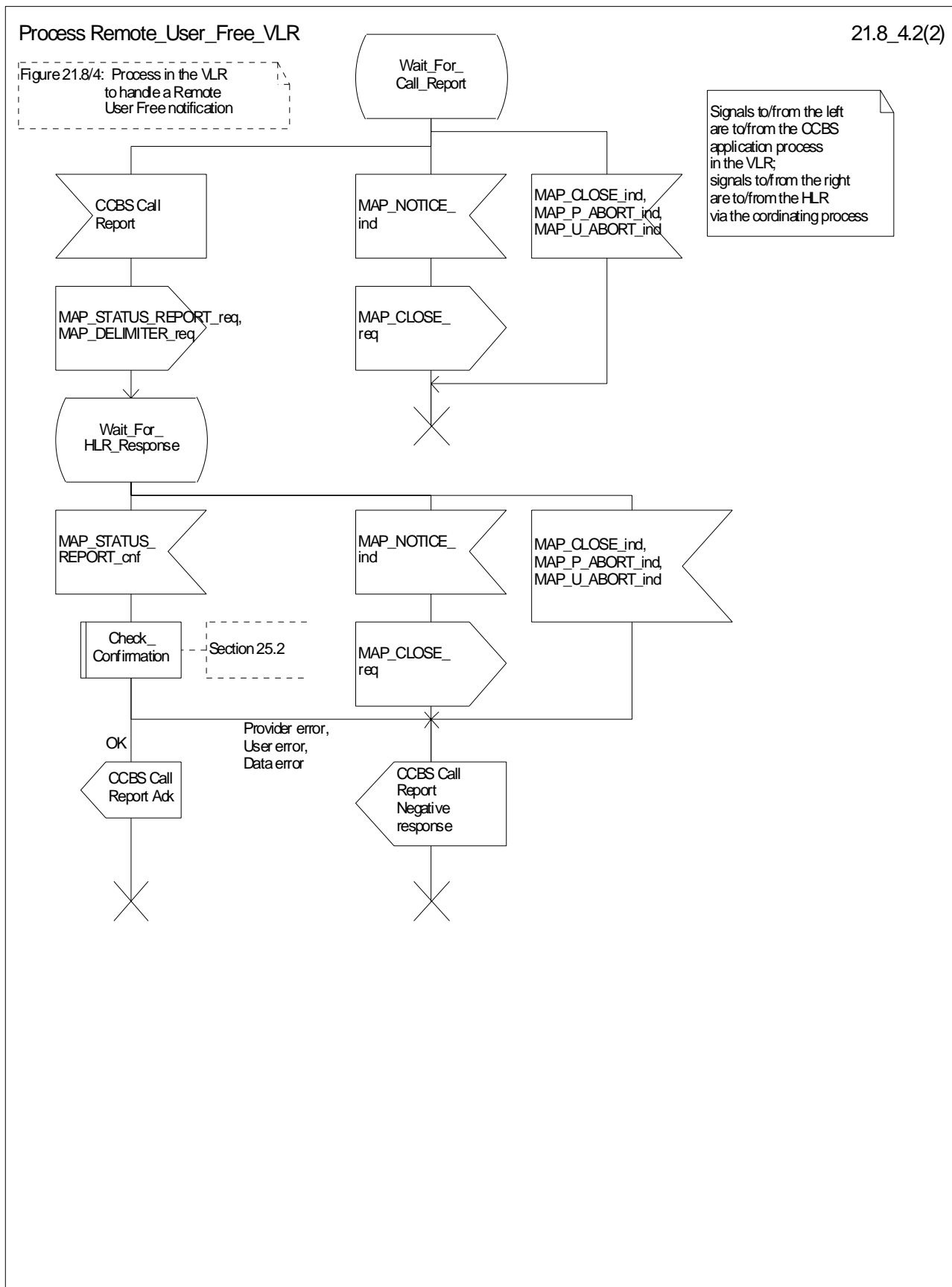

Figure 21.8/4 (sheet 2 of 2): Process Remote_User_Free_VLR

21.9 IST Alert

21.9.1 General

The Immediate Service Termination Alert procedure is used to keep track of the call activities performed by IST subscribers and, eventually, to terminate the alerted call activities, or all the call activities related to the alerted subscriber.

The message flow for alerting and terminating the call(s) is shown in figure 21.9/1, where the MSC may be a Visited MSC or a Gateway MSC.

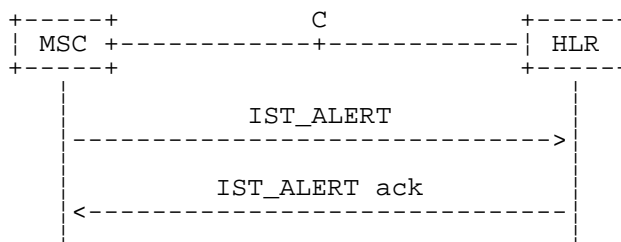

Figure 21.9/1: IST Alert

21.9.2 Procedure in the MSC

The MAP process in the MSC (Visited MSC or Gateway MSC) is shown in figure 21.9/2. The MAP process invokes macros not defined in this clause; the definitions of these macros can be found as follows:

Receive_Open_Cnf	see clause 25.1.2;
Check_Confirmation	see clause 25.2.2.

Successful Outcome

When the MAP process receives an IST Alert request from a call handling process in the Visited MSC or Gateway MSC, it requests a dialogue with the HLR that the subscriber belongs to, by sending a MAP_OPEN service request, a MAP_IST_ALERT service request, and a MAP_DELIMITER service request. The MSC then invokes the macro Receive_Open_Cnf to wait for the response to the dialogue opening request. If the dialogue opening is successful, the MAP process waits for a response from the HLR.

If the MAP process receives a MAP_IST_ALERT service confirm from the HLR, the MAP process invokes the macro Check_Confirmation to check the content of the confirm.

If the macro Check_Confirmation takes the OK exit, the MAP process sends a IST Alert ack containing the information received from the HLR to the call handling process in the MSC and returns to the idle state.

Failure of dialogue opening with the HLR

If the macro Receive_Open_Cnf takes the Vr exit or the Error exit, the MAP process sends a negative response to the call handling process in the MSC, and returns to the idle state.

Error in MAP_IST_ALERT confirm

If the MAP_IST_ALERT service confirm contains a user error or a provider error, or the macro Check_Confirmation indicates that there is a data error, the MAP process sends a negative response to the call handling process in the MSC, and returns to the idle state.

Abort of HLR dialogue

When the MAP process is waiting for an HLR response to the MAP_IST_ALERT, the MAP service provider may abort the dialogue by issuing a MAP_CLOSE, a MAP_P_ABORT or a MAP_U_ABORT indication. In this case, the MAP process sends a negative response to the call handling process in the MSC, and returns to the idle state.

If the MAP provider indicates a protocol problem by sending a MAP_NOTICE indication when the MAP process is waiting for an HLR response to the MAP_IST_ALERT, the MAP process closes the dialogue with the HLR, sends a negative response to the call handling process in the MSC, and returns to the idle state.

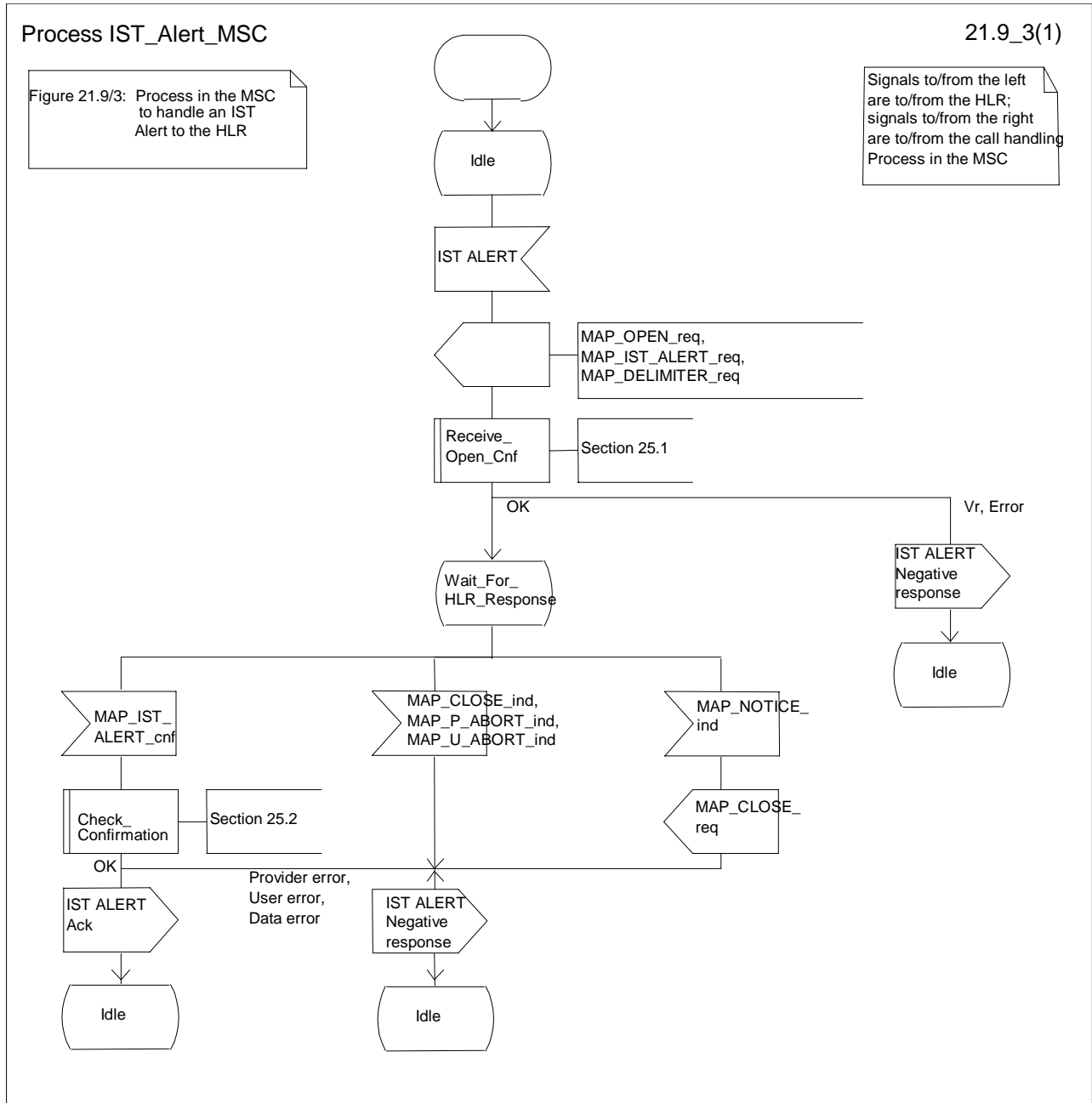

Figure 21.9/2: Process IST_Alert_MSC

21.9.3 Procedure in the HLR

The MAP process in the HLR is shown in figure 21.9/3. The MAP process invokes a macro not defined in this clause; the definition of this macro can be found as follows:

Receive_Open_Ind see clause 25.1.1;

Successful outcome

When the MAP process in the HLR receives a request to open a dialogue, it invokes the macro Receive_Open_Ind to check if the dialogue can be opened.

If the dialogue can be opened, and the service indication received is a MAP_IST_ALERT, the HLR then sends the IST alert indication to the call handling process in the HLR, and waits for a response.

If the call handling process in the HLR returns a positive response, the MAP process constructs a MAP_IST_ALERT service response and a MAP_CLOSE service request, sends them to the MSC, and returns to the idle state.

Negative response from HLR call handling process

If the call handling process in the HLR returns a negative response, the MAP process constructs a MAP_IST_ALERT service response containing the appropriate error and a MAP_CLOSE service request, sends them to the MSC and returns to the idle state.

Failure of dialogue opening in the HLR

If the macro Receive_Open_Ind takes the Vr exit or the Error exit, the MAP process returns to the idle state.

Abort of MSC dialogue

If the MAP process receives a MAP_P_ABORT indication before receiving a service indication, the MAP process returns to the idle state.

When the MAP process receives a MAP_NOTICE indication before receiving a service indication, the MAP process closes the dialogue with the MSC, and returns to the idle state.

When the MAP process is waiting for the application response to the IST Alert, the MAP service provider may abort the dialogue by issuing a MAP_CLOSE, a MAP_P_ABORT or a MAP_U_ABORT indication. In this case, the MAP process returns to the idle state.

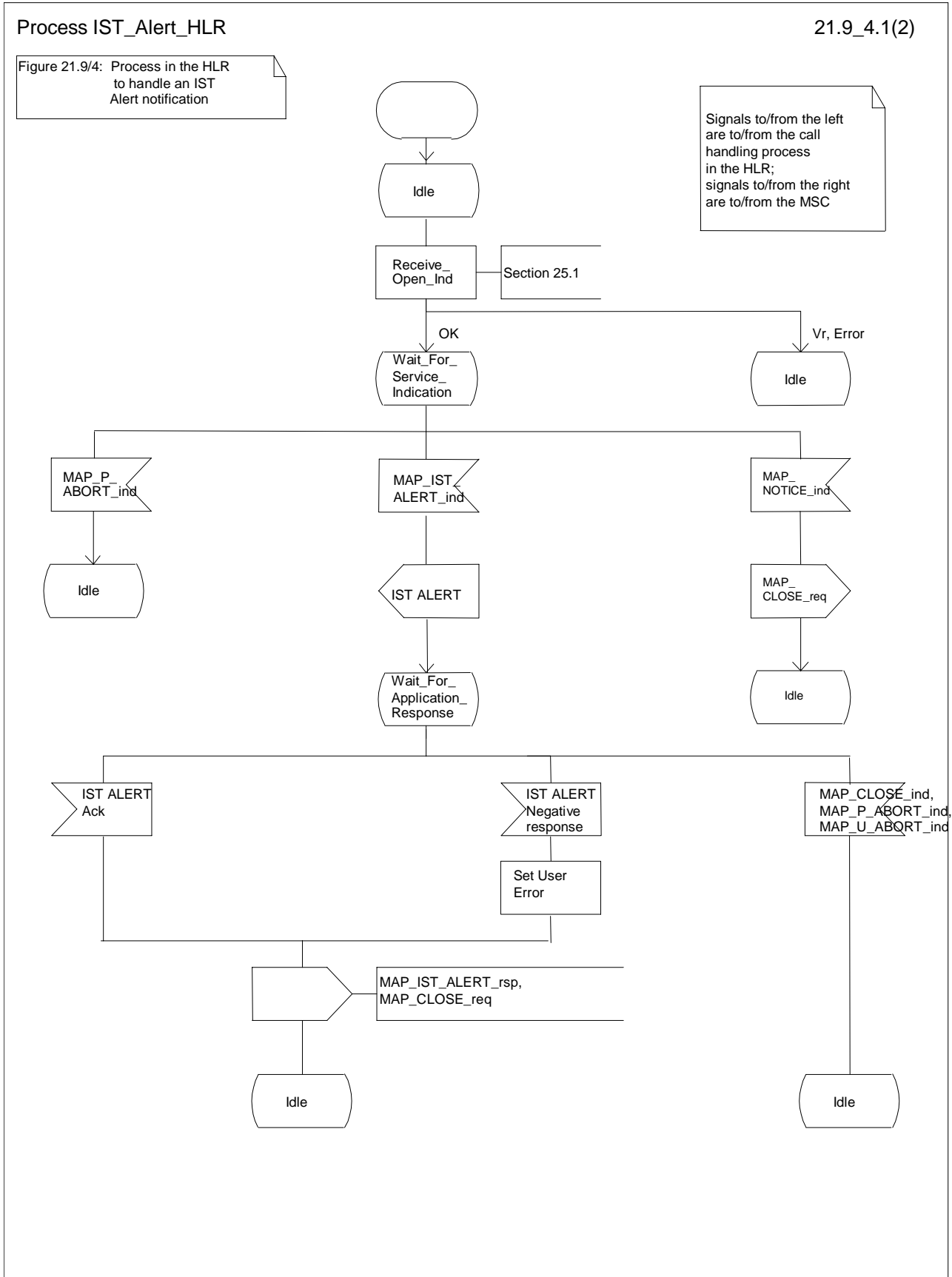

Figure 21.9/3: Process IST_Alert_HLR

21.10 IST Command

21.10.1 General

The Immediate Service Termination Command procedure is used to terminate the call activities related to a subscriber.

The message flow for the IST Command service is shown in figure 21.10/1, where the MSC may be a Visited MSC or a Gateway MSC.

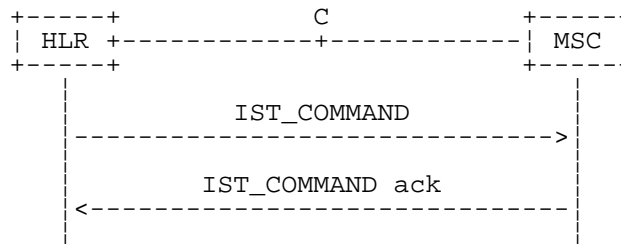

Figure 21.10/1: IST Command

21.10.2 Procedure in the HLR

The MAP process in the HLR is shown in figure 21.10/2. The MAP process invokes macros not defined in this clause; the definitions of these macros can be found as follows:

- Receive_Open_Cnf see clause 25.1.2;
- Check_Confirmation see clause 25.2.2.

Successful Outcome

When the MAP process receives an IST Command request, it requests a dialogue with the MSC (Gateway MSC or Visited MSC), by sending a MAP_OPEN service request, a MAP_IST_COMMAND service request, and a MAP_DELIMITER service request. The HLR then invokes the macro Receive_Open_Cnf to wait for the response to the dialogue opening request. If the dialogue opening is successful, the MAP process waits for a response from the MSC.

If the MAP process receives a MAP_IST_COMMAND service confirm from the MSC, the MAP process invokes the macro Check_Confirmation to check the content of the confirm.

If the macro Check_Confirmation takes the OK exit, the MAP process sends a IST Command ack containing the information received from the MSC to the call handling process in the HLR and returns to the idle state.

Failure of dialogue opening with the HLR

If the macro Receive_Open_Cnf takes the Vr exit or the Error exit, the MAP process sends a negative response to the call handling process in the HLR, and returns to the idle state.

Error in MAP_IST_COMMAND confirm

If the MAP_IST_COMMAND service confirm contains a user error or a provider error, or the macro Check_Confirmation indicates that there is a data error, the MAP process sends a negative response to the call handling process in the HLR, and returns to the idle state.

Abort of MSC dialogue

When the MAP process is waiting for an MSC response to the MAP_IST_COMMAND, the MAP service provider may abort the dialogue by issuing a MAP_CLOSE, a MAP_P_ABORT or a MAP_U_ABORT indication. In this case, the MAP process sends a negative response to the call handling process in the HLR, and returns to the idle state.

If the MAP provider indicates a protocol problem by sending a MAP_NOTICE indication when the MAP process is waiting for an MSC response to the MAP_IST_COMMAND, the MAP process closes the dialogue with the MSC, sends a negative response to the call handling process in the HLR, and returns to the idle state.

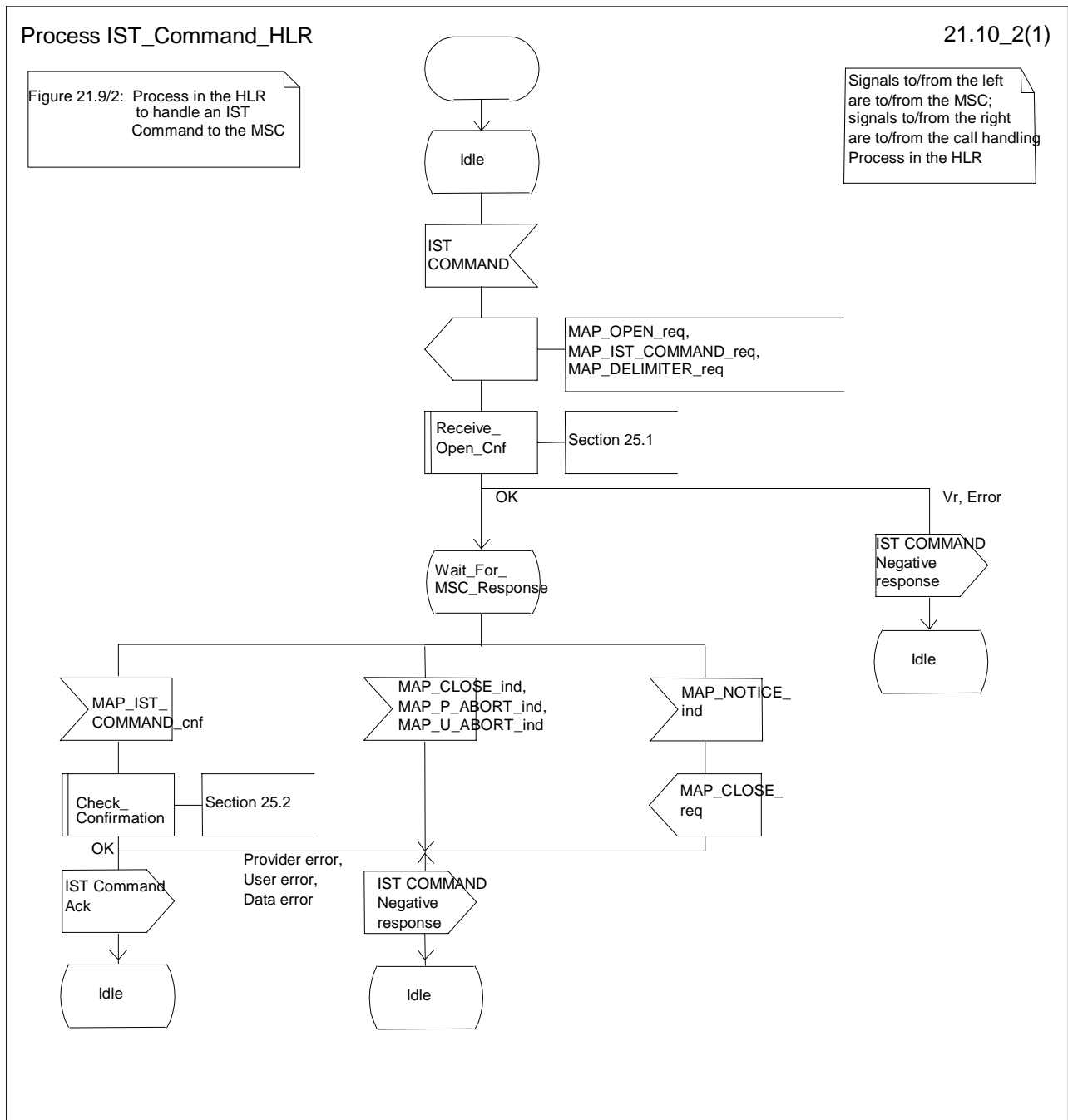

Figure 21.10/2: Process IST_Command_HLR

21.10.3 Procedure in the MSC

The MAP process in the MSC is shown in figure 21.10/3. The MAP process invokes a macro not defined in this clause; the definition of this macro can be found as follows:

Receive_Open_Ind see clause 25.1.1.

Successful outcome

When the MAP process in the MSC receives a request to open a dialogue, it invokes the macro Receive_Open_Ind to check if the dialogue can be opened.

If the dialogue can be opened, and the service indication received is a MAP_IST_COMMAND, the MSC then sends the IST command indication to the call handling process in the MSC, and waits for a response.

If the call handling process in the MSC returns a positive response, the MAP process constructs a MAP_IST_COMMAND service response and a MAP_CLOSE service request, sends them to the HLR, and returns to the idle state.

Negative response from MSC call handling process

If the call handling process in the MSC returns a negative response, the MAP process constructs a MAP_IST_COMMAND service response containing the appropriate error and a MAP_CLOSE service request, sends them to the HLR and returns to the idle state.

Failure of dialogue opening in the MSC

If the macro Receive_Open_Ind takes the Vr exit or the Error exit, the MAP process returns to the idle state.

Abort of HLR dialogue

If the MAP process receives a MAP_P_ABORT indication before receiving a service indication, the MAP process returns to the idle state.

When the MAP process receives a MAP_NOTICE indication before receiving a service indication, the MAP process closes the dialogue with the HLR, and returns to the idle state.

When the MAP process is waiting for the application response to the IST Command, the MAP service provider may abort the dialogue by issuing a MAP_CLOSE, a MAP_P_ABORT or a MAP_U_ABORT indication. In this case, the MAP process returns to the idle state.

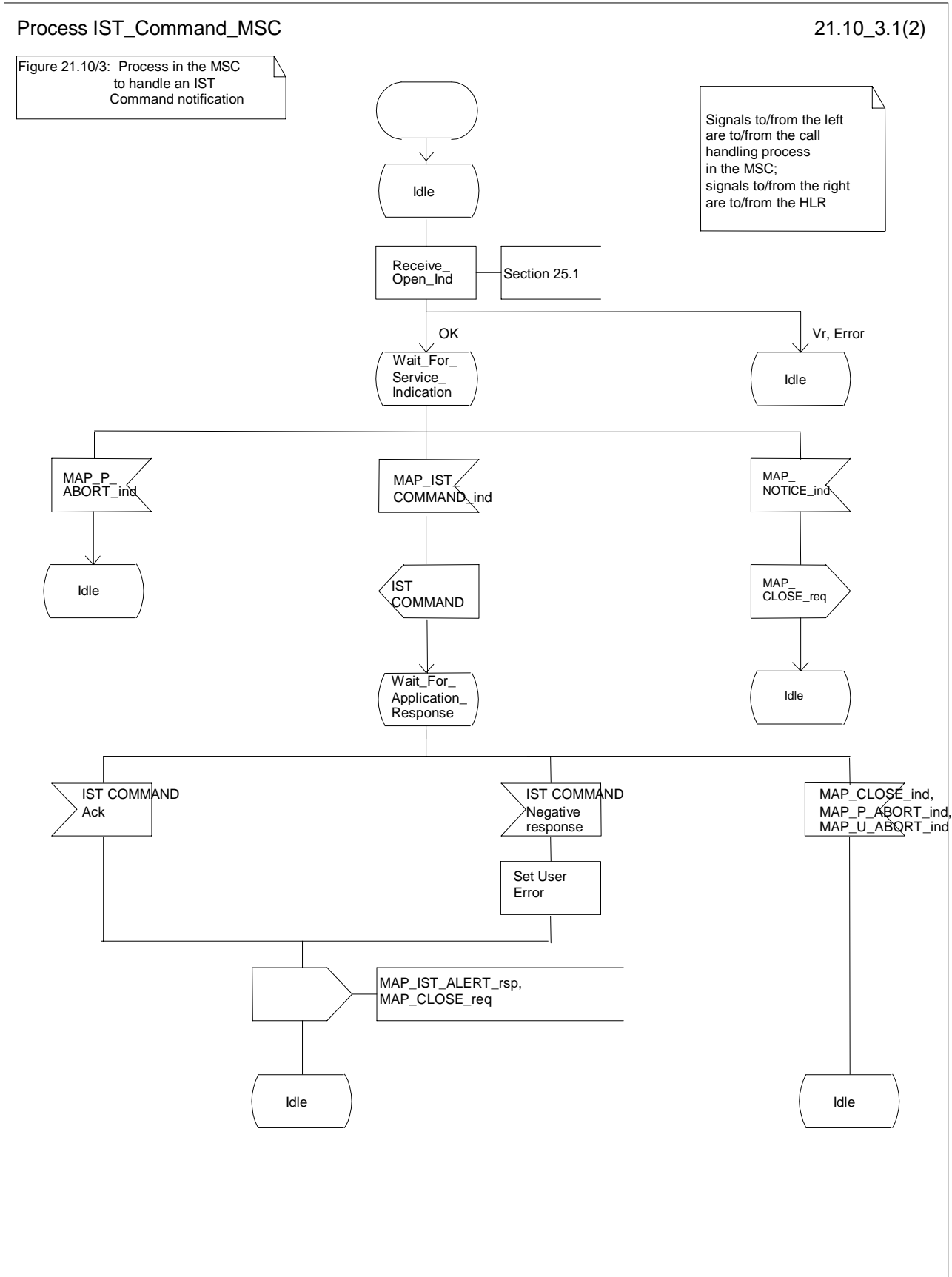

Figure 21.10/3: Process IST_Command_MSC

22 Supplementary services procedures

The following application contexts exist for handling of supplementary services:

- accessUnstructuredSsContext;
- accessFunctionalSsContext.

The accessUnstructuredSsContext refers to a simple MAP user, for which the corresponding MAP process can be identified by the MAP-Provider directly.

However, the accessFunctionalSsContext refers to a complex MAP-User consisting of several processes. For this user, a process co-ordinator is defined for each network entity, in order to identify the correct process to invoke. These processes open and validate the dialogue, then invoke the necessary operation-specific process. These processes are described below.

22.1 Functional supplementary service processes

22.1.1 Functional supplementary service process co-ordinator for MSC

Upon receipt of a CM-Service request with CM-service type = SS, the MSC initiates the process access request procedure towards the VLR as described in clause 25 of the present document.

Once a CM connection is established, the MSC can handle supplementary service indications from the MS. Table 22.1/1 shows the co-ordinating process' reaction on receipt of specific SS service indications on the air interface. After the relevant process is invoked, the received air interface service indication is sent to that process. The creation of service requests on the basis of air interface messages is described in 3GPP TS 29.011 [59].

Table 22.1/1: Relationship between received service indication and invoked process in the MSC

Service indication received	Process invoked
A_REGISTER_SS_ind	REGISTER_SS_MSC
A_ERASE_SS_ind	ERASE_SS_MSC
A_ACTIVATE_SS_ind	ACTIVATE_SS_MSC
A_DEACTIVATE_SS_ind	DEACTIVATE_SS_MSC
A_INTERROGATE_SS_ind	INTERROGATE_SS_MSC
A_REGISTER_PASSWORD	REGISTER_PASSWORD_MSC

Figure 22.1/1 shows the co-ordinating process in the MSC.

Process SS_Coordinator_MSC

22.1_1(1)

Figure 22.1/1: Supplementary Service Coordination process in the MSC, to identify which functional supplementary service process shall be invoked.

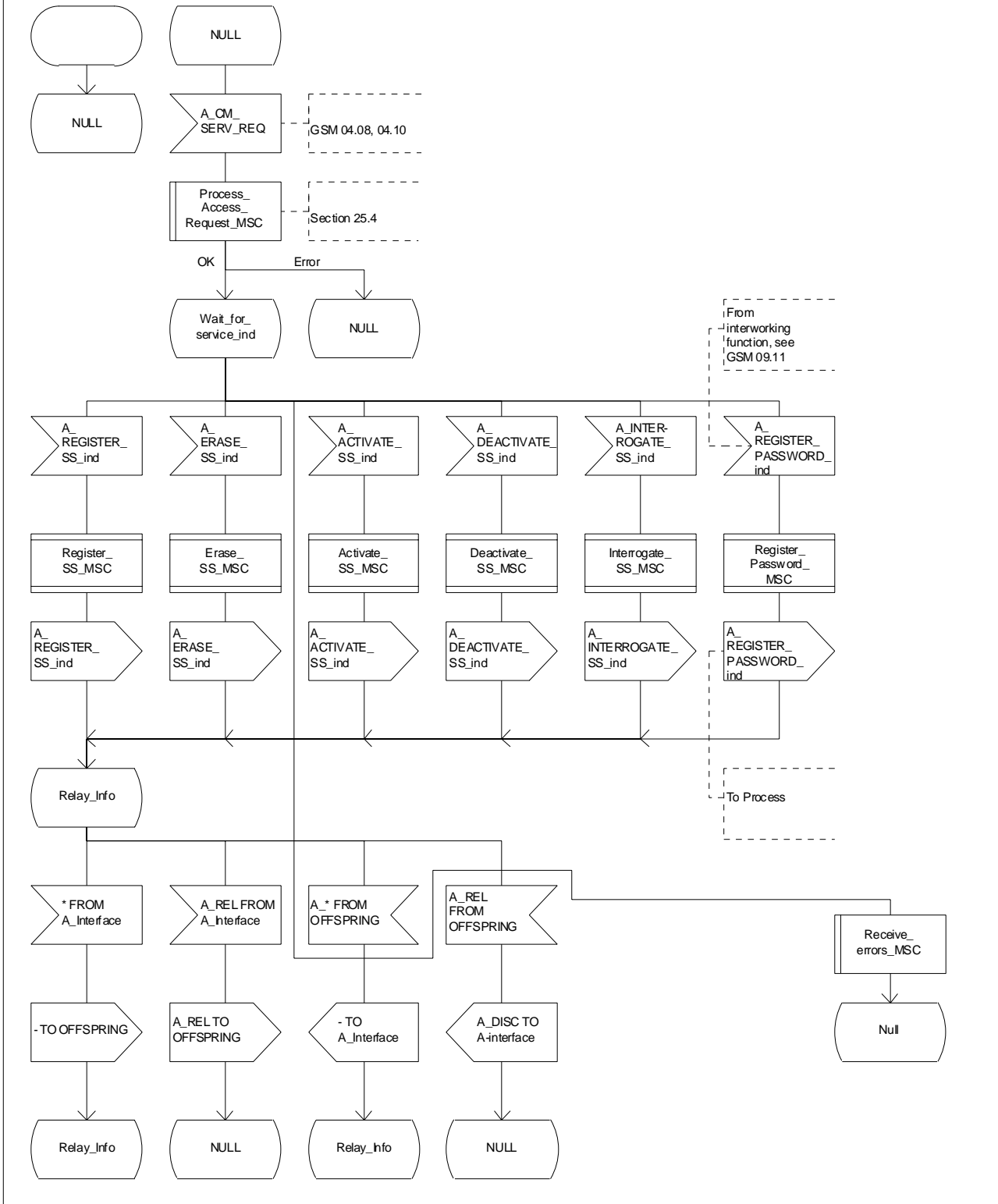

Figure 22.1/1: Process SS_Coordinator_MSC

22.1.2 Functional supplementary service process co-ordinator for VLR

Any functional SS process in the VLR starts by the VLR receiving the MAP_PROCESS_ACCESS_REQUEST indication. The VLR then acts as described in clause 25 of the present document.

If the Process Access Request was successful, the VLR can handle supplementary service indications from the MSC. Table 22.1/2 shows the co-ordinating process' reaction on receipt of specific SS service indications from the MSC. After the relevant process is invoked, the received service indication is sent to that process, and the co-ordinating process terminates.

Table 22.1/2: Relationship between received service indication and invoked process in the VLR

Service indication received	Process invoked
MAP_REGISTER_SS_ind	REGISTER_SS_VLR
MAP_ERASE_SS_ind	ERASE_SS_VLR
MAP_ACTIVATE_SS_ind	ACTIVATE_SS_VLR
MAP_DEACTIVATE_SS_ind	DEACTIVATE_SS_VLR
MAP_INTERROGATE_SS_ind	INTERROGATE_SS_VLR
MAP_REGISTER_PASSWORD	REGISTER_PASSWORD_VLR

Figure 22.1/2 shows the co-ordinating process in the VLR.

Process SS_Coordinator_VLR

22.1_2.1(2)

Figure 22.1/2: Supplementary Service Coordination process in the VLR, to open and process the access request from the MSC, and then identify which functional supplementary service process shall be invoked.

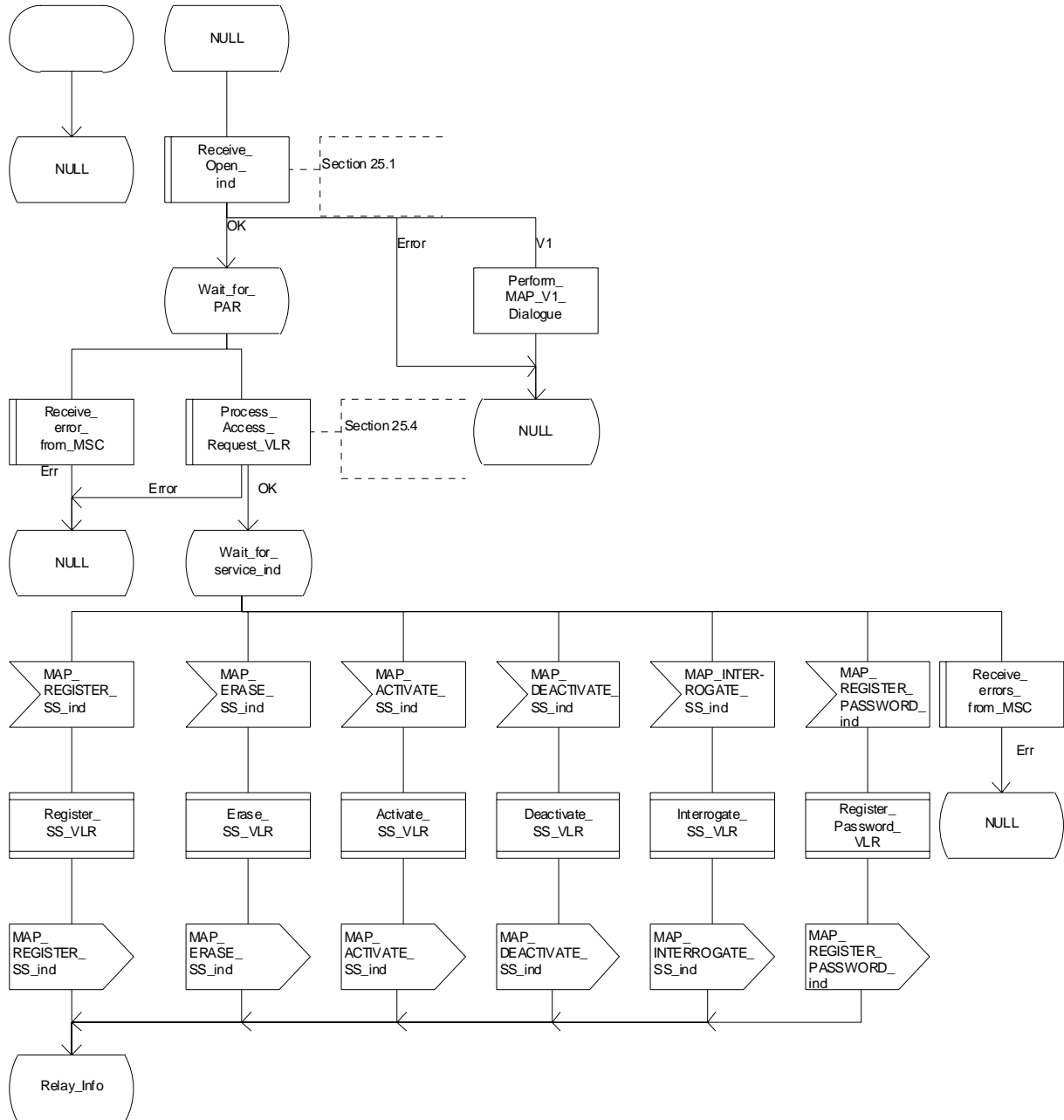

Figure 22.1/2 (sheet 1 of 2): Process SS_Coordinator_VLR

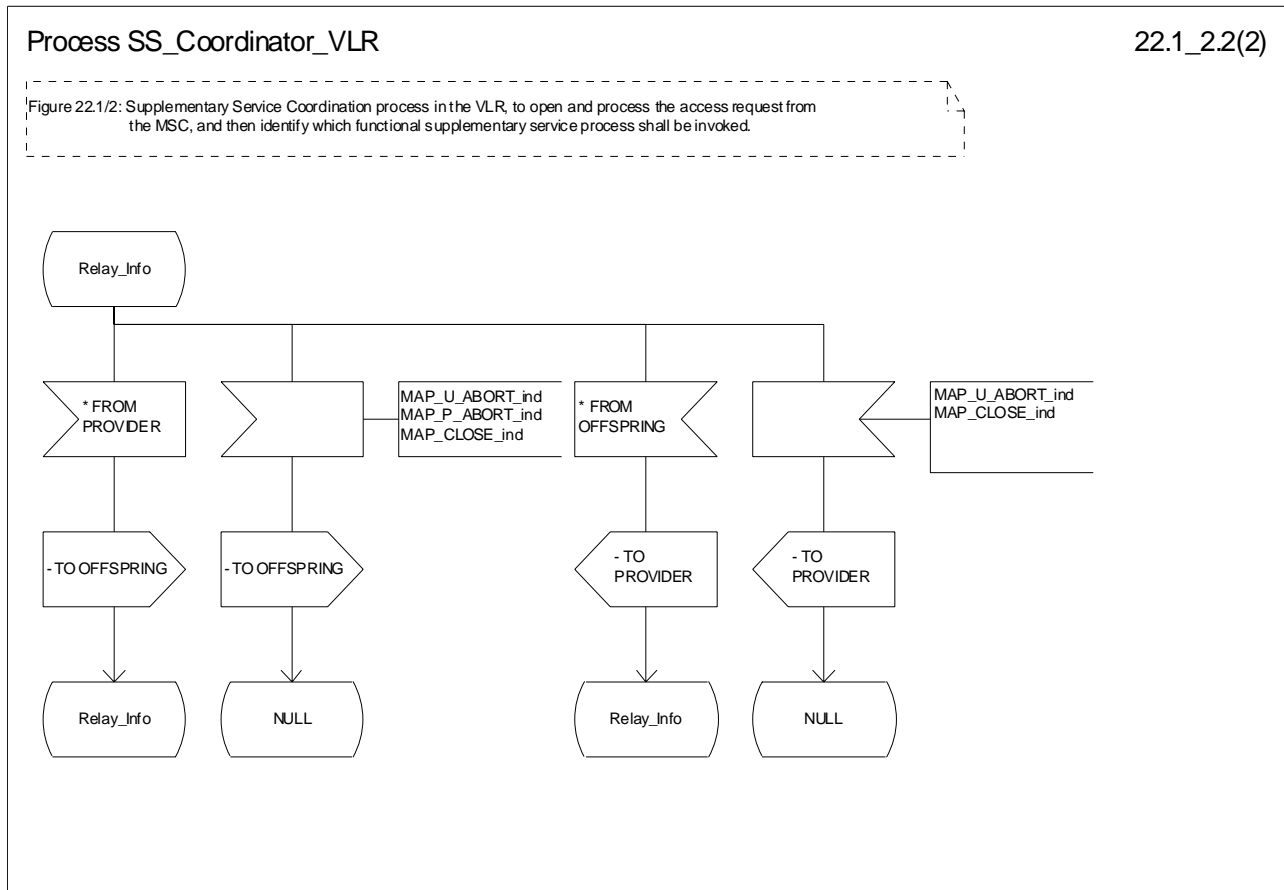

Figure 22.1/2 (sheet 2 of 2): Process SS_Coordinator_VLR

22.1.3 Functional supplementary service process co-ordinator for HLR

Any functional SS process in the HLR starts by the HLR receiving a MAP-OPEN service indication. If that service is successful, the HLR can handle supplementary service indications from the VLR. Table 22.1/3 shows the co-ordinating process' reaction on receipt of specific SS service indications from the VLR. After the relevant process is invoked, the received service indication is sent to that process, and the co-ordinating process terminates.

Table 22.1/3: Relationship between received service indication and invoked process in the HLR

Service indication received	Process invoked
MAP_REGISTER_SS_ind	REGISTER_SS_HLR
MAP_ERASE_SS_ind	ERASE_SS_HLR
MAP_ACTIVATE_SS_ind	ACTIVATE_SS_HLR
MAP_DEACTIVATE_SS_ind	DEACTIVATE_SS_HLR
MAP_INTERROGATE_SS_ind	INTERROGATE_SS_HLR
MAP_REGISTER_PASSWORD	REGISTER_PASSWORD_HLR

Figure 22.1/3 shows the co-ordinating process in the HLR.

Process SS_Coordinator_HLR

22.1_3.1(2)

Figure 22.1/3: Supplementary Service Coordination process in the HLR, to identify which functional supplementary service process shall be invoked.

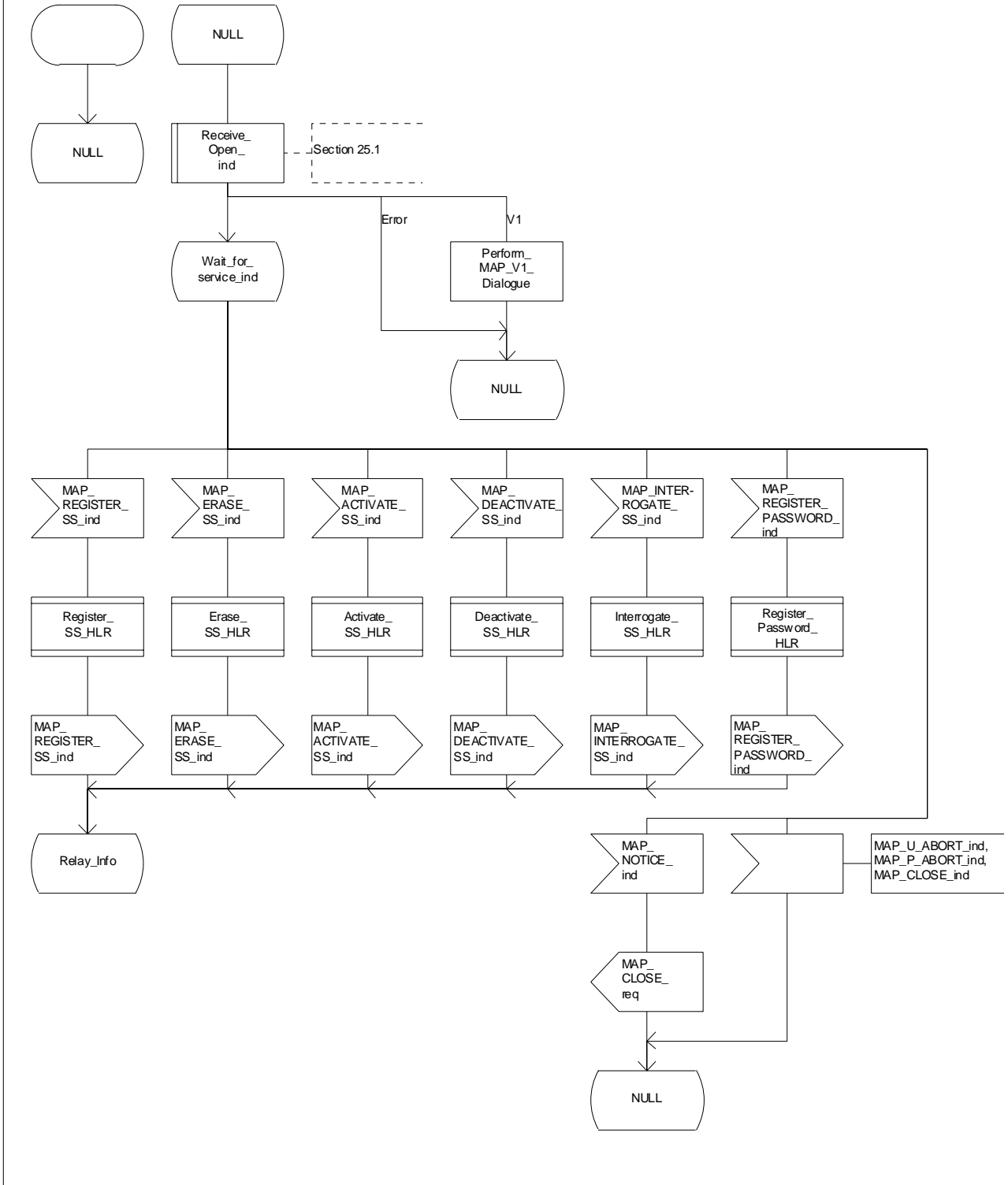

Figure 22.1/3 (sheet 1 of 2): Process SS_Coordinator_HLR

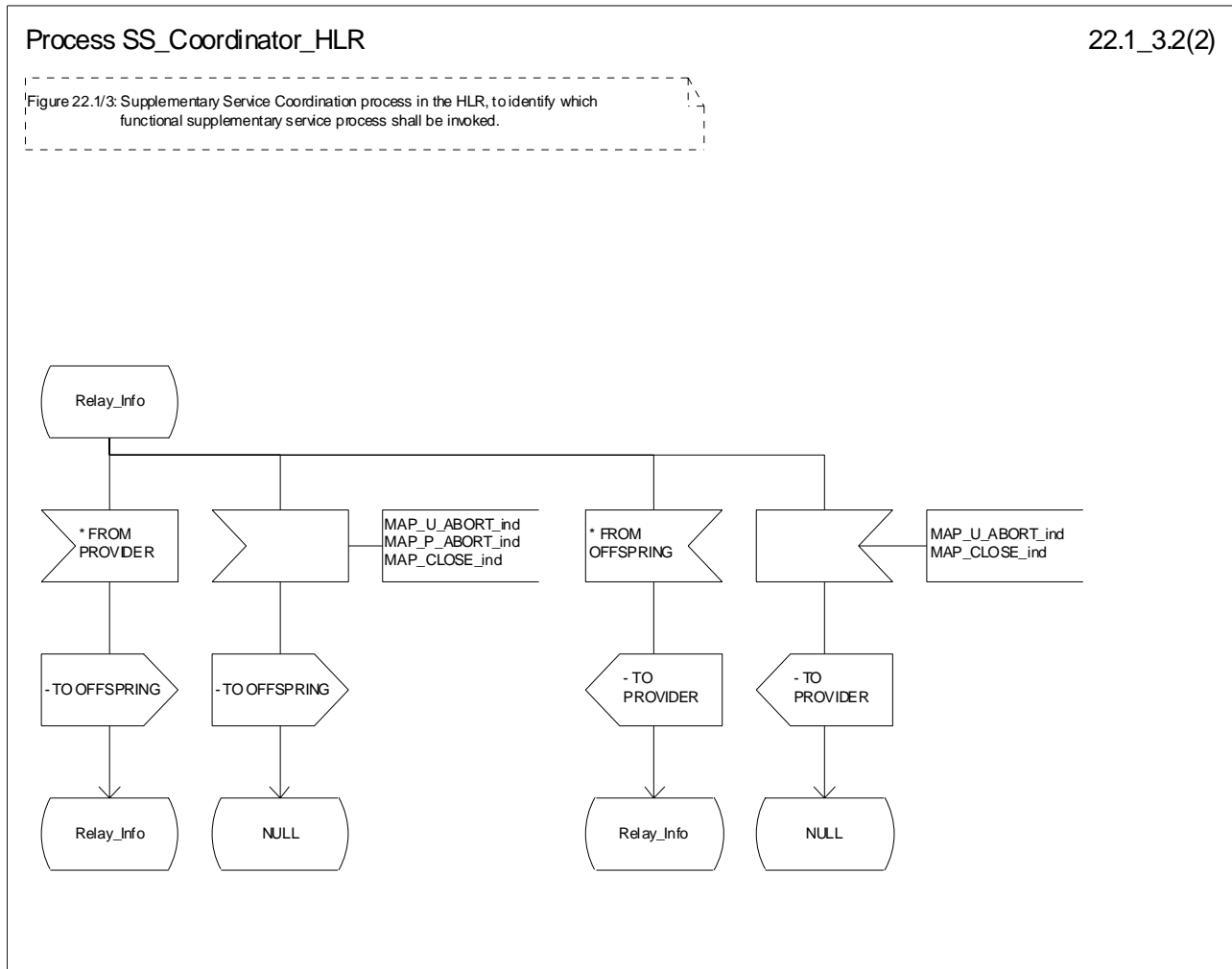

Figure 22.1/3 (sheet 2 of 2): Process SS_Coordinator_HLR

22.1.4 Call completion supplementary service process co-ordinator for HLR

The MAP co-ordinating process in the HLR to handle a dialogue opened with the callCompletion application context is shown in figure 22.1/4. The MAP process invokes a macro not defined in this clause; the definition of this macro can be found as follows:

Receive_Open_Ind see clause 25.1.1.

Any call completion SS process in the HLR starts by the HLR receiving a MAP-OPEN service indication. If that service is successful, the HLR can handle call completion supplementary service indications from the VLR.

Table 22.1/4 shows the co-ordinating process' reaction on receipt of specific call completion SS service indications from the VLR. After the relevant process is invoked, the received service indication is sent to that process.

Table 22.1/4: Relationship between received service indication and invoked process in the HLR

Service indication received	Process invoked
MAP_REGISTER_CC_ENTRY_ind	REGISTER_CC_ENTRY_HLR
MAP_ERASE_CC_ENTRY_ind	ERASE_CC_ENTRY_HLR

After creation of the user process the Co-ordinator relays the messages between the MAP_PM and the invoked process until a request or an indication for dialogue termination is received.

The Call_Completion Co-ordinator is shown in figure 22.1/4.

Process CC_Coord_HLR

22.1_4(1)

Figure 22.1/4: Coordinating process in the HLR to handle a dialogue opened with the AC CallCompletionContext

Signals to/from the left are to/from the VLR via the MAP provider; signals to/from the right are to/from the child process

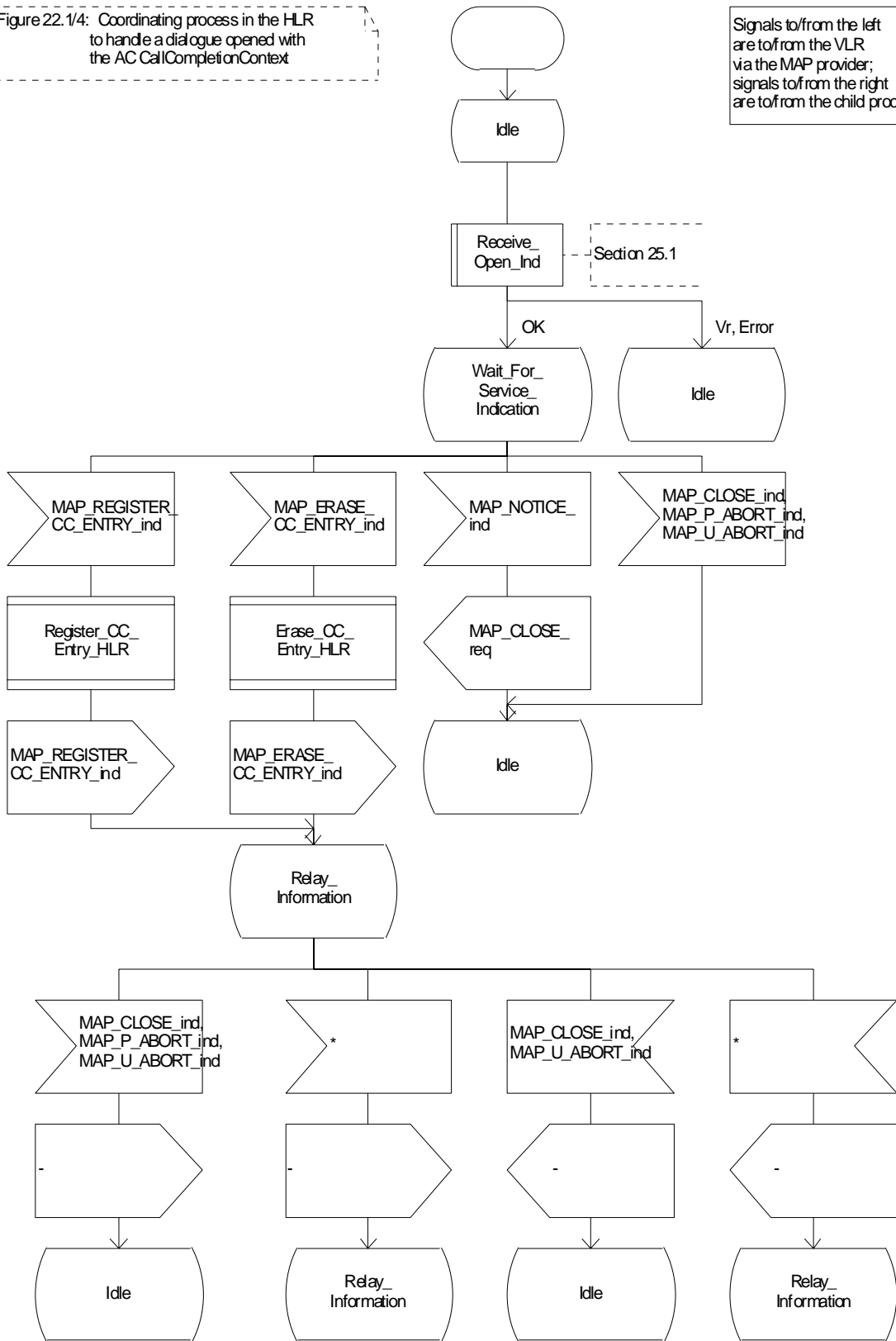

Figure 22.1/4: Process_CC_Coord_HLR

22.2 Registration procedure

22.2.1 General

The registration procedure is used to register data related to a supplementary service in the HLR. The registration procedure is a fully transparent communication between the MS and the HLR, except that some services may be invoked as a result of the procedure, as described in the clauses below.

The registration procedure is shown in figure 22.2.1/1.

The following services may be used:

- MAP_PROCESS_ACCESS_REQUEST (defined in clauses 8 and 25);
- MAP_TRACE_SUBSCRIBER_ACTIVITY (defined in clauses 9 and 25);
- MAP_PROVIDE_IMSI (defined in clauses 8 and 25);
- MAP_FORWARD_NEW_TMSI (defined in clauses 8 and 25);
- MAP_AUTHENTICATE (defined in clauses 8 and 25);
- MAP_SET_CIPHERING_MODE (defined in clauses 8 and 25);
- MAP_CHECK_IMEI (defined in clauses 8 and 25);
- MAP_READY_FOR_SM (defined in clauses 12 and 25);
- MAP_INSERT_SUBSCRIBER_DATA (defined in clauses 8 and 25);
- MAP_REGISTER_SS (defined in clause 11).

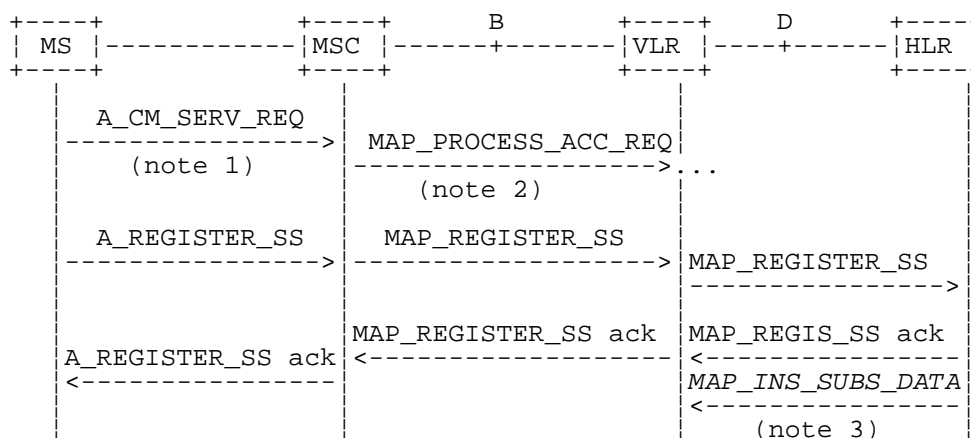

- NOTE 1: For details of the procedure on the radio path, see 3GPP TS 24.008 [35], 04.10, 04.8x and 04.9x. Services shown in dotted lines indicate the trigger provided by the signalling on the radio path, and the signalling triggered on the radio path.
- NOTE 2: For details on the Process Access Request procedure, please refer to clause 25 in the present document.
- NOTE 3: Services printed in *italics* are optional.

Figure 22.2.1/1: Interfaces and services for supplementary service registration

22.2.2 Procedures in the MSC

Supplementary service registration

The A_REGISTER_SS service indication received by the MAP user in the MSC contains the SS-Code and any parameters that are related to the supplementary service.

The MAP user transfers the received information to the VLR in the MAP_REGISTER_SS request without checking the contents of the service indication. Rules for the mapping are described in 3GPP TS 29.011 [59].

The MSC then awaits the receipt of the MAP_REGISTER_SS confirm from the VLR. The outcome of the procedure is reported to the MS in the A_REGISTER_SS response message as described in GSM 04.8x, 04.9x and 09.11. Finally the SS-connection is released.

For call independent SS operations, each message shall only contain a single component. Messages which contain more than one component will be stopped at the air interface (as specified in 3GPP TS 29.011 [59]).

Error handling

If at any time during the supplementary service part of this procedure a MAP_P_ABORT, MAP_U_ABORT, MAP_NOTICE or unexpected MAP_CLOSE indication is received from the VLR concerning the process, a CM_RELEASE_COMPLETE indication is sent to the MS (as specified in 3GPP TS 29.011 [59]). Upon receipt of a MAP_NOTICE indication from the VLR, the MSC must close the VLR dialogue by sending a MAP_CLOSE request. The process is then terminated.

If an A_CM_RELEASE indication is received from the MS, all open transactions shall be released using the MAP_U_ABORT request indicating application procedure cancellation, and the process is terminated.

The registration procedure in the MSC is shown in figure 22.2.2/1.

Process SS_REGISTER_MSC

22.2.2_1(1)

Figure 22.2.2/1 : Mobile initiated registration of supplementary service in the MSC

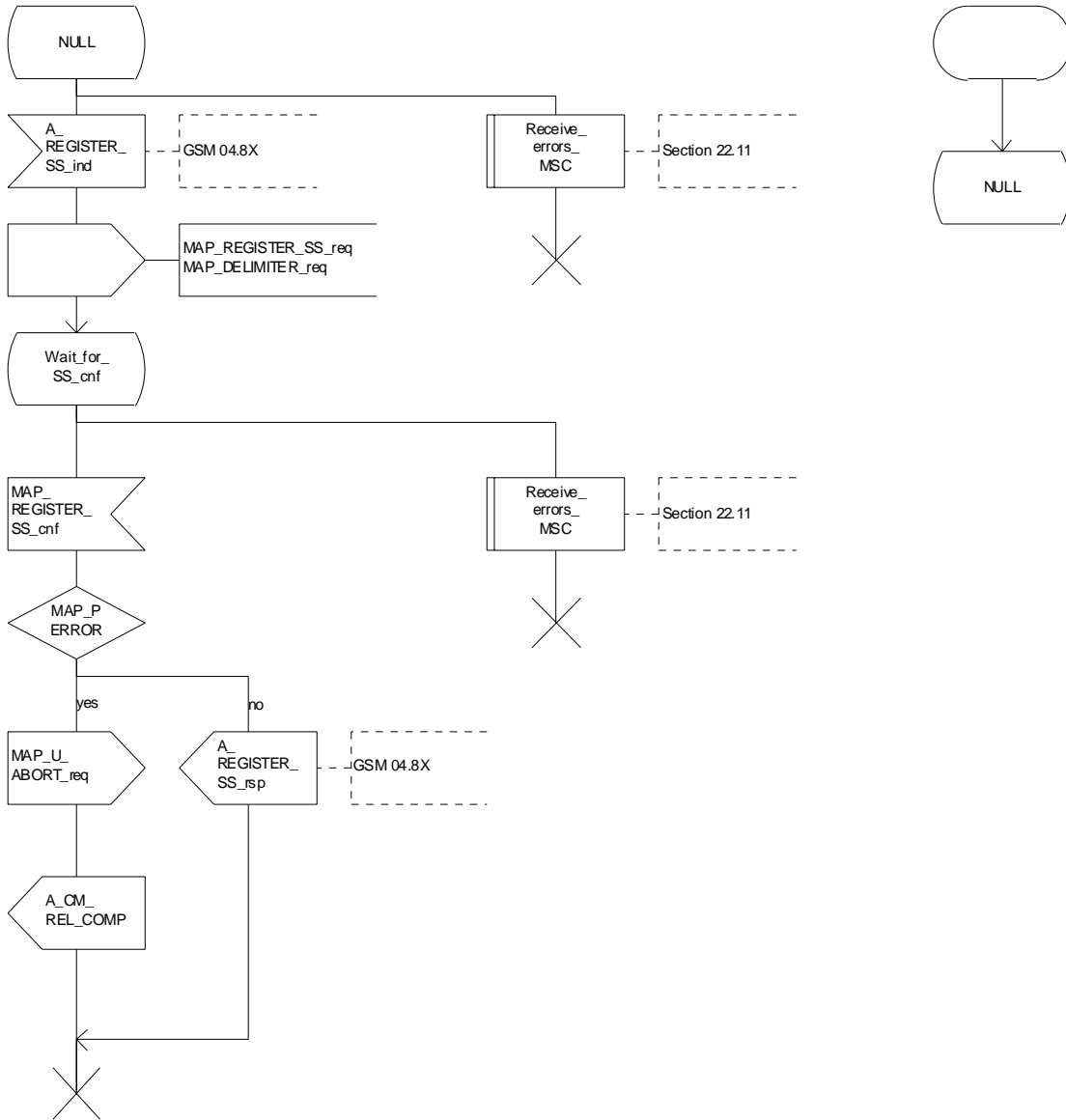

Figure 22.2.2/1: Procedure SS_Register_MSC

22.2.3 Procedures in the VLR

Supplementary service registration

When receiving the MAP_REGISTER_SS indication, the MAP user in the VLR transfers the information to the HLR in the MAP_REGISTER_SS request without checking the contents of the service indication.

The VLR then awaits the receipt of the MAP_REGISTER_SS confirm from the HLR. The MAP user in the VLR shall transfer the information contained in this primitive to the MSC in the MAP_REGISTER_SS response without checking its contents.

For call independent SS operations, each message shall only contain a single component. Messages which contain more than one component will be stopped at the air interface (as specified in 3GPP TS 29.011 [59]).

Error handling

If at any time during this procedure a MAP_P_ABORT, MAP_U_ABORT, MAP_NOTICE or unexpected MAP_CLOSE indication is received from the MSC concerning the process, a MAP_U_ABORT request indicating application procedure cancellation is sent to the HLR (if a connection exists). If a MAP_NOTICE indication was received from the MSC, that dialogue must be closed by sending a MAP_CLOSE request towards the MSC. The process is terminated.

If a MAP_P_ABORT, MAP_U_ABORT or MAP_CLOSE indication is received from the HLR, a MAP_U_ABORT request shall be sent to the MSC terminating the process. If a MAP_NOTICE indication was received from the HLR, that dialogue must be closed by sending a MAP_CLOSE request towards the HLR. The process terminates.

The registration procedure in the VLR is shown in figure 22.2.3/1.

Process SS_REGISTER_VLR

22.2.3_1.1(2)

Figure 22.2.3/1: Mobile initiated registration of supplementary services in the VLR

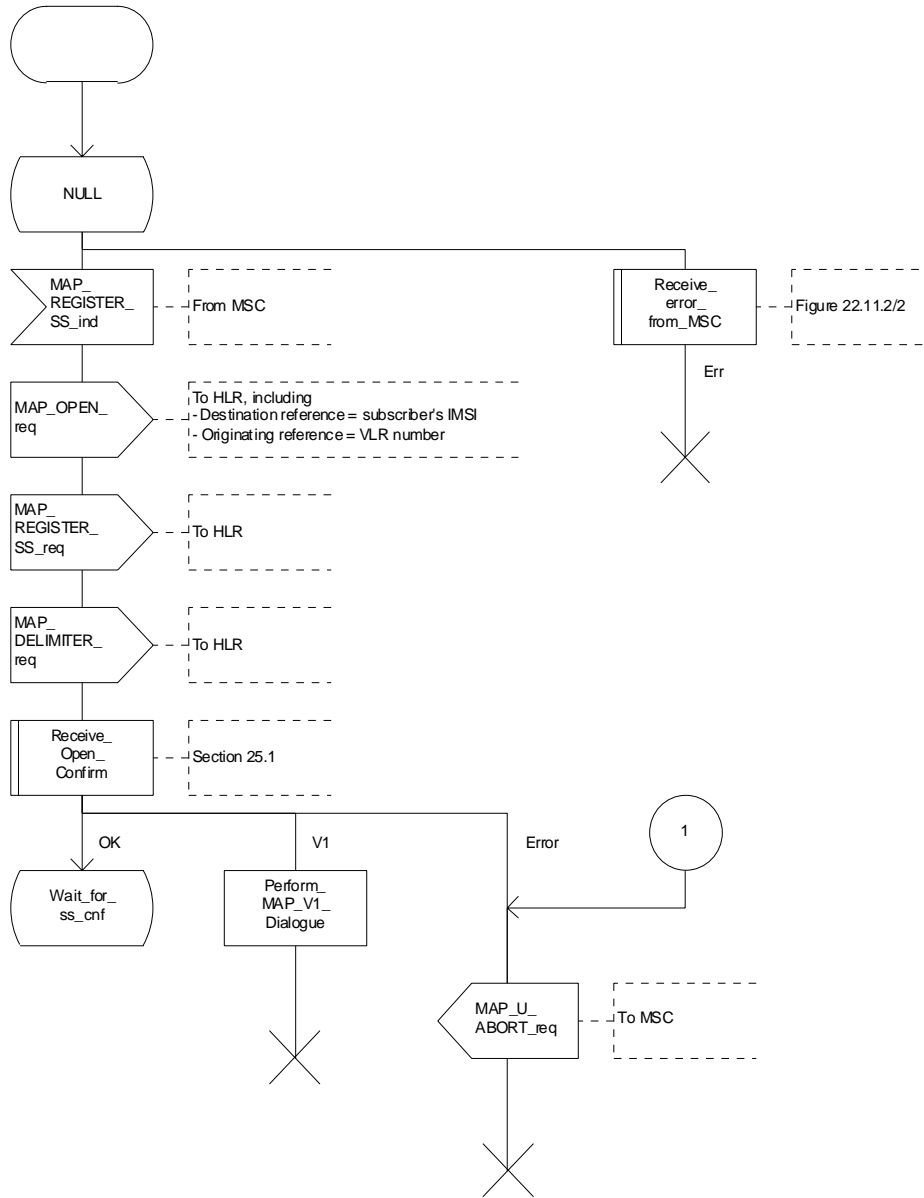

Figure 22.2.3/1 (sheet 1 of 2): Procedure SS_Register_VLR

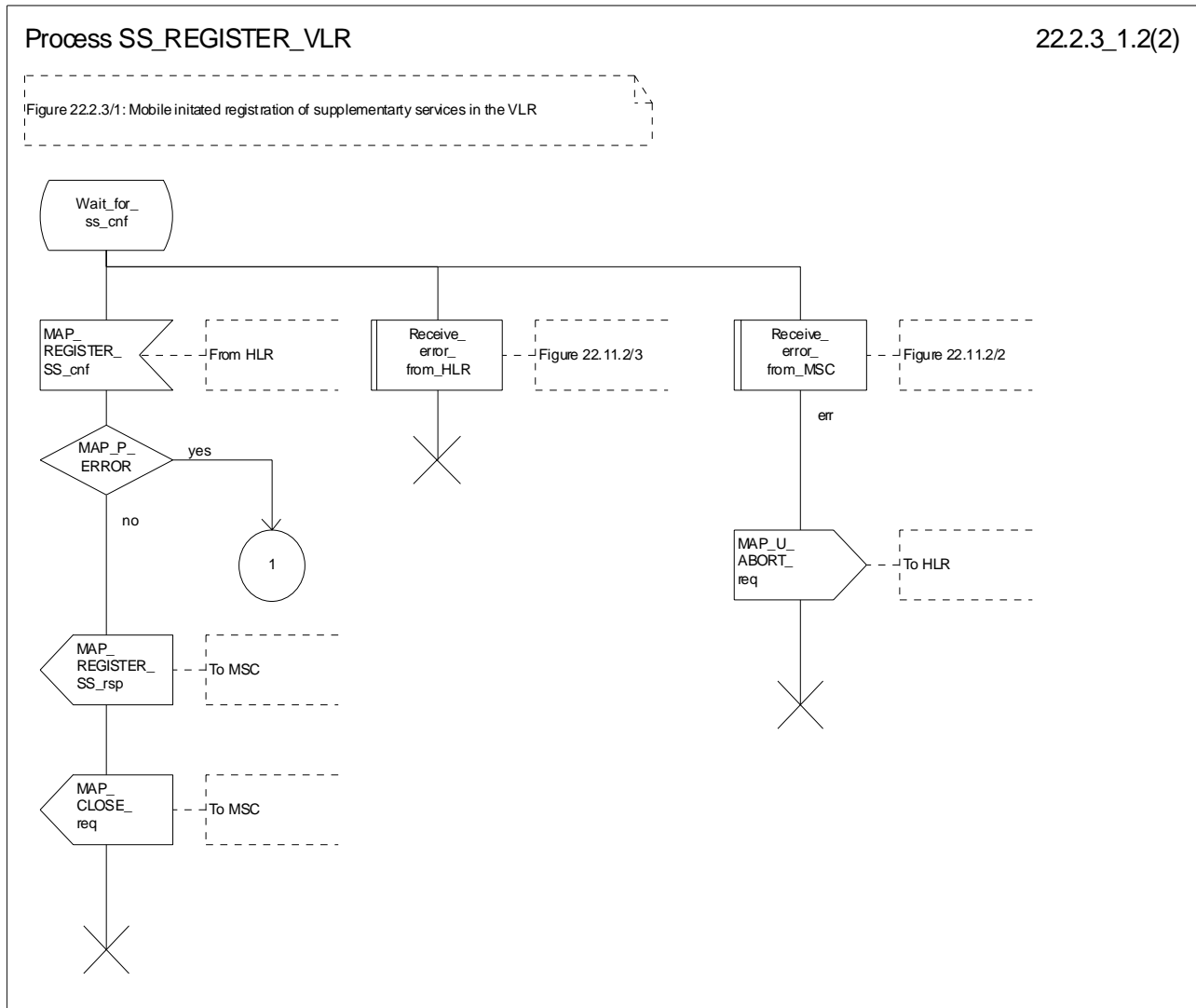

Figure 22.2.3/1 (sheet 2 of 2): Procedure SS_Register_VLR

22.2.4 Procedures in the HLR

The procedure in the HLR is initiated when it receives a MAP_REGISTER_SS indication.

The HLR acts as follows:

- if the operator has barred the subscriber from access to supplementary services, the Call Barred error should be returned to the VLR. The parameter "operatorBarring" shall be included with the error.

The supplementary service request shall then be processed according to 3GPP TS 23.011 [22] and the 03.8x and 03.9x-series of technical specifications. This handling may lead to either a successful result, a partially successful result, or an error being returned.

For call independent SS operations, each message shall only contain a single component. Messages which contain more than one component will be stopped at the air interface (as specified in 3GPP TS 29.011 [59]):

- if the VLR is to be updated after the supplementary service registration, the MAP_INSERT_SUBS_DATA_HLR process shall be initiated;
- if at any time during this procedure a MAP_P_ABORT, MAP_U_ABORT or MAP_CLOSE indication concerning the process is received from the VLR, the process is terminated. If a MAP_NOTICE indication is received, a MAP_CLOSE request is sent towards the VLR.

The registration procedure in the HLR is shown in figure 22.2.4/1.

Process SS_REGISTER_HLR

22.2.4_1.1(2)

Figure 22.2.4/1: Registration of supplementary services procedure in HLR

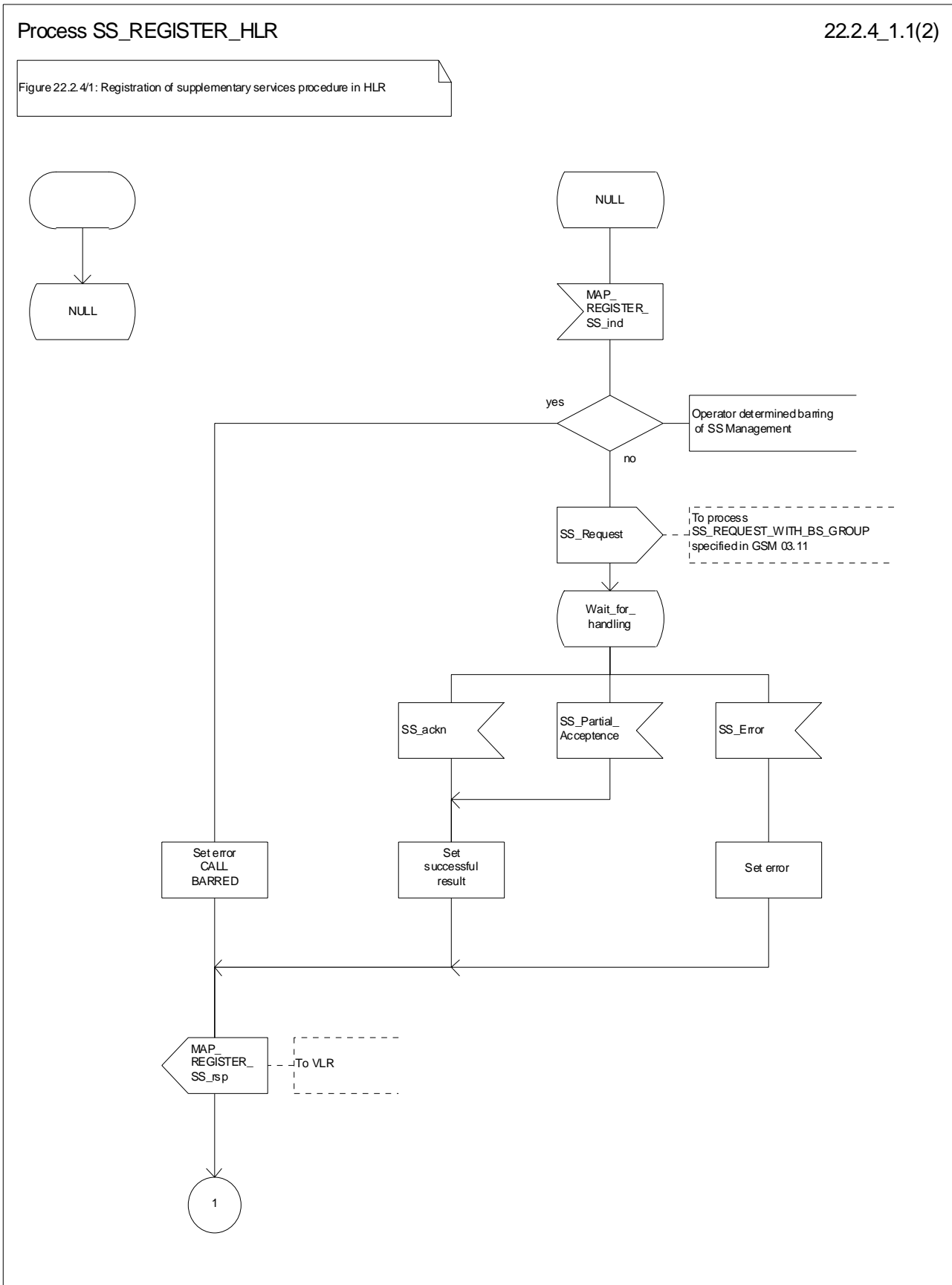

Figure 22.2.4/1 (sheet 1 of 2): Procedure SS_Register_HLR

Process SS_REGISTER_HLR

22.2.4_1.2(2)

Figure 22.2.4/1: Registration of supplementary services procedure in HLR

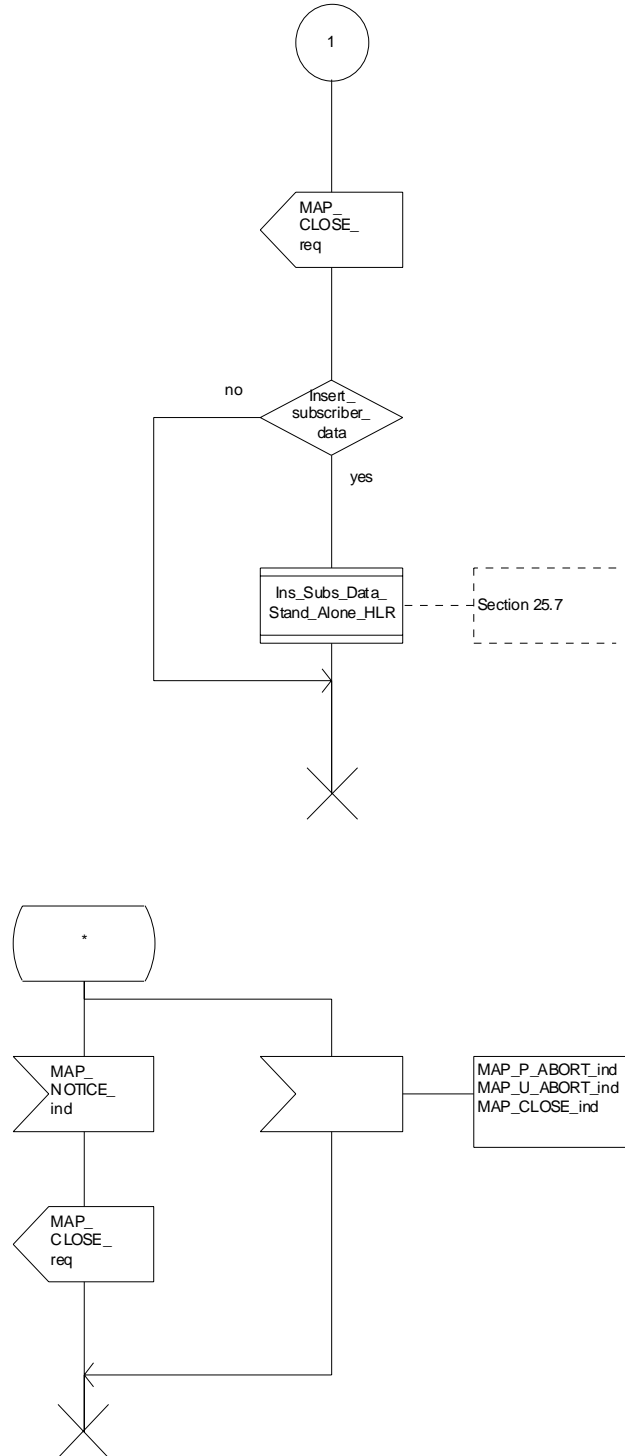

Figure 22.2.4/1 (sheet 2 of 2): Procedure SS_Register_HLR

22.3 Erasure procedure

22.3.1 General

The erasure procedure is used to erase data related to a supplementary service in the HLR. The erasure procedure is a fully transparent communication between the MS and the HLR, except that some services may be invoked as a result of the procedure, as described in the clauses below.

The erasure procedure is shown in figure 22.3.1/1.

The following services may be used:

- MAP_PROCESS_ACCESS_REQUEST (defined in clauses 8 and 25);
- MAP_TRACE_SUBSCRIBER_ACTIVITY (defined in clauses 9 and 25);
- MAP_PROVIDE_IMSI (defined in clauses 8 and 25);
- MAP_FORWARD_NEW_TMSI (defined in clauses 8 and 25);
- MAP_AUTHENTICATE (defined in clauses 8 and 25);
- MAP_SET_CIPHERING_MODE (defined in clauses 8 and 25);
- MAP_CHECK_IMEI (defined in clauses 8 and 25);
- MAP_READY_FOR_SM (defined in clauses 12 and 25);
- MAP_INSERT_SUBSCRIBER_DATA (defined in clauses 8 and 25);
- MAP_ERASE_SS (defined in clause 11).

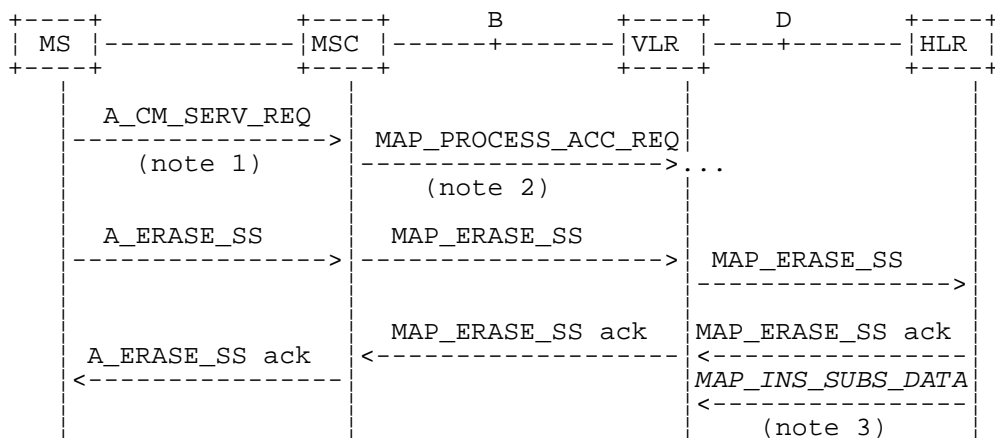

- NOTE 1: For details of the procedure on the radio path, see 3GPP TS 24.008 [35], 04.10, 04.8x and 04.9x. Services shown in dotted lines indicate the trigger provided by the signalling on the radio path, and the signalling triggered on the radio path.
- NOTE 2: For details on the Process Access Request procedure, please refer to clause 25 in the present document.
- NOTE 3: Services printed in *italics* are optional.

Figure 22.3.1/1: Interfaces and services for supplementary service erasure

22.3.2 Procedures in the MSC

The MSC procedures for erasure are identical to those specified for registration in clause 22.2.2. The text and diagrams in clause 22.2.2 apply with all references to registration changed to erasure.

22.3.3 Procedures in the VLR

The VLR procedures for erasure are identical to those specified for registration in clause 22.2.3. The text and diagrams in clause 22.2.3 apply with all references to registration changed to erasure.

22.3.4 Procedures in the HLR

The HLR procedure for erasure is identical to those specified for registration in clause 22.2.4. The text and diagrams in clause 22.2.4 apply with all references to registration changed to erasure.

22.4 Activation procedure

22.4.1 General

The activation procedure is used to activate a supplementary service in the HLR. The activation procedure is a fully transparent communication between the MS and the HLR, except that some services may be invoked as a result of the procedure, as described in the clauses below.

The activation procedure is shown in figure 22.4.1/1.

The following services may be used:

MAP_PROCESS_ACCESS_REQUEST	(defined in clauses 8 and 25);
MAP_TRACE_SUBSCRIBER_ACTIVITY	(defined in clauses 9 and 25);
MAP_PROVIDE_IMSI	(defined in clauses 8 and 25);
MAP_FORWARD_NEW_TMSI	(defined in clauses 8 and 25);
MAP_AUTHENTICATE	(defined in clauses 8 and 25);
MAP_SET_CIPHERING_MODE	(defined in clauses 8 and 25);
MAP_CHECK_IMEI	(defined in clauses 8 and 25);
MAP_READY_FOR_SM	(defined in clauses 12 and 25);
MAP_GET_PASSWORD	(defined in clause 11);
MAP_INSERT_SUBSCRIBER_DATA	(defined in clauses 8 and 25);
MAP_ACTIVATE_SS	(defined in clause 11).

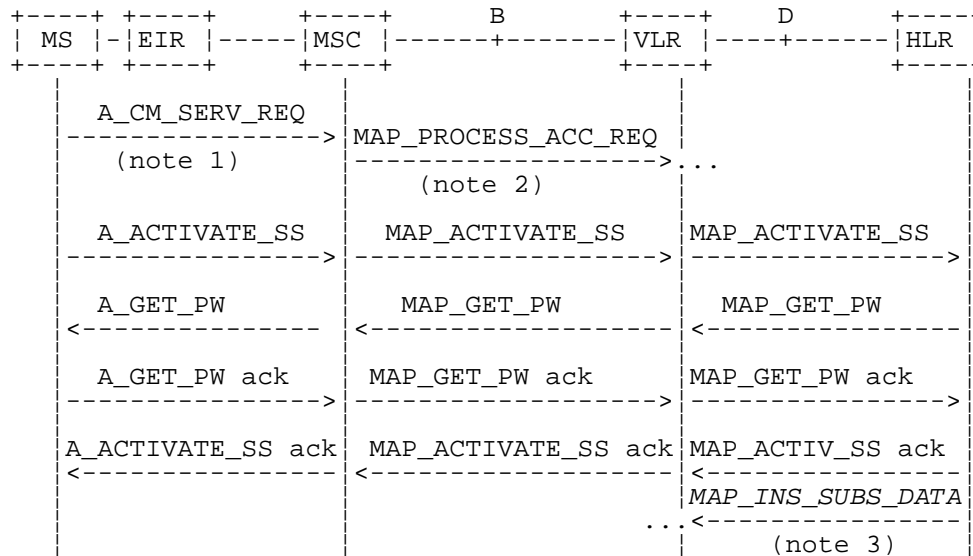

- NOTE 1: For details of the procedure on the radio path, see 3GPP TS 24.008 [35], 04.10, 04.8x and 04.9x. Services shown in dotted lines indicate the trigger provided by the signalling on the radio path, and the signalling triggered on the radio path.
- NOTE 2: For details on the Process Access Request procedure, please refer to clause 25 of this document.
- NOTE 3: Services printed in italics are optional.

Figure 22.4.1/1: Interfaces and services for supplementary service activation

22.4.2 Procedures in the MSC

The A_ACTIVATE_SS service indication received by the MAP user in the MSC contains the SS-Code and any parameters related to the supplementary service.

The MSC transfers the received information to the VLR in the MAP_ACTIVATE_SS request without checking the contents of the service indication. Rules for the mapping are described in 3GPP TS 29.011 [59].

The MAP user may subsequently receive the MAP_GET_PASSWORD indication from the VLR. Upon receipt of this indication, the MSC sends the A_GET_PASSWORD message towards the MS and then awaits the response from the MS. When an A_GET_PASSWORD confirm message is received from the MS, the MSC initiates the MAP_GET_PASSWORD response towards the VLR without checking further the contents of the indication. Also see 3GPP TS 29.011 [59].

The MSC will receive a MAP_ACTIVATE_SS confirm from the VLR. The outcome of the procedure is reported to the MS in the A_ACTIVATE_SS response message, see GSM 04.8x, 04.9x and 09.11. Finally the SS connection is released.

For call independent SS operations, each message shall only contain a single component. Messages which contain more than one component will be stopped at the air interface (as specified in 3GPP TS 29.011 [59]).

The handling of MAP_P_ABORT, MAP_U_ABORT, MAP_NOTICE and unexpected MAP_CLOSE or A_CM_RELEASE in this procedure is identical to the handling in the Registration procedure in the MSC, see clause 22.2.2 of the present document.

The activation procedure in the MSC is shown in figure 22.4.2/1.

Process ACTIVATE_SS_MSC

22.4.2_1(1)

Figure 22.4.2/1: Mobile initiated activation of supplementary service in the MSC

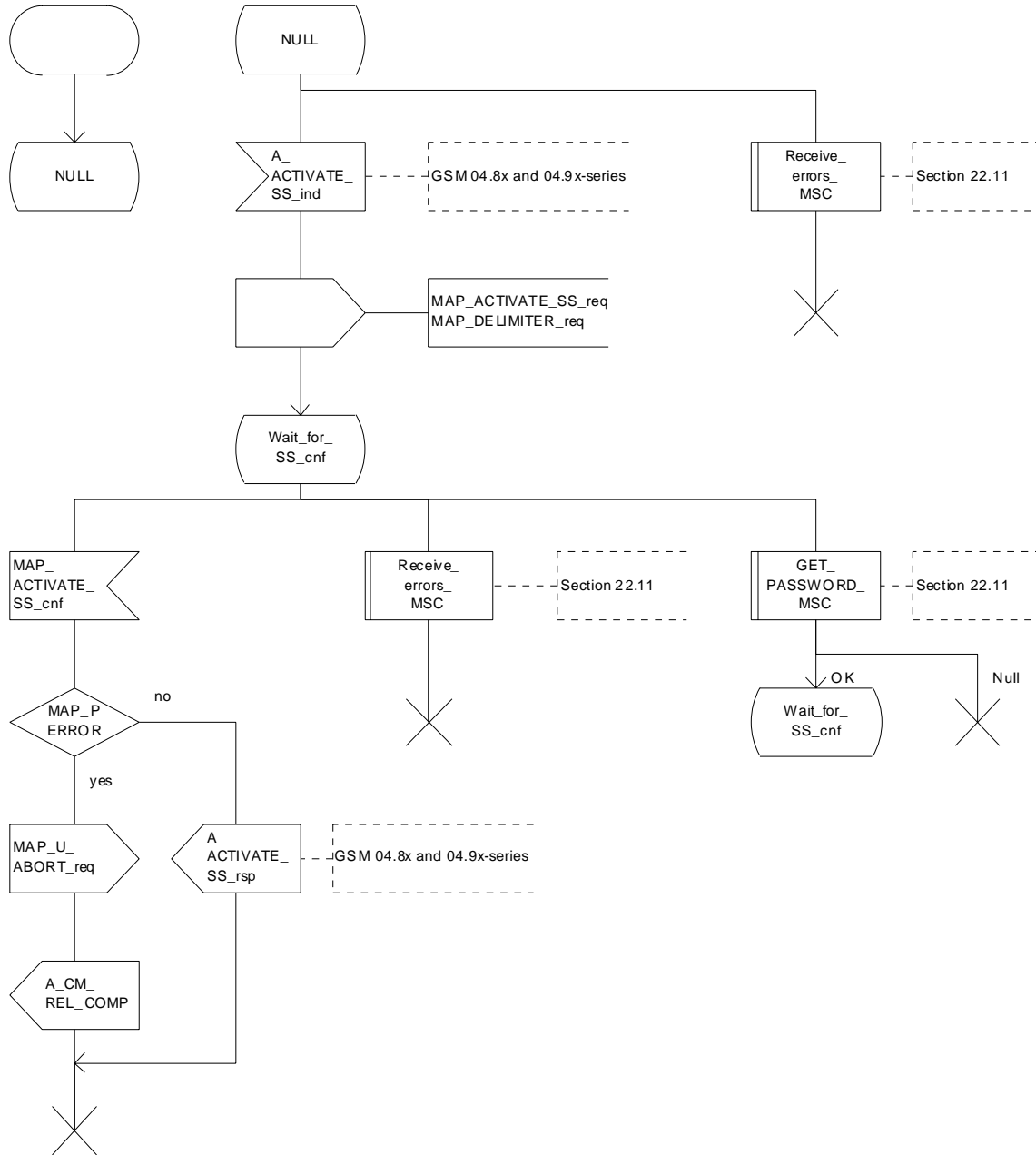

Figure 22.4.2/1: Procedure Activate_SS_MSC

22.4.3 Procedures in the VLR

Supplementary service activation

When receiving the MAP_ACTIVATE_SS indication, the MAP user in the VLR transfers the information to the HLR in the MAP_ACTIVATE_SS request without checking the contents of the service indication.

The VLR may then receive the MAP_GET_PASSWORD indication. This information is transferred to the MSC in the MAP_GET_PASSWORD request. If a MAP_GET_PASSWORD confirm primitive is received from the MSC, the VLR initiates the MAP_GET_PASSWORD response towards the HLR.

The VLR will receive the MAP_ACTIVATE_SS confirm from the HLR. The MAP user in the VLR shall transfer the information contained in this primitive to the MSC in the MAP_ACTIVATE_SS response without checking its contents.

For call independent SS operations, each message shall only contain a single component. Messages which contain more than one component will be stopped at the air interface (as specified in 3GPP TS 29.011 [59]).

Error handling

The handling of MAP_P_ABORT, MAP_U_ABORT, MAP_NOTICE and unexpected MAP_CLOSE in this procedure is identical to the handling in the Registration procedure in the VLR, see clause 22.2.3 of the present document.

The activation procedure in the VLR is shown in figure 22.4.3/1.

Process ACTIVATE_SS_VLR

22.4.3_1.1(2)

Figure 22.4.3/1: Activation of supplementary service procedure in the VLR

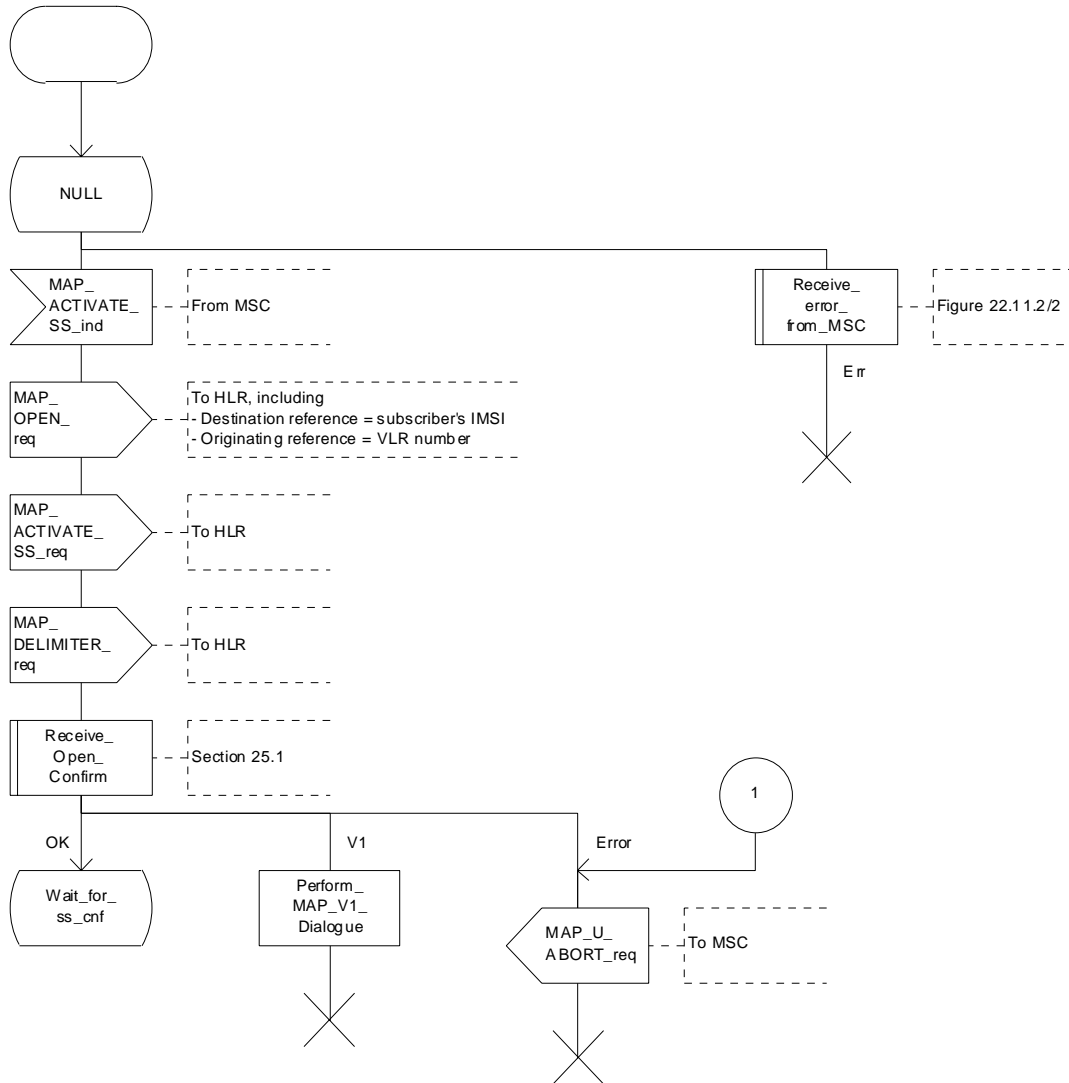

Figure 22.4.3/1 (sheet 1 of 2): Procedure Activate_SS_VLR

Process ACTIVATE_SS_VLR

22.4.3_1.2(2)

Figure 22.4.3/1: Activation of supplementary service procedure in the VLR

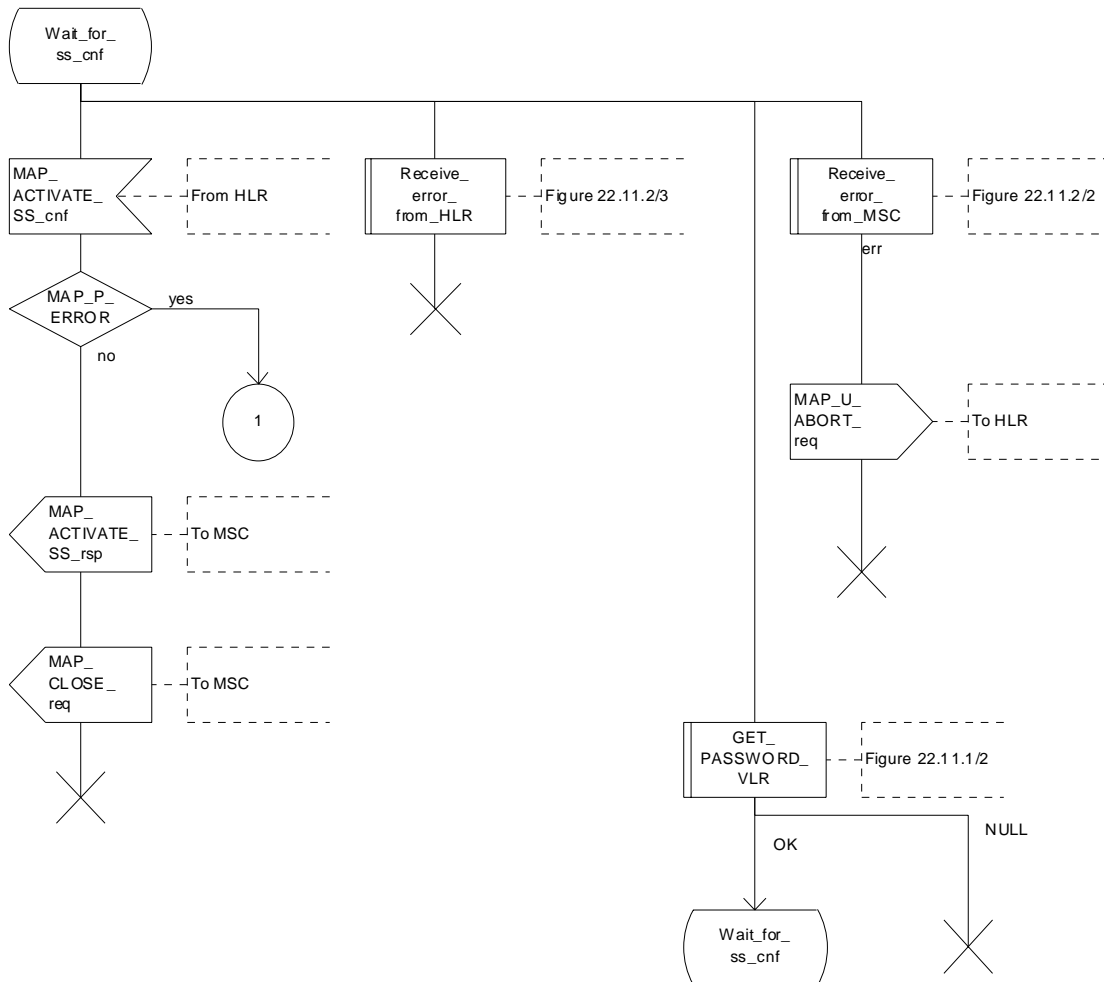

Figure 22.4.3/1 (sheet 2 of 2): Procedure SS_Activate_VLR

22.4.4 Procedures in the HLR

The procedure in the HLR is initiated when it receives a MAP_ACTIVATE_SS indication.

The HLR acts as follows:

- if the operator has barred the subscriber from access to supplementary services, the Call Barred error should be returned to the VLR. The parameter "operatorBarring" shall be included with the error.

The supplementary service request shall then be processed according to 3GPP TS 23.011 [22] and the 03.8x and 03.9x-series of technical specifications. This handling may lead to either a successful result, a partially successful result, or an error being returned.

During the handling of activation, the get password procedure may be initiated (as specified in 3GPP TS 23.011 [22]). This will involve the sending of a MAP_GET_PASSWORD request to the VLR.

For call independent SS operations, each message shall only contain a single component. Messages which contain more than one component will be stopped at the air interface (as specified in 3GPP TS 29.011 [59]):

- if the VLR is to be updated after the supplementary service activation, the MAP_INSERT_SUBS_DATA_HLR process is initiated;
- handling of receipt of MAP_P_ABORT, MAP_U_ABORT or MAP_CLOSE indications from the VLR is identical to their handling in the registration procedure, see clause 22.2.4 above.

The activation procedure in the HLR is shown in figure 22.4.4/1.

Process ACTIVATE_SS_HLR

22.4.4_1.1(2)

Figure 22.4.4/1: Activation of supplementary services procedure in HLR.

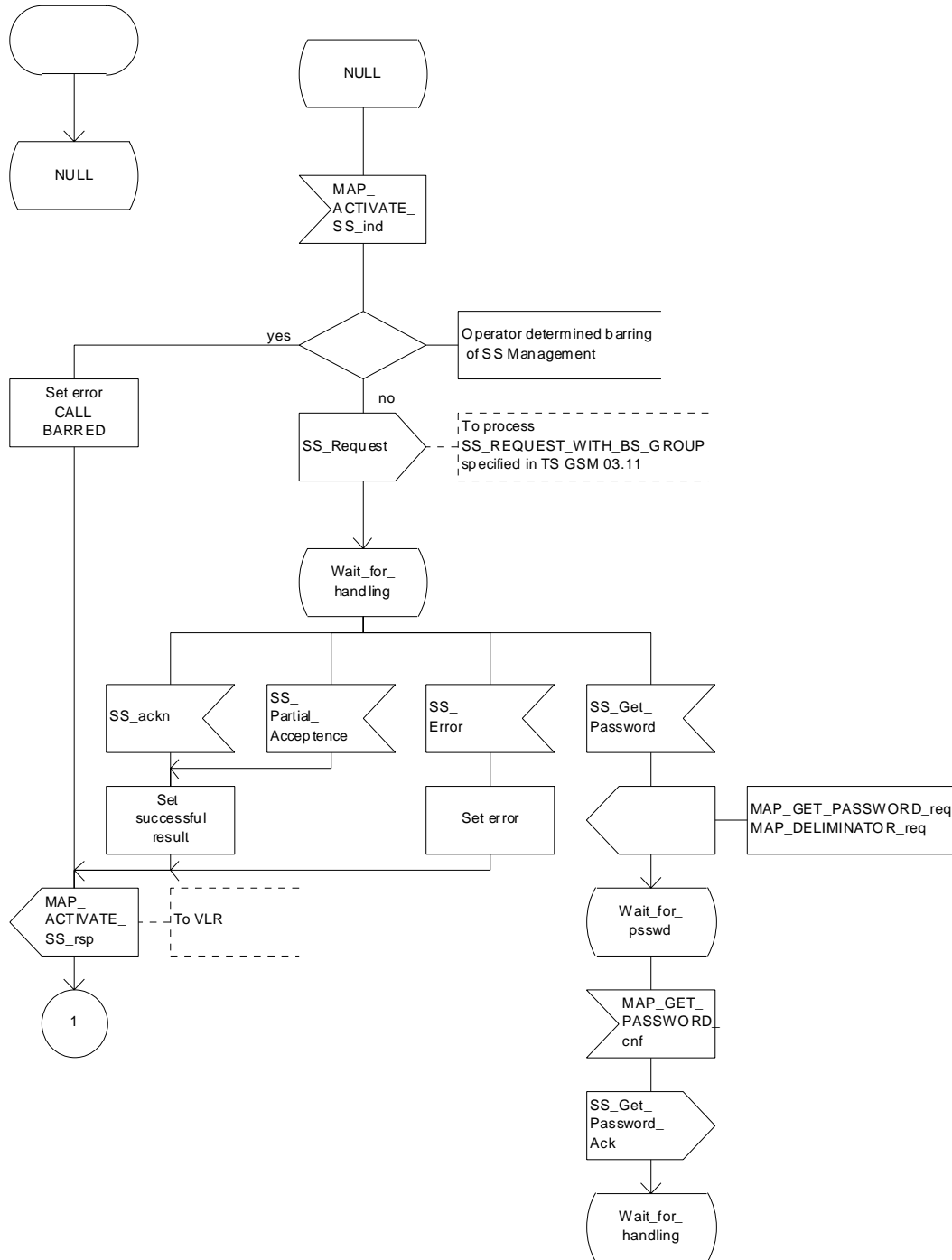

Figure 22.4.4/1 (sheet 1 of 2): Procedure Activate_SS_HLR

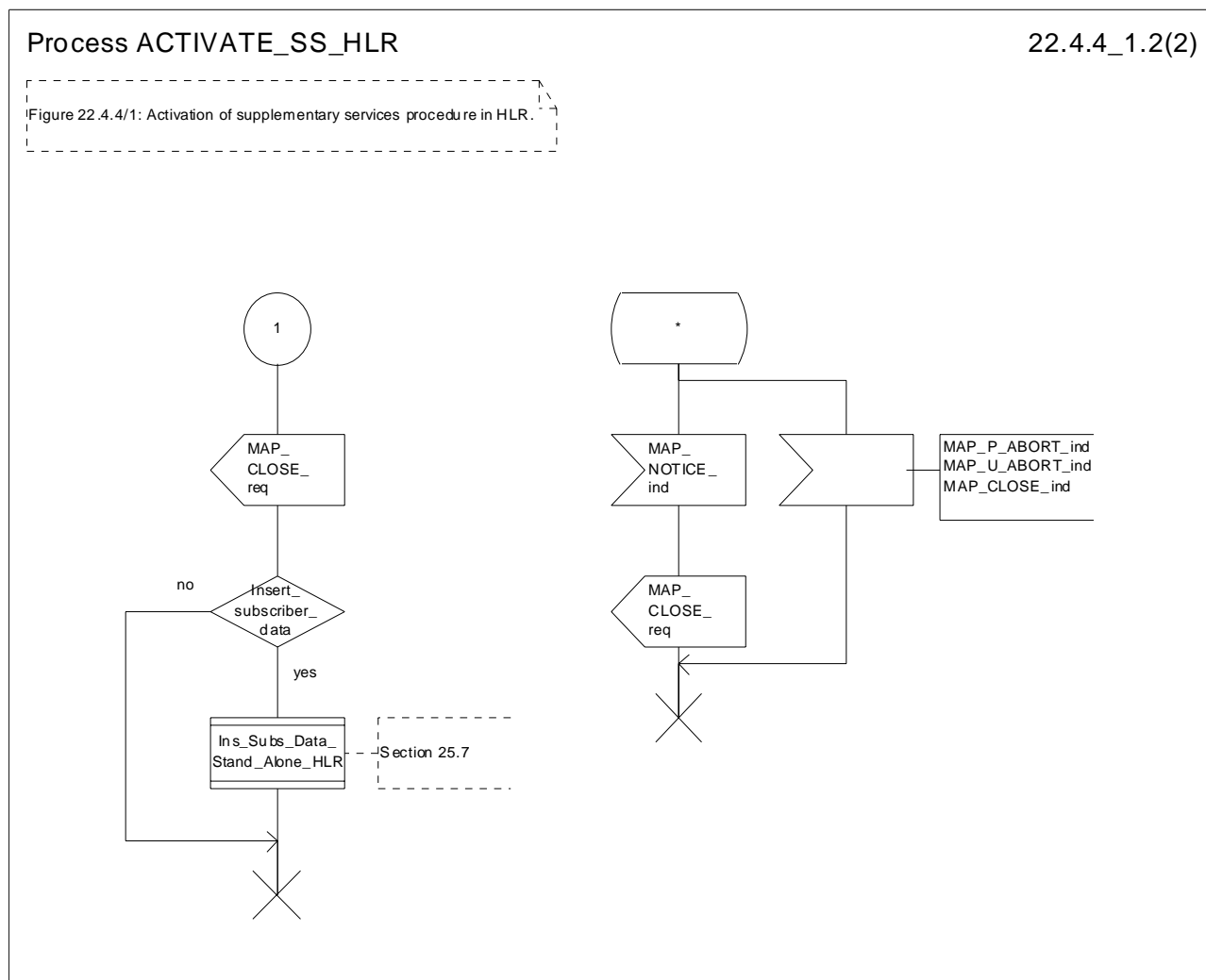

Figure 22.4.4/1 (sheet 2 of 2): Procedure Activate_SS_HLR

22.5 Deactivation procedure

22.5.1 General

The deactivation procedure is used to deactivate a supplementary service in the HLR. The deactivation procedure is a fully transparent communication between the MS and the HLR, except that some services may be invoked as a result of the procedure, as described in the clauses below.

The deactivation procedure is shown in figure 22.5.1/1.

The following services may be used:

- MAP_PROCESS_ACCESS_REQUEST (defined in clauses 8 and 25);
- MAP_TRACE_SUBSCRIBER_ACTIVITY (defined in clauses 9 and 25);
- MAP_PROVIDE_IMSI (defined in clauses 8 and 25);
- MAP_FORWARD_NEW_TMSI (defined in clauses 8 and 25);
- MAP_AUTHENTICATE (defined in clauses 8 and 25);
- MAP_SET_CIPHERING_MODE (defined in clauses 8 and 25);
- MAP_CHECK_IMEI (defined in clauses 8 and 25);

- MAP_READY_FOR_SM (defined in clauses 12 and 25);
- MAP_GET_PASSWORD (defined in clause 11);
- MAP_INSERT_SUBSCRIBER_DATA (defined in clauses 8 and 25);
- MAP_DEACTIVATE_SS (defined in clause 11).

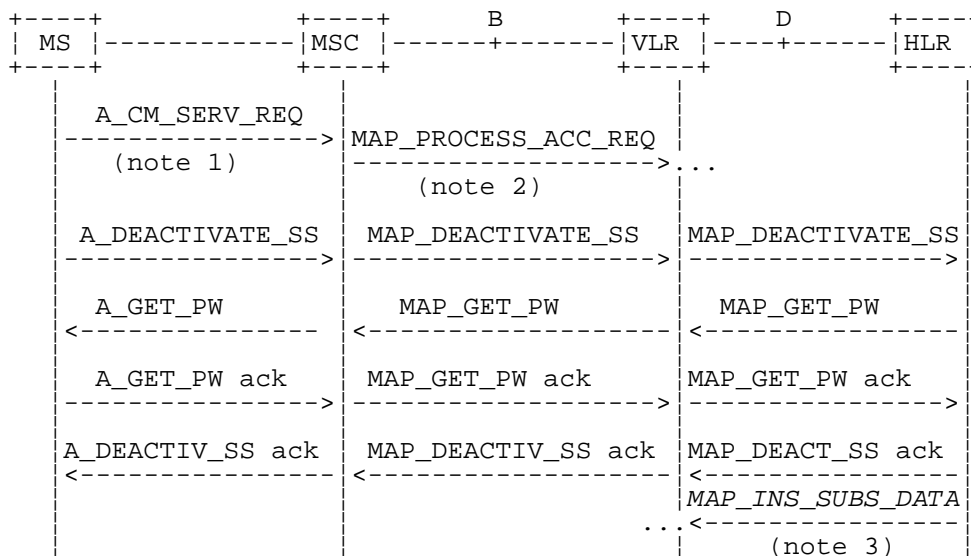

NOTE 1: For details of the procedure on the radio path, see 3GPP TS 24.008 [35], 04.10, 04.8x and 04.9x. Services shown in dotted lines indicate the trigger provided by the signalling on the radio path, and the signalling triggered on the radio path.

NOTE 2: For details on the Process Access Request procedure, please refer to clause 25 in the present document.

NOTE 3: Services printed in *italics* are optional.

Figure 22.5.1/1: Interfaces and services for supplementary service deactivation

22.5.2 Procedures in the MSC

The MSC procedures for deactivation are identical to those specified for activation in clause 22.4.2. The text and diagrams in clause 22.4.2 apply with all references to activation changed to deactivation.

22.5.3 Procedures in the VLR

The VLR procedures for deactivation are identical to those specified for activation in clause 22.4.3. The text and diagrams in clause 22.4.3 apply with all references to activation changed to deactivation.

22.5.4 Procedures in the HLR

The HLR procedures for deactivation are identical to those specified for activation in clause 22.4.4. The text and diagrams in clause 22.4.4 apply with all references to activation changed to deactivation.

22.6 Interrogation procedure

22.6.1 General

The interrogation procedure is used to retrieve information related to a supplementary service from the VLR or the HLR. It is the VLR which decides whether an interrogation request should be forwarded to the HLR or not. Some non-supplementary service related services may be invoked as a result of the procedure, as described in the clauses below.

The interrogation procedure is shown in figure 22.6.1/1.

The following services may be used:

- MAP_PROCESS_ACCESS_REQUEST (defined in clauses 8 and 25);
- MAP_TRACE_SUBSCRIBER_ACTIVITY (defined in clauses 9 and 25);
- MAP_PROVIDE_IMSI (defined in clauses 8 and 25);
- MAP_FORWARD_NEW_TMSI (defined in clauses 8 and 25);
- MAP_AUTHENTICATE (defined in clauses 8 and 25);
- MAP_SET_CIPHERING_MODE (defined in clauses 8 and 25);
- MAP_CHECK_IMEI (defined in clauses 8 and 25);
- MAP_READY_FOR_SM (defined in clauses 12 and 25);
- MAP_INTERROGATE_SS (defined in clause 11).

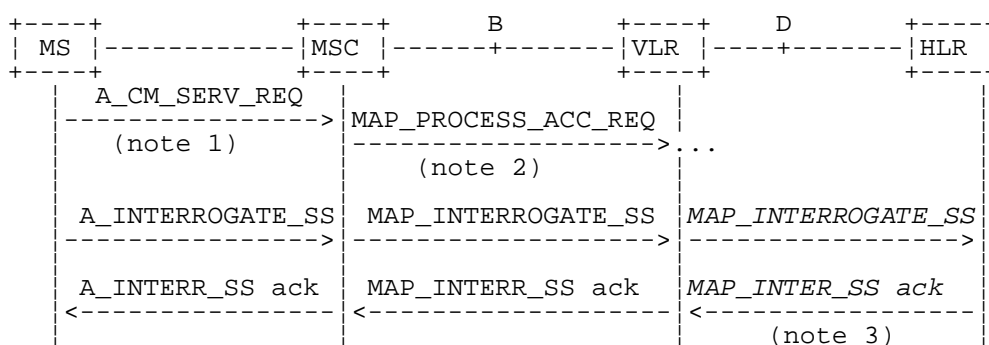

NOTE 1: For details of the procedure on the radio path, see 3GPP TS 24.008 [35], 04.10, 04.8x and 04.9x. Services shown in dotted lines indicate the trigger provided by the signalling on the radio path, and the signalling triggered on the radio path.

NOTE 2: For details on the Process Access Request procedure, please refer to clause 25 in the present document.

NOTE 3: Services printed in italics are optional.

Figure 22.6.1/1: Interfaces and services for supplementary service interrogation

22.6.2 Procedures in the MSC

The MSC procedures for interrogation are identical to those specified for registration in clause 22.2.2. The text and diagrams in clause 22.2.2 apply with all references to registration changed to interrogation.

22.6.3 Procedures in the VLR

Supplementary service interrogation

When receiving the MAP_INTERROGATE_SS indication, the MAP user acts as follows:

- if the operator has barred the subscriber from access to supplementary services, the error Call Barred is returned to the MSC. The parameter "operatorBarring" shall be included with the error.

The interrogation is either answered by the VLR or by the HLR, depending on the service interrogated.

a) Interrogation to be handled by the VLR

The supplementary service request shall then be processed according to 3GPP TS 23.011 [22] and the 03.8x and 03.9x-series of technical specifications. This handling may lead to either a successful result, a partially successful result, or an error being returned.

For call independent SS operations, each message shall only contain a single component. Messages which contain more than one component will be stopped at the air interface (as specified in 3GPP TS 29.011 [59]).

b) Interrogation to be handled by HLR

If the interrogation is to be handled by the HLR, on receiving the MAP_INTERROGATE_SS indication, the MAP user in the VLR transfers the information to the HLR in the MAP_INTERROGATE_SS request without further checking the contents of the service indication.

The VLR will receive the MAP_INTERROGATE_SS confirm from the HLR. The MAP user in the VLR shall transfer the information contained in this primitive to the MSC in the MAP_INTERROGATE_SS response without checking its contents.

For call independent SS operations, each message shall only contain a single component. Messages which contain more than one component will be stopped at the air interface (as specified in 3GPP TS 29.011 [59]).

Error handling

Handling of MAP_P_ABORT, MAP_U_ABORT, MAP_NOTICE and unexpected MAP_CLOSE in this procedure is identical to the handling in the Registration procedure in the VLR, clause 22.2.3. The Interrogation procedure is described in figure 22.6.3/1.

Process INTERROGATE_SS_VLR

22.6.3_1.1(3)

Figure 22.6.3/1: Interrogation of supplementary service procedure in VLR

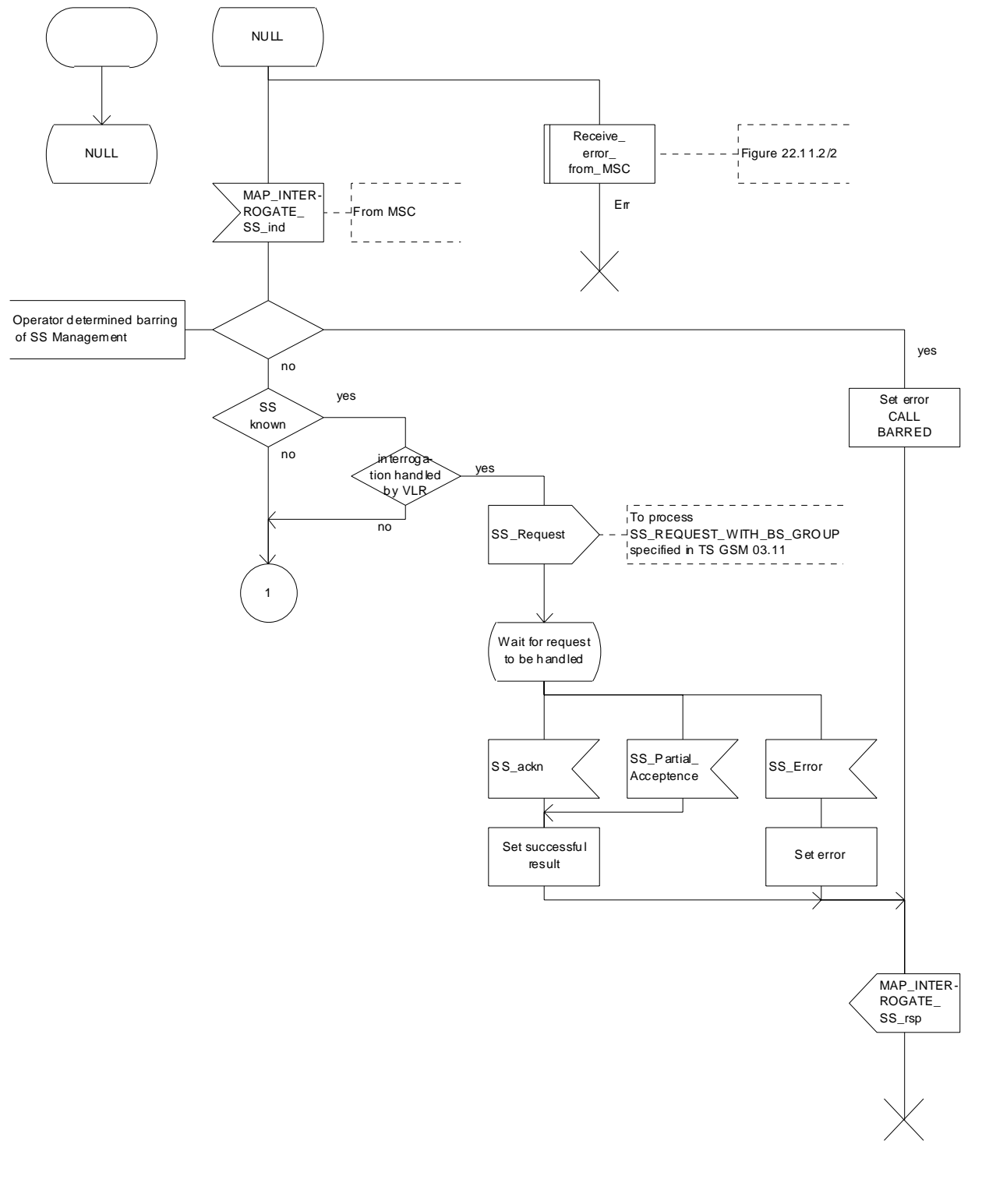

Figure 22.6.3/1 (sheet 1 of 3): Procedure Interrogate_SS_VLR

Process INTERROGATE_SS_VLR

22.6.3_1.2(3)

Figure 22.6.3/1: Interrogation of supplementary service procedure in VLR

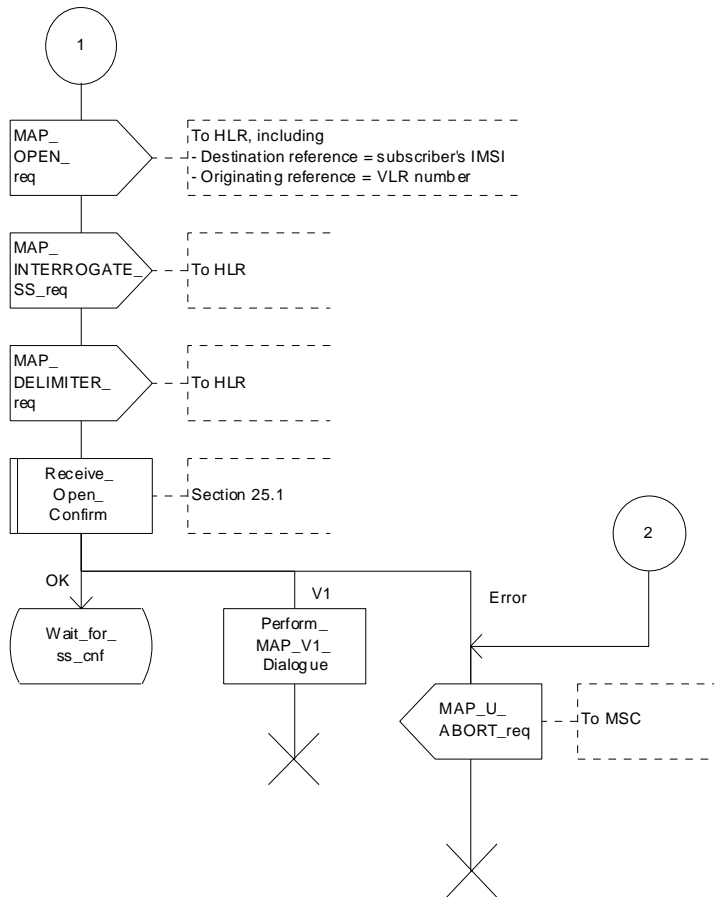

Figure 22.6.3/1 (sheet 2 of 3): Procedure Interrogate_SS_VLR

Process INTERROGATE_SS_VLR

22.6.3_1.3(3)

Figure 22.6.3/1: Interrogation of supplementary service procedure in VLR

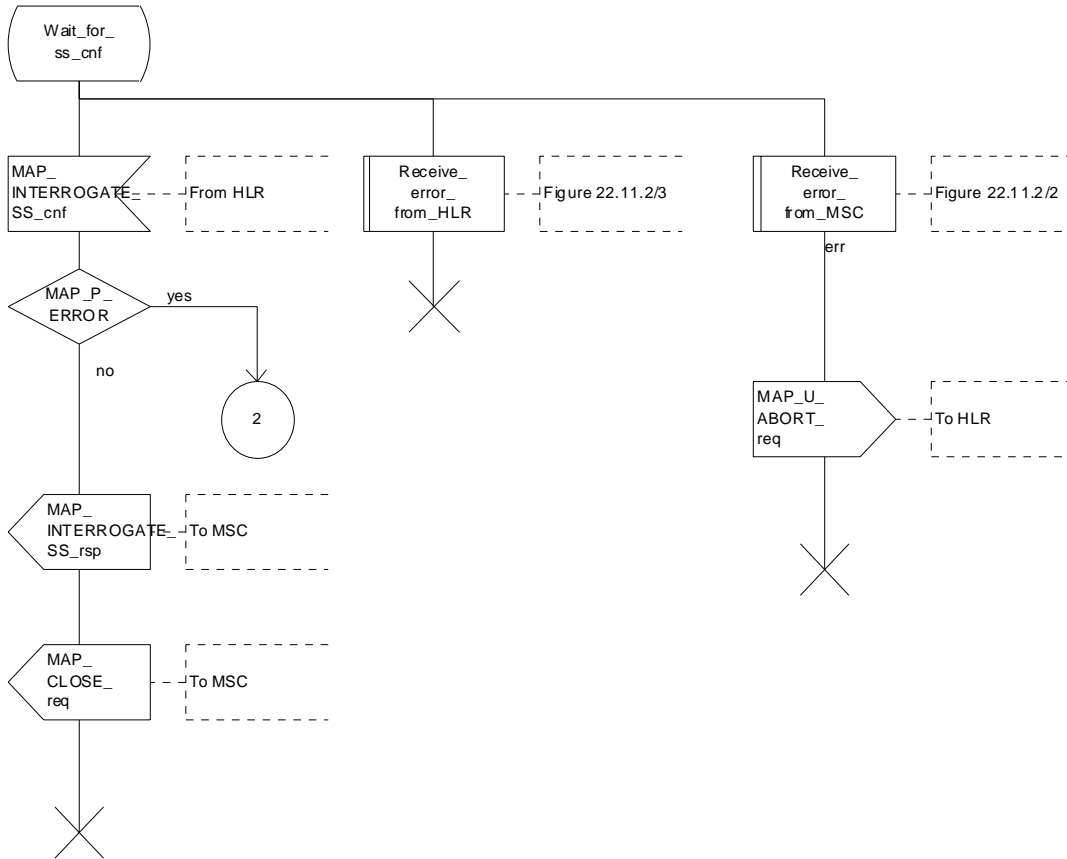

Figure 22.6.3/1 (sheet 3 of 3): Procedure Interrogate_SS_VLR

22.6.4 Procedures in the HLR

When receiving the MAP_INTERROGATE_SS indication, the MAP user acts as follows:

- if the operator has barred the subscriber from access to supplementary services, the error Call Barred is returned to the MSC. The parameter "operatorBarring" shall be included with the error;
- if the supplementary service is not supported in the HLR, the error Unexpected Data Value is returned to the VLR.

The interrogation is either answered by the VLR or by the HLR, depending on the service interrogated.

a) Interrogation to be handled by the VLR

If the interrogation procedure should have been answered by the VLR, then the HLR assumes that the VLR does not support the interrogated supplementary service, and returns the SS Not Available error to the VLR.

b) Interrogation to be handled by HLR

The supplementary service request shall be processed according to 3GPP TS 23.011 [22] and the 03.8x and 03.9x-series of technical specifications. This handling may lead to either a successful result or an error being returned.

For call independent SS operations, each message shall only contain a single component.

Error handling

Handling of MAP_P_ABORT, MAP_U_ABORT, MAP_NOTICE and unexpected MAP_CLOSE in this procedure is identical to the handling in the Registration procedure in the VLR, clause 22.2.3. The Interrogation procedure is described in figure 22.6.4/1.

Process INTERROGATE_SS_HLR

22.6.4_1(1)

Figure 22.6.4/1: Interrogation of supplementary services procedure in HLR

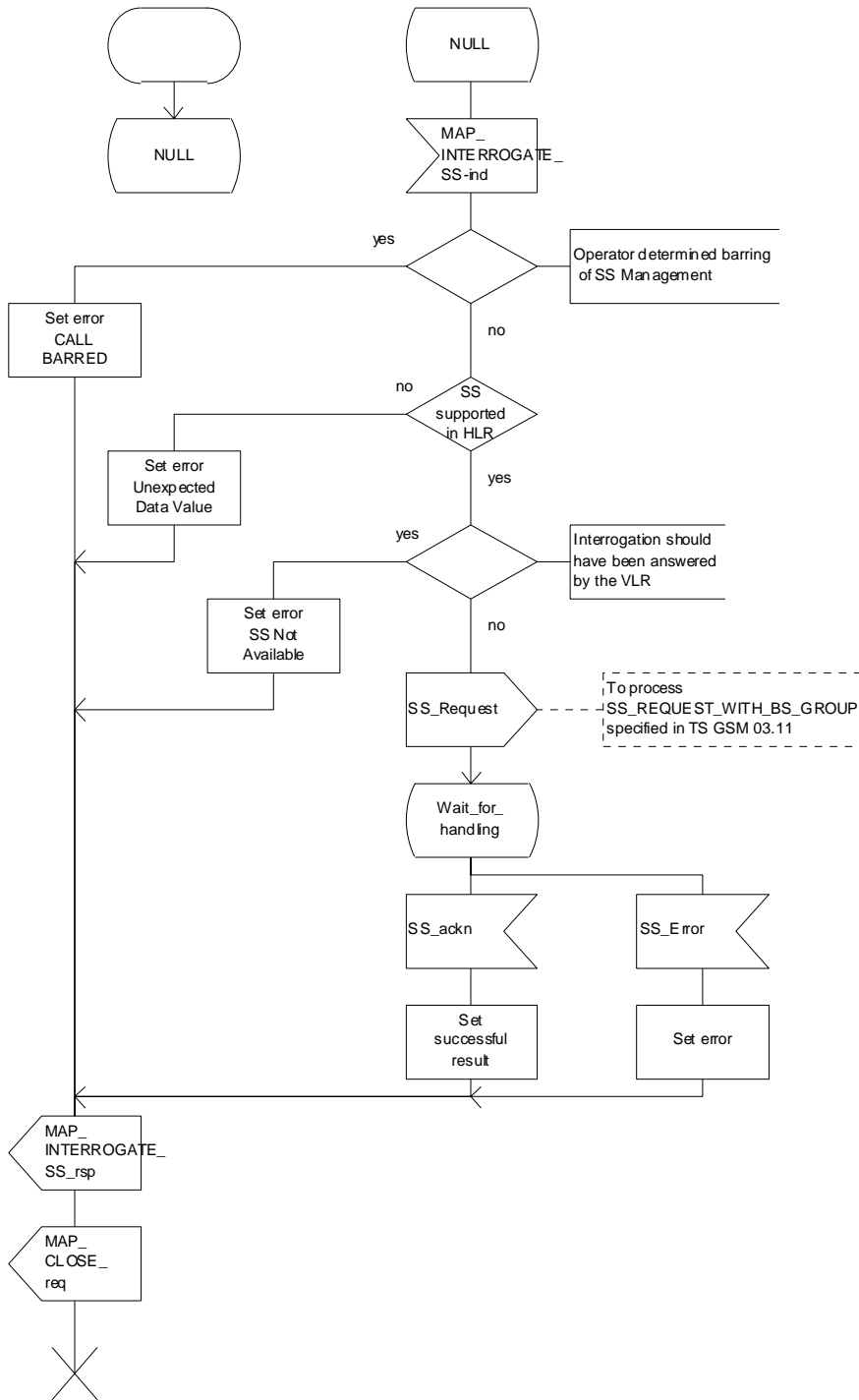

Figure 22.6.4/1: Procedure Interrogate_SS_HLR

22.7 Invocation procedure

22.7.1 General

The invocation procedure is used to check subscription data in the VLR for certain supplementary services which are invoked after the call set-up phase is finished. For invocation of supplementary services which are invoked during the call set-up phase, please refer to the Call Handling procedure descriptions.

The invocation procedure is shown in figure 22.7.1/1. Note that some optional services may be invoked in connection with this procedure, as described in the clause below.

The following services are used:

MAP_PROCESS_ACCESS_REQUEST	(defined in clauses 8 and 25);
MAP_TRACE_SUBSCRIBER_ACTIVITY	(defined in clauses 9 and 25);
MAP_PROVIDE_IMSI	(defined in clauses 8 and 25);
MAP_FORWARD_NEW_TMSI	(defined in clauses 8 and 25);
MAP_AUTHENTICATE	(defined in clauses 8 and 25);
MAP_SET_CIPHERING_MODE	(defined in clauses 8 and 25);
MAP_CHECK_IMEI	(defined in clauses 8 and 25);
MAP_READY_FOR_SM	(defined in clauses 12 and 25);
MAP_INVOKE_SS	(defined in clause 11).

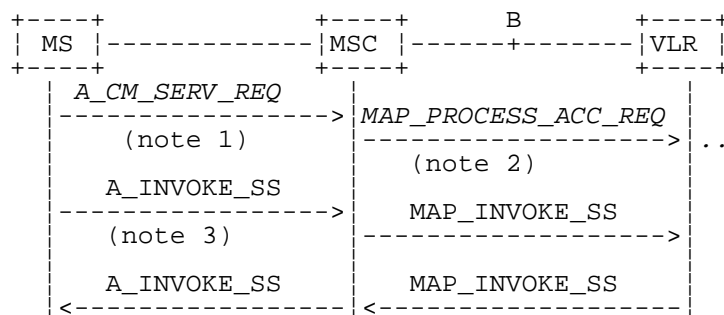

NOTE 1: For details of the procedure on the radio path, see 3GPP TS 24.008 [35], 04.10, 04.8x and 04.9x. Services shown in dotted lines indicate the trigger provided by the signalling on the radio path, and the signalling triggered on the radio path.

NOTE 2: For details on the Process Access Request procedure, please refer to clause 25 in the present document.

NOTE 3: A_INVOKESS is a generic message to illustrate any supplementary service invocation request message on the air interface, e.g. BuildMPTY, see 3GPP TS 24.080 [38].

Figure 22.7.1/1: Interfaces and services for supplementary service invocation

22.7.2 Procedures in the MSC

Process access request

Before the Call Hold or Multi-Party supplementary services can be invoked, a CC connection must be established between the MS and the MSC as described in 3GPP TS 24.008 [35] and the Call Handling procedure descriptions within the present document.

When an A_INVOKE_SS request message arrives at the MSC during a call (as described in 3GPP TS 24.010 [36], 04.8x and 04.9x-series of technical specifications), then if control of subscription to the invoked supplementary service is required, the MSC initiates the process access request procedure towards the VLR as described in clause 25 of the present document.

Supplementary service invocation

If the Process Access Request procedure towards the VLR is successful, the MSC shall forward a MAP_INVOKE_SS service request towards the VLR. This request shall contain the SS-Code of the supplementary service to be invoked, and possibly the Basic service code. Mapping from the A_INVOKE_SS to this service request is described in 3GPP TS 29.011 [59].

The MSC will receive a MAP_INVOKE_SS confirm from the VLR. If the outcome of the service is successful (i.e. the service confirm is empty), the MSC will invoke the requested supplementary service as described in GSM 02.8x-series, 03.8x and 03.9x-series of technical specifications. If the outcome of the service is unsuccessful, the MSC shall send an appropriate A_INVOKE_SS response towards the MS. The structure of this message is described in 3GPP TS 29.011 [59] and 04.8x and 04.9x-series of technical specifications.

Error handling

If at any time during this procedure a MAP_P_ABORT, MAP_U_ABORT, MAP_NOTICE or MAP_CLOSE indication concerning the process is received from the VLR, the process is terminated. If a MAP_NOTICE indication was received from the VLR, the VLR dialogue must also be aborted by sending a MAP_U_ABORT request indicating Procedure error towards the VLR. Possible signalling to the MS is described in 3GPP TS 24.010 [36].

If an A_CM_RELEASE indication is received from the MS, all open transactions are released using the MAP_U_ABORT request indicating application procedure cancellation; the process terminates.

The invocation procedure in the MSC is shown in figure 22.7.2/1.

Process INVOKE_SS_MSC

22.7.2_1.1(2)

Figure 22.7.2/1: Mobile initiated invocation of supplementary service procedure in the MSC

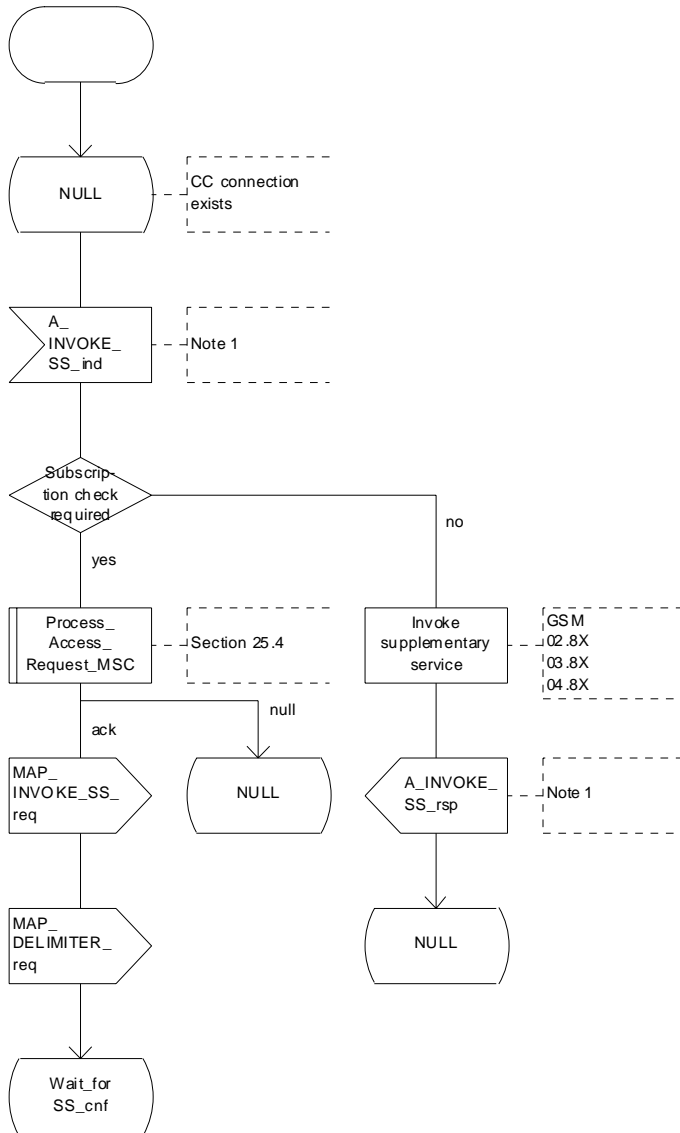

Note 1: Fictitious signal to indicate receipt/sending of SS invocation in voke component on the air interface (eg. BuildMPTY). Described in GSM 04.8X and 09.11.

Figure 22.7.2/1 (sheet 1 of 2): Procedure Invoke_SS_MSC

Process INVOKE_SS_MSC

22.7.2_1.2(2)

Figure 22.7.2/1: Mobile initiated invocation of supplementary service procedure in the MSC

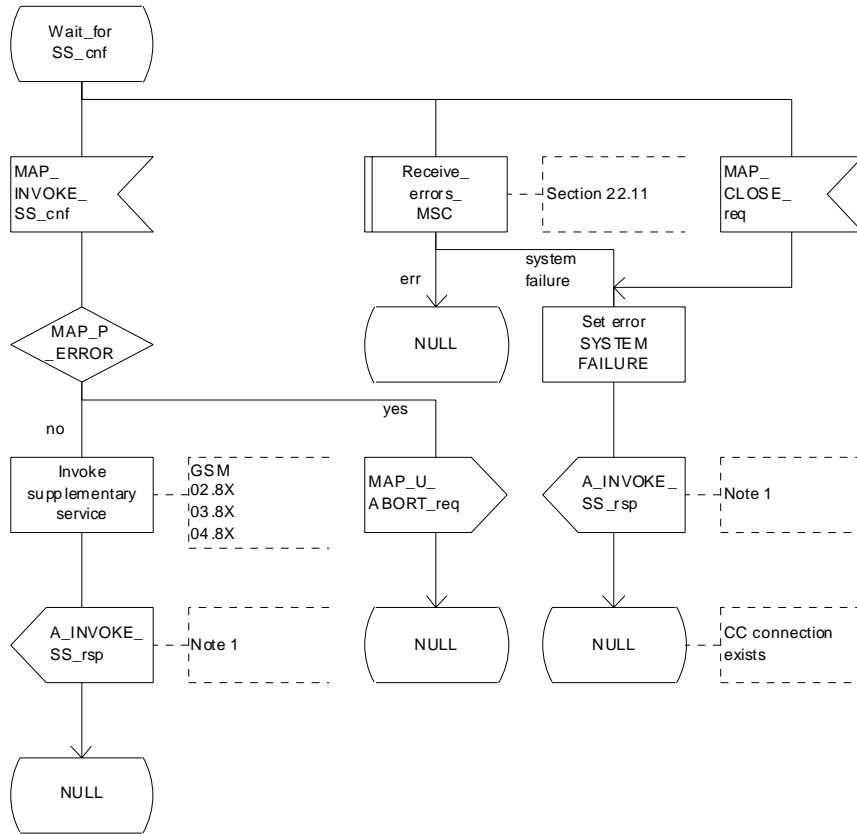

Note 1: Fictitious signal to indicate receipt/ sending of SS invocation invoke component on the air interface, (eg. BuildMPTY). Described in GSM 04.08X and 09.11.

Figure 22.7.2/1 (sheet 2 of 2): Procedure Invoke_SS_MSC

22.7.3 Procedures in the VLR

Process Access Request

When receiving the MAP_PROCESS_ACCESS_REQUEST indication, the VLR acts as described in clause 25 of the present document.

Supplementary service invocation

When receiving the MAP_INVOKE_SS indication, the MAP user acts as follows:

- if the operator has barred the subscriber from access to supplementary services, the error "Call Barred" is returned to the MSC. The parameter "operatorBarring" shall be included with the error;
- if any irrelevant information elements (according to the service description) or invalid information element values are present in the service request, then the unexpected data value error is returned to the MSC in the MAP_INVOKE_SS response;
- if the VLR does not support the invoked supplementary service then the VLR shall respond with the SS Not Available error;
- if the requested supplementary service cannot be invoked by subscriber actions, then the VLR shall respond with the Illegal SS Operation error;
- if the subscriber is not provided with (i.e. subscribed to) the requested supplementary service, then the SS error status error (possibly including the SS-Status as parameter) is returned to the MSC in the MAP_INVOKE_SS response.

If all checks are passed the VLR returns an empty MAP_INVOKE_SS response to the MSC, thus indicating that the invocation request was accepted.

If at any time during this procedure a MAP_P_ABORT, MAP_U_ABORT, MAP_NOTICE or unexpected MAP_CLOSE indication concerning the process is received from the MSC, the process terminates. If a MAP_NOTICE indication was received from the MSC, that dialogue must be aborted by sending a MAP_U_ABORT request indicating Procedure error towards the MSC. The process terminates.

The invocation procedure in the VLR is shown in figure 22.7.3/1.

Process INVOKE_SS_VLR

22.7.3_1(1)

Figure 22.7.3/1: Invocation of supplementary service procedure in VLR

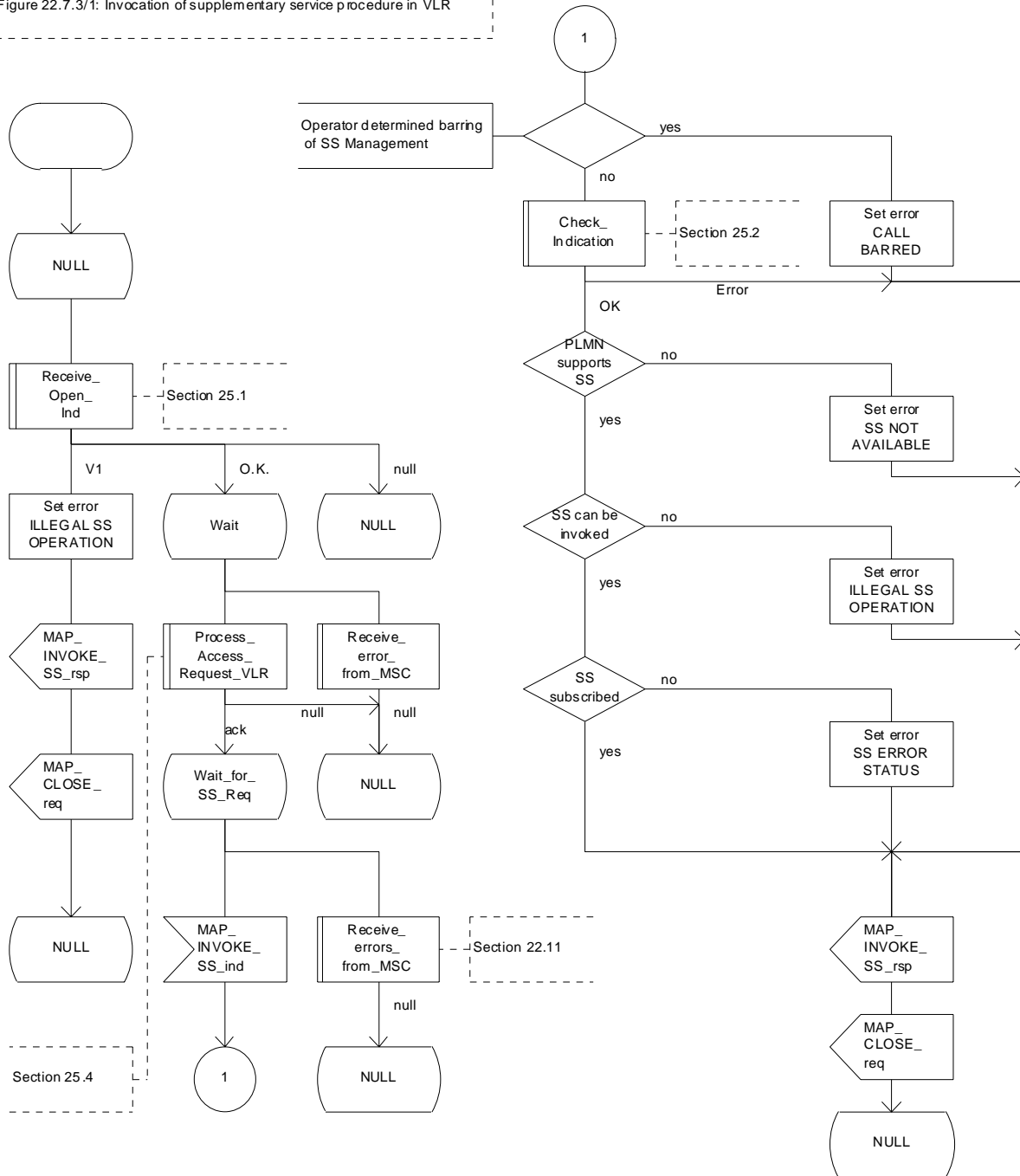

Figure 22.7.3/1: Procedure Invoke_SS_VLR

22.8 Password registration procedure

22.8.1 General

The password registration procedure is used to register a password in the HLR. The password registration procedure is a fully transparent communication between the MS and the HLR, except that some services may be invoked as a result of the procedure, as described below.

The password registration procedure is shown in figure 22.8.1/1.

The following services may be used:

- MAP_PROCESS_ACCESS_REQUEST (defined in clauses 8 and 25);
- MAP_TRACE_SUBSCRIBER_ACTIVITY (defined in clauses 9 and 25);
- MAP_PROVIDE_IMSI (defined in clauses 8 and 25);
- MAP_FORWARD_NEW_TMSI (defined in clauses 8 and 25);
- MAP_AUTHENTICATE (defined in clauses 8 and 25);
- MAP_SET_CIPHERING_MODE (defined in clauses 8 and 25);
- MAP_CHECK_IMEI (defined in clauses 8 and 25);
- MAP_READY_FOR_SM (defined in clauses 12 and 25);
- MAP_GET_PASSWORD (defined in clause 11).

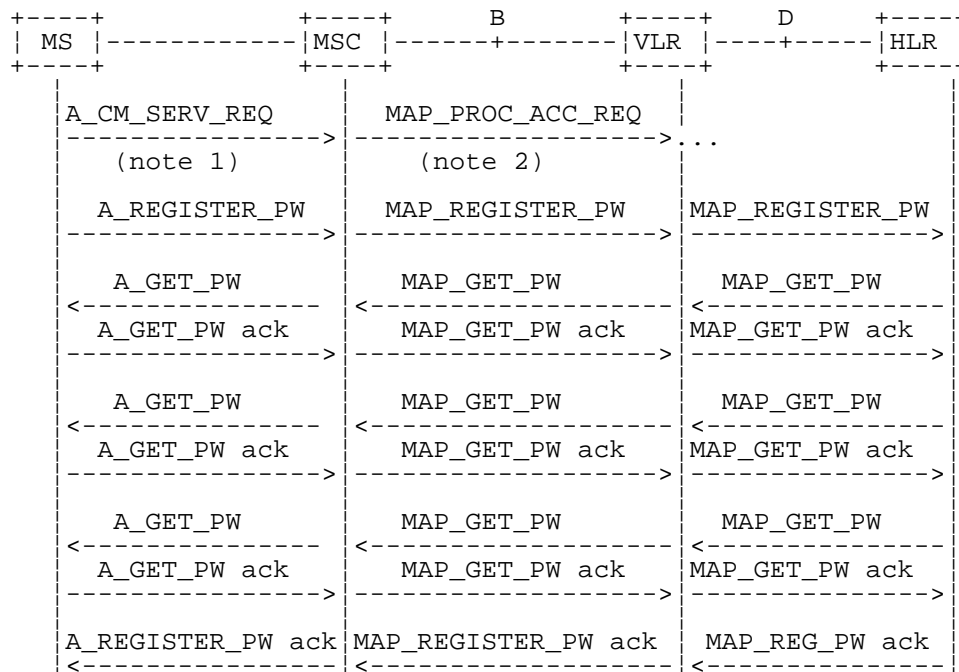

- NOTE 1: For details of the procedure on the radio path, see 3GPP TS 24.008 [35], 04.10, 04.8x and 04.9x. Services shown in dotted lines are triggers/ triggered signalling on the radio path.
- NOTE 2: For details on the Process Access Request procedure, please refer to clause 25 in the present document.
- NOTE 3: Use of each of the three MAP_GET_PASSWORD operations is described in clause 22.8.4.

Figure 22.8.1/1: Interfaces and services for supplementary service password registration

22.8.2 Procedures in the MSC

The password registration procedure in the MSC is identical to that for activation specified in clause 22.4.2. All the text and diagrams in clause 22.4.2 apply with all references to activation changed to password registration.

22.8.3 Procedures in the VLR

The password registration procedure in the VLR is identical to that for activation specified in clause 22.4.3. All the text and diagrams in clause 22.4.3 apply with all references to activation changed to password registration.

22.8.4 Procedures in the HLR

The procedure in the HLR is initiated when it receives a MAP_REGISTER_PASSWORD indication.

The HLR acts as follows:

- if the operator has barred the subscriber for access to supplementary services, the Call Barred error is returned to the VLR. The parameter "operatorBarring" shall be included with the error;
- if any irrelevant information elements (according to the service description) or invalid information element values are present, then the unexpected data value error is returned to the VLR in the response. This error should thus be returned if the SS-Code provided by the mobile subscriber is not allocated.

The HLR shall then process the MAP_REGISTER_PASSWORD indication as specified in 3GPP TS 23.011 [22]. During the handling of password registration, the password procedure will be initiated (as specified in 3GPP TS 23.011 [22]) This will involve the sending of MAP_GET_PASSWORD requests to the VLR.

- Handling of receipt of MAP_P_ABORT, MAP_U_ABORT or MAP_CLOSE indications from the VLR is identical to their handling in the registration procedure, see clause 22.2.4 above.

The password registration procedure in the HLR is shown in figure 22.8.4/1.

Process REGISTER_PASSWORD_HLR

22.8.4_1.1(2)

Figure 22.8.4/1: Registration of supplementary service password procedure in HLR

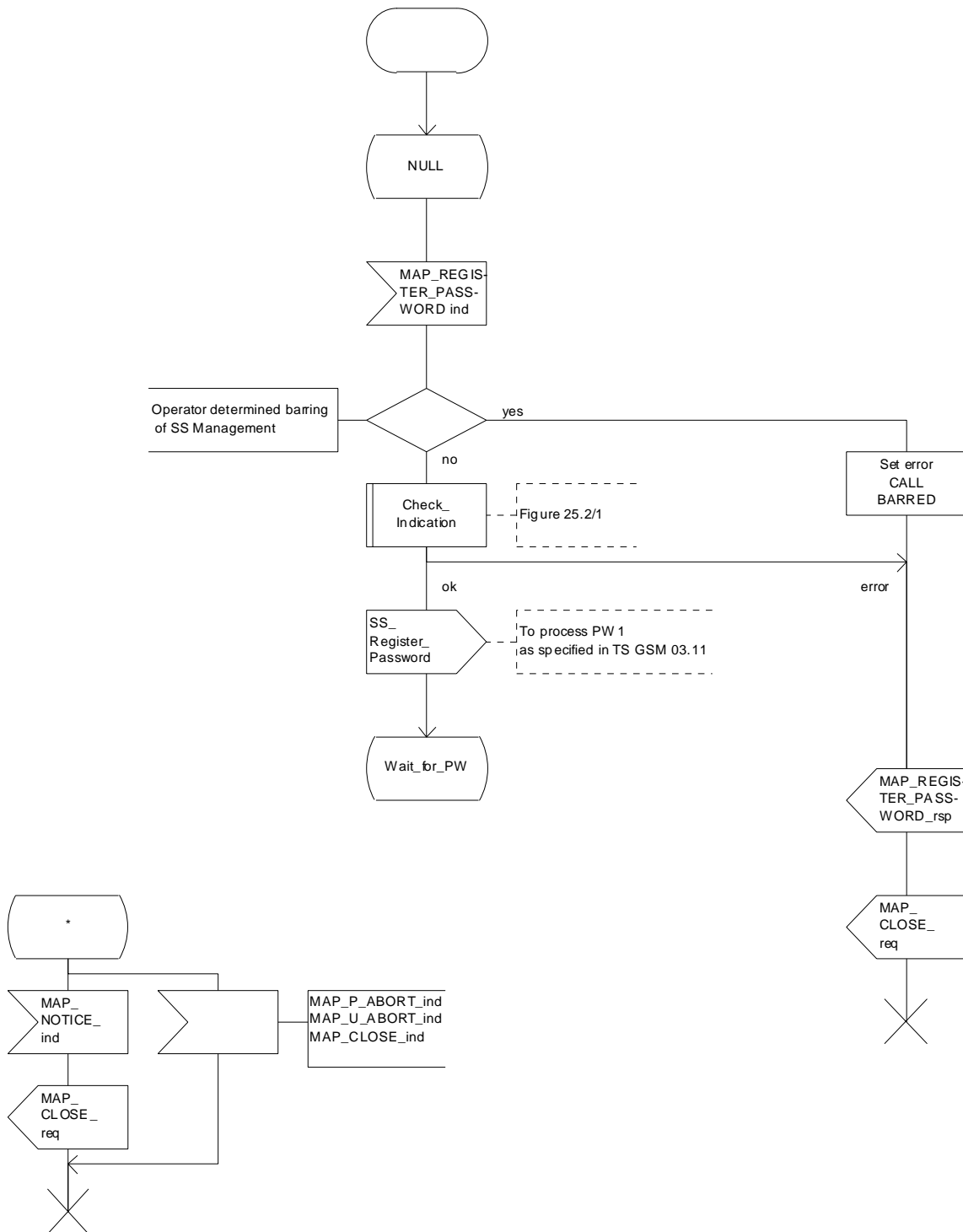

Figure 22.8.4/1 (sheet 1 of 2): Procedure Register_PW_HLR

Process REGISTER_PASSWORD_HLR

22.8.4_1.2(2)

Figure 22.8.4/1: Registration of supplementary service password procedure in HLR

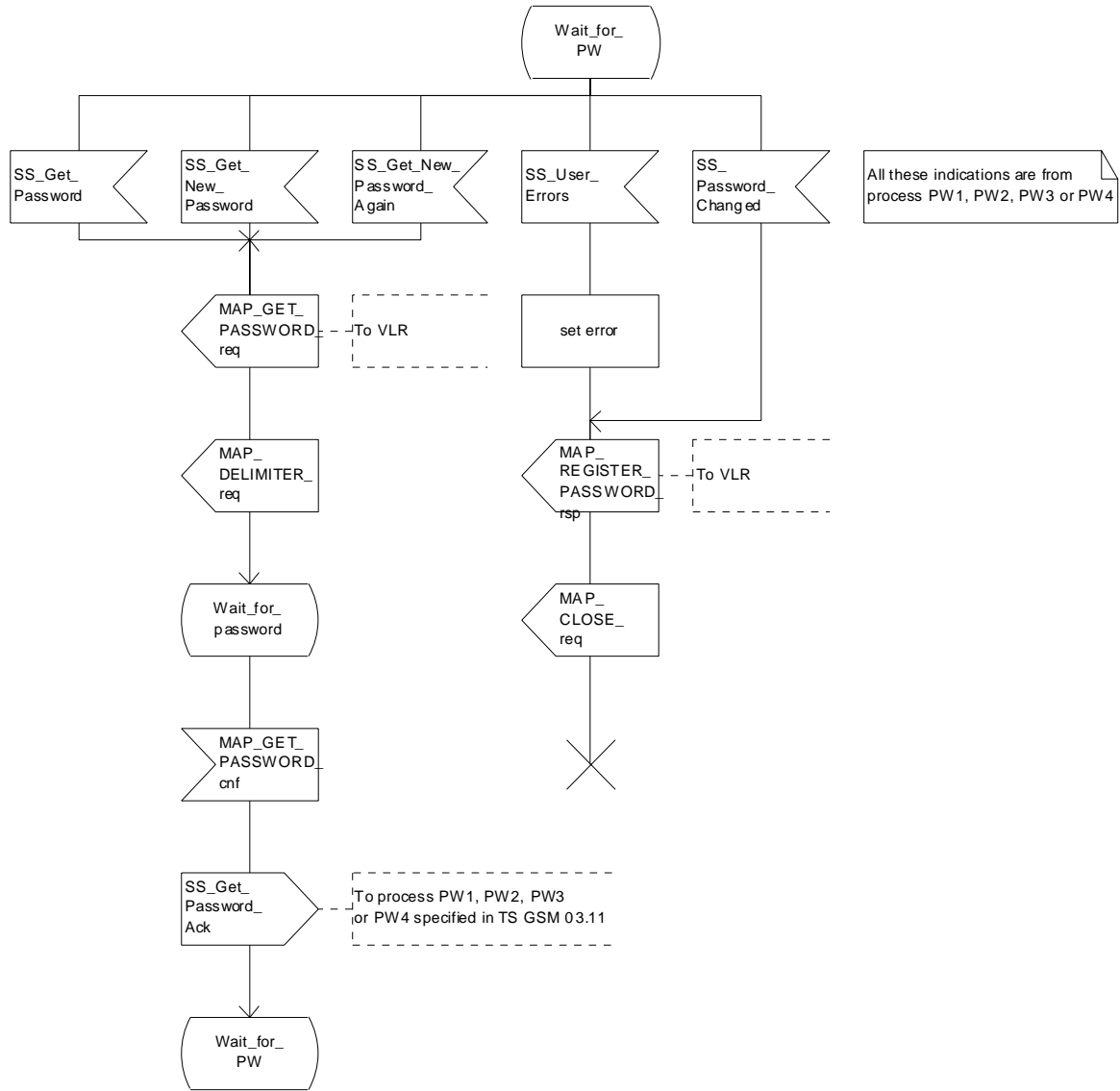

Figure 22.8.4/1 (sheet 2 of 2): Procedure Register_PW_HLR

22.9 Mobile Initiated USSD procedure

22.9.1 General

The procedure supports supplementary service signalling procedures which can allow PLMN specific services to be introduced.

The message flow for the procedure can be found in 3GPP TS 23.090 [34].

The following services may be used:

MAP_PROCESS_ACCESS_REQUEST	(defined in clauses 8 and 25);
MAP_TRACE_SUBSCRIBER_ACTIVITY	(defined in clauses 9 and 25);
MAP_PROVIDE_IMSI	(defined in clauses 8 and 25);
MAP_FORWARD_NEW_TMSI	(defined in clauses 8 and 25);
MAP_AUTHENTICATE	(defined in clauses 8 and 25);
MAP_SET_CIPHERING_MODE	(defined in clauses 8 and 25);
MAP_CHECK_IMEI	(defined in clauses 8 and 25);
MAP_READY_FOR_SM	(defined in clauses 12 and 25);
MAP_UNSTRUCTURED_SS_REQUEST	(defined in clause 11);
MAP_UNSTRUCTURED_SS_NOTIFY	(defined in clause 11).

The following service is certainly used:

MAP_PROCESS_UNSTRUCTURED_SS_REQUEST (defined in clause 11).

22.9.2 Procedures in the MSC

Before the Process Unstructured SS Request service can be invoked, a call independent CM connection must be created between the MS and the MSC.

Once a CM-connection is established, the MSC may handle the A_PROCESS_UNSTRUCTURED_SS_REQUEST from the MS. This message contains information input by the user, the message may be fed to an application contained locally in the MSC or to the VLR. The rules for determining this are specified in 3GPP TS 23.090 [34].

1) Message Destined for VLR

If the message is destined for the VLR then the MSC shall transfer the message to the VLR using the mapping specified in detail in 3GPP TS 29.011 [59].

The MSC may subsequently receive one or more MAP_UNSTRUCTURED_SS_REQUEST or MAP_UNSTRUCTURED_SS_NOTIFY indications from the VLR. These shall be sent transparently to the MS. When a confirmation is received from the MS this shall be returned to the VLR.

When the MSC receives a MAP_PROCESS_UNSTRUCTURED_SS_REQUEST confirmation from the VLR then it shall pass this to the MS and initiate release of the CM connection.

2) Message Destined for Local Application

If the message is destined for the local USSD application then the MSC shall transfer the message to the application.

The MSC may subsequently receive one or more requests from the application which correspond to the MAP_UNSTRUCTURED_SS_REQUEST or MAP_UNSTRUCTURED_SS_NOTIFY indications. These shall be sent transparently to the MS. When a confirmation is received from the MS this shall be returned to the application.

When the MSC receives the result of the original operation from the application then it shall pass this to the MS and initiate release of the CM connection.

Error Handling

Both the MS and the VLR or USSD Application may initiate release of the CM-connection at any time. This is handled as shown in the diagrams.

The procedure in the MSC is shown in figure 22.9.2/1.

Process MS_INIT_USSD_MSC

22.9.2_1.1(2)

Figure 22.9.2/1: Handling of mobile initiated USSD at MSC

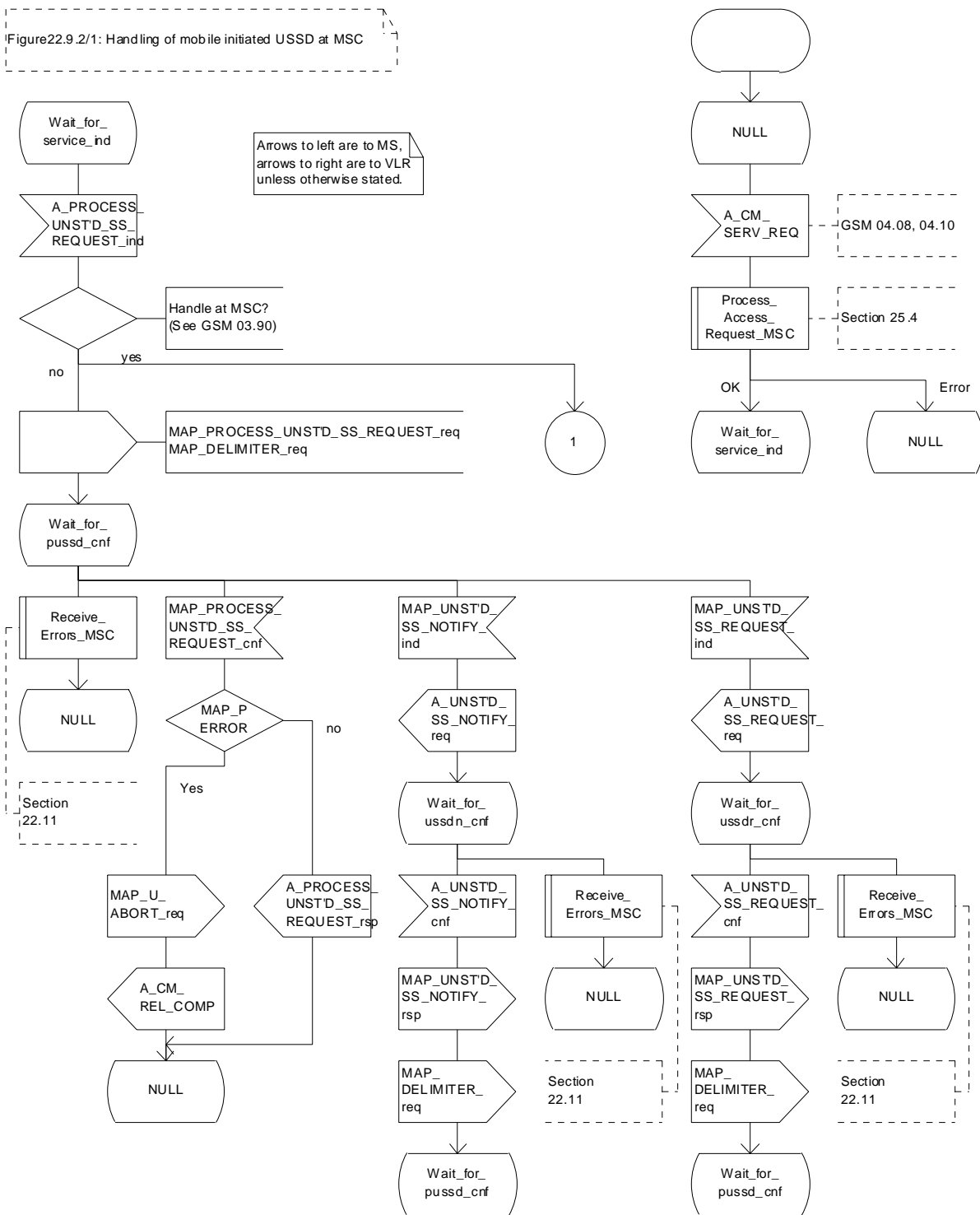

Figure 22.9.2/1 (sheet 1 of 2): Procedure MI_USSD_MSC

Process MS_INIT_USSD_MSC

22.9.2_1.2(2)

Figure 22.9.2/1: Handling of mobile initiated USSD at MSC

Arrows to left are to MS, arrows to right are to USSD application unless otherwise stated.

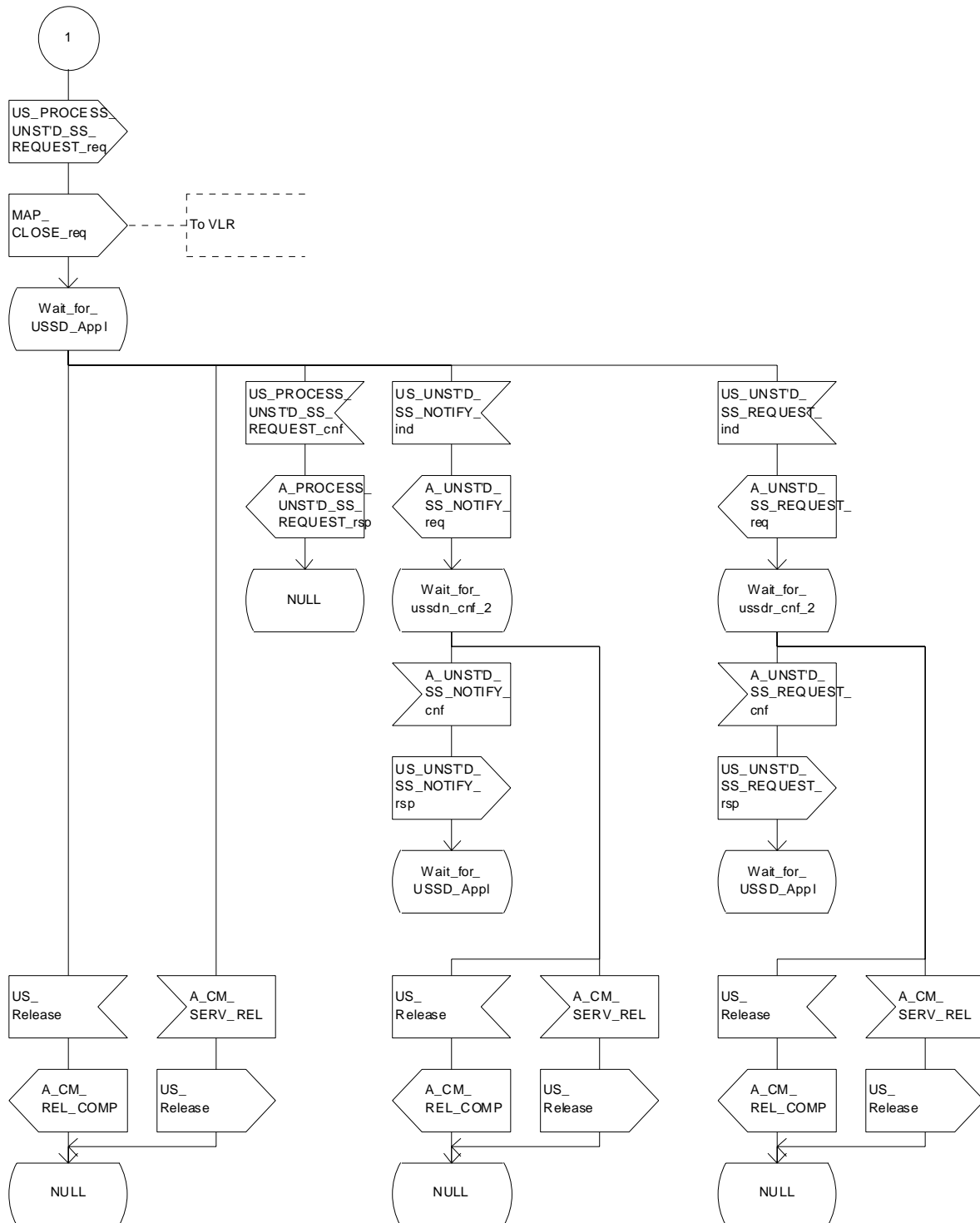

Figure 22.9.2/1 (sheet 2 of 2): Procedure MI_USSD_MSC

22.9.3 Procedures in the VLR

The initiation of the process is shown in clause 22.1.2.

Once a MAP dialogue is established, the VLR may handle the MAP_PROCESS_UNSTRUCTURED_SS_REQUEST from the MSC. This message contains information input by the user, the message may be fed to an application contained locally in the VLR or to the HLR. The rules for determining this are specified in 3GPP TS 23.090 [34].

Message Destined for HLR

If the message is destined for the HLR then the VLR shall transfer the message transparently to the HLR.

The VLR may subsequently receive one or more MAP_UNSTRUCTURED_SS_REQUEST or MAP_UNSTRUCTURED_SS_NOTIFY indications from the HLR. These shall be sent transparently to the MSC. When a confirmation is received from the MSC this shall be returned to the HLR.

When the VLR receives a MAP_PROCESS_UNSTRUCTURED_SS_REQUEST confirmation from the HLR then it shall pass this to the MS and close the MAP provider service.

Message Destined for Local Application

If the message is destined for the local USSD application then the VLR shall transfer the message to the application.

The VLR may subsequently receive one or more requests from the application which correspond to the MAP_UNSTRUCTURED_SS_REQUEST or MAP_UNSTRUCTURED_SS_NOTIFY indications. These shall be sent transparently to the MSC. When a confirmation is received from the MSC this shall be returned to the application.

When the VLR receives the result of the original operation from the application then it shall pass this to the MSC and initiate release of the CM connection.

Error Handling

Both the MSC and the HLR or USSD Application may initiate release of the MAP service at any time. This is handled as shown in the diagrams.

The procedure in the VLR is shown in figures 22.9.3/1 and 22.9.3/2.

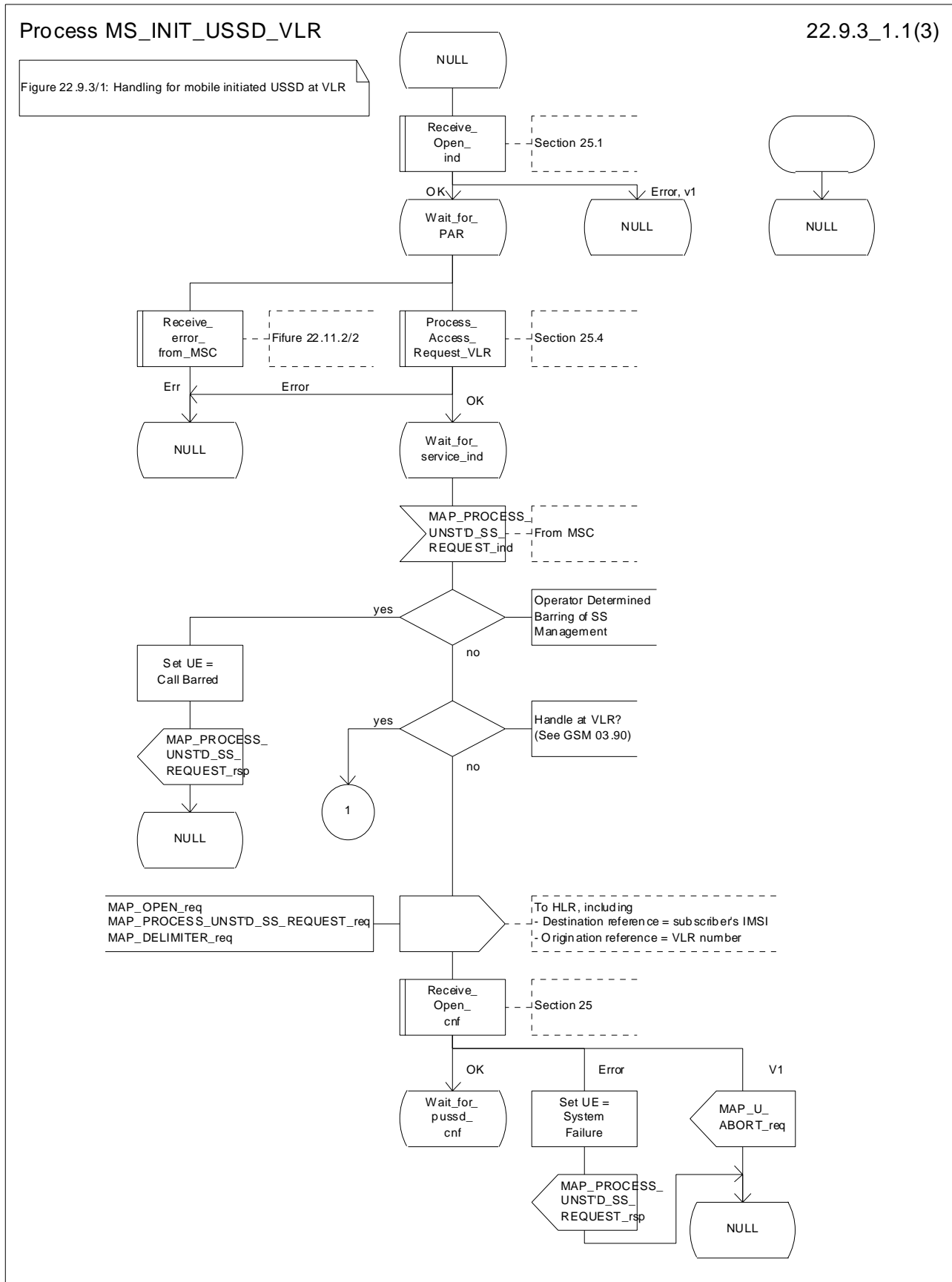

Figure 22.9.3/1 (sheet 1 of 3): Procedure MI_USSD_VLR

Process MS_INIT_USSD_VLR

22.9.3_1.2(3)

Figure 22.9.3/1: Handling for mobile initiated USSD at VLR

Arrows to left are to MSC, arrows to right are to HLR unless otherwise stated.

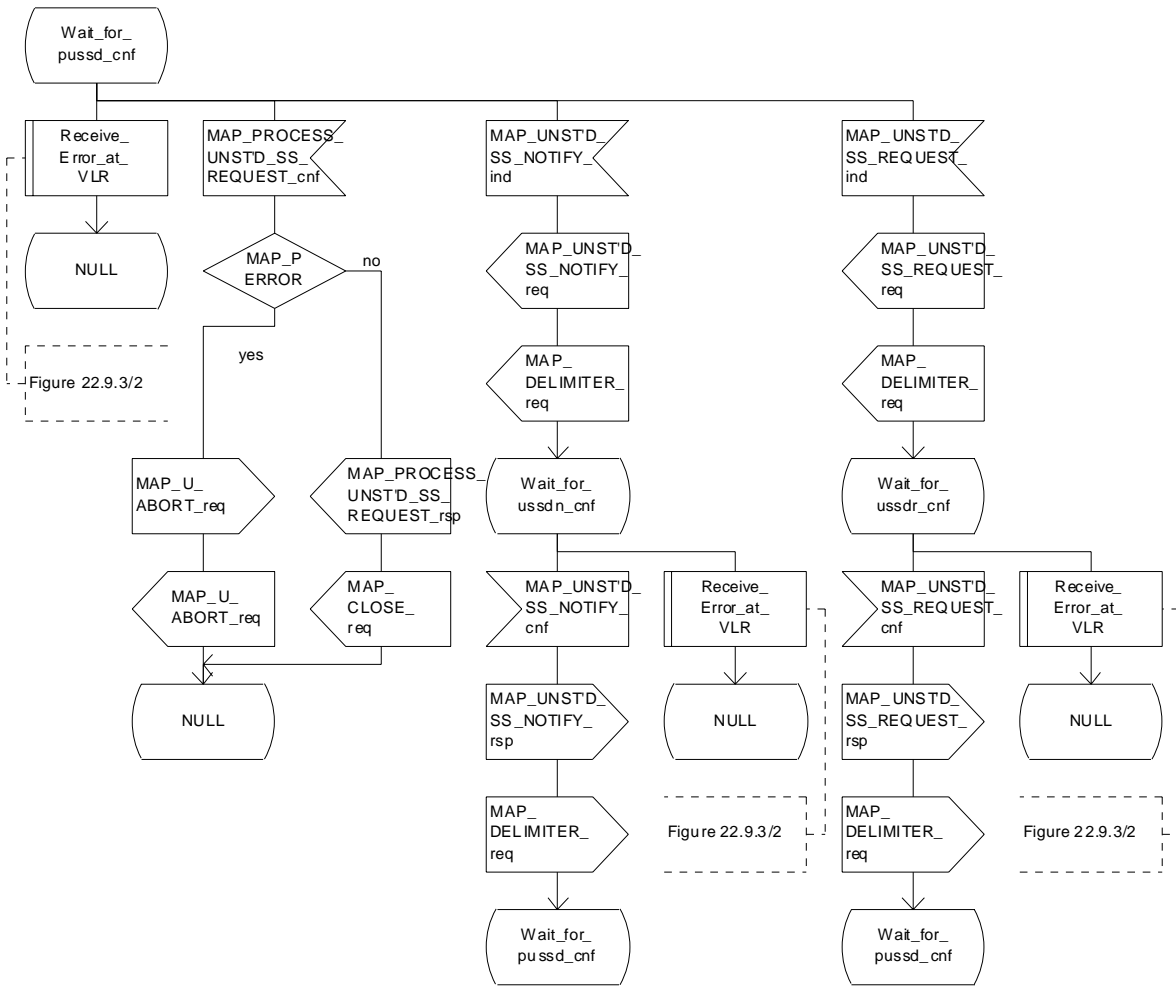

Figure 22.9.3/1 (sheet 2 of 3): Procedure MI_USSD_VLR

Process MS_INIT_USSD_VLR

22.9.3_1.3(3)

Figure 22.9.3/1: Handling for mobile initiated USSD at VLR

Arrows to left are to MSC, arrows to right are to USSD application unless otherwise stated.

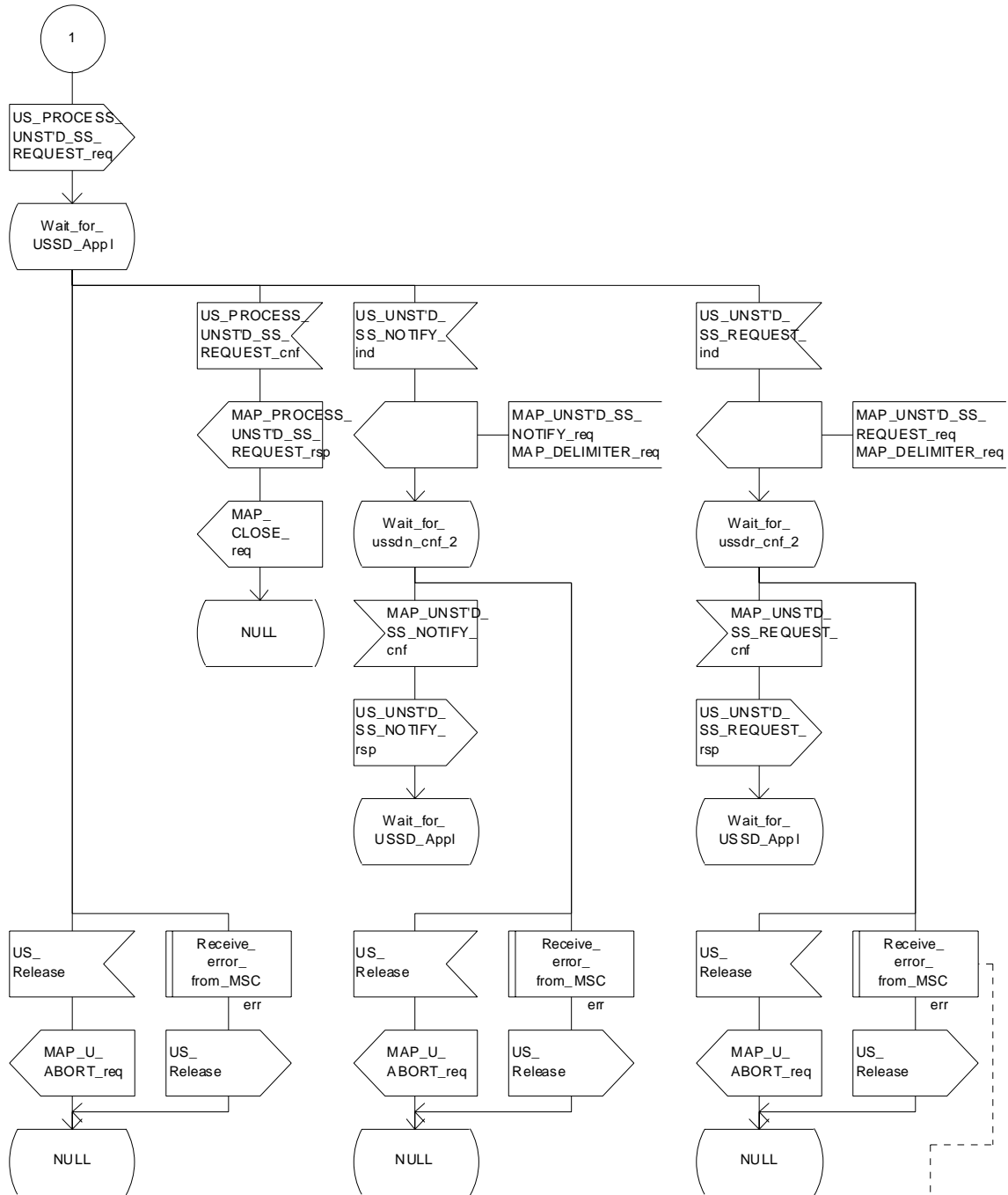

Figure 22.11.2/2

Figure 22.9.3/1 (sheet 3 of 3): Procedure_MI_USSD_VLR

Macrodefinition Receive_Error_at_VLR

22.9.3_2(1)

Figure 22.9.3/2: Handling of errors at VLR for USSD

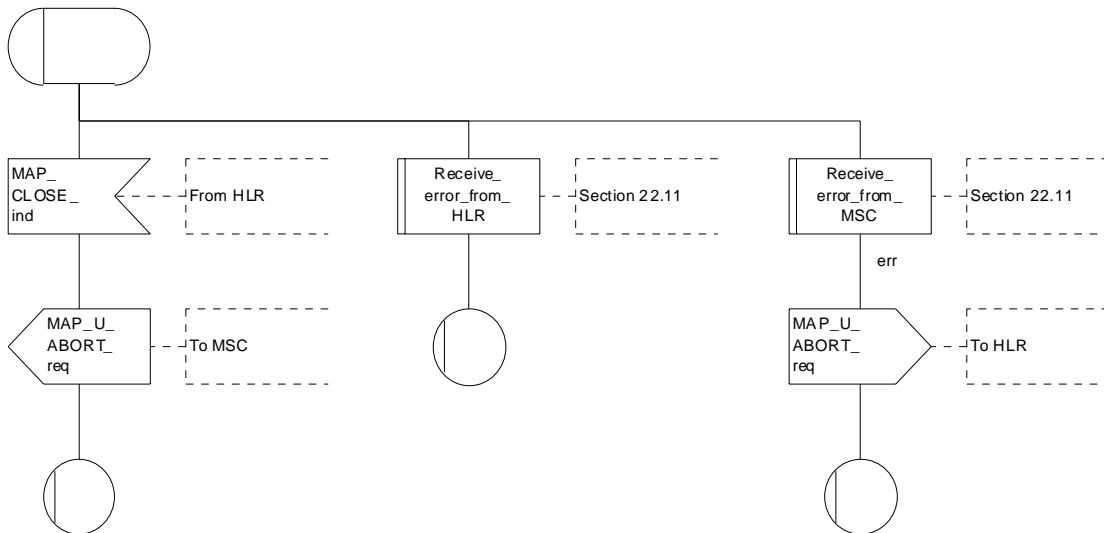

Figure 22.9.3/2: Macro Receive_Error_at_VLR

22.9.4 Procedures in the HLR

The Mobile initiated USSD Procedure in the HLR starts by the HLR receiving a MAP-OPEN service indication from the VLR.

Once a MAP dialogue is established, the HLR may handle the MAP_PROCESS_UNSTRUCTURED_SS_REQUEST from the VLR. This message contains information input by the user. If the alphabet used for the message is understood then the message shall either be fed to an application contained locally in the HLR or to the gsmSCF or to a secondary HLR where the USSD application is located. If the alphabet is not understood then the error "UnknownAlphabet" shall be returned.

Message Destined for Local Application

If the message is destined for the local USSD application then the HLR shall transfer the message to the local application.

The HLR may subsequently receive one or more requests from the application which correspond to the MAP_UNSTRUCTURED_SS_REQUEST or MAP_UNSTRUCTURED_SS_NOTIFY indications. These shall be sent transparently to the VLR. When a confirmation is received from the VLR this shall be returned to the application.

When the HLR receives the result of the original operation from the application then it shall pass this to the VLR and initiate release of the CM connection.

Message Destined for gsmSCF or secondary HLR

If the message is destined for the gsmSCF or secondary HLR then the primary HLR shall transfer the message transparently to the next node.

The primary HLR may subsequently receive one or more MAP_UNSTRUCTURED_SS_REQUEST or MAP_UNSTRUCTURED_SS_NOTIFY indications from the gsmSCF. These shall be sent transparently to the VLR. When a confirmation is received from the VLR this shall be returned to the gsmSCF.

When the primary HLR receives a MAP_PROCESS_UNSTRUCTURED_SS_REQUEST confirmation from the gsmSCF then it shall pass this to the VLR and closes the MAP provider service.

Error Handling

The VLR, the USSD Application and the gsmSCF or secondary HLR may initiate release of the MAP service at any time. This is handled as shown in the diagrams.

The procedure in the primary HLR is shown in figure 22.9.4/1.

Process MS_INIT_USSD_HLR

1(4)

Handling of mobile initiated USSD at HLR

Signals to/from the left are to/from the VLR; Signals to/from the right are to/from the USSD application

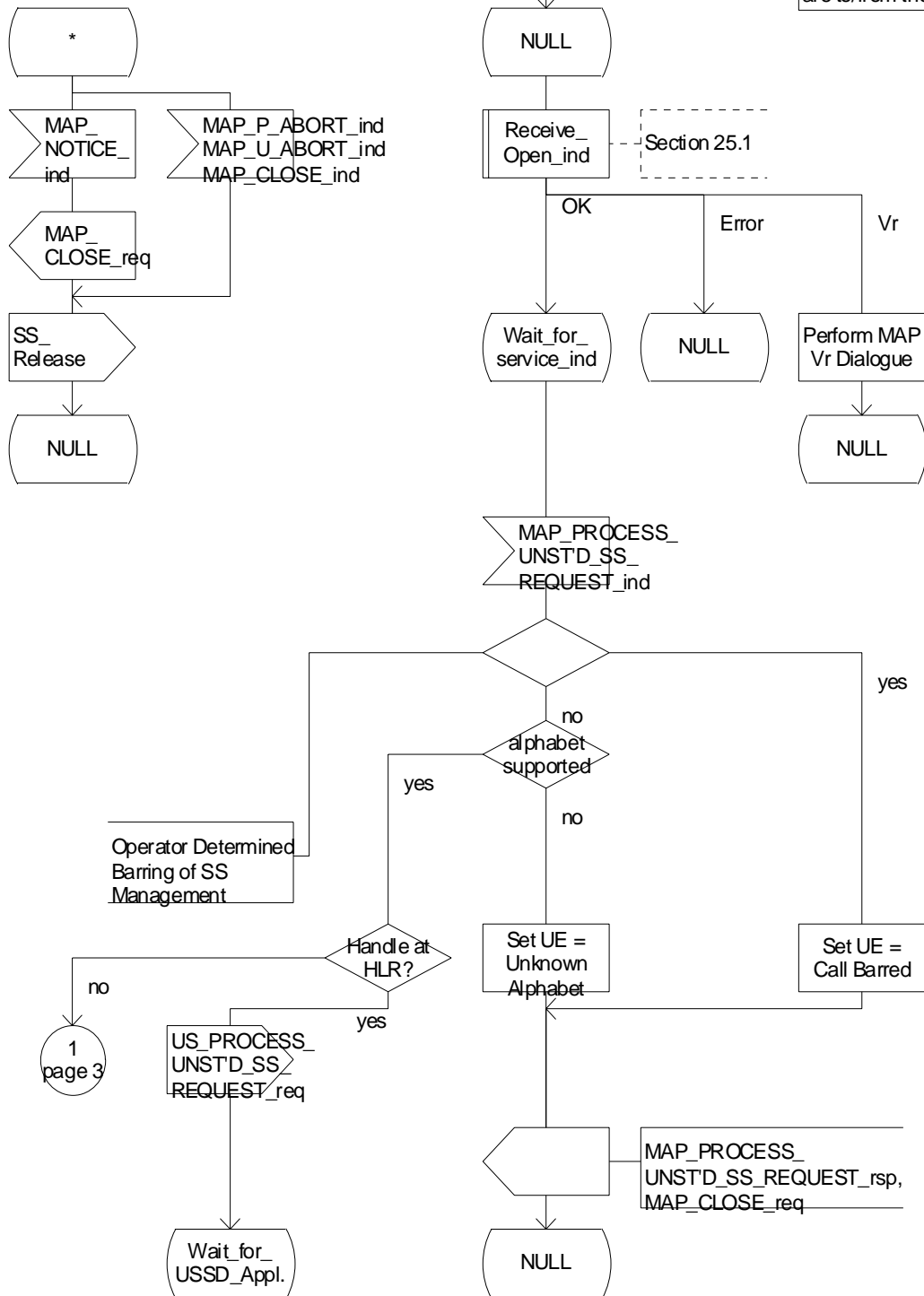

Figure 22.9.4/1 (sheet 1 of 4): Procedure MI_USSD_HLR

Process MS_INIT_USSD_HLR

22.9.4_1.2(4)

Figure 22.9.4/1: Handling of mobile initiated USSD at HLR.

Arrows to left are to VLR, arrows to right are to USSD application unless otherwise stated.

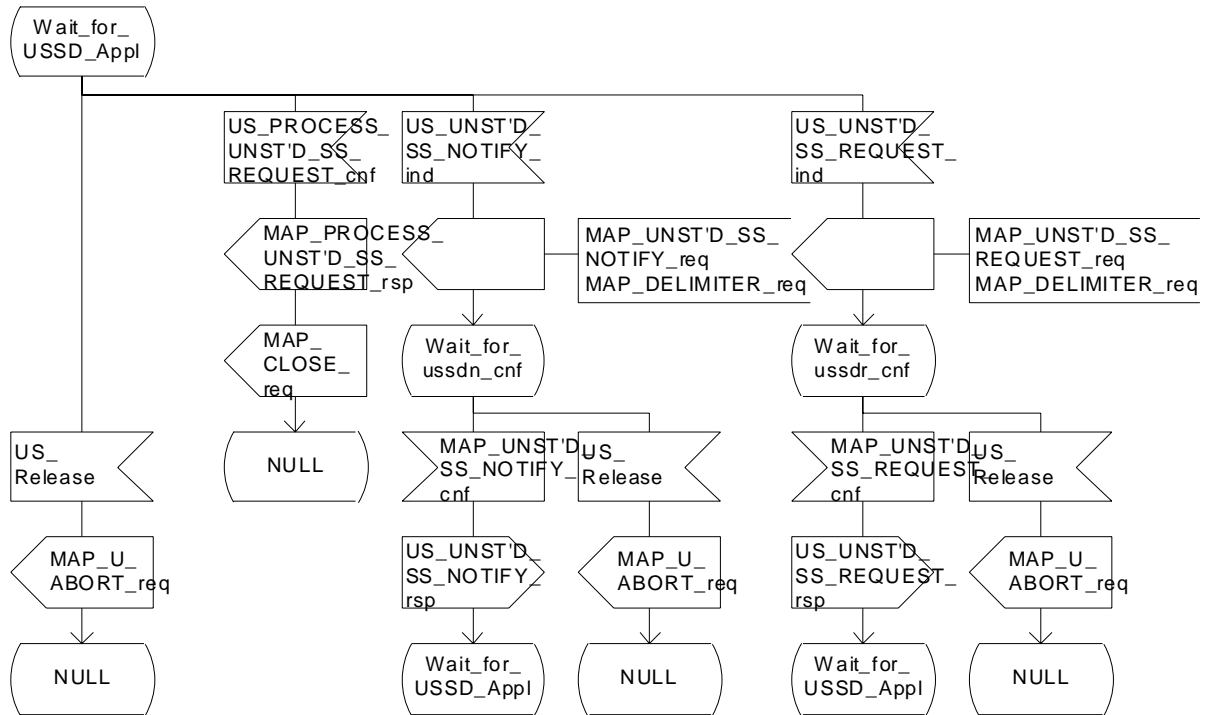

Figure 22.9.4/1 (sheet 2 of 4): Procedure MI_USSD_HLR

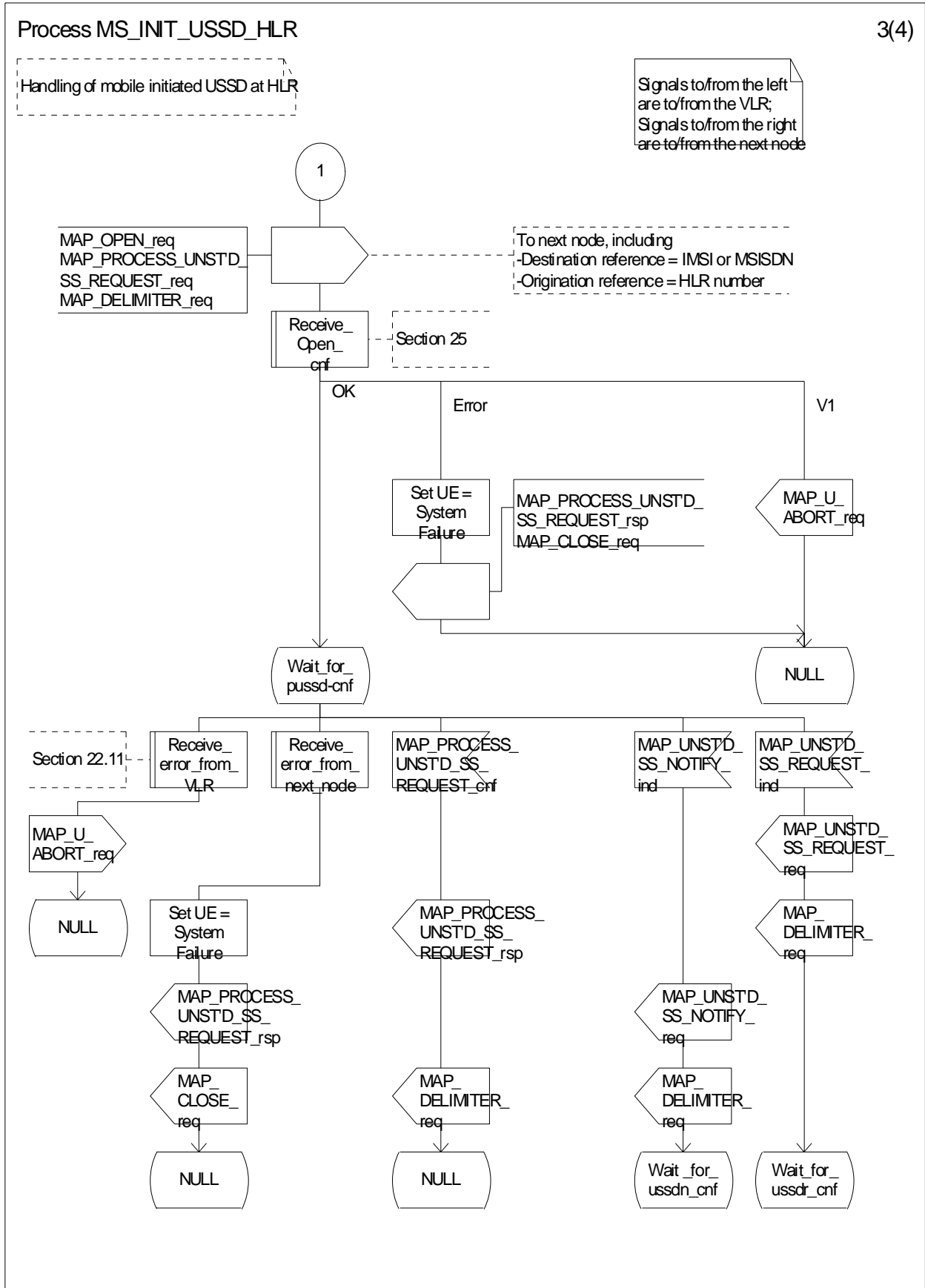

Figure 22.9.4/1 (sheet 3 of 4): Procedure MI_USSD_HLR

Process MS_INIT_USSD_HLR

22.9.4_1.4(4)

Figure 22.9.4/1: Handling of mobile initiated USSD at HLR.

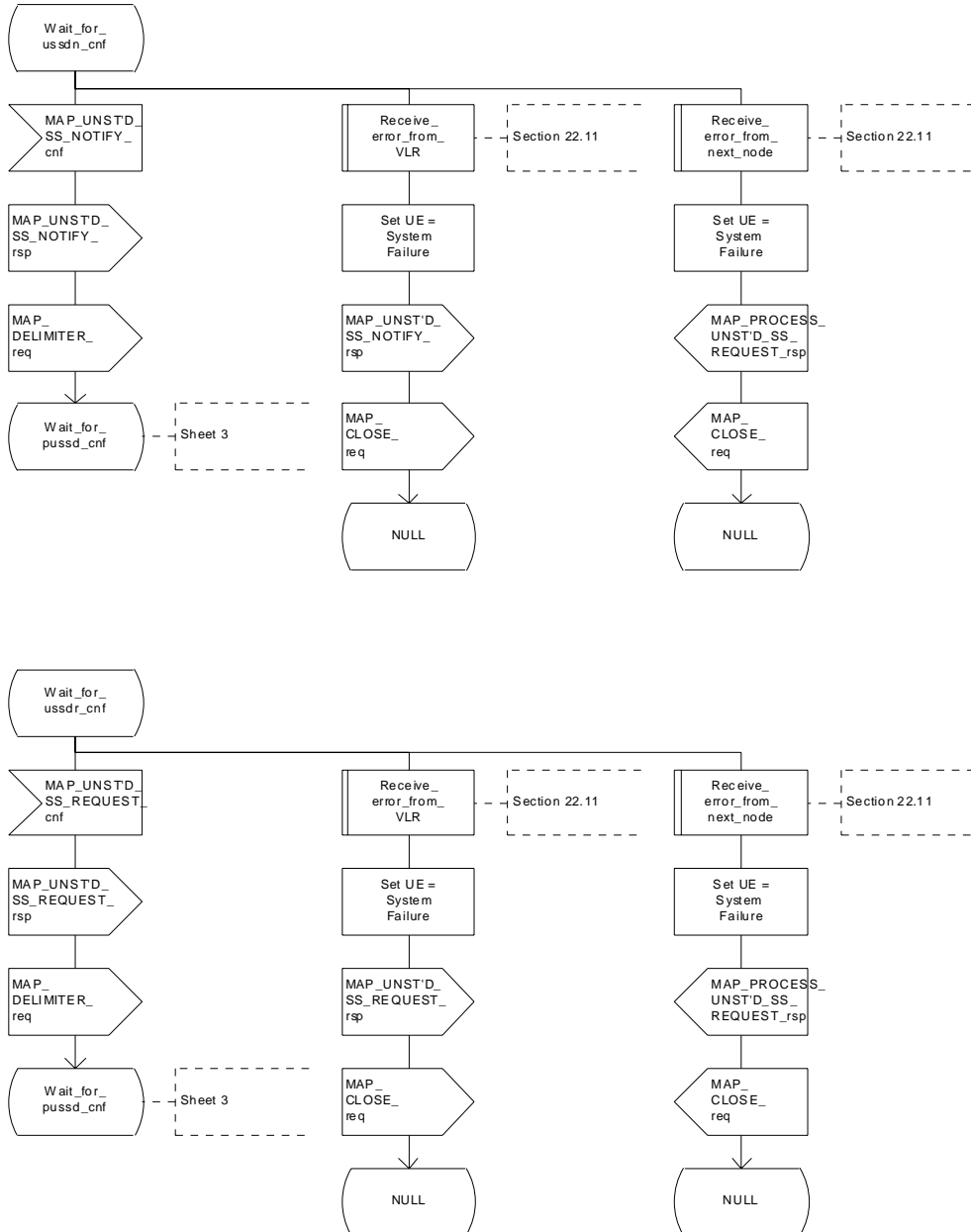

Figure 22.9.4/1 (sheet 4 of 4): Procedure MI_USSD_HLR

22.9.5 Procedures in the gsmSCF/secondary HLR

The Mobile initiated USSD Procedure in the gsmSCF/secondary HLR starts by the gsmSCF/secondary HLR receiving a MAP-OPEN service indication from the HLR.

Once a MAP dialogue is established, the gsmSCF/secondary HLR may handle the MAP_PROCESS_UNSTRUCTURED_SS_REQUEST from the HLR.

The gsmSCF/secondary HLR shall transfer the message to the local application.

The gsmSCF/secondary HLR may subsequently receive one or more requests from the application which correspond to the MAP_UNSTRUCTURED_SS_REQUEST or MAP_UNSTRUCTURED_SS_NOTIFY indications. These shall be sent transparently to the HLR. When a confirmation is received from the HLR this shall be returned to the application.

When the gsmSCF/secondary HLR receives the result of the original operation from the application then it shall pass this to the HLR and initiate release of the CM connection.

Error Handling

Both the HLR and the USSD Application may initiate release of the MAP service at any time. This is handled as shown in the diagrams.

The procedure in the gsmSCF and secondary HLR is shown in figure 22.9.5/1.

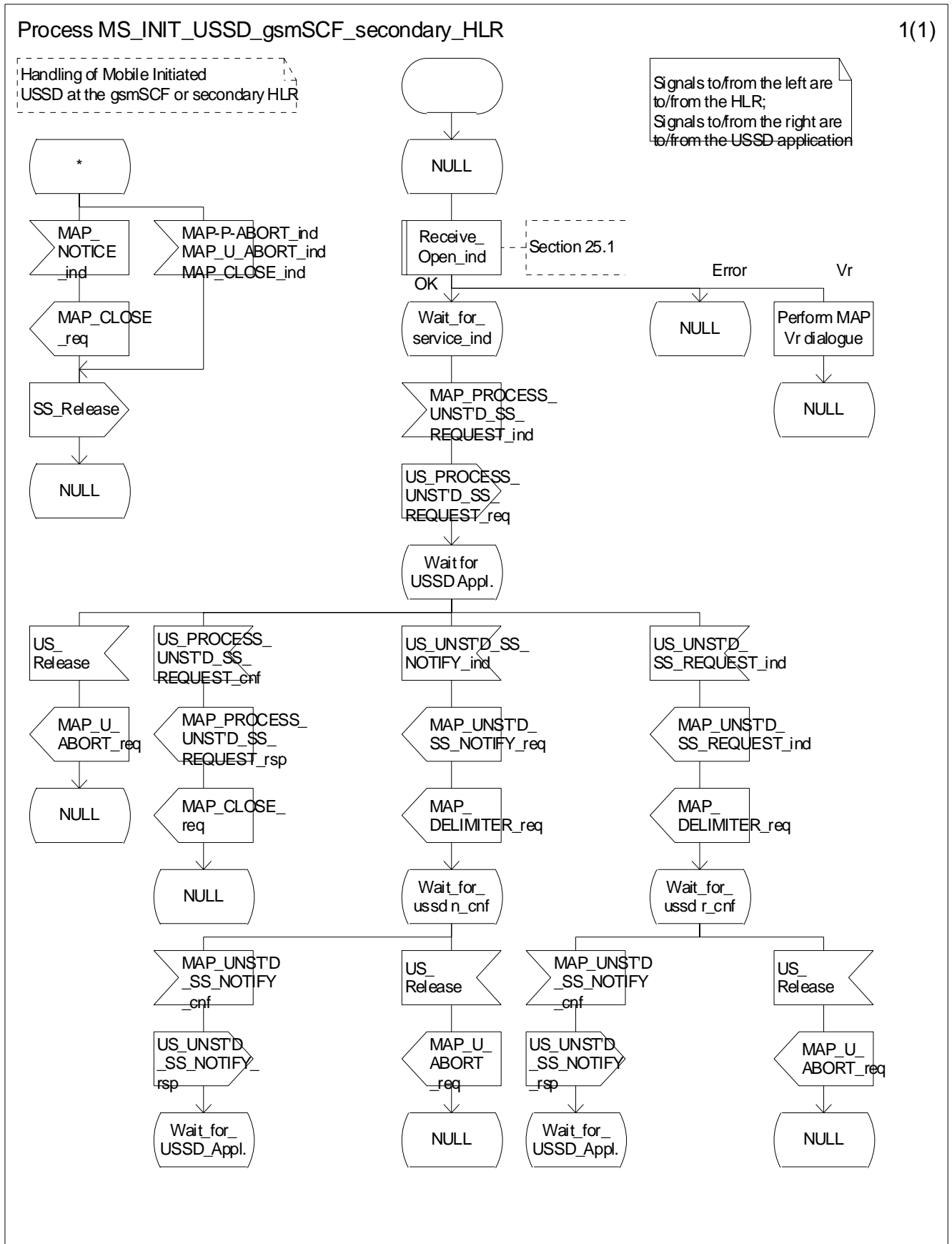

Figure 22.9.5/1 Process MS_INIT_USSD_gsmSCF_secondary_HLR

22.10 Network initiated USSD procedure

22.10.1 General

The procedure supports supplementary service signalling procedures which can allow PLMN specific services to be introduced.

The message flow for the procedure can be found in 3GPP TS 23.090 [34].

The following services may be used:

MAP_PAGE	(defined in clauses 8 and 25);
MAP_SEARCH_FOR_MOBILE_SUBSCRIBER	(defined in clauses 8 and 25);
MAP_PROCESS_ACCESS_REQUEST	(defined in clauses 8 and 25);
MAP_AUTHENTICATE	(defined in clauses 8 and 25);
MAP_SET_CIPHERING_MODE	(defined in clauses 8 and 25);
MAP_FORWARD_NEW_TMSI	(defined in clauses 8 and 25);
MAP_READY_FOR_SM	(defined in clauses 12 and 25).

At least one of the following services will certainly be used, and both may be used:

MAP_UNSTRUCTURED_SS_REQUEST	(defined in clause 11);
MAP_UNSTRUCTURED_SS_NOTIFY	(defined in clause 11).

22.10.2 Procedure in the MSC

The procedure may be invoked either by the VLR or by a USSD application local to the MSC. They may start by using either the MAP_UNSTRUCTURED_SS_REQUEST or MAP_UNSTRUCTURED_SS_NOTIFY service. If the request is initiated by a local USSD application then the MSC will open a dialogue with the VLR.

In both cases the MSC will initiate a CM connection to the MS (using the page or search macros defined in clause 25.3). Once the connection is successfully established the message received from the VLR or USSD application will be sent to the MS using the mapping specified in 3GPP TS 29.011 [59].

Following transfer of the message the MSC will wait for a confirmation from the MS. This will be sent to the VLR or USSD application as appropriate.

Following this, the MSC may receive further uses of the MAP_UNSTRUCTURED_SS_REQUEST or MAP_UNSTRUCTURED_SS_NOTIFY services, or may receive an indication to release the connection to the MS.

In the event of an error, the connection to the MS shall be released, and the MAP process with the VLR shall be aborted as shown in the diagram.

The procedure in the MSC is shown in figure 22.10.2/1.

Process NW_INIT_USSD_MSC

22.10.2_1.1(4)

Figure 22.10.2/1: Handling of network initiated USSD in MSC

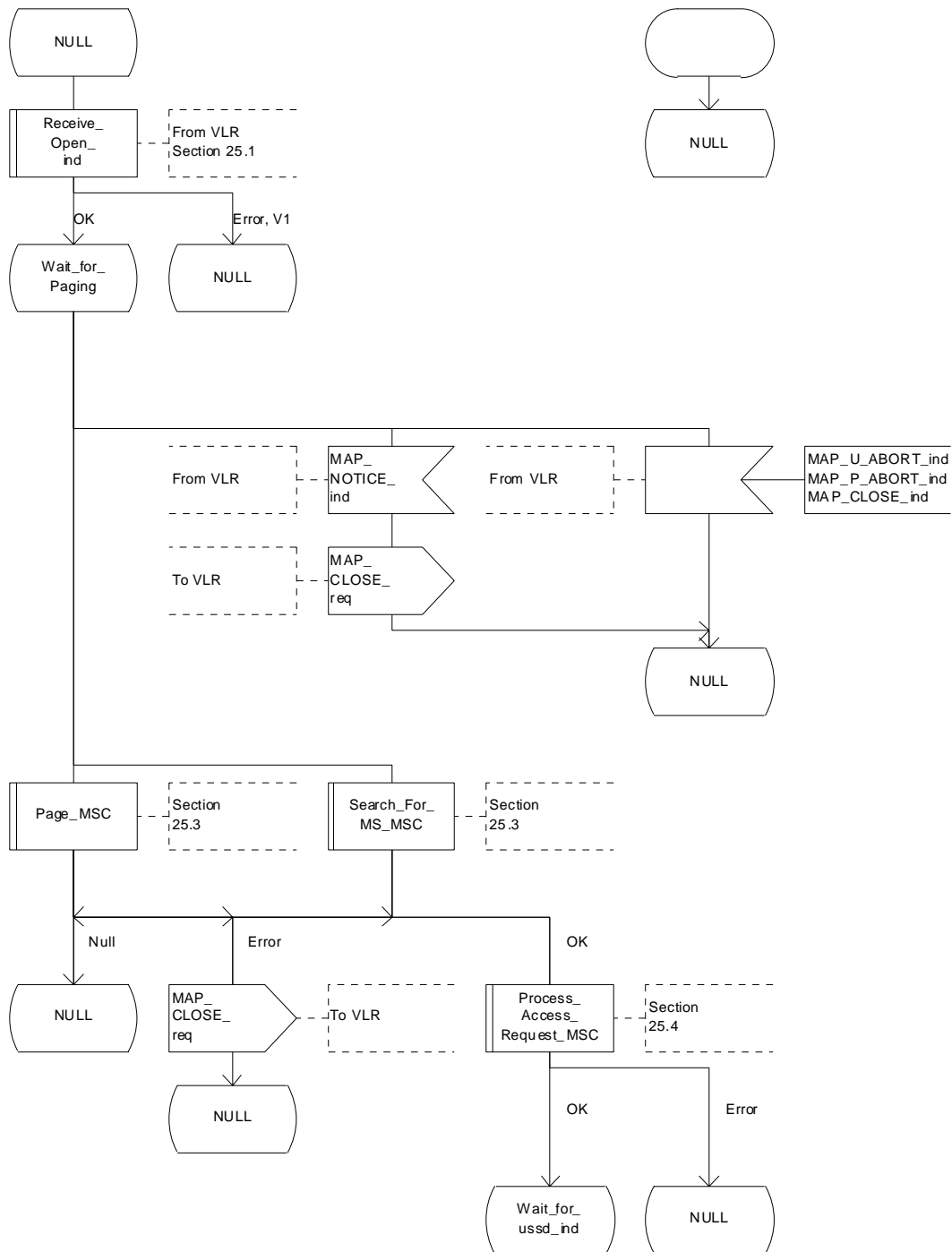

Figure 22.10.2/1 (sheet 1 of 4): Procedure NI_USSD_MSC

Process NW_INIT_USSD_MSC

22.10.2_1.2(4)

Figure 22.10.2/1: Handling of network initiated USSD in MSC

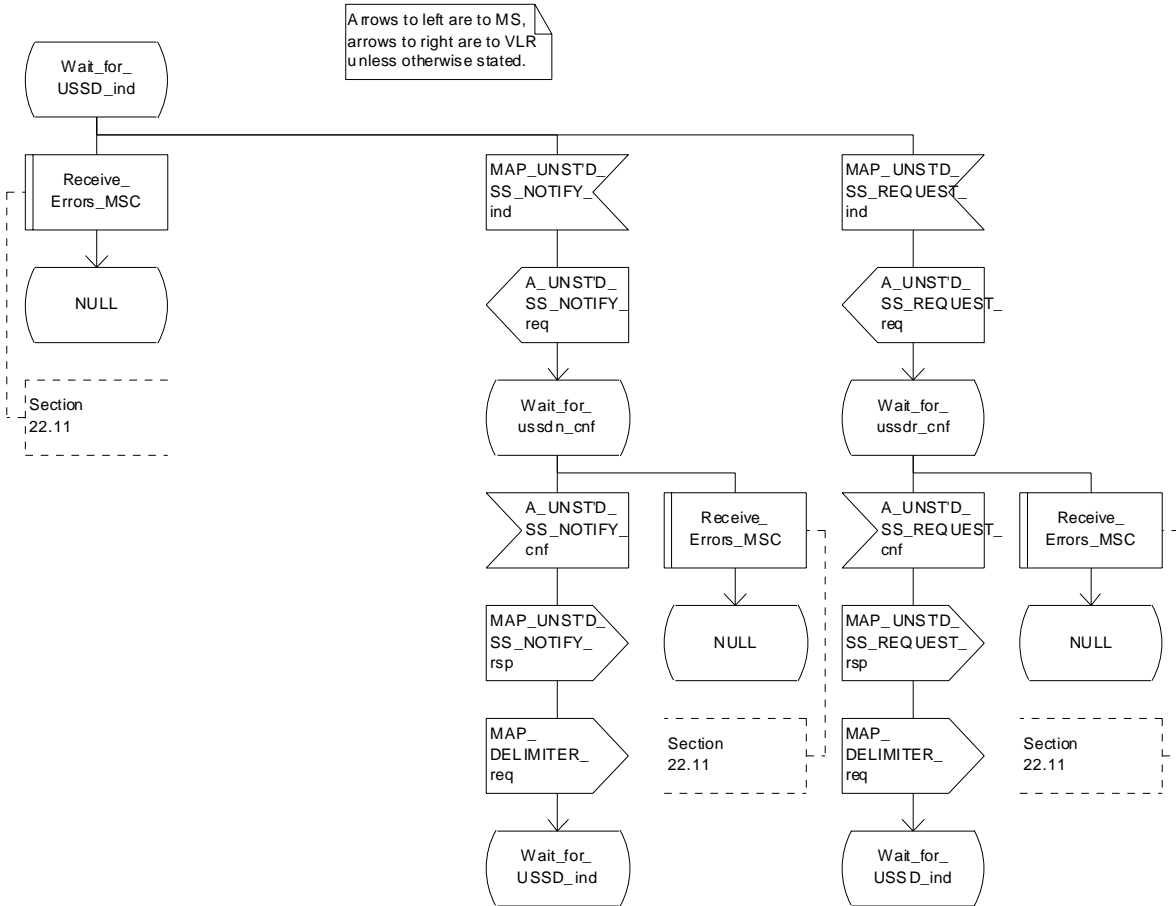

Figure 22.10.2/1 (sheet 2 of 4): Procedure NI_USSD_MSC

Process NW_INIT_USSD_MSC

22.10.2_1.3(4)

Figure 22.10.2/1: Handling of network initiated USSD in MSC

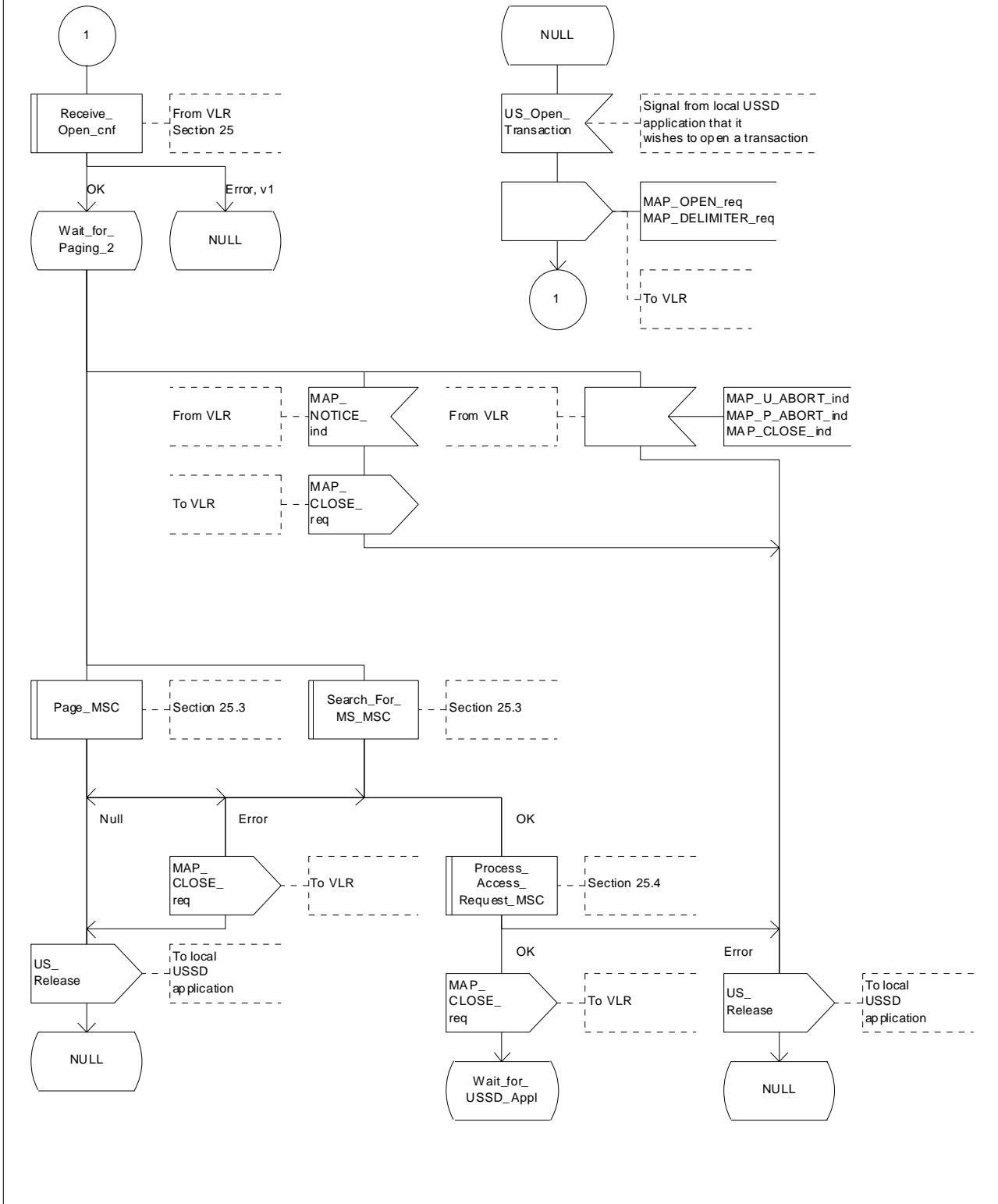

Figure 22.10.2/1 (sheet 3 of 4): Procedure NI_USSD_MSC

Process NW_INIT_USSD_MSC

22.10.2_1.4(4)

Figure 22.10.2/1: Handling of network initiated USSD in MSC

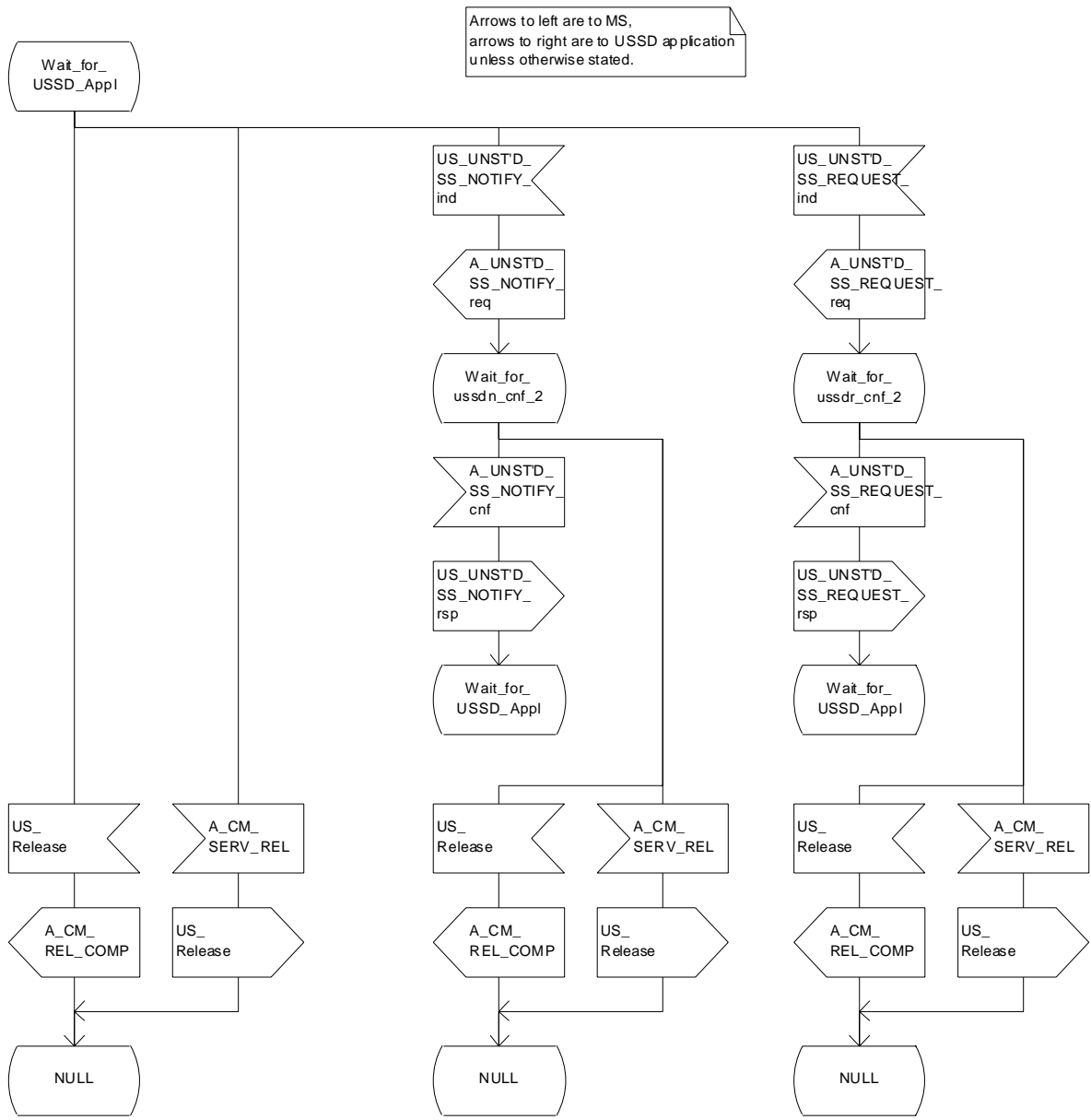

Figure 22.10.2/1 (sheet 4 of 4): Procedure NI_USSD_MSC

22.10.3 Procedure in the VLR

The procedure may be invoked either by the HLR or by a USSD application local to the VLR. They may start by using either the MAP_UNSTRUCTURED_SS_REQUEST or MAP_UNSTRUCTURED_SS_NOTIFY service.

In both cases the VLR will first initiate a MAP dialogue with the MSC. When the indication for the unstructured SS request or notify is received then the macro Start_USSD_VLR will be used to page the MS and open a CM connection. Once the CM connection is successfully established the indication received from the HLR or USSD application will be sent to the MSC.

Following transfer of the message the VLR will wait for a confirmation from the MSC. This will be sent to the HLR or USSD application as appropriate.

Following this, the VLR may receive further uses of the MAP_UNSTRUCTURED_SS_REQUEST or MAP_UNSTRUCTURED_SS_NOTIFY services, or may receive a MAP_CLOSE_ind.

In the event of an error, the MAP process with the MSC shall be released, and if necessary the MAP process with the HLR shall be aborted as shown in the diagram.

The procedure in the VLR is shown in figure 22.10.3/1.

MSC Initiated USSD

If a USSD application in the MSC wishes to use the network initiated USSD procedure, and a connection to the MS does not exist then it shall open a dialogue to the VLR. This dialogue will automatically lead to the VLR performing page and search using the macro Start_USSD_VLR.

Macro Start_USSD_VLR

This macro is used to initiate a CM connection with the MS for transfer of network initiated unstructured SS data.

It first checks for correct data in the VLR. If a problem is found then "Err" is returned.

A page or search procedure (as appropriate) will then be used to contact the MS. Following successful page or search the macro Process_Access_Request_VLR specified in clause 25.4 will be used to handle the CM connection establishment.

The macro is shown in figure 22.10.3/2.

Process NW_INIT_USSD_VLR

22.10.3_1.1(4)

Figure 22.10.3/1: Handling of network initiated USSD at VLR

Arrows to left are to MSC, Arrows to right are to HLR unless otherwise stated.

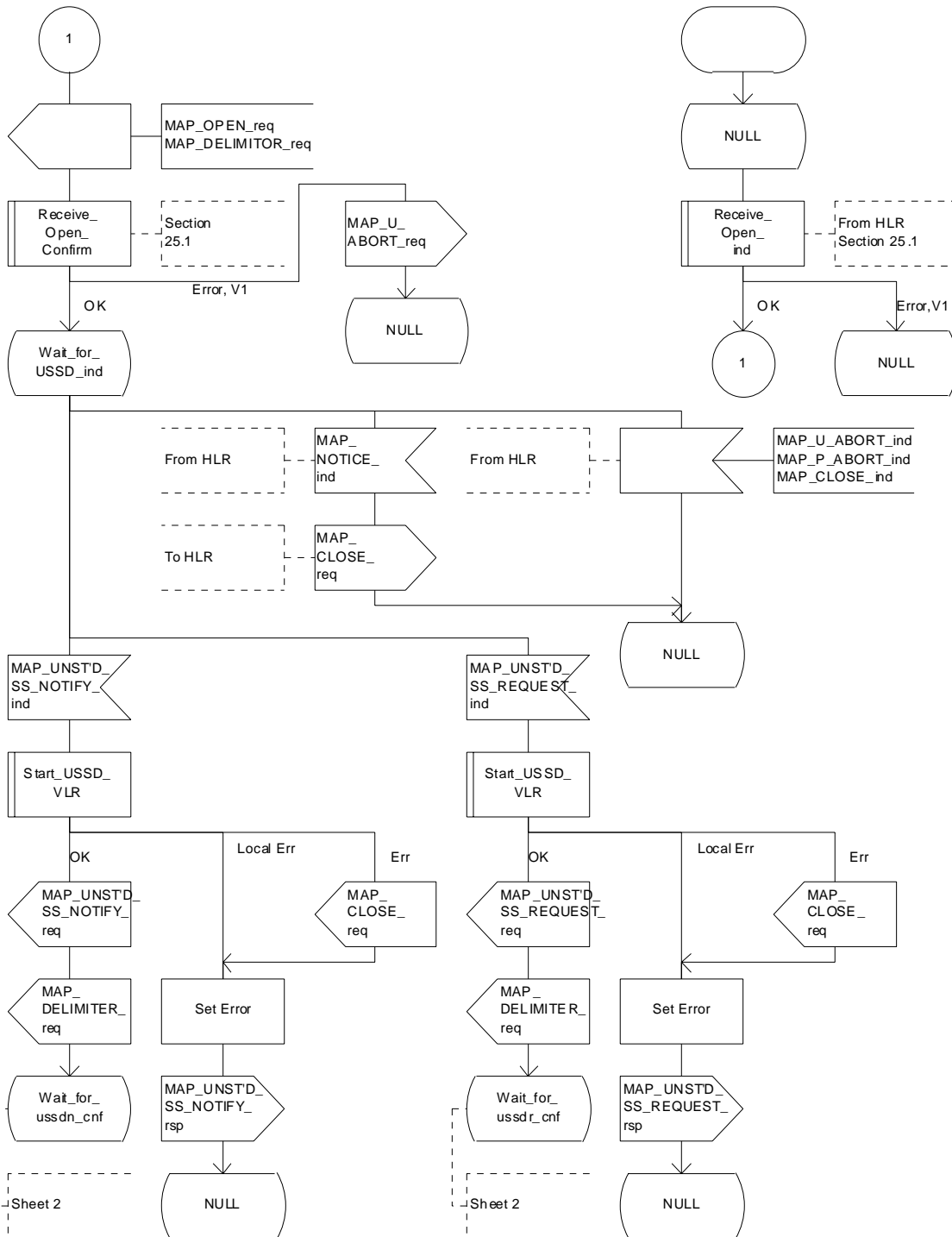

Figure 22.10.3/1 (sheet 1 of 4): Procedure NI_USSD_VLR

Process NW_INIT_USSD_VLR

22.10.3_1.2(4)

Figure 22.10.3/1: Handling of network initiated USSD at VLR

Arrows to left are to MSC, arrows to right are to HLR unless otherwise stated.

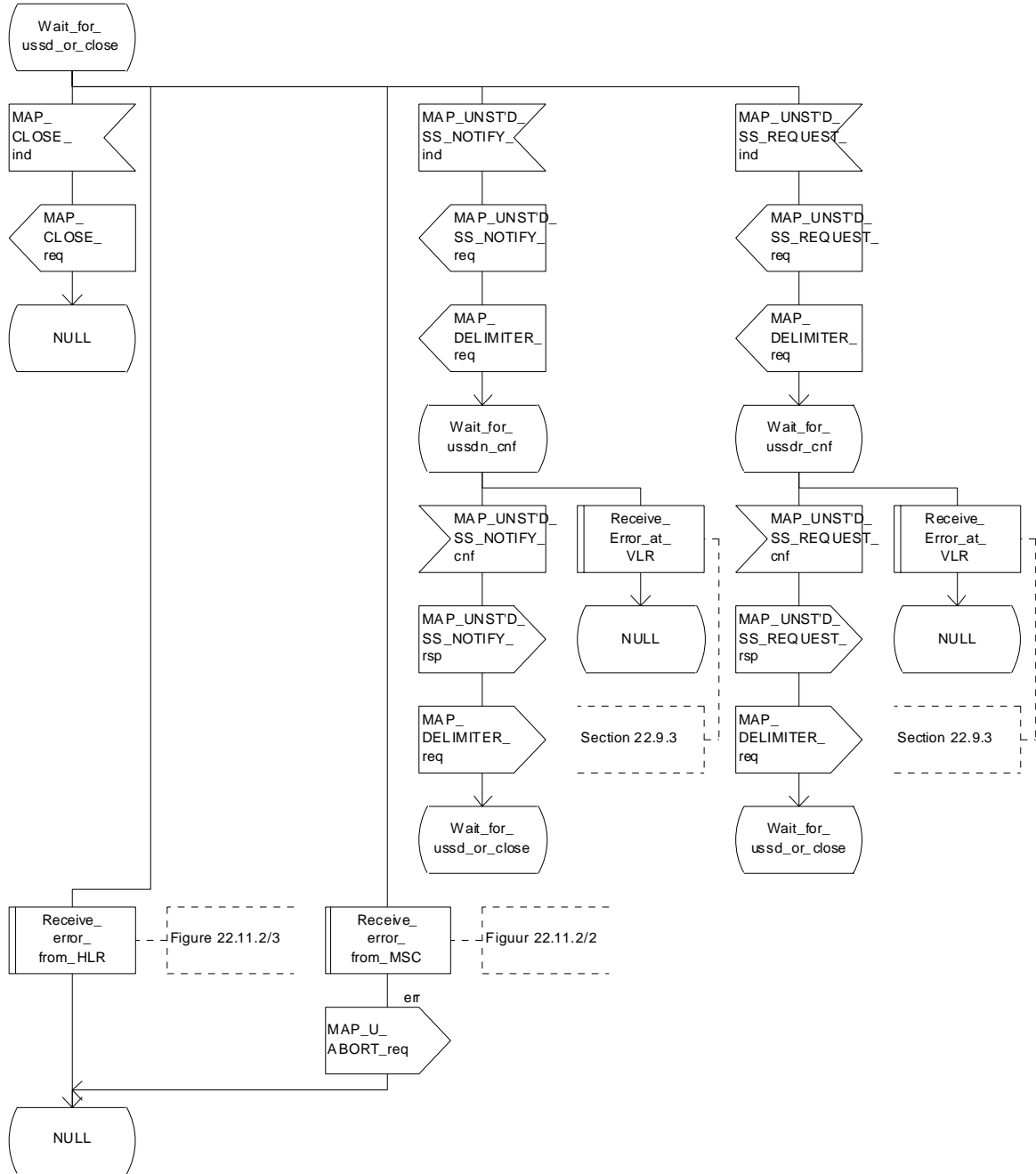

Figure 22.10.3/1 (sheet 2 of 4): Procedure NI_USSD_VLR

Process NW_INIT_USSD_VLR

22.10.3_1.3(4)

Figure 22.10.3/1: Handling of network initiated USSD at VLR

Arrows to left are to MSC, arrows to right are to USSD application unless otherwise stated.

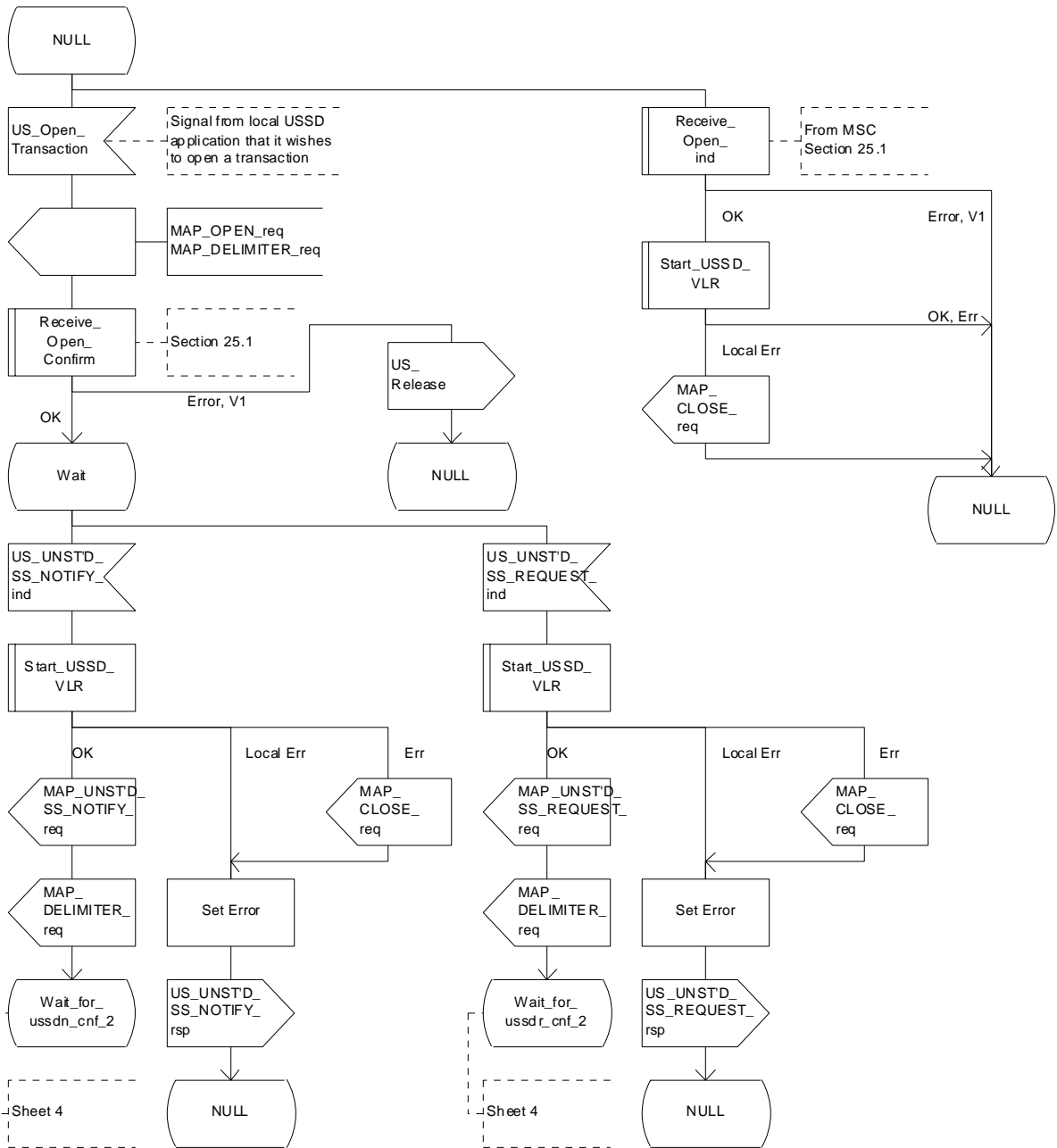

Figure 22.10.3/1 (sheet 3 of 4): Procedure NI_USSD_VLR

Process NW_INIT_USSD_VLR

22.10.3_1.4(4)

Figure 22.10.3/1: Handling of network initiated USSD at VLR

Arrows to left are to MSC, arrows to right are to USSD application unless otherwise stated.

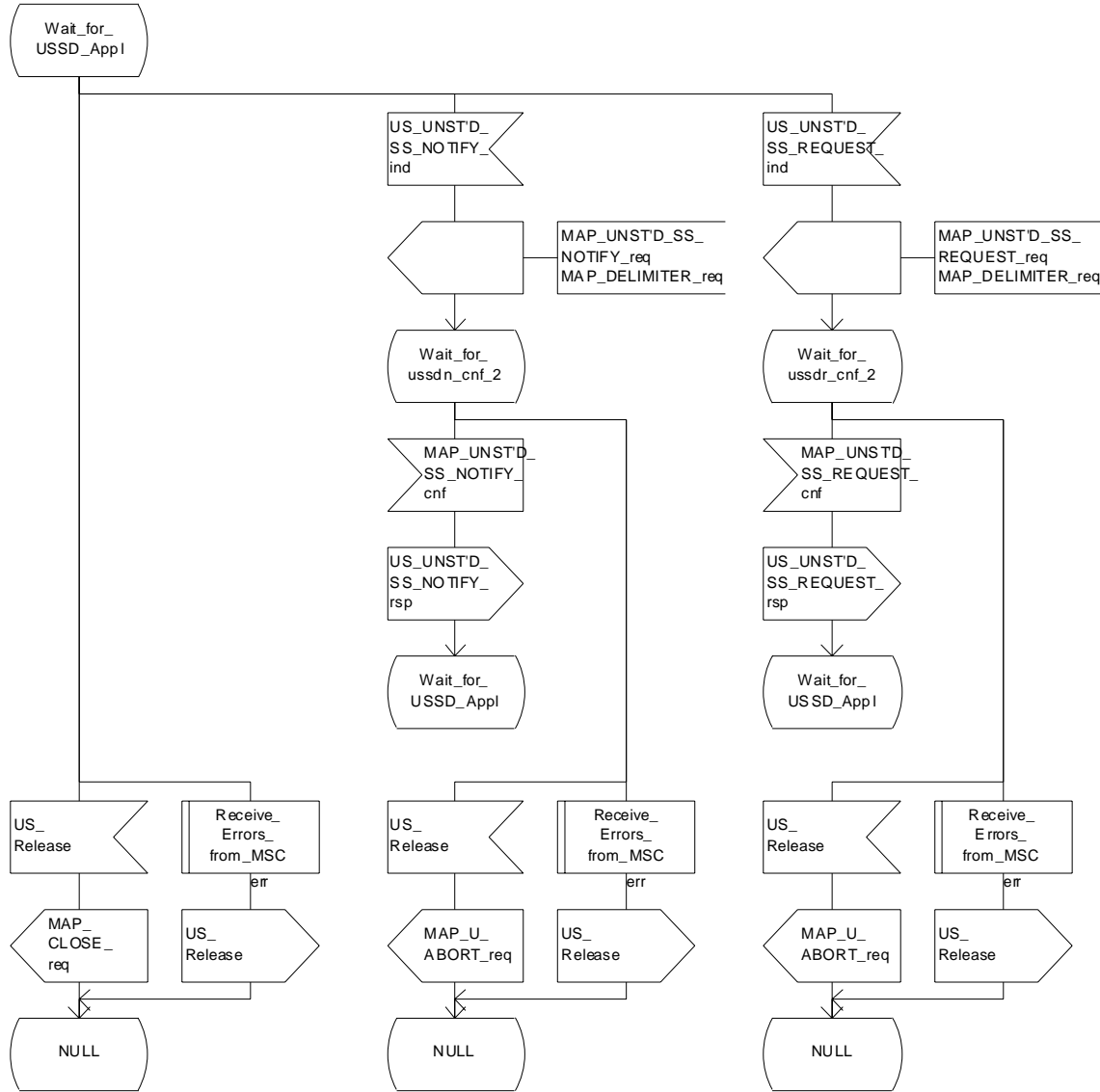

Figure 22.10.3/1 (sheet 4 of 4): Procedure NI_USSD_VLR

Macrodefinition Start_USSD_VLR

22.10.3_2.1(2)

Figure 22.10.3/2: Macro to establish a connection to the MS for a network initiated USSD operation

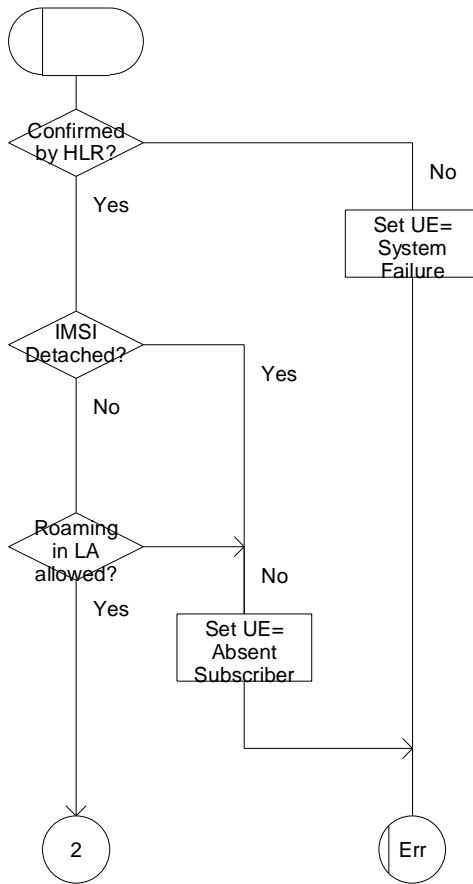

Figure 22.10.3/2 (sheet 1 of 2): Macro Start_USSD_VLR

Macrodefinition Start_USSD_VLR

22.10.3_2.2(2)

Figure 22.10.3/2: Macro to establish a connection to the MS for a network initiated USSD operation.

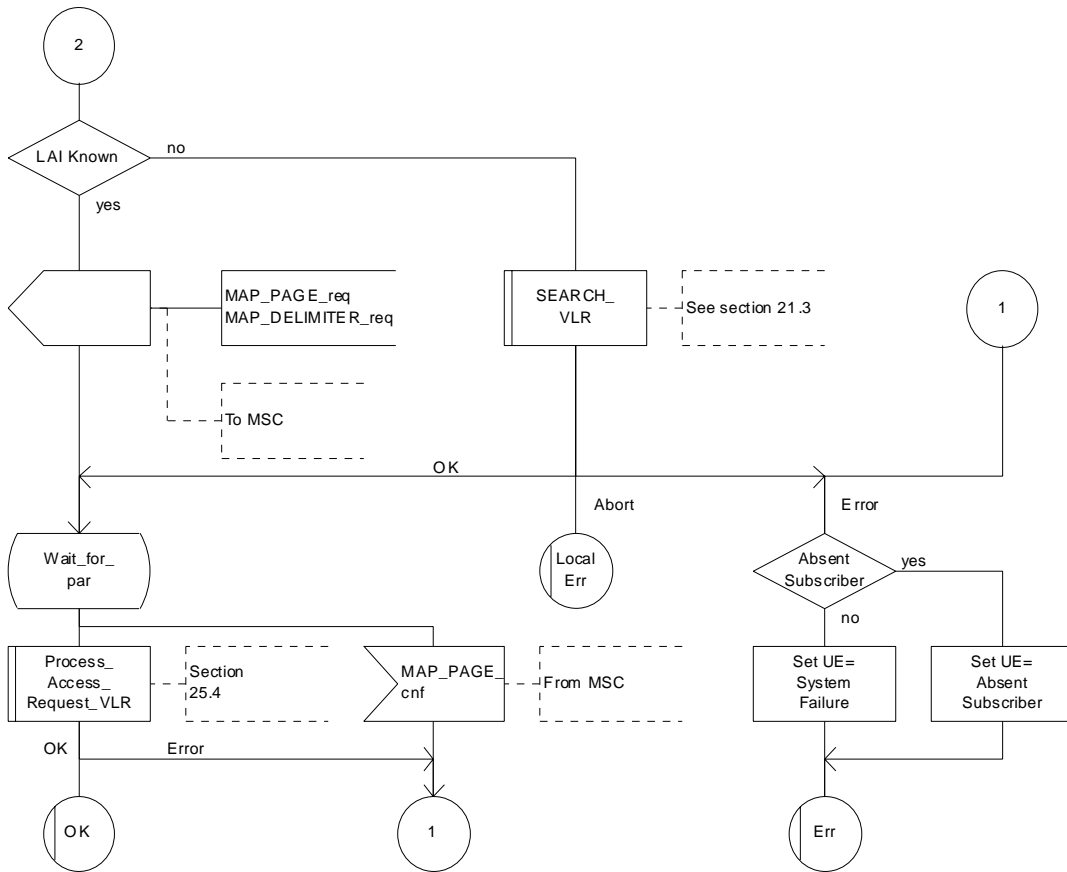

Figure 22.10.3/2 (sheet 2 of 2): Macro Start_USSD_VLR

22.10.4 Procedure in the HLR

The procedure may be invoked either by a gsmSCF, a secondary HLR or by a USSD application local to the primary HLR. It may start by using either the MAP_UNSTRUCTURED_SS_REQUEST or MAP_UNSTRUCTURED_SS_NOTIFY service.

In both cases the primary HLR will first check whether the MS is reachable .

If the MS is reachable, the primary HLR will initiate a MAP dialogue with the VLR and send the message received from the gsmSCF or secondary HLR or USSD application to the VLR.

Following transfer of the message the primary HLR will wait for a confirmation from the VLR. This will be sent to the gsmSCF or secondary HLR or USSD application as appropriate.

Following this, the primary HLR may receive further uses of the MAP_UNSTRUCTURED_SS_REQUEST or MAP_UNSTRUCTURED_SS_NOTIFY services, or may receive a MAP_CLOSE_ind.

In the event of an error, the MAP process with the VLR shall be released and if necessary the MAP process with the gsmSCF or secondary HLR shall be aborted, as shown in the diagram.

Message Originated by gsmSCF or secondary HLR

If the message is originated by the gsmSCF or a secondary HLR then the primary HLR shall transfer the message transparently to the VLR.

The primary HLR may subsequently receive one or more MAP_UNSTRUCTURED_SS_REQUEST_ind or MAP_UNSTRUCTURED_SS_NOTIFY_ind indications from the gsmSCF or secondary HLR. These shall be sent transparently to the VLR. When a confirmation is received from the VLR this shall be returned to the next node as appropriate.

When the primary HLR receives a MAP_CLOSE_ind from the gsmSCF or secondary HLR then it shall pass this to the VLR and close the MAP dialogue.

The procedure in the primary HLR is shown in figure 22.10.4/1 and 22.10.4/2.

Process NW_INIT_USSD_HLR

22.10.4_1.1(5)

Figure 22.10.4/1 Handling of network initiated USSD at HLR

Arrows to left are to VLR.
Arrows to right are to the next node
unless otherwise stated.

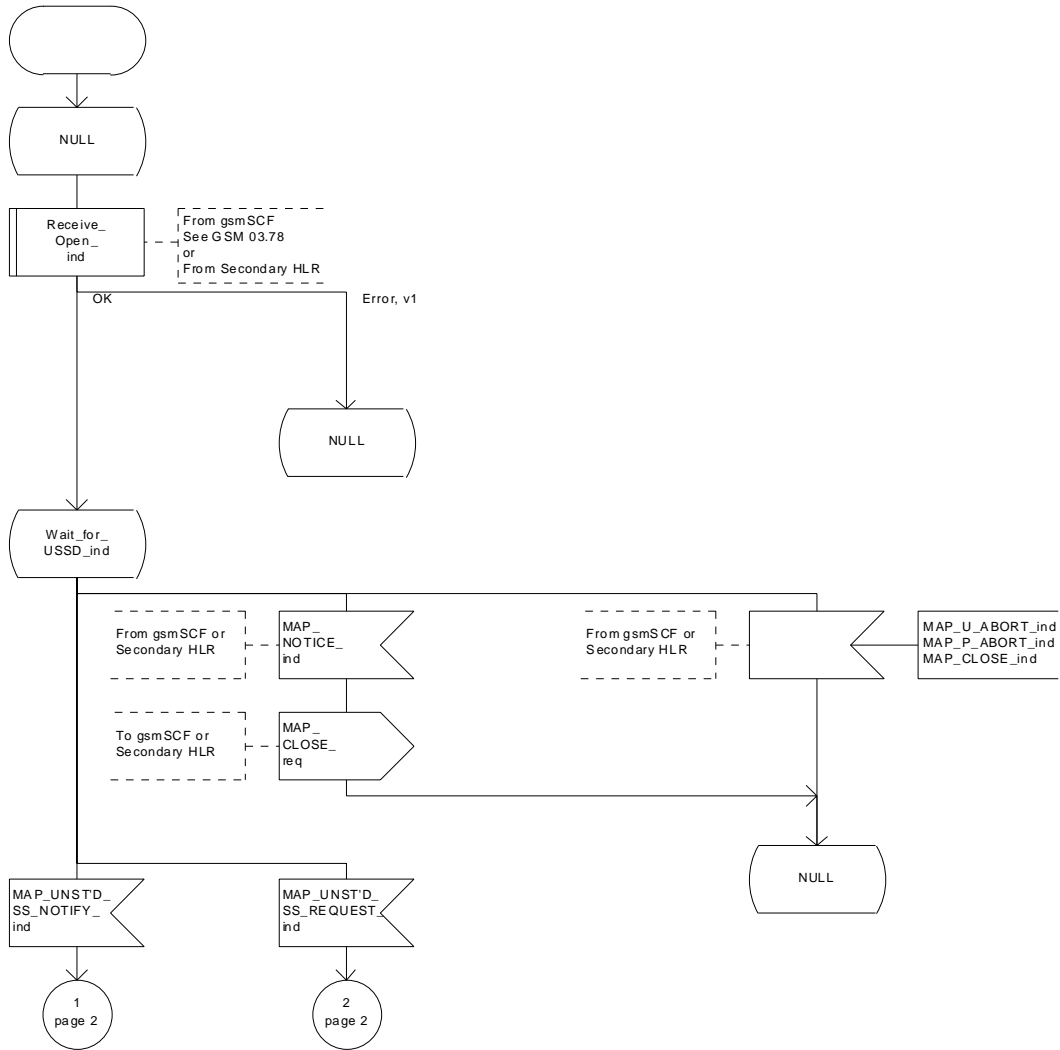

Figure 22.10.4/1 (sheet 1 of 5): Procedure NI_USSD_HLR

Process NW_INIT_USSD_HLR

2(5)

Handling of Network initiated
USSD at the HLR

signals to/from the left
are to/from the VLR;
signals to/from the right
are to/from the next node

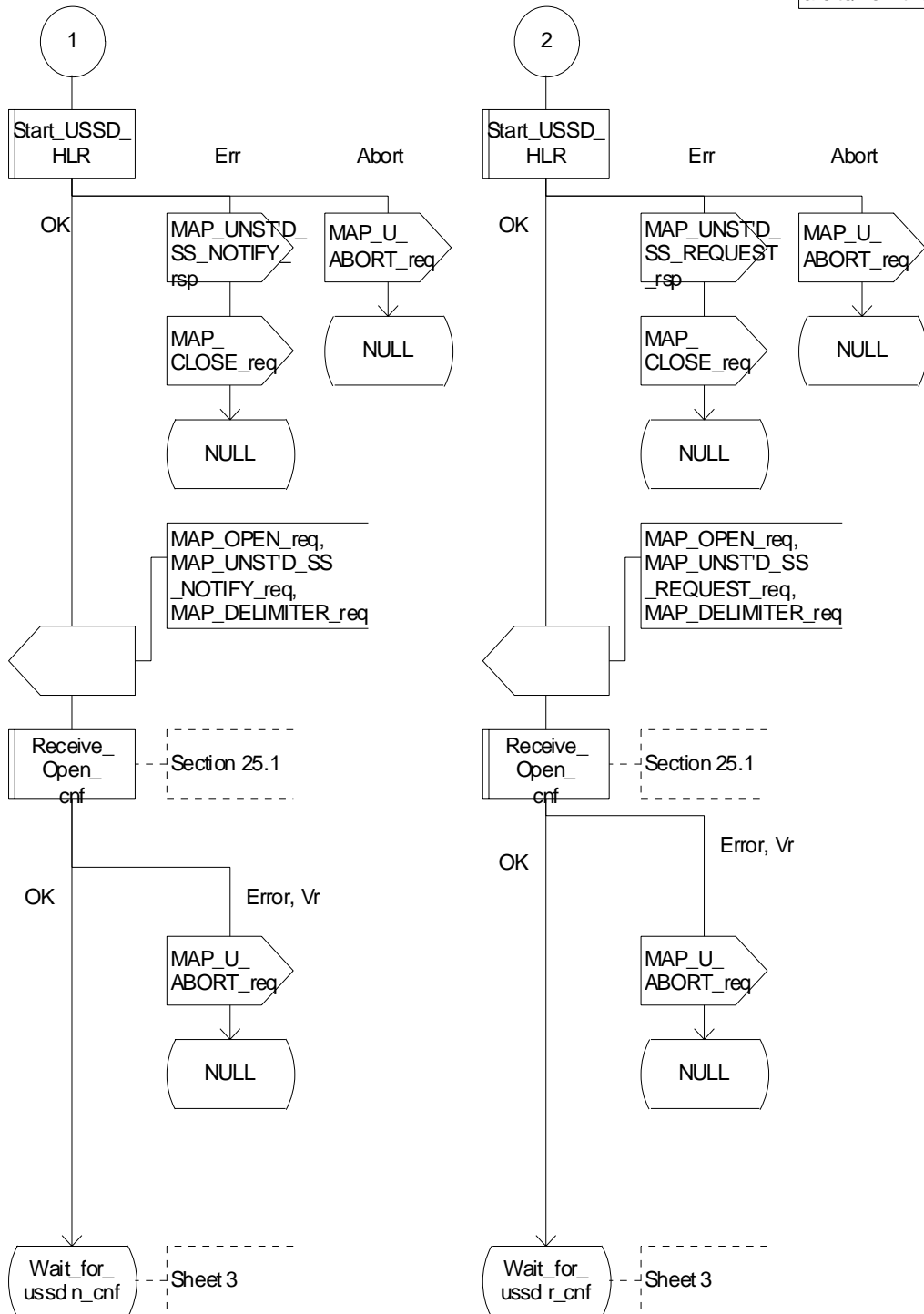

Figure 22.10.4/1 (sheet 2 of 5): Procedure NI_USSD_HLR

Process NW_INIT_USSD_HLR

22.10.4_1.3(5)

Figure 22.10.4/1 Handling of network initiated USSD at HLR

Arrows to left are to VLR.
Arrows to right are to the next node unless otherwise stated.

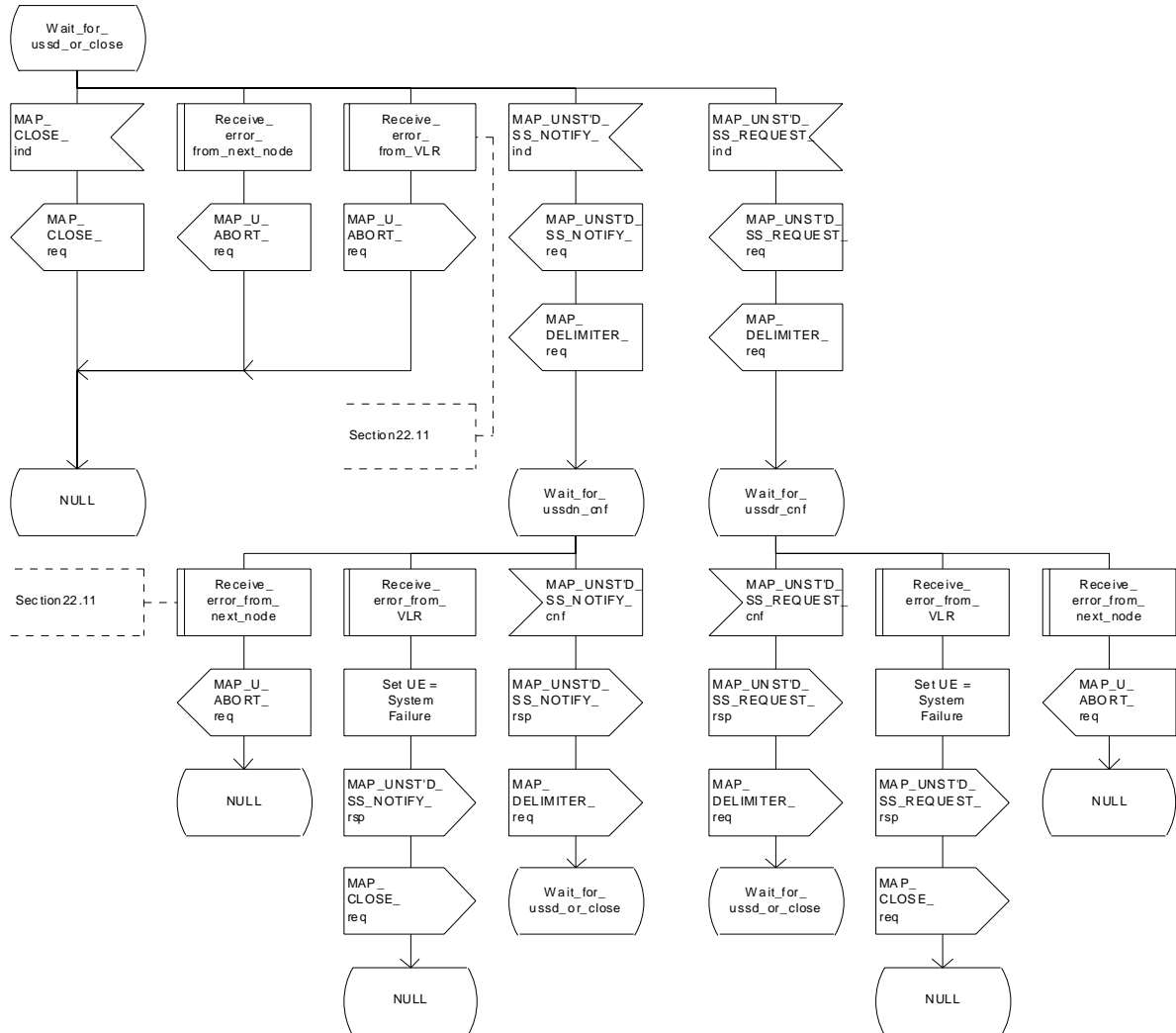

Figure 22.10.4/1 (sheet 3 of 5): Procedure NI_USSD_HLR

Process NW_INIT_USSD_HLR

4(5)

Handling of Network initiated
USSD at the HLR

signals to/from the left
are to/from the VLR;
signals to/from the right
are to/from the USSD application

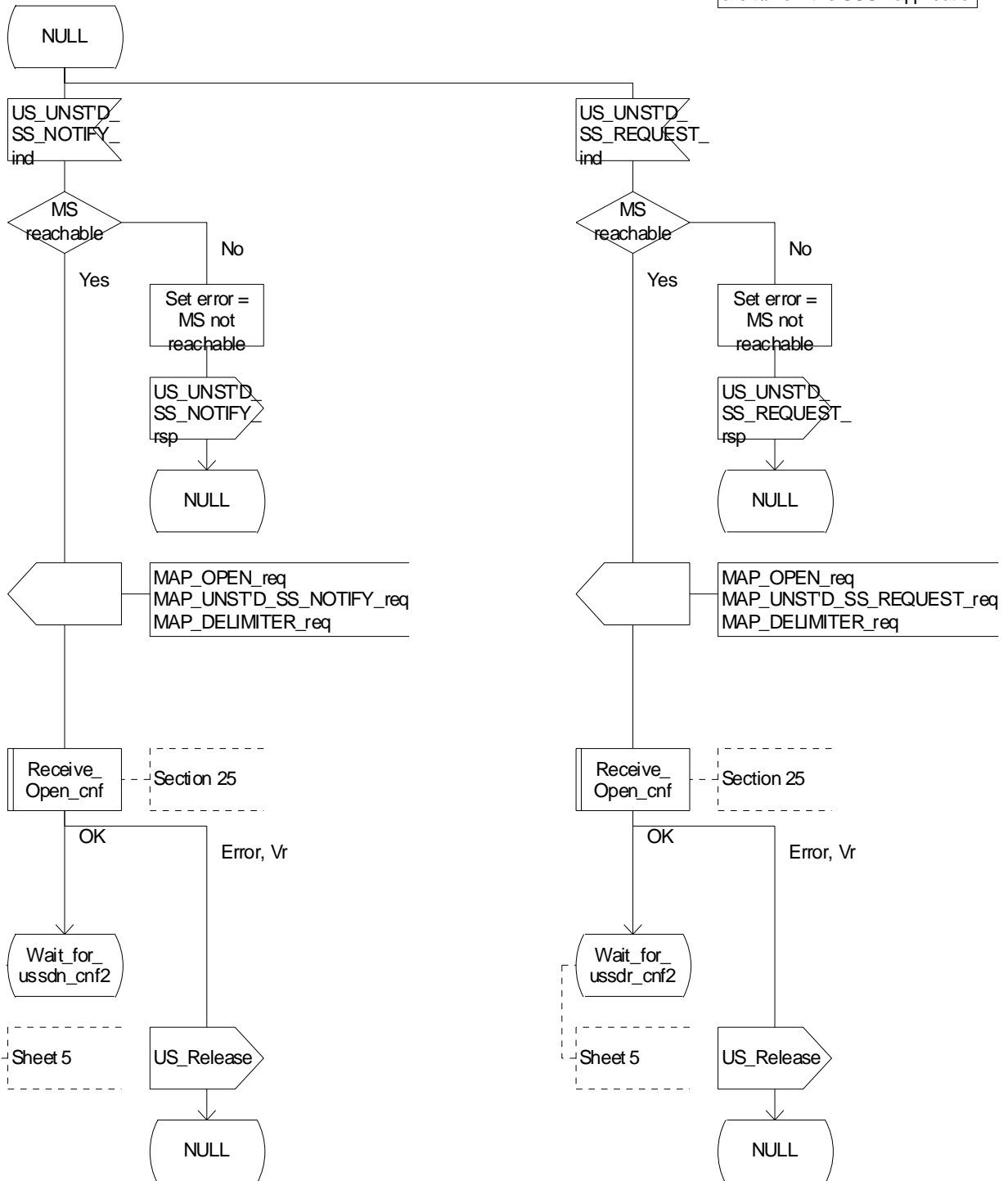

Figure 22.10.4/1 (sheet 4 of 5): Procedure NI_USSD_HLR

Process NW_INIT_USSD_HLR

5(5)

Handling of Network initiated
USSD at the HLR

signals to/from the left
are to/from the VLR;
signals to/from the right
are to/from the USSD application

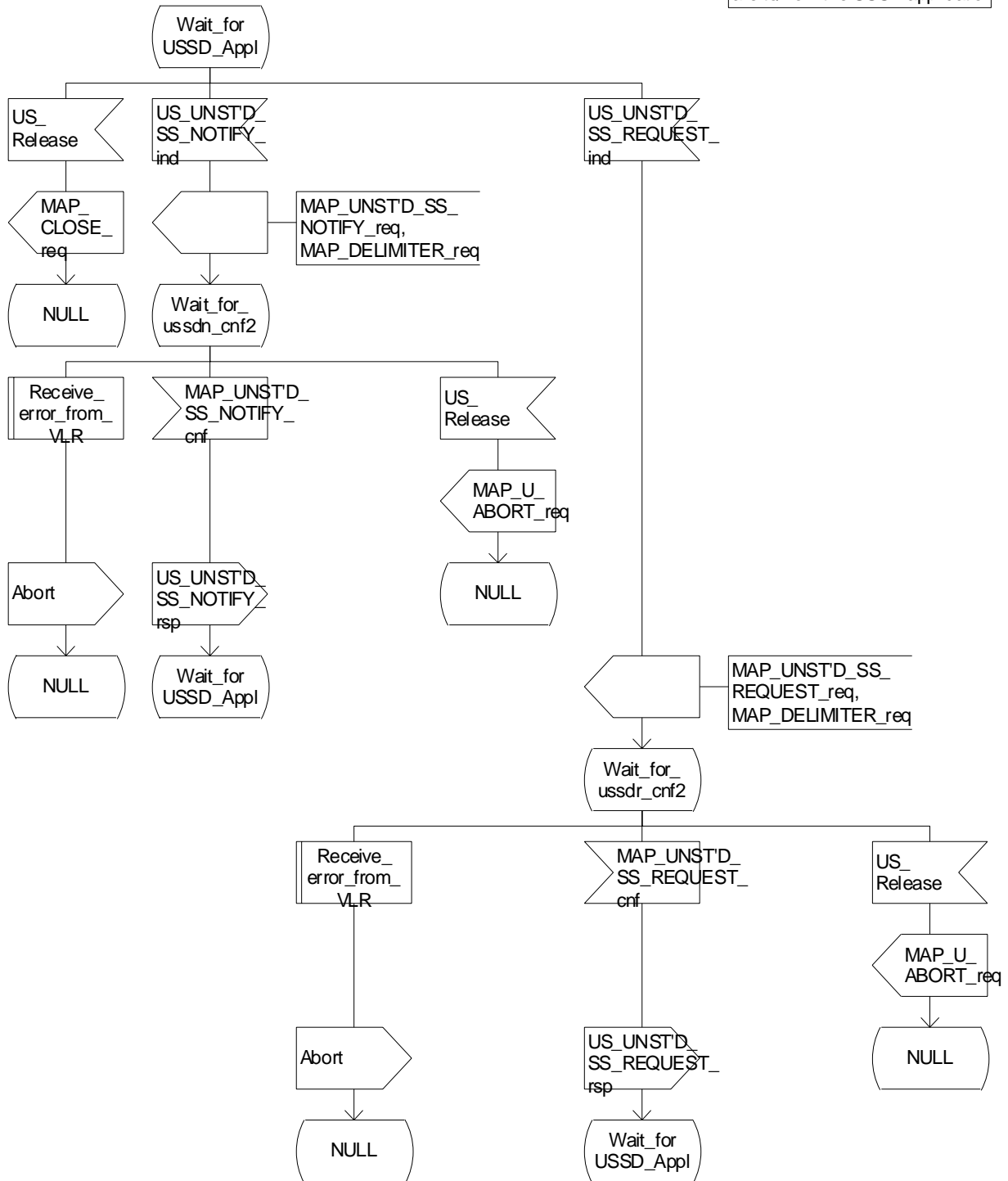

Figure 22.10.4/1 (sheet 5 of 5): Procedure NI_USSD_HLR

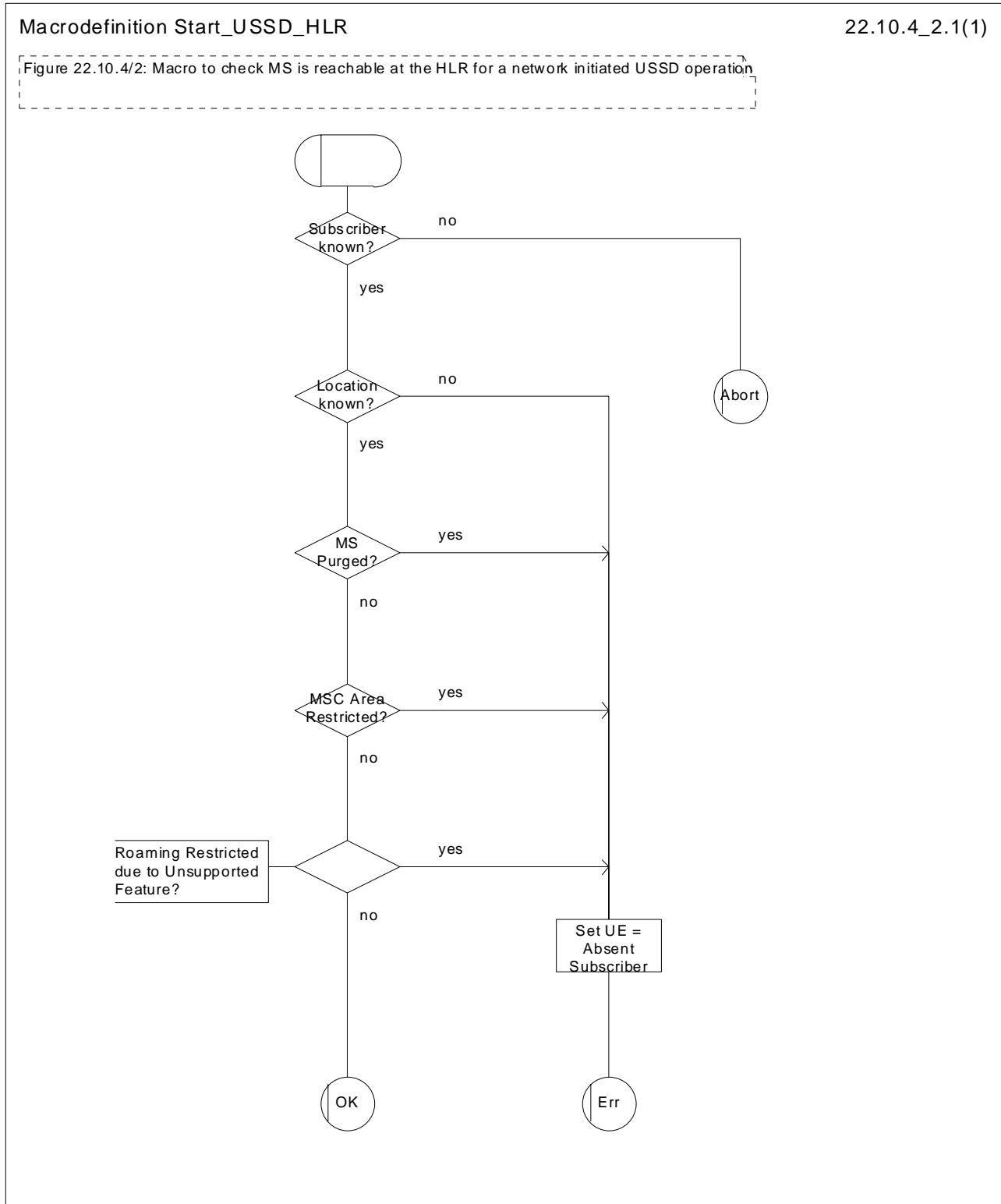

Figure 22.10.4/2: Macro Start_USSD_HLR

22.10.5 Procedure in the gsmSCF and secondary HLR

The procedure is invoked by an USSD application local to the gsmSCF/secondary HLR. It may start by using either the MAP_UNSTRUCTURED_SS_REQUEST or MAP_UNSTRUCTURED_SS_NOTIFY service.

In both cases the gsmSCF will initiate a MAP dialogue with the HLR and send the message received from the USSD application to the HLR.

Following transfer of the message the gsmSCF will wait for a confirmation from the HLR. This will be relayed to the USSD application..

Following this, the gsmSCF/secondary HLR may receive further UNSTRUCTURED_SS_REQUEST or UNSTRUCTURED_SS_NOTIFY requests, or may receive a Release from the USSD application.

In the event of an error, the MAP dialogue with the HLR shall be released as shown in the diagram.

The procedure in the gsmSCF and secondary HLR is shown in figure 22.10.5/1.

Process NW_INIT_USSD_gsmSCF_secondary_HLR

1(2)

Handling of network initiated
USSD at the gsmSCF and
secondary HLR

signals to/from the left
are to/from the HLR;
signals to/from the right
are to/from the USSD application

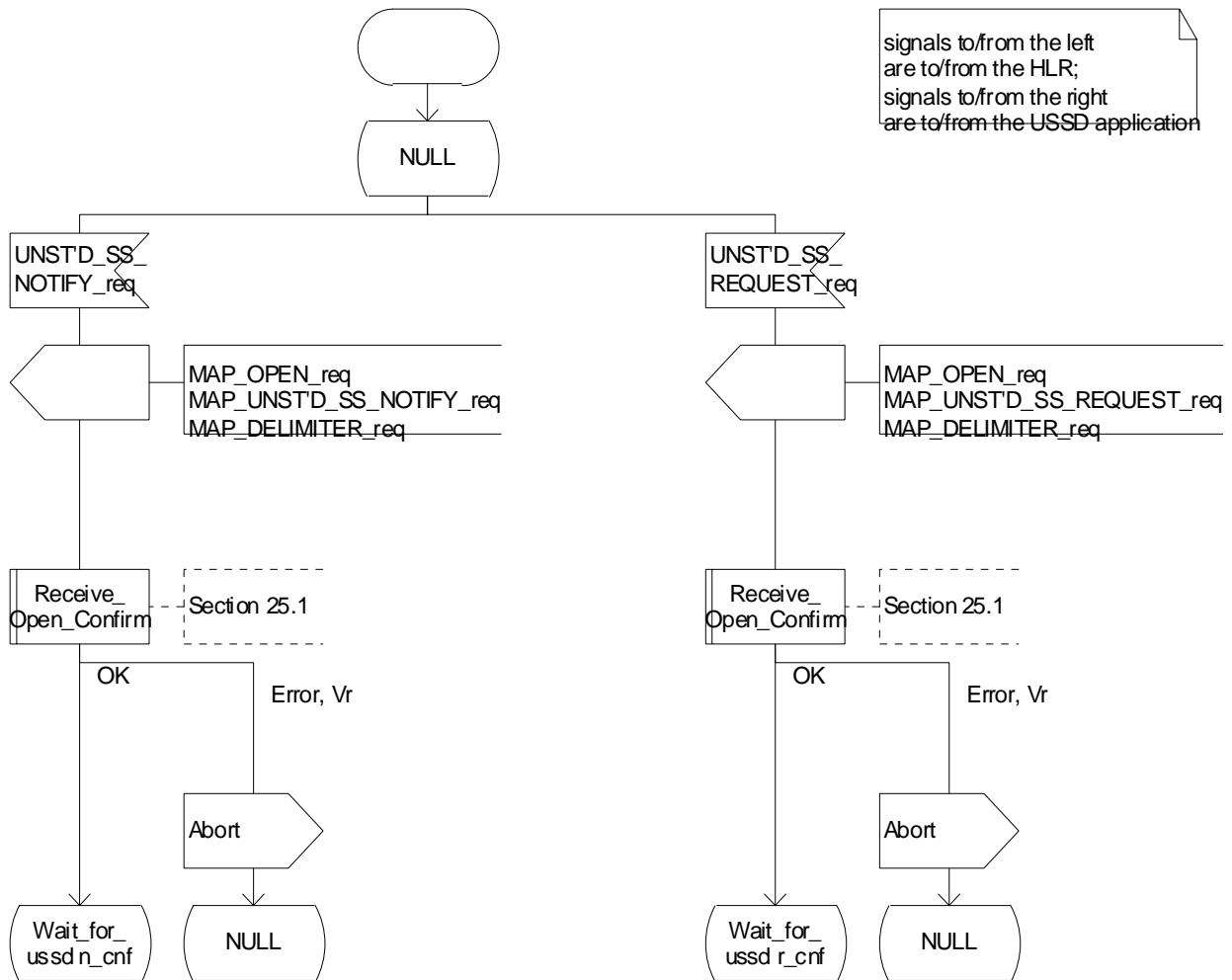

Figure 22.10.5/1 (sheet 1 of 2): Procedure NI_USSD_gsmSCF_secondary_HLR

Process NW_INIT_USSD_gsmSCF_secondary_HLR

2(2)

Handling of network initiated
USSD at the gsmSCF and
secondary HLR

signals to/from the left
are to/from the HLR;
signals to/from the right
are to/from the USSD application

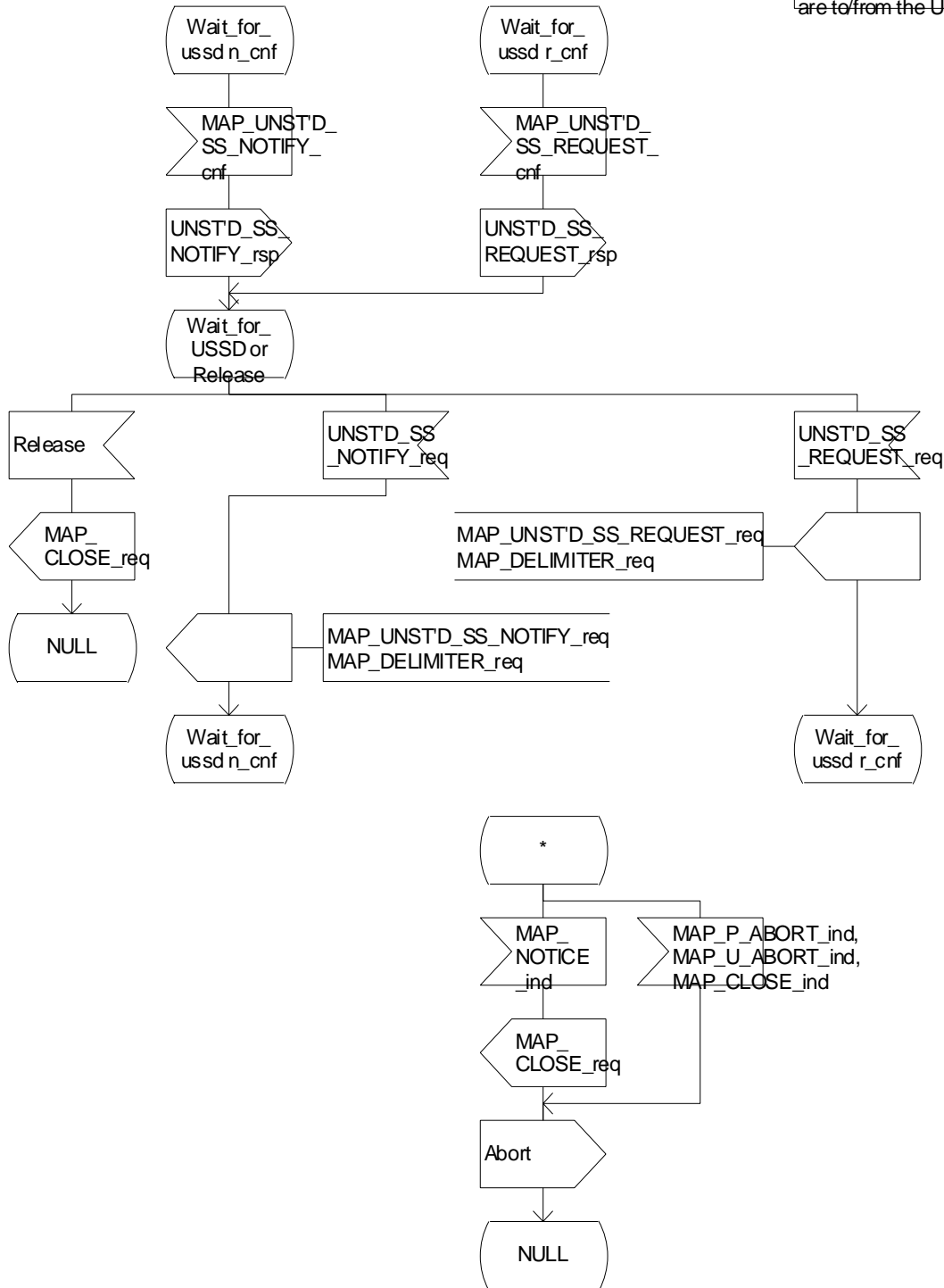

Figure 22.10.5/1 (sheet 2 of 2): Procedure NI_USSD_gsmSCF_secondary_HLR

22.11 Common macros for clause 22

The following macros are used for the description of more than one of the supplementary service processes described in clause 22.

22.11.1 SS Password handling macros

Macro Get_Password_MSC

This macro is used by the MSC to relay a request for password from the VLR to the MS, and to relay a response from the MS back to the VLR. The macro is described in figure 22.11.1/1.

Macro Get_Password_VLR

This macro is used by the VLR to relay a request for password from the HLR to the MSC, and to relay a response from the MSC back to the HLR. The macro is described in figure 22.11.1/2.

Macrodefinition GET_PASSWORD_MSC

22.11.1_1(1)

Figure 22.11.1/1: Macro which relays a GetPassword request from the VLR to the MS and relays the GetPassword response from the MS to the VLR

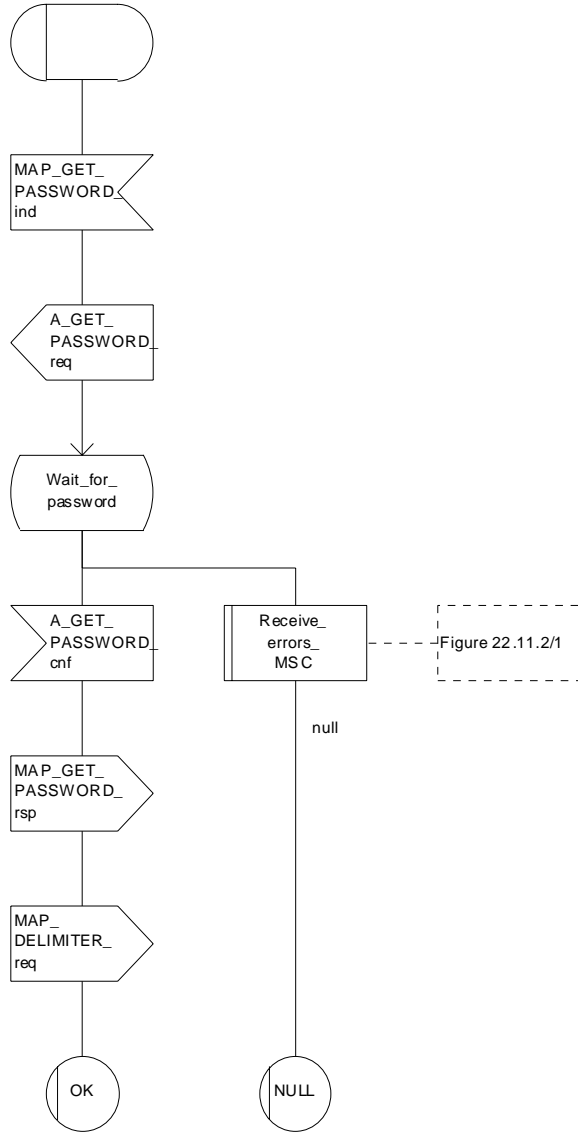

Figure 22.11.1/1: Macro Get_PW_MSC

Macrodefinition GET_PASSWORD_VLR

22.11.1_2(1)

Figure 22.11.1/2: Macro which relay a GetPassword request from the HLR to the VLR and relays the GetPassword response from the VLR to the HLR

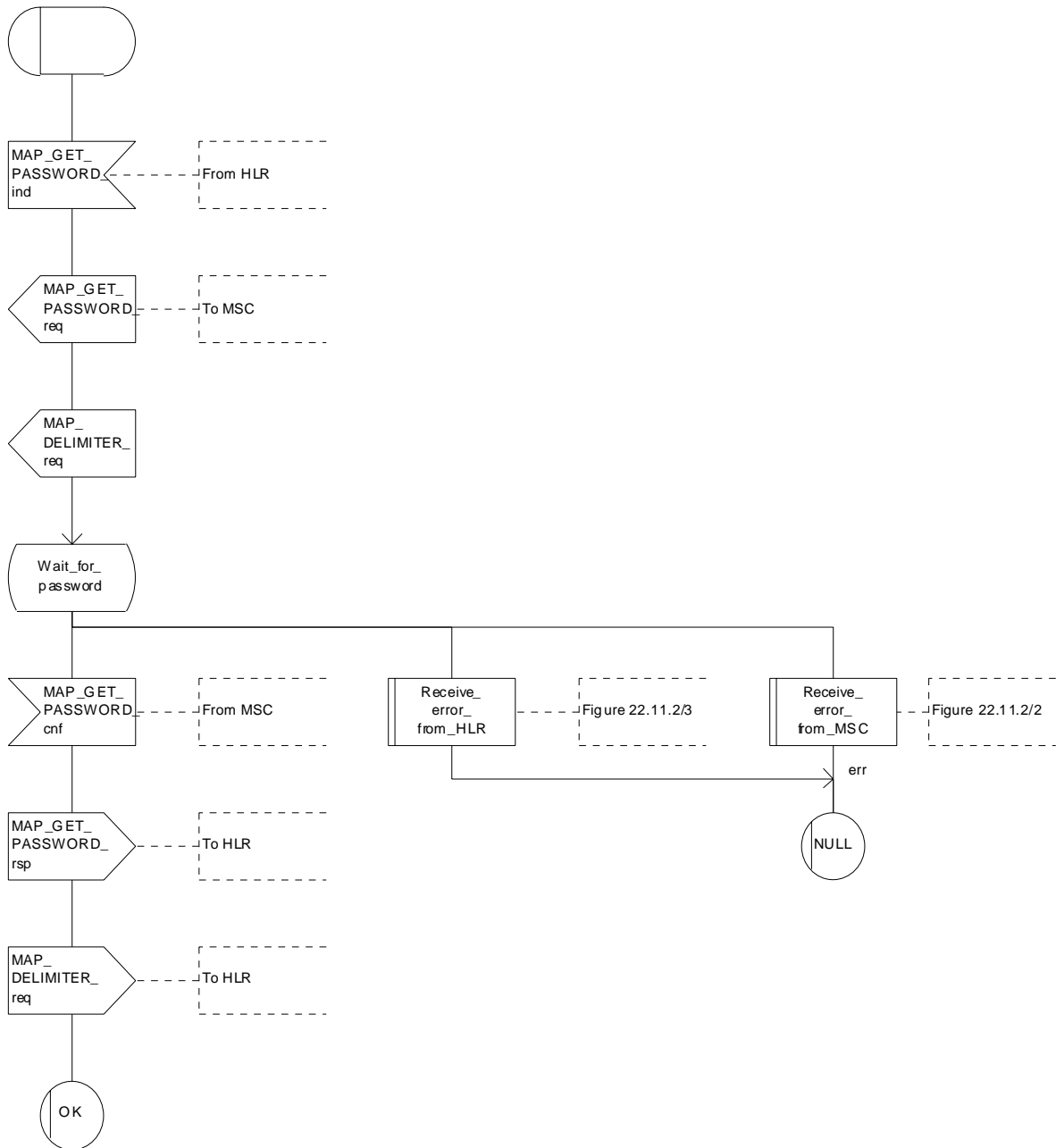

Figure 22.11.1/2: Macro Get_PW_VLR

22.11.2 SS Error handling macros

Macro Receive_errors_MSC

This macro is used by the MSC to receive signals which should lead to failure if received in any state of a supplementary service process. If the air interface connection is released by the MS, the communication towards the VLR is aborted, and the MSC should return to a stable "NULL" state. If a MAP_NOTICE indication is received from the VLR, or the VLR aborts or unexpectedly closes the connection, then the air interface connection shall be released. The macro is described in figure 22.11.2/1.

Macro Receive_error_from_MSC

This macro is used by the VLR to receive signals from the MSC which should lead to failure if received in any state of a supplementary service process. If a MAP_NOTICE indication is received from the MSC, that connection is closed before the only outcome of the macro, "err" is reported back to the calling process. The macro is described in figure 22.11.2/2.

Macro Receive_error_from_HLR

This macro is used by the VLR to receive signals from the HLR which should lead to failure if received in any state of a supplementary service process. If a MAP_NOTICE indication is received from the HLR, that connection is closed. The macro is described in figure 22.11.2/3.

Macro Receive_error_from_VLR

This macro is used by the HLR to receive signals from the VLR that should lead to failure if received in any state of a supplementary service process. If a MAP_NOTICE indication is received from the VLR, that connection is closed before the only outcome of the macro, "err" is reported back to the calling process. The macro is described in figure 22.11.2/4.

Macro Receive_error_from_next_node

This macro is used by the primary HLR to receive signals from the gsmSCF or secondary HLR that should lead to failure if received in any state of a supplementary service process. If a MAP_NOTICE indication is received from the next node, that connection is closed. The macro is described in figure 22.11.2/5.

Macrodefinition Receive_errors_MSC

22.11.2_1(1)

Figure 22.11.2/1: Macro which handles possible error situations while the MSC is waiting for a confirmation of a supplementary service request to the VLR

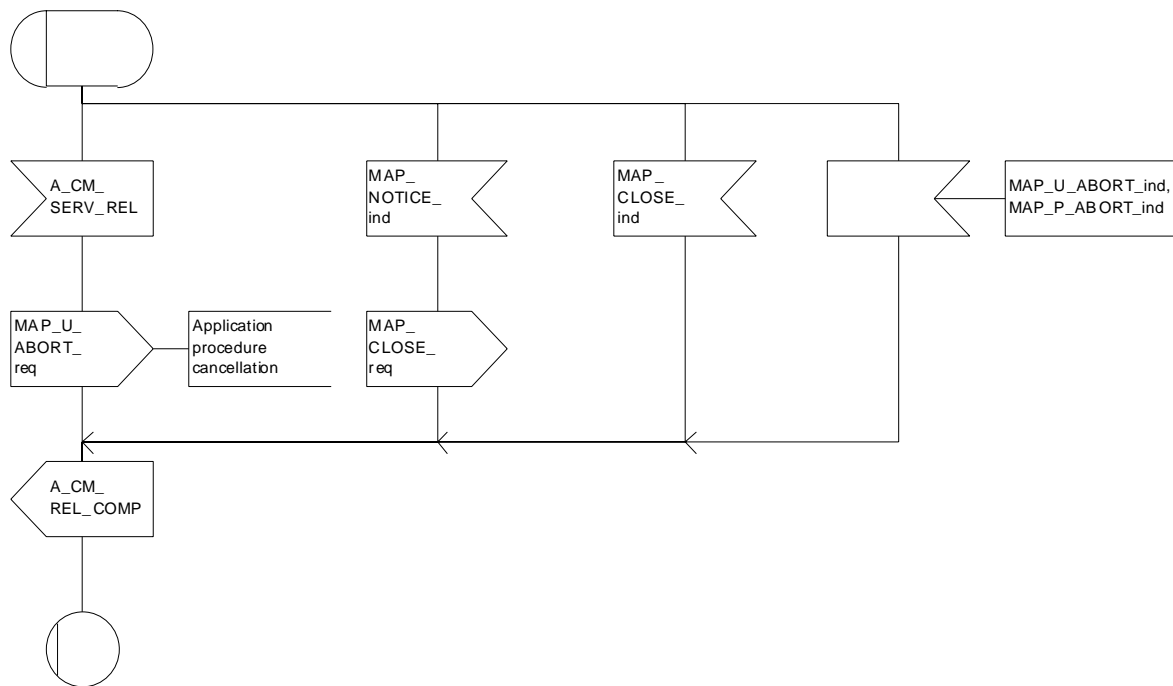

Figure 22.11.2/1: Macro Receive_Errors_MSC

Macrodefinition Receive_error_from_MSC

22.11.2_2(1)

Figure 22.11.2/2: Macro to receive errors from the MSC during supplementary services procedures in the VLR

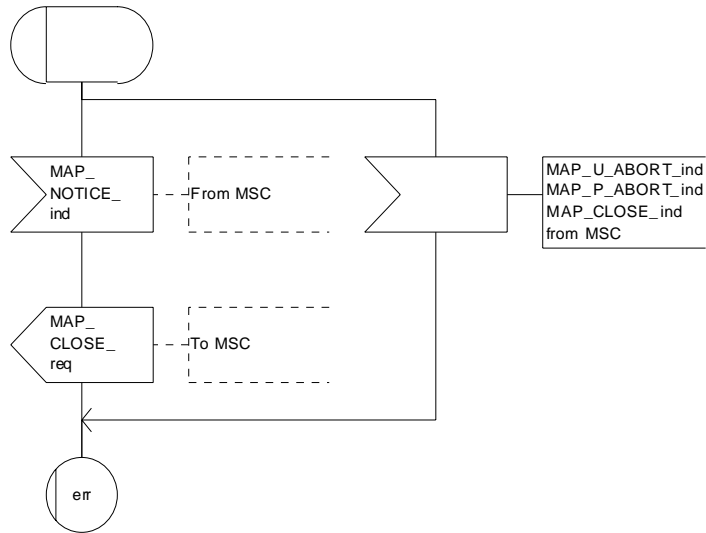

Figure 22.11.2/2: Macro Receive_Error_from_MSC

Macrodefinition Receive_error_from_HLR

22.11.2_3(1)

Figure 22.11.2/3: Macro to receive errors from the HLR while the VLR is waiting for a confirmation of a supplementary service request sent to the HLR

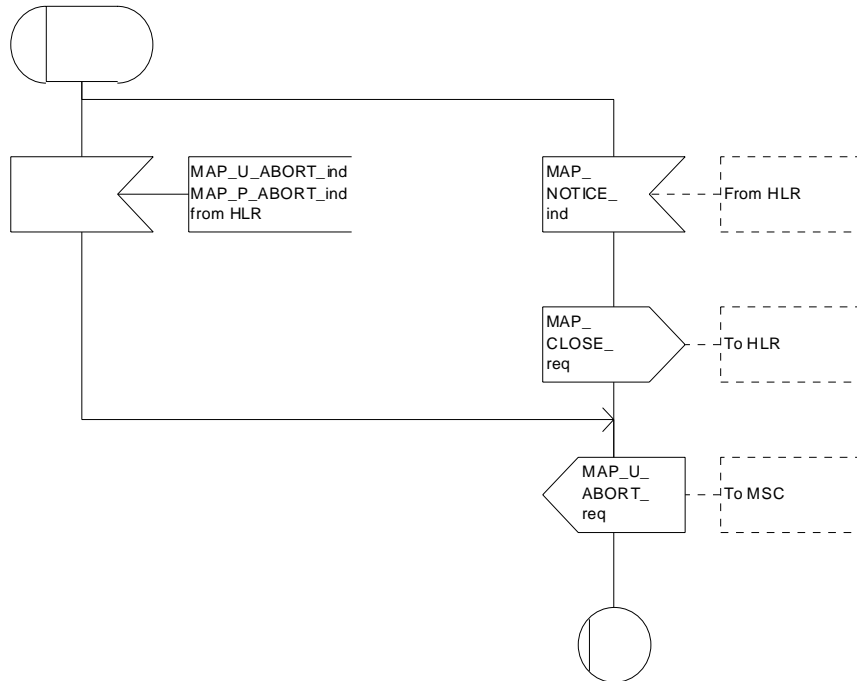

Figure 22.11.2/3: Macro Receive_Errors_HLR

Macrodefinition Receive_error_from_VLR

22.11.2_4(1)

Figure 22.11.2/4: Macro to receive errors from the VLR during supplementary services procedures in the HLR

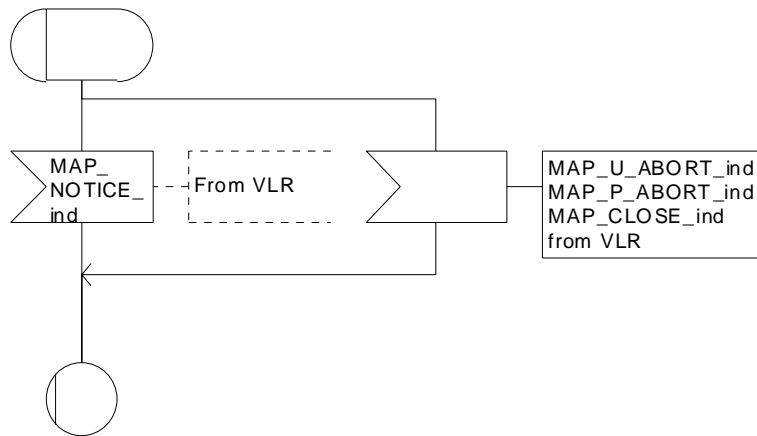

Figure 22.11.2/4: Macro Receive_error_from_VLR

Macrodefinition Receive_error_from_next_node

22.11.2_5(1)

Figure 22.11.2/5: Macro to receive errors from the next node while the HLR is waiting for a confirmation of a supplementary service request sent to the next node

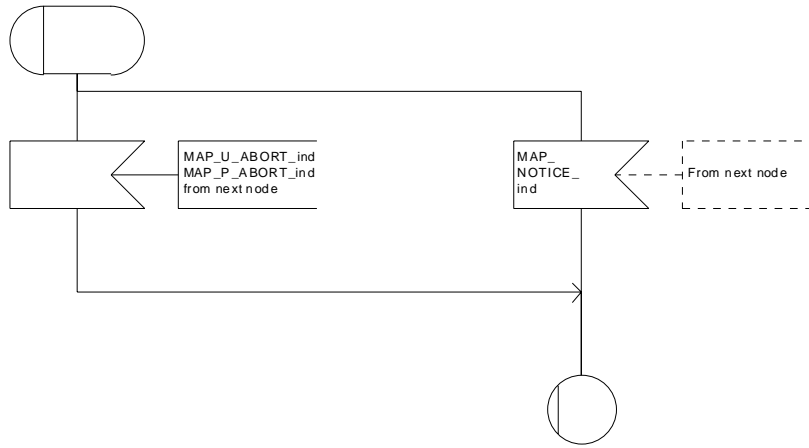

Figure 22.11.2/5: Macro Receive_error_from_next_node

22.12 Supplementary Service Invocation Notification procedure

22.12.1 General

The Supplementary Service Invocation Notification procedure is used to notify a gsmSCF about the invocation of a GSM Supplementary Service.

The password registration procedure is shown in figure 22.12.1/1.

The following services may be used:

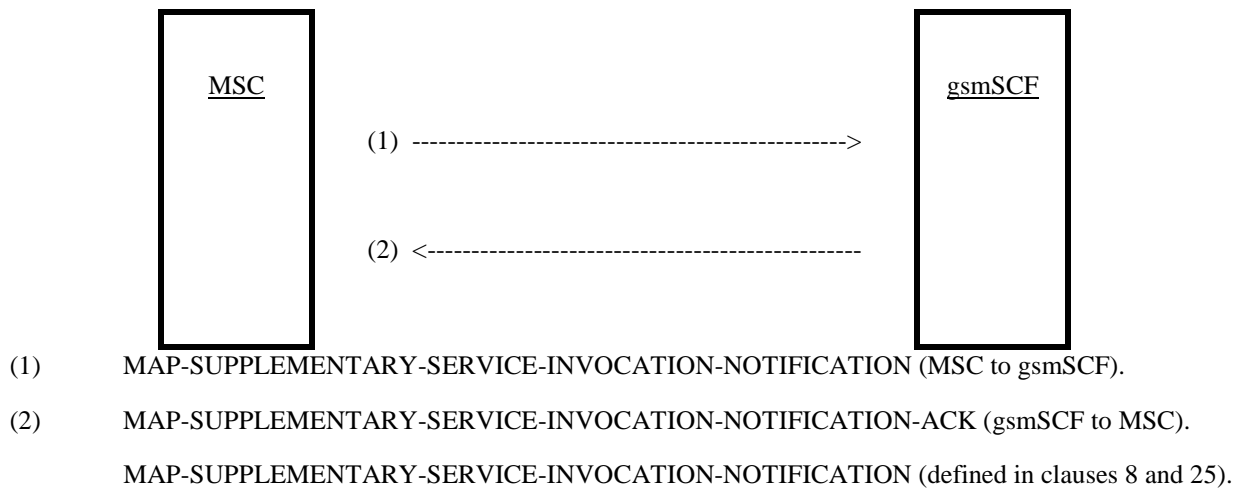

Figure 22.12.1/1: Interfaces and services for supplementary service invocation notification

22.12.2 Procedures in the MSC

The supplementary service invocation notification procedure in the MSC is triggered when the requested supplementary service is invoked at the MSC. The MSC notifies the gsmSCF of a supplementary service invocation via the MAP-SUPPLEMENTARY-SERVICE-INVOCATION-NOTIFICATION service. This is sent in a TCAP TC-BEGIN primitive. The MSC then awaits a positive or negative acknowledgement from the gsmSCF to the MAP-SUPPLEMENTARY-SERVICE-INVOCATION-NOTIFICATION. This is received in a TCAP TC-END primitive, and upon receipt the relationship between the MSC and the gsmSCF is terminated. Similarly, the relationship is terminated at the MSC by the sending of or receipt of a TCAP P-ABORT primitive. This is illustrated in figure 22.12.2/1.

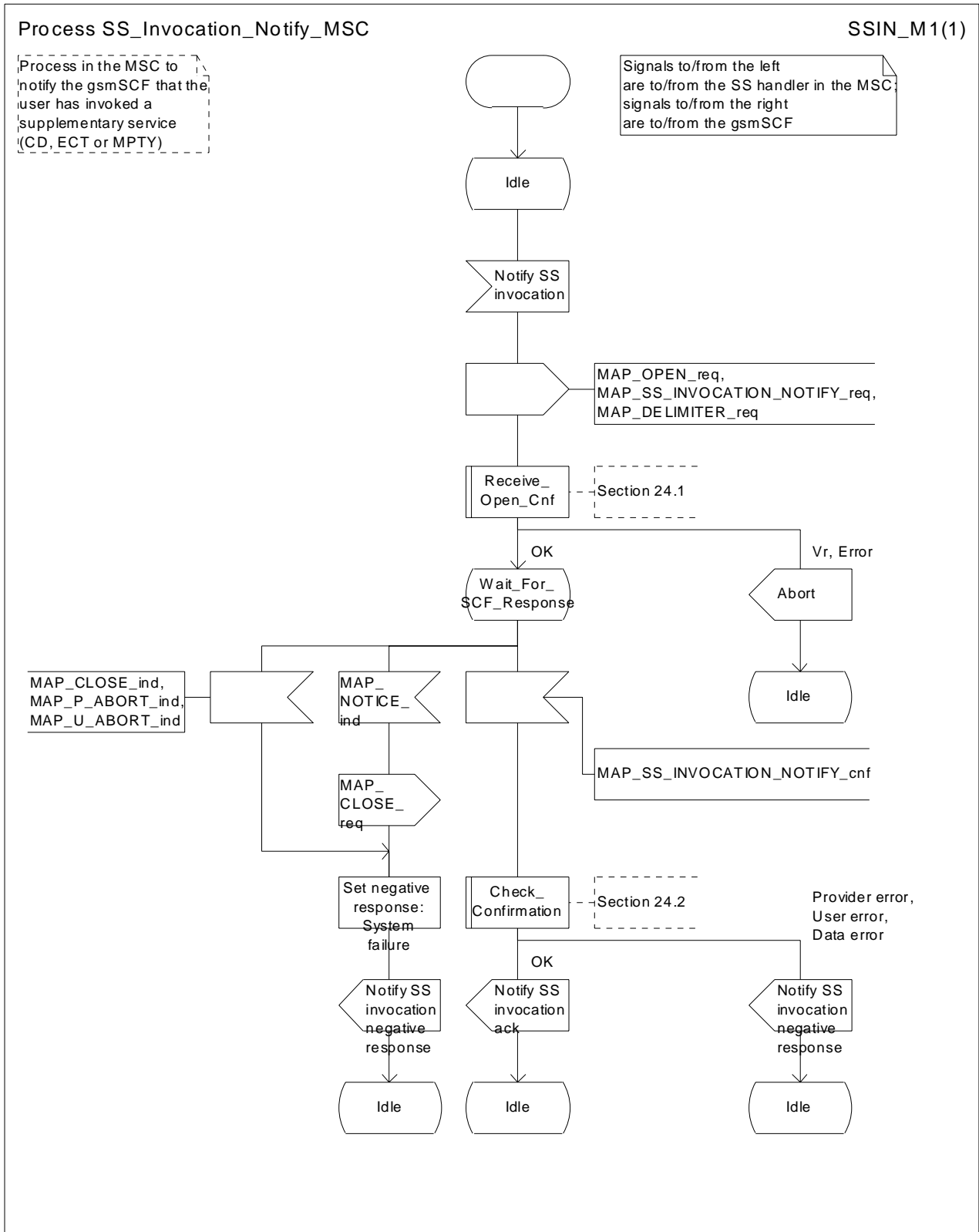

Figure 22.12.2/1: Process SS_Invocation_Notify_MSC (sheet 1 of 1)

22.12.3 Procedures in the gsmSCF

Upon receiving notification of the supplementary service invocation via the MAP-SUPPLEMENTARY-SERVICE-INVOCATION-NOTIFICATION service, the gsmSCF analyses the received information. If the gsmSCF understands the information sent via the MAP-SUPPLEMENTARY-SERVICE-INVOCATION-NOTIFICATION service then it returns a positive acknowledgement to the MAP-SUPPLEMENTARY-SERVICE-INVOCATION-NOTIFICATION, indicating the success of the service. This is returned in a TCAP TC-END primitive, using the basic end procedure.

Otherwise, a negative acknowledgement to the MAP-SUPPLEMENTARY-SERVICE-INVOCATION-NOTIFICATION is returned. This is also returned in a TCAP TC-END primitive, again using the basic end procedure. The gsmSCF TCAP service may also choose to abort the relationship to the MSC by sending a TCAP P-ABORT primitive. It will immediately terminate processing of a MAP-SUPPLEMENTARY-SERVICE-INVOCATION-NOTIFICATION should a TCAP P-ABORT primitive be received from the MSC. This is illustrated in figure 22.12.3/1.

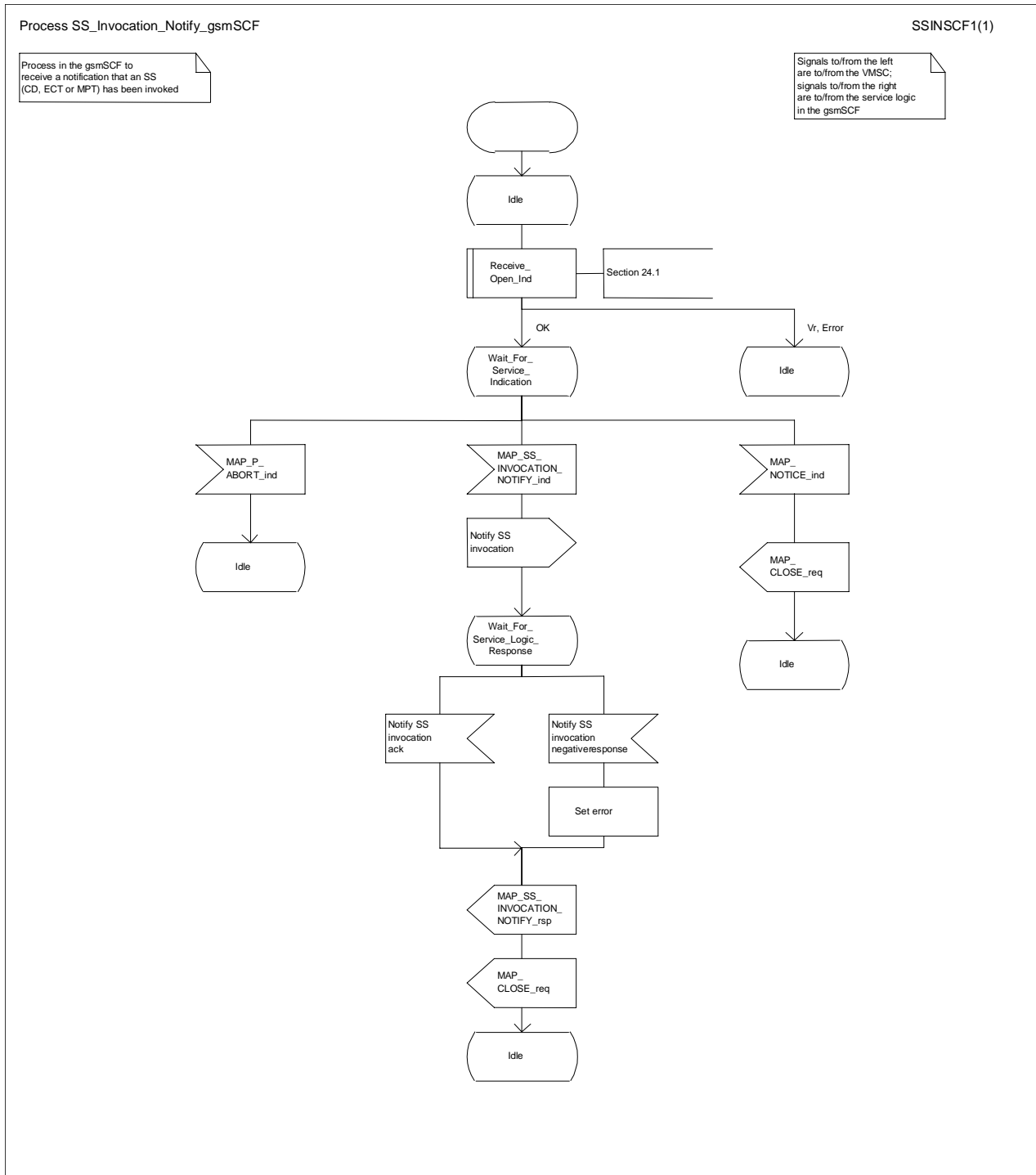

Figure 22.12.3/1: Process SS_Invocation_Notify_gsmSCF (sheet 1 of 1)

22.13 Activation of a CCBS request

22.13.1 General

The message flow to activate a CCBS request is shown in figure 22.13.1/1.

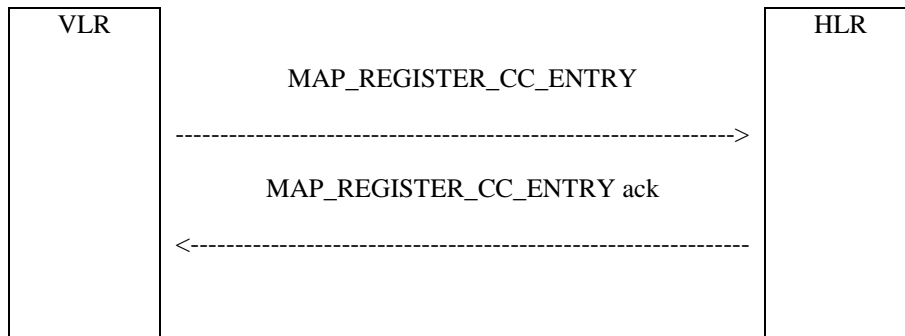

Figure 22.13.1/1: Message flow to activate a CCBS request

22.13.2 Procedure in the VLR

The MAP process in the VLR to activate a CCBS request is shown in figure 22.13.2/1. The MAP process invokes macros not defined in this clause; the definitions of these macros can be found as follows:

Receive_Open_Cnf	see clause 25.1.2;
Check_Confirmation	see clause 25.2.2.

Successful Outcome

When the MAP process receives a CCBS Request message from the CCBS application process in the VLR, it requests a dialogue with the HLR whose identity is contained in the request by sending a MAP_OPEN service request and the necessary information in a MAP_REGISTER_CC_ENTRY service request. The VLR then invokes the macro Receive_Open_Cnf to wait for the response to the dialogue opening request. If the dialogue opening is successful, the MAP process waits for a response from the HLR.

If the MAP process receives a MAP_REGISTER_CC_ENTRY service confirm from the HLR, the MAP process invokes the macro Check_Confirmation to check the content of the confirm.

If the macro Check_Confirmation takes the OK exit, the MAP process sends a CCBS Request Ack message containing the information received from the HLR to the CCBS application process in the VLR and returns to the idle state.

Failure of dialogue opening with the HLR

If the macro Receive_Open_Cnf takes the Vr exit or the Error exit, the MAP process sends a CCBS Request Negative response message to the CCBS application process in the VLR and returns to the idle state.

Error in MAP_REGISTER_CC_ENTRY confirm

If the MAP_REGISTER_CC_ENTRY service confirm contains a user error or a provider error, or the macro Check_Confirmation indicates that there is a data error, the MAP process sends a CCBS Request Negative response message to the CCBS application process in the VLR and returns to the idle state.

Abort of HLR dialogue

After the dialogue with the HLR has been established, the MAP service provider may abort the dialogue by issuing a MAP_P_ABORT indication. In this case, the MAP process sends a CCBS Request negative response to the CCBS application process in the VLR and returns to the idle state.

If the MAP provider indicates a protocol problem by sending a MAP_NOTICE indication, the MAP process closes the dialogue with the HLR, sends a CCBS Request negative response indicating system failure to the CCBS application process in the VLR and returns to the idle state.

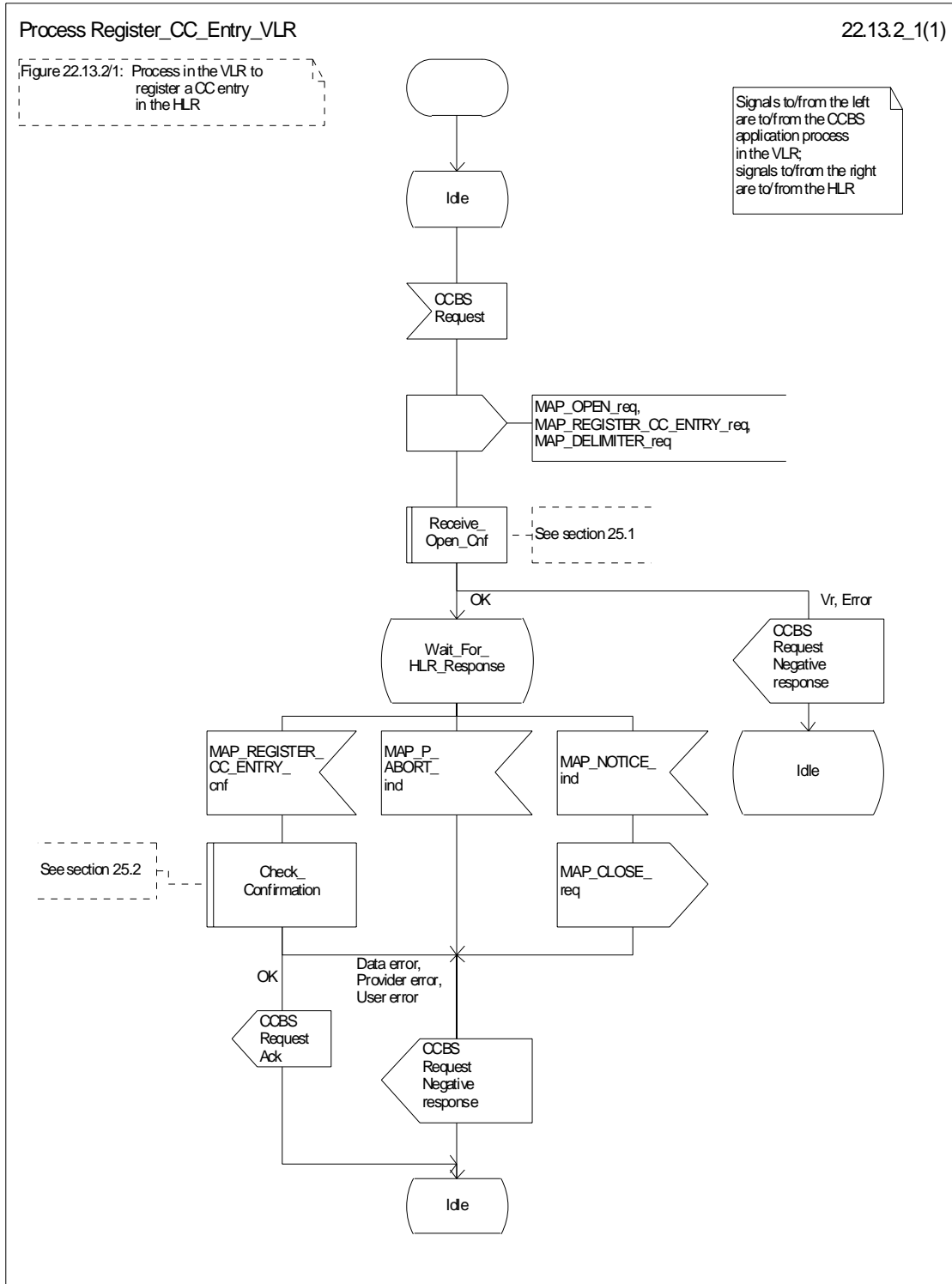

Figure 22.13.2/1: Process Register_CC_Entry_VLR

22.13.3 Procedure in the HLR

Successful outcome

When the MAP process receives a MAP_REGISTER_CC_ENTRY_indication from the co-ordinating process, it sends a CCBS Request message to the CCBS application process in the HLR, and waits for a response. The request contains the parameters received in the MAP_REGISTER_CC_ENTRY service indication.

If the CCBS application process in the HLR returns a positive response, the MAP process constructs a MAP_REGISTER_CC_ENTRY service response, constructs a MAP_CLOSE service request, sends them to the co-ordinating process and terminates.

Negative response from HLR CCBS application process

If the CCBS application process in the HLR returns a negative response, the MAP process constructs a MAP_REGISTER_CC_ENTRY service response containing the appropriate error, constructs a MAP_CLOSE service request, sends them to the co-ordinating process and terminates.

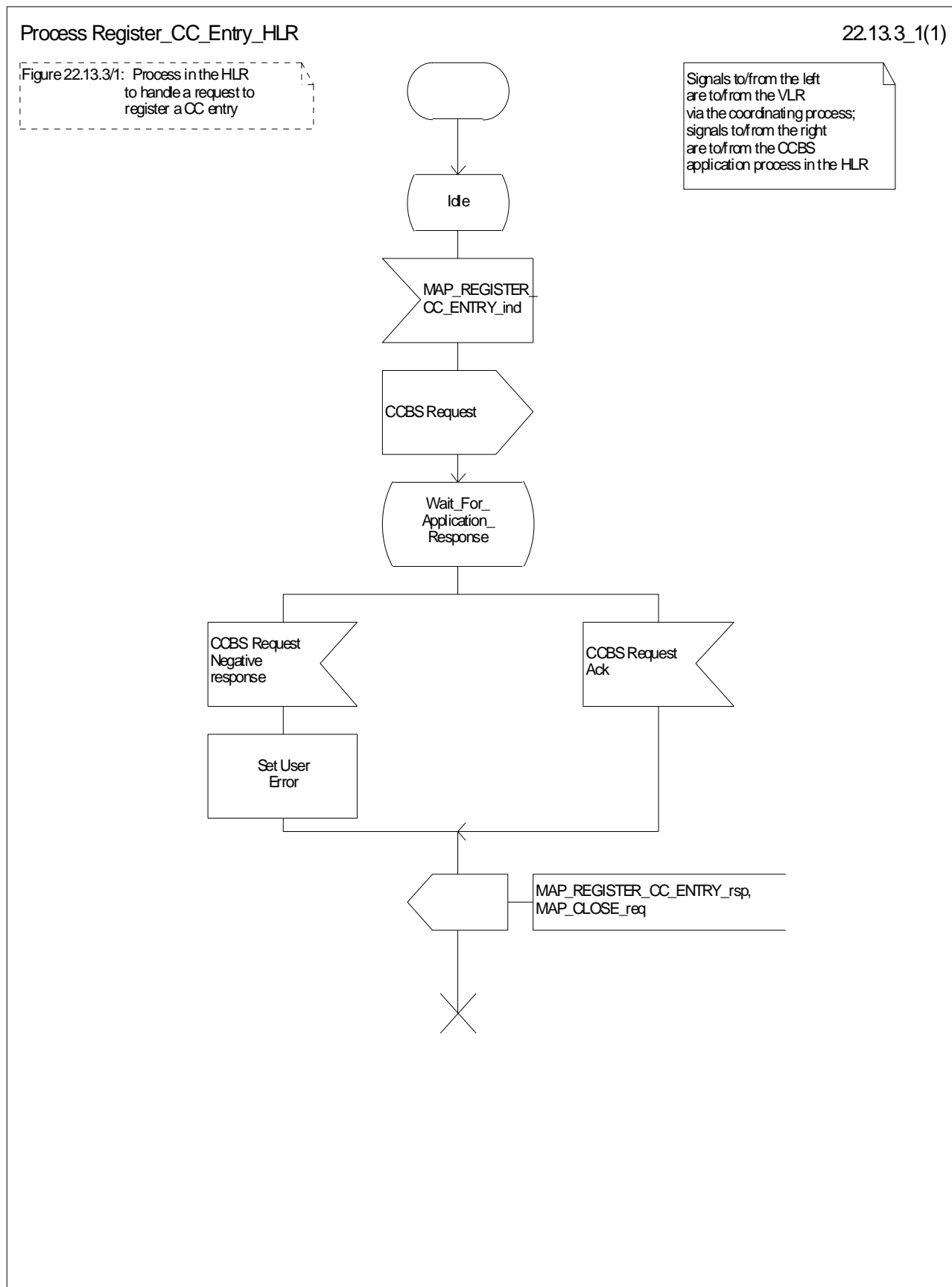

Figure 22.13.3/1: Process Register_CC_Entry_HLR

22.14 Deactivation of a CCBS request

22.14.1 General

The message flow to deactivate a CCBS request is shown in figure 22.14.1/1.

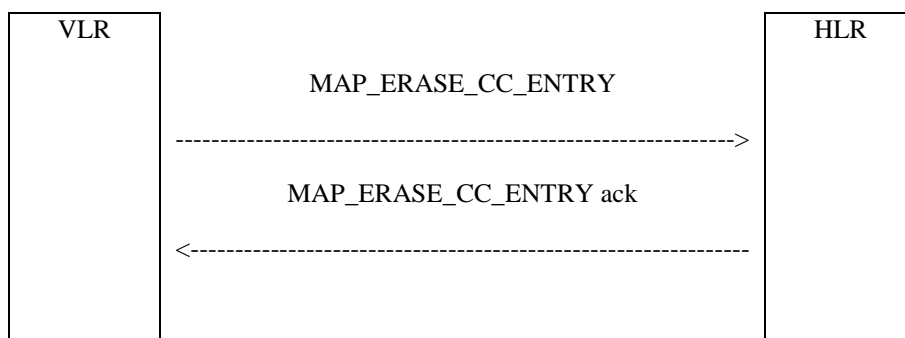

Figure 22.14.1/1: Message flow to deactivate a CCBS request

22.14.2 Procedure in the VLR

The MAP process in the VLR to deactivate a CCBS request is shown in figure 22.14.2/1. The MAP process invokes macros not defined in this clause; the definitions of these macros can be found as follows:

Receive_Open_Cnf	see clause 25.1.2;
Check_Confirmation	see clause 25.2.2.

Successful Outcome

When the MAP process receives a Deactivate CCBS message from the CCBS application process in the VLR, it requests a dialogue with the HLR whose identity is contained in the request by sending a MAP_OPEN service request and the necessary information in a MAP_ERASE_CC_ENTRY service request. The VLR then invokes the macro Receive_Open_Cnf to wait for the response to the dialogue opening request. If the dialogue opening is successful, the MAP process waits for a response from the HLR.

If the MAP process receives a MAP_ERASE_CC_ENTRY service confirm from the HLR, the MAP process invokes the macro Check_Confirmation to check the content of the confirm.

If the macro Check_Confirmation takes the OK exit, the MAP process sends a Deactivate CCBS Ack message containing the information received from the HLR to the CCBS application process in the VLR and returns to the idle state.

Failure of dialogue opening with the HLR

If the macro Receive_Open_Cnf takes the Vr exit or the Error exit, the MAP process sends a Deactivate CCBS Negative response message to the CCBS application process in the VLR and returns to the idle state.

Error in MAP_ERASE_CC_ENTRY confirm

If the MAP_ERASE_CC_ENTRY service confirm contains a user error or a provider error, or the macro Check_Confirmation indicates that there is a data error, the MAP process sends a Deactivate CCBS Negative response message to the CCBS application process in the VLR and returns to the idle state.

Abort of HLR dialogue

After the dialogue with the HLR has been established, the MAP service provider may abort the dialogue by issuing a MAP_P_ABORT indication. In this case, the MAP process sends a Deactivate CCBS negative response to the CCBS application process in the VLR and returns to the idle state.

If the MAP provider indicates a protocol problem by sending a MAP_NOTICE indication, the MAP process closes the dialogue with the HLR, sends a Deactivate CCBS negative response indicating system failure to the CCBS application process in the VLR and returns to the idle state.

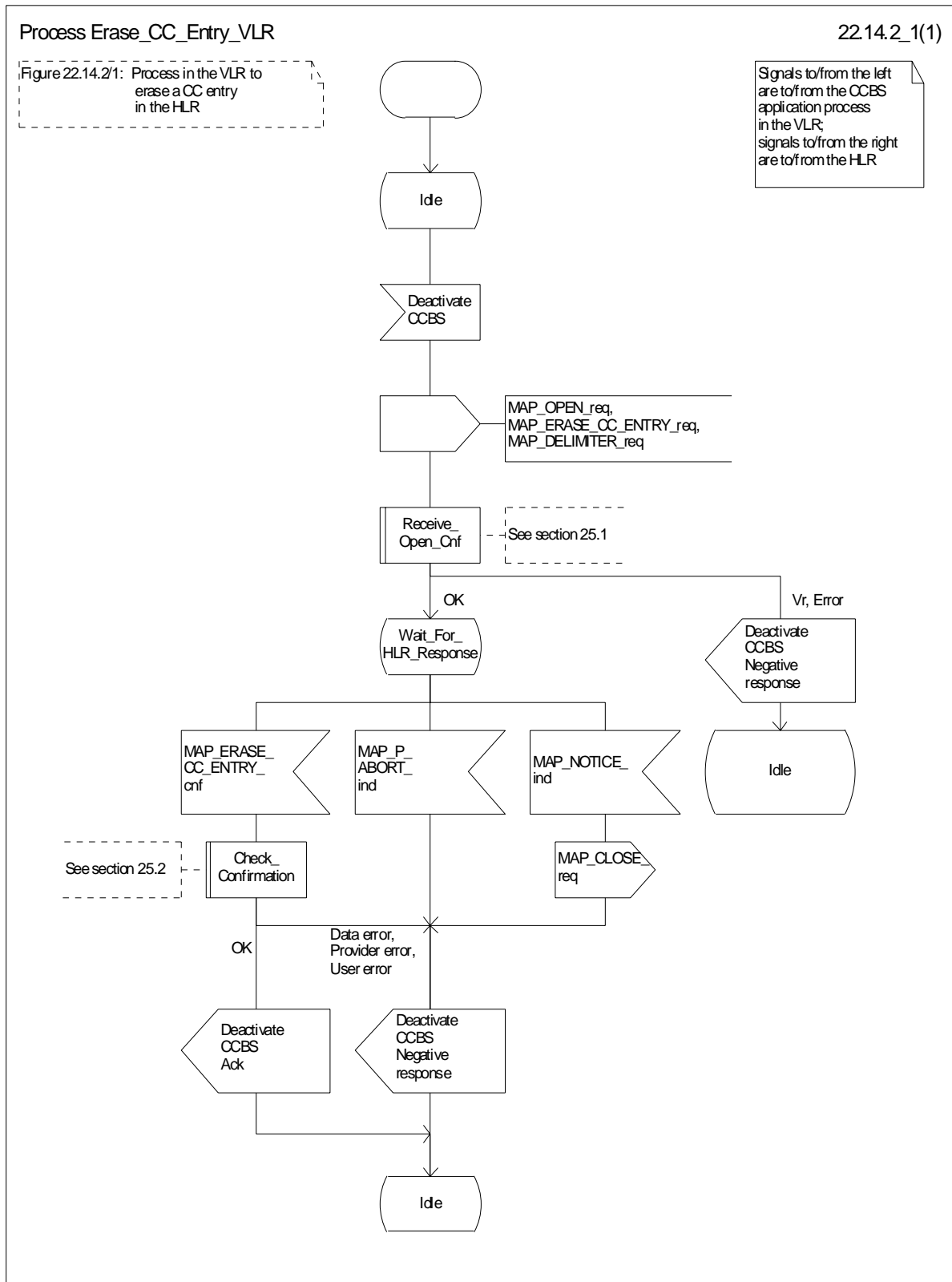

Figure 22.14.2/1: Process Erase_CC_Entry_VLR

22.14.3 Procedure in the HLR

Successful outcome

When the MAP process receives a MAP_ERASE_CC_ENTRY_indication from the co-ordinating process, it sends a Deactivate CCBS message to the CCBS application process in the HLR, and waits for a response. The message contains the parameters received in the MAP_ERASE_CC_ENTRY service indication.

If the CCBS application process in the HLR returns a positive response, the MAP process constructs a MAP_ERASE_CC_ENTRY service response, constructs a MAP_CLOSE service request, sends them to the co-ordinating process and terminates.

Negative response from HLR CCBS application process

If the CCBS application process in the HLR returns a negative response, the MAP process constructs a MAP_ERASE_CC_ENTRY service response containing the appropriate error, constructs a MAP_CLOSE service request, sends them to the co-ordinating process and terminates.

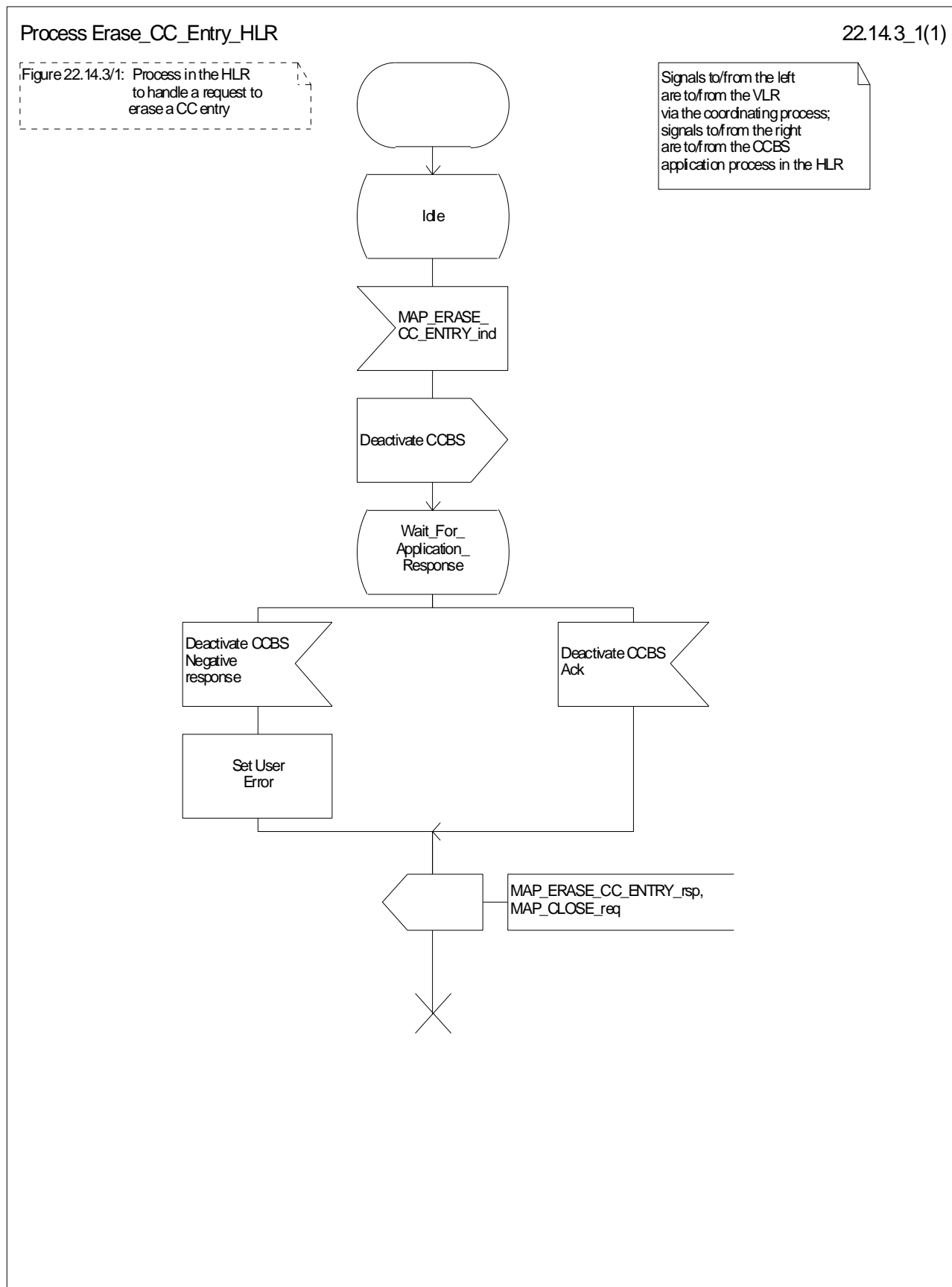

Figure 22.14.3/1: Process Erase_CC_Entry_HLR

23 Short message service procedures

23.1 General

The short message service procedures are used to control both mobile originated and mobile terminated short message transfer.

Four procedures exist for short message services:

- mobile originated short message service transfer;
- mobile terminated short message service transfer;
- short message alert procedure;
- short message waiting data set procedure.

The following application context refers to a complex MAP user consisting of several processes:

- shortMessageGatewayContext.

This application context needs a co-ordinating process in the HLR. Additionally a Co-ordinator has to be defined for the mobile originated situation in the MSC, because the A_CM_SERV_REQ message does not distinguish between mobile originated short message transfer and the short message alert procedures.

NOTE: A_CM_SERV_REQ message is not used for SMS over GPRS.

23.1.1 Mobile originated short message service Co-ordinator for the MSC

The A_CM_SERV_REQ message (3GPP TS 24.008 [35]) is received from the A-interface containing the CM service type. This parameter indicates mobile originated short message service. The service MAP_PROCESS_ACCESS_REQUEST is started.

If the MAP_PROCESS_ACCESS_REQUEST service ends successfully, the MS initiates mobile originated short message transfer or alerting indication. Depending on the situation, the appropriate process is initiated as follows:

- if the A_RP_MO_DATA indication is received, the process MOSM_MSC is initiated (see clause 23.2.1);
- if the A_RP_SM_MEMORY_AVAILABLE indication is received, the process SC_Alert_MSC is initiated (see clause 23.4.1).

After creation of the user process the Co-ordinator relays the messages between the A-interface and the invoked process until a request or an indication for dialogue termination is received.

The SMS process Co-ordinator is shown in the figure 23.1/1.

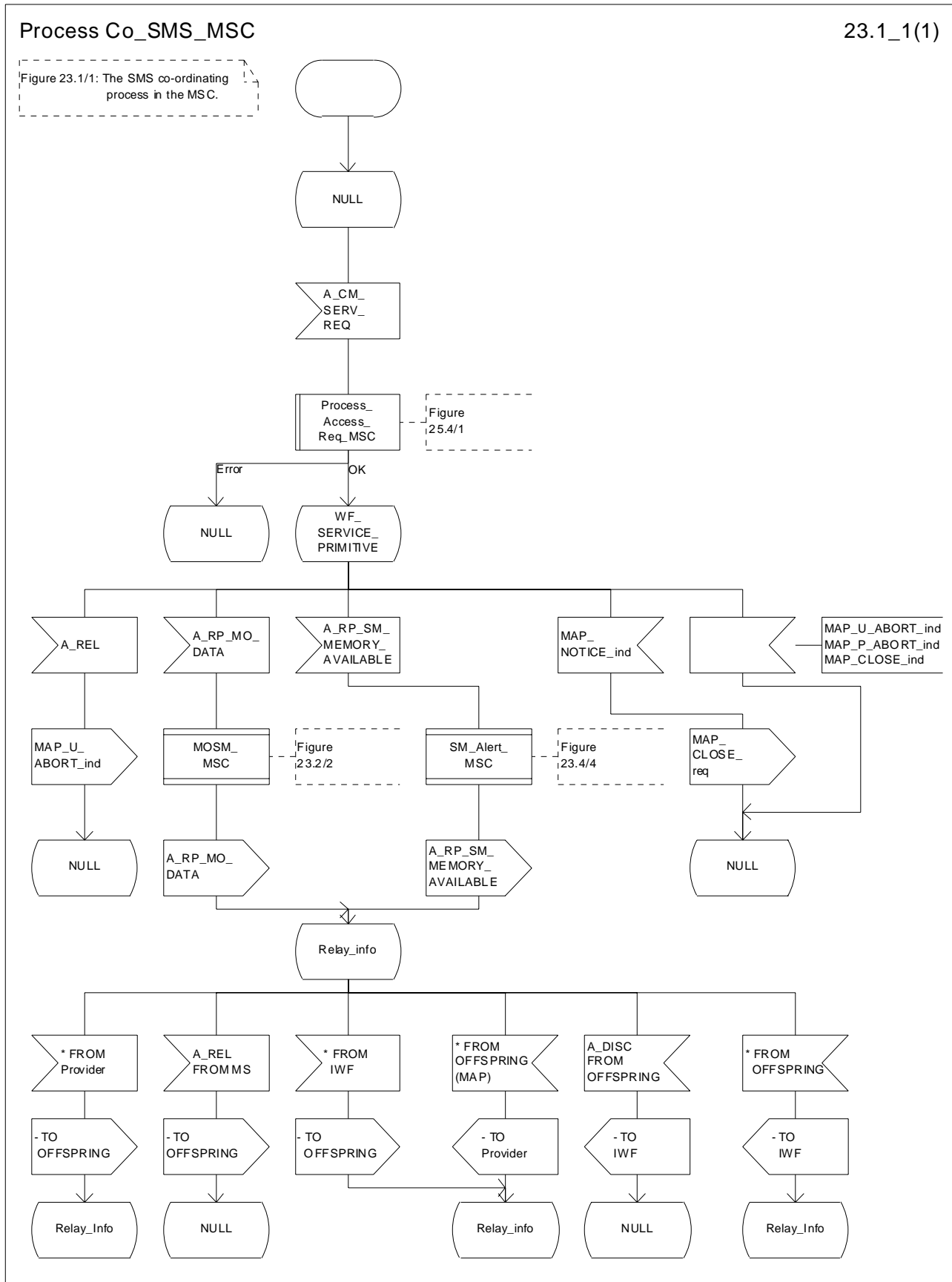

23.1.2 Short message Gateway Co-ordinator for the HLR

The MAP_OPEN indication opens a dialogue for the short message procedure between the gateway MSC and the HLR when the application context shortMessageGatewayContext is received. If that service is successful, the Co-ordinator can receive the first service primitive from the MAP_PM. Depending on the received primitive, the user process is created as follows:

- if the MAP_SEND_ROUTING_INFO_FOR_SM indication is received, the process Mobile_Terminated_SM_HLR is created;
- if the MAP_REPORT_SM_DELIVERY_STATUS indication is received, the process Report_SM_delivery_stat_HLR is created.

After creation of the user process the Co-ordinator relays the messages between the MAP_PM and the invoked process until a request or an indication for dialogue termination is received.

The SM Gateway Co-ordinator is shown in the figure 23.1/2.

If the Receive_Open_Ind macro takes the Vr exit then HLR shall perform the MAP Vr dialogue. But based on the subscriber data, handling at the MAP user application level may be performed as described in release 97 :

- If the subscriber is not a GPRS subscriber then the behaviour of the HLR shall be the same as described in the corresponding MAP Vr release.
- If the subscriber is a GPRS subscriber and a non-GPRS subscriber with the option « transfer of SM via the MSC when GPRS is not supported in the GMSC » then the behaviour of the HLR shall be the same as described in the corresponding MAP Vr release.
- If the subscriber is a GPRS subscriber and a non-GPRS subscriber with the option « transfer of SM via the SGSN when GPRS is not supported in the GMSC » or if the subscriber is a GPRS subscriber only then the behaviour of the HLR shall be the same as for the case transfer over GPRS described in MAP release 97, with the following precision: because GMSC does not support MAP release 97, the previous MAP protocol release is used. When the HLR sends the MAP_SEND_ROUTING_INFO_FOR_SM_Resp, the SGSN number is mapped to the MAP parameter « MSC number ». When the HLR sends the MAP_INFORM_SERVICE_CENTRE_resp, the MNRG status shall be mapped to the MAP parameter « mnrf-set ». When the HLR receives the MAP_REPORT_SM_DELIVERY_STATUS_Ind, it shall interpret the delivery outcome as a GPRS delivery outcome.

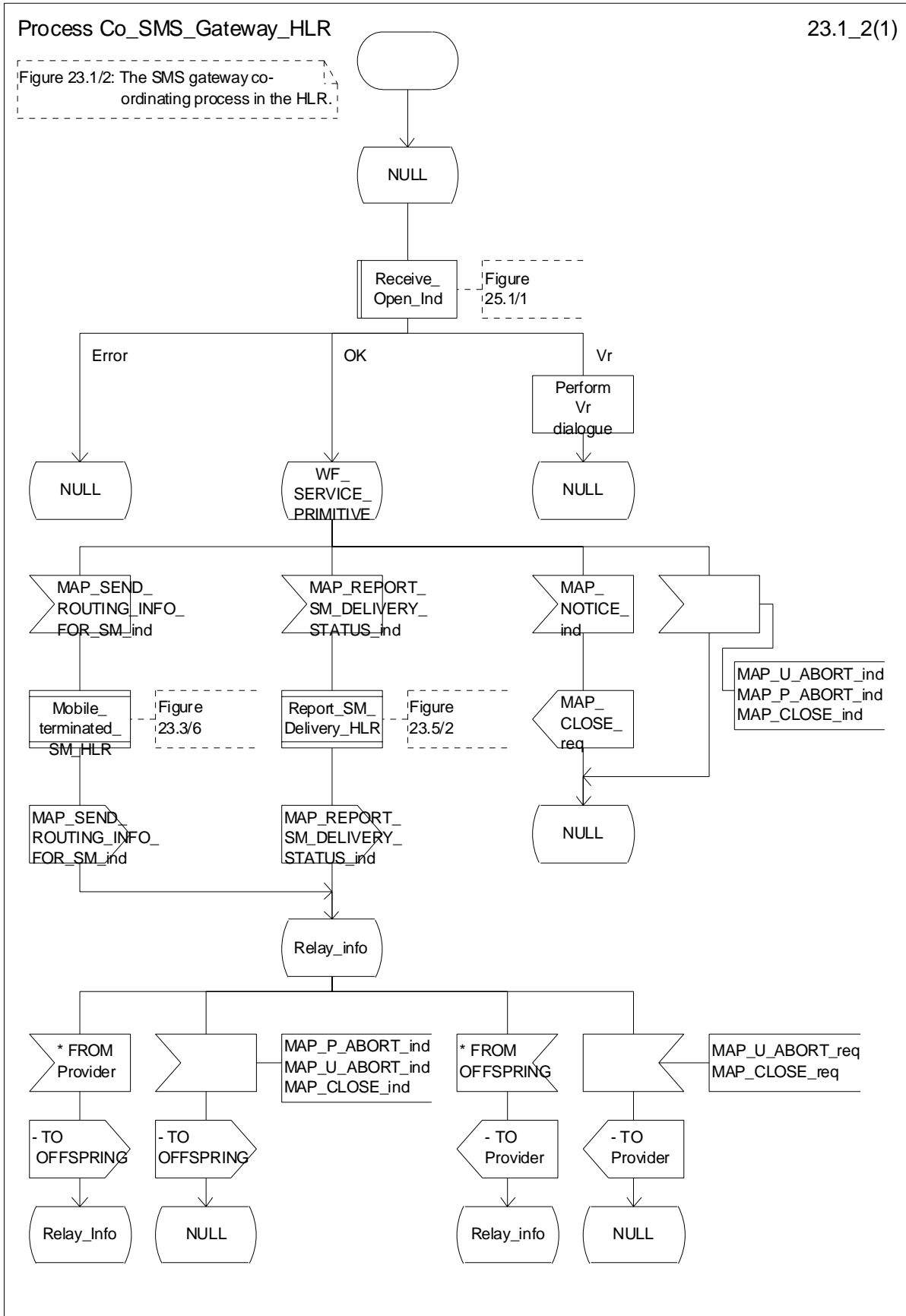

Figure 23.1/2: Process Co_SMS_Gateway_HLR

23.1.3 Mobile originated short message service Co-ordinator for the SGSN

The MS initiates mobile originated short message transfer or alerting indication. Depending on the situation, the appropriate process is initiated as follows:

- if the A_RP_MO_DATA indication is received, the process MOSM_SGSN is initiated (see clause 23.2.4);
- if the A_RP_SM_MEMORY_AVAILABLE indication is received, the process SC_Alert_SGSN is initiated (see clause 23.4.5).

After creation of the user process the Co-ordinator relays the messages between the SGSN and the MS, and the invoked process until a request or an indication for dialogue termination is received.

The SMS process Co-ordinator is shown in the figure 23.1/3.

Process Co_SMS_SGSN

23.1_3(1)

Figure 23.1/3: The SMS co-ordinating process in the SGSN

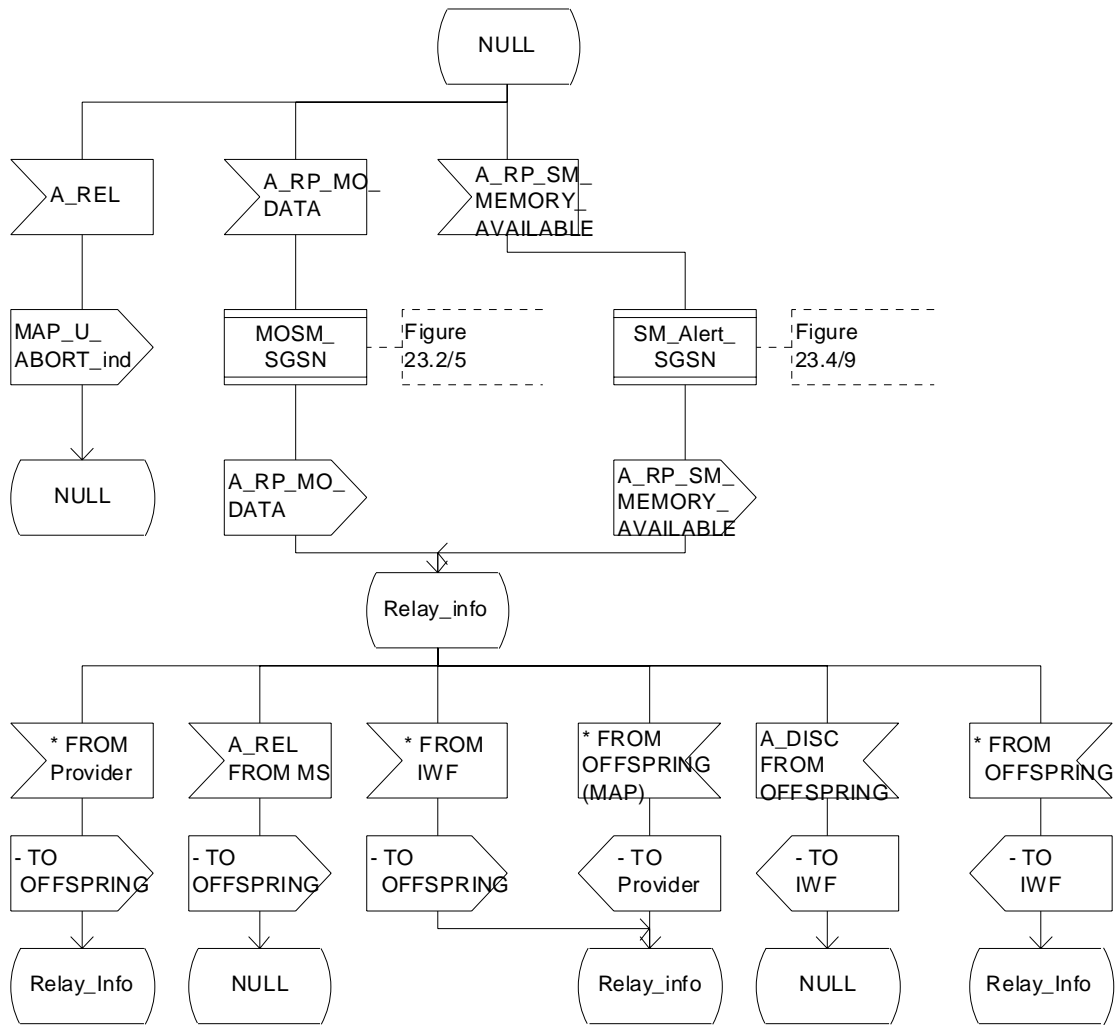
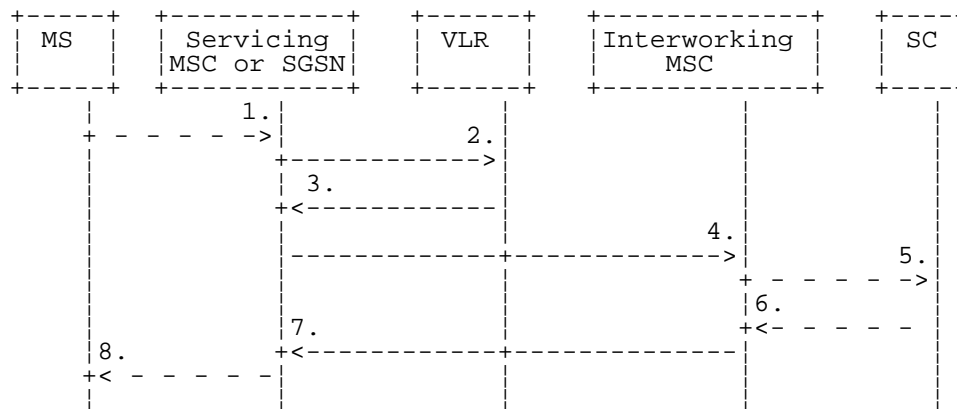

Figure 23.1/3: Process Co_SMS_SGSN

23.2 The mobile originated short message transfer procedure

The mobile originated short message service procedure is used to forward short message from a mobile subscriber to a Service Centre. The mobile originated short message service procedure is shown in figure 23.2/1.



- 1) Short Message (3GPP TS 24.011 [37]).
- 2) MAP_SEND_INFO_FOR_MO_SMS (*).
- 3) MAP_SEND_INFO_FOR_MO_SMS_ACK (*).
- 4) MAP_MO_FORWARD_SHORT_MESSAGE.
- 5) Short message (3GPP TS 23.140).
- 6) Short message Acknowledgement (3GPP TS 23.140).
- 7) MAP_MO_FORWARD_SHORT_MESSAGE_ACK.
- 8) Short Message Acknowledgement (3GPP TS 24.011 [37]).
- (*) Messages 2) and 3) are not used by SGSN.

Figure 23.2/1: Mobile originated short message transfer

In addition the following MAP services are used:

MAP_PROCESS_ACCESS_REQUEST	(see clause 8.3); (*)
MAP_AUTHENTICATE	(see clause 8.5); (*)
MAP_SET_CIPHERING_MODE	(see clause 8.6); (*)
MAP_PROVIDE_IMSI	(see clause 8.9); (*)
MAP_CHECK_IMEI	(see clause 8.7);
MAP_FORWARD_NEW_TMSI	(see clause 8.9); (*)
MAP_TRACE_SUBSCRIBER_ACTIVITY	(see clause 9.1); (*)
MAP_READY_FOR_SM	(see clause 12.4).

(*) Those messages are not used by SGSN.

23.2.1 Procedure in the servicing MSC

The activation of the MAP_PROCESS_ACCESS_REQUEST service is described in the clause 25.4.1.

When receiving the short message from the A-interface, the MSC sends the MAP_SEND_INFO_FOR_MO_SMS request to the VLR. As a response the MSC will receive the MAP_SEND_INFO_FOR_MO_SMS confirmation from VLR indicating that:

- the service ends successfully. If the MSC is not itself the IWMSC, the short message transmission towards the IWMSC is initiated using the MAP_MO_FORWARD_SHORT_MESSAGE request;

- the service ends unsuccessfully. The error cause in the MAP_SEND_INFO_FOR_MO_SMS confirmation indicates the reason for the unsuccessful end. The mapping between MAP error causes and RP_ERROR causes is described in 3GPP TS 23.140.

If there are data errors in the MAP_SEND_INFO_FOR_MO_SMS confirmation, or there is an operation failure in MAP, the RP_ERROR cause network out of order is forwarded to the mobile station.

The MSC opens a CAMEL dialogue as specified in 3GPP TS 23.078. If the CAMEL service bars the MO SM then the failure is reported to MS.

The MSC checks the barring as follows;

- if the short message transfer would contravene operator determined barring, the failure is reported to the CAMEL service as specified in 3GPP TS 23.078 and the call barred error with cause operator barring is returned to MS;
- if the short message transfer would contravene the supplementary service call barring conditions, the failure is reported to the CAMEL service as specified in 3GPP TS 23.078 and the call barred error with cause barring service active is returned to MS.

If the service MAP_MO_FORWARD_SHORT_MESSAGE is started, the MSC will check whether the grouping of MAP_OPEN request and MAP_MO_FORWARD_SHORT_MESSAGE request needs segmentation. If this is the case then the MAP_OPEN request primitive shall be sent first without any associated MAP service request primitive and the dialogue confirmation must be received before the MAP_MO_FORWARD_SHORT_MESSAGE request is sent. As a response to the procedure, the servicing MSC will receive the MAP_MO_FORWARD_SHORT_MESSAGE confirmation from the IWMSC indicating that:

- the short message has been successfully delivered to the Service Centre. The successful submission of SM is reported to the CAMEL service as specified in 3GPP TS 23.078 and the acknowledgement is sent to the mobile station;
- one of several error cases has occurred. The mapping between MAP error causes and RP_ERROR causes is described in 3GPP TS 23.140. The failure in the SM submission is reported to the CAMEL service as specified in 3GPP TS 23.078 and the appropriate indication is provided to the mobile station.

If the procedure failed, a provider error or an abort indication is received. The RP_ERROR cause network out of order is provided to the mobile station.

If the MSC itself is the interworking MSC, the short message is forwarded to the Service Centre. In that case the service MAP_MO_FORWARD_SHORT_MESSAGE is not initiated. The acknowledgement message from the Service Centre is forwarded to the mobile station (3GPP TS 23.140, 3GPP TS 24.011 [37]).

The mobile originated short message service procedure is shown in figure 23.2/2.

Process MOSM_MSC

23.2_2.1(3)

Figure 23.2/2: The mobile originated short message service process in the MSC.

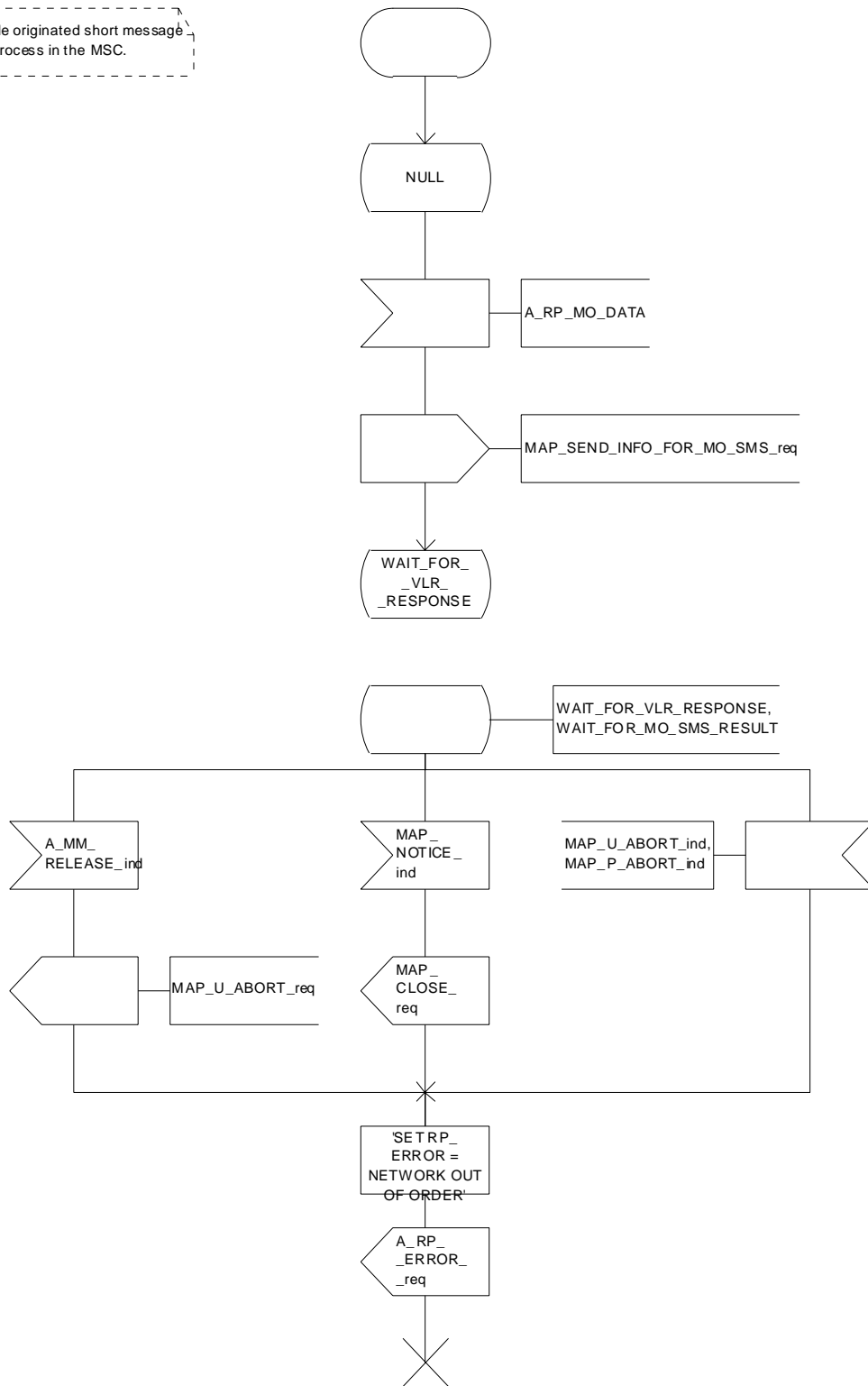

Figure 23.2/2 (sheet 1 of 4): Process MOSM_MSC

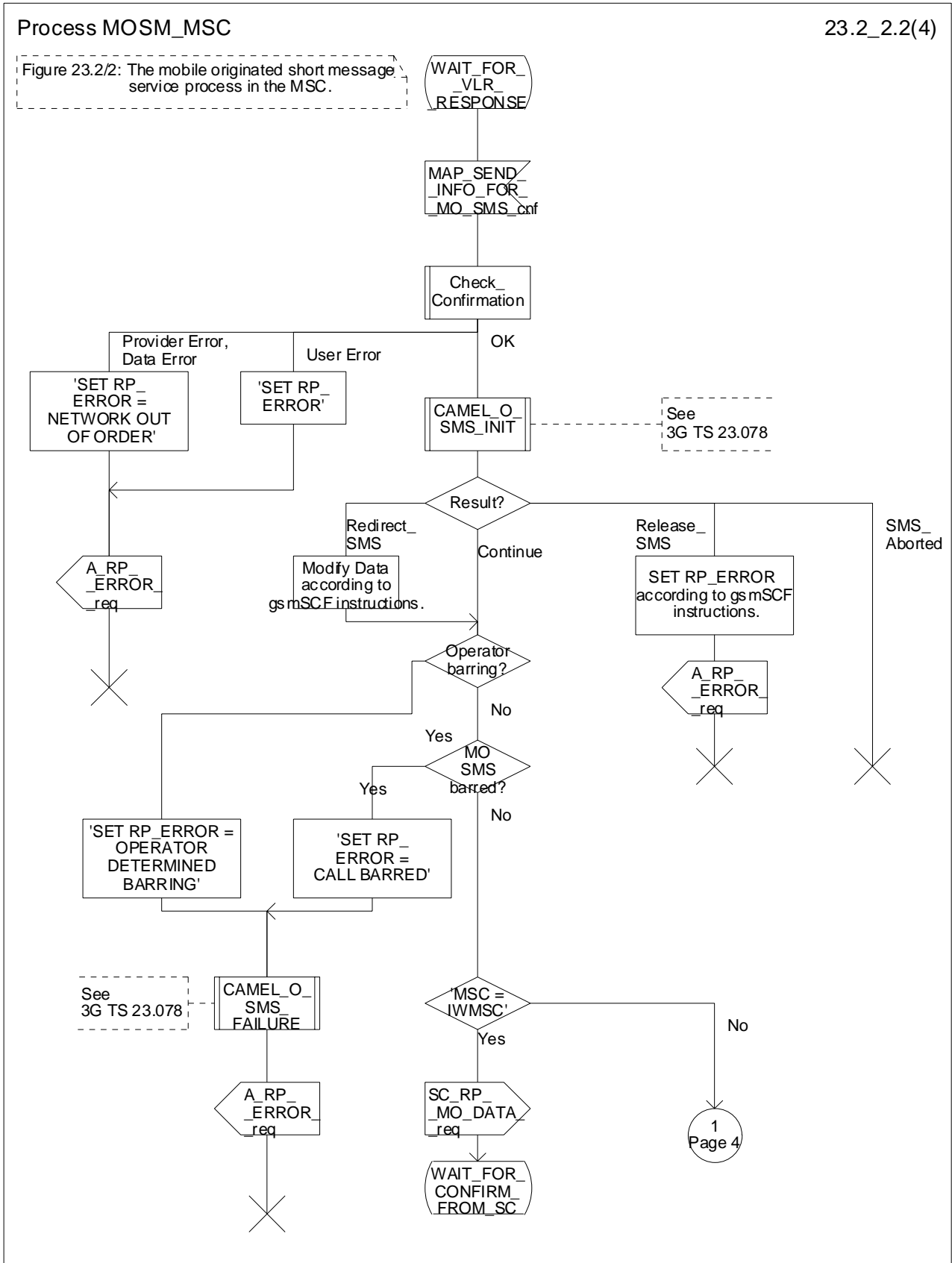

Figure 23.2/2 (sheet 2 of 4): Process MOSM_MSC

Process MOSM_MSC

23.2_2.new3(4)

Figure 23.2/2: The mobile originated short message service process in the MSC.

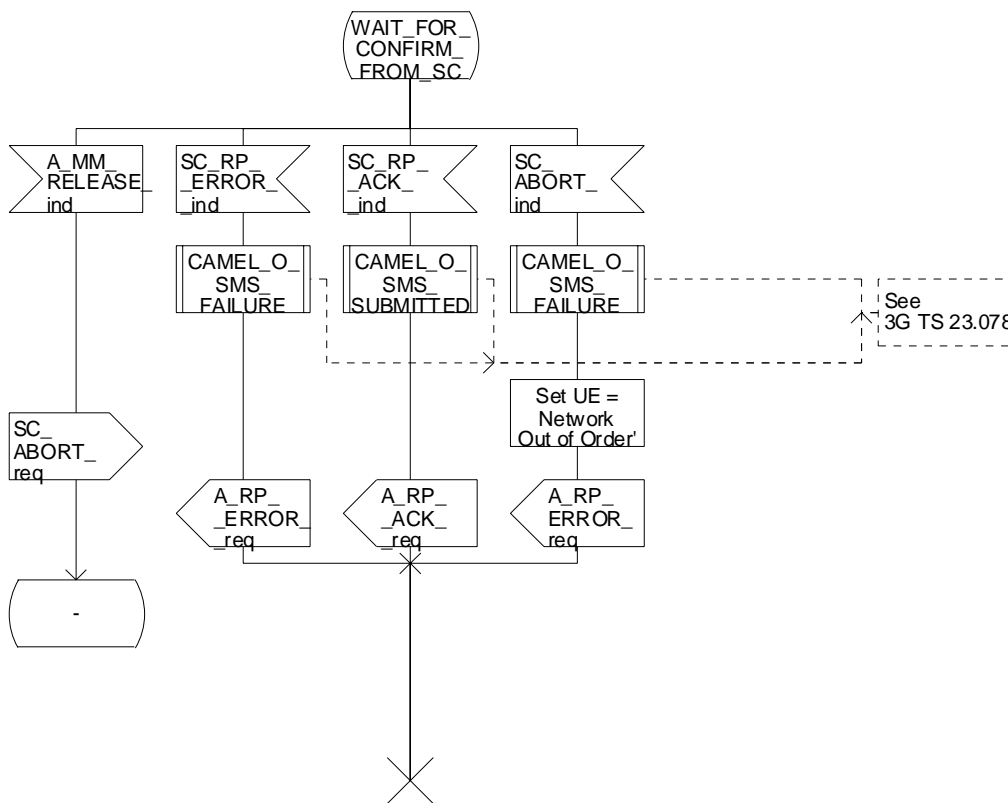

Figure 23.2/2 (sheet 3 of 4): Process MOSM_MSC

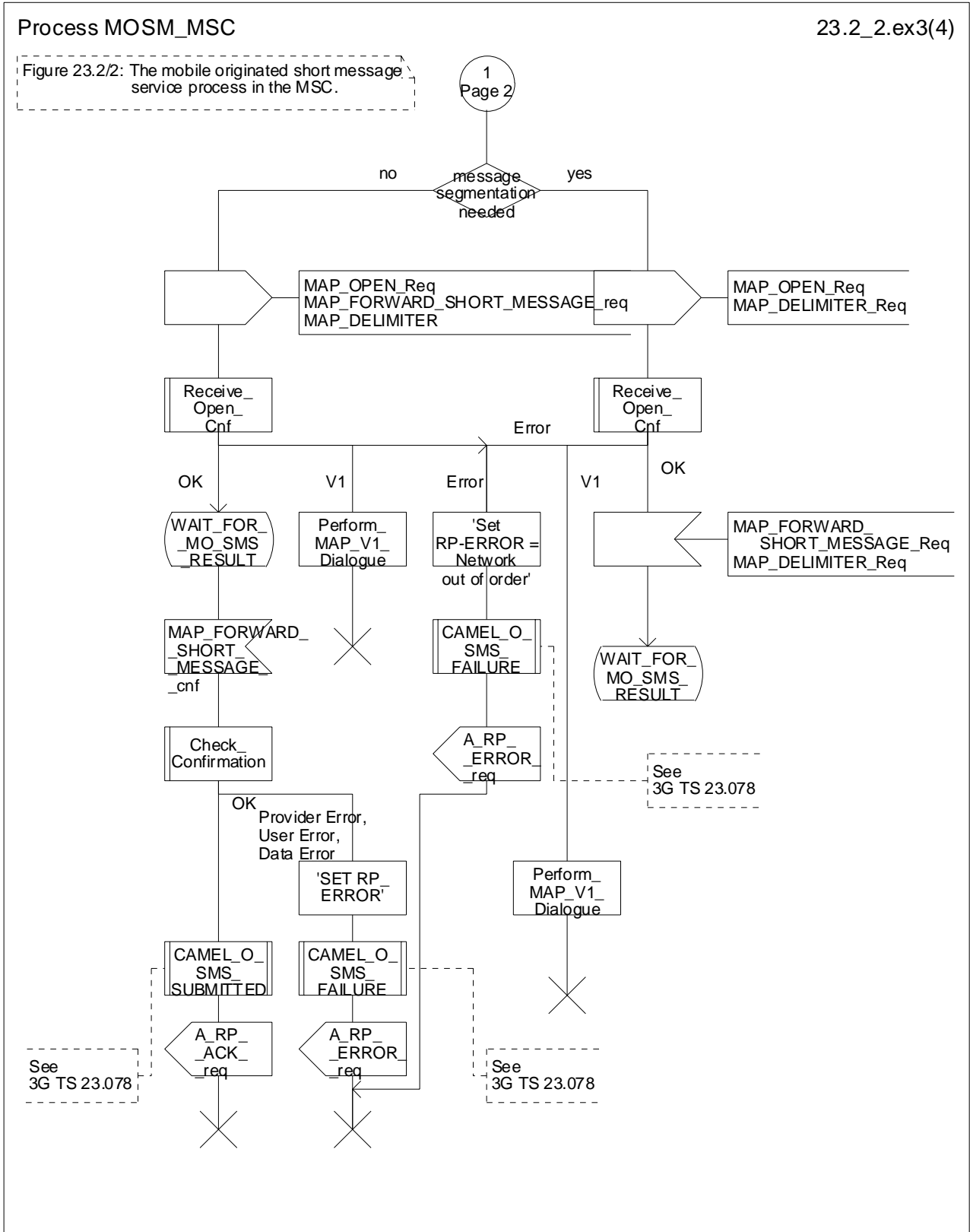

Figure 23.2/2 (sheet 4 of 4): Process MOSM_MSC

23.2.2 Procedure in the VLR

The MAP_PROCESS_ACCESS_REQUEST indication starts the MAP_PROCESS_ACCESS_REQUEST service in the VLR. The application context in the MAP_OPEN indication is mobile originated short message transfer.

If the service MAP_PROCESS_ACCESS_REQUEST is successful, the VLR waits for the next message from the MSC. When receiving the MAP_SEND_INFO_FOR_MO_SMS indication, the VLR acts as follows:

- if there is incompatibility in the subscription check, the error teleservice not provisioned is returned to the MSC;
- if the short message transfer would contravene Operator determined Barring (BAOC), the call barred error with cause operator barring is returned;
- if the short message transfer would contravene the supplementary service call barring conditions (BAOC) in the VLR, the call barred error with cause barring service active is returned.

When the mobile subscriber has passed all checks, the MAP_SEND_INFO_FOR_MO_SMS response is initiated and the procedure is terminated in the VLR. The mobile originated short message transfer procedure in the VLR is shown in figure 23.2/3.

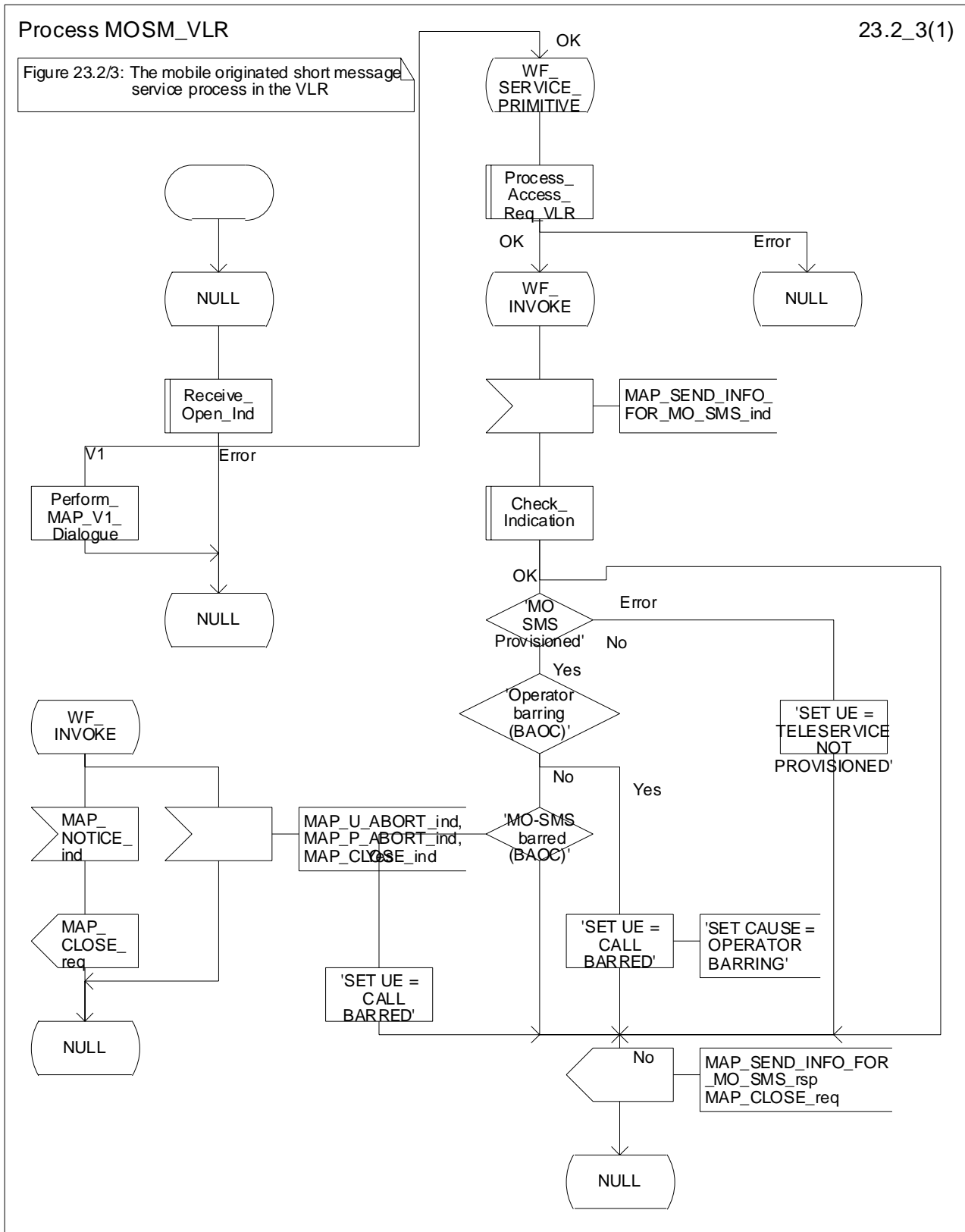

Figure 23.2/3: Process MOSM_VLR

23.2.3 Procedure in the interworking MSC

This procedure applies only when the IWMSC is not the servicing MSC or SGSN.

When receiving a MAP_OPEN indication primitive that is not associated with any MAP service indication primitive and if the dialogue is accepted, the MAP service-user in the interworking MSC issues a MAP_DELIMITER request primitive in order to trigger the local MAP service-provider to confirm the dialogue. Then a MAP_MO_FORWARD_SHORT_MESSAGE indication shall be received.

When a MAP_MO_FORWARD_SHORT_MESSAGE indication is correctly received, the Interworking MSC invokes forwarding of the short message to the Service Centre. If invalid data content is detected, an unexpected data value error or a data missing error is returned to the servicing MSC or SGSN.

The outcome of the procedure with the Service Centre is awaited before a MAP_MO_FORWARD_SHORT_MESSAGE response is given back to the servicing MSC or SGSN:

- if a short message is accepted by the Service Centre, an acknowledgement is sent back to the servicing MSC or SGSN;
- if the Service Centre is not identified, the SM Delivery Failure error is returned to the servicing MSC or SGSN;
- if the Service Centre returns an error indication, the SM Delivery Failure error is returned to the servicing MSC with the error cause and any diagnostic information received from the Service Centre;
- if the short message cannot be forwarded to the Service Centre or the procedure towards the Service Centre fails for some reason, a system failure error is sent to the servicing MSC or SGSN.

The mobile originated short message service transfer in the IWMSC is shown in figure 23.2/4.

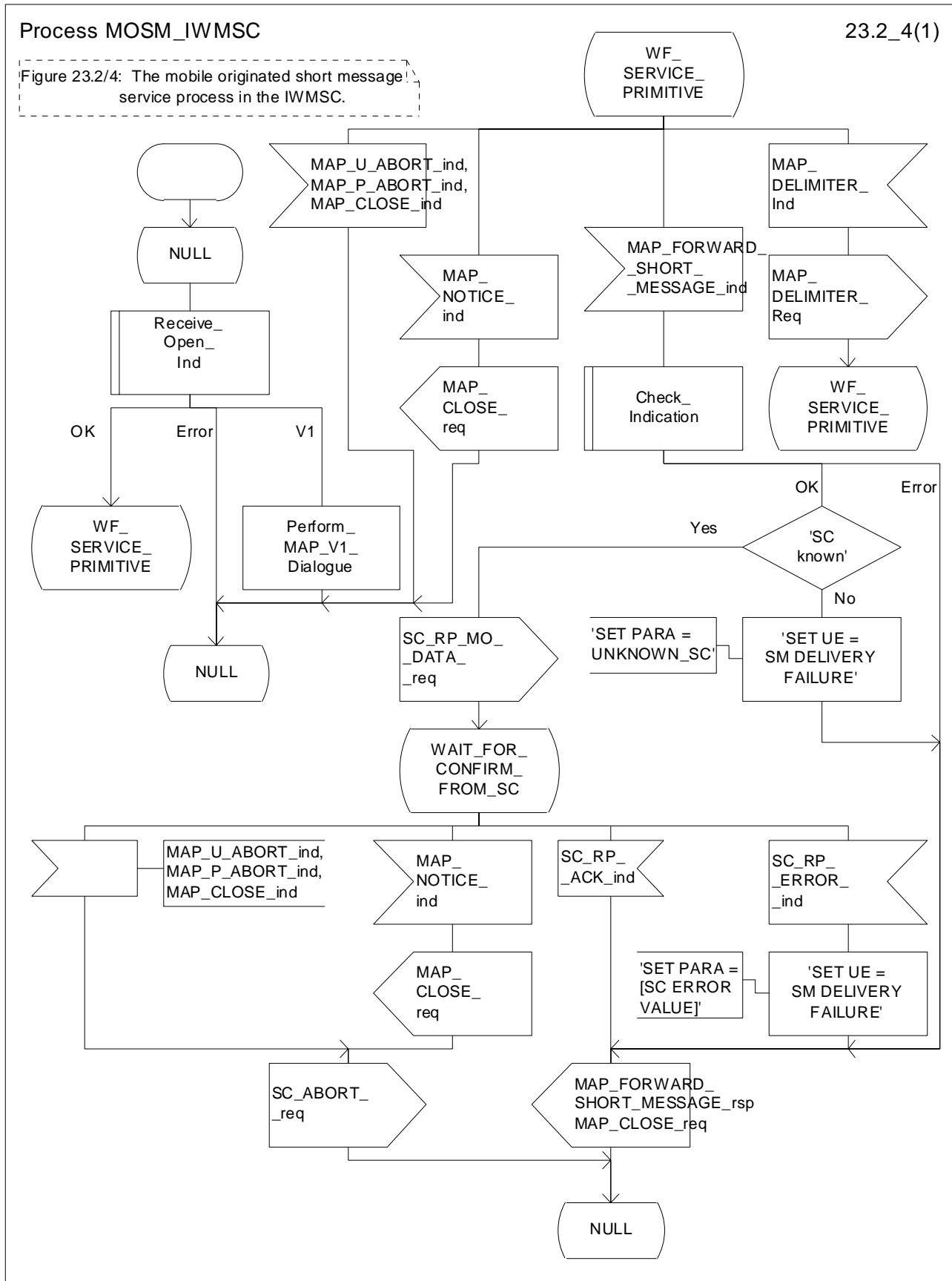

Figure 23.2/4: Process MOSM_IWMSC

23.2.4 Procedure in the servicing SGSN

When receiving the short message from the MS, the SGSN acts as follows:

- if there is incompatibility in the subscription check, the RP_ERROR cause requested facility not subscribed is provided to the mobile station;
- the SGSN opens a CAMEL dialogue as specified in 3GPP TS 23.078. If the CAMEL service bars the MO SM then the failure is reported to MS;
- if the short message transfer would contravene operator determined barring, , the failure is reported to the CAMEL service as specified in 3GPP TS 23.078 and the RP_ERROR cause operator determined barring is provided to the mobile station;

NOTE: The RP_ERROR causes are described in 3GPP TS 24.011 [37].

- if no error is detected, the short message transmission towards the IWMSC is initiated using the MAP_MO_FORWARD_SHORT_MESSAGE request.

If the service MAP_MO_FORWARD_SHORT_MESSAGE is started, the SGSN will check whether the grouping of MAP_OPEN request and MAP_MO_FORWARD_SHORT_MESSAGE request needs segmentation.

If this is the case then the MAP_OPEN request primitive shall be sent first without any associated MAP service request primitive and the dialogue confirmation must be received before the MAP_MO_FORWARD_SHORT_MESSAGE request is sent. As a response to the procedure, the servicing SGSN will receive the MAP_MO_FORWARD_SHORT_MESSAGE confirmation from the IWMSC indicating that:

- the short message has been successfully delivered to the Service Centre. The successful submission of SM is reported to the CAMEL service as specified in 3GPP TS 23.078 and the acknowledgement is sent to the mobile station;
- one of several error cases has occurred. The mapping between MAP error causes and RP_ERROR causes is described in 3GPP TS 23.140. The failure in SM submission is reported to the CAMEL service as specified in 3GPP TS 23.078 and the appropriate indication is provided to the mobile station.

If the procedure failed, a provider error or an abort indication is received. The RP_ERROR cause network out of order is provided to the mobile station.

The mobile originated short message service procedure is shown in figure 23.2/5.

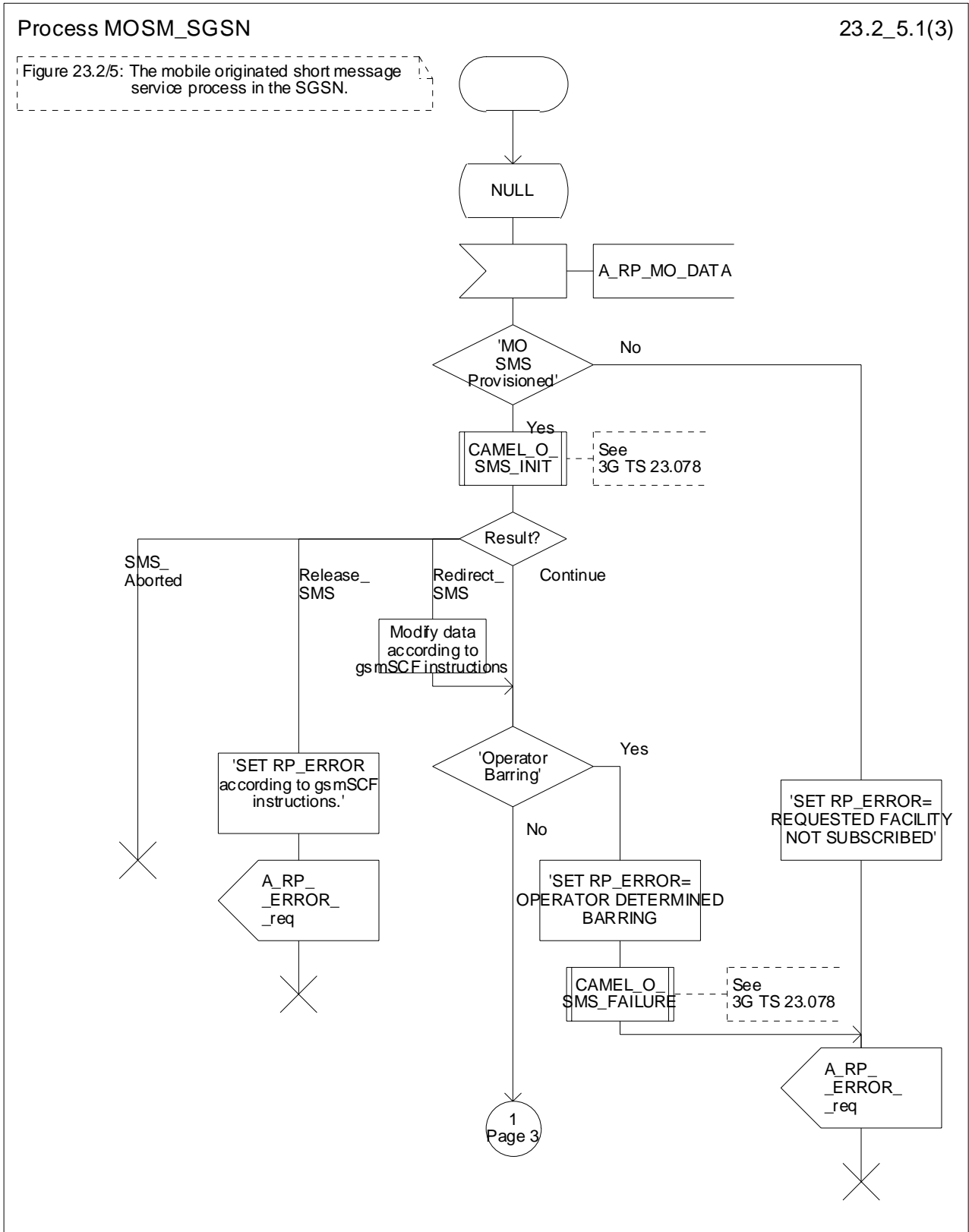

Figure 23.2/5 (sheet 1 of 3): Process MOSM_SGSN

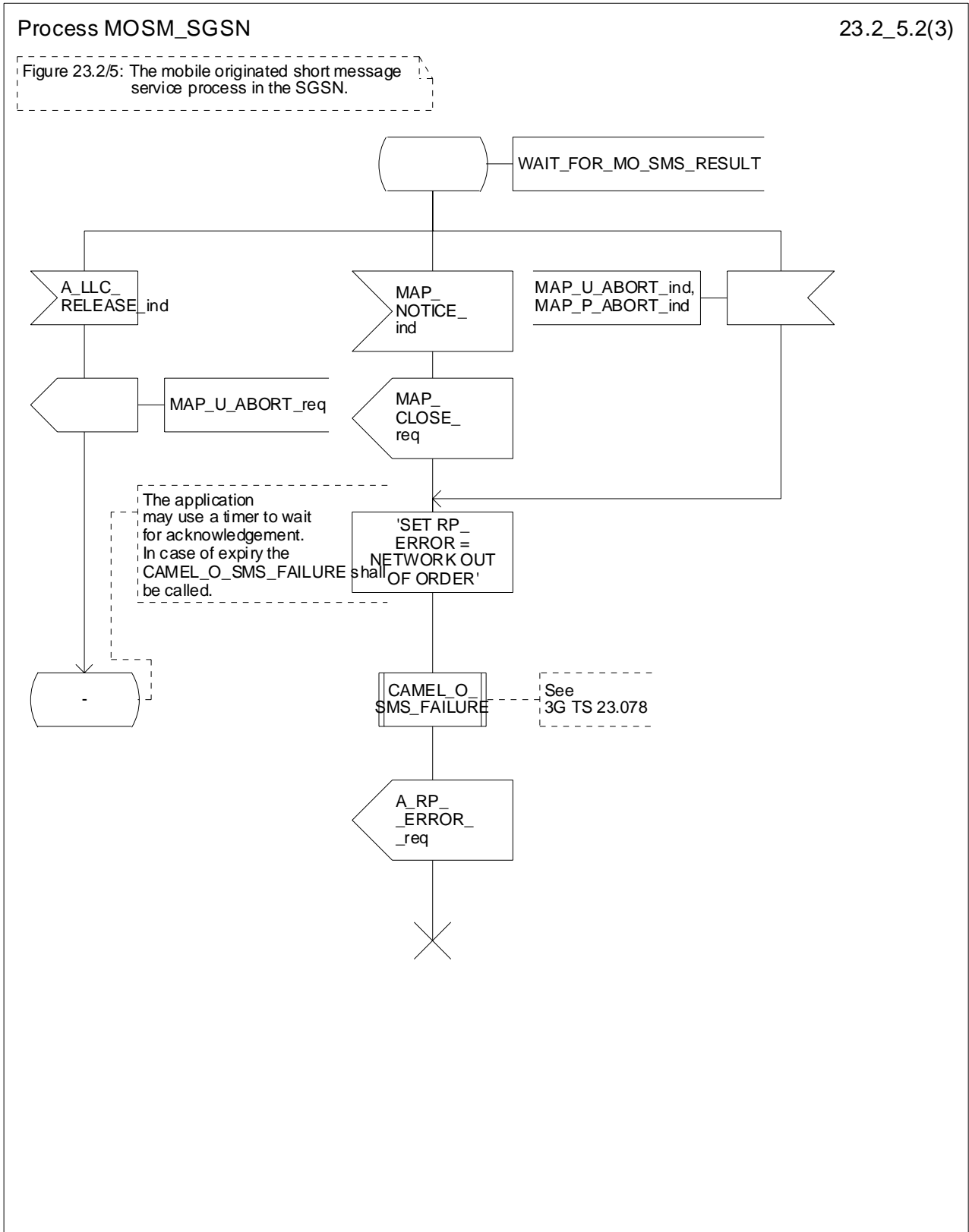

Figure 23.2/5 (sheet 2 of 3): Process MOSM_SGSN

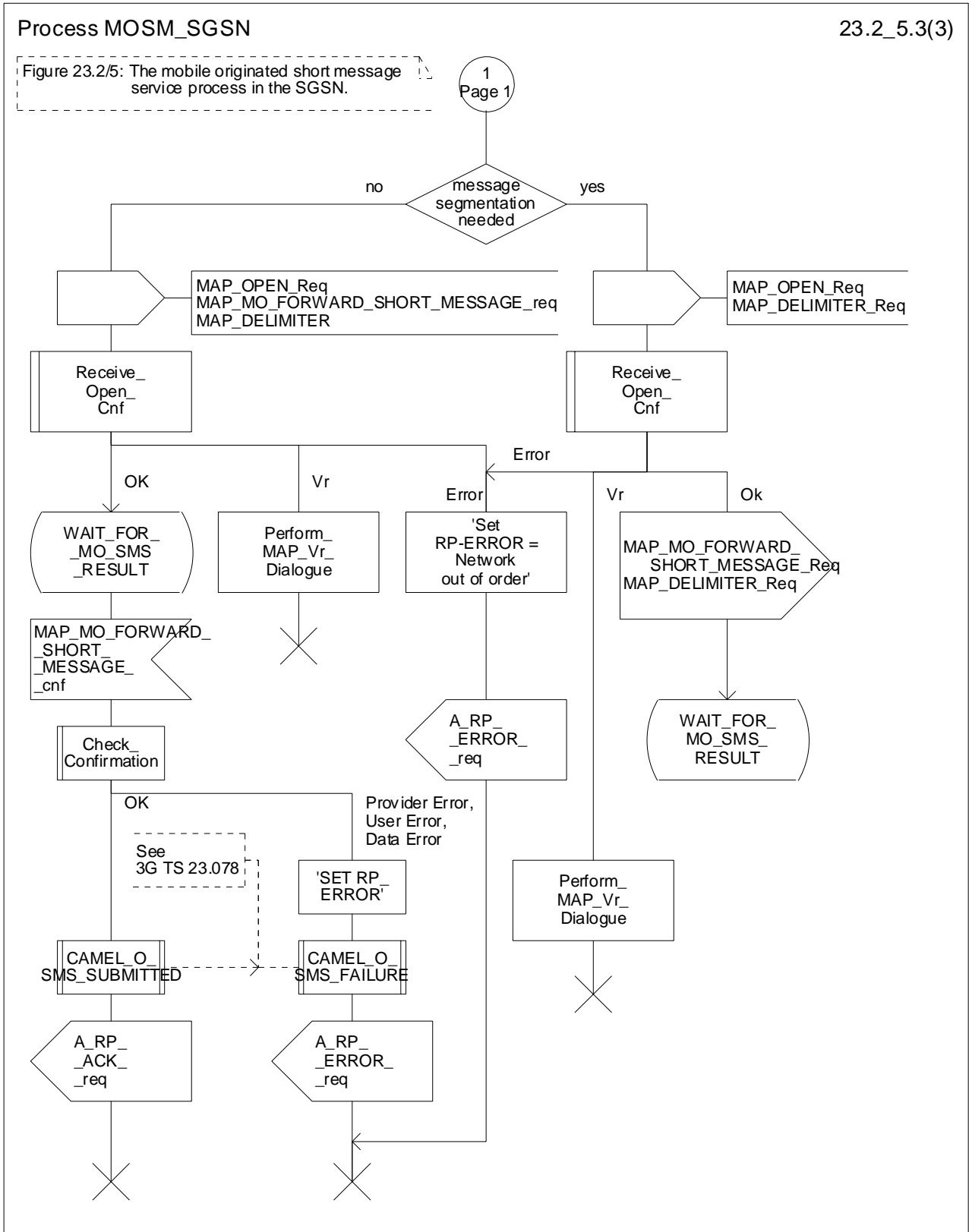

Figure 23.2/5 (sheet 3 of 3): Process MOSM_SGSN

23.3 The mobile terminated short message transfer procedure

The mobile terminated short message transfer procedure is used for forwarding a short message or several short messages from a Service Centre to a mobile subscriber. The mobile terminated short message procedure for a single short message transfer is shown in figure 23.3/1.

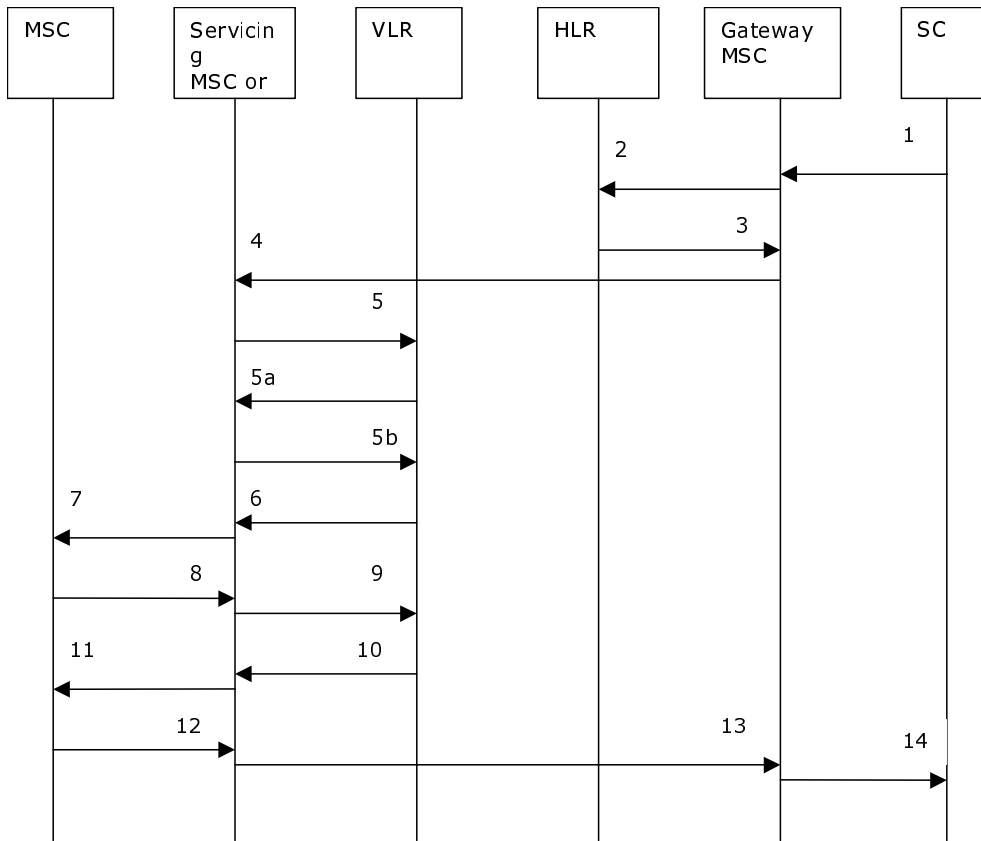

Figure 23.3/1: Mobile terminated short message service procedures

- 1) Short Message (3GPP TS 23.140).
- 2) MAP_SEND_ROUTING_INFO_FOR_SM.
- 3) MAP_SEND_ROUTING_INFO_FOR_SM_ACK.
- 4) MAP_MT_FORWARD_SHORT_MESSAGE.
- 5) MAP_SEND_INFO_FOR_MT_SMS (*).
- 5a) MAP_CONTINUE_CAMEL_SMS_HANDLING (*)(**)
- 5b) MAP_SEND_INFO_FOR_MT_SMS (*)(**)
- 6) MAP_PAGE/MAP_SEARCH_FOR_MOBILE_SUBSCRIBER (*).
- 7) Page (3GPP TS 24.008 [35]).
- 8) Page response (3GPP TS 24.008 [35]).
- 9) MAP_PROCESS_ACCESS_REQUEST_ACK and MAP_SEARCH_FOR_MOBILE_SUBSCRIBER_ACK (*).
- 10) MAP_SEND_INFO_FOR_MT_SMS_ACK (*).
- 11) Short Message (3GPP TS 24.011 [37]).
- 12) Short Message Acknowledgement (3GPP TS 24.011 [37]).
- 13) MAP_MT_FORWARD_SHORT_MESSAGE_ACK.
- 14) Short Message Acknowledgement (3GPP TS 23.140).

(*) Messages 5), 5a), 5b), 6), 9), and 10) are not used by the SGSN.

(**) These messages are used only for a subscriber provisioned with MT-SMS-CSI in the VLR.

The mobile terminated short message procedure for multiple short message transfer is shown in figure 23.3/2.

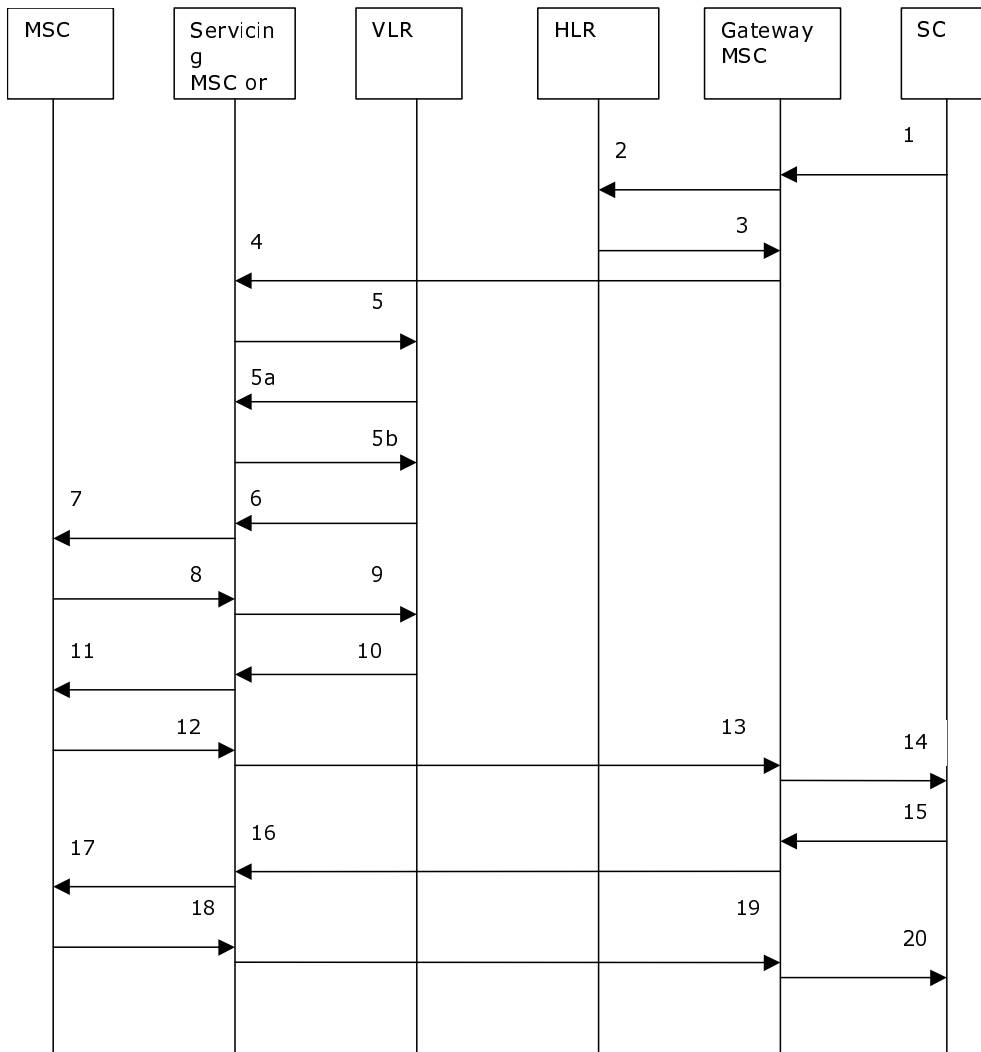

Figure 23.3/2: Mobile terminated short message procedure for multiple short message transfer

- 1) Short Message (3GPP TS 23.140).
- 2) MAP_SEND_ROUTING_INFO_FOR_SM.
- 3) MAP_SEND_ROUTING_INFO_FOR_SM_ACK.
- 4) MAP_MT_FORWARD_SHORT_MESSAGE (note 1).
- 5) MAP_SEND_INFO_FOR_MT_SMS (*).
- 5a) MAP_CONTINUE_CAMEL_SMS_HANDLING (*)(**)
- 5b) MAP_SEND_INFO_FOR_MT_SMS (*)(**)
- 6) MAP_PAGE/MAP_SEARCH_FOR_MOBILE_SUBSCRIBER (*).
- 7) Page (3GPP TS 48.008 [49]).
- 8) Page response (3GPP TS 24.008 [35]).
- 9) MAP_PROCESS_ACCESS_REQUEST_ACK and MAP_SEARCH_FOR_MOBILE_SUBSCRIBER_ACK (*).
- 10) MAP_SEND_INFO_FOR_MT_SMS_ACK (*).
- 11) Short Message (3GPP TS 24.011 [37]).
- 12) Short Message Acknowledgement (3GPP TS 24.011 [37]).
- 13) MAP_MT_FORWARD_SHORT_MESSAGE_ACK.
- 14) Short Message Acknowledgement (3GPP TS 23.140).
- 15) Short Message (3GPP TS 23.140).
- 16) MAP_MT_FORWARD_SHORT_MESSAGE (note 2).
- 17) Short Message (3GPP TS 24.011 [37]).
- 18) Short Message Acknowledgement (3GPP TS 24.011 [37]).
- 19) MAP_MT_FORWARD_SHORT_MESSAGE_ACK.
- 20) Short Message Acknowledgement (3GPP TS 23.140).

(*) Messages 5), 5a), 5b) 6), 9), and 10) are not used by the SGSN.

(**) These messages are used only for a subscriber provisioned with MT-SMS-CSI in the VLR.

NOTE 1: The "More Messages To Send" flag is TRUE.

NOTE 2: The "More Messages To Send" flag is FALSE.

In the multiple short message transfer the service MAP_MT_FORWARD_SHORT_MESSAGE can be used several times. However, the short message transfer is always acknowledged to the Service Centre before the next short message is sent.

In addition the following MAP services are used:

MAP_PROCESS_ACCESS_REQUEST	(see clause 8.3); (*)
MAP_PAGE	(see clause 8.2); (*)
MAP_SEARCH_FOR_MS	(see clause 8.2); (*)
MAP_AUTHENTICATE	(see clause 8.5); (*)
MAP_SET_CIPHERING_MODE	(see clause 8.6); (*)
MAP_CHECK_IMEI	(see clause 8.7);
MAP_FORWARD_NEW_TMSI	(see clause 8.9); (*)
MAP_REPORT_SM_DELIVERY_STATUS	(see clause 12.3);
MAP_INFORM_SERVICE_CENTRE	see clause 12.6);
MAP_TRACE_SUBSCRIBER_ACTIVITY	(see clause 9.1); (*)
MAP_READY_FOR_SM	(see clause 12.4).

(*) Those messages are not used by SGSN.

23.3.1 Procedure in the Servicing MSC

When initiating the dialogue with the servicing MSC, the SMS Gateway MSC must provide the IMSI of the subscriber to whom the short message is directed.

The IMSI can be included either in the Destination Reference of the MAP_OPEN indication received from the SMS Gateway MSC or in the sm-RP-DA information field of the MAP_MT_FORWARD_SHORT_MESSAGE indication.

When receiving a MAP_OPEN indication primitive that is not associated with any MAP service indication primitive and if the dialogue is accepted, the MAP service-user in the servicing MSC issues a MAP_DELIMITER request primitive in order to trigger the local MAP service-provider to confirm the dialogue.

When receiving the first MAP_MT_FORWARD_SHORT_MESSAGE indication from the gateway MSC, the servicing MSC sends the MAP_SEND_INFO_FOR_MT_SMS request primitive to the VLR, if the MAP service primitive is accepted and if short message service is supported in the servicing MSC.

The MAP_MT_FORWARD_SHORT_MESSAGE indication primitive is checked by the macro "Check_Indication". If the received MAP service primitive contains errors, the service is aborted and an unexpected data value error or data missing error is returned to the GMSC.

If the MSC does not support the short message service, the service is aborted in the servicing MSC and the error "Facility Not Supported" is returned to the GMSC.

The subscriber identity information that may be included in the MAP_OPEN indication primitive and in the MAP service indication primitive is checked by the macro "Check_Subscr_Identity_For_MT_SMS" as follows.

If a Destination Reference has been received in the MAP_OPEN indication, an LMSI must be present in the sm-RP-DA information field of the MAP_MT_FORWARD_SHORT_MESSAGE indication. The LMSI shall be included in the sm-RP-DA information field of the MAP_SEND_INFO_FOR_MT_SMS request sent to the VLR; the associated MAP_OPEN request must contain a Destination Reference that carries an IMSI.

Otherwise, if the IMSI is included in the sm-RP-DA information field of the MAP_MT_FORWARD_SHORT_MESSAGE indication, it is mapped into the sm-RP-DA information field of the MAP_SEND_INFO_FOR_MT_SMS request that is sent to the VLR. In this case, the IMSI is not accompanied by an LMSI and neither the MAP_OPEN indication received from the gateway MSC nor the MAP_OPEN request sent to the VLR shall include a Destination Reference.

If a Destination Reference has been received in the servicing MSC and the sm-RP-DA information field of the MAP_MT_FORWARD_SHORT_MESSAGE indication does not include an LMSI or if no Destination Reference has been received and the sm-RP-DA information field does not cover an IMSI the service is aborted in the servicing MSC and the error "Unexpected Data Value" is returned to the SMS GMSC.

The following responses to the MAP_SEND_INFO_FOR_MT_SMS request may be received from the VLR:

- unidentified subscriber or system failure error. The error code is forwarded to the GMSC;
- absent subscriber error. The absent subscriber_SM error is forwarded to the GMSC with the absent subscriber diagnostic indication set to 'IMSI Detached';
- unknown subscriber error. The system failure indication is provided to the GMSC;
- data missing or unexpected data value error. The system failure indication is provided to the GMSC;
- a provider error or an abort indication. The system failure indication is provided to the GMSC;
- subscriber busy for MT SMS. The error code is forwarded to the GMSC;
- paging procedure invocation (see clause 25.3) reporting the successful outcome of the procedure;
- search procedure invocation (see clause 25.3) reporting the successful outcome of the procedure.

The result of the paging or the search procedure is processed as follows:

- if the procedure is completed successfully, the MSC will send the MAP_PROCESS_ACCESS_REQUEST request to the VLR (see clause 25.4);
- if the procedure is completed successfully, but the MS has no mobile terminated short message transfer capability, the procedure is terminated and SM delivery failure indication with cause "equipment not SM equipped" is provided to the GMSC;
- if the procedure ends unsuccessfully, the termination of the procedure is awaited from the VLR. The absent subscriber_SM error is forwarded to the GMSC with the absent subscriber diagnostic indication set to 'No Paging Response', but the other error causes are reported as a system failure indication.

If the short message transfer is aborted for any reason, the dialogue with the VLR is aborted. If the procedure with the VLR is aborted by the VLR or by the provider, a system failure indication is provided to the GMSC.

The unsuccessful outcome of the MAP_PROCESS_ACCESS_REQUEST service is reported by using the system failure error to the GMSC.

When the service MAP_PROCESS_ACCESS_REQUEST is carried out, the MSC will receive the MAP_SEND_INFO_FOR_MT_SMS confirmation indicating:

- the unsuccessful outcome of the procedure. The error indication received from the VLR is forwarded to the GMSC;
- the successful outcome of the procedure. The MSC initiates forwarding of the short message to the MS.

The MSC may receive MAP_CONTINUE_CAMEL_SMS_HANDLING. The MSC then opens a CAMEL dialogue with the gsmSCF, as specified in 3GPP TS 23.078. If the CAMEL service bars the MT SM, then the failure is reported to the SMS-GMSC, and the MT SM is not delivered to the MS. Otherwise, the MSC shall send a second MAP_SEND_INFO_FOR_MT_SMS request to the VLR.

If the primitive itself is badly formatted or data is missing, the system failure error is sent to the GMSC.

If forwarding of the short message is initiated, the MSC awaits the result before one of the following responses is sent back to the GMSC:

- an acknowledgement if the short message has been successfully delivered to the mobile subscriber. The successful MT SM delivery is reported to the gsmSCF as specified in 3GPP TS 23.078;
- an SM delivery failure error containing a parameter indicating either of the following: there is a MS protocol error or the MS memory capacity is exceeded; detailed diagnostic information (see clause 7.6.1.4) may also be carried. The failure in the MT SM delivery is reported to the gsmSCF as specified in 3GPP TS 23.078;
- a system failure error if the delivery procedure is aborted. The failure in the MT SM delivery is reported to the gsmSCF as specified in 3GPP TS 23.078.

If the More Messages To Send flag was FALSE or the service MAP_MT_FORWARD_SHORT_MESSAGE ends unsuccessfully, the transaction to the gateway MSC is terminated. If the More Messages To Send flag was TRUE, then the servicing MSC waits for the next short message from the Service Centre.

When receiving the next MAP_MT_FORWARD_SHORT_MESSAGE indication from the gateway MSC the servicing MSC will act as follows:

- if the received primitive contains errors, then the unexpected data value error or data missing error is provided to the gateway MSC;
- The MSC opens a CAMEL dialogue as specified in 3GPP TS 23.078 for each SM. If the CAMEL service bars the MT SM, then the failure is reported to the GMSC, and the MT SM is not delivered to the MS.
- if the More Messages To Send flag is FALSE, then the serving MSC will start the short message transfer procedure to the mobile subscriber. The successful or unsuccessful outcome of this procedure is reported to the gsmSCF as specified in 3GPP TS 23.078 and to the gateway MSC and the transaction is terminated.
- if the More Messages To Send flag is TRUE, then the serving MSC will start the short message transfer to the mobile subscriber. If the outcome of this procedure is unsuccessful, then the SM delivery failure is reported to the gsmSCF and the reason is reported to the gateway MSC and the procedure is terminated. If the procedure is successful, then the MT SM delivery is reported to the gsmSCF as specified in 3GPP TS 23.078, and it is acknowledged to the gateway MSC and more short messages can be received.

The tracing procedure may be activated. It is described in detail in the clause 20.

The mobile terminated short message transfer procedure in the servicing MSC is shown in figures 23.3/3 and 23.3/4. The page and search procedures are shown in figure 25.3/1 and 25.3/2.

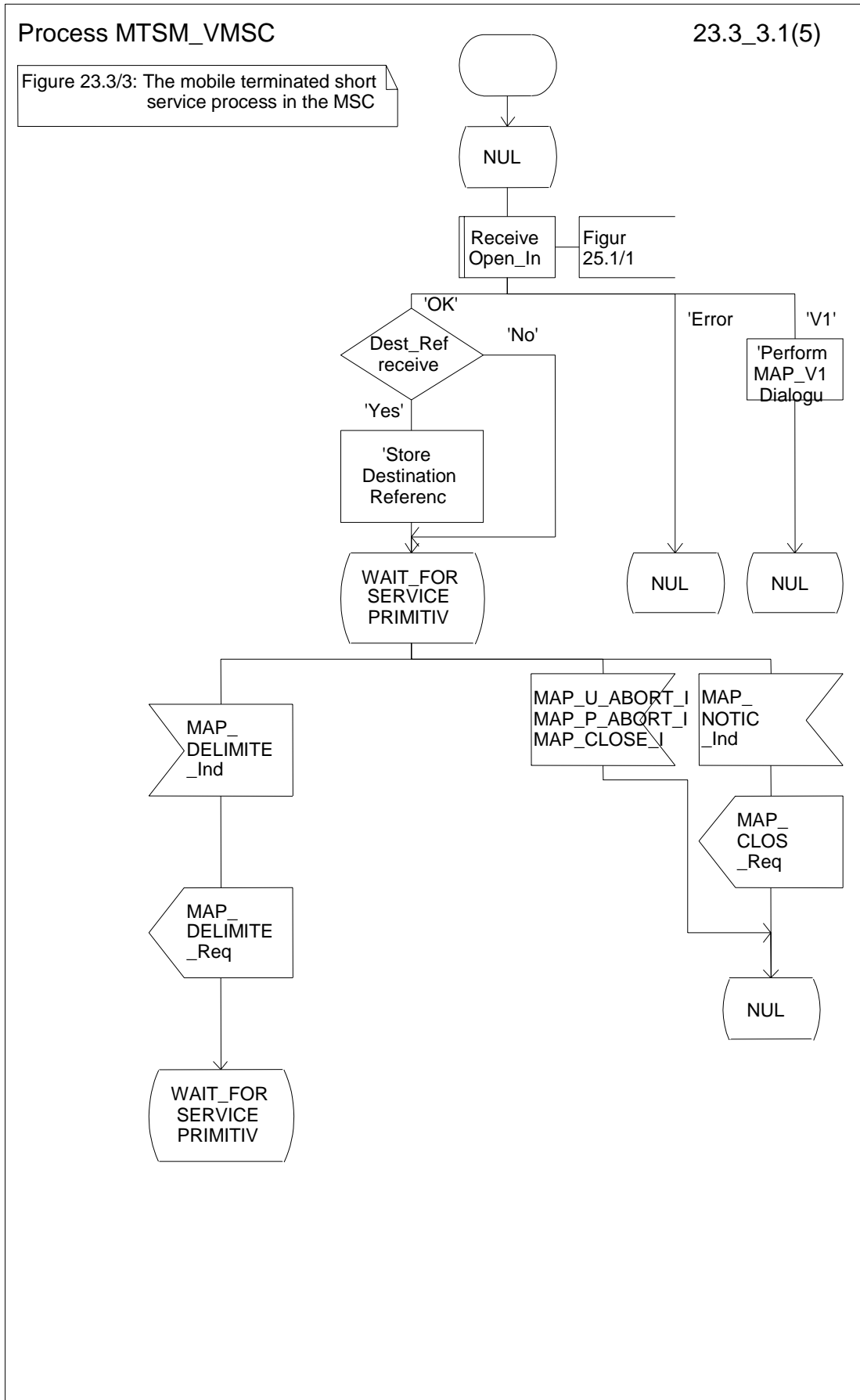

Figure 23.3/3 (sheet 1 of 5): Procedure MTSM_VMSC

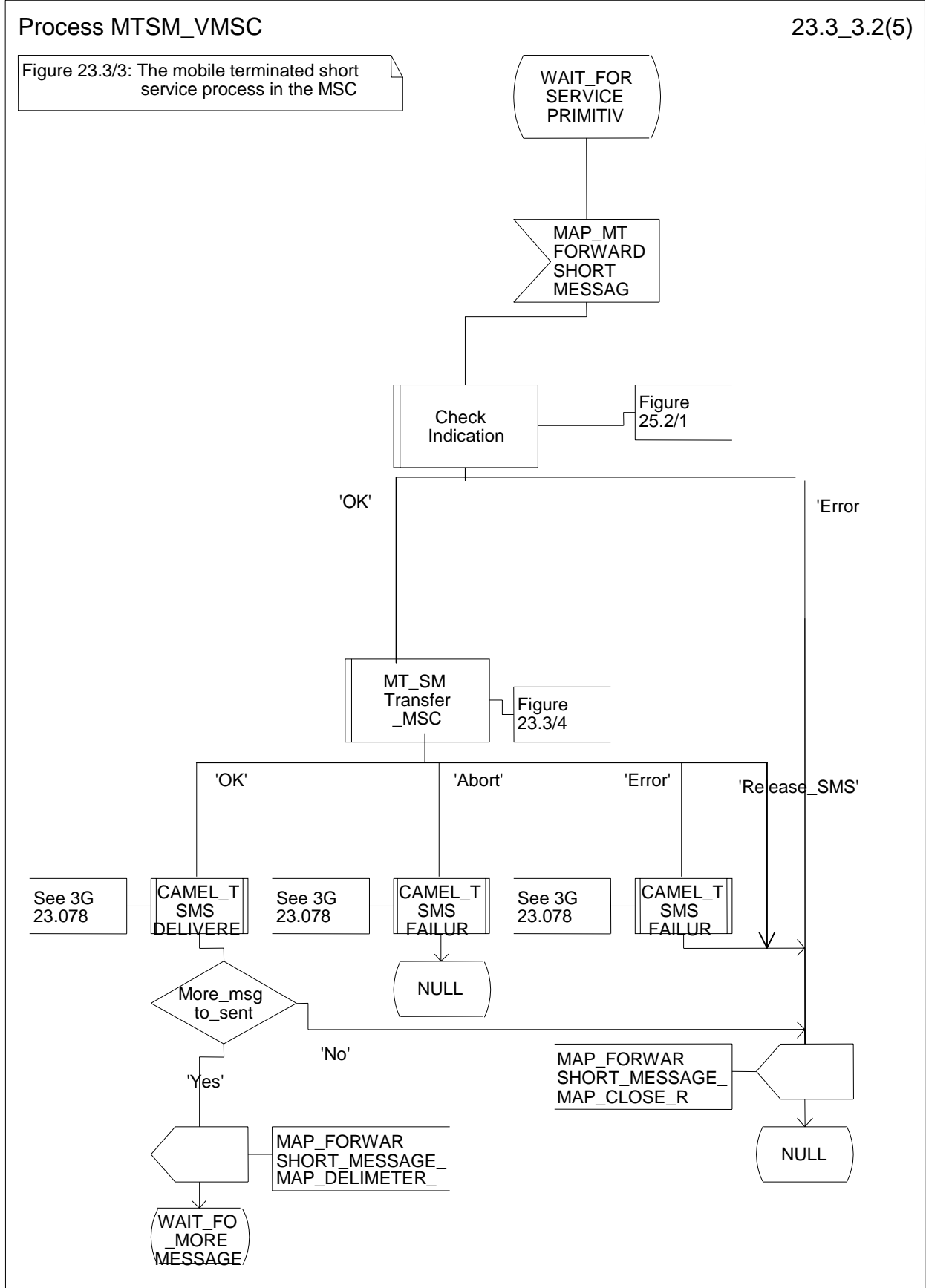

Figure 23.3/3 (sheet 2 of 5): Procedure MTSM_VMSC

Process MTSM_VMSC

23.3_3.3(5)

Figure 23.3/3: The mobile terminated short message service process in the MSC

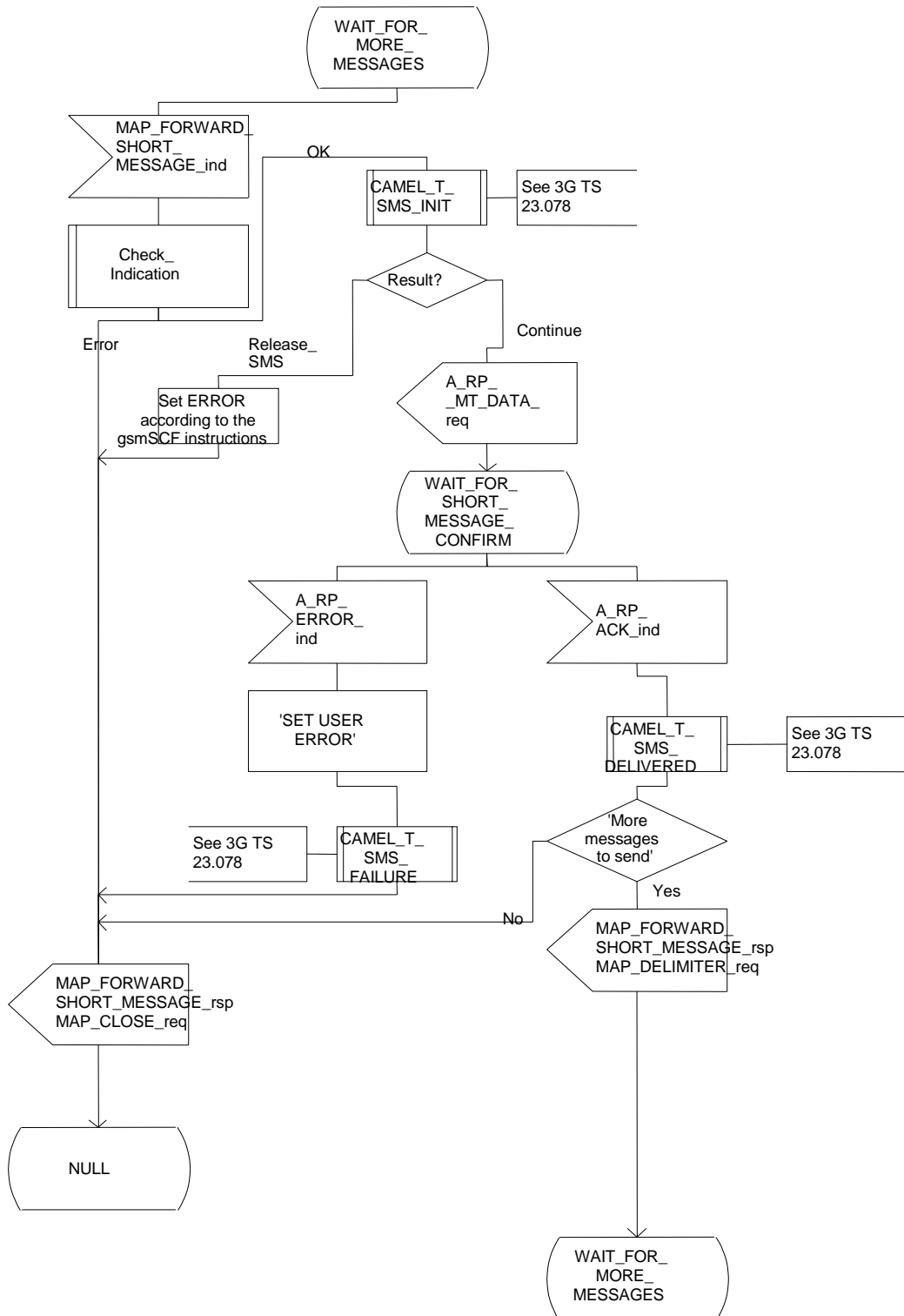

Figure 23.3/3 (sheet 3 of 5): Procedure MTSM_VMSC

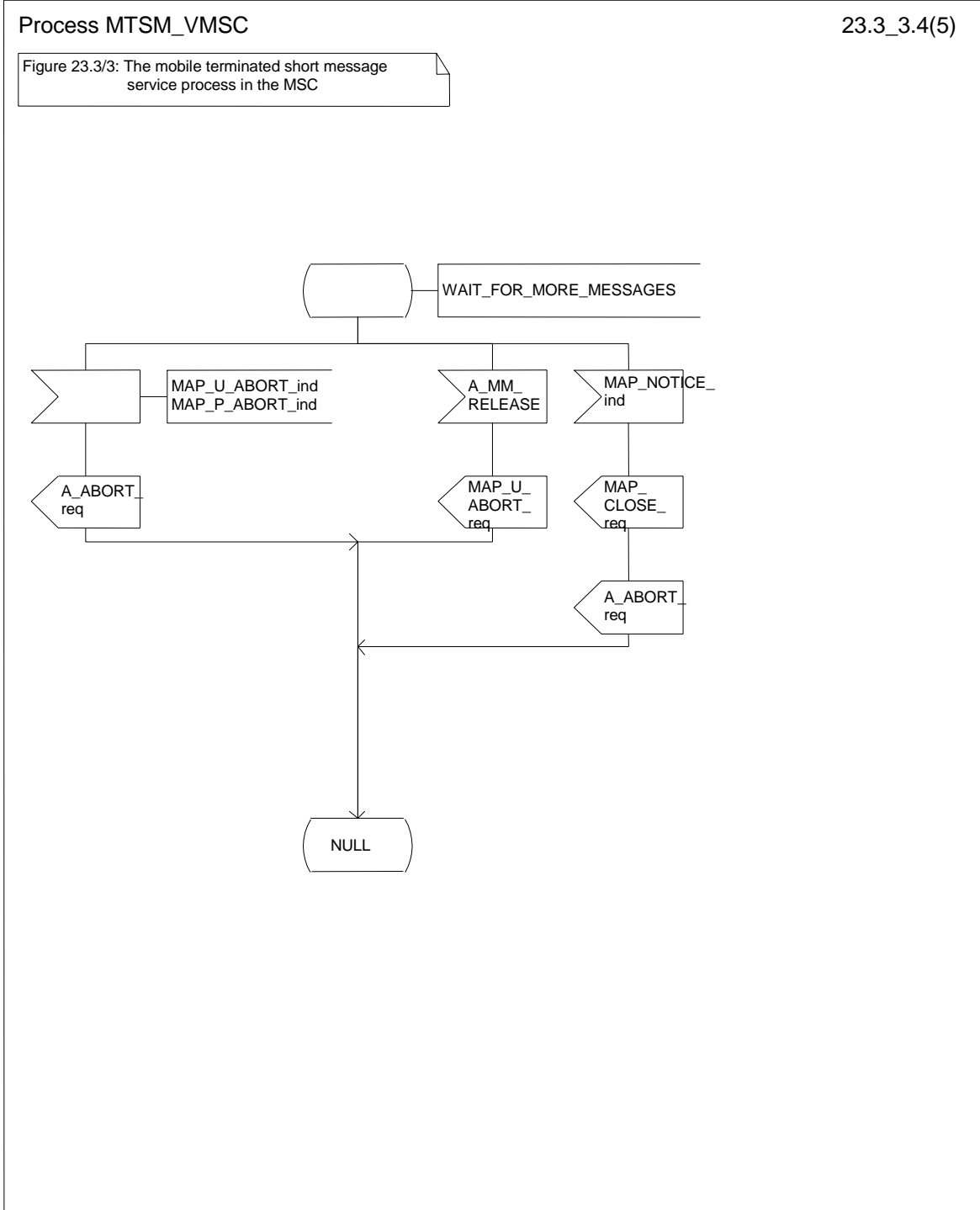

Figure 23.3/3 (sheet 4 of 5): Procedure MTSM_VMSC

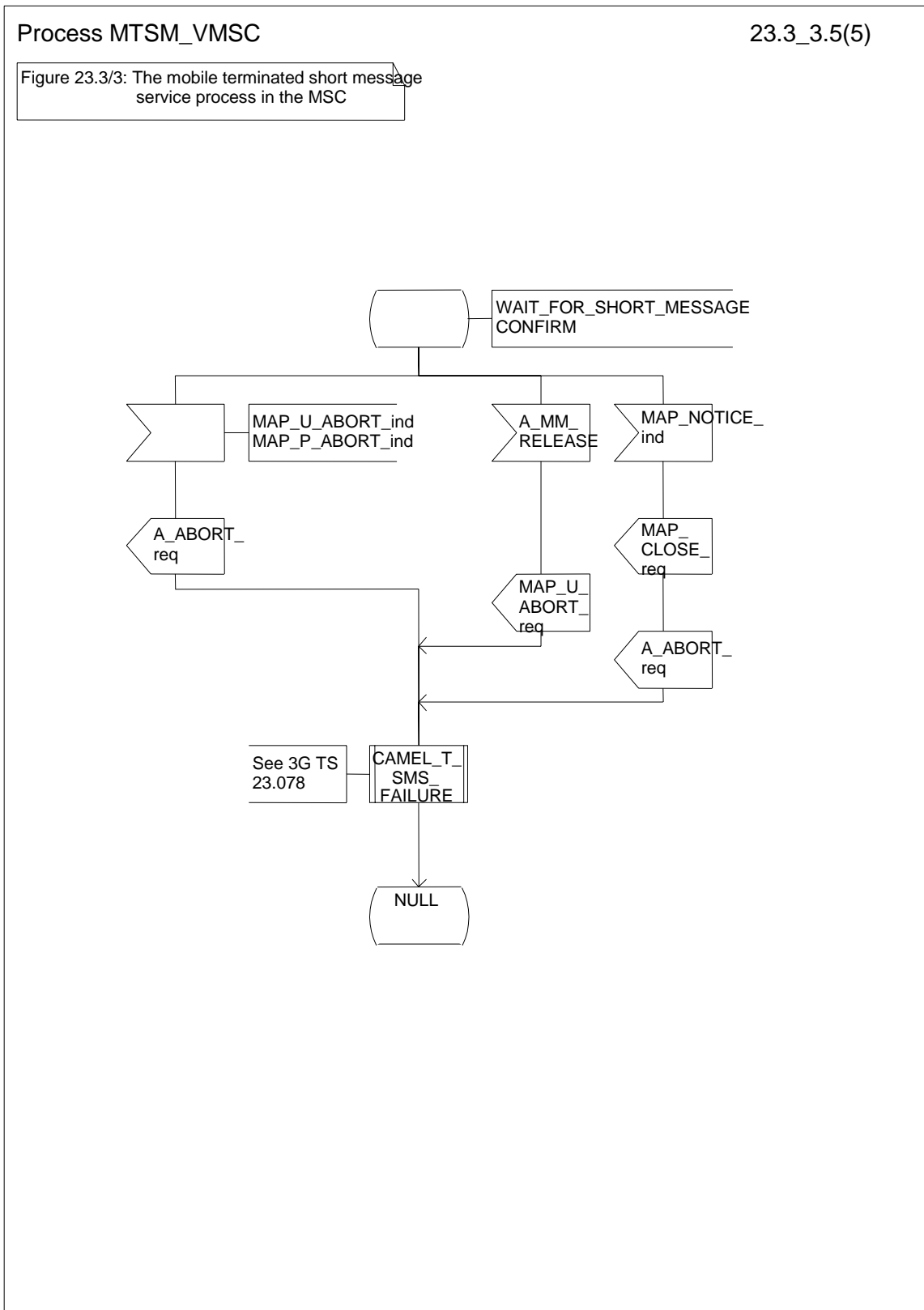

Figure 23.3/3 (sheet 5 of 5): Procedure MTSM_VMSC

Macrodefinition MT_SM_Transfer_MSC

23.3_4.1(4)

Figure 23.3/4: The mobile terminated short transfer macro in the MSC

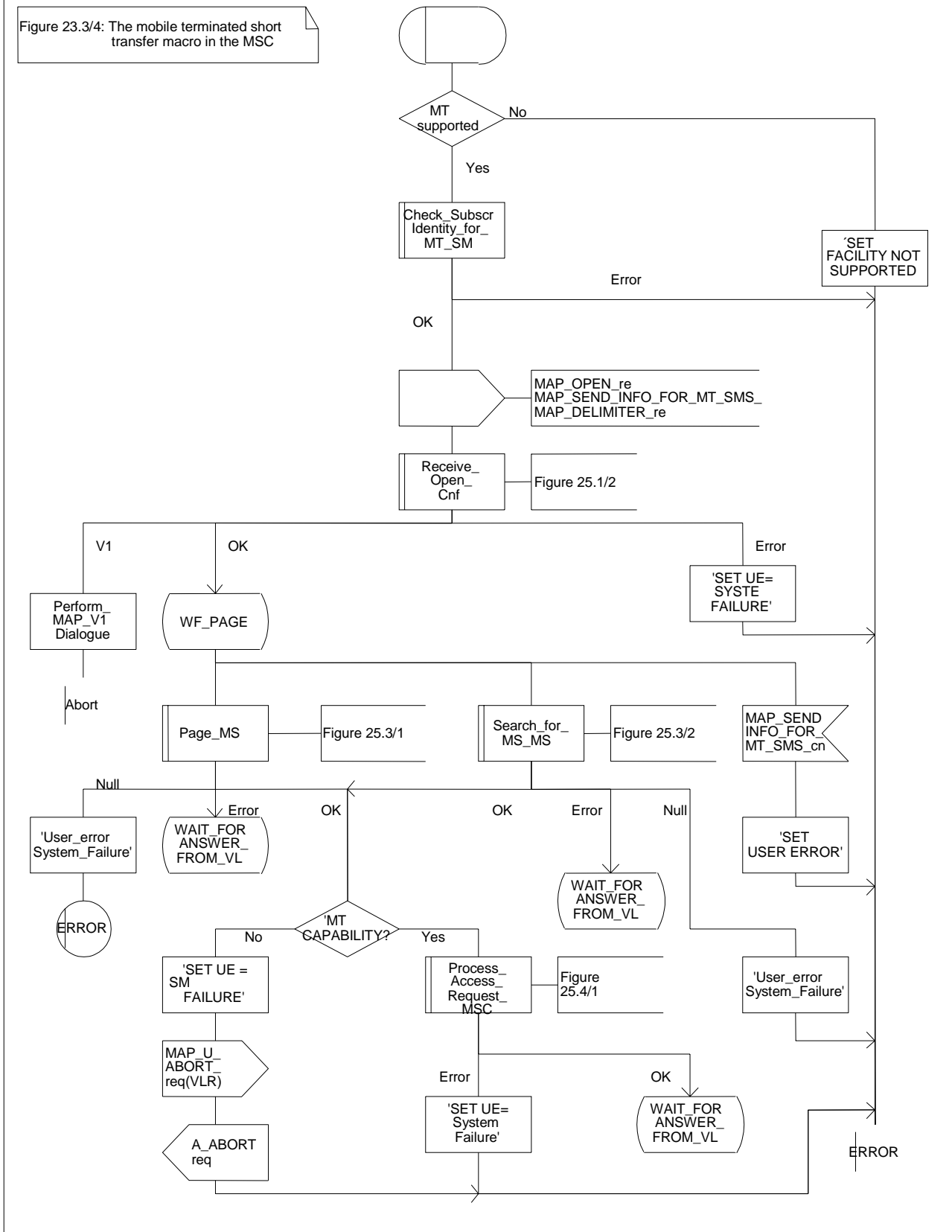

Figure 23.3/4 (sheet 1 of 4): Macro MT_SM_Transfer_MSC

Macrodefinition MT_SM_Transfer_MSC

23.3_4.2(4)

Figure 23.3/4: The mobile terminated short message transfer macro in the MSC

Signals to/from the right are to/from the VLR

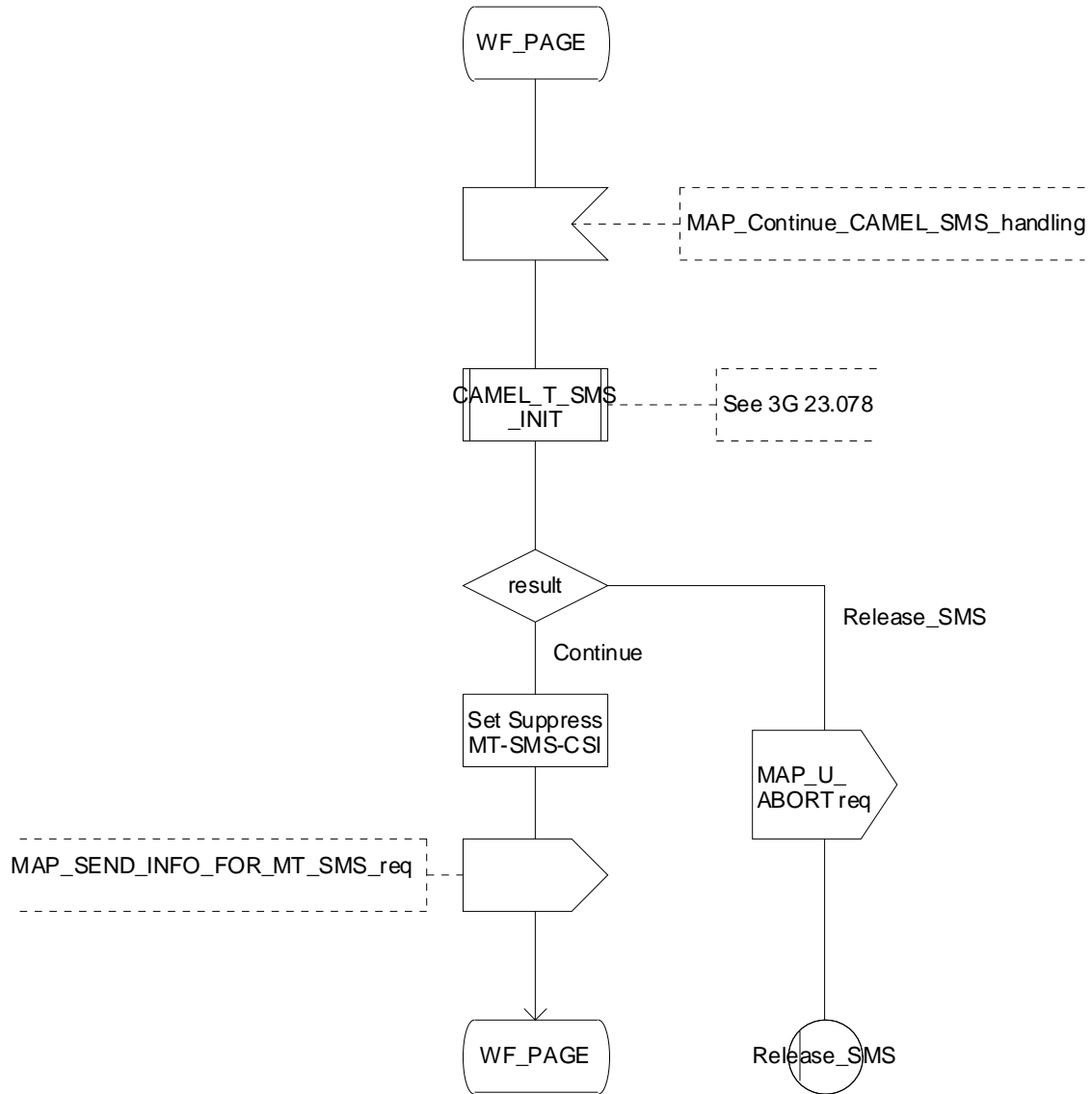

Figure 23.3/4 (sheet 2 of 4): Macro MT_SM_Transfer_MSC

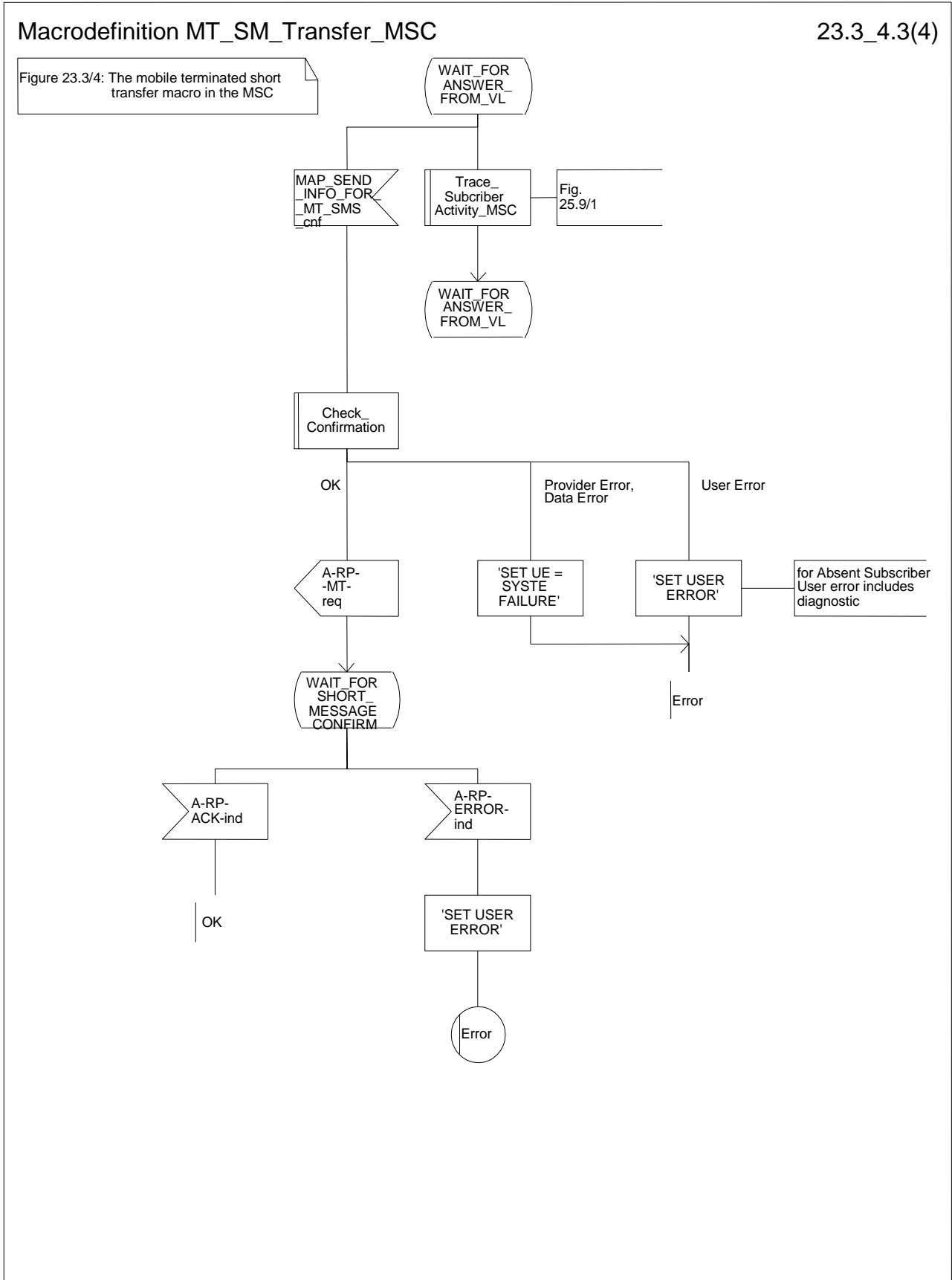

Figure 23.3/4 (sheet 3 of 4): Macro MT_SM_Transfer_MSC

Macrodefinition

23.3_4.4(4)

Figure 23.3/4: The mobile terminated short transfer macro in the MSC

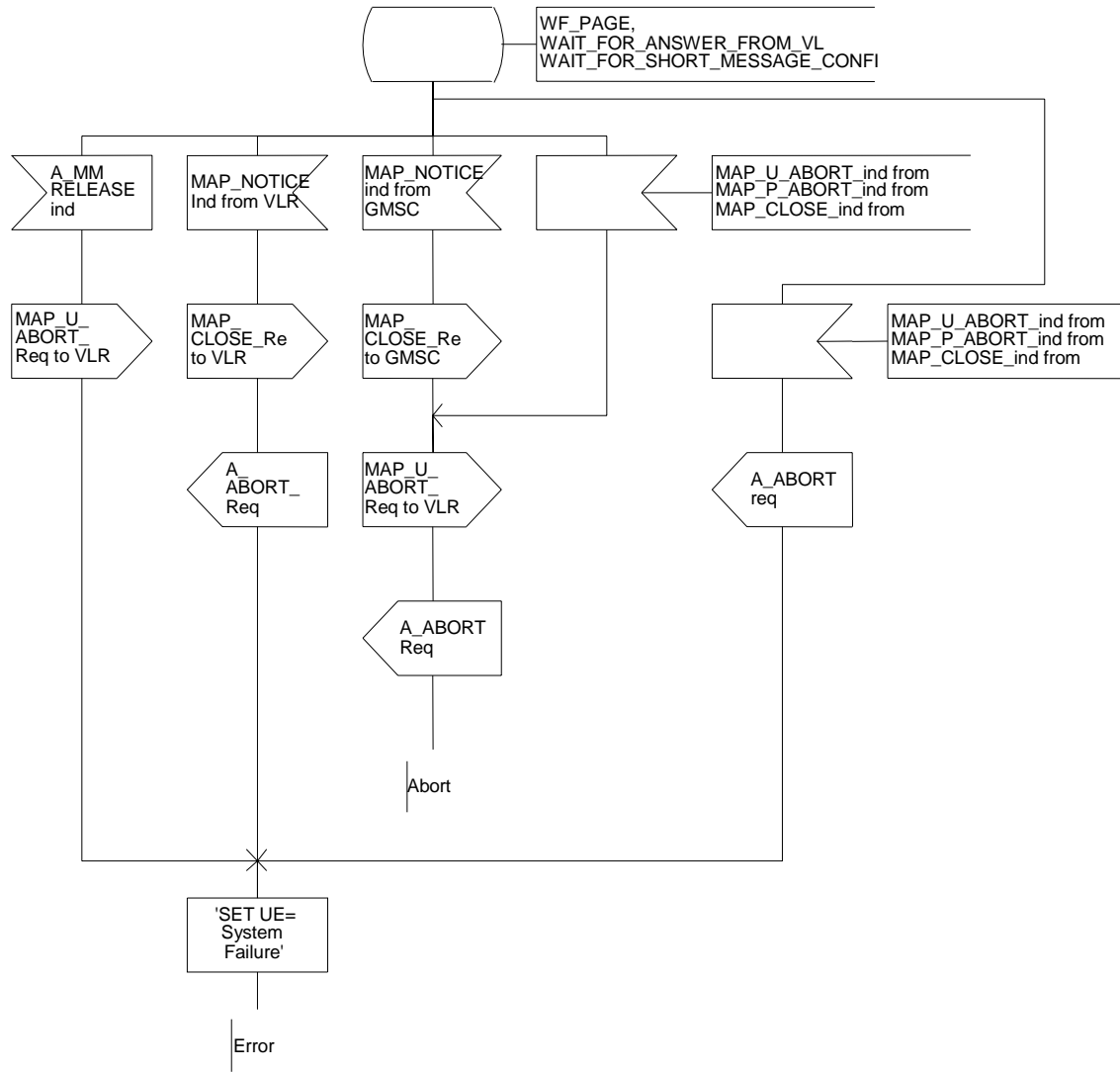

Figure 23.3/4 (sheet 4 of 4): Macro MT_SM_Transfer_MSC

23.3.2 Procedures in the VLR

When receiving the MAP_SEND_INFO_FOR_MT_SMS indication, the VLR will act as follows:

- the parameters and data in the primitive are checked by the macro "Check_Indication". A data failure is reported as an unexpected data value error or a data missing error depending on the nature of the failure;
- for mobile terminated short message the mobile subscriber is identified either by the IMSI only or by the IMSI accompanied by the LMSI. The subscriber identity information that may be included in the MAP_OPEN indication primitive and in the MAP service indication primitive is checked by the macro "Check_Subscr_Identity_For_MT_SMS". In the first case, the IMSI is included in the sm-RP-DA information field and the Destination Reference must not be present in the MAP_OPEN primitive. In the latter case the IMSI must be obtained from the Destination Reference of the MAP_OPEN indication primitive and an LMSI must be present in the sm-RP-DA information field of the MAP_SEND_INFO_FOR_MT_SMS indication. If the mobile subscriber is unknown, the unidentified subscriber error is returned;
- if the "Confirmed by HLR" indicator is set to "Not Confirmed", the unidentified subscriber error is returned;
- if the IMSI Detached Flag is set to detached or the LA Not Allowed Flag is set to not allowed in the VLR, an absent subscriber error with the diagnostic indication set to 'IMSI Detached' is returned and the MS not reachable flag (MNRF) is set;
- if the MAP_SEND_INFO_FOR_MT_SMS indication has passed the tests and the subscriber is provisioned with MT-SMS-CSI in the VLR, then the VLR shall send MT-SMS-CSI to the MSC in order to have the MSC initiate a CAMEL dialogue with the CSE.
- if the MAP_SEND_INFO_FOR_MT_SMS indication has passed all the tests, the VLR will initiate the paging procedure. If the location area identification is known and the "Confirmed by Radio Contact" indicator is set to "Confirmed", the MAP_PAGE service is used. Otherwise the MAP_SEARCH_FOR_MOBILE_SUBSCRIBER service is started.

The following responses to the paging procedure may be received from the MSC:

- the MAP_SEARCH_FOR_MOBILE_SUBSCRIBER confirmation indicating a successful outcome, if the search procedure is used. After that the VLR awaits the MAP_PROCESS_ACCESS_REQUEST indication from the MSC;
- the MAP_PAGE confirmation or MAP_SEARCH_FOR_MOBILE_SUBSCRIBER confirmation indicating unsuccessful outcome. If an absent subscriber error is received, the MS not reachable flag (MNRF) is set in the VLR. The errors are forwarded to the MSC in the MAP_SEND_INFO_FOR_MT_SMS response, the absent subscriber error is forwarded with the diagnostic indication set to 'No Paging Response for non GPRS'. If the unexpected data value, or unknown location area error is received, the system failure indication is given to the MSC; if subscriber busy for MT SMS is received, this cause is given to the MSC.
- the MAP_PROCESS_ACCESS_REQUEST indication telling that the outcome of the service MAP_PAGE is successful.

If the paging procedure or process access request procedure or any other procedure invoked fails, the appropriate error is reported to the MSC.

If the process access request procedure is successful, the VLR will send the MAP_SEND_INFO_FOR_MT_SMS response to the MSC and the transaction is terminated in the VLR.

The mobile terminated short message transfer procedure in the VLR is shown in figure 23.3/5.

Process MT_SM_VLR

23.3_5.1(3)

Figure 23.3/5: The mobile terminated short message service process in the VLR

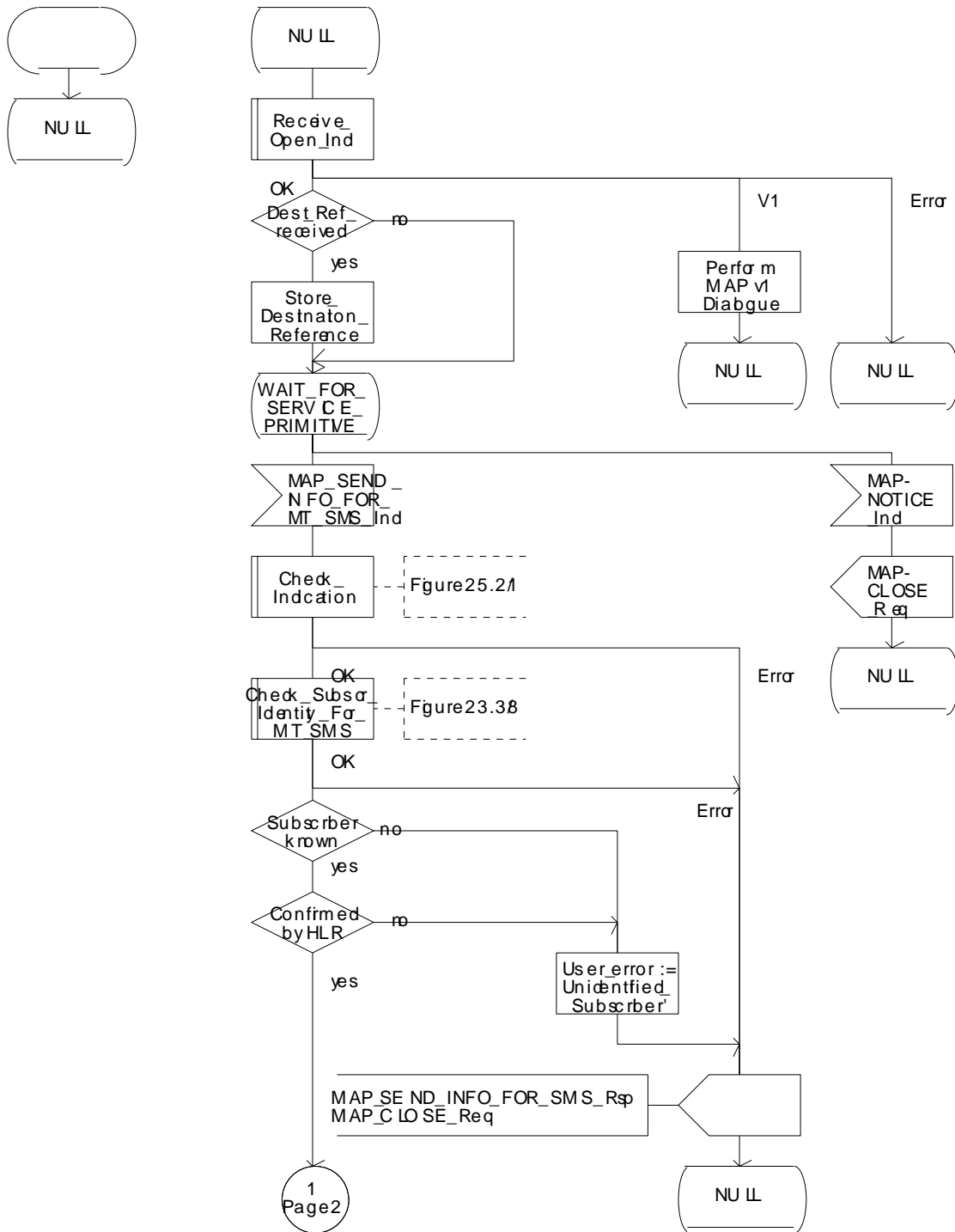

Figure 23.3/5 (sheet 1 of 3): Process MT_SM_VLR

Process MT_SM_VLR

23.3_5.2(3)

Figure 23.3/5: The mobile terminated short message service process in the VLR

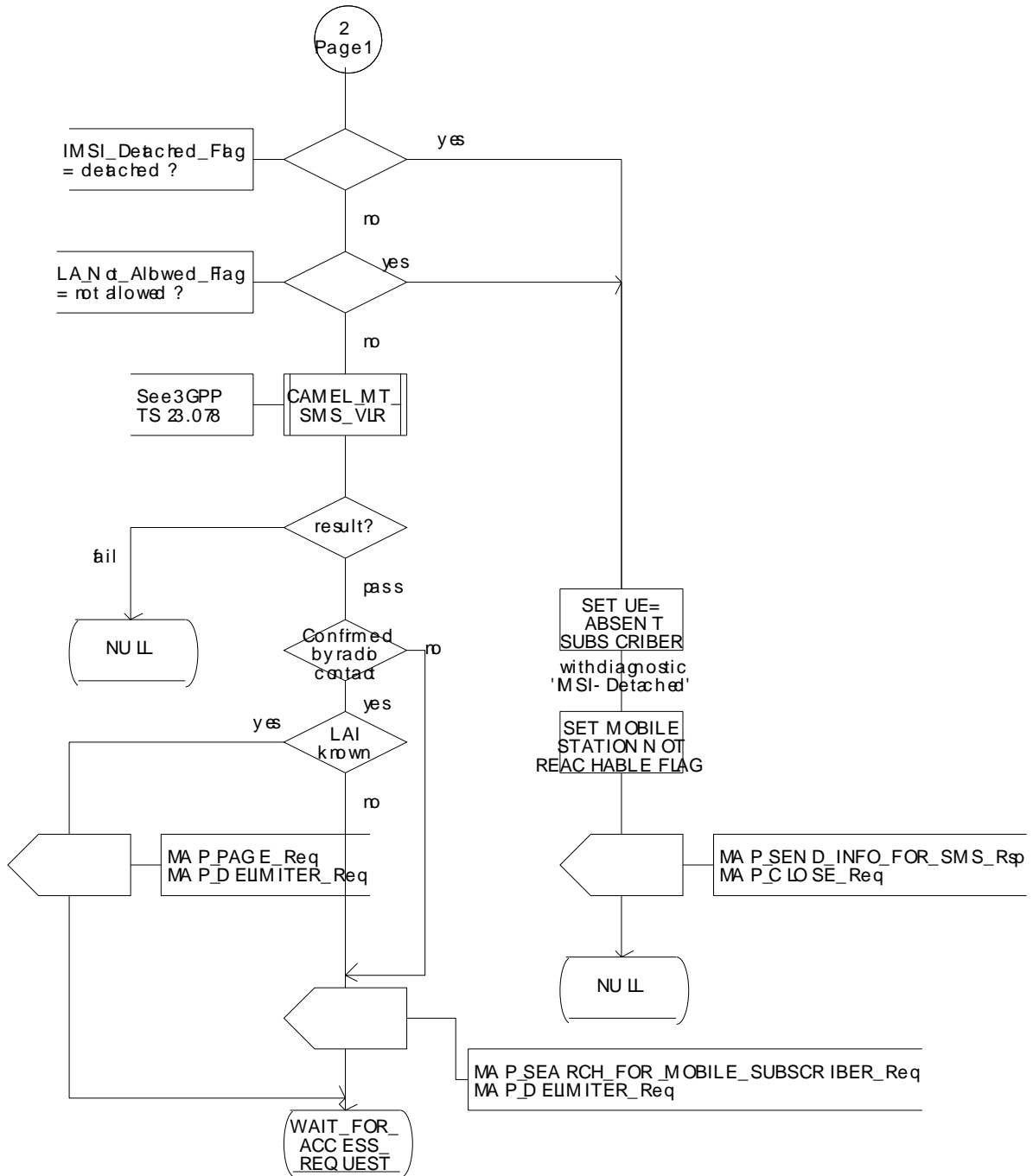

Figure 23.3/5 (sheet 2 of 3): Process MT_SM_VLR

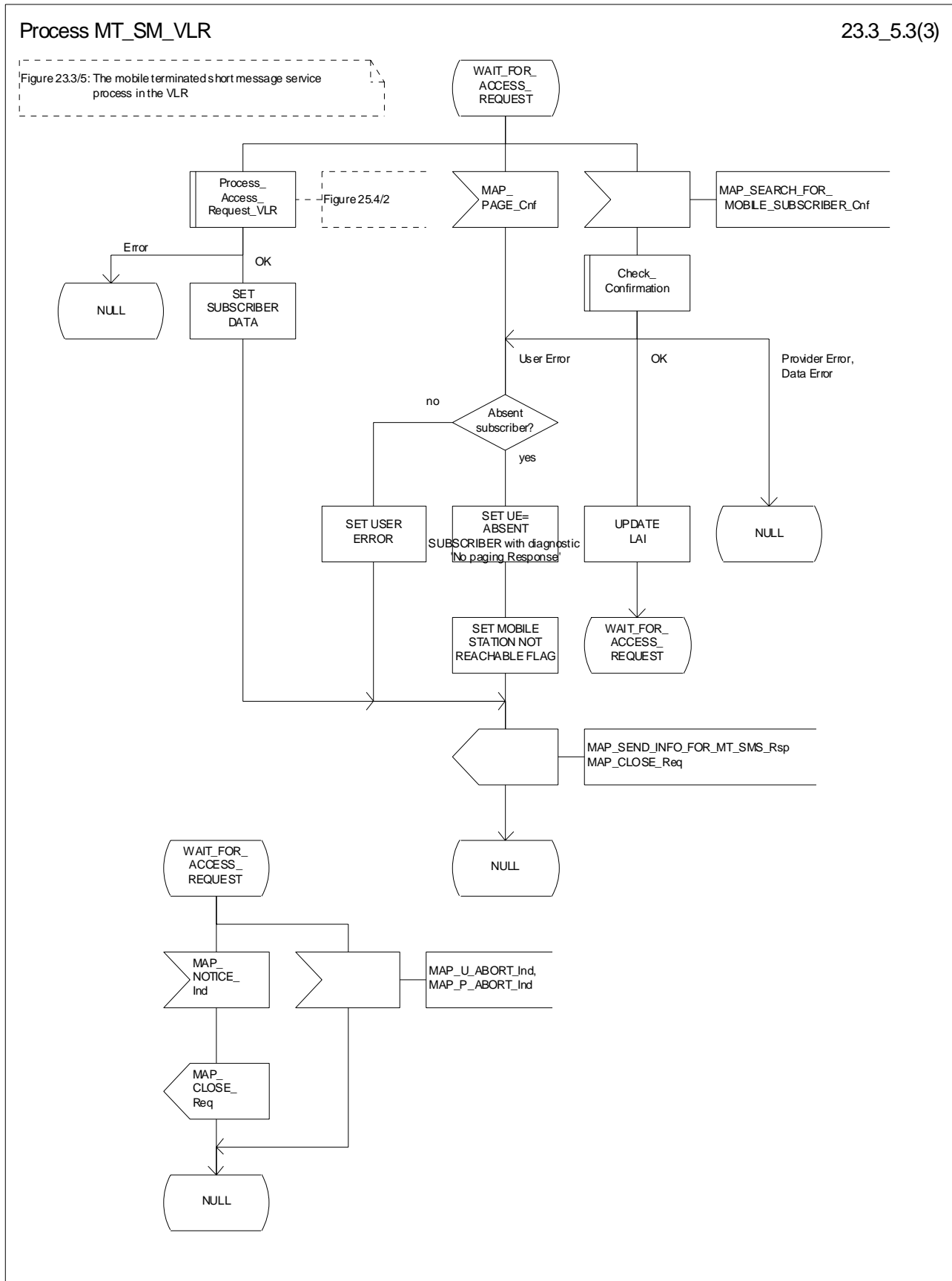

Figure 23.3/5 (sheet 3 to 3): Process MT_SM_VLR

23.3.3 Procedures in the HLR

The MAP_SEND_ROUTING_INFO_FOR_SM indication is received from the GMSC. The following error cases are reported to the GMSC in the MAP_SEND_ROUTING_INFO_FOR_SM response as an unsuccessful outcome of the procedure:

- if the necessary parameters and data are not present in the primitive or they are badly formatted, the data missing or unexpected data value error is returned;
- if the mobile subscriber is unknown, i.e. it cannot be identified from the MSISDN given, an unknown subscriber error is returned;
- if the short message transfer would contravene operator determined barring, the call barred error with cause operator barring is returned;
- if the short message transfer would contravene the « SM filtering by the HPLMN » function criteria, the call barred error with cause unauthorised Message Originator is returned (the definition of the filtering function is out of the scope of GSM specification. Filtering may be based on SM-RP-SMEA information element if received from the GMSC);
- if the mobile subscription identified by the given MSISDN number does not include the short message service, the teleservice not provisioned error is returned;
- if the GMSC does not support the GPRS functionality, the behaviour of the HLR depends on the following conditions:
 - if the subscriber is not a GPRS subscriber then the behaviour of the HLR shall be the same as for a subscriber only registered as non GPRS and for SMS delivery;
 - if the subscriber is a GPRS subscriber and a non-GPRS subscriber with the option « transfer of SM via the MSC when GPRS is not supported in the GMSC » then the behaviour of the HLR shall be the same as for a subscriber only registered as non GPRS and for SMS delivery;
 - if the subscriber is a GPRS subscriber and a non-GPRS subscriber with the option « transfer of SM via the SGSN when GPRS is not supported in the GMSC » or if the subscriber is a GPRS subscriber only then the behaviour of the HLR shall be the same as for the case transfer over GPRS described in MAP release 97, with the following precision: because GMSC does not support MAP release 97, the previous MAP protocol release is used. When the HLR sends the MAP_SEND_ROUTING_INFO_FOR_SM_Resp, the SGSN number is mapped to the MAP parameter « MSC number ». When the HLR sends the MAP_INFORM_SERVICE_CENTRE_resp, the MNRG status shall be mapped to the MAP parameter « mnrf-set ».

The HLR may send the MSC, SGSN or both numbers as routing information to SMS-GMSC based on the following:

A) The subscriber may only be registered as non GPRS and for SMS delivery:

- if the short message transfer would contravene the supplementary service barring, the call barred error with cause barring service active is returned;
- if the location registration of the mobile subscriber shows that the VLR in the visited PLMN does not support the MT short message service, the facility not supported error is returned;
- if no MSC identity is stored for the mobile subscriber or the "MSC Area Restricted Flag" is set or the "MS purged for non GPRS" flag is set, i.e. the MS is not reachable, the MSISDN-Alert and the SC address are included in the MWD (if possible), the flag MNRF is set and the "Absent Subscriber_SM" error is returned with the appropriate absent subscriber diagnostic indication, i.e. 'Deregistered in HLR for non GPRS ', 'Roaming Restricted' or 'MS-Purged for non GPRS '.

The priority parameter (SM_RP_PRI) is processed as follows:

- if the priority is low (SM_RP_PRI = False) and the mobile station not reachable flag (MNRF) is set, an absent subscriber_SM error is returned. If a reason for the subscriber's absence for non GPRS is stored in the mobile not reachable reason (MNRR) in the subscriber data, then this is returned with the absent subscriber_SM error. The SC-address given in the request will be included in the MWD if possible. The service MAP_INFORM_SERVICE_CENTRE including the parameter MW Status is invoked to indicate whether or not the SC address has been included in the MWD list.
- if the priority is low (SM_RP_PRI = False), and the MNRF is clear, the routing information with MSC number is retrieved as described below;
- if the priority is high (SM_RP_PRI = True) and the MNRF is set, the HLR will send the acknowledge primitive containing the routing information with MSC number to the gateway MSC. In addition the service MAP_INFORM_SERVICE_CENTRE including the parameter MW Status is invoked to indicate whether or not the SC address is already included in the MWD list.

B) The subscriber may only be registered as GPRS and for SMS delivery:

- if the location registration of the mobile subscriber shows that the SGSN in the visited PLMN does not support the MT short message service, the facility not supported error is returned;
- if no SGSN identity is stored for the mobile subscriber or the "SGSN Area Restricted Flag" is set or the "MS purged for GPRS" flag is set, i.e. the MS is not reachable, the MSISDN-Alert and the SC address are included in the MWD (if possible), the flag MNRG is set and the "Absent Subscriber_SM" error is returned with the appropriate absent subscriber diagnostic indication, i.e. 'Deregistered in HLR for GPRS', 'Roaming Restricted' or 'MS-Purged for GPRS'.

The priority parameter (SM_RP_PRI) is processed as follows:

- if the priority is low (SM_RP_PRI = False) and the mobile station not reachable for GPRS (MNRG) flag is set, an absent subscriber_SM error is returned. If a reason for the subscriber's absence for GPRS is stored in the mobile not reachable reason (MNRR) in the subscriber data, then this is returned with the absent subscriber_SM error. The SC-address given in the request will be included in the MWD if possible. The service MAP_INFORM_SERVICE_CENTRE including the parameter MW Status is invoked to indicate whether or not the SC address has been included in the MWD list.
- if the priority is low (SM_RP_PRI = False), and the MNRG is clear, the routing information with SGSN number is retrieved as described below;
- if the priority is high (SM_RP_PRI = True) and the MNRG is set, the HLR will send the acknowledge primitive containing the routing information with SGSN number to the gateway MSC. In addition the service MAP_INFORM_SERVICE_CENTRE including the parameter MW Status is invoked to indicate whether or not the SC address is already included in the MWD list.

C) The subscriber may be registered as non GPRS and GPRS and for SMS Delivery:

- if the short message transfer would contravene the supplementary service barring, the behaviour is the same as for a subscriber only registered for GPRS and SMS delivery.
- if the location registration of the mobile subscriber shows that the VLR in the visited PLMN does not support the MT short message service, the behaviour is the same as for a subscriber only registered for GPRS and SMS delivery;
- if the location registration of the mobile subscriber shows that the SGSN in the visited PLMN does not support the MT short message service, the behaviour is the same as for a subscriber only registered for non GPRS and SMS delivery;
- if no MSC and SGSN identities are stored for the mobile subscriber or the "MSC and SGSN Area Restricted Flags" are set or the "MS purged for non GPRS and GPRS" flags are set or a combination of these errors for non GPRS and GPRS are used, i.e. the MS is not reachable, the MSISDN-Alert and the SC address are included in the MWD (if possible), the flags MNRF and MNRG are set and the "Absent Subscriber_SM" error is returned with the appropriate absent subscriber diagnostic indication, i.e. 'Deregistered in HLR for non GPRS or GPRS', 'Roaming Restricted', 'MS-Purged for non GPRS or GPRS' or both.

The priority parameter (SM_RP_PRI) is processed as follows:

- if the priority is low (SM_RP_PRI = False), the MNRF and MNRG are set, an absent subscriber_SM error is returned. If reasons for the subscriber's absence for non GPRS and GPRS are stored in MNRR in the subscriber data, then this is returned with the absent subscriber_SM error. The SC-address given in the request will be included in the MWD if possible. The service MAP_INFORM_SERVICE_CENTRE including the parameter MW Status is invoked to indicate whether or not the SC address has been included in the MWD list.
- if the priority is low (SM_RP_PRI = False), and the MNRF is clear and MNRG is set, the routing information with MSC number is retrieved as described below;
- if the priority is low (SM_RP_PRI = False), and the MNRF is set and MNRG is clear, the routing information with SGSN number is retrieved as described below;
- if the priority is low (SM_RP_PRI = False), and the MNRF and MNRG are clear, the routing information with MSC and SGSN numbers is retrieved as described below;
- if the priority is high (SM_RP_PRI = True) and the MNRF, the MNRG or both are set, the HLR will send the acknowledge primitive containing the routing information with both MSC and SGSN numbers to the gateway MSC. In addition the service MAP_INFORM_SERVICE_CENTRE including the parameter MW Status is invoked to indicate whether or not the SC address is already included in the MWD list.

If the MSISDN-Alert number of the mobile subscriber stored in the MWD is not the same as that received in the MAP_SEND_ROUTING_INFO_FOR_SM indication, the HLR will include in the MAP_INFORM_SERVICE_CENTRE request to the GMSC the MSISDN-Alert number stored.

The MAP_INFORM_SERVICE_CENTRE request is sent also when the MCEF, MNRF, MNRG or both are set but the routing information is still sent to the GMSC. The status of the flags is indicated in the parameter MW Status.

The routing information is included in a MAP_SEND_ROUTING_INFO_FOR_SM response as follows:

- the IMSI will be returned to the GMSC together with the MSC, SGSN or both numbers and may be optionally accompanied by the LMSI.
- an indication specifying which number belongs the MSC and the SGSN will be returned to the GSMC.

LMSI shall not be used in case only the SGSN number is sent by HLR.

The mobile terminated short message transfer procedure in the HLR is shown in figure 23.3/6.

Process Mobile_terminated_SM_HLR

23.3_6.1(5)

Figure 23.3/6: The mobile terminated short message service process in the HLR in case the subscriber is registered as non-GPRS and/or GPRS

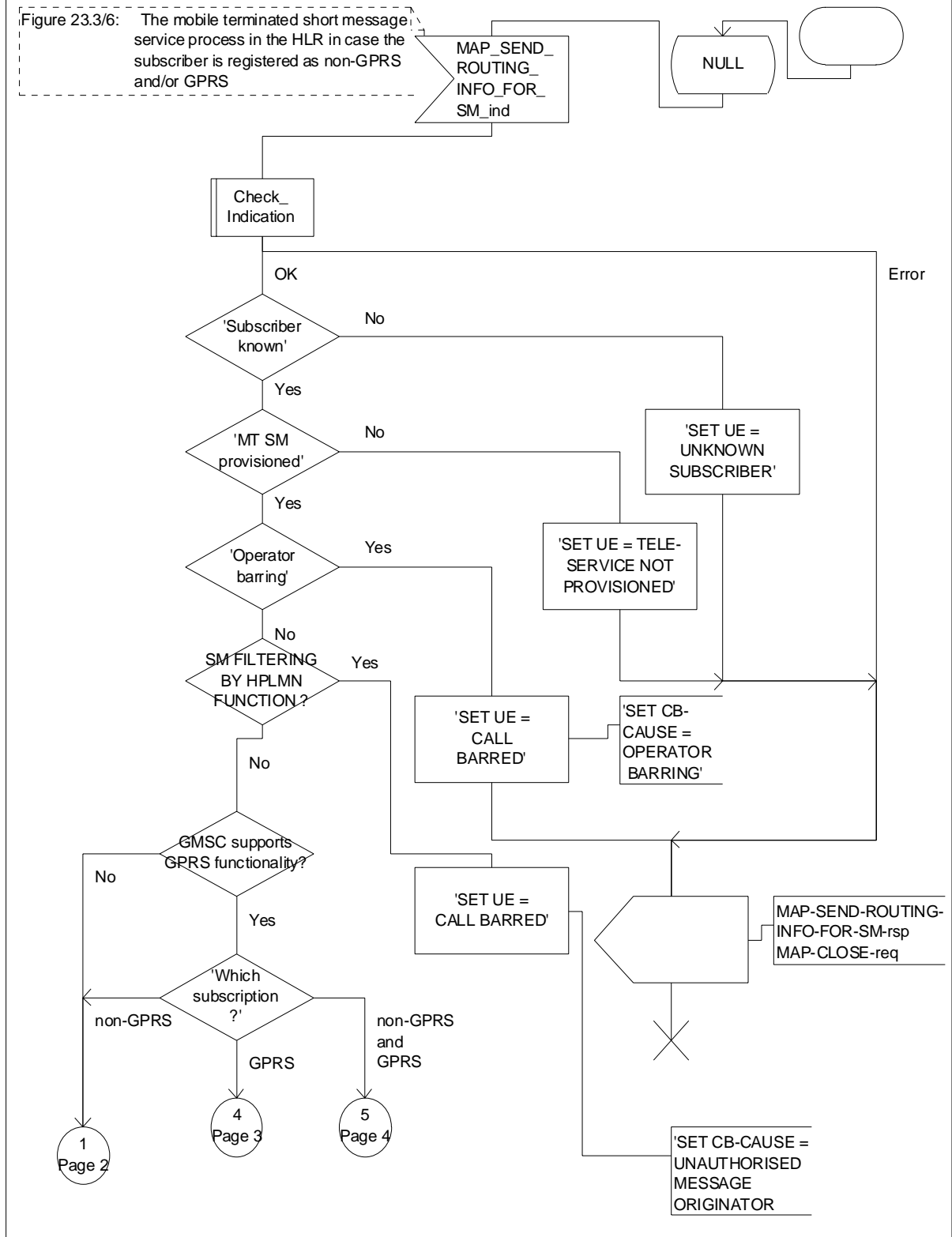

Figure 23.3/6 (sheet 1 of 5): Process Mobile_terminated_SM_HLR

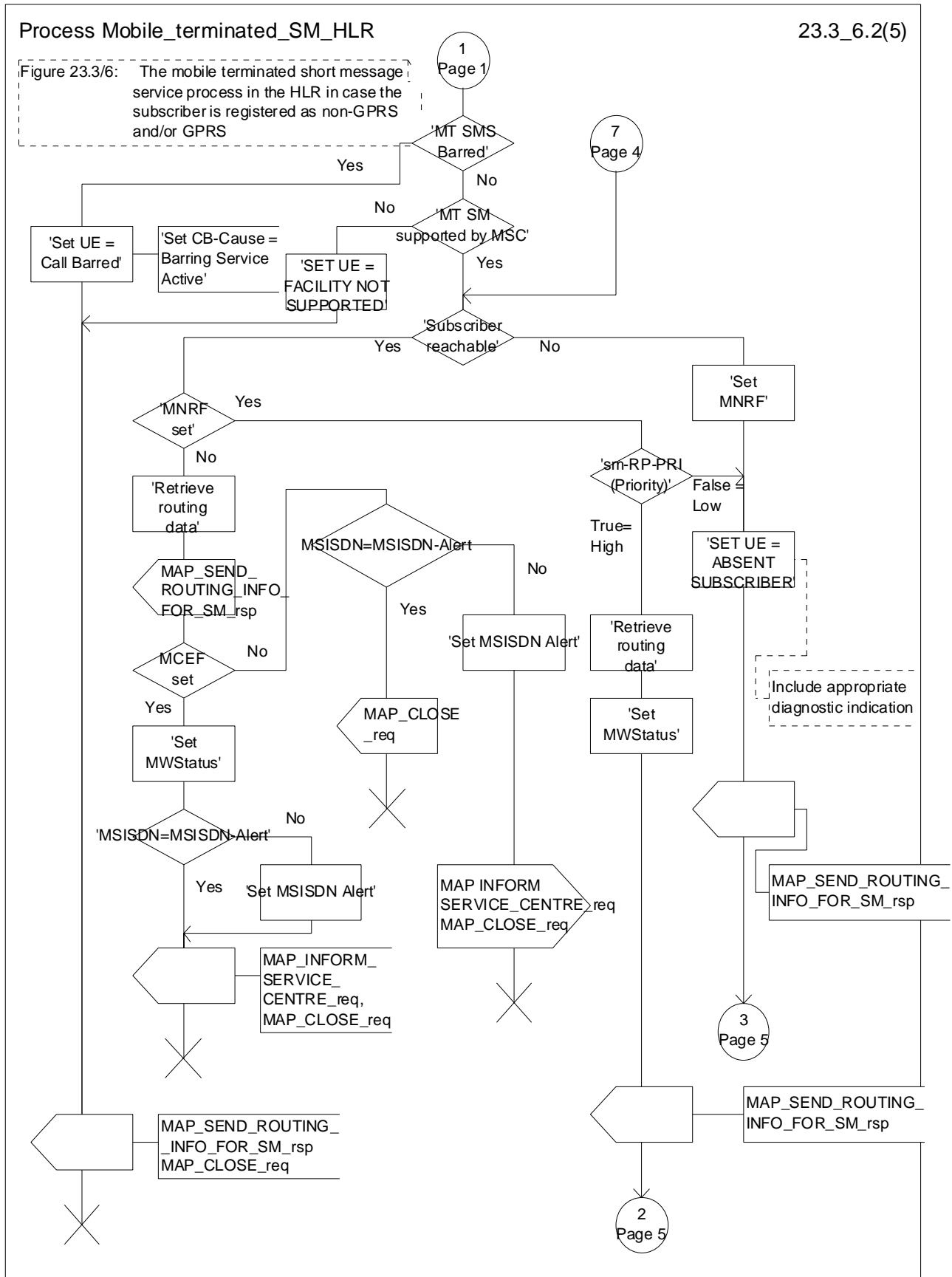

Figure 23.3/6 (sheet 2 of 5): Process Mobile_terminated_SM_HLR

Process Mobile_terminated_SM_HLR

23.3_6.3(5)

Figure 23.3/6: The mobile terminated short message service process in the HLR in case the subscriber is registered as non-GPRS and/or GPRS

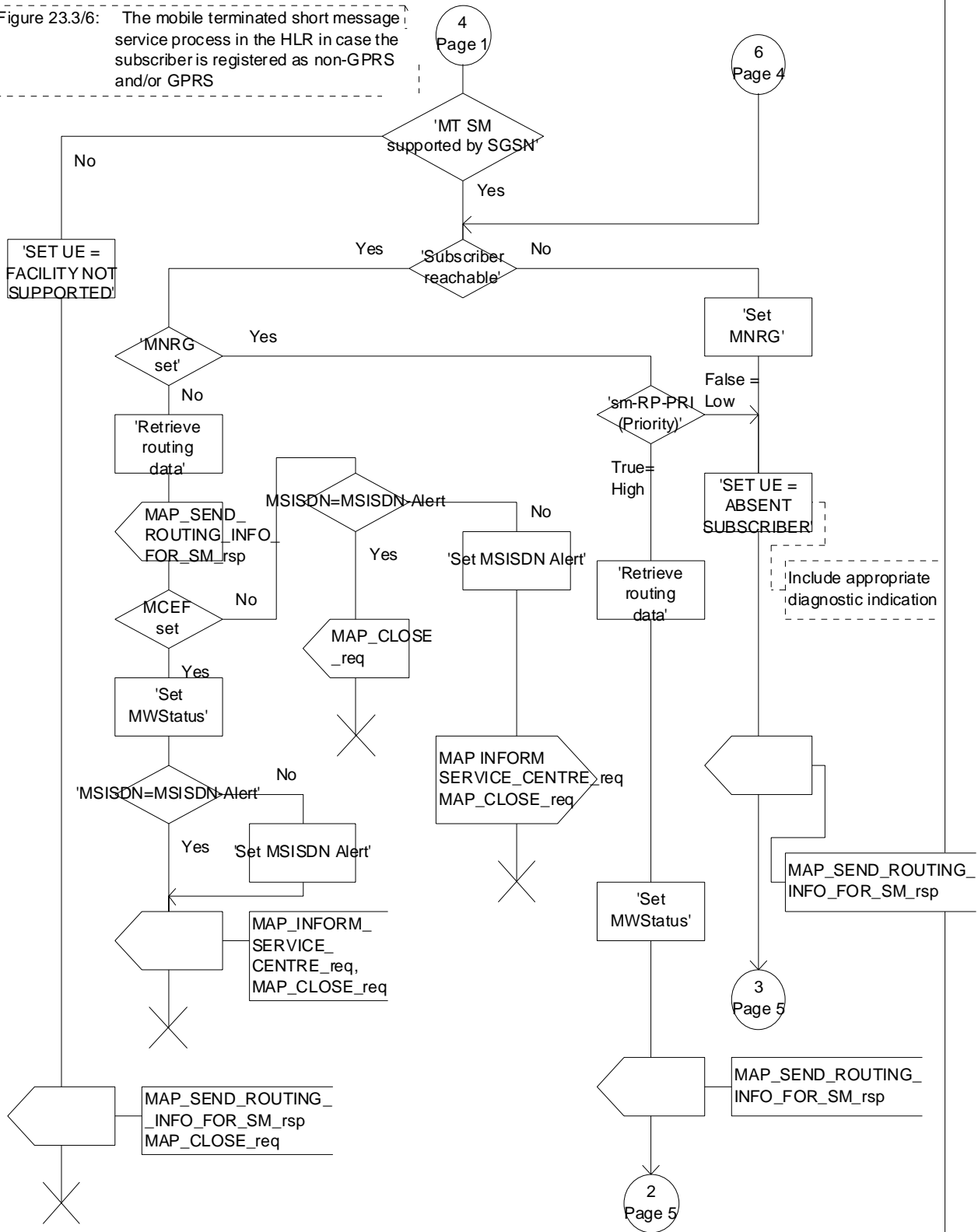

Figure 23.3/6 (sheet 3 of 5): Process Mobile_terminated_SM_HLR

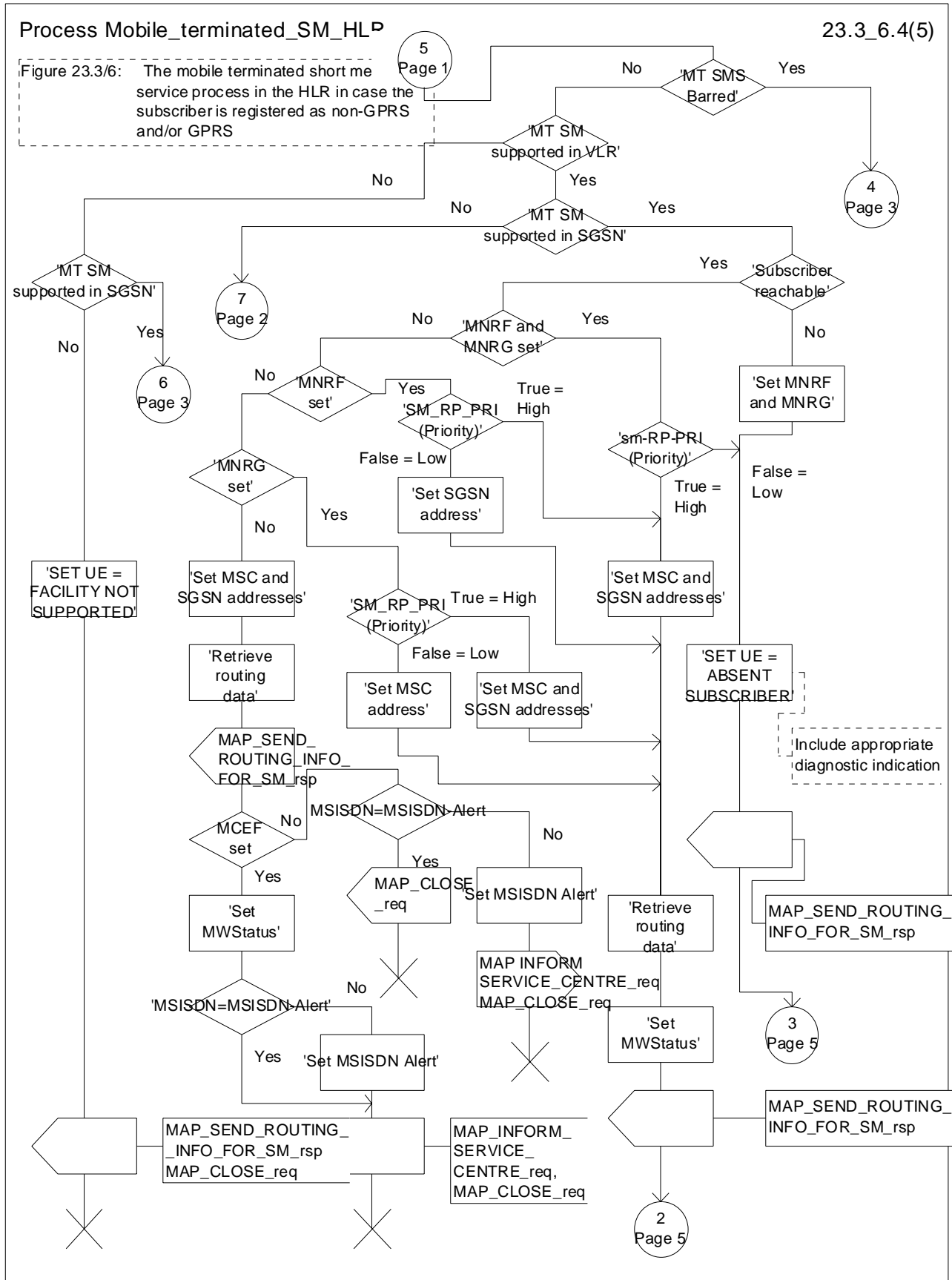

Figure 23.3/6 (sheet 4 of 5): Process Mobile_terminated_SM_HLR

Process Mobile_terminated_SM_HLR

23.3_6.5(5)

Figure 23.3/6: The mobile terminated short message service process in the HLR in case the subscriber is registered as non-GPRS and/or GPRS

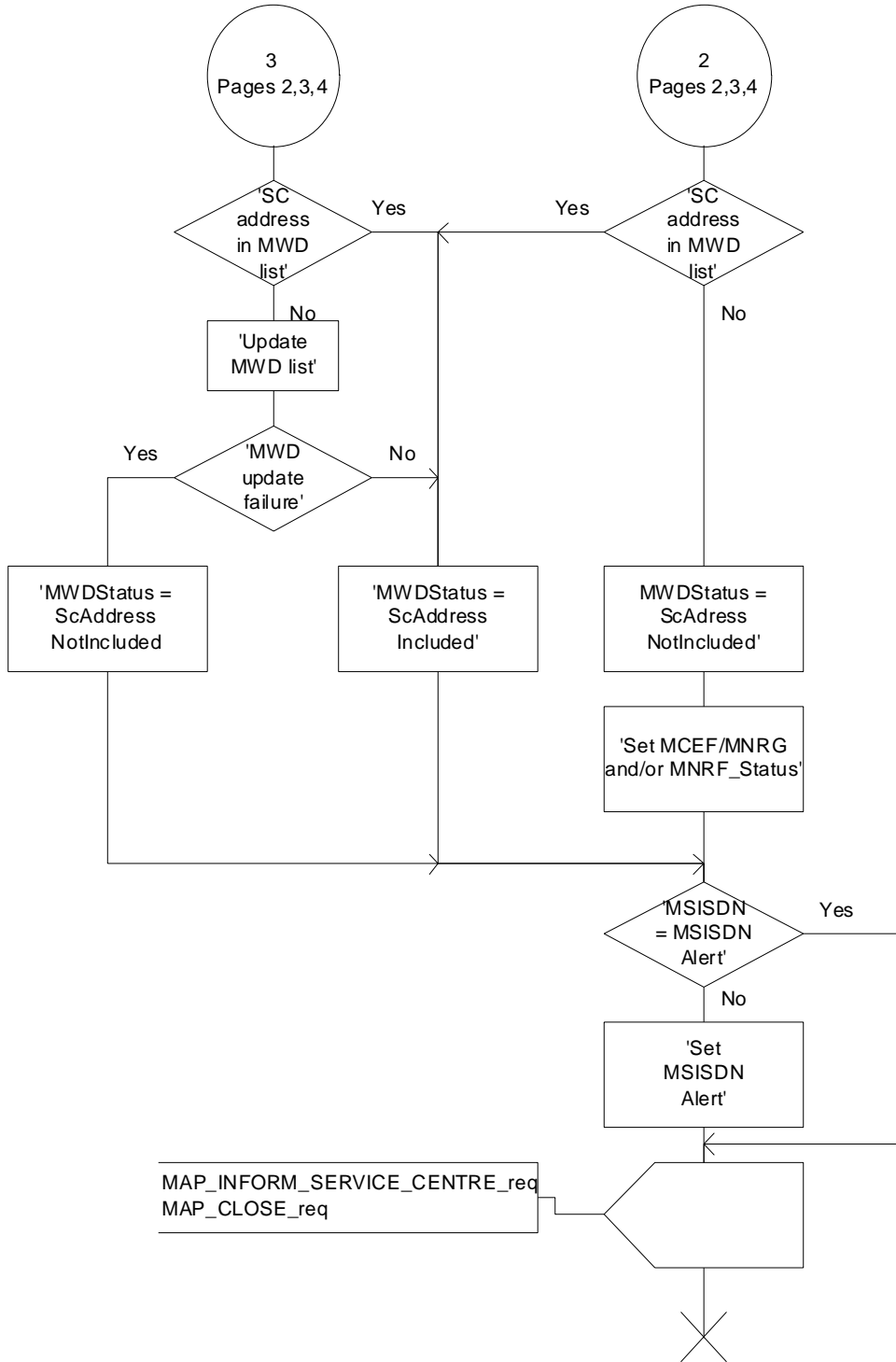

Figure 23.3/6 (sheet 5 of 5): Process Mobile_terminated_SM_HLR

Procedure Select_Transfer_Nodes

23.3_11(1)

Figure 23.3/11: Procedure in the HLR to select the node (MSC or/and SGSN) to which the SMS-GMSC has to send Short Message

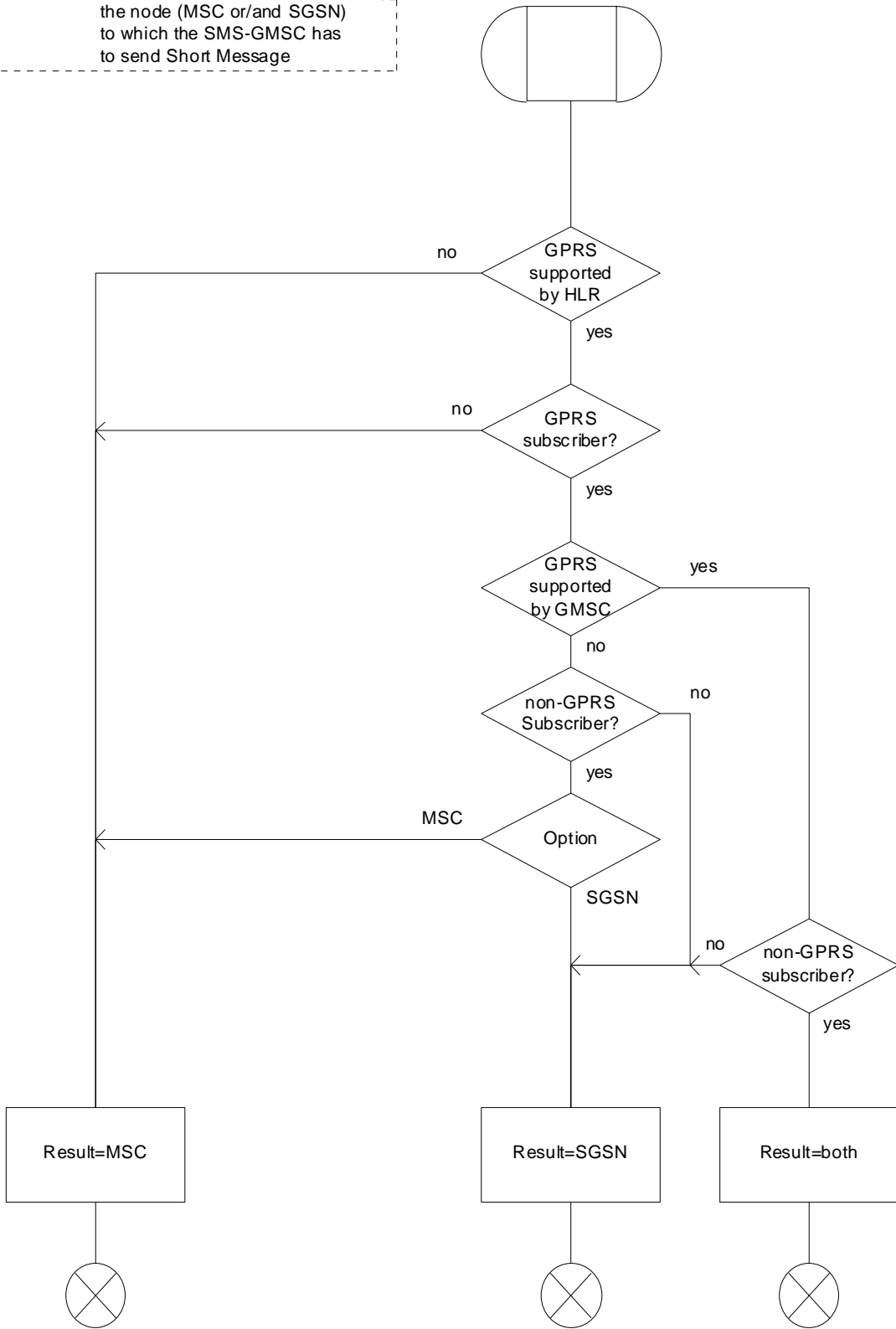

Figure 23.3/11: Procedure Select_Transfer_Nodes

23.3.4 Procedures in the gateway MSC

The short message handling function of the GMSC will request routing information when a mobile terminated short message is received from a Service Centre. The GMSC sends the MAP_SEND_ROUTING_INFO_FOR_SM request to the HLR containing the subscriber data of the mobile subscriber and the indication that the SMS-GMSC supports the GPRS functionality.

As an outcome of the procedure the MAP_SEND_ROUTING_INFO_FOR_SM confirmation is received indicating:

- an unsuccessful event indication containing an error;

The mapping between the MAP error causes and the RP_ERROR causes is explained in 3GPP TS 23.140.

- a successful event indication containing following parameters:
 - an IMSI optionally accompanied by an LMSI; and
 - routing addresses (servicing MSC, SGSN or both numbers).

The LMSI shall not be used in case the short message is routed towards the SGSN.

The GMSC may also receive a MAP_INFORM_SERVICE_CENTRE indication after the MAP_SEND_ROUTING_INFO_FOR_SM confirmation. The parameter MW Status in the message indicates whether or not the Service Centre address is stored in the Message Waiting Data. It also indicates the status of the MCEF, MNRF and MNRG flags in the HLR. The message also indicates the value of the MNRR if this is stored in the HLR and one or both of the MNRF and MNRG flags is set in the HLR.

If the MSISDN-Alert stored in the MWD data is not the same as the one sent to the HLR, the MSISDN-Alert is received in the MAP_INFORM_SERVICE_CENTRE indication. This MSISDN number shall be transferred in a delivery failure report to the SC.

In the abnormal end or in the provider error case the system failure error is provided to the SC.

The forward short message procedure is initiated when the GMSC has obtained the routing information needed to forward a mobile terminated short message to the servicing MSC or SGSN.

If both numbers MSC and SGSN are received from HLR as routing information, the SMS-GMSC may choose which path (SGSN or MSC) first the SMS is to be transferred.

If an LMSI has been provided in the MAP_SEND_ROUTING_INFO_FOR_SM confirmation, it can be included in the sm-RP-DA information field of the first MAP_MT_FORWARD_SHORT_MESSAGE request sent to the servicing MSC. In this case, the IMSI must be included in the Destination Reference of the MAP_OPEN request. If the LMSI is not sent by the SMS Gateway MSC, the sm-RP-DA information field in the first MAP_MT_FORWARD_SHORT_MESSAGE request sent to the servicing MSC or SGSN shall contain the IMSI and the Destination Reference in the MAP_OPEN request shall not be present. The Service Centre address is sent in the parameter SM_RP_OA. The More Messages To Send flag is set to TRUE or FALSE depending on the information received from the Service Centre.

If the GMSC is the servicing MSC then the MAP service is not initiated. The procedure in the Servicing MSC is described in clause 23.3.1 and in the figure 23.3/4.

If the grouping of MAP_OPEN request and MAP_MT_FORWARD_SHORT_MESSAGE request together would need segmenting, these primitives must not be grouped together. The MAP_OPEN request primitive is sent first without any associated MAP service request primitive and the dialogue confirmation must be received before the MAP_MT_FORWARD_SHORT_MESSAGE request is sent.

As a response to the procedure, the GMSC will receive the MAP_MT_FORWARD_SHORT_MESSAGE confirmation indicating:

- a successful forwarding of the short message. This indication is passed to the SC;
- unsuccessful forwarding of the short message:

In case only one number (MSC or SGSN) was received from HLR as routing information, the mapping of the MAP error causes and the RP_ERROR causes is explained in 3GPP TS 23.140. The appropriate error indication is sent to the SC.

In case both numbers (MSC and SGSN) were received from HLR as routing information, the transfer of SMS is re-attempted towards the second path only when one of the following errors is received from the unsuccessful transfer over the first path:

Facility Not Supported

Unidentified Subscriber

Absent Subscriber with indication: GPRS or IMSI Detach

Unexpected Data Value

System failure

Data Missing

Subscriber Busy for MT SMS: GPRS Connection Suspended

otherwise, the mapping of the MAP error causes and the RP_ERROR causes is performed (see 3GPP TS 23.140) and the appropriate error indication is sent to the SC.

If second forwarding of short message is unsuccessful, the mapping of the MAP error causes and the RP_ERROR causes is explained in 3GPP TS 23.140. The appropriate error indications are sent to the SC.

If second forwarding of short message is successful, the successful indication is passed to the SC.

A provider error is indicated as a system failure error to the SC.

The GMSC invokes the procedure MAP_REPORT_SM_DELIVERY_STATUS, if:

- an absent subscriber_SM, an unidentified subscriber or SM delivery failure with error cause MS memory capacity exceeded indication is received from the servicing MSC, SGSN or both, and
- the SC address is not yet included in the MWD set, or
- the reason received from the serving node (MSC or SGSN) for failure to deliver the message is absent subscriber_SM, unidentified subscriber or SM delivery failure with error cause MS memory capacity exceeded, and the corresponding flag in the HLR (as indicated the information received in the MAP_INFORM_SERVICE_CENTRE) is not set, or
- the reason received from the serving node (MSC or SGSN) for failure to deliver the message is absent subscriber_SM and the absent subscriber diagnostic is different from the absent subscriber diagnostic received in the MAP_INFORM_SERVICE_CENTRE.

If absent subscriber diagnostic information (see 3GPP TS 23.140) is included with the absent subscriber_SM error indication then this information is relayed to the HLR using the procedure MAP_REPORT_SM_DELIVERY_STATUS.

In case the SMS was attempted to be delivered towards the MSC and the SGSN, and both delivery failed with causes described above, the two unsuccessful SMS delivery outcomes for GPRS and non GPRS are sent to the HLR.

In case the SMS was attempted to be delivered towards the MSC and the SGSN, and the first delivery failed with causes described above and the second delivery succeeded, the unsuccessful and successful SMS delivery outcomes for GPRS and non GPRS are sent to HLR.

The gateway MSC may also invoke the procedure when the first SMS delivery was successful towards MSC, if the MNRF, MCEF flags or both were set in the HLR.

The gateway MSC may also invoke the procedure when the first SMS delivery was successful towards SGSN, if the MNRG, MCEF flags or both were set in the HLR.

This procedure is described in detail in clause 23.5.

Unexpected data value, system failure errors are indicated as a system failure to the SC. Other errors are indicated using appropriate cause values and diagnostic information between the GMSC and the SC as described in 3GPP TS 23.140 and 3GPP TS 24.011 [37].

The unidentified subscriber error is indicated to the SC as absent subscriber with diagnostic information set to 'Unidentified subscriber' as described in 3GPP TS 23.140.

Note that the indication, on which number belongs the SGSN and MSC, received from the HLR at routing information result (see clause 23.3.3) will enable the GMSC to map the causes received from the SGSN, MSC or both into the appropriate causes for non GPRS, GPRS or both, and send them to the SC and HLR.

If there are more short messages to send in the Service Centre and the previous short message transfer succeeded, then the gateway MSC awaits the next short message.

When receiving the next short message from the SC, the gateway MSC sets the More Messages To Send flag according to the information received and starts the service MAP_MT_FORWARD_SHORT_MESSAGE again.

If the gateway MSC is the servicing MSC, then the short message transfer to mobile subscriber is started as described in the clause 23.3.1.

The mobile terminated short message transfer procedure in the gateway MSC is shown in figure 23.3/7.

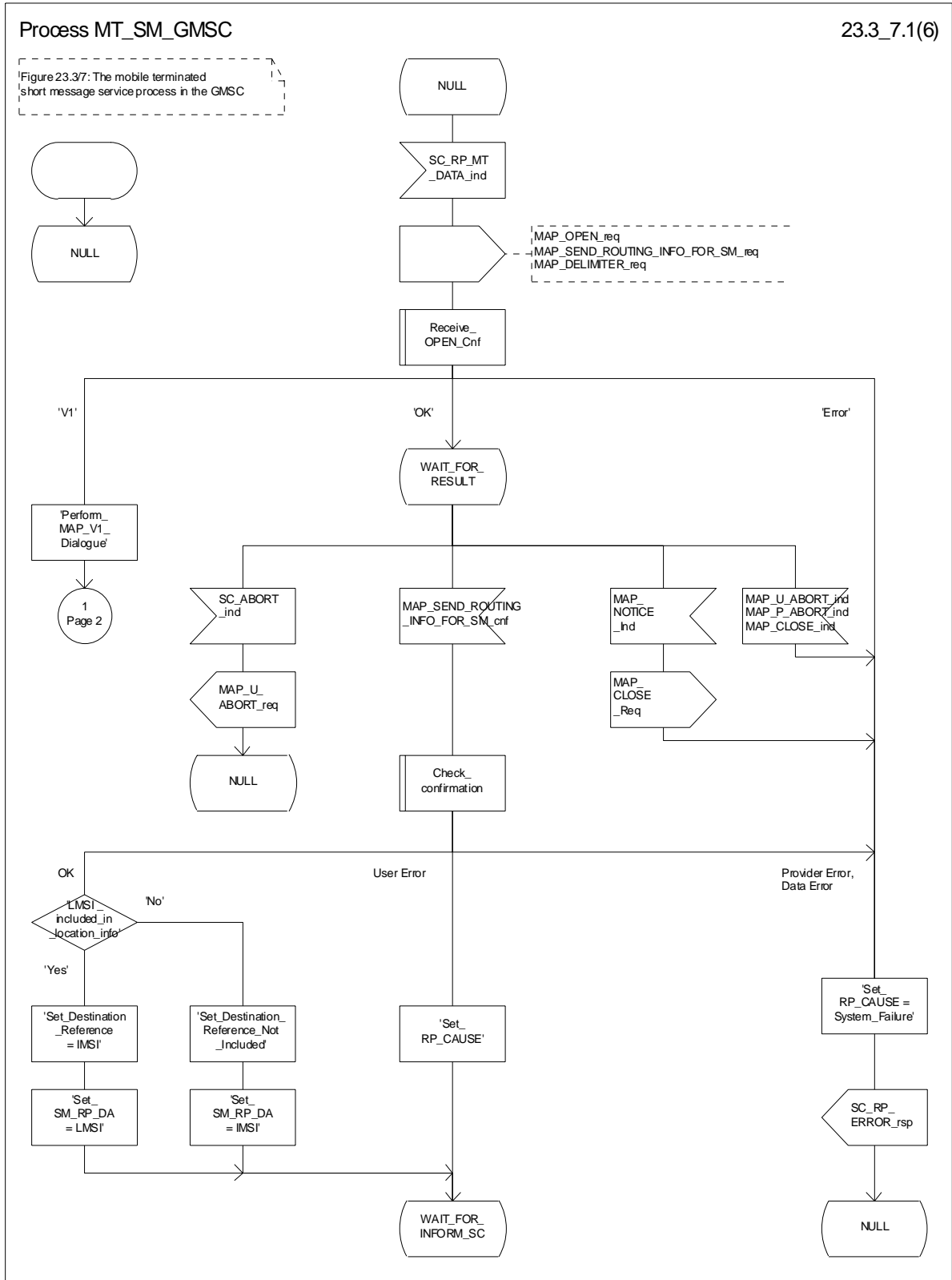

Figure 23.3/7 (sheet 1 of 6): Procedure MT_SM_GMSC

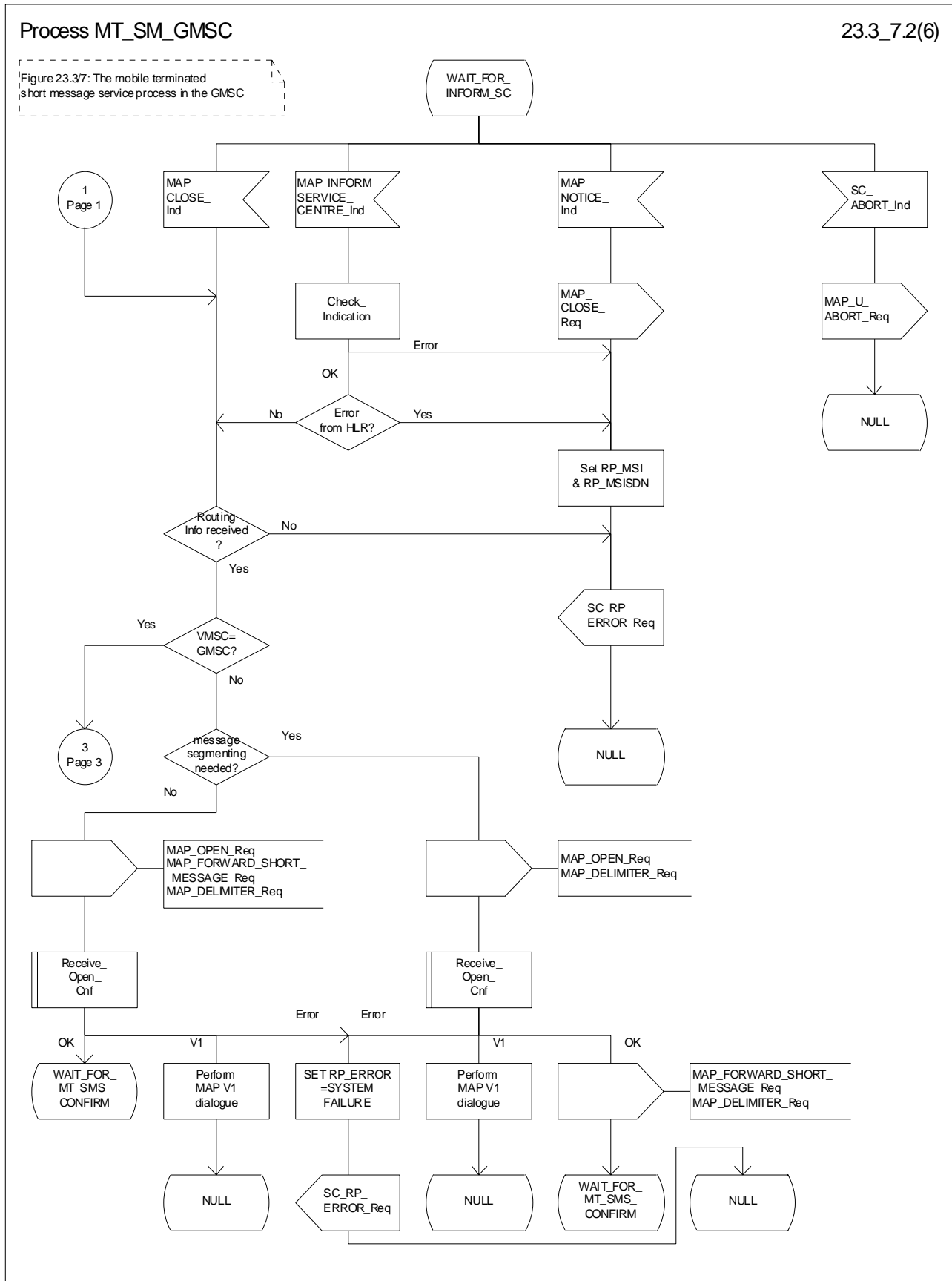

Figure 23.3/7 (sheet 2 to 6): Procedure MT_SM_GMSC

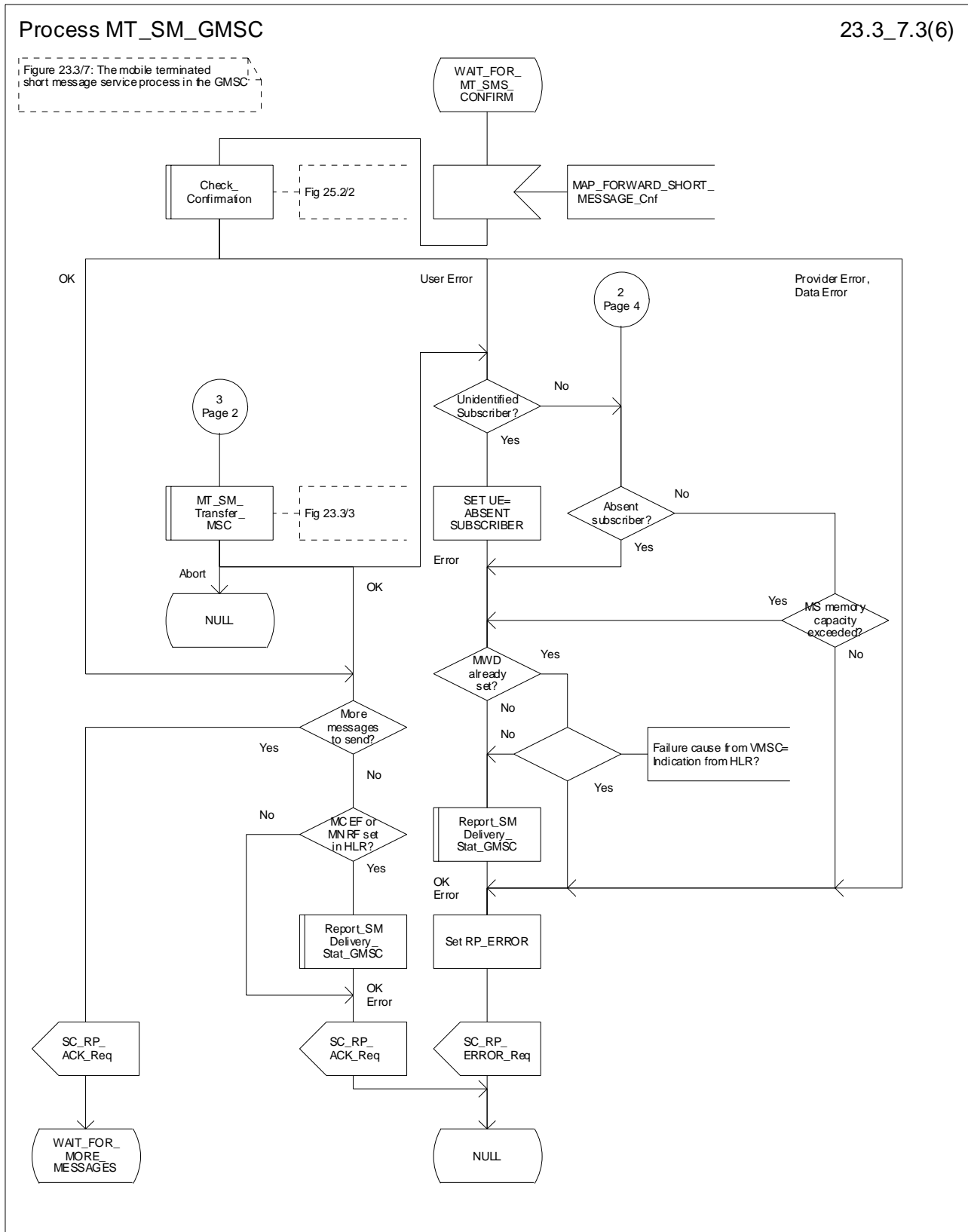

Figure 23.3/7 (sheet 3 of 6): Procedure MT_SM_GMSC

Process MT_SM_GMSC

23.3_7.4(6)

Figure 23.3/7: The mobile terminated short message service process in the GMSC

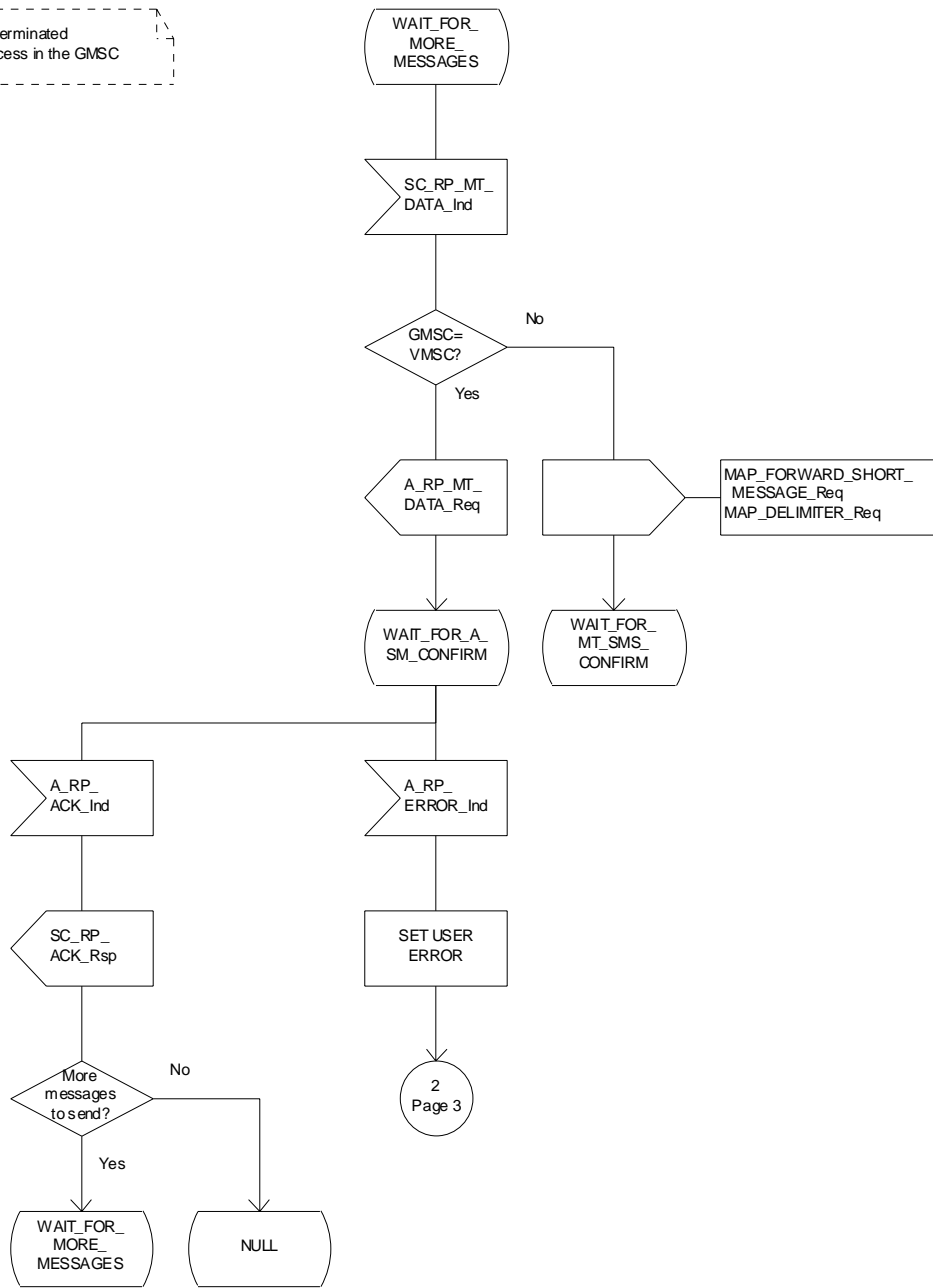

Figure 23.3/7 (sheet 4 of 6): Procedure_MT_SM_GMSC

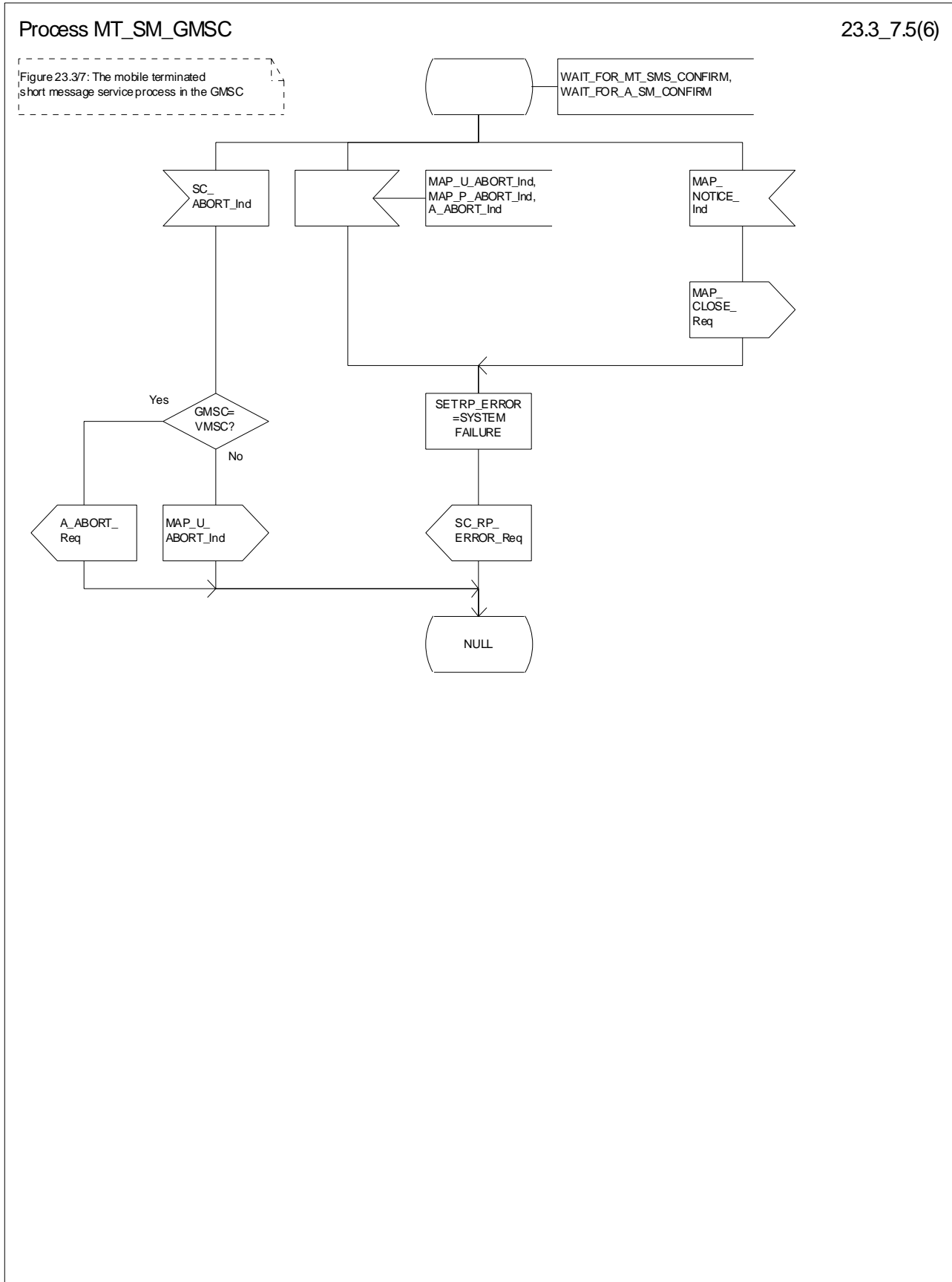

Figure 23.3/7 (sheet 5 to 6): Procedure MT_SM_GMSC

Process MT_SM_GMSC

23.3_7.6(6)

Figure 23.37: The mobile terminated short message service process in the GMSC

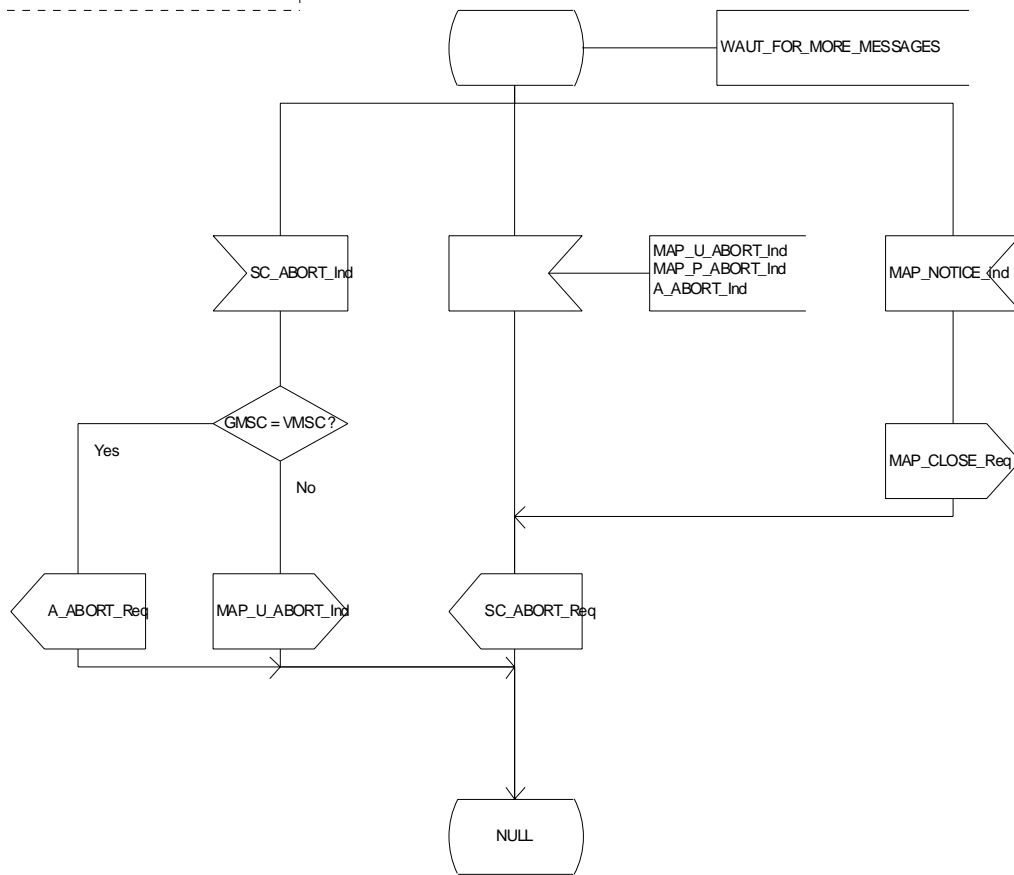

Figure 23.3/7 (sheet 6 of 6): Procedure MT_SM_GMSC

Macrodefinition Check_Subscr_Identity_For_MT_SMS

23.3_8(1)

Figure 23.3/8: Check of the subscriber identity for a mobile terminated short message in the servicing MSC and in the VLR

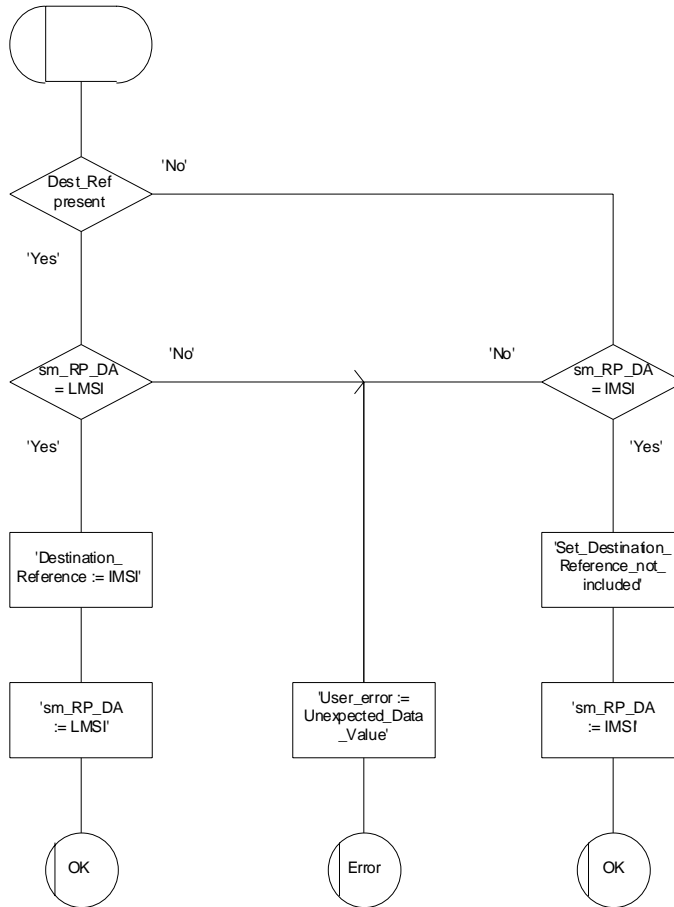

Figure 23.3/8: Macro Check_Subscr_Identity_For_MT_SMS

23.3.5 Procedure in the Servicing SGSN

When initiating the dialogue with the servicing SGSN, the SMS Gateway MSC must provide the IMSI of the subscriber to whom the short message is directed.

The IMSI is included in the sm-RP-DA information field of the MAP_MT_FORWARD_SHORT_MESSAGE indication.

When receiving a MAP_OPEN indication primitive that is not associated with any MAP service indication primitive and if the dialogue is accepted, the MAP service-user in the servicing SGSN issues a MAP_DELIMITER request primitive in order to trigger the local MAP service-provider to confirm the dialogue.

When receiving the first MAP_MT_FORWARD_SHORT_MESSAGE indication from the gateway MSC, the servicing SGSN performs some subscriber data checks, if the MAP service primitive is accepted and if short message service is supported in the servicing SGSN.

The MAP_MT_FORWARD_SHORT_MESSAGE indication primitive is checked by the macro "Check_Indication". If the received MAP service primitive contains errors, the service is aborted and an unexpected data value error or data missing error is returned to the GMSC.

If the SGSN does not support the short message service, the service is aborted in the servicing SGSN and the error "Facility Not Supported" is returned to the GMSC.

If the connection is GPRS suspended, the SGSN sends to the GMSC an error specifying that the GPRS connection is suspended.

The subscriber identity information that are included in the MAP service indication primitive is checked by the macro "Check_Subscr_Identity_For_MT_SMS" as follows:

If the IMSI is included in the sm-RP-DA information field of the MAP_MT_FORWARD_SHORT_MESSAGE indication, the MAP_OPEN indication received from the gateway MSC shall not include a Destination Reference.

If no Destination Reference has been received and the sm-RP-DA information field does not cover an IMSI the service is aborted in the servicing SGSN and the error "Unexpected Data Value" is returned to the GMSC.

The following outcomes from the subscriber data checks can occur in SGSN:

- if the mobile subscriber is unknown, the unidentified subscriber error is forwarded to the GMSC;
- if the "Confirmed by HLR" indicator is set to "Not Confirmed", the unidentified subscriber error is forwarded to the GMSC.
- if the GPRS Detached Flag is set to detached or the LA Not Allowed Flag is set to not allowed in the SGSN, an absent subscriber error with the diagnostic indication set to 'GPRS Detached' is forwarded to the GMSC and the MS not reachable for GPRS (MNRG) flag is set;
- If the location area identification is known and the "Confirmed by Radio Contact" indicator is set to "Confirmed", the paging procedure is invoked (see clause 25.3). Otherwise the search procedure is invoked (see clause 25.3).

After the subscriber data checks the SGSN opens a CAMEL dialogue as specified in 3GPP TS 23.078. If the CAMEL service bars the MT SM then the failure is reported to the GMSC, and the MT SM is not delivered to MS.

The result of the paging or the search procedure is processed as follows:

- if the procedure is completed successfully, the SGSN may trigger the Authentication, Ciphering and IMEI check procedures (see clauses 25.4 and 25.5). Then, if the procedure are completed successfully, the SGSN will send the short message to the MS;
- if the procedure is completed successfully, but the MS has no mobile terminated short message transfer capability, the SM delivery failure indication with cause "equipment not SM equipped" is provided to the GMSC;
- if the procedure is ended unsuccessfully because of subscriber already busy for SMS, another paging, emergency call, location updating, inter SGSN routing area update or a call set-up, the subscriber busy for MT SMS is provided to the GMSC.

- if the procedure is ended unsuccessfully, the absent subscriber_SM error is forwarded to the GMSC with the absent subscriber diagnostic indication set to 'No Paging Response for GPRS', but if the location area is unknown, the system failure indication is provided to the GMSC.

If forwarding of the short message is initiated, the SGSN awaits the result before one of the following responses is sent back to the GMSC:

- an acknowledgement if the short message has been successfully delivered to the mobile subscriber. The successful MT SM delivery is reported to the gsmSCF as specified in 3GPP TS 23.078;
- an SM delivery failure error containing a parameter indicating either of the following: there is a MS protocol error or the MS memory capacity is exceeded; detailed diagnostic information (see clause 7.6.1.4) may also be carried. The failure in the MT SM delivery is reported to the gsmSCF as specified in 3GPP TS 23.078;
- a system failure error if the delivery procedure is aborted. The failure in the MT SM delivery is reported to the gsmSCF as specified in 3GPP TS 23.078.

If the More Messages To Send flag was FALSE or the service MAP_MT_FORWARD_SHORT_MESSAGE ends unsuccessfully, the transaction to the gateway MSC is terminated. If the More Messages To Send flag was TRUE, then the servicing SGSN waits for the next short message from the Service Centre.

When receiving the next MAP_MT_FORWARD_SHORT_MESSAGE indication from the gateway MSC the servicing SGSN will act as follows:

- if the received primitive contains errors, the unexpected data value error or data missing error is provided to the gateway MSC;
- The SGSN opens a CAMEL dialogue as specified in 3GPP TS 23.078 for each SM. If the CAMEL service bars the MT SM then the failure is reported to the GMSC, and the MT SM is not delivered to the MS.
- if the More Messages To Send flag is FALSE, the servicing SGSN will start the short message transfer procedure to the mobile subscriber. The successful or unsuccessful outcome of this procedure is reported to the gsmSCF as specified in 3GPP TS 23.078 and gateway MSC, and the transaction is terminated.
- if the More Messages To Send flag is TRUE, the servicing SGSN will start the short message transfer to the mobile subscriber. If the outcome of this procedure is unsuccessful, the SM delivery failure is reported to the gsmSCF and the reason is reported to the gateway MSC and the procedure is terminated. If the procedure is successful, then the MT SM delivery is reported to the gsmSCF as specified in 3GPP TS 23.078, and it is acknowledged to the gateway MSC and more short messages can be received.

The mobile terminated short message transfer procedure in the servicing SGSN is shown in figures 23.3/9 and 23.3/10. The page and search procedures are shown in figure 25.3/1 and 25.3/2.

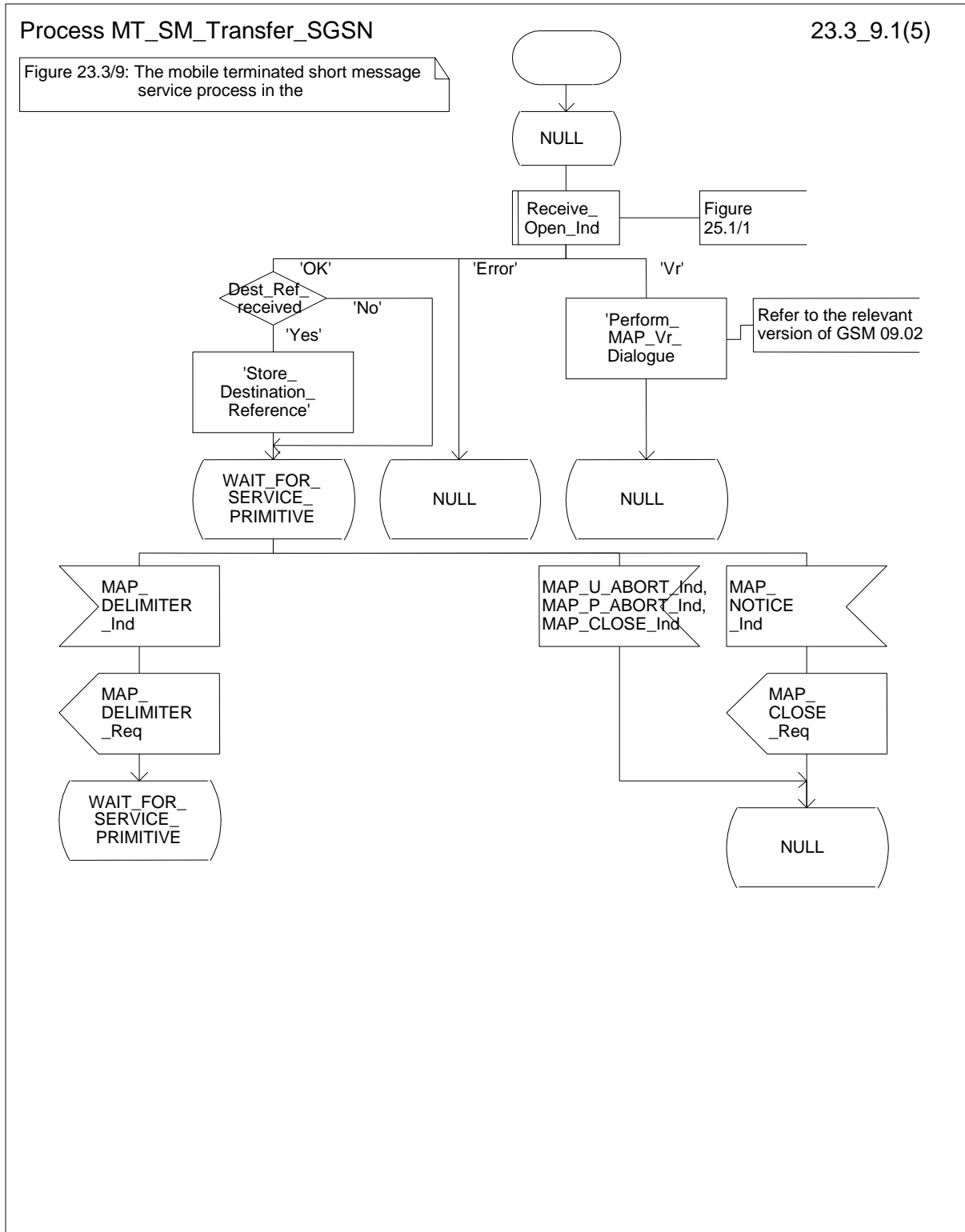

Figure 23.3/9 (sheet 1 of 5): Procedure MT_SM_Transfer_SGSN

Process

23.3_9.2(5)

Figure 23.3/9: The mobile terminated short message service process in the SGSN

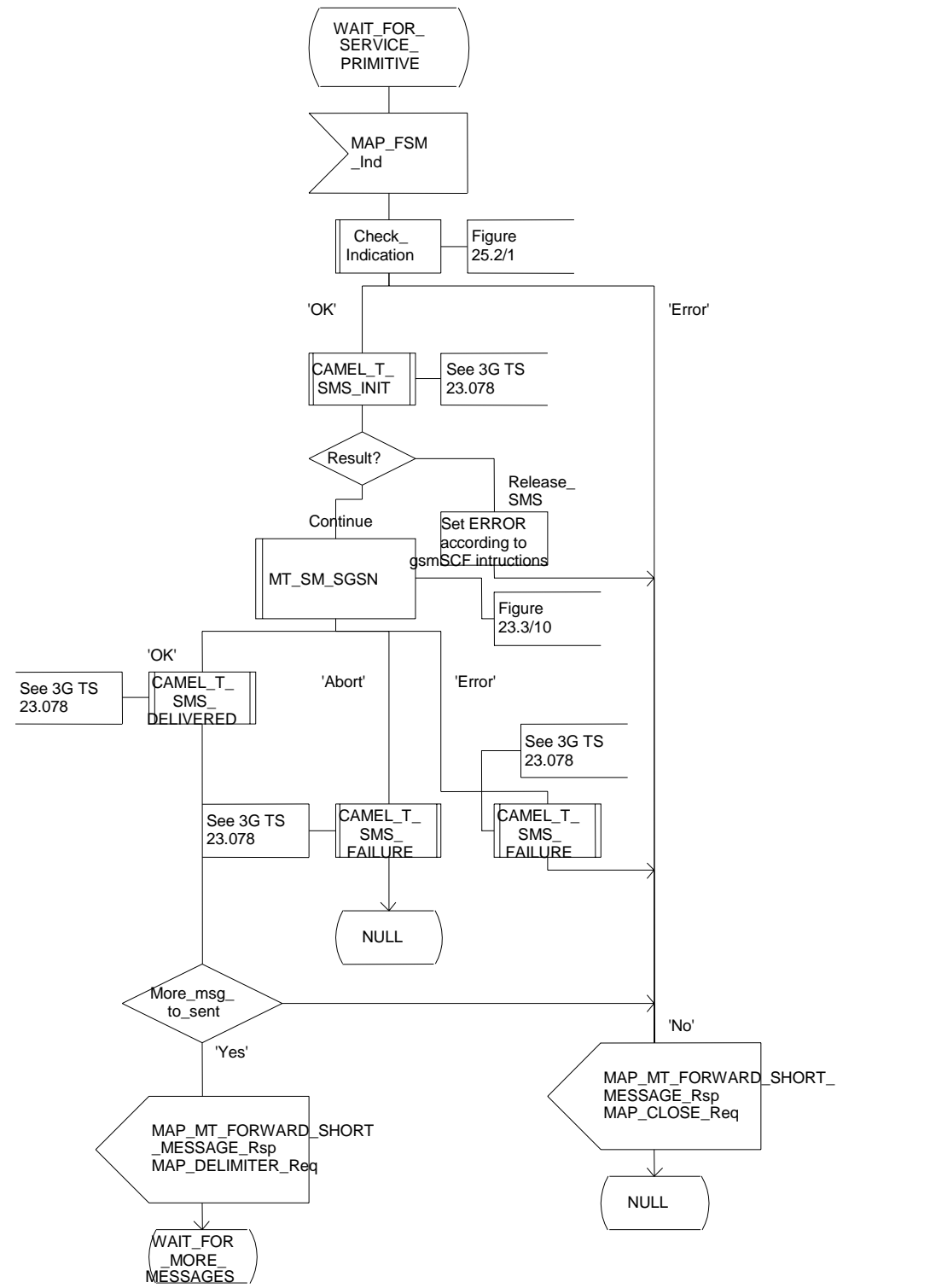

Figure 23.3/9 (sheet 2 of 5): Procedure MT_SM_Transfer_SGSN

Process MT_SM_Transfer_SGSN

23.3_9.3(5)

Figure 23.3/9: The mobile terminated short service process in the

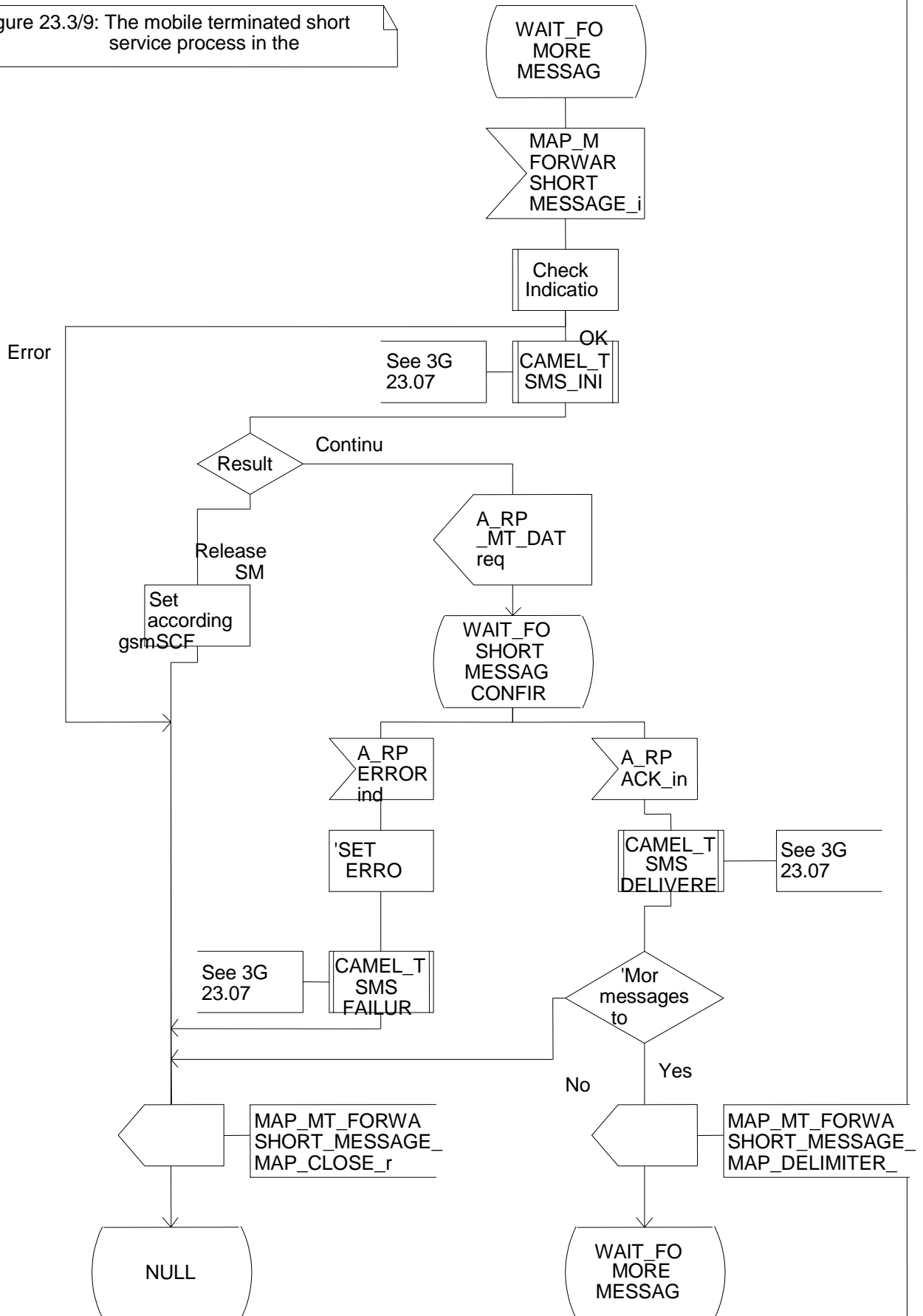

Figure 23.3/9 (sheet 3 of 5): Procedure MT_SM_Transfer_SGSN

Process MT_SM_Transfer_SGSN

23.3_9.4(5)

Figure 23.3/9: The mobile terminated short message service process in the SGSN

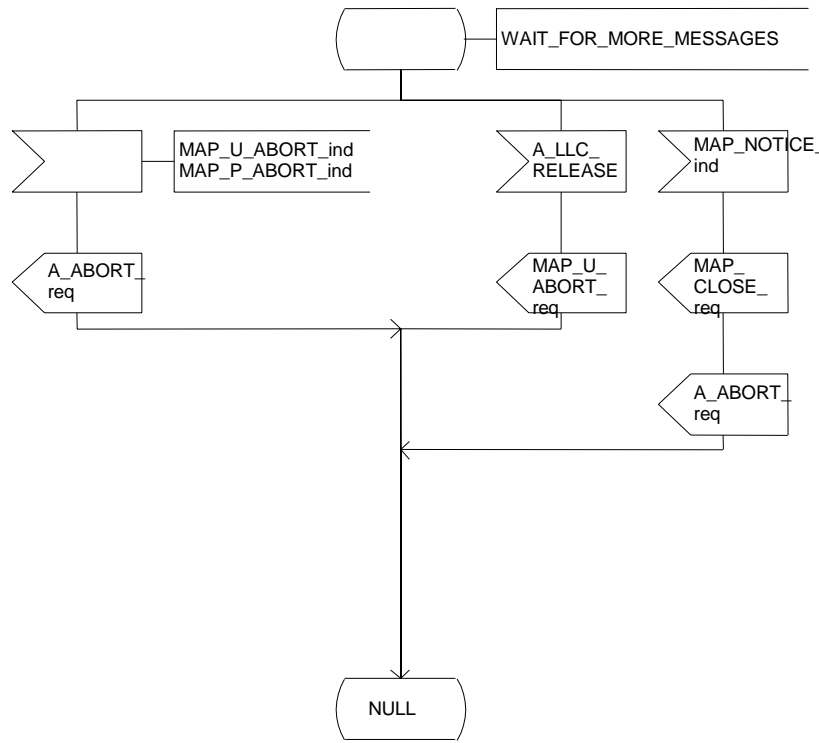

Figure 23.3/9 (sheet 4 of 5): Procedure MT_SM_Transfer_SGSN

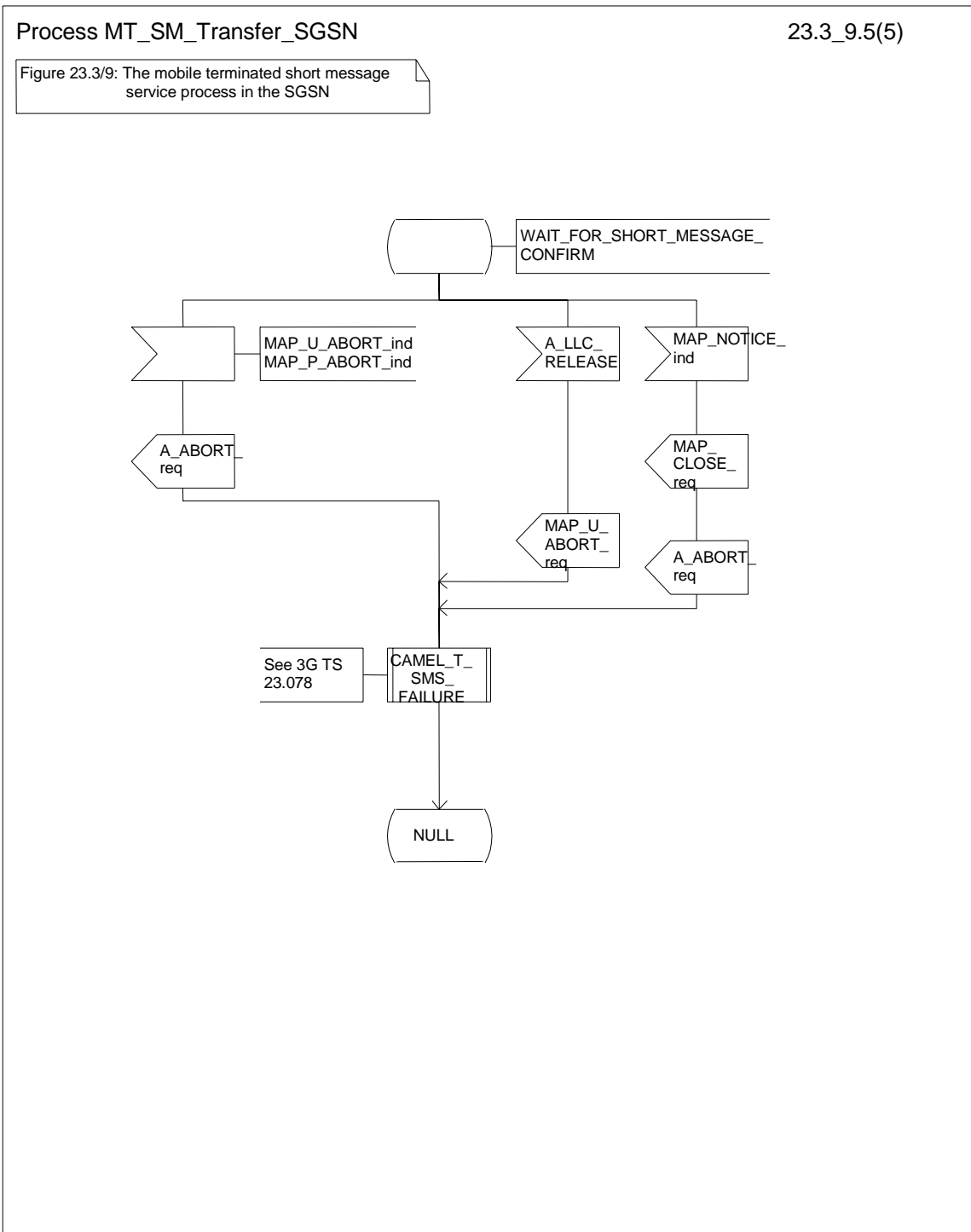

Figure 23.3/9 (sheet 5 of 5): Procedure MT_SM_Transfer_SGSN

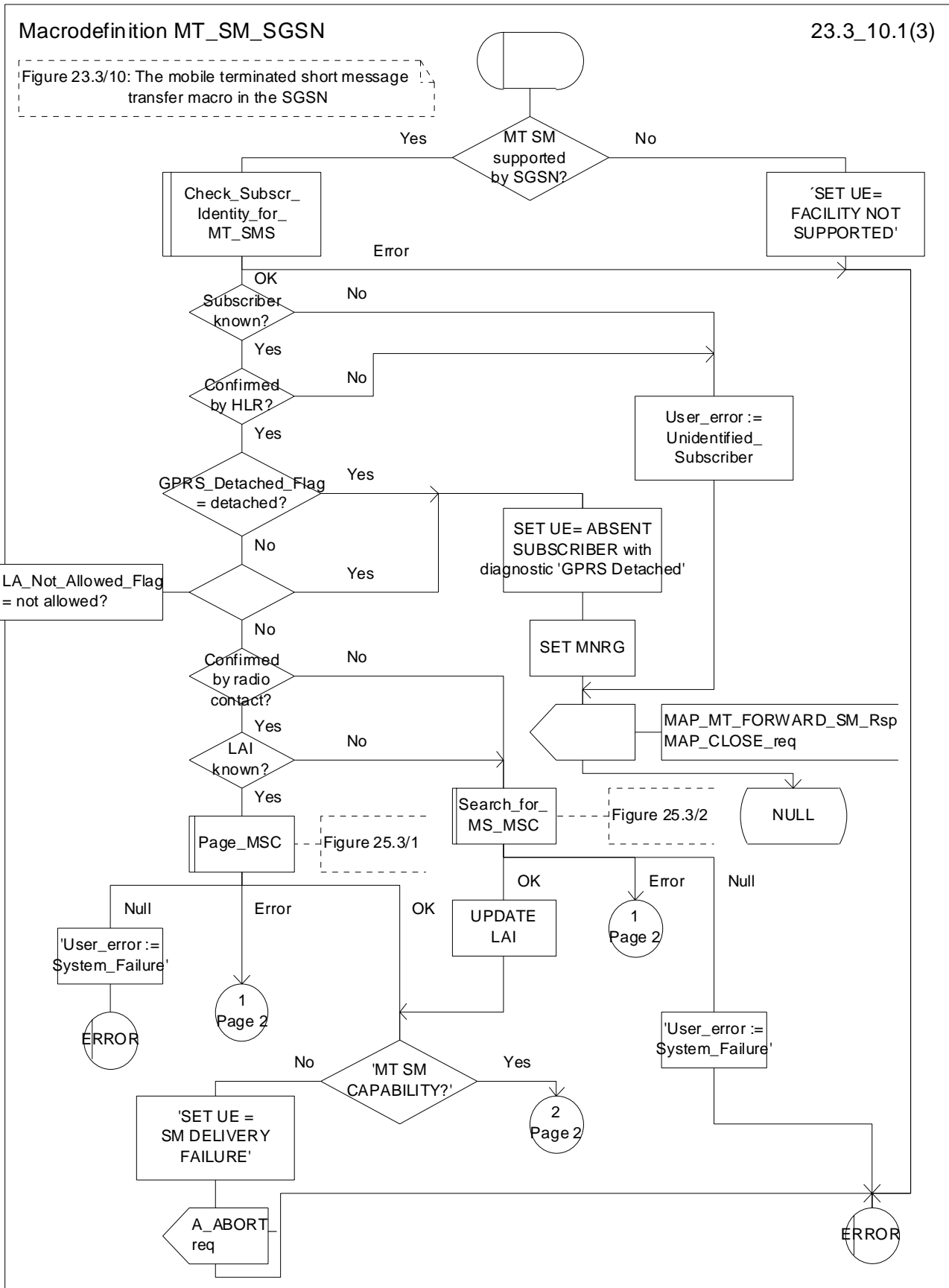

Figure 23.3/10 (sheet 1 of 3): Macro MT_SM_SGSN

Macrodefinition MT_SM_SGSN

23.3_10.2(3)

Figure 23.3/10: The mobile terminated short message transfer macro in the SGSN

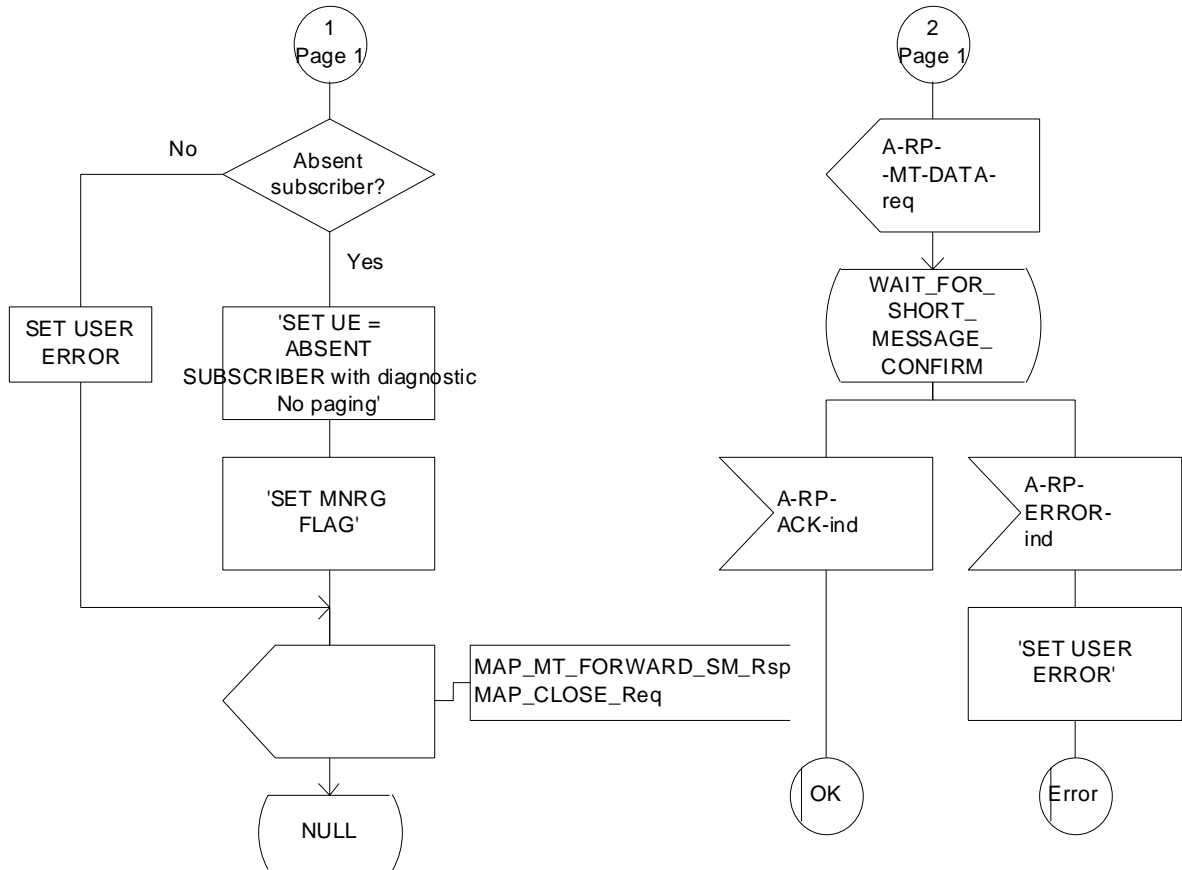

Figure 23.3/10 (sheet 2 of 3): Macro MT_SM_SGSN

Macrodefinition MT_SM_SGSN

23.3_10.3(3)

Figure 23.3/10: The mobile terminated short message transfer macro in the SGSN

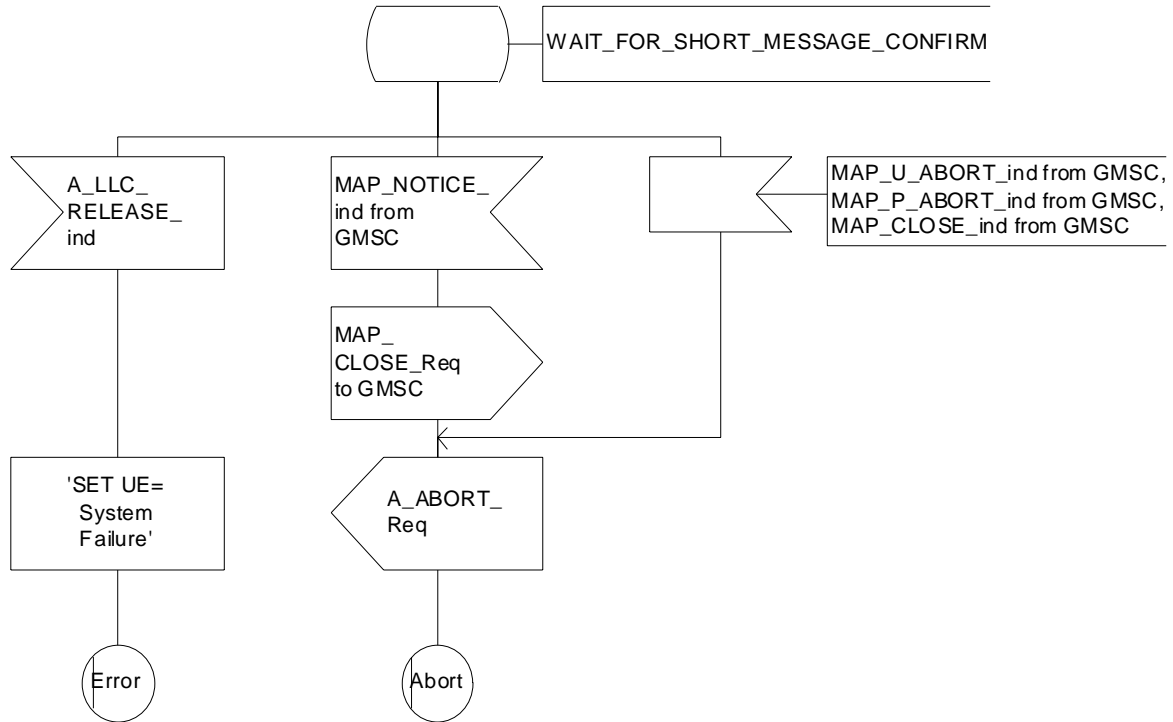
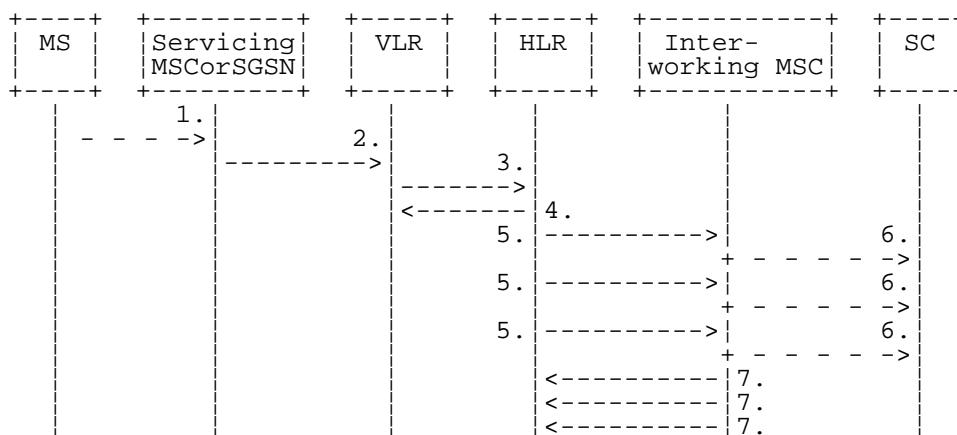

Figure 23.3/10 (sheet 3 of 3): Macro MT_SM_SGSN

23.4 The Short Message Alert procedure

The Short Message Alert procedure is used for alerting the Service Centre when the mobile subscriber is active after a short message transfer has failed because the mobile subscriber is not reachable or when the MS has indicated that it has memory capacity to accept a short message.

The Short Message Alert procedure for the case when the mobile subscriber was not reachable is shown in figure 23.4/1.



- 1) CM Service Request (**), Page response or Location Updating (3GPP TS 24.008 [35]).
- 2) MAP_PROCESS_ACCESS_REQUEST / MAP_UPDATE_LOCATION_AREA (**).
- 3) MAP_READY_FOR_SM (Mobile Present) / MAP_UPDATE_LOCATION / Supplementary Service Control Request (*).
- 4) MAP_READY_FOR_SM_ACK (*).
- 5) MAP_ALERT_SERVICE_CENTRE (notes 1 and 2).
- 6) Alert Service Centre (3GPP TS 23.140).
- 7) MAP_ALERT_SERVICE_CENTRE_ACK.

NOTE 1: To all Service Centres in the Message Waiting List.

NOTE 2: The HLR initiates the MAP_ALERT_SERVICE_CENTRE service only if the MS Memory Capacity Exceeded flag is clear.

(*) In case of GPRS, messages 3) and 4) are sent/received by SGSN.

(**) Those messages are not used by SGSN.

Figure 23.4/1: Short message alert procedure (Mobile is present)

The Short Message Alert procedure for the case where the MS indicates that it has memory capacity to accept one or more short messages is shown in figure 23.4/2.

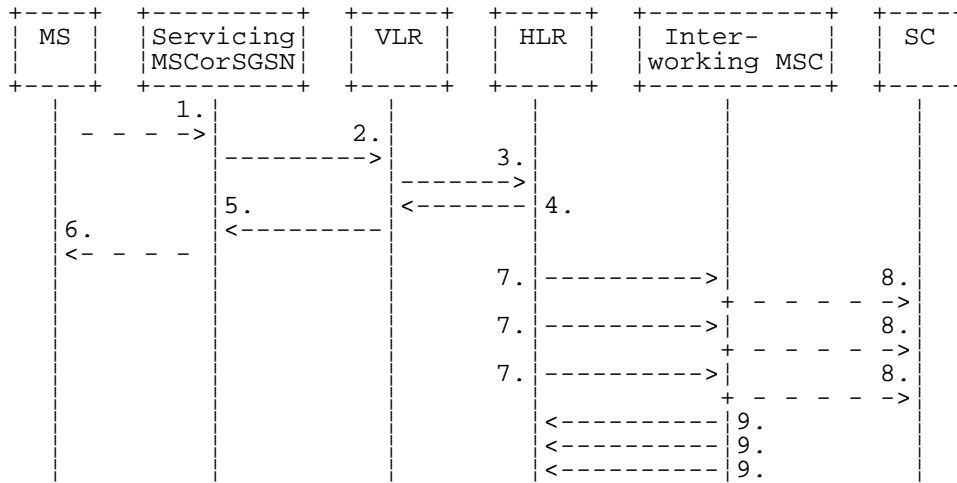

- 1) SM memory capacity available (3GPP TS 24.011 [37]).
 - 2) MAP_READY_FOR_SM (Memory Available) (*).
 - 3) MAP_READY_FOR_SM (Memory Available) (**).
 - 4) MAP_READY_FOR_SM_ACK (**).
 - 5) MAP_READY_FOR_SM_ACK (*).
 - 6) SM memory capacity available (Acknowledge) (3GPP TS 24.011 [37]).
 - 7) MAP_ALERT_SERVICE_CENTRE (note).
 - 8) Alert Service Centre (3GPP TS 23.140).
 - 9) MAP_ALERT_SERVICE_CENTRE_ACK.
- NOTE: To all Service Centres in the Message Waiting List.
- (*) Message 2) and 5) are not used by SGSN.
- (**) In the case of GPRS messages 3) and 4) are sent/received by SGSN.

Figure 23.4/2: Short message alert procedure (MS memory capacity available)

In addition the following MAP services are used in the MS memory available case:

- MAP_PROCESS_ACCESS_REQUEST (see clause 8.3); (*)
- MAP_AUTHENTICATE (see clause 8.5); (*)
- MAP_SET_CIPHERING_MODE (see clause 8.6); (*)
- MAP_PROVIDE_IMSI (see clause 8.9); (*)
- MAP_CHECK_IMEI (see clause 8.7);
- MAP_FORWARD_NEW_TMSI (see clause 8.9); (*)
- MAP_TRACE_SUBSCRIBER_ACTIVITY (see clause 9.1). (*)

(*) Those messages are not used by SGSN.

The Short Message Alert procedure when the MS indicates successful transfer after polling is shown in figure 23.4/3.

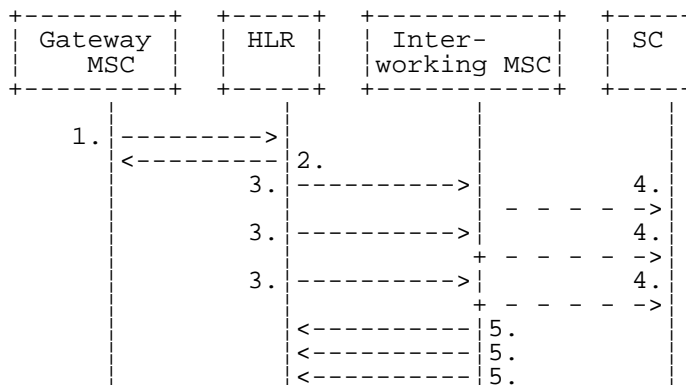

- 1) MAP_REPORT_SM_DELIVERY_STATUS (Successful Transfer).
 - 2) MAP_REPORT_SM_DELIVERY_STATUS_ACK.
 - 3) MAP_ALERT_SERVICE_CENTRE (note).
 - 4) Alert Service Centre (3GPP TS 23.140).
 - 5) MAP_ALERT_SERVICE_CENTRE_ACK.
- NOTE: To all Service Centres in the Message Waiting List.

Figure 23.4/3: Short message alert procedure (Successful transfer after polling)

23.4.1 Procedures in the Servicing MSC

The activation of the MAP_PROCESS_ACCESS_REQUEST service is described in the clause 23.6.2.

After receiving the SM memory capacity available indication, the servicing MSC sends the MAP_READY_FOR_SM request to the VLR indicating memory available. The outcome of that procedure is one of the following:

- successful acknowledgement. The MSC sends the corresponding message to the MS;
- negative acknowledgement, where the error causes are treated as follows:
 - unexpected data value, data missing and system failure errors are reported as network out of order error to the MS;
 - facility not supported is reported as requested facility not implemented error to the MS;
 - procedure failure, which is reported as network out of order error to the MS if a connection to the MS still exists.

The short message alert procedure in the MSC for the MS memory capacity available case is shown in figure 23.4/4.

Process SM_Alert_MSC

23.4_4(1)

Figure 23.4/4: The short message alert process in the servicing MSC for MS memory capacity available.

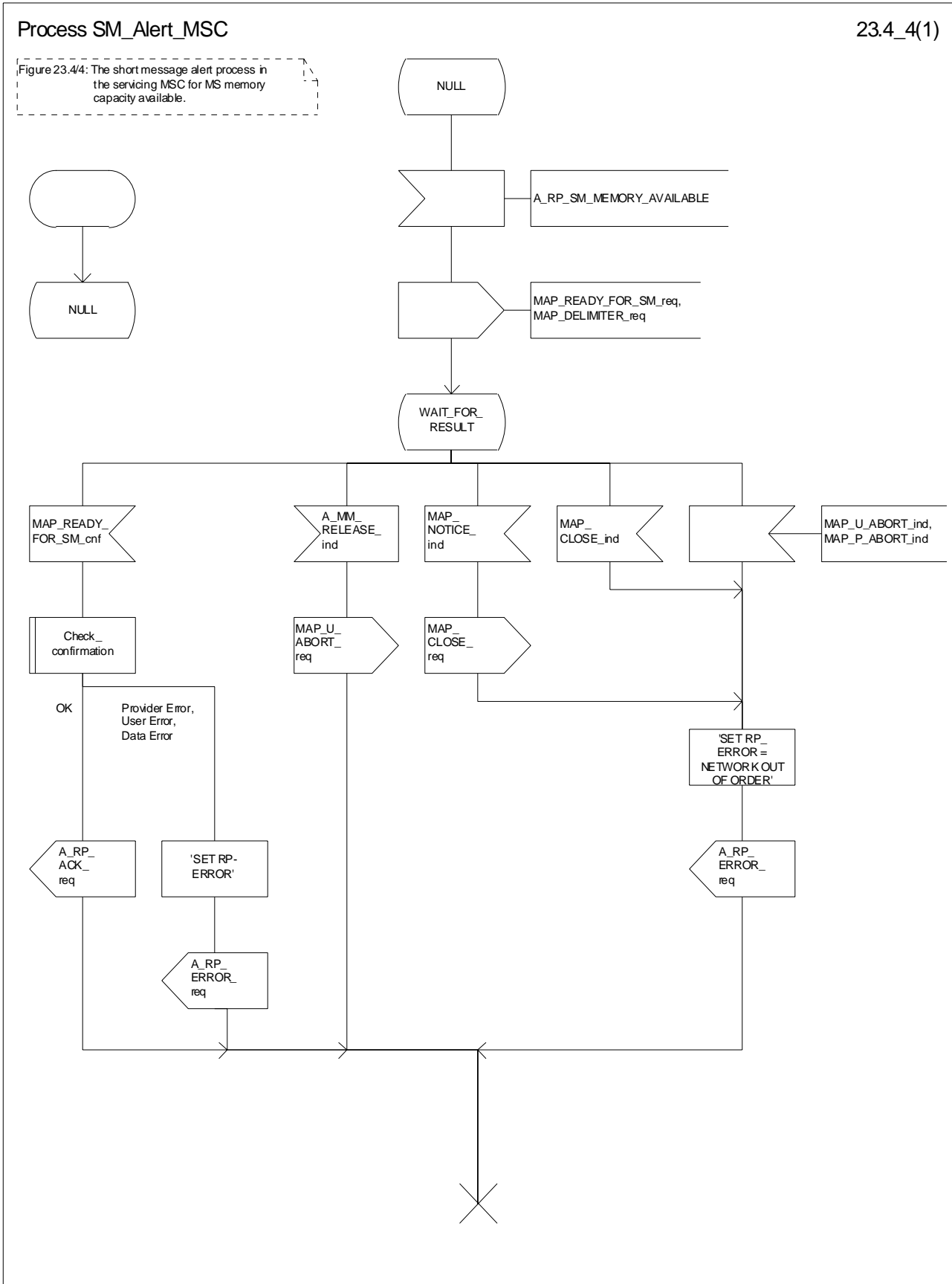

Figure 23.4/4: Procedure SM_Alert_MSC

23.4.2 Procedures in the VLR

23.4.2.1 The Mobile Subscriber is present

When receiving the MAP_PROCESS_ACCESS_REQUEST indication, MAP_UPDATE_LOCATION_AREA indication while the MS not reachable flag (MNRf) is set, the VLR will send the MAP_READY_FOR_SM request towards the HLR. The Alert Reason is set to indicate that the mobile subscriber is present for non GPRS. If the authentication procedure is initiated and it fails, the VLR will not initiate the service. The process in VLR is described in detail in the clause 25.10.

23.4.2.2 The Mobile Equipment has memory available

The MAP_PROCESS_ACCESS_REQUEST indication starts the MAP_PROCESS_ACCESS_REQUEST service in the VLR. The application context in the MAP_OPEN indication refers to the short message alerting procedure.

If the service MAP_PROCESS_ACCESS_REQUEST is successful, the VLR waits for the next message from the MSC. When receiving the MAP_READY_FOR_SM indication from the MSC, the VLR will check the contents. Data errors are reported to the MSC as an unexpected data value or data missing error, depending on the error. If the primitive passes the data check, the VLR forwards it to the HLR and awaits an acknowledgement.

When receiving the MAP_READY_FOR_SM confirmation from the HLR and the Alert Reason is MS memory available, the VLR will act as follows:

- the MAP_READY_FOR_SM response is sent to the MSC as follows:
 - an acknowledgement in the positive case;
 - system failure error, if unexpected data value, data missing, or unknown subscriber errors are received, otherwise the error cause received from the HLR;
 - a facility not supported error, if the HLR supports MAP Vr only;
 - procedure failure is reported as a system failure error.

The short message alert procedure in the VLR is shown in figures 23.4/5.

Process SM_Alert_VLR

23.4_5(1)

Figure 23.4/5: The short messages alert process in the VLR for MS memory capacity available

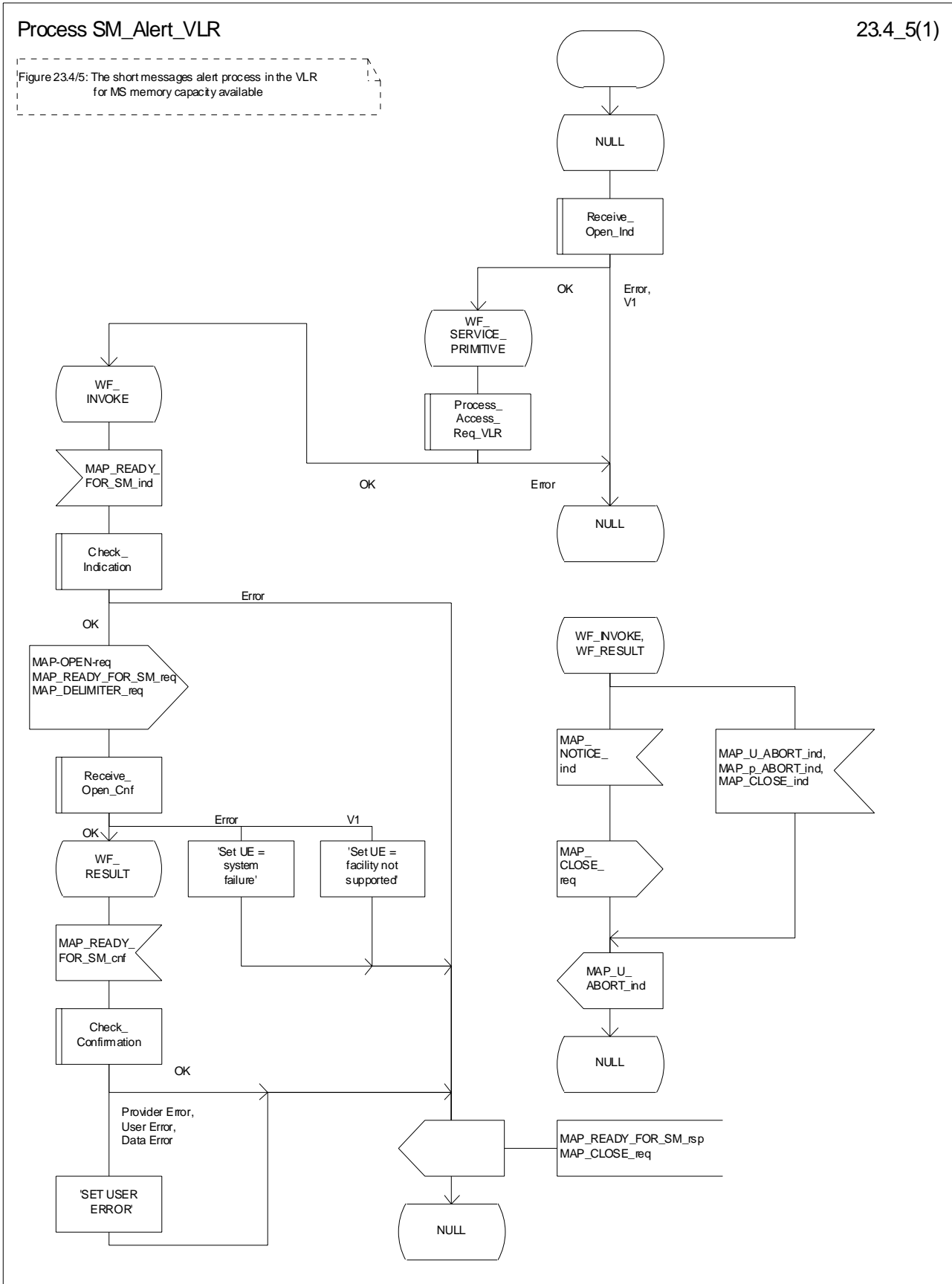

Figure 23.4/5: Procedure SM_Alert_VLR

23.4.3 Procedures in the HLR

When receiving the MAP_READY_FOR_SM indication, the HLR will check the contents. Data errors are reported to the VLR as an unexpected data value or a data missing error depending on the error. If the HLR does not support the MNRF or MNRG, MCEF, and MWD a facility not supported error is reported to the VLR or SGSN. If the IMSI is unknown an unknown subscriber error is reported to the VLR or SGSN. Otherwise an acknowledgement is returned to the VLR or SGSN.

If neither the MS not reachable flag (MNRF) or the MS not reachable for GPRS (MNRG) flag, nor the memory capacity exceeded flag (MCEF) are set, and MAP_READY_FOR_SM is received from the VLR or SGSN, the HLR sets a timer and waits for it to expire. This ensures that in the race situation the MAP_REPORT_SM_DELIVERY_STATUS service (as described in the clause 23.6) for the same subscriber can be carried out when delayed in the GMSC.

If the Alert Reason indicates the mobile present for non GPRS situation, or when the update location procedure has been successfully completed or Supplementary Service Control request is received, the MS not reachable flag (MNRF) is cleared and the service centre alert procedure is initiated. If the memory capacity exceeded flag is set, the MS not reachable flag is cleared and stored reason for absence for non GPRS are cleared but the alert procedure is not started.

If the Alert Reason indicates the mobile present for GPRS situation, or when the Update GPRS location procedure has been successfully completed, the MS not reachable for GPRS (MNRG) flag is cleared and the service centre alert procedure is initiated. If the memory capacity exceeded flag is set, the MS detach for GPRS flag is cleared and stored reason for absence for GPRS are cleared but the alert procedure is not started.

If the Alert Reason indicates the memory available for non GPRS situation, the HLR initiates the alert procedure. The MS not reachable and memory capacity available flags are cleared.

If the Alert Reason indicates the memory available for GPRS situation, the HLR initiates the alert procedure. The MS detach for GPRS and memory capacity available flags are cleared.

If the MAP_REPORT_SM_DELIVERY_STATUS indication is received and it indicates the successful transfer of the mobile terminated short message for non GPRS, the HLR initiates the alert procedure described in the clause 25.10 and clears MCEF and MNRF flags and stored reason for absence for non GPRS are cleared.

If the MAP_REPORT_SM_DELIVERY_STATUS indication is received and it indicates the successful transfer of the mobile terminated short message for GPRS, the HLR initiates the alert procedure described in the clause 25.10 and clears MCEF and MNRG flags and stored reason for absence for GPRS are cleared.

The short message alert procedure in the HLR is shown in figures 23.4/6 and 25.10/2.

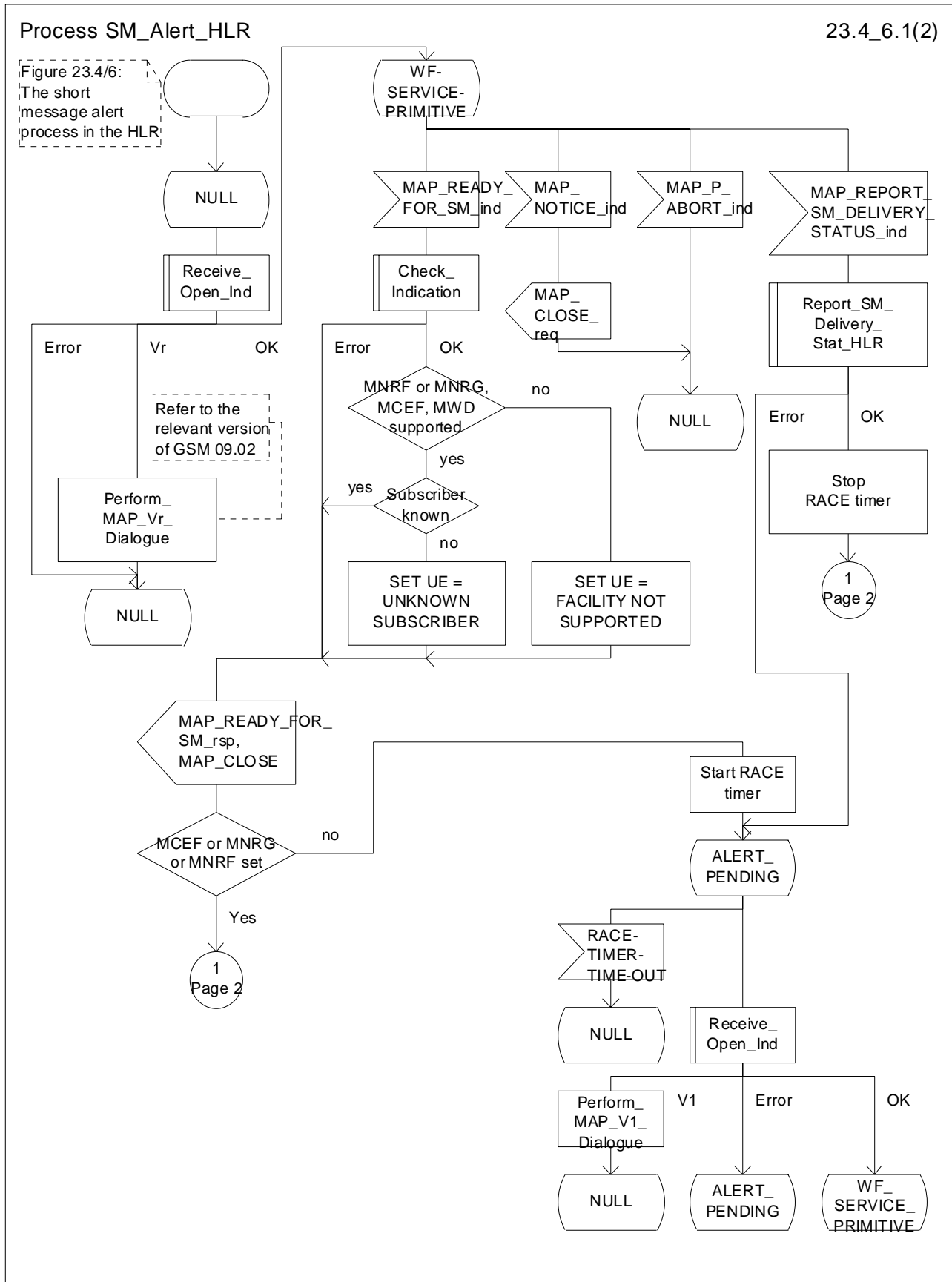

Figure 23.4/6 (sheet 1 of 2): Process SM_Alert_HLR

Process SM_Alert_HLR

23.4_6.2(2)

Figure 23.4/6:
The short
message alert
process in the HLR

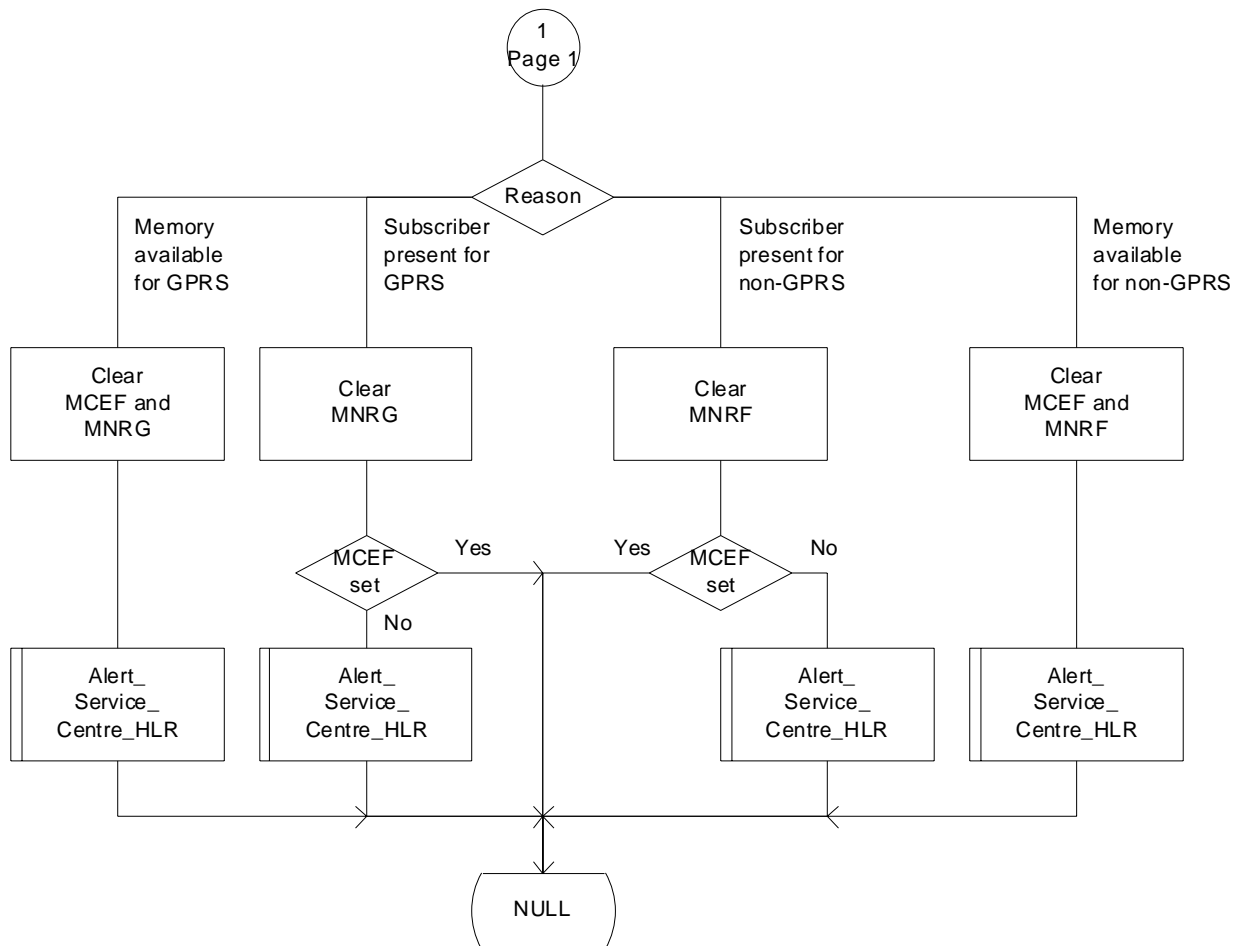

Figure 23.4/6 (sheet 2 of 2): Process SM_Alert_HLR

23.4.4 Procedures in the Interworking MSC

When a MAP_ALERT_SERVICE_CENTRE indication is correctly received by the IW MSC, the IW MSC will forward the alerting to the given Service Centre if possible.

Data errors are reported to the HLR as an unexpected data value or a data missing error depending on the error.

The short message alert procedure is shown in figure 23.4/7.

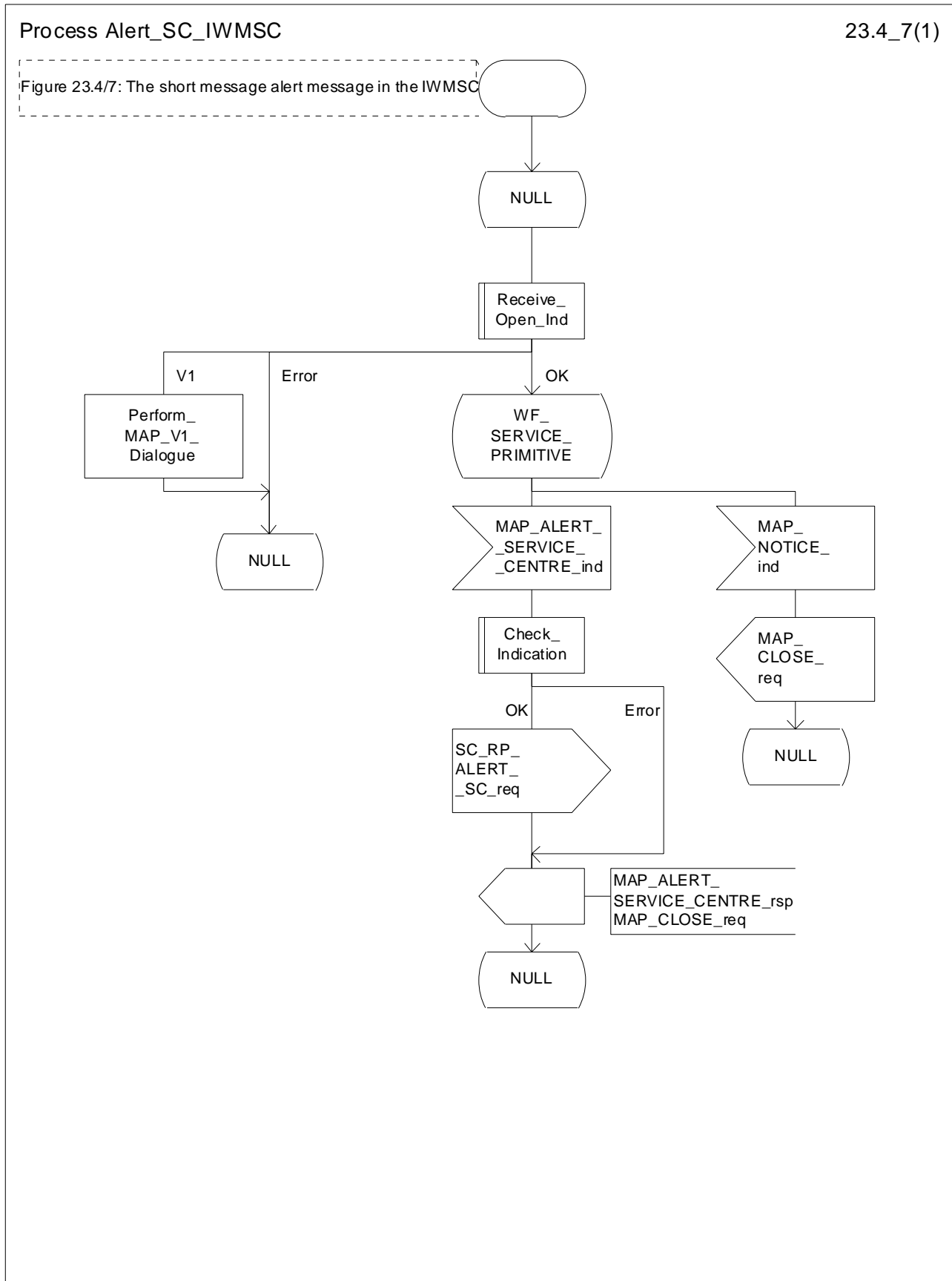

Figure 23.4/7: Process Alert_SC_IWMSC

23.4.5 Procedures in the Servicing SGSN

23.4.5.1 The Mobile Subscriber is present

When receiving Page response, Attach request or Routing area update request messages (3GPP TS 24.008 [35]), while the MS not reachable for GPRS (MNRG) flag is set, the SGSN will send the MAP_READY_FOR_SM request towards the HLR. The Alert Reason is set to indicate that the mobile subscriber is present for GPRS.

When receiving the answer, the SGSN will act as follows:

- MNRG is cleared if the procedure is successful
- MNRG is not cleared if the procedure is not successful

The process in SGSN is described in detail in the clause 25.10/3.

23.4.5.2 The Mobile Equipment has memory available

After receiving the SM memory capacity available indication, the servicing SGSN sends the MAP_READY_FOR_SM request to the HLR indicating memory available for GPRS. The outcome of that procedure is one of the following:

- successful acknowledgement. The SGSN sends the corresponding message to the MS;
- negative acknowledgement, where the error causes are treated as follows:
 - unexpected data value, data missing and system failure errors are reported as network out of order error to the MS;
 - facility not supported is reported as requested facility not implemented error to the MS;
 - procedure failure, which is reported as network out of order error to the MS if a connection to the MS still exists.

The short message alert procedure in the SGSN for the MS memory capacity available case is shown in figure 23.4/8.

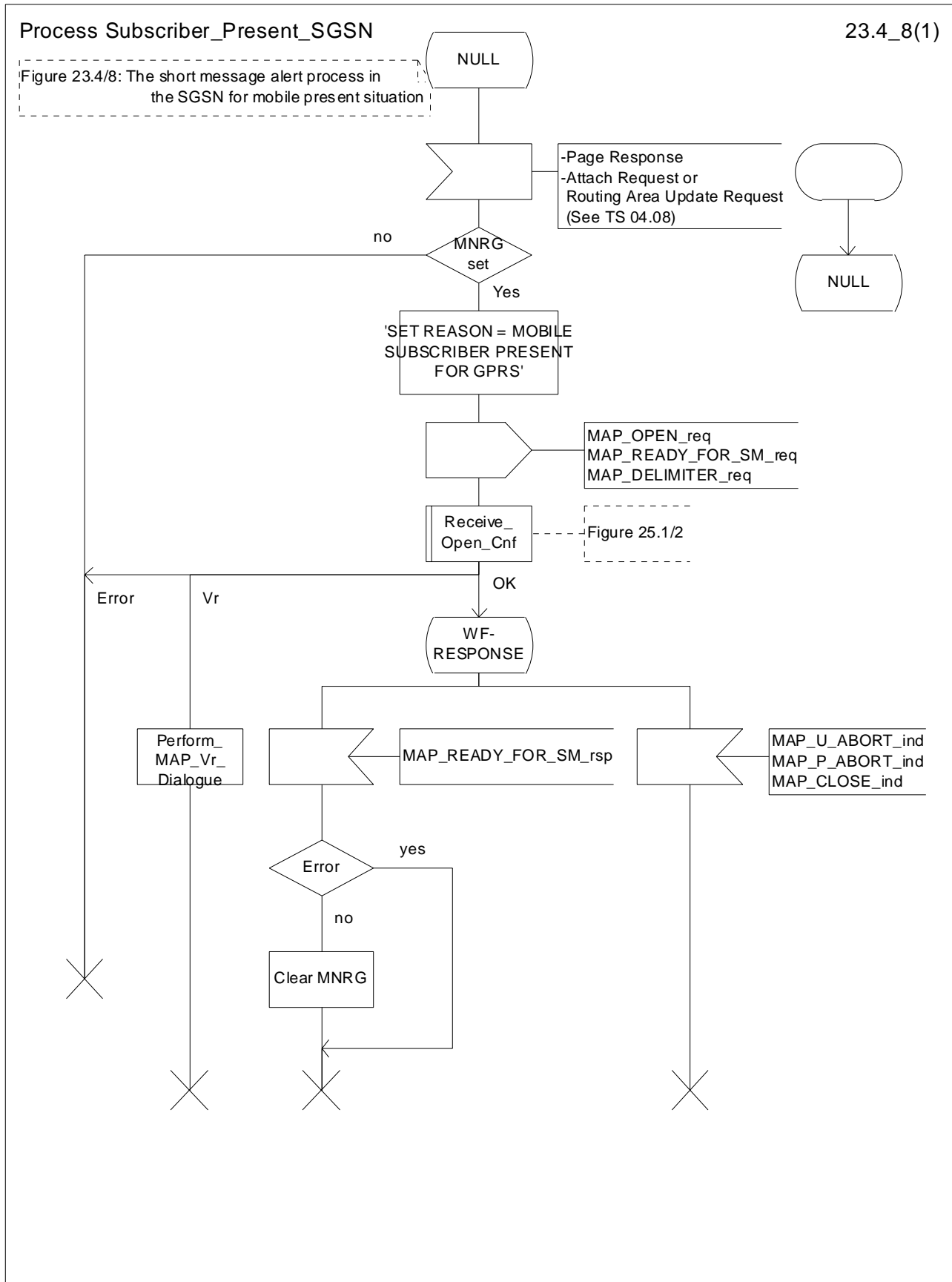

Figure 23.4/8: Process Subscriber_Present_SGSN

23.5 The SM delivery status report procedure

The SM delivery status report procedure is used to set the Service Centre address into the message waiting list in the HLR because the subscriber is absent or unidentified or the memory capacity is exceeded. The procedure sets

- the memory capacity exceeded flag in the HLR if the MS memory does not have room for more messages
- and/or the MS not reachable flag for non GPRS in the case of unidentified or absent subscriber
- and/or the MS not reachable for GPRS flag in the case of unidentified or absent subscriber for GPRS

Additionally the procedure is used to report the HLR about the successful transfer for GPRS or non GPRS after the Service Centre has polled the subscriber. This procedure is described also in the clause 23.4.

The SM delivery status report procedure is shown in figure 23.5/1.

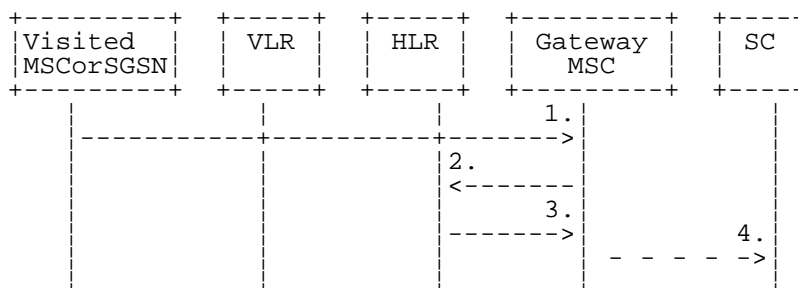

- 1) MAP_MT_FORWARD_SHORT_MESSAGE_ACK/_NACK (Absent subscriber_SM, unidentified subscriber or memory capacity exceeded).
- 2) MAP_REPORT_SM_DELIVERY_STATUS.
- 3) MAP_REPORT_SM_DELIVERY_STATUS_ACK.
- 4) Short Message Negative Acknowledgement (3GPP TS 23.140).

Figure 23.5/1: Short message delivery status report procedure

23.5.1 Procedures in the HLR

When the HLR receives a MAP_REPORT_SM_DELIVERY_STATUS indication, it acts as described in the clause 23.6, macro Report_SM_Delivery_Stat_HLR.

The short message delivery status report process in the HLR is shown in figure 23.5/2.

Process SM_Delivery_Status_Report_HLR

23.5_2(1)

Figure 23.5/2: The report SM delivery process in the HLR

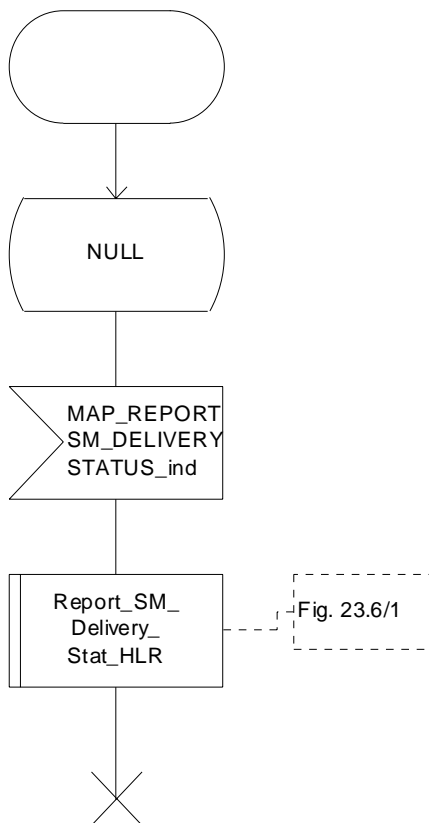

Figure 23.5/2: Process SM_Delivery_Status_Report_HLR

23.5.2 Procedures in the gateway MSC

The GMSC invokes the short message delivery status report procedure if an absent subscriber_SM indication, unidentified subscriber indication, SM delivery failure error indicating MS memory capacity exceeded or both are received from the servicing MSC, SGSN or both during a mobile terminated short message transfer, and the HLR has not indicated that the SC address is included in the MWD. The unidentified subscriber indication is however processed as the absent subscriber_SM indication.

In case of successful SMS delivery on the second path, the successful SMS Delivery outcome is sent in combination with the unsuccessful SMS Delivery outcome to the HLR.

The service is invoked also when the HLR has indicated that either of the flags MCEF, MNRF or both are set and the first SM delivery was successful from the servicing MSC or, in case of subsequent SM, the last SM delivery was successful from the servicing MSC.

The service is invoked also when the HLR has indicated that either of the flags MCEF, MNRF or both are set and the SM delivery was successful from the servicing SGSN or, in case of subsequent SM, the last SM delivery was successful from the servicing SGSN.

The reason for unsuccessful, successful for GPRS, non GPRS or both deliveries of the short message are included in the SM Delivery Outcome in the MAP_REPORT_SM_DELIVERY_STATUS request. In the case of an unsuccessful delivery due to the subscriber being absent the absent subscriber diagnostic indication (if available) is also included in the MAP_REPORT_SM_DELIVERY_STATUS request.

If the reason for unsuccessful delivery is absent subscriber with diagnostic 'Paging failure' for GPRS or non GPRS, the two SM Delivery Outcomes absent subscriber with both diagnostics 'Paging failure' for GPRS and non GPRS is included in the MAP_REPORT_SM_DELIVERY_STATUS request.

The GMSC sends the MAP_REPORT_SM_DELIVERY_STATUS request to the HLR. As a response the GMSC will receive the MAP_REPORT_SM_DELIVERY_STATUS confirmation reporting:

- successful outcome of the procedure. The acknowledge primitive may contain the MSISDN-Alert number which is stored in the MWD List in the HLR;
- unsuccessful outcome of the procedure. The system failure indication is forwarded to the SC. In that case, if the SM Delivery Outcome was successful SMS delivery for GPRS or non GPRS (combined or not with another unsuccessful reason), a successful report is forwarded to the SC.

A provider error is indicated as a system failure to the SC.

Note that the indication, on which number belongs the SGSN and MSC, received from the HLR at routing information result (see clause 23.3.3) will enable the GMSC to map the causes received from the SGSN, MSC or both into the appropriate causes for GPRS, non GPRS or both, and send them to the SC and HLR.

The procedure towards the Service Centre may also be aborted. If so the operation towards the HLR is also aborted.

The short message delivery status report procedure in the GMSC is shown in figure 23.5/3.

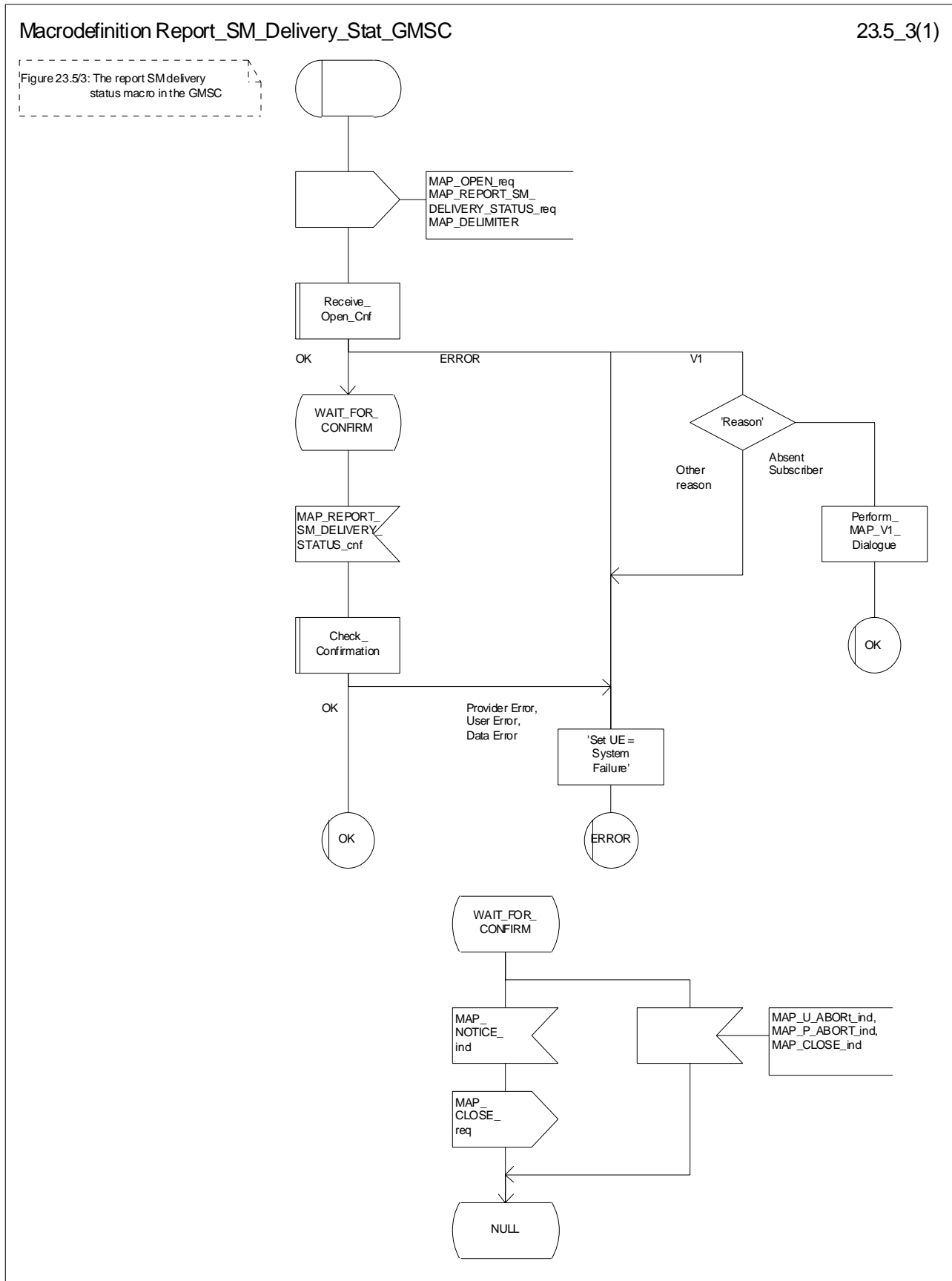

Figure 23.5/3: Macro Report_SM_Delivery_Stat_GMSC

23.6 Common procedures for the short message clause

23.6.1 The macro Report_SM_Delivery_Stat_HLR

This macro is used when the HLR receives a MAP_REPORT_SM_DELIVERY_STATUS indication from the GMSC. The HLR responds to the indication as follows:

- if the flag « GPRS Support Indicator » is absent then if the subscriber is a GPRS subscriber and a non-GPRS subscriber with the option « transfer of SM via the SGSN when GPRS is not supported in the GMSC » or if the subscriber is a GPRS subscriber only, the HLR shall interpret the delivery outcome as a GPRS delivery outcome.
- if invalid data content is detected, an unexpected data value error or a data missing error is returned to the GMSC;
- if the MSISDN number provided is not recognised by the HLR, an unknown subscriber error is returned to the GMSC;
- if the MAP_REPORT_SM_DELIVERY_STATUS indication reports a successful SM delivery, the Service Centres in the Message Waiting list are alerted as described in the clause 25.10;
- if the SM Delivery Outcome reports unsuccessful delivery and the inclusion of the SC address in the MWD is not possible, a message waiting list full error is returned to the GMSC;
- if the SM Delivery Outcome reports unsuccessful delivery and the message waiting list is not full, the given Service Centre address is inserted and an acknowledgement is sent to the GMSC. If the MSISDN-Alert stored in the subscriber data is not the same as that received in the MAP_REPORT_SM_DELIVERY_STATUS indication, the MSISDN-Alert is sent in a response primitive to the GMSC;

The SC address is only stored in the MWD if the unsuccessful SM Delivery Outcome is not received in combination with another successful SM Delivery Outcome

- if the SM Delivery Outcome is MS memory capacity exceeded for non GPRS, the HLR sets the memory capacity exceeded flag in the subscriber data and resets the MNRF;
- if the SM Delivery Outcome is MS memory capacity exceeded for GPRS the HLR sets the memory capacity exceeded flag in the subscriber data and resets the MNRG;
- if the SM Delivery Outcome is absent subscriber for non GPRS, the HLR sets the mobile station not reachable flag in the subscriber data. If a reason for absence is provided by the GMSC then this is stored in the mobile station not reachable reason (MNRR) in the subscriber data.
- if the SM Delivery Outcome is absent subscriber for GPRS, the HLR sets the mobile station not reachable for GPRS flag in the subscriber data. If a reason for absence is provided by the GMSC then this is stored in the mobile station not reachable reason (MNRR) in the subscriber data.

Note that a combination of all the SM Delivery Outcome specified above may be provided to the HLR from the SMS-GMSC.

The short message delivery status report macro in the HLR is shown in figure 23.6/1.

Macrodefinition Report_SM_Delivery_Stat_HLR

23.6_1(1)

Figure 23.6/1: The report SM delivery status macro in the HLR

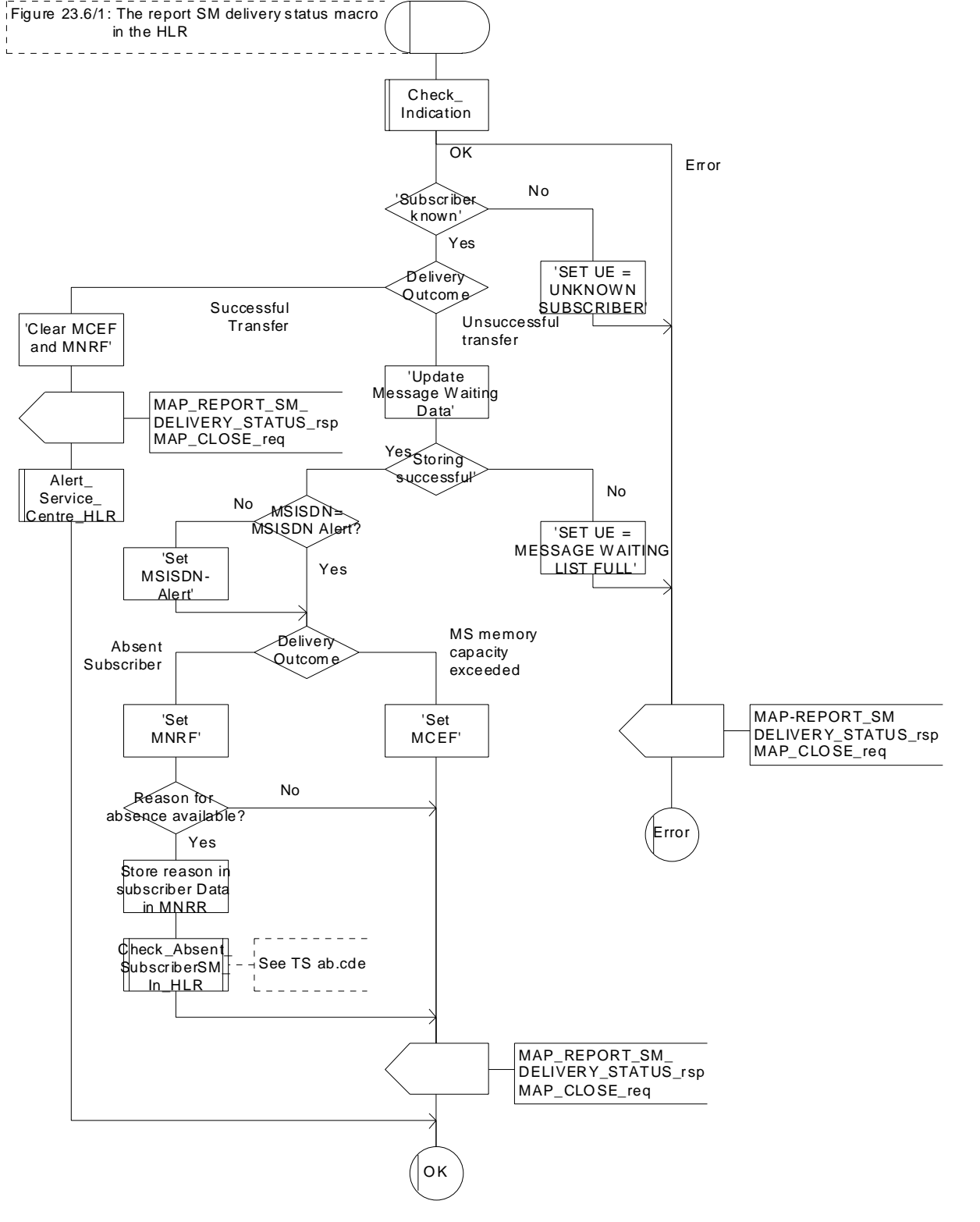

Figure 23.6/1: Macro Report_SM_Delivery_Stat_HLR

24 GPRS process description

24.1 General

The MAP GPRS procedures are used for the Network Requested PDP-Context Activation procedures.

The stage 2 specification for General Packet Radio Service (GPRS) is in 3GPP TS 23.060 [104] [100].

24.1.1 Process in the HLR for Send Routing Information for GPRS

The MAP process in the HLR to provide routing information for a network-requested PDP context activation is shown in figure 24.1/1. The MAP process invokes macros not defined in this clause; the definition of these macros can be found as follows:

Receive_Open_Ind	see clause 25.1.1;
Check_Indication	see clause 25.2.1.

Successful outcome

When the MAP process receives a MAP_OPEN indication with the application context gprsLocationInfoRetrieval, it checks it by invoking the macro Receive_Open_Ind.

If the macro takes the OK exit, the MAP process waits for a service indication.

If a MAP_SEND_ROUTING_INFO_FOR_GPRS service indication is received, the HLR sends a Send Routing Info For Gprs request to the GPRS application process in the HLR, and waits for a response. The Send Routing Info For Gprs request contains the parameter received in the MAP_SEND_ROUTING_INFO_FOR_GPRS service indication.

If the GPRS application process in the HLR returns a positive response containing the routing information, the MAP process constructs a MAP_SEND_ROUTING_INFO_FOR_GPRS service response containing the routing info, constructs a MAP_CLOSE service request, sends them to the GGSN and returns to the idle state.

Negative response from HLR GPRS application process

If the GPRS application process in the HLR returns a negative response, the MAP process constructs a MAP_SEND_ROUTING_INFO_FOR_GPRS service response containing the appropriate error, constructs a MAP_CLOSE service request, sends them to the GGSN and returns to the idle state.

Failure of dialogue opening with the GGSN

If the macro Receive_Open_Ind takes the Vr exit or the Error exit, the MAP process returns to the idle state.

If the MAP provider sends a MAP_P_ABORT while the MAP process is waiting for a service indication, the MAP process returns to the idle state.

If the MAP provider sends a MAP_NOTICE while the MAP process is waiting for a service indication, the MAP process sends a MAP_CLOSE request to terminate the dialogue and returns to the idle state.

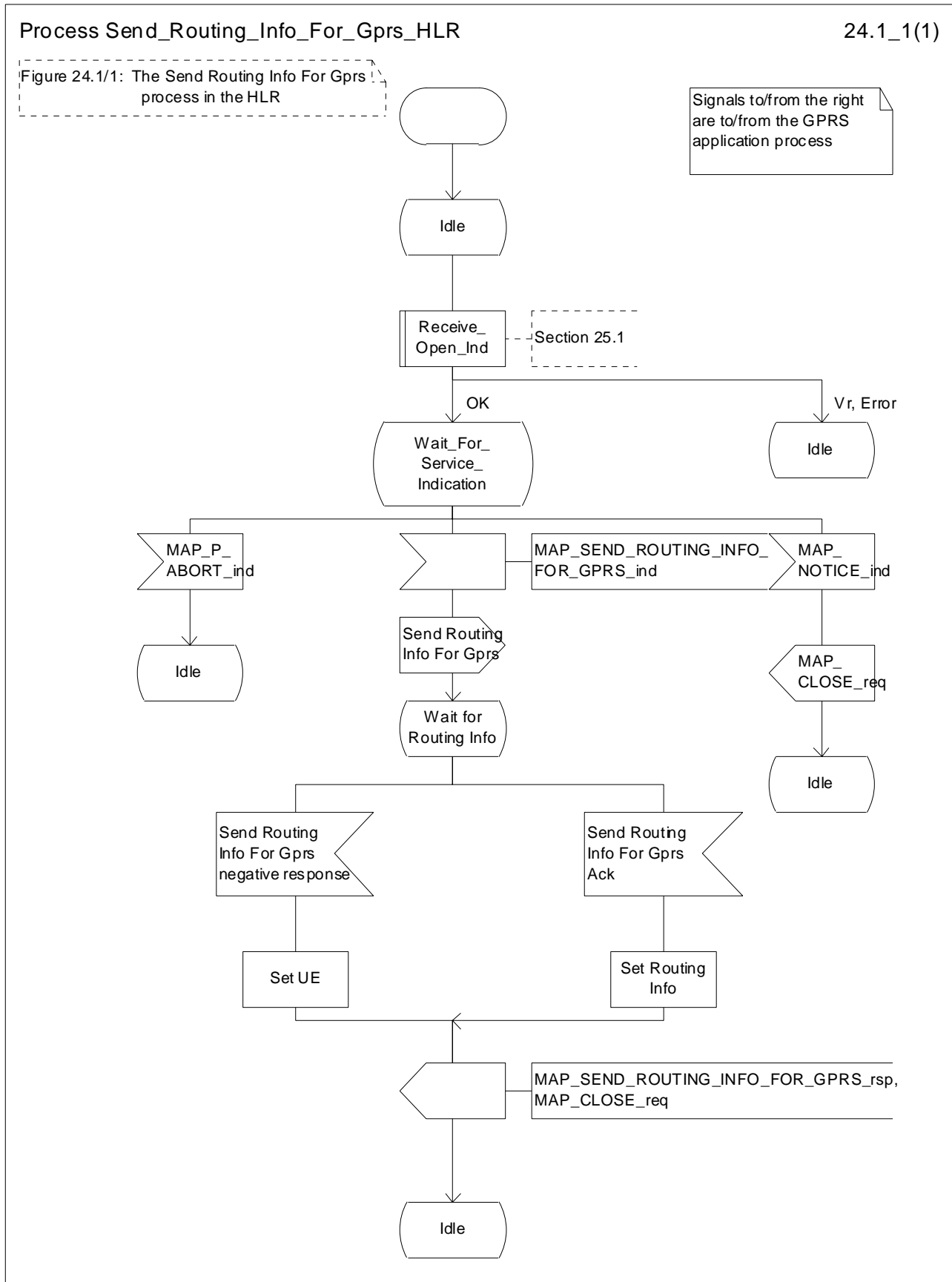

24.1.2 Process in the GGSN for Send Routing Information for GPRS

Successful Outcome

When the MAP process receives a Send Routing Info For Gprs request from the GPRS application process in the GGSN, it requests a dialogue with the HLR whose identity is contained in the Send Routing Info For Gprs request by sending a MAP_OPEN service request, requests routing information using a MAP_SEND_ROUTING_INFO_FOR_GPRS service request and invokes the macro Receive_Open_Cnf to wait for the response to the dialogue opening request. If the dialogue opening is successful, the MAP process waits for a response from the HLR.

If the MAP process receives a MAP_SEND_ROUTING_INFO_FOR_GPRS service confirm from the HLR, the MAP process invokes the macro Check_Confirmation to check the content of the confirm.

If the macro Check_Confirmation takes the OK exit, the MAP process sends a Send Routing Info For Gprs ack containing the routing information received from the HLR to the GPRS application process in the GGSN and returns to the idle state.

Failure of dialogue opening with the HLR

If the macro Receive_Open_Cnf takes the Vr exit or the Error exit, the MAP process sends a negative response to the GPRS application process in the GGSN and returns to the idle state.

Error in MAP_SEND_ROUTING_INFO_FOR_GPRS confirm

If the MAP_SEND_ROUTING_INFO_FOR_GPRS service confirm contains a user error or a provider error, or the macro Check_Confirmation indicates that there is a data error, the MAP process sends a Send Routing Info For Gprs negative response to the GPRS application process in the GGSN and returns to the idle state.

Abort of HLR dialogue

After the dialogue with the HLR has been established, the MAP service provider may abort the dialogue by issuing a MAP_P_ABORT or a MAP_U_ABORT indication. In this case, the MAP process sends a Send Routing Info For Gprs negative response to the GPRS application process in the GGSN and returns to the idle state.

If the MAP provider indicates a protocol problem by sending a MAP_NOTICE indication, the MAP process closes the dialogue with the HLR, sends a Send Routing Info For Gprs negative response indicating system failure to the GPRS application process in the GGSN and returns to the idle state.

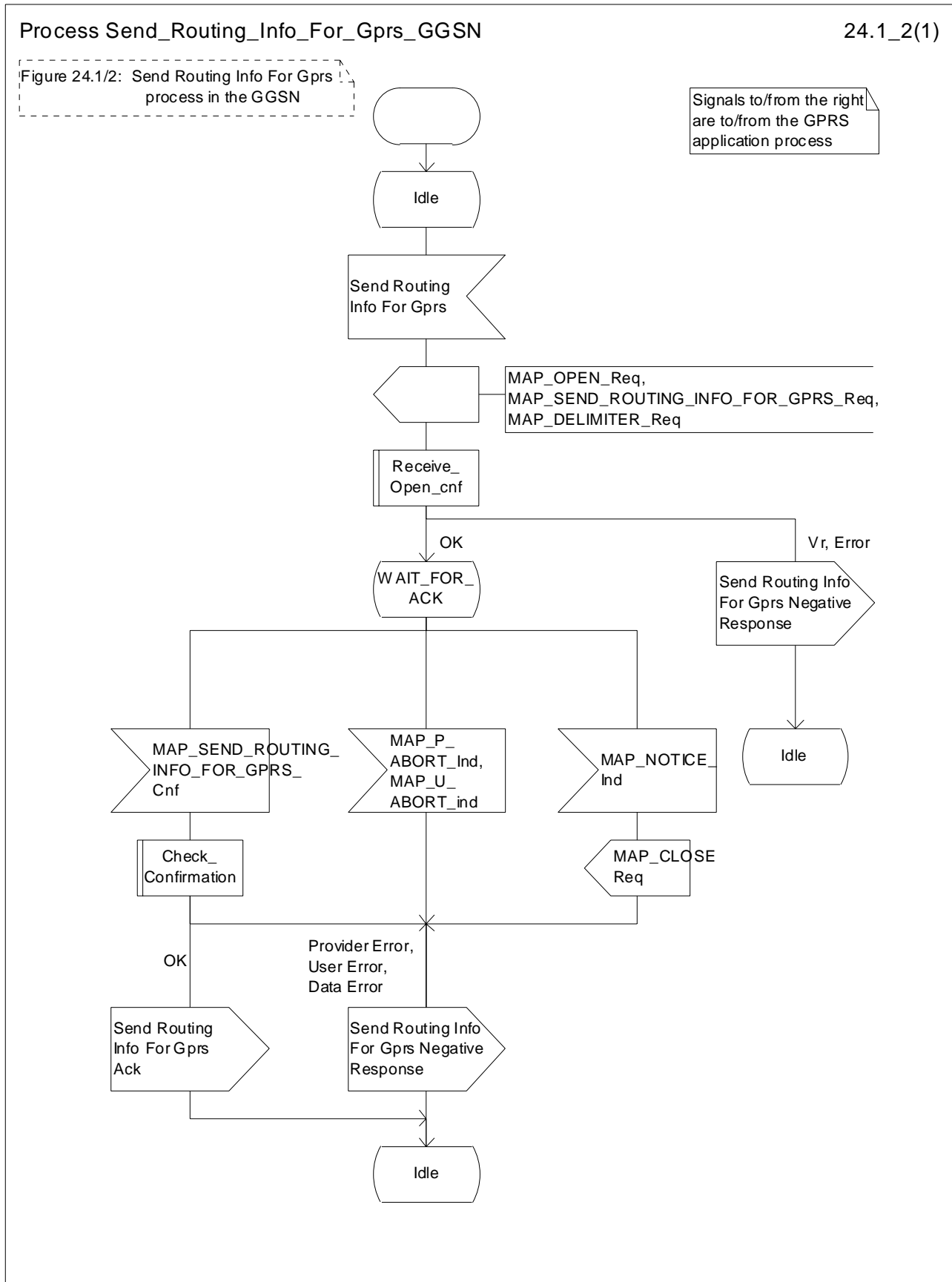

Figure 24.1/2: Process Send_Routing_Info_For_Gprs_GGSN

24.2.1 Process in the HLR for Failure Report

The MAP process in the HLR to set the MNRG (Mobile station Not Reachable for GPRS) flag for the subscriber is shown in figure 24.2/1. The MAP process invokes macros not defined in this clause; the definition of these macros can be found as follows:

Receive_Open_Ind see clause 25.1.1;

Check Indication see clause 25.2.1.

Successful outcome

When the MAP process receives a MAP_OPEN indication with the application context failureReport, it checks it by invoking the macro Receive_Open_Ind.

If the macro takes the OK exit, the MAP process waits for a service indication.

If a MAP_FAILURE_REPORT service indication is received, the HLR sends a Failure Report request to the GPRS application process in the HLR, and waits for a response. The Failure Report request contains the parameter received in the MAP_FAILURE_REPORT service indication.

If a positive response is received, the MAP process constructs a MAP_FAILURE_REPORT service response, constructs a MAP_CLOSE service request, sends them to the GGSN and returns to the idle state.

Negative response from HLR GPRS application process

If the GPRS application process in the HLR returns a negative response, the MAP process constructs a MAP_FAILURE_REPORT service response containing the appropriate error, constructs a MAP_CLOSE service request, sends them to the GGSN and returns to the idle state.

Failure of dialogue opening with the GGSN

If the macro Receive_Open_Ind takes the Vr exit or the Error exit, the MAP process returns to the idle state.

If the MAP provider sends a MAP_P_ABORT while the MAP process is waiting for a service indication, the MAP process returns to the idle state.

If the MAP provider sends a MAP_NOTICE while the MAP process is waiting for a service indication, the MAP process sends a MAP_CLOSE request to terminate the dialogue and returns to the idle state.

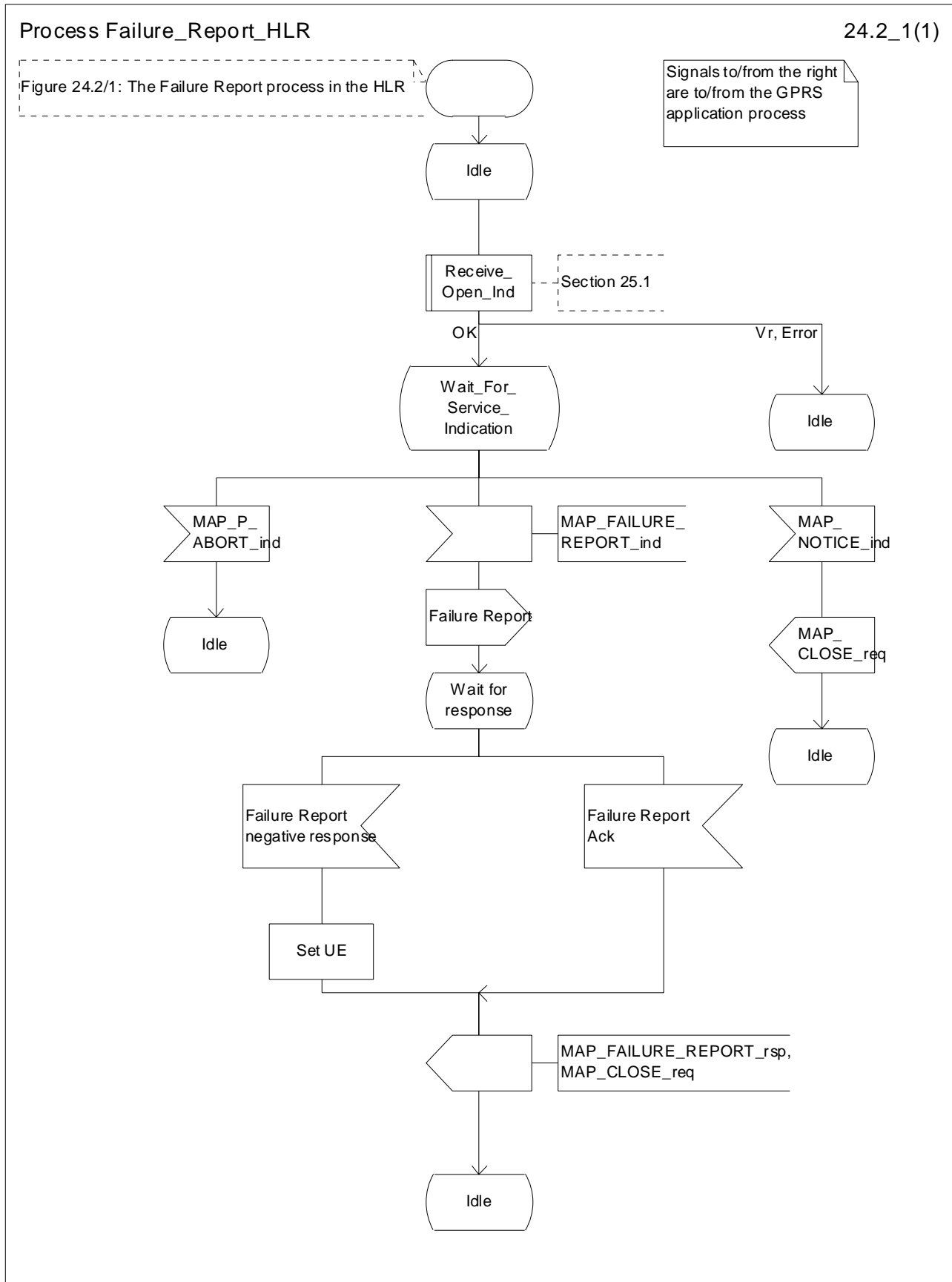

Figure 24.2/1: Process Failure_Report_HLR

24.2.2 Process in the GGSN for Failure Report

Successful Outcome

When the MAP process receives a Failure Report request from the GPRS application process in the GGSN, it requests a dialogue with the HLR whose identity is contained in the Failure Report request by sending a MAP_OPEN service request, sending failure information using a MAP_FAILURE_REPORT service request and invokes the macro Receive_Open_Cnf to wait for the response to the dialogue opening request. If the dialogue opening is successful, the MAP process waits for a response from the HLR.

If the MAP process receives a MAP_FAILURE_REPORT service confirm from the HLR, the MAP process invokes the macro Check_Confirmation to check the content of the confirm.

If the macro Check_Confirmation takes the OK exit, the MAP process sends a Failure Report ack containing the information received from the HLR to the GPRS application process in the GGSN and returns to the idle state.

Failure of dialogue opening with the HLR

If the macro Receive_Open_Cnf takes the Vr exit or the Error exit, the MAP process sends a negative response to the GPRS application process in the GGSN and returns to the idle state.

Error in MAP_FAILURE_REPORT confirm

If the MAP_FAILURE_REPORT service confirm contains a user error or a provider error, or the macro Check_Confirmation indicates that there is a data error, the MAP process sends a Failure Report negative response to the GPRS application process in the GGSN and returns to the idle state.

Abort of HLR dialogue

After the dialogue with the HLR has been established, the MAP service provider may abort the dialogue by issuing a MAP_P_ABORT or a MAP_U_ABORT indication. In this case, the MAP process sends a Failure Report negative response to the GPRS application process in the GGSN and returns to the idle state.

If the MAP provider indicates a protocol problem by sending a MAP_NOTICE indication, the MAP process closes the dialogue with the HLR, sends a Failure Report negative response indicating system failure to the GPRS application process in the GGSN and returns to the idle state.

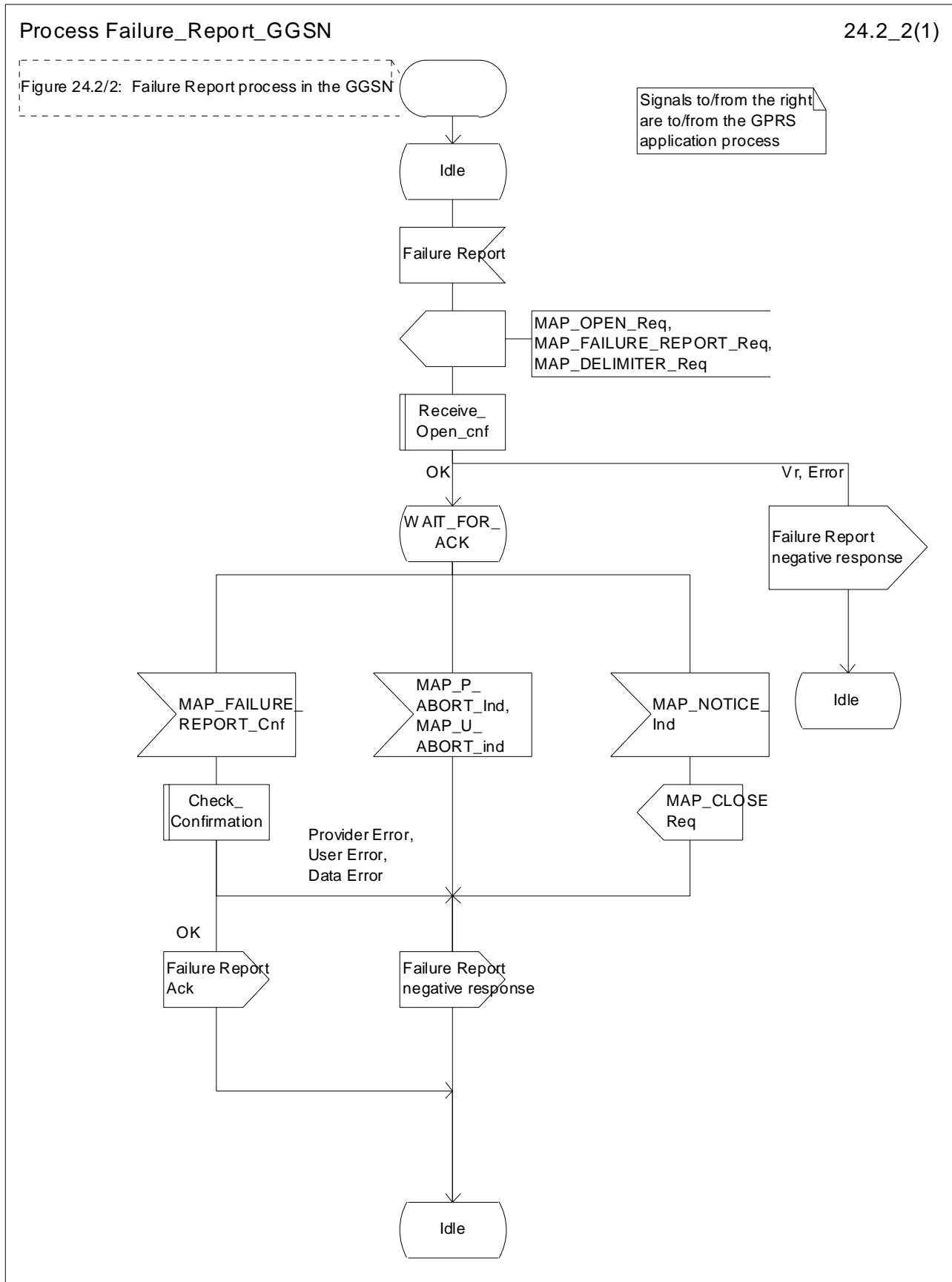

24.3.1 Process in the GGSN for Note Ms Present For Gprs

The MAP process in the GGSN to inform that the subscriber is present for GPRS again is shown in figure 24.3/1. The MAP process invokes macros not defined in this clause; the definition of these macros can be found as follows:

Receive_Open_Ind	see clause 25.1.1;
Check_Indication	see clause 25.2.1.

Successful outcome

When the MAP process receives a MAP_OPEN indication with the application context gprsNotify, it checks it by invoking the macro Receive_Open_Ind.

If the macro takes the OK exit, the MAP process waits for a service indication.

If a MAP_NOTE_MS_PRESENT_FOR_GPRS service indication is received, the GGSN sends a Note Ms Present For Gprs request to the GPRS application process in the GGSN, and waits for a response. The Note Ms Present For Gprs request contains the parameter received in the MAP_NOTE_MS_PRESENT_FOR_GPRS service indication.

If the GPRS application process in the GGSN returns a positive response, the MAP process constructs a MAP_NOTE_MS_PRESENT_FOR_GPRS service response, constructs a MAP_CLOSE service request, sends them to the HLR and returns to the idle state.

Negative response from GGSN GPRS application process

If the GPRS application process in the GGSN returns a negative response, the MAP process constructs a MAP_NOTE_MS_PRESENT_FOR_GPRS service response containing the appropriate error, constructs a MAP_CLOSE service request, sends them to the HLR and returns to the idle state.

Failure of dialogue opening with the HLR

If the macro Receive_Open_Ind takes the Vr exit or the Error exit, the MAP process returns to the idle state.

If the MAP provider sends a MAP_P_ABORT while the MAP process is waiting for a service indication, the MAP process returns to the idle state.

If the MAP provider sends a MAP_NOTICE while the MAP process is waiting for a service indication, the MAP process sends a MAP_CLOSE request to terminate the dialogue and returns to the idle state.

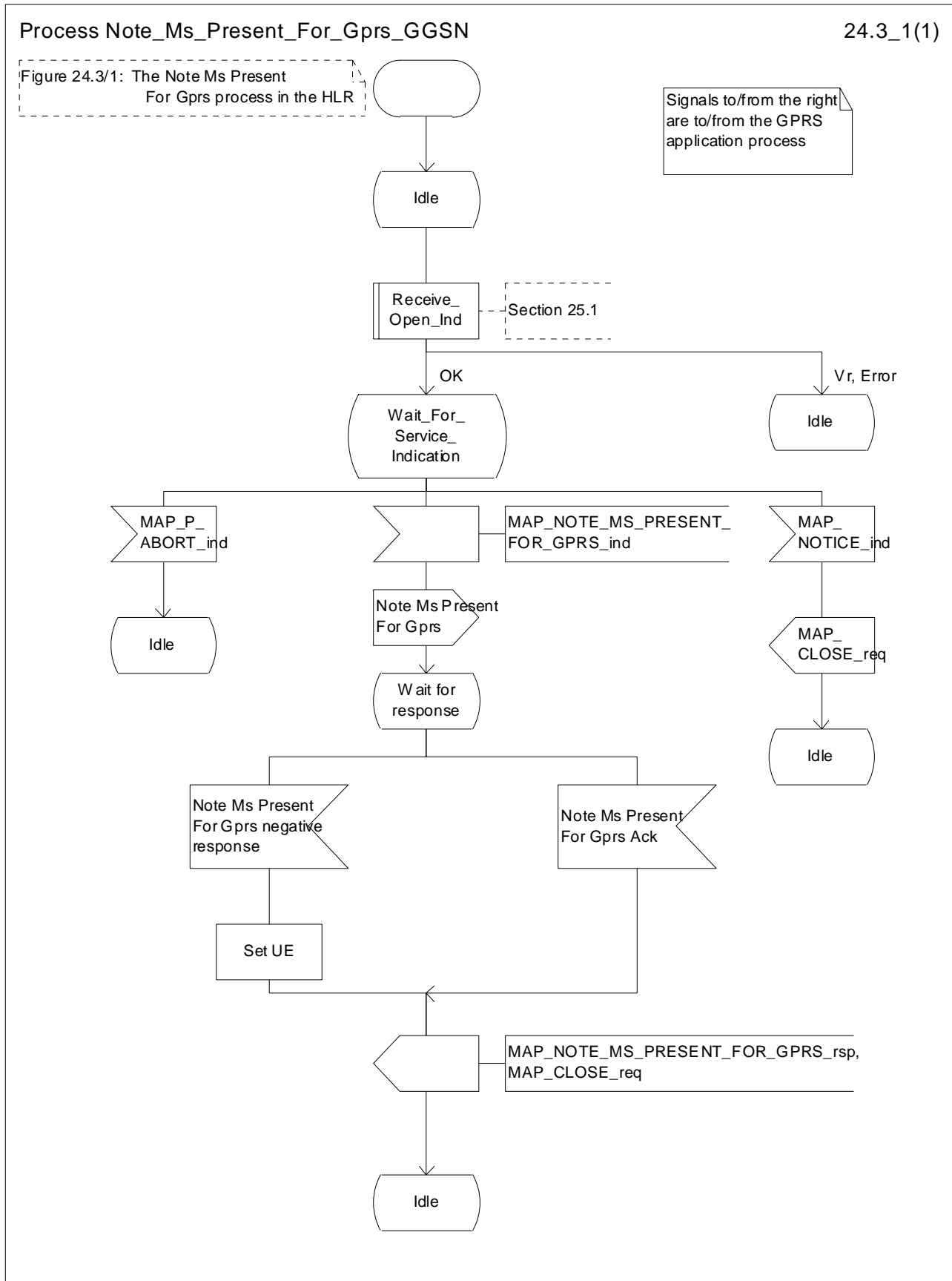

Figure 24.3/1: Process Note_Ms_Present_For_Gprs_GGSN

24.3.2 Process in the HLR for Note Ms Present For Gprs

Successful Outcome

When the MAP process receives a Note Ms Present For Gprs request from the GPRS application process in the HLR, it requests a dialogue with the GGSN whose identity is contained in the Note Ms Present For Gprs request by sending a MAP_OPEN service request, sending necessary information using a MAP_NOTE_MS_PRESENT_FOR_GPRS service request and invokes the macro Receive_Open_Cnf to wait for the response to the dialogue opening request. If the dialogue opening is successful, the MAP process waits for a response from the GGSN.

If the MAP process receives a MAP_NOTE_MS_PRESENT_FOR_GPRS service confirm from the GGSN, the MAP process invokes the macro Check_Confirmation to check the content of the confirm.

If the macro Check_Confirmation takes the OK exit, the MAP process sends a Note Ms Present For Gprs ack containing the information received from the GGSN to the GPRS application process in the HLR and returns to the idle state.

Failure of dialogue opening with the GGSN

If the macro Receive_Open_Cnf takes the Vr exit or the Error exit, the MAP process sends a negative response to the GPRS application process in the HLR and returns to the idle state.

Error in MAP_NOTE_MS_PRESENT_FOR_GPRS confirm

If the MAP_NOTE_MS_PRESENT_FOR_GPRS service confirm contains a user error or a provider error, or the macro Check_Confirmation indicates that there is a data error, the MAP process sends a Note Ms Present For Gprs negative response to the GPRS application process in the HLR and returns to the idle state.

Abort of GGSN dialogue

After the dialogue with the GGSN has been established, the MAP service provider may abort the dialogue by issuing a MAP_P_ABORT or a MAP_U_ABORT indication. In this case, the MAP process sends a Note Ms Present For Gprs negative response to the GPRS application process in the HLR and returns to the idle state.

If the MAP provider indicates a protocol problem by sending a MAP_NOTICE indication, the MAP process closes the dialogue with the GGSN, sends a Failure Report negative response indicating system failure to the GPRS application process in the HLR and returns to the idle state.

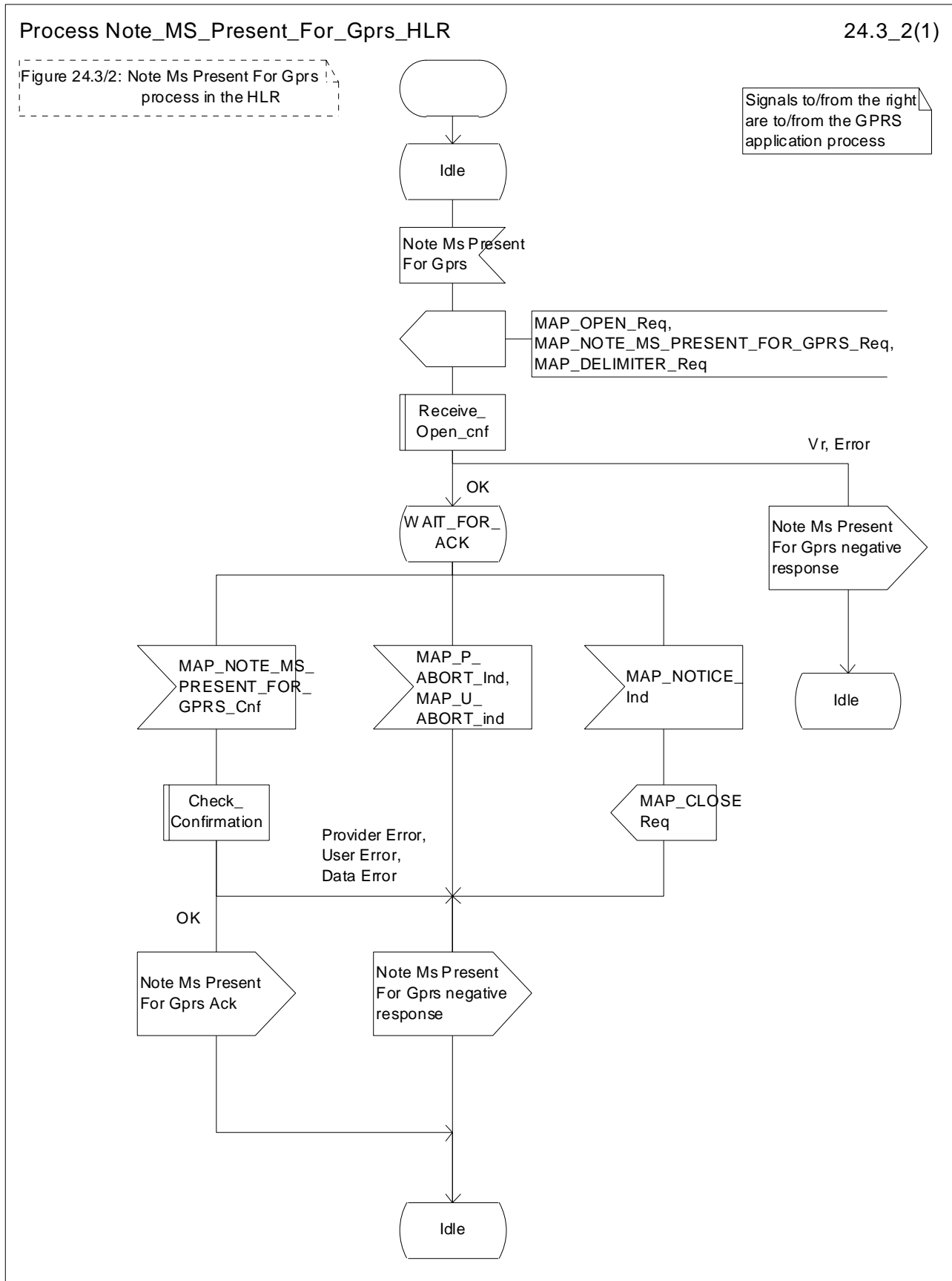

Figure 24.3/2: Process Note_Ms_Present_For_Gprs_HLR

24A CSE control of subscriber data

24A.1 Any Time Subscription Interrogation procedure

24A.1.1 General

The message flows for successful retrieval of subscription information related to an any time interrogation from the CAMEL server are shown in figure 24A.1/1.

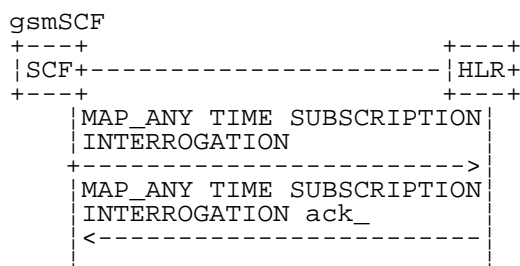

Figure 24A.1/1: Message flow for any time subscription interrogation

The following MAP services are used to retrieve requested information:

MAP_ANY_TIME_SUBSCRIPTION_INTERROGATION see clause 8.11.x.

24A.1.2 Process in the gsmSCF

Out of the scope of the MAP specification.

24A.1.3 Process in the HLR

The MAP process in the HLR to provide subscription information in response to an interrogation from the CAMEL server is shown in figure 24A.1/2. The MAP process invokes macros not defined in this clause; the definitions of these macros can be found as follows:

Receive_Open_Ind see clause 25.1.1;

Successful outcome

When the MAP process receives a MAP_OPEN indication with the application context anyTimeInformationHandlng, it checks it by invoking the macro Receive_Open_Ind.

If the macro takes the OK exit, the MAP process waits for a service indication.

If a MAP_ANY_TIME_SUBSCRIPTION_INTERROGATION service indication is received, the MAP process sends an Any Time Subscription Interrogation request to the call handling process in the HLR (described in 3GPP TS 23.078), and waits for a response. The Any Time Subscription Interrogation request contains the parameters received in the MAP_ANY_TIME_SUBSCRIPTION_INTERROGATION service indication.

If the call handling process in the HLR returns an Any Time Subscription Interrogation response, the MAP process constructs a MAP_ANY_TIME_SUBSCRIPTION_INTERROGATION service response containing the subscription information contained in the Any Time Subscription Interrogation response, constructs a MAP_CLOSE service request, sends them to the CAMEL server and returns to the idle state. If the MAP_ANY_TIME_SUBSCRIPTION_INTERROGATION service response cannot be carried in a single TC-Result component, it is carried in one or more TC-Result-NL components (each sent in a TC-CONTINUE), followed by a TC-Result-L component in a TC-END message.

Negative response from HLR call handling process

If the call handling process in the HLR returns a negative response to obtain subscription information, the MAP process constructs a MAP_ANY_TIME_SUBSCRIPTION_INTERROGATION service response containing the appropriate error, constructs a MAP_CLOSE service request, sends them to the CAMEL server and returns to the idle state.

Failure of dialogue opening with the CAMEL server

If the macro Receive_Open_Ind takes the Vr or Error exit, the MAP process returns to the idle state.

If the MAP provider sends a MAP_P_ABORT while the MAP process is waiting for a service indication, the MAP process returns to the idle state.

If the MAP provider sends a MAP_NOTICE while the MAP process is waiting for a service indication, the MAP process sends a MAP_CLOSE request to terminate the dialogue and returns to the idle state.

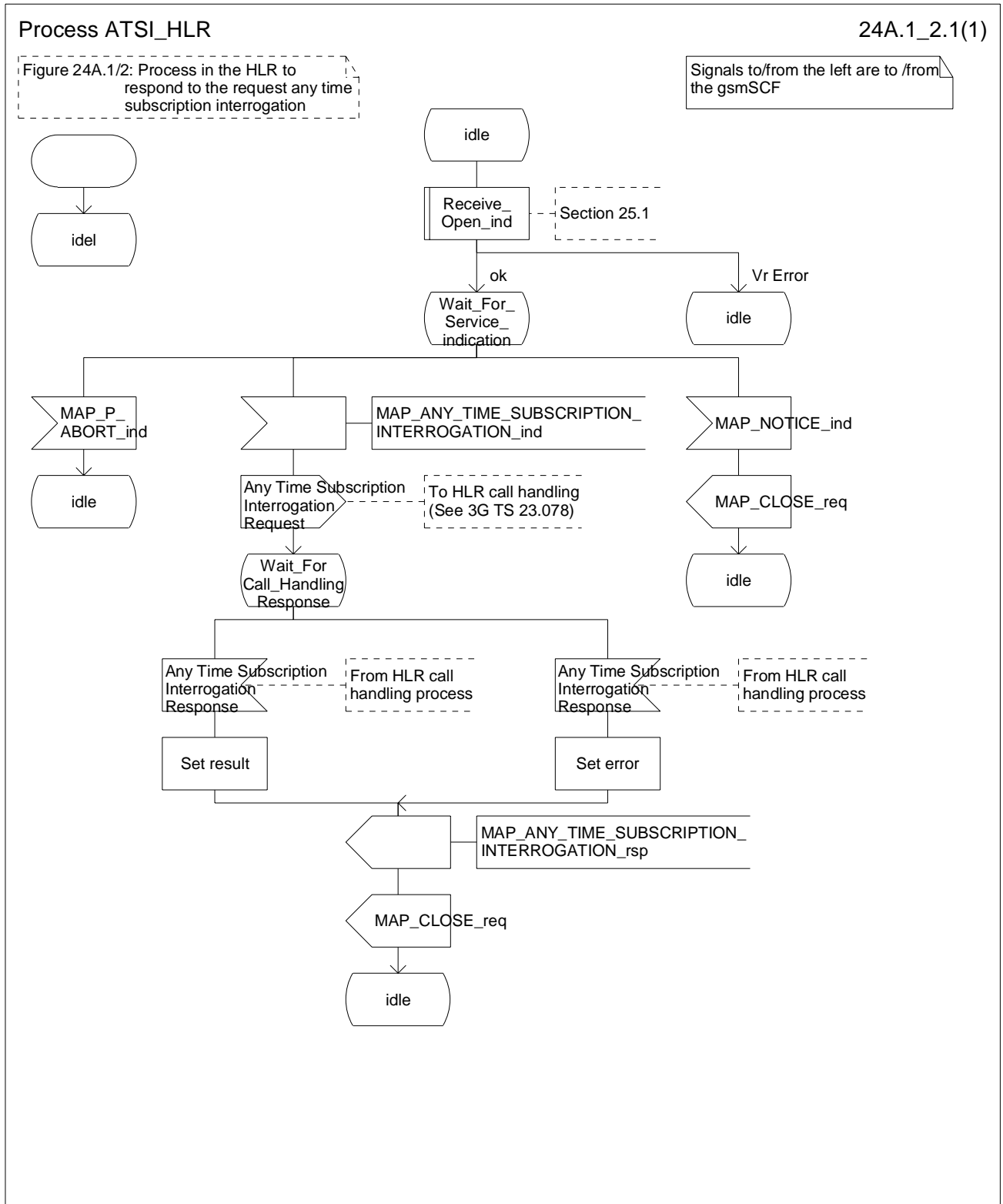

Figure 24A.1/2: Process ATSI_HLR

24A.2 Any Time Modification procedure

24A.2.1 General

The message flows for successful modification of subscriber information related to an any time modification from the CAMEL server are shown in figure 24A.2/1

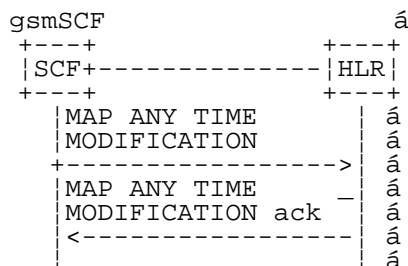

Figure 24A.2/1: Message flow for any time modification

The following MAP services are used to modify subscription information:

MAP_ANY_TIME_MODIFICATION see clause 8.11.x.

24A.2.2 Process in the gsmSCF

Out of the scope of the MAP specification.

24A.2.3 Process in the HLR

The MAP process in the HLR to modify subscriber information in response to a modification request from the CAMEL server is shown in figure 24A.2/2. The MAP process invokes macros not defined in this clause; the definitions of these macros can be found as follows:

Receive_Open_Ind see clause 25.1.1;

Insert_Sub_Data_Stand_Alone_HLR see clause 25.7.2;

Successful outcome

When the MAP process receives a MAP_OPEN indication with the application context anyTimeInformationHandling, it checks it by invoking the macro Receive_Open_Ind.

If the macro takes the OK exit, the MAP process waits for a service indication.

If a MAP_ANY_TIME_MODIFICATION service indication is received, the MAP process sends an Any Time modification request to the call handling process in the HLR (described in 3GPP TS 23.078), and waits for a response. The Any Time modification request contains the parameters received in the MAP_ANY_TIME_MODIFICATION service indication.

If the call handling process in the HLR returns an Any Time modification response, the MAP process constructs a MAP_ANY_TIME_MODIFICATION service response containing the modified subscription information contained in the Any Time modification response, constructs a MAP_CLOSE service request, sends them to the CAMEL server. If the MAP_ANY_TIME_MODIFICATION service response cannot be carried in a single TC-Result component, it is carried in one or more TC-Result-NL components (each sent in a TC-CONTINUE), followed by a TC-Result-L component in a TC-END message. If the VLR/SGSN is to be updated after the modification, the MAP_INSERT_SUBS_DATA_HLR process shall be initiated and then returns to the idle state.

Negative response from HLR call handling process

If the call handling process in the HLR returns a negative response to modify subscription information, the MAP process constructs a MAP_ANY_TIME_MODIFICATION service response containing the appropriate error, constructs a MAP_CLOSE service request, sends them to the CAMEL server and returns to the idle state.

Failure of dialogue opening with the CAMEL server

If the macro Receive_Open_Ind takes the Vr or Error exit, the MAP process returns to the idle state.

If the MAP provider sends a MAP_P_ABORT while the MAP process is waiting for a service indication, the MAP process returns to the idle state.

If the MAP provider sends a MAP_NOTICE while the MAP process is waiting for a service indication, the MAP process sends a MAP_CLOSE request to terminate the dialogue and returns to the idle state.

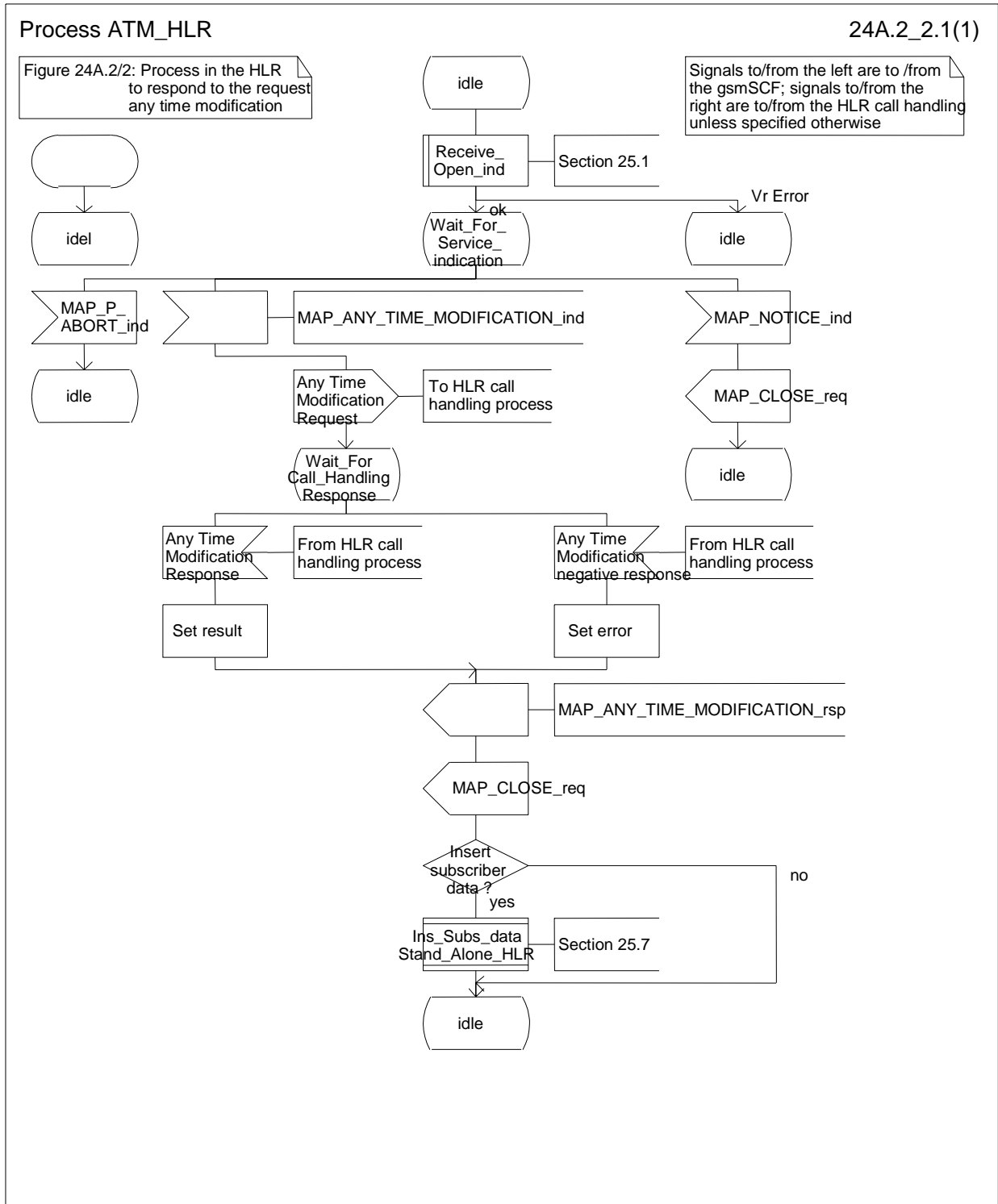

Figure 24A.2/2: Process ATM_HLR

24A.3 Subscriber Data Modification Notification procedure

24A.3.1 General

The Subscriber Data Modification Notification procedure is used to notify a gsmSCF about the modification of subscriber data.

The stage 2 specification for Subscriber Data Modification Notification is in 3GPP TS 23.078. The interworking between the MAP signalling procedures and the Subscriber Data Modification Notification procedures for each entity (HLR, gsmSCF) is shown by the transfer of signals between these procedures.

The following services are used:

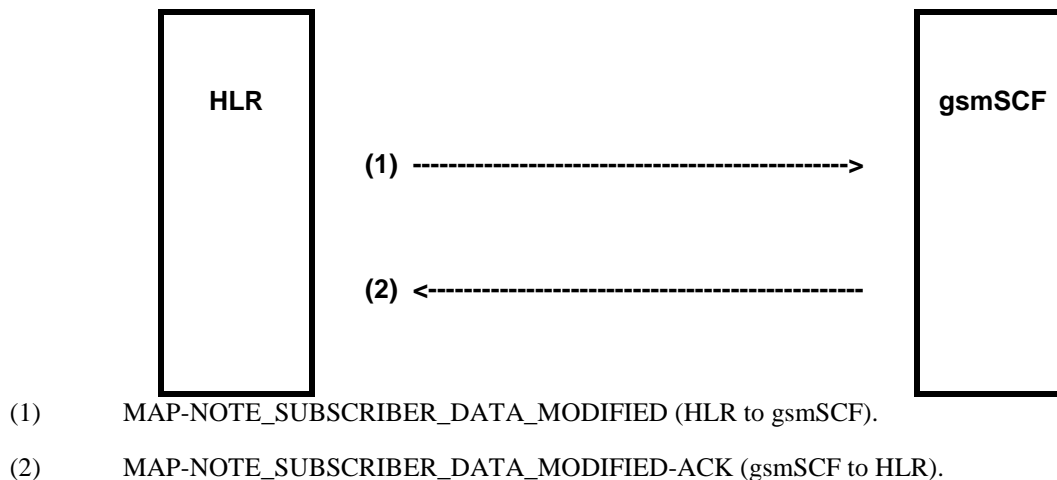

Figure 24A.3/1: Interfaces and services for subscriber data modification notification

24A.3.2 Processes in the MAP Entities

The text in this clause is a supplement to the definition in the SDL diagrams; it does not duplicate the information in the SDL diagrams.

24A.3.2.1 Process in the HLR

The MAP process in the HLR to send modified data to the gsmSCF is shown in figure 24A.3/2. The MAP process invokes macros not defined in this clause; the definitions of these macros can be found as follows:

Receive_Open_Cnf	see clause 25.1.2;
Check_Confirmation	see clause 25.2.2.

Successful Outcome

When the MAP process receives a Notify Subscriber Data Change request from the process in the HLR, it requests a dialogue with the gsmSCF whose identity is contained in the Note Subscriber Data Modified request by sending a MAP_OPEN service request, notifies modified subscriber data to the gsmSCF using a MAP_NOTE_SUBSCRIBER_DATA_MODIFIED service request and invokes the macro Receive_Open_Cnf to wait for the response to the dialogue opening request. If the dialogue opening is successful, the MAP process waits for a response from the gsmSCF.

If the HLR notices after receiving a Notify Subscriber Data Change request that the segmentation is needed the HLR does not set the "All Information Sent" indicator. Otherwise the indicator is set and the process returns to the Wait for SCF response state.

If the MAP process receives a MAP_NOTE_SUBSCRIBER_DATA_MODIFIED service confirm from the gsmSCF, the MAP process invokes the macro Check_Confirmation to check the content of the confirm.

If the macro Check_Confirmation takes the OK exit, the MAP process checks if the “All Information Sent” indicator is set. If it is set the MAP process sends a Notify Subscriber Data Modified ack to the process in the HLR and returns to the idle state. If the “All Information Sent” indicator is not set the MAP process checks if the further segmentation is needed. If segmentation is needed the HLR does not set the indicator and sends MAP_NOTE_SUBSCRIBER_DATA_MODIFIED service request to the gsmSCF. Otherwise the indicator is set and the MAP_NOTE_SUBSCRIBER_DATA_MODIFIED service request is sent to the gsmSCF.

Dialogue opening failure

If the macro Receive_Open_Cnf indicates that the dialogue with the gsmSCF could not be opened or that the dialogue can be opened only at an earlier version, the MAP process sends a Notify Subscriber Data Modified negative response indicating system failure to the process in the HLR and returns to the idle state.

Error in MAP_NOTE_SUBSCRIBER_DATA_MODIFIED confirm

If the MAP_NOTE_SUBSCRIBER_DATA_MODIFIED service confirm contains a user error or a provider error, the MAP process sends a Notify Subscriber Data Change negative response to the process in the HLR and returns to the idle state.

Abort of gsmSCF dialogue

After the dialogue with the gsmSCF has been established, the MAP service provider may abort the dialogue by issuing a MAP_P_ABORT indication, or the gsmSCF may send a MAP_CLOSE indication. In either of these cases, the MAP process sends a Notify Subscriber Data Change negative response to the process in the HLR and returns to the idle state.

If the MAP provider indicates a protocol problem by sending a MAP_NOTICE indication, the MAP process closes the dialogue with the gsmSCF, sends a Notify Subscriber Data Change negative response indicating system failure to the process in the HLR and returns to the idle state.

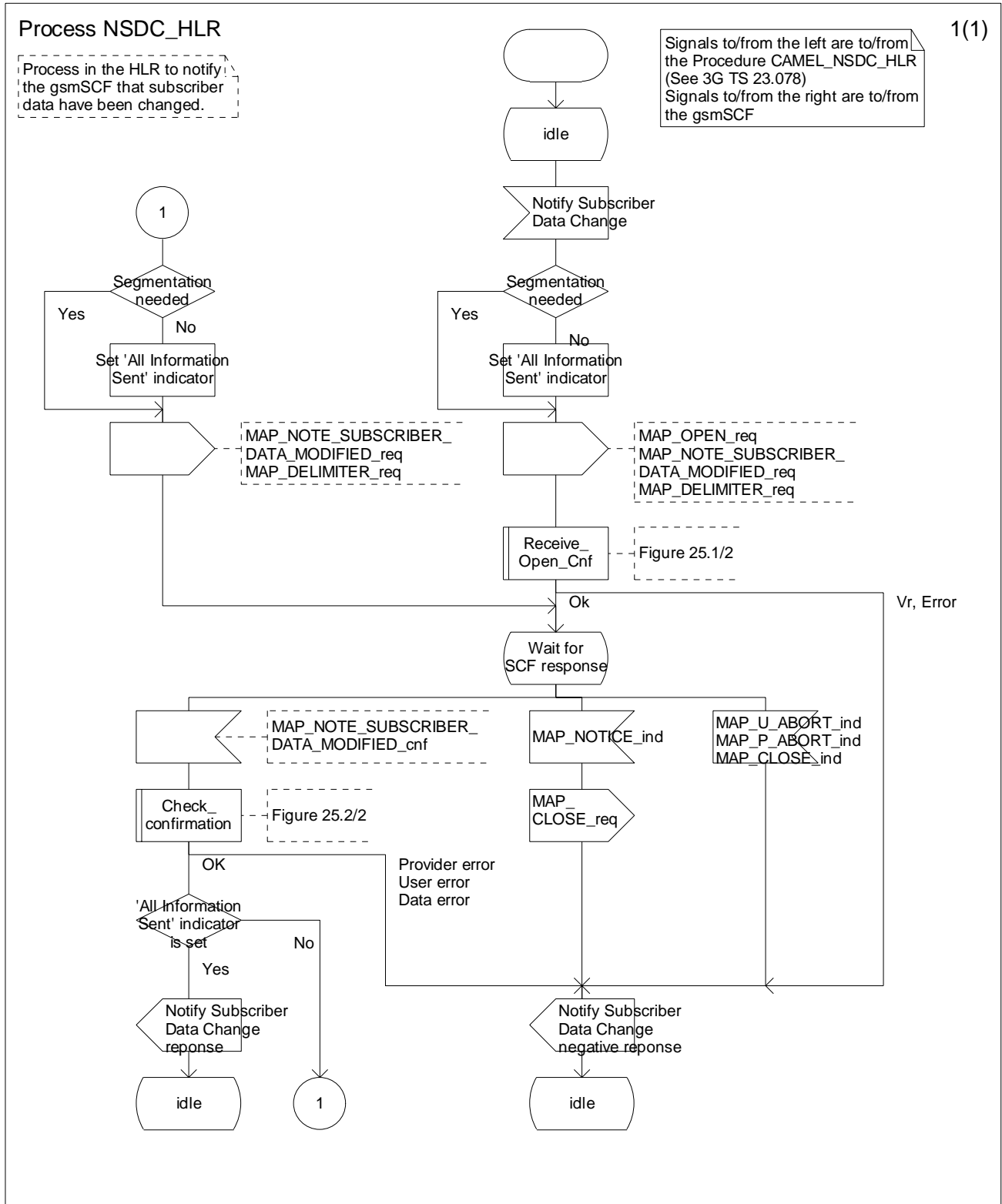

Figure 24A.3/2 Process Subscriber_Data_Modification_Notification_HLR (sheet 1 of 1)

24A.3.2.2 Process in the gsmSCF

The MAP process in the gsmSCF to handle a notification to the gsmSCF of change of subscriber data resume is shown in figure 24A.3/3. The MAP process invokes a macro not defined in this clause; the definition of this macro can be found as follows:

Receive_Open_Ind see clause 25.1.1;

Successful outcome

When the MAP process receives a MAP_OPEN indication with the application context noteSubscriberDataModified, it checks it by invoking the macro Receive_Open_Ind.

If the macro takes the OK exit, the MAP process waits for a service indication.

If a MAP_NOTE_SUBSCRIBER_DATA_MODIFIED service indication is received, the MAP process checks if the “All Information Sent” indicator is set and if so it sends a Subscriber Data Changed request including all the stored data to the process in the gsmSCF, and waits for a response. The Subscriber Data Changed request contains the parameters received in the MAP_NOTE_SUBSCRIBER_DATA_MODIFIED service indication. If the “All Information Sent” indicator is not set, the received data is stored and the MAP process constructs an empty MAP_NOTE_SUBSCRIBER_DATA_MODIFIED service response, sends it to the HLR and returns to the Wait for response state.

If the process in the gsmSCF returns a negative response, the MAP process constructs a MAP_NOTE_SUBSCRIBER_DATA_MODIFIED service response, constructs a MAP_CLOSE service request, sends them to the HLR and returns to the idle state.

Failure of dialogue opening with the HLR

If the macro Receive_Open_Ind takes the Vr exit or the Error exit, the MAP process returns to the idle state.

If the MAP provider sends a MAP_P_ABORT while the MAP process is waiting for a service indication, the MAP process returns to the idle state.

If the MAP provider sends a MAP_NOTICE while the MAP process is waiting for a service indication, the MAP process sends a MAP_CLOSE request to terminate the dialogue and returns to the idle.

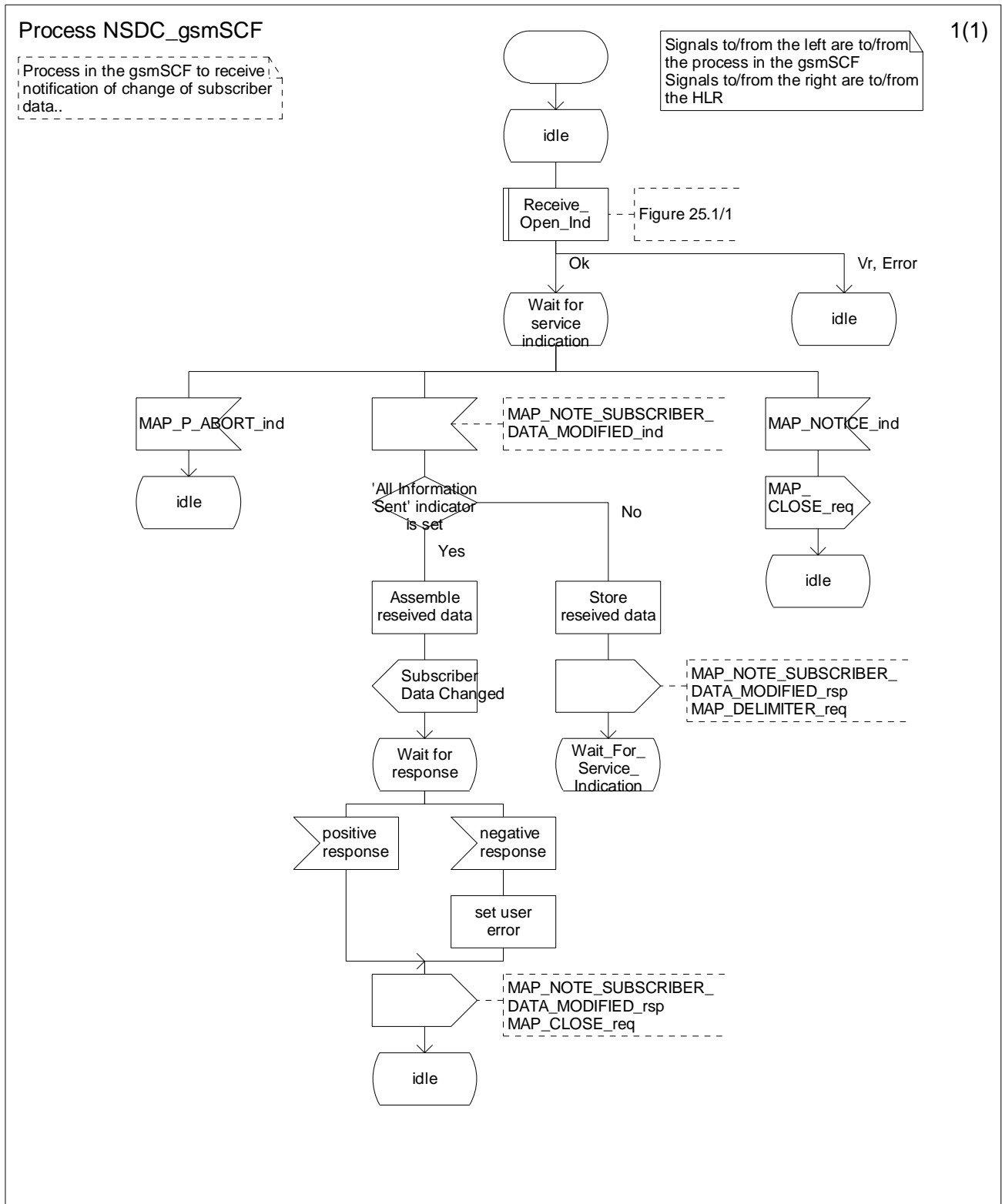

Figure 24A.3/3: Process Subscriber_Data_Modification_Notification_gsmSCF (sheet 1 of 1)

24B Location Service process description

24B.1 Routeing information retrieval procedure for LCS

24B.1.1 General

The message flows for successful retrieval of routeing information related to location services are shown in figure 24B.1/1.

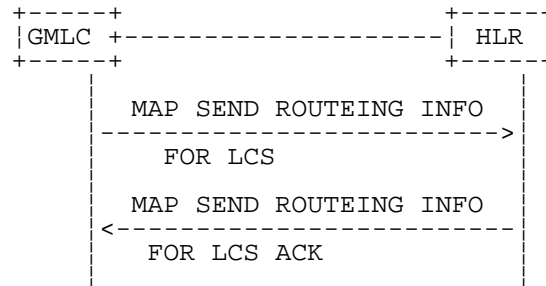

Figure 24B.1/1: Message flow for retrieval of routeing information for LCS

The following MAP services are used to retrieve routeing information:

MAP_SEND_ROUTING_INFO_FOR_LCS see clause 13A.1.

24B.1.2 Process in the GMLC

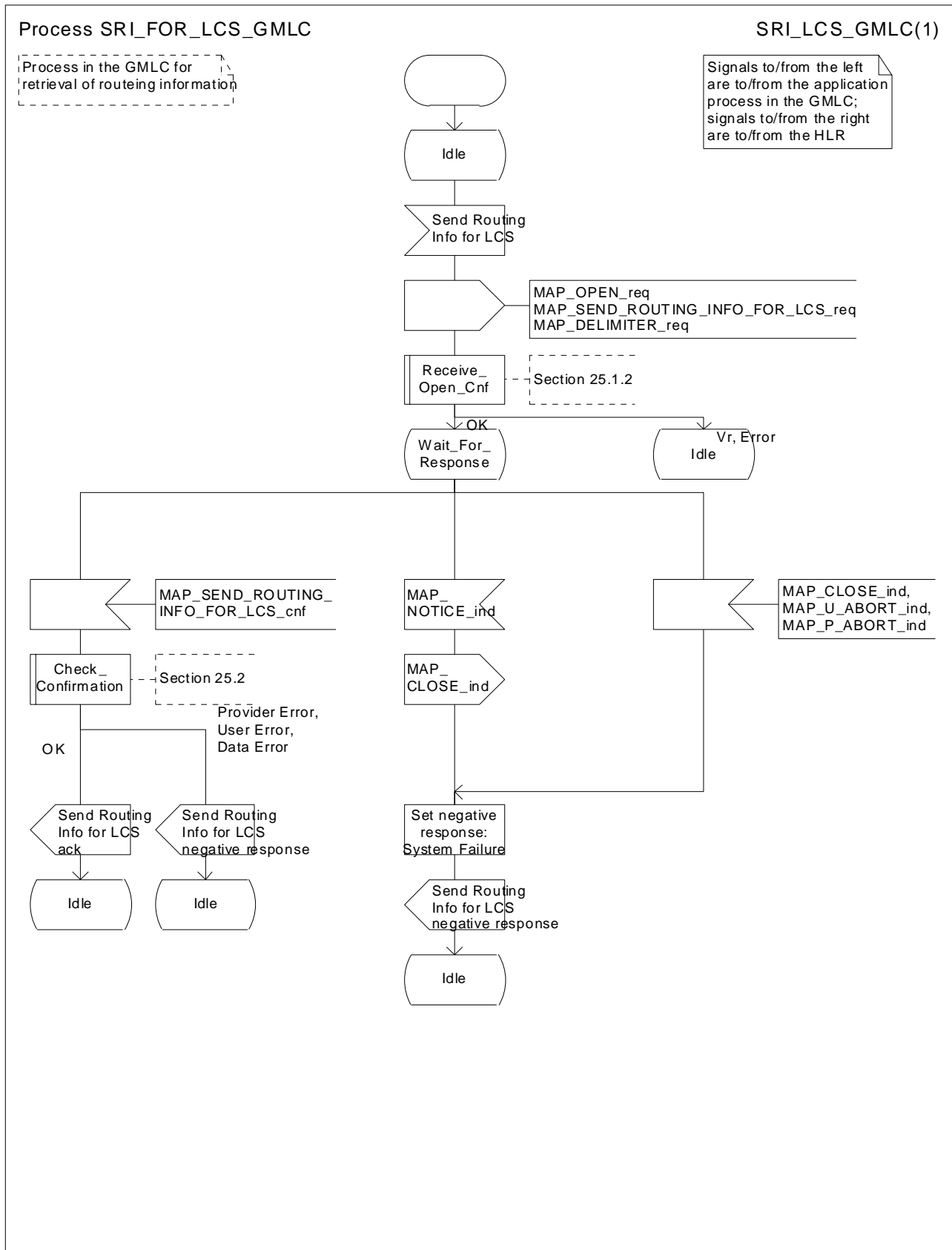

Figure 24B.1/2: Process SRI_FOR_LCS_GMLC

24B.1.3 Process in the HLR

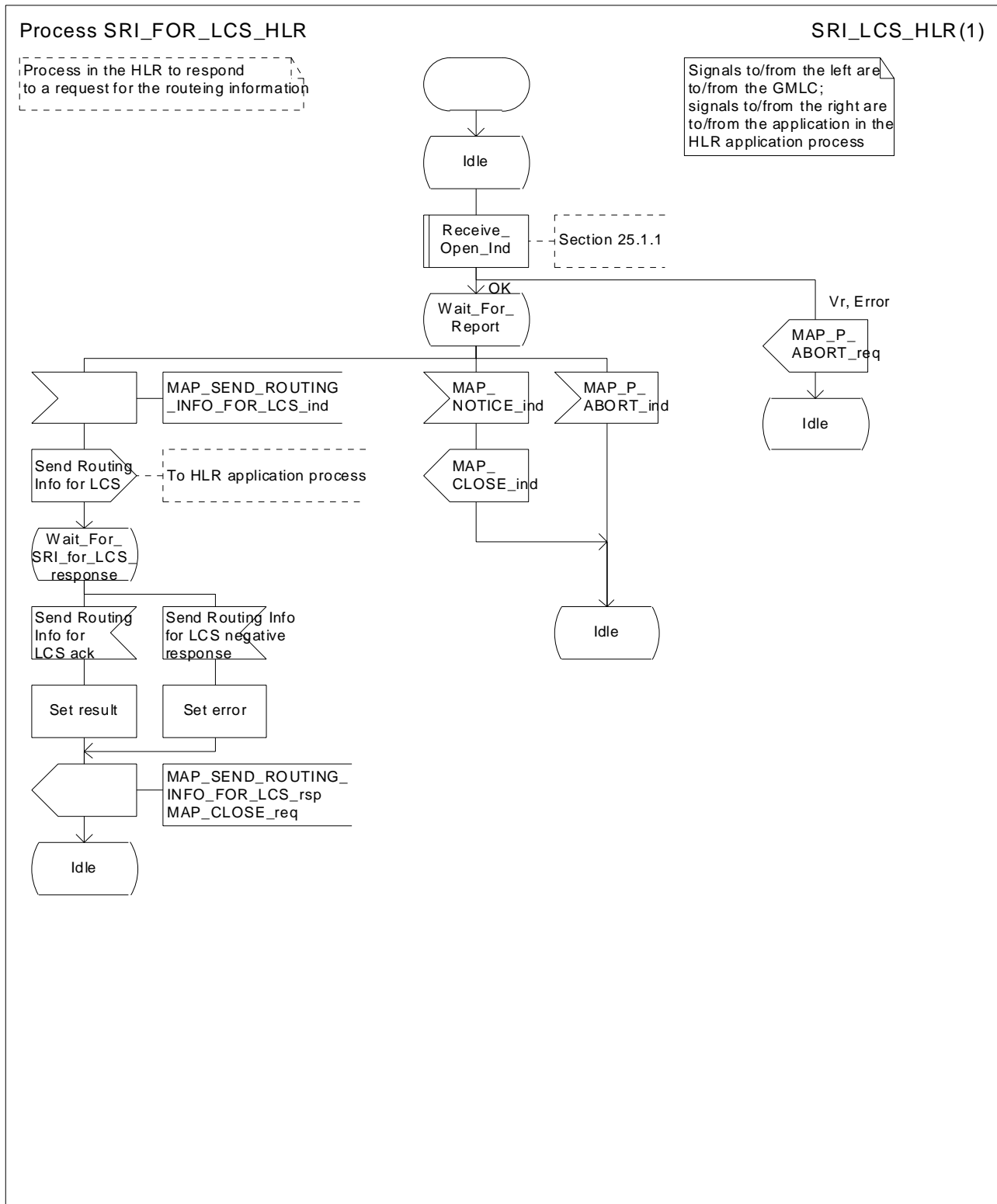

Figure 24B.1/3: Process SRI_FOR_LCS_HLR

24B.2 Provide Subscriber Location procedure

24B.2.1 General

The message flows for successful retrieval of the location information of a target MS related to location services are shown in figure 24B.1/1.

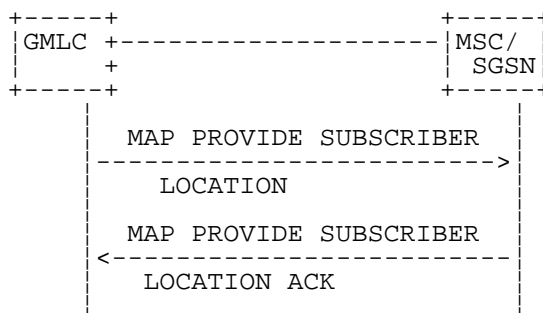

Figure 24B.2/1: Message flow for request of the location information

The following MAP services are used to retrieve location information:

MAP_PROVIDE_SUBSCRIBER_LOCATION see clause 13A.2.

24B.2.2 Process in the GMLC

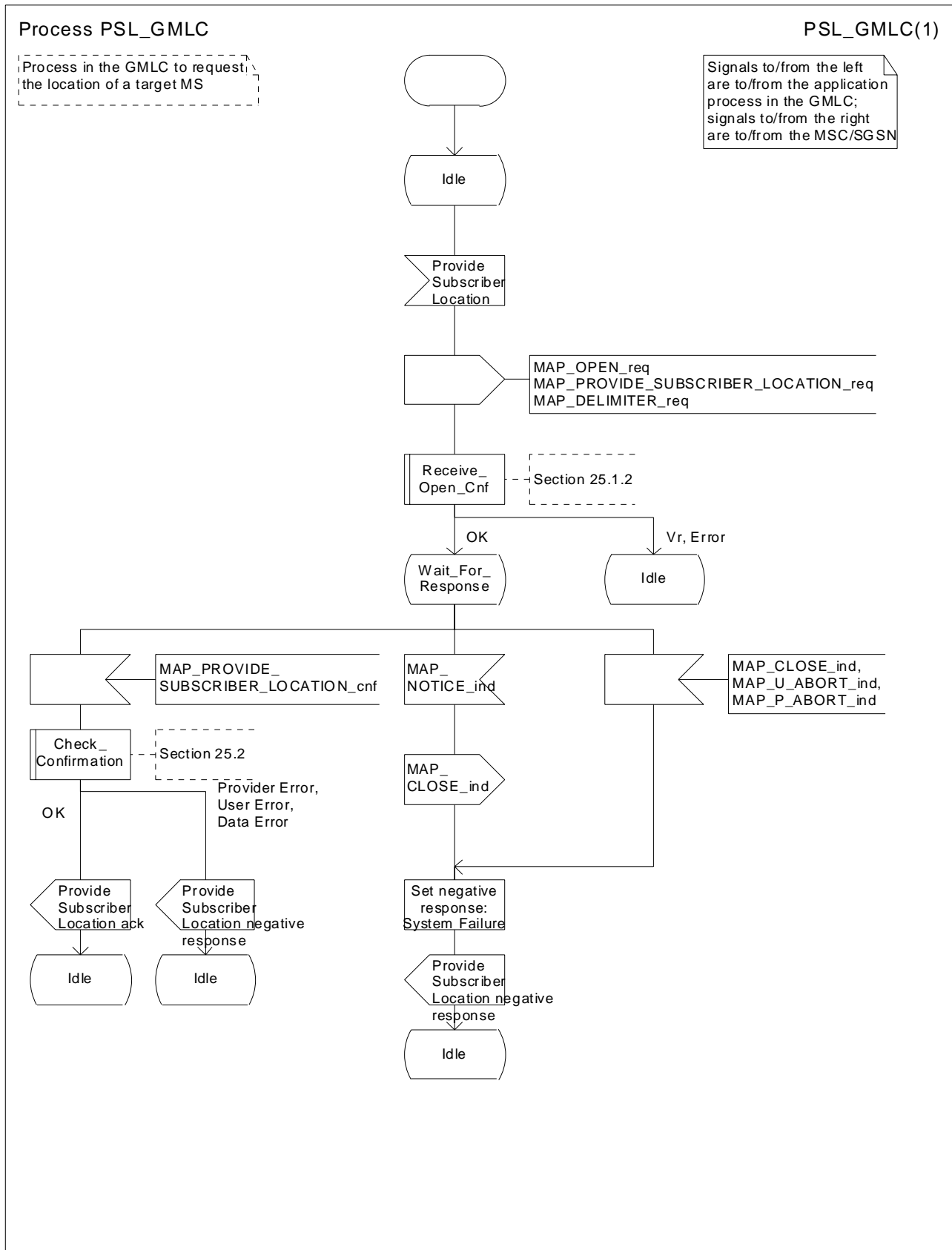

Figure 24B.2/2: Process PSL_GMLC

24B.2.3 Process in the MSC

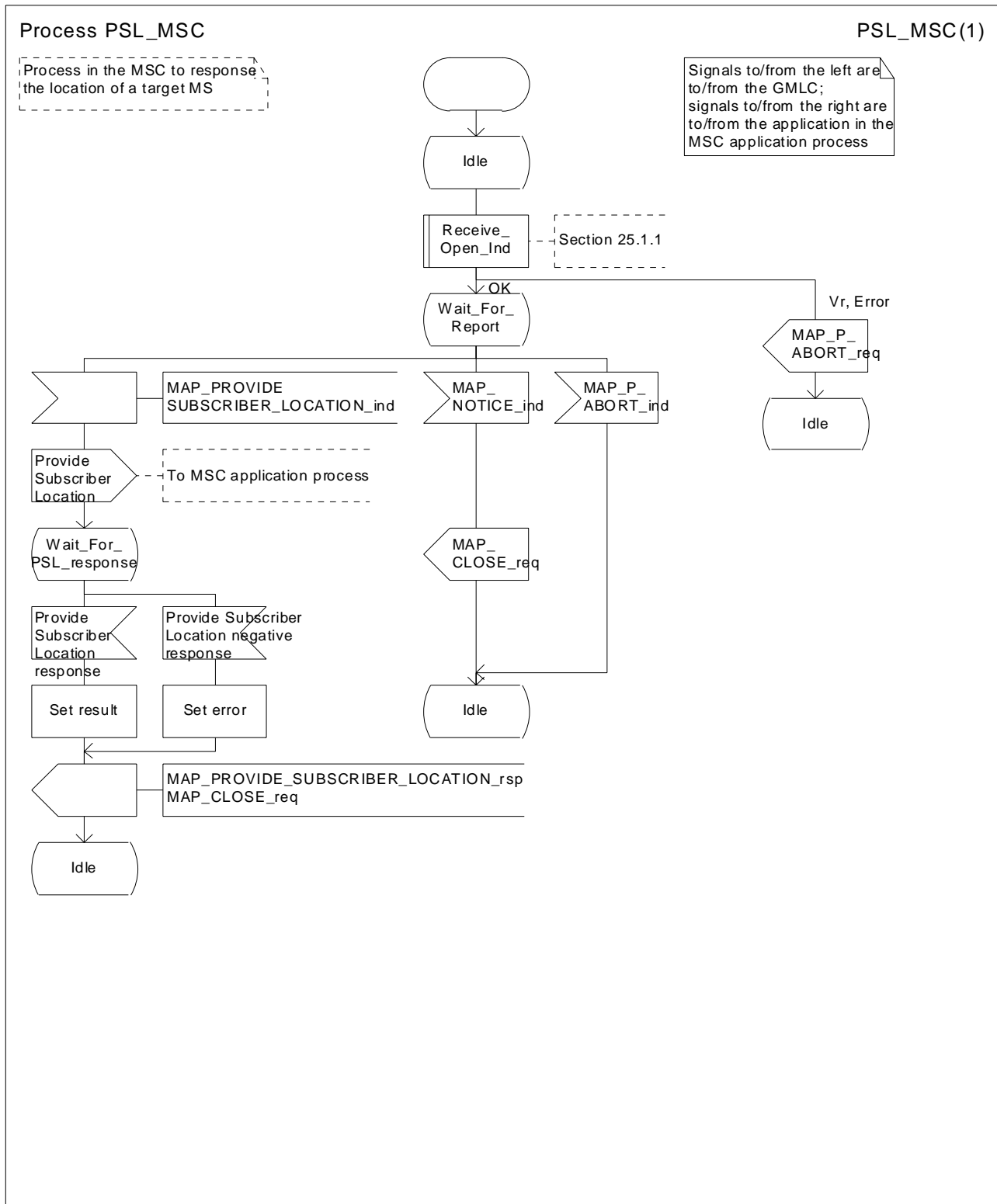

Figure 24B.2/3: Process PSL_MSC

24B.2.4 Process in the SGSN

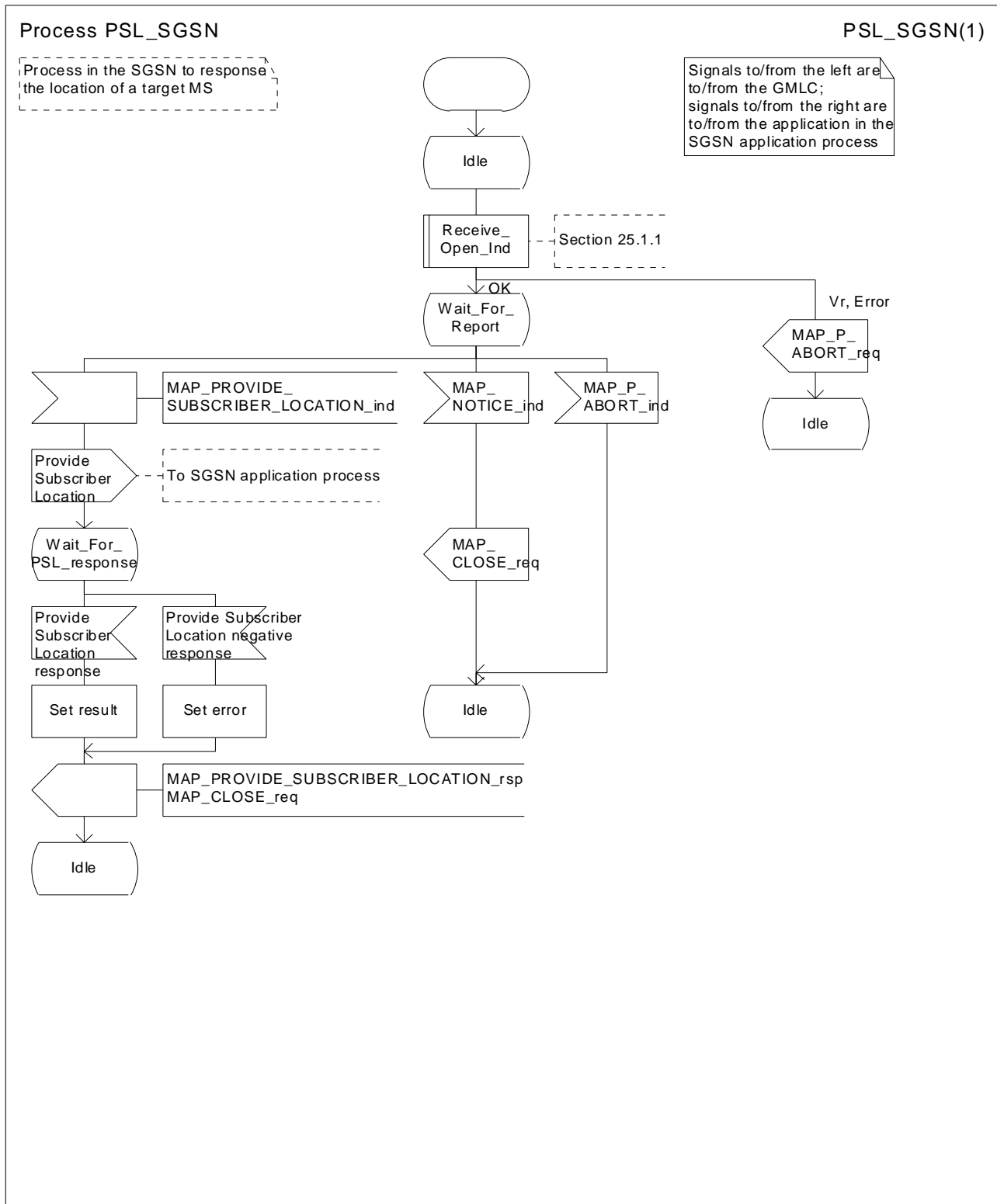

Figure 24B.2/4: Process PSL_SGSN

24B.3 Subscriber Location Report procedure

24B.3.1 General

The message flows for successful report of the location information of a target MS related to location services are shown in figure 24B.3/1.

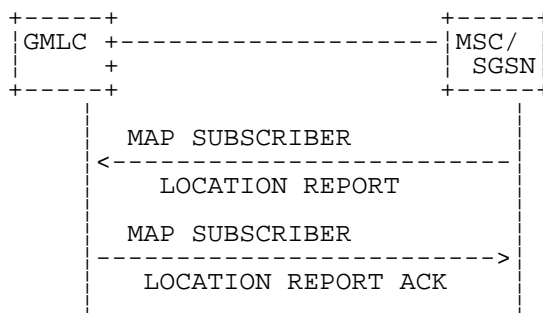

Figure 24B.3/1: Message flow for report of the location information

The following MAP services are used to report location information:

MAP_SUBSCRIBER_LOCATION_REPORT see clause 13A.3.

24B.3.2 Process in the GMLC

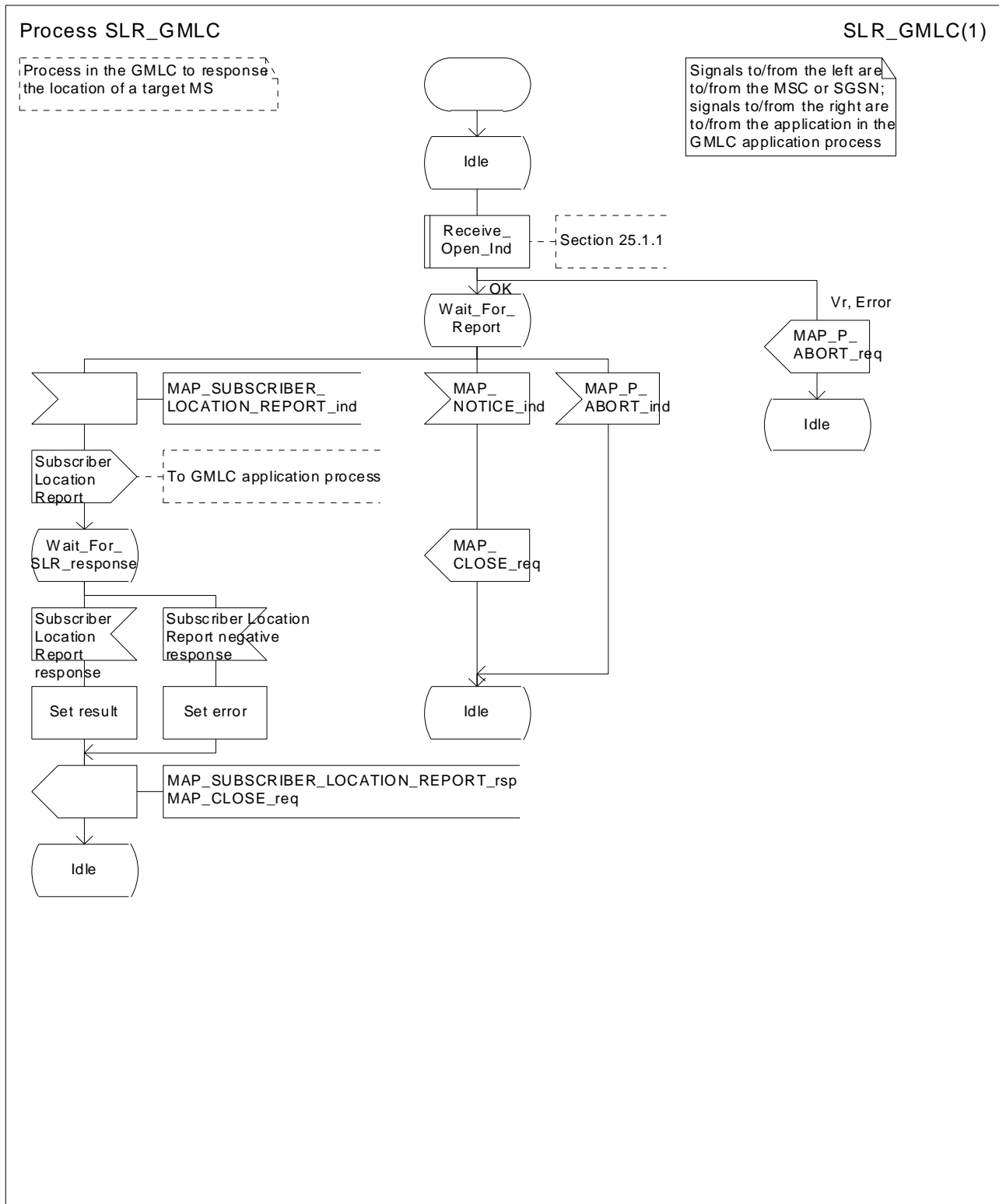

Figure 24B.3/2 Process SLR_GMLC

24B.3.3 Process in the MSC

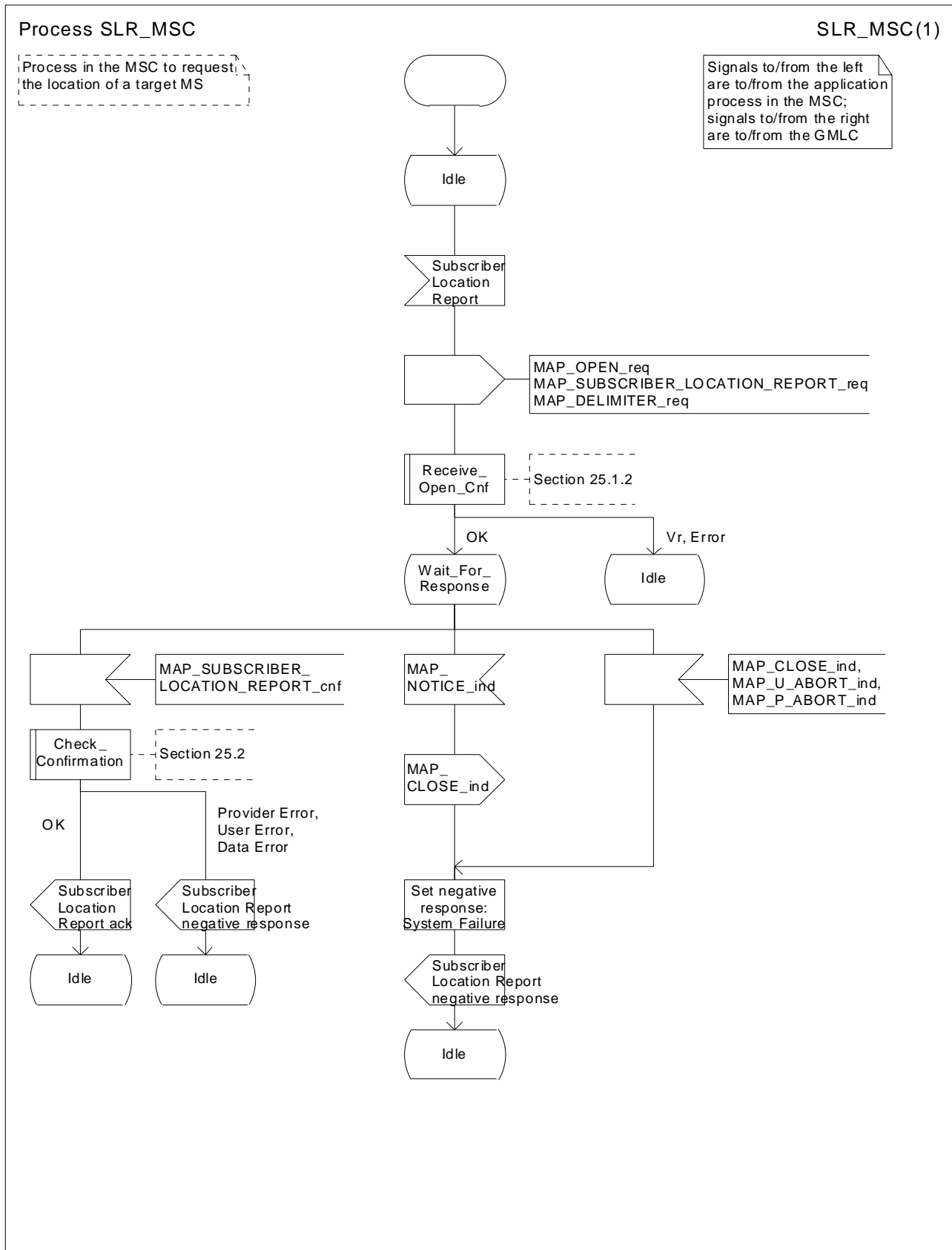

Figure 24B.3/3 Process SLR_MSC

24B.3.4 Process in the SGSN

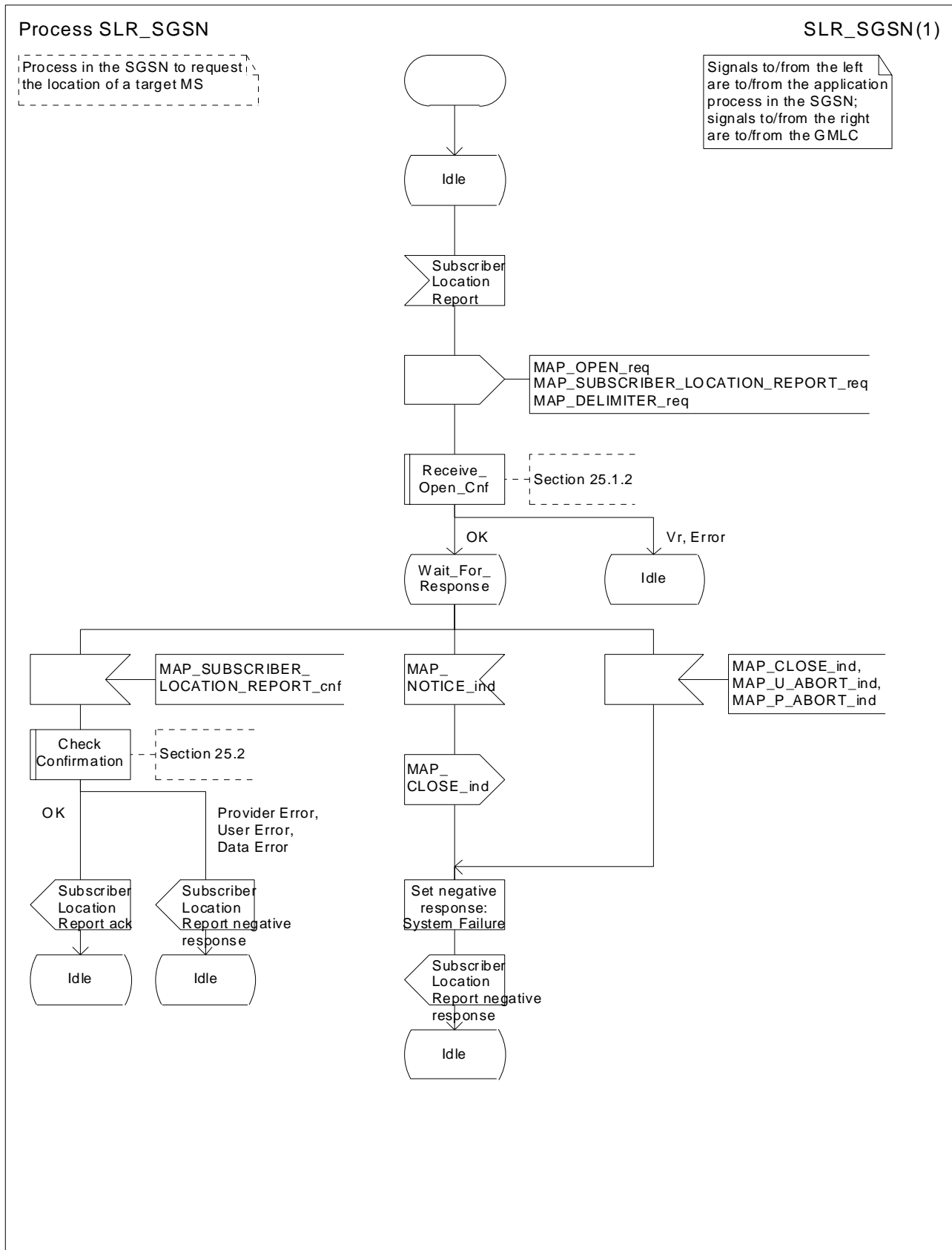

Figure 24B.3/4 Process SLR_SGSN

25 General macro description

25.1 MAP open macros

25.1.1 Macro Receive_Open_Ind

This macro is used by a MAP service-user procedure when a peer entity requests opening of a dialogue.

If the application context received in the MAP-OPEN indication primitive indicates a context name of the MAP version one context set, the macro takes the Vr exit..

If an application-context different from version 1 is received, the presence of MAP_OPEN information is checked. If no MAP_OPEN information has been received, the MAP_OPEN response with:

- Result set to Dialogue Accepted; and
- Application Context Name set to the received value,

is returned.

If the received version (Vr) is the one described in this version of MAP, the macro takes the OK exit, otherwise it takes the Vr exit..

If MAP_OPEN information is received, the macro "CHECK_REFERENCE" is called in order to check whether the received values for Destination Reference and Originating Reference correspond with the requirements of the received application-context-name. If the outcome of this check is an error, the MAP_OPEN responds with:

- Result set to Dialogue Refused;
- Refuse Reason set to Invalid Destination Reference or Invalid Originating Reference;
- Application Context Name set to the highest version supported,

is returned and the macro takes the error exit.

If the data values received for Destination Reference and Originating Reference are accepted for the associated application-context-name it is checked whether the Destination Reference is known if this check is required by the process that calls the macro.

If the Destination Reference (e.g. a subscribers IMSI) is unknown, the MAP_OPEN response with

- Result set to Dialogue Refused;
- Refuse Reason set to Invalid Destination Reference;
- Application Context Name set to the highest version supported,

is returned and the macro takes the error exit.

Else, if the Destination Reference is accepted or if no check is required, the MAP_OPEN response with

- Result set to Dialogue Accepted; and
- Application Context Name set to the received value,

is returned and

If the received version (Vr) is the one described in this version of MAP, the macro takes the OK exit, otherwise it takes the Vr exit.

25.1.2 Macro Receive_Open_Cnf

This macro is used by a user procedure after it requested opening of a dialogue towards a peer entity.

On receipt of a MAP_OPEN Confirmation with a "Result" parameter indicating "Dialogue Accepted", the macro takes the OK exit.

If the "Result" parameter indicates "Dialogue Refused", the "Refuse-reason" parameter is examined. If the "Refuse-reason" parameter indicates "Potential Version Incompatibility", the macro terminates in a way that causes restart of the dialogue by using the version 1 protocol.

If the "Refuse-reason" parameter indicates "Application Context Not Supported" and if the received Application Context Name indicates "Version V_r " ($V_r < V_n$), the macro terminates in a way that causes restart of the dialogue by using the version V_r protocol. Otherwise, the macro takes the Error exit.

If the "Refuse-reason" parameter indicates neither "Potential Version Incompatibility" nor "Application Context Not Supported", the macro takes the Error exit.

If a MAP_U_ABORT, a MAP_P_ABORT or a MAP_NOTICE Indication is received, the macro takes the Error exit.

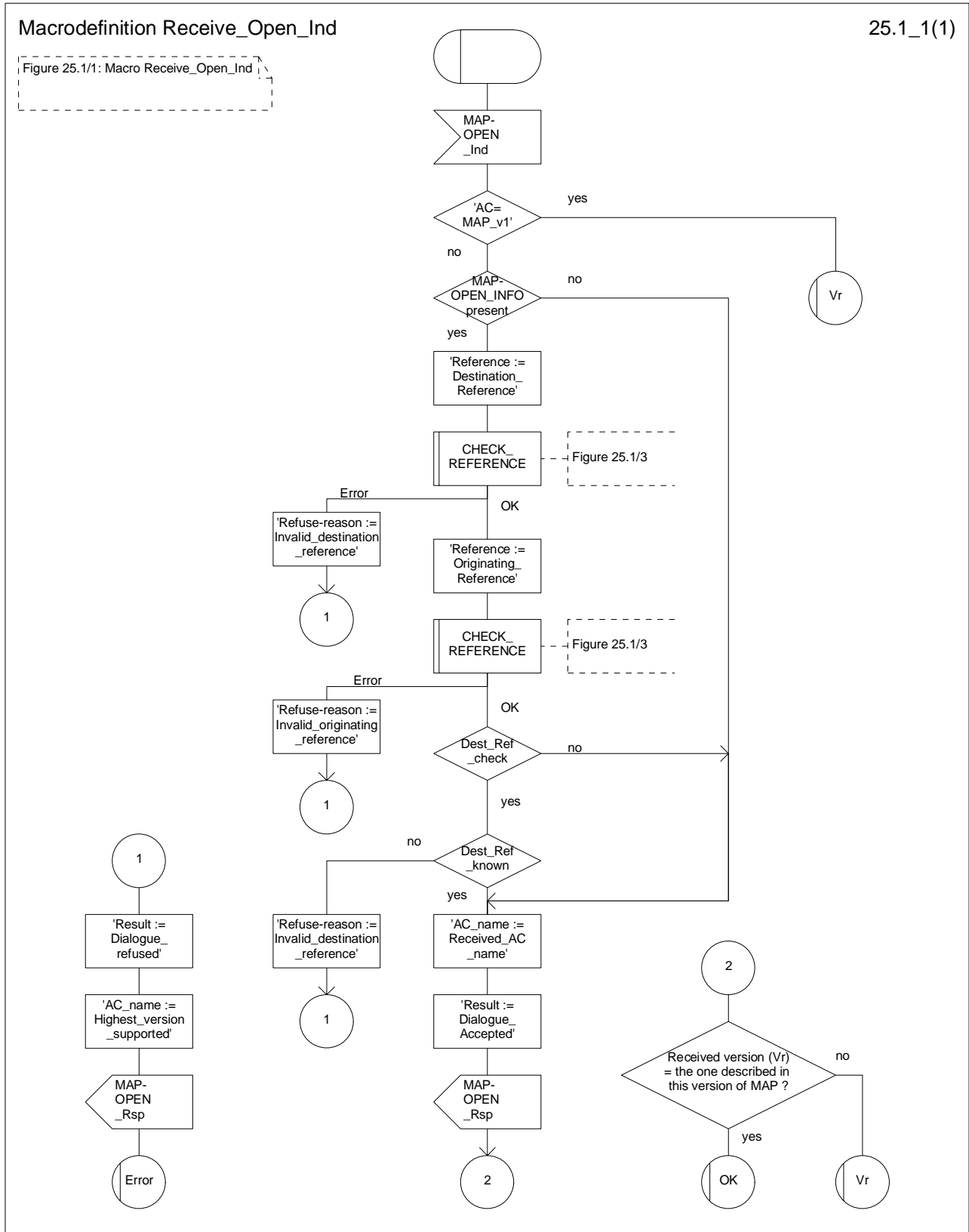

Figure 25.1/1: Macro Receive_Open_Ind

Macrodefinition Receive_Open_Cnf

25.1_2(1)

Figure 25.1/2: Macro to receive a MAP_OPEN_Cnf

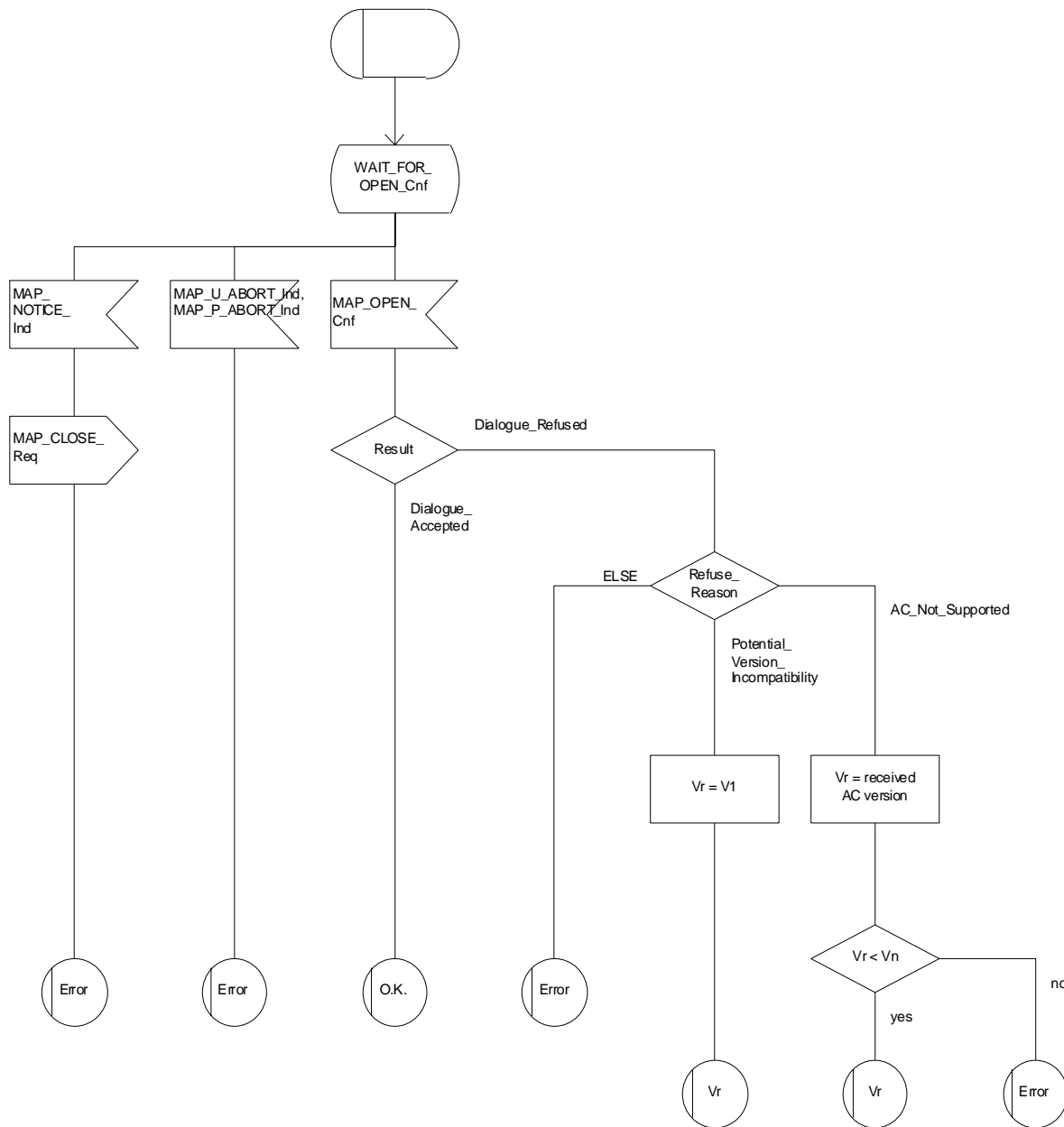

Figure 25.1/2: Macro Receive_Open_Cnf

Macrodefinition CHECK_REFERENCE

25.1_3(1)

Figure 25.1/3: Check of Destination Reference and Originating Reference received in a MAP-OPEN indication primitive

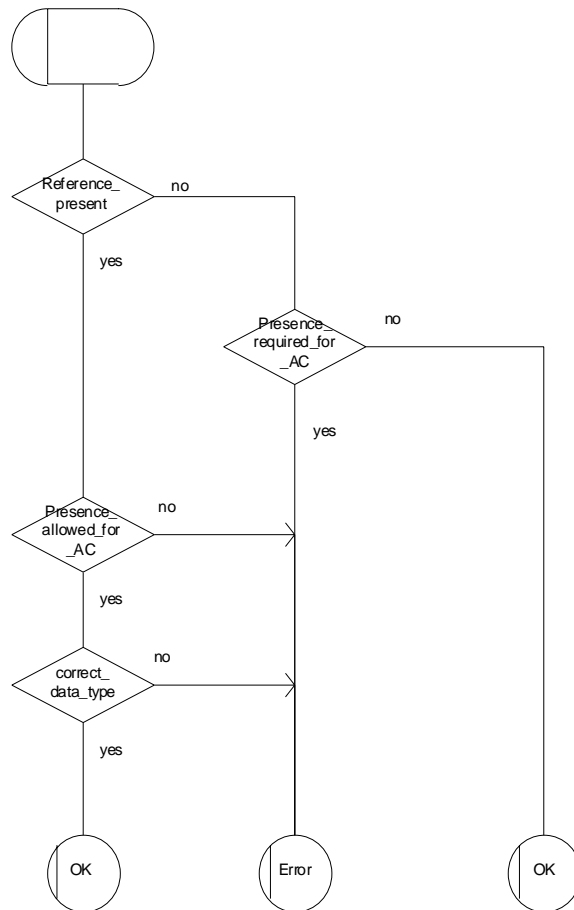

Figure 25.1/3: Macro CHECK_REFERENCE

25.2 Macros to check the content of indication and confirmation primitives

25.2.1 Macro Check_Indication

If a parameter required by the application is missing from the indication, the macro takes the error exit, with a user error of "Data Missing".

If a parameter not expected by the application is present in the indication, or an expected parameter has a value not in the set of values permitted by the application, the macro takes the error exit, with a user error of "Unexpected Data Value".

Otherwise the macro takes the "OK" exit.

The macro is shown in figure 25.2/1.

25.2.2 Macro Check_Confirmation

If the confirmation contains a provider error the macro issues a MAP CLOSE request and takes the provider error exit.

Otherwise, if the confirmation contains a user error the macro takes the user error exit.

Otherwise, if a parameter required by the application is missing from the confirmation, or a parameter not expected by the application is present in the confirmation, or an expected parameter has a value not in the set of values permitted by the application, the macro takes the data error exit.

Otherwise the macro takes the "OK" exit.

The macro is shown in figure 25.2/2.

Macrodefinition Check_Indication

25.2_1(1)

Figure 25.2/1: Macro to check the parameters of an indication primitive

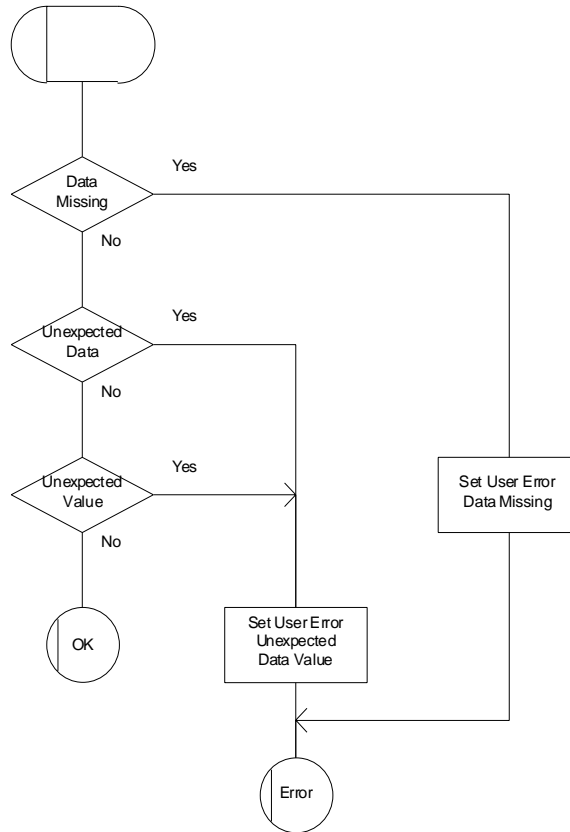

Figure 25.2/1: Macro Check_Indication

Macrodefinition Check_Confirmation

25.2_2(1)

Figure 25.2/2: Macro to check the parameters of a confirmation primitive

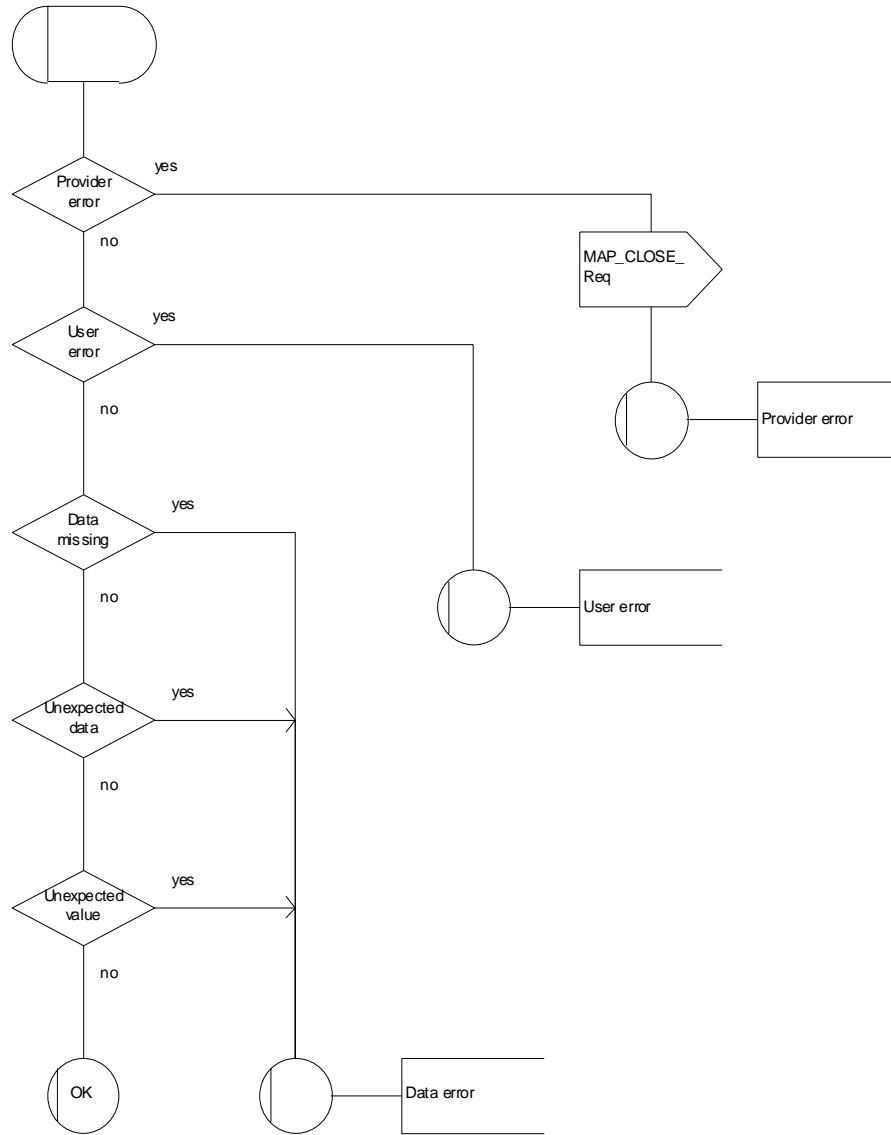

Figure 25.2/2: Macro Check_Confirmation

25.3 The page and search macros

25.3.1 Macro PAGE_MSC

This macro (see figure 25.3/1) is called if a mobile terminating call set-up, an unstructured SS notification, a network-initiated unstructured SS request or a mobile terminating short message is to be delivered to the MS and the current location area identity of the MS is known in the VLR.

When the MSC receives a MAP_PAGE indication, parameter checks are performed first (macro Check_Indication, see clause 25.2). If parameter errors are detected, the MSC returns a MAP_PAGE response containing the appropriate error cause and the macro terminates with unsuccessful outcome.

Thereafter, several checks on the indication content are performed. The macro terminates by returning the MAP_PAGE response with error:

Unknown Location Area if the LAI is not known in the MSC;

System Failure if the call has been released by the calling subscriber or the SMS or SS transaction for this subscriber has been released by the originating entity in the meantime.

Next, the MSC checks if an MM-connection over the radio link already exists for the given IMSI. If so,

- in the case of mobile terminating call set-up the MSC determines whether the busy condition can be established (see 3GPP TS 22.001 [2] for a definition of busy states). If the MSC determines that the MS is busy, it returns a MAP_PAGE response with error Busy Subscriber, qualified by either More Calls Allowed or No More Calls Allowed. The macro then terminates with unsuccessful outcome.
- if the service requested is short message service or an unstructured SS notification or network-initiated unstructured SS request, or if the service is mobile terminating call set-up, but the existing connection is for signalling purposes only (i.e. a service different from call set-up), the access connection status is set according to the characteristics of the existing connection (i.e. RR-connection established, ciphering mode on/off, MM-connection existing and authenticated or not), and the macro terminates with successful outcome.

If no MM-connection for the given IMSI exists, paging is initiated at the radio interface within all cells of the location area indicated by the VLR. If the VLR provided the TMSI, the MSC uses it to identify the MS at the radio interface; otherwise the MSC uses the IMSI. The IMSI will also be used to determine the page group (see 3GPP TS 24.008 [35]). There are several possible outcomes of paging:

- the MS responds to paging, causing the access connection status to be set accordingly (i.e. no RR-connection, in which case other values are not significant), and the macro terminates with successful outcome;
- the MS responds with a channel request containing an establishment cause which is not "answer to paging". The MSC sends a MAP_PAGE response primitive with user error Busy Subscriber before the macro terminates with unsuccessful outcome. This will give priority to the mobile originating request. Alternatively, as an implementation option, the MSC may treat this as a response to paging, which will give priority to the mobile terminating request.
- there is no response from the MS. The MSC sends a MAP_PAGE response primitive with user error Absent Subscriber before the macro terminates with unsuccessful outcome;
- the call handling connection or MAP transaction on which the call, SMS or unstructured SS transaction is waiting for delivery, is released before a response is received from the MS (indicated in the SDL by the input signal I-REL). The MAP transaction with the VLR will be released in this case by a MAP_U_ABORT request, and the unsuccessful macro termination will indicate transaction termination.
- the MAP transaction with the VLR may be released by receiving a MAP_U_ABORT or MAP_P_ABORT indication. The call handling connection or MAP transaction on which the call, SMS or unstructured SS transaction is waiting for delivery, is released (indicated in the SDL by the output signal I-REL), and the unsuccessful macro termination will indicate transaction termination.

25.3.2 Macro Search_For_MS_MSC

This macro (see figure 25.3/2) is called if a mobile terminating call set-up, an unstructured SS notification, a network-initiated unstructured SS request or a mobile terminating short message is to be delivered to the MS and the current location area identity of the MS is not known in VLR.

When the MSC receives a MAP_SEARCH_FOR_MS Indication, parameter checks are performed first (macro Check_indication, see clause 25.2). If parameter errors are detected, the MSC returns a MAP_SEARCH_FOR_MS response containing the appropriate error cause and the macro terminates with unsuccessful outcome.

Thereafter, the MSC checks whether the call or the SMS or SS transaction still exists in the MSC. If the call or the SMS or SS transaction has been released, the MSC returns a MAP_SEARCH_FOR_MS response with error System Failure and the macro terminates with unsuccessful outcome.

Next, the MSC checks if an MM-connection over the radio link already exists for the given IMSI. If so,

- in the case of mobile terminating call set-up the MSC determines whether the busy condition can be established (see 3GPP TS 22.001 [2] for a definition of busy states). If the MSC determines that the MS is busy, it returns a MAP_SEARCH_FOR_MS response with error Busy Subscriber, qualified by either More Calls Allowed or No More Calls Allowed. The macro then terminates with unsuccessful outcome.
- if the service requested is short message service or an unstructured SS notification or network-initiated unstructured SS request, or if the service is mobile terminating call set-up, but the existing connection is for signalling purposes only (i.e. a service different from call set-up), a MAP_SEARCH_FOR_MS response containing the IMSI and current location area identification of the called MS is returned to the VLR. The access connection status is set according to the characteristics of the existing connection (i.e. RR-connection established, ciphering mode on/off, MM-connection existing and authenticated or not), and the macro terminates with successful outcome.

If no MM-connection for the given IMSI exists, paging is initiated at the radio interface within all cells of all location areas of the VLR, using the IMSI to identify the subscriber and the page group (see 3GPP TS 24.008 [35]). There are several possible outcomes of paging:

- the MS responds to paging, causing a MAP_SEARCH_FOR_MS response containing the IMSI and current location area identification of the called MS to be returned to the VLR. The access connection status will be set accordingly (i.e. no RR-connection, in which case other values are not significant), and the macro terminates with successful outcome.
- the MS responds with a channel request containing an establishment cause which is not "answer to paging". The MSC sends a MAP_SEARCH_FOR_MS response primitive with user error "Busy Subscriber" before the macro terminates with unsuccessful outcome. This will give priority to the mobile originating request. Alternatively, as an implementation option, the MSC may treat this as a response to paging, which will give priority to the mobile terminating request.
- there is no response from the MS. The MSC sends a MAP_SEARCH_FOR_MS response primitive with user error "Absent Subscriber" before the macro terminates with unsuccessful outcome.
- the call handling connection or MAP transaction on which the call, SMS or unstructured SS transaction is waiting for delivery, is released before a response is received from the MS (indicated in the SDL by the input signal I-REL). The MAP transaction with the VLR will be released in this case by a MAP_U_ABORT request, and the unsuccessful macro termination will indicate transaction termination.
- the MAP transaction with the VLR may be released by receiving a MAP_U_ABORT or MAP_P_ABORT indication. The call handling connection or MAP transaction on which the call, SMS or unstructured SS transaction is waiting for delivery, is released (indicated in the SDL by the output signal I-REL), and the unsuccessful macro termination will indicate transaction termination.

Macrodefinition Page_MSC

25.3_1(1)

Figure 25.3/1:
Macro Page_MSC

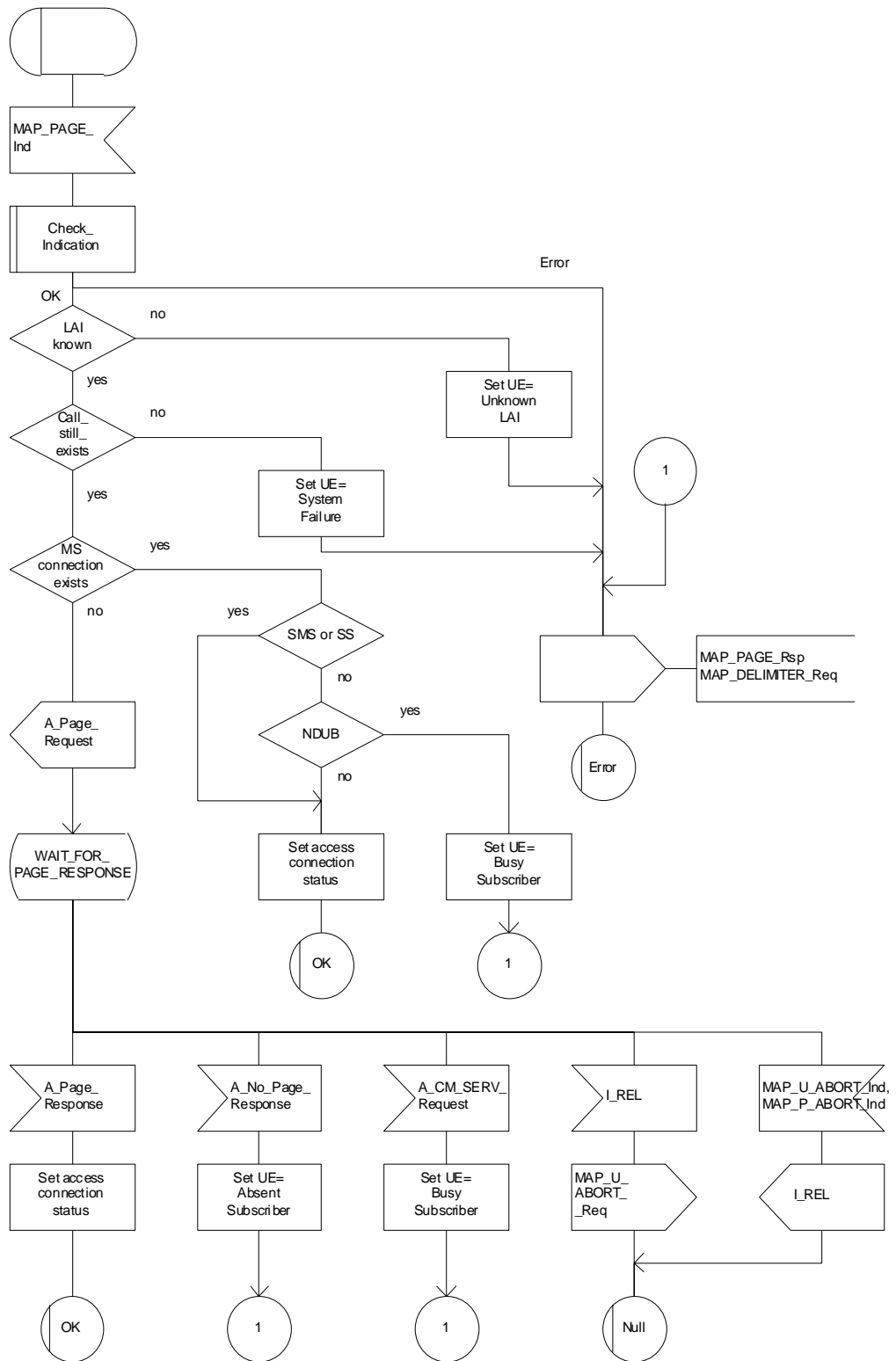

Figure 25.3/1: Macro Page_MSC

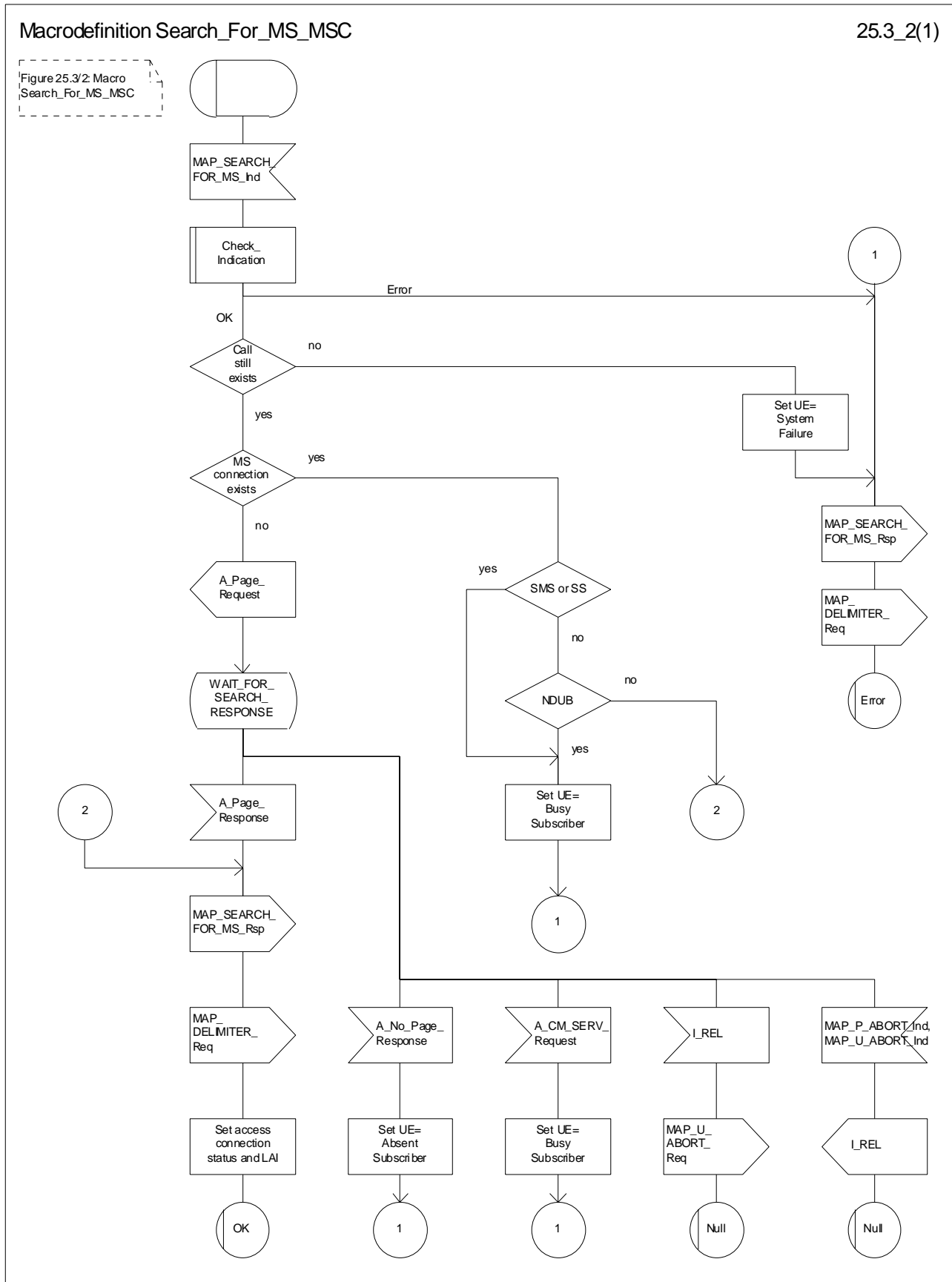

Figure 25.3/2: Macro Search_for_MS_MSC

25.4 Macros for handling an Access Request

These macros are invoked when a MS accesses the network, e.g. to set up an outgoing call or when responding to paging. The macro handles identification and authentication of the mobile subscriber as well as invocation of security related features (see 3GPP TS 42.009 [6]).

25.4.1 Macro Process_Access_Request_MSC

This macro is invoked by any procedure receiving an access request from the MS, e.g. the page response at mobile terminating call set-up or the request for outgoing call set-up.

If no dialogue with the VLR exists (e.g. within the procedure for outgoing call set-up), the MSC will open a dialogue towards the VLR by sending a MAP_OPEN request without any user specific parameters.

In any case, the parameters received from the MS are mapped to a MAP_PROCESS_ACCESS_REQUEST request primitive, containing:

- the received subscriber identification (IMSI, TMSI) or - in case of emergency call set-up - an IMEI;
- the CM service type, indicating the type of request;
- the status of the access connection, i.e. whether a connection to this MS already exists and if so, whether it is already authenticated and ciphered;
- the current location area id of the MS; and
- the CKSN received from the MS.

If opening of the dialogue was required, the MSC will wait for the dialogue confirmation (see macro Receive_Open_Confirmation, clause 25.1), leading either to:

- immediate unsuccessful exit from the macro, in case no dialogue is possible;
- reversion to MAP version one dialogue if indicated by the VLR. The macro terminates with unsuccessful outcome, as the complete dialogue will be covered by the version one procedure, so that no further action from the calling process is required;
- continuation as given below, if the dialogue is accepted by the VLR.

The MSC waits then for the MAP_PROCESS_ACCESS_REQUEST confirmation. In between, several other indications may be received from the VLR:

- the MSC may receive a MAP_PROVIDE_IMSI indication, handled by the macro Obtain_IMSI_MSC defined in clause 25.8. In case of positive outcome, the procedure continues waiting for the MAP_PROCESS_ACCESS_REQUEST confirmation, else the macro terminates with unsuccessful outcome;
- the MSC may receive a MAP_AUTHENTICATE indication, handled by the macro Authenticate_MSC defined in clause 25.5. In case of positive outcome, the procedure continues waiting for the MAP_PROCESS_ACCESS_REQUEST confirmation, else the macro terminates with unsuccessful outcome;
- the MSC may receive a MAP_TRACE_SUBSCRIBER_ACTIVITY indication, handled by the macro Trace_Subscriber_Activity_MSC defined in clause 25.9;
- the MSC may receive a MAP_SET_CIPHERING_MODE indication, which will be stored for initiating ciphering later on;
- the MSC may receive a MAP_CHECK_IMEI indication, handled by the macro Check_IMEI_MSC defined in clause 25.6. In case of positive outcome, the procedure continues waiting for the MAP_PROCESS_ACCESS_REQUEST confirmation, else the macro terminates with unsuccessful outcome;
- the MSC may receive a MAP_Obtain_IMEI indication, handled by the macro Obtain_IMEI_MSC defined in clause 25.6. In case of positive outcome, the procedure continues waiting for the MAP_PROCESS_ACCESS_REQUEST confirmation, else the macro terminates with unsuccessful outcome;

- the MSC may receive a MAP_U_ABORT or MAP_P_ABORT indication, or a premature MAP_CLOSE indication from the VLR. In all these cases, the macro terminates with unsuccessful outcome, after sending the appropriate reject towards the MS (see 3GPP TS 29.010 [58]);
- the MSC may receive a MAP_NOTICE indication from the VLR. In this case, the dialogue towards the VLR is terminated by a MAP_CLOSE primitive, the appropriate reject is sent towards the MS (see 3GPP TS 29.010 [58]), and the macro terminates with unsuccessful outcome;
- the MSC may receive an indication for release of the radio path, in which case the dialogue towards the VLR will be terminated by a MAP_U_ABORT primitive, containing the diagnostic information Radio Channel Release.

When the MAP_PROCESS_ACCESS_REQUEST confirmation is received, the parameters of this primitive are checked first. In case of unsuccessful outcome of the service, the MAP User Error received is mapped onto the appropriate radio interface message (see 3GPP TS 29.010 [58]), before the macro terminates with unsuccessful outcome.

In case of positive outcome of the service, ciphering is initiated on the radio path, if this had been requested by the VLR (see above). Otherwise, if the access request was not triggered by a page response from the MS, the access request is accepted explicitly by sending a CM_Service_Accept message to the MS. If the access request was triggered by a page response from the MS then no CM Service Accept message is sent.

After ciphering has been initiated, the MSC will wait for the MAP_FORWARD_NEW_TMSI indication from the VLR. While waiting, the MSC may receive:

- a MAP_U_ABORT or MAP_P_ABORT indication, or a premature MAP_CLOSE indication from the VLR. In these cases, the macro terminates with unsuccessful outcome, after sending a release request towards the MS (see 3GPP TS 29.010 [58]);
- a MAP_NOTICE indication from the VLR. In this case, the dialogue towards the VLR is terminated by a MAP_CLOSE primitive, the appropriate reject is sent towards the MS (see 3GPP TS 29.010 [58]), and the macro terminates with unsuccessful outcome;
- an indication for release of the radio path, in which case the dialogue towards the VLR will be terminated by a MAP_U_ABORT primitive, containing the diagnostic information Radio Channel Release;
- a MAP_DELIMITER request from the VLR. This will be taken as a successful outcome of the macro (i.e. the VLR did not require TMSI reallocation), and it terminates successfully;
- an A_SETUP request from the MS. This will be saved for handling by the procedure which invoked the macro Process_Access_Request_MSC after the macro has terminated.

When the MAP_FORWARD_NEW_TMSI indication is received in the MSC, the TMSI Reallocation Command is sent to the MS, and the MSC waits for an acknowledgement from the MS. In case a positive acknowledgement is received, the MSC sends an empty MAP_FORWARD_NEW_TMSI response primitive to the VLR and terminates successfully. Else, the dialogue is terminated locally (MAP_CLOSE_Req with Release method Prearranged End) without any further action.

If the MSC receives an A_SETUP request while it is waiting for the TMSI acknowledgement from the MS, the A_SETUP is saved for handling by the procedure which invoked the macro Process_Access_Request_MSC after the macro has terminated.

If the dialogue is aborted by the VLR while waiting for the TMSI acknowledgement from the MS, the MSC regards the access request to be failed and terminates with unsuccessful outcome, after sending a release request towards the MS (see 3GPP TS 29.010 [58]).

Macrodefinition Process_Access_Request_MSC

25.4_1.1(3)

Figure 25.4/1: Macro for processing the access request in MSC

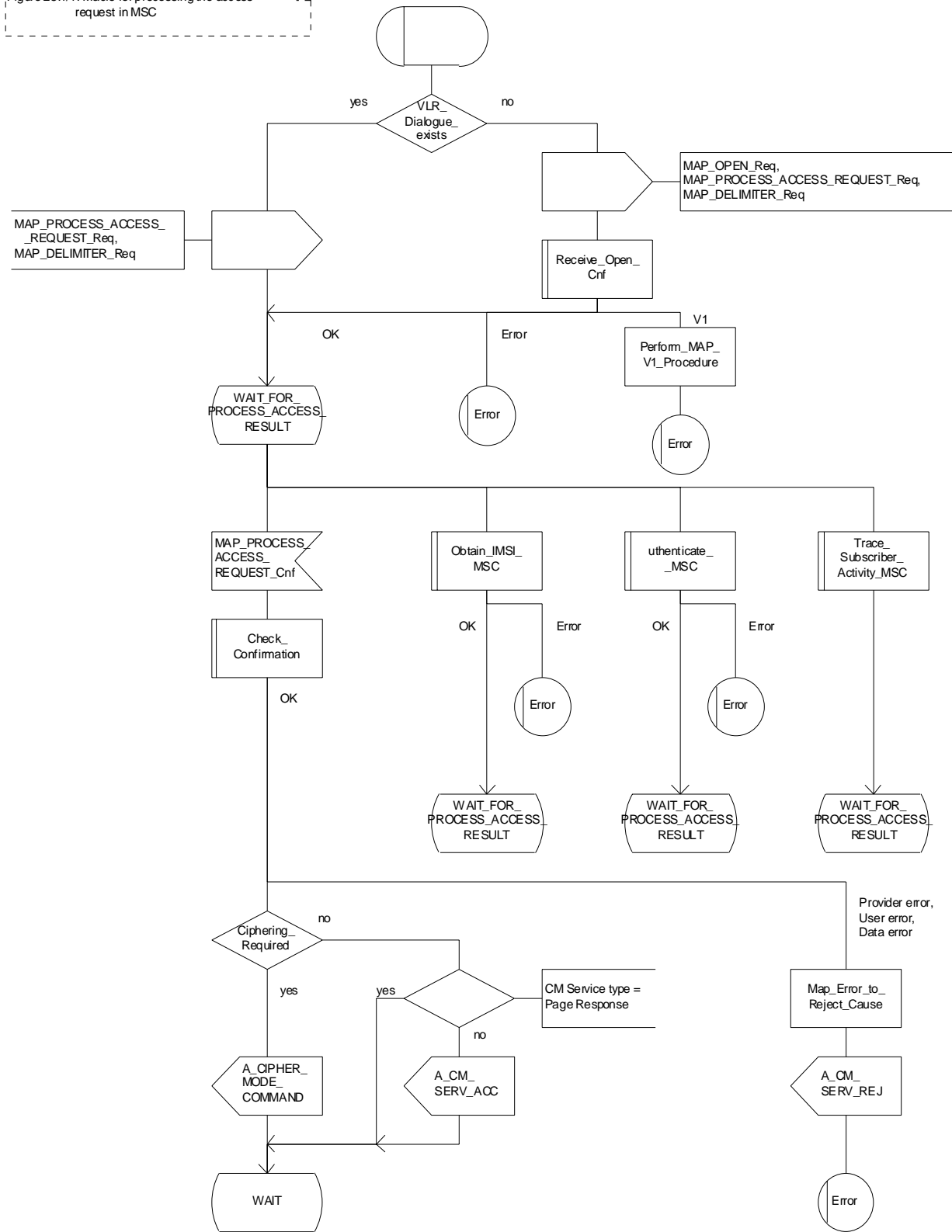

Figure 25.4/1 (sheet 1 of 3): Macro Process_Access_Request_MSC

Macrodefinition Process_Access_Request_MSC

25.4_1.2(3)

Figure 25.4/1: Macro for processing the access request in MSC

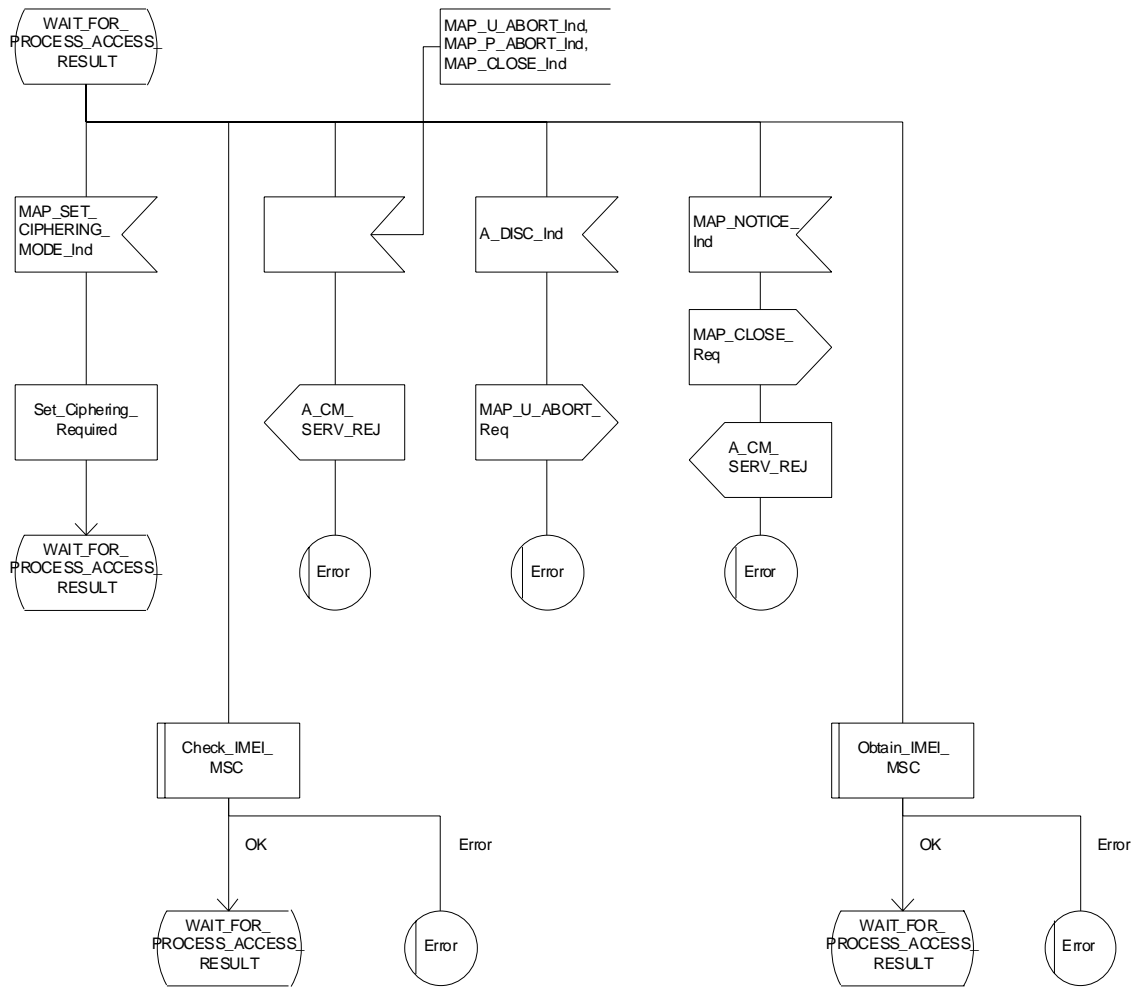

Figure 25.4/1 (sheet 2 of 3): Macro Process_Access_Request_MSC

Macrodefinition Process_Access_Request_MSC

25.4_1.3(3)

Figure 25.4/1: Macro for processing the access request in MSC

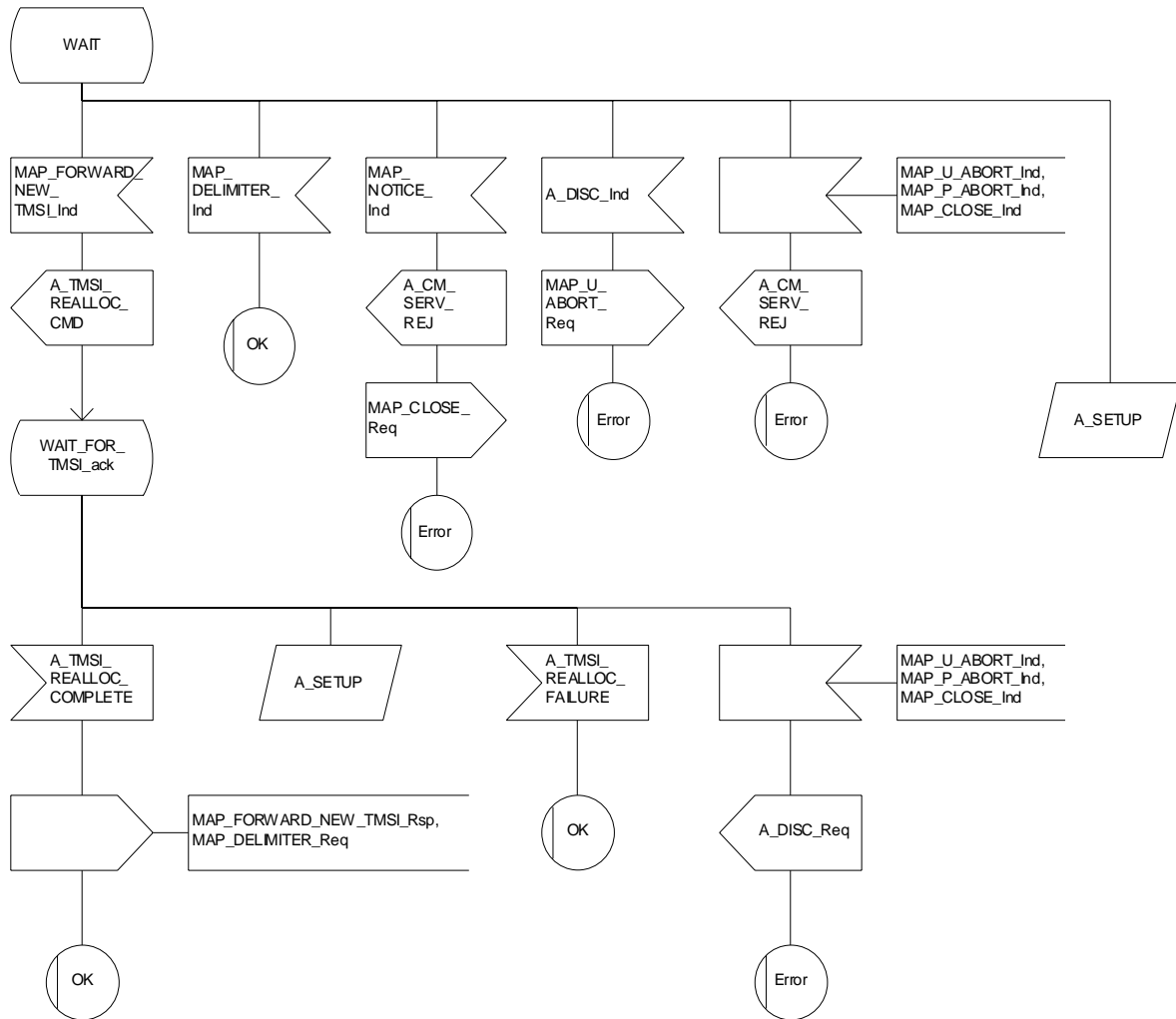

Figure 25.4/1 (sheet 3 of 3): Macro Process_Access_Request_MSC

25.4.2 Macro Process_Access_Request_VLR

When the VLR receives a MAP_PROCESS_ACCESS_REQUEST indication, the VLR will check this indication first (macro Check_Indication, see clause 25.2). In case of negative outcome, the macro will proceed with the error handling described below.

If the indication data are correct, it is checked first whether the subscriber identification (IMSI or TMSI) is known if included:

- if the identification is not known, the IMSI may be requested from the MS, described in the macro Identification_Procedure (see below) with outcome:
 - OK, if a IMSI known in the VLR has been received;
 - Error, if the VLR did not recognise the subscriber's identity. The macro will proceed with the error handling described below;
 - Aborted, if the transaction to the MSC is released. The macro will terminate immediately with unsuccessful.

In case the identity received is an IMEI, the error System Failure is set and the macro proceeds with the error handling described below.

NOTE: Emergency Call with IMEI may be accepted within the error handling phase.

For a known subscriber the authentication check is performed next (see macro Authenticate_VLR, clause 25.5), if required. If a negative result is received, the VLR proceeds on receipt of user error:

- illegal subscriber depending on the identity used for authentication;

In case IMSI is already used or no new authentication attempt with IMSI shall not be performed (operator option), the error Illegal Subscriber is set and the macro proceeds with the error handling described below.

If a new authentication attempt with IMSI shall be performed, the IMSI is requested from the MS (macro Obtain_IMSI_VLR, see clause 25.8):

- the authentication will be performed again if a IMSI known in the VLR is received;
- the error Unidentified Subscriber is set and the macro proceeds with the error handling described below, if the IMSI received is unknown in VLR;
- if the IMSI request procedure fails for any other reason, the error System Failure is set and the macro proceeds with the error handling described below;
- if the dialogue has been aborted during the IMSI request, the macro terminates immediately with unsuccessful outcome;
- unknown subscriber by setting the error Unidentified Subscriber and proceeding with the error handling described below.

NOTE: This can occur only in case of data inconsistency between HLR and VLR;

- procedure error by setting the error System Failure and proceeding with the error handling described below;
- null (i.e. the dialogue towards the MSC is terminated) by terminating immediately with unsuccessful outcome.

The MS access is accepted if no authentication is required or after successful authentication. Then, the indicator "Confirmed by Radio Contact" is set to "Confirmed". If the indicator "Location Information Confirmed in HLR" is set to "Not Confirmed", HLR updating will be started as an independent process (Update_Location_VLR, see clause 19.1.1.6).

If the indicator "Confirmed by HLR" is set to "Not Confirmed", the error Unidentified Subscriber is set and the macro proceeds with the error handling described below.

If roaming is not allowed in the location area indicated in the Current Location Area Id parameter, the error Roaming Not Allowed qualified by the roaming restriction reason is set and the macro proceeds with the error handling described below.

In case roaming is allowed, the IMSI is set to attached and the process for notifying the HLR that the subscriber is present is started if required (Subscriber Present VLR, see clause 25.10).

At next, tracing is invoked if required by the operator (macro Trace_Subscriber_Activity_VLR, see clause 25.9). Thereafter,

if ciphering is not required, IMEI checking is invoked if required by the operator (see macro Check_IMEI_VLR defined in clause 25.6).

The error Illegal Equipment is set in case of unsuccessful outcome of the IMEI check, the subscriber is marked as detached and the macro proceeds with the error handling described below.

The macro terminates immediately with unsuccessful outcome if the MSC dialogue has been released during the IMEI check.

Else, the macro terminates successfully by returning the MAP_PROCESS_ACCESS_REQUEST response containing the IMSI to indicate acceptance of the MS access.

if ciphering is required, the MAP_SET_CIPHERING_MODE request containing:

- the cipher mode indicating the cipher algorithm required; and
- the cipher key to be used;

is sent to the MSC.

As a further operator option, IMEI checking may be performed next.

The error Illegal Equipment is set in case of unsuccessful outcome of the IMEI check, the subscriber is marked as detached and the macro proceeds with the error handling described below.

The macro terminates immediately with unsuccessful outcome if the MSC dialogue has been released during the IMEI check.

Else, the macro terminates successfully by returning the MAP_PROCESS_ACCESS_REQUEST response containing the IMSI to indicate acceptance of the MS access.

IF no TMSI reallocation is required (again an operator option), the macro terminates thereafter. Else, TMSI reallocation is performed by sending a MAP_FORWARD_NEW_TMSI request, containing the new TMSI as parameter. The old TMSI will be frozen until an acknowledgement from the MS has been received. Before the macro terminates, the VLR will wait for the MAP_FORWARD_NEW_TMSI response, containing no parameters if reallocation has been confirmed by the MS, or a Provider Error, otherwise, in which case the old TMSI is kept frozen to avoid double allocation. In this case, both the old as the new TMSI are subsequently regarded valid when used by the MS.

Error handling

In case some error is detected during handling the access request, a respective error has been set. Before returning this error cause to the MSC in a MAP_PROCESS_ACCESS_REQUEST response, it need to be checked whether this access is for emergency call set-up, as this will require extra treatment.

If the CM Service type given in the MAP_PROCESS_ACCESS_REQUEST indication is emergency call set-up, it is checked whether EC set-up in the particular error situation is permitted (operator option). If so, it is checked whether the IMEI is required, and if so the IMEI is requested from the MS (macro Obtain_IMEI_VLR, see clause 25.6).

The macro will terminate immediately with unsuccessful outcome if the MSC transaction has been aborted during the IMEI retrieval.

In case of an error reported back from IMEI retrieval, MAP_PROCESS_ACCESS_REQUEST response containing the error cause set previously is returned to the MSC, the dialogue is closed (MAP_CLOSE request indicating normal release) and the macro terminates with unsuccessful outcome.

When a subscriber identity required by the operator (IMSI or IMEI) is available, the user error set previously is deleted, the respective identity is returned in the MAP_PROCESS_ACCESS_REQUEST response to indicate acceptance of emergency call, and the macro terminates with successful outcome.

In all other cases, the MAP_PROCESS_ACCESS_REQUEST response containing the error cause set previously is returned to the MSC, the dialogue is closed (MAP_CLOSE request indicating normal release) and the macro terminates with unsuccessful outcome.

25.4.3 Macro Identification Procedure

This macro is invoked by the macro Process_Access_Request_VLR in case the subscribers identity is not known in the VLR.

If the identity received from the MS is an IMSI, the error Unidentified Subscriber will be set and reported back to the calling macro (to be sent in the MAP_PROCESS_ACCESS_REQUEST response). The same error is used in case a TMSI was received from the MS, but the operator does not allow open identification of the MS.

If open identification of the MS is allowed, the macro Obtain_IMSI_VLR is invoked, requesting the subscribers IMSI from the MS (see clause 25.8), with outcome

OK, in which case it is checked whether for the IMSI received there exists a subscriber record in the VLR. If so, the macro terminates successfully, else the error Unidentified Subscriber will be set and reported back to the calling macro.

Error, in which case the error System Failure will be set and reported back to the calling macro.

Aborted, i.e. the MSC transaction is released, in which the macro terminates accordingly.

Macrodefinition Process_Access_Request_VLR

25.4_2.1(3)

Figure 25.4/2:
Macro for processing
on access request
in VLR

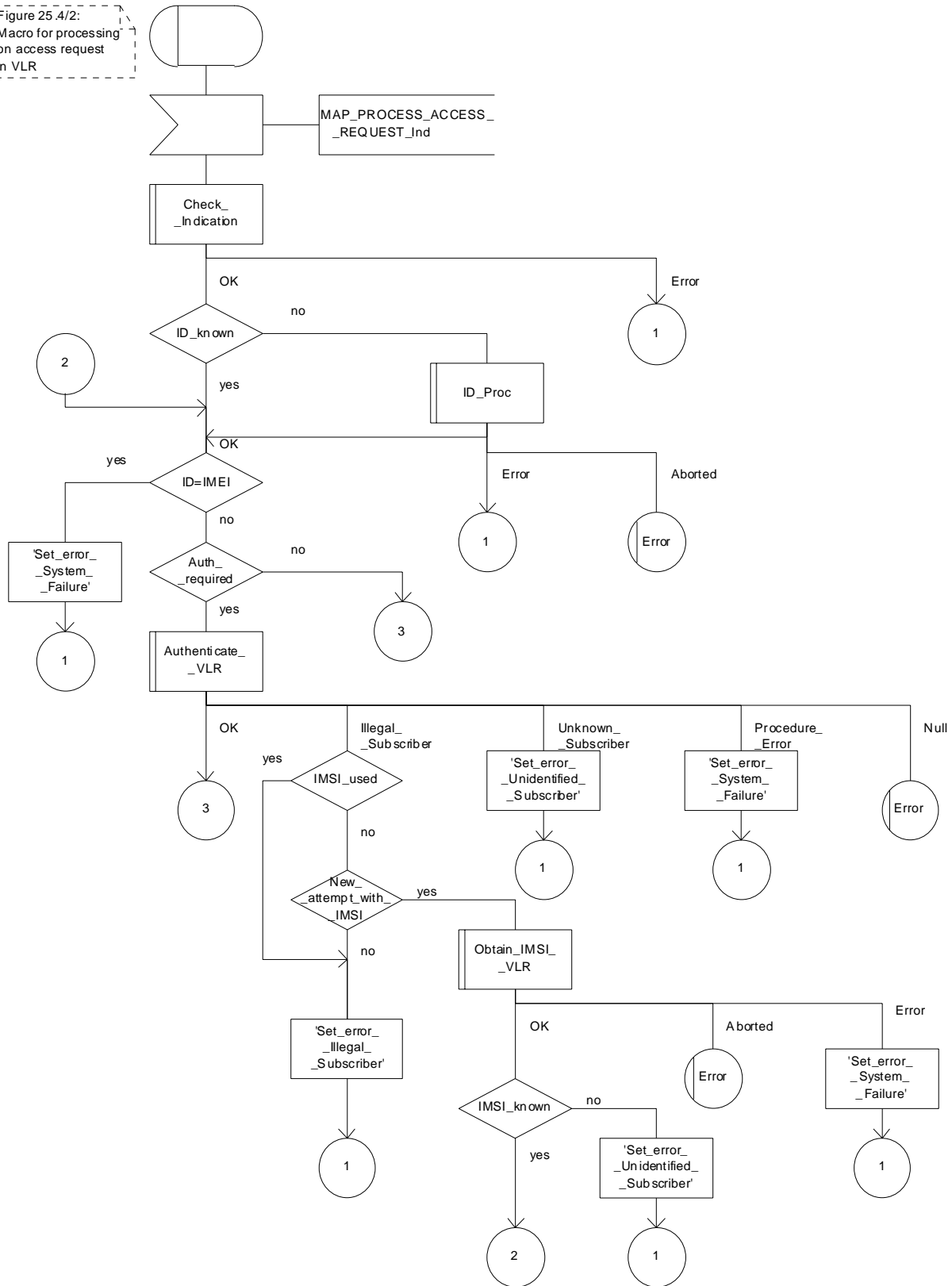

Figure 25.4/2 (sheet 1 of 3): Macro Process_Access_Request_VLR

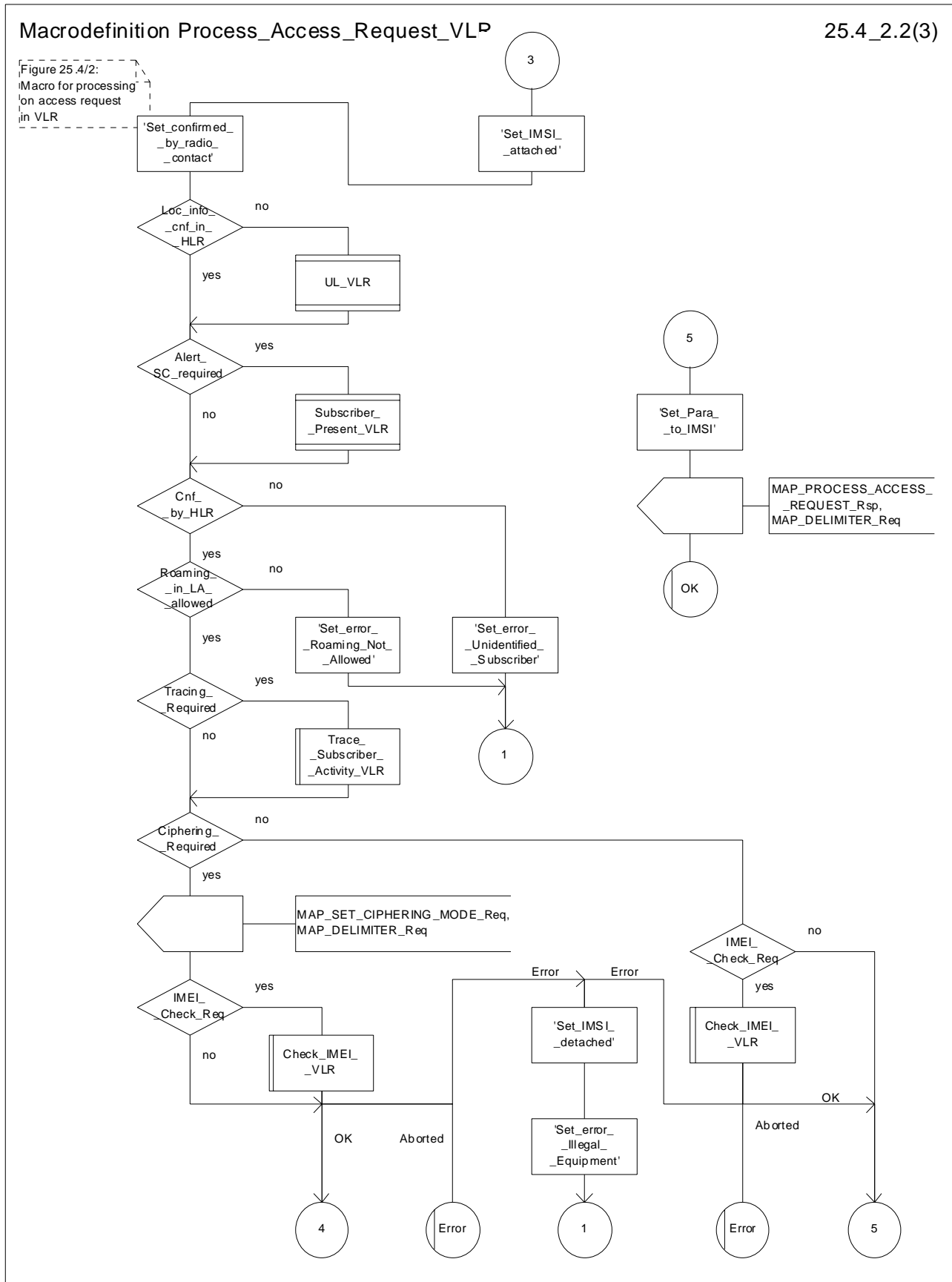

Figure 25.4/2 (sheet 2 of 3): Macro Process_Access_Request_VLR

Macrodefinition Process_Access_Request_VLR

25.4_2.3(3)

Figure 25.4/2:
Macro for processing
on access request
in VLR

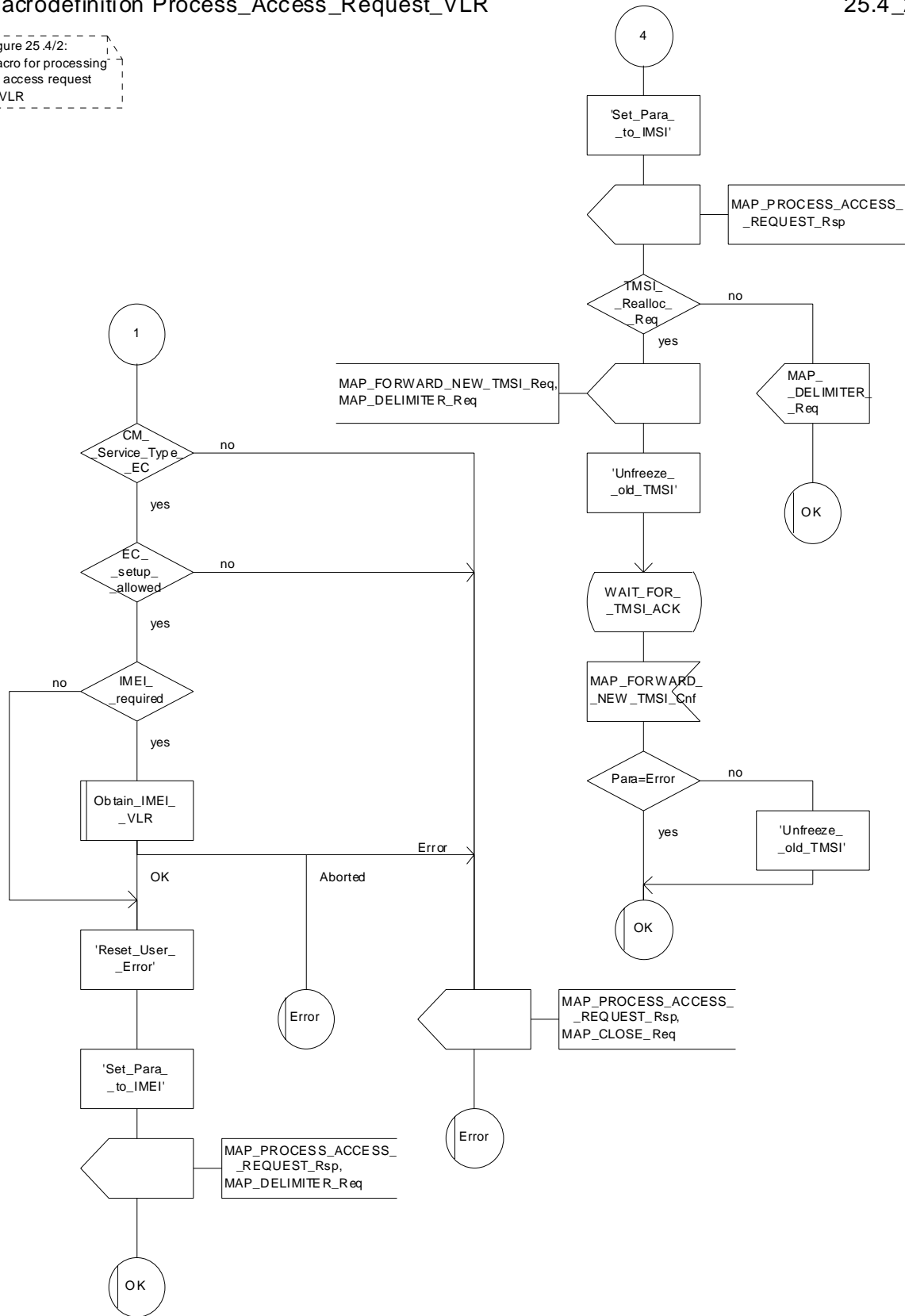

Figure 25.4/2 (sheet 3 of 3): Macro Process_Access_Request_VLR

Macrodefinition ID_Proc_VLR

25.4_3(1)

Figure 25.4/3

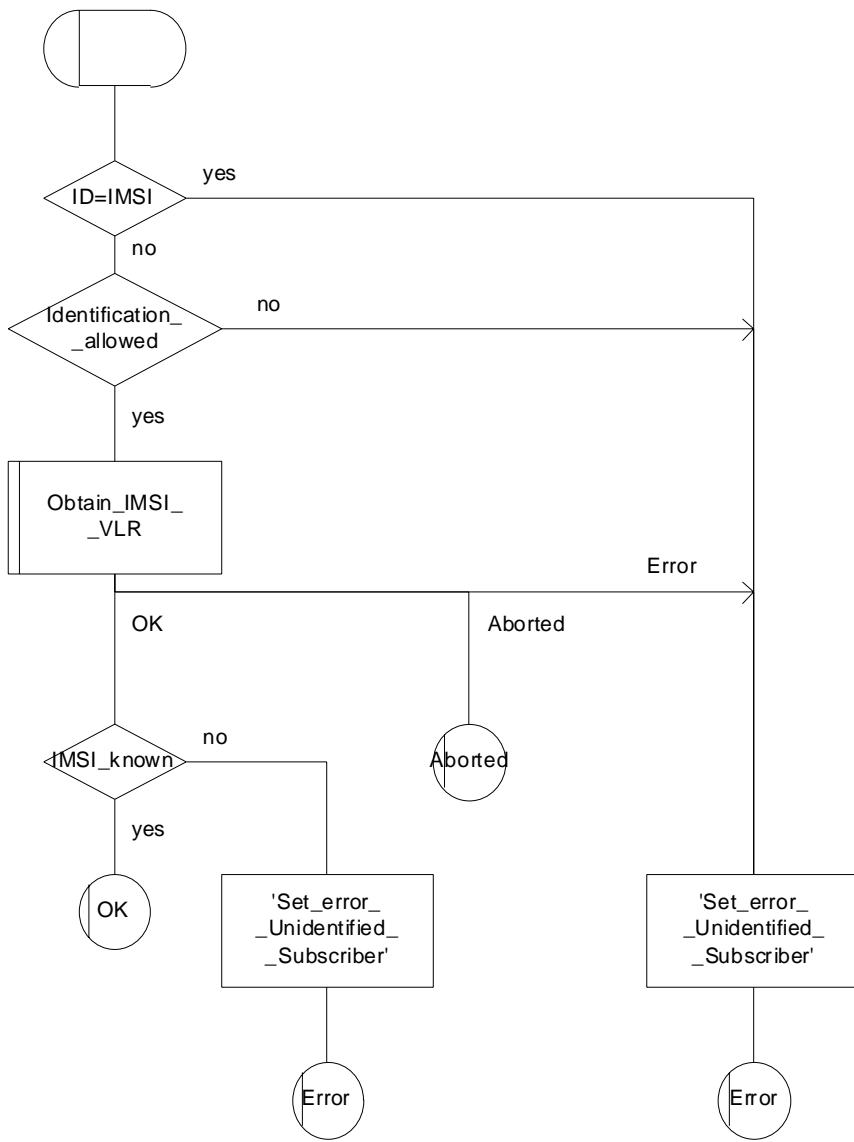

Figure 25.4/3: Macro ID_Proc_VLR

25.5 Authentication macros and processes

The following macros are used in the GSM network in order to enable authentication of a mobile subscriber.

25.5.1 Macro Authenticate_MSC

This macro is used by the MSC to relay a request for authentication transparently from the VLR to the MS, wait for a response from the MS and to relay the response from the MS back to the VLR. If, while the MSC is waiting for the authentication response, the air interface connection is released or a MAP_U_ABORT, MAP_P_ABORT or MAP_CLOSE indication is received from the VLR, then necessary connections are released and the "Error" exit is used. The macro is described in figure 25.5/1.

25.5.2 Macro Authenticate_VLR

This macro is used by the VLR to control the authentication of a subscriber. The macro proceeds as follows:

- if there are not enough authentication vectors in the VLR to perform the authentication, then the macro "Obtain_Authent_Para_VLR" described below is invoked. If this macro fails, then the corresponding error (Unknown Subscriber or Procedure Error) is returned to the calling process;
- if there are enough authentication vectors in the VLR, or the Obtain_Authent_Para_VLR macro was successful, then a MAP_AUTHENTICATE request is sent to the MSC. This request contains the RAND, CKSN or KSI, and possibly AUTN parameters as indicated in the service description;
- the VLR then waits for a response from the MSC;
- if a MAP_U_ABORT, MAP_P_ABORT or MAP_CLOSE indication is received from the MSC in this wait state, the VLR checks whether authentication sets are available. If no sets are available the process Obtain_Authent_Sets_VLR is invoked to fetch authentication sets from the HLR. The "Null" exit is then used;
- if a MAP_NOTICE indication is received from the MSC in this wait state, the VLR closes the dialogue with the MSC, then checks whether authentication sets are available. If no sets are available the process Obtain_Authent_Sets_VLR is invoked to fetch authentication sets from the HLR. The "Null" exit is then used;
- if a MAP_AUTHENTICATE confirmation is received by the VLR, it checks whether the received Signed Result (SRES) is identical to the stored one (see 3GPP TS 43.020 [24]), or whether the received RES is identical to the stored XRES. If this is not the case, the "Illegal Subscriber" exit is used. If the SRES values or RES and XRES are identical, then the "OK" exit is used;
- before exit, the VLR may fetch a new set of triplets from the HLR. This is done by initiating a separate Obtain_Authent_Sets_VLR process described below.

The macro is described in figure 25.5/2.

25.5.3 Process Obtain_Authentication_Sets_VLR

This process is initiated by the VLR to fetch authentication vectors from a subscriber's HLR in a stand-alone, independent manner. The Obtain_Authent_Para_VLR macro described below is simply called; the process is described in figure 25.5/3.

25.5.4 Macro Obtain_Authent_Para_VLR

This macro is used by the VLR to request authentication vectors from the HLR. The macro proceeds as follows:

- a connection is opened, and a MAP_SEND_AUTHENTICATION_INFO request sent to the HLR;
- if the HLR indicates that a MAP version 1 or 2 dialogue is to be used, the VLR performs the equivalent MAP version 1 or 2 dialogue. which can return a positive result containing authentication sets, an empty positive result, or an error;
- if the dialogue opening fails, the "Procedure Error" exit is used. Otherwise, the VLR waits for the response from the HLR;

- if a MAP_SEND_AUTHENTICATION_INFO confirmation is received from the HLR, the VLR checks the received data.

One of the following positive responses may be received from a MAP version 1 or MAP version 2 dialogue with the HLR:

- Authentication triplets, in which case the outcome is successful;
- Empty response, in which case the VLR may re-use old triplets, if allowed by the PLMN operator.

If the VLR cannot re-use old triplets (or no such triplets are available) then the "Procedure Error" exit is used.

If the outcome was successful or re-use of old parameters in the VLR is allowed, then the "OK" exit is used.

If an "Unknown Subscriber" error is returned by the MAP version 1 or 2 dialogue, then the "Unknown Subscriber" exit is used.

In a MAP version 3 dialogue a (possibly empty) set of authentication vectors may be received, transferred by means of the TC-RESULT-L service, from the HLR followed by a MAP_CLOSE_Indication or by a MAP_DELIMITER_Indication. If a MAP_DELIMITER_Indication is received, the VLR may request additional authentication vectors from the HLR by sending a new MAP_SEND_AUTHENTICATION_INFO_Request with no parameter part. If a MAP_CLOSE_Indication is received, and authentication vectors have been received during the dialogue, then the "OK" exit is used. If no authentication vectors have been received during the dialogue, the VLR checks whether old GSM Triplets are available and can be re-used. If so, the "OK" exit is used, otherwise the "Procedure Error" exit is used. Note that re-use of old UMTS Quintuplets is not allowed.

If in a MAP version 3 dialogue an "Unknown Subscriber" error is received, then the "Unknown Subscriber" exit is used. If other errors are received, the VLR checks whether old GSM Triplets are available and can be re-used. If so, the "OK" exit is used, otherwise the "Procedure Error" exit is used. Note that re-use of old UMTS Quintuplets is not allowed.

- if a MAP-U-ABORT, MAP_P_ABORT, MAP_NOTICE or unexpected MAP_CLOSE service indication is received from the MSC, then open connections are terminated, and the macro takes the "Null" exit;
- if a MAP-U-ABORT, MAP_P_ABORT or unexpected MAP_CLOSE service indication is received from the HLR, then the VLR checks whether old authentication parameters (GSM triplets) can be re-used. If old parameters cannot be re-used the macro takes the "Procedure Error" exit; otherwise it takes the "OK" exit; note that re-use of old UMTS Quintuplets is not allowed;
- if a MAP_NOTICE service indication is received from the HLR, then the dialogue with the HLR is closed. The VLR then checks whether old authentication parameters (GSM triplets) can be re-used. If old parameters cannot be re-used the macro takes the "Procedure Error" exit; otherwise it takes the "OK" exit; note that re-use of old UMTS Quintuplets is not allowed.

The macro is described in figure 25.5/4.

25.5.5 Process Obtain_Auth_Sets_HLR

Opening of the dialogue is described in the macro Receive_Open_Ind in clause 25.1, with outcomes:

- reversion to version one or two procedure;
- procedure termination; or
- dialogue acceptance, with proceeding as below.

This process is used by the HLR to obtain authentication vectors from the AuC, upon request from the VLR or from the SGSN. The process acts as follows:

- a MAP_SEND_AUTHENTICATION_INFO indication is received by the HLR;
- the HLR checks the service indication for errors. If any, they are reported to the VLR or to the SGSN in the MAP_SEND_AUTHENTICATION_INFO response. If no errors are detected, authentication vectors are fetched from the AuC. Further details are found in 3GPP TS 43.020 [24];

- If Network Access Mode is set to “non-GPRS only” and if the Requesting Node Type is present and indicates ‘SGSN’, the error Unknown Subscriber (with diagnostic value set to “Gprs Subscription Unknown”) is returned in the response. The process terminates;
- If Network Access Mode is set to “GPRS only” and if the Requesting Node Type is present and indicates ‘VLR’, the error Unknown Subscriber is returned in the response. The process terminates;
- if errors are detected they are reported to the VLR or to the SGSN in the MAP_SEND_AUTHENTICATION_INFO response. Otherwise the authentication vectors are returned by means of the TC-RESULT-L service.
- if segmentation of the response message is required and allowed, a MAP_SEND_AUTHENTICATION_INFO_response transferred by means of the TC-RESULT-L service, containing at least one authentication vector, followed by a MAP_DELIMITER_request is returned to the VLR or SGSN, the remaining authentication vectors are stored and the HLR waits for a new service indication from the VLR or SGSN.

The process is described in figure 25.5/5.

Macrodefinition Authenticate_MSC

25.5_1(1)

Figure 25.5/1: Authentication macro in the MSC, relaying authentication indication from the VLR to the MS, and relaying the confirmation from the MSC to the VLR

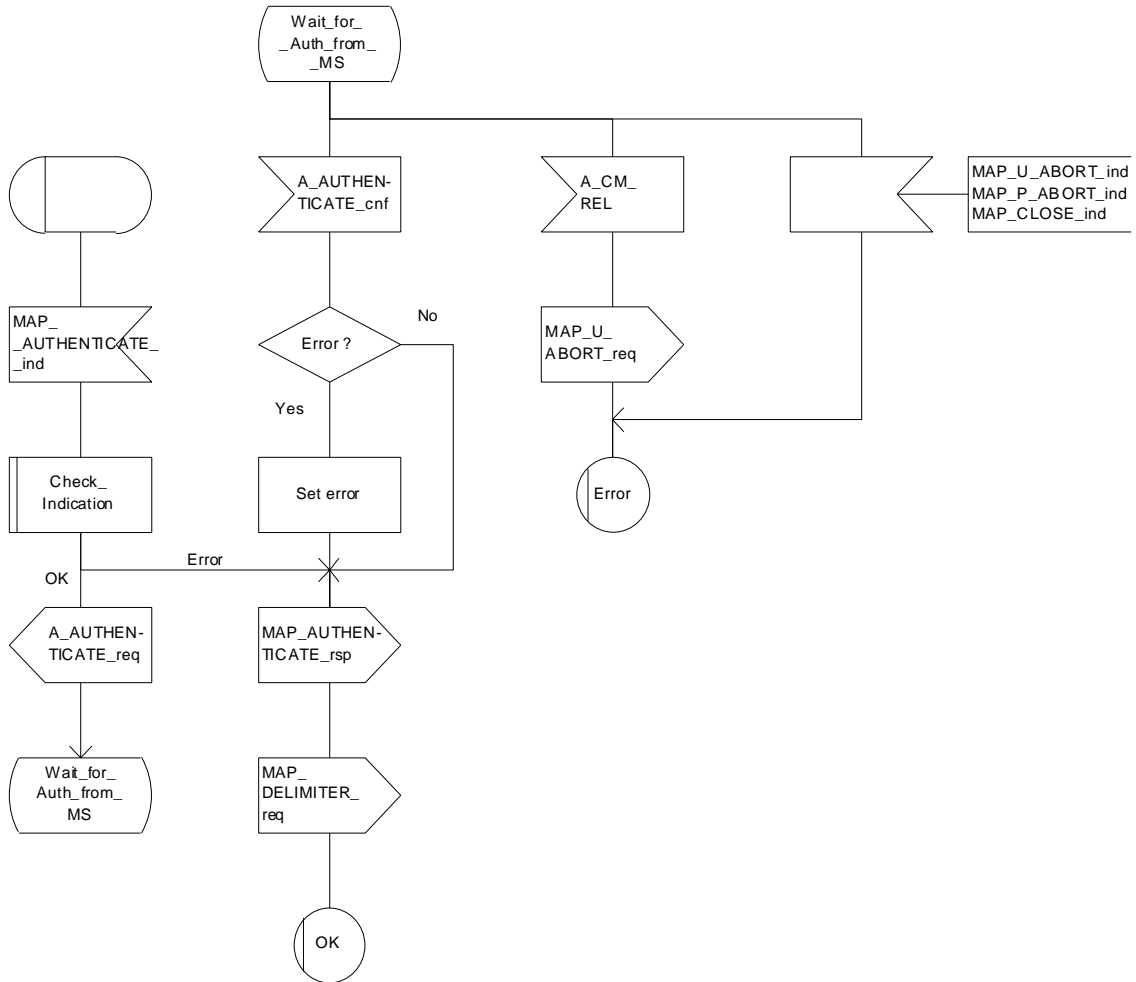

Figure 25.5/1: Macro Authenticate_MSC

Macrodefinition Authenticate_VLR

215_2(1)

Figure 25.5/2: Authentication macro in the VLR, controlling the authentication procedure towards the MSC/MS and obtaining authentication vectors from the HLR as applicable.

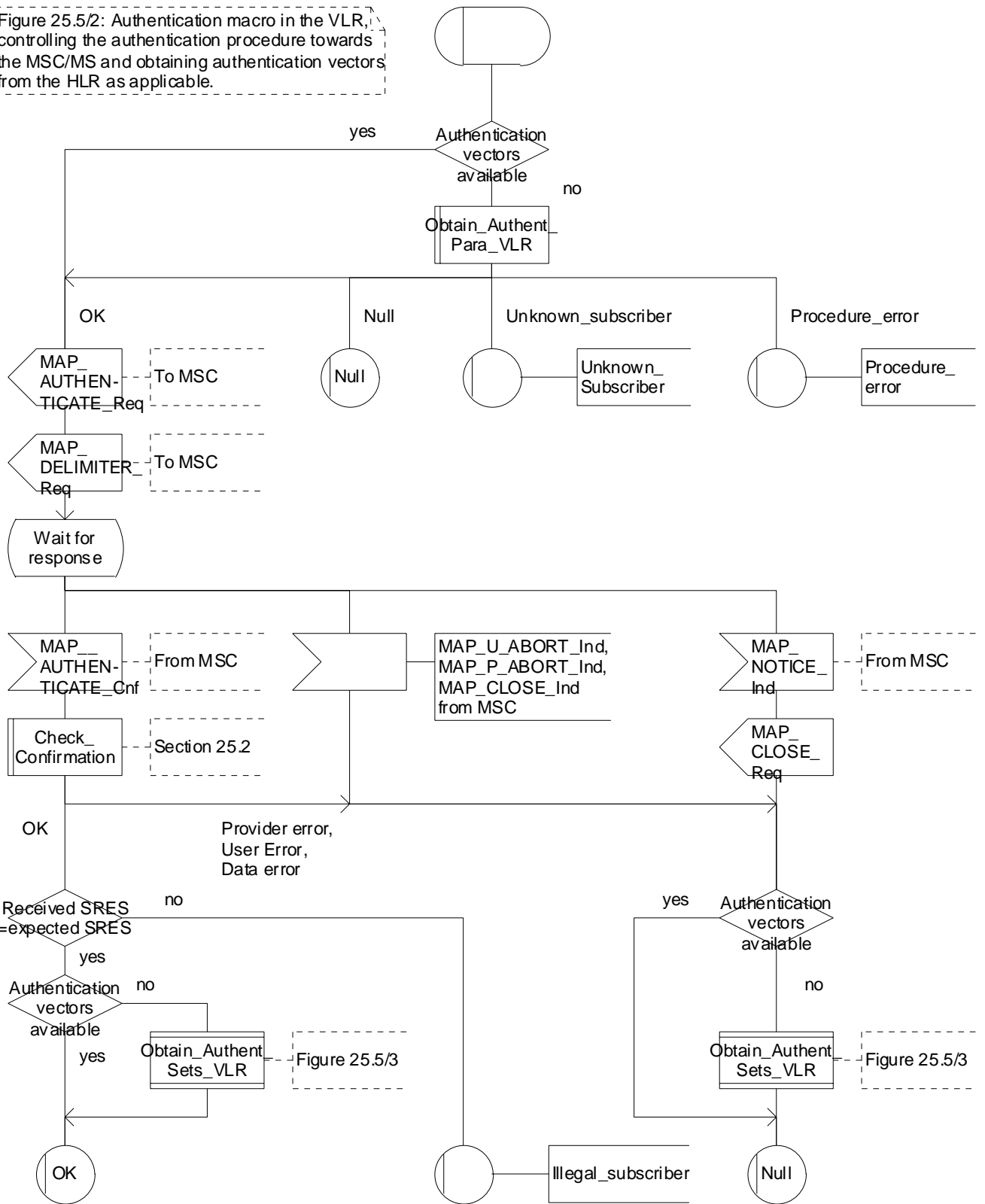

Figure 25.5/2: Macro Authenticate_VLR

Process Obtain_Authent_Sets_VLR

25.5_3(1)

Figure 25.5/3: Process to obtain authentication sets from the HLR to the VLR

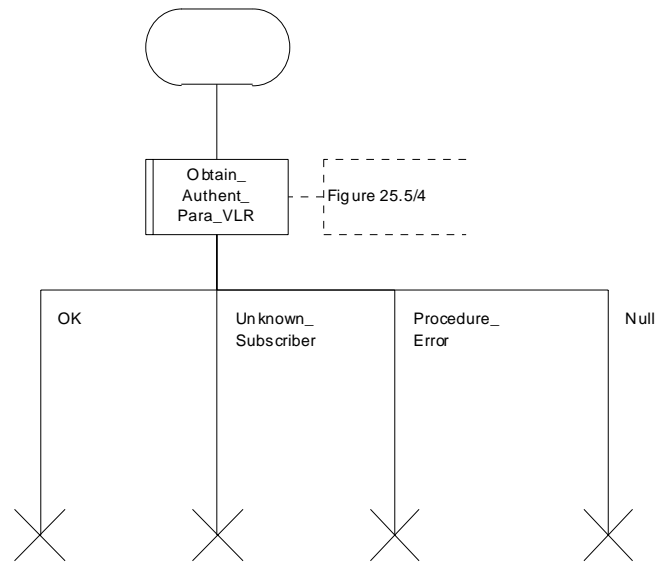

Figure 25.5/3: Process Obtain_Authentication_Sets_VLR

Macrodefinition OBTAIN_AUTHENT_PARA_VLR

1(3)

Figure 25.5/4: Macro to obtain authentication parameters from the HLR to the VLR

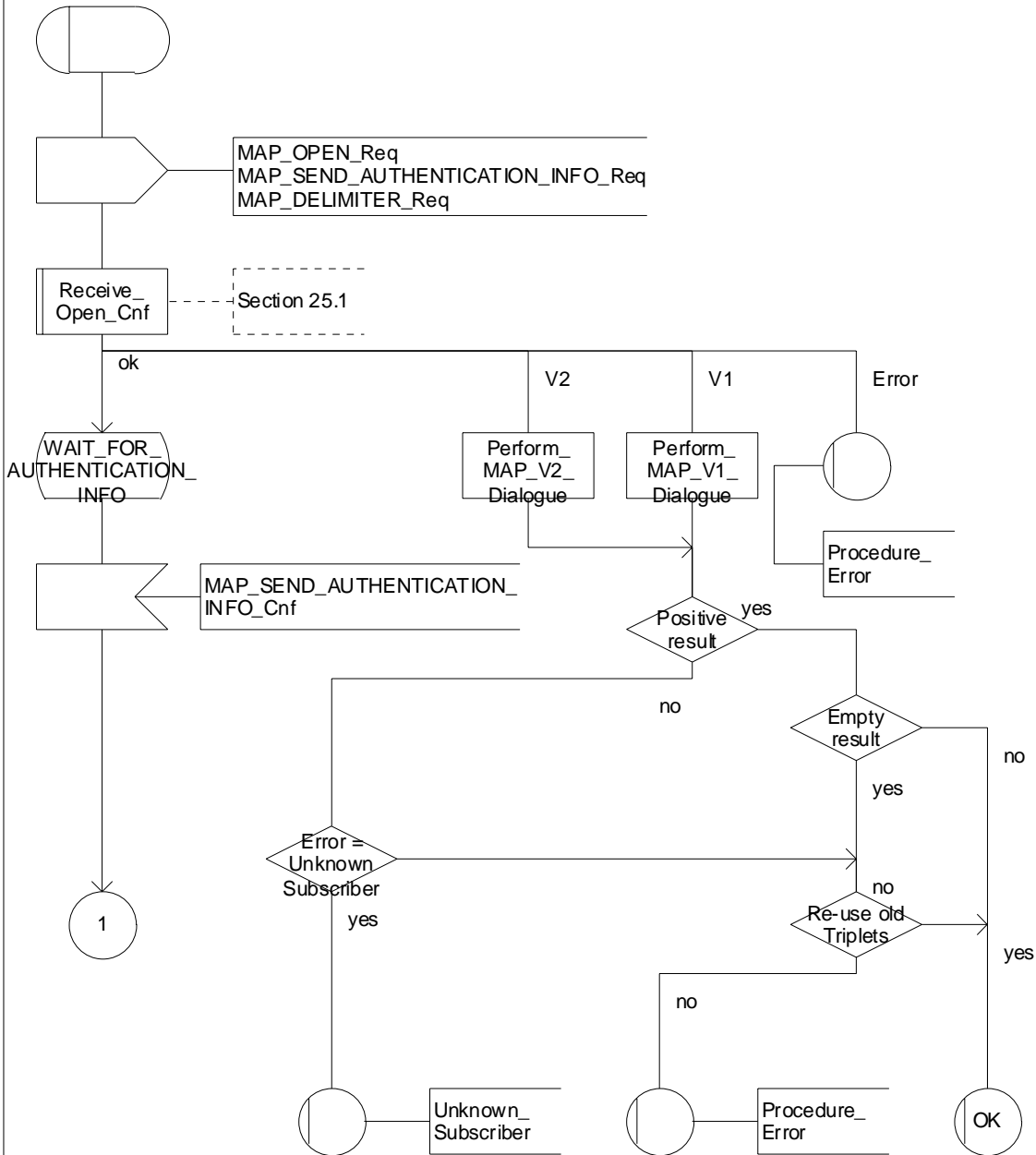

Figure 25.5/4 (sheet 1 of 3): Macro Obtain_Authent_Para_VLR

Macrodefinition OBTAIN_AUTHENT_PARA_VLR

2(3)

Figure 25.5/4: Macro to obtain authentication parameters from the HLR to the VLR

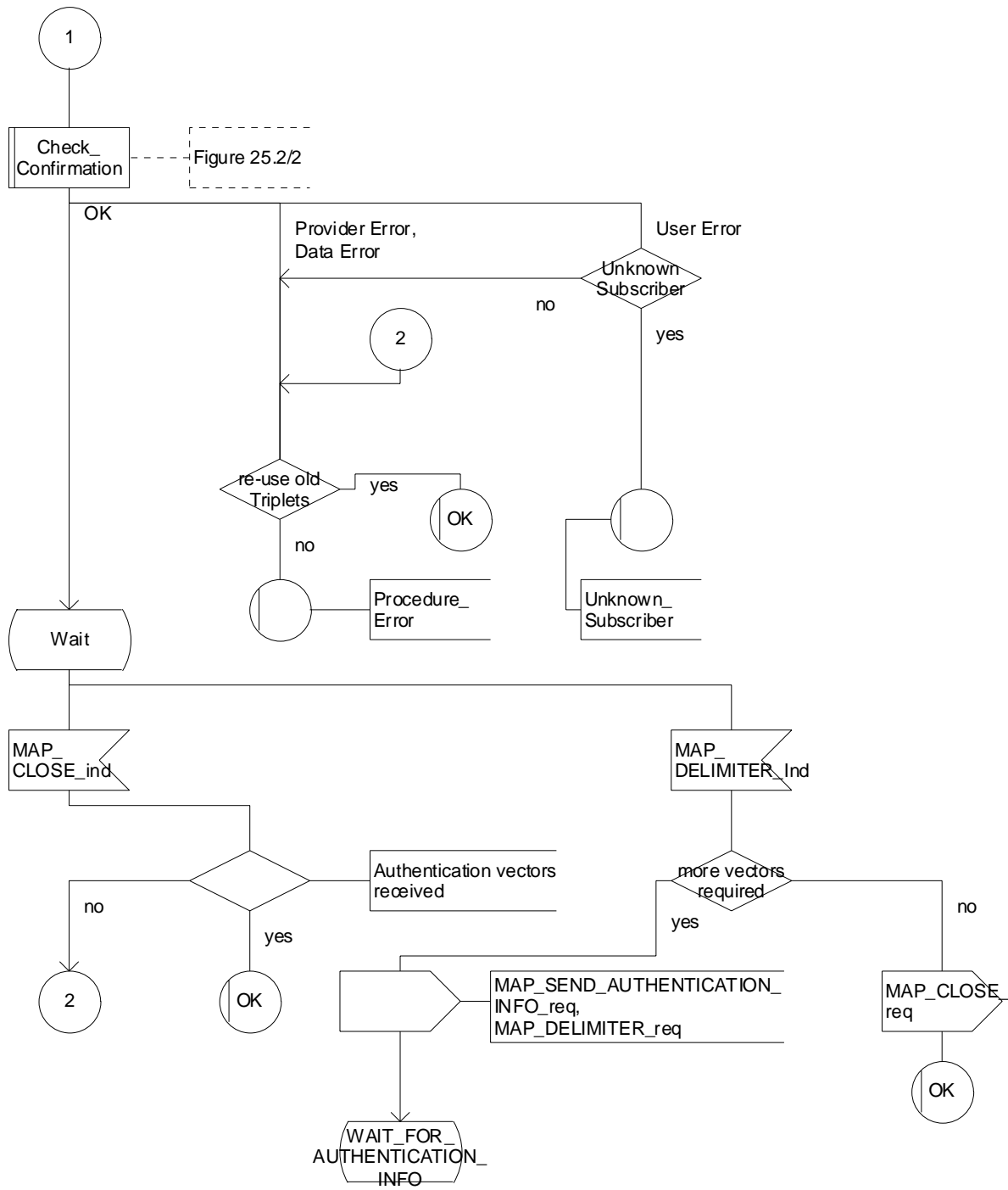

Figure 25.5/4 (sheet 2 of 3): Macro Obtain_Authent_Para_VLR

Macrodefinition OBTAIN_AUTHENT_PARA_VLR

3(3)

Figure 25.5/4: Macro to obtain authentication parameters from the HLR to the VLR

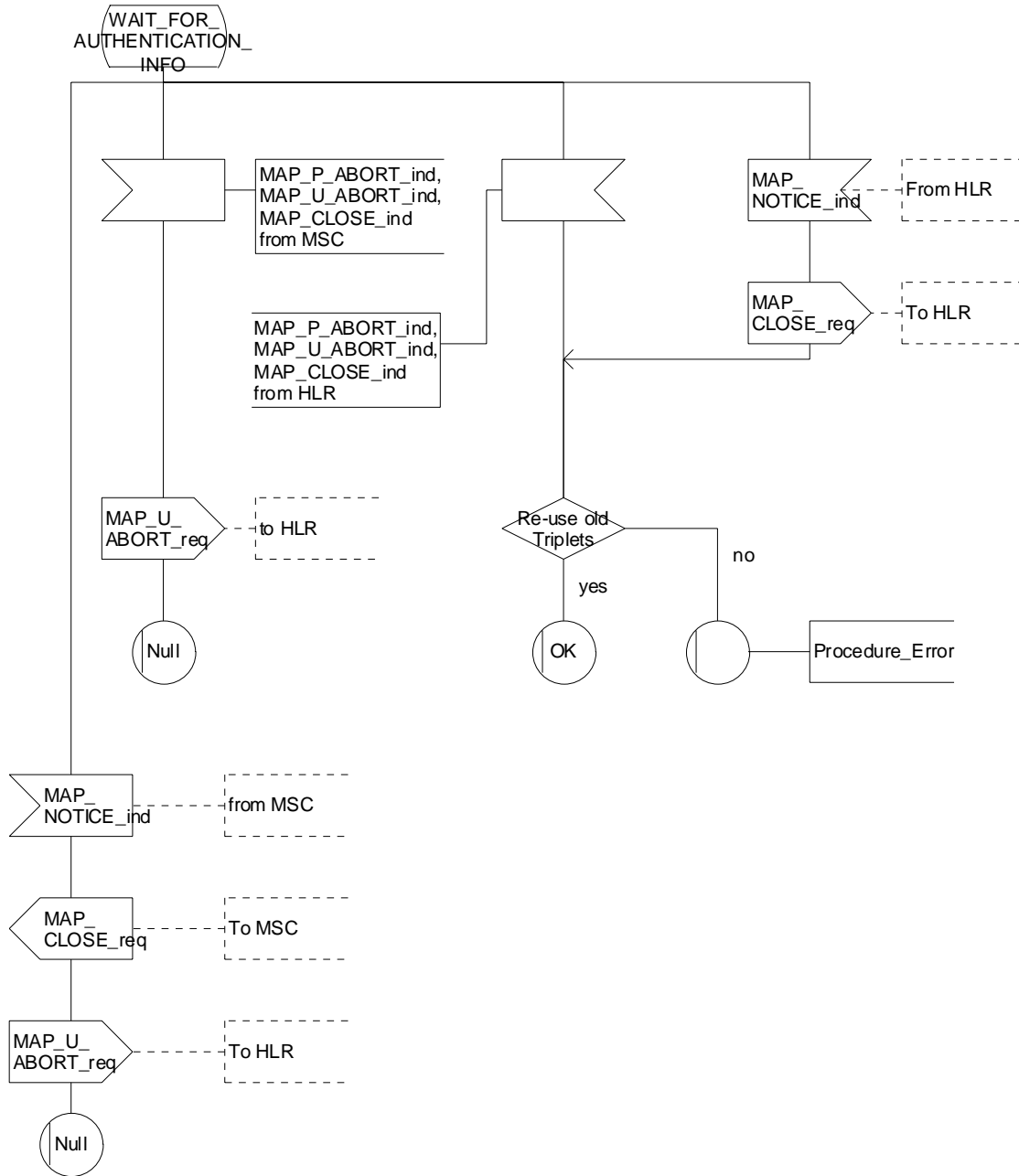

Figure 25.5/4 (sheet 3 of 3): Macro Obtain_Authent_Para_VLR

Process Obtain_Auth_Sets_HLR

1(2)

Figure 25.5/5: Process in the HLR to obtain authentication sets from the AuC and relay them to the VLR

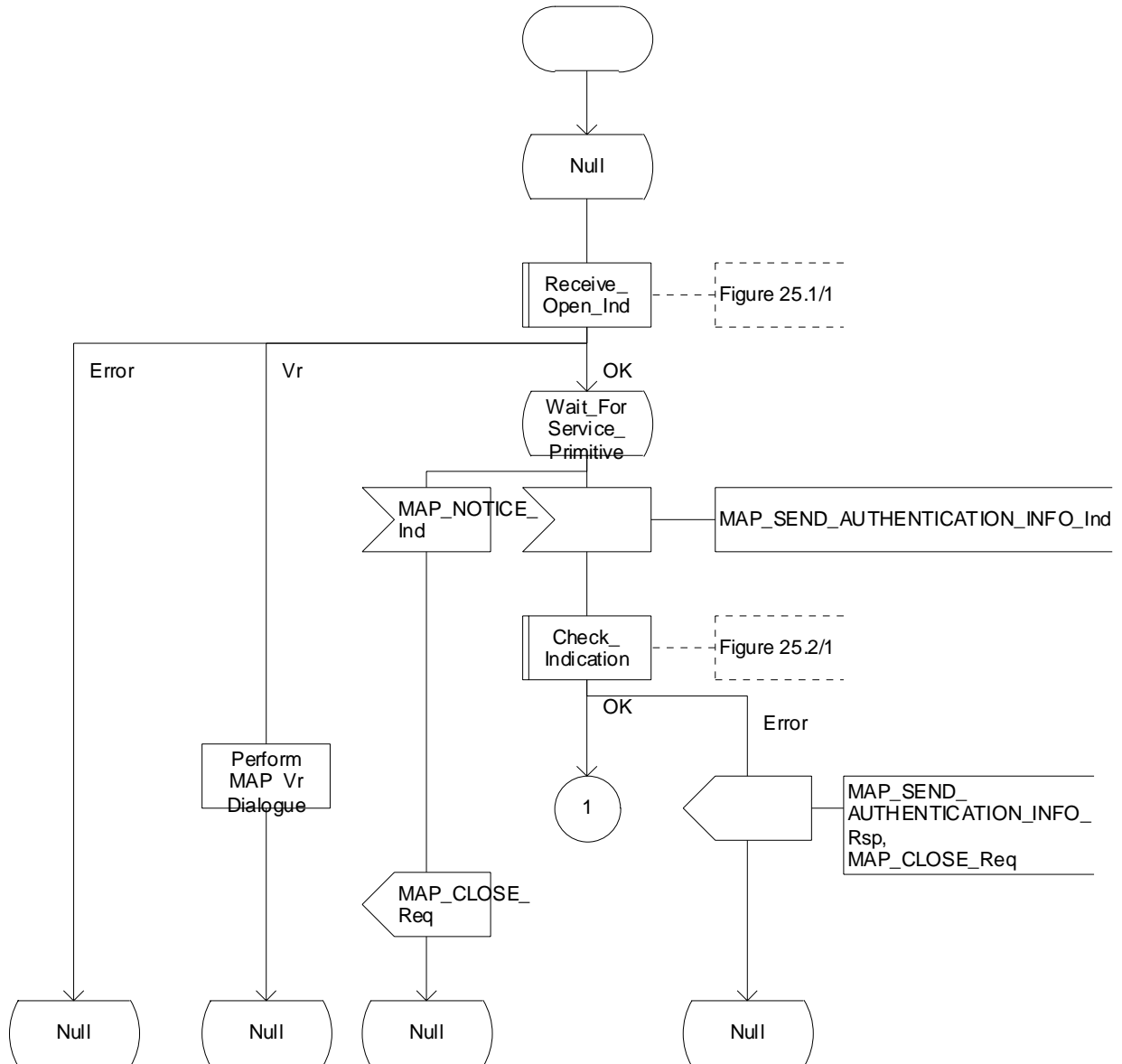

Figure 25.5/5 (sheet 1 of 2): Process Obtain_Auth_Sets_HLR

process Obtain_Auth_Sets_HLR

2(2)

Figure 25.5/5: Process in the HLR to obtain authentication sets from the AuC and relay them to the VLR

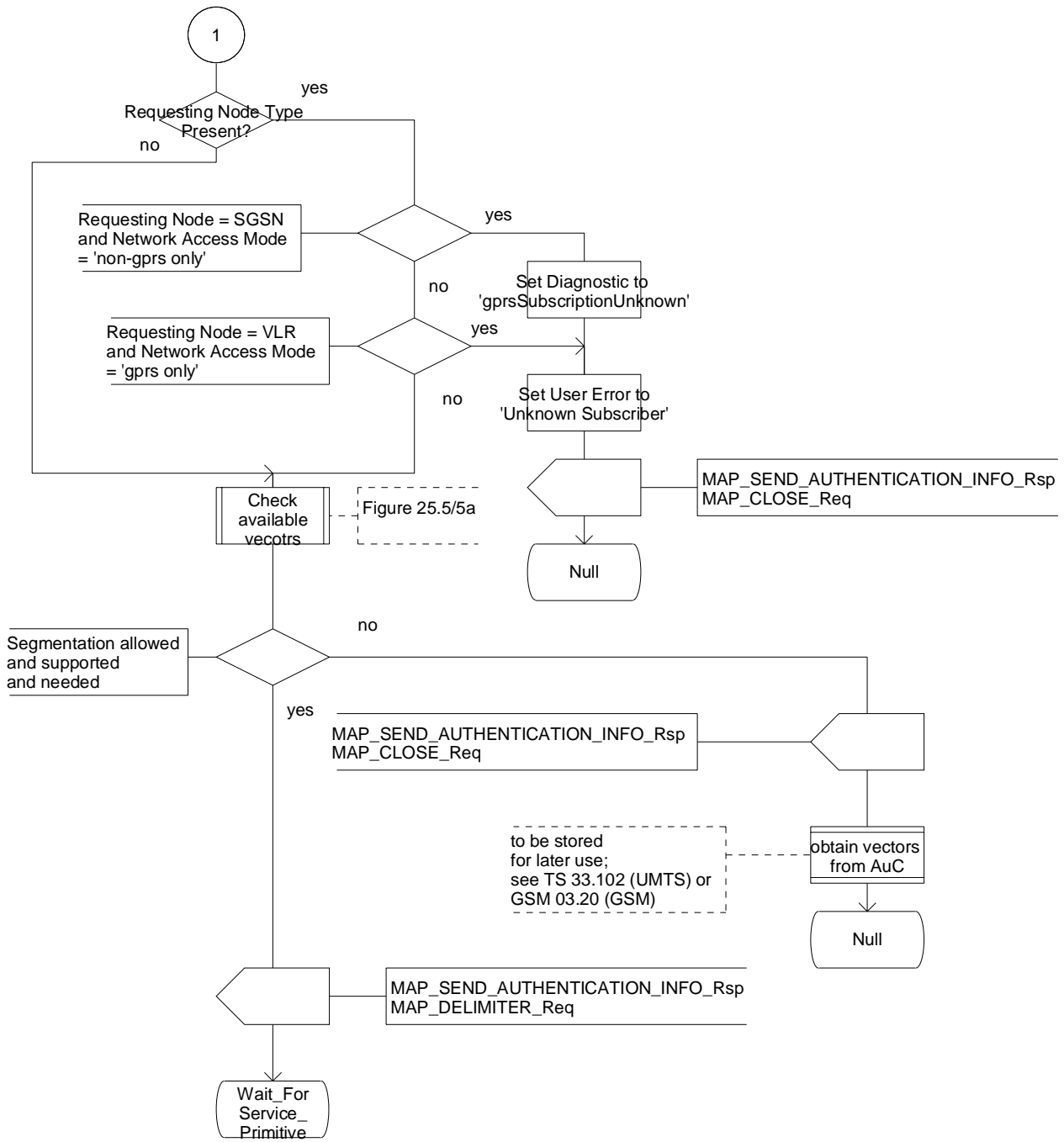

Figure 25.5/5 (sheet 2 of 2): Process Obtain_Auth_Sets_HLR

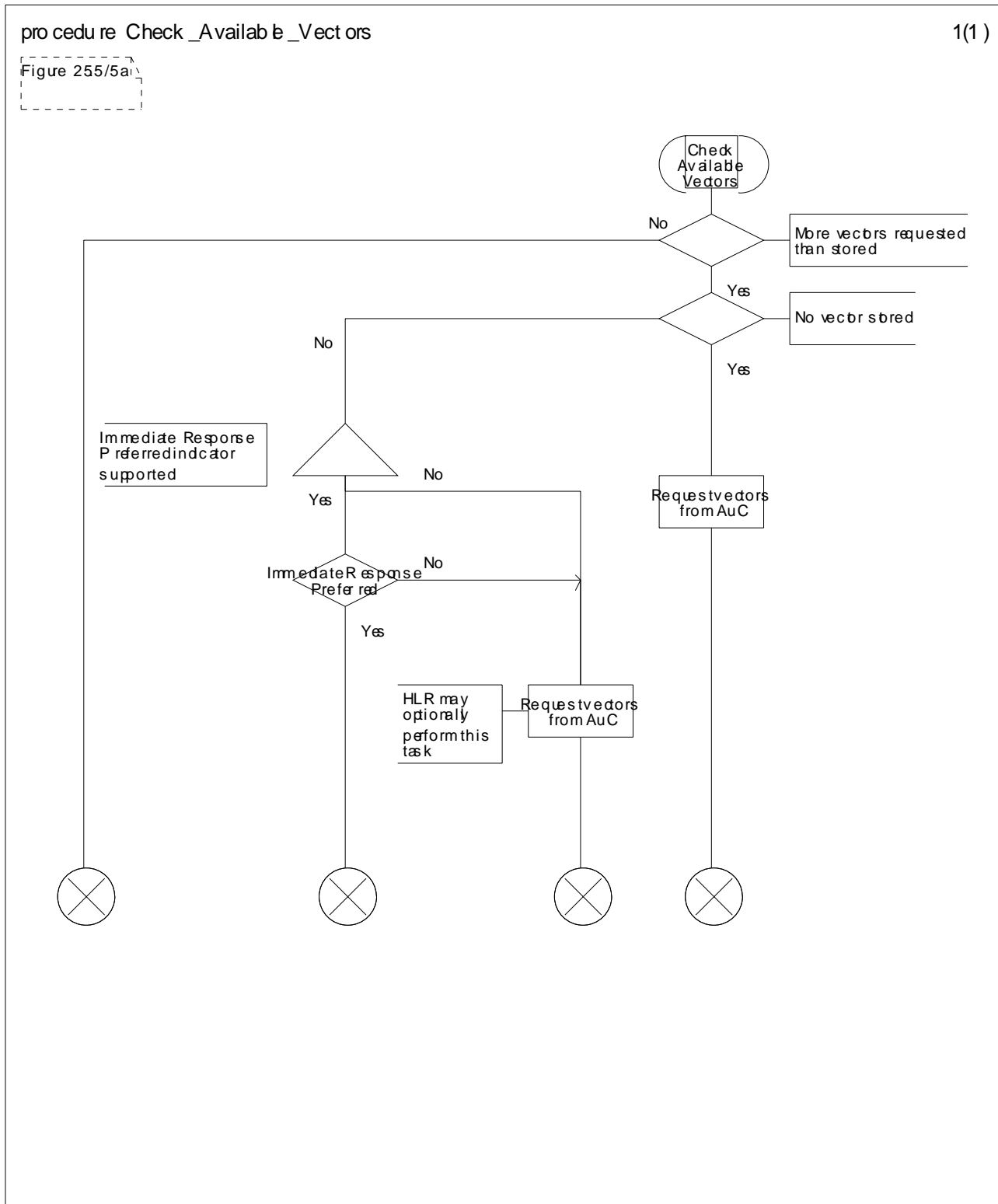

Figure 25.5/6: Procedure Check_Available_Vectors

25.5.6 Process Obtain_Authent_Para_SGSN

For authentication procedure description see 3GPP TS 23.060 [104] and 3GPP TS 24.008 [35].

This Process is used by the SGSN to request authentication vectors from the HLR.

If the SGSN does not know the subscriber's HLR address (e.g. no IMSI translation exists), the Authentication Parameter negative response with error "Unknown HLR" is returned to the requesting process.

Otherwise, the Process proceeds as follows:

- a connection is opened, and a MAP_SEND_AUTHENTICATION_INFO request sent to the HLR;
- if the HLR indicates that a MAP version 1 or 2 dialogue is to be used, the SGSN performs the equivalent MAP version 1 or 2 dialogue. which can return a positive result containing authentication sets, an empty positive result, or an error;
- if the dialogue opening fails, the Authentication Parameters negative response with appropriate error is sent to the requesting process. Otherwise, the SGSN waits for the response from the HLR;
- if a MAP_SEND_AUTHENTICATION_INFO confirmation is received from the HLR, the SGSN checks the received data.

One of the following positive responses may be received from a MAP version 1 or MAP version 2 dialogue with the HLR:

- Authentication triplets, in which case the outcome is successful;
- Empty response, in which case the SGSN may re-use old triplets, if allowed by the PLMN operator.

If the SGSN cannot re-use old triplets (or no such triplets are available) then the Authentication Parameters negative response with appropriate error is sent to the requesting process.

If the outcome was successful or re-use of old parameters in the SGSN is allowed, then the Authentication Parameters response is sent to the requesting process

If an "Unknown Subscriber" error is included in the MAP_SEND_AUTHENTICATION_INFO confirm or is returned by the MAP version 1 dialogue, then the appropriate error is sent to the requesting process in the Authentication Parameters negative response

In a MAP version 3 dialogue a (possibly empty) set of authentication vectors may be received, transferred by means of the TC-RESULT-L service, from the HLR followed by a MAP_CLOSE_Indication or by a MAP_DELIMITER_Indication. If a MAP_DELIMITER_Indication is received, the SGSN may request additional authentication vectors from the HLR by sending a new MAP_SEND_AUTHENTICATION_INFO_Request. If a MAP_CLOSE_Indication is received, and authentication vectors have been received during the dialogue, then the "OK" exit is used. If no authentication vectors have been received during the dialogue, the SGSN checks whether old GSM Triplets are available and can be re-used. If so, the "OK" exit is used, otherwise the "Procedure Error" exit is used. Note that re-use of old UMTS Quintuplets is not allowed.

If in a MAP version 3 dialogue an "Unknown Subscriber" error is received, then the "Unknown Subscriber" exit is used. If other errors are received, the SGSN checks whether old GSM Triplets are available and can be re-used. If so, the "OK" exit is used, otherwise the "Procedure Error" exit is used. Note that re-use of old UMTS Quintuplets is not allowed.

- if a MAP-U-ABORT, MAP_P_ABORT or unexpected MAP_CLOSE service indication is received from the HLR, then the SGSN checks whether old authentication parameters can be re-used. If old parameters cannot be re-used the Authentication Parameters negative response with appropriate error is sent to the requesting process.
- if a MAP_NOTICE service indication is received from the HLR, then the dialogue with the HLR is closed. The SGSN then checks whether old authentication parameters can be re-used. If old parameters cannot be re-used the process terminates and the Authentication Parameters negative response with appropriate error is sent to the requesting process; Otherwise the Authentication Parameters response is sent to requesting process.

The process is described in figure 25.5/6.

Process Obtain_Authent_Para_SGSN

1(3)

Figure 25.5/6: Process to obtain authentication parameters from the HLR to the SGSN

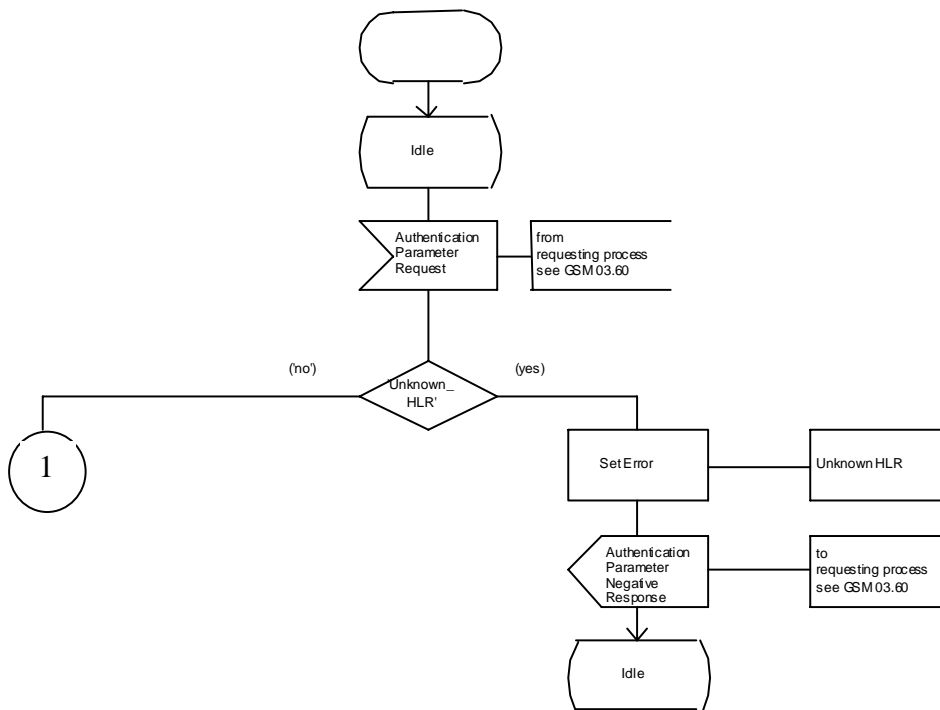

Figure 25.5/6 (sheet 1 of 3): Process Obtain_Authent_Para_SGSN

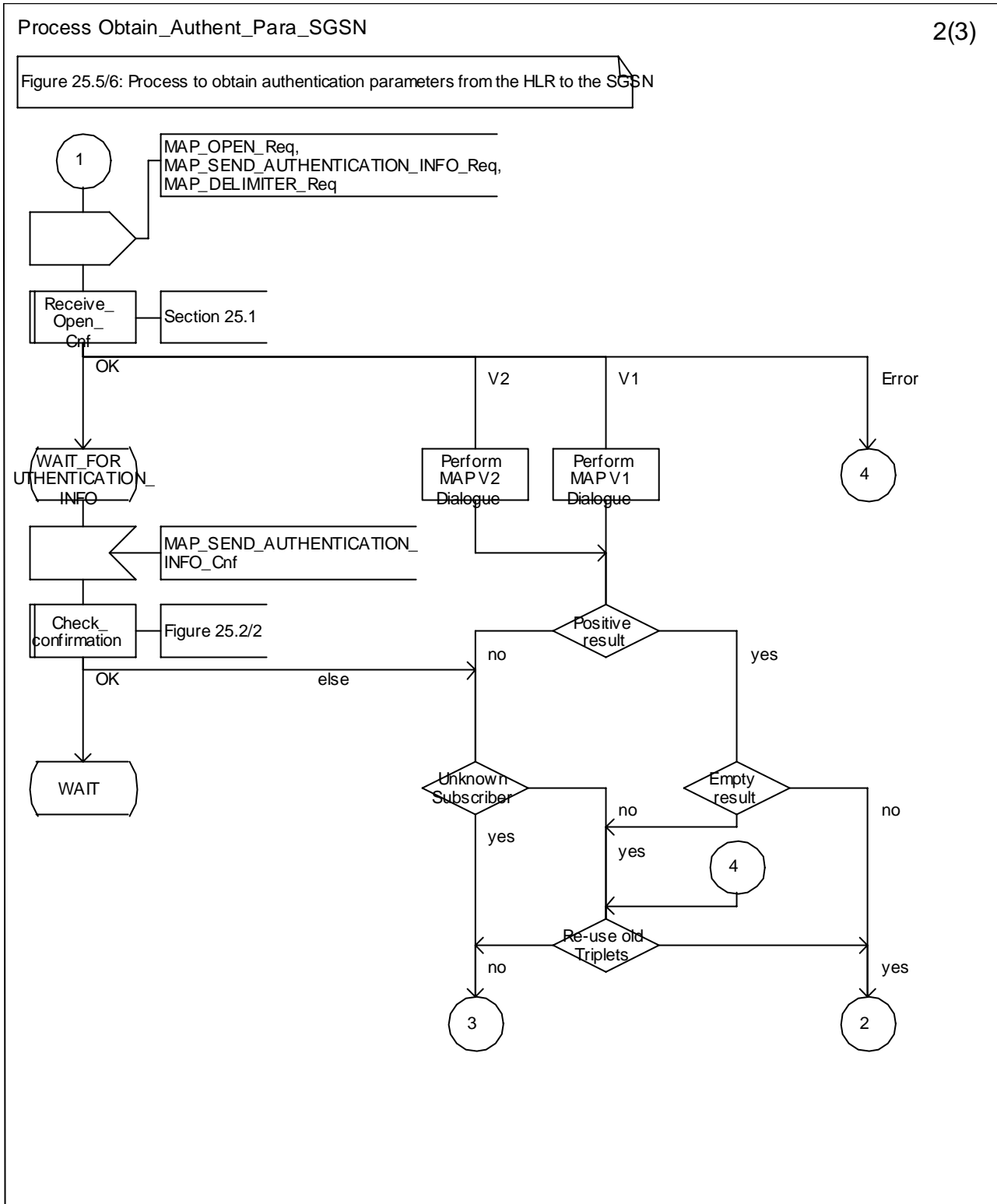

Figure 25.5/6 (sheet 2 of 3): Process Obtain_Authen_Para_SGSN

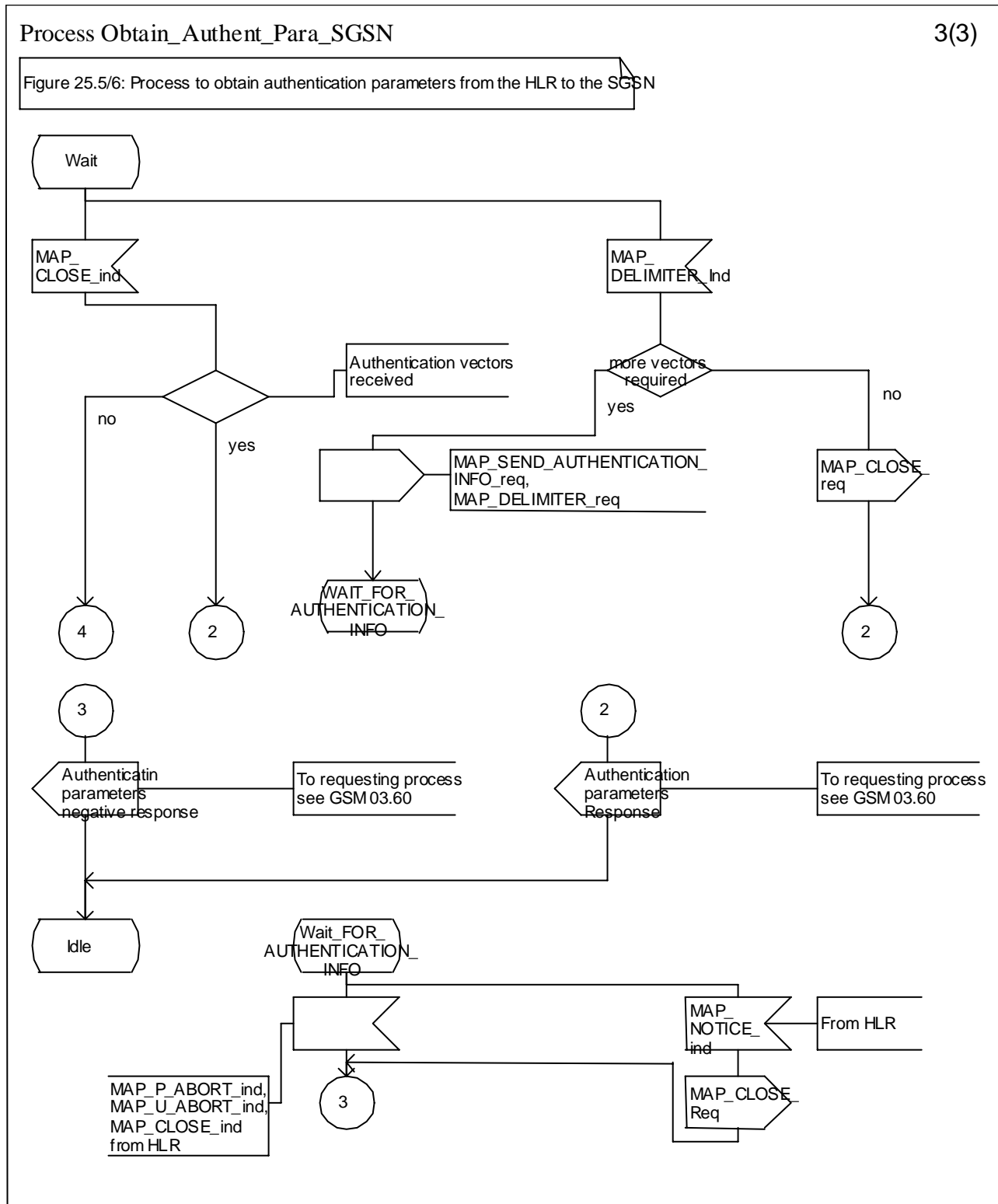

Figure 25.5/6 (sheet 3 of 3): Process Obtain_Authen_Para_SGSN

25.5.7 Process Authentication_Failure_Report

25.5.7.1 General

The Authentication Failure Report procedure is used to notify a HLR about the occurrence of an authentication failure in the SGSN or VLR.

The procedure is shown in figure 25.5/7.

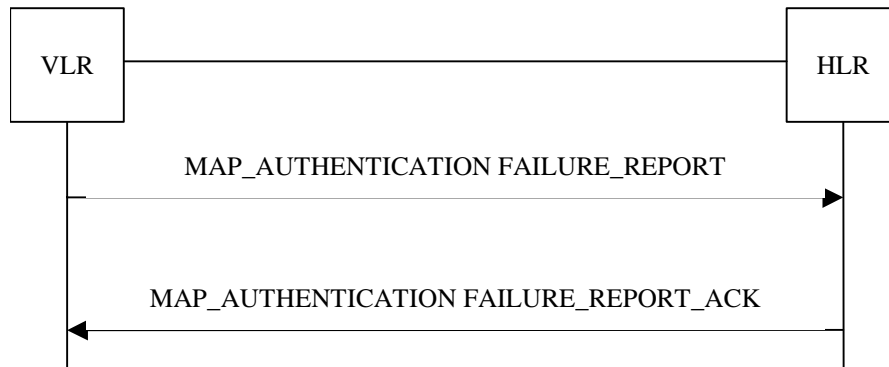

Figure 25.5/7: Message Flows to Authentication Failure Report

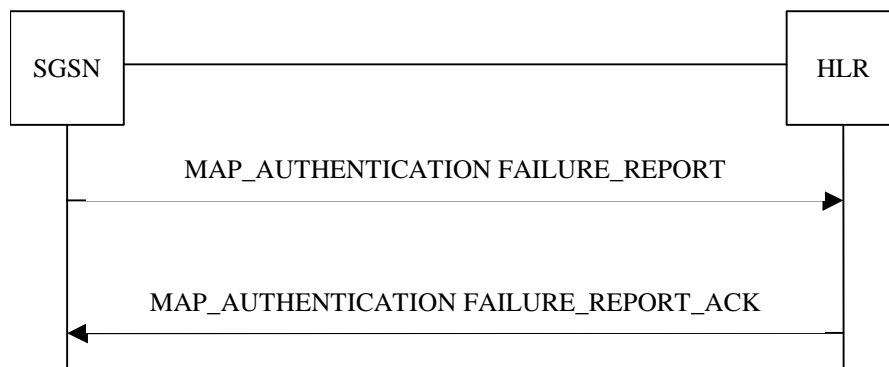

Figure 25.6/7: Message Flows to Authentication Failure Report

25.5.7.2 Process in the VLR

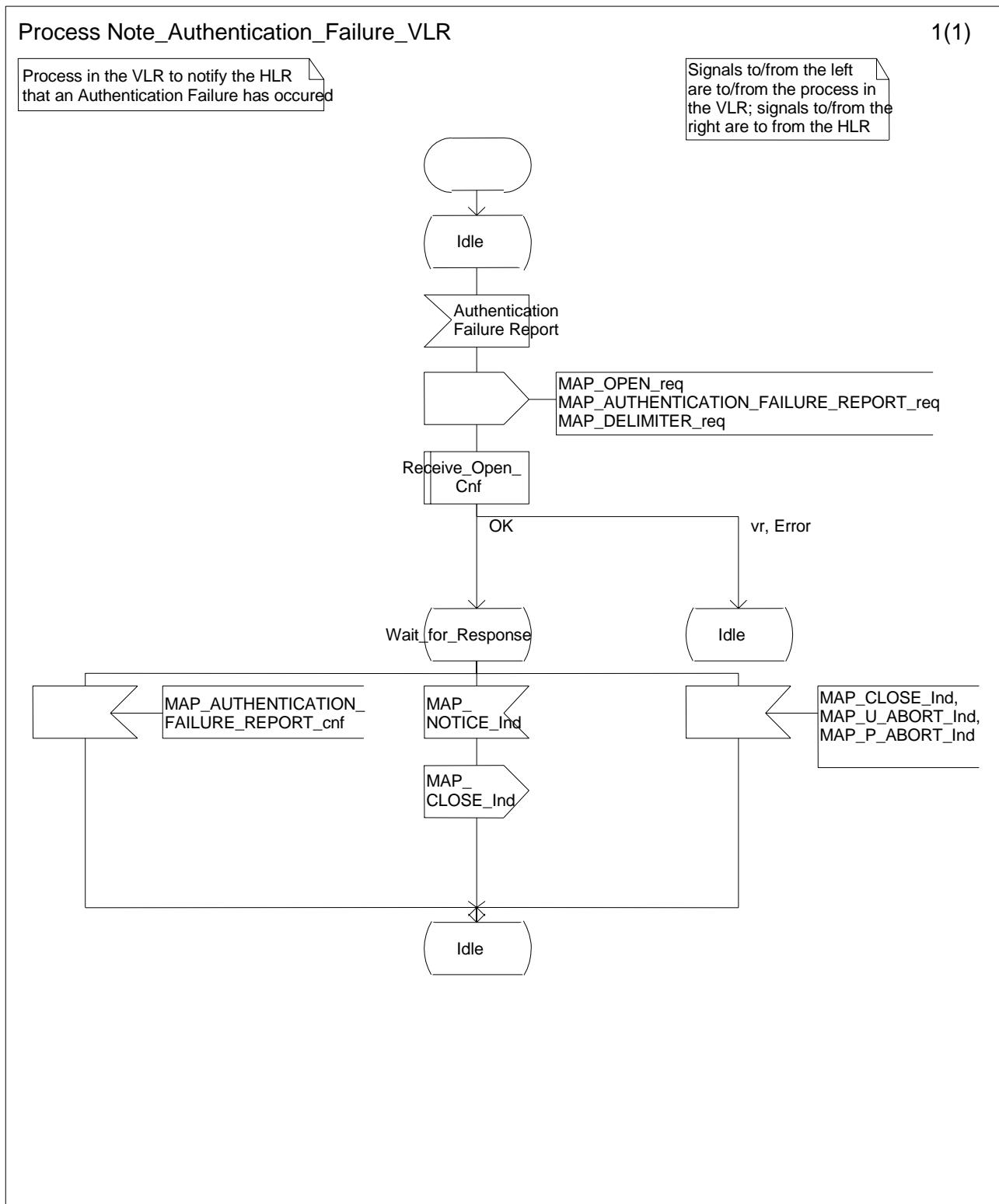

Figure 25.6/8: Process Note_Authentication_Failure_VLR

25.5.7.3 Process in the SGSN

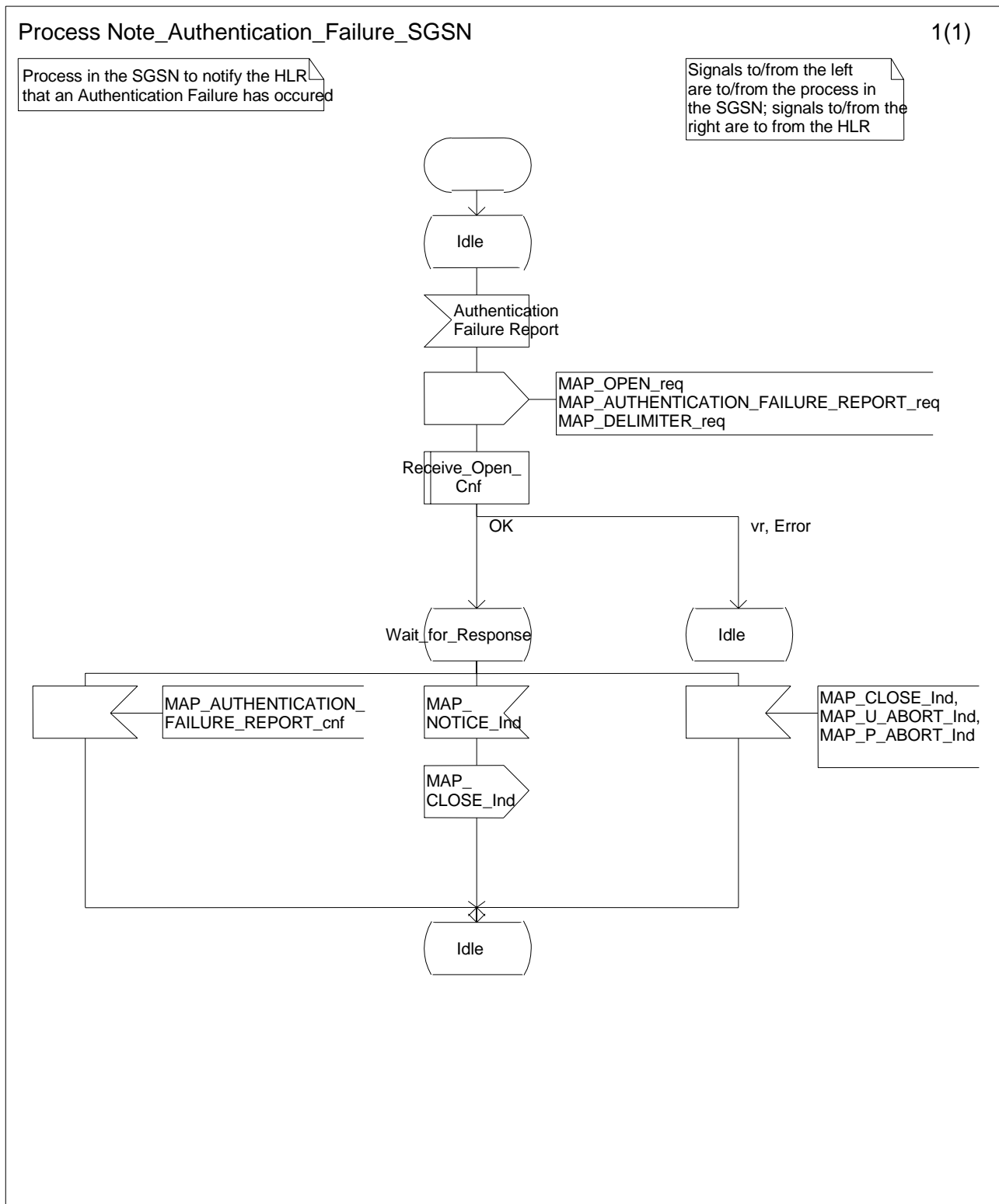

Figure 25.6/9: Process Note_Authentication_Failure_SGSN

25.5.7.4 Process in the HLR

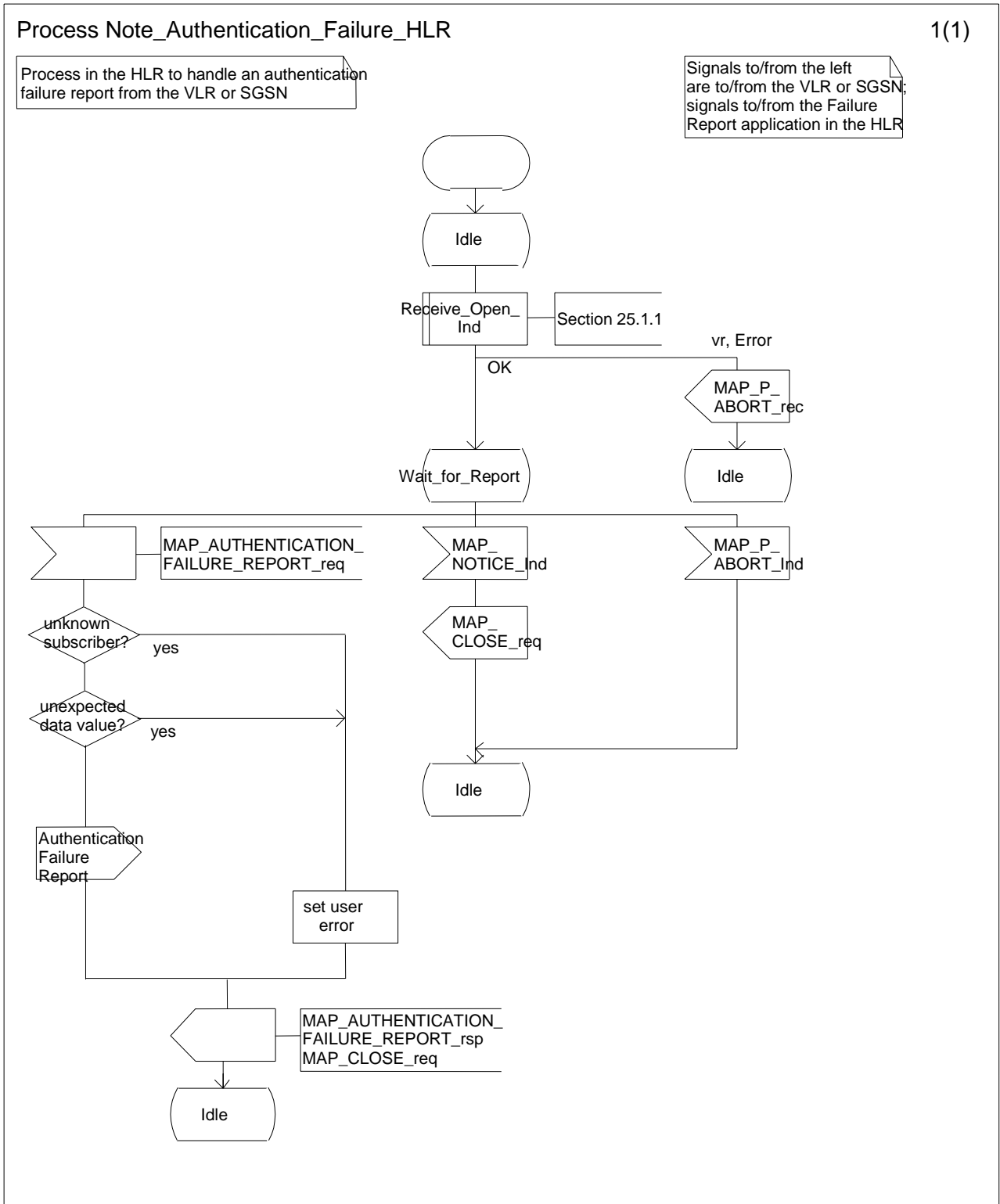

Figure 25.6/10: Process Note_Authentication_Failure_HLR

25.6 IMEI Handling Macros

The following macros are used in the GSM network in order to enable handling and checking of the mobile equipment identity.

25.6.1 Macro Check_IMEI_MSC

This macro is used by the MSC to receive a request from the VLR, relay it to the EIR, and pass the result from the EIR back to the VLR. The macro proceeds as follows:

- a MAP_CHECK_IMEI service indication containing only the Invoke Id is received from the VLR;
- if the IMEI is not available in the MSC, it is requested from the MS using the IDENTITY REQUEST message;
- if the MS releases the radio resources, a MAP_U_ABORT request indicating "Application procedure Cancellation" is sent to the VLR, and the "Error" exit of the macro is used;
- when the IMEI is known, a connection is set up towards the EIR, and a MAP_CHECK_IMEI service request is sent including the IMEI;
- if the opening of the dialogue fails, a System Failure is reported to the VLR. Otherwise, the MSC waits for a response from the EIR;
- when the MAP_CHECK_IMEI service confirm is received, it is checked for errors. Any errors discovered in the MSC lead to the System Failure error to be reported to the VLR in the MAP_CHECK_IMEI response. Any errors reported from the EIR are sent directly to the VLR in the MAP_CHECK_IMEI service response. If no errors are detected by or reported to the MSC, the IMEI is added to the MAP_CHECK_IMEI service response returned to the VLR. The "OK" exit is used in all cases;
- if a MAP_P_ABORT, MAP_U_ABORT, MAP_CLOSE or MAP_NOTICE service indication is received from the EIR, the MSC closes the transaction with the EIR (if necessary), reports a System Failure error back to the VLR in the MAP_CHECK_IMEI response, and uses the macro's "OK" exit;
- if a MAP_P_ABORT, MAP_U_ABORT, MAP_CLOSE or MAP_NOTICE indication is received from the VLR, the MSC closes the transaction with the VLR (if necessary) and aborts the connections towards the EIR and the MS; the macro takes the "Error" exit.

If the dialogue with the EIR drops back to version 1, the result or error returned by the EIR is checked. The use of the "Check_Confirmation" macro in the SDL diagram indicates that the checks carried out on the result returned by the EIR in a MAP v1 dialogue are functionally equivalent to those carried out on the parameters of the MAP_CHECK_IMEI confirm received from the EIR in a MAP v2 dialogue.

The macro is described in figure 25.6/1.

25.6.2 Macro Check_IMEI_VLR

This macro is used by the VLR to control the check of a mobile equipment's IMEI. The macro proceeds as follows:

- a MAP_CHECK_IMEI service request is sent to the MSC, including only the Invoke Id;
- the VLR then waits for the response from the MSC;
- if a MAP_CHECK_IMEI service confirm including either:
 - the IMEI and the Equipment Status; or
 - an error;

is received, the VLR checks whether the response requires that an alarm be generated on the Operation and Maintenance interface. The criteria for such alarms are PLMN operator dependent;

- the VLR then checks whether the response from the MSC means that service is granted to the MS. The criteria for granting service depending on the equipment status or errors received in the MAP_CHECK_IMEI service response are also PLMN operator dependent;

- if a MAP_P_ABORT, MAP_U_ABORT, MAP_CLOSE or MAP_NOTICE indication is received from the MSC, then the MSC connection is closed (if necessary) and the macro takes the "Aborted" exit.

The macro is described in figure 25.6/2.

25.6.3 Process Check_IMEI_EIR

This process is used by the EIR to obtain the status of a piece of mobile equipment, upon request from the MSC or from the SGSN. The process acts as follows:

- a MAP_OPEN service indication is received (macro Receive_Open_Ind, clause 25.1.1). If the dialogue opening fails, the process terminates;
- otherwise, a MAP_CHECK_IMEI indication is received by the EIR, containing the IMEI to be checked;
- the EIR checks the service indication for errors. If there are any, they are reported to the MSC or to the SGSN in the MAP_CHECK_IMEI response. If no errors are detected, the EIR data base function is interrogated for the status of the given equipment. Further details are found in 3GPP TS 22.016 [7];
- the status of the equipment (white-listed, grey-listed, black-listed or unknown) is returned to the MSC or to the SGSN in the MAP_CHECK_IMEI service response;
- if a MAP_U_ABORT, MAP_P_ABORT, MAP_NOTICE or MAP_CLOSE indication is received from the MSC or from the SGSN at any time during this process, the process in the EIR terminates.

The process is described in figure 25.6/3.

25.6.4 Macro Obtain_IMEI_MSC

This macro is used by the MSC to respond to a request from the VLR to provide the IMEI. The macro proceeds as follows:

- a MAP_OBTAIN_IMEI service indication containing only the Invoke Id is received from the VLR;
- if the IMEI is not available in the MSC, it is requested from the MS using the IDENTITY REQUEST message;
- when the IMEI is known, it is returned to the VLR in the MAP_OBTAIN_IMEI service response. The macro terminates at the "OK" exit;
- if the IMEI cannot be obtained by the MSC, the System Failure error is reported back to the VLR in the MAP_OBTAIN_IMEI service response. The macro terminates at the "OK" exit;
- if a MAP_P_ABORT, MAP_U_ABORT or MAP_CLOSE indication is received from the VLR, the macro terminates at the "Error" exit.

The macro is described in figure 25.6/4.

25.6.5 Macro Obtain_IMEI_VLR

This macro is used by the VLR to obtain the IMEI from the MSC, e.g. to enable handling of emergency calls in case of authentication failure (in which case the IMEI may be used by some operators as an alternative to the IMSI). It proceeds as follows:

- the MAP_OBTAIN_IMEI service request is sent to the MSC, including only the Invoke Id;
- the VLR then waits for the response from the MSC;
- if the IMEI is received in the MAP_OBTAIN_IMEI service response, the macro terminates at the "OK" exit;
- if the System Failure error is reported in the MAP_OBTAIN_IMEI service response, the "Error" exit is used;
- if the MSC terminates the dialogue using a MAP_P_ABORT, MAP_U_ABORT, MAP_CLOSE or MAP_NOTICE service indication, the necessary connections are released, and the "Aborted" exit is used for termination of the macro.

The macro is shown in figure 25.6/5.

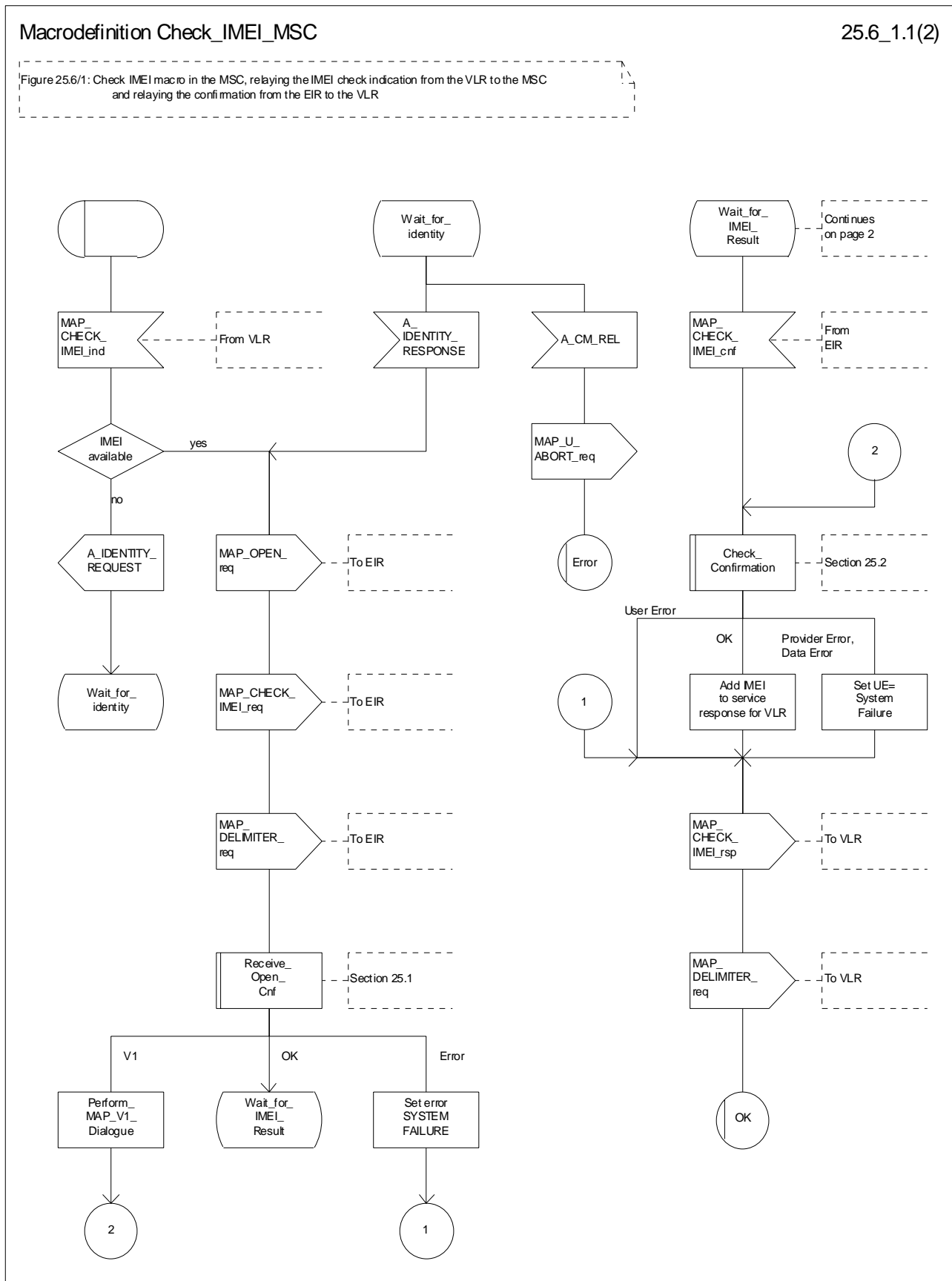

Figure 25.6/1 (sheet 1 of 2): Process Check_IMEI_MSC

Macrodefinition Check_IMEI_MSC

25.6_1.2(2)

Figure 25.6/1: Check IMEI macro in the MSC, relaying the IMEI check indication from the VLR to the MSC and relaying the confirmation from the EIR to the VLR

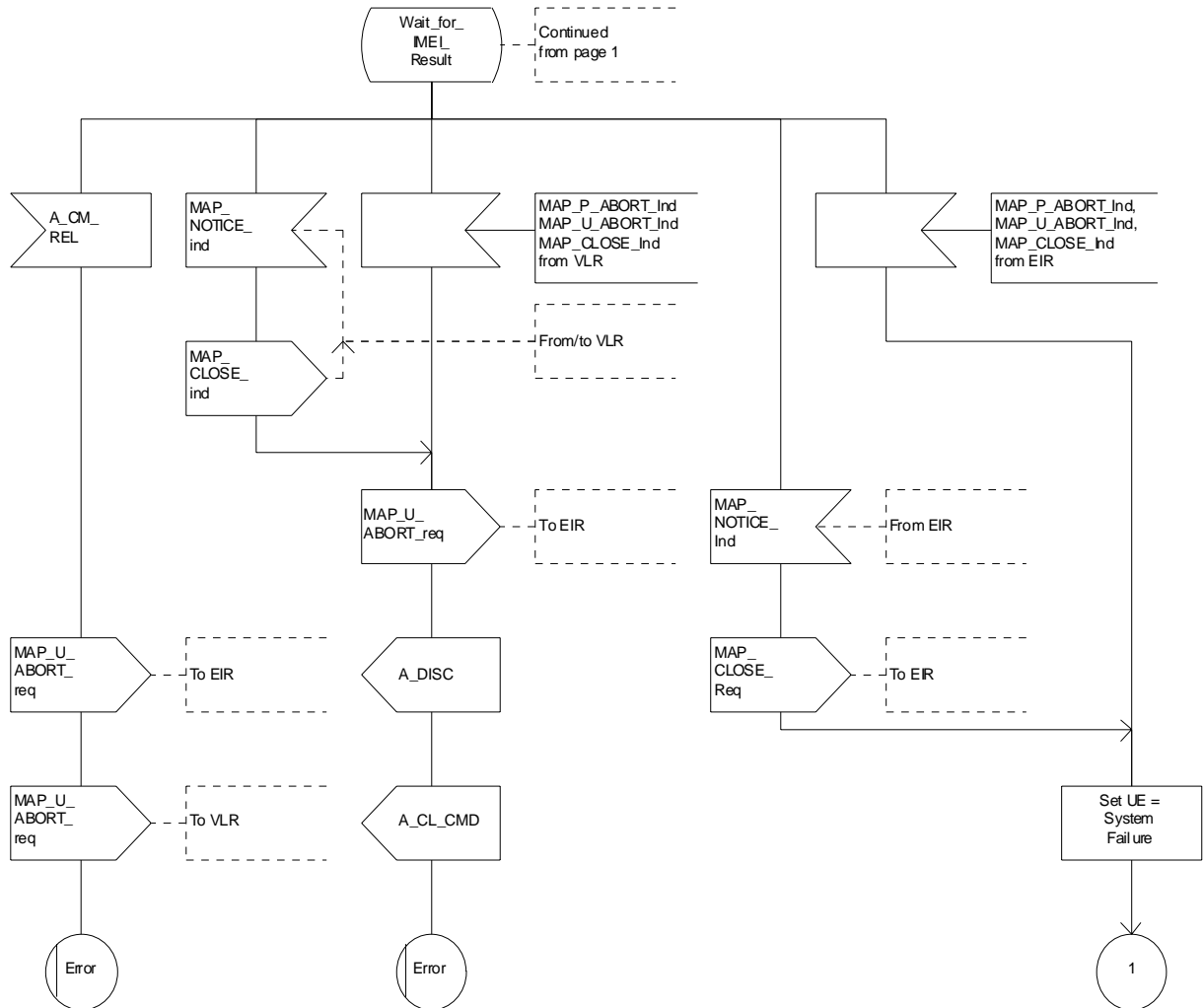

Figure 25.6/1 (sheet 2 of 2): Process Check_IMEI_MSC

Macrodefinition Check_IMEI_VLR

25.6_2(1)

Figure 25.6/2: Check IMEI macro in the VLR, containing the request towards the MSC/EIR

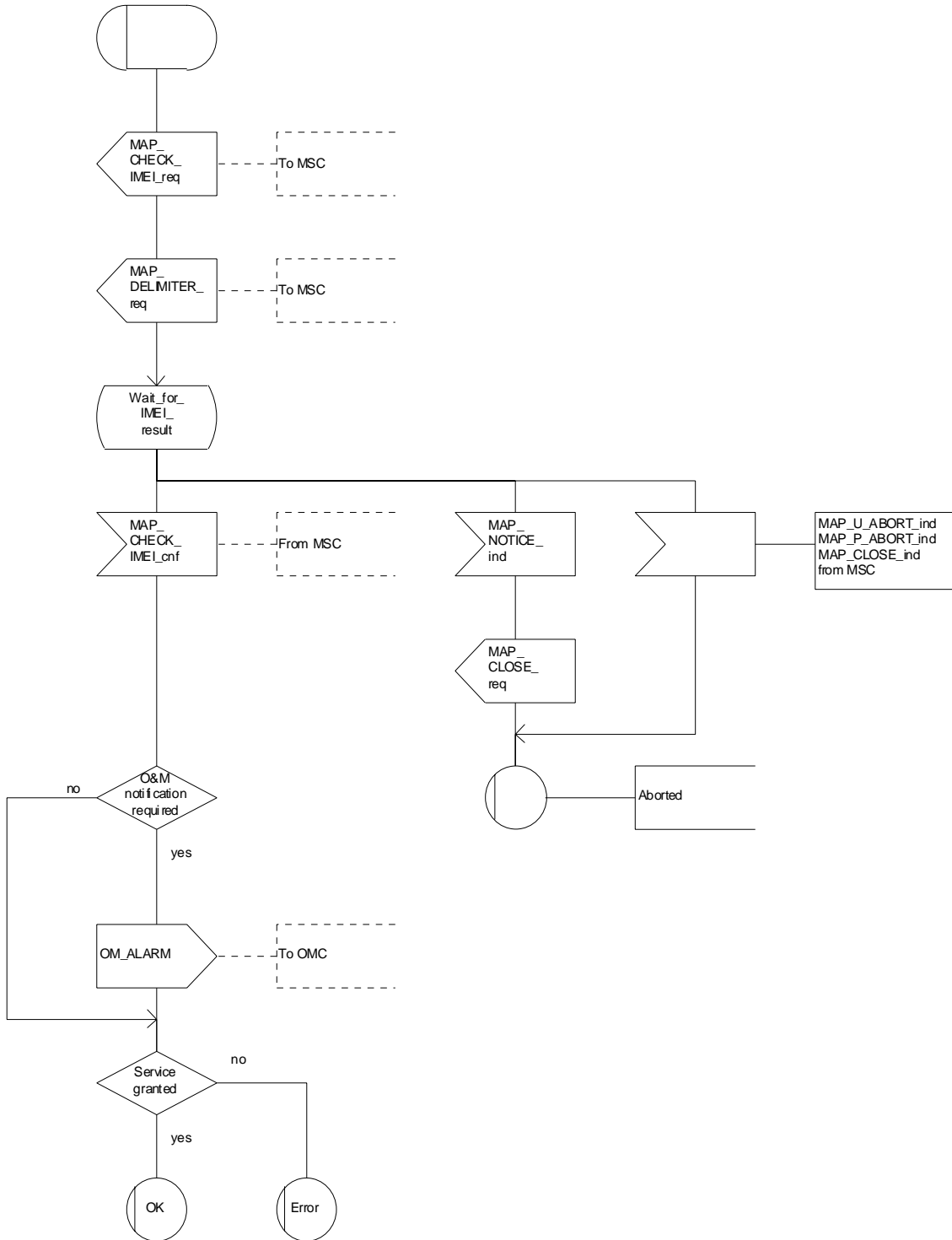

Figure 25.6/2: Process Check_IMEI_VLR

Process Check_IMEI_EIR

25.6_3(1)

Figure 25.6/3: The process in the EIR to check an IMEI

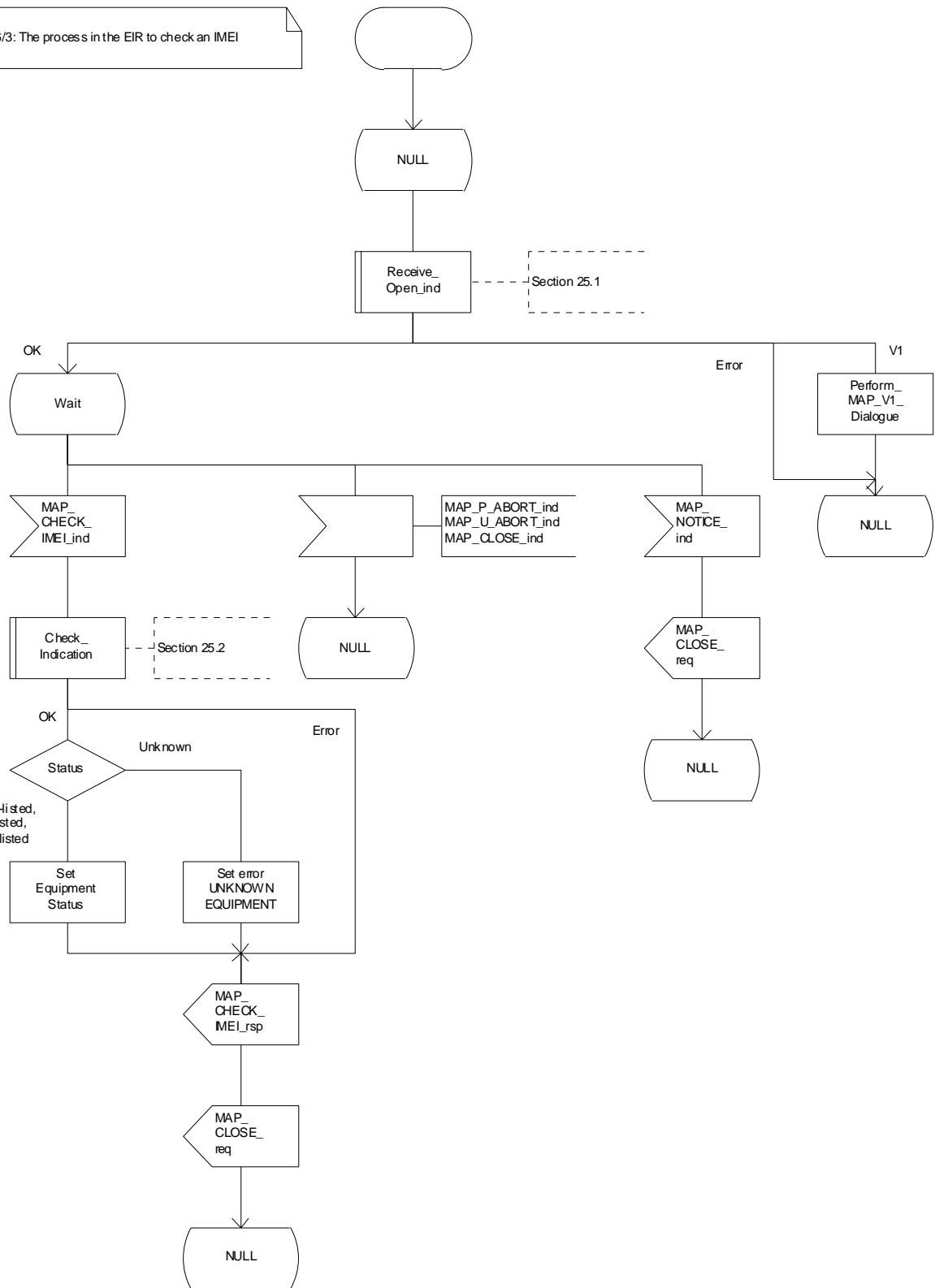

Figure 25.6/3: Process Check_IMEI_EIR

Macrodefinition Obtain_IMEI_MSC

25.6_4(1)

Figure 25.6/4: Obtain IMEI macro in the MSC, receiving the Obtain_IMEI indication from the VLR to the MSC and returning the confirmation to the VLR

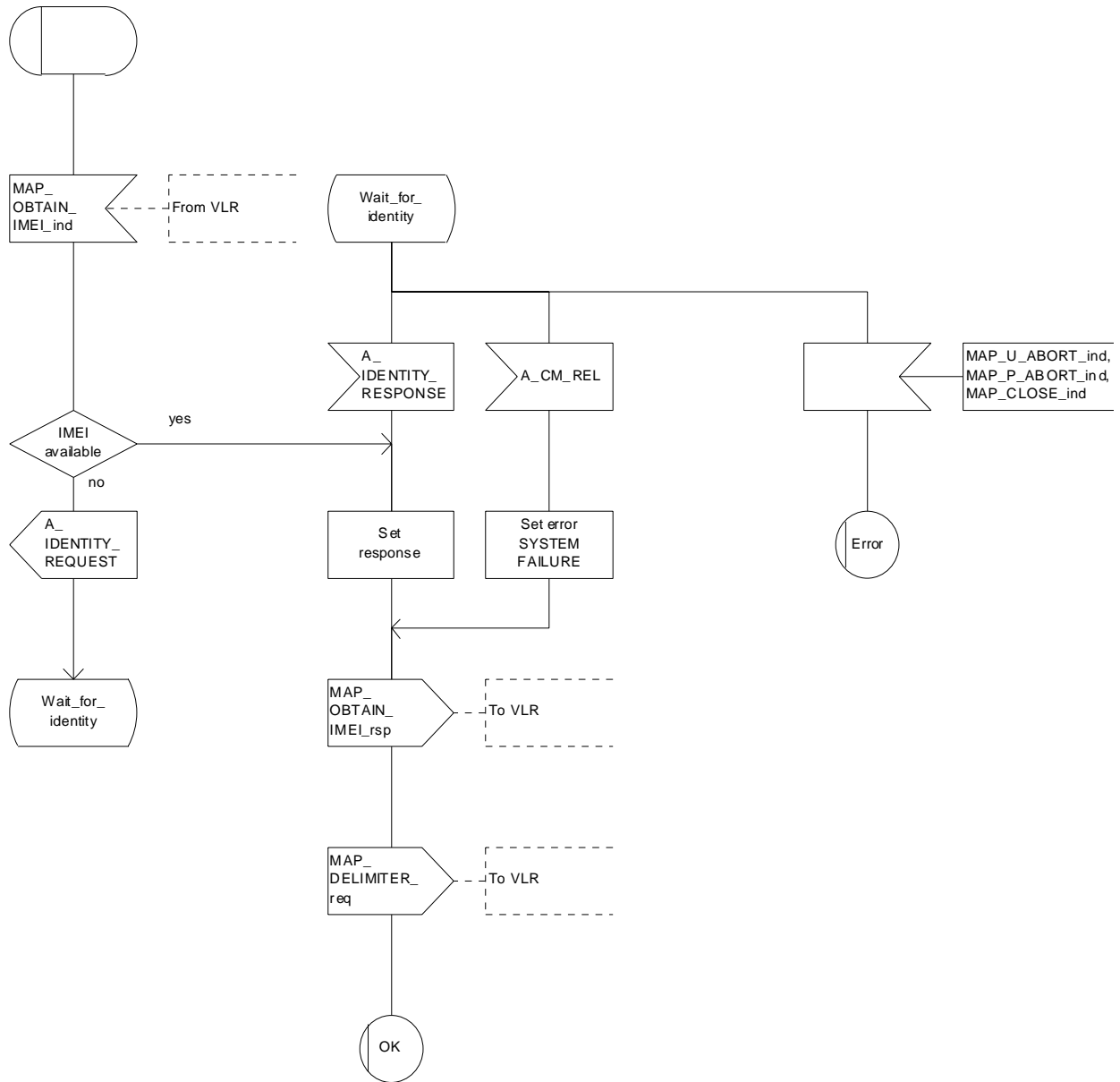

Figure 25.6/4: Process Obtain_IMEI_MSC

Macrodefinition Obtain_IMEI_VLR

25.6_5(1)

Figure 25.6/5: Obtain IMEI macro in the VLR, controlling the request towards the MSC

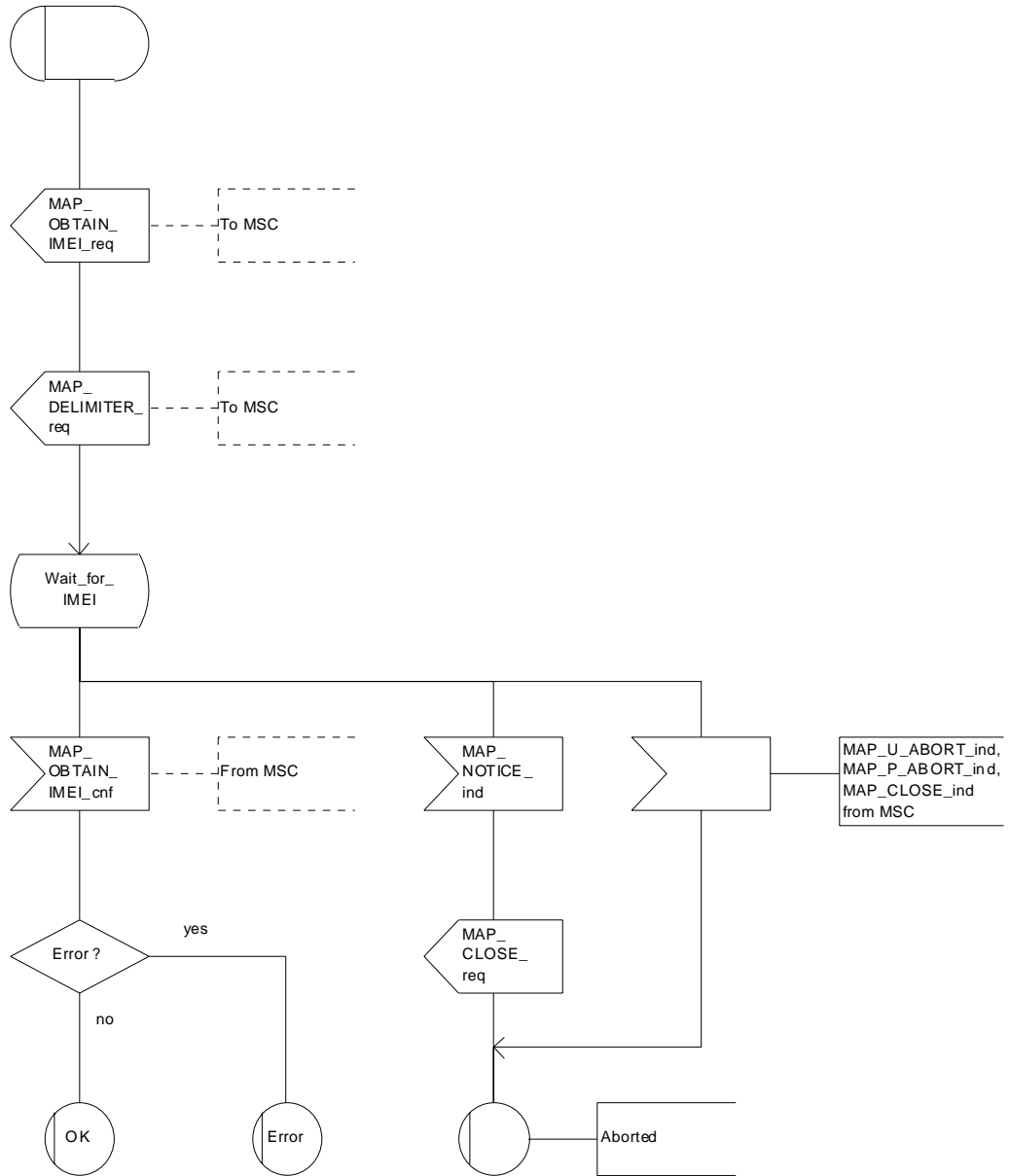

Figure 25.6/5: Process Obtain_IMEI_VLR

25.6.6 Process Check_IMEI_SGSN

This process is used by the SGSN to control the check of a mobile equipment's IMEI. The process proceeds as follows:

- if the MS does not complete successfully the procedure, the "Error" exit of the macro is used;
- when the IMEI is known, a connection is set up towards the EIR, and a MAP_CHECK_IMEI service request is sent including the IMEI;
- if the opening of the dialogue fails, a System Failure is set. Otherwise, the SGSN waits for a response from the EIR;
- if a MAP_CHECK_IMEI service confirm including either:
 - the IMEI and the Equipment Status; or
 - an error;is received, the SGSN checks whether the response requires that an alarm be generated on the Operation and Maintenance interface. The criteria for such alarms are PLMN operator dependent;
- the SGSN then checks whether the response from the EIR means that service is granted to the MS. The criteria for granting service depending on the equipment status or errors received in the MAP_CHECK_IMEI service response are also PLMN operator dependent;

If the dialogue with the EIR drops back to version 1, the result or error returned by the EIR is checked. The use of the "Check_Confirmation" macro in the SDL diagram indicates that the checks carried out on the result returned by the EIR in a MAP v1 dialogue are functionally equivalent to those carried out on the parameters of the MAP_CHECK_IMEI confirm received from the EIR in a MAP v2 dialogue.

The process is described in figure 25.6/6.

Process Check_IMEI_SGSN

25.6_6.1(2)

Figure 25.6/6: Check IMEI process in the SGSN

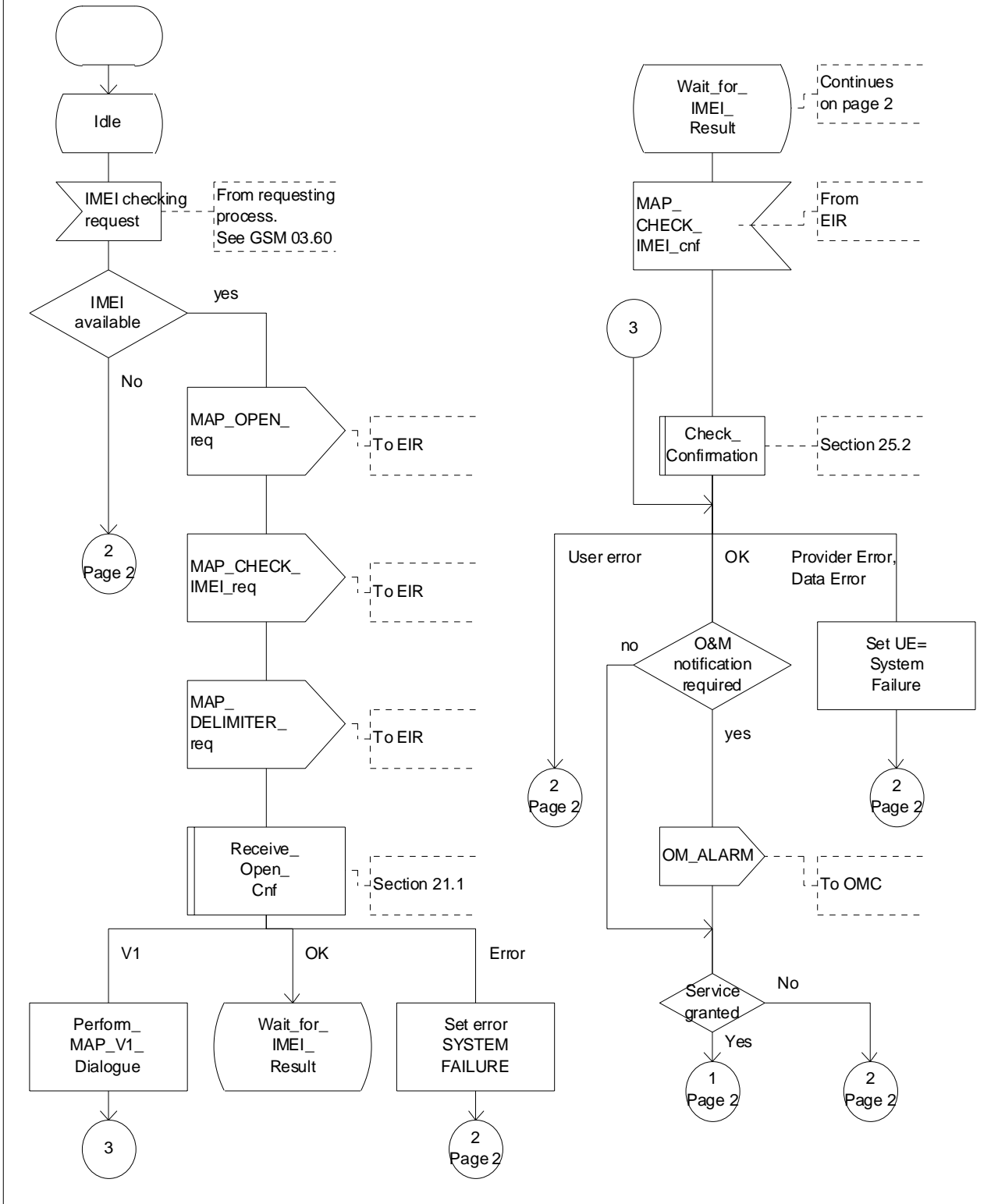

Figure 25.6/6 (sheet 1 of 2): Process Check_IMEI_SGSN

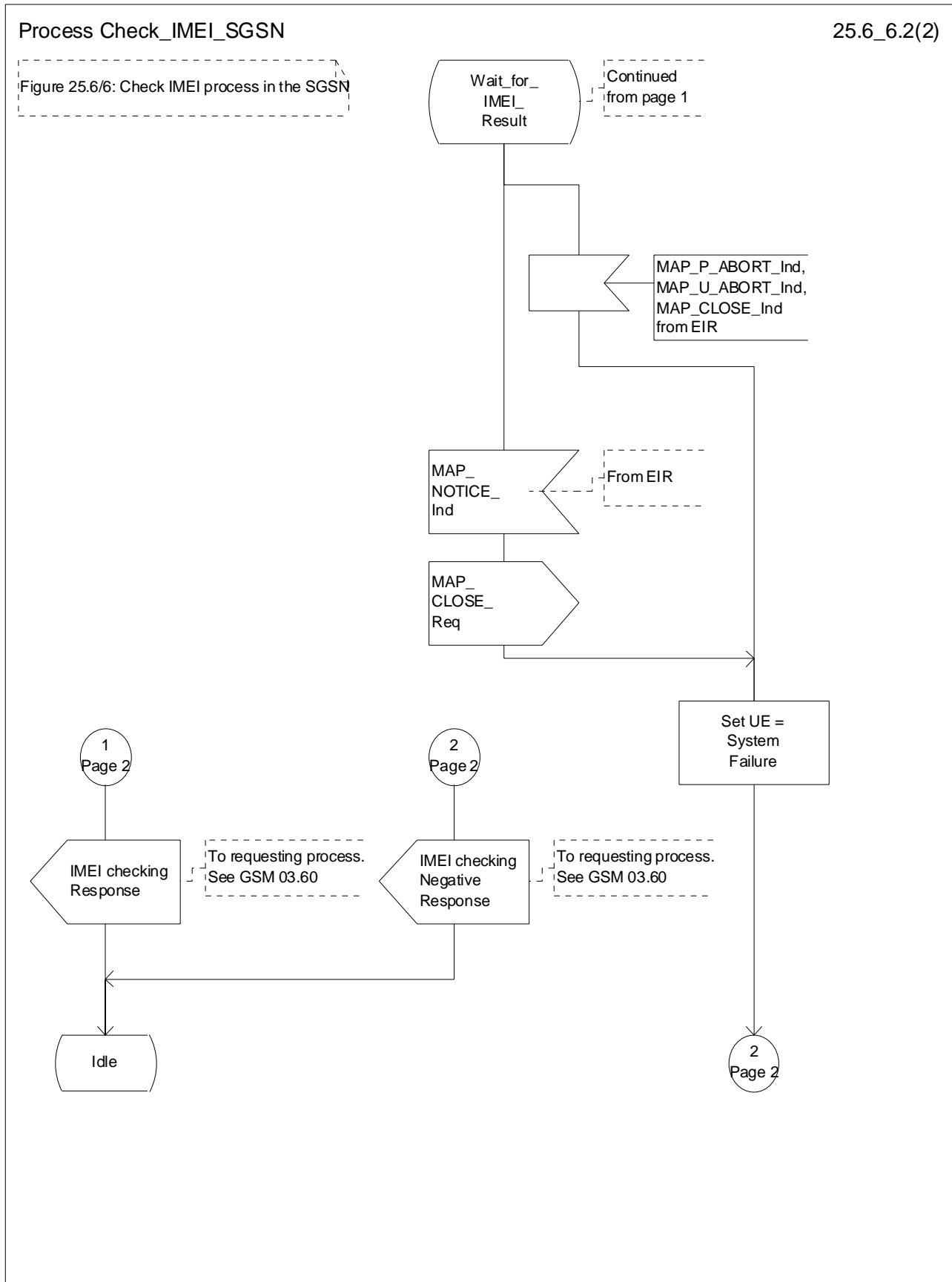

Figure 25.6/6 (sheet 2 of 2): Process Check_IMEI_SGSN

25.7 Insert Subscriber Data Macros

25.7.1 Macro Insert_SubData_VLR

This macro describes the reception of the InsertSubscriberData service indication. This macro is used by any procedure that triggers the reception of subscriber data (e.g. Update Location or Restore Data).

If the VLR does not support any basic or supplementary service or the network feature Operator Determined Barring, or there is a problem with Regional Subscription Data then it reports it to the HLR.

If the entire MSC area is restricted due to regional subscription this is reported to the HLR.

The SDL diagram is shown in figure 25.7/1.

Macrodefinition Insert_Subscriber_Data_VLR

25.7_1(1)

Figure 25.7/1: Macro to receive and store subscriber data in the VLR

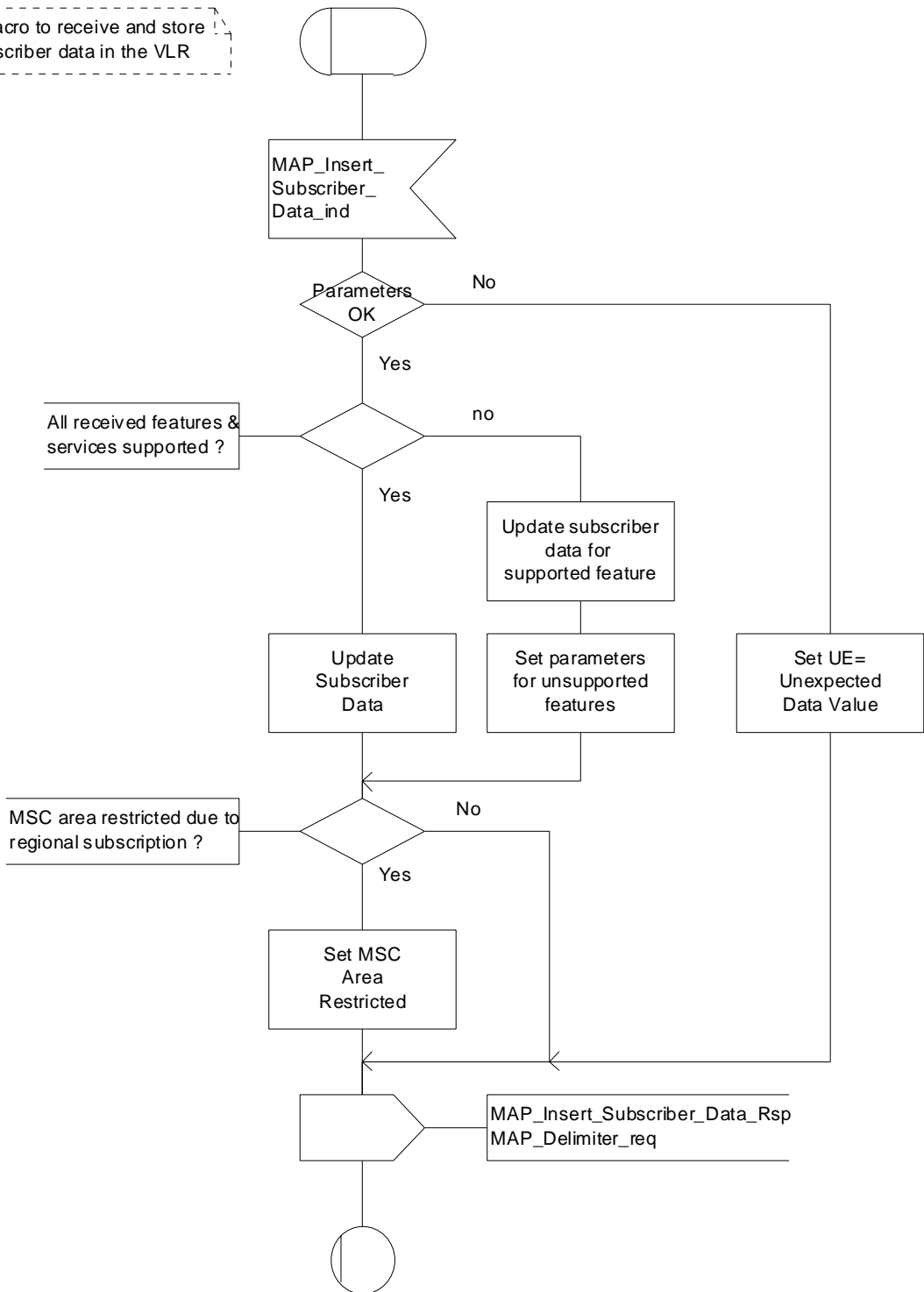

Figure 25.7/1: Macro Insert_Subscriber_Data_VLR

25.7.2 Process Insert_Subscriber_Data_Stand_Alone_HLR

This process is used by HLR to transfer subscriber data to VLR or to SGSN in a stand alone mode, i.e. in its own dialogue. This is done whenever a change of subscriber data is performed either by the operator or by the subscriber and this change has to be reported to VLR or to SGSN.

The process, after opening the dialogue with VLR or with SGSN, sends as many requests of the InsertSubscriberData service as necessary to transfer the subscriber data. The call to the process "Send_Insert_Subscriber_Data" (see clause 25.7.4) is meant to describe two possible behaviours of the HLR when more than one service request has to be sent:

- either the HLR handles the requests and the confirmations in parallel; or
- the HLR sends every request after receiving the confirmation to the previous one.

The macros "Wait_for_Insert_Subscriber_Data_Cnf" and "Wait_for_Insert_GPRS_Subscriber_Data_Cnf" (see clauses 25.7.3 and 25.7.6) are also called in order to handle every single confirmation.

If the result of a primitive received from the VLR or from the SGSN is unsuccessful, the HLR may initiate re-attempts; the number of repeat attempts and the time in between are HLR operator options, depending on the error returned by the VLR or by the SGSN.

If certain services required for a subscriber are not supported by the VLR or by the SGSN (e.g. Advice of Charge Charging Level), this may result in one of the following outcomes:

- the HLR stores and sends "Roaming Restriction Due To Unsupported Feature" in a subsequent MAP_INSERT_SUBSCRIBER_DATA service. If "Roaming Restriction Due To Unsupported Feature" is stored in the HLR, the "MSC Area Restricted Flag" shall be set to "restricted". This will prevent MT calls, MT SM and MT USSD from being forwarded to the MSC/VLR.
- the HLR stores and sends other induced subscriber data (e.g. a specific barring program) in a subsequent MAP_INSERT_SUBSCRIBER_DATA service. This will cause rejection of mobile originated service requests, except emergency calls.
- the HLR stores and sends "Roaming Restricted In SGSN Due To Unsupported Feature" in a subsequent MAP_INSERT_SUBSCRIBER_DATA service. If "Roaming Restricted In SGSN Due To Unsupported Feature" is stored in the HLR, the "SGSN Area Restricted Flag" shall be set to "restricted". This will prevent MT SM from being forwarded to the SGSN and Network Requested PDP-Context activation.

When the VLR receives regional subscription data (Zone Code List) it may respond with "MSC Area Restricted" in the MAP_INSERT_SUBSCRIBER_DATA response. In this case the "MSC Area Restricted Flag" shall be set to "restricted" in the HLR. This will prevent MT calls, MT SM and MT USSD from being forwarded to the MSC/VLR.

When the SGSN receives regional subscription data (Zone Code List) it may respond with "SGSN Area Restricted" in the MAP_INSERT_SUBSCRIBER_DATA response. In this case the "SGSN Area Restricted Flag" shall be set to "restricted" in the HLR. This will prevent MT SM from being forwarded to the SGSN and Network Requested PDP-Context activation.

If subscriber data for CAMEL Phase 2 or 3 services are sent to a VLR which does not support CAMEL Phase 2 or 3, the service behaviour may be unpredictable or incorrect. The HLR therefore needs to ensure that at the conclusion of a stand alone Insert Subscriber data procedure that the data in the VLR do not require a capability that the VLR does not have. Possible mechanisms to ensure this are described in 3GPP TS 23.078.

The HLR should send a Forwarded-to number which is not in E.164 international format to the VLR only when the HLR has ascertained that the VLR supports CAMEL Phase 2 or 3. Thus, the ISD message containing the Forwarded-to number which is not in E.164 international format shall be sent to the VLR only if the HLR previously received confirmation from the VLR at Location Update that CAMEL Phase 2 or 3 is supported.

A Forwarded-to number in non-international E.164 format shall only be sent from an HLR to a VLR if the VLR supports CAMEL Phase 2, or a subsequent version of CAMEL.

If the HLR does not store "Roaming Restriction Due To Unsupported Feature" as a consequence of the stand alone Insert Subscriber Data procedure and the HLR does not receive "MSC Area Restricted" in the MAP_INSERT_SUBSCRIBER_DATA response and "Roaming Restriction Due To Unsupported Feature" has not been stored in the HLR in the course of a previous subscriber data retrieval procedure, the "MSC Area Restricted Flag" in the HLR shall be set to "not restricted".

If the HLR does not store "Roaming Restricted In SGSN Due To Unsupported Feature" as a consequence of the stand alone Insert Subscriber Data procedure and the HLR does not receive "SGSN Area Restricted" in the MAP_INSERT_SUBSCRIBER_DATA response and "Roaming Restricted In SGSN Due To Unsupported Feature" has not been stored in the HLR in the course of a previous subscriber data retrieval procedure, the "SGSN Area Restricted Flag" in the HLR shall be set to "not restricted".

The SDL diagram of process between HLR and VLR is shown in figure 25.7/2;

The SDL diagram of process between HLR and SGSN is shown in figure 25.7/5.

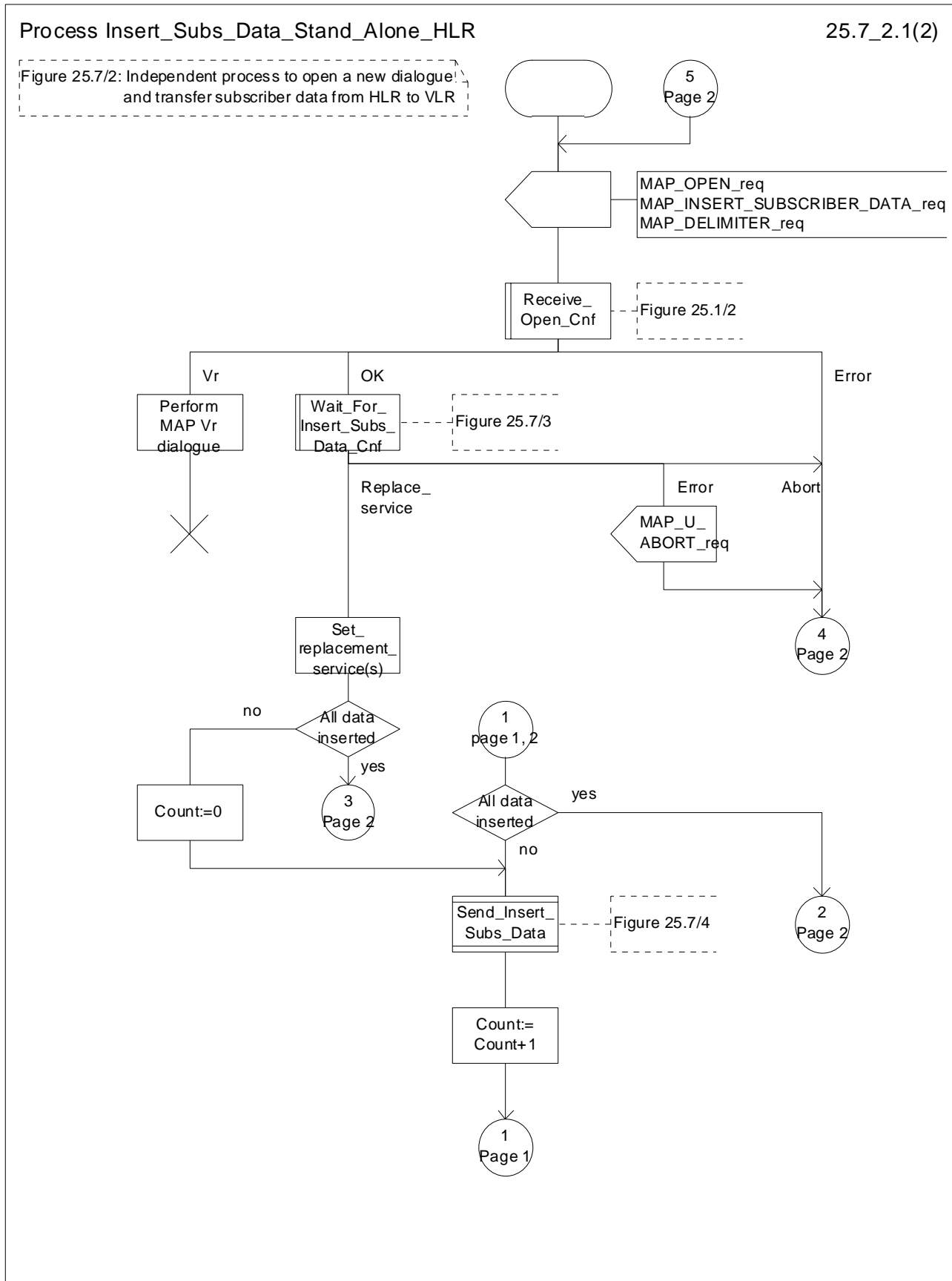

Figure 25.7/2 (sheet 1 of 2): Process Insert_Subs_Data_Stand_Alone_HLR

Process Insert_Subscriber_Data_Stand_Alone_HLR

25.7_2.2(2)

Figure 25.7/2: Independent process to open a new dialogue and transfer subscriber data from HLR to VLR

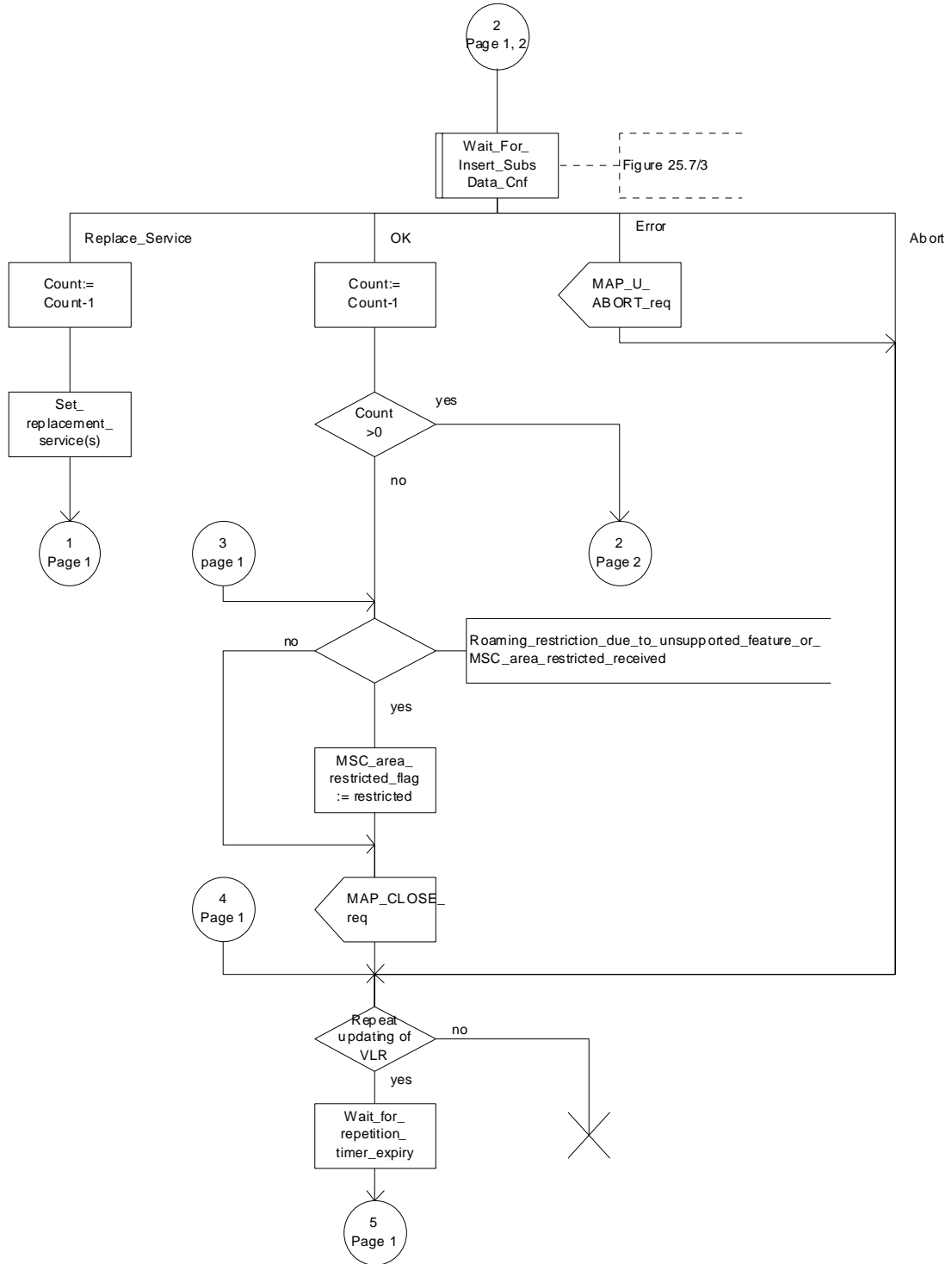

Figure 25.7/2 (sheet 2 of 2): Process Insert_Subscriber_Data_Stand_Alone_HLR

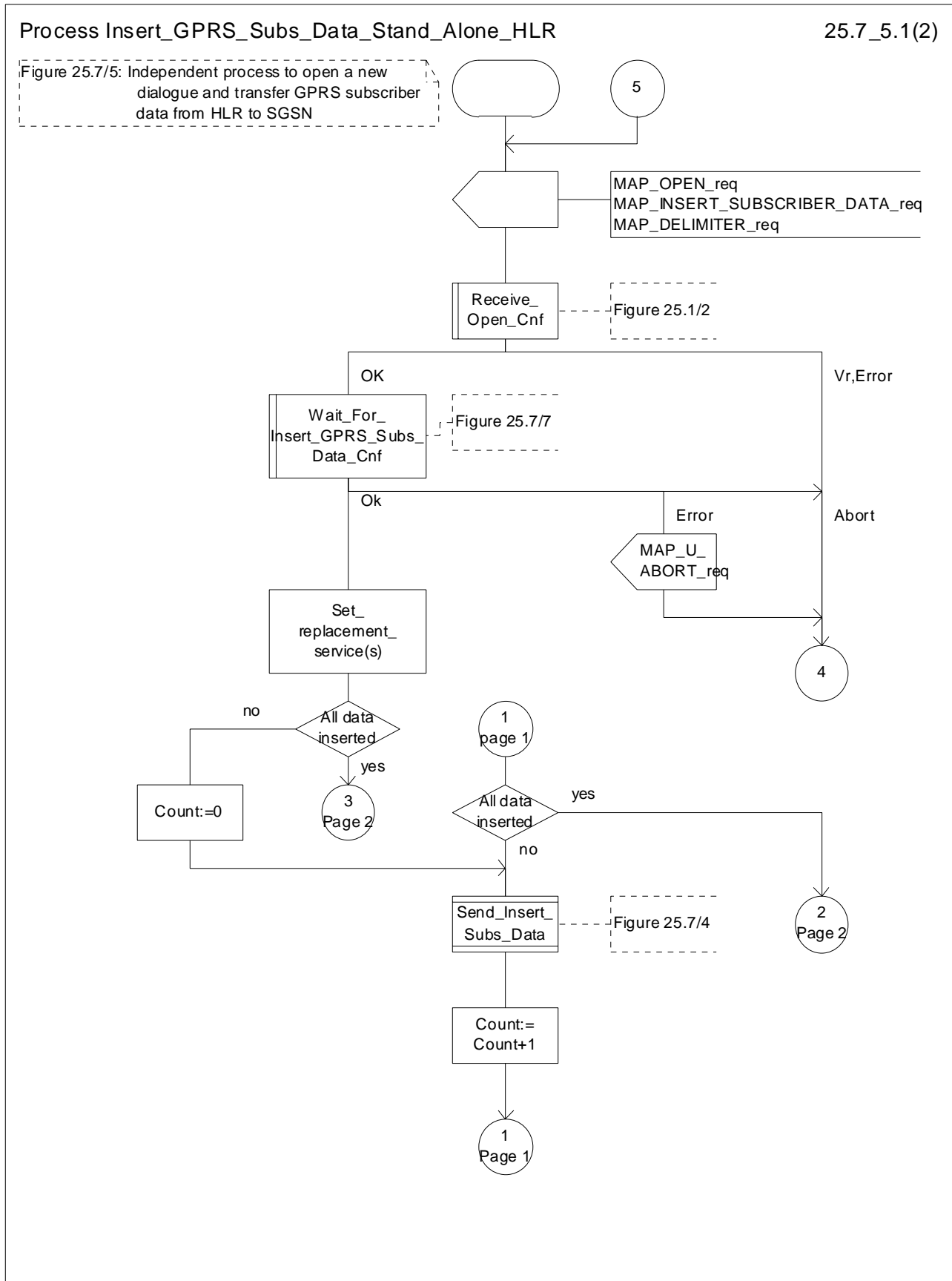

Figure 25.7/5 (sheet 1 of 2): Process Insert_GPRS_Subscriber_Data_Stand_Alone_HLR

Process Insert_GPRS_Subscriber_Data_Stand_Alone_HLR

25.7_5.2(2)

Figure 25.7/5: Independent process to open a new dialogue and transfer GPRS subscriber data from HLR to SGSN

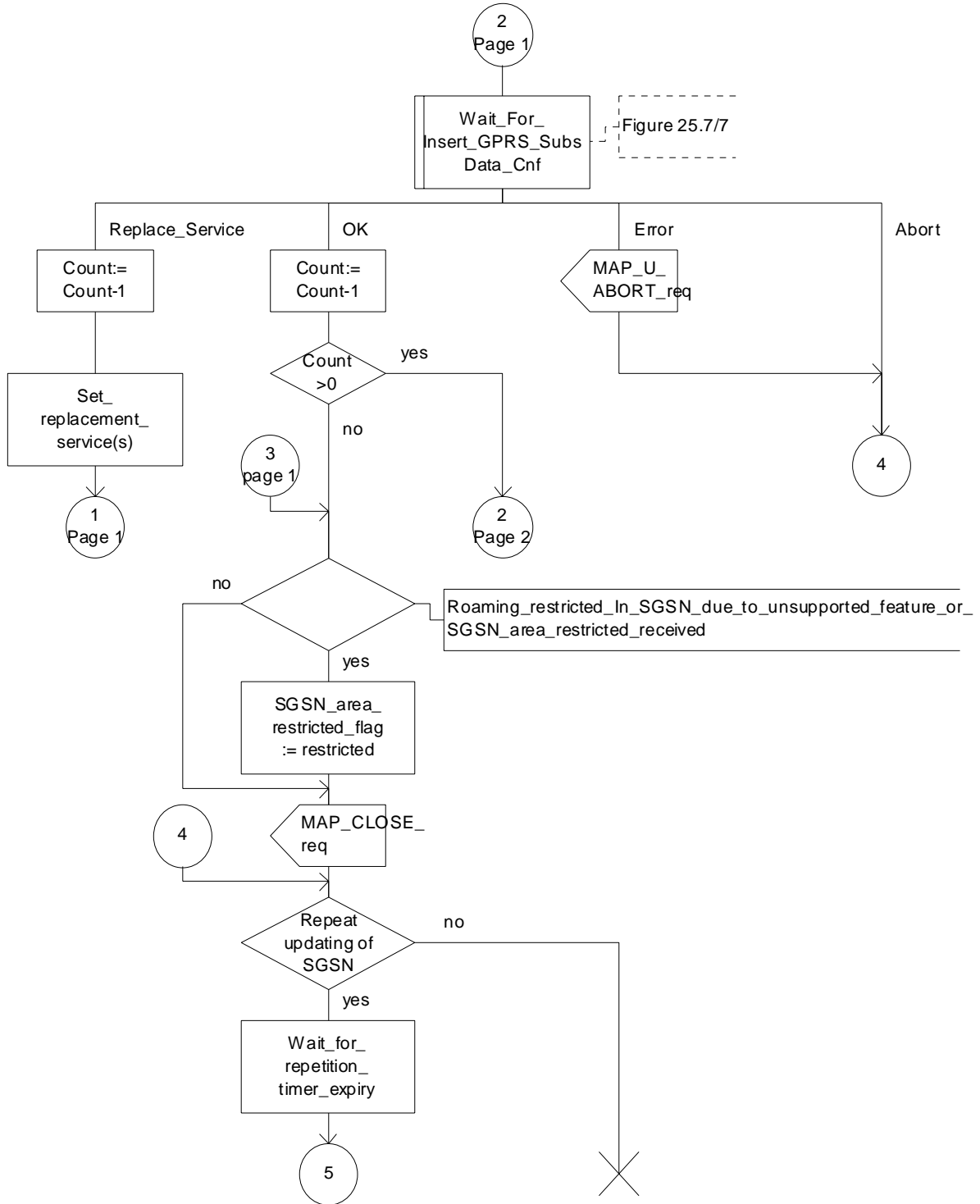

Figure 25.7/5 (sheet 2 of 2): Process Insert_GPRS_Subscriber_Data_Stand_Alone_HLR

25.7.3 Macro Wait_for_Insert_Subs_Data_Cnf

This macro is used by any process or macro that describes the handling of the reception of the Insert_Subscriber_Data service in HLR that is coming from VLR (e.g. Update Location or Restore Data).

If the VLR reports the non-support of some basic or supplementary service or the network feature Operator Determined Barring then three actions are possible:

- to ignore the information received;
- to replace the not supported service;
- or to perform any other internal action.

The SDL diagram is shown in figure 25.7/3.

Macrodefinition Wait_For_Insert_Subscriber_Data_Cnf

25.7_3(1)

Figure 25.7/3: Macro to receive confirmation or error indication for MAP_INSERT_SUBSCRIBER_DATA

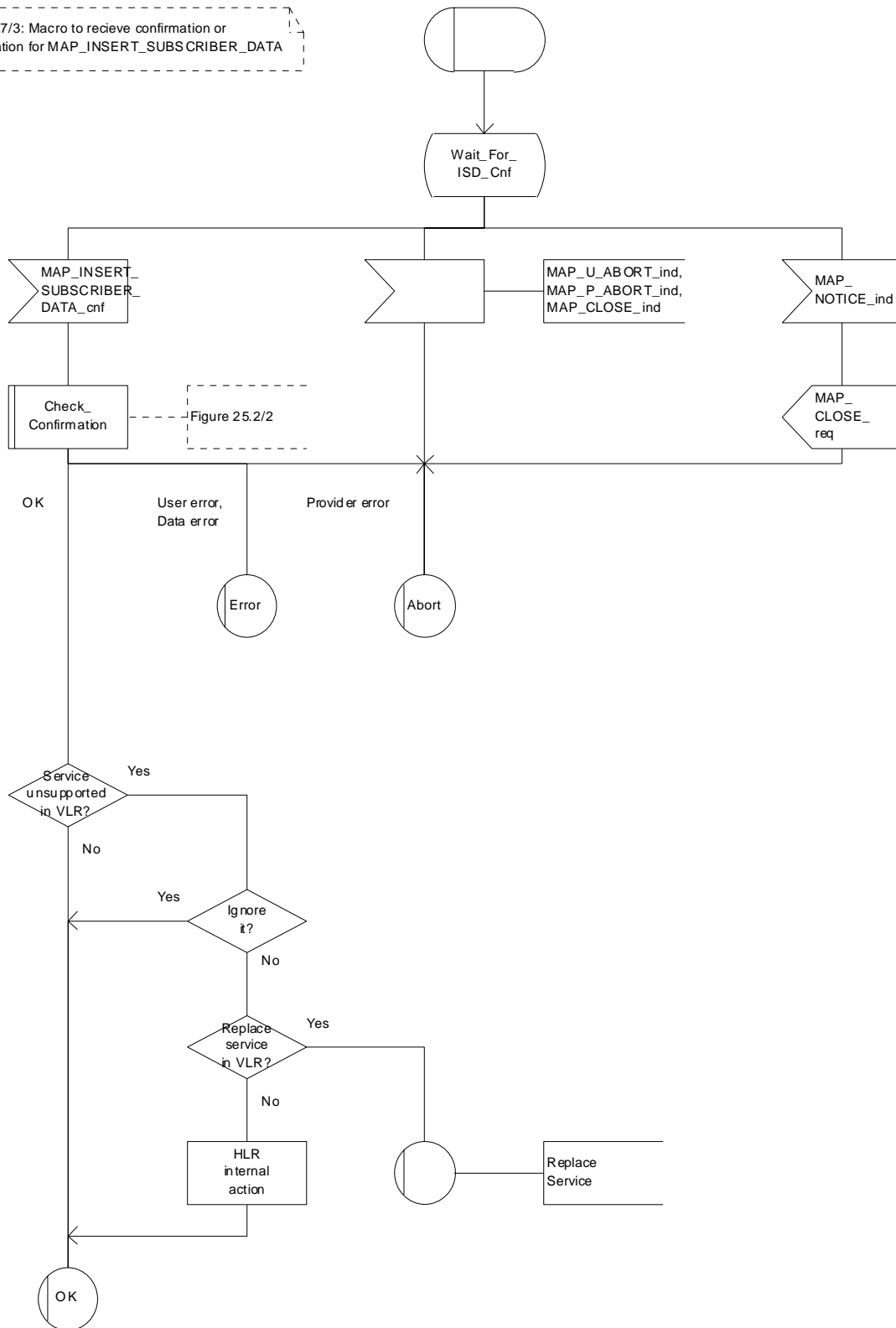

Figure 25.7/3: Macro Wait_for_Insert_Subscriber_Data_Cnf

25.7.4 Process Send_Insert_SubData

This process is used by any process or macro where the Insert_Subscriber_Data request is sent to VLR or to SGSN.

The SDL diagram is shown in figure 25.7/4.

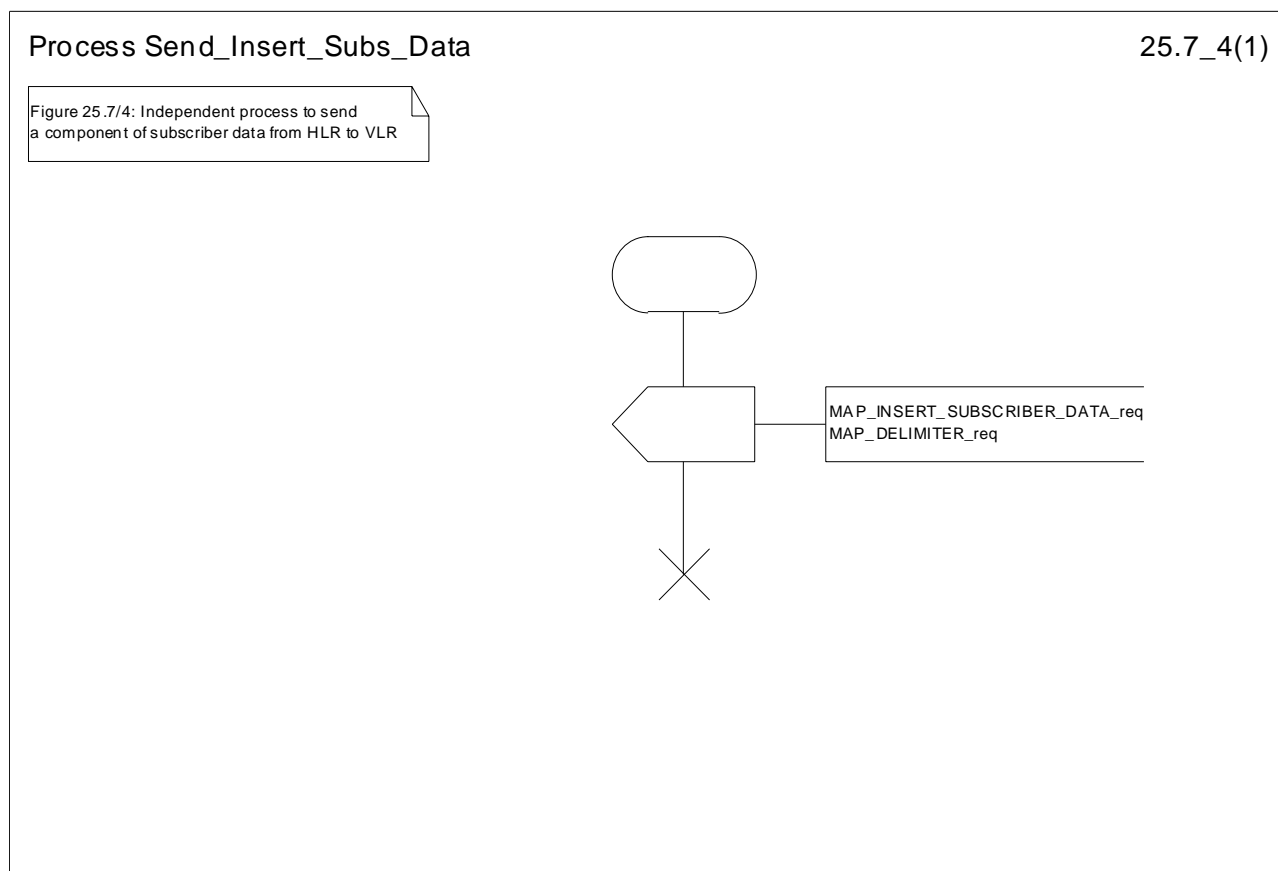

Figure 25.7/4: Process Send_Insert_SubData

25.7.5 Macro Insert_SubData_SGSN

This macro describes the reception of the InsertSubscriberData service indication. This macro is used by any procedure that triggers the reception of subscriber data (e.g. Update GPRS Location).

If the SGSN does not support any basic or the network feature Operator Determined Barring, or there is a problem with Regional Subscription Data then it reports it to the HLR.

If the entire SGSN area is restricted due to regional subscription this is reported to the HLR.

The SDL diagram is shown in figure 25.7/6.

Macrodefinition Insert_Subscriber_Data_SGSN

25.7_6(1)

Figure 25.7/6: Macro to receive and store subscriber data in the SGSN

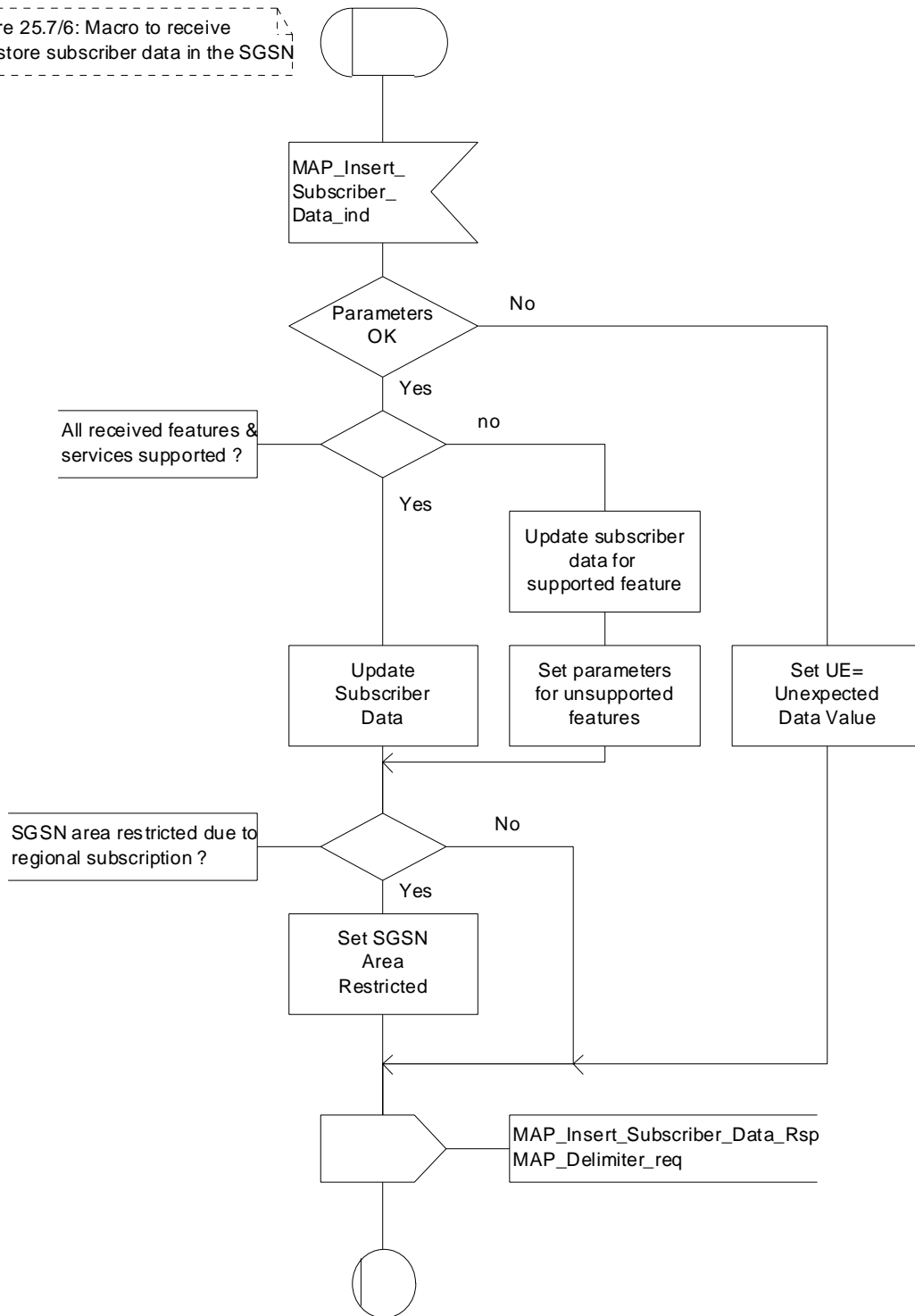

Figure 25.7/6: Macro Insert_Subscriber_Data_SGSN

25.7.6 Macro Wait_for_Insert_GPRS_Subscriber_Data_Cnf

This macro is used by any process or macro that describes the handling of the reception of the Insert_Subscriber_Data service in HLR that is coming from SGSN (e.g. Update GPRS Location).

If the SGSN reports the non-support of some basic or the network feature Operator Determined Barring then three actions are possible:

- to ignore the information received;
- to replace the not supported service;
- or to perform any other internal action.

The SDL diagram is shown in figure 25.7/7.

Macrodefinition Wait_For_Insert_GPRS_Subscriber_Data_Cnf

25.7_7(1)

Figure 25.7/7: Macro to receive confirmation or error indication for MAP_INSERT_SUBSCRIBER_DATA from SGSN

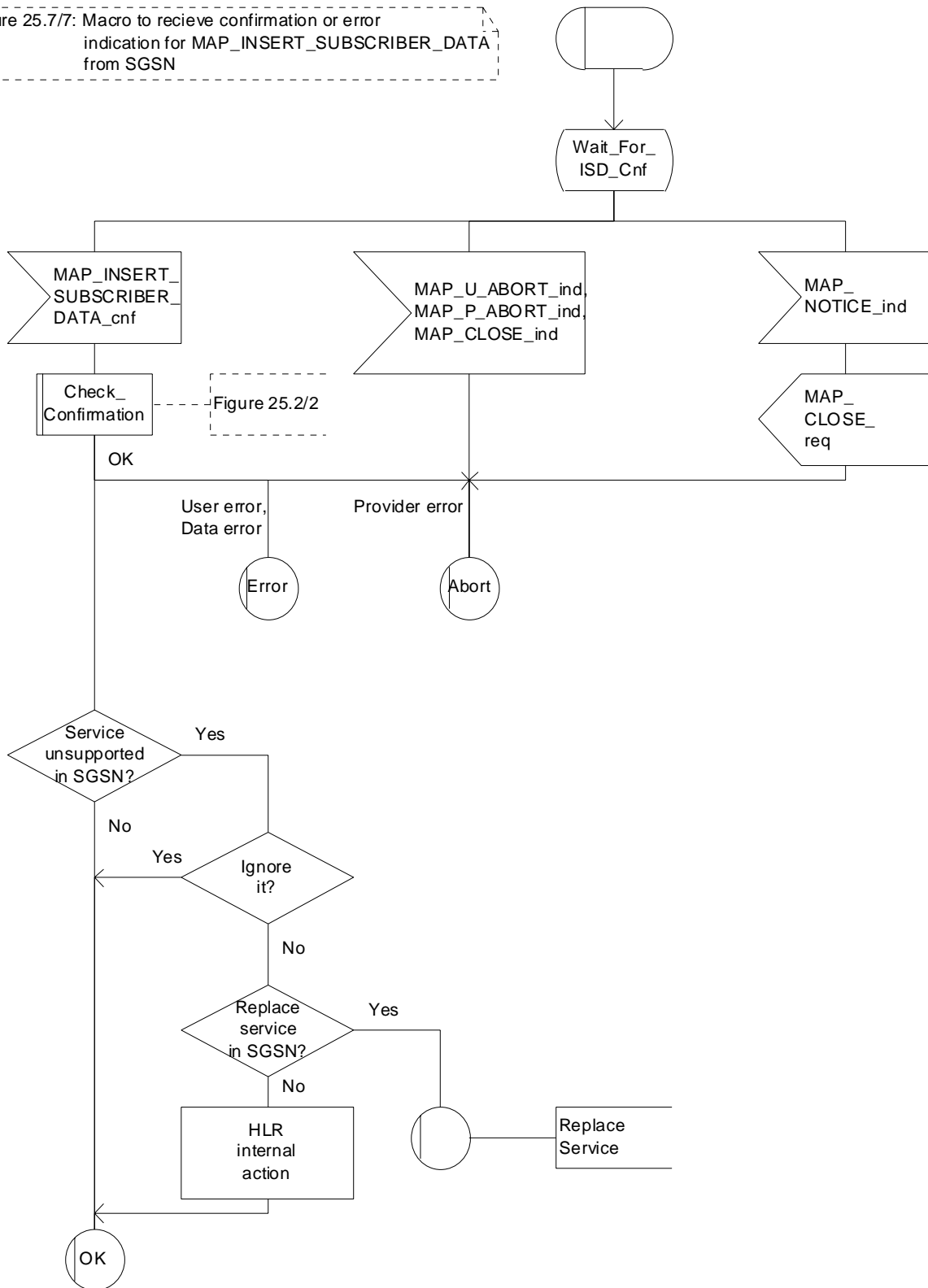

Figure 25.7/7: Macro Wait_for_Insert_GPRS_Subscriber_Data_Cnf

25.8 Request IMSI Macros

25.8.1 Macro Obtain_IMSI_MSC

This macro describes the handling of the request received from the VLR to provide the IMSI of a subscriber (e.g. at Location Updating).

The SDL diagram is shown in figure 25.8/1.

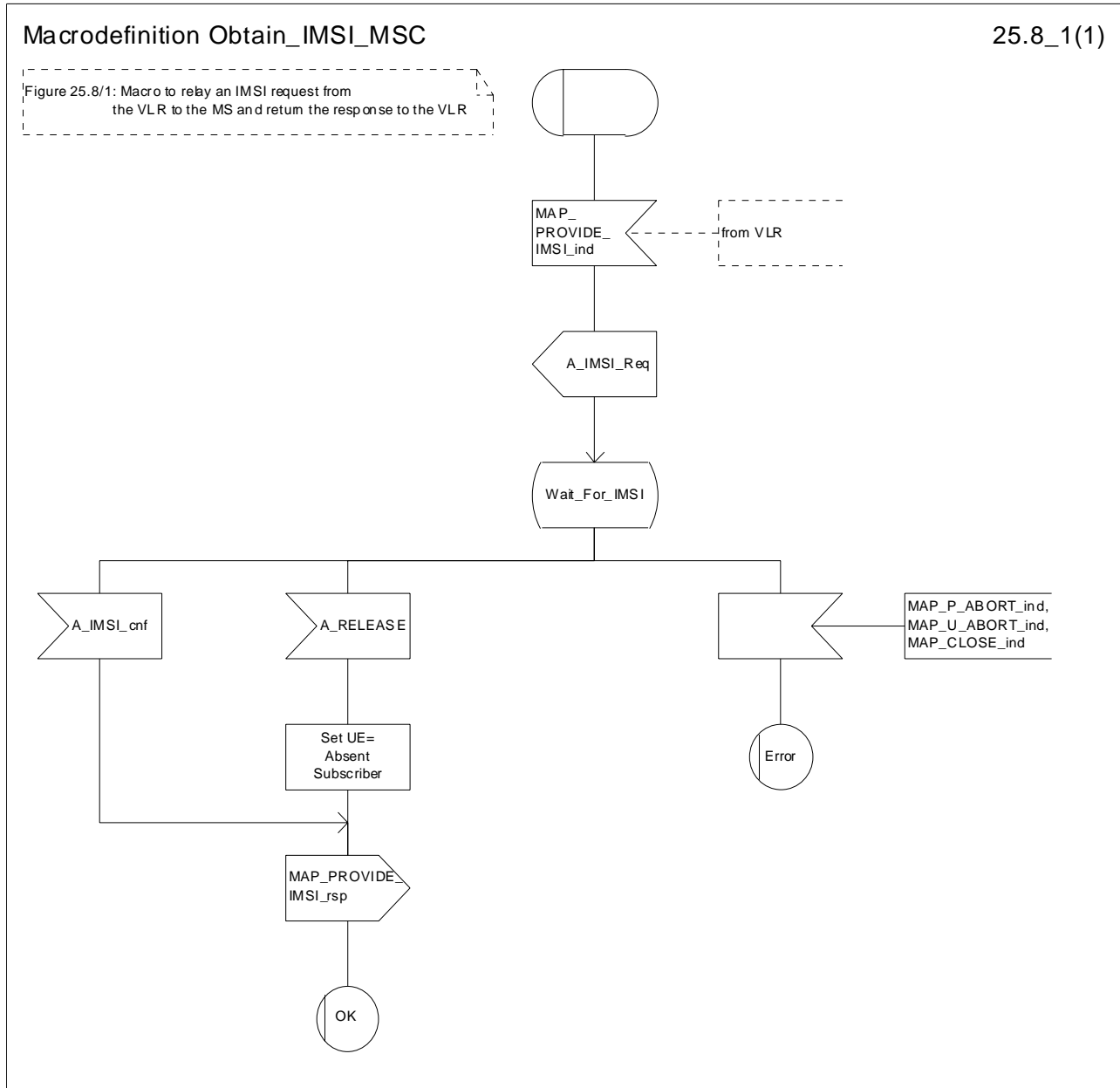

Figure 25.8/1: Macro Obtain_IMSI_MSC

25.8.2 Macro Obtain_IMSI_VLR

This macro describes the way VLR requests the MSC the IMSI of a subscriber (e.g. at Location Updating).

The SDL diagram is shown in figure 25.8/2.

Macrodefinition Obtain_IMSI_VLR

25.8_2(1)

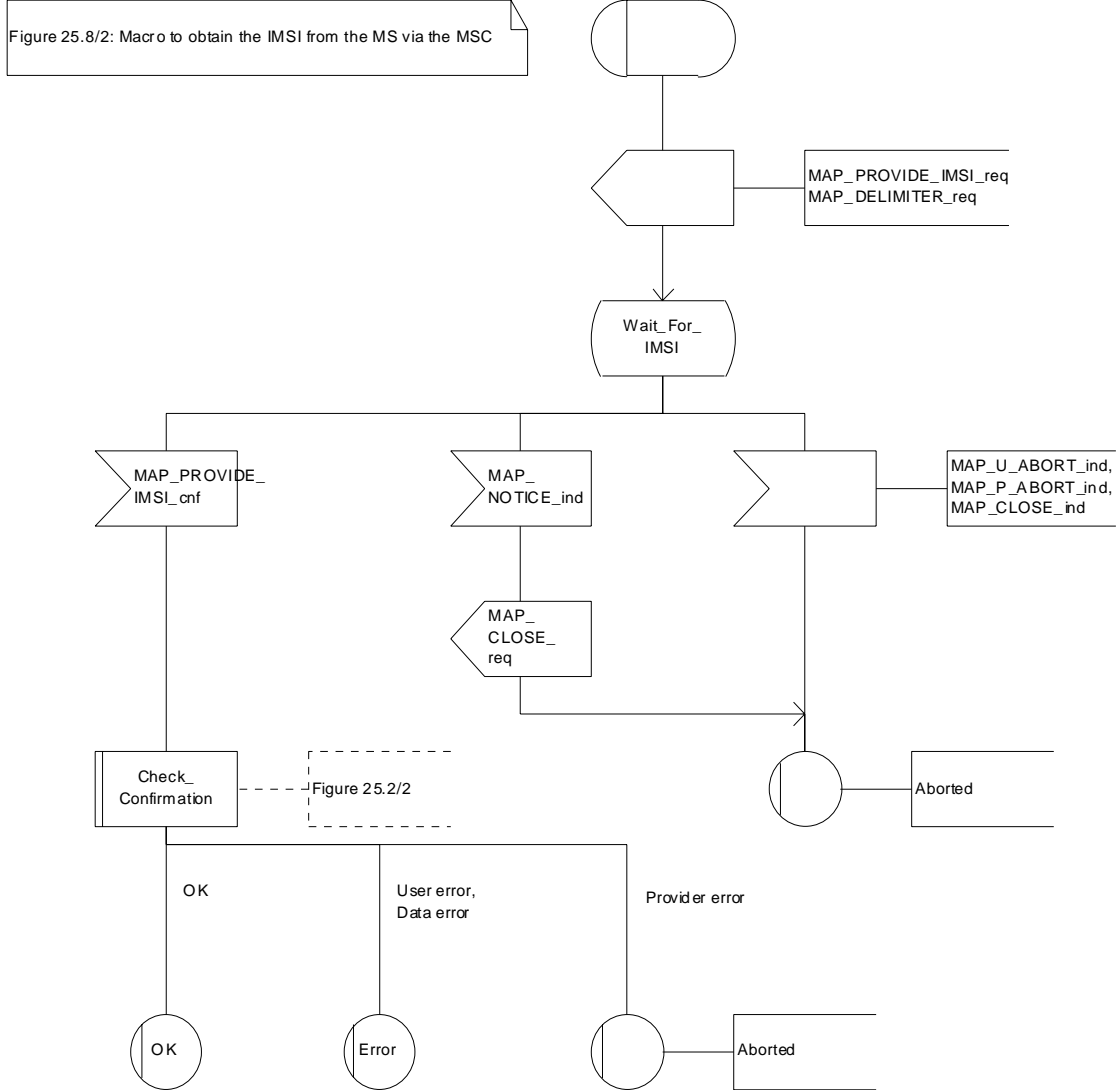

Figure 25.8/2: Macro Obtain_IMSI_VLR

25.9 Tracing macros

25.9.1 Macro Trace_Subscriber_Activity_MSC

The Trace_Subscriber_Activity_MSC is invoked in the MSC, when the MSC receives the MAP_TRACE_SUBSCRIBER_ACTIVITY indication from the VLR. The data of the primitive is checked and the tracing in the MSC is started if the content includes no errors. No response is returned to the VLR.

The Trace_Subscriber_Activity_MSC macro is described in the figure 25.9/1.

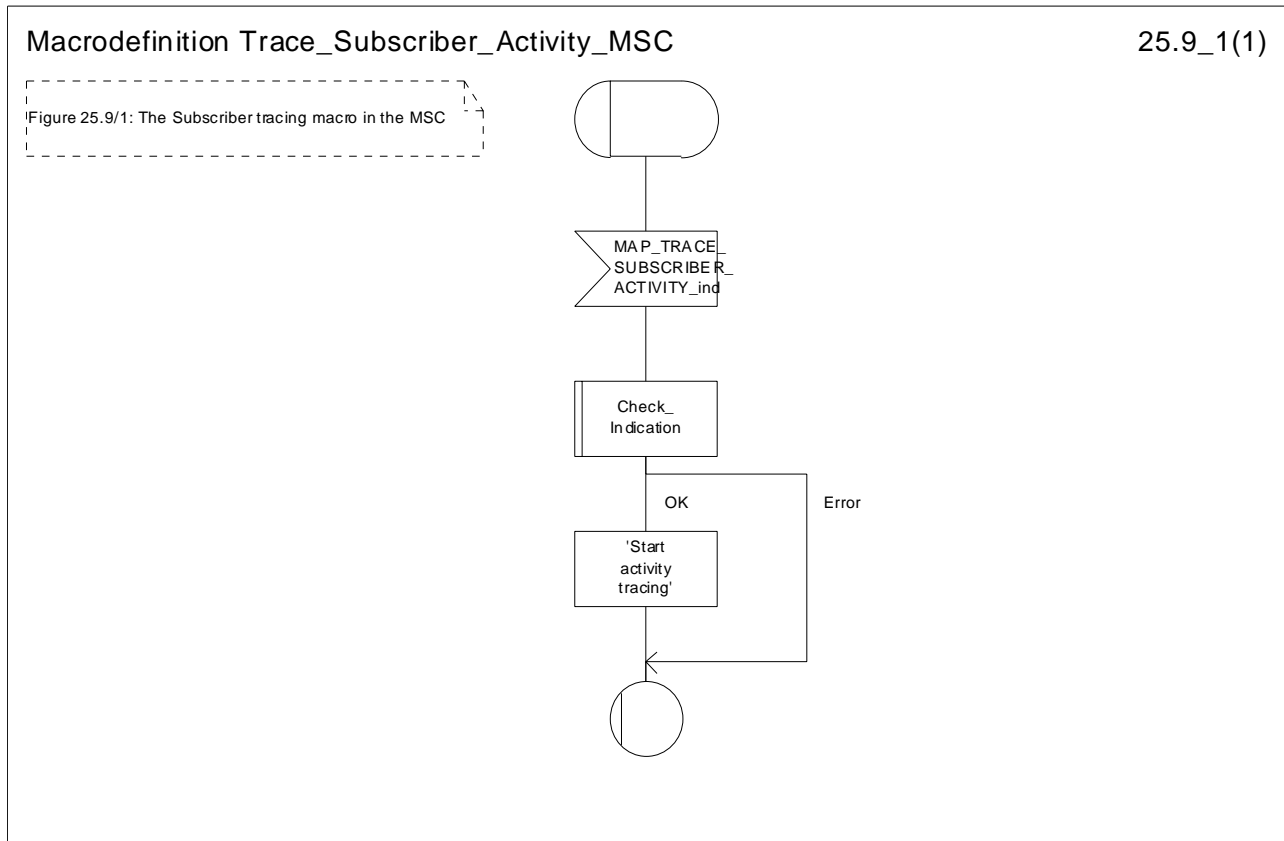

Figure 25.9/1: Macro Trace_Subscriber_Activity_MSC

25.9.2 Macro Trace_Subscriber_Activity_VLR

The macro Trace_Subscriber_Activity_VLR is invoked, if the subscriber activity is detected by the VLR and the tracing is active. The VLR sends MAP_TRACE_SUBSCRIBER_ACTIVITY request to the MSC. No answer is awaited from the MSC.

The Trace_Subscriber_Activity_VLR macro is shown in the figure 25.9/2.

Macrodefinition Trace_Subscriber_Activity_VLR

25.9_2(1)

Figure 25.9/2: The subscriber tracing macro in the VLR

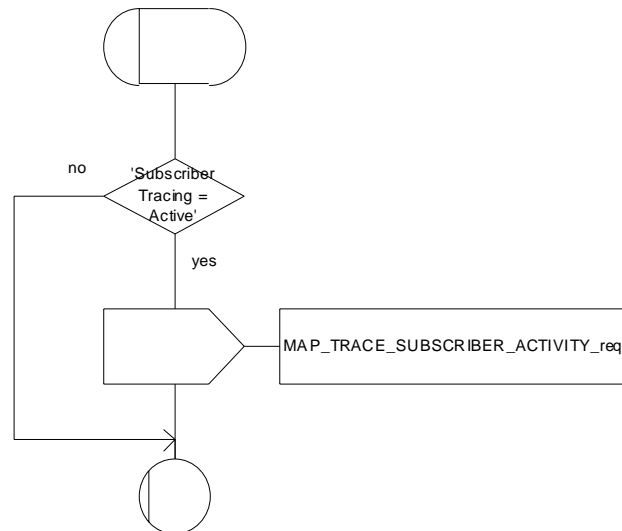

Figure 25.9/2: Macro Trace_Subscriber_Activity_VLR

25.9.3 Macro Activate_Tracing_VLR

The Activate_Tracing_VLR macro is invoked, when the MAP_ACTIVATE_TRACE_MODE indication is received from the HLR. The primitive is processed in the VLR as follows:

- if the data contains errors, a data missing or unexpected data value indication is returned to the HLR;
- if the tracing is not supported, a facility not supported indication is returned to the HLR;
- if the tracing buffer does not have any space left for the data, a tracing buffer full indication is returned to the HLR;
- if no errors are detected, the tracing is set active and a positive acknowledgement is returned to the HLR.

The Activate_Tracing_VLR macro is described in the figure 25.9/3.

Macrodefinition Activate_Tracing_VLR

25.9_3(1)

Figure 25.9/3: The activate trace mode macro in the VLR

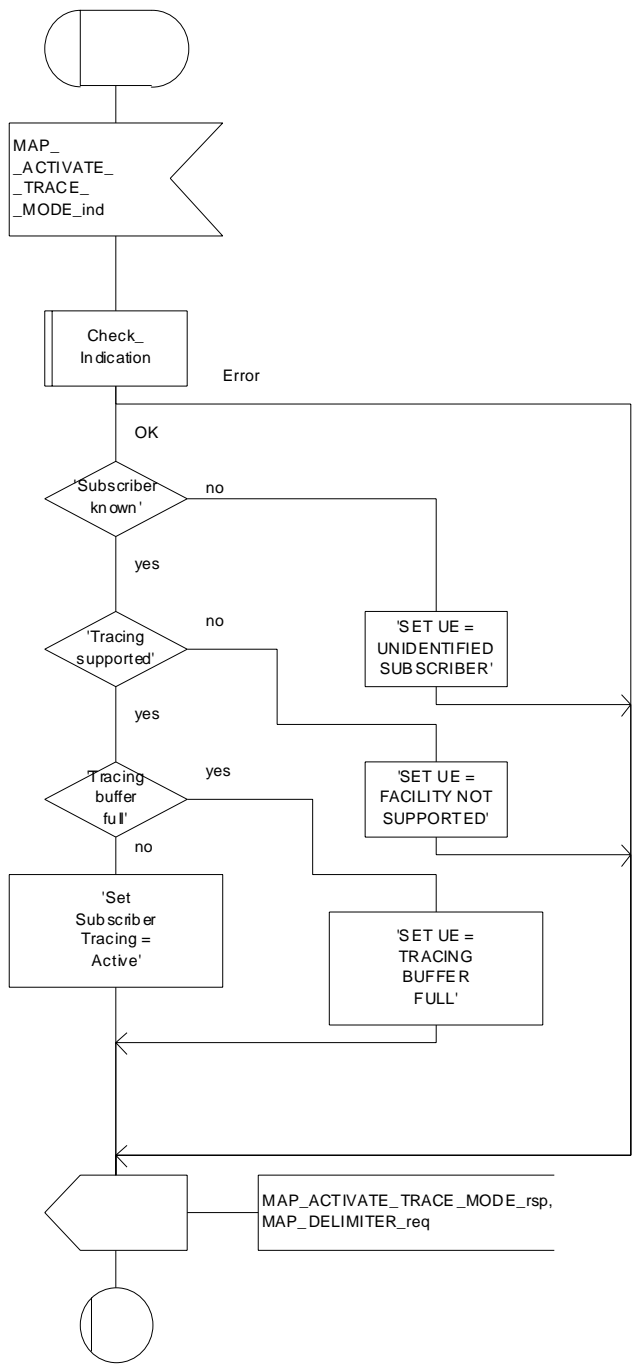

Figure 25.9/3: Macro Activate_Tracing_VLR

25.9.4 Macro Control_Tracing_HLR

The Control_Tracing_HLR macro may be invoked in the HLR, if subscriber related activity is detected. If the tracing is active in the HLR and not active in the VLR or in the SGSN, the MAP_ACTIVATE_TRACE_MODE request is sent to the VLR or to the SGSN.

The MAP_ACTIVATE_TRACE_MODE confirmation from the VLR or from the SGSN is processed as follows:

- if the primitive contains a successful acknowledgement, the tracing in VLR or in the SGSN is set active;
- if the primitive contains errors, the tracing in VLR or in SGSN is set to deactivate.

The Control_Tracing_HLR macro between HLR and VLR is shown in the figure 25.9/4.

The Control_Tracing_HLR_with_SGSN macro between HLR and SGSN is shown in the figure 25.9/5.

Macrodefinition Control_Tracing_HLR

25.9_4(1)

Figure 25.9/4: The subscriber tracing activation macro in the HLR

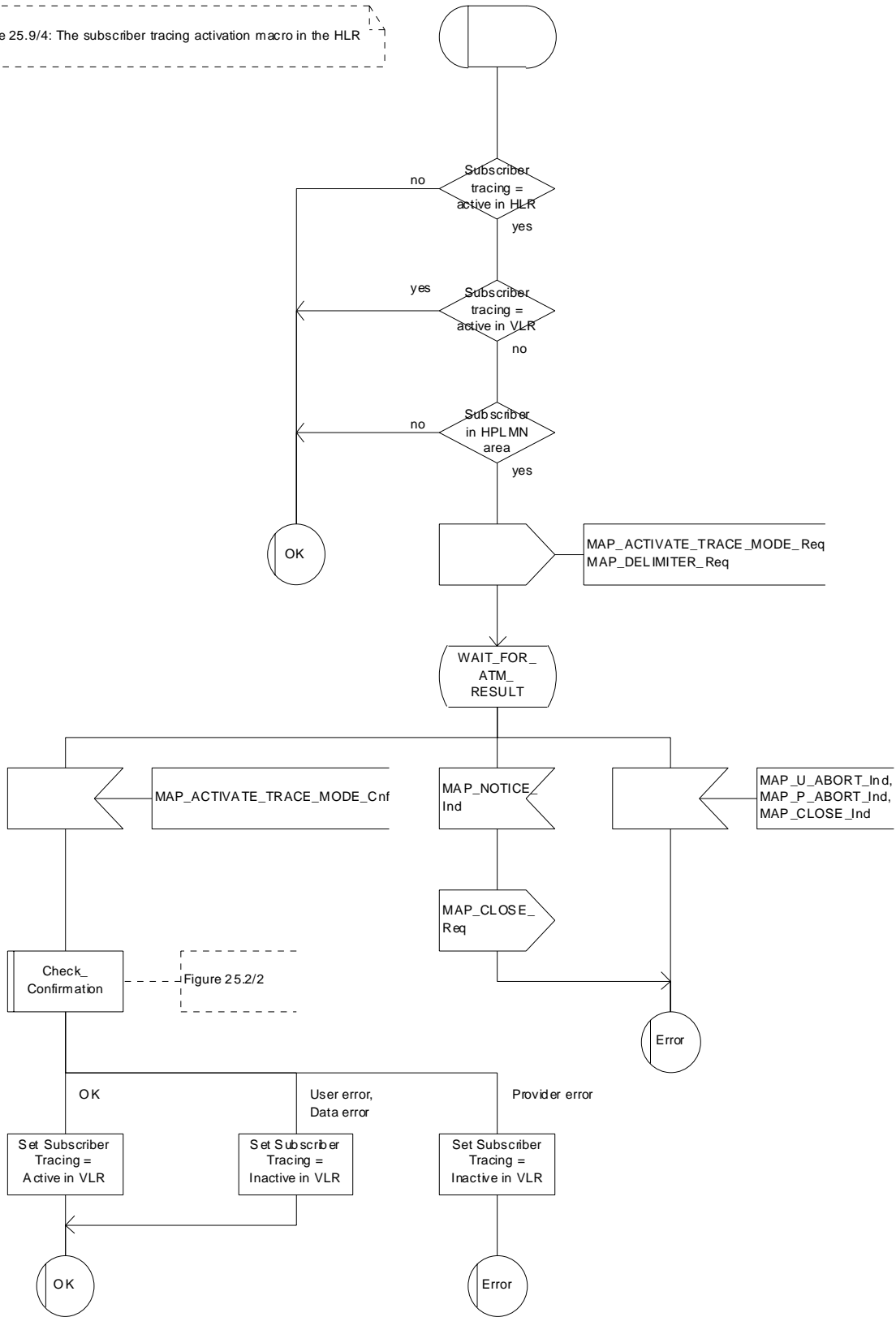

Figure 25.9/4: Macro Control_Tracing_HLR

Macrodefinition Control_Tracing_HLR_with_SGSN

25.9_5(1)

Figure 25.9/5: The subscriber tracing activation macro in the HLR

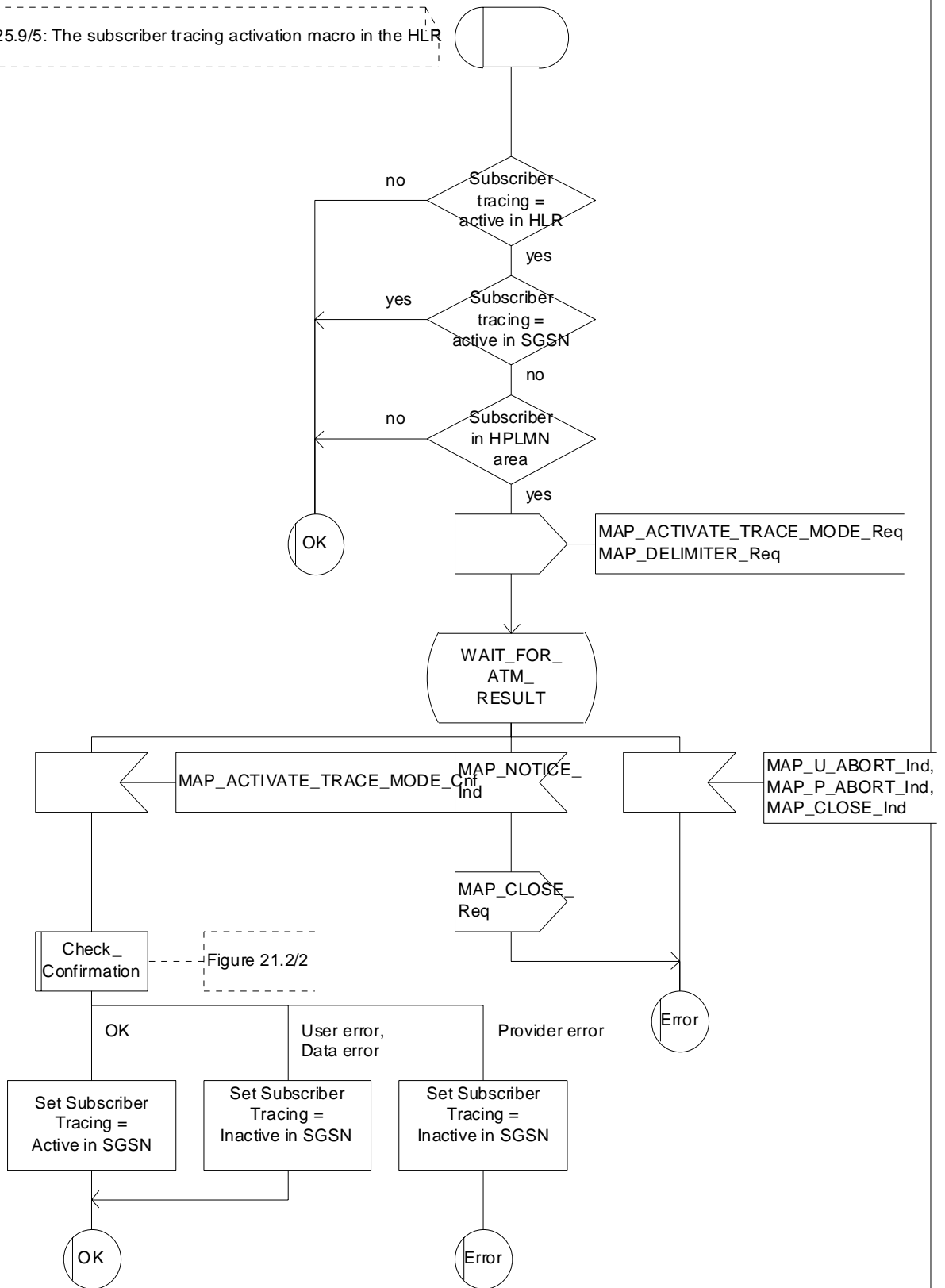

Figure 25.9/5: Macro Control_Tracing_HLR_with_SGSN

25.9.5 Macro Trace_Subscriber_Activity_SGSN

The macro Trace_Subscriber_Activity_SGSN is invoked, if the subscriber activity is detected by the SGSN and the tracing is active.

The Trace_Subscriber_Activity_SGSN macro is shown in the figure 25.9/6.

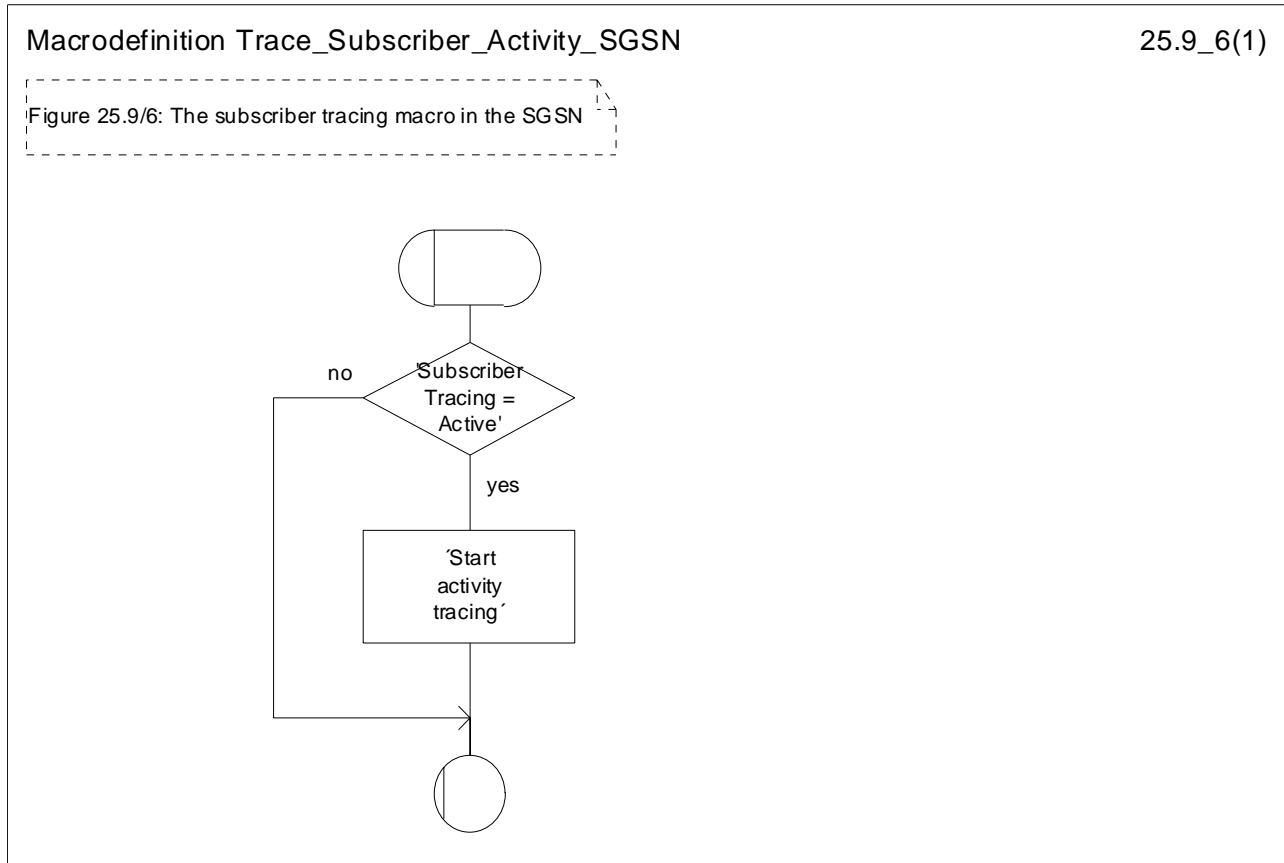

Figure 25.9/6: Macro Trace_Subscriber_Activity_SGSN

25.9.6 Macro Activate_Tracing_SGSN

The Activate_Tracing_SGSN macro is invoked, when the MAP_ACTIVATE_TRACE_MODE indication is received from the HLR. The primitive is processed in the SGSN as follows:

- if the data contains errors, a data missing or unexpected data value indication is returned to the HLR;
- if the tracing is not supported, a facility not supported indication is returned to the HLR;
- if the tracing buffer does not have any space left for the data, a tracing buffer full indication is returned to the HLR;
- if no errors are detected, the tracing is set active and a positive acknowledgement is returned to the HLR.

The Activate_Tracing_SGSN macro is described in the figure 25.9/7.

Macrodefinition Activate_Tracing_SGSN

25.9_7(1)

Figure 25.9/7: The activate trace mode macro in the SGSN

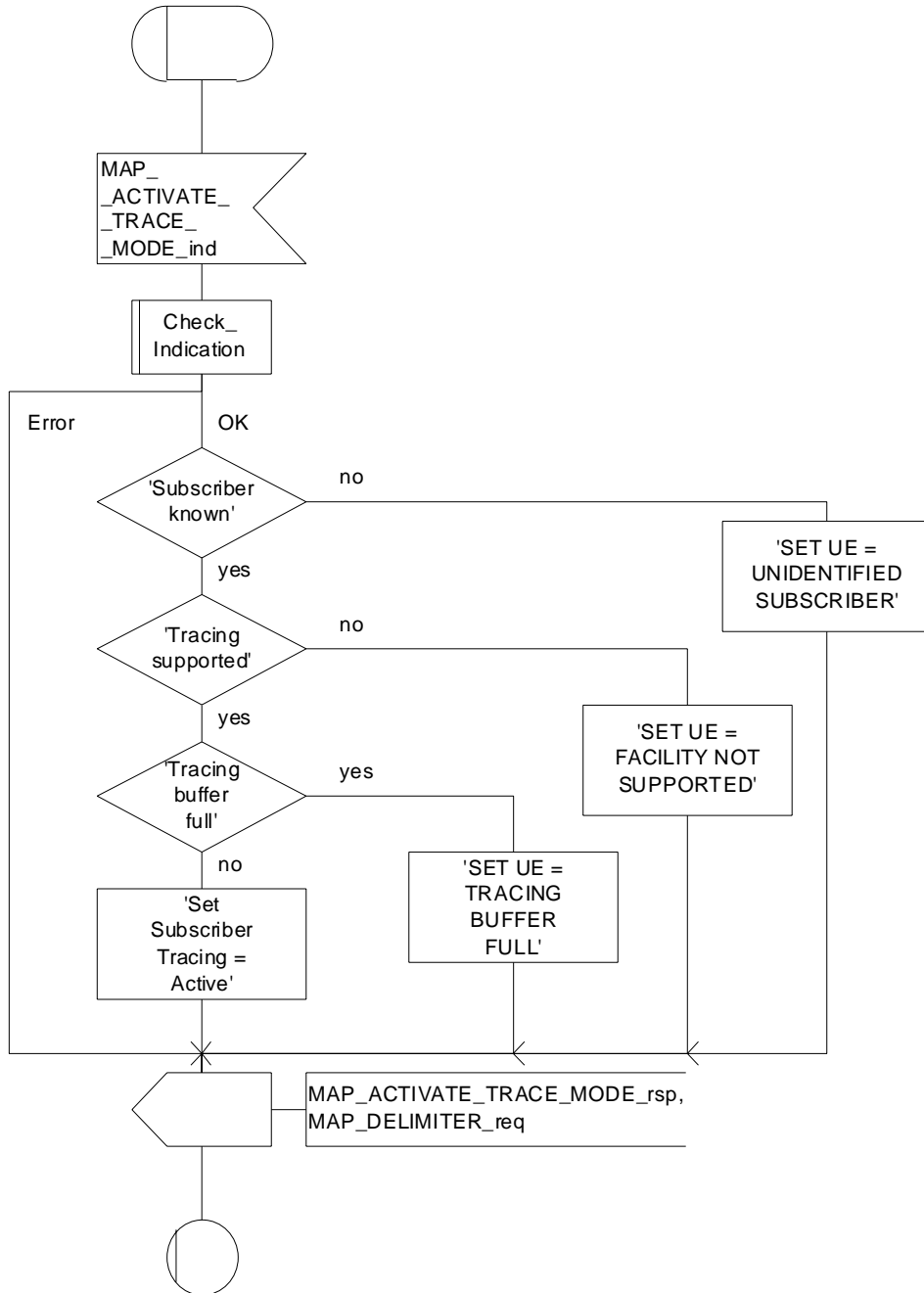

Figure 25.9/7: Macro Activate_Tracing_SGSN

25.10 Short Message Alert procedures

25.10.1 Subscriber_Present_VLR process

The Subscriber_Present_VLR process is invoked by the VLR, when the mobile subscriber becomes active and the MNRF flag is set. The general description of the short message alert procedures is in the clause 23.4.

The VLR sends the MAP_READY_FOR_SM request to the HLR and waits for the HLR to answer. When receiving the answer, the VLR will act as follows:

- the MNRF flag is cleared if the procedure is successful;
- the MNRF flag is not cleared if the procedure is not successful.

The Subscriber_Present_VLR process is shown in the figure 25.10/1.

Process Subscriber_Present_VLR

25.10_1(1)

Figure 25.10/1: The short message alert process in the VLR for mobile present situation

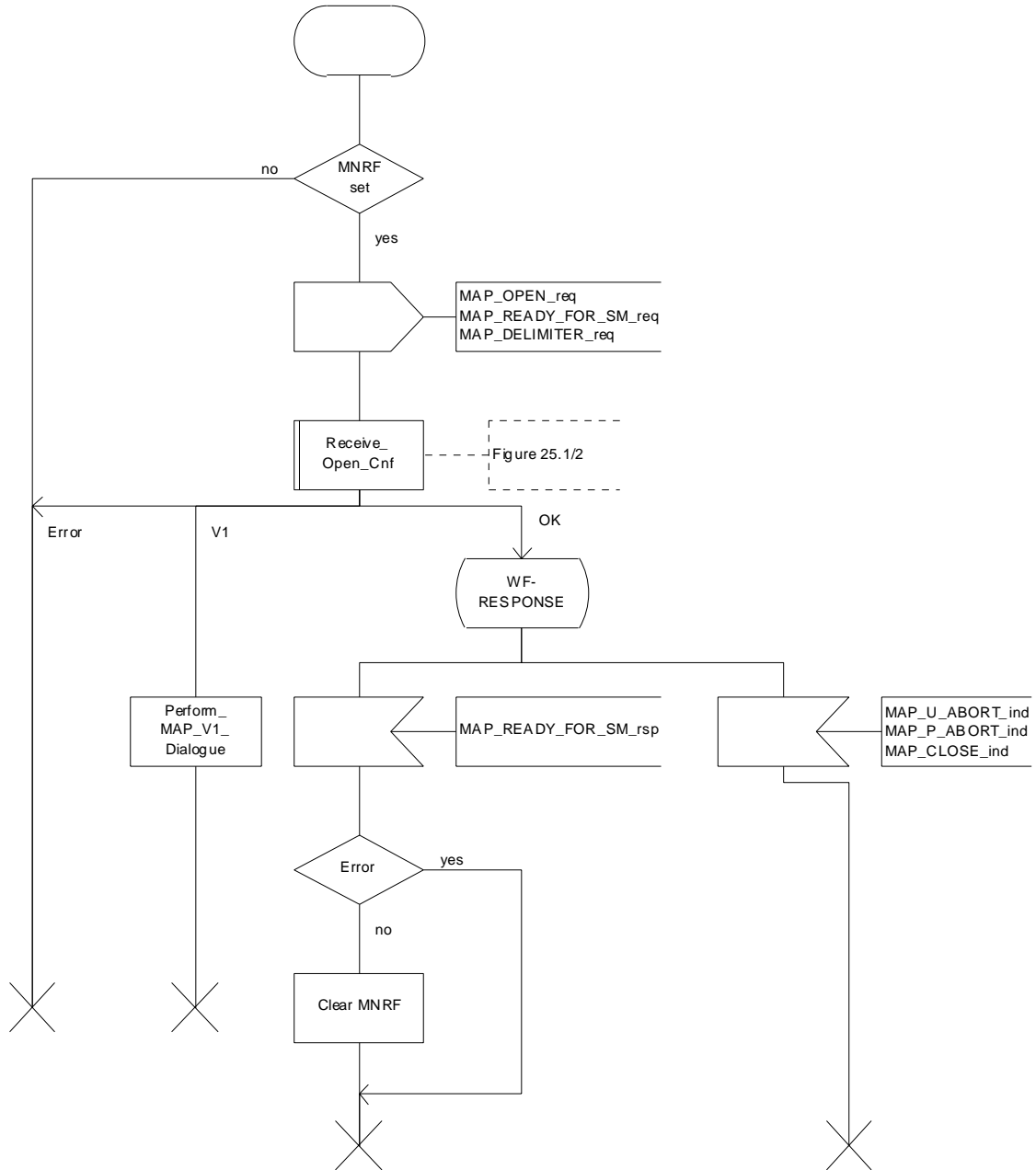

Figure 25.10/1: Process Subscriber_Present_VLR

25.10.2 Macro Alert_Service_Centre_HLR

The Alert_Service_Centre_HLR macro is initiated when the HLR notices that the Service Centre(s) shall be alerted. The macro starts process Alert_Service_Centre_HLR for every SC address in the MWD list.

In the process Alert_Service_Centre_HLR the HLR sends MAP_ALERT_SERVICE_CENTRE request to the appropriate IWMSC. The MWD entry is deleted when the positive acknowledgement is received from the IWMSC. The unsuccessful alert may be repeated. The MWD entry should be purged in the unsuccessful case, at least when a suitable time period has expired.

The Alert_Service_Centre_HLR macro is shown in the figure 25.10/2 and the Alert_Service_Centre_HLR process is shown in the figure 25.10/3.

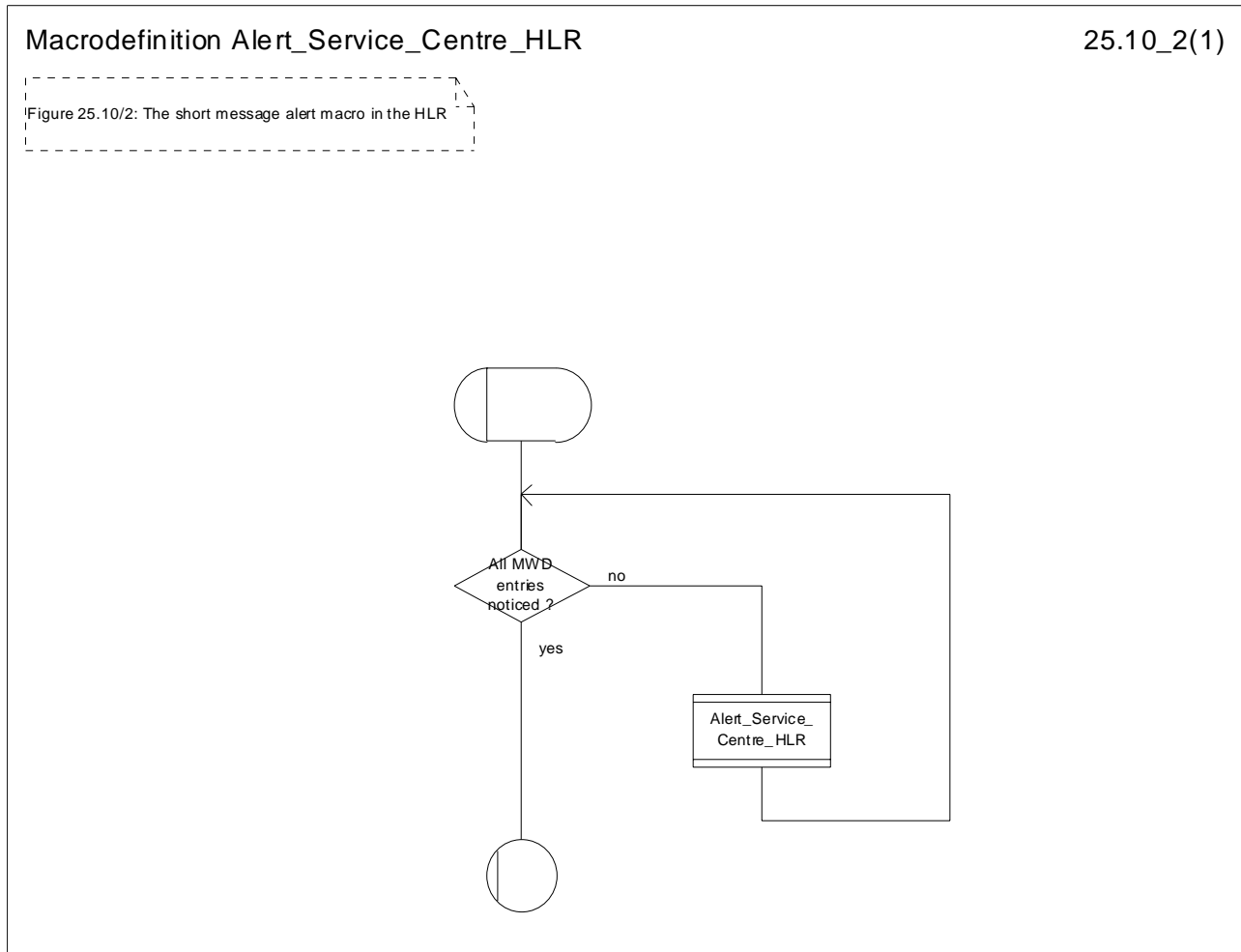

Figure 25.10/2: Macro Alert_Service_Centre_HLR

Process Alert_Service_Centre_HLR

22.10_3(1)

Figure 25.10/3: The short message alert process in the HLR

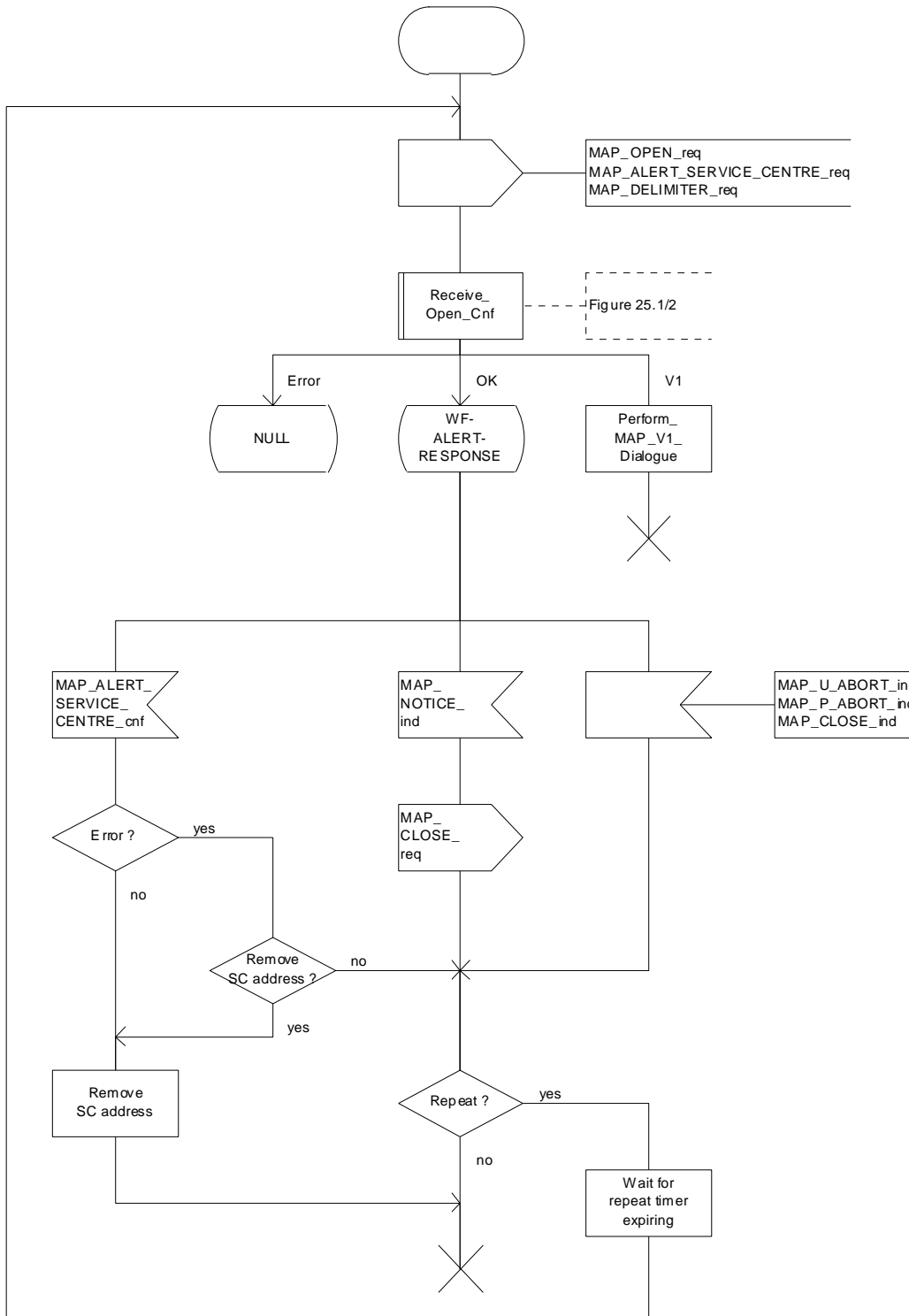

Figure 25.10/3: Process Alert_Service_Centre_HLR

25.10.3 The Mobile Subscriber is present

When receiving Page response, Attach request or Routing area update request messages (3GPP TS 24.008 [35]), while the MS not reachable for GPRS (MNRG) flag is set, the SGSN will send the MAP_READY_FOR_SM request towards the HLR. The Alert Reason is set to indicate that the mobile subscriber is present for GPRS.

When receiving the answer, the SGSN will act as follows:

- MNRG is cleared if the procedure is successful
- MNRG is not cleared if the procedure is not successful

The Subscriber_Present_SGSN process is shown in the figure 25.10/4.

Process Subscriber_Present_SGSN

25.10_4(1)

Figure 25.10/4: The short message alert process in the SGSN for mobile present situation

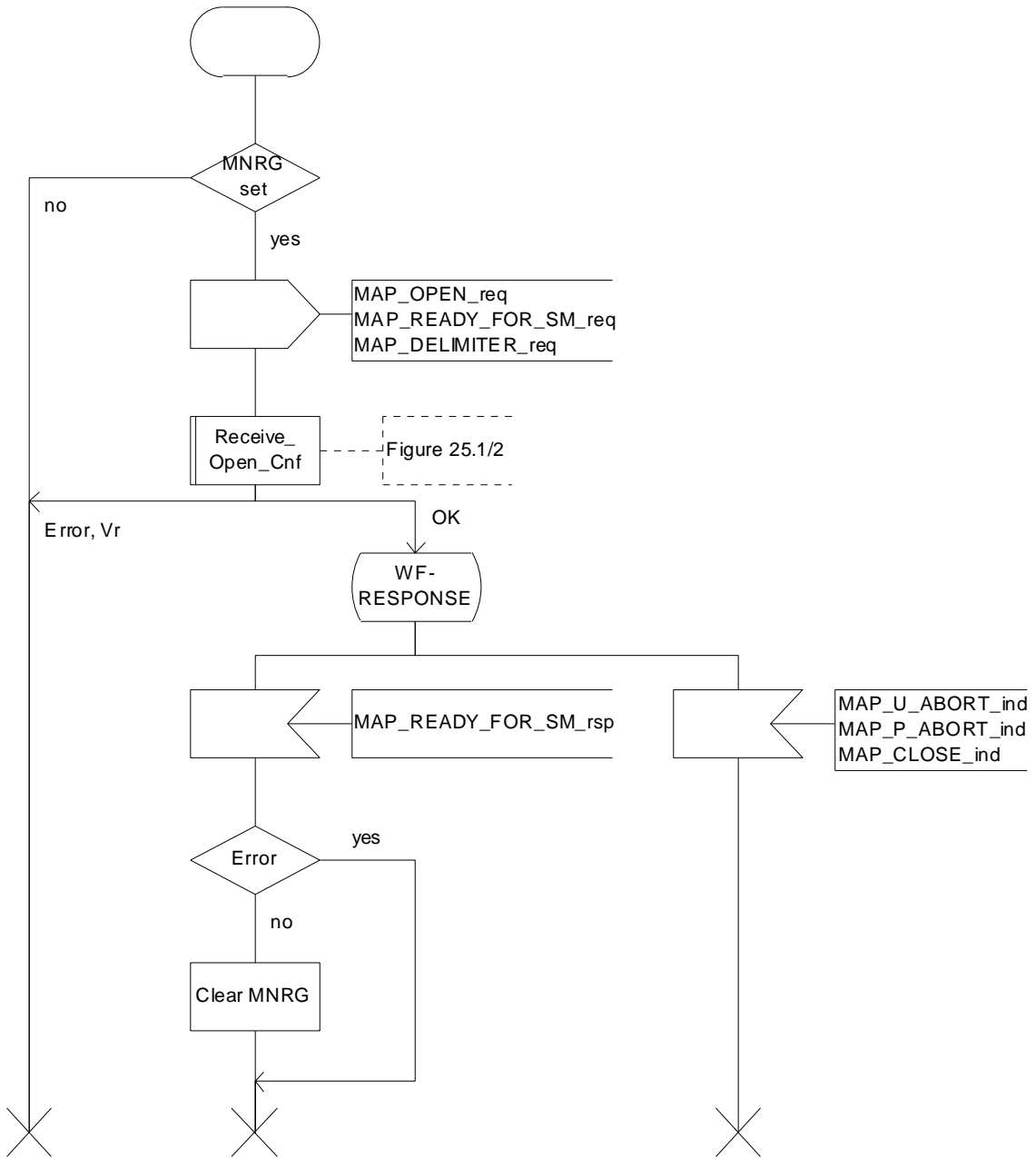

Figure 25.10/4: Process Subscriber_Present_SGSN

Annex A (informative): Cross-reference for abstract syntaxes of MAP

Annex A is not part of the standard, it is included for information purposes only.

For every ASN.1 item such as identifier, type-reference or value-reference the cross-reference allows to locate all occurrences by means of module-name and line numbers. For that purpose line numbers are printed at the left margin in front of each ASN.1 source line starting with 1 for every module.

The items are sorted alphabetically in the cross-reference in a case-insensitive manner. Occurrences of an item are its definition and all its usages such as in exports, imports or within a type or value assignment.

For every item additional information is provided such as kind of item (identifier, value reference, type reference), and tag, associated type and value if applicable.

The cross-reference for a root module includes all modules referred to directly or indirectly via imports. The cross-references for the root modules MAP-Protocol/TCAPMessages and MAP-DialoguePDU are included.

TAG R5.40 Cross Reference Listing for MAP-Protocol 2002-06-07 14:47:03 PAGE 1

```

&extensionId.....identifier of FieldSpec
  DEFINED in MAP-ExtensionDataTypes : 24
  USED in MAP-ExtensionDataTypes : 41

&ExtensionType.....identifier of FieldSpec
  DEFINED in MAP-ExtensionDataTypes : 23
  USED in MAP-ExtensionDataTypes : 43

abort.....identifier of [APPLICATION 7] IMPLICIT Abort
  DEFINED in TCAPMessages : 56

Abort.....type reference SEQUENCE
  DEFINED in TCAPMessages : 74
  USED in TCAPMessages : 56

absentSubscriber.....value reference AbsentSubscriber, CHOICE VALUE
  DEFINED in MAP-Protocol : 394

AbsentSubscriber.....type reference ERROR
  DEFINED in MAP-Errors : 284
  USED in MAP-Protocol : 145 394
  USED in MAP-MobileServiceOpera : 93 441
  USED in MAP-CallHandlingOperat : 40 96 115 188
  USED in MAP-SupplementaryServi : 50 197 211
  USED in MAP-LocationServiceOpe : 28 63 79
  USED in MAP-Errors : 48

absentSubscriber.....identifier of Named Number, 1
  DEFINED in MAP-SM-DataTypes : 169

absentSubscriberDiagnosticSM.....identifier of [0] AbsentSubscriberDiagnosticSM
  DEFINED in MAP-SM-DataTypes : 148

absentSubscriberDiagnosticSM.....identifier of AbsentSubscriberDiagnosticSM
  DEFINED in MAP-SM-DataTypes : 188

absentSubscriberDiagnosticSM.....identifier of AbsentSubscriberDiagnosticSM
  DEFINED in MAP-ER-DataTypes : 164

AbsentSubscriberDiagnosticSM.....type reference INTEGER
  DEFINED in MAP-ER-DataTypes : 174
  USED in MAP-MS-DataTypes : 203 1754
  USED in MAP-SM-DataTypes : 41 148 161 188 189
  USED in MAP-ER-DataTypes : 43 164 169

absentSubscriberParam.....identifier of AbsentSubscriberParam
  DEFINED in MAP-Errors : 286

```

AbsentSubscriberParam.....type reference SEQUENCE
DEFINED in MAP-ER-DataTypes : 253
USED in MAP-Errors : 128 286
USED in MAP-ER-DataTypes : 34

absentSubscriberReason.....identifier of [0] AbsentSubscriberReason
DEFINED in MAP-ER-DataTypes : 256

AbsentSubscriberReason.....type reference ENUMERATED
DEFINED in MAP-ER-DataTypes : 258
USED in MAP-ER-DataTypes : 256

absentsubscriberSM.....value reference AbsentSubscriberSM, CHOICE VALUE
DEFINED in MAP-Protocol : 440

AbsentSubscriberSM.....type reference ERROR
DEFINED in MAP-Errors : 419
USED in MAP-Protocol : 166 440
USED in MAP-ShortMessageServic : 40 79 109
USED in MAP-Errors : 80

absentSubscriberSM-Param.....identifier of AbsentSubscriberSM-Param
DEFINED in MAP-Errors : 421

AbsentSubscriberSM-Param.....type reference SEQUENCE
DEFINED in MAP-ER-DataTypes : 163
USED in MAP-Errors : 138 421
USED in MAP-ER-DataTypes : 42

accepted.....identifier of Named Number, 0
DEFINED in MAP-CH-DataTypes : 408

TAG R5.40 Cross Reference Listing for MAP-Protocol 2002-06-07 14:47:03 PAGE 2

accessNetworkProtocolId.....identifier of AccessNetworkProtocolId
DEFINED in MAP-CommonDataTypes : 242

AccessNetworkProtocolId.....type reference ENUMERATED
DEFINED in MAP-CommonDataTypes : 258
USED in MAP-CommonDataTypes : 242

AccessNetworkSignalInfo.....type reference SEQUENCE
DEFINED in MAP-CommonDataTypes : 241
USED in MAP-MS-DataTypes : 172 453 511 552 599 605 610 624
USED in MAP-CommonDataTypes : 23

accessOutsideLSAsAllowed.....identifier of Named Number, 0
DEFINED in MAP-MS-DataTypes : 905

accessOutsideLSAsRestricted.....identifier of Named Number, 1
DEFINED in MAP-MS-DataTypes : 906

accessType.....identifier of AccessType
DEFINED in MAP-MS-DataTypes : 393

AccessType.....type reference ENUMERATED
DEFINED in MAP-MS-DataTypes : 398
USED in MAP-MS-DataTypes : 393

activate.....identifier of Named Number, 1
DEFINED in MAP-MS-DataTypes : 2193

activateDeferredLocation.....identifier of Named Number, 3
DEFINED in MAP-LCS-DataTypes : 133

activateSS.....value reference ActivateSS, CHOICE VALUE
DEFINED in MAP-Protocol : 259

ActivateSS.....type reference OPERATION
DEFINED in MAP-SupplementaryServi : 121
USED in MAP-Protocol : 71 259
USED in MAP-SupplementaryServi : 15

activateTraceMode.....value reference ActivateTraceMode, CHOICE VALUE
DEFINED in MAP-Protocol : 236

ActivateTraceMode.....type reference OPERATION
DEFINED in MAP-OperationAndMainte : 50
USED in MAP-Protocol : 46 236
USED in MAP-OperationAndMainte : 13

activateTraceModeArg.....identifier of ActivateTraceModeArg
DEFINED in MAP-OperationAndMainte : 52

ActivateTraceModeArg.....type reference SEQUENCE
DEFINED in MAP-OM-DataTypes : 36
USED in MAP-OperationAndMainte : 34 52
USED in MAP-OM-DataTypes : 14

activateTraceModeRes.....identifier of ActivateTraceModeRes
DEFINED in MAP-OperationAndMainte : 54

ActivateTraceModeRes.....type reference SEQUENCE
DEFINED in MAP-OM-DataTypes : 50
USED in MAP-OperationAndMainte : 35 54
USED in MAP-OM-DataTypes : 15

active.....identifier of Named Number, 2
DEFINED in MAP-SS-DataTypes : 288

additionalAbsentSubscriberDiagnosticSM..identifier of [5] AbsentSubscriberDiagnosticSM
DEFINED in MAP-SM-DataTypes : 161

additionalAbsentSubscriberDiagnosticSM..identifier of [0] AbsentSubscriberDiagnosticSM
DEFINED in MAP-SM-DataTypes : 189

additionalAbsentSubscriberDiagnosticSM..identifier of [0] AbsentSubscriberDiagnosticSM
DEFINED in MAP-ER-DataTypes : 169

additionalRequestedCAMEL-SubscriptionInfo identifier of [7] AdditionalRequestedCAMEL-SubscriptionInfo
DEFINED in MAP-MS-DataTypes : 2071

AdditionalRequestedCAMEL-SubscriptionInfo reference ENUMERATED
DEFINED in MAP-MS-DataTypes : 2086
USED in MAP-MS-DataTypes : 2072 2188

TAG R5.40 Cross Reference Listing for MAP-Protocol 2002-06-07 14:47:03 PAGE 3

additionalRequestedCAMEL-SubscriptionIdentifier of [4] AdditionalRequestedCAMEL-SubscriptionInfo
 DEFINED in MAP-MS-DataTypes : 2187

additionalSignalInfo.....identifier of [17] Ext-ExternalSignalInfo
 DEFINED in MAP-CH-DataTypes : 113

additionalSignalInfo.....identifier of [14] Ext-ExternalSignalInfo
 DEFINED in MAP-CH-DataTypes : 219

additionalSM-DeliveryOutcome.....identifier of [4] SM-DeliveryOutcome
 DEFINED in MAP-SM-DataTypes : 158

additional-Number.....identifier of [6] Additional-Number
 DEFINED in MAP-SM-DataTypes : 94

Additional-Number.....type reference CHOICE

DEFINED in MAP-SM-DataTypes : 98
 USED in MAP-SM-DataTypes : 28 94
 USED in MAP-LCS-DataTypes : 60 101

additional-Number.....identifier of [3] Additional-Number
 DEFINED in MAP-LCS-DataTypes : 101

AddressString.....type reference OCTET STRING

DEFINED in MAP-CommonDataTypes : 100
 USED in MAP-MS-DataTypes : 168 2158
 USED in MAP-CommonDataTypes : 16 144 150 379
 USED in MAP-OM-DataTypes : 21 40
 USED in MAP-SS-DataTypes : 44 75 301
 USED in MAP-SM-DataTypes : 32 56 136 141 146 180
 USED in MAP-LCS-DataTypes : 30 149

Add-GeographicalInformation.....type reference OCTET STRING

DEFINED in MAP-LCS-DataTypes : 325
 USED in MAP-LCS-DataTypes : 24 251 359

add-Ics-PrivacyExceptionList.....identifier of [3] LCS-PrivacyExceptionList
 DEFINED in MAP-MS-DataTypes : 767

add-LocationEstimate.....identifier of [2] Add-GeographicalInformation
 DEFINED in MAP-LCS-DataTypes : 251

add-LocationEstimate.....identifier of [8] Add-GeographicalInformation
 DEFINED in MAP-LCS-DataTypes : 359

AgeIndicator.....type reference OCTET STRING

DEFINED in MAP-MS-DataTypes : 240
 USED in MAP-MS-DataTypes : 238 747

ageOfLocationEstimate.....identifier of [0] AgeOfLocationInformation
 DEFINED in MAP-LCS-DataTypes : 248

ageOfLocationEstimate.....identifier of [6] AgeOfLocationInformation
 DEFINED in MAP-LCS-DataTypes : 356

ageOfLocationInformation.....identifier of AgeOfLocationInformation
 DEFINED in MAP-MS-DataTypes : 1901

ageOfLocationInformation.....identifier of [9] AgeOfLocationInformation
 DEFINED in MAP-MS-DataTypes : 1929

AgeOfLocationInformation.....type reference INTEGER

DEFINED in MAP-CommonDataTypes : 516
 USED in MAP-MS-DataTypes : 186 1901 1929
 USED in MAP-CommonDataTypes : 57
 USED in MAP-LCS-DataTypes : 36 248 356

alertingCategory-1.....value reference AlertingPattern, '00000100'B
 DEFINED in MAP-CommonDataTypes : 286

alertingCategory-2.....value reference AlertingPattern, '00000101'B
 DEFINED in MAP-CommonDataTypes : 287

alertingCategory-3.....value reference AlertingPattern, '00000110'B
 DEFINED in MAP-CommonDataTypes : 288

alertingCategory-4.....value reference AlertingPattern, '00000111'B
DEFINED in MAP-CommonDataTypes : 289

alertingCategory-5.....value reference AlertingPattern, '00001000'B
DEFINED in MAP-CommonDataTypes : 290

TAG R5.40 Cross Reference Listing for MAP-Protocol 2002-06-07 14:47:03 PAGE 4

alertingLevel-0.....value reference AlertingPattern, '00000000'B
 DEFINED in MAP-CommonDataTypes : 280

alertingLevel-1.....value reference AlertingPattern, '00000001'B
 DEFINED in MAP-CommonDataTypes : 281

alertingLevel-2.....value reference AlertingPattern, '00000010'B
 DEFINED in MAP-CommonDataTypes : 282

AlertingPattern.....type reference OCTET STRING
 DEFINED in MAP-CommonDataTypes : 267
 USED in MAP-CommonDataTypes : 26 280 281 282 286 287 288 289 290
 USED in MAP-CH-DataTypes : 71 110 216 398
 USED in MAP-SS-DataTypes : 50 225

alertingPattern.....identifier of [14] AlertingPattern
 DEFINED in MAP-CH-DataTypes : 110

alertingPattern.....identifier of [12] AlertingPattern
 DEFINED in MAP-CH-DataTypes : 216

alertingPattern.....identifier of [5] AlertingPattern
 DEFINED in MAP-CH-DataTypes : 398

alertingPattern.....identifier of AlertingPattern
 DEFINED in MAP-SS-DataTypes : 225

alertReason.....identifier of AlertReason
 DEFINED in MAP-SM-DataTypes : 205

AlertReason.....type reference ENUMERATED
 DEFINED in MAP-SM-DataTypes : 217
 USED in MAP-SM-DataTypes : 27 205

alertReasonIndicator.....identifier of NULL
 DEFINED in MAP-SM-DataTypes : 206

alertServiceCentre.....value reference AlertServiceCentre, CHOICE VALUE
 DEFINED in MAP-Protocol : 279

AlertServiceCentre.....type reference OPERATION
 DEFINED in MAP-ShortMessageService : 123
 USED in MAP-Protocol : 91 279
 USED in MAP-ShortMessageService : 17

alertServiceCentreArg.....identifier of AlertServiceCentreArg
 DEFINED in MAP-ShortMessageService : 125

AlertServiceCentreArg.....type reference SEQUENCE
 DEFINED in MAP-SM-DataTypes : 178
 USED in MAP-ShortMessageService : 53 125
 USED in MAP-SM-DataTypes : 22

allAdditionalInfoTransferSS.....value reference SS-Code, '10000000'B
 DEFINED in MAP-SS-Code : 107

allAlternateSpeech-DataCDA.....value reference BearerServiceCode, '00110000'B
 DEFINED in MAP-BS-Code : 82

allAlternateSpeech-DataCDS.....value reference BearerServiceCode, '00111000'B
 DEFINED in MAP-BS-Code : 84

allAsynchronousServices.....value reference BearerServiceCode, '01100000'B
 DEFINED in MAP-BS-Code : 95

allBarringSS.....value reference SS-Code, '10010000'B
 DEFINED in MAP-SS-Code : 117

allBearerServices.....value reference BearerServiceCode, '00000000'B
 DEFINED in MAP-BS-Code : 49

allCallCompletionSS.....value reference SS-Code, '01000000'B
 DEFINED in MAP-SS-Code : 72

allCallOfferingSS.....value reference SS-Code, '00110000'B

DEFINED in MAP-SS-Code : 63

allCallPrioritySS.....value reference SS-Code, '1010000'B
DEFINED in MAP-SS-Code : 153

allChargingSS.....value reference SS-Code, '01110000'B
DEFINED in MAP-SS-Code : 99

TAG R5.40 Cross Reference Listing for MAP-Protocol 2002-06-07 14:47:03 PAGE 5

allCommunityOfInterest-SS.....value reference SS-Code, '01100000'B
DEFINED in MAP-SS-Code : 93

allCondForwardingSS.....value reference SS-Code, '00101000'B
DEFINED in MAP-SS-Code : 52

allDataCDA-Services.....value reference BearerServiceCode, '00010000'B
DEFINED in MAP-BS-Code : 51

allDataCDS-Services.....value reference BearerServiceCode, '00011000'B
DEFINED in MAP-BS-Code : 60

allDataCircuitAsynchronous.....value reference BearerServiceCode, '01010000'B
DEFINED in MAP-BS-Code : 92

allDataCircuitSynchronous.....value reference BearerServiceCode, '01011000'B
DEFINED in MAP-BS-Code : 98

allDataPDS-Services.....value reference BearerServiceCode, '00101000'B
DEFINED in MAP-BS-Code : 76

allDataTeleservices.....value reference TeleserviceCode, '01110000'B
DEFINED in MAP-TS-Code : 55

allECT-Barred.....identifier of Named Number, 9
DEFINED in MAP-MS-DataTypes : 989

allFacsimileTransmissionServices.....value reference TeleserviceCode, '01100000'B
DEFINED in MAP-TS-Code : 48

allForwardingSS.....value reference SS-Code, '00100000'B
DEFINED in MAP-SS-Code : 48

allGPRSDData.....identifier of NULL
DEFINED in MAP-MS-DataTypes : 1334

allIC-CallsBarred.....identifier of Named Number, 19
DEFINED in MAP-MS-DataTypes : 999

allInformationSent.....identifier of [4] NULL
DEFINED in MAP-MS-DataTypes : 2204

allInformationSent.....identifier of [11] NULL
DEFINED in MAP-CH-DataTypes : 242

allLCSPrivacyException.....value reference SS-Code, '10110000'B
DEFINED in MAP-SS-Code : 159

allLineIdentificationSS.....value reference SS-Code, '00010000'B
DEFINED in MAP-SS-Code : 25

allLSAData.....identifier of NULL
DEFINED in MAP-MS-DataTypes : 1341

allMOLR-SS.....value reference SS-Code, '11000000'B
DEFINED in MAP-SS-Code : 173

allMultiPartySS.....value reference SS-Code, '01010000'B
DEFINED in MAP-SS-Code : 87

allNameIdentificationSS.....value reference SS-Code, '00011000'B
DEFINED in MAP-SS-Code : 40

allOG-CallsBarred.....identifier of Named Number, 0
DEFINED in MAP-MS-DataTypes : 980

allowedGSM-Algorithms.....identifier of [4] AllowedGSM-Algorithms
DEFINED in MAP-MS-DataTypes : 457

AllowedGSM-Algorithms.....type reference OCTET STRING
DEFINED in MAP-MS-DataTypes : 466
USED in MAP-MS-DataTypes : 457 517

allowedGSM-Algorithms.....identifier of [9] AllowedGSM-Algorithms

DEFINED in MAP-MS-DataTypes : 517

allowedUMTS-Algorithms.....identifier of [5] AllowedUMTS-Algorithms
DEFINED in MAP-MS-DataTypes : 458

AllowedUMTS-Algorithms.....type reference SEQUENCE
DEFINED in MAP-MS-DataTypes : 471

TAG R5.40 Cross Reference Listing for MAP-Protocol 2002-06-07 14:47:03 PAGE 6

USED in MAP-MS-DataTypes : 458 518

allowedUMTS-Algorithms.....identifier of [10] AllowedUMTS-Algorithms
DEFINED in MAP-MS-DataTypes : 518

allPacketOrientedServicesBarred.....identifier of Named Number, 15
DEFINED in MAP-MS-DataTypes : 995

allPadAccessCA-Services.....value reference BearerServiceCode, '00100000'B
DEFINED in MAP-BS-Code : 67

allPLMN-specificBS.....value reference BearerServiceCode, '11010000'B
DEFINED in MAP-BS-Code : 110

allPLMN-specificSS.....value reference SS-Code, '11110000'B
DEFINED in MAP-SS-Code : 136

allPLMN-specificTS.....value reference TeleserviceCode, '11010000'B
DEFINED in MAP-TS-Code : 71

allShortMessageServices.....value reference TeleserviceCode, '00100000'B
DEFINED in MAP-TS-Code : 44

allSpeechFollowedByDataCDA.....value reference BearerServiceCode, '01000000'B
DEFINED in MAP-BS-Code : 86

allSpeechFollowedByDataCDS.....value reference BearerServiceCode, '01001000'B
DEFINED in MAP-BS-Code : 88

allSpeechTransmissionServices.....value reference TeleserviceCode, '00010000'B
DEFINED in MAP-TS-Code : 40

allSS.....value reference SS-Code, '00000000'B
DEFINED in MAP-SS-Code : 21

allSynchronousServices.....value reference BearerServiceCode, '01101000'B
DEFINED in MAP-BS-Code : 101

allTeleservices.....value reference TeleserviceCode, '00000000'B
DEFINED in MAP-TS-Code : 38

allTeleservices-ExeptSMS.....value reference TeleserviceCode, '10000000'B
DEFINED in MAP-TS-Code : 58

allVoiceGroupCallServices.....value reference TeleserviceCode, '10010000'B
DEFINED in MAP-TS-Code : 67

anonymousLocation.....identifier of Named Number, 3
DEFINED in MAP-CommonDataTypes : 387

anyTimeInterrogation.....value reference AnyTimeInterrogation, CHOICE VALUE
DEFINED in MAP-Protocol : 288

AnyTimeInterrogation.....type reference OPERATION
DEFINED in MAP-MobileServiceOpera : 244
USED in MAP-Protocol : 31 288
USED in MAP-MobileServiceOpera : 27

anyTimeInterrogationArg.....identifier of AnyTimeInterrogationArg
DEFINED in MAP-MobileServiceOpera : 246

AnyTimeInterrogationArg.....type reference SEQUENCE
DEFINED in MAP-MS-DataTypes : 2030
USED in MAP-MobileServiceOpera : 151 246
USED in MAP-MS-DataTypes : 109

anyTimeInterrogationRes.....identifier of AnyTimeInterrogationRes
DEFINED in MAP-MobileServiceOpera : 248

AnyTimeInterrogationRes.....type reference SEQUENCE
DEFINED in MAP-MS-DataTypes : 2037
USED in MAP-MobileServiceOpera : 152 248
USED in MAP-MS-DataTypes : 110

anyTimeModification.....value reference AnyTimeModification, CHOICE VALUE

DEFINED in MAP-Protocol : 293

AnyTimeModification.....type reference OPERATION

DEFINED in MAP-MobileServiceOpera : 275

USED in MAP-Protocol : 33 293

USED in MAP-MobileServiceOpera : 31

TAG R5.40 Cross Reference Listing for MAP-Protocol 2002-06-07 14:47:03 PAGE 7

anyTimeModificationArg.....identifier of AnyTimeModificationArg
DEFINED in MAP-MobileServiceOpera : 277

AnyTimeModificationArg.....type reference SEQUENCE
DEFINED in MAP-MS-DataTypes : 2136
USED in MAP-MobileServiceOpera : 147 277
USED in MAP-MS-DataTypes : 115

anyTimeModificationRes.....identifier of AnyTimeModificationRes
DEFINED in MAP-MobileServiceOpera : 279

AnyTimeModificationRes.....type reference SEQUENCE
DEFINED in MAP-MS-DataTypes : 2147
USED in MAP-MobileServiceOpera : 148 279
USED in MAP-MS-DataTypes : 116

anyTimeSubscriptionInterrogation.value reference AnyTimeSubscriptionInterrogation, CHOICE VALUE
DEFINED in MAP-Protocol : 292

AnyTimeSubscriptionInterrogation.....type reference OPERATION
DEFINED in MAP-MobileServiceOpera : 258
USED in MAP-Protocol : 32 292
USED in MAP-MobileServiceOpera : 30

anyTimeSubscriptionInterrogationArg.....identifier of AnyTimeSubscriptionInterrogationArg
DEFINED in MAP-MobileServiceOpera : 260

AnyTimeSubscriptionInterrogationArg.....type reference SEQUENCE
DEFINED in MAP-MS-DataTypes : 2045
USED in MAP-MobileServiceOpera : 145 260
USED in MAP-MS-DataTypes : 113

anyTimeSubscriptionInterrogationRes.....identifier of AnyTimeSubscriptionInterrogationRes
DEFINED in MAP-MobileServiceOpera : 262

AnyTimeSubscriptionInterrogationRes.....type reference SEQUENCE
DEFINED in MAP-MS-DataTypes : 2053
USED in MAP-MobileServiceOpera : 146 262
USED in MAP-MS-DataTypes : 114

an-APDU.....identifier of AccessNetworkSignalInfo
DEFINED in MAP-MS-DataTypes : 453

an-APDU.....identifier of [2] AccessNetworkSignalInfo
DEFINED in MAP-MS-DataTypes : 511

an-APDU.....identifier of [2] AccessNetworkSignalInfo
DEFINED in MAP-MS-DataTypes : 552

an-APDU.....identifier of [3] AccessNetworkSignalInfo
DEFINED in MAP-MS-DataTypes : 599

an-APDU.....identifier of AccessNetworkSignalInfo
DEFINED in MAP-MS-DataTypes : 605

an-APDU.....identifier of AccessNetworkSignalInfo
DEFINED in MAP-MS-DataTypes : 610

an-APDU.....identifier of AccessNetworkSignalInfo
DEFINED in MAP-MS-DataTypes : 624

aocc.....value reference SS-Code, '01110010'B
DEFINED in MAP-SS-Code : 104

aoci.....value reference SS-Code, '01110001'B
DEFINED in MAP-SS-Code : 102

apn.....identifier of [20] APN
DEFINED in MAP-MS-DataTypes : 801

APN.....type reference OCTET STRING
DEFINED in MAP-MS-DataTypes : 877
USED in MAP-MS-DataTypes : 86 801 1988 1989
USED in MAP-LCS-DataTypes : 55 153

apn-InUse.....identifier of [5] APN
DEFINED in MAP-MS-DataTypes : 1989

apn-Subscribed.....identifier of [4] APN
DEFINED in MAP-MS-DataTypes : 1988

asciCallReference.....identifier of ASCI-CallReference

TAG R5.40 Cross Reference Listing for MAP-Protocol 2002-06-07 14:47:03 PAGE 8

DEFINED in MAP-GR-DataTypes : 51

ASCI-CallReference.....type reference TBCD-STRING
 DEFINED in MAP-CommonDataTypes : 310
 USED in MAP-CommonDataTypes : 40
 USED in MAP-GR-DataTypes : 26 51

assetManagement.....value reference LCSServiceTypeID, 4
 DEFINED in MAP-CommonDataTypes : 400

assumedIdle.....identifier of [0] NULL
 DEFINED in MAP-MS-DataTypes : 1967

ati-NotAllowed.....value reference ATI-NotAllowed, CHOICE VALUE
 DEFINED in MAP-Protocol : 406

ATI-NotAllowed.....type reference ERROR
 DEFINED in MAP-Errors : 328
 USED in MAP-Protocol : 152 406
 USED in MAP-MobileServiceOpera : 90 251
 USED in MAP-Errors : 55

ati-NotAllowedParam.....identifier of ATI-NotAllowedParam
 DEFINED in MAP-Errors : 330

ATI-NotAllowedParam.....type reference SEQUENCE
 DEFINED in MAP-ER-DataTypes : 290
 USED in MAP-Errors : 135 330
 USED in MAP-ER-DataTypes : 39

atm-NotAllowed.....value reference ATM-NotAllowed, CHOICE VALUE
 DEFINED in MAP-Protocol : 410

ATM-NotAllowed.....type reference ERROR
 DEFINED in MAP-Errors : 339
 USED in MAP-Protocol : 177 410
 USED in MAP-MobileServiceOpera : 96 281
 USED in MAP-Errors : 59

atm-NotAllowedParam.....identifier of ATM-NotAllowedParam
 DEFINED in MAP-Errors : 341

ATM-NotAllowedParam.....type reference SEQUENCE
 DEFINED in MAP-ER-DataTypes : 298
 USED in MAP-Errors : 150 341
 USED in MAP-ER-DataTypes : 56

atsi-NotAllowed.....value reference ATSI-NotAllowed, CHOICE VALUE
 DEFINED in MAP-Protocol : 409

ATSI-NotAllowed.....type reference ERROR
 DEFINED in MAP-Errors : 334
 USED in MAP-Protocol : 176 409
 USED in MAP-MobileServiceOpera : 95 264
 USED in MAP-Errors : 58

atsi-NotAllowedParam.....identifier of ATSI-NotAllowedParam
 DEFINED in MAP-Errors : 336

ATSI-NotAllowedParam.....type reference SEQUENCE
 DEFINED in MAP-ER-DataTypes : 294
 USED in MAP-Errors : 149 336
 USED in MAP-ER-DataTypes : 55

attach.....identifier of Named Number, 1
 DEFINED in MAP-MS-DataTypes : 866

attachChangeOfPosition.....identifier of Named Number, 2
 DEFINED in MAP-MS-DataTypes : 867

authenticationFailureReport.....value reference AuthenticationFailureReport, CHOICE VALUE
 DEFINED in MAP-Protocol : 212

AuthenticationFailureReport.....type reference OPERATION
 DEFINED in MAP-MobileServiceOpera : 367

USED in MAP-Protocol : 23 212
USED in MAP-MobileServiceOpera : 46

authenticationFailureReportArg.....identifier of AuthenticationFailureReportArg
DEFINED in MAP-MobileServiceOpera : 369

AuthenticationFailureReportArg.....type reference SEQUENCE

TAG R5.40 Cross Reference Listing for MAP-Protocol 2002-06-07 14:47:03 PAGE 9

DEFINED in MAP-MS-DataTypes : 387
 USED in MAP-MobileServiceOpera : 133 369
 USED in MAP-MS-DataTypes : 46

authenticationFailureReportRes.....identifier of AuthenticationFailureReportRes
 DEFINED in MAP-MobileServiceOpera : 371

AuthenticationFailureReportRes.....type reference SEQUENCE
 DEFINED in MAP-MS-DataTypes : 413
 USED in MAP-MobileServiceOpera : 134 371
 USED in MAP-MS-DataTypes : 47

AuthenticationQuintuplet.....type reference SEQUENCE
 DEFINED in MAP-MS-DataTypes : 342
 USED in MAP-MS-DataTypes : 334

authenticationSetList.....identifier of AuthenticationSetList
 DEFINED in MAP-MS-DataTypes : 319

AuthenticationSetList.....type reference CHOICE
 DEFINED in MAP-MS-DataTypes : 326
 USED in MAP-MS-DataTypes : 319 710

authenticationSetList.....identifier of AuthenticationSetList
 DEFINED in MAP-MS-DataTypes : 710

AuthenticationTriplet.....type reference SEQUENCE
 DEFINED in MAP-MS-DataTypes : 336
 USED in MAP-MS-DataTypes : 331

autn.....identifier of AUTN
 DEFINED in MAP-MS-DataTypes : 347

AUTN.....type reference OCTET STRING
 DEFINED in MAP-MS-DataTypes : 377
 USED in MAP-MS-DataTypes : 347

automaticFacsimileGroup3.....value reference TeleserviceCode, '01100010'B
 DEFINED in MAP-TS-Code : 50

autonomousSelfLocation.....value reference SS-Code, '11000010'B
 DEFINED in MAP-SS-Code : 177

AUTS.....type reference OCTET STRING
 DEFINED in MAP-MS-DataTypes : 379
 USED in MAP-MS-DataTypes : 706

auts.....identifier of AUTS
 DEFINED in MAP-MS-DataTypes : 706

a-side.....identifier of Named Number, 0
 DEFINED in MAP-CH-DataTypes : 371

badlyFormattedTransactionPortion.....identifier of Named Number, 2
 DEFINED in TCAPMessages : 105

badlyStructuredComponent.....identifier of Named Number, 2
 DEFINED in TCAPMessages : 181

baic.....value reference SS-Code, '10011010'B
 DEFINED in MAP-SS-Code : 130

baoc.....value reference SS-Code, '10010010'B
 DEFINED in MAP-SS-Code : 121

barringOfIncomingCalls.....value reference SS-Code, '10011001'B
 DEFINED in MAP-SS-Code : 128

barringOfOutgoingCalls.....value reference SS-Code, '10010001'B
 DEFINED in MAP-SS-Code : 119

barringServiceActive.....identifier of Named Number, 0
 DEFINED in MAP-ER-DataTypes : 116

basicCall.....identifier of Named Number, 0

DEFINED in MAP-CH-DataTypes : 126

basicSTSupported.....identifier of Named Number, 0
DEFINED in MAP-MS-DataTypes : 245

basicSelfLocation.....value reference SS-Code, '11000001'B
DEFINED in MAP-SS-Code : 175

TAG R5.40 Cross Reference Listing for MAP-Protocol 2002-06-07 14:47:03 PAGE 10

basicService.....identifier of Ext-BasicServiceCode
DEFINED in MAP-MS-DataTypes : 1046

basicService.....identifier of Ext-BasicServiceCode
DEFINED in MAP-MS-DataTypes : 1105

basicService.....identifier of Ext-BasicServiceCode
DEFINED in MAP-MS-DataTypes : 1148

basicService.....identifier of [1] Ext-BasicServiceCode
DEFINED in MAP-MS-DataTypes : 2156

basicService.....identifier of [1] Ext-BasicServiceCode
DEFINED in MAP-MS-DataTypes : 2167

basicService.....identifier of [5] Ext-BasicServiceCode
DEFINED in MAP-CH-DataTypes : 159

basicService.....identifier of BasicServiceCode
DEFINED in MAP-SS-DataTypes : 74

basicService.....identifier of BasicServiceCode
DEFINED in MAP-SS-DataTypes : 100

basicService.....identifier of BasicServiceCode
DEFINED in MAP-SS-DataTypes : 157

basicService.....identifier of BasicServiceCode
DEFINED in MAP-SS-DataTypes : 186

basicService.....identifier of BasicServiceCode
DEFINED in MAP-ER-DataTypes : 138

BasicServiceCode.....type reference CHOICE
DEFINED in MAP-CommonDataTypes : 448
USED in MAP-CommonDataTypes : 47
USED in MAP-SS-DataTypes : 49 74 100 157 186 210 265
USED in MAP-ER-DataTypes : 75 138

basicServiceCriteria.....identifier of [1] BasicServiceCriteria
DEFINED in MAP-MS-DataTypes : 1508

basicServiceCriteria.....identifier of [0] BasicServiceCriteria
DEFINED in MAP-MS-DataTypes : 1516

BasicServiceCriteria.....type reference SEQUENCE OF
DEFINED in MAP-MS-DataTypes : 1536
USED in MAP-MS-DataTypes : 73 1508 1516

basicServiceGroup.....identifier of [9] Ext-BasicServiceCode
DEFINED in MAP-CH-DataTypes : 104

basicServiceGroup.....identifier of [1] Ext-BasicServiceCode
DEFINED in MAP-CH-DataTypes : 233

basicServiceGroup.....identifier of [3] BasicServiceCode
DEFINED in MAP-SS-DataTypes : 210

basicServiceGroupList.....identifier of Ext-BasicServiceGroupList
DEFINED in MAP-MS-DataTypes : 1123

basicServiceGroupList.....identifier of Ext-BasicServiceGroupList
DEFINED in MAP-MS-DataTypes : 1170

basicServiceGroupList.....identifier of BasicServiceGroupList
DEFINED in MAP-SS-DataTypes : 165

basicServiceGroupList.....identifier of [2] BasicServiceGroupList
DEFINED in MAP-SS-DataTypes : 217

BasicServiceGroupList.....type reference SEQUENCE OF
DEFINED in MAP-SS-DataTypes : 264
USED in MAP-SS-DataTypes : 165 217

basicServiceList.....identifier of [1] BasicServiceList
DEFINED in MAP-MS-DataTypes : 1299

BasicServiceList.....type reference SEQUENCE OF
DEFINED in MAP-MS-DataTypes : 1347
USED in MAP-MS-DataTypes : 1299

TAG R5.40 Cross Reference Listing for MAP-Protocol 2002-06-07 14:47:03 PAGE 11

bearerService.....identifier of [2] BearerServiceCode
 DEFINED in MAP-CommonDataTypes : 449

BearerServiceCode.....type reference OCTET STRING
 DEFINED in MAP-BS-Code : 11
 USED in MAP-CommonDataTypes : 70 449
 USED in MAP-BS-Code : 49 51 52 53 54 55 56 57 58
 60 61 62 63 64 65 67 68 69
 70 71 72 73 74 76 77 78 79
 80 82 84 86 88 92 95 98 101
 110 111 112 113 114 115 116 117 118
 119 120 121 122 123 124 125

bearerServiceList.....identifier of [4] BearerServiceList
 DEFINED in MAP-MS-DataTypes : 941

BearerServiceList.....type reference SEQUENCE OF
 DEFINED in MAP-MS-DataTypes : 963
 USED in MAP-MS-DataTypes : 941 1283

bearerServiceList.....identifier of [2] BearerServiceList
 DEFINED in MAP-MS-DataTypes : 1283

bearerServiceNotProvisioned.....value reference BearerServiceNotProvisioned, CHOICE VALUE
 DEFINED in MAP-Protocol : 369

BearerServiceNotProvisioned.....type reference ERROR
 DEFINED in MAP-Errors : 244
 USED in MAP-Protocol : 138 369
 USED in MAP-MobileServiceOpera : 97 268 285
 USED in MAP-CallHandlingOperat : 37 94
 USED in MAP-SupplementaryServi : 37 97 114 131 151 169
 USED in MAP-Errors : 32

bearerServNotProvParam.....identifier of BearerServNotProvParam
 DEFINED in MAP-Errors : 246

BearerServNotProvParam.....type reference SEQUENCE
 DEFINED in MAP-ER-DataTypes : 237
 USED in MAP-Errors : 123 246
 USED in MAP-ER-DataTypes : 30

begin.....identifier of [APPLICATION 2] IMPLICIT Begin
 DEFINED in TCAPMessages : 53

Begin.....type reference SEQUENCE
 DEFINED in TCAPMessages : 61
 USED in TCAPMessages : 53

bicRoam.....value reference SS-Code, '10011011'B
 DEFINED in MAP-SS-Code : 132

blackListed.....identifier of Named Number, 1
 DEFINED in MAP-MS-DataTypes : 726

boic.....value reference SS-Code, '10010011'B
 DEFINED in MAP-SS-Code : 123

boicExHC.....value reference SS-Code, '10010100'B
 DEFINED in MAP-SS-Code : 125

bothMSCAndSGSN.....identifier of Named Number, 0
 DEFINED in MAP-MS-DataTypes : 783

broadcastInitEntitlement.....identifier of NULL
 DEFINED in MAP-MS-DataTypes : 1825

broadcastService.....identifier of Named Number, 0
 DEFINED in MAP-CommonDataTypes : 384

bssmap-ServiceHandover.....identifier of [9] BSSMAP-ServiceHandover
 DEFINED in MAP-MS-DataTypes : 463

bssmap-ServiceHandover.....identifier of [13] BSSMAP-ServiceHandover
 DEFINED in MAP-MS-DataTypes : 523

BSSMAP-ServiceHandover.....type reference OCTET STRING
DEFINED in MAP-MS-DataTypes : 527
USED in MAP-MS-DataTypes : 463 523

busy.....identifier of Named Number, 1
DEFINED in MAP-CH-DataTypes : 135

TAG R5.40 Cross Reference Listing for MAP-Protocol 2002-06-07 14:47:03 PAGE 12

busy.....identifier of Named Number, 2
 DEFINED in MAP-CH-DataTypes : 381

busySubscriber.....value reference BusySubscriber, CHOICE VALUE
 DEFINED in MAP-Protocol : 395

BusySubscriber.....type reference ERROR
 DEFINED in MAP-Errors : 291
 USED in MAP-Protocol : 146 395
 USED in MAP-CallHandlingOperat : 41 97 190
 USED in MAP-Errors : 46

busySubscriberParam.....identifier of BusySubscriberParam
 DEFINED in MAP-Errors : 293

BusySubscriberParam.....type reference SEQUENCE
 DEFINED in MAP-ER-DataTypes : 272
 USED in MAP-Errors : 129 293
 USED in MAP-ER-DataTypes : 35

b-side.....identifier of Named Number, 1
 DEFINED in MAP-CH-DataTypes : 372

b-subscriberNumber.....identifier of [1] ISDN-AddressString
 DEFINED in MAP-SS-DataTypes : 208

b-subscriberNumber.....identifier of [5] ISDN-AddressString
 DEFINED in MAP-SS-DataTypes : 281

b-subscriberSubaddress.....identifier of [2] ISDN-SubaddressString
 DEFINED in MAP-SS-DataTypes : 209

b-Subscriber-Address.....identifier of [3] ISDN-AddressString
 DEFINED in MAP-CH-DataTypes : 292

call.....identifier of Named Number, 0
 DEFINED in MAP-MS-DataTypes : 399

callBarred.....value reference CallBarred, CHOICE VALUE
 DEFINED in MAP-Protocol : 397

CallBarred.....type reference ERROR
 DEFINED in MAP-Errors : 301
 USED in MAP-Protocol : 148 397
 USED in MAP-MobileServiceOpera : 99 270 287 446
 USED in MAP-CallHandlingOperat : 43 99
 USED in MAP-SupplementaryServi : 39 99 116 133 153 171 185 226 260
 277
 USED in MAP-ShortMessageServic : 36 78
 USED in MAP-Errors : 49

callBarredParam.....identifier of CallBarredParam
 DEFINED in MAP-Errors : 303

CallBarredParam.....type reference CHOICE
 DEFINED in MAP-ER-DataTypes : 108
 USED in MAP-Errors : 131 303
 USED in MAP-ER-DataTypes : 15

callBarringCause.....identifier of CallBarringCause
 DEFINED in MAP-ER-DataTypes : 109

CallBarringCause.....type reference ENUMERATED
 DEFINED in MAP-ER-DataTypes : 115
 USED in MAP-ER-DataTypes : 109 120

callBarringCause.....identifier of CallBarringCause
 DEFINED in MAP-ER-DataTypes : 120

callBarringData.....identifier of [2] CallBarringData
 DEFINED in MAP-MS-DataTypes : 2055

CallBarringData.....type reference SEQUENCE
 DEFINED in MAP-MS-DataTypes : 2098

USED in MAP-MS-DataTypes : 2055

CallBarringFeature.....type reference SEQUENCE

DEFINED in MAP-SS-DataTypes : 156

USED in MAP-SS-DataTypes : 154

callBarringFeatureList.....identifier of Ext-CallBarFeatureList

TAG R5.40 Cross Reference Listing for MAP-Protocol 2002-06-07 14:47:03 PAGE 13

DEFINED in MAP-MS-DataTypes : 1097

callBarringFeatureList.....identifier of Ext-CallBarFeatureList
DEFINED in MAP-MS-DataTypes : 2099

callBarringFeatureList.....identifier of [1] Ext-CallBarFeatureList
DEFINED in MAP-MS-DataTypes : 2245

callBarringFeatureList.....identifier of CallBarringFeatureList
DEFINED in MAP-SS-DataTypes : 150

CallBarringFeatureList.....type reference SEQUENCE OF
DEFINED in MAP-SS-DataTypes : 153
USED in MAP-SS-DataTypes : 150

callBarringInfo.....identifier of [1] Ext-CallBarInfo
DEFINED in MAP-MS-DataTypes : 1030

callBarringInfo.....identifier of [1] CallBarringInfo
DEFINED in MAP-SS-DataTypes : 87

CallBarringInfo.....type reference SEQUENCE
DEFINED in MAP-SS-DataTypes : 148
USED in MAP-SS-DataTypes : 87

callBarringInfoFor-CSE.....identifier of [1] Ext-CallBarringInfoFor-CSE
DEFINED in MAP-MS-DataTypes : 2201

callBarringInfoFor-CSE.....identifier of [1] Ext-CallBarringInfoFor-CSE
DEFINED in MAP-MS-DataTypes : 2233

CallDirection.....type reference OCTET STRING
DEFINED in MAP-CH-DataTypes : 299
USED in MAP-CH-DataTypes : 291

callDiversionTreatmentIndicator.....identifier of [20] CallDiversionTreatmentIndicator
DEFINED in MAP-CH-DataTypes : 116

CallDiversionTreatmentIndicator.....type reference OCTET STRING
DEFINED in MAP-CH-DataTypes : 144
USED in MAP-CH-DataTypes : 116

calledPartySS-InteractionViolation.....identifier of Named Number, 7
DEFINED in MAP-ER-DataTypes : 134

callForwardingData.....identifier of [1] CallForwardingData
DEFINED in MAP-MS-DataTypes : 2054

CallForwardingData.....type reference SEQUENCE
DEFINED in MAP-MS-DataTypes : 2092
USED in MAP-MS-DataTypes : 2054

callInfo.....identifier of [1] ExternalSignalInfo
DEFINED in MAP-CH-DataTypes : 394

callInfo.....identifier of [3] ExternalSignalInfo
DEFINED in MAP-SS-DataTypes : 314

callOriginator.....identifier of [8] NULL
DEFINED in MAP-GR-DataTypes : 122

callOutcome.....identifier of [1] CallOutcome
DEFINED in MAP-CH-DataTypes : 366

CallOutcome.....type reference ENUMERATED
DEFINED in MAP-CH-DataTypes : 378
USED in MAP-CH-DataTypes : 366

callReferenceNumber.....identifier of [7] CallReferenceNumber
DEFINED in MAP-CH-DataTypes : 102

CallReferenceNumber.....type reference OCTET STRING
DEFINED in MAP-CH-DataTypes : 131
USED in MAP-CH-DataTypes : 22 102 212 232

callReferenceNumber.....identifier of [9] CallReferenceNumber
DEFINED in MAP-CH-DataTypes : 212

callReferenceNumber.....identifier of [0] CallReferenceNumber
DEFINED in MAP-CH-DataTypes : 232

callReportdata.....identifier of [2] CallReportData

TAG R5.40 Cross Reference Listing for MAP-Protocol 2002-06-07 14:47:03 PAGE 14

DEFINED in MAP-CH-DataTypes : 355

CallReportData.....type reference SEQUENCE
DEFINED in MAP-CH-DataTypes : 364
USED in MAP-CH-DataTypes : 355

callSessionRelated.....value reference SS-Code, '10110010'B
DEFINED in MAP-SS-Code : 163

callSessionUnrelated.....value reference SS-Code, '10110011'B
DEFINED in MAP-SS-Code : 166

callTerminationIndicator.....identifier of [2] CallTerminationIndicator
DEFINED in MAP-CH-DataTypes : 431

CallTerminationIndicator.....type reference ENUMERATED
DEFINED in MAP-CH-DataTypes : 444
USED in MAP-CH-DataTypes : 431

callToClientNotSetup.....identifier of Named Number, 2
DEFINED in MAP-ER-DataTypes : 359

callTypeCriteria.....identifier of [2] CallTypeCriteria
DEFINED in MAP-MS-DataTypes : 1509

CallTypeCriteria.....type reference ENUMERATED
DEFINED in MAP-MS-DataTypes : 1547
USED in MAP-MS-DataTypes : 1509

call-Direction.....identifier of [2] CallDirection
DEFINED in MAP-CH-DataTypes : 291

camelBusy.....identifier of [1] NULL
DEFINED in MAP-MS-DataTypes : 1968

camelCapabilityHandling.....identifier of [1] CamelCapabilityHandling
DEFINED in MAP-MS-DataTypes : 831

camelCapabilityHandling.....identifier of [1] CamelCapabilityHandling
DEFINED in MAP-MS-DataTypes : 1402

camelCapabilityHandling.....identifier of [0] CamelCapabilityHandling
DEFINED in MAP-MS-DataTypes : 1461

CamelCapabilityHandling.....type reference INTEGER
DEFINED in MAP-MS-DataTypes : 1578
USED in MAP-MS-DataTypes : 72 831 1402 1461 1595 1708

camelCapabilityHandling.....identifier of [1] CamelCapabilityHandling
DEFINED in MAP-MS-DataTypes : 1595

camelCapabilityHandling.....identifier of [0] CamelCapabilityHandling
DEFINED in MAP-MS-DataTypes : 1708

camelInfo.....identifier of [11] CamelInfo
DEFINED in MAP-CH-DataTypes : 106

CamelInfo.....type reference SEQUENCE
DEFINED in MAP-CH-DataTypes : 263
USED in MAP-CH-DataTypes : 106

camelRoutingInfo.....identifier of [8] CamelRoutingInfo
DEFINED in MAP-CH-DataTypes : 271

CamelRoutingInfo.....type reference SEQUENCE
DEFINED in MAP-CH-DataTypes : 273
USED in MAP-CH-DataTypes : 271

camelSubscriptionInfoWithdraw.....identifier of [9] NULL
DEFINED in MAP-MS-DataTypes : 1307

camel-invoked.....identifier of Named Number, 1
DEFINED in MAP-SS-DataTypes : 320

camel-SubscriptionInfo.....identifier of [4] CAMEL-SubscriptionInfo

DEFINED in MAP-MS-DataTypes : 2057

CAMEL-SubscriptionInfo.....type reference SEQUENCE

DEFINED in MAP-MS-DataTypes : 2114

USED in MAP-MS-DataTypes : 2057 2149 2203

camel-SubscriptionInfo.....identifier of [1] CAMEL-SubscriptionInfo

TAG R5.40 Cross Reference Listing for MAP-Protocol 2002-06-07 14:47:03 PAGE 15

DEFINED in MAP-MS-DataTypes : 2149

camel-SubscriptionInfo.....identifier of [3] CAMEL-SubscriptionInfo
DEFINED in MAP-MS-DataTypes : 2203

cancelDeferredLocation.....identifier of Named Number, 4
DEFINED in MAP-LCS-DataTypes : 134

cancellationType.....identifier of CancellationType
DEFINED in MAP-MS-DataTypes : 273

CancellationType.....type reference ENUMERATED
DEFINED in MAP-MS-DataTypes : 278
USED in MAP-MS-DataTypes : 273

cancelLocation.....value reference CancelLocation, CHOICE VALUE
DEFINED in MAP-Protocol : 194

CancelLocation.....type reference OPERATION
DEFINED in MAP-MobileServiceOpera : 188
USED in MAP-Protocol : 13 194
USED in MAP-MobileServiceOpera : 16

cancelLocationArg.....identifier of CancelLocationArg
DEFINED in MAP-MobileServiceOpera : 190

CancelLocationArg.....type reference [3] SEQUENCE
DEFINED in MAP-MS-DataTypes : 271
USED in MAP-MobileServiceOpera : 115 190
USED in MAP-MS-DataTypes : 18

cancelLocationRes.....identifier of CancelLocationRes
DEFINED in MAP-MobileServiceOpera : 192

CancelLocationRes.....type reference SEQUENCE
DEFINED in MAP-MS-DataTypes : 285
USED in MAP-MobileServiceOpera : 116 192
USED in MAP-MS-DataTypes : 19

category.....identifier of [2] Category
DEFINED in MAP-MS-DataTypes : 939

Category.....type reference OCTET STRING
DEFINED in MAP-MS-DataTypes : 956
USED in MAP-MS-DataTypes : 939

CauseValue.....type reference OCTET STRING
DEFINED in MAP-MS-DataTypes : 1565
USED in MAP-MS-DataTypes : 1556 1559

ccbsIdle.....identifier of Named Number, 1
DEFINED in MAP-CH-DataTypes : 344

ccbsNotIdle.....identifier of Named Number, 0
DEFINED in MAP-CH-DataTypes : 343

ccbsNotReachable.....identifier of Named Number, 2
DEFINED in MAP-CH-DataTypes : 345

ccbs-A.....value reference SS-Code, '01000011'B
DEFINED in MAP-SS-Code : 79

ccbs-B.....value reference SS-Code, '01000100'B
DEFINED in MAP-SS-Code : 81

ccbs-Busy.....identifier of [1] NULL
DEFINED in MAP-ER-DataTypes : 276

ccbs-Call.....identifier of [15] NULL
DEFINED in MAP-CH-DataTypes : 111

ccbs-Call.....identifier of [13] NULL
DEFINED in MAP-CH-DataTypes : 217

ccbs-Data.....identifier of [1] CCBS-Data

DEFINED in MAP-SS-DataTypes : 307

CCBS-Data.....type reference SEQUENCE

DEFINED in MAP-SS-DataTypes : 310

USED in MAP-SS-DataTypes : 307

ccbs-Feature.....identifier of [2] CCBS-Feature

TAG R5.40 Cross Reference Listing for MAP-Protocol 2002-06-07 14:47:03 PAGE 16

DEFINED in MAP-CH-DataTypes : 395

CCBS-Feature.....type reference SEQUENCE
DEFINED in MAP-SS-DataTypes : 206
USED in MAP-CH-DataTypes : 58 395
USED in MAP-SS-DataTypes : 36 202 311 325

ccbs-Feature.....identifier of [0] CCBS-Feature
DEFINED in MAP-SS-DataTypes : 311

ccbs-Feature.....identifier of [0] CCBS-Feature
DEFINED in MAP-SS-DataTypes : 325

ccbs-FeatureList.....identifier of [2] CCBS-FeatureList
DEFINED in MAP-SS-DataTypes : 196

CCBS-FeatureList.....type reference SEQUENCE OF
DEFINED in MAP-SS-DataTypes : 201
USED in MAP-SS-DataTypes : 196

ccbs-Index.....identifier of [0] CCBS-Index
DEFINED in MAP-SS-DataTypes : 207

CCBS-Index.....type reference INTEGER
DEFINED in MAP-SS-DataTypes : 213
USED in MAP-SS-DataTypes : 207 330

ccbs-Index.....identifier of [1] CCBS-Index
DEFINED in MAP-SS-DataTypes : 330

ccbs-Indicators.....identifier of [11] CCBS-Indicators
DEFINED in MAP-CH-DataTypes : 166

CCBS-Indicators.....type reference SEQUENCE
DEFINED in MAP-CH-DataTypes : 182
USED in MAP-CH-DataTypes : 166

ccbs-Monitoring.....identifier of [2] ReportingState
DEFINED in MAP-CH-DataTypes : 325

ccbs-Possible.....identifier of [0] NULL
DEFINED in MAP-CH-DataTypes : 183

ccbs-Possible.....identifier of [8] NULL
DEFINED in MAP-CH-DataTypes : 239

ccbs-Possible.....identifier of [0] NULL
DEFINED in MAP-ER-DataTypes : 275

ccbs-RequestState.....identifier of [6] CCBS-RequestState
DEFINED in MAP-SS-DataTypes : 282

CCBS-RequestState.....type reference ENUMERATED
DEFINED in MAP-SS-DataTypes : 285
USED in MAP-SS-DataTypes : 282

ccbs-SubscriberStatus.....identifier of [0] CCBS-SubscriberStatus
DEFINED in MAP-CH-DataTypes : 338

CCBS-SubscriberStatus.....type reference ENUMERATED
DEFINED in MAP-CH-DataTypes : 342
USED in MAP-CH-DataTypes : 338 360

ccbs-SubscriberStatus.....identifier of [0] CCBS-SubscriberStatus
DEFINED in MAP-CH-DataTypes : 360

cd.....value reference SS-Code, '00100100'B
DEFINED in MAP-SS-Code : 60

cellGlobalIdOrServiceAreaIdFixedLength..identifier of [0] CellGlobalIdOrServiceAreaIdFixedLength
DEFINED in MAP-CommonDataTypes : 414

CellGlobalIdOrServiceAreaIdFixedLength..type reference OCTET STRING
DEFINED in MAP-CommonDataTypes : 417
USED in MAP-CommonDataTypes : 414

cellGlobalIdOrServiceAreaIdOrLAI.....identifier of [3] CellGlobalIdOrServiceAreaIdOrLAI
DEFINED in MAP-MS-DataTypes : 1905

cellGlobalIdOrServiceAreaIdOrLAI.....identifier of [0] CellGlobalIdOrServiceAreaIdOrLAI
DEFINED in MAP-MS-DataTypes : 1919

TAG R5.40 Cross Reference Listing for MAP-Protocol 2002-06-07 14:47:03 PAGE 17

CellGlobalIdOrServiceAreaIdOrLAI.....type reference CHOICE
DEFINED in MAP-CommonDataTypes : 413
USED in MAP-MS-DataTypes : 180 1905 1919
USED in MAP-CommonDataTypes : 44

cfb.....value reference SS-Code, '00101001'B
DEFINED in MAP-SS-Code : 54

cfnc.....value reference SS-Code, '00101011'B
DEFINED in MAP-SS-Code : 58

cfny.....value reference SS-Code, '00101010'B
DEFINED in MAP-SS-Code : 56

cfu.....value reference SS-Code, '00100001'B
DEFINED in MAP-SS-Code : 50

channelType.....identifier of [0] ExternalSignalInfo
DEFINED in MAP-CH-DataTypes : 312

chargeableECT-Barred.....identifier of Named Number, 10
DEFINED in MAP-MS-DataTypes : 990

chargingCharacteristics.....identifier of [18] ChargingCharacteristics
DEFINED in MAP-MS-DataTypes : 751

ChargingCharacteristics.....type reference OCTET STRING
DEFINED in MAP-MS-DataTypes : 901
USED in MAP-MS-DataTypes : 751 805 1999

chargingCharacteristics.....identifier of [15] ChargingCharacteristics
DEFINED in MAP-MS-DataTypes : 1999

chargingId.....identifier of [14] GPRSCchargingID
DEFINED in MAP-MS-DataTypes : 1998

checkIMEI.....value reference CheckIMEI, CHOICE VALUE
DEFINED in MAP-Protocol : 217

CheckIMEI.....type reference OPERATION
DEFINED in MAP-MobileServiceOpera : 380
USED in MAP-Protocol : 24 217
USED in MAP-MobileServiceOpera : 49

chosenChannel.....identifier of [4] ExternalSignalInfo
DEFINED in MAP-CH-DataTypes : 293

chosenChannel.....identifier of [1] ExternalSignalInfo
DEFINED in MAP-CH-DataTypes : 313

chosenChannel.....identifier of [0] ExternalSignalInfo
DEFINED in MAP-CH-DataTypes : 318

chosenChannelInfo.....identifier of [0] ChosenChannelInfo
DEFINED in MAP-MS-DataTypes : 581

ChosenChannelInfo.....type reference OCTET STRING
DEFINED in MAP-MS-DataTypes : 586
USED in MAP-MS-DataTypes : 581

ChosenEncryptionAlgorithm.....type reference OCTET STRING
DEFINED in MAP-MS-DataTypes : 573
USED in MAP-MS-DataTypes : 562

ChosenIntegrityProtectionAlgorithm.....type reference OCTET STRING
DEFINED in MAP-MS-DataTypes : 566
USED in MAP-MS-DataTypes : 561

chosenRadioResourceInformation.....identifier of [6] ChosenRadioResourceInformation
DEFINED in MAP-MS-DataTypes : 556

ChosenRadioResourceInformation.....type reference SEQUENCE
DEFINED in MAP-MS-DataTypes : 580
USED in MAP-MS-DataTypes : 556 613

chosenRadioResourceInformation.....identifier of [3] ChosenRadioResourceInformation
DEFINED in MAP-MS-DataTypes : 613

chosenSpeechVersion.....identifier of [1] ChosenSpeechVersion
DEFINED in MAP-MS-DataTypes : 582

ChosenSpeechVersion.....type reference OCTET STRING

TAG R5.40 Cross Reference Listing for MAP-Protocol 2002-06-07 14:47:03 PAGE 18

DEFINED in MAP-MS-DataTypes : 590
 USED in MAP-MS-DataTypes : 582

cipheringAlgorithm.....identifier of CipheringAlgorithm
 DEFINED in MAP-GR-DataTypes : 53

CipheringAlgorithm.....type reference OCTET STRING
 DEFINED in MAP-GR-DataTypes : 100
 USED in MAP-GR-DataTypes : 53

citySightseeing.....value reference LCSServiceTypeID, 9
 DEFINED in MAP-CommonDataTypes : 405

ck.....identifier of CK
 DEFINED in MAP-MS-DataTypes : 345

ck.....identifier of CK
 DEFINED in MAP-MS-DataTypes : 360

CK.....type reference OCTET STRING
 DEFINED in MAP-MS-DataTypes : 373
 USED in MAP-MS-DataTypes : 345 360

cksn.....identifier of Cksn
 DEFINED in MAP-MS-DataTypes : 356

Cksn.....type reference OCTET STRING
 DEFINED in MAP-MS-DataTypes : 381
 USED in MAP-MS-DataTypes : 356

clientIdentity.....identifier of LCSCClientExternalID
 DEFINED in MAP-MS-DataTypes : 1222

clientNotInMSPrivacyExceptionList.....identifier of Named Number, 1
 DEFINED in MAP-ER-DataTypes : 358

clip.....value reference SS-Code, '00010001'B
 DEFINED in MAP-SS-Code : 28

clir.....value reference SS-Code, '00010010'B
 DEFINED in MAP-SS-Code : 30

cliRestrictionOption.....identifier of [2] CliRestrictionOption
 DEFINED in MAP-SS-DataTypes : 172

CliRestrictionOption.....type reference ENUMERATED
 DEFINED in MAP-SS-DataTypes : 175
 USED in MAP-SS-DataTypes : 29 172 192

cliRestrictionOption.....identifier of CliRestrictionOption
 DEFINED in MAP-SS-DataTypes : 192

clir-invoked.....identifier of Named Number, 0
 DEFINED in MAP-SS-DataTypes : 319

cnap.....value reference SS-Code, '00011001'B
 DEFINED in MAP-SS-Code : 42

codec-Info.....identifier of CODEC-Info
 DEFINED in MAP-GR-DataTypes : 52

CODEC-Info.....type reference OCTET STRING
 DEFINED in MAP-GR-DataTypes : 95
 USED in MAP-GR-DataTypes : 52

codewordCheckApplicable.....identifier of Named Number, 0
 DEFINED in MAP-LCS-DataTypes : 75

codewordCheckNotApplicable.....identifier of Named Number, 1
 DEFINED in MAP-LCS-DataTypes : 76

collectedInfo.....identifier of Named Number, 2
 DEFINED in MAP-MS-DataTypes : 1488

colp.....value reference SS-Code, '00010011'B

DEFINED in MAP-SS-Code : 32

colr.....value reference SS-Code, '00010100'B

DEFINED in MAP-SS-Code : 34

completed.....identifier of Named Number, 3

DEFINED in MAP-SS-DataTypes : 289

TAG R5.40 Cross Reference Listing for MAP-Protocol

2002-06-07 14:47:03 PAGE 19

completeDataListIncluded.....identifier of NULL
 DEFINED in MAP-MS-DataTypes : 811

completeDataListIncluded.....identifier of NULL
 DEFINED in MAP-MS-DataTypes : 921

Component.....type reference CHOICE
 DEFINED in TCAPMessages : 124
 USED in TCAPMessages : 47 115

ComponentPortion.....type reference [APPLICATION 12] IMPLICIT SEQUENCE OF
 DEFINED in TCAPMessages : 115
 USED in TCAPMessages : 59 63 67 72

components.....identifier of ComponentPortion
 DEFINED in TCAPMessages : 59

components.....identifier of ComponentPortion
 DEFINED in TCAPMessages : 63

components.....identifier of ComponentPortion
 DEFINED in TCAPMessages : 67

components.....identifier of ComponentPortion
 DEFINED in TCAPMessages : 72

congestion.....identifier of Named Number, 3
 DEFINED in MAP-LCS-DataTypes : 398

congestion.....identifier of Named Number, 0
 DEFINED in MAP-ER-DataTypes : 372

ContextId.....type reference INTEGER
 DEFINED in MAP-MS-DataTypes : 808
 USED in MAP-MS-DataTypes : 796 1338 1984

contextIdList.....identifier of ContextIdList
 DEFINED in MAP-MS-DataTypes : 1335

ContextIdList.....type reference SEQUENCE OF
 DEFINED in MAP-MS-DataTypes : 1337
 USED in MAP-MS-DataTypes : 1335

Continue.....type reference SEQUENCE
 DEFINED in TCAPMessages : 69
 USED in TCAPMessages : 55

continueCall.....identifier of Named Number, 0
 DEFINED in MAP-MS-DataTypes : 1571

continueTransaction.....identifier of Named Number, 0
 DEFINED in MAP-MS-DataTypes : 858

continueTransaction.....identifier of Named Number, 0
 DEFINED in MAP-MS-DataTypes : 1645

continue-ME.....identifier of [APPLICATION 5] IMPLICIT Continue
 DEFINED in TCAPMessages : 55

controllingMSC.....identifier of Named Number, 4
 DEFINED in MAP-CommonDataTypes : 356

csiActive.....identifier of [2] NULL
 DEFINED in MAP-MS-DataTypes : 1463

csi-Active.....identifier of [4] NULL
 DEFINED in MAP-MS-DataTypes : 834

csi-Active.....identifier of [4] NULL
 DEFINED in MAP-MS-DataTypes : 1405

csi-Active.....identifier of [1] NULL
 DEFINED in MAP-MS-DataTypes : 1433

csi-Active.....identifier of [4] NULL
DEFINED in MAP-MS-DataTypes : 1598

csi-Active.....identifier of [3] NULL
DEFINED in MAP-MS-DataTypes : 1658

csi-Active.....identifier of [3] NULL

TAG R5.40 Cross Reference Listing for MAP-Protocol 2002-06-07 14:47:03 PAGE 20

DEFINED in MAP-MS-DataTypes : 1669

csi-Active.....identifier of [2] NULL
DEFINED in MAP-MS-DataTypes : 1710

cs-AllocationRetentionPriority.....identifier of [29] CS-AllocationRetentionPriority
DEFINED in MAP-MS-DataTypes : 749

CS-AllocationRetentionPriority.....type reference OCTET STRING
DEFINED in MAP-MS-DataTypes : 756
USED in MAP-MS-DataTypes : 749

cs-Domain.....identifier of Named Number, 0
DEFINED in MAP-MS-DataTypes : 1894

cs-LCS-NotSupportedByUE.....identifier of [12] NULL
DEFINED in MAP-MS-DataTypes : 224

cug.....value reference SS-Code, '01100001'B
DEFINED in MAP-SS-Code : 96

cugIC-CallBarred.....identifier of Named Number, 1
DEFINED in MAP-MS-DataTypes : 1134

cugOG-CallBarred.....identifier of Named Number, 2
DEFINED in MAP-MS-DataTypes : 1135

cugSubscriptionFlag.....identifier of [6] NULL
DEFINED in MAP-CH-DataTypes : 156

CUG-CheckInfo.....type reference SEQUENCE
DEFINED in MAP-CH-DataTypes : 86
USED in MAP-CH-DataTypes : 96 155 236

cug-CheckInfo.....identifier of [1] CUG-CheckInfo
DEFINED in MAP-CH-DataTypes : 96

cug-CheckInfo.....identifier of [3] CUG-CheckInfo
DEFINED in MAP-CH-DataTypes : 155

cug-CheckInfo.....identifier of [4] CUG-CheckInfo
DEFINED in MAP-CH-DataTypes : 236

CUG-Feature.....type reference SEQUENCE
DEFINED in MAP-MS-DataTypes : 1147
USED in MAP-MS-DataTypes : 1140

cug-FeatureList.....identifier of CUG-FeatureList
DEFINED in MAP-MS-DataTypes : 1112

CUG-FeatureList.....type reference SEQUENCE OF
DEFINED in MAP-MS-DataTypes : 1139
USED in MAP-MS-DataTypes : 1112

cug-Index.....identifier of CUG-Index
DEFINED in MAP-MS-DataTypes : 1120

CUG-Index.....type reference INTEGER
DEFINED in MAP-MS-DataTypes : 1127
USED in MAP-MS-DataTypes : 76 1120 1149

cug-Info.....identifier of [2] CUG-Info
DEFINED in MAP-MS-DataTypes : 1031

CUG-Info.....type reference SEQUENCE
DEFINED in MAP-MS-DataTypes : 1110
USED in MAP-MS-DataTypes : 77 1031

cug-Interlock.....identifier of CUG-Interlock
DEFINED in MAP-MS-DataTypes : 1121

CUG-Interlock.....type reference OCTET STRING
DEFINED in MAP-MS-DataTypes : 1130
USED in MAP-MS-DataTypes : 78 1121
USED in MAP-CH-DataTypes : 42 87

cug-Interlock.....identifier of CUG-Interlock
DEFINED in MAP-CH-DataTypes : 87

cug-OutgoingAccess.....identifier of NULL
DEFINED in MAP-CH-DataTypes : 88

TAG R5.40 Cross Reference Listing for MAP-Protocol 2002-06-07 14:47:03 PAGE 21

cug-Reject.....value reference CUG-Reject, CHOICE VALUE
DEFINED in MAP-Protocol : 401

CUG-Reject.....type reference ERROR
DEFINED in MAP-Errors : 316
USED in MAP-Protocol : 151 401
USED in MAP-CallHandlingOperat : 46 100
USED in MAP-Errors : 52

cug-RejectCause.....identifier of CUG-RejectCause
DEFINED in MAP-ER-DataTypes : 126

CUG-RejectCause.....type reference ENUMERATED
DEFINED in MAP-ER-DataTypes : 130
USED in MAP-ER-DataTypes : 126

cug-RejectParam.....identifier of CUG-RejectParam
DEFINED in MAP-Errors : 318

CUG-RejectParam.....type reference SEQUENCE
DEFINED in MAP-ER-DataTypes : 125
USED in MAP-Errors : 134 318
USED in MAP-ER-DataTypes : 16

CUG-Subscription.....type reference SEQUENCE
DEFINED in MAP-MS-DataTypes : 1119
USED in MAP-MS-DataTypes : 1117

cug-SubscriptionList.....identifier of CUG-SubscriptionList
DEFINED in MAP-MS-DataTypes : 1111

CUG-SubscriptionList.....type reference SEQUENCE OF
DEFINED in MAP-MS-DataTypes : 1116
USED in MAP-MS-DataTypes : 1111

currentLocation.....identifier of [3] NULL
DEFINED in MAP-MS-DataTypes : 1886

currentLocation.....identifier of Named Number, 0
DEFINED in MAP-LCS-DataTypes : 129

currentLocationRetrieved.....identifier of [8] NULL
DEFINED in MAP-MS-DataTypes : 1911

currentLocationRetrieved.....identifier of [8] NULL
DEFINED in MAP-MS-DataTypes : 1928

currentOrLastKnownLocation.....identifier of Named Number, 1
DEFINED in MAP-LCS-DataTypes : 130

currentPassword.....identifier of Password
DEFINED in MAP-SupplementaryServi : 238

currentSecurityContext.....identifier of [2] CurrentSecurityContext
DEFINED in MAP-MS-DataTypes : 320

CurrentSecurityContext.....type reference CHOICE
DEFINED in MAP-MS-DataTypes : 350
USED in MAP-MS-DataTypes : 320

cw.....value reference SS-Code, '01000001'B
DEFINED in MAP-SS-Code : 75

dataCDA-1200bps.....value reference BearerServiceCode, '00010010'B
DEFINED in MAP-BS-Code : 53

dataCDA-1200-75bps.....value reference BearerServiceCode, '00010011'B
DEFINED in MAP-BS-Code : 54

dataCDA-2400bps.....value reference BearerServiceCode, '00010100'B
DEFINED in MAP-BS-Code : 55

dataCDA-300bps.....value reference BearerServiceCode, '00010001'B
DEFINED in MAP-BS-Code : 52

dataCDA-4800bps.....value reference BearerServiceCode, '00010101'B
DEFINED in MAP-BS-Code : 56

dataCDA-9600bps.....value reference BearerServiceCode, '00010110'B
DEFINED in MAP-BS-Code : 57

dataCDS-1200bps.....value reference BearerServiceCode, '00011010'B

TAG R5.40 Cross Reference Listing for MAP-Protocol 2002-06-07 14:47:03 PAGE 22

DEFINED in MAP-BS-Code : 61

dataCDS-2400bps.....value reference BearerServiceCode, '00011100'B
DEFINED in MAP-BS-Code : 62

dataCDS-4800bps.....value reference BearerServiceCode, '00011101'B
DEFINED in MAP-BS-Code : 63

dataCDS-9600bps.....value reference BearerServiceCode, '00011110'B
DEFINED in MAP-BS-Code : 64

dataCodingScheme.....identifier of [0] USSD-DataCodingScheme
DEFINED in MAP-LCS-DataTypes : 168

dataCodingScheme.....identifier of [0] USSD-DataCodingScheme
DEFINED in MAP-LCS-DataTypes : 182

dataCodingScheme.....identifier of [0] USSD-DataCodingScheme
DEFINED in MAP-LCS-DataTypes : 238

dataMissing.....value reference DataMissing, CHOICE VALUE
DEFINED in MAP-Protocol : 348

DataMissing.....type reference ERROR
DEFINED in MAP-Errors : 174
USED in MAP-Protocol : 127 348
USED in MAP-MobileServiceOpera : 83 183 195 205 215 239 252 265 282
303 317 344 363 387 399 410 429 443
458 472 483
USED in MAP-OperationAndMainte : 24 58 72 83
USED in MAP-CallHandlingOperat : 31 88 111 128 137 149 163 177 186
USED in MAP-SupplementaryServi : 34 95 112 129 149 167 182 195 209
224 247 258 275
USED in MAP-ShortMessageServic : 28 73 101 118 129 143
USED in MAP-LocationServiceOpe : 24 59 73 91
USED in MAP-SecureTransportOpe : 24 48 57
USED in MAP-Errors : 15

dataMissingParam.....identifier of DataMissingParam
DEFINED in MAP-Errors : 176

DataMissingParam.....type reference SEQUENCE
DEFINED in MAP-ER-DataTypes : 189
USED in MAP-Errors : 114 176
USED in MAP-ER-DataTypes : 21

dataPDS-2400bps.....value reference BearerServiceCode, '00101100'B
DEFINED in MAP-BS-Code : 77

dataPDS-4800bps.....value reference BearerServiceCode, '00101101'B
DEFINED in MAP-BS-Code : 78

dataPDS-9600bps.....value reference BearerServiceCode, '00101110'B
DEFINED in MAP-BS-Code : 79

deactivate.....identifier of Named Number, 0
DEFINED in MAP-MS-DataTypes : 2192

deactivateSS.....value reference DeactivateSS, CHOICE VALUE
DEFINED in MAP-Protocol : 260

DeactivateSS.....type reference OPERATION
DEFINED in MAP-SupplementaryServi : 141
USED in MAP-Protocol : 72 260
USED in MAP-SupplementaryServi : 16

deactivateTraceMode.....value reference DeactivateTraceMode, CHOICE VALUE
DEFINED in MAP-Protocol : 237

DeactivateTraceMode.....type reference OPERATION
DEFINED in MAP-OperationAndMainte : 64
USED in MAP-Protocol : 47 237
USED in MAP-OperationAndMainte : 14

deactivateTraceModeArg.....identifier of DeactivateTraceModeArg

DEFINED in MAP-OperationAndMainte : 66

DeactivateTraceModeArg.....type reference SEQUENCE

DEFINED in MAP-OM-DataTypes : 54

USED in MAP-OperationAndMainte : 36 66

USED in MAP-OM-DataTypes : 16

TAG R5.40 Cross Reference Listing for MAP-Protocol 2002-06-07 14:47:03 PAGE 23

deactivateTraceModeRes.....identifier of DeactivateTraceModeRes
DEFINED in MAP-OperationAndMainte : 68

DeactivateTraceModeRes.....type reference SEQUENCE
DEFINED in MAP-OM-DataTypes : 60
USED in MAP-OperationAndMainte : 37 68
USED in MAP-OM-DataTypes : 17

defaultCallHandling.....identifier of DefaultCallHandling
DEFINED in MAP-MS-DataTypes : 1424

defaultCallHandling.....identifier of [1] DefaultCallHandling
DEFINED in MAP-MS-DataTypes : 1480

DefaultCallHandling.....type reference ENUMERATED
DEFINED in MAP-MS-DataTypes : 1570
USED in MAP-MS-DataTypes : 71 1424 1480 1727

defaultCallHandling.....identifier of [1] DefaultCallHandling
DEFINED in MAP-MS-DataTypes : 1727

DefaultGPRS-Handling.....type reference ENUMERATED
DEFINED in MAP-MS-DataTypes : 857
USED in MAP-MS-DataTypes : 852

defaultPriority.....identifier of EMLPP-Priority
DEFINED in MAP-CommonDataTypes : 458

defaultPriority.....identifier of [7] EMLPP-Priority
DEFINED in MAP-SS-DataTypes : 79

defaultPriority.....identifier of EMLPP-Priority
DEFINED in MAP-SS-DataTypes : 167

defaultPriority.....identifier of [1] EMLPP-Priority
DEFINED in MAP-SS-DataTypes : 195

defaultSessionHandling.....identifier of [3] DefaultGPRS-Handling
DEFINED in MAP-MS-DataTypes : 852

defaultSMS-Handling.....identifier of [3] DefaultSMS-Handling
DEFINED in MAP-MS-DataTypes : 1617

DefaultSMS-Handling.....type reference ENUMERATED
DEFINED in MAP-MS-DataTypes : 1644
USED in MAP-MS-DataTypes : 1617

deferredLocationEventType.....identifier of [1] DeferredLocationEventType
DEFINED in MAP-LCS-DataTypes : 126

DeferredLocationEventType.....type reference BIT STRING
DEFINED in MAP-LCS-DataTypes : 139
USED in MAP-LCS-DataTypes : 126 377

deferredLocationEventType.....identifier of DeferredLocationEventType
DEFINED in MAP-LCS-DataTypes : 377

deferredmt-IrData.....identifier of [9] Deferredmt-IrData
DEFINED in MAP-LCS-DataTypes : 360

Deferredmt-IrData.....type reference SEQUENCE
DEFINED in MAP-LCS-DataTypes : 376
USED in MAP-LCS-DataTypes : 360

deferredmt-IrResponse.....identifier of Named Number, 3
DEFINED in MAP-LCS-DataTypes : 389

deferredmt-IrResponseIndicator.....identifier of [3] NULL
DEFINED in MAP-LCS-DataTypes : 252

delaytolerant.....identifier of Named Number, 1
DEFINED in MAP-LCS-DataTypes : 221

deleted.....identifier of Named Number, 6
DEFINED in MAP-SS-DataTypes : 292

deleteSubscriberData.....value reference DeleteSubscriberData, CHOICE VALUE
DEFINED in MAP-Protocol : 223

DeleteSubscriberData.....type reference OPERATION
DEFINED in MAP-MobileServiceOpera : 403
USED in MAP-Protocol : 26 223

TAG R5.40 Cross Reference Listing for MAP-Protocol 2002-06-07 14:47:03 PAGE 24

USED in MAP-MobileServiceOpera : 53

deleteSubscriberDataArg.....identifier of DeleteSubscriberDataArg
DEFINED in MAP-MobileServiceOpera : 405

DeleteSubscriberDataArg.....type reference SEQUENCE
DEFINED in MAP-MS-DataTypes : 1297
USED in MAP-MobileServiceOpera : 138 405
USED in MAP-MS-DataTypes : 57

deleteSubscriberDataRes.....identifier of DeleteSubscriberDataRes
DEFINED in MAP-MobileServiceOpera : 407

DeleteSubscriberDataRes.....type reference SEQUENCE
DEFINED in MAP-MS-DataTypes : 1352
USED in MAP-MobileServiceOpera : 139 407
USED in MAP-MS-DataTypes : 58

deliveryOutcomeIndicator.....identifier of [3] NULL
DEFINED in MAP-SM-DataTypes : 155

derivable.....identifier of InvokeldType
DEFINED in TCAPMessages : 167

destinationNumberCriteria.....identifier of [0] DestinationNumberCriteria
DEFINED in MAP-MS-DataTypes : 1507

DestinationNumberCriteria.....type reference SEQUENCE
DEFINED in MAP-MS-DataTypes : 1520
USED in MAP-MS-DataTypes : 1507

destinationNumberLengthList.....identifier of [2] DestinationNumberLengthList
DEFINED in MAP-MS-DataTypes : 1523

DestinationNumberLengthList.....type reference SEQUENCE OF
DEFINED in MAP-MS-DataTypes : 1533
USED in MAP-MS-DataTypes : 1523

destinationNumberList.....identifier of [1] DestinationNumberList
DEFINED in MAP-MS-DataTypes : 1522

DestinationNumberList.....type reference SEQUENCE OF
DEFINED in MAP-MS-DataTypes : 1528
USED in MAP-MS-DataTypes : 1522

DestTransactionID.....type reference [APPLICATION 9] IMPLICIT TransactionID
DEFINED in TCAPMessages : 98
USED in TCAPMessages : 65 70 74

diagnosticInfo.....identifier of SignallInfo
DEFINED in MAP-ER-DataTypes : 159

dialledNumber.....identifier of ISDN-AddressString
DEFINED in MAP-MS-DataTypes : 1421

dialoguePortion.....identifier of DialoguePortion
DEFINED in TCAPMessages : 58

dialoguePortion.....identifier of DialoguePortion
DEFINED in TCAPMessages : 62

dialoguePortion.....identifier of DialoguePortion
DEFINED in TCAPMessages : 66

dialoguePortion.....identifier of DialoguePortion
DEFINED in TCAPMessages : 71

dialoguePortion.....identifier of DialoguePortion
DEFINED in TCAPMessages : 77

DialoguePortion.....type reference [APPLICATION 11] EXTERNAL
DEFINED in TCAPMessages : 82
USED in TCAPMessages : 58 62 66 71 77

disallowedByLocalRegulatoryRequirements.identifier of Named Number, 4

DEFINED in MAP-ER-DataTypes : 361

DomainType.....type reference ENUMERATED

DEFINED in MAP-MS-DataTypes : 1893

USED in MAP-MS-DataTypes : 1887

doublyChargeableECT-Barred.....identifier of Named Number, 13

TAG R5.40 Cross Reference Listing for MAP-Protocol 2002-06-07 14:47:03 PAGE 25

DEFINED in MAP-MS-DataTypes : 993

downlinkAttached.....identifier of [5] NULL
DEFINED in MAP-GR-DataTypes : 119

dp-AnalysedInfoCriteriaList.....identifier of [0] DP-AnalysedInfoCriteriaList
DEFINED in MAP-MS-DataTypes : 1401

DP-AnalysedInfoCriteriaList.....type reference SEQUENCE OF
DEFINED in MAP-MS-DataTypes : 1415
USED in MAP-MS-DataTypes : 1401

DP-AnalysedInfoCriterium.....type reference SEQUENCE
DEFINED in MAP-MS-DataTypes : 1420
USED in MAP-MS-DataTypes : 1416

dtid.....identifier of DestTransactionID
DEFINED in TCAPMessages : 65

dtid.....identifier of DestTransactionID
DEFINED in TCAPMessages : 70

dtid.....identifier of DestTransactionID
DEFINED in TCAPMessages : 74

dualCommunication.....identifier of [7] NULL
DEFINED in MAP-GR-DataTypes : 121

duplicateInvokeID.....identifier of Named Number, 0
DEFINED in TCAPMessages : 183

d-csi.....identifier of Named Number, 3
DEFINED in MAP-MS-DataTypes : 1321

d-CSI.....identifier of [9] D-CSI
DEFINED in MAP-MS-DataTypes : 1368

D-CSI.....type reference SEQUENCE
DEFINED in MAP-MS-DataTypes : 1400
USED in MAP-MS-DataTypes : 66 1368 2117
USED in MAP-CH-DataTypes : 44 244 286

d-csi.....identifier of Named Number, 8
DEFINED in MAP-MS-DataTypes : 2084

d-CSI.....identifier of [2] D-CSI
DEFINED in MAP-MS-DataTypes : 2117

d-csi.....identifier of [12] D-CSI
DEFINED in MAP-CH-DataTypes : 244

d-csi.....identifier of [5] D-CSI
DEFINED in MAP-CH-DataTypes : 286

ect.....value reference SS-Code, '00110001'B
DEFINED in MAP-SS-Code : 66

eir.....identifier of Named Number, 6
DEFINED in MAP-CommonDataTypes : 358

ellipsoidArc.....identifier of Named Number, 6
DEFINED in MAP-LCS-DataTypes : 233

ellipsoidPoint.....identifier of Named Number, 0
DEFINED in MAP-LCS-DataTypes : 227

ellipsoidPointWithAltitude.....identifier of Named Number, 4
DEFINED in MAP-LCS-DataTypes : 231

ellipsoidPointWithAltitudeAndUncertainty.....identifier of Named Number, 5
DEFINED in MAP-LCS-DataTypes : 232

ellipsoidPointWithUncertaintyCircle.....identifier of Named Number, 1
DEFINED in MAP-LCS-DataTypes : 228

ellipsoidPointWithUncertaintyEllipse....identifier of Named Number, 2
DEFINED in MAP-LCS-DataTypes : 229

emergencyAlertServices.....value reference LCSServiceTypeID, 1
DEFINED in MAP-CommonDataTypes : 397

emergencyCall.....identifier of Named Number, 1

TAG R5.40 Cross Reference Listing for MAP-Protocol 2002-06-07 14:47:03 PAGE 26

DEFINED in MAP-MS-DataTypes : 400

emergencyCallOrigination.....identifier of Named Number, 0
 DEFINED in MAP-LCS-DataTypes : 385

emergencyCallRelease.....identifier of Named Number, 1
 DEFINED in MAP-LCS-DataTypes : 386

emergencyCalls.....value reference TeleserviceCode, '00010010'B
 DEFINED in MAP-TS-Code : 42

emergencyServices.....value reference LCSServiceTypeID, 0
 DEFINED in MAP-CommonDataTypes : 396

emergencyServices.....identifier of Named Number, 0
 DEFINED in MAP-LCS-DataTypes : 157

emlpp.....value reference SS-Code, '10100001'B
 DEFINED in MAP-SS-Code : 156

emlpp-Info.....identifier of [4] EMLPP-Info
 DEFINED in MAP-MS-DataTypes : 1033

EMLPP-Info.....type reference SEQUENCE
 DEFINED in MAP-CommonDataTypes : 456
 USED in MAP-MS-DataTypes : 183 1033
 USED in MAP-CommonDataTypes : 49

EMLPP-Priority.....type reference INTEGER
 DEFINED in MAP-CommonDataTypes : 462
 USED in MAP-CommonDataTypes : 50 457 458 468 469 470 471 472 473
 474
 USED in MAP-SS-DataTypes : 51 79 167 194 195
 USED in MAP-GR-DataTypes : 25 56

enabling.....identifier of Named Number, 1
 DEFINED in MAP-MS-DataTypes : 1553

encryptionAlgorithm.....identifier of [1] ChosenEncryptionAlgorithm
 DEFINED in MAP-MS-DataTypes : 562

encryptionAlgorithms.....identifier of [1] PermittedEncryptionAlgorithms
 DEFINED in MAP-MS-DataTypes : 473

encryptionInfo.....identifier of [1] EncryptionInformation
 DEFINED in MAP-MS-DataTypes : 455

encryptionInfo.....identifier of [6] EncryptionInformation
 DEFINED in MAP-MS-DataTypes : 515

EncryptionInformation.....type reference OCTET STRING
 DEFINED in MAP-MS-DataTypes : 676
 USED in MAP-MS-DataTypes : 455 515

End.....type reference SEQUENCE
 DEFINED in TCAPMessages : 65
 USED in TCAPMessages : 54

end-ME.....identifier of [APPLICATION 4] IMPLICIT End
 DEFINED in TCAPMessages : 54

enterNewPW.....identifier of Named Number, 1
 DEFINED in MAP-SS-DataTypes : 250

enterNewPW-Again.....identifier of Named Number, 2
 DEFINED in MAP-SS-DataTypes : 251

enterPW.....identifier of Named Number, 0
 DEFINED in MAP-SS-DataTypes : 249

equipmentNotSM-Equipped.....identifier of Named Number, 2
 DEFINED in MAP-ER-DataTypes : 151

equipmentProtocolError.....identifier of Named Number, 1
 DEFINED in MAP-ER-DataTypes : 150

equipmentStatus.....identifier of EquipmentStatus
DEFINED in MAP-MobileServiceOpera : 384

EquipmentStatus.....type reference ENUMERATED
DEFINED in MAP-MS-DataTypes : 724
USED in MAP-MobileServiceOpera : 135 384

TAG R5.40 Cross Reference Listing for MAP-Protocol 2002-06-07 14:47:03 PAGE 27

USED in MAP-MS-DataTypes : 50

eraseCC-Entry.....value reference EraseCC-Entry, CHOICE VALUE
DEFINED in MAP-Protocol : 269

EraseCC-Entry.....type reference OPERATION
DEFINED in MAP-SupplementaryServi : 268
USED in MAP-Protocol : 81 269
USED in MAP-SupplementaryServi : 25

eraseCC-EntryArg.....identifier of EraseCC-EntryArg
DEFINED in MAP-SupplementaryServi : 270

EraseCC-EntryArg.....type reference SEQUENCE
DEFINED in MAP-SS-DataTypes : 328
USED in MAP-SupplementaryServi : 72 270
USED in MAP-SS-DataTypes : 39

eraseCC-EntryRes.....identifier of EraseCC-EntryRes
DEFINED in MAP-SupplementaryServi : 272

EraseCC-EntryRes.....type reference SEQUENCE
DEFINED in MAP-SS-DataTypes : 333
USED in MAP-SupplementaryServi : 73 272
USED in MAP-SS-DataTypes : 40

eraseSS.....value reference EraseSS, CHOICE VALUE
DEFINED in MAP-Protocol : 258

EraseSS.....type reference OPERATION
DEFINED in MAP-SupplementaryServi : 104
USED in MAP-Protocol : 70 258
USED in MAP-SupplementaryServi : 14

errorCode.....identifier of ERROR
DEFINED in TCAPMessages : 158
USED in TCAPMessages : 159

errorCode.....identifier of [1] ErrorCode
DEFINED in MAP-ST-DataTypes : 87

ErrorCode.....type reference CHOICE
DEFINED in MAP-ST-DataTypes : 94
USED in MAP-ST-DataTypes : 87

errorundefined.....identifier of Named Number, 1
DEFINED in MAP-LCS-DataTypes : 396

ets-300102-1.....identifier of Named Number, 4
DEFINED in MAP-CommonDataTypes : 222

ets-300356.....identifier of Named Number, 1
DEFINED in MAP-CommonDataTypes : 233

eventMet.....identifier of [0] MM-Code
DEFINED in MAP-MS-DataTypes : 2217

eventReportData.....identifier of [1] EventReportData
DEFINED in MAP-CH-DataTypes : 354

EventReportData.....type reference SEQUENCE
DEFINED in MAP-CH-DataTypes : 359
USED in MAP-CH-DataTypes : 354

extendedRoutingInfo.....identifier of ExtendedRoutingInfo
DEFINED in MAP-CH-DataTypes : 154

ExtendedRoutingInfo.....type reference CHOICE
DEFINED in MAP-CH-DataTypes : 269
USED in MAP-CH-DataTypes : 154

extensibleCallBarredParam.....identifier of ExtensibleCallBarredParam
DEFINED in MAP-ER-DataTypes : 111

ExtensibleCallBarredParam.....type reference SEQUENCE

DEFINED in MAP-ER-DataTypes : 119
USED in MAP-ER-DataTypes : 111

extensibleSystemFailureParam.....identifier of ExtensibleSystemFailureParam
DEFINED in MAP-ER-DataTypes : 180

ExtensibleSystemFailureParam.....type reference SEQUENCE

TAG R5.40 Cross Reference Listing for MAP-Protocol 2002-06-07 14:47:03 PAGE 28

DEFINED in MAP-ER-DataTypes : 184
USED in MAP-ER-DataTypes : 180

extensionContainer.....identifier of ExtensionContainer
DEFINED in MAP-MS-DataTypes : 220

extensionContainer.....identifier of ExtensionContainer
DEFINED in MAP-MS-DataTypes : 228

extensionContainer.....identifier of ExtensionContainer
DEFINED in MAP-MS-DataTypes : 268

extensionContainer.....identifier of ExtensionContainer
DEFINED in MAP-MS-DataTypes : 274

extensionContainer.....identifier of ExtensionContainer
DEFINED in MAP-MS-DataTypes : 286

extensionContainer.....identifier of ExtensionContainer
DEFINED in MAP-MS-DataTypes : 293

extensionContainer.....identifier of ExtensionContainer
DEFINED in MAP-MS-DataTypes : 299

extensionContainer.....identifier of ExtensionContainer
DEFINED in MAP-MS-DataTypes : 311

extensionContainer.....identifier of [3] ExtensionContainer
DEFINED in MAP-MS-DataTypes : 321

extensionContainer.....identifier of ExtensionContainer
DEFINED in MAP-MS-DataTypes : 390

extensionContainer.....identifier of ExtensionContainer
DEFINED in MAP-MS-DataTypes : 414

extensionContainer.....identifier of ExtensionContainer
DEFINED in MAP-MS-DataTypes : 427

extensionContainer.....identifier of [1] ExtensionContainer
DEFINED in MAP-MS-DataTypes : 435

extensionContainer.....identifier of ExtensionContainer
DEFINED in MAP-MS-DataTypes : 447

extensionContainer.....identifier of [3] ExtensionContainer
DEFINED in MAP-MS-DataTypes : 460

extensionContainer.....identifier of [2] ExtensionContainer
DEFINED in MAP-MS-DataTypes : 474

extensionContainer.....identifier of [8] ExtensionContainer
DEFINED in MAP-MS-DataTypes : 520

extensionContainer.....identifier of [4] ExtensionContainer
DEFINED in MAP-MS-DataTypes : 557

extensionContainer.....identifier of [2] ExtensionContainer
DEFINED in MAP-MS-DataTypes : 563

extensionContainer.....identifier of [5] ExtensionContainer
DEFINED in MAP-MS-DataTypes : 601

extensionContainer.....identifier of [0] ExtensionContainer
DEFINED in MAP-MS-DataTypes : 606

extensionContainer.....identifier of [0] ExtensionContainer
DEFINED in MAP-MS-DataTypes : 615

extensionContainer.....identifier of [0] ExtensionContainer
DEFINED in MAP-MS-DataTypes : 625

extensionContainer.....identifier of [0] ExtensionContainer
DEFINED in MAP-MS-DataTypes : 629

extensionContainer.....identifier of [2] ExtensionContainer
DEFINED in MAP-MS-DataTypes : 698

extensionContainer.....identifier of ExtensionContainer
DEFINED in MAP-MS-DataTypes : 711

extensionContainer.....identifier of [14] ExtensionContainer

TAG R5.40 Cross Reference Listing for MAP-Protocol 2002-06-07 14:47:03 PAGE 29

- DEFINED in MAP-MS-DataTypes : 735
- extensionContainer.....identifier of [21] ExtensionContainer
DEFINED in MAP-MS-DataTypes : 802
- extensionContainer.....identifier of [2] ExtensionContainer
DEFINED in MAP-MS-DataTypes : 816
- extensionContainer.....identifier of [2] ExtensionContainer
DEFINED in MAP-MS-DataTypes : 822
- extensionContainer.....identifier of [2] ExtensionContainer
DEFINED in MAP-MS-DataTypes : 832
- extensionContainer.....identifier of [4] ExtensionContainer
DEFINED in MAP-MS-DataTypes : 853
- extensionContainer.....identifier of [3] ExtensionContainer
DEFINED in MAP-MS-DataTypes : 917
- extensionContainer.....identifier of [3] ExtensionContainer
DEFINED in MAP-MS-DataTypes : 927
- extensionContainer.....identifier of ExtensionContainer
DEFINED in MAP-MS-DataTypes : 976
- extensionContainer.....identifier of [0] ExtensionContainer
DEFINED in MAP-MS-DataTypes : 1039
- extensionContainer.....identifier of [9] ExtensionContainer
DEFINED in MAP-MS-DataTypes : 1055
- extensionContainer.....identifier of ExtensionContainer
DEFINED in MAP-MS-DataTypes : 1098
- extensionContainer.....identifier of ExtensionContainer
DEFINED in MAP-MS-DataTypes : 1107
- extensionContainer.....identifier of [0] ExtensionContainer
DEFINED in MAP-MS-DataTypes : 1113
- extensionContainer.....identifier of [0] ExtensionContainer
DEFINED in MAP-MS-DataTypes : 1124
- extensionContainer.....identifier of ExtensionContainer
DEFINED in MAP-MS-DataTypes : 1151
- extensionContainer.....identifier of [5] ExtensionContainer
DEFINED in MAP-MS-DataTypes : 1171
- extensionContainer.....identifier of [3] ExtensionContainer
DEFINED in MAP-MS-DataTypes : 1194
- extensionContainer.....identifier of [2] ExtensionContainer
DEFINED in MAP-MS-DataTypes : 1227
- extensionContainer.....identifier of [2] ExtensionContainer
DEFINED in MAP-MS-DataTypes : 1259
- extensionContainer.....identifier of [0] ExtensionContainer
DEFINED in MAP-MS-DataTypes : 1270
- extensionContainer.....identifier of [7] ExtensionContainer
DEFINED in MAP-MS-DataTypes : 1288
- extensionContainer.....identifier of [6] ExtensionContainer
DEFINED in MAP-MS-DataTypes : 1308
- extensionContainer.....identifier of ExtensionContainer
DEFINED in MAP-MS-DataTypes : 1354
- extensionContainer.....identifier of [1] ExtensionContainer
DEFINED in MAP-MS-DataTypes : 1359
- extensionContainer.....identifier of [2] ExtensionContainer

DEFINED in MAP-MS-DataTypes : 1403

extensionContainer.....identifier of ExtensionContainer
DEFINED in MAP-MS-DataTypes : 1425

extensionContainer.....identifier of ExtensionContainer
DEFINED in MAP-MS-DataTypes : 1430

TAG R5.40 Cross Reference Listing for MAP-Protocol 2002-06-07 14:47:03 PAGE 30

extensionContainer.....identifier of [0] ExtensionContainer
DEFINED in MAP-MS-DataTypes : 1441

extensionContainer.....identifier of ExtensionContainer
DEFINED in MAP-MS-DataTypes : 1459

extensionContainer.....identifier of [2] ExtensionContainer
DEFINED in MAP-MS-DataTypes : 1481

extensionContainer.....identifier of [4] ExtensionContainer
DEFINED in MAP-MS-DataTypes : 1512

extensionContainer.....identifier of [2] ExtensionContainer
DEFINED in MAP-MS-DataTypes : 1596

extensionContainer.....identifier of [4] ExtensionContainer
DEFINED in MAP-MS-DataTypes : 1618

extensionContainer.....identifier of [1] ExtensionContainer
DEFINED in MAP-MS-DataTypes : 1656

extensionContainer.....identifier of [1] ExtensionContainer
DEFINED in MAP-MS-DataTypes : 1667

extensionContainer.....identifier of ExtensionContainer
DEFINED in MAP-MS-DataTypes : 1706

extensionContainer.....identifier of [2] ExtensionContainer
DEFINED in MAP-MS-DataTypes : 1728

extensionContainer.....identifier of [3] ExtensionContainer
DEFINED in MAP-MS-DataTypes : 1748

extensionContainer.....identifier of [3] ExtensionContainer
DEFINED in MAP-MS-DataTypes : 1755

extensionContainer.....identifier of [3] ExtensionContainer
DEFINED in MAP-MS-DataTypes : 1764

extensionContainer.....identifier of [1] ExtensionContainer
DEFINED in MAP-MS-DataTypes : 1769

extensionContainer.....identifier of [3] ExtensionContainer
DEFINED in MAP-MS-DataTypes : 1778

extensionContainer.....identifier of [0] ExtensionContainer
DEFINED in MAP-MS-DataTypes : 1782

extensionContainer.....identifier of ExtensionContainer
DEFINED in MAP-MS-DataTypes : 1796

extensionContainer.....identifier of ExtensionContainer
DEFINED in MAP-MS-DataTypes : 1803

extensionContainer.....identifier of ExtensionContainer
DEFINED in MAP-MS-DataTypes : 1820

extensionContainer.....identifier of ExtensionContainer
DEFINED in MAP-MS-DataTypes : 1826

extensionContainer.....identifier of [3] ExtensionContainer
DEFINED in MAP-MS-DataTypes : 1839

extensionContainer.....identifier of ExtensionContainer
DEFINED in MAP-MS-DataTypes : 1844

extensionContainer.....identifier of [2] ExtensionContainer
DEFINED in MAP-MS-DataTypes : 1850

extensionContainer.....identifier of [2] ExtensionContainer
DEFINED in MAP-MS-DataTypes : 1884

extensionContainer.....identifier of [4] ExtensionContainer
DEFINED in MAP-MS-DataTypes : 1906

extensionContainer.....identifier of [5] ExtensionContainer
DEFINED in MAP-MS-DataTypes : 1924

extensionContainer.....identifier of [17] ExtensionContainer
DEFINED in MAP-MS-DataTypes : 2001

TAG R5.40 Cross Reference Listing for MAP-Protocol 2002-06-07 14:47:03 PAGE 31

extensionContainer.....identifier of [2] ExtensionContainer
DEFINED in MAP-MS-DataTypes : 2034

extensionContainer.....identifier of ExtensionContainer
DEFINED in MAP-MS-DataTypes : 2039

extensionContainer.....identifier of [3] ExtensionContainer
DEFINED in MAP-MS-DataTypes : 2049

extensionContainer.....identifier of [7] ExtensionContainer
DEFINED in MAP-MS-DataTypes : 2060

extensionContainer.....identifier of [6] ExtensionContainer
DEFINED in MAP-MS-DataTypes : 2069

extensionContainer.....identifier of [0] ExtensionContainer
DEFINED in MAP-MS-DataTypes : 2095

extensionContainer.....identifier of ExtensionContainer
DEFINED in MAP-MS-DataTypes : 2103

extensionContainer.....identifier of ExtensionContainer
DEFINED in MAP-MS-DataTypes : 2111

extensionContainer.....identifier of [13] ExtensionContainer
DEFINED in MAP-MS-DataTypes : 2128

extensionContainer.....identifier of [5] ExtensionContainer
DEFINED in MAP-MS-DataTypes : 2142

extensionContainer.....identifier of [2] ExtensionContainer
DEFINED in MAP-MS-DataTypes : 2150

extensionContainer.....identifier of [7] ExtensionContainer
DEFINED in MAP-MS-DataTypes : 2162

extensionContainer.....identifier of [6] ExtensionContainer
DEFINED in MAP-MS-DataTypes : 2172

extensionContainer.....identifier of [2] ExtensionContainer
DEFINED in MAP-MS-DataTypes : 2178

extensionContainer.....identifier of [3] ExtensionContainer
DEFINED in MAP-MS-DataTypes : 2185

extensionContainer.....identifier of ExtensionContainer
DEFINED in MAP-MS-DataTypes : 2205

extensionContainer.....identifier of ExtensionContainer
DEFINED in MAP-MS-DataTypes : 2209

extensionContainer.....identifier of [6] ExtensionContainer
DEFINED in MAP-MS-DataTypes : 2222

extensionContainer.....identifier of ExtensionContainer
DEFINED in MAP-MS-DataTypes : 2228

extensionContainer.....identifier of [3] ExtensionContainer
DEFINED in MAP-MS-DataTypes : 2240

extensionContainer.....identifier of [5] ExtensionContainer
DEFINED in MAP-MS-DataTypes : 2249

extensionContainer.....identifier of ExtensionContainer
DEFINED in MAP-CommonDataTypes : 203

extensionContainer.....identifier of ExtensionContainer
DEFINED in MAP-CommonDataTypes : 229

extensionContainer.....identifier of ExtensionContainer
DEFINED in MAP-CommonDataTypes : 246

extensionContainer.....identifier of [1] ExtensionContainer
DEFINED in MAP-CommonDataTypes : 363

extensionContainer.....identifier of [1] ExtensionContainer
DEFINED in MAP-CommonDataTypes : 380

extensionContainer.....identifier of ExtensionContainer
DEFINED in MAP-CommonDataTypes : 459

extensionContainer.....identifier of [4] ExtensionContainer

TAG R5.40 Cross Reference Listing for MAP-Protocol 2002-06-07 14:47:03 PAGE 32

- DEFINED in MAP-CommonDataTypes : 482
- extensionContainer.....identifier of [4] ExtensionContainer
DEFINED in MAP-OM-DataTypes : 41
- extensionContainer.....identifier of [0] ExtensionContainer
DEFINED in MAP-OM-DataTypes : 51
- extensionContainer.....identifier of [2] ExtensionContainer
DEFINED in MAP-OM-DataTypes : 57
- extensionContainer.....identifier of [0] ExtensionContainer
DEFINED in MAP-OM-DataTypes : 61
- extensionContainer.....identifier of ExtensionContainer
DEFINED in MAP-CH-DataTypes : 89
- extensionContainer.....identifier of [13] ExtensionContainer
DEFINED in MAP-CH-DataTypes : 108
- extensionContainer.....identifier of [0] ExtensionContainer
DEFINED in MAP-CH-DataTypes : 162
- extensionContainer.....identifier of [2] ExtensionContainer
DEFINED in MAP-CH-DataTypes : 185
- extensionContainer.....identifier of [7] ExtensionContainer
DEFINED in MAP-CH-DataTypes : 199
- extensionContainer.....identifier of [11] ExtensionContainer
DEFINED in MAP-CH-DataTypes : 214
- extensionContainer.....identifier of ExtensionContainer
DEFINED in MAP-CH-DataTypes : 228
- extensionContainer.....identifier of [7] ExtensionContainer
DEFINED in MAP-CH-DataTypes : 238
- extensionContainer.....identifier of [3] ExtensionContainer
DEFINED in MAP-CH-DataTypes : 250
- extensionContainer.....identifier of ExtensionContainer
DEFINED in MAP-CH-DataTypes : 260
- extensionContainer.....identifier of ExtensionContainer
DEFINED in MAP-CH-DataTypes : 266
- extensionContainer.....identifier of [1] ExtensionContainer
DEFINED in MAP-CH-DataTypes : 276
- extensionContainer.....identifier of [2] ExtensionContainer
DEFINED in MAP-CH-DataTypes : 282
- extensionContainer.....identifier of [7] ExtensionContainer
DEFINED in MAP-CH-DataTypes : 296
- extensionContainer.....identifier of [1] ExtensionContainer
DEFINED in MAP-CH-DataTypes : 308
- extensionContainer.....identifier of [2] ExtensionContainer
DEFINED in MAP-CH-DataTypes : 314
- extensionContainer.....identifier of [1] ExtensionContainer
DEFINED in MAP-CH-DataTypes : 319
- extensionContainer.....identifier of [3] ExtensionContainer
DEFINED in MAP-CH-DataTypes : 326
- extensionContainer.....identifier of [1] ExtensionContainer
DEFINED in MAP-CH-DataTypes : 339
- extensionContainer.....identifier of [3] ExtensionContainer
DEFINED in MAP-CH-DataTypes : 356
- extensionContainer.....identifier of [1] ExtensionContainer

DEFINED in MAP-CH-DataTypes : 361

extensionContainer.....identifier of [2] ExtensionContainer
DEFINED in MAP-CH-DataTypes : 367

extensionContainer.....identifier of [0] ExtensionContainer
DEFINED in MAP-CH-DataTypes : 389

TAG R5.40 Cross Reference Listing for MAP-Protocol 2002-06-07 14:47:03 PAGE 33

extensionContainer.....identifier of [6] ExtensionContainer
DEFINED in MAP-CH-DataTypes : 399

extensionContainer.....identifier of [1] ExtensionContainer
DEFINED in MAP-CH-DataTypes : 404

extensionContainer.....identifier of [1] ExtensionContainer
DEFINED in MAP-CH-DataTypes : 425

extensionContainer.....identifier of [3] ExtensionContainer
DEFINED in MAP-CH-DataTypes : 432

extensionContainer.....identifier of [1] ExtensionContainer
DEFINED in MAP-CH-DataTypes : 437

extensionContainer.....identifier of ExtensionContainer
DEFINED in MAP-CH-DataTypes : 441

extensionContainer.....identifier of [4] ExtensionContainer
DEFINED in MAP-SS-DataTypes : 279

extensionContainer.....identifier of ExtensionContainer
DEFINED in MAP-SS-DataTypes : 296

extensionContainer.....identifier of [6] ExtensionContainer
DEFINED in MAP-SM-DataTypes : 57

extensionContainer.....identifier of [4] ExtensionContainer
DEFINED in MAP-SM-DataTypes : 83

extensionContainer.....identifier of ExtensionContainer
DEFINED in MAP-SM-DataTypes : 89

extensionContainer.....identifier of ExtensionContainer
DEFINED in MAP-SM-DataTypes : 111

extensionContainer.....identifier of ExtensionContainer
DEFINED in MAP-SM-DataTypes : 117

extensionContainer.....identifier of ExtensionContainer
DEFINED in MAP-SM-DataTypes : 125

extensionContainer.....identifier of ExtensionContainer
DEFINED in MAP-SM-DataTypes : 130

extensionContainer.....identifier of [1] ExtensionContainer
DEFINED in MAP-SM-DataTypes : 150

extensionContainer.....identifier of ExtensionContainer
DEFINED in MAP-SM-DataTypes : 174

extensionContainer.....identifier of ExtensionContainer
DEFINED in MAP-SM-DataTypes : 186

extensionContainer.....identifier of ExtensionContainer
DEFINED in MAP-SM-DataTypes : 209

extensionContainer.....identifier of ExtensionContainer
DEFINED in MAP-SM-DataTypes : 213

extensionContainer.....identifier of [4] ExtensionContainer
DEFINED in MAP-GR-DataTypes : 58

extensionContainer.....identifier of ExtensionContainer
DEFINED in MAP-GR-DataTypes : 63

extensionContainer.....identifier of ExtensionContainer
DEFINED in MAP-GR-DataTypes : 68

extensionContainer.....identifier of ExtensionContainer
DEFINED in MAP-GR-DataTypes : 72

extensionContainer.....identifier of ExtensionContainer
DEFINED in MAP-GR-DataTypes : 82

extensionContainer.....identifier of ExtensionContainer
DEFINED in MAP-GR-DataTypes : 90

extensionContainer.....identifier of [2] ExtensionContainer
DEFINED in MAP-LCS-DataTypes : 70

TAG R5.40 Cross Reference Listing for MAP-Protocol 2002-06-07 14:47:03 PAGE 34

extensionContainer.....identifier of [2] ExtensionContainer
DEFINED in MAP-LCS-DataTypes : 84

extensionContainer.....identifier of [1] ExtensionContainer
DEFINED in MAP-LCS-DataTypes : 97

extensionContainer.....identifier of [8] ExtensionContainer
DEFINED in MAP-LCS-DataTypes : 115

extensionContainer.....identifier of [4] ExtensionContainer
DEFINED in MAP-LCS-DataTypes : 199

extensionContainer.....identifier of [1] ExtensionContainer
DEFINED in MAP-LCS-DataTypes : 249

extensionContainer.....identifier of [7] ExtensionContainer
DEFINED in MAP-LCS-DataTypes : 357

extensionContainer.....identifier of ExtensionContainer
DEFINED in MAP-LCS-DataTypes : 412

extensionContainer.....identifier of ExtensionContainer
DEFINED in MAP-ER-DataTypes : 101

extensionContainer.....identifier of ExtensionContainer
DEFINED in MAP-ER-DataTypes : 121

extensionContainer.....identifier of ExtensionContainer
DEFINED in MAP-ER-DataTypes : 127

extensionContainer.....identifier of ExtensionContainer
DEFINED in MAP-ER-DataTypes : 160

extensionContainer.....identifier of ExtensionContainer
DEFINED in MAP-ER-DataTypes : 167

extensionContainer.....identifier of ExtensionContainer
DEFINED in MAP-ER-DataTypes : 186

extensionContainer.....identifier of ExtensionContainer
DEFINED in MAP-ER-DataTypes : 190

extensionContainer.....identifier of ExtensionContainer
DEFINED in MAP-ER-DataTypes : 194

extensionContainer.....identifier of ExtensionContainer
DEFINED in MAP-ER-DataTypes : 198

extensionContainer.....identifier of ExtensionContainer
DEFINED in MAP-ER-DataTypes : 204

extensionContainer.....identifier of ExtensionContainer
DEFINED in MAP-ER-DataTypes : 208

extensionContainer.....identifier of ExtensionContainer
DEFINED in MAP-ER-DataTypes : 222

extensionContainer.....identifier of ExtensionContainer
DEFINED in MAP-ER-DataTypes : 226

extensionContainer.....identifier of ExtensionContainer
DEFINED in MAP-ER-DataTypes : 230

extensionContainer.....identifier of ExtensionContainer
DEFINED in MAP-ER-DataTypes : 234

extensionContainer.....identifier of ExtensionContainer
DEFINED in MAP-ER-DataTypes : 238

extensionContainer.....identifier of ExtensionContainer
DEFINED in MAP-ER-DataTypes : 242

extensionContainer.....identifier of ExtensionContainer
DEFINED in MAP-ER-DataTypes : 246

extensionContainer.....identifier of ExtensionContainer
DEFINED in MAP-ER-DataTypes : 250

extensionContainer.....identifier of ExtensionContainer
DEFINED in MAP-ER-DataTypes : 254

extensionContainer.....identifier of ExtensionContainer

TAG R5.40 Cross Reference Listing for MAP-Protocol 2002-06-07 14:47:03 PAGE 35

DEFINED in MAP-ER-DataTypes : 273

extensionContainer.....identifier of ExtensionContainer
 DEFINED in MAP-ER-DataTypes : 279

extensionContainer.....identifier of ExtensionContainer
 DEFINED in MAP-ER-DataTypes : 283

extensionContainer.....identifier of ExtensionContainer
 DEFINED in MAP-ER-DataTypes : 287

extensionContainer.....identifier of ExtensionContainer
 DEFINED in MAP-ER-DataTypes : 291

extensionContainer.....identifier of ExtensionContainer
 DEFINED in MAP-ER-DataTypes : 295

extensionContainer.....identifier of ExtensionContainer
 DEFINED in MAP-ER-DataTypes : 299

extensionContainer.....identifier of ExtensionContainer
 DEFINED in MAP-ER-DataTypes : 303

extensionContainer.....identifier of ExtensionContainer
 DEFINED in MAP-ER-DataTypes : 307

extensionContainer.....identifier of ExtensionContainer
 DEFINED in MAP-ER-DataTypes : 311

extensionContainer.....identifier of ExtensionContainer
 DEFINED in MAP-ER-DataTypes : 315

extensionContainer.....identifier of ExtensionContainer
 DEFINED in MAP-ER-DataTypes : 319

extensionContainer.....identifier of ExtensionContainer
 DEFINED in MAP-ER-DataTypes : 326

extensionContainer.....identifier of ExtensionContainer
 DEFINED in MAP-ER-DataTypes : 330

extensionContainer.....identifier of ExtensionContainer
 DEFINED in MAP-ER-DataTypes : 334

extensionContainer.....identifier of ExtensionContainer
 DEFINED in MAP-ER-DataTypes : 338

extensionContainer.....identifier of ExtensionContainer
 DEFINED in MAP-ER-DataTypes : 348

extensionContainer.....identifier of [1] ExtensionContainer
 DEFINED in MAP-ER-DataTypes : 353

extensionContainer.....identifier of [1] ExtensionContainer
 DEFINED in MAP-ER-DataTypes : 368

extensionContainer.....identifier of ExtensionContainer
 DEFINED in MAP-ER-DataTypes : 386

extensionContainer.....identifier of ExtensionContainer
 DEFINED in MAP-ER-DataTypes : 390

extensionContainer.....identifier of ExtensionContainer
 DEFINED in MAP-ER-DataTypes : 395

ExtensionContainer.....type reference SEQUENCE
 DEFINED in MAP-ExtensionDataTypes : 32
 USED in MAP-MS-DataTypes : 198 220 228 268 274 286 293 299 311
 321 390 414 427 435 447 460 474 520
 557 563 601 606 615 625 629 698 711
 735 802 816 822 832 853 917 927 976
 1039 1055 1098 1107 1113 1124 1151 1171 1194
 1227 1259 1270 1288 1308 1354 1359 1403 1425
 1430 1441 1459 1481 1512 1596 1618 1656 1667
 1706 1728 1748 1755 1764 1769 1778 1782 1796

1803 1820 1826 1839 1844 1850 1884 1906 1924
2001 2034 2039 2049 2060 2069 2095 2103 2111
2128 2142 2150 2162 2172 2178 2185 2205 2209
2222 2228 2240 2249
USED in MAP-CommonDataTypes : 81 203 229 246 363 380 459 482
USED in MAP-OM-DataTypes : 27 41 51 57 61
USED in MAP-CH-DataTypes : 79 89 108 162 185 199 214 228 238

TAG R5.40 Cross Reference Listing for MAP-Protocol 2002-06-07 14:47:03 PAGE 36

250 260 266 276 282 296 308 314 319
 326 339 356 361 367 389 399 404 425
 432 437 441
 USED in MAP-SS-DataTypes : 60 279 296
 USED in MAP-SM-DataTypes : 46 57 83 89 111 117 125 130 150
 174 186 209 213
 USED in MAP-GR-DataTypes : 42 58 63 68 72 82 90
 USED in MAP-LCS-DataTypes : 44 70 84 97 115 199 249 357 412
 USED in MAP-ER-DataTypes : 93 101 121 127 160 167 186 190 194
 198 204 208 222 226 230 234 238 242
 246 250 254 273 279 283 287 291 295
 299 303 307 311 315 319 326 330 334
 338 348 353 368 386 390 395
 USED in MAP-ExtensionDataTypes : 16

ExtensionSet.....information object set reference MAP-EXTENSION, Information Object Set
 DEFINED in MAP-ExtensionDataTypes : 48
 USED in MAP-ExtensionDataTypes : 42 44

externalAddress.....identifier of [0] AddressString
 DEFINED in MAP-CommonDataTypes : 379

ExternalClient.....type reference SEQUENCE
 DEFINED in MAP-MS-DataTypes : 1221
 USED in MAP-MS-DataTypes : 1207 1217

externalClientList.....identifier of [1] ExternalClientList
 DEFINED in MAP-MS-DataTypes : 1187

ExternalClientList.....type reference SEQUENCE OF
 DEFINED in MAP-MS-DataTypes : 1206
 USED in MAP-MS-DataTypes : 1187

ExternalSignalInfo.....type reference SEQUENCE
 DEFINED in MAP-CommonDataTypes : 198
 USED in MAP-CommonDataTypes : 21
 USED in MAP-CH-DataTypes : 66 105 208 209 289 290 293 294 295
 312 313 318 394
 USED in MAP-SS-DataTypes : 54 314 315

extId.....identifier of InformationObjectClassFieldType
 DEFINED in MAP-ExtensionDataTypes : 41

extType.....identifier of InformationObjectClassFieldType
 DEFINED in MAP-ExtensionDataTypes : 43

Ext-BasicServiceCode.....type reference CHOICE
 DEFINED in MAP-CommonDataTypes : 452
 USED in MAP-MS-DataTypes : 181 1046 1105 1143 1148 1348 1537 2156 2167
 USED in MAP-CommonDataTypes : 48
 USED in MAP-CH-DataTypes : 70 104 159 233

Ext-BasicServiceGroupList.....type reference SEQUENCE OF
 DEFINED in MAP-MS-DataTypes : 1142
 USED in MAP-MS-DataTypes : 1123 1170

ext-BearerService.....identifier of [2] Ext-BearerServiceCode
 DEFINED in MAP-CommonDataTypes : 453

Ext-BearerServiceCode.....type reference OCTET STRING
 DEFINED in MAP-BS-Code : 25
 USED in MAP-MS-DataTypes : 157 964
 USED in MAP-CommonDataTypes : 71 453

Ext-CallBarFeatureList.....type reference SEQUENCE OF
 DEFINED in MAP-MS-DataTypes : 1101
 USED in MAP-MS-DataTypes : 1097 2099 2245

Ext-CallBarInfo.....type reference SEQUENCE
 DEFINED in MAP-MS-DataTypes : 1095
 USED in MAP-MS-DataTypes : 1030

Ext-CallBarringFeature.....type reference SEQUENCE
 DEFINED in MAP-MS-DataTypes : 1104
 USED in MAP-MS-DataTypes : 1102

Ext-CallBarringInfoFor-CSE.....type reference SEQUENCE
DEFINED in MAP-MS-DataTypes : 2243
USED in MAP-MS-DataTypes : 2201 2233

ext-externalClientList.....identifier of [4] Ext-ExternalClientList
DEFINED in MAP-MS-DataTypes : 1196

TAG R5.40 Cross Reference Listing for MAP-Protocol 2002-06-07 14:47:03 PAGE 37

Ext-ExternalClientList.....type reference SEQUENCE OF
DEFINED in MAP-MS-DataTypes : 1216
USED in MAP-MS-DataTypes : 1196

Ext-ExternalSignallInfo.....type reference SEQUENCE
DEFINED in MAP-CommonDataTypes : 224
USED in MAP-CommonDataTypes : 22
USED in MAP-CH-DataTypes : 67 113 219

Ext-ForwardingInfoFor-CSE.....type reference SEQUENCE
DEFINED in MAP-MS-DataTypes : 2236
USED in MAP-MS-DataTypes : 2200 2232

Ext-ForwFeature.....type reference SEQUENCE
DEFINED in MAP-MS-DataTypes : 1045
USED in MAP-MS-DataTypes : 1043

Ext-ForwFeatureList.....type reference SEQUENCE OF
DEFINED in MAP-MS-DataTypes : 1042
USED in MAP-MS-DataTypes : 1038 2093 2238

Ext-ForwInfo.....type reference SEQUENCE
DEFINED in MAP-MS-DataTypes : 1036
USED in MAP-MS-DataTypes : 1029

Ext-ForwOptions.....type reference OCTET STRING
DEFINED in MAP-MS-DataTypes : 1059
USED in MAP-MS-DataTypes : 1053

Ext-GeographicalInformation.....type reference OCTET STRING
DEFINED in MAP-LCS-DataTypes : 265
USED in MAP-LCS-DataTypes : 22 247 355

Ext-NoRepCondTime.....type reference INTEGER
DEFINED in MAP-MS-DataTypes : 1088
USED in MAP-MS-DataTypes : 1054 2160

ext-ProtocollId.....identifier of Ext-ProtocollId
DEFINED in MAP-CommonDataTypes : 225

Ext-ProtocollId.....type reference ENUMERATED
DEFINED in MAP-CommonDataTypes : 232
USED in MAP-CommonDataTypes : 225

ext-QoS-Subscribed.....identifier of [0] Ext-QoS-Subscribed
DEFINED in MAP-MS-DataTypes : 804

Ext-QoS-Subscribed.....type reference OCTET STRING
DEFINED in MAP-MS-DataTypes : 894
USED in MAP-MS-DataTypes : 59 804 1995 1996 1997

Ext-SS-Data.....type reference SEQUENCE
DEFINED in MAP-MS-DataTypes : 1166
USED in MAP-MS-DataTypes : 1032

Ext-SS-Info.....type reference CHOICE
DEFINED in MAP-MS-DataTypes : 1028
USED in MAP-MS-DataTypes : 1026

Ext-SS-InfoFor-CSE.....type reference CHOICE
DEFINED in MAP-MS-DataTypes : 2231
USED in MAP-MS-DataTypes : 2148

Ext-SS-InfoList.....type reference SEQUENCE OF
DEFINED in MAP-MS-DataTypes : 1025
USED in MAP-MS-DataTypes : 947

Ext-SS-Status.....type reference OCTET STRING
DEFINED in MAP-CommonDataTypes : 492
USED in MAP-MS-DataTypes : 189 1047 1106 1168 1181 1269 2157 2168
USED in MAP-CommonDataTypes : 54 479

ext-Teleservice.....identifier of [3] Ext-TeleserviceCode
DEFINED in MAP-CommonDataTypes : 454

Ext-TeleserviceCode.....type reference OCTET STRING
DEFINED in MAP-TS-Code : 20
USED in MAP-MS-DataTypes : 162 969
USED in MAP-CommonDataTypes : 65 454
USED in MAP-GR-DataTypes : 31 50

TAG R5.40 Cross Reference Listing for MAP-Protocol 2002-06-07 14:47:03 PAGE 38

facilityNotSupParam.....identifier of FacilityNotSupParam
 DEFINED in MAP-Errors : 188

FacilityNotSupParam.....type reference SEQUENCE
 DEFINED in MAP-ER-DataTypes : 197
 USED in MAP-Errors : 116 188
 USED in MAP-ER-DataTypes : 23

facilityNotSupported.....value reference FacilityNotSupported, CHOICE VALUE
 DEFINED in MAP-Protocol : 350

FacilityNotSupported.....type reference ERROR
 DEFINED in MAP-Errors : 186
 USED in MAP-Protocol : 129 350
 USED in MAP-OperationAndMainte : 26 60 74
 USED in MAP-CallHandlingOperat : 33 90 113 165 203 216
 USED in MAP-SupplementaryServi : 55 266
 USED in MAP-ShortMessageServic : 30 75 90 103 145
 USED in MAP-LocationServiceOpe : 26 61 75
 USED in MAP-Errors : 17

facsimileGroup3AndAlterSpeech.....value reference TeleserviceCode, '01100001'B
 DEFINED in MAP-TS-Code : 49

facsimileGroup4.....value reference TeleserviceCode, '01100011'B
 DEFINED in MAP-TS-Code : 51

failure.....identifier of Named Number, 1
 DEFINED in MAP-CH-DataTypes : 380

failureCause.....identifier of FailureCause
 DEFINED in MAP-MS-DataTypes : 389

FailureCause.....type reference ENUMERATED
 DEFINED in MAP-MS-DataTypes : 417
 USED in MAP-MS-DataTypes : 389

failureReport.....value reference FailureReport, CHOICE VALUE
 DEFINED in MAP-Protocol : 322

FailureReport.....type reference OPERATION
 DEFINED in MAP-MobileServiceOpera : 450
 USED in MAP-Protocol : 35 322
 USED in MAP-MobileServiceOpera : 64

failureReportArg.....identifier of FailureReportArg
 DEFINED in MAP-MobileServiceOpera : 452

FailureReportArg.....type reference SEQUENCE
 DEFINED in MAP-MS-DataTypes : 1760
 USED in MAP-MobileServiceOpera : 155 452
 USED in MAP-MS-DataTypes : 127

failureReportRes.....identifier of FailureReportRes
 DEFINED in MAP-MobileServiceOpera : 454

FailureReportRes.....type reference SEQUENCE
 DEFINED in MAP-MS-DataTypes : 1767
 USED in MAP-MobileServiceOpera : 156 454
 USED in MAP-MS-DataTypes : 128

fleetManagement.....value reference LCSServiceTypeID, 3
 DEFINED in MAP-CommonDataTypes : 399

foreignNumberPortedToForeignNetwork.....identifier of Named Number, 2
 DEFINED in MAP-CH-DataTypes : 176

forwardAccessSignalling.....value reference ForwardAccessSignalling, CHOICE VALUE
 DEFINED in MAP-Protocol : 204

ForwardAccessSignalling.....type reference OPERATION
 DEFINED in MAP-MobileServiceOpera : 333
 USED in MAP-Protocol : 20 204
 USED in MAP-MobileServiceOpera : 41

forwardAccessSignalling-Arg.....identifier of ForwardAccessSignalling-Arg
DEFINED in MAP-MobileServiceOpera : 335

ForwardAccessSignalling-Arg.....type reference [3] SEQUENCE
DEFINED in MAP-MS-DataTypes : 452
USED in MAP-MobileServiceOpera : 125 335
USED in MAP-MS-DataTypes : 33

TAG R5.40 Cross Reference Listing for MAP-Protocol 2002-06-07 14:47:03 PAGE 39

forwardCheckSS-Indication.....value reference ForwardCheckSS-Indication, CHOICE VALUE
 DEFINED in MAP-Protocol : 229

ForwardCheckSS-Indication.....type reference OPERATION
 DEFINED in MAP-MobileServiceOpera : 420
 USED in MAP-Protocol : 28 229
 USED in MAP-MobileServiceOpera : 57

forwarded.....identifier of Named Number, 0
 DEFINED in MAP-MS-DataTypes : 1548

forwardedToNumber.....identifier of [5] ISDN-AddressString
 DEFINED in MAP-MS-DataTypes : 1048

forwardedToNumber.....identifier of [3] AddressString
 DEFINED in MAP-MS-DataTypes : 2158

forwardedToNumber.....identifier of [5] ISDN-AddressString
 DEFINED in MAP-CH-DataTypes : 193

forwardedToNumber.....identifier of [4] AddressString
 DEFINED in MAP-SS-DataTypes : 75

forwardedToNumber.....identifier of [5] ISDN-AddressString
 DEFINED in MAP-SS-DataTypes : 102

forwardedToSubaddress.....identifier of [8] ISDN-SubaddressString
 DEFINED in MAP-MS-DataTypes : 1052

forwardedToSubaddress.....identifier of [4] ISDN-SubaddressString
 DEFINED in MAP-MS-DataTypes : 2159

forwardedToSubaddress.....identifier of [4] ISDN-SubaddressString
 DEFINED in MAP-CH-DataTypes : 197

forwardedToSubaddress.....identifier of [6] ISDN-SubaddressString
 DEFINED in MAP-SS-DataTypes : 76

forwardedToSubaddress.....identifier of [8] ISDN-SubaddressString
 DEFINED in MAP-SS-DataTypes : 103

forwardGroupCallSignalling.....value reference ForwardGroupCallSignalling, CHOICE VALUE
 DEFINED in MAP-Protocol : 309

ForwardGroupCallSignalling.....type reference OPERATION
 DEFINED in MAP-Group-Call-Operati : 67
 USED in MAP-Protocol : 101 309
 USED in MAP-Group-Call-Operati : 15

forwardGroupCallSignallingArg.....identifier of ForwardGroupCallSignallingArg
 DEFINED in MAP-Group-Call-Operati : 69

ForwardGroupCallSignallingArg.....type reference SEQUENCE
 DEFINED in MAP-GR-DataTypes : 75
 USED in MAP-Group-Call-Operati : 35 69
 USED in MAP-GR-DataTypes : 18

forwarding.....identifier of Named Number, 1
 DEFINED in MAP-CH-DataTypes : 127

forwardingData.....identifier of ForwardingData
 DEFINED in MAP-CH-DataTypes : 190

ForwardingData.....type reference SEQUENCE
 DEFINED in MAP-CH-DataTypes : 192
 USED in MAP-CH-DataTypes : 190 234 274

forwardingData.....identifier of [2] ForwardingData
 DEFINED in MAP-CH-DataTypes : 234

forwardingData.....identifier of ForwardingData
 DEFINED in MAP-CH-DataTypes : 274

forwardingFailed.....value reference ForwardingFailed, CHOICE VALUE

DEFINED in MAP-Protocol : 398

ForwardingFailed.....type reference ERROR

DEFINED in MAP-Errors : 311

USED in MAP-Protocol : 150 398

USED in MAP-CallHandlingOperat : 45 125

USED in MAP-Errors : 51

TAG R5.40 Cross Reference Listing for MAP-Protocol 2002-06-07 14:47:03 PAGE 40

forwardingFailedParam.....identifier of ForwardingFailedParam
 DEFINED in MAP-Errors : 313

ForwardingFailedParam.....type reference SEQUENCE
 DEFINED in MAP-ER-DataTypes : 286
 USED in MAP-Errors : 133 313
 USED in MAP-ER-DataTypes : 38

ForwardingFeature.....type reference SEQUENCE
 DEFINED in MAP-SS-DataTypes : 99
 USED in MAP-SS-DataTypes : 97

forwardingFeatureList.....identifier of Ext-ForwFeatureList
 DEFINED in MAP-MS-DataTypes : 1038

forwardingFeatureList.....identifier of Ext-ForwFeatureList
 DEFINED in MAP-MS-DataTypes : 2093

forwardingFeatureList.....identifier of [1] Ext-ForwFeatureList
 DEFINED in MAP-MS-DataTypes : 2238

forwardingFeatureList.....identifier of ForwardingFeatureList
 DEFINED in MAP-SS-DataTypes : 92

ForwardingFeatureList.....type reference SEQUENCE OF
 DEFINED in MAP-SS-DataTypes : 95
 USED in MAP-SS-DataTypes : 92 218

forwardingFeatureList.....identifier of [3] ForwardingFeatureList
 DEFINED in MAP-SS-DataTypes : 218

forwardingInfo.....identifier of [0] Ext-ForwInfo
 DEFINED in MAP-MS-DataTypes : 1029

forwardingInfo.....identifier of [0] ForwardingInfo
 DEFINED in MAP-SS-DataTypes : 86

ForwardingInfo.....type reference SEQUENCE
 DEFINED in MAP-SS-DataTypes : 90
 USED in MAP-SS-DataTypes : 86

forwardingInfoFor-CSE.....identifier of [0] Ext-ForwardingInfoFor-CSE
 DEFINED in MAP-MS-DataTypes : 2200

forwardingInfoFor-CSE.....identifier of [0] Ext-ForwardingInfoFor-CSE
 DEFINED in MAP-MS-DataTypes : 2232

forwardingInterrogationRequired.....identifier of [4] NULL
 DEFINED in MAP-CH-DataTypes : 160

forwardingOptions.....identifier of [6] Ext-ForwOptions
 DEFINED in MAP-MS-DataTypes : 1053

forwardingOptions.....identifier of [6] ForwardingOptions
 DEFINED in MAP-CH-DataTypes : 198

forwardingOptions.....identifier of [6] ForwardingOptions
 DEFINED in MAP-SS-DataTypes : 104

ForwardingOptions.....type reference OCTET STRING
 DEFINED in MAP-SS-DataTypes : 124
 USED in MAP-CH-DataTypes : 56 198
 USED in MAP-SS-DataTypes : 31 104

forwardingReason.....identifier of [8] ForwardingReason
 DEFINED in MAP-CH-DataTypes : 103

ForwardingReason.....type reference ENUMERATED
 DEFINED in MAP-CH-DataTypes : 133
 USED in MAP-CH-DataTypes : 103

forwardingViolation.....value reference ForwardingViolation, CHOICE VALUE
 DEFINED in MAP-Protocol : 400

ForwardingViolation.....type reference ERROR
DEFINED in MAP-Errors : 306
USED in MAP-Protocol : 149 400
USED in MAP-CallHandlingOperat : 44 101
USED in MAP-Errors : 50

forwardingViolationParam.....identifier of ForwardingViolationParam

TAG R5.40 Cross Reference Listing for MAP-Protocol 2002-06-07 14:47:03 PAGE 41

DEFINED in MAP-Errors : 308

ForwardingViolationParam.....type reference SEQUENCE
 DEFINED in MAP-ER-DataTypes : 282
 USED in MAP-Errors : 132 308
 USED in MAP-ER-DataTypes : 37

freezeP-TMSI.....identifier of [1] NULL
 DEFINED in MAP-MS-DataTypes : 298

freezeTMSI.....identifier of [0] NULL
 DEFINED in MAP-MS-DataTypes : 297

frozen.....identifier of Named Number, 5
 DEFINED in MAP-SS-DataTypes : 291

FTN-AddressString.....type reference AddressString
 DEFINED in MAP-CommonDataTypes : 149
 USED in MAP-MS-DataTypes : 171 1057
 USED in MAP-CommonDataTypes : 19
 USED in MAP-CH-DataTypes : 65 201
 USED in MAP-SS-DataTypes : 47 107

generalProblem.....identifier of [0] IMPLICIT GeneralProblem
 DEFINED in TCAPMessages : 170

GeneralProblem.....type reference INTEGER
 DEFINED in TCAPMessages : 179
 USED in TCAPMessages : 170

general-dataCDA.....value reference BearerServiceCode, '00010111'B
 DEFINED in MAP-BS-Code : 58

general-dataCDS.....value reference BearerServiceCode, '00011111'B
 DEFINED in MAP-BS-Code : 65

general-dataPDS.....value reference BearerServiceCode, '00101111'B
 DEFINED in MAP-BS-Code : 80

general-padAccessCA.....value reference BearerServiceCode, '00100111'B
 DEFINED in MAP-BS-Code : 74

GenericServiceInfo.....type reference SEQUENCE
 DEFINED in MAP-SS-DataTypes : 190
 USED in MAP-SS-DataTypes : 219

genericServiceInfo.....identifier of [4] GenericServiceInfo
 DEFINED in MAP-SS-DataTypes : 219

geodeticInformation.....identifier of [7] GeodeticInformation
 DEFINED in MAP-MS-DataTypes : 1910

geodeticInformation.....identifier of [7] GeodeticInformation
 DEFINED in MAP-MS-DataTypes : 1927

GeodeticInformation.....type reference OCTET STRING
 DEFINED in MAP-MS-DataTypes : 1951
 USED in MAP-MS-DataTypes : 1910 1927

geographicalInformation.....identifier of [0] GeographicalInformation
 DEFINED in MAP-MS-DataTypes : 1902

geographicalInformation.....identifier of [2] GeographicalInformation
 DEFINED in MAP-MS-DataTypes : 1921

GeographicalInformation.....type reference OCTET STRING
 DEFINED in MAP-MS-DataTypes : 1941
 USED in MAP-MS-DataTypes : 94 1902 1921

getPassword.....value reference GetPassword, CHOICE VALUE
 DEFINED in MAP-Protocol : 267

GetPassword.....type reference OPERATION
 DEFINED in MAP-SupplementaryServi : 234
 USED in MAP-Protocol : 78 267

USED in MAP-SupplementaryServi : 22 232

ggsn-Address.....identifier of [1] GSN-Address
DEFINED in MAP-MS-DataTypes : 1746

ggsn-Address.....identifier of [1] GSN-Address
DEFINED in MAP-MS-DataTypes : 1753

TAG R5.40 Cross Reference Listing for MAP-Protocol 2002-06-07 14:47:03 PAGE 42

ggsn-Address.....identifier of [2] GSN-Address
DEFINED in MAP-MS-DataTypes : 1763

ggsn-Address.....identifier of [0] GSN-Address
DEFINED in MAP-MS-DataTypes : 1768

ggsn-Address.....identifier of [2] GSN-Address
DEFINED in MAP-MS-DataTypes : 1777

ggsn-Address.....identifier of [10] GSN-Address
DEFINED in MAP-MS-DataTypes : 1994

ggsn-Number.....identifier of [2] ISDN-AddressString
DEFINED in MAP-MS-DataTypes : 1747

ggsn-Number.....identifier of [1] ISDN-AddressString
DEFINED in MAP-MS-DataTypes : 1762

GlobalCellId.....type reference OCTET STRING
DEFINED in MAP-CommonDataTypes : 338
USED in MAP-MS-DataTypes : 179 508 596
USED in MAP-CommonDataTypes : 36

globalValue.....identifier of OBJECT IDENTIFIER
DEFINED in MAP-ST-DataTypes : 92

globalValue.....identifier of OBJECT IDENTIFIER
DEFINED in MAP-ST-DataTypes : 96

gmlc-List.....identifier of [0] GMLC-List
DEFINED in MAP-MS-DataTypes : 763

GMLC-List.....type reference SEQUENCE OF
DEFINED in MAP-MS-DataTypes : 775
USED in MAP-MS-DataTypes : 763

gmlc-List.....identifier of Named Number, 0
DEFINED in MAP-MS-DataTypes : 1231

gmlc-ListWithdraw.....identifier of [13] NULL
DEFINED in MAP-MS-DataTypes : 1313

gmlc-Restriction.....identifier of [0] GMLC-Restriction
DEFINED in MAP-MS-DataTypes : 1223

GMLC-Restriction.....type reference ENUMERATED
DEFINED in MAP-MS-DataTypes : 1230
USED in MAP-MS-DataTypes : 1223 1255

gmlc-Restriction.....identifier of [0] GMLC-Restriction
DEFINED in MAP-MS-DataTypes : 1255

gmscCamelSubscriptionInfo.....identifier of [0] GmscCamelSubscriptionInfo
DEFINED in MAP-CH-DataTypes : 275

GmscCamelSubscriptionInfo.....type reference SEQUENCE
DEFINED in MAP-CH-DataTypes : 279
USED in MAP-CH-DataTypes : 275

gmsc-Address.....identifier of [8] ISDN-AddressString
DEFINED in MAP-CH-DataTypes : 211

gmsc-OrGsmSCF-Address.....identifier of [6] ISDN-AddressString
DEFINED in MAP-CH-DataTypes : 101

gprsAttach.....identifier of Named Number, 5
DEFINED in MAP-MS-DataTypes : 404

GPRSChargingID.....type reference OCTET STRING
DEFINED in MAP-MS-DataTypes : 2017
USED in MAP-MS-DataTypes : 106 1998

gprsConnectionSuspended.....identifier of NULL
DEFINED in MAP-ER-DataTypes : 321

GPRSDataList.....type reference SEQUENCE OF
DEFINED in MAP-MS-DataTypes : 790
USED in MAP-MS-DataTypes : 815

gprsDataList.....identifier of [1] GPRSDataList
DEFINED in MAP-MS-DataTypes : 815

TAG R5.40 Cross Reference Listing for MAP-Protocol 2002-06-07 14:47:03 PAGE 43

gprsEnhancementsSupportIndicator.....identifier of [3] NULL
DEFINED in MAP-MS-DataTypes : 438

GPRSMSCClass.....type reference SEQUENCE
DEFINED in MAP-MS-DataTypes : 1868
USED in MAP-MS-DataTypes : 96 1856

gprsNodeIndicator.....identifier of [5] NULL
DEFINED in MAP-SM-DataTypes : 91

gprsNodeIndicator.....identifier of [2] NULL
DEFINED in MAP-LCS-DataTypes : 99

gprsSubscriptionData.....identifier of [16] GPRSSubscriptionData
DEFINED in MAP-MS-DataTypes : 739

GPRSSubscriptionData.....type reference SEQUENCE
DEFINED in MAP-MS-DataTypes : 810
USED in MAP-MS-DataTypes : 739

gprsSubscriptionDataWithdraw.....identifier of [10] GPRSSubscriptionDataWithdraw
DEFINED in MAP-MS-DataTypes : 1310

GPRSSubscriptionDataWithdraw.....type reference CHOICE
DEFINED in MAP-MS-DataTypes : 1333
USED in MAP-MS-DataTypes : 1310

gprsSubscriptionUnknown.....identifier of Named Number, 1
DEFINED in MAP-ER-DataTypes : 214

gprsSupportIndicator.....identifier of [7] NULL
DEFINED in MAP-SM-DataTypes : 59

gprsSupportIndicator.....identifier of [2] NULL
DEFINED in MAP-SM-DataTypes : 152

GPRS-CamelTDPData.....type reference SEQUENCE
DEFINED in MAP-MS-DataTypes : 848
USED in MAP-MS-DataTypes : 844

gprs-CamelTDPDataList.....identifier of [0] GPRS-CamelTDPDataList
DEFINED in MAP-MS-DataTypes : 830

GPRS-CamelTDPDataList.....type reference SEQUENCE OF
DEFINED in MAP-MS-DataTypes : 843
USED in MAP-MS-DataTypes : 830

gprs-CSI.....identifier of [0] GPRS-CSI
DEFINED in MAP-MS-DataTypes : 820

GPRS-CSI.....type reference SEQUENCE
DEFINED in MAP-MS-DataTypes : 829
USED in MAP-MS-DataTypes : 820 2124

gprs-csi.....identifier of Named Number, 7
DEFINED in MAP-MS-DataTypes : 1325

gprs-CSI.....identifier of Named Number, 4
DEFINED in MAP-MS-DataTypes : 2080

gprs-CSI.....identifier of [9] GPRS-CSI
DEFINED in MAP-MS-DataTypes : 2124

gprs-MS-Class.....identifier of [7] GPRSMSCClass
DEFINED in MAP-MS-DataTypes : 1856

gprs-TriggerDetectionPoint.....identifier of [0] GPRS-TriggerDetectionPoint
DEFINED in MAP-MS-DataTypes : 849

GPRS-TriggerDetectionPoint.....type reference ENUMERATED
DEFINED in MAP-MS-DataTypes : 865
USED in MAP-MS-DataTypes : 849

greyListed.....identifier of Named Number, 2

DEFINED in MAP-MS-DataTypes : 727

groupCallNumber.....identifier of ISDN-AddressString
DEFINED in MAP-GR-DataTypes : 62

groupId.....identifier of GroupId
DEFINED in MAP-MS-DataTypes : 1819

TAG R5.40 Cross Reference Listing for MAP-Protocol 2002-06-07 14:47:03 PAGE 44

groupid.....identifier of GroupId
DEFINED in MAP-MS-DataTypes : 1824

GroupId.....type reference OCTET STRING
DEFINED in MAP-MS-DataTypes : 1829
USED in MAP-MS-DataTypes : 1819 1824

groupKey.....identifier of [1] Kc
DEFINED in MAP-GR-DataTypes : 55

groupKeyNumber.....identifier of [0] GroupKeyNumber
DEFINED in MAP-GR-DataTypes : 54

GroupKeyNumber.....type reference INTEGER
DEFINED in MAP-GR-DataTypes : 93
USED in MAP-GR-DataTypes : 54

gsmSCF-Address.....identifier of [2] ISDN-AddressString
DEFINED in MAP-MS-DataTypes : 851

gsmSCF-Address.....identifier of ISDN-AddressString
DEFINED in MAP-MS-DataTypes : 1423

gsmSCF-Address.....identifier of ISDN-AddressString
DEFINED in MAP-MS-DataTypes : 1440

gsmSCF-Address.....identifier of [0] ISDN-AddressString
DEFINED in MAP-MS-DataTypes : 1479

gsmSCF-Address.....identifier of [2] ISDN-AddressString
DEFINED in MAP-MS-DataTypes : 1616

gsmSCF-Address.....identifier of [0] ISDN-AddressString
DEFINED in MAP-MS-DataTypes : 1655

gsmSCF-Address.....identifier of [0] ISDN-AddressString
DEFINED in MAP-MS-DataTypes : 1666

gsmSCF-Address.....identifier of [0] ISDN-AddressString
DEFINED in MAP-MS-DataTypes : 1726

gsmSCF-Address.....identifier of [3] ISDN-AddressString
DEFINED in MAP-MS-DataTypes : 2033

gsmSCF-Address.....identifier of [2] ISDN-AddressString
DEFINED in MAP-MS-DataTypes : 2048

gsmSCF-Address.....identifier of [1] ISDN-AddressString
DEFINED in MAP-MS-DataTypes : 2138

gsmSCF-InitiatedCall.....identifier of [24] NULL
DEFINED in MAP-CH-DataTypes : 120

gsm-0408.....identifier of Named Number, 1
DEFINED in MAP-CommonDataTypes : 218

gsm-0806.....identifier of Named Number, 2
DEFINED in MAP-CommonDataTypes : 219

gsm-BearerCapability.....identifier of [5] ExternalSignalInfo
DEFINED in MAP-CH-DataTypes : 208

gsm-BearerCapability.....identifier of [0] ExternalSignalInfo
DEFINED in MAP-CH-DataTypes : 289

gsm-BSSMAP.....identifier of Named Number, 3
DEFINED in MAP-CommonDataTypes : 220

gsm-SecurityContextData.....identifier of [0] GSM-SecurityContextData
DEFINED in MAP-MS-DataTypes : 351

GSM-SecurityContextData.....type reference SEQUENCE
DEFINED in MAP-MS-DataTypes : 354
USED in MAP-MS-DataTypes : 351

GSN-Address.....type reference OCTET STRING
DEFINED in MAP-MS-DataTypes : 442
USED in MAP-MS-DataTypes : 30 426 1746 1752 1753 1763 1768 1776 1777
1994 2000

guidanceInfo.....identifier of GuidanceInfo

TAG R5.40 Cross Reference Listing for MAP-Protocol 2002-06-07 14:47:03 PAGE 45

DEFINED in MAP-SupplementaryServi : 236

GuidanceInfo.....type reference ENUMERATED
DEFINED in MAP-SS-DataTypes : 248
USED in MAP-SupplementaryServi : 67 236
USED in MAP-SS-DataTypes : 25

handoverNumber.....identifier of [0] ISDN-AddressString
DEFINED in MAP-MS-DataTypes : 550

handoverNumber.....identifier of ISDN-AddressString
DEFINED in MAP-MS-DataTypes : 651

highLayerCompatibility.....identifier of [6] ExternalSignalInfo
DEFINED in MAP-CH-DataTypes : 295

hlr.....identifier of Named Number, 1
DEFINED in MAP-CommonDataTypes : 353

HLR-Id.....type reference IMSI
DEFINED in MAP-CommonDataTypes : 327
USED in MAP-CommonDataTypes : 332

hlr-List.....identifier of HLR-List
DEFINED in MAP-MS-DataTypes : 1790

HLR-List.....type reference SEQUENCE OF
DEFINED in MAP-CommonDataTypes : 331
USED in MAP-MS-DataTypes : 176 1790
USED in MAP-CommonDataTypes : 34

hlr-Number.....identifier of ISDN-AddressString
DEFINED in MAP-MS-DataTypes : 266

hlr-Number.....identifier of ISDN-AddressString
DEFINED in MAP-MS-DataTypes : 446

hlr-Number.....identifier of ISDN-AddressString
DEFINED in MAP-MS-DataTypes : 1789

hlr-Number.....identifier of ISDN-AddressString
DEFINED in MAP-MS-DataTypes : 1801

hold.....value reference SS-Code, '01000010'B
DEFINED in MAP-SS-Code : 77

home-Country.....identifier of Named Number, 1
DEFINED in MAP-MS-DataTypes : 1232

horizontal-accuracy.....identifier of [0] Horizontal-Accuracy
DEFINED in MAP-LCS-DataTypes : 196

Horizontal-Accuracy.....type reference OCTET STRING
DEFINED in MAP-LCS-DataTypes : 202
USED in MAP-LCS-DataTypes : 20 196

ho-NumberNotRequired.....identifier of NULL
DEFINED in MAP-MS-DataTypes : 509

identity.....identifier of Identity
DEFINED in MAP-MS-DataTypes : 272

Identity.....type reference CHOICE
DEFINED in MAP-CommonDataTypes : 300
USED in MAP-MS-DataTypes : 178 272
USED in MAP-CommonDataTypes : 31

ik.....identifier of IK
DEFINED in MAP-MS-DataTypes : 346

ik.....identifier of IK
DEFINED in MAP-MS-DataTypes : 361

IK.....type reference OCTET STRING
DEFINED in MAP-MS-DataTypes : 375

USED in MAP-MS-DataTypes : 346 361

illegalEquipment.....value reference IllegalEquipment, CHOICE VALUE
DEFINED in MAP-Protocol : 368

IllegalEquipment.....type reference ERROR
DEFINED in MAP-Errors : 238

TAG R5.40 Cross Reference Listing for MAP-Protocol 2002-06-07 14:47:03 PAGE 46

USED in MAP-Protocol : 137 368
 USED in MAP-SupplementaryServi : 52 199 213
 USED in MAP-ShortMessageServic : 34 106
 USED in MAP-LocationServiceOpe : 35 78
 USED in MAP-Errors : 31

illegalEquipmentParam.....identifier of IllegalEquipmentParam
 DEFINED in MAP-Errors : 240

IllegalEquipmentParam.....type reference SEQUENCE
 DEFINED in MAP-ER-DataTypes : 233
 USED in MAP-Errors : 122 240
 USED in MAP-ER-DataTypes : 29

illegalSS-Operation.....value reference IllegalSS-Operation, CHOICE VALUE
 DEFINED in MAP-Protocol : 420

IllegalSS-Operation.....type reference ERROR
 DEFINED in MAP-Errors : 352
 USED in MAP-Protocol : 153 420
 USED in MAP-MobileServiceOpera : 100 271 288
 USED in MAP-SupplementaryServi : 40 100 117 134 154 172 261 278
 USED in MAP-Errors : 63

illegalSS-OperationParam.....identifier of IllegalSS-OperationParam
 DEFINED in MAP-Errors : 354

IllegalSS-OperationParam.....type reference SEQUENCE
 DEFINED in MAP-ER-DataTypes : 302
 USED in MAP-Errors : 151 354
 USED in MAP-ER-DataTypes : 57

illegalSubscriber.....value reference IllegalSubscriber, CHOICE VALUE
 DEFINED in MAP-Protocol : 367

IllegalSubscriber.....type reference ERROR
 DEFINED in MAP-Errors : 232
 USED in MAP-Protocol : 136 367
 USED in MAP-SupplementaryServi : 51 198 212
 USED in MAP-ShortMessageServic : 33 105
 USED in MAP-LocationServiceOpe : 36 77
 USED in MAP-Errors : 30

illegalSubscriberParam.....identifier of IllegalSubscriberParam
 DEFINED in MAP-Errors : 234

IllegalSubscriberParam.....type reference SEQUENCE
 DEFINED in MAP-ER-DataTypes : 229
 USED in MAP-Errors : 121 234
 USED in MAP-ER-DataTypes : 28

imei.....identifier of IMEI
 DEFINED in MAP-MobileServiceOpera : 382

imei.....identifier of [5] IMEI
 DEFINED in MAP-MS-DataTypes : 1854

imei.....identifier of [6] NULL
 DEFINED in MAP-MS-DataTypes : 1888

IMEI.....type reference TBCD-STRING
 DEFINED in MAP-CommonDataTypes : 320
 USED in MAP-MobileServiceOpera : 167 382
 USED in MAP-MS-DataTypes : 174 1854
 USED in MAP-CommonDataTypes : 33
 USED in MAP-LCS-DataTypes : 32 112 352

imei.....identifier of [5] IMEI
 DEFINED in MAP-LCS-DataTypes : 112

imei.....identifier of [2] IMEI
 DEFINED in MAP-LCS-DataTypes : 352

immediateResponsePreferred.....identifier of [1] NULL
 DEFINED in MAP-MS-DataTypes : 694

imsi.....identifier of IMSI
DEFINED in MAP-OperationAndMainte : 81

imsi.....identifier of IMSI
DEFINED in MAP-MS-DataTypes : 215

TAG R5.40 Cross Reference Listing for MAP-Protocol 2002-06-07 14:47:03 PAGE 47

```

imsi.....identifier of IMSI
  DEFINED in MAP-MS-DataTypes : 290

imsi.....identifier of IMSI
  DEFINED in MAP-MS-DataTypes : 315

imsi.....identifier of IMSI
  DEFINED in MAP-MS-DataTypes : 388

imsi.....identifier of IMSI
  DEFINED in MAP-MS-DataTypes : 424

imsi.....identifier of [4] IMSI
  DEFINED in MAP-MS-DataTypes : 513

imsi.....identifier of [0] IMSI
  DEFINED in MAP-MS-DataTypes : 689

imsi.....identifier of [0] IMSI
  DEFINED in MAP-MS-DataTypes : 733

imsi.....identifier of [0] IMSI
  DEFINED in MAP-MS-DataTypes : 1298

imsi.....identifier of [0] IMSI
  DEFINED in MAP-MS-DataTypes : 1745

imsi.....identifier of [0] IMSI
  DEFINED in MAP-MS-DataTypes : 1761

imsi.....identifier of [0] IMSI
  DEFINED in MAP-MS-DataTypes : 1775

imsi.....identifier of IMSI
  DEFINED in MAP-MS-DataTypes : 1794

imsi.....identifier of [0] IMSI
  DEFINED in MAP-MS-DataTypes : 1836

imsi.....identifier of IMSI
  DEFINED in MAP-MS-DataTypes : 2198

imsi.....identifier of [1] IMSI
  DEFINED in MAP-MS-DataTypes : 2218

IMSI.....type reference TBCD-STRING
  DEFINED in MAP-CommonDataTypes : 297
  USED in MAP-OperationAndMainte : 43 81
  USED in MAP-MS-DataTypes : 173 215 290 315 388 424 513 689 733
    1298 1745 1761 1775 1794 1836 2198 2218
  USED in MAP-CommonDataTypes : 29 301 305 317 327 374
  USED in MAP-OM-DataTypes : 22 37 55
  USED in MAP-CH-DataTypes : 68 150 204 235 323 353 393 424 436
  USED in MAP-SS-DataTypes : 48 270
  USED in MAP-SM-DataTypes : 35 81 113 134 204
  USED in MAP-GR-DataTypes : 24 67 76
  USED in MAP-LCS-DataTypes : 33 109 351
  USED in MAP-ST-DataTypes : 18

imsi.....identifier of IMSI
  DEFINED in MAP-CommonDataTypes : 301

imsi.....identifier of IMSI
  DEFINED in MAP-CommonDataTypes : 305

imsi.....identifier of [0] IMSI
  DEFINED in MAP-CommonDataTypes : 317

imsi.....identifier of [0] IMSI
  DEFINED in MAP-CommonDataTypes : 374

imsi.....identifier of [0] IMSI
  DEFINED in MAP-OM-DataTypes : 37

imsi.....identifier of [0] IMSI
  
```

DEFINED in MAP-OM-DataTypes : 55

imsi.....identifier of [9] IMSI
DEFINED in MAP-CH-DataTypes : 150

imsi.....identifier of [0] IMSI
DEFINED in MAP-CH-DataTypes : 204

TAG R5.40 Cross Reference Listing for MAP-Protocol

2002-06-07 14:47:03 PAGE 48

imsi.....identifier of [3] IMSI
 DEFINED in MAP-CH-DataTypes : 235

imsi.....identifier of [0] IMSI
 DEFINED in MAP-CH-DataTypes : 323

imsi.....identifier of [0] IMSI
 DEFINED in MAP-CH-DataTypes : 353

imsi.....identifier of [0] IMSI
 DEFINED in MAP-CH-DataTypes : 393

imsi.....identifier of [0] IMSI
 DEFINED in MAP-CH-DataTypes : 424

imsi.....identifier of [0] IMSI
 DEFINED in MAP-CH-DataTypes : 436

imsi.....identifier of [0] IMSI
 DEFINED in MAP-SS-DataTypes : 270

imsi.....identifier of IMSI
 DEFINED in MAP-SM-DataTypes : 81

imsi.....identifier of IMSI
 DEFINED in MAP-SM-DataTypes : 113

imsi.....identifier of [0] IMSI
 DEFINED in MAP-SM-DataTypes : 134

imsi.....identifier of [0] IMSI
 DEFINED in MAP-SM-DataTypes : 204

imsi.....identifier of IMSI
 DEFINED in MAP-GR-DataTypes : 67

imsi.....identifier of IMSI
 DEFINED in MAP-GR-DataTypes : 76

imsi.....identifier of [2] IMSI
 DEFINED in MAP-LCS-DataTypes : 109

imsi.....identifier of [1] IMSI
 DEFINED in MAP-LCS-DataTypes : 351

imsiDetach.....identifier of Named Number, 0
 DEFINED in MAP-ER-DataTypes : 259

imsiDetached.....identifier of Named Number, 1
 DEFINED in MAP-MS-DataTypes : 2024

imsiUnknown.....identifier of Named Number, 0
 DEFINED in MAP-ER-DataTypes : 213

imsi-WithLMSI.....identifier of IMSI-WithLMSI
 DEFINED in MAP-CommonDataTypes : 302

IMSI-WithLMSI.....type reference SEQUENCE
 DEFINED in MAP-CommonDataTypes : 304
 USED in MAP-CommonDataTypes : 302

incomingCallsBarredWithinCUG.....identifier of Named Number, 0
 DEFINED in MAP-ER-DataTypes : 131

incompatibleTerminal.....value reference IncompatibleTerminal, CHOICE VALUE
 DEFINED in MAP-Protocol : 351

IncompatibleTerminal.....type reference ERROR
 DEFINED in MAP-Errors : 192
 USED in MAP-Protocol : 171 351
 USED in MAP-CallHandlingOperat : 48 187
 USED in MAP-Errors : 18

incompatibleTerminalParam.....identifier of IncompatibleTerminalParam

DEFINED in MAP-Errors : 194

IncompatibleTerminalParam.....type reference SEQUENCE

DEFINED in MAP-ER-DataTypes : 337

USED in MAP-Errors : 141 194

USED in MAP-ER-DataTypes : 46

TAG R5.40 Cross Reference Listing for MAP-Protocol 2002-06-07 14:47:03 PAGE 49

inconsistentMeasurementData.....identifier of Named Number, 3
DEFINED in MAP-ER-DataTypes : 375

incorrectTransactionPortion.....identifier of Named Number, 3
DEFINED in TCAPMessages : 106

informationNotAvailable.....value reference InformationNotAvailable, CHOICE VALUE
DEFINED in MAP-Protocol : 411

InformationNotAvailable.....type reference ERROR
DEFINED in MAP-Errors : 344
USED in MAP-Protocol : 178 411
USED in MAP-MobileServiceOpera : 105 273 292
USED in MAP-Errors : 60

informationNotAvailableParam.....identifier of InformationNotAvailableParam
DEFINED in MAP-Errors : 346

InformationNotAvailableParam.....type reference SEQUENCE
DEFINED in MAP-ER-DataTypes : 314
USED in MAP-Errors : 154 346
USED in MAP-ER-DataTypes : 60

informPreviousNetworkEntity.....identifier of [11] NULL
DEFINED in MAP-MS-DataTypes : 223

informPreviousNetworkEntity.....identifier of [1] NULL
DEFINED in MAP-MS-DataTypes : 430

informServiceCentre.....value reference InformServiceCentre, CHOICE VALUE
DEFINED in MAP-Protocol : 278

InformServiceCentre.....type reference OPERATION
DEFINED in MAP-ShortMessageServ : 132
USED in MAP-Protocol : 92 278
USED in MAP-ShortMessageServ : 18

informServiceCentreArg.....identifier of InformServiceCentreArg
DEFINED in MAP-ShortMessageServ : 134

InformServiceCentreArg.....type reference SEQUENCE
DEFINED in MAP-SM-DataTypes : 183
USED in MAP-ShortMessageServ : 54 134
USED in MAP-SM-DataTypes : 23

inhibiting.....identifier of Named Number, 0
DEFINED in MAP-MS-DataTypes : 1552

initialisationVector.....identifier of InitialisationVector
DEFINED in MAP-ST-DataTypes : 44

InitialisationVector.....type reference OCTET STRING
DEFINED in MAP-ST-DataTypes : 72
USED in MAP-ST-DataTypes : 44

initialLocation.....identifier of Named Number, 2
DEFINED in MAP-LCS-DataTypes : 131

initiatingRelease.....identifier of Named Number, 4
DEFINED in TCAPMessages : 187

insertSubscriberData.....value reference InsertSubscriberData, CHOICE VALUE
DEFINED in MAP-Protocol : 222

InsertSubscriberData.....type reference OPERATION
DEFINED in MAP-MobileServiceOpera : 392
USED in MAP-Protocol : 25 222
USED in MAP-MobileServiceOpera : 52

insertSubscriberDataArg.....identifier of InsertSubscriberDataArg
DEFINED in MAP-MobileServiceOpera : 394

InsertSubscriberDataArg.....type reference SEQUENCE
DEFINED in MAP-MS-DataTypes : 732
USED in MAP-MobileServiceOpera : 136 394

USED in MAP-MS-DataTypes : 54

insertSubscriberDataRes.....identifier of InsertSubscriberDataRes
DEFINED in MAP-MobileServiceOpera : 396

InsertSubscriberDataRes.....type reference SEQUENCE
DEFINED in MAP-MS-DataTypes : 1281

TAG R5.40 Cross Reference Listing for MAP-Protocol 2002-06-07 14:47:03 PAGE 50

USED in MAP-MobileServiceOpera : 137 396
USED in MAP-MS-DataTypes : 55

insufficientMeasurementData.....identifier of Named Number, 2
DEFINED in MAP-ER-DataTypes : 374

insufficientResources.....identifier of Named Number, 1
DEFINED in MAP-ER-DataTypes : 373

integrityProtectionAlgorithm.....identifier of [0] ChosenIntegrityProtectionAlgorithm
DEFINED in MAP-MS-DataTypes : 561

integrityProtectionAlgorithms.....identifier of [0] PermittedIntegrityProtectionAlgorithms
DEFINED in MAP-MS-DataTypes : 472

integrityProtectionInfo.....identifier of [0] IntegrityProtectionInformation
DEFINED in MAP-MS-DataTypes : 454

integrityProtectionInfo.....identifier of [5] IntegrityProtectionInformation
DEFINED in MAP-MS-DataTypes : 514

IntegrityProtectionInformation.....type reference OCTET STRING
DEFINED in MAP-MS-DataTypes : 666
USED in MAP-MS-DataTypes : 454 514

interCUG-Restrictions.....identifier of InterCUG-Restrictions
DEFINED in MAP-MS-DataTypes : 1150

InterCUG-Restrictions.....type reference OCTET STRING
DEFINED in MAP-MS-DataTypes : 1154
USED in MAP-MS-DataTypes : 79 1150

internalTimeout.....identifier of Named Number, 2
DEFINED in MAP-LCS-DataTypes : 397

internationalECT-Barred.....identifier of Named Number, 11
DEFINED in MAP-MS-DataTypes : 991

internationalOGCallsBarred.....identifier of Named Number, 1
DEFINED in MAP-MS-DataTypes : 981

internationalOGCallsNotToHPLMN-CountryBaidentifier of Named Number, 2
DEFINED in MAP-MS-DataTypes : 982

interrogateSS.....value reference InterrogateSS, CHOICE VALUE
DEFINED in MAP-Protocol : 261

InterrogateSS.....type reference OPERATION
DEFINED in MAP-SupplementaryServi : 160
USED in MAP-Protocol : 73 261
USED in MAP-SupplementaryServi : 17

interrogateSS-Res.....identifier of InterrogateSS-Res
DEFINED in MAP-SupplementaryServi : 164

InterrogateSS-Res.....type reference CHOICE
DEFINED in MAP-SS-DataTypes : 215
USED in MAP-SupplementaryServi : 63 164
USED in MAP-SS-DataTypes : 19

interrogationType.....identifier of [3] InterrogationType
DEFINED in MAP-CH-DataTypes : 98

InterrogationType.....type reference ENUMERATED
DEFINED in MAP-CH-DataTypes : 125
USED in MAP-CH-DataTypes : 98

interzonalECT-Barred.....identifier of Named Number, 12
DEFINED in MAP-MS-DataTypes : 992

interzonalOGCallsAndInternationalOGCallsidentifier of Named Number, 8
DEFINED in MAP-MS-DataTypes : 985

interzonalOGCallsBarred.....identifier of Named Number, 6
DEFINED in MAP-MS-DataTypes : 983

interzonalOGCallsNotToHPLMN-CountryBarreidentifier of Named Number, 7
DEFINED in MAP-MS-DataTypes : 984

intraCUG-Options.....identifier of IntraCUG-Options
DEFINED in MAP-MS-DataTypes : 1122

TAG R5.40 Cross Reference Listing for MAP-Protocol 2002-06-07 14:47:03 PAGE 51

IntraCUG-Options.....type reference ENUMERATED
 DEFINED in MAP-MS-DataTypes : 1132
 USED in MAP-MS-DataTypes : 80 1122

invalidFormat.....identifier of Named Number, 1
 DEFINED in MAP-ER-DataTypes : 144

invalidSME-Address.....identifier of Named Number, 5
 DEFINED in MAP-ER-DataTypes : 154

invoke.....identifier of [1] IMPLICIT Invoke
 DEFINED in TCAPMessages : 125

Invoke.....type reference SEQUENCE
 DEFINED in TCAPMessages : 133
 USED in TCAPMessages : 125

invokeID.....identifier of InvokeldType
 DEFINED in TCAPMessages : 134

invokeID.....identifier of InvokeldType
 DEFINED in TCAPMessages : 145

invokeID.....identifier of InvokeldType
 DEFINED in TCAPMessages : 157

invokeID.....identifier of CHOICE
 DEFINED in TCAPMessages : 166

InvokeldType.....type reference INTEGER
 DEFINED in TCAPMessages : 175
 USED in TCAPMessages : 47 134 135 145 157 167

invokeProblem.....identifier of [1] IMPLICIT InvokeProblem
 DEFINED in TCAPMessages : 171

InvokeProblem.....type reference INTEGER
 DEFINED in TCAPMessages : 183
 USED in TCAPMessages : 171

ISDN-AddressString.....type reference AddressString
 DEFINED in MAP-CommonDataTypes : 143
 USED in MAP-OperationAndMainte : 42 79
 USED in MAP-MS-DataTypes : 169 217 218 266 291 292 395 396 425
 446 550 597 651 776 851 938 1048 1421
 1423 1440 1479 1529 1616 1655 1666 1726 1747
 1762 1789 1801 1903 1909 1922 2033 2048 2138
 2199 2219
 USED in MAP-CommonDataTypes : 17 375
 USED in MAP-CH-DataTypes : 63 95 101 161 167 189 193 205 206
 211 227 240 292 307 396
 USED in MAP-SS-DataTypes : 45 102 208 226 271 281 312
 USED in MAP-SM-DataTypes : 33 54 87 99 100 140 145 173 179
 184
 USED in MAP-GR-DataTypes : 23 62
 USED in MAP-LCS-DataTypes : 31 68 94 106 110 350 353 354

isdn-BearerCapability.....identifier of [1] ExternalSignalInfo
 DEFINED in MAP-CH-DataTypes : 290

ISDN-SubaddressString.....type reference OCTET STRING
 DEFINED in MAP-CommonDataTypes : 158
 USED in MAP-MS-DataTypes : 170 1052 2159
 USED in MAP-CommonDataTypes : 20
 USED in MAP-CH-DataTypes : 64 197
 USED in MAP-SS-DataTypes : 46 76 103 209

istAlert.....value reference IST-Alert, CHOICE VALUE
 DEFINED in MAP-Protocol : 251

istAlertArg.....identifier of IST-AlertArg
 DEFINED in MAP-CallHandlingOperat : 194

istAlertRes.....identifier of IST-AlertRes
 DEFINED in MAP-CallHandlingOperat : 196

istAlertTimer.....identifier of [26] IST-AlertTimerValue
DEFINED in MAP-MS-DataTypes : 746

istAlertTimer.....identifier of [14] IST-AlertTimerValue
DEFINED in MAP-CH-DataTypes : 169

TAG R5.40 Cross Reference Listing for MAP-Protocol 2002-06-07 14:47:03 PAGE 52

istAlertTimer.....identifier of [0] IST-AlertTimerValue
 DEFINED in MAP-CH-DataTypes : 429

istCommand.....value reference IST-Command, CHOICE VALUE
 DEFINED in MAP-Protocol : 252

istCommandArg.....identifier of IST-CommandArg
 DEFINED in MAP-CallHandlingOperat : 207

istCommandRes.....identifier of IST-CommandRes
 DEFINED in MAP-CallHandlingOperat : 209

istCommandSupported.....identifier of Named Number, 1
 DEFINED in MAP-MS-DataTypes : 246

istInformationWithdraw.....identifier of [14] NULL
 DEFINED in MAP-MS-DataTypes : 1314

istInformationWithdraw.....identifier of [1] NULL
 DEFINED in MAP-CH-DataTypes : 430

istSupportIndicator.....identifier of [1] IST-SupportIndicator
 DEFINED in MAP-MS-DataTypes : 231

istSupportIndicator.....identifier of [18] IST-SupportIndicator
 DEFINED in MAP-CH-DataTypes : 114

IST-Alert.....type reference OPERATION
 DEFINED in MAP-CallHandlingOperat : 192
 USED in MAP-Protocol : 62 251
 USED in MAP-CallHandlingOperat : 21

IST-AlertArg.....type reference SEQUENCE
 DEFINED in MAP-CH-DataTypes : 423
 USED in MAP-CallHandlingOperat : 70 194
 USED in MAP-CH-DataTypes : 33

IST-AlertRes.....type reference SEQUENCE
 DEFINED in MAP-CH-DataTypes : 428
 USED in MAP-CallHandlingOperat : 71 196
 USED in MAP-CH-DataTypes : 34

IST-AlertTimerValue.....type reference INTEGER
 DEFINED in MAP-MS-DataTypes : 760
 USED in MAP-MS-DataTypes : 83 746
 USED in MAP-CH-DataTypes : 48 169 429

IST-Command.....type reference OPERATION
 DEFINED in MAP-CallHandlingOperat : 205
 USED in MAP-Protocol : 63 252
 USED in MAP-CallHandlingOperat : 22

IST-CommandArg.....type reference SEQUENCE
 DEFINED in MAP-CH-DataTypes : 435
 USED in MAP-CallHandlingOperat : 72 207
 USED in MAP-CH-DataTypes : 35

IST-CommandRes.....type reference SEQUENCE
 DEFINED in MAP-CH-DataTypes : 440
 USED in MAP-CallHandlingOperat : 73 209
 USED in MAP-CH-DataTypes : 36

IST-SupportIndicator.....type reference ENUMERATED
 DEFINED in MAP-MS-DataTypes : 244
 USED in MAP-MS-DataTypes : 26 231
 USED in MAP-CH-DataTypes : 47 114

kc.....identifier of Kc
 DEFINED in MAP-MS-DataTypes : 339

kc.....identifier of Kc
 DEFINED in MAP-MS-DataTypes : 355

Kc.....type reference OCTET STRING
 DEFINED in MAP-MS-DataTypes : 369

USED in MAP-MS-DataTypes : 51 339 355
USED in MAP-GR-DataTypes : 36 55

keepCCBS-CallIndicator.....identifier of [1] NULL
DEFINED in MAP-CH-DataTypes : 184

keyStatus.....identifier of [2] KeyStatus

TAG R5.40 Cross Reference Listing for MAP-Protocol 2002-06-07 14:47:03 PAGE 53

DEFINED in MAP-MS-DataTypes : 456

KeyStatus.....type reference ENUMERATED
DEFINED in MAP-MS-DataTypes : 499
USED in MAP-MS-DataTypes : 456

ksi.....identifier of KSI
DEFINED in MAP-MS-DataTypes : 362

KSI.....type reference OCTET STRING
DEFINED in MAP-MS-DataTypes : 384
USED in MAP-MS-DataTypes : 362

laiFixedLength.....identifier of [1] LAIFixedLength
DEFINED in MAP-CommonDataTypes : 415

LAIFixedLength.....type reference OCTET STRING
DEFINED in MAP-CommonDataTypes : 433
USED in MAP-CommonDataTypes : 415

lawfullInterceptServices.....identifier of Named Number, 3
DEFINED in MAP-LCS-DataTypes : 160

lcsAPN.....identifier of [5] APN
DEFINED in MAP-LCS-DataTypes : 153

lcsCapabilitySet1.....identifier of Named Number, 0
DEFINED in MAP-MS-DataTypes : 252

lcsCapabilitySet2.....identifier of Named Number, 1
DEFINED in MAP-MS-DataTypes : 253

lcsCapabilitySet3.....identifier of Named Number, 2
DEFINED in MAP-MS-DataTypes : 254

lcsClientDialedByMS.....identifier of [2] AddressString
DEFINED in MAP-LCS-DataTypes : 149

LCSCClientExternalID.....type reference SEQUENCE
DEFINED in MAP-CommonDataTypes : 378
USED in MAP-MS-DataTypes : 187 1222
USED in MAP-CommonDataTypes : 58
USED in MAP-LCS-DataTypes : 37 148

lcsClientExternalID.....identifier of [1] LCSCClientExternalID
DEFINED in MAP-LCS-DataTypes : 148

LCSCClientInternalID.....type reference ENUMERATED
DEFINED in MAP-CommonDataTypes : 383
USED in MAP-MS-DataTypes : 188 1212
USED in MAP-CommonDataTypes : 59
USED in MAP-LCS-DataTypes : 38 150

lcsClientInternalID.....identifier of [3] LCSCClientInternalID
DEFINED in MAP-LCS-DataTypes : 150

lcsClientName.....identifier of [4] LCSCClientName
DEFINED in MAP-LCS-DataTypes : 151

LCSCClientName.....type reference SEQUENCE
DEFINED in MAP-LCS-DataTypes : 167
USED in MAP-LCS-DataTypes : 18 151

lcsClientType.....identifier of [0] LCSCClientType
DEFINED in MAP-LCS-DataTypes : 147

LCSCClientType.....type reference ENUMERATED
DEFINED in MAP-LCS-DataTypes : 156
USED in MAP-LCS-DataTypes : 147

lcsCodeword.....identifier of [11] LCSCCodeword
DEFINED in MAP-LCS-DataTypes : 119

LCSCCodeword.....type reference SEQUENCE
DEFINED in MAP-LCS-DataTypes : 237

USED in MAP-LCS-DataTypes : 26 119

lcsCodewordApplicability.....identifier of [3] LCSCodewordApplicability
DEFINED in MAP-LCS-DataTypes : 72

LCSCodewordApplicability.....type reference ENUMERATED
DEFINED in MAP-LCS-DataTypes : 74

TAG R5.40 Cross Reference Listing for MAP-Protocol 2002-06-07 14:47:03 PAGE 54

USED in MAP-LCS-DataTypes : 72

lcsCodewordNotification.....identifier of [3] NULL
 DEFINED in MAP-LCS-DataTypes : 86

lcsCodewordString.....identifier of [1] LCSCodewordString
 DEFINED in MAP-LCS-DataTypes : 239

LCSCodewordString.....type reference USSD-String
 DEFINED in MAP-LCS-DataTypes : 242
 USED in MAP-LCS-DataTypes : 239

lcsInformation.....identifier of [22] LCSInformation
 DEFINED in MAP-MS-DataTypes : 745

LCSInformation.....type reference SEQUENCE
 DEFINED in MAP-MS-DataTypes : 762
 USED in MAP-MS-DataTypes : 745

lcsLocationInfo.....identifier of [1] LCSLocationInfo
 DEFINED in MAP-LCS-DataTypes : 83

LCSLocationInfo.....type reference SEQUENCE
 DEFINED in MAP-LCS-DataTypes : 93
 USED in MAP-LCS-DataTypes : 83 349 379

lcsLocationInfo.....identifier of LCSLocationInfo
 DEFINED in MAP-LCS-DataTypes : 349

lcsLocationInfo.....identifier of [1] LCSLocationInfo
 DEFINED in MAP-LCS-DataTypes : 379

lcsRequestorID.....identifier of [6] LCSRequestorID
 DEFINED in MAP-LCS-DataTypes : 154

LCSRequestorID.....type reference SEQUENCE
 DEFINED in MAP-LCS-DataTypes : 181
 USED in MAP-LCS-DataTypes : 25 154

LCSServiceTypeID.....type reference INTEGER
 DEFINED in MAP-CommonDataTypes : 392
 USED in MAP-MS-DataTypes : 190 1254
 USED in MAP-CommonDataTypes : 60 396 397 398 399 400 401 402 403
 404 405 406 407
 USED in MAP-LCS-DataTypes : 39 118

lcsServiceTypeID.....identifier of [10] LCSServiceTypeID
 DEFINED in MAP-LCS-DataTypes : 118

lcs-ClientID.....identifier of [0] LCS-ClientID
 DEFINED in MAP-LCS-DataTypes : 107

LCS-ClientID.....type reference SEQUENCE
 DEFINED in MAP-LCS-DataTypes : 146
 USED in MAP-LCS-DataTypes : 107 348

lcs-ClientID.....identifier of LCS-ClientID
 DEFINED in MAP-LCS-DataTypes : 348

lcs-Event.....identifier of LCS-Event
 DEFINED in MAP-LCS-DataTypes : 347

LCS-Event.....type reference ENUMERATED
 DEFINED in MAP-LCS-DataTypes : 384
 USED in MAP-LCS-DataTypes : 347

lcs-Priority.....identifier of [6] LCS-Priority
 DEFINED in MAP-LCS-DataTypes : 113

LCS-Priority.....type reference OCTET STRING
 DEFINED in MAP-LCS-DataTypes : 190
 USED in MAP-LCS-DataTypes : 113

LCS-PrivacyClass.....type reference SEQUENCE
 DEFINED in MAP-MS-DataTypes : 1179

USED in MAP-MS-DataTypes : 1175

lcs-PrivacyExceptionList.....identifier of [1] LCS-PrivacyExceptionList
DEFINED in MAP-MS-DataTypes : 764

LCS-PrivacyExceptionList.....type reference SEQUENCE OF
DEFINED in MAP-MS-DataTypes : 1174

TAG R5.40 Cross Reference Listing for MAP-Protocol

2002-06-07 14:47:03 PAGE 55

USED in MAP-MS-DataTypes : 764 767

lcs-QoS.....identifier of [7] LCS-QoS
 DEFINED in MAP-LCS-DataTypes : 114

LCS-QoS.....type reference SEQUENCE
 DEFINED in MAP-LCS-DataTypes : 195
 USED in MAP-LCS-DataTypes : 19 114

linkedID.....identifier of [0] IMPLICIT InvokeldType
 DEFINED in TCAPMessages : 135

linkedResponseUnexpected.....identifier of Named Number, 6
 DEFINED in TCAPMessages : 189

lmsi.....identifier of [10] LMSI
 DEFINED in MAP-MS-DataTypes : 219

lmsi.....identifier of LMSI
 DEFINED in MAP-MS-DataTypes : 1795

lmsi.....identifier of [1] LMSI
 DEFINED in MAP-MS-DataTypes : 1837

lmsi.....identifier of LMSI
 DEFINED in MAP-CommonDataTypes : 306

LMSI.....type reference OCTET STRING
 DEFINED in MAP-CommonDataTypes : 336
 USED in MAP-MS-DataTypes : 177 219 1795 1837
 USED in MAP-CommonDataTypes : 35 306
 USED in MAP-CH-DataTypes : 69 207 324
 USED in MAP-SM-DataTypes : 36 88 135
 USED in MAP-LCS-DataTypes : 34 96 111

lmsi.....identifier of [4] LMSI
 DEFINED in MAP-CH-DataTypes : 207

lmsi.....identifier of [1] LMSI
 DEFINED in MAP-CH-DataTypes : 324

lmsi.....identifier of LMSI
 DEFINED in MAP-SM-DataTypes : 88

lmsi.....identifier of [1] LMSI
 DEFINED in MAP-SM-DataTypes : 135

lmsi.....identifier of [0] LMSI
 DEFINED in MAP-LCS-DataTypes : 96

lmsi.....identifier of [4] LMSI
 DEFINED in MAP-LCS-DataTypes : 111

lmu-Indicator.....identifier of [21] NULL
 DEFINED in MAP-MS-DataTypes : 744

localizedAdvertising.....value reference LCSServiceTypeID, 10
 DEFINED in MAP-CommonDataTypes : 406

localValue.....identifier of INTEGER
 DEFINED in MAP-ST-DataTypes : 91

localValue.....identifier of INTEGER
 DEFINED in MAP-ST-DataTypes : 95

locationEstimate.....identifier of Ext-GeographicalInformation
 DEFINED in MAP-LCS-DataTypes : 247

locationEstimate.....identifier of [5] Ext-GeographicalInformation
 DEFINED in MAP-LCS-DataTypes : 355

locationEstimateType.....identifier of [0] LocationEstimateType
 DEFINED in MAP-LCS-DataTypes : 124

LocationEstimateType.....type reference ENUMERATED

DEFINED in MAP-LCS-DataTypes : 128
USED in MAP-LCS-DataTypes : 124

locationInformation.....identifier of [0] LocationInformation
DEFINED in MAP-MS-DataTypes : 1848

locationInformation.....identifier of [0] NULL

TAG R5.40 Cross Reference Listing for MAP-Protocol 2002-06-07 14:47:03 PAGE 56

DEFINED in MAP-MS-DataTypes : 1882

LocationInformation.....type reference SEQUENCE
DEFINED in MAP-MS-DataTypes : 1900
USED in MAP-MS-DataTypes : 102 1848 2220

locationInformation.....identifier of [3] LocationInformation
DEFINED in MAP-MS-DataTypes : 2220

locationInformationGPRS.....identifier of [3] LocationInformationGPRS
DEFINED in MAP-MS-DataTypes : 1852

LocationInformationGPRS.....type reference SEQUENCE
DEFINED in MAP-MS-DataTypes : 1918
USED in MAP-MS-DataTypes : 103 1852 2224

locationInformationGPRS.....identifier of [7] LocationInformationGPRS
DEFINED in MAP-MS-DataTypes : 2224

locationInfoWithLMSI.....identifier of [0] LocationInfoWithLMSI
DEFINED in MAP-SM-DataTypes : 82

LocationInfoWithLMSI.....type reference SEQUENCE
DEFINED in MAP-SM-DataTypes : 86
USED in MAP-SM-DataTypes : 82

locationNotAllowed.....identifier of Named Number, 3
DEFINED in MAP-MS-DataTypes : 1243

locationNumber.....identifier of [2] LocationNumber
DEFINED in MAP-MS-DataTypes : 1904

LocationNumber.....type reference OCTET STRING
DEFINED in MAP-MS-DataTypes : 1963
USED in MAP-MS-DataTypes : 1904

locationProcedureNotCompleted.....identifier of Named Number, 4
DEFINED in MAP-ER-DataTypes : 376

locationProcedureNotSupportedByTargetMS.identifier of Named Number, 5
DEFINED in MAP-ER-DataTypes : 377

locationType.....identifier of LocationType
DEFINED in MAP-LCS-DataTypes : 105

LocationType.....type reference SEQUENCE
DEFINED in MAP-LCS-DataTypes : 123
USED in MAP-LCS-DataTypes : 17 105

locationUpdating.....identifier of Named Number, 2
DEFINED in MAP-MS-DataTypes : 401

longForwardedToNumber.....identifier of [10] FTN-AddressString
DEFINED in MAP-MS-DataTypes : 1057

longForwardedToNumber.....identifier of [8] FTN-AddressString
DEFINED in MAP-CH-DataTypes : 201

longForwardedToNumber.....identifier of [9] FTN-AddressString
DEFINED in MAP-SS-DataTypes : 107

longFTN-Supported.....identifier of [4] NULL
DEFINED in MAP-MS-DataTypes : 233

longFTN-Supported.....identifier of [4] NULL
DEFINED in MAP-MS-DataTypes : 2050

longFTN-Supported.....identifier of [6] NULL
DEFINED in MAP-MS-DataTypes : 2143

longFTN-Supported.....identifier of [21] NULL
DEFINED in MAP-CH-DataTypes : 117

longFTN-Supported.....identifier of [18] NULL
DEFINED in MAP-CH-DataTypes : 222

longFTN-Supported.....identifier of [9] NULL
DEFINED in MAP-SS-DataTypes : 81

longFTN-Supported.....identifier of [4] NULL
DEFINED in MAP-SS-DataTypes : 188

TAG R5.40 Cross Reference Listing for MAP-Protocol 2002-06-07 14:47:03 PAGE 57

LongSignalInfo.....type reference OCTET STRING
DEFINED in MAP-CommonDataTypes : 249
USED in MAP-CommonDataTypes : 243

longTermDenial.....value reference LongTermDenial, CHOICE VALUE
DEFINED in MAP-Protocol : 432

LongTermDenial.....type reference ERROR
DEFINED in MAP-Errors : 397
USED in MAP-Protocol : 170 432
USED in MAP-SupplementaryServi : 54 265
USED in MAP-Errors : 74

longTermDenialParam.....identifier of LongTermDenialParam
DEFINED in MAP-Errors : 399

LongTermDenialParam.....type reference SEQUENCE
DEFINED in MAP-ER-DataTypes : 344
USED in MAP-Errors : 143 399
USED in MAP-ER-DataTypes : 48

lowdelay.....identifier of Named Number, 0
DEFINED in MAP-LCS-DataTypes : 220

lowerLayerCompatibility.....identifier of [5] ExternalSignalInfo
DEFINED in MAP-CH-DataTypes : 294

IsaActiveModeIndicator.....identifier of [2] NULL
DEFINED in MAP-MS-DataTypes : 916

IsaAttributes.....identifier of [1] LSAAttributes
DEFINED in MAP-MS-DataTypes : 915

LSAAttributes.....type reference OCTET STRING
DEFINED in MAP-MS-DataTypes : 933
USED in MAP-MS-DataTypes : 915

LSADData.....type reference SEQUENCE
DEFINED in MAP-MS-DataTypes : 913
USED in MAP-MS-DataTypes : 909

LSADDataList.....type reference SEQUENCE OF
DEFINED in MAP-MS-DataTypes : 908
USED in MAP-MS-DataTypes : 926

IsaDataList.....identifier of [2] LSADDataList
DEFINED in MAP-MS-DataTypes : 926

LSAIdentity.....identifier of [0] LSAIdentity
DEFINED in MAP-MS-DataTypes : 914

LSAIdentity.....type reference OCTET STRING
DEFINED in MAP-MS-DataTypes : 930
USED in MAP-MS-DataTypes : 56 914 1345 1908 1923

LSAIdentityList.....identifier of LSAIdentityList
DEFINED in MAP-MS-DataTypes : 1342

LSAIdentityList.....type reference SEQUENCE OF
DEFINED in MAP-MS-DataTypes : 1344
USED in MAP-MS-DataTypes : 1342

LSAInformation.....identifier of [25] LSAInformation
DEFINED in MAP-MS-DataTypes : 743

LSAInformation.....type reference SEQUENCE
DEFINED in MAP-MS-DataTypes : 920
USED in MAP-MS-DataTypes : 743

LSAInformationWithdraw.....identifier of [12] LSAInformationWithdraw
DEFINED in MAP-MS-DataTypes : 1312

LSAInformationWithdraw.....type reference CHOICE
DEFINED in MAP-MS-DataTypes : 1340
USED in MAP-MS-DataTypes : 1312

LSAOnlyAccessIndicator.....type reference ENUMERATED
DEFINED in MAP-MS-DataTypes : 904
USED in MAP-MS-DataTypes : 925

lsaOnlyAccessIndicator.....identifier of [1] LSAOnlyAccessIndicator
DEFINED in MAP-MS-DataTypes : 925

TAG R5.40 Cross Reference Listing for MAP-Protocol 2002-06-07 14:47:03 PAGE 58

mah.....value reference SS-Code, '00110010'B
DEFINED in MAP-SS-Code : 68

MAP-BS-Code.....module reference
DEFINED in MAP-BS-Code : 1
USED in MAP-MS-DataTypes : 158
USED in MAP-CommonDataTypes : 72

MAP-CallHandlingOperations.....module reference
DEFINED in MAP-CallHandlingOperat : 1
USED in MAP-Protocol : 64

MAP-CH-DataTypes.....module reference
DEFINED in MAP-CH-DataTypes : 1
USED in MAP-CallHandlingOperat : 74

MAP-CommonDataTypes.....module reference
DEFINED in MAP-CommonDataTypes : 1
USED in MAP-MobileServiceOpera : 168
USED in MAP-OperationAndMainte : 44
USED in MAP-MS-DataTypes : 194
USED in MAP-OM-DataTypes : 23
USED in MAP-CH-DataTypes : 75
USED in MAP-SS-DataTypes : 56
USED in MAP-SM-DataTypes : 37
USED in MAP-GR-DataTypes : 27
USED in MAP-LCS-DataTypes : 40
USED in MAP-ST-DataTypes : 20
USED in MAP-ER-DataTypes : 77

MAP-Errors.....module reference
DEFINED in MAP-Errors : 1
USED in MAP-Protocol : 185
USED in MAP-MobileServiceOpera : 109
USED in MAP-OperationAndMainte : 30
USED in MAP-CallHandlingOperat : 51
USED in MAP-SupplementaryServi : 56
USED in MAP-ShortMessageServic : 41
USED in MAP-Group-Call-Operati : 27
USED in MAP-LocationServiceOpe : 37
USED in MAP-SecureTransportOpe : 28

MAP-ER-DataTypes.....module reference
DEFINED in MAP-ER-DataTypes : 1
USED in MAP-Errors : 161
USED in MAP-MS-DataTypes : 204
USED in MAP-SM-DataTypes : 42

MAP-EXTENSION.....information object class reference CLASS
DEFINED in MAP-ExtensionDataTypes : 22
USED in MAP-ExtensionDataTypes : 41 43 48

MAP-ExtensionDataTypes.....module reference
DEFINED in MAP-ExtensionDataTypes : 1
USED in MAP-MS-DataTypes : 199
USED in MAP-CommonDataTypes : 82
USED in MAP-OM-DataTypes : 28
USED in MAP-CH-DataTypes : 80
USED in MAP-SS-DataTypes : 61
USED in MAP-SM-DataTypes : 47
USED in MAP-GR-DataTypes : 43
USED in MAP-LCS-DataTypes : 45
USED in MAP-ER-DataTypes : 94

MAP-Group-Call-Operations.....module reference
DEFINED in MAP-Group-Call-Operati : 1
USED in MAP-Protocol : 103

MAP-GR-DataTypes.....module reference
DEFINED in MAP-GR-DataTypes : 1
USED in MAP-Group-Call-Operati : 37

MAP-LCS-DataTypes.....module reference
DEFINED in MAP-LCS-DataTypes : 1

USED in MAP-LocationServiceOpe : 47

MAP-LocationServiceOperations.....module reference

DEFINED in MAP-LocationServiceOpe : 1

USED in MAP-Protocol : 111

MAP-MobileServiceOperations.....module reference

TAG R5.40 Cross Reference Listing for MAP-Protocol

2002-06-07 14:47:03 PAGE 59

DEFINED in MAP-MobileServiceOpera : 1
 USED in MAP-Protocol : 41

MAP-MS-DataTypes.....module reference

DEFINED in MAP-MS-DataTypes : 1
 USED in MAP-MobileServiceOpera : 163
 USED in MAP-CH-DataTypes : 52
 USED in MAP-GR-DataTypes : 37
 USED in MAP-LCS-DataTypes : 56

MAP-OM-DataTypes.....module reference

DEFINED in MAP-OM-DataTypes : 1
 USED in MAP-OperationAndMainte : 38

MAP-OperationAndMaintenanceOperations...module reference

DEFINED in MAP-OperationAndMainte : 1
 USED in MAP-Protocol : 49

MAP-Protocol.....module reference

DEFINED in MAP-Protocol : 1

MAP-SecureTransportOperations.....module reference

DEFINED in MAP-SecureTransportOpe : 1
 USED in MAP-Protocol : 121

MAP-ShortMessageServiceOperations.....module reference

DEFINED in MAP-ShortMessageServic : 1
 USED in MAP-Protocol : 94

MAP-SM-DataTypes.....module reference

DEFINED in MAP-SM-DataTypes : 1
 USED in MAP-ShortMessageServic : 57
 USED in MAP-LCS-DataTypes : 61

MAP-SS-Code.....module reference

DEFINED in MAP-SS-Code : 1
 USED in MAP-SupplementaryServi : 79
 USED in MAP-MS-DataTypes : 153
 USED in MAP-CommonDataTypes : 77
 USED in MAP-SS-DataTypes : 66
 USED in MAP-ER-DataTypes : 89

MAP-SS-DataTypes.....module reference

DEFINED in MAP-SS-DataTypes : 1
 USED in MAP-SupplementaryServi : 74
 USED in MAP-Errors : 106
 USED in MAP-MS-DataTypes : 148
 USED in MAP-CH-DataTypes : 59
 USED in MAP-LCS-DataTypes : 51
 USED in MAP-ER-DataTypes : 70

MAP-ST-DataTypes.....module reference

DEFINED in MAP-ST-DataTypes : 1
 USED in MAP-SecureTransportOpe : 35
 USED in MAP-ER-DataTypes : 83

MAP-SupplementaryServiceOperations.....module reference

DEFINED in MAP-SupplementaryServi : 1
 USED in MAP-Protocol : 82

MAP-TS-Code.....module reference

DEFINED in MAP-TS-Code : 1
 USED in MAP-MS-DataTypes : 163
 USED in MAP-CommonDataTypes : 66
 USED in MAP-GR-DataTypes : 32

matchType.....identifier of [0] MatchType

DEFINED in MAP-MS-DataTypes : 1521

MatchType.....type reference ENUMERATED

DEFINED in MAP-MS-DataTypes : 1551
 USED in MAP-MS-DataTypes : 1521

maxAddressLength.....value reference INTEGER, 20

DEFINED in MAP-CommonDataTypes : 141

USED in MAP-CommonDataTypes : 100

maxAdd-GeographicalInformation.....value reference INTEGER, 91

DEFINED in MAP-LCS-DataTypes : 343

USED in MAP-LCS-DataTypes : 325

maxEventSpecification.....value reference INTEGER, 2

TAG R5.40 Cross Reference Listing for MAP-Protocol 2002-06-07 14:47:03 PAGE 60

DEFINED in MAP-SS-DataTypes : 303
USED in MAP-SS-DataTypes : 300

maxExt-GeographicalInformation.....value reference INTEGER, 20
DEFINED in MAP-LCS-DataTypes : 321
USED in MAP-LCS-DataTypes : 265

maxFTN-AddressLength.....value reference INTEGER, 15
DEFINED in MAP-CommonDataTypes : 156
USED in MAP-CommonDataTypes : 150

maximumentitledPriority.....identifier of EMLPP-Priority
DEFINED in MAP-CommonDataTypes : 457

maximumEntitledPriority.....identifier of [0] EMLPP-Priority
DEFINED in MAP-SS-DataTypes : 194

maxISDN-AddressLength.....value reference INTEGER, 9
DEFINED in MAP-CommonDataTypes : 147
USED in MAP-CommonDataTypes : 18 144

maxISDN-SubaddressLength.....value reference INTEGER, 21
DEFINED in MAP-CommonDataTypes : 196
USED in MAP-CommonDataTypes : 159

maxLCSCodewordStringLength.....value reference INTEGER, 127
DEFINED in MAP-LCS-DataTypes : 244
USED in MAP-LCS-DataTypes : 242

maxLongSignalInfoLength.....value reference INTEGER, 2560
DEFINED in MAP-CommonDataTypes : 251
USED in MAP-CommonDataTypes : 249

MaxMC-Bearers.....type reference INTEGER
DEFINED in MAP-CommonDataTypes : 485
USED in MAP-CommonDataTypes : 52 480
USED in MAP-SS-DataTypes : 52 197

maxNameStringLength.....value reference INTEGER, 63
DEFINED in MAP-LCS-DataTypes : 179
USED in MAP-LCS-DataTypes : 177

maxNrOfRABs.....value reference INTEGER, 255
DEFINED in MAP-MS-DataTypes : 658
USED in MAP-MS-DataTypes : 656

maxNumOfBasicServiceGroups.....value reference INTEGER, 13
DEFINED in MAP-SS-DataTypes : 267
USED in MAP-SS-DataTypes : 96 153 264

maxNumOfBasicServices.....value reference INTEGER, 70
DEFINED in MAP-MS-DataTypes : 1350
USED in MAP-MS-DataTypes : 1347

maxNumOfBearerServices.....value reference INTEGER, 50
DEFINED in MAP-MS-DataTypes : 966
USED in MAP-MS-DataTypes : 963

maxNumOfCamelBasicServiceCriteria.....value reference INTEGER, 5
DEFINED in MAP-MS-DataTypes : 1545
USED in MAP-MS-DataTypes : 1536

maxNumOfCamelDestinationNumberLengths...value reference INTEGER, 3
DEFINED in MAP-MS-DataTypes : 1543
USED in MAP-MS-DataTypes : 1533

maxNumOfCamelDestinationNumbers.....value reference INTEGER, 10
DEFINED in MAP-MS-DataTypes : 1541
USED in MAP-MS-DataTypes : 1528

maxNumOfCamelSSEvents.....value reference INTEGER, 10
DEFINED in MAP-MS-DataTypes : 1455
USED in MAP-MS-DataTypes : 1444

maxNumOfCamelTDPData.....value reference INTEGER, 10

DEFINED in MAP-MS-DataTypes : 1474
USED in MAP-MS-DataTypes : 75 843 1373 1467 1499 1502 1608 1715

maxNumOfCAMEL-O-CauseValueCriteria.....value reference INTEGER, 5

DEFINED in MAP-MS-DataTypes : 1561
USED in MAP-MS-DataTypes : 1555

TAG R5.40 Cross Reference Listing for MAP-Protocol 2002-06-07 14:47:03 PAGE 61

maxNumOfCAMEL-T-CauseValueCriteria.....value reference INTEGER, 5
DEFINED in MAP-MS-DataTypes : 1563
USED in MAP-MS-DataTypes : 1558

maxNumOfCCBS-Requests.....value reference INTEGER, 5
DEFINED in MAP-SS-DataTypes : 204
USED in MAP-SS-DataTypes : 201 213

maxNumOfCUG.....value reference INTEGER, 10
DEFINED in MAP-MS-DataTypes : 1137
USED in MAP-MS-DataTypes : 1116

maxNumOfDP-AnalysedInfoCriteria.....value reference INTEGER, 10
DEFINED in MAP-MS-DataTypes : 1418
USED in MAP-MS-DataTypes : 1415

maxNumOfEncryptionInfo.....value reference INTEGER, 100
DEFINED in MAP-MS-DataTypes : 684
USED in MAP-MS-DataTypes : 676

maxNumOfExternalClient.....value reference INTEGER, 5
DEFINED in MAP-MS-DataTypes : 1209
USED in MAP-MS-DataTypes : 1206

maxNumOfExt-BasicServiceGroups.....value reference INTEGER, 32
DEFINED in MAP-MS-DataTypes : 1145
USED in MAP-MS-DataTypes : 1042 1101 1139 1142

maxNumOfExt-ExternalClient.....value reference INTEGER, 35
DEFINED in MAP-MS-DataTypes : 1219
USED in MAP-MS-DataTypes : 1216

maxNumOfGMLC.....value reference INTEGER, 5
DEFINED in MAP-MS-DataTypes : 779
USED in MAP-MS-DataTypes : 775

maxNumOfHLR-Id.....value reference INTEGER, 50
DEFINED in MAP-CommonDataTypes : 334
USED in MAP-CommonDataTypes : 331

maxNumOfIntegrityInfo.....value reference INTEGER, 100
DEFINED in MAP-MS-DataTypes : 674
USED in MAP-MS-DataTypes : 666

maxNumOfISDN-AddressDigits.....value reference INTEGER, 15
DEFINED in MAP-MS-DataTypes : 1539
USED in MAP-MS-DataTypes : 1534

maxNumOfLSAs.....value reference INTEGER, 20
DEFINED in MAP-MS-DataTypes : 911
USED in MAP-MS-DataTypes : 908 1344

maxNumOfMC-Bearers.....value reference INTEGER, 7
DEFINED in MAP-CommonDataTypes : 489
USED in MAP-CommonDataTypes : 485 487

maxNumOfMobilityTriggers.....value reference INTEGER, 10
DEFINED in MAP-MS-DataTypes : 1677
USED in MAP-MS-DataTypes : 1674

maxNumOfMOLR-Class.....value reference INTEGER, 3
DEFINED in MAP-MS-DataTypes : 1265
USED in MAP-MS-DataTypes : 1262

maxNumOfPDP-Contexts.....value reference INTEGER, 50
DEFINED in MAP-MS-DataTypes : 793
USED in MAP-MS-DataTypes : 790 808 1337 1980

maxNumOfPLMNClient.....value reference INTEGER, 5
DEFINED in MAP-MS-DataTypes : 1214
USED in MAP-MS-DataTypes : 1211

maxNumOfPrivacyClass.....value reference INTEGER, 4
DEFINED in MAP-MS-DataTypes : 1177
USED in MAP-MS-DataTypes : 1174

maxNumOfPrivateExtensions.....value reference INTEGER, 10
DEFINED in MAP-ExtensionDataTypes : 46
USED in MAP-ExtensionDataTypes : 37

maxNumOfRadioResources.....value reference INTEGER, 7
DEFINED in MAP-MS-DataTypes : 547

TAG R5.40 Cross Reference Listing for MAP-Protocol 2002-06-07 14:47:03 PAGE 62

USED in MAP-MS-DataTypes : 538

maxNumOfRelocationNumber.....value reference INTEGER, 7
 DEFINED in MAP-MS-DataTypes : 660
 USED in MAP-MS-DataTypes : 645 648

maxNumOfServiceType.....value reference INTEGER, 32
 DEFINED in MAP-MS-DataTypes : 1251
 USED in MAP-MS-DataTypes : 1248

maxNumOfSS.....value reference INTEGER, 30
 DEFINED in MAP-SS-DataTypes : 259
 USED in MAP-MS-DataTypes : 143 1025
 USED in MAP-SS-DataTypes : 32 256 261

maxNumOfTeleservices.....value reference INTEGER, 20
 DEFINED in MAP-MS-DataTypes : 971
 USED in MAP-MS-DataTypes : 968

maxNumOfTPDUtypes.....value reference INTEGER, 5
 DEFINED in MAP-MS-DataTypes : 1385
 USED in MAP-MS-DataTypes : 1381

maxNumOfVBSGroupIds.....value reference INTEGER, 50
 DEFINED in MAP-MS-DataTypes : 1814
 USED in MAP-MS-DataTypes : 1808

maxNumOfVGCSSGroupIds.....value reference INTEGER, 50
 DEFINED in MAP-MS-DataTypes : 1816
 USED in MAP-MS-DataTypes : 1811

maxNumOfZoneCodes.....value reference INTEGER, 10
 DEFINED in MAP-MS-DataTypes : 1279
 USED in MAP-MS-DataTypes : 64 1273

maxPermittedEncryptionAlgorithmsLength..value reference INTEGER, 9
 DEFINED in MAP-MS-DataTypes : 497
 USED in MAP-MS-DataTypes : 489

maxPermittedIntegrityProtectionAlgorithmvalue reference INTEGER, 9
 DEFINED in MAP-MS-DataTypes : 486
 USED in MAP-MS-DataTypes : 478

maxRequestorIDStringLength.....value reference INTEGER, 127
 DEFINED in MAP-LCS-DataTypes : 188
 USED in MAP-LCS-DataTypes : 186

maxSignalInfoLength.....value reference INTEGER, 200
 DEFINED in MAP-CommonDataTypes : 209
 USED in MAP-CommonDataTypes : 25 207

maxUSSD-StringLength.....value reference INTEGER, 160
 DEFINED in MAP-SS-DataTypes : 242
 USED in MAP-SS-DataTypes : 238

mc.....value reference SS-Code, '01000101'B
 DEFINED in MAP-SS-Code : 84

mcef-Set.....identifier of Named Number, 2
 DEFINED in MAP-SM-DataTypes : 198

mci.....value reference SS-Code, '00010101'B
 DEFINED in MAP-SS-Code : 36

MC-Bearers.....type reference INTEGER
 DEFINED in MAP-CommonDataTypes : 487
 USED in MAP-CommonDataTypes : 53 481
 USED in MAP-SS-DataTypes : 53 80 168 198 199

mc-SS-Info.....identifier of [28] MC-SS-Info
 DEFINED in MAP-MS-DataTypes : 748

MC-SS-Info.....type reference SEQUENCE
 DEFINED in MAP-CommonDataTypes : 477
 USED in MAP-MS-DataTypes : 184 748

USED in MAP-CommonDataTypes : 51

memoryAvailable.....identifier of Named Number, 1
DEFINED in MAP-SM-DataTypes : 219

memoryCapacityExceeded.....identifier of Named Number, 0
DEFINED in MAP-SM-DataTypes : 168

TAG R5.40 Cross Reference Listing for MAP-Protocol 2002-06-07 14:47:03 PAGE 63

memoryCapacityExceeded.....identifier of Named Number, 0
DEFINED in MAP-ER-DataTypes : 149

MessageType.....type reference CHOICE
DEFINED in TCAPMessages : 51
USED in TCAPMessages : 47

messageWaitingListFull.....value reference MessageWaitingListFull, CHOICE VALUE
DEFINED in MAP-Protocol : 439

MessageWaitingListFull.....type reference ERROR
DEFINED in MAP-Errors : 414
USED in MAP-Protocol : 165 439
USED in MAP-ShortMessageServic : 39 121
USED in MAP-Errors : 79

messageWaitListFullParam.....identifier of MessageWaitListFullParam
DEFINED in MAP-Errors : 416

MessageWaitListFullParam.....type reference SEQUENCE
DEFINED in MAP-ER-DataTypes : 325
USED in MAP-Errors : 137 416
USED in MAP-ER-DataTypes : 41

mg-csi.....identifier of [5] MG-CSI
DEFINED in MAP-MS-DataTypes : 826

mg-csi.....identifier of Named Number, 10
DEFINED in MAP-MS-DataTypes : 1328

MG-CSI.....type reference SEQUENCE
DEFINED in MAP-MS-DataTypes : 1663
USED in MAP-MS-DataTypes : 826 2133

mg-csi.....identifier of Named Number, 1
DEFINED in MAP-MS-DataTypes : 2088

mg-csi.....identifier of [17] MG-CSI
DEFINED in MAP-MS-DataTypes : 2133

mistypedComponent.....identifier of Named Number, 1
DEFINED in TCAPMessages : 180

mistypedParameter.....identifier of Named Number, 2
DEFINED in TCAPMessages : 185

mistypedParameter.....identifier of Named Number, 2
DEFINED in TCAPMessages : 194

mistypedParameter.....identifier of Named Number, 4
DEFINED in TCAPMessages : 200

mlcNumber.....identifier of [0] ISDN-AddressString
DEFINED in MAP-LCS-DataTypes : 68

mlc-Number.....identifier of ISDN-AddressString
DEFINED in MAP-LCS-DataTypes : 106

MM-Code.....type reference OCTET STRING
DEFINED in MAP-MS-DataTypes : 1679
USED in MAP-MS-DataTypes : 1675 2217

mm-EventNotSupported.....value reference MM-EventNotSupported, CHOICE VALUE
DEFINED in MAP-Protocol : 451

MM-EventNotSupported.....type reference ERROR
DEFINED in MAP-Errors : 453
USED in MAP-Protocol : 179 451
USED in MAP-MobileServiceOpera : 94 486
USED in MAP-Errors : 92

mm-EventNotSupported-Param.....identifier of MM-EventNotSupported-Param
DEFINED in MAP-Errors : 455

MM-EventNotSupported-Param.....type reference SEQUENCE
DEFINED in MAP-ER-DataTypes : 389
USED in MAP-Errors : 148 455
USED in MAP-ER-DataTypes : 53

mnrf-Set.....identifier of Named Number, 1
DEFINED in MAP-SM-DataTypes : 197

TAG R5.40 Cross Reference Listing for MAP-Protocol 2002-06-07 14:47:03 PAGE 64

mnrg-Set.....identifier of Named Number, 3
 DEFINED in MAP-SM-DataTypes : 199

mobileNotReachableReason.....identifier of [2] AbsentSubscriberDiagnosticSM
 DEFINED in MAP-MS-DataTypes : 1754

mobileYellowPages.....value reference LCSServiceTypeID, 11
 DEFINED in MAP-CommonDataTypes : 407

mobilityTriggers.....identifier of MobilityTriggers
 DEFINED in MAP-MS-DataTypes : 1653

mobilityTriggers.....identifier of MobilityTriggers
 DEFINED in MAP-MS-DataTypes : 1664

MobilityTriggers.....type reference SEQUENCE OF
 DEFINED in MAP-MS-DataTypes : 1674
 USED in MAP-MS-DataTypes : 1653 1664

ModificationInstruction.....type reference ENUMERATED
 DEFINED in MAP-MS-DataTypes : 2191
 USED in MAP-MS-DataTypes : 2161 2171 2177 2183 2184

modificationRequestFor-CB-Info.....identifier of [3] ModificationRequestFor-CB-Info
 DEFINED in MAP-MS-DataTypes : 2140

ModificationRequestFor-CB-Info.....type reference SEQUENCE
 DEFINED in MAP-MS-DataTypes : 2165
 USED in MAP-MS-DataTypes : 2140

modificationRequestFor-CF-Info.....identifier of [2] ModificationRequestFor-CF-Info
 DEFINED in MAP-MS-DataTypes : 2139

ModificationRequestFor-CF-Info.....type reference SEQUENCE
 DEFINED in MAP-MS-DataTypes : 2154
 USED in MAP-MS-DataTypes : 2139

modificationRequestFor-CSI.....identifier of [4] ModificationRequestFor-CSI
 DEFINED in MAP-MS-DataTypes : 2141

ModificationRequestFor-CSI.....type reference SEQUENCE
 DEFINED in MAP-MS-DataTypes : 2181
 USED in MAP-MS-DataTypes : 2141

modificationRequestFor-ODB-data.....identifier of [7] ModificationRequestFor-ODB-data
 DEFINED in MAP-MS-DataTypes : 2145

ModificationRequestFor-ODB-data.....type reference SEQUENCE
 DEFINED in MAP-MS-DataTypes : 2175
 USED in MAP-MS-DataTypes : 2145

modifyCSI-State.....identifier of [2] ModificationInstruction
 DEFINED in MAP-MS-DataTypes : 2184

modifyNotificationToCSE.....identifier of [6] ModificationInstruction
 DEFINED in MAP-MS-DataTypes : 2161

modifyNotificationToCSE.....identifier of [5] ModificationInstruction
 DEFINED in MAP-MS-DataTypes : 2171

modifyNotificationToCSE.....identifier of [1] ModificationInstruction
 DEFINED in MAP-MS-DataTypes : 2177

modifyNotificationToCSE.....identifier of [1] ModificationInstruction
 DEFINED in MAP-MS-DataTypes : 2183

MOLR-Class.....type reference SEQUENCE
 DEFINED in MAP-MS-DataTypes : 1267
 USED in MAP-MS-DataTypes : 1263

molr-List.....identifier of [2] MOLR-List
 DEFINED in MAP-MS-DataTypes : 765

MOLR-List.....type reference SEQUENCE OF

DEFINED in MAP-MS-DataTypes : 1262
USED in MAP-MS-DataTypes : 765

monitoringMode.....identifier of [0] MonitoringMode
DEFINED in MAP-CH-DataTypes : 365

MonitoringMode.....type reference ENUMERATED

TAG R5.40 Cross Reference Listing for MAP-Protocol 2002-06-07 14:47:03 PAGE 65

DEFINED in MAP-CH-DataTypes : 370
USED in MAP-CH-DataTypes : 365

moreMessagesToSend.....identifier of NULL
DEFINED in MAP-SM-DataTypes : 124

mo-forwardSM.....value reference MO-ForwardSM, CHOICE VALUE
DEFINED in MAP-Protocol : 275

MO-ForwardSM.....type reference OPERATION
DEFINED in MAP-ShortMessageServic : 81
USED in MAP-Protocol : 88 275
USED in MAP-ShortMessageServic : 14

mo-forwardSM-Arg.....identifier of MO-ForwardSM-Arg
DEFINED in MAP-ShortMessageServic : 83

MO-ForwardSM-Arg.....type reference SEQUENCE
DEFINED in MAP-SM-DataTypes : 107
USED in MAP-ShortMessageServic : 47 83
USED in MAP-SM-DataTypes : 16

mo-forwardSM-Res.....identifier of MO-ForwardSM-Res
DEFINED in MAP-ShortMessageServic : 85

MO-ForwardSM-Res.....type reference SEQUENCE
DEFINED in MAP-SM-DataTypes : 115
USED in MAP-ShortMessageServic : 48 85
USED in MAP-SM-DataTypes : 17

mo-lr.....identifier of Named Number, 2
DEFINED in MAP-LCS-DataTypes : 387

mo-sms-CSI.....identifier of [1] SMS-CSI
DEFINED in MAP-MS-DataTypes : 821

mo-sms-csi.....identifier of Named Number, 5
DEFINED in MAP-MS-DataTypes : 1323

mo-sms-CSI.....identifier of [6] SMS-CSI
DEFINED in MAP-MS-DataTypes : 1365

mo-sms-CSI.....identifier of Named Number, 5
DEFINED in MAP-MS-DataTypes : 2081

mo-sms-CSI.....identifier of [10] SMS-CSI
DEFINED in MAP-MS-DataTypes : 2125

msAvailable.....identifier of Named Number, 0
DEFINED in MAP-LCS-DataTypes : 140

msc-Number.....identifier of [1] ISDN-AddressString
DEFINED in MAP-MS-DataTypes : 217

msc-Number.....identifier of [6] ISDN-AddressString
DEFINED in MAP-MS-DataTypes : 1909

msc-Number.....identifier of [1] ISDN-AddressString
DEFINED in MAP-CH-DataTypes : 205

msc-Number.....identifier of [0] ISDN-AddressString
DEFINED in MAP-SM-DataTypes : 99

msisdn.....identifier of ISDN-AddressString
DEFINED in MAP-OperationAndMainte : 79

msisdn.....identifier of [1] ISDN-AddressString
DEFINED in MAP-MS-DataTypes : 938

msisdn.....identifier of ISDN-AddressString
DEFINED in MAP-MS-DataTypes : 2199

msisdn.....identifier of [2] ISDN-AddressString
DEFINED in MAP-MS-DataTypes : 2219

msisdn.....identifier of [1] ISDN-AddressString
DEFINED in MAP-CommonDataTypes : 375

msisdn.....identifier of [0] ISDN-AddressString
DEFINED in MAP-CH-DataTypes : 95

msisdn.....identifier of [12] ISDN-AddressString

TAG R5.40 Cross Reference Listing for MAP-Protocol 2002-06-07 14:47:03 PAGE 66

DEFINED in MAP-CH-DataTypes : 167

msisdn.....identifier of [2] ISDN-AddressString
DEFINED in MAP-CH-DataTypes : 206

msisdn.....identifier of [9] ISDN-AddressString
DEFINED in MAP-CH-DataTypes : 240

msisdn.....identifier of [0] ISDN-AddressString
DEFINED in MAP-SS-DataTypes : 226

msisdn.....identifier of [1] ISDN-AddressString
DEFINED in MAP-SS-DataTypes : 271

msisdn.....identifier of [0] ISDN-AddressString
DEFINED in MAP-SM-DataTypes : 54

msisdn.....identifier of [2] ISDN-AddressString
DEFINED in MAP-SM-DataTypes : 140

msisdn.....identifier of ISDN-AddressString
DEFINED in MAP-SM-DataTypes : 145

msisdn.....identifier of ISDN-AddressString
DEFINED in MAP-SM-DataTypes : 179

msisdn.....identifier of [3] ISDN-AddressString
DEFINED in MAP-LCS-DataTypes : 110

msisdn.....identifier of [0] ISDN-AddressString
DEFINED in MAP-LCS-DataTypes : 350

mSNetworkCapability.....identifier of [0] MSNetworkCapability
DEFINED in MAP-MS-DataTypes : 1869

MSNetworkCapability.....type reference OCTET STRING
DEFINED in MAP-MS-DataTypes : 1873
USED in MAP-MS-DataTypes : 1869

msNotReachable.....identifier of NULL
DEFINED in MAP-MS-DataTypes : 1802

msPurged.....identifier of Named Number, 0
DEFINED in MAP-MS-DataTypes : 2023

mSRadioAccessCapability.....identifier of [1] MSRadioAccessCapability
DEFINED in MAP-MS-DataTypes : 1870

MSRadioAccessCapability.....type reference OCTET STRING
DEFINED in MAP-MS-DataTypes : 1877
USED in MAP-MS-DataTypes : 1870

ms-classmark.....identifier of [5] NULL
DEFINED in MAP-MS-DataTypes : 1889

ms-Classmark2.....identifier of [6] MS-Classmark2
DEFINED in MAP-MS-DataTypes : 1855

MS-Classmark2.....type reference OCTET STRING
DEFINED in MAP-MS-DataTypes : 1864
USED in MAP-MS-DataTypes : 95 1855

ms-Present.....identifier of Named Number, 0
DEFINED in MAP-SM-DataTypes : 218

mt-forwardSM.....value reference MT-ForwardSM, CHOICE VALUE
DEFINED in MAP-Protocol : 276

MT-ForwardSM.....type reference OPERATION
DEFINED in MAP-ShortMessageServic : 93
USED in MAP-Protocol : 89 276
USED in MAP-ShortMessageServic : 15

mt-forwardSM-Arg.....identifier of MT-ForwardSM-Arg
DEFINED in MAP-ShortMessageServic : 95

MT-ForwardSM-Arg.....type reference SEQUENCE
DEFINED in MAP-SM-DataTypes : 120
USED in MAP-ShortMessageService : 49 95
USED in MAP-SM-DataTypes : 18

mt-forwardSM-Res.....identifier of MT-ForwardSM-Res

TAG R5.40 Cross Reference Listing for MAP-Protocol 2002-06-07 14:47:03 PAGE 67

DEFINED in MAP-ShortMessageServic : 97

MT-ForwardSM-Res.....type reference SEQUENCE
DEFINED in MAP-SM-DataTypes : 128
USED in MAP-ShortMessageServic : 50 97
USED in MAP-SM-DataTypes : 19

mt-IrRestart.....identifier of Named Number, 4
DEFINED in MAP-LCS-DataTypes : 399

MT-smsCAMELTDP-Criteria.....type reference SEQUENCE
DEFINED in MAP-MS-DataTypes : 1376
USED in MAP-MS-DataTypes : 1374

mt-smsCAMELTDP-CriteriaList.....identifier of [4] MT-smsCAMELTDP-CriteriaList
DEFINED in MAP-MS-DataTypes : 825

mt-smsCAMELTDP-CriteriaList.....identifier of [11] MT-smsCAMELTDP-CriteriaList
DEFINED in MAP-MS-DataTypes : 1370

MT-smsCAMELTDP-CriteriaList.....type reference SEQUENCE OF
DEFINED in MAP-MS-DataTypes : 1373
USED in MAP-MS-DataTypes : 825 1370 2132

mt-smsCAMELTDP-CriteriaList.....identifier of [16] MT-smsCAMELTDP-CriteriaList
DEFINED in MAP-MS-DataTypes : 2132

mt-sms-CSI.....identifier of [3] SMS-CSI
DEFINED in MAP-MS-DataTypes : 824

mt-sms-csi.....identifier of Named Number, 9
DEFINED in MAP-MS-DataTypes : 1327

mt-sms-CSI.....identifier of [10] SMS-CSI
DEFINED in MAP-MS-DataTypes : 1369

mt-sms-CSI.....identifier of Named Number, 0
DEFINED in MAP-MS-DataTypes : 2087

mt-sms-CSI.....identifier of [15] SMS-CSI
DEFINED in MAP-MS-DataTypes : 2131

MT-SMS-TPDU-Type.....type reference ENUMERATED
DEFINED in MAP-MS-DataTypes : 1387
USED in MAP-MS-DataTypes : 1382

multicallBearerInfo.....identifier of [3] MulticallBearerInfo
DEFINED in MAP-MS-DataTypes : 553

MulticallBearerInfo.....type reference INTEGER
DEFINED in MAP-MS-DataTypes : 648
USED in MAP-MS-DataTypes : 553

multipleBearerNotSupported.....identifier of NULL
DEFINED in MAP-MS-DataTypes : 554

multipleBearerRequested.....identifier of [3] NULL
DEFINED in MAP-MS-DataTypes : 512

multipleECT-Barred.....identifier of Named Number, 14
DEFINED in MAP-MS-DataTypes : 994

multiPTY.....value reference SS-Code, '01010001'B
DEFINED in MAP-SS-Code : 90

mw-Status.....identifier of MW-Status
DEFINED in MAP-SM-DataTypes : 185

MW-Status.....type reference BIT STRING
DEFINED in MAP-SM-DataTypes : 195
USED in MAP-SM-DataTypes : 185

m-csi.....identifier of Named Number, 6
DEFINED in MAP-MS-DataTypes : 1324

m-CSI.....identifier of [5] M-CSI
DEFINED in MAP-MS-DataTypes : 1364

M-CSI.....type reference SEQUENCE
DEFINED in MAP-MS-DataTypes : 1652
USED in MAP-MS-DataTypes : 1364 2127

TAG R5.40 Cross Reference Listing for MAP-Protocol 2002-06-07 14:47:03 PAGE 68

m-CSI.....identifier of Named Number, 7
 DEFINED in MAP-MS-DataTypes : 2083

m-CSI.....identifier of [12] M-CSI
 DEFINED in MAP-MS-DataTypes : 2127

NAEA-CIC.....type reference OCTET STRING
 DEFINED in MAP-CommonDataTypes : 366
 USED in MAP-CommonDataTypes : 39 362

naea-PreferredCI.....identifier of [15] NAEA-PreferredCI
 DEFINED in MAP-MS-DataTypes : 737

NAEA-PreferredCI.....type reference SEQUENCE
 DEFINED in MAP-CommonDataTypes : 361
 USED in MAP-MS-DataTypes : 182 737
 USED in MAP-CommonDataTypes : 38
 USED in MAP-CH-DataTypes : 72 164

naea-PreferredCI.....identifier of [10] NAEA-PreferredCI
 DEFINED in MAP-CH-DataTypes : 164

naea-PreferredCIC.....identifier of [0] NAEA-CIC
 DEFINED in MAP-CommonDataTypes : 362

nameString.....identifier of [2] NameString
 DEFINED in MAP-LCS-DataTypes : 169

NameString.....type reference USSD-String
 DEFINED in MAP-LCS-DataTypes : 177
 USED in MAP-LCS-DataTypes : 169

navigation.....value reference LCSServiceTypeID, 8
 DEFINED in MAP-CommonDataTypes : 404

na-ESRD.....identifier of [3] ISDN-AddressString
 DEFINED in MAP-LCS-DataTypes : 353

na-ESRK.....identifier of [4] ISDN-AddressString
 DEFINED in MAP-LCS-DataTypes : 354

nbrSB.....identifier of [2] MaxMC-Bearers
 DEFINED in MAP-CommonDataTypes : 480

nbrSB.....identifier of [3] MaxMC-Bearers
 DEFINED in MAP-SS-DataTypes : 197

nbrSN.....identifier of [5] MC-Bearers
 DEFINED in MAP-SS-DataTypes : 199

nbrUser.....identifier of [3] MC-Bearers
 DEFINED in MAP-CommonDataTypes : 481

nbrUser.....identifier of [8] MC-Bearers
 DEFINED in MAP-SS-DataTypes : 80

nbrUser.....identifier of [5] MC-Bearers
 DEFINED in MAP-SS-DataTypes : 168

nbrUser.....identifier of [4] MC-Bearers
 DEFINED in MAP-SS-DataTypes : 198

neededLcsCapabilityNotSupportedInServingidentifier of [1] NULL
 DEFINED in MAP-ER-DataTypes : 201

negativePW-Check.....value reference NegativePW-Check, CHOICE VALUE
 DEFINED in MAP-Protocol : 428

NegativePW-Check.....type reference ERROR
 DEFINED in MAP-Errors : 388
 USED in MAP-Protocol : 161 428
 USED in MAP-SupplementaryServi : 46 138 157 229
 USED in MAP-Errors : 71

netDetNotReachable.....identifier of NotReachableReason

DEFINED in MAP-MS-DataTypes : 1969

networkAccessMode.....identifier of [24] NetworkAccessMode
DEFINED in MAP-MS-DataTypes : 742

NetworkAccessMode.....type reference ENUMERATED
DEFINED in MAP-MS-DataTypes : 782

TAG R5.40 Cross Reference Listing for MAP-Protocol 2002-06-07 14:47:03 PAGE 69

USED in MAP-MS-DataTypes : 742

networkNode-AreaRestricted.....identifier of Named Number, 0
DEFINED in MAP-MS-DataTypes : 1292

networkNode-Number.....identifier of [1] ISDN-AddressString
DEFINED in MAP-SM-DataTypes : 87

networkNode-Number.....identifier of ISDN-AddressString
DEFINED in MAP-LCS-DataTypes : 94

NetworkResource.....type reference ENUMERATED
DEFINED in MAP-CommonDataTypes : 351
USED in MAP-CommonDataTypes : 37
USED in MAP-ER-DataTypes : 76 178 185

networkResource.....identifier of NetworkResource
DEFINED in MAP-ER-DataTypes : 178

networkResource.....identifier of NetworkResource
DEFINED in MAP-ER-DataTypes : 185

networkSignalInfo.....identifier of [10] ExternalSignalInfo
DEFINED in MAP-CH-DataTypes : 105

networkSignalInfo.....identifier of [6] ExternalSignalInfo
DEFINED in MAP-CH-DataTypes : 209

networkSignalInfo.....identifier of [4] ExternalSignalInfo
DEFINED in MAP-SS-DataTypes : 315

new.....identifier of Named Number, 1
DEFINED in MAP-MS-DataTypes : 501

newPassword.....identifier of Password
DEFINED in MAP-SupplementaryServi : 221

newPasswordsMismatch.....identifier of Named Number, 2
DEFINED in MAP-ER-DataTypes : 145

noAdditionalInformation.....identifier of Named Number, 0
DEFINED in MAP-ER-DataTypes : 357

noCUG-Restrictions.....identifier of Named Number, 0
DEFINED in MAP-MS-DataTypes : 1133

noGroupCallNbParam.....identifier of NoGroupCallNbParam
DEFINED in MAP-Errors : 428

NoGroupCallNbParam.....type reference SEQUENCE
DEFINED in MAP-ER-DataTypes : 333
USED in MAP-Errors : 140 428
USED in MAP-ER-DataTypes : 45

noGroupCallNumberAvailable.....value reference NoGroupCallNumberAvailable, CHOICE VALUE
DEFINED in MAP-Protocol : 415

NoGroupCallNumberAvailable.....type reference ERROR
DEFINED in MAP-Errors : 426
USED in MAP-Protocol : 168 415
USED in MAP-Group-Call-Operati : 26 53
USED in MAP-Errors : 83

noHandoverNumberAvailable.....value reference NoHandoverNumberAvailable, CHOICE VALUE
DEFINED in MAP-Protocol : 377

NoHandoverNumberAvailable.....type reference ERROR
DEFINED in MAP-Errors : 259
USED in MAP-Protocol : 140 377
USED in MAP-MobileServiceOpera : 91 319
USED in MAP-Errors : 36

noPageResponse.....identifier of Named Number, 2
DEFINED in MAP-ER-DataTypes : 261

noReply.....identifier of Named Number, 2
DEFINED in MAP-CH-DataTypes : 136

noReplyConditionTime.....identifier of [7] Ext-NoRepCondTime
DEFINED in MAP-MS-DataTypes : 1054

noReplyConditionTime.....identifier of [5] Ext-NoRepCondTime

TAG R5.40 Cross Reference Listing for MAP-Protocol 2002-06-07 14:47:03 PAGE 70

DEFINED in MAP-MS-DataTypes : 2160

noReplyConditionTime.....identifier of [5] NoReplyConditionTime
DEFINED in MAP-SS-DataTypes : 77

NoReplyConditionTime.....type reference INTEGER
DEFINED in MAP-SS-DataTypes : 83
USED in MAP-SS-DataTypes : 30 77 105

noReplyConditionTime.....identifier of [7] NoReplyConditionTime
DEFINED in MAP-SS-DataTypes : 105

noResponseFromBusyMS.....identifier of Named Number, 3
DEFINED in MAP-CH-DataTypes : 411

noResponseFromFreeMS.....identifier of Named Number, 2
DEFINED in MAP-CH-DataTypes : 410

normal.....identifier of Named Number, 0
DEFINED in MAP-LCS-DataTypes : 395

noRoamingNbParam.....identifier of NoRoamingNbParam
DEFINED in MAP-Errors : 281

NoRoamingNbParam.....type reference SEQUENCE
DEFINED in MAP-ER-DataTypes : 249
USED in MAP-Errors : 126 281
USED in MAP-ER-DataTypes : 33

noRoamingNumberAvailable.....value reference NoRoamingNumberAvailable, CHOICE VALUE
DEFINED in MAP-Protocol : 393

NoRoamingNumberAvailable.....type reference ERROR
DEFINED in MAP-Errors : 279
USED in MAP-Protocol : 144 393
USED in MAP-CallHandlingOperat : 39 116
USED in MAP-Errors : 45

noSM-RP-DA.....identifier of [5] NULL
DEFINED in MAP-SM-DataTypes : 137

noSM-RP-OA.....identifier of [5] NULL
DEFINED in MAP-SM-DataTypes : 142

noSubscriberReply.....value reference NoSubscriberReply, CHOICE VALUE
DEFINED in MAP-Protocol : 396

NoSubscriberReply.....type reference ERROR
DEFINED in MAP-Errors : 296
USED in MAP-Protocol : 147 396
USED in MAP-CallHandlingOperat : 42 98
USED in MAP-Errors : 47

noSubscriberReplyParam.....identifier of NoSubscriberReplyParam
DEFINED in MAP-Errors : 298

NoSubscriberReplyParam.....type reference SEQUENCE
DEFINED in MAP-ER-DataTypes : 278
USED in MAP-Errors : 130 298
USED in MAP-ER-DataTypes : 36

NoteMM-Event.....type reference OPERATION
DEFINED in MAP-MobileServiceOpera : 477
USED in MAP-Protocol : 37
USED in MAP-MobileServiceOpera : 70

noteMM-EventArg.....identifier of NoteMM-EventArg
DEFINED in MAP-MobileServiceOpera : 479

NoteMM-EventArg.....type reference SEQUENCE
DEFINED in MAP-MS-DataTypes : 2215
USED in MAP-MobileServiceOpera : 159 479
USED in MAP-MS-DataTypes : 135

noteMM-EventRes.....identifier of NoteMM-EventRes

DEFINED in MAP-MobileServiceOpera : 481

NoteMM-EventRes.....type reference SEQUENCE

DEFINED in MAP-MS-DataTypes : 2227

USED in MAP-MobileServiceOpera : 160 481

USED in MAP-MS-DataTypes : 136

TAG R5.40 Cross Reference Listing for MAP-Protocol 2002-06-07 14:47:03 PAGE 71

noteMsPresentForGprs.....value reference NoteMsPresentForGprs, CHOICE VALUE
DEFINED in MAP-Protocol : 326

NoteMsPresentForGprs.....type reference OPERATION
DEFINED in MAP-MobileServiceOpera : 464
USED in MAP-Protocol : 36 326
USED in MAP-MobileServiceOpera : 67

noteMsPresentForGprsArg.....identifier of NoteMsPresentForGprsArg
DEFINED in MAP-MobileServiceOpera : 466

NoteMsPresentForGprsArg.....type reference SEQUENCE
DEFINED in MAP-MS-DataTypes : 1774
USED in MAP-MobileServiceOpera : 157 466
USED in MAP-MS-DataTypes : 131

noteMsPresentForGprsRes.....identifier of NoteMsPresentForGprsRes
DEFINED in MAP-MobileServiceOpera : 468

NoteMsPresentForGprsRes.....type reference SEQUENCE
DEFINED in MAP-MS-DataTypes : 1781
USED in MAP-MobileServiceOpera : 158 468
USED in MAP-MS-DataTypes : 132

noteSubscriberDataModified.....value reference NoteSubscriberDataModified, CHOICE VALUE
DEFINED in MAP-Protocol : 297

NoteSubscriberDataModified.....type reference OPERATION
DEFINED in MAP-MobileServiceOpera : 296
USED in MAP-Protocol : 38 297
USED in MAP-MobileServiceOpera : 34

noteSubscriberDataModifiedArg.....identifier of NoteSubscriberDataModifiedArg
DEFINED in MAP-MobileServiceOpera : 298

NoteSubscriberDataModifiedArg.....type reference SEQUENCE
DEFINED in MAP-MS-DataTypes : 2197
USED in MAP-MobileServiceOpera : 149 298
USED in MAP-MS-DataTypes : 119

noteSubscriberDataModifiedRes.....identifier of NoteSubscriberDataModifiedRes
DEFINED in MAP-MobileServiceOpera : 300

NoteSubscriberDataModifiedRes.....type reference SEQUENCE
DEFINED in MAP-MS-DataTypes : 2208
USED in MAP-MobileServiceOpera : 150 300
USED in MAP-MS-DataTypes : 120

notForwarded.....identifier of Named Number, 1
DEFINED in MAP-MS-DataTypes : 1549

notificationToCSE.....identifier of [3] NULL
DEFINED in MAP-MS-DataTypes : 833

notificationToCSE.....identifier of [3] NULL
DEFINED in MAP-MS-DataTypes : 1404

notificationToCSE.....identifier of [0] NULL
DEFINED in MAP-MS-DataTypes : 1432

notificationToCSE.....identifier of [1] NULL
DEFINED in MAP-MS-DataTypes : 1462

notificationToCSE.....identifier of [3] NULL
DEFINED in MAP-MS-DataTypes : 1597

notificationToCSE.....identifier of [2] NULL
DEFINED in MAP-MS-DataTypes : 1657

notificationToCSE.....identifier of [2] NULL
DEFINED in MAP-MS-DataTypes : 1668

notificationToCSE.....identifier of [1] NULL
DEFINED in MAP-MS-DataTypes : 1709

notificationToCSE.....identifier of NULL
DEFINED in MAP-MS-DataTypes : 2094

notificationToCSE.....identifier of NULL
DEFINED in MAP-MS-DataTypes : 2102

notificationToCSE.....identifier of NULL

TAG R5.40 Cross Reference Listing for MAP-Protocol 2002-06-07 14:47:03 PAGE 72

DEFINED in MAP-MS-DataTypes : 2110

notificationToCSE.....identifier of [2] NULL
DEFINED in MAP-MS-DataTypes : 2239

notificationToCSE.....identifier of [4] NULL
DEFINED in MAP-MS-DataTypes : 2248

notificationToMSUser.....identifier of [0] NotificationToMSUser
DEFINED in MAP-MS-DataTypes : 1182

notificationToMSUser.....identifier of [1] NotificationToMSUser
DEFINED in MAP-MS-DataTypes : 1224

NotificationToMSUser.....type reference ENUMERATED
DEFINED in MAP-MS-DataTypes : 1238
USED in MAP-MS-DataTypes : 81 1182 1224 1256

notificationToMSUser.....identifier of [1] NotificationToMSUser
DEFINED in MAP-MS-DataTypes : 1256

notifyAndVerify-LocationAllowedIfNoRespoidentifier of Named Number, 1
DEFINED in MAP-MS-DataTypes : 1240

notifyAndVerify-LocationNotAllowedIfNoReidentifier of Named Number, 2
DEFINED in MAP-MS-DataTypes : 1241

notifyLocationAllowed.....identifier of Named Number, 0
DEFINED in MAP-MS-DataTypes : 1239

notKnownToBePorted.....identifier of Named Number, 0
DEFINED in MAP-CH-DataTypes : 174

notProvidedFromSGSN.....identifier of [0] NULL
DEFINED in MAP-MS-DataTypes : 1973

notProvidedFromVLR.....identifier of [2] NULL
DEFINED in MAP-MS-DataTypes : 1970

notReachable.....identifier of Named Number, 0
DEFINED in MAP-CH-DataTypes : 134

NotReachableReason.....type reference ENUMERATED
DEFINED in MAP-MS-DataTypes : 2022
USED in MAP-MS-DataTypes : 1969

notRegistered.....identifier of Named Number, 3
DEFINED in MAP-MS-DataTypes : 2026

not-derivable.....identifier of NULL
DEFINED in TCAPMessages : 168

npdbMismatch.....identifier of Named Number, 2
DEFINED in MAP-ER-DataTypes : 216

nsapi.....identifier of [6] NSAPI
DEFINED in MAP-MS-DataTypes : 1990

NSAPI.....type reference INTEGER
DEFINED in MAP-MS-DataTypes : 2004
USED in MAP-MS-DataTypes : 1990

numberChanged.....value reference NumberChanged, CHOICE VALUE
DEFINED in MAP-Protocol : 358

NumberChanged.....type reference ERROR
DEFINED in MAP-Errors : 210
USED in MAP-Protocol : 131 358
USED in MAP-CallHandlingOperat : 36 93
USED in MAP-Errors : 23

numberChangedParam.....identifier of NumberChangedParam
DEFINED in MAP-Errors : 212

NumberChangedParam.....type reference SEQUENCE

DEFINED in MAP-ER-DataTypes : 221
USED in MAP-Errors : 118 212
USED in MAP-ER-DataTypes : 26

NumberOfForwarding.....type reference INTEGER
DEFINED in MAP-CH-DataTypes : 92
USED in MAP-CH-DataTypes : 20 97

TAG R5.40 Cross Reference Listing for MAP-Protocol 2002-06-07 14:47:03 PAGE 73

numberOfForwarding.....identifier of [2] NumberOfForwarding
 DEFINED in MAP-CH-DataTypes : 97

numberOfPW-AttemptsViolation.....value reference NumberOfPW-AttemptsViolation, CHOICE VALUE
 DEFINED in MAP-Protocol : 429

NumberOfPW-AttemptsViolation.....type reference ERROR
 DEFINED in MAP-Errors : 390
 USED in MAP-Protocol : 162 429
 USED in MAP-SupplementaryServi : 47 139 158 230
 USED in MAP-Errors : 72

numberOfRequestedVectors.....identifier of NumberOfRequestedVectors
 DEFINED in MAP-MS-DataTypes : 304

numberOfRequestedVectors.....identifier of NumberOfRequestedVectors
 DEFINED in MAP-MS-DataTypes : 690

NumberOfRequestedVectors.....type reference INTEGER
 DEFINED in MAP-MS-DataTypes : 702
 USED in MAP-MS-DataTypes : 304 690

numberPortabilityStatus.....identifier of [13] NumberPortabilityStatus
 DEFINED in MAP-CH-DataTypes : 168

NumberPortabilityStatus.....type reference ENUMERATED
 DEFINED in MAP-CH-DataTypes : 173
 USED in MAP-CH-DataTypes : 168

odb.....identifier of [2] NULL
 DEFINED in MAP-MS-DataTypes : 2065

odb-Data.....identifier of [8] ODB-Data
 DEFINED in MAP-MS-DataTypes : 948

ODB-Data.....type reference SEQUENCE
 DEFINED in MAP-MS-DataTypes : 973
 USED in MAP-MS-DataTypes : 61 948 2109 2176

odb-Data.....identifier of ODB-Data
 DEFINED in MAP-MS-DataTypes : 2109

odb-data.....identifier of [0] ODB-Data
 DEFINED in MAP-MS-DataTypes : 2176

odb-GeneralData.....identifier of ODB-GeneralData
 DEFINED in MAP-MS-DataTypes : 974

ODB-GeneralData.....type reference BIT STRING
 DEFINED in MAP-MS-DataTypes : 979
 USED in MAP-MS-DataTypes : 974 1285

odb-GeneralData.....identifier of [4] ODB-GeneralData
 DEFINED in MAP-MS-DataTypes : 1285

odb-HPLMN-Data.....identifier of ODB-HPLMN-Data
 DEFINED in MAP-MS-DataTypes : 975

ODB-HPLMN-Data.....type reference BIT STRING
 DEFINED in MAP-MS-DataTypes : 1014
 USED in MAP-MS-DataTypes : 975

odb-Info.....identifier of [3] ODB-Info
 DEFINED in MAP-MS-DataTypes : 2056

ODB-Info.....type reference SEQUENCE
 DEFINED in MAP-MS-DataTypes : 2108
 USED in MAP-MS-DataTypes : 2056 2152 2202

odb-Info.....identifier of [3] ODB-Info
 DEFINED in MAP-MS-DataTypes : 2152

odb-Info.....identifier of [2] ODB-Info
 DEFINED in MAP-MS-DataTypes : 2202

old.....identifier of Named Number, 0
DEFINED in MAP-MS-DataTypes : 500

omc-Id.....identifier of [3] AddressString
DEFINED in MAP-OM-DataTypes : 40

TAG R5.40 Cross Reference Listing for MAP-Protocol 2002-06-07 14:47:03 PAGE 74

onlyMSC.....identifier of Named Number, 1
 DEFINED in MAP-MS-DataTypes : 784

onlySGSN.....identifier of Named Number, 2
 DEFINED in MAP-MS-DataTypes : 785

operationCode.....identifier of OPERATION
 DEFINED in TCAPMessages : 136
 USED in TCAPMessages : 137

operationCode.....identifier of OPERATION
 DEFINED in TCAPMessages : 147
 USED in TCAPMessages : 148

operationCode.....identifier of [0] OperationCode
 DEFINED in MAP-ST-DataTypes : 86

OperationCode.....type reference CHOICE
 DEFINED in MAP-ST-DataTypes : 90
 USED in MAP-ST-DataTypes : 86

operatorBarring.....identifier of Named Number, 1
 DEFINED in MAP-ER-DataTypes : 117

operatorDeterminedBarring.....identifier of Named Number, 1
 DEFINED in MAP-MS-DataTypes : 961

operatorDeterminedBarring.....identifier of Named Number, 3
 DEFINED in MAP-ER-DataTypes : 106

originalComponentIdentifier.....identifier of OriginalComponentIdentifier
 DEFINED in MAP-ST-DataTypes : 43

OriginalComponentIdentifier.....type reference CHOICE
 DEFINED in MAP-ST-DataTypes : 85
 USED in MAP-ST-DataTypes : 43

OrigTransactionID.....type reference [APPLICATION 8] IMPLICIT TransactionID
 DEFINED in TCAPMessages : 97
 USED in TCAPMessages : 61 69

orNotSupportedInGMSC.....identifier of [16] NULL
 DEFINED in MAP-CH-DataTypes : 220

or-Capability.....identifier of [5] OR-Phase
 DEFINED in MAP-CH-DataTypes : 100

or-Interrogation.....identifier of [4] NULL
 DEFINED in MAP-CH-DataTypes : 99

or-Interrogation.....identifier of [10] NULL
 DEFINED in MAP-CH-DataTypes : 213

or-NotAllowed.....value reference OR-NotAllowed, CHOICE VALUE
 DEFINED in MAP-Protocol : 399

OR-NotAllowed.....type reference ERROR
 DEFINED in MAP-Errors : 321
 USED in MAP-Protocol : 143 399
 USED in MAP-CallHandlingOperat : 34 91 114 126
 USED in MAP-Errors : 44

or-NotAllowedParam.....identifier of OR-NotAllowedParam
 DEFINED in MAP-Errors : 323

OR-NotAllowedParam.....type reference SEQUENCE
 DEFINED in MAP-ER-DataTypes : 203
 USED in MAP-Errors : 127 323
 USED in MAP-ER-DataTypes : 24

OR-Phase.....type reference INTEGER
 DEFINED in MAP-CH-DataTypes : 129
 USED in MAP-CH-DataTypes : 100

otid.....identifier of OrigTransactionID

DEFINED in TCAPMessages : 61

otid.....identifier of OrigTransactionID
DEFINED in TCAPMessages : 69

overrideCategory.....identifier of [1] OverrideCategory
DEFINED in MAP-SS-DataTypes : 173

TAG R5.40 Cross Reference Listing for MAP-Protocol 2002-06-07 14:47:03 PAGE 75

OverrideCategory.....type reference ENUMERATED
 DEFINED in MAP-SS-DataTypes : 180
 USED in MAP-SS-DataTypes : 28 173

overrideDisabled.....identifier of Named Number, 1
 DEFINED in MAP-SS-DataTypes : 182

overrideEnabled.....identifier of Named Number, 0
 DEFINED in MAP-SS-DataTypes : 181

ownNumberPortedOut.....identifier of Named Number, 1
 DEFINED in MAP-CH-DataTypes : 175

o-andM-HPLMN.....identifier of Named Number, 1
 DEFINED in MAP-CommonDataTypes : 385

o-andM-VPLMN.....identifier of Named Number, 2
 DEFINED in MAP-CommonDataTypes : 386

O-BcsmCamelTDPCriteriaList.....type reference SEQUENCE OF
 DEFINED in MAP-MS-DataTypes : 1499
 USED in MAP-MS-DataTypes : 67 1362 2116
 USED in MAP-CH-DataTypes : 45 284

O-BcsmCamelTDPData.....type reference SEQUENCE
 DEFINED in MAP-MS-DataTypes : 1476
 USED in MAP-MS-DataTypes : 1468

o-BcsmCamelTDPDataList.....identifier of O-BcsmCamelTDPDataList
 DEFINED in MAP-MS-DataTypes : 1458

O-BcsmCamelTDPDataList.....type reference SEQUENCE OF
 DEFINED in MAP-MS-DataTypes : 1467
 USED in MAP-MS-DataTypes : 1458

O-BcsmCamelTDP-Criteria.....type reference SEQUENCE
 DEFINED in MAP-MS-DataTypes : 1505
 USED in MAP-MS-DataTypes : 1500

o-BcsmCamelTDP-CriteriaList.....identifier of [4] O-BcsmCamelTDPCriteriaList
 DEFINED in MAP-MS-DataTypes : 1362

o-BcsmCamelTDP-CriteriaList.....identifier of [1] O-BcsmCamelTDPCriteriaList
 DEFINED in MAP-MS-DataTypes : 2116

o-BcsmCamelTDP-CriteriaList.....identifier of [3] O-BcsmCamelTDPCriteriaList
 DEFINED in MAP-CH-DataTypes : 284

o-BcsmTriggerDetectionPoint.....identifier of O-BcsmTriggerDetectionPoint
 DEFINED in MAP-MS-DataTypes : 1477

O-BcsmTriggerDetectionPoint.....type reference ENUMERATED
 DEFINED in MAP-MS-DataTypes : 1487
 USED in MAP-MS-DataTypes : 1477 1506

o-BcsmTriggerDetectionPoint.....identifier of O-BcsmTriggerDetectionPoint
 DEFINED in MAP-MS-DataTypes : 1506

o-CauseValueCriteria.....identifier of [3] O-CauseValueCriteria
 DEFINED in MAP-MS-DataTypes : 1511

O-CauseValueCriteria.....type reference SEQUENCE OF
 DEFINED in MAP-MS-DataTypes : 1555
 USED in MAP-MS-DataTypes : 1511

o-csi.....identifier of Named Number, 0
 DEFINED in MAP-MS-DataTypes : 1318

o-CSI.....identifier of [0] O-CSI
 DEFINED in MAP-MS-DataTypes : 1358

O-CSI.....type reference SEQUENCE
 DEFINED in MAP-MS-DataTypes : 1457
 USED in MAP-MS-DataTypes : 65 1358 2115

USED in MAP-CH-DataTypes : 43 237 281

o-CSI.....identifier of Named Number, 0
DEFINED in MAP-MS-DataTypes : 2076

o-CSI.....identifier of [0] O-CSI
DEFINED in MAP-MS-DataTypes : 2115

TAG R5.40 Cross Reference Listing for MAP-Protocol 2002-06-07 14:47:03 PAGE 76

o-CSI.....identifier of [5] O-CSI
DEFINED in MAP-CH-DataTypes : 237

o-CSI.....identifier of [1] O-CSI
DEFINED in MAP-CH-DataTypes : 281

padAccessCA-1200bps.....value reference BearerServiceCode, '00100010'B
DEFINED in MAP-BS-Code : 69

padAccessCA-1200-75bps.....value reference BearerServiceCode, '00100011'B
DEFINED in MAP-BS-Code : 70

padAccessCA-2400bps.....value reference BearerServiceCode, '00100100'B
DEFINED in MAP-BS-Code : 71

padAccessCA-300bps.....value reference BearerServiceCode, '00100001'B
DEFINED in MAP-BS-Code : 68

padAccessCA-4800bps.....value reference BearerServiceCode, '00100101'B
DEFINED in MAP-BS-Code : 72

padAccessCA-9600bps.....value reference BearerServiceCode, '00100110'B
DEFINED in MAP-BS-Code : 73

parameter.....identifier of ANY DEFINED BY operationCode
DEFINED in TCAPMessages : 137

parameter.....identifier of ANY DEFINED BY operationCode
DEFINED in TCAPMessages : 148

parameter.....identifier of ANY DEFINED BY errorCode
DEFINED in TCAPMessages : 159

password.....identifier of Password
DEFINED in MAP-MS-DataTypes : 2100

password.....identifier of [3] Password
DEFINED in MAP-MS-DataTypes : 2169

password.....identifier of [2] Password
DEFINED in MAP-MS-DataTypes : 2246

Password.....type reference NumericString
DEFINED in MAP-SS-DataTypes : 244
USED in MAP-SupplementaryServi : 66 221 238
USED in MAP-MS-DataTypes : 147 2100 2169 2246
USED in MAP-SS-DataTypes : 24

pcs-Extensions.....identifier of [1] PCS-Extensions
DEFINED in MAP-ExtensionDataTypes : 34

PCS-Extensions.....type reference SEQUENCE
DEFINED in MAP-ExtensionDataTypes : 56
USED in MAP-ExtensionDataTypes : 34

pdpContextActivation.....identifier of Named Number, 8
DEFINED in MAP-MS-DataTypes : 407

pdpContextDeactivation.....identifier of Named Number, 9
DEFINED in MAP-MS-DataTypes : 408

pdp-Address.....identifier of [17] PDP-Address
DEFINED in MAP-MS-DataTypes : 798

PDP-Address.....type reference OCTET STRING
DEFINED in MAP-MS-DataTypes : 883
USED in MAP-MS-DataTypes : 798 1987

pdp-Address.....identifier of [3] PDP-Address
DEFINED in MAP-MS-DataTypes : 1987

pdp-ChargingCharacteristics.....identifier of [1] ChargingCharacteristics
DEFINED in MAP-MS-DataTypes : 805

PDP-Context.....type reference SEQUENCE
DEFINED in MAP-MS-DataTypes : 795
USED in MAP-MS-DataTypes : 791

pdp-ContextActive.....identifier of [1] NULL
DEFINED in MAP-MS-DataTypes : 1985

TAG R5.40 Cross Reference Listing for MAP-Protocol 2002-06-07 14:47:03 PAGE 77

pdp-ContextChangeOfPosition.....identifier of Named Number, 14
 DEFINED in MAP-MS-DataTypes : 870

pdp-ContextEstablishment.....identifier of Named Number, 11
 DEFINED in MAP-MS-DataTypes : 868

pdp-ContextEstablishmentAcknowledgement.identifier of Named Number, 12
 DEFINED in MAP-MS-DataTypes : 869

pdp-ContextId.....identifier of ContextId
 DEFINED in MAP-MS-DataTypes : 796

pdp-ContextIdentifier.....identifier of [0] ContextId
 DEFINED in MAP-MS-DataTypes : 1984

PDP-ContextInfo.....type reference SEQUENCE
 DEFINED in MAP-MS-DataTypes : 1983
 USED in MAP-MS-DataTypes : 1981

PDP-ContextInfoList.....type reference SEQUENCE OF
 DEFINED in MAP-MS-DataTypes : 1980
 USED in MAP-MS-DataTypes : 1977 1978

pdp-Type.....identifier of [16] PDP-Type
 DEFINED in MAP-MS-DataTypes : 797

PDP-Type.....type reference OCTET STRING
 DEFINED in MAP-MS-DataTypes : 880
 USED in MAP-MS-DataTypes : 797 1986

pdp-Type.....identifier of [2] PDP-Type
 DEFINED in MAP-MS-DataTypes : 1986

permanent.....identifier of Named Number, 0
 DEFINED in MAP-SS-DataTypes : 176

PermittedEncryptionAlgorithms.....type reference OCTET STRING
 DEFINED in MAP-MS-DataTypes : 488
 USED in MAP-MS-DataTypes : 473

PermittedIntegrityProtectionAlgorithms..type reference OCTET STRING
 DEFINED in MAP-MS-DataTypes : 477
 USED in MAP-MS-DataTypes : 472

personTracking.....value reference LCSServiceTypeID, 2
 DEFINED in MAP-CommonDataTypes : 398

phase1.....identifier of Named Number, 0
 DEFINED in MAP-MS-DataTypes : 1586

phase2.....identifier of Named Number, 1
 DEFINED in MAP-MS-DataTypes : 1587

phase3.....identifier of Named Number, 2
 DEFINED in MAP-MS-DataTypes : 1588

phase4.....identifier of Named Number, 3
 DEFINED in MAP-MS-DataTypes : 1589

plmn.....identifier of Named Number, 0
 DEFINED in MAP-CommonDataTypes : 352

plmnClientList.....identifier of [2] PLMNClientList
 DEFINED in MAP-MS-DataTypes : 1192

PLMNClientList.....type reference SEQUENCE OF
 DEFINED in MAP-MS-DataTypes : 1211
 USED in MAP-MS-DataTypes : 1192

plmnoperator.....value reference SS-Code, '10110100'B
 DEFINED in MAP-SS-Code : 168

plmnOperatorServices.....identifier of Named Number, 2
 DEFINED in MAP-LCS-DataTypes : 159

plmnRoamingNotAllowed.....identifier of Named Number, 0
DEFINED in MAP-ER-DataTypes : 105

plmn-SpecificBarringType1.....identifier of Named Number, 0
DEFINED in MAP-MS-DataTypes : 1015

plmn-SpecificBarringType2.....identifier of Named Number, 1

TAG R5.40 Cross Reference Listing for MAP-Protocol 2002-06-07 14:47:03 PAGE 78

DEFINED in MAP-MS-DataTypes : 1016

plmn-SpecificBarringType3.....identifier of Named Number, 2
DEFINED in MAP-MS-DataTypes : 1017

plmn-SpecificBarringType4.....identifier of Named Number, 3
DEFINED in MAP-MS-DataTypes : 1018

plmn-specificBS-1.....value reference BearerServiceCode, '11010001'B
DEFINED in MAP-BS-Code : 111

plmn-specificBS-2.....value reference BearerServiceCode, '11010010'B
DEFINED in MAP-BS-Code : 112

plmn-specificBS-3.....value reference BearerServiceCode, '11010011'B
DEFINED in MAP-BS-Code : 113

plmn-specificBS-4.....value reference BearerServiceCode, '11010100'B
DEFINED in MAP-BS-Code : 114

plmn-specificBS-5.....value reference BearerServiceCode, '11010101'B
DEFINED in MAP-BS-Code : 115

plmn-specificBS-6.....value reference BearerServiceCode, '11010110'B
DEFINED in MAP-BS-Code : 116

plmn-specificBS-7.....value reference BearerServiceCode, '11010111'B
DEFINED in MAP-BS-Code : 117

plmn-specificBS-8.....value reference BearerServiceCode, '11011000'B
DEFINED in MAP-BS-Code : 118

plmn-specificBS-9.....value reference BearerServiceCode, '11011001'B
DEFINED in MAP-BS-Code : 119

plmn-specificBS-A.....value reference BearerServiceCode, '11011010'B
DEFINED in MAP-BS-Code : 120

plmn-specificBS-B.....value reference BearerServiceCode, '11011011'B
DEFINED in MAP-BS-Code : 121

plmn-specificBS-C.....value reference BearerServiceCode, '11011100'B
DEFINED in MAP-BS-Code : 122

plmn-specificBS-D.....value reference BearerServiceCode, '11011101'B
DEFINED in MAP-BS-Code : 123

plmn-specificBS-E.....value reference BearerServiceCode, '11011110'B
DEFINED in MAP-BS-Code : 124

plmn-specificBS-F.....value reference BearerServiceCode, '11011111'B
DEFINED in MAP-BS-Code : 125

plmn-specificSS-1.....value reference SS-Code, '11110001'B
DEFINED in MAP-SS-Code : 137

plmn-specificSS-2.....value reference SS-Code, '11110010'B
DEFINED in MAP-SS-Code : 138

plmn-specificSS-3.....value reference SS-Code, '11110011'B
DEFINED in MAP-SS-Code : 139

plmn-specificSS-4.....value reference SS-Code, '11110100'B
DEFINED in MAP-SS-Code : 140

plmn-specificSS-5.....value reference SS-Code, '11110101'B
DEFINED in MAP-SS-Code : 141

plmn-specificSS-6.....value reference SS-Code, '11110110'B
DEFINED in MAP-SS-Code : 142

plmn-specificSS-7.....value reference SS-Code, '11110111'B
DEFINED in MAP-SS-Code : 143

plmn-specificSS-8.....value reference SS-Code, '11111000'B

DEFINED in MAP-SS-Code : 144

plmn-specificSS-9.....value reference SS-Code, '11111001'B
DEFINED in MAP-SS-Code : 145

plmn-specificSS-A.....value reference SS-Code, '11111010'B
DEFINED in MAP-SS-Code : 146

TAG R5.40 Cross Reference Listing for MAP-Protocol 2002-06-07 14:47:03 PAGE 79

plmn-specificSS-B.....value reference SS-Code, '11111011'B
 DEFINED in MAP-SS-Code : 147

plmn-specificSS-C.....value reference SS-Code, '11111100'B
 DEFINED in MAP-SS-Code : 148

plmn-specificSS-D.....value reference SS-Code, '11111101'B
 DEFINED in MAP-SS-Code : 149

plmn-specificSS-E.....value reference SS-Code, '11111110'B
 DEFINED in MAP-SS-Code : 150

plmn-specificSS-F.....value reference SS-Code, '11111111'B
 DEFINED in MAP-SS-Code : 151

plmn-specificTS-1.....value reference TeleserviceCode, '11010001'B
 DEFINED in MAP-TS-Code : 72

plmn-specificTS-2.....value reference TeleserviceCode, '11010010'B
 DEFINED in MAP-TS-Code : 73

plmn-specificTS-3.....value reference TeleserviceCode, '11010011'B
 DEFINED in MAP-TS-Code : 74

plmn-specificTS-4.....value reference TeleserviceCode, '11010100'B
 DEFINED in MAP-TS-Code : 75

plmn-specificTS-5.....value reference TeleserviceCode, '11010101'B
 DEFINED in MAP-TS-Code : 76

plmn-specificTS-6.....value reference TeleserviceCode, '11010110'B
 DEFINED in MAP-TS-Code : 77

plmn-specificTS-7.....value reference TeleserviceCode, '11010111'B
 DEFINED in MAP-TS-Code : 78

plmn-specificTS-8.....value reference TeleserviceCode, '11011000'B
 DEFINED in MAP-TS-Code : 79

plmn-specificTS-9.....value reference TeleserviceCode, '11011001'B
 DEFINED in MAP-TS-Code : 80

plmn-specificTS-A.....value reference TeleserviceCode, '11011010'B
 DEFINED in MAP-TS-Code : 81

plmn-specificTS-B.....value reference TeleserviceCode, '11011011'B
 DEFINED in MAP-TS-Code : 82

plmn-specificTS-C.....value reference TeleserviceCode, '11011100'B
 DEFINED in MAP-TS-Code : 83

plmn-specificTS-D.....value reference TeleserviceCode, '11011101'B
 DEFINED in MAP-TS-Code : 84

plmn-specificTS-E.....value reference TeleserviceCode, '11011110'B
 DEFINED in MAP-TS-Code : 85

plmn-specificTS-F.....value reference TeleserviceCode, '11011111'B
 DEFINED in MAP-TS-Code : 86

polygon.....identifier of Named Number, 3
 DEFINED in MAP-LCS-DataTypes : 230

positionMethodFailure.....value reference PositionMethodFailure, CHOICE VALUE
 DEFINED in MAP-Protocol : 446

PositionMethodFailure.....type reference ERROR
 DEFINED in MAP-Errors : 443
 USED in MAP-Protocol : 174 446
 USED in MAP-LocationServiceOpe : 31 82
 USED in MAP-Errors : 88

positionMethodFailure-Diagnostic.....identifier of [0] PositionMethodFailure-Diagnostic
 DEFINED in MAP-ER-DataTypes : 367

PositionMethodFailure-Diagnostic.....type reference ENUMERATED

DEFINED in MAP-ER-DataTypes : 371

USED in MAP-ER-DataTypes : 367

positionMethodFailure-Param.....identifier of PositionMethodFailure-Param

DEFINED in MAP-Errors : 445

TAG R5.40 Cross Reference Listing for MAP-Protocol 2002-06-07 14:47:03 PAGE 80

PositionMethodFailure-Param.....type reference SEQUENCE
 DEFINED in MAP-ER-DataTypes : 366
 USED in MAP-Errors : 146 445
 USED in MAP-ER-DataTypes : 51

positionMethodNotAvailableInLocationAreaIdentifier of Named Number, 8
 DEFINED in MAP-ER-DataTypes : 380

positionMethodNotAvailableInNetwork.....identifier of Named Number, 7
 DEFINED in MAP-ER-DataTypes : 379

preferentialCUG-Indicator.....identifier of CUG-Index
 DEFINED in MAP-MS-DataTypes : 1149

premiumRateEntertainmentOGCallsBarred..identifier of Named Number, 4
 DEFINED in MAP-MS-DataTypes : 987

premiumRateInformationOGCallsBarred.....identifier of Named Number, 3
 DEFINED in MAP-MS-DataTypes : 986

prepareGroupCall.....value reference PrepareGroupCall, CHOICE VALUE
 DEFINED in MAP-Protocol : 306

PrepareGroupCall.....type reference OPERATION
 DEFINED in MAP-Group-Call-Operati : 46
 USED in MAP-Protocol : 99 306
 USED in MAP-Group-Call-Operati : 13

prepareGroupCallArg.....identifier of PrepareGroupCallArg
 DEFINED in MAP-Group-Call-Operati : 48

PrepareGroupCallArg.....type reference SEQUENCE
 DEFINED in MAP-GR-DataTypes : 49
 USED in MAP-Group-Call-Operati : 31 48
 USED in MAP-GR-DataTypes : 14

prepareGroupCallRes.....identifier of PrepareGroupCallRes
 DEFINED in MAP-Group-Call-Operati : 50

PrepareGroupCallRes.....type reference SEQUENCE
 DEFINED in MAP-GR-DataTypes : 61
 USED in MAP-Group-Call-Operati : 32 50
 USED in MAP-GR-DataTypes : 15

prepareHandover.....value reference PrepareHandover, CHOICE VALUE
 DEFINED in MAP-Protocol : 201

PrepareHandover.....type reference OPERATION
 DEFINED in MAP-MobileServiceOpera : 310
 USED in MAP-Protocol : 17 201
 USED in MAP-MobileServiceOpera : 38

prepareHO-Arg.....identifier of PrepareHO-Arg
 DEFINED in MAP-MobileServiceOpera : 312

PrepareHO-Arg.....type reference [3] SEQUENCE
 DEFINED in MAP-MS-DataTypes : 507
 USED in MAP-MobileServiceOpera : 123 312
 USED in MAP-MS-DataTypes : 34

prepareHO-Res.....identifier of PrepareHO-Res
 DEFINED in MAP-MobileServiceOpera : 314

PrepareHO-Res.....type reference [3] SEQUENCE
 DEFINED in MAP-MS-DataTypes : 549
 USED in MAP-MobileServiceOpera : 124 314
 USED in MAP-MS-DataTypes : 35

prepareSubsequentHandover.....value reference PrepareSubsequentHandover, CHOICE VALUE
 DEFINED in MAP-Protocol : 205

PrepareSubsequentHandover.....type reference OPERATION
 DEFINED in MAP-MobileServiceOpera : 337
 USED in MAP-Protocol : 21 205

USED in MAP-MobileServiceOpera : 42

prepareSubsequentHO-Arg.....identifier of PrepareSubsequentHO-Arg
DEFINED in MAP-MobileServiceOpera : 339

PrepareSubsequentHO-Arg.....type reference [3] SEQUENCE
DEFINED in MAP-MS-DataTypes : 595

TAG R5.40 Cross Reference Listing for MAP-Protocol 2002-06-07 14:47:03 PAGE 81

USED in MAP-MobileServiceOpera : 130 339
USED in MAP-MS-DataTypes : 36

prepareSubsequentHO-Res.....identifier of PrepareSubsequentHO-Res
DEFINED in MAP-MobileServiceOpera : 341

PrepareSubsequentHO-Res.....type reference [3] SEQUENCE
DEFINED in MAP-MS-DataTypes : 604
USED in MAP-MobileServiceOpera : 129 341
USED in MAP-MS-DataTypes : 37

pre-pagingSupported.....identifier of [19] NULL
DEFINED in MAP-CH-DataTypes : 115

pre-pagingSupported.....identifier of [17] NULL
DEFINED in MAP-CH-DataTypes : 221

priority.....identifier of [2] EMLPP-Priority
DEFINED in MAP-GR-DataTypes : 56

priorityLevel0.....value reference EMLPP-Priority, 0
DEFINED in MAP-CommonDataTypes : 470

priorityLevel1.....value reference EMLPP-Priority, 1
DEFINED in MAP-CommonDataTypes : 471

priorityLevel2.....value reference EMLPP-Priority, 2
DEFINED in MAP-CommonDataTypes : 472

priorityLevel3.....value reference EMLPP-Priority, 3
DEFINED in MAP-CommonDataTypes : 473

priorityLevel4.....value reference EMLPP-Priority, 4
DEFINED in MAP-CommonDataTypes : 474

priorityLevelA.....value reference EMLPP-Priority, 6
DEFINED in MAP-CommonDataTypes : 468

priorityLevelB.....value reference EMLPP-Priority, 5
DEFINED in MAP-CommonDataTypes : 469

privacyOverride.....identifier of [1] NULL
DEFINED in MAP-LCS-DataTypes : 108

privacyOverrideNotApplicable.....identifier of Named Number, 3
DEFINED in MAP-ER-DataTypes : 360

privacyViolation.....identifier of Named Number, 5
DEFINED in MAP-LCS-DataTypes : 400

PrivateExtension.....type reference SEQUENCE
DEFINED in MAP-ExtensionDataTypes : 40
USED in MAP-ExtensionDataTypes : 15 38

privateExtensionList.....identifier of [0] PrivateExtensionList
DEFINED in MAP-ExtensionDataTypes : 33

PrivateExtensionList.....type reference SEQUENCE OF
DEFINED in MAP-ExtensionDataTypes : 37
USED in MAP-ExtensionDataTypes : 33

problem.....identifier of CHOICE
DEFINED in TCAPMessages : 169

processAccessSignalling.....value reference ProcessAccessSignalling, CHOICE VALUE
DEFINED in MAP-Protocol : 203

ProcessAccessSignalling.....type reference OPERATION
DEFINED in MAP-MobileServiceOpera : 329
USED in MAP-Protocol : 19 203
USED in MAP-MobileServiceOpera : 40

processAccessSignalling-Arg.....identifier of ProcessAccessSignalling-Arg
DEFINED in MAP-MobileServiceOpera : 331

ProcessAccessSignalling-Arg.....type reference [3] SEQUENCE

DEFINED in MAP-MS-DataTypes : 609

USED in MAP-MobileServiceOpera : 126 331

USED in MAP-MS-DataTypes : 38

processGroupCallSignalling.....value reference ProcessGroupCallSignalling, CHOICE VALUE

DEFINED in MAP-Protocol : 308

TAG R5.40 Cross Reference Listing for MAP-Protocol 2002-06-07 14:47:03 PAGE 82

ProcessGroupCallSignalling.....type reference OPERATION
 DEFINED in MAP-Group-Call-Operati : 63
 USED in MAP-Protocol : 100 308
 USED in MAP-Group-Call-Operati : 16

processGroupCallSignallingArg.....identifier of ProcessGroupCallSignallingArg
 DEFINED in MAP-Group-Call-Operati : 65

ProcessGroupCallSignallingArg.....type reference SEQUENCE
 DEFINED in MAP-GR-DataTypes : 86
 USED in MAP-Group-Call-Operati : 36 65
 USED in MAP-GR-DataTypes : 19

processUnstructuredSS-Request.....value reference ProcessUnstructuredSS-Request, CHOICE VALUE
 DEFINED in MAP-Protocol : 262

ProcessUnstructuredSS-Request.....type reference OPERATION
 DEFINED in MAP-SupplementaryServi : 175
 USED in MAP-Protocol : 74 262
 USED in MAP-SupplementaryServi : 18

protectedPayload.....identifier of ProtectedPayload
 DEFINED in MAP-ST-DataTypes : 27

protectedPayload.....identifier of ProtectedPayload
 DEFINED in MAP-ST-DataTypes : 35

ProtectedPayload.....type reference OCTET STRING
 DEFINED in MAP-ST-DataTypes : 47
 USED in MAP-ST-DataTypes : 14 27 35
 USED in MAP-ER-DataTypes : 82 400

protectedPayload.....identifier of ProtectedPayload
 DEFINED in MAP-ER-DataTypes : 400

protocollId.....identifier of ProtocollId
 DEFINED in MAP-CommonDataTypes : 199

ProtocollId.....type reference ENUMERATED
 DEFINED in MAP-CommonDataTypes : 217
 USED in MAP-CommonDataTypes : 199

provideRoamingNumber.....value reference ProvideRoamingNumber, CHOICE VALUE
 DEFINED in MAP-Protocol : 244

ProvideRoamingNumber.....type reference OPERATION
 DEFINED in MAP-CallHandlingOperat : 103
 USED in MAP-Protocol : 55 244
 USED in MAP-CallHandlingOperat : 14

provideRoamingNumberArg.....identifier of ProvideRoamingNumberArg
 DEFINED in MAP-CallHandlingOperat : 106

ProvideRoamingNumberArg.....type reference SEQUENCE
 DEFINED in MAP-CH-DataTypes : 203
 USED in MAP-CallHandlingOperat : 56 106
 USED in MAP-CH-DataTypes : 16

provideRoamingNumberRes.....identifier of ProvideRoamingNumberRes
 DEFINED in MAP-CallHandlingOperat : 108

ProvideRoamingNumberRes.....type reference SEQUENCE
 DEFINED in MAP-CH-DataTypes : 226
 USED in MAP-CallHandlingOperat : 57 108
 USED in MAP-CH-DataTypes : 17

provideSIWFSNumber.....value reference ProvideSIWFSNumber, CHOICE VALUE
 DEFINED in MAP-Protocol : 246

ProvideSIWFSNumber.....type reference OPERATION
 DEFINED in MAP-CallHandlingOperat : 130
 USED in MAP-Protocol : 57 246
 USED in MAP-CallHandlingOperat : 16

provideSIWFSNumberArg.....identifier of ProvideSIWFSNumberArg
DEFINED in MAP-CallHandlingOperat : 132

ProvideSIWFSNumberArg.....type reference SEQUENCE
DEFINED in MAP-CH-DataTypes : 288
USED in MAP-CallHandlingOperat : 60 132
USED in MAP-CH-DataTypes : 23

TAG R5.40 Cross Reference Listing for MAP-Protocol 2002-06-07 14:47:03 PAGE 83

provideSIWFSNumberRes.....identifier of ProvideSIWFSNumberRes
DEFINED in MAP-CallHandlingOperat : 134

ProvideSIWFSNumberRes.....type reference SEQUENCE
DEFINED in MAP-CH-DataTypes : 306
USED in MAP-CallHandlingOperat : 61 134
USED in MAP-CH-DataTypes : 24

provideSubscriberInfo.....value reference ProvideSubscriberInfo, CHOICE VALUE
DEFINED in MAP-Protocol : 284

ProvideSubscriberInfo.....type reference OPERATION
DEFINED in MAP-MobileServiceOpera : 233
USED in MAP-Protocol : 30 284
USED in MAP-MobileServiceOpera : 24

provideSubscriberInfoArg.....identifier of ProvideSubscriberInfoArg
DEFINED in MAP-MobileServiceOpera : 235

ProvideSubscriberInfoArg.....type reference SEQUENCE
DEFINED in MAP-MS-DataTypes : 1835
USED in MAP-MobileServiceOpera : 143 235
USED in MAP-MS-DataTypes : 99

provideSubscriberInfoRes.....identifier of ProvideSubscriberInfoRes
DEFINED in MAP-MobileServiceOpera : 237

ProvideSubscriberInfoRes.....type reference SEQUENCE
DEFINED in MAP-MS-DataTypes : 1842
USED in MAP-MobileServiceOpera : 144 237
USED in MAP-MS-DataTypes : 100

provideSubscriberLocation.....value reference ProvideSubscriberLocation, CHOICE VALUE
DEFINED in MAP-Protocol : 330

ProvideSubscriberLocation.....type reference OPERATION
DEFINED in MAP-LocationServiceOpe : 66
USED in MAP-Protocol : 108 330
USED in MAP-LocationServiceOpe : 13

provideSubscriberLocation-Arg.....identifier of ProvideSubscriberLocation-Arg
DEFINED in MAP-LocationServiceOpe : 68

ProvideSubscriberLocation-Arg.....type reference SEQUENCE
DEFINED in MAP-LCS-DataTypes : 104
USED in MAP-LocationServiceOpe : 43 68
USED in MAP-LCS-DataTypes : 13

provideSubscriberLocation-Res.....identifier of ProvideSubscriberLocation-Res
DEFINED in MAP-LocationServiceOpe : 70

ProvideSubscriberLocation-Res.....type reference SEQUENCE
DEFINED in MAP-LCS-DataTypes : 246
USED in MAP-LocationServiceOpe : 44 70
USED in MAP-LCS-DataTypes : 14

provisionedSS.....identifier of [7] Ext-SS-InfoList
DEFINED in MAP-MS-DataTypes : 947

ps-AttachedNotReachableForPaging.....identifier of [2] NULL
DEFINED in MAP-MS-DataTypes : 1975

ps-AttachedReachableForPaging.....identifier of [3] NULL
DEFINED in MAP-MS-DataTypes : 1976

ps-Detached.....identifier of [1] NULL
DEFINED in MAP-MS-DataTypes : 1974

ps-Domain.....identifier of Named Number, 1
DEFINED in MAP-MS-DataTypes : 1895

ps-LCS-NotSupportedByUE.....identifier of [2] NULL
DEFINED in MAP-MS-DataTypes : 431

ps-PDP-ActiveNotReachableForPaging.....identifier of [4] PDP-ContextInfoList
DEFINED in MAP-MS-DataTypes : 1977

ps-PDP-ActiveReachableForPaging.....identifier of [5] PDP-ContextInfoList
DEFINED in MAP-MS-DataTypes : 1978

ps-SubscriberState.....identifier of [4] PS-SubscriberState

TAG R5.40 Cross Reference Listing for MAP-Protocol 2002-06-07 14:47:03 PAGE 84

DEFINED in MAP-MS-DataTypes : 1853

PS-SubscriberState.....type reference CHOICE
DEFINED in MAP-MS-DataTypes : 1972
USED in MAP-MS-DataTypes : 1853

purgedMS.....identifier of Named Number, 3
DEFINED in MAP-ER-DataTypes : 263

purgeMS.....value reference PurgeMS, CHOICE VALUE
DEFINED in MAP-Protocol : 195

PurgeMS.....type reference OPERATION
DEFINED in MAP-MobileServiceOpera : 198
USED in MAP-Protocol : 14 195
USED in MAP-MobileServiceOpera : 17

purgeMS-Arg.....identifier of PurgeMS-Arg
DEFINED in MAP-MobileServiceOpera : 200

PurgeMS-Arg.....type reference [3] SEQUENCE
DEFINED in MAP-MS-DataTypes : 289
USED in MAP-MobileServiceOpera : 117 200
USED in MAP-MS-DataTypes : 20

purgeMS-Res.....identifier of PurgeMS-Res
DEFINED in MAP-MobileServiceOpera : 202

PurgeMS-Res.....type reference SEQUENCE
DEFINED in MAP-MS-DataTypes : 296
USED in MAP-MobileServiceOpera : 118 202
USED in MAP-MS-DataTypes : 21

pvlr.....identifier of Named Number, 3
DEFINED in MAP-CommonDataTypes : 355

pw-RegistrationFailure.....value reference PW-RegistrationFailure, CHOICE VALUE
DEFINED in MAP-Protocol : 427

PW-RegistrationFailure.....type reference ERROR
DEFINED in MAP-Errors : 384
USED in MAP-Protocol : 160 427
USED in MAP-SupplementaryServi : 45 228
USED in MAP-Errors : 70

pw-RegistrationFailureCause.....identifier of PW-RegistrationFailureCause
DEFINED in MAP-Errors : 386

PW-RegistrationFailureCause.....type reference ENUMERATED
DEFINED in MAP-ER-DataTypes : 142
USED in MAP-Errors : 111 386
USED in MAP-ER-DataTypes : 18

p-abortCause.....identifier of P-AbortCause
DEFINED in TCAPMessages : 76

P-AbortCause.....type reference [APPLICATION 10] IMPLICIT INTEGER
DEFINED in TCAPMessages : 102
USED in TCAPMessages : 76

qoSNotAttainable.....identifier of Named Number, 6
DEFINED in MAP-ER-DataTypes : 378

qoS-Negotiated.....identifier of [13] Ext-QoS-Subscribed
DEFINED in MAP-MS-DataTypes : 1997

qoS-Requested.....identifier of [12] Ext-QoS-Subscribed
DEFINED in MAP-MS-DataTypes : 1996

qoS-Subscribed.....identifier of [18] QoS-Subscribed
DEFINED in MAP-MS-DataTypes : 799

QoS-Subscribed.....type reference OCTET STRING
DEFINED in MAP-MS-DataTypes : 891
USED in MAP-MS-DataTypes : 82 799

qos-Subscribed.....identifier of [11] Ext-QoS-Subscribed
DEFINED in MAP-MS-DataTypes : 1995

quintupletList.....identifier of [1] QuintupletList
DEFINED in MAP-MS-DataTypes : 328

TAG R5.40 Cross Reference Listing for MAP-Protocol 2002-06-07 14:47:03 PAGE 85

QuintupletList.....type reference SEQUENCE OF
 DEFINED in MAP-MS-DataTypes : 333
 USED in MAP-MS-DataTypes : 328

rab-Id.....identifier of [12] RAB-Id
 DEFINED in MAP-MS-DataTypes : 522

rab-Id.....identifier of RAB-Id
 DEFINED in MAP-MS-DataTypes : 543

rab-Id.....identifier of RAB-Id
 DEFINED in MAP-MS-DataTypes : 652

RAB-Id.....type reference INTEGER
 DEFINED in MAP-MS-DataTypes : 656
 USED in MAP-MS-DataTypes : 522 543 600 614 652

RadioResource.....type reference SEQUENCE
 DEFINED in MAP-MS-DataTypes : 541
 USED in MAP-MS-DataTypes : 539

radioResourceInformation.....identifier of [6] RadioResourceInformation
 DEFINED in MAP-MS-DataTypes : 459

radioResourceInformation.....identifier of [7] RadioResourceInformation
 DEFINED in MAP-MS-DataTypes : 516

radioResourceInformation.....identifier of RadioResourceInformation
 DEFINED in MAP-MS-DataTypes : 542

RadioResourceInformation.....type reference OCTET STRING
 DEFINED in MAP-MS-DataTypes : 662
 USED in MAP-MS-DataTypes : 459 516 542

radioResourceList.....identifier of [7] RadioResourceList
 DEFINED in MAP-MS-DataTypes : 462

radioResourceList.....identifier of [11] RadioResourceList
 DEFINED in MAP-MS-DataTypes : 519

RadioResourceList.....type reference SEQUENCE OF
 DEFINED in MAP-MS-DataTypes : 538
 USED in MAP-MS-DataTypes : 462 519

RAIdentity.....type reference OCTET STRING
 DEFINED in MAP-MS-DataTypes : 1935
 USED in MAP-MS-DataTypes : 104 1920

ranap-ServiceHandover.....identifier of [8] RANAP-ServiceHandover
 DEFINED in MAP-MS-DataTypes : 464

ranap-ServiceHandover.....identifier of [14] RANAP-ServiceHandover
 DEFINED in MAP-MS-DataTypes : 524

RANAP-ServiceHandover.....type reference OCTET STRING
 DEFINED in MAP-MS-DataTypes : 531
 USED in MAP-MS-DataTypes : 464 524

rand.....identifier of RAND
 DEFINED in MAP-MS-DataTypes : 337

rand.....identifier of RAND
 DEFINED in MAP-MS-DataTypes : 343

RAND.....type reference OCTET STRING
 DEFINED in MAP-MS-DataTypes : 365
 USED in MAP-MS-DataTypes : 337 343 394 705

rand.....identifier of RAND
 DEFINED in MAP-MS-DataTypes : 394

rand.....identifier of RAND
 DEFINED in MAP-MS-DataTypes : 705

readyForSM.....value reference ReadyForSM, CHOICE VALUE

DEFINED in MAP-Protocol : 280

ReadyForSM.....type reference OPERATION
DEFINED in MAP-ShortMessageService : 136
USED in MAP-Protocol : 93 280
USED in MAP-ShortMessageService : 19

TAG R5.40 Cross Reference Listing for MAP-Protocol 2002-06-07 14:47:03 PAGE 86

readyForSM-Arg.....identifier of ReadyForSM-Arg
DEFINED in MAP-ShortMessageServic : 138

ReadyForSM-Arg.....type reference SEQUENCE
DEFINED in MAP-SM-DataTypes : 203
USED in MAP-ShortMessageServic : 55 138
USED in MAP-SM-DataTypes : 24

readyForSM-Res.....identifier of ReadyForSM-Res
DEFINED in MAP-ShortMessageServic : 140

ReadyForSM-Res.....type reference SEQUENCE
DEFINED in MAP-SM-DataTypes : 212
USED in MAP-ShortMessageServic : 56 140
USED in MAP-SM-DataTypes : 25

reason.....identifier of CHOICE
DEFINED in TCAPMessages : 75

recall.....identifier of Named Number, 1
DEFINED in MAP-SS-DataTypes : 287

regionalSubscNotSupported.....identifier of Named Number, 3
DEFINED in MAP-MS-DataTypes : 1295

regionalSubscriptionData.....identifier of [10] ZoneCodeList
DEFINED in MAP-MS-DataTypes : 950

regionalSubscriptionIdentifier.....identifier of [5] ZoneCode
DEFINED in MAP-MS-DataTypes : 1304

regionalSubscriptionResponse.....identifier of [5] RegionalSubscriptionResponse
DEFINED in MAP-MS-DataTypes : 1286

RegionalSubscriptionResponse.....type reference ENUMERATED
DEFINED in MAP-MS-DataTypes : 1291
USED in MAP-MS-DataTypes : 1286 1353

regionalSubscriptionResponse.....identifier of [0] RegionalSubscriptionResponse
DEFINED in MAP-MS-DataTypes : 1353

registerCC-Entry.....value reference RegisterCC-Entry, CHOICE VALUE
DEFINED in MAP-Protocol : 268

RegisterCC-Entry.....type reference OPERATION
DEFINED in MAP-SupplementaryServi : 251
USED in MAP-Protocol : 80 268
USED in MAP-SupplementaryServi : 24

registerCC-EntryArg.....identifier of RegisterCC-EntryArg
DEFINED in MAP-SupplementaryServi : 253

RegisterCC-EntryArg.....type reference SEQUENCE
DEFINED in MAP-SS-DataTypes : 305
USED in MAP-SupplementaryServi : 70 253
USED in MAP-SS-DataTypes : 37

registerCC-EntryRes.....identifier of RegisterCC-EntryRes
DEFINED in MAP-SupplementaryServi : 255

RegisterCC-EntryRes.....type reference SEQUENCE
DEFINED in MAP-SS-DataTypes : 324
USED in MAP-SupplementaryServi : 71 255
USED in MAP-SS-DataTypes : 38

registerPassword.....value reference RegisterPassword, CHOICE VALUE
DEFINED in MAP-Protocol : 266

RegisterPassword.....type reference OPERATION
DEFINED in MAP-SupplementaryServi : 217
USED in MAP-Protocol : 77 266
USED in MAP-SupplementaryServi : 21

registerSS.....value reference RegisterSS, CHOICE VALUE
DEFINED in MAP-Protocol : 257

RegisterSS.....type reference OPERATION
DEFINED in MAP-SupplementaryServi : 87
USED in MAP-Protocol : 69 257
USED in MAP-SupplementaryServi : 13

registerSS-Arg.....identifier of RegisterSS-Arg

TAG R5.40 Cross Reference Listing for MAP-Protocol 2002-06-07 14:47:03 PAGE 87

DEFINED in MAP-SupplementaryServi : 89

RegisterSS-Arg.....type reference SEQUENCE
DEFINED in MAP-SS-DataTypes : 72
USED in MAP-SupplementaryServi : 60 89
USED in MAP-SS-DataTypes : 14

registrationAllCF-Barred.....identifier of Named Number, 24
DEFINED in MAP-MS-DataTypes : 1004

registrationCFNotToHPLMN-Barred.....identifier of Named Number, 25
DEFINED in MAP-MS-DataTypes : 1005

registrationInterzonalCFNotToHPLMN-Barreidentifier of Named Number, 27
DEFINED in MAP-MS-DataTypes : 1007

registrationInterzonalCF-Barred.....identifier of Named Number, 26
DEFINED in MAP-MS-DataTypes : 1006

reject.....identifier of [4] IMPLICIT Reject
DEFINED in TCAPMessages : 128

Reject.....type reference SEQUENCE
DEFINED in TCAPMessages : 165
USED in TCAPMessages : 128

rejected.....identifier of Named Number, 1
DEFINED in MAP-CH-DataTypes : 409

releaseCall.....identifier of Named Number, 1
DEFINED in MAP-MS-DataTypes : 1572

releaseGroupCall.....identifier of [2] NULL
DEFINED in MAP-GR-DataTypes : 89

releaseTransaction.....identifier of Named Number, 1
DEFINED in MAP-MS-DataTypes : 859

releaseTransaction.....identifier of Named Number, 1
DEFINED in MAP-MS-DataTypes : 1646

RelocationNumber.....type reference SEQUENCE
DEFINED in MAP-MS-DataTypes : 650
USED in MAP-MS-DataTypes : 646

relocationNumberList.....identifier of [1] RelocationNumberList
DEFINED in MAP-MS-DataTypes : 551

RelocationNumberList.....type reference SEQUENCE OF
DEFINED in MAP-MS-DataTypes : 645
USED in MAP-MS-DataTypes : 551

remoteUserFree.....value reference RemoteUserFree, CHOICE VALUE
DEFINED in MAP-Protocol : 250

RemoteUserFree.....type reference OPERATION
DEFINED in MAP-CallHandlingOperat : 179
USED in MAP-Protocol : 61 250
USED in MAP-CallHandlingOperat : 20

remoteUserFreeArg.....identifier of RemoteUserFreeArg
DEFINED in MAP-CallHandlingOperat : 181

RemoteUserFreeArg.....type reference SEQUENCE
DEFINED in MAP-CH-DataTypes : 392
USED in MAP-CallHandlingOperat : 68 181
USED in MAP-CH-DataTypes : 31

remoteUserFreeRes.....identifier of RemoteUserFreeRes
DEFINED in MAP-CallHandlingOperat : 183

RemoteUserFreeRes.....type reference SEQUENCE
DEFINED in MAP-CH-DataTypes : 402
USED in MAP-CallHandlingOperat : 69 183
USED in MAP-CH-DataTypes : 32

replaceB-Number.....identifier of [4] NULL
DEFINED in MAP-CH-DataTypes : 397

ReportingState.....type reference ENUMERATED
DEFINED in MAP-CH-DataTypes : 329
USED in MAP-CH-DataTypes : 325

TAG R5.40 Cross Reference Listing for MAP-Protocol 2002-06-07 14:47:03 PAGE 88

reportSM-DeliveryStatus.....value reference ReportSM-DeliveryStatus, CHOICE VALUE
 DEFINED in MAP-Protocol : 277

ReportSM-DeliveryStatus.....type reference OPERATION
 DEFINED in MAP-ShortMessageServ : 111
 USED in MAP-Protocol : 90 277
 USED in MAP-ShortMessageServ : 16

reportSM-DeliveryStatusArg.....identifier of ReportSM-DeliveryStatusArg
 DEFINED in MAP-ShortMessageServ : 113

ReportSM-DeliveryStatusArg.....type reference SEQUENCE
 DEFINED in MAP-SM-DataTypes : 144
 USED in MAP-ShortMessageServ : 51 113
 USED in MAP-SM-DataTypes : 20

reportSM-DeliveryStatusRes.....identifier of ReportSM-DeliveryStatusRes
 DEFINED in MAP-ShortMessageServ : 115

ReportSM-DeliveryStatusRes.....type reference SEQUENCE
 DEFINED in MAP-SM-DataTypes : 172
 USED in MAP-ShortMessageServ : 52 115
 USED in MAP-SM-DataTypes : 21

request.....identifier of Named Number, 0
 DEFINED in MAP-SS-DataTypes : 286

requestedBasicServiceViolatesCUG-Constraidentifier of Named Number, 5
 DEFINED in MAP-ER-DataTypes : 133

requestedCAMEL-SubscriptionInfo.....identifier of [3] RequestedCAMEL-SubscriptionInfo
 DEFINED in MAP-MS-DataTypes : 2066

RequestedCAMEL-SubscriptionInfo.....type reference ENUMERATED
 DEFINED in MAP-MS-DataTypes : 2075
 USED in MAP-MS-DataTypes : 2066 2182

requestedCamel-SubscriptionInfo.....identifier of [0] RequestedCAMEL-SubscriptionInfo
 DEFINED in MAP-MS-DataTypes : 2182

requestedDomain.....identifier of [4] DomainType
 DEFINED in MAP-MS-DataTypes : 1887

requestedInfo.....identifier of [2] RequestedInfo
 DEFINED in MAP-MS-DataTypes : 1838

RequestedInfo.....type reference SEQUENCE
 DEFINED in MAP-MS-DataTypes : 1881
 USED in MAP-MS-DataTypes : 1838 2032

requestedInfo.....identifier of [1] RequestedInfo
 DEFINED in MAP-MS-DataTypes : 2032

requestedSS-Info.....identifier of [1] SS-ForBS-Code
 DEFINED in MAP-MS-DataTypes : 2064

requestedSubscriptionInfo.....identifier of [1] RequestedSubscriptionInfo
 DEFINED in MAP-MS-DataTypes : 2047

RequestedSubscriptionInfo.....type reference SEQUENCE
 DEFINED in MAP-MS-DataTypes : 2063
 USED in MAP-MS-DataTypes : 2047

requestingNodeType.....identifier of [3] RequestingNodeType
 DEFINED in MAP-MS-DataTypes : 700

RequestingNodeType.....type reference ENUMERATED
 DEFINED in MAP-MS-DataTypes : 714
 USED in MAP-MS-DataTypes : 700

requestorIDString.....identifier of [1] RequestorIDString
 DEFINED in MAP-LCS-DataTypes : 183

RequestorIDString.....type reference USSD-String

DEFINED in MAP-LCS-DataTypes : 186
USED in MAP-LCS-DataTypes : 183

reset.....value reference Reset, CHOICE VALUE
DEFINED in MAP-Protocol : 228

Reset.....type reference OPERATION

TAG R5.40 Cross Reference Listing for MAP-Protocol 2002-06-07 14:47:03 PAGE 89

DEFINED in MAP-MobileServiceOpera : 416
 USED in MAP-Protocol : 27 228
 USED in MAP-MobileServiceOpera : 56

resetArg.....identifier of ResetArg
 DEFINED in MAP-MobileServiceOpera : 418

ResetArg.....type reference SEQUENCE
 DEFINED in MAP-MS-DataTypes : 1788
 USED in MAP-MobileServiceOpera : 140 418
 USED in MAP-MS-DataTypes : 89

resourceLimitation.....value reference ResourceLimitation, CHOICE VALUE
 DEFINED in MAP-Protocol : 352

ResourceLimitation.....type reference ERROR
 DEFINED in MAP-Errors : 197
 USED in MAP-Protocol : 167 352
 USED in MAP-CallHandlingOperat : 47 136 148 164 200 213
 USED in MAP-LocationServiceOpe : 32 92
 USED in MAP-Errors : 19

resourceLimitation.....identifier of Named Number, 4
 DEFINED in TCAPMessages : 107

resourceLimitation.....identifier of Named Number, 3
 DEFINED in TCAPMessages : 186

resourceLimitationParam.....identifier of ResourceLimitationParam
 DEFINED in MAP-Errors : 199

ResourceLimitationParam.....type reference SEQUENCE
 DEFINED in MAP-ER-DataTypes : 329
 USED in MAP-Errors : 139 199
 USED in MAP-ER-DataTypes : 44

responseTime.....identifier of [3] ResponseTime
 DEFINED in MAP-LCS-DataTypes : 198

ResponseTime.....type reference SEQUENCE
 DEFINED in MAP-LCS-DataTypes : 214
 USED in MAP-LCS-DataTypes : 21 198

responseTimeCategory.....identifier of ResponseTimeCategory
 DEFINED in MAP-LCS-DataTypes : 215

ResponseTimeCategory.....type reference ENUMERATED
 DEFINED in MAP-LCS-DataTypes : 219
 USED in MAP-LCS-DataTypes : 215

restoreData.....value reference RestoreData, CHOICE VALUE
 DEFINED in MAP-Protocol : 231

RestoreData.....type reference OPERATION
 DEFINED in MAP-MobileServiceOpera : 422
 USED in MAP-Protocol : 29 231
 USED in MAP-MobileServiceOpera : 58

restoreDataArg.....identifier of RestoreDataArg
 DEFINED in MAP-MobileServiceOpera : 424

RestoreDataArg.....type reference SEQUENCE
 DEFINED in MAP-MS-DataTypes : 1793
 USED in MAP-MobileServiceOpera : 141 424
 USED in MAP-MS-DataTypes : 90

restoreDataRes.....identifier of RestoreDataRes
 DEFINED in MAP-MobileServiceOpera : 426

RestoreDataRes.....type reference SEQUENCE
 DEFINED in MAP-MS-DataTypes : 1800
 USED in MAP-MobileServiceOpera : 142 426
 USED in MAP-MS-DataTypes : 91

restrictedArea.....identifier of Named Number, 2

DEFINED in MAP-MS-DataTypes : 2025

restrictedArea.....identifier of Named Number, 1
DEFINED in MAP-ER-DataTypes : 260

result-RR.....identifier of SEQUENCE
DEFINED in TCAPMessages : 146

TAG R5.40 Cross Reference Listing for MAP-Protocol 2002-06-07 14:47:03 PAGE 90

resumeCallHandling.....value reference ResumeCallHandling, CHOICE VALUE
DEFINED in MAP-Protocol : 245

ResumeCallHandling.....type reference OPERATION
DEFINED in MAP-CallHandlingOperat : 118
USED in MAP-Protocol : 56 245
USED in MAP-CallHandlingOperat : 15

resumeCallHandlingArg.....identifier of ResumeCallHandlingArg
DEFINED in MAP-CallHandlingOperat : 120

ResumeCallHandlingArg.....type reference SEQUENCE
DEFINED in MAP-CH-DataTypes : 231
USED in MAP-CallHandlingOperat : 58 120
USED in MAP-CH-DataTypes : 18

resumeCallHandlingRes.....identifier of ResumeCallHandlingRes
DEFINED in MAP-CallHandlingOperat : 122

ResumeCallHandlingRes.....type reference SEQUENCE
DEFINED in MAP-CH-DataTypes : 259
USED in MAP-CallHandlingOperat : 59 122
USED in MAP-CH-DataTypes : 19

returnError.....identifier of [3] IMPLICIT ReturnError
DEFINED in TCAPMessages : 127

ReturnError.....type reference SEQUENCE
DEFINED in TCAPMessages : 156
USED in TCAPMessages : 127

returnErrorProblem.....identifier of [3] IMPLICIT ReturnErrorProblem
DEFINED in TCAPMessages : 173

ReturnErrorProblem.....type reference INTEGER
DEFINED in TCAPMessages : 196
USED in TCAPMessages : 173

returnErrorUnexpected.....identifier of Named Number, 1
DEFINED in TCAPMessages : 197

ReturnResult.....type reference SEQUENCE
DEFINED in TCAPMessages : 144
USED in TCAPMessages : 126 129

returnResultLast.....identifier of [2] IMPLICIT ReturnResult
DEFINED in TCAPMessages : 126

returnResultNotLast.....identifier of [7] IMPLICIT ReturnResult
DEFINED in TCAPMessages : 129

returnResultProblem.....identifier of [2] IMPLICIT ReturnResultProblem
DEFINED in TCAPMessages : 172

ReturnResultProblem.....type reference INTEGER
DEFINED in TCAPMessages : 192
USED in TCAPMessages : 172

returnResultUnexpected.....identifier of Named Number, 1
DEFINED in TCAPMessages : 193

re-attempt.....identifier of BOOLEAN
DEFINED in MAP-MS-DataTypes : 392

re-synchronisationInfo.....identifier of Re-synchronisationInfo
DEFINED in MAP-MS-DataTypes : 697

Re-synchronisationInfo.....type reference SEQUENCE
DEFINED in MAP-MS-DataTypes : 704
USED in MAP-MS-DataTypes : 697

RNCId.....type reference OCTET STRING
DEFINED in MAP-MS-DataTypes : 632
USED in MAP-MS-DataTypes : 510 598

rnc-Address.....identifier of [16] GSN-Address
DEFINED in MAP-MS-DataTypes : 2000

roadsideAssistance.....value reference LCSServiceTypeID, 6
DEFINED in MAP-CommonDataTypes : 402

TAG R5.40 Cross Reference Listing for MAP-Protocol 2002-06-07 14:47:03 PAGE 91

roamerAccessToHPLMN-AP-Barred.....identifier of Named Number, 16
DEFINED in MAP-MS-DataTypes : 996

roamerAccessToVPLMN-AP-Barred.....identifier of Named Number, 17
DEFINED in MAP-MS-DataTypes : 997

roamingNotAllowed.....value reference RoamingNotAllowed, CHOICE VALUE
DEFINED in MAP-Protocol : 366

RoamingNotAllowed.....type reference ERROR
DEFINED in MAP-Errors : 228
USED in MAP-Protocol : 135 366
USED in MAP-MobileServiceOpera : 89 186 229
USED in MAP-Errors : 29

roamingNotAllowedCause.....identifier of RoamingNotAllowedCause
DEFINED in MAP-ER-DataTypes : 100

RoamingNotAllowedCause.....type reference ENUMERATED
DEFINED in MAP-ER-DataTypes : 104
USED in MAP-ER-DataTypes : 100

roamingNotAllowedParam.....identifier of RoamingNotAllowedParam
DEFINED in MAP-Errors : 230

RoamingNotAllowedParam.....type reference SEQUENCE
DEFINED in MAP-ER-DataTypes : 99
USED in MAP-Errors : 120 230
USED in MAP-ER-DataTypes : 14

roamingNumber.....identifier of ISDN-AddressString
DEFINED in MAP-CH-DataTypes : 189

roamingNumber.....identifier of ISDN-AddressString
DEFINED in MAP-CH-DataTypes : 227

roamingOutsidePLMNICountryIC-CallsBarredidentifier of Named Number, 21
DEFINED in MAP-MS-DataTypes : 1001

roamingOutsidePLMNIC-CallsBarred.....identifier of Named Number, 20
DEFINED in MAP-MS-DataTypes : 1000

roamingOutsidePLMNOG-CallsBarred.....identifier of Named Number, 18
DEFINED in MAP-MS-DataTypes : 998

roamingOutsidePLMN-Barred.....identifier of Named Number, 22
DEFINED in MAP-MS-DataTypes : 1002

roamingOutsidePLMN-CountryBarred.....identifier of Named Number, 23
DEFINED in MAP-MS-DataTypes : 1003

roamingRestrictedInSgsnDueToUnsupportedFidentifier of [23] NULL
DEFINED in MAP-MS-DataTypes : 740

roamingRestrictedInSgsnDueToUnsuppportedidentifier of [11] NULL
DEFINED in MAP-MS-DataTypes : 1311

roamingRestrictionDueToUnsupportedFeaturidentifier of [9] NULL
DEFINED in MAP-MS-DataTypes : 949

roamingRestrictionDueToUnsupportedFeaturidentifier of [4] NULL
DEFINED in MAP-MS-DataTypes : 1303

routingAreaIdentity.....identifier of [1] RAIdentity
DEFINED in MAP-MS-DataTypes : 1920

routeSelectFailure.....identifier of Named Number, 4
DEFINED in MAP-MS-DataTypes : 1490

routingAreaUpdating.....identifier of Named Number, 6
DEFINED in MAP-MS-DataTypes : 405

RoutingInfo.....type reference CHOICE
DEFINED in MAP-CH-DataTypes : 188
USED in MAP-CH-DataTypes : 270

routingInfo.....identifier of RoutingInfo
DEFINED in MAP-CH-DataTypes : 270

routingInfoForLCS-Arg.....identifier of RoutingInfoForLCS-Arg
DEFINED in MAP-LocationServiceOpe : 54

TAG R5.40 Cross Reference Listing for MAP-Protocol 2002-06-07 14:47:03 PAGE 92

RoutingInfoForLCS-Arg.....type reference SEQUENCE
DEFINED in MAP-LCS-DataTypes : 67
USED in MAP-LocationServiceOpe : 41 54
USED in MAP-LCS-DataTypes : 11

routingInfoForLCS-Res.....identifier of RoutingInfoForLCS-Res
DEFINED in MAP-LocationServiceOpe : 56

RoutingInfoForLCS-Res.....type reference SEQUENCE
DEFINED in MAP-LCS-DataTypes : 81
USED in MAP-LocationServiceOpe : 42 56
USED in MAP-LCS-DataTypes : 12

routingInfoForSM-Arg.....identifier of RoutingInfoForSM-Arg
DEFINED in MAP-ShortMessageServic : 68

RoutingInfoForSM-Arg.....type reference SEQUENCE
DEFINED in MAP-SM-DataTypes : 53
USED in MAP-ShortMessageServic : 45 68
USED in MAP-SM-DataTypes : 14

routingInfoForSM-Res.....identifier of RoutingInfoForSM-Res
DEFINED in MAP-ShortMessageServic : 70

RoutingInfoForSM-Res.....type reference SEQUENCE
DEFINED in MAP-SM-DataTypes : 80
USED in MAP-ShortMessageServic : 46 70
USED in MAP-SM-DataTypes : 15

routingToNearestCommercialEnterprise....value reference LCSServiceTypeID, 7
DEFINED in MAP-CommonDataTypes : 403

rss.....identifier of Named Number, 7
DEFINED in MAP-CommonDataTypes : 359

ruf-Outcome.....identifier of [0] RUF-Outcome
DEFINED in MAP-CH-DataTypes : 403

RUF-Outcome.....type reference ENUMERATED
DEFINED in MAP-CH-DataTypes : 407
USED in MAP-CH-DataTypes : 403

sai-Present.....identifier of [9] NULL
DEFINED in MAP-MS-DataTypes : 1912

sai-Present.....identifier of [6] NULL
DEFINED in MAP-MS-DataTypes : 1926

sc-AddressNotIncluded.....identifier of Named Number, 0
DEFINED in MAP-SM-DataTypes : 196

sc-Congestion.....identifier of Named Number, 4
DEFINED in MAP-ER-DataTypes : 153

secureTransportArg.....identifier of SecureTransportArg
DEFINED in MAP-SecureTransportOpe : 43

secureTransportArg.....identifier of SecureTransportArg
DEFINED in MAP-SecureTransportOpe : 54

secureTransportArg.....identifier of SecureTransportArg
DEFINED in MAP-SecureTransportOpe : 63

secureTransportArg.....identifier of SecureTransportArg
DEFINED in MAP-SecureTransportOpe : 70

SecureTransportArg.....type reference SEQUENCE
DEFINED in MAP-ST-DataTypes : 25
USED in MAP-SecureTransportOpe : 32 43 54 63 70
USED in MAP-ST-DataTypes : 11

secureTransportClass1.....value reference SecureTransportClass1, CHOICE VALUE
DEFINED in MAP-Protocol : 339

SecureTransportClass1.....type reference OPERATION

DEFINED in MAP-SecureTransportOpe : 40
USED in MAP-Protocol : 116 339
USED in MAP-SecureTransportOpe : 13

secureTransportClass2.....value reference SecureTransportClass2, CHOICE VALUE
DEFINED in MAP-Protocol : 340

TAG R5.40 Cross Reference Listing for MAP-Protocol 2002-06-07 14:47:03 PAGE 93

SecureTransportClass2.....type reference OPERATION
 DEFINED in MAP-SecureTransportOpe : 51
 USED in MAP-Protocol : 117 340
 USED in MAP-SecureTransportOpe : 14

secureTransportClass3.....value reference SecureTransportClass3, CHOICE VALUE
 DEFINED in MAP-Protocol : 341

SecureTransportClass3.....type reference OPERATION
 DEFINED in MAP-SecureTransportOpe : 60
 USED in MAP-Protocol : 118 341
 USED in MAP-SecureTransportOpe : 15

secureTransportClass4.....value reference SecureTransportClass4, CHOICE VALUE
 DEFINED in MAP-Protocol : 342

SecureTransportClass4.....type reference OPERATION
 DEFINED in MAP-SecureTransportOpe : 67
 USED in MAP-Protocol : 119 342
 USED in MAP-SecureTransportOpe : 16

secureTransportError.....value reference SecureTransportError, CHOICE VALUE
 DEFINED in MAP-Protocol : 455

SecureTransportError.....type reference ERROR
 DEFINED in MAP-Errors : 460
 USED in MAP-Protocol : 181 455
 USED in MAP-SecureTransportOpe : 25 47 56
 USED in MAP-Errors : 95

secureTransportErrorParam.....identifier of SecureTransportErrorParam
 DEFINED in MAP-Errors : 462

SecureTransportErrorParam.....type reference SEQUENCE
 DEFINED in MAP-ER-DataTypes : 398
 USED in MAP-Errors : 156 462
 USED in MAP-ER-DataTypes : 54

secureTransportRes.....identifier of SecureTransportRes
 DEFINED in MAP-SecureTransportOpe : 45

secureTransportRes.....identifier of SecureTransportRes
 DEFINED in MAP-SecureTransportOpe : 65

SecureTransportRes.....type reference SEQUENCE
 DEFINED in MAP-ST-DataTypes : 33
 USED in MAP-SecureTransportOpe : 33 45 65
 USED in MAP-ST-DataTypes : 12

securityHeader.....identifier of SecurityHeader
 DEFINED in MAP-ST-DataTypes : 26

securityHeader.....identifier of SecurityHeader
 DEFINED in MAP-ST-DataTypes : 34

SecurityHeader.....type reference SEQUENCE
 DEFINED in MAP-ST-DataTypes : 41
 USED in MAP-ST-DataTypes : 13 26 34
 USED in MAP-ER-DataTypes : 81 399

securityHeader.....identifier of SecurityHeader
 DEFINED in MAP-ER-DataTypes : 399

securityParametersIndex.....identifier of SecurityParametersIndex
 DEFINED in MAP-ST-DataTypes : 42

SecurityParametersIndex.....type reference OCTET STRING
 DEFINED in MAP-ST-DataTypes : 70
 USED in MAP-ST-DataTypes : 42

segmentationProhibited.....identifier of NULL
 DEFINED in MAP-MS-DataTypes : 308

segmentationProhibited.....identifier of NULL
 DEFINED in MAP-MS-DataTypes : 691

selectedGSM-Algorithm.....identifier of [2] SelectedGSM-Algorithm
DEFINED in MAP-MS-DataTypes : 612

SelectedGSM-Algorithm.....type reference OCTET STRING
DEFINED in MAP-MS-DataTypes : 618
USED in MAP-MS-DataTypes : 612

TAG R5.40 Cross Reference Listing for MAP-Protocol 2002-06-07 14:47:03 PAGE 94

selectedLSAIdentity.....identifier of [4] LSAIdentity
DEFINED in MAP-MS-DataTypes : 1923

selectedLSA-Id.....identifier of [5] LSAIdentity
DEFINED in MAP-MS-DataTypes : 1908

selectedRab-Id.....identifier of [4] RAB-Id
DEFINED in MAP-MS-DataTypes : 600

selectedRab-Id.....identifier of [4] RAB-Id
DEFINED in MAP-MS-DataTypes : 614

selectedUMTS-Algorithms.....identifier of [5] SelectedUMTS-Algorithms
DEFINED in MAP-MS-DataTypes : 555

SelectedUMTS-Algorithms.....type reference SEQUENCE
DEFINED in MAP-MS-DataTypes : 560
USED in MAP-MS-DataTypes : 555 611

selectedUMTS-Algorithms.....identifier of [1] SelectedUMTS-Algorithms
DEFINED in MAP-MS-DataTypes : 611

sendAuthenticationInfo.....value reference SendAuthenticationInfo, CHOICE VALUE
DEFINED in MAP-Protocol : 211

SendAuthenticationInfo.....type reference OPERATION
DEFINED in MAP-MobileServiceOpera : 350
USED in MAP-Protocol : 22 211
USED in MAP-MobileServiceOpera : 45

sendAuthenticationInfoArg.....identifier of SendAuthenticationInfoArg
DEFINED in MAP-MobileServiceOpera : 352

SendAuthenticationInfoArg.....type reference SEQUENCE
DEFINED in MAP-MS-DataTypes : 688
USED in MAP-MobileServiceOpera : 131 352
USED in MAP-MS-DataTypes : 44

sendAuthenticationInfoRes.....identifier of SendAuthenticationInfoRes
DEFINED in MAP-MobileServiceOpera : 359

SendAuthenticationInfoRes.....type reference [3] SEQUENCE
DEFINED in MAP-MS-DataTypes : 709
USED in MAP-MobileServiceOpera : 132 359
USED in MAP-MS-DataTypes : 45

sendEndSignal.....value reference SendEndSignal, CHOICE VALUE
DEFINED in MAP-Protocol : 202

SendEndSignal.....type reference OPERATION
DEFINED in MAP-MobileServiceOpera : 322
USED in MAP-Protocol : 18 202
USED in MAP-MobileServiceOpera : 39

sendEndSignal-Arg.....identifier of SendEndSignal-Arg
DEFINED in MAP-MobileServiceOpera : 324

SendEndSignal-Arg.....type reference [3] SEQUENCE
DEFINED in MAP-MS-DataTypes : 623
USED in MAP-MobileServiceOpera : 127 324
USED in MAP-MS-DataTypes : 39

sendEndSignal-Res.....identifier of SendEndSignal-Res
DEFINED in MAP-MobileServiceOpera : 326

SendEndSignal-Res.....type reference SEQUENCE
DEFINED in MAP-MS-DataTypes : 628
USED in MAP-MobileServiceOpera : 128 326
USED in MAP-MS-DataTypes : 40

sendGroupCallEndSignal.....value reference SendGroupCallEndSignal, CHOICE VALUE
DEFINED in MAP-Protocol : 307

SendGroupCallEndSignal.....type reference OPERATION

DEFINED in MAP-Group-Call-Operati : 56
USED in MAP-Protocol : 102 307
USED in MAP-Group-Call-Operati : 14

sendGroupCallEndSignalArg.....identifier of SendGroupCallEndSignalArg
DEFINED in MAP-Group-Call-Operati : 58

TAG R5.40 Cross Reference Listing for MAP-Protocol 2002-06-07 14:47:03 PAGE 95

SendGroupCallEndSignalArg.....type reference SEQUENCE
DEFINED in MAP-GR-DataTypes : 66
USED in MAP-Group-Call-Operati : 33 58
USED in MAP-GR-DataTypes : 16

sendGroupCallEndSignalRes.....identifier of SendGroupCallEndSignalRes
DEFINED in MAP-Group-Call-Operati : 60

SendGroupCallEndSignalRes.....type reference SEQUENCE
DEFINED in MAP-GR-DataTypes : 71
USED in MAP-Group-Call-Operati : 34 60
USED in MAP-GR-DataTypes : 17

sendIdentification.....value reference SendIdentification, CHOICE VALUE
DEFINED in MAP-Protocol : 196

SendIdentification.....type reference OPERATION
DEFINED in MAP-MobileServiceOpera : 209
USED in MAP-Protocol : 15 196
USED in MAP-MobileServiceOpera : 18

sendIdentificationArg.....identifier of SendIdentificationArg
DEFINED in MAP-MobileServiceOpera : 211

SendIdentificationArg.....type reference SEQUENCE
DEFINED in MAP-MS-DataTypes : 302
USED in MAP-MobileServiceOpera : 119 211
USED in MAP-MS-DataTypes : 22

sendIdentificationRes.....identifier of SendIdentificationRes
DEFINED in MAP-MobileServiceOpera : 213

SendIdentificationRes.....type reference [3] SEQUENCE
DEFINED in MAP-MS-DataTypes : 314
USED in MAP-MobileServiceOpera : 120 213
USED in MAP-MS-DataTypes : 23

sendIMSI.....value reference SendIMSI, CHOICE VALUE
DEFINED in MAP-Protocol : 238

SendIMSI.....type reference OPERATION
DEFINED in MAP-OperationAndMainte : 77
USED in MAP-Protocol : 48 238
USED in MAP-OperationAndMainte : 15

sendRoutingInfo.....value reference SendRoutingInfo, CHOICE VALUE
DEFINED in MAP-Protocol : 243

SendRoutingInfo.....type reference OPERATION
DEFINED in MAP-CallHandlingOperat : 80
USED in MAP-Protocol : 54 243
USED in MAP-CallHandlingOperat : 13

sendRoutingInfoArg.....identifier of SendRoutingInfoArg
DEFINED in MAP-CallHandlingOperat : 83

SendRoutingInfoArg.....type reference SEQUENCE
DEFINED in MAP-CH-DataTypes : 94
USED in MAP-CallHandlingOperat : 54 83
USED in MAP-CH-DataTypes : 14

sendRoutingInfoForGprs.....value reference SendRoutingInfoForGprs, CHOICE VALUE
DEFINED in MAP-Protocol : 318

SendRoutingInfoForGprs.....type reference OPERATION
DEFINED in MAP-MobileServiceOpera : 435
USED in MAP-Protocol : 34 318
USED in MAP-MobileServiceOpera : 61

sendRoutingInfoForGprsArg.....identifier of SendRoutingInfoForGprsArg
DEFINED in MAP-MobileServiceOpera : 437

SendRoutingInfoForGprsArg.....type reference SEQUENCE
DEFINED in MAP-MS-DataTypes : 1744
USED in MAP-MobileServiceOpera : 153 437

USED in MAP-MS-DataTypes : 123

sendRoutingInfoForGprsRes.....identifier of SendRoutingInfoForGprsRes
DEFINED in MAP-MobileServiceOpera : 439

SendRoutingInfoForGprsRes.....type reference SEQUENCE
DEFINED in MAP-MS-DataTypes : 1751

TAG R5.40 Cross Reference Listing for MAP-Protocol 2002-06-07 14:47:03 PAGE 96

USED in MAP-MobileServiceOpera : 154 439
 USED in MAP-MS-DataTypes : 124

sendRoutingInfoForLCS.....value reference SendRoutingInfoForLCS, CHOICE VALUE
 DEFINED in MAP-Protocol : 331

SendRoutingInfoForLCS.....type reference OPERATION
 DEFINED in MAP-LocationServiceOpe : 52
 USED in MAP-Protocol : 109 331
 USED in MAP-LocationServiceOpe : 14

sendRoutingInfoForSM.....value reference SendRoutingInfoForSM, CHOICE VALUE
 DEFINED in MAP-Protocol : 274

SendRoutingInfoForSM.....type reference OPERATION
 DEFINED in MAP-ShortMessageServic : 66
 USED in MAP-Protocol : 87 274
 USED in MAP-ShortMessageServic : 13

sendRoutingInfoRes.....identifier of SendRoutingInfoRes
 DEFINED in MAP-CallHandlingOperat : 85

SendRoutingInfoRes.....type reference [3] SEQUENCE
 DEFINED in MAP-CH-DataTypes : 149
 USED in MAP-CallHandlingOperat : 55 85
 USED in MAP-CH-DataTypes : 15

sendSubscriberData.....identifier of [0] NULL
 DEFINED in MAP-MS-DataTypes : 237

serviceCentreAddress.....identifier of [2] AddressString
 DEFINED in MAP-SM-DataTypes : 56

serviceCentreAddress.....identifier of AddressString
 DEFINED in MAP-SM-DataTypes : 146

serviceCentreAddress.....identifier of AddressString
 DEFINED in MAP-SM-DataTypes : 180

serviceCentreAddressDA.....identifier of [4] AddressString
 DEFINED in MAP-SM-DataTypes : 136

serviceCentreAddressOA.....identifier of [4] AddressString
 DEFINED in MAP-SM-DataTypes : 141

serviceGranted.....identifier of Named Number, 0
 DEFINED in MAP-MS-DataTypes : 960

serviceIndicator.....identifier of [2] ServiceIndicator
 DEFINED in MAP-SS-DataTypes : 313

ServiceIndicator.....type reference BIT STRING
 DEFINED in MAP-SS-DataTypes : 318
 USED in MAP-SS-DataTypes : 313

serviceKey.....identifier of [1] ServiceKey
 DEFINED in MAP-MS-DataTypes : 850

serviceKey.....identifier of ServiceKey
 DEFINED in MAP-MS-DataTypes : 1422

serviceKey.....identifier of ServiceKey
 DEFINED in MAP-MS-DataTypes : 1478

ServiceKey.....type reference INTEGER
 DEFINED in MAP-MS-DataTypes : 1485
 USED in MAP-MS-DataTypes : 70 850 1422 1478 1615 1654 1665 1725 2216

serviceKey.....identifier of [1] ServiceKey
 DEFINED in MAP-MS-DataTypes : 1615

serviceKey.....identifier of ServiceKey
 DEFINED in MAP-MS-DataTypes : 1654

serviceKey.....identifier of ServiceKey

DEFINED in MAP-MS-DataTypes : 1665

serviceKey.....identifier of ServiceKey
DEFINED in MAP-MS-DataTypes : 1725

serviceKey.....identifier of ServiceKey
DEFINED in MAP-MS-DataTypes : 2216

TAG R5.40 Cross Reference Listing for MAP-Protocol 2002-06-07 14:47:03 PAGE 97

serviceRequest.....identifier of Named Number, 7
DEFINED in MAP-MS-DataTypes : 406

ServiceType.....type reference SEQUENCE
DEFINED in MAP-MS-DataTypes : 1253
USED in MAP-MS-DataTypes : 1249

serviceType.....value reference SS-Code, '10110101'B
DEFINED in MAP-SS-Code : 170

serviceTypeIdentity.....identifier of LCSServiceTypeID
DEFINED in MAP-MS-DataTypes : 1254

serviceTypeList.....identifier of [5] ServiceTypeList
DEFINED in MAP-MS-DataTypes : 1199

ServiceTypeList.....type reference SEQUENCE OF
DEFINED in MAP-MS-DataTypes : 1248
USED in MAP-MS-DataTypes : 1199

setReportingState.....value reference SetReportingState, CHOICE VALUE
DEFINED in MAP-Protocol : 248

SetReportingState.....type reference OPERATION
DEFINED in MAP-CallHandlingOperat : 153
USED in MAP-Protocol : 59 248
USED in MAP-CallHandlingOperat : 18

setReportingStateArg.....identifier of SetReportingStateArg
DEFINED in MAP-CallHandlingOperat : 155

SetReportingStateArg.....type reference SEQUENCE
DEFINED in MAP-CH-DataTypes : 322
USED in MAP-CallHandlingOperat : 64 155
USED in MAP-CH-DataTypes : 27

setReportingStateRes.....identifier of SetReportingStateRes
DEFINED in MAP-CallHandlingOperat : 157

SetReportingStateRes.....type reference SEQUENCE
DEFINED in MAP-CH-DataTypes : 337
USED in MAP-CallHandlingOperat : 65 157
USED in MAP-CH-DataTypes : 28

sgsn.....identifier of Named Number, 1
DEFINED in MAP-MS-DataTypes : 716

sgsn-Address.....identifier of GSN-Address
DEFINED in MAP-MS-DataTypes : 426

sgsn-Address.....identifier of [0] GSN-Address
DEFINED in MAP-MS-DataTypes : 1752

sgsn-Address.....identifier of [1] GSN-Address
DEFINED in MAP-MS-DataTypes : 1776

sgsn-CAMEL-SubscriptionInfo.....identifier of [17] SGSN-CAMEL-SubscriptionInfo
DEFINED in MAP-MS-DataTypes : 750

SGSN-CAMEL-SubscriptionInfo.....type reference SEQUENCE
DEFINED in MAP-MS-DataTypes : 819
USED in MAP-MS-DataTypes : 750

sgsn-Capability.....identifier of [0] SGSN-Capability
DEFINED in MAP-MS-DataTypes : 429

SGSN-Capability.....type reference SEQUENCE
DEFINED in MAP-MS-DataTypes : 433
USED in MAP-MS-DataTypes : 429

sgsn-Number.....identifier of [1] ISDN-AddressString
DEFINED in MAP-MS-DataTypes : 292

sgsn-Number.....identifier of [1] ISDN-AddressString

DEFINED in MAP-MS-DataTypes : 396

sgsn-Number.....identifier of ISDN-AddressString
DEFINED in MAP-MS-DataTypes : 425

sgsn-Number.....identifier of [3] ISDN-AddressString
DEFINED in MAP-MS-DataTypes : 1922

TAG R5.40 Cross Reference Listing for MAP-Protocol 2002-06-07 14:47:03 PAGE 98

sgsn-Number.....identifier of [1] ISDN-AddressString
 DEFINED in MAP-SM-DataTypes : 100

shapeOfLocationEstimateNotSupported.....identifier of Named Number, 6
 DEFINED in MAP-LCS-DataTypes : 402

shapeOfLocationEstimateNotSupported.....identifier of [0] NULL
 DEFINED in MAP-ER-DataTypes : 200

shortMessage.....identifier of Named Number, 4
 DEFINED in MAP-MS-DataTypes : 403

shortMessageMO-PP.....value reference TeleserviceCode, '00100010'B
 DEFINED in MAP-TS-Code : 46

shortMessageMT-PP.....value reference TeleserviceCode, '00100001'B
 DEFINED in MAP-TS-Code : 45

shortTermDenial.....value reference ShortTermDenial, CHOICE VALUE
 DEFINED in MAP-Protocol : 431

ShortTermDenial.....type reference ERROR
 DEFINED in MAP-Errors : 392
 USED in MAP-Protocol : 169 431
 USED in MAP-SupplementaryServi : 53 264
 USED in MAP-Errors : 73

shortTermDenialParam.....identifier of ShortTermDenialParam
 DEFINED in MAP-Errors : 394

ShortTermDenialParam.....type reference SEQUENCE
 DEFINED in MAP-ER-DataTypes : 341
 USED in MAP-Errors : 142 394
 USED in MAP-ER-DataTypes : 47

signallInfo.....identifier of SignallInfo
 DEFINED in MAP-CommonDataTypes : 200

SignallInfo.....type reference OCTET STRING
 DEFINED in MAP-CommonDataTypes : 207
 USED in MAP-CommonDataTypes : 24 200 226
 USED in MAP-SM-DataTypes : 34 110 116 123 129
 USED in MAP-ER-DataTypes : 74 159

signallInfo.....identifier of SignallInfo
 DEFINED in MAP-CommonDataTypes : 226

signallInfo.....identifier of LongSignallInfo
 DEFINED in MAP-CommonDataTypes : 243

sIWFSNumber.....identifier of [0] ISDN-AddressString
 DEFINED in MAP-CH-DataTypes : 307

sIWFSsignallingModify.....value reference sIWFSsignallingModify, CHOICE VALUE
 DEFINED in MAP-Protocol : 247

sIWFSsignallingModify.....type reference OPERATION
 DEFINED in MAP-CallHandlingOperat : 141
 USED in MAP-Protocol : 58 247
 USED in MAP-CallHandlingOperat : 17

sIWFSsignallingModifyArg.....identifier of sIWFSsignallingModifyArg
 DEFINED in MAP-CallHandlingOperat : 143

sIWFSsignallingModifyArg.....type reference SEQUENCE
 DEFINED in MAP-CH-DataTypes : 311
 USED in MAP-CallHandlingOperat : 62 143
 USED in MAP-CH-DataTypes : 25

sIWFSsignallingModifyRes.....identifier of sIWFSsignallingModifyRes
 DEFINED in MAP-CallHandlingOperat : 145

sIWFSsignallingModifyRes.....type reference SEQUENCE
 DEFINED in MAP-CH-DataTypes : 317

USED in MAP-CallHandlingOperat : 63 145
USED in MAP-CH-DataTypes : 26

SMS-CAMEL-TDP-Data.....type reference SEQUENCE
DEFINED in MAP-MS-DataTypes : 1613
USED in MAP-MS-DataTypes : 1609

TAG R5.40 Cross Reference Listing for MAP-Protocol 2002-06-07 14:47:03 PAGE 99

sms-CAMEL-TDP-DataList.....identifier of [0] SMS-CAMEL-TDP-DataList
DEFINED in MAP-MS-DataTypes : 1594

SMS-CAMEL-TDP-DataList.....type reference SEQUENCE OF
DEFINED in MAP-MS-DataTypes : 1608
USED in MAP-MS-DataTypes : 1594

sms-CollectedInfo.....identifier of Named Number, 1
DEFINED in MAP-MS-DataTypes : 1623

SMS-CSI.....type reference SEQUENCE
DEFINED in MAP-MS-DataTypes : 1593
USED in MAP-MS-DataTypes : 821 824 1365 1369 2125 2131

sms-DELIVER.....identifier of Named Number, 0
DEFINED in MAP-MS-DataTypes : 1388

sms-DeliveryRequest.....identifier of Named Number, 2
DEFINED in MAP-MS-DataTypes : 1625

sms-STATUS-REPORT.....identifier of Named Number, 2
DEFINED in MAP-MS-DataTypes : 1390

sms-SUBMIT-REPORT.....identifier of Named Number, 1
DEFINED in MAP-MS-DataTypes : 1389

sms-TriggerDetectionPoint.....identifier of SMS-TriggerDetectionPoint
DEFINED in MAP-MS-DataTypes : 1377

sms-TriggerDetectionPoint.....identifier of [0] SMS-TriggerDetectionPoint
DEFINED in MAP-MS-DataTypes : 1614

SMS-TriggerDetectionPoint.....type reference ENUMERATED
DEFINED in MAP-MS-DataTypes : 1622
USED in MAP-MS-DataTypes : 1377 1614

sm-DeliveryFailure.....value reference SM-DeliveryFailure, CHOICE VALUE
DEFINED in MAP-Protocol : 438

SM-DeliveryFailure.....type reference ERROR
DEFINED in MAP-Errors : 410
USED in MAP-Protocol : 164 438
USED in MAP-ShortMessageServic : 38 91 108
USED in MAP-Errors : 78

sm-DeliveryFailureCause.....identifier of SM-DeliveryFailureCause
DEFINED in MAP-Errors : 412

SM-DeliveryFailureCause.....type reference SEQUENCE
DEFINED in MAP-ER-DataTypes : 157
USED in MAP-Errors : 112 412
USED in MAP-ER-DataTypes : 19

sm-DeliveryOutcome.....identifier of SM-DeliveryOutcome
DEFINED in MAP-SM-DataTypes : 147

SM-DeliveryOutcome.....type reference ENUMERATED
DEFINED in MAP-SM-DataTypes : 167
USED in MAP-SM-DataTypes : 26 147 158

SM-EnumeratedDeliveryFailureCause.....type reference ENUMERATED
DEFINED in MAP-ER-DataTypes : 148
USED in MAP-ER-DataTypes : 158

sm-EnumeratedDeliveryFailureCause.....identifier of SM-EnumeratedDeliveryFailureCause
DEFINED in MAP-ER-DataTypes : 158

sm-RP-DA.....identifier of SM-RP-DA
DEFINED in MAP-SM-DataTypes : 108

sm-RP-DA.....identifier of SM-RP-DA
DEFINED in MAP-SM-DataTypes : 121

SM-RP-DA.....type reference CHOICE
DEFINED in MAP-SM-DataTypes : 133

USED in MAP-SM-DataTypes : 108 121

sm-RP-MTI.....identifier of [8] SM-RP-MTI
DEFINED in MAP-SM-DataTypes : 62

SM-RP-MTI.....type reference INTEGER
DEFINED in MAP-SM-DataTypes : 65

TAG R5.40 Cross Reference Listing for MAP-Protocol 2002-06-07 14:47:03 PAGE 100

USED in MAP-SM-DataTypes : 62

sm-RP-OA.....identifier of SM-RP-OA
DEFINED in MAP-SM-DataTypes : 109

sm-RP-OA.....identifier of SM-RP-OA
DEFINED in MAP-SM-DataTypes : 122

SM-RP-OA.....type reference CHOICE
DEFINED in MAP-SM-DataTypes : 139
USED in MAP-SM-DataTypes : 109 122

sm-RP-PRI.....identifier of [1] BOOLEAN
DEFINED in MAP-SM-DataTypes : 55

sm-RP-SMEA.....identifier of [9] SM-RP-SMEA
DEFINED in MAP-SM-DataTypes : 63

SM-RP-SMEA.....type reference OCTET STRING
DEFINED in MAP-SM-DataTypes : 72
USED in MAP-SM-DataTypes : 63

sm-RP-UI.....identifier of SignallInfo
DEFINED in MAP-SM-DataTypes : 110

sm-RP-UI.....identifier of SignallInfo
DEFINED in MAP-SM-DataTypes : 116

sm-RP-UI.....identifier of SignallInfo
DEFINED in MAP-SM-DataTypes : 123

sm-RP-UI.....identifier of SignallInfo
DEFINED in MAP-SM-DataTypes : 129

solsaSupportIndicator.....identifier of [2] NULL
DEFINED in MAP-MS-DataTypes : 230

solsaSupportIndicator.....identifier of NULL
DEFINED in MAP-MS-DataTypes : 434

specificCSIDeletedList.....identifier of [14] SpecificCSI-Withdraw
DEFINED in MAP-MS-DataTypes : 2130

specificCSI-Withdraw.....identifier of [15] SpecificCSI-Withdraw
DEFINED in MAP-MS-DataTypes : 1315

SpecificCSI-Withdraw.....type reference BIT STRING
DEFINED in MAP-MS-DataTypes : 1317
USED in MAP-MS-DataTypes : 1315 2130

sres.....identifier of SRES
DEFINED in MAP-MS-DataTypes : 338

SRES.....type reference OCTET STRING
DEFINED in MAP-MS-DataTypes : 367
USED in MAP-MS-DataTypes : 338

ss-AccessBarred.....identifier of Named Number, 5
DEFINED in MAP-MS-DataTypes : 988

ss-CamelData.....identifier of SS-CamelData
DEFINED in MAP-MS-DataTypes : 1429

SS-CamelData.....type reference SEQUENCE
DEFINED in MAP-MS-DataTypes : 1438
USED in MAP-MS-DataTypes : 1429

ss-Code.....identifier of SS-Code
DEFINED in MAP-SupplementaryServi : 219

ss-Code.....identifier of SS-Code
DEFINED in MAP-MS-DataTypes : 1037

ss-Code.....identifier of SS-Code
DEFINED in MAP-MS-DataTypes : 1096

ss-Code.....identifier of SS-Code
DEFINED in MAP-MS-DataTypes : 1167

ss-Code.....identifier of SS-Code
DEFINED in MAP-MS-DataTypes : 1180

TAG R5.40 Cross Reference Listing for MAP-Protocol 2002-06-07 14:47:03 PAGE 101

ss-Code.....identifier of SS-Code
 DEFINED in MAP-MS-DataTypes : 1268

ss-Code.....identifier of [0] SS-Code
 DEFINED in MAP-MS-DataTypes : 2155

ss-Code.....identifier of [0] SS-Code
 DEFINED in MAP-MS-DataTypes : 2166

ss-Code.....identifier of [0] SS-Code
 DEFINED in MAP-MS-DataTypes : 2237

ss-Code.....identifier of [0] SS-Code
 DEFINED in MAP-MS-DataTypes : 2244

ss-Code.....identifier of [0] SS-Code
 DEFINED in MAP-CommonDataTypes : 478

ss-Code.....identifier of SS-Code
 DEFINED in MAP-SS-DataTypes : 73

ss-Code.....identifier of SS-Code
 DEFINED in MAP-SS-DataTypes : 91

ss-Code.....identifier of SS-Code
 DEFINED in MAP-SS-DataTypes : 149

ss-Code.....identifier of SS-Code
 DEFINED in MAP-SS-DataTypes : 162

ss-Code.....identifier of SS-Code
 DEFINED in MAP-SS-DataTypes : 185

ss-Code.....identifier of [0] SS-Code
 DEFINED in MAP-SS-DataTypes : 306

ss-Code.....identifier of [0] SS-Code
 DEFINED in MAP-SS-DataTypes : 329

ss-Code.....identifier of [0] SS-Code
 DEFINED in MAP-SS-DataTypes : 334

SS-Code.....type reference OCTET STRING
 DEFINED in MAP-SS-Code : 11
 USED in MAP-SupplementaryServi : 78 219
 USED in MAP-MS-DataTypes : 152 1037 1096 1167 1180 1268 1444 2155 2166
 2237 2244
 USED in MAP-CommonDataTypes : 76 478
 USED in MAP-SS-DataTypes : 65 73 91 149 162 185 257 272 306
 329 334
 USED in MAP-SS-Code : 21 25 28 30 32 34 36 40 42
 48 50 52 54 56 58 60 63 66
 68 72 75 77 79 81 84 87 90
 93 96 99 102 104 107 110 112 114
 117 119 121 123 125 128 130 132 136
 137 138 139 140 141 142 143 144 145
 146 147 148 149 150 151 153 156 159
 161 163 166 168 170 173 175 177 180
 USED in MAP-ER-DataTypes : 88 137

ss-Code.....identifier of [1] SS-Code
 DEFINED in MAP-ER-DataTypes : 137

ss-csi.....identifier of Named Number, 1
 DEFINED in MAP-MS-DataTypes : 1319

ss-CSI.....identifier of [2] SS-CSI
 DEFINED in MAP-MS-DataTypes : 1361

SS-CSI.....type reference SEQUENCE
 DEFINED in MAP-MS-DataTypes : 1428
 USED in MAP-MS-DataTypes : 69 1361 2126

ss-CSI.....identifier of Named Number, 6
 DEFINED in MAP-MS-DataTypes : 2082

ss-CSI.....identifier of [11] SS-CSI
DEFINED in MAP-MS-DataTypes : 2126

ss-Data.....identifier of [3] Ext-SS-Data
DEFINED in MAP-MS-DataTypes : 1032

TAG R5.40 Cross Reference Listing for MAP-Protocol 2002-06-07 14:47:03 PAGE 102

ss-Data.....identifier of [3] SS-Data
 DEFINED in MAP-SS-DataTypes : 88

SS-Data.....type reference SEQUENCE
 DEFINED in MAP-SS-DataTypes : 161
 USED in MAP-SS-DataTypes : 33 88

ss-ErrorStatus.....value reference SS-ErrorStatus, CHOICE VALUE
 DEFINED in MAP-Protocol : 421

SS-ErrorStatus.....type reference ERROR
 DEFINED in MAP-Errors : 358
 USED in MAP-Protocol : 154 421
 USED in MAP-MobileServiceOpera : 101 290
 USED in MAP-SupplementaryServi : 41 101 118 135 155 262 279
 USED in MAP-Errors : 64

ss-Event.....identifier of [2] SS-Code
 DEFINED in MAP-SS-DataTypes : 272

ss-EventList.....identifier of SS-EventList
 DEFINED in MAP-MS-DataTypes : 1439

SS-EventList.....type reference SEQUENCE OF
 DEFINED in MAP-MS-DataTypes : 1444
 USED in MAP-MS-DataTypes : 1439

ss-EventSpecification.....identifier of [3] SS-EventSpecification
 DEFINED in MAP-SS-DataTypes : 278

SS-EventSpecification.....type reference SEQUENCE OF
 DEFINED in MAP-SS-DataTypes : 300
 USED in MAP-SS-DataTypes : 278

ss-ForBS.....identifier of SS-ForBS-Code
 DEFINED in MAP-SupplementaryServi : 106

ss-ForBS.....identifier of SS-ForBS-Code
 DEFINED in MAP-SupplementaryServi : 123

ss-ForBS.....identifier of SS-ForBS-Code
 DEFINED in MAP-SupplementaryServi : 143

ss-ForBS.....identifier of SS-ForBS-Code
 DEFINED in MAP-SupplementaryServi : 162

SS-ForBS-Code.....type reference SEQUENCE
 DEFINED in MAP-SS-DataTypes : 184
 USED in MAP-SupplementaryServi : 62 106 123 143 162
 USED in MAP-MS-DataTypes : 146 2064
 USED in MAP-SS-DataTypes : 18

ss-Incompatibility.....value reference SS-Incompatibility, CHOICE VALUE
 DEFINED in MAP-Protocol : 424

SS-Incompatibility.....type reference ERROR
 DEFINED in MAP-Errors : 375
 USED in MAP-Protocol : 157 424
 USED in MAP-MobileServiceOpera : 103 291
 USED in MAP-SupplementaryServi : 44 102 137 263
 USED in MAP-Errors : 67

ss-IncompatibilityCause.....identifier of SS-IncompatibilityCause
 DEFINED in MAP-Errors : 377

SS-IncompatibilityCause.....type reference SEQUENCE
 DEFINED in MAP-ER-DataTypes : 136
 USED in MAP-Errors : 110 377
 USED in MAP-ER-DataTypes : 17

ss-Info.....identifier of SS-Info
 DEFINED in MAP-SupplementaryServi : 91

ss-Info.....identifier of SS-Info
 DEFINED in MAP-SupplementaryServi : 108

ss-Info.....identifier of SS-Info
DEFINED in MAP-SupplementaryServi : 125

ss-Info.....identifier of SS-Info
DEFINED in MAP-SupplementaryServi : 145

TAG R5.40 Cross Reference Listing for MAP-Protocol 2002-06-07 14:47:03 PAGE 103

SS-Info.....type reference CHOICE
 DEFINED in MAP-SS-DataTypes : 85
 USED in MAP-SupplementaryServi : 61 91 108 125 145
 USED in MAP-SS-DataTypes : 15 262

ss-InfoFor-CSE.....identifier of [0] Ext-SS-InfoFor-CSE
 DEFINED in MAP-MS-DataTypes : 2148

SS-InfoList.....type reference SEQUENCE OF
 DEFINED in MAP-SS-DataTypes : 261
 USED in MAP-SS-DataTypes : 27

ss-InvocationNotification.....value reference SS-InvocationNotification, CHOICE VALUE
 DEFINED in MAP-Protocol : 301

SS-InvocationNotification.....type reference OPERATION
 DEFINED in MAP-SupplementaryServi : 240
 USED in MAP-Protocol : 79 301
 USED in MAP-SupplementaryServi : 23

ss-InvocationNotificationArg.....identifier of SS-InvocationNotificationArg
 DEFINED in MAP-SupplementaryServi : 242

SS-InvocationNotificationArg.....type reference SEQUENCE
 DEFINED in MAP-SS-DataTypes : 269
 USED in MAP-SupplementaryServi : 68 242
 USED in MAP-SS-DataTypes : 34

ss-InvocationNotificationRes.....identifier of SS-InvocationNotificationRes
 DEFINED in MAP-SupplementaryServi : 244

SS-InvocationNotificationRes.....type reference SEQUENCE
 DEFINED in MAP-SS-DataTypes : 295
 USED in MAP-SupplementaryServi : 69 244
 USED in MAP-SS-DataTypes : 35

ss-List.....identifier of [3] SS-List
 DEFINED in MAP-MS-DataTypes : 1284

ss-List.....identifier of [2] SS-List
 DEFINED in MAP-MS-DataTypes : 1302

ss-List.....identifier of [1] SS-List
 DEFINED in MAP-CH-DataTypes : 158

SS-List.....type reference SEQUENCE OF
 DEFINED in MAP-SS-DataTypes : 256
 USED in MAP-MS-DataTypes : 145 1284 1302
 USED in MAP-CH-DataTypes : 57 158
 USED in MAP-SS-DataTypes : 26

ss-NotAvailable.....value reference SS-NotAvailable, CHOICE VALUE
 DEFINED in MAP-Protocol : 422

SS-NotAvailable.....type reference ERROR
 DEFINED in MAP-Errors : 363
 USED in MAP-Protocol : 155 422
 USED in MAP-MobileServiceOpera : 102 272
 USED in MAP-SupplementaryServi : 42 173
 USED in MAP-Errors : 65

ss-NotAvailableParam.....identifier of SS-NotAvailableParam
 DEFINED in MAP-Errors : 365

SS-NotAvailableParam.....type reference SEQUENCE
 DEFINED in MAP-ER-DataTypes : 306
 USED in MAP-Errors : 152 365
 USED in MAP-ER-DataTypes : 58

ss-Status.....identifier of SS-Status
 DEFINED in MAP-Errors : 360

ss-Status.....identifier of [4] Ext-SS-Status
 DEFINED in MAP-MS-DataTypes : 1047

ss-Status.....identifier of [4] Ext-SS-Status
DEFINED in MAP-MS-DataTypes : 1106

ss-Status.....identifier of [4] Ext-SS-Status
DEFINED in MAP-MS-DataTypes : 1168

ss-Status.....identifier of Ext-SS-Status

TAG R5.40 Cross Reference Listing for MAP-Protocol 2002-06-07 14:47:03 PAGE 104

DEFINED in MAP-MS-DataTypes : 1181

ss-Status.....identifier of Ext-SS-Status
DEFINED in MAP-MS-DataTypes : 1269

ss-Status.....identifier of [2] Ext-SS-Status
DEFINED in MAP-MS-DataTypes : 2157

ss-Status.....identifier of [2] Ext-SS-Status
DEFINED in MAP-MS-DataTypes : 2168

ss-Status.....identifier of [1] Ext-SS-Status
DEFINED in MAP-CommonDataTypes : 479

ss-Status.....identifier of [4] SS-Status
DEFINED in MAP-SS-DataTypes : 101

SS-Status.....type reference OCTET STRING
DEFINED in MAP-SS-DataTypes : 109
USED in MAP-Errors : 105 360
USED in MAP-SS-DataTypes : 16 101 158 163 191 216 335
USED in MAP-ER-DataTypes : 69 139

ss-Status.....identifier of [4] SS-Status
DEFINED in MAP-SS-DataTypes : 158

ss-Status.....identifier of [4] SS-Status
DEFINED in MAP-SS-DataTypes : 163

ss-Status.....identifier of SS-Status
DEFINED in MAP-SS-DataTypes : 191

ss-Status.....identifier of [0] SS-Status
DEFINED in MAP-SS-DataTypes : 216

ss-Status.....identifier of [1] SS-Status
DEFINED in MAP-SS-DataTypes : 335

ss-Status.....identifier of [4] SS-Status
DEFINED in MAP-ER-DataTypes : 139

ss-SubscriptionOption.....identifier of SS-SubscriptionOption
DEFINED in MAP-MS-DataTypes : 1169

ss-SubscriptionOption.....identifier of SS-SubscriptionOption
DEFINED in MAP-SS-DataTypes : 164

SS-SubscriptionOption.....type reference CHOICE
DEFINED in MAP-SS-DataTypes : 171
USED in MAP-MS-DataTypes : 144 1169
USED in MAP-SS-DataTypes : 17 164

ss-SubscriptionViolation.....value reference SS-SubscriptionViolation, CHOICE VALUE
DEFINED in MAP-Protocol : 423

SS-SubscriptionViolation.....type reference ERROR
DEFINED in MAP-Errors : 369
USED in MAP-Protocol : 156 423
USED in MAP-MobileServiceOpera : 104 289
USED in MAP-SupplementaryServi : 43 136 156 227
USED in MAP-Errors : 66

ss-SubscriptionViolationParam.....identifier of SS-SubscriptionViolationParam
DEFINED in MAP-Errors : 371

SS-SubscriptionViolationParam.....type reference SEQUENCE
DEFINED in MAP-ER-DataTypes : 310
USED in MAP-Errors : 153 371
USED in MAP-ER-DataTypes : 59

startMonitoring.....identifier of Named Number, 1
DEFINED in MAP-CH-DataTypes : 331

stateAttributes.....identifier of [5] StateAttributes
DEFINED in MAP-GR-DataTypes : 84

StateAttributes.....type reference SEQUENCE

DEFINED in MAP-GR-DataTypes : 118

USED in MAP-GR-DataTypes : 84

statusReport.....value reference StatusReport, CHOICE VALUE

DEFINED in MAP-Protocol : 249

TAG R5.40 Cross Reference Listing for MAP-Protocol 2002-06-07 14:47:03 PAGE 105

StatusReport.....type reference OPERATION
DEFINED in MAP-CallHandlingOperat : 167
USED in MAP-Protocol : 60 249
USED in MAP-CallHandlingOperat : 19

statusReportArg.....identifier of StatusReportArg
DEFINED in MAP-CallHandlingOperat : 169

StatusReportArg.....type reference SEQUENCE
DEFINED in MAP-CH-DataTypes : 352
USED in MAP-CallHandlingOperat : 66 169
USED in MAP-CH-DataTypes : 29

statusReportRes.....identifier of StatusReportRes
DEFINED in MAP-CallHandlingOperat : 171

StatusReportRes.....type reference SEQUENCE
DEFINED in MAP-CH-DataTypes : 388
USED in MAP-CallHandlingOperat : 67 171
USED in MAP-CH-DataTypes : 30

stopMonitoring.....identifier of Named Number, 0
DEFINED in MAP-CH-DataTypes : 330

storedMSISDN.....identifier of ISDN-AddressString
DEFINED in MAP-SM-DataTypes : 173

storedMSISDN.....identifier of ISDN-AddressString
DEFINED in MAP-SM-DataTypes : 184

subBusyForMT-SMS-Param.....identifier of SubBusyForMT-SMS-Param
DEFINED in MAP-Errors : 407

SubBusyForMT-SMS-Param.....type reference SEQUENCE
DEFINED in MAP-ER-DataTypes : 318
USED in MAP-Errors : 136 407
USED in MAP-ER-DataTypes : 40

subscriberBusyForMT-SMS.....value reference SubscriberBusyForMT-SMS, CHOICE VALUE
DEFINED in MAP-Protocol : 437

SubscriberBusyForMT-SMS.....type reference ERROR
DEFINED in MAP-Errors : 405
USED in MAP-Protocol : 163 437
USED in MAP-ShortMessageServic : 37 107
USED in MAP-Errors : 77

SubscriberData.....type reference SEQUENCE
DEFINED in MAP-MS-DataTypes : 937
USED in MAP-MS-DataTypes : 60 734

subscriberDataStored.....identifier of [1] AgeIndicator
DEFINED in MAP-MS-DataTypes : 238

SubscriberId.....type reference CHOICE
DEFINED in MAP-CommonDataTypes : 316
USED in MAP-CommonDataTypes : 32

subscriberIdentity.....identifier of [0] SubscriberIdentity
DEFINED in MAP-MS-DataTypes : 2031

subscriberIdentity.....identifier of [0] SubscriberIdentity
DEFINED in MAP-MS-DataTypes : 2046

subscriberIdentity.....identifier of [0] SubscriberIdentity
DEFINED in MAP-MS-DataTypes : 2137

SubscriberIdentity.....type reference CHOICE
DEFINED in MAP-CommonDataTypes : 373
USED in MAP-MS-DataTypes : 185 2031 2046 2137
USED in MAP-CommonDataTypes : 41
USED in MAP-LCS-DataTypes : 35 69 82

subscriberInfo.....identifier of SubscriberInfo

DEFINED in MAP-MS-DataTypes : 1843

SubscriberInfo.....type reference SEQUENCE

DEFINED in MAP-MS-DataTypes : 1847

USED in MAP-MS-DataTypes : 101 1843 2038

USED in MAP-CH-DataTypes : 40 157

TAG R5.40 Cross Reference Listing for MAP-Protocol 2002-06-07 14:47:03 PAGE 106

subscriberInfo.....identifier of SubscriberInfo
 DEFINED in MAP-MS-DataTypes : 2038

subscriberInfo.....identifier of [7] SubscriberInfo
 DEFINED in MAP-CH-DataTypes : 157

subscriberLocationReport.....value reference SubscriberLocationReport, CHOICE VALUE
 DEFINED in MAP-Protocol : 332

SubscriberLocationReport.....type reference OPERATION
 DEFINED in MAP-LocationServiceOpe : 84
 USED in MAP-Protocol : 110 332
 USED in MAP-LocationServiceOpe : 15

subscriberLocationReport-Arg.....identifier of SubscriberLocationReport-Arg
 DEFINED in MAP-LocationServiceOpe : 86

SubscriberLocationReport-Arg.....type reference SEQUENCE
 DEFINED in MAP-LCS-DataTypes : 346
 USED in MAP-LocationServiceOpe : 45 86
 USED in MAP-LCS-DataTypes : 15

subscriberLocationReport-Res.....identifier of SubscriberLocationReport-Res
 DEFINED in MAP-LocationServiceOpe : 88

SubscriberLocationReport-Res.....type reference SEQUENCE
 DEFINED in MAP-LCS-DataTypes : 411
 USED in MAP-LocationServiceOpe : 46 88
 USED in MAP-LCS-DataTypes : 16

subscriberNotMemberOfCUG.....identifier of Named Number, 1
 DEFINED in MAP-ER-DataTypes : 132

subscriberNotSC-Subscriber.....identifier of Named Number, 6
 DEFINED in MAP-ER-DataTypes : 155

subscriberState.....identifier of [1] SubscriberState
 DEFINED in MAP-MS-DataTypes : 1849

subscriberState.....identifier of [1] NULL
 DEFINED in MAP-MS-DataTypes : 1883

SubscriberState.....type reference CHOICE
 DEFINED in MAP-MS-DataTypes : 1966
 USED in MAP-MS-DataTypes : 105 1849

subscriberStatus.....identifier of [3] SubscriberStatus
 DEFINED in MAP-MS-DataTypes : 940

SubscriberStatus.....type reference ENUMERATED
 DEFINED in MAP-MS-DataTypes : 959
 USED in MAP-MS-DataTypes : 62 940

subscriptionWithdraw.....identifier of Named Number, 1
 DEFINED in MAP-MS-DataTypes : 280

subsequentHandoverFailure.....value reference SubsequentHandoverFailure, CHOICE VALUE
 DEFINED in MAP-Protocol : 379

SubsequentHandoverFailure.....type reference ERROR
 DEFINED in MAP-Errors : 261
 USED in MAP-Protocol : 141 379
 USED in MAP-MobileServiceOpera : 92 346
 USED in MAP-Errors : 37

success.....identifier of Named Number, 0
 DEFINED in MAP-CH-DataTypes : 379

successfulTransfer.....identifier of Named Number, 2
 DEFINED in MAP-SM-DataTypes : 170

SuperChargerInfo.....type reference CHOICE
 DEFINED in MAP-MS-DataTypes : 236
 USED in MAP-MS-DataTypes : 232 437

superChargerSupportedInHLR.....identifier of [27] AgeIndicator
DEFINED in MAP-MS-DataTypes : 747

superChargerSupportedInServingNetworkEntidentifier of [3] SuperChargerInfo
DEFINED in MAP-MS-DataTypes : 232

superChargerSupportedInServingNetworkEntidentifier of [2] SuperChargerInfo

TAG R5.40 Cross Reference Listing for MAP-Protocol 2002-06-07 14:47:03 PAGE 107

DEFINED in MAP-MS-DataTypes : 437

supplementaryService.....identifier of Named Number, 3
DEFINED in MAP-MS-DataTypes : 402

supportedCamelPhases.....identifier of [0] SupportedCamelPhases
DEFINED in MAP-MS-DataTypes : 227

supportedCamelPhases.....identifier of [4] SupportedCamelPhases
DEFINED in MAP-MS-DataTypes : 439

supportedCamelPhases.....identifier of [6] SupportedCamelPhases
DEFINED in MAP-MS-DataTypes : 1287

SupportedCamelPhases.....type reference BIT STRING
DEFINED in MAP-MS-DataTypes : 1585
USED in MAP-MS-DataTypes : 74 227 439 1287 2058 2059 2221
USED in MAP-CH-DataTypes : 41 170 218 264

supportedCAMELPhases.....identifier of [5] SupportedCamelPhases
DEFINED in MAP-MS-DataTypes : 2221

supportedCamelPhases.....identifier of [15] SupportedCamelPhases
DEFINED in MAP-CH-DataTypes : 170

supportedCamelPhases.....identifier of SupportedCamelPhases
DEFINED in MAP-CH-DataTypes : 264

supportedCamelPhasesInGMSC.....identifier of [15] SupportedCamelPhases
DEFINED in MAP-CH-DataTypes : 218

supportedCCBS-Phase.....identifier of [16] SupportedCCBS-Phase
DEFINED in MAP-CH-DataTypes : 112

SupportedCCBS-Phase.....type reference INTEGER
DEFINED in MAP-CH-DataTypes : 138
USED in MAP-CH-DataTypes : 112

supportedGADShapes.....identifier of [9] SupportedGADShapes
DEFINED in MAP-LCS-DataTypes : 117

SupportedGADShapes.....type reference BIT STRING
DEFINED in MAP-LCS-DataTypes : 226
USED in MAP-LCS-DataTypes : 23 117

supportedLCS-CapabilitySets.....identifier of [5] SupportedLCS-CapabilitySets
DEFINED in MAP-MS-DataTypes : 234

SupportedLCS-CapabilitySets.....type reference BIT STRING
DEFINED in MAP-MS-DataTypes : 251
USED in MAP-MS-DataTypes : 27 234 440

supportedLCS-CapabilitySets.....identifier of [5] SupportedLCS-CapabilitySets
DEFINED in MAP-MS-DataTypes : 440

supportedSGSN-CAMEL-Phases.....identifier of [6] SupportedCamelPhases
DEFINED in MAP-MS-DataTypes : 2059

supportedSGSN-CAMEL-Phases.....identifier of [5] NULL
DEFINED in MAP-MS-DataTypes : 2068

supportedVLR-CAMEL-Phases.....identifier of [5] SupportedCamelPhases
DEFINED in MAP-MS-DataTypes : 2058

supportedVLR-CAMEL-Phases.....identifier of [4] NULL
DEFINED in MAP-MS-DataTypes : 2067

suppressIncomingCallBarring.....identifier of [23] NULL
DEFINED in MAP-CH-DataTypes : 119

suppressionOfAnnouncement.....identifier of [12] SuppressionOfAnnouncement
DEFINED in MAP-CH-DataTypes : 107

SuppressionOfAnnouncement.....type reference NULL
DEFINED in MAP-CH-DataTypes : 123

USED in MAP-CH-DataTypes : 21 107 210

suppressionOfAnnouncement.....identifier of [7] SuppressionOfAnnouncement
DEFINED in MAP-CH-DataTypes : 210

suppress-T-CSI.....identifier of NULL
DEFINED in MAP-CH-DataTypes : 265

TAG R5.40 Cross Reference Listing for MAP-Protocol

2002-06-07 14:47:03 PAGE 108

suppress-VT-CSI.....identifier of [22] NULL
 DEFINED in MAP-CH-DataTypes : 118

suppress-VT-CSI.....identifier of [19] NULL
 DEFINED in MAP-CH-DataTypes : 223

suspended.....identifier of Named Number, 4
 DEFINED in MAP-SS-DataTypes : 290

systemFailure.....value reference SystemFailure, CHOICE VALUE
 DEFINED in MAP-Protocol : 347

SystemFailure.....type reference ERROR
 DEFINED in MAP-Errors : 169
 USED in MAP-Protocol : 126 347
 USED in MAP-MobileServiceOpera : 82 182 226 250 316 362 374 386 428
 442 457 471
 USED in MAP-OperationAndMainte : 23 57 71
 USED in MAP-CallHandlingOperat : 30 87 110 139 151 160 175 189 202
 215
 USED in MAP-SupplementaryServi : 33 94 111 128 148 166 181 194 208
 223 257 274
 USED in MAP-ShortMessageServic : 27 72 88 100 128
 USED in MAP-Group-Call-Operati : 24 52
 USED in MAP-LocationServiceOpe : 23 58 72 90
 USED in MAP-Errors : 14

systemFailureParam.....identifier of SystemFailureParam
 DEFINED in MAP-Errors : 171

SystemFailureParam.....type reference CHOICE
 DEFINED in MAP-ER-DataTypes : 177
 USED in MAP-Errors : 113 171
 USED in MAP-ER-DataTypes : 20

targetCellId.....identifier of [0] GlobalCellId
 DEFINED in MAP-MS-DataTypes : 508

targetCellId.....identifier of [0] GlobalCellId
 DEFINED in MAP-MS-DataTypes : 596

targetCellOutsideGCA-Param.....identifier of TargetCellOutsideGCA-Param
 DEFINED in MAP-Errors : 265

TargetCellOutsideGCA-Param.....type reference SEQUENCE
 DEFINED in MAP-ER-DataTypes : 394
 USED in MAP-Errors : 155 265
 USED in MAP-ER-DataTypes : 61

targetCellOutsideGroupCallArea.....value reference TargetCellOutsideGroupCallArea, CHOICE VALUE
 DEFINED in MAP-Protocol : 381

TargetCellOutsideGroupCallArea.....type reference ERROR
 DEFINED in MAP-Errors : 263
 USED in MAP-Protocol : 180 381
 USED in MAP-MobileServiceOpera : 106 320
 USED in MAP-Errors : 38

targetMS.....identifier of [1] SubscriberIdentity
 DEFINED in MAP-LCS-DataTypes : 69

targetMS.....identifier of [0] SubscriberIdentity
 DEFINED in MAP-LCS-DataTypes : 82

targetMSC-Number.....identifier of [1] ISDN-AddressString
 DEFINED in MAP-MS-DataTypes : 597

targetMSsubscribedService.....identifier of Named Number, 4
 DEFINED in MAP-CommonDataTypes : 388

targetRNCId.....identifier of [1] RNCId
 DEFINED in MAP-MS-DataTypes : 510

targetRNCId.....identifier of [2] RNCId

DEFINED in MAP-MS-DataTypes : 598

TBCD-STRING.....type reference OCTET STRING

DEFINED in MAP-CommonDataTypes : 90

USED in MAP-CommonDataTypes : 297 310 320

tBusy.....identifier of Named Number, 13

TAG R5.40 Cross Reference Listing for MAP-Protocol

2002-06-07 14:47:03 PAGE 109

DEFINED in MAP-MS-DataTypes : 1734

TCAPMessages.....module reference
 DEFINED in TCAPMessages : 1
 USED in MAP-MobileServiceOpera : 79
 USED in MAP-OperationAndMainte : 20
 USED in MAP-CallHandlingOperat : 27
 USED in MAP-SupplementaryServi : 30
 USED in MAP-ShortMessageServic : 24
 USED in MAP-Group-Call-Operati : 21
 USED in MAP-LocationServiceOpe : 20
 USED in MAP-SecureTransportOpe : 21
 USED in MAP-Errors : 102

TEID.....type reference OCTET STRING
 DEFINED in MAP-MS-DataTypes : 2012
 USED in MAP-MS-DataTypes : 1992 1993

teid-ForGnAndGp.....identifier of [8] TEID
 DEFINED in MAP-MS-DataTypes : 1992

teid-Forlu.....identifier of [9] TEID
 DEFINED in MAP-MS-DataTypes : 1993

telephony.....value reference TeleserviceCode, '00010001'B
 DEFINED in MAP-TS-Code : 41

teleservice.....identifier of [3] TeleserviceCode
 DEFINED in MAP-CommonDataTypes : 450

teleservice.....identifier of Ext-TeleserviceCode
 DEFINED in MAP-GR-DataTypes : 50

TeleserviceCode.....type reference OCTET STRING
 DEFINED in MAP-TS-Code : 11
 USED in MAP-CommonDataTypes : 64 450
 USED in MAP-TS-Code : 38 40 41 42 44 45 46 48 49
 50 51 55 58 67 68 69 71 72
 73 74 75 76 77 78 79 80 81
 82 83 84 85 86

teleserviceList.....identifier of [6] TeleserviceList
 DEFINED in MAP-MS-DataTypes : 944

TeleserviceList.....type reference SEQUENCE OF
 DEFINED in MAP-MS-DataTypes : 968
 USED in MAP-MS-DataTypes : 944 1282

teleserviceList.....identifier of [1] TeleserviceList
 DEFINED in MAP-MS-DataTypes : 1282

teleserviceNotProvisioned.....value reference TeleserviceNotProvisioned, CHOICE VALUE
 DEFINED in MAP-Protocol : 371

TeleserviceNotProvisioned.....type reference ERROR
 DEFINED in MAP-Errors : 250
 USED in MAP-Protocol : 139 371
 USED in MAP-MobileServiceOpera : 98 269 286
 USED in MAP-CallHandlingOperat : 38 95
 USED in MAP-SupplementaryServi : 38 98 115 132 152 170
 USED in MAP-ShortMessageServic : 35 77
 USED in MAP-Errors : 33

teleservNotProvParam.....identifier of TeleservNotProvParam
 DEFINED in MAP-Errors : 252

TeleservNotProvParam.....type reference SEQUENCE
 DEFINED in MAP-ER-DataTypes : 241
 USED in MAP-Errors : 124 252
 USED in MAP-ER-DataTypes : 31

temporaryDefaultAllowed.....identifier of Named Number, 2
 DEFINED in MAP-SS-DataTypes : 178

temporaryDefaultRestricted.....identifier of Named Number, 1

DEFINED in MAP-SS-DataTypes : 177

termAttemptAuthorized.....identifier of Named Number, 12
DEFINED in MAP-MS-DataTypes : 1732

terminateAllCallActivities.....identifier of Named Number, 1
DEFINED in MAP-CH-DataTypes : 446

TAG R5.40 Cross Reference Listing for MAP-Protocol 2002-06-07 14:47:03 PAGE 110

terminateCallActivityReferred.....identifier of Named Number, 0
DEFINED in MAP-CH-DataTypes : 445

terminationCause.....identifier of [0] TerminationCause
DEFINED in MAP-LCS-DataTypes : 378

TerminationCause.....type reference ENUMERATED
DEFINED in MAP-LCS-DataTypes : 394
USED in MAP-LCS-DataTypes : 378

tif-csi.....identifier of Named Number, 2
DEFINED in MAP-MS-DataTypes : 1320

tif-CSI.....identifier of [3] NULL
DEFINED in MAP-MS-DataTypes : 1363

tif-CSI.....identifier of Named Number, 3
DEFINED in MAP-MS-DataTypes : 2079

tif-CSI.....identifier of [7] NULL
DEFINED in MAP-MS-DataTypes : 2122

tif-CSI-NotificationToCSE.....identifier of [8] NULL
DEFINED in MAP-MS-DataTypes : 2123

tmsi.....identifier of TMSI
DEFINED in MAP-MS-DataTypes : 303

TMSI.....type reference OCTET STRING
DEFINED in MAP-CommonDataTypes : 314
USED in MAP-MS-DataTypes : 175 303
USED in MAP-CommonDataTypes : 30 318

tmsi.....identifier of [1] TMSI
DEFINED in MAP-CommonDataTypes : 318

tNoAnswer.....identifier of Named Number, 14
DEFINED in MAP-MS-DataTypes : 1735

tooManyZoneCodes.....identifier of Named Number, 1
DEFINED in MAP-MS-DataTypes : 1293

tpdu-TypeCriterion.....identifier of [0] TPDU-TypeCriterion
DEFINED in MAP-MS-DataTypes : 1378

TPDU-TypeCriterion.....type reference SEQUENCE OF
DEFINED in MAP-MS-DataTypes : 1381
USED in MAP-MS-DataTypes : 1378

traceReference.....identifier of [1] TraceReference
DEFINED in MAP-OM-DataTypes : 38

TraceReference.....type reference OCTET STRING
DEFINED in MAP-OM-DataTypes : 44
USED in MAP-OM-DataTypes : 38 56

traceReference.....identifier of [1] TraceReference
DEFINED in MAP-OM-DataTypes : 56

traceType.....identifier of [2] TraceType
DEFINED in MAP-OM-DataTypes : 39

TraceType.....type reference INTEGER
DEFINED in MAP-OM-DataTypes : 46
USED in MAP-OM-DataTypes : 39

tracingBufferFull.....value reference TracingBufferFull, CHOICE VALUE
DEFINED in MAP-Protocol : 388

TracingBufferFull.....type reference ERROR
DEFINED in MAP-Errors : 271
USED in MAP-Protocol : 142 388
USED in MAP-OperationAndMainte : 29 62
USED in MAP-Errors : 41

tracingBufferFullParam.....identifier of TracingBufferFullParam
DEFINED in MAP-Errors : 273

TracingBufferFullParam.....type reference SEQUENCE
DEFINED in MAP-ER-DataTypes : 245
USED in MAP-Errors : 125 273

TAG R5.40 Cross Reference Listing for MAP-Protocol 2002-06-07 14:47:03 PAGE 111

USED in MAP-ER-DataTypes : 32

trafficCongestionReporting.....value reference LCSServiceTypeID, 5
DEFINED in MAP-CommonDataTypes : 401

TransactionID.....type reference OCTET STRING
DEFINED in TCAPMessages : 100
USED in TCAPMessages : 47 97 98

transactionId.....identifier of [7] TransactionId
DEFINED in MAP-MS-DataTypes : 1991

TransactionId.....type reference OCTET STRING
DEFINED in MAP-MS-DataTypes : 2007
USED in MAP-MS-DataTypes : 1991

transferToThirdParty.....value reference SS-Code, '11000011'B
DEFINED in MAP-SS-Code : 180

translatedB-Number.....identifier of [3] ISDN-AddressString
DEFINED in MAP-CH-DataTypes : 396

translatedB-Number.....identifier of [1] ISDN-AddressString
DEFINED in MAP-SS-DataTypes : 312

tripletList.....identifier of [0] TripletList
DEFINED in MAP-MS-DataTypes : 327

TripletList.....type reference SEQUENCE OF
DEFINED in MAP-MS-DataTypes : 330
USED in MAP-MS-DataTypes : 327

ts3G-25413.....identifier of Named Number, 2
DEFINED in MAP-CommonDataTypes : 260

ts3G-48006.....identifier of Named Number, 1
DEFINED in MAP-CommonDataTypes : 259

T-BcsmCamelTDPData.....type reference SEQUENCE
DEFINED in MAP-MS-DataTypes : 1723
USED in MAP-MS-DataTypes : 1716

t-BcsmCamelTDPDataList.....identifier of T-BcsmCamelTDPDataList
DEFINED in MAP-MS-DataTypes : 1705

T-BcsmCamelTDPDataList.....type reference SEQUENCE OF
DEFINED in MAP-MS-DataTypes : 1715
USED in MAP-MS-DataTypes : 1705

t-BcsmTriggerDetectionPoint.....identifier of T-BcsmTriggerDetectionPoint
DEFINED in MAP-MS-DataTypes : 1724

T-BcsmTriggerDetectionPoint.....type reference ENUMERATED
DEFINED in MAP-MS-DataTypes : 1731
USED in MAP-MS-DataTypes : 85 1515 1724

T-BCSM-CAMEL-TDP-Criteria.....type reference SEQUENCE
DEFINED in MAP-MS-DataTypes : 1514
USED in MAP-MS-DataTypes : 1503

t-BCSM-CAMEL-TDP-CriteriaList.....identifier of [8] T-BCSM-CAMEL-TDP-CriteriaList
DEFINED in MAP-MS-DataTypes : 1367

T-BCSM-CAMEL-TDP-CriteriaList.....type reference SEQUENCE OF
DEFINED in MAP-MS-DataTypes : 1502
USED in MAP-MS-DataTypes : 68 1367 2119 2121
USED in MAP-CH-DataTypes : 46 285

t-BCSM-CAMEL-TDP-CriteriaList.....identifier of [4] T-BCSM-CAMEL-TDP-CriteriaList
DEFINED in MAP-MS-DataTypes : 2119

t-BCSM-CAMEL-TDP-CriteriaList.....identifier of [4] T-BCSM-CAMEL-TDP-CriteriaList
DEFINED in MAP-CH-DataTypes : 285

t-BCSM-TriggerDetectionPoint.....identifier of T-BcsmTriggerDetectionPoint

DEFINED in MAP-MS-DataTypes : 1515

t-CauseValueCriteria.....identifier of [1] T-CauseValueCriteria
DEFINED in MAP-MS-DataTypes : 1517

T-CauseValueCriteria.....type reference SEQUENCE OF
DEFINED in MAP-MS-DataTypes : 1558

TAG R5.40 Cross Reference Listing for MAP-Protocol 2002-06-07 14:47:03 PAGE 112

USED in MAP-MS-DataTypes : 1517

t-csi.....identifier of Named Number, 8
DEFINED in MAP-MS-DataTypes : 1326

T-CSI.....type reference SEQUENCE
DEFINED in MAP-MS-DataTypes : 1704
USED in MAP-MS-DataTypes : 84 1366 2118 2120
USED in MAP-CH-DataTypes : 49 280

t-CSI.....identifier of Named Number, 1
DEFINED in MAP-MS-DataTypes : 2077

t-CSI.....identifier of [3] T-CSI
DEFINED in MAP-MS-DataTypes : 2118

t-CSI.....identifier of [0] T-CSI
DEFINED in MAP-CH-DataTypes : 280

udubFromBusyMS.....identifier of Named Number, 5
DEFINED in MAP-CH-DataTypes : 413

udubFromFreeMS.....identifier of Named Number, 4
DEFINED in MAP-CH-DataTypes : 412

umts-SecurityContextData.....identifier of [1] UMTS-SecurityContextData
DEFINED in MAP-MS-DataTypes : 352

UMTS-SecurityContextData.....type reference SEQUENCE
DEFINED in MAP-MS-DataTypes : 359
USED in MAP-MS-DataTypes : 352

unauthorisedMessageOriginator.....identifier of [1] NULL
DEFINED in MAP-ER-DataTypes : 123

unauthorizedLCSCClient.....value reference UnauthorizedLCSCClient, CHOICE VALUE
DEFINED in MAP-Protocol : 445

UnauthorizedLCSCClient.....type reference ERROR
DEFINED in MAP-Errors : 438
USED in MAP-Protocol : 173 445
USED in MAP-LocationServiceOpe : 30 81
USED in MAP-Errors : 87

unauthorizedLCSCClient-Diagnostic.....identifier of [0] UnauthorizedLCSCClient-Diagnostic
DEFINED in MAP-ER-DataTypes : 352

UnauthorizedLCSCClient-Diagnostic.....type reference ENUMERATED
DEFINED in MAP-ER-DataTypes : 356
USED in MAP-ER-DataTypes : 352

unauthorizedLCSCClient-Param.....identifier of UnauthorizedLCSCClient-Param
DEFINED in MAP-Errors : 440

UnauthorizedLCSCClient-Param.....type reference SEQUENCE
DEFINED in MAP-ER-DataTypes : 351
USED in MAP-Errors : 145 440
USED in MAP-ER-DataTypes : 50

unauthorizedRequestingNetwork.....value reference UnauthorizedRequestingNetwork, CHOICE VALUE
DEFINED in MAP-Protocol : 444

UnauthorizedRequestingNetwork.....type reference ERROR
DEFINED in MAP-Errors : 433
USED in MAP-Protocol : 172 444
USED in MAP-LocationServiceOpe : 29 64 80 95
USED in MAP-Errors : 86

unauthorizedRequestingNetwork-Param.....identifier of UnauthorizedRequestingNetwork-Param
DEFINED in MAP-Errors : 435

UnauthorizedRequestingNetwork-Param.....type reference SEQUENCE
DEFINED in MAP-ER-DataTypes : 347
USED in MAP-Errors : 144 435
USED in MAP-ER-DataTypes : 49

undetermined.....identifier of Named Number, 0
DEFINED in MAP-ER-DataTypes : 143

unexpectedDataParam.....identifier of UnexpectedDataParam
DEFINED in MAP-Errors : 182

TAG R5.40 Cross Reference Listing for MAP-Protocol 2002-06-07 14:47:03 PAGE 113

UnexpectedDataParam.....type reference SEQUENCE
 DEFINED in MAP-ER-DataTypes : 193
 USED in MAP-Errors : 115 182
 USED in MAP-ER-DataTypes : 22

unexpectedDataValue.....value reference UnexpectedDataValue, CHOICE VALUE
 DEFINED in MAP-Protocol : 349

UnexpectedDataValue.....type reference ERROR
 DEFINED in MAP-Errors : 180
 USED in MAP-Protocol : 128 349
 USED in MAP-MobileServiceOpera : 84 184 196 206 227 240 253 266 283
 304 318 343 364 375 400 411 430 444
 459 473 484
 USED in MAP-OperationAndMainte : 25 59 73 84
 USED in MAP-CallHandlingOperat : 32 89 112 127 138 150 162 176 185
 199 212
 USED in MAP-SupplementaryServi : 35 96 113 130 150 168 183 196 210
 225 248 259 276
 USED in MAP-ShortMessageServic : 29 74 89 102 119 130 144
 USED in MAP-Group-Call-Operati : 25 54
 USED in MAP-LocationServiceOpe : 25 60 74 93
 USED in MAP-SecureTransportOpe : 26 49 58
 USED in MAP-Errors : 16

unexpectedError.....identifier of Named Number, 3
 DEFINED in TCAPMessages : 199

unexpectedLinkedOperation.....identifier of Named Number, 7
 DEFINED in TCAPMessages : 190

unidentifiedSubParam.....identifier of UnidentifiedSubParam
 DEFINED in MAP-Errors : 219

UnidentifiedSubParam.....type reference SEQUENCE
 DEFINED in MAP-ER-DataTypes : 225
 USED in MAP-Errors : 119 219
 USED in MAP-ER-DataTypes : 27

unidentifiedSubscriber.....value reference UnidentifiedSubscriber, CHOICE VALUE
 DEFINED in MAP-Protocol : 360

UnidentifiedSubscriber.....type reference ERROR
 DEFINED in MAP-Errors : 217
 USED in MAP-Protocol : 133 360
 USED in MAP-MobileServiceOpera : 87 216 401 412
 USED in MAP-OperationAndMainte : 28 61 75
 USED in MAP-CallHandlingOperat : 49 161
 USED in MAP-ShortMessageServic : 32 104
 USED in MAP-LocationServiceOpe : 34 76
 USED in MAP-Errors : 25

unidirectional.....identifier of [APPLICATION 1] IMPLICIT Unidirectional
 DEFINED in TCAPMessages : 52

Unidirectional.....type reference SEQUENCE
 DEFINED in TCAPMessages : 58
 USED in TCAPMessages : 52

universal.....value reference SS-Code, '10110001'B
 DEFINED in MAP-SS-Code : 161

unknownAlphabet.....value reference UnknownAlphabet, CHOICE VALUE
 DEFINED in MAP-Protocol : 425

UnknownAlphabet.....type reference ERROR
 DEFINED in MAP-Errors : 380
 USED in MAP-Protocol : 158 425
 USED in MAP-SupplementaryServi : 48 184 200 214
 USED in MAP-Errors : 68

unknownEquipment.....value reference UnknownEquipment, CHOICE VALUE
 DEFINED in MAP-Protocol : 361

UnknownEquipment.....type reference ERROR

DEFINED in MAP-Errors : 223
USED in MAP-Protocol : 134 361
USED in MAP-MobileServiceOpera : 88 388
USED in MAP-Errors : 26

unknownMSC.....value reference UnknownMSC, CHOICE VALUE
DEFINED in MAP-Protocol : 359

TAG R5.40 Cross Reference Listing for MAP-Protocol 2002-06-07 14:47:03 PAGE 114

UnknownMSC.....type reference ERROR

DEFINED in MAP-Errors : 215
 USED in MAP-Protocol : 132 359
 USED in MAP-MobileServiceOpera : 86 345
 USED in MAP-Errors : 24

unknownOrUnreachableLCSCClient.....value reference UnknownOrUnreachableLCSCClient, CHOICE VALUE

DEFINED in MAP-Protocol : 447

UnknownOrUnreachableLCSCClient.....type reference ERROR

DEFINED in MAP-Errors : 448
 USED in MAP-Protocol : 175 447
 USED in MAP-LocationServiceOpe : 33 96
 USED in MAP-Errors : 89

unknownOrUnreachableLCSCClient-Param.....identifier of UnknownOrUnreachableLCSCClient-Param

DEFINED in MAP-Errors : 450

UnknownOrUnreachableLCSCClient-Param.....type reference SEQUENCE

DEFINED in MAP-ER-DataTypes : 385
 USED in MAP-Errors : 147 450
 USED in MAP-ER-DataTypes : 52

unknownServiceCentre.....identifier of Named Number, 3

DEFINED in MAP-ER-DataTypes : 152

unknownSubscriber.....value reference UnknownSubscriber, CHOICE VALUE

DEFINED in MAP-Protocol : 357

UnknownSubscriber.....type reference ERROR

DEFINED in MAP-Errors : 204
 USED in MAP-Protocol : 130 357
 USED in MAP-MobileServiceOpera : 85 185 207 228 254 267 284 305 365
 376 431 445 460 474 485
 USED in MAP-OperationAndMainte : 27 85
 USED in MAP-CallHandlingOperat : 35 92 174 201 214
 USED in MAP-SupplementaryServi : 36 249
 USED in MAP-ShortMessageServic : 31 76 120 146
 USED in MAP-LocationServiceOpe : 27 62 94
 USED in MAP-Errors : 22

unknownSubscriberDiagnostic.....identifier of UnknownSubscriberDiagnostic

DEFINED in MAP-ER-DataTypes : 210

UnknownSubscriberDiagnostic.....type reference ENUMERATED

DEFINED in MAP-ER-DataTypes : 212
 USED in MAP-ER-DataTypes : 210

unknownSubscriberParam.....identifier of UnknownSubscriberParam

DEFINED in MAP-Errors : 206

UnknownSubscriberParam.....type reference SEQUENCE

DEFINED in MAP-ER-DataTypes : 207
 USED in MAP-Errors : 117 206
 USED in MAP-ER-DataTypes : 25

unrecognizedComponent.....identifier of Named Number, 0

DEFINED in TCAPMessages : 179

unrecognizedError.....identifier of Named Number, 2

DEFINED in TCAPMessages : 198

unrecognizedInvokeID.....identifier of Named Number, 0

DEFINED in TCAPMessages : 192

unrecognizedInvokeID.....identifier of Named Number, 0

DEFINED in TCAPMessages : 196

unrecognizedLinkedID.....identifier of Named Number, 5

DEFINED in TCAPMessages : 188

unrecognizedMessageType.....identifier of Named Number, 0

DEFINED in TCAPMessages : 103

unrecognizedOperation.....identifier of Named Number, 1
DEFINED in TCAPMessages : 184

unrecognizedTransactionID.....identifier of Named Number, 1
DEFINED in TCAPMessages : 104

unstructuredSS-Notify.....value reference UnstructuredSS-Notify, CHOICE VALUE

TAG R5.40 Cross Reference Listing for MAP-Protocol 2002-06-07 14:47:03 PAGE 115

DEFINED in MAP-Protocol : 265

UnstructuredSS-Notify.....type reference OPERATION
DEFINED in MAP-SupplementaryServi : 203
USED in MAP-Protocol : 76 265
USED in MAP-SupplementaryServi : 20

unstructuredSS-Request.....value reference UnstructuredSS-Request, CHOICE VALUE
DEFINED in MAP-Protocol : 264

UnstructuredSS-Request.....type reference OPERATION
DEFINED in MAP-SupplementaryServi : 187
USED in MAP-Protocol : 75 264
USED in MAP-SupplementaryServi : 19

updateGprsLocation.....value reference UpdateGprsLocation, CHOICE VALUE
DEFINED in MAP-Protocol : 314

UpdateGprsLocation.....type reference OPERATION
DEFINED in MAP-MobileServiceOpera : 220
USED in MAP-Protocol : 16 314
USED in MAP-MobileServiceOpera : 21

updateGprsLocationArg.....identifier of UpdateGprsLocationArg
DEFINED in MAP-MobileServiceOpera : 222

UpdateGprsLocationArg.....type reference SEQUENCE
DEFINED in MAP-MS-DataTypes : 423
USED in MAP-MobileServiceOpera : 121 222
USED in MAP-MS-DataTypes : 24

updateGprsLocationRes.....identifier of UpdateGprsLocationRes
DEFINED in MAP-MobileServiceOpera : 224

UpdateGprsLocationRes.....type reference SEQUENCE
DEFINED in MAP-MS-DataTypes : 445
USED in MAP-MobileServiceOpera : 122 224
USED in MAP-MS-DataTypes : 25

updateLocation.....value reference UpdateLocation, CHOICE VALUE
DEFINED in MAP-Protocol : 193

UpdateLocation.....type reference OPERATION
DEFINED in MAP-MobileServiceOpera : 176
USED in MAP-Protocol : 12 193
USED in MAP-MobileServiceOpera : 15

updateLocationArg.....identifier of UpdateLocationArg
DEFINED in MAP-MobileServiceOpera : 178

UpdateLocationArg.....type reference SEQUENCE
DEFINED in MAP-MS-DataTypes : 214
USED in MAP-MobileServiceOpera : 113 178
USED in MAP-MS-DataTypes : 16

updateLocationRes.....identifier of UpdateLocationRes
DEFINED in MAP-MobileServiceOpera : 180

UpdateLocationRes.....type reference SEQUENCE
DEFINED in MAP-MS-DataTypes : 265
USED in MAP-MobileServiceOpera : 114 180
USED in MAP-MS-DataTypes : 17

updateProcedure.....identifier of Named Number, 0
DEFINED in MAP-MS-DataTypes : 279

uplinkAttached.....identifier of [6] NULL
DEFINED in MAP-GR-DataTypes : 120

uplinkFree.....identifier of [3] NULL
DEFINED in MAP-GR-DataTypes : 57

uplinkRejectCommand.....identifier of [2] NULL
DEFINED in MAP-GR-DataTypes : 79

uplinkReleaseCommand.....identifier of [4] NULL
DEFINED in MAP-GR-DataTypes : 81

uplinkReleaseIndication.....identifier of [1] NULL
DEFINED in MAP-GR-DataTypes : 78

uplinkReleaseIndication.....identifier of [1] NULL

TAG R5.40 Cross Reference Listing for MAP-Protocol 2002-06-07 14:47:03 PAGE 116

DEFINED in MAP-GR-DataTypes : 88

uplinkRequest.....identifier of [0] NULL
DEFINED in MAP-GR-DataTypes : 87

uplinkRequestAck.....identifier of [0] NULL
DEFINED in MAP-GR-DataTypes : 77

uplinkSeizedCommand.....identifier of [3] NULL
DEFINED in MAP-GR-DataTypes : 80

userInfo.....identifier of [2] NULL
DEFINED in MAP-ST-DataTypes : 88

ussd-Arg.....identifier of USSD-Arg
DEFINED in MAP-SupplementaryServi : 177

ussd-Arg.....identifier of USSD-Arg
DEFINED in MAP-SupplementaryServi : 189

ussd-Arg.....identifier of USSD-Arg
DEFINED in MAP-SupplementaryServi : 205

USSD-Arg.....type reference SEQUENCE
DEFINED in MAP-SS-DataTypes : 221
USED in MAP-SupplementaryServi : 64 177 189 205
USED in MAP-SS-DataTypes : 20

ussd-Busy.....value reference USSD-Busy, CHOICE VALUE
DEFINED in MAP-Protocol : 426

USSD-Busy.....type reference ERROR
DEFINED in MAP-Errors : 382
USED in MAP-Protocol : 159 426
USED in MAP-SupplementaryServi : 49 201 215
USED in MAP-Errors : 69

ussd-DataCodingScheme.....identifier of USSD-DataCodingScheme
DEFINED in MAP-SS-DataTypes : 222

ussd-DataCodingScheme.....identifier of USSD-DataCodingScheme
DEFINED in MAP-SS-DataTypes : 229

USSD-DataCodingScheme.....type reference OCTET STRING
DEFINED in MAP-SS-DataTypes : 233
USED in MAP-SS-DataTypes : 22 222 229
USED in MAP-LCS-DataTypes : 49 168 182 238

ussd-Res.....identifier of USSD-Res
DEFINED in MAP-SupplementaryServi : 179

ussd-Res.....identifier of USSD-Res
DEFINED in MAP-SupplementaryServi : 191

USSD-Res.....type reference SEQUENCE
DEFINED in MAP-SS-DataTypes : 228
USED in MAP-SupplementaryServi : 65 179 191
USED in MAP-SS-DataTypes : 21

ussd-String.....identifier of USSD-String
DEFINED in MAP-SS-DataTypes : 223

ussd-String.....identifier of USSD-String
DEFINED in MAP-SS-DataTypes : 230

USSD-String.....type reference OCTET STRING
DEFINED in MAP-SS-DataTypes : 238
USED in MAP-SS-DataTypes : 23 223 230
USED in MAP-LCS-DataTypes : 50 177 186 242

uui.....identifier of [1] UUI
DEFINED in MAP-CH-DataTypes : 248

UUI.....type reference OCTET STRING
DEFINED in MAP-CH-DataTypes : 256

USED in MAP-CH-DataTypes : 248

uuIndicator.....identifier of [0] UUIndicator
DEFINED in MAP-CH-DataTypes : 247

UUIndicator.....type reference OCTET STRING
DEFINED in MAP-CH-DataTypes : 253

TAG R5.40 Cross Reference Listing for MAP-Protocol 2002-06-07 14:47:03 PAGE 117

USED in MAP-CH-DataTypes : 247

uus1.....value reference SS-Code, '10000001'B
DEFINED in MAP-SS-Code : 110

uus2.....value reference SS-Code, '10000010'B
DEFINED in MAP-SS-Code : 112

uus3.....value reference SS-Code, '10000011'B
DEFINED in MAP-SS-Code : 114

uusCFInteraction.....identifier of [2] NULL
DEFINED in MAP-CH-DataTypes : 249

uu-Data.....identifier of [10] UU-Data
DEFINED in MAP-CH-DataTypes : 241

UU-Data.....type reference SEQUENCE
DEFINED in MAP-CH-DataTypes : 246
USED in MAP-CH-DataTypes : 241

valueAddedServices.....identifier of Named Number, 1
DEFINED in MAP-LCS-DataTypes : 158

VBSDataList.....type reference SEQUENCE OF
DEFINED in MAP-MS-DataTypes : 1808
USED in MAP-MS-DataTypes : 951

vbsGroupIndication.....identifier of [7] NULL
DEFINED in MAP-MS-DataTypes : 1305

vbsSubscriptionData.....identifier of [11] VBSDataList
DEFINED in MAP-MS-DataTypes : 951

verticalCoordinateRequest.....identifier of [1] NULL
DEFINED in MAP-LCS-DataTypes : 197

vertical-accuracy.....identifier of [2] Vertical-Accuracy
DEFINED in MAP-LCS-DataTypes : 198

Vertical-Accuracy.....type reference OCTET STRING
DEFINED in MAP-LCS-DataTypes : 208
USED in MAP-LCS-DataTypes : 198

VGCSDataList.....type reference SEQUENCE OF
DEFINED in MAP-MS-DataTypes : 1811
USED in MAP-MS-DataTypes : 952

vgcsGroupIndication.....identifier of [8] NULL
DEFINED in MAP-MS-DataTypes : 1306

vgcsSubscriptionData.....identifier of [12] VGCSDataList
DEFINED in MAP-MS-DataTypes : 952

vlr.....identifier of Named Number, 0
DEFINED in MAP-MS-DataTypes : 715

vlr.....identifier of Named Number, 2
DEFINED in MAP-CommonDataTypes : 354

vlrCamelSubscriptionInfo.....identifier of [13] VlrCamelSubscriptionInfo
DEFINED in MAP-MS-DataTypes : 953

VlrCamelSubscriptionInfo.....type reference SEQUENCE
DEFINED in MAP-MS-DataTypes : 1357
USED in MAP-MS-DataTypes : 953

vlr-Capability.....identifier of [6] VLR-Capability
DEFINED in MAP-MS-DataTypes : 222

VLR-Capability.....type reference SEQUENCE
DEFINED in MAP-MS-DataTypes : 226
USED in MAP-MS-DataTypes : 222 1798

vlr-Capability.....identifier of [6] VLR-Capability

DEFINED in MAP-MS-DataTypes : 1798

vlr-Number.....identifier of ISDN-AddressString
DEFINED in MAP-MS-DataTypes : 218

vlr-Number.....identifier of [0] ISDN-AddressString
DEFINED in MAP-MS-DataTypes : 291

TAG R5.40 Cross Reference Listing for MAP-Protocol 2002-06-07 14:47:03 PAGE 118

vlr-Number.....identifier of [0] ISDN-AddressString
 DEFINED in MAP-MS-DataTypes : 395

vlr-number.....identifier of [1] ISDN-AddressString
 DEFINED in MAP-MS-DataTypes : 1903

vmsc.....identifier of Named Number, 5
 DEFINED in MAP-CommonDataTypes : 357

vmsc-Address.....identifier of [2] ISDN-AddressString
 DEFINED in MAP-CH-DataTypes : 161

voiceBroadcastCall.....value reference TeleserviceCode, '10010010'B
 DEFINED in MAP-TS-Code : 69

VoiceBroadcastData.....type reference SEQUENCE
 DEFINED in MAP-MS-DataTypes : 1823
 USED in MAP-MS-DataTypes : 1809

voiceGroupCall.....value reference TeleserviceCode, '10010001'B
 DEFINED in MAP-TS-Code : 68

VoiceGroupCallData.....type reference SEQUENCE
 DEFINED in MAP-MS-DataTypes : 1818
 USED in MAP-MS-DataTypes : 1812

vplmnAddressAllowed.....identifier of [19] NULL
 DEFINED in MAP-MS-DataTypes : 800

vt-BCSM-CAMEL-TDP-CriteriaList.....identifier of [6] T-BCSM-CAMEL-TDP-CriteriaList
 DEFINED in MAP-MS-DataTypes : 2121

vt-csi.....identifier of Named Number, 4
 DEFINED in MAP-MS-DataTypes : 1322

vt-CSI.....identifier of [7] T-CSI
 DEFINED in MAP-MS-DataTypes : 1366

vt-CSI.....identifier of Named Number, 2
 DEFINED in MAP-MS-DataTypes : 2078

vt-CSI.....identifier of [5] T-CSI
 DEFINED in MAP-MS-DataTypes : 2120

whiteListed.....identifier of Named Number, 0
 DEFINED in MAP-MS-DataTypes : 725

wrongNetworkSignature.....identifier of Named Number, 1
 DEFINED in MAP-MS-DataTypes : 419

wrongPasswordAttemptsCounter.....identifier of WrongPasswordAttemptsCounter
 DEFINED in MAP-MS-DataTypes : 2101

WrongPasswordAttemptsCounter.....type reference INTEGER
 DEFINED in MAP-MS-DataTypes : 2106
 USED in MAP-MS-DataTypes : 2101 2170 2247

wrongPasswordAttemptsCounter.....identifier of [4] WrongPasswordAttemptsCounter
 DEFINED in MAP-MS-DataTypes : 2170

wrongPasswordAttemptsCounter.....identifier of [3] WrongPasswordAttemptsCounter
 DEFINED in MAP-MS-DataTypes : 2247

wrongUserResponse.....identifier of Named Number, 0
 DEFINED in MAP-MS-DataTypes : 418

xres.....identifier of XRES
 DEFINED in MAP-MS-DataTypes : 344

XRES.....type reference OCTET STRING
 DEFINED in MAP-MS-DataTypes : 371
 USED in MAP-MS-DataTypes : 344

ZoneCode.....type reference OCTET STRING

DEFINED in MAP-MS-DataTypes : 1276
USED in MAP-MS-DataTypes : 1274 1304

ZoneCodeList.....type reference SEQUENCE OF
DEFINED in MAP-MS-DataTypes : 1273
USED in MAP-MS-DataTypes : 63 950

TAG R5.40 Cross Reference Listing for MAP-Protocol 2002-06-07 14:47:03 PAGE 119

zoneCodesConflict.....identifier of Named Number, 2
DEFINED in MAP-MS-DataTypes : 1294

Annex B (informative): Fully expanded ASN.1 sources for abstract syntaxes of MAP

Annex B is not part of the standard, it is included for information purposes only.

For every (Value)Assignment in the root ASN.1 module all the used defined types and defined values, which are defined within the ASN.1 module or imported from ASN.1 modules, are replaced by the constructs this type or value is composed of.

The fully expanded ASN.1 root module is itself a correct and equivalent representation of the MAP-Protocol.

It allows to see at all the parameters, including all nested ones for a specific operationcode or errorcode at once.

Note that for those operations which use a result without parameters the keyword RESULT is not shown. Empty results are only defined in the ASN.1 description in clause 17.

B.1 Fully Expanded ASN.1 Source of MAP- Protocol/TCAPMessages

```
-- Expanded ASN1 Module 'MAP-Protocol'
--SIEMENS ASN.1 Compiler R5.40 (Production_5.40)
-- Date: 2002-06-07 Time: 14:47:03

MAP-Protocol{ 0 identified-organization (4) etsi (0) mobileDomain (0) gsm-Network (1) modules (3) map-Protocol (4) version8 (8) }

DEFINITIONS

 ::=

BEGIN

updateLocation OPERATION
ARGUMENT
  updateLocationArg SEQUENCE {
    imsi OCTET STRING ( SIZE ( 3 .. 8 ) ),
    msc-Number [1] IMPLICIT OCTET STRING ( SIZE ( 1 .. 20 ) ) ( SIZE ( 1 .. 9 ) ),
    vlr-Number OCTET STRING ( SIZE ( 1 .. 20 ) ) ( SIZE ( 1 .. 9 ) ),
    lmsi [10] IMPLICIT OCTET STRING ( SIZE ( 4 ) ) OPTIONAL,
    extensionContainer SEQUENCE {
      privateExtensionList [0] IMPLICIT SEQUENCE ( SIZE ( 1 .. 10 ) ) OF
        SEQUENCE {
          extId MAP-EXTENSION .&extensionId ( {
            '
            ...} ) ,
          extType MAP-EXTENSION .&ExtensionType ( {
            '
            ...} { @extId } ) OPTIONAL} OPTIONAL,
      pcs-Extensions [1] IMPLICIT SEQUENCE {
        ... } OPTIONAL,
        ... } OPTIONAL,
      ... ,
    vlr-Capability [6] IMPLICIT SEQUENCE {
      supportedCamelPhases [0] IMPLICIT BIT STRING {
        phase1 ( 0 ) ,
        phase2 ( 1 ) ,
        phase3 ( 2 ) ,
        phase4 ( 3 ) } ( SIZE ( 1 .. 16 ) ) OPTIONAL,
      extensionContainer SEQUENCE {
        privateExtensionList [0] IMPLICIT SEQUENCE ( SIZE ( 1 .. 10 ) ) OF
          SEQUENCE {
            extId MAP-EXTENSION .&extensionId ( {
              '
              ...} ) ,
            extType MAP-EXTENSION .&ExtensionType ( {
              '
              ...} { @extId } ) OPTIONAL} OPTIONAL,
            pcs-Extensions [1] IMPLICIT SEQUENCE {
              ... } OPTIONAL,
              ... } OPTIONAL,
            ... ,
          }
        }
      }
    }
  }
}
```

```

    ...} ),
    extType MAP-EXTENSION .&ExtensionType ( {
        '
        ...}{ @extId } ) OPTIONAL} OPTIONAL,
    pcs-Extensions [1] IMPLICIT SEQUENCE {
        ... } OPTIONAL,
        ... } OPTIONAL,
    ... ,
    solsaSupportIndicator [2] IMPLICIT NULL OPTIONAL,
    istSupportIndicator [1] IMPLICIT ENUMERATED {
        basicISTSupported (0),
        istCommandSupported (1),
        ... } OPTIONAL,
    superChargerSupportedInServingNetworkEntity [3] CHOICE {
        sendSubscriberData [0] IMPLICIT NULL,
        subscriberDataStored [1] IMPLICIT OCTET STRING ( SIZE ( 1 .. 6 ) )} OPTIONAL,
    longFTN-Supported [4] IMPLICIT NULL OPTIONAL,
    supportedLCS-CapabilitySets [5] IMPLICIT BIT STRING {
        lcsCapabilitySet1 (0),
        lcsCapabilitySet2 (1),
        lcsCapabilitySet3 (2)} ( SIZE ( 2 .. 16 ) ) OPTIONAL} OPTIONAL,
    informPreviousNetworkEntity [11] IMPLICIT NULL OPTIONAL,
    cs-LCS-NotSupportedByUE [12] IMPLICIT NULL OPTIONAL}
RESULT
updateLocationRes SEQUENCE {
    hr-Number OCTET STRING ( SIZE ( 1 .. 20 ) ) ( SIZE ( 1 .. 9 ) ),
    extensionContainer SEQUENCE {
        privateExtensionList [0] IMPLICIT SEQUENCE ( SIZE ( 1 .. 10 ) ) OF
        SEQUENCE {
            extId MAP-EXTENSION .&extensionId ( {
                '
                ...} ),
            extType MAP-EXTENSION .&ExtensionType ( {
                '
                ...}{ @extId } ) OPTIONAL} OPTIONAL,
            pcs-Extensions [1] IMPLICIT SEQUENCE {
                ... } OPTIONAL,
                ... } OPTIONAL,
            ... }
ERRORS {
-- systemFailure -- localValue : 34,
-- dataMissing -- localValue : 35,
-- unexpectedDataValue -- localValue : 36,
-- unknownSubscriber -- localValue : 1,
-- roamingNotAllowed -- localValue : 8}
::= localValue : 2

cancelLocation OPERATION
ARGUMENT
cancelLocationArg [3] IMPLICIT SEQUENCE {
    identity CHOICE {
        imsi OCTET STRING ( SIZE ( 3 .. 8 ) ),
        imsi-WithLMSI SEQUENCE {
            imsi OCTET STRING ( SIZE ( 3 .. 8 ) ),
            lmsi OCTET STRING ( SIZE ( 4 ) ),
            ... }},
    cancellationType ENUMERATED {
        updateProcedure (0),
        subscriptionWithdraw (1),
        ... } OPTIONAL,
    extensionContainer SEQUENCE {
        privateExtensionList [0] IMPLICIT SEQUENCE ( SIZE ( 1 .. 10 ) ) OF
        SEQUENCE {
            extId MAP-EXTENSION .&extensionId ( {
                '
                ...} ),
            extType MAP-EXTENSION .&ExtensionType ( {
                '
                ...}{ @extId } ) OPTIONAL} OPTIONAL,
            pcs-Extensions [1] IMPLICIT SEQUENCE {
                ... } OPTIONAL,
                ... } OPTIONAL,
            ... }
RESULT
cancelLocationRes SEQUENCE {
    extensionContainer SEQUENCE {
        privateExtensionList [0] IMPLICIT SEQUENCE ( SIZE ( 1 .. 10 ) ) OF

```

```

SEQUENCE {
  extId  MAP-EXTENSION .&extensionId ( {
    '
    ... } ),
  extType  MAP-EXTENSION .&ExtensionType ( {
    '
    ... } { @extId } ) OPTIONAL } OPTIONAL,
  pcs-Extensions  [1] IMPLICIT SEQUENCE {
    ... } OPTIONAL,
  ... } OPTIONAL,
  ... }
ERRORS {
  -- dataMissing -- localValue : 35,
  -- unexpectedDataValue -- localValue : 36}
 ::= localValue : 3

purgeMS OPERATION
ARGUMENT
  purgeMS-Arg [3] IMPLICIT SEQUENCE {
    imsi  OCTET STRING ( SIZE ( 3 .. 8 ) ),
    vlr-Number  [0] IMPLICIT OCTET STRING ( SIZE ( 1 .. 20 ) ) ( SIZE ( 1 .. 9 ) ) OPTIONAL,
    sgsn-Number  [1] IMPLICIT OCTET STRING ( SIZE ( 1 .. 20 ) ) ( SIZE ( 1 .. 9 ) ) OPTIONAL,
    extensionContainer  SEQUENCE {
      privateExtensionList  [0] IMPLICIT SEQUENCE ( SIZE ( 1 .. 10 ) ) OF
      SEQUENCE {
        extId  MAP-EXTENSION .&extensionId ( {
          '
          ... } ),
        extType  MAP-EXTENSION .&ExtensionType ( {
          '
          ... } { @extId } ) OPTIONAL } OPTIONAL,
        pcs-Extensions  [1] IMPLICIT SEQUENCE {
          ... } OPTIONAL,
          ... } OPTIONAL,
          ... }
      ... }
    }
  RESULT
    purgeMS-Res SEQUENCE {
      freezeTMSI  [0] IMPLICIT NULL OPTIONAL,
      freezeP-TMSI  [1] IMPLICIT NULL OPTIONAL,
      extensionContainer  SEQUENCE {
        privateExtensionList  [0] IMPLICIT SEQUENCE ( SIZE ( 1 .. 10 ) ) OF
        SEQUENCE {
          extId  MAP-EXTENSION .&extensionId ( {
            '
            ... } ),
          extType  MAP-EXTENSION .&ExtensionType ( {
            '
            ... } { @extId } ) OPTIONAL } OPTIONAL,
          pcs-Extensions  [1] IMPLICIT SEQUENCE {
            ... } OPTIONAL,
            ... } OPTIONAL,
            ... }
          ... }
        }
      ERRORS {
        -- dataMissing -- localValue : 35,
        -- unexpectedDataValue -- localValue : 36,
        -- unknownSubscriber -- localValue : 1}
      ::= localValue : 67

sendIdentification OPERATION
ARGUMENT
  sendIdentificationArg SEQUENCE {
    tmsi  OCTET STRING ( SIZE ( 1 .. 4 ) ),
    numberOfRequestedVectors  INTEGER ( 1 .. 5 ) OPTIONAL,
    segmentationProhibited  NULL OPTIONAL,
    extensionContainer  SEQUENCE {
      privateExtensionList  [0] IMPLICIT SEQUENCE ( SIZE ( 1 .. 10 ) ) OF
      SEQUENCE {
        extId  MAP-EXTENSION .&extensionId ( {
          '
          ... } ),
        extType  MAP-EXTENSION .&ExtensionType ( {
          '
          ... } { @extId } ) OPTIONAL } OPTIONAL,
        pcs-Extensions  [1] IMPLICIT SEQUENCE {
          ... } OPTIONAL,
          ... } OPTIONAL,
          ... }
        ... }
      ... }
    }
  }

```

RESULT

```

sendIdentificationRes [3] IMPLICIT SEQUENCE {
  imsi          OCTET STRING ( SIZE ( 3 .. 8 ) ) OPTIONAL,
  authenticationSetList CHOICE {
    tripletList [0] IMPLICIT SEQUENCE ( SIZE ( 1 .. 5 ) ) OF
      SEQUENCE {
        rand  OCTET STRING ( SIZE ( 16 ) ),
        sres  OCTET STRING ( SIZE ( 4 ) ),
        kc    OCTET STRING ( SIZE ( 8 ) ),
        ... },
    quintupletList [1] IMPLICIT SEQUENCE ( SIZE ( 1 .. 5 ) ) OF
      SEQUENCE {
        rand  OCTET STRING ( SIZE ( 16 ) ),
        xres  OCTET STRING ( SIZE ( 4 .. 16 ) ),
        ck    OCTET STRING ( SIZE ( 16 ) ),
        ik    OCTET STRING ( SIZE ( 16 ) ),
        autn  OCTET STRING ( SIZE ( 16 ) ),
        ... } } OPTIONAL,
  currentSecurityContext [2] CHOICE {
    gsm-SecurityContextData [0] IMPLICIT SEQUENCE {
      kc    OCTET STRING ( SIZE ( 8 ) ),
      cksn  OCTET STRING ( SIZE ( 1 ) ),
      ... },
    umts-SecurityContextData [1] IMPLICIT SEQUENCE {
      ck    OCTET STRING ( SIZE ( 16 ) ),
      ik    OCTET STRING ( SIZE ( 16 ) ),
      ksi   OCTET STRING ( SIZE ( 1 ) ),
      ... } } OPTIONAL,
  extensionContainer [3] IMPLICIT SEQUENCE {
    privateExtensionList [0] IMPLICIT SEQUENCE ( SIZE ( 1 .. 10 ) ) OF
      SEQUENCE {
        extId  MAP-EXTENSION .&extensionId ( {
          '
          ... } ),
        extType  MAP-EXTENSION .&ExtensionType ( {
          '
          ... } { @extId } ) OPTIONAL } OPTIONAL,
    pcs-Extensions [1] IMPLICIT SEQUENCE {
      ... } OPTIONAL,
      ... } OPTIONAL,
      ... }
  }
ERRORS {
  -- dataMissing -- localValue : 35,
  -- unidentifiedSubscriber -- localValue : 5}
 ::= localValue : 55

```

prepareHandover OPERATION

ARGUMENT

```

prepareHO-Arg [3] IMPLICIT SEQUENCE {
  targetCellId [0] IMPLICIT OCTET STRING ( SIZE ( 5 .. 7 ) ) OPTIONAL,
  ho-NumberNotRequired NULL OPTIONAL,
  targetRNCId [1] IMPLICIT OCTET STRING ( SIZE ( 7 ) ) OPTIONAL,
  an-APDU [2] IMPLICIT SEQUENCE {
    accessNetworkProtocolId ENUMERATED {
      ts3G-48006 ( 1 ),
      ts3G-25413 ( 2 ),
      ... },
    signalInfo OCTET STRING ( SIZE ( 1 .. 2560 ) ),
    extensionContainer SEQUENCE {
      privateExtensionList [0] IMPLICIT SEQUENCE ( SIZE ( 1 .. 10 ) ) OF
        SEQUENCE {
          extId  MAP-EXTENSION .&extensionId ( {
            '
            ... } ),
          extType  MAP-EXTENSION .&ExtensionType ( {
            '
            ... } { @extId } ) OPTIONAL } OPTIONAL,
        pcs-Extensions [1] IMPLICIT SEQUENCE {
          ... } OPTIONAL,
          ... } OPTIONAL,
          ... } OPTIONAL,
          ... } OPTIONAL,
    multipleBearerRequested [3] IMPLICIT NULL OPTIONAL,
    imsi [4] IMPLICIT OCTET STRING ( SIZE ( 3 .. 8 ) ) OPTIONAL,
    integrityProtectionInfo [5] IMPLICIT OCTET STRING ( SIZE ( 18 .. 100 ) ) OPTIONAL,
    encryptionInfo [6] IMPLICIT OCTET STRING ( SIZE ( 18 .. 100 ) ) OPTIONAL,
    radioResourceInformation [7] IMPLICIT OCTET STRING ( SIZE ( 3 .. 13 ) ) OPTIONAL,
    allowedGSM-Algorithms [9] IMPLICIT OCTET STRING ( SIZE ( 1 ) ) OPTIONAL,

```

```
allowedUMTS-Algorithms [10] IMPLICIT SEQUENCE {
  integrityProtectionAlgorithms [0] IMPLICIT OCTET STRING ( SIZE ( 1 .. 9 ) ) OPTIONAL,
  encryptionAlgorithms [1] IMPLICIT OCTET STRING ( SIZE ( 1 .. 9 ) ) OPTIONAL,
  extensionContainer [2] IMPLICIT SEQUENCE {
    privateExtensionList [0] IMPLICIT SEQUENCE ( SIZE ( 1 .. 10 ) ) OF
      SEQUENCE {
        extId MAP-EXTENSION .&extensionId ( {
          ,
          ... } ),
        extType MAP-EXTENSION .&ExtensionType ( {
          ,
          ... } { @extId } ) OPTIONAL } OPTIONAL,
    pcs-Extensions [1] IMPLICIT SEQUENCE {
      ... } OPTIONAL,
      ... } OPTIONAL,
      ... } OPTIONAL,
      ... } OPTIONAL,
radioResourceList [11] IMPLICIT SEQUENCE ( SIZE ( 2 .. 7 ) ) OF
  SEQUENCE {
    radioResourceInformation OCTET STRING ( SIZE ( 3 .. 13 ) ),
    rab-Id INTEGER ( 1 .. 255 ),
    ... } OPTIONAL,
extensionContainer [8] IMPLICIT SEQUENCE {
  privateExtensionList [0] IMPLICIT SEQUENCE ( SIZE ( 1 .. 10 ) ) OF
    SEQUENCE {
      extId MAP-EXTENSION .&extensionId ( {
        ,
        ... } ),
      extType MAP-EXTENSION .&ExtensionType ( {
        ,
        ... } { @extId } ) OPTIONAL } OPTIONAL,
    pcs-Extensions [1] IMPLICIT SEQUENCE {
      ... } OPTIONAL,
      ... } OPTIONAL,
      ... } OPTIONAL,
  ... ,
  rab-Id [12] IMPLICIT INTEGER ( 1 .. 255 ) OPTIONAL,
  bssmap-ServiceHandover [13] IMPLICIT OCTET STRING ( SIZE ( 1 ) ) OPTIONAL,
  ranap-ServiceHandover [14] IMPLICIT OCTET STRING ( SIZE ( 1 ) ) OPTIONAL}
RESULT
prepareHO-Res [3] IMPLICIT SEQUENCE {
  handoverNumber [0] IMPLICIT OCTET STRING ( SIZE ( 1 .. 20 ) ) ( SIZE ( 1 .. 9 ) ) OPTIONAL,
  relocationNumberList [1] IMPLICIT SEQUENCE ( SIZE ( 1 .. 7 ) ) OF
    SEQUENCE {
      handoverNumber OCTET STRING ( SIZE ( 1 .. 20 ) ) ( SIZE ( 1 .. 9 ) ),
      rab-Id INTEGER ( 1 .. 255 ),
      ... } OPTIONAL,
an-APDU [2] IMPLICIT SEQUENCE {
  accessNetworkProtocolId ENUMERATED {
    ts3G-48006 ( 1 ),
    ts3G-25413 ( 2 ),
    ... },
  signalInfo OCTET STRING ( SIZE ( 1 .. 2560 ) ),
  extensionContainer SEQUENCE {
    privateExtensionList [0] IMPLICIT SEQUENCE ( SIZE ( 1 .. 10 ) ) OF
      SEQUENCE {
        extId MAP-EXTENSION .&extensionId ( {
          ,
          ... } ),
        extType MAP-EXTENSION .&ExtensionType ( {
          ,
          ... } { @extId } ) OPTIONAL } OPTIONAL,
    pcs-Extensions [1] IMPLICIT SEQUENCE {
      ... } OPTIONAL,
      ... } OPTIONAL,
      ... } OPTIONAL,
      ... } OPTIONAL,
multicastBearerInfo [3] IMPLICIT INTEGER ( 1 .. 7 ) OPTIONAL,
multipleBearerNotSupported NULL OPTIONAL,
selectedUMTS-Algorithms [5] IMPLICIT SEQUENCE {
  integrityProtectionAlgorithm [0] IMPLICIT OCTET STRING ( SIZE ( 1 ) ) OPTIONAL,
  encryptionAlgorithm [1] IMPLICIT OCTET STRING ( SIZE ( 1 ) ) OPTIONAL,
  extensionContainer [2] IMPLICIT SEQUENCE {
    privateExtensionList [0] IMPLICIT SEQUENCE ( SIZE ( 1 .. 10 ) ) OF
      SEQUENCE {
        extId MAP-EXTENSION .&extensionId ( {
          ,
          ... } ),
        extType MAP-EXTENSION .&ExtensionType ( {
          ,
          ... } )
```

```

        ...} { @extId } ) OPTIONAL} OPTIONAL,
    pcs-Extensions [1] IMPLICIT SEQUENCE {
        ... } OPTIONAL,
        ... } OPTIONAL,
        ... } OPTIONAL,
    chosenRadioResourceInformation [6] IMPLICIT SEQUENCE {
        chosenChannellInfo [0] IMPLICIT OCTET STRING ( SIZE ( 1 ) ) OPTIONAL,
        chosenSpeechVersion [1] IMPLICIT OCTET STRING ( SIZE ( 1 ) ) OPTIONAL,
        ... } OPTIONAL,
    extensionContainer [4] IMPLICIT SEQUENCE {
        privateExtensionList [0] IMPLICIT SEQUENCE ( SIZE ( 1 .. 10 ) ) OF
        SEQUENCE {
            extId MAP-EXTENSION .&extensionId ( {
                '
                ...} ),
            extType MAP-EXTENSION .&ExtensionType ( {
                '
                ...} { @extId } ) OPTIONAL} OPTIONAL,
        pcs-Extensions [1] IMPLICIT SEQUENCE {
            ... } OPTIONAL,
            ... } OPTIONAL,
            ... }
    }
ERRORS {
    -- systemFailure -- localValue : 34,
    -- dataMissing -- localValue : 35,
    -- unexpectedDataValue -- localValue : 36,
    -- noHandoverNumberAvailable -- localValue : 25,
    -- targetCellOutsideGroupCallArea -- localValue : 42}
 ::= localValue : 68

```

sendEndSignal OPERATION

ARGUMENT

```

sendEndSignal-Arg [3] IMPLICIT SEQUENCE {
    an-APDU SEQUENCE {
        accessNetworkProtocolId ENUMERATED {
            ts3G-48006 ( 1 ),
            ts3G-25413 ( 2 ),
            ... },
        signalInfo OCTET STRING ( SIZE ( 1 .. 2560 ) ),
        extensionContainer SEQUENCE {
            privateExtensionList [0] IMPLICIT SEQUENCE ( SIZE ( 1 .. 10 ) ) OF
            SEQUENCE {
                extId MAP-EXTENSION .&extensionId ( {
                    '
                    ...} ),
                extType MAP-EXTENSION .&ExtensionType ( {
                    '
                    ...} { @extId } ) OPTIONAL} OPTIONAL,
            pcs-Extensions [1] IMPLICIT SEQUENCE {
                ... } OPTIONAL,
                ... } OPTIONAL,
                ... }
            },
        extensionContainer [0] IMPLICIT SEQUENCE {
            privateExtensionList [0] IMPLICIT SEQUENCE ( SIZE ( 1 .. 10 ) ) OF
            SEQUENCE {
                extId MAP-EXTENSION .&extensionId ( {
                    '
                    ...} ),
                extType MAP-EXTENSION .&ExtensionType ( {
                    '
                    ...} { @extId } ) OPTIONAL} OPTIONAL,
            pcs-Extensions [1] IMPLICIT SEQUENCE {
                ... } OPTIONAL,
                ... } OPTIONAL,
                ... }
            }
        }
    }

```

RESULT

```

sendEndSignal-Res SEQUENCE {
    extensionContainer [0] IMPLICIT SEQUENCE {
        privateExtensionList [0] IMPLICIT SEQUENCE ( SIZE ( 1 .. 10 ) ) OF
        SEQUENCE {
            extId MAP-EXTENSION .&extensionId ( {
                '
                ...} ),
            extType MAP-EXTENSION .&ExtensionType ( {
                '
                ...} { @extId } ) OPTIONAL} OPTIONAL,
            pcs-Extensions [1] IMPLICIT SEQUENCE {

```

```

    ... } OPTIONAL,
    ... } OPTIONAL,
    ... }
 ::= localValue : 29

```

processAccessSignalling OPERATION

ARGUMENT

```

processAccessSignalling-Arg [3] IMPLICIT SEQUENCE {
  an-APDU SEQUENCE {
    accessNetworkProtocolId ENUMERATED {
      ts3G-48006 (1),
      ts3G-25413 (2),
      ... },
    signalInfo OCTET STRING ( SIZE (1 .. 2560) ),
    extensionContainer SEQUENCE {
      privateExtensionList [0] IMPLICIT SEQUENCE ( SIZE (1 .. 10) ) OF
        SEQUENCE {
          extId MAP-EXTENSION .&extensionId ( {
            '
            ... } ),
          extType MAP-EXTENSION .&ExtensionType ( {
            '
            ... } { @extId } ) OPTIONAL } OPTIONAL,
        pcs-Extensions [1] IMPLICIT SEQUENCE {
          ... } OPTIONAL,
          ... } OPTIONAL,
          ... },
      selectedUMTS-Algorithms [1] IMPLICIT SEQUENCE {
        integrityProtectionAlgorithm [0] IMPLICIT OCTET STRING ( SIZE (1) ) OPTIONAL,
        encryptionAlgorithm [1] IMPLICIT OCTET STRING ( SIZE (1) ) OPTIONAL,
        extensionContainer [2] IMPLICIT SEQUENCE {
          privateExtensionList [0] IMPLICIT SEQUENCE ( SIZE (1 .. 10) ) OF
            SEQUENCE {
              extId MAP-EXTENSION .&extensionId ( {
                '
                ... } ),
              extType MAP-EXTENSION .&ExtensionType ( {
                '
                ... } { @extId } ) OPTIONAL } OPTIONAL,
            pcs-Extensions [1] IMPLICIT SEQUENCE {
              ... } OPTIONAL,
              ... } OPTIONAL,
              ... } OPTIONAL,
            selectedGSM-Algorithm [2] IMPLICIT OCTET STRING ( SIZE (1) ) OPTIONAL,
            chosenRadioResourceInformation [3] IMPLICIT SEQUENCE {
              chosenChannelInfo [0] IMPLICIT OCTET STRING ( SIZE (1) ) OPTIONAL,
              chosenSpeechVersion [1] IMPLICIT OCTET STRING ( SIZE (1) ) OPTIONAL,
              ... } OPTIONAL,
            selectedRab-Id [4] IMPLICIT INTEGER ( 1 .. 255 ) OPTIONAL,
          extensionContainer [0] IMPLICIT SEQUENCE {
            privateExtensionList [0] IMPLICIT SEQUENCE ( SIZE (1 .. 10) ) OF
              SEQUENCE {
                extId MAP-EXTENSION .&extensionId ( {
                  '
                  ... } ),
                extType MAP-EXTENSION .&ExtensionType ( {
                  '
                  ... } { @extId } ) OPTIONAL } OPTIONAL,
            pcs-Extensions [1] IMPLICIT SEQUENCE {
              ... } OPTIONAL,
              ... } OPTIONAL,
              ... }
          ::= localValue : 33

```

forwardAccessSignalling OPERATION

ARGUMENT

```

forwardAccessSignalling-Arg [3] IMPLICIT SEQUENCE {
  an-APDU SEQUENCE {
    accessNetworkProtocolId ENUMERATED {
      ts3G-48006 (1),
      ts3G-25413 (2),
      ... },
    signalInfo OCTET STRING ( SIZE (1 .. 2560) ),
    extensionContainer SEQUENCE {
      privateExtensionList [0] IMPLICIT SEQUENCE ( SIZE (1 .. 10) ) OF
        SEQUENCE {
          extId MAP-EXTENSION .&extensionId ( {

```

```

    ... } ),
    extType MAP-EXTENSION .&ExtensionType ( {
        ... } { @extId } ) OPTIONAL } OPTIONAL,
    pcs-Extensions [1] IMPLICIT SEQUENCE {
        ... } OPTIONAL,
    ... } OPTIONAL,
    ... },
    integrityProtectionInfo [0] IMPLICIT OCTET STRING ( SIZE ( 18 .. 100 ) ) OPTIONAL,
    encryptionInfo [1] IMPLICIT OCTET STRING ( SIZE ( 18 .. 100 ) ) OPTIONAL,
    keyStatus [2] IMPLICIT ENUMERATED {
        old ( 0 ),
        new ( 1 ),
        ... } OPTIONAL,
    allowedGSM-Algorithms [4] IMPLICIT OCTET STRING ( SIZE ( 1 ) ) OPTIONAL,
    allowedUMTS-Algorithms [5] IMPLICIT SEQUENCE {
        integrityProtectionAlgorithms [0] IMPLICIT OCTET STRING ( SIZE ( 1 .. 9 ) ) OPTIONAL,
        encryptionAlgorithms [1] IMPLICIT OCTET STRING ( SIZE ( 1 .. 9 ) ) OPTIONAL,
        extensionContainer [2] IMPLICIT SEQUENCE {
            privateExtensionList [0] IMPLICIT SEQUENCE ( SIZE ( 1 .. 10 ) ) OF
            SEQUENCE {
                extId MAP-EXTENSION .&extensionId ( {
                    ... } ),
                extType MAP-EXTENSION .&ExtensionType ( {
                    ... } { @extId } ) OPTIONAL } OPTIONAL,
                pcs-Extensions [1] IMPLICIT SEQUENCE {
                    ... } OPTIONAL,
                ... } OPTIONAL,
                ... } OPTIONAL,
            } OPTIONAL,
        radioResourceInformation [6] IMPLICIT OCTET STRING ( SIZE ( 3 .. 13 ) ) OPTIONAL,
        extensionContainer [3] IMPLICIT SEQUENCE {
            privateExtensionList [0] IMPLICIT SEQUENCE ( SIZE ( 1 .. 10 ) ) OF
            SEQUENCE {
                extId MAP-EXTENSION .&extensionId ( {
                    ... } ),
                extType MAP-EXTENSION .&ExtensionType ( {
                    ... } { @extId } ) OPTIONAL } OPTIONAL,
                pcs-Extensions [1] IMPLICIT SEQUENCE {
                    ... } OPTIONAL,
                ... } OPTIONAL,
            } OPTIONAL,
        ... },
        radioResourceList [7] IMPLICIT SEQUENCE ( SIZE ( 2 .. 7 ) ) OF
        SEQUENCE {
            radioResourceInformation OCTET STRING ( SIZE ( 3 .. 13 ) ),
            rab-Id INTEGER ( 1 .. 255 ),
            ... } OPTIONAL,
        bssmap-ServiceHandover [9] IMPLICIT OCTET STRING ( SIZE ( 1 ) ) OPTIONAL,
        ranap-ServiceHandover [8] IMPLICIT OCTET STRING ( SIZE ( 1 ) ) OPTIONAL }
 ::= localValue : 34

```

prepareSubsequentHandover OPERATION

ARGUMENT

```

prepareSubsequentHO-Arg [3] IMPLICIT SEQUENCE {
    targetCellId [0] IMPLICIT OCTET STRING ( SIZE ( 5 .. 7 ) ) OPTIONAL,
    targetMSC-Number [1] IMPLICIT OCTET STRING ( SIZE ( 1 .. 20 ) ) ( SIZE ( 1 .. 9 ) ),
    targetRNCId [2] IMPLICIT OCTET STRING ( SIZE ( 7 ) ) OPTIONAL,
    an-APDU [3] IMPLICIT SEQUENCE {
        accessNetworkProtocolId ENUMERATED {
            ts3G-48006 ( 1 ),
            ts3G-25413 ( 2 ),
            ... },
        signalInfo OCTET STRING ( SIZE ( 1 .. 2560 ) ),
        extensionContainer SEQUENCE {
            privateExtensionList [0] IMPLICIT SEQUENCE ( SIZE ( 1 .. 10 ) ) OF
            SEQUENCE {
                extId MAP-EXTENSION .&extensionId ( {
                    ... } ),
                extType MAP-EXTENSION .&ExtensionType ( {
                    ... } { @extId } ) OPTIONAL } OPTIONAL,
                pcs-Extensions [1] IMPLICIT SEQUENCE {

```

```

    ... } OPTIONAL,
    ... } OPTIONAL,
    ... } OPTIONAL,
selectedRab-Id [4] IMPLICIT INTEGER ( 1 .. 255 ) OPTIONAL,
extensionContainer [5] IMPLICIT SEQUENCE {
  privateExtensionList [0] IMPLICIT SEQUENCE ( SIZE ( 1 .. 10 )) OF
  SEQUENCE {
    extId MAP-EXTENSION .&extensionId ( {
      '
      ... } ),
    extType MAP-EXTENSION .&ExtensionType ( {
      '
      ... } { @extId } ) OPTIONAL } OPTIONAL,
  pcs-Extensions [1] IMPLICIT SEQUENCE {
    ... } OPTIONAL,
    ... } OPTIONAL,
  ... }
}
RESULT
prepareSubsequentHO-Res [3] IMPLICIT SEQUENCE {
  an-APDU SEQUENCE {
    accessNetworkProtocolId ENUMERATED {
      ts3G-48006 ( 1 ),
      ts3G-25413 ( 2 ),
      ... },
    signalInfo OCTET STRING ( SIZE ( 1 .. 2560 ) ),
    extensionContainer SEQUENCE {
      privateExtensionList [0] IMPLICIT SEQUENCE ( SIZE ( 1 .. 10 )) OF
      SEQUENCE {
        extId MAP-EXTENSION .&extensionId ( {
          '
          ... } ),
        extType MAP-EXTENSION .&ExtensionType ( {
          '
          ... } { @extId } ) OPTIONAL } OPTIONAL,
        pcs-Extensions [1] IMPLICIT SEQUENCE {
          ... } OPTIONAL,
          ... } OPTIONAL,
        ... },
      extensionContainer [0] IMPLICIT SEQUENCE {
        privateExtensionList [0] IMPLICIT SEQUENCE ( SIZE ( 1 .. 10 )) OF
        SEQUENCE {
          extId MAP-EXTENSION .&extensionId ( {
            '
            ... } ),
          extType MAP-EXTENSION .&ExtensionType ( {
            '
            ... } { @extId } ) OPTIONAL } OPTIONAL,
          pcs-Extensions [1] IMPLICIT SEQUENCE {
            ... } OPTIONAL,
            ... } OPTIONAL,
          ... }
        }
      }
    }
  }
}
ERRORS {
  -- unexpectedDataValue -- localValue : 36,
  -- dataMissing -- localValue : 35,
  -- unknownMSC -- localValue : 3,
  -- subsequentHandoverFailure -- localValue : 26)
::= localValue : 69

```

sendAuthenticationInfo OPERATION

ARGUMENT

```

sendAuthenticationInfoArg SEQUENCE {
  imsi [0] IMPLICIT OCTET STRING ( SIZE ( 3 .. 8 ) ),
  numberOfRequestedVectors INTEGER ( 1 .. 5 ),
  segmentationProhibited NULL OPTIONAL,
  immediateResponsePreferred [1] IMPLICIT NULL OPTIONAL,
  re-synchronisationInfo SEQUENCE {
    rand OCTET STRING ( SIZE ( 16 ) ),
    auts OCTET STRING ( SIZE ( 14 ) ),
    ... } OPTIONAL,
  extensionContainer [2] IMPLICIT SEQUENCE {
    privateExtensionList [0] IMPLICIT SEQUENCE ( SIZE ( 1 .. 10 )) OF
    SEQUENCE {
      extId MAP-EXTENSION .&extensionId ( {
        '
        ... } ),
      extType MAP-EXTENSION .&ExtensionType ( {
        '

```

```

        ...}{ @extId } ) OPTIONAL} OPTIONAL,
    pcs-Extensions [1] IMPLICIT SEQUENCE {
        ... } OPTIONAL,
        ... } OPTIONAL,
    ... ,
    requestingNodeType [3] IMPLICIT ENUMERATED {
        vlr (0),
        sgsn (1),
        ... } OPTIONAL}
RESULT
sendAuthenticationInfoRes [3] IMPLICIT SEQUENCE {
    authenticationSetList CHOICE {
        tripletList [0] IMPLICIT SEQUENCE ( SIZE ( 1 .. 5 ) ) OF
            SEQUENCE {
                rand OCTET STRING ( SIZE ( 16 ) ),
                sres OCTET STRING ( SIZE ( 4 ) ),
                kc OCTET STRING ( SIZE ( 8 ) ),
                ... },
        quintupletList [1] IMPLICIT SEQUENCE ( SIZE ( 1 .. 5 ) ) OF
            SEQUENCE {
                rand OCTET STRING ( SIZE ( 16 ) ),
                xres OCTET STRING ( SIZE ( 4 .. 16 ) ),
                ck OCTET STRING ( SIZE ( 16 ) ),
                ik OCTET STRING ( SIZE ( 16 ) ),
                autn OCTET STRING ( SIZE ( 16 ) ),
                ... } OPTIONAL,
    extensionContainer SEQUENCE {
        privateExtensionList [0] IMPLICIT SEQUENCE ( SIZE ( 1 .. 10 ) ) OF
            SEQUENCE {
                extId MAP-EXTENSION .&extensionId ( {
                    '
                    ... } ),
                extType MAP-EXTENSION .&ExtensionType ( {
                    '
                    ...}{ @extId } ) OPTIONAL} OPTIONAL,
        pcs-Extensions [1] IMPLICIT SEQUENCE {
            ... } OPTIONAL,
            ... } OPTIONAL,
        ... }
ERRORS {
    -- systemFailure -- localValue : 34,
    -- dataMissing -- localValue : 35,
    -- unexpectedDataValue -- localValue : 36,
    -- unknownSubscriber -- localValue : 1}
 ::= localValue : 56

authenticationFailureReport OPERATION
ARGUMENT
authenticationFailureReportArg SEQUENCE {
    imsi OCTET STRING ( SIZE ( 3 .. 8 ) ),
    failureCause ENUMERATED {
        wrongUserResponse (0),
        wrongNetworkSignature (1)},
    extensionContainer SEQUENCE {
        privateExtensionList [0] IMPLICIT SEQUENCE ( SIZE ( 1 .. 10 ) ) OF
            SEQUENCE {
                extId MAP-EXTENSION .&extensionId ( {
                    '
                    ... } ),
                extType MAP-EXTENSION .&ExtensionType ( {
                    '
                    ...}{ @extId } ) OPTIONAL} OPTIONAL,
        pcs-Extensions [1] IMPLICIT SEQUENCE {
            ... } OPTIONAL,
            ... } OPTIONAL,
        ... ,
    re-attempt BOOLEAN OPTIONAL,
    accessType ENUMERATED {
        call (0),
        emergencyCall (1),
        locationUpdating (2),
        supplementaryService (3),
        shortMessage (4),
        gprsAttach (5),
        routingAreaUpdating (6),
        serviceRequest (7),
        pdpContextActivation (8),

```

```

    pdpContextDeactivation (9),
    ... } OPTIONAL,
    rand OCTET STRING ( SIZE (16) ) OPTIONAL,
    vlr-Number [0] IMPLICIT OCTET STRING ( SIZE (1 .. 20) ) ( SIZE (1 .. 9) ) OPTIONAL,
    sgsn-Number [1] IMPLICIT OCTET STRING ( SIZE (1 .. 20) ) ( SIZE (1 .. 9) ) OPTIONAL,
RESULT
authenticationFailureReportRes SEQUENCE {
    extensionContainer SEQUENCE {
        privateExtensionList [0] IMPLICIT SEQUENCE ( SIZE (1 .. 10) ) OF
        SEQUENCE {
            extId MAP-EXTENSION .&extensionId ( {
                '
                ... } ),
            extType MAP-EXTENSION .&ExtensionType ( {
                '
                ... } { @extId } ) OPTIONAL } OPTIONAL,
        pcs-Extensions [1] IMPLICIT SEQUENCE {
            ... } OPTIONAL,
            ... } OPTIONAL,
            ... }
    ... }
ERRORS {
    -- systemFailure -- localValue : 34,
    -- unexpectedDataValue -- localValue : 36,
    -- unknownSubscriber -- localValue : 1}
 ::= localValue : 15

checkIMEI OPERATION
ARGUMENT
imei OCTET STRING ( SIZE (8) )
RESULT
equipmentStatus ENUMERATED {
    whiteListed (0),
    blackListed (1),
    greyListed (2)}
ERRORS {
    -- systemFailure -- localValue : 34,
    -- dataMissing -- localValue : 35,
    -- unknownEquipment -- localValue : 7}
 ::= localValue : 43

insertSubscriberData OPERATION
ARGUMENT
insertSubscriberDataArg SEQUENCE {
    imsi [0] IMPLICIT OCTET STRING ( SIZE (3 .. 8) ) OPTIONAL,
    msisdn [1] IMPLICIT OCTET STRING ( SIZE (1 .. 20) ) ( SIZE (1 .. 9) ) OPTIONAL,
    category [2] IMPLICIT OCTET STRING ( SIZE (1) ) OPTIONAL,
    subscriberStatus [3] IMPLICIT ENUMERATED {
        serviceGranted (0),
        operatorDeterminedBarring (1) } OPTIONAL,
    bearerServiceList [4] IMPLICIT SEQUENCE ( SIZE (1 .. 50) ) OF
    OCTET STRING ( SIZE (1 .. 5) ) OPTIONAL,
    teleserviceList [6] IMPLICIT SEQUENCE ( SIZE (1 .. 20) ) OF
    OCTET STRING ( SIZE (1 .. 5) ) OPTIONAL,
    provisionedSS [7] IMPLICIT SEQUENCE ( SIZE (1 .. 30) ) OF
    CHOICE {
        forwardingInfo [0] IMPLICIT SEQUENCE {
            ss-Code OCTET STRING ( SIZE (1) ),
            forwardingFeatureList SEQUENCE ( SIZE (1 .. 32) ) OF
            SEQUENCE {
                basicService CHOICE {
                    ext-BearerService [2] IMPLICIT OCTET STRING ( SIZE (1 .. 5) ),
                    ext-Teleservice [3] IMPLICIT OCTET STRING ( SIZE (1 .. 5) ) } OPTIONAL,
                    ss-Status [4] IMPLICIT OCTET STRING ( SIZE (1 .. 5) ),
                    forwardedToNumber [5] IMPLICIT OCTET STRING ( SIZE (1 .. 20) ) ( SIZE (1 .. 9) ) OPTIONAL,
                    forwardedToSubaddress [8] IMPLICIT OCTET STRING ( SIZE (1 .. 21) ) OPTIONAL,
                    forwardingOptions [6] IMPLICIT OCTET STRING ( SIZE (1 .. 5) ) OPTIONAL,
                    noReplyConditionTime [7] IMPLICIT INTEGER (1 .. 100) OPTIONAL,
                    extensionContainer [9] IMPLICIT SEQUENCE {
                        privateExtensionList [0] IMPLICIT SEQUENCE ( SIZE (1 .. 10) ) OF
                        SEQUENCE {
                            extId MAP-EXTENSION .&extensionId ( {
                                '
                                ... } ),
                            extType MAP-EXTENSION .&ExtensionType ( {
                                '
                                ... } { @extId } ) OPTIONAL } OPTIONAL,
                        pcs-Extensions [1] IMPLICIT SEQUENCE {

```



```

... } OPTIONAL,
... } OPTIONAL,
... ,
longForwardedToNumber [10] IMPLICIT OCTET STRING ( SIZE ( 1 .. 20 ) ) ( SIZE ( 1 .. 15 ) ) OPTIONAL,
extensionContainer [0] IMPLICIT SEQUENCE {
privateExtensionList [0] IMPLICIT SEQUENCE ( SIZE ( 1 .. 10 ) ) OF
SEQUENCE {
extId MAP-EXTENSION .&extensionId ( {
'
...} ),
extType MAP-EXTENSION .&ExtensionType ( {
'
...} { @extId } ) OPTIONAL } OPTIONAL,
pcs-Extensions [1] IMPLICIT SEQUENCE {
... } OPTIONAL,
... } OPTIONAL,
... },
callBarringInfo [1] IMPLICIT SEQUENCE {
ss-Code OCTET STRING ( SIZE ( 1 ) ),
callBarringFeatureList SEQUENCE ( SIZE ( 1 .. 32 ) ) OF
SEQUENCE {
basicService CHOICE {
ext-BearerService [2] IMPLICIT OCTET STRING ( SIZE ( 1 .. 5 ) ),
ext-Teleservice [3] IMPLICIT OCTET STRING ( SIZE ( 1 .. 5 ) ) } OPTIONAL,
ss-Status [4] IMPLICIT OCTET STRING ( SIZE ( 1 .. 5 ) ),
extensionContainer SEQUENCE {
privateExtensionList [0] IMPLICIT SEQUENCE ( SIZE ( 1 .. 10 ) ) OF
SEQUENCE {
extId MAP-EXTENSION .&extensionId ( {
'
...} ),
extType MAP-EXTENSION .&ExtensionType ( {
'
...} { @extId } ) OPTIONAL } OPTIONAL,
pcs-Extensions [1] IMPLICIT SEQUENCE {
... } OPTIONAL,
... } OPTIONAL,
... },
extensionContainer SEQUENCE {
privateExtensionList [0] IMPLICIT SEQUENCE ( SIZE ( 1 .. 10 ) ) OF
SEQUENCE {
extId MAP-EXTENSION .&extensionId ( {
'
...} ),
extType MAP-EXTENSION .&ExtensionType ( {
'
...} { @extId } ) OPTIONAL } OPTIONAL,
pcs-Extensions [1] IMPLICIT SEQUENCE {
... } OPTIONAL,
... } OPTIONAL,
... },
cug-Info [2] IMPLICIT SEQUENCE {
cug-SubscriptionList SEQUENCE ( SIZE ( 0 .. 10 ) ) OF
SEQUENCE {
cug-Index INTEGER ( 0 .. 32767 ),
cug-Interlock OCTET STRING ( SIZE ( 4 ) ),
intraCUG-Options ENUMERATED {
noCUG-Restrictions ( 0 ),
cugIC-CallBarred ( 1 ),
cugOG-CallBarred ( 2 ) },
basicServiceGroupList SEQUENCE ( SIZE ( 1 .. 32 ) ) OF
CHOICE {
ext-BearerService [2] IMPLICIT OCTET STRING ( SIZE ( 1 .. 5 ) ),
ext-Teleservice [3] IMPLICIT OCTET STRING ( SIZE ( 1 .. 5 ) ) } OPTIONAL,
extensionContainer [0] IMPLICIT SEQUENCE {
privateExtensionList [0] IMPLICIT SEQUENCE ( SIZE ( 1 .. 10 ) ) OF
SEQUENCE {
extId MAP-EXTENSION .&extensionId ( {
'
...} ),
extType MAP-EXTENSION .&ExtensionType ( {
'
...} { @extId } ) OPTIONAL } OPTIONAL,
pcs-Extensions [1] IMPLICIT SEQUENCE {
... } OPTIONAL,
... } OPTIONAL,
... },

```

```

cug-FeatureList     SEQUENCE ( SIZE ( 1 .. 32 ) ) OF
SEQUENCE {
    basicService     CHOICE {
        ext-BearerService [2] IMPLICIT OCTET STRING ( SIZE ( 1 .. 5 ) ),
        ext-Teleservice [3] IMPLICIT OCTET STRING ( SIZE ( 1 .. 5 ) ) } OPTIONAL,
    preferentialCUG-Indicator INTEGER ( 0 .. 32767 ) OPTIONAL,
    interCUG-Restrictions OCTET STRING ( SIZE ( 1 ) ),
    extensionContainer SEQUENCE {
        privateExtensionList [0] IMPLICIT SEQUENCE ( SIZE ( 1 .. 10 ) ) OF
        SEQUENCE {
            extId MAP-EXTENSION .&extensionId ( {
                '
                ... } ),
            extType MAP-EXTENSION .&ExtensionType ( {
                '
                ... } { @extId } ) OPTIONAL } OPTIONAL,
        pcs-Extensions [1] IMPLICIT SEQUENCE {
            ... } OPTIONAL,
        ... } OPTIONAL,
        ... } OPTIONAL,
    extensionContainer [0] IMPLICIT SEQUENCE {
        privateExtensionList [0] IMPLICIT SEQUENCE ( SIZE ( 1 .. 10 ) ) OF
        SEQUENCE {
            extId MAP-EXTENSION .&extensionId ( {
                '
                ... } ),
            extType MAP-EXTENSION .&ExtensionType ( {
                '
                ... } { @extId } ) OPTIONAL } OPTIONAL,
        pcs-Extensions [1] IMPLICIT SEQUENCE {
            ... } OPTIONAL,
        ... } OPTIONAL,
        ... },
    ss-Data [3] IMPLICIT SEQUENCE {
        ss-Code OCTET STRING ( SIZE ( 1 ) ),
        ss-Status [4] IMPLICIT OCTET STRING ( SIZE ( 1 .. 5 ) ),
        ss-SubscriptionOption CHOICE {
            cliRestrictionOption [2] IMPLICIT ENUMERATED {
                permanent (0),
                temporaryDefaultRestricted (1),
                temporaryDefaultAllowed (2) },
            overrideCategory [1] IMPLICIT ENUMERATED {
                overrideEnabled (0),
                overrideDisabled (1) } } OPTIONAL,
        basicServiceGroupList SEQUENCE ( SIZE ( 1 .. 32 ) ) OF
        CHOICE {
            ext-BearerService [2] IMPLICIT OCTET STRING ( SIZE ( 1 .. 5 ) ),
            ext-Teleservice [3] IMPLICIT OCTET STRING ( SIZE ( 1 .. 5 ) ) } OPTIONAL,
        extensionContainer [5] IMPLICIT SEQUENCE {
            privateExtensionList [0] IMPLICIT SEQUENCE ( SIZE ( 1 .. 10 ) ) OF
            SEQUENCE {
                extId MAP-EXTENSION .&extensionId ( {
                    '
                    ... } ),
                extType MAP-EXTENSION .&ExtensionType ( {
                    '
                    ... } { @extId } ) OPTIONAL } OPTIONAL,
            pcs-Extensions [1] IMPLICIT SEQUENCE {
                ... } OPTIONAL,
            ... } OPTIONAL,
            ... },
        emlpp-Info [4] IMPLICIT SEQUENCE {
            maximumentitledPriority INTEGER ( 0 .. 15 ),
            defaultPriority INTEGER ( 0 .. 15 ),
            extensionContainer SEQUENCE {
                privateExtensionList [0] IMPLICIT SEQUENCE ( SIZE ( 1 .. 10 ) ) OF
                SEQUENCE {
                    extId MAP-EXTENSION .&extensionId ( {
                        '
                        ... } ),
                    extType MAP-EXTENSION .&ExtensionType ( {
                        '
                        ... } { @extId } ) OPTIONAL } OPTIONAL,
                pcs-Extensions [1] IMPLICIT SEQUENCE {
                    ... } OPTIONAL,
                ... } OPTIONAL,
                ... } } OPTIONAL,
        ... } }
    
```

```

odb-Data [8] IMPLICIT SEQUENCE {
  odb-GeneralData BIT STRING {
    allOG-CallsBarred (0),
    internationalOGCallsBarred (1),
    internationalOGCallsNotToHPLMN-CountryBarred (2),
    interzonalOGCallsBarred (6),
    interzonalOGCallsNotToHPLMN-CountryBarred (7),
    interzonalOGCallsAndInternationalOGCallsNotToHPLMN-CountryBarred (8),
    premiumRateInformationOGCallsBarred (3),
    premiumRateEntertainmentOGCallsBarred (4),
    ss-AccessBarred (5),
    allECT-Barred (9),
    chargeableECT-Barred (10),
    internationalECT-Barred (11),
    interzonalECT-Barred (12),
    doublyChargeableECT-Barred (13),
    multipleECT-Barred (14),
    allPacketOrientedServicesBarred (15),
    roamerAccessToHPLMN-AP-Barred (16),
    roamerAccessToVPLMN-AP-Barred (17),
    roamingOutsidePLMNOG-CallsBarred (18),
    allIC-CallsBarred (19),
    roamingOutsidePLMNIC-CallsBarred (20),
    roamingOutsidePLMNICountryIC-CallsBarred (21),
    roamingOutsidePLMN-Barred (22),
    roamingOutsidePLMN-CountryBarred (23),
    registrationAllCF-Barred (24),
    registrationCFNotToHPLMN-Barred (25),
    registrationInterzonalCF-Barred (26),
    registrationInterzonalCFNotToHPLMN-Barred (27) } ( SIZE (15 .. 32) ),
  odb-HPLMN-Data BIT STRING {
    plmn-SpecificBarringType1 (0),
    plmn-SpecificBarringType2 (1),
    plmn-SpecificBarringType3 (2),
    plmn-SpecificBarringType4 (3) } ( SIZE (4 .. 32) ) OPTIONAL,
  extensionContainer SEQUENCE {
    privateExtensionList [0] IMPLICIT SEQUENCE ( SIZE (1 .. 10) ) OF
      SEQUENCE {
        extId MAP-EXTENSION .&extensionId ( {
          '
          ... } ),
        extType MAP-EXTENSION .&ExtensionType ( {
          '
          ... } { @extId } ) OPTIONAL } OPTIONAL,
    pcs-Extensions [1] IMPLICIT SEQUENCE {
      ... } OPTIONAL,
      ... } OPTIONAL,
      ... } OPTIONAL,
      ... } OPTIONAL,
  roamingRestrictionDueToUnsupportedFeature [9] IMPLICIT NULL OPTIONAL,
  regionalSubscriptionData [10] IMPLICIT SEQUENCE ( SIZE (1 .. 10) ) OF
    OCTET STRING ( SIZE (2) ) OPTIONAL,
  vbsSubscriptionData [11] IMPLICIT SEQUENCE ( SIZE (1 .. 50) ) OF
    SEQUENCE {
      groupId OCTET STRING ( SIZE (3) ),
      broadcastInitEntitlement NULL OPTIONAL,
      extensionContainer SEQUENCE {
        privateExtensionList [0] IMPLICIT SEQUENCE ( SIZE (1 .. 10) ) OF
          SEQUENCE {
            extId MAP-EXTENSION .&extensionId ( {
              '
              ... } ),
            extType MAP-EXTENSION .&ExtensionType ( {
              '
              ... } { @extId } ) OPTIONAL } OPTIONAL,
          pcs-Extensions [1] IMPLICIT SEQUENCE {
            ... } OPTIONAL,
            ... } OPTIONAL,
            ... } OPTIONAL,
            ... } OPTIONAL,
      vgcsSubscriptionData [12] IMPLICIT SEQUENCE ( SIZE (1 .. 50) ) OF
        SEQUENCE {
          groupId OCTET STRING ( SIZE (3) ),
          extensionContainer SEQUENCE {
            privateExtensionList [0] IMPLICIT SEQUENCE ( SIZE (1 .. 10) ) OF
              SEQUENCE {
                extId MAP-EXTENSION .&extensionId ( {
                  '
                  ... } ),

```

```

    extType MAP-EXTENSION .&ExtensionType ( {
        '
        ... } { @extId } ) OPTIONAL } OPTIONAL,
    pcs-Extensions [1] IMPLICIT SEQUENCE {
        ... } OPTIONAL,
        ... } OPTIONAL,
        ... } OPTIONAL,
    vlrCamelSubscriptionInfo [13] IMPLICIT SEQUENCE {
    o-CSI [0] IMPLICIT SEQUENCE {
    o-BcsmCamelTDPDataList SEQUENCE ( SIZE ( 1 .. 10 ) ) OF
    SEQUENCE {
        o-BcsmTriggerDetectionPoint ENUMERATED {
            collectedInfo ( 2 ),
            ... ,
            routeSelectFailure ( 4 ) },
        serviceKey INTEGER ( 0 .. 2147483647 ),
        gsmSCF-Address [0] IMPLICIT OCTET STRING ( SIZE ( 1 .. 20 ) ) ( SIZE ( 1 .. 9 ) ),
        defaultCallHandling [1] IMPLICIT ENUMERATED {
            continueCall ( 0 ),
            releaseCall ( 1 ),
            ... },
        extensionContainer [2] IMPLICIT SEQUENCE {
        privateExtensionList [0] IMPLICIT SEQUENCE ( SIZE ( 1 .. 10 ) ) OF
        SEQUENCE {
            extId MAP-EXTENSION .&extensionId ( {
                '
                ... } ),
            extType MAP-EXTENSION .&ExtensionType ( {
                '
                ... } { @extId } ) OPTIONAL } OPTIONAL,
            pcs-Extensions [1] IMPLICIT SEQUENCE {
                ... } OPTIONAL,
                ... } OPTIONAL,
                ... },
        extensionContainer SEQUENCE {
        privateExtensionList [0] IMPLICIT SEQUENCE ( SIZE ( 1 .. 10 ) ) OF
        SEQUENCE {
            extId MAP-EXTENSION .&extensionId ( {
                '
                ... } ),
            extType MAP-EXTENSION .&ExtensionType ( {
                '
                ... } { @extId } ) OPTIONAL } OPTIONAL,
            pcs-Extensions [1] IMPLICIT SEQUENCE {
                ... } OPTIONAL,
                ... } OPTIONAL,
                ... },
        camelCapabilityHandling [0] IMPLICIT INTEGER ( 1 .. 16 ) OPTIONAL,
        notificationToCSE [1] IMPLICIT NULL OPTIONAL,
        csiActive [2] IMPLICIT NULL OPTIONAL } OPTIONAL,
    extensionContainer [1] IMPLICIT SEQUENCE {
    privateExtensionList [0] IMPLICIT SEQUENCE ( SIZE ( 1 .. 10 ) ) OF
    SEQUENCE {
        extId MAP-EXTENSION .&extensionId ( {
            '
            ... } ),
        extType MAP-EXTENSION .&ExtensionType ( {
            '
            ... } { @extId } ) OPTIONAL } OPTIONAL,
        pcs-Extensions [1] IMPLICIT SEQUENCE {
            ... } OPTIONAL,
            ... } OPTIONAL,
            ... },
    ss-CSI [2] IMPLICIT SEQUENCE {
    ss-CamelData SEQUENCE {
        ss-EventList SEQUENCE ( SIZE ( 1 .. 10 ) ) OF
        OCTET STRING ( SIZE ( 1 ) ),
        gsmSCF-Address OCTET STRING ( SIZE ( 1 .. 20 ) ) ( SIZE ( 1 .. 9 ) ),
        extensionContainer [0] IMPLICIT SEQUENCE {
        privateExtensionList [0] IMPLICIT SEQUENCE ( SIZE ( 1 .. 10 ) ) OF
        SEQUENCE {
            extId MAP-EXTENSION .&extensionId ( {
                '
                ... } ),
            extType MAP-EXTENSION .&ExtensionType ( {
                '
                ... } { @extId } ) OPTIONAL } OPTIONAL,

```

```

    pcs-Extensions      [1] IMPLICIT SEQUENCE {
      ... } OPTIONAL,
      ... } OPTIONAL,
    ... },
  extensionContainer SEQUENCE {
    privateExtensionList [0] IMPLICIT SEQUENCE ( SIZE (1 .. 10) ) OF
      SEQUENCE {
        extId  MAP-EXTENSION .&extensionId ( {
          '
          ... } ),
        extType  MAP-EXTENSION .&ExtensionType ( {
          '
          ... } { @extId } ) OPTIONAL } OPTIONAL,
    pcs-Extensions      [1] IMPLICIT SEQUENCE {
      ... } OPTIONAL,
      ... } OPTIONAL,
    ... ,
  notificationToCSE [0] IMPLICIT NULL OPTIONAL,
  csi-Active         [1] IMPLICIT NULL OPTIONAL } OPTIONAL,
o-BcsmCamelTDP-CriteriaList [4] IMPLICIT SEQUENCE ( SIZE (1 .. 10) ) OF
SEQUENCE {
  o-BcsmTriggerDetectionPoint ENUMERATED {
    collectedInfo      (2),
    ... ,
    routeSelectFailure (4) },
  destinationNumberCriteria [0] IMPLICIT SEQUENCE {
    matchType          [0] IMPLICIT ENUMERATED {
      inhibiting (0),
      enabling (1) },
    destinationNumberList [1] IMPLICIT SEQUENCE ( SIZE (1 .. 10) ) OF
      OCTET STRING ( SIZE (1 .. 20) ) ( SIZE (1 .. 9) ) OPTIONAL,
    destinationNumberLengthList [2] IMPLICIT SEQUENCE ( SIZE (1 .. 3) ) OF
      INTEGER (1 .. 15) OPTIONAL,
    ... } OPTIONAL,
  basicServiceCriteria [1] IMPLICIT SEQUENCE ( SIZE (1 .. 5) ) OF
    CHOICE {
      ext-BearerService [2] IMPLICIT OCTET STRING ( SIZE (1 .. 5) ),
      ext-Teleservice [3] IMPLICIT OCTET STRING ( SIZE (1 .. 5) ) } OPTIONAL,
  callTypeCriteria [2] IMPLICIT ENUMERATED {
    forwarded (0),
    notForwarded (1) } OPTIONAL,
  ... ,
  o-CauseValueCriteria [3] IMPLICIT SEQUENCE ( SIZE (1 .. 5) ) OF
    OCTET STRING ( SIZE (1) ) OPTIONAL,
  extensionContainer [4] IMPLICIT SEQUENCE {
    privateExtensionList [0] IMPLICIT SEQUENCE ( SIZE (1 .. 10) ) OF
      SEQUENCE {
        extId  MAP-EXTENSION .&extensionId ( {
          '
          ... } ),
        extType  MAP-EXTENSION .&ExtensionType ( {
          '
          ... } { @extId } ) OPTIONAL } OPTIONAL,
    pcs-Extensions      [1] IMPLICIT SEQUENCE {
      ... } OPTIONAL,
      ... } OPTIONAL } OPTIONAL,
  tif-CSI [3] IMPLICIT NULL OPTIONAL,
  m-CSI [5] IMPLICIT SEQUENCE {
    mobilityTriggers SEQUENCE ( SIZE (1 .. 10) ) OF
      OCTET STRING ( SIZE (1) ),
    serviceKey INTEGER (0 .. 2147483647),
    gsmSCF-Address [0] IMPLICIT OCTET STRING ( SIZE (1 .. 20) ) ( SIZE (1 .. 9) ),
    extensionContainer [1] IMPLICIT SEQUENCE {
      privateExtensionList [0] IMPLICIT SEQUENCE ( SIZE (1 .. 10) ) OF
        SEQUENCE {
          extId  MAP-EXTENSION .&extensionId ( {
            '
            ... } ),
          extType  MAP-EXTENSION .&ExtensionType ( {
            '
            ... } { @extId } ) OPTIONAL } OPTIONAL,
      pcs-Extensions      [1] IMPLICIT SEQUENCE {
        ... } OPTIONAL,
        ... } OPTIONAL,
      notificationToCSE [2] IMPLICIT NULL OPTIONAL,
      csi-Active [3] IMPLICIT NULL OPTIONAL,
      ... } OPTIONAL,

```

```

mo-sms-CSI [6] IMPLICIT SEQUENCE {
  sms-CAMEL-TDP-DataList [0] IMPLICIT SEQUENCE ( SIZE (1 .. 10) ) OF
  SEQUENCE {
    sms-TriggerDetectionPoint [0] IMPLICIT ENUMERATED {
      sms-CollectedInfo (1),
      ... ,
      sms-DeliveryRequest (2)},
    serviceKey [1] IMPLICIT INTEGER (0 .. 2147483647),
    gsmSCF-Address [2] IMPLICIT OCTET STRING ( SIZE (1 .. 20) ) ( SIZE (1 .. 9) ),
    defaultSMS-Handling [3] IMPLICIT ENUMERATED {
      continueTransaction (0),
      releaseTransaction (1),
      ... },
    extensionContainer [4] IMPLICIT SEQUENCE {
      privateExtensionList [0] IMPLICIT SEQUENCE ( SIZE (1 .. 10) ) OF
      SEQUENCE {
        extId MAP-EXTENSION .&extensionId ( {
          '
          ... } ),
        extType MAP-EXTENSION .&ExtensionType ( {
          '
          ... } { @extId } ) OPTIONAL} OPTIONAL,
        pcs-Extensions [1] IMPLICIT SEQUENCE {
          ... } OPTIONAL,
          ... } OPTIONAL,
          ... } OPTIONAL,
        camelCapabilityHandling [1] IMPLICIT INTEGER (1 .. 16) OPTIONAL,
        extensionContainer [2] IMPLICIT SEQUENCE {
          privateExtensionList [0] IMPLICIT SEQUENCE ( SIZE (1 .. 10) ) OF
          SEQUENCE {
            extId MAP-EXTENSION .&extensionId ( {
              '
              ... } ),
            extType MAP-EXTENSION .&ExtensionType ( {
              '
              ... } { @extId } ) OPTIONAL} OPTIONAL,
            pcs-Extensions [1] IMPLICIT SEQUENCE {
              ... } OPTIONAL,
              ... } OPTIONAL,
              ... } OPTIONAL,
            notificationToCSE [3] IMPLICIT NULL OPTIONAL,
            csi-Active [4] IMPLICIT NULL OPTIONAL,
            ... } OPTIONAL,
          vt-CSI [7] IMPLICIT SEQUENCE {
            t-BcsmCamelTDPDataList SEQUENCE ( SIZE (1 .. 10) ) OF
            SEQUENCE {
              t-BcsmTriggerDetectionPoint ENUMERATED {
                termAttemptAuthorized (12),
                ... ,
                tBusy (13),
                tNoAnswer (14)},
              serviceKey INTEGER (0 .. 2147483647),
              gsmSCF-Address [0] IMPLICIT OCTET STRING ( SIZE (1 .. 20) ) ( SIZE (1 .. 9) ),
              defaultCallHandling [1] IMPLICIT ENUMERATED {
                continueCall (0),
                releaseCall (1),
                ... },
              extensionContainer [2] IMPLICIT SEQUENCE {
                privateExtensionList [0] IMPLICIT SEQUENCE ( SIZE (1 .. 10) ) OF
                SEQUENCE {
                  extId MAP-EXTENSION .&extensionId ( {
                    '
                    ... } ),
                  extType MAP-EXTENSION .&ExtensionType ( {
                    '
                    ... } { @extId } ) OPTIONAL} OPTIONAL,
                  pcs-Extensions [1] IMPLICIT SEQUENCE {
                    ... } OPTIONAL,
                    ... } OPTIONAL,
                    ... } OPTIONAL,
                  extensionContainer SEQUENCE {
                    privateExtensionList [0] IMPLICIT SEQUENCE ( SIZE (1 .. 10) ) OF
                    SEQUENCE {
                      extId MAP-EXTENSION .&extensionId ( {
                        '
                        ... } ),
                      extType MAP-EXTENSION .&ExtensionType ( {

```

```

... } { @extId } ) OPTIONAL} OPTIONAL,
pcs-Extensions [1] IMPLICIT SEQUENCE {
... } OPTIONAL,
... } OPTIONAL,
... ,
camelCapabilityHandling [0] IMPLICIT INTEGER ( 1 .. 16 ) OPTIONAL,
notificationToCSE [1] IMPLICIT NULL OPTIONAL,
csi-Active [2] IMPLICIT NULL OPTIONAL} OPTIONAL,
t-BCSM-CAMEL-TDP-CriteriaList [8] IMPLICIT SEQUENCE ( SIZE ( 1 .. 10 ) ) OF
SEQUENCE {
t-BCSM-TriggerDetectionPoint ENUMERATED {
termAttemptAuthorized ( 12 ),
... ,
tBusy ( 13 ),
tNoAnswer ( 14 )},
basicServiceCriteria [0] IMPLICIT SEQUENCE ( SIZE ( 1 .. 5 ) ) OF
CHOICE {
ext-BearerService [2] IMPLICIT OCTET STRING ( SIZE ( 1 .. 5 ) ),
ext-Teleservice [3] IMPLICIT OCTET STRING ( SIZE ( 1 .. 5 ) )} OPTIONAL,
t-CauseValueCriteria [1] IMPLICIT SEQUENCE ( SIZE ( 1 .. 5 ) ) OF
OCTET STRING ( SIZE ( 1 ) ) OPTIONAL,
... } OPTIONAL,
d-CSI [9] IMPLICIT SEQUENCE {
dp-AnalysedInfoCriteriaList [0] IMPLICIT SEQUENCE ( SIZE ( 1 .. 10 ) ) OF
SEQUENCE {
dialledNumber OCTET STRING ( SIZE ( 1 .. 20 ) ) ( SIZE ( 1 .. 9 ) ),
serviceKey INTEGER ( 0 .. 2147483647 ),
gsmSCF-Address OCTET STRING ( SIZE ( 1 .. 20 ) ) ( SIZE ( 1 .. 9 ) ),
defaultCallHandling ENUMERATED {
continueCall ( 0 ),
releaseCall ( 1 ),
... },
extensionContainer SEQUENCE {
privateExtensionList [0] IMPLICIT SEQUENCE ( SIZE ( 1 .. 10 ) ) OF
SEQUENCE {
extId MAP-EXTENSION .&extensionId ( {
'
... } ),
extType MAP-EXTENSION .&ExtensionType ( {
'
... } { @extId } ) OPTIONAL} OPTIONAL,
pcs-Extensions [1] IMPLICIT SEQUENCE {
... } OPTIONAL,
... } OPTIONAL,
... } OPTIONAL,
camelCapabilityHandling [1] IMPLICIT INTEGER ( 1 .. 16 ) OPTIONAL,
extensionContainer [2] IMPLICIT SEQUENCE {
privateExtensionList [0] IMPLICIT SEQUENCE ( SIZE ( 1 .. 10 ) ) OF
SEQUENCE {
extId MAP-EXTENSION .&extensionId ( {
'
... } ),
extType MAP-EXTENSION .&ExtensionType ( {
'
... } { @extId } ) OPTIONAL} OPTIONAL,
pcs-Extensions [1] IMPLICIT SEQUENCE {
... } OPTIONAL,
... } OPTIONAL,
notificationToCSE [3] IMPLICIT NULL OPTIONAL,
csi-Active [4] IMPLICIT NULL OPTIONAL,
... } OPTIONAL,
mt-sms-CSI [10] IMPLICIT SEQUENCE {
sms-CAMEL-TDP-DataList [0] IMPLICIT SEQUENCE ( SIZE ( 1 .. 10 ) ) OF
SEQUENCE {
sms-TriggerDetectionPoint [0] IMPLICIT ENUMERATED {
sms-CollectedInfo ( 1 ),
... ,
sms-DeliveryRequest ( 2 )},
serviceKey [1] IMPLICIT INTEGER ( 0 .. 2147483647 ),
gsmSCF-Address [2] IMPLICIT OCTET STRING ( SIZE ( 1 .. 20 ) ) ( SIZE ( 1 .. 9 ) ),
defaultSMS-Handling [3] IMPLICIT ENUMERATED {
continueTransaction ( 0 ),
releaseTransaction ( 1 ),
... },
extensionContainer [4] IMPLICIT SEQUENCE {
privateExtensionList [0] IMPLICIT SEQUENCE ( SIZE ( 1 .. 10 ) ) OF
SEQUENCE {

```

```

    extId  MAP-EXTENSION .&extensionId ( {
        '
        ... } ),
    extType  MAP-EXTENSION .&ExtensionType ( {
        '
        ... } { @extId } ) OPTIONAL} OPTIONAL,
    pcs-Extensions  [1] IMPLICIT SEQUENCE {
        ... } OPTIONAL,
    ... } OPTIONAL,
    ... } OPTIONAL,
camelCapabilityHandling  [1] IMPLICIT INTEGER ( 1 .. 16 ) OPTIONAL,
extensionContainer  [2] IMPLICIT SEQUENCE {
    privateExtensionList  [0] IMPLICIT SEQUENCE ( SIZE ( 1 .. 10 ) ) OF
    SEQUENCE {
        extId  MAP-EXTENSION .&extensionId ( {
            '
            ... } ),
        extType  MAP-EXTENSION .&ExtensionType ( {
            '
            ... } { @extId } ) OPTIONAL} OPTIONAL,
        pcs-Extensions  [1] IMPLICIT SEQUENCE {
            ... } OPTIONAL,
            ... } OPTIONAL,
            notificationToCSE  [3] IMPLICIT NULL OPTIONAL,
            csi-Active  [4] IMPLICIT NULL OPTIONAL,
            ... } OPTIONAL,
        mt-smsCAMELTDP-CriteriaList  [11] IMPLICIT SEQUENCE ( SIZE ( 1 .. 10 ) ) OF
        SEQUENCE {
            sms-TriggerDetectionPoint  ENUMERATED {
                sms-CollectedInfo  ( 1 ),
                ... ,
                sms-DeliveryRequest  ( 2 ) },
            tpdu-TypeCriterion  [0] IMPLICIT SEQUENCE ( SIZE ( 1 .. 5 ) ) OF
            ENUMERATED {
                sms-DELIVER  ( 0 ),
                sms-SUBMIT-REPORT  ( 1 ),
                sms-STATUS-REPORT  ( 2 ),
                ... } OPTIONAL,
            ... } OPTIONAL} OPTIONAL,
        extensionContainer  [14] IMPLICIT SEQUENCE {
            privateExtensionList  [0] IMPLICIT SEQUENCE ( SIZE ( 1 .. 10 ) ) OF
            SEQUENCE {
                extId  MAP-EXTENSION .&extensionId ( {
                    '
                    ... } ),
                extType  MAP-EXTENSION .&ExtensionType ( {
                    '
                    ... } { @extId } ) OPTIONAL} OPTIONAL,
                pcs-Extensions  [1] IMPLICIT SEQUENCE {
                    ... } OPTIONAL,
                    ... } OPTIONAL,
                    ... } OPTIONAL,
                    ... } OPTIONAL,
                    naea-PreferredCI  [15] IMPLICIT SEQUENCE {
                        naea-PreferredCIC  [0] IMPLICIT OCTET STRING ( SIZE ( 3 ) ),
                        extensionContainer  [1] IMPLICIT SEQUENCE {
                            privateExtensionList  [0] IMPLICIT SEQUENCE ( SIZE ( 1 .. 10 ) ) OF
                            SEQUENCE {
                                extId  MAP-EXTENSION .&extensionId ( {
                                    '
                                    ... } ),
                                extType  MAP-EXTENSION .&ExtensionType ( {
                                    '
                                    ... } { @extId } ) OPTIONAL} OPTIONAL,
                                    pcs-Extensions  [1] IMPLICIT SEQUENCE {
                                        ... } OPTIONAL,
                                        ... } OPTIONAL,
                                        ... } OPTIONAL,
                                        ... } OPTIONAL,
                                        gprsSubscriptionData  [16] IMPLICIT SEQUENCE {
                                            completeDataListIncluded  NULL OPTIONAL,
                                            gprsDataList  [1] IMPLICIT SEQUENCE ( SIZE ( 1 .. 50 ) ) OF
                                            SEQUENCE {
                                                pdp-ContextId  INTEGER ( 1 .. 50 ),
                                                pdp-Type  [16] IMPLICIT OCTET STRING ( SIZE ( 2 ) ),
                                                pdp-Address  [17] IMPLICIT OCTET STRING ( SIZE ( 1 .. 16 ) ) OPTIONAL,
                                                qos-Subscribed  [18] IMPLICIT OCTET STRING ( SIZE ( 3 ) ),
                                                vplmnAddressAllowed  [19] IMPLICIT NULL OPTIONAL,
                                                apn  [20] IMPLICIT OCTET STRING ( SIZE ( 2 .. 63 ) ),

```



```

extensionContainer [21] IMPLICIT SEQUENCE {
  privateExtensionList [0] IMPLICIT SEQUENCE ( SIZE ( 1 .. 10 ) ) OF
  SEQUENCE {
    extId MAP-EXTENSION .&extensionId ( {
      '
      ... } ),
    extType MAP-EXTENSION .&ExtensionType ( {
      '
      ... } { @extId } ) OPTIONAL } OPTIONAL,
  pcs-Extensions [1] IMPLICIT SEQUENCE {
    ... } OPTIONAL,
  ... } OPTIONAL,
  ... ,
  ext-QoS-Subscribed [0] IMPLICIT OCTET STRING ( SIZE ( 1 .. 9 ) ) OPTIONAL,
  pdp-ChargingCharacteristics [1] IMPLICIT OCTET STRING ( SIZE ( 2 ) ) OPTIONAL,
extensionContainer [2] IMPLICIT SEQUENCE {
  privateExtensionList [0] IMPLICIT SEQUENCE ( SIZE ( 1 .. 10 ) ) OF
  SEQUENCE {
    extId MAP-EXTENSION .&extensionId ( {
      '
      ... } ),
    extType MAP-EXTENSION .&ExtensionType ( {
      '
      ... } { @extId } ) OPTIONAL } OPTIONAL,
  pcs-Extensions [1] IMPLICIT SEQUENCE {
    ... } OPTIONAL,
  ... } OPTIONAL,
  ... } OPTIONAL,
  roamingRestrictedInSgsnDueToUnsupportedFeature [23] IMPLICIT NULL OPTIONAL,
networkAccessMode [24] IMPLICIT ENUMERATED {
  bothMSCAndSGSN ( 0 ),
  onlyMSC ( 1 ),
  onlySGSN ( 2 ),
  ... } OPTIONAL,
IsaInformation [25] IMPLICIT SEQUENCE {
  completeDataListIncluded NULL OPTIONAL,
  IsaOnlyAccessIndicator [1] IMPLICIT ENUMERATED {
    accessOutsideLSAsAllowed ( 0 ),
    accessOutsideLSAsRestricted ( 1 ) } OPTIONAL,
  IsaDataList [2] IMPLICIT SEQUENCE ( SIZE ( 1 .. 20 ) ) OF
  SEQUENCE {
    IsaIdentity [0] IMPLICIT OCTET STRING ( SIZE ( 3 ) ),
    IsaAttributes [1] IMPLICIT OCTET STRING ( SIZE ( 1 ) ),
    IsaActiveModeIndicator [2] IMPLICIT NULL OPTIONAL,
    extensionContainer [3] IMPLICIT SEQUENCE {
      privateExtensionList [0] IMPLICIT SEQUENCE ( SIZE ( 1 .. 10 ) ) OF
      SEQUENCE {
        extId MAP-EXTENSION .&extensionId ( {
          '
          ... } ),
        extType MAP-EXTENSION .&ExtensionType ( {
          '
          ... } { @extId } ) OPTIONAL } OPTIONAL,
      pcs-Extensions [1] IMPLICIT SEQUENCE {
        ... } OPTIONAL,
      ... } OPTIONAL,
      ... } OPTIONAL,
    extensionContainer [3] IMPLICIT SEQUENCE {
      privateExtensionList [0] IMPLICIT SEQUENCE ( SIZE ( 1 .. 10 ) ) OF
      SEQUENCE {
        extId MAP-EXTENSION .&extensionId ( {
          '
          ... } ),
        extType MAP-EXTENSION .&ExtensionType ( {
          '
          ... } { @extId } ) OPTIONAL } OPTIONAL,
      pcs-Extensions [1] IMPLICIT SEQUENCE {
        ... } OPTIONAL,
      ... } OPTIONAL,
      ... } OPTIONAL,
    lmu-Indicator [21] IMPLICIT NULL OPTIONAL,
  lcsInformation [22] IMPLICIT SEQUENCE {
    gmlc-List [0] IMPLICIT SEQUENCE ( SIZE ( 1 .. 5 ) ) OF
    OCTET STRING ( SIZE ( 1 .. 20 ) ) ( SIZE ( 1 .. 9 ) ) OPTIONAL,
    lcs-PrivacyExceptionList [1] IMPLICIT SEQUENCE ( SIZE ( 1 .. 4 ) ) OF
    SEQUENCE {
      ss-Code OCTET STRING ( SIZE ( 1 ) ),

```

```

ss-Status          OCTET STRING ( SIZE ( 1 .. 5 ) ),
notificationToMSUser [0] IMPLICIT ENUMERATED {
  notifyLocationAllowed          ( 0 ),
  notifyAndVerify-LocationAllowedIfNoResponse ( 1 ),
  notifyAndVerify-LocationNotAllowedIfNoResponse ( 2 ),
  ... ,
  locationNotAllowed            ( 3 ) } OPTIONAL,
externalClientList [1] IMPLICIT SEQUENCE ( SIZE ( 0 .. 5 ) ) OF
SEQUENCE {
  clientIdentity SEQUENCE {
    externalAddress [0] IMPLICIT OCTET STRING ( SIZE ( 1 .. 20 ) ) OPTIONAL,
    extensionContainer [1] IMPLICIT SEQUENCE {
      privateExtensionList [0] IMPLICIT SEQUENCE ( SIZE ( 1 .. 10 ) ) OF
      SEQUENCE {
        extId MAP-EXTENSION .&extensionId ( {
          '
          ... } ),
        extType MAP-EXTENSION .&ExtensionType ( {
          '
          ... } { @extId } ) OPTIONAL } OPTIONAL,
      pcs-Extensions [1] IMPLICIT SEQUENCE {
        ... } OPTIONAL,
        ... } OPTIONAL,
      ... },
    gmlc-Restriction [0] IMPLICIT ENUMERATED {
      gmlc-List ( 0 ),
      home-Country ( 1 ),
      ... } OPTIONAL,
    notificationToMSUser [1] IMPLICIT ENUMERATED {
      notifyLocationAllowed ( 0 ),
      notifyAndVerify-LocationAllowedIfNoResponse ( 1 ),
      notifyAndVerify-LocationNotAllowedIfNoResponse ( 2 ),
      ... ,
      locationNotAllowed ( 3 ) } OPTIONAL,
    extensionContainer [2] IMPLICIT SEQUENCE {
      privateExtensionList [0] IMPLICIT SEQUENCE ( SIZE ( 1 .. 10 ) ) OF
      SEQUENCE {
        extId MAP-EXTENSION .&extensionId ( {
          '
          ... } ),
        extType MAP-EXTENSION .&ExtensionType ( {
          '
          ... } { @extId } ) OPTIONAL } OPTIONAL,
      pcs-Extensions [1] IMPLICIT SEQUENCE {
        ... } OPTIONAL,
        ... } OPTIONAL,
        ... } OPTIONAL,
      ... },
    plmnClientList [2] IMPLICIT SEQUENCE ( SIZE ( 1 .. 5 ) ) OF
    ENUMERATED {
      broadcastService ( 0 ),
      o-andM-HPLMN ( 1 ),
      o-andM-VPLMN ( 2 ),
      anonymousLocation ( 3 ),
      targetMSsubscribedService ( 4 ),
      ... } OPTIONAL,
    extensionContainer [3] IMPLICIT SEQUENCE {
      privateExtensionList [0] IMPLICIT SEQUENCE ( SIZE ( 1 .. 10 ) ) OF
      SEQUENCE {
        extId MAP-EXTENSION .&extensionId ( {
          '
          ... } ),
        extType MAP-EXTENSION .&ExtensionType ( {
          '
          ... } { @extId } ) OPTIONAL } OPTIONAL,
      pcs-Extensions [1] IMPLICIT SEQUENCE {
        ... } OPTIONAL,
        ... } OPTIONAL,
      ... },
    ... ,
    ext-externalClientList [4] IMPLICIT SEQUENCE ( SIZE ( 1 .. 35 ) ) OF
    SEQUENCE {
      clientIdentity SEQUENCE {
        externalAddress [0] IMPLICIT OCTET STRING ( SIZE ( 1 .. 20 ) ) OPTIONAL,
        extensionContainer [1] IMPLICIT SEQUENCE {
          privateExtensionList [0] IMPLICIT SEQUENCE ( SIZE ( 1 .. 10 ) ) OF
          SEQUENCE {
            extId MAP-EXTENSION .&extensionId ( {
              '

```

```

...}),
  extType MAP-EXTENSION .&ExtensionType ( {
    ...}{ @extId } ) OPTIONAL} OPTIONAL,
  pcs-Extensions [1] IMPLICIT SEQUENCE {
    ... } OPTIONAL,
    ... } OPTIONAL,
  ... },
  gmlc-Restriction [0] IMPLICIT ENUMERATED {
    gmlc-List (0),
    home-Country (1),
    ... } OPTIONAL,
  notificationToMSUser [1] IMPLICIT ENUMERATED {
    notifyLocationAllowed (0),
    notifyAndVerify-LocationAllowedIfNoResponse (1),
    notifyAndVerify-LocationNotAllowedIfNoResponse (2),
    ... ,
    locationNotAllowed (3) } OPTIONAL,
  extensionContainer [2] IMPLICIT SEQUENCE {
    privateExtensionList [0] IMPLICIT SEQUENCE ( SIZE (1 .. 10) ) OF
    SEQUENCE {
      extId MAP-EXTENSION .&extensionId ( {
        ... } ),
      extType MAP-EXTENSION .&ExtensionType ( {
        ...}{ @extId } ) OPTIONAL} OPTIONAL,
      pcs-Extensions [1] IMPLICIT SEQUENCE {
        ... } OPTIONAL,
        ... } OPTIONAL,
        ... } OPTIONAL,
      ... } OPTIONAL,
    serviceTypeList [5] IMPLICIT SEQUENCE ( SIZE (1 .. 32) ) OF
    SEQUENCE {
      serviceTypeIdentity INTEGER (0 .. 127),
      gmlc-Restriction [0] IMPLICIT ENUMERATED {
        gmlc-List (0),
        home-Country (1),
        ... } OPTIONAL,
      notificationToMSUser [1] IMPLICIT ENUMERATED {
        notifyLocationAllowed (0),
        notifyAndVerify-LocationAllowedIfNoResponse (1),
        notifyAndVerify-LocationNotAllowedIfNoResponse (2),
        ... ,
        locationNotAllowed (3) } OPTIONAL,
      extensionContainer [2] IMPLICIT SEQUENCE {
        privateExtensionList [0] IMPLICIT SEQUENCE ( SIZE (1 .. 10) ) OF
        SEQUENCE {
          extId MAP-EXTENSION .&extensionId ( {
            ... } ),
            ... } ),
          extType MAP-EXTENSION .&ExtensionType ( {
            ...}{ @extId } ) OPTIONAL} OPTIONAL,
            pcs-Extensions [1] IMPLICIT SEQUENCE {
              ... } OPTIONAL,
              ... } OPTIONAL,
              ... } OPTIONAL,
            ... } OPTIONAL,
          ... } OPTIONAL,
        molr-List [2] IMPLICIT SEQUENCE ( SIZE (1 .. 3) ) OF
        SEQUENCE {
          ss-Code OCTET STRING ( SIZE (1) ),
          ss-Status OCTET STRING ( SIZE (1 .. 5) ),
          extensionContainer [0] IMPLICIT SEQUENCE {
            privateExtensionList [0] IMPLICIT SEQUENCE ( SIZE (1 .. 10) ) OF
            SEQUENCE {
              extId MAP-EXTENSION .&extensionId ( {
                ... } ),
                ... } ),
              extType MAP-EXTENSION .&ExtensionType ( {
                ...}{ @extId } ) OPTIONAL} OPTIONAL,
                pcs-Extensions [1] IMPLICIT SEQUENCE {
                  ... } OPTIONAL,
                  ... } OPTIONAL,
                  ... } OPTIONAL,
                ... } OPTIONAL,
              add-Ics-PrivacyExceptionList [3] IMPLICIT SEQUENCE ( SIZE (1 .. 4) ) OF
              SEQUENCE {

```

```

ss-Code          OCTET STRING ( SIZE ( 1 ) ),
ss-Status        OCTET STRING ( SIZE ( 1.. 5 ) ),
notificationToMSUser [0] IMPLICIT ENUMERATED {
  notifyLocationAllowed          ( 0 ),
  notifyAndVerify-LocationAllowedIfNoResponse ( 1 ),
  notifyAndVerify-LocationNotAllowedIfNoResponse ( 2 ),
  ... ,
  locationNotAllowed              ( 3 ) } OPTIONAL,
externalClientList [1] IMPLICIT SEQUENCE ( SIZE ( 0.. 5 ) ) OF
SEQUENCE {
  clientIdentity SEQUENCE {
    externalAddress [0] IMPLICIT OCTET STRING ( SIZE ( 1.. 20 ) ) OPTIONAL,
    extensionContainer [1] IMPLICIT SEQUENCE {
      privateExtensionList [0] IMPLICIT SEQUENCE ( SIZE ( 1.. 10 ) ) OF
      SEQUENCE {
        extId MAP-EXTENSION .&extensionId ( {
          '
          ... } ),
        extType MAP-EXTENSION .&ExtensionType ( {
          '
          ... } { @extId } ) OPTIONAL } OPTIONAL,
      pcs-Extensions [1] IMPLICIT SEQUENCE {
        ... } OPTIONAL,
        ... } OPTIONAL,
      ... },
    gmlc-Restriction [0] IMPLICIT ENUMERATED {
      gmlc-List ( 0 ),
      home-Country ( 1 ),
      ... } OPTIONAL,
    notificationToMSUser [1] IMPLICIT ENUMERATED {
      notifyLocationAllowed ( 0 ),
      notifyAndVerify-LocationAllowedIfNoResponse ( 1 ),
      notifyAndVerify-LocationNotAllowedIfNoResponse ( 2 ),
      ... ,
      locationNotAllowed ( 3 ) } OPTIONAL,
    extensionContainer [2] IMPLICIT SEQUENCE {
      privateExtensionList [0] IMPLICIT SEQUENCE ( SIZE ( 1.. 10 ) ) OF
      SEQUENCE {
        extId MAP-EXTENSION .&extensionId ( {
          '
          ... } ),
        extType MAP-EXTENSION .&ExtensionType ( {
          '
          ... } { @extId } ) OPTIONAL } OPTIONAL,
      pcs-Extensions [1] IMPLICIT SEQUENCE {
        ... } OPTIONAL,
        ... } OPTIONAL,
      ... } OPTIONAL,
    plmnClientList [2] IMPLICIT SEQUENCE ( SIZE ( 1.. 5 ) ) OF
    ENUMERATED {
      broadcastService ( 0 ),
      o-andM-HPLMN ( 1 ),
      o-andM-VPLMN ( 2 ),
      anonymousLocation ( 3 ),
      targetMSsubscribedService ( 4 ),
      ... } OPTIONAL,
    extensionContainer [3] IMPLICIT SEQUENCE {
      privateExtensionList [0] IMPLICIT SEQUENCE ( SIZE ( 1.. 10 ) ) OF
      SEQUENCE {
        extId MAP-EXTENSION .&extensionId ( {
          '
          ... } ),
        extType MAP-EXTENSION .&ExtensionType ( {
          '
          ... } { @extId } ) OPTIONAL } OPTIONAL,
      pcs-Extensions [1] IMPLICIT SEQUENCE {
        ... } OPTIONAL,
        ... } OPTIONAL,
      ... },
    ext-externalClientList [4] IMPLICIT SEQUENCE ( SIZE ( 1.. 35 ) ) OF
    SEQUENCE {
      clientIdentity SEQUENCE {
        externalAddress [0] IMPLICIT OCTET STRING ( SIZE ( 1.. 20 ) ) OPTIONAL,
        extensionContainer [1] IMPLICIT SEQUENCE {
          privateExtensionList [0] IMPLICIT SEQUENCE ( SIZE ( 1.. 10 ) ) OF
          SEQUENCE {
            extId MAP-EXTENSION .&extensionId ( {

```

```

    ... } ,
    extType MAP-EXTENSION .&ExtensionType ( {
        ... } { @extId } ) OPTIONAL } OPTIONAL,
    pcs-Extensions [1] IMPLICIT SEQUENCE {
        ... } OPTIONAL,
    ... } OPTIONAL,
    ... } ,
    gmlc-Restriction [0] IMPLICIT ENUMERATED {
    gmlc-List (0),
    home-Country (1),
    ... } OPTIONAL,
    notificationToMSUser [1] IMPLICIT ENUMERATED {
    notifyLocationAllowed (0),
    notifyAndVerify-LocationAllowedIfNoResponse (1),
    notifyAndVerify-LocationNotAllowedIfNoResponse (2),
    ... ,
    locationNotAllowed (3) } OPTIONAL,
    extensionContainer [2] IMPLICIT SEQUENCE {
    privateExtensionList [0] IMPLICIT SEQUENCE ( SIZE (1 .. 10) ) OF
    SEQUENCE {
        extId MAP-EXTENSION .&extensionId ( {
            ,
            ... } ) ,
        extType MAP-EXTENSION .&ExtensionType ( {
            ,
            ... } { @extId } ) OPTIONAL } OPTIONAL,
        pcs-Extensions [1] IMPLICIT SEQUENCE {
            ... } OPTIONAL,
            ... } OPTIONAL,
            ... } OPTIONAL,
            ... } OPTIONAL } OPTIONAL,
    serviceTypeList [5] IMPLICIT SEQUENCE ( SIZE (1 .. 32) ) OF
    SEQUENCE {
    serviceTypeIdentity INTEGER (0 .. 127),
    gmlc-Restriction [0] IMPLICIT ENUMERATED {
    gmlc-List (0),
    home-Country (1),
    ... } OPTIONAL,
    notificationToMSUser [1] IMPLICIT ENUMERATED {
    notifyLocationAllowed (0),
    notifyAndVerify-LocationAllowedIfNoResponse (1),
    notifyAndVerify-LocationNotAllowedIfNoResponse (2),
    ... ,
    locationNotAllowed (3) } OPTIONAL,
    extensionContainer [2] IMPLICIT SEQUENCE {
    privateExtensionList [0] IMPLICIT SEQUENCE ( SIZE (1 .. 10) ) OF
    SEQUENCE {
        extId MAP-EXTENSION .&extensionId ( {
            ,
            ... } ) ,
        extType MAP-EXTENSION .&ExtensionType ( {
            ,
            ... } { @extId } ) OPTIONAL } OPTIONAL,
        pcs-Extensions [1] IMPLICIT SEQUENCE {
            ... } OPTIONAL,
            ... } OPTIONAL,
            ... } OPTIONAL } OPTIONAL,
    istAlertTimer [26] IMPLICIT INTEGER ( 15 .. 255 ) OPTIONAL,
    superChargerSupportedInHLR [27] IMPLICIT OCTET STRING ( SIZE (1 .. 6) ) OPTIONAL,
    mc-SS-Info [28] IMPLICIT SEQUENCE {
    ss-Code [0] IMPLICIT OCTET STRING ( SIZE (1) ),
    ss-Status [1] IMPLICIT OCTET STRING ( SIZE (1 .. 5) ),
    nbrSB [2] IMPLICIT INTEGER ( 2 .. 7 ),
    nbrUser [3] IMPLICIT INTEGER ( 1 .. 7 ),
    extensionContainer [4] IMPLICIT SEQUENCE {
    privateExtensionList [0] IMPLICIT SEQUENCE ( SIZE (1 .. 10) ) OF
    SEQUENCE {
        extId MAP-EXTENSION .&extensionId ( {
            ,
            ... } ) ,
        extType MAP-EXTENSION .&ExtensionType ( {
            ,
            ... } { @extId } ) OPTIONAL } OPTIONAL,
        pcs-Extensions [1] IMPLICIT SEQUENCE {
            ... } OPTIONAL,
            ... } OPTIONAL,
            ... } OPTIONAL,
            ... } OPTIONAL } OPTIONAL,

```

```

... } OPTIONAL,
cs-AllocationRetentionPriority [29] IMPLICIT OCTET STRING ( SIZE ( 1 ) ) OPTIONAL,
sgsn-CAMEL-SubscriptionInfo [17] IMPLICIT SEQUENCE {
  gprs-CSI [0] IMPLICIT SEQUENCE {
    gprs-CamelTDPDataList [0] IMPLICIT SEQUENCE ( SIZE ( 1 .. 10 ) ) OF
      SEQUENCE {
        gprs-TriggerDetectionPoint [0] IMPLICIT ENUMERATED {
          attach ( 1 ),
          attachChangeOfPosition ( 2 ),
          pdp-ContextEstablishment ( 11 ),
          pdp-ContextEstablishmentAcknowledgement ( 12 ),
          pdp-ContextChangeOfPosition ( 14 ),
          ... },
        serviceKey [1] IMPLICIT INTEGER ( 0 .. 2147483647 ),
        gsmSCF-Address [2] IMPLICIT OCTET STRING ( SIZE ( 1 .. 20 ) ) ( SIZE ( 1 .. 9 ) ),
        defaultSessionHandling [3] IMPLICIT ENUMERATED {
          continueTransaction ( 0 ),
          releaseTransaction ( 1 ),
          ... },
        extensionContainer [4] IMPLICIT SEQUENCE {
          privateExtensionList [0] IMPLICIT SEQUENCE ( SIZE ( 1 .. 10 ) ) OF
            SEQUENCE {
              extId MAP-EXTENSION .&extensionId ( {
                '
                ... } ),
              extType MAP-EXTENSION .&ExtensionType ( {
                '
                ... } { @extId } ) OPTIONAL } OPTIONAL,
          pcs-Extensions [1] IMPLICIT SEQUENCE {
            ... } OPTIONAL,
            ... } OPTIONAL,
            ... } OPTIONAL,
            camelCapabilityHandling [1] IMPLICIT INTEGER ( 1 .. 16 ) OPTIONAL,
            extensionContainer [2] IMPLICIT SEQUENCE {
              privateExtensionList [0] IMPLICIT SEQUENCE ( SIZE ( 1 .. 10 ) ) OF
                SEQUENCE {
                  extId MAP-EXTENSION .&extensionId ( {
                    '
                    ... } ),
                  extType MAP-EXTENSION .&ExtensionType ( {
                    '
                    ... } { @extId } ) OPTIONAL } OPTIONAL,
              pcs-Extensions [1] IMPLICIT SEQUENCE {
                ... } OPTIONAL,
                ... } OPTIONAL,
                notificationToCSE [3] IMPLICIT NULL OPTIONAL,
                csi-Active [4] IMPLICIT NULL OPTIONAL,
                ... } OPTIONAL,
            mo-sms-CSI [1] IMPLICIT SEQUENCE {
              sms-CAMEL-TDP-DataList [0] IMPLICIT SEQUENCE ( SIZE ( 1 .. 10 ) ) OF
                SEQUENCE {
                  sms-TriggerDetectionPoint [0] IMPLICIT ENUMERATED {
                    sms-CollectedInfo ( 1 ),
                    ... ,
                    sms-DeliveryRequest ( 2 ) },
                  serviceKey [1] IMPLICIT INTEGER ( 0 .. 2147483647 ),
                  gsmSCF-Address [2] IMPLICIT OCTET STRING ( SIZE ( 1 .. 20 ) ) ( SIZE ( 1 .. 9 ) ),
                  defaultSMS-Handling [3] IMPLICIT ENUMERATED {
                    continueTransaction ( 0 ),
                    releaseTransaction ( 1 ),
                    ... },
                  extensionContainer [4] IMPLICIT SEQUENCE {
                    privateExtensionList [0] IMPLICIT SEQUENCE ( SIZE ( 1 .. 10 ) ) OF
                      SEQUENCE {
                        extId MAP-EXTENSION .&extensionId ( {
                          '
                          ... } ),
                        extType MAP-EXTENSION .&ExtensionType ( {
                          '
                          ... } { @extId } ) OPTIONAL } OPTIONAL,
                    pcs-Extensions [1] IMPLICIT SEQUENCE {
                      ... } OPTIONAL,
                      ... } OPTIONAL,
                      ... } OPTIONAL,
                      camelCapabilityHandling [1] IMPLICIT INTEGER ( 1 .. 16 ) OPTIONAL,
                      extensionContainer [2] IMPLICIT SEQUENCE {
                        privateExtensionList [0] IMPLICIT SEQUENCE ( SIZE ( 1 .. 10 ) ) OF

```

```

SEQUENCE {
  extId MAP-EXTENSION.&extensionId ( {
    '
    ... } ),
  extType MAP-EXTENSION.&ExtensionType ( {
    '
    ... } { @extId } ) OPTIONAL } OPTIONAL,
  pcs-Extensions [1] IMPLICIT SEQUENCE {
    ... } OPTIONAL,
    ... } OPTIONAL,
  notificationToCSE [3] IMPLICIT NULL OPTIONAL,
  csi-Active [4] IMPLICIT NULL OPTIONAL,
  ... } OPTIONAL,
  extensionContainer [2] IMPLICIT SEQUENCE {
  privateExtensionList [0] IMPLICIT SEQUENCE ( SIZE ( 1 .. 10 ) ) OF
  SEQUENCE {
    extId MAP-EXTENSION.&extensionId ( {
      '
      ... } ),
    extType MAP-EXTENSION.&ExtensionType ( {
      '
      ... } { @extId } ) OPTIONAL } OPTIONAL,
    pcs-Extensions [1] IMPLICIT SEQUENCE {
      ... } OPTIONAL,
      ... } OPTIONAL,
      ... } OPTIONAL,
    ... } OPTIONAL,
  mt-sms-CSI [3] IMPLICIT SEQUENCE {
  sms-CAMEL-TDP-DataList [0] IMPLICIT SEQUENCE ( SIZE ( 1 .. 10 ) ) OF
  SEQUENCE {
    sms-TriggerDetectionPoint [0] IMPLICIT ENUMERATED {
      sms-CollectedInfo ( 1 ),
      ... ,
      sms-DeliveryRequest ( 2 ) },
    serviceKey [1] IMPLICIT INTEGER ( 0 .. 2147483647 ),
    gsmSCF-Address [2] IMPLICIT OCTET STRING ( SIZE ( 1 .. 20 ) ) ( SIZE ( 1 .. 9 ) ),
    defaultSMS-Handling [3] IMPLICIT ENUMERATED {
      continueTransaction ( 0 ),
      releaseTransaction ( 1 ),
      ... },
    extensionContainer [4] IMPLICIT SEQUENCE {
      privateExtensionList [0] IMPLICIT SEQUENCE ( SIZE ( 1 .. 10 ) ) OF
      SEQUENCE {
        extId MAP-EXTENSION.&extensionId ( {
          '
          ... } ),
        extType MAP-EXTENSION.&ExtensionType ( {
          '
          ... } { @extId } ) OPTIONAL } OPTIONAL,
        pcs-Extensions [1] IMPLICIT SEQUENCE {
          ... } OPTIONAL,
          ... } OPTIONAL,
          ... } OPTIONAL,
        camelCapabilityHandling [1] IMPLICIT INTEGER ( 1 .. 16 ) OPTIONAL,
        extensionContainer [2] IMPLICIT SEQUENCE {
        privateExtensionList [0] IMPLICIT SEQUENCE ( SIZE ( 1 .. 10 ) ) OF
        SEQUENCE {
          extId MAP-EXTENSION.&extensionId ( {
            '
            ... } ),
            extType MAP-EXTENSION.&ExtensionType ( {
              '
              ... } { @extId } ) OPTIONAL } OPTIONAL,
            pcs-Extensions [1] IMPLICIT SEQUENCE {
              ... } OPTIONAL,
              ... } OPTIONAL,
              ... } OPTIONAL,
            notificationToCSE [3] IMPLICIT NULL OPTIONAL,
            csi-Active [4] IMPLICIT NULL OPTIONAL,
            ... } OPTIONAL,
          mt-smsCAMELTDP-CriteriaList [4] IMPLICIT SEQUENCE ( SIZE ( 1 .. 10 ) ) OF
          SEQUENCE {
            sms-TriggerDetectionPoint ENUMERATED {
              sms-CollectedInfo ( 1 ),
              ... ,
              sms-DeliveryRequest ( 2 ) },
            tpdu-TypeCriterion [0] IMPLICIT SEQUENCE ( SIZE ( 1 .. 5 ) ) OF
            ENUMERATED {
              sms-DELIVER ( 0 ),

```

```

        sms-SUBMIT-REPORT (1),
        sms-STATUS-REPORT (2),
        ... } OPTIONAL,
    ... } OPTIONAL,
mg-csi [5] IMPLICIT SEQUENCE {
    mobilityTriggers SEQUENCE ( SIZE (1 .. 10) ) OF
        OCTET STRING ( SIZE (1) ),
    serviceKey INTEGER ( 0 .. 2147483647 ),
    gsmSCF-Address [0] IMPLICIT OCTET STRING ( SIZE (1 .. 20) ) ( SIZE (1 .. 9) ),
    extensionContainer [1] IMPLICIT SEQUENCE {
        privateExtensionList [0] IMPLICIT SEQUENCE ( SIZE (1 .. 10) ) OF
            SEQUENCE {
                extId MAP-EXTENSION .&extensionId ( {
                    '
                    ... } ),
                extType MAP-EXTENSION .&ExtensionType ( {
                    '
                    ... } { @extId } ) OPTIONAL } OPTIONAL,
        pcs-Extensions [1] IMPLICIT SEQUENCE {
            ... } OPTIONAL,
            ... } OPTIONAL,
        notificationToCSE [2] IMPLICIT NULL OPTIONAL,
        csi-Active [3] IMPLICIT NULL OPTIONAL,
        ... } OPTIONAL } OPTIONAL,
    chargingCharacteristics [18] IMPLICIT OCTET STRING ( SIZE (2) ) OPTIONAL }
RESULT
insertSubscriberDataRes SEQUENCE {
    teleserviceList [1] IMPLICIT SEQUENCE ( SIZE (1 .. 20) ) OF
        OCTET STRING ( SIZE (1 .. 5) ) OPTIONAL,
    bearerServiceList [2] IMPLICIT SEQUENCE ( SIZE (1 .. 50) ) OF
        OCTET STRING ( SIZE (1 .. 5) ) OPTIONAL,
    ss-List [3] IMPLICIT SEQUENCE ( SIZE (1 .. 30) ) OF
        OCTET STRING ( SIZE (1) ) OPTIONAL,
    odb-GeneralData [4] IMPLICIT BIT STRING {
        allOG-CallsBarred (0),
        internationalOGCallsBarred (1),
        internationalOGCallsNotToHPLMN-CountryBarred (2),
        interzonalOGCallsBarred (6),
        interzonalOGCallsNotToHPLMN-CountryBarred (7),
        interzonalOGCallsAndInternationalOGCallsNotToHPLMN-CountryBarred (8),
        premiumRateInformationOGCallsBarred (3),
        premiumRateEntertainmentOGCallsBarred (4),
        ss-AccessBarred (5),
        allECT-Barred (9),
        chargeableECT-Barred (10),
        internationalECT-Barred (11),
        interzonalECT-Barred (12),
        doublyChargeableECT-Barred (13),
        multipleECT-Barred (14),
        allPacketOrientedServicesBarred (15),
        roamerAccessToHPLMN-AP-Barred (16),
        roamerAccessToVPLMN-AP-Barred (17),
        roamingOutsidePLMNOG-CallsBarred (18),
        allIC-CallsBarred (19),
        roamingOutsidePLMNIC-CallsBarred (20),
        roamingOutsidePLMNICountryIC-CallsBarred (21),
        roamingOutsidePLMN-Barred (22),
        roamingOutsidePLMN-CountryBarred (23),
        registrationAllCF-Barred (24),
        registrationCFNotToHPLMN-Barred (25),
        registrationInterzonalCF-Barred (26),
        registrationInterzonalCFNotToHPLMN-Barred (27) } ( SIZE (15 .. 32) ) OPTIONAL,
    regionalSubscriptionResponse [5] IMPLICIT ENUMERATED {
        networkNode-AreaRestricted (0),
        tooManyZoneCodes (1),
        zoneCodesConflict (2),
        regionalSubscNotSupported (3) } OPTIONAL,
    supportedCamelPhases [6] IMPLICIT BIT STRING {
        phase1 (0),
        phase2 (1),
        phase3 (2),
        phase4 (3) } ( SIZE (1 .. 16) ) OPTIONAL,
    extensionContainer [7] IMPLICIT SEQUENCE {
        privateExtensionList [0] IMPLICIT SEQUENCE ( SIZE (1 .. 10) ) OF
            SEQUENCE {
                extId MAP-EXTENSION .&extensionId ( {
                    '

```



```

        ...} ),
        extType MAP-EXTENSION .&ExtensionType ( {
            '
            ... } { @extId } ) OPTIONAL } OPTIONAL,
        pcs-Extensions [1] IMPLICIT SEQUENCE {
            ... } OPTIONAL,
            ... } OPTIONAL,
        ... }
ERRORS {
    -- dataMissing -- localValue : 35,
    -- unexpectedDataValue -- localValue : 36,
    -- unidentifiedSubscriber -- localValue : 5}
 ::= localValue : 7

deleteSubscriberData OPERATION
ARGUMENT
deleteSubscriberDataArg SEQUENCE {
    imsi [0] IMPLICIT OCTET STRING ( SIZE ( 3 .. 8 ) ),
    basicServiceList [1] IMPLICIT SEQUENCE ( SIZE ( 1 .. 70 ) ) OF
        CHOICE {
            ext-BearerService [2] IMPLICIT OCTET STRING ( SIZE ( 1 .. 5 ) ),
            ext-Teleservice [3] IMPLICIT OCTET STRING ( SIZE ( 1 .. 5 ) ) } OPTIONAL,
    ss-List [2] IMPLICIT SEQUENCE ( SIZE ( 1 .. 30 ) ) OF
        OCTET STRING ( SIZE ( 1 ) ) OPTIONAL,
    roamingRestrictionDueToUnsupportedFeature [4] IMPLICIT NULL OPTIONAL,
    regionalSubscriptionIdentifier [5] IMPLICIT OCTET STRING ( SIZE ( 2 ) ) OPTIONAL,
    vbsGroupIndication [7] IMPLICIT NULL OPTIONAL,
    vgcsGroupIndication [8] IMPLICIT NULL OPTIONAL,
    camelSubscriptionInfoWithdraw [9] IMPLICIT NULL OPTIONAL,
    extensionContainer [6] IMPLICIT SEQUENCE {
        privateExtensionList [0] IMPLICIT SEQUENCE ( SIZE ( 1 .. 10 ) ) OF
            SEQUENCE {
                extId MAP-EXTENSION .&extensionId ( {
                    '
                    ... } ),
                    extType MAP-EXTENSION .&ExtensionType ( {
                        '
                        ... } { @extId } ) OPTIONAL } OPTIONAL,
                pcs-Extensions [1] IMPLICIT SEQUENCE {
                    ... } OPTIONAL,
                    ... } OPTIONAL,
                ... ,
            gprsSubscriptionDataWithdraw [10] CHOICE {
                allGPRSDData NULL,
                contextIdList SEQUENCE ( SIZE ( 1 .. 50 ) ) OF
                    INTEGER ( 1 .. 50 ) } OPTIONAL,
                roamingRestrictedInSgsnDueToUnsupportedFeature [11] IMPLICIT NULL OPTIONAL,
            lsaInformationWithdraw [12] CHOICE {
                allLSAData NULL,
                lsaIdentityList SEQUENCE ( SIZE ( 1 .. 20 ) ) OF
                    OCTET STRING ( SIZE ( 3 ) ) } OPTIONAL,
                gmlc-ListWithdraw [13] IMPLICIT NULL OPTIONAL,
                istInformationWithdraw [14] IMPLICIT NULL OPTIONAL,
                specificCSI-Withdraw [15] IMPLICIT BIT STRING {
                    o-csi ( 0 ),
                    ss-csi ( 1 ),
                    tif-csi ( 2 ),
                    d-csi ( 3 ),
                    vt-csi ( 4 ),
                    mo-sms-csi ( 5 ),
                    m-csi ( 6 ),
                    gprs-csi ( 7 ),
                    t-csi ( 8 ),
                    mt-sms-csi ( 9 ),
                    mg-csi ( 10 ) } ( SIZE ( 8 .. 32 ) ) OPTIONAL }
}
RESULT
deleteSubscriberDataRes SEQUENCE {
    regionalSubscriptionResponse [0] IMPLICIT ENUMERATED {
        networkNode-AreaRestricted ( 0 ),
        tooManyZoneCodes ( 1 ),
        zoneCodesConflict ( 2 ),
        regionalSubscNotSupported ( 3 ) } OPTIONAL,
    extensionContainer SEQUENCE {
        privateExtensionList [0] IMPLICIT SEQUENCE ( SIZE ( 1 .. 10 ) ) OF
            SEQUENCE {
                extId MAP-EXTENSION .&extensionId ( {
                    '
                    ... } ),
                    extType MAP-EXTENSION .&ExtensionType ( {
                        '
                        ... } { @extId } ) OPTIONAL } OPTIONAL,
                pcs-Extensions [1] IMPLICIT SEQUENCE {
                    ... } OPTIONAL,
                    ... } OPTIONAL,
                ... ,
            gprsSubscriptionDataWithdraw [10] CHOICE {
                allGPRSDData NULL,
                contextIdList SEQUENCE ( SIZE ( 1 .. 50 ) ) OF
                    INTEGER ( 1 .. 50 ) } OPTIONAL,
                roamingRestrictedInSgsnDueToUnsupportedFeature [11] IMPLICIT NULL OPTIONAL,
            lsaInformationWithdraw [12] CHOICE {
                allLSAData NULL,
                lsaIdentityList SEQUENCE ( SIZE ( 1 .. 20 ) ) OF
                    OCTET STRING ( SIZE ( 3 ) ) } OPTIONAL,
                gmlc-ListWithdraw [13] IMPLICIT NULL OPTIONAL,
                istInformationWithdraw [14] IMPLICIT NULL OPTIONAL,
                specificCSI-Withdraw [15] IMPLICIT BIT STRING {
                    o-csi ( 0 ),
                    ss-csi ( 1 ),
                    tif-csi ( 2 ),
                    d-csi ( 3 ),
                    vt-csi ( 4 ),
                    mo-sms-csi ( 5 ),
                    m-csi ( 6 ),
                    gprs-csi ( 7 ),
                    t-csi ( 8 ),
                    mt-sms-csi ( 9 ),
                    mg-csi ( 10 ) } ( SIZE ( 8 .. 32 ) ) OPTIONAL }
}

```

```

...}),
extType MAP-EXTENSION .&ExtensionType ({
    ...}{ @extId } ) OPTIONAL} OPTIONAL,
pcs-Extensions [1] IMPLICIT SEQUENCE {
    ... } OPTIONAL,
    ... } OPTIONAL,
... }
ERRORS {
-- dataMissing -- localValue : 35,
-- unexpectedDataValue -- localValue : 36,
-- unidentifiedSubscriber -- localValue : 5}
::= localValue : 8

reset OPERATION
ARGUMENT
resetArg SEQUENCE {
    hlr-Number OCTET STRING ( SIZE (1 .. 20) ) ( SIZE (1 .. 9) ),
    hlr-List SEQUENCE ( SIZE (1 .. 50) ) OF
        OCTET STRING ( SIZE (3 .. 8) ) OPTIONAL,
    ... }
::= localValue : 37

forwardCheckSS-Indication OPERATION
::= localValue : 38

restoreData OPERATION
ARGUMENT
restoreDataArg SEQUENCE {
    imsi OCTET STRING ( SIZE (3 .. 8) ),
    lmsi OCTET STRING ( SIZE (4) ) OPTIONAL,
    extensionContainer SEQUENCE {
        privateExtensionList [0] IMPLICIT SEQUENCE ( SIZE (1 .. 10) ) OF
            SEQUENCE {
                extId MAP-EXTENSION .&extensionId ({
                    ...}),
                extType MAP-EXTENSION .&ExtensionType ({
                    ...}{ @extId } ) OPTIONAL} OPTIONAL,
                pcs-Extensions [1] IMPLICIT SEQUENCE {
                    ... } OPTIONAL,
                    ... } OPTIONAL,
                ... },
        vlr-Capability [6] IMPLICIT SEQUENCE {
            supportedCamelPhases [0] IMPLICIT BIT STRING {
                phase1 (0),
                phase2 (1),
                phase3 (2),
                phase4 (3) } ( SIZE (1 .. 16) ) OPTIONAL,
            extensionContainer SEQUENCE {
                privateExtensionList [0] IMPLICIT SEQUENCE ( SIZE (1 .. 10) ) OF
                    SEQUENCE {
                        extId MAP-EXTENSION .&extensionId ({
                            ...}),
                        extType MAP-EXTENSION .&ExtensionType ({
                            ...}{ @extId } ) OPTIONAL} OPTIONAL,
                            pcs-Extensions [1] IMPLICIT SEQUENCE {
                                ... } OPTIONAL,
                                ... } OPTIONAL,
                            ... },
                solsaSupportIndicator [2] IMPLICIT NULL OPTIONAL,
                istSupportIndicator [1] IMPLICIT ENUMERATED {
                    basicISTSupported (0),
                    istCommandSupported (1),
                    ... } OPTIONAL,
                superChargerSupportedInServingNetworkEntity [3] CHOICE {
                    sendSubscriberData [0] IMPLICIT NULL,
                    subscriberDataStored [1] IMPLICIT OCTET STRING ( SIZE (1 .. 6) )} OPTIONAL,
                    longFTN-Supported [4] IMPLICIT NULL OPTIONAL,
                    supportedLCS-CapabilitySets [5] IMPLICIT BIT STRING {
                        lcsCapabilitySet1 (0),
                        lcsCapabilitySet2 (1),
                        lcsCapabilitySet3 (2) } ( SIZE (2 .. 16) ) OPTIONAL} OPTIONAL}
    RESULT

```

```

restoreDataRes SEQUENCE {
  hlr-Number OCTET STRING ( SIZE (1 .. 20) ) ( SIZE (1 .. 9) ),
  msNotReachable NULL OPTIONAL,
  extensionContainer SEQUENCE {
    privateExtensionList [0] IMPLICIT SEQUENCE ( SIZE (1 .. 10) ) OF
    SEQUENCE {
      extId MAP-EXTENSION .&extensionId ( {
        '
        ...} ),
      extType MAP-EXTENSION .&ExtensionType ( {
        '
        ...} { @extId } ) OPTIONAL} OPTIONAL,
    pcs-Extensions [1] IMPLICIT SEQUENCE {
      ... } OPTIONAL,
      ... } OPTIONAL,
      ... }
  ... }
ERRORS {
  -- systemFailure -- localValue : 34,
  -- dataMissing -- localValue : 35,
  -- unexpectedDataValue -- localValue : 36,
  -- unknownSubscriber -- localValue : 1}
 ::= localValue : 57

```

activateTraceMode OPERATION

ARGUMENT

```

activateTraceModeArg SEQUENCE {
  imsi [0] IMPLICIT OCTET STRING ( SIZE (3 .. 8) ) OPTIONAL,
  traceReference [1] IMPLICIT OCTET STRING ( SIZE (1 .. 2) ),
  traceType [2] IMPLICIT INTEGER ( 0 .. 255 ),
  omc-Id [3] IMPLICIT OCTET STRING ( SIZE (1 .. 20) ) OPTIONAL,
  extensionContainer [4] IMPLICIT SEQUENCE {
    privateExtensionList [0] IMPLICIT SEQUENCE ( SIZE (1 .. 10) ) OF
    SEQUENCE {
      extId MAP-EXTENSION .&extensionId ( {
        '
        ...} ),
      extType MAP-EXTENSION .&ExtensionType ( {
        '
        ...} { @extId } ) OPTIONAL} OPTIONAL,
    pcs-Extensions [1] IMPLICIT SEQUENCE {
      ... } OPTIONAL,
      ... } OPTIONAL,
      ... }
  ... }

```

RESULT

```

activateTraceModeRes SEQUENCE {
  extensionContainer [0] IMPLICIT SEQUENCE {
    privateExtensionList [0] IMPLICIT SEQUENCE ( SIZE (1 .. 10) ) OF
    SEQUENCE {
      extId MAP-EXTENSION .&extensionId ( {
        '
        ...} ),
      extType MAP-EXTENSION .&ExtensionType ( {
        '
        ...} { @extId } ) OPTIONAL} OPTIONAL,
    pcs-Extensions [1] IMPLICIT SEQUENCE {
      ... } OPTIONAL,
      ... } OPTIONAL,
      ... }
  ... }

```

ERRORS {

```

  -- systemFailure -- localValue : 34,
  -- dataMissing -- localValue : 35,
  -- unexpectedDataValue -- localValue : 36,
  -- facilityNotSupported -- localValue : 21,
  -- unidentifiedSubscriber -- localValue : 5,
  -- tracingBufferFull -- localValue : 40}
 ::= localValue : 50

```

deactivateTraceMode OPERATION

ARGUMENT

```

deactivateTraceModeArg SEQUENCE {
  imsi [0] IMPLICIT OCTET STRING ( SIZE (3 .. 8) ) OPTIONAL,
  traceReference [1] IMPLICIT OCTET STRING ( SIZE (1 .. 2) ),
  extensionContainer [2] IMPLICIT SEQUENCE {
    privateExtensionList [0] IMPLICIT SEQUENCE ( SIZE (1 .. 10) ) OF
    SEQUENCE {
      extId MAP-EXTENSION .&extensionId ( {
        '

```

```

        ...} ),
        extType MAP-EXTENSION .&ExtensionType ( {
            '
            ... } { @extId } ) OPTIONAL } OPTIONAL,
        pcs-Extensions [1] IMPLICIT SEQUENCE {
            ... } OPTIONAL,
            ... } OPTIONAL,
        ... }
    ... }
RESULT
deactivateTraceModeRes SEQUENCE {
    extensionContainer [0] IMPLICIT SEQUENCE {
        privateExtensionList [0] IMPLICIT SEQUENCE ( SIZE ( 1 .. 10 ) ) OF
        SEQUENCE {
            extId MAP-EXTENSION .&extensionId ( {
                '
                ... } ),
            extType MAP-EXTENSION .&ExtensionType ( {
                '
                ... } { @extId } ) OPTIONAL } OPTIONAL,
            pcs-Extensions [1] IMPLICIT SEQUENCE {
                ... } OPTIONAL,
                ... } OPTIONAL,
            ... } OPTIONAL,
        ... }
    ... }
ERRORS {
    -- systemFailure -- localValue : 34,
    -- dataMissing -- localValue : 35,
    -- unexpectedDataValue -- localValue : 36,
    -- facilityNotSupported -- localValue : 21,
    -- unidentifiedSubscriber -- localValue : 5)
::= localValue : 51

sendIMSI OPERATION
ARGUMENT
    msisdn OCTET STRING ( SIZE ( 1 .. 20 ) ) ( SIZE ( 1 .. 9 ) )
RESULT
    imsi OCTET STRING ( SIZE ( 3 .. 8 ) )
ERRORS {
    -- dataMissing -- localValue : 35,
    -- unexpectedDataValue -- localValue : 36,
    -- unknownSubscriber -- localValue : 1)
::= localValue : 58

sendRoutingInfo OPERATION
ARGUMENT
    sendRoutingInfoArg SEQUENCE {
        msisdn [0] IMPLICIT OCTET STRING ( SIZE ( 1 .. 20 ) ) ( SIZE ( 1 .. 9 ) ),
        cug-CheckInfo [1] IMPLICIT SEQUENCE {
            cug-Interlock OCTET STRING ( SIZE ( 4 ) ),
            cug-OutgoingAccess NULL OPTIONAL,
            extensionContainer SEQUENCE {
                privateExtensionList [0] IMPLICIT SEQUENCE ( SIZE ( 1 .. 10 ) ) OF
                SEQUENCE {
                    extId MAP-EXTENSION .&extensionId ( {
                        '
                        ... } ),
                    extType MAP-EXTENSION .&ExtensionType ( {
                        '
                        ... } { @extId } ) OPTIONAL } OPTIONAL,
                pcs-Extensions [1] IMPLICIT SEQUENCE {
                    ... } OPTIONAL,
                    ... } OPTIONAL,
                    ... } OPTIONAL,
                ... } OPTIONAL,
            numberOfForwarding [2] IMPLICIT INTEGER ( 1 .. 5 ) OPTIONAL,
            interrogationType [3] IMPLICIT ENUMERATED {
                basicCall ( 0 ),
                forwarding ( 1 ) },
            or-Interrogation [4] IMPLICIT NULL OPTIONAL,
            or-Capability [5] IMPLICIT INTEGER ( 1 .. 127 ) OPTIONAL,
            gmsc-OrGsmSCF-Address [6] IMPLICIT OCTET STRING ( SIZE ( 1 .. 20 ) ) ( SIZE ( 1 .. 9 ) ),
            callReferenceNumber [7] IMPLICIT OCTET STRING ( SIZE ( 1 .. 8 ) ) OPTIONAL,
            forwardingReason [8] IMPLICIT ENUMERATED {
                notReachable ( 0 ),
                busy ( 1 ),
                noReply ( 2 ) } OPTIONAL,
            basicServiceGroup [9] CHOICE {
                ext-BearerService [2] IMPLICIT OCTET STRING ( SIZE ( 1 .. 5 ) ),
                ext-Teleservice [3] IMPLICIT OCTET STRING ( SIZE ( 1 .. 5 ) ) } OPTIONAL,

```

```

networkSignalInfo      [10] IMPLICIT SEQUENCE {
  protocolId    ENUMERATED {
    gsm-0408    (1),
    gsm-0806    (2),
    gsm-BSSMAP  (3),
    ets-300102-1 (4)},
  signalInfo    OCTET STRING ( SIZE (1 .. 200) ),
  extensionContainer SEQUENCE {
    privateExtensionList [0] IMPLICIT SEQUENCE ( SIZE (1 .. 10) ) OF
      SEQUENCE {
        extId    MAP-EXTENSION .&extensionId ( {
          '
          ...} ),
        extType  MAP-EXTENSION .&ExtensionType ( {
          '
          ...} { @extId } ) OPTIONAL} OPTIONAL,
    pcs-Extensions [1] IMPLICIT SEQUENCE {
      ... } OPTIONAL,
      ... } OPTIONAL,
      ... } OPTIONAL,
  }
camellInfo            [11] IMPLICIT SEQUENCE {
  supportedCamelPhases BIT STRING {
    phase1 (0),
    phase2 (1),
    phase3 (2),
    phase4 (3) ( SIZE (1 .. 16) ),
  }
  suppress-T-CSI      NULL OPTIONAL,
  extensionContainer SEQUENCE {
    privateExtensionList [0] IMPLICIT SEQUENCE ( SIZE (1 .. 10) ) OF
      SEQUENCE {
        extId    MAP-EXTENSION .&extensionId ( {
          '
          ...} ),
        extType  MAP-EXTENSION .&ExtensionType ( {
          '
          ...} { @extId } ) OPTIONAL} OPTIONAL,
    pcs-Extensions [1] IMPLICIT SEQUENCE {
      ... } OPTIONAL,
      ... } OPTIONAL,
      ... } OPTIONAL,
  }
  suppressionOfAnnouncement [12] IMPLICIT NULL OPTIONAL,
  extensionContainer      [13] IMPLICIT SEQUENCE {
    privateExtensionList [0] IMPLICIT SEQUENCE ( SIZE (1 .. 10) ) OF
      SEQUENCE {
        extId    MAP-EXTENSION .&extensionId ( {
          '
          ...} ),
        extType  MAP-EXTENSION .&ExtensionType ( {
          '
          ...} { @extId } ) OPTIONAL} OPTIONAL,
    pcs-Extensions [1] IMPLICIT SEQUENCE {
      ... } OPTIONAL,
      ... } OPTIONAL,
      ... } OPTIONAL,
  }
  ... ,
  alertingPattern      [14] IMPLICIT OCTET STRING ( SIZE (1) ) OPTIONAL,
  ccbs-Call            [15] IMPLICIT NULL OPTIONAL,
  supportedCCBS-Phase [16] IMPLICIT INTEGER ( 1 .. 127 ) OPTIONAL,
  additionalSignalInfo [17] IMPLICIT SEQUENCE {
    ext-ProtocolId    ENUMERATED {
      ets-300356 (1),
      ... },
    signalInfo        OCTET STRING ( SIZE (1 .. 200) ),
    extensionContainer SEQUENCE {
      privateExtensionList [0] IMPLICIT SEQUENCE ( SIZE (1 .. 10) ) OF
        SEQUENCE {
          extId    MAP-EXTENSION .&extensionId ( {
            '
            ...} ),
          extType  MAP-EXTENSION .&ExtensionType ( {
            '
            ...} { @extId } ) OPTIONAL} OPTIONAL,
        pcs-Extensions [1] IMPLICIT SEQUENCE {
          ... } OPTIONAL,
          ... } OPTIONAL,
          ... } OPTIONAL,
        }
  }
  istSupportIndicator [18] IMPLICIT ENUMERATED {
    basicSTSupported (0),

```

```

    istCommandSupported (1),
    ... } OPTIONAL,
pre-pagingSupported [19] IMPLICIT NULL OPTIONAL,
callDiversionTreatmentIndicator [20] IMPLICIT OCTET STRING ( SIZE (1) ) OPTIONAL,
longFTN-Supported [21] IMPLICIT NULL OPTIONAL,
suppress-VT-CSI [22] IMPLICIT NULL OPTIONAL,
suppressIncomingCallBarring [23] IMPLICIT NULL OPTIONAL,
gsmSCF-InitiatedCall [24] IMPLICIT NULL OPTIONAL
RESULT
sendRoutingInfoRes [3] IMPLICIT SEQUENCE {
imsi [9] IMPLICIT OCTET STRING ( SIZE (3..8) ) OPTIONAL,
extendedRoutingInfo CHOICE {
routingInfo CHOICE {
roamingNumber OCTET STRING ( SIZE (1..20) ) ( SIZE (1..9) ),
forwardingData SEQUENCE {
forwardedToNumber [5] IMPLICIT OCTET STRING ( SIZE (1..20) ) ( SIZE (1..9) ) OPTIONAL,
forwardedToSubaddress [4] IMPLICIT OCTET STRING ( SIZE (1..21) ) OPTIONAL,
forwardingOptions [6] IMPLICIT OCTET STRING ( SIZE (1) ) OPTIONAL,
extensionContainer [7] IMPLICIT SEQUENCE {
privateExtensionList [0] IMPLICIT SEQUENCE ( SIZE (1..10) ) OF
SEQUENCE {
extId MAP-EXTENSION .&extensionId ( {
'
...} ),
extType MAP-EXTENSION .&ExtensionType ( {
'
...} { @extId } ) OPTIONAL } OPTIONAL,
pcs-Extensions [1] IMPLICIT SEQUENCE {
... } OPTIONAL,
... } OPTIONAL,
... ,
longForwardedToNumber [8] IMPLICIT OCTET STRING ( SIZE (1..20) ) ( SIZE (1..15) ) OPTIONAL}},
camelRoutingInfo [8] IMPLICIT SEQUENCE {
forwardingData SEQUENCE {
forwardedToNumber [5] IMPLICIT OCTET STRING ( SIZE (1..20) ) ( SIZE (1..9) ) OPTIONAL,
forwardedToSubaddress [4] IMPLICIT OCTET STRING ( SIZE (1..21) ) OPTIONAL,
forwardingOptions [6] IMPLICIT OCTET STRING ( SIZE (1) ) OPTIONAL,
extensionContainer [7] IMPLICIT SEQUENCE {
privateExtensionList [0] IMPLICIT SEQUENCE ( SIZE (1..10) ) OF
SEQUENCE {
extId MAP-EXTENSION .&extensionId ( {
'
...} ),
extType MAP-EXTENSION .&ExtensionType ( {
'
...} { @extId } ) OPTIONAL } OPTIONAL,
pcs-Extensions [1] IMPLICIT SEQUENCE {
... } OPTIONAL,
... } OPTIONAL,
... ,
longForwardedToNumber [8] IMPLICIT OCTET STRING ( SIZE (1..20) ) ( SIZE (1..15) ) OPTIONAL} OPTIONAL,
gsmSCF-InitiatedCall [0] IMPLICIT SEQUENCE {
t-CSI [0] IMPLICIT SEQUENCE {
t-BcsmCamelITDPDataList SEQUENCE ( SIZE (1..10) ) OF
SEQUENCE {
t-BcsmTriggerDetectionPoint ENUMERATED {
termAttemptAuthorized (12),
...,
tBusy (13),
tNoAnswer (14) },
serviceKey INTEGER ( 0..2147483647 ),
gsmSCF-Address [0] IMPLICIT OCTET STRING ( SIZE (1..20) ) ( SIZE (1..9) ),
defaultCallHandling [1] IMPLICIT ENUMERATED {
continueCall (0),
releaseCall (1),
... },
extensionContainer [2] IMPLICIT SEQUENCE {
privateExtensionList [0] IMPLICIT SEQUENCE ( SIZE (1..10) ) OF
SEQUENCE {
extId MAP-EXTENSION .&extensionId ( {
'
...} ),
extType MAP-EXTENSION .&ExtensionType ( {
'
...} { @extId } ) OPTIONAL } OPTIONAL,
pcs-Extensions [1] IMPLICIT SEQUENCE {
... } OPTIONAL,

```

```

... } OPTIONAL,
... },
extensionContainer SEQUENCE {
  privateExtensionList [0] IMPLICIT SEQUENCE ( SIZE ( 1 .. 10 ) ) OF
  SEQUENCE {
    extId MAP-EXTENSION .&extensionId ( {
      '
      ... } ),
    extType MAP-EXTENSION .&ExtensionType ( {
      '
      ... } { @extId } ) OPTIONAL } OPTIONAL,
  pcs-Extensions [1] IMPLICIT SEQUENCE {
    ... } OPTIONAL,
  ... } OPTIONAL,
... ,
camelCapabilityHandling [0] IMPLICIT INTEGER ( 1 .. 16 ) OPTIONAL,
notificationToCSE [1] IMPLICIT NULL OPTIONAL,
csi-Active [2] IMPLICIT NULL OPTIONAL } OPTIONAL,
o-CSI [1] IMPLICIT SEQUENCE {
o-BcsmCamelTDPDataList SEQUENCE ( SIZE ( 1 .. 10 ) ) OF
SEQUENCE {
  o-BcsmTriggerDetectionPoint ENUMERATED {
    collectedInfo ( 2 ),
    ... ,
    routeSelectFailure ( 4 ) },
  serviceKey INTEGER ( 0 .. 2147483647 ),
  gsmSCF-Address [0] IMPLICIT OCTET STRING ( SIZE ( 1 .. 20 ) ) ( SIZE ( 1 .. 9 ) ),
  defaultCallHandling [1] IMPLICIT ENUMERATED {
    continueCall ( 0 ),
    releaseCall ( 1 ),
    ... },
  extensionContainer [2] IMPLICIT SEQUENCE {
    privateExtensionList [0] IMPLICIT SEQUENCE ( SIZE ( 1 .. 10 ) ) OF
    SEQUENCE {
      extId MAP-EXTENSION .&extensionId ( {
        '
        ... } ),
      extType MAP-EXTENSION .&ExtensionType ( {
        '
        ... } { @extId } ) OPTIONAL } OPTIONAL,
    pcs-Extensions [1] IMPLICIT SEQUENCE {
      ... } OPTIONAL,
    ... } OPTIONAL,
  ... },
  extensionContainer SEQUENCE {
    privateExtensionList [0] IMPLICIT SEQUENCE ( SIZE ( 1 .. 10 ) ) OF
    SEQUENCE {
      extId MAP-EXTENSION .&extensionId ( {
        '
        ... } ),
      extType MAP-EXTENSION .&ExtensionType ( {
        '
        ... } { @extId } ) OPTIONAL } OPTIONAL,
    pcs-Extensions [1] IMPLICIT SEQUENCE {
      ... } OPTIONAL,
    ... } OPTIONAL,
  ... },
  camelCapabilityHandling [0] IMPLICIT INTEGER ( 1 .. 16 ) OPTIONAL,
  notificationToCSE [1] IMPLICIT NULL OPTIONAL,
  csiActive [2] IMPLICIT NULL OPTIONAL } OPTIONAL,
  extensionContainer [2] IMPLICIT SEQUENCE {
    privateExtensionList [0] IMPLICIT SEQUENCE ( SIZE ( 1 .. 10 ) ) OF
    SEQUENCE {
      extId MAP-EXTENSION .&extensionId ( {
        '
        ... } ),
      extType MAP-EXTENSION .&ExtensionType ( {
        '
        ... } { @extId } ) OPTIONAL } OPTIONAL,
    pcs-Extensions [1] IMPLICIT SEQUENCE {
      ... } OPTIONAL,
    ... } OPTIONAL,
  ... },
o-BcsmCamelTDP-CriteriaList [3] IMPLICIT SEQUENCE ( SIZE ( 1 .. 10 ) ) OF
SEQUENCE {
  o-BcsmTriggerDetectionPoint ENUMERATED {
    collectedInfo ( 2 ),

```

```

... ,
routeSelectFailure (4)),
destinationNumberCriteria [0] IMPLICIT SEQUENCE {
matchType [0] IMPLICIT ENUMERATED {
inhibiting (0),
enabling (1)},
destinationNumberList [1] IMPLICIT SEQUENCE ( SIZE (1 .. 10) ) OF
OCTET STRING ( SIZE (1 .. 20) ) ( SIZE (1 .. 9) ) OPTIONAL,
destinationNumberLengthList [2] IMPLICIT SEQUENCE ( SIZE (1 .. 3) ) OF
INTEGER (1 .. 15) OPTIONAL,
... } OPTIONAL,
basicServiceCriteria [1] IMPLICIT SEQUENCE ( SIZE (1 .. 5) ) OF
CHOICE {
ext-BearerService [2] IMPLICIT OCTET STRING ( SIZE (1 .. 5) ),
ext-Teleservice [3] IMPLICIT OCTET STRING ( SIZE (1 .. 5) )} OPTIONAL,
callTypeCriteria [2] IMPLICIT ENUMERATED {
forwarded (0),
notForwarded (1) } OPTIONAL,
... ,
o-CauseValueCriteria [3] IMPLICIT SEQUENCE ( SIZE (1 .. 5) ) OF
OCTET STRING ( SIZE (1) ) OPTIONAL,
extensionContainer [4] IMPLICIT SEQUENCE {
privateExtensionList [0] IMPLICIT SEQUENCE ( SIZE (1 .. 10) ) OF
SEQUENCE {
extId MAP-EXTENSION .&extensionId ( {
'
...} ),
extType MAP-EXTENSION .&ExtensionType ( {
'
...} { @extId } ) OPTIONAL} OPTIONAL,
pcs-Extensions [1] IMPLICIT SEQUENCE {
... } OPTIONAL,
... } OPTIONAL} OPTIONAL,
t-BCSM-CAMEL-TDP-CriteriaList [4] IMPLICIT SEQUENCE ( SIZE (1 .. 10) ) OF
SEQUENCE {
t-BCSM-TriggerDetectionPoint ENUMERATED {
termAttemptAuthorized (12),
... ,
tBusy (13),
tNoAnswer (14)},
basicServiceCriteria [0] IMPLICIT SEQUENCE ( SIZE (1 .. 5) ) OF
CHOICE {
ext-BearerService [2] IMPLICIT OCTET STRING ( SIZE (1 .. 5) ),
ext-Teleservice [3] IMPLICIT OCTET STRING ( SIZE (1 .. 5) )} OPTIONAL,
t-CauseValueCriteria [1] IMPLICIT SEQUENCE ( SIZE (1 .. 5) ) OF
OCTET STRING ( SIZE (1) ) OPTIONAL,
... } OPTIONAL,
d-csi [5] IMPLICIT SEQUENCE {
dp-AnalysedInfoCriteriaList [0] IMPLICIT SEQUENCE ( SIZE (1 .. 10) ) OF
SEQUENCE {
dialledNumber OCTET STRING ( SIZE (1 .. 20) ) ( SIZE (1 .. 9) ),
serviceKey INTEGER (0 .. 2147483647),
gsmSCF-Address OCTET STRING ( SIZE (1 .. 20) ) ( SIZE (1 .. 9) ),
defaultCallHandling ENUMERATED {
continueCall (0),
releaseCall (1),
... },
extensionContainer SEQUENCE {
privateExtensionList [0] IMPLICIT SEQUENCE ( SIZE (1 .. 10) ) OF
SEQUENCE {
extId MAP-EXTENSION .&extensionId ( {
'
...} ),
extType MAP-EXTENSION .&ExtensionType ( {
'
...} { @extId } ) OPTIONAL} OPTIONAL,
pcs-Extensions [1] IMPLICIT SEQUENCE {
... } OPTIONAL,
... } OPTIONAL,
... } OPTIONAL,
camelCapabilityHandling [1] IMPLICIT INTEGER (1 .. 16) OPTIONAL,
extensionContainer [2] IMPLICIT SEQUENCE {
privateExtensionList [0] IMPLICIT SEQUENCE ( SIZE (1 .. 10) ) OF
SEQUENCE {
extId MAP-EXTENSION .&extensionId ( {
'
...} ),

```



```

    extType MAP-EXTENSION .&ExtensionType ( {
        '
        ... } { @extId } ) OPTIONAL} OPTIONAL,
    pcs-Extensions [1] IMPLICIT SEQUENCE {
        ... } OPTIONAL,
        ... } OPTIONAL,
    notificationToCSE [3] IMPLICIT NULL OPTIONAL,
    csi-Active [4] IMPLICIT NULL OPTIONAL,
    ... } OPTIONAL},
    extensionContainer [1] IMPLICIT SEQUENCE {
    privateExtensionList [0] IMPLICIT SEQUENCE ( SIZE ( 1 .. 10 ) ) OF
    SEQUENCE {
        extId MAP-EXTENSION .&extensionId ( {
            '
            ... } ),
        extType MAP-EXTENSION .&ExtensionType ( {
            '
            ... } { @extId } ) OPTIONAL} OPTIONAL,
            pcs-Extensions [1] IMPLICIT SEQUENCE {
                ... } OPTIONAL,
                ... } OPTIONAL,
                ... } OPTIONAL,
                ... } OPTIONAL,
            } OPTIONAL,
        cug-CheckInfo [3] IMPLICIT SEQUENCE {
            cug-Interlock OCTET STRING ( SIZE ( 4 ) ),
            cug-OutgoingAccess NULL OPTIONAL,
            extensionContainer SEQUENCE {
                privateExtensionList [0] IMPLICIT SEQUENCE ( SIZE ( 1 .. 10 ) ) OF
                SEQUENCE {
                    extId MAP-EXTENSION .&extensionId ( {
                        '
                        ... } ),
                    extType MAP-EXTENSION .&ExtensionType ( {
                        '
                        ... } { @extId } ) OPTIONAL} OPTIONAL,
                        pcs-Extensions [1] IMPLICIT SEQUENCE {
                            ... } OPTIONAL,
                            ... } OPTIONAL,
                            ... } OPTIONAL,
                            ... } OPTIONAL,
                        } OPTIONAL,
                    cugSubscriptionFlag [6] IMPLICIT NULL OPTIONAL,
                    subscriberInfo [7] IMPLICIT SEQUENCE {
                    locationInformation [0] IMPLICIT SEQUENCE {
                        ageOfLocationInformation INTEGER ( 0 .. 32767 ) OPTIONAL,
                        geographicalInformation [0] IMPLICIT OCTET STRING ( SIZE ( 8 ) ) OPTIONAL,
                        vlr-number [1] IMPLICIT OCTET STRING ( SIZE ( 1 .. 20 ) ) ( SIZE ( 1 .. 9 ) ) OPTIONAL,
                        locationNumber [2] IMPLICIT OCTET STRING ( SIZE ( 2 .. 10 ) ) OPTIONAL,
                        cellGlobalIdOrServiceAreaIdOrLAI [3] CHOICE {
                            cellGlobalIdOrServiceAreaIdFixedLength [0] IMPLICIT OCTET STRING ( SIZE ( 7 ) ),
                            laiFixedLength [1] IMPLICIT OCTET STRING ( SIZE ( 5 ) ) } OPTIONAL,
                        extensionContainer [4] IMPLICIT SEQUENCE {
                            privateExtensionList [0] IMPLICIT SEQUENCE ( SIZE ( 1 .. 10 ) ) OF
                            SEQUENCE {
                                extId MAP-EXTENSION .&extensionId ( {
                                    '
                                    ... } ),
                                extType MAP-EXTENSION .&ExtensionType ( {
                                    '
                                    ... } { @extId } ) OPTIONAL} OPTIONAL,
                                    pcs-Extensions [1] IMPLICIT SEQUENCE {
                                        ... } OPTIONAL,
                                        ... } OPTIONAL,
                                        ... } OPTIONAL,
                                    } OPTIONAL,
                                ... ,
                                selectedLSA-Id [5] IMPLICIT OCTET STRING ( SIZE ( 3 ) ) OPTIONAL,
                                msc-Number [6] IMPLICIT OCTET STRING ( SIZE ( 1 .. 20 ) ) ( SIZE ( 1 .. 9 ) ) OPTIONAL,
                                geodeticInformation [7] IMPLICIT OCTET STRING ( SIZE ( 10 ) ) OPTIONAL,
                                currentLocationRetrieved [8] IMPLICIT NULL OPTIONAL,
                                sai-Present [9] IMPLICIT NULL OPTIONAL} OPTIONAL,
                                subscriberState [1] CHOICE {
                                    assumedIdle [0] IMPLICIT NULL,
                                    camelBusy [1] IMPLICIT NULL,
                                    netDetNotReachable ENUMERATED {
                                        msPurged ( 0 ),
                                        imsiDetached ( 1 ),
                                        restrictedArea ( 2 ),
                                        notRegistered ( 3 )},
                                    notProvidedFromVLR [2] IMPLICIT NULL} OPTIONAL,
                                extensionContainer [2] IMPLICIT SEQUENCE {
                                    privateExtensionList [0] IMPLICIT SEQUENCE ( SIZE ( 1 .. 10 ) ) OF

```

```

SEQUENCE {
  extId  MAP-EXTENSION .&extensionId ( {
    '
    ... } ),
  extType  MAP-EXTENSION .&ExtensionType ( {
    '
    ... } { @extId } ) OPTIONAL} OPTIONAL,
  pcs-Extensions  [1] IMPLICIT SEQUENCE {
  ... } OPTIONAL,
  ... } OPTIONAL,
... ,
locationInformationGPRS  [3] IMPLICIT SEQUENCE {
  cellGlobalIdOrServiceAreaIdOrLAI  [0] CHOICE {
    cellGlobalIdOrServiceAreaIdFixedLength  [0] IMPLICIT OCTET STRING ( SIZE ( 7 ) ),
    laiFixedLength  [1] IMPLICIT OCTET STRING ( SIZE ( 5 ) )} OPTIONAL,
  routingAreaIdentity  [1] IMPLICIT OCTET STRING ( SIZE ( 6 ) ) OPTIONAL,
  geographicalInformation  [2] IMPLICIT OCTET STRING ( SIZE ( 8 ) ) OPTIONAL,
  sgsn-Number  [3] IMPLICIT OCTET STRING ( SIZE ( 1 .. 20 ) ) ( SIZE ( 1 .. 9 ) ) OPTIONAL,
  selectedLSAIdentity  [4] IMPLICIT OCTET STRING ( SIZE ( 3 ) ) OPTIONAL,
  extensionContainer  [5] IMPLICIT SEQUENCE {
  privateExtensionList  [0] IMPLICIT SEQUENCE ( SIZE ( 1 .. 10 ) ) OF
  SEQUENCE {
    extId  MAP-EXTENSION .&extensionId ( {
      '
      ... } ),
    extType  MAP-EXTENSION .&ExtensionType ( {
      '
      ... } { @extId } ) OPTIONAL} OPTIONAL,
  pcs-Extensions  [1] IMPLICIT SEQUENCE {
  ... } OPTIONAL,
  ... } OPTIONAL,
... ,
  sai-Present  [6] IMPLICIT NULL OPTIONAL,
  geodeticInformation  [7] IMPLICIT OCTET STRING ( SIZE ( 10 ) ) OPTIONAL,
  currentLocationRetrieved  [8] IMPLICIT NULL OPTIONAL,
  ageOfLocationInformation  [9] IMPLICIT INTEGER ( 0 .. 32767 ) OPTIONAL} OPTIONAL,
ps-SubscriberState  [4] CHOICE {
  notProvidedFromSGSN  [0] IMPLICIT NULL,
  ps-Detached  [1] IMPLICIT NULL,
  ps-AttachedNotReachableForPaging  [2] IMPLICIT NULL,
  ps-AttachedReachableForPaging  [3] IMPLICIT NULL,
  ps-PDP-ActiveNotReachableForPaging  [4] IMPLICIT SEQUENCE ( SIZE ( 1 .. 50 ) ) OF
  SEQUENCE {
    pdp-ContextIdentifier  [0] IMPLICIT INTEGER ( 1 .. 50 ),
    pdp-ContextActive  [1] IMPLICIT NULL OPTIONAL,
    pdp-Type  [2] IMPLICIT OCTET STRING ( SIZE ( 2 ) ),
    pdp-Address  [3] IMPLICIT OCTET STRING ( SIZE ( 1 .. 16 ) ) OPTIONAL,
    apn-Subscribed  [4] IMPLICIT OCTET STRING ( SIZE ( 2 .. 63 ) ) OPTIONAL,
    apn-InUse  [5] IMPLICIT OCTET STRING ( SIZE ( 2 .. 63 ) ) OPTIONAL,
    nsapi  [6] IMPLICIT INTEGER ( 0 .. 15 ) OPTIONAL,
    transactionId  [7] IMPLICIT OCTET STRING ( SIZE ( 1 .. 2 ) ) OPTIONAL,
    teid-ForGnAndGp  [8] IMPLICIT OCTET STRING ( SIZE ( 4 ) ) OPTIONAL,
    teid-ForLu  [9] IMPLICIT OCTET STRING ( SIZE ( 4 ) ) OPTIONAL,
    ggsn-Address  [10] IMPLICIT OCTET STRING ( SIZE ( 5 .. 17 ) ) OPTIONAL,
    qos-Subscribed  [11] IMPLICIT OCTET STRING ( SIZE ( 1 .. 9 ) ) OPTIONAL,
    qos-Requested  [12] IMPLICIT OCTET STRING ( SIZE ( 1 .. 9 ) ) OPTIONAL,
    qos-Negotiated  [13] IMPLICIT OCTET STRING ( SIZE ( 1 .. 9 ) ) OPTIONAL,
    chargingId  [14] IMPLICIT OCTET STRING ( SIZE ( 4 ) ) OPTIONAL,
    chargingCharacteristics  [15] IMPLICIT OCTET STRING ( SIZE ( 2 ) ) OPTIONAL,
    rnc-Address  [16] IMPLICIT OCTET STRING ( SIZE ( 5 .. 17 ) ) OPTIONAL,
    extensionContainer  [17] IMPLICIT SEQUENCE {
      privateExtensionList  [0] IMPLICIT SEQUENCE ( SIZE ( 1 .. 10 ) ) OF
      SEQUENCE {
        extId  MAP-EXTENSION .&extensionId ( {
          '
          ... } ),
        extType  MAP-EXTENSION .&ExtensionType ( {
          '
          ... } { @extId } ) OPTIONAL} OPTIONAL,
      pcs-Extensions  [1] IMPLICIT SEQUENCE {
      ... } OPTIONAL,
      ... } OPTIONAL,
      ... },
ps-PDP-ActiveReachableForPaging  [5] IMPLICIT SEQUENCE ( SIZE ( 1 .. 50 ) ) OF
  SEQUENCE {
    pdp-ContextIdentifier  [0] IMPLICIT INTEGER ( 1 .. 50 ),
    pdp-ContextActive  [1] IMPLICIT NULL OPTIONAL,

```

```

pdp-Type [2] IMPLICIT OCTET STRING ( SIZE ( 2 ) ),
pdp-Address [3] IMPLICIT OCTET STRING ( SIZE ( 1 .. 16 ) ) OPTIONAL,
apn-Subscribed [4] IMPLICIT OCTET STRING ( SIZE ( 2 .. 63 ) ) OPTIONAL,
apn-InUse [5] IMPLICIT OCTET STRING ( SIZE ( 2 .. 63 ) ) OPTIONAL,
nsapi [6] IMPLICIT INTEGER ( 0 .. 15 ) OPTIONAL,
transactionId [7] IMPLICIT OCTET STRING ( SIZE ( 1 .. 2 ) ) OPTIONAL,
teid-ForGnAndGp [8] IMPLICIT OCTET STRING ( SIZE ( 4 ) ) OPTIONAL,
teid-ForLu [9] IMPLICIT OCTET STRING ( SIZE ( 4 ) ) OPTIONAL,
ggsn-Address [10] IMPLICIT OCTET STRING ( SIZE ( 5 .. 17 ) ) OPTIONAL,
qos-Subscribed [11] IMPLICIT OCTET STRING ( SIZE ( 1 .. 9 ) ) OPTIONAL,
qos-Requested [12] IMPLICIT OCTET STRING ( SIZE ( 1 .. 9 ) ) OPTIONAL,
qos-Negotiated [13] IMPLICIT OCTET STRING ( SIZE ( 1 .. 9 ) ) OPTIONAL,
chargingId [14] IMPLICIT OCTET STRING ( SIZE ( 4 ) ) OPTIONAL,
chargingCharacteristics [15] IMPLICIT OCTET STRING ( SIZE ( 2 ) ) OPTIONAL,
rnc-Address [16] IMPLICIT OCTET STRING ( SIZE ( 5 .. 17 ) ) OPTIONAL,
extensionContainer [17] IMPLICIT SEQUENCE {
  privateExtensionList [0] IMPLICIT SEQUENCE ( SIZE ( 1 .. 10 ) ) OF
    SEQUENCE {
      extId MAP-EXTENSION .&extensionId ( {
        '
        ... } ),
      extType MAP-EXTENSION .&ExtensionType ( {
        '
        ... } { @extId } ) OPTIONAL} OPTIONAL,
  pcs-Extensions [1] IMPLICIT SEQUENCE {
    ... } OPTIONAL,
  ... } OPTIONAL,
  ... } OPTIONAL,
imei [5] IMPLICIT OCTET STRING ( SIZE ( 8 ) ) OPTIONAL,
ms-Classmark2 [6] IMPLICIT OCTET STRING ( SIZE ( 3 ) ) OPTIONAL,
gprs-MS-Class [7] IMPLICIT SEQUENCE {
  mSNetworkCapability [0] IMPLICIT OCTET STRING ( SIZE ( 1 .. 8 ) ),
  mSRadioAccessCapability [1] IMPLICIT OCTET STRING ( SIZE ( 1 .. 50 ) ) OPTIONAL} OPTIONAL} OPTIONAL,
ss-List [1] IMPLICIT SEQUENCE ( SIZE ( 1 .. 30 ) ) OF
  OCTET STRING ( SIZE ( 1 ) ) OPTIONAL,
basicService [5] CHOICE {
  ext-BearerService [2] IMPLICIT OCTET STRING ( SIZE ( 1 .. 5 ) ),
  ext-Teleservice [3] IMPLICIT OCTET STRING ( SIZE ( 1 .. 5 ) ) OPTIONAL,
  forwardingInterrogationRequired [4] IMPLICIT NULL OPTIONAL,
  vmsc-Address [2] IMPLICIT OCTET STRING ( SIZE ( 1 .. 20 ) ) ( SIZE ( 1 .. 9 ) ) OPTIONAL,
  extensionContainer [0] IMPLICIT SEQUENCE {
    privateExtensionList [0] IMPLICIT SEQUENCE ( SIZE ( 1 .. 10 ) ) OF
      SEQUENCE {
        extId MAP-EXTENSION .&extensionId ( {
          '
          ... } ),
        extType MAP-EXTENSION .&ExtensionType ( {
          '
          ... } { @extId } ) OPTIONAL} OPTIONAL,
    pcs-Extensions [1] IMPLICIT SEQUENCE {
      ... } OPTIONAL,
    ... } OPTIONAL,
    ... } OPTIONAL,
  ... },
naea-PreferredCl [10] IMPLICIT SEQUENCE {
  naea-PreferredClC [0] IMPLICIT OCTET STRING ( SIZE ( 3 ) ),
  extensionContainer [1] IMPLICIT SEQUENCE {
    privateExtensionList [0] IMPLICIT SEQUENCE ( SIZE ( 1 .. 10 ) ) OF
      SEQUENCE {
        extId MAP-EXTENSION .&extensionId ( {
          '
          ... } ),
        extType MAP-EXTENSION .&ExtensionType ( {
          '
          ... } { @extId } ) OPTIONAL} OPTIONAL,
    pcs-Extensions [1] IMPLICIT SEQUENCE {
      ... } OPTIONAL,
    ... } OPTIONAL,
    ... } OPTIONAL,
  ... },
ccbs-Indicators [11] IMPLICIT SEQUENCE {
  ccbs-Possible [0] IMPLICIT NULL OPTIONAL,
  keepCCBS-CallIndicator [1] IMPLICIT NULL OPTIONAL,
  extensionContainer [2] IMPLICIT SEQUENCE {
    privateExtensionList [0] IMPLICIT SEQUENCE ( SIZE ( 1 .. 10 ) ) OF
      SEQUENCE {
        extId MAP-EXTENSION .&extensionId ( {
          '
          ... } ),

```

```

    extType MAP-EXTENSION .&ExtensionType ( {
        '
        ... } { @extId } ) OPTIONAL} OPTIONAL,
    pcs-Extensions [1] IMPLICIT SEQUENCE {
        ... } OPTIONAL,
        ... } OPTIONAL,
        ... } OPTIONAL,
    msisdn [12] IMPLICIT OCTET STRING ( SIZE ( 1 .. 20 ) ) ( SIZE ( 1 .. 9 ) ) OPTIONAL,
    numberPortabilityStatus [13] IMPLICIT ENUMERATED {
        notKnownToBePorted ( 0 ),
        ownNumberPortedOut ( 1 ),
        foreignNumberPortedToForeignNetwork ( 2 ),
        ... } OPTIONAL,
    istAlertTimer [14] IMPLICIT INTEGER ( 15 .. 255 ) OPTIONAL,
    supportedCamelPhases [15] IMPLICIT BIT STRING {
        phase1 ( 0 ),
        phase2 ( 1 ),
        phase3 ( 2 ),
        phase4 ( 3 ) } ( SIZE ( 1 .. 16 ) ) OPTIONAL}
ERRORS {
-- systemFailure -- localValue : 34,
-- dataMissing -- localValue : 35,
-- unexpectedDataValue -- localValue : 36,
-- facilityNotSupported -- localValue : 21,
-- or-NotAllowed -- localValue : 48,
-- unknownSubscriber -- localValue : 1,
-- numberChanged -- localValue : 44,
-- bearerServiceNotProvisioned -- localValue : 10,
-- teleserviceNotProvisioned -- localValue : 11,
-- absentSubscriber -- localValue : 27,
-- busySubscriber -- localValue : 45,
-- noSubscriberReply -- localValue : 46,
-- callBarred -- localValue : 13,
-- cug-Reject -- localValue : 15,
-- forwardingViolation -- localValue : 14}
::= localValue : 22

```

provideRoamingNumber OPERATION

ARGUMENT

```

provideRoamingNumberArg SEQUENCE {
    imsi [0] IMPLICIT OCTET STRING ( SIZE ( 3 .. 8 ) ),
    msc-Number [1] IMPLICIT OCTET STRING ( SIZE ( 1 .. 20 ) ) ( SIZE ( 1 .. 9 ) ),
    msisdn [2] IMPLICIT OCTET STRING ( SIZE ( 1 .. 20 ) ) ( SIZE ( 1 .. 9 ) ) OPTIONAL,
    lmsi [4] IMPLICIT OCTET STRING ( SIZE ( 4 ) ) OPTIONAL,
    gsm-BearerCapability [5] IMPLICIT SEQUENCE {
        protocolId ENUMERATED {
            gsm-0408 ( 1 ),
            gsm-0806 ( 2 ),
            gsm-BSSMAP ( 3 ),
            ets-300102-1 ( 4 ) },
        signalInfo OCTET STRING ( SIZE ( 1 .. 200 ) ),
        extensionContainer SEQUENCE {
            privateExtensionList [0] IMPLICIT SEQUENCE ( SIZE ( 1 .. 10 ) ) OF
                SEQUENCE {
                    extId MAP-EXTENSION .&extensionId ( {
                        '
                        ... } ),
                    extType MAP-EXTENSION .&ExtensionType ( {
                        '
                        ... } { @extId } ) OPTIONAL} OPTIONAL,
                    pcs-Extensions [1] IMPLICIT SEQUENCE {
                        ... } OPTIONAL,
                        ... } OPTIONAL,
                        ... } OPTIONAL,
                    networkSignalInfo [6] IMPLICIT SEQUENCE {
                        protocolId ENUMERATED {
                            gsm-0408 ( 1 ),
                            gsm-0806 ( 2 ),
                            gsm-BSSMAP ( 3 ),
                            ets-300102-1 ( 4 ) },
                        signalInfo OCTET STRING ( SIZE ( 1 .. 200 ) ),
                        extensionContainer SEQUENCE {
                            privateExtensionList [0] IMPLICIT SEQUENCE ( SIZE ( 1 .. 10 ) ) OF
                                SEQUENCE {
                                    extId MAP-EXTENSION .&extensionId ( {
                                        '
                                        ... } ),

```

```

    extType MAP-EXTENSION .&ExtensionType ( {
        '
        ... } { @extId } ) OPTIONAL} OPTIONAL,
    pcs-Extensions [1] IMPLICIT SEQUENCE {
        ... } OPTIONAL,
    ... } OPTIONAL,
    ... } OPTIONAL,
    suppressionOfAnnouncement [7] IMPLICIT NULL OPTIONAL,
    gsmc-Address [8] IMPLICIT OCTET STRING ( SIZE ( 1 .. 20 ) ) ( SIZE ( 1 .. 9 ) ) OPTIONAL,
    callReferenceNumber [9] IMPLICIT OCTET STRING ( SIZE ( 1 .. 8 ) ) OPTIONAL,
    or-Interrogation [10] IMPLICIT NULL OPTIONAL,
    extensionContainer [11] IMPLICIT SEQUENCE {
        privateExtensionList [0] IMPLICIT SEQUENCE ( SIZE ( 1 .. 10 ) ) OF
        SEQUENCE {
            extId MAP-EXTENSION .&extensionId ( {
                '
                ... } ) ,
            extType MAP-EXTENSION .&ExtensionType ( {
                '
                ... } { @extId } ) OPTIONAL} OPTIONAL,
            pcs-Extensions [1] IMPLICIT SEQUENCE {
                ... } OPTIONAL,
            ... } OPTIONAL,
            ... } OPTIONAL,
        ... ,
        alertingPattern [12] IMPLICIT OCTET STRING ( SIZE ( 1 ) ) OPTIONAL,
        ccbs-Call [13] IMPLICIT NULL OPTIONAL,
        supportedCamelPhasesInGMSC [15] IMPLICIT BIT STRING {
            phase1 ( 0 ),
            phase2 ( 1 ),
            phase3 ( 2 ),
            phase4 ( 3 ) } ( SIZE ( 1 .. 16 ) ) OPTIONAL,
        additionalSignalInfo [14] IMPLICIT SEQUENCE {
            ext-ProtocollId ENUMERATED {
                ets-300356 ( 1 ),
                ... },
            signalInfo OCTET STRING ( SIZE ( 1 .. 200 ) ),
            extensionContainer SEQUENCE {
                privateExtensionList [0] IMPLICIT SEQUENCE ( SIZE ( 1 .. 10 ) ) OF
                SEQUENCE {
                    extId MAP-EXTENSION .&extensionId ( {
                        '
                        ... } ) ,
                    extType MAP-EXTENSION .&ExtensionType ( {
                        '
                        ... } { @extId } ) OPTIONAL} OPTIONAL,
                    pcs-Extensions [1] IMPLICIT SEQUENCE {
                        ... } OPTIONAL,
                    ... } OPTIONAL,
                    ... } OPTIONAL,
                orNotSupportedInGMSC [16] IMPLICIT NULL OPTIONAL,
                pre-pagingSupported [17] IMPLICIT NULL OPTIONAL,
                longFTN-Supported [18] IMPLICIT NULL OPTIONAL,
                suppress-VT-CSI [19] IMPLICIT NULL OPTIONAL}
        }
    }
RESULT
    provideRoamingNumberRes SEQUENCE {
        roamingNumber OCTET STRING ( SIZE ( 1 .. 20 ) ) ( SIZE ( 1 .. 9 ) ),
        extensionContainer SEQUENCE {
            privateExtensionList [0] IMPLICIT SEQUENCE ( SIZE ( 1 .. 10 ) ) OF
            SEQUENCE {
                extId MAP-EXTENSION .&extensionId ( {
                    '
                    ... } ) ,
                extType MAP-EXTENSION .&ExtensionType ( {
                    '
                    ... } { @extId } ) OPTIONAL} OPTIONAL,
                pcs-Extensions [1] IMPLICIT SEQUENCE {
                    ... } OPTIONAL,
                    ... } OPTIONAL,
                    ... } OPTIONAL,
                ... }
    }
ERRORS {
    -- systemFailure -- localValue : 34,
    -- dataMissing -- localValue : 35,
    -- unexpectedDataValue -- localValue : 36,
    -- facilityNotSupported -- localValue : 21,
    -- or-NotAllowed -- localValue : 48,
    -- absentSubscriber -- localValue : 27,
    -- noRoamingNumberAvailable -- localValue : 39}

```

::= localValue : 4

resumeCallHandling OPERATION
ARGUMENT

```

resumeCallHandlingArg SEQUENCE {
  callReferenceNumber [0] IMPLICIT OCTET STRING ( SIZE ( 1 .. 8 ) ) OPTIONAL,
  basicServiceGroup [1] CHOICE {
    ext-BearerService [2] IMPLICIT OCTET STRING ( SIZE ( 1 .. 5 ) ),
    ext-Teleservice [3] IMPLICIT OCTET STRING ( SIZE ( 1 .. 5 ) ) } OPTIONAL,
  forwardingData [2] IMPLICIT SEQUENCE {
    forwardedToNumber [5] IMPLICIT OCTET STRING ( SIZE ( 1 .. 20 ) ) ( SIZE ( 1 .. 9 ) ) OPTIONAL,
    forwardedToSubaddress [4] IMPLICIT OCTET STRING ( SIZE ( 1 .. 21 ) ) OPTIONAL,
    forwardingOptions [6] IMPLICIT OCTET STRING ( SIZE ( 1 ) ) OPTIONAL,
    extensionContainer [7] IMPLICIT SEQUENCE {
      privateExtensionList [0] IMPLICIT SEQUENCE ( SIZE ( 1 .. 10 ) ) OF
        SEQUENCE {
          extId MAP-EXTENSION .&extensionId ( {
            '
            ... } ),
          extType MAP-EXTENSION .&ExtensionType ( {
            '
            ... } { @extId } ) OPTIONAL } OPTIONAL,
      pcs-Extensions [1] IMPLICIT SEQUENCE {
        ... } OPTIONAL,
      ... } OPTIONAL,
    ... },
  longForwardedToNumber [8] IMPLICIT OCTET STRING ( SIZE ( 1 .. 20 ) ) ( SIZE ( 1 .. 15 ) ) OPTIONAL } OPTIONAL,
  imsi [3] IMPLICIT OCTET STRING ( SIZE ( 3 .. 8 ) ) OPTIONAL,
  cug-CheckInfo [4] IMPLICIT SEQUENCE {
    cug-Interlock OCTET STRING ( SIZE ( 4 ) ),
    cug-OutgoingAccess NULL OPTIONAL,
    extensionContainer SEQUENCE {
      privateExtensionList [0] IMPLICIT SEQUENCE ( SIZE ( 1 .. 10 ) ) OF
        SEQUENCE {
          extId MAP-EXTENSION .&extensionId ( {
            '
            ... } ),
          extType MAP-EXTENSION .&ExtensionType ( {
            '
            ... } { @extId } ) OPTIONAL } OPTIONAL,
      pcs-Extensions [1] IMPLICIT SEQUENCE {
        ... } OPTIONAL,
      ... } OPTIONAL,
    ... } OPTIONAL,
  o-CSI [5] IMPLICIT SEQUENCE {
    o-BcsmCamelTDPDataList SEQUENCE ( SIZE ( 1 .. 10 ) ) OF
      SEQUENCE {
        o-BcsmTriggerDetectionPoint ENUMERATED {
          collectedInfo ( 2 ),
          ... },
        routeSelectFailure ( 4 ) },
    serviceKey INTEGER ( 0 .. 2147483647 ),
    gsmSCF-Address [0] IMPLICIT OCTET STRING ( SIZE ( 1 .. 20 ) ) ( SIZE ( 1 .. 9 ) ),
    defaultCallHandling [1] IMPLICIT ENUMERATED {
      continueCall ( 0 ),
      releaseCall ( 1 ),
      ... },
    extensionContainer [2] IMPLICIT SEQUENCE {
      privateExtensionList [0] IMPLICIT SEQUENCE ( SIZE ( 1 .. 10 ) ) OF
        SEQUENCE {
          extId MAP-EXTENSION .&extensionId ( {
            '
            ... } ),
          extType MAP-EXTENSION .&ExtensionType ( {
            '
            ... } { @extId } ) OPTIONAL } OPTIONAL,
      pcs-Extensions [1] IMPLICIT SEQUENCE {
        ... } OPTIONAL,
      ... } OPTIONAL,
    ... },
  extensionContainer SEQUENCE {
    privateExtensionList [0] IMPLICIT SEQUENCE ( SIZE ( 1 .. 10 ) ) OF
      SEQUENCE {
        extId MAP-EXTENSION .&extensionId ( {
          '
          ... } ),
        extType MAP-EXTENSION .&ExtensionType ( {

```

```

    ... } { @extId } ) OPTIONAL} OPTIONAL,
    pcs-Extensions [1] IMPLICIT SEQUENCE {
    ... } OPTIONAL,
    ... } OPTIONAL,
    ... ,
    camelCapabilityHandling [0] IMPLICIT INTEGER ( 1 .. 16 ) OPTIONAL,
    notificationToCSE [1] IMPLICIT NULL OPTIONAL,
    csiActive [2] IMPLICIT NULL OPTIONAL} OPTIONAL,
    extensionContainer [7] IMPLICIT SEQUENCE {
    privateExtensionList [0] IMPLICIT SEQUENCE ( SIZE ( 1 .. 10 ) ) OF
    SEQUENCE {
    extId MAP-EXTENSION .&extensionId ( {
    '
    ... } ) ,
    extType MAP-EXTENSION .&ExtensionType ( {
    '
    ... } { @extId } ) OPTIONAL} OPTIONAL,
    pcs-Extensions [1] IMPLICIT SEQUENCE {
    ... } OPTIONAL,
    ... } OPTIONAL,
    ... } OPTIONAL,
    ccbs-Possible [8] IMPLICIT NULL OPTIONAL,
    msisdN [9] IMPLICIT OCTET STRING ( SIZE ( 1 .. 20 ) ) ( SIZE ( 1 .. 9 ) ) OPTIONAL,
    uu-Data [10] IMPLICIT SEQUENCE {
    uuIndicator [0] IMPLICIT OCTET STRING ( SIZE ( 1 ) ) OPTIONAL,
    uui [1] IMPLICIT OCTET STRING ( SIZE ( 1 .. 131 ) ) OPTIONAL,
    uusCFInteraction [2] IMPLICIT NULL OPTIONAL,
    extensionContainer [3] IMPLICIT SEQUENCE {
    privateExtensionList [0] IMPLICIT SEQUENCE ( SIZE ( 1 .. 10 ) ) OF
    SEQUENCE {
    extId MAP-EXTENSION .&extensionId ( {
    '
    ... } ) ,
    extType MAP-EXTENSION .&ExtensionType ( {
    '
    ... } { @extId } ) OPTIONAL} OPTIONAL,
    pcs-Extensions [1] IMPLICIT SEQUENCE {
    ... } OPTIONAL,
    ... } OPTIONAL,
    ... } OPTIONAL,
    allInformationSent [11] IMPLICIT NULL OPTIONAL,
    ... ,
    d-csi [12] IMPLICIT SEQUENCE {
    dp-AnalysedInfoCriteriaList [0] IMPLICIT SEQUENCE ( SIZE ( 1 .. 10 ) ) OF
    SEQUENCE {
    dialledNumber OCTET STRING ( SIZE ( 1 .. 20 ) ) ( SIZE ( 1 .. 9 ) ) ,
    serviceKey INTEGER ( 0 .. 2147483647 ) ,
    gsmSCF-Address OCTET STRING ( SIZE ( 1 .. 20 ) ) ( SIZE ( 1 .. 9 ) ) ,
    defaultCallHandling ENUMERATED {
    continueCall ( 0 ) ,
    releaseCall ( 1 ) ,
    ... } ,
    extensionContainer SEQUENCE {
    privateExtensionList [0] IMPLICIT SEQUENCE ( SIZE ( 1 .. 10 ) ) OF
    SEQUENCE {
    extId MAP-EXTENSION .&extensionId ( {
    '
    ... } ) ,
    extType MAP-EXTENSION .&ExtensionType ( {
    '
    ... } { @extId } ) OPTIONAL} OPTIONAL,
    pcs-Extensions [1] IMPLICIT SEQUENCE {
    ... } OPTIONAL,
    ... } OPTIONAL,
    ... } OPTIONAL,
    camelCapabilityHandling [1] IMPLICIT INTEGER ( 1 .. 16 ) OPTIONAL,
    extensionContainer [2] IMPLICIT SEQUENCE {
    privateExtensionList [0] IMPLICIT SEQUENCE ( SIZE ( 1 .. 10 ) ) OF
    SEQUENCE {
    extId MAP-EXTENSION .&extensionId ( {
    '
    ... } ) ,
    extType MAP-EXTENSION .&ExtensionType ( {
    '
    ... } { @extId } ) OPTIONAL} OPTIONAL,
    pcs-Extensions [1] IMPLICIT SEQUENCE {
    ... } OPTIONAL,

```

```

... } OPTIONAL,
notificationToCSE [3] IMPLICIT NULL OPTIONAL,
csi-Active [4] IMPLICIT NULL OPTIONAL,
... } OPTIONAL}
RESULT
resumeCallHandlingRes SEQUENCE {
  extensionContainer SEQUENCE {
    privateExtensionList [0] IMPLICIT SEQUENCE ( SIZE ( 1 .. 10 )) OF
      SEQUENCE {
        extId MAP-EXTENSION .&extensionId ( {
          '
          ... } ),
        extType MAP-EXTENSION .&ExtensionType ( {
          '
          ... } { @extId } ) OPTIONAL} OPTIONAL,
        pcs-Extensions [1] IMPLICIT SEQUENCE {
          ... } OPTIONAL,
          ... } OPTIONAL,
          ... }
ERRORS {
  -- forwardingFailed -- localValue : 47,
  -- or-NotAllowed -- localValue : 48,
  -- unexpectedDataValue -- localValue : 36,
  -- dataMissing -- localValue : 35}
 ::= localValue : 6

provideSIWFSNumber OPERATION
ARGUMENT
provideSIWFSNumberArg SEQUENCE {
  gsm-BearerCapability [0] IMPLICIT SEQUENCE {
    protocolId ENUMERATED {
      gsm-0408 ( 1 ),
      gsm-0806 ( 2 ),
      gsm-BSSMAP ( 3 ),
      ets-300102-1 ( 4 )},
    signalInfo OCTET STRING ( SIZE ( 1 .. 200 ) ),
    extensionContainer SEQUENCE {
      privateExtensionList [0] IMPLICIT SEQUENCE ( SIZE ( 1 .. 10 )) OF
        SEQUENCE {
          extId MAP-EXTENSION .&extensionId ( {
            '
            ... } ),
          extType MAP-EXTENSION .&ExtensionType ( {
            '
            ... } { @extId } ) OPTIONAL} OPTIONAL,
          pcs-Extensions [1] IMPLICIT SEQUENCE {
            ... } OPTIONAL,
            ... } OPTIONAL,
            ... },
    isdn-BearerCapability [1] IMPLICIT SEQUENCE {
      protocolId ENUMERATED {
        gsm-0408 ( 1 ),
        gsm-0806 ( 2 ),
        gsm-BSSMAP ( 3 ),
        ets-300102-1 ( 4 )},
      signalInfo OCTET STRING ( SIZE ( 1 .. 200 ) ),
      extensionContainer SEQUENCE {
        privateExtensionList [0] IMPLICIT SEQUENCE ( SIZE ( 1 .. 10 )) OF
          SEQUENCE {
            extId MAP-EXTENSION .&extensionId ( {
              '
              ... } ),
            extType MAP-EXTENSION .&ExtensionType ( {
              '
              ... } { @extId } ) OPTIONAL} OPTIONAL,
            pcs-Extensions [1] IMPLICIT SEQUENCE {
              ... } OPTIONAL,
              ... } OPTIONAL,
              ... },
      call-Direction [2] IMPLICIT OCTET STRING ( SIZE ( 1 ) ),
      b-Subscriber-Address [3] IMPLICIT OCTET STRING ( SIZE ( 1 .. 20 )) ( SIZE ( 1 .. 9 ) ),
      chosenChannel [4] IMPLICIT SEQUENCE {
        protocolId ENUMERATED {
          gsm-0408 ( 1 ),
          gsm-0806 ( 2 ),
          gsm-BSSMAP ( 3 ),
          ets-300102-1 ( 4 )},

```



```

signallInfo    OCTET STRING ( SIZE ( 1 .. 200 ) ),
extensionContainer SEQUENCE {
  privateExtensionList [0] IMPLICIT SEQUENCE ( SIZE ( 1 .. 10 ) ) OF
  SEQUENCE {
    extId    MAP-EXTENSION .&extensionId ( {
      '
      ... } ),
    extType  MAP-EXTENSION .&ExtensionType ( {
      '
      ... } { @extId } ) OPTIONAL} OPTIONAL,
  pcs-Extensions [1] IMPLICIT SEQUENCE {
    ... } OPTIONAL,
  ... } OPTIONAL,
  ... },
lowerLayerCompatibility [5] IMPLICIT SEQUENCE {
  protocolId  ENUMERATED {
    gsm-0408 (1),
    gsm-0806 (2),
    gsm-BSSMAP (3),
    ets-300102-1 (4)},
  signallInfo    OCTET STRING ( SIZE ( 1 .. 200 ) ),
  extensionContainer SEQUENCE {
    privateExtensionList [0] IMPLICIT SEQUENCE ( SIZE ( 1 .. 10 ) ) OF
    SEQUENCE {
      extId    MAP-EXTENSION .&extensionId ( {
        '
        ... } ),
      extType  MAP-EXTENSION .&ExtensionType ( {
        '
        ... } { @extId } ) OPTIONAL} OPTIONAL,
    pcs-Extensions [1] IMPLICIT SEQUENCE {
      ... } OPTIONAL,
    ... } OPTIONAL,
    ... } OPTIONAL,
  highLayerCompatibility [6] IMPLICIT SEQUENCE {
    protocolId  ENUMERATED {
      gsm-0408 (1),
      gsm-0806 (2),
      gsm-BSSMAP (3),
      ets-300102-1 (4)},
    signallInfo    OCTET STRING ( SIZE ( 1 .. 200 ) ),
    extensionContainer SEQUENCE {
      privateExtensionList [0] IMPLICIT SEQUENCE ( SIZE ( 1 .. 10 ) ) OF
      SEQUENCE {
        extId    MAP-EXTENSION .&extensionId ( {
          '
          ... } ),
        extType  MAP-EXTENSION .&ExtensionType ( {
          '
          ... } { @extId } ) OPTIONAL} OPTIONAL,
      pcs-Extensions [1] IMPLICIT SEQUENCE {
        ... } OPTIONAL,
        ... } OPTIONAL,
        ... } OPTIONAL,
  extensionContainer [7] IMPLICIT SEQUENCE {
    privateExtensionList [0] IMPLICIT SEQUENCE ( SIZE ( 1 .. 10 ) ) OF
    SEQUENCE {
      extId    MAP-EXTENSION .&extensionId ( {
        '
        ... } ),
      extType  MAP-EXTENSION .&ExtensionType ( {
        '
        ... } { @extId } ) OPTIONAL} OPTIONAL,
    pcs-Extensions [1] IMPLICIT SEQUENCE {
      ... } OPTIONAL,
      ... } OPTIONAL,
      ... }
  ... }
RESULT
provideSIWFsNumberRes SEQUENCE {
  siWFsNumber [0] IMPLICIT OCTET STRING ( SIZE ( 1 .. 20 ) ) ( SIZE ( 1 .. 9 ) ),
  extensionContainer [1] IMPLICIT SEQUENCE {
    privateExtensionList [0] IMPLICIT SEQUENCE ( SIZE ( 1 .. 10 ) ) OF
    SEQUENCE {
      extId    MAP-EXTENSION .&extensionId ( {
        '
        ... } ),
      extType  MAP-EXTENSION .&ExtensionType ( {

```

```

        ... } { @extId } ) OPTIONAL} OPTIONAL,
    pcs-Extensions [1] IMPLICIT SEQUENCE {
        ... } OPTIONAL,
        ... } OPTIONAL,
    ... }
ERRORS {
-- resourceLimitation -- localValue : 51,
-- dataMissing -- localValue : 35,
-- unexpectedDataValue -- localValue : 36,
-- systemFailure -- localValue : 34}
::= localValue : 31

sIWFFSSignallingModify OPERATION
ARGUMENT
sIWFFSSignallingModifyArg SEQUENCE {
    channelType [0] IMPLICIT SEQUENCE {
        protocolId ENUMERATED {
            gsm-0408 (1),
            gsm-0806 (2),
            gsm-BSSMAP (3),
            ets-300102-1 (4)},
        signalInfo OCTET STRING ( SIZE (1 .. 200) ),
        extensionContainer SEQUENCE {
            privateExtensionList [0] IMPLICIT SEQUENCE ( SIZE (1 .. 10) ) OF
                SEQUENCE {
                    extId MAP-EXTENSION .&extensionId ( {
                        '
                        ... } ),
                    extType MAP-EXTENSION .&ExtensionType ( {
                        '
                        ... } { @extId } ) OPTIONAL} OPTIONAL,
                    pcs-Extensions [1] IMPLICIT SEQUENCE {
                        ... } OPTIONAL,
                        ... } OPTIONAL,
                        ... } OPTIONAL,
                    ... } OPTIONAL,
                chosenChannel [1] IMPLICIT SEQUENCE {
                    protocolId ENUMERATED {
                        gsm-0408 (1),
                        gsm-0806 (2),
                        gsm-BSSMAP (3),
                        ets-300102-1 (4)},
                    signalInfo OCTET STRING ( SIZE (1 .. 200) ),
                    extensionContainer SEQUENCE {
                        privateExtensionList [0] IMPLICIT SEQUENCE ( SIZE (1 .. 10) ) OF
                            SEQUENCE {
                                extId MAP-EXTENSION .&extensionId ( {
                                    '
                                    ... } ),
                                extType MAP-EXTENSION .&ExtensionType ( {
                                    '
                                    ... } { @extId } ) OPTIONAL} OPTIONAL,
                                pcs-Extensions [1] IMPLICIT SEQUENCE {
                                    ... } OPTIONAL,
                                    ... } OPTIONAL,
                                    ... } OPTIONAL,
                                extensionContainer [2] IMPLICIT SEQUENCE {
                                    privateExtensionList [0] IMPLICIT SEQUENCE ( SIZE (1 .. 10) ) OF
                                        SEQUENCE {
                                            extId MAP-EXTENSION .&extensionId ( {
                                                '
                                                ... } ),
                                            extType MAP-EXTENSION .&ExtensionType ( {
                                                '
                                                ... } { @extId } ) OPTIONAL} OPTIONAL,
                                            pcs-Extensions [1] IMPLICIT SEQUENCE {
                                                ... } OPTIONAL,
                                                ... } OPTIONAL,
                                                ... } OPTIONAL,
                                            ... }
                                RESULT
                                sIWFFSSignallingModifyRes SEQUENCE {
                                    chosenChannel [0] IMPLICIT SEQUENCE {
                                        protocolId ENUMERATED {
                                            gsm-0408 (1),
                                            gsm-0806 (2),
                                            gsm-BSSMAP (3),
                                            ets-300102-1 (4)},

```

```

signallInfo    OCTET STRING ( SIZE (1 .. 200) ),
extensionContainer SEQUENCE {
  privateExtensionList [0] IMPLICIT SEQUENCE ( SIZE (1 .. 10) ) OF
  SEQUENCE {
    extId    MAP-EXTENSION .&extensionId ( {
      '
      ... } ),
    extType  MAP-EXTENSION .&ExtensionType ( {
      '
      ... } { @extId } ) OPTIONAL } OPTIONAL,
  pcs-Extensions [1] IMPLICIT SEQUENCE {
    ... } OPTIONAL,
  ... } OPTIONAL,
  ... } OPTIONAL,
extensionContainer [1] IMPLICIT SEQUENCE {
  privateExtensionList [0] IMPLICIT SEQUENCE ( SIZE (1 .. 10) ) OF
  SEQUENCE {
    extId    MAP-EXTENSION .&extensionId ( {
      '
      ... } ),
    extType  MAP-EXTENSION .&ExtensionType ( {
      '
      ... } { @extId } ) OPTIONAL } OPTIONAL,
  pcs-Extensions [1] IMPLICIT SEQUENCE {
    ... } OPTIONAL,
  ... } OPTIONAL,
  ... }
ERRORS {
-- resourceLimitation -- localValue : 51,
-- dataMissing -- localValue : 35,
-- unexpectedDataValue -- localValue : 36,
-- systemFailure -- localValue : 34}
::= localValue : 32

setReportingState OPERATION
ARGUMENT
  setReportingStateArg SEQUENCE {
    imsi [0] IMPLICIT OCTET STRING ( SIZE (3 .. 8) ) OPTIONAL,
    lmsi [1] IMPLICIT OCTET STRING ( SIZE (4) ) OPTIONAL,
    ccbs-Monitoring [2] IMPLICIT ENUMERATED {
      stopMonitoring (0),
      startMonitoring (1),
      ... } OPTIONAL,
    extensionContainer [3] IMPLICIT SEQUENCE {
      privateExtensionList [0] IMPLICIT SEQUENCE ( SIZE (1 .. 10) ) OF
      SEQUENCE {
        extId    MAP-EXTENSION .&extensionId ( {
          '
          ... } ),
        extType  MAP-EXTENSION .&ExtensionType ( {
          '
          ... } { @extId } ) OPTIONAL } OPTIONAL,
      pcs-Extensions [1] IMPLICIT SEQUENCE {
        ... } OPTIONAL,
      ... } OPTIONAL,
      ... }
RESULT
  setReportingStateRes SEQUENCE {
    ccbs-SubscriberStatus [0] IMPLICIT ENUMERATED {
      ccbsNotIdle (0),
      ccbsIdle (1),
      ccbsNotReachable (2),
      ... } OPTIONAL,
    extensionContainer [1] IMPLICIT SEQUENCE {
      privateExtensionList [0] IMPLICIT SEQUENCE ( SIZE (1 .. 10) ) OF
      SEQUENCE {
        extId    MAP-EXTENSION .&extensionId ( {
          '
          ... } ),
        extType  MAP-EXTENSION .&ExtensionType ( {
          '
          ... } { @extId } ) OPTIONAL } OPTIONAL,
      pcs-Extensions [1] IMPLICIT SEQUENCE {
        ... } OPTIONAL,
      ... } OPTIONAL,
      ... }
ERRORS {

```

```

-- systemFailure -- localValue : 34,
-- unidentifiedSubscriber -- localValue : 5,
-- unexpectedDataValue -- localValue : 36,
-- dataMissing -- localValue : 35,
-- resourceLimitation -- localValue : 51,
-- facilityNotSupported -- localValue : 21}
::= localValue : 73

```

statusReport OPERATION

ARGUMENT

```

statusReportArg SEQUENCE {
  imsi [0] IMPLICIT OCTET STRING ( SIZE ( 3 .. 8 ) ),
  eventReportData [1] IMPLICIT SEQUENCE {
    ccbs-SubscriberStatus [0] IMPLICIT ENUMERATED {
      ccbsNotIdle (0),
      ccbsIdle (1),
      ccbsNotReachable (2),
      ... } OPTIONAL,
    extensionContainer [1] IMPLICIT SEQUENCE {
      privateExtensionList [0] IMPLICIT SEQUENCE ( SIZE ( 1 .. 10 ) ) OF
        SEQUENCE {
          extId MAP-EXTENSION .&extensionId ( {
            '
            ...} ) ),
          extType MAP-EXTENSION .&ExtensionType ( {
            '
            ...} { @extId } ) OPTIONAL} OPTIONAL,
      pcs-Extensions [1] IMPLICIT SEQUENCE {
        ... } OPTIONAL,
        ... } OPTIONAL,
        ... } OPTIONAL,
        ... } OPTIONAL,
    callReportdata [2] IMPLICIT SEQUENCE {
      monitoringMode [0] IMPLICIT ENUMERATED {
        a-side (0),
        b-side (1),
        ... } OPTIONAL,
      callOutcome [1] IMPLICIT ENUMERATED {
        success (0),
        failure (1),
        busy (2),
        ... } OPTIONAL,
      extensionContainer [2] IMPLICIT SEQUENCE {
        privateExtensionList [0] IMPLICIT SEQUENCE ( SIZE ( 1 .. 10 ) ) OF
          SEQUENCE {
            extId MAP-EXTENSION .&extensionId ( {
              '
              ...} ) ),
            extType MAP-EXTENSION .&ExtensionType ( {
              '
              ...} { @extId } ) OPTIONAL} OPTIONAL,
          pcs-Extensions [1] IMPLICIT SEQUENCE {
            ... } OPTIONAL,
            ... } OPTIONAL,
            ... } OPTIONAL,
            ... } OPTIONAL,
          extensionContainer [3] IMPLICIT SEQUENCE {
            privateExtensionList [0] IMPLICIT SEQUENCE ( SIZE ( 1 .. 10 ) ) OF
              SEQUENCE {
                extId MAP-EXTENSION .&extensionId ( {
                  '
                  ...} ) ),
                extType MAP-EXTENSION .&ExtensionType ( {
                  '
                  ...} { @extId } ) OPTIONAL} OPTIONAL,
            pcs-Extensions [1] IMPLICIT SEQUENCE {
              ... } OPTIONAL,
              ... } OPTIONAL,
              ... } OPTIONAL,
              ... } OPTIONAL,
            ... }
  }

```

RESULT

```

statusReportRes SEQUENCE {
  extensionContainer [0] IMPLICIT SEQUENCE {
    privateExtensionList [0] IMPLICIT SEQUENCE ( SIZE ( 1 .. 10 ) ) OF
      SEQUENCE {
        extId MAP-EXTENSION .&extensionId ( {
          '
          ...} ) ),
        extType MAP-EXTENSION .&ExtensionType ( {
          '
          ...}
        }
  }

```

```

        ...} { @extId } ) OPTIONAL} OPTIONAL,
    pcs-Extensions [1] IMPLICIT SEQUENCE {
        ... } OPTIONAL,
        ... } OPTIONAL,
    ... }
ERRORS {
    -- unknownSubscriber -- localValue : 1,
    -- systemFailure -- localValue : 34,
    -- unexpectedDataValue -- localValue : 36,
    -- dataMissing -- localValue : 35}
 ::= localValue : 74

remoteUserFree OPERATION
ARGUMENT
remoteUserFreeArg SEQUENCE {
    imsi [0] IMPLICIT OCTET STRING ( SIZE ( 3 .. 8 ) ),
    callInfo [1] IMPLICIT SEQUENCE {
        protocolId ENUMERATED {
            gsm-0408 (1),
            gsm-0806 (2),
            gsm-BSSMAP (3),
            ets-300102-1 (4) },
        signalInfo OCTET STRING ( SIZE ( 1 .. 200 ) ),
        extensionContainer SEQUENCE {
            privateExtensionList [0] IMPLICIT SEQUENCE ( SIZE ( 1 .. 10 ) ) OF
                SEQUENCE {
                    extId MAP-EXTENSION .&extensionId ( {
                        '
                        ... } ),
                    extType MAP-EXTENSION .&ExtensionType ( {
                        '
                        ... } { @extId } ) OPTIONAL} OPTIONAL,
            pcs-Extensions [1] IMPLICIT SEQUENCE {
                ... } OPTIONAL,
                ... } OPTIONAL,
            ... },
        ccbs-Feature [2] IMPLICIT SEQUENCE {
            ccbs-Index [0] IMPLICIT INTEGER ( 1 .. 5 ) OPTIONAL,
            b-subscriberNumber [1] IMPLICIT OCTET STRING ( SIZE ( 1 .. 20 ) ) ( SIZE ( 1 .. 9 ) ) OPTIONAL,
            b-subscriberSubaddress [2] IMPLICIT OCTET STRING ( SIZE ( 1 .. 21 ) ) OPTIONAL,
            basicServiceGroup [3] CHOICE {
                bearerService [2] IMPLICIT OCTET STRING ( SIZE ( 1 ) ),
                teleservice [3] IMPLICIT OCTET STRING ( SIZE ( 1 ) ) } OPTIONAL,
            ... },
        translatedB-Number [3] IMPLICIT OCTET STRING ( SIZE ( 1 .. 20 ) ) ( SIZE ( 1 .. 9 ) ),
        replaceB-Number [4] IMPLICIT NULL OPTIONAL,
        alertingPattern [5] IMPLICIT OCTET STRING ( SIZE ( 1 ) ) OPTIONAL,
        extensionContainer [6] IMPLICIT SEQUENCE {
            privateExtensionList [0] IMPLICIT SEQUENCE ( SIZE ( 1 .. 10 ) ) OF
                SEQUENCE {
                    extId MAP-EXTENSION .&extensionId ( {
                        '
                        ... } ),
                    extType MAP-EXTENSION .&ExtensionType ( {
                        '
                        ... } { @extId } ) OPTIONAL} OPTIONAL,
            pcs-Extensions [1] IMPLICIT SEQUENCE {
                ... } OPTIONAL,
                ... } OPTIONAL,
            ... }
        ... }
RESULT
remoteUserFreeRes SEQUENCE {
    ruf-Outcome [0] IMPLICIT ENUMERATED {
        accepted (0),
        rejected (1),
        noResponseFromFreeMS (2),
        noResponseFromBusyMS (3),
        udubFromFreeMS (4),
        udubFromBusyMS (5),
        ... },
    extensionContainer [1] IMPLICIT SEQUENCE {
        privateExtensionList [0] IMPLICIT SEQUENCE ( SIZE ( 1 .. 10 ) ) OF
            SEQUENCE {
                extId MAP-EXTENSION .&extensionId ( {
                    '
                    ... } ),
                extType MAP-EXTENSION .&ExtensionType ( {

```

```

        ...}{ @extId } ) OPTIONAL} OPTIONAL,
    pcs-Extensions [1] IMPLICIT SEQUENCE {
        ... } OPTIONAL,
    ... } OPTIONAL,
    ... }
istAlert OPERATION
ARGUMENT
istAlertArg SEQUENCE {
    imsi [0] IMPLICIT OCTET STRING ( SIZE ( 3 .. 8 ) ),
    extensionContainer [1] IMPLICIT SEQUENCE {
        privateExtensionList [0] IMPLICIT SEQUENCE ( SIZE ( 1 .. 10 ) ) OF
        SEQUENCE {
            extId MAP-EXTENSION .&extensionId ( {
                '
                ...} ),
            extType MAP-EXTENSION .&ExtensionType ( {
                '
                ...}{ @extId } ) OPTIONAL} OPTIONAL,
        pcs-Extensions [1] IMPLICIT SEQUENCE {
            ... } OPTIONAL,
            ... } OPTIONAL,
            ... }
RESULT
istAlertRes SEQUENCE {
    istAlertTimer [0] IMPLICIT INTEGER ( 15 .. 255 ) OPTIONAL,
    istInformationWithdraw [1] IMPLICIT NULL OPTIONAL,
    callTerminationIndicator [2] IMPLICIT ENUMERATED {
        terminateCallActivityReferred ( 0 ),
        terminateAllCallActivities ( 1 ),
        ... } OPTIONAL,
    extensionContainer [3] IMPLICIT SEQUENCE {
        privateExtensionList [0] IMPLICIT SEQUENCE ( SIZE ( 1 .. 10 ) ) OF
        SEQUENCE {
            extId MAP-EXTENSION .&extensionId ( {
                '
                ...} ),
            extType MAP-EXTENSION .&ExtensionType ( {
                '
                ...}{ @extId } ) OPTIONAL} OPTIONAL,
        pcs-Extensions [1] IMPLICIT SEQUENCE {
            ... } OPTIONAL,
            ... } OPTIONAL,
            ... }
ERRORS {
    -- unexpectedDataValue -- localValue : 36,
    -- resourceLimitation -- localValue : 51,
    -- unknownSubscriber -- localValue : 1,
    -- systemFailure -- localValue : 34,
    -- facilityNotSupported -- localValue : 21}
::= localValue : 87

istCommand OPERATION
ARGUMENT
istCommandArg SEQUENCE {
    imsi [0] IMPLICIT OCTET STRING ( SIZE ( 3 .. 8 ) ),
    extensionContainer [1] IMPLICIT SEQUENCE {
        privateExtensionList [0] IMPLICIT SEQUENCE ( SIZE ( 1 .. 10 ) ) OF
        SEQUENCE {
            extId MAP-EXTENSION .&extensionId ( {
                '
                ...} ),
            extType MAP-EXTENSION .&ExtensionType ( {
                '
                ...}{ @extId } ) OPTIONAL} OPTIONAL,
        pcs-Extensions [1] IMPLICIT SEQUENCE {
            ... } OPTIONAL,
            ... } OPTIONAL,
            ... }

```

```

... }
RESULT
istCommandRes SEQUENCE {
  extensionContainer SEQUENCE {
    privateExtensionList [0] IMPLICIT SEQUENCE ( SIZE ( 1 .. 10 ) ) OF
    SEQUENCE {
      extId MAP-EXTENSION .&extensionId ( {
        '
        ... } ) ,
      extType MAP-EXTENSION .&ExtensionType ( {
        '
        ... } { @extId } ) OPTIONAL } OPTIONAL,
    pcs-Extensions [1] IMPLICIT SEQUENCE {
      ... } OPTIONAL,
      ... } OPTIONAL,
      ... }
    ... }
  }
}
ERRORS {
  -- unexpectedDataValue -- localValue : 36,
  -- resourceLimitation -- localValue : 51,
  -- unknownSubscriber -- localValue : 1,
  -- systemFailure -- localValue : 34,
  -- facilityNotSupported -- localValue : 21}
 ::= localValue : 88

registerSS OPERATION
ARGUMENT
registerSS-Arg SEQUENCE {
  ss-Code OCTET STRING ( SIZE ( 1 ) ),
  basicService CHOICE {
    bearerService [2] IMPLICIT OCTET STRING ( SIZE ( 1 ) ),
    teleservice [3] IMPLICIT OCTET STRING ( SIZE ( 1 ) ) } OPTIONAL,
  forwardedToNumber [4] IMPLICIT OCTET STRING ( SIZE ( 1 .. 20 ) ) OPTIONAL,
  forwardedToSubaddress [6] IMPLICIT OCTET STRING ( SIZE ( 1 .. 21 ) ) OPTIONAL,
  noReplyConditionTime [5] IMPLICIT INTEGER ( 5 .. 30 ) OPTIONAL,
  ... ,
  defaultPriority [7] IMPLICIT INTEGER ( 0 .. 15 ) OPTIONAL,
  nbrUser [8] IMPLICIT INTEGER ( 1 .. 7 ) OPTIONAL,
  longFTN-Supported [9] IMPLICIT NULL OPTIONAL }
RESULT
ss-Info CHOICE {
  forwardingInfo [0] IMPLICIT SEQUENCE {
    ss-Code OCTET STRING ( SIZE ( 1 ) ) OPTIONAL,
    forwardingFeatureList SEQUENCE ( SIZE ( 1 .. 13 ) ) OF
    SEQUENCE {
      basicService CHOICE {
        bearerService [2] IMPLICIT OCTET STRING ( SIZE ( 1 ) ),
        teleservice [3] IMPLICIT OCTET STRING ( SIZE ( 1 ) ) } OPTIONAL,
      ss-Status [4] IMPLICIT OCTET STRING ( SIZE ( 1 ) ) OPTIONAL,
      forwardedToNumber [5] IMPLICIT OCTET STRING ( SIZE ( 1 .. 20 ) ) ( SIZE ( 1 .. 9 ) ) OPTIONAL,
      forwardedToSubaddress [8] IMPLICIT OCTET STRING ( SIZE ( 1 .. 21 ) ) OPTIONAL,
      forwardingOptions [6] IMPLICIT OCTET STRING ( SIZE ( 1 ) ) OPTIONAL,
      noReplyConditionTime [7] IMPLICIT INTEGER ( 5 .. 30 ) OPTIONAL,
      ... ,
      longForwardedToNumber [9] IMPLICIT OCTET STRING ( SIZE ( 1 .. 20 ) ) ( SIZE ( 1 .. 15 ) ) OPTIONAL,
      ... } ,
    callBarringInfo [1] IMPLICIT SEQUENCE {
      ss-Code OCTET STRING ( SIZE ( 1 ) ) OPTIONAL,
      callBarringFeatureList SEQUENCE ( SIZE ( 1 .. 13 ) ) OF
      SEQUENCE {
        basicService CHOICE {
          bearerService [2] IMPLICIT OCTET STRING ( SIZE ( 1 ) ),
          teleservice [3] IMPLICIT OCTET STRING ( SIZE ( 1 ) ) } OPTIONAL,
          ss-Status [4] IMPLICIT OCTET STRING ( SIZE ( 1 ) ) OPTIONAL,
          ... } ,
        ... } ,
      ss-Data [3] IMPLICIT SEQUENCE {
        ss-Code OCTET STRING ( SIZE ( 1 ) ) OPTIONAL,
        ss-Status [4] IMPLICIT OCTET STRING ( SIZE ( 1 ) ) OPTIONAL,
        ss-SubscriptionOption CHOICE {
          cliRestrictionOption [2] IMPLICIT ENUMERATED {
            permanent ( 0 ),
            temporaryDefaultRestricted ( 1 ),
            temporaryDefaultAllowed ( 2 ) } ,
          overrideCategory [1] IMPLICIT ENUMERATED {
            overrideEnabled ( 0 ),
            overrideDisabled ( 1 ) } } OPTIONAL,
        basicServiceGroupList SEQUENCE ( SIZE ( 1 .. 13 ) ) OF

```

```

    CHOICE {
        bearerService [2] IMPLICIT OCTET STRING ( SIZE ( 1 ) ),
        teleservice [3] IMPLICIT OCTET STRING ( SIZE ( 1 ) )} OPTIONAL,
    ... ,
    defaultPriority INTEGER ( 0 .. 15 ) OPTIONAL,
    nbrUser [5] IMPLICIT INTEGER ( 1 .. 7 ) OPTIONAL}}
ERRORS {
-- systemFailure -- localValue : 34,
-- dataMissing -- localValue : 35,
-- unexpectedDataValue -- localValue : 36,
-- bearerServiceNotProvisioned -- localValue : 10,
-- teleserviceNotProvisioned -- localValue : 11,
-- callBarred -- localValue : 13,
-- illegalSS-Operation -- localValue : 16,
-- ss-ErrorStatus -- localValue : 17,
-- ss-Incompatibility -- localValue : 20}
::= localValue : 10

eraseSS OPERATION
ARGUMENT
ss-ForBS SEQUENCE {
    ss-Code OCTET STRING ( SIZE ( 1 ) ),
    basicService CHOICE {
        bearerService [2] IMPLICIT OCTET STRING ( SIZE ( 1 ) ),
        teleservice [3] IMPLICIT OCTET STRING ( SIZE ( 1 ) )} OPTIONAL,
    ... ,
    longFTN-Supported [4] IMPLICIT NULL OPTIONAL}
RESULT
ss-Info CHOICE {
    forwardingInfo [0] IMPLICIT SEQUENCE {
        ss-Code OCTET STRING ( SIZE ( 1 ) ) OPTIONAL,
        forwardingFeatureList SEQUENCE ( SIZE ( 1 .. 13 ) ) OF
        SEQUENCE {
            basicService CHOICE {
                bearerService [2] IMPLICIT OCTET STRING ( SIZE ( 1 ) ),
                teleservice [3] IMPLICIT OCTET STRING ( SIZE ( 1 ) )} OPTIONAL,
            ss-Status [4] IMPLICIT OCTET STRING ( SIZE ( 1 ) ) OPTIONAL,
            forwardedToNumber [5] IMPLICIT OCTET STRING ( SIZE ( 1 .. 20 ) ) ( SIZE ( 1 .. 9 ) ) OPTIONAL,
            forwardedToSubaddress [8] IMPLICIT OCTET STRING ( SIZE ( 1 .. 21 ) ) OPTIONAL,
            forwardingOptions [6] IMPLICIT OCTET STRING ( SIZE ( 1 ) ) OPTIONAL,
            noReplyConditionTime [7] IMPLICIT INTEGER ( 5 .. 30 ) OPTIONAL,
            ... ,
            longForwardedToNumber [9] IMPLICIT OCTET STRING ( SIZE ( 1 .. 20 ) ) ( SIZE ( 1 .. 15 ) ) OPTIONAL,
            ... },
        callBarringInfo [1] IMPLICIT SEQUENCE {
            ss-Code OCTET STRING ( SIZE ( 1 ) ) OPTIONAL,
            callBarringFeatureList SEQUENCE ( SIZE ( 1 .. 13 ) ) OF
            SEQUENCE {
                basicService CHOICE {
                    bearerService [2] IMPLICIT OCTET STRING ( SIZE ( 1 ) ),
                    teleservice [3] IMPLICIT OCTET STRING ( SIZE ( 1 ) )} OPTIONAL,
                ss-Status [4] IMPLICIT OCTET STRING ( SIZE ( 1 ) ) OPTIONAL,
                ... },
            ... },
        ss-Data [3] IMPLICIT SEQUENCE {
            ss-Code OCTET STRING ( SIZE ( 1 ) ) OPTIONAL,
            ss-Status [4] IMPLICIT OCTET STRING ( SIZE ( 1 ) ) OPTIONAL,
            ss-SubscriptionOption CHOICE {
                cliRestrictionOption [2] IMPLICIT ENUMERATED {
                    permanent ( 0 ),
                    temporaryDefaultRestricted ( 1 ),
                    temporaryDefaultAllowed ( 2 )},
                overrideCategory [1] IMPLICIT ENUMERATED {
                    overrideEnabled ( 0 ),
                    overrideDisabled ( 1 )}} OPTIONAL,
            basicServiceGroupList SEQUENCE ( SIZE ( 1 .. 13 ) ) OF
            CHOICE {
                bearerService [2] IMPLICIT OCTET STRING ( SIZE ( 1 ) ),
                teleservice [3] IMPLICIT OCTET STRING ( SIZE ( 1 ) )} OPTIONAL,
            ... ,
            defaultPriority INTEGER ( 0 .. 15 ) OPTIONAL,
            nbrUser [5] IMPLICIT INTEGER ( 1 .. 7 ) OPTIONAL}}
ERRORS {
-- systemFailure -- localValue : 34,
-- dataMissing -- localValue : 35,
-- unexpectedDataValue -- localValue : 36,
-- bearerServiceNotProvisioned -- localValue : 10,

```



```

-- teleserviceNotProvisioned -- localValue : 11,
-- callBarred -- localValue : 13,
-- illegalSS-Operation -- localValue : 16,
-- ss-ErrorStatus -- localValue : 17}
::= localValue : 11

```

activateSS OPERATION

ARGUMENT

```

ss-ForBS SEQUENCE {
  ss-Code OCTET STRING ( SIZE ( 1 ) ),
  basicService CHOICE {
    bearerService [2] IMPLICIT OCTET STRING ( SIZE ( 1 ) ),
    teleservice [3] IMPLICIT OCTET STRING ( SIZE ( 1 ) )} OPTIONAL,
  ... ,
  longFTN-Supported [4] IMPLICIT NULL OPTIONAL}

```

RESULT

```

ss-Info CHOICE {
  forwardingInfo [0] IMPLICIT SEQUENCE {
    ss-Code OCTET STRING ( SIZE ( 1 ) ) OPTIONAL,
    forwardingFeatureList SEQUENCE ( SIZE ( 1 .. 13 ) ) OF
      SEQUENCE {
        basicService CHOICE {
          bearerService [2] IMPLICIT OCTET STRING ( SIZE ( 1 ) ),
          teleservice [3] IMPLICIT OCTET STRING ( SIZE ( 1 ) )} OPTIONAL,
        ss-Status [4] IMPLICIT OCTET STRING ( SIZE ( 1 ) ) OPTIONAL,
        forwardedToNumber [5] IMPLICIT OCTET STRING ( SIZE ( 1 .. 20 ) ) ( SIZE ( 1 .. 9 ) ) OPTIONAL,
        forwardedToSubaddress [8] IMPLICIT OCTET STRING ( SIZE ( 1 .. 21 ) ) OPTIONAL,
        forwardingOptions [6] IMPLICIT OCTET STRING ( SIZE ( 1 ) ) OPTIONAL,
        noReplyConditionTime [7] IMPLICIT INTEGER ( 5 .. 30 ) OPTIONAL,
        ... ,
        longForwardedToNumber [9] IMPLICIT OCTET STRING ( SIZE ( 1 .. 20 ) ) ( SIZE ( 1 .. 15 ) ) OPTIONAL},
    ... },
  callBarringInfo [1] IMPLICIT SEQUENCE {
    ss-Code OCTET STRING ( SIZE ( 1 ) ) OPTIONAL,
    callBarringFeatureList SEQUENCE ( SIZE ( 1 .. 13 ) ) OF
      SEQUENCE {
        basicService CHOICE {
          bearerService [2] IMPLICIT OCTET STRING ( SIZE ( 1 ) ),
          teleservice [3] IMPLICIT OCTET STRING ( SIZE ( 1 ) )} OPTIONAL,
        ss-Status [4] IMPLICIT OCTET STRING ( SIZE ( 1 ) ) OPTIONAL,
        ... },
    ... },
  ss-Data [3] IMPLICIT SEQUENCE {
    ss-Code OCTET STRING ( SIZE ( 1 ) ) OPTIONAL,
    ss-Status [4] IMPLICIT OCTET STRING ( SIZE ( 1 ) ) OPTIONAL,
    ss-SubscriptionOption CHOICE {
      cliRestrictionOption [2] IMPLICIT ENUMERATED {
        permanent ( 0 ),
        temporaryDefaultRestricted ( 1 ),
        temporaryDefaultAllowed ( 2 )},
      overrideCategory [1] IMPLICIT ENUMERATED {
        overrideEnabled ( 0 ),
        overrideDisabled ( 1 )} OPTIONAL,
      basicServiceGroupList SEQUENCE ( SIZE ( 1 .. 13 ) ) OF
        CHOICE {
          bearerService [2] IMPLICIT OCTET STRING ( SIZE ( 1 ) ),
          teleservice [3] IMPLICIT OCTET STRING ( SIZE ( 1 ) )} OPTIONAL,
        ... ,
      defaultPriority INTEGER ( 0 .. 15 ) OPTIONAL,
      nbrUser [5] IMPLICIT INTEGER ( 1 .. 7 ) OPTIONAL}

```

ERRORS {

```

-- systemFailure -- localValue : 34,
-- dataMissing -- localValue : 35,
-- unexpectedDataValue -- localValue : 36,
-- bearerServiceNotProvisioned -- localValue : 10,
-- teleserviceNotProvisioned -- localValue : 11,
-- callBarred -- localValue : 13,
-- illegalSS-Operation -- localValue : 16,
-- ss-ErrorStatus -- localValue : 17,
-- ss-SubscriptionViolation -- localValue : 19,
-- ss-Incompatibility -- localValue : 20,
-- negativePW-Check -- localValue : 38,
-- numberOPW-AttemptsViolation -- localValue : 43}
::= localValue : 12

```

deactivateSS OPERATION

ARGUMENT

```

ss-ForBS SEQUENCE {
  ss-Code      OCTET STRING ( SIZE ( 1 ) ),
  basicService CHOICE {
    bearerService [2] IMPLICIT OCTET STRING ( SIZE ( 1 ) ),
    teleservice   [3] IMPLICIT OCTET STRING ( SIZE ( 1 ) )} OPTIONAL,
  ... ,
  longFTN-Supported [4] IMPLICIT NULL OPTIONAL}
RESULT
ss-Info CHOICE {
  forwardingInfo [0] IMPLICIT SEQUENCE {
    ss-Code      OCTET STRING ( SIZE ( 1 ) ) OPTIONAL,
    forwardingFeatureList SEQUENCE ( SIZE ( 1 .. 13 ) ) OF
      SEQUENCE {
        basicService CHOICE {
          bearerService [2] IMPLICIT OCTET STRING ( SIZE ( 1 ) ),
          teleservice   [3] IMPLICIT OCTET STRING ( SIZE ( 1 ) )} OPTIONAL,
        ss-Status      [4] IMPLICIT OCTET STRING ( SIZE ( 1 ) ) OPTIONAL,
        forwardedToNumber [5] IMPLICIT OCTET STRING ( SIZE ( 1 .. 20 ) ) ( SIZE ( 1 .. 9 ) ) OPTIONAL,
        forwardedToSubaddress [8] IMPLICIT OCTET STRING ( SIZE ( 1 .. 21 ) ) OPTIONAL,
        forwardingOptions [6] IMPLICIT OCTET STRING ( SIZE ( 1 ) ) OPTIONAL,
        noReplyConditionTime [7] IMPLICIT INTEGER ( 5 .. 30 ) OPTIONAL,
        ... ,
        longForwardedToNumber [9] IMPLICIT OCTET STRING ( SIZE ( 1 .. 20 ) ) ( SIZE ( 1 .. 15 ) ) OPTIONAL},
    ... },
  callBarringInfo [1] IMPLICIT SEQUENCE {
    ss-Code      OCTET STRING ( SIZE ( 1 ) ) OPTIONAL,
    callBarringFeatureList SEQUENCE ( SIZE ( 1 .. 13 ) ) OF
      SEQUENCE {
        basicService CHOICE {
          bearerService [2] IMPLICIT OCTET STRING ( SIZE ( 1 ) ),
          teleservice   [3] IMPLICIT OCTET STRING ( SIZE ( 1 ) )} OPTIONAL,
        ss-Status      [4] IMPLICIT OCTET STRING ( SIZE ( 1 ) ) OPTIONAL,
        ... },
    ... },
  ss-Data [3] IMPLICIT SEQUENCE {
    ss-Code      OCTET STRING ( SIZE ( 1 ) ) OPTIONAL,
    ss-Status      [4] IMPLICIT OCTET STRING ( SIZE ( 1 ) ) OPTIONAL,
    ss-SubscriptionOption CHOICE {
      cliRestrictionOption [2] IMPLICIT ENUMERATED {
        permanent ( 0 ),
        temporaryDefaultRestricted ( 1 ),
        temporaryDefaultAllowed ( 2 )},
      overrideCategory [1] IMPLICIT ENUMERATED {
        overrideEnabled ( 0 ),
        overrideDisabled ( 1 )} OPTIONAL,
      basicServiceGroupList SEQUENCE ( SIZE ( 1 .. 13 ) ) OF
        CHOICE {
          bearerService [2] IMPLICIT OCTET STRING ( SIZE ( 1 ) ),
          teleservice   [3] IMPLICIT OCTET STRING ( SIZE ( 1 ) )} OPTIONAL,
        ... ,
      defaultPriority INTEGER ( 0 .. 15 ) OPTIONAL,
      nbrUser [5] IMPLICIT INTEGER ( 1 .. 7 ) OPTIONAL}}
ERRORS {
  -- systemFailure -- localValue : 34,
  -- dataMissing -- localValue : 35,
  -- unexpectedDataValue -- localValue : 36,
  -- bearerServiceNotProvisioned -- localValue : 10,
  -- teleserviceNotProvisioned -- localValue : 11,
  -- callBarred -- localValue : 13,
  -- illegalSS-Operation -- localValue : 16,
  -- ss-ErrorStatus -- localValue : 17,
  -- ss-SubscriptionViolation -- localValue : 19,
  -- negativePW-Check -- localValue : 38,
  -- numberOfPW-AttemptsViolation -- localValue : 43}
::= localValue : 13

```

interrogateSS OPERATION

ARGUMENT

```

ss-ForBS SEQUENCE {
  ss-Code      OCTET STRING ( SIZE ( 1 ) ),
  basicService CHOICE {
    bearerService [2] IMPLICIT OCTET STRING ( SIZE ( 1 ) ),
    teleservice   [3] IMPLICIT OCTET STRING ( SIZE ( 1 ) )} OPTIONAL,
  ... ,
  longFTN-Supported [4] IMPLICIT NULL OPTIONAL}
RESULT
interrogateSS-Res CHOICE {

```

```

ss-Status          [0] IMPLICIT OCTET STRING ( SIZE ( 1 ) ),
basicServiceGroupList [2] IMPLICIT SEQUENCE ( SIZE ( 1 .. 13 ) ) OF
CHOICE {
  bearerService    [2] IMPLICIT OCTET STRING ( SIZE ( 1 ) ),
  teleservice      [3] IMPLICIT OCTET STRING ( SIZE ( 1 ) ) },
forwardingFeatureList [3] IMPLICIT SEQUENCE ( SIZE ( 1 .. 13 ) ) OF
SEQUENCE {
  basicService     CHOICE {
    bearerService  [2] IMPLICIT OCTET STRING ( SIZE ( 1 ) ),
    teleservice    [3] IMPLICIT OCTET STRING ( SIZE ( 1 ) ) } OPTIONAL,
  ss-Status       [4] IMPLICIT OCTET STRING ( SIZE ( 1 ) ) OPTIONAL,
  forwardedToNumber [5] IMPLICIT OCTET STRING ( SIZE ( 1 .. 20 ) ) ( SIZE ( 1 .. 9 ) ) OPTIONAL,
  forwardedToSubaddress [8] IMPLICIT OCTET STRING ( SIZE ( 1 .. 21 ) ) OPTIONAL,
  forwardingOptions [6] IMPLICIT OCTET STRING ( SIZE ( 1 ) ) OPTIONAL,
  noReplyConditionTime [7] IMPLICIT INTEGER ( 5 .. 30 ) OPTIONAL,
  ... ,
  longForwardedToNumber [9] IMPLICIT OCTET STRING ( SIZE ( 1 .. 20 ) ) ( SIZE ( 1 .. 15 ) ) OPTIONAL,
genericServiceInfo [4] IMPLICIT SEQUENCE {
  ss-Status       OCTET STRING ( SIZE ( 1 ) ),
  cliRestrictionOption ENUMERATED {
    permanent      ( 0 ),
    temporaryDefaultRestricted ( 1 ),
    temporaryDefaultAllowed ( 2 ) } OPTIONAL,
  ... ,
  maximumEntitledPriority [0] IMPLICIT INTEGER ( 0 .. 15 ) OPTIONAL,
  defaultPriority [1] IMPLICIT INTEGER ( 0 .. 15 ) OPTIONAL,
  ccbs-FeatureList [2] IMPLICIT SEQUENCE ( SIZE ( 1 .. 5 ) ) OF
SEQUENCE {
  ccbs-Index      [0] IMPLICIT INTEGER ( 1 .. 5 ) OPTIONAL,
  b-subscriberNumber [1] IMPLICIT OCTET STRING ( SIZE ( 1 .. 20 ) ) ( SIZE ( 1 .. 9 ) ) OPTIONAL,
  b-subscriberSubaddress [2] IMPLICIT OCTET STRING ( SIZE ( 1 .. 21 ) ) OPTIONAL,
  basicServiceGroup [3] CHOICE {
    bearerService  [2] IMPLICIT OCTET STRING ( SIZE ( 1 ) ),
    teleservice    [3] IMPLICIT OCTET STRING ( SIZE ( 1 ) ) } OPTIONAL,
  ... } OPTIONAL,
  nbrSB          [3] IMPLICIT INTEGER ( 2 .. 7 ) OPTIONAL,
  nbrUser        [4] IMPLICIT INTEGER ( 1 .. 7 ) OPTIONAL,
  nbrSN          [5] IMPLICIT INTEGER ( 1 .. 7 ) OPTIONAL } }
ERRORS {
  -- systemFailure -- localValue : 34,
  -- dataMissing -- localValue : 35,
  -- unexpectedDataValue -- localValue : 36,
  -- bearerServiceNotProvisioned -- localValue : 10,
  -- teleserviceNotProvisioned -- localValue : 11,
  -- callBarred -- localValue : 13,
  -- illegalSS-Operation -- localValue : 16,
  -- ss-NotAvailable -- localValue : 18 }
 ::= localValue : 14

```

processUnstructuredSS-Request OPERATION

ARGUMENT

```

ussd-Arg SEQUENCE {
  ussd-DataCodingScheme OCTET STRING ( SIZE ( 1 ) ),
  ussd-String           OCTET STRING ( SIZE ( 1 .. 160 ) ),
  ... ,
  alertingPattern      OCTET STRING ( SIZE ( 1 ) ) OPTIONAL,
  msisdN               [0] IMPLICIT OCTET STRING ( SIZE ( 1 .. 20 ) ) ( SIZE ( 1 .. 9 ) ) OPTIONAL }

```

RESULT

```

ussd-Res SEQUENCE {
  ussd-DataCodingScheme OCTET STRING ( SIZE ( 1 ) ),
  ussd-String           OCTET STRING ( SIZE ( 1 .. 160 ) ),
  ... }

```

ERRORS {

```

  -- systemFailure -- localValue : 34,
  -- dataMissing -- localValue : 35,
  -- unexpectedDataValue -- localValue : 36,
  -- unknownAlphabet -- localValue : 71,
  -- callBarred -- localValue : 13 }

```

```
 ::= localValue : 59
```

unstructuredSS-Request OPERATION

ARGUMENT

```

ussd-Arg SEQUENCE {
  ussd-DataCodingScheme OCTET STRING ( SIZE ( 1 ) ),
  ussd-String           OCTET STRING ( SIZE ( 1 .. 160 ) ),
  ... ,
  alertingPattern      OCTET STRING ( SIZE ( 1 ) ) OPTIONAL,

```

```

    msisdn          [0] IMPLICIT OCTET STRING ( SIZE (1 .. 20) ) ( SIZE (1 .. 9) ) OPTIONAL}
RESULT
  ussd-Res SEQUENCE {
    ussd-DataCodingScheme OCTET STRING ( SIZE (1) ),
    ussd-String           OCTET STRING ( SIZE (1 .. 160) ),
    ... }
ERRORS {
  -- systemFailure -- localValue : 34,
  -- dataMissing -- localValue : 35,
  -- unexpectedDataValue -- localValue : 36,
  -- absentSubscriber -- localValue : 27,
  -- illegalSubscriber -- localValue : 9,
  -- illegalEquipment -- localValue : 12,
  -- unknownAlphabet -- localValue : 71,
  -- ussd-Busy -- localValue : 72}
::= localValue : 60

```

```

unstructuredSS-Notify OPERATION
ARGUMENT
  ussd-Arg SEQUENCE {
    ussd-DataCodingScheme OCTET STRING ( SIZE (1) ),
    ussd-String           OCTET STRING ( SIZE (1 .. 160) ),
    ... ,
    alertingPattern      OCTET STRING ( SIZE (1) ) OPTIONAL,
    msisdn               [0] IMPLICIT OCTET STRING ( SIZE (1 .. 20) ) ( SIZE (1 .. 9) ) OPTIONAL}
ERRORS {
  -- systemFailure -- localValue : 34,
  -- dataMissing -- localValue : 35,
  -- unexpectedDataValue -- localValue : 36,
  -- absentSubscriber -- localValue : 27,
  -- illegalSubscriber -- localValue : 9,
  -- illegalEquipment -- localValue : 12,
  -- unknownAlphabet -- localValue : 71,
  -- ussd-Busy -- localValue : 72}
::= localValue : 61

```

```

registerPassword OPERATION
ARGUMENT
  ss-Code OCTET STRING ( SIZE (1) )
RESULT
  newPassword NumericString ( FROM ("0"|"1"|"2"|"3"|"4"|"5"|"6"|"7"|"8"|"9" ) ) ( SIZE (4) )
ERRORS {
  -- systemFailure -- localValue : 34,
  -- dataMissing -- localValue : 35,
  -- unexpectedDataValue -- localValue : 36,
  -- callBarred -- localValue : 13,
  -- ss-SubscriptionViolation -- localValue : 19,
  -- pw-RegistrationFailure -- localValue : 37,
  -- negativePW-Check -- localValue : 38,
  -- numberOPW-AttemptsViolation -- localValue : 43}
LINKED {
  -- getPassword -- localValue : 18}
::= localValue : 17

```

```

getPassword OPERATION
ARGUMENT
  guidanceInfo ENUMERATED {
    enterPW          (0),
    enterNewPW       (1),
    enterNewPW-Again (2)}
RESULT
  currentPassword NumericString ( FROM ("0"|"1"|"2"|"3"|"4"|"5"|"6"|"7"|"8"|"9" ) ) ( SIZE (4) )
::= localValue : 18

```

```

registerCC-Entry OPERATION
ARGUMENT
  registerCC-EntryArg SEQUENCE {
    ss-Code [0] IMPLICIT OCTET STRING ( SIZE (1) ),
    ccbs-Data [1] IMPLICIT SEQUENCE {
      ccbs-Feature [0] IMPLICIT SEQUENCE {
        ccbs-Index [0] IMPLICIT INTEGER ( 1 .. 5 ) OPTIONAL,
        b-subscriberNumber [1] IMPLICIT OCTET STRING ( SIZE (1 .. 20) ) ( SIZE (1 .. 9) ) OPTIONAL,
        b-subscriberSubaddress [2] IMPLICIT OCTET STRING ( SIZE (1 .. 21) ) OPTIONAL,
        basicServiceGroup [3] CHOICE {
          bearerService [2] IMPLICIT OCTET STRING ( SIZE (1) ),
          teleservice [3] IMPLICIT OCTET STRING ( SIZE (1) )} OPTIONAL,
        ... },
    ... },

```

```

translatedB-Number [1] IMPLICIT OCTET STRING ( SIZE ( 1 .. 20 ) ) ( SIZE ( 1 .. 9 ) ),
serviceIndicator [2] IMPLICIT BIT STRING {
  clr-invoked ( 0 ),
  camel-invoked ( 1 ) } ( SIZE ( 2 .. 32 ) ) OPTIONAL,
callInfo [3] IMPLICIT SEQUENCE {
  protocolId ENUMERATED {
    gsm-0408 ( 1 ),
    gsm-0806 ( 2 ),
    gsm-BSSMAP ( 3 ),
    ets-300102-1 ( 4 ) },
  signalInfo OCTET STRING ( SIZE ( 1 .. 200 ) ),
  extensionContainer SEQUENCE {
    privateExtensionList [0] IMPLICIT SEQUENCE ( SIZE ( 1 .. 10 ) ) OF
      SEQUENCE {
        extId MAP-EXTENSION .&extensionId ( {
          '
          ... } ),
        extType MAP-EXTENSION .&ExtensionType ( {
          '
          ... } { @extId } ) OPTIONAL } OPTIONAL,
    pcs-Extensions [1] IMPLICIT SEQUENCE {
      ... } OPTIONAL,
      ... } OPTIONAL,
      ... },
  networkSignalInfo [4] IMPLICIT SEQUENCE {
    protocolId ENUMERATED {
      gsm-0408 ( 1 ),
      gsm-0806 ( 2 ),
      gsm-BSSMAP ( 3 ),
      ets-300102-1 ( 4 ) },
    signalInfo OCTET STRING ( SIZE ( 1 .. 200 ) ),
    extensionContainer SEQUENCE {
      privateExtensionList [0] IMPLICIT SEQUENCE ( SIZE ( 1 .. 10 ) ) OF
        SEQUENCE {
          extId MAP-EXTENSION .&extensionId ( {
            '
            ... } ),
          extType MAP-EXTENSION .&ExtensionType ( {
            '
            ... } { @extId } ) OPTIONAL } OPTIONAL,
      pcs-Extensions [1] IMPLICIT SEQUENCE {
        ... } OPTIONAL,
        ... } OPTIONAL,
        ... },
      ... } OPTIONAL,
      ... }
  ... }
}
RESULT
registerCC-EntryRes SEQUENCE {
  ccbs-Feature [0] IMPLICIT SEQUENCE {
    ccbs-Index [0] IMPLICIT INTEGER ( 1 .. 5 ) OPTIONAL,
    b-subscriberNumber [1] IMPLICIT OCTET STRING ( SIZE ( 1 .. 20 ) ) ( SIZE ( 1 .. 9 ) ) OPTIONAL,
    b-subscriberSubaddress [2] IMPLICIT OCTET STRING ( SIZE ( 1 .. 21 ) ) OPTIONAL,
    basicServiceGroup [3] CHOICE {
      bearerService [2] IMPLICIT OCTET STRING ( SIZE ( 1 ) ),
      teleservice [3] IMPLICIT OCTET STRING ( SIZE ( 1 ) ) } OPTIONAL,
      ... } OPTIONAL,
      ... }
}
ERRORS {
  -- systemFailure -- localValue : 34,
  -- dataMissing -- localValue : 35,
  -- unexpectedDataValue -- localValue : 36,
  -- callBarred -- localValue : 13,
  -- illegalSS-Operation -- localValue : 16,
  -- ss-ErrorStatus -- localValue : 17,
  -- ss-Incompatibility -- localValue : 20,
  -- shortTermDenial -- localValue : 29,
  -- longTermDenial -- localValue : 30,
  -- facilityNotSupported -- localValue : 21}
 ::= localValue : 76

eraseCC-Entry OPERATION
ARGUMENT
eraseCC-EntryArg SEQUENCE {
  ss-Code [0] IMPLICIT OCTET STRING ( SIZE ( 1 ) ),
  ccbs-Index [1] IMPLICIT INTEGER ( 1 .. 5 ) OPTIONAL,
  ... }
RESULT

```

```

eraseCC-EntryRes SEQUENCE {
  ss-Code [0] IMPLICIT OCTET STRING ( SIZE ( 1 ) ),
  ss-Status [1] IMPLICIT OCTET STRING ( SIZE ( 1 ) ) OPTIONAL,
  ... }
ERRORS {
  -- systemFailure -- localValue : 34,
  -- dataMissing -- localValue : 35,
  -- unexpectedDataValue -- localValue : 36,
  -- callBarred -- localValue : 13,
  -- illegalSS-Operation -- localValue : 16,
  -- ss-ErrorStatus -- localValue : 17 }
 ::= localValue : 77

sendRoutingInfoForSM OPERATION
ARGUMENT
  routingInfoForSM-Arg SEQUENCE {
    msisdn [0] IMPLICIT OCTET STRING ( SIZE ( 1 .. 20 ) ) ( SIZE ( 1 .. 9 ) ),
    sm-RP-PRI [1] IMPLICIT BOOLEAN,
    serviceCentreAddress [2] IMPLICIT OCTET STRING ( SIZE ( 1 .. 20 ) ),
    extensionContainer [6] IMPLICIT SEQUENCE {
      privateExtensionList [0] IMPLICIT SEQUENCE ( SIZE ( 1 .. 10 ) ) OF
        SEQUENCE {
          extId MAP-EXTENSION .&extensionId ( {
            '
            ... } ),
          extType MAP-EXTENSION .&ExtensionType ( {
            '
            ... } { @extId } ) OPTIONAL } OPTIONAL,
          pcs-Extensions [1] IMPLICIT SEQUENCE {
            ... } OPTIONAL,
            ... } OPTIONAL,
            ... ,
            gprsSupportIndicator [7] IMPLICIT NULL OPTIONAL,
            sm-RP-MTI [8] IMPLICIT INTEGER ( 0 .. 10 ) OPTIONAL,
            sm-RP-SMEA [9] IMPLICIT OCTET STRING ( SIZE ( 1 .. 12 ) ) OPTIONAL }
RESULT
  routingInfoForSM-Res SEQUENCE {
    imsi OCTET STRING ( SIZE ( 3 .. 8 ) ),
    locationInfoWithLMSI [0] IMPLICIT SEQUENCE {
      networkNode-Number [1] IMPLICIT OCTET STRING ( SIZE ( 1 .. 20 ) ) ( SIZE ( 1 .. 9 ) ),
      imsi OCTET STRING ( SIZE ( 4 ) ) OPTIONAL,
      extensionContainer SEQUENCE {
        privateExtensionList [0] IMPLICIT SEQUENCE ( SIZE ( 1 .. 10 ) ) OF
          SEQUENCE {
            extId MAP-EXTENSION .&extensionId ( {
              '
              ... } ),
            extType MAP-EXTENSION .&ExtensionType ( {
              '
              ... } { @extId } ) OPTIONAL } OPTIONAL,
            pcs-Extensions [1] IMPLICIT SEQUENCE {
              ... } OPTIONAL,
              ... } OPTIONAL,
              ... ,
              gprsNodeIndicator [5] IMPLICIT NULL OPTIONAL,
              additional-Number [6] CHOICE {
                msc-Number [0] IMPLICIT OCTET STRING ( SIZE ( 1 .. 20 ) ) ( SIZE ( 1 .. 9 ) ),
                sgsn-Number [1] IMPLICIT OCTET STRING ( SIZE ( 1 .. 20 ) ) ( SIZE ( 1 .. 9 ) ) } OPTIONAL,
              extensionContainer [4] IMPLICIT SEQUENCE {
                privateExtensionList [0] IMPLICIT SEQUENCE ( SIZE ( 1 .. 10 ) ) OF
                  SEQUENCE {
                    extId MAP-EXTENSION .&extensionId ( {
                      '
                      ... } ),
                    extType MAP-EXTENSION .&ExtensionType ( {
                      '
                      ... } { @extId } ) OPTIONAL } OPTIONAL,
                    pcs-Extensions [1] IMPLICIT SEQUENCE {
                      ... } OPTIONAL,
                      ... } OPTIONAL,
                      ... }
            ... }
ERRORS {
  -- systemFailure -- localValue : 34,
  -- dataMissing -- localValue : 35,
  -- unexpectedDataValue -- localValue : 36,
  -- facilityNotSupported -- localValue : 21,
  -- unknownSubscriber -- localValue : 1,

```

```

-- teleserviceNotProvisioned -- localValue : 11,
-- callBarred -- localValue : 13,
-- absentSubscriberSM -- localValue : 6}
 ::= localValue : 45

```

mo-forwardSM OPERATION

ARGUMENT

```

mo-forwardSM-Arg SEQUENCE {
  sm-RP-DA CHOICE {
    imsi [0] IMPLICIT OCTET STRING ( SIZE ( 3 .. 8 ) ),
    lmsi [1] IMPLICIT OCTET STRING ( SIZE ( 4 ) ),
    serviceCentreAddressDA [4] IMPLICIT OCTET STRING ( SIZE ( 1 .. 20 ) ),
    noSM-RP-DA [5] IMPLICIT NULL},
  sm-RP-OA CHOICE {
    msisdn [2] IMPLICIT OCTET STRING ( SIZE ( 1 .. 20 ) ) ( SIZE ( 1 .. 9 ) ),
    serviceCentreAddressOA [4] IMPLICIT OCTET STRING ( SIZE ( 1 .. 20 ) ),
    noSM-RP-OA [5] IMPLICIT NULL},
  sm-RP-UI OCTET STRING ( SIZE ( 1 .. 200 ) ),
  extensionContainer SEQUENCE {
    privateExtensionList [0] IMPLICIT SEQUENCE ( SIZE ( 1 .. 10 ) ) OF
      SEQUENCE {
        extId MAP-EXTENSION .&extensionId ( {
          '
          ...} ),
        extType MAP-EXTENSION .&ExtensionType ( {
          '
          ...} { @extId } ) OPTIONAL} OPTIONAL,
        pcs-Extensions [1] IMPLICIT SEQUENCE {
          ... } OPTIONAL,
          ... } OPTIONAL,
          ... }
    imsi OCTET STRING ( SIZE ( 3 .. 8 ) ) OPTIONAL}

```

RESULT

```

mo-forwardSM-Res SEQUENCE {
  sm-RP-UI OCTET STRING ( SIZE ( 1 .. 200 ) ) OPTIONAL,
  extensionContainer SEQUENCE {
    privateExtensionList [0] IMPLICIT SEQUENCE ( SIZE ( 1 .. 10 ) ) OF
      SEQUENCE {
        extId MAP-EXTENSION .&extensionId ( {
          '
          ...} ),
        extType MAP-EXTENSION .&ExtensionType ( {
          '
          ...} { @extId } ) OPTIONAL} OPTIONAL,
        pcs-Extensions [1] IMPLICIT SEQUENCE {
          ... } OPTIONAL,
          ... } OPTIONAL,
          ... }
  ... }

```

ERRORS {

```

-- systemFailure -- localValue : 34,
-- unexpectedDataValue -- localValue : 36,
-- facilityNotSupported -- localValue : 21,
-- sm-DeliveryFailure -- localValue : 32}
 ::= localValue : 46

```

mt-forwardSM OPERATION

ARGUMENT

```

mt-forwardSM-Arg SEQUENCE {
  sm-RP-DA CHOICE {
    imsi [0] IMPLICIT OCTET STRING ( SIZE ( 3 .. 8 ) ),
    lmsi [1] IMPLICIT OCTET STRING ( SIZE ( 4 ) ),
    serviceCentreAddressDA [4] IMPLICIT OCTET STRING ( SIZE ( 1 .. 20 ) ),
    noSM-RP-DA [5] IMPLICIT NULL},
  sm-RP-OA CHOICE {
    msisdn [2] IMPLICIT OCTET STRING ( SIZE ( 1 .. 20 ) ) ( SIZE ( 1 .. 9 ) ),
    serviceCentreAddressOA [4] IMPLICIT OCTET STRING ( SIZE ( 1 .. 20 ) ),
    noSM-RP-OA [5] IMPLICIT NULL},
  sm-RP-UI OCTET STRING ( SIZE ( 1 .. 200 ) ),
  moreMessagesToSend NULL OPTIONAL,
  extensionContainer SEQUENCE {
    privateExtensionList [0] IMPLICIT SEQUENCE ( SIZE ( 1 .. 10 ) ) OF
      SEQUENCE {
        extId MAP-EXTENSION .&extensionId ( {
          '
          ...} ),
        extType MAP-EXTENSION .&ExtensionType ( {
          '
          ...} { @extId } ) OPTIONAL} OPTIONAL,
        pcs-Extensions [1] IMPLICIT SEQUENCE {
          ... } OPTIONAL,
          ... } OPTIONAL,
          ... }
  ... }

```

```

        ...}{ @extId } ) OPTIONAL} OPTIONAL,
    pcs-Extensions [1] IMPLICIT SEQUENCE {
        ... } OPTIONAL,
        ... } OPTIONAL,
    ... }
RESULT
mt-forwardSM-Res SEQUENCE {
    sm-RP-UI OCTET STRING ( SIZE ( 1 .. 200 ) ) OPTIONAL,
    extensionContainer SEQUENCE {
        privateExtensionList [0] IMPLICIT SEQUENCE ( SIZE ( 1 .. 10 ) ) OF
        SEQUENCE {
            extId MAP-EXTENSION .&extensionId ( {
                '
                ... } ),
            extType MAP-EXTENSION .&ExtensionType ( {
                '
                ...}{ @extId } ) OPTIONAL} OPTIONAL,
        pcs-Extensions [1] IMPLICIT SEQUENCE {
            ... } OPTIONAL,
            ... } OPTIONAL,
        ... }
    ... }
ERRORS {
    -- systemFailure -- localValue : 34,
    -- dataMissing -- localValue : 35,
    -- unexpectedDataValue -- localValue : 36,
    -- facilityNotSupported -- localValue : 21,
    -- unidentifiedSubscriber -- localValue : 5,
    -- illegalSubscriber -- localValue : 9,
    -- illegalEquipment -- localValue : 12,
    -- subscriberBusyForMT-SMS -- localValue : 31,
    -- sm-DeliveryFailure -- localValue : 32,
    -- absentsubscriberSM -- localValue : 6}
 ::= localValue : 44

reportSM-DeliveryStatus OPERATION
ARGUMENT
reportSM-DeliveryStatusArg SEQUENCE {
    msisdn OCTET STRING ( SIZE ( 1 .. 20 ) ) ( SIZE ( 1 .. 9 ) ),
    serviceCentreAddress OCTET STRING ( SIZE ( 1 .. 20 ) ),
    sm-DeliveryOutcome ENUMERATED {
        memoryCapacityExceeded ( 0 ),
        absentSubscriber ( 1 ),
        successfulTransfer ( 2 ) },
    absentSubscriberDiagnosticSM [0] IMPLICIT INTEGER ( 0 .. 255 ) OPTIONAL,
    extensionContainer [1] IMPLICIT SEQUENCE {
        privateExtensionList [0] IMPLICIT SEQUENCE ( SIZE ( 1 .. 10 ) ) OF
        SEQUENCE {
            extId MAP-EXTENSION .&extensionId ( {
                '
                ... } ),
            extType MAP-EXTENSION .&ExtensionType ( {
                '
                ...}{ @extId } ) OPTIONAL} OPTIONAL,
        pcs-Extensions [1] IMPLICIT SEQUENCE {
            ... } OPTIONAL,
            ... } OPTIONAL,
        ... },
    gprsSupportIndicator [2] IMPLICIT NULL OPTIONAL,
    deliveryOutcomeIndicator [3] IMPLICIT NULL OPTIONAL,
    additionalSM-DeliveryOutcome [4] IMPLICIT ENUMERATED {
        memoryCapacityExceeded ( 0 ),
        absentSubscriber ( 1 ),
        successfulTransfer ( 2 ) } OPTIONAL,
    additionalAbsentSubscriberDiagnosticSM [5] IMPLICIT INTEGER ( 0 .. 255 ) OPTIONAL}
RESULT
reportSM-DeliveryStatusRes SEQUENCE {
    storedMSISDN OCTET STRING ( SIZE ( 1 .. 20 ) ) ( SIZE ( 1 .. 9 ) ) OPTIONAL,
    extensionContainer SEQUENCE {
        privateExtensionList [0] IMPLICIT SEQUENCE ( SIZE ( 1 .. 10 ) ) OF
        SEQUENCE {
            extId MAP-EXTENSION .&extensionId ( {
                '
                ... } ),
            extType MAP-EXTENSION .&ExtensionType ( {
                '
                ...}{ @extId } ) OPTIONAL} OPTIONAL,
        pcs-Extensions [1] IMPLICIT SEQUENCE {

```



```

    ... } OPTIONAL,
    ... } OPTIONAL,
    ... }
ERRORS {
-- dataMissing -- localValue : 35,
-- unexpectedDataValue -- localValue : 36,
-- unknownSubscriber -- localValue : 1,
-- messageWaitingListFull -- localValue : 33}
::= localValue : 47

informServiceCentre OPERATION
ARGUMENT
informServiceCentreArg SEQUENCE {
storedMSISDN          OCTET STRING ( SIZE ( 1 .. 20 ) ) ( SIZE ( 1 .. 9 ) ) OPTIONAL,
mw-Status             BIT STRING {
sc-AddressNotIncluded ( 0 ),
mnr-Set ( 1 ),
mcef-Set ( 2 ),
mnrng-Set ( 3 ) } ( SIZE ( 6 .. 16 ) ) OPTIONAL,
extensionContainer    SEQUENCE {
privateExtensionList [ 0 ] IMPLICIT SEQUENCE ( SIZE ( 1 .. 10 ) ) OF
SEQUENCE {
extId  MAP-EXTENSION .&extensionId ( {
'
... } ),
extType  MAP-EXTENSION .&ExtensionType ( {
'
... } { @extId } ) OPTIONAL } OPTIONAL,
pcs-Extensions [ 1 ] IMPLICIT SEQUENCE {
... } OPTIONAL,
... } OPTIONAL,
... ,
absentSubscriberDiagnosticSM      INTEGER ( 0 .. 255 ) OPTIONAL,
additionalAbsentSubscriberDiagnosticSM [ 0 ] IMPLICIT INTEGER ( 0 .. 255 ) OPTIONAL }
::= localValue : 63

alertServiceCentre OPERATION
ARGUMENT
alertServiceCentreArg SEQUENCE {
msisdn          OCTET STRING ( SIZE ( 1 .. 20 ) ) ( SIZE ( 1 .. 9 ) ),
serviceCentreAddress OCTET STRING ( SIZE ( 1 .. 20 ) ),
... }
ERRORS {
-- systemFailure -- localValue : 34,
-- dataMissing -- localValue : 35,
-- unexpectedDataValue -- localValue : 36}
::= localValue : 64

readyForSM OPERATION
ARGUMENT
readyForSM-Arg SEQUENCE {
imsi          [ 0 ] IMPLICIT OCTET STRING ( SIZE ( 3 .. 8 ) ),
alertReason   ENUMERATED {
ms-Present ( 0 ),
memoryAvailable ( 1 ) },
alertReasonIndicator NULL OPTIONAL,
extensionContainer SEQUENCE {
privateExtensionList [ 0 ] IMPLICIT SEQUENCE ( SIZE ( 1 .. 10 ) ) OF
SEQUENCE {
extId  MAP-EXTENSION .&extensionId ( {
'
... } ),
extType  MAP-EXTENSION .&ExtensionType ( {
'
... } { @extId } ) OPTIONAL } OPTIONAL,
pcs-Extensions [ 1 ] IMPLICIT SEQUENCE {
... } OPTIONAL,
... } OPTIONAL,
... }
RESULT
readyForSM-Res SEQUENCE {
extensionContainer SEQUENCE {
privateExtensionList [ 0 ] IMPLICIT SEQUENCE ( SIZE ( 1 .. 10 ) ) OF
SEQUENCE {
extId  MAP-EXTENSION .&extensionId ( {
'
... } ),

```

```

    extType MAP-EXTENSION .&ExtensionType ( {
        '
        ... } { @extId } ) OPTIONAL } OPTIONAL,
    pcs-Extensions [1] IMPLICIT SEQUENCE {
        ... } OPTIONAL,
        ... } OPTIONAL,
        ... }
    ERRORS {
        -- dataMissing -- localValue : 35,
        -- unexpectedDataValue -- localValue : 36,
        -- facilityNotSupported -- localValue : 21,
        -- unknownSubscriber -- localValue : 1}
    ::= localValue : 66

```

provideSubscriberInfo OPERATION

ARGUMENT

```

    provideSubscriberInfoArg SEQUENCE {
        imsi [0] IMPLICIT OCTET STRING ( SIZE ( 3 .. 8 ) ),
        lmsi [1] IMPLICIT OCTET STRING ( SIZE ( 4 ) ) OPTIONAL,
        requestedInfo [2] IMPLICIT SEQUENCE {
            locationInformation [0] IMPLICIT NULL OPTIONAL,
            subscriberState [1] IMPLICIT NULL OPTIONAL,
            extensionContainer [2] IMPLICIT SEQUENCE {
                privateExtensionList [0] IMPLICIT SEQUENCE ( SIZE ( 1 .. 10 ) ) OF
                SEQUENCE {
                    extId MAP-EXTENSION .&extensionId ( {
                        '
                        ... } ),
                    extType MAP-EXTENSION .&ExtensionType ( {
                        '
                        ... } { @extId } ) OPTIONAL } OPTIONAL,
                    pcs-Extensions [1] IMPLICIT SEQUENCE {
                        ... } OPTIONAL,
                        ... } OPTIONAL,
                        ... }
                currentLocation [3] IMPLICIT NULL OPTIONAL,
                requestedDomain [4] IMPLICIT ENUMERATED {
                    cs-Domain ( 0 ),
                    ps-Domain ( 1 ),
                    ... } OPTIONAL,
                imei [6] IMPLICIT NULL OPTIONAL,
                ms-classmark [5] IMPLICIT NULL OPTIONAL,
            extensionContainer [3] IMPLICIT SEQUENCE {
                privateExtensionList [0] IMPLICIT SEQUENCE ( SIZE ( 1 .. 10 ) ) OF
                SEQUENCE {
                    extId MAP-EXTENSION .&extensionId ( {
                        '
                        ... } ),
                    extType MAP-EXTENSION .&ExtensionType ( {
                        '
                        ... } { @extId } ) OPTIONAL } OPTIONAL,
                    pcs-Extensions [1] IMPLICIT SEQUENCE {
                        ... } OPTIONAL,
                        ... } OPTIONAL,
                        ... }
            ... }

```

RESULT

```

    provideSubscriberInfoRes SEQUENCE {
        subscriberInfo SEQUENCE {
            locationInformation [0] IMPLICIT SEQUENCE {
                ageOfLocationInformation INTEGER ( 0 .. 32767 ) OPTIONAL,
                geographicalInformation [0] IMPLICIT OCTET STRING ( SIZE ( 8 ) ) OPTIONAL,
                vlr-number [1] IMPLICIT OCTET STRING ( SIZE ( 1 .. 20 ) ) ( SIZE ( 1 .. 9 ) ) OPTIONAL,
                locationNumber [2] IMPLICIT OCTET STRING ( SIZE ( 2 .. 10 ) ) OPTIONAL,
                cellGlobalIdOrServiceAreaIdOrLAI [3] CHOICE {
                    cellGlobalIdOrServiceAreaIdFixedLength [0] IMPLICIT OCTET STRING ( SIZE ( 7 ) ),
                    laiFixedLength [1] IMPLICIT OCTET STRING ( SIZE ( 5 ) ) } OPTIONAL,
                extensionContainer [4] IMPLICIT SEQUENCE {
                    privateExtensionList [0] IMPLICIT SEQUENCE ( SIZE ( 1 .. 10 ) ) OF
                    SEQUENCE {
                        extId MAP-EXTENSION .&extensionId ( {
                            '
                            ... } ),
                        extType MAP-EXTENSION .&ExtensionType ( {
                            '
                            ... } { @extId } ) OPTIONAL } OPTIONAL,
                        pcs-Extensions [1] IMPLICIT SEQUENCE {
                            ... } OPTIONAL,
                            ... }
                    ... }

```

```

... } OPTIONAL,
... ,
selectedLSA-Id          [5] IMPLICIT OCTET STRING ( SIZE ( 3 ) ) OPTIONAL,
msc-Number              [6] IMPLICIT OCTET STRING ( SIZE ( 1 .. 20 ) ) ( SIZE ( 1 .. 9 ) ) OPTIONAL,
geodeticInformation     [7] IMPLICIT OCTET STRING ( SIZE ( 10 ) ) OPTIONAL,
currentLocationRetrieved [8] IMPLICIT NULL OPTIONAL,
sai-Present             [9] IMPLICIT NULL OPTIONAL} OPTIONAL,
subscriberState         [1] CHOICE {
assumedIdle             [0] IMPLICIT NULL,
camelBusy               [1] IMPLICIT NULL,
netDetNotReachable     ENUMERATED {
msPurged ( 0 ),
imsiDetached ( 1 ),
restrictedArea ( 2 ),
notRegistered ( 3 )},
notProvidedFromVLR     [2] IMPLICIT NULL} OPTIONAL,
extensionContainer      [2] IMPLICIT SEQUENCE {
privateExtensionList [0] IMPLICIT SEQUENCE ( SIZE ( 1 .. 10 ) ) OF
SEQUENCE {
extId MAP-EXTENSION .&extensionId ( {
'
... } ) },
extType MAP-EXTENSION .&ExtensionType ( {
'
... } { @extId } ) OPTIONAL} OPTIONAL,
pcs-Extensions         [1] IMPLICIT SEQUENCE {
... } OPTIONAL,
... } OPTIONAL,
... ,
locationInformationGPRS [3] IMPLICIT SEQUENCE {
cellGlobalIdOrServiceAreaIdOrLAI [0] CHOICE {
cellGlobalIdOrServiceAreaIdFixedLength [0] IMPLICIT OCTET STRING ( SIZE ( 7 ) ),
laiFixedLength [1] IMPLICIT OCTET STRING ( SIZE ( 5 ) )} OPTIONAL,
routingAreaIdentity [1] IMPLICIT OCTET STRING ( SIZE ( 6 ) ) OPTIONAL,
geographicalInformation [2] IMPLICIT OCTET STRING ( SIZE ( 8 ) ) OPTIONAL,
sgsn-Number [3] IMPLICIT OCTET STRING ( SIZE ( 1 .. 20 ) ) ( SIZE ( 1 .. 9 ) ) OPTIONAL,
selectedLSAIdentity [4] IMPLICIT OCTET STRING ( SIZE ( 3 ) ) OPTIONAL,
extensionContainer [5] IMPLICIT SEQUENCE {
privateExtensionList [0] IMPLICIT SEQUENCE ( SIZE ( 1 .. 10 ) ) OF
SEQUENCE {
extId MAP-EXTENSION .&extensionId ( {
'
... } ) },
extType MAP-EXTENSION .&ExtensionType ( {
'
... } { @extId } ) OPTIONAL} OPTIONAL,
pcs-Extensions [1] IMPLICIT SEQUENCE {
... } OPTIONAL,
... } OPTIONAL,
... ,
sai-Present [6] IMPLICIT NULL OPTIONAL,
geodeticInformation [7] IMPLICIT OCTET STRING ( SIZE ( 10 ) ) OPTIONAL,
currentLocationRetrieved [8] IMPLICIT NULL OPTIONAL,
ageOfLocationInformation [9] IMPLICIT INTEGER ( 0 .. 32767 ) OPTIONAL} OPTIONAL,
ps-SubscriberState [4] CHOICE {
notProvidedFromSGSN [0] IMPLICIT NULL,
ps-Detached [1] IMPLICIT NULL,
ps-AttachedNotReachableForPaging [2] IMPLICIT NULL,
ps-AttachedReachableForPaging [3] IMPLICIT NULL,
ps-PDP-ActiveNotReachableForPaging [4] IMPLICIT SEQUENCE ( SIZE ( 1 .. 50 ) ) OF
SEQUENCE {
pdp-ContextIdentifier [0] IMPLICIT INTEGER ( 1 .. 50 ),
pdp-ContextActive [1] IMPLICIT NULL OPTIONAL,
pdp-Type [2] IMPLICIT OCTET STRING ( SIZE ( 2 ) ),
pdp-Address [3] IMPLICIT OCTET STRING ( SIZE ( 1 .. 16 ) ) OPTIONAL,
apn-Subscribed [4] IMPLICIT OCTET STRING ( SIZE ( 2 .. 63 ) ) OPTIONAL,
apn-InUse [5] IMPLICIT OCTET STRING ( SIZE ( 2 .. 63 ) ) OPTIONAL,
nsapi [6] IMPLICIT INTEGER ( 0 .. 15 ) OPTIONAL,
transactionId [7] IMPLICIT OCTET STRING ( SIZE ( 1 .. 2 ) ) OPTIONAL,
teid-ForGnAndGp [8] IMPLICIT OCTET STRING ( SIZE ( 4 ) ) OPTIONAL,
teid-ForLu [9] IMPLICIT OCTET STRING ( SIZE ( 4 ) ) OPTIONAL,
ggsn-Address [10] IMPLICIT OCTET STRING ( SIZE ( 5 .. 17 ) ) OPTIONAL,
qos-Subscribed [11] IMPLICIT OCTET STRING ( SIZE ( 1 .. 9 ) ) OPTIONAL,
qos-Requested [12] IMPLICIT OCTET STRING ( SIZE ( 1 .. 9 ) ) OPTIONAL,
qos-Negotiated [13] IMPLICIT OCTET STRING ( SIZE ( 1 .. 9 ) ) OPTIONAL,
chargingId [14] IMPLICIT OCTET STRING ( SIZE ( 4 ) ) OPTIONAL,
chargingCharacteristics [15] IMPLICIT OCTET STRING ( SIZE ( 2 ) ) OPTIONAL,

```

```

rnc-Address      [16] IMPLICIT OCTET STRING ( SIZE ( 5 .. 17 ) ) OPTIONAL,
extensionContainer [17] IMPLICIT SEQUENCE {
  privateExtensionList [0] IMPLICIT SEQUENCE ( SIZE ( 1 .. 10 ) ) OF
  SEQUENCE {
    extId  MAP-EXTENSION .&extensionId ( {
      '
      ... } ),
    extType  MAP-EXTENSION .&ExtensionType ( {
      '
      ... } { @extId } ) OPTIONAL } OPTIONAL,
  pcs-Extensions [1] IMPLICIT SEQUENCE {
    ... } OPTIONAL,
    ... } OPTIONAL,
  ... },
ps-PDP-ActiveReachableForPaging [5] IMPLICIT SEQUENCE ( SIZE ( 1 .. 50 ) ) OF
SEQUENCE {
  pdp-ContextIdentifier [0] IMPLICIT INTEGER ( 1 .. 50 ),
  pdp-ContextActive [1] IMPLICIT NULL OPTIONAL,
  pdp-Type [2] IMPLICIT OCTET STRING ( SIZE ( 2 ) ),
  pdp-Address [3] IMPLICIT OCTET STRING ( SIZE ( 1 .. 16 ) ) OPTIONAL,
  apn-Subscribed [4] IMPLICIT OCTET STRING ( SIZE ( 2 .. 63 ) ) OPTIONAL,
  apn-InUse [5] IMPLICIT OCTET STRING ( SIZE ( 2 .. 63 ) ) OPTIONAL,
  nsapi [6] IMPLICIT INTEGER ( 0 .. 15 ) OPTIONAL,
  transactionId [7] IMPLICIT OCTET STRING ( SIZE ( 1 .. 2 ) ) OPTIONAL,
  teid-ForGnAndGp [8] IMPLICIT OCTET STRING ( SIZE ( 4 ) ) OPTIONAL,
  teid-ForLu [9] IMPLICIT OCTET STRING ( SIZE ( 4 ) ) OPTIONAL,
  ggsn-Address [10] IMPLICIT OCTET STRING ( SIZE ( 5 .. 17 ) ) OPTIONAL,
  qos-Subscribed [11] IMPLICIT OCTET STRING ( SIZE ( 1 .. 9 ) ) OPTIONAL,
  qos-Requested [12] IMPLICIT OCTET STRING ( SIZE ( 1 .. 9 ) ) OPTIONAL,
  qos-Negotiated [13] IMPLICIT OCTET STRING ( SIZE ( 1 .. 9 ) ) OPTIONAL,
  chargingId [14] IMPLICIT OCTET STRING ( SIZE ( 4 ) ) OPTIONAL,
  chargingCharacteristics [15] IMPLICIT OCTET STRING ( SIZE ( 2 ) ) OPTIONAL,
  rnc-Address [16] IMPLICIT OCTET STRING ( SIZE ( 5 .. 17 ) ) OPTIONAL,
  extensionContainer [17] IMPLICIT SEQUENCE {
    privateExtensionList [0] IMPLICIT SEQUENCE ( SIZE ( 1 .. 10 ) ) OF
    SEQUENCE {
      extId  MAP-EXTENSION .&extensionId ( {
        '
        ... } ),
      extType  MAP-EXTENSION .&ExtensionType ( {
        '
        ... } { @extId } ) OPTIONAL } OPTIONAL,
    pcs-Extensions [1] IMPLICIT SEQUENCE {
      ... } OPTIONAL,
      ... } OPTIONAL,
      ... } OPTIONAL,
    ... } OPTIONAL,
  imei [5] IMPLICIT OCTET STRING ( SIZE ( 8 ) ) OPTIONAL,
  ms-Classmark2 [6] IMPLICIT OCTET STRING ( SIZE ( 3 ) ) OPTIONAL,
  gprs-MS-Class [7] IMPLICIT SEQUENCE {
    mSNetworkCapability [0] IMPLICIT OCTET STRING ( SIZE ( 1 .. 8 ) ),
    mSRadioAccessCapability [1] IMPLICIT OCTET STRING ( SIZE ( 1 .. 50 ) ) OPTIONAL } OPTIONAL,
  extensionContainer SEQUENCE {
    privateExtensionList [0] IMPLICIT SEQUENCE ( SIZE ( 1 .. 10 ) ) OF
    SEQUENCE {
      extId  MAP-EXTENSION .&extensionId ( {
        '
        ... } ),
      extType  MAP-EXTENSION .&ExtensionType ( {
        '
        ... } { @extId } ) OPTIONAL } OPTIONAL,
    pcs-Extensions [1] IMPLICIT SEQUENCE {
      ... } OPTIONAL,
      ... } OPTIONAL,
      ... }
  ... }
ERRORS {
  -- dataMissing -- localValue : 35,
  -- unexpectedDataValue -- localValue : 36}
::= localValue : 70

```

anyTimeInterrogation OPERATION

ARGUMENT

```

anyTimeInterrogationArg SEQUENCE {
  subscriberIdentity [0] CHOICE {
    imsi [0] IMPLICIT OCTET STRING ( SIZE ( 3 .. 8 ) ),
    msisdn [1] IMPLICIT OCTET STRING ( SIZE ( 1 .. 20 ) ) ( SIZE ( 1 .. 9 ) ),
  requestedInfo [1] IMPLICIT SEQUENCE {
    locationInformation [0] IMPLICIT NULL OPTIONAL,

```

```

subscriberState [1] IMPLICIT NULL OPTIONAL,
extensionContainer [2] IMPLICIT SEQUENCE {
  privateExtensionList [0] IMPLICIT SEQUENCE ( SIZE ( 1 .. 10 ) ) OF
  SEQUENCE {
    extId MAP-EXTENSION .&extensionId ( {
      '
      ... } ),
    extType MAP-EXTENSION .&ExtensionType ( {
      '
      ... } { @extId } ) OPTIONAL } OPTIONAL,
  pcs-Extensions [1] IMPLICIT SEQUENCE {
    ... } OPTIONAL,
  ... } OPTIONAL,
... ,
currentLocation [3] IMPLICIT NULL OPTIONAL,
requestedDomain [4] IMPLICIT ENUMERATED {
  cs-Domain ( 0 ),
  ps-Domain ( 1 ),
  ... } OPTIONAL,
imei [6] IMPLICIT NULL OPTIONAL,
ms-classmark [5] IMPLICIT NULL OPTIONAL,
gsmSCF-Address [3] IMPLICIT OCTET STRING ( SIZE ( 1 .. 20 ) ) ( SIZE ( 1 .. 9 ) ),
extensionContainer [2] IMPLICIT SEQUENCE {
  privateExtensionList [0] IMPLICIT SEQUENCE ( SIZE ( 1 .. 10 ) ) OF
  SEQUENCE {
    extId MAP-EXTENSION .&extensionId ( {
      '
      ... } ),
    extType MAP-EXTENSION .&ExtensionType ( {
      '
      ... } { @extId } ) OPTIONAL } OPTIONAL,
  pcs-Extensions [1] IMPLICIT SEQUENCE {
    ... } OPTIONAL,
  ... } OPTIONAL,
... }
}
RESULT
anyTimeInterrogationRes SEQUENCE {
  subscriberInfo SEQUENCE {
    locationInformation [0] IMPLICIT SEQUENCE {
      ageOfLocationInformation INTEGER ( 0 .. 32767 ) OPTIONAL,
      geographicalInformation [0] IMPLICIT OCTET STRING ( SIZE ( 8 ) ) OPTIONAL,
      vlr-number [1] IMPLICIT OCTET STRING ( SIZE ( 1 .. 20 ) ) ( SIZE ( 1 .. 9 ) ) OPTIONAL,
      locationNumber [2] IMPLICIT OCTET STRING ( SIZE ( 2 .. 10 ) ) OPTIONAL,
      cellGlobalIdOrServiceAreaIdOrLAI [3] CHOICE {
        cellGlobalIdOrServiceAreaIdFixedLength [0] IMPLICIT OCTET STRING ( SIZE ( 7 ) ),
        laiFixedLength [1] IMPLICIT OCTET STRING ( SIZE ( 5 ) ) OPTIONAL,
      }
    },
    extensionContainer [4] IMPLICIT SEQUENCE {
      privateExtensionList [0] IMPLICIT SEQUENCE ( SIZE ( 1 .. 10 ) ) OF
      SEQUENCE {
        extId MAP-EXTENSION .&extensionId ( {
          '
          ... } ),
        extType MAP-EXTENSION .&ExtensionType ( {
          '
          ... } { @extId } ) OPTIONAL } OPTIONAL,
      pcs-Extensions [1] IMPLICIT SEQUENCE {
        ... } OPTIONAL,
      ... } OPTIONAL,
    ... ,
    selectedLSA-Id [5] IMPLICIT OCTET STRING ( SIZE ( 3 ) ) OPTIONAL,
    msc-Number [6] IMPLICIT OCTET STRING ( SIZE ( 1 .. 20 ) ) ( SIZE ( 1 .. 9 ) ) OPTIONAL,
    geodeticInformation [7] IMPLICIT OCTET STRING ( SIZE ( 10 ) ) OPTIONAL,
    currentLocationRetrieved [8] IMPLICIT NULL OPTIONAL,
    sai-Present [9] IMPLICIT NULL OPTIONAL } OPTIONAL,
  },
  subscriberState [1] CHOICE {
    assumedIdle [0] IMPLICIT NULL,
    camelBusy [1] IMPLICIT NULL,
    netDetNotReachable ENUMERATED {
      msPurged ( 0 ),
      imsiDetached ( 1 ),
      restrictedArea ( 2 ),
      notRegistered ( 3 ) },
    notProvidedFromVLR [2] IMPLICIT NULL } OPTIONAL,
  extensionContainer [2] IMPLICIT SEQUENCE {
    privateExtensionList [0] IMPLICIT SEQUENCE ( SIZE ( 1 .. 10 ) ) OF
    SEQUENCE {
      extId MAP-EXTENSION .&extensionId ( {

```

```

    ... } ),
    extType MAP-EXTENSION .&ExtensionType ( {
        ... } { @extId } ) OPTIONAL } OPTIONAL,
    pcs-Extensions [1] IMPLICIT SEQUENCE {
        ... } OPTIONAL,
    ... } OPTIONAL,
... ,
locationInformationGPRS [3] IMPLICIT SEQUENCE {
    cellGlobalIdOrServiceAreaIdOrLAI [0] CHOICE {
        cellGlobalIdOrServiceAreaIdFixedLength [0] IMPLICIT OCTET STRING ( SIZE ( 7 ) ),
        laiFixedLength [1] IMPLICIT OCTET STRING ( SIZE ( 5 ) ) } OPTIONAL,
    routingAreaIdentity [1] IMPLICIT OCTET STRING ( SIZE ( 6 ) ) OPTIONAL,
    geographicalInformation [2] IMPLICIT OCTET STRING ( SIZE ( 8 ) ) OPTIONAL,
    sgsn-Number [3] IMPLICIT OCTET STRING ( SIZE ( 1 .. 20 ) ) ( SIZE ( 1 .. 9 ) ) OPTIONAL,
    selectedLSAidentity [4] IMPLICIT OCTET STRING ( SIZE ( 3 ) ) OPTIONAL,
    extensionContainer [5] IMPLICIT SEQUENCE {
        privateExtensionList [0] IMPLICIT SEQUENCE ( SIZE ( 1 .. 10 ) ) OF
        SEQUENCE {
            extId MAP-EXTENSION .&extensionId ( {
                ... } ),
            extType MAP-EXTENSION .&ExtensionType ( {
                ... } { @extId } ) OPTIONAL } OPTIONAL,
            pcs-Extensions [1] IMPLICIT SEQUENCE {
                ... } OPTIONAL,
            ... } OPTIONAL,
        ... ,
        sai-Present [6] IMPLICIT NULL OPTIONAL,
        geodeticInformation [7] IMPLICIT OCTET STRING ( SIZE ( 10 ) ) OPTIONAL,
        currentLocationRetrieved [8] IMPLICIT NULL OPTIONAL,
        ageOfLocationInformation [9] IMPLICIT INTEGER ( 0 .. 32767 ) OPTIONAL } OPTIONAL,
    ps-SubscriberState [4] CHOICE {
        notProvidedFromSGSN [0] IMPLICIT NULL,
        ps-Detached [1] IMPLICIT NULL,
        ps-AttachedNotReachableForPaging [2] IMPLICIT NULL,
        ps-AttachedReachableForPaging [3] IMPLICIT NULL,
        ps-PDP-ActiveNotReachableForPaging [4] IMPLICIT SEQUENCE ( SIZE ( 1 .. 50 ) ) OF
        SEQUENCE {
            pdp-ContextIdentifier [0] IMPLICIT INTEGER ( 1 .. 50 ),
            pdp-ContextActive [1] IMPLICIT NULL OPTIONAL,
            pdp-Type [2] IMPLICIT OCTET STRING ( SIZE ( 2 ) ),
            pdp-Address [3] IMPLICIT OCTET STRING ( SIZE ( 1 .. 16 ) ) OPTIONAL,
            apn-Subscribed [4] IMPLICIT OCTET STRING ( SIZE ( 2 .. 63 ) ) OPTIONAL,
            apn-InUse [5] IMPLICIT OCTET STRING ( SIZE ( 2 .. 63 ) ) OPTIONAL,
            nsapi [6] IMPLICIT INTEGER ( 0 .. 15 ) OPTIONAL,
            transactionId [7] IMPLICIT OCTET STRING ( SIZE ( 1 .. 2 ) ) OPTIONAL,
            teid-ForGnAndGp [8] IMPLICIT OCTET STRING ( SIZE ( 4 ) ) OPTIONAL,
            teid-ForLu [9] IMPLICIT OCTET STRING ( SIZE ( 4 ) ) OPTIONAL,
            ggsn-Address [10] IMPLICIT OCTET STRING ( SIZE ( 5 .. 17 ) ) OPTIONAL,
            qos-Subscribed [11] IMPLICIT OCTET STRING ( SIZE ( 1 .. 9 ) ) OPTIONAL,
            qos-Requested [12] IMPLICIT OCTET STRING ( SIZE ( 1 .. 9 ) ) OPTIONAL,
            qos-Negotiated [13] IMPLICIT OCTET STRING ( SIZE ( 1 .. 9 ) ) OPTIONAL,
            chargingId [14] IMPLICIT OCTET STRING ( SIZE ( 4 ) ) OPTIONAL,
            chargingCharacteristics [15] IMPLICIT OCTET STRING ( SIZE ( 2 ) ) OPTIONAL,
            rnc-Address [16] IMPLICIT OCTET STRING ( SIZE ( 5 .. 17 ) ) OPTIONAL,
            extensionContainer [17] IMPLICIT SEQUENCE {
                privateExtensionList [0] IMPLICIT SEQUENCE ( SIZE ( 1 .. 10 ) ) OF
                SEQUENCE {
                    extId MAP-EXTENSION .&extensionId ( {
                        ... } ),
                    extType MAP-EXTENSION .&ExtensionType ( {
                        ... } { @extId } ) OPTIONAL } OPTIONAL,
                    pcs-Extensions [1] IMPLICIT SEQUENCE {
                        ... } OPTIONAL,
                    ... } OPTIONAL,
                ... },
            ps-PDP-ActiveReachableForPaging [5] IMPLICIT SEQUENCE ( SIZE ( 1 .. 50 ) ) OF
            SEQUENCE {
                pdp-ContextIdentifier [0] IMPLICIT INTEGER ( 1 .. 50 ),
                pdp-ContextActive [1] IMPLICIT NULL OPTIONAL,
                pdp-Type [2] IMPLICIT OCTET STRING ( SIZE ( 2 ) ),
                pdp-Address [3] IMPLICIT OCTET STRING ( SIZE ( 1 .. 16 ) ) OPTIONAL,

```

```

apn-Subscribed      [4] IMPLICIT OCTET STRING ( SIZE ( 2 .. 63 ) ) OPTIONAL,
apn-InUse           [5] IMPLICIT OCTET STRING ( SIZE ( 2 .. 63 ) ) OPTIONAL,
nsapi               [6] IMPLICIT INTEGER ( 0 .. 15 ) OPTIONAL,
transactionId      [7] IMPLICIT OCTET STRING ( SIZE ( 1 .. 2 ) ) OPTIONAL,
teid-ForGnAndGp    [8] IMPLICIT OCTET STRING ( SIZE ( 4 ) ) OPTIONAL,
teid-Forlu         [9] IMPLICIT OCTET STRING ( SIZE ( 4 ) ) OPTIONAL,
ggsn-Address       [10] IMPLICIT OCTET STRING ( SIZE ( 5 .. 17 ) ) OPTIONAL,
qos-Subscribed     [11] IMPLICIT OCTET STRING ( SIZE ( 1 .. 9 ) ) OPTIONAL,
qos-Requested      [12] IMPLICIT OCTET STRING ( SIZE ( 1 .. 9 ) ) OPTIONAL,
qos-Negotiated     [13] IMPLICIT OCTET STRING ( SIZE ( 1 .. 9 ) ) OPTIONAL,
chargingId         [14] IMPLICIT OCTET STRING ( SIZE ( 4 ) ) OPTIONAL,
chargingCharacteristics [15] IMPLICIT OCTET STRING ( SIZE ( 2 ) ) OPTIONAL,
rnc-Address        [16] IMPLICIT OCTET STRING ( SIZE ( 5 .. 17 ) ) OPTIONAL,
extensionContainer [17] IMPLICIT SEQUENCE {
  privateExtensionList [0] IMPLICIT SEQUENCE ( SIZE ( 1 .. 10 ) ) OF
  SEQUENCE {
    extId  MAP-EXTENSION .&extensionId ( {
      '
      ... } ),
    extType  MAP-EXTENSION .&ExtensionType ( {
      '
      ... } { @extId } ) OPTIONAL} OPTIONAL,
  pcs-Extensions [1] IMPLICIT SEQUENCE {
    ... } OPTIONAL,
  ... } OPTIONAL,
  ... } OPTIONAL,
}
imei [5] IMPLICIT OCTET STRING ( SIZE ( 8 ) ) OPTIONAL,
ms-Classmark2 [6] IMPLICIT OCTET STRING ( SIZE ( 3 ) ) OPTIONAL,
gprs-MS-Class [7] IMPLICIT SEQUENCE {
  mSNetworkCapability [0] IMPLICIT OCTET STRING ( SIZE ( 1 .. 8 ) ),
  mSRadioAccessCapability [1] IMPLICIT OCTET STRING ( SIZE ( 1 .. 50 ) ) OPTIONAL} OPTIONAL,
extensionContainer SEQUENCE {
  privateExtensionList [0] IMPLICIT SEQUENCE ( SIZE ( 1 .. 10 ) ) OF
  SEQUENCE {
    extId  MAP-EXTENSION .&extensionId ( {
      '
      ... } ),
    extType  MAP-EXTENSION .&ExtensionType ( {
      '
      ... } { @extId } ) OPTIONAL} OPTIONAL,
  pcs-Extensions [1] IMPLICIT SEQUENCE {
    ... } OPTIONAL,
  ... } OPTIONAL,
  ... }
}
ERRORS {
-- systemFailure -- localValue : 34,
-- ati-NotAllowed -- localValue : 49,
-- dataMissing -- localValue : 35,
-- unexpectedDataValue -- localValue : 36,
-- unknownSubscriber -- localValue : 1}
 ::= localValue : 71

```

anyTimeSubscriptionInterrogation OPERATION

ARGUMENT

```

anyTimeSubscriptionInterrogationArg SEQUENCE {
  subscriberIdentity [0] CHOICE {
    imsi [0] IMPLICIT OCTET STRING ( SIZE ( 3 .. 8 ) ),
    msisdn [1] IMPLICIT OCTET STRING ( SIZE ( 1 .. 20 ) ) ( SIZE ( 1 .. 9 ) ) },
  requestedSubscriptionInfo [1] IMPLICIT SEQUENCE {
    requestedSS-Info [1] IMPLICIT SEQUENCE {
      ss-Code OCTET STRING ( SIZE ( 1 ) ),
      basicService CHOICE {
        bearerService [2] IMPLICIT OCTET STRING ( SIZE ( 1 ) ),
        teleservice [3] IMPLICIT OCTET STRING ( SIZE ( 1 ) ) } OPTIONAL,
      ... ,
      longFTN-Supported [4] IMPLICIT NULL OPTIONAL} OPTIONAL,
    odb [2] IMPLICIT NULL OPTIONAL,
    requestedCAMEL-SubscriptionInfo [3] IMPLICIT ENUMERATED {
      o-CSI ( 0 ),
      t-CSI ( 1 ),
      vt-CSI ( 2 ),
      tif-CSI ( 3 ),
      gprs-CSI ( 4 ),
      mo-sms-CSI ( 5 ),
      ss-CSI ( 6 ),
      m-CSI ( 7 ),
      d-csi ( 8 ) } OPTIONAL,

```

```

supportedVLR-CAMEL-Phases [4] IMPLICIT NULL OPTIONAL,
supportedSGSN-CAMEL-Phases [5] IMPLICIT NULL OPTIONAL,
extensionContainer [6] IMPLICIT SEQUENCE {
  privateExtensionList [0] IMPLICIT SEQUENCE ( SIZE ( 1 .. 10 )) OF
  SEQUENCE {
    extId MAP-EXTENSION .&extensionId ( {
      '
      ... } ),
    extType MAP-EXTENSION .&ExtensionType ( {
      '
      ... } { @extId } ) OPTIONAL } OPTIONAL,
  pcs-Extensions [1] IMPLICIT SEQUENCE {
    ... } OPTIONAL,
  ... } OPTIONAL,
  ... ,
additionalRequestedCAMEL-SubscriptionInfo [7] IMPLICIT ENUMERATED {
  mt-sms-CSI ( 0 ),
  mg-csi ( 1 ),
  ... } OPTIONAL,
gsmSCF-Address [2] IMPLICIT OCTET STRING ( SIZE ( 1 .. 20 )) ( SIZE ( 1 .. 9 ) ),
extensionContainer [3] IMPLICIT SEQUENCE {
  privateExtensionList [0] IMPLICIT SEQUENCE ( SIZE ( 1 .. 10 )) OF
  SEQUENCE {
    extId MAP-EXTENSION .&extensionId ( {
      '
      ... } ),
    extType MAP-EXTENSION .&ExtensionType ( {
      '
      ... } { @extId } ) OPTIONAL } OPTIONAL,
  pcs-Extensions [1] IMPLICIT SEQUENCE {
    ... } OPTIONAL,
  ... } OPTIONAL,
  longFTN-Supported [4] IMPLICIT NULL OPTIONAL,
  ... }
RESULT
anyTimeSubscriptionInterrogationRes SEQUENCE {
  callForwardingData [1] IMPLICIT SEQUENCE {
  forwardingFeatureList SEQUENCE ( SIZE ( 1 .. 32 )) OF
  SEQUENCE {
    basicService CHOICE {
      ext-BearerService [2] IMPLICIT OCTET STRING ( SIZE ( 1 .. 5 ) ),
      ext-Teleservice [3] IMPLICIT OCTET STRING ( SIZE ( 1 .. 5 )) OPTIONAL,
      ss-Status [4] IMPLICIT OCTET STRING ( SIZE ( 1 .. 5 ) ),
      forwardedToNumber [5] IMPLICIT OCTET STRING ( SIZE ( 1 .. 20 )) ( SIZE ( 1 .. 9 )) OPTIONAL,
      forwardedToSubaddress [8] IMPLICIT OCTET STRING ( SIZE ( 1 .. 21 )) OPTIONAL,
      forwardingOptions [6] IMPLICIT OCTET STRING ( SIZE ( 1 .. 5 )) OPTIONAL,
      noReplyConditionTime [7] IMPLICIT INTEGER ( 1 .. 100 ) OPTIONAL,
      extensionContainer [9] IMPLICIT SEQUENCE {
        privateExtensionList [0] IMPLICIT SEQUENCE ( SIZE ( 1 .. 10 )) OF
        SEQUENCE {
          extId MAP-EXTENSION .&extensionId ( {
            '
            ... } ),
          extType MAP-EXTENSION .&ExtensionType ( {
            '
            ... } { @extId } ) OPTIONAL } OPTIONAL,
          pcs-Extensions [1] IMPLICIT SEQUENCE {
            ... } OPTIONAL,
          ... } OPTIONAL,
          ... ,
          longForwardedToNumber [10] IMPLICIT OCTET STRING ( SIZE ( 1 .. 20 )) ( SIZE ( 1 .. 15 )) OPTIONAL,
        notificationToCSE NULL OPTIONAL,
      extensionContainer [0] IMPLICIT SEQUENCE {
        privateExtensionList [0] IMPLICIT SEQUENCE ( SIZE ( 1 .. 10 )) OF
        SEQUENCE {
          extId MAP-EXTENSION .&extensionId ( {
            '
            ... } ),
          extType MAP-EXTENSION .&ExtensionType ( {
            '
            ... } { @extId } ) OPTIONAL } OPTIONAL,
          pcs-Extensions [1] IMPLICIT SEQUENCE {
            ... } OPTIONAL,
            ... } OPTIONAL,
            ... } OPTIONAL,
            callBarringData [2] IMPLICIT SEQUENCE {
            callBarringFeatureList SEQUENCE ( SIZE ( 1 .. 32 )) OF

```



```

SEQUENCE {
  basicService CHOICE {
    ext-BearerService [2] IMPLICIT OCTET STRING ( SIZE ( 1 .. 5 ) ),
    ext-Teleservice [3] IMPLICIT OCTET STRING ( SIZE ( 1 .. 5 ) ) } OPTIONAL,
  ss-Status [4] IMPLICIT OCTET STRING ( SIZE ( 1 .. 5 ) ),
  extensionContainer SEQUENCE {
    privateExtensionList [0] IMPLICIT SEQUENCE ( SIZE ( 1 .. 10 ) ) OF
      SEQUENCE {
        extId MAP-EXTENSION .&extensionId ( {
          '
          ... } ),
        extType MAP-EXTENSION .&ExtensionType ( {
          '
          ... } { @extId } ) OPTIONAL } OPTIONAL,
    pcs-Extensions [1] IMPLICIT SEQUENCE {
      ... } OPTIONAL,
    ... } OPTIONAL,
    ... },
  password NumericString ( FROM ("0"|"1"|"2"|"3"|"4"|"5"|"6"|"7"|"8"|"9" ) ) ( SIZE ( 4 ) ) OPTIONAL,
  wrongPasswordAttemptsCounter INTEGER ( 0 .. 4 ) OPTIONAL,
  notificationToCSE NULL OPTIONAL,
  extensionContainer SEQUENCE {
    privateExtensionList [0] IMPLICIT SEQUENCE ( SIZE ( 1 .. 10 ) ) OF
      SEQUENCE {
        extId MAP-EXTENSION .&extensionId ( {
          '
          ... } ),
        extType MAP-EXTENSION .&ExtensionType ( {
          '
          ... } { @extId } ) OPTIONAL } OPTIONAL,
    pcs-Extensions [1] IMPLICIT SEQUENCE {
      ... } OPTIONAL,
    ... } OPTIONAL,
    ... } OPTIONAL,
  odb-Info [3] IMPLICIT SEQUENCE {
    odb-Data SEQUENCE {
      odb-GeneralData BIT STRING {
        allOG-CallsBarred ( 0 ),
        internationalOGCallsBarred ( 1 ),
        internationalOGCallsNotToHPLMN-CountryBarred ( 2 ),
        interzonalOGCallsBarred ( 6 ),
        interzonalOGCallsNotToHPLMN-CountryBarred ( 7 ),
        interzonalOGCallsAndInternationalOGCallsNotToHPLMN-CountryBarred ( 8 ),
        premiumRateInformationOGCallsBarred ( 3 ),
        premiumRateEntertainmentOGCallsBarred ( 4 ),
        ss-AccessBarred ( 5 ),
        allECT-Barred ( 9 ),
        chargeableECT-Barred ( 10 ),
        internationalECT-Barred ( 11 ),
        interzonalECT-Barred ( 12 ),
        doublyChargeableECT-Barred ( 13 ),
        multipleECT-Barred ( 14 ),
        allPacketOrientedServicesBarred ( 15 ),
        roamerAccessToHPLMN-AP-Barred ( 16 ),
        roamerAccessToVPLMN-AP-Barred ( 17 ),
        roamingOutsidePLMNOG-CallsBarred ( 18 ),
        allIC-CallsBarred ( 19 ),
        roamingOutsidePLMNIC-CallsBarred ( 20 ),
        roamingOutsidePLMNICountryIC-CallsBarred ( 21 ),
        roamingOutsidePLMN-Barred ( 22 ),
        roamingOutsidePLMN-CountryBarred ( 23 ),
        registrationAllICF-Barred ( 24 ),
        registrationCFNotToHPLMN-Barred ( 25 ),
        registrationInterzonalCF-Barred ( 26 ),
        registrationInterzonalCFNotToHPLMN-Barred ( 27 ) } ( SIZE ( 15 .. 32 ) ),
    odb-HPLMN-Data BIT STRING {
      plmn-SpecificBarringType1 ( 0 ),
      plmn-SpecificBarringType2 ( 1 ),
      plmn-SpecificBarringType3 ( 2 ),
      plmn-SpecificBarringType4 ( 3 ) } ( SIZE ( 4 .. 32 ) ) OPTIONAL,
    extensionContainer SEQUENCE {
      privateExtensionList [0] IMPLICIT SEQUENCE ( SIZE ( 1 .. 10 ) ) OF
        SEQUENCE {
          extId MAP-EXTENSION .&extensionId ( {
            '
            ... } ),
          extType MAP-EXTENSION .&ExtensionType ( {

```

```

        ... } { @extId } ) OPTIONAL} OPTIONAL,
    pcs-Extensions [1] IMPLICIT SEQUENCE {
        ... } OPTIONAL,
        ... } OPTIONAL,
    ... },
notificationToCSE NULL OPTIONAL,
extensionContainer SEQUENCE {
    privateExtensionList [0] IMPLICIT SEQUENCE ( SIZE (1 .. 10) ) OF
    SEQUENCE {
        extId MAP-EXTENSION .&extensionId ( {
            '
            ... } ),
        extType MAP-EXTENSION .&ExtensionType ( {
            '
            ... } { @extId } ) OPTIONAL} OPTIONAL,
        pcs-Extensions [1] IMPLICIT SEQUENCE {
            ... } OPTIONAL,
            ... } OPTIONAL,
            ... } OPTIONAL,
        ... } OPTIONAL,
    camel-SubscriptionInfo [4] IMPLICIT SEQUENCE {
    o-CSI [0] IMPLICIT SEQUENCE {
    o-BcsmCamelTDPDataList SEQUENCE ( SIZE (1 .. 10) ) OF
    SEQUENCE {
        o-BcsmTriggerDetectionPoint ENUMERATED {
            collectedInfo (2),
            ... ,
            routeSelectFailure (4) },
        serviceKey INTEGER (0 .. 2147483647),
        gsmSCF-Address [0] IMPLICIT OCTET STRING ( SIZE (1 .. 20) ) ( SIZE (1 .. 9) ),
        defaultCallHandling [1] IMPLICIT ENUMERATED {
            continueCall (0),
            releaseCall (1),
            ... },
        extensionContainer [2] IMPLICIT SEQUENCE {
        privateExtensionList [0] IMPLICIT SEQUENCE ( SIZE (1 .. 10) ) OF
        SEQUENCE {
            extId MAP-EXTENSION .&extensionId ( {
                '
                ... } ),
            extType MAP-EXTENSION .&ExtensionType ( {
                '
                ... } { @extId } ) OPTIONAL} OPTIONAL,
            pcs-Extensions [1] IMPLICIT SEQUENCE {
                ... } OPTIONAL,
                ... } OPTIONAL,
                ... } OPTIONAL,
            ... },
        extensionContainer SEQUENCE {
        privateExtensionList [0] IMPLICIT SEQUENCE ( SIZE (1 .. 10) ) OF
        SEQUENCE {
            extId MAP-EXTENSION .&extensionId ( {
                '
                ... } ),
            extType MAP-EXTENSION .&ExtensionType ( {
                '
                ... } { @extId } ) OPTIONAL} OPTIONAL,
            pcs-Extensions [1] IMPLICIT SEQUENCE {
                ... } OPTIONAL,
                ... } OPTIONAL,
                ... } OPTIONAL,
            ... },
        camelCapabilityHandling [0] IMPLICIT INTEGER (1 .. 16) OPTIONAL,
        notificationToCSE [1] IMPLICIT NULL OPTIONAL,
        csiActive [2] IMPLICIT NULL OPTIONAL} OPTIONAL,
    o-BcsmCamelTDP-CriteriaList [1] IMPLICIT SEQUENCE ( SIZE (1 .. 10) ) OF
    SEQUENCE {
        o-BcsmTriggerDetectionPoint ENUMERATED {
            collectedInfo (2),
            ... ,
            routeSelectFailure (4) },
        destinationNumberCriteria [0] IMPLICIT SEQUENCE {
            matchType [0] IMPLICIT ENUMERATED {
                inhibiting (0),
                enabling (1) },
            destinationNumberList [1] IMPLICIT SEQUENCE ( SIZE (1 .. 10) ) OF
            OCTET STRING ( SIZE (1 .. 20) ) ( SIZE (1 .. 9) ) OPTIONAL,
            destinationNumberLengthList [2] IMPLICIT SEQUENCE ( SIZE (1 .. 3) ) OF
            INTEGER (1 .. 15) OPTIONAL,

```

```

... } OPTIONAL,
basicServiceCriteria [1] IMPLICIT SEQUENCE ( SIZE ( 1 .. 5 ) ) OF
CHOICE {
  ext-BearerService [2] IMPLICIT OCTET STRING ( SIZE ( 1 .. 5 ) ),
  ext-Teleservice [3] IMPLICIT OCTET STRING ( SIZE ( 1 .. 5 ) ) } OPTIONAL,
callTypeCriteria [2] IMPLICIT ENUMERATED {
  forwarded ( 0 ),
  notForwarded ( 1 ) } OPTIONAL,
... ,
o-CauseValueCriteria [3] IMPLICIT SEQUENCE ( SIZE ( 1 .. 5 ) ) OF
OCTET STRING ( SIZE ( 1 ) ) OPTIONAL,
extensionContainer [4] IMPLICIT SEQUENCE {
  privateExtensionList [0] IMPLICIT SEQUENCE ( SIZE ( 1 .. 10 ) ) OF
  SEQUENCE {
    extId MAP-EXTENSION .&extensionId ( {
      '
      ... } ),
    extType MAP-EXTENSION .&ExtensionType ( {
      '
      ... } { @extId } ) OPTIONAL } OPTIONAL,
  pcs-Extensions [1] IMPLICIT SEQUENCE {
    ... } OPTIONAL,
  ... } OPTIONAL } OPTIONAL,
d-CSI [2] IMPLICIT SEQUENCE {
  dp-AnalysedInfoCriteriaList [0] IMPLICIT SEQUENCE ( SIZE ( 1 .. 10 ) ) OF
  SEQUENCE {
    dialledNumber OCTET STRING ( SIZE ( 1 .. 20 ) ) ( SIZE ( 1 .. 9 ) ),
    serviceKey INTEGER ( 0 .. 2147483647 ),
    gsmSCF-Address OCTET STRING ( SIZE ( 1 .. 20 ) ) ( SIZE ( 1 .. 9 ) ),
    defaultCallHandling ENUMERATED {
      continueCall ( 0 ),
      releaseCall ( 1 ),
      ... },
    extensionContainer SEQUENCE {
      privateExtensionList [0] IMPLICIT SEQUENCE ( SIZE ( 1 .. 10 ) ) OF
      SEQUENCE {
        extId MAP-EXTENSION .&extensionId ( {
          '
          ... } ),
        extType MAP-EXTENSION .&ExtensionType ( {
          '
          ... } { @extId } ) OPTIONAL } OPTIONAL,
      pcs-Extensions [1] IMPLICIT SEQUENCE {
        ... } OPTIONAL,
      ... } OPTIONAL,
      ... } OPTIONAL,
    camelCapabilityHandling [1] IMPLICIT INTEGER ( 1 .. 16 ) OPTIONAL,
    extensionContainer [2] IMPLICIT SEQUENCE {
      privateExtensionList [0] IMPLICIT SEQUENCE ( SIZE ( 1 .. 10 ) ) OF
      SEQUENCE {
        extId MAP-EXTENSION .&extensionId ( {
          '
          ... } ),
        extType MAP-EXTENSION .&ExtensionType ( {
          '
          ... } { @extId } ) OPTIONAL } OPTIONAL,
      pcs-Extensions [1] IMPLICIT SEQUENCE {
        ... } OPTIONAL,
      ... } OPTIONAL,
      notificationToCSE [3] IMPLICIT NULL OPTIONAL,
      csi-Active [4] IMPLICIT NULL OPTIONAL,
      ... } OPTIONAL,
  t-CSI [3] IMPLICIT SEQUENCE {
    t-BcsmCamelTDPDataList SEQUENCE ( SIZE ( 1 .. 10 ) ) OF
    SEQUENCE {
      t-BcsmTriggerDetectionPoint ENUMERATED {
        termAttemptAuthorized ( 12 ),
        ... ,
        tBusy ( 13 ),
        tNoAnswer ( 14 ) },
      serviceKey INTEGER ( 0 .. 2147483647 ),
      gsmSCF-Address [0] IMPLICIT OCTET STRING ( SIZE ( 1 .. 20 ) ) ( SIZE ( 1 .. 9 ) ),
      defaultCallHandling [1] IMPLICIT ENUMERATED {
        continueCall ( 0 ),
        releaseCall ( 1 ),
        ... },
      extensionContainer [2] IMPLICIT SEQUENCE {

```

```

privateExtensionList [0] IMPLICIT SEQUENCE ( SIZE (1 .. 10) ) OF
SEQUENCE {
  extId MAP-EXTENSION .&extensionId ( {
    '
    ... } ),
  extType MAP-EXTENSION .&ExtensionType ( {
    '
    ... } { @extId } ) OPTIONAL} OPTIONAL,
pcs-Extensions [1] IMPLICIT SEQUENCE {
  ... } OPTIONAL,
... } OPTIONAL,
... },
extensionContainer SEQUENCE {
  privateExtensionList [0] IMPLICIT SEQUENCE ( SIZE (1 .. 10) ) OF
SEQUENCE {
  extId MAP-EXTENSION .&extensionId ( {
    '
    ... } ),
  extType MAP-EXTENSION .&ExtensionType ( {
    '
    ... } { @extId } ) OPTIONAL} OPTIONAL,
pcs-Extensions [1] IMPLICIT SEQUENCE {
  ... } OPTIONAL,
... } OPTIONAL,
... },
camelCapabilityHandling [0] IMPLICIT INTEGER ( 1 .. 16 ) OPTIONAL,
notificationToCSE [1] IMPLICIT NULL OPTIONAL,
csi-Active [2] IMPLICIT NULL OPTIONAL} OPTIONAL,
t-BCSM-CAMEL-TDP-CriteriaList [4] IMPLICIT SEQUENCE ( SIZE (1 .. 10) ) OF
SEQUENCE {
  t-BCSM-TriggerDetectionPoint ENUMERATED {
    termAttemptAuthorized (12),
    ... ,
    tBusy (13),
    tNoAnswer (14) },
  basicServiceCriteria [0] IMPLICIT SEQUENCE ( SIZE (1 .. 5) ) OF
CHOICE {
  ext-BearerService [2] IMPLICIT OCTET STRING ( SIZE (1 .. 5) ),
  ext-Teleservice [3] IMPLICIT OCTET STRING ( SIZE (1 .. 5) )} OPTIONAL,
  t-CauseValueCriteria [1] IMPLICIT SEQUENCE ( SIZE (1 .. 5) ) OF
OCTET STRING ( SIZE (1) ) OPTIONAL,
... } OPTIONAL,
vt-CSI [5] IMPLICIT SEQUENCE {
  t-BcsmCamelTDPDataList SEQUENCE ( SIZE (1 .. 10) ) OF
SEQUENCE {
  t-BcsmTriggerDetectionPoint ENUMERATED {
    termAttemptAuthorized (12),
    ... ,
    tBusy (13),
    tNoAnswer (14) },
  serviceKey INTEGER ( 0 .. 2147483647 ),
  gsmSCF-Address [0] IMPLICIT OCTET STRING ( SIZE (1 .. 20) ) ( SIZE (1 .. 9) ),
  defaultCallHandling [1] IMPLICIT ENUMERATED {
    continueCall (0),
    releaseCall (1),
    ... },
  extensionContainer [2] IMPLICIT SEQUENCE {
  privateExtensionList [0] IMPLICIT SEQUENCE ( SIZE (1 .. 10) ) OF
SEQUENCE {
  extId MAP-EXTENSION .&extensionId ( {
    '
    ... } ),
  extType MAP-EXTENSION .&ExtensionType ( {
    '
    ... } { @extId } ) OPTIONAL} OPTIONAL,
pcs-Extensions [1] IMPLICIT SEQUENCE {
  ... } OPTIONAL,
... } OPTIONAL,
... },
extensionContainer SEQUENCE {
  privateExtensionList [0] IMPLICIT SEQUENCE ( SIZE (1 .. 10) ) OF
SEQUENCE {
  extId MAP-EXTENSION .&extensionId ( {
    '
    ... } ),
  extType MAP-EXTENSION .&ExtensionType ( {
    '

```

```

...} { @extId } ) OPTIONAL} OPTIONAL,
pcs-Extensions [1] IMPLICIT SEQUENCE {
... } OPTIONAL,
... } OPTIONAL,
... ,
camelCapabilityHandling [0] IMPLICIT INTEGER ( 1 .. 16 ) OPTIONAL,
notificationToCSE [1] IMPLICIT NULL OPTIONAL,
csi-Active [2] IMPLICIT NULL OPTIONAL} OPTIONAL,
vt-BCSM-CAMEL-TDP-CriteriaList [6] IMPLICIT SEQUENCE ( SIZE ( 1 .. 10 ) ) OF
SEQUENCE {
t-BCSM-TriggerDetectionPoint ENUMERATED {
termAttemptAuthorized ( 12 ),
... ,
tBusy ( 13 ),
tNoAnswer ( 14 )},
basicServiceCriteria [0] IMPLICIT SEQUENCE ( SIZE ( 1 .. 5 ) ) OF
CHOICE {
ext-BearerService [2] IMPLICIT OCTET STRING ( SIZE ( 1 .. 5 ) ),
ext-Teleservice [3] IMPLICIT OCTET STRING ( SIZE ( 1 .. 5 ) )} OPTIONAL,
t-CauseValueCriteria [1] IMPLICIT SEQUENCE ( SIZE ( 1 .. 5 ) ) OF
OCTET STRING ( SIZE ( 1 ) ) OPTIONAL,
... } OPTIONAL,
tif-CSI [7] IMPLICIT NULL OPTIONAL,
tif-CSI-NotificationToCSE [8] IMPLICIT NULL OPTIONAL,
gprs-CSI [9] IMPLICIT SEQUENCE {
gprs-CamelTDPDataList [0] IMPLICIT SEQUENCE ( SIZE ( 1 .. 10 ) ) OF
SEQUENCE {
gprs-TriggerDetectionPoint [0] IMPLICIT ENUMERATED {
attach ( 1 ),
attachChangeOfPosition ( 2 ),
pdp-ContextEstablishment ( 11 ),
pdp-ContextEstablishmentAcknowledgement ( 12 ),
pdp-ContextChangeOfPosition ( 14 ),
... },
serviceKey [1] IMPLICIT INTEGER ( 0 .. 2147483647 ),
gsmSCF-Address [2] IMPLICIT OCTET STRING ( SIZE ( 1 .. 20 ) ) ( SIZE ( 1 .. 9 ) ),
defaultSessionHandling [3] IMPLICIT ENUMERATED {
continueTransaction ( 0 ),
releaseTransaction ( 1 ),
... },
extensionContainer [4] IMPLICIT SEQUENCE {
privateExtensionList [0] IMPLICIT SEQUENCE ( SIZE ( 1 .. 10 ) ) OF
SEQUENCE {
extId MAP-EXTENSION .&extensionId ( {
'
... } ),
extType MAP-EXTENSION .&ExtensionType ( {
'
...} { @extId } ) OPTIONAL} OPTIONAL,
pcs-Extensions [1] IMPLICIT SEQUENCE {
... } OPTIONAL,
... } OPTIONAL,
... } OPTIONAL,
camelCapabilityHandling [1] IMPLICIT INTEGER ( 1 .. 16 ) OPTIONAL,
extensionContainer [2] IMPLICIT SEQUENCE {
privateExtensionList [0] IMPLICIT SEQUENCE ( SIZE ( 1 .. 10 ) ) OF
SEQUENCE {
extId MAP-EXTENSION .&extensionId ( {
'
... } ),
extType MAP-EXTENSION .&ExtensionType ( {
'
...} { @extId } ) OPTIONAL} OPTIONAL,
pcs-Extensions [1] IMPLICIT SEQUENCE {
... } OPTIONAL,
... } OPTIONAL,
notificationToCSE [3] IMPLICIT NULL OPTIONAL,
csi-Active [4] IMPLICIT NULL OPTIONAL,
... } OPTIONAL,
mo-sms-CSI [10] IMPLICIT SEQUENCE {
sms-CAMEL-TDP-DataList [0] IMPLICIT SEQUENCE ( SIZE ( 1 .. 10 ) ) OF
SEQUENCE {
sms-TriggerDetectionPoint [0] IMPLICIT ENUMERATED {
sms-CollectedInfo ( 1 ),
... ,
sms-DeliveryRequest ( 2 )},
serviceKey [1] IMPLICIT INTEGER ( 0 .. 2147483647 ),

```

```

gsmSCF-Address      [2] IMPLICIT OCTET STRING ( SIZE (1 .. 20) ) ( SIZE (1 .. 9) ),
defaultSMS-Handling [3] IMPLICIT ENUMERATED {
  continueTransaction (0),
  releaseTransaction (1),
  ... },
extensionContainer  [4] IMPLICIT SEQUENCE {
  privateExtensionList [0] IMPLICIT SEQUENCE ( SIZE (1 .. 10) ) OF
  SEQUENCE {
    extId  MAP-EXTENSION .&extensionId ( {
      '
      ... } ),
    extType  MAP-EXTENSION .&ExtensionType ( {
      '
      ... } { @extId } ) OPTIONAL } OPTIONAL,
  pcs-Extensions [1] IMPLICIT SEQUENCE {
    ... } OPTIONAL,
    ... } OPTIONAL,
    ... } OPTIONAL,
  camelCapabilityHandling [1] IMPLICIT INTEGER ( 1 .. 16 ) OPTIONAL,
  extensionContainer [2] IMPLICIT SEQUENCE {
  privateExtensionList [0] IMPLICIT SEQUENCE ( SIZE (1 .. 10) ) OF
  SEQUENCE {
    extId  MAP-EXTENSION .&extensionId ( {
      '
      ... } ),
    extType  MAP-EXTENSION .&ExtensionType ( {
      '
      ... } { @extId } ) OPTIONAL } OPTIONAL,
  pcs-Extensions [1] IMPLICIT SEQUENCE {
    ... } OPTIONAL,
    ... } OPTIONAL,
  notificationToCSE [3] IMPLICIT NULL OPTIONAL,
  csi-Active [4] IMPLICIT NULL OPTIONAL,
  ... } OPTIONAL,
ss-CSI [11] IMPLICIT SEQUENCE {
  ss-CamelData SEQUENCE {
  ss-EventList SEQUENCE ( SIZE (1 .. 10) ) OF
  OCTET STRING ( SIZE (1) ),
  gsmSCF-Address OCTET STRING ( SIZE (1 .. 20) ) ( SIZE (1 .. 9) ),
  extensionContainer [0] IMPLICIT SEQUENCE {
  privateExtensionList [0] IMPLICIT SEQUENCE ( SIZE (1 .. 10) ) OF
  SEQUENCE {
    extId  MAP-EXTENSION .&extensionId ( {
      '
      ... } ),
    extType  MAP-EXTENSION .&ExtensionType ( {
      '
      ... } { @extId } ) OPTIONAL } OPTIONAL,
  pcs-Extensions [1] IMPLICIT SEQUENCE {
    ... } OPTIONAL,
    ... } OPTIONAL,
    ... },
  extensionContainer SEQUENCE {
  privateExtensionList [0] IMPLICIT SEQUENCE ( SIZE (1 .. 10) ) OF
  SEQUENCE {
    extId  MAP-EXTENSION .&extensionId ( {
      '
      ... } ),
    extType  MAP-EXTENSION .&ExtensionType ( {
      '
      ... } { @extId } ) OPTIONAL } OPTIONAL,
  pcs-Extensions [1] IMPLICIT SEQUENCE {
    ... } OPTIONAL,
    ... } OPTIONAL,
  ... },
  notificationToCSE [0] IMPLICIT NULL OPTIONAL,
  csi-Active [1] IMPLICIT NULL OPTIONAL } OPTIONAL,
m-CSI [12] IMPLICIT SEQUENCE {
  mobilityTriggers SEQUENCE ( SIZE (1 .. 10) ) OF
  OCTET STRING ( SIZE (1) ),
  serviceKey INTEGER ( 0 .. 2147483647 ),
  gsmSCF-Address [0] IMPLICIT OCTET STRING ( SIZE (1 .. 20) ) ( SIZE (1 .. 9) ),
  extensionContainer [1] IMPLICIT SEQUENCE {
  privateExtensionList [0] IMPLICIT SEQUENCE ( SIZE (1 .. 10) ) OF
  SEQUENCE {
    extId  MAP-EXTENSION .&extensionId ( {
      '

```

```

...} ),
extType MAP-EXTENSION .&ExtensionType ( {
    '
    ...} { @extId } ) OPTIONAL} OPTIONAL,
pcs-Extensions [1] IMPLICIT SEQUENCE {
    ... } OPTIONAL,
    ... } OPTIONAL,
notificationToCSE [2] IMPLICIT NULL OPTIONAL,
csi-Active [3] IMPLICIT NULL OPTIONAL,
... } OPTIONAL,
extensionContainer [13] IMPLICIT SEQUENCE {
privateExtensionList [0] IMPLICIT SEQUENCE ( SIZE ( 1 .. 10 ) ) OF
SEQUENCE {
    extId MAP-EXTENSION .&extensionId ( {
        '
        ...} ),
    extType MAP-EXTENSION .&ExtensionType ( {
        '
        ...} { @extId } ) OPTIONAL} OPTIONAL,
pcs-Extensions [1] IMPLICIT SEQUENCE {
    ... } OPTIONAL,
    ... } OPTIONAL,
    ... } OPTIONAL,
... ,
specificCSIDeletedList [14] IMPLICIT BIT STRING {
o-csi ( 0 ),
ss-csi ( 1 ),
tif-csi ( 2 ),
d-csi ( 3 ),
vt-csi ( 4 ),
mo-sms-csi ( 5 ),
m-csi ( 6 ),
gprs-csi ( 7 ),
t-csi ( 8 ),
mt-sms-csi ( 9 ),
mg-csi ( 10 ) } ( SIZE ( 8 .. 32 ) ) OPTIONAL,
mt-sms-CSI [15] IMPLICIT SEQUENCE {
sms-CAMEL-TDP-DataList [0] IMPLICIT SEQUENCE ( SIZE ( 1 .. 10 ) ) OF
SEQUENCE {
    sms-TriggerDetectionPoint [0] IMPLICIT ENUMERATED {
        sms-CollectedInfo ( 1 ),
        ... ,
        sms-DeliveryRequest ( 2 ) },
serviceKey [1] IMPLICIT INTEGER ( 0 .. 2147483647 ),
gsmSCF-Address [2] IMPLICIT OCTET STRING ( SIZE ( 1 .. 20 ) ) ( SIZE ( 1 .. 9 ) ),
defaultSMS-Handling [3] IMPLICIT ENUMERATED {
    continueTransaction ( 0 ),
    releaseTransaction ( 1 ),
    ... },
extensionContainer [4] IMPLICIT SEQUENCE {
privateExtensionList [0] IMPLICIT SEQUENCE ( SIZE ( 1 .. 10 ) ) OF
SEQUENCE {
    extId MAP-EXTENSION .&extensionId ( {
        '
        ...} ),
    extType MAP-EXTENSION .&ExtensionType ( {
        '
        ...} { @extId } ) OPTIONAL} OPTIONAL,
pcs-Extensions [1] IMPLICIT SEQUENCE {
    ... } OPTIONAL,
    ... } OPTIONAL,
    ... } OPTIONAL,
camelCapabilityHandling [1] IMPLICIT INTEGER ( 1 .. 16 ) OPTIONAL,
extensionContainer [2] IMPLICIT SEQUENCE {
privateExtensionList [0] IMPLICIT SEQUENCE ( SIZE ( 1 .. 10 ) ) OF
SEQUENCE {
    extId MAP-EXTENSION .&extensionId ( {
        '
        ...} ),
    extType MAP-EXTENSION .&ExtensionType ( {
        '
        ...} { @extId } ) OPTIONAL} OPTIONAL,
pcs-Extensions [1] IMPLICIT SEQUENCE {
    ... } OPTIONAL,
    ... } OPTIONAL,
notificationToCSE [3] IMPLICIT NULL OPTIONAL,
csi-Active [4] IMPLICIT NULL OPTIONAL,
... } OPTIONAL,

```

```

mt-smsCAMELTDP-CriteriaList [16] IMPLICIT SEQUENCE ( SIZE ( 1 .. 10 ) ) OF
SEQUENCE {
  sms-TriggerDetectionPoint ENUMERATED {
    sms-CollectedInfo ( 1 ),
    ... ,
    sms-DeliveryRequest ( 2 )},
  tpdu-TypeCriterion [0] IMPLICIT SEQUENCE ( SIZE ( 1 .. 5 ) ) OF
  ENUMERATED {
    sms-DELIVER ( 0 ),
    sms-SUBMIT-REPORT ( 1 ),
    sms-STATUS-REPORT ( 2 ),
    ... } OPTIONAL,
  ... } OPTIONAL,
mg-csi [17] IMPLICIT SEQUENCE {
  mobilityTriggers SEQUENCE ( SIZE ( 1 .. 10 ) ) OF
  OCTET STRING ( SIZE ( 1 ) ),
  serviceKey INTEGER ( 0 .. 2147483647 ),
  gsmSCF-Address [0] IMPLICIT OCTET STRING ( SIZE ( 1 .. 20 ) ) ( SIZE ( 1 .. 9 ) ),
  extensionContainer [1] IMPLICIT SEQUENCE {
    privateExtensionList [0] IMPLICIT SEQUENCE ( SIZE ( 1 .. 10 ) ) OF
  SEQUENCE {
    extId MAP-EXTENSION .&extensionId ( {
      '
      ...} ),
    extType MAP-EXTENSION .&ExtensionType ( {
      '
      ...} { @extId } ) OPTIONAL} OPTIONAL,
    pcs-Extensions [1] IMPLICIT SEQUENCE {
      ... } OPTIONAL,
      ... } OPTIONAL,
      notificationToCSE [2] IMPLICIT NULL OPTIONAL,
      csi-Active [3] IMPLICIT NULL OPTIONAL,
      ... } OPTIONAL} OPTIONAL,
supportedVLR-CAMEL-Phases [5] IMPLICIT BIT STRING {
  phase1 ( 0 ),
  phase2 ( 1 ),
  phase3 ( 2 ),
  phase4 ( 3 )} ( SIZE ( 1 .. 16 ) ) OPTIONAL,
supportedSGSN-CAMEL-Phases [6] IMPLICIT BIT STRING {
  phase1 ( 0 ),
  phase2 ( 1 ),
  phase3 ( 2 ),
  phase4 ( 3 )} ( SIZE ( 1 .. 16 ) ) OPTIONAL,
extensionContainer [7] IMPLICIT SEQUENCE {
  privateExtensionList [0] IMPLICIT SEQUENCE ( SIZE ( 1 .. 10 ) ) OF
  SEQUENCE {
    extId MAP-EXTENSION .&extensionId ( {
      '
      ...} ),
    extType MAP-EXTENSION .&ExtensionType ( {
      '
      ...} { @extId } ) OPTIONAL} OPTIONAL,
    pcs-Extensions [1] IMPLICIT SEQUENCE {
      ... } OPTIONAL,
      ... } OPTIONAL,
      ... }
ERRORS {
  -- atsi-NotAllowed -- localValue : 60,
  -- dataMissing -- localValue : 35,
  -- unexpectedDataValue -- localValue : 36,
  -- unknownSubscriber -- localValue : 1,
  -- bearerServiceNotProvisioned -- localValue : 10,
  -- teleserviceNotProvisioned -- localValue : 11,
  -- callBarred -- localValue : 13,
  -- illegalSS-Operation -- localValue : 16,
  -- ss-NotAvailable -- localValue : 18,
  -- informationNotAvailable -- localValue : 62}
 ::= localValue : 62

anyTimeModification OPERATION
ARGUMENT
anyTimeModificationArg SEQUENCE {
  subscriberIdentity [0] CHOICE {
    imsi [0] IMPLICIT OCTET STRING ( SIZE ( 3 .. 8 ) ),
    msisdn [1] IMPLICIT OCTET STRING ( SIZE ( 1 .. 20 ) ) ( SIZE ( 1 .. 9 ) )},
  gsmSCF-Address [1] IMPLICIT OCTET STRING ( SIZE ( 1 .. 20 ) ) ( SIZE ( 1 .. 9 ) ),
  modificationRequestFor-CF-Info [2] IMPLICIT SEQUENCE {

```



```

ss-Code [0] IMPLICIT OCTET STRING ( SIZE ( 1 ) ),
basicService [1] CHOICE {
  ext-BearerService [2] IMPLICIT OCTET STRING ( SIZE ( 1 .. 5 ) ),
  ext-Teleservice [3] IMPLICIT OCTET STRING ( SIZE ( 1 .. 5 ) ) } OPTIONAL,
ss-Status [2] IMPLICIT OCTET STRING ( SIZE ( 1 .. 5 ) ) OPTIONAL,
forwardedToNumber [3] IMPLICIT OCTET STRING ( SIZE ( 1 .. 20 ) ) OPTIONAL,
forwardedToSubaddress [4] IMPLICIT OCTET STRING ( SIZE ( 1 .. 21 ) ) OPTIONAL,
noReplyConditionTime [5] IMPLICIT INTEGER ( 1 .. 100 ) OPTIONAL,
modifyNotificationToCSE [6] IMPLICIT ENUMERATED {
  deactivate ( 0 ),
  activate ( 1 ) } OPTIONAL,
extensionContainer [7] IMPLICIT SEQUENCE {
  privateExtensionList [0] IMPLICIT SEQUENCE ( SIZE ( 1 .. 10 ) ) OF
  SEQUENCE {
    extId MAP-EXTENSION .&extensionId ( {
      '
      ... } ),
    extType MAP-EXTENSION .&ExtensionType ( {
      '
      ... } { @extId } ) OPTIONAL } OPTIONAL,
  pcs-Extensions [1] IMPLICIT SEQUENCE {
    ... } OPTIONAL,
    ... } OPTIONAL,
    ... } OPTIONAL,
  }
modificationRequestFor-CB-Info [3] IMPLICIT SEQUENCE {
  ss-Code [0] IMPLICIT OCTET STRING ( SIZE ( 1 ) ),
  basicService [1] CHOICE {
    ext-BearerService [2] IMPLICIT OCTET STRING ( SIZE ( 1 .. 5 ) ),
    ext-Teleservice [3] IMPLICIT OCTET STRING ( SIZE ( 1 .. 5 ) ) } OPTIONAL,
  ss-Status [2] IMPLICIT OCTET STRING ( SIZE ( 1 .. 5 ) ) OPTIONAL,
  password [3] IMPLICIT NumericString ( FROM ("0"|"1"|"2"|"3"|"4"|"5"|"6"|"7"|"8"|"9" ) ) ( SIZE ( 4 ) ) OPTIONAL,
  wrongPasswordAttemptsCounter [4] IMPLICIT INTEGER ( 0 .. 4 ) OPTIONAL,
  modifyNotificationToCSE [5] IMPLICIT ENUMERATED {
    deactivate ( 0 ),
    activate ( 1 ) } OPTIONAL,
  extensionContainer [6] IMPLICIT SEQUENCE {
    privateExtensionList [0] IMPLICIT SEQUENCE ( SIZE ( 1 .. 10 ) ) OF
    SEQUENCE {
      extId MAP-EXTENSION .&extensionId ( {
        '
        ... } ),
      extType MAP-EXTENSION .&ExtensionType ( {
        '
        ... } { @extId } ) OPTIONAL } OPTIONAL,
    pcs-Extensions [1] IMPLICIT SEQUENCE {
      ... } OPTIONAL,
      ... } OPTIONAL,
      ... } OPTIONAL,
    }
modificationRequestFor-CSI [4] IMPLICIT SEQUENCE {
  requestedCamel-SubscriptionInfo [0] IMPLICIT ENUMERATED {
    o-CSI ( 0 ),
    t-CSI ( 1 ),
    vt-CSI ( 2 ),
    tif-CSI ( 3 ),
    gprs-CSI ( 4 ),
    mo-sms-CSI ( 5 ),
    ss-CSI ( 6 ),
    m-CSI ( 7 ),
    d-csi ( 8 ) },
  modifyNotificationToCSE [1] IMPLICIT ENUMERATED {
    deactivate ( 0 ),
    activate ( 1 ) } OPTIONAL,
  modifyCSI-State [2] IMPLICIT ENUMERATED {
    deactivate ( 0 ),
    activate ( 1 ) } OPTIONAL,
  extensionContainer [3] IMPLICIT SEQUENCE {
    privateExtensionList [0] IMPLICIT SEQUENCE ( SIZE ( 1 .. 10 ) ) OF
    SEQUENCE {
      extId MAP-EXTENSION .&extensionId ( {
        '
        ... } ),
      extType MAP-EXTENSION .&ExtensionType ( {
        '
        ... } { @extId } ) OPTIONAL } OPTIONAL,
    pcs-Extensions [1] IMPLICIT SEQUENCE {
      ... } OPTIONAL,
      ... } OPTIONAL,
      ... } OPTIONAL,
    }

```

```

... ,
additionalRequestedCAMEL-SubscriptionInfo [4] IMPLICIT ENUMERATED {
  mt-sms-CSI (0),
  mg-csi (1),
  ... } OPTIONAL} OPTIONAL,
extensionContainer [5] IMPLICIT SEQUENCE {
  privateExtensionList [0] IMPLICIT SEQUENCE ( SIZE (1 .. 10) ) OF
  SEQUENCE {
    extId MAP-EXTENSION .&extensionId ( {
      '
      ...} ),
    extType MAP-EXTENSION .&ExtensionType ( {
      '
      ...} { @extId } ) OPTIONAL} OPTIONAL,
  pcs-Extensions [1] IMPLICIT SEQUENCE {
    ... } OPTIONAL,
    ... } OPTIONAL,
longFTN-Supported [6] IMPLICIT NULL OPTIONAL,
... ,
modificationRequestFor-ODB-data [7] IMPLICIT SEQUENCE {
  odb-data [0] IMPLICIT SEQUENCE {
    odb-GeneralData BIT STRING {
      allOG-CallsBarred (0),
      internationalOGCallsBarred (1),
      internationalOGCallsNotToHPLMN-CountryBarred (2),
      interzonalOGCallsBarred (6),
      interzonalOGCallsNotToHPLMN-CountryBarred (7),
      interzonalOGCallsAndInternationalOGCallsNotToHPLMN-CountryBarred (8),
      premiumRateInformationOGCallsBarred (3),
      premiumRateEntertainmentOGCallsBarred (4),
      ss-AccessBarred (5),
      allECT-Barred (9),
      chargeableECT-Barred (10),
      internationalECT-Barred (11),
      interzonalECT-Barred (12),
      doublyChargeableECT-Barred (13),
      multipleECT-Barred (14),
      allPacketOrientedServicesBarred (15),
      roamerAccessToHPLMN-AP-Barred (16),
      roamerAccessToVPLMN-AP-Barred (17),
      roamingOutsidePLMNOG-CallsBarred (18),
      allIC-CallsBarred (19),
      roamingOutsidePLMNIC-CallsBarred (20),
      roamingOutsidePLMNICountryIC-CallsBarred (21),
      roamingOutsidePLMN-Barred (22),
      roamingOutsidePLMN-CountryBarred (23),
      registrationAllCF-Barred (24),
      registrationCFNotToHPLMN-Barred (25),
      registrationInterzonalCF-Barred (26),
      registrationInterzonalCFNotToHPLMN-Barred (27) } ( SIZE (15 .. 32) ),
    odb-HPLMN-Data BIT STRING {
      plmn-SpecificBarringType1 (0),
      plmn-SpecificBarringType2 (1),
      plmn-SpecificBarringType3 (2),
      plmn-SpecificBarringType4 (3) } ( SIZE (4 .. 32) ) OPTIONAL,
  extensionContainer SEQUENCE {
    privateExtensionList [0] IMPLICIT SEQUENCE ( SIZE (1 .. 10) ) OF
    SEQUENCE {
      extId MAP-EXTENSION .&extensionId ( {
        '
        ...} ),
      extType MAP-EXTENSION .&ExtensionType ( {
        '
        ...} { @extId } ) OPTIONAL} OPTIONAL,
    pcs-Extensions [1] IMPLICIT SEQUENCE {
      ... } OPTIONAL,
      ... } OPTIONAL,
    ... } OPTIONAL,
  modifyNotificationToCSE [1] IMPLICIT ENUMERATED {
    deactivate (0),
    activate (1) } OPTIONAL,
  extensionContainer [2] IMPLICIT SEQUENCE {
    privateExtensionList [0] IMPLICIT SEQUENCE ( SIZE (1 .. 10) ) OF
    SEQUENCE {
      extId MAP-EXTENSION .&extensionId ( {
        '
        ...} ),

```

```

    extType MAP-EXTENSION .&ExtensionType ( {
        '
        ... } { @extId } ) OPTIONAL} OPTIONAL,
    pcs-Extensions [1] IMPLICIT SEQUENCE {
        ... } OPTIONAL,
        ... } OPTIONAL,
        ... } OPTIONAL}
RESULT
anyTimeModificationRes SEQUENCE {
    ss-InfoFor-CSE [0] CHOICE {
        forwardingInfoFor-CSE [0] IMPLICIT SEQUENCE {
            ss-Code [0] IMPLICIT OCTET STRING ( SIZE ( 1 ) ),
            forwardingFeatureList [1] IMPLICIT SEQUENCE ( SIZE ( 1 .. 32 ) ) OF
            SEQUENCE {
                basicService CHOICE {
                    ext-BearerService [2] IMPLICIT OCTET STRING ( SIZE ( 1 .. 5 ) ),
                    ext-Teleservice [3] IMPLICIT OCTET STRING ( SIZE ( 1 .. 5 ) )} OPTIONAL,
                ss-Status [4] IMPLICIT OCTET STRING ( SIZE ( 1 .. 5 ) ),
                forwardedToNumber [5] IMPLICIT OCTET STRING ( SIZE ( 1 .. 20 ) ) ( SIZE ( 1 .. 9 ) ) OPTIONAL,
                forwardedToSubaddress [8] IMPLICIT OCTET STRING ( SIZE ( 1 .. 21 ) ) OPTIONAL,
                forwardingOptions [6] IMPLICIT OCTET STRING ( SIZE ( 1 .. 5 ) ) OPTIONAL,
                noReplyConditionTime [7] IMPLICIT INTEGER ( 1 .. 100 ) OPTIONAL,
                extensionContainer [9] IMPLICIT SEQUENCE {
                    privateExtensionList [0] IMPLICIT SEQUENCE ( SIZE ( 1 .. 10 ) ) OF
                    SEQUENCE {
                        extId MAP-EXTENSION .&extensionId ( {
                            '
                            ... } ),
                        extType MAP-EXTENSION .&ExtensionType ( {
                            '
                            ... } { @extId } ) OPTIONAL} OPTIONAL,
                    pcs-Extensions [1] IMPLICIT SEQUENCE {
                        ... } OPTIONAL,
                        ... } OPTIONAL,
                        ... } OPTIONAL,
                    ... },
                longForwardedToNumber [10] IMPLICIT OCTET STRING ( SIZE ( 1 .. 20 ) ) ( SIZE ( 1 .. 15 ) ) OPTIONAL,
            notificationToCSE [2] IMPLICIT NULL OPTIONAL,
            extensionContainer [3] IMPLICIT SEQUENCE {
                privateExtensionList [0] IMPLICIT SEQUENCE ( SIZE ( 1 .. 10 ) ) OF
                SEQUENCE {
                    extId MAP-EXTENSION .&extensionId ( {
                        '
                        ... } ),
                    extType MAP-EXTENSION .&ExtensionType ( {
                        '
                        ... } { @extId } ) OPTIONAL} OPTIONAL,
                pcs-Extensions [1] IMPLICIT SEQUENCE {
                    ... } OPTIONAL,
                    ... } OPTIONAL,
                    ... } OPTIONAL,
                ... },
            callBarringInfoFor-CSE [1] IMPLICIT SEQUENCE {
                ss-Code [0] IMPLICIT OCTET STRING ( SIZE ( 1 ) ),
                callBarringFeatureList [1] IMPLICIT SEQUENCE ( SIZE ( 1 .. 32 ) ) OF
                SEQUENCE {
                    basicService CHOICE {
                        ext-BearerService [2] IMPLICIT OCTET STRING ( SIZE ( 1 .. 5 ) ),
                        ext-Teleservice [3] IMPLICIT OCTET STRING ( SIZE ( 1 .. 5 ) )} OPTIONAL,
                    ss-Status [4] IMPLICIT OCTET STRING ( SIZE ( 1 .. 5 ) ),
                    extensionContainer SEQUENCE {
                        privateExtensionList [0] IMPLICIT SEQUENCE ( SIZE ( 1 .. 10 ) ) OF
                        SEQUENCE {
                            extId MAP-EXTENSION .&extensionId ( {
                                '
                                ... } ),
                            extType MAP-EXTENSION .&ExtensionType ( {
                                '
                                ... } { @extId } ) OPTIONAL} OPTIONAL,
                            pcs-Extensions [1] IMPLICIT SEQUENCE {
                                ... } OPTIONAL,
                                ... } OPTIONAL,
                                ... } OPTIONAL,
                            ... },
                    password [2] IMPLICIT NumericString ( FROM ("0"|"1"|"2"|"3"|"4"|"5"|"6"|"7"|"8"|"9" ) ) ( SIZE ( 4 ) ) OPTIONAL,
                    wrongPasswordAttemptsCounter [3] IMPLICIT INTEGER ( 0 .. 4 ) OPTIONAL,
                    notificationToCSE [4] IMPLICIT NULL OPTIONAL,
                    extensionContainer [5] IMPLICIT SEQUENCE {
                        privateExtensionList [0] IMPLICIT SEQUENCE ( SIZE ( 1 .. 10 ) ) OF
                        SEQUENCE {

```

```

    extId  MAP-EXTENSION .&extensionId ( {
        '
        ... } ),
    extType  MAP-EXTENSION .&ExtensionType ( {
        '
        ... } { @extId } ) OPTIONAL} OPTIONAL,
    pcs-Extensions  [1] IMPLICIT SEQUENCE {
        ... } OPTIONAL,
        ... } OPTIONAL,
        ... } OPTIONAL,
        ... } OPTIONAL,
    camel-SubscriptionInfo  [1] IMPLICIT SEQUENCE {
    o-CSI  [0] IMPLICIT SEQUENCE {
    o-BcsmCamelTDPDataList  SEQUENCE ( SIZE ( 1 .. 10 ) ) OF
    SEQUENCE {
        o-BcsmTriggerDetectionPoint  ENUMERATED {
            collectedInfo  ( 2 ),
            ... ,
            routeSelectFailure  ( 4 )},
        serviceKey  INTEGER ( 0 .. 2147483647 ),
        gsmSCF-Address  [0] IMPLICIT OCTET STRING ( SIZE ( 1 .. 20 ) ) ( SIZE ( 1 .. 9 ) ),
        defaultCallHandling  [1] IMPLICIT ENUMERATED {
            continueCall  ( 0 ),
            releaseCall  ( 1 ),
            ... },
        extensionContainer  [2] IMPLICIT SEQUENCE {
            privateExtensionList  [0] IMPLICIT SEQUENCE ( SIZE ( 1 .. 10 ) ) OF
            SEQUENCE {
                extId  MAP-EXTENSION .&extensionId ( {
                    '
                    ... } ),
                extType  MAP-EXTENSION .&ExtensionType ( {
                    '
                    ... } { @extId } ) OPTIONAL} OPTIONAL,
                pcs-Extensions  [1] IMPLICIT SEQUENCE {
                    ... } OPTIONAL,
                    ... } OPTIONAL,
                    ... } OPTIONAL,
                    ... },
            extensionContainer  SEQUENCE {
                privateExtensionList  [0] IMPLICIT SEQUENCE ( SIZE ( 1 .. 10 ) ) OF
                SEQUENCE {
                    extId  MAP-EXTENSION .&extensionId ( {
                        '
                        ... } ),
                    extType  MAP-EXTENSION .&ExtensionType ( {
                        '
                        ... } { @extId } ) OPTIONAL} OPTIONAL,
                    pcs-Extensions  [1] IMPLICIT SEQUENCE {
                        ... } OPTIONAL,
                        ... } OPTIONAL,
                        ... } OPTIONAL,
                        ... },
                camelCapabilityHandling  [0] IMPLICIT INTEGER ( 1 .. 16 ) OPTIONAL,
                notificationToCSE  [1] IMPLICIT NULL OPTIONAL,
                csiActive  [2] IMPLICIT NULL OPTIONAL} OPTIONAL,
                o-BcsmCamelTDP-CriteriaList  [1] IMPLICIT SEQUENCE ( SIZE ( 1 .. 10 ) ) OF
                SEQUENCE {
                    o-BcsmTriggerDetectionPoint  ENUMERATED {
                        collectedInfo  ( 2 ),
                        ... ,
                        routeSelectFailure  ( 4 )},
                    destinationNumberCriteria  [0] IMPLICIT SEQUENCE {
                        matchType  [0] IMPLICIT ENUMERATED {
                            inhibiting  ( 0 ),
                            enabling  ( 1 )},
                        destinationNumberList  [1] IMPLICIT SEQUENCE ( SIZE ( 1 .. 10 ) ) OF
                        OCTET STRING ( SIZE ( 1 .. 20 ) ) ( SIZE ( 1 .. 9 ) ) OPTIONAL,
                        destinationNumberLengthList  [2] IMPLICIT SEQUENCE ( SIZE ( 1 .. 3 ) ) OF
                        INTEGER ( 1 .. 15 ) OPTIONAL,
                        ... } OPTIONAL,
                    basicServiceCriteria  [1] IMPLICIT SEQUENCE ( SIZE ( 1 .. 5 ) ) OF
                    CHOICE {
                        ext-BearerService  [2] IMPLICIT OCTET STRING ( SIZE ( 1 .. 5 ) ),
                        ext-Teleservice  [3] IMPLICIT OCTET STRING ( SIZE ( 1 .. 5 ) )} OPTIONAL,
                    callTypeCriteria  [2] IMPLICIT ENUMERATED {
                        forwarded  ( 0 ),
                        notForwarded  ( 1 )} OPTIONAL,
                    ... ,
                    o-CauseValueCriteria  [3] IMPLICIT SEQUENCE ( SIZE ( 1 .. 5 ) ) OF

```

```

OCTET STRING ( SIZE ( 1 ) ) OPTIONAL,
extensionContainer [4] IMPLICIT SEQUENCE {
  privateExtensionList [0] IMPLICIT SEQUENCE ( SIZE ( 1 .. 10 ) ) OF
  SEQUENCE {
    extId MAP-EXTENSION .&extensionId ( {
      '
      ... } ),
    extType MAP-EXTENSION .&ExtensionType ( {
      '
      ... } { @extId } ) OPTIONAL} OPTIONAL,
  pcs-Extensions [1] IMPLICIT SEQUENCE {
    ... } OPTIONAL,
  ... } OPTIONAL} OPTIONAL,
d-CSI [2] IMPLICIT SEQUENCE {
  dp-AnalysedInfoCriteriaList [0] IMPLICIT SEQUENCE ( SIZE ( 1 .. 10 ) ) OF
  SEQUENCE {
    dialledNumber OCTET STRING ( SIZE ( 1 .. 20 ) ) ( SIZE ( 1 .. 9 ) ),
    serviceKey INTEGER ( 0 .. 2147483647 ),
    gsmSCF-Address OCTET STRING ( SIZE ( 1 .. 20 ) ) ( SIZE ( 1 .. 9 ) ),
    defaultCallHandling ENUMERATED {
      continueCall ( 0 ),
      releaseCall ( 1 ),
      ... },
    extensionContainer SEQUENCE {
      privateExtensionList [0] IMPLICIT SEQUENCE ( SIZE ( 1 .. 10 ) ) OF
      SEQUENCE {
        extId MAP-EXTENSION .&extensionId ( {
          '
          ... } ),
        extType MAP-EXTENSION .&ExtensionType ( {
          '
          ... } { @extId } ) OPTIONAL} OPTIONAL,
      pcs-Extensions [1] IMPLICIT SEQUENCE {
        ... } OPTIONAL,
        ... } OPTIONAL,
        ... } OPTIONAL,
    camelCapabilityHandling [1] IMPLICIT INTEGER ( 1 .. 16 ) OPTIONAL,
    extensionContainer [2] IMPLICIT SEQUENCE {
      privateExtensionList [0] IMPLICIT SEQUENCE ( SIZE ( 1 .. 10 ) ) OF
      SEQUENCE {
        extId MAP-EXTENSION .&extensionId ( {
          '
          ... } ),
        extType MAP-EXTENSION .&ExtensionType ( {
          '
          ... } { @extId } ) OPTIONAL} OPTIONAL,
      pcs-Extensions [1] IMPLICIT SEQUENCE {
        ... } OPTIONAL,
        ... } OPTIONAL,
        ... } OPTIONAL,
    notificationToCSE [3] IMPLICIT NULL OPTIONAL,
    csi-Active [4] IMPLICIT NULL OPTIONAL,
    ... } OPTIONAL,
  t-CSI [3] IMPLICIT SEQUENCE {
    t-BcsmCamelTDPDataList SEQUENCE ( SIZE ( 1 .. 10 ) ) OF
    SEQUENCE {
      t-BcsmTriggerDetectionPoint ENUMERATED {
        termAttemptAuthorized ( 12 ),
        ... ,
        tBusy ( 13 ),
        tNoAnswer ( 14 ) },
      serviceKey INTEGER ( 0 .. 2147483647 ),
      gsmSCF-Address [0] IMPLICIT OCTET STRING ( SIZE ( 1 .. 20 ) ) ( SIZE ( 1 .. 9 ) ),
      defaultCallHandling [1] IMPLICIT ENUMERATED {
        continueCall ( 0 ),
        releaseCall ( 1 ),
        ... },
      extensionContainer [2] IMPLICIT SEQUENCE {
        privateExtensionList [0] IMPLICIT SEQUENCE ( SIZE ( 1 .. 10 ) ) OF
        SEQUENCE {
          extId MAP-EXTENSION .&extensionId ( {
            '
            ... } ),
          extType MAP-EXTENSION .&ExtensionType ( {
            '
            ... } { @extId } ) OPTIONAL} OPTIONAL,
          pcs-Extensions [1] IMPLICIT SEQUENCE {
            ... } OPTIONAL,

```

```

... } OPTIONAL,
... },
extensionContainer SEQUENCE {
  privateExtensionList [0] IMPLICIT SEQUENCE ( SIZE ( 1 .. 10 ) ) OF
  SEQUENCE {
    extId MAP-EXTENSION .&extensionId ( {
      '
      ... } ),
    extType MAP-EXTENSION .&ExtensionType ( {
      '
      ... } { @extId } ) OPTIONAL } OPTIONAL,
  pcs-Extensions [1] IMPLICIT SEQUENCE {
    ... } OPTIONAL,
  ... } OPTIONAL,
... ,
camelCapabilityHandling [0] IMPLICIT INTEGER ( 1 .. 16 ) OPTIONAL,
notificationToCSE [1] IMPLICIT NULL OPTIONAL,
csi-Active [2] IMPLICIT NULL OPTIONAL } OPTIONAL,
t-BCSM-CAMEL-TDP-CriteriaList [4] IMPLICIT SEQUENCE ( SIZE ( 1 .. 10 ) ) OF
SEQUENCE {
  t-BCSM-TriggerDetectionPoint ENUMERATED {
    termAttemptAuthorized ( 12 ),
    ... ,
    tBusy ( 13 ),
    tNoAnswer ( 14 ) },
  basicServiceCriteria [0] IMPLICIT SEQUENCE ( SIZE ( 1 .. 5 ) ) OF
  CHOICE {
    ext-BearerService [2] IMPLICIT OCTET STRING ( SIZE ( 1 .. 5 ) ),
    ext-Teleservice [3] IMPLICIT OCTET STRING ( SIZE ( 1 .. 5 ) ) } OPTIONAL,
  t-CauseValueCriteria [1] IMPLICIT SEQUENCE ( SIZE ( 1 .. 5 ) ) OF
  OCTET STRING ( SIZE ( 1 ) ) OPTIONAL,
  ... } OPTIONAL,
vt-CSI [5] IMPLICIT SEQUENCE {
  t-BcsmCamelTDPDataList SEQUENCE ( SIZE ( 1 .. 10 ) ) OF
  SEQUENCE {
    t-BcsmTriggerDetectionPoint ENUMERATED {
      termAttemptAuthorized ( 12 ),
      ... ,
      tBusy ( 13 ),
      tNoAnswer ( 14 ) },
    serviceKey INTEGER ( 0 .. 2147483647 ),
    gsmSCF-Address [0] IMPLICIT OCTET STRING ( SIZE ( 1 .. 20 ) ) ( SIZE ( 1 .. 9 ) ),
    defaultCallHandling [1] IMPLICIT ENUMERATED {
      continueCall ( 0 ),
      releaseCall ( 1 ),
      ... },
    extensionContainer [2] IMPLICIT SEQUENCE {
      privateExtensionList [0] IMPLICIT SEQUENCE ( SIZE ( 1 .. 10 ) ) OF
      SEQUENCE {
        extId MAP-EXTENSION .&extensionId ( {
          '
          ... } ),
        extType MAP-EXTENSION .&ExtensionType ( {
          '
          ... } { @extId } ) OPTIONAL } OPTIONAL,
      pcs-Extensions [1] IMPLICIT SEQUENCE {
        ... } OPTIONAL,
      ... } OPTIONAL,
    ... },
  extensionContainer SEQUENCE {
    privateExtensionList [0] IMPLICIT SEQUENCE ( SIZE ( 1 .. 10 ) ) OF
    SEQUENCE {
      extId MAP-EXTENSION .&extensionId ( {
        '
        ... } ),
      extType MAP-EXTENSION .&ExtensionType ( {
        '
        ... } { @extId } ) OPTIONAL } OPTIONAL,
    pcs-Extensions [1] IMPLICIT SEQUENCE {
      ... } OPTIONAL,
    ... } OPTIONAL,
  ... ,
  camelCapabilityHandling [0] IMPLICIT INTEGER ( 1 .. 16 ) OPTIONAL,
  notificationToCSE [1] IMPLICIT NULL OPTIONAL,
  csi-Active [2] IMPLICIT NULL OPTIONAL } OPTIONAL,
vt-BCSM-CAMEL-TDP-CriteriaList [6] IMPLICIT SEQUENCE ( SIZE ( 1 .. 10 ) ) OF
SEQUENCE {

```

```

t-BCSM-TriggerDetectionPoint ENUMERATED {
  termAttemptAuthorized (12),
  ... ,
  tBusy (13),
  tNoAnswer (14)},
basicServiceCriteria [0] IMPLICIT SEQUENCE ( SIZE (1 .. 5) ) OF
CHOICE {
  ext-BearerService [2] IMPLICIT OCTET STRING ( SIZE (1 .. 5) ),
  ext-Teleservice [3] IMPLICIT OCTET STRING ( SIZE (1 .. 5) )} OPTIONAL,
t-CauseValueCriteria [1] IMPLICIT SEQUENCE ( SIZE (1 .. 5) ) OF
OCTET STRING ( SIZE (1) ) OPTIONAL,
... } OPTIONAL,
tif-CSI [7] IMPLICIT NULL OPTIONAL,
tif-CSI-NotificationToCSE [8] IMPLICIT NULL OPTIONAL,
gprs-CSI [9] IMPLICIT SEQUENCE {
  gprs-CamelTDPDataList [0] IMPLICIT SEQUENCE ( SIZE (1 .. 10) ) OF
SEQUENCE {
  gprs-TriggerDetectionPoint [0] IMPLICIT ENUMERATED {
    attach (1),
    attachChangeOfPosition (2),
    pdp-ContextEstablishment (11),
    pdp-ContextEstablishmentAcknowledgement (12),
    pdp-ContextChangeOfPosition (14),
    ... },
  serviceKey [1] IMPLICIT INTEGER ( 0 .. 2147483647 ),
  gsmSCF-Address [2] IMPLICIT OCTET STRING ( SIZE (1 .. 20) ) ( SIZE (1 .. 9) ),
  defaultSessionHandling [3] IMPLICIT ENUMERATED {
    continueTransaction (0),
    releaseTransaction (1),
    ... },
  extensionContainer [4] IMPLICIT SEQUENCE {
    privateExtensionList [0] IMPLICIT SEQUENCE ( SIZE (1 .. 10) ) OF
SEQUENCE {
      extId MAP-EXTENSION .&extensionId ( {
        '
        ... } ),
      extType MAP-EXTENSION .&ExtensionType ( {
        '
        ... } { @extId } ) OPTIONAL} OPTIONAL,
    pcs-Extensions [1] IMPLICIT SEQUENCE {
      ... } OPTIONAL,
      ... } OPTIONAL,
      ... } OPTIONAL,
      ... } OPTIONAL,
  camelCapabilityHandling [1] IMPLICIT INTEGER ( 1 .. 16 ) OPTIONAL,
  extensionContainer [2] IMPLICIT SEQUENCE {
    privateExtensionList [0] IMPLICIT SEQUENCE ( SIZE (1 .. 10) ) OF
SEQUENCE {
      extId MAP-EXTENSION .&extensionId ( {
        '
        ... } ),
      extType MAP-EXTENSION .&ExtensionType ( {
        '
        ... } { @extId } ) OPTIONAL} OPTIONAL,
    pcs-Extensions [1] IMPLICIT SEQUENCE {
      ... } OPTIONAL,
      ... } OPTIONAL,
      ... } OPTIONAL,
  notificationToCSE [3] IMPLICIT NULL OPTIONAL,
  csi-Active [4] IMPLICIT NULL OPTIONAL,
  ... } OPTIONAL,
mo-sms-CSI [10] IMPLICIT SEQUENCE {
  sms-CAMEL-TDP-DataList [0] IMPLICIT SEQUENCE ( SIZE (1 .. 10) ) OF
SEQUENCE {
  sms-TriggerDetectionPoint [0] IMPLICIT ENUMERATED {
    sms-CollectedInfo (1),
    ... ,
    sms-DeliveryRequest (2)},
  serviceKey [1] IMPLICIT INTEGER ( 0 .. 2147483647 ),
  gsmSCF-Address [2] IMPLICIT OCTET STRING ( SIZE (1 .. 20) ) ( SIZE (1 .. 9) ),
  defaultSMS-Handling [3] IMPLICIT ENUMERATED {
    continueTransaction (0),
    releaseTransaction (1),
    ... },
  extensionContainer [4] IMPLICIT SEQUENCE {
    privateExtensionList [0] IMPLICIT SEQUENCE ( SIZE (1 .. 10) ) OF
SEQUENCE {
      extId MAP-EXTENSION .&extensionId ( {
        '

```

```

        ...} ),
        extType MAP-EXTENSION .&ExtensionType ( {
            '
            ... } { @extId } ) OPTIONAL } OPTIONAL,
        pcs-Extensions [1] IMPLICIT SEQUENCE {
            ... } OPTIONAL,
            ... } OPTIONAL,
            ... } OPTIONAL,
        camelCapabilityHandling [1] IMPLICIT INTEGER ( 1 .. 16 ) OPTIONAL,
        extensionContainer [2] IMPLICIT SEQUENCE {
            privateExtensionList [0] IMPLICIT SEQUENCE ( SIZE ( 1 .. 10 ) ) OF
            SEQUENCE {
                extId MAP-EXTENSION .&extensionId ( {
                    '
                    ... } ),
                extType MAP-EXTENSION .&ExtensionType ( {
                    '
                    ... } { @extId } ) OPTIONAL } OPTIONAL,
                    pcs-Extensions [1] IMPLICIT SEQUENCE {
                        ... } OPTIONAL,
                        ... } OPTIONAL,
                        notificationToCSE [3] IMPLICIT NULL OPTIONAL,
                        csi-Active [4] IMPLICIT NULL OPTIONAL,
                        ... } OPTIONAL,
                    ss-CSI [11] IMPLICIT SEQUENCE {
                        ss-CamelData SEQUENCE {
                            ss-EventList SEQUENCE ( SIZE ( 1 .. 10 ) ) OF
                            OCTET STRING ( SIZE ( 1 ) ),
                            gsmSCF-Address OCTET STRING ( SIZE ( 1 .. 20 ) ) ( SIZE ( 1 .. 9 ) ),
                            extensionContainer [0] IMPLICIT SEQUENCE {
                                privateExtensionList [0] IMPLICIT SEQUENCE ( SIZE ( 1 .. 10 ) ) OF
                                SEQUENCE {
                                    extId MAP-EXTENSION .&extensionId ( {
                                        '
                                        ... } ),
                                    extType MAP-EXTENSION .&ExtensionType ( {
                                        '
                                        ... } { @extId } ) OPTIONAL } OPTIONAL,
                                        pcs-Extensions [1] IMPLICIT SEQUENCE {
                                            ... } OPTIONAL,
                                            ... } OPTIONAL,
                                        ... },
                                    extensionContainer SEQUENCE {
                                        privateExtensionList [0] IMPLICIT SEQUENCE ( SIZE ( 1 .. 10 ) ) OF
                                        SEQUENCE {
                                            extId MAP-EXTENSION .&extensionId ( {
                                                '
                                                ... } ),
                                            extType MAP-EXTENSION .&ExtensionType ( {
                                                '
                                                ... } { @extId } ) OPTIONAL } OPTIONAL,
                                                pcs-Extensions [1] IMPLICIT SEQUENCE {
                                                    ... } OPTIONAL,
                                                    ... } OPTIONAL,
                                                ... },
                                            notificationToCSE [0] IMPLICIT NULL OPTIONAL,
                                            csi-Active [1] IMPLICIT NULL OPTIONAL } OPTIONAL,
                                        m-CSI [12] IMPLICIT SEQUENCE {
                                            mobilityTriggers SEQUENCE ( SIZE ( 1 .. 10 ) ) OF
                                            OCTET STRING ( SIZE ( 1 ) ),
                                            serviceKey INTEGER ( 0 .. 2147483647 ),
                                            gsmSCF-Address [0] IMPLICIT OCTET STRING ( SIZE ( 1 .. 20 ) ) ( SIZE ( 1 .. 9 ) ),
                                            extensionContainer [1] IMPLICIT SEQUENCE {
                                                privateExtensionList [0] IMPLICIT SEQUENCE ( SIZE ( 1 .. 10 ) ) OF
                                                SEQUENCE {
                                                    extId MAP-EXTENSION .&extensionId ( {
                                                        '
                                                        ... } ),
                                                        extType MAP-EXTENSION .&ExtensionType ( {
                                                            '
                                                            ... } { @extId } ) OPTIONAL } OPTIONAL,
                                                            pcs-Extensions [1] IMPLICIT SEQUENCE {
                                                                ... } OPTIONAL,
                                                                ... } OPTIONAL,
                                                            notificationToCSE [2] IMPLICIT NULL OPTIONAL,
                                                            csi-Active [3] IMPLICIT NULL OPTIONAL,
                                                            ... } OPTIONAL,

```



```

extensionContainer      [13] IMPLICIT SEQUENCE {
  privateExtensionList [0] IMPLICIT SEQUENCE ( SIZE (1 .. 10) ) OF
  SEQUENCE {
    extId   MAP-EXTENSION .&extensionId ( {
      '
      ... } ),
    extType MAP-EXTENSION .&ExtensionType ( {
      '
      ... } { @extId } ) OPTIONAL} OPTIONAL,
  pcs-Extensions      [1] IMPLICIT SEQUENCE {
    ... } OPTIONAL,
  ... } OPTIONAL,
... ,
specificCSIDeletedList [14] IMPLICIT BIT STRING {
  o-csi (0),
  ss-csi (1),
  tif-csi (2),
  d-csi (3),
  vt-csi (4),
  mo-sms-csi (5),
  m-csi (6),
  gprs-csi (7),
  t-csi (8),
  mt-sms-csi (9),
  mg-csi (10) } ( SIZE (8 .. 32) ) OPTIONAL,
mt-sms-CSI             [15] IMPLICIT SEQUENCE {
  sms-CAMEL-TDP-DataList [0] IMPLICIT SEQUENCE ( SIZE (1 .. 10) ) OF
  SEQUENCE {
    sms-TriggerDetectionPoint [0] IMPLICIT ENUMERATED {
      sms-CollectedInfo (1),
      ... ,
      sms-DeliveryRequest (2) },
    serviceKey [1] IMPLICIT INTEGER (0 .. 2147483647),
    gsmSCF-Address [2] IMPLICIT OCTET STRING ( SIZE (1 .. 20) ) ( SIZE (1 .. 9) ),
    defaultSMS-Handling [3] IMPLICIT ENUMERATED {
      continueTransaction (0),
      releaseTransaction (1),
      ... },
    extensionContainer [4] IMPLICIT SEQUENCE {
      privateExtensionList [0] IMPLICIT SEQUENCE ( SIZE (1 .. 10) ) OF
      SEQUENCE {
        extId   MAP-EXTENSION .&extensionId ( {
          '
          ... } ),
        extType MAP-EXTENSION .&ExtensionType ( {
          '
          ... } { @extId } ) OPTIONAL} OPTIONAL,
      pcs-Extensions [1] IMPLICIT SEQUENCE {
        ... } OPTIONAL,
      ... } OPTIONAL,
      ... } OPTIONAL,
    camelCapabilityHandling [1] IMPLICIT INTEGER (1 .. 16) OPTIONAL,
    extensionContainer [2] IMPLICIT SEQUENCE {
      privateExtensionList [0] IMPLICIT SEQUENCE ( SIZE (1 .. 10) ) OF
      SEQUENCE {
        extId   MAP-EXTENSION .&extensionId ( {
          '
          ... } ),
        extType MAP-EXTENSION .&ExtensionType ( {
          '
          ... } { @extId } ) OPTIONAL} OPTIONAL,
      pcs-Extensions [1] IMPLICIT SEQUENCE {
        ... } OPTIONAL,
        ... } OPTIONAL,
      notificationToCSE [3] IMPLICIT NULL OPTIONAL,
      csi-Active [4] IMPLICIT NULL OPTIONAL,
      ... } OPTIONAL,
    mt-smsCAMELTDP-CriteriaList [16] IMPLICIT SEQUENCE ( SIZE (1 .. 10) ) OF
    SEQUENCE {
      sms-TriggerDetectionPoint ENUMERATED {
        sms-CollectedInfo (1),
        ... ,
        sms-DeliveryRequest (2) },
      tpdu-TypeCriterion [0] IMPLICIT SEQUENCE ( SIZE (1 .. 5) ) OF
      ENUMERATED {
        sms-DELIVER (0),
        sms-SUBMIT-REPORT (1),

```

```

        sms-STATUS-REPORT (2),
        ... } OPTIONAL,
    ... } OPTIONAL,
mg-csi [17] IMPLICIT SEQUENCE {
    mobilityTriggers SEQUENCE ( SIZE (1 .. 10) ) OF
        OCTET STRING ( SIZE (1) ),
    serviceKey INTEGER ( 0 .. 2147483647 ),
    gsmSCF-Address [0] IMPLICIT OCTET STRING ( SIZE (1 .. 20) ) ( SIZE (1 .. 9) ),
    extensionContainer [1] IMPLICIT SEQUENCE {
        privateExtensionList [0] IMPLICIT SEQUENCE ( SIZE (1 .. 10) ) OF
            SEQUENCE {
                extId MAP-EXTENSION .&extensionId ( {
                    '
                    ... } ),
                extType MAP-EXTENSION .&ExtensionType ( {
                    '
                    ... } { @extId } ) OPTIONAL } OPTIONAL,
        pcs-Extensions [1] IMPLICIT SEQUENCE {
            ... } OPTIONAL,
        ... } OPTIONAL,
    notificationToCSE [2] IMPLICIT NULL OPTIONAL,
    csi-Active [3] IMPLICIT NULL OPTIONAL,
    ... } OPTIONAL } OPTIONAL,
extensionContainer [2] IMPLICIT SEQUENCE {
    privateExtensionList [0] IMPLICIT SEQUENCE ( SIZE (1 .. 10) ) OF
        SEQUENCE {
            extId MAP-EXTENSION .&extensionId ( {
                '
                ... } ),
            extType MAP-EXTENSION .&ExtensionType ( {
                '
                ... } { @extId } ) OPTIONAL } OPTIONAL,
    pcs-Extensions [1] IMPLICIT SEQUENCE {
        ... } OPTIONAL,
    ... } OPTIONAL,
... ,
odb-Info [3] IMPLICIT SEQUENCE {
    odb-Data SEQUENCE {
        odb-GeneralData BIT STRING {
            allOG-CallsBarred (0),
            internationalOGCallsBarred (1),
            internationalOGCallsNotToHPLMN-CountryBarred (2),
            interzonalOGCallsBarred (6),
            interzonalOGCallsNotToHPLMN-CountryBarred (7),
            interzonalOGCallsAndInternationalOGCallsNotToHPLMN-CountryBarred (8),
            premiumRateInformationOGCallsBarred (3),
            premiumRateEntertainmentOGCallsBarred (4),
            ss-AccessBarred (5),
            allECT-Barred (9),
            chargeableECT-Barred (10),
            internationalECT-Barred (11),
            interzonalECT-Barred (12),
            doublyChargeableECT-Barred (13),
            multipleECT-Barred (14),
            allPacketOrientedServicesBarred (15),
            roamerAccessToHPLMN-AP-Barred (16),
            roamerAccessToVPLMN-AP-Barred (17),
            roamingOutsidePLMNOG-CallsBarred (18),
            allIC-CallsBarred (19),
            roamingOutsidePLMNIC-CallsBarred (20),
            roamingOutsidePLMNICountryIC-CallsBarred (21),
            roamingOutsidePLMN-Barred (22),
            roamingOutsidePLMN-CountryBarred (23),
            registrationAllCF-Barred (24),
            registrationCFNotToHPLMN-Barred (25),
            registrationInterzonalCF-Barred (26),
            registrationInterzonalCFNotToHPLMN-Barred (27) } ( SIZE (15 .. 32) ),
        odb-HPLMN-Data BIT STRING {
            plmn-SpecificBarringType1 (0),
            plmn-SpecificBarringType2 (1),
            plmn-SpecificBarringType3 (2),
            plmn-SpecificBarringType4 (3) } ( SIZE (4 .. 32) ) OPTIONAL,
        extensionContainer SEQUENCE {
            privateExtensionList [0] IMPLICIT SEQUENCE ( SIZE (1 .. 10) ) OF
                SEQUENCE {
                    extId MAP-EXTENSION .&extensionId ( {
                        '
                    ... } ),
                    extType MAP-EXTENSION .&ExtensionType ( {
                        '
                        ... } { @extId } ) OPTIONAL } OPTIONAL,
                pcs-Extensions [1] IMPLICIT SEQUENCE {
                    ... } OPTIONAL,
                ... } OPTIONAL,
            ... } OPTIONAL,
        ... } OPTIONAL,
    ... } OPTIONAL,
}

```

```

    ...} ),
    extType MAP-EXTENSION .&ExtensionType ( {
        '
        ...} { @extId } ) OPTIONAL} OPTIONAL,
    pcs-Extensions [1] IMPLICIT SEQUENCE {
        ... } OPTIONAL,
        ... } OPTIONAL,
    ... },
    notificationToCSE NULL OPTIONAL,
    extensionContainer SEQUENCE {
        privateExtensionList [0] IMPLICIT SEQUENCE ( SIZE ( 1 .. 10 ) ) OF
        SEQUENCE {
            extId MAP-EXTENSION .&extensionId ( {
                '
                ...} ),
            extType MAP-EXTENSION .&ExtensionType ( {
                '
                ...} { @extId } ) OPTIONAL} OPTIONAL,
            pcs-Extensions [1] IMPLICIT SEQUENCE {
                ... } OPTIONAL,
                ... } OPTIONAL,
                ... } OPTIONAL,
                ... } OPTIONAL
        }
    }
ERRORS {
-- atm-NotAllowed -- localValue : 61,
-- dataMissing -- localValue : 35,
-- unexpectedDataValue -- localValue : 36,
-- unknownSubscriber -- localValue : 1,
-- bearerServiceNotProvisioned -- localValue : 10,
-- teleserviceNotProvisioned -- localValue : 11,
-- callBarred -- localValue : 13,
-- illegalSS-Operation -- localValue : 16,
-- ss-SubscriptionViolation -- localValue : 19,
-- ss-ErrorStatus -- localValue : 17,
-- ss-Incompatibility -- localValue : 20,
-- informationNotAvailable -- localValue : 62
 ::= localValue : 65
}

noteSubscriberDataModified OPERATION
ARGUMENT
noteSubscriberDataModifiedArg SEQUENCE {
    imsi OCTET STRING ( SIZE ( 3 .. 8 ) ),
    msisdn OCTET STRING ( SIZE ( 1 .. 20 ) ) ( SIZE ( 1 .. 9 ) ),
    forwardingInfoFor-CSE [0] IMPLICIT SEQUENCE {
        ss-Code [0] IMPLICIT OCTET STRING ( SIZE ( 1 ) ),
        forwardingFeatureList [1] IMPLICIT SEQUENCE ( SIZE ( 1 .. 32 ) ) OF
        SEQUENCE {
            basicService CHOICE {
                ext-BearerService [2] IMPLICIT OCTET STRING ( SIZE ( 1 .. 5 ) ),
                ext-Teleservice [3] IMPLICIT OCTET STRING ( SIZE ( 1 .. 5 ) )} OPTIONAL,
                ss-Status [4] IMPLICIT OCTET STRING ( SIZE ( 1 .. 5 ) ),
                forwardedToNumber [5] IMPLICIT OCTET STRING ( SIZE ( 1 .. 20 ) ) ( SIZE ( 1 .. 9 ) ) OPTIONAL,
                forwardedToSubaddress [8] IMPLICIT OCTET STRING ( SIZE ( 1 .. 21 ) ) OPTIONAL,
                forwardingOptions [6] IMPLICIT OCTET STRING ( SIZE ( 1 .. 5 ) ) OPTIONAL,
                noReplyConditionTime [7] IMPLICIT INTEGER ( 1 .. 100 ) OPTIONAL,
                extensionContainer [9] IMPLICIT SEQUENCE {
                    privateExtensionList [0] IMPLICIT SEQUENCE ( SIZE ( 1 .. 10 ) ) OF
                    SEQUENCE {
                        extId MAP-EXTENSION .&extensionId ( {
                            '
                            ...} ),
                        extType MAP-EXTENSION .&ExtensionType ( {
                            '
                            ...} { @extId } ) OPTIONAL} OPTIONAL,
                            pcs-Extensions [1] IMPLICIT SEQUENCE {
                                ... } OPTIONAL,
                                ... } OPTIONAL,
                                ... } OPTIONAL,
                                ... } OPTIONAL
                    }
                }
            },
            longForwardedToNumber [10] IMPLICIT OCTET STRING ( SIZE ( 1 .. 20 ) ) ( SIZE ( 1 .. 15 ) ) OPTIONAL,
            notificationToCSE [2] IMPLICIT NULL OPTIONAL,
            extensionContainer [3] IMPLICIT SEQUENCE {
                privateExtensionList [0] IMPLICIT SEQUENCE ( SIZE ( 1 .. 10 ) ) OF
                SEQUENCE {
                    extId MAP-EXTENSION .&extensionId ( {
                        '
                        ...} ),
                    extType MAP-EXTENSION .&ExtensionType ( {
                            '
                            ...} { @extId } ) OPTIONAL} OPTIONAL,
                            pcs-Extensions [1] IMPLICIT SEQUENCE {
                                ... } OPTIONAL,
                                ... } OPTIONAL,
                                ... } OPTIONAL,
                                ... } OPTIONAL
                    }
                }
            }
        }
    }
}

```

```

        ...} { @extld } ) OPTIONAL} OPTIONAL,
    pcs-Extensions [1] IMPLICIT SEQUENCE {
        ... } OPTIONAL,
        ... } OPTIONAL,
        ... } OPTIONAL,
    callBarringInfoFor-CSE [1] IMPLICIT SEQUENCE {
        ss-Code [0] IMPLICIT OCTET STRING ( SIZE ( 1 ) ),
        callBarringFeatureList [1] IMPLICIT SEQUENCE ( SIZE ( 1 .. 32 ) ) OF
        SEQUENCE {
            basicService CHOICE {
                ext-BearerService [2] IMPLICIT OCTET STRING ( SIZE ( 1 .. 5 ) ),
                ext-Teleservice [3] IMPLICIT OCTET STRING ( SIZE ( 1 .. 5 ) )} OPTIONAL,
            ss-Status [4] IMPLICIT OCTET STRING ( SIZE ( 1 .. 5 ) ),
            extensionContainer SEQUENCE {
                privateExtensionList [0] IMPLICIT SEQUENCE ( SIZE ( 1 .. 10 ) ) OF
                SEQUENCE {
                    extld MAP-EXTENSION .&extensionId ( {
                        '
                        ...} ),
                    extType MAP-EXTENSION .&ExtensionType ( {
                        '
                        ...} { @extld } ) OPTIONAL} OPTIONAL,
                pcs-Extensions [1] IMPLICIT SEQUENCE {
                    ... } OPTIONAL,
                    ... } OPTIONAL,
                    ... } OPTIONAL,
                    ... },
                password [2] IMPLICIT NumericString ( FROM ("0"|"1"|"2"|"3"|"4"|"5"|"6"|"7"|"8"|"9" ) ) ( SIZE ( 4 ) ) OPTIONAL,
                wrongPasswordAttemptsCounter [3] IMPLICIT INTEGER ( 0 .. 4 ) OPTIONAL,
                notificationToCSE [4] IMPLICIT NULL OPTIONAL,
                extensionContainer [5] IMPLICIT SEQUENCE {
                    privateExtensionList [0] IMPLICIT SEQUENCE ( SIZE ( 1 .. 10 ) ) OF
                    SEQUENCE {
                        extld MAP-EXTENSION .&extensionId ( {
                            '
                            ...} ),
                        extType MAP-EXTENSION .&ExtensionType ( {
                            '
                            ...} { @extld } ) OPTIONAL} OPTIONAL,
                    pcs-Extensions [1] IMPLICIT SEQUENCE {
                        ... } OPTIONAL,
                        ... } OPTIONAL,
                        ... } OPTIONAL,
                        ... } OPTIONAL,
                odb-Info [2] IMPLICIT SEQUENCE {
                odb-Data SEQUENCE {
                    odb-GeneralData BIT STRING {
                        allOG-CallsBarred ( 0 ),
                        internationalOGCallsBarred ( 1 ),
                        internationalOGCallsNotToHPLMN-CountryBarred ( 2 ),
                        interzonalOGCallsBarred ( 6 ),
                        interzonalOGCallsNotToHPLMN-CountryBarred ( 7 ),
                        interzonalOGCallsAndInternationalOGCallsNotToHPLMN-CountryBarred ( 8 ),
                        premiumRateInformationOGCallsBarred ( 3 ),
                        premiumRateEntertainmentOGCallsBarred ( 4 ),
                        ss-AccessBarred ( 5 ),
                        allECT-Barred ( 9 ),
                        chargeableECT-Barred ( 10 ),
                        internationalECT-Barred ( 11 ),
                        interzonalECT-Barred ( 12 ),
                        doublyChargeableECT-Barred ( 13 ),
                        multipleECT-Barred ( 14 ),
                        allPacketOrientedServicesBarred ( 15 ),
                        roamerAccessToHPLMN-AP-Barred ( 16 ),
                        roamerAccessToVPLMN-AP-Barred ( 17 ),
                        roamingOutsidePLMNOG-CallsBarred ( 18 ),
                        allIC-CallsBarred ( 19 ),
                        roamingOutsidePLMNIC-CallsBarred ( 20 ),
                        roamingOutsidePLMNICountryIC-CallsBarred ( 21 ),
                        roamingOutsidePLMN-Barred ( 22 ),
                        roamingOutsidePLMN-CountryBarred ( 23 ),
                        registrationAllICF-Barred ( 24 ),
                        registrationCFNotToHPLMN-Barred ( 25 ),
                        registrationInterzonalCF-Barred ( 26 ),
                        registrationInterzonalCFNotToHPLMN-Barred ( 27 )} ( SIZE ( 15 .. 32 ) ),
                    odb-HPLMN-Data BIT STRING {
                        plmn-SpecificBarringType1 ( 0 ),
                        plmn-SpecificBarringType2 ( 1 ),
                        plmn-SpecificBarringType3 ( 2 ),

```

```

    plmn-SpecificBarringType4 (3) ( SIZE (4 .. 32) ) OPTIONAL,
    extensionContainer SEQUENCE {
      privateExtensionList [0] IMPLICIT SEQUENCE ( SIZE (1 .. 10) ) OF
        SEQUENCE {
          extId MAP-EXTENSION .&extensionId ( {
            '
            ... } ),
          extType MAP-EXTENSION .&ExtensionType ( {
            '
            ... } { @extId } ) OPTIONAL } OPTIONAL,
      pcs-Extensions [1] IMPLICIT SEQUENCE {
        ... } OPTIONAL,
        ... } OPTIONAL,
        ... } OPTIONAL,
    },
    notificationToCSE NULL OPTIONAL,
    extensionContainer SEQUENCE {
      privateExtensionList [0] IMPLICIT SEQUENCE ( SIZE (1 .. 10) ) OF
        SEQUENCE {
          extId MAP-EXTENSION .&extensionId ( {
            '
            ... } ),
          extType MAP-EXTENSION .&ExtensionType ( {
            '
            ... } { @extId } ) OPTIONAL } OPTIONAL,
      pcs-Extensions [1] IMPLICIT SEQUENCE {
        ... } OPTIONAL,
        ... } OPTIONAL,
        ... } OPTIONAL,
    },
    camel-SubscriptionInfo [3] IMPLICIT SEQUENCE {
      o-CSI [0] IMPLICIT SEQUENCE {
        o-BcsmCamelTDPDataList SEQUENCE ( SIZE (1 .. 10) ) OF
          SEQUENCE {
            o-BcsmTriggerDetectionPoint ENUMERATED {
              collectedInfo (2),
              ... ,
              routeSelectFailure (4) },
            serviceKey INTEGER (0 .. 2147483647),
            gsmSCF-Address [0] IMPLICIT OCTET STRING ( SIZE (1 .. 20) ) ( SIZE (1 .. 9) ),
            defaultCallHandling [1] IMPLICIT ENUMERATED {
              continueCall (0),
              releaseCall (1),
              ... },
            extensionContainer [2] IMPLICIT SEQUENCE {
              privateExtensionList [0] IMPLICIT SEQUENCE ( SIZE (1 .. 10) ) OF
                SEQUENCE {
                  extId MAP-EXTENSION .&extensionId ( {
                    '
                    ... } ),
                  extType MAP-EXTENSION .&ExtensionType ( {
                    '
                    ... } { @extId } ) OPTIONAL } OPTIONAL,
              pcs-Extensions [1] IMPLICIT SEQUENCE {
                ... } OPTIONAL,
                ... } OPTIONAL,
                ... } OPTIONAL,
            },
            extensionContainer SEQUENCE {
              privateExtensionList [0] IMPLICIT SEQUENCE ( SIZE (1 .. 10) ) OF
                SEQUENCE {
                  extId MAP-EXTENSION .&extensionId ( {
                    '
                    ... } ),
                  extType MAP-EXTENSION .&ExtensionType ( {
                    '
                    ... } { @extId } ) OPTIONAL } OPTIONAL,
              pcs-Extensions [1] IMPLICIT SEQUENCE {
                ... } OPTIONAL,
                ... } OPTIONAL,
                ... } OPTIONAL,
            },
            camelCapabilityHandling [0] IMPLICIT INTEGER (1 .. 16) OPTIONAL,
            notificationToCSE [1] IMPLICIT NULL OPTIONAL,
            csiActive [2] IMPLICIT NULL OPTIONAL } OPTIONAL,
      o-BcsmCamelTDP-CriteriaList [1] IMPLICIT SEQUENCE ( SIZE (1 .. 10) ) OF
        SEQUENCE {
          o-BcsmTriggerDetectionPoint ENUMERATED {
            collectedInfo (2),
            ... ,
            routeSelectFailure (4) },

```

```

destinationNumberCriteria [0] IMPLICIT SEQUENCE {
  matchType [0] IMPLICIT ENUMERATED {
    inhibiting (0),
    enabling (1)},
  destinationNumberList [1] IMPLICIT SEQUENCE ( SIZE (1 .. 10) ) OF
    OCTET STRING ( SIZE (1 .. 20) ) ( SIZE (1 .. 9) ) OPTIONAL,
  destinationNumberLengthList [2] IMPLICIT SEQUENCE ( SIZE (1 .. 3) ) OF
    INTEGER (1 .. 15) OPTIONAL,
  ... } OPTIONAL,
basicServiceCriteria [1] IMPLICIT SEQUENCE ( SIZE (1 .. 5) ) OF
  CHOICE {
    ext-BearerService [2] IMPLICIT OCTET STRING ( SIZE (1 .. 5) ),
    ext-Teleservice [3] IMPLICIT OCTET STRING ( SIZE (1 .. 5) )} OPTIONAL,
callTypeCriteria [2] IMPLICIT ENUMERATED {
  forwarded (0),
  notForwarded (1) } OPTIONAL,
... ,
o-CauseValueCriteria [3] IMPLICIT SEQUENCE ( SIZE (1 .. 5) ) OF
  OCTET STRING ( SIZE (1) ) OPTIONAL,
extensionContainer [4] IMPLICIT SEQUENCE {
  privateExtensionList [0] IMPLICIT SEQUENCE ( SIZE (1 .. 10) ) OF
    SEQUENCE {
      extId MAP-EXTENSION .&extensionId ( {
        '
        ... } ),
      extType MAP-EXTENSION .&ExtensionType ( {
        '
        ... } { @extId } ) OPTIONAL} OPTIONAL,
  pcs-Extensions [1] IMPLICIT SEQUENCE {
    ... } OPTIONAL,
  ... } OPTIONAL} OPTIONAL,
d-CSI [2] IMPLICIT SEQUENCE {
  dp-AnalysedInfoCriteriaList [0] IMPLICIT SEQUENCE ( SIZE (1 .. 10) ) OF
    SEQUENCE {
      dialledNumber OCTET STRING ( SIZE (1 .. 20) ) ( SIZE (1 .. 9) ),
      serviceKey INTEGER ( 0 .. 2147483647 ),
      gsmSCF-Address OCTET STRING ( SIZE (1 .. 20) ) ( SIZE (1 .. 9) ),
      defaultCallHandling ENUMERATED {
        continueCall (0),
        releaseCall (1),
        ... },
      extensionContainer SEQUENCE {
        privateExtensionList [0] IMPLICIT SEQUENCE ( SIZE (1 .. 10) ) OF
          SEQUENCE {
            extId MAP-EXTENSION .&extensionId ( {
              '
              ... } ),
            extType MAP-EXTENSION .&ExtensionType ( {
              '
              ... } { @extId } ) OPTIONAL} OPTIONAL,
        pcs-Extensions [1] IMPLICIT SEQUENCE {
          ... } OPTIONAL,
          ... } OPTIONAL,
          ... } OPTIONAL,
        camelCapabilityHandling [1] IMPLICIT INTEGER (1 .. 16) OPTIONAL,
        extensionContainer [2] IMPLICIT SEQUENCE {
          privateExtensionList [0] IMPLICIT SEQUENCE ( SIZE (1 .. 10) ) OF
            SEQUENCE {
              extId MAP-EXTENSION .&extensionId ( {
                '
                ... } ),
              extType MAP-EXTENSION .&ExtensionType ( {
                '
                ... } { @extId } ) OPTIONAL} OPTIONAL,
          pcs-Extensions [1] IMPLICIT SEQUENCE {
            ... } OPTIONAL,
            ... } OPTIONAL,
            ... } OPTIONAL,
          notificationToCSE [3] IMPLICIT NULL OPTIONAL,
          csi-Active [4] IMPLICIT NULL OPTIONAL,
          ... } OPTIONAL,
        t-CSI [3] IMPLICIT SEQUENCE {
          t-BcsmCamelTDPDataList SEQUENCE ( SIZE (1 .. 10) ) OF
            SEQUENCE {
              t-BcsmTriggerDetectionPoint ENUMERATED {
                termAttemptAuthorized (12),
                ... ,
                tBusy (13),

```

```

    tNoAnswer          (14)),
    serviceKey         INTEGER ( 0 .. 2147483647 ),
    gsmSCF-Address     [0] IMPLICIT OCTET STRING ( SIZE (1 .. 20) ) ( SIZE (1 .. 9) ),
    defaultCallHandling [1] IMPLICIT ENUMERATED {
    continueCall (0),
    releaseCall (1),
    ... },
    extensionContainer [2] IMPLICIT SEQUENCE {
    privateExtensionList [0] IMPLICIT SEQUENCE ( SIZE (1 .. 10) ) OF
    SEQUENCE {
    extId MAP-EXTENSION .&extensionId ( {
    '
    ... } ),
    extType MAP-EXTENSION .&ExtensionType ( {
    '
    ... } { @extId } ) OPTIONAL} OPTIONAL,
    pcs-Extensions [1] IMPLICIT SEQUENCE {
    ... } OPTIONAL,
    ... } OPTIONAL,
    ... },
    extensionContainer SEQUENCE {
    privateExtensionList [0] IMPLICIT SEQUENCE ( SIZE (1 .. 10) ) OF
    SEQUENCE {
    extId MAP-EXTENSION .&extensionId ( {
    '
    ... } ),
    extType MAP-EXTENSION .&ExtensionType ( {
    '
    ... } { @extId } ) OPTIONAL} OPTIONAL,
    pcs-Extensions [1] IMPLICIT SEQUENCE {
    ... } OPTIONAL,
    ... } OPTIONAL,
    ... },
    camelCapabilityHandling [0] IMPLICIT INTEGER ( 1 .. 16 ) OPTIONAL,
    notificationToCSE [1] IMPLICIT NULL OPTIONAL,
    csi-Active [2] IMPLICIT NULL OPTIONAL} OPTIONAL,
    t-BCSM-CAMEL-TDP-CriteriaList [4] IMPLICIT SEQUENCE ( SIZE (1 .. 10) ) OF
    SEQUENCE {
    t-BCSM-TriggerDetectionPoint ENUMERATED {
    termAttemptAuthorized (12),
    ... ,
    tBusy (13),
    tNoAnswer (14)),
    basicServiceCriteria [0] IMPLICIT SEQUENCE ( SIZE (1 .. 5) ) OF
    CHOICE {
    ext-BearerService [2] IMPLICIT OCTET STRING ( SIZE (1 .. 5) ),
    ext-Teleservice [3] IMPLICIT OCTET STRING ( SIZE (1 .. 5) )} OPTIONAL,
    t-CauseValueCriteria [1] IMPLICIT SEQUENCE ( SIZE (1 .. 5) ) OF
    OCTET STRING ( SIZE (1) ) OPTIONAL,
    ... } OPTIONAL,
    vt-CSI [5] IMPLICIT SEQUENCE {
    t-BcsmCamelTDPDataList SEQUENCE ( SIZE (1 .. 10) ) OF
    SEQUENCE {
    t-BcsmTriggerDetectionPoint ENUMERATED {
    termAttemptAuthorized (12),
    ... ,
    tBusy (13),
    tNoAnswer (14)),
    serviceKey INTEGER ( 0 .. 2147483647 ),
    gsmSCF-Address [0] IMPLICIT OCTET STRING ( SIZE (1 .. 20) ) ( SIZE (1 .. 9) ),
    defaultCallHandling [1] IMPLICIT ENUMERATED {
    continueCall (0),
    releaseCall (1),
    ... },
    extensionContainer [2] IMPLICIT SEQUENCE {
    privateExtensionList [0] IMPLICIT SEQUENCE ( SIZE (1 .. 10) ) OF
    SEQUENCE {
    extId MAP-EXTENSION .&extensionId ( {
    '
    ... } ),
    extType MAP-EXTENSION .&ExtensionType ( {
    '
    ... } { @extId } ) OPTIONAL} OPTIONAL,
    pcs-Extensions [1] IMPLICIT SEQUENCE {
    ... } OPTIONAL,
    ... } OPTIONAL,
    ... },

```

```

extensionContainer SEQUENCE {
  privateExtensionList [0] IMPLICIT SEQUENCE ( SIZE ( 1 .. 10 ) ) OF
  SEQUENCE {
    extId MAP-EXTENSION .&extensionId ( {
      '
      ... } ),
    extType MAP-EXTENSION .&ExtensionType ( {
      '
      ... } { @extId } ) OPTIONAL } OPTIONAL,
  pcs-Extensions [1] IMPLICIT SEQUENCE {
    ... } OPTIONAL,
  ... } OPTIONAL,
... ,
camelCapabilityHandling [0] IMPLICIT INTEGER ( 1 .. 16 ) OPTIONAL,
notificationToCSE [1] IMPLICIT NULL OPTIONAL,
csi-Active [2] IMPLICIT NULL OPTIONAL } OPTIONAL,
vt-BCSM-CAMEL-TDP-CriteriaList [6] IMPLICIT SEQUENCE ( SIZE ( 1 .. 10 ) ) OF
SEQUENCE {
  t-BCSM-TriggerDetectionPoint ENUMERATED {
    termAttemptAuthorized ( 12 ),
    ... ,
    tBusy ( 13 ),
    tNoAnswer ( 14 ) },
  basicServiceCriteria [0] IMPLICIT SEQUENCE ( SIZE ( 1 .. 5 ) ) OF
  CHOICE {
    ext-BearerService [2] IMPLICIT OCTET STRING ( SIZE ( 1 .. 5 ) ),
    ext-Teleservice [3] IMPLICIT OCTET STRING ( SIZE ( 1 .. 5 ) ) } OPTIONAL,
  t-CauseValueCriteria [1] IMPLICIT SEQUENCE ( SIZE ( 1 .. 5 ) ) OF
  OCTET STRING ( SIZE ( 1 ) ) OPTIONAL,
  ... } OPTIONAL,
tif-CSI [7] IMPLICIT NULL OPTIONAL,
tif-CSI-NotificationToCSE [8] IMPLICIT NULL OPTIONAL,
gprs-CSI [9] IMPLICIT SEQUENCE {
  gprs-CamelTDPDataList [0] IMPLICIT SEQUENCE ( SIZE ( 1 .. 10 ) ) OF
  SEQUENCE {
    gprs-TriggerDetectionPoint [0] IMPLICIT ENUMERATED {
      attach ( 1 ),
      attachChangeOfPosition ( 2 ),
      pdp-ContextEstablishment ( 11 ),
      pdp-ContextEstablishmentAcknowledgement ( 12 ),
      pdp-ContextChangeOfPosition ( 14 ),
      ... },
    serviceKey [1] IMPLICIT INTEGER ( 0 .. 2147483647 ),
    gsmSCF-Address [2] IMPLICIT OCTET STRING ( SIZE ( 1 .. 20 ) ) ( SIZE ( 1 .. 9 ) ),
    defaultSessionHandling [3] IMPLICIT ENUMERATED {
      continueTransaction ( 0 ),
      releaseTransaction ( 1 ),
      ... },
    extensionContainer [4] IMPLICIT SEQUENCE {
      privateExtensionList [0] IMPLICIT SEQUENCE ( SIZE ( 1 .. 10 ) ) OF
      SEQUENCE {
        extId MAP-EXTENSION .&extensionId ( {
          '
          ... } ),
        extType MAP-EXTENSION .&ExtensionType ( {
          '
          ... } { @extId } ) OPTIONAL } OPTIONAL,
      pcs-Extensions [1] IMPLICIT SEQUENCE {
        ... } OPTIONAL,
        ... } OPTIONAL,
        ... } OPTIONAL,
      camelCapabilityHandling [1] IMPLICIT INTEGER ( 1 .. 16 ) OPTIONAL,
      extensionContainer [2] IMPLICIT SEQUENCE {
        privateExtensionList [0] IMPLICIT SEQUENCE ( SIZE ( 1 .. 10 ) ) OF
        SEQUENCE {
          extId MAP-EXTENSION .&extensionId ( {
            '
            ... } ),
            extType MAP-EXTENSION .&ExtensionType ( {
              '
              ... } { @extId } ) OPTIONAL } OPTIONAL,
            pcs-Extensions [1] IMPLICIT SEQUENCE {
              ... } OPTIONAL,
              ... } OPTIONAL,
              notificationToCSE [3] IMPLICIT NULL OPTIONAL,
              csi-Active [4] IMPLICIT NULL OPTIONAL,
              ... } OPTIONAL,

```



```

mo-sms-CSI [10] IMPLICIT SEQUENCE {
  sms-CAMEL-TDP-DataList [0] IMPLICIT SEQUENCE ( SIZE (1 .. 10) ) OF
  SEQUENCE {
    sms-TriggerDetectionPoint [0] IMPLICIT ENUMERATED {
      sms-CollectedInfo (1),
      ... ,
      sms-DeliveryRequest (2)},
    serviceKey [1] IMPLICIT INTEGER (0 .. 2147483647),
    gsmSCF-Address [2] IMPLICIT OCTET STRING ( SIZE (1 .. 20) ) ( SIZE (1 .. 9) ),
    defaultSMS-Handling [3] IMPLICIT ENUMERATED {
      continueTransaction (0),
      releaseTransaction (1),
      ... },
    extensionContainer [4] IMPLICIT SEQUENCE {
      privateExtensionList [0] IMPLICIT SEQUENCE ( SIZE (1 .. 10) ) OF
      SEQUENCE {
        extId MAP-EXTENSION .&extensionId ( {
          '
          ... } ),
        extType MAP-EXTENSION .&ExtensionType ( {
          '
          ... } { @extId } ) OPTIONAL} OPTIONAL,
      pcs-Extensions [1] IMPLICIT SEQUENCE {
        ... } OPTIONAL,
        ... } OPTIONAL,
        ... } OPTIONAL,
        camelCapabilityHandling [1] IMPLICIT INTEGER (1 .. 16) OPTIONAL,
        extensionContainer [2] IMPLICIT SEQUENCE {
          privateExtensionList [0] IMPLICIT SEQUENCE ( SIZE (1 .. 10) ) OF
          SEQUENCE {
            extId MAP-EXTENSION .&extensionId ( {
              '
              ... } ),
            extType MAP-EXTENSION .&ExtensionType ( {
              '
              ... } { @extId } ) OPTIONAL} OPTIONAL,
            pcs-Extensions [1] IMPLICIT SEQUENCE {
              ... } OPTIONAL,
              ... } OPTIONAL,
              notificationToCSE [3] IMPLICIT NULL OPTIONAL,
              csi-Active [4] IMPLICIT NULL OPTIONAL,
              ... } OPTIONAL,
            ss-CSI [11] IMPLICIT SEQUENCE {
              ss-CamelData SEQUENCE {
                ss-EventList SEQUENCE ( SIZE (1 .. 10) ) OF
                OCTET STRING ( SIZE (1) ),
                gsmSCF-Address OCTET STRING ( SIZE (1 .. 20) ) ( SIZE (1 .. 9) ),
                extensionContainer [0] IMPLICIT SEQUENCE {
                  privateExtensionList [0] IMPLICIT SEQUENCE ( SIZE (1 .. 10) ) OF
                  SEQUENCE {
                    extId MAP-EXTENSION .&extensionId ( {
                      '
                      ... } ),
                    extType MAP-EXTENSION .&ExtensionType ( {
                      '
                      ... } { @extId } ) OPTIONAL} OPTIONAL,
                    pcs-Extensions [1] IMPLICIT SEQUENCE {
                      ... } OPTIONAL,
                      ... } OPTIONAL,
                      ... },
                    extensionContainer SEQUENCE {
                      privateExtensionList [0] IMPLICIT SEQUENCE ( SIZE (1 .. 10) ) OF
                      SEQUENCE {
                        extId MAP-EXTENSION .&extensionId ( {
                          '
                          ... } ),
                        extType MAP-EXTENSION .&ExtensionType ( {
                          '
                          ... } { @extId } ) OPTIONAL} OPTIONAL,
                        pcs-Extensions [1] IMPLICIT SEQUENCE {
                          ... } OPTIONAL,
                          ... } OPTIONAL,
                          ... },
                        notificationToCSE [0] IMPLICIT NULL OPTIONAL,
                        csi-Active [1] IMPLICIT NULL OPTIONAL} OPTIONAL,
                    m-CSI [12] IMPLICIT SEQUENCE {
                      mobilityTriggers SEQUENCE ( SIZE (1 .. 10) ) OF

```

```

OCTET STRING ( SIZE ( 1 ) ),
serviceKey    INTEGER ( 0 .. 2147483647 ),
gsmSCF-Address [0] IMPLICIT OCTET STRING ( SIZE ( 1 .. 20 ) ) ( SIZE ( 1 .. 9 ) ),
extensionContainer [1] IMPLICIT SEQUENCE {
  privateExtensionList [0] IMPLICIT SEQUENCE ( SIZE ( 1 .. 10 ) ) OF
  SEQUENCE {
    extId    MAP-EXTENSION .&extensionId ( {
      '
      ... } ),
    extType  MAP-EXTENSION .&ExtensionType ( {
      '
      ... } { @extId } ) OPTIONAL} OPTIONAL,
  pcs-Extensions [1] IMPLICIT SEQUENCE {
    ... } OPTIONAL,
    ... } OPTIONAL,
  notificationToCSE [2] IMPLICIT NULL OPTIONAL,
  csi-Active [3] IMPLICIT NULL OPTIONAL,
  ... } OPTIONAL,
extensionContainer [13] IMPLICIT SEQUENCE {
  privateExtensionList [0] IMPLICIT SEQUENCE ( SIZE ( 1 .. 10 ) ) OF
  SEQUENCE {
    extId    MAP-EXTENSION .&extensionId ( {
      '
      ... } ),
    extType  MAP-EXTENSION .&ExtensionType ( {
      '
      ... } { @extId } ) OPTIONAL} OPTIONAL,
  pcs-Extensions [1] IMPLICIT SEQUENCE {
    ... } OPTIONAL,
    ... } OPTIONAL,
  ... } OPTIONAL,
... ,
specificCSIDeletedList [14] IMPLICIT BIT STRING {
  o-csi ( 0 ),
  ss-csi ( 1 ),
  tif-csi ( 2 ),
  d-csi ( 3 ),
  vt-csi ( 4 ),
  mo-sms-csi ( 5 ),
  m-csi ( 6 ),
  gprs-csi ( 7 ),
  t-csi ( 8 ),
  mt-sms-csi ( 9 ),
  mg-csi ( 10 ) } ( SIZE ( 8 .. 32 ) ) OPTIONAL,
mt-sms-CSI [15] IMPLICIT SEQUENCE {
  sms-CAMEL-TDP-DataList [0] IMPLICIT SEQUENCE ( SIZE ( 1 .. 10 ) ) OF
  SEQUENCE {
    sms-TriggerDetectionPoint [0] IMPLICIT ENUMERATED {
      sms-CollectedInfo ( 1 ),
      ... ,
      sms-DeliveryRequest ( 2 ) },
    serviceKey [1] IMPLICIT INTEGER ( 0 .. 2147483647 ),
    gsmSCF-Address [2] IMPLICIT OCTET STRING ( SIZE ( 1 .. 20 ) ) ( SIZE ( 1 .. 9 ) ),
    defaultSMS-Handling [3] IMPLICIT ENUMERATED {
      continueTransaction ( 0 ),
      releaseTransaction ( 1 ),
      ... },
    extensionContainer [4] IMPLICIT SEQUENCE {
      privateExtensionList [0] IMPLICIT SEQUENCE ( SIZE ( 1 .. 10 ) ) OF
      SEQUENCE {
        extId    MAP-EXTENSION .&extensionId ( {
          '
          ... } ),
        extType  MAP-EXTENSION .&ExtensionType ( {
          '
          ... } { @extId } ) OPTIONAL} OPTIONAL,
      pcs-Extensions [1] IMPLICIT SEQUENCE {
        ... } OPTIONAL,
        ... } OPTIONAL,
        ... } OPTIONAL,
      camelCapabilityHandling [1] IMPLICIT INTEGER ( 1 .. 16 ) OPTIONAL,
      extensionContainer [2] IMPLICIT SEQUENCE {
        privateExtensionList [0] IMPLICIT SEQUENCE ( SIZE ( 1 .. 10 ) ) OF
        SEQUENCE {
          extId    MAP-EXTENSION .&extensionId ( {
            '
            ... } ),
          extType  MAP-EXTENSION .&ExtensionType ( {

```

```

        ... } { @extId } ) OPTIONAL} OPTIONAL,
    pcs-Extensions [1] IMPLICIT SEQUENCE {
        ... } OPTIONAL,
        ... } OPTIONAL,
    notificationToCSE [3] IMPLICIT NULL OPTIONAL,
    csi-Active [4] IMPLICIT NULL OPTIONAL,
    ... } OPTIONAL,
mt-smsCAMELTDP-CriteriaList [16] IMPLICIT SEQUENCE ( SIZE ( 1 .. 10 ) ) OF
SEQUENCE {
    sms-TriggerDetectionPoint ENUMERATED {
        sms-CollectedInfo ( 1 ),
        ... ,
        sms-DeliveryRequest ( 2 ) },
    tpdu-TypeCriterion [0] IMPLICIT SEQUENCE ( SIZE ( 1 .. 5 ) ) OF
    ENUMERATED {
        sms-DELIVER ( 0 ),
        sms-SUBMIT-REPORT ( 1 ),
        sms-STATUS-REPORT ( 2 ),
        ... } OPTIONAL,
    ... } OPTIONAL,
mg-csi [17] IMPLICIT SEQUENCE {
    mobilityTriggers SEQUENCE ( SIZE ( 1 .. 10 ) ) OF
    OCTET STRING ( SIZE ( 1 ) ),
    serviceKey INTEGER ( 0 .. 2147483647 ),
    gsmSCF-Address [0] IMPLICIT OCTET STRING ( SIZE ( 1 .. 20 ) ) ( SIZE ( 1 .. 9 ) ),
    extensionContainer [1] IMPLICIT SEQUENCE {
        privateExtensionList [0] IMPLICIT SEQUENCE ( SIZE ( 1 .. 10 ) ) OF
        SEQUENCE {
            extId MAP-EXTENSION .&extensionId ( {
                '
                ... } ),
            extType MAP-EXTENSION .&ExtensionType ( {
                '
                ... } { @extId } ) OPTIONAL} OPTIONAL,
        pcs-Extensions [1] IMPLICIT SEQUENCE {
            ... } OPTIONAL,
            ... } OPTIONAL,
        notificationToCSE [2] IMPLICIT NULL OPTIONAL,
        csi-Active [3] IMPLICIT NULL OPTIONAL,
        ... } OPTIONAL} OPTIONAL,
    allInformationSent [4] IMPLICIT NULL OPTIONAL,
    extensionContainer SEQUENCE {
        privateExtensionList [0] IMPLICIT SEQUENCE ( SIZE ( 1 .. 10 ) ) OF
        SEQUENCE {
            extId MAP-EXTENSION .&extensionId ( {
                '
                ... } ),
            extType MAP-EXTENSION .&ExtensionType ( {
                '
                ... } { @extId } ) OPTIONAL} OPTIONAL,
        pcs-Extensions [1] IMPLICIT SEQUENCE {
            ... } OPTIONAL,
            ... } OPTIONAL,
        ... }
    ... }
RESULT
noteSubscriberDataModifiedRes SEQUENCE {
    extensionContainer SEQUENCE {
        privateExtensionList [0] IMPLICIT SEQUENCE ( SIZE ( 1 .. 10 ) ) OF
        SEQUENCE {
            extId MAP-EXTENSION .&extensionId ( {
                '
                ... } ),
            extType MAP-EXTENSION .&ExtensionType ( {
                '
                ... } { @extId } ) OPTIONAL} OPTIONAL,
        pcs-Extensions [1] IMPLICIT SEQUENCE {
            ... } OPTIONAL,
            ... } OPTIONAL,
        ... }
    ... }
ERRORS {
    -- dataMissing -- localValue : 35,
    -- unexpectedDataValue -- localValue : 36,
    -- unknownSubscriber -- localValue : 1}
 ::= localValue : 5

```

ss-InvocationNotification OPERATION

ARGUMENT

```

ss-InvocationNotificationArg SEQUENCE {
  imsi          [0] IMPLICIT OCTET STRING ( SIZE ( 3 .. 8 ) ),
  msisdn        [1] IMPLICIT OCTET STRING ( SIZE ( 1 .. 20 ) ) ( SIZE ( 1 .. 9 ) ),
  ss-Event      [2] IMPLICIT OCTET STRING ( SIZE ( 1 ) ),
  ss-EventSpecification [3] IMPLICIT SEQUENCE ( SIZE ( 1 .. 2 ) ) OF
  OCTET STRING ( SIZE ( 1 .. 20 ) ) OPTIONAL,
  extensionContainer [4] IMPLICIT SEQUENCE {
    privateExtensionList [0] IMPLICIT SEQUENCE ( SIZE ( 1 .. 10 ) ) OF
    SEQUENCE {
      extId  MAP-EXTENSION .&extensionId ( {
        '
        ... } ),
      extType  MAP-EXTENSION .&ExtensionType ( {
        '
        ... } { @extId } ) OPTIONAL } OPTIONAL,
    pcs-Extensions [1] IMPLICIT SEQUENCE {
      ... } OPTIONAL,
      ... } OPTIONAL,
    ... ,
    b-subscriberNumber [5] IMPLICIT OCTET STRING ( SIZE ( 1 .. 20 ) ) ( SIZE ( 1 .. 9 ) ) OPTIONAL,
    ccbs-RequestState [6] IMPLICIT ENUMERATED {
      request ( 0 ),
      recall ( 1 ),
      active ( 2 ),
      completed ( 3 ),
      suspended ( 4 ),
      frozen ( 5 ),
      deleted ( 6 ) } OPTIONAL }
}

```

RESULT

```

ss-InvocationNotificationRes SEQUENCE {
  extensionContainer SEQUENCE {
    privateExtensionList [0] IMPLICIT SEQUENCE ( SIZE ( 1 .. 10 ) ) OF
    SEQUENCE {
      extId  MAP-EXTENSION .&extensionId ( {
        '
        ... } ),
      extType  MAP-EXTENSION .&ExtensionType ( {
        '
        ... } { @extId } ) OPTIONAL } OPTIONAL,
    pcs-Extensions [1] IMPLICIT SEQUENCE {
      ... } OPTIONAL,
      ... } OPTIONAL,
    ... }
}

```

ERRORS {

```

-- dataMissing -- localValue : 35,
-- unexpectedDataValue -- localValue : 36,
-- unknownSubscriber -- localValue : 1}

```

```

::= localValue : 72

```

prepareGroupCall OPERATION

ARGUMENT

```

prepareGroupCallArg SEQUENCE {
  teleservice      OCTET STRING ( SIZE ( 1 .. 5 ) ),
  asciiCallReference OCTET STRING ( SIZE ( 1 .. 8 ) ),
  codec-Info       OCTET STRING ( SIZE ( 5 .. 10 ) ),
  cipheringAlgorithm OCTET STRING ( SIZE ( 1 ) ),
  groupKeyNumber   [0] IMPLICIT INTEGER ( 0 .. 15 ) OPTIONAL,
  groupKey         [1] IMPLICIT OCTET STRING ( SIZE ( 8 ) ) OPTIONAL,
  priority         [2] IMPLICIT INTEGER ( 0 .. 15 ) OPTIONAL,
  uplinkFree       [3] IMPLICIT NULL OPTIONAL,
  extensionContainer [4] IMPLICIT SEQUENCE {
    privateExtensionList [0] IMPLICIT SEQUENCE ( SIZE ( 1 .. 10 ) ) OF
    SEQUENCE {
      extId  MAP-EXTENSION .&extensionId ( {
        '
        ... } ),
      extType  MAP-EXTENSION .&ExtensionType ( {
        '
        ... } { @extId } ) OPTIONAL } OPTIONAL,
    pcs-Extensions [1] IMPLICIT SEQUENCE {
      ... } OPTIONAL,
      ... } OPTIONAL,
    ... }
}

```

RESULT

```

prepareGroupCallRes SEQUENCE {
  groupCallNumber OCTET STRING ( SIZE ( 1 .. 20 ) ) ( SIZE ( 1 .. 9 ) ),
}

```

```

extensionContainer SEQUENCE {
  privateExtensionList [0] IMPLICIT SEQUENCE ( SIZE ( 1 .. 10 ) ) OF
  SEQUENCE {
    extId MAP-EXTENSION .&extensionId ( {
      ... } ),
    extType MAP-EXTENSION .&ExtensionType ( {
      ... } { @extId } ) OPTIONAL } OPTIONAL,
  pcs-Extensions [1] IMPLICIT SEQUENCE {
    ... } OPTIONAL,
  ... } OPTIONAL,
  ... }
ERRORS {
  -- systemFailure -- localValue : 34,
  -- noGroupCallNumberAvailable -- localValue : 50,
  -- unexpectedDataValue -- localValue : 36}
 ::= localValue : 39

sendGroupCallEndSignal OPERATION
ARGUMENT
  sendGroupCallEndSignalArg SEQUENCE {
    imsi OCTET STRING ( SIZE ( 3 .. 8 ) ) OPTIONAL,
    extensionContainer SEQUENCE {
      privateExtensionList [0] IMPLICIT SEQUENCE ( SIZE ( 1 .. 10 ) ) OF
      SEQUENCE {
        extId MAP-EXTENSION .&extensionId ( {
          ... } ),
        extType MAP-EXTENSION .&ExtensionType ( {
          ... } { @extId } ) OPTIONAL } OPTIONAL,
        pcs-Extensions [1] IMPLICIT SEQUENCE {
          ... } OPTIONAL,
        ... } OPTIONAL,
        ... }
      ... }
    RESULT
      sendGroupCallEndSignalRes SEQUENCE {
        extensionContainer SEQUENCE {
          privateExtensionList [0] IMPLICIT SEQUENCE ( SIZE ( 1 .. 10 ) ) OF
          SEQUENCE {
            extId MAP-EXTENSION .&extensionId ( {
              ... } ),
            extType MAP-EXTENSION .&ExtensionType ( {
              ... } { @extId } ) OPTIONAL } OPTIONAL,
            pcs-Extensions [1] IMPLICIT SEQUENCE {
              ... } OPTIONAL,
            ... } OPTIONAL,
            ... }
          ... }
        ::= localValue : 40

processGroupCallSignalling OPERATION
ARGUMENT
  processGroupCallSignallingArg SEQUENCE {
    uplinkRequest [0] IMPLICIT NULL OPTIONAL,
    uplinkReleaseIndication [1] IMPLICIT NULL OPTIONAL,
    releaseGroupCall [2] IMPLICIT NULL OPTIONAL,
    extensionContainer SEQUENCE {
      privateExtensionList [0] IMPLICIT SEQUENCE ( SIZE ( 1 .. 10 ) ) OF
      SEQUENCE {
        extId MAP-EXTENSION .&extensionId ( {
          ... } ),
        extType MAP-EXTENSION .&ExtensionType ( {
          ... } { @extId } ) OPTIONAL } OPTIONAL,
        pcs-Extensions [1] IMPLICIT SEQUENCE {
          ... } OPTIONAL,
        ... } OPTIONAL,
        ... }
      ... }
    ::= localValue : 41

forwardGroupCallSignalling OPERATION
ARGUMENT
  forwardGroupCallSignallingArg SEQUENCE {

```

```

imsi          OCTET STRING ( SIZE ( 3 .. 8 ) ) OPTIONAL,
uplinkRequestAck [0] IMPLICIT NULL OPTIONAL,
uplinkReleaseIndication [1] IMPLICIT NULL OPTIONAL,
uplinkRejectCommand [2] IMPLICIT NULL OPTIONAL,
uplinkSeizedCommand [3] IMPLICIT NULL OPTIONAL,
uplinkReleaseCommand [4] IMPLICIT NULL OPTIONAL,
extensionContainer SEQUENCE {
  privateExtensionList [0] IMPLICIT SEQUENCE ( SIZE ( 1 .. 10 ) ) OF
    SEQUENCE {
      extId MAP-EXTENSION .&extensionId ( {
        '
        ... } ),
      extType MAP-EXTENSION .&ExtensionType ( {
        '
        ... } { @extId } ) OPTIONAL } OPTIONAL,
  pcs-Extensions [1] IMPLICIT SEQUENCE {
    ... } OPTIONAL,
  ... } OPTIONAL,
... ,
stateAttributes [5] IMPLICIT SEQUENCE {
  downlinkAttached [5] IMPLICIT NULL OPTIONAL,
  uplinkAttached [6] IMPLICIT NULL OPTIONAL,
  dualCommunication [7] IMPLICIT NULL OPTIONAL,
  callOriginator [8] IMPLICIT NULL OPTIONAL } OPTIONAL
 ::= localValue : 42

updateGprsLocation OPERATION
ARGUMENT
updateGprsLocationArg SEQUENCE {
  imsi          OCTET STRING ( SIZE ( 3 .. 8 ) ),
  sgsn-Number   OCTET STRING ( SIZE ( 1 .. 20 ) ) ( SIZE ( 1 .. 9 ) ),
  sgsn-Address  OCTET STRING ( SIZE ( 5 .. 17 ) ),
  extensionContainer SEQUENCE {
    privateExtensionList [0] IMPLICIT SEQUENCE ( SIZE ( 1 .. 10 ) ) OF
      SEQUENCE {
        extId MAP-EXTENSION .&extensionId ( {
          '
          ... } ),
        extType MAP-EXTENSION .&ExtensionType ( {
          '
          ... } { @extId } ) OPTIONAL } OPTIONAL,
    pcs-Extensions [1] IMPLICIT SEQUENCE {
      ... } OPTIONAL,
    ... } OPTIONAL,
... ,
sgsn-Capability [0] IMPLICIT SEQUENCE {
  solsaSupportIndicator NULL OPTIONAL,
  extensionContainer [1] IMPLICIT SEQUENCE {
    privateExtensionList [0] IMPLICIT SEQUENCE ( SIZE ( 1 .. 10 ) ) OF
      SEQUENCE {
        extId MAP-EXTENSION .&extensionId ( {
          '
          ... } ),
        extType MAP-EXTENSION .&ExtensionType ( {
          '
          ... } { @extId } ) OPTIONAL } OPTIONAL,
    pcs-Extensions [1] IMPLICIT SEQUENCE {
      ... } OPTIONAL,
    ... } OPTIONAL,
... ,
superChargerSupportedInServingNetworkEntity [2] CHOICE {
  sendSubscriberData [0] IMPLICIT NULL,
  subscriberDataStored [1] IMPLICIT OCTET STRING ( SIZE ( 1 .. 6 ) ) } OPTIONAL,
gprsEnhancementsSupportIndicator [3] IMPLICIT NULL OPTIONAL,
supportedCamelPhases [4] IMPLICIT BIT STRING {
  phase1 ( 0 ),
  phase2 ( 1 ),
  phase3 ( 2 ),
  phase4 ( 3 ) } ( SIZE ( 1 .. 16 ) ) OPTIONAL,
supportedLCS-CapabilitySets [5] IMPLICIT BIT STRING {
  lcsCapabilitySet1 ( 0 ),
  lcsCapabilitySet2 ( 1 ),
  lcsCapabilitySet3 ( 2 ) } ( SIZE ( 2 .. 16 ) ) OPTIONAL } OPTIONAL,
informPreviousNetworkEntity [1] IMPLICIT NULL OPTIONAL,
ps-LCS-NotSupportedByUE [2] IMPLICIT NULL OPTIONAL
RESULT
updateGprsLocationRes SEQUENCE {

```

```

hlr-Number      OCTET STRING ( SIZE (1 .. 20) ) ( SIZE (1 .. 9) ),
extensionContainer SEQUENCE {
  privateExtensionList [0] IMPLICIT SEQUENCE ( SIZE (1 .. 10) ) OF
  SEQUENCE {
    extId  MAP-EXTENSION .&extensionId ( {
      '
      ... } ),
    extType MAP-EXTENSION .&ExtensionType ( {
      '
      ... } { @extId } ) OPTIONAL } OPTIONAL,
  pcs-Extensions [1] IMPLICIT SEQUENCE {
    ... } OPTIONAL,
  ... } OPTIONAL,
  ... }
ERRORS {
-- systemFailure -- localValue : 34,
-- unexpectedDataValue -- localValue : 36,
-- unknownSubscriber -- localValue : 1,
-- roamingNotAllowed -- localValue : 8}
::= localValue : 23

sendRoutingInfoForGprs OPERATION
ARGUMENT
  sendRoutingInfoForGprsArg SEQUENCE {
    imsi [0] IMPLICIT OCTET STRING ( SIZE (3 .. 8) ),
    ggsn-Address [1] IMPLICIT OCTET STRING ( SIZE (5 .. 17) ) OPTIONAL,
    ggsn-Number [2] IMPLICIT OCTET STRING ( SIZE (1 .. 20) ) ( SIZE (1 .. 9) ),
    extensionContainer [3] IMPLICIT SEQUENCE {
      privateExtensionList [0] IMPLICIT SEQUENCE ( SIZE (1 .. 10) ) OF
      SEQUENCE {
        extId  MAP-EXTENSION .&extensionId ( {
          '
          ... } ),
        extType MAP-EXTENSION .&ExtensionType ( {
          '
          ... } { @extId } ) OPTIONAL } OPTIONAL,
      pcs-Extensions [1] IMPLICIT SEQUENCE {
        ... } OPTIONAL,
      ... } OPTIONAL,
      ... }
RESULT
  sendRoutingInfoForGprsRes SEQUENCE {
    sgsn-Address [0] IMPLICIT OCTET STRING ( SIZE (5 .. 17) ),
    ggsn-Address [1] IMPLICIT OCTET STRING ( SIZE (5 .. 17) ) OPTIONAL,
    mobileNotReachableReason [2] IMPLICIT INTEGER ( 0 .. 255 ) OPTIONAL,
    extensionContainer [3] IMPLICIT SEQUENCE {
      privateExtensionList [0] IMPLICIT SEQUENCE ( SIZE (1 .. 10) ) OF
      SEQUENCE {
        extId  MAP-EXTENSION .&extensionId ( {
          '
          ... } ),
        extType MAP-EXTENSION .&ExtensionType ( {
          '
          ... } { @extId } ) OPTIONAL } OPTIONAL,
      pcs-Extensions [1] IMPLICIT SEQUENCE {
        ... } OPTIONAL,
      ... } OPTIONAL,
      ... }
ERRORS {
-- absentSubscriber -- localValue : 27,
-- systemFailure -- localValue : 34,
-- dataMissing -- localValue : 35,
-- unexpectedDataValue -- localValue : 36,
-- unknownSubscriber -- localValue : 1,
-- callBarred -- localValue : 13}
::= localValue : 24

failureReport OPERATION
ARGUMENT
  failureReportArg SEQUENCE {
    imsi [0] IMPLICIT OCTET STRING ( SIZE (3 .. 8) ),
    ggsn-Number [1] IMPLICIT OCTET STRING ( SIZE (1 .. 20) ) ( SIZE (1 .. 9) ),
    ggsn-Address [2] IMPLICIT OCTET STRING ( SIZE (5 .. 17) ) OPTIONAL,
    extensionContainer [3] IMPLICIT SEQUENCE {
      privateExtensionList [0] IMPLICIT SEQUENCE ( SIZE (1 .. 10) ) OF
      SEQUENCE {
        extId  MAP-EXTENSION .&extensionId ( {

```

```

    ...}),
    extType MAP-EXTENSION .&ExtensionType ({
    ...}{ @extId } ) OPTIONAL} OPTIONAL,
    pcs-Extensions [1] IMPLICIT SEQUENCE {
    ... } OPTIONAL,
    ... } OPTIONAL,
    ... }
RESULT
failureReportRes SEQUENCE {
    ggsn-Address [0] IMPLICIT OCTET STRING ( SIZE ( 5 .. 17 ) ) OPTIONAL,
    extensionContainer [1] IMPLICIT SEQUENCE {
    privateExtensionList [0] IMPLICIT SEQUENCE ( SIZE ( 1 .. 10 ) ) OF
    SEQUENCE {
    extId MAP-EXTENSION .&extensionId ({
    ...}),
    extType MAP-EXTENSION .&ExtensionType ({
    ...}{ @extId } ) OPTIONAL} OPTIONAL,
    pcs-Extensions [1] IMPLICIT SEQUENCE {
    ... } OPTIONAL,
    ... } OPTIONAL,
    ... }
ERRORS {
    -- systemFailure -- localValue : 34,
    -- dataMissing -- localValue : 35,
    -- unexpectedDataValue -- localValue : 36,
    -- unknownSubscriber -- localValue : 1}
 ::= localValue : 25

```

noteMsPresentForGprs OPERATION

```

ARGUMENT
noteMsPresentForGprsArg SEQUENCE {
    imsi [0] IMPLICIT OCTET STRING ( SIZE ( 3 .. 8 ) ),
    sgsn-Address [1] IMPLICIT OCTET STRING ( SIZE ( 5 .. 17 ) ),
    ggsn-Address [2] IMPLICIT OCTET STRING ( SIZE ( 5 .. 17 ) ) OPTIONAL,
    extensionContainer [3] IMPLICIT SEQUENCE {
    privateExtensionList [0] IMPLICIT SEQUENCE ( SIZE ( 1 .. 10 ) ) OF
    SEQUENCE {
    extId MAP-EXTENSION .&extensionId ({
    ...}),
    extType MAP-EXTENSION .&ExtensionType ({
    ...}{ @extId } ) OPTIONAL} OPTIONAL,
    pcs-Extensions [1] IMPLICIT SEQUENCE {
    ... } OPTIONAL,
    ... } OPTIONAL,
    ... }
RESULT
noteMsPresentForGprsRes SEQUENCE {
    extensionContainer [0] IMPLICIT SEQUENCE {
    privateExtensionList [0] IMPLICIT SEQUENCE ( SIZE ( 1 .. 10 ) ) OF
    SEQUENCE {
    extId MAP-EXTENSION .&extensionId ({
    ...}),
    extType MAP-EXTENSION .&ExtensionType ({
    ...}{ @extId } ) OPTIONAL} OPTIONAL,
    pcs-Extensions [1] IMPLICIT SEQUENCE {
    ... } OPTIONAL,
    ... } OPTIONAL,
    ... }
ERRORS {
    -- systemFailure -- localValue : 34,
    -- dataMissing -- localValue : 35,
    -- unexpectedDataValue -- localValue : 36,
    -- unknownSubscriber -- localValue : 1}
 ::= localValue : 26

```

provideSubscriberLocation OPERATION

```

ARGUMENT
provideSubscriberLocation-Arg SEQUENCE {
    locationType SEQUENCE {

```



```

locationEstimateType [0] IMPLICIT ENUMERATED {
  currentLocation (0),
  currentOrLastKnownLocation (1),
  initialLocation (2),
  ... ,
  activateDeferredLocation (3),
  cancelDeferredLocation (4)},
... ,
deferredLocationEventType [1] IMPLICIT BIT STRING {
  msAvailable (0)} ( SIZE (1 .. 16) ) OPTIONAL},
mlc-Number OCTET STRING ( SIZE (1 .. 20) ) ( SIZE (1 .. 9) ),
lcs-ClientID [0] IMPLICIT SEQUENCE {
  lcsClientType [0] IMPLICIT ENUMERATED {
    emergencyServices (0),
    valueAddedServices (1),
    plmnOperatorServices (2),
    lawfulInterceptServices (3),
    ... },
  lcsClientExternalID [1] IMPLICIT SEQUENCE {
    externalAddress [0] IMPLICIT OCTET STRING ( SIZE (1 .. 20) ) OPTIONAL,
    extensionContainer [1] IMPLICIT SEQUENCE {
      privateExtensionList [0] IMPLICIT SEQUENCE ( SIZE (1 .. 10) ) OF
      SEQUENCE {
        extId MAP-EXTENSION .&extensionId ( {
          '
          ... } ),
        extType MAP-EXTENSION .&ExtensionType ( {
          '
          ... } { @extId } ) OPTIONAL} OPTIONAL,
      pcs-Extensions [1] IMPLICIT SEQUENCE {
        ... } OPTIONAL,
        ... } OPTIONAL,
        ... } OPTIONAL,
      lcsClientDialedByMS [2] IMPLICIT OCTET STRING ( SIZE (1 .. 20) ) OPTIONAL,
      lcsClientInternalID [3] IMPLICIT ENUMERATED {
        broadcastService (0),
        o-andM-HPLMN (1),
        o-andM-VPLMN (2),
        anonymousLocation (3),
        targetMSsubscribedService (4),
        ... } OPTIONAL,
      lcsClientName [4] IMPLICIT SEQUENCE {
        dataCodingScheme [0] IMPLICIT OCTET STRING ( SIZE (1) ),
        nameString [2] IMPLICIT OCTET STRING ( SIZE (1 .. 160) ) ( SIZE (1 .. 63) ),
        ... } OPTIONAL,
      ... ,
      lcsAPN [5] IMPLICIT OCTET STRING ( SIZE (2 .. 63) ) OPTIONAL,
      lcsRequestorID [6] IMPLICIT SEQUENCE {
        dataCodingScheme [0] IMPLICIT OCTET STRING ( SIZE (1) ),
        requestorIDString [1] IMPLICIT OCTET STRING ( SIZE (1 .. 160) ) ( SIZE (0 .. 127) ),
        ... } OPTIONAL} OPTIONAL,
      privacyOverride [1] IMPLICIT NULL OPTIONAL,
      imsi [2] IMPLICIT OCTET STRING ( SIZE (3 .. 8) ) OPTIONAL,
      msisdh [3] IMPLICIT OCTET STRING ( SIZE (1 .. 20) ) ( SIZE (1 .. 9) ) OPTIONAL,
      lmsi [4] IMPLICIT OCTET STRING ( SIZE (4) ) OPTIONAL,
      imei [5] IMPLICIT OCTET STRING ( SIZE (8) ) OPTIONAL,
      lcs-Priority [6] IMPLICIT OCTET STRING ( SIZE (1) ) OPTIONAL,
      lcs-QoS [7] IMPLICIT SEQUENCE {
        horizontal-accuracy [0] IMPLICIT OCTET STRING ( SIZE (1) ) OPTIONAL,
        verticalCoordinateRequest [1] IMPLICIT NULL OPTIONAL,
        vertical-accuracy [2] IMPLICIT OCTET STRING ( SIZE (1) ) OPTIONAL,
        responseTime [3] IMPLICIT SEQUENCE {
          responseTimeCategory ENUMERATED {
            lowdelay (0),
            delaytolerant (1),
            ... },
          ... } OPTIONAL,
        extensionContainer [4] IMPLICIT SEQUENCE {
          privateExtensionList [0] IMPLICIT SEQUENCE ( SIZE (1 .. 10) ) OF
          SEQUENCE {
            extId MAP-EXTENSION .&extensionId ( {
              '
              ... } ),
            extType MAP-EXTENSION .&ExtensionType ( {
              '
              ... } { @extId } ) OPTIONAL} OPTIONAL,
          pcs-Extensions [1] IMPLICIT SEQUENCE {

```

```

    ... } OPTIONAL,
    ... } OPTIONAL,
    ... } OPTIONAL,
extensionContainer [8] IMPLICIT SEQUENCE {
  privateExtensionList [0] IMPLICIT SEQUENCE ( SIZE ( 1 .. 10 ) ) OF
  SEQUENCE {
    extId MAP-EXTENSION .&extensionId ( {
      '
      ... } ) ,
    extType MAP-EXTENSION .&ExtensionType ( {
      '
      ... } { @extId } ) OPTIONAL } OPTIONAL,
  pcs-Extensions [1] IMPLICIT SEQUENCE {
    ... } OPTIONAL,
    ... } OPTIONAL,
... ,
supportedGADShapes [9] IMPLICIT BIT STRING {
  ellipsoidPoint ( 0 ) ,
  ellipsoidPointWithUncertaintyCircle ( 1 ) ,
  ellipsoidPointWithUncertaintyEllipse ( 2 ) ,
  polygon ( 3 ) ,
  ellipsoidPointWithAltitude ( 4 ) ,
  ellipsoidPointWithAltitudeAndUncertaintyEllipsoid ( 5 ) ,
  ellipsoidArc ( 6 ) } ( SIZE ( 7 .. 16 ) ) OPTIONAL,
lcsServiceTypeID [10] IMPLICIT INTEGER ( 0 .. 127 ) OPTIONAL,
lcsCodeword [11] IMPLICIT SEQUENCE {
  dataCodingScheme [0] IMPLICIT OCTET STRING ( SIZE ( 1 ) ) ,
  lcsCodewordString [1] IMPLICIT OCTET STRING ( SIZE ( 1 .. 160 ) ) ( SIZE ( 1 .. 127 ) ) ,
  ... } OPTIONAL }
RESULT
provideSubscriberLocation-Res SEQUENCE {
  locationEstimate OCTET STRING ( SIZE ( 1 .. 20 ) ) ,
  ageOfLocationEstimate [0] IMPLICIT INTEGER ( 0 .. 32767 ) OPTIONAL,
  extensionContainer [1] IMPLICIT SEQUENCE {
    privateExtensionList [0] IMPLICIT SEQUENCE ( SIZE ( 1 .. 10 ) ) OF
    SEQUENCE {
      extId MAP-EXTENSION .&extensionId ( {
        '
        ... } ) ,
      extType MAP-EXTENSION .&ExtensionType ( {
        '
        ... } { @extId } ) OPTIONAL } OPTIONAL,
    pcs-Extensions [1] IMPLICIT SEQUENCE {
      ... } OPTIONAL,
      ... } OPTIONAL,
... ,
  add-LocationEstimate [2] IMPLICIT OCTET STRING ( SIZE ( 1 .. 91 ) ) OPTIONAL,
  deferredmt-IrResponseIndicator [3] IMPLICIT NULL OPTIONAL }
ERRORS {
-- systemFailure -- localValue : 34,
-- dataMissing -- localValue : 35,
-- unexpectedDataValue -- localValue : 36,
-- facilityNotSupported -- localValue : 21,
-- unidentifiedSubscriber -- localValue : 5,
-- illegalSubscriber -- localValue : 9,
-- illegalEquipment -- localValue : 12,
-- absentSubscriber -- localValue : 27,
-- unauthorizedRequestingNetwork -- localValue : 52,
-- unauthorizedLCSClient -- localValue : 53,
-- positionMethodFailure -- localValue : 54 }
::= localValue : 83

sendRoutingInfoForLCS OPERATION
ARGUMENT
routingInfoForLCS-Arg SEQUENCE {
  mlcNumber [0] IMPLICIT OCTET STRING ( SIZE ( 1 .. 20 ) ) ( SIZE ( 1 .. 9 ) ) ,
  targetMS [1] CHOICE {
    imsi [0] IMPLICIT OCTET STRING ( SIZE ( 3 .. 8 ) ) ,
    msisdn [1] IMPLICIT OCTET STRING ( SIZE ( 1 .. 20 ) ) ( SIZE ( 1 .. 9 ) ) ,
  }
  extensionContainer [2] IMPLICIT SEQUENCE {
    privateExtensionList [0] IMPLICIT SEQUENCE ( SIZE ( 1 .. 10 ) ) OF
    SEQUENCE {
      extId MAP-EXTENSION .&extensionId ( {
        '
        ... } ) ,
      extType MAP-EXTENSION .&ExtensionType ( {
        '

```

```

        ...} { @extId } ) OPTIONAL} OPTIONAL,
    pcs-Extensions [1] IMPLICIT SEQUENCE {
        ... } OPTIONAL,
        ... } OPTIONAL,
    ... ,
    lcsCodewordApplicability [3] IMPLICIT ENUMERATED {
        codewordCheckApplicable (0),
        codewordCheckNotApplicable (1),
        ... } OPTIONAL}
RESULT
routingInfoForLCS-Res SEQUENCE {
    targetMS [0] CHOICE {
        imsi [0] IMPLICIT OCTET STRING ( SIZE (3..8)),
        msisdn [1] IMPLICIT OCTET STRING ( SIZE (1..20)) ( SIZE (1..9))},
    lcsLocationInfo [1] IMPLICIT SEQUENCE {
        networkNode-Number OCTET STRING ( SIZE (1..20)) ( SIZE (1..9)),
        lmsi [0] IMPLICIT OCTET STRING ( SIZE (4)) OPTIONAL,
        extensionContainer [1] IMPLICIT SEQUENCE {
            privateExtensionList [0] IMPLICIT SEQUENCE ( SIZE (1..10)) OF
                SEQUENCE {
                    extId MAP-EXTENSION .&extensionId ( {
                        '
                        ...} ),
                    extType MAP-EXTENSION .&ExtensionType ( {
                        '
                        ...} { @extId } ) OPTIONAL} OPTIONAL,
                    pcs-Extensions [1] IMPLICIT SEQUENCE {
                        ... } OPTIONAL,
                        ... } OPTIONAL,
                    ... ,
                    gprsNodeIndicator [2] IMPLICIT NULL OPTIONAL,
                    additional-Number [3] CHOICE {
                        msc-Number [0] IMPLICIT OCTET STRING ( SIZE (1..20)) ( SIZE (1..9)),
                        sgsn-Number [1] IMPLICIT OCTET STRING ( SIZE (1..20)) ( SIZE (1..9))} OPTIONAL},
                    extensionContainer [2] IMPLICIT SEQUENCE {
                        privateExtensionList [0] IMPLICIT SEQUENCE ( SIZE (1..10)) OF
                            SEQUENCE {
                                extId MAP-EXTENSION .&extensionId ( {
                                    '
                                    ...} ),
                                extType MAP-EXTENSION .&ExtensionType ( {
                                    '
                                    ...} { @extId } ) OPTIONAL} OPTIONAL,
                                pcs-Extensions [1] IMPLICIT SEQUENCE {
                                    ... } OPTIONAL,
                                    ... } OPTIONAL,
                                ... ,
                                lcsCodewordNotification [3] IMPLICIT NULL OPTIONAL}
                }
            }
        }
    }
}
ERRORS {
-- systemFailure -- localValue : 34,
-- dataMissing -- localValue : 35,
-- unexpectedDataValue -- localValue : 36,
-- facilityNotSupported -- localValue : 21,
-- unknownSubscriber -- localValue : 1,
-- absentSubscriber -- localValue : 27,
-- unauthorizedRequestingNetwork -- localValue : 52}
 ::= localValue : 85

subscriberLocationReport OPERATION
ARGUMENT
subscriberLocationReport-Arg SEQUENCE {
    lcs-Event ENUMERATED {
        emergencyCallOrigination (0),
        emergencyCallRelease (1),
        mo-lr (2),
        ... ,
        deferredmt-lrResponse (3)},
    lcs-ClientID SEQUENCE {
        lcsClientType [0] IMPLICIT ENUMERATED {
            emergencyServices (0),
            valueAddedServices (1),
            plmnOperatorServices (2),
            lawfulInterceptServices (3),
            ... },
        lcsClientExternalID [1] IMPLICIT SEQUENCE {
            externalAddress [0] IMPLICIT OCTET STRING ( SIZE (1..20)) OPTIONAL,
            extensionContainer [1] IMPLICIT SEQUENCE {

```

```

privateExtensionList [0] IMPLICIT SEQUENCE ( SIZE ( 1 .. 10 ) ) OF
SEQUENCE {
  extId MAP-EXTENSION .&extensionId ( {
    '
    ... } ),
  extType MAP-EXTENSION .&ExtensionType ( {
    '
    ... } { @extId } ) OPTIONAL} OPTIONAL,
pcs-Extensions [1] IMPLICIT SEQUENCE {
  ... } OPTIONAL,
  ... } OPTIONAL,
  ... } OPTIONAL,
lcsClientDialedByMS [2] IMPLICIT OCTET STRING ( SIZE ( 1 .. 20 ) ) OPTIONAL,
lcsClientInternalID [3] IMPLICIT ENUMERATED {
  broadcastService (0),
  o-andM-HPLMN (1),
  o-andM-VPLMN (2),
  anonymousLocation (3),
  targetMSsubscribedService (4),
  ... } OPTIONAL,
lcsClientName [4] IMPLICIT SEQUENCE {
  dataCodingScheme [0] IMPLICIT OCTET STRING ( SIZE ( 1 ) ),
  nameString [2] IMPLICIT OCTET STRING ( SIZE ( 1 .. 160 ) ) ( SIZE ( 1 .. 63 ) ),
  ... } OPTIONAL,
... ,
lcsAPN [5] IMPLICIT OCTET STRING ( SIZE ( 2 .. 63 ) ) OPTIONAL,
lcsRequestorID [6] IMPLICIT SEQUENCE {
  dataCodingScheme [0] IMPLICIT OCTET STRING ( SIZE ( 1 ) ),
  requestorIDString [1] IMPLICIT OCTET STRING ( SIZE ( 1 .. 160 ) ) ( SIZE ( 0 .. 127 ) ),
  ... } OPTIONAL},
lcsLocationInfo SEQUENCE {
  networkNode-Number OCTET STRING ( SIZE ( 1 .. 20 ) ) ( SIZE ( 1 .. 9 ) ),
  lmsi [0] IMPLICIT OCTET STRING ( SIZE ( 4 ) ) OPTIONAL,
  extensionContainer [1] IMPLICIT SEQUENCE {
    privateExtensionList [0] IMPLICIT SEQUENCE ( SIZE ( 1 .. 10 ) ) OF
    SEQUENCE {
      extId MAP-EXTENSION .&extensionId ( {
        '
        ... } ),
      extType MAP-EXTENSION .&ExtensionType ( {
        '
        ... } { @extId } ) OPTIONAL} OPTIONAL,
    pcs-Extensions [1] IMPLICIT SEQUENCE {
      ... } OPTIONAL,
      ... } OPTIONAL,
    ... ,
    gprsNodeIndicator [2] IMPLICIT NULL OPTIONAL,
    additional-Number [3] CHOICE {
      msc-Number [0] IMPLICIT OCTET STRING ( SIZE ( 1 .. 20 ) ) ( SIZE ( 1 .. 9 ) ),
      sgsn-Number [1] IMPLICIT OCTET STRING ( SIZE ( 1 .. 20 ) ) ( SIZE ( 1 .. 9 ) )} OPTIONAL},
    msisdn [0] IMPLICIT OCTET STRING ( SIZE ( 1 .. 20 ) ) ( SIZE ( 1 .. 9 ) ) OPTIONAL,
    imsi [1] IMPLICIT OCTET STRING ( SIZE ( 3 .. 8 ) ) OPTIONAL,
    imei [2] IMPLICIT OCTET STRING ( SIZE ( 8 ) ) OPTIONAL,
    na-ESRD [3] IMPLICIT OCTET STRING ( SIZE ( 1 .. 20 ) ) ( SIZE ( 1 .. 9 ) ) OPTIONAL,
    na-ESRK [4] IMPLICIT OCTET STRING ( SIZE ( 1 .. 20 ) ) ( SIZE ( 1 .. 9 ) ) OPTIONAL,
    locationEstimate [5] IMPLICIT OCTET STRING ( SIZE ( 1 .. 20 ) ) OPTIONAL,
    ageOfLocationEstimate [6] IMPLICIT INTEGER ( 0 .. 32767 ) OPTIONAL,
    extensionContainer [7] IMPLICIT SEQUENCE {
      privateExtensionList [0] IMPLICIT SEQUENCE ( SIZE ( 1 .. 10 ) ) OF
      SEQUENCE {
        extId MAP-EXTENSION .&extensionId ( {
          '
          ... } ),
        extType MAP-EXTENSION .&ExtensionType ( {
          '
          ... } { @extId } ) OPTIONAL} OPTIONAL,
      pcs-Extensions [1] IMPLICIT SEQUENCE {
        ... } OPTIONAL,
        ... } OPTIONAL,
      ... ,
      add-LocationEstimate [8] IMPLICIT OCTET STRING ( SIZE ( 1 .. 91 ) ) OPTIONAL,
      deferredmt-IrData [9] IMPLICIT SEQUENCE {
        deferredLocationEventType BIT STRING {
          msAvailable (0)} ( SIZE ( 1 .. 16 ) ),
        terminationCause [0] IMPLICIT ENUMERATED {
          normal (0),
          errorundefined (1),

```

```

internalTimeout          (2),
congestion               (3),
mt-IrRestart             (4),
privacyViolation         (5),
... ,
shapeOfLocationEstimateNotSupported (6)} OPTIONAL,
lcsLocationInfo         [1] IMPLICIT SEQUENCE {
networkNode-Number      OCTET STRING ( SIZE (1 .. 20 )) ( SIZE (1 .. 9) ),
lmsi                    [0] IMPLICIT OCTET STRING ( SIZE (4) ) OPTIONAL,
extensionContainer      [1] IMPLICIT SEQUENCE {
privateExtensionList    [0] IMPLICIT SEQUENCE ( SIZE (1 .. 10) ) OF
SEQUENCE {
extId    MAP-EXTENSION .&extensionId ( {
'
...} ),
extType  MAP-EXTENSION .&ExtensionType ( {
'
...} { @extId } ) OPTIONAL} OPTIONAL,
pcs-Extensions [1] IMPLICIT SEQUENCE {
... } OPTIONAL,
... } OPTIONAL,
... ,
gprsNodeIndicator [2] IMPLICIT NULL OPTIONAL,
additional-Number [3] CHOICE {
msc-Number [0] IMPLICIT OCTET STRING ( SIZE (1 .. 20 )) ( SIZE (1 .. 9) ),
sgsn-Number [1] IMPLICIT OCTET STRING ( SIZE (1 .. 20 )) ( SIZE (1 .. 9) )} OPTIONAL} OPTIONAL,
... } OPTIONAL}
RESULT
subscriberLocationReport-Res SEQUENCE {
extensionContainer SEQUENCE {
privateExtensionList [0] IMPLICIT SEQUENCE ( SIZE (1 .. 10) ) OF
SEQUENCE {
extId    MAP-EXTENSION .&extensionId ( {
'
...} ),
extType  MAP-EXTENSION .&ExtensionType ( {
'
...} { @extId } ) OPTIONAL} OPTIONAL,
pcs-Extensions [1] IMPLICIT SEQUENCE {
... } OPTIONAL,
... } OPTIONAL,
... }
ERRORS {
-- systemFailure -- localValue : 34,
-- dataMissing -- localValue : 35,
-- resourceLimitation -- localValue : 51,
-- unexpectedDataValue -- localValue : 36,
-- unknownSubscriber -- localValue : 1,
-- unauthorizedRequestingNetwork -- localValue : 52,
-- unknownOrUnreachableLCSClient -- localValue : 58}
::= localValue : 86

```

secureTransportClass1 OPERATION

ARGUMENT

```

secureTransportArg SEQUENCE {
securityHeader SEQUENCE {
securityParametersIndex OCTET STRING ( SIZE (4) ),
originalComponentIdentifier CHOICE {
operationCode [0] CHOICE {
localValue INTEGER,
globalValue OBJECT IDENTIFIER},
errorCode [1] CHOICE {
localValue INTEGER,
globalValue OBJECT IDENTIFIER},
userInfo [2] IMPLICIT NULL},
initialisationVector OCTET STRING ( SIZE (14) ) OPTIONAL,
... },
protectedPayload OCTET STRING ( SIZE (1 .. 3438) ) OPTIONAL}

```

RESULT

```

secureTransportRes SEQUENCE {
securityHeader SEQUENCE {
securityParametersIndex OCTET STRING ( SIZE (4) ),
originalComponentIdentifier CHOICE {
operationCode [0] CHOICE {
localValue INTEGER,
globalValue OBJECT IDENTIFIER},
errorCode [1] CHOICE {

```

```

        localValue    INTEGER,
        globalValue   OBJECT IDENTIFIER},
        userInfo      [2] IMPLICIT NULL},
        initialisationVector    OCTET STRING ( SIZE ( 14 ) ) OPTIONAL,
        ... },
        protectedPayload    OCTET STRING ( SIZE ( 1 .. 3438 ) ) OPTIONAL}
ERRORS {
-- secureTransportError -- localValue : 4,
-- dataMissing -- localValue : 35,
-- unexpectedDataValue -- localValue : 36}
::= localValue : 78

```

secureTransportClass2 OPERATION

```

ARGUMENT
secureTransportArg SEQUENCE {
  securityHeader SEQUENCE {
    securityParametersIndex    OCTET STRING ( SIZE ( 4 ) ),
    originalComponentIdentifier CHOICE {
      operationCode [0] CHOICE {
        localValue    INTEGER,
        globalValue   OBJECT IDENTIFIER},
      errorCode [1] CHOICE {
        localValue    INTEGER,
        globalValue   OBJECT IDENTIFIER},
      userInfo [2] IMPLICIT NULL},
    initialisationVector    OCTET STRING ( SIZE ( 14 ) ) OPTIONAL,
    ... },
  protectedPayload    OCTET STRING ( SIZE ( 1 .. 3438 ) ) OPTIONAL}
ERRORS {
-- secureTransportError -- localValue : 4,
-- dataMissing -- localValue : 35,
-- unexpectedDataValue -- localValue : 36}
::= localValue : 79

```

secureTransportClass3 OPERATION

```

ARGUMENT
secureTransportArg SEQUENCE {
  securityHeader SEQUENCE {
    securityParametersIndex    OCTET STRING ( SIZE ( 4 ) ),
    originalComponentIdentifier CHOICE {
      operationCode [0] CHOICE {
        localValue    INTEGER,
        globalValue   OBJECT IDENTIFIER},
      errorCode [1] CHOICE {
        localValue    INTEGER,
        globalValue   OBJECT IDENTIFIER},
      userInfo [2] IMPLICIT NULL},
    initialisationVector    OCTET STRING ( SIZE ( 14 ) ) OPTIONAL,
    ... },
  protectedPayload    OCTET STRING ( SIZE ( 1 .. 3438 ) ) OPTIONAL}
RESULT
secureTransportRes SEQUENCE {
  securityHeader SEQUENCE {
    securityParametersIndex    OCTET STRING ( SIZE ( 4 ) ),
    originalComponentIdentifier CHOICE {
      operationCode [0] CHOICE {
        localValue    INTEGER,
        globalValue   OBJECT IDENTIFIER},
      errorCode [1] CHOICE {
        localValue    INTEGER,
        globalValue   OBJECT IDENTIFIER},
      userInfo [2] IMPLICIT NULL},
    initialisationVector    OCTET STRING ( SIZE ( 14 ) ) OPTIONAL,
    ... },
  protectedPayload    OCTET STRING ( SIZE ( 1 .. 3438 ) ) OPTIONAL}
::= localValue : 80

```

secureTransportClass4 OPERATION

```

ARGUMENT
secureTransportArg SEQUENCE {
  securityHeader SEQUENCE {
    securityParametersIndex    OCTET STRING ( SIZE ( 4 ) ),
    originalComponentIdentifier CHOICE {
      operationCode [0] CHOICE {
        localValue    INTEGER,
        globalValue   OBJECT IDENTIFIER},
      errorCode [1] CHOICE {

```

```

        localValue    INTEGER,
        globalValue   OBJECT IDENTIFIER},
        userInfo      [2] IMPLICIT NULL},
        initialisationVector  OCTET STRING ( SIZE ( 14 ) ) OPTIONAL,
        ... },
        protectedPayload  OCTET STRING ( SIZE ( 1 .. 3438 ) ) OPTIONAL}
 ::= localValue : 81

systemFailure ERROR
PARAMETER
systemFailureParam CHOICE {
networkResource    ENUMERATED {
    plmn      ( 0 ),
    hlr      ( 1 ),
    vlr      ( 2 ),
    pvlr     ( 3 ),
    controllingMSC ( 4 ),
    vmsc     ( 5 ),
    eir      ( 6 ),
    rss      ( 7 )},
extensibleSystemFailureParam SEQUENCE {
networkResource    ENUMERATED {
    plmn      ( 0 ),
    hlr      ( 1 ),
    vlr      ( 2 ),
    pvlr     ( 3 ),
    controllingMSC ( 4 ),
    vmsc     ( 5 ),
    eir      ( 6 ),
    rss      ( 7 )} OPTIONAL,
extensionContainer SEQUENCE {
privateExtensionList [0] IMPLICIT SEQUENCE ( SIZE ( 1 .. 10 ) ) OF
SEQUENCE {
    extId  MAP-EXTENSION .&extensionId ( {
        '
        ... } ),
    extType  MAP-EXTENSION .&ExtensionType ( {
        '
        ... } { @extId } ) OPTIONAL} OPTIONAL,
pcs-Extensions [1] IMPLICIT SEQUENCE {
    ... } OPTIONAL,
    ... } OPTIONAL,
    ... } }
 ::= localValue : 34

dataMissing ERROR
PARAMETER
dataMissingParam SEQUENCE {
extensionContainer SEQUENCE {
privateExtensionList [0] IMPLICIT SEQUENCE ( SIZE ( 1 .. 10 ) ) OF
SEQUENCE {
    extId  MAP-EXTENSION .&extensionId ( {
        '
        ... } ),
    extType  MAP-EXTENSION .&ExtensionType ( {
        '
        ... } { @extId } ) OPTIONAL} OPTIONAL,
pcs-Extensions [1] IMPLICIT SEQUENCE {
    ... } OPTIONAL,
    ... } OPTIONAL,
    ... }
 ::= localValue : 35

unexpectedDataValue ERROR
PARAMETER
unexpectedDataParam SEQUENCE {
extensionContainer SEQUENCE {
privateExtensionList [0] IMPLICIT SEQUENCE ( SIZE ( 1 .. 10 ) ) OF
SEQUENCE {
    extId  MAP-EXTENSION .&extensionId ( {
        '
        ... } ),
    extType  MAP-EXTENSION .&ExtensionType ( {
        '
        ... } { @extId } ) OPTIONAL} OPTIONAL,
pcs-Extensions [1] IMPLICIT SEQUENCE {
    ... } OPTIONAL,
    ... }

```

```

    ... } OPTIONAL,
    ... }
 ::= localValue : 36

```

facilityNotSupported ERROR

PARAMETER

```

facilityNotSupParam SEQUENCE {
  extensionContainer SEQUENCE {
    privateExtensionList [0] IMPLICIT SEQUENCE ( SIZE ( 1 .. 10 )) OF
    SEQUENCE {
      extId MAP-EXTENSION .&extensionId ( {
        '
        ... } ),
      extType MAP-EXTENSION .&ExtensionType ( {
        '
        ... } { @extId } ) OPTIONAL } OPTIONAL,
    pcs-Extensions [1] IMPLICIT SEQUENCE {
      ... } OPTIONAL,
      ... } OPTIONAL,
    ... ,
    shapeOfLocationEstimateNotSupported [0] IMPLICIT NULL OPTIONAL,
    neededLcsCapabilityNotSupportedInServingNode [1] IMPLICIT NULL OPTIONAL }
 ::= localValue : 21

```

incompatibleTerminal ERROR

PARAMETER

```

incompatibleTerminalParam SEQUENCE {
  extensionContainer SEQUENCE {
    privateExtensionList [0] IMPLICIT SEQUENCE ( SIZE ( 1 .. 10 )) OF
    SEQUENCE {
      extId MAP-EXTENSION .&extensionId ( {
        '
        ... } ),
      extType MAP-EXTENSION .&ExtensionType ( {
        '
        ... } { @extId } ) OPTIONAL } OPTIONAL,
    pcs-Extensions [1] IMPLICIT SEQUENCE {
      ... } OPTIONAL,
      ... } OPTIONAL,
    ... }
 ::= localValue : 28

```

resourceLimitation ERROR

PARAMETER

```

resourceLimitationParam SEQUENCE {
  extensionContainer SEQUENCE {
    privateExtensionList [0] IMPLICIT SEQUENCE ( SIZE ( 1 .. 10 )) OF
    SEQUENCE {
      extId MAP-EXTENSION .&extensionId ( {
        '
        ... } ),
      extType MAP-EXTENSION .&ExtensionType ( {
        '
        ... } { @extId } ) OPTIONAL } OPTIONAL,
    pcs-Extensions [1] IMPLICIT SEQUENCE {
      ... } OPTIONAL,
      ... } OPTIONAL,
    ... }
 ::= localValue : 51

```

unknownSubscriber ERROR

PARAMETER

```

unknownSubscriberParam SEQUENCE {
  extensionContainer SEQUENCE {
    privateExtensionList [0] IMPLICIT SEQUENCE ( SIZE ( 1 .. 10 )) OF
    SEQUENCE {
      extId MAP-EXTENSION .&extensionId ( {
        '
        ... } ),
      extType MAP-EXTENSION .&ExtensionType ( {
        '
        ... } { @extId } ) OPTIONAL } OPTIONAL,
    pcs-Extensions [1] IMPLICIT SEQUENCE {
      ... } OPTIONAL,
      ... } OPTIONAL,
    ... ,
    unknownSubscriberDiagnostic ENUMERATED {

```



```

    imsiUnknown          (0),
    gprsSubscriptionUnknown (1),
    ...,
    npdbMismatch          (2)} OPTIONAL}
 ::= localValue : 1

numberChanged ERROR
PARAMETER
  numberChangedParam SEQUENCE {
    extensionContainer SEQUENCE {
      privateExtensionList [0] IMPLICIT SEQUENCE ( SIZE (1 .. 10) ) OF
      SEQUENCE {
        extId  MAP-EXTENSION .&extensionId ( {
          '
          ...} ),
        extType  MAP-EXTENSION .&ExtensionType ( {
          '
          ...}{ @extId } ) OPTIONAL} OPTIONAL,
        pcs-Extensions [1] IMPLICIT SEQUENCE {
          ... } OPTIONAL,
          ... } OPTIONAL,
          ... }
 ::= localValue : 44

unknownMSC ERROR
 ::= localValue : 3

unidentifiedSubscriber ERROR
PARAMETER
  unidentifiedSubParam SEQUENCE {
    extensionContainer SEQUENCE {
      privateExtensionList [0] IMPLICIT SEQUENCE ( SIZE (1 .. 10) ) OF
      SEQUENCE {
        extId  MAP-EXTENSION .&extensionId ( {
          '
          ...} ),
        extType  MAP-EXTENSION .&ExtensionType ( {
          '
          ...}{ @extId } ) OPTIONAL} OPTIONAL,
        pcs-Extensions [1] IMPLICIT SEQUENCE {
          ... } OPTIONAL,
          ... } OPTIONAL,
          ... }
 ::= localValue : 5

unknownEquipment ERROR
 ::= localValue : 7

roamingNotAllowed ERROR
PARAMETER
  roamingNotAllowedParam SEQUENCE {
    roamingNotAllowedCause ENUMERATED {
      plmnRoamingNotAllowed (0),
      operatorDeterminedBarring (3)},
    extensionContainer SEQUENCE {
      privateExtensionList [0] IMPLICIT SEQUENCE ( SIZE (1 .. 10) ) OF
      SEQUENCE {
        extId  MAP-EXTENSION .&extensionId ( {
          '
          ...} ),
        extType  MAP-EXTENSION .&ExtensionType ( {
          '
          ...}{ @extId } ) OPTIONAL} OPTIONAL,
        pcs-Extensions [1] IMPLICIT SEQUENCE {
          ... } OPTIONAL,
          ... } OPTIONAL,
          ... }
 ::= localValue : 8

illegalSubscriber ERROR
PARAMETER
  illegalSubscriberParam SEQUENCE {
    extensionContainer SEQUENCE {
      privateExtensionList [0] IMPLICIT SEQUENCE ( SIZE (1 .. 10) ) OF
      SEQUENCE {
        extId  MAP-EXTENSION .&extensionId ( {
          '

```

```

...}),
extType MAP-EXTENSION .&ExtensionType ({
  ...}{ @extId } ) OPTIONAL} OPTIONAL,
pcs-Extensions [1] IMPLICIT SEQUENCE {
  ... } OPTIONAL,
  ... } OPTIONAL,
  ... }
 ::= localValue : 9

```

```

illegalEquipment ERROR
PARAMETER
illegalEquipmentParam SEQUENCE {
  extensionContainer SEQUENCE {
    privateExtensionList [0] IMPLICIT SEQUENCE ( SIZE (1 .. 10) ) OF
    SEQUENCE {
      extId MAP-EXTENSION .&extensionId ({
        ...}),
      extType MAP-EXTENSION .&ExtensionType ({
        ...}{ @extId } ) OPTIONAL} OPTIONAL,
        pcs-Extensions [1] IMPLICIT SEQUENCE {
          ... } OPTIONAL,
          ... } OPTIONAL,
          ... }
        ::= localValue : 12

```

```

bearerServiceNotProvisioned ERROR
PARAMETER
bearerServNotProvParam SEQUENCE {
  extensionContainer SEQUENCE {
    privateExtensionList [0] IMPLICIT SEQUENCE ( SIZE (1 .. 10) ) OF
    SEQUENCE {
      extId MAP-EXTENSION .&extensionId ({
        ...}),
      extType MAP-EXTENSION .&ExtensionType ({
        ...}{ @extId } ) OPTIONAL} OPTIONAL,
        pcs-Extensions [1] IMPLICIT SEQUENCE {
          ... } OPTIONAL,
          ... } OPTIONAL,
          ... }
        ::= localValue : 10

```

```

teleserviceNotProvisioned ERROR
PARAMETER
teleservNotProvParam SEQUENCE {
  extensionContainer SEQUENCE {
    privateExtensionList [0] IMPLICIT SEQUENCE ( SIZE (1 .. 10) ) OF
    SEQUENCE {
      extId MAP-EXTENSION .&extensionId ({
        ...}),
      extType MAP-EXTENSION .&ExtensionType ({
        ...}{ @extId } ) OPTIONAL} OPTIONAL,
        pcs-Extensions [1] IMPLICIT SEQUENCE {
          ... } OPTIONAL,
          ... } OPTIONAL,
          ... }
        ::= localValue : 11

```

```

noHandoverNumberAvailable ERROR
 ::= localValue : 25

```

```

subsequentHandoverFailure ERROR
 ::= localValue : 26

```

```

targetCellOutsideGroupCallArea ERROR
PARAMETER
targetCellOutsideGCA-Param SEQUENCE {
  extensionContainer SEQUENCE {
    privateExtensionList [0] IMPLICIT SEQUENCE ( SIZE (1 .. 10) ) OF
    SEQUENCE {
      extId MAP-EXTENSION .&extensionId ({

```

```

        ...}),
        extType MAP-EXTENSION .&ExtensionType ({
            ...}{ @extId } ) OPTIONAL} OPTIONAL,
        pcs-Extensions [1] IMPLICIT SEQUENCE {
            ... } OPTIONAL,
        ... } OPTIONAL,
        ... }
 ::= localValue : 42

tracingBufferFull ERROR
PARAMETER
tracingBufferFullParam SEQUENCE {
    extensionContainer SEQUENCE {
        privateExtensionList [0] IMPLICIT SEQUENCE ( SIZE (1 .. 10) ) OF
        SEQUENCE {
            extId MAP-EXTENSION .&extensionId ({
                ...}),
            extType MAP-EXTENSION .&ExtensionType ({
                ...}{ @extId } ) OPTIONAL} OPTIONAL,
            pcs-Extensions [1] IMPLICIT SEQUENCE {
                ... } OPTIONAL,
            ... } OPTIONAL,
            ... }
 ::= localValue : 40

noRoamingNumberAvailable ERROR
PARAMETER
noRoamingNbParam SEQUENCE {
    extensionContainer SEQUENCE {
        privateExtensionList [0] IMPLICIT SEQUENCE ( SIZE (1 .. 10) ) OF
        SEQUENCE {
            extId MAP-EXTENSION .&extensionId ({
                ...}),
            extType MAP-EXTENSION .&ExtensionType ({
                ...}{ @extId } ) OPTIONAL} OPTIONAL,
            pcs-Extensions [1] IMPLICIT SEQUENCE {
                ... } OPTIONAL,
            ... } OPTIONAL,
            ... }
 ::= localValue : 39

absentSubscriber ERROR
PARAMETER
absentSubscriberParam SEQUENCE {
    extensionContainer SEQUENCE {
        privateExtensionList [0] IMPLICIT SEQUENCE ( SIZE (1 .. 10) ) OF
        SEQUENCE {
            extId MAP-EXTENSION .&extensionId ({
                ...}),
            extType MAP-EXTENSION .&ExtensionType ({
                ...}{ @extId } ) OPTIONAL} OPTIONAL,
            pcs-Extensions [1] IMPLICIT SEQUENCE {
                ... } OPTIONAL,
            ... } OPTIONAL,
            ... ,
            absentSubscriberReason [0] IMPLICIT ENUMERATED {
                imsiDetach (0),
                restrictedArea (1),
                noPageResponse (2),
                ... ,
                purgedMS (3) } OPTIONAL}
 ::= localValue : 27

busySubscriber ERROR
PARAMETER
busySubscriberParam SEQUENCE {
    extensionContainer SEQUENCE {
        privateExtensionList [0] IMPLICIT SEQUENCE ( SIZE (1 .. 10) ) OF
        SEQUENCE {

```

```

    extId    MAP-EXTENSION .&extensionId ( {
        '
        ... } ),
    extType  MAP-EXTENSION .&ExtensionType ( {
        '
        ... } { @extId } ) OPTIONAL} OPTIONAL,
    pcs-Extensions [1] IMPLICIT SEQUENCE {
        ... } OPTIONAL,
    ... } OPTIONAL,
    ... ,
    ccbs-Possible [0] IMPLICIT NULL OPTIONAL,
    ccbs-Busy [1] IMPLICIT NULL OPTIONAL}
 ::= localValue : 45

noSubscriberReply ERROR
PARAMETER
noSubscriberReplyParam SEQUENCE {
    extensionContainer SEQUENCE {
        privateExtensionList [0] IMPLICIT SEQUENCE ( SIZE ( 1 .. 10 ) ) OF
        SEQUENCE {
            extId    MAP-EXTENSION .&extensionId ( {
                '
                ... } ),
            extType  MAP-EXTENSION .&ExtensionType ( {
                '
                ... } { @extId } ) OPTIONAL} OPTIONAL,
            pcs-Extensions [1] IMPLICIT SEQUENCE {
                ... } OPTIONAL,
            ... } OPTIONAL,
            ... }
        }
 ::= localValue : 46

callBarred ERROR
PARAMETER
callBarredParam CHOICE {
    callBarringCause ENUMERATED {
        barringServiceActive ( 0 ),
        operatorBarring ( 1 )},
    extensibleCallBarredParam SEQUENCE {
        callBarringCause ENUMERATED {
            barringServiceActive ( 0 ),
            operatorBarring ( 1 )} OPTIONAL,
        extensionContainer SEQUENCE {
            privateExtensionList [0] IMPLICIT SEQUENCE ( SIZE ( 1 .. 10 ) ) OF
            SEQUENCE {
                extId    MAP-EXTENSION .&extensionId ( {
                    '
                    ... } ),
                extType  MAP-EXTENSION .&ExtensionType ( {
                    '
                    ... } { @extId } ) OPTIONAL} OPTIONAL,
                pcs-Extensions [1] IMPLICIT SEQUENCE {
                    ... } OPTIONAL,
                ... } OPTIONAL,
                ... ,
                unauthorisedMessageOriginator [1] IMPLICIT NULL OPTIONAL}}
        }
 ::= localValue : 13

forwardingFailed ERROR
PARAMETER
forwardingFailedParam SEQUENCE {
    extensionContainer SEQUENCE {
        privateExtensionList [0] IMPLICIT SEQUENCE ( SIZE ( 1 .. 10 ) ) OF
        SEQUENCE {
            extId    MAP-EXTENSION .&extensionId ( {
                '
                ... } ),
            extType  MAP-EXTENSION .&ExtensionType ( {
                '
                ... } { @extId } ) OPTIONAL} OPTIONAL,
            pcs-Extensions [1] IMPLICIT SEQUENCE {
                ... } OPTIONAL,
            ... } OPTIONAL,
            ... }
        }
 ::= localValue : 47

or-NotAllowed ERROR

```

PARAMETER

```

or-NotAllowedParam SEQUENCE {
  extensionContainer SEQUENCE {
    privateExtensionList [0] IMPLICIT SEQUENCE ( SIZE ( 1 .. 10 )) OF
    SEQUENCE {
      extId MAP-EXTENSION .&extensionId ( {
        '
        ... } ),
      extType MAP-EXTENSION .&ExtensionType ( {
        '
        ... } { @extId } ) OPTIONAL } OPTIONAL,
    pcs-Extensions [1] IMPLICIT SEQUENCE {
      ... } OPTIONAL,
      ... } OPTIONAL,
      ... }
}

```

::= localValue : 48

forwardingViolation ERROR

PARAMETER

```

forwardingViolationParam SEQUENCE {
  extensionContainer SEQUENCE {
    privateExtensionList [0] IMPLICIT SEQUENCE ( SIZE ( 1 .. 10 )) OF
    SEQUENCE {
      extId MAP-EXTENSION .&extensionId ( {
        '
        ... } ),
      extType MAP-EXTENSION .&ExtensionType ( {
        '
        ... } { @extId } ) OPTIONAL } OPTIONAL,
    pcs-Extensions [1] IMPLICIT SEQUENCE {
      ... } OPTIONAL,
      ... } OPTIONAL,
      ... }
}

```

::= localValue : 14

cug-Reject ERROR

PARAMETER

```

cug-RejectParam SEQUENCE {
  cug-RejectCause ENUMERATED {
    incomingCallsBarredWithinCUG (0),
    subscriberNotMemberOfCUG (1),
    requestedBasicServiceViolatesCUG-Constraints (5),
    calledPartySS-InteractionViolation (7) } OPTIONAL,
  extensionContainer SEQUENCE {
    privateExtensionList [0] IMPLICIT SEQUENCE ( SIZE ( 1 .. 10 )) OF
    SEQUENCE {
      extId MAP-EXTENSION .&extensionId ( {
        '
        ... } ),
      extType MAP-EXTENSION .&ExtensionType ( {
        '
        ... } { @extId } ) OPTIONAL } OPTIONAL,
    pcs-Extensions [1] IMPLICIT SEQUENCE {
      ... } OPTIONAL,
      ... } OPTIONAL,
      ... }
}

```

::= localValue : 15

ati-NotAllowed ERROR

PARAMETER

```

ati-NotAllowedParam SEQUENCE {
  extensionContainer SEQUENCE {
    privateExtensionList [0] IMPLICIT SEQUENCE ( SIZE ( 1 .. 10 )) OF
    SEQUENCE {
      extId MAP-EXTENSION .&extensionId ( {
        '
        ... } ),
      extType MAP-EXTENSION .&ExtensionType ( {
        '
        ... } { @extId } ) OPTIONAL } OPTIONAL,
    pcs-Extensions [1] IMPLICIT SEQUENCE {
      ... } OPTIONAL,
      ... } OPTIONAL,
      ... }
}

```

::= localValue : 49

atsi-NotAllowed ERROR

PARAMETER

```

atsi-NotAllowedParam SEQUENCE {
  extensionContainer SEQUENCE {
    privateExtensionList [0] IMPLICIT SEQUENCE ( SIZE ( 1 .. 10 )) OF
    SEQUENCE {
      extId MAP-EXTENSION .&extensionId ( {
        '
        ... } ),
      extType MAP-EXTENSION .&ExtensionType ( {
        '
        ... } { @extId } ) OPTIONAL } OPTIONAL,
    pcs-Extensions [1] IMPLICIT SEQUENCE {
      ... } OPTIONAL,
      ... } OPTIONAL,
      ... }
}

```

::= localValue : 60

atm-NotAllowed ERROR

PARAMETER

```

atm-NotAllowedParam SEQUENCE {
  extensionContainer SEQUENCE {
    privateExtensionList [0] IMPLICIT SEQUENCE ( SIZE ( 1 .. 10 )) OF
    SEQUENCE {
      extId MAP-EXTENSION .&extensionId ( {
        '
        ... } ),
      extType MAP-EXTENSION .&ExtensionType ( {
        '
        ... } { @extId } ) OPTIONAL } OPTIONAL,
    pcs-Extensions [1] IMPLICIT SEQUENCE {
      ... } OPTIONAL,
      ... } OPTIONAL,
      ... }
}

```

::= localValue : 61

informationNotAvailable ERROR

PARAMETER

```

informationNotAvailableParam SEQUENCE {
  extensionContainer SEQUENCE {
    privateExtensionList [0] IMPLICIT SEQUENCE ( SIZE ( 1 .. 10 )) OF
    SEQUENCE {
      extId MAP-EXTENSION .&extensionId ( {
        '
        ... } ),
      extType MAP-EXTENSION .&ExtensionType ( {
        '
        ... } { @extId } ) OPTIONAL } OPTIONAL,
    pcs-Extensions [1] IMPLICIT SEQUENCE {
      ... } OPTIONAL,
      ... } OPTIONAL,
      ... }
}

```

::= localValue : 62

noGroupCallNumberAvailable ERROR

PARAMETER

```

noGroupCallNbParam SEQUENCE {
  extensionContainer SEQUENCE {
    privateExtensionList [0] IMPLICIT SEQUENCE ( SIZE ( 1 .. 10 )) OF
    SEQUENCE {
      extId MAP-EXTENSION .&extensionId ( {
        '
        ... } ),
      extType MAP-EXTENSION .&ExtensionType ( {
        '
        ... } { @extId } ) OPTIONAL } OPTIONAL,
    pcs-Extensions [1] IMPLICIT SEQUENCE {
      ... } OPTIONAL,
      ... } OPTIONAL,
      ... }
}

```

::= localValue : 50

illegalSS-Operation ERROR

PARAMETER

```

illegalSS-OperationParam SEQUENCE {
  extensionContainer SEQUENCE {
    privateExtensionList [0] IMPLICIT SEQUENCE ( SIZE ( 1 .. 10 )) OF
    SEQUENCE {

```

```

    extId    MAP-EXTENSION .&extensionId ( {
        '
        ... } ),
    extType  MAP-EXTENSION .&ExtensionType ( {
        '
        ... } { @extId } ) OPTIONAL } OPTIONAL,
    pcs-Extensions [1] IMPLICIT SEQUENCE {
        ... } OPTIONAL,
    ... } OPTIONAL,
    ... }
 ::= localValue : 16

ss-ErrorStatus ERROR
PARAMETER
    ss-Status OCTET STRING ( SIZE ( 1 ) )
 ::= localValue : 17

ss-NotAvailable ERROR
PARAMETER
    ss-NotAvailableParam SEQUENCE {
        extensionContainer SEQUENCE {
            privateExtensionList [0] IMPLICIT SEQUENCE ( SIZE ( 1 .. 10 ) ) OF
            SEQUENCE {
                extId    MAP-EXTENSION .&extensionId ( {
                    '
                    ... } ),
                extType  MAP-EXTENSION .&ExtensionType ( {
                    '
                    ... } { @extId } ) OPTIONAL } OPTIONAL,
            pcs-Extensions [1] IMPLICIT SEQUENCE {
                ... } OPTIONAL,
            ... } OPTIONAL,
            ... }
 ::= localValue : 18

ss-SubscriptionViolation ERROR
PARAMETER
    ss-SubscriptionViolationParam SEQUENCE {
        extensionContainer SEQUENCE {
            privateExtensionList [0] IMPLICIT SEQUENCE ( SIZE ( 1 .. 10 ) ) OF
            SEQUENCE {
                extId    MAP-EXTENSION .&extensionId ( {
                    '
                    ... } ),
                extType  MAP-EXTENSION .&ExtensionType ( {
                    '
                    ... } { @extId } ) OPTIONAL } OPTIONAL,
            pcs-Extensions [1] IMPLICIT SEQUENCE {
                ... } OPTIONAL,
            ... } OPTIONAL,
            ... }
 ::= localValue : 19

ss-Incompatibility ERROR
PARAMETER
    ss-IncompatibilityCause SEQUENCE {
        ss-Code [1] IMPLICIT OCTET STRING ( SIZE ( 1 ) ) OPTIONAL,
        basicService CHOICE {
            bearerService [2] IMPLICIT OCTET STRING ( SIZE ( 1 ) ),
            teleservice [3] IMPLICIT OCTET STRING ( SIZE ( 1 ) ) } OPTIONAL,
        ss-Status [4] IMPLICIT OCTET STRING ( SIZE ( 1 ) ) OPTIONAL,
        ... }
 ::= localValue : 20

unknownAlphabet ERROR
 ::= localValue : 71

ussd-Busy ERROR
 ::= localValue : 72

pw-RegistrationFailure ERROR
PARAMETER
    pw-RegistrationFailureCause ENUMERATED {
        undetermined (0),
        invalidFormat (1),
        newPasswordsMismatch (2) }
 ::= localValue : 37

```

negativePW-Check ERROR

::= localValue : 38

numberOfPW-AttemptsViolation ERROR

::= localValue : 43

shortTermDenial ERROR

PARAMETER

shortTermDenialParam SEQUENCE {
... }

::= localValue : 29

longTermDenial ERROR

PARAMETER

longTermDenialParam SEQUENCE {
... }

::= localValue : 30

subscriberBusyForMT-SMS ERROR

PARAMETER

subBusyForMT-SMS-Param SEQUENCE {
extensionContainer SEQUENCE {
privateExtensionList [0] IMPLICIT SEQUENCE (SIZE (1 .. 10)) OF
SEQUENCE {
extId MAP-EXTENSION .&extensionId ({
'
... }) ,
extType MAP-EXTENSION .&ExtensionType ({
'
... } { @extId }) OPTIONAL } OPTIONAL,
pcs-Extensions [1] IMPLICIT SEQUENCE {
... } OPTIONAL,
... } OPTIONAL,
... ,
gprsConnectionSuspended NULL OPTIONAL }
::= localValue : 31

sm-DeliveryFailure ERROR

PARAMETER

sm-DeliveryFailureCause SEQUENCE {
sm-EnumeratedDeliveryFailureCause ENUMERATED {
memoryCapacityExceeded (0),
equipmentProtocolError (1),
equipmentNotSM-Equipped (2),
unknownServiceCentre (3),
sc-Congestion (4),
invalidSME-Address (5),
subscriberNotSC-Subscriber (6) },
diagnosticInfo OCTET STRING (SIZE (1 .. 200)) OPTIONAL,
extensionContainer SEQUENCE {
privateExtensionList [0] IMPLICIT SEQUENCE (SIZE (1 .. 10)) OF
SEQUENCE {
extId MAP-EXTENSION .&extensionId ({
'
... }) ,
extType MAP-EXTENSION .&ExtensionType ({
'
... } { @extId }) OPTIONAL } OPTIONAL,
pcs-Extensions [1] IMPLICIT SEQUENCE {
... } OPTIONAL,
... } OPTIONAL,
... }
::= localValue : 32

messageWaitingListFull ERROR

PARAMETER

messageWaitListFullParam SEQUENCE {
extensionContainer SEQUENCE {
privateExtensionList [0] IMPLICIT SEQUENCE (SIZE (1 .. 10)) OF
SEQUENCE {
extId MAP-EXTENSION .&extensionId ({
'
... }) ,
extType MAP-EXTENSION .&ExtensionType ({
'
... } { @extId }) OPTIONAL } OPTIONAL,
... }
::= localValue : 33

```

    pcs-Extensions    [1] IMPLICIT SEQUENCE {
      ... } OPTIONAL,
      ... } OPTIONAL,
      ... }
  ::= localValue : 33

```

absentsubscriberSM ERROR

PARAMETER

```

absentSubscriberSM-Param SEQUENCE {
  absentSubscriberDiagnosticSM    INTEGER ( 0 .. 255 ) OPTIONAL,
  extensionContainer              SEQUENCE {
    privateExtensionList [0] IMPLICIT SEQUENCE ( SIZE ( 1 .. 10 ) ) OF
      SEQUENCE {
        extId    MAP-EXTENSION .&extensionId ( {
          '
          ... } ),
        extType  MAP-EXTENSION .&ExtensionType ( {
          '
          ... } { @extId } ) OPTIONAL } OPTIONAL,
        pcs-Extensions    [1] IMPLICIT SEQUENCE {
          ... } OPTIONAL,
          ... } OPTIONAL,
          ... }
      ... ,
      additionalAbsentSubscriberDiagnosticSM [0] IMPLICIT INTEGER ( 0 .. 255 ) OPTIONAL }
  ::= localValue : 6

```

unauthorizedRequestingNetwork ERROR

PARAMETER

```

unauthorizedRequestingNetwork-Param SEQUENCE {
  extensionContainer SEQUENCE {
    privateExtensionList [0] IMPLICIT SEQUENCE ( SIZE ( 1 .. 10 ) ) OF
      SEQUENCE {
        extId    MAP-EXTENSION .&extensionId ( {
          '
          ... } ),
        extType  MAP-EXTENSION .&ExtensionType ( {
          '
          ... } { @extId } ) OPTIONAL } OPTIONAL,
        pcs-Extensions    [1] IMPLICIT SEQUENCE {
          ... } OPTIONAL,
          ... } OPTIONAL,
          ... }
      ... }
  ::= localValue : 52

```

unauthorizedLCSCClient ERROR

PARAMETER

```

unauthorizedLCSCClient-Param SEQUENCE {
  unauthorizedLCSCClient-Diagnostic [0] IMPLICIT ENUMERATED {
    noAdditionalInformation          ( 0 ),
    clientNotInMSPPrivacyExceptionList ( 1 ),
    callToClientNotSetup            ( 2 ),
    privacyOverrideNotApplicable    ( 3 ),
    disallowedByLocalRegulatoryRequirements ( 4 ),
    ... } OPTIONAL,
  extensionContainer [1] IMPLICIT SEQUENCE {
    privateExtensionList [0] IMPLICIT SEQUENCE ( SIZE ( 1 .. 10 ) ) OF
      SEQUENCE {
        extId    MAP-EXTENSION .&extensionId ( {
          '
          ... } ),
        extType  MAP-EXTENSION .&ExtensionType ( {
          '
          ... } { @extId } ) OPTIONAL } OPTIONAL,
        pcs-Extensions    [1] IMPLICIT SEQUENCE {
          ... } OPTIONAL,
          ... } OPTIONAL,
          ... }
      ... }
  ::= localValue : 53

```

positionMethodFailure ERROR

PARAMETER

```

positionMethodFailure-Param SEQUENCE {
  positionMethodFailure-Diagnostic [0] IMPLICIT ENUMERATED {
    congestion          ( 0 ),
    insufficientResources ( 1 ),
    insufficientMeasurementData ( 2 ),
    inconsistentMeasurementData ( 3 ),

```

```

locationProcedureNotCompleted (4),
locationProcedureNotSupportedByTargetMS (5),
qoSNotAttainable (6),
positionMethodNotAvailableInNetwork (7),
positionMethodNotAvailableInLocationArea (8),
... } OPTIONAL,
extensionContainer [1] IMPLICIT SEQUENCE {
privateExtensionList [0] IMPLICIT SEQUENCE ( SIZE (1 .. 10) ) OF
SEQUENCE {
extId MAP-EXTENSION .&extensionId ( {
'
...} ),
extType MAP-EXTENSION .&ExtensionType ( {
'
...} { @extId } ) OPTIONAL} OPTIONAL,
pcs-Extensions [1] IMPLICIT SEQUENCE {
... } OPTIONAL,
... } OPTIONAL,
... }
 ::= localValue : 54

```

```

unknownOrUnreachableLCSCClient ERROR
PARAMETER
unknownOrUnreachableLCSCClient-Param SEQUENCE {
extensionContainer SEQUENCE {
privateExtensionList [0] IMPLICIT SEQUENCE ( SIZE (1 .. 10) ) OF
SEQUENCE {
extId MAP-EXTENSION .&extensionId ( {
'
...} ),
extType MAP-EXTENSION .&ExtensionType ( {
'
...} { @extId } ) OPTIONAL} OPTIONAL,
pcs-Extensions [1] IMPLICIT SEQUENCE {
... } OPTIONAL,
... } OPTIONAL,
... }
 ::= localValue : 58

```

```

mm-EventNotSupported ERROR
PARAMETER
mm-EventNotSupported-Param SEQUENCE {
extensionContainer SEQUENCE {
privateExtensionList [0] IMPLICIT SEQUENCE ( SIZE (1 .. 10) ) OF
SEQUENCE {
extId MAP-EXTENSION .&extensionId ( {
'
...} ),
extType MAP-EXTENSION .&ExtensionType ( {
'
...} { @extId } ) OPTIONAL} OPTIONAL,
pcs-Extensions [1] IMPLICIT SEQUENCE {
... } OPTIONAL,
... } OPTIONAL,
... }
 ::= localValue : 59

```

```

secureTransportError ERROR
PARAMETER
secureTransportErrorParam SEQUENCE {
securityHeader SEQUENCE {
securityParametersIndex OCTET STRING ( SIZE (4) ),
originalComponentIdentifier CHOICE {
operationCode [0] CHOICE {
localValue INTEGER,
globalValue OBJECT IDENTIFIER},
errorCode [1] CHOICE {
localValue INTEGER,
globalValue OBJECT IDENTIFIER},
userInfo [2] IMPLICIT NULL},
initialisationVector OCTET STRING ( SIZE (14) ) OPTIONAL,
... },
protectedPayload OCTET STRING ( SIZE (1 .. 3438) ) OPTIONAL}
 ::= localValue : 4

```

END

B.2 Fully Expanded ASN.1 Source of MAP-DialogueInformation

```

-- Expanded ASN1 Module 'MAP-DialogueInformation'
--SIEMENS ASN.1 Compiler R5.40 (Production_5.40)
-- Date: 2002-06-07 Time: 14:47:17

MAP-DialogueInformation{ 0 identified-organization (4) etsi (0) mobileDomain (0) gsm-Network (1) modules (3) map-
DialogueInformation (3) version8 (8) }

DEFINITIONS

 ::=

BEGIN

EXPORTS
  map-DialogueAS,
  MAP-DialoguePDU,
  map-ProtectedDialogueAS,
  MAP-ProtectedDialoguePDU;

map-DialogueAS OBJECT IDENTIFIER ::= { ccitt (0) identified-organization (4) etsi (0) mobileDomain (0) gsm-Network (1) 1 map-
DialoguePDU (1) version1 (1) }

MAP-DialoguePDU ::= CHOICE {
  map-open [0] IMPLICIT SEQUENCE {
    destinationReference [0] IMPLICIT OCTET STRING ( SIZE (1 .. 20) ) OPTIONAL,
    originationReference [1] IMPLICIT OCTET STRING ( SIZE (1 .. 20) ) OPTIONAL,
    ... ,
    extensionContainer SEQUENCE {
      privateExtensionList [0] IMPLICIT SEQUENCE ( SIZE (1 .. 10) ) OF
        SEQUENCE {
          extId MAP-EXTENSION .&extensionId ( {
            '
            ... } ),
          extType MAP-EXTENSION .&ExtensionType ( {
            '
            ... } { @extId } ) OPTIONAL } OPTIONAL,
          pcs-Extensions [1] IMPLICIT SEQUENCE {
            ... } OPTIONAL,
            ... } OPTIONAL },
    map-accept [1] IMPLICIT SEQUENCE {
      ... ,
      extensionContainer SEQUENCE {
        privateExtensionList [0] IMPLICIT SEQUENCE ( SIZE (1 .. 10) ) OF
          SEQUENCE {
            extId MAP-EXTENSION .&extensionId ( {
              '
              ... } ),
            extType MAP-EXTENSION .&ExtensionType ( {
              '
              ... } { @extId } ) OPTIONAL } OPTIONAL,
            pcs-Extensions [1] IMPLICIT SEQUENCE {
              ... } OPTIONAL,
              ... } OPTIONAL },
    map-close [2] IMPLICIT SEQUENCE {
      ... ,
      extensionContainer SEQUENCE {
        privateExtensionList [0] IMPLICIT SEQUENCE ( SIZE (1 .. 10) ) OF
          SEQUENCE {
            extId MAP-EXTENSION .&extensionId ( {
              '
              ... } ),
            extType MAP-EXTENSION .&ExtensionType ( {
              '
              ... } { @extId } ) OPTIONAL } OPTIONAL,
            pcs-Extensions [1] IMPLICIT SEQUENCE {
              ... } OPTIONAL,
              ... } OPTIONAL },
    map-refuse [3] IMPLICIT SEQUENCE {
      reason
        ENUMERATED {

```

```

noReasonGiven          (0),
invalidDestinationReference (1),
invalidOriginatingReference (2),
encapsulatedAC-NotSupported (3),
transportProtectionNotAdequate (4)),
... ,
extensionContainer      SEQUENCE {
  privateExtensionList [0] IMPLICIT SEQUENCE ( SIZE (1 .. 10) ) OF
    SEQUENCE {
      extId  MAP-EXTENSION .&extensionId ( {
        '
        ...} ),
      extType MAP-EXTENSION .&ExtensionType ( {
        '
        ...} { @extId } ) OPTIONAL} OPTIONAL,
  pcs-Extensions [1] IMPLICIT SEQUENCE {
    ... } OPTIONAL,
  ... } OPTIONAL,
  alternativeApplicationContext OBJECT IDENTIFIER OPTIONAL},
map-userAbort [4] IMPLICIT SEQUENCE {
  map-UserAbortChoice CHOICE {
    userSpecificReason [0] IMPLICIT NULL,
    userResourceLimitation [1] IMPLICIT NULL,
    resourceUnavailable [2] IMPLICIT ENUMERATED {
      shortTermResourceLimitation (0),
      longTermResourceLimitation (1) },
    applicationProcedureCancellation [3] IMPLICIT ENUMERATED {
      handoverCancellation (0),
      radioChannelRelease (1),
      networkPathRelease (2),
      callRelease (3),
      associatedProcedureFailure (4),
      tandemDialogueRelease (5),
      remoteOperationsFailure (6) }},
  ... ,
extensionContainer SEQUENCE {
  privateExtensionList [0] IMPLICIT SEQUENCE ( SIZE (1 .. 10) ) OF
    SEQUENCE {
      extId  MAP-EXTENSION .&extensionId ( {
        '
        ...} ),
      extType MAP-EXTENSION .&ExtensionType ( {
        '
        ...} { @extId } ) OPTIONAL} OPTIONAL,
  pcs-Extensions [1] IMPLICIT SEQUENCE {
    ... } OPTIONAL,
  ... } OPTIONAL},
map-providerAbort [5] IMPLICIT SEQUENCE {
  map-ProviderAbortReason ENUMERATED {
    abnormalDialogue (0),
    invalidPDU (1) },
  ... ,
extensionContainer SEQUENCE {
  privateExtensionList [0] IMPLICIT SEQUENCE ( SIZE (1 .. 10) ) OF
    SEQUENCE {
      extId  MAP-EXTENSION .&extensionId ( {
        '
        ...} ),
      extType MAP-EXTENSION .&ExtensionType ( {
        '
        ...} { @extId } ) OPTIONAL} OPTIONAL,
  pcs-Extensions [1] IMPLICIT SEQUENCE {
    ... } OPTIONAL,
  ... } OPTIONAL}}

MAP-OpenInfo ::= SEQUENCE {
  destinationReference [0] IMPLICIT OCTET STRING ( SIZE (1 .. 20) ) OPTIONAL,
  originationReference [1] IMPLICIT OCTET STRING ( SIZE (1 .. 20) ) OPTIONAL,
  ... ,
extensionContainer SEQUENCE {
  privateExtensionList [0] IMPLICIT SEQUENCE ( SIZE (1 .. 10) ) OF
    SEQUENCE {
      extId  MAP-EXTENSION .&extensionId ( {
        '
        ...} ),
      extType MAP-EXTENSION .&ExtensionType ( {
        '

```

```

...{ @extId } ) OPTIONAL} OPTIONAL,
pcs-Extensions [1] IMPLICIT SEQUENCE {
... } OPTIONAL,
... } OPTIONAL}

```

```

MAP-AcceptInfo ::= SEQUENCE {
... ,
extensionContainer SEQUENCE {
privateExtensionList [0] IMPLICIT SEQUENCE ( SIZE (1 .. 10) ) OF
SEQUENCE {
extId MAP-EXTENSION .&extensionId ( {
'
...} ) ,
extType MAP-EXTENSION .&ExtensionType ( {
'
...{ @extId } ) OPTIONAL} OPTIONAL,
pcs-Extensions [1] IMPLICIT SEQUENCE {
... } OPTIONAL,
... } OPTIONAL}

```

```

MAP-CloseInfo ::= SEQUENCE {
... ,
extensionContainer SEQUENCE {
privateExtensionList [0] IMPLICIT SEQUENCE ( SIZE (1 .. 10) ) OF
SEQUENCE {
extId MAP-EXTENSION .&extensionId ( {
'
...} ) ,
extType MAP-EXTENSION .&ExtensionType ( {
'
...{ @extId } ) OPTIONAL} OPTIONAL,
pcs-Extensions [1] IMPLICIT SEQUENCE {
... } OPTIONAL,
... } OPTIONAL}

```

```

MAP-RefuseInfo ::= SEQUENCE {
reason ENUMERATED {
noReasonGiven (0),
invalidDestinationReference (1),
invalidOriginatingReference (2),
encapsulatedAC-NotSupported (3),
transportProtectionNotAdequate (4) },
... ,
extensionContainer SEQUENCE {
privateExtensionList [0] IMPLICIT SEQUENCE ( SIZE (1 .. 10) ) OF
SEQUENCE {
extId MAP-EXTENSION .&extensionId ( {
'
...} ) ,
extType MAP-EXTENSION .&ExtensionType ( {
'
...{ @extId } ) OPTIONAL} OPTIONAL,
pcs-Extensions [1] IMPLICIT SEQUENCE {
... } OPTIONAL,
... } OPTIONAL,
alternativeApplicationContext OBJECT IDENTIFIER OPTIONAL}

```

```

Reason ::= ENUMERATED {
noReasonGiven (0),
invalidDestinationReference (1),
invalidOriginatingReference (2),
encapsulatedAC-NotSupported (3),
transportProtectionNotAdequate (4) }

```

```

MAP-UserAbortInfo ::= SEQUENCE {
map-UserAbortChoice CHOICE {
userSpecificReason [0] IMPLICIT NULL,
userResourceLimitation [1] IMPLICIT NULL,
resourceUnavailable [2] IMPLICIT ENUMERATED {
shortTermResourceLimitation (0),
longTermResourceLimitation (1) },
applicationProcedureCancellation [3] IMPLICIT ENUMERATED {
handoverCancellation (0),
radioChannelRelease (1),
networkPathRelease (2),
callRelease (3),
associatedProcedureFailure (4) },

```

```

    tandemDialogueRelease    (5),
    remoteOperationsFailure  (6 )}},
... ,
extensionContainer SEQUENCE {
  privateExtensionList [0] IMPLICIT SEQUENCE ( SIZE (1 .. 10) ) OF
  SEQUENCE {
    extId  MAP-EXTENSION .&extensionId ( {
      '
      ... } ) ,
    extType  MAP-EXTENSION .&ExtensionType ( {
      '
      ... } { @extId } ) OPTIONAL } OPTIONAL,
  pcs-Extensions [1] IMPLICIT SEQUENCE {
    ... } OPTIONAL,
  ... } OPTIONAL }

```

```

MAP-UserAbortChoice ::= CHOICE {
  userSpecificReason [0] IMPLICIT NULL,
  userResourceLimitation [1] IMPLICIT NULL,
  resourceUnavailable [2] IMPLICIT ENUMERATED {
    shortTermResourceLimitation (0),
    longTermResourceLimitation (1)},
  applicationProcedureCancellation [3] IMPLICIT ENUMERATED {
    handoverCancellation (0),
    radioChannelRelease (1),
    networkPathRelease (2),
    callRelease (3),
    associatedProcedureFailure (4),
    tandemDialogueRelease (5),
    remoteOperationsFailure (6 )}}

```

```

ResourceUnavailableReason ::= ENUMERATED {
  shortTermResourceLimitation (0),
  longTermResourceLimitation (1)}

```

```

ProcedureCancellationReason ::= ENUMERATED {
  handoverCancellation (0),
  radioChannelRelease (1),
  networkPathRelease (2),
  callRelease (3),
  associatedProcedureFailure (4),
  tandemDialogueRelease (5),
  remoteOperationsFailure (6)}

```

```

MAP-ProviderAbortInfo ::= SEQUENCE {
  map-ProviderAbortReason ENUMERATED {
    abnormalDialogue (0),
    invalidPDU (1)},
... ,
extensionContainer SEQUENCE {
  privateExtensionList [0] IMPLICIT SEQUENCE ( SIZE (1 .. 10) ) OF
  SEQUENCE {
    extId  MAP-EXTENSION .&extensionId ( {
      '
      ... } ) ,
    extType  MAP-EXTENSION .&ExtensionType ( {
      '
      ... } { @extId } ) OPTIONAL } OPTIONAL,
  pcs-Extensions [1] IMPLICIT SEQUENCE {
    ... } OPTIONAL,
  ... } OPTIONAL }

```

```

MAP-ProviderAbortReason ::= ENUMERATED {
  abnormalDialogue (0),
  invalidPDU (1)}

```

```

map-ProtectedDialogueAS OBJECT IDENTIFIER ::= { ccitt (0) identified-organization (4) etsi (0) mobileDomain (0) gsm-Network (1) 1
map-ProtectedDialoguePDU (3) version1 (1) }

```

```

MAP-ProtectedDialoguePDU ::= SEQUENCE {
  encapsulatedAC OBJECT IDENTIFIER,
  securityHeader SEQUENCE {
    securityParametersIndex OCTET STRING ( SIZE (4) ),
    originalComponentIdentifier CHOICE {
      operationCode [0] CHOICE {
        localValue INTEGER,
        globalValue OBJECT IDENTIFIER},

```

```
errorCode    [1] CHOICE {  
  localValue  INTEGER,  
  globalValue OBJECT IDENTIFIER},  
userInfo     [2] IMPLICIT NULL,  
initialisationVector OCTET STRING ( SIZE (14) ) OPTIONAL,  
... } OPTIONAL,  
protectedPayload OCTET STRING ( SIZE (1 .. 3438) ) OPTIONAL,  
... }
```

END

Annex C :
Void

Annex D (informative): Clause mapping table

D.1 Mapping of Clause numbers

The clause numbers have been modified according to table D.1.

Table D.1: Clause mapping from Version 5.9.0 to Version 6.0.0

Old Clause No (V5.9.0)	New Clause No (V6.0.0)	Old Clause No (V5.9.0)	New Clause No (V6.0.0)
1.1	2	17.*	20.*
1.2	3	18.*	21.*
2.*	4.*	19.*	22.*
3.*	5.*	19.0.*	22.1.*
4.*	6.*	19.1.*	22.2.*
5.*	7.*	19.2.*	22.3.*
6.*	8.*	19.3.*	22.4.*
7.*	9.*	19.4.*	22.5.*
8.*	10.*	19.5.*	22.6.*
9.*	11.*	19.6.*	22.7.*
10.*	12.*	19.7.*	22.8.*
new11.*	13.*	19.8.*	22.9.*
old11.*	14.*	19.9.*	22.10.*
12.*	15.*	19.10.*	22.11.*
13.*	16.*	19.11.*	22.12.*
14.*	17.*	20.*	23.*
15.*	18.*	new22.*	24.*
16.*	19.*	old21.*	25.*

Annex E (informative): Change History

SMG#	TDoc	SPEC	VERS	CR	REV	PHAS E	CAT	SUBJECT	NEW_VERS	WORKITEM
04	N2-99227	29.002	3.0.0	A002	3	R98	A	Use of E interface	3.1.0	
04	N2-99578	29.002	3.0.0	A003		R98	B	Introduction of TIF-CSI for Call Deflection	3.1.0	
04	N2-99233	29.002	3.0.0	A004		R98	A	Clarification in ASN.1 encoding of O-CSI and T-CSI	3.1.0	
04	N2-99269	29.002	3.0.0	A005		R98	C	Introduction of MSISDN in USSD operation	3.1.0	
04	N2-99650	29.002	3.0.0	A006		R98	A	Modification of the O-CSI ASN.1 structure	3.1.0	
04	N2-99250	29.002	3.0.0	A007		R98	A	Adding of MAP_DELIMITER_req to the Status report operation	3.1.0	
04	N2-99628	29.002	3.0.0	A008		R98	A	Correction to the Purge MS "Detailed procedure in the HLR"	3.1.0	
04	N2-99677	29.002	3.0.0	A009		R98	A	Adding of MNP-indicator to the SRI ack	3.1.0	
04	N2-99228	29.002	3.0.0	A010		R98	F	New subscription options for call forwarding	3.1.0	
04	N2-99585	29.002	3.0.0	A011		R98	C	Adding the support of ANSI SCCP which is required in North America (World Zone 1)	3.1.0	
04	N2-99515	29.002	3.0.0	A012		R98	A	Introduction of 3-digit MNCs correction	3.1.0	
04	N2-99520	29.002	3.0.0	A013		R98	F	Export of NAEA-CIC	3.1.0	
04	N2-99548	29.002	3.0.0	A014		R98	D	Clarification to text to identify how the LSA data relevant in the current VPLMN can be determined	3.1.0	
04	3C99-468	29.002	3.0.0	A015		R97	F	Alignment with 04.80	3.1.0	
04	N2-99519	29.002	3.0.0	A016		R98	A	VBS data	3.1.0	
04	N2-99461	29.002	3.0.0	A017		R98	F	Introduction of Data Missing error to the Resume Call Handling	3.1.0	
04	N2-99583	29.002	3.0.0	A018		R97	F	Removal of 3-digit MNCs	3.1.0	
04	N2-99676	29.002	3.0.0	A019		R98	A	Corrections of mapping from MAP service to TC service	3.1.0	
04	3C99-206	29.002	3.0.0	A020		R98	B	Introduction of UUS service to Resume Call Handling	3.1.0	
05	N2-99906	29.002	3.1.0	021		R99	A	Clarification on VLR CAMEL Subscription Info	3.2.0	CAMEL Phase 2
05	N2-99908	29.002	3.1.0	022		R99	A	Clarification on DestinationNumberCriteria	3.2.0	CAMEL Phase 2
05	N2-99910	29.002	3.1.0	023		R99	A	Removal of TDP-Criteria from RCH	3.2.0	CAMEL Phase 2
05	N2-99934	29.002	3.1.0	025		R99	A	Various corrections related to GGSN-HLR Interface.	3.2.0	GPRS
05	N2-99936	29.002	3.1.0	034		R99	A	Update Location handling for GPRS-only subscription	3.2.0	GPRS
05	N2-99938	29.002	3.1.0	035		R99	A	Correction of OP & AC definitions for NoteMS-PresentForGPRS	3.2.0	GPRS
05	N2-99952	29.002	3.1.0	036		R99	A	Removal of redundant information from RCH	3.2.0	UUS
05	N2-99956	29.002	3.1.0	026		R99	A	OR capability IE in PRN	3.2.0	TEI
05	N2-99964	29.002	3.1.0	024	1	R99	A	GMSC-CAMEL phase 2 support IE in PRN	3.2.0	CAMEL Phase 2
05	N2-99A19	29.002	3.1.0	028		R99	A	Alignment of 29.002 with 02.67	3.2.0	eMLPP
05	N2-99A45	29.002	3.1.0	029	1	R99	B	Non-CAMEL IST implementation	3.2.0	IST
05	N2-99B57	29.002	3.1.0	027	2	R99	B	Addition of the information elements and the ASN.1 definitions for Pre-paging	3.2.0	Pre-Paging
05	N2-99C27	29.002	3.1.0	042		R99	A	Clarification on 'Supported CAMEL Phases' in ISD ack	3.2.0	CAMEL Phase 2
05	N2-99C78	29.002	3.1.0	044		R99	A	Editing error correction on VLR capabilities	3.2.0	SoLSA
05	N2-99D06	29.002	3.1.0	043	1	R99	A	Addition of exception handling to the CancellationType	3.2.0	GPRS
05	N2-99D33	29.002	3.1.0	046		R99	A	Clarification of LR-REJECT cause corresponding to RoamingRestrictionDueTo UnsupportedFeature	3.2.0	TEI

SMG#	TDoc	SPEC	VERS	CR	REV	PHASE	CAT	SUBJECT	NEW_VERS	WORKITEM
05	N2-99D35	29.002	3.1.0	047		R99		Clarification of returning the MSISDN in SRlack	3.2.0	MNP
06	N2-99G06	29.002	3.2.0	033	3	R99	C	Introduction of the Super-Charger Concept in TS 29.002	3.3.0	Super Charger
06	N2-99G18	29.002	3.2.0	032	2	R99	C	Introduction of White Book SCCP in MAP	3.3.0	TEI
06	N2-99G50	29.002	3.2.0	070		R99	A	Addition of GGSN number for the SRIforGPRS	3.3.0	GPRS
06	N2-99J88	29.002	3.2.0	075	1	R99	B	Introduction of Follow Me	3.3.0	Follow Me
06	N2-99K12	29.002	3.2.0	077		R99	A	Use of SSN for GPRS	3.3.0	GPRS
06	N2-99K24	29.002	3.2.0	069		R99	A	Correction of the USSD procedure in the HLR.	3.3.0	USSD & Follow Me
06	N2-99K52	29.002	3.2.0	060	1	R99	C	MAP Impacts for Location Services (LCS)	3.3.0	Location Services
06	N2-99K58	29.002	3.2.0	045	4	R99	B	Authentication Enhancements	3.3.0	Security
06	N2-99K60	29.002	3.2.0	050	5	R99	C	QoS-Subscribed field modification	3.3.0	QoS enhancements
06	N2-99L20	29.002	3.2.0	073	1	R99	C	Introduction of CAMEL Phase 3 in 3G TS 29.002	3.3.0	CAMEL Phase 3
06	N2-99J52	29.002	3.2.0	074		R99	D	Restructuring of MAP Location Management Procedures for the Circuit Switched Domain	3.3.0	TEI
06	N2-99J92	29.002	3.2.0	068		R99	B	Update of SDLs to support Super-Charger	3.3.0	Super-Charger
			3.3.0					New version created to fix a CR implementation error	3.3.1	
07	N2B000436	29.002	3.3.1	048	5	R99	B	Introduction of Multicall	3.4.0	Multicall
07	N2B000319	29.002	3.3.1	059	1	R99	B	Alternative solution for ALR	3.4.0	CAMEL phase 3
07	N2B000461	29.002	3.3.1	063	4	R99	B	MNP Database Mismatch	3.4.0	MNP
07	N2B000375	29.002	3.3.1	066	5	R99	B	Addition of the FTN-AddressString	3.4.0	Call Forwarding Enhancements
07	N2B000456	29.002	3.3.1	079	4	R99	C	Correction of SS Invocation Notification for CCBS	3.4.0	CAMEL Phase 3
07	N2A000023	29.002	3.3.1	080		R99	F	Corrections to ATSI, ATM, NCSD	3.4.0	CAMEL Phase 3
07	N2B000046	29.002	3.3.1	083		R99	A	Privacy notification/verification for call related privacy class	3.4.0	Location Services (LCS)
07	N2B000142	29.002	3.3.1	084	2	R99	B	Addition of CS Allocation/retention priority	3.4.0	QoS enhancements
07	N2B000144	29.022	3.3.1	086	1	R99	D	Editorial cleanup of 29.002	3.4.0	TEI
07	N2B000100	29.002	3.3.1	087		R99	A	Correction of LSA information	3.4.0	SoLSA
07	N2B000067	29.002	3.3.1	089		R99	F	Security interworking between release 99 and pre-99 MSC/VLRs	3.4.0	Security
07	N2B000113	29.002	3.3.1	090	1	R99	B	Improving GPRS charging efficiency	3.4.0	GPRS
07	N2B000120	29.002	3.3.1	094	2	R99	C	QoS-Subscribed field enhancements	3.4.0	QoS enhancements
07	N2B000322	29.002	3.3.1	095	1	R99	C	RANAP support on the E-interface	3.4.0	Handover
07	N2B000191	29.002	3.3.1	099		R99	B	UMTS Authentication	3.4.0	Security
07	N2B000466	29.002	3.3.1	100	5	R99	C	Support of 3G Handover, including Multicall	3.4.0	Multicall
07	N2B000372	29.002	3.3.1	101	1	R99	B	Introduction of Service Area Identification	3.4.0	TEI
07	N2B000380	29.002	3.3.1	102	2	R99	F	Clarification on Authentication Info Retrieval	3.4.0	Security
07	N2B000330	29.002	3.3.1	103	1	R99	B	Addition of UMTS security to MAP B interface	3.4.0	Security
07	N2B000244	29.002	3.3.1	104		R99	F	Re-Synchronisation Info	3.4.0	UMTS Security
07	N2B000324	29.002	3.3.1	105	1	R99	C	Introduction of additional service parameters for inter-system handover	3.4.0	Handover
07	N2B000281	29.002	3.3.1	107		R99	D	Removal of architectural information from clause 4	3.4.0	TEI

SMG#	TDoc	SPEC	VERS	CR	REV	PHAS E	CAT	SUBJECT	NEW_VERS	WORKITEM
07	N2-000454	29.002	3.3.1	110	1	R99	B	Introduction of Authentication Failure Report	3.4.0	Security
07	N2B000357	29.002	3.3.1	111		R99	B	Use of MAP private extensions to implement region-specific requirements	3.4.0	TEI
07	N2B000470	29.002	3.3.1	112		R99	A	Prioritisation of MAP application context related to VGCS/VBS	3.4.0	ASCI Phase 2
07	N2B000472	29.002	3.3.1	113		R99	F	Correction of SS-Codes for LCS	3.4.0	LCS
08	N4-000098	29.002	3.4.0	115	1	R99	F	Minor corrections to CAMEL3 NSDC/ATM/ATSI information flows	3.5.0	CAMEL Phase 3
08	N4-000094	29.002	3.4.0	117	1	R99	A	Using DSD to delete CCBS-B from the subscriber	3.5.0	CCBS
08	N4-000089	29.002	3.4.0	118	1	R99	F	Indication in PRN of support of Long FTNs	3.5.0	CF enhancements
08	N4-000073	29.002	3.4.0	120	1	R99	F	QoS-Subscribed field enhancements	3.5.0	QoS enhancements
08	N4-000050	29.002	3.4.0	121		R99	F	Correction of introduction of additional service parameters for inter-system handover	3.5.0	Handover/Relocation
08	N4-000100	29.002	3.4.0	122	2	R99	C	Proposed information flow on NSDC	3.5.0	CAMEL Phase 3
08	N4-000321	29.002	3.4.0	124	3	R99	C	CAMEL Subscription Info	3.5.0	CAMEL Phase 3
08	N4-000068	29.002	3.4.0	125		R99	A	Clarification to GMLC List definition	3.5.0	LCS
08	N4-000320	29.002	3.4.0	127	1	R99	F	Optionality of parameters in d-csi and in sms-csi	3.5.0	CAMEL Phase 3
08	N4-000209	29.002	3.4.0	130		R99	F	Version 3 tags for handover messages	3.5.0	Handover
08	N4-000211	29.002	3.4.0	132		R99	A	Correction of version handling at dialogue establishment	3.5.0	TEI
08	N4-000357	29.002	3.4.0	133	1	R99	F	Various corrections and/or cleanup to 29.002	3.5.0	TEI
08	N4-000217	29.002	3.4.0	134		R99	A	Correction of errors in Figure 25.1/1: Macro Receive_Open_Ind	3.5.0	TEI
08	N4-000326	29.002	3.4.0	135	1	R99	B	Addition of charging characteristics per PDP context	3.5.0	TEI
08	N4-000264	29.002	3.4.0	138		R99	F	Clarification of SAI-ack segmentation procedure	3.5.0	Security
08	N4-000392	29.002	3.4.0	139	1	R99	A	Indication of unsupported position method	3.5.0	LCS
08	N4-000276	29.002	3.4.0	141		R99	A	Clarification for ReportSM-DeliveryStatus operation	3.5.0	GPRS
08	N4-000349	29.002	3.4.0	142	1	R99	C	Addition of a parameter in the subsequent Handover from UMTS to GSM with Multicall	3.5.0	Multicall
08	N4-000278	29.002	3.4.0	143		R99	D	Editorial correction to MSC-A handover SDLs	3.5.0	Multicall
08	N4-000378	29.002	3.4.0	144	1	R99	A	Use of NAM parameter with MAP-INSERT-SUBSCRIBER-DATA service between HLR and SGSN	3.5.0	GPRS
08	N4-000293	29.002	3.4.0	145		R99	F	Addition of state attributes in Forward group call signalling	3.5.0	ASCI
08	N4-000294	29.002	3.4.0	146		R99	F	New user error 'target cell outside group call area' in MAP Prepare Handover message	3.5.0	ASCI
08	N4-000374	29.002	3.4.0	149		R99	A	Correction to the description of MAP-MO-Forward-Short-Message service	3.5.0	TEI
08	N4-000407	29.002	3.5.0	148	4	R00	B	Changes to MAP for secure transport of MAP messages	4.0.0	Security
08		29.002	4.0.0			R00		Version 4.0.1 created to allow inclusion of automatic update of Annexes A and B and of section 17	4.0.1	
09	N4-000543	29.002	4.0.1	152	1	R00	F	Clarifications for secure MAP transport	4.1.0	Core Network Security
09	N4-000539	29.002	4.0.1	153	1	R00	D	Generalization of version handling text in clause 18.2.4	4.1.0	TEI
09	N4-000491	29.002	4.0.1	158		R00	A	Deletion of informative Annexe C	4.1.0	TEI
09	N4-000540	29.002	4.0.1	159		R00	A	Aligning 29.002 with 25.413 (UTRAN lu Interface RANAP Signalling)	4.1.0	Handover

SMG#	TDoc	SPEC	VERS	CR	REV	PHAS E	CAT	SUBJECT	NEW_VERS	WORKITEM
09	N4-000541	29.002	4.0.1	160		R00	A	AUTS and AUTN parameter length	4.1.0	Security
09	N4-000744	29.002	4.0.1	161	2	R00	A	Clarification on Authentication Failure Report ack	4.1.0	Security
09	N4-000666	29.002	4.0.1	163	1	R00	A	Correction on Location Information	4.1.0	CAMEL phase 3
09	N4-000777	29.002	4.0.1	174	2	R00	A	Optionality of parameters in GPRS-CSI	4.1.0	CAMEL phase 3
09	N4-000788	29.002	4.0.1	176	1	R00	A	Correction to QoS indication	4.1.0	LCS
09	N4-000747	29.002	4.0.1	178	1	R00	A	Clarification of use of Radio Resource Information	4.1.0	Handover
09	N4-000750	29.002	4.0.1	180	2	R00	A	Correction to MSC-A handover SDLs	4.1.0	TEI
09	N4-000736	29.002	4.0.1	182		R00	A	Removal of LSAIdentity from NoteMM-EventArg	4.1.0	CAMEL phase 3
09	N4-000772	29.002	4.0.1	184		R00	A	LCS Support for CAMEL Phase 3	4.1.0	LCS
09	N4-000751	29.002	4.0.1	186	1	R00	A	Correction to MSC-A handover SDLs	4.1.0	TEI
09	N4-000779	29.002	4.0.1	188		R00	A	Clarification for segmentation of D-CSI and SMS-CSI	4.1.0	CAMEL phase 3
10	N4-000912	29.002	4.0.1	166	3	Rel-4	A	Corrections and clarifications for USSD procedures on the HLR - gsmSCF interface	4.2.0	USSD
10	N4-000908	29.002	4.1.0	191	1	Rel-4	A	Corrections of ISD data structure for CAMEL phase 3	4.2.0	CAMEL phase 3
10	N4-001069	29.002	4.1.0	193	2	Rel-4	A	USSD Corrections for Follow Me	4.2.0	USSD
10	N4-001071	29.002	4.1.0	196	1	Rel-4	A	GSM to 3G Handover: MAP parameter Target Cell ID	4.2.0	Handover
10	N4-000921	29.002	4.1.0	198		Rel-4	A	ASN.1 description of targetCellId	4.2.0	Handover
10	N4-001073	29.002	4.1.0	200	1	Rel-4	A	IMSI in MAP_PREPARE_HANDOVER	4.2.0	Handover
10	N4-001076	29.002	4.1.0	208	1	Rel-4	A	Alignment of the Target RNC-ID	4.2.0	Handover
10	N4-001089	29.002	4.1.0	211	1	Rel-4	A	Export of GSN-Address data type	4.2.0	CAMEL phase 3
10	N4-001095	29.002	4.1.0	212		Rel-4	A	Transport of long RANAP messages on MAP-E interface	4.2.0	Handover
-	-	29.002	4.2.0	-	-	Rel-4	-	Automatic update of annexes A and B	4.2.1	-
11	N4-010036	29.002	4.2.1	206	1	Rel-4	A	Correction to LCS application context	4.3.0	LCS
11	N4-010276	29.002	4.2.1	215	2	Rel-4	B	Add parameters to ISD and SRI for GPRS to handle ODB for PS	4.3.0	ODB enhancements
11	N4-010033	29.002	4.2.1	217		Rel-4	A	Correction to maximum number of RAB's	4.3.0	Multicall
11	N4-010198	29.002	4.2.1	222	2	Rel-4	B	PS domain support for LCS Release 4	4.3.0	LCS
11	N4-010058	29.002	4.2.1	224		Rel-4	A	Failure of Update GPRS Location when HLR is not reachable	4.3.0	GPRS R97
11	N4-010287	29.002	4.2.1	231	1	Rel-4	B	Extension of call related privacy class for LCS Release 4	4.3.0	LCS
11	N4-010375	29.002	4.2.1	232	2	Rel4	B	Maximum number of LCS Clients	4.3.0	LCS
11	N4-010261	29.002	4.2.1	234		Rel-4	B	MAP over IP according to SIGTRAN	4.3.0	SS7IP
11	N4-010465	29.002	4.2.1	236	1	Rel-4	B	Requesting node type in authentication set request	4.3.0	SEC1-EHCS
11	N4-010360	29.002	4.2.1	246		Rel-4	A	Adding EXPORT definition for LSAIdentity	4.3.0	Camel 3

SMG#	TDoc	SPEC	VERS	CR	REV	PHASE	CAT	SUBJECT	NEW_VERS	WORKITEM
11	N4-010361	29.002	4.2.1	247		Rel-4	A	Removing duplicate parameters from ss-CSI	4.3.0	CAMEL 3
11	N4-010362	29.002	4.2.1	248		Rel-4	A	Correction to description of SS-CSI in HLR to VLR information flow	4.3.0	CAMEL 3
11	N4-010365	29.002	4.2.1	250		Rel-4	A	GSM to UMTS handover: addition of MAP parameter RNC ID	4.3.0	Handover
11	N4-010393	29.002	4.2.1	252		Rel-4	A	Clarification of the use of multicall bearer information	4.3.0	Multicall
11	N4-010428	29.002	4.2.1	258		Rel-4	A	Adding EXPORT definition for GeographicalInformation	4.3.0	Camel 3
11	N4-010446	29.002	4.2.1	260		Rel-4	A	Failure of Authentication Parameter GPRS when HLR is not reachable	4.3.0	GPRS R97
11	N4-010484	29.002	4.2.1	262	1	Rel-4	A	Correction to D-CSI	4.3.0	CAMEL 3
12	N4-010728	29.002	4.3.0	239	4	Rel-4	A	Addition of selected UMTS algorithm indication to the handover procedures	4.4.0	Handover
12	N4-010730	29.002	4.3.0	241	4	Rel-4	A	Addition of allowed GSM algorithms indication to the handover procedures	4.4.0	Handover
12	N4-010733	29.002	4.3.0	244	4	Rel-4	A	Addition of allowed UMTS algorithm indication to the handover procedures	4.4.0	Handover
12	N4-010735	29.002	4.3.0	245	4	Rel-4	A	Addition of selected GSM algorithm indication to the handover procedures	4.4.0	Handover
12	N4-010739	29.002	4.3.0	254	2	Rel-4	A	Addition of radio resource list to the handover procedures	4.4.0	Multicall
12	NP-010247	29.002	4.3.0	256	3	Rel-4	A	Addition of GSM channel type and GSM chosen channel indications to handover procedures	4.4.0	Handover
12	N4-010787	29.002	4.3.0	264	3	Rel-4	A	Add support in MAP for all shapes defined in 23.032	4.4.0	LCS
12	N4-010633	29.002	4.3.0	270	1	Rel-4	A	Correction to description of RNCid parameter	4.4.0	Handover
12	N4-010635	29.002	4.3.0	272	1	Rel-4	A	Correction to Encryption Information and Integrity Protection parameters	4.4.0	Handover
12	N4-010767	29.002	4.3.0	279	3	Rel-4	A	Essential drawbacks on services due to introduction of Super-Charger function	4.4.0	TEI
12	N4-010741	29.002	4.3.0	283	1	Rel-4	A	Introduction of selected Rab-id to the Process Access Signalling operation	4.4.0	Multicall
12	N4-010673	29.002	4.3.0	285		Rel-4	A	Mistake in the definition of Authentication Failure Report Application Context	4.4.0	SEC
12	N4-010551	29.002	4.3.0	266		Rel-4	A	Add support in MAP for Ellipsoid Point	4.4.0	LCS
12	N4-010778	29.002	4.3.0	168	5	Rel-4	C	Security Header modification	4.4.0	Security
12	N4-010785	29.002	4.3.0	267	3	Rel-4	C	Additional Parameters in Authentication Failure Report	4.4.0	SEC1 - EHCS
12	N4-010783	29.002	4.3.0	268	3	Rel-4	F	MS presence notification procedure for LCS	4.4.0	LCS1

SMG#	TDoc	SPEC	VERS	CR	REV	PHAS E	CAT	SUBJECT	NEW_VERS	WORKITEM
12	N4-010790	29.002	4.3.0	289	2	Rel-4	F	Component level granularity of protection	4.4.0	SEC1
		29.002	4.4.0			Rel-4		Corrupted headers fixed	4.4.1	
13	N4-010840	29.002	4.4.1	290		Rel-4	F	Clarifications on long forwarded-to numbers	4.5.0	TEI4
13	N4-010929	29.002	4.4.1	291	1	Rel-4	F	Corrections for Deferred MT-LR	4.5.0	LCS1
13	N4-010930	29.002	4.4.1	292	2	Rel-4	F	Clarifications on SupportedLCS-CapabilitySets	4.5.0	LCS1
13	N4-010958	29.002	4.4.1	295	2	Rel4	F	Corrections on the introduction of LCS for PS domain	4.5.0	LCS1
13	N4-010970	29.002	4.4.1	302	2	Rel-4	F	Additional SGSN related values to Access Type	4.5.0	SEC1-EHCS
13	N4-010976	29.002	4.4.1	306		Rel-4	A	Addition of data type definitions to EXPORT statements for the usage in CAP	4.5.0	CAMEL3
13	N4-011017	29.002	4.4.1	307	2	Rel-4	A	Minimum MAP application context for intersystem MSC handover from GSM to UMTS	4.5.0	Handover
13	N4-011019	29.002	4.4.1	309	2	Rel-4	A	Minimum MAP application context for intersystem MSC handover from UMTS to GSM	4.5.0	Handover
13	N4-010845	29.002	4.4.1	277	1	Rel4	F	Correction on the SDL of NW initiated USSD operations	4.5.0	TEI
13		29.002	4.4.1			Rel-4		Editorial Clean up	4.5.0	
14	N4-011031	29.002	4.5.0	313		Rel-4	A	Clarification on LCS parameters in MAP	4.6.0	LCS1
14	N4-011043	29.002	4.5.0	314		Rel-4	F	Handling of linked operations in the MAP protocol machine	4.6.0	TEI4
14	N4-011285	29.002	4.5.0	316		Rel-4	F	Corrections on the SDL diagrams for LCS	4.6.0	LCS1
14	N4-011198	29.002	4.5.0	318	1	Rel-4	A	Indication of deletion of CSI in Notify Subscriber Data Change	4.6.0	CAMEL3
14	N4-011074	29.002	4.5.0	320		Rel-4	A	Correct length of Add-GeographicalInformation	4.6.0	LCS
14	N4-011091	29.002	4.5.0	322		Rel-4	A	Clarify encoding of RNC Id	4.6.0	Handover
14	N4-011094	29.002	4.5.0	324		Rel-4	A	Clarify encoding of RANAP parameters in MAP	4.6.0	Handover
14	N4-011097	29.002	4.5.0	325		Rel-4	F	Clarifications on long forwarded-to numbers	4.6.0	TEI4
14	N4-011227	29.002	4.5.0	331	1	Rel-4	A	Clarification of methodology for maintaining data consistency in Supercharger	4.6.0	TEI
14	N4-011173	29.002	4.5.0	334		Rel-4	A	Addition of RAB ID to Prepare Handover procedure	4.6.0	Multicall
14	N4-011175	29.002	4.5.0	336		Rel-4	A	Correction to the Allowed GSM Algorithms parameter	4.6.0	Handover
14	N4-011177	29.002	4.5.0	337	1	Rel-4	F	Correction of references	4.6.0	TEI4
14	N4-011190	29.002	4.5.0	339		Rel-4	A	CUG-Info is not exported from 29.002	4.6.0	CAMEL3
14	N4-011209	29.002	4.5.0	341		Rel-4	A	Clarification on NSCD when data is withdrawn	4.6.0	CAMEL phase 3
14	N4-011211	29.002	4.5.0	343		Rel-4	A	Clarification of sending CAMEL information in stand alone ISD case	4.6.0	CAMEL phase 3
14	N4-011262	29.002	4.5.0	344		Rel-4	F	Correction of the priority for "SRI for LCS"	4.6.0	LCS1

SMG#	TDoc	SPEC	VERS	CR	REV	PHASE	CAT	SUBJECT	NEW_VERS	WORKITEM
14	N4-011273	29.002	4.5.0	347		Rel-4	A	ASN.1 correction	4.6.0	CAMEL
14	N4-011437	29.002	4.5.0	349	2	Rel-4	F	Handling of MNRR in the HLR & SMS-GMSC	4.6.0	TEI4
14	N4-011433	29.002	4.5.0	354	1	Rel-4	A	Minimum MAP application context for G2G inter-MSC handover	4.6.0	Handover
14	N4-011439	29.002	4.5.0	359	2	Rel-4	A	Alignment of parameter lengths with those prescribed in 08.08	4.6.0	TEI
14	N4-011423	29.002	4.5.0	360	1	Rel-4	F	Aligning the security header elements with TS33.200	4.6.0	TEI-4
14	N4-011394	29.002	4.5.0	364		Rel-4	A	Syntax error in the ATM result and ATSI result	4.6.0	CAMEL phase 3
14	N4-011381	29.002	4.6.0	355	1	Rel-5	B	LCS Capability Handling for UE's	5.0.0	TEI5
15	N4-020300	29.002	5.0.0	368	4	Rel-5	B	Collective CAMEL Phase 4 CR	5.1.0	CAMEL4
15	N4-020013	29.002	5.0.0	373		Rel-5	A	Inclusion of complete ODB data in ATSI and NSDC	5.1.0	CAMEL3
15	N4-020266	29.002	5.0.0	381	2	Rel-5	B	Introduction of the "Requestor ID"	5.1.0	LCS1
15	N4-020068	29.002	5.0.0	386		Rel-5	A	Correction to AC version of gprsLocationInfoRetrievalContext	5.1.0	TEI4
15	N4-020248	29.002	5.0.0	390	1	Rel-5	A	Incomplete description of Restore Data parameters	5.1.0	TEI4
15	N4-020183	29.002	5.0.0	403		Rel-5	A	Clarification on CODEC-Info	5.1.0	TEI
15	N4-020250	29.002	5.0.0	407	1	Rel-5	A	ODB alignment	5.1.0	TEI4
16	N4-020530	29.002	5.1.0	428	2	Rel-5	A	LCS: error handling if shape not supported by GMLC	5.2.0	LCS1
16	N4-020622	29.002	5.1.0	453		Rel-5	A	Addition of Radio Resource List to the Forward Access Signalling operation	5.2.0	Multicall
16	N4-020641	29.002	5.1.0	460		Rel-5	A	Clarification on Resume Call Handling	5.2.0	TEI
16	N4-020746	29.002	5.1.0	440	2	Rel-5	A	Clarification on SendAuthenticationInfo	5.2.0	TEI
16	N4-020750	29.002	5.1.0	446	1	Rel-5	A	Addition of Service Handover parameters to MAP Handover messages	5.2.0	Handover
16	N4-020318	29.002	5.1.0	398		Rel-5	C	Check of NAM and Requesting Node Type on receipt of SendAuthenticationInfo	5.2.0	TEI4
16	N4-020333	29.002	5.1.0	410		Rel-5	A	Handling the MNRR flag in the HLR & SMS-GMSC	5.2.0	TEI4
16	N4-020499	29.002	5.1.0	420	1	Rel-5	A	Clarification of introducing Session related and unrelated class	5.2.0	LCS1-PS
16	N4-020511	29.002	5.1.0	430	1	Rel-5	A	Corrections on the introduction of LCS for PS domain	5.2.0	LCS
16	N4-020743	29.002	5.1.0	448	1	Rel-5	A	Corrections in SS-code chapter	5.2.0	TEI
16	N4-020408	29.002	5.1.0	423		Rel-5	C	Clarification of handling of MT-SMS-TPDU-Type and SMS-TDP	5.2.0	CAMEL4
16	N4-020410	29.002	5.1.0	425		Rel-5	A	Clarify conditions to trigger restart of MTLR-Deferred procedure	5.2.0	LCS1
16	N4-020468	29.002	5.1.0	414	1	Rel-5	F	Corrections to the handling of Any Time Interrogation and Provide Subscriber Info	5.2.0	CAMEL4

SMG#	TDoc	SPEC	VERS	CR	REV	PHASE	CAT	SUBJECT	NEW_VERS	WORKITEM
16	N4-020476	29.002	5.1.0	435	1	Rel-5	D	Change PS-connected in PS-PDPactive	5.2.0	CAMEL4
16	N4-020483	29.002	5.1.0	422	1	Rel-5	F	Triggering of gsmSCF for MT-SMS-CSI	5.2.0	CAMEL4
16	N4-020485	29.002	5.1.0	408	2	Rel-5	C	Transferring the MS classmark & IMEI to the gsmSCF	5.2.0	CAMEL4
16	N4-020543	29.002	5.1.0	441		Rel-5	F	Correction of Object Identifiers for ASN.1 modules	5.2.0	TEI
16	N4-020608	29.002	5.1.0	450		Rel-5	C	Enhancement to LCS in the PS domain	5.2.0	LCS
16	N4-020623	29.002	5.1.0	454		Rel-5	F	Addition of Location Information GPRS to Note MM Event operation	5.2.0	CAMEL4-NMM
16	N4-020703	29.002	5.1.0	421	4	Rel-5	B	LCS: Codeword and Service Type	5.2.0	LCS1
16	N4-020756	29.002	5.1.0	436	2	Rel-5	B	Splitting of CAMEL phase 4	5.2.0	CAMEL4

History

Document history		
V5.1.0	March 2002	Publication
V5.2.0	June 2002	Publication