

# ETSI TS 129 060 V5.9.0 (2004-03)

---

*Technical Specification*

**Digital cellular telecommunications system (Phase 2+);  
Universal Mobile Telecommunications System (UMTS);  
General Packet Radio Service (GPRS);  
GPRS Tunnelling Protocol (GTP)  
across the Gn and Gp interface  
(3GPP TS 29.060 version 5.9.0 Release 5)**

---



---

Reference

RTS/TSGN-0429060v590

---

Keywords

GSM, UMTS

**ETSI**

650 Route des Lucioles  
F-06921 Sophia Antipolis Cedex - FRANCE

Tel.: +33 4 92 94 42 00 Fax: +33 4 93 65 47 16

Siret N° 348 623 562 00017 - NAF 742 C  
Association à but non lucratif enregistrée à la  
Sous-Préfecture de Grasse (06) N° 7803/88

---

**Important notice**

Individual copies of the present document can be downloaded from:

<http://www.etsi.org>

The present document may be made available in more than one electronic version or in print. In any case of existing or perceived difference in contents between such versions, the reference version is the Portable Document Format (PDF). In case of dispute, the reference shall be the printing on ETSI printers of the PDF version kept on a specific network drive within ETSI Secretariat.

Users of the present document should be aware that the document may be subject to revision or change of status. Information on the current status of this and other ETSI documents is available at

<http://portal.etsi.org/tb/status/status.asp>

If you find errors in the present document, send your comment to:

[editor@etsi.org](mailto:editor@etsi.org)

---

**Copyright Notification**

No part may be reproduced except as authorized by written permission.  
The copyright and the foregoing restriction extend to reproduction in all media.

© European Telecommunications Standards Institute 2004.  
All rights reserved.

**DECT**<sup>TM</sup>, **PLUGTESTS**<sup>TM</sup> and **UMTS**<sup>TM</sup> are Trade Marks of ETSI registered for the benefit of its Members.  
**TIPHON**<sup>TM</sup> and the **TIPHON logo** are Trade Marks currently being registered by ETSI for the benefit of its Members.  
**3GPP**<sup>TM</sup> is a Trade Mark of ETSI registered for the benefit of its Members and of the 3GPP Organizational Partners.

---

## Intellectual Property Rights

IPRs essential or potentially essential to the present document may have been declared to ETSI. The information pertaining to these essential IPRs, if any, is publicly available for **ETSI members and non-members**, and can be found in ETSI SR 000 314: *"Intellectual Property Rights (IPRs); Essential, or potentially Essential, IPRs notified to ETSI in respect of ETSI standards"*, which is available from the ETSI Secretariat. Latest updates are available on the ETSI Web server (<http://webapp.etsi.org/IPR/home.asp>).

Pursuant to the ETSI IPR Policy, no investigation, including IPR searches, has been carried out by ETSI. No guarantee can be given as to the existence of other IPRs not referenced in ETSI SR 000 314 (or the updates on the ETSI Web server) which are, or may be, or may become, essential to the present document.

---

## Foreword

This Technical Specification (TS) has been produced by ETSI 3rd Generation Partnership Project (3GPP).

The present document may refer to technical specifications or reports using their 3GPP identities, UMTS identities or GSM identities. These should be interpreted as being references to the corresponding ETSI deliverables.

The cross reference between GSM, UMTS, 3GPP and ETSI identities can be found under <http://webapp.etsi.org/key/queryform.asp>.

# Contents

|   |    |
|---|----|
| Intellectual Property Rights .....                        | 2  |
| Foreword.....   | 2  |
| Foreword.....   | 7  |
| 1 Scope .....   | 8  |
| 2 References .....  | 8  |
| 3 Definitions and abbreviations.....                      | 9  |
| 3.1 Definitions .....                                     | 9  |
| 3.2 Abbreviations .....                                   | 10 |
| 4 General .....   | 10 |
| 5 Transmission Order and Bit Definitions.....             | 11 |
| 6 GTP Header.....   | 12 |
| 6.1 Extension headers.....                                | 14 |
| 6.1.1 PDCP PDU Number .....                               | 14 |
| 6.1.2 Suspend Request.....                                | 14 |
| 6.1.3 Suspend Response .....                              | 15 |
| 7 GTP Messages and Message Formats .....                  | 15 |
| 7.1 Message Formats.....                                  | 15 |
| 7.1.1 Presence requirements of Information Elements ..... | 16 |
| 7.2 Path Management Messages.....                         | 17 |
| 7.2.1 Echo Request .....                                  | 17 |
| 7.2.2 Echo Response.....                                  | 17 |
| 7.2.3 Version Not Supported .....                         | 18 |
| 7.2.4 Supported Extension Headers Notification.....       | 18 |
| 7.3 Tunnel Management Messages .....                      | 18 |
| 7.3.1 Create PDP Context Request .....                    | 18 |
| 7.3.2 Create PDP Context Response.....                    | 20 |
| 7.3.3 Update PDP Context Request .....                    | 23 |
| 7.3.4 Update PDP Context Response.....                    | 25 |
| 7.3.5 Delete PDP Context Request .....                    | 27 |
| 7.3.6 Delete PDP Context Response.....                    | 28 |
| 7.3.7 Error Indication.....                               | 29 |
| 7.3.8 PDU Notification Request .....                      | 30 |
| 7.3.9 PDU Notification Response.....                      | 31 |
| 7.3.10 PDU Notification Reject Request .....              | 31 |
| 7.3.11 PDU Notification Reject Response.....              | 32 |
| 7.4 Location Management Messages .....                    | 32 |
| 7.4.1 Send Routeing Information for GPRS Request .....    | 33 |
| 7.4.2 Send Routeing Information for GPRS Response .....   | 33 |
| 7.4.3 Failure Report Request .....                        | 34 |
| 7.4.4 Failure Report Response.....                        | 34 |
| 7.4.5 Note MS GPRS Present Request .....                  | 35 |
| 7.4.6 Note MS GPRS Present Response.....                  | 35 |
| 7.5 Mobility Management Messages.....                     | 36 |
| 7.5.1 Identification Request.....                         | 36 |
| 7.5.2 Identification Response.....                        | 36 |
| 7.5.3 SGSN Context Request.....                           | 37 |
| 7.5.4 SGSN Context Response .....                         | 38 |
| 7.5.5 SGSN Context Acknowledge .....                      | 39 |
| 7.5.6 Forward Relocation Request.....                     | 40 |
| 7.5.7 Forward Relocation Response .....                   | 41 |
| 7.5.8 Forward Relocation Complete .....                   | 42 |

|          |   |    |
|----------|---|----|
| 7.5.9    | Relocation Cancel Request .....                       | 42 |
| 7.5.10   | Relocation Cancel Response .....                      | 42 |
| 7.5.11   | Forward Relocation Complete Acknowledge .....         | 43 |
| 7.5.12   | Forward SRNS Context Acknowledge .....                | 43 |
| 7.5.13   | Forward SRNS Context .....                            | 43 |
| 7.5.14   | RAN Information Management Messages .....             | 44 |
| 7.5.14.1 | RAN Information Relay .....                           | 44 |
| 7.6      | Reliable Delivery of Signalling Messages .....        | 44 |
| 7.7      | Information Elements .....                            | 45 |
| 7.7.1    | Cause .....   | 46 |
| 7.7.2    | International Mobile Subscriber Identity (IMSI) ..... | 48 |
| 7.7.3    | Routeing Area Identity (RAI) .....                    | 49 |
| 7.7.4    | Temporary Logical Link Identity (TLLI) .....          | 49 |
| 7.7.5    | Packet TMSI (P-TMSI) .....                            | 50 |
| 7.7.6    | Reordering Required .....                             | 50 |
| 7.7.7    | Authentication Triplet .....                          | 50 |
| 7.7.8    | MAP Cause .....                                       | 50 |
| 7.7.9    | P-TMSI Signature .....                                | 51 |
| 7.7.10   | MS Validated .....                                    | 51 |
| 7.7.11   | Recovery .....  | 51 |
| 7.7.12   | Selection Mode .....                                  | 52 |
| 7.7.13   | Tunnel Endpoint Identifier Data I .....               | 52 |
| 7.7.14   | Tunnel Endpoint Identifier Control Plane .....        | 52 |
| 7.7.15   | Tunnel Endpoint Identifier Data II .....              | 53 |
| 7.7.16   | Teardown Ind .....                                    | 53 |
| 7.7.17   | NSAPI .....   | 54 |
| 7.7.18   | RANAP Cause .....                                     | 54 |
| 7.7.19   | RAB Context .....                                     | 54 |
| 7.7.20   | Radio Priority SMS .....                              | 55 |
| 7.7.21   | Radio Priority .....                                  | 55 |
| 7.7.22   | Packet Flow Id .....                                  | 55 |
| 7.7.23   | Charging Characteristics .....                        | 56 |
| 7.7.24   | Trace Reference .....                                 | 56 |
| 7.7.25   | Trace Type .....                                      | 56 |
| 7.7.25A  | MS Not Reachable Reason .....                         | 56 |
| 7.7.25B  | Radio Priority LCS .....                              | 57 |
| 7.7.26   | Charging ID .....                                     | 57 |
| 7.7.27   | End User Address .....                                | 57 |
| 7.7.28   | MM Context .....                                      | 59 |
| 7.7.29   | PDP Context .....                                     | 61 |
| 7.7.30   | Access Point Name .....                               | 64 |
| 7.7.31   | Protocol Configuration Options .....                  | 64 |
| 7.7.32   | GSN Address .....                                     | 64 |
| 7.7.33   | MS International PSTN/ISDN Number (MSISDN) .....      | 65 |
| 7.7.34   | Quality of Service (QoS) Profile .....                | 65 |
| 7.7.35   | Authentication Quintuplet .....                       | 66 |
| 7.7.36   | Traffic Flow Template (TFT) .....                     | 66 |
| 7.7.37   | Target Identification .....                           | 67 |
| 7.7.38   | UTRAN Transparent Container .....                     | 67 |
| 7.7.39   | RAB Setup Information .....                           | 68 |
| 7.7.40   | Extension Header Type List .....                      | 68 |
| 7.7.41   | Trigger Id .....                                      | 68 |
| 7.7.42   | OMC Identity .....                                    | 69 |
| 7.7.43   | RAN Transparent Container .....                       | 69 |
| 7.7.44   | Charging Gateway Address .....                        | 69 |
| 7.7.45   | PDP Context Prioritization .....                      | 70 |
| 7.7.45A  | Additional RAB Setup Information .....                | 70 |
| 7.7.46   | Private Extension .....                               | 71 |
| 8        | Control Plane (GTP-C) .....                           | 71 |
| 8.1      | Control Plane Protocol .....                          | 71 |
| 8.2      | Usage of the GTP-C Header .....                       | 72 |

|           |  |    |
|-----------|--|----|
| 9         | GTP-U .....  | 73 |
| 9.1       | GTP-U Protocol Entity .....  | 73 |
| 9.1.1     | Handling of Sequence Numbers .....   | 73 |
| 9.2       | GTP-U Service Access Points and Primitives .....   | 74 |
| 9.2.1     | GTP-U-CONTROL SAP .....  | 74 |
| 9.2.1.1   | GTP-U-CONTROL-RX primitives .....  | 74 |
| 9.2.1.1.1 | GTP-U-CONTROL-RX-SETUP.request .....   | 74 |
| 9.2.1.1.2 | GTP-U-CONTROL-RX-SETUP.confirm .....   | 75 |
| 9.2.1.1.3 | GTP-U-CONTROL-RX-RELEASE.request .....   | 75 |
| 9.2.1.1.4 | GTP-U-CONTROL-RX-RELEASE.confirm .....   | 75 |
| 9.2.1.1.5 | GTP-U-CONTROL-RX-ERROR.indication .....  | 75 |
| 9.2.1.2   | GTP-U-CONTROL-TX primitives .....  | 75 |
| 9.2.1.2.1 | GTP-U-CONTROL-TX-SETUP.request .....   | 75 |
| 9.2.1.2.2 | GTP-U-CONTROL-TX-SETUP.confirm .....   | 75 |
| 9.2.1.2.3 | GTP-U-CONTROL-TX-RELEASE.request .....   | 75 |
| 9.2.1.2.4 | GTP-U-CONTROL-TX-RELEASE.confirm .....   | 75 |
| 9.2.1.2.5 | GTP-U-CONTROL-TX-ERROR.indication .....  | 76 |
| 9.2.2     | GTP-U-UNIT-DATA SAP and Primitives .....   | 76 |
| 9.2.2.1   | GTP-U-UNIT-DATA.request .....  | 76 |
| 9.2.2.2   | GTP-U- UNIT-DATA.indication .....  | 76 |
| 9.3       | Protocol Stack .....   | 76 |
| 9.3.1     | Usage of the GTP-U Header .....  | 76 |
| 9.3.1.1   | Usage of Sequence Number .....   | 77 |
| 9.4       | Tunnelling between SGSNs .....   | 78 |
| 9.5       | Tunnelling between Source RNC and Target RNC .....   | 78 |
| 9.6       | Tunnelling between GGSNs .....   | 78 |
| 10        | Path Protocols .....   | 78 |
| 10.1      | UDP/IP .....   | 78 |
| 10.1.1    | UDP Header .....   | 78 |
| 10.1.1.1  | Request Messages .....   | 78 |
| 10.1.1.2  | Response Messages .....  | 78 |
| 10.1.1.3  | Encapsulated T-PDUs .....  | 78 |
| 10.1.1.4  | Error Indication, RAN Information Relay, Version Not Supported and Supported Extension<br>Headers Notification ..... | 78 |
| 10.1.2    | IP Header .....  | 79 |
| 10.1.2.1  | Request Messages and Encapsulated T-PDUs .....   | 79 |
| 10.1.2.2  | Response Messages .....  | 79 |
| 10.1.2.3  | Error Indication, RAN Information Relay, Version Not supported and Supported Extension<br>Headers Notification ..... | 79 |
| 11        | Error Handling .....   | 79 |
| 11.1      | Protocol Errors .....  | 79 |
| 11.1.1    | Different GTP Versions .....   | 80 |
| 11.1.2    | GTP Message Too Short .....  | 80 |
| 11.1.3    | Unknown GTP Signalling Message .....   | 80 |
| 11.1.4    | Unexpected GTP Signalling Message .....  | 80 |
| 11.1.5    | Missing Mandatorily Present Information Element .....  | 80 |
| 11.1.6    | Invalid Length .....   | 80 |
| 11.1.7    | Invalid Mandatory Information Element .....  | 80 |
| 11.1.8    | Invalid Optional Information Element .....   | 81 |
| 11.1.9    | Unknown Information Element .....  | 81 |
| 11.1.10   | Out of Sequence Information Elements .....   | 81 |
| 11.1.11   | Unexpected Information Element .....   | 81 |
| 11.1.12   | Repeated Information Elements .....  | 81 |
| 11.1.13   | Incorrect Optional Information Elements .....  | 81 |
| 11.2      | Path Failure .....   | 81 |
| 11.3      | MS Detach .....  | 82 |
| 11.4      | Restoration and Recovery .....   | 82 |
| 12        | Security provided to GTP Communication over Gn and Gp Interfaces .....   | 82 |
| 13        | IP, The Networking Technology used by GTP .....  | 82 |

|                               |   |           |
|-------------------------------|---|-----------|
| 13.1                          | IP Version.....                                   | 82        |
| 13.2                          | IP Fragmentation .....                            | 82        |
| 13.2.1                        | MO Direction.....                                 | 82        |
| 13.2.2                        | MT Direction .....                                | 83        |
| 13.2.3                        | Tunnelling from old to new SGSN .....             | 83        |
| 14                            | GTP Parameters.....                               | 83        |
| 14.1                          | Timers .....                                      | 83        |
| 14.2                          | Others .....                                      | 83        |
| <b>Annex A (informative):</b> | <b>A method for sequence number checking.....</b> | <b>89</b> |
| <b>Annex B (informative):</b> | <b>Change history .....</b>                       | <b>90</b> |
| History .....                 |   | 95        |

---

# Foreword

This Technical Specification (TS) has been produced by the 3<sup>rd</sup> Generation Partnership Project (3GPP).

The present document defines the Gn and Gp interfaces for the General Packet Radio Service (GPRS) within the 3GPP system.

The contents of the present document are subject to continuing work within the TSG and may change following formal TSG approval. Should the TSG modify the contents of the present document, it will be re-released by the TSG with an identifying change of release date and an increase in version number as follows:

Version x.y.z

where:

- x the first digit:
  - 1 presented to TSG for information;
  - 2 presented to TSG for approval;
  - 3 or greater indicates TSG approved document under change control.
- y the second digit is incremented for all changes of substance, i.e. technical enhancements, corrections, updates, etc.
- z the third digit is incremented when editorial only changes have been incorporated in the document.



---

# 1 Scope

The present document defines the second version of GTP used on:

- the Gn and Gp interfaces of the General Packet Radio Service (GPRS);
- the Iu, Gn and Gp interfaces of the UMTS system.

NOTE: The version number used in the message headers is 0 for the first version of GTP described in GSM 09.60, and 1 for the second version in 3GPP TS 29.060.

---

# 2 References

The following documents contain provisions which, through reference in this text, constitute provisions of the present document.

- References are either specific (identified by date of publication, edition number, version number, etc.) or non-specific.
- For a specific reference, subsequent revisions do not apply.
- For a non-specific reference, the latest version applies. In the case of a reference to a 3GPP document (including a GSM document), a non-specific reference implicitly refers to the latest version of that document *in the same Release as the present document*.

- [1] 3GPP TR 21.905: "Vocabulary for 3GPP Specifications".
- [2] 3GPP TS 23.003: "Numbering, addressing and identification".
- [3] 3GPP TS 23.007: "Restoration procedures".
- [4] 3GPP TS 23.060: "General Packet Radio Service (GPRS); Service description; Stage 2".
- [5] 3GPP TS 24.008: "Mobile radio interface Layer 3 specification; Core network protocols; Stage 3".
- [6] 3GPP TS 29.002: "Mobile Application Part (MAP) specification".
- [7] 3GPP TS 25.413: "UTRAN Iu interface RANAP signalling".
- [8] 3GPP TS 33.102: "3G security; Security architecture".
- [9] 3GPP TS 43.020: " Security related network functions".
- [10] 3GPP TS 43.064: "Overall description of the GPRS radio interface; Stage 2".
- [11] 3GPP TS 44.064: "Mobile Station - Serving GPRS Support Node (MS-SGSN) Logical Link Control (LLC) layer specification".
- [12] IETF RFC 791 (STD 0005): "Internet Protocol", J. Postel.
- [13] IETF RFC 768 (STD 0006): "User Datagram Protocol", J. Postel.
- [14] IETF RFC 1700: "Assigned numbers", J. Reynolds and J. Postel.
- [15] IETF RFC 2181: "Clarifications to the DNS specification", R. Elz and R. Bush.
- [16] Void.
- [17] 3GPP TS 23.121: "Architectural requirements for Release 1999".
- [18] 3GPP TS 32.215: "Telecommunication management; Charging management; Charging data description for the Packet Switched (PS) domain".

- [19] 3GPP TS 23.236: "Intra domain connection of Radio Access Network (RAN) nodes to multiple Core Network (CN) nodes".
- [20] 3GPP TS 48.018: "General Packet Radio Service (GPRS); Base Station System (BSS) - Serving GPRS Support Node (SGSN); BSS GPRS protocol".
- [21] 3GPP TR 44.901 (Release 5): "External Network Assisted Cell Change (NACC)".
- [22] 3GPP TS 33.210: "3G security; Network Domain Security (NDS); IP network layer security".
- [23] 3GPP TS 25.414: "UTRAN Iu interface data transport and transport signalling".
- [24] 3GPP TS 23.195: "Provision of User Equipment Specific Behaviour Information (UESBI) to network entities".

---

## 3 Definitions and abbreviations

### 3.1 Definitions

For the purposes of the present document, the following terms and definitions apply:

**G-PDU:** is a user data message, It consists of a T-PDU plus a GTP header

**GTP Tunnel:** in the GTP-U plane is defined for each PDP Context in the GSNs and/or each RAB in the RNC. A GTP tunnel in the GTP-C plane is defined for all PDP Contexts with the same PDP address and APN (for Tunnel Management messages) or for each MS (for messages not related to Tunnel Management). A GTP tunnel is identified in each node with a TEID, an IP address and a UDP port number. A GTP tunnel is necessary to forward packets between an external packet data network and an MS user.

**MM Context:** information sets held in MS and GSNs for a GPRS subscriber related to Mobility Management (MM) (please refer to the MM Context Information Element)

**Network Service Access Point Identifier (NSAPI):** integer value in the range [0; 15], identifying a certain PDP Context. It identifies a PDP context belonging to a specific MM Context ID

**path:** UDP/IP path is used to multiplex GTP tunnels

**Path Protocol:** protocol used as a bearer of GTP between GSNs or between a GSN and a RNC

**Packet Data Protocol (PDP):** network protocol used by an external packet data network interfacing to GPRS

**PDP Context:** information sets held in MS and GSNs for a PDP address (please refer to the PDP Context Information Element)

**Quality of Service (QoS):** may be applicable for the GPRS backbone and the Iu interface if the path media supports it. Separate paths with different priorities may be defined between a GSN pair or between a GSN and an RNC.

**GTP-C Message:** GTP-C or control plane messages are exchanged between GSN/RNC pairs in a path. The control plane messages are used to transfer GSN capability information between GSN pairs, to create, update and delete GTP tunnels and for path management.

**GTP-U Message:** GTP-U or user plane messages are exchanged between GSN pairs or GSN/RNC pairs in a path. The user plane messages are used to carry user data packets, and signalling messages for path management and error indication.

**GTP-PDU:** GTP Protocol Data Unit is either a GTP-C message or a GTP-U message

**Signalling Message:** any GTP-PDU except the G-PDU

**T-PDU:** original packet, for example an IP datagram, from an MS or a network node in an external packet data network. A T-PDU is the payload that is tunnelled in the GTP-U tunnel.

**Traffic Flow Template (TFTs):** used by GGSN to distinguish between different user payload packets and transmit packets with different QoS requirements via different PDP context but to the same PDP address

**Tunnel Endpoint Identifier (TEID):** unambiguously identifies a tunnel endpoint in the receiving GTP-U or GTP-C protocol entity

The receiving end side of a GTP tunnel locally assigns the TEID value the transmitting side has to use. The TEID values are exchanged between tunnel endpoints using GTP-C (or RANAP, over the Iu) messages.

**UDP/IP Path:** connection-less unidirectional or bidirectional path defined by two end-points

An IP address and a UDP port number define an end-point. A UDP/IP path carries GTP messages between GSN nodes, and between GSN and RNC nodes related to one or more GTP tunnels.

## 3.2 Abbreviations

Abbreviations used in the present document are listed in 3GPP TS 21.905 [1]

For the purposes of the present document, the following additional abbreviations apply:

|              |  |
|--------------|--|
| BB           | Backbone Bearer  |
| DF           | Don't Fragment   |
| FFS          | For Further Study  |
| Gn interface | Interface between GPRS Support Nodes (GSNs) within a PLMN      |
| Gp interface | Interface between GPRS Support Nodes (GSNs) in different PLMNs |
| GTP          | GPRS Tunnelling Protocol                                       |
| GTP-C        | GTP Control  |
| GTP-U        | GTP User   |
| IANA         | Internet Assigned Number Authority                             |
| ICMP         | Internet Control Message Protocol                              |
| IE           | Information Element  |
| IP           | Internet Protocol  |
| IPv4         | Internet Protocol version 4                                    |
| IPv6         | Internet Protocol version 6                                    |
| MTU          | Maximum Transmission Unit                                      |
| NACC         | Network Assisted Cell Change                                   |
| QoS          | Quality of Service   |
| RAN          | Radio Access Network   |
| RANAP        | Radio Access Network Application Part                          |
| RIM          | RAN Information Management                                     |
| RNC          | Radio Network Controller                                       |
| TEID         | Tunnel Endpoint Identifier                                     |
| TFT          | Traffic Flow Template  |
| UDP          | User Datagram Protocol   |
| UTRAN        | UMTS Terrestrial Radio Access Network                          |

---

## 4 General

The present document defines the GPRS Tunnelling Protocol (GTP), i.e. the protocol between GPRS Support Nodes (GSNs) in the UMTS/GPRS backbone network. It includes both the GTP control plane (GTP-C) and data transfer (GTP-U) procedures. GTP also lists the messages and information elements used by the GTP based charging protocol GTP', which is described in 3GPP TS 32.215 [18].

GTP (GTP-C and GTP-U) is defined for the Gn interface, i.e. the interface between GSNs within a PLMN, and for the Gp interface between GSNs in different PLMNs. Only GTP-U is defined for the Iu interface between Serving GPRS Support Node (SGSN) and the UMTS Terrestrial Radio Access Network (UTRAN).

On the Iu interface, the Radio Access Network Application Part (RANAP) protocol and signalling part of GTP-U are performing the control function for user plane (GTP-U).

GTP' is defined for the interface between CDR generating functional network elements and Charging Gateway(s) within a PLMN. Charging Gateway(s) and GTP' protocol are optional, as the Charging Gateway Functionality may either be

located in separate network elements (Charging Gateways), or alternatively be embedded into the CDR generating network elements (GSNs) when the GSN-CGF interface is not necessarily visible outside the network element. These interfaces relevant to GTP are between the grey boxes shown in figure 1.

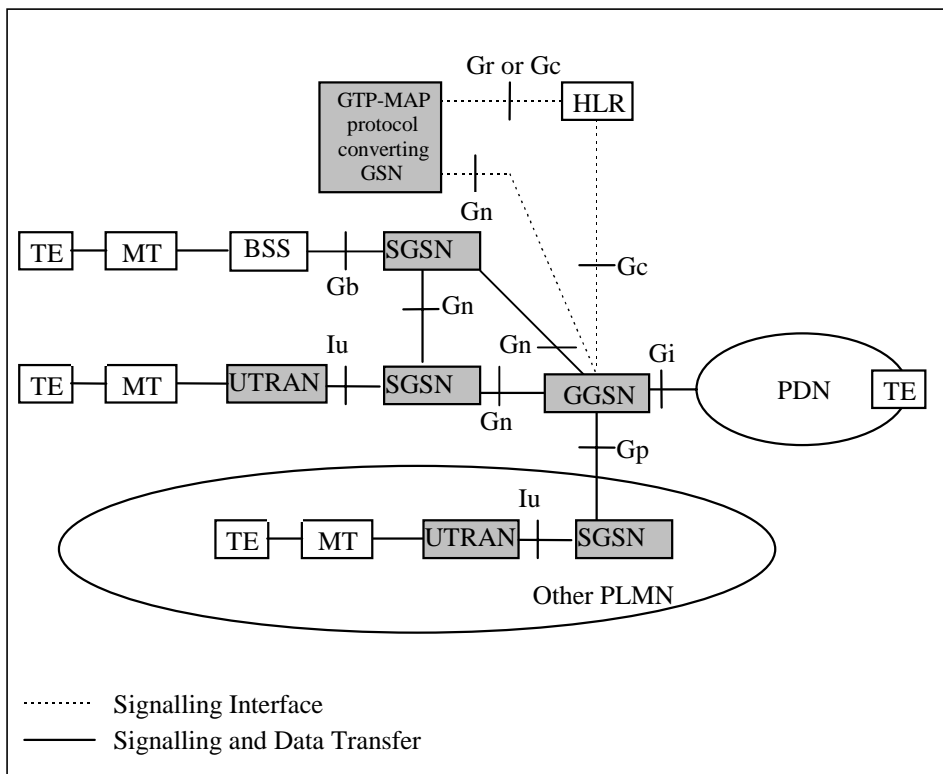

**Figure 1: GPRS Logical Architecture with interface name denotations**

GTP allows multi-protocol packets to be tunnelled through the UMTS/GPRS Backbone between GSNs and between SGSN and UTRAN.

In the control plane, GTP specifies a tunnel control and management protocol (GTP-C) which allows the SGSN to provide packet data network access for an MS. Control Plane signalling is used to create, modify and delete tunnels.

In the user plane, GTP uses a tunnelling mechanism (GTP-U) to provide a service for carrying user data packets.

The GTP-U protocol is implemented by SGSNs and GGSNs in the UMTS/GPRS Backbone and by Radio Network Controllers (RNCs) in the UTRAN. SGSNs and GGSNs in the UMTS/GPRS Backbone implement the GTP-C protocol. No other systems need to be aware of GTP. UMTS/GPRS MSs are connected to an SGSN without being aware of GTP.

It is assumed that there will be a many-to-many relationship between SGSNs and GGSNs. A SGSN may provide service to many GGSNs. A single GGSN may associate with many SGSNs to deliver traffic to a large number of geographically diverse mobile stations.

SGSN and GGSN implementing GTP protocol version 1 should be able to fallback to GTP protocol version 0. All GSNs should be able to support all earlier GTP versions.

## 5 Transmission Order and Bit Definitions

The messages in this document shall be transmitted in network octet order starting with octet 1. Where information elements are repeated within a message the order shall be determined by the order of appearance in the table defining the information elements in the message.

The most significant bit of an octet in a GTP message is bit 8. If a value in a GTP message spans several octets and nothing else is stated, the most significant bit is bit 8 of the octet with the lowest number.

## 6 GTP Header

The GTP header is a variable length header used for both the GTP-C and the GTP-U protocols. The minimum length of the GTP header is 8 bytes. There are three flags that are used to signal the presence of additional optional fields: the PN flag, the S flag and the E flag. The PN flag is used to signal the presence of N-PDU Numbers. The S flag is used to signal the presence of the GTP Sequence Number field. The E flag is used to signal the presence of the Extension Header field, used to enable future extensions of the GTP header defined in this document, without the need to use another version number. If and only if one or more of these three flags are set, the fields Sequence Number, N-PDU and Extension Header shall be present. The sender shall set all the bits of the unused fields to zero. The receiver shall not evaluate the unused fields.

The GTP-C and the GTP-U use some of the fields in the GTP header differently. The detailed use of such fields is described in the sections related to GTP-C and to GTP-U.

### Always present fields:

- Version field: This field is used to determine the version of the GTP protocol. For the treatment of other versions, see clause 11.1.1, "Different GTP versions". The version number shall be set to '1'.
- Protocol Type (PT): This bit is used as a protocol discriminator between GTP (when PT is '1') and GTP' (when PT is '0'). GTP is described in this document and the GTP' protocol in 3GPP TS 32.215 [18]. Note that the interpretation of the header fields may be different in GTP' than in GTP.
- Extension Header flag (E): This flag indicates the presence of a meaningful value of the Next Extension Header field. When it is set to '0', the Next Extension Header field either is not present or, if present, shall not be interpreted. When it is set to '1', the Next Extension Header field is present, and shall be interpreted, as described below in this section.
- Sequence number flag (S): This flag indicates the presence of a meaningful value of the Sequence Number field. When it is set to '0', the Sequence Number field either is not present or, if present, shall not be interpreted. When it is set to '1', the Sequence Number field is present, and shall be interpreted, as described below in this section.
- N-PDU Number flag (PN): This flag indicates the presence of a meaningful value of the N-PDU Number field. When it is set to '0', the N-PDU Number field either is not present, or, if present, shall not be interpreted. When it is set to '1', the N-PDU Number field is present, and shall be interpreted, as described below in this section.
- Message Type: This field indicates the type of GTP message. The valid values of the message type are defined in clause 7.1 for both GTP-C and GTP-U.
- Length: This field indicates the length in octets of the payload, i.e. the rest of the packet following the mandatory part of the GTP header (that is the first 8 octets). The Sequence Number, the N-PDU Number or any Extension headers shall be considered to be part of the payload, i.e. included in the length count.
- Tunnel Endpoint Identifier (TEID): This field unambiguously identifies a tunnel endpoint in the receiving GTP-U or GTP-C protocol entity. The receiving end side of a GTP tunnel locally assigns the TEID value the transmitting side has to use. The TEID values are exchanged between tunnel endpoints using GTP-C (or RANAP, over the Iu) messages.

### Optional fields:

- Sequence Number: This field is an optional field in G -PDUs. It is used as a transaction identity for signalling messages having a response message defined for a request message, that is the Sequence Number value is copied from the request to the response message header. In the user plane, an increasing sequence number for T-PDUs is transmitted via GTP-U tunnels, when transmission order must be preserved.
- N-PDU Number: This field is used at the Inter SGSN Routeing Area Update procedure and some inter-system handover procedures (e.g. between 2G and 3G radio access networks). This field is used to co-ordinate the data transmission for acknowledged mode of communication between the MS and the SGSN. The exact meaning of this field depends upon the scenario. (For example, for GSM/GPRS to GSM/GPRS, the SNDCCP N-PDU number is present in this field).
- Next Extension Header Type: This field defines the type of Extension Header that follows this field in the GTP-PDU.

| Octets | Bits   |   |    |     |   |   |    |   |
|--------|--|---|----|-----|---|---|----|---|
|        | 8  | 7 | 6  | 5   | 4 | 3 | 2  | 1 |
| 1      | Version  |   | PT | (*) | E | S | PN |   |
| 2      | Message Type   |   |    |     |   |   |    |   |
| 3      | Length (1 <sup>st</sup> Octet)                           |   |    |     |   |   |    |   |
| 4      | Length (2 <sup>nd</sup> Octet)                           |   |    |     |   |   |    |   |
| 5      | Tunnel Endpoint Identifier (1 <sup>st</sup> Octet)       |   |    |     |   |   |    |   |
| 6      | Tunnel Endpoint Identifier (2 <sup>nd</sup> Octet)       |   |    |     |   |   |    |   |
| 7      | Tunnel Endpoint Identifier (3 <sup>rd</sup> Octet)       |   |    |     |   |   |    |   |
| 8      | Tunnel Endpoint Identifier (4 <sup>th</sup> Octet)       |   |    |     |   |   |    |   |
| 9      | Sequence Number (1 <sup>st</sup> Octet) <sup>1) 4)</sup> |   |    |     |   |   |    |   |
| 10     | Sequence Number (2 <sup>nd</sup> Octet) <sup>1) 4)</sup> |   |    |     |   |   |    |   |
| 11     | N-PDU Number <sup>2) 4)</sup>                            |   |    |     |   |   |    |   |
| 12     | Next Extension Header Type <sup>3) 4)</sup>              |   |    |     |   |   |    |   |

NOTE 0: (\*) This bit is a spare bit. It shall be sent as '0'. The receiver shall not evaluate this bit.

NOTE 1: 1) This field shall only be evaluated when indicated by the S flag set to 1.

NOTE 2: 2) This field shall only be evaluated when indicated by the PN flag set to 1.

NOTE 3: 3) This field shall only be evaluated when indicated by the E flag set to 1.

NOTE 4: 4) This field shall be present if and only if any one or more of the S, PN and E flags are set.

**Figure 2: Outline of the GTP Header**

The format of GTP Extension Headers is depicted in figure 2. The Extension Header Length field specifies the length of the particular Extension header in 4 octets units. The Next Extension Header Type field specifies the type of any Extension Header that may follow a particular Extension Header. If no such Header follows, then the value of the Next Extension Header Type shall be 0.

|        |       |                                   |
|--------|-------|-----------------------------------|
| Octets | 1     | Extension Header Length           |
|        | 2 - m | Extension Header Content          |
|        | m+1   | Next Extension Header Type (note) |

NOTE: The value of this field is 0 if no other Extension header follows.

**Figure 3: Outline of the Extension Header Format**

The length of the Extension header shall be defined in a variable length of 4 octets, i.e.  $m+1 = n*4$  octets, where  $n$  is a positive integer.

Bits 7 and 8 of the Next Extension Header Type define how the recipient shall handle unknown Extension Types. The recipient of an extension header of unknown type but marked as 'comprehension not required' for that recipient shall read the 'Next Extension Header Type' field (using the Extension Header Length field to identify its location in the GTP-PDU).

The recipient of an extension header of unknown type but marked as 'comprehension required' for that recipient shall:

- If the message with the unknown extension header was a request, send a response message back with CAUSE set to "unknown mandatory extension header".
- Send a Supported Extension Headers Notification to the originator of the GTP PDU.
- Log an error.

Bits 7 and 8 of the Next Extension Header Type have the following meaning:

| Bits |   | Meaning   |
|------|---|---|
| 8    | 7 |   |
| 0    | 0 | Comprehension of this extension header is not required. An Intermediate Node shall forward it to any Receiver Endpoint  |
| 0    | 1 | Comprehension of this extension header is not required. An Intermediate Node shall discard the Extension Header Content and not forward it to any Receiver Endpoint. Other extension headers shall be treated independently of this extension header. |
| 1    | 0 | Comprehension of this extension header is required by the Endpoint Receiver but not by an Intermediate Node. An Intermediate Node shall forward the whole field to the Endpoint Receiver.   |
| 1    | 1 | Comprehension of this header type is required by recipient (either Endpoint Receiver or Intermediate Node)  |

**Figure 4: Definition of bits 7 and 8 of the Extension Header Type**

An Endpoint Receiver is the ultimate receiver of the GTP-PDU (e.g. an RNC or the GGSN for the GTP-U plane). An Intermediate Node is a node that handles GTP but is not the ultimate endpoint (e.g. an SGSN for the GTP-U plane traffic between GGSN and RNC).

| Next Extension Header Field Value | Type of Extension Header  |
|-----------------------------------|---------------------------|
| 0000 0000                         | No more extension headers |
| 1100 0000                         | PDCP PDU number           |
| 1100 0001                         | Suspend Request           |
| 1100 0010                         | Suspend Response          |

**Figure 5: Definition of Extension Header Type**

## 6.1 Extension headers

### 6.1.1 PDCP PDU Number

This extension header is transmitted, for example, at SRNS relocation time to provide the PDCP sequence number of not yet acknowledged N-PDUs. It is 4 octets long, and therefore the Length field has value 1.

| Octets | Bits                              |   |   |   |   |   |   |   |
|--------|-----------------------------------|---|---|---|---|---|---|---|
|        | 8                                 | 7 | 6 | 5 | 4 | 3 | 2 | 1 |
| 1      | 1                                 |   |   |   |   |   |   |   |
| 2      | PDCP PDU number                   |   |   |   |   |   |   |   |
| 3      | PDCP PDU number.                  |   |   |   |   |   |   |   |
| 4      | Next Extension Header Type (note) |   |   |   |   |   |   |   |

NOTE: The value of this field is 0 if no other Extension header follows.

**Figure 6: PDCP PDU number Extension Header**

### 6.1.2 Suspend Request

This extension header is transmitted at inter-SGSN handover, when a DTM capable MS has an ongoing circuit call and it moves to a cell that does not support DTM, under the domain of a new 2G SGSN. When the new SGSN receives a "Suspend" message from the BSS, it sends a SGSN context request with this additional extension header to the old SGSN. The old SGSN shall reply with a SGSN context response, including the Extension Header described in subclause 6.1.3. The SGSN Context Request message shall not be handled other than for the purpose of implementing the Suspend functionality as described in 3GPP TS 23.060 [4]. The "SGSN context request" message shall not include the "IMSI", "packet-TMSI", "packet TMSI signature" and "MS validated" IEs.

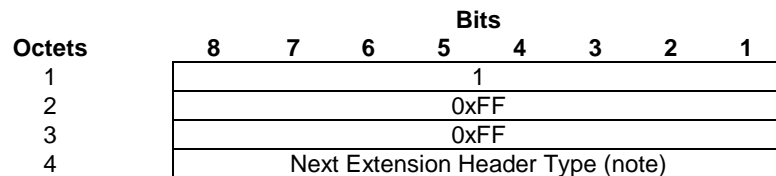

NOTE: The value of this field is 0 if no other Extension header follows.

**Figure 7: Suspend Request Extension Header**

### 6.1.3 Suspend Response

When a SGSN receives a SGSN Context Request with the extension header "Suspend Request" described in subclause 6.1.2, it shall perform the actions specified in 3GPP TS 23.060 [4] and it shall return a SGSN Context Response with this extension header included. The SGSN Context Response message shall not be handled other than for the purpose of implementing the Suspend functionality as described in 3GPP TS 23.060 [4]. The "SGSN context response" shall not include the "IMSI", "Radio priority SMS", "Radio priority", "packet flow ID", "MM context", "PDP context" and "SGSN Address for control plane" IEs.

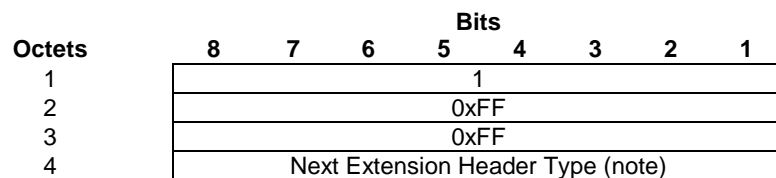

NOTE: The value of this field is 0 if no other Extension header follows.

**Figure 8: Suspend Response Extension Header**

## 7 GTP Messages and Message Formats

### 7.1 Message Formats

GTP defines a set of messages between two associated GSNs or an SGSN and an RNC. The messages to be used are defined in the table below. The three columns to the right define which parts (GTP-C, GTP-U or GTP') that send or receive the specific message type.

**Table 1: Messages in GTP**

| Message Type value (Decimal) | Message   | Reference              | GTP-C | GTP-U | GTP' |
|------------------------------|---|------------------------|-------|-------|------|
| 0                            | For future use. Shall not be sent. If received, shall be treated as an Unknown message. |                        |       |       |      |
| 1                            | Echo Request  | 7.2.1                  | X     | X     | x    |
| 2                            | Echo Response   | 7.2.2                  | X     | X     | x    |
| 3                            | Version Not Supported   | 7.2.3                  | X     |       | x    |
| 4                            | Node Alive Request  | 3GPP TS<br>32.215 [18] |       |       | X    |
| 5                            | Node Alive Response   | 3GPP TS<br>32.215 [18] |       |       | X    |
| 6                            | Redirection Request   | 3GPP TS<br>32.215 [18] |       |       | X    |
| 7                            | Redirection Response  | 3GPP TS<br>32.215 [18] |       |       | X    |
| 8-15                         | For future use. Shall not be sent. If received, shall be treated as an Unknown message. |                        |       |       |      |
| 16                           | Create PDP Context Request  | 7.3.1                  | X     |       |      |
| 17                           | Create PDP Context Response   | 7.3.2                  | X     |       |      |
| 18                           | Update PDP Context Request  | 7.3.3                  | X     |       |      |



| Message Type value (Decimal) | Message   | Reference           | GTP-C | GTP-U | GTP' |
|------------------------------|---|---------------------|-------|-------|------|
| 19                           | Update PDP Context Response   | 7.3.4               | X     |       |      |
| 20                           | Delete PDP Context Request  | 7.3.5               | X     |       |      |
| 21                           | Delete PDP Context Response   | 7.3.6               | X     |       |      |
| 22-25                        | For future use. Shall not be sent. If received, shall be treated as an Unknown message. |                     |       |       |      |
| 26                           | Error Indication  | 7.3.7               |       | X     |      |
| 27                           | PDU Notification Request  | 7.3.8               | X     |       |      |
| 28                           | PDU Notification Response   | 7.3.9               | X     |       |      |
| 29                           | PDU Notification Reject Request   | 7.3.10              | X     |       |      |
| 30                           | PDU Notification Reject Response  | 7.3.11              | X     |       |      |
| 31                           | Supported Extension Headers Notification  | 7.2.4               | X     | X     |      |
| 32                           | Send Routeing Information for GPRS Request  | 7.4.1               | X     |       |      |
| 33                           | Send Routeing Information for GPRS Response   | 7.4.2               | X     |       |      |
| 34                           | Failure Report Request  | 7.4.3               | X     |       |      |
| 35                           | Failure Report Response   | 7.4.4               | X     |       |      |
| 36                           | Note MS GPRS Present Request  | 7.4.5               | X     |       |      |
| 37                           | Note MS GPRS Present Response   | 7.4.6               | X     |       |      |
| 38-47                        | For future use. Shall not be sent. If received, shall be treated as an Unknown message. |                     |       |       |      |
| 48                           | Identification Request  | 7.5.1               | X     |       |      |
| 49                           | Identification Response   | 7.5.2               | X     |       |      |
| 50                           | SGSN Context Request  | 7.5.3               | X     |       |      |
| 51                           | SGSN Context Response   | 7.5.4               | X     |       |      |
| 52                           | SGSN Context Acknowledge  | 7.5.5               | X     |       |      |
| 53                           | Forward Relocation Request  | 7.5.6               | X     |       |      |
| 54                           | Forward Relocation Response   | 7.5.7               | X     |       |      |
| 55                           | Forward Relocation Complete   | 7.5.8               | X     |       |      |
| 56                           | Relocation Cancel Request   | 7.5.9               | X     |       |      |
| 57                           | Relocation Cancel Response  | 7.5.10              | X     |       |      |
| 58                           | Forward SRNS Context  | 7.5.13              | X     |       |      |
| 59                           | Forward Relocation Complete Acknowledge   | 7.5.11              | X     |       |      |
| 60                           | Forward SRNS Context Acknowledge  | 7.5.12              | X     |       |      |
| 61-69                        | For future use. Shall not be sent. If received, shall be treated as an Unknown message. |                     |       |       |      |
| 70                           | RAN Information Relay   | 7.5.14.1            | X     |       |      |
| 71-239                       | For future use. Shall not be sent. If received, shall be treated as an Unknown message. |                     |       |       |      |
| 240                          | Data Record Transfer Request  | 3GPP TS 32.215 [18] |       |       | X    |
| 241                          | Data Record Transfer Response   | 3GPP TS 32.215 [18] |       |       | X    |
| 242-254                      | For future use. Shall not be sent. If received, shall be treated as an Unknown message. |                     |       |       |      |
| 255                          | G-PDU   | 9.3.1               |       | X     |      |

### 7.1.1 Presence requirements of Information Elements

There are three different presence requirements (Mandatory, Conditional, or Optional) for an IE within a given GTP-PDU:

- **Mandatory** means that the IE shall be included by the sending side, and that the receiver diagnoses a "Mandatory IE missing" error when detecting that the IE is not present.
- **Conditional** means:
  - that inclusion of the IE by the sender depends on conditions specified in the relevant protocol specification;
  - that the receiver can expect that the IE is present based on its parameter combination in the message and/or on the state of the receiving node.

- **Optional** means that the IE shall be included as a service option. Therefore, the IE may be included or not in a message.

For error handling, refer to section 11.

## 7.2 Path Management Messages

The Path Management messages may be sent between any type of GSN or GSN - RNC pair.

### 7.2.1 Echo Request

An Echo Request may be sent on a path to another GSN or RNC to find out if the peer GSN or RNC is alive (see section Path Failure). Echo Request messages may be sent for each path in use. A path is considered to be in use if at least one PDP context uses the path to the other GSN. When and how often an Echo Request message may be sent is implementation specific but an Echo Request shall not be sent more often than every 60 s on each path.

A GSN or RNC shall be prepared to receive an Echo Request at any time and it shall reply with an Echo Response. A GSN or RNC may optionally send Echo Request messages.

The optional Private Extension contains vendor or operator specific information.

**Table 2: Information Elements in an Echo Request**

| Information element | Presence requirement | Reference |
|---------------------|----------------------|-----------|
| Private Extension   | Optional             | 7.7.46    |

### 7.2.2 Echo Response

The message shall be sent as a response to a received Echo Request.

The Recovery information element contains the local Restart Counter (see section Restoration and Recovery) value for the GSN that sends the Echo Response message. For GTP-U the Restart Counter value shall not be used, i.e. it shall be set to zero by the sender and shall be ignored by the receiver.

The GSN that receives an Echo Response from a peer GSN shall compare the Restart Counter value received with the previous Restart Counter value stored for that peer GSN. If no previous value was stored, the Restart Counter value received in the Echo Response shall be stored for the peer GSN.

The value of a Restart Counter previously stored for a peer GSN may differ from the Restart Counter value received in the Echo Response from that peer GSN. In this case, the GSN that sent the Echo Response shall be considered as restarted by the GSN that received the Echo Response. The new Restart Counter value received shall be stored by the receiving entity, replacing the value previously stored for the sending GSN.

If the sending GSN is a GGSN and the receiving GSN is an SGSN, the SGSN shall consider all PDP contexts using the GGSN as inactive. For further actions of the SGSN refer to 3GPP TS 23.007 [3].

If the sending GSN is an SGSN and the receiving GSN is a GGSN, the GGSN shall consider all PDP contexts using the SGSN as inactive. For further actions of the GGSN refer to 3GPP TS 23.007 [3].

The optional Private Extension contains vendor or operator specific information.

**Table 3: Information Elements in an Echo Response**

| Information element | Presence requirement | Reference |
|---------------------|----------------------|-----------|
| Recovery            | Mandatory            | 7.7.11    |
| Private Extension   | Optional             | 7.7.46    |

### 7.2.3 Version Not Supported

This message contains only the GTP header and indicates the latest GTP version that the GTP entity on the identified UDP/IP address can support (see subclause 11.1.1).

### 7.2.4 Supported Extension Headers Notification

This message indicates a list of supported Extension Headers that the GTP entity on the identified IP address can support. This message is sent only in case a GTP entity was required to interpret a mandatory Extension Header but the GSN or RNC was not yet upgraded to support that extension header. The GTP endpoint at the GSN or RNC sending this message is marked as not enabled to support some extension headers (as derived from the supported extension header list). The GSN may retry to use all the extension headers with that node, in an attempt to verify it has been upgraded. Implementers should avoid repeated attempts to use unknown extension headers with an endpoint that has signalled its inability to interpret them.

**Table 4: Information Elements in Supported Extension Headers Notification**

| Information element        | Presence requirement | Reference |
|----------------------------|----------------------|-----------|
| Extension Header Type List | Mandatory            | 7.7.40    |

## 7.3 Tunnel Management Messages

### 7.3.1 Create PDP Context Request

A Create PDP Context Request shall be sent from a SGSN node to a GGSN node as a part of the GPRS PDP Context Activation procedure. After sending the Create PDP Context Request message, the SGSN marks the PDP context as 'waiting for response'. In this state the SGSN shall accept G-PDUs from the GGSN but shall not send these G-PDUs to the MS. A valid request initiates the creation of a tunnel between a PDP Context in a SGSN and a PDP Context in a GGSN. If the procedure is not successfully completed, the SGSN repeats the Create PDP Context Request message to the next GGSN address in the list of IP addresses, if there is one. If the list is exhausted the activation procedure fails.

The Tunnel Endpoint Identifier Data I field specifies a downlink Tunnel Endpoint Identifier for G-PDUs which is chosen by the SGSN. The GGSN shall include this Tunnel Endpoint Identifier in the GTP header of all subsequent downlink G-PDUs which are related to the requested PDP context.

The Tunnel Endpoint Identifier Control Plane field specifies a downlink Tunnel Endpoint Identifier for control plane messages which is chosen by the SGSN. The GGSN shall include this Tunnel Endpoint Identifier in the GTP header of all subsequent downlink control plane messages which are related to the requested PDP context. If the SGSN has already confirmed successful assignment of its Tunnel Endpoint Identifier Control Plane to the peer GGSN, this field shall not be present. The SGSN confirms successful assignment of its Tunnel Endpoint Identifier Control Plane the GGSN when it receives any message with its assigned Tunnel Endpoint Identifier Control Plane in the GTP header from the GGSN.

The MSISDN of the MS is passed to the GGSN inside the Create PDP Context Request; This additional information can be used when a secure access to a remote application residing on a server is needed. The GGSN would be in fact able to provide the user identity (i.e. the MSISDN) to the remote application server, providing it with the level of trust granted to users through successfully performing the GPRS authentication procedures, without having to re-authenticate the user at the application level.

If the MS requests a dynamic PDP address and a dynamic PDP address is allowed, then the PDP Address field in the End User Address information element shall be empty. If the MS requests a static PDP Address then the PDP Address field in the End User Address information element shall contain the static PDP Address. In case the PDP addresses carried in the End User Address and optionally in the Protocol Configuration Option information element contain contradicting information, the PDP address carried in the End User Address information element takes the higher precedence. The Quality of Service Profile information element shall be the QoS values to be negotiated between the MS and the SGSN at PDP Context activation.

The SGSN shall include an SGSN Address for control plane and an SGSN address for user traffic, which may differ from that provided by the underlying network service (e.g. IP). The GGSN shall store these SGSN Addresses and use them when sending control plane on this GTP tunnel or G-PDUs to the SGSN for the MS.

The SGSN shall include a Recovery information element into the Create PDP Context Request if the SGSN is in contact with the GGSN for the very first time or if the SGSN has restarted recently and the new Restart Counter value has not yet been indicated to the GGSN. The GGSN that receives a Recovery information element in the Create PDP Context Request message element shall handle it in the same way as when receiving an Echo Response message. The Create PDP Context Request message shall be considered as a valid activation request for the PDP context included in the message.

The SGSN shall include either the MS provided APN, a subscribed APN or an SGSN selected APN in the message; the Access Point Name may be used by the GGSN to differentiate accesses to different external networks.

The Selection Mode information element shall indicate the origin of the APN in the message.

For contexts created by the Secondary PDP Context Activation Procedure the SGSN shall include the linked NSAPI. Linked NSAPI indicates the NSAPI assigned to any one of the already activated PDP contexts for this PDP address and APN.

The Secondary PDP Context Activation Procedure may be executed without providing a Traffic Flow Template (TFT) to the newly activated PDP context if all other active PDP contexts for this PDP address and APN already have an associated TFT, otherwise a TFT shall be provided. TFT is used for packet filtering in the GGSN.

When using the Secondary PDP Context Activation Procedure, the Selection mode, IMSI, MSISDN, End User Address and Access Point Name elements shall not be included in the message.

The Protocol Configuration Options (PCO) information element may be included in the request when the MS provides the GGSN with application specific parameters. The SGSN includes this IE in the Create PDP Context Request if the associated Activate PDP Context Request or Activate Secondary PDP Context Request from the MS includes protocol configuration options. The SGSN shall copy the content of this IE transparently from the content of the PCO IE in the Activate PDP Context Request message or Activate Secondary PDP Context Request.

The SGSN shall select one GGSN based on the user provided or SGSN selected APN. The GGSN may have a logical name that is converted to an address. The conversion may be performed with any name-to-address function. The converted address shall be stored in the "GGSN Address in Use" field in the PDP context and be used during the entire lifetime of the PDP context.

NOTE: A DNS query may be used as the name-to-IP address mapping of the GGSN. The IP address returned in the DNS response is then stored in the "GGSN Address in Use" field in the PDP context.

The IMSI information element together with the NSAPI information element uniquely identifies the PDP context to be created.

The SGSN shall not send a Create PDP Context Request for an already active context.

If a new Create PDP Context Request is incoming on TEID 0 for an already active PDP context, this Create PDP Context Request must be considered related to a new session. The existing PDP context shall be torn down locally, and the associated PDP contexts deleted locally, before the new session is created. If a new Create PDP Context Request is incoming on a TEID which is different from 0 and this TEID is already allocated to one or more activated PDP contexts, and the NSAPI IE value in this message matches the NSAPI value of an active PDP context, the GGSN shall send back a Create PDP Context Response with a rejection cause code. It is implementation dependent deciding whether to teardown or keep the existing PDP context.

If the GGSN uses the MNRG flag and the flag is set, the GGSN should treat the Create PDP Context Request as a Note MS Present Request and clear the MNRG flag.

The SGSN shall determine Charging Characteristics from the Subscribed Charging Characteristics and/or PDP Context Charging Characteristics depending on the presence of the information in the Packet Domain Subscription Data as defined in 3GPP TS 23.060 [4]. The requirements for the presence of the Charging Characteristics IE are defined in 3GPP TS 23.060 [4]. The contents of the Charging Characteristics IE are defined in 3GPP TS 32.215 [18].

The SGSN shall include Trace Reference, Trace Type, Trigger Id, and OMC Identity in the message if GGSN trace is activated. The SGSN shall copy Trace Reference, Trace Type, and OMC Identity from the trace request received from the HLR or OMC.

The SGSN may include the Routing Area Identity (RAI) of the SGSN where the MS is registered. The MCC and MNC components shall be populated with the MCC and MNC, respectively, of the SGSN where the MS is registered. The LAC and RAC components shall be populated by the SGSN with the value of 'FFFE' and 'FF', respectively.

The optional Private Extension contains vendor or operator specific information.

**Table 5: Information Elements in a Create PDP Context Request**

| Information element                      | Presence requirement | Reference          |
|--|----------------------|--------------------|
| IMSI                                     | Conditional          | 7.7.2              |
| Routeing Area Identity (RAI)             | Optional             | 7.7.3              |
| Recovery                                 | Optional             | 7.7.11             |
| Selection mode                           | Conditional          | 7.7.12             |
| Tunnel Endpoint Identifier Data I        | Mandatory            | 7.7.13             |
| Tunnel Endpoint Identifier Control Plane | Conditional          | 7.7.14             |
| NSAPI                                    | Mandatory            | 7.7.17             |
| Linked NSAPI                             | Conditional          | 7.7.17             |
| Charging Characteristics                 | Conditional          | 7.7.23             |
| Trace Reference                          | Optional             | 7.7.24             |
| Trace Type                               | Optional             | 7.7.25             |
| End User Address                         | Conditional          | 7.7.27             |
| Access Point Name                        | Conditional          | 7.7.30             |
| Protocol Configuration Options           | Optional             | 7.7.31             |
| SGSN Address for signalling              | Mandatory            | GSN Address 7.7.32 |
| SGSN Address for user traffic            | Mandatory            | GSN Address 7.7.32 |
| MSISDN                                   | Conditional          | 7.7.33             |
| Quality of Service Profile               | Mandatory            | 7.7.34             |
| TFT                                      | Conditional          | 7.7.36             |
| Trigger Id                               | Optional             | 7.7.41             |
| OMC Identity                             | Optional             | 7.7.42             |
| Private Extension                        | Optional             | 7.7.46             |

### 7.3.2 Create PDP Context Response

The message shall be sent from a GGSN node to a SGSN node as a response of a Create PDP Context Request. When the SGSN receives a Create PDP Context Response with the Cause value indicating 'Request Accepted', the SGSN activates the PDP context and may start to forward T-PDUs to/from the MS from/to the external data network.

The Cause value indicates if a PDP context has been created in the GGSN or not. A PDP context has not been created in the GGSN if the Cause differs from 'Request accepted'. Possible Cause values are:

- "Request Accepted".
- "Context not found"
- "No resources available".
- "All dynamic PDP addresses are occupied".
- "No memory is available".
- "Missing or unknown APN".
- "Unknown PDP address or PDP type".
- "User authentication failed".
- "System failure".
- "Semantic error in the TFT operation".
- "Syntactic error in the TFT operation".
- "Semantic errors in packet filter(s)".
- "Syntactic errors in packet filters(s)".
- "Mandatory IE incorrect".

- "Mandatory IE missing".
- "Optional IE incorrect".
- "Invalid message format".
- "PDP context without TFT already activated".
- "APN access denied – no subscription".

'No resources available' indicates that not enough resources are available within the network to allow the PDP Context to be created e.g. that all dynamic PDP addresses are occupied. 'Missing or unknown APN' indicates e.g. when the GGSN does not support the Access Point Name. 'Unknown PDP address or PDP type' indicates when the GGSN does not support the PDP type or the PDP address.

'User authentication failed' indicates that the external packet network has rejected the service requested by the user e.g. the authentication check in the RADIUS server failed. 'PDP context without TFT already activated' indicates that a PDP context has already been activated without a TFT for that MS. 'Context not found' indicates that a Create PDP Request for a subsequent PDP context has been received, but the PDP context associated with the request, which the SGSN believes to be active does not exist on the GGSN. 'APN access denied – no subscription' indicates that the GGSN has denied the user access to an APN because a subscription is required, but the subscriber does not have the necessary subscription.

Only the Cause information element, optionally Protocol Configuration Options and optionally the Recovery information element shall be included in the response if the Cause contains another value than 'Request accepted'.

All information elements, except Recovery, Protocol Configuration Options, Charging Gateway Address, Tunnel Endpoint Identifier Control Plane and Private Extension, are mandatory if the Cause contains the value 'Request accepted'.

The Tunnel Endpoint Identifier for Data (I) field specifies an uplink Tunnel Endpoint Identifier for G-PDUs that is chosen by the GGSN. The SGSN shall include this Tunnel Endpoint Identifier in the GTP header of all subsequent uplink G-PDUs which are related to the requested PDP context.

The Tunnel Endpoint Identifier Control Plane field specifies an uplink Tunnel Endpoint Identifier for control plane messages, which is chosen by the GGSN. The SGSN shall include this Tunnel Endpoint Identifier in the GTP header of all subsequent uplink-control plane messages, which are related to the requested PDP context. If the GGSN has already confirmed successful assignment of its Tunnel Endpoint Identifier Control Plane to the peer SGSN, this field shall not be present. The GGSN confirms successful assignment of its Tunnel Endpoint Identifier Control Plane to the SGSN when it receives any message with its assigned Tunnel Endpoint Identifier Control Plane in the GTP header from the SGSN.

The GGSN shall include a GGSN Address for control plane and a GGSN address for user traffic, which may differ from that provided by the underlying network service (e.g. IP).

If the Create PDP Context Request received from the SGSN included IPv6 SGSN address, an IPv4/IPv6 capable GGSN shall include IPv6 addresses in the fields GGSN Address for Control Plane and GGSN Address for user traffic, and IPv4 addresses in the fields Alternative GGSN Address for Control Plane and Alternative GGSN Address for user traffic. If SGSN included only an IPv4 SGSN address in the request, IPv4/IPv6 capable GGSN shall include IPv4 addresses in the fields GGSN Address for Control Plane and GGSN Address for user traffic, and IPv6 addresses in the fields Alternative GGSN Address for Control Plane and Alternative GGSN Address for user traffic. The SGSN shall store these GGSN Addresses and use one set of them when sending control plane on this GTP tunnel or G-PDUs to the GGSN for the MS.

If the MS requests a dynamic PDP address with the PDP Type IPv4 or IPv6 and a dynamic PDP address is allowed, then the End User Address information element shall be included and the PDP Address field in the End User Address information element shall contain the dynamic PDP Address allocated by the GGSN.

If the MS requests a static PDP address with the PDP Type IPv4 or IPv6, or a PDP address is specified with PDP Type PPP, then the End User Address information element shall be included and the PDP Address field shall not be included.

The PDP address in End User Address IE and in the Protocol configuration options IE shall be the same, if both IEs are present in the create PDP context response.

The QoS values supplied in the Create PDP Context Request may be negotiated downwards by the GGSN. The negotiated values or the original values from SGSN are inserted in the Quality of Service Profile information element of the Create PDP Context Response message.

The GGSN may start to forward T-PDUs after the Create PDP Context Response has been sent. The SGSN may start to forward T-PDUs when the Create PDP Context Response has been received. In this case the SGSN shall also be prepared to receive T-PDUs from the GGSN after it has sent a Create PDP Context Request but before a Create PDP Context Response has been received.

The Reordering Required value supplied in the Create PDP Context Response indicates whether the end user protocol benefits from packet in sequence delivery and whether the SGSN and the GGSN therefore shall perform reordering or not. In other words, if reordering is required by the GGSN, the SGSN and the GGSN shall perform reordering of incoming T-PDUs on this path. When the Quality of Service (QoS) Profile is Release 99 the receiving entity shall ignore the Reordering Required.

The GGSN shall include the Recovery information element into the Create PDP Context Response if the GGSN is in contact with the SGSN for the first time or the GGSN has restarted recently and the new Restart Counter value has not yet been indicated to the SGSN. The SGSN receiving the Recovery information element shall handle it as when an Echo Response message is received but shall consider the PDP context being created as active if the response indicates successful context activation at the GGSN.

The Charging ID is used to identify all charging records produced in SGSN(s) and the GGSN for this PDP context. The Charging ID is generated by the GGSN and shall be unique within the GGSN.

The Charging Gateway Address is the IP address of the recommended Charging Gateway Functionality to which the SGSN should transfer the Charging Detail Records (CDR) for this PDP Context.

The Alternative Charging Gateway Address IE has a similar purpose as the Charging Gateway Address but enables co-existence of IPv4 and IPv6 stacks in the Ga charging interfaces, without mandating **any** node to have a dual stack. The format of the optional Alternative Charging Gateway Address information element is the same as the format of the Charging Gateway Address.

When both these addresses are present, the Charging Gateway address IE shall contain the IPv4 address of the Charging Gateway Function and the Alternative Charging Gateway address IE shall contain the IPv6 address of the Charging Gateway Function.

NOTE: The Charging Gateway Address and Alternative Charging Gateway Address both refer to the same Charging Gateway Function.

The optional Private Extension contains vendor or operator specific information.

The Protocol Configuration Options (PCO) information element may be included in the response when the GGSN provides the MS with application specific parameters.

**Table 6: Information Elements in a Create PDP Context Response**

| Information element                        | Presence requirement | Reference          |
|--|----------------------|--------------------|
| Cause                                      | Mandatory            | 7.7.1              |
| Reordering required                        | Conditional          | 7.7.6              |
| Recovery                                   | Optional             | 7.7.11             |
| Tunnel Endpoint Identifier Data I          | Conditional          | 7.7.13             |
| Tunnel Endpoint Identifier Control Plane   | Conditional          | 7.7.14             |
| Charging ID                                | Conditional          | 7.7.26             |
| End User Address                           | Conditional          | 7.7.27             |
| Protocol Configuration Options             | Optional             | 7.7.31             |
| GGSN Address for Control Plane             | Conditional          | GSN Address 7.7.32 |
| GGSN Address for user traffic              | Conditional          | GSN Address 7.7.32 |
| Alternative GGSN Address for Control Plane | Conditional          | GSN Address 7.7.32 |
| Alternative GGSN Address for user traffic  | Conditional          | GSN Address 7.7.32 |
| Quality of Service Profile                 | Conditional          | 7.7.34             |
| Charging Gateway Address                   | Optional             | 7.7.44             |
| Alternative Charging Gateway Address       | Optional             | 7.7.44             |
| Private Extension                          | Optional             | 7.7.46             |

### 7.3.3 Update PDP Context Request

An Update PDP Context Request message shall be sent from a SGSN to a GGSN as part of the GPRS Inter SGSN Routeing Update procedure or the PDP Context Modification procedure or to redistribute contexts due to load sharing. It shall be used to change the QoS and the path. In addition it shall be used if it is necessary to change the GTP version of a tunnel to a GGSN from GTP v0 to GTP v1. The message shall be sent by the new SGSN at the Inter SGSN Routeing Update procedure.

The NSAPI information element together with the Tunnel Endpoint Identifier in the GTP header unambiguously identifies a PDP Context in the GGSN.

The IMSI shall be included if the message is sent during an Inter SGSN change when changing the GTP version from GTP v0 to GTP v1; this is required, as the TEID in the header of the message is set to all zeros in this case.

The Tunnel Endpoint Identifier Data field specifies a downlink Tunnel Endpoint Identifier for G-PDUs which is chosen by the SGSN. The GGSN shall include this Tunnel Endpoint Identifier in the GTP header of all subsequent downlink G-PDUs that are related to the requested PDP context.

The Tunnel Endpoint Identifier Control Plane field specifies a downlink Tunnel Endpoint Identifier Control Plane messages which is chosen by the SGSN. The GGSN shall include this Tunnel Endpoint Identifier in the GTP header of all subsequent downlink control plane messages that are related to the requested PDP context. If the SGSN has already confirmed successful assignment of its Tunnel Endpoint Identifier Control Plane to the peer GGSN, this field shall not be present. The SGSN confirms successful assignment of its Tunnel Endpoint Identifier Control Plane to the GGSN when it receives any message with its assigned Tunnel Endpoint Identifier Control Plane in the GTP header from the GGSN.

The Quality of Service Profile information element shall include the QoS negotiated between the MS and SGSN at PDP Context activation or the new QoS negotiated in the PDP Context Modification procedure.

The SGSN shall include an SGSN Address for control plane and an SGSN address for user traffic, which may differ from that provided by the underlying network service (e.g. IP).

If an IPv4/IPv6 capable SGSN received IPv4 GGSN addresses from the old SGSN, it shall include IPv4 addresses in the fields SGSN Address for Control Plane and SGSN Address for User Traffic and IPv6 addresses in the fields Alternative SGSN Address for Control Plane and Alternative SGSN Address for User Traffic. Otherwise, an IPv4/IPv6 capable SGSN shall use only SGSN IPv6 addresses if it has GGSN IPv6 addresses available. If the GGSN supports IPv6 below GTP, it shall store and use the IPv6 SGSN addresses for communication with the SGSN and ignore the IPv4 SGSN addresses. If the GGSN supports only IPv4 below GTP, it shall store and use the IPv4 SGSN addresses for communication with the SGSN and ignore the IPv6 SGSN addresses. When active contexts are being redistributed due to load sharing, G-PDUs that are in transit across the Gn-interface are in an undetermined state and may be lost.

The SGSN shall include a Recovery information element into the Update PDP Context Request if the SGSN is in contact with the GGSN for the very first time or if the SGSN has restarted recently and the new Restart Counter value has not yet been indicated to the GGSN. The GGSN that receives a Recovery information element in the Update PDP Context Request message element shall handle it in the same way as when receiving an Echo Response message. The Update PDP Context Request message shall be considered as a valid update request for the PDP context indicated in the message.

The Traffic Flow Template (TFT) is used to distinguish between different user traffic flows.

The SGSN shall include Trace Reference, Trace Type, Trigger Id, and OMC Identity in the message if GGSN trace is activated while the PDP context is active. The SGSN shall copy Trace Reference, Trace Type, and OMC Identity from the trace request received from the HLR or OMC.

The SGSN may include the Routeing Area Identity (RAI) of the SGSN where the MS is registered. The MCC and MNC components shall be populated with the MCC and MNC, respectively, of the SGSN where the MS is registered. The LAC and RAC components shall be populated by the SGSN with the value of 'FFFE' and 'FF', respectively.

The optional Private Extension contains vendor or operator specific information.

The MS includes the Protocol Configuration Options (PCO) information element in the request if the MS wishes to provide the GGSN with application specific parameters. The SGSN includes this IE in the Update PDP Context Request if the associated Modify PDP Context Request from the MS includes protocol configuration options. The SGSN shall copy the content of this IE transparently from the content of the PCO IE in the Modify PDP Context Request message.



**Table 7: Information Elements in an SGSN-Initiated Update PDP Context Request**

| Information element                        | Presence requirement | Reference          |
|--|----------------------|--------------------|
| IMSI                                       | Conditional          | 7.7.2              |
| Routing Area Identity (RAI)                | Optional             | 7.7.3              |
| Recovery                                   | Optional             | 7.7.11             |
| Tunnel Endpoint Identifier Data I          | Mandatory            | 7.7.13             |
| Tunnel Endpoint Identifier Control Plane   | Conditional          | 7.7.14             |
| NSAPI                                      | Mandatory            | 7.7.17             |
| Trace Reference                            | Optional             | 7.7.24             |
| Trace Type                                 | Optional             | 7.7.25             |
| Protocol Configuration Options             | Optional             | 7.7.31             |
| SGSN Address for Control Plane             | Mandatory            | GSN Address 7.7.32 |
| SGSN Address for User Traffic              | Mandatory            | GSN Address 7.7.32 |
| Alternative SGSN Address for Control Plane | Conditional          | GSN Address 7.7.32 |
| Alternative SGSN Address for User Traffic  | Conditional          | GSN Address 7.7.32 |
| Quality of Service Profile                 | Mandatory            | 7.7.34             |
| TFT  | Optional             | 7.7.36             |
| Trigger Id                                 | Optional             | 7.7.41             |
| OMC Identity                               | Optional             | 7.7.42             |
| Private Extension                          | Optional             | 7.7.46             |

An Update PDP Context Request may also be sent from a GGSN to a SGSN to re-negotiate the QoS of a PDP context. The GGSN-initiated Update PDP Context Request can also be used to provide a PDP address to the SGSN (and MS). The latter shall be used by GGSN when it acts as a DHCP Relay Agent or Mobil IP Foreign Agent. A GGSN may send an update PDP context to a SGSN to check that the PDP context is still active at the SGSN. In such a case, the GGSN shall include the optional IMSI IE, to add robustness against the case the SGSN has re-assigned the TEID to another PDP context (this may happen when the PDP context is dangling at the GGSN). Also, the "Quality of service profile" IE and the "End user Address" IE shall not be included in this case.

The Quality of Service Profile information element shall include the GGSN requested QoS.

The End User Address information element shall contain a valid IPv4 or IPv6 address.

The GGSN shall include a Recovery information element into the Update PDP Context Request if the GGSN has restarted recently and the new Restart Counter value has not yet been indicated to the SGSN. The SGSN that receives a Recovery information element in the Update PDP Context Request message element shall handle it in the same way as when receiving an Echo Response message. The Update PDP Context Request message shall be considered as a valid update request for the PDP context indicated in the message.

The NSAPI information element together with the Tunnel Endpoint Identifier in the GTP header unambiguously identifies a PDP Context in the SGSN.

The GGSN includes the Protocol Configuration Options (PCO) information element in the request if the GGSN wishes to provide the MS with application specific parameters. The SGSN includes this IE in the Modify PDP Context Request message if the associated Update PDP Context Request message from the GGSN includes protocol configuration options. The SGSN shall copy the content of this IE transparently from the content of the PCO IE in the Update PDP Context Request message.

The optional Private Extension contains vendor or operator specific information.

**Table 8: Information Elements in a GGSN-Initiated Update PDP Context Request**

| Information element            | Presence requirement | Reference |
|--------------------------------|----------------------|-----------|
| IMSI                           | optional             | 7.7.2     |
| Recovery                       | Optional             | 7.7.11    |
| NSAPI                          | Mandatory            | 7.7.17    |
| End User Address               | Optional             | 7.7.27    |
| Protocol Configuration Options | Optional             | 7.7.31    |
| Quality of Service Profile     | Optional             | 7.7.34    |
| Private Extension              | Optional             | 7.7.46    |

### 7.3.4 Update PDP Context Response

The message shall be sent from a GGSN node to a SGSN node as a response of an Update PDP Context Request.

If the SGSN receives an Update PDP Context Response with a Cause value other than 'Request accepted', it shall abort the update of the PDP context.

Only the Cause information element and optionally the Recovery information element shall be included in the response if the Cause contains another value than 'Request accepted'.

Possible Cause values are:

- 'Request Accepted'.
- 'Non-existent'.
- 'Service not supported'.
- 'System failure'.
- 'Semantic error in the TFT operation'.
- 'Syntactic error in the TFT operation'.
- 'Semantic errors in packet filter(s)'.
- 'Syntactic errors in packet filters(s)'.
- 'Mandatory IE incorrect'.
- 'Mandatory IE missing'.
- 'Optional IE incorrect'.
- 'Invalid message format'.

The Tunnel Endpoint Identifier Data field specifies an uplink Tunnel Endpoint Identifier for G-PDUs that is chosen by the GGSN. The SGSN shall include this Tunnel Endpoint Identifier in the GTP header of all subsequent uplink G-PDUs that are related to the requested PDP context. This information element shall be included if the Cause contains the value 'Request accepted'.

The Tunnel Endpoint Identifier Control Plane field specifies an uplink Tunnel Endpoint Identifier Control Plane messages which is chosen by the GGSN. The SGSN shall include this Tunnel Endpoint Identifier in the GTP header of all subsequent uplink control plane messages which are related to the requested PDP context. If the GGSN has already confirmed successful assignment of its Tunnel Endpoint Identifier Control Plane to the peer SGSN, this field shall not be present. The GGSN confirms successful assignment of its Tunnel Endpoint Identifier Control Plane to the SGSN when it receives any message with its assigned Tunnel Endpoint Identifier Control Plane in the GTP header from the SGSN.

The QoS values supplied in the Update PDP Context Request may be negotiated downwards by the GGSN. The negotiated values or the original value from SGSN is inserted in the Quality of Service Profile information element. This information element shall be included if the Cause contains the value 'Request accepted'.

The GGSN may start to forward T-PDUs after the Update PDP Context Response has been sent. The SGSN may start to forward T-PDUs when the Update PDP Context Response has been received. In this case the SGSN shall also be prepared to receive T-PDUs from the GGSN after it has sent an Update PDP Context Request but before an Update PDP Context Response has been received.

The GGSN shall include a GGSN address for user traffic, which may differ from that provided by the underlying network service (e.g. IP). IPv4/IPv6 capable GGSN shall include both its IP version addresses. If the Update PDP Context Request received from the SGSN included IPv6 SGSN addresses, an IPv4/IPv6 capable GGSN shall include an IPv6 address in the field GGSN Address for User Traffic and a corresponding IPv4 address in the field Alternative GGSN Address for User Traffic. If SGSN included only an IPv4 SGSN address in the request, IPv4/IPv6 capable GGSN shall include IPv4 address for user traffic in the field GGSN Address for User Traffic and IPv6 address in the field Alternative GGSN Address for User Traffic. The SGSN shall store the GGSN Addresses and use one of them when sending G-PDUs to the GGSN for the MS. When active contexts are being redistributed due to load sharing, G-PDUs that are in transit across the Gn-interface are in an undetermined state and may be lost.

The GGSN shall also include a GGSN address for control plane, which shall not differ from that provided at PDP context setup time and shall remain unchanged for the lifetime of the PDP context. If the Update PDP Context Request received from the SGSN included IPv6 SGSN addresses, an IPv4/IPv6 capable GGSN shall include an IPv6 address in the field GGSN Address for Control Plane and a corresponding IPv4 address in the field Alternative GGSN Address for Control Plane. If SGSN included only an IPv4 SGSN address in the request, IPv4/IPv6 capable GGSN shall include IPv4 address for Control plane in the field GGSN Address for Control Plane and IPv6 address for Control plane in the field Alternative GGSN Address for Control Plane.

The GGSN Address for control plane and the GGSN Address for user traffic shall be included if the Cause contains the value 'Request accepted'. The Alternative GGSN Addresses shall be included if the GGSN supports IPv6 below GTP and the Cause contains the value 'Request accepted'.

The GGSN shall include the Recovery information element into the Update PDP Context Response if the GGSN is in contact with the SGSN for the first time or if the GGSN has restarted recently and the new Restart Counter value has not yet been indicated to the SGSN. The SGSN receiving the Recovery information element shall handle it as when an Echo Response message is received but shall consider the PDP context as updated and active if the response cause indicates a successful operation at the GGSN.

The Charging ID is used to identify all charging records produced in SGSN(s) and the GGSN for this PDP context. The Charging ID has been previously generated by the GGSN and is unique for this PDP context. If an inter-SGSN routing area update occurs, it is transferred to the new SGSN as part of each active PDP context. This information element shall be included if the Cause contains the value 'Request accepted'.

The Charging Gateway Address is the IP address of the recommended Charging Gateway Functionality to which the SGSN should transfer the Charging Detail Records (CDR) for this PDP Context.

The Alternative Charging Gateway Address IE has a similar purpose as the Charging Gateway Address but enables co-existence of IPv4 and IPv6 stacks in the Ga charging interfaces, without mandating **any** node to have a dual stack. The format of the optional Alternative Charging Gateway Address information element is the same as the format of the Charging Gateway Address.

When both these addresses are present, the Charging Gateway address IE shall contain the IPv4 address of the Charging Gateway Function and the Alternative Charging Gateway address IE shall contain the IPv6 address of the Charging Gateway Function.

NOTE: The Charging Gateway Address and Alternative Charging Gateway Address both refer to the same Charging Gateway Function.

The optional Private Extension contains vendor or operator specific information.

The GGSN includes the Protocol Configuration Options (PCO) information element in the response if the GGSN wishes to provide the MS with application specific parameters.

**Table 9: Information Elements in an Update PDP Context Response sent by a GGSN**

| Information element                        | Presence requirement | Reference          |
|--|----------------------|--------------------|
| Cause                                      | Mandatory            | 7.7.1              |
| Recovery                                   | Optional             | 7.7.11             |
| Tunnel Endpoint Identifier Data I          | Conditional          | 7.7.13             |
| Tunnel Endpoint Identifier Control Plane   | Conditional          | 7.7.14             |
| Charging ID                                | Conditional          | 7.7.26             |
| Protocol Configuration Options             | Optional             | 7.7.31             |
| GGSN Address for Control Plane             | Conditional          | GSN Address 7.7.32 |
| GGSN Address for User Traffic              | Conditional          | GSN Address 7.7.32 |
| Alternative GGSN Address for Control Plane | Conditional          | GSN Address 7.7.32 |
| Alternative GGSN Address for User Traffic  | Conditional          | GSN Address 7.7.32 |
| Quality of Service Profile                 | Conditional          | 7.7.34             |
| Charging Gateway Address                   | Optional             | 7.7.44             |
| Alternative Charging Gateway Address       | Optional             | 7.7.44             |
| Private Extension                          | Optional             | 7.7.46             |

The message can also be sent from a SGSN node to a GGSN node as a response of a GGSN-initiated Update PDP Context Request.

If the GGSN receives an Update PDP Context Response with a Cause value other than 'Request accepted', it shall abort the update of the PDP context if the associated Update PDP Context Request was sent only to re-negotiate the QoS of a PDP context. Furthermore if the associated Update PDP Context Request included an 'End User Address' information element the GGSN shall delete the PDP context using the Delete PDP Context procedure and may notify the Operation and Maintenance network element.

Only the Cause information element and optionally the Recovery information element shall be included in the response if the Cause contains another value than 'Request accepted'.

Possible Cause values are the same as for the Update PDP Context Response sent by a GGSN. When the optional IMSI IE value differs from the IMSI IE value associated to the PDP context, the SGSN shall respond using the cause value 'Non-existent'.

The SGSN includes the Protocol Configuration Options (PCO) information element in the response if the MS wishes to provide the GGSN with application specific parameters. The SGSN includes this IE in the Update PDP Context Response message if the associated Modify PDP Context Accept message from the MS includes protocol configuration options. The SGSN shall copy the content of this IE transparently from the content of the PCO IE in the Modify PDP Context Accept message.

The QoS values supplied in the Update PDP Context Request may be negotiated downwards by the SGSN. The negotiated values or the original value from GGSN is inserted in the Quality of Service Profile information element. This information element shall be included if the Cause contains the value 'Request accepted' and a QoS information element was supplied in the corresponding request message.

The SGSN shall include the Recovery information element into the Update PDP Context Response if the SGSN has restarted recently and the new Restart Counter value has not yet been indicated to the GGSN. The GGSN receiving the Recovery information element shall handle it as when an Echo Response message is received but shall consider the PDP context as updated and active if the response cause indicates a successful operation at the SGSN.

**Table 10: Information Elements in an Update PDP Context Response sent by a SGSN**

| Information element            | Presence requirement | Reference |
|--------------------------------|----------------------|-----------|
| Cause                          | Mandatory            | 7.7.1     |
| Recovery                       | Optional             | 7.7.11    |
| Protocol Configuration Options | Optional             | 7.7.31    |
| Quality of Service Profile     | Conditional          | 7.7.34    |
| Private Extension              | Optional             | 7.7.46    |

### 7.3.5 Delete PDP Context Request

A Delete PDP Context Request shall be sent from a SGSN node to a GGSN node as part of the GPRS Detach procedure or the GPRS PDP Context Deactivation procedure or from a GGSN node to a SGSN node as part of the PDP Context

Deactivation Initiated by GGSN procedure. A request shall be used to deactivate an activated PDP Context or an activated set of PDP contexts associated to a PDP address assigned to a single MS.

A GSN shall be prepared to receive a Delete PDP Context Request at any time and shall always reply regardless if the PDP context exists or not (as per the Delete PDP Context Response message description section), except in cases described below.

If any collision occurs, the Delete PDP Context Request takes precedence over any other Tunnel Management message.

The Teardown Ind is used to indicate whether all PDP contexts that share the PDP address with the PDP context identified in the request should also be deactivated. This may trigger the deletion of all the information kept for a MS at a GSN, if no other PDP contexts associated to other PDP addresses are active on the GSN. If the Teardown Ind information element value is set to '1', then all PDP contexts that share the same PDP address with the PDP context identified by the NSAPI included in the Delete PDP Context Request Message shall be torn down. Only the PDP context identified by the NSAPI included in the Delete PDP context Request shall be torn down if the value of this information element is '0' or this information is not included. The SGSN shall copy this IE to the Delete PDP Context Request from the associated Deactivate PDP Context Request initiated by MS, if it is included. This information element shall NOT be included by the SGSN if the Deactivate PDP Context Request message from the MS does NOT include the Tear down indicator at PDP Context Deactivation initiated by MS. However, exceptionally this information element shall be included and its value set to '1' by the sending GSN only when the last PDP context associated to a PDP address is torn down and there are no outstanding Create PDP context requests for other PDP context different from the one being torn down for that PDP address.

If a GSN receives a Delete PDP context without a Teardown Indicator or with a Teardown Indicator with value set to '0' and only that PDP context is active for a PDP address, then the GSN shall ignore the message. (Note: This is symptom of a race condition. The reliable delivery of signalling messages will eventually lead to a consistent situation, allowing the teardown of the PDP context.)

In the MS to GGSN direction, the SGSN includes the Protocol Configuration Options (PCO) information element in the request if the MS wishes to provide the GGSN with application specific parameters. The SGSN includes this IE in the Delete PDP Context Request message if the associated Deactivate PDP Context Request message from the MS includes protocol configuration options. The SGSN shall copy the content of this IE transparently from the PCO IE in the Deactivate PDP Context Request message.

In the GGSN to MS direction, the GGSN includes the Protocol Configuration Options (PCO) information element in the request if the GGSN wishes to provide the MS with application specific parameters. The SGSN includes this IE in the Deactivate PDP Context Request message if the associated Delete PDP Context Request message from the GGSN includes protocol configuration options. The SGSN shall copy the content of this IE transparently from the PCO IE in the Delete PDP Context Request message.

The optional Private Extension contains vendor or operator specific information.

**Table 11: Information Elements in a Delete PDP Context Request**

| Information element            | Presence requirement | Reference |
|--------------------------------|----------------------|-----------|
| Teardown Ind                   | Conditional          | 7.7.16    |
| NSAPI                          | Mandatory            | 7.7.17    |
| Protocol Configuration Options | Optional             | 7.7.31    |
| Private Extension              | Optional             | 7.7.46    |

### 7.3.6 Delete PDP Context Response

The message shall be sent as a response of a Delete PDP Context Request.

A GSN shall ignore a Delete PDP Context Response for a non-existing PDP context.

If a GSN receives a Delete PDP Context Request message for a non existing PDP context, it shall send back to the source of the message a Delete PDP Context Response message with cause value "Non existent". The TEID value used in the response message shall be zero.

Possible Cause values are:

- 'Request Accepted'.

- 'Mandatory IE incorrect'.
- 'Mandatory IE missing'.
- 'Optional IE Incorrect'.
- 'Invalid message format'.
- 'Non existent'.

If the received Delete PDP Context Response contains a cause value other than 'Request accepted' and 'Non Existent', the PDP context shall be kept active.

In the GGSN to MS direction, the GGSN includes the Protocol Configuration Options (PCO) information element in the response if the GGSN wishes to provide the MS with application specific parameters. The SGSN includes this IE in the Deactivate PDP Context Accept message if the associated Delete PDP Context Response message from the GGSN includes protocol configuration options. The SGSN shall copy the content of the IE transparently from the PCO IE in the Delete PDP Context Response message.

In the MS to GGSN direction, the SGSN includes the Protocol Configuration Options (PCO) information element in the response if the MS wishes to provide the GGSN with application specific parameters. The SGSN includes this IE in the Delete PDP Context Response message if the associated Deactivate PDP Context Accept message from the MS includes protocol configuration options. The SGSN shall copy the content of the IE transparently from the PCO IE in the Deactivate PDP Context Accept message.

The optional Private Extension contains vendor or operator specific information.

**Table 12: Information Elements in a Delete PDP Context Response**

| Information element            | Presence requirement | Reference |
|--------------------------------|----------------------|-----------|
| Cause                          | Mandatory            | 7.7.1     |
| Protocol Configuration Options | Optional             | 7.7.31    |
| Private Extension              | Optional             | 7.7.46    |

### 7.3.7 Error Indication

A GSN/RNC shall send an Error Indication to the other GSN or RNC if no active PDP context or RAB exists for a received G-PDU.

When an Error Indication is received from a GSN, the receiving GSN shall delete its PDP context and the GSN may notify the Operation and Maintenance network element.

The SGSN shall indicate to the MS when a PDP context has been deleted due to the reception of an Error Indication message from the GGSN. The MS may then request the re-establishment of the PDP context.

The behaviour of the SGSN when it receives an Error Indication from an RNC is specified in 3GPP TS 23.060 [4].

The behaviour of the RNC when it receives an Error Indication from a SGSN is specified in 3GPP TS 23.060 [4].

The information element Tunnel Endpoint Identifier Data I shall be the TEID fetched from the G-PDU that triggered this procedure.

The information element GSN Address shall be the destination address (e.g. destination IP address) fetched from the original user data message that triggered this procedure. A GSN Address can be a GGSN, SGSN or RNC address. The TEID and GSN Address together uniquely identify the related PDP context or RAB in the receiving node. The format of the RNC IP address is the same as the GSN address as defined in 3GPP TS 23.003 [2].

The optional Private Extension contains vendor or operator specific information.

**Table 13: Information Elements in an Error Indication**

| Information element               | Presence requirement | Reference |
|-----------------------------------|----------------------|-----------|
| Tunnel Endpoint Identifier Data I | Mandatory            | 7.7.13    |
| GSN Address                       | Mandatory            | 7.7.32    |
| Private Extension                 | Optional             | 7.7.46    |

### 7.3.8 PDU Notification Request

When receiving a T-PDU the GGSN checks if a PDP context is established for that PDP address. If no PDP context has been previously established, the GGSN may try to deliver the T-PDU by initiating the Network-Requested PDP Context Activation procedure. The criteria, used by the GGSN to determine whether trying to deliver the T-PDU to the MS or not, may be based on subscription information in the GGSN and are outside the scope of GPRS standardisation.

As part of the Network-Requested PDP Context Activation procedure the GGSN sends a PDU Notification Request message to the SGSN indicated by the HLR. If the GGSN has an active PDP context with different SGSN from the one indicated by the HLR, then the SGSN information shall be obtained from an active PDP context. When receiving this message, the SGSN shall be responsible for requesting the MS to activate the indicated PDP Context.

The IMSI is inserted in the IMSI information element in the PDU Notification Request message.

The End User Address information element contains the PDP type and PDP address that the SGSN shall request the MS to activate.

The Access Point Name information element identifies the access point of packet data network that wishes to connect to the MS.

The GGSN shall include a GGSN Address for control plane. The SGSN shall store this GGSN Address and use it when sending control plane messages to the GGSN.

The Tunnel Endpoint Identifier Control Plane information element shall be a tunnel endpoint identifier Control Plane selected by the GGSN and shall be used by the SGSN in the GTP header of the corresponding PDU Notification Response or PDU Notification Request Reject message.

The GGSN includes the Protocol Configuration Options (PCO) information element in the request if the GGSN wishes to provide the MS with application specific parameters. The SGSN includes this IE in the Request PDP Context Activation message if the associated PDU Notification Request message from the GGSN includes protocol configuration options. The SGSN shall copy the content of the IE transparently from the PCO IE in the PDU Notification Request message.

If the GGSN receives a Create PDP Context Request before the PDU Notification Response, the GGSN shall handle the Create PDP Context Request as normal context activation and ignore the following PDU Notification Response.

If the SGSN receives a PDU Notification Request after a Create PDP Context Request has been sent but before a Create PDP Context Response has been received, the SGSN shall:

- send a PDU Notification Response with Cause 'Request accepted' without any further processing; and then
- wait for the Create PDP Context Response.

The optional Private Extension contains vendor or operator specific information.

**Table 14: Information Elements in a PDU Notification Request**

| Information element                      | Presence requirement | Reference |
|--|----------------------|-----------|
| IMSI                                     | Mandatory            | 7.7.2     |
| Tunnel Endpoint Identifier Control Plane | Mandatory            | 7.7.14    |
| End User Address                         | Mandatory            | 7.7.27    |
| Access Point Name                        | Mandatory            | 7.7.30    |
| Protocol Configuration Options           | Optional             | 7.7.31    |
| GGSN Address for Control Plane           | Mandatory            | 7.7.32    |
| Private Extension                        | Optional             | 7.7.46    |

### 7.3.9 PDU Notification Response

The message is sent by a SGSN to GGSN as a response of a PDU Notification Request.

The Cause value 'Request accepted' indicates if the PDP context activation will proceed. The PDP context activation procedure will not proceed for other Cause values.

Possible Cause values are:

- 'Request Accepted'.
- 'No resources available'.
- 'Service not supported'.
- 'System failure'.
- 'IMSI not known'.
- 'MS is GPRS Detached'.
- 'GPRS connection suspended'.
- 'Mandatory IE incorrect'.
- 'Mandatory IE missing'.
- 'Optional IE incorrect'.
- 'Invalid message format'.
- 'Roaming restriction'.

After an unsuccessful activation attempt the GSNs may perform some actions to prevent unnecessary enquires to the HLR as described in the section Unsuccessful Network-Requested PDP Context Activation procedure in 3GPP TS 23.060 [4].

The optional Private Extension contains vendor or operator specific information.

**Table 15: Information Elements in a PDU Notification Response**

| Information element | Presence requirement | Reference |
|---------------------|----------------------|-----------|
| Cause               | Mandatory            | 7.7.1     |
| Private Extension   | Optional             | 7.7.46    |

### 7.3.10 PDU Notification Reject Request

If the PDP context activation proceeds after the PDU Notification Response, but the PDP context was not established, the SGSN sends a PDU Notification Reject Request message. The Cause value indicates the reason why the PDP Context could not be established:

- 'MS Not GPRS Responding'.
- 'MS Refuses'.

When receiving the PDU Notification Reject Request message the GGSN may reject or discard the stored T-PDU(s) depending on the PDP type.

After an unsuccessful activation attempt the GSNs may perform some actions to prevent unnecessary enquiries to the HLR as described in the section Unsuccessful Network-Requested PDP Context Activation procedure in 3GPP TS 23.060 [4].

The Tunnel Endpoint Identifier in the GTP header of the PDU Notification Reject Request message shall be the same as the Tunnel Endpoint Identifier Control Plane information element of the PDU Notification Request that triggered the reject.



The Tunnel Endpoint Identifier Control Plane information element shall be a tunnel endpoint identifier Control Plane selected by the SGSN and shall be used by the GGSN in the GTP header of the corresponding PDU Notification Reject Response message.

The End User Address information element contains the PDP type and PDP address of the PDP context that could not be activated.

The Access Point Name shall be the same as the Access Point Name of the received PDU Notification Request message that triggered the reject.

The SGSN includes the Protocol Configuration Options (PCO) information element in the request if the MS wishes to provide the GGSN with application specific parameters. The SGSN includes this IE in the PDU Notification Reject Request message if the associated Request PDP Context Activation Reject message from the MS includes protocol configuration options. The SGSN shall copy the content of the IE transparently from the PCO IE in the Request PDP Context Activation Reject message.

The optional Private Extension contains vendor or operator specific information.

**Table 16: Information Elements in a PDU Notification Reject Request**

| Information element                      | Presence requirement | Reference |
|--|----------------------|-----------|
| Cause                                    | Mandatory            | 7.7.1     |
| Tunnel Endpoint Identifier Control Plane | Mandatory            | 7.7.14    |
| End User Address                         | Mandatory            | 7.7.27    |
| Access Point Name                        | Mandatory            | 7.7.30    |
| Protocol Configuration Options           | Optional             | 7.7.31    |
| Private Extension                        | Optional             | 7.7.46    |

### 7.3.11 PDU Notification Reject Response

The message is sent by a GGSN to SGSN as a response of a PDU Notification Reject Request.

Possible Cause values are:

- 'Request Accepted'.
- 'Mandatory IE incorrect'.
- 'Mandatory IE missing'.
- 'Optional IE incorrect'.
- 'Invalid message format'.

The optional Private Extension contains vendor or operator specific information.

**Table 17: Information Elements in a PDU Notification Reject Response**

| Information element | Presence requirement | Reference |
|---------------------|----------------------|-----------|
| Cause               | Mandatory            | 7.7.1     |
| Private Extension   | Optional             | 7.7.46    |

## 7.4 Location Management Messages

The optional Location Management messages are defined to support the case when Network-Requested PDP Context Activation procedures are used and a GGSN does not have a SS7 MAP interface, i.e. a Gc interface. GTP is then used to transfer control plane messages between the GGSN and a GTP-MAP protocol-converting GSN in the GPRS backbone network. The GTP-MAP protocol-converting GSN converts the control plane messages described in this section between GTP and MAP. The MAP messages are sent to and received from the HLR. The GTP-MAP protocol-converting function is described in 3GPP TS 23.060 [4]. The MAP protocol describing the corresponding procedures and messages is described in 3GPP TS 29.002 [6]. This alternative method is illustrated in figure 7.

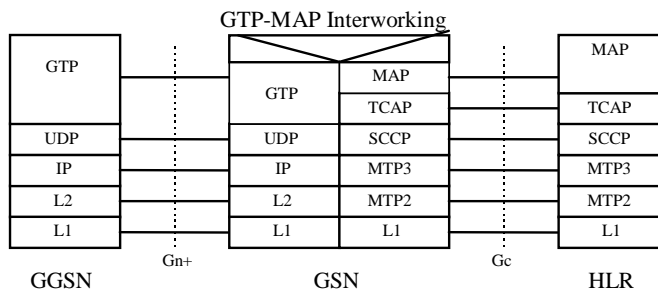

**Figure 7: GGSN - HLR Signalling via a GTP-MAP Protocol-Converter in a GSN**

When receiving a T-PDU the GGSN checks if a PDP Context is established for that PDP address. If no PDP context has been previously established the GGSN may store the T-PDU, try to initiate the Network-Requested PDP Context Activation procedure and, when the activation procedure is completed, deliver the T-PDU.

To support Network-Requested PDP Context Activation the GGSN has to have static PDP information about the PDP address.

### 7.4.1 Send Routeing Information for GPRS Request

The GGSN may send a Send Routeing Information for GPRS Request message to a GTP-MAP protocol-converting GSN, to obtain the IP address of the SGSN where the MS is located, when no PDP context is established.

The IMSI information element contains the IMSI to be used as a key to get the IP address of the SGSN.

If the GGSN receives a Create PDP Context Request after a Send Routeing Information for GPRS Request has been sent but before a Send Routeing Information for GPRS Response has been received, the GGSN shall:

- handle the Create PDP Context Request as a normal context activation; and
- ignore the following Send Routeing Information for GPRS Response.

The optional Private Extension contains vendor or operator specific information.

**Table 18: Information Elements in a Send Routeing Information for GPRS Request**

| Information element | Presence requirement | Reference |
|---------------------|----------------------|-----------|
| IMSI                | Mandatory            | 7.7.2     |
| Private Extension   | Optional             | 7.7.46    |

### 7.4.2 Send Routeing Information for GPRS Response

The GTP-MAP protocol-converting GSN sends a Send Routeing Information for GPRS Response message as a response to the Send Routeing Information for GPRS Request message to the GGSN that sent the request.

The Cause value indicates if the GTP-MAP protocol-converting GSN accepted the request or not.

Possible Cause values are:

- 'Request Accepted'.
- 'No resources available'.
- 'Service not supported'.
- 'System failure'.
- 'Mandatory IE incorrect'.
- 'Mandatory IE missing'.

- 'Optional IE incorrect'.
- 'Invalid message format'.

The MAP Cause information element contains the MAP error code received from the HLR and shall not be included if the Cause contains another value than 'Request accepted'.

The GSN Address information element contains the IP address of the SGSN and shall not be included if the Cause contains another value than 'Request accepted'.

It is an implementation issue what to do if the Cause or MAP Cause indicates that no location information is available. The MS not Reachable Reason information element indicates the reason for the setting of the Mobile station Not Reachable for GPRS (MNRG) flag and shall not be included if the Cause contains another value than 'Request accepted'.

The optional Private Extension contains vendor or operator specific information.

**Table 19: Information Elements in a Send Routing Information for GPRS Response**

| Information element     | Presence requirement | Reference |
|-------------------------|----------------------|-----------|
| Cause                   | Mandatory            | 7.7.1     |
| IMSI                    | Mandatory            | 7.7.2     |
| MAP Cause               | Optional             | 7.7.8     |
| MS not Reachable Reason | Optional             | 7.7.25A   |
| GSN Address             | Optional             | 7.7.32    |
| Private Extension       | Optional             | 7.7.46    |

### 7.4.3 Failure Report Request

The GGSN may send this message to the GTP-MAP protocol-converting GSN to set the MNRG flag for the IMSI in the HLR.

The IMSI information element contains the IMSI for which the MNRG shall be set.

The optional Private Extension contains vendor or operator specific information.

**Table 20: Information Elements in a Failure Report Request**

| Information element | Presence requirement | Reference |
|---------------------|----------------------|-----------|
| IMSI                | Mandatory            | 7.7.2     |
| Private Extension   | Optional             | 7.7.46    |

### 7.4.4 Failure Report Response

The GTP-MAP protocol-converting GSN sends a Failure Report Response message as a response to the Failure Report Request message to the GGSN that sent the request.

The Cause value indicates if the GTP-MAP protocol-converting GSN accepted the request or not.

Possible Cause values are:

- 'Request Accepted'.
- 'No resources available'.
- 'Service not supported'.
- 'System failure'.
- 'Mandatory IE incorrect'.
- 'Mandatory IE missing'.
- 'Optional IE incorrect'.

- 'Invalid message format'.

The MAP Cause information element contains the MAP error code received from the HLR and shall not be included if the Cause contains another value than 'Request accepted'.

It is an implementation issue what to do if the Cause or MAP Cause indicates that the HLR has not received the request or rejected the request.

The optional Private Extension contains vendor or operator specific information.

**Table 21: Information Elements in a Failure Report Response**

| Information element | Presence requirement | Reference |
|---------------------|----------------------|-----------|
| Cause               | Mandatory            | 7.7.1     |
| MAP Cause           | Optional             | 7.7.8     |
| Private Extension   | Optional             | 7.7.46    |

## 7.4.5 Note MS GPRS Present Request

The GTP-MAP protocol-converting GSN sends a Note MS GPRS Present message to notify that an MS should be reachable for GPRS again.

The GGSN shall use the IMSI in the request and find all PDP contexts for the IMSI. The MNRG shall be cleared and the SGSN IP address from the request shall be stored in each found PDP context.

The IMSI information element contains the IMSI for the PDP contexts.

The GSN Address information element contains the IP address of the SGSN.

The optional Private Extension contains vendor or operator specific information.

**Table 22: Information Elements in a Note MS Present Request**

| Information element | Presence requirement | Reference |
|---------------------|----------------------|-----------|
| IMSI                | Mandatory            | 7.7.2     |
| GSN Address         | Mandatory            | 7.7.32    |
| Private Extension   | Optional             | 7.7.46    |

## 7.4.6 Note MS GPRS Present Response

The GGSN sends a Note MS GPRS Present Response message to the GTP-MAP protocol converting GSN as a response to the Note MS GPRS Present Request.

Possible Cause values are:

- 'Request Accepted'.
- 'Mandatory IE incorrect'.
- 'Mandatory IE missing'.
- 'Optional IE incorrect'.
- 'Invalid message format'.

The optional Private Extension contains vendor or operator specific information.

**Table 23: Information Elements in a Note MS Present Response**

| Information element | Presence requirement | Reference |
|---------------------|----------------------|-----------|
| Cause               | Mandatory            | 7.7.1     |
| Private Extension   | Optional             | 7.7.46    |

## 7.5 Mobility Management Messages

The Mobility Management messages are the control plane messages, defined in 3GPP TS 23.060 [4] and 3GPP TS 24.008 [5], that are sent between SGSNs at the GPRS Attach and Inter SGSN Routeing Update procedures. The new SGSN derives the address of the old SGSN from the old routeing area identity. The address translation mechanism is implementation specific. Some possible translation mechanisms are found in annex C in 3GPP TS 23.003 [2].

Generally, the purpose of the control plane is to transfer data associated with the MS from the old SGSN to the new SGSN.

### 7.5.1 Identification Request

If the MS, at GPRS Attach, identifies itself with P-TMSI and it has changed SGSN since detach, the new SGSN shall send an Identification Request message to the old SGSN to request the IMSI.

For Intra Domain Connection of RAN Nodes to Multiple CN Nodes, where the old SGSN belongs to an SGSN pool, the new SGSN cannot in the general case determine the old SGSN. The new SGSN shall in this case send the Identification Request message to an SGSN based on the old RAI, as usual. If an SGSN within an SGSN pool receives an Identification Request message for an MS that has been attached to another SGSN of the same SGSN pool, the SGSN shall include the source IP address of the received Identification Request message in the optional parameter SGSN Address for Control Plane. The Identification Request message is then relayed to the old SGSN, keeping the other parts of the message unchanged. The SGSN within an SGSN pool can determine if the received Identification Request message was meant for itself or for another SGSN of the SGSN pool by looking at the Network Resource Identifier contained in the P-TMSI parameter. See 3GPP TS 23.003 [2] for details on the coding of the P-TMSI and see 3GPP TS 23.236 [19] for details on SGSN pool.

Note that an SGSN relaying the Identification Request message shall not supervise the Identification Response message.

The P-TMSI and RAI is a P-TMSI and an RAI in the old SGSN. The P-TMSI Signature is conditionally provided by the MS to the new SGSN for identification checking purposes as defined in 3GPP TS 23.060 [4] and 3GPP TS 24.008 [5]. If the MS has provided the P-TMSI Signature, the new SGSN shall include this parameter in the Identification Request message.

The optional Private Extension contains vendor or operator specific information.

**Table 24: Information Elements in an Identification Request**

| Information element            | Presence requirement | Reference |
|--------------------------------|----------------------|-----------|
| Routeing Area Identity (RAI)   | Mandatory            | 7.7.3     |
| Packet TMSI                    | Mandatory            | 7.7.5     |
| P-TMSI Signature               | Conditional          | 7.7.9     |
| SGSN Address for Control Plane | Optional             | 7.7.32    |
| Private Extension              | Optional             | 7.7.46    |

### 7.5.2 Identification Response

The old SGSN shall send an Identification Response to the new SGSN as a response to a previous Identification Request.

For Intra Domain Connection of RAN Nodes to Multiple CN Nodes, if an old SGSN within an SGSN pool receives an Identification Request message that contains the optional parameter SGSN Address for Control Plane, the old SGSN shall use this address as destination IP address of the Identification Response message.

Possible Cause values are:

- 'Request Accepted'.
- 'TMSI not known'.
- 'System failure'.

- 'Mandatory IE incorrect'.
- 'Mandatory IE missing'.
- 'Optional IE incorrect'.
- 'Invalid message format'.
- 'P-TMSI Signature mismatch'.

Only the Cause information element shall be included in the response if the Cause contains another value than 'Request accepted'.

The IMSI information element is mandatory if the Cause contains the value 'Request accepted'.

One or several Authentication Triplet information elements or up to 5 Authentication Quintuplet information elements may be included in the message if the Cause contains the value 'Request accepted'.

The optional Private Extension contains vendor or operator specific information.

**Table 25: Information Elements in an Identification Response**

| Information element       | Presence requirement | Reference |
|---------------------------|----------------------|-----------|
| Cause                     | Mandatory            | 7.7.1     |
| IMSI                      | Conditional          | 7.7.2     |
| Authentication Triplet    | Conditional          | 7.7.7     |
| Authentication Quintuplet | Conditional          | 7.7.35    |
| Private Extension         | Optional             | 7.7.46    |

### 7.5.3 SGSN Context Request

The new SGSN shall send an SGSN Context Request to the old SGSN to get the MM and PDP Contexts for the MS.

For Intra Domain Connection of RAN Nodes to Multiple CN Nodes, where the old SGSN belongs to an SGSN pool, the new SGSN cannot in the general case determine the old SGSN. The new SGSN shall in this case send the SGSN Context Request message to an SGSN based on the old RAI, as usual. If an SGSN within an SGSN pool receives an SGSN Context Request message for an MS that has been attached to another SGSN of the same SGSN pool, the SGSN shall relay the SGSN Context Request message unchanged to the old SGSN. The SGSN within an SGSN pool can determine if the received SGSN Context Request message was meant for itself or for another SGSN of the SGSN pool by looking at the Network Resource Identifier contained in the P-TMSI parameter, or alternatively in the TLLI parameter. See 3GPP TS 23.003 [2] for details on the coding of the P-TMSI and see 3GPP TS 23.236 [19] for details on SGSN pool.

Note that an SGSN relaying the SGSN Context Request message shall not supervise the SGSN Context Response message.

The MS is identified in the old SGSN by its old RAI and old TLLI/old P-TMSI values. The TLLI/P-TMSI and RAI is a foreign TLLI/P-TMSI and an RAI in the old SGSN. Exactly one of the TLLI, P-TMSI or IMSI information fields shall be present.

The old SGSN responds with an SGSN Context Response.

The new SGSN shall include a SGSN Address for control plane. The old SGSN shall store this SGSN Address and use it when sending control plane messages for the MS to the new SGSN in the SGSN context transfer procedure.

The Tunnel Endpoint Identifier Control Plane field specifies a Tunnel Endpoint Identifier for control plane messages, which is chosen by the new SGSN. The old SGSN shall include this Tunnel Endpoint Identifier in the GTP header of all subsequent control plane messages that are sent from the old SGSN to the new SGSN and related to the PDP context(s) requested.

The MS Validated indicates that the new SGSN has successfully authenticated the MS. IMSI shall be included if MS Validated indicates 'Yes'.

The P-TMSI Signature is conditionally provided by the MS to the new SGSN for identification checking purposes as defined in 3GPP TS 23.060 [4] and 3GPP TS 24.008 [5]. If the MS has provided the P-TMSI Signature, the new SGSN shall include this parameter in the SGSN Context Request message.

The optional Private Extension contains vendor or operator specific information.

**Table 26: Information Elements in a SGSN Context Request**

| Information element                      | Presence requirement | Reference |
|--|----------------------|-----------|
| IMSI                                     | Conditional          | 7.7.2     |
| Routing Area Identity (RAI)              | Mandatory            | 7.7.3     |
| Temporary Logical Link Identifier (TLLI) | Conditional          | 7.7.4     |
| Packet TMSI (P-TMSI)                     | Conditional          | 7.7.5     |
| P-TMSI Signature                         | Conditional          | 7.7.9     |
| MS Validated                             | Optional             | 7.7.10    |
| Tunnel Endpoint Identifier Control Plane | Mandatory            | 7.7.14    |
| SGSN Address for Control Plane           | Mandatory            | 7.7.32    |
| Private Extension                        | Optional             | 7.7.46    |

## 7.5.4 SGSN Context Response

The old SGSN shall send an SGSN Context Response to the new SGSN as a response to a previous SGSN Context Request.

Possible Cause values are:

- 'Request Accepted'.
- 'IMSI not known'.
- 'System failure'.
- 'Mandatory IE incorrect'.
- 'Mandatory IE missing'.
- 'Optional IE incorrect'.
- 'Invalid message format'.
- 'P-TMSI Signature mismatch'.

If the Cause contains the value 'Request accepted', all information elements are mandatory, except PDP Context, RAB Context and Private Extension.

If the Cause contains the value 'P-TMSI Signature mismatch' the IMSI information element shall be included in the response, otherwise only the Cause information element shall be included in the response.

The old SGSN shall include a SGSN Address for control plane. The new SGSN shall store this SGSN Address and use it when sending control plane messages for the MS to the old SGSN in the SGSN context transfer procedure.

The Tunnel Endpoint Identifier Control Plane field specifies a Tunnel Endpoint Identifier, which is chosen by the old SGSN. The new SGSN shall include this Tunnel Endpoint Identifier in the GTP header of all subsequent control plane messages, which are sent from the new SGSN to the old SGSN and related to the PDP context(s) requested.

The IMSI information element contains the IMSI matching the TLLI or P-TMSI (for GSM or UMTS respectively) and RAI in the SGSN Context Request.

The MM Context contains necessary mobility management and security parameters. An SGSN supporting the 'PUESBINE' feature (see 3GPP TS 23.195 [24] for more information) shall include the IMEISV in the MM Context when transferring the IMEISV from the old SGSN to the new SGSN.

All active PDP contexts in the old SGSN shall be included as PDP Context information elements. The PDP contexts are included in an implementation dependant prioritized order, and the most important PDP context is placed first. When the PDP Context Prioritization IE is included, it informs the new SGSN that the PDP contexts are sent prioritized. If the

new SGSN is not able to maintain active all the PDP contexts received from the old SGSN when it is indicated that prioritization of the PDP contexts is applied, the new SGSN should use the prioritisation sent by old SGSN as input when deciding which PDP contexts to maintain active and which ones to delete.

If there is at least one active PDP context, the old SGSN shall start the T3-TUNNEL timer and store the address of the new SGSN in the "New SGSN Address" field of the MM context. The old SGSN shall wait for SGSN Context Acknowledge before sending T-PDUs to the new SGSN. If an SGSN Context Acknowledge message is not received within a time defined by T3-RESPONSE, the old SGSN shall retransmit the SGSN Context Response to the new SGSN as long as the total number of attempts is less than N3-REQUESTS. After N3-REQUESTS unsuccessfully attempts, the old SGSN shall proceed as described in section 'Reliable delivery of signalling messages' in case the transmission of a control plane message fails N3-REQUESTS times.

For each RAB using lossless PDCP context, the old SGSN shall include a RAB Context. If a RAB Context is included in the SGSN Context Response, the new SGSN shall ignore the N-PDU number fields and sequence number fields received in the PDP Context IE.

Radio Priority SMS contains the radio priority level for MO SMS transmission, and shall be included if a valid Radio Priority SMS value exists for the MS in the old SGSN.

Radio Priority LCS contains the radio priority level for MO LCS transmission, and shall be included if a valid Radio Priority LCS value exists for the MS in the old SGSN.

Radio Priority is the radio priority level that the MS uses when accessing the network for the transmission of uplink user data for a particular PDP context. One Radio Priority IE shall be included per PDP context that has a valid radio priority value assigned to it in the old SGSN.

Packet Flow Id is the packet flow identifier assigned to the PDP context. One Packet Flow Id IE shall be included per PDP context that has a valid packet flow identifier value assigned to it in the old SGSN.

Charging Characteristics IE contains the charging characteristics which apply for a PDP context; see 3GPP TS 32.215 [18]. One Charging Characteristics IE shall be included per PDP context IE. If no PDP context is active, this IE shall not be included. The mapping of a Charging Characteristics IE to a PDP Context IE is done according to the sequence of their appearance, e.g. the first Charging Characteristics IE is mapped to the first PDP Context IE.

The optional Private Extension contains vendor or operator specific information.

**Table 27: Information Elements in a SGSN Context Response**

| Information element                      | Presence requirement | Reference |
|--|----------------------|-----------|
| Cause                                    | Mandatory            | 7.7.1     |
| IMSI                                     | Conditional          | 7.7.2     |
| Tunnel Endpoint Identifier Control Plane | Conditional          | 7.7.14    |
| RAB Context                              | Conditional          | 7.7.19    |
| Radio Priority SMS                       | Optional             | 7.7.20    |
| Radio Priority                           | Optional             | 7.7.21    |
| Packet Flow Id                           | Optional             | 7.7.22    |
| Charging Characteristics                 | Optional             | 7.7.23    |
| Radio Priority LCS                       | Optional             | 7.7.25B   |
| MM Context                               | Conditional          | 7.7.28    |
| PDP Context                              | Conditional          | 7.7.29    |
| SGSN Address for Control Plane           | Conditional          | 7.7.32    |
| PDP Context Prioritization               | Optional             | 7.7.45    |
| Private Extension                        | Optional             | 7.7.46    |

### 7.5.5 SGSN Context Acknowledge

The new SGSN shall send an SGSN Context Acknowledge message to the old SGSN as a response to the SGSN Context Response message. Only after receiving the SGSN Context Acknowledge message, shall the old SGSN start to forward user data packets. SGSN Context Acknowledge indicates to the old SGSN that the new SGSN has correctly received PDP Context information and is ready to receive user data packets identified by the corresponding Tunnel Endpoint Identifier values. This message shall not be sent if the SGSN Context Request was rejected.

Possible cause values are:



- 'Request accepted'.
- 'System failure'.
- 'Mandatory IE incorrect'.
- 'Mandatory IE missing'.
- 'Optional IE incorrect'.
- 'No resources available'.
- 'Invalid message format'.
- 'Authentication failure'.

Only the Cause information element shall be included in the acknowledgement if the Cause contains a value other than 'Request accepted'.

For each active PDP context (i.e. those which have a tunnel established between the old SGSN and the GGSN) the new SGSN shall include a Tunnel Endpoint Identifier Data II information element. The Tunnel Endpoint Identifier Data II field specifies a Tunnel Endpoint Identifier which is chosen by the new SGSN for a particular PDP context. The old SGSN shall include this Tunnel Endpoint Identifier in the GTP header of all subsequent G-PDUs which are sent from the old SGSN to the new SGSN and related to the particular PDP context. When active PDP context(s) exist, this information element shall be included if the Cause contains the value 'Request accepted'.

The new SGSN shall include an SGSN Address for user traffic, which may differ from that provided by the underlying network service (e.g. IP). The old SGSN shall store this SGSN Address and use it when sending G-PDUs to the new SGSN for the MS. When active PDP context(s) exist, this information element shall be included if the Cause contains the value 'Request accepted'.

The optional Private Extension contains vendor or operator specific information.

**Table 28: Information Elements in a SGSN Context Acknowledge**

| Information element                | Presence requirement | Reference          |
|------------------------------------|----------------------|--------------------|
| Cause                              | Mandatory            | 7.7.1              |
| Tunnel Endpoint Identifier Data II | Conditional          | 7.7.15             |
| SGSN Address for user traffic      | Conditional          | GSN Address 7.7.32 |
| Private Extension                  | Optional             | 7.7.46             |

## 7.5.6 Forward Relocation Request

The old SGSN shall send a Forward Relocation Request to the new SGSN to convey necessary information to perform the SRNS Relocation procedure between new SGSN and Target RNC.

All information elements are mandatory, except PDP Context and Private Extension.

The IMSI information element contains the IMSI of the target MS for SRNS Relocation procedure.

The old SGSN shall include a SGSN Address for control plane. The new SGSN shall store this SGSN Address and use it when sending control plane messages for the MS to the old SGSN in the SRNS Relocation procedure.

The Tunnel Endpoint Identifier Control Plane field specifies a tunnel endpoint identifier, which is chosen by the old SGSN. The new SGSN shall include this Tunnel Endpoint Identifier Control Plane in the GTP header of all subsequent control plane messages, which are sent from the new SGSN to the old SGSN.

The MM Context contains necessary mobility management and security parameters. An SGSN supporting the 'PUESBINE' feature (see 3GPP TS 23.195 [24] for more information) shall include the IMEISV in the MM Context when transferring the IMEISV from the old to the new SGSN.

All active PDP contexts in the old SGSN shall be included as PDP Context information elements. The PDP contexts are included in an implementation dependant prioritized order, and the most important PDP context is placed first. When the PDP Context Prioritization IE is included, it informs the new SGSN that the PDP contexts are sent prioritized. If the

new SGSN is not able to maintain active all the PDP contexts received from the old SGSN when it is indicated that prioritization of the PDP contexts is applied, the new SGSN should use the prioritisation sent by old SGSN as input when deciding which PDP contexts to maintain active and which ones to delete. In case no PDP context is active, neither of these IEs shall be included.

UTRAN transparent container, Target identification and RANAP Cause are information from the source RNC in the old SGSN.

Charging Characteristics IE contains the charging characteristics which apply for a PDP context; see 3GPP TS 32.215 [18]. One Charging Characteristics IE shall be included per PDP context IE. If no PDP context is active, this IE shall not be included. The mapping of a Charging Characteristics IE to a PDP Context IE is done according to the sequence of their appearance, e.g. the first Charging Characteristics IE is mapped to the first PDP Context IE.

The optional Private Extension contains vendor or operator specific information.

**Table 29: Information Elements in a Forward Relocation Request**

| Information element                      | Presence requirement | Reference |
|--|----------------------|-----------|
| IMSI                                     | Mandatory            | 7.7.2     |
| Tunnel Endpoint Identifier Control Plane | Mandatory            | 7.7.14    |
| RANAP Cause                              | Mandatory            | 7.7.18    |
| Charging Characteristics                 | Optional             | 7.7.23    |
| MM Context                               | Mandatory            | 7.7.28    |
| PDP Context                              | Conditional          | 7.7.29    |
| SGSN Address for Control plane           | Mandatory            | 7.7.32    |
| Target Identification                    | Mandatory            | 7.7.37    |
| UTRAN transparent container              | Mandatory            | 7.7.38    |
| PDP Context Prioritization               | Optional             | 7.7.45    |
| Private Extension                        | Optional             | 7.7.46    |

## 7.5.7 Forward Relocation Response

The new SGSN shall send a Forward Relocation Response to the old SGSN as a response to a previous Forward Relocation Request.

Possible Cause values is:

- 'Request Accepted'.
- 'System failure'.
- 'Mandatory IE incorrect'.
- 'Mandatory IE missing'.
- 'Optional IE incorrect'.
- 'No resources available'.
- 'Invalid message format'.
- 'Relocation failure'.

RANAP Cause is mandatory if cause value is contained in RANAP message.

RAB Setup Information, UTRAN transparent container and RANAP Cause are information from the target RNC in the new SGSN.

One or more RAB Setup Information parameters may be sent in this message. This information element shall be included if the Cause contains the value 'Request accepted' and there is at least one RAB assigned in the new SGSN.

The new SGSN shall include a SGSN Address for control plane. The old SGSN shall store this SGSN Address and use it when sending control plane messages for the MS to the new SGSN in the SRNS Relocation Procedure.

The Tunnel Endpoint Identifier Control Plane field specifies a Tunnel Endpoint Identifier that is chosen by the new SGSN. The old SGSN shall include this Tunnel Endpoint Identifier in the GTP header of all subsequent signalling messages that are sent from the old SGSN to the new SGSN. This information element shall be included if the Cause contains the value 'Request accepted'.

One or more Additional RAB Setup Information parameters may be sent in this message for IPv6. This information element shall be included if the Cause contains the value 'Request accepted' and there is at least one RAB assigned in the new SGSN.

The optional Private Extension contains vendor or operator specific information.

**Table 30: Information Elements in a Forward Relocation Response**

| Information element                      | Presence requirement | Reference |
|--|----------------------|-----------|
| Cause                                    | Mandatory            | 7.7.1     |
| Tunnel Endpoint Identifier Control Plane | Conditional          | 7.7.14    |
| RANAP Cause                              | Conditional          | 7.7.18    |
| SGSN Address for Control plane           | Conditional          | 7.7.32    |
| UTRAN transparent container              | Optional             | 7.7.38    |
| RAB Setup Information                    | Conditional          | 7.7.39    |
| Additional RAB Setup Information         | Conditional          | 7.7.45A   |
| Private Extension                        | Optional             | 7.7.46    |

## 7.5.8 Forward Relocation Complete

The new SGSN shall send a Forward Relocation Complete to the old SGSN to indicate that the SRNS relocation procedure has been successfully finished.

The optional Private Extension contains vendor or operator specific information.

**Table 31: Information Elements in a Forward Relocation Complete**

| Information element | Presence requirement | Reference |
|---------------------|----------------------|-----------|
| Private Extension   | Optional             | 7.7.46    |

## 7.5.9 Relocation Cancel Request

The Relocation Cancel Request message is sent from the old SGSN to the new SGSN when the old SGSN is requested to cancel the relocation procedure by the source RNC by means of RANAP message.

The optional Private Extension contains vendor or operator specific information.

**Table 32: Information Elements in a Relocation Cancel Request**

| Information element | Presence requirement | Reference |
|---------------------|----------------------|-----------|
| IMSI                | Mandatory            | 7.7.2     |
| Private Extension   | Optional             | 7.7.46    |

## 7.5.10 Relocation Cancel Response

The Relocation Cancel Response message is sent from the new SGSN to the old SGSN when the relocation procedure has been cancelled in the old SGSN. This message is used as the response to the Relocation Cancel Request message.

Possible Cause values are:

- 'Request Accepted'.
- 'IMSI not known'.
- 'Mandatory IE incorrect'.
- 'Mandatory IE missing'.

- 'Optional IE incorrect'.
- 'Invalid message format'.

The optional Private Extension contains vendor or operator specific information.

**Table 33: Information Elements in a Relocation Cancel Response**

| Information element | Presence requirement | Reference |
|---------------------|----------------------|-----------|
| Cause               | Mandatory            | 7.7.1     |
| Private Extension   | Optional             | 7.7.46    |

## 7.5.11 Forward Relocation Complete Acknowledge

The old SGSN sends a Forward Relocation Complete Acknowledge message to the new SGSN as a response to Forward Relocation Complete.

Possible Cause Values are:

- 'Request Accepted'.
- 'Optional IE incorrect'.
- 'Invalid message format'.

The optional Private Extension contains vendor or operator specific information.

**Table 34: Information elements in a Forward Relocation Complete Acknowledge**

| Information element | Presence requirement | Reference |
|---------------------|----------------------|-----------|
| Cause               | Mandatory            | 7.7.1     |
| Private Extension   | Optional             | 7.7.26    |

## 7.5.12 Forward SRNS Context Acknowledge

The new SGSN sends a Forward SRNS Context Acknowledge message to the old SGSN as a response to Forward SRNS Context.

Possible Cause values are:

- 'Request Accepted'.
- 'Mandatory IE incorrect'.
- 'Mandatory IE missing'.
- 'Optional IE incorrect'.
- 'Invalid message format'.

**Table 35: Information elements in a Forward SRNS Context Acknowledge**

| Information element | Presence requirement | Reference |
|---------------------|----------------------|-----------|
| Cause               | Mandatory            | 7.7.1     |
| Private Extension   | Optional             | 7.7.26    |

## 7.5.13 Forward SRNS Context

The Forward SRNS Context message is used in case of hard handover with switch in CN. When the old SGSN receives the RANAP message Forward SRNS Context, the old SGSN shall send a Forward SRNS Context message to the new SGSN. The new SGSN shall forward the message to the target RNC using the corresponding RANAP message.

For each RAB context in the received RANAP message, the old SGSN shall include a RAB Context IE in the GTP-C Forward SRNS Context message.

**Table 36: Information Elements in a Forward SRNS Context**

| Information element | Presence requirement | Reference |
|---------------------|----------------------|-----------|
| RAB Context         | Mandatory            | 7.7.19    |
| Private Extension   | Optional             | 7.7.46    |

## 7.5.14 RAN Information Management Messages

The RAN Information Relay is used over the Gn interface to tunnel RAN INFORMATION messages received by an SGSN from a BSS. The procedures are specified in 3GPP TS 23.060 [4] and the RAN INFORMATION messages are specified in 3GPP TS 48.018 [20].

### 7.5.14.1 RAN Information Relay

All information elements from the RAN INFORMATION messages, starting from and including the BSSGP 'PDU type', shall be contained within the RAN Transparent Container and forwarded to the destination SGSN in the RAN Information Relay message. For handling of protocol errors the RAN Information Relay message is treated as a Response message.

The optional Private Extension contains vendor or operator specific information.

**Table 7.5.14.1: Information Elements in a RAN Information Relay**

| Information element       | Presence requirement | Reference |
|---------------------------|----------------------|-----------|
| RAN Transparent Container | Mandatory            | 7.7.43    |
| Private Extension         | Optional             | 7.7.46    |

## 7.6 Reliable Delivery of Signalling Messages

Each path maintains a queue with signalling messages to be sent to the peer. The message at the front of the queue, if it is a request for which a response has been defined, shall be sent with a Sequence Number, and shall be held in a path list until a response is received. Each path has its own list. The Sequence Number shall be unique for each outstanding request message sourced from the same IP/UDP endpoint. A GSN or RNC may have several outstanding requests while waiting for responses.

The T3-RESPONSE timer shall be started when a signalling request message (for which a response has been defined) is sent. A signalling message request or response has probably been lost if a response has not been received before the T3-RESPONSE timer expires. The request is then retransmitted if the total number of request attempts is less than N3-REQUESTS times. The timer shall be implemented in the control plane application as well as user plane application for Echo Request / Echo Response. The wait time for a response (T3-RESPONSE timer value) and the number of retries (N3-REQUESTS) shall be configurable per procedure. The total wait time shall be shorter than the MS wait time between retries of Attach and RA Update messages.

For Intra Domain Connection of RAN Nodes to Multiple CN Nodes, an SGSN relaying a received Identification Request message or a received SGSN Context Request message to another SGSN shall not supervise the Identification Response message or the SGSN Context Response message respectively, i.e. the T3-RESPONSE timer shall not be started in the SGSN relaying any of these two messages. Also, such an SGSN shall not modify the Sequence Number when relaying the Identification Request message or the SGSN Context Request message.

All received request messages shall be responded to and all response messages associated with a certain request shall always include the same information. Duplicated response messages shall be discarded, and, for the SGSN Context Response case, the SGSN Context Acknowledge message shall be sent unless the SGSN Context Request was rejected. A response message without a matching outstanding request should be considered as a duplicate.

The Forward Relocation Complete and Forward SRNS Context messages shall be treated as signalling request messages. The SGSN Context Acknowledge, Forward Relocation Complete Acknowledge and Forward SRNS Context Acknowledge messages shall be treated as response messages.

The SGSN Context Response message needs special treatment by the old SGSN and New SGSN.

The New SGSN must consider this as a regular response to the outstanding SGSN Context Request message, but also copy the sequence number in the header of the SGSN Context Acknowledge it shall send back to the old SGSN unless the SGSN Context Request was rejected. The Old SG SN, when it expects the new SGSN to send back a SGSN Context Acknowledge in response to a SGSN Context Response, shall keep track of the SGSN Context Response message sequence number and apply to this message the rules valid for a Request message too. If a GSN or RNC is not successful with the transfer of a signalling message, e.g. a Create PDP Context Request message, it shall inform the upper layer of the unsuccessful transfer so that the controlling upper entity may take the necessary measures.

## 7.7 Information Elements

A GTP Signalling message may contain several information elements. The TLV (Type, Length, Value) or TV (Type, Value) encoding format shall be used for the GTP information elements. The information elements shall be sorted, with the Type fields in ascending order, in the signalling messages. The Length field contains the length of the information element excluding the Type and Length field.

For all the length fields, bit 8 of the lowest numbered octet is the most significant bit and bit 1 of the highest numbered octet is the least significant bit.

Within information elements, certain fields may be described as spare. These bits shall be transmitted with the value defined for them. To allow for future features, the receiver shall not evaluate these bits.

The most significant bit in the Type field is set to 0 when the TV format is used and set to 1 for the TLV format.

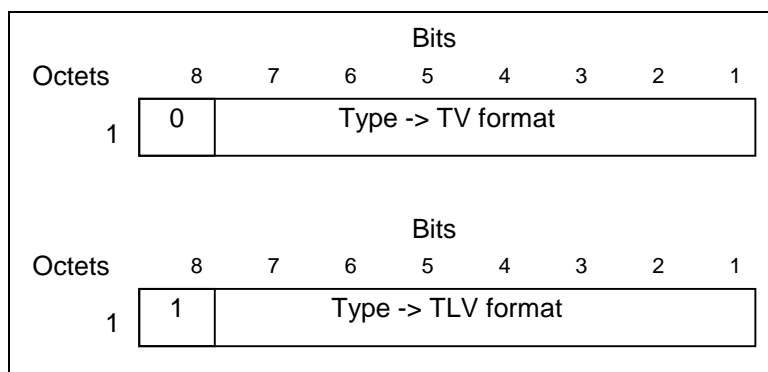

Figure 8: Type field for TV and TLV format

Table 37: Information Elements

| IE Type Value | Format | Information Element                             | Reference |
|---------------|--------|---|-----------|
| 1             | TV     | Cause   | 7.7.1     |
| 2             | TV     | International Mobile Subscriber Identity (IMSI) | 7.7.2     |
| 3             | TV     | Routeing Area Identity (RAI)                    | 7.7.3     |
| 4             | TV     | Temporary Logical Link Identity (TLLI)          | 7.7.4     |
| 5             | TV     | Packet TMSI (P-TMSI)                            | 7.7.5     |
| 6-7           | Spare  |   |           |
| 8             | TV     | Reordering Required                             | 7.7.6     |
| 9             | TV     | Authentication Triplet                          | 7.7.7     |
| 10            | Spare  |   |           |
| 11            | TV     | MAP Cause                                       | 7.7.8     |
| 12            | TV     | P-TMSI Signature                                | 7.7.9     |
| 13            | TV     | MS Validated                                    | 7.7.10    |
| 14            | TV     | Recovery  | 7.7.11    |
| 15            | TV     | Selection Mode                                  | 7.7.12    |
| 16            | TV     | Tunnel Endpoint Identifier Data I               | 7.7.13    |
| 17            | TV     | Tunnel Endpoint Identifier Control Plane        | 7.7.14    |
| 18            | TV     | Tunnel Endpoint Identifier Data II              | 7.7.15    |
| 19            | TV     | Teardown Ind                                    | 7.7.16    |

| IE Type Value | Format  | Information Element                        | Reference |
|---------------|---|--|-----------|
| 20            | TV  | NSAPI                                      | 7.7.17    |
| 21            | TV  | RANAP Cause                                | 7.7.18    |
| 22            | TV  | RAB Context                                | 7.7.19    |
| 23            | TV  | Radio Priority SMS                         | 7.7.20    |
| 24            | TV  | Radio Priority                             | 7.7.21    |
| 25            | TV  | Packet Flow Id                             | 7.7.22    |
| 26            | TV  | Charging Characteristics                   | 7.7.23    |
| 27            | TV  | Trace Reference                            | 7.7.24    |
| 28            | TV  | Trace Type                                 | 7.7.25    |
| 29            | TV  | MS Not Reachable Reason                    | 7.7.25A   |
| 30            | TV  | Radio Priority LCS                         | 7.7.25B   |
| 117-126       | Reserved for the GPRS charging protocol (see GTP' in 3GPP TS 32.215 [18]) |  |           |
| 127           | TV  | Charging ID                                | 7.7.26    |
| 128           | TLV   | End User Address                           | 7.7.27    |
| 129           | TLV   | MM Context                                 | 7.7.28    |
| 130           | TLV   | PDP Context                                | 7.7.29    |
| 131           | TLV   | Access Point Name                          | 7.7.30    |
| 132           | TLV   | Protocol Configuration Options             | 7.7.31    |
| 133           | TLV   | GSN Address                                | 7.7.32    |
| 134           | TLV   | MS International PSTN/ISDN Number (MSISDN) | 7.7.33    |
| 135           | TLV   | Quality of Service Profile                 | 7.7.34    |
| 136           | TLV   | Authentication Quintuplet                  | 7.7.35    |
| 137           | TLV   | Traffic Flow Template                      | 7.7.36    |
| 138           | TLV   | Target Identification                      | 7.7.37    |
| 139           | TLV   | UTRAN Transparent Container                | 7.7.38    |
| 140           | TLV   | RAB Setup Information                      | 7.7.39    |
| 141           | TLV   | Extension Header Type List                 | 7.7.40    |
| 142           | TLV   | Trigger Id                                 | 7.7.41    |
| 143           | TLV   | OMC Identity                               | 7.7.42    |
| 144           | TLV   | RAN Transparent Container                  | 7.7.43    |
| 145           | TLV   | PDP Context Prioritization                 | 7.7.45    |
| 146           | TLV   | Additional RAB Setup Information           | 7.7.45A   |
| 239-250       | Reserved for the GPRS charging protocol (see GTP' in 3GPP TS 32.215 [18]) |  |           |
| 251           | TLV   | Charging Gateway Address                   | 7.7.44    |
| 252-254       | Reserved for the GPRS charging protocol (see GTP' in 3GPP TS 32.215 [18]) |  |           |
| 255           | TLV   | Private Extension                          | 7.7.46    |

## 7.7.1 Cause

In a request, the Cause Value indicates the reason for the request. The Cause shall be included in the request message.

In a response, the Cause Value indicates the acceptance or the rejection of the corresponding request. In addition, the Cause Value may indicate what was the reason for the corresponding request. The Cause value shall be included in the response message.

Cause values are shared with the GTP' protocol specified in 3GPP TS 32.215 [18].

'Request accepted' is returned when a GSN has accepted a control plane request.

'Non-existent' indicates a non-existent or an inactive PDP context.

'TMSI not known' indicates a non-existent MM context.

'MS is GPRS Detached' indicates an idle MM context.

'MS is not GPRS Responding' and 'MS Refuses' may be used by SGSN to reject a Network-Requested PDP Context Activation.

'Version not supported' is returned when the recipient does not recognise the version number in the request message.

'Request IMSI', 'Request IMEI', 'Request IMSI and IMEI' and 'No identity needed' are used by GGSN to notify SGSN what to do.

'No resources available' is a generic temporary error condition e.g. all dynamic PDP addresses occupied or no memory available.

'Service not supported' is a generic error indicated that the GSN do not support the requested service.

'User authentication failed' indicates that the external packet network has rejected the user's service request.

'System failure' is a generic permanent error condition.

'Roaming restriction' indicates that the SGSN cannot activate the requested PDP context because of the roaming restrictions.

'P-TMSI Signature mismatch' is returned if either:

- the P-TMSI Signature stored in the old SGSN does not match the value sent by the MS via the new SGSN; or
- the MS does not provide the P-TMSI Signature to the new SGSN while the old SGSN has stored the P-TMSI Signature for that MS.

'Semantic error in the TFT operation', 'Syntactic error in the TFT operation', 'Semantic errors in packet filter(s)' and 'Syntactic errors in packet filters(s)' and 'PDP context without TFT already activated' are indications of abnormal cases involving TFTs. The abnormal TFT cases and the use of the cause codes are defined in 3GPP TS 24.008 [5].

'Invalid message format', 'Mandatory IE incorrect', 'Mandatory IE missing' and 'Optional IE incorrect' are indications of protocol errors described in the section Error handling.

'GPRS connection suspended' indicates that the GPRS activities of the mobile station are suspended.

'Authentication failure' indicates that the user authentication failed in the new SGSN.

'Context not found' indicates that the PDP Context referenced in an Active Secondary Context Request message was not found in the receiving GGSN.

'Relocation failure' indicates that the SRNS relocation failed in the new SGSN side.

'Unknown mandatory extension header' signals in a response message that the corresponding request included an extension header for which comprehension was required but unknown to the receiving end.

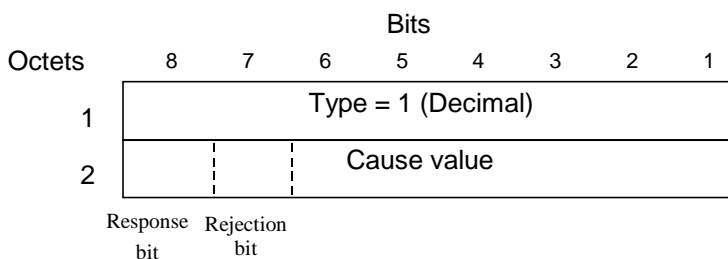

**Figure 9: Cause information element**

**Table 38: Cause Values**

| Cause                                   | Value (Decimal)           |       |
|---|---------------------------|-------|
| request                                 | Request IMSI              | 0     |
|   | Request IMEI              | 1     |
|   | Request IMSI and IMEI     | 2     |
|   | No identity needed        | 3     |
|   | MS Refuses                | 4     |
|   | MS is not GPRS Responding | 5     |
|   | For future use            | 6-48  |
| Cause values reserved for GPRS charging |                           | 49-63 |



| Cause  |  | Value (Decimal)  |         |
|--|--|--|---------|
|  | protocol use (see GTP' in 3GPP TS 32.215 [18]) |  |         |
| For future use   |  | 64-127   |         |
| response   | acc  | Request accepted   | 128     |
|  |  | For future use   | 129-176 |
|  |  | Cause values reserved for GPRS charging protocol use (see GTP' in 3GPP TS 32.215 [18]) | 177-191 |
|  | rej  | Non-existent   | 192     |
|  |  | Invalid message format   | 193     |
|  |  | IMSI not known   | 194     |
|  |  | MS is GPRS Detached  | 195     |
|  |  | MS is not GPRS Responding  | 196     |
|  |  | MS Refuses   | 197     |
|  |  | Version not supported  | 198     |
|  |  | No resources available   | 199     |
|  |  | Service not supported  | 200     |
|  |  | Mandatory IE incorrect   | 201     |
|  |  | Mandatory IE missing   | 202     |
|  |  | Optional IE incorrect  | 203     |
|  |  | System failure   | 204     |
|  |  | Roaming restriction  | 205     |
|  |  | P-TMSI Signature mismatch  | 206     |
|  |  | GPRS connection suspended  | 207     |
|  |  | Authentication failure   | 208     |
|  |  | User authentication failed   | 209     |
|  |  | Context not found  | 210     |
|  |  | All dynamic PDP addresses are occupied   | 211     |
|  |  | No memory is available   | 212     |
|  |  | Relocation failure   | 213     |
|  |  | Unknown mandatory extension header   | 214     |
|  |  | Semantic error in the TFT operation  | 215     |
|  |  | Syntactic error in the TFT operation   | 216     |
|  |  | Semantic errors in packet filter(s)  | 217     |
|  |  | Syntactic errors in packet filter(s)   | 218     |
|  |  | Missing or unknown APN   | 219     |
|  |  | Unknown PDP address or PDP type  | 220     |
|  |  | PDP context without TFT already activated  | 221     |
| APN access denied – no subscription  | 222  |  |         |
| For future use   | 223-240  |  |         |
| Cause values reserved for GPRS charging protocol use (see GTP' in 3GPP TS 32.215 [18])   | 241-255  |  |         |
| NOTE: With this coding, bits 8 and 7 of the Cause Value respectively indicate whether the message was a request or a response, and whether the request was accepted or rejected. |  |  |         |

Table 39: Use of the Cause Values

| Cause 8  | value bits 7 | Result                |
|--|--------------|-----------------------|
| 0  | 0            | Request               |
| 0  | 1            | For future use (note) |
| 1  | 0            | Acceptance            |
| 1  | 1            | Rejection             |
| NOTE: The value '01' is for future use and shall not be sent. If received in a response, it shall be treated as a rejection. |              |                       |

## 7.7.2 International Mobile Subscriber Identity (IMSI)

The IMSI shall be the subscriber identity of the MS. The IMSI is defined in 3GPP TS 23.003 [2].

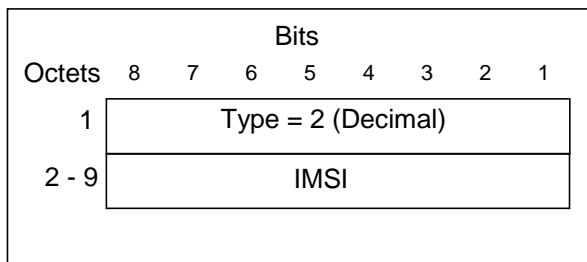
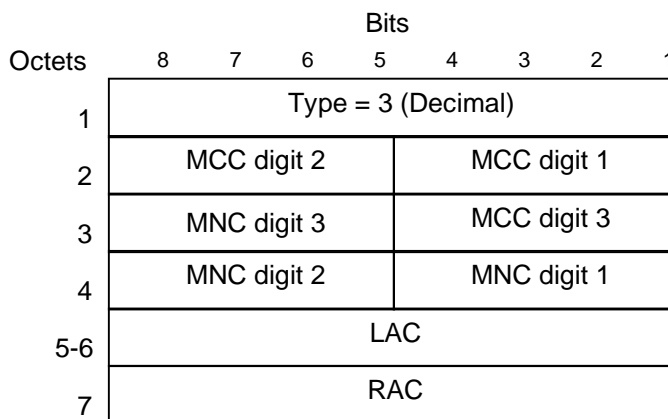

**Figure 10: IMSI Information Element**

The IMSI is TBCD-coded with a fixed length of 8 octets. Bits 8765 of octet n+1 encodes digit 2n, bits 4321 of octet n+1 encodes digit 2n-1. Each unused half octets shall be coded as binary "1 1 1 1". Digits are packed contiguously with no internal padding.

### 7.7.3 Routeing Area Identity (RAI)

The RAI information element is given by:



The MCC, MNC, LAC and RAC are defined in TS 23.003

**Figure 11: RAI Information Element**

If an Administration decides to include only two digits in the MNC, then bits 5 to 8 of octet 3 are coded as "1111".

### 7.7.4 Temporary Logical Link Identity (TLLI)

The information element of the TLLI associated with a given MS and routeing area is given by:

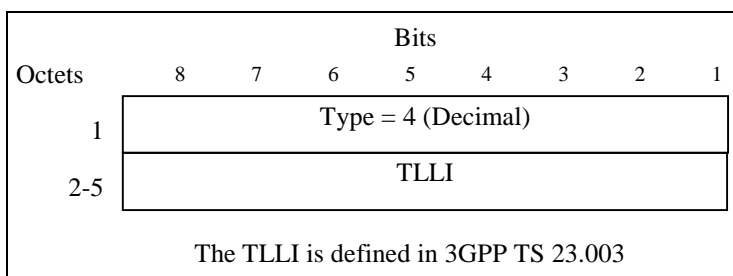

**Figure 12: TLLI Information Element**

### 7.7.5 Packet TMSI (P-TMSI)

The Packet TMSI, unambiguously associated with a given MS and routing area, is given by:

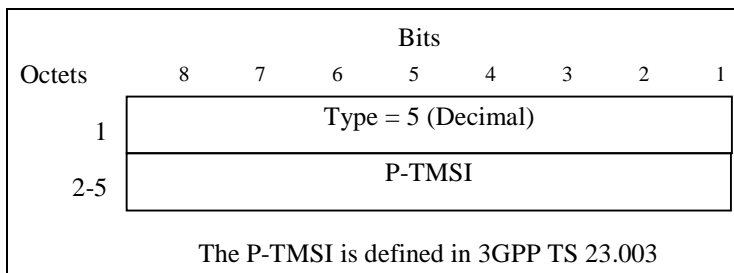

Figure 13: The Packet TMSI Information Element

### 7.7.6 Reordering Required

The Reordering Required information element states whether reordering by GTP is required or not.

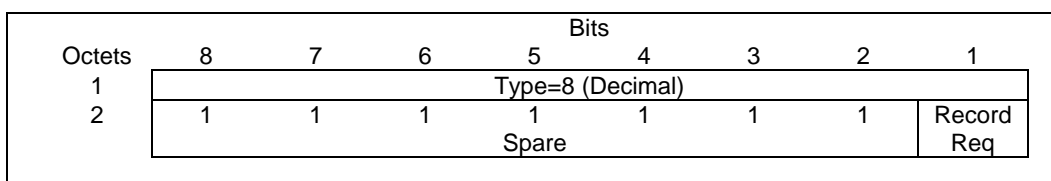

Figure 14: Reordering Required Information Element

Table 40: Reordering Required Values

| Reordering required | Value (Decimal) |
|---------------------|-----------------|
| No                  | 0               |
| Yes                 | 1               |

### 7.7.7 Authentication Triplet

An Authentication triplet consists of a Random string (RAND), a Signed Response (SRES) and a ciphering Key (Kc) (see 3GPP TS 43.020 [9]).

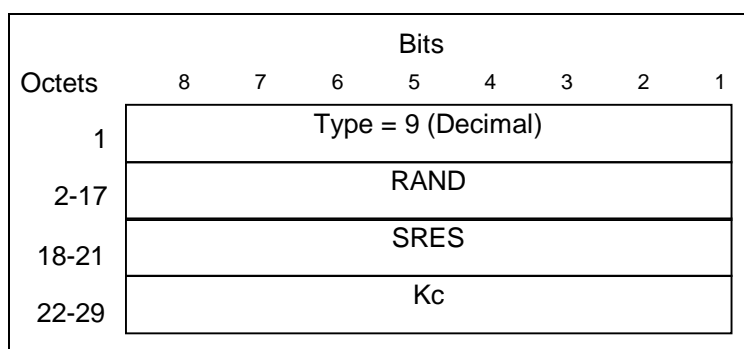

Figure 15: Authentication Triplet Information Element

### 7.7.8 MAP Cause

The MAP Cause is a value that the GTP-MAP protocol-converting GSN relays transparently from HLR to the GGSN. The possible MAP Cause values for the appropriate messages are described in 3GPP TS 29.002 [6].

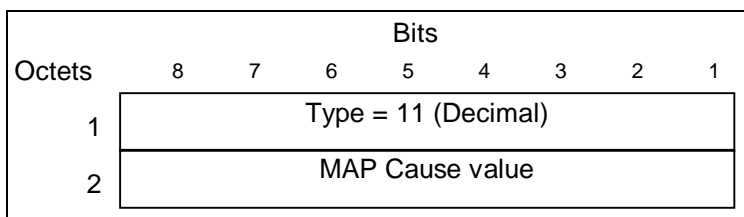

Figure 16: MAP Cause Information Element

### 7.7.9 P-TMSI Signature

The P-TMSI Signature information element is provided by the MS in the Routing Area Update Request and Attach Request messages to the SGSN for identification checking purposes. The content and the coding of the P-TMSI Signature information element are defined in 3GPP TS 24.008 [5].

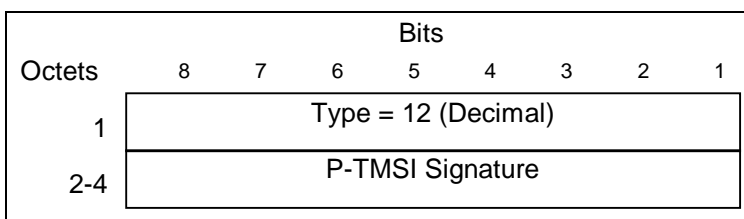

Figure 17: P-TMSI Signature Information Element

### 7.7.10 MS Validated

The MS Validated information element indicates whether the new SGSN has successfully authenticated the MS.

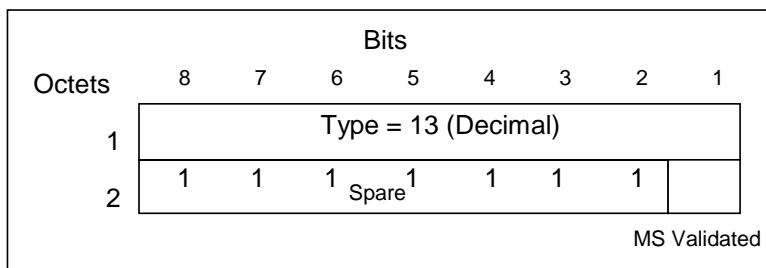

Figure 18: MS Validated Information Element

Table 41: MS Validated Values

| MS Validated | Value |
|--------------|-------|
| No           | 0     |
| Yes          | 1     |

### 7.7.11 Recovery

The Recovery information element indicates if the peer GSN has restarted. The Restart Counter shall be the value described in the section Restoration and Recovery.

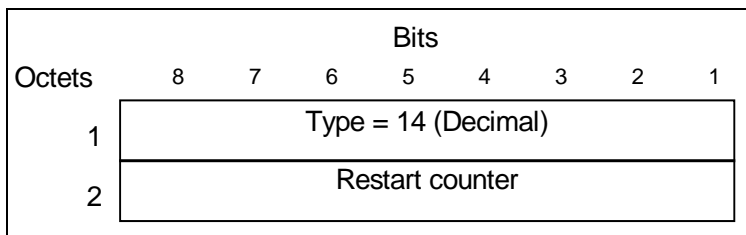

Figure 19: Restart Counter Information Element

### 7.7.12 Selection Mode

The Selection mode information element indicates the origin of the APN in the message.

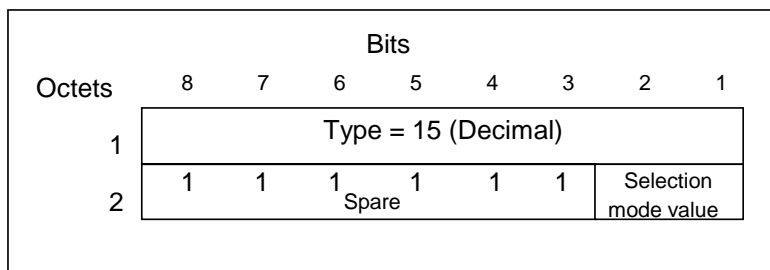

Figure 20: Selection Mode Information Element

Table 42: Selection Mode Values

| Selection mode value   | Value (Decimal) |
|--|-----------------|
| MS or network provided APN, subscribed verified  | 0               |
| MS provided APN, subscription not verified   | 1               |
| Network provided APN, subscription not verified  | 2               |
| For future use. Shall not be sent. If received, shall be interpreted as the value '2'. | 3               |

### 7.7.13 Tunnel Endpoint Identifier Data I

The Tunnel Endpoint Identifier Data I information element contains the Tunnel Endpoint Identifier for data transmission requested by the receiver of the flow.

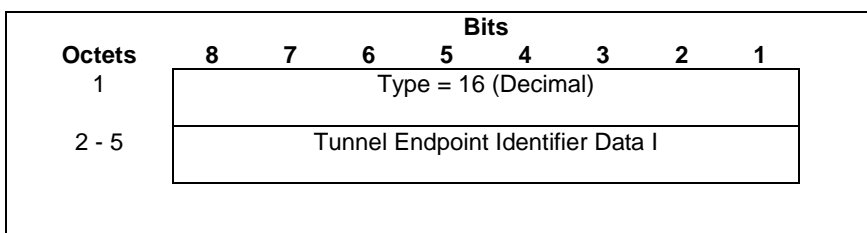

Figure 21: Tunnel Endpoint Identifier Data I Information Element

### 7.7.14 Tunnel Endpoint Identifier Control Plane

The Tunnel Endpoint Identifier Control Plane information element contains the Tunnel Endpoint Identifier for the control plane; it is assigned by the receiver of the flow. It distinguishes the tunnel from other tunnels between the same pair of entities. The value 0 is reserved for special cases defined in subclause 8.2.

If the receiver has not yet assigned a TEID for this tunnel, it shall assign an unused value to the TEID.

If the receiver has already assigned a Tunnel Endpoint Identifier Control Plane to the tunnel, but has not yet received confirmation of successful assignment from the transmitter, this information element shall take the same value as was sent before for this tunnel.

The receiver receives confirmation of successful assignment of its Tunnel Endpoint Identifier Control Plane from the transmitter when it receives any message with its assigned Tunnel Endpoint Identifier Control Plane in the GTP header from the transmitter.

If the Tunnel Endpoint Identifier Control Plane is received from the transmitter, this information element shall be stored.

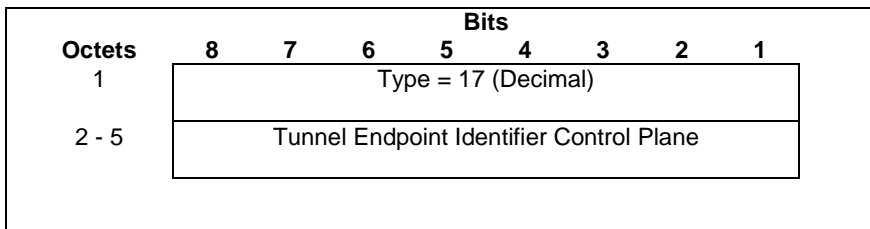

Figure 22: Tunnel Endpoint Identifier Control Plane Information Element

### 7.7.15 Tunnel Endpoint Identifier Data II

The Tunnel Endpoint Identifier Data II information element contains the Tunnel Endpoint Identifier for data transmission between old and new SGSN for a particular PDP context and is requested by the new SGSN.

The spare bits x indicate unused bits, which shall be set to 0 by the sending side and which shall not be evaluated by the receiving side.

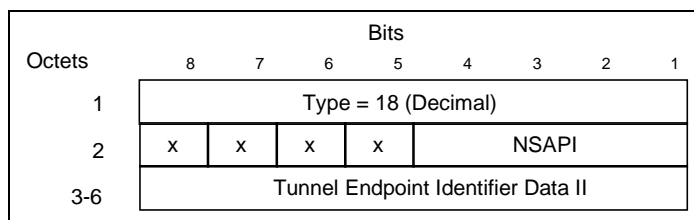

Figure 23: Tunnel Endpoint Identifier Data II Information Element

### 7.7.16 Teardown Ind

If the Teardown Ind information element value is set to '1', then all PDP contexts that share the same PDP address with the PDP context identified by the NSAPI included in the Delete PDP Context Request Message shall be torn down. Only the PDP context identified by the NSAPI included in the Delete PDP context Request shall be torn down if the value of this information element is '0'.

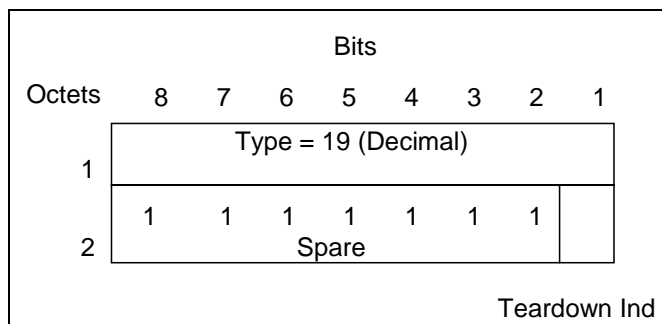

Figure 24: Teardown Ind Information Element

**Table 43: Teardown Ind**

| Teardown Ind | Value |
|--------------|-------|
| No           | 0     |
| Yes          | 1     |

### 7.7.17 NSAPI

The NSAPI information element contains an NSAPI identifying a PDP Context in a mobility management context specified by the Tunnel Endpoint Identifier Control Plane.

The spare bits x indicate unused bits, which shall be set to 0 by the sending side, and the sending side shall not evaluate them.

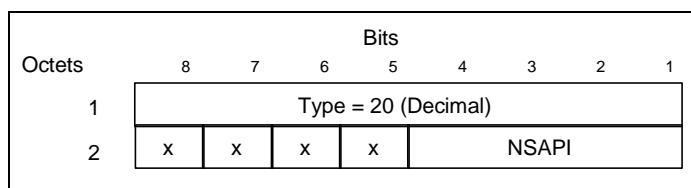

**Figure 25: NSAPI Information Element**

### 7.7.18 RANAP Cause

The RANAP Cause information element contains the cause as defined in 3GPP TS 25.413 [7]. The value part (which has a range of 1..255) of the RANAP Cause IE which is transferred over the Iu interface is encoded into one octet from the binary encoding of the value part of the RANAP Cause IE.

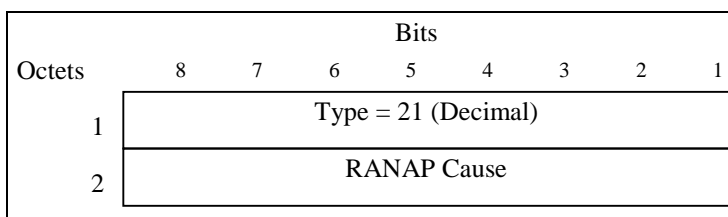

**Figure 26: RANAP Cause Information Element**

### 7.7.19 RAB Context

The RAB context information element contains sequence number status for one RAB in RNC, which corresponds to one PDP context in CN. The RAB contexts are transferred between the RNCs via the SGSNs at inter SGSN hard handover.

NSAPI identifies the PDP context and the associated RAB for which the RAB context IE is intended.

DL GTP-U Sequence Number is the number for the next downlink GTP-U T-PDU to be sent to the MS.

UL GTP-U Sequence Number is the number for the next uplink GTP-U T-PDU to be tunnelled to the GGSN.

DL PDCP Sequence Number is the number for the next downlink PDCP-PDU to be sent to the MS.

UL PDCP Sequence Number is the number for the next uplink PDCP-PDU to be received from the MS.

|      |                          |       |
|------|--------------------------|-------|
| 1    | Type = 22 (Decimal)      |       |
| 2    | Spare (0 0 0 0)          | NSAPI |
| 3-4  | DL GTP-U Sequence Number |       |
| 5-6  | UL GTP-U Sequence Number |       |
| 7-8  | DL PDCP Sequence Number  |       |
| 9-10 | UL PDCP Sequence Number  |       |

Figure 27: RAB Context Information Element

### 7.7.20 Radio Priority SMS

The Radio Priority SMS information element contains the radio priority level for MO SMS transmission.

|        |                     |   |   |   |                    |   |   |   |  |
|--------|---------------------|---|---|---|--------------------|---|---|---|--|
|        | Bits                |   |   |   |                    |   |   |   |  |
| Octets | 8                   | 7 | 6 | 5 | 4                  | 3 | 2 | 1 |  |
| 1      | Type = 23 (Decimal) |   |   |   |                    |   |   |   |  |
| 2      | Reserved            |   |   |   | Radio Priority SMS |   |   |   |  |

Figure 28: Radio Priority SMS Information Element

### 7.7.21 Radio Priority

The Radio Priority information element contains the radio priority level that the MS uses when accessing the network for the transmission of uplink user data for a PDP context as identified by NSAPI.

|        |                     |   |   |   |               |                |   |   |  |
|--------|---------------------|---|---|---|---------------|----------------|---|---|--|
|        | Bits                |   |   |   |               |                |   |   |  |
| Octets | 8                   | 7 | 6 | 5 | 4             | 3              | 2 | 1 |  |
| 1      | Type = 24 (Decimal) |   |   |   |               |                |   |   |  |
| 2      | NSAPI               |   |   |   | Res-<br>erved | Radio Priority |   |   |  |

Figure 29: Radio Priority Information Element

### 7.7.22 Packet Flow Id

The Packet Flow Id information element contains the packet flow identifier assigned to a PDP context as identified by NSAPI.

|        |                     |   |   |   |       |   |   |   |  |
|--------|---------------------|---|---|---|-------|---|---|---|--|
|        | Bits                |   |   |   |       |   |   |   |  |
| Octets | 8                   | 7 | 6 | 5 | 4     | 3 | 2 | 1 |  |
| 1      | Type = 25 (Decimal) |   |   |   |       |   |   |   |  |
| 2      | Reserved            |   |   |   | NSAPI |   |   |   |  |
| 3      | Packet Flow Id      |   |   |   |       |   |   |   |  |

Figure 30: Packet Flow Id Information Element



### 7.7.23 Charging Characteristics

The charging characteristics information element is a way of informing both the SGSN and GGSN of the rules for producing charging information based on operator configured triggers. For the encoding of this information element see 3GPP TS 32.215 [18].

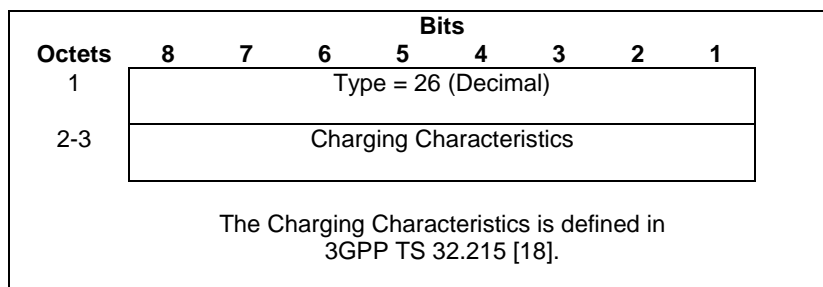

Figure 31: Charging Characteristics Information Element

### 7.7.24 Trace Reference

The Trace Reference information element identifies a record or a collection of records for a particular trace. The Trace Reference is allocated by the triggering entity.

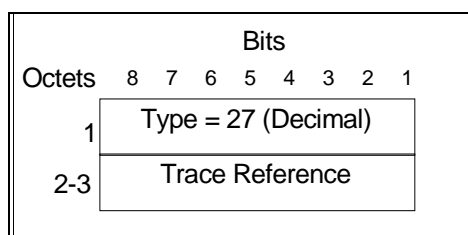

Figure 32: Trace Reference Information Element

### 7.7.25 Trace Type

The Trace Type information element indicates the type of the trace.

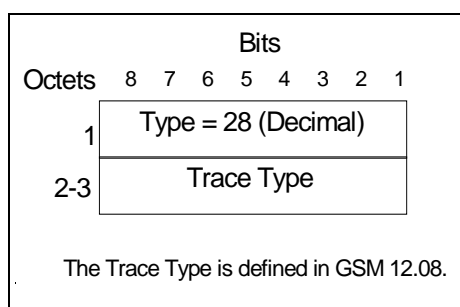
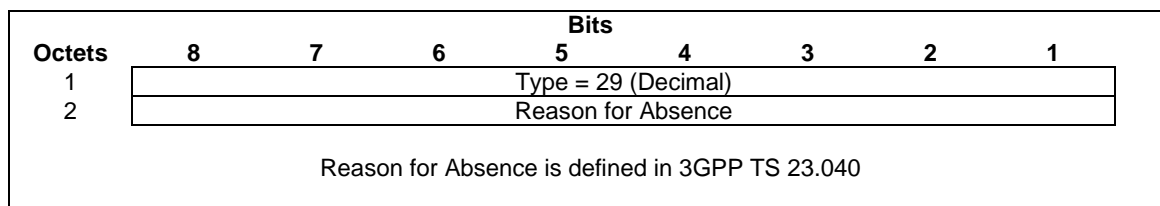

Figure 33: Trace Type Information Element

The Trace Type value 0 (Decimal) and the Trace Type value which is not understood by the receiver shall be treated as a basic trace type.

### 7.7.25A MS Not Reachable Reason

The MS Not Reachable Reason indicates the reason for the setting of the MNRG flag.



**Figure 33a: MS Not Reachable Reason Information Element**

### 7.7.25B Radio Priority LCS

The Radio Priority LCS information element contains the radio priority level for MO LCS transmission.

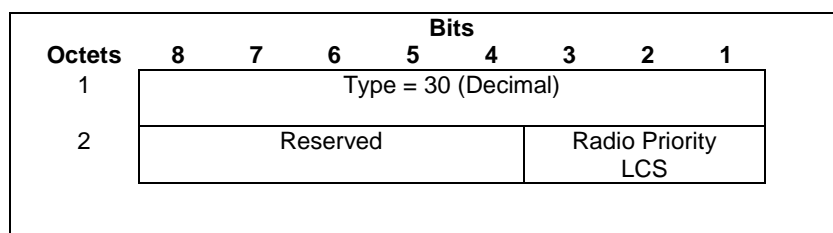

**Figure 33b: Radio Priority LCS Information Element**

### 7.7.26 Charging ID

The Charging ID is a unique four-octet value generated by the GGSN when a PDP context is activated. A Charging ID is generated for each activated context. The Charging ID value 0 is reserved and shall not be assigned by the GGSN.

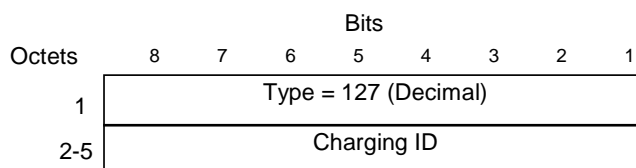

**Figure 34: Charging ID Information Element**

### 7.7.27 End User Address

The purpose of the End User Address information element shall be to supply protocol specific information of the external packet data network accessed by the GPRS subscriber.

The Length field value shall be 2 in an End User Address information element with an empty PDP Address.

The PDP Type defines the end user protocol to be used between the external packet data network and the MS and is divided into an Organisation field and a Number field.

The PDP Type Organisation is the organisation that is responsible for the PDP Type Number field and the PDP Address format.

For PPP the PDP Type Organisation is ETSI and the PDP Type Number is 1 and there shall be no address in the End User Address IE. In this case the address is negotiated later as part of the PPP protocol.

If the PDP Type Organisation is IETF, the PDP Type Number is a compressed number (i.e. the most significant HEX(00) is skipped) in the "Assigned PPP DLL Protocol Numbers" list in the most recent "Assigned Numbers" RFC (RFC 1700 or later). The most recent "Assigned PPP DLL Protocol Numbers" can also be found using the URL = .

The PDP Address shall be the address that this PDP context of the MS is identified with from the external packet data network.

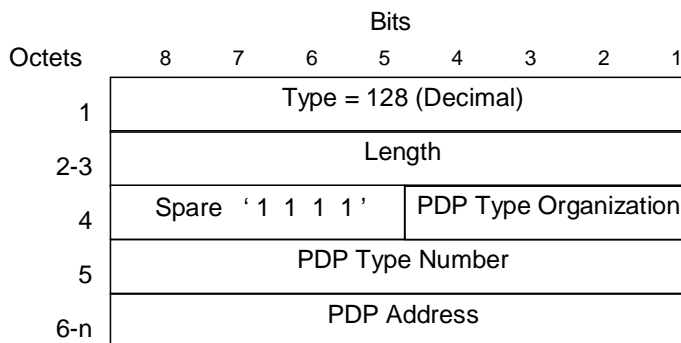

Figure 35: End User Address Information Element

Table 44: PDP Type Organisation Values

| PDP Type Organisation         | Value (Decimal) |
|-------------------------------|-----------------|
| ETSI                          | 0               |
| IETF                          | 1               |
| All other values are reserved |                 |

Table 45: ETSI defined PDP Type Values

| PDP Type Number               | Value (Decimal) |
|-------------------------------|-----------------|
| PPP                           | 1               |
| All other values are reserved |                 |

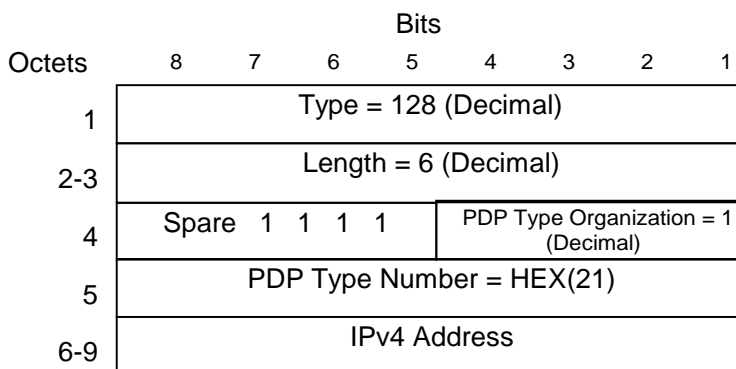

Figure 36: End User Address Information Element for IPv4

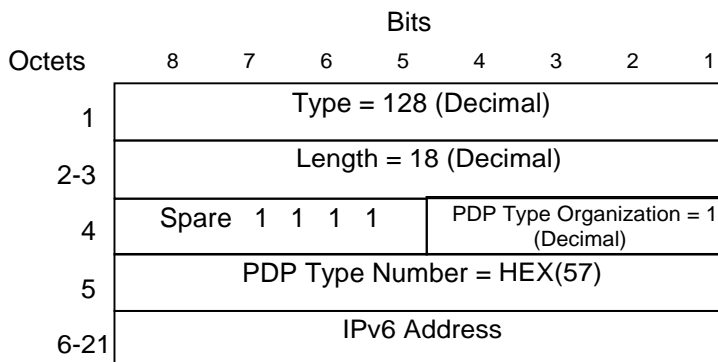
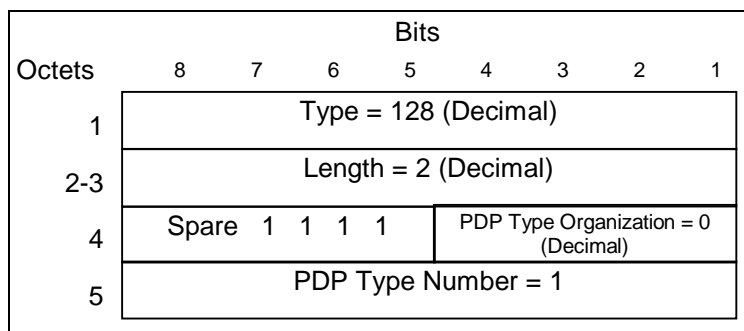

Figure 37: End User Address Information Element for IPv6



**Figure 38: End User Address Information Element for PPP**

## 7.7.28 MM Context

The MM Context information element contains the Mobility Management, MS and security parameters that are necessary to transfer between SGSNs at the Inter SGSN Routeing Area Update procedure.

Security Mode indicates the type of security keys (GSM/UMTS) and Authentication Vectors (quintuplets/triplets) that are passed to the new SGSN.

Ciphering Key Sequence Number (CKSN) is described in 3GPP TS 24.008 [5]. Possible values are integers in the range [0; 6]. The value 7 is reserved. CKSN identifies Kc. During the Intersystem Change to 3G-SGSN, the KSI shall be assigned the value of CKSN.

Key Set Identifier (KSI) identifies CK and IK. During the Intersystem Change to 2G-SGSN, the CKSN shall be assigned the value of KSI.

Used Cipher indicates the GSM ciphering algorithm that is in use.

Kc is the GSM ciphering key currently used by the old SGSN. Kc shall be present if GSM key is indicated in the Security Mode.

CK is the UMTS ciphering key currently used by the old SGSN. CK shall be present if UMTS keys are indicated in the Security Mode.

IK is the UMTS integrity key currently used by the old SGSN. IK shall be present if UMTS keys are indicated in the Security Mode.

The Triplet array contains triplets encoded as the value in the Authentication Triplet information element. The Triplet array shall be present if indicated in the Security Mode.

The Quintuplet array contains Quintuplets encoded as the value in the Authentication Quintuplet information element. The Quintuplet array shall be present if indicated in the Security Mode. If the quintuplet array is present, the Quintuplet length field indicates its length.

DRX parameter indicates whether the MS uses DRX mode or not.

MS Network Capability provides the network with information concerning aspects of the MS related to GPRS. MS Network Capability and MS Network Capability Length are coded as in the value part described in 3GPP TS 24.008 [5].

DRX parameter is coded as described in 3GPP TS 24.008 [5], the value part only.

The two octets Container Length holds the length of the Container, excluding the Container Length octets.

Container contains one or several optional information elements as described in the clause 'Overview', from the clause 'General message format and information elements coding' in 3GPP TS 24.008 [5]. An SGSN supporting the 'PUESBINE' feature (see 3GPP TS 23.195 [24] for more information) shall include the IMEISV in the Container.

| Octets      | Bits                         |   |               |   |   |             |   |   |
|-------------|------------------------------|---|---------------|---|---|-------------|---|---|
|             | 8                            | 7 | 6             | 5 | 4 | 3           | 2 | 1 |
| 1           | Type = 129 (Decimal)         |   |               |   |   |             |   |   |
| 2-3         | Length                       |   |               |   |   |             |   |   |
| 4           | Spare 1111                   |   |               |   |   | CKSN        |   |   |
| 5           | Security Mode                |   | No of Vectors |   |   | Used Cipher |   |   |
| 6-13        | Kc                           |   |               |   |   |             |   |   |
| 14-m        | Triplet [0..4]               |   |               |   |   |             |   |   |
| (m+1)-(m+2) | DRX parameter                |   |               |   |   |             |   |   |
| (m+3)       | MS Network Capability Length |   |               |   |   |             |   |   |
| (m+4)-n     | MS Network Capability        |   |               |   |   |             |   |   |
| (n+1)-(n+2) | Container length             |   |               |   |   |             |   |   |
| (n+3)-o     | Container                    |   |               |   |   |             |   |   |

Figure 40: MM Context Information Element with GSM Key and Triplets

| Octets      | Bits                         |   |               |   |   |           |   |   |
|-------------|------------------------------|---|---------------|---|---|-----------|---|---|
|             | 8                            | 7 | 6             | 5 | 4 | 3         | 2 | 1 |
| 1           | Type = 129 (Decimal)         |   |               |   |   |           |   |   |
| 2-3         | Length                       |   |               |   |   |           |   |   |
| 4           | Spare 1111                   |   |               |   |   | KSI       |   |   |
| 5           | Security Mode                |   | No of Vectors |   |   | Spare 111 |   |   |
| 6-21        | CK                           |   |               |   |   |           |   |   |
| 22-37       | IK                           |   |               |   |   |           |   |   |
| 38-39       | Quintuplet Length            |   |               |   |   |           |   |   |
| 40-m        | Quintuplet [0..4]            |   |               |   |   |           |   |   |
| (m+1)-(m+2) | DRX parameter                |   |               |   |   |           |   |   |
| (m+3)       | MS Network Capability Length |   |               |   |   |           |   |   |
| (m+4)-n     | MS Network Capability        |   |               |   |   |           |   |   |
| (n+1)-(n+2) | Container length             |   |               |   |   |           |   |   |
| (n+3)-o     | Container                    |   |               |   |   |           |   |   |

Figure 41: MM Context Information Element with UMTS Keys and Quintuplets

| Octets      | Bits                         |   |               |   |   |             |   |   |
|-------------|------------------------------|---|---------------|---|---|-------------|---|---|
|             | 8                            | 7 | 6             | 5 | 4 | 3           | 2 | 1 |
| 1           | Type = 129 (Decimal)         |   |               |   |   |             |   |   |
| 2-3         | Length                       |   |               |   |   |             |   |   |
| 4           | Spare 1111                   |   |               |   |   | CKSN        |   |   |
| 5           | Security Mode                |   | No of Vectors |   |   | Used Cipher |   |   |
| 6-13        | Kc                           |   |               |   |   |             |   |   |
| 14-15       | Quintuplet Length            |   |               |   |   |             |   |   |
| 16-m        | Quintuplet [0..4]            |   |               |   |   |             |   |   |
| (m+1)-(m+2) | DRX parameter                |   |               |   |   |             |   |   |
| (m+3)       | MS Network Capability Length |   |               |   |   |             |   |   |
| (m+4)-n     | MS Network Capability        |   |               |   |   |             |   |   |
| n+1-n+2     | Container length             |   |               |   |   |             |   |   |
| n+3-o       | Container                    |   |               |   |   |             |   |   |

Figure 42: MM Context Information Element with GSM Keys and UMTS Quintuplets

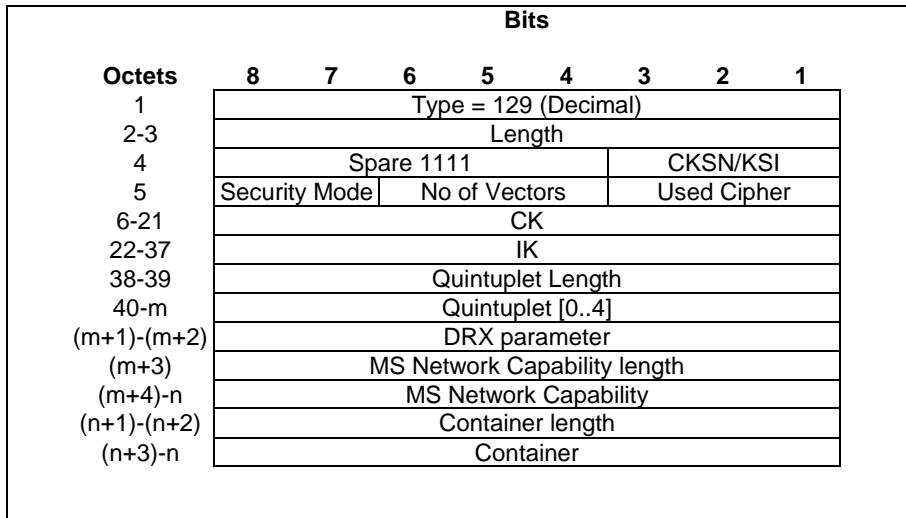

**Figure 42A: MM Context Information Element with Used Cipher value, UMTS Keys and Quintuplets**

**Table 46: Used Cipher Values**

| Cipher Algorithm | Value (Decimal) |
|------------------|-----------------|
| No ciphering     | 0               |
| GEA/1            | 1               |
| GEA/2            | 2               |
| GEA/3            | 3               |
| GEA/4            | 4               |
| GEA/5            | 5               |
| GEA/6            | 6               |
| GEA/7            | 7               |

**Table 47: Security Mode Values**

| Security Type                                | Value (Decimal) |
|--|-----------------|
| GSM key and triplets                         | 1               |
| GSM key and quintuplets                      | 3               |
| UMTS key and quintuplets                     | 2               |
| Used cipher value, UMTS Keys and Quintuplets | 0               |

### 7.7.29 PDP Context

The PDP Context information element contains the Session Management parameters, defined for an external packet data network address, that are necessary to transfer between SGSNs at the Inter SGSN Routeing Area Update procedure.

NSAPI is an integer value in the range [0; 15].

The NSAPI points out the affected PDP context.

The SAPI indicates the LLC SAPI that is associated with the NSAPI.

The Transaction Identifier is the 4 or 12 bit Transaction Identifier used in the 3GPP TS 24.008 [5] Session Management messages which control this PDP Context. If the length of the Transaction Identifier is 4 bit, the second octet shall be set to all zeros. The encoding is defined in 3GPP TS 24.007 [3]. The latest Transaction Identifier sent from SGSN to MS is stored in the PDP context IE.

NOTE: Bit 5-8 of the first octet in the encoding defined in 3GPP TS 24.007 [3] is mapped into bit 1-4 of the first octet in this field.

Reordering Required (Order) indicates whether the SGSN shall reorder T-PDUs before delivering the T-PDUs to the MS. When the Quality of Service Negotiated (QoS Neg) is Release 99, the Reordering Required (Order) shall be ignored by receiving entity.

The VPLMN Address Allowed (VAA) indicates whether the MS is allowed to use the APN in the domain of the HPLMN only or additionally the APN in the domain of the VPLMN.

The QoS Sub Length, QoS Req Length and QoS Neg Length represent respectively the lengths of the QoS Sub, QoS Req and QoS Neg fields, excluding the QoS Length octet.

The Quality of Service Subscribed (QoS Sub), Quality of Service Requested (QoS Req) and Quality of Service Negotiated (QoS Neg) are encoded as described in section 'Quality of Service (QoS) Profile'. Their minimum length is 4 octets; their maximum length may be 255 octets.

The Sequence Number Down is the number of the next T-PDU that shall be sent from the new SGSN to the MS. The number is associated to the Sequence Number from the GTP Header of an encapsulated T-PDU. The new SGSN shall ignore Sequence Number Down when the PDP context QoS profile does not require transmission order to be preserved. In this case the new SGSN shall not include Sequence number field in the G-PDUs of the PDP context.

The Sequence Number Up is the number that new SGSN shall use as the Sequence Number in the GTP Header for the next encapsulated T-PDU from the MS to the GGSN. The new SGSN shall ignore Sequence Number Up when the PDP context QoS profile does not require transmission order to be preserved. In this case, the new SGSN shall not include Sequence number field in the G-PDUs of the PDP context.

The Send N-PDU Number is used only when acknowledged peer-to-peer LLC operation is used for the PDP context. Send N-PDU Number is the N-PDU number to be assigned by SNDCP to the next down link N-PDU received from the GGSN. It shall be set to 255 if unacknowledged peer-to-peer LLC operation is used for the PDP context.

The Receive N-PDU Number is used only when acknowledged peer-to-peer LLC operation is used for the PDP context. The Receive N-PDU Number is the N-PDU number expected by SNDCP from the next up link N-PDU to be received from the MS. It shall be set to 255 if unacknowledged peer-to-peer LLC operation is used for the PDP context.

The Uplink Tunnel Endpoint Identifier Control Plane is the Tunnel Endpoint Identifier used between the old SGSN and the GGSN in up link direction for control plane purpose. It shall be used by the new SGSN within the GTP header of the Update PDP Context Request message.

The GGSN Address for User Traffic and the Uplink Tunnel Endpoint Identifier Data I are the GGSN address and the Tunnel Endpoint Identifier used between the old SGSN and the GGSN in uplink direction for user plane traffic on a PDP context. They shall be used by the new SGSN to send uplink user plane PDU to the GGSN until new GGSN address for User Traffic is possibly received from GGSN (in Update PDP Context Response).

The PDP Context Identifier is used to identify a PDP context for the subscriber. The SGSN shall set the value of PDP Context Identifier to binary (1111 1111) if after inter-SGSN RAU using GTPv0 the new SGSN is not able to assign a correct PDP Context Identifier to the existing PDP contexts.

The PDP Type Organisation and PDP Type Number are encoded as in the End User Address information element.

The PDP Address Length represents the length of the PDP Address field, excluding the PDP Address Length octet.

The PDP Address is an octet array with a format dependent on the PDP Type. The PDP Address is encoded as in the End User Address information element if the PDP Type is IPv4 or IPv6.

The GGSN Address Length represents the length of the GGSN Address field, excluding the GGSN Address Length octet.

When forwarding the GGSN addresses to another SGSN (in PDP Context IE in Forward Relocation Request or SGSN Context Response message), the IPv4/IPv6 capable SGSN shall include GGSN addresses according to the IP version capability of the receiving SGSN.

The old SGSN includes the GGSN Address for control plane that it has received from GGSN at PDP context activation or update. If the new SGSN is IPv6 capable and the old SGSN has IPv6 control plane address of the GGSN available, the old IPv4/IPv6 capable SGSN includes the IPv6 GGSN control plane address in the field GGSN Address for control plane. If the new SGSN is IPv4 only capable or the old SGSN does not have any IPv6 GGSN address for control plane, the old SGSN includes the IPv4 GGSN Address in the field GGSN Address for control plane.

The use of Ipv6 addressing in pre-Release 5 nodes can cause interoperability problems and as such the use of IPv6 GSN addressing is not recommended in pre-Release 5.

NOTE: There is still the need for further study of the included addresses on SRNS relocation.

The APN is the Access Point Name in use in the old SGSN. This APN field shall be composed of the APN Network Identifier part and the APN Operator Identifier part.

The spare bits x indicate unused bits that shall be set to 0 by the sending side and which shall not be evaluated by the receiving side.

| Octets              | Bits  |     |               |       |                        |   |   |   |
|---------------------|---|-----|---------------|-------|------------------------|---|---|---|
|                     | 8   | 7   | 6             | 5     | 4                      | 3 | 2 | 1 |
| 1                   | Type = 130 (Decimal)                            |     |               |       |                        |   |   |   |
| 2-3                 | Length  |     |               |       |                        |   |   |   |
| 4                   | Res-<br>erved                                   | VAA | Res-<br>erved | Order | NSAPI                  |   |   |   |
| 5                   | X   | X   | X             | X     | SAPI                   |   |   |   |
| 6                   | QoS Sub Length                                  |     |               |       |                        |   |   |   |
| 7 - (q+6)           | QoS Sub [4..255]                                |     |               |       |                        |   |   |   |
| q+7                 | QoS Req Length                                  |     |               |       |                        |   |   |   |
| (q+8)-(2q+7)        | QoS Req [4..255]                                |     |               |       |                        |   |   |   |
| 2q+8                | QoS Neg. Length                                 |     |               |       |                        |   |   |   |
| (2q+9)-<br>(3q+8)   | QoS Neg [4..255]                                |     |               |       |                        |   |   |   |
| (3q+9)-<br>(3q+10)  | Sequence Number Down (SND) (note)               |     |               |       |                        |   |   |   |
| (3q+11)-<br>(3q+12) | Sequence Number Up (SNU) (note)                 |     |               |       |                        |   |   |   |
| 3q+13               | Send N-PDU Number (note)                        |     |               |       |                        |   |   |   |
| 3q+14               | Receive N-PDU Number (note)                     |     |               |       |                        |   |   |   |
| (3q+15)-<br>(3q+18) | Uplink Tunnel Endpoint Identifier Control Plane |     |               |       |                        |   |   |   |
| (3q+19)-<br>(3q+22) | UplinkTunnel Endpoint Identifier Data I         |     |               |       |                        |   |   |   |
| 3q+23               | PDP Context Identifier                          |     |               |       |                        |   |   |   |
| 3q+24               | Spare 1 1 1 1                                   |     |               |       | PDP Type Organisation  |   |   |   |
| 3q+25               | PDP Type Number                                 |     |               |       |                        |   |   |   |
| 3q+26               | PDP Address Length                              |     |               |       |                        |   |   |   |
| (3q+27)-m           | PDP Address [0..63]                             |     |               |       |                        |   |   |   |
| m+1                 | GGSN Address for control plane Length           |     |               |       |                        |   |   |   |
| (m+2)-n             | GGSN Address for control plane [4..16]          |     |               |       |                        |   |   |   |
| n+1                 | GGSN Address for User Traffic Length            |     |               |       |                        |   |   |   |
| (n+2)-o             | GGSN Address for User Traffic [4..16]           |     |               |       |                        |   |   |   |
| o+1                 | APN length                                      |     |               |       |                        |   |   |   |
| (o+2)-p             | APN   |     |               |       |                        |   |   |   |
| p+1                 | Spare (sent as 0 0 0 0)                         |     |               |       | Transaction Identifier |   |   |   |
| p+2                 | Transaction Identifier                          |     |               |       |                        |   |   |   |

NOTE: This field shall not be evaluated when the PDP context is received during UMTS intra system handover/relocation.

Figure 43: PDP Context Information Element

Table 48: Reordering Required Values

| Reordering Required | Value (Decimal) |
|---------------------|-----------------|
| No                  | 0               |
| Yes                 | 1               |



**Table 49: VPLMN Address Allowed Values**

| VPLMN Address Allowed | Value (Decimal) |
|-----------------------|-----------------|
| No                    | 0               |
| Yes                   | 1               |

### 7.7.30 Access Point Name

The Access Point Name is sent from the GGSN in the Network-requested PDP Context Activation procedure that is used to identify the access point of the packet data network that wishes to connect to the MS.

The Access Point Name is information from the MS or SGSN that may be used by the GGSN to differentiate between accesses to different external packet data networks using the same PDP Type.

The Access Point Name contains a logical name that is the APN Network Identifier (see 3GPP TS 23.060 [4]). It is coded as in the value part defined in 3GPP TS 24.008 [5] (i.e. the 3GPP TS 24.008 [5] IEI and 3GPP TS 24.008 [5] octet length indicator are not included).

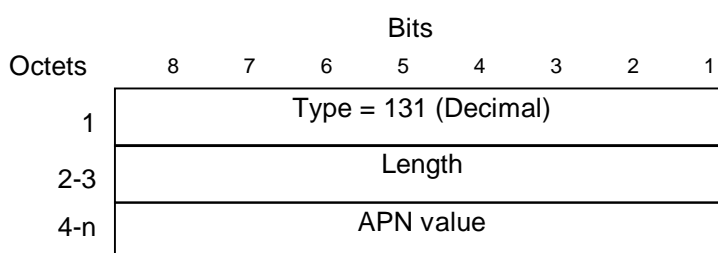
**Figure 44: Access Point Name Information Element**

### 7.7.31 Protocol Configuration Options

The Protocol Configuration Options contains external network protocol options that may be necessary to transfer between the GGSN and the MS. The content and the coding of the Protocol Configuration are defined in octet 3-z of the Protocol Configuration Options in 3GPP TS 24.008 [5].

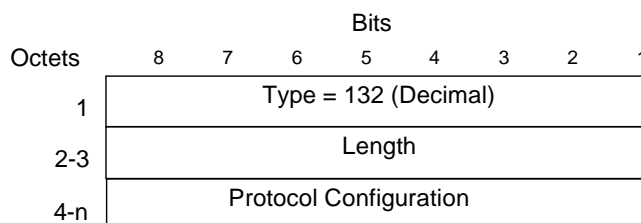
**Figure 45: Protocol Configuration Options Information Element**

### 7.7.32 GSN Address

The GSN Address information element contains the address of a GSN as defined in 3GPP TS 23.003 [2]. The Address Type and Address Length fields from 3GPP TS 23.003 [2] are not included in the GSN Address field.

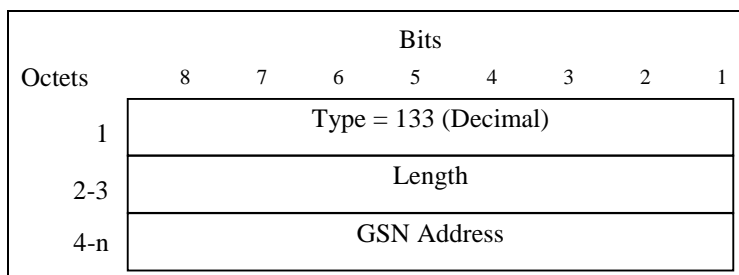

**Figure 46: GSN Address Information Element**

### 7.7.33 MS International PSTN/ISDN Number (MSISDN)

The MS international ISDN numbers are allocated from the ITU-T Recommendation E.164 numbering plan, see 3GPP TS 23.003 [2]. The MSISDN is coded according to the contents of ISDN-AddressString data type defined in 3GPP TS 29.002 [6]. The MSISDN shall be in international format and the "nature of address indicator" shall indicate "international number".

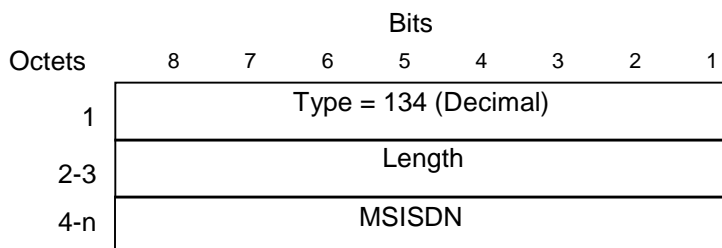

**Figure 47: MSISDN Information Element**

### 7.7.34 Quality of Service (QoS) Profile

The Quality of Service (QoS) Profile shall include the values of the defined QoS parameters.

Octet 4 carries the allocation/retention priority octet that is defined in 3GPP TS 23.107. The allocation/retention priority octet encodes each priority level defined in 3GPP TS 23.107 as the binary value of the priority level. The allocation/retention priority shall be ignored if the QoS profile is pre-Release '99 or the QoS profile is present in Quality of Service Requested (QoS Req) of the PDP context.

Octets 5 – n are coded according to 3GPP TS 24.008 [5] Quality of Service IE, The minimum length of the field QoS Profile Data is 3 octets; the maximum length is 254 octets.

A receiving end shall interpret the QoS profile Data field to be coded based on the Length field of this parameter as follows.

- If the Length field value is 4, octets 5 – n are coded according to 3GPP TS 24.008 [5] Quality of Service IE, octets 3 – 5 (i.e. according to the pre-Release '99 format).
- If the Length field value is 12, octets 5 – n are coded according to 3GPP TS 24.008 [5] Quality of Service IE, octets 3 – 13.
- If the Length field value is 13 or greater, octets 5 – n are coded according to 3GPP TS 24.008 [5] Quality of Service IE, octets 3 – 16 and the remaining octets, if present, shall be ignored by the receiving entity.
- If the Length field value is other than described above, the QoS profile Data field shall be interpreted as invalid data.

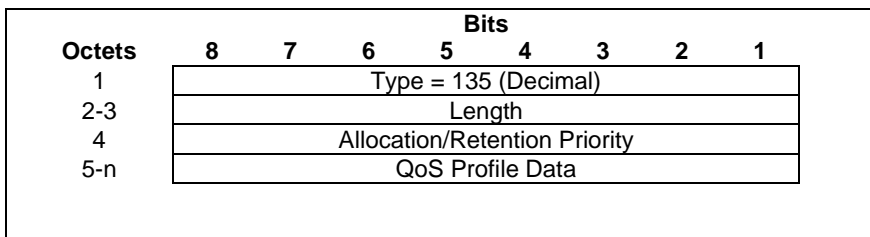

Figure 48: Quality of Service (QoS) Profile Information Element

### 7.7.35 Authentication Quintuplet

An Authentication Quintuplet consists of a Random challenge (RAND), an Expected user response (XRES), a Cipher key (CK), an Integrity key (IK), an Authentication token (AUTN) (see 3GPP TS 33.102 [8]).

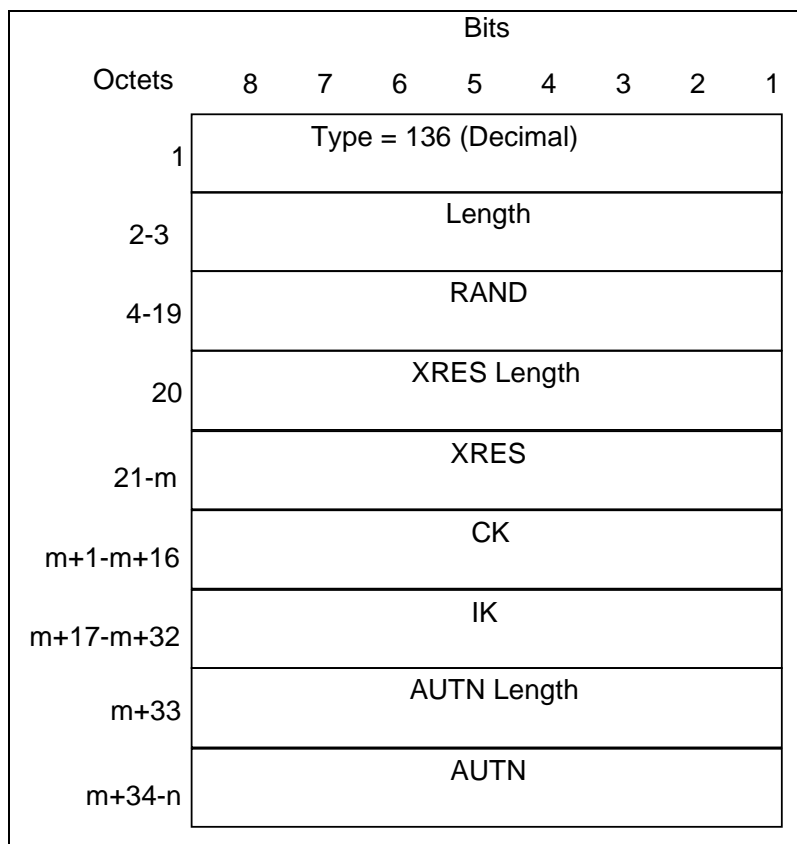

Figure 49: Authentication Quintuplet Information Element

### 7.7.36 Traffic Flow Template (TFT)

The Traffic Flow Template (TFT) is used to distinguish between different user traffic flows.

The content and the coding of the TFT are defined in 3GPP TS 24.008 [5].

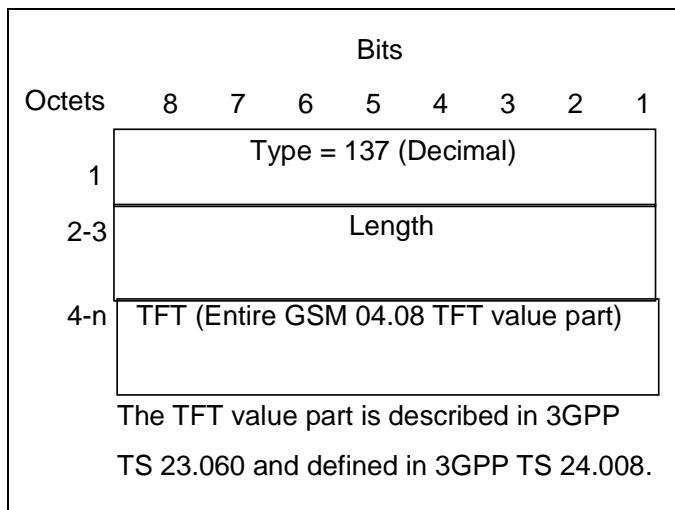

Figure 50: Traffic Flow Template Information Element

### 7.7.37 Target Identification

The Target Identification information element contains the identification of a target RNC as defined in 3GPP TS 25.413 [7].

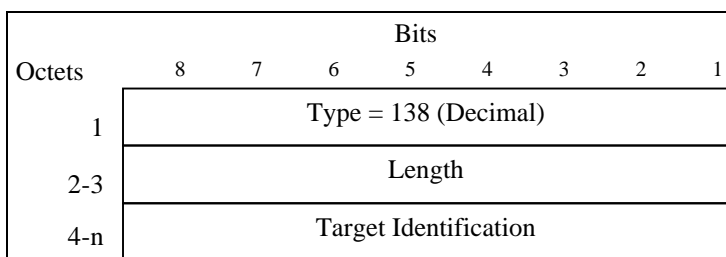

Figure 51: Target Identification Information Element

### 7.7.38 UTRAN Transparent Container

The UTRAN transparent container information element contains the radio-related information. The contents of this information element are only used by RNC so that GSN does not refer the contents.

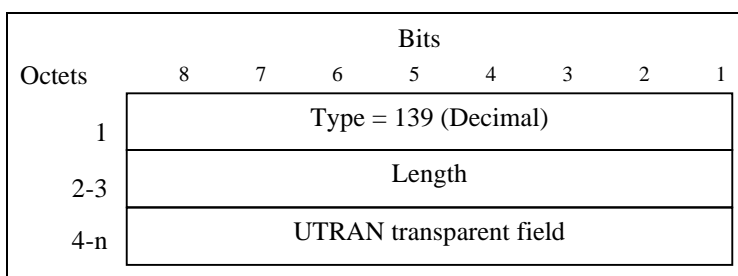

Figure 52: UTRAN Transparent Container Information Element

### 7.7.39 RAB Setup Information

If the target RNC successfully allocated resources associated with the NSAPI, the RAB Setup Information IE contains the RNC Tunnel Endpoint Identifier and RNC IP address for data forwarding from source RNC to target RNC. If the target RNC or the new SGSN failed to allocate resources the RAB Setup Information IE contains only Length and NSAPI indicating that the source RNC shall release the resources associated with the NSAPI.

The spare bits x indicate unused bits, which shall be set to 0 by the sending side and which shall not be evaluated by the receiving side.

The format of the RNC IP address is the same as the GSN address as defined in 3GPP TS 23.003 [2]. The Address Type and Address Length fields from 3GPP TS 23.003 [2] are not included in the RNC IP Address field.

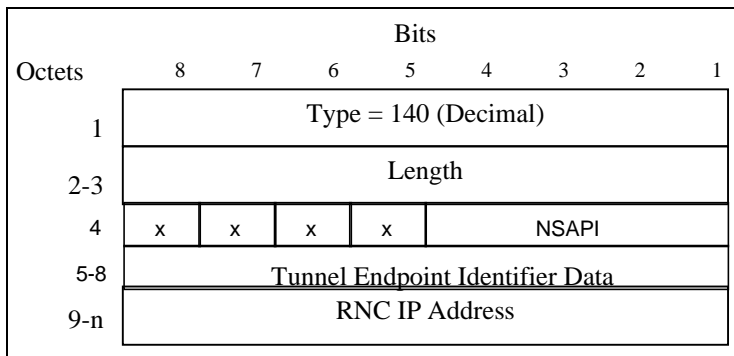

Figure 53: RAB Setup Information IE for data forwarding

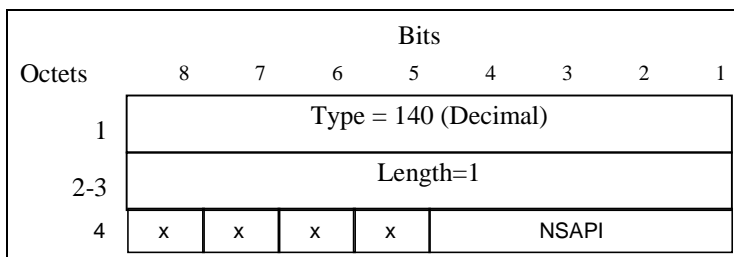

Figure 54: RAB Setup Information IE for release of resources

### 7.7.40 Extension Header Type List

This information element contains a list of 'n' Extension Header Types. The length field is set to the number of extension header types included.

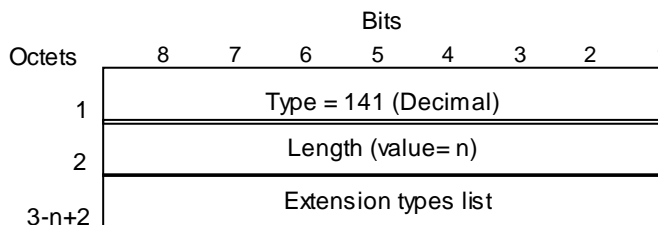

Figure 55: Extension Header Type List Information Element

### 7.7.41 Trigger Id

The Trigger Id information element identifies the entity that triggered the trace.

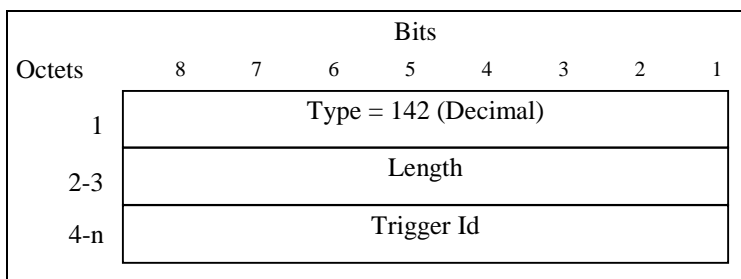

Figure 56: Trigger Id Information Element

### 7.7.42 OMC Identity

The OMC Identity information element identifies the OMC that shall receive the trace record(s).

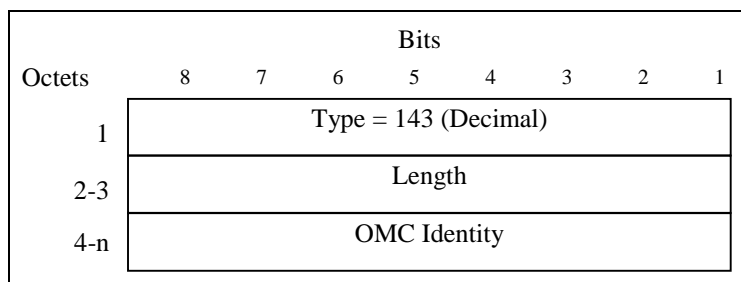

Figure 57: OMC Identity Information Element

### 7.7.43 RAN Transparent Container

The information in the value part of the RAN Transparent Container IE contains all information elements (starting with and including the BSSGP 'PDU Type') in either of the RAN INFORMATION, RAN INFORMATION REQUEST, RAN INFORMATION ACK or RAN INFORMATION ERROR messages respectively as specified in 3GPP TS 48.018 [20].

The two octets Length field holds the length of the RAN Transparent Container field Container (octets 4-n).

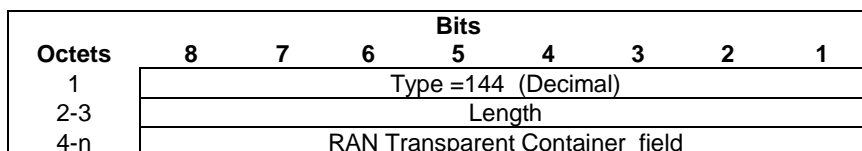

Figure 58: RAN Transparent Container Information Element

### 7.7.44 Charging Gateway Address

The Charging Gateway Address information element contains an Ipv4 or Ipv6 address of a Charging Gateway.

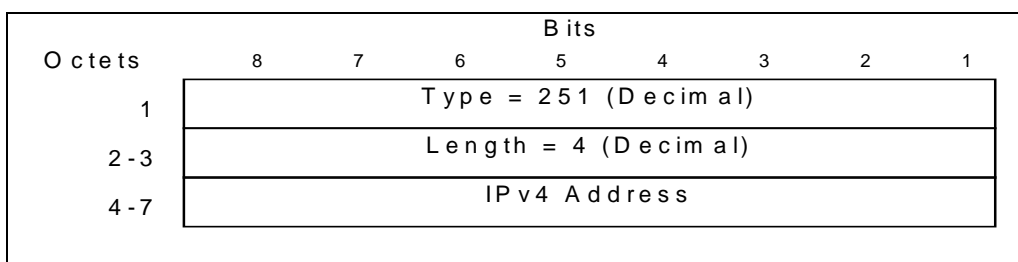

Figure 59a: Ipv4 Charging Gateway Address Information Element

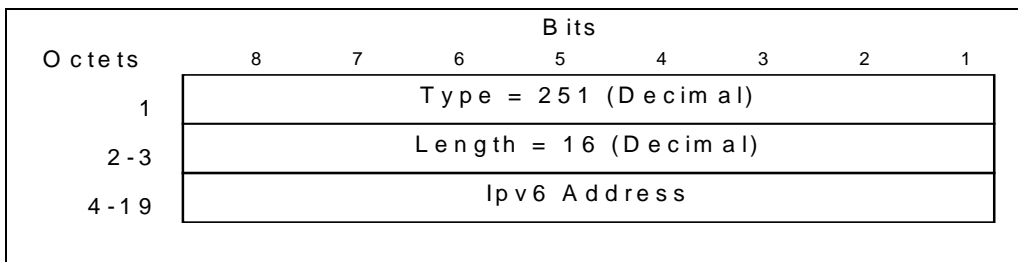

Figure 59b: Ipv6 Charging Gateway Address Information Element

### 7.7.45 PDP Context Prioritization

The PDP Context Prioritization information element is used by the old SGSN to inform the new SGSN that prioritisation of the PDP Contexts has been applied. When the information element is included, the length is set to zero.

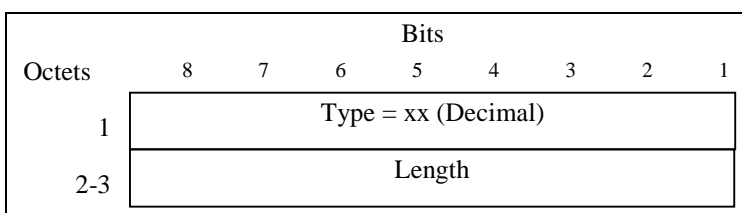

Figure 60 : PDP Context Prioritization Information Element

### 7.7.45A Additional RAB Setup Information

If the target RNC successfully allocated resources associated with the NSAPI, the Additional RAB Setup Information IE contains the RNC Tunnel Endpoint Identifier and RNC IP address for data forwarding from source RNC to target RNC for IPv6. If the target RNC or the new SGSN failed to allocate resources the Additional RAB Setup Information IE contains only Length and NSAPI indicating that the source RNC shall release the resources associated with the NSAPI.

The spare bits x indicate unused bits, which shall be set to 0 by the sending side and which shall not be evaluated by the receiving side.

The format of the RNC IPv6 address is the same as the GSN address as defined in 3GPP TS 23.003 [2]. The Address Type and Address Length fields from 3GPP TS 23.003 [2] are not included in the RNC IP Address field.

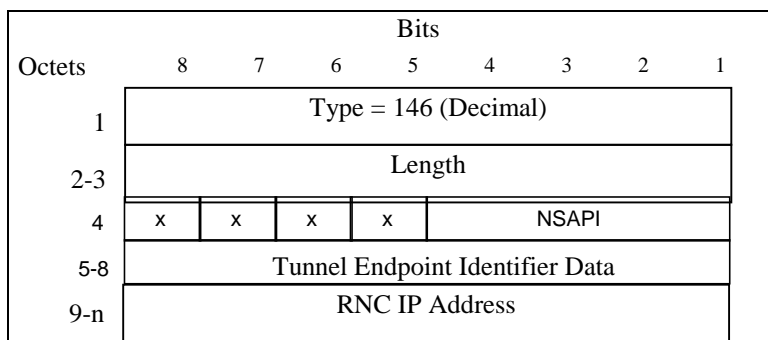

Figure 60a: Additional RAB Setup Information IE for data forwarding

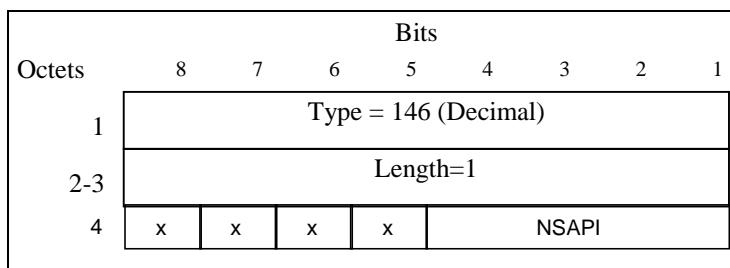

Figure 60b: Additional RAB Setup Information IE for release of resources

### 7.7.46 Private Extension

The Private Extension information element contains vendor specific information. The Extension Identifier is a value defined in the Private Enterprise number list in the most recent "Assigned Numbers" RFC (RFC 1700 or later).

This is an optional information element that may be included in any GTP Signalling message. A signalling message may include more than one information element of the Private Extension type.

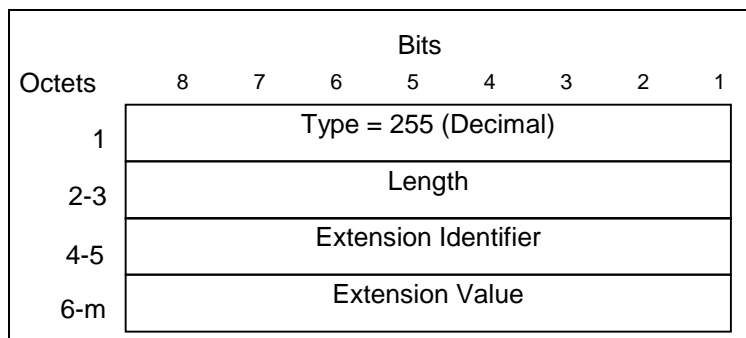

Figure 61: Private Extension Information Element

## 8 Control Plane (GTP-C)

The control plane in this case relates to GPRS Mobility Management functions like for example GPRS Attach, GPRS Routing Area Update and Activation of PDP Contexts. The GPRS Tunneling Protocol-Control plane (GTP-C) shall perform the control plane signalling between GSN nodes.

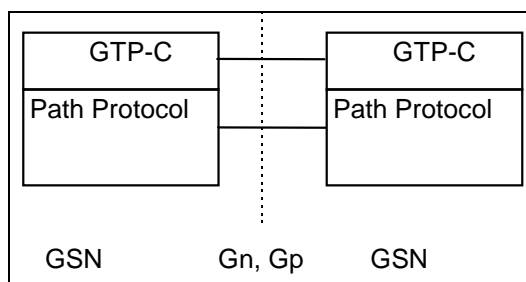

Figure 62: Signalling Plane - Protocol Stack

### 8.1 Control Plane Protocol

The GTP-C control plane flow shall be logically associated with, but separate from, the GTP-U tunnels. For each GSN-GSN pair one or more paths exist. One or more tunnels may use each path. GTP-C shall be the means by which tunnels are established, used, managed and released. A path may be maintained by keep-alive echo messages. This ensures that a connectivity failure between GSNs can be detected in a timely manner.



## 8.2 Usage of the GTP-C Header

For control plane messages the GTP header shall be used as specified in clause 6 with the following clarifications and additions:

- Version shall be set to decimal 1 ('001').
- Protocol Type flag (PT) shall be set to '1'.
- Sequence number flag (S) shall be set to '1'.
- N-PDU Number flag (PN) shall be set to '0'. A GTP-C receiver shall not return an error if this flag is set to '1'.
- Message Type shall be set to the unique value that is used for each type of control plane message. Valid message types are marked with an x in the GTP-C column in table 1.
- Length shall be the length in octets of the payload, i.e. the rest of the packet following the mandatory part of the GTP header (that is the first 8 octets). The Sequence Number, the N-PDU Number or any Extension headers shall be considered to be part of the payload, i.e. included in the length count.
- The Tunnel Endpoint Identifier is set by the sending entity to the value requested by the corresponding entity (SGSN or GGSN); it identifies all the PDP Contexts with the same PDP address and APN (for Tunnel Management messages) or it identifies each MS and its associated context data (for messages not related to Tunnel Management), except for the following cases:
  - The Create PDP Context Request message for a given MS sent to a specific GGSN shall have the Tunnel Endpoint Identifier set to all zeroes, if the SGSN has not been assigned a Tunnel Endpoint Identifier Control Plane by the GGSN.
  - The Update PDP Context Request message for a given MS sent to a specific GGSN shall have the Tunnel Endpoint Identifier set to all zeros, if it is used to switch the GTP version of the tunnel to the GGSN from GTP v0 to GTP v1.
  - The Identification Request/Response messages, where the Tunnel Endpoint Identifier shall be set to all zeroes.
  - The SGSN Context Request message, where the Tunnel Endpoint Identifier shall be set to all zeroes.
  - The Echo Request/Response, Supported Extension Headers notification and the Version Not Supported messages, where the Tunnel Endpoint Identifier shall be set to all zeroes.
  - The Forward Relocation Request message, where the Tunnel Endpoint Identifier shall be set to all zeroes.
  - The PDU Notification Request message, where the Tunnel Endpoint Identifier shall be set to all zeroes.
  - The RAN Information Relay message, where the Tunnel Endpoint Identifier shall be set to all zeroes.
  - The Relocation Cancel Request message where the Tunnel Endpoint Identifier shall be set to all zeroes, except for the case where the old SGSN has already been assigned the Tunnel Endpoint Identifier Control Plane of the new SGSN.
  - All Location Management messages, where the Tunnel Endpoint Identifier shall be set to all zeroes.
  - If a GSN receives a GTP-C message requesting action related to a PDP context that the sending node believes is in existence, but that is not recognised by the receiving node, the receiving node shall send back to the source of the message, a response with the appropriate cause value (either 'Non-existent' or 'Context not found'). The Tunnel Endpoint Identifier used in the response message shall be set to all zeroes.

The GSN Address for Control Plane set in the request message could be different from the IP Source address of the message. The Tunnel Endpoint Identifier notified in the request message is also used in this case for sending the corresponding response message.

- Sequence Number shall be a message number valid for a path. Within a given set of contiguous Sequence Numbers from 0 to 65535, a given Sequence Number shall, if used, unambiguously define a GTP control plane request message sent on the path (see section Reliable delivery of signalling messages). The Sequence Number

in a control plane response message shall be copied from the control plane request message that the GSN is replying to. For GTP-C messages not having a defined response message for a request message, i.e. for messages Version Not Supported, RAN Information Relay and Supported Extension Headers Notification, the Sequence Number shall be ignored by the receiver.

- N-PDU Number shall not be interpreted.

The GTP-C header may be followed by subsequent information elements dependent on the type of control plane message. Only one information element of each type is allowed in a single control plane message, except for the Authentication Triplet, the PDP Context and the Tunnel Endpoint Identifier Data II information element where several occurrences of each type are allowed.

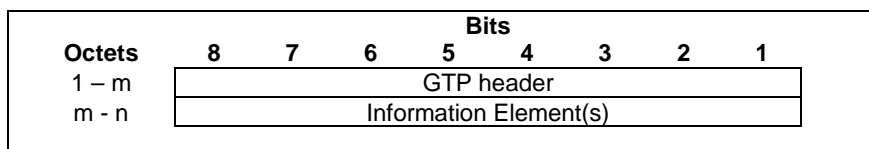

Figure 63: GTP Header followed by subsequent Information Elements

## 9 GTP-U

GTP-U Tunnels are used to carry encapsulated T-PDUs and signalling messages between a given pair of GTP-U Tunnel Endpoints. The Tunnel Endpoint ID (TEID) which is present in the GTP header shall indicate which tunnel a particular T-PDU belongs to. In this manner, packets are multiplexed and de-multiplexed by GTP-U between a given pair of Tunnel Endpoints. The TEID value to be used in the TEID field shall be negotiated for instance during the GTP-C Create PDP Context and the RAB assignment procedures that take place on the control plane.

The maximum size of a T-PDU that may be transmitted without fragmentation by GGSN or the MS is defined in 3GPP TS 23.060 [4]. The GGSN shall fragment, reject or discard T-PDUs, depending on the PDP type and implementation decisions, directed to the MS if the T-PDU size exceeds the maximum size. The decision if the T-PDUs shall be fragmented or discarded is dependent on the external packet data network protocol.

### 9.1 GTP-U Protocol Entity

The GTP-U protocol entity provides packet transmission and reception services to user plane entities in the GGSN, in the SGSN and, in UMTS systems, in the RNC. The GTP-U protocol entity receives traffic from a number of GTP-U tunnel endpoints and transmits traffic to a number of GTP-U tunnel endpoints. There is a GTP-U protocol entity per IP address.

The TEID in the GTP-U header is used to de-multiplex traffic incoming from remote tunnel endpoints so that it is delivered to the User plane entities in a way that allows multiplexing of different users, different packet protocols and different QoS levels. Therefore no two remote GTP-U endpoints shall send traffic to a GTP-U protocol entity using the same TEID value except for data forwarding as part of the SRNS relocation or Intersystem Change procedures.

#### 9.1.1 Handling of Sequence Numbers

This functionality is provided only when the S bit is set to 1 in the GTP-U header.

The GTP-U protocol entity must reorder out of sequence T-PDUs when in sequence delivery is required. This is optional at the SGSN in UMTS. The GTP-U protocol entity shall deliver to the user plane entity only in sequence T-PDUs and notify the sequence number associated to each of them. The notification of the sequence number is not necessary at the GGSN, but it is mandatory at the SGSN and RNC. The user plane entity shall provide a sequence number to the GTP-U layer together with T-PDUs to be transmitted in sequence. GTP-U protocol entities at the GGSN may optionally generate autonomously the sequence number, but should be able to use sequence numbers provided by the user plane entity. The sequence number is handled on a per GTP-U Tunnel (that is TEID) basis.

When the sequence number is included in the GTP-U header, a user plane entity acting as a relay of T-PDUs between GTP-U protocol entities, or between PDCP (or SNDCP) protocol entities and GTP-U protocol entities, shall relay the sequence numbers between those entities as well. In this way it is possible to keep consistent values of sequence

numbers from the GGSN to the UE (MS in GPRS) by relaying the sequence number across the CN GTP-U bearer, the Iu GTP-U bearer and the Radio bearer (via PDCP or SNDCP N-PDU numbers). This functionality is beneficial during SRNS relocation.

For GTP-U signalling messages having a response message defined for a request message, Sequence Number shall be a message number valid for a path. Within a given set of continuous Sequence Numbers from 0 to 65535, a given Sequence Number shall, if used, unambiguously define a GTP-U signalling request message sent on the path (see section Reliable delivery of signalling messages). The Sequence Number in a signalling response message shall be copied from the signalling request message that the GSN or RNC is replying to. For GTP-U messages not having a defined response message for a request message, i.e. for messages Supported Extension Headers Notification and Error Indication, the Sequence Number shall be ignored by the receiver.

## 9.2 GTP-U Service Access Points and Primitives

The GTP-U protocol entity offers packet Transmission services between a pair of GTP-U tunnel endpoints. The tunnel between two GTP-U endpoints is established via control plane procedures defined in protocols such as GTP-C and RANAP. The control of GTP-U resource allocation and tunnel set-up takes place via the GTP-U-CONTROL SAP. The GTP-U packet transmission (and packet reception) services are accessed via the GTP-U-UNIT-DATA SAP.

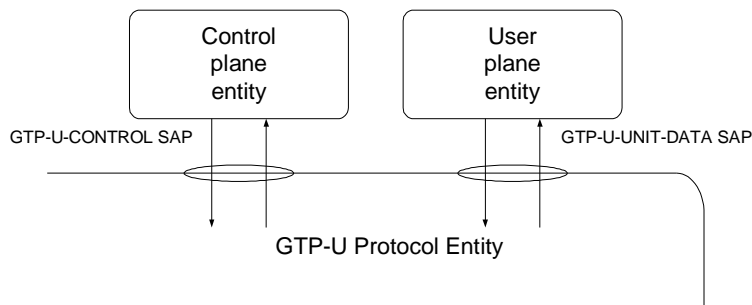

Figure 64: The GTP-U-Control SAP and GTP-U-DATA SAP

### 9.2.1 GTP-U-CONTROL SAP

The GTP-U-CONTROL SAP is used by a control plane entity to control the allocation of GTP-U resources and associate them to an identifier (the TEID) a user plane entity uses to access them via the GTP-U-UNIT-DATA SAP. It also defines in which way to control tunnel establishment. In particular, it provides means to control the GTP-U packet reception section and the GTP-U packet transmission section. The RX and TX suffix is used in the following to discriminate between primitives used to control the reception section and primitives used to control the transmission section.

#### 9.2.1.1 GTP-U-CONTROL-RX primitives

Table 50

| Primitive                         | Parameters                 | Reference |
|-----------------------------------|----------------------------|-----------|
| GTP-U-CONTROL-RX-SETUP.request    | QoS info; IP address; TEID | 9.2.1.1.1 |
| GTP-U-CONTROL-RX-SETUP.confirm    | Result                     | 9.2.1.1.2 |
| GTP-U-CONTROL-RX-RELEASE.request  | TEID                       | 9.2.1.1.3 |
| GTP-U-CONTROL-RX-RELEASE.confirm  | -                          | 9.2.1.1.4 |
| GTP-U-CONTROL-RX-ERROR.indication | Cause                      | 9.2.1.1.5 |

##### 9.2.1.1.1 GTP-U-CONTROL-RX-SETUP.request

This primitive is used to allocate packet reception resources according to a QoS profile specified via the 'QoS' parameter. These resources are to be associated to a tunnel endpoint identified via the TEID specified in the 'TEID' parameter. In case this TEID is already being used, this shall be interpreted as a resource modification request.

The 'IP address' parameter is used to identify the IP address of the remote GTP-U protocol entity where the GTP-U tunnel is terminated. This implicitly identifies the path being used. The knowledge of the path being used is necessary in order to send ECHO messages used to detect path failure.

#### 9.2.1.1.2 GTP-U-CONTROL-RX-SETUP.confirm

This primitive acknowledges the corresponding resources set up request. Any information to report is delivered in the parameter 'Result', which may be used to indicate set up failure and the reason of the failure.

#### 9.2.1.1.3 GTP-U-CONTROL-RX-RELEASE.request

This primitive is used to dispose the resources associated to a tunnel identified by TEID.

#### 9.2.1.1.4 GTP-U-CONTROL-RX-RELEASE.confirm

This primitive acknowledges the corresponding resources release request.

#### 9.2.1.1.5 GTP-U-CONTROL-RX-ERROR.indication

This primitive is used to indicate to the controlling entity any error conditions detected on the GTP-U reception section. The error condition is specified in the parameter 'Cause'.

### 9.2.1.2 GTP-U-CONTROL-TX primitives

**Table 51**

| Primitive                         | Parameters                 | Reference |
|-----------------------------------|----------------------------|-----------|
| GTP-U-CONTROL-TX-SETUP.request    | QoS info; IP address; TEID | 9.2.1.2.1 |
| GTP-U-CONTROL-TX-SETUP.confirm    | Result                     | 9.2.1.2.2 |
| GTP-U-CONTROL-TX-RELEASE.request  | TEID; IP address           | 9.2.1.2.3 |
| GTP-U-CONTROL-TX-RELEASE.confirm  | -                          | 9.2.1.2.4 |
| GTP-U-CONTROL-TX-ERROR.indication | Cause                      | 9.2.1.2.5 |

#### 9.2.1.2.1 GTP-U-CONTROL-TX-SETUP.request

This primitive is used to allocate packet transmission resources according to a QoS profile specified via the 'QoS' parameter. These resources are to be associated to a tunnel endpoint identified via the TEID specified in the 'TEID' parameter. In case this TEID is already being used, this shall be interpreted as a resource modification request.

The 'IP address' parameter is used to identify the IP address of the remote GTP-U protocol entity where the GTP-U tunnel is terminated. This implicitly identifies the path being used. The knowledge of the path being used is necessary in order to send ECHO messages to detect PATH failure.

#### 9.2.1.2.2 GTP-U-CONTROL-TX-SETUP.confirm

This primitive acknowledges the corresponding resources set up request. Any information to report is delivered in the parameter 'Result', which maybe used to indicate set up failure and the reason of the failure.

#### 9.2.1.2.3 GTP-U-CONTROL-TX-RELEASE.request

This primitive is used to dispose the resources associated to a tunnel identified by TEID and the IP address of the remote GTP-U protocol entity where the tunnel is terminated.

#### 9.2.1.2.4 GTP-U-CONTROL-TX-RELEASE.confirm

This primitive acknowledges the corresponding resources release request.

9.2.1.2.5 GTP-U-CONTROL-TX-ERROR.indication

This primitive is used to indicate to the controlling entity any error conditions detected on the GTP-U Transmission section. The error condition is specified in the parameter 'Cause'.

9.2.2 GTP-U-UNIT-DATA SAP and Primitives

The GTP-U-UNIT-DATA SAP is used to send and receive T-PDUs in an unacknowledged mode. Sequence numbers and system dependent info is conditionally passed to the user plane entity using the GTP-U-. This information is identified as 'Other info' in the following.

Table 52

| Primitive  | Parameters                                       | Reference |
|--|--|-----------|
| GTP-U-UNIT-DATA.request  | DATA; TEID; IP address; <i>Other info</i> (note) | 9.2.2.1   |
| GTP-U- UNIT-DATA.indication  | DATA; TEID; <i>Other info</i> (note)             | 9.2.2.2   |
| NOTE: It is conditionally present (only if the TEID is associated to tunnels providing in sequence delivery, see subclause 9.1.1). |  |           |

9.2.2.1 GTP-U-UNIT-DATA.request

This primitive is used to send a T-PDU (DATA) by means of a specific GTP-U layer resource (tunnel) identified by the parameter TEID and the IP address where the tunnel is terminated. *Other info* may be conditionally present and transmitted together with T-PDUs.

9.2.2.2 GTP-U- UNIT-DATA.indication

A T-PDU (DATA) is received from a GPT-U peer entity and delivered to a user plane entity. The T-PDU is associated to the to the PDP or RNC context identified by TEID (that is the Tunnel Endpoint ID). *Other info* may be conditionally present and delivered together with T-PDUs.

9.3 Protocol Stack

The GTP-U protocol is used to transmit T-PDUs between GSN pairs (or between an SGSN and an RNC in UMTS), encapsulated in G-PDUs. A G-PDU is a packet including a GTP-U header and a T-PDU. The Path Protocol defines the path and the GTP-U header defines the tunnel. Several tunnels may be multiplexed on a single path. The frames have the following general structure.

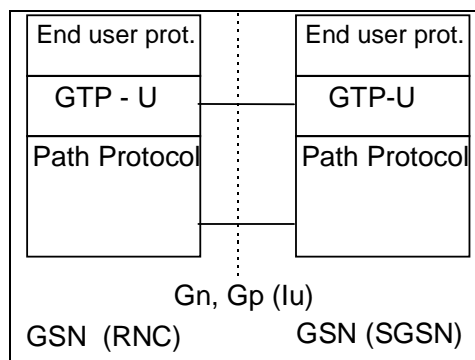

Figure 65: GTP-U - Protocol Stack (GTP-U over the lu in brackets)

9.3.1 Usage of the GTP-U Header

The GTP-U header shall be used as specified in clause 6 with the following details:

- Version shall be set to decimal 1 ('001').

- Protocol Type flag (PT) shall be set to '1'.
- If the Sequence Number flag (S) is set to '1' the sequence number field is present and meaningful otherwise it is set to '0'. For GTP-U messages Echo Request, Echo Response, Error Indication and Supported Extension Headers Notification, the S flag shall be set to '1'.
- N-PDU Number flag (PN): the GTP-U header contains a meaningful N-PDU Number field if the PN flag is set to 1.
- Message Type shall be set according to table 1. The value 255 is used when T-PDUs are transmitted. The value 1 and 2 are used for "Echo" messages. The value 26 is used for "Error Indication" message. The value 31 is used for "Supported Extension Headers Notification" message.
- Length: This field indicates the length in octets of the payload, i.e. the rest of the packet following the mandatory part of the GTP header (that is the first 8 octets). The Sequence Number, the N-PDU Number or any Extension headers shall be considered to be part of the payload, i.e. included in the length count.
- Sequence Number: This field is meaningful if and only if the S field is set to 1. Its presence is defined in clause 6. The handling of this field is specified in subclause 9.1.1. It shall be used in order to decide whether or not to discard a received T-PDU, as specified in subclause 9.3.1.1 Usage of the Sequence Number or as a transaction identity for GTP-U signalling messages having a response message defined for a request message. For GTP-U message, Supported Extension Headers Notification and Error Indication the Sequence Number shall be ignored by the receiver.
- N-PDU Number: This field is meaningful if and only if the PN flag is set to 1. Its presence is defined in clause 6. In this case, the old SGSN (or RNC) uses it, at the Inter SGSN Routeing Area Update procedure (or SRNS relocation), to inform the new SGSN (or RNC) of the N-PDU number assigned to T-PDU. If an N-PDU number was not assigned to the T-PDU by PDCP, or if the T-PDU is to be transferred using unacknowledged peer-to-peer LLC operation, then PN shall be set to 0.
- TEID: Contains the Tunnel Endpoint Identifier for the tunnel to which this T-PDU belongs. The TEID shall be used by the receiving entity to find the PDP context, except for the following cases:
  - The Echo Request/Response and Supported Extension Headers notification messages, where the Tunnel Endpoint Identifier shall be set to all zeroes.
  - The Error Indication message where the Tunnel Endpoint Identifier shall be set to all zeros.

### 9.3.1.1 Usage of Sequence Number

The sending GGSN and SRNC shall use 0 for the value of the Sequence Number of the first G-PDU in a tunnel, only during the PDP context activation, and shall increment the Sequence Number for each following G-PDU. The value shall wrap to zero after 65535.

The receiving GGSN and SRNC shall set the content of a counter to zero, only during the PDP context activation. When the receiving GGSN and SRNC receives a valid G-PDU, it shall increment this counter by one. This counter shall wrap to zero after 65535. It defines the 'Expected Sequence Number'.

Based on the received and Expected Sequence Number values, the receiving GGSN and SRNC may decide whether or not to discard the received G-PDU. Annex A (Informative) describes a method to determine whether a received G-PDU is valid.

The receiving GGSN and SRNC shall reorder the incoming T-PDUs in sequence if the Reordering Required flag in the PDP context is set. In this case, if needed, the receiving GGSN and SRNC shall take into account a maximum number of valid received frames and a maximum elapsed time to assume that a G-PDU was lost.

The G-PDU sequence numbers allocated by the GGSN (down-link) and SRNC (uplink) are kept unchanged irrespective of the number of GTP tunnels the PDU is transferred over. Therefore, SGSN shall use on the Iu interface for down-link PDUs the G-PDU sequence number received from the GGSN, and shall use on the Gn interface for uplink PDUs the G-PDU sequence number received from the SRNC. In case of SRNS relocation and intersystem change, the SRNC and SGSN shall tunnel PDUs without changing the G-PDU sequence numbers.

## 9.4 Tunnelling between SGSNs

T-PDUs, stored in the old SGSN and not yet sent to the MS, shall be tunnelled to the new SGSN as a part of the Inter SGSN Routing Update procedure described in 3GPP TS 23.060 [4]. Some T-PDUs may still be on their way from the GGSN to the old SGSN because they have been sent before the tunnel change. These T-PDUs shall also be tunnelled to the new SGSN.

For intersystem SRNS Relocation, the establishment of the GTP tunnel(s) for the forwarding of G-PDUs is as described in the 3GPP TS 23.121 [17] and in the 3GPP TS 23.060 [4] specifications.

## 9.5 Tunnelling between Source RNC and Target RNC

For the 3G-3G SRNS Relocation, the establishment of the GTP tunnel for the forwarding of G-PDUs between source and target RNC, is as described in the 3GPP TS 23.121 [17] and in the 3GPP TS 23.060 [4] specifications.

## 9.6 Tunnelling between GGSNs

GTP shall not specify tunnelling between GGSNs. Transfer of MS-to-MS traffic between GGSNs shall use the Gi interface.

---

# 10 Path Protocols

## 10.1 UDP/IP

UDP/IP is the only path protocol defined to transfer GTP messages in the version 1 of GTP. A User Datagram Protocol (UDP) compliant with RFC 768 shall be used.

### 10.1.1 UDP Header

#### 10.1.1.1 Request Messages

The UDP Destination Port number for GTP-C request messages is 2123. It is the registered port number for GTP-C.

The UDP Destination Port number for GTP-U request messages is 2152. It is the registered port number for GTP-U.

The UDP Source Port is a locally allocated port number at the sending GSN/RNC.

#### 10.1.1.2 Response Messages

The UDP Destination Port value shall be the value of the UDP Source Port of the corresponding request message.

The UDP Source Port shall be the value from the UDP Destination Port of the corresponding request message.

#### 10.1.1.3 Encapsulated T-PDUs

The UDP Destination Port number shall be 2152. It is the registered port number for GTP-U. The UDP Source Port is a locally allocated port number at the sending GSN/RNC.

#### 10.1.1.4 Error Indication, RAN Information Relay, Version Not Supported and Supported Extension Headers Notification

The UDP destination port for the Error Indication shall be the user plane UDP port (2152).

The UDP destination port for the Version Not Supported and the RAN Information Relay messages shall be the control plane UDP port (2123).

The UDP destination port for the Supported Extension Headers Notification shall be the UDP port for User plane (2152) if the trigger for it was a user plane message, the control plane port (2123) if the trigger for it was a control plane message.

The UDP source port shall be locally assigned at the sending node.

## 10.1.2 IP Header

An Internet Protocol (IP) compliant with RFC 791 shall be used.

### 10.1.2.1 Request Messages and Encapsulated T-PDUs

The IP Source Address shall be an IP address of the source GSN/RNC from which the message is originating.

The IP Destination Address in a GTP request message shall be an IP address of the destination GSN/RNC. The IP Destination Address in an encapsulated T-PDU GTP shall be an IP address of the destination GSN/RNC.

### 10.1.2.2 Response Messages

The IP Source Address shall be an IP address of the source GSN/RNC from which the message is originating.

The IP Destination Address shall be copied from the IP Source Address of the GTP request message to which this GSN/RNC is replying.

NOTE: The source IP address of the Echo Response message shall be the same as the destination IP address of the Echo Request message.

### 10.1.2.3 Error Indication, RAN Information Relay, Version Not supported and Supported Extension Headers Notification

The IP source address shall be an address of the source GSN/RNC from which the message is originated. In particular, the source Address of the "Version Not Supported" or the "Supported Extension Headers Notification" message, shall be set to the destination address of the message that triggered the GSN/RNC to send the "Version Not Supported" or the "Supported Extension Headers Notification" message.

The IP destination address for Error Indication, Version Not Supported and Supported Extension Headers Notification shall be the source address of the GTP-PDU that is the cause for the GSN/RNC to send one of these messages. The IP destination address for RAN Information Relay is the address of the SGSN which the messages is relayed to.

---

# 11 Error Handling

## 11.1 Protocol Errors

A protocol error is defined as a message with unknown, unforeseen or erroneous content. The term silently discarded used in the following subclauses means that the implementation shall discard the message without further processing and should log the event including the erroneous message and should include the error in a statistical counter.

An information element with 'Mandatory' in the 'Presence requirement' column of a message definition shall always be present in that message.

The conditions for a conditional information element define whether the information element is semantically:

- mandatorily present;
- optionally present;
- mandatorily absent.

An information element, which is semantically mandatorily present but is omitted from the message, is treated as missing data.



An information element, which is semantically mandatorily absent but is present in the message, is treated as unexpected data.

The Error Indication, Version Not Supported, RAN Information Relay, Supported Extension Headers Notification and the SGSN Context Acknowledge messages shall be considered as Responses for the purpose of this subclause.

The subclauses 11.1.1 to 11.1.13 shall be applied in decreasing priorities.

### 11.1.1 Different GTP Versions

If a receiving node receives a GTP message of an unsupported version, that node shall return a GTP Version Not Supported message indicating in the Version field of the GTP header the latest GTP version that that node supports. The received GTP-PDU shall then be discarded.

A GTP version '0' only GSN may not be listening on port 2123 and as such it will not be able to send back a Version Not Supported message to a peer trying to establish a dialogue with it using GTP-C. As such, a GSN supporting both version '1' and version '0' shall fall back to version '0' if the attempt to contact a peer using version '1' fails.

It is an implementation option keeping a shortlist of recently contacted version '0' only GSNs, as well of the version supported by those nodes sending back a Version Not Supported message.

### 11.1.2 GTP Message Too Short

When a GTP message is received, and is too short to contain the GTP header for the GTP version that the sender claims to use, the GTP-PDU message shall be silently discarded.

### 11.1.3 Unknown GTP Signalling Message

When a message using a Message Type value defining an Unknown GTP signalling message is received, it shall be silently discarded.

### 11.1.4 Unexpected GTP Signalling Message

When an unexpected GTP control plane message is received, e.g. a Response message for which there is no corresponding outstanding Request, or a GTP control plane message a GSN is not expected to handle (such as a PDU Notification Request received by a GGSN), it shall be silently discarded.

### 11.1.5 Missing Mandatorily Present Information Element

The receiver of a GTP signalling Request message with a missing mandatorily present information element shall discard the request, should log the error, and shall send a Response with Cause set to 'Mandatory IE missing'. The receiver of a Response with a missing mandatory information element shall notify the upper layer and should log the error.

### 11.1.6 Invalid Length

In a received GTP signalling message Request, a mandatory TLV format information element may have a Length different from the Length defined in the version that this message claims to use. In this case, this information element shall be discarded, the error should be logged, and a Response shall be sent with Cause set to 'Mandatory IE incorrect'.

In a received GTP signalling message Response, if a mandatory TLV format information element has a Length different from the Length defined in the version that this message claims to use, then the requesting entity shall treat the GTP signalling procedure as having failed.

### 11.1.7 Invalid Mandatory Information Element

The receiver of a GTP signalling message Request including a mandatory information element with a Value that is not in the range defined for this information element value shall discard the request, should log the error, and shall send a response with Cause set to 'Mandatory IE incorrect'.

The receiver of a GTP signalling message Response including a mandatory information element with a Value that is not in the range defined for this information element shall notify the upper layer that a message with this sequence number has been received and should log the error.

If a GSN receives an information element with a value which is shown as reserved, it shall treat that information element as not being in the range defined for the information element.

NOTE: The receiver does not check the content of an information element field that is defined as 'spare'.

### 11.1.8 Invalid Optional Information Element

The receiver of a GTP signalling message including an optional information element with a Value that is not in the range defined for this information element value shall discard this IE, should log the error, and shall treat the rest of the message as if this IE was absent.

If a GSN receives an information element with a value which is shown as reserved, it shall treat that information element as not being in the range defined for the information element.

NOTE: The receiver does not check the content of an information element field that is defined as 'spare'.

### 11.1.9 Unknown Information Element

An information element with an unknown Type value shall be ignored by the receiver of the message. If this is a TLV element, this information element shall be skipped using its Length value. If this is a TV element, the receiver shall discard the rest of the message.

If the receiving node cannot interpret the rest of the message because of the ignored information element, the receiving node shall discard the message and should log the error. If the message was a Request, it shall, in addition, return a response with Cause set to 'Invalid message format'.

### 11.1.10 Out of Sequence Information Elements

If two or more information elements are out of sequence in a message, the receiving node shall discard the message and should log the error. In addition, if the message was a Request, the receiving node shall return a Response with Cause set to 'Invalid message format'.

### 11.1.11 Unexpected Information Element

An information element with a Type value which is defined in GTP but is not expected in the received GTP signalling message shall be ignored (skipped) and the rest of the message processed as if this information element was not present.

### 11.1.12 Repeated Information Elements

If an information element is repeated in a GTP signalling message in which repetition of the information element is not specified, only the contents of the information element appearing first shall be handled and all subsequent repetitions of the information element shall be ignored. When repetition of information elements is specified, only the contents of specified repeated information elements shall be handled.

### 11.1.13 Incorrect Optional Information Elements

All optional information elements that are incorrect in a GTP signalling message shall be treated as not present in the message. However, if the receiving node may not handle the message correctly because of the incorrect information element, the receiving node should log the error and shall return a response with Cause set to 'Optional IE incorrect'.

## 11.2 Path Failure

A path counter shall be reset each time a response is received on the path and incremented when the T3-RESPONSE timer expires for any message sent on the path. The path shall be considered to be down if the counter exceeds N3-

REQUESTS. In this case, the GSN or RNC may notify the Operation and Maintenance network element. GTP shall also notify the upper layer of the path failure, so that PDP contexts associated with this path may be deleted.

## 11.3 MS Detach

When an MS detaches, all ongoing GTP control plane procedures related to this MS shall be aborted. The SGSN shall send Delete PDP Context Request messages for all active PDP contexts to the peer GGSNs.

## 11.4 Restoration and Recovery

All GSNs shall maintain in non-volatile memory a Restart Counter of local significance. A GSN that restarts shall change the Restart Counter value immediately after the restart procedure has been completed. The value shall be incremented by 1 modulo 256 (see 3GPP TS 23.007 [3]).

All GSNs shall also maintain in volatile memory a Restart Counter for each GSN that it is in contact with. The Restart Counters stored for all GSNs that it is in contact with shall be cleared after the restart procedure has been completed (see 3GPP TS 23.007 [3]).

---

# 12 Security provided to GTP Communication over Gn and Gp Interfaces

Protection of GTP communication over Gn and Gp interfaces shall be provided according to security mechanisms defined in 3GPP TS 33.210 [22].

---

# 13 IP, The Networking Technology used by GTP

## 13.1 IP Version

On the Gn and Gp interfaces the IPv4 (RFC 791) protocol shall be supported, IPv6 (RFC 2460) support is optional. This also applies to the Iu interface, when the ATM transport option is applied. When the IP transport option is applied on the Iu interface, both the IPv6 (RFC 2460) protocol and the IPv4 (RFC 791) protocol shall be supported.

## 13.2 IP Fragmentation

Here it is described how the fragmentation mechanism shall work together with GTP, when the GPRS backbone is based on IPv4.

However, fragmentation should be avoided if possible. Examples of fragmentation drawbacks are, e.g.:

- Fragmentation is inefficient, since the complete IP header is duplicated in each fragment.
- If one fragment is lost, the complete packet has to be discarded. The reason is that no selective retransmission of fragments is possible.

By using Path MTU discovery the application may find out the MTU, and thereby utilise more efficient segmentation mechanisms in other protocol layers than IP.

The maximum size of a T-PDU that may be transmitted without fragmentation by GGSN or the MS is defined in 3GPP TS 23.060 [4]. All backbone links should have MTU values that exceeds the sum of the maximum value plus the size of the tunnel headers (IP header, UDP and GTP header) in order to avoid fragmentation in the backbone.

### 13.2.1 MO Direction

Functionality for IP fragmentation on the Iu interface is defined in 3GPP TS 25.414 [23].

**SGSN:** A packet from an MS shall be encapsulated at the SGSN with a GTP header, UDP and IP header. If the resulting IP packet is larger than the MTU of the first link towards the GGSN, fragmentation of the IP packet shall be performed by the SGSN. The SGSN should preferably fragment the IP packet if it is larger than the MTU of any link between SGSN and GGSN.

**Backbone router:** Any router in the backbone may fragment the GTP packet if needed, according to IPv4.

**GGSN:** The GGSN shall assemble any IP fragments received from SGSNs, according to IPv4. Note that if any fragment is lost, the whole packet shall be discarded.

### 13.2.2 MT Direction

Functionality for IP fragmentation on the Iu interface is defined in 3GPP TS 25.414 [23].

**GGSN:** A packet from an external host shall be encapsulated at the GGSN with a GTP header, UDP and IP header. If the resulting IP packet is larger than the MTU on the first link towards the SGSN, fragmentation of the IP packet shall be performed by the GGSN. The GGSN should preferably fragment the IP packet if it is larger than the MTU of any link between GGSN and SGSN.

**Backbone Router:** Any router in the backbone may fragment the GTP packet if needed, according to IPv4.

**SGSN:** The SGSN shall assemble any IP fragments received from the GGSN, according to IPv4. Note that if any fragment is lost, the whole packet shall be discarded.

### 13.2.3 Tunnelling from old to new SGSN

**Old SGSN:** A user packet shall be encapsulated with a GTP header, UDP and IP header. If the resulting IP packet is larger than the MTU on the first link towards the new SGSN, fragmentation of the IP packet shall be performed by the old SGSN. The old SGSN should preferably fragment the IP packet if it is larger than the MTU of any link between old and new SGSN.

**Backbone router:** Any router in the backbone may fragment the GTP packet if needed, according to IPv4.

**New SGSN:** The new SGSN shall assemble any IP fragments received from the old SGSN, according to IPv4. Note that if any fragment is lost, the whole packet shall be discarded.

---

## 14 GTP Parameters

The GTP system parameters defined here and their recommended values shall not be fixed, but shall be possible to configure as described in section 'Reliable delivery of messages'.

### 14.1 Timers

The timer T3-RESPONSE holds the maximum wait time for a response of a request message.

The timer T3-TUNNEL holds the time when PDUs shall be forwarded from the old SGSN to the new SGSN. The timer is started in the old SGSN when it receives a GTP SGSN Context Request message and there is at least one active PDP context. GTP shall indicate to the upper layer when the timer has expired. The recommended timer value is 20 s.

### 14.2 Others

The counter N3-REQUESTS holds the maximum number of attempts made by GTP to send a request message. The recommended value is 5.

---

## Tables

|   |    |
|---|----|
| Table 1: Messages in GTP.....   | 15 |
| Table 2: Information Elements in an Echo Request .....                                | 17 |
| Table 3: Information Elements in an Echo Response.....                                | 17 |
| Table 4: Information Elements in Supported Extension Headers Notification .....       | 18 |
| Table 5: Information Elements in a Create PDP Context Request .....                   | 20 |
| Table 6: Information Elements in a Create PDP Context Response.....                   | 22 |
| Table 7: Information Elements in an SGSN-Initiated Update PDP Context Request .....   | 24 |
| Table 8: Information Elements in a GGSN-Initiated Update PDP Context Request.....     | 24 |
| Table 9: Information Elements in an Update PDP Context Response sent by a GGSN.....   | 27 |
| Table 10: Information Elements in an Update PDP Context Response sent by a SGSN ..... | 27 |
| Table 11: Information Elements in a Delete PDP Context Request .....                  | 28 |
| Table 12: Information Elements in a Delete PDP Context Response.....                  | 29 |
| Table 13: Information Elements in an Error Indication.....                            | 30 |
| Table 14: Information Elements in a PDU Notification Request .....                    | 30 |
| Table 15: Information Elements in a PDU Notification Response.....                    | 31 |
| Table 16: Information Elements in a PDU Notification Reject Request .....             | 32 |
| Table 17: Information Elements in a PDU Notification Reject Response.....             | 32 |
| Table 18: Information Elements in a Send Routing Information for GPRS Request .....   | 33 |
| Table 19: Information Elements in a Send Routing Information for GPRS Response.....   | 34 |
| Table 20: Information Elements in a Failure Report Request .....                      | 34 |
| Table 21: Information Elements in a Failure Report Response.....                      | 35 |
| Table 22: Information Elements in a Note MS Present Request .....                     | 35 |
| Table 23: Information Elements in a Note MS Present Response.....                     | 35 |
| Table 24: Information Elements in an Identification Request.....                      | 36 |
| Table 25: Information Elements in an Identification Response .....                    | 37 |
| Table 26: Information Elements in a SGSN Context Request.....                         | 38 |
| Table 27: Information Elements in a SGSN Context Response .....                       | 39 |
| Table 28: Information Elements in a SGSN Context Acknowledge .....                    | 40 |
| Table 29: Information Elements in a Forward Relocation Request.....                   | 41 |
| Table 30: Information Elements in a Forward Relocation Response .....                 | 42 |
| Table 31: Information Elements in a Forward Relocation Complete .....                 | 42 |
| Table 32: Information Elements in a Relocation Cancel Request .....                   | 42 |
| Table 33: Information Elements in a Relocation Cancel Response.....                   | 43 |

|  |    |
|--|----|
| Table 34: Information elements in a Forward Relocation Complete Acknowledge..... | 43 |
| Table 35: Information elements in a Forward SRNS Context Acknowledge.....        | 43 |
| Table 36: Information Elements in a Forward SRNS Context .....                   | 44 |
| Table 7.5.14.1: Information Elements in a RAN Information Relay.....             | 44 |
| Table 37: Information Elements.....  | 45 |
| Table 38: Cause Values.....  | 47 |
| Table 39: Use of the Cause Values.....   | 48 |
| Table 40: Reordering Required Values .....                                       | 50 |
| Table 41: MS Validated Values .....  | 51 |
| Table 42: Selection Mode Values.....   | 52 |
| Table 43: Teardown Ind .....   | 54 |
| Table 44: PDP Type Organisation Values.....                                      | 58 |
| Table 45: ETSI defined PDP Type Values .....                                     | 58 |
| Table 46: Used Cipher Values.....  | 61 |
| Table 47: Security Mode Values .....   | 61 |
| Table 48: Reordering Required Values .....                                       | 63 |
| Table 49: VPLMN Address Allowed Values .....                                     | 64 |
| Table 50.....  | 74 |
| Table 51.....  | 75 |
| Table 52.....  | 76 |

---

## Figures

|   |    |
|---|----|
| Figure 1: GPRS Logical Architecture with interface name denotations .....       | 11 |
| Figure 2: Outline of the GTP Header .....                                       | 13 |
| Figure 3: Outline of the Extension Header Format .....                          | 13 |
| Figure 4: Definition of bits 7 and 8 of the Extension Header Type.....          | 14 |
| Figure 5: Definition of Extension Header Type .....                             | 14 |
| Figure 6: PDCP PDU number Extension Header .....                                | 14 |
| Figure 7: Suspend Request Extension Header.....                                 | 15 |
| Figure 8: Suspend Response Extension Header .....                               | 15 |
| Figure 7: GGSN - HLR Signalling via a GTP-MAP Protocol-Converter in a GSN ..... | 33 |
| Figure 8: Type field for TV and TLV format.....                                 | 45 |
| Figure 9: Cause information element .....                                       | 47 |
| Figure 10: IMSI Information Element.....  | 49 |
| Figure 11: RAI Information Element .....  | 49 |
| Figure 12: TLLI Information Element .....                                       | 49 |
| Figure 13: The Packet TMSI Information Element.....                             | 50 |
| Figure 14: Reordering Required Information Element.....                         | 50 |
| Figure 15: Authentication Triplet Information Element.....                      | 50 |
| Figure 16: MAP Cause Information Element.....                                   | 51 |
| Figure 17: P-TMSI Signature Information Element.....                            | 51 |
| Figure 18: MS Validated Information Element .....                               | 51 |
| Figure 19: Restart Counter Information Element .....                            | 52 |
| Figure 20: Selection Mode Information Element.....                              | 52 |
| Figure 21: Tunnel Endpoint Identifier Data I Information Element.....           | 52 |
| Figure 22: Tunnel Endpoint Identifier Control Plane Information Element.....    | 53 |
| Figure 23: Tunnel Endpoint Identifier Data II Information Element .....         | 53 |
| Figure 24: Teardown Ind Information Element.....                                | 53 |
| Figure 25: NSAPI Information Element.....                                       | 54 |
| Figure 26: RANAP Cause Information Element.....                                 | 54 |
| Figure 27: RAB Context Information Element .....                                | 55 |
| Figure 28: Radio Priority SMS Information Element .....                         | 55 |
| Figure 29: Radio Priority Information Element .....                             | 55 |
| Figure 30: Packet Flow Id Information Element .....                             | 55 |
| Figure 31: Charging Characteristics Information Element.....                    | 56 |

|   |    |
|---|----|
| Figure 32: Trace Reference Information Element .....  | 56 |
| Figure 33: Trace Type Information Element .....   | 56 |
| Figure 33a: MS Not Reachable Reason Information Element .....                                     | 57 |
| Figure 33b: Radio Priority LCS Information Element .....  | 57 |
| Figure 34: Charging ID Information Element .....  | 57 |
| Figure 35: End User Address Information Element .....   | 58 |
| Figure 36: End User Address Information Element for IPv4 .....                                    | 58 |
| Figure 37: End User Address Information Element for IPv6 .....                                    | 58 |
| Figure 38: End User Address Information Element for PPP .....                                     | 59 |
| Figure 40: MM Context Information Element with GSM Key and Triplets .....                         | 60 |
| Figure 41: MM Context Information Element with UMTS Keys and Quintuplets .....                    | 60 |
| Figure 42: MM Context Information Element with GSM Keys and UMTS Quintuplets .....                | 60 |
| Figure 42A: MM Context Information Element with Used Cipher value, UMTS Keys and Quintuplets..... | 61 |
| Figure 43: PDP Context Information Element .....  | 63 |
| Figure 44: Access Point Name Information Element .....  | 64 |
| Figure 45: Protocol Configuration Options Information Element.....                                | 64 |
| Figure 46: GSN Address Information Element .....  | 65 |
| Figure 47: MSISDN Information Element .....   | 65 |
| Figure 48: Quality of Service (QoS) Profile Information Element .....                             | 66 |
| Figure 49: Authentication Quintuplet Information Element .....                                    | 66 |
| Figure 50: Traffic Flow Template Information Element .....  | 67 |
| Figure 51: Target Identification Information Element .....  | 67 |
| Figure 52: UTRAN Transparent Container Information Element.....                                   | 67 |
| Figure 53: RAB Setup Information IE for data forwarding .....                                     | 68 |
| Figure 54: RAB Setup Information IE for release of resources .....                                | 68 |
| Figure 55: Extension Header Type List Information Element .....                                   | 68 |
| Figure 56: Trigger Id Information Element.....  | 69 |
| Figure 57: OMC Identity Information Element.....  | 69 |
| Figure 58: RAN Transparent Container Information Element.....                                     | 69 |
| Figure 59a: Ipv4 Charging Gateway Address Information Element .....                               | 69 |
| Figure 59b: Ipv6 Charging Gateway Address Information Element .....                               | 70 |
| Figure 60 : PDP Context Prioritization Information Element .....                                  | 70 |
| Figure 60a: Additional RAB Setup Information IE for data forwarding.....                          | 70 |
| Figure 60b: Additional RAB Setup Information IE for release of resources .....                    | 71 |
| Figure 61: Private Extension Information Element.....   | 71 |



Figure 62: Signalling Plane - Protocol Stack.....71

Figure 63: GTP Header followed by subsequent Information Elements.....73

Figure 64: The GTP-U-Control SAP and GTP-U-DATA SAP.....74

Figure 65: GTP-U - Protocol Stack (GTP-U over the Iu in brackets) .....76

---

## Annex A (informative): A method for sequence number checking

This annex describes a method to determine whether or not a received T-PDU is valid, for the Usage of the Sequence Number, subclause 9.3.1.1.

This method deals with two distinct problems.

The first one is the 'drifting' between the Sequence Number value that we expect to receive in the light of the total number of T-PDU received for this tunnel (the Expected value), and the effective received value. The probability that the received T-PDU is not correct because not awaited is higher if the distance between expected and received Sequence Numbers is high than if this distance is low. This leads to Condition 1. Its left part represents the distance between the Expected and received values, in a circular 65536 dimension.

The second one is the duplication of T-PDU frames within a given number of last received frames that have been accepted by the condition 1.

This leads to the following actions:

- This operation shall start when the dialogue is established between the GSNs. When each T-PDU is received during the dialogue, if this T-PDU is valid, its Sequence Number shall be saved. The last 'A' saved Sequence Numbers represent the 'Recorded Sequence Number Set'.

A received T-PDU sequence number is valid only if it satisfies both of the following conditions:

- 1)  $\text{Min}(\text{Abs}(E - r), \text{Abs}(r - 65536 - E), \text{Abs}(E - 65536 - r)) < 'B'$  Condition 1  
Where: 'E' is the Expected Sequence Number and 'r' is the received Sequence Number.
- 2) The received Sequence Number is not a member of the Recorded Sequence Number Set. Condition 2.

'A' and 'B' are parameters. The receiving GSN shall discard a received T-PDU with an invalid Sequence Number.

$\text{Abs}(X)$  represents the absolute value of the number X.

$\text{Min}(X, Y, Z)$  represents the lowest value taken from the numbers X, Y, and Z.

## Annex B (informative): Change history

| Change history |           |         |       |         |             |   |
|----------------|-----------|---------|-------|---------|-------------|---|
| TSG CN#        | Spec      | Version | CR    | <Phase> | New Version | Subject/Comment   |
| Apr 1999       | GSM 09.60 | 7.0.0   |       |         |             | Transferred to 3GPP CN1   |
| CN#03          | 29.060    |         |       | R99     | 3.0.0       | Approved at CN#03   |
|                |           |         | 001   | R99     |             | Replacing the V(R) transfer mechanism with the N-PDU number transfer mechanism in routing area update |
| CN#4           | 29.060    | 3.0.0   | 002   | R99     | 3.1.0       | Clarification of ambiguous/superfluous information  |
|                |           |         | 003   | R99     |             | Timer handling in GTP   |
|                |           |         | 005   | R99     |             | Mandatory SGSN Context Acknowledge message  |
|                |           |         | 006   | R99     |             | Mandatory info in MM Context IE   |
|                |           |         | 007   | R99     |             | APN to be transferred in the PDP context at inter SGSN RA update                                      |
|                |           |         | 008   | R99     |             | Consistency on implemented CRs from SMG#28  |
|                |           |         | 009   | R99     |             | Removal of changes in PDP context establishment and restoration                                       |
|                |           |         | 010   | R99     |             | MSISDN in the Create PDP Context request  |
| CN#05          | 29.060    | 3.1.0   | 014r2 | R99     | 3.2.0       | Specification of the MSISDN Information Element in GSM 09.60  |
| CN#06          | 29.060    | 3.2.1   | 017r4 | R99     | 3.3.0       | QoS enhancements  |
| CN#06          | 29.060    | 3.2.1   | 031   | R99     | 3.3.0       | Merged CRs on GTP Enhancements  |
| CN#07          | 29.060    | 3.3.0   | 033r2 | R99     | 3.4.0       | Addition of Radio Priority to the SGSN Context Response   |
| CN#07          | 29.060    | 3.3.0   | 035r2 | R99     | 3.4.0       | Addition of Packet Flow Id to the SGSN Context Response   |
| CN#07          | 29.060    | 3.3.0   | 036r1 | R99     | 3.4.0       | Change the attribution of the PDP Context IE  |
| CN#07          | 29.060    | 3.3.0   | 037   | R99     | 3.4.0       | Add new cause value   |
| CN#07          | 29.060    | 3.3.0   | 038   | R99     | 3.4.0       | Addition of NSAPI to GGSN-initiated Update PDP Context  |
| CN#07          | 29.060    | 3.3.0   | 040   | R99     | 3.4.0       | Improving charging efficiency   |
| CN#07          | 29.060    | 3.3.0   | 041r1 | R99     | 3.4.0       | Subscriber and equipment trace for PS domain  |
| CN#07          | 29.060    | 3.3.0   | 042   | R99     | 3.4.0       | Necessity of the function of the calculation an SGSN IP address from the target ID                    |
| CN#07          | 29.060    | 3.3.0   | 045r1 | R99     | 3.4.0       | Removal of Anonymous Access   |
| CN#07          | 29.060    | 3.3.0   | 046r1 | R99     | 3.4.0       | Clarification of Authentication Type and Import of Parameters   |
| CN#07          | 29.060    | 3.3.0   | 048   | R99     | 3.4.0       | Correction of IE types and order  |
| CN#07          | 29.060    | 3.3.0   | 050r2 | R99     | 3.4.0       | Clarification on Protocol Type in GTP Header  |
| CN#07          | 29.060    | 3.3.0   | 051   | R99     | 3.4.0       | Clarification of Repeated Information Element Ordering  |
| CN#07          | 29.060    | 3.3.0   | 052r2 | R99     | 3.4.0       | Method for GTP extension headers support  |
| CN#07          | 29.060    | 3.3.0   | 053r2 | R99     | 3.4.0       | The addition of the conditional description of the GTP parameters                                     |
| CN#07          | 29.060    | 3.3.0   | 056   | R99     | 3.4.0       | Change of naming when referring to primary and secondary contexts                                     |
| CN#07          | 29.060    | 3.3.0   | 057   | R99     | 3.4.0       | Removal of X.25   |
| CN#07          | 29.060    | 3.3.0   | 058r1 | R99     | 3.4.0       | Use of 3 Digit MNCs in GTP for R'99   |
| CN#07          | 29.060    | 3.3.0   | 063r2 | R99     | 3.4.0       | QoS Profile IE modification   |
| CN#07          | 29.060    | 3.3.0   | 067r1 | R99     | 3.4.0       | Distribution of security data   |
| CN#07          | 29.060    | 3.3.0   | 069r1 | R99     | 3.4.0       | New cause codes for TFT and packet filter errors  |
| CN#07          | 29.060    | 3.3.0   | 070   | R99     | 3.4.0       | IPv6 support as optional in lu and Gn   |
| CN#07          | 29.060    | 3.3.0   | 072r4 | R99     | 3.4.0       | Clarification on the use of TEID in the GTP header  |
| CN#07          | 29.060    | 3.3.0   | 073   | R99     | 3.4.0       | Clarification to the function of the calculation of an SGSN IP address from the target ID             |
| CN#07          | 29.060    | 3.3.0   | 075   | R99     | 3.4.0       | Changing references from GSM specifications to 3GPP TS  |
| CN#07          | 29.060    | 3.3.0   | 076   | R99     | 3.4.0       | New table for Information Elements  |
| CN#07          | 29.060    | 3.3.0   | 077   | R99     | 3.4.0       | Forward SRSN Context  |
| CN#07          | 29.060    | 3.3.0   | 078r1 | R99     | 3.4.0       | PDCP sequence numbers in SRNC relocation and inter-system handover                                    |
| CN#07          | 29.060    | 3.3.0   | 079   | R99     | 3.4.0       | Removal of TCP support in the packet domain PLMN backbone network                                     |
| CN#07          | 29.060    | 3.3.0   | 081   | R99     | 3.4.0       | Addition of PDP Context Identifier to PDP Context Information Element                                 |

| Change history |        |         |       |         |             |   |
|----------------|--------|---------|-------|---------|-------------|---|
| TSG CN#        | Spec   | Version | CR    | <Phase> | New Version | Subject/Comment   |
| CN#07          | 29.060 | 3.3.0   | 083   | R99     | 3.4.0       | Editorial clarification of information elements in the SGSN Context Response      |
| CN#08          | 29.060 | 3.4.0   | 084   | R99     | 3.5.0       | 16-bit PDCP sequence numbers in GTP header  |
| CN#08          | 29.060 | 3.4.0   | 085   | R99     | 3.5.0       | Mandatory inclusion of IMSI in SGSN Context Response if P-TMSI Signature Mismatch |
| CN#08          | 29.060 | 3.4.0   | 086r1 | R99     | 3.5.0       | Encoding of spare IMSI Digits   |
| CN#08          | 29.060 | 3.4.0   | 087r1 | R99     | 3.5.0       | Reliable delivery of signalling messages  |
| CN#08          | 29.060 | 3.4.0   | 088   | R99     | 3.5.0       | Possible cause codes for Relocation Cancel Response                               |
| CN#08          | 29.060 | 3,4,0   | 089   | R99     | 3.5.0       | Condition for evaluating the sequence number fields in PDP context                |
| CN#08          | 29.060 | 3.4.0   | 090r1 | R99     | 3.5.0       | Target RNC Information  |
| CN#08          | 29.060 | 3.4.0   | 091r1 | R99     | 3.5.0       | Change of the length of TI  |
| CN#08          | 29.060 | 3.4.0   | 092r1 | R99     | 3.5.0       | Clean up for 29.060   |
| CN#08          | 29.060 | 3.4.0   | 093r2 | R99     | 3.5.0       | Clarification on the TEID handling  |
| CN#08          | 29.060 | 3.4.0   | 094r1 | R99     | 3.5.0       | QoS Profile IE modification   |
| CN#08          | 29.060 | 3.4.0   | 096   | R99     | 3.5.0       | Restart counter in Echo response  |
| CN#08          | 29.060 | 3.4.0   | 097r1 | R99     | 3.5.0       | Clarification on the use of TEID in the GTP-C header                              |
| CN#08          | 29.060 | 3.4.0   | 098   | R99     | 3.5.0       | Add APN IE for PDU Notification Reject Request message                            |
| CN#08          | 29.060 | 3.4.0   | 099r1 | R99     | 3.5.0       | Addition of response code Delete PDP Context Response                             |
| CN#08          | 29.060 | 3.4.0   | 100r1 | R99     | 3.5.0       | Introduction of a different port number for GTP-C and GTP-U                       |
| CN#08          | 29.060 | 3.4.0   | 101r1 | R99     | 3.5.0       | Addition of charging characteristics per PDP context                              |
| CN#08          | 29.060 | 3.4.0   | 102   | R99     | 3.5.0       | Alignment of text with tables   |
| CN#08          | 29.060 | 3.4.0   | 106   | R99     | 3.5.0       | Removal of Connection oriented paths  |
| CN#08          | 29.060 | 3.4.0   | 108   | R99     | 3.5.0       | On the use of the Sequence number in GTP-C  |
| CN#08          | 29.060 | 3.4.0   | 109   | R99     | 3.5.0       | N-PDU number in GTP-C   |
| CN#08          | 29.060 | 3.4.0   | 110r1 | R99     | 3.5.0       | Editorial modifications due to the upgrade from GTPv0 to GTPv1 for R'99           |
| CN#08          | 29.060 | 3.4.0   | 111r1 | R99     | 3.5.0       | Editorial modifications concerning GTP-U and GTP-C                                |
| CN#08          | 29.060 | 3.4.0   | 112   | R99     | 3.5.0       | Introducing Supported Extension Headers Notification to GTP-U                     |
| CN#08          | 29.060 | 3.4.0   | 113   | R99     | 3.5.0       | Missing IEs in Error Indication   |
| CN#08          | 29.060 | 3.4.0   | 114   | R99     | 3.5.0       | Clarification of the Cause of Create PDP Context Response                         |
| CN#08          | 29.060 | 3.4.0   | 115   | R99     | 3.5.0       | Clarification of the TEID for Signalling  |
| CN#08          | 29.060 | 3.4.0   | 116   | R99     | 3.5.0       | Clarification on the TEID for Signalling of the PDU Notification Reject Request   |
| CN#08          | 29.060 | 3.4.0   | 117r2 | R99     | 3.5.0       | Clarification of the conditional information elements                             |
| CN#08          | 29.060 | 3.4.0   | 119   | R99     | 3.5.0       | Clarification on the use of SGSN address at PDU notification procedure (R99)      |
| CN#09          | 29.060 | 3.5.0   | 105r1 | R99     | 3.6.0       | Race Conditions Avoidance   |
| CN#09          | 29.060 | 3.5.0   | 121   | R99     | 3.6.0       | Definition of TEID value in GTP-U header  |
| CN#09          | 29.060 | 3.5.0   | 122r3 | R99     | 3.6.0       | Solution for race condition of GTP procedures                                     |
| CN#09          | 29.060 | 3.5.0   | 123r1 | R99     | 3.6.0       | Clarifications concerning the use of TEID in the Control Plane                    |
| CN#09          | 29.060 | 3.5.0   | 124r1 | R99     | 3.6.0       | Editorial modifications concerning TEID Control Plane and TEID Data               |
| CN#09          | 29.060 | 3.5.0   | 126r2 | R99     | 3.6.0       | Sequence number in signalling messages  |
| CN#09          | 29.060 | 3.5.0   | 127   | R99     | 3.6.0       | Clarification of the conditional information elements                             |
| CN#09          | 29.060 | 3.5.0   | 128r1 | R99     | 3.6.0       | Enhancement of MS Network capability and GPRS Ciphering Algorithm                 |
| CN#09          | 29.060 | 3.5.0   | 129   | R99     | 3.6.0       | IPv6 support for Charging Gateway Address   |
| CN#09          | 29.060 | 3.5.0   | 130   | R99     | 3.6.0       | Signalling messages in GTP  |
| CN#09          | 29.060 | 3.5.0   | 131r1 | R99     | 3.6.0       | Security parameter transport in case of 2G-3G interworking                        |
| CN#09          | 29.060 | 3.5.0   | 132r1 | R99     | 3.6.0       | Encoding of IMSI  |
| CN#09          | 29.060 | 3.5.0   | 133   | R99     | 3.6.0       | Removal of IHOSS from GTP   |
| CN#09          | 29.060 | 3.5.0   | 135   | R99     | 3.6.0       | Addition of MS Not Reachable Reason to Send Routing Information For GPRS Response |
| CN#09          | 29.060 | 3.5.0   | 138r1 | R99     | 3.6.0       | Coding of TI in PDP Context   |
| CN#09          | 29.060 | 3.5.0   | 139r1 | R99     | 3.6.0       | Clarifications on the use of TEID in the Control Plane                            |

| Change history |        |         |       |         |             |   |
|----------------|--------|---------|-------|---------|-------------|---|
| TSG CN#        | Spec   | Version | CR    | <Phase> | New Version | Subject/Comment   |
| CN#09          | 29.060 | 3.5.0   | 140   | R99     | 3.6.0       | Correction on the handling of the PDP Context at unsuccessful PDP Context modification                            |
| CN#09          | 29.060 | 3.5.0   | 141r2 | R99     | 3.6.0       | Categorize Error indication as the GTP-U message  |
| CN#09          | 29.060 | 3.5.0   | 142   | R99     | 3.6.0       | Clarifications on the presence condition of TLLI/P-TMSI in SGSN Context request                                   |
| CN#09          | 29.060 | 3.5.0   | 143r2 | R99     | 3.6.0       | Correction on Reliable transmission of signalling messages  |
| CN#09          | 29.060 | 3.5.0   | 144   | R99     | 3.6.0       | Alignment of the description of tables for Identification Request and SGSN Context Request                        |
| CN#09          | 29.060 | 3.5.0   | 145r1 | R99     | 3.6.0       | Correction to the SGSN Context transfer Request and response messages   |
| CN#09          | 29.060 | 3.5.0   | 146r2 | R99     | 3.6.0       | Correction to the SGSN Forward relocation Request and Response messages   |
| CN#09          | 29.060 | 3.5.0   | 147   | R99     | 3.6.0       | Clarification on the handling of response messages  |
| CN#09          | 29.060 | 3.5.0   | 148   | R99     | 3.6.0       | Clarification on SGSN context acknowledge message   |
| CN#10          | 29.060 | 3.6.0   | 136r2 | R99     | 3.7.0       | Compatibility GTPv0/GTPv1 in case of SGSN change  |
| CN#10          | 29.060 | 3.6.0   | 149   | R99     | 3.7.0       | Clarification on the use of Teardown Indicator  |
| CN#10          | 29.060 | 3.6.0   | 150   | R99     | 3.7.0       | Correction to the PDU Notification Request message  |
| CN#10          | 29.060 | 3.6.0   | 151r1 | R99     | 3.7.0       | Correction of wrong entry in information table  |
| CN#10          | 29.060 | 3.6.0   | 152   | R99     | 3.7.0       | Moving of Annex A to 3GPP TS 23.003   |
| CN#10          | 29.060 | 3.6.0   | 153r2 | R99     | 3.7.0       | Selecting GGSN IP address   |
| CN#10          | 29.060 | 3.6.0   | 154r1 | R99     | 3.7.0       | Removal of 'Version not Supported' for GTP-U  |
| CN#10          | 29.060 | 3.6.0   | 157   | R99     | 3.7.0       | Correction of Security parameters length  |
| CN#10          | 29.060 | 3.6.0   | 159   | R99     | 3.7.0       | MS Network Capability in MM Context   |
| CN#10          | 29.060 | 3.6.0   | 161   | R99     | 3.7.0       | Clarifications to the usage of CKSN and KSI for security type 0   |
| CN#11          | 29.060 | 3.7.0   | 155r4 | R99     | 3.8.0       | Adding Uplink TEID Data I and user plane GGSN address to PDP Context IE   |
| CN#11          | 29.060 | 3.7.0   | 162   | R99     | 3.8.0       | Handling of sequence numbers for reliable transmission of control plane messages                                  |
| CN#11          | 29.060 | 3.7.0   | 163   | R99     | 3.8.0       | Re-configure the IEs in the PDU Notification Request to make it in ascending order                                |
| CN#11          | 29.060 | 3.7.0   | 166   | R99     | 3.8.0       | Corrections to editor work of 29.060 v 3.7.0  |
| CN#11          | 29.060 | 3.7.0   | 170r2 | R99     | 3.8.0       | Clarification on the TEID value of the signalling messages  |
| CN#11          | 29.060 | 3.7.0   | 173r3 | R99     | 3.8.0       | Clarifications to the GTP-U protocol  |
| CN#11          | 29.060 | 3.7.0   | 174r1 | R99     | 3.8.0       | Essential Correction of the delete PDP context procedure  |
| CN#11          | 29.060 | 3.7.0   | 178   | R99     | 3.8.0       | Re-configure the IEs in the Send Routing Information for GPRS Response message to make it in ascending order      |
| CN#11          | 29.060 | 3.7.0   | 180r1 | R99     | 3.8.0       | IMSI Encoding Clarification   |
| CN#11          | 29.060 | 3.7.0   | 181r1 | R99     | 3.8.0       | Fix an ambiguous description on the treatment for the PDP Type PPP in PDP context creation procedure              |
| CN#11          | 29.060 | 3.7.0   | 182r2 | R99     | 3.8.0       | GSN address in Error Indication   |
| CN#11          | 29.060 | 3.7.0   | 186r1 | R99     | 3.8.0       | Clarification of Error Indication   |
| CN#11          | 29.060 | 3.7.0   | 187   | R99     | 3.8.0       | Clarification on the handling of sequence numbers in the GTP user plane   |
| CN#11          | 29.060 | 3.7.0   | 188   | R99     | 3.8.0       | Clarifications and clean up of the error handling section   |
| CN#11          | 29.060 | 3.7.0   | 191r1 | R99     | 3.8.0       | Clarification on the use of the term G-PDU  |
| CN#11          | 29.060 | 3.8.0   |       | Rel-4   | 4.0.0       | Version increased from R99 to Rel-4 after CN#11.  |
| CN#12          | 29.060 | 4.0.0   | 194   | Rel-4   | 4.1.0       | Correction/Clarification of GGSN handling of Update PDP Context Response  |
| CN#12          | 29.060 | 4.0.0   | 196   | Rel-4   | 4.1.0       | Correction due to incorrectly implemented CR on the Error indication message                                      |
| CN#12          | 29.060 | 4.0.0   | 198   | Rel-4   | 4.1.0       | RNC IP Address IE format  |
| CN#12          | 29.060 | 4.0.0   | 208   | Rel-4   | 4.1.0       | GTP Message Treatment   |
| CN#12          | 29.060 | 4.0.0   | 220   | Rel-4   | 4.1.0       | Clarification of the handling of Version Not Supported; Supported Extension Headers and Error Indication messages |
| CN#12          | 29.060 | 4.0.0   | 221   | Rel-4   | 4.1.0       | Removal of the useless "version not supported" cause code from GTP messages                                       |

| Change history |        |         |       |         |             |  |
|----------------|--------|---------|-------|---------|-------------|--|
| TSG CN#        | Spec   | Version | CR    | <Phase> | New Version | Subject/Comment  |
| CN#12          | 29.060 | 4.0.0   | 222   | Rel-4   | 4.1.0       | Ambiguous text description of the Charging Gateway Address IE handling in the GTP create PDP context request message |
| CN#12          | 29.060 | 4.0.0   | 227   | Rel-4   | 4.1.0       | Alignment of the 29.060 with the 23.060 for the SRNS Relocation procedure  |
| CN#13          | 29.060 | 4.1.0   |       | Rel-4   | 4.2.0       | Editorial clean up   |
| CN#13          | 29.060 | 4.1.0   | 230r1 | Rel-4   | 4.2.0       | Introduction of the Suspend-resume functionality in Rel-4 GTP specification  |
| CN#13          | 29.060 | 4.1.0   | 236   | Rel-4   | 4.2.0       | Clarification of the term TLLI in SGSN Context Request   |
| CN#13          | 29.060 | 4.1.0   | 238r1 | Rel-4   | 4.2.0       | Rewording usage of P-TIMSI and TLLI in "SGSN context request"  |
| CN#13          | 29.060 | 4.1.0   | 240   | Rel-4   | 4.2.0       | Alignment with 23.060 on the use of SGSN Context Acknowledge message   |
| CN#13          | 29.060 | 4.1.0   | 245r1 | Rel-4   | 4.2.0       | Charging Characteristics Inclusion in Create PDP Context Message   |
| CN#13          | 29.060 | 4.1.0   | 247   | Rel-4   | 4.2.0       | Clarification to the usage of the TEID-C   |
| CN#13          | 29.060 | 4.1.0   | 248r1 | Rel-4   | 4.2.0       | Clarification on the use of the teardown indicator IE  |
| CN#14          | 29.060 | 4.2.0   | 255   | Rel-4   | 4.3.0       | Add APN.OI sub-field to the APN in PDP context IE  |
| CN#14          | 29.060 | 4.2.0   | 264   | Rel-4   | 4.3.0       | Clarification of header marker setting for Error Indication  |
| CN#14          | 29.060 | 4.2.0   | 268r1 | Rel-4   | 4.3.0       | GGSN address for control plane must not be changed in "Update PDP Context Response"                                  |
| CN#14          | 29.060 | 4.2.0   | 273   | Rel-4   | 4.3.0       | Clarification on the handling of the GTP MM Context IE   |
| CN#14          | 29.060 | 4.2.0   | 274   | Rel-4   | 4.3.0       | Clarification on the GTP PDP context IE  |
| CN#14          | 29.060 | 4.2.0   | 283   | Rel-4   | 4.3.0       | Clarification on the handling of protocol configuration options IE   |
| CN#14          | 29.060 | 4.3.0   | 259r1 | Rel-5   | 5.0.0       | Relay of Identification Request message and SGSN Context Request message   |
| CN#14          | 29.060 | 4.3.0   | 272   | Rel-5   | 5.0.0       | Support for Radio Priority LCS   |
| CN#14          | 29.060 | 4.3.0   | 282   | Rel-5   | 5.0.0       | Clarification on IMSI format (Unused fields)   |
| Jan 2002       | 29.060 | 5.0.0   |       | Rel-5   | 5.0.1       | A coversheet fixed   |
| CN#15          | 29.060 | 5.0.1   | 291r1 | Rel-5   | 5.1.0       | Clarification on the use of the Teardown indicator IE  |
| CN#15          | 29.060 | 5.0.1   | 294r1 | Rel-5   | 5.1.0       | Dangling PDP contexts handling   |
| CN#15          | 29.060 | 5.0.1   | 297r1 | Rel-5   | 5.1.0       | Re-define the attributions of GTP Information Element  |
| CN#15          | 29.060 | 5.0.1   | 299r1 | Rel-5   | 5.1.0       | Clarification on PDP address field and end user address information element in create PDP context response           |
| CN#15          | 29.060 | 5.0.1   | 300r3 | Rel-5   | 5.1.0       | Generic RAN Information Procedure  |
| CN#15          | 29.060 | 5.0.1   | 301   | Rel-5   | 5.1.0       | Priority of PDP Contexts at Inter-SGSN RA Update   |
| CN#15          | 29.060 | 5.0.1   | 309r1 | Rel-5   | 5.1.0       | IMS Enhancements (PCO in Secondary PDP context activation procedures)  |
| CN#16          | 29.060 | 5.1.0   | 311   | Rel-5   | 5.2.0       | Clarification on create PDP context for existing PDP context   |
| CN#16          | 29.060 | 5.1.0   | 318   | Rel-5   | 5.2.0       | Support of IPv4 and IPv6 node addresses in Core Network  |
| CN#16          | 29.060 | 5.1.0   | 319r2 | Rel-5   | 5.2.0       | Reference to 3GPP TS 33.210 for protection of GTP.   |
| CN#17          | 29.060 | 5.2.0   | 322r1 | Rel-5   | 5.3.0       | Clarification re. response message   |
| CN#17          | 29.060 | 5.2.0   | 323r2 | Rel-5   | 5.3.0       | Clarification re. Version Not Supported message  |
| CN#17          | 29.060 | 5.2.0   | 324r1 | Rel-5   | 5.3.0       | Incorrect references   |
| CN#17          | 29.060 | 5.2.0   | 325r2 | Rel-5   | 5.3.0       | RAB Setup Information for IPv6   |
| CN#17          | 29.060 | 5.2.0   | 328r2 | Rel-5   | 5.3.0       | Clarification on the coding of RANAP cause value   |
| CN#17          | 29.060 | 5.2.0   | 329r1 | Rel-5   | 5.3.0       | Addition of PCO IE to Update PDP context procedures  |
| CN#17          | 29.060 | 5.2.0   | 332r1 | Rel-5   | 5.3.0       | Setting PDP ID after inter-SGSN RAU using GTPv0  |
| CN#17          | 29.060 | 5.2.0   | 336   | Rel-5   | 5.3.0       | Removing inconsistency in definition of PDP Address length   |
| CN#17          | 29.060 | 5.2.0   | 339   | Rel-5   | 5.3.0       | 16 bit PDCP sequence numbers in RAB Context  |
| CN#17          | 29.060 | 5.2.0   | 342r1 | Rel-5   | 5.3.0       | Forward Relocation Response without 'RAB Setup Information' IE   |
| CN#17          | 29.060 | 5.2.0   | 347   | Rel-5   | 5.3.0       | No equivalent Cause Code in GTP to 'PDP context without TFT already activated'                                       |
| CN#18          | 29.060 | 5.3.0   | 333r1 | Rel-5   | 5.4.0       | Support of mandatory IPv6 on the lu interface  |

| Change history |        |         |       |         |             |   |
|----------------|--------|---------|-------|---------|-------------|---|
| TSG CN#        | Spec   | Version | CR    | <Phase> | New Version | Subject/Comment   |
| CN#18          | 29.060 | 5.3.0   | 348r4 | Rel-5   | 5.4.0       | Introduction of PCO IE in session management messages used in the MS Initiated PDP Context Deactivation procedure (direction MS to NW)    |
| CN#18          | 29.060 | 5.3.0   | 350r1 | Rel-5   | 5.4.0       | Clarification on the inclusion of TEID II in SGSN Context Ack   |
| CN#18          | 29.060 | 5.3.0   | 354r1 | Rel-5   | 5.4.0       | Removal of limitation in the Create PDP Context Request message   |
| CN#18          | 29.060 | 5.3.0   | 355   | Rel-5   | 5.4.0       | Introduction of PCO IE in session management messages used in the Network-Requested PDP Context Activation Procedure (direction NW to MS) |
| CN#18          | 29.060 | 5.3.0   | 356r1 | Rel-5   | 5.4.0       | Introduction of PCO IE in session management messages used in the GGSN-Initiated PDP Context Modification procedure (direction NW to MS)  |
| CN#18          | 29.060 | 5.3.0   | 357r1 | Rel-5   | 5.4.0       | Introduction of PCO IE in session management messages used in the GGSN-Initiated PDP Context Deactivation Procedure (direction NW to MS)  |
| CN#18          | 29.060 | 5.3.0   | 360r1 | Rel-5   | 5.4.0       | PDCP sequence numbers in SGSN Context Response  |
| CN#18          | 29.060 | 5.3.0   | 362r3 | Rel-5   | 5.4.0       | Clarification of the placement of the fields in the PDP Context IE  |
| CN#18          | 29.060 | 5.3.0   | 363r4 | Rel-5   | 5.4.0       | Enabling control of content served to subscribers based on their location   |
| CN#18          | 29.060 | 5.3.0   | 373r2 | Rel-5   | 5.4.0       | Clarification on IP fragmentation over Lu interface   |
| CN#18          | 29.060 | 5.3.0   | 375r2 | Rel-5   | 5.4.0       | Transfer of Charging characteristics in case of inter SGSN change   |
| CN#18          | 29.060 | 5.3.0   | 382r1 | Rel-5   | 5.4.0       | Clarification on presence of optional fields in GTP header  |
| CN#19          | 29.060 | 5.4.0   | 386r1 | Rel-5   | 5.5.0       | Reinstatement of cause code version not supported   |
| CN#19          | 29.060 | 5.4.0   | 387   | Rel-5   | 5.5.0       | Correction on the handling of PCO   |
| CN#19          | 29.060 | 5.4.0   | 388   | Rel-5   | 5.5.0       | Removal of the N3-BUFFER-SIZE parameter   |
| CN#19          | 29.060 | 5.4.0   | 389   | Rel-5   | 5.5.0       | Correction of presence requirement for the PCO IE   |
| CN#19          | 29.060 | 5.4.0   | 395r3 | Rel-5   | 5.5.0       | TEID for GTP-C messages related to unknown PDP Contexts   |
| CN#19          | 29.060 | 5.4.0   | 399   | Rel-5   | 5.5.0       | Correction of GTP' references   |
| CN#19          | 29.060 | 5.4.0   | 402r2 | Rel-5   | 5.5.0       | IPv4 and IPv6 form of Charging Gateway Address  |
| CN#20          | 29.060 | 5.5.0   | 407r1 | Rel-5   | 5.6.0       | Correction for PDP Context Response with no PDP Contexts  |
| CN#20          | 29.060 | 5.5.0   | 411r1 | Rel-5   | 5.6.0       | Enhancement of description for error codes for Create PDP Context response message  |
| CN#20          | 29.060 | 5.5.0   | 419r2 | Rel-5   | 5.6.0       | Definition of reserved TEID value   |
| CN#20          | 29.060 | 5.5.0   | 421   | Rel-5   | 5.6.0       | QoS Profile Data parameter in the Quality of Service (Data) Profile IE extended with one octet  |
| CN#20          | 29.060 | 5.5.0   | 423   | Rel-5   | 5.6.0       | IMEISV to be included in the Container within the MM Context  |
| CN#21          | 29.060 | 5.6.0   | 433   | Rel-5   | 5.7.0       | Correction of incorrect reference to a withdrawn specification  |
| CN#21          | 29.060 | 5.6.0   | 454   | Rel-5   | 5.7.0       | Change of Early UE feature to PUESBINE  |
| CN#22          | 29.060 | 5.7.0   | 460   | Rel-5   | 5.8.0       | Correction of Sequence Number Up handling   |
| CN#22          | 29.060 | 5.7.0   | 476   | Rel-5   | 5.8.0       | Correction of incorrect reference to a withdrawn specification  |
| CN#22          | 29.060 | 5.7.0   | 456   | Rel-5   | 5.8.0       | Removal of RAB Context IE in Forward Relocation Request   |
| CN#22          | 29.060 | 5.7.0   | 462r3 | Rel-5   | 5.8.0       | HSDPA impacts to GTP  |
| CN#23          | 29.060 | 5.8.0   | 489r1 | Rel-5   | 5.9.0       | PDCP and GTP-U sequence numbers received in the PDP Context information element inside SGSN Context Response message                      |

---

## History

| <b>Document history</b> |                |             |
|-------------------------|----------------|-------------|
| V5.1.0                  | March 2002     | Publication |
| V5.2.0                  | June 2002      | Publication |
| V5.3.0                  | September 2002 | Publication |
| V5.4.0                  | December 2002  | Publication |
| V5.5.0                  | March 2003     | Publication |
| V5.6.0                  | June 2003      | Publication |
| V5.7.0                  | September 2003 | Publication |
| V5.8.0                  | December 2003  | Publication |
| V5.9.0                  | March 2004     | Publication |