

ETSI TS 129 060 V9.4.0 (2010-10)

Technical Specification

**Digital cellular telecommunications system (Phase 2+);
Universal Mobile Telecommunications System (UMTS);
General Packet Radio Service (GPRS);
GPRS Tunnelling Protocol (GTP)
across the Gn and Gp interface
(3GPP TS 29.060 version 9.4.0 Release 9)**



Reference

RTS/TSGC-0429060v940

Keywords

GSM, UMTS

ETSI

650 Route des Lucioles
F-06921 Sophia Antipolis Cedex - FRANCE

Tel.: +33 4 92 94 42 00 Fax: +33 4 93 65 47 16

Siret N° 348 623 562 00017 - NAF 742 C
Association à but non lucratif enregistrée à la
Sous-Préfecture de Grasse (06) N° 7803/88

Important notice

Individual copies of the present document can be downloaded from:

<http://www.etsi.org>

The present document may be made available in more than one electronic version or in print. In any case of existing or perceived difference in contents between such versions, the reference version is the Portable Document Format (PDF). In case of dispute, the reference shall be the printing on ETSI printers of the PDF version kept on a specific network drive within ETSI Secretariat.

Users of the present document should be aware that the document may be subject to revision or change of status. Information on the current status of this and other ETSI documents is available at

<http://portal.etsi.org/tb/status/status.asp>

If you find errors in the present document, please send your comment to one of the following services:

http://portal.etsi.org/chaicor/ETSI_support.asp

Copyright Notification

No part may be reproduced except as authorized by written permission.
The copyright and the foregoing restriction extend to reproduction in all media.

© European Telecommunications Standards Institute 2010.
All rights reserved.

DECTTM, **PLUGTESTS**TM, **UMTS**TM, **TIPHON**TM, the TIPHON logo and the ETSI logo are Trade Marks of ETSI registered for the benefit of its Members.

3GPPTM is a Trade Mark of ETSI registered for the benefit of its Members and of the 3GPP Organizational Partners.

LTETM is a Trade Mark of ETSI currently being registered

for the benefit of its Members and of the 3GPP Organizational Partners.

GSM[®] and the GSM logo are Trade Marks registered and owned by the GSM Association.

Intellectual Property Rights

IPRs essential or potentially essential to the present document may have been declared to ETSI. The information pertaining to these essential IPRs, if any, is publicly available for **ETSI members and non-members**, and can be found in ETSI SR 000 314: "*Intellectual Property Rights (IPRs); Essential, or potentially Essential, IPRs notified to ETSI in respect of ETSI standards*", which is available from the ETSI Secretariat. Latest updates are available on the ETSI Web server (<http://webapp.etsi.org/IPR/home.asp>).

Pursuant to the ETSI IPR Policy, no investigation, including IPR searches, has been carried out by ETSI. No guarantee can be given as to the existence of other IPRs not referenced in ETSI SR 000 314 (or the updates on the ETSI Web server) which are, or may be, or may become, essential to the present document.

Foreword

This Technical Specification (TS) has been produced by ETSI 3rd Generation Partnership Project (3GPP).

The present document may refer to technical specifications or reports using their 3GPP identities, UMTS identities or GSM identities. These should be interpreted as being references to the corresponding ETSI deliverables.

The cross reference between GSM, UMTS, 3GPP and ETSI identities can be found under <http://webapp.etsi.org/key/queryform.asp>.

Contents

| | |
|--|----|
| Intellectual Property Rights | 2 |
| Foreword..... | 2 |
| Foreword..... | 8 |
| 1 Scope | 9 |
| 2 References | 9 |
| 3 Definitions and abbreviations..... | 11 |
| 3.1 Definitions | 11 |
| 3.2 Abbreviations | 12 |
| 4 General | 13 |
| 4.1 General Description..... | 13 |
| 4.2 Removing support for GTPv1 to GTPv0 interworking | 14 |
| 5 Transmission Order and Bit Definitions..... | 14 |
| 6 GTP Header..... | 15 |
| 6.1 Extension headers..... | 17 |
| 6.1.1 PDCP PDU Number | 17 |
| 6.1.2 Suspend Request | 17 |
| 6.1.3 Suspend Response | 18 |
| 6.1.4 MBMS support indication | 18 |
| 6.1.5 MS Info Change Reporting support indication | 19 |
| 7 GTP Messages and Message Formats | 19 |
| 7.1 Message Formats..... | 19 |
| 7.1.1 Presence requirements of Information Elements | 21 |
| 7.2 Path Management Messages..... | 21 |
| 7.2.1 Echo Request | 21 |
| 7.2.2 Echo Response..... | 22 |
| 7.2.3 Version Not Supported | 22 |
| 7.2.4 Supported Extension Headers Notification..... | 22 |
| 7.3 Tunnel Management Messages | 23 |
| 7.3.1 Create PDP Context Request | 23 |
| 7.3.2 Create PDP Context Response..... | 26 |
| 7.3.3 Update PDP Context Request | 29 |
| 7.3.4 Update PDP Context Response..... | 33 |
| 7.3.5 Delete PDP Context Request | 37 |
| 7.3.6 Delete PDP Context Response..... | 38 |
| 7.3.7 Error Indication..... | 39 |
| 7.3.8 PDU Notification Request | 40 |
| 7.3.9 PDU Notification Response..... | 40 |
| 7.3.10 PDU Notification Reject Request | 41 |
| 7.3.11 PDU Notification Reject Response..... | 42 |
| 7.3.12 Initiate PDP Context Activation Request..... | 42 |
| 7.3.13 Initiate PDP Context Activation Response | 43 |
| 7.4 Location Management Messages | 44 |
| 7.4.1 Send Routing Information for GPRS Request | 44 |
| 7.4.2 Send Routing Information for GPRS Response | 45 |
| 7.4.3 Failure Report Request | 46 |
| 7.4.4 Failure Report Response | 46 |
| 7.4.5 Note MS GPRS Present Request | 46 |
| 7.4.6 Note MS GPRS Present Response | 47 |
| 7.5 Mobility Management Messages..... | 47 |
| 7.5.1 Identification Request..... | 47 |
| 7.5.2 Identification Response..... | 48 |

| | | |
|-----------|---|----|
| 7.5.3 | SGSN Context Request..... | 49 |
| 7.5.4 | SGSN Context Response | 50 |
| 7.5.5 | SGSN Context Acknowledge | 52 |
| 7.5.6 | Forward Relocation Request..... | 53 |
| 7.5.7 | Forward Relocation Response | 55 |
| 7.5.8 | Forward Relocation Complete | 57 |
| 7.5.9 | Relocation Cancel Request | 57 |
| 7.5.10 | Relocation Cancel Response..... | 57 |
| 7.5.11 | Forward Relocation Complete Acknowledge | 58 |
| 7.5.12 | Forward SRNS Context Acknowledge | 58 |
| 7.5.13 | Forward SRNS Context | 58 |
| 7.5.14 | RAN Information Management Messages..... | 59 |
| 7.5.14.1 | RAN Information Relay | 59 |
| 7.5A | MBMS Messages | 60 |
| 7.5A.1 | UE Specific MBMS Messages..... | 60 |
| 7.5A.1.1 | MBMS Notification Request..... | 60 |
| 7.5A.1.2 | MBMS Notification Response | 60 |
| 7.5A.1.3 | MBMS Notification Reject Request | 61 |
| 7.5A.1.4 | MBMS Notification Reject Response | 62 |
| 7.5A.1.5 | Create MBMS Context Request..... | 62 |
| 7.5A.1.6 | Create MBMS Context Response | 64 |
| 7.5A.1.7 | Update MBMS Context Request..... | 66 |
| 7.5A.1.8 | Update MBMS Context Response | 67 |
| 7.5A.1.9 | Delete MBMS Context Request..... | 69 |
| 7.5A.1.10 | Delete MBMS Context Response | 70 |
| 7.5A.2 | Service Specific MBMS Messages | 70 |
| 7.5A.2.1 | MBMS Registration Request | 71 |
| 7.5A.2.2 | MBMS Registration Response | 71 |
| 7.5A.2.3 | MBMS De-registration Request..... | 73 |
| 7.5A.2.4 | MBMS De-Registration Response..... | 73 |
| 7.5A.2.5 | MBMS Session Start Request | 74 |
| 7.5A.2.6 | MBMS Session Start Response..... | 75 |
| 7.5A.2.7 | MBMS Session Stop Request | 77 |
| 7.5A.2.8 | MBMS Session Stop Response..... | 77 |
| 7.5A.2.9 | MBMS Session Update Request | 78 |
| 7.5A.2.10 | MBMS Session Update Response..... | 79 |
| 7.5B.1 | MS Info Change Reporting Messages | 80 |
| 7.5B.1.1 | MS Info Change Notification Request | 80 |
| 7.5B.1.2 | MS Info Change Notification Response..... | 80 |
| 7.6 | Reliable Delivery of Signalling Messages..... | 81 |
| 7.7 | Information Elements | 82 |
| 7.7.1 | Cause | 84 |
| 7.7.2 | International Mobile Subscriber Identity (IMSI) | 87 |
| 7.7.3 | Routeing Area Identity (RAI) | 88 |
| 7.7.4 | Temporary Logical Link Identity (TLLI) | 88 |
| 7.7.5 | Packet TMSI (P-TMSI) | 88 |
| 7.7.6 | Reordering Required..... | 89 |
| 7.7.7 | Authentication Triplet..... | 89 |
| 7.7.8 | MAP Cause | 89 |
| 7.7.9 | P-TMSI Signature | 90 |
| 7.7.10 | MS Validated..... | 90 |
| 7.7.11 | Recovery | 90 |
| 7.7.12 | Selection Mode | 90 |
| 7.7.13 | Tunnel Endpoint Identifier Data I..... | 91 |
| 7.7.14 | Tunnel Endpoint Identifier Control Plane..... | 91 |
| 7.7.15 | Tunnel Endpoint Identifier Data II..... | 92 |
| 7.7.16 | Teardown Ind..... | 92 |
| 7.7.17 | NSAPI..... | 93 |
| 7.7.18 | RANAP Cause | 93 |
| 7.7.19 | RAB Context | 93 |
| 7.7.20 | Radio Priority SMS..... | 94 |
| 7.7.21 | Radio Priority..... | 94 |

| | | |
|---------|---|-----|
| 7.7.22 | Packet Flow Id | 94 |
| 7.7.23 | Charging Characteristics | 95 |
| 7.7.24 | Trace Reference | 95 |
| 7.7.25 | Trace Type | 95 |
| 7.7.25A | MS Not Reachable Reason | 95 |
| 7.7.25B | Radio Priority LCS | 96 |
| 7.7.26 | Charging ID | 96 |
| 7.7.27 | End User Address | 96 |
| 7.7.28 | MM Context | 99 |
| 7.7.29 | PDP Context | 102 |
| 7.7.30 | Access Point Name | 106 |
| 7.7.31 | Protocol Configuration Options | 106 |
| 7.7.32 | GSN Address | 106 |
| 7.7.33 | MS International PSTN/ISDN Number (MSISDN) | 107 |
| 7.7.34 | Quality of Service (QoS) Profile | 107 |
| 7.7.35 | Authentication Quintuplet | 108 |
| 7.7.36 | Traffic Flow Template (TFT) | 108 |
| 7.7.37 | Target Identification | 109 |
| 7.7.38 | UTRAN Transparent Container | 109 |
| 7.7.39 | RAB Setup Information | 109 |
| 7.7.40 | Extension Header Type List | 110 |
| 7.7.41 | Trigger Id | 110 |
| 7.7.42 | OMC Identity | 111 |
| 7.7.43 | RAN Transparent Container | 111 |
| 7.7.44 | Charging Gateway Address | 111 |
| 7.7.45 | PDP Context Prioritization | 112 |
| 7.7.45A | Additional RAB Setup Information | 112 |
| 7.7.46 | Private Extension | 113 |
| 7.7.47 | SGSN Number | 113 |
| 7.7.48 | Common Flags | 113 |
| 7.7.49 | APN Restriction | 114 |
| 7.7.50 | RAT Type | 114 |
| 7.7.51 | User Location Information | 115 |
| 7.7.52 | MS Time Zone | 117 |
| 7.7.53 | International Mobile Equipment Identity (and Software Version) (IMEI(SV)) | 117 |
| 7.7.54 | CAMEL Charging Information Container | 117 |
| 7.7.55 | MBMS UE Context | 118 |
| 7.7.56 | Temporary Mobile Group Identity | 119 |
| 7.7.57 | RIM Routing Address | 119 |
| 7.7.58 | MBMS Protocol Configuration Options | 120 |
| 7.7.59 | MBMS Session Duration | 120 |
| 7.7.60 | MBMS Service Area | 120 |
| 7.7.61 | Source RNC PDCP context info | 120 |
| 7.7.62 | Additional Trace Info | 121 |
| 7.7.63 | Hop Counter | 121 |
| 7.7.64 | Selected PLMN ID | 122 |
| 7.7.65 | MBMS Session Identifier | 122 |
| 7.7.66 | MBMS 2G/3G Indicator | 122 |
| 7.7.67 | Enhanced NSAPI | 123 |
| 7.7.68 | Additional MBMS Trace Info | 123 |
| 7.7.69 | MBMS Session Repetition Number | 124 |
| 7.7.70 | MBMS Time To Data Transfer | 124 |
| 7.7.71 | Void | 124 |
| 7.7.72 | BSS Container | 124 |
| 7.7.73 | Cell Identification | 125 |
| 7.7.74 | PDU Numbers | 125 |
| 7.7.75 | BSSGP Cause | 126 |
| 7.7.76 | Required MBMS Bearer Capabilities | 126 |
| 7.7.77 | RIM Routing Address Discriminator | 126 |
| 7.7.78 | List of set-up PFCs | 127 |
| 7.7.79 | PS Handover XID Parameters | 127 |
| 7.7.80 | MS Info Change Reporting Action | 128 |

| | | |
|-----------|--|-----|
| 7.7.81 | Direct Tunnel Flags | 128 |
| 7.7.82 | Correlation-ID..... | 129 |
| 7.7.83 | Bearer Control Mode | 129 |
| 7.7.84 | MBMS Flow Identifier | 129 |
| 7.7.85 | MBMS IP Multicast Distribution..... | 130 |
| 7.7.86 | MBMS Distribution Acknowledgement | 130 |
| 7.7.87 | Reliable INTER RAT HANDOVER INFO..... | 130 |
| 7.7.88 | RFSP Index | 131 |
| 7.7.89 | PDP Type..... | 131 |
| 7.7.90 | Fully Qualified Domain Name (FQDN)..... | 131 |
| 7.7.91 | Evolved Allocation/Retention Priority I | 131 |
| 7.7.92 | Evolved Allocation/Retention Priority II | 132 |
| 7.7.93 | Extended Common Flags..... | 132 |
| 7.7.94 | User CSG Information (UCI)..... | 133 |
| 7.7.95 | CSG Information Reporting Action..... | 134 |
| 7.7.96 | CSG ID | 134 |
| 7.7.97 | CSG Membership Indication (CMI)..... | 134 |
| 7.7.98 | Aggregate Maximum Bit Rate (AMBR)..... | 135 |
| 8 | Control Plane (GTP-C)..... | 135 |
| 8.1 | Control Plane Protocol | 135 |
| 8.2 | Usage of the GTP-C Header..... | 136 |
| 9 | GTP-U | 137 |
| 9.1 | GTP-U Protocol Entity | 137 |
| 9.1.1 | Handling of Sequence Numbers | 138 |
| 9.2 | GTP-U Service Access Points and Primitives | 138 |
| 9.2.1 | GTP-U-CONTROL SAP | 138 |
| 9.2.1.1 | GTP-U-CONTROL-RX primitives..... | 139 |
| 9.2.1.1.1 | GTP-U-CONTROL-RX-SETUP.request | 139 |
| 9.2.1.1.2 | GTP-U-CONTROL-RX-SETUP.confirm | 139 |
| 9.2.1.1.3 | GTP-U-CONTROL-RX-RELEASE.request | 139 |
| 9.2.1.1.4 | GTP-U-CONTROL-RX-RELEASE.confirm | 139 |
| 9.2.1.1.5 | GTP-U-CONTROL-RX-ERROR.indication..... | 139 |
| 9.2.1.2 | GTP-U-CONTROL-TX primitives | 139 |
| 9.2.1.2.1 | GTP-U-CONTROL-TX-SETUP.request..... | 139 |
| 9.2.1.2.2 | GTP-U-CONTROL-TX-SETUP.confirm..... | 140 |
| 9.2.1.2.3 | GTP-U-CONTROL-TX-RELEASE.request | 140 |
| 9.2.1.2.4 | GTP-U-CONTROL-TX-RELEASE.confirm | 140 |
| 9.2.1.2.5 | GTP-U-CONTROL-TX-ERROR.indication | 140 |
| 9.2.2 | GTP-U-UNIT-DATA SAP and Primitives | 140 |
| 9.2.2.1 | GTP-U-UNIT-DATA.request | 140 |
| 9.2.2.2 | GTP-U- UNIT-DATA.indication..... | 140 |
| 9.3 | Protocol Stack | 140 |
| 9.3.1 | Usage of the GTP-U Header | 141 |
| 9.3.1.1 | Usage of Sequence Number | 141 |
| 9.4 | Tunnelling between SGSNs | 142 |
| 9.5 | Tunnelling between Source RNC and Target RNC..... | 142 |
| 9.6 | Tunnelling between GGSNs..... | 142 |
| 10 | Path Protocols..... | 142 |
| 10.1 | UDP/IP | 142 |
| 10.1.1 | UDP Header..... | 142 |
| 10.1.1.1 | Request Messages | 142 |
| 10.1.1.2 | Response Messages..... | 143 |
| 10.1.1.3 | Encapsulated T-PDUs | 143 |
| 10.1.1.4 | Error Indication, RAN Information Relay, Version Not Supported and Supported Extension Headers Notification | 143 |
| 10.1.2 | IP Header | 143 |
| 10.1.2.1 | Request Messages and Encapsulated T-PDUs | 143 |
| 10.1.2.2 | Response Messages | 143 |
| 10.1.2.3 | Error Indication, RAN Information Relay, Version Not supported and Supported Extension Headers Notification | 143 |

| | | |
|--|---|------------|
| 11 | Error Handling..... | 144 |
| 11.1 | Protocol Errors | 144 |
| 11.1.1 | Different GTP Versions | 144 |
| 11.1.2 | GTP Message Too Short..... | 144 |
| 11.1.3 | Unknown GTP Signalling Message..... | 144 |
| 11.1.4 | Unexpected GTP Signalling Message | 144 |
| 11.1.5 | Missing Mandatorily Present Information Element | 144 |
| 11.1.6 | Invalid Length..... | 145 |
| 11.1.7 | Invalid Mandatory Information Element | 145 |
| 11.1.8 | Invalid Optional Information Element..... | 145 |
| 11.1.9 | Unknown Information Element | 145 |
| 11.1.10 | Out of Sequence Information Elements | 145 |
| 11.1.11 | Unexpected Information Element | 145 |
| 11.1.12 | Repeated Information Elements..... | 146 |
| 11.1.13 | Incorrect Optional Information Elements | 146 |
| 11.2 | Path Failure | 146 |
| 11.3 | MS Detach..... | 146 |
| 11.4 | Restoration and Recovery | 146 |
| 12 | Security provided to GTP Communication over Gn and Gp Interfaces..... | 146 |
| 13 | IP, The Networking Technology used by GTP | 146 |
| 13.1 | IP Version..... | 146 |
| 13.2 | IP Fragmentation | 147 |
| 13.2.1 | MO Direction..... | 147 |
| 13.2.2 | MT Direction | 147 |
| 13.2.3 | Tunnelling from old to new SGSN | 147 |
| 14 | GTP Parameters..... | 148 |
| 14.1 | Timers | 148 |
| 14.2 | Others | 148 |
| 15 | Mapping of BSSGP and RANAP causes | 148 |
| Annex A (informative): A method for sequence number checking..... | | 150 |
| Annex B (informative): Change history | | 151 |
| History | | 160 |

Foreword

This Technical Specification (TS) has been produced by the 3rd Generation Partnership Project (3GPP).

The present document defines the Gn and Gp interfaces for the General Packet Radio Service (GPRS) within the 3GPP system.

The contents of the present document are subject to continuing work within the TSG and may change following formal TSG approval. Should the TSG modify the contents of the present document, it will be re-released by the TSG with an identifying change of release date and an increase in version number as follows:

Version x.y.z

where:

- x the first digit:
 - 1 presented to TSG for information;
 - 2 presented to TSG for approval;
 - 3 or greater indicates TSG approved document under change control.
- y the second digit is incremented for all changes of substance, i.e. technical enhancements, corrections, updates, etc.
- z the third digit is incremented when editorial only changes have been incorporated in the document.

1 Scope

The present document defines the second version of GTP used on:

- the Gn and Gp interfaces of the General Packet Radio Service (GPRS);
- the Iu, Gn and Gp interfaces of the UMTS system.

NOTE: The version number used in the message headers is 0 for the first version of GTP described in GSM 09.60, and 1 for the second version in 3GPP TS 29.060.

From release 8 onwards, the normative specification of the user plane of GTP version 1 is 3GPP TS 29.281 [41]. All provisions about GTPv1 user plane in the present document shall be superseded by 3GPP TS 29.281 [41].

2 References

The following documents contain provisions which, through reference in this text, constitute provisions of the present document.

- References are either specific (identified by date of publication, edition number, version number, etc.) or non-specific.
- For a specific reference, subsequent revisions do not apply.
- For a non-specific reference, the latest version applies. In the case of a reference to a 3GPP document (including a GSM document), a non-specific reference implicitly refers to the latest version of that document *in the same Release as the present document*.

- [1] 3GPP TR 21.905: "Vocabulary for 3GPP Specifications".
- [2] 3GPP TS 23.003: "Numbering, addressing and identification".
- [3] 3GPP TS 23.007: "Restoration procedures".
- [4] 3GPP TS 23.060: "General Packet Radio Service (GPRS); Service description; Stage 2".
- [5] 3GPP TS 24.008: "Mobile radio interface Layer 3 specification; Core network protocols; Stage 3".
- [6] 3GPP TS 29.002: "Mobile Application Part (MAP) specification".
- [7] 3GPP TS 25.413: "UTRAN Iu interface RANAP signalling".
- [8] 3GPP TS 33.102: "3G security; Security architecture".
- [9] 3GPP TS 43.020: " Security related network functions".
- [10] 3GPP TS 43.064: "Overall description of the GPRS radio interface; Stage 2".
- [11] 3GPP TS 44.064: "Mobile Station - Serving GPRS Support Node (MS-SGSN) Logical Link Control (LLC) layer specification".
- [12] IETF RFC 791 (STD 0005): "Internet Protocol", J. Postel.
- [13] IETF RFC 768 (STD 0006): "User Datagram Protocol", J. Postel.
- [14] IETF RFC 1700: "Assigned numbers", J. Reynolds and J. Postel.
- [15] IETF RFC 2181: "Clarifications to the DNS specification", R. Elz and R. Bush.
- [16] Void.
- [17] 3GPP TS 23.121: "Architectural requirements for Release 1999".

- [18] 3GPP TS 32.251: "Telecommunication management; Charging management; Packet Switched (PS) domain charging".
- [19] 3GPP TS 23.236: "Intra domain connection of Radio Access Network (RAN) nodes to multiple Core Network (CN) nodes".
- [20] 3GPP TS 48.018: "General Packet Radio Service (GPRS); Base Station System (BSS) - Serving GPRS Support Node (SGSN); BSS GPRS protocol".
- [21] 3GPP TR 44.901 (Release 5): "External Network Assisted Cell Change (NACC)".
- [22] 3GPP TS 33.210: "3G security; Network Domain Security (NDS); IP network layer security".
- [23] 3GPP TS 25.414: "UTRAN Iu interface data transport and transport signalling".
- [24] 3GPP TS 23.271: " Technical Specification Group Services and System Aspects; Functional stage 2 description of LCS".
- [25] 3GPP TS 23.195: "Provision of User Equipment Specific Behaviour Information (UESBI) to network entities".
- [26] 3GPP TS 23.246: "Multimedia Broadcast/Multicast Service (MBMS) Architecture and Functional Description".
- [27] 3GPP TS 29.061: "Interworking between the Public Land Mobile Network (PLMN) supporting Packet Based Services and Packet Data Networks (PDN) "
- [28] 3GPP TS 23.040: "Technical realization of the Short Message Service (SMS)".
- [29] 3GPP TS 22.101: "Service Principles".
- [30] 3GPP TS 32.421: "Subscriber and equipment trace: Trace concepts and requirements".
- [31] 3GPP TS 32.422: "Subscriber and equipment trace: Trace Control and Configuration Management".
- [32] 3GPP TS 32.423: "Subscriber and equipment trace: Trace data definition and management".
- [33] 3GPP TS 32.295: "Telecommunication management; Charging management; Charging Data Record (CDR) transfer".
- [34] 3GPP TS 32.298: "Telecommunication management; Charging management; Charging Data Record (CDR) parameter description".
- [35] 3GPP TS 23.251: "Network Sharing; Architecture and Functional Description".
- [36] IETF RFC 3588: "Diameter Base Protocol"
- [37] 3GPP TS 43.129: " Packet-switched handover for GERAN A/Gb mode; Stage 2".
- [38] 3GPP TS 44.065: "Mobile Station (MS) - Serving GPRS Support Node (SGSN);Subnetwork Dependent Convergence Protocol (SNDCP)".
- [39] 3GPP TS 23.203: "Policy and charging control architecture; Stage 2".
- [40] 3GPP TR 25.999: " HSPA Evolution (FDD)".

- [41] 3GPP TS 29.281: "GPRS Tunnelling Protocol User Plane (GTPv1-U)".
- [42] 3GPP TS 24.301: "Non-Access-Stratum (NAS) protocol for Evolved Packet System (EPS); Stage 3".
- [43] 3GPP TS 29.212: "Policy and charging control over Gx reference point".
- [44] IETF RFC 4607: "Source-Specific Multicast for IP".
- [45] IETF RFC 1035: "Domain Names - Implementation and Specification".
- [46] 3GPP TS 29.303: "Domain Name System Procedures; Stage 3".
- [47] 3GPP TS 23.401: "General Packet Radio Service (GPRS) enhancements for Evolved Universal Terrestrial Radio Access Network (E-UTRAN) access".

3 Definitions and abbreviations

3.1 Definitions

For the purposes of the present document, the following terms and definitions apply:

Enhanced Network Service Access Point Identifier (Enhanced NSAPI): integer value in the range [128; 255], identifying a certain Multimedia Broadcast/Multicast Service (MBMS) UE Context. **G-PDU:** is a user data message, It consists of a T-PDU plus a GTP header

GTP Tunnel: in the GTP-U plane is defined for each PDP Context or each MBMS service in the GSNs and/or each RAB in the RNC. A GTP tunnel in the GTP-C plane is defined for all PDP Contexts with the same PDP address or two IP addresses (one IPv4 and one IPv6 if PDP Type IPv4v6 is supported and used) and APN (for Tunnel Management messages and UE Specific MBMS message), for each MBMS service (for Service Specific MBMS messages) or for each MS (for other types of messages). A GTP tunnel is identified in each node with a TEID, an IP address and a UDP port number. A GTP tunnel is necessary to forward packets between an external packet data network and an MS user.

MBMS Bearer Context: contains all information describing a particular MBMS bearer service.

MBMS UE Context: contains UE-specific information related to a particular MBMS service that the UE has joined.

MM Context: information sets held in MS and GSNs for a GPRS subscriber related to Mobility Management (MM) (please refer to the MM Context Information Element)

Network Service Access Point Identifier (NSAPI): integer value in the range [0; 15], identifying a certain PDP Context. It identifies a PDP context belonging to a specific MM Context ID

path: UDP/IP path is used to multiplex GTP tunnels

Path Protocol: protocol used as a bearer of GTP between GSNs or between a GSN and a RNC

Packet Data Protocol (PDP): network protocol used by an external packet data network interfacing to GPRS

PDP Context: information sets held in MS and GSNs for a PDP address or two IP addresses (one IPv4 and one IPv6 if PDP Type IPv4v6 is supported and used) (please refer to the PDP Context Information Element)

PS Handover procedure: used to enable MS with one or more packet flows to be moved between two cells with minimal service interruption through allocation of radio resources in the target cell while the MS is still in the source cell.

PS Handover XID Parameters: contains LLC XID parameters (with SNDCP XID parameters contained within) that need to be transferred between SGSNs during the PS handover procedure.

Quality of Service (QoS): may be applicable for the GPRS backbone and the Iu interface if the path media supports it. Separate paths with different priorities may be defined between a GSN pair or between a GSN and an RNC.

GTP-C Message: GTP-C or control plane messages are exchanged between GSN/RNC pairs in a path. The control plane messages are used to transfer GSN capability information between GSN pairs, to create, update and delete GTP tunnels and for path management.

GTP-U Message: GTP-U or user plane messages are exchanged between GSN pairs or GSN/RNC pairs in a path. The user plane messages are used to carry user data packets, and signalling messages for path management and error indication.

GTP-PDU: GTP Protocol Data Unit is either a GTP-C message or a GTP-U message

Signalling Message: any GTP-PDU except the G-PDU

T-PDU: original packet, for example an IP datagram, from an MS or a network node in an external packet data network. A T-PDU is the payload that is tunnelled in the GTP-U tunnel.

Traffic Flow Template (TFTs): used by GGSN to distinguish between different user payload packets and transmit packets with different QoS requirements via different PDP context but to the same PDP address or two IP addresses (one IPv4 and one IPv6 if PDP Type IPv4v6 is supported and used)

Tunnel Endpoint Identifier (TEID): unambiguously identifies a tunnel endpoint in the receiving GTP-U or GTP-C protocol entity

The receiving end side of a GTP tunnel locally assigns the TEID value the transmitting side has to use. The TEID values are exchanged between tunnel endpoints using GTP-C (or RANAP, over the Iu) messages.

UDP/IP Path: connection-less unidirectional or bidirectional path defined by two end-points

An IP address and a UDP port number define an end-point. A UDP/IP path carries GTP messages between GSN nodes, and between GSN and RNC nodes related to one or more GTP tunnels.

3.2 Abbreviations

Abbreviations used in the present document are listed in 3GPP TS 21.905 [1]

For the purposes of the present document, the following additional abbreviations apply:

| | |
|--------------|--|
| ADD | Automatic Device Detection |
| APN-AMBR | APN-Aggregate Maximum Bit Rate |
| BB | Backbone Bearer |
| DF | Don't Fragment |
| DTI | Direct Tunnel Indication |
| FFS | For Further Study |
| GCSI | GPRS CAMEL Subscription Information |
| GMLC | Gateway Mobile Location Centre |
| Gn interface | Interface between GPRS Support Nodes (GSNs) within a PLMN |
| Gp interface | Interface between GPRS Support Nodes (GSNs) in different PLMNs |
| GTP | GPRS Tunneling Protocol |
| GTP-C | GTP Control |
| GTP-U | GTP User |
| IANA | Internet Assigned Number Authority |
| ICMP | Internet Control Message Protocol |
| IE | Information Element |
| IGMP | Internet Group Management Protocol |
| IP | Internet Protocol |
| IPv4 | Internet Protocol version 4 |
| IPv6 | Internet Protocol version 6 |
| MBMS | MultiMedia Broadcast/Multicast Service |
| MLD | Multicast Listener Discover |
| MTU | Maximum Transmission Unit |
| NACC | Network Assisted Cell Change |
| NRSN | Network Requested Support Network |
| PUESBINE | Provision of User Equipment Specific Behaviour Information to Network Entities |
| QoS | Quality of Service |
| RAN | Radio Access Network |
| RANAP | Radio Access Network Application Part |

| | |
|---------|---------------------------------------|
| RIM | RAN Information Management |
| RNC | Radio Network Controller |
| TEID | Tunnel Endpoint Identifier |
| TFT | Traffic Flow Template |
| UDP | User Datagram Protocol |
| UE-AMBR | UE- Aggregate Maximum Bit Rate |
| UTRAN | UMTS Terrestrial Radio Access Network |

4 General

4.1 General Description

From release 8 onwards, the normative specification of the user plane of GTP version 1 is 3GPP TS 29.281 [41]. All provisions about GTPv1 user plane in the present document shall be superseded by 3GPP TS 29.281 [41].

The present document defines the GPRS Tunnelling Protocol (GTP), i.e. the protocol between GPRS Support Nodes (GSNs) in the UMTS/GPRS backbone network. It includes both the GTP control plane (GTP-C) and data transfer (GTP-U) procedures. GTP also lists the messages and information elements used by the GTP based charging protocol GTP', which is described in 3GPP TS 32.295 [33].

GTP (GTP-C and GTP-U) is defined for the Gn interface, i.e. the interface between GSNs within a PLMN, and for the Gp interface between GSNs in different PLMNs. Only GTP-U is defined for the Iu interface between Serving GPRS Support Node (SGSN) and the UMTS Terrestrial Radio Access Network (UTRAN).

On the Iu interface, the Radio Access Network Application Part (RANAP) protocol and signalling part of GTP-U are performing the control function for user plane (GTP-U).

GTP' is defined for the interface between CDR generating functional network elements and Charging Gateway(s) within a PLMN. Charging Gateway(s) and GTP' protocol are optional, as the Charging Gateway Functionality may either be located in separate network elements (Charging Gateways), or alternatively be embedded into the CDR generating network elements (GSNs) when the GSN-CGF interface is not necessarily visible outside the network element. These interfaces relevant to GTP are between the grey boxes shown in figure 1.

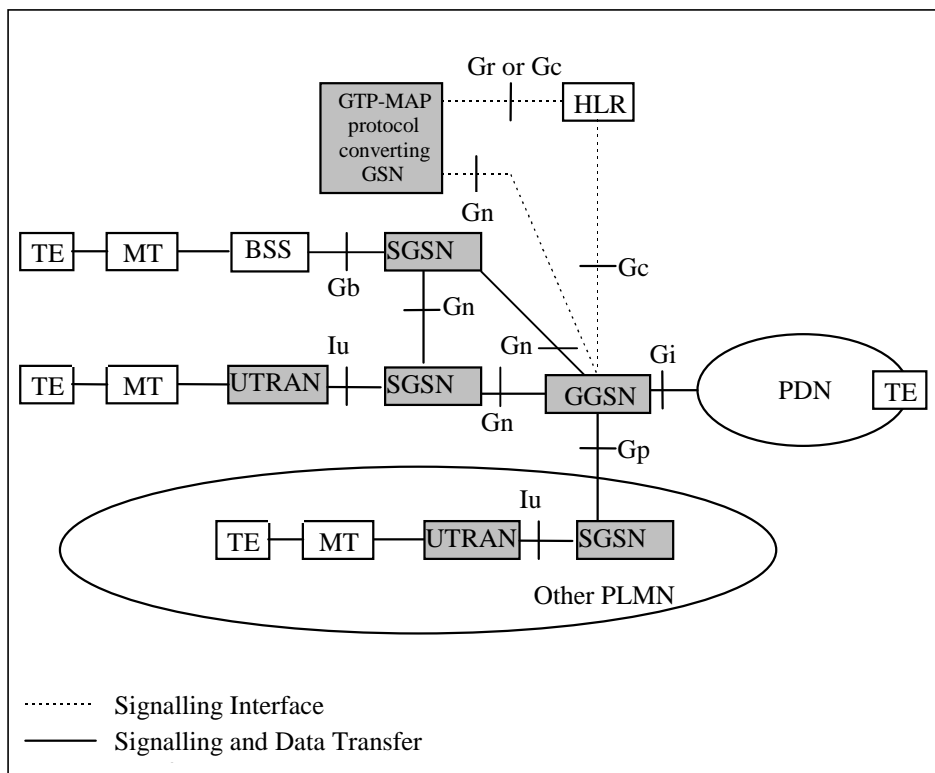

Figure 1: GPRS Logical Architecture with interface name denotations

GTP allows multi-protocol packets to be tunnelled through the UMTS/GPRS Backbone between GSNs and between SGSN and UTRAN.

In the control plane, GTP specifies a tunnel control and management protocol (GTP-C) which allows the SGSN to provide packet data network access for an MS. Control Plane signalling is used to create, modify and delete tunnels. GTP also allows creation, and deletion of a single multicast service tunnel, that can be used for delivering packets to all the users who have joined a particular multicast service.

In the user plane, GTP uses a tunnelling mechanism (GTP-U) to provide a service for carrying user data packets.

The GTP-U protocol is implemented by SGSNs and GGSNs in the UMTS/GPRS Backbone and by Radio Network Controllers (RNCs) in the UTRAN. SGSNs and GGSNs in the UMTS/GPRS Backbone implement the GTP-C protocol. No other systems need to be aware of GTP. UMTS/GPRS MSs are connected to an SGSN without being aware of GTP.

It is assumed that there will be a many-to-many relationship between SGSNs and GGSNs. A SGSN may provide service to many GGSNs. A single GGSN may associate with many SGSNs to deliver traffic to a large number of geographically diverse mobile stations.

4.2 Removing support for GTPv1 to GTPv0 interworking

Support for GTPv1 to GTPv0 interworking is removed from 3GPP Rel-8 GTPv1 specification. Therefore, 3GPP Rel-8 and onwards GTPv1 entity may or may not listen to the well-known GTPv0 port 3386. If GTPv1 entity listens to the GTPv0 port, the entity should silently discard any received GTPv0 message.

5 Transmission Order and Bit Definitions

The messages in this document shall be transmitted in network octet order starting with octet 1. Where information elements are repeated within a message the order shall be determined by the order of appearance in the table defining the information elements in the message.

The most significant bit of an octet in a GTP message is bit 8. If a value in a GTP message spans several octets and nothing else is stated, the most significant bit is bit 8 of the octet with the lowest number.

6 GTP Header

The GTP header is a variable length header used for both the GTP-C and the GTP-U protocols. The minimum length of the GTP header is 8 bytes. There are three flags that are used to signal the presence of additional optional fields: the PN flag, the S flag and the E flag. The PN flag is used to signal the presence of N-PDU Numbers. The S flag is used to signal the presence of the GTP Sequence Number field. The E flag is used to signal the presence of the Extension Header field, used to enable future extensions of the GTP header defined in this document, without the need to use another version number. If and only if one or more of these three flags are set, the fields Sequence Number, N-PDU and Extension Header shall be present. The sender shall set all the bits of the unused fields to zero. The receiver shall not evaluate the unused fields.

The GTP-C and the GTP-U use some of the fields in the GTP header differently. The detailed use of such fields is described in the sections related to GTP-C and to GTP-U.

Always present fields:

- Version field: This field is used to determine the version of the GTP protocol. For the treatment of other versions, see clause 11.1.1, "Different GTP versions". The version number shall be set to "1".
- Protocol Type (PT): This bit is used as a protocol discriminator between GTP (when PT is "1") and GTP' (when PT is "0"). GTP is described in this document and the GTP' protocol in 3GPP TS 32.295 [33]. Note that the interpretation of the header fields may be different in GTP' than in GTP.
- Extension Header flag (E): This flag indicates the presence of a meaningful value of the Next Extension Header field. When it is set to "0", the Next Extension Header field either is not present or, if present, shall not be interpreted. When it is set to "1", the Next Extension Header field is present, and shall be interpreted, as described below in this section.
- Sequence number flag (S): This flag indicates the presence of a meaningful value of the Sequence Number field. When it is set to "0", the Sequence Number field either is not present or, if present, shall not be interpreted. When it is set to "1", the Sequence Number field is present, and shall be interpreted, as described below in this section.
- N-PDU Number flag (PN): This flag indicates the presence of a meaningful value of the N-PDU Number field. When it is set to "0", the N-PDU Number field either is not present, or, if present, shall not be interpreted. When it is set to "1", the N-PDU Number field is present, and shall be interpreted, as described below in this section.
- Message Type: This field indicates the type of GTP message. The valid values of the message type are defined in clause 7.1 for both GTP-C and GTP-U.
- Length: This field indicates the length in octets of the payload, i.e. the rest of the packet following the mandatory part of the GTP header (that is the first 8 octets). The Sequence Number, the N-PDU Number or any Extension headers shall be considered to be part of the payload, i.e. included in the length count.
- Tunnel Endpoint Identifier (TEID): This field unambiguously identifies a tunnel endpoint in the receiving GTP-U or GTP-C protocol entity. The receiving end side of a GTP tunnel locally assigns the TEID value the transmitting side has to use. The TEID values are exchanged between tunnel endpoints using GTP-C (or RANAP, over the Iu) messages.

Optional fields:

- Sequence Number: This field is an optional field in G -PDUs. It is used as a transaction identity for signalling messages having a response message defined for a request message, that is the Sequence Number value is copied from the request to the response message header. In the user plane, an increasing sequence number for T-PDUs is transmitted via GTP-U tunnels, when transmission order must be preserved.
- N-PDU Number: This field is used at the Inter SGSN Routeing Area Update procedure and some inter-system handover procedures (e.g. between 2G and 3G radio access networks). This field is used to co-ordinate the data transmission for acknowledged mode of communication between the MS and the SGSN. The exact meaning of this field depends upon the scenario. (For example, for GSM/GPRS to GSM/GPRS, the SNDCCP N-PDU number is present in this field).
- Next Extension Header Type: This field defines the type of Extension Header that follows this field in the GTP-PDU.

| Octets | Bits | | | | | | | |
|--------|--|---|----|-----|---|---|----|---|
| | 8 | 7 | 6 | 5 | 4 | 3 | 2 | 1 |
| 1 | Version | | PT | (*) | E | S | PN | |
| 2 | Message Type | | | | | | | |
| 3 | Length (1 st Octet) | | | | | | | |
| 4 | Length (2 nd Octet) | | | | | | | |
| 5 | Tunnel Endpoint Identifier (1 st Octet) | | | | | | | |
| 6 | Tunnel Endpoint Identifier (2 nd Octet) | | | | | | | |
| 7 | Tunnel Endpoint Identifier (3 rd Octet) | | | | | | | |
| 8 | Tunnel Endpoint Identifier (4 th Octet) | | | | | | | |
| 9 | Sequence Number (1 st Octet) ^{1) 4)} | | | | | | | |
| 10 | Sequence Number (2 nd Octet) ^{1) 4)} | | | | | | | |
| 11 | N-PDU Number ^{2) 4)} | | | | | | | |
| 12 | Next Extension Header Type ^{3) 4)} | | | | | | | |

NOTE 0: (*) This bit is a spare bit. It shall be sent as "0". The receiver shall not evaluate this bit.

NOTE 1: 1) This field shall only be evaluated when indicated by the S flag set to 1.

NOTE 2: 2) This field shall only be evaluated when indicated by the PN flag set to 1.

NOTE 3: 3) This field shall only be evaluated when indicated by the E flag set to 1.

NOTE 4: 4) This field shall be present if and only if any one or more of the S, PN and E flags are set.

Figure 2: Outline of the GTP Header

The format of GTP Extension Headers is depicted in figure 2. The Extension Header Length field specifies the length of the particular Extension header in 4 octets units. The Next Extension Header Type field specifies the type of any Extension Header that may follow a particular Extension Header. If no such Header follows, then the value of the Next Extension Header Type shall be 0.

| | | |
|--------|-------|-----------------------------------|
| Octets | 1 | Extension Header Length |
| | 2 - m | Extension Header Content |
| | m+1 | Next Extension Header Type (note) |

NOTE: The value of this field is 0 if no other Extension header follows.

Figure 3: Outline of the Extension Header Format

The length of the Extension header shall be defined in a variable length of 4 octets, i.e. $m+1 = n*4$ octets, where n is a positive integer.

Bits 7 and 8 of the Next Extension Header Type define how the recipient shall handle unknown Extension Types. The recipient of an extension header of unknown type but marked as "comprehension not required" for that recipient shall read the "Next Extension Header Type" field (using the Extension Header Length field to identify its location in the GTP-PDU).

The recipient of an extension header of unknown type but marked as "comprehension required" for that recipient shall:

- If the message with the unknown extension header was a request, send a response message back with CAUSE set to "unknown mandatory extension header".
- Send a Supported Extension Headers Notification to the originator of the GTP PDU.
- Log an error.

Bits 7 and 8 of the Next Extension Header Type have the following meaning:

| Bits | | Meaning |
|------|---|---|
| 8 | 7 | |
| 0 | 0 | Comprehension of this extension header is not required. An Intermediate Node shall forward it to any Receiver Endpoint |
| 0 | 1 | Comprehension of this extension header is not required. An Intermediate Node shall discard the Extension Header Content and not forward it to any Receiver Endpoint. Other extension headers shall be treated independently of this extension header. |
| 1 | 0 | Comprehension of this extension header is required by the Endpoint Receiver but not by an Intermediate Node. An Intermediate Node shall forward the whole field to the Endpoint Receiver. |
| 1 | 1 | Comprehension of this header type is required by recipient (either Endpoint Receiver or Intermediate Node) |

Figure 4: Definition of bits 7 and 8 of the Extension Header Type

An Endpoint Receiver is the ultimate receiver of the GTP-PDU (e.g. an RNC or the GGSN for the GTP-U plane). An Intermediate Node is a node that handles GTP but is not the ultimate endpoint (e.g. an SGSN for the GTP-U plane traffic between GGSN and RNC).

| Next Extension Header Field Value | Type of Extension Header |
|-----------------------------------|---|
| 0000 0000 | No more extension headers |
| 0000 0001 | MBMS support indication |
| 0000 0010 | MS Info Change Reporting support indication |
| 1100 0000 | PDCP PDU number |
| 1100 0001 | Suspend Request |
| 1100 0010 | Suspend Response |

Figure 5: Definition of Extension Header Type

6.1 Extension headers

6.1.1 PDCP PDU Number

This extension header is transmitted, for example, at SRNS relocation time to provide the PDCP sequence number of not yet acknowledged N-PDUs. It is 4 octets long, and therefore the Length field has value 1.

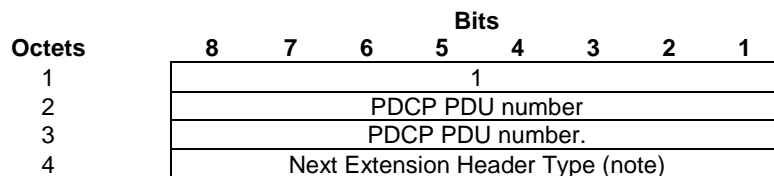

NOTE: The value of this field is 0 if no other Extension header follows.

Figure 6: PDCP PDU number Extension Header

6.1.2 Suspend Request

This extension header is transmitted at inter-SGSN handover, when a DTM capable MS has an ongoing circuit call and it moves to a cell that does not support DTM, under the domain of a new 2G SGSN. When the new SGSN receives a "Suspend" message from the BSS, it sends a SGSN context request with this additional extension header to the old SGSN. The old SGSN shall reply with a SGSN context response, including the Extension Header described in subclause 6.1.3. The SGSN Context Request message shall not be handled other than for the purpose of implementing

the Suspend functionality as described in 3GPP TS 23.060 [4]. The "SGSN context request" message shall not include the "IMSI", "packet-TMSI" and "MS validated" IEs.

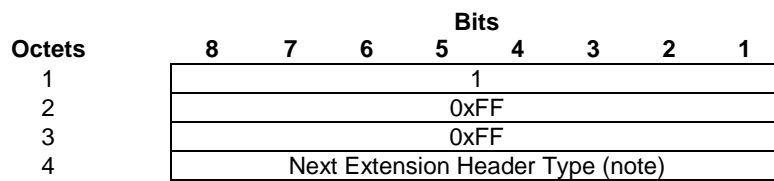

NOTE: The value of this field is 0 if no other Extension header follows.

Figure 7: Suspend Request Extension Header

6.1.3 Suspend Response

When a SGSN receives a SGSN Context Request with the extension header "Suspend Request" described in subclause 6.1.2, it shall perform the actions specified in 3GPP TS 23.060 [4] and it shall return a SGSN Context Response with this extension header included. The SGSN Context Response message shall not be handled other than for the purpose of implementing the Suspend functionality as described in 3GPP TS 23.060 [4]. The "SGSN context response" shall not include the "IMSI", "Radio priority SMS", "Radio priority", "packet flow ID", "MM context", "PDP context" and "SGSN Address for control plane" IEs.

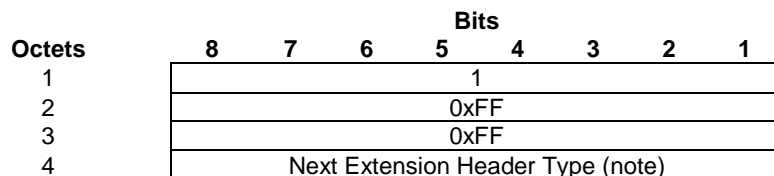

NOTE: The value of this field is 0 if no other Extension header follows.

Figure 8: Suspend Response Extension Header

6.1.4 MBMS support indication

This Extension Header shall be included by an SGSN supporting MBMS in all Create PDP Context Request messages, Update PDP Context Request messages, SGSN Context Request messages and Forward Relocation Response messages.

A GGSN supporting MBMS receiving this Extension Header in a Create PDP Context Request or in an Update PDP Context Request shall assume the SGSN originating the message supports MBMS in the handling of all subsequent MBMS-related procedures. If this Extension Header is not received in a Create PDP Context Request or in an Update PDP Context Request, then the GGSN shall assume that the SGSN originating the message does not support MBMS in the handling of all subsequent MBMS-related procedures.

An SGSN supporting MBMS receiving this Extension Header in an SGSN Context Request or in a Forward Relocation Response shall assume the SGSN originating the message supports MBMS in the handling of all subsequent MBMS-related procedures. If this Extension Header is not received in a SGSN Context Request or in a Forward Relocation Response, then the receiving SGSN shall deactivate the associated MBMS UE Contexts.

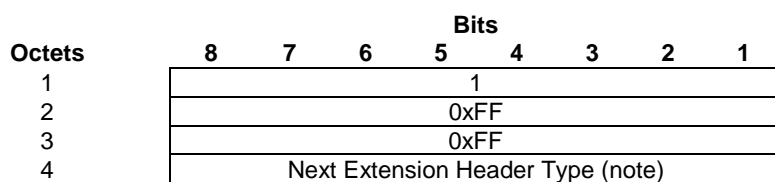

NOTE: The value of this field is 0 if no other Extension header follows.

Figure 8A: MBMS support indication Extension Header

6.1.5 MS Info Change Reporting support indication

This Extension Header shall be included by an SGSN supporting the MS Info Change Reporting mechanism in all Create PDP Context Request messages and Update PDP Context Request messages. It is 4 octets long, and therefore the Length field has the value 1.

A GGSN supporting the MS Info Change Reporting mechanism receiving this Extension Header in a Create PDP Context Request or in an Update PDP Context Request shall assume that the SGSN originating the message supports the MS Info Change Reporting mechanism. If this Extension Header is not received by a GGSN in a Create PDP Context Request or in an Update PDP Context Request, then the GGSN shall assume that the SGSN originating the message does not support the MS Info Change Reporting mechanism. The MS Info Change Reporting mechanism is defined in clause 7.5B.1.

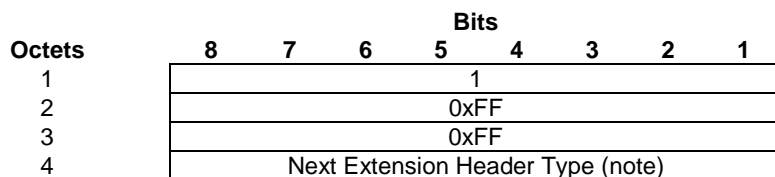

NOTE: The value of this field is 0 if no other Extension header follows.

Figure 6.1.5/1: MS Info Change Reporting support indication Extension Header

7 GTP Messages and Message Formats

7.1 Message Formats

GTP defines a set of messages between two associated GSNs or an SGSN and an RNC. The messages to be used are defined in the table below. The three columns to the right define which parts (GTP-C, GTP-U or GTP') that send or receive the specific message type.

Table 1: Messages in GTP

| Message Type value (Decimal) | Message | Reference | GTP-C | GTP-U | GTP' |
|------------------------------|---|---------------------|-------|-------|------|
| 0 | For future use. Shall not be sent. If received, shall be treated as an Unknown message. | | | | |
| 1 | Echo Request | 7.2.1 | X | X | x |
| 2 | Echo Response | 7.2.2 | X | X | x |
| 3 | Version Not Supported | 7.2.3 | X | | x |
| 4 | Node Alive Request | 3GPP TS 32.295 [33] | | | X |
| 5 | Node Alive Response | 3GPP TS 32.295 [33] | | | X |
| 6 | Redirection Request | 3GPP TS | | | X |

| Message Type value (Decimal) | Message | Reference | GTP-C | GTP-U | GTP' |
|------------------------------|---|---------------------|-------|-------|------|
| | | 32.295 [33] | | | |
| 7 | Redirection Response | 3GPP TS 32.295 [33] | | | X |
| 8-15 | For future use. Shall not be sent. If received, shall be treated as an Unknown message. | | | | |
| 16 | Create PDP Context Request | 7.3.1 | X | | |
| 17 | Create PDP Context Response | 7.3.2 | X | | |
| 18 | Update PDP Context Request | 7.3.3 | X | | |
| 19 | Update PDP Context Response | 7.3.4 | X | | |
| 20 | Delete PDP Context Request | 7.3.5 | X | | |
| 21 | Delete PDP Context Response | 7.3.6 | X | | |
| 22 | Initiate PDP Context Activation Request | 7.3.12 | X | | |
| 23 | Initiate PDP Context Activation Response | 7.3.13 | X | | |
| 24-25 | For future use. Shall not be sent. If received, shall be treated as an Unknown message. | | | | |
| 26 | Error Indication | 7.3.7 | | X | |
| 27 | PDU Notification Request | 7.3.8 | X | | |
| 28 | PDU Notification Response | 7.3.9 | X | | |
| 29 | PDU Notification Reject Request | 7.3.10 | X | | |
| 30 | PDU Notification Reject Response | 7.3.11 | X | | |
| 31 | Supported Extension Headers Notification | 7.2.4 | X | X | |
| 32 | Send Routeing Information for GPRS Request | 7.4.1 | X | | |
| 33 | Send Routeing Information for GPRS Response | 7.4.2 | X | | |
| 34 | Failure Report Request | 7.4.3 | X | | |
| 35 | Failure Report Response | 7.4.4 | X | | |
| 36 | Note MS GPRS Present Request | 7.4.5 | X | | |
| 37 | Note MS GPRS Present Response | 7.4.6 | X | | |
| 38-47 | For future use. Shall not be sent. If received, shall be treated as an Unknown message. | | | | |
| 48 | Identification Request | 7.5.1 | X | | |
| 49 | Identification Response | 7.5.2 | X | | |
| 50 | SGSN Context Request | 7.5.3 | X | | |
| 51 | SGSN Context Response | 7.5.4 | X | | |
| 52 | SGSN Context Acknowledge | 7.5.5 | X | | |
| 53 | Forward Relocation Request | 7.5.6 | X | | |
| 54 | Forward Relocation Response | 7.5.7 | X | | |
| 55 | Forward Relocation Complete | 7.5.8 | X | | |
| 56 | Relocation Cancel Request | 7.5.9 | X | | |
| 57 | Relocation Cancel Response | 7.5.10 | X | | |
| 58 | Forward SRNS Context | 7.5.13 | X | | |
| 59 | Forward Relocation Complete Acknowledge | 7.5.11 | X | | |
| 60 | Forward SRNS Context Acknowledge | 7.5.12 | X | | |
| 61-69 | For future use. Shall not be sent. If received, shall be treated as an Unknown message. | | | | |
| 70 | RAN Information Relay | 7.5.14.1 | X | | |
| 71-95 | For future use. Shall not be sent. If received, shall be treated as an Unknown message. | | | | |
| 96 | MBMS Notification Request | 7.5A.1.1 | X | | |
| 97 | MBMS Notification Response | 7.5A.1.2 | X | | |
| 98 | MBMS Notification Reject Request | 7.5A.1.3 | X | | |
| 99 | MBMS Notification Reject Response | 7.5A.1.4 | X | | |
| 100 | Create MBMS Context Request | 7.5A.1.5 | X | | |
| 101 | Create MBMS Context Response | 7.5A.1.6 | X | | |
| 102 | Update MBMS Context Request | 7.5A.1.7 | X | | |
| 103 | Update MBMS Context Response | 7.5A.1.8 | X | | |
| 104 | Delete MBMS Context Request | 7.5A.1.9 | X | | |
| 105 | Delete MBMS Context Response | 7.5A.1.10 | X | | |
| 106 - 111 | For future use. Shall not be sent. If received, shall be treated as an Unknown message. | | | | |
| 112 | MBMS Registration Request | 7.5A.2.1 | X | | |
| 113 | MBMS Registration Response | 7.5A.2.2 | X | | |
| 114 | MBMS De-Registration Request | 7.5A.2.3 | X | | |
| 115 | MBMS De-Registration Response | 7.5A.2.4 | X | | |

| Message Type value (Decimal) | Message | Reference | GTP-C | GTP-U | GTP' |
|------------------------------|---|---------------------|-------|-------|------|
| 116 | MBMS Session Start Request | 7.5A.2.5 | X | | |
| 117 | MBMS Session Start Response | 7.5A.2.6 | X | | |
| 118 | MBMS Session Stop Request | 7.5A.2.7 | X | | |
| 119 | MBMS Session Stop Response | 7.5A.2.8 | X | | |
| 120 | MBMS Session Update Request | 7.5A.2.9 | X | | |
| 121 | MBMS Session Update Response | 7.5A.2.10 | X | | |
| 122-127 | For future use. Shall not be sent. If received, shall be treated as an Unknown message. | | | | |
| 128 | MS Info Change Notification Request | 7.5B.1.1 | X | | |
| 129 | MS Info Change Notification Response | 7.5B.1.2 | X | | |
| 130-239 | For future use. Shall not be sent. If received, shall be treated as an Unknown message. | | | | |
| 240 | Data Record Transfer Request | 3GPP TS 32.295 [33] | | | X |
| 241 | Data Record Transfer Response | 3GPP TS 32.295 [33] | | | X |
| 242-253 | For future use. Shall not be sent. If received, shall be treated as an Unknown message. | | | | |
| 254 | End Marker | 3GPP TS 29.281 [41] | | X | |
| 255 | G-PDU | 3GPP TS 29.281 [41] | | X | |

7.1.1 Presence requirements of Information Elements

There are three different presence requirements (Mandatory, Conditional, or Optional) for an IE within a given GTP-PDU:

- **Mandatory** means that the IE shall be included by the sending side, and that the receiver diagnoses a "Mandatory IE missing" error when detecting that the IE is not present.
- **Conditional** means:
 - that inclusion of the IE by the sender depends on conditions specified in the relevant protocol specification;
 - that the receiver can expect that the IE is present based on its parameter combination in the message and/or on the state of the receiving node.
- **Optional** means that the IE shall be included as a service option. Therefore, the IE may be included or not in a message.

For error handling, refer to section 11.

7.2 Path Management Messages

The Path Management messages may be sent between any type of GSN or GSN - RNC pair.

7.2.1 Echo Request

A GSN or an RNC may send an Echo Request on a path to the other GSN or RNC to find out if the peer GSN or RNC is alive (see section Path Failure). Echo Request messages may be sent for each path in use. A path is considered to be in use if at least one PDP context, or MBMS UE context, or MBMS bearer context uses the path to the other GSN or RNC. When and how often an Echo Request message may be sent is implementation specific but an Echo Request shall not be sent more often than every 60 s on each path.

A GSN or RNC shall be prepared to receive an Echo Request at any time and it shall reply with an Echo Response. The optional Private Extension contains vendor or operator specific information.

Table 2: Information Elements in an Echo Request

| Information element | Presence requirement | Reference |
|---------------------|----------------------|-----------|
| Private Extension | Optional | 7.7.46 |

7.2.2 Echo Response

The message shall be sent as a response to a received Echo Request.

The Recovery information element contains the local Restart Counter (see section Restoration and Recovery) value for the GSN that sends the Echo Response message. For GTP-U the Restart Counter value shall not be used, i.e. it shall be set to zero by the sender and shall be ignored by the receiver.

The GSN that receives an Echo Response from a peer GSN shall compare the Restart Counter value received with the previous Restart Counter value stored for that peer GSN. If no previous value was stored, the Restart Counter value received in the Echo Response shall be stored for the peer GSN.

The value of a Restart Counter previously stored for a peer GSN may differ from the Restart Counter value received in the Echo Response from that peer GSN. In this case, the GSN that sent the Echo Response shall be considered as restarted by the GSN that received the Echo Response. The new Restart Counter value received shall be stored by the receiving entity, replacing the value previously stored for the sending GSN.

If the sending GSN is a GGSN and the receiving GSN is an SGSN, the SGSN shall consider all PDP contexts using the GGSN as inactive. For further actions of the SGSN refer to 3GPP TS 23.007 [3].

If the sending GSN is an SGSN and the receiving GSN is a GGSN, the GGSN shall consider all PDP contexts using the SGSN as inactive. For further actions of the GGSN refer to 3GPP TS 23.007 [3].

The optional Private Extension contains vendor or operator specific information.

Table 3: Information Elements in an Echo Response

| Information element | Presence requirement | Reference |
|---------------------|----------------------|-----------|
| Recovery | Mandatory | 7.7.11 |
| Private Extension | Optional | 7.7.46 |

7.2.3 Version Not Supported

This message contains only the GTP header and indicates the latest GTP version that the GTP entity on the identified UDP/IP address can support (see subclause 11.1.1).

7.2.4 Supported Extension Headers Notification

This message indicates a list of supported Extension Headers that the GTP entity on the identified IP address can support. This message is sent only in case a GTP entity was required to interpret a mandatory Extension Header but the GSN or RNC was not yet upgraded to support that extension header. The GTP endpoint at the GSN or RNC sending this message is marked as not enabled to support some extension headers (as derived from the supported extension header list). The GSN may retry to use all the extension headers with that node, in an attempt to verify it has been upgraded. Implementers should avoid repeated attempts to use unknown extension headers with an endpoint that has signalled its inability to interpret them.

Table 4: Information Elements in Supported Extension Headers Notification

| Information element | Presence requirement | Reference |
|----------------------------|----------------------|-----------|
| Extension Header Type List | Mandatory | 7.7.40 |

7.3 Tunnel Management Messages

7.3.1 Create PDP Context Request

A Create PDP Context Request shall be sent from a SGSN node to a GGSN node as a part of the GPRS PDP Context Activation procedure. After sending the Create PDP Context Request message, the SGSN marks the PDP context as "waiting for response". In this state the SGSN shall accept G-PDUs from the GGSN but shall not send these G-PDUs to the MS. A valid request initiates the creation of a tunnel between a PDP Context in a SGSN and a PDP Context in a GGSN. If the procedure is not successfully completed, the SGSN repeats the Create PDP Context Request message to the next GGSN address in the list of IP addresses, if there is one. If the list is exhausted the activation procedure fails.

The Tunnel Endpoint Identifier Data I field specifies a downlink Tunnel Endpoint Identifier for G-PDUs which is chosen by the SGSN. The GGSN shall include this Tunnel Endpoint Identifier in the GTP header of all subsequent downlink G-PDUs which are related to the requested PDP context.

The Tunnel Endpoint Identifier Control Plane field specifies a downlink Tunnel Endpoint Identifier for control plane messages which is chosen by the SGSN. The GGSN shall include this Tunnel Endpoint Identifier in the GTP header of all subsequent downlink control plane messages which are related to the requested PDP context. If the SGSN has already confirmed successful assignment of its Tunnel Endpoint Identifier Control Plane to the peer GGSN, this field shall not be present. The SGSN confirms successful assignment of its Tunnel Endpoint Identifier Control Plane the GGSN when it receives any message with its assigned Tunnel Endpoint Identifier Control Plane in the GTP header from the GGSN.

The MSISDN of the MS is passed to the GGSN inside the Create PDP Context Request; This additional information can be used when a secure access to a remote application residing on a server is needed. The GGSN would be in fact able to provide the user identity (i.e. the MSISDN) to the remote application server, providing it with the level of trust granted to users through successfully performing the GPRS authentication procedures, without having to re-authenticate the user at the application level.

If the MS requests a dynamic PDP address and a dynamic PDP address is allowed, then the PDP Address field in the End User Address information element shall be empty. If the MS requests a static PDP Address then the PDP Address field in the End User Address information element shall contain the static PDP Address. In case the PDP addresses carried in the End User Address and optionally in the Protocol Configuration Option information element contain contradicting information, the PDP address carried in the End User Address information element takes the higher precedence. The Quality of Service Profile information element shall be the QoS values to be negotiated between the MS and the SGSN at PDP Context activation. The Evolved Allocation/Retention Priority I information element include the negotiated Evolved Allocation/Retention Priority based on the subscribed one received via Gr interface and SGSN capabilities if the SGSN supports this IE. The APN-AMBR IE shall be included based on the subscribed one received via Gr interface from the HLR and SGSN capabilities if the SGSN supports this IE.

The SGSN shall include an SGSN Address for control plane and an SGSN address for user traffic, which may differ from that provided by the underlying network service (e.g. IP). The GGSN shall store these SGSN Addresses and use them when sending control plane on this GTP tunnel or G-PDUs to the SGSN for the MS.

The SGSN shall include a Recovery information element into the Create PDP Context Request if the SGSN is in contact with the GGSN for the very first time or if the SGSN has restarted recently and the new Restart Counter value has not yet been indicated to the GGSN. The GGSN that receives a Recovery information element in the Create PDP Context Request message element shall handle it in the same way as when receiving an Echo Response message. The Create PDP Context Request message shall be considered as a valid activation request for the PDP context included in the message.

The SGSN shall include either the MS provided APN, a subscribed APN or an SGSN selected APN in the message; the Access Point Name may be used by the GGSN to differentiate accesses to different external networks.

The Selection Mode information element shall indicate the origin of the APN in the message.

For contexts created by the Secondary PDP Context Activation Procedure the SGSN shall include the linked NSAPI. Linked NSAPI indicates the NSAPI assigned to any one of the already activated PDP contexts for this PDP address or two IP addresses (one IPv4 and one IPv6 if PDP Type IPv4v6 is supported and used) and APN. If the requested PDP type is allowed by subscription and if the requested PDP type is IPv4v6, the SGSN sets the PDP type as requested if the GGSN supports PDP type IPv4v6. Otherwise, the SGSN shall set the PDP type to IPv4 or IPv6 where the selection between IPv4 and IPv6 is based on the result of the check.

NOTE1: The check for PDP type IPv4v6 is implementation specific and configuration may be shared in roaming agreements.

NOTE2: A Gn/Gp SGSN assumes coherent support for PDP type IPv4v6 across all SGSNs in a PLMN.

The Secondary PDP Context Activation Procedure may be executed without providing a Traffic Flow Template (TFT) to the newly activated PDP context if all other active PDP contexts for this PDP address or the two IP addresses (one IPv4 and one IPv6 if PDP Type IPv4v6 is supported and used) and APN already have an associated TFT, otherwise a TFT shall be provided. TFT is used for packet filtering in the GGSN.

When using the Secondary PDP Context Activation Procedure, the Selection mode, IMSI, MSISDN, End User Address, Access Point Name and APN Restriction information elements shall not be included in the message.

If the MS is emergency attached and the MS is UICCless (i.e. the mobile terminal cannot obtain IMSI at all) or the IMSI is unauthenticated, the International Mobile Equipment Identity (IMEI) shall be used as the MS identity. If the MS is emergency attached and the MS is UICCless, the IMSI cannot not be included in the message and therefore IMSI shall not be included in the message.

The Protocol Configuration Options (PCO) information element may be included in the request when the MS provides the GGSN with application specific parameters. The SGSN includes this IE in the Create PDP Context Request if the associated Activate PDP Context Request or Activate Secondary PDP Context Request from the MS includes protocol configuration options. The SGSN shall copy the content of this IE transparently from the content of the PCO IE in the Activate PDP Context Request message or Activate Secondary PDP Context Request.

The SGSN shall select one GGSN based on the user provided or SGSN selected APN. The GGSN may have a logical name that is converted to an address. The conversion may be performed with any name-to-address function. The converted address shall be stored in the "GGSN Address in Use" field in the PDP context and be used during the entire lifetime of the PDP context.

If the converted address includes an IPv6 address, the IPv4/IPv6 capable SGSN sends Create PDP Context Request to the GGSN including IPv6 addresses in the fields SGSN Address for Control Plane and SGSN Address for user traffic. If the converted address only includes an IPv4 address, IPv4/IPv6 capable SGSN shall include IPv4 addresses in the fields SGSN Address for Control Plane and SGSN Address for user traffic.

NOTE: A DNS query may be used as the name-to-IP address mapping of the GGSN. The IP address returned in the DNS response is then stored in the "GGSN Address in Use" field in the PDP context.

The IMSI information element together with the NSAPI information element uniquely identifies the PDP context to be created.

The SGSN shall not send a Create PDP Context Request for an already active context.

If a new Create PDP Context Request is incoming on TEID 0 for an already active PDP context, this Create PDP Context Request must be considered related to a new session. The existing PDP context shall be torn down locally, and the associated PDP contexts deleted locally, before the new session is created. If a new Create PDP Context Request is incoming on a TEID which is different from 0 and this TEID is already allocated to one or more activated PDP contexts, and the NSAPI IE value in this message matches the NSAPI value of an active PDP context, the GGSN shall send back a Create PDP Context Response with a rejection cause code. It is implementation dependent deciding whether to teardown or keep the existing PDP context.

If the GGSN uses the MNRG flag and the flag is set, the GGSN should treat the Create PDP Context Request as a Note MS Present Request and clear the MNRG flag.

The SGSN shall determine Charging Characteristics from the Subscribed Charging Characteristics and/or PDP Context Charging Characteristics depending on the presence of the information in the Packet Domain Subscription Data as defined in 3GPP TS 23.060 [4]. The requirements for the presence of the Charging Characteristics IE are defined in 3GPP TS 23.060 [4]. The contents of the Charging Characteristics IE are defined in 3GPP TS 32.251 [18] and 3GPP TS 32.298 [34].

The SGSN shall include Trace Reference, Trace Type, Trigger Id, OMC Identity and Additional Trace Info (Trace reference2, Trace Recording Session Reference, triggering events in GGSN, Trace Depth, List of interfaces to trace in GGSN and Trace Activity Control) in the message if GGSN trace is activated. The SGSN shall copy Trace Reference, Trace Type, OMC Identity and Additional Trace Info from the trace request received from the HLR or OMC and the Trace Activity Control shall be set to Trace Activation

For more detailed description of Trace Session activation/deactivation procedures see 3GPP TS 32.422 [31]

For SGSN and GGSN trace record description see 3GPP TS 32.423 [32].

The SGSN may include the Routing Area Identity (RAI) of the SGSN where the MS is registered. The MCC and MNC components shall be populated with the MCC and MNC, respectively, of the SGSN where the MS is registered. The LAC and RAC components shall be populated by the SGSN with the value of "FFFE" and "FF", respectively.

The APN Restriction is an optional information element. In this instance it is used by the SGSN to convey to the GGSN the highest restriction type out of all the currently active PDP Contexts for a particular subscriber.

The presence of the Common Flags IE is optional. If the NRSN bit of the Common Flags IE is set to 1, the SGSN supports the network requested bearer control. If NRSN bit of the Common Flags IE is set to 0 or the Common Flags IE is absent then the SGSN does not support network requested bearer control. If the Upgrade QoS Supported bit of the Common Flags IE is set to 1, the SGSN supports the QoS upgrade in Response message functionality. If Upgrade QoS Supported bit of the Common Flags IE is set to 0 or the Common Flags IE is absent then the SGSN does not support QoS upgrade in Response message functionality. If Dual Address Bearer Flag bit of the Common Flags IE is set to 1, the MS requests PDP type IPv4v6 and all SGSNs, which the MS may be handed over to, are Release9 or above supporting dual addressing, which is determined based on node pre-configuration by the operator.

The SGSN may include the User Location Information IE, MS Time Zone IE, RAT Type IE, IMEI(SV) IE and the CAMEL Charging Information Container IE, User CSG Information if they are available (see sub-clause 15.1.1a of 3GPP TS 23.060 [4] for more information). If the User Location Information IE is included then the SGSN shall include the CGI or SAI in the "Geographic Location" field depending on whether the MS is in a cell or a service area respectively. If the MS is emergency attached and the MS is UICCless or the IMSI is unauthenticated, the International Mobile Equipment Identity (IMEI) shall be included and used as the MS identity. If the User CSG Information IE is included then the SGSN shall include the CSG ID, Access mode, the CSG Membership Indication shall also be included if the Access mode is Hybrid Mode.

The Correlation-ID shall be included if the PDP Context Activation is performed as part of the Network Requested Secondary PDP Context Activation Procedure.

The presence of the Extended Common Flags IE is optional. The Unauthenticated IMSI bit field shall be set to 1 if the IMSI present in the message is not authenticated and is for an emergency attached MS. The CSG Change Reporting Support Indication (CCRSI) bit field shall be set to 1 if the SGSN supports CSG Information Change Reporting. If the CCRSI bit field is set to 0 or the Extended Common Flags IE is not included in the message, the GGSN shall assume that the SGSN originating the message does not support the CSG Information Change Reporting. 3GPP TS 23.060 [4] (e.g. subclause 9.2.2.1) defines the SGSN shall send the MS Info Change Reporting Support Indication to the GGSN. In such case SGSN shall use the CSG Change Reporting Support Indication for CSG Information Reporting even if stage 2 refers to MS Info Change Reporting Support Indication.

The optional Private Extension contains vendor or operator specific information.

Table 5: Information Elements in a Create PDP Context Request

| Information element | Presence requirement | Reference |
|--|----------------------|--------------------|
| IMSI | Conditional | 7.7.2 |
| Routeing Area Identity (RAI) | Optional | 7.7.3 |
| Recovery | Optional | 7.7.11 |
| Selection mode | Conditional | 7.7.12 |
| Tunnel Endpoint Identifier Data I | Mandatory | 7.7.13 |
| Tunnel Endpoint Identifier Control Plane | Conditional | 7.7.14 |
| NSAPI | Mandatory | 7.7.17 |
| Linked NSAPI | Conditional | 7.7.17 |
| Charging Characteristics | Conditional | 7.7.23 |
| Trace Reference | Optional | 7.7.24 |
| Trace Type | Optional | 7.7.25 |
| End User Address | Conditional | 7.7.27 |
| Access Point Name | Conditional | 7.7.30 |
| Protocol Configuration Options | Optional | 7.7.31 |
| SGSN Address for signalling | Mandatory | GSN Address 7.7.32 |
| SGSN Address for user traffic | Mandatory | GSN Address 7.7.32 |
| MSISDN | Conditional | 7.7.33 |
| Quality of Service Profile | Mandatory | 7.7.34 |
| TFT | Conditional | 7.7.36 |
| Trigger Id | Optional | 7.7.41 |
| OMC Identity | Optional | 7.7.42 |
| Common Flags | Optional | 7.7.48 |
| APN Restriction | Optional | 7.7.49 |
| RAT Type | Optional | 7.7.50 |
| User Location Information | Optional | 7.7.51 |
| MS Time Zone | Optional | 7.7.52 |
| IMEI(SV) | Conditional | 7.7.53 |
| CAMEL Charging Information Container | Optional | 7.7.54 |
| Additional Trace Info | Optional | 7.7.62 |
| Correlation-ID | Optional | 7.7.82 |
| Evolved Allocation/Retention Priority I | Optional | 7.7.91 |
| Extended Common Flags | Optional | 7.7.93 |
| User CSG Information | Optional | 7.7.94 |
| APN-AMBR | Optional | 7.7.98 |
| Private Extension | Optional | 7.7.46 |

7.3.2 Create PDP Context Response

The message shall be sent from a GGSN node to a SGSN node as a response of a Create PDP Context Request. When the SGSN receives a Create PDP Context Response with the Cause value indicating "Request Accepted", the SGSN activates the PDP context and may start to forward T-PDUs to/from the MS from/to the external data network.

The Cause value indicates if a PDP context has been created in the GGSN or not. A PDP context has not been created in the GGSN if the Cause differs from "Request accepted". Possible Cause values are:

- "Request Accepted".
- "Context not found"
- "No resources available".
- "All dynamic PDP addresses are occupied".
- "No memory is available".
- "Missing or unknown APN".
- "Unknown PDP address or PDP type".
- "User authentication failed".
- "System failure".

- "Semantic error in the TFT operation".
- "Syntactic error in the TFT operation".
- "Semantic errors in packet filter(s)".
- "Syntactic errors in packet filters(s)".
- "Mandatory IE incorrect".
- "Mandatory IE missing".
- "Optional IE incorrect".
- "Invalid message format".
- "PDP context without TFT already activated".
- "APN access denied – no subscription".
- "APN Restriction type incompatibility with currently active PDP Contexts"
- "Collision with network initiated request"
- "New PDP type due to network preference".
- "New PDP type due to single address bearer only".

"No resources available" indicates that not enough resources are available within the network to allow the PDP Context to be created. "Missing or unknown APN" indicates e.g. when the GGSN does not support the Access Point Name. "Unknown PDP address or PDP type" indicates when the GGSN does not support the PDP type or the PDP address.

"User authentication failed" indicates that the external packet network has rejected the service requested by the user e.g. the authentication check in the RADIUS server failed. "PDP context without TFT already activated" indicates that a PDP context has already been activated without a TFT for that MS. "Context not found" indicates that a Create PDP Request for a subsequent PDP context has been received, but the PDP context associated with the request, which the SGSN believes to be active does not exist on the GGSN. "APN access denied – no subscription" indicates that the GGSN has denied the user access to an APN because a subscription is required, but the subscriber does not have the necessary subscription.

"New PDP type due to network preference" indicates that the GGSN has selected a PDP type different from the one sent by the MS. "New PDP type due to single address bearer only" indicates that the MS has requested PDP type IPv4v6 and both IPv4 and IPv6 addressing is possible in the PDN but the Dual Address Bearer Flag bit of the Common Flags IE is set to 0 or the Common Flags IE is absent, or only single IP version addressing is possible in the PDN.

Only the Cause information element, optionally Protocol Configuration Options and optionally the Recovery information element shall be included in the response if the Cause contains another value than "Request accepted".

All information elements, except Recovery, Protocol Configuration Options, Charging Gateway Address, Tunnel Endpoint Identifier Control Plane and Private Extension, are mandatory if the Cause contains the value "Request accepted".

The Tunnel Endpoint Identifier for Data (I) field specifies an uplink Tunnel Endpoint Identifier for G-PDUs that is chosen by the GGSN. The SGSN shall include this Tunnel Endpoint Identifier in the GTP header of all subsequent uplink G-PDUs which are related to the requested PDP context.

The Tunnel Endpoint Identifier Control Plane field specifies an uplink Tunnel Endpoint Identifier for control plane messages, which is chosen by the GGSN. The SGSN shall include this Tunnel Endpoint Identifier in the GTP header of all subsequent uplink-control plane messages, which are related to the requested PDP context. If the GGSN has already confirmed successful assignment of its Tunnel Endpoint Identifier Control Plane to the peer SGSN, this field shall not be present. The GGSN confirms successful assignment of its Tunnel Endpoint Identifier Control Plane to the SGSN when it receives any message with its assigned Tunnel Endpoint Identifier Control Plane in the GTP header from the SGSN.

The GGSN may include the NSAPI received from the SGSN in the Create PDP Context Request message, in order to facilitate error handling in SGSN.

NOTE: If an SGSN receives a Create PDP Context Response with an NSAPI IE included for which there is no corresponding outstanding request, an SGSN may send a Delete PDP Context Request towards the GGSN that sent the Create PDP Context Response with the NSAPI included

The GGSN shall include a GGSN Address for control plane and a GGSN address for user traffic, which may differ from that provided by the underlying network service (e.g. IP).

If the Create PDP Context Request received from the SGSN included IPv6 SGSN address, an IPv4/IPv6 capable GGSN shall include IPv6 addresses in the fields GGSN Address for Control Plane and GGSN Address for user traffic, and IPv4 addresses in the fields Alternative GGSN Address for Control Plane and Alternative GGSN Address for user traffic. If SGSN included IPv4 SGSN addresses in the request, an IPv4/IPv6 capable GGSN shall include IPv4 addresses in the fields GGSN Address for Control Plane and GGSN Address for user traffic, and IPv6 addresses in the fields Alternative GGSN Address for Control Plane and Alternative GGSN Address for user traffic. An IPv4/IPv6 capable SGSN shall store these GGSN Addresses and use one set of them when sending control plane on this GTP tunnel or G-PDUs to the GGSN for the MS. An IPv4 only SGSN shall not store the IPv6 address included in the Alternative GGSN Address.

If the MS requests a dynamic PDP address with the PDP Type IPv4, IPv6 or IPv4v6 and a dynamic PDP address is allowed, then the End User Address information element shall be included and the PDP Address field in the End User Address information element shall contain the dynamic PDP Address(es) allocated by the GGSN.

If the MS requests a static PDP address with the PDP Type IPv4, IPv6 or IPv4v6, or a PDP address is specified with PDP Type PPP, then the End User Address information element shall be included and the PDP Address field shall not be included.

The PDP address in End User Address IE and in the Protocol configuration options IE shall be the same, if both IEs are present in the create PDP context response. When using the Secondary PDP Context Activation Procedure, the End User Address element shall not be included in the message.

The QoS values supplied in the Create PDP Context Request may be negotiated downwards by the GGSN. If the SGSN has indicated support for upgrade of QoS in the request message, the QoS values may also be negotiated upwards by the GGSN. The negotiated values or the original values from SGSN are inserted in the Quality of Service Profile information element of the Create PDP Context Response message. The Evolved Allocation/Retention Priority I IE shall be included as the authorized Evolved Allocation/Retention Priority if the GGSN supports this IE and if the Evolved Allocation/Retention Priority I IE has been included in the corresponding request message. If there is no authorized Evolved ARP received from GGSN, SGSN shall continue to use legacy ARP included in the Quality of Service (QoS) Profile IE. The APN-AMBR IE shall be included as the authorized APN-AMBR if the GGSN supports this IE and if the APN-AMBR IE has been included in the corresponding request message.

The GGSN may start to forward T-PDUs after the Create PDP Context Response has been sent. The SGSN may start to forward T-PDUs when the Create PDP Context Response has been received. In this case the SGSN shall also be prepared to receive T-PDUs from the GGSN after it has sent a Create PDP Context Request but before a Create PDP Context Response has been received.

The Reordering Required value supplied in the Create PDP Context Response indicates whether the end user protocol benefits from packet in sequence delivery and whether the SGSN and the GGSN therefore shall perform reordering or not. In other words, if reordering is required by the GGSN, the SGSN and the GGSN shall perform reordering of incoming T-PDUs on this path. When the Quality of Service (QoS) Profile is Release 99 the receiving entity shall ignore the Reordering Required.

The GGSN shall include the Recovery information element into the Create PDP Context Response if the GGSN is in contact with the SGSN for the first time or the GGSN has restarted recently and the new Restart Counter value has not yet been indicated to the SGSN. The SGSN receiving the Recovery information element shall handle it as when an Echo Response message is received but shall consider the PDP context being created as active if the response indicates successful context activation at the GGSN.

The Charging ID is used to identify all charging records produced in SGSN(s) and the GGSN for this PDP context. The Charging ID is generated by the GGSN and shall be unique within the GGSN.

The Charging Gateway Address is the IP address of the recommended Charging Gateway Functionality to which the SGSN should transfer the Charging Detail Records (CDR) for this PDP Context.

The Alternative Charging Gateway Address IE has a similar purpose as the Charging Gateway Address but enables co-existence of IPv4 and IPv6 stacks in the Ga charging interfaces, without mandating any node to have a dual stack. The

format of the optional Alternative Charging Gateway Address information element is the same as the format of the Charging Gateway Address.

When both these addresses are present, the Charging Gateway address IE shall contain the IPv4 address of the Charging Gateway Function and the Alternative Charging Gateway address IE shall contain the IPv6 address of the Charging Gateway Function.

NOTE: The Charging Gateway Address and Alternative Charging Gateway Address both refer to the same Charging Gateway Function.

The APN Restriction is an optional information element. In this instance it is used by the GGSN to convey to the SGSN the restriction type of the associated PDP Context being set up.

The optional Private Extension contains vendor or operator specific information.

The Protocol Configuration Options (PCO) information element may be included in the response when the GGSN provides the MS with application specific parameters or to indicate the Bearer Control Mode to the MS.

If Bearer Control Mode is provided by the GGSN in the PCO, the Bearer Control Mode IE shall be included in order to inform the SGSN about the bearer control mode and shall indicate the same bearer control mode as indicated to the MS in the PCO.

The presence of the Common Flags IE is optional. If the Prohibit Payload Compression bit of the Common Flags IE is set to 1, then for A/Gb mode access the SGSN shall not compress the payload of user data regardless of whether the user asks for payload compression. If the Prohibit Payload Compression bit of the Common Flags IE is set to 0 or the Common Flags IE is absent then the SGSN shall perform payload compression when the user asks for it as per normal operation.

If the MS Info Change Reporting mechanism is to be started or stopped for this subscriber, then the GGSN shall include the MS Info Change Reporting Action IE in the message and shall set the value of the Action field appropriately.

Table 6: Information Elements in a Create PDP Context Response

| Information element | Presence requirement | Reference |
|--|----------------------|--------------------|
| Cause | Mandatory | 7.7.1 |
| Reordering required | Conditional | 7.7.6 |
| Recovery | Optional | 7.7.11 |
| Tunnel Endpoint Identifier Data I | Conditional | 7.7.13 |
| Tunnel Endpoint Identifier Control Plane | Conditional | 7.7.14 |
| NSAPI | Optional | 7.7.17 |
| Charging ID | Conditional | 7.7.26 |
| End User Address | Conditional | 7.7.27 |
| Protocol Configuration Options | Optional | 7.7.31 |
| GGSN Address for Control Plane | Conditional | GSN Address 7.7.32 |
| GGSN Address for user traffic | Conditional | GSN Address 7.7.32 |
| Alternative GGSN Address for Control Plane | Conditional | GSN Address 7.7.32 |
| Alternative GGSN Address for user traffic | Conditional | GSN Address 7.7.32 |
| Quality of Service Profile | Conditional | 7.7.34 |
| Charging Gateway Address | Optional | 7.7.44 |
| Alternative Charging Gateway Address | Optional | 7.7.44 |
| Common Flags | Optional | 7.7.48 |
| APN Restriction | Optional | 7.7.49 |
| MS Info Change Reporting Action | Optional | 7.7.80 |
| Bearer Control Mode | Optional | 7.7.83 |
| Evolved Allocation/Retention Priority I | Optional | 7.7.91 |
| APN-AMBR | Optional | 7.7.98 |
| Private Extension | Optional | 7.7.46 |

7.3.3 Update PDP Context Request

An Update PDP Context Request message shall be sent from an SGSN to a GGSN as part of the GPRS inter-SGSN Routeing Area Update procedure, the PDP Context Modification procedure, to redistribute contexts due to load sharing or as part of the inter-system intra-SGSN update procedure i.e. UE transitioning between UTRAN and GERAN A/Gb

mode (and vice versa) on the same SGSN and if the SGSN decides to enable a direct GTP-U tunnel between the GGSN and the RNC. It shall be used to change the QoS and the path. For the inter-SGSN Routing Area Update procedure the message shall be sent by the new SGSN. The Update PDP Context Request shall also be used as part of the Secondary PDP Context Activation Procedure to indicate that RAN Procedures are ready and that the SGSN is ready to receive payload from the GGSN on the new PDP Context.

The NSAPI information element together with the Tunnel Endpoint Identifier in the GTP header unambiguously identifies a PDP Context in the GGSN.

The IMSI may be included if the message is sent during an Inter SGSN change.

The Tunnel Endpoint Identifier Data field specifies a downlink Tunnel Endpoint Identifier for G-PDUs which is chosen by the SGSN. The GGSN shall include this Tunnel Endpoint Identifier in the GTP header of all subsequent downlink G-PDUs that are related to the requested PDP context.

The Tunnel Endpoint Identifier Control Plane field specifies a downlink Tunnel Endpoint Identifier Control Plane messages which is chosen by the SGSN. The GGSN shall include this Tunnel Endpoint Identifier in the GTP header of all subsequent downlink control plane messages that are related to the requested PDP context. If the SGSN has already confirmed successful assignment of its Tunnel Endpoint Identifier Control Plane to the peer GGSN, this field shall not be present. The SGSN confirms successful assignment of its Tunnel Endpoint Identifier Control Plane to the GGSN when it receives any message with its assigned Tunnel Endpoint Identifier Control Plane in the GTP header from the GGSN.

The Quality of Service Profile information element shall include the QoS negotiated between the MS and SGSN at PDP Context activation or the new QoS negotiated in the PDP Context Modification procedure. The Evolved Allocation/Retention Priority I information element shall include the negotiated Evolved Allocation/Retention Priority if the SGSN supports it and if the support of Evolved ARP has been indicated by the current GGSN or if the SGSN has no information if GGSN supports Evolved ARP. The APN-AMBR shall include the negotiated APN-AMBR if the SGSN supports it and if the support of APN-AMBR has been indicated by the current GGSN and the current SGSN changes the APN-AMBR or if the SGSN has no information if GGSN supports APN-AMBR.

The SGSN shall include an SGSN Address for control plane and an SGSN address for user traffic, which may differ from that provided by the underlying network service (e.g. IP).

If an IPv4/IPv6 capable SGSN received IPv4 GGSN addresses from the old SGSN, it shall include IPv4 addresses in the fields SGSN Address for Control Plane and SGSN Address for User Traffic and IPv6 addresses in the fields Alternative SGSN Address for Control Plane and Alternative SGSN Address for User Traffic. Otherwise, an IPv4/IPv6 capable SGSN shall use only SGSN IPv6 addresses if it has GGSN IPv6 addresses available. If the GGSN supports IPv6 below GTP, it shall store and use the IPv6 SGSN addresses for communication with the SGSN and ignore the IPv4 SGSN addresses. If the GGSN supports only IPv4 below GTP, it shall store and use the IPv4 SGSN addresses for communication with the SGSN and ignore the IPv6 SGSN addresses. When active contexts are being redistributed due to load sharing, G-PDUs that are in transit across the Gn-interface are in an undetermined state and may be lost.

The SGSN shall include a Recovery information element into the Update PDP Context Request if the SGSN is in contact with the GGSN for the very first time or if the SGSN has restarted recently and the new Restart Counter value has not yet been indicated to the GGSN. The GGSN that receives a Recovery information element in the Update PDP Context Request message element shall handle it in the same way as when receiving an Echo Response message. The Update PDP Context Request message shall be considered as a valid update request for the PDP context indicated in the message.

The Traffic Flow Template (TFT) is used to distinguish between different user traffic flows.

The SGSN shall include Trace Reference, Trace Type, Trigger Id, OMC Identity and Additional Trace Info (Trace reference 2, Trace Recording Session Reference, triggering events in GGSN, Trace Depth, List of interfaces to trace in GGSN and Trace Activity Control) in the message if GGSN trace is activated while the PDP context is active. The SGSN shall copy Trace Reference, Trace Type, OMC Identity and Additional Trace Info from the trace request received from the HLR or OMC and the Trace Activity Control of the Additional Trace Info shall be set to Trace Activation

If SGSN deactivates the Trace Session to GGSN, the SGSN shall include the Additional Trace Info in the message and the Trace Activity Control shall be set to Trace Deactivation.

For more detailed description of Trace Session activation/deactivation procedures see 3GPP TS 32.422 [31]

For SGSN and GGSN trace record description see 3GPP TS 32.423 [32]

The SGSN may include the Routing Area Identity (RAI) of the SGSN where the MS is registered. The MCC and MNC components shall be populated with the MCC and MNC, respectively, of the SGSN where the MS is registered. The LAC and RAC components shall be populated by the SGSN with the value of "FFFE" and "FF", respectively.

The optional Private Extension contains vendor or operator specific information.

The MS includes the Protocol Configuration Options (PCO) information element in the request if the MS wishes to provide the GGSN with application specific parameters. The SGSN includes this IE in the Update PDP Context Request if the associated Modify PDP Context Request from the MS includes protocol configuration options. The SGSN shall copy the content of this IE transparently from the content of the PCO IE in the Modify PDP Context Request message.

The presence of the Common Flags IE is optional. If the RAN Procedures Ready bit of the Common Flags IE is set to 1, then SGSN is ready to receive payload on the PDP Context indicated in the message. If RAN Procedures Ready bit of the Common Flags IE is set to 0 or the Common Flags IE is absent then the RAN procedures in the SGSN may or may not be ready. If the NRSN bit of the Common Flags IE is set to 1, the SGSN supports the network requested bearer control. If NRSN bit of the Common Flags IE is set to 0 or the Common Flags IE is absent then the SGSN does not support network requested bearer control. If the No QoS negotiation bit of the Common Flags IE is set to 1, then GGSN shall not re-negotiate QoS in the corresponding Update PDP Context Response. If the No QoS negotiation bit of the Common Flags IE is set to 0 or the Common Flags IE is absent then the GGSN may re-negotiate QoS in the corresponding Update PDP Context Response. If the Upgrade QoS Supported bit of the Common Flags IE is set to 1, the SGSN supports the QoS upgrade in Response message functionality. If Upgrade QoS Supported bit of the Common Flags IE is set to 0 or the Common Flags IE is absent then the SGSN does not support QoS upgrade in Response message functionality.

If the Direct Tunnel Flags IE is included and if the DTI bit of the Direct Tunnel Flags IE is set to 1, this indicates to the GGSN that for this PDP Context the SGSN is invoking a direct tunnel. If the DTI bit of the Direct Tunnel Flags IE is set to 0 or the Direct Tunnel Flags IE is absent, this indicates to the GGSN that for this PDP Context the SGSN is not invoking a direct tunnel. All other fields of the Direct Tunnel Flags IE shall be ignored.

The SGSN may include the User Location Information IE, RAT Type IE and MS Time Zone IE, User CSG Information if they are available (see sub-clause 15.1.1a of 3GPP TS 23.060 [4] for more information). If the User Location Information IE is included then the SGSN shall include the CGI or SAI in the "Geographic Location" field depending on whether the MS is in a cell or a service area respectively. If the User CSG Information IE is included then the SGSN shall include the CSG ID, Access mode, the CSG Membership Indication shall also be included if the Access mode is Hybrid Mode.

The presence of the Extended Common Flags IE is optional. The CSG Change Reporting Support Indication (CCRSI) bit field shall be set to 1 if the SGSN supports CSG Information Change Reporting. If the CCRSI bit field is set to 0 or the Extended Common Flags IE is not included in the message, the GGSN shall assume that the SGSN originating the message does not support the CSG Information Change Reporting. 3GPP TS 23.060 [4] (e.g. subclause 9.2.2.1) defines the SGSN shall send the MS Info Change Reporting Support Indication to the GGSN. In such case SGSN shall use the CSG Change Reporting Support Indication for CSG Information Reporting even if stage 2 refers to MS Info Change Reporting Support Indication.

Table 7: Information Elements in an SGSN-Initiated Update PDP Context Request

| Information element | Presence requirement | Reference |
|--|----------------------|--------------------|
| IMSI | Optional | 7.7.2 |
| Routing Area Identity (RAI) | Optional | 7.7.3 |
| Recovery | Optional | 7.7.11 |
| Tunnel Endpoint Identifier Data I | Mandatory | 7.7.13 |
| Tunnel Endpoint Identifier Control Plane | Conditional | 7.7.14 |
| NSAPI | Mandatory | 7.7.17 |
| Trace Reference | Optional | 7.7.24 |
| Trace Type | Optional | 7.7.25 |
| Protocol Configuration Options | Optional | 7.7.31 |
| SGSN Address for Control Plane | Mandatory | GSN Address 7.7.32 |
| SGSN Address for User Traffic | Mandatory | GSN Address 7.7.32 |
| Alternative SGSN Address for Control Plane | Conditional | GSN Address 7.7.32 |
| Alternative SGSN Address for User Traffic | Conditional | GSN Address 7.7.32 |
| Quality of Service Profile | Mandatory | 7.7.34 |
| TFT | Optional | 7.7.36 |
| Trigger Id | Optional | 7.7.41 |
| OMC Identity | Optional | 7.7.42 |
| Common Flags | Optional | 7.7.48 |
| RAT Type | Optional | 7.7.50 |
| User Location Information | Optional | 7.7.51 |
| MS Time Zone | Optional | 7.7.52 |
| Additional Trace Info | Optional | 7.7.62 |
| Direct Tunnel Flags | Optional | 7.7.81 |
| Evolved Allocation/Retention Priority I | Optional | 7.7.91 |
| Extended Common Flags | Optional | 7.7.93 |
| User CSG Information | Optional | 7.7.94 |
| APN-AMBR | Optional | 7.7.98 |
| Private Extension | Optional | 7.7.46 |

An Update PDP Context Request may also be sent from a GGSN to an SGSN to re-negotiate the QoS of a PDP context. The GGSN-initiated Update PDP Context Request can also be used to provide a PDP address to the SGSN (and MS). The latter shall be used by GGSN when it acts as a DHCP Relay Agent or Mobil IP Foreign Agent. A GGSN may send an update PDP context to a SGSN to check that the PDP context is still active at the SGSN. In such a case, the GGSN shall include the optional IMSI IE, to add robustness against the case the SGSN has re-assigned the TEID to another PDP context (this may happen when the PDP context is dangling at the GGSN). Also, the "Quality of service profile" IE and the "End user Address" IE shall not be included in this case. For network requested bearer control a GGSN may send an update PDP context to a SGSN in order to add, modify or delete the TFT related to the PDP Context or to change the Bearer Control Mode. A GGSN sends an Update PDP Context to an SGSN when a direct tunnel is used and the GGSN receives an Error Indication message from the RNC. In such a case, the GGSN shall include the NSAPI IE and the Direct Tunnel Flags IE with the EI bit set.

NOTE: SGSN and GGSN behaviour for RNC failure and recovery is defined in 3GPP TS 23.060 [4].

The Quality of Service Profile information element shall include the GGSN requested QoS. The Evolved Allocation/Retention Priority I IE shall be included if Evolved Allocation/Retention Priority has been newly authorized and if the GGSN supports this IE and if the support of Evolved ARP has been indicated by the current SGSN. The APN-AMBR IE shall be included if APN-AMBR has been newly authorized and if the GGSN supports this IE and if the support of APN-AMBR has been indicated by the current SGSN.

The End User Address information element shall contain a valid IPv4 or IPv6 address.

The GGSN shall include a Recovery information element into the Update PDP Context Request if the GGSN has restarted recently and the new Restart Counter value has not yet been indicated to the SGSN. The SGSN that receives a Recovery information element in the Update PDP Context Request message element shall handle it in the same way as when receiving an Echo Response message. The Update PDP Context Request message shall be considered as a valid update request for the PDP context indicated in the message.

The NSAPI information element together with the Tunnel Endpoint Identifier in the GTP header unambiguously identifies a PDP Context in the SGSN.

The GGSN includes the Protocol Configuration Options (PCO) information element in the request if the GGSN wishes to provide the MS with application specific parameters or to indicate the Bearer Control Mode to the MS. The SGSN includes this IE in the Modify PDP Context Request message if the associated Update PDP Context Request message from the GGSN includes protocol configuration options. The SGSN shall copy the content of this IE transparently from the content of the PCO IE in the Update PDP Context Request message.

The optional Private Extension contains vendor or operator specific information.

The TFT is optional and included in order to add, modify or delete the TFT related to the PDP Context for network requested bearer control.

If Bearer Control Mode is provided by the GGSN in the PCO, the Bearer Control Mode IE shall be included in order to inform the SGSN about the bearer control mode and shall indicate the same bearer control mode as indicated to the MS in the PCO.

The presence of the Common Flags IE is optional. If the Prohibit Payload Compression bit of the Common Flags IE is set to 1, then for A/Gb mode access the SGSN shall not compress the payload of user data regardless of whether the user asks for payload compression. If the Prohibit Payload Compression bit of the Common Flags IE is set to 0 or the Common Flags IE is absent then the SGSN shall perform payload compression when the user asks for it as per normal operation.

The APN Restriction is an optional information element. In this instance it is used by the GGSN to convey to the SGSN the restriction type of the associated PDP Context being updated.

If the MS Info Change Reporting mechanism is to be started or stopped for this subscriber, then the GGSN shall include the MS Info Change Reporting Action IE in the message and shall set the value of the Action field appropriately.

If the CSG Information Reporting mechanism is to be started or stopped for this subscriber, then the GGSN shall include the CSG Information Reporting Action IE in the message and shall set the value of the Action field appropriately.

Table 8: Information Elements in a GGSN-Initiated Update PDP Context Request

| Information element | Presence requirement | Reference |
|---|----------------------|-----------|
| IMSI | Optional | 7.7.2 |
| Recovery | Optional | 7.7.11 |
| NSAPI | Mandatory | 7.7.17 |
| End User Address | Optional | 7.7.27 |
| Protocol Configuration Options | Optional | 7.7.31 |
| Quality of Service Profile | Optional | 7.7.34 |
| TFT | Optional | 7.7.36 |
| Common Flags | Optional | 7.7.48 |
| APN Restriction | Optional | 7.7.49 |
| MS Info Change Reporting Action | Optional | 7.7.80 |
| Direct Tunnel Flags | Optional | 7.7.81 |
| Bearer Control Mode | Optional | 7.7.83 |
| Evolved Allocation/Retention Priority I | Optional | 7.7.91 |
| CSG Information Reporting Action | Optional | 7.7.95 |
| APN-AMBR | Optional | 7.7.98 |
| Private Extension | Optional | 7.7.46 |

7.3.4 Update PDP Context Response

The message shall be sent from a GGSN node to a SGSN node as a response of an Update PDP Context Request.

If the SGSN receives an Update PDP Context Response with a Cause value other than "Request accepted", it shall abort the update of the PDP context.

If the SGSN receives an Update PDP Context Response with a Cause value "Non-existent", it shall delete the PDP Context.

Only the Cause information element, optionally Protocol Configuration Options and optionally the Recovery information element shall be included in the response if the Cause contains another value than "Request accepted".

Possible Cause values are:

- "Request Accepted".
- "Non-existent".
- "Service not supported".
- "System failure".
- "Semantic error in the TFT operation".
- "Syntactic error in the TFT operation".
- "Semantic errors in packet filter(s)".
- "Syntactic errors in packet filters(s)".
- "Mandatory IE incorrect".
- "Mandatory IE missing".
- "Optional IE incorrect".
- "Invalid message format".
- "Bearer Control Mode violation".

The Tunnel Endpoint Identifier Data field specifies an uplink Tunnel Endpoint Identifier for G-PDUs that is chosen by the GGSN. The SGSN shall include this Tunnel Endpoint Identifier in the GTP header of all subsequent uplink G-PDUs that are related to the requested PDP context. This information element shall be included if the Cause contains the value "Request accepted".

The Tunnel Endpoint Identifier Control Plane field specifies an uplink Tunnel Endpoint Identifier Control Plane messages which is chosen by the GGSN. The SGSN shall include this Tunnel Endpoint Identifier in the GTP header of all subsequent uplink control plane messages which are related to the requested PDP context. If the GGSN has already confirmed successful assignment of its Tunnel Endpoint Identifier Control Plane to the peer SGSN, this field shall not be present. The GGSN confirms successful assignment of its Tunnel Endpoint Identifier Control Plane to the SGSN when it receives any message with its assigned Tunnel Endpoint Identifier Control Plane in the GTP header from the SGSN.

The QoS values supplied in the Update PDP Context Request may be negotiated downwards by the GGSN. If the SGSN has indicated support for upgrade of QoS in the request message, the QoS values may also be negotiated upwards by the GGSN. In case the No QoS negotiation flag has been set by the SGSN in the corresponding request, the QoS values shall not be renegotiated, neither upwards nor downwards. The negotiated values or the original value from SGSN is inserted in the Quality of Service Profile information element. This information element shall be included if the Cause contains the value "Request accepted". The Evolved Allocation/Retention Priority IE shall be included if Evolved Allocation/Retention Priority has been newly authorized and if the GGSN supports this IE and if the Evolved ARP has been included in the corresponding request message. If there is no authorized Evolved ARP received from GGSN, SGSN shall continue to use legacy ARP included in the Quality of Service (QoS) Profile IE. The APN-AMBR IE shall be included if APN-AMBR has been newly authorized and if the GGSN supports this IE and if the APN-AMBR has been included in the corresponding request message.

The GGSN may start to forward T-PDUs after the Update PDP Context Response has been sent. The SGSN may start to forward T-PDUs when the Update PDP Context Response has been received. In this case the SGSN shall also be prepared to receive T-PDUs from the GGSN after it has sent an Update PDP Context Request but before an Update PDP Context Response has been received.

The GGSN shall include a GGSN address for user traffic, which may differ from that provided by the underlying network service (e.g. IP). An IPv4/IPv6 capable GGSN shall include both its IP version addresses. If the Update PDP Context Request received from the SGSN included IPv6 SGSN addresses, an IPv4/IPv6 capable GGSN shall include an IPv6 address in the field GGSN Address for User Traffic and a corresponding IPv4 address in the field Alternative GGSN Address for User Traffic. If SGSN included only an IPv4 SGSN address in the request, IPv4/IPv6 capable GGSN shall include IPv4 address for user traffic in the field GGSN Address for User Traffic and IPv6 address in the field Alternative GGSN Address for User Traffic. An IPv4/IPv6 capable SGSN shall store the GGSN Addresses and use one of them when sending G-PDUs to the GGSN for the MS. An IPv4 only SGSN shall not store the IPv6 address included in the Alternative GGSN Address. When active contexts are being redistributed due to load sharing, G-PDUs that are in transit across the Gn-interface are in an undetermined state and may be lost.

The GGSN shall also include a GGSN address for control plane, which shall not differ from that provided at PDP context setup time and shall remain unchanged for the lifetime of the PDP context. If the Update PDP Context Request received from the SGSN included IPv6 SGSN addresses, an IPv4/IPv6 capable GGSN shall include an IPv6 address in the field GGSN Address for Control Plane and a corresponding IPv4 address in the field Alternative GGSN Address for Control Plane. If SGSN included only an IPv4 SGSN address in the request, IPv4/IPv6 capable GGSN shall include IPv4 address for Control plane in the field GGSN Address for Control Plane and IPv6 address for Control plane in the field Alternative GGSN Address for Control Plane.

The GGSN Address for control plane and the GGSN Address for user traffic shall be included if the Cause contains the value "Request accepted". The Alternative GGSN Addresses shall be included if the GGSN supports IPv6 below GTP and the Cause contains the value "Request accepted".

The GGSN shall include the Recovery information element into the Update PDP Context Response if the GGSN is in contact with the SGSN for the first time or if the GGSN has restarted recently and the new Restart Counter value has not yet been indicated to the SGSN. The SGSN receiving the Recovery information element shall handle it as when an Echo Response message is received but shall consider the PDP context as updated and active if the response cause indicates a successful operation at the GGSN.

The Charging ID is used to identify all charging records produced in SGSN(s) and the GGSN for this PDP context. The Charging ID has been previously generated by the GGSN and is unique for this PDP context. If an inter-SGSN routing area update occurs, it is transferred to the new SGSN as part of each active PDP context. This information element shall be included if the Cause contains the value "Request accepted".

The Charging Gateway Address is the IP address of the recommended Charging Gateway Functionality to which the SGSN should transfer the Charging Detail Records (CDR) for this PDP Context.

The Alternative Charging Gateway Address IE has a similar purpose as the Charging Gateway Address but enables co-existence of IPv4 and IPv6 stacks in the Ga charging interfaces, without mandating any node to have a dual stack. The format of the optional Alternative Charging Gateway Address information element is the same as the format of the Charging Gateway Address.

When both these addresses are present, the Charging Gateway address IE shall contain the IPv4 address of the Charging Gateway Function and the Alternative Charging Gateway address IE shall contain the IPv6 address of the Charging Gateway Function.

NOTE: The Charging Gateway Address and Alternative Charging Gateway Address both refer to the same Charging Gateway Function.

The optional Private Extension contains vendor or operator specific information.

The GGSN includes the Protocol Configuration Options (PCO) information element in the response if the GGSN wishes to provide the MS with application specific parameters or to indicate the Bearer Control Mode to the MS.

The presence of the Common Flags IE is optional. If the Prohibit Payload Compression bit of the Common Flags IE is set to 1, then for A/Gb mode access the SGSN shall not compress the payload of user data regardless of whether the user asks for payload compression. If the Prohibit Payload Compression bit of the Common Flags IE is set to 0 or the Common Flags IE is absent then the SGSN shall perform payload compression when the user asks for it as per normal operation.

The APN Restriction is an optional information element. In this instance it is used by the GGSN to convey to the SGSN the restriction type of the associated PDP Context being updated.

If Bearer Control Mode is provided by the GGSN in the PCO, the Bearer Control Mode IE shall be included in order to inform the SGSN about the bearer control mode and shall indicate the same bearer control mode as indicated to the MS in the PCO.

If the MS Info Change Reporting mechanism is to be started or stopped for this subscriber in the SGSN, then the GGSN shall include the MS Info Change Reporting Action IE in the message and shall set the value of Action field appropriately.

Table 9: Information Elements in an Update PDP Context Response sent by a GGSN

| Information element | Presence requirement | Reference |
|--|----------------------|--------------------|
| Cause | Mandatory | 7.7.1 |
| Recovery | Optional | 7.7.11 |
| Tunnel Endpoint Identifier Data I | Conditional | 7.7.13 |
| Tunnel Endpoint Identifier Control Plane | Conditional | 7.7.14 |
| Charging ID | Conditional | 7.7.26 |
| Protocol Configuration Options | Optional | 7.7.31 |
| GGSN Address for Control Plane | Conditional | GSN Address 7.7.32 |
| GGSN Address for User Traffic | Conditional | GSN Address 7.7.32 |
| Alternative GGSN Address for Control Plane | Conditional | GSN Address 7.7.32 |
| Alternative GGSN Address for User Traffic | Conditional | GSN Address 7.7.32 |
| Quality of Service Profile | Conditional | 7.7.34 |
| Charging Gateway Address | Optional | 7.7.44 |
| Alternative Charging Gateway Address | Optional | 7.7.44 |
| Common Flags | Optional | 7.7.48 |
| APN Restriction | Optional | 7.7.49 |
| Bearer Control Mode | Optional | 7.7.83 |
| MS Info Change Reporting Action | Optional | 7.7.80 |
| Evolved Allocation/Retention Priority I | Optional | 7.7.91 |
| APN-AMBR | Optional | 7.7.98 |
| Private Extension | Optional | 7.7.46 |

The message can also be sent from a SGSN node to a GGSN node as a response of a GGSN-initiated Update PDP Context Request.

If the GGSN receives an Update PDP Context Response with a Cause value other than "Request accepted", it shall abort the update of the PDP context if the associated Update PDP Context Request was sent only to re-negotiate the QoS of a PDP context. Furthermore if the associated Update PDP Context Request included an "End User Address" information element the GGSN shall delete the PDP context using the Delete PDP Context procedure and may notify the Operation and Maintenance network element.

Only the Cause information element, optionally Protocol Configuration Options and optionally the Recovery information element shall be included in the response if the Cause contains another value than "Request accepted".

Possible Cause values are the same as for the Update PDP Context Response sent by a GGSN. When the optional IMSI IE value differs from the IMSI IE value associated to the PDP context, the SGSN shall respond using the cause value "Non-existent".

The SGSN includes the Protocol Configuration Options (PCO) information element in the response if the MS wishes to provide the GGSN with application specific parameters. The SGSN includes this IE in the Update PDP Context Response message if the associated Modify PDP Context Accept message from the MS includes protocol configuration options. The SGSN shall copy the content of this IE transparently from the content of the PCO IE in the Modify PDP Context Accept message.

The QoS values supplied in the Update PDP Context Request may be negotiated downwards by the SGSN. The negotiated values or the original value from GGSN is inserted in the Quality of Service Profile information element. This information element shall be included if the Cause contains the value "Request accepted" and a QoS information element was supplied in the corresponding request message. The Evolved Allocation/Retention Priority I information element shall include the negotiated Evolved Allocation/Retention Priority if the SGSN supports this IE and if an Evolved Allocation/Retention Priority I information element was supplied in the corresponding request message.

The SGSN shall include the Recovery information element into the Update PDP Context Response if the SGSN has restarted recently and the new Restart Counter value has not yet been indicated to the GGSN. The GGSN receiving the

Recovery information element shall handle it as when an Echo Response message is received but shall consider the PDP context as updated and active if the response cause indicates a successful operation at the SGSN.

If the SGSN sends Update PDP Context Response message in order to re-establish the user plane tunnel between SGSN and GGSN, then the SGSN includes only the Cause IE, the SGSN Address for User Traffic IE and Tunnel Endpoint Identifier Data IE. The GGSN shall include Tunnel Endpoint Identifier Data in the GTP header of all subsequent downlink G-PDUs which are related to the requested PDP Context.

In the MS to GGSN direction, the SGSN includes the User Location Information and the MS Time Zone information elements.

If the Direct Tunnel Flags IE is included and if the DTI bit of the Direct Tunnel Flags IE is set to 1, this indicates to the GGSN that for this PDP Context the SGSN is invoking a direct tunnel. If the DTI bit of the Direct Tunnel Flags IE is set to 0 or the Direct Tunnel Flags IE is absent, this indicates to the GGSN that for this PDP Context the SGSN is not invoking a direct tunnel. All other fields of the Direct Tunnel Flags IE shall be ignored.

If the Direct Tunnel Flags IE is included with the DTI bit set to 1, and if the SGSN Address for User Traffic IE and Tunnel Endpoint Identifier Data IE are also included, they shall contain RNC's User Plane address and TEID.

If the Direct Tunnel Flags IE is absent, or the DTI bit is set to 0, but the SGSN Address for User Traffic IE and Tunnel Endpoint Identifier Data IE are included they shall contain SGSN's User Plane addresses and TEID.

NOTE: Use case, when the DT is still used and the RNC TEID and/or user plane address has changed cannot be clarified in this release for backward compatibility reasons.

Table 10: Information Elements in an Update PDP Context Response sent by a SGSN

| Information element | Presence requirement | Reference |
|---|----------------------|-----------------------|
| Cause | Mandatory | 7.7.1 |
| Recovery | Optional | 7.7.11 |
| Tunnel Endpoint Identifier Data I | Optional | 7.7.13 |
| Protocol Configuration Options | Optional | 7.7.31 |
| SGSN Address for User Traffic | Optional | GSN Address 7.7.32 |
| Quality of Service Profile | Conditional | 7.7.34 |
| User Location Information | Optional | 7.7.51 |
| MS Time Zone | Optional | 7.7.52 |
| Direct Tunnel Flags | Optional | 7.7.81 |
| Evolved Allocation/Retention Priority I | Optional | 7.7.91 |
| APN-AMBR | Optional | 7.7.98 |
| Private Extension | Optional | 7.7.46 |

7.3.5 Delete PDP Context Request

A Delete PDP Context Request shall be sent from a SGSN node to a GGSN node as part of the GPRS Detach procedure or the GPRS PDP Context Deactivation procedure or from a GGSN node to a SGSN node as part of the PDP Context Deactivation Initiated by GGSN procedure. A request shall be used to deactivate an activated PDP Context or an activated set of PDP contexts associated to a PDP address or two IP addresses (one IPv4 and one IPv6 if PDP Type IPv4v6 is supported and used) assigned to a single MS.

A GSN shall be prepared to receive a Delete PDP Context Request at any time and shall always reply regardless if the PDP context exists or not (as per the Delete PDP Context Response message description section), except in cases described below.

If any collision occurs, the Delete PDP Context Request takes precedence over any other Tunnel Management message.

The Teardown Ind is used to indicate whether all PDP contexts that share the PDP address or two IP addresses (one IPv4 and one IPv6 if PDP Type IPv4v6 is supported and used) with the PDP context identified in the request should also be deactivated. This may trigger the deletion of all the information kept for a MS at a GSN, if no other PDP contexts associated to other PDP addresses are active on the GSN. If the Teardown Ind information element value is set to "1", then all PDP contexts that share the same PDP address or two IP addresses (one IPv4 and one IPv6 if PDP Type IPv4v6 is supported and used) with the PDP context identified by the NSAPI included in the Delete PDP Context Request Message shall be torn down. If more than one PDP Contexts are active that share the same PDP address or two IP addresses (one IPv4 and one IPv6 if PDP Type IPv4v6 is supported and used), only the PDP context identified by the NSAPI included in the Delete PDP context Request shall be torn down if the value of this information element is "0" or this information is not included. The SGSN shall copy this IE to the Delete PDP Context Request from the associated Deactivate PDP Context Request initiated by MS, if it is included. This information element shall NOT be included by the SGSN if the Deactivate PDP Context Request message from the MS does NOT include the Tear down indicator at PDP Context Deactivation initiated by MS. However, exceptionally this information element shall be included and its value set to "1" by the sending GSN only when the last PDP context associated to a PDP address or two IP addresses (one IPv4 and one IPv6 if PDP Type IPv4v6 is supported and used) is torn down and there are no outstanding Create PDP context requests for other PDP context different from the one being torn down for that PDP address or two IP addresses (one IPv4 and one IPv6 if PDP Type IPv4v6 is supported and used).

If a GSN receives a Delete PDP context without a Teardown Indicator or with a Teardown Indicator with value set to "0" and only that PDP context is active for a PDP address or two IP addresses (one IPv4 and one IPv6 if PDP Type IPv4v6 is supported and used), then the GSN shall ignore the message. (Note: This is symptom of a race condition. The reliable delivery of signalling messages will eventually lead to a consistent situation, allowing the teardown of the PDP context.)

In the MS to GGSN direction, the SGSN includes the Protocol Configuration Options (PCO) information element in the request if the MS wishes to provide the GGSN with application specific parameters. The SGSN includes this IE in the Delete PDP Context Request message if the associated Deactivate PDP Context Request message from the MS includes protocol configuration options. The SGSN shall copy the content of this IE transparently from the PCO IE in the Deactivate PDP Context Request message.

In the GGSN to MS direction, the GGSN includes the Protocol Configuration Options (PCO) information element in the request if the GGSN wishes to provide the MS with application specific parameters. The SGSN includes this IE in the Deactivate PDP Context Request message if the associated Delete PDP Context Request message from the GGSN includes protocol configuration options. The SGSN shall copy the content of this IE transparently from the PCO IE in the Delete PDP Context Request message.

The optional Private Extension contains vendor or operator specific information.

Table 11: Information Elements in a Delete PDP Context Request

| Information element | Presence requirement | Reference |
|--------------------------------|----------------------|-----------|
| Teardown Ind | Conditional | 7.7.16 |
| NSAPI | Mandatory | 7.7.17 |
| Protocol Configuration Options | Optional | 7.7.31 |
| Private Extension | Optional | 7.7.46 |

7.3.6 Delete PDP Context Response

The message shall be sent as a response of a Delete PDP Context Request. A GSN shall delete PDP context(s) when GSN receives Delete PDP Context Request message.

A GSN shall ignore a Delete PDP Context Response for a non-existing PDP context.

If a GSN receives a Delete PDP Context Request message for a non existing PDP context, it shall send back to the source of the message a Delete PDP Context Response message with cause value "Non existent". The TEID value used in the response message shall be zero.

Possible Cause values are:

- "Request Accepted".
- "Mandatory IE incorrect".
- "Mandatory IE missing".

- "Optional IE Incorrect".
- "Invalid message format".
- "Non existent".

For error handling, if the received Delete PDP Context Response contains a cause value other than "Request accepted" and "Non Existent", refer to section 11.

In the GGSN to MS direction, the GGSN includes the Protocol Configuration Options (PCO) information element in the response if the GGSN wishes to provide the MS with application specific parameters. The SGSN includes this IE in the Deactivate PDP Context Accept message if the associated Delete PDP Context Response message from the GGSN includes protocol configuration options. The SGSN shall copy the content of the IE transparently from the PCO IE in the Delete PDP Context Response message.

In the MS to GGSN direction, the SGSN includes the Protocol Configuration Options (PCO) information element in the response if the MS wishes to provide the GGSN with application specific parameters. The SGSN includes this IE in the Delete PDP Context Response message if the associated Deactivate PDP Context Accept message from the MS includes protocol configuration options. The SGSN shall copy the content of the IE transparently from the PCO IE in the Deactivate PDP Context Accept message.

In the MS to GGSN direction, the SGSN includes the User Location Information and the MS Time Zone information elements.

The optional Private Extension contains vendor or operator specific information.

Table 12: Information Elements in a Delete PDP Context Response

| Information element | Presence requirement | Reference |
|--------------------------------|----------------------|-----------|
| Cause | Mandatory | 7.7.1 |
| Protocol Configuration Options | Optional | 7.7.31 |
| User Location Information | Optional | 7.7.51 |
| MS Time Zone | Optional | 7.7.52 |
| Private Extension | Optional | 7.7.46 |

7.3.7 Error Indication

When a GSN/RNC receives a G-PDU for which no active PDP context, MBMS Bearer context, or RAB exists, the GSN/RNC shall discard the G-PDU and return a GTP error indication to the originating node.

Handling of the received Error Indication is specified in 3GPP TS 23.007 [3].

The information element Tunnel Endpoint Identifier Data I shall be the TEID fetched from the G-PDU that triggered this procedure.

The information element GSN Address shall be the destination address (e.g. destination IP address, MBMS Bearer Context,) fetched from the original user data message that triggered this procedure. A GSN Address can be a GGSN, SGSN or RNC address. The TEID and GSN Address together uniquely identify the related PDP context or RAB in the receiving node. The format of the RNC IP address is the same as the GSN address as defined in 3GPP TS 23.003 [2].

The optional Private Extension contains vendor or operator specific information.

Table 13: Information Elements in an Error Indication

| Information element | Presence requirement | Reference |
|-----------------------------------|----------------------|-----------|
| Tunnel Endpoint Identifier Data I | Mandatory | 7.7.13 |
| GSN Address | Mandatory | 7.7.32 |
| Private Extension | Optional | 7.7.46 |

7.3.8 PDU Notification Request

When receiving a T-PDU the GGSN checks if a PDP context is established for that PDP address or two IP addresses (one IPv4 and one IPv6 if PDP Type IPv4v6 is supported and used). If no PDP context has been previously established, the GGSN may try to deliver the T-PDU by initiating the Network-Requested PDP Context Activation procedure. The criteria, used by the GGSN to determine whether trying to deliver the T-PDU to the MS or not, may be based on subscription information in the GGSN and are outside the scope of GPRS standardisation.

As part of the Network-Requested PDP Context Activation procedure the GGSN sends a PDU Notification Request message to the SGSN indicated by the HLR. If the GGSN has an active PDP context with different SGSN from the one indicated by the HLR, then the SGSN information shall be obtained from an active PDP context. When receiving this message, the SGSN shall be responsible for requesting the MS to activate the indicated PDP Context.

The IMSI is inserted in the IMSI information element in the PDU Notification Request message.

The End User Address information element contains the PDP type and PDP address(es) that the SGSN shall request the MS to activate.

The Access Point Name information element identifies the access point of packet data network that wishes to connect to the MS.

The GGSN shall include a GGSN Address for control plane. The SGSN shall store this GGSN Address and use it when sending control plane messages to the GGSN.

The Tunnel Endpoint Identifier Control Plane information element shall be a tunnel endpoint identifier Control Plane selected by the GGSN and shall be used by the SGSN in the GTP header of the corresponding PDU Notification Response or PDU Notification Request Reject message.

The GGSN includes the Protocol Configuration Options (PCO) information element in the request if the GGSN wishes to provide the MS with application specific parameters. The SGSN includes this IE in the Request PDP Context Activation message if the associated PDU Notification Request message from the GGSN includes protocol configuration options. The SGSN shall copy the content of the IE transparently from the PCO IE in the PDU Notification Request message.

If the GGSN receives a Create PDP Context Request before the PDU Notification Response, the GGSN shall handle the Create PDP Context Request as normal context activation and ignore the following PDU Notification Response.

If the SGSN receives a PDU Notification Request after a Create PDP Context Request has been sent but before a Create PDP Context Response has been received, the SGSN shall:

- send a PDU Notification Response with Cause "Request accepted" without any further processing; and then
- wait for the Create PDP Context Response.

The optional Private Extension contains vendor or operator specific information.

Table 14: Information Elements in a PDU Notification Request

| Information element | Presence requirement | Reference |
|--|----------------------|-----------|
| IMSI | Mandatory | 7.7.2 |
| Tunnel Endpoint Identifier Control Plane | Mandatory | 7.7.14 |
| End User Address | Mandatory | 7.7.27 |
| Access Point Name | Mandatory | 7.7.30 |
| Protocol Configuration Options | Optional | 7.7.31 |
| GGSN Address for Control Plane | Mandatory | 7.7.32 |
| Private Extension | Optional | 7.7.46 |

7.3.9 PDU Notification Response

The message is sent by a SGSN to GGSN as a response of a PDU Notification Request.

The Cause value "Request accepted" indicates if the PDP context activation will proceed. The PDP context activation procedure will not proceed for other Cause values.

Possible Cause values are:

- "Request Accepted".
- "No resources available".
- "Service not supported".
- "System failure".
- "IMSI not known".
- "MS is GPRS Detached".
- "GPRS connection suspended".
- "Mandatory IE incorrect".
- "Mandatory IE missing".
- "Optional IE incorrect".
- "Invalid message format".
- "Roaming restriction".

After an unsuccessful activation attempt the GSNs may perform some actions to prevent unnecessary enquires to the HLR as described in the section Unsuccessful Network-Requested PDP Context Activation procedure in 3GPP TS 23.060 [4].

The optional Private Extension contains vendor or operator specific information.

Table 15: Information Elements in a PDU Notification Response

| Information element | Presence requirement | Reference |
|---------------------|----------------------|-----------|
| Cause | Mandatory | 7.7.1 |
| Private Extension | Optional | 7.7.46 |

7.3.10 PDU Notification Reject Request

If the PDP context activation proceeds after the PDU Notification Response, but the PDP context was not established, the SGSN sends a PDU Notification Reject Request message. The Cause value indicates the reason why the PDP Context could not be established:

- "MS is not GPRS Responding".
- "MS Refuses".

When receiving the PDU Notification Reject Request message the GGSN may reject or discard the stored T-PDU(s) depending on the PDP type.

After an unsuccessful activation attempt the GSNs may perform some actions to prevent unnecessary enquiries to the HLR as described in the section Unsuccessful Network-Requested PDP Context Activation procedure in 3GPP TS 23.060 [4].

The Tunnel Endpoint Identifier in the GTP header of the PDU Notification Reject Request message shall be the same as the Tunnel Endpoint Identifier Control Plane information element of the PDU Notification Request that triggered the reject.

The Tunnel Endpoint Identifier Control Plane information element shall be a tunnel endpoint identifier Control Plane selected by the SGSN and shall be used by the GGSN in the GTP header of the corresponding PDU Notification Reject Response message.

The End User Address information element contains the PDP type and PDP address(es) of the PDP context that could not be activated.

The Access Point Name shall be the same as the Access Point Name of the received PDU Notification Request message that triggered the reject.

The SGSN includes the Protocol Configuration Options (PCO) information element in the request if the MS wishes to provide the GGSN with application specific parameters. The SGSN includes this IE in the PDU Notification Reject Request message if the associated Request PDP Context Activation Reject message from the MS includes protocol configuration options. The SGSN shall copy the content of the IE transparently from the PCO IE in the Request PDP Context Activation Reject message.

The optional Private Extension contains vendor or operator specific information.

Table 16: Information Elements in a PDU Notification Reject Request

| Information element | Presence requirement | Reference |
|--|----------------------|-----------|
| Cause | Mandatory | 7.7.1 |
| Tunnel Endpoint Identifier Control Plane | Mandatory | 7.7.14 |
| End User Address | Mandatory | 7.7.27 |
| Access Point Name | Mandatory | 7.7.30 |
| Protocol Configuration Options | Optional | 7.7.31 |
| Private Extension | Optional | 7.7.46 |

7.3.11 PDU Notification Reject Response

The message is sent by a GGSN to SGSN as a response of a PDU Notification Reject Request.

Possible Cause values are:

- "Request Accepted".
- "Mandatory IE incorrect".
- "Mandatory IE missing".
- "Optional IE incorrect".
- "Invalid message format".

The optional Private Extension contains vendor or operator specific information.

Table 17: Information Elements in a PDU Notification Reject Response

| Information element | Presence requirement | Reference |
|---------------------|----------------------|-----------|
| Cause | Mandatory | 7.7.1 |
| Private Extension | Optional | 7.7.46 |

7.3.12 Initiate PDP Context Activation Request

The GGSN sends an Initiate PDP Context Activation Request message to the SGSN to initiate the Secondary PDP Context Activation Procedure for network requested bearer control.

The Initiate PDP Context Activation Request shall be sent to the SGSN Address for Control Plane and TEID associated with any one of the already activated PDP contexts for this PDP address or two IP addresses (one IPv4 and one IPv6 if PDP Type IPv4v6 is supported and used) and APN.

Linked NSAPI indicates the NSAPI assigned to any one of the already activated PDP contexts for this PDP address or two IP addresses (one IPv4 and one IPv6 if PDP Type IPv4v6 is supported and used) and APN.

Quality of Service Profile is the QoS Requested by the GGSN. The Evolved Allocation/Retention Priority I IE may be included if the GGSN supports this IE and if the support of Evolved ARP has been indicated by the current SGSN.

The Protocol Configuration Options (PCO) information element may be included in the request when the GGSN provides the UE with application specific parameters. The SGSN shall copy the content of this IE transparently to the content of the PCO IE in the Request Secondary PDP Context Activation.

The Traffic Flow Template (TFT) may be provided. The detailed use cases are detailed described in clause 9.2.2.3 of 3GPP TS 23.060 [4]. TFT is used for packet filtering. The SGSN shall copy the content of this IE transparently to the content of the TFT IE in the Request Secondary PDP Context Activation.

The Correlation-ID shall be included and is used to correlate the subsequent Secondary PDP Context Activation Procedure with the Initiate PDP Context Activation message.

NOTE: The Correlation-ID is used in GTP and corresponds over the air-interface to the TI, which is assigned by the SGSN and sent to MS in the Request Secondary Context Activation as described in 3GPP TS 23.060 [4].

The optional Private Extension contains vendor or operator specific information.

Table 7.3.12.1: Information Elements in an Initiate PDP Context Activation Request

| Information element | Presence requirement | Reference |
|---|----------------------|-----------|
| Linked NSAPI | Mandatory | 7.7.17 |
| Protocol Configuration Options | Optional | 7.7.31 |
| Quality of Service Profile | Mandatory | 7.7.34 |
| TFT | Conditional | 7.7.36 |
| Correlation-ID | Mandatory | 7.7.82 |
| Evolved Allocation/Retention Priority I | Optional | 7.7.91 |
| Private Extension | Optional | 7.7.46 |

7.3.13 Initiate PDP Context Activation Response

The message is sent by a SGSN to GGSN as a response of an Initiate PDP Context Activation Request message after the SGSN receives from the UE either a positive acknowledgment (Activate Secondary PDP Context Request message) or a negative acknowledgment (Secondary PDP Context Activation Reject message), or if SGSN does not receive any response from the UE before the Radio Interface timer T3385 expires (see TS 24.008 [5]). If the PDP context was not established, the SGSN includes a Cause Code to indicate the reason why the PDP Context could not be established.

The Cause value "Request accepted" indicates that the Initiate PDP Context Activation was successful. The Initiate PDP Context Activation procedure was not successful for other Cause values.

Possible Cause values are:

- "Request Accepted".
- "No resources available".
- "Service not supported".
- "System failure".
- "Mandatory IE incorrect".
- "Mandatory IE missing".
- "Optional IE incorrect".
- "Invalid message format".
- "Context not found".
- "Semantic error in the TFT operation",
- "Syntactic error in the TFT operation",
- "Semantic errors in packet filter(s)"
- "Syntactic errors in packet filters(s)"
- "MS is not GPRS Responding".

- "MS Refuses".
- "Invalid Correlation-ID".
- "PDP Context without TFT already activated".
- "Bearer Control Mode violation".

The SGSN includes the Protocol Configuration Options (PCO) information element in the response if the MS wishes to provide the GGSN with application specific parameters. The SGSN includes this IE in the Initiate PDP Context Activation Response message if the Request PDP Context Activation Reject message from the MS includes protocol configuration options. The SGSN shall copy the content of the IE transparently from the PCO IE in the Request PDP Context Activation Reject message. The optional Private Extension contains vendor or operator specific information.

Table 7.3.13.1: Information Elements in an Initiate PDP Context Activation Response

| Information element | Presence requirement | Reference |
|--------------------------------|----------------------|-----------|
| Cause | Mandatory | 7.7.1 |
| Protocol Configuration Options | Conditional | 7.7.31 |
| Private Extension | Optional | 7.7.46 |

7.4 Location Management Messages

The optional Location Management messages are defined to support the case when Network-Requested PDP Context Activation procedures are used and a GGSN does not have a SS7 MAP interface, i.e. a Gc interface. GTP is then used to transfer control plane messages between the GGSN and a GTP-MAP protocol-converting GSN in the GPRS backbone network. The GTP-MAP protocol-converting GSN converts the control plane messages described in this section between GTP and MAP. The MAP messages are sent to and received from the HLR. The GTP-MAP protocol-converting function is described in 3GPP TS 23.060 [4]. The MAP protocol describing the corresponding procedures and messages is described in 3GPP TS 29.002 [6]. This alternative method is illustrated in figure 7.

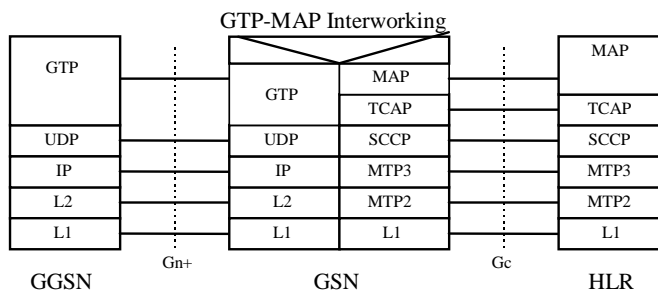

Figure 7: GGSN - HLR Signalling via a GTP-MAP Protocol-Converter in a GSN

When receiving a T-PDU the GGSN checks if a PDP Context is established for that PDP address or two IP addresses (one IPv4 and one IPv6 if PDP Type IPv4v6 is supported and used). If no PDP context has been previously established the GGSN may store the T-PDU, try to initiate the Network-Requested PDP Context Activation procedure and, when the activation procedure is completed, deliver the T-PDU.

To support Network-Requested PDP Context Activation the GGSN has to have static PDP information about the PDP address or two IP addresses (one IPv4 and one IPv6 if PDP Type IPv4v6 is supported and used).

7.4.1 Send Routing Information for GPRS Request

The GGSN may send a Send Routing Information for GPRS Request message to a GTP-MAP protocol-converting GSN, to obtain the IP address of the SGSN where the MS is located, when no PDP context is established.

The IMSI information element contains the IMSI to be used as a key to get the IP address of the SGSN.

If the GGSN receives a Create PDP Context Request after a Send Routing Information for GPRS Request has been sent but before a Send Routing Information for GPRS Response has been received, the GGSN shall:

- handle the Create PDP Context Request as a normal context activation; and
- ignore the following Send Routing Information for GPRS Response.

The optional Private Extension contains vendor or operator specific information.

Table 18: Information Elements in a Send Routing Information for GPRS Request

| Information element | Presence requirement | Reference |
|---------------------|----------------------|-----------|
| IMSI | Mandatory | 7.7.2 |
| Private Extension | Optional | 7.7.46 |

7.4.2 Send Routing Information for GPRS Response

The GTP-MAP protocol-converting GSN sends a Send Routing Information for GPRS Response message as a response to the Send Routing Information for GPRS Request message to the GGSN that sent the request.

The Cause value indicates if the GTP-MAP protocol-converting GSN accepted the request or not.

Possible Cause values are:

- "Request Accepted".
- "No resources available".
- "Service not supported".
- "System failure".
- "Mandatory IE incorrect".
- "Mandatory IE missing".
- "Optional IE incorrect".
- "Invalid message format".

The MAP Cause information element contains the MAP error code received from the HLR and shall not be included if the Cause contains another value than "Request accepted".

The GSN Address information element contains the IP address of the SGSN and shall not be included if the Cause contains another value than "Request accepted".

It is an implementation issue what to do if the Cause or MAP Cause indicates that no location information is available. The MS not Reachable Reason information element indicates the reason for the setting of the Mobile station Not Reachable for GPRS (MNRG) flag and shall not be included if the Cause contains another value than "Request accepted".

The optional Private Extension contains vendor or operator specific information.

Table 19: Information Elements in a Send Routing Information for GPRS Response

| Information element | Presence requirement | Reference |
|-------------------------|----------------------|-----------|
| Cause | Mandatory | 7.7.1 |
| IMSI | Mandatory | 7.7.2 |
| MAP Cause | Optional | 7.7.8 |
| MS not Reachable Reason | Optional | 7.7.25A |
| GSN Address | Optional | 7.7.32 |
| Private Extension | Optional | 7.7.46 |

7.4.3 Failure Report Request

The GGSN may send this message to the GTP-MAP protocol-converting GSN to set the MNRG flag for the IMSI in the HLR.

The IMSI information element contains the IMSI for which the MNRG shall be set.

The optional Private Extension contains vendor or operator specific information.

Table 20: Information Elements in a Failure Report Request

| Information element | Presence requirement | Reference |
|---------------------|----------------------|-----------|
| IMSI | Mandatory | 7.7.2 |
| Private Extension | Optional | 7.7.46 |

7.4.4 Failure Report Response

The GTP-MAP protocol-converting GSN sends a Failure Report Response message as a response to the Failure Report Request message to the GGSN that sent the request.

The Cause value indicates if the GTP-MAP protocol-converting GSN accepted the request or not.

Possible Cause values are:

- "Request Accepted".
- "No resources available".
- "Service not supported".
- "System failure".
- "Mandatory IE incorrect".
- "Mandatory IE missing".
- "Optional IE incorrect".
- "Invalid message format".

The MAP Cause information element contains the MAP error code received from the HLR and shall not be included if the Cause contains another value than "Request accepted".

It is an implementation issue what to do if the Cause or MAP Cause indicates that the HLR has not received the request or rejected the request.

The optional Private Extension contains vendor or operator specific information.

Table 21: Information Elements in a Failure Report Response

| Information element | Presence requirement | Reference |
|---------------------|----------------------|-----------|
| Cause | Mandatory | 7.7.1 |
| MAP Cause | Optional | 7.7.8 |
| Private Extension | Optional | 7.7.46 |

7.4.5 Note MS GPRS Present Request

The GTP-MAP protocol-converting GSN sends a Note MS GPRS Present message to notify that an MS should be reachable for GPRS again.

The GGSN shall use the IMSI in the request and find all PDP contexts for the IMSI. The MNRG shall be cleared and the SGSN IP address from the request shall be stored in each found PDP context.

The IMSI information element contains the IMSI for the PDP contexts.

The GSN Address information element contains the IP address of the SGSN.

The optional Private Extension contains vendor or operator specific information.

Table 22: Information Elements in a Note MS Present Request

| Information element | Presence requirement | Reference |
|---------------------|----------------------|-----------|
| IMSI | Mandatory | 7.7.2 |
| GSN Address | Mandatory | 7.7.32 |
| Private Extension | Optional | 7.7.46 |

7.4.6 Note MS GPRS Present Response

The GGSN sends a Note MS GPRS Present Response message to the GTP-MAP protocol converting GSN as a response to the Note MS GPRS Present Request.

Possible Cause values are:

- "Request Accepted".
- "Mandatory IE incorrect".
- "Mandatory IE missing".
- "Optional IE incorrect".
- "Invalid message format".

The optional Private Extension contains vendor or operator specific information.

Table 23: Information Elements in a Note MS Present Response

| Information element | Presence requirement | Reference |
|---------------------|----------------------|-----------|
| Cause | Mandatory | 7.7.1 |
| Private Extension | Optional | 7.7.46 |

7.5 Mobility Management Messages

The Mobility Management messages are the control plane messages, defined in 3GPP TS 23.060 [4] and 3GPP TS 24.008 [5], that are sent between SGSNs at the GPRS Attach and Inter SGSN Routing Update procedures. The new SGSN derives the address of the old SGSN from the old routing area identity. The address translation mechanism is implementation specific. Some possible translation mechanisms are found in annex C in 3GPP TS 23.003 [2].

Generally, the purpose of the control plane is to transfer data associated with the MS from the old SGSN to the new SGSN.

7.5.1 Identification Request

If the MS, at GPRS Attach, identifies itself with P-TMSI and it has changed SGSN since detach, the new SGSN shall send an Identification Request message to the old SGSN to request the IMSI.

For Intra Domain Connection of RAN Nodes to Multiple CN Nodes, where the old SGSN belongs to an SGSN pool, the new SGSN cannot in the general case determine the old SGSN. The new SGSN shall in this case send the Identification Request message to an SGSN based on the old RAI, as usual. If an SGSN within an SGSN pool receives an Identification Request message for an MS that has been attached to another SGSN of the same SGSN pool, the SGSN shall:

- a) include the source IP address of the received Identification Request message in the optional parameter "SGSN Address for Control Plane" if the optional parameter "SGSN Address for Control Plane" is not present in the received Identification Request message; and

- b) decrement the Hop Counter value if the optional parameter "Hop Counter" is present in the received Identification Request message; otherwise may include a Hop Counter with a value of max-1 where max is the maximum defined value for Hop Counter.

The Identification Request message is then relayed to the old SGSN, keeping the other parts of the message unchanged. Received Identification Request messages with a Hop Counter value of 0 shall not be relayed; instead a system failure indication shall be returned to the new SGSN. The SGSN within an SGSN pool can determine if the received Identification Request message was meant for itself or for another SGSN of the SGSN pool by looking at the Network Resource Identifier contained in the P-TMSI parameter. See 3GPP TS 23.003 [2] for details on the coding of the P-TMSI and see 3GPP TS 23.236 [19] for details on SGSN pool.

Note that an SGSN relaying the Identification Request message shall not supervise the Identification Response message.

The P-TMSI and RAI is a P-TMSI and an RAI in the old SGSN. The P-TMSI Signature is conditionally provided by the MS to the new SGSN for identification checking purposes as defined in 3GPP TS 23.060 [4] and 3GPP TS 24.008 [5]. If the MS has provided the P-TMSI Signature, the new SGSN shall include this parameter in the Identification Request message.

The optional Private Extension contains vendor or operator specific information.

Table 24: Information Elements in an Identification Request

| Information element | Presence requirement | Reference |
|--------------------------------|----------------------|-----------|
| Routing Area Identity (RAI) | Mandatory | 7.7.3 |
| Packet TMSI | Mandatory | 7.7.5 |
| P-TMSI Signature | Conditional | 7.7.9 |
| SGSN Address for Control Plane | Optional | 7.7.32 |
| Hop Counter | Optional | 7.7.63 |
| Private Extension | Optional | 7.7.46 |

7.5.2 Identification Response

The old SGSN shall send an Identification Response to the new SGSN as a response to a previous Identification Request.

For Intra Domain Connection of RAN Nodes to Multiple CN Nodes, if an old SGSN within an SGSN pool receives an Identification Request message that contains the optional parameter SGSN Address for Control Plane, the old SGSN shall use this address as destination IP address of the Identification Response message.

Possible Cause values are:

- "Request Accepted".
- "IMSI not known".
- "System failure".
- "Mandatory IE incorrect".
- "Mandatory IE missing".
- "Optional IE incorrect".
- "Invalid message format".
- "P-TMSI Signature mismatch".

Only the Cause information element shall be included in the response if the Cause contains another value than "Request accepted".

The IMSI information element is mandatory if the Cause contains the value "Request accepted".

One or several Authentication Triplet information elements or up to 5 Authentication Quintuplet information elements may be included in the message if the Cause contains the value "Request accepted".

The optional Private Extension contains vendor or operator specific information.

Table 25: Information Elements in an Identification Response

| Information element | Presence requirement | Reference |
|---------------------------|----------------------|-----------|
| Cause | Mandatory | 7.7.1 |
| IMSI | Conditional | 7.7.2 |
| Authentication Triplet | Conditional | 7.7.7 |
| Authentication Quintuplet | Conditional | 7.7.35 |
| Private Extension | Optional | 7.7.46 |

7.5.3 SGSN Context Request

The new SGSN shall send an SGSN Context Request to the old SGSN to get the MM and PDP Contexts for the MS.

For Intra Domain Connection of RAN Nodes to Multiple CN Nodes, where the old SGSN belongs to an SGSN pool, the new SGSN cannot in the general case determine the old SGSN. The new SGSN shall in this case send the SGSN Context Request message to an SGSN based on the old RAI, as usual. If an SGSN within an SGSN pool receives an SGSN Context Request message for an MS that has been attached to another SGSN of the same SGSN pool, the SGSN shall:

if the optional parameter "Hop Counter" is present in the received SGSN Context Request message, decrement the Hop Counter value, otherwise may include a Hop Counter with a value of max-1 where max is the maximum defined value for Hop Counter;

the SGSN Context Request message is then relayed to the old SGSN, keeping the other parts of the message unchanged. Received SGSN Context Request messages with a Hop Counter value of 0 shall not be relayed; instead a system failure indication shall be returned to the new SGSN. The SGSN within an SGSN pool can determine if the received SGSN Context Request message was meant for itself or for another SGSN of the SGSN pool by looking at the Network Resource Identifier contained in the P-TMSI parameter, or alternatively in the TLLI parameter. See 3GPP TS 23.003 [2] for details on the coding of the P-TMSI and see 3GPP TS 23.236 [19] for details on SGSN pool.

Note that an SGSN relaying the SGSN Context Request message shall not supervise the SGSN Context Response message.

The MS is identified in the old SGSN by its old RAI and old TLLI/old P-TMSI values. The TLLI/P-TMSI and RAI is a foreign TLLI/P-TMSI and an RAI in the old SGSN. Exactly one of the TLLI, P-TMSI or IMSI information fields shall be present.

The old SGSN responds with an SGSN Context Response.

The new SGSN shall include a SGSN Address for control plane. If the new SGSN is IPv4/ IPv6 capable, it shall include IPv4 address in the field of SGSN Address for Control Plane and IPv6 address in the field of Alternative SGSN Address for Control Plane. If the old SGSN is IPv6 capable, it shall store and use the IPv6 SGSN address when sending control plane messages for the MS to the new SGSN in the SGSN context transfer procedure. Otherwise if the old SGSN is only IPv4 capable, it shall store and use the IPv4 SGSN address in the SGSN context transfer procedure. The old SGSN shall store this SGSN Address and use it when sending control plane messages for the MS to the new SGSN in the SGSN context transfer procedure

The new SGSN may include its SGSN number. If the old SGSN receives the SGSN number of the new SGSN it shall include this number when informing interworking core network nodes that there is a need to re-route previously sent requests against the new SGSN, e.g. in LCS the GMLC will use this SGSN number to re-activate the Location Request to the new SGSN (3GPP TS 23.271 [24]).

The Tunnel Endpoint Identifier Control Plane field specifies a Tunnel Endpoint Identifier for control plane messages, which is chosen by the new SGSN. The old SGSN shall include this Tunnel Endpoint Identifier in the GTP header of all subsequent control plane messages that are sent from the old SGSN to the new SGSN and related to the PDP context(s) requested.

The MS Validated indicates that the new SGSN has successfully authenticated the MS. IMSI shall be included if MS Validated indicates "Yes".

The P-TMSI Signature is conditionally provided by the MS to the new SGSN for identification checking purposes as defined in 3GPP TS 23.060 [4] and 3GPP TS 24.008 [5]. If the MS has provided the P-TMSI Signature, the new SGSN shall include this parameter in the SGSN Context Request message.

The RAT Type indicates the Radio Access Technology which is used in the new SGSN.

The optional Private Extension contains vendor or operator specific information.

Table 26: Information Elements in a SGSN Context Request

| Information element | Presence requirement | Reference |
|--|----------------------|-----------|
| IMSI | Conditional | 7.7.2 |
| Routeing Area Identity (RAI) | Mandatory | 7.7.3 |
| Temporary Logical Link Identifier (TLLI) | Conditional | 7.7.4 |
| Packet TMSI (P-TMSI) | Conditional | 7.7.5 |
| P-TMSI Signature | Conditional | 7.7.9 |
| MS Validated | Optional | 7.7.10 |
| Tunnel Endpoint Identifier Control Plane | Mandatory | 7.7.14 |
| SGSN Address for Control Plane | Mandatory | 7.7.32 |
| Alternative SGSN Address for Control Plane | Optional | 7.7.32 |
| SGSN Number | Optional | 7.7.47 |
| RAT Type | Optional | 7.7.50 |
| Hop Counter | Optional | 7.7.63 |
| Private Extension | Optional | 7.7.46 |

7.5.4 SGSN Context Response

The old SGSN shall send an SGSN Context Response to the new SGSN as a response to a previous SGSN Context Request.

Possible Cause values are:

- "Request Accepted".
- "IMSI not known".
- "System failure".
- "Mandatory IE incorrect".
- "Mandatory IE missing".
- "Optional IE incorrect".
- "Invalid message format".
- "P-TMSI Signature mismatch".

If the Cause contains the value "Request accepted", all information elements are mandatory, except PDP Context, MBMS UE Context, RAB Context and Private Extension.

If the Cause contains the value "P-TMSI Signature mismatch" the IMSI information element and, for Intra Domain Connection of RAN Nodes to Multiple CN Nodes, a SGSN Address for control plane shall be included in the response, otherwise only the Cause information element shall be included in the response. The IMSI shall not be included in the message if the MS is emergency attached and the MS is UICCless.

The old SGSN shall include a SGSN Address for control plane. If the SGSN Context Request received from the new SGSN includes an IPv6 SGSN address, an IPv4/IPv6 capable old SGSN shall include IPv6 address in the field of SGSN address for control plane; Otherwise it shall include IPv4 address in this field. The new SGSN shall store this SGSN Address and use it when sending control plane messages for the MS to the old SGSN in the SGSN context transfer procedure.

The Tunnel Endpoint Identifier Control Plane field specifies a Tunnel Endpoint Identifier, which is chosen by the old SGSN. The new SGSN shall include this Tunnel Endpoint Identifier in the GTP header of all subsequent control plane messages, which are sent from the new SGSN to the old SGSN and related to the PDP context(s) requested.

The IMSI information element contains the IMSI matching the TLLI or P-TMSI (for GSM or UMTS respectively) and RAI in the SGSN Context Request.

The MM Context contains necessary mobility management and security parameters. The IMEISV shall, if available, be included in the MM Context from the old SGSN to the new SGSN. If the MS is emergency attached and the MS is UICCless or the IMSI is unauthenticated, the International Mobile Equipment Identity (IMEI) shall be included and used as the MS identity.

All active PDP contexts in the old SGSN shall be included as PDP Context information elements. The PDP contexts are included in an implementation dependant prioritized order, and the most important PDP context is placed first. When the PDP Context Prioritization IE is included, it informs the new SGSN that the PDP contexts are sent prioritized. If the new SGSN is not able to maintain active all the PDP contexts received from the old SGSN when it is indicated that prioritization of the PDP contexts is applied, the new SGSN should use the prioritisation sent by old SGSN as input when deciding which PDP contexts to maintain active and which ones to delete.

The old SGSN shall include the current Evolved Allocation/Retention Priority for each active PDP Context in the Evolved Allocation/Retention Priority II information elements if the information is available.

If there is at least one active PDP context, the old SGSN shall start the T3-TUNNEL timer and store the address of the new SGSN in the "New SGSN Address" field of the MM context. The old SGSN shall wait for SGSN Context Acknowledge before sending T-PDUs to the new SGSN. If an SGSN Context Acknowledge message is not received within a time defined by T3-RESPONSE, the old SGSN shall retransmit the SGSN Context Response to the new SGSN as long as the total number of attempts is less than N3-REQUESTS. After N3-REQUESTS unsuccessfully attempts, the old SGSN shall proceed as described in section "Reliable delivery of signalling messages" in case the transmission of a control plane message fails N3-REQUESTS times.

For each RAB using lossless PDCP context, the old SGSN shall include a RAB Context. If a RAB Context is included in the SGSN Context Response, the new SGSN shall ignore the N-PDU number fields and sequence number fields received in the PDP Context IE.

Radio Priority SMS contains the radio priority level for MO SMS transmission, and shall be included if a valid Radio Priority SMS value exists for the MS in the old SGSN.

Radio Priority LCS contains the radio priority level for MO LCS transmission, and shall be included if a valid Radio Priority LCS value exists for the MS in the old SGSN.

Radio Priority is the radio priority level that the MS uses when accessing the network for the transmission of uplink user data for a particular PDP context. One Radio Priority IE shall be included per PDP context that has a valid radio priority value assigned to it in the old SGSN.

Packet Flow Id is the packet flow identifier assigned to the PDP context. One Packet Flow Id IE shall be included per PDP context that has a valid packet flow identifier value assigned to it in the old SGSN.

Charging Characteristics IE contains the charging characteristics which apply for a PDP context; see 3GPP TS 32.251 [18] and 3GPP TS 32.298 [34]. One Charging Characteristics IE shall be included per PDP context IE. If no PDP context is active, this IE shall not be included. The mapping of a Charging Characteristics IE to a PDP Context IE is done according to the sequence of their appearance, e.g. the first Charging Characteristics IE is mapped to the first PDP Context IE.

All MBMS UE Contexts in the old SGSN shall be included as MBMS UE Context information elements if the new SGSN supports MBMS (i.e. MBMS support indication has been sent from the new SGSN).

Both RFSP Index values shall be forwarded to the new SGSN during inter-SGSN mobility procedures.

The Co-located GGSN-PGW FQDN may be included which applies for a PDP context. One Co-located GGSN-PGW FQDN shall be included per PDP context IE. The mapping of a Co-located GGSN-PGW FQDN IE to a PDP Context IE is done according to the sequence of their appearance, e.g. the first Co-located GGSN-PGW FQDN IE is mapped to the first PDP Context IE. If the activated PDP Contexts of the PDP address and APN do not have the Co-located GGSN-PGW FQDN Information, the length field of the Co-located GGSN-PGW FQDN IE shall be set to 0. If all the activated PDP Contexts of the UE do not have the Co-located GGSN-PGW FQDN Information, the FQDN IE shall not be present in this message.

The presence of the Extended Common Flags IE is optional. The Unauthenticated IMSI bit field shall be set to 1 if the IMSI present in the message is not authenticated and is for an emergency attached MS.

The optional Private Extension contains vendor or operator specific information.

Table 27: Information Elements in a SGSN Context Response

| Information element | Presence requirement | Reference |
|--|----------------------|-----------|
| Cause | Mandatory | 7.7.1 |
| IMSI | Conditional | 7.7.2 |
| Tunnel Endpoint Identifier Control Plane | Conditional | 7.7.14 |
| RAB Context | Conditional | 7.7.19 |
| Radio Priority SMS | Optional | 7.7.20 |
| Radio Priority | Optional | 7.7.21 |
| Packet Flow Id | Optional | 7.7.22 |
| CharingCharacteristics | Optional | 7.7.23 |
| Radio Priority LCS | Optional | 7.7.25B |
| MM Context | Conditional | 7.7.28 |
| PDP Context | Conditional | 7.7.29 |
| SGSN Address for Control Plane | Conditional | 7.7.32 |
| PDP Context Prioritization | Optional | 7.7.45 |
| MBMS UE Context | Optional | 7.7.55 |
| Subscribed RFSP Index | Optional | 7.7.88 |
| RFSP Index in use | Optional | 7.7.88 |
| Co-located GGSN-PGW FQDN | Optional | 7.7.90 |
| Evolved Allocation/Retention Priority II | Optional | 7.7.92 |
| Extended Common Flags | Optional | 7.7.93 |
| Private Extension | Optional | 7.7.46 |

7.5.5 SGSN Context Acknowledge

The new SGSN shall send an SGSN Context Acknowledge message to the old SGSN as a response to the SGSN Context Response message. Only after receiving the SGSN Context Acknowledge message, shall the old SGSN start to forward user data packets. SGSN Context Acknowledge indicates to the old SGSN that the new SGSN has correctly received PDP Context information and is ready to receive user data packets identified by the corresponding Tunnel Endpoint Identifier values. This message shall not be sent if the SGSN Context Request was rejected.

Possible cause values are:

- "Request accepted".
- "System failure".
- "Mandatory IE incorrect".
- "Mandatory IE missing".
- "Optional IE incorrect".
- "No resources available".
- "Invalid message format".
- "Authentication failure".

Only the Cause information element shall be included in the acknowledgement if the Cause contains a value other than "Request accepted".

For each active PDP context (i.e. those which have a tunnel established between the old SGSN and the GGSN) the new SGSN shall include a Tunnel Endpoint Identifier Data II information element. The Tunnel Endpoint Identifier Data II field specifies a Tunnel Endpoint Identifier which is chosen by the new SGSN for a particular PDP context. The old SGSN shall include this Tunnel Endpoint Identifier in the GTP header of all subsequent G-PDUs which are sent from the old SGSN to the new SGSN and related to the particular PDP context. When active PDP context(s) exist, this information element shall be included if the Cause contains the value "Request accepted".

The new SGSN shall include an SGSN Address for user traffic, which may differ from that provided by the underlying network service (e.g. IP). If MME acts as a new SGSN during the Gn/Gp SGSN to MME TAU procedure (see annex D.3.6 in 3GPP TS 23.401 [47]), the MME shall send the following values in the SGSN Context Acknowledge message in order to discard the packets received from the old SGSN (because MME does not have user plane):

- any reserved TEID (e.g. all 0's, or all 1's) for Tunnel Endpoint Identifier Data II value;
- any reserved (implementation dependent) IP address for SGSN Address for user traffic value.

NOTE: An implementation may provide the mentioned reserved IP address e.g. from one of the reserved IP address ranges (see RFC5735 or <http://www.iana.net/assignments/ipv4-address-space/ipv4-address-space.xml>), or the IP address may be provisioned by a configuration.

If the SGSN Context Response received from the old SGSN includes an IPv6 SGSN address, an IPv4/IPv6 capable new SGSN shall include an IPv6 address in the field of SGSN Address for user traffic, Otherwise it shall include IPv4 address in this field. The old SGSN shall store this SGSN Address and use it when sending G-PDUs to the new SGSN for the MS. When active PDP context(s) exist, this information element shall be included if the Cause contains the value "Request accepted".

The optional Private Extension contains vendor or operator specific information.

Table 28: Information Elements in a SGSN Context Acknowledge

| Information element | Presence requirement | Reference |
|------------------------------------|----------------------|--------------------|
| Cause | Mandatory | 7.7.1 |
| Tunnel Endpoint Identifier Data II | Conditional | 7.7.15 |
| SGSN Address for user traffic | Conditional | GSN Address 7.7.32 |
| Private Extension | Optional | 7.7.46 |

7.5.6 Forward Relocation Request

The old SGSN shall send a Forward Relocation Request to the new SGSN to convey necessary information to perform the SRNS Relocation procedure between new SGSN and Target RNC or to perform the PS handover procedure between new SGSN and Target BSS.

The IMSI information element contains the IMSI of the target MS for SRNS Relocation or PS handover procedure. The IMSI shall not be included in the message if the MS is emergency attached and the MS is UICCless.

The old SGSN shall include a SGSN Address for control plane. The new SGSN shall store this SGSN Address and use it when sending control plane messages for the MS to the old SGSN in the SRNS Relocation procedure. If the new SGSN is IPv6 capable, an IPv4/IPv6 capable old SGSN shall include an IPv6 address in the field SGSN Address for Control Plane, otherwise it shall include an IPv4 address in this field.

The Tunnel Endpoint Identifier Control Plane field specifies a tunnel endpoint identifier, which is chosen by the old SGSN. The new SGSN shall include this Tunnel Endpoint Identifier Control Plane in the GTP header of all subsequent control plane messages, which are sent from the new SGSN to the old SGSN.

The MM Context contains necessary mobility management and security parameters. The IMEISV shall, if available, be included in the MM Context from the old SGSN to the new SGSN. If the MS is emergency attached and the MS is UICCless or the IMSI is unauthenticated, the International Mobile Equipment Identity (IMEI) shall be included and used as the MS identity.

All active PDP contexts in the old SGSN shall be included as PDP Context information elements. The PDP contexts are included in an implementation dependant prioritized order, and the most important PDP context is placed first. When the PDP Context Prioritization IE is included, it informs the new SGSN that the PDP contexts are sent prioritized. If the new SGSN is not able to maintain active all the PDP contexts received from the old SGSN when it is indicated that prioritization of the PDP contexts is applied, the new SGSN should use the prioritisation sent by old SGSN as input when deciding which PDP contexts to maintain active and which ones to delete. In case no PDP context is active, neither of these IEs shall be included.

The old SGSN shall include the current Evolved Allocation/Retention Priority for each active PDP Context in the Allocation/Retention Priority II information elements if the information is available.

The old SGSN shall include in the Forward Relocation Request message:

- the Packet Flow ID IE, BSS Container IE and Cell Identification IE when this message is used for PS handover from A/Gb mode to A/Gb mode and from Iu mode to A/Gb mode.
- the PS Handover XID Parameters IE when this message is used for PS Handover to or from A/Gb mode. The old SGSN may not be able to provide the XID parameters in the PS Handover XID Parameters IE for PS handover from Iu mode to A/Gb mode, see clause 7.7.79.

The old SGSN should include in the Forward Relocation Request message the "Reliable INTER RAT HANDOVER INFO" if received in a PS Handover Required message from the BSS.

The new SGSN receiving the PS Handover XID Parameters IE shall proceed with the PS Handover procedure. The PS Handover XID Parameters IE shall be included for each SAPI included in the Forward Relocation Request. The Packet Flow ID IE shall be included for each PDP Context included in the Forward Relocation Request.

BSS Container IE and Cell Identification IE are the IEs sent from the source BSS/RNC to the old SGSN. These IEs will be included in the Forward Relocation Request message to the new SGSN only if the PS Handover XID Parameter IE and the Packet Flow ID IE are present. BSS Container IE contains the radio-related network information for the PS handover procedure. Cell Identification IE contains the identification of a source cell (for PS handover from A/Gb mode to A/Gb mode) or an RNC-ID (for PS handover from Iu mode to A/Gb mode) and the identification of the target cell.

All MBMS UE Contexts in the old SGSN shall be included as MBMS UE Context information elements.

UTRAN transparent container, Target identification and RANAP Cause are information from the source RNC/BSS in the old SGSN. The old SGSN shall include in the Forward Relocation Request message the RANAP Cause IE, UTRAN transparent container IE and Target Identification IE when this message is used for the SRNS relocation procedure. For PS handover from A/Gb mode to A/Gb mode, the old SGSN shall set the value part of UTRAN transparent container IE and Target Identification IE to empty, according to their defined minimum length and set the RANAP Cause to cause #43 "Relocation desirable for radio reasons" as defined in 3GPP TS25.413. For PS handover from A/Gb mode to Iu mode, the old SGSN shall set the RANAP Cause to cause #43 "Relocation desirable for radio reasons" as defined in 3GPP TS25.413. For PS handover from Iu mode to A/Gb mode, the old SGSN shall set the value part of UTRAN transparent container IE and Target Identification IE to empty, according to their defined minimum length and set the RANAP Cause to the value received from the source RNC/BSS.

The old SGSN shall include the CSG ID, if the CSG ID is received from the source RNC. The old SGSN shall include the CSG Membership Indication, if the source RNC indicates the target cell is a hybrid cell.

For PS handover from A/Gb mode the BSSGP Cause IE shall be included and shall be set to the cause value received from the source BSC.

Charging Characteristics IE contains the charging characteristics which apply for a PDP context; see 3GPP TS 32.251 [18] and 3GPP TS 32.298 [34]. One Charging Characteristics IE shall be included per PDP context IE. If no PDP context is active, this IE shall not be included. The mapping of a Charging Characteristics IE to a PDP Context IE is done according to the sequence of their appearance, e.g. the first Charging Characteristics IE is mapped to the first PDP Context IE.

The Selected PLMN ID IE indicates the core network operator selected for the MS in a shared network. The old SGSN shall include this IE if the selected PLMN identity is available; see 3GPP TS 23.251 [35] and 3GPP TS 25.413 [7] for details.

The presence of the Extended Common Flags IE is optional. The Unauthenticated IMSI bit field shall be set to 1 if the IMSI present in the message is not authenticated and is for an emergency attached MS.

If the Direct Tunnel Flags IE is included and if the GCSI bit of the Direct Tunnel Flags IE is set to 1, this indicates to the new SGSN that a GPRS-CSI was present in the subscriber's profile in the old SGSN and hence, a direct GTP-U tunnel was prohibited. If the GCSI bit of the Direct Tunnel Flags IE is set to 0, this indicates to the new SGSN that a GPRS-CSI was absent from the subscriber's profile in the old SGSN and the new SGSN may or may not wait for the subscriber's profile from HLR before establishing a direct tunnel between the RNC and GGSN. All other fields of the Direct Tunnel Flags IE shall be ignored.

NOTE: If the Direct Tunnel Flags IE is absent, then the new SGSN cannot know if a GPRS-CSI was present in the subscriber's profile in the old SGSN. Hence, the new SGSN has to wait for the subscriber's profile from the HLR before the direct tunnel decisions are made. Therefore, sending the Direct Tunnel Flags IE allows the new SGSN to make the direct tunnel decisions before the subscriber's profile is received from HLR.

Both RFSP Index values shall be forwarded to the new SGSN during inter-SGSN mobility procedures.

The Co-located GGSN-PGW FQDN which applies for a PDP context may be included. One Co-located GGSN-PGW FQDN shall be included per PDP context IE. The mapping of a Co-located GGSN-PGW FQDN IE to a PDP Context IE is done according to the sequence of their appearance, e.g. the first Co-located GGSN-PGW FQDN IE is mapped to the first PDP Context IE. If the activated PDP Contexts of the PDP address and APN do not have the Co-located GGSN-PGW FQDN Information, the length field of the Co-located GGSN-PGW FQDN IE shall be set to 0. If all the activated PDP Contexts of the UE do not have the Co-located GGSN-PGW FQDN Information, the FQDN IE shall not be present in this message.

The optional Private Extension contains vendor or operator specific information.

Table 29: Information Elements in a Forward Relocation Request

| Information element | Presence requirement | Reference |
|--|----------------------|-----------|
| IMSI | Conditional | 7.7.2 |
| Tunnel Endpoint Identifier Control Plane | Mandatory | 7.7.14 |
| RANAP Cause | Mandatory | 7.7.18 |
| Packet Flow ID | Optional | 7.7.22 |
| Charging Characteristics | Optional | 7.7.23 |
| MM Context | Mandatory | 7.7.28 |
| PDP Context | Conditional | 7.7.29 |
| SGSN Address for Control plane | Mandatory | 7.7.32 |
| Target Identification | Mandatory | 7.7.37 |
| UTRAN transparent container | Mandatory | 7.7.38 |
| PDP Context Prioritization | Optional | 7.7.45 |
| MBMS UE Context | Optional | 7.7.55 |
| Selected PLMN ID | Optional | 7.7.64 |
| BSS Container | Optional | 7.7.72 |
| Cell Identification | Optional | 7.7.73 |
| BSSGP Cause | Optional | 7.7.75 |
| PS Handover XID Parameters | Optional | 7.7.79 |
| Direct Tunnel Flags | Optional | 7.7.81 |
| Reliable INTER RAT HANDOVER INFO | Optional | 7.7.87 |
| Subscribed RFSP Index | Optional | 7.7.88 |
| RFSP Index in use | Optional | 7.7.88 |
| Co-located GGSN-PGW FQDN | Optional | 7.7.90 |
| Evolved Allocation/Retention Priority II | Optional | 7.7.92 |
| Extended Common Flags | Optional | 7.7.93 |
| CSG ID | Optional | 7.7.96 |
| CSG Membership Indication | Optional | 7.7.97 |
| Private Extension | Optional | 7.7.46 |

7.5.7 Forward Relocation Response

The new SGSN shall send a Forward Relocation Response to the old SGSN as a response to a previous Forward Relocation Request.

Possible Cause values is:

- "Request Accepted".
- "System failure".
- "Mandatory IE incorrect".
- "Mandatory IE missing".
- "Optional IE incorrect".

- "No resources available".
- "Invalid message format".
- "Relocation failure".

RANAP Cause is mandatory if cause value is contained in RANAP message.

RAB Setup Information, UTRAN transparent container and RANAP Cause are information from the target RNC in the new SGSN.

One or more RAB Setup Information parameters may be sent in this message. This information element shall be included if the Cause contains the value "Request accepted" and there is at least one RAB assigned in the new SGSN.

The new SGSN shall include a SGSN Address for control plane. The old SGSN shall store this SGSN Address and use it when sending control plane messages for the MS to the new SGSN in the SRNS Relocation Procedure. If the Forward Relocation Request received from the old SGSN includes an IPv6 SGSN address, an IPv4/IPv6 capable SGSN shall include an IPv6 address in the field SGSN Address for Control Plane, otherwise, it shall include an IPv4 address in this field.

The Tunnel Endpoint Identifier Control Plane field specifies a Tunnel Endpoint Identifier that is chosen by the new SGSN. The old SGSN shall include this Tunnel Endpoint Identifier in the GTP header of all subsequent signalling messages that are sent from the old SGSN to the new SGSN. This information element shall be included if the Cause contains the value "Request accepted".

One or more Additional RAB Setup Information parameters may be sent in this message for IPv6. This information element shall be included if the Cause contains the value "Request accepted" and there is at least one RAB assigned in the new SGSN.

The new SGSN may include its SGSN number. If the old SGSN receives the SGSN number of the new SGSN it shall include this number when informing interworking core network nodes that there is a need to re-route previously sent requests against the new SGSN, e.g. in LCS the GMLC will use this SGSN number to re-activate the Location Request to the new SGSN (3GPP TS 23.271 [24]).

For PS handover to A/Gb mode, if a cause value is received from the Target BSC, the BSSGP Cause IE shall be included and shall be set to the cause value received from the target BSC.

If the new SGSN has received the Cell Identification IE in the Forward Relocation Request message and the PS handover continues for at least one PDP Context, the NSAPI for each of the active PDP Contexts received in the Forward Relocation Request for which the PS handover continues are indicated in their priority order, highest priority first. One instance of the NSAPI IE will be inserted for each of these PDP Contexts.

The BSS Container information element contains the radio-related and core network information for the PS handover to A/Gb mode. For PS handover to Iu mode, the UTRAN transparent container shall be used. This information element shall be included if the Cause contains the value "Request accepted" .

The Tunnel Endpoint Identifier Data II IE, one information for each PDP context, contains the tunnel endpoint of the new SGSN. The SGSN Address for User Traffic contains the IP address of the new SGSN for data forwarding to the new SGSN during the PS handover procedure. The List of set-up PFCs IE contains the Packet Flow Identifiers of the PFCs that were successfully allocated in the target system during a PS handover.

The new SGSN receiving a Forward Relocation Request with the optional PS Handover XID Parameters, Packet Flow ID IE, BSS Container, Cell Identification IEs mandatory UTRAN transparent container, Target identification IEs having their value part empty according to their minimum defined length and RANAP Cause IEs set to cause #43 shall not reject this message if it supports the PS handover.

The optional Private Extension contains vendor or operator specific information.

Table 30: Information Elements in a Forward Relocation Response

| Information element | Presence requirement | Reference |
|--|----------------------|-----------|
| Cause | Mandatory | 7.7.1 |
| Tunnel Endpoint Identifier Control Plane | Conditional | 7.7.14 |
| Tunnel Endpoint Identifier Data II | Optional | 7.7.15 |
| RANAP Cause | Conditional | 7.7.18 |
| SGSN Address for Control plane | Conditional | 7.7.32 |
| SGSN Address for User Traffic | Optional | 7.7.32 |
| UTRAN transparent container | Optional | 7.7.38 |
| RAB Setup Information | Conditional | 7.7.39 |
| Additional RAB Setup Information | Conditional | 7.7.45A |
| SGSN Number | Optional | 7.7.47 |
| BSS Container | Optional | 7.7.72 |
| BSSGP Cause | Optional | 7.7.75 |
| List of set-up PFCs | Optional | 7.7.78 |
| Private Extension | Optional | 7.7.46 |

7.5.8 Forward Relocation Complete

The new SGSN shall send a Forward Relocation Complete to the old SGSN to indicate that the SRNS relocation procedure or the PS Handover procedure has been successfully finished.

The optional Private Extension contains vendor or operator specific information.

Table 31: Information Elements in a Forward Relocation Complete

| Information element | Presence requirement | Reference |
|---------------------|----------------------|-----------|
| Private Extension | Optional | 7.7.46 |

7.5.9 Relocation Cancel Request

The Relocation Cancel Request message is sent from the old SGSN to the new SGSN either when the old SGSN is requested to cancel the relocation procedure by the source RNC by means of a RANAP message or is requested to cancel the PS Handover procedure by the source BSS by means of a BSSGP message.

The old SGSN terminates the PS Handover towards the target cell by sending a Relocation Cancel Request message to the new SGSN.

The optional Private Extension contains vendor or operator specific information.

Table 32: Information Elements in a Relocation Cancel Request

| Information element | Presence requirement | Reference |
|---------------------|----------------------|-----------|
| IMSI | Mandatory | 7.7.2 |
| Private Extension | Optional | 7.7.46 |

7.5.10 Relocation Cancel Response

The Relocation Cancel Response message is sent from the new SGSN to the old SGSN either when the relocation procedure has been cancelled in the old SGSN or when the PS handover procedure has been cancelled in the old SGSN. This message is used as the response to the Relocation Cancel Request message.

Possible Cause values are:

- "Request Accepted".
- "IMSI not known".
- "Mandatory IE incorrect".
- "Mandatory IE missing".

- "Optional IE incorrect".
- "Invalid message format".

The optional Private Extension contains vendor or operator specific information.

Table 33: Information Elements in a Relocation Cancel Response

| Information element | Presence requirement | Reference |
|---------------------|----------------------|-----------|
| Cause | Mandatory | 7.7.1 |
| Private Extension | Optional | 7.7.46 |

7.5.11 Forward Relocation Complete Acknowledge

The old SGSN sends a Forward Relocation Complete Acknowledge message to the new SGSN as a response to Forward Relocation Complete.

Possible Cause Values are:

- "Request Accepted".
- "Optional IE incorrect".
- "Invalid message format".

The optional Private Extension contains vendor or operator specific information.

Table 34: Information elements in a Forward Relocation Complete Acknowledge

| Information element | Presence requirement | Reference |
|---------------------|----------------------|-----------|
| Cause | Mandatory | 7.7.1 |
| Private Extension | Optional | 7.7.26 |

7.5.12 Forward SRNS Context Acknowledge

The new SGSN sends a Forward SRNS Context Acknowledge message to the old SGSN as a response to Forward SRNS Context.

Possible Cause values are:

- "Request Accepted".
- "Mandatory IE incorrect".
- "Mandatory IE missing".
- "Optional IE incorrect".
- "Invalid message format".

Table 35: Information elements in a Forward SRNS Context Acknowledge

| Information element | Presence requirement | Reference |
|---------------------|----------------------|-----------|
| Cause | Mandatory | 7.7.1 |
| Private Extension | Optional | 7.7.26 |

7.5.13 Forward SRNS Context

The Forward SRNS Context message is used for hard handover with switch in CN. When the old SGSN receives the RANAP message Forward SRNS Context, the old SGSN shall send a Forward SRNS Context message to the new SGSN. The new SGSN shall forward the message to the target RNC using the corresponding RANAP message.

When the old SGSN receives a BSSGP message PS Handover Required and the acknowledged peer-to-peer LLC operation is used for the PDP context or when "delivery order" is set in the PDP Context QoS profile, the old SGSN shall send a Forward SRNS Context message with the PDU Numbers IE to the new SGSN. The new SGSN shall forward the Forward SRNS Context message to the target RNC / target BSS using the corresponding RANAP message only for PS handover to *Iu mode*.

For each RAB context in the received RANAP message, the old SGSN shall include a RAB Context IE in the GTP-C Forward SRNS Context message.

If available, the old SGSN shall include a Source RNC PDCP context info in the Forward SRNS Context message.

When the old SGSN receives a BSSGP message PS Handover Required from source BSS/RNC for PS handover to A/Gb mode, the value part of RAB Context IE shall be empty according to its defined minimum length.

Table 36: Information Elements in a Forward SRNS Context

| Information element | Presence requirement | Reference |
|------------------------------|----------------------|-----------|
| RAB Context | Mandatory | 7.7.19 |
| Source RNC PDCP context info | Optional | 7.7.61 |
| PDU Numbers | Optional | 7.7.74 |
| Private Extension | Optional | 7.7.46 |

7.5.14 RAN Information Management Messages

The RAN Information Relay is used over the Gn interface to tunnel RAN INFORMATION messages received by an SGSN from a BSS or from RNS. The procedures are specified in 3GPP TS 23.060 [4] and the RAN INFORMATION messages are specified in 3GPP TS 48.018 [20].

7.5.14.1 RAN Information Relay

All information elements from the RAN INFORMATION messages, starting from and including the BSSGP "PDU type", shall be contained within the RAN Transparent Container and forwarded to the destination SGSN or MME in the RAN Information Relay message. For handling of protocol errors the RAN Information Relay message is treated as a Response message.

The RIM Routing Address contains:

- the destination RNC Identity when the target is UTRAN or GERAN operating in GERAN *Iu mode*;
- the destination Cell Identifier when the target is GERAN;
- the Target eNodeB ID when the target is E-UTRAN.

The RIM Routing Address Discriminator indicates which type of address is provided in the RIM Routing Address. If RIM Routing Address Discriminator IE is not included, the RIM Routing Address shall be processed as an RNC identifier, or as if "RIM Routing Address discriminator = 0001".

The optional Private Extension contains vendor or operator specific information.

Table 7.5.14.1: Information Elements in a RAN Information Relay

| Information element | Presence requirement | Reference |
|-----------------------------------|----------------------|-----------|
| RAN Transparent Container | Mandatory | 7.7.43 |
| RIM Routing Address | Optional | 7.7.57 |
| RIM Routing Address Discriminator | Optional | 7.7.77 |
| Private Extension | Optional | 7.7.46 |

7.5A MBMS Messages

The MBMS messages defined here are control plane messages that are used in accordance with 3GPP TS 23.246 [26]. These are further categorised into control plane messages related to UE specific MBMS signalling, and control plane messages related to MBMS service specific signalling.

7.5A.1 UE Specific MBMS Messages

7.5A.1.1 MBMS Notification Request

When receiving an IGMP/MLD join message within a G-PDU, an MBMS capable GGSN shall initiate the authorisation procedure towards the BM-SC as outlined within TS29.061 [27]. Upon successful authorisation, the GGSN sends an MBMS Notification Request message to the SGSN from where the G-PDU was received. The IP address of the SGSN shall be derived from the address currently stored in the GGSN under the SGSN Address for Control Plane for the UE's active PDP context.

The End User Address information element contains the PDP type and IP Multicast PDP address that the SGSN shall request the MS to activate. The IP multicast address shall be the one requested by the UE in the Join request.

The Access Point Name information element identifies the access point of packet data network that the UE should connect to receive the required MBMS service. It should be noted that the APN may resolve to a GGSN that is different from the GGSN sending the MBMS Notification Request. The configuration of this APN may be based on subscription information in the GGSN and is outside the scope of the standardisation.

The NSAPI information element is the NSAPI of the PDP context over which the IGMP/MLD join message was received.

The GGSN shall include a GGSN Address for control plane. The SGSN shall store this GGSN Address and use it when sending control plane messages to the GGSN.

The Tunnel Endpoint Identifier Control Plane information element shall be a tunnel endpoint identifier Control Plane selected by the GGSN and shall be used by the SGSN in the GTP header of the corresponding MBMS Notification Response or MBMS Notification Request Reject message.

The MBMS Protocol Configuration Options (MBMS PCO) information element may be included in the request when the GGSN wishes to provide the MS with MBMS specific parameters. The SGSN includes this IE in the Request MBMS Context Activation message if the associated MBMS Notification Request message from the GGSN includes MBMS protocol configuration options. The SGSN shall copy the content of this IE transparently from the content of the MBMS PCO IE in the MBMS Notification Request message.

Table 7.5A.1: Information Elements in an MBMS Notification Request

| Information element | Presence requirement | Reference |
|--|----------------------|-----------|
| IMSI | Mandatory | 7.7.2 |
| Tunnel Endpoint Identifier Control Plane | Mandatory | 7.7.14 |
| NSAPI | Mandatory | 7.7.17 |
| End User Address | Mandatory | 7.7.27 |
| Access Point Name | Mandatory | 7.7.30 |
| GGSN Address for Control Plane | Mandatory | 7.7.32 |
| MBMS Protocol Configuration Options | Optional | 7.7.58 |
| Private Extension | Optional | 7.7.46 |

7.5A.1.2 MBMS Notification Response

The message is sent by a SGSN to GGSN as a response of a MBMS Notification Request.

The Cause value "Request accepted" indicates if the MBMS context activation will proceed. The MBMS context activation procedure will not proceed for all other Cause values.

Possible Cause values are:

- "Request Accepted".
- "No resources available".
- "Service not supported".
- "System failure".
- "GPRS connection suspended".
- "Mandatory IE incorrect".
- "Mandatory IE missing".
- "Optional IE incorrect".
- "Invalid message format".
- "Roaming restriction".

After an unsuccessful MBMS activation attempt the GGSN may, dependent the cause value indicated, and based on operator configuration fall back to IP multicast access as defined in 3GPP TS29.061[27].

The optional Private Extension contains vendor or operator specific information.

Table 7.5A.2: Information Elements in a MBMS Notification Response

| Information element | Presence requirement | Reference |
|---------------------|----------------------|-----------|
| Cause | Mandatory | 7.7.1 |
| Private Extension | Optional | 7.7.46 |

7.5A.1.3 MBMS Notification Reject Request

If the MBMS context activation proceeds after the MBMS Notification Response, but the MBMS UE context was not established, due to explicit rejection of the MBMS context Activation Request by the MS, or the MS not responding, or the MS MBMS Bearer Capabilities are insufficient, the SGSN sends a MBMS Notification Reject Request message. The Cause value indicates the reason why the MBMS UE Context could not be established:

- "MS is not GPRS Responding".
- "MS Refuses".
- "MS MBMS Capabilities Insufficient".

When receiving the MBMS Notification Reject Request message the GGSN may, dependent the cause value indicated, and based on operator configuration fall back to IP multicast access as defined in 3GPP TS29.061[27].

The Tunnel Endpoint Identifier in the GTP header of the MBMS Notification Reject Request message shall be the same as the Tunnel Endpoint Identifier Control Plane information element of the MBMS Notification Request that triggered the reject.

The Tunnel Endpoint Identifier Control Plane information element shall be a tunnel endpoint identifier Control Plane selected by the SGSN and shall be used by the GGSN in the GTP header of the corresponding MBMS Notification Reject Response message.

The SGSN may include an SGSN Address for control plane, which may be used by the GGSN in the corresponding MBMS Notification Reject Response message.

The End User Address information element contains the PDP type and IP Multicast PDP address that could not be activated. The IP multicast address shall be the one requested by the UE in the Join request.

The Access Point Name shall be the same as the Access Point Name of the received MBMS Notification Request message that triggered the reject.

The NSAPI information element is the NSAPI of the PDP context over which the IGMP/MLD join message was received that triggered the MBMS Notification Request

The optional Private Extension contains vendor or operator specific information.

Table 7.5A.3: Information Elements in a MBMS Notification Reject Request

| Information element | Presence requirement | Reference |
|--|----------------------|-----------|
| Cause | Mandatory | 7.7.1 |
| Tunnel Endpoint Identifier Control Plane | Mandatory | 7.7.14 |
| NSAPI | Mandatory | 7.7.17 |
| End User Address | Mandatory | 7.7.27 |
| Access Point Name | Mandatory | 7.7.30 |
| SGSN Address for Control Plane | Optional | 7.7.32 |
| Private Extension | Optional | 7.7.46 |

7.5A.1.4 MBMS Notification Reject Response

The message is sent by a GGSN to SGSN as a response of a MBMS Notification Reject Request.

Possible Cause values are:

- "Request Accepted".
- "Mandatory IE incorrect".
- "Mandatory IE missing".
- "Optional IE incorrect".
- "Invalid message format".

The optional Private Extension contains vendor or operator specific information.

Table 7.5A.4: Information Elements in a MBMS Notification Reject Response

| Information element | Presence requirement | Reference |
|---------------------|----------------------|-----------|
| Cause | Mandatory | 7.7.1 |
| Private Extension | Optional | 7.7.46 |

7.5A.1.5 Create MBMS Context Request

A Create MBMS Context Request shall be sent from an SGSN node to a GGSN node as part of the MBMS Context Activation procedure. After sending the Create MBMS Context Request message, the SGSN marks the MBMS UE context as "waiting for response". A valid request creates a MBMS UE Context within the SGSN and GGSN, (see 3GPP TS 23.246 [26]). Furthermore, a valid request creates a GTP tunnel in the GTP-C plane, however no GTP-U tunnel is created at this step.

The Tunnel Endpoint Identifier Control Plane field specifies a downlink Tunnel Endpoint Identifier for control plane messages which is chosen by the SGSN. The GGSN shall include this Tunnel Endpoint Identifier in the GTP header of all subsequent downlink control plane messages which are related to the requested MBMS UE context.

The MSISDN of the MS is passed to the GGSN inside the Create MBMS Context Request; This additional information can be used when a secure access to a remote application residing on a server is needed. The GGSN would be in fact able to provide the user identity (i.e. the MSISDN) to the remote application server, providing it with the level of trust

granted to users through successfully performing the GPRS authentication procedures, without having to re-authenticate the user at the application level.

The IMSI information element together with the Enhanced NSAPI information element uniquely identifies the MBMS UE context to be created.

The End User Address information element contains the PDP type and IP Multicast PDP address that the UE requires to be activated. The SGSN shall include either the UE provided APN, a subscribed APN or an SGSN selected APN in the message. The Access Point Name information element identifies the access point of packet data network that the UE requires to connect to receive the required MBMS service. The Selection Mode information element shall indicate the origin of the APN in the message. The APN and End User Address information element shall uniquely identify the MBMS service.

The SGSN shall include an SGSN Address for control plane, which may differ from that provided by the underlying network service (e.g. IP). If the GGSN is IPv6 capable, the IPv4/IPv6 capable SGSN shall include IPv6 addresses in the field SGSN Address for signalling. Otherwise, it shall include IPv4 addresses in this field. The GGSN shall store the SGSN Address and use them when sending control plane on this GTP tunnel for the UE.

The SGSN shall include a Recovery information element into the Create MBMS Context Request if the SGSN is in contact with the GGSN for the very first time or if the SGSN has restarted recently and the new Restart Counter value has not yet been indicated to the GGSN. The GGSN that receives a Recovery information element in the Create MBMS Context Request message element shall handle it in the same way as when receiving an Echo Response message. The Create MBMS Context Request message shall be considered as a valid activation request for the MBMS UE context included in the message.

The SGSN shall include Trace Reference, Trace Type, Trigger Id, OMC Identity and Additional Trace Info in the message if GGSN trace is activated in the GGSN. The SGSN shall copy Trace Reference, Trace Type, and OMC Identity from the trace request received from the HLR or OMC and the Trace Activity Control shall be set to Trace Activation.

If BM-SC trace is to be activated in the BM-SC (via the GGSN), the SGSN shall include Additional BM-SC Trace Info in the message. The SGSN shall populate the Additional MBMS Trace Info IE with the values of the relevant parameters included in the trace request received from the HLR or OMC, and the Trace Activity Control For BM-SC value shall be set to Trace Activation.

If Additional Trace Info and Additional MBMS Trace Info are both included within the message, the values of Trace Reference2 and Trace Recording Session Reference shall be the same in each IE.

For more detailed description of Trace Session activation/deactivation procedures see 3GPP TS 32.422 [31]

For SGSN and GGSN trace record description see 3GPP TS 32.423 [32]

The SGSN shall include the Routing Area Identity (RAI) of the SGSN where the UE is registered. The MCC and MNC components shall be populated with the MCC and MNC, respectively, of the SGSN where the UE is registered. The LAC and RAC components shall be populated by the SGSN with the LAC and RAC, respectively, of where the UE is located at the time of the MBMS Context invocation.

The SGSN shall include the User Location Information IE, MS Time Zone IE, RAT Type IE and the IMEI(SV) IE if they are available (see sub-clause 15.1.1a of 3GPP TS 23.060 [4] for more information). If the User Location Information IE is included then the SGSN shall include the CGI or SAI in the "Geographic Location" field depending on whether the MS is in a cell or a service area respectively.

The optional Private Extension contains vendor or operator specific information.

The MBMS Protocol Configuration Options (MBMS PCO) information element may be included in the request when the MS provides the GGSN with MBMS specific parameters. The SGSN includes this IE in the Create MBMS Context Request if the associated Activate MBMS Context Request from the MS includes MBMS protocol configuration options. The SGSN shall copy the content of this IE transparently from the content of the MBMS PCO IE in the Activate MBMS Context Request message.

Table 7.5A.5: Information Elements in a Create MBMS Context Request

| Information element | Presence requirement | Reference |
|--|----------------------|--------------------|
| IMSI | Conditional | 7.7.2 |
| Routing Area Identity (RAI) | Mandatory | 7.7.3 |
| Recovery | Optional | 7.7.11 |
| Selection mode | Conditional | 7.7.12 |
| Tunnel Endpoint Identifier Control Plane | Conditional | 7.7.14 |
| Trace Reference | Optional | 7.7.24 |
| Trace Type | Optional | 7.7.25 |
| End User Address | Mandatory | 7.7.27 |
| Access Point Name | Mandatory | 7.7.30 |
| SGSN Address for signalling | Mandatory | GSN Address 7.7.32 |
| MSISDN | Conditional | 7.7.33 |
| Trigger Id | Optional | 7.7.41 |
| OMC Identity | Optional | 7.7.42 |
| RAT Type | Optional | 7.7.50 |
| User Location Information | Optional | 7.7.51 |
| MS Time Zone | Optional | 7.7.52 |
| IMEI(SV) | Optional | 7.7.53 |
| MBMS Protocol Configuration Options | Optional | 7.7.58 |
| Additional Trace Info | Optional | 7.7.62 |
| Enhanced NSAPI | Mandatory | 7.7.67 |
| Additional MBMS Trace Info | Optional | 7.7.68 |
| Private Extension | Optional | 7.7.46 |

7.5A.1.6 Create MBMS Context Response

The message shall be sent from a GGSN node to a SGSN node as a response of a Create MBMS Context Request. When the SGSN receives a Create MBMS Context Response with the Cause value indicating "Request Accepted", the SGSN may be required to register with the GGSN. For further details see MBMS Registration Request procedure.

The Cause value indicates if a MBMS UE context has been created in the GGSN or not. An MBMS UE context has not been created in the GGSN if the Cause differs from "Request accepted". Possible Cause values are:

- "Request Accepted".
- "No resources available".
- "No memory is available".
- "Missing or unknown APN".
- "Unknown PDP address or PDP type".
- "User authentication failed".
- "System failure".
- "Mandatory IE incorrect".
- "Mandatory IE missing".
- "Optional IE incorrect".
- "Invalid message format".

- "APN access denied – no subscription".

"No resources available" indicates that not enough resources are available within the network to allow the MBMS UE Context to be created. "Missing or unknown APN" indicates e.g. when the GGSN does not support the Access Point Name. "Unknown PDP address or PDP type" indicates when the GGSN does not support the PDP type or the PDP address. Within the scope of MBMS message, an unknown PDP address is considered to be unknown multicast address / service.

"User authentication failed" indicates that the external packet network has rejected the service requested by the user. Only the Cause information element shall be included in the response if the Cause contains another value than "Request accepted".

All information elements, except Recovery, Charging Gateway Address, Tunnel Endpoint Identifier Control Plane and Private Extension, are mandatory if the Cause contains the value "Request accepted".

The Tunnel Endpoint Identifier Control Plane field specifies an uplink Tunnel Endpoint Identifier for control plane messages, which is chosen by the GGSN. The SGSN shall include this Tunnel Endpoint Identifier in the GTP header of all subsequent uplink-control plane messages, which are related to the requested MBMS UE context.

The GGSN shall include a GGSN Address for control plane, which may differ from that provided by the underlying network service (e.g. IP).

If the Create MBMS Context Request received from the SGSN included IPv6 SGSN address, an IPv4/IPv6 capable GGSN shall include IPv6 addresses in the fields GGSN Address for Control Plane, and IPv4 addresses in the fields Alternative GGSN Address for Control Plane. If SGSN included only an IPv4 SGSN address in the request, IPv4/IPv6 capable GGSN shall include IPv4 addresses in the fields GGSN Address for Control Plane and IPv6 addresses in the fields Alternative GGSN Address for Control Plane. The SGSN shall store these GGSN Addresses and use one set of them when sending control plane on this GTP tunnel.

The GGSN shall include the Recovery information element into the Create MBMS Context Response if the GGSN is in contact with the SGSN for the first time or the GGSN has restarted recently and the new Restart Counter value has not yet been indicated to the SGSN. The SGSN receiving the Recovery information element shall handle it as when an Echo Response message is received but shall consider the MBMS UE context being created as active if the response indicates successful context activation at the GGSN.

The Charging ID is used to identify all charging records produced in SGSN(s) and the GGSN for this MBMS UE context. The Charging ID is generated by the GGSN and shall be unique within the GGSN.

The Charging Gateway Address is the IP address of the recommended Charging Gateway Functionality to which the SGSN should transfer the Charging Detail Records (CDR) for this MBMS UE Context.

The Alternative Charging Gateway Address IE has a similar purpose as the Charging Gateway Address but enables co-existence of IPv4 and IPv6 stacks in the Ga charging interfaces, without mandating any node to have a dual stack. The format of the optional Alternative Charging Gateway Address information element is the same as the format of the Charging Gateway Address.

When both these addresses are present, the Charging Gateway address IE shall contain the IPv4 address of the Charging Gateway Function and the Alternative Charging Gateway address IE shall contain the IPv6 address of the Charging Gateway Function.

NOTE: The Charging Gateway Address and Alternative Charging Gateway Address both refer to the same Charging Gateway Function.

The optional Private Extension contains vendor or operator specific information.

The MBMS Protocol Configuration Options (MBMS PCO) information element may be included in the response when the GGSN provides the MS with MBMS specific parameters. The SGSN includes this IE in the Activate MBMS Context Accept message if the associated Create MBMS Context Response message from the GGSN includes MBMS protocol configuration options. The SGSN shall copy the content of this IE transparently from the content of the MBMS PCO IE in the Create MBMS Context Response message.

Table 7.5A.6: Information Elements in a Create MBMS Context Response

| Information element | Presence requirement | Reference |
|--|----------------------|--------------------|
| Cause | Mandatory | 7.7.1 |
| Recovery | Optional | 7.7.11 |
| Tunnel Endpoint Identifier Control Plane | Conditional | 7.7.14 |
| Charging ID | Conditional | 7.7.26 |
| GGSN Address for Control Plane | Conditional | GSN Address 7.7.32 |
| Alternative GGSN Address for Control Plane | Conditional | GSN Address 7.7.32 |
| Charging Gateway Address | Optional | 7.7.44 |
| Alternative Charging Gateway Address | Optional | 7.7.44 |
| MBMS Protocol Configuration Options | Optional | 7.7.58 |
| Private Extension | Optional | 7.7.46 |

7.5A.1.7 Update MBMS Context Request

An Update MBMS Context Request message shall be sent from an SGSN to a GGSN as part of the GPRS inter-SGSN Routing Area Update procedure, to redistribute contexts due to load sharing or as part of the inter-system intra-SGSN update procedure i.e. UE transitioning between UTRAN and GERAN A/Gb mode (and vice versa) on the same SGSN. For the inter-SGSN Routing Area Update procedure -the message shall be sent by the new SGSN. The GGSN shall update the MBMS UE context fields accordingly.

The Enhanced NSAPI information element together with the Tunnel Endpoint Identifier in the GTP header unambiguously identifies a MBMS UE Context in the GGSN.

The Tunnel Endpoint Identifier Control Plane field specifies a downlink Tunnel Endpoint Identifier Control Plane messages which is chosen by the SGSN. The GGSN shall include this Tunnel Endpoint Identifier in the GTP header of all subsequent downlink control plane messages that are related to the requested PDP context.

The SGSN shall include an SGSN Address for control plane, which may differ from that provided by the underlying network service (e.g. IP).

If an IPv4/IPv6 capable SGSN received IPv4 GGSN addresses from the old SGSN, it shall include IPv4 addresses in the fields SGSN Address for Control Plane and IPv6 addresses in the fields Alternative SGSN Address for Control Plane. Otherwise, an IPv4/IPv6 capable SGSN shall use only SGSN IPv6 addresses if it has GGSN IPv6 addresses available. If the GGSN supports IPv6 below GTP, it shall store and use the IPv6 SGSN addresses for communication with the SGSN and ignore the IPv4 SGSN addresses. If the GGSN supports only IPv4 below GTP, it shall store and use the IPv4 SGSN addresses for communication with the SGSN and ignore the IPv6 SGSN addresses. When active contexts are being redistributed due to load sharing, G-PDUs that are in transit across the Gn-interface are in an undetermined state and may be lost.

The SGSN shall include a Recovery information element into the Update MBMS Context Request if the SGSN is in contact with the GGSN for the very first time or if the SGSN has restarted recently and the new Restart Counter value has not yet been indicated to the GGSN. The GGSN that receives a Recovery information element in the Update MBMS Context Request message element shall handle it in the same way as when receiving an Echo Response message. The Update PDP Context Request message shall be considered as a valid update request for the MBMS UE context indicated in the message.

The SGSN shall include Trace Reference, Trace Type, Trigger Id, OMC Identity and Additional Trace Info in the message if GGSN trace is activated while the MBMS UE context is active. The SGSN shall copy Trace Reference, Trace Type, OMC Identity and Additional Trace Info from the trace request received from the HLR or OMC and the Trace Activity Control shall be set to Trace Activation.

If SGSN deactivates the Trace Session to GGSN, the SGSN shall include the Additional Trace Info in the message and the Trace Activity Control shall be set to Trace Deactivation.

If BM-SC trace is to be activated in the BM-SC (via the GGSN), the SGSN shall include Additional MBMS Trace Info in the message. The SGSN shall populate the Additional BM-SC Trace Info IE with the values of the relevant parameters included in the trace request received from the HLR or OMC, and the Trace Activity Control For BM-SC value shall be set to Trace Activation.

If the SGSN deactivates the Trace Session to the BM-SC, then the SGSN shall include the Additional MBMS Trace Info in the message and the Trace Activity Control For BM-SC value shall be set to Trace Deactivation.

If Additional Trace Info and Additional MBMS Trace Info are both included within the message, the values of Trace Reference2 and Trace Recording Session Reference shall be the same in each IE.

For more detailed description of Trace Session activation/deactivation procedures see 3GPP TS 32.422 [31]

For SGSN and GGSN trace record description see 3GPP TS 32.423 [32] The SGSN shall include the Routing Area Identity (RAI) of the SGSN where the UE is registered. The MCC and MNC components shall be populated with the MCC and MNC, respectively, of the SGSN where the UE is registered. The LAC and RAC components shall be populated by the SGSN with the value of "FFFE" and "FF", respectively.

The SGSN shall include the User Location Information IE, RAT Type IE and MS Time Zone IE if they are available (see sub-clause 15.1.1a of 3GPP TS 23.060 [4] for more information). If the User Location Information IE is included then the SGSN shall include the CGI or SAI in the "Geographic Location" field depending on whether the MS is in a cell or a service area respectively.

The optional Private Extension contains vendor or operator specific information.

Table 7.5A.7: Information Elements in an Update MBMS Context Request

| Information element | Presence requirement | Reference |
|--|----------------------|--------------------|
| Routing Area Identity (RAI) | Mandatory | 7.7.3 |
| Recovery | Optional | 7.7.11 |
| Tunnel Endpoint Identifier Control Plane | Conditional | 7.7.14 |
| Trace Reference | Optional | 7.7.24 |
| Trace Type | Optional | 7.7.25 |
| SGSN Address for Control Plane | Mandatory | GSN Address 7.7.32 |
| Alternative SGSN Address for Control Plane | Conditional | GSN Address 7.7.32 |
| Trigger Id | Optional | 7.7.41 |
| OMC Identity | Optional | 7.7.42 |
| RAT Type | Optional | 7.7.50 |
| User Location Information | Optional | 7.7.51 |
| MS Time Zone | Optional | 7.7.52 |
| Additional Trace Info | Optional | 7.7.62 |
| Enhanced NSAPI | Mandatory | 7.7.67 |
| Additional MBMS Trace Info | Optional | 7.7.68 |
| Private Extension | Optional | 7.7.46 |

7.5A.1.8 Update MBMS Context Response

The message shall be sent from a GGSN node to a SGSN node as a response of an Update MBMS Context Request.

If the SGSN receives an Update MBMS Context Response with a Cause value other than "Request accepted", it shall abort the update of the MBMS UE context.

If the SGSN receives an Update MBMS Context Response with a Cause value "Non-existent", it shall delete the MBMS UE Context.

Only the Cause information element and optionally the Recovery information element shall be included in the response if the Cause contains another value than "Request accepted".

Possible Cause values are:

- "Request Accepted".
- "Non-existent".
- "Service not supported".
- "System failure".

- "Mandatory IE incorrect".
- "Mandatory IE missing".
- "Optional IE incorrect".
- "Invalid message format".

The Tunnel Endpoint Identifier Control Plane field specifies an uplink Tunnel Endpoint Identifier Control Plane messages which is chosen by the GGSN. The SGSN shall include this Tunnel Endpoint Identifier in the GTP header of all subsequent uplink control plane messages which are related to the requested MBMS UE context.

The GGSN shall also include a GGSN address for control plane, which shall not differ from that provided at MBMS UE context setup time and shall remain unchanged for the lifetime of the MBMS UE context. If the Update MBMS Context Request received from the SGSN included IPv6 SGSN addresses, an IPv4/IPv6 capable GGSN shall include an IPv6 address in the field GGSN Address for Control Plane and a corresponding IPv4 address in the field Alternative GGSN Address for Control Plane. If SGSN included only an IPv4 SGSN address in the request, IPv4/IPv6 capable GGSN shall include IPv4 address for Control plane in the field GGSN Address for Control Plane and IPv6 address for Control plane in the field Alternative GGSN Address for Control Plane.

The GGSN Address for control plane shall be included if the Cause contains the value "Request accepted". The Alternative GGSN Address shall be included if the GGSN supports IPv6 below GTP and the Cause contains the value "Request accepted".

The GGSN shall include the Recovery information element into the Update MBMS Context Response if the GGSN is in contact with the SGSN for the first time or if the GGSN has restarted recently and the new Restart Counter value has not yet been indicated to the SGSN. The SGSN receiving the Recovery information element shall handle it as when an Echo Response message is received but shall consider the MBMS UE context as updated and active if the response cause indicates a successful operation at the GGSN.

The Charging ID is used to identify all charging records produced in SGSN(s) and the GGSN for this MBMS UE context. The Charging ID has been previously generated by the GGSN and is unique for this MBMS UE context. If an inter-SGSN routing area update occurs, it is transferred to the new SGSN as part of each active MBMS UE context. This information element shall be included if the Cause contains the value "Request accepted".

The Charging Gateway Address is the IP address of the recommended Charging Gateway Functionality to which the SGSN should transfer the Charging Detail Records (CDR) for this MBMS UE Context.

The Alternative Charging Gateway Address IE has a similar purpose as the Charging Gateway Address but enables co-existence of IPv4 and IPv6 stacks in the Ga charging interfaces, without mandating any node to have a dual stack. The format of the optional Alternative Charging Gateway Address information element is the same as the format of the Charging Gateway Address.

When both these addresses are present, the Charging Gateway address IE shall contain the IPv4 address of the Charging Gateway Function and the Alternative Charging Gateway address IE shall contain the IPv6 address of the Charging Gateway Function.

NOTE: The Charging Gateway Address and Alternative Charging Gateway Address both refer to the same Charging Gateway Function.

The optional Private Extension contains vendor or operator specific information.

Table 7.5A.8: Information Elements in an Update MBMS Context Response

| Information element | Presence requirement | Reference |
|--|----------------------|--------------------|
| Cause | Mandatory | 7.7.1 |
| Recovery | Optional | 7.7.11 |
| Tunnel Endpoint Identifier Control Plane | Conditional | 7.7.14 |
| Charging ID | Conditional | 7.7.26 |
| GGSN Address for Control Plane | Conditional | GSN Address 7.7.32 |
| Alternative GGSN Address for Control Plane | Conditional | GSN Address 7.7.32 |
| Charging Gateway Address | Optional | 7.7.44 |
| Alternative Charging Gateway Address | Optional | 7.7.44 |
| Private Extension | Optional | 7.7.46 |

7.5A.1.9 Delete MBMS Context Request

A Delete MBMS Context Request can be sent either from a SGSN node to a GGSN node as part of the GPRS Detach procedure or from the GGSN node to the SGSN node as part of the MBMS UE Context Deactivation procedure initiated by the UE by the sending of an IGMP/MLD leave message. A Delete MBMS Context Request shall also be sent from an SGSN node to a GGSN node at Inter SGSN change if the new SGSN does not support MBMS. If the deactivation of the MBMS UE context results in no more users being registered within the GSN for the Multicast Service, the SGSN may initiate the MBMS deregistration procedure. (For further information see 3GPP TS 23.246 [26]).

A GSN shall be prepared to receive a Delete MBMS Context Request at any time and shall always reply regardless if the MBMS UE context exists or not. If any collision occurs, the Delete MBMS Context Request takes precedence over any other Tunnel Management message.

An SGSN initiated Delete MBMS Context Request shall only include the Enhanced NSAPI which shall uniquely identify the MBMS UE context to be deactivated and the optional Private Extension contains vendor or operator specific information.

If the MBMS UE context to be deactivated (indicated by the multicast address within the IGMP/MLD leave message) resides on the same GGSN as which the IGMP/MLD leave message is received, a GGSN initiated Delete MBMS Context Request shall only include the Enhanced NSAPI which shall uniquely identify the MBMS UE context to be deactivated and the optional Private Extension contains vendor or operator specific information.

If the MBMS UE context to be deactivated (indicated by the multicast address within the IGMP/MLD leave message) resides on a different GGSN from that which the IGMP/MLD leave message is received, a GGSN initiated Delete MBMS Context Request shall contain the IMSI, TEID Control Plane, End User Address, APN, the optional Private Extension contains vendor or operator specific information. This message will then trigger the SGSN to send a SGSN initiated Delete MBMS Context Request for the identified MBMS UE context toward the GGSN hosting the MBMS UE context.

The IMSI shall unambiguously identify the user. The End User Address information element contains the PDP type and IP Multicast PDP address that the GGSN shall request the SGSN to de-activate. The IP multicast address shall be the one included by the UE in the Leave request.

The Access Point Name information element further identifies the access point of packet data network that the SGSN will use to identify which MBMS UE context to deactivate. The APN and End User Address information element shall uniquely identify the MBMS service.

The Tunnel Endpoint Identifier Control Plane information element shall be a tunnel endpoint identifier Control Plane selected by the GGSN and shall be used by the SGSN in the GTP header of the corresponding Delete MBMS Context Response message.

In the MS to GGSN direction, the SGSN includes the MBMS Protocol Configuration Options (MBMS PCO) information element in the request if the MS wishes to provide the GGSN with MBMS specific parameters. The SGSN includes this IE in the Delete MBMS Context Request message if the associated message from the MS includes MBMS protocol configuration options. The SGSN shall copy the content of this IE transparently from the MBMS PCO IE in the Deactivate PDP Context Request message.

In the GGSN to MS direction, the GGSN includes the MBMS Protocol Configuration Options (MBMS PCO) information element in the request if the GGSN wishes to provide the MS with MBMS specific parameters. The SGSN includes this IE in the Deactivate PDP Context Request message if the associated Delete MBMS Context Request message from the GGSN includes MBMS protocol configuration options. The SGSN shall copy the content of this IE transparently from the MBMS PCO IE in the Delete MBMS Context Request message.

Table 7.5A.9: Information Elements in a Delete MBMS Context Request

| Information element | Presence requirement | Reference |
|--|----------------------|-----------|
| IMSI | Conditional | 7.7.2 |
| Tunnel Endpoint Identifier Control Plane | Conditional | 7.7.14 |
| End User Address | Conditional | 7.7.27 |
| Access Point Name | Conditional | 7.7.30 |
| MBMS Protocol Configuration Options | Optional | 7.7.58 |
| Enhanced NSAPI | Conditional | 7.7.67 |
| Private Extension | Optional | 7.7.46 |

7.5A.1.10 Delete MBMS Context Response

The message shall be sent as a response to a Delete MBMS Context Request.

A GSN shall ignore a Delete MBMS Context Response for a non-existing MBMS UE context.

If a GSN receives a Delete MBMS Context Request message for a non existing MBMS UE context, it shall send back to the source of the message a Delete MBMS Context Response message with cause value "Non existent". The TEID value used in the response message shall be zero.

Possible Cause values are:

- "Request Accepted".
- "Mandatory IE incorrect".
- "Mandatory IE missing".
- "Optional IE Incorrect".
- "Invalid message format".
- "Non existent".

If the received Delete MBMS Context Response contains a cause value other than "Request accepted" and "Non Existent", the PDP context shall be kept active.

The optional Private Extension contains vendor or operator specific information.

In the GGSN to MS direction, the GGSN includes the MBMS Protocol Configuration Options (MBMS PCO) information element in the response if the GGSN wishes to provide the MS with MBMS specific parameters. The SGSN includes this IE in the Deactivate PDP Context Accept message if the associated Delete MBMS Context Response message from the GGSN includes MBMS protocol configuration options. The SGSN shall copy the content of the IE transparently from the MBMS PCO IE in the Delete MBMS Context Response message.

In the MS to GGSN direction, the SGSN includes the MBMS Protocol Configuration Options (MBMS PCO) information element in the response if the MS wishes to provide the GGSN with MBMS specific parameters. The SGSN includes this IE in the Delete MBMS Context Response message if the associated Deactivate PDP Context Accept message from the MS includes MBMS protocol configuration options. The SGSN shall copy the content of the IE transparently from the MBMS PCO IE in the Deactivate PDP Context Accept message.

Table 7.5A.10: Information Elements in a Delete MBMS Context Response

| Information element | Presence requirement | Reference |
|-------------------------------------|----------------------|-----------|
| Cause | Mandatory | 7.7.1 |
| MBMS Protocol Configuration Options | Optional | 7.7.58 |
| Private Extension | Optional | 7.7.46 |

7.5A.2 Service Specific MBMS Messages

7.5A.2.1 MBMS Registration Request

An MBMS Registration Request shall be sent by an SGSN in order to request registration with a GGSN and receive future session attributes and data for a particular MBMS service from the GGSN. This message shall be sent when the first MBMS UE context for a particular MBMS service is created in the SGSN, or when an MBMS registration Request is received from an RNC that is registering for a particular MBMS service that is not present in the SGSN. A successful registration causes the creation of an MBMS Bearer Context in the SGSN, and GGSN. (see 3GPP TS 23.246 [26])

The End User Address information element contains the PDP type and IP Multicast PDP address of the MBMS service for which the SGSN is registering. The Access Point Name information element identifies the access point of packet data network that the GGSN requires to connect to receive the required MBMS service. The APN and End User Address information element shall uniquely identify the MBMS service.

If the MBMS Registration Request is being sent as a result of the first MBMS UE context being created on the SGSN, the SGSN shall copy the End User Address and APN information from the MBMS UE Context. If the MBMS Registration Request is received from an RNC that is registering for a particular MBMS service that is not established in SGSN, the SGSN shall copy the End User Address and APN information from the corresponding message sent by the RNC.

The selection of the GGSN will be dependent on the reason for the registration request. If the MBMS Registration Request is being sent due to the first MBMS UE context for a particular service, the SGSN shall send the MBMS registration Request to the GGSN address identified in the MBMS UE context (APN was resolved by SGSN at MBMS UE context establishment). Alternatively, if the MBMS Registration Request is being sent due to an MBMS registration Request that received from an RNC which is registering for a particular MBMS service that is not established in the SGSN, the GGSN shall be selected via APN resolution. If the registration process is successful, the SGSN shall keep this address for de-registration procedures.

The Tunnel Endpoint Identifier Control Plane field specifies a downlink Tunnel Endpoint Identifier for control plane messages that is chosen by the SGSN. The GGSN shall include this Tunnel Endpoint Identifier in the GTP header of all subsequent downlink control plane messages which are related to the MBMS Bearer context. If the SGSN has already confirmed successful assignment of its Tunnel Endpoint Identifier Control Plane, this field shall not be present.

If SGSN has not established control plane tunnel to GGSN for the given MBMS service, the SGSN shall include an SGSN Address for Control Plane, which may differ from that provided by the underlying network service (e.g. IP). The GGSN shall store the SGSN Address and use it when sending control plane messages on this GTP tunnel for the MBMS Bearer context. IPv4/IPv6 capable SGSN shall include IPv6 address in SGSN Address for Control Plane field and IPv4 address in Alternative SGSN Address for Control Plane field. IPv4 only capable SGSN shall not include Alternative SGSN Address for Control Plane field.

Table 7.5A.2.1: Information Elements in a MBMS Registration Request

| Information element | Presence requirement | Reference |
|--|----------------------|-----------------------|
| Tunnel Endpoint Identifier Control Plane | Conditional | 7.7.14 |
| End User Address | Mandatory | 7.7.27 |
| Access Point Name | Mandatory | 7.7.30 |
| SGSN Address for Control Plane | Conditional | GSN Address 7.7.32 |
| Alternative SGSN Address for Control Plane | Optional | GSN Address 7.7.32 |
| Private Extension | Optional | 7.7.46 |

7.5A.2.2 MBMS Registration Response

An MBMS Registration Response is sent by an GGSN in response to a received MBMS Registration Request. If the GGSN is already registered for the indicated MBMS service, the GGSN can immediately send back this response, adding the SGSN to its list of registered nodes for that MBMS service. If the GGSN is not registered for the indicated MBMS service it shall register with the BM-SC as defined in 3GPP TS29.061 [27].

The Cause value indicates if a registration has been successful in the GGSN. An MBMS Bearer Context has not been created in the GGSN if the Cause differs from "Request accepted". Possible Cause values are:

- "Request Accepted".
- "No resources available".
- "No memory is available".
- "Missing or unknown APN".
- "Unknown PDP address or PDP type".
- "System failure".
- "Mandatory IE incorrect".
- "Mandatory IE missing".
- "Optional IE incorrect".
- "Invalid message format".

The Temporary Mobile Group Identity information element shall be the TMGI allocated by the BM-SC.

The Tunnel Endpoint Identifier Control Plane field specifies an uplink Tunnel Endpoint Identifier for control plane messages that is chosen by the GGSN. The SGSN shall include this Tunnel Endpoint Identifier in the GTP header of all subsequent uplink control plane messages which are related to the MBMS Bearer context. If the GGSN has already confirmed successful assignment of its Tunnel Endpoint Identifier Control Plane, this field shall not be present.

If GGSN has not established control plane tunnel to SGSN for the given MBMS service, the GGSN shall include a GGSN Address for control plane, which may differ from that provided by the underlying network service (e.g. IP).

If the GGSN has received an IPv6 address in the SGSN Address for the Control Plane field with MBMS Registration Request message, then an IPv6 capable GGSN shall include its own IPv6 address in the GGSN Address for the Control Plane field of the response message.

If the SGSN has provided its own IPv4 address, an IPv4 only capable GGSN shall include its own IPv4 address in the GGSN Address for the Control Plane field of the response message.

The SGSN shall store the GGSN Address and use it when sending control plane messages on this GTP tunnel for the MBMS Bearer context.

All information elements, except Private Extension, are mandatory if the Cause contains the value "Request accepted".

"No resources available" indicates that not enough resources are available within the network to allow the MBMS Context to be created. "Missing or unknown APN" indicates e.g. when the GGSN does not support the Access Point Name. "Unknown PDP address or PDP type" indicates when the GGSN does not support the PDP type or the PDP address. Within the scope of MBMS message, an unknown PDP address is considered to be unknown multicast address / service.

Required MBMS bearer capabilities shall contain the minimum bearer capabilities the UE needs to support, as received from the BM-SC.

Table 7.5A.2.2: Information Elements in an MBMS Registration Response

| Information element | Presence requirement | Reference |
|--|----------------------|-----------------------|
| Cause | Mandatory | 7.7.1 |
| Temporary Mobile Group Identity (TMGI) | Conditional | 7.7.56 |
| Tunnel Endpoint Identifier Control Plane | Conditional | 7.7.14 |
| GGSN Address for Control Plane | Conditional | GSN Address 7.7.32 |
| Required MBMS bearer capabilities | Conditional | 7.7.76 |
| Private Extension | Optional | 7.7.46 |

7.5A.2.3 MBMS De-registration Request

An MBMS De-registration Request shall be sent by an SGSN in order to inform an GGSN that it no longer requires to receive session attributes and data for a particular MBMS service. This message shall be sent when the last MBMS UE context for a particular MBMS service is deleted in the SGSN, or when an MBMS De-registration Request is received from an RNC that is de-registering for a particular MBMS service that is currently established in the SGSN that has no MBMS UE context associated. This message is also sent by a GGSN to an SGSN as a part of the BM-SC initiated MBMS De-Registration procedure.

The End User Address information element contains the PDP type and IP Multicast PDP address of the MBMS service for which the SGSN is de-registering. The Access Point Name information element identifies the access point of packet data network that the sending GSN requires to connect to de-register the MBMS service, if this is the last SGSN that was registered for the MBMS service or if the MBMS De-Registration was initiated by the BM-SC.

If the MBMS De-registration Request is being sent as a result of the last MBMS UE context being deleted on the SGSN, the SGSN shall copy the End User Address and APN information from the MBMS UE Context. If the MBMS De-registration Request is received from an RNC that is de-registering for a particular MBMS service for which the SGSN has no MBMS UE Contexts, the SGSN shall copy the End User Address and APN information from the corresponding message sent by the RNC. If the MBMS De-Registration was initiated by the BM-SC, the GGSN shall copy the End User Address and APN information from the MBMS UE Context.

When the SGSN sends this message, the selection of the GGSN will be dependent on the reason for the de-registration request. If the MBMS De-registration Request is being sent due to the leaving of the last MBMS UE context for a particular service, the SGSN shall send the MBMS De-registration Request to the GGSN address identified in the MBMS UE context. Alternatively, if the MBMS De-registration Request is being sent due to an MBMS De-registration Request that received from an RNC for which the SGSN has no MBMS UE contexts established, the GGSN shall be selected via the address stored during registration.

Table 7.5A.2.3: Information Elements in a MBMS De-registration Request

| Information element | Presence requirement | Reference |
|---------------------|----------------------|-----------|
| End User Address | Mandatory | 7.7.27 |
| Access Point Name | Mandatory | 7.7.30 |
| Private Extension | Optional | 7.7.46 |

7.5A.2.4 MBMS De-Registration Response

An MBMS De-registration Response is sent by an SGSN or a GGSN in response to a received MBMS De-registration Request. When the GGSN sends this message, if the SGSN is the last registered downstream node within the MBMS bearer context of the GGSN, the GGSN shall de-register itself with the BM-SC as defined in 3GPP TS29.061[27].

The Cause value indicates if the de-registration has been successful in the sending GSN. An MBMS Bearer Context has not been created in the sending GSN if the Cause differs from "Request accepted". Possible Cause values are:

- "Request Accepted".

- "Missing or unknown APN".
- "Unknown PDP address or PDP type".
- "System failure".
- "Mandatory IE incorrect".
- "Mandatory IE missing".
- "Optional IE incorrect".
- "Invalid message format".
- "Non-existent"

"Missing or unknown APN" indicates e.g. when the GGSN does not support the Access Point Name. "Unknown PDP address or PDP type" indicates when the GGSN does not support the PDP type or the PDP address. Within the scope of MBMS message, an unknown PDP address is considered to be unknown multicast address / service. "Non-existent" indicates a non-existent MBMS UE context.

Table 7.5A.2.4: Information Elements in an MBMS De-registration Response

| Information element | Presence requirement | Reference |
|---------------------|----------------------|-----------|
| Cause | Mandatory | 7.7.1 |
| Private Extension | Optional | 7.7.46 |

7.5A.2.5 MBMS Session Start Request

An MBMS Session Start Request message shall only ever be sent by the GGSN, and will be triggered by the BM-SC when it is ready to send data for the indicated MBMS service. An MBMS Session Start Request message may also be triggered by an Error Indication from an SGSN for broadcast mode. An MBMS Session Start Request shall trigger the SGSN to setup the necessary MBMS user plane resources and indicate to the RAN to setup the appropriate radio bearers.

The GGSN shall include a Recovery information element into the MBMS Session Start Request if the GGSN is in contact with the SGSN for the very first time or if the GGSN has restarted recently and the new Restart Counter value has not yet been indicated to the SGSN. The SGSN that receives a Recovery information element in the MBMS Session Start Request message element shall handle it in the same way as when receiving an Echo Response message. The Session Start Request message shall be considered as a valid activation request for the MBMS Bearer context included in the message.

The MBMS Session Duration information element indicates the estimated session duration of the MBMS service data transmission. This information is provided by the BM-SC.

The Tunnel Endpoint Identifier Control Plane and GGSN Address for Control Plane shall be included in Broadcast mode. In Multicast mode, the control plane tunnel has already been established at the MBMS Registration.

The Tunnel Endpoint Identifier Control Plane field specifies an uplink Tunnel Endpoint Identifier for control plane messages that is chosen by the GGSN. The SGSN shall include this Tunnel Endpoint Identifier in the GTP header of all subsequent uplink control plane messages which are related to the MBMS Bearer context.

The GGSN shall include a GGSN Address for control plane, which may differ from that provided by the underlying network service (e.g. IP). The SGSN shall store the GGSN Address and use it when sending control plane messages on this GTP tunnel for the MBMS Bearer context. IPv4/IPv6 capable GGSN shall include IPv6 address in GGSN Address for Control Plane field and IPv4 address in Alternative GGSN Address for Control Plane field. IPv4 only capable GGSN shall not include Alternative GGSN Address for Control Plane field.

The End User Address information element contains the PDP type and IP Multicast PDP address of the MBMS service. The Access Point Name information element identifies the access point of packet data network that the GGSN requires to connect to receive the required MBMS service. The optional MBMS Flow Identifier allows to differentiate the sub-sessions of an MBMS user service providing location-dependent content in broadcast mode. The APN and End User Address and, if present, the MBMS Flow Identifier information elements shall uniquely identify the MBMS bearer context.

The Quality of Service Profile information element shall be the QoS required from the MBMS bearer.

The MBMS Service Type bit of the Common Flags information element contains explicit information whether the MBMS session is for multicast service or for broadcast service. This information is provided by the BM-SC. If the MBMS Service Type bit of the Common Flags information element is set to 0, then the MBMS session is for multicast service. If the MBMS Service Type bit of the Common Flags information element is set to 1, then the MBMS session is for broadcast service.

The MBMS Counting Information bit of the Common Flags information element contains explicit information whether the Counting procedures are applicable for this MBMS session. This information is provided by the BM-SC. If the MBMS Counting Information bit of the Common Flags information element is set to 0, then counting is not applicable for the MBMS session. If the MBMS Counting Information bit of the Common Flags information element is set to 1, then counting is applicable for the MBMS session.

The Temporary Mobile Group Identity information element shall be the TMGI allocated by the BM-SC.

The MBMS Service Area information element indicates the area over which the MBMS service has to be distributed. This information is provided by the BM-SC.

The MBMS Session Identifier and MBMS Session Repetition Number shall be forwarded to the SGSN if they are provided by the BM-SC.

The MBMS Time To Data Transfer shall be forwarded to the SGSN. This information is provided by the BM-SC.

The MBMS 2G/3G Indicator is provided by the BM-SC and informs the SGSN whether the MBMS Session Start Request message shall be forwarded to the BSCs and/or the RNCs.

If MBMS IP multicast distribution is supported, the GGSN shall inform the SGSN that an IP multicast based user plane is available for the MBMS session by sending MBMS IP Multicast Distribution information element. MBMS IP Multicast Distribution IE shall be forwarded by the SGSN to the RNCs.

The optional Private Extension contains vendor or operator specific information.

Table 7.5A.2.5: Information Elements in an MBMS Session Start Request

| Information element | Presence requirement | Reference |
|--|----------------------|--------------------|
| Recovery | Optional | 7.7.11 |
| Tunnel Endpoint Identifier Control Plane | Conditional | 7.7.14 |
| End User Address | Mandatory | 7.7.27 |
| Access Point Name | Mandatory | 7.7.30 |
| GGSN Address for Control Plane | Conditional | GSN Address 7.7.32 |
| Alternative GGSN Address for Control Plane | Optional | GSN Address 7.7.32 |
| Quality of Service Profile | Mandatory | 7.7.34 |
| Common Flags | Mandatory | 7.7.48 |
| Temporary Mobile Group Identity (TMGI) | Mandatory | 7.7.56 |
| MBMS Service Area | Mandatory | 7.7.60 |
| MBMS Session Identifier | Optional | 7.7.65 |
| MBMS 2G/3G Indicator | Mandatory | 7.7.66 |
| MBMS Session Duration | Mandatory | 7.7.59 |
| MBMS Session Repetition Number | Optional | 7.7.69 |
| MBMS Time To Data Transfer | Mandatory | 7.7.70 |
| MBMS Flow Identifier | Optional | 7.7.84 |
| MBMS IP Multicast Distribution | Optional | 7.7.85 |
| Private Extension | Optional | 7.7.46 |

7.5A.2.6 MBMS Session Start Response

An MBMS Session Start Response is sent by an SGSN in response to a received MBMS Session Start Request. When the GGSN receives a MBMS Session Start Response with the Cause value indicating "Request Accepted", the GGSN shall mark the MBMS Bearer Context as Active, and may start to forward T-PDUs to the SGSN using the indicated TEID and SGSN Address.

The procedure has not been successful if the Cause differs from "Request accepted". Possible Cause values are:

- "Request Accepted".
- "Context not found"
- "No resources available".
- "No memory is available".
- "System failure".
- "Mandatory IE incorrect".
- "Mandatory IE missing".
- "Optional IE incorrect".
- "Invalid message format".
- "MBMS Bearer Context Superseded".

"No resources available" indicates that not enough resources are available within the network to allow the MBMS Bearer to be created.

"MBMS Bearer Context Superseded" indicates that the SGSN has already established an MBMS bearer plane with another GGSN. The GGSN receiving the MBMS Session Start Response with this cause value shall not request establishment of the bearer plane.

Only the Cause information element shall be included in the response if the Cause contains another value than "Request accepted".

The SGSN shall include the Recovery information element into the MBMS Session Start Response if the SGSN is in contact with the GGSN for the first time or the SGSN has restarted recently and the new Restart Counter value has not yet been indicated to the GGSN. The GGSN receiving the Recovery information element shall handle it as when an Echo Response message is received but shall consider the MBMS Bearer context being activated if the response indicates successful context activation at the SGSN.

The Tunnel Endpoint Identifier for Data (I) field specifies a downlink Tunnel Endpoint Identifier for G-PDUs that is chosen by the SGSN. The GGSN shall include this Tunnel Endpoint Identifier in the GTP header of all subsequent downlink G-PDUs which are related to the MBMS Bearer context.

The SGSN shall include an SGSN address for user traffic, which may differ from that provided by the underlying network service (e.g. IP). The GGSN shall store these SGSN Addresses and use them when G-PDUs to the SGSN for the MBMS Bearer context. IPv4/IPv6 capable SGSN shall include IPv6 address in SGSN Address for user traffic field and IPv4 address in Alternative SGSN Address for user traffic field. IPv4 only capable SGSN shall not include Alternative SGSN Address for user traffic field.

The Tunnel Endpoint Identifier Control Plane and SGSN Address for Control Plane shall be included in Broadcast mode. In Multicast mode, the control plane tunnel has already been established at the MBMS Registration.

The Tunnel Endpoint Identifier Control Plane field specifies a downlink Tunnel Endpoint Identifier for control plane messages that is chosen by the SGSN. The GGSN shall include this Tunnel Endpoint Identifier in the GTP header of all subsequent downlink control plane messages which are related to the MBMS Bearer context.

The SGSN shall include an SGSN Address for Control Plane, which may differ from that provided by the underlying network service (e.g. IP).

If SGSN has received IPv6 address in GGSN Address for Control Plane field with MBMS Session Start Request message, then IPv6 capable SGSN shall include own IPv6 address in SGSN Address for Control Plane field of the response message.

If the SGSN has provided its own IPv4 address, IPv4 only capable SGSN shall include own IPv4 address in SGSN Address for Control Plane field of the response message.

The GGSN shall store the SGSN Address and use it when sending control plane messages on this GTP tunnel for the MBMS Bearer context.

The MBMS Distribution Acknowledgement field is used by the SGSN to indicate to the GGSN if a) all RNCs have accepted IP multicast distribution, b) no RNCs have accepted IP multicast distribution, or c) some RNCs have accepted IP multicast distribution.

The optional Private Extension contains vendor or operator specific information.

Table 7.5A.2.6: Information Elements in MBMS Session Start Response

| Information element | Presence requirement | Reference |
|---|----------------------|--------------------|
| Cause | Mandatory | 7.7.1 |
| Recovery | Optional | 7.7.11 |
| Tunnel Endpoint Identifier Data I | Conditional | 7.7.13 |
| Tunnel Endpoint Identifier Control Plane | Conditional | 7.7.14 |
| SGSN Address for Control Plane | Conditional | GSN Address 7.7.32 |
| SGSN Address for user traffic | Conditional | GSN Address 7.7.32 |
| Alternative SGSN Address for user traffic | Optional | GSN Address 7.7.32 |
| MBMS Distribution Acknowledgement | Optional | 7.7.86 |
| Private Extension | Optional | 7.7.46 |

7.5A.2.7 MBMS Session Stop Request

An MBMS Session Stop Request message shall be sent by the GGSN, when triggered by the BM-SC when it no longer has any data to be sent for the indicated MBMS service. An MBMS Session Stop Request shall trigger the SGSN to teardown the MBMS user plane resources and indicate to the RAN to teardown the Radio bearers associated with the MBMS Service.

An MBMS Session Stop Request message may also be sent by the SGSN, when the SGSN no longer will receive or process the indicated MBMS broadcast service. An MBMS Session Stop Request shall trigger the GGSN to remove the SGSN from the associated MBMS broadcast Service.

The End User Address information element contains the PDP type and IP Multicast PDP address of the MBMS service. The Access Point Name information element identifies the access point of packet data network that the GGSN requires to connect to receive the required MBMS service. The optional MBMS Flow Identifier allows to differentiate the sub-sessions of an MBMS user service providing location-dependent content in broadcast mode. The APN and End User Address and, if present, the MBMS Flow Identifier information elements shall uniquely identify the MBMS bearer context.

The optional Private Extension contains vendor or operator specific information.

Table 7.5A.2.7: Information Elements in an MBMS Session Stop Request

| Information element | Presence requirement | Reference |
|----------------------|----------------------|-----------|
| End User Address | Mandatory | 7.7.27 |
| Access Point Name | Mandatory | 7.7.30 |
| MBMS Flow Identifier | Optional | 7.7.84 |
| Private Extension | Optional | 7.7.46 |

7.5A.2.8 MBMS Session Stop Response

An MBMS Session Stop Response is sent by an GSN in response to a received MBMS Session Stop Request. When a GSN receives an MBMS Session Stop Response with the Cause value indicating "Request Accepted", the GSN shall mark the MBMS Bearer Context as Standby, indicating no user plane resource are setup, and will no longer forward T-PDU for this MBMS context.

The procedure has not been successful if the Cause differs from "Request accepted". Possible Cause values are:

- "Request Accepted".

- "Context not found"
- "System failure".
- "Mandatory IE incorrect".
- "Mandatory IE missing".
- "Optional IE incorrect".
- "Invalid message format".

Only the Cause information element shall be included in the response if the Cause contains another value than "Request accepted".

The optional Private Extension contains vendor or operator specific information.

Table 7.5A.2.8: Information Elements in MBMS Session Stop Response

| Information element | Presence requirement | Reference |
|---------------------|----------------------|-----------|
| Cause | Mandatory | 7.7.1 |
| Private Extension | Optional | 7.7.46 |

7.5A.2.9 MBMS Session Update Request

The MBMS Session Update Request message is sent by a GGSN node to SGSN nodes where the MBMS Broadcast Session needs to be updated.. The GGSN sends the message, triggered by the BM-SC when the service area for an ongoing MBMS Broadcast service session shall be modified.

The GGSN may include Tunnel Endpoint Identifier Control Plane field, which may differ from one provided to SGSN by MBMS Session Start Request message (broadcast) or by MBMS Registration Response message (multicast).

The GGSN may include GGSN Address for control plane, which may differ from that provided by the underlying network service (e.g. IP).

The MBMS Session Duration information element indicates the estimated session duration of the MBMS service data transmission. This information is provided by the BM-SC.

The End User Address information element contains the PDP type and IP Multicast PDP address of the MBMS service. The Access Point Name information element identifies the access point of packet data network that the GGSN requires to connect to receive the required MBMS service. The optional MBMS Flow Identifier allows to differentiate the sub-sessions of an MBMS user service providing location-dependent content in broadcast mode. The APN and End User Address, if present, the MBMS Flow Identifier information elements shall uniquely identify the MBMS bearer context.

The Temporary Mobile Group Identity information element shall be the TMGI allocated by the BM-SC.

The MBMS Service Area information element indicates the area over which the MBMS service has to be distributed. This information is provided by the BM-SC.

The MBMS Session Identifier and MBMS Session Repetition Number shall be forwarded to the SGSN if they are provided by the BM-SC.

The optional Private Extension contains vendor or operator specific information.

Table 7.5A.2.9: Information Elements in an MBMS Session Update Request

| Information element | Presence requirement | Reference |
|--|----------------------|--------------------|
| Tunnel Endpoint Identifier Control Plane | Optional | 7.7.14 |
| End User Address | Mandatory | 7.7.27 |
| Access Point Name | Mandatory | 7.7.30 |
| GGSN Address for Control Plane | Optional | GSN Address 7.7.32 |
| Temporary Mobile Group Identity (TMGI) | Mandatory | 7.7.56 |
| MBMS Session Duration | Mandatory | 7.7.59 |
| MBMS Service Area | Mandatory | 7.7.60 |
| MBMS Session Identifier | Optional | 7.7.65 |
| MBMS Session Repetition Number | Optional | 7.7.69 |
| MBMS Flow Identifier | Optional | 7.7.84 |
| Private Extension | Optional | 7.7.46 |

7.5A.2.10 MBMS Session Update Response

An MBMS Session Update Response is sent by SGSN in response to a received MBMS Session Update Request.

The procedure has not been successful if the Cause differs from "Request accepted". Possible Cause values are:

- "Request Accepted".
- "Context not found"
- "No resources available".
- "No memory is available".
- "System failure".
- "Mandatory IE incorrect".
- "Mandatory IE missing".
- "Optional IE incorrect".
- "Invalid message format".

"No resources available" indicates that not enough resources are available within the network to allow the MBMS Bearer to be updated.

Only the Cause information element shall be included in the response if the Cause contains another value than "Request accepted".

The SGSN may include Tunnel Endpoint Identifier Data field, which may differ from one provided to GGSN by MBMS Session Start Response message.

The SGSN may include Tunnel Endpoint Identifier Control Plane field, which may differ from one provided to GGSN by MBMS Session Start Response message (broadcast) or MBMS Registration Request message (multicast).

The SGSN may include SGSN Address for Data I, which may differ from one provided to GGSN by MBMS Session Start Response message.

The SGSN may include SGSN Address for control plane, which may differ from that provided by the underlying network service (e.g. IP).

The optional Private Extension contains vendor or operator specific information.

Table 7.5A.2.10: Information Elements in MBMS Session Update Response

| Information element | Presence requirement | Reference |
|--|----------------------|--------------------|
| Cause | Mandatory | 7.7.1 |
| Tunnel Endpoint Identifier Data I | Optional | 7.7.13 |
| Tunnel Endpoint Identifier Control Plane | Optional | 7.7.14 |
| SGSN Address for Data I | Optional | GSN Address 7.7.32 |
| SGSN Address for Control Plane | Optional | GSN Address 7.7.32 |
| Private Extension | Optional | 7.7.46 |

7.5B.1 MS Info Change Reporting Messages

The Location Change Reporting messages defined here are control plane messages that are used in accordance with 3GPP TS 23.060 [4], section 15.1.1a, and 3GPP TS 23.203 [39].

An SGSN conveys its support of both the MS Info Change Notification Request and MS Info Change Notification Response messages for Location Change Reporting mechanism using the GTP extension header defined in section 6.1.5.

An SGSN conveys its support of both the MS Info Change Notification Request and MS Info Change Notification Response messages for CSG Information Change Reporting mechanism using the CCRSI flag defined in the Extended Common flags IE in section 7.7.93.

7.5B.1.1 MS Info Change Notification Request

This message is sent by an SGSN to a GGSN when the GGSN has requested to receive MS Info Change Notifications.

The TEID value used in this message shall be zero.

The SGSN shall include the IMSI IE and shall set it to the IMSI of the subscriber.

The SGSN optionally includes Linked NSAPI. The Linked NSAPI indicates the NSAPI assigned to any of the already activated PDP context of the PDP address and APN. This IE also indicates the GGSN that the MS Info Change Notification Request is supported per PDP address and APN.

The SGSN shall include the RAT Type IE and shall set its value appropriately, respective of which access technology is current being used by the MS.

The SGSN shall include the User Location Information IE if the MS is located in a RAT Type of GERAN, UTRAN or GAN and shall include the CGI, SAI or RAI in the "Geographic Location" field depending on whether the MS is in a cell, a service or a routing area respectively. The SGSN may optionally include the User Location Information for other RAT Types.

The SGSN shall include the User CSG Information IE if the MS is located in the CSG cell or the hybrid cell and the GGSN has requested to receive the CSG Information.

The optional Private Extension contains vendor or operator specific information.

Table 7.5B.1.1.1: Information Elements in Location Change Notification Request

| Information element | Presence requirement | Reference |
|---------------------------|----------------------|-----------|
| IMSI | Mandatory | 7.7.2 |
| Linked NSAPI | Optional | 7.7.17 |
| RAT Type | Mandatory | 7.7.50 |
| User Location Information | Conditional | 7.7.51 |
| User CSG Information | Optional | 7.7.94 |
| Private Extension | Optional | 7.7.46 |

7.5B.1.2 MS Info Change Notification Response

This message is sent by a GGSN to an SGSN to acknowledge the receipt of a Location Change Notification Request.

The TEID value used in this message shall be zero.

The GGSN shall include the IMSI IE and shall set it to the IMSI received in the corresponding request message. If an SGSN receives an MS Info Change Notification Response with an unknown IMSI, then the message shall be silently discarded and no further processing of the IEs shall continue i.e. the Cause value is not processed.

The Cause value indicates whether or not the MS Info Change Notification Request was received correctly. Possible Cause values are:

- "Request accepted"
- "Invalid message format"
- "IMSI not known"
- "Mandatory IE incorrect"
- "Mandatory IE missing"
- "Optional IE incorrect"
- "System failure"

If the received MS Info Change Notification Response contains a Cause value of "IMSI not known", then the MS Info Change Reporting mechanism shall be stopped in the SGSN for all PDP Contexts associated with the IMSI received and the GGSN from which the response was received. The SGSN shall then initiate an Update PDP Context for all of these PDP Contexts associated with the GGSN.

For error handling if the received MS Info Change Notification Response contains a Cause value other than "Request accepted", "IMSI not known" and "System failure", refer to clause 11.

The GGSN shall include same value of NSAPI if the NSAPI IE is received in the MS Info Change Notification Request message and if the GGSN supports NSAPI in this message. This IE indicates the SGSN that the MS Info Change Notification Request message per PDP address and APN is supported by the GGSN.

If the MS Info Change Reporting mechanism is to be stopped for this subscriber in the SGSN, then the GGSN shall include the MS Info Change Reporting Action IE in the message and shall set the value of the Action field appropriately.

If the CSG Information Reporting mechanism is to be stopped for this subscriber in the SGSN, then the GGSN shall include the CSG Information Reporting Action IE in the message and shall set the value of the Action field appropriately.

The optional Private Extension contains vendor or operator specific information.

Table 7.5B.1.2.1: Information Elements in Location Change Notification Response

| Information element | Presence requirement | Reference |
|----------------------------------|----------------------|-----------|
| IMSI | Mandatory | 7.7.2 |
| Cause | Mandatory | 7.7.1 |
| Linked NSAPI | Optional | 7.7.17 |
| MS Info Change Reporting Action | Optional | 7.7.80 |
| CSG Information Reporting Action | Optional | 7.7.95 |
| Private Extension | Optional | 7.7.46 |

7.6 Reliable Delivery of Signalling Messages

Each path maintains a queue with signalling messages to be sent to the peer. The message at the front of the queue, if it is a request for which a response has been defined, shall be sent with a Sequence Number, and shall be held in a path list until a response is received. Each path has its own list. The Sequence Number shall be unique for each outstanding request message sourced from the same IP/UDP endpoint. A GSN or RNC may have several outstanding requests while waiting for responses.

The T3-RESPONSE timer shall be started when a signalling request message (for which a response has been defined) is sent. A signalling message request or response has probably been lost if a response has not been received before the T3-RESPONSE timer expires. The request is then retransmitted if the total number of request attempts is less than N3-REQUESTS times. The timer shall be implemented in the control plane application as well as user plane application for Echo Request / Echo Response. The wait time for a response (T3-RESPONSE timer value) and the number of retries (N3-REQUESTS) shall be configurable per procedure. The total wait time shall be shorter than the MS wait time between retries of Attach and RA Update messages.

For Intra Domain Connection of RAN Nodes to Multiple CN Nodes, an SGSN relaying a received Identification Request message or a received SGSN Context Request message to another SGSN shall not supervise the Identification Response message or the SGSN Context Response message respectively, i.e. the T3-RESPONSE timer shall not be started in the SGSN relaying any of these two messages. Also, such an SGSN shall not modify the Sequence Number when relaying the Identification Request message or the SGSN Context Request message.

All received request messages shall be responded to and all response messages associated with a certain request shall always include the same information. Duplicated response messages shall be discarded, and, for the SGSN Context Response case, the SGSN Context Acknowledge message shall be sent unless the SGSN Context Request was rejected. A response message without a matching outstanding request should be considered as a duplicate.

The Forward Relocation Complete and Forward SRNS Context messages shall be treated as signalling request messages. The SGSN Context Acknowledge, Forward Relocation Complete Acknowledge and Forward SRNS Context Acknowledge messages shall be treated as response messages.

The SGSN Context Response message needs special treatment by the old SGSN and New SGSN.

The New SGSN must consider this as a regular response to the outstanding SGSN Context Request message, but also copy the sequence number in the header of the SGSN Context Acknowledge it shall send back to the old SGSN unless the SGSN Context Request was rejected. The Old SGSN, when it expects the new SGSN to send back a SGSN Context Acknowledge in response to a SGSN Context Response, shall keep track of the SGSN Context Response message sequence number and apply to this message the rules valid for a Request message too. If a GSN or RNC is not successful with the transfer of a signalling message, e.g. a Create PDP Context Request message, it shall inform the upper layer of the unsuccessful transfer so that the controlling upper entity may take the necessary measures.

7.7 Information Elements

A GTP Signalling message may contain several information elements. The TLV (Type, Length, Value) or TV (Type, Value) encoding format shall be used for the GTP information elements. The information elements shall be sorted, with the Type fields in ascending order, in the signalling messages. The Length field contains the length of the information element excluding the Type and Length field.

For all the length fields, bit 8 of the lowest numbered octet is the most significant bit and bit 1 of the highest numbered octet is the least significant bit.

Within information elements, certain fields may be described as spare. These bits shall be transmitted with the value defined for them. To allow for future features, the receiver shall not evaluate these bits.

The most significant bit in the Type field is set to 0 when the TV format is used and set to 1 for the TLV format.

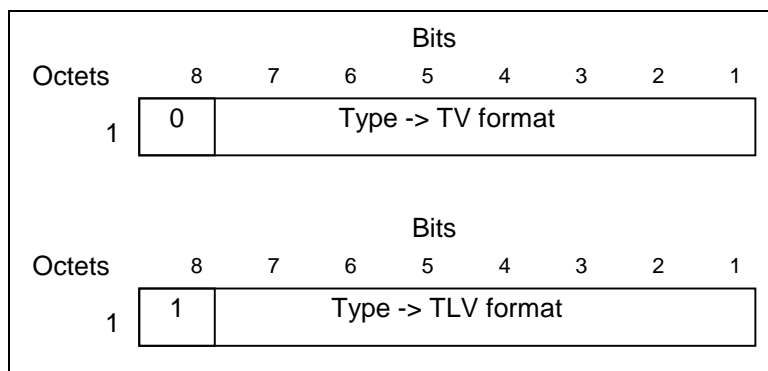

Figure 8: Type field for TV and TLV format

Table 37: Information Elements

| IE Type Value | Format | Information Element | Reference |
|---------------|---|---|-----------|
| 1 | TV | Cause | 7.7.1 |
| 2 | TV | International Mobile Subscriber Identity (IMSI) | 7.7.2 |
| 3 | TV | Routeing Area Identity (RAI) | 7.7.3 |
| 4 | TV | Temporary Logical Link Identity (TLLI) | 7.7.4 |
| 5 | TV | Packet TMSI (P-TMSI) | 7.7.5 |
| 6-7 | Spare | | |
| 8 | TV | Reordering Required | 7.7.6 |
| 9 | TV | Authentication Triplet | 7.7.7 |
| 10 | Spare | | |
| 11 | TV | MAP Cause | 7.7.8 |
| 12 | TV | P-TMSI Signature | 7.7.9 |
| 13 | TV | MS Validated | 7.7.10 |
| 14 | TV | Recovery | 7.7.11 |
| 15 | TV | Selection Mode | 7.7.12 |
| 16 | TV | Tunnel Endpoint Identifier Data I | 7.7.13 |
| 17 | TV | Tunnel Endpoint Identifier Control Plane | 7.7.14 |
| 18 | TV | Tunnel Endpoint Identifier Data II | 7.7.15 |
| 19 | TV | Teardown Ind | 7.7.16 |
| 20 | TV | NSAPI | 7.7.17 |
| 21 | TV | RANAP Cause | 7.7.18 |
| 22 | TV | RAB Context | 7.7.19 |
| 23 | TV | Radio Priority SMS | 7.7.20 |
| 24 | TV | Radio Priority | 7.7.21 |
| 25 | TV | Packet Flow Id | 7.7.22 |
| 26 | TV | Charging Characteristics | 7.7.23 |
| 27 | TV | Trace Reference | 7.7.24 |
| 28 | TV | Trace Type | 7.7.25 |
| 29 | TV | MS Not Reachable Reason | 7.7.25A |
| 117-126 | Reserved for the GPRS charging protocol (see GTP' in 3GPP TS 32.295 [33]) | | |
| 127 | TV | Charging ID | 7.7.26 |
| 128 | TLV | End User Address | 7.7.27 |
| 129 | TLV | MM Context | 7.7.28 |
| 130 | TLV | PDP Context | 7.7.29 |
| 131 | TLV | Access Point Name | 7.7.30 |
| 132 | TLV | Protocol Configuration Options | 7.7.31 |
| 133 | TLV | GSN Address | 7.7.32 |
| 134 | TLV | MS International PSTN/ISDN Number (MSISDN) | 7.7.33 |
| 135 | TLV | Quality of Service Profile | 7.7.34 |
| 136 | TLV | Authentication Quintuplet | 7.7.35 |
| 137 | TLV | Traffic Flow Template | 7.7.36 |
| 138 | TLV | Target Identification | 7.7.37 |
| 139 | TLV | UTRAN Transparent Container | 7.7.38 |
| 140 | TLV | RAB Setup Information | 7.7.39 |
| 141 | TLV | Extension Header Type List | 7.7.40 |
| 142 | TLV | Trigger Id | 7.7.41 |
| 143 | TLV | OMC Identity | 7.7.42 |
| 144 | TLV | RAN Transparent Container | 7.7.43 |
| 145 | TLV | PDP Context Prioritization | 7.7.45 |
| 146 | TLV | Additional RAB Setup Information | 7.7.45A |
| 147 | TLV | SGSN Number | 7.7.47 |
| 148 | TLV | Common Flags | 7.7.48 |
| 149 | TLV | APN Restriction | 7.7.49 |
| 150 | TLV | Radio Priority LCS | 7.7.25B |
| 151 | TLV | RAT Type | 7.7.50 |
| 152 | TLV | User Location Information | 7.7.51 |
| 153 | TLV | MS Time Zone | 7.7.52 |
| 154 | TLV | IMEI(SV) | 7.7.53 |
| 155 | TLV | CAMEL Charging Information Container | 7.7.54 |
| 156 | TLV | MBMS UE Context | 7.7.55 |

| IE Type Value | Format | Information Element | Reference |
|---------------|--------|---|-----------|
| 157 | TLV | Temporary Mobile Group Identity (TMGI) | 7.7.56 |
| 158 | TLV | RIM Routing Address | 7.7.57 |
| 159 | TLV | MBMS Protocol Configuration Options | 7.7.58 |
| 160 | TLV | MBMS Service Area | 7.7.60 |
| 161 | TLV | Source RNC PDCP context info | 7.7.61 |
| 162 | TLV | Additional Trace Info | 7.7.62 |
| 163 | TLV | Hop Counter | 7.7.63 |
| 164 | TLV | Selected PLMN ID | 7.7.64 |
| 165 | TLV | MBMS Session Identifier | 7.7.65 |
| 166 | TLV | MBMS 2G/3G Indicator | 7.7.66 |
| 167 | TLV | Enhanced NSAPI | 7.7.67 |
| 168 | TLV | MBMS Session Duration | 7.7.59 |
| 169 | TLV | Additional MBMS Trace Info | 7.7.68 |
| 170 | TLV | MBMS Session Repetition Number | 7.7.69 |
| 171 | TLV | MBMS Time To Data Transfer | 7.7.70 |
| 172 | TLV | PS Handover Request Context | 7.7.71 |
| 173 | TLV | BSS Container | 7.7.72 |
| 174 | TLV | Cell Identification | 7.7.73 |
| 175 | TLV | PDU Numbers | 7.7.74 |
| 176 | TLV | BSSGP Cause | 7.7.75 |
| 177 | TLV | Required MBMS bearer capabilities | 7.7.76 |
| 178 | TLV | RIM Routing Address Discriminator | 7.7.77 |
| 179 | TLV | List of set-up PFCs | 7.7.78 |
| 180 | TLV | PS Handover XID Parameters | 7.7.79 |
| 181 | TLV | MS Info Change Reporting Action | 7.7.80 |
| 182 | TLV | Direct Tunnel Flags | 7.7.81 |
| 183 | TLV | Correlation-ID | 7.7.82 |
| 184 | TLV | Bearer Control Mode | 7.7.83 |
| 185 | TLV | MBMS Flow Identifier | 7.7.84 |
| 186 | TLV | MBMS IP Multicast Distribution | 7.7.85 |
| 187 | TLV | MBMS Distribution Acknowledgement | 7.7.86 |
| 188 | TLV | Reliable INTER RAT HANDOVER INFO | 7.7.87 |
| 189 | TLV | RFSP Index | 7.7.88 |
| 190 | TLV | Fully Qualified Domain Name (FQDN) | 7.7.90 |
| 191 | TLV | Evolved Allocation/Retention Priority I | 7.7.91 |
| 192 | TLV | Evolved Allocation/Retention Priority II | 7.7.92 |
| 193 | TLV | Extended Common Flags | 7.7.93 |
| 194 | TLV | User CSG Information (UCI) | 7.7.94 |
| 195 | TLV | CSG Information Reporting Action | 7.7.95 |
| 196 | TLV | CSG ID | 7.7.96 |
| 197 | TLV | CSG Membership Indication (CMI) | 7.7.97 |
| 198 | TLV | Aggregate Maximum Bit Rate (AMBR) | 7.7.98 |
| 239-250 | | Reserved for the GPRS charging protocol (see GTP' in 3GPP TS 32.295 [33]) | |
| 251 | TLV | Charging Gateway Address | 7.7.44 |
| 252-254 | | Reserved for the GPRS charging protocol (see GTP' in 3GPP TS 32.295 [33]) | |
| 255 | TLV | Private Extension | 7.7.46 |

7.7.1 Cause

In a request, the Cause Value indicates the reason for the request. The Cause shall be included in the request message.

In a response, the Cause Value indicates the acceptance or the rejection of the corresponding request. In addition, the Cause Value may indicate what was the reason for the corresponding request. The Cause value shall be included in the response message.

Cause values are shared with the GTP' protocol specified in 3GPP TS 32.295 [33].

"Request accepted" is returned when a GSN has accepted a control plane request.

"Non-existent" indicates a non-existent or an inactive PDP context.

"New PDP type due to network preference" indicates that the GGSN has selected a PDP type different from the one sent by the MS."

"New PDP type due to single address bearer only" indicates that the MS has requested PDP type IPv4v6 and both IPv4 and IPv6 addressing is possible in the PDN but the Dual Address Bearer Flag of the Common Flags IE is set to 0 or the Common Flags IE is absent, or only single IP version addressing is possible in the PDN .

IMSI not known" indicates a non-existent MM context.

"MS is GPRS Detached" indicates an idle MM context.

"MS is not GPRS Responding" and "MS Refuses" may be used by SGSN to reject a Network-Requested PDP Context Activation.

"Version not supported" is returned when the recipient does not recognise the version number in the request message.

"Request IMSI", "Request IMEI", "Request IMSI and IMEI" and "No identity needed" are used by GGSN to notify SGSN what to do.

"No resources available" is a generic temporary error condition indicating that some kind of resource is used up for that moment excluding the conditions all dynamic PDP addresses are occupied and no memory is available.

"All dynamic PDP addresses occupied" indicates that the GSN does not have a free dynamic PDP address to allocate any longer.

"No memory available" indicates that the GSN does not have enough memory to use.

"Service not supported" is a generic error indicated that the GSN do not support the requested service.

"User authentication failed" indicates that the external packet network has rejected the user's service request.

"System failure" is a generic permanent error condition.

"Roaming restriction" indicates that the SGSN cannot activate the requested PDP context because of the roaming restrictions.

"P-TMSI Signature mismatch" is returned if either:

- the P-TMSI Signature stored in the old SGSN does not match the value sent by the MS via the new SGSN; or
- the MS does not provide the P-TMSI Signature to the new SGSN while the old SGSN has stored the P-TMSI Signature for that MS.

"Semantic error in the TFT operation", "Syntactic error in the TFT operation", "Semantic errors in packet filter(s)" and "Syntactic errors in packet filters(s)" and "PDP context without TFT already activated" are indications of abnormal cases involving TFTs. The abnormal TFT cases and the use of the cause codes are defined in 3GPP TS 24.008 [5].

"Invalid message format", "Mandatory IE incorrect", "Mandatory IE missing" and "Optional IE incorrect" are indications of protocol errors described in the section Error handling.

"GPRS connection suspended" indicates that the GPRS activities of the mobile station are suspended.

"Authentication failure" indicates that the user authentication failed in the new SGSN.

"Context not found" indicates that the PDP Context referenced in an Active Secondary Context Request message was not found in the receiving GGSN.

"Relocation failure" indicates that the SRNS relocation failed in the new SGSN side.

"Unknown mandatory extension header" signals in a response message that the corresponding request included an extension header for which comprehension was required but unknown to the receiving end.

"APN Restriction type incompatibility with currently active PDP Contexts" conveys to an SGSN that a PDP Context was not allowed to be created or moved by the GGSN because if it had been created or moved, the rules for PDP Context coexistence as described in 3GPP TS 23.060 [4], sub-clause 15.4, would have been broken.

"MS MBMS Capabilities Insufficient" is used by the SGSN to notify the GGSN that the MS MBMS Bearer Capabilities are less than the Required MBMS Bearer Capabilities.

"MBMS Bearer Context Superseded" indicates that the SGSN has already established an MBMS bearer plane with another GGSN.

"Invalid Correlation-ID" indicates that the Correlation-ID was already in use in the SGSN.

"Bearer Control Mode violation" indicates that a request is violating the current Bearer Control Mode.

"Collision with network initiated request" indicates that the UE-initiated request was rejected since the network has requested a secondary PDP context activation for the same service using a network-initiated procedure.

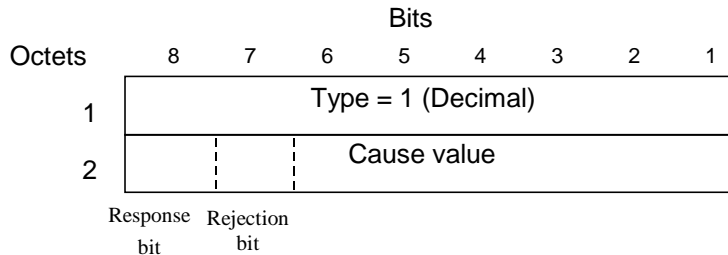

Figure 9: Cause information element

Table 38: Cause Values

| Cause | | Value (Decimal) | |
|---------------------------|--|--|---------|
| request | Request IMSI | 0 | |
| | Request IMEI | 1 | |
| | Request IMSI and IMEI | 2 | |
| | No identity needed | 3 | |
| | MS Refuses | 4 | |
| | MS is not GPRS Responding | 5 | |
| | For future use | 6-48 | |
| | Cause values reserved for GPRS charging protocol use (see GTP' in 3GPP TS 32.295 [33]) | 49-63 | |
| For future use | | 64-127 | |
| | acc | Request accepted | 128 |
| | | New PDP type due to network preference | 129 |
| | | New PDP type due to single address bearer only | 130 |
| response | | For future use | 131-176 |
| | | Cause values reserved for GPRS charging protocol use (see GTP' in 3GPP TS 32.295 [33]) | 177-191 |
| | rej | Non-existent | 192 |
| | | Invalid message format | 193 |
| | | IMSI not known | 194 |
| | | MS is GPRS Detached | 195 |
| | | MS is not GPRS Responding | 196 |
| | | MS Refuses | 197 |
| | | Version not supported | 198 |
| | | No resources available | 199 |
| | | Service not supported | 200 |
| | | Mandatory IE incorrect | 201 |
| | | Mandatory IE missing | 202 |
| | | Optional IE incorrect | 203 |
| | | System failure | 204 |
| | | Roaming restriction | 205 |
| | | P-TMSI Signature mismatch | 206 |
| GPRS connection suspended | 207 | | |
| Authentication failure | 208 | | |

| Cause | | Value (Decimal) |
|-------|--|-----------------|
| | User authentication failed | 209 |
| | Context not found | 210 |
| | All dynamic PDP addresses are occupied | 211 |
| | No memory is available | 212 |
| | Relocation failure | 213 |
| | Unknown mandatory extension header | 214 |
| | Semantic error in the TFT operation | 215 |
| | Syntactic error in the TFT operation | 216 |
| | Semantic errors in packet filter(s) | 217 |
| | Syntactic errors in packet filter(s) | 218 |
| | Missing or unknown APN | 219 |
| | Unknown PDP address or PDP type | 220 |
| | PDP context without TFT already activated | 221 |
| | APN access denied – no subscription | 222 |
| | APN Restriction type incompatibility with currently active PDP Contexts | 223 |
| | MS MBMS Capabilities Insufficient | 224 |
| | Invalid Correlation-ID | 225 |
| | MBMS Bearer Context Superseded | 226 |
| | Bearer Control Mode violation | 227 |
| | Collision with network initiated request | 228 |
| | For future use | 229-240 |
| | Cause values reserved for GPRS charging protocol use (see GTP' in 3GPP TS 32.295 [33]) | 241-255 |

NOTE: With this coding, bits 8 and 7 of the Cause Value respectively indicate whether the message was a request or a response, and whether the request was accepted or rejected.

Table 39: Use of the Cause Values

| Cause 8 | value bits 7 | Result |
|---------|--------------|-----------------------|
| 0 | 0 | Request |
| 0 | 1 | For future use (note) |
| 1 | 0 | Acceptance |
| 1 | 1 | Rejection |

NOTE: The value "01" is for future use and shall not be sent. If received in a response, it shall be treated as a rejection.

7.7.2 International Mobile Subscriber Identity (IMSI)

The IMSI shall be the subscriber identity of the MS. The IMSI is defined in 3GPP TS 23.003 [2].

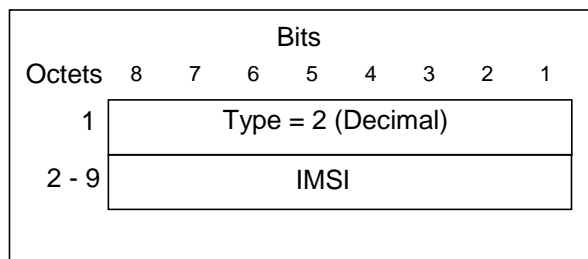
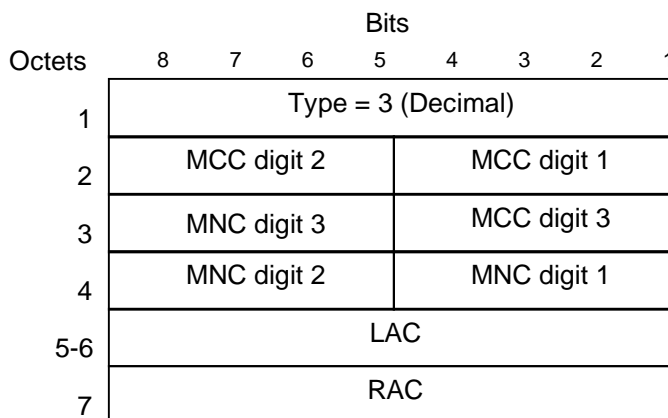

Figure 10: IMSI Information Element

The IMSI is TBCD-coded with a fixed length of 8 octets. Bits 8765 of octet n+1 encodes digit 2n, bits 4321 of octet n+1 encodes digit 2n-1. Each unused half octets shall be coded as binary "1 1 1 1". Digits are packed contiguously with no internal padding.

7.7.3 Routeing Area Identity (RAI)

The RAI information element is given by:



The MCC, MNC, LAC and RAC are defined in TS 23.003

Figure 11: RAI Information Element

If an Administration decides to include only two digits in the MNC, then bits 5 to 8 of octet 3 are coded as "1111".

7.7.4 Temporary Logical Link Identity (TLLI)

The information element of the TLLI associated with a given MS and routeing area is given by:

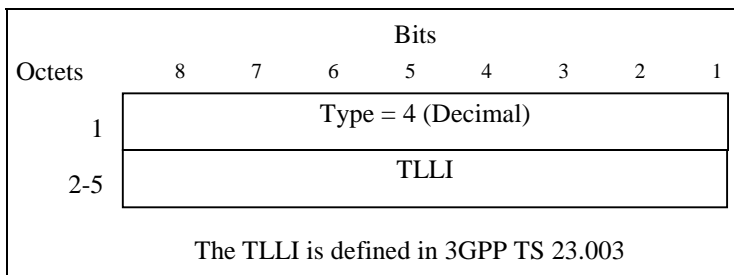

Figure 12: TLLI Information Element

7.7.5 Packet TMSI (P-TMSI)

The Packet TMSI, unambiguously associated with a given MS and routeing area, is given by:

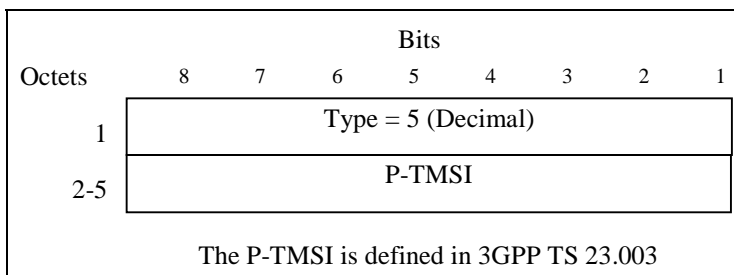

Figure 13: The Packet TMSI Information Element

7.7.6 Reordering Required

The Reordering Required information element states whether reordering by GTP is required or not.

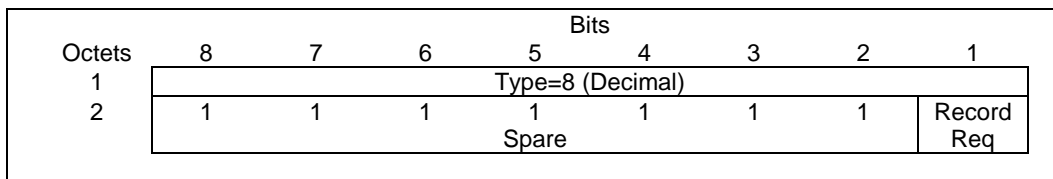

Figure 14: Reordering Required Information Element

Table 40: Reordering Required Values

| Reordering required | Value (Decimal) |
|---------------------|-----------------|
| No | 0 |
| Yes | 1 |

7.7.7 Authentication Triplet

An Authentication triplet consists of a Random string (RAND), a Signed Response (SRES) and a ciphering Key (Kc) (see 3GPP TS 43.020 [9]).

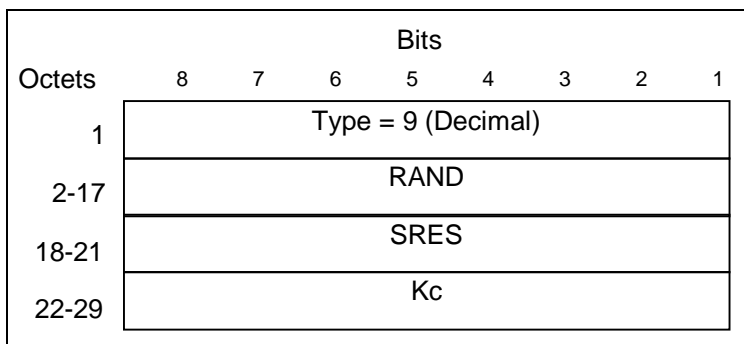

Figure 15: Authentication Triplet Information Element

7.7.8 MAP Cause

The MAP Cause is a value that the GTP-MAP protocol-converting GSN relays transparently from HLR to the GGSN. The possible MAP Cause values for the appropriate messages are described in 3GPP TS 29.002 [6].

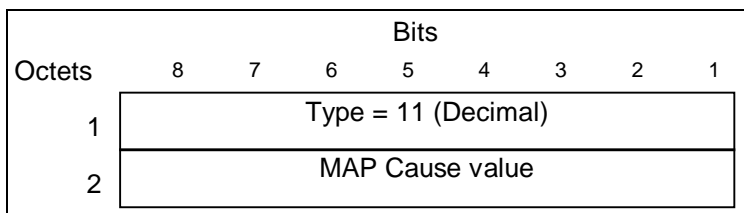

Figure 16: MAP Cause Information Element

7.7.9 P-TMSI Signature

The P-TMSI Signature information element is provided by the MS in the Routing Area Update Request and Attach Request messages to the SGSN for identification checking purposes. The content and the coding of the P-TMSI Signature information element are defined in 3GPP TS 24.008 [5].

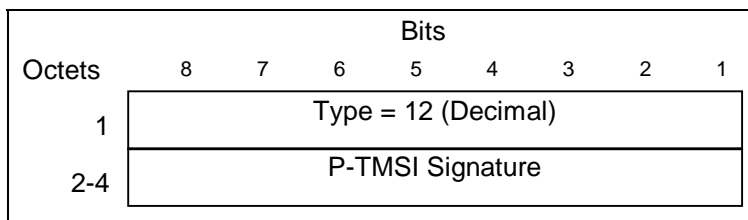

Figure 17: P-TMSI Signature Information Element

7.7.10 MS Validated

The MS Validated information element indicates whether the new SGSN has successfully authenticated the MS.

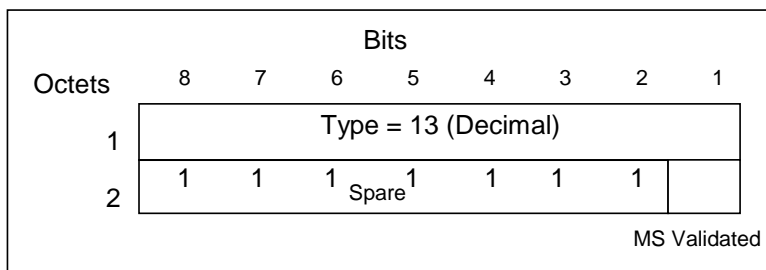

Figure 18: MS Validated Information Element

Table 41: MS Validated Values

| MS Validated | Value |
|--------------|-------|
| No | 0 |
| Yes | 1 |

7.7.11 Recovery

The Recovery information element indicates if the peer GSN has restarted. The Restart Counter shall be the value described in the section Restoration and Recovery.

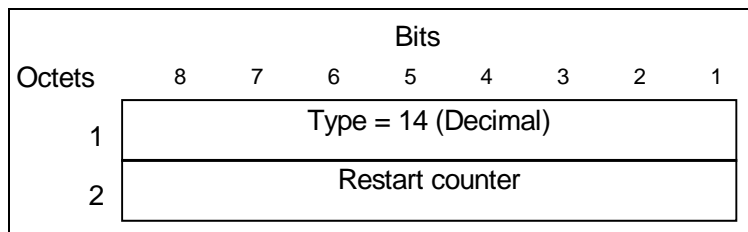

Figure 19: Restart Counter Information Element

7.7.12 Selection Mode

The Selection mode information element indicates the origin of the APN in the message.

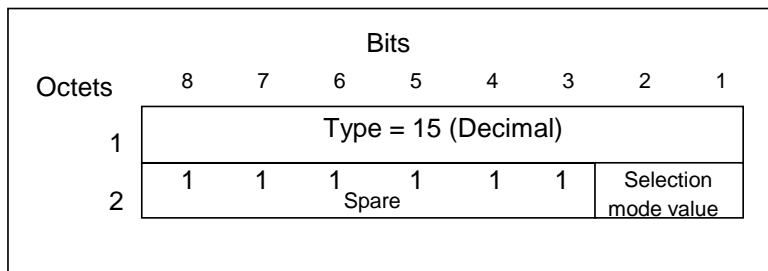

Figure 20: Selection Mode Information Element

Table 42: Selection Mode Values

| Selection mode value | Value (Decimal) |
|--|-----------------|
| MS or network provided APN, subscribed verified | 0 |
| MS provided APN, subscription not verified | 1 |
| Network provided APN, subscription not verified | 2 |
| For future use. Shall not be sent. If received, shall be interpreted as the value "2". | 3 |

7.7.13 Tunnel Endpoint Identifier Data I

The Tunnel Endpoint Identifier Data I information element contains the Tunnel Endpoint Identifier for data transmission requested by the receiver of the flow.

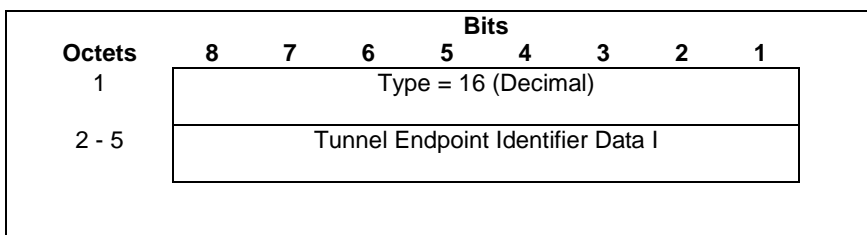

Figure 21: Tunnel Endpoint Identifier Data I Information Element

7.7.14 Tunnel Endpoint Identifier Control Plane

The Tunnel Endpoint Identifier Control Plane information element contains the Tunnel Endpoint Identifier for the control plane; it is assigned by the receiver of the flow. It distinguishes the tunnel from other tunnels between the same pair of entities. The value 0 is reserved for special cases defined in subclause 8.2.

If the receiver has not yet assigned a TEID for this tunnel, it shall assign an unused value to the TEID.

If the receiver has already assigned a Tunnel Endpoint Identifier Control Plane to the tunnel, but has not yet received confirmation of successful assignment from the transmitter, this information element shall take the same value as was sent before for this tunnel.

The receiver receives confirmation of successful assignment of its Tunnel Endpoint Identifier Control Plane from the transmitter when it receives any message with its assigned Tunnel Endpoint Identifier Control Plane in the GTP header from the transmitter.

If the Tunnel Endpoint Identifier Control Plane is received from the transmitter, this information element shall be stored.

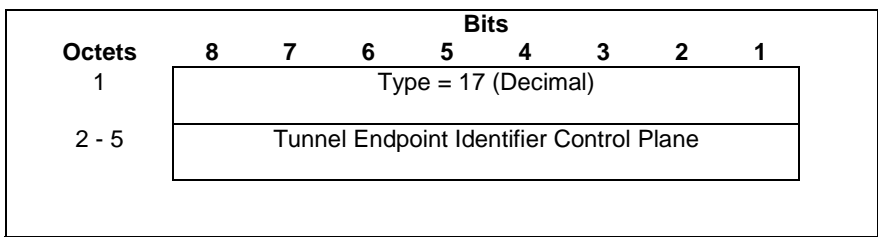

Figure 22: Tunnel Endpoint Identifier Control Plane Information Element

7.7.15 Tunnel Endpoint Identifier Data II

The Tunnel Endpoint Identifier Data II information element contains the Tunnel Endpoint Identifier for data transmission between old and new SGSN for a particular PDP context and is requested by the new SGSN.

The spare bits x indicate unused bits, which shall be set to 0 by the sending side and which shall not be evaluated by the receiving side.

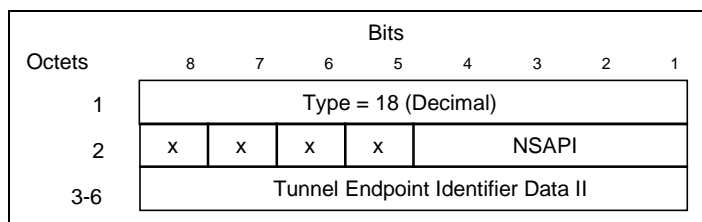

Figure 23: Tunnel Endpoint Identifier Data II Information Element

7.7.16 Teardown Ind

If the Teardown Ind information element value is set to "1", then all PDP contexts that share the same PDP address or two IP addresses (one IPv4 and one IPv6 if PDP Type IPv4v6 is supported and used) with the PDP context identified by the NSAPI included in the Delete PDP Context Request Message shall be torn down. Only the PDP context identified by the NSAPI included in the Delete PDP context Request shall be torn down if the value of this information element is "0".

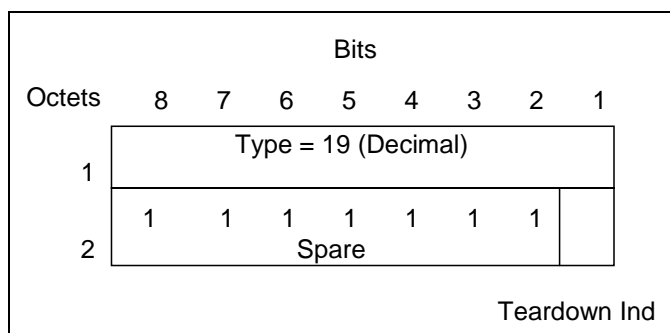

Figure 24: Teardown Ind Information Element

Table 43: Teardown Ind

| Teardown Ind | Value |
|--------------|-------|
| No | 0 |
| Yes | 1 |

7.7.17 NSAPI

The NSAPI information element contains an NSAPI identifying a PDP Context in a mobility management context specified by the Tunnel Endpoint Identifier Control Plane.

The spare bits x indicate unused bits, which shall be set to 0 by the sending side, and the sending side shall not evaluate them.

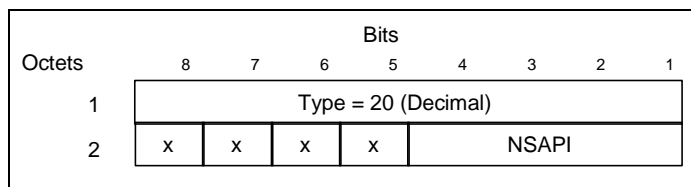

Figure 25: NSAPI Information Element

7.7.18 RANAP Cause

The RANAP Cause information element contains the cause as defined in 3GPP TS 25.413 [7]. The value part (which has a range of 1..255) of the RANAP Cause IE which is transferred over the Iu interface is encoded into one octet from the binary encoding of the value part of the RANAP Cause IE.

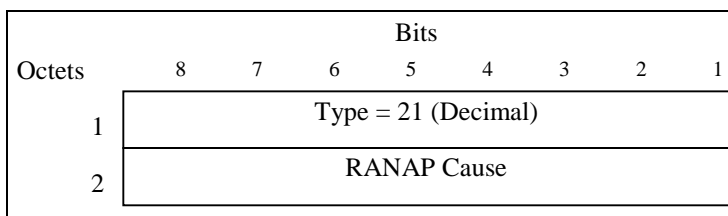

Figure 26: RANAP Cause Information Element

7.7.19 RAB Context

The RAB context information element contains sequence number status for one RAB in RNC, which corresponds to one PDP context in CN. The RAB contexts are transferred between the RNCs via the SGSNs at inter SGSN hard handover.

NSAPI identifies the PDP context and the associated RAB for which the RAB context IE is intended.

DL GTP-U Sequence Number is the number for the next downlink GTP-U T-PDU to be sent to the MS.

UL GTP-U Sequence Number is the number for the next uplink GTP-U T-PDU to be tunnelled to the GGSN.

DL PDCP Sequence Number is the number for the next downlink PDCP-PDU to be sent to the MS.

UL PDCP Sequence Number is the number for the next uplink PDCP-PDU to be received from the MS.

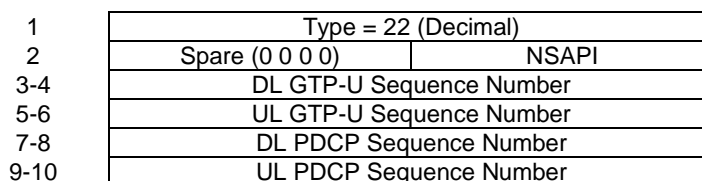

Figure 27: RAB Context Information Element

7.7.20 Radio Priority SMS

The Radio Priority SMS information element contains the radio priority level for MO SMS transmission.

The spare bits x indicate unused bits, which shall be set to 0 by the sending side and which shall not be evaluated by the receiving side.

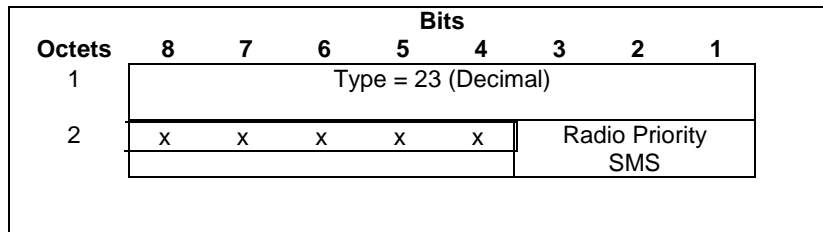

Figure 28: Radio Priority SMS Information Element

7.7.21 Radio Priority

The Radio Priority information element contains the radio priority level that the MS uses when accessing the network for the transmission of uplink user data for a PDP context as identified by NSAPI.

The spare bits x indicate unused bits, which shall be set to 0 by the sending side and which shall not be evaluated by the receiving side.

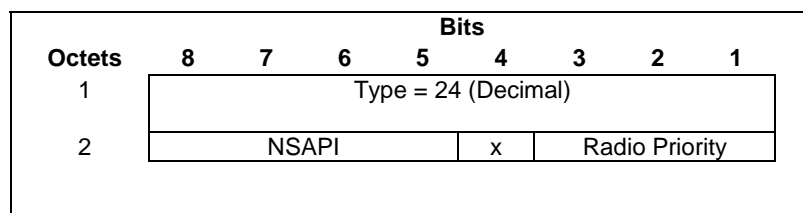

Figure 29: Radio Priority Information Element

7.7.22 Packet Flow Id

The Packet Flow Id information element contains the packet flow identifier assigned to a PDP context as identified by NSAPI.

The spare bits x indicate unused bits, which shall be set to 0 by the sending side and which shall not be evaluated by the receiving side.

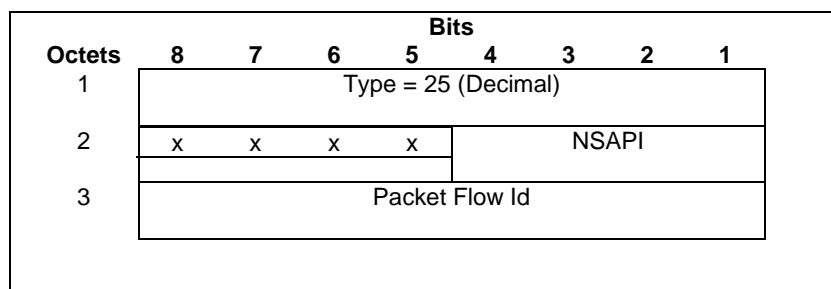

Figure 30: Packet Flow Id Information Element

7.7.23 Charging Characteristics

The charging characteristics information element is a way of informing both the SGSN and GGSN of the rules for producing charging information based on operator configured triggers. For the encoding of this information element see 3GPP TS 32.298 [34].

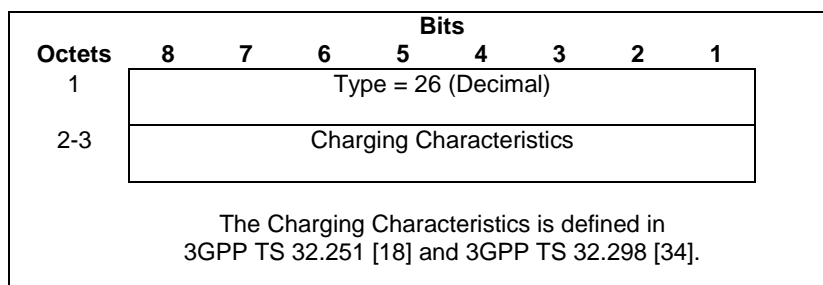

Figure 31: Charging Characteristics Information Element

7.7.24 Trace Reference

The Trace Reference information element identifies a record or a collection of records for a particular trace. The Trace Reference is allocated by the triggering entity.

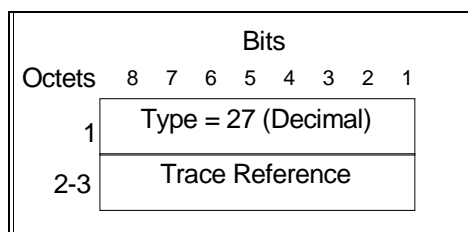

Figure 32: Trace Reference Information Element

7.7.25 Trace Type

The Trace Type information element indicates the type of the trace.

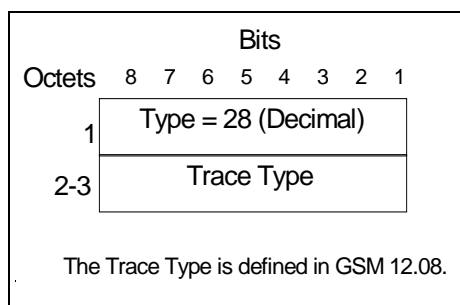

Figure 33: Trace Type Information Element

The Trace Type value 0 (Decimal) and the Trace Type value which is not understood by the receiver shall be treated as a basic trace type.

7.7.25A MS Not Reachable Reason

The MS Not Reachable Reason indicates the reason for the setting of the MNRG flag.

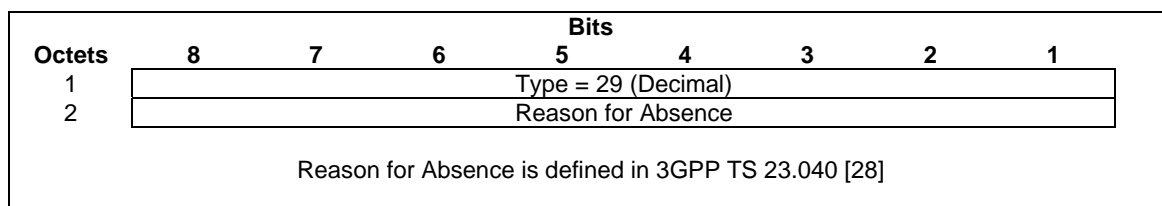

Figure 33a: MS Not Reachable Reason Information Element

7.7.25B Radio Priority LCS

The Radio Priority LCS information element contains the radio priority level for MO LCS transmission.

The spare bits x indicate unused bits, which shall be set to 0 by the sending side and which shall not be evaluated by the receiving side.

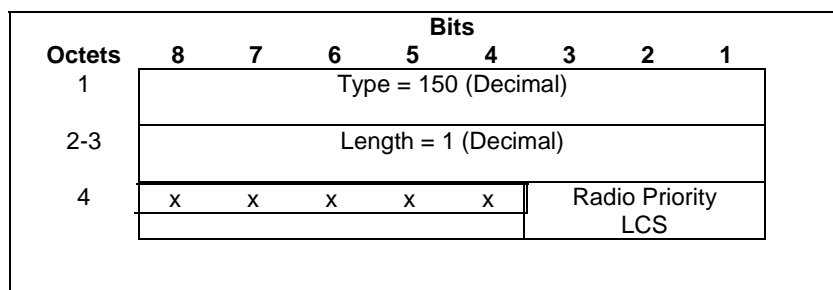

Figure 33b: Radio Priority LCS Information Element

7.7.26 Charging ID

The Charging ID is a unique four-octet value generated by the GGSN when a PDP context is activated. A Charging ID is generated for each activated context. The Charging ID value 0 is reserved and shall not be assigned by the GGSN.

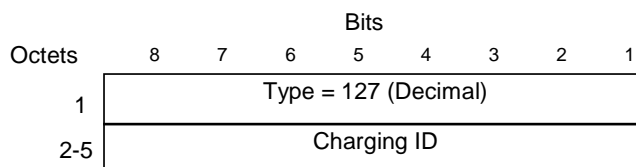

Figure 34: Charging ID Information Element

7.7.27 End User Address

The purpose of the End User Address information element shall be to supply protocol specific information of the external packet data network accessed by the GPRS subscriber.

The Length field value shall be 2 in an End User Address information element with no PDP Address. In the Create PDP Context Request message for a primary PDP Context creation, if the PDP Type Number is set to be HEX(8D), which is indicating the PDP type IPv4v6:

- if IPv4 is static and IPv6 is dynamic, then the Length of End User Address IE shall be set to 6. Only the static IPv4 address shall be coded into octets 6 to 9;
- if IPv4 is dynamic and IPv6 is static, then the Length of End User Address IE is set to 18. Only the static IPv6 address shall be coded into octets 6 to 21;

- if both addresses are static, the Length of End User Address IE is set to 22. IPv4 address shall be coded into octets 6 to 9, and IPv6 address into octets 10 to 25.

The PDP Type defines the end user protocol to be used between the external packet data network and the MS and is divided into an Organisation field and a Number field.

The PDP Type Organisation is the organisation that is responsible for the PDP Type Number field and the PDP Address format.

For PPP the PDP Type Organisation is ETSI and the PDP Type Number is 1 and there shall be no address in the End User Address IE. In this case the address is negotiated later as part of the PPP protocol.

If the PDP Type Organisation is IETF, the PDP Type Number is a compressed number (i.e. the most significant HEX(00) is skipped) in the "Assigned PPP DLL Protocol Numbers" list in the most recent "Assigned Numbers" RFC (RFC 1700 or later). The most recent "Assigned PPP DLL Protocol Numbers" can also be found using the URL = .

The PDP Address shall be the address that this PDP context of the MS is identified with from the external packet data network.

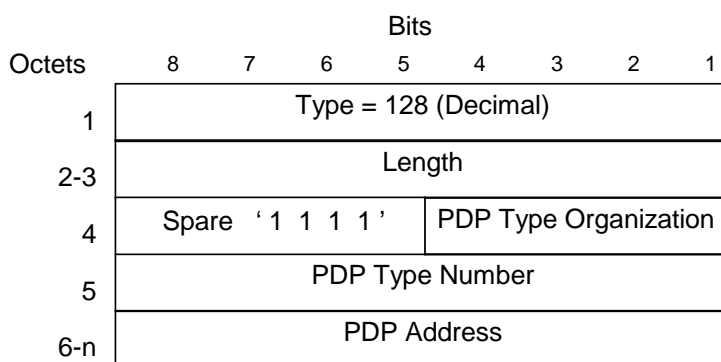

Figure 35: End User Address Information Element

Table 44: PDP Type Organisation Values

| PDP Type Organisation | Value (Decimal) |
|-------------------------------|-----------------|
| ETSI | 0 |
| IETF | 1 |
| All other values are reserved | |

Table 45: ETSI defined PDP Type Values

| PDP Type Number | Value (Decimal) |
|-------------------------------|-----------------|
| PPP | 1 |
| All other values are reserved | |

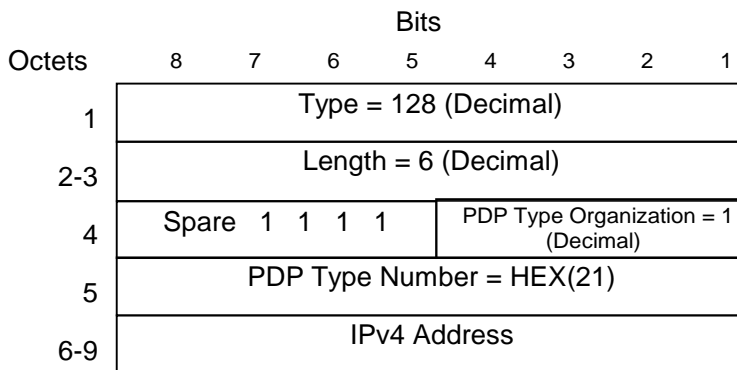

Figure 36: End User Address Information Element for IPv4

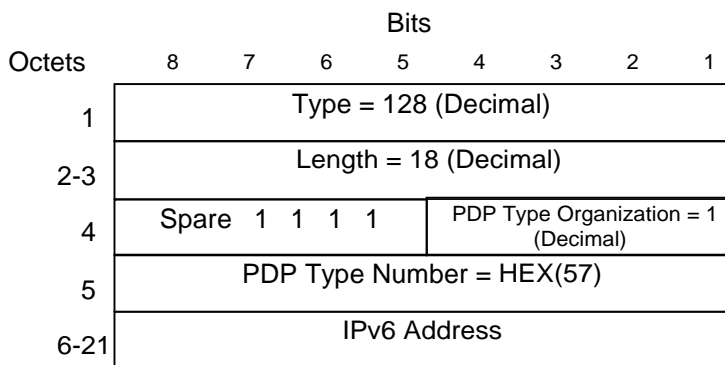

Figure 37: End User Address Information Element for IPv6

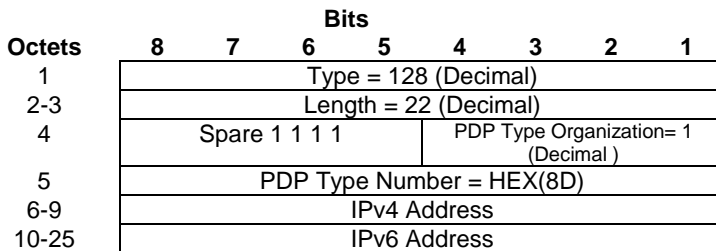

Figure 37A: End User Address Information Element for IPv4v6

NOTE: There is no IANA defined PDP type for IPv4v6. The PDP Type Number is chosen to be HEX(8D), which is inline with 3GPP TS 24.008 [5].

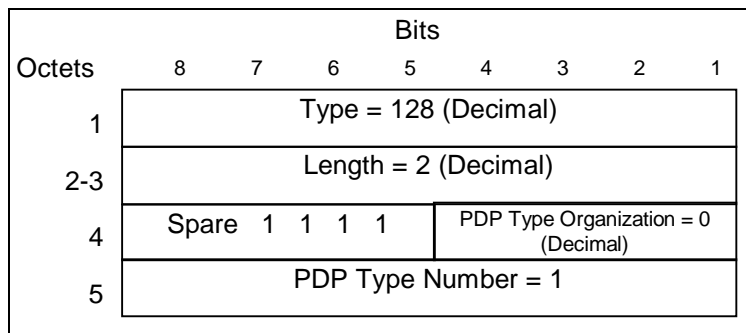

Figure 38: End User Address Information Element for PPP

7.7.28 MM Context

The MM Context information element contains the Mobility Management, MS and security parameters that are necessary to transfer between SGSNs at the Inter SGSN Routeing Area Update procedure.

Security Mode indicates the type of security keys (GSM/UMTS) and Authentication Vectors (quintuplets/triplets) that are passed to the new SGSN.

Ciphering Key Sequence Number (CKSN) is described in 3GPP TS 24.008 [5]. Possible values are integers in the range [0; 6]. The value 7 is reserved. CKSN identifies Kc. During the Intersystem Change to 3G-SGSN, the KSI shall be assigned the value of CKSN.

Key Set Identifier (KSI) identifies CK and IK. During the Intersystem Change to 2G-SGSN, the CKSN shall be assigned the value of KSI.

Used Cipher indicates the GSM ciphering algorithm that is in use.

Kc is the GSM ciphering key of the GSM security context to be used by the new SGSN. This is the GSM security context agreed with the MS during the latest successful authentication procedure. Kc shall be present if GSM key is indicated in the Security Mode.

CK is the UMTS ciphering key of the UMTS security context to be used by the new SGSN. This is the UMTS security context agreed with the MS during the latest successful authentication procedure. CK shall be present if UMTS keys are indicated in the Security Mode.

IK is the UMTS integrity key of the UMTS security context to be used by the new SGSN. This is the UMTS security context agreed with the MS during the latest successful authentication procedure. IK shall be present if UMTS keys are indicated in the Security Mode.

The Triplet array contains triplets encoded as the value in the Authentication Triplet information element. The Triplet array shall be present if indicated in the Security Mode.

The Quintuplet array contains Quintuplets encoded as the value in the Authentication Quintuplet information element. The Quintuplet array shall be present if indicated in the Security Mode. If the quintuplet array is present, the Quintuplet length field indicates its length.

The DRX parameter carries the DRX settings that the UE is using within the network.

MS Network Capability provides the network with information concerning aspects of the MS related to GPRS. MS Network Capability and MS Network Capability Length are coded as in the value part described in 3GPP TS 24.008 [5]. If MS Network Capability is not included, its Length field value shall be set to 0.

DRX parameter is coded as described in 3GPP TS 24.008 [5], the value part only.

The two octets Container Length holds the length of the Container, excluding the Container Length octets.

Container contains one or several optional information elements as described in the clause "Overview", from the clause "General message format and information elements coding" in 3GPP TS 24.008 [5]. For the definition of the IEI see

table 47a, "IEIs for information elements used in the container". The IMEISV shall, if available, be included in the Container. The IMEISV is included in the Mobile identity IE. If Container is not included, its Length field value shall be set to 0. If the MS is emergency attached and the MS is UICCless or the IMSI is unauthenticated, the International Mobile Equipment Identity (IMEI) shall be used as the MS identity.

UE network capability provides the network with information concerning aspects of the UE related to EPS or interworking with GPRS. UE network capability Length is coded as octet 2 of the UE network capability information element defined in 3GPP TS 24.301 [42]. UE network capability is coded as octets 3 to (length + 2) of the UE network capability information element defined in 3GPP TS 24.301 [42]. If UE Network Capability is not included, its Length field value shall be set to 0.

The Subscribed UE-AMBR for Uplink and Downlink is coded as Unsigned32 integer values in kbps (1000 bps) for all non-GBR PDP Contexts according to the subscription of the user. If the Subscribed UE-AMBR for Uplink and Downlink is not included, its length field value shall be set to 0.

The Authorized UE-AMBR for Uplink and Downlink is coded as Unsigned32 integer values in kbps (1000 bps) for all non-GBR PDP Contexts currently being used by the user. If the Used UE-AMBR for Uplink and Downlink is not included, its length field value shall be set to 0.

| Octets | Bits | | | | | | |
|--------------|---|---------------|---|---|-------------|---|---|
| | 8 | 7 | 6 | 5 | 4 | 3 | 2 |
| 1 | Type = 129 (Decimal) | | | | | | |
| 2-3 | Length | | | | | | |
| 4 | Spare 1111 | | | | CKSN | | |
| 5 | Security Mode | No of Vectors | | | Used Cipher | | |
| 6-13 | Kc | | | | | | |
| 14-m | Triplet [0..4] | | | | | | |
| (m+1)-(m+2) | DRX parameter | | | | | | |
| (m+3) | MS Network Capability Length | | | | | | |
| (m+4)-n | MS Network Capability | | | | | | |
| (n+1)-(n+2) | Container length | | | | | | |
| (n+3)-o | Container | | | | | | |
| (o+1) | UE Network Capability Length | | | | | | |
| (o+2)-p | UE Network Capability | | | | | | |
| (p+1)-(p+2) | Subscribed UE-AMBR for Uplink and Downlink Length | | | | | | |
| (p+3)-(p+6) | Subscribed UE-AMBR for Uplink | | | | | | |
| (p+7)-(p+10) | Subscribed UE-AMBR for Downlink | | | | | | |
| q-(q+1) | Authorized UE-AMBR for Uplink and Downlink Length | | | | | | |
| (q+2)-(q+5) | Authorized UE-AMBR for Uplink | | | | | | |
| (q+6)-(q+9) | Authorized UE-AMBR for Downlink | | | | | | |

Figure 40: MM Context Information Element with GSM Key and Triplets

| Octets | Bits | | | | | | |
|-------------|------------------------------|---------------|---|---|-----------|---|---|
| | 8 | 7 | 6 | 5 | 4 | 3 | 2 |
| 1 | Type = 129 (Decimal) | | | | | | |
| 2-3 | Length | | | | | | |
| 4 | Spare 1111 | | | | KSI | | |
| 5 | Security Mode | No of Vectors | | | Spare 111 | | |
| 6-21 | CK | | | | | | |
| 22-37 | IK | | | | | | |
| 38-39 | Quintuplet Length | | | | | | |
| 40-m | Quintuplet [0..4] | | | | | | |
| (m+1)-(m+2) | DRX parameter | | | | | | |
| (m+3) | MS Network Capability Length | | | | | | |
| (m+4)-n | MS Network Capability | | | | | | |
| (n+1)-(n+2) | Container length | | | | | | |
| (n+3)-o | Container | | | | | | |
| (o+1) | UE Network Capability Length | | | | | | |

| | |
|--------------|---|
| (o+2)-p | UE Network Capability |
| (p+1)-(p+2) | Subscribed UE-AMBR for Uplink and Downlink Length |
| (p+3)-(p+6) | Subscribed UE-AMBR for Uplink |
| (p+7)-(p+10) | Subscribed UE-AMBR for Downlink |
| q-(q+1) | Authorized UE-AMBR for Uplink and Downlink Length |
| (q+2)-(q+5) | Authorized UE-AMBR for Uplink |
| (q+6)-(q+9) | Authorized UE-AMBR for Downlink |

Figure 41: MM Context Information Element with UMTS Keys and Quintuplets

| Octets | Bits | | | | | | | |
|--------------|---|---|---------------|---|---|-------------|---|---|
| | 8 | 7 | 6 | 5 | 4 | 3 | 2 | 1 |
| 1 | Type = 129 (Decimal) | | | | | | | |
| 2-3 | Length | | | | | | | |
| 4 | Spare 1111 | | | | | CKSN | | |
| 5 | Security Mode | | No of Vectors | | | Used Cipher | | |
| 6-13 | Kc | | | | | | | |
| 14-15 | Quintuplet Length | | | | | | | |
| 16-m | Quintuplet [0..4] | | | | | | | |
| (m+1)-(m+2) | DRX parameter | | | | | | | |
| (m+3) | MS Network Capability Length | | | | | | | |
| (m+4)-n | MS Network Capability | | | | | | | |
| n+1-n+2 | Container length | | | | | | | |
| n+3-o | Container | | | | | | | |
| (o+1) | UE Network Capability Length | | | | | | | |
| (o+2)-p | UE Network Capability | | | | | | | |
| (p+1)-(p+2) | Subscribed UE-AMBR for Uplink and Downlink Length | | | | | | | |
| (p+3)-(p+6) | Subscribed UE-AMBR for Uplink | | | | | | | |
| (p+7)-(p+10) | Subscribed UE-AMBR for Downlink | | | | | | | |
| q-(q+1) | Authorized UE-AMBR for Uplink and Downlink Length | | | | | | | |
| (q+2)-(q+5) | Authorized UE-AMBR for Uplink | | | | | | | |
| (q+6)-(q+9) | Authorized UE-AMBR for Downlink | | | | | | | |

Figure 42: MM Context Information Element with GSM Keys and UMTS Quintuplets

| Octets | Bits | | | | | | | |
|--------------|---|---|---------------|---|---|-------------|---|---|
| | 8 | 7 | 6 | 5 | 4 | 3 | 2 | 1 |
| 1 | Type = 129 (Decimal) | | | | | | | |
| 2-3 | Length | | | | | | | |
| 4 | Spare 1111 | | | | | CKSN/KSI | | |
| 5 | Security Mode | | No of Vectors | | | Used Cipher | | |
| 6-21 | CK | | | | | | | |
| 22-37 | IK | | | | | | | |
| 38-39 | Quintuplet Length | | | | | | | |
| 40-m | Quintuplet [0..4] | | | | | | | |
| (m+1)-(m+2) | DRX parameter | | | | | | | |
| (m+3) | MS Network Capability length | | | | | | | |
| (m+4)-n | MS Network Capability | | | | | | | |
| (n+1)-(n+2) | Container length | | | | | | | |
| (n+3)-o | Container | | | | | | | |
| (o+1) | UE Network Capability Length | | | | | | | |
| (o+2)-p | UE Network Capability | | | | | | | |
| (p+1)-(p+2) | Subscribed UE-AMBR for Uplink and Downlink Length | | | | | | | |
| (p+3)-(p+6) | Subscribed UE-AMBR for Uplink | | | | | | | |
| (p+7)-(p+10) | Subscribed UE-AMBR for Downlink | | | | | | | |
| q-(q+1) | Authorized UE-AMBR for Uplink and Downlink Length | | | | | | | |

| | | |
|-------------|---------------------------------|--|
| (q+2)-(q+5) | Authorized UE-AMBR for Uplink | |
| (q+6)-(q+9) | Authorized UE-AMBR for Downlink | |

Figure 42A: MM Context Information Element with Used Cipher value, UMTS Keys and Quintuplets

Table 46: Used Cipher Values

| Cipher Algorithm | Value (Decimal) |
|------------------|-----------------|
| No ciphering | 0 |
| GEA/1 | 1 |
| GEA/2 | 2 |
| GEA/3 | 3 |
| GEA/4 | 4 |
| GEA/5 | 5 |
| GEA/6 | 6 |
| GEA/7 | 7 |

Table 47: Security Mode Values

| Security Type | Value (Decimal) |
|--|-----------------|
| GSM key and triplets | 1 |
| GSM key and quintuplets | 3 |
| UMTS key and quintuplets | 2 |
| Used cipher value, UMTS Keys and Quintuplets | 0 |

Table 47A: IEIs for information elements used in the container

| IEI | Information element |
|--|---------------------|
| 0x23 | Mobile identity |
| NOTE: In 3GPP TS 24.008 [5] the IEI definition is message dependent. The table is added to have a unique definition in the present document for the used IEI in the MMcontext. | |

7.7.29 PDP Context

The PDP Context information element contains the Session Management parameters, defined for an external packet data network address, that are necessary to transfer between SGSNs at the Inter SGSN Routing Area Update procedure.

NSAPI is an integer value in the range [0; 15].

The NSAPI points out the affected PDP context.

The SAPI indicates the LLC SAPI that is associated with the NSAPI.

The Transaction Identifier is the 4 or 12 bit Transaction Identifier used in the 3GPP TS 24.008 [5] Session Management messages which control this PDP Context. If the length of the Transaction Identifier is 4 bit, the second octet shall be set to all zeros. The encoding is defined in 3GPP TS 24.007 [3]. The latest Transaction Identifier sent from SGSN to MS is stored in the PDP context IE.

NOTE: Bit 5-8 of the first octet in the encoding defined in 3GPP TS 24.007 [3] is mapped into bit 1-4 of the first octet in this field.

Reordering Required (Order) indicates whether the SGSN shall reorder T-PDUs before delivering the T-PDUs to the MS. When the Quality of Service Negotiated (QoS Neg) is Release 99, the Reordering Required (Order) shall be ignored by receiving entity.

The VPLMN Address Allowed (VAA) indicates whether the MS is allowed to use the APN in the domain of the HPLMN only or additionally the APN in the domain of the VPLMN.

The Activity Status Indicator (ASI) indicates whether there is an active RAB/PFC associated with the PDP Context. This indicator is of interest when the PDP Context IE is included in a FORWARD RELOCATION REQUEST message or an inter SGSN RAU (SGSN Context Response) triggered by a Directed Signalling Connection Re-establishment.

NOTE: If the ASI indicates that there is no active RAB/PFC associated with the concerned PDP Context at the source side, no RAB/PFC needs to be set up on the target side.

The Extended End User Address (EA) indicates, when set to 1, that the MS uses Dual Stack IPv4v6 address and that octets "p+3" to "r" shall be included and contain the second part of the IPv4v6 Address, i.e. PDP Type Number at the Octet "3q+25" shall be set to HEX(2) , and PDP Type Number at the Octet "p+3" shall be set to HEX(57) or vice versa..

The QoS Sub Length, QoS Req Length and QoS Neg Length represent respectively the lengths of the QoS Sub, QoS Req and QoS Neg fields, excluding the QoS Length octet.

The Quality of Service Subscribed (QoS Sub), Quality of Service Requested (QoS Req) and Quality of Service Negotiated (QoS Neg) are encoded as described in section "Quality of Service (QoS) Profile". Their minimum length is 4 octets; their maximum length may be 255 octets.

The Sequence Number Down is the number of the next T-PDU that shall be sent from the new SGSN to the MS. The number is associated to the Sequence Number from the GTP Header of an encapsulated T-PDU. The new SGSN shall ignore Sequence Number Down when the PDP context QoS profile does not require transmission order to be preserved. In this case the new SGSN shall not include Sequence number field in the G-PDUs of the PDP context.

The Sequence Number Up is the number that new SGSN shall use as the Sequence Number in the GTP Header for the next encapsulated T-PDU from the MS to the GGSN. The new SGSN shall ignore Sequence Number Up when the PDP context QoS profile does not require transmission order to be preserved. In this case, the new SGSN shall not include Sequence number field in the G-PDUs of the PDP context.

The Send N-PDU Number is used only when acknowledged peer-to-peer LLC operation is used for the PDP context. Send N-PDU Number is the N-PDU number to be assigned by SNDCP to the next down link N-PDU received from the GGSN. It shall be set to 255 if unacknowledged peer-to-peer LLC operation is used for the PDP context.

The Receive N-PDU Number is used only when acknowledged peer-to-peer LLC operation is used for the PDP context. The Receive N-PDU Number is the N-PDU number expected by SNDCP from the next up link N-PDU to be received from the MS. It shall be set to 255 if unacknowledged peer-to-peer LLC operation is used for the PDP context.

The Uplink Tunnel Endpoint Identifier Control Plane is the Tunnel Endpoint Identifier used between the old SGSN and the GGSN in up link direction for control plane purpose. It shall be used by the new SGSN within the GTP header of the Update PDP Context Request message.

The GGSN Address for User Traffic and the Uplink Tunnel Endpoint Identifier Data I are the GGSN address and the Tunnel Endpoint Identifier used between the old SGSN and the GGSN in uplink direction for user plane traffic on a PDP context. They shall be used by the new SGSN to send uplink user plane PDU to the GGSN until new GGSN address for User Traffic is possibly received from GGSN (in Update PDP Context Response).

The PDP Context Identifier is used to identify a PDP context for the subscriber.

The PDP Type Organisation and PDP Type Number are encoded as in the End User Address information element.

The PDP Address Length represents the length of the PDP Address field, excluding the PDP Address Length octet.

The PDP Address is an octet array with a format dependent on the PDP Type. The PDP Address is encoded as in the End User Address information element if the PDP Type is IPv4 or IPv6.

The GGSN Address Length represents the length of the GGSN Address field, excluding the GGSN Address Length octet.

When forwarding the GGSN addresses to another SGSN (in PDP Context IE in Forward Relocation Request or SGSN Context Response message), the IPv4/IPv6 capable SGSN shall include GGSN addresses according to the IP version capability of the receiving SGSN. Determining the Capability of the receiving SGSN is implementation dependent.

The old SGSN includes the GGSN Address for control plane that it has received from GGSN at PDP context activation or update. If the new SGSN is IPv6 capable and the old SGSN has IPv6 control plane address of the GGSN available,

the old IPv4/IPv6 capable SGSN includes the IPv6 GGSN control plane address in the field GGSN Address for control plane. If the new SGSN is IPv4 only capable or the old SGSN does not have any IPv6 GGSN address for control plane, the old SGSN includes the IPv4 GGSN Address in the field GGSN Address for control plane.

The use of Ipv6 addressing in pre-Release 5 nodes can cause interoperability problems and as such the use of IPv6 GSN addressing is not recommended in pre-Release 5.

The APN is the Access Point Name in use in the old SGSN. This APN field shall be composed of the APN Network Identifier part and the APN Operator Identifier part.

The old SGSN includes the Authorized APN-AMBR for Uplink and Downlink which is received from GGSN at PDP context activation or update. The Authorized APN-AMBR for Uplink and Downlink is coded as Unsigned32 integer values in kbps (1000 bps) for all non-GBR PDP Contexts of the APN. If the Authorized APN-AMBR for Uplink and Downlink is not included, its length field value shall be set to 0.

The spare bits x indicate unused bits that shall be set to 0 by the sending side and which shall not be evaluated by the receiving side.

| Octets | Bits | | | | | | |
|-----------------|--|-----|-----|------------------------|-------|---|---|
| | 8 | 7 | 6 | 5 | 4 | 3 | 2 |
| 1 | Type = 130 (Decimal) | | | | | | |
| 2-3 | Length | | | | | | |
| 4 | EA | VAA | ASI | Order | NSAPI | | |
| 5 | X | X | X | X | SAPI | | |
| 6 | QoS Sub Length | | | | | | |
| 7 - (q+6) | QoS Sub [4..255] | | | | | | |
| q+7 | QoS Req Length | | | | | | |
| (q+8)-(2q+7) | QoS Req [4..255] | | | | | | |
| 2q+8 | QoS Neg. Length | | | | | | |
| (2q+9)-(3q+8) | QoS Neg [4..255] | | | | | | |
| (3q+9)-(3q+10) | Sequence Number Down (SND) (note) | | | | | | |
| (3q+11)-(3q+12) | Sequence Number Up (SNU) (note) | | | | | | |
| 3q+13 | Send N-PDU Number (note) | | | | | | |
| 3q+14 | Receive N-PDU Number (note) | | | | | | |
| (3q+15)-(3q+18) | Uplink Tunnel Endpoint Identifier Control Plane | | | | | | |
| (3q+19)-(3q+22) | UplinkTunnel Endpoint Identifier Data I | | | | | | |
| 3q+23 | PDP Context Identifier | | | | | | |
| 3q+24 | Spare 1 1 1 1 | | | PDP Type Organisation | | | |
| 3q+25 | PDP Type Number | | | | | | |
| 3q+26 | PDP Address Length | | | | | | |
| (3q+27)-m | PDP Address [0..63] | | | | | | |
| m+1 | GGSN Address for control plane Length | | | | | | |
| (m+2)-n | GGSN Address for control plane [4..16] | | | | | | |
| n+1 | GGSN Address for User Traffic Length | | | | | | |
| (n+2)-o | GGSN Address for User Traffic [4..16] | | | | | | |
| o+1 | APN length | | | | | | |
| (o+2)-p | APN | | | | | | |
| p+1 | Spare (sent as 0 0 0 0) | | | Transaction Identifier | | | |
| p+2 | Transaction Identifier | | | | | | |
| p+3 | PDP Type Number | | | | | | |
| p+4 | PDP Address Length | | | | | | |
| (p+5)-r | PDP Address [0..63] | | | | | | |
| (r+1)-(r+2) | Authorized APN-AMBR for Uplink and Downlink Length | | | | | | |
| (r+3)-(r+6) | Authorized APN-AMBR for Uplink | | | | | | |
| (r+7)-(r+10) | Authorized APN-AMBR for Downlink | | | | | | |

NOTE: This field shall not be evaluated when the PDP context is received during UMTS intra system handover/relocation.

Figure 43: PDP Context Information Element

Table 48: Reordering Required Values

| Reordering Required | Value (Decimal) |
|---------------------|-----------------|
| No | 0 |
| Yes | 1 |

Table 49: VPLMN Address Allowed Values

| VPLMN Address Allowed | Value (Decimal) |
|-----------------------|-----------------|
| No | 0 |
| Yes | 1 |

Table 49A: Activity Status Indicator Values

| Active RAB/PFC exists | Value (Decimal) |
|-----------------------|-----------------|
| Yes | 0 |
| No | 1 |

7.7.30 Access Point Name

The Access Point Name is sent by the SGSN or by GGSN as defined in 3GPP TS 23.060 [4].

The Access Point Name contains a logical name (see 3GPP TS 23.060 [4]). It is coded as in the value part defined in 3GPP TS 24.008 [5] (i.e. the 3GPP TS 24.008 [5] IEI and 3GPP TS 24.008 [5] octet length indicator are not included).

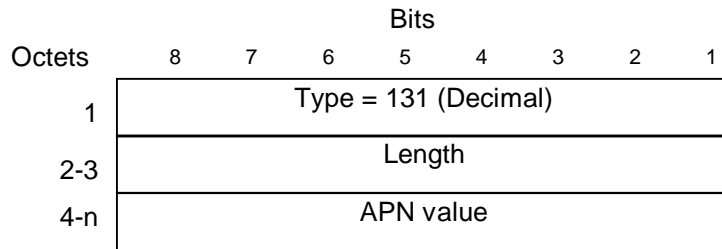

Figure 44: Access Point Name Information Element

7.7.31 Protocol Configuration Options

The Protocol Configuration Options contains external network protocol options that may be necessary to transfer between the GGSN and the MS. The content and the coding of the Protocol Configuration are defined in octet 3-z of the Protocol Configuration Options in 3GPP TS 24.008 [5].

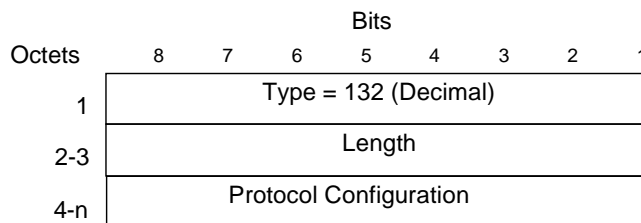

Figure 45: Protocol Configuration Options Information Element

7.7.32 GSN Address

The GSN Address information element contains the address of a GSN as defined in 3GPP TS 23.003 [2]. The Address Type and Address Length fields from 3GPP TS 23.003 [2] are not included in the GSN Address field.

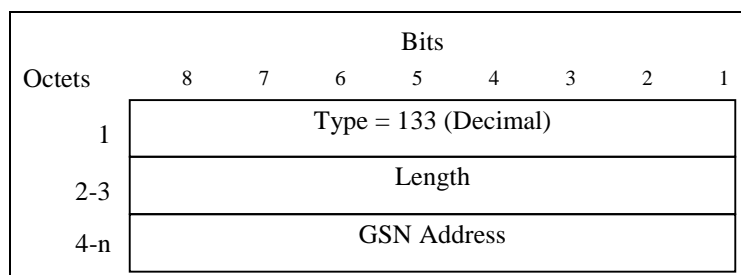

Figure 46: GSN Address Information Element

7.7.33 MS International PSTN/ISDN Number (MSISDN)

The MS international ISDN numbers are allocated from the ITU-T Recommendation E.164 numbering plan, see 3GPP TS 23.003 [2]. The MSISDN is coded according to the contents of ISDN-AddressString data type defined in 3GPP TS 29.002 [6]. The MSISDN shall be in international format and the "nature of address indicator" shall indicate "international number".

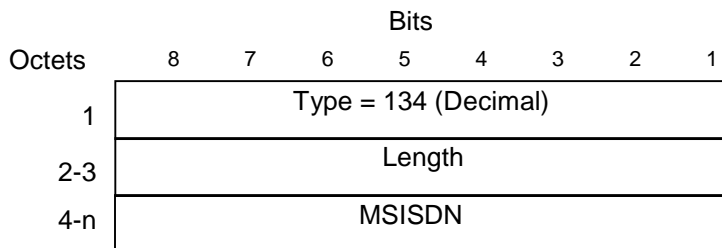

Figure 47: MSISDN Information Element

7.7.34 Quality of Service (QoS) Profile

The Quality of Service (QoS) Profile shall include the values of the defined QoS parameters.

Octet 4 carries the allocation/retention priority octet that is defined in 3GPP TS 23.107. The allocation/retention priority octet encodes each priority level defined in 3GPP TS 23.107 as the binary value of the priority level.

The allocation/retention priority field shall be ignored by the receiver if:

- the QoS profile is pre-Release '99.
- the QoS profile IE is used to encode the Quality of Service Requested (QoS Req) field of the PDP context IE.

Octets 5 – n (QoS Profile Data field) are coded according to 3GPP TS 24.008 [5] Quality of Service IE, octets 3-m. The minimum length of the field QoS Profile Data is 3 octets; the maximum length is 254 octets.

Clause 11.1.6 "Error handling" defines the handling of the case when sent QoS Profile information element has a Length different from the Length expected by the receiving GTP entity.

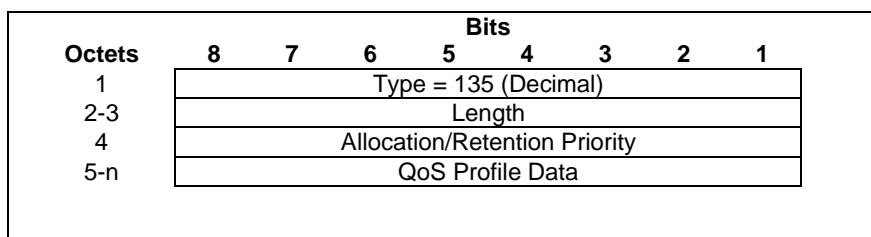

Figure 48: Quality of Service (QoS) Profile Information Element

7.7.35 Authentication Quintuplet

An Authentication Quintuplet consists of a Random challenge (RAND), an Expected user response (XRES), a Cipher key (CK), an Integrity key (IK), an Authentication token (AUTN) (see 3GPP TS 33.102 [8]).

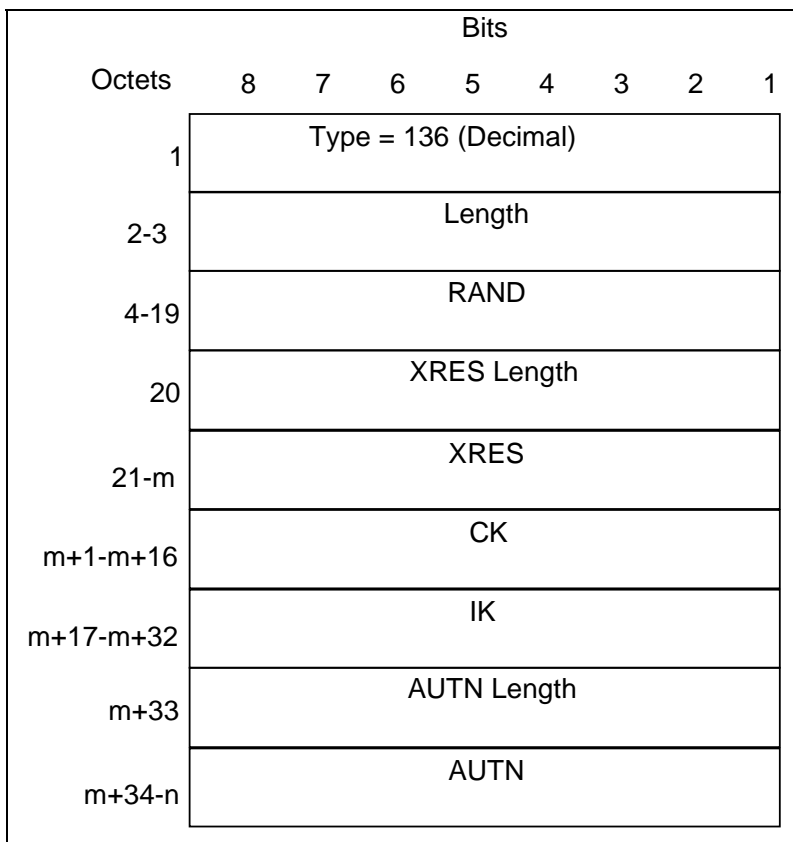

Figure 49: Authentication Quintuplet Information Element

7.7.36 Traffic Flow Template (TFT)

The Traffic Flow Template (TFT) is used to distinguish between different user traffic flows.

The content and the coding of the TFT are defined in 3GPP TS 24.008 [5].

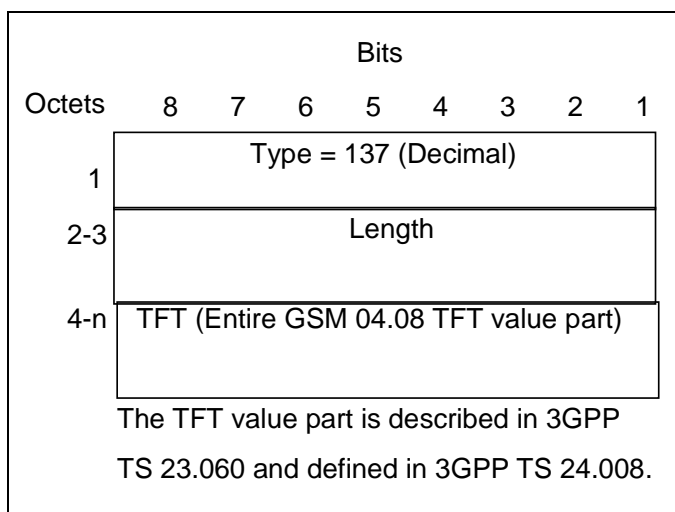

Figure 50: Traffic Flow Template Information Element

7.7.37 Target Identification

The Target Identification information element contains the identification of a target RNC. Octets 4-n shall be encoded as the "Target RNC-ID" part of the "Target ID" parameter in 3GPP TS 25.413 [7]. Therefore, the "Choice Target ID" that indicates "Target RNC-ID" (numerical value of 0x20) shall not be included in the "Target RNC-ID" value in octets 4-n.

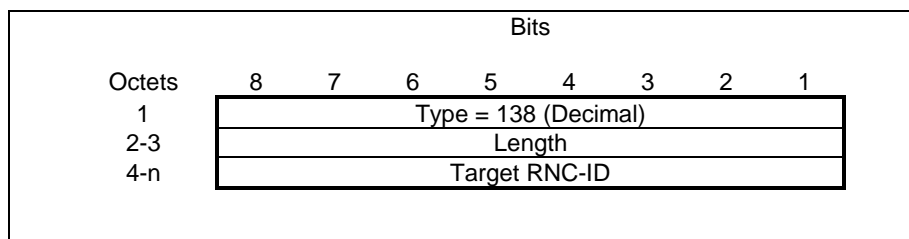

Figure 51: Target Identification Information Element

7.7.38 UTRAN Transparent Container

The UTRAN transparent container information element contains the radio-related information. The contents of this information element are only used by RNC so that GSN does not refer the contents.

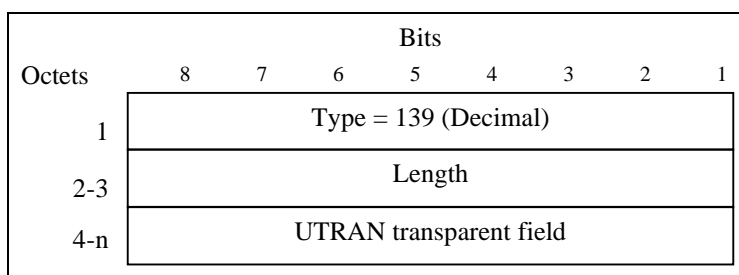

Figure 52: UTRAN Transparent Container Information Element

7.7.39 RAB Setup Information

If the target RNC successfully allocated resources associated with the NSAPI, the RAB Setup Information IE contains the RNC Tunnel Endpoint Identifier and RNC IP address for data forwarding from source RNC to target RNC. If the target RNC or the new SGSN failed to allocate resources the RAB Setup Information IE contains only Length and NSAPI indicating that the source RNC shall release the resources associated with the NSAPI.

In the 3G Gn/Gp SGSN to MME combined hard handover and SRNS relocation procedure, if the indirect data forwarding is used, the target MME shall construct the Tunnel Endpoint Identifier and RNC IP address using the SGW Tunnel Endpoint Identifier and SGW IP address for data forwarding. If the direct data forwarding is used, the target MME shall construct the Tunnel Endpoint Identifier and RNC IP address using the eNodeB Tunnel Endpoint Identifier and eNodeB IP address for data forwarding. If the target eNodeB, target MME or the target SGW failed to allocate resources the RAB Setup Information IE contains only Length and NSAPI indicating that the source RNC shall release the resources associated with the NSAPI.

The spare bits x indicate unused bits, which shall be set to 0 by the sending side and which shall not be evaluated by the receiving side.

The format of the RNC IP address is the same as the GSN address as defined in 3GPP TS 23.003 [2]. The Address Type and Address Length fields from 3GPP TS 23.003 [2] are not included in the RNC IP Address field.

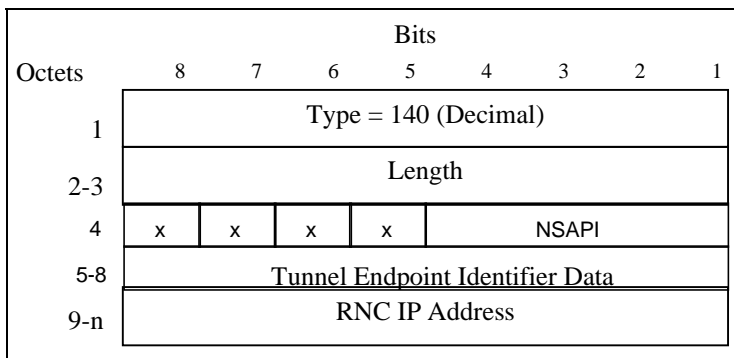

Figure 53: RAB Setup Information IE for data forwarding

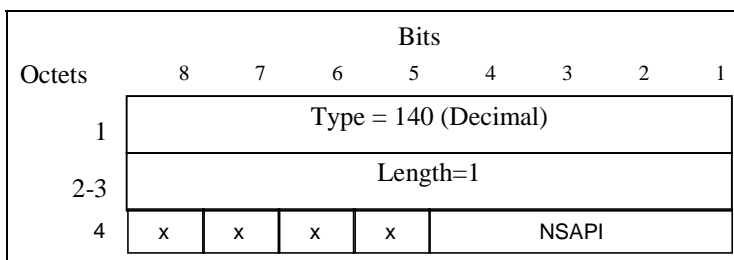

Figure 54: RAB Setup Information IE for release of resources

7.7.40 Extension Header Type List

This information element contains a list of "n" Extension Header Types. The length field is set to the number of extension header types included.

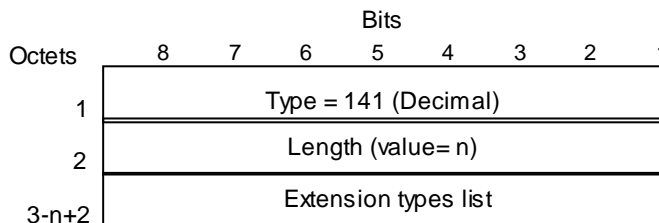

Figure 55: Extension Header Type List Information Element

7.7.41 Trigger Id

The Trigger Id information element identifies the entity that triggered the trace.

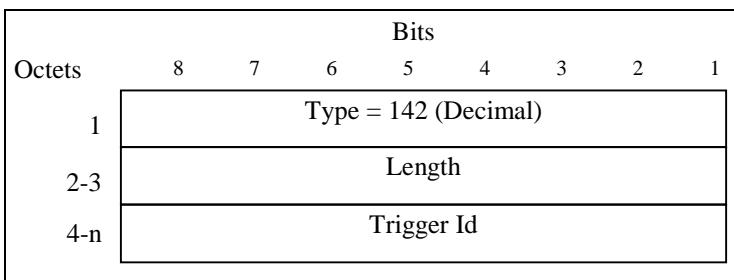

Figure 56: Trigger Id Information Element

7.7.42 OMC Identity

The OMC Identity information element identifies the OMC that shall receive the trace record(s).

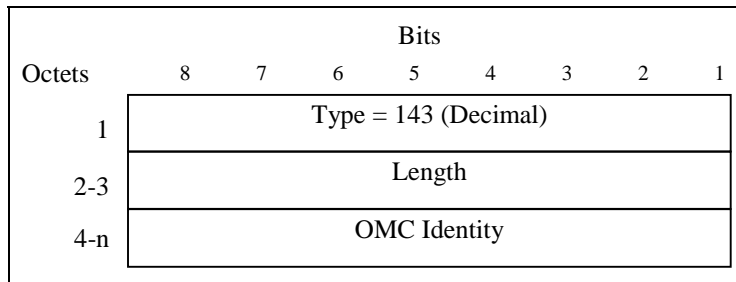

Figure 57: OMC Identity Information Element

7.7.43 RAN Transparent Container

The information in the value part of the RAN Transparent Container IE contains all information elements (starting with and including the BSSGP "PDU Type") in either of the RAN INFORMATION, RAN INFORMATION REQUEST, RAN INFORMATION ACK or RAN INFORMATION ERROR messages respectively as specified in 3GPP TS 48.018 [20].

The two octets Length field holds the length of the RAN Transparent Container field Container (octets 4-n).

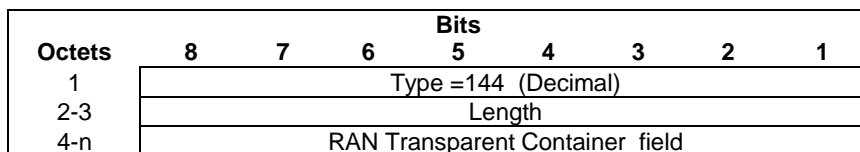

Figure 58: RAN Transparent Container Information Element

7.7.44 Charging Gateway Address

The Charging Gateway Address information element contains an Ipv4 or Ipv6 address of a Charging Gateway.

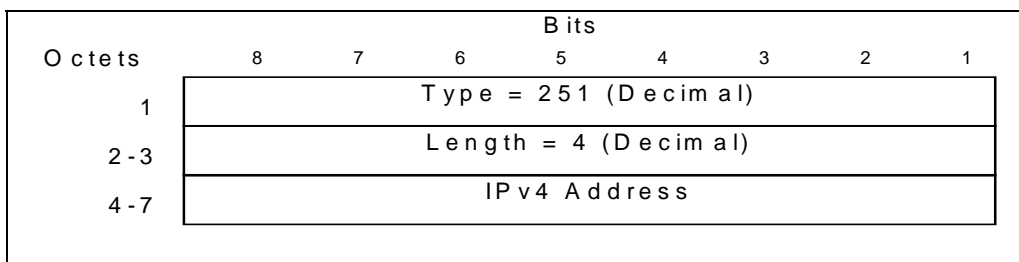

Figure 59a: Ipv4 Charging Gateway Address Information Element

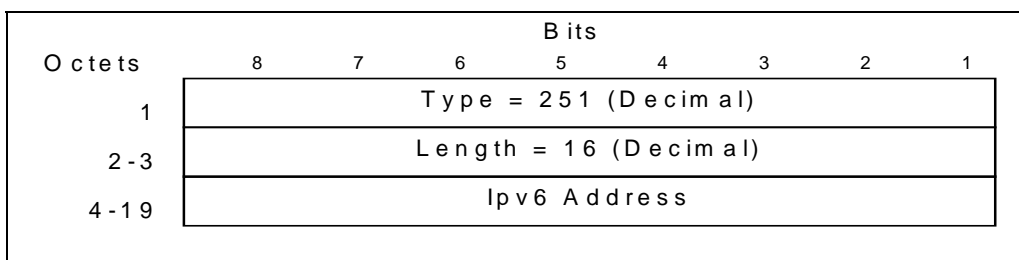

Figure 59b: Ipv6 Charging Gateway Address Information Element

7.7.45 PDP Context Prioritization

The PDP Context Prioritization information element is used by the old SGSN to inform the new SGSN that prioritisation of the PDP Contexts has been applied. When the information element is included, the length is set to zero.

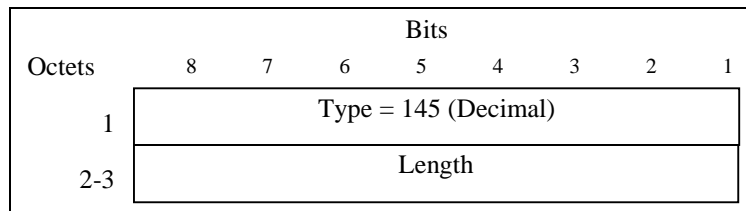

Figure 60 : PDP Context Prioritization Information Element

7.7.45A Additional RAB Setup Information

If the target RNC successfully allocated resources associated with the NSAPI, the Additional RAB Setup Information IE contains the RNC Tunnel Endpoint Identifier and RNC IP address for data forwarding from source RNC to target RNC for IPv6. If the target RNC or the new SGSN failed to allocate resources the Additional RAB Setup Information IE contains only Length and NSAPI indicating that the source RNC shall release the resources associated with the NSAPI.

In the 3G Gn/Gp SGSN to MME combined hard handover and SRNS relocation procedure, if the indirect data forwarding is used, the target MME shall construct the Tunnel Endpoint Identifier and RNC IP address using the SGW Tunnel Endpoint Identifier and SGW IP address for data forwarding. If the direct data forwarding is used, the target MME shall construct the Tunnel Endpoint Identifier and RNC IP address using the eNodeB Tunnel Endpoint Identifier and eNodeB IP address for data forwarding. If the target eNodeB, target MME or the target SGW failed to allocate resources the RAB Setup Information IE contains only Length and NSAPI indicating that the source RNC shall release the resources associated with the NSAPI. The spare bits x indicate unused bits, which shall be set to 0 by the sending side and which shall not be evaluated by the receiving side.

The format of the RNC IPv6 address is the same as the GSN address as defined in 3GPP TS 23.003 [2]. The Address Type and Address Length fields from 3GPP TS 23.003 [2] are not included in the RNC IP Address field.

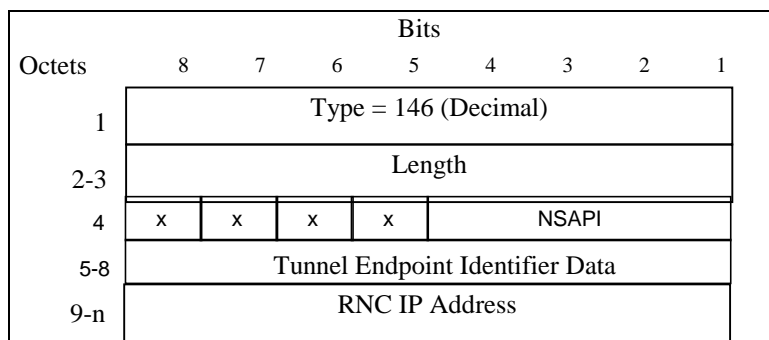

Figure 60a: Additional RAB Setup Information IE for data forwarding

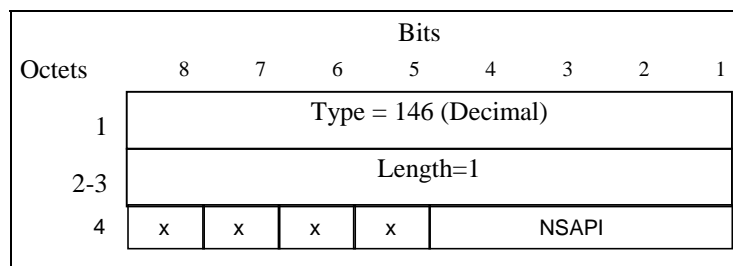

Figure 60b: Additional RAB Setup Information IE for release of resources

7.7.46 Private Extension

The Private Extension information element contains vendor specific information. The Extension Identifier is a value defined in the Private Enterprise number list in the most recent "Assigned Numbers" RFC (RFC 1700 or later).

This is an optional information element that may be included in any GTP Signalling message. A signalling message may include more than one information element of the Private Extension type.

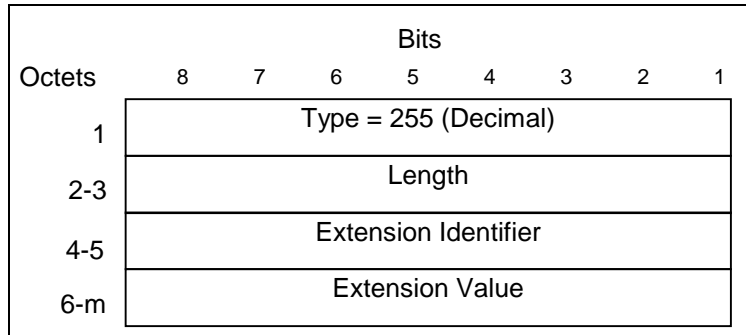

Figure 61: Private Extension Information Element

7.7.47 SGSN Number

The SGSN number refers to the ISDN number of a SGSN. The SGSN Number is defined in 3GPP TS 23.003 [2].

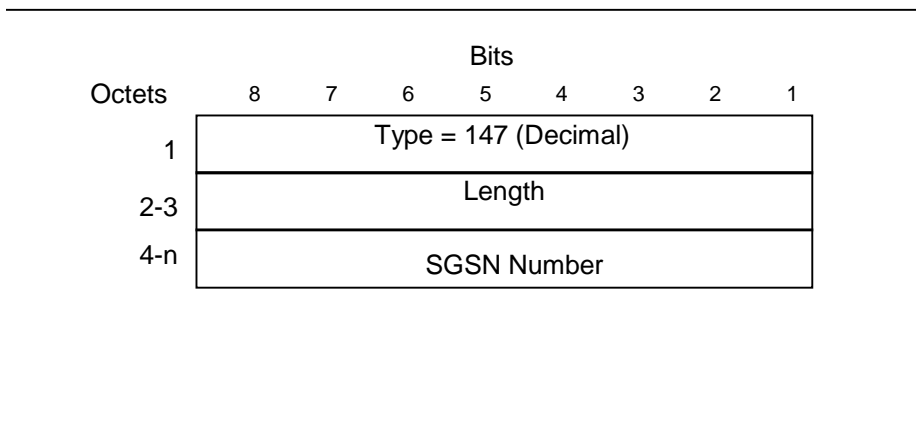

Figure 62: SGSN Number Information Element

7.7.48 Common Flags

The Common Flags information element is used to hold values for multiple bit flags.

The Prohibit Payload Compression bit field is relevant only for A/Gb mode access and is used to determine whether or not an SGSN should attempt to compress the payload of user data when the users asks for it to be compressed.

The MBMS Service Type bit field is relevant only for MBMS session start procedure and is used to determine whether the MBMS session is for multicast service or for broadcast service.

The RAN Procedures Ready bit field is relevant for the Secondary PDP Context Activation Procedure and is used to indicate that RAN Procedures are ready and that the SGSN is ready to receive payload from the GGSN on the new PDP Context.

The MBMS Counting Information bit field is relevant only for MBMS session start procedure and is used to determine whether the MBMS counting procedures are applicable for this MBMS session.

The NRSN bit field is relevant for Create PDP Context and Update PDP Context procedures and is used by SGSN to indicate to GGSN support of network requested bearer control procedure in the SGSN.

The No QoS negotiation bit field is relevant for an Update PDP Context procedure and is used by SGSN to indicate to GGSN whether QoS re-negotiation may be done during the Update procedure.

The Upgrade QoS Supported bit field is relevant for an Create PDP Context or Update PDP Context procedure and is used by SGSN to indicate to GGSN whether QoS upgrade in Response message functionality is supported.

Dual Address Bearer Flag bit field is relevant for the PDP Context Activation procedure and is used by SGSN to indicate to the GGSN that the MS requests PDP type IPv4v6 and all SGSNs, which the MS may be handed over to, are Release 9 or above supporting dual addressing, which is determined based on node pre-configuration by the operator.

Bits marked as Spare shall be assigned the value 0 by the sending node and shall not be evaluated by the receiving node.

| Octets | Bits | | | | | | | |
|--------|--------------------------|-----------------------|------|--------------------|---------------------------|----------------------|-------------------|------------------------------|
| | 8 | 7 | 6 | 5 | 4 | 3 | 2 | 1 |
| 1 | Type=148 (Decimal) | | | | | | | |
| 2-3 | Length | | | | | | | |
| 4 | Dual Address Bearer Flag | Upgrade QoS Supported | NRSN | No QoS negotiation | MBMS Counting Information | RAN Procedures Ready | MBMS Service Type | Prohibit Payload Compression |

Figure 62a: Common Flags Information Element

7.7.49 APN Restriction

The APN Restriction information element, when used in messages from the GGSN to the SGSN, contains an unsigned integer value indicating the level of restriction imposed on primary PDP Contexts created to the associated APN. When used in messages from the SGSN to GGSN, it contains an unsigned integer value indicating the highest level of restriction type for all currently active PDP Contexts associated with the subscriber. In both cases, the meaning of the value contained within the IE is as defined in 3GPP TS 23.060 [4], sub-clause 15.4.

The structure of the APN Restriction IE is as follows:

| Octets | Bits | | | | | | | |
|--------|------------------------|---|---|---|---|---|---|---|
| | 8 | 7 | 6 | 5 | 4 | 3 | 2 | 1 |
| 1 | Type = 149 (Decimal) | | | | | | | |
| 2-3 | Length = 1 | | | | | | | |
| 4 | Restriction Type value | | | | | | | |

Figure 62b: Restriction Type Information Element

7.7.50 RAT Type

The "RAT Type" information element is used to indicate which Radio Access Technology is currently serving the UE.

| Octets | Bits | | | | | | | |
|--------|----------------------|---|---|---|---|---|---|---|
| | 8 | 7 | 6 | 5 | 4 | 3 | 2 | 1 |
| 1 | Type = 151 (Decimal) | | | | | | | |
| 2-3 | Length = 1 | | | | | | | |
| 4 | RAT Type value | | | | | | | |

Figure 7.7.50.1: RAT Type Information Element

Table 7.7.50.1: RAT Type values

| RAT Type values | Value(s) (Decimal) |
|-----------------|--------------------|
| <reserved> | 0 |
| UTRAN | 1 |
| GERAN | 2 |
| WLAN | 3 |
| GAN | 4 |
| HSPA Evolution | 5 |
| <spare> | 6-255 |

NOTE: Currently it is only possible to detect the difference between GERAN and UTRAN when GERAN Gb mode is used. If GERAN Iu mode is used, then an SGSN may not be able to detect the difference between GERAN and UTRAN. Across the Gb interface, the SGSN may also not be able to detect the difference between GERAN and GAN. If SGSN cannot detect that the HSPA Evolution 3GPP TR 25.999 [40] network is behind the Iu interface, the SGSN will send the "UTRAN" RAT Type.

7.7.51 User Location Information

The "User Location Information" IE is used to indicate CGI/SAI/RAI of where the MS is currently located.

The "Geographic Location Type" field is used to convey what type of location information is present in the "Geographic Location field". The types of locations that can be conveyed are defined in table 7.7.51A.

The "Geographic Location" field is used to convey the actual geographic information as indicated in the "Geographic Location Type" field.

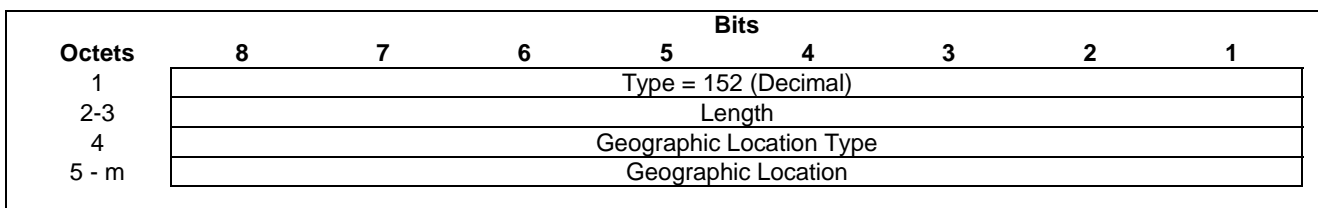

Figure 7.7.51.1: User Location Information IE

Table 7.7.51A: Geographic Location Type values and their meanings

| Value (Decimal) | Definition | Encoding Definition |
|-----------------|---|---------------------|
| 0 | Geographic Location field included and it holds the Cell Global Identification (CGI) of where the user currently is registered. CGI is defined in sub-clause 4.3.1 of 3GPP TS 23.003 [2]. | Figure 7.7.51.2. |
| 1 | Geographic Location field included and it holds the Service Area Identity (SAI) of where the user currently is registered. SAI is defined in sub-clause 9.2.3.9 of 3GPP TS 25.413 [7]. | Figure 7.7.51.3. |
| 2 | Geographic Location field included and it holds the Routing Area Identification (RAI) of where the user currently is registered. RAI is defined in sub-clause 4.2 of 3GPP TS 23.003 [2]. | Figure 7.7.51.4 |

NOTE: The decimal values 3 to 255 are reserved for future use.

| Octets | Bits | | | | | | | |
|--------|-------------|---|---|-------------|---|---|---|---|
| | 8 | 7 | 6 | 5 | 4 | 3 | 2 | 1 |
| 5 | MCC digit 2 | | | MCC digit 1 | | | | |
| 6 | MNC digit 3 | | | MCC digit 3 | | | | |
| 7 | MNC digit 2 | | | MNC digit 1 | | | | |
| 8-9 | LAC | | | | | | | |
| 10-11 | CI | | | | | | | |

Figure 7.7.51.2: Geographic Location field for CGI

If only two digits are included in the MNC, then bits 5 to 8 of octet 6 are coded as "1111".

The location area code consists of 2 octets and is found in octet 8 and octet 9. Bit 8 of octet 8 is the most significant bit and bit 1 of octet 9 the least significant bit. The coding of the location area code is the responsibility of each administration. Coding using full hexadecimal representation shall be used.

The cell identity consists of 2 octets and is found in octet 10 and octet 11. Bit 8 of octet 10 is the most significant bit and bit 1 of octet 11 the least significant bit. The coding of the cell identity is the responsibility of each administration. Coding using full hexadecimal representation shall be used.

| Octets | Bits | | | | | | | |
|--------|-------------|---|---|-------------|---|---|---|---|
| | 8 | 7 | 6 | 5 | 4 | 3 | 2 | 1 |
| 5 | MCC digit 2 | | | MCC digit 1 | | | | |
| 6 | MNC digit 3 | | | MCC digit 3 | | | | |
| 7 | MNC digit 2 | | | MNC digit 1 | | | | |
| 8-9 | LAC | | | | | | | |
| 10-11 | SAC | | | | | | | |

Figure 7.7.51.3: Geographic Location field for SAI

If only two digits are included in the MNC, then bits 5 to 8 of octet 6 are coded as "1111".

The location area code consists of 2 octets and is found in octet 8 and octet 9. Bit 8 of octet 8 is the most significant bit and bit 1 of octet 9 the least significant bit. The coding of the location area code is the responsibility of each administration. Coding using full hexadecimal representation shall be used. See 3GPP TS 24.008 [5] for more information.

The service area code consists of 2 octets and is found in octet 10 and octet 11. Bit 8 of octet 10 is the most significant bit and bit 1 of octet 11 the least significant bit. The SAC is defined by the operator. See 3GPP TS 23.003 [2] section 12.5 for more information.

| Octets | Bits | | | | | | | |
|--------|-------------|---|---|-------------|---|---|---|---|
| | 8 | 7 | 6 | 5 | 4 | 3 | 2 | 1 |
| 5 | MCC digit 2 | | | MCC digit 1 | | | | |
| 6 | MNC digit 3 | | | MCC digit 3 | | | | |
| 7 | MNC digit 2 | | | MNC digit 1 | | | | |
| 8-9 | LAC | | | | | | | |
| 10-11 | RAC | | | | | | | |

Figure 7.7.51.4: Geographic Location field for RAI

If only two digits are included in the MNC, then bits 5 to 8 of octet 6 are coded as "1111".

The routing area code consists of 2 octets and is found in octet 10 and octet 11. Only the first octet (10) contains the RAC and the second octet (11) is coded as "11111111". The RAC is defined by the operator. See 3GPP TS 23.003 [2] section 4.2 for more information.

7.7.52 MS Time Zone

The "MS Time Zone" IE is used to indicate the offset between universal time and local time in steps of 15 minutes of where the MS currently resides. The "Time Zone" field uses the same format as the "Time Zone" IE in 3GPP TS 24.008 [5].

Bits marked as Spare shall be assigned the value 0 by the sending node and shall not be evaluated by the receiving node.

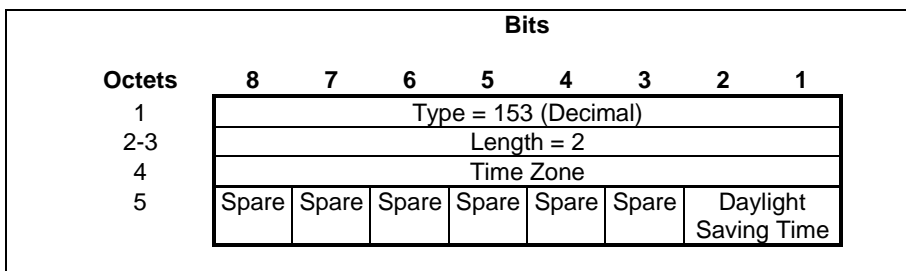

Figure 7.7.52.1: MS Time Zone IE

Table 7.7.52A Possible values for the "Daylight Saving Time" field and their meanings.

| Daylight Saving Time | Value (binary) | |
|--|----------------|-------|
| | Bit 2 | Bit 1 |
| No adjustment for Daylight Saving Time | 0 | 0 |
| +1 hour adjustment for Daylight Saving Time | 0 | 1 |
| +2 hours adjustment for Daylight Saving Time | 1 | 0 |
| Reserved | 1 | 1 |

7.7.53 International Mobile Equipment Identity (and Software Version) (IMEI(SV))

The structure of the IMEI and IMEISV are defined in sub-clause 6.2 of 3GPP TS 23.003 [2]. The "IMEI(SV)" field shall contain the IMEISV if it is available. If only the IMEI is available, then the IMEI shall be placed in the IMEI(SV) field and the last semi-octet of octet 11 shall be set to "1111". Both IMEI and IMEISV are TBCD encoded. Bits 5 to 8 of octet n+3 (where n represents the octet of the IMEI(SV) being encoded) encodes digit 2n, bits 1 to 4 of octet n+3 encodes digit 2n-1 (i.e the order of digits is swapped in each octet compared to the digit order defined in 3GPP TS 23.003 [2]). Digits are packed contiguously with no internal padding.

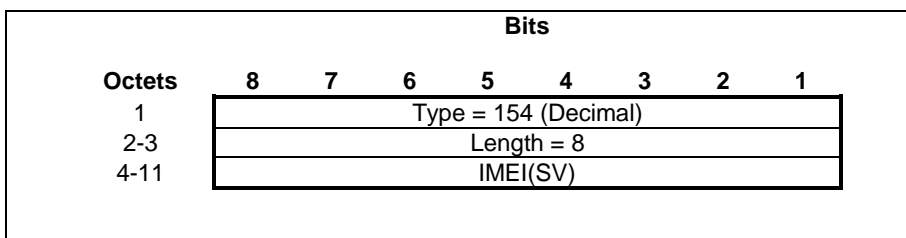

Figure 7.7.53.1: IMEI(SV) Information Element

7.7.54 CAMEL Charging Information Container

The "CAMEL Charging Information Container" IE is used to copy the CAMELInformationPDP IE including Tag and Length from the SGSN's CDR (S-CDR). The CAMELInformationPDP IE within an S-CDR is defined in 3GPP TS 32.298 [34].

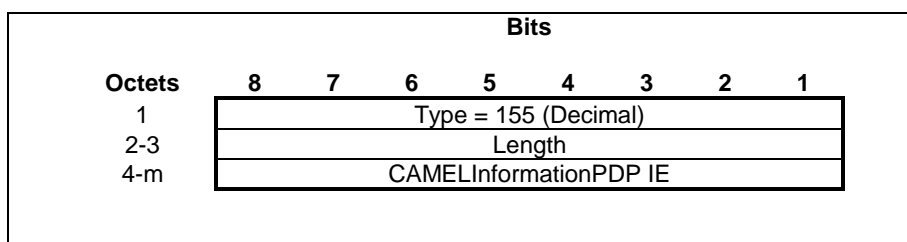

Figure 7.7.54.1: CAMEL Charging Information Container Information Element

7.7.55 MBMS UE Context

The MBMS UE Context information element contains UE-specific information related to a particular MBMS service that the UE has joined, that are necessary to transfer between SGSNs at the Inter SGSN Routeing Area Update procedure and Inter SGSN SRNS Relocation procedure.

Linked NSAPI is an interger value in the range [0, 15].

The Linked NSAPI identifies the PDP Context used by the UE to carry IGMP/MLD signalling.

Enhanced NSAPI is an integer value in the range [128; 255].

The Enhanced NSAPI points out the affected MBMS UE context.

The Uplink Tunnel Endpoint Identifier Control Plane is the Tunnel Endpoint Identifier used between the old SGSN and the GGSN in up link direction for control plane purpose. It shall be used by the new SGSN within the GTP header of the Update MBMS Context Request message.

The PDP Type Organisation and PDP Type Number are encoded as in the End User Address information element.

The PDP Address Length represents the length of the PDP Address field, excluding the PDP Address Length octet.

The PDP Address is an octet array with a format dependent on the PDP Type. The PDP Address is encoded as in the End User Address information element.

The GGSN Address Length represents the length of the GGSN Address field, excluding the GGSN Address Length octet.

When forwarding the GGSN address to another SGSN (in the MBMS UE Context IE in Forward Relocation Request or SGSN Context Response message), the IPv4/IPv6 capable SGSN shall include GGSN address according to the IP version capability of the receiving SGSN. Determining the Capability of the receiving SGSN is implementation dependent.

The old SGSN includes the GGSN Address for control plane that it has received from GGSN at MBMS service activation or update. If the new SGSN is IPv6 capable and the old SGSN has IPv6 control plane address of the GGSN available, the old IPv4/IPv6 capable SGSN includes the IPv6 GGSN control plane address in the field GGSN Address for control plane. If the new SGSN is IPv4 only capable or the old SGSN does not have any IPv6 GGSN address for control plane, the old SGSN includes the IPv4 GGSN Address in the field GGSN Address for control plane.

The APN is the Access Point Name in use in the old SGSN.

The Transaction Identifier is the 4 or 12 bit Transaction Identifier used in the 3GPP TS 24.008 [5] Session Management messages which control this MBMS UE Context. If the length of the Transaction Identifier is 4 bit, the second octet shall be set to all zeros. The encoding is defined in 3GPP TS 24.007 [3]. The latest Transaction Identifier sent from SGSN to MS is stored in the MBMS UE context IE.

NOTE: Bit 5-8 of the first octet in the encoding defined in 3GPP TS 24.007 [3] is mapped into bit 1-4 of the first octet in this field.

The spare bits x indicate unused bits that shall be set to 0 by the sending side and which shall not be evaluated by the receiving side.

| Octets | Bits | | | | | | | |
|---------|---|---|---|---|-------------------------|---|---|---|
| | 8 | 7 | 6 | 5 | 4 | 3 | 2 | 1 |
| 1 | Type = 156 (Decimal) | | | | | | | |
| 2-3 | Length | | | | | | | |
| 4 | Linked NSAPI | | | | Spare (sent as 0 0 0 0) | | | |
| 5-8 | Uplink Tunnel Endpoint Identifier Control Plane | | | | | | | |
| 167 | Enhanced NSAPI | | | | | | | |
| 9 | Spare 1 1 1 1 | | | | PDP Type Organisation | | | |
| 10 | PDP Type Number | | | | | | | |
| 11 | PDP Address Length | | | | | | | |
| 12-□ | PDP Address [0..63] | | | | | | | |
| □+1 | GGSN Address for control plane Length | | | | | | | |
| (□+2)-□ | GGSN Address for control plane [4..16] | | | | | | | |
| n+1 | APN length | | | | | | | |
| (n+2)-o | APN | | | | | | | |
| (o+1) | Spare (sent as 0 0 0 0) | | | | Transaction Identifier | | | |
| o+2 | Transaction Identifier | | | | | | | |

Figure 7.7.55.1: MBMS UE Context Information Element

7.7.56 Temporary Mobile Group Identity

The Temporary Mobile Group Identity (TMGI) information element contains a TMGI allocated by the BM-SC. The BM-SC always includes the MCC and MNC when allocating the TMGI, see 3GPP TS 29.061[27]. The TMGI shall be coded as the value part defined in 3GPP T S 24.008 [5] (i.e. the IEI and octet length indicator are not included).

| Octets | Bits | | | | | | | |
|--------|---------------------------------|---|---|---|---|---|---|---|
| | 8 | 7 | 6 | 5 | 4 | 3 | 2 | 1 |
| 1 | Type = 157 (Decimal) | | | | | | | |
| 2-3 | Length = 6 | | | | | | | |
| 4-9 | Temporary Mobile Group Identity | | | | | | | |

Figure 7.7.56.1: Temporary Mobile Group Identity

7.7.57 RIM Routing Address

Octets 4-n are coded according to 3GPP TS 48.018 [20] RIM Routing Information IE octets 4-n.

| Octets | Bits | | | | | | | |
|--------|----------------------|---|---|---|---|---|---|---|
| | 8 | 7 | 6 | 5 | 4 | 3 | 2 | 1 |
| 1 | Type = 158 (Decimal) | | | | | | | |
| 2-3 | Length | | | | | | | |
| 4-n | RIM Routing Address | | | | | | | |

7.7.58 MBMS Protocol Configuration Options

The MBMS Protocol Configuration Options contains protocol options associated with an MBMS context, that may be necessary to transfer between the GGSN and the MS. The content and the coding of the MBMS Protocol Configuration Options are defined in octets 3-z of the MBMS Protocol Configuration Options in 3GPP TS 24.008 [5].

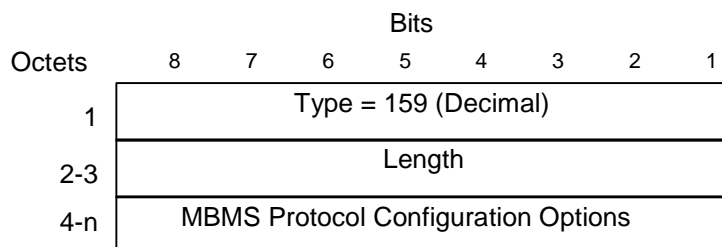

Figure 7.7.58.1: MBMS Protocol Configuration Options Information Element

7.7.59 MBMS Session Duration

The MBMS Session Duration is defined in 3GPP TS 23.246 [26]. The MBMS Session Duration information element indicates the estimated session duration of the MBMS service data transmission if available. The payload shall be encoded as per the MBMS-Session-Duration AVP defined in 3GPP TS 29.061 [27], excluding the AVP Header fields (as defined in IETF RFC 3588 [36], section 4.1).

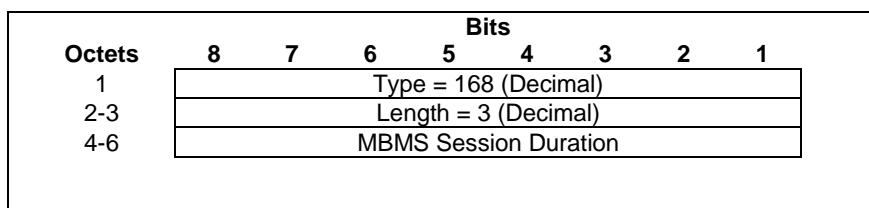

Figure 7.7.59.1: MBMS Session Duration Information Element

7.7.60 MBMS Service Area

The MBMS Service Area is defined in 3GPP TS 23.246 [26]. The MBMS Service Area information element indicates the area over which the Multimedia Broadcast/Multicast Service is to be distributed. The payload shall be encoded as per the MBMS-Service-Area AVP defined in 3GPP TS 29.061 [27], excluding the AVP Header fields (as defined in IETF RFC 3588 [36], section 4.1).

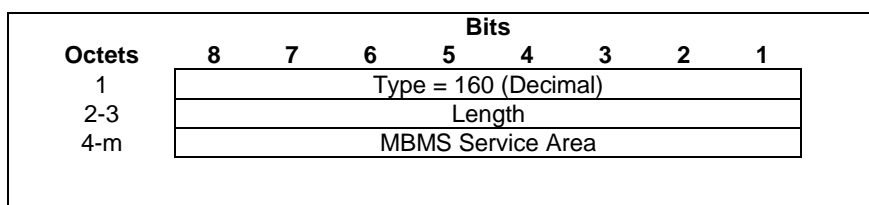

Figure 7.7.60.1: MBMS Service Area Information Element

7.7.61 Source RNC PDCP context info

The purpose of the Source RNC PDCP context info IE is to transfer RNC PDCP context information from a source RNC to a target RNC during an SRNS relocation.

This IE is transparent to CN .

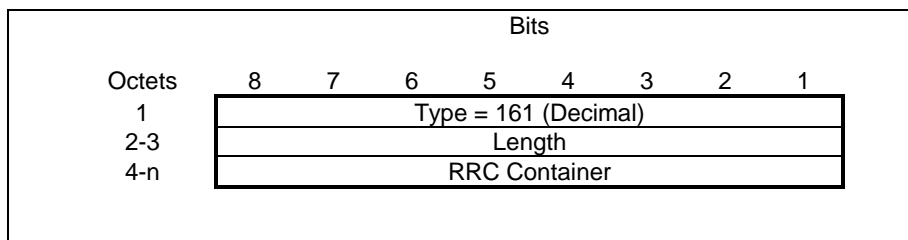

Figure 7.7.61.1: Source RNC PDCP context info Information Element

7.7.62 Additional Trace Info

The additional Trace Info is used to inform the GGSN of the additional trace parameters. An Additional Trace Info consists of Trace Reference2, Trace Recording Session Reference, triggering events in GGSN, Trace Depth, List of interfaces to trace in GGSN and a Trace Activity Control. The encoding are defined in 3GPP TS 32.422 [31].

The Trace Activity Control is used to indicate to GGSN whether the Trace is activated or deactivated.

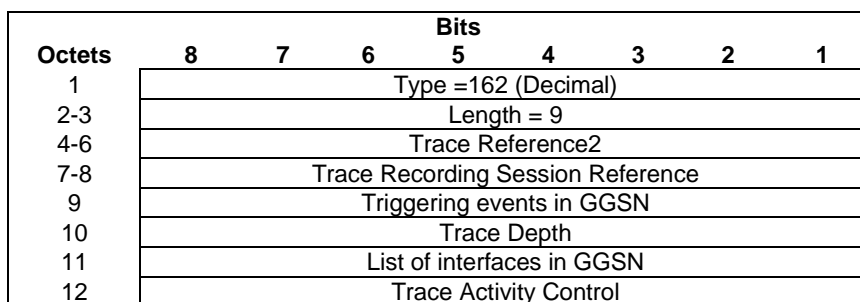

Figure 7.7.62.1: Additional Trace Info Information Element

| Trace Activity Control | Value (Decimal) |
|-------------------------------|-----------------|
| Trace Activation | 1 |
| Trace Deactivation | 0 |
| All other values are reserved | |

Figure 7.7.62.2: Trace Activity Control Value

7.7.63 Hop Counter

Where Intra Domain Connection of RAN Nodes to Multiple CN Nodes is applied, the Hop Counter may be used to prevent endless loops when relaying Identification Request messages and SGSN Context Request messages. The maximum value is operator specific and shall not be lower than 1.

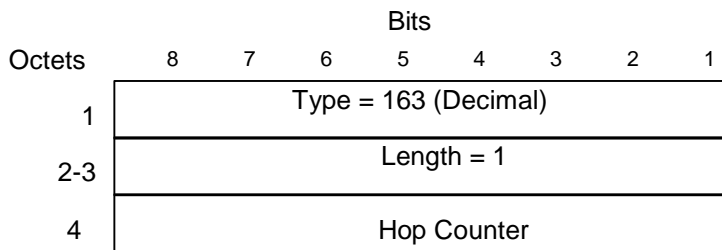

Figure 7.7.63.1: Hop Counter Information Element

7.7.64 Selected PLMN ID

The Selected PLMN ID IE contains the core network operator selected for the MS in a shared network. Octets 4-6 shall be encoded as the content part of the "Selected PLMN Identity" parameter in 3GPP TS 25.413 [7].

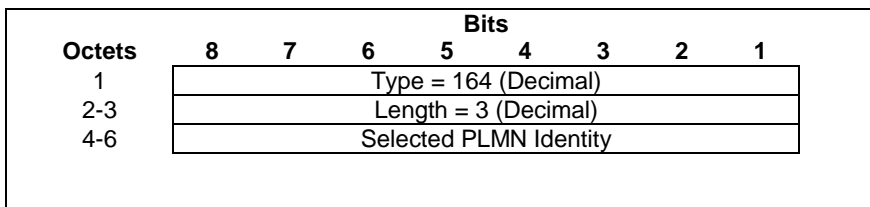

Figure 7.7.64.1: Selected PLMN ID Information Element

7.7.65 MBMS Session Identifier

The MBMS Session Identifier information element contains a Session Identifier allocated by the BM-SC. The MBMS Session Identifier value part consists of 1 octet. The content and the coding are defined in 3GPP TS 29.061 [27].

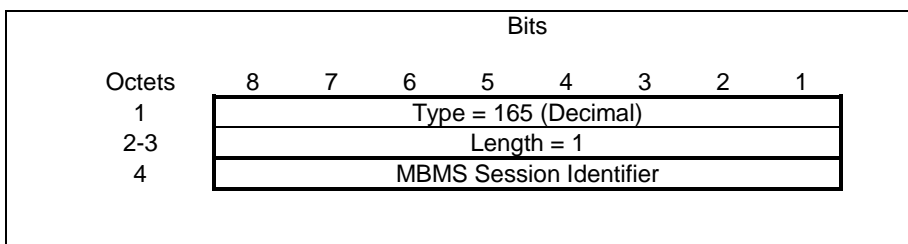

Figure 7.7.65.1: MBMS Session Identifier

7.7.66 MBMS 2G/3G Indicator

The MBMS 2G/3G Indicator information element is provided by the BM-SC. It informs the SGSN to perform the session start procedure towards 2G or 3G radio networks, or both.

The possible values are:

- 0 – 2G only.
- 1 – 3G only.
- 2 – both 2G and 3G.

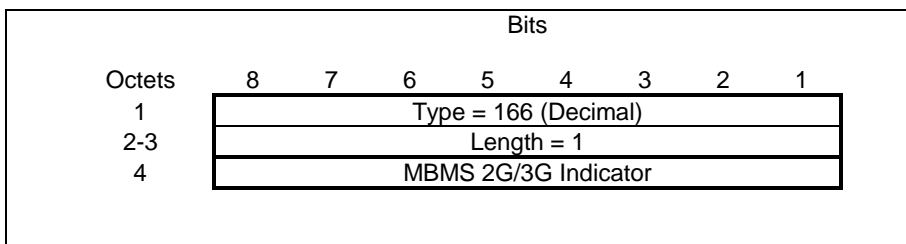

Figure 7.7.66.1: MBMS 2G/3G Indicator

7.7.67 Enhanced NSAPI

The Enhanced NSAPI information element contains an Enhanced NSAPI identifying a MBMS UE Context in a mobility management context specified by the Tunnel Endpoint Identifier Control Plane.

The content and the coding of the Enhanced NSAPI are defined in octet 2 of the Enhanced NSAPI in 3GPP TS 24.008 [5].

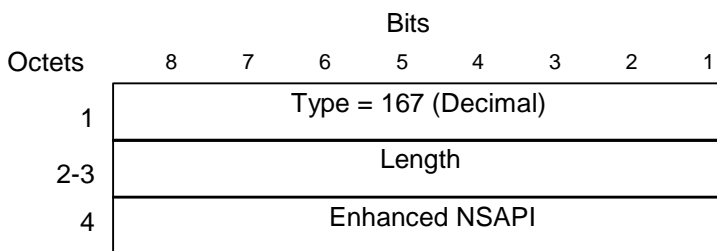

Figure 7.7.67.1: Enhanced NSAPI Information Element

7.7.68 Additional MBMS Trace Info

The Additional MBMS Trace Info IE is used to inform the GGSN of Additional Trace parameters to be passed to the BM-SC over the Gmb interface. An Additional MBMS Trace Info consists of Trace Reference2, Trace Recording Session Reference, Triggering events in BM-SC, Trace Depth for BM-SC, List of interfaces to trace in BM-SC and a Trace Activity Control For BM-SC. The encoding of these elements is defined in 3GPP TS 32.422 [31].

The Trace Activity Control For BM-SC is used to indicate to BM-SC whether the Trace is activated or deactivated.

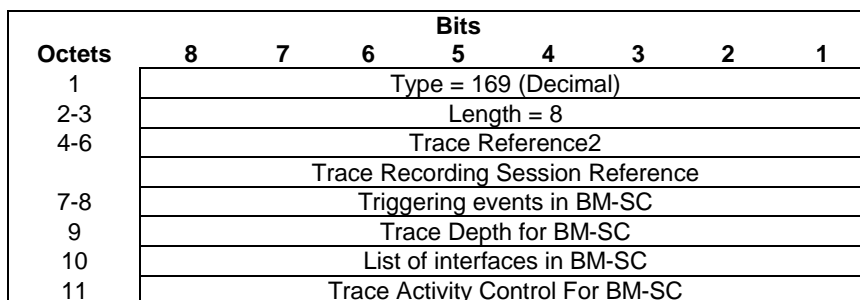

Figure 7.7.68.1: Additional MBMS Trace Info Information Element

| Trace Activity Control | Value (Decimal) |
|-------------------------------|-----------------|
| Trace Activation | 1 |
| Trace Deactivation | 0 |
| All other values are reserved | |

Figure 7.7.68.2: Trace Activity Control For BM-SC Value

7.7.69 MBMS Session Repetition Number

The MBMS Session Repetition Number is defined in 3GPP TS 23.246 [26]. The MBMS Session Repetition Number information element contains a MBMS Session Repetition Number allocated by the BM-SC. The payload shall be encoded as per the MBMS-Session- Repetition-Number AVP defined in 3GPP TS 29.061 [27], excluding the AVP Header fields (as defined in IETF RFC 3588 [36], section 4.1).

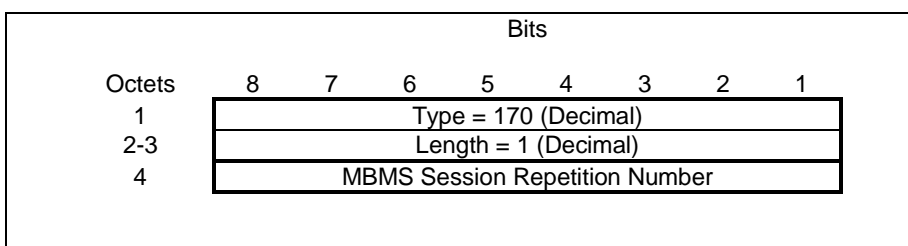

Figure 7.7.69.1: MBMS Session Repetition Number Information Element

7.7.70 MBMS Time To Data Transfer

The MBMS Time To Data Transfer is defined in 3GPP TS 23.246 [26]. The MBMS Time To Data Transfer information element contains a MBMS Time To Data Transfer allocated by the BM-SC. The payload shall be encoded as per the MBMS-Time-To-Data-Transfer AVP defined in 3GPP TS 29.061 [27], excluding the AVP Header fields (as defined in IETF RFC 3588 [36], section 4.1).

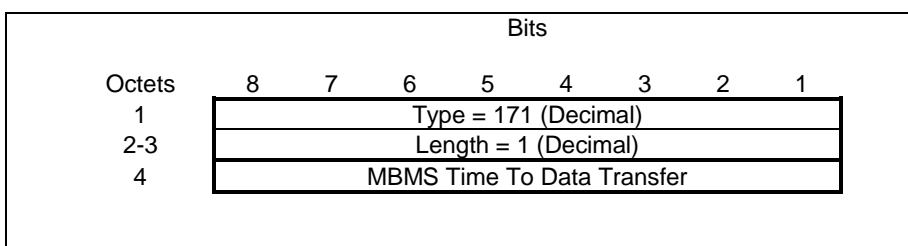

Figure 7.7.70.1: MBMS Time To Data Transfer Information Element

7.7.71 Void

7.7.72 BSS Container

The BSS Container information element contains the radio-related information in the source cell to target cell direction and radio-related and core network information in the target cell to source cell direction. The content of this container is defined in 3GPP TS 48.018 [20].

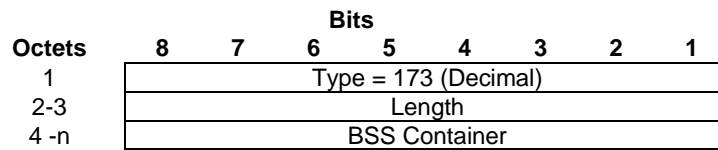

Figure 7.7.72.1: BSS Container Information Element

7.7.73 Cell Identification

The Cell Identification information element contains

- for PS handover from A/Gb mode, the identification of a target cell (Target Cell ID) and the identification of the source cell (Source Cell ID) as defined in 3GPP TS 48.018 [20].
- for PS handover from Iu mode, the identification of a target cell (Target Cell ID) and the identification of the source RNC (Source RNC-ID) as defined in 3GPP TS 48.018 [20].

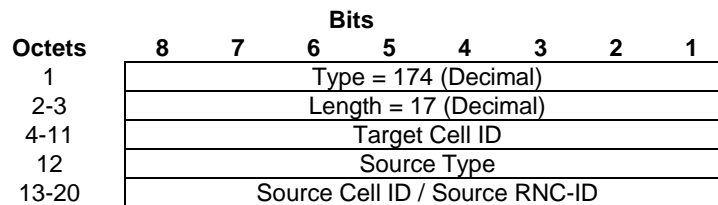

Figure 7.7.73.1: Cell Identification Information Element

Source Type indicates whether the source is identified by a Cell ID (A/Gb) or by a RNC-ID (Iu).

Table 7.7.73.1: Source Type Values

| Source Type | Value |
|----------------|-------|
| Source Cell ID | 0 |
| Source RNC-ID | 1 |

7.7.74 PDU Numbers

The PDU Numbers information element contains the sequence number status corresponding to a PDP context in the old SGSN. This information element shall be sent only when acknowledged peer-to-peer LLC operation is used for the PDP context or when the "delivery order" QoS attribute is set in the PDP context QoS profile.

NSAPI identifies the PDP context for which the PDU Number IE is intended.

DL GTP-U Sequence Number is the number for the next downlink GTP-U T-PDU to be sent to the MS when "delivery order" is set.

UL GTP-U Sequence Number is the number for the next uplink GTP-U T-PDU to be tunnelled to the GGSN when "delivery order" is set.

The Send N-PDU Number is used only when acknowledged peer-to-peer LLC operation is used for the PDP context. Send N-PDU Number is the N-PDU number to be assigned by SNDCP to the next down link N-PDU received from the GGSN.

The Receive N-PDU Number is used only when acknowledged peer-to-peer LLC operation is used for the PDP context. The Receive N-PDU Number is the N-PDU number expected by SNDCP from the next up link N-PDU to be received from the MS.

The PDU Number IE will be repeated for each PDP Context for which this IE is required.

| Octets | Bits | | | | | | | |
|--------|--------------------------|---|---|---|-------|---|---|---|
| | 8 | 7 | 6 | 5 | 4 | 3 | 2 | 1 |
| 1 | Type = 175 (Decimal) | | | | | | | |
| 2-3 | Length = 9 | | | | | | | |
| 4 | Spare (0 0 0 0) | | | | NSAPI | | | |
| 5-6 | DL GTP-U Sequence Number | | | | | | | |
| 7-8 | UL GTP-U Sequence Number | | | | | | | |
| 9-10 | Send N-PDU Number | | | | | | | |
| 11-12 | Receive N-PDU Number | | | | | | | |

Figure 7.7.74.1: PDU Numbers Information Element

7.7.75 BSSGP Cause

The BSSGP Cause information element contains the cause as defined in 3GPP TS 48.018 [20]. The value part (which has a range of 1..255) of the BSSGP Cause IE which is transferred over the Gb interface is encoded into one octet from the binary encoding of the value part of the BSSGP Cause IE.

| Octets | Bits | | | | | | | |
|--------|----------------------|---|---|---|---|---|---|---|
| | 8 | 7 | 6 | 5 | 4 | 3 | 2 | 1 |
| 1 | Type = 176 (Decimal) | | | | | | | |
| 2-3 | Length = 1 (Decimal) | | | | | | | |
| 4 | BSSGP Cause | | | | | | | |

Figure 7.7.75.1: BSSGP Cause Information Element

7.7.76 Required MBMS Bearer Capabilities

The Required MBMS Bearer Capabilities are defined in 3GPP TS 23.246 [26]. The Required MBMS Bearer Capabilities information element contains the minimum bearer capabilities the UE needs to support. The payload shall be encoded as per the Required-MBMS-Bearer-Capabilities AVP defined in 3GPP TS 29.061 [27], excluding the AVP Header fields (as defined in IETF RFC 3588 [36], section 4.1).

| Octets | Bits | | | | | | | |
|--------|-----------------------------------|---|---|---|---|---|---|---|
| | 8 | 7 | 6 | 5 | 4 | 3 | 2 | 1 |
| 1 | Type = 177 (Decimal) | | | | | | | |
| 2-3 | Length | | | | | | | |
| 4-m | Required MBMS Bearer Capabilities | | | | | | | |

Figure 7.7.76.1: Required MBMS Bearer Capabilities Information Element

7.7.77 RIM Routing Address Discriminator

Octet 4 bits 4 – 1 is coded according to 3GPP TS 48.018 [20] RIM Routing Information IE octet 3 bits 4 - 1. Bits 8 – 5 are coded "0000".

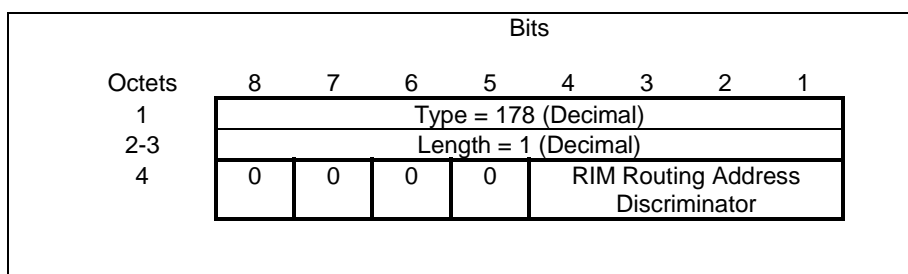

Figure 7.7.77.1: RIM Routing Address Discriminator

7.7.78 List of set-up PFCs

The List of set-up PFCs information element contains the Packet Flow Identifiers of the PFCs that were successfully allocated in the target system during a PS handover. The content and the coding of this IE are defined in octet 3-z of the List of set-up PFCs IE in 3GPP TS 48.018 [20].

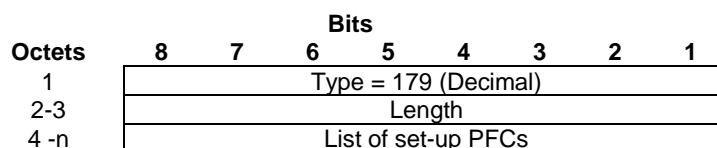

Figure 7.7.78.1: List of set-up PFCs Information Element

7.7.79 PS Handover XiD Parameters

The PS Handover XiD Parameters IE contains for a particular packet flow the LLC XiD parameters (with the SMDCP XiD parameters contained within) that need to be transferred between SGSNs during the PS handover procedure (see 3GPP TS 43.129 [37]).

The PS Handover XiD Parameters IE shall contain a SAPI and XiD parameters for each unique SAPI value contained within the PDP Contexts included in the Forward Relocation Request message.

The SAPI is an integer value in the range [0; 15].

The XiD parameters IE contains the SMDCP / LLC XiD parameter between peer SMDCP /LLC entities in the MS and old SGSN as defined in 3GPP TS44.064 [11], 3GPP TS44.065 [36].

The XiD parameters Length represents the length of the XiD parameters field, excluding the XiD parameters Length octet. If the XiD parameters do not exist in the old SGSN, the XiD parameters Length shall be set to zero.

The spare bits x indicate unused bits, which shall be set to 0 by the sending side and which shall not be evaluated by the receiving side.

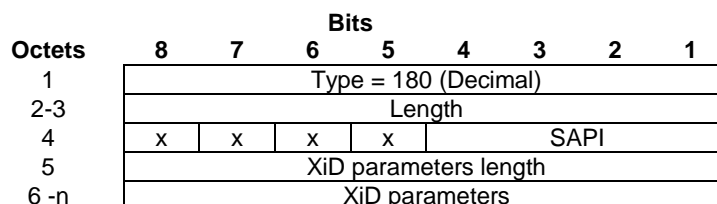

Figure 7.7.79: PS Handover XiD Parameters Information Element

7.7.80 MS Info Change Reporting Action

The MS Info Change Reporting Action IE is used by the GGSN to enable and disable the MS Info Change Reporting mechanism. For more information on this feature, see sub-clause 7.5B.1.

The structure of the MS Info Change Reporting Action IE is as follows:

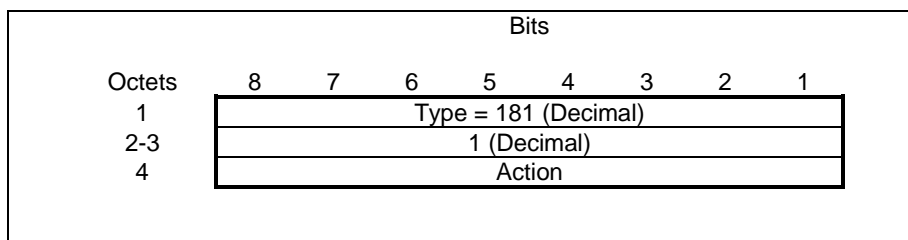

Figure 7.7.80.1: Restriction Type Information Element

The Action field contains an unsigned number, whose values indicate the following:

Table 7.7.80.1: Action values

| Action | Value (Decimal) |
|-------------------------|-----------------|
| Stop Reporting | 0 |
| Start Reporting CGI/SAI | 1 |
| Start Reporting RAI | 2 |
| <spare> | 3-255 |

If the Action field contains a value not defined in the above table, then the receiving entity shall always silently discard the IE and shall not change the state of the MS Info Change Reporting mechanism.

7.7.81 Direct Tunnel Flags

The Direct Tunnel Flags information element is used to hold values for multiple bit flags related to the GTP direct tunnel feature.

The Direct Tunnel Indicator (DTI) bit field is relevant only for the Update PDP Context procedure to indicate whether the procedure is being used for the establishment of a direct GTP-U tunnel between the GGSN and the RNC.

The GPRS-CSI (GCSI) bit field is relevant only for the SRNS Relocation procedure and Inter-RAT handover procedure and is used to indicate to the new SGSN whether the subscriber's profile in the old SGSN contained a GCSI.

The Error Indication (EI) bit is relevant only for the case when a direct tunnel is used and the GGSN receives an Error Indication message from the RNC.

Bits marked as "Spare" shall be assigned the value 0 by the sending node and shall not be evaluated by the receiving node.

If a receiving entity receives this IE with a length longer than expected, it shall process the first octet(s) that are expected and shall silently discard the remaining octets.

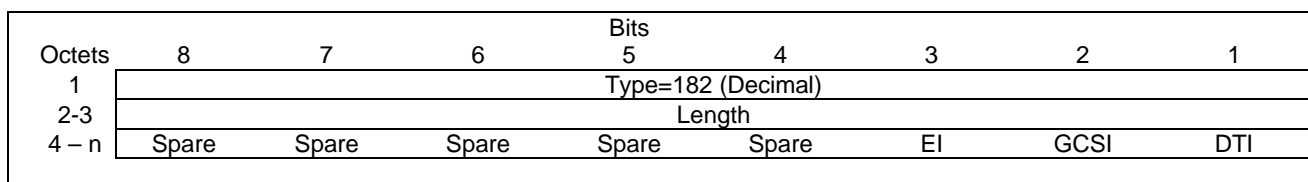

NOTE: In the present release of the present document, n=4 in the above figure. In future releases of the present document, n may be greater.

Figure 7.7.81.1: Direct Tunnel Flags Information Element

7.7.82 Correlation-ID

The Correlation-ID is used in the GGSN to correlate the subsequent Secondary PDP Context Activation Procedure with the Initiate PDP Context Activation Request message in the Network Requested Secondary PDP Context Activation Procedure.

| Octets | Bits | | | | | | | |
|--------|----------------------|---|---|---|---|---|---|---|
| | 8 | 7 | 6 | 5 | 4 | 3 | 2 | 1 |
| 1 | Type = 183 (Decimal) | | | | | | | |
| 2-3 | Length | | | | | | | |
| 4 | Correlation-ID | | | | | | | |

Figure 7.7.82.1: Correlation-ID Information Element

7.7.83 Bearer Control Mode

Bearer Control Mode is sent by the GGSN to the SGSN and indicates the Bearer Control Mode applicable to all PDP Contexts within the activated PDP Address/APN pair.

| Octets | Bits | | | | | | | |
|--------|----------------------|---|---|---|---|---|---|---|
| | 8 | 7 | 6 | 5 | 4 | 3 | 2 | 1 |
| 1 | Type = 184 (Decimal) | | | | | | | |
| 2-3 | Length | | | | | | | |
| 4 | Bearer Control Mode | | | | | | | |

Figure 7.7.83.1: Bearer Control Mode Information Element

Valid codes for the Bearer Control Mode octet are:

- 0 (Selected Bearer Control Mode – "MS_only");
- 1 (Selected Bearer Control Mode – "MS/NW").

All other values are reserved.

7.7.84 MBMS Flow Identifier

The MBMS Flow Identifier is defined in 3GPP TS 23.246 [26]. In broadcast mode, the MBMS Flow Identifier information element is included in MBMS Session Management messages to differentiate the different sub-sessions of an MBMS user service (identified by the TMGI) providing location-dependent content. The payload shall be encoded as per the MBMS-Flow-Identifier AVP defined in 3GPP TS 29.061 [27], excluding the AVP Header fields (as defined in IETF RFC 3588 [36], section 4.1).

| Octets | Bits | | | | | | | |
|--------|----------------------|---|---|---|---|---|---|---|
| | 8 | 7 | 6 | 5 | 4 | 3 | 2 | 1 |
| 1 | Type = 185 (Decimal) | | | | | | | |
| 2-3 | Length (Decimal) | | | | | | | |
| 4-n | MBMS Flow Identifier | | | | | | | |

Figure 7.7.84.1: MBMS Flow Identifier Information Element

7.7.85 MBMS IP Multicast Distribution

The MBMS IP Multicast Distribution IE is sent by the GGSN to the SGSN in the MBMS Session Start Request. The SGSN forwards the Session Start Request to the RNCs, which uses the information to establish reception of the MBMS payload. Source Specific Multicasting is used according to IETF RFC 4607 [44].

The IP Multicast Distribution Address and the IP Multicast Source Address fields contain the IPv4 or IPv6 address as defined in 3GPP TS 23.003 [2]. The Address Type and Address Length fields from 3GPP TS 23.003 [2] shall be included in each field.

MBMS HC Indicator represents an indication if header compression should be used for MBMS user plane data. The values are defined in 3GPP TS 25.413 [7].

| Octets | Bits | | | | | | |
|---------|--|---|---|---|---|---|---|
| | 8 | 7 | 6 | 5 | 4 | 3 | 2 |
| 1 | Type = 186 (Decimal) | | | | | | |
| 2-3 | Length (Decimal) | | | | | | |
| 4-7 | Common Tunnel Endpoint Identifier Data | | | | | | |
| 8-n | IP Multicast Distribution Address (IPv4 or IPv6) | | | | | | |
| (n+1)-k | IP Multicast Source Address (IPv4 or IPv6) | | | | | | |
| k+1 | MBMS HC Indicator | | | | | | |

Figure 7.7.85.1: MBMS IP Multicast Distribution Information Element

7.7.86 MBMS Distribution Acknowledgement

The MBMS Distribution Acknowledgement IE is sent by the SGSN to the GGSN in the MBMS Session Start Response. It is used by the GGSN to decide if an IP Multicast Distribution user plane shall be established, or a normal point-to-point user plane, or both.

| Octets | Bits | | | | | | |
|--------|----------------------|---|---|---|---|-----------|---|
| | 8 | 7 | 6 | 5 | 4 | 3 | 2 |
| 1 | Type = 187 (Decimal) | | | | | | |
| 2-3 | Length = 1 (Decimal) | | | | | | |
| 4 | Spare | | | | | Distr Ind | |

Figure 7.7.86.1: MBMS Distribution Acknowledgement Information Element

Table 7.7.86.1: Distribution Indication values

| Distribution Indication | Value (Decimal) |
|---|-----------------|
| No RNCs have accepted IP multicast distribution | 0 |
| All RNCs have accepted IP multicast distribution | 1 |
| Some RNCs have accepted IP multicast distribution | 2 |
| Spare. For future use. | 3 |

7.7.87 Reliable INTER RAT HANDOVER INFO

The Reliable INTER RAT HANDOVER INFO information element contains the indicator, which is sent from the source BSS to the target BSS on the reliability of the INTER RAT HANDOVER INFO. This information element is defined in 3GPP TS 48.018 [20]. The encoding of the Reliable INTER RAT HANDOVER INFO field (i.e. octet 4) shall be equal to octet 3 of the Reliable Inter-RAT Handover Info IE in 3GPP TS 48.018 [20].

| | | | | | | | | | | |
|--|--------|----------------------------------|---|---|---|---|---|---|---|--|
| | | Bits | | | | | | | | |
| | Octets | 8 | 7 | 6 | 5 | 4 | 3 | 2 | 1 | |
| | 1 | Type = 188 (Decimal) | | | | | | | | |
| | 2-3 | Length | | | | | | | | |
| | 4 | Reliable INTER RAT HANDOVER INFO | | | | | | | | |

Figure 7.7.87.1: Reliable INTER RAT HANDOVER INFO

7.7.88 RFSP Index

Index to RAT/Frequency Selection Priority (RFSP Index) is coded as depicted in Figure 7.7.88.1. It is defined in 3GPP TS 25.413 [7] and in 3GPP TS 48.018 [20] as a Subscriber Profile ID for RAT/Frequency priority (SPIRFP). The SPIRFP is an integer between 1 and 256, which requires two octets.

| | | | | | | | | | |
|--------|--|----------------------|---|---|---|---|---|---|---|
| | | Bits | | | | | | | |
| Octets | | 8 | 7 | 6 | 5 | 4 | 3 | 2 | 1 |
| 1 | | Type = 189 (Decimal) | | | | | | | |
| 2-3 | | Length = 2 (Decimal) | | | | | | | |
| 4-5 | | RFSP Index | | | | | | | |

Figure 7.7.88.1: RFSP Index

7.7.89 PDP Type

This specification does not define generic PDP Type IE, but PDP type is specified within a number of other IE type definitions (see subclauses 7.7.27, 7.7.29, 7.7.48, 7.7.55 and also 8.2). Regarding the IP protocol suite, these subclauses specify the coding of IPv4, IPv6 and IPv4v6 (dual stack) PDP types.

7.7.90 Fully Qualified Domain Name (FQDN)

Fully Qualified Domain Name (FQDN) is coded as depicted in Figure 7.7.90.1.

| | | | | | | | | | |
|------------|--|----------------------|---|---|---|---|---|---|---|
| | | Bits | | | | | | | |
| Octets | | 8 | 7 | 6 | 5 | 4 | 3 | 2 | 1 |
| 1 | | Type = 190 (decimal) | | | | | | | |
| 2 to 3 | | Length = n | | | | | | | |
| 4 to (n+3) | | FQDN | | | | | | | |

Figure 7.7.x.1: Fully Qualified Domain Name (FQDN)

The FQDN field encoding shall be identical to the encoding of a FQDN within a DNS message of section 3.1 of IETF RFC 1035 [45] but excluding the trailing zero byte.

NOTE 1: The FQDN field in the IE is not encoded as a dotted string as commonly used in DNS master zone files.

A "Co-located GGSN-PGW FQDN" IE is a combined GGSN-PGW host name as per subclause 4.3.2 of 3GPP TS 29.303 [46] when the Co-located GGSN-PGW FQDN IE is populated from 3GPP TS 29.303 [46] procedures. Specifically, the first DNS label is either "topon" or "topoff", and the canonical node name of the Co-located GGSN-PGW starts at the third label.

7.7.91 Evolved Allocation/Retention Priority I

The Evolved Allocation/Retention Priority I shall be included if the sending SGSN/GGSN supports this IE. The subscribed Evolved Allocation/Retention Priority information is received via Gr interface. The IE shall be used between SGSN and GGSN.

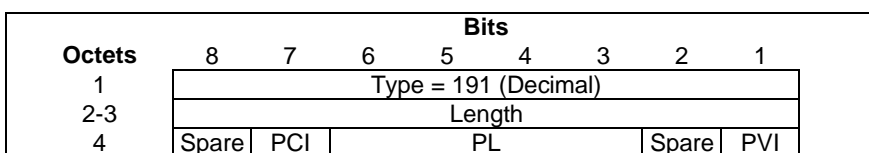

Figure 7.7.91.1: Evolved Allocation/Retention Priority Information Element

The bits within the octet 4 are:

- Bit 1 – PVI (Pre-emption Vulnerability)
- Bit 2 – spare
- Bit 3-6 – PL (Priority Level)
- Bit 7 – PCI (Pre-emption Capability)
- Bit 8 – spare

The meaning and value range of the fields within the Allocation/Retention Priority octet is as defined in 3GPP TS 29.212 [43]. PL encodes each priority level defined in 3GPP TS 29.212 [43] for the Priority-Level AVP as the binary value of the priority level.

7.7.92 Evolved Allocation/Retention Priority II

The Evolved Allocation/Retention Priority shall be included if the sending SGSN supports this IE. The IE shall be used between SGSNs.

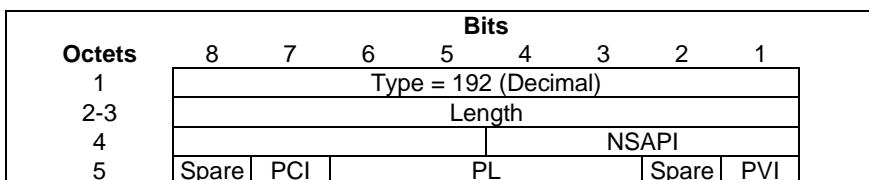

Figure 7.7.92.1: Evolved Allocation/Retention Priority Information Element

The bits within the octet 5 are:

- Bit 1 – PVI (Pre-emption Vulnerability)
- Bit 2 – spare
- Bit 3-6 – PL (Priority Level)
- Bit 7 – PCI (Pre-emption Capability)
- Bit 8 – spare

The meaning and value range of the fields within the Allocation/Retention Priority octet is as defined in 3GPP TS 29.212 [43]. PL encodes each priority level defined in 3GPP TS 29.212 [43] for the Priority-Level AVP as the binary value of the priority level.

7.7.93 Extended Common Flags

The Extended Common Flags element is used to hold values for multiple bit flags.

The Unauthenticated IMSI bit field is relevant for Create PDP Context Request, Forward Relocation Request and SGSN Context Response and shall be set to 1 if the IMSI present in the message is not authenticated and is for an emergency attached MS.

The CCRSI (CSG Change Reporting Support Indication) bit field is relevant for Create PDP Context Request and Update PDP Context Request messages and shall be set to 1 if the SGSN supports the CSG Information Change Reporting mechanism.

Bits marked as Spare shall be assigned the value 0 by the sending node and shall not be evaluated by the receiving node.

If a receiving entity receives this IE with a length longer than expected, it shall process the first octet(s) that are expected and shall silently discard the remaining octets.

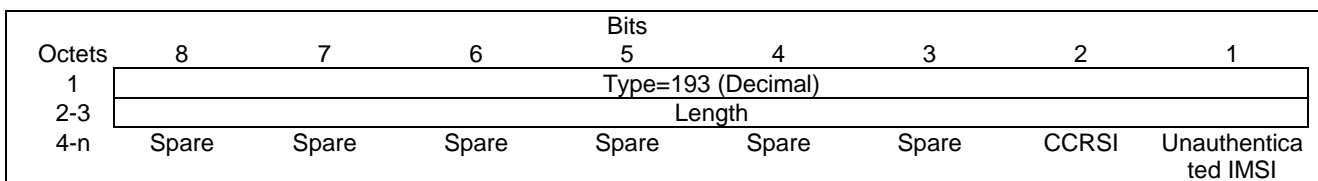

Figure 7.7.93.1: Extended Common Flags Information Element

7.7.94 User CSG Information (UCI)

User CSG Information (UCI) is coded as depicted in Figure 7.7.94.1. The CSG ID is defined in 3GPP TS 23.003 [2].

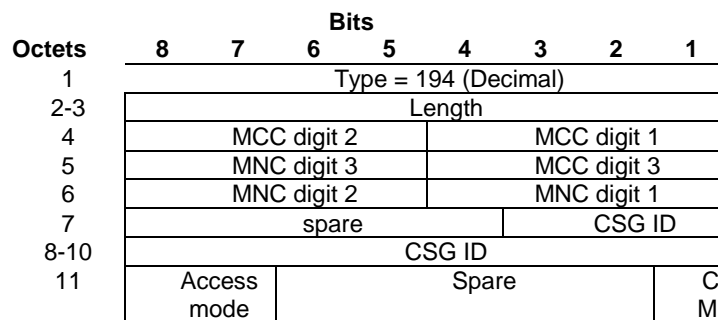

Figure 7.7.94.1: User CSG Information

For two digits MNCs, bits 5 to 8 of octet 6 are coded as "1111".

The CSG ID consists of 4 octets. Bit 3 of Octet 7 is the most significant bit and bit 1 of Octet 10 is the least significant bit. The coding of the CSG ID is the responsibility of the operator that allocates the CSG ID by administrative means. Coding using full hexadecimal representation shall be used.

Access mode values are specified in Table 7.7.94.1.

Table 7.7.94.1: Access mode values and their meanings

| Access Mode | Values (Decimal) |
|-------------|------------------|
| Closed Mode | 0 |
| Hybrid Mode | 1 |
| Reserved | 2-3 |

CSG Membership Indication (CMI) values are specified in Table 7.7.94.2. CMI shall be included in the User CSG Information if the Access mode is Hybrid Mode. For the other values of Access Mode, the CMI shall be set to 0 by the sender and ignored by the receiver.

Table 7.7.94.2: CSG Membership Indication (CMI)

| CMI | Values (Decimal) |
|--------------------|------------------|
| CSG membership | 0 |
| Non CSG membership | 1 |

7.7.95 CSG Information Reporting Action

The CSG Information Reporting Action is coded as depicted in Figure 7.7.95.1.

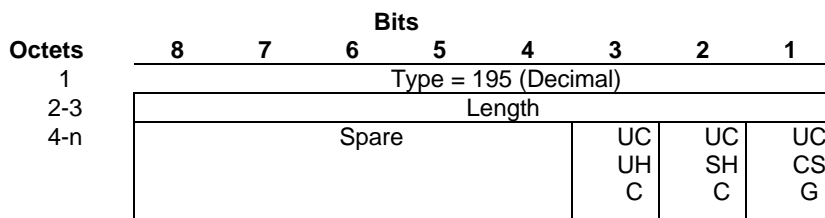

Figure 7.7.95.1: CSG Information Reporting Action

The following bits within Octet 4 shall indicate:

- Bit 1 – UCICSG: When set to ‘1’, shall indicate to start reporting User CSG Info when the UE enters/leaves/access through the CSG Cell.
- Bit 2 – UCISHC: When set to ‘1’, shall indicate to start reporting User CSG Info when the UE enters/leaves/access through Subscribed Hybrid Cell.
- Bit 3 – UCIUHC: When set to ‘1’, shall indicate to start Reporting User CSG Info when the UE enters/leaves/access through Unsubscribed Hybrid Cell.

All the bits 1 to 3 shall be set to 0 to stop reporting User CSG Info.

Bits marked as Spare shall be assigned the value 0 by the sending node and shall not be evaluated by the receiving node.

If a receiving entity receives this IE with a length longer than expected, it shall process the first octet(s) that are expected and shall silently discard the remaining octets.

7.7.96 CSG ID

CSG ID is coded as depicted in Figure 7.7.96.1. The CSG ID is defined in 3GPP TS 23.003 [2].

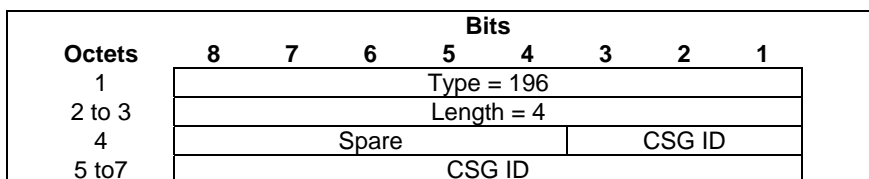

Figure 7.7.96.1: CSG ID

The CSG ID consists of 4 octets. Bit 3 of Octet 4 is the most significant bit and bit 1 of Octet 7 is the least significant bit. The coding of the CSG ID is the responsibility of the operator that allocates the CSG ID by administrative means. Coding using full hexadecimal representation shall be used.

7.7.97 CSG Membership Indication (CMI)

CSG Membership Indication is coded as depicted in Figure 7.7.97.1.

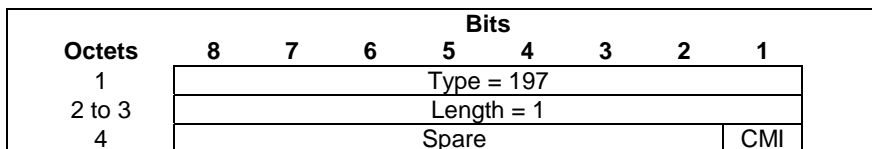

Figure 7.7.97.1: CSG Membership Indication

CSG Membership Indication (CMI) values are specified in Table 7.7.97.1.

Table 7.7.97.1: CSG Membership indication (CMI)

| CMI | Values (Decimal) |
|--------------------|------------------|
| CSG membership | 0 |
| Non CSG membership | 1 |

7.7.98 Aggregate Maximum Bit Rate (AMBR)

AMBR is defined in clause 9.9.4.2 of 3GPP TS 24.301 [42], but shall be formatted as shown in Figure 7.7.98-1 as Unsigned32 binary integer values in kbps (1000 bits per second).

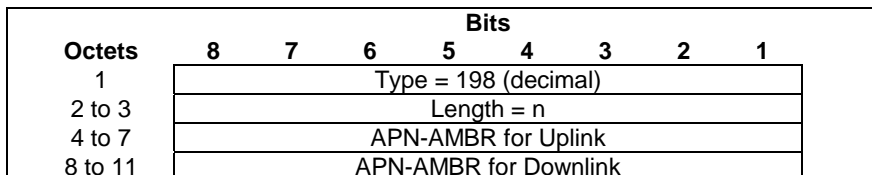

Figure 7.7.98.1: Aggregate Maximum Bit Rate (AMBR)

8 Control Plane (GTP-C)

The control plane in this case relates to GPRS Mobility Management functions like for example GPRS Attach, GPRS Routing Area Update and Activation of PDP Contexts. The GPRS Tunnelling Protocol-Control plane (GTP-C) shall perform the control plane signalling between GSN nodes.

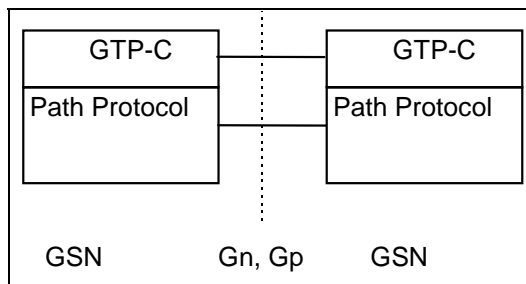

Figure 63: Signalling Plane - Protocol Stack

8.1 Control Plane Protocol

The GTP-C control plane flow shall be logically associated with, but separate from, the GTP-U tunnels. For each GSN-GSN pair one or more paths exist. One or more tunnels may use each path. GTP-C shall be the means by which tunnels are established, used, managed and released. A path may be maintained by keep-alive echo messages. This ensures that a connectivity failure between GSNs can be detected in a timely manner.

8.2 Usage of the GTP-C Header

For control plane messages the GTP header shall be used as specified in clause 6 with the following clarifications and additions:

- Version shall be set to decimal 1 ("001").
- Protocol Type flag (PT) shall be set to "1".
- Sequence number flag (S) shall be set to "1".
- N-PDU Number flag (PN) shall be set to "0". A GTP-C receiver shall not return an error if this flag is set to "1".
- Message Type shall be set to the unique value that is used for each type of control plane message. Valid message types are marked with an x in the GTP-C column in table 1.
- Length shall be the length in octets of the payload, i.e. the rest of the packet following the mandatory part of the GTP header (that is the first 8 octets). The Sequence Number, the N-PDU Number or any Extension headers shall be considered to be part of the payload, i.e. included in the length count.
- The Tunnel Endpoint Identifier is set by the sending entity to the value requested by the corresponding entity (SGSN or GGSN); it identifies all the PDP Contexts with the same PDP address or two IP addresses (one IPv4 and one IPv6 if PDP Type IPv4v6 is supported and used) and APN (for Tunnel Management messages) or it identifies each MS and its associated context data (for messages not related to Tunnel Management), except for the following cases:
 - The Create PDP Context Request message and the Create MBMS Context Request message for a given MS sent to a specific GGSN shall have the Tunnel Endpoint Identifier set to all zeroes, if the SGSN has not been assigned a Tunnel Endpoint Identifier Control Plane by the GGSN.
 - The Identification Request/Response messages, where the Tunnel Endpoint Identifier shall be set to all zeroes.
 - The SGSN Context Request message, where the Tunnel Endpoint Identifier shall be set to all zeroes.
 - The Echo Request/Response, Supported Extension Headers notification and the Version Not Supported messages, where the Tunnel Endpoint Identifier shall be set to all zeroes.
 - The Forward Relocation Request message, where the Tunnel Endpoint Identifier shall be set to all zeroes.
 - The PDU Notification Request message, where the Tunnel Endpoint Identifier shall be set to all zeroes.
 - The MBMS Notification Request message, where the Tunnel Endpoint Identifier shall be set to all zeroes.
 - The RAN Information Relay message, where the Tunnel Endpoint Identifier shall be set to all zeroes.
 - The Relocation Cancel Request message where the Tunnel Endpoint Identifier shall be set to all zeroes, except for the case where the old SGSN has already been assigned the Tunnel Endpoint Identifier Control Plane of the new SGSN.
 - All Location Management messages, where the Tunnel Endpoint Identifier shall be set to all zeroes.
 - If a GSN receives a GTP-C message requesting action related to a PDP context that the sending node believes is in existence, but that is not recognised by the receiving node, the receiving node shall send back to the source of the message, a response with the appropriate cause value (either "Non-existent" or "Context not found"). The Tunnel Endpoint Identifier used in the response message shall be set to all zeroes.
 - The MBMS Registration Request message, if successful assignment of Tunnel Endpoint Identifier Control Plane has not been confirmed, and, for MBMS Broadcast, the MBMS Session Start Request message, where the Tunnel Endpoint Identifier shall be set to all zeroes.
 - The MS Info Change Reporting messages, where the Tunnel Endpoint Identifier shall be set to all zeroes.

The GSN Address for Control Plane set in the request message could be different from the IP Source address of the message. The Tunnel Endpoint Identifier notified in the request message is also used in this case for sending the corresponding response message.

- Sequence Number shall be a message number valid for a path. Within a given set of contiguous Sequence Numbers from 0 to 65535, a given Sequence Number shall, if used, unambiguously define a GTP control plane request message sent on the path (see section Reliable delivery of signalling messages). The Sequence Number in a control plane response message shall be copied from the control plane request message that the GSN is replying to. For GTP-C messages not having a defined response message for a request message, i.e. for messages Version Not Supported, RAN Information Relay and Supported Extension Headers Notification, the Sequence Number shall be ignored by the receiver.
- N-PDU Number shall not be interpreted.

The GTP-C header may be followed by subsequent information elements dependent on the type of control plane message. Only one information element of each type is allowed in a single control plane message, except for the Authentication Triplet, the PDP Context, the Tunnel Endpoint Identifier Data II, NSAPI, PS Handover XID Parameters, Packet Flow ID, RFSP Index, PDU Numbers, Evolved Allocation/Retention Priority II and the FQDN information element where several occurrences of each type are allowed.

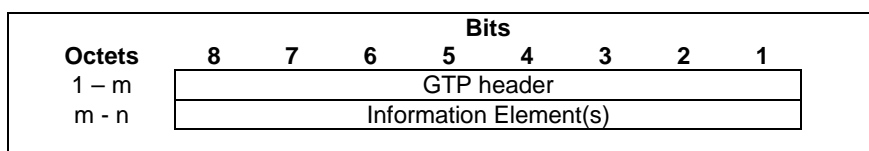

Figure 64: GTP Header followed by subsequent Information Elements

9 GTP-U

From release 8 onwards, the normative specification of the user plane of GTP version 1 is 3GPP TS 29.281 [41]. All provisions about GTPv1 user plane in the present document shall be superseded by 3GPP TS 29.281 [41].

GTP-U Tunnels are used to carry encapsulated T-PDUs and signalling messages between a given pair of GTP-U Tunnel Endpoints. The Tunnel Endpoint ID (TEID) which is present in the GTP header shall indicate which tunnel a particular T-PDU belongs to. In this manner, packets are multiplexed and de-multiplexed by GTP-U between a given pair of Tunnel Endpoints. The TEID value to be used in the TEID field shall be negotiated for instance during the GTP-C Create PDP Context and the RAB assignment procedures that take place on the control plane.

The maximum size of a T-PDU that may be transmitted without fragmentation by GGSN or the MS is defined in 3GPP TS 23.060 [4]. The GGSN shall fragment, reject or discard T-PDUs, depending on the PDP type and implementation decisions, directed to the MS if the T-PDU size exceeds the maximum size. The decision if the T-PDUs shall be fragmented or discarded is dependent on the external packet data network protocol.

9.1 GTP-U Protocol Entity

The GTP-U protocol entity provides packet transmission and reception services to user plane entities in the GGSN, in the SGSN and, in UMTS systems, in the RNC. The GTP-U protocol entity receives traffic from a number of GTP-U tunnel endpoints and transmits traffic to a number of GTP-U tunnel endpoints. There is a GTP-U protocol entity per IP address.

The TEID in the GTP-U header is used to de-multiplex traffic incoming from remote tunnel endpoints so that it is delivered to the User plane entities in a way that allows multiplexing of different users, different packet protocols and different QoS levels. Therefore no two remote GTP-U endpoints shall send traffic to a GTP-U protocol entity using the same TEID value except for data forwarding as part of the SRNS relocation or Intersystem Change procedures.

9.1.1 Handling of Sequence Numbers

This functionality is provided only when the S bit is set to 1 in the GTP-U header.

The GTP-U protocol entity must reorder out of sequence T-PDUs when in sequence delivery is required. This is optional at the SGSN in UMTS. The GTP-U protocol entity shall deliver to the user plane entity only in sequence T-PDUs and notify the sequence number associated to each of them. The notification of the sequence number is not necessary at the GGSN, but it is mandatory at the SGSN and RNC. The user plane entity shall provide a sequence number to the GTP-U layer together with T-PDUs to be transmitted in sequence. GTP-U protocol entities at the GGSN may optionally generate autonomously the sequence number, but should be able to use sequence numbers provided by the user plane entity. The sequence number is handled on a per GTP-U Tunnel (that is TEID) basis.

When the sequence number is included in the GTP-U header, a user plane entity acting as a relay of T-PDUs between GTP-U protocol entities, or between PDCP (or SNDCP) protocol entities and GTP-U protocol entities, shall relay the sequence numbers between those entities as well. In this way it is possible to keep consistent values of sequence numbers from the GGSN to the UE (MS in GPRS) by relaying the sequence number across the CN GTP-U bearer, the Iu GTP-U bearer and the Radio bearer (via PDCP or SNDCP N-PDU numbers). This functionality is beneficial during SRNS relocation.

For GTP-U signalling messages having a response message defined for a request message, Sequence Number shall be a message number valid for a path. Within a given set of continuous Sequence Numbers from 0 to 65535, a given Sequence Number shall, if used, unambiguously define a GTP-U signalling request message sent on the path (see section Reliable delivery of signalling messages). The Sequence Number in a signalling response message shall be copied from the signalling request message that the GSN or RNC is replying to. For GTP-U messages not having a defined response message for a request message, i.e. for messages Supported Extension Headers Notification and Error Indication, the Sequence Number shall be ignored by the receiver.

9.2 GTP-U Service Access Points and Primitives

The GTP-U protocol entity offers packet Transmission services between a pair of GTP-U tunnel endpoints. The tunnel between two GTP-U endpoints is established via control plane procedures defined in protocols such as GTP-C and RANAP. The control of GTP-U resource allocation and tunnel set-up takes place via the GTP-U-CONTROL SAP. The GTP-U packet transmission (and packet reception) services are accessed via the GTP-U-UNIT-DATA SAP.

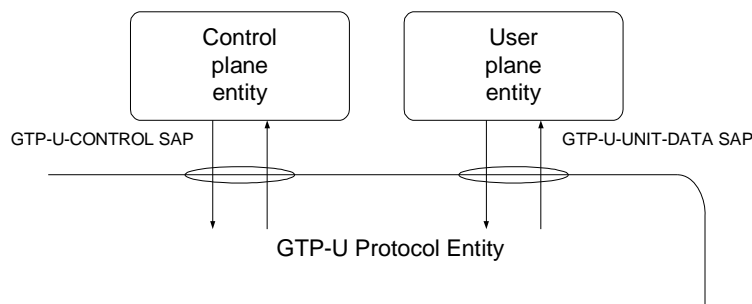

Figure 65: The GTP-U-Control SAP and GTP-U-DATA SAP

9.2.1 GTP-U-CONTROL SAP

The GTP-U-CONTROL SAP is used by a control plane entity to control the allocation of GTP-U resources and associate them to an identifier (the TEID) a user plane entity uses to access them via the GTP-U-UNIT-DATA SAP. It also defines in which way to control tunnel establishment. In particular, it provides means to control the GTP-U packet reception section and the GTP-U packet transmission section. The RX and TX suffix is used in the following to discriminate between primitives used to control the reception section and primitives used to control the transmission section.

9.2.1.1 GTP-U-CONTROL-RX primitives

Table 50

| Primitive | Parameters | Reference |
|-----------------------------------|----------------------------|-----------|
| GTP-U-CONTROL-RX-SETUP.request | QoS info; IP address; TEID | 9.2.1.1.1 |
| GTP-U-CONTROL-RX-SETUP.confirm | Result | 9.2.1.1.2 |
| GTP-U-CONTROL-RX-RELEASE.request | TEID | 9.2.1.1.3 |
| GTP-U-CONTROL-RX-RELEASE.confirm | - | 9.2.1.1.4 |
| GTP-U-CONTROL-RX-ERROR.indication | Cause | 9.2.1.1.5 |

9.2.1.1.1 GTP-U-CONTROL-RX-SETUP.request

This primitive is used to allocate packet reception resources according to a QoS profile specified via the "QoS" parameter. These resources are to be associated to a tunnel endpoint identified via the TEID specified in the "TEID" parameter. In case this TEID is already being used, this shall be interpreted as a resource modification request.

The "IP address" parameter is used to identify the IP address of the remote GTP-U protocol entity where the GTP-U tunnel is terminated. This implicitly identifies the path being used. The knowledge of the path being used is necessary in order to send ECHO messages used to detect path failure.

9.2.1.1.2 GTP-U-CONTROL-RX-SETUP.confirm

This primitive acknowledges the corresponding resources set up request. Any information to report is delivered in the parameter "Result", which may be used to indicate set up failure and the reason of the failure.

9.2.1.1.3 GTP-U-CONTROL-RX-RELEASE.request

This primitive is used to dispose the resources associated to a tunnel identified by TEID.

9.2.1.1.4 GTP-U-CONTROL-RX-RELEASE.confirm

This primitive acknowledges the corresponding resources release request.

9.2.1.1.5 GTP-U-CONTROL-RX-ERROR.indication

This primitive is used to indicate to the controlling entity any error conditions detected on the GTP-U reception section. The error condition is specified in the parameter "Cause".

9.2.1.2 GTP-U-CONTROL-TX primitives

Table 51

| Primitive | Parameters | Reference |
|-----------------------------------|----------------------------|-----------|
| GTP-U-CONTROL-TX-SETUP.request | QoS info; IP address; TEID | 9.2.1.2.1 |
| GTP-U-CONTROL-TX-SETUP.confirm | Result | 9.2.1.2.2 |
| GTP-U-CONTROL-TX-RELEASE.request | TEID; IP address | 9.2.1.2.3 |
| GTP-U-CONTROL-TX-RELEASE.confirm | - | 9.2.1.2.4 |
| GTP-U-CONTROL-TX-ERROR.indication | Cause | 9.2.1.2.5 |

9.2.1.2.1 GTP-U-CONTROL-TX-SETUP.request

This primitive is used to allocate packet transmission resources according to a QoS profile specified via the "QoS" parameter. These resources are to be associated to a tunnel endpoint identified via the TEID specified in the "TEID" parameter. In case this TEID is already being used, this shall be interpreted as a resource modification request.

The "IP address" parameter is used to identify the IP address of the remote GTP-U protocol entity where the GTP-U tunnel is terminated. This implicitly identifies the path being used. The knowledge of the path being used is necessary in order to send ECHO messages to detect PATH failure.

9.2.1.2.2 GTP-U-CONTROL-TX-SETUP.confirm

This primitive acknowledges the corresponding resources set up request. Any information to report is delivered in the parameter "Result", which maybe used to indicate set up failure and the reason of the failure.

9.2.1.2.3 GTP-U-CONTROL-TX-RELEASE.request

This primitive is used to dispose the resources associated to a tunnel identified by TEID and the IP address of the remote GTP-U protocol entity where the tunnel is terminated.

9.2.1.2.4 GTP-U-CONTROL-TX-RELEASE.confirm

This primitive acknowledges the corresponding resources release request.

9.2.1.2.5 GTP-U-CONTROL-TX-ERROR.indication

This primitive is used to indicate to the controlling entity any error conditions detected on the GTP-U Transmission section. The error condition is specified in the parameter "Cause".

9.2.2 GTP-U-UNIT-DATA SAP and Primitives

The GTP-U-UNIT-DATA SAP is used to send and receive T-PDUs in an unacknowledged mode. Sequence numbers and system dependent info is conditionally passed to the user plane entity using the GTP-U-. This information is identified as "*Other info*" in the following.

Table 52

| Primitive | Parameters | Reference |
|--|--|-----------|
| GTP-U-UNIT-DATA.request | DATA; TEID; IP address; <i>Other info</i> (note) | 9.2.2.1 |
| GTP-U- UNIT-DATA.indication | DATA; TEID; <i>Other info</i> (note) | 9.2.2.2 |
| NOTE: It is conditionally present (only if the TEID is associated to tunnels providing in sequence delivery, see subclause 9.1.1). | | |

9.2.2.1 GTP-U-UNIT-DATA.request

This primitive is used to send a T-PDU (DATA) by means of a specific GTP-U layer resource (tunnel) identified by the parameter TEID and the IP address where the tunnel is terminated. *Other info* may be conditionally present and transmitted together with T-PDUs.

9.2.2.2 GTP-U- UNIT-DATA.indication

A T-PDU (DATA) is received from a GPT-U peer entity and delivered to a user plane entity. The T-PDU is associated to the to the PDP or RNC context identified by TEID (that is the Tunnel Endpoint ID). *Other info* may be conditionally present and delivered together with T-PDUs.

9.3 Protocol Stack

The GTP-U protocol is used to transmit T-PDUs between GSN pairs (or between an SGSN and an RNC in UMTS), encapsulated in G-PDUs. A G-PDU is a packet including a GTP-U header and a T-PDU. The Path Protocol defines the path and the GTP-U header defines the tunnel. Several tunnels may be multiplexed on a single path. The frames have the following general structure.

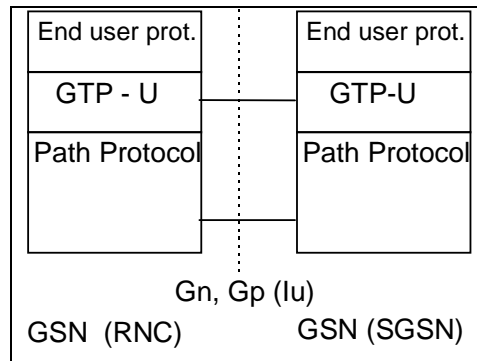

Figure 66: GTP-U - Protocol Stack (GTP-U over the lu in brackets)

9.3.1 Usage of the GTP-U Header

The GTP-U header shall be used as specified in clause 6 with the following details:

- Version shall be set to decimal 1 ("001").
- Protocol Type flag (PT) shall be set to "1".
- If the Sequence Number flag (S) is set to "1" the sequence number field is present and meaningful otherwise it is set to "0". For GTP-U messages Echo Request, Echo Response, Error Indication and Supported Extension Headers Notification, the S flag shall be set to "1".
- N-PDU Number flag (PN): the GTP-U header contains a meaningful N-PDU Number field if the PN flag is set to 1.
- Message Type shall be set according to table 1. The value 255 is used when T-PDUs are transmitted. The value 1 and 2 are used for "Echo" messages. The value 26 is used for "Error Indication" message. The value 31 is used for "Supported Extension Headers Notification" message.
- Length: This field indicates the length in octets of the payload, i.e. the rest of the packet following the mandatory part of the GTP header (that is the first 8 octets). The Sequence Number, the N-PDU Number or any Extension headers shall be considered to be part of the payload, i.e. included in the length count.
- Sequence Number: This field is meaningful if and only if the S field is set to 1. Its presence is defined in clause 6. The handling of this field is specified in subclause 9.1.1. It shall be used in order to decide whether or not to discard a received T-PDU, as specified in subclause 9.3.1.1 Usage of the Sequence Number or as a transaction identity for GTP-U signalling messages having a response message defined for a request message. For GTP-U message, Supported Extension Headers Notification and Error Indication the Sequence Number shall be ignored by the receiver.
- N-PDU Number: This field is meaningful if and only if the PN flag is set to 1. Its presence is defined in clause 6. In this case, the old SGSN (or RNC) uses it, at the Inter SGSN Routeing Area Update procedure (or SRNS relocation), to inform the new SGSN (or RNC) of the N-PDU number assigned to T-PDU. If an N-PDU number was not assigned to the T-PDU by PDCP, or if the T-PDU is to be transferred using unacknowledged peer-to-peer LLC operation, then PN shall be set to 0.
- TEID: Contains the Tunnel Endpoint Identifier for the tunnel to which this T-PDU belongs. The TEID shall be used by the receiving entity to find the PDP context, except for the following cases:
 - The Echo Request/Response and Supported Extension Headers notification messages, where the Tunnel Endpoint Identifier shall be set to all zeroes.
 - The Error Indication message where the Tunnel Endpoint Identifier shall be set to all zeros.

9.3.1.1 Usage of Sequence Number

The sending GGSN and SRNC shall use 0 for the value of the Sequence Number of the first G-PDU in a tunnel, only during the PDP context activation, and shall increment the Sequence Number for each following G-PDU. The value shall wrap to zero after 65535.

The receiving GGSN and SRNC shall set the content of a counter to zero, only during the PDP context activation. When the receiving GGSN and SRNC receives a valid G-PDU, it shall increment this counter by one. This counter shall wrap to zero after 65535. It defines the "Expected Sequence Number".

Based on the received and Expected Sequence Number values, the receiving GGSN and SRNC may decide whether or not to discard the received G-PDU. Annex A (Informative) describes a method to determine whether a received G-PDU is valid.

The receiving GGSN and SRNC shall reorder the incoming T-PDUs in sequence if the Reordering Required flag in the PDP context is set. In this case, if needed, the receiving GGSN and SRNC shall take into account a maximum number of valid received frames and a maximum elapsed time to assume that a G-PDU was lost.

The G-PDU sequence numbers allocated by the GGSN (down-link) and SRNC (uplink) are kept unchanged irrespective of the number of GTP tunnels the PDU is transferred over. Therefore, SGSN shall use on the Iu interface for down-link PDUs the G-PDU sequence number received from the GGSN, and shall use on the Gn interface for uplink PDUs the G-PDU sequence number received from the SRNC. In case of SRNS relocation and intersystem change, the SRNC and SGSN shall tunnel PDUs without changing the G-PDU sequence numbers.

9.4 Tunnelling between SGSNs

T-PDUs, stored in the old SGSN and not yet sent to the MS, shall be tunnelled to the new SGSN as a part of the Inter SGSN Routing Update procedure described in 3GPP TS 23.060 [4]. Some T-PDUs may still be on their way from the GGSN to the old SGSN because they have been sent before the tunnel change. These T-PDUs shall also be tunnelled to the new SGSN.

For intersystem SRNS Relocation, the establishment of the GTP tunnel(s) for the forwarding of G-PDUs is as described in the 3GPP TS 23.121 [17] and in the 3GPP TS 23.060 [4] specifications.

For PS Handover, the establishment of the GTP tunnel(s) for the forwarding of G-PDUs is as described in the 3GPP TS 43.129 [37].

9.5 Tunnelling between Source RNC and Target RNC

For the 3G-3G SRNS Relocation, the establishment of the GTP tunnel for the forwarding of G-PDUs between source and target RNC, is as described in the 3GPP TS 23.121 [17] and in the 3GPP TS 23.060 [4] specifications.

9.6 Tunnelling between GGSNs

GTP shall not specify tunnelling between GGSNs. Transfer of MS-to-MS traffic between GGSNs shall use the Gi interface.

10 Path Protocols

10.1 UDP/IP

UDP/IP is the only path protocol defined to transfer GTP messages in the version 1 of GTP. A User Datagram Protocol (UDP) compliant with RFC 768 shall be used.

10.1.1 UDP Header

10.1.1.1 Request Messages

The UDP Destination Port number for GTP-C request messages is 2123. It is the registered port number for GTP-C.

The UDP Destination Port number for GTP-U request messages is 2152. It is the registered port number for GTP-U.

The UDP Source Port is a locally allocated port number at the sending GSN/RNC.

10.1.1.2 Response Messages

The UDP Destination Port value shall be the value of the UDP Source Port of the corresponding request message.

The UDP Source Port shall be the value from the UDP Destination Port of the corresponding request message.

10.1.1.3 Encapsulated T-PDUs

The UDP Destination Port number shall be 2152. It is the registered port number for GTP-U. The UDP Source Port is a locally allocated port number at the sending GSN/RNC.

10.1.1.4 Error Indication, RAN Information Relay, Version Not Supported and Supported Extension Headers Notification

The UDP destination port for the Error Indication shall be the user plane UDP port (2152).

The UDP destination port for the Version Not Supported and the RAN Information Relay messages shall be the control plane UDP port (2123).

The UDP destination port for the Supported Extension Headers Notification shall be the UDP port for User plane (2152) if the trigger for it was a user plane message, the control plane port (2123) if the trigger for it was a control plane message.

The UDP source port shall be locally assigned at the sending node.

10.1.2 IP Header

An Internet Protocol (IP) compliant with RFC 791 shall be used.

10.1.2.1 Request Messages and Encapsulated T-PDUs

The IP Source Address shall be an IP address of the source GSN/RNC from which the message is originating.

The IP Destination Address in a GTP request message shall be an IP address of the destination GSN/RNC. The IP Destination Address in an encapsulated T-PDU GTP shall be an IP address of the destination GSN/RNC.

10.1.2.2 Response Messages

The IP Source Address shall be an IP address of the source GSN/RNC from which the message is originating.

The IP Destination Address shall be copied from the IP Source Address of the GTP request message to which this GSN/RNC is replying.

NOTE: The source IP address of the Echo Response message shall be the same as the destination IP address of the Echo Request message.

10.1.2.3 Error Indication, RAN Information Relay, Version Not supported and Supported Extension Headers Notification

The IP source address shall be an address of the source GSN/RNC from which the message is originated. In particular, the source Address of the "Version Not Supported" or the "Supported Extension Headers Notification" message, shall be set to the destination address of the message that triggered the GSN/RNC to send the "Version Not Supported" or the "Supported Extension Headers Notification" message.

The IP destination address for Error Indication, Version Not Supported and Supported Extension Headers Notification shall be the source address of the GTP-PDU that is the cause for the GSN/RNC to send one of these messages. The IP destination address for RAN Information Relay is the address of the SGSN which the messages is relayed to.

11 Error Handling

11.1 Protocol Errors

A protocol error is defined as a message with unknown, unforeseen or erroneous content. The term silently discarded used in the following subclauses means that the implementation shall discard the message without further processing and should log the event including the erroneous message and should include the error in a statistical counter.

An information element with "Mandatory" in the "Presence requirement" column of a message definition shall always be present in that message.

The conditions for a conditional information element define whether the information element is semantically:

- mandatorily present;
- optionally present;
- mandatorily absent.

An information element, which is semantically mandatorily present but is omitted from the message, is treated as missing data.

An information element, which is semantically mandatorily absent but is present in the message, is treated as unexpected data.

The Error Indication, Version Not Supported, RAN Information Relay, Supported Extension Headers Notification and the SGSN Context Acknowledge messages shall be considered as Responses for the purpose of this subclause.

The subclauses 11.1.1 to 11.1.13 shall be applied in decreasing priorities.

11.1.1 Different GTP Versions

If a receiving node receives a GTP-C message of an unsupported version, that node shall return a GTP Version Not Supported message indicating in the Version field of the GTP header the latest GTP version that that node supports. The received GTP-PDU shall then be discarded.

11.1.2 GTP Message Too Short

When a GTP message is received, and is too short to contain the GTP header for the GTP version that the sender claims to use, the GTP-PDU message shall be silently discarded.

11.1.3 Unknown GTP Signalling Message

When a message using a Message Type value defining an Unknown GTP signalling message is received, it shall be silently discarded.

11.1.4 Unexpected GTP Signalling Message

When an unexpected GTP control plane message is received, e.g. a Response message for which there is no corresponding outstanding Request, or a GTP control plane message a GSN is not expected to handle (such as a PDU Notification Request received by a GGSN), it shall be silently discarded.

11.1.5 Missing Mandatorily Present Information Element

The receiver of a GTP signalling Request message with a missing mandatorily present information element shall discard the request, should log the error, and shall send a Response with Cause set to "Mandatory IE missing". The receiver of a Response with a missing mandatory information element shall notify the upper layer and should log the error.

11.1.6 Invalid Length

TLV format information element may have a variable length, or may have a fixed length. The variable length is indicated in the information element definition by a variable that represents the overall number of octets to be used. In a received GTP signalling message Request, a mandatory TLV format information element may have a Length different from the Length defined in the version that this message claims to use. In this case, this information element shall be discarded, the error should be logged, and a Response shall be sent with Cause set to "Mandatory IE incorrect".

In a received GTP signalling message Response, if a mandatory TLV format information element has a Length different from the Length defined in the version that this message claims to use, then the requesting entity shall treat the GTP signalling procedure as having failed.

11.1.7 Invalid Mandatory Information Element

The receiver of a GTP signalling message Request including a mandatory information element with a Value that is not in the range defined for this information element value shall discard the request, should log the error, and shall send a response with Cause set to "Mandatory IE incorrect".

The receiver of a GTP signalling message Response including a mandatory information element with a Value that is not in the range defined for this information element shall notify the upper layer that a message with this sequence number has been received and should log the error.

If a GSN receives an information element with a value which is shown as reserved, it shall treat that information element as not being in the range defined for the information element.

NOTE: The receiver does not check the content of an information element field that is defined as "spare".

11.1.8 Invalid Optional Information Element

The receiver of a GTP signalling message including an optional information element with a Value that is not in the range defined for this information element value shall discard this IE, should log the error, and shall treat the rest of the message as if this IE was absent.

If a GSN receives an information element with a value which is shown as reserved, it shall treat that information element as not being in the range defined for the information element.

NOTE: The receiver does not check the content of an information element field that is defined as "spare".

11.1.9 Unknown Information Element

An information element with an unknown Type value shall be ignored by the receiver of the message. If this is a TLV element, this information element shall be skipped using its Length value. If this is an unknown TV element, the receiver shall discard the rest of the message. However, if the TV element is known but not expected, then the handling defined in section 11.1.11 shall apply.

If the receiving node cannot interpret the rest of the message because of the ignored information element, the receiving node shall discard the message and should log the error. If the message was a Request, it shall, in addition, return a response with Cause set to "Invalid message format".

11.1.10 Out of Sequence Information Elements

If two or more information elements are out of sequence in a message, the receiving node shall discard the message and should log the error. In addition, if the message was a Request, the receiving node shall return a Response with Cause set to "Invalid message format".

11.1.11 Unexpected Information Element

An information element with a Type value which is defined in section 7.7 of the present specification but is not expected in the received GTP signalling message shall be ignored (skipped) and the rest of the message processed as if this information element was not present. For all information elements of type TV, a receiving entity shall be able to

determine how long each IE is, even if that IE should never be received in any message by that particular network entity.

11.1.12 Repeated Information Elements

If an information element is repeated in a GTP signalling message in which repetition of the information element is not specified, only the contents of the information element appearing first shall be handled and all subsequent repetitions of the information element shall be ignored. When repetition of information elements is specified, only the contents of specified repeated information elements shall be handled.

11.1.13 Incorrect Optional Information Elements

All optional information elements that are incorrect in a GTP signalling message shall be treated as not present in the message. However, if the receiving node may not handle the message correctly because of the incorrect information element, the receiving node should log the error and shall return a response with Cause set to "Optional IE incorrect".

11.2 Path Failure

A path counter shall be reset each time a response is received on the path and incremented when the T3-RESPONSE timer expires for any message sent on the path. The path shall be considered to be down if the counter exceeds N3-REQUESTS. In this case, the GSN or RNC may notify the Operation and Maintenance network element. GTP shall also notify the upper layer of the path failure, so that PDP contexts associated with this path may be deleted.

11.3 MS Detach

When an MS detaches, all ongoing GTP control plane procedures related to this MS shall be aborted. The SGSN shall send Delete PDP Context Request messages for all active PDP contexts to the peer GGSNs.

11.4 Restoration and Recovery

All GSNs shall maintain in non-volatile memory a Restart Counter of local significance. A GSN that restarts shall change the Restart Counter value immediately after the restart procedure has been completed. The value shall be incremented by 1 modulo 256 (see 3GPP TS 23.007 [3]).

All GSNs shall also maintain in volatile memory a Restart Counter for each GSN that it is in contact with. The Restart Counters stored for all GSNs that it is in contact with shall be cleared after the restart procedure has been completed (see 3GPP TS 23.007 [3]).

12 Security provided to GTP Communication over Gn and Gp Interfaces

Protection of GTP communication over Gn and Gp interfaces shall be provided according to security mechanisms defined in 3GPP TS 33.210 [22].

13 IP, The Networking Technology used by GTP

13.1 IP Version

On the Gn and Gp interfaces the IPv4 (RFC 791) protocol shall be supported, IPv6 (RFC 2460) support is optional. This also applies to the Iu interface, when the ATM transport option is applied. When the IP transport option is applied on the Iu interface, both the IPv6 (RFC 2460) protocol and the IPv4 (RFC 791) protocol shall be supported.

13.2 IP Fragmentation

Here it is described how the fragmentation mechanism shall work together with GTP, when the GPRS backbone is based on IPv4.

However, fragmentation should be avoided if possible. Examples of fragmentation drawbacks are, e.g.:

- Fragmentation is inefficient, since the complete IP header is duplicated in each fragment.
- If one fragment is lost, the complete packet has to be discarded. The reason is that no selective retransmission of fragments is possible.

By using Path MTU discovery the application may find out the MTU, and thereby utilise more efficient segmentation mechanisms in other protocol layers than IP.

The maximum size of a T-PDU that may be transmitted without fragmentation by GGSN or the MS is defined in 3GPP TS 23.060 [4]. All backbone links should have MTU values that exceeds the sum of the maximum value plus the size of the tunnel headers (IP header, UDP and GTP header) in order to avoid fragmentation in the backbone.

13.2.1 MO Direction

Functionality for IP fragmentation on the Iu interface is defined in 3GPP TS 25.414 [23].

SGSN: A packet from an MS shall be encapsulated at the SGSN with a GTP header, UDP and IP header. If the resulting IP packet is larger than the MTU of the first link towards the GGSN, fragmentation of the IP packet shall be performed by the SGSN. The SGSN should preferably fragment the IP packet if it is larger than the MTU of any link between SGSN and GGSN.

Backbone router: Any router in the backbone may fragment the GTP packet if needed, according to IPv4.

GGSN: The GGSN shall assemble any IP fragments received from SGSNs, according to IPv4. Note that if any fragment is lost, the whole packet shall be discarded.

13.2.2 MT Direction

Functionality for IP fragmentation on the Iu interface is defined in 3GPP TS 25.414 [23].

GGSN: A packet from an external host shall be encapsulated at the GGSN with a GTP header, UDP and IP header. If the resulting IP packet is larger than the MTU on the first link towards the SGSN, fragmentation of the IP packet shall be performed by the GGSN. The GGSN should preferably fragment the IP packet if it is larger than the MTU of any link between GGSN and SGSN.

Backbone Router: Any router in the backbone may fragment the GTP packet if needed, according to IPv4.

SGSN: The SGSN shall assemble any IP fragments received from the GGSN, according to IPv4. Note that if any fragment is lost, the whole packet shall be discarded.

13.2.3 Tunnelling from old to new SGSN

Old SGSN: A user packet shall be encapsulated with a GTP header, UDP and IP header. If the resulting IP packet is larger than the MTU on the first link towards the new SGSN, fragmentation of the IP packet shall be performed by the old SGSN. The old SGSN should preferably fragment the IP packet if it is larger than the MTU of any link between old and new SGSN.

Backbone router: Any router in the backbone may fragment the GTP packet if needed, according to IPv4.

New SGSN: The new SGSN shall assemble any IP fragments received from the old SGSN, according to IPv4. Note that if any fragment is lost, the whole packet shall be discarded.

14 GTP Parameters

The GTP system parameters defined here and their recommended values shall not be fixed, but shall be possible to configure as described in section "Reliable delivery of messages".

14.1 Timers

The timer T3-RESPONSE holds the maximum wait time for a response of a request message.

The timer T3-TUNNEL holds the time when PDUs shall be forwarded from the old SGSN to the new SGSN. The timer is started in the old SGSN when it receives a GTP SGSN Context Request message and there is at least one active PDP context. GTP shall indicate to the upper layer when the timer has expired. The recommended timer value is 20 s.

14.2 Others

The counter N3-REQUESTS holds the maximum number of attempts made by GTP to send a request message. The recommended value is 5.

15 Mapping of BSSGP and RANAP causes

Table 15.1 through Table 15.4 define a mapping of BSSGP and RANAP causes used in connection with inter-RAT PS Handover to avoid different mappings in different implementations.

Inter-RAT PS Handover from GERAN to UTRAN:

Table 15.1: Cause value mapping from PS HANDOVER REQUIRED to RELOCATION REQUEST

| 48.018 | 25.413 |
|-------------------------|--|
| PS HANDOVER REQUIRED | RELOCATION REQUEST |
| Uplink quality | Time Critical Relocation |
| Uplink strength | Time Critical Relocation |
| Downlink quality | Time Critical Relocation |
| Downlink strength | Time Critical Relocation |
| Distance | Time Critical Relocation |
| Better cell | Relocation Desirable for Radio Reasons |
| Traffic | Resource Optimisation Relocation |
| Cell traffic congestion | Reduce Load in Serving Cell |
| Any other value | Relocation Desirable for Radio Reasons |

Table 15.2: Cause value mapping from RELOCATION FAILURE to PS HANDOVER NACK

| 25.413 | 48.018 |
|--|--|
| RELOCATION FAILURE | PS HANDOVER REQUIRED NACK |
| No Radio Resources Available in Target Cell | Cell traffic congestion |
| Requested Ciphering and/or Integrity Protection algorithms not supported | Requested ciphering and/or integrity protection algorithms not supported |
| Incoming Relocation Not Supported Due To | Incoming relocation not supported due to |

| | |
|--|-------------------------------------|
| PUESBINE Feature | PUESBINE feature |
| Traffic Load In The Target Cell Higher Than In The Source Cell | Cell traffic congestion |
| O&M Intervention | O&M intervention |
| Any other value | Relocation failure in target system |

Inter-RAT PS Handover from UTRAN to GERAN:**Table 15.3: Cause value mapping from RELOCATION REQUIRED to PS HANDOVER REQUEST**

| 25.413 | 48.018 |
|--|--------------------------|
| RELOCATION REQUIRED | PS HANDOVER REQUEST |
| Time Critical Relocation | Time critical relocation |
| Resource Optimisation Relocation | Traffic |
| Relocation Desirable for Radio Reasons | Better cell |
| Directed Retry | Directed Retry |
| Reduce load in Serving Cell | Cell traffic congestion |
| Any other value | Better cell |

Table 15.4: Cause value mapping from PS HANDOVER NACK to RELOCATION PREPARATION FAILURE

| 48.018 | 25.413 |
|--------------------------|--|
| PS HANDOVER REQUEST NACK | RELOCATION PREPARATION FAILURE |
| PFC create failure | Relocation Failure in Target CN/RNC or Target System |
| Cell traffic congestion | No Radio Resources Available in Target Cell |
| Equipment failure | Relocation Failure in Target CN/RNC or Target System |
| O&M intervention | O&M Intervention |
| Any other value | Relocation Failure in Target CN/RNC or Target System |

Annex A (informative): A method for sequence number checking

This annex describes a method to determine whether or not a received T-PDU is valid, for the Usage of the Sequence Number, subclause 9.3.1.1.

This method deals with two distinct problems.

The first one is the "drifting" between the Sequence Number value that we expect to receive in the light of the total number of T-PDU received for this tunnel (the Expected value), and the effective received value. The probability that the received T-PDU is not correct because not awaited is higher if the distance between expected and received Sequence Numbers is high than if this distance is low. This leads to Condition 1. Its left part represents the distance between the Expected and received values, in a circular 65536 dimension.

The second one is the duplication of T-PDU frames within a given number of last received frames that have been accepted by the condition 1.

This leads to the following actions:

- This operation shall start when the dialogue is established between the GSNs. When each T-PDU is received during the dialogue, if this T-PDU is valid, its Sequence Number shall be saved. The last "A" saved Sequence Numbers represent the "Recorded Sequence Number Set".

A received T-PDU sequence number is valid only if it satisfies both of the following conditions:

- 1) $\text{Min}(\text{Abs}(E - r), \text{Abs}(r - 65536 - E), \text{Abs}(E - 65536 - r)) < "B"$ Condition 1
Where: "E" is the Expected Sequence Number and "r" is the received Sequence Number.
- 2) The received Sequence Number is not a member of the Recorded Sequence Number Set. Condition 2.

"A" and "B" are parameters. The receiving GSN shall discard a received T-PDU with an invalid Sequence Number.

$\text{Abs}(X)$ represents the absolute value of the number X.

$\text{Min}(X, Y, Z)$ represents the lowest value taken from the numbers X, Y, and Z.

Annex B (informative): Change history

| Change history | | | | | | |
|----------------|-----------|---------|-------|---------|-------------|---|
| TSG CN# | Spec | Version | CR | <Phase> | New Version | Subject/Comment |
| Apr 1999 | GSM 09.60 | 7.0.0 | | | | Transferred to 3GPP CN1 |
| CN#03 | 29.060 | | | R99 | 3.0.0 | Approved at CN#03 |
| | | | 001 | R99 | | Replacing the V(R) transfer mechanism with the N-PDU number transfer mechanism in routing area update |
| CN#4 | 29.060 | 3.0.0 | 002 | R99 | 3.1.0 | Clarification of ambiguous/superfluous information |
| | | | 003 | R99 | | Timer handling in GTP |
| | | | 005 | R99 | | Mandatory SGSN Context Acknowledge message |
| | | | 006 | R99 | | Mandatory info in MM Context IE |
| | | | 007 | R99 | | APN to be transferred in the PDP context at inter SGSN RA update |
| | | | 008 | R99 | | Consistency on implemented CRs from SMG#28 |
| | | | 009 | R99 | | Removal of changes in PDP context establishment and restoration |
| | | | 010 | R99 | | MSISDN in the Create PDP Context request |
| CN#05 | 29.060 | 3.1.0 | 014r2 | R99 | 3.2.0 | Specification of the MSISDN Information Element in GSM 09.60 |
| CN#06 | 29.060 | 3.2.1 | 017r4 | R99 | 3.3.0 | QoS enhancements |
| CN#06 | 29.060 | 3.2.1 | 031 | R99 | 3.3.0 | Merged CRs on GTP Enhancements |
| CN#07 | 29.060 | 3.3.0 | 033r2 | R99 | 3.4.0 | Addition of Radio Priority to the SGSN Context Response |
| CN#07 | 29.060 | 3.3.0 | 035r2 | R99 | 3.4.0 | Addition of Packet Flow Id to the SGSN Context Response |
| CN#07 | 29.060 | 3.3.0 | 036r1 | R99 | 3.4.0 | Change the attribution of the PDP Context IE |
| CN#07 | 29.060 | 3.3.0 | 037 | R99 | 3.4.0 | Add new cause value |
| CN#07 | 29.060 | 3.3.0 | 038 | R99 | 3.4.0 | Addition of NSAPI to GGSN-initiated Update PDP Context |
| CN#07 | 29.060 | 3.3.0 | 040 | R99 | 3.4.0 | Improving charging efficiency |
| CN#07 | 29.060 | 3.3.0 | 041r1 | R99 | 3.4.0 | Subscriber and equipment trace for PS domain |
| CN#07 | 29.060 | 3.3.0 | 042 | R99 | 3.4.0 | Necessity of the function of the calculation an SGSN IP address from the target ID |
| CN#07 | 29.060 | 3.3.0 | 045r1 | R99 | 3.4.0 | Removal of Anonymous Access |
| CN#07 | 29.060 | 3.3.0 | 046r1 | R99 | 3.4.0 | Clarification of Authentication Type and Import of Parameters |
| CN#07 | 29.060 | 3.3.0 | 048 | R99 | 3.4.0 | Correction of IE types and order |
| CN#07 | 29.060 | 3.3.0 | 050r2 | R99 | 3.4.0 | Clarification on Protocol Type in GTP Header |
| CN#07 | 29.060 | 3.3.0 | 051 | R99 | 3.4.0 | Clarification of Repeated Information Element Ordering |
| CN#07 | 29.060 | 3.3.0 | 052r2 | R99 | 3.4.0 | Method for GTP extension headers support |
| CN#07 | 29.060 | 3.3.0 | 053r2 | R99 | 3.4.0 | The addition of the conditional description of the GTP parameters |
| CN#07 | 29.060 | 3.3.0 | 056 | R99 | 3.4.0 | Change of naming when referring to primary and secondary contexts |
| CN#07 | 29.060 | 3.3.0 | 057 | R99 | 3.4.0 | Removal of X.25 |
| CN#07 | 29.060 | 3.3.0 | 058r1 | R99 | 3.4.0 | Use of 3 Digit MNCs in GTP for R'99 |
| CN#07 | 29.060 | 3.3.0 | 063r2 | R99 | 3.4.0 | QoS Profile IE modification |
| CN#07 | 29.060 | 3.3.0 | 067r1 | R99 | 3.4.0 | Distribution of security data |
| CN#07 | 29.060 | 3.3.0 | 069r1 | R99 | 3.4.0 | New cause codes for TFT and packet filter errors |
| CN#07 | 29.060 | 3.3.0 | 070 | R99 | 3.4.0 | IPv6 support as optional in lu and Gn |
| CN#07 | 29.060 | 3.3.0 | 072r4 | R99 | 3.4.0 | Clarification on the use of TEID in the GTP header |
| CN#07 | 29.060 | 3.3.0 | 073 | R99 | 3.4.0 | Clarification to the function of the calculation of an SGSN IP address from the target ID |
| CN#07 | 29.060 | 3.3.0 | 075 | R99 | 3.4.0 | Changing references from GSM specifications to 3GPP TS |
| CN#07 | 29.060 | 3.3.0 | 076 | R99 | 3.4.0 | New table for Information Elements |
| CN#07 | 29.060 | 3.3.0 | 077 | R99 | 3.4.0 | Forward SRSN Context |
| CN#07 | 29.060 | 3.3.0 | 078r1 | R99 | 3.4.0 | PDCP sequence numbers in SRNC relocation and inter-system handover |
| CN#07 | 29.060 | 3.3.0 | 079 | R99 | 3.4.0 | Removal of TCP support in the packet domain PLMN backbone network |
| CN#07 | 29.060 | 3.3.0 | 081 | R99 | 3.4.0 | Addition of PDP Context Identifier to PDP Context Information Element |

| Change history | | | | | | |
|----------------|--------|---------|-------|---------|-------------|---|
| TSG CN# | Spec | Version | CR | <Phase> | New Version | Subject/Comment |
| CN#07 | 29.060 | 3.3.0 | 083 | R99 | 3.4.0 | Editorial clarification of information elements in the SGSN Context Response |
| CN#08 | 29.060 | 3.4.0 | 084 | R99 | 3.5.0 | 16-bit PDCP sequence numbers in GTP header |
| CN#08 | 29.060 | 3.4.0 | 085 | R99 | 3.5.0 | Mandatory inclusion of IMSI in SGSN Context Response if P-TMSI Signature Mismatch |
| CN#08 | 29.060 | 3.4.0 | 086r1 | R99 | 3.5.0 | Encoding of spare IMSI Digits |
| CN#08 | 29.060 | 3.4.0 | 087r1 | R99 | 3.5.0 | Reliable delivery of signalling messages |
| CN#08 | 29.060 | 3.4.0 | 088 | R99 | 3.5.0 | Possible cause codes for Relocation Cancel Response |
| CN#08 | 29.060 | 3,4,0 | 089 | R99 | 3.5.0 | Condition for evaluating the sequence number fields in PDP context |
| CN#08 | 29.060 | 3.4.0 | 090r1 | R99 | 3.5.0 | Target RNC Information |
| CN#08 | 29.060 | 3.4.0 | 091r1 | R99 | 3.5.0 | Change of the length of TI |
| CN#08 | 29.060 | 3.4.0 | 092r1 | R99 | 3.5.0 | Clean up for 29.060 |
| CN#08 | 29.060 | 3.4.0 | 093r2 | R99 | 3.5.0 | Clarification on the TEID handling |
| CN#08 | 29.060 | 3.4.0 | 094r1 | R99 | 3.5.0 | QoS Profile IE modification |
| CN#08 | 29.060 | 3.4.0 | 096 | R99 | 3.5.0 | Restart counter in Echo response |
| CN#08 | 29.060 | 3.4.0 | 097r1 | R99 | 3.5.0 | Clarification on the use of TEID in the GTP-C header |
| CN#08 | 29.060 | 3.4.0 | 098 | R99 | 3.5.0 | Add APN IE for PDU Notification Reject Request message |
| CN#08 | 29.060 | 3.4.0 | 099r1 | R99 | 3.5.0 | Addition of response code Delete PDP Context Response |
| CN#08 | 29.060 | 3.4.0 | 100r1 | R99 | 3.5.0 | Introduction of a different port number for GTP-C and GTP-U |
| CN#08 | 29.060 | 3.4.0 | 101r1 | R99 | 3.5.0 | Addition of charging characteristics per PDP context |
| CN#08 | 29.060 | 3.4.0 | 102 | R99 | 3.5.0 | Alignment of text with tables |
| CN#08 | 29.060 | 3.4.0 | 106 | R99 | 3.5.0 | Removal of Connection oriented paths |
| CN#08 | 29.060 | 3.4.0 | 108 | R99 | 3.5.0 | On the use of the Sequence number in GTP-C |
| CN#08 | 29.060 | 3.4.0 | 109 | R99 | 3.5.0 | N-PDU number in GTP-C |
| CN#08 | 29.060 | 3.4.0 | 110r1 | R99 | 3.5.0 | Editorial modifications due to the upgrade from GTPv0 to GTPv1 for R'99 |
| CN#08 | 29.060 | 3.4.0 | 111r1 | R99 | 3.5.0 | Editorial modifications concerning GTP-U and GTP-C |
| CN#08 | 29.060 | 3.4.0 | 112 | R99 | 3.5.0 | Introducing Supported Extension Headers Notification to GTP-U |
| CN#08 | 29.060 | 3.4.0 | 113 | R99 | 3.5.0 | Missing IEs in Error Indication |
| CN#08 | 29.060 | 3.4.0 | 114 | R99 | 3.5.0 | Clarification of the Cause of Create PDP Context Response |
| CN#08 | 29.060 | 3.4.0 | 115 | R99 | 3.5.0 | Clarification of the TEID for Signalling |
| CN#08 | 29.060 | 3.4.0 | 116 | R99 | 3.5.0 | Clarification on the TEID for Signalling of the PDU Notification Reject Request |
| CN#08 | 29.060 | 3.4.0 | 117r2 | R99 | 3.5.0 | Clarification of the conditional information elements |
| CN#08 | 29.060 | 3.4.0 | 119 | R99 | 3.5.0 | Clarification on the use of SGSN address at PDU notification procedure (R99) |
| CN#09 | 29.060 | 3.5.0 | 105r1 | R99 | 3.6.0 | Race Conditions Avoidance |
| CN#09 | 29.060 | 3.5.0 | 121 | R99 | 3.6.0 | Definition of TEID value in GTP-U header |
| CN#09 | 29.060 | 3.5.0 | 122r3 | R99 | 3.6.0 | Solution for race condition of GTP procedures |
| CN#09 | 29.060 | 3.5.0 | 123r1 | R99 | 3.6.0 | Clarifications concerning the use of TEID in the Control Plane |
| CN#09 | 29.060 | 3.5.0 | 124r1 | R99 | 3.6.0 | Editorial modifications concerning TEID Control Plane and TEID Data |
| CN#09 | 29.060 | 3.5.0 | 126r2 | R99 | 3.6.0 | Sequence number in signalling messages |
| CN#09 | 29.060 | 3.5.0 | 127 | R99 | 3.6.0 | Clarification of the conditional information elements |
| CN#09 | 29.060 | 3.5.0 | 128r1 | R99 | 3.6.0 | Enhancement of MS Network capability and GPRS Ciphering Algorithm |
| CN#09 | 29.060 | 3.5.0 | 129 | R99 | 3.6.0 | IPv6 support for Charging Gateway Address |
| CN#09 | 29.060 | 3.5.0 | 130 | R99 | 3.6.0 | Signalling messages in GTP |
| CN#09 | 29.060 | 3.5.0 | 131r1 | R99 | 3.6.0 | Security parameter transport in case of 2G-3G interworking |
| CN#09 | 29.060 | 3.5.0 | 132r1 | R99 | 3.6.0 | Encoding of IMSI |
| CN#09 | 29.060 | 3.5.0 | 133 | R99 | 3.6.0 | Removal of IHOSS from GTP |
| CN#09 | 29.060 | 3.5.0 | 135 | R99 | 3.6.0 | Addition of MS Not Reachable Reason to Send Routing Information For GPRS Response |
| CN#09 | 29.060 | 3.5.0 | 138r1 | R99 | 3.6.0 | Coding of TI in PDP Context |
| CN#09 | 29.060 | 3.5.0 | 139r1 | R99 | 3.6.0 | Clarifications on the use of TEID in the Control Plane |

| Change history | | | | | | |
|----------------|--------|---------|-------|---------|-------------|---|
| TSG CN# | Spec | Version | CR | <Phase> | New Version | Subject/Comment |
| CN#09 | 29.060 | 3.5.0 | 140 | R99 | 3.6.0 | Correction on the handling of the PDP Context at unsuccessful PDP Context modification |
| CN#09 | 29.060 | 3.5.0 | 141r2 | R99 | 3.6.0 | Categorize Error indication as the GTP-U message |
| CN#09 | 29.060 | 3.5.0 | 142 | R99 | 3.6.0 | Clarifications on the presence condition of TLLI/P-TMSI in SGSN Context request |
| CN#09 | 29.060 | 3.5.0 | 143r2 | R99 | 3.6.0 | Correction on Reliable transmission of signalling messages |
| CN#09 | 29.060 | 3.5.0 | 144 | R99 | 3.6.0 | Alignment of the description of tables for Identification Request and SGSN Context Request |
| CN#09 | 29.060 | 3.5.0 | 145r1 | R99 | 3.6.0 | Correction to the SGSN Context transfer Request and response messages |
| CN#09 | 29.060 | 3.5.0 | 146r2 | R99 | 3.6.0 | Correction to the SGSN Forward relocation Request and Response messages |
| CN#09 | 29.060 | 3.5.0 | 147 | R99 | 3.6.0 | Clarification on the handling of response messages |
| CN#09 | 29.060 | 3.5.0 | 148 | R99 | 3.6.0 | Clarification on SGSN context acknowledge message |
| CN#10 | 29.060 | 3.6.0 | 136r2 | R99 | 3.7.0 | Compatibility GTPv0/GTPv1 in case of SGSN change |
| CN#10 | 29.060 | 3.6.0 | 149 | R99 | 3.7.0 | Clarification on the use of Teardown Indicator |
| CN#10 | 29.060 | 3.6.0 | 150 | R99 | 3.7.0 | Correction to the PDU Notification Request message |
| CN#10 | 29.060 | 3.6.0 | 151r1 | R99 | 3.7.0 | Correction of wrong entry in information table |
| CN#10 | 29.060 | 3.6.0 | 152 | R99 | 3.7.0 | Moving of Annex A to 3GPP TS 23.003 |
| CN#10 | 29.060 | 3.6.0 | 153r2 | R99 | 3.7.0 | Selecting GGSN IP address |
| CN#10 | 29.060 | 3.6.0 | 154r1 | R99 | 3.7.0 | Removal of "Version not Supported" for GTP-U |
| CN#10 | 29.060 | 3.6.0 | 157 | R99 | 3.7.0 | Correction of Security parameters length |
| CN#10 | 29.060 | 3.6.0 | 159 | R99 | 3.7.0 | MS Network Capability in MM Context |
| CN#10 | 29.060 | 3.6.0 | 161 | R99 | 3.7.0 | Clarifications to the usage of CKSN and KSI for security type 0 |
| CN#11 | 29.060 | 3.7.0 | 155r4 | R99 | 3.8.0 | Adding Uplink TEID Data I and user plane GGSN address to PDP Context IE |
| CN#11 | 29.060 | 3.7.0 | 162 | R99 | 3.8.0 | Handling of sequence numbers for reliable transmission of control plane messages |
| CN#11 | 29.060 | 3.7.0 | 163 | R99 | 3.8.0 | Re-configure the IEs in the PDU Notification Request to make it in ascending order |
| CN#11 | 29.060 | 3.7.0 | 166 | R99 | 3.8.0 | Corrections to editor work of 29.060 v 3.7.0 |
| CN#11 | 29.060 | 3.7.0 | 170r2 | R99 | 3.8.0 | Clarification on the TEID value of the signalling messages |
| CN#11 | 29.060 | 3.7.0 | 173r3 | R99 | 3.8.0 | Clarifications to the GTP-U protocol |
| CN#11 | 29.060 | 3.7.0 | 174r1 | R99 | 3.8.0 | Essential Correction of the delete PDP context procedure |
| CN#11 | 29.060 | 3.7.0 | 178 | R99 | 3.8.0 | Re-configure the IEs in the Send Routing Information for GPRS Response message to make it in ascending order |
| CN#11 | 29.060 | 3.7.0 | 180r1 | R99 | 3.8.0 | IMSI Encoding Clarification |
| CN#11 | 29.060 | 3.7.0 | 181r1 | R99 | 3.8.0 | Fix an ambiguous description on the treatment for the PDP Type PPP in PDP context creation procedure |
| CN#11 | 29.060 | 3.7.0 | 182r2 | R99 | 3.8.0 | GSN address in Error Indication |
| CN#11 | 29.060 | 3.7.0 | 186r1 | R99 | 3.8.0 | Clarification of Error Indication |
| CN#11 | 29.060 | 3.7.0 | 187 | R99 | 3.8.0 | Clarification on the handling of sequence numbers in the GTP user plane |
| CN#11 | 29.060 | 3.7.0 | 188 | R99 | 3.8.0 | Clarifications and clean up of the error handling section |
| CN#11 | 29.060 | 3.7.0 | 191r1 | R99 | 3.8.0 | Clarification on the use of the term G-PDU |
| CN#11 | 29.060 | 3.8.0 | | Rel-4 | 4.0.0 | Version increased from R99 to Rel-4 after CN#11. |
| CN#12 | 29.060 | 4.0.0 | 194 | Rel-4 | 4.1.0 | Correction/Clarification of GGSN handling of Update PDP Context Response |
| CN#12 | 29.060 | 4.0.0 | 196 | Rel-4 | 4.1.0 | Correction due to incorrectly implemented CR on the Error indication message |
| CN#12 | 29.060 | 4.0.0 | 198 | Rel-4 | 4.1.0 | RNC IP Address IE format |
| CN#12 | 29.060 | 4.0.0 | 208 | Rel-4 | 4.1.0 | GTP Message Treatment |
| CN#12 | 29.060 | 4.0.0 | 220 | Rel-4 | 4.1.0 | Clarification of the handling of Version Not Supported; Supported Extension Headers and Error Indication messages |
| CN#12 | 29.060 | 4.0.0 | 221 | Rel-4 | 4.1.0 | Removal of the useless "version not supported" cause code from GTP messages |

| Change history | | | | | | |
|----------------|--------|---------|-------|---------|-------------|--|
| TSG CN# | Spec | Version | CR | <Phase> | New Version | Subject/Comment |
| CN#12 | 29.060 | 4.0.0 | 222 | Rel-4 | 4.1.0 | Ambiguous text description of the Charging Gateway Address IE handling in the GTP create PDP context request message |
| CN#12 | 29.060 | 4.0.0 | 227 | Rel-4 | 4.1.0 | Alignment of the 29.060 with the 23.060 for the SRNS Relocation procedure |
| CN#13 | 29.060 | 4.1.0 | | Rel-4 | 4.2.0 | Editorial clean up |
| CN#13 | 29.060 | 4.1.0 | 230r1 | Rel-4 | 4.2.0 | Introduction of the Suspend-resume functionality in Rel-4 GTP specification |
| CN#13 | 29.060 | 4.1.0 | 236 | Rel-4 | 4.2.0 | Clarification of the term TLLI in SGSN Context Request |
| CN#13 | 29.060 | 4.1.0 | 238r1 | Rel-4 | 4.2.0 | Rewording usage of P-TIMSI and TLLI in "SGSN context request" |
| CN#13 | 29.060 | 4.1.0 | 240 | Rel-4 | 4.2.0 | Alignment with 23.060 on the use of SGSN Context Acknowledge message |
| CN#13 | 29.060 | 4.1.0 | 245r1 | Rel-4 | 4.2.0 | Charging Characteristics Inclusion in Create PDP Context Message |
| CN#13 | 29.060 | 4.1.0 | 247 | Rel-4 | 4.2.0 | Clarification to the usage of the TEID-C |
| CN#13 | 29.060 | 4.1.0 | 248r1 | Rel-4 | 4.2.0 | Clarification on the use of the teardown indicator IE |
| CN#14 | 29.060 | 4.2.0 | 255 | Rel-4 | 4.3.0 | Add APN.OI sub-field to the APN in PDP context IE |
| CN#14 | 29.060 | 4.2.0 | 264 | Rel-4 | 4.3.0 | Clarification of header marker setting for Error Indication |
| CN#14 | 29.060 | 4.2.0 | 268r1 | Rel-4 | 4.3.0 | GGSN address for control plane must not be changed in "Update PDP Context Response" |
| CN#14 | 29.060 | 4.2.0 | 273 | Rel-4 | 4.3.0 | Clarification on the handling of the GTP MM Context IE |
| CN#14 | 29.060 | 4.2.0 | 274 | Rel-4 | 4.3.0 | Clarification on the GTP PDP context IE |
| CN#14 | 29.060 | 4.2.0 | 283 | Rel-4 | 4.3.0 | Clarification on the handling of protocol configuration options IE |
| CN#14 | 29.060 | 4.3.0 | 259r1 | Rel-5 | 5.0.0 | Relay of Identification Request message and SGSN Context Request message |
| CN#14 | 29.060 | 4.3.0 | 272 | Rel-5 | 5.0.0 | Support for Radio Priority LCS |
| CN#14 | 29.060 | 4.3.0 | 282 | Rel-5 | 5.0.0 | Clarification on IMSI format (Unused fields) |
| Jan 2002 | 29.060 | 5.0.0 | | Rel-5 | 5.0.1 | A coversheet fixed |
| CN#15 | 29.060 | 5.0.1 | 291r1 | Rel-5 | 5.1.0 | Clarification on the use of the Teardown indicator IE |
| CN#15 | 29.060 | 5.0.1 | 294r1 | Rel-5 | 5.1.0 | Dangling PDP contexts handling |
| CN#15 | 29.060 | 5.0.1 | 297r1 | Rel-5 | 5.1.0 | Re-define the attributions of GTP Information Element |
| CN#15 | 29.060 | 5.0.1 | 299r1 | Rel-5 | 5.1.0 | Clarification on PDP address field and end user address information element in create PDP context response |
| CN#15 | 29.060 | 5.0.1 | 300r3 | Rel-5 | 5.1.0 | Generic RAN Information Procedure |
| CN#15 | 29.060 | 5.0.1 | 301 | Rel-5 | 5.1.0 | Priority of PDP Contexts at Inter-SGSN RA Update |
| CN#15 | 29.060 | 5.0.1 | 309r1 | Rel-5 | 5.1.0 | IMS Enhancements (PCO in Secondary PDP context activation procedures) |
| CN#16 | 29.060 | 5.1.0 | 311 | Rel-5 | 5.2.0 | Clarification on create PDP context for existing PDP context |
| CN#16 | 29.060 | 5.1.0 | 318 | Rel-5 | 5.2.0 | Support of IPv4 and IPv6 node addresses in Core Network |
| CN#16 | 29.060 | 5.1.0 | 319r2 | Rel-5 | 5.2.0 | Reference to 3GPP TS 33.210 for protection of GTP. |
| CN#17 | 29.060 | 5.2.0 | 322r1 | Rel-5 | 5.3.0 | Clarification re. response message |
| CN#17 | 29.060 | 5.2.0 | 323r2 | Rel-5 | 5.3.0 | Clarification re. Version Not Supported message |
| CN#17 | 29.060 | 5.2.0 | 324r1 | Rel-5 | 5.3.0 | Incorrect references |
| CN#17 | 29.060 | 5.2.0 | 325r2 | Rel-5 | 5.3.0 | RAB Setup Information for IPv6 |
| CN#17 | 29.060 | 5.2.0 | 328r2 | Rel-5 | 5.3.0 | Clarification on the coding of RANAP cause value |
| CN#17 | 29.060 | 5.2.0 | 329r1 | Rel-5 | 5.3.0 | Addition of PCO IE to Update PDP context procedures |
| CN#17 | 29.060 | 5.2.0 | 332r1 | Rel-5 | 5.3.0 | Setting PDP ID after inter-SGSN RAU using GTPv0 |
| CN#17 | 29.060 | 5.2.0 | 336 | Rel-5 | 5.3.0 | Removing inconsistency in definition of PDP Address length |
| CN#17 | 29.060 | 5.2.0 | 339 | Rel-5 | 5.3.0 | 16 bit PDCP sequence numbers in RAB Context |
| CN#17 | 29.060 | 5.2.0 | 342r1 | Rel-5 | 5.3.0 | Forward Relocation Response without "RAB Setup Information" IE |
| CN#17 | 29.060 | 5.2.0 | 347 | Rel-5 | 5.3.0 | No equivalent Cause Code in GTP to "PDP context without TFT already activated" |
| CN#18 | 29.060 | 5.3.0 | 333r1 | Rel-5 | 5.4.0 | Support of mandatory IPv6 on the lu interface |

| Change history | | | | | | |
|----------------|--------|---------|-------|---------|-------------|---|
| TSG CN# | Spec | Version | CR | <Phase> | New Version | Subject/Comment |
| CN#18 | 29.060 | 5.3.0 | 348r4 | Rel-5 | 5.4.0 | Introduction of PCO IE in session management messages used in the MS Initiated PDP Context Deactivation procedure (direction MS to NW) |
| CN#18 | 29.060 | 5.3.0 | 350r1 | Rel-5 | 5.4.0 | Clarification on the inclusion of TEID II in SGSN Context Ack |
| CN#18 | 29.060 | 5.3.0 | 354r1 | Rel-5 | 5.4.0 | Removal of limitation in the Create PDP Context Request message |
| CN#18 | 29.060 | 5.3.0 | 355 | Rel-5 | 5.4.0 | Introduction of PCO IE in session management messages used in the Network-Requested PDP Context Activation Procedure (direction NW to MS) |
| CN#18 | 29.060 | 5.3.0 | 356r1 | Rel-5 | 5.4.0 | Introduction of PCO IE in session management messages used in the GGSN-Initiated PDP Context Modification procedure (direction NW to MS) |
| CN#18 | 29.060 | 5.3.0 | 357r1 | Rel-5 | 5.4.0 | Introduction of PCO IE in session management messages used in the GGSN-Initiated PDP Context Deactivation Procedure (direction NW to MS) |
| CN#18 | 29.060 | 5.3.0 | 360r1 | Rel-5 | 5.4.0 | PDCP sequence numbers in SGSN Context Response |
| CN#18 | 29.060 | 5.3.0 | 362r3 | Rel-5 | 5.4.0 | Clarification of the placement of the fields in the PDP Context IE |
| CN#18 | 29.060 | 5.3.0 | 363r4 | Rel-5 | 5.4.0 | Enabling control of content served to subscribers based on their location |
| CN#18 | 29.060 | 5.3.0 | 373r2 | Rel-5 | 5.4.0 | Clarification on IP fragmentation over Lu interface |
| CN#18 | 29.060 | 5.3.0 | 375r2 | Rel-5 | 5.4.0 | Transfer of Charging characteristics in case of inter SGSN change |
| CN#18 | 29.060 | 5.3.0 | 382r1 | Rel-5 | 5.4.0 | Clarification on presence of optional fields in GTP header |
| CN#19 | 29.060 | 5.4.0 | 386r1 | Rel-5 | 5.5.0 | Reinstatement of cause code version not supported |
| CN#19 | 29.060 | 5.4.0 | 387 | Rel-5 | 5.5.0 | Correction on the handling of PCO |
| CN#19 | 29.060 | 5.4.0 | 388 | Rel-5 | 5.5.0 | Removal of the N3-BUFFER-SIZE parameter |
| CN#19 | 29.060 | 5.4.0 | 389 | Rel-5 | 5.5.0 | Correction of presence requirement for the PCO IE |
| CN#19 | 29.060 | 5.4.0 | 395r3 | Rel-5 | 5.5.0 | TEID for GTP-C messages related to unknown PDP Contexts |
| CN#19 | 29.060 | 5.4.0 | 399 | Rel-5 | 5.5.0 | Correction of GTP' references |
| CN#19 | 29.060 | 5.4.0 | 402r2 | Rel-5 | 5.5.0 | IPv4 and IPv6 form of Charging Gateway Address |
| CN#19 | 29.060 | 5.5.0 | 390r1 | Rel-6 | 6.0.0 | Introduction of SGSN Number in SGSN Context Request message |
| CN#19 | 29.060 | 5.5.0 | 403 | Rel-6 | 6.0.0 | Introduction of SGSN Number in the Forward Relocation Response message |
| CN#20 | 29.060 | 6.0.0 | 408r1 | Rel-6 | 6.1.0 | Correction for PDP Context Response with no PDP Contexts |
| CN#20 | 29.060 | 6.0.0 | 410 | Rel-6 | 6.1.0 | Controlling compression performed on the SGSN |
| CN#20 | 29.060 | 6.0.0 | 412r1 | Rel-6 | 6.1.0 | Enhancement of description for error codes for Create PDP Context response message |
| CN#20 | 29.060 | 6.0.0 | 420r2 | Rel-6 | 6.1.0 | Definition of reserved TEID value |
| CN#20 | 29.060 | 6.0.0 | 422 | Rel-6 | 6.1.0 | QoS Profile Data parameter in the Quality of Service (Data) Profile IE extended with one octet |
| CN#20 | 29.060 | 6.0.0 | 424 | Rel-6 | 6.1.0 | IMEISV to be included in the Container within the MM Context |
| CN#21 | 29.060 | 6.1.0 | 434 | Rel-6 | 6.2.0 | Correction of incorrect reference to a withdrawn specification |
| CN#21 | 29.060 | 6.1.0 | 436r1 | Rel-6 | 6.2.0 | Removal of End User Address from Create Subsequent PDP Context Response |
| CN#21 | 29.060 | 6.1.0 | 448r2 | Rel-6 | 6.2.0 | Correction/Clarification of GTP Cause Value |
| CN#21 | 29.060 | 6.1.0 | 453r2 | Rel-6 | 6.2.0 | Correction/Clarification of SGSN handling of Update PDP Context Response |
| CN#21 | 29.060 | 6.1.0 | 455 | Rel-6 | 6.2.0 | Change of Early UE feature to PUESBINE |
| CN#22 | 29.060 | 6.2.0 | 457 | Rel-6 | 6.3.0 | Removal of RAB Context IE in Forward Relocation Request |
| CN#22 | 29.060 | 6.2.0 | 461 | Rel-6 | 6.3.0 | Correction of Sequence Number Up handling |
| CN#22 | 29.060 | 6.2.0 | 477 | Rel-6 | 6.3.0 | Correction of incorrect reference to a withdrawn specification |
| CN#22 | 29.060 | 6.2.0 | 463r3 | Rel-6 | 6.3.0 | HSDPA impacts to GTP |
| CN#22 | 29.060 | 6.2.0 | 469r2 | Rel-6 | 6.3.0 | Introducing MBMS |
| CN#23 | 29.060 | 6.3.0 | 431r3 | Rel-6 | 6.4.0 | Enhancement of Recovery IE to reduce number of dangling PDP Contexts |

| Change history | | | | | | |
|----------------|--------|---------|-------|---------|-------------|--|
| TSG CN# | Spec | Version | CR | <Phase> | New Version | Subject/Comment |
| CN#23 | 29.060 | 6.3.0 | 465r3 | Rel-6 | 6.4.0 | Controlling the creation of multiple, concurrent PDP Contexts |
| CN#23 | 29.060 | 6.3.0 | 480r1 | Rel-6 | 6.4.0 | Introduction of the MBMS Support Indication extension header |
| CN#23 | 29.060 | 6.3.0 | 481r2 | Rel-6 | 6.4.0 | Clarification in the definition of the QoS Profile IE encoding |
| CN#23 | 29.060 | 6.3.0 | 482r1 | Rel-6 | 6.4.0 | PDCP and GTP-U sequence numbers received in the PDP Context information element inside SGSN Context Response message |
| CN#23 | 29.060 | 6.3.0 | 483 | Rel-6 | 6.4.0 | Corrections to the Common Flags IE |
| CN#23 | 29.060 | 6.3.0 | 484 | Rel-6 | 6.4.0 | Change to the definition of GTP Tunnel for MBMS |
| CN#23 | 29.060 | 6.3.0 | 485 | Rel-6 | 6.4.0 | Removal of the GGSN address for Control Plane in the Delete MBMS Context Request |
| CN#24 | 29.060 | 6.4.0 | 478r4 | Rel-6 | 6.5.0 | Provision of S-CDR information to the GGSN |
| CN#24 | 29.060 | 6.4.0 | 486r2 | Rel-6 | 6.5.0 | Support of Inter-SGSN RA update for MBMS |
| CN#24 | 29.060 | 6.4.0 | 488r2 | Rel-6 | 6.5.0 | Automatic Device Detection (ADD) support in Inter-SGSN Routing Area Update procedures |
| CN#24 | 29.060 | 6.4.0 | 493 | Rel-6 | 6.5.0 | Change the attribution of Radio Priority LCS from TV to TLV |
| CN#24 | 29.060 | 6.4.0 | 495r1 | Rel-6 | 6.5.0 | Addition of BM-SC initiated De-registration |
| CN#24 | 29.060 | 6.4.0 | 496r1 | Rel-6 | 6.5.0 | Addition of TMGI |
| CN#24 | 29.060 | 6.4.0 | 497 | Rel-6 | 6.5.0 | Another Cause for MBMS Notification Reject Request |
| CN#24 | 29.060 | 6.4.0 | 498r1 | Rel-6 | 6.5.0 | Clarification of the Target Identification IE |
| CN#25 | 29.060 | 6.5.0 | 501 | Rel-6 | 6.6.0 | Alignment and enhancement of the "RAT Type" IE |
| CN#25 | 29.060 | 6.5.0 | 502 | Rel-6 | 6.6.0 | Corrections to charging information IEs |
| CN#25 | 29.060 | 6.5.0 | 507r1 | Rel-6 | 6.6.0 | RIM transparent routing |
| CN#25 | 29.060 | 6.5.0 | 511 | Rel-6 | 6.6.0 | Handling of ciphering and integrity keys at inter-SGSN RAU |
| CN#25 | 29.060 | 6.5.0 | 505 | Rel-6 | 6.6.0 | Error Indication during an ongoing MBMS data transfer |
| CN#25 | 29.060 | 6.5.0 | 506 | Rel-6 | 6.6.0 | Addition of Recovery IE in MBMS |
| CN#25 | 29.060 | 6.5.0 | 510r2 | Rel-6 | 6.6.0 | Introduction of a transparent container field for MBMS |
| CN#25 | 29.060 | 6.5.0 | 512 | Rel-6 | 6.6.0 | SGSN Context Request and IMSI |
| CN#26 | 29.060 | 6.6.0 | 520r1 | Rel-6 | 6.7.0 | Additional support of IPv4 and IPv6 node addresses in Create PDP and MBMS context procedures |
| CN#26 | 29.060 | 6.6.0 | 513r1 | Rel-6 | 6.7.0 | Clarification on the usage of the Alternative GGSN Address |
| CN#26 | 29.060 | 6.6.0 | 514r1 | Rel-6 | 6.7.0 | Addition of IEs to MBMS Session Start Request message |
| CN#26 | 29.060 | 6.6.0 | 515r1 | Rel-6 | 6.7.0 | Introduction of MBMS support indication between SGSNs |
| CN#26 | 29.060 | 6.6.0 | 524 | Rel-6 | 6.7.0 | GTP-C tunnel for MBMS broadcast |
| CN#27 | 29.060 | 6.7.0 | 534r1 | Rel-6 | 6.8.0 | Add Source RNC PDCP context info IE in Forward SRNS Context message |
| CN#27 | 29.060 | 6.7.0 | 470r7 | Rel-6 | 6.8.0 | Additional Trace Information |
| CN#27 | 29.060 | 6.7.0 | 528r2 | Rel-6 | 6.8.0 | Clarification to error handling of IEs of type TV |
| CN#27 | 29.060 | 6.7.0 | 529r1 | Rel-6 | 6.8.0 | Introduction of Hop Counter to Identification Request and SGSN Context Request |
| CN#27 | 29.060 | 6.7.0 | 530 | Rel-6 | 6.8.0 | Update of references to charging specifications |
| CN#27 | 29.060 | 6.7.0 | 531 | Rel-6 | 6.8.0 | Providing the BM-SC with approximate UE location information at MBMS context activation |
| CN#27 | 29.060 | 6.7.0 | 535r1 | Rel-6 | 6.8.0 | Clarification of IPv4 and IPv6 node addresses in the SRNS Relocation Procedure. |
| CN#27 | 29.060 | 6.7.0 | 536r1 | Rel-6 | 6.8.0 | Support of IPv4 and IPv6 node addresses in Inter-SGSN RAU procedure |
| CN#27 | 29.060 | 6.7.0 | 537r1 | Rel-6 | 6.8.0 | Add the Common Flags IE to GGSN-Initiated Update PDP Context Request message |
| CN#27 | 29.060 | 6.7.0 | 538r1 | Rel-6 | 6.8.0 | Addition of Selected PLMN-ID for network sharing |
| CN#27 | 29.060 | 6.7.0 | 539 | Rel-6 | 6.8.0 | Correction of type values |
| CN#27 | 29.060 | 6.7.0 | 540r1 | Rel-6 | 6.8.0 | Clarification of PCO IE in Update PDP context response |
| CN#27 | 29.060 | 6.7.0 | 543r1 | Rel-6 | 6.8.0 | Management Based Trace Activation Signalling |
| CN#27 | 29.060 | 6.7.0 | 544 | Rel-6 | 6.8.0 | Addition of RIM Routing Address for GERAN |
| CN#27 | 29.060 | 6.7.0 | 546r1 | Rel-6 | 6.8.0 | Adding missing parameters to the MBMS Session Start Request message |
| CN#27 | 29.060 | 6.7.0 | 547r1 | Rel-6 | 6.8.0 | Enhanced NSAPI for MBMS |
| CN#27 | 29.060 | 6.7.0 | 549 | Rel-6 | 6.8.0 | Change of newly added IEs in Rel 6 to type TLV |

| Change history | | | | | | |
|----------------|--------|---------|--------|---------|-------------|---|
| TSG CN# | Spec | Version | CR | <Phase> | New Version | Subject/Comment |
| CN#27 | 29.060 | 6.7.0 | 550 | Rel-6 | 6.8.0 | Correction to Radio Priority LCS IE |
| CT#28 | 29.060 | 6.8.0 | 532r2 | Rel-6 | 6.9.0 | Correction to charging information for MBMS |
| CT#28 | 29.060 | 6.8.0 | 554r3 | Rel-6 | 6.9.0 | IE description to allow Signalling Activated Trace of the BM-SC |
| CT#28 | 29.060 | 6.8.0 | 555r1 | Rel-6 | 6.9.0 | Reference update following incorrectly implemented CR537 |
| CT#28 | 29.060 | 6.8.0 | 556 | Rel-6 | 6.9.0 | MBMS Session Duration |
| CT#29 | 29.060 | 6.9.0 | 558 | Rel-6 | 6.10.0 | Correction to encoding of MBMS information elements |
| CT#29 | 29.060 | 6.9.0 | 560 | Rel-6 | 6.10.0 | Correct type value of Radio Priority LCS Information Element |
| CT#29 | 29.060 | 6.9.0 | 563r2 | Rel-6 | 6.10.0 | MBMS Session Identity Repetition number |
| CT#29 | 29.060 | 6.9.0 | 564r1 | Rel-6 | 6.10.0 | Time to Data transfer |
| CT#30 | 29.060 | 6.10.0 | 0565 | Rel-6 | 6.11.0 | Inter-system Intra-SGSN change |
| CT#30 | 29.060 | 6.10.0 | 0569 | Rel-6 | 6.11.0 | MBMS Time to data transfer IE coding |
| CT#30 | 29.060 | 6.10.0 | 0568 | Rel-6 | 6.11.0 | PS handover procedure in GERAN A/Gb mode |
| CT#30 | 29.060 | 6.10.0 | 0570 | Rel-6 | 6.11.0 | New cause IE for PS Handover |
| CT#30 | 29.060 | 6.11.0 | 0566r2 | Rel-7 | 7.0.0 | Clarification of format for IMEI IE |
| CT#31 | 29.060 | 7.0.0 | 0572r1 | Rel-7 | 7.1.0 | Adding Required MBMS Bearer Capabilities IE to MBMS Registration Response |
| CT#31 | 29.060 | 7.0.0 | 0574r1 | Rel-7 | 7.1.0 | Introduction of RAT Type in SGSN Context Request message |
| CT#31 | 29.060 | 7.0.0 | 0580 | Rel-7 | 7.1.0 | SGSN Address for User-Plane Data Forwarding in Inter-RAT PS Handover |
| CT#32 | 29.060 | 7.1.0 | 0587r3 | Rel-7 | 7.2.0 | Indication of activity status for PDP Context |
| CT#32 | 29.060 | 7.1.0 | 0581r1 | Rel-7 | 7.2.0 | Misalignment between 23.060, 29.060 and 24.008 for the De-activation of a PDP Context |
| CT#32 | 29.060 | 7.1.0 | 0582r2 | Rel-7 | 7.2.0 | Clarification on usage of IEI definition in container of MMcontext |
| CT#32 | 29.060 | 7.1.0 | 0588r1 | Rel-7 | 7.2.0 | GTP Path Failure Changes |
| CT#32 | 29.060 | 7.1.0 | 0584 | Rel-7 | 7.2.0 | PS Handover List of PFCs |
| CT#32 | 29.060 | 7.1.0 | 0590r1 | Rel-7 | 7.2.0 | PS Handover corrections |
| CT#32 | 29.060 | 7.1.0 | 0600r2 | Rel-7 | 7.2.0 | Modification of parameters for Forward Relocation Request |
| CT#32 | 29.060 | 7.1.0 | 0604r1 | Rel-7 | 7.2.0 | Cell ID IE correction |
| CT#32 | 29.060 | 7.1.0 | 0607r1 | Rel-7 | 7.2.0 | Addition of RIM Routing Address Discriminator IE |
| CT#32 | 29.060 | 7.1.0 | 0609 | Rel-7 | 7.2.0 | NSAPI length correction |
| CT#33 | 29.060 | 7.2.0 | 0592r1 | Rel-7 | 7.3.0 | SGSN indication of RAB setup complete at Secondary PDP context activation |
| | | 7.2.0 | 0612r1 | | | PS HO correction |
| | | 7.2.0 | 0614r2 | | | MBMS TEID Corrections |
| | | 7.2.0 | 0616 | | | PS HO tunnelling |
| | | 7.2.0 | 0618r1 | | | RIM Routing Address Correction |
| | | 7.2.0 | 0619r1 | | | MBMS Session Update |
| | | 7.2.0 | 0621 | | | Inclusion of the MBMS Counting Information Indication to the MBMS Session Start Request message |
| CT#34 | 29.060 | 7.3.0 | 0610r3 | Rel-7 | 7.4.0 | Support for location based charging models in GPRS |
| | | | 0622r1 | | | DSCR due to low traffic |
| | | | 0624r1 | | | Amendments to MBMS Registration procedure |
| | | | 0625r2 | | | Amendments to MBMS Session Start procedure |
| | | | 0626 | | | Amendments to MBMS Session Update procedure |
| | | | 0632r2 | | | MBMS Session Repetition Number Correction |
| | | | 0635 | | | GTP Path Failure Changes to MBMS |
| | | | 0637r1 | | | Missing address in MBMS Notification Reject Request |
| | | | 0640r2 | | | Clarification on presence of Teardown indicator |
| CT#35 | 29.060 | 7.4.0 | 0627r7 | Rel-7 | 7.5.0 | Direct Tunnel Indication |
| | | | 0630r2 | | | Update PDP context without negotiation |
| | | | 0633r6 | | | Additions for support of Network-Initiated QoS |
| | | | 0641r1 | | | Addition of Cause for MBMS Session Start Response |
| | | | 0643r1 | | | Mapping between BSSGP and RANAP cause values for PS HO |
| | | | 0645r2 | | | Direct Tunnel functionality – RNC failure |
| | | | 0646r1 | | | Clarifications to IMEI(SV) coding definition |
| | | | 0649r2 | | | Correction to a wrong reference for TMGI definition |
| | | | 0651 | | | Correction to the Additional Trace Info IE |

| Change history | | | | | | |
|----------------|--|---------|--------|---------|-------------|---|
| TSG CN# | Spec | Version | CR | <Phase> | New Version | Subject/Comment |
| March 2003 | 29.060 | 7.5.0 | 0652 | | 7.5.1 | Correction of reserved bits |
| | | | | | | The Error Indication (EI) moved into 7.7.81. Tables and figures information removed. |
| CT#36 | 29.060 | 7.5.1 | 0648r2 | Rel-7 | 7.6.0 | Correction to the length of the MBMS Session Duration IE |
| | | | 0654 | | | Correction to the APN IE definition |
| | | | 0655r1 | | | Usage of Echo Request / Response for MBMS |
| | | | 0658 | | | Error Indications between RNC and GGSN in the case of Direct Tunnelling |
| | | | 0659r2 | | | NSAPI in Create PDP Context Response |
| CT#36 | 29.060 | 7.6.0 | 0656 | Rel-8 | 8.0.0 | Extendibility of TLV coded IEs |
| CT#37 | 29.060 | 8.0.0 | 0661r1 | Rel-8 | 8.1.0 | TFT in Initiate PDP Context Activation Request message |
| | | | 0671 | | | Correction to the User Location Information procedure |
| | | | 0672 | | | PDP contexts with upwards QoS negotiation |
| | | | 0673 | | | Target Identification encoding |
| | | | 0674 | | | QoS Extension |
| CT#38 | 29.060 | 8.1.0 | 0680 | Rel-8 | 8.2.0 | Direct Tunnel Correction |
| | | | 0681 | | | Specification Update of GBR and MBR due to MIMO |
| | | | 0682r1 | | | Aligning GTPv1 spec with Rel-7 RAN specs on RNC merged with NodeB feature |
| CT#39 | 29.060 | 8.2.0 | 0684 | Rel-8 | 8.3.0 | Correction of location reporting |
| CT#40 | 29.060 | 8.3.0 | 0686r1 | Rel-8 | 8.4.0 | Essential correction to the Initiate PDP Context Activation Response message |
| CT#41 | 29.060 | 8.4.0 | 0688r1 | Rel-8 | 8.5.0 | MBMS Flow Identifier |
| | | | 0690 | | | MBMS Reject |
| | | | 0692 | | | Changes due to bearer mapping for NRSPCA |
| | | | 0693r1 | | | Removing support for GTPv0 from R8 GTPv1 |
| | | | 0696r1 | | | Clarification on the format of TMGI |
| CT#42 | 29.060 | 8.5.0 | 0697r1 | Rel-8 | 8.6.0 | Reference to 29.281 as normative for User Plane |
| | | | 0699 | | | Essential correction to RAT Type handling in Update PDP Context Request message |
| CT#43 | 29.060 | 8.6.0 | 0701 | Rel-8 | 8.7.0 | Adding UE Network Capability IE to GTPv1-C |
| | | | 0702 | | | Cause Codes for NRSPCA |
| | | | 0703r2 | | | ARP correction |
| | | | 0704r1 | | | GERAN, UTRAN and E-UTRAN DRX parameter |
| CT#44 | 29.060 | 8.7.0 | 0705r2 | Rel-8 | 8.8.0 | IE Ordering in MBMS Session Start Request |
| | | | 0706r3 | | | MBMS for HSPA Evolution |
| CT#45 | 29.060 | 8.8.0 | 0709r1 | Rel-8 | 8.9.0 | Cause code to resolve race condition between UE-initiated and NW-initiated secondary PDP context activation |
| | | | 0710 | | | ARP in QoS correction |
| | | | 0714r3 | | | Clarifications to DT functionality |
| | | | 0716 | | | P-TMSI Signature for Suspend Request |
| CT#45 | 29.060 | 8.9.0 | 0711r1 | Rel-9 | 9.0.0 | Dual stack support in GTPv1 |
| CT#46 | 29.060 | 9.0.0 | 0734r2 | Rel-9 | 9.1.0 | Addition of "Reliable INTER RAT PS HANDOVER" indicator |
| | | | 0730r1 | | | Enhanced handling of RFSP index at the SGSN. GTPv1 |
| | | | 0735 | | | Essential correction to the PDP type in the End User Address IE |
| | | | 0719r2 | | | GGSN FQDN |
| | | | 0720r4 | | | Evolved ARP |
| | | | 0721r1 | | | Unauthenticated or missing IMSI for Emergency Service |
| | | | 0722 | | | MS TimeZone and ULI included in Resp messages |
| | | | 0723r4 | | | Support for CSG based charging |
| | | | 0725 | | | Updating the Error Indication subclause |
| | | | 0728 | | | PDP Context Updated for Dual Stack Support in GTPv1 |
| | | | CT#47 | | | 29.060 |
| 0741r2 | Include CSG ID and CSG Membership Indication in Gn | | | | | |
| 0739r1 | Resolving ambiguity for Target Identification IE coding | | | | | |
| 0747r1 | Corrections to the RAN Information Management procedures | | | | | |
| 0748 | BCM violation in GGSN | | | | | |

| Change history | | | | | | |
|----------------|--------|---------|--------|---------|-------------|---|
| TSG CN# | Spec | Version | CR | <Phase> | New Version | Subject/Comment |
| CT#48 | 29.060 | 9.2.0 | 0749r1 | Rel-9 | 9.3.0 | Evolved ARP in Network Initiated Secondary PDP Context Activation End Marker |
| | | | 0752r1 | | | |
| CT#49 | 29.060 | 9.3.0 | 0754r1 | Rel-9 | 9.4.0 | UE-AMBR and APN-AMBR for Gn/Gp SGSN Dual Stack IP address Co-located GGSN-PGW FQDN CSG Information Reporting Action Dual Stack IP address Essential correction to MS Info Change Notification Request MS Info Change Reporting Support Indication Critical deficiency in Gn/Gp SGSN to MME TAU procedure |
| | | | 0763r1 | | | |
| | | | 0764r1 | | | |
| | | | 0756r2 | | | |
| | | | 0760r1 | | | |
| | | | 0759r2 | | | |
| | | | 0765r3 | | | |
| 0762r2 | | | | | | |

History

| Document history | | |
|-------------------------|--------------|-------------|
| V9.1.0 | January 2010 | Publication |
| V9.2.0 | April 2010 | Publication |
| V9.3.0 | June 2010 | Publication |
| V9.4.0 | October 2010 | Publication |
| | | |