

# ETSI TS 129 163 V6.10.0 (2006-09)

---

*Technical Specification*

**Digital cellular telecommunications system (Phase 2+);  
Universal Mobile Telecommunications System (UMTS);  
Interworking between the IP Multimedia (IM) Core Network (CN)  
subsystem and Circuit Switched (CS) networks  
(3GPP TS 29.163 version 6.10.0 Release 6)**

---



---

**Reference**RTS/TSGC-0329163v6a0

---

**Keywords**GSM, UMTS

---

**ETSI**

650 Route des Lucioles  
F-06921 Sophia Antipolis Cedex - FRANCE

---

Tel.: +33 4 92 94 42 00 Fax: +33 4 93 65 47 16

Siret N° 348 623 562 00017 - NAF 742 C  
Association à but non lucratif enregistrée à la  
Sous-Préfecture de Grasse (06) N° 7803/88

---

**Important notice**

---

Individual copies of the present document can be downloaded from:

<http://www.etsi.org>

The present document may be made available in more than one electronic version or in print. In any case of existing or perceived difference in contents between such versions, the reference version is the Portable Document Format (PDF). In case of dispute, the reference shall be the printing on ETSI printers of the PDF version kept on a specific network drive within ETSI Secretariat.

Users of the present document should be aware that the document may be subject to revision or change of status. Information on the current status of this and other ETSI documents is available at

<http://portal.etsi.org/tb/status/status.asp>

If you find errors in the present document, please send your comment to one of the following services:

[http://portal.etsi.org/chaicor/ETSI\\_support.asp](http://portal.etsi.org/chaicor/ETSI_support.asp)

---

**Copyright Notification**

---

No part may be reproduced except as authorized by written permission.  
The copyright and the foregoing restriction extend to reproduction in all media.

© European Telecommunications Standards Institute 2006.  
All rights reserved.

**DECT**<sup>TM</sup>, **PLUGTESTS**<sup>TM</sup> and **UMTS**<sup>TM</sup> are Trade Marks of ETSI registered for the benefit of its Members.  
**TIPHON**<sup>TM</sup> and the **TIPHON logo** are Trade Marks currently being registered by ETSI for the benefit of its Members.  
**3GPP**<sup>TM</sup> is a Trade Mark of ETSI registered for the benefit of its Members and of the 3GPP Organizational Partners.

---

## Intellectual Property Rights

IPRs essential or potentially essential to the present document may have been declared to ETSI. The information pertaining to these essential IPRs, if any, is publicly available for **ETSI members and non-members**, and can be found in ETSI SR 000 314: *"Intellectual Property Rights (IPRs); Essential, or potentially Essential, IPRs notified to ETSI in respect of ETSI standards"*, which is available from the ETSI Secretariat. Latest updates are available on the ETSI Web server (<http://webapp.etsi.org/IPR/home.asp>).

Pursuant to the ETSI IPR Policy, no investigation, including IPR searches, has been carried out by ETSI. No guarantee can be given as to the existence of other IPRs not referenced in ETSI SR 000 314 (or the updates on the ETSI Web server) which are, or may be, or may become, essential to the present document.

---

## Foreword

This Technical Specification (TS) has been produced by ETSI 3rd Generation Partnership Project (3GPP).

The present document may refer to technical specifications or reports using their 3GPP identities, UMTS identities or GSM identities. These should be interpreted as being references to the corresponding ETSI deliverables.

The cross reference between GSM, UMTS, 3GPP and ETSI identities can be found under <http://webapp.etsi.org/key/queryform.asp>.

# Contents

Intellectual Property Rights .....	2
Foreword.....	2
Foreword.....	10
1 Scope .....	11
2 References .....	11
3 Definitions and abbreviations.....	13
3.1 Definitions .....	13
3.2 Abbreviations .....	14
4 General .....	15
4.1 General interworking overview .....	15
5 Network characteristics .....	15
5.1 Key characteristics of ISUP/BICC based CS networks .....	15
5.2 Key characteristics of IM CN subsystem .....	15
6 Interworking with CS networks .....	15
6.1 Interworking reference model .....	15
6.1.1 Interworking reference points and interfaces .....	16
6.1.2 Interworking functional entities .....	16
6.1.2.1 Signalling Gateway Function (SGW) .....	16
6.1.2.2 Media Gateway Control Function (MGCF) .....	16
6.1.2.3 IP Multimedia - Media Gateway Function (IM-MGW) .....	17
6.2 Control plane interworking model.....	17
6.3 User plane interworking model .....	17
7 Control plane interworking .....	17
7.1 General .....	17
7.2 Interworking between CS networks supporting ISUP and the IM CN subsystem .....	18
7.2.1 Services performed by network entities in the control plane .....	18
7.2.1.1 Services performed by the SS7 signalling function .....	18
7.2.1.2 Services of the SGW .....	19
7.2.1.3 Services of the MGCF.....	19
7.2.1.4 Services of the SIP signalling function .....	19
7.2.2 Signalling interactions between network entities in the control plane .....	19
7.2.2.1 Signalling between the SS7 signalling function and MGCF .....	19
7.2.2.1.1 Signalling from MGCF to SS7 signalling function .....	19
7.2.2.1.2 Signalling from SS7 signalling function to MGCF .....	19
7.2.2.1.3 Services offered by SCTP and M3UA.....	19
7.2.2.1.3.1 Services offered by SCTP.....	19
7.2.2.1.3.2 Services offered by M3UA.....	20
7.2.2.2 Signalling between the MGCF and SIP signalling function.....	20
7.2.3 SIP-ISUP protocol interworking.....	20
7.2.3.1 Incoming call interworking from SIP to ISUP at I-MGCF .....	20
7.2.3.1.1 Sending of IAM.....	20
7.2.3.1.2 Coding of the IAM .....	21
7.2.3.1.2.1 Called party number.....	21
7.2.3.1.2.2 Nature of connection indicators .....	21
7.2.3.1.2.3 Forward call indicators .....	21
7.2.3.1.2.4 Calling party's category .....	22
7.2.3.1.2.5 Transmission medium requirement.....	22
7.2.3.1.2.6 Calling party number .....	22
7.2.3.1.2.7 Generic number.....	25
7.2.3.1.2.8 User service information.....	25
7.2.3.1.2.9 Hop Counter (National option) .....	25

7.2.3.1.3	Sending of COT.....	26
7.2.3.1.4	Sending of 180 ringing.....	26
7.2.3.1.5	Sending of the 200 OK (INVITE).....	27
7.2.3.1.6	Sending of the Release message (REL).....	27
7.2.3.1.7	Coding of the REL.....	28
7.2.3.1.8	Receipt of the Release Message.....	28
7.2.3.1.9	Receipt of RSC, GRS or CGB (H/W oriented).....	29
7.2.3.1.10	Autonomous Release at I-MGCF.....	29
7.2.3.1.11	Internal through connection of the bearer path.....	30
7.2.3.2	Outgoing Call Interworking from ISUP to SIP at O-MGCF.....	30
7.2.3.2.1	Sending of INVITE.....	30
7.2.3.2.2	Coding of the INVITE.....	31
7.2.3.2.2.1	REQUEST URI Header.....	31
7.2.3.2.2.2	SDP Media Description.....	31
7.2.3.2.2.3	P-Asserted-Identity, From and Privacy header fields.....	32
7.2.3.2.2.4	Max Forwards header.....	34
7.2.3.2.3	Receipt of CONTINUITY.....	35
7.2.3.2.4	Sending of ACM and awaiting answer indication.....	35
7.2.3.2.5	Coding of the ACM.....	36
7.2.3.2.5.1	Backward call indicators.....	36
7.2.3.2.6	Sending of the Call Progress message (CPG).....	37
7.2.3.2.7	Coding of the CPG.....	37
7.2.3.2.7.1	Event information.....	37
7.2.3.2.7a	Receipt of 200 OK(INVITE).....	37
7.2.3.2.8	Sending of the Answer Message (ANM).....	37
7.2.3.2.9	Coding of the ANM.....	38
7.2.3.2.9.1	Backwards Call Indicators.....	38
7.2.3.2.10	Sending of the Connect message (CON).....	38
7.2.3.2.11	Coding of the CON.....	38
7.2.3.2.11.1	Backward call indicators.....	38
7.2.3.2.12	Receipt of Status Codes 4xx, 5xx or 6xx.....	38
7.2.3.2.13	Receipt of a BYE.....	40
7.2.3.2.14	Receipt of the Release Message.....	40
7.2.3.2.15	Receipt of RSC, GRS or CGB (H/W oriented).....	40
7.2.3.2.16	Autonomous Release at O-MGCF.....	40
7.2.3.2.17	Special handling of 580 precondition failure received in response to either an INVITE or UPDATE.....	41
7.2.3.2.17.1	580 Precondition failure response to an INVITE.....	41
7.2.3.2.17.2	580 Precondition failure response to an UPDATE within an early dialog.....	41
7.2.3.2.18	Sending of CANCEL.....	41
7.2.3.2.19	Receipt of SIP redirect (3xx) response.....	42
7.2.3.3	Timers.....	42
7.3	Interworking between CS networks supporting BICC and the IM CN subsystem.....	42
7.3.1	Services performed by network entities in the control plane.....	44
7.3.2	Signalling interactions between network entities in the control plane.....	44
7.3.2.1	Signalling between the SS7 signalling function and MGCF.....	44
7.3.2.1.1	Signalling from MGCF to SS7 signalling function.....	44
7.3.2.1.2	Signalling from SS7 signalling function to MGCF.....	44
7.3.2.1.3	Services offered by STC, SCTP and M3UA.....	44
7.3.2.1.3.1	Services offer by SCTP.....	44
7.3.2.1.3.2	Services offered by M3UA.....	44
7.3.2.1.3.3	Services offered by STC.....	44
7.3.2.2	Signalling between the MGCF and SIP signalling function.....	44
7.3.3	SIP-BICC protocol interworking.....	44
7.3.3.1	Incoming call interworking from SIP to ISUP at I-MGCF.....	44
7.3.3.1.1	Sending of IAM.....	44
7.3.3.1.2	Coding of IAM.....	45
7.3.3.1.2.1	Called party number.....	45
7.3.3.1.2.2	Nature of connection indicators.....	45
7.3.3.1.2.3	Forward call indicators.....	45
7.3.3.1.2.4	Calling party's category.....	45
7.3.3.1.2.5	Transmission medium requirement.....	45

7.3.3.1.2.6	Calling party number .....	45
7.3.3.1.2.7	Generic number.....	46
7.3.3.1.2.8	User service information.....	46
7.3.3.1.2.9	Hop counter (National option) .....	46
7.3.3.1.3	Sending of COT.....	46
7.3.3.1.4	Sending of 180 Ringing.....	46
7.3.3.1.5	Sending of the 200 OK (INVITE) .....	46
7.3.3.1.6	Sending of the Release message (REL).....	46
7.3.3.1.7	Coding of the REL.....	46
7.3.3.1.8	Receipt of the Release Message .....	46
7.3.3.1.9	Receipt of RSC, GRS or CGB (H/W oriented) .....	46
7.3.3.1.10	Internal through connection of the bearer path.....	46
7.3.3.1.11	Out of Band DTMF .....	47
7.3.3.2	Outgoing Call Interworking from BICC to SIP at O-MGCF .....	47
7.3.3.2.1	Sending of INVITE .....	47
7.3.3.2.2	Coding of the INVITE.....	47
7.3.3.2.2.1	REQUEST URI Header .....	47
7.3.3.2.2.2	SDP Media Description .....	47
7.3.3.2.2.3	P-Asserted-Identity and privacy header fields .....	47
7.3.3.2.2.4	Max Forwards header .....	47
7.3.3.2.3	Sending of UPDATE.....	48
7.3.3.2.4	Sending of ACM and Awaiting Answer indication.....	48
7.3.3.2.5	Coding of the ACM .....	48
7.3.3.2.5.1	Backward call indicators.....	48
7.3.3.2.6	Sending of the Call Progress message (CPG).....	48
7.3.3.2.7	Coding of the CPG .....	48
7.3.3.2.7.1	Event information .....	48
7.3.3.2.7a	Receipt of 200 OK (INVITE).....	48
7.3.3.2.8	Sending of the Answer Message (ANM).....	49
7.3.3.2.9	Coding of the ANM.....	49
7.3.3.2.10	Sending of the Connect message (CON).....	49
7.3.3.2.11	Coding of the CON.....	49
7.3.3.2.11.1	Backward call indicators.....	49
7.3.3.2.12	Receipt of Status Codes 4xx, 5xx or 6xx.....	49
7.3.3.2.13	Receipt of a BYE.....	49
7.3.3.2.14	Receipt of the Release Message .....	49
7.3.3.2.15	Receipt of RSC, GRS or CGB (H/W oriented) .....	49
7.3.3.2.16	Out of Band DTMF .....	49
7.3.3.2.17	Sending of CANCEL.....	49
7.3.3.2.18	Autonomous Release at O-MGCF.....	49
7.3.3.2.19	Special handling of 580 precondition failure received in response to either an INVITE or UPDATE .....	50
7.3.3.2.20	Receipt of SIP redirect (3xx) response .....	50
7.3.3.3	Timers .....	50
7.4	Supplementary services.....	50
7.4.1	Calling line identification presentation/restriction (CLIP/CLIR) .....	50
7.4.2	Connected line presentation and restriction (COLP/COLR).....	50
7.4.2.1	Incoming Call Interworking From SIP to BICC/ISUP At The I-MGCF.....	50
7.4.2.1.1	INVITE to IAM interworking (SIP to ISUP/BICC calls).....	50
7.4.2.1.2	ANM/CON to 200 OK (INVITE) .....	50
7.4.2.2	Outgoing Call Interworking from BICC/ISUP to SIP at O-MGCF .....	52
7.4.2.2.1	IAM to INVITE interworking (ISUP to SIP calls) .....	52
7.4.2.2.2	1XX to ANM or CON interworking.....	52
7.4.2.2.3	200 OK (INVITE) to ANM/CON interworking.....	52
7.4.3	Direct Dialling In (DDI) .....	53
7.4.4	Malicious call identification .....	53
7.4.5	Sub-addressing (SUB) .....	54
7.4.6	Call Forwarding Busy (CFB)/ Call Forwarding No Reply (CFNR) / Call Forwarding Unconditional (CFU).....	54
7.4.7	Call Deflection (CD).....	54
7.4.8	Explicit Call Transfer (ECT) .....	54
7.4.9	Call Waiting.....	54

7.4.10	Call Hold.....	54
7.4.10.1	Session hold initiated from the IM CN subsystem side.....	54
7.4.10.2	Session hold initiated from the CS network side.....	55
7.4.11	Call Completion on busy subscriber .....	56
7.4.12	Completion of Calls on No Reply (CCNR) .....	56
7.4.13	Terminal Portability (TP).....	56
7.4.14	Conference calling (CONF).....	56
7.4.15	Three-Party Service (3PTY) .....	56
7.4.16	Closed User Group (CUG) .....	57
7.4.17	Multi-Level Precedence and Pre-emption (MLPP).....	57
7.4.18	Global Virtual Network Service (GVNS).....	57
7.4.19	International telecommunication charge card (ITCC) .....	57
7.4.20	Reverse charging (REV).....	57
7.4.21	User-to-User Signalling (UUS).....	57
7.4.22	Multiple Subscriber Number (MSN) .....	57
8	User plane interworking .....	57
8.1	Interworking between IM CN subsystem and bearer independent CS network .....	57
8.1.1	Transcoder-less Mb to Nb Interworking .....	58
8.1.1.1	Initialisation .....	58
8.1.1.2	Time alignment .....	58
8.1.1.3	Rate control.....	59
8.1.1.4	Frame quality indication .....	59
8.1.1.5	Framing .....	59
8.1.1.6	Transcoding.....	59
8.1.1.7	Discontinuous transmission .....	59
8.1.1.8	Timing and sequence information.....	60
8.2	Interworking between IM CN subsystem and TDM-based CS network .....	60
8.3	Transcoding requirements .....	60
8.4	Diffserv code point requirements .....	60
9	MGCF – IM-MGW Interaction.....	61
9.1	Overview .....	61
9.2	Mn signalling interactions .....	61
9.2.1	Network model .....	61
9.2.2	Basic IM CN subsystem originated session.....	62
9.2.2.1	BICC forward bearer establishment.....	62
9.2.2.1.1	IM-MGW selection .....	62
9.2.2.1.2	CS network side bearer establishment.....	62
9.2.2.1.3	IM CN subsystem side termination reservation.....	62
9.2.2.1.4	IM CN subsystem side session establishment .....	62
9.2.2.1.5	Through-connection .....	63
9.2.2.1.6	Codec handling.....	63
9.2.2.1.7	Failure handling in MGCF .....	63
9.2.2.1.8	Message sequence chart.....	63
9.2.2.2	BICC backward bearer establishment .....	65
9.2.2.2.1	IM-MGW selection .....	65
9.2.2.2.2	IM CN subsystem side termination reservation.....	65
9.2.2.2.3	IM CN subsystem side session establishment .....	65
9.2.2.2.4	CS network side bearer establishment.....	66
9.2.2.2.5	Through-connection .....	66
9.2.2.2.6	Codec handling.....	66
9.2.2.2.7	Failure handling in MGCF .....	66
9.2.2.2.8	Message sequence chart.....	66
9.2.2.3	ISUP .....	68
9.2.2.3.1	IM-MGW selection .....	68
9.2.2.3.2	IM CN subsystem side termination reservation.....	68
9.2.2.3.3	IM CN subsystem side session establishment .....	68
9.2.2.3.4	CS network side circuit reservation.....	69
9.2.2.3.5	Through-connection .....	69
9.2.2.3.6	Continuity check.....	69
9.2.2.3.7	Codec handling.....	69

9.2.2.3.8	Voice processing function .....	69
9.2.2.3.9	Failure handling in MGCF .....	69
9.2.2.3.10	Message sequence chart.....	69
9.2.3	Basic CS network originated session .....	71
9.2.3.1	BICC forward bearer establishment.....	71
9.2.3.1.1	IM-MGW selection .....	71
9.2.3.1.2	IM CN subsystem side termination reservation.....	71
9.2.3.1.3	IM CN subsystem side session establishment .....	71
9.2.3.1.4	CS network side bearer establishment .....	71
9.2.3.1.5	Called party alerting .....	71
9.2.3.1.6	Called party answer .....	72
9.2.3.1.7	Through-Connection.....	72
9.2.3.1.8	Codec handling.....	72
9.2.3.1.9	Failure handling in MGCF .....	72
9.2.3.1.10	Message sequence chart.....	72
9.2.3.2	BICC Backward bearer establishment .....	74
9.2.3.2.1	IM-MGW selection .....	74
9.2.3.2.2	CS network side bearer establishment .....	74
9.2.3.2.3	IM CN subsystem side termination reservation.....	74
9.2.3.2.4	IM CN subsystem side session establishment .....	75
9.2.3.2.5	Called party alerting .....	75
9.2.3.2.6	Called party answer .....	75
9.2.3.2.7	Through-Connection.....	75
9.2.3.2.8	Codec handling.....	75
9.2.3.2.9	Failure handling in MGCF .....	76
9.2.3.2.10	Message sequence chart.....	76
9.2.3.3	ISUP .....	78
9.2.3.3.1	IM-MGW selection .....	78
9.2.3.3.2	CS network side circuit reservation.....	78
9.2.3.3.3	IM CN subsystem side termination reservation.....	78
9.2.3.3.4	IM CN subsystem side session establishment .....	78
9.2.3.3.5	Called party alerting .....	79
9.2.3.3.6	Called party answer .....	79
9.2.3.3.7	Through-Connection.....	79
9.2.3.3.8	Continuity Check.....	79
9.2.3.3.9	Codec handling.....	79
9.2.3.3.10	Voice Processing function.....	79
9.2.3.3.11	Failure handling in MGCF .....	80
9.2.3.3.12	Message sequence chart.....	80
9.2.3.4	Handling of Forking .....	82
9.2.3.4.1	Detection of Forking.....	82
9.2.3.4.2	IM CN subsystem side session establishment .....	82
9.2.3.4.3	IM CN subsystem side session establishment completion .....	83
9.2.3.4.4	Message sequence chart.....	83
9.2.4	Session release initiated from IM CN subsystem side .....	86
9.2.4.1	BICC .....	86
9.2.4.1.1	Session release in the IM CN subsystem side.....	86
9.2.4.1.2	Session release in the CS network side.....	86
9.2.4.1.3	Message sequence chart.....	86
9.2.4.2	ISUP .....	87
9.2.4.2.1	Session release in the IM CN subsystem side.....	87
9.2.4.2.2	Session release in the CS network side.....	87
9.2.4.2.3	Message sequence chart.....	87
9.2.5	Session release initiated from CS network side .....	87
9.2.5.1	BICC .....	87
9.2.5.1.1	Session release in the CS network side.....	87
9.2.5.1.2	Session release in the IM CN subsystem side.....	88
9.2.5.1.3	Message sequence chart.....	88
9.2.5.2	ISUP .....	88
9.2.5.2.1	Session release in the CS network side.....	88
9.2.5.2.2	Session release in the IM CN subsystem side.....	88
9.2.5.2.3	Message sequence chart.....	89



9.2.6	Session release initiated by MGCF.....	89
9.2.6.1	BICC.....	89
9.2.6.1.1	Session release in the CS network side.....	89
9.2.6.1.2	Session release in the IM CN subsystem side.....	89
9.2.6.1.3	Message sequence chart.....	89
9.2.6.2	ISUP.....	90
9.2.6.2.1	Session release in the CS network side.....	90
9.2.6.2.2	Session release in the IM CN subsystem side.....	90
9.2.6.2.3	Message sequence chart.....	90
9.2.7	Session release initiated by IM-MGW.....	91
9.2.7.1	BICC.....	91
9.2.7.1.1	Session release in the CS network side.....	91
9.2.7.1.2	Session release in the IM CN subsystem side.....	91
9.2.7.1.3	Message sequence chart.....	91
9.2.7.2	ISUP.....	92
9.2.7.2.1	Session release in the CS network side.....	92
9.2.7.2.2	Session release in the IM CN subsystem side.....	92
9.2.7.2.3	Message sequence chart.....	93
9.2.8	Handling of RTP telephone events.....	93
9.2.8.1	Sending DTMF digits out-of-band to CS CN (BICC).....	94
9.2.8.2	Sending and receiving DTMF digits inband to/from CS CN (ISUP or BICC).....	95
9.2.8.3	Receiving DTMF digits out-of-band from CS CN (BICC).....	96
9.2.9	Session hold initiated from IM CN subsystem.....	97
9.2.10	Session hold initiated from CS network.....	99
9.3	Mn Signalling procedures.....	100
9.3.1	Procedures related to terminations towards the IM CN Subsystem.....	100
9.3.1.1	Reserve IMS connection point.....	101
9.3.1.2	Configure IMS resources.....	101
9.3.1.3	Reserve IMS Connection point and configure remote resources.....	102
9.3.1.4	Release IMS termination.....	103
9.3.1.5	Detect IMS RTP Tel event.....	103
9.3.1.6	Notify IMS RTP Tel event.....	103
9.3.1.7	Void.....	104
9.3.1.8	Send IMS RTP Tel event.....	104
9.3.1.9	Stop IMS RTP Tel event.....	104
9.3.1.10	IMS Bearer Released.....	104
9.3.1.11	End IMS RTP Tel event.....	104
9.3.1.12	IMS Send Tone.....	104
9.3.1.13	IMS Stop Tone.....	104
9.3.1.14	IMS Tone Completed.....	104
9.3.2	Procedures related to a termination towards an ISUP network.....	104
9.3.2.1	Reserve TDM circuit.....	104
9.3.2.2	Change TDM through-connection.....	105
9.3.2.3	Activate TDM voice-processing function.....	105
9.3.2.4	Send TDM tone.....	105
9.3.2.5	Stop TDM tone.....	105
9.3.2.6	Play TDM announcement.....	105
9.3.2.7	TDM announcement completed.....	105
9.3.2.8	Stop TDM announcement.....	106
9.3.2.9	Continuity check.....	106
9.3.2.10	Continuity check verify.....	106
9.3.2.11	Continuity check response.....	106
9.3.2.12	Release TDM termination.....	107
9.3.2.13	Termination Out-of-Service.....	107
9.3.2.14	Bearer Released.....	107
9.3.2.15	TDM tone completed.....	107
9.3.3	Procedures related to a termination towards a BICC network.....	107
9.3.4	Non-call related procedures.....	108

<b>Annex A (informative):</b>	<b>Summary of differences items between 3GPP TS 29.163 and ITU-T</b>	
	<b>Q.1912.5.....</b>	<b>110</b>
A.1	List of differences.....	110

<b>Annex B (normative):</b>	<b>Codec Negotiation between a BICC CS network and the IM CN subsystem.....</b>	<b>111</b>
B.1	Introduction .....	111
B.2	Control plane interworking.....	111
B.2.1	Incoming call interworking from SIP to BICC at I-MGCF .....	111
B.2.1.1	Sending of IAM .....	111
B.2.1.2	Sending of SDP answer.....	111
B.2.2	Outgoing call interworking from BICC to SIP at O-MGCF.....	111
B.2.2.1	Sending of INVITE.....	111
B.2.2.2	Responding to serving node initiating codec negotiation.....	112
B.2.3	Mid-call interworking from SIP to BICC at I-MGCF or O-MGCF.....	112
B.2.3.1	Receipt of SDP offer .....	112
B.2.3.2	Generating SDP answer .....	113
B.2.4	Mid-call interworking from BICC to SIP at I-MGCF or O-MGCF.....	113
B.2.4.1	Receipt of mid-call codec negotiation request .....	113
B.2.4.2	Responding to serving node initiating mid-call codec negotiation .....	113
B.2.4.3	Receipt of codec modification request.....	113
B.2.5	Codec parameter translation between BICC CS network and the IM CN subsystem.....	114
B.2.5.1	Codec parameters for 3GPP AMR-NB codecs .....	114
B.2.5.2	Codec parameters for 3GPP AMR-WB codecs.....	116
B.2.5.3	Codec parameters for 3GPP non-AMR codecs.....	118
B.2.5.4	Codec parameters for ITU-T codecs .....	118
B.3	MGCF – IM-MGW interaction during interworking of codec negotiation.....	119
B.3.1	Basic IM CN subsystem originated session.....	119
B.3.1.1	BICC forward bearer establishment.....	119
B.3.1.1.1	IM-MGW selection .....	119
B.3.1.1.2	CS network side bearer establishment.....	119
B.3.1.1.3	IM CN subsystem side session establishment .....	119
B.3.1.1.4	Through-connection .....	120
B.3.1.1.5	Codec handling.....	120
B.3.1.1.6	Failure handling in MGCF .....	120
B.3.1.1.7	Message sequence chart.....	120
B.3.2	Basic CS network originated session.....	122
B.3.2.1	BICC forward bearer establishment.....	122
B.3.2.1.1	IM-MGW selection .....	122
B.3.2.1.2	IM CN subsystem side termination reservation.....	122
B.3.2.1.3	IM CN subsystem side session establishment .....	122
B.3.2.1.4	CS network side bearer establishment.....	122
B.3.2.1.5	Called party alerting .....	123
B.3.2.1.6	Called party answer .....	123
B.3.2.1.7	Through-Connection.....	123
B.3.2.1.8	Codec handling.....	123
B.3.2.1.9	Failure handling in MGCF .....	123
B.3.2.1.10	Message sequence chart.....	123
B.3.3	CS network initiated mid-call codec negotiation .....	126
B.3.4	IM CN subsystem initiated mid-call codec negotiation.....	127
<b>Annex C (informative):</b>	<b>Change history .....</b>	<b>128</b>
History .....		130

---

# Foreword

This Technical Specification has been produced by the 3<sup>rd</sup> Generation Partnership Project (3GPP).

The contents of the present document are subject to continuing work within the TSG and may change following formal TSG approval. Should the TSG modify the contents of the present document, it will be re-released by the TSG with an identifying change of release date and an increase in version number as follows:

Version x.y.z

where:

- x the first digit:
  - 1 presented to TSG for information;
  - 2 presented to TSG for approval;
  - 3 or greater indicates TSG approved document under change control.
- y the second digit is incremented for all changes of substance, i.e. technical enhancements, corrections, updates, etc.
- z the third digit is incremented when editorial only changes have been incorporated in the document.

---

# 1 Scope

The present document specifies the principles of interworking between the 3GPP IM CN subsystem and BICC/ISUP based legacy CS networks, in order to support IM basic voice calls.

The present document addresses the areas of control and user plane interworking between the IM CN subsystem and CS networks through the network functions, which include the MGCF and IM-MGW. For the specification of control plane interworking, areas such as the interworking between SIP and BICC or ISUP are detailed in terms of the processes and protocol mappings required for the support of both IM originated and terminated voice calls.

Other areas addressed encompass the transport protocol and signalling issues for negotiation and mapping of bearer capabilities and QoS information.

The present document specifies the interworking between 3GPP profile of SIP (as detailed according to 3GPP TS 24.229 [9]) and BICC or ISUP, as specified in ITU-T Recommendations Q.1902.1 to Q.1902.6 [30] and ITU-T Q761 to Q764 [4] respectively.

The present document addresses two interworking scenarios with respect to the properties of the CS network:.

- The CS network does not use any 3GPP specific additions.
- The CS network uses 3GPP specific additions.

---

# 2 References

The following documents contain provisions which, through reference in this text, constitute provisions of the present document.

- References are either specific (identified by date of publication, edition number, version number, etc.) or non-specific.
- For a specific reference, subsequent revisions do not apply.
- For a non-specific reference, the latest version applies. In the case of a reference to a 3GPP document (including a GSM document), a non-specific reference implicitly refers to the latest version of that document *in the same Release as the present document*.

- [1] ITU-T Recommendation G.711: "Pulse Code Modulation (PCM) of voice frequencies".
- [2] ITU-T Recommendation H.248.1 (2002): "Gateway control protocol: Version 2".
- [3] ITU-T Recommendation Q.701 to Q.709: "Functional description of the message transfer part (MTP) of Signalling System No. 7".
- [4] ITU-T Recommendations Q.761 to Q.764 (2000): "Specifications of Signalling System No.7 ISDN User Part (ISUP)".
- [5] Void.
- [6] 3GPP TR 21.905: "Vocabulary for 3GPP Specifications".
- [7] Void.
- [8] 3GPP TS 24.228: "Signalling flows for the IP multimedia call control based on SIP and SDP".
- [9] 3GPP TS 24.229: "IP Multimedia Call Control Protocol based on SIP and SDP".
- [10] 3GPP TS 23.002: "Network Architecture".
- [11] 3GPP TS 22.228: "Service requirements for the IP Multimedia Core Network Subsystem".
- [12] 3GPP TS 23.228: "IP Multimedia subsystem (IMS)".

- [13] Void.
- [14] 3GPP TS 29.205: "Application of Q.1900 series to Bearer Independent CS Network architecture; Stage 3".
- [15] 3GPP TS 29.332: "Media Gateway Control Function (MGCF) – IM-Media Gateway (IM-MGW) interface, Stage 3".
- [16] IETF RFC 791: "Internet Protocol".
- [17] IETF RFC 768: "User Datagram Protocol".
- [18] IETF RFC 2960: "Stream Control Transmission Protocol".
- [19] IETF RFC 3261: "SIP: Session Initiation Protocol".
- [20] 3GPP TS 29.202: "Signalling System No. 7 (SS7) signalling transport in core network; Stage 3".
- [21] IETF RFC 2474: "Definition of the Differentiated Services Field (DS Field) in the IPv4 and IPv6 Headers".
- [22] IETF RFC 2475: "An Architecture for Differentiated Services".
- [23] IETF RFC 3267: "Real-Time Transport Protocol (RTP) payload format and file storage format for the Adaptive Multi-Rate (AMR) Adaptive Multi-Rate Wideband (AMR-WB) audio codecs".
- [24] IETF RFC 793: "Transmission Control Protocol".
- [25] 3GPP TS 29.414: "Core network Nb data transport and transport signalling".
- [26] 3GPP TS 29.415: "Core network Nb interface user plane protocols".
- [27] 3GPP TS 23.205: "Bearer-independent circuit-switched core network; Stage 2".
- [28] Void.
- [29] ITU-T Recommendation Q.2150.1: "Signalling transport converter on MTP3 and MTP3b".
- [30] ITU-T Recommendations Q.1902.1 to Q.1902.6 (07/2001): "Bearer Independent Call Control".
- [31] ITU-T Recommendation Q.1950 (2002): "Bearer independent call bearer control protocol".
- [32] 3GPP TS 26.236: "Packet switched conversational multimedia applications; Transport protocols".
- [33] 3GPP TS 29.232: "Media Gateway Controller (MGC) – Media Gateway (MGW) interface; Stage 3".
- [34] IETF RFC 2833: "RTP Payload for DTMF Digits, Telephony Tones and Telephony Signals".
- [35] ITU-T Recommendation Q.765.5: "Signalling system No. 7 – Application transport mechanism: Bearer Independent Call Control (BICC)".
- [36] IETF RFC 3264: "An Offer/Answer Model with the Session Description Protocol (SDP)".
- [37] IETF RFC 3312: "Integration of Resource Management and Session Initiation Protocol (SIP)".
- [38] ITU-T Recommendation Q.850 (1998): "Usage of cause and location in the Digital Subscriber Signalling System No. 1 and the Signalling System No. 7 ISDN User Part".
- [39] IETF RFC 2460: "Internet Protocol, Version 6 (IPv6) Specification"
- [40] IETF RFC 3323: "A Privacy Mechanism for the Session Initiation Protocol (SIP)".
- [41] IETF RFC 3325: "Private Extensions to the Session Initiation Protocol (SIP) for Asserted Identity within Trusted Networks".
- [42] ITU-T Recommendation Q.730 to Q.737 (12/1999): "ISDN user part supplementary services".

- [43] ITU-T Recommendation I.363.5 (1996): "B-ISDN ATM Adaptation Layer specification: Type 5 AAL".
- [44] ITU-T Recommendation Q.2110 (1994): "B-ISDN ATM adaptation layer - Service Specific Connection Oriented Protocol (SSCOP)".
- [45] ITU-T Recommendation Q.2140 (1995): "B-ISDN ATM adaptation layer - Service specific coordination function for signalling at the network node interface (SSCF AT NNI)".
- [46] ITU-T Recommendation Q.2210 (1996): "Message transfer part level 3 functions and messages using the services of ITU-T Recommendation Q.2140".
- [47] 3GPP TS 23.221: "Architectural requirements".
- [48] ITU-T Recommendation E.164 (05/1997): "The international public telecommunication numbering plan".
- [49] ITU-T Recommendation Q.1912.5: "Interworking between Session Initiation Protocol (SIP) and Bearer Independent Call Control Protocol or ISDN User Part".
- [50] 3GPP TS 26.102: "Adaptive Multi-Rate (AMR) speech codec; Interface to Iu and Uu".
- [51] IETF RFC 3550: "RTP: A Transport Protocol for Real-Time Applications".
- [52] IETF RFC 3551: "RTP Profile for Audio and Video Conferences with Minimal Control".
- [53] IETF RFC 3555: "MIME Type Registration of RTP Payload Formats".
- [54] IETF RFC 3262: "Reliability of provisional responses".
- [55] IETF RFC 3311: "SIP UPDATE method".
- [56] IETF RFC 2327: "SDP: Session Description Protocol".
- [57] 3GPP TS 26.103: "Speech Codec List for GSM and UMTS".
- [58] 3GPP TS 28.062: "Inband Tandem Free Operation (TFO) of speech codecs".
- [59] IETF RFC 3556: "Session Description Protocol (SDP) Bandwidth Modifiers for RTP Control Protocol (RTCP) bandwidth".

---

## 3 Definitions and abbreviations

### 3.1 Definitions

For the purposes of the present document, the terms and definitions given in 3GPP TR 21.905 [6], ITU-T Recommendation E.164 [48] and the following apply:

**SS7 signalling function:** function in the CS network, which has the capabilities to transport the SS7 MTP-User parts ISUP and BICC+STC<sub>mtp</sub>

**SIP signalling function:** function in the IM CN subsystem, which has the capabilities to transport SIP

**Incoming or Outgoing:** used in the present document to indicate the direction of a call (not signalling information) with respect to a reference point.

**Incoming MGCF (I-MGCF):** entity that terminates incoming SIP calls from the IMS side and originates outgoing calls towards the CS side using the BICC or ISUP protocols.

**Outgoing Interworking Unit (O-MGCF):** entity that terminates incoming BICC or ISUP calls from the CS side and originates outgoing calls towards the IMS using SIP.

**Root Termination:** refers to Media Gateway as an entity in itself, rather than a Termination within it. A special TerminationID, "Root" is reserved for this purpose. See ITU-T Recommendation H.248.1.

**Signalling Transport Converter (STC):** function that converts the services provided by a particular Signalling Transport to the services required by the Generic Signalling Transport Service.

**STCmtp:** Signalling Transport Converter on MTP. See ITU-T Recommendation Q.2150.1 [29].

**BICC+STCmtp:** this terminology means that BICC signaling always need to be used on top of STCmtp sublayer.

## 3.2 Abbreviations

For the purposes of the present document, the abbreviations as defined in 3GPP TR 21.905 [6] and the following apply:

ACM	Address Complete Message
ANM	ANswer Message
APRI	Address Presentation Restriction Indicator
BGCF	Breakout Gateway Control Function
BICC	Bearer Independent Call Control
CC	Country Code
CLIP	Calling Line Identification Presentation
CLIR	Calling Line Identification Restriction
CN	Core Network
COLP	Connected line presentation
COLR	Connected line restriction
CPG	Call ProGress message
CS	Circuit Switched
CSCF	Call Session Control Function
DDI	Direct-Dialling-In
GTP	GPRS Tunneling Protocol
H/W	Hardware
IP	Internet Protocol
IM-MGW	IP Multimedia Media Gateway Function
ISDN	Integrated Services Data Network
ISUP	Integrated Services User Part
M3UA	MTP-L3 User Adaptation layer
MGCF	Media Gateway Control Function
MGW	Media Gateway
MSN	Multiple Subscriber Number
MTP	Message Transfer Part
NDC	National Destination Code
NOA	Nature Of Address
PLMN	GSM Public Land Mobile Network
SCTP	Stream Control Transmission Protocol
SDP	Session Description Protocol
SGW	Signalling Gateway
SIP	Session Initiated Protocol
SN	Subscriber Number
SS7	Signalling System No. 7
TNL	Transport Network Layer
UAC	User Agent Client
UE	User Equipment
URL	Uniform Resource Location

---

## 4 General

### 4.1 General interworking overview

The IM CN subsystem shall interwork with BICC and ISUP based legacy CS networks, e.g. PSTN, ISDN, CS PLMNs, in order to provide the ability to support basic voice calls (see 3GPP TS 22.228 [11]), between a UE located in the IM CN subsystem and user equipment located in a CS network.

For the ability to support the delivery of basic voice calls between the IM CN subsystem and CS networks, basic protocol interworking between SIP (as specified in 3GPP TS 24.229 [9]) and BICC or ISUP (as specified in ITU-T Recommendations Q.1902.1-6 [30] and ITU-T Recommendations Q761 to Q764 [4] respectively) has to occur at a control plane level, in order that call setup, call maintenance and call release procedures can be supported. The MGCF shall provide this protocol mapping functionality within the IM CN subsystem.

User plane interworking between the IM CN subsystem and CS network bearers (e.g. 64k TDM, ATM/AAL2 circuit or IP bearer) are supported by the functions within the IM-MGW. The IM-MGW resides in the IM CN subsystem and shall provide the bearer channel interconnection. The MGCF shall provide the call control to bearer setup association.

The IM CN subsystem shall interwork, at the control and user plane, with BICC and ISUP based legacy CS networks. The support of supplementary services shall be as defined in 3GPP TS 22.228 [11]. The MGCF and IMS-MGW shall support the interworking of the IM CN subsystem to an external ISUP based CS network. They may also support interworking to a BICC based CS network where no 3GPP specific extension is applied. The MGCF and the IM-MGW may also support interworking to a BICC based CS network where 3GPP specific extensions in accordance with 3GPP TS 29.205 [14] are applied.

---

## 5 Network characteristics

### 5.1 Key characteristics of ISUP/BICC based CS networks

This signalling interface to a PSTN is either based on BICC Capability Set 2 as specified in ITU-T Recommendations Q.1902.1 to Q.1902.6 [30], or on ISUP (see ITU-T Recommendations Q.761 to Q.764 [4]).

The interface towards a CS-PLMN may either be one of the interfaces mentioned in the paragraph above or a signalling interface based on BICC with 3GPP specific extensions, as specified for the 3GPP Nc interface in 3GPP TS 29.205 [14], and the IM-MGW may support the 3GPP Nb interface, as specified in 3GPP TS 29.414 [25] and 3GPP TS 29.415 [26]. If the 3GPP Nc interface is applied as signalling interface, the 3GPP Nb interface is used as user plane interface and the Nb UP Framing protocol is applied.

### 5.2 Key characteristics of IM CN subsystem

The IM CN subsystem uses SIP to manage IP multimedia sessions in a 3GPP environment, it also uses IPv6, as defined in RFC 2460 [39], as the transport mechanism for both SIP session signalling and media transport. The 3GPP profile of SIP defining the usage of SIP within the IM CN subsystem is specified in 3GPP TS 24.229 [9]. Example callflows are provided in 3GPP TS 24.228 [8].

---

## 6 Interworking with CS networks

### 6.1 Interworking reference model

Figure 1 details the reference model required to support interworking between the 3GPP IM CN subsystem and CS networks for IM basic voice calls.



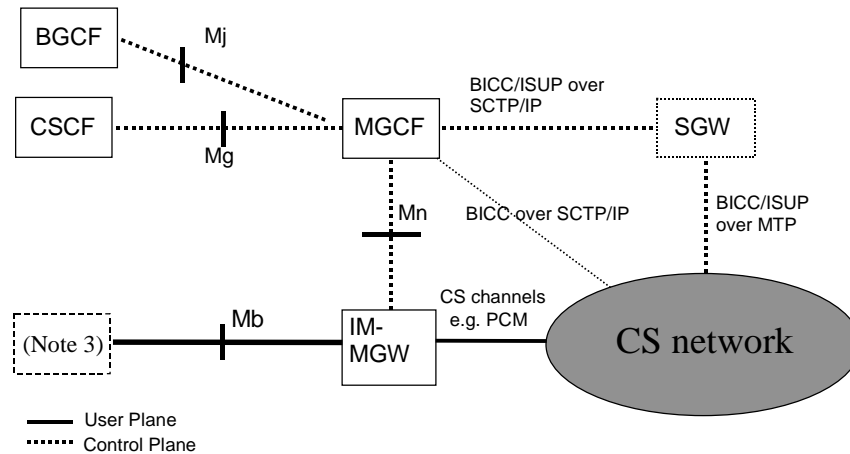

- NOTE 1: The logical split of the signalling and bearer path between the CS network and the IM CN subsystem is as shown, however the signalling and bearer may be logically directly connected to the IM-MGW.
- NOTE 2: The SGW may be implemented as a stand-alone entity or it may be located in another entity either in the CS network or the IM-MGW. The implementation options are not discussed in the present document.
- NOTE 3: The IM-MGW may be connected via the Mb to various network entities, such as a UE (via a GTP Tunnel to a GGSN), an MRFP, or an application server.
- NOTE 4: A SGW function is not required for certain signalling transports, where M3UA+SCTP+IP is used in CS network and IM-MGCF.

**Figure 1: IM CN subsystem to CS network logical interworking reference model**

## 6.1.1 Interworking reference points and interfaces

The reference points and network interfaces shown in figure 1 are as described:

**Protocol for Mg reference point:** The single call control protocol applied across the Mg reference point (i.e. between CSCF and MGCF) will be based on the 3GPP profile of SIP as defined in accordance with 3GPP TS 24.229 [9].

**Protocol for Mn reference point:** The Mn reference point describes the interfaces between the MGCF and IM-MGW, and has the properties as detailed in 3GPP TS 29.332 [15].

**Protocol for Mj reference point:** The single call control protocol applied across the Mj reference point (i.e. between BGCF and MGCF) will be based on the 3GPP profile of SIP as defined in accordance with 3GPP TS 24.229 [9].

**Protocol for Mb reference point:** The Mb reference point is defined in accordance with 3GPP TS 23.002 [10] and is IPv6 based.

## 6.1.2 Interworking functional entities

### 6.1.2.1 Signalling Gateway Function (SGW)

This component performs the call related signalling conversion to or from BICC/ISUP based MTP transport networks to BICC/ISUP based SCTP/IP transport networks, and forwards the converted signalling to or from the MGCF. The functionality within SGW shall be in accordance with 3GPP TS 23.002 [10].

### 6.1.2.2 Media Gateway Control Function (MGCF)

This is the component within the IM CN subsystem, which controls the IM-MGW, and also performs SIP to BICC or SIP to ISUP call related signalling interworking.

The functionality defined within MGCF shall be defined in accordance with 3GPP TS 23.002 [10].

### 6.1.2.3 IP Multimedia - Media Gateway Function (IM-MGW)

This is the component within the IM CN subsystem, which provides the interface between the PS domain and the CS domain, and it shall support the functions as defined in accordance with 3GPP TS 23.002 [10].

## 6.2 Control plane interworking model

Within the IM CN subsystem, the 3GPP profile of SIP is used to originate and terminate IM sessions to and from the UE.

External CS networks use BICC or ISUP to originate and terminate voice calls to and from the IM CN subsystem.

Therefore, in order to provide the required interworking to enable inter network session control, the control plane protocols shall be interworked within the IM CN subsystem. This function is performed within the MGCF (see clause 6.1.2).

## 6.3 User plane interworking model

Within the IM CN subsystem, IPv6, and framing protocols such as RTP, are used to transport media packets to and from the IM CN subsystem entity like UE or MRFP.

External legacy CS networks use circuit switched bearer channels like TDM circuits (e.g. 64 kbits PCM), ATM/AAL2 circuit or IP bearers to carry encoded voice frames, to and from the IM CN subsystem.

Other CN networks use ATM/AAL 1 or AAL 2 or IP as a backbone, with different framing protocols.

Therefore, in order to provide the required interworking to enable media data exchange, the user plane protocols shall be translated within the IM CN subsystem. This function is performed within the IM-MGW (see clause 6.1.2).

---

# 7 Control plane interworking

Signalling from CS networks to or from IM CN subsystem, where the associated supported signalling protocols are SS7/M3UA+ SCTP+IP and M3UA+SCTP+IP respectively, requires a level of interworking between the nodes across the Control Plane, i.e. the SS7 signalling function, SGW (if applicable), MGCF and SIP signalling function. This interworking is required in order to provide a seamless support of a user part, i.e. SIP and BICC+STC<sub>mtp</sub> or SIP and ISUP.

The transport of SS7 signalling protocol messages of any protocol layer that is identified by MTP level 3, in SS7 terms, as a user part (MTP3-user) shall be accomplished in accordance with the protocol architecture defined in the following clauses. For the present document these protocol layers include, but are not limited to, Bearer Independent Call Control (BICC)+STC<sub>mtp</sub> and ISDN User Part (ISUP).

## 7.1 General

The following sub-clauses define the signalling interworking between the Bearer Independent Call Control (BICC) or ISDN User Part (ISUP) protocols and Session Initiation Protocol (SIP) with its associated Session Description Protocol (SDP) at a MGCF. The MGCF shall act as a Type A exchange (ITU-T Recommendation Q.764 [4]) for the purposes of ISUP and BICC Compatibility procedures. The services that can be supported through the use of the signalling interworking are limited to the services that are supported by BICC or ISUP and SIP based network domains.

BICC is the call control protocol used between Nodes in a network that incorporates separate call and bearer control. The BICC/ISUP capabilities or signalling information defined for national use is outside the scope of the present document. It does not imply interworking for national-specific capabilities is not feasible.

The capabilities of SIP and SDP that are interworked with BICC or ISUP are defined in 3GPP TS 24.229 [9]

Services that are common in SIP and BICC or ISUP network domains will seamlessly interwork by using the function of the MGCF. The MGCF will originate and/or terminate services or capabilities that do not interwork seamlessly across domains according to the relevant protocol recommendation or specification.

Table 1 lists the services seamlessly interworked and therefore within the scope of the present document.

**Table 1: Interworking Capabilities between BICC/ISUP and SIP profile for 3GPP**

Service
Speech/3.1 kHz audio
En bloc address signalling
Overlap address signalling from the CS side towards the IMS
Out of band transport of DTMF tones and information. (BICC only)
Inband transport of DTMF tones and information. (BICC and ISUP)
Direct-Dialling-In (DDI)
Multiple Subscriber Number (MSN)
Calling Line Identification Presentation (CLIP)
Calling Line Identification Restriction (CLIR)
Connected line presentation (COLP)
Connected line restriction (COLR)

## 7.2 Interworking between CS networks supporting ISUP and the IM CN subsystem

The control plane between CS networks supporting ISUP and the IM CN subsystem supporting SIP, where the underlying network is SS7 and IP respectively is as shown in figure 2.

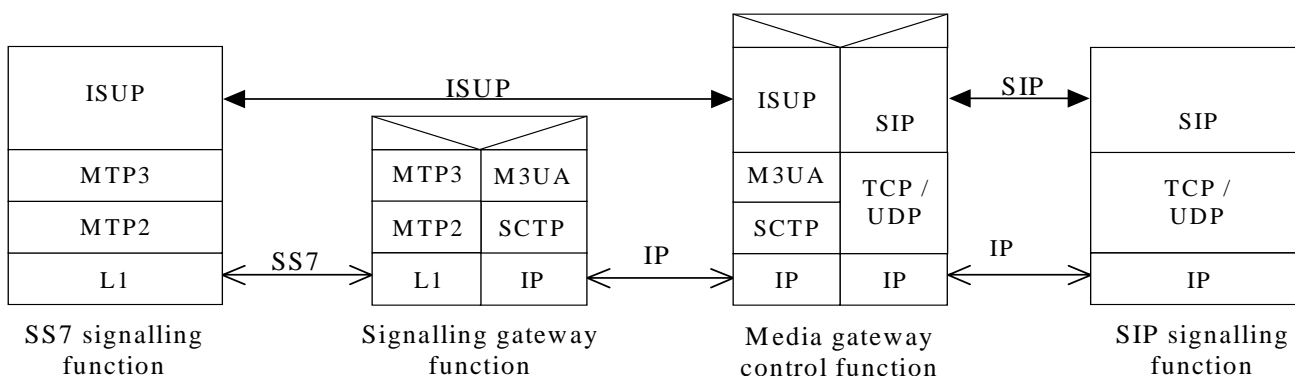

**Figure 2: Control plane interworking between CS networks supporting ISUP and the IM CN subsystem**

### 7.2.1 Services performed by network entities in the control plane

#### 7.2.1.1 Services performed by the SS7 signalling function

The SS7 signalling function provides the capabilities to deliver or receive SS7 MTP3-User information (e.g. ISUP or BICC+STC<sub>mtp</sub>) across the SS7 signalling network. The functional interface of the MTP, the MTP User parts and the signalling network are as detailed in ITU-T Recommendations Q.701 to Q.709 [3].

### 7.2.1.2 Services of the SGW

The SGW shall perform the functions as described in 3GPP TS 23.002 [10].

In order to support the seamless operation of the MTP3-User part information between networks incorporating SS7 and IP (either IPv4, see RFC 791 [16], or IPv6, see RFC 2460 [39]), the SGW shall support the services of MTP as well as the services of the M3UA (see 3GPP TS 29.202 [20]) and SCTP (see RFC 2960 [18]).

### 7.2.1.3 Services of the MGCF

The session handling and session control of the MGCF shall be as detailed in 3GPP TS 24.229 [9].

The MGCF shall provide the interaction, through the use of its interworking function, between the SS7 MTP3-User part information, e.g. ISUP, and SIP. It shall also provide the interaction between the mechanism used to transport the SS7 MTP3-User part information and SIP, i.e. the interaction between M3UA and SCTP and UDP/TCP (see RFC 768 [17] and RFC 793 [24]).

The MGCF interworking function shall also provide the translation between the SS7 MTP3-User part information and SIP, where the interworking of SIP to ISUP and BICC+STC<sub>mtp</sub> are detailed below.

### 7.2.1.4 Services of the SIP signalling function

The SIP signalling function is a logical entity that provides the capabilities to deliver or receive multimedia session information across the IM CN subsystem signalling system.

## 7.2.2 Signalling interactions between network entities in the control plane

### 7.2.2.1 Signalling between the SS7 signalling function and MGCF

The SGW shall enable the signalling interaction between the SS7 signalling function and the MGCF.

#### 7.2.2.1.1 Signalling from MGCF to SS7 signalling function

For signalling from the MGCF to the SS7 signalling function, the SGW shall terminate the SCTP and M3UA protocol layers and deliver the MTP3-User protocol messages, e.g. ISUP messages, towards the SS7 signalling function. The SGW transmits and receives SS7 Message Signalling Units (MSUs) to and from the SS7 signalling function over standard SS7 network interfaces, using MTP to provide reliable transport of the messages.

#### 7.2.2.1.2 Signalling from SS7 signalling function to MGCF

For signalling from the SS7 signalling function to the MGCF, the SGW shall terminate SS7 MTP2 and MTP3 protocol layers and deliver MTP3-User part information messages, e.g. ISUP, towards the MGCF. In order to direct messages received from the SS7 MTP3 network to the appropriate IP destination, e.g. MGCF, the SGW shall perform a message distribution function using the information received from the MTP3-User message. Message distribution at the SGW shall be performed in accordance with 3GPP TS 29.202 [20].

#### 7.2.2.1.3 Services offered by SCTP and M3UA

The SGW internal protocol mapping and transportation between BICC or ISUP messages and IP encapsulated BICC or ISUP messages respectively is supported by the services of the M3UA adaptation layer and the underlying SCTP layer. The SGW shall allow for the transfer of MTP3-User signalling messages, e.g. BICC or ISUP, to and from an MGCF, where the peer MTP3-User protocol exists.

##### 7.2.2.1.3.1 Services offered by SCTP

SCTP offers the ability to reliably transfer the SCTP User applications, e.g. M3UA, between the SCTP User application peers. The initialization procedure used for an association between two SCTP end-to-end peers, and the initialization to the SCTP User applications shall be performed as detailed in RFC 2960 [18].

### 7.2.2.1.3.2 Services offered by M3UA

When an association between two SCTP peers has been established, the use of M3UA shall provide the transport service in accordance with MTP (see ITU-T Recommendations Q.701 to Q.709 [3]) to the MTP3-User, e.g. ISUP.

### 7.2.2.2 Signalling between the MGCF and SIP signalling function

Signalling between the SIP signalling function and the MGCF uses the services of IP (RFC 2460 [39]), TCP (RFC 793 [24]) or UDP (RFC 768 [17]) and SIP.

The naming and addressing concepts between the MGCF and SIP signalling function shall be detailed in accordance with 3GPP TS 23.228 [12]. The issues of general IP address management are discussed in 3GPP TS 23.221 [47].

## 7.2.3 SIP-ISUP protocol interworking

When a coding of a parameter value is omitted it implies that it is not affected by the interworking and the values are assigned by normal protocol procedures.

### 7.2.3.1 Incoming call interworking from SIP to ISUP at I-MGCF

#### 7.2.3.1.1 Sending of IAM

On reception of a SIP INVITE requesting an audio session, the I-MGCF shall send an IAM message.

The I-MGCF shall interwork forked INVITE requests with different request URIs.

If a Continuity Check procedure is supported in the ISUP network, the I-MGCF shall send the IAM immediately after the reception of the INVITE, as shown in figure 3. This procedure applies when the value of the continuity indicator is either set to "continuity check required" or "continuity check performed on a previous circuit". If the continuity indicator is set to "continuity check required" the corresponding procedures at the Mn interface described in clause 9.2.2.3 also apply.

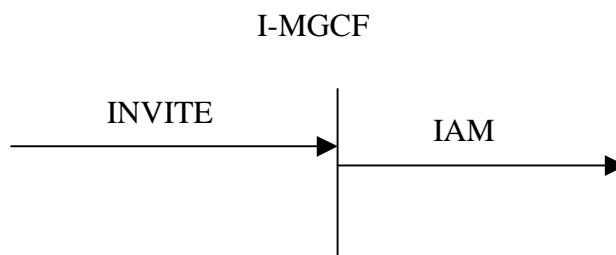

**Figure 3: Receipt of an Invite request (continuity procedure supported in the ISUP network)**

If no Continuity Check procedure is supported in the ISUP network, the I-MGCF shall delay sending the IAM until the SIP preconditions are met.

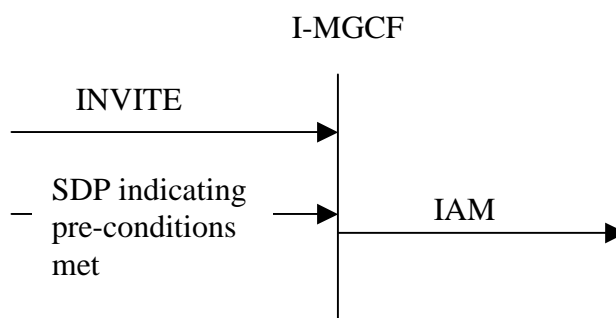

**Figure 4: Receipt of an Invite request (continuity procedure not supported in the ISUP network)**

The I-MGCF shall reject an INVITE request for a non-audio session by sending a status code 488 "Not Acceptable Here". If audio media streams and non-audio media streams are contained in a single INVITE request, the non-audio media streams shall be rejected in the SDP answer, as detailed in RFC 3264 [36].

The I-MGCF shall include a To tag in the first backward non-100 provisional response, in order to establish an early dialog as described in RFC 3261 [19].

### 7.2.3.1.2 Coding of the IAM

The following ISDN user part parameters description can be found in ITU-T Recommendation Q.763 [4].

#### 7.2.3.1.2.1 Called party number

The E.164 address encoded in the Request-URI shall be mapped to the called party number parameter of the IAM message.

**Table 2: Coding of the called party number**

INVITE→	IAM→
<b>Request-URI</b>	<b>Called Party Number</b>
E.164 address (e.g. as User info in SIP URI with user=phone, or as tel URL)	Address Signal

#### 7.2.3.1.2.2 Nature of connection indicators

bits BA Satellite indicator

0 1 one satellite circuit in the connection

bits DC Continuity check indicator

0 0 *continuity check not required*) if the continuity check procedure is not supported in the succeeding network (figure 4).

0 1 *continuity check required*, if a continuity check shall be carried out on the succeeding circuit. (figure 3)

1 0 continuity check performed on a previous circuit otherwise, if the continuity check procedure is supported in the succeeding network, but shall not be carried out on the succeeding circuit otherwise. (figure 3)

bit E Echo control device indicator

1 outgoing echo control device included

#### 7.2.3.1.2.3 Forward call indicators

bits CB End-to-end method indicator

0 0 no end-to-end method available (only link-by-link method available)

bit D Interworking indicator

1 interworking encountered

bit E End-to-end information indicator (national use)

0 no end-to-end information available

bit F ISDN user part/BICC indicator

- 0 ISDN user part/BICC not used all the way
- bits HG ISDN user part/BICC preference indicator
- 0 1 ISDN user part/BICC not required all the way
- bit I ISDN access indicator
- 0 originating access non-ISDN
- bits KJ SCCP method indicator
- 0 0 no indication

#### 7.2.3.1.2.4 Calling party's category

0 0 0 0 1 0 1 0 ordinary calling subscriber

#### 7.2.3.1.2.5 Transmission medium requirement

The TMR parameter is set to "3.1 kHz audio" or "speech".

#### 7.2.3.1.2.6 Calling party number

The SIP "Privacy" header is defined within RFC 3323 [40]. The SIP "P-Asserted-Identity" header is defined in RFC 3325 [41].

Table 3: Mapping of SIP From/P-Asserted-Identity/Privacy headers to CLI parameters

Has a "P-Asserted-Identity" header field (note 2, note 5, note 6) been received?	Has a "From" header field (note 3) containing a URI that encodes an E.164 address been received (note 6)?	Calling Party Number parameter Address signals	Calling Party Number parameter APRI	Generic Number (additional calling party number) address signals	Generic Number parameter APRI
No	No	Network option to either include a network provided E.164 number (See table 4) or omit the Address signals. (note 4)	Network option to set APRI to 'presentation restricted' or 'presentation allowed' (note 4) (See table 5)	Parameter not included	Not applicable
No	Yes	Network Option to either include a network provided E.164 number (See table 4) or omit the Address signals. (note 4)	Network option to set APRI to 'presentation restricted' or 'presentation allowed' (note 4) (See table 5)	Network Option to either omit the parameter (if CgPN has been omitted) or derive from the 'From' header (note 1) (See table 6)	APRI = 'presentation restricted' or 'presentation allowed' depending on SIP Privacy header. (See table 6)
Yes	No	Derive from P-Asserted-Identity (See table 5)	APRI = 'presentation restricted' or 'presentation allowed' depending on SIP Privacy header. (See table 5)	Not included	Not applicable
Yes	Yes	Derived from P-Asserted-Identity (See table 5)	APRI = 'presentation restricted' or 'presentation allowed' depending on SIP Privacy header. (See table 5)	Network Option to either omit the parameter or derive from the 'From' header (note 1) (See table 6)	APRI = 'presentation restricted' or 'presentation allowed' depending on SIP Privacy header. (see table 6)
<p>Note 1: This mapping effectively gives the equivalent of Special Arrangement to all SIP UAC with access to the I-MGCF.</p> <p>Note 2: It is possible that the P-Asserted-Identity header field includes both a tel URL and a sip or sips URI. In this case, the tel URL is used.</p> <p>Note 3: The 'From' header may contain an 'Anonymous URI'. An 'Anonymous URI' includes information that does not point to the calling party. RFC 3261 recommends that the display-name component contain "Anonymous". RFC 3323 [40] recommends that the Anonymous URI itself have the value "anonymous@anonymous.invalid".</p> <p>Note 4: A national option exists to set the APRI to 'Address not available'.</p> <p>Note 5: 3GPP TS 24.229 guarantees that the received number is an E.164 number formatted as an international number, with a '+' sign as prefix.</p> <p>Note 6: The E.164 numbers considered within the present document are composed by a Country Code (CC), followed by a National Destination Code (NDC), followed by a Subscriber Number (SN). On the IMS side, the numbers are international public telecommunication numbers ('CC'+NDC+'SN') and are prefixed by a '+' sign. On the CS side, it is a network option to omit the CC.</p>					



**Table 4: Setting of the network-provided BICC/ISUP calling party number parameter with a CLI (network option)**

BICC/ISUP CgPN Parameter field	Value
Screening Indicator	"network provided"
Number Incomplete Indicator	"complete"
Number Plan Indicator	ISDN/Telephony (E.164)
Address Presentation Restricted Indicator	Presentation allowed/restricted
Nature of Address Indicator	If next BICC/ISUP node is located in the same country set to 'National (Significant) number' else set to "International number"
Address signals	If NOA is "national (significant) number" no country code should be included. If NOA is "international number", then the country code of the network-provided number should be included.

**Table 5: Mapping of P-Asserted-Identity and privacy headers to the ISUP/BICC calling party number parameter**

SIP Component	Value	BICC/ISUP Parameter / field	Value
P-Asserted-Identity header field (note 1)	E.164 number	Calling Party Number	
		Number incomplete indicator	"Complete"
		Numbering Plan Indicator	"ISDN/Telephony (E.164)"
		Nature of Address Indicator	If CC encoded in the URI is equal to the CC of the country where MGCF is located AND the next BICC/ISUP node is located in the same country then set to "national (significant) number" else set to "international number"
		Address Presentation Restricted Indicator (APRI)	Depends on priv-value in Privacy header.
		Screening indicator	Network Provided
Addr-spec	"CC" "NDC" "SN" from the URI	Address signal	if NOA is "national (significant) number" then set to "NDC" + "SN" If NOA is 'international number' Then set to "CC"+"NDC"+"SN"
Privacy header field is not present		APRI	Presentation allowed
Privacy header field	priv-value	APRI	"Address Presentation Restricted Indicator"
priv-value	"header"	APRI	Presentation restricted
	"user"	APRI	Presentation restricted
	"none"	APRI	Presentation allowed
	"id"	APRI	Presentation restricted
Note 1: It is possible that a P-Asserted-Identity header field includes both a TEL URI and a SIP or SIPS URI. In this case, the TEL URL is used.			

7.2.3.1.2.7 Generic number

**Table 6: Mapping of SIP from header field to BICC/ISUP generic number (additional calling party number) parameter (network option)**

SIP component	Value	BICC/ISUP parameter / field	Value
From header field	name-addr or addr-spec	Generic Number Number Qualifier Indicator	"Additional Calling Party number"
from-spec	( name-addr / addr-spec)		
		Nature of Address Indicator	If CC encoded in the URI is equal to the CC of the country where MGCF is located AND the next BICC/ISUP node is located in the same country then Set to "national (significant) number" Else set to "international number"
		Number incomplete indicator	"Complete"
		Numbering Plan Indicator	"ISDN/Telephony (E.164)"
		APRI	Depends on priv-value
		Screening indicator	"user provided not verified"
Addr-spec	"CC" "NDC" + "SN" from the URI	Address signal	if NOA is "national (significant) number" then set to "NDC" + "SN" If NOA is "international number" Then set to "CC"+'NDC'+ 'SN'
Privacy header field	priv-value	APRI	"Address Presentation Restricted Indicator"
Use same APRI setting as for Calling Party Number.			

7.2.3.1.2.8 User service information

The Information Transfer Capability Information element is coded as 'speech' or "3.1 kHz audio".

7.2.3.1.2.9 Hop Counter (National option)

The I-MGCF shall perform the following interworking procedure if the Hop Counter procedure is supported in the CS network.

At the I-MGCF the Max-Forwards SIP header shall be used to derive the Hop Counter parameter if applicable. Due to the different default values (that are based on network demands/provisions) of the SIP Max-Forwards header and the Hop Counter, a factor shall be used to adapt the Max Forwards to the Hop Counter at the I-MGCF. For example, the following guidelines could be applied.

- 1) Max-Forwards for a given message should be monotone decreasing with each successive visit to a SIP entity, regardless of intervening interworking, and similarly for Hop Counter.
- 2) The initial and successively mapped values of Max-Forwards should be large enough to accommodate the maximum number of hops that may be expected of a validly routed call.

Table 7 shows the principle of the mapping:

**Table 7: Max forwards -- hop counter**

Max-Forwards	= X	Hop Counter	= INTEGER part of (X /Factor) =Y
Note: The Mapping of value X to Y should be done with the used (implemented) adaptation mechanism.			

The Principle of adoption could be implemented on a basis of the network provision, trust domain rules and bilateral agreement.

7.2.3.1.3 Sending of COT

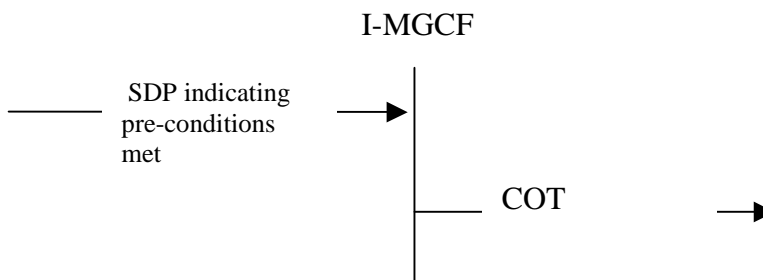

Figure 5: Sending of COT

If the IAM has already been sent, the Continuity message shall be sent indicating "continuity check successful", when all of the following conditions have been met:

- the requested preconditions in the IMS network have been met
- A possible outstanding continuity check procedure is successfully performed on the outgoing circuit

7.2.3.1.4 Sending of 180 ringing

The I-MGCF shall send the SIP 180 Ringing when receiving any of the following messages:

- ACM with Called party's status indicator set to subscriber free.

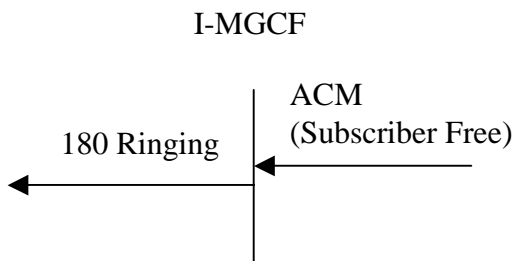

Figure 6: The receipt of ACM

- CPG with Event indicator set to alerting

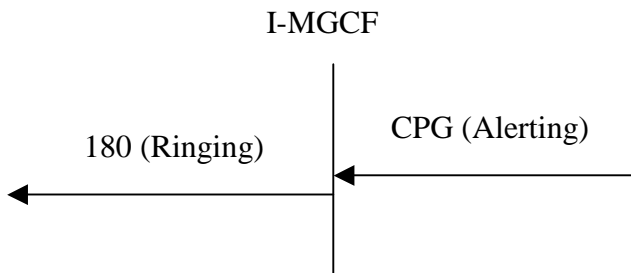

Figure 7: Receipt of CPG (Alerting)

7.2.3.1.5 Sending of the 200 OK (INVITE)

The following cases are possible trigger conditions for sending the 200 OK (INVITE):

- The reception of the ANM.

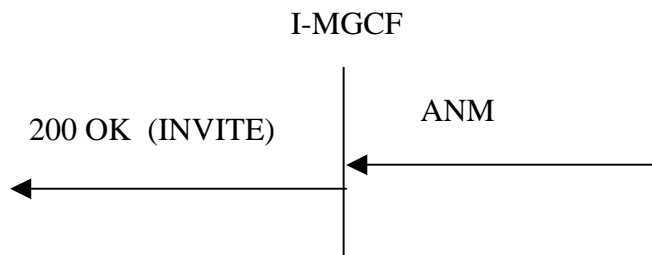

Figure 8: Receipt of ANM

- The reception of the CON message.

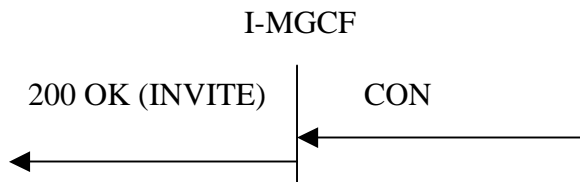

Figure 9: Receipt of CON

7.2.3.1.6 Sending of the Release message (REL)

The following are possible triggers for sending the Release message:

- Receipt of the BYE method.

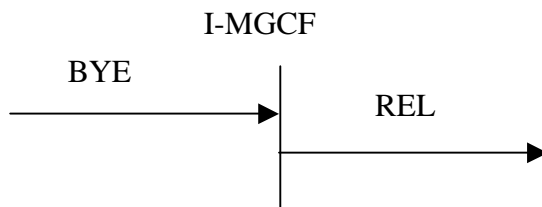

Figure 10: Receipt of the Bye method

- Receipt of the CANCEL method

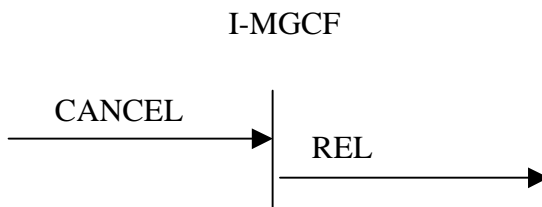

Figure 11: Receipt of Cancel method

Additional triggers are contained in table 10.

### 7.2.3.1.7 Coding of the REL

The SIP BYE and CANCEL requests are mapped into a REL message with cause value #16 and #31 respectively as indicated in table 8.

**Table 8: Coding of REL**

SIP Message →	REL →
Request	cause parameter
BYE	Cause value No. 16 (normal clearing)
CANCEL	Cause value No. 31 (normal unspecified)

NOTE: If an optional Reason header field is included in the BYE or CANCEL, then the Cause Value can be mapped to the ISUP Cause Value field in the ISUP REL. The mapping between the Cause Indicators parameter and the Reason header is out of the scope of the present specification.

### 7.2.3.1.8 Receipt of the Release Message

If the REL message is received and a final response (i.e. 200 OK (INVITE)) has already been sent, the I-MGCF shall send a BYE message.

NOTE: According to SIP procedures, in the case that the REL message is received and a final response (e.g. 200 OK (INVITE)) has already been sent (but no ACK has been received) on the incoming side of the I-MGCF then the I-MGCF does not send a 487 Request terminated and instead waits until the ACK is received before sending a BYE message.

If the REL message is received and the final response (i.e. 200 OK (INVITE)) has not already been sent, the I-MGCF shall send Status-Code 4xx (Client Error) or 5xx (Server Error). The Status code to be sent is determined by examining the Cause code value received in the REL message. Table 9 specifies the mapping of the cause code values, as defined in ITU-T Recommendation Q.850 [38], to SIP response status codes. Cause code values not appearing in the table shall have the same mapping as the appropriate class defaults according to ITU-T Recommendation Q.850 [38].

**Table 9: Receipt of the Release message (REL)**

←SIP Message	← REL
Status code	Cause parameter
404 Not Found	Cause value No. 1 (unallocated (unassigned) number)
500 Server Internal error	Cause value No 2 (no route to network)
500 Server Internal error	Cause value No 3 (no route to destination)
500 Server Internal error	Cause value No. 4 (Send special information tone)
404 Not Found	Cause value No. 5 (Misdialed trunk prefix)
486 Busy Here	Cause value No. 17 (user busy)
480 Temporarily unavailable	Cause value No 18 (no user responding)
480 Temporarily unavailable	Cause value No 19 (no answer from the user)
480 Temporarily unavailable	Cause value No. 20 (subscriber absent)
480 Temporarily unavailable	Cause value No 21 (call rejected)
410 Gone	Cause value No 22 (number changed)
480 Temporarily unavailable	Cause value No 25 (Exchange routing error)
502 Bad Gateway	Cause value No 27 (destination out of order)
484 Address Incomplete	Cause value No. 28 invalid number format (address incomplete)

←SIP Message	← REL
Status code	Cause parameter
500 Server Internal error	Cause value No 29 (facility rejected)
480 Temporarily unavailable	Cause value No 31 (normal unspecified) (class default) (Note 1)
486 Busy here if Diagnostics indicator includes the (CCBS indicator = CCBS possible) else 480 Temporarily unavailable	Cause value in the Class 010 (resource unavailable, Cause value No 34)
500 Server Internal error	Cause value in the Class 010 (resource unavailable, Cause value No"s. 38, 41, 42, 43, 44, & 47) (47 is class default)
500 Server Internal error	Cause value No 50 (requested facility no subscribed)
500 Server Internal error	Cause value No 57 (bearer capability not authorised)
500 Server Internal error	Cause value No 58 (bearer capability not presently)
500 Server Internal error	Cause value No 63 (service option not available, unspecified) (class default)
500 Server Internal error	Cause value in the Class 100 (service or option not implemented, Cause value No"s. 65, 70 & 79) 79 is class default
500 Server Internal error	Cause value No 88 (incompatible destination)
404 Not Found	Cause value No 91 (invalid transit network selection)
500 Server Internal error	Cause value No 95 (invalid message) (class default)
500 Server Internal error	Cause value No 97 (Message type non-existent or not implemented)
500 Server Internal error	Cause value No 99 (information element/parameter non-existent or not implemented)
480 Temporarily unavailable	Cause value No. 102 (recovery on timer expiry)
500 Server Internal error	Cause value No 110 (Message with unrecognised Parameter, discarded)
500 Server Internal error	Cause value No. 111 (protocol error, unspecified) (class default)
480 Temporarily unavailable	Cause value No. 127 (interworking unspecified) (class default)
NOTE 1: Class 1 and class 2 have the same default value.	

### 7.2.3.1.9 Receipt of RSC, GRS or CGB (H/W oriented)

If a RSC, GRS or CGB (H/W oriented) message is received after an initial address message has been sent for that circuit and after at least one backward message relating to that call has been received then:

- 1) If the final response (i.e. 200 OK (INVITE)) has already been sent, the I-MGCF shall send a BYE message.
- 2) If the final response (i.e. 200 OK (INVITE)) has not already been sent, the I-MGCF shall send a SIP response with Status-Code 480 Temporarily Unavailable.

### 7.2.3.1.10 Autonomous Release at I-MGCF

Table 10 shows the trigger events at the MGCF and the release initiated by the MGCF when the call is traversing from SIP to ISUP/BICC.

**Table 10: Autonomous Release at I-MGCF**

← SIP Response	Trigger event	REL → cause parameter
484 Address Incomplete	Determination that insufficient digits received.	Not sent.
480 Temporarily Unavailable	Congestion at the MGCF/Call is not routable.	Not sent.
BYE	ISUP/BICC procedures result in release after answer	According to ISUP/BICC procedures.
BYE	SIP procedures result in release after answer.	127 (Interworking unspecified)
500 Server Internal error	Call release due to the ISUP/BICC compatibility procedure (note)	According to ISUP/BICC procedures.
484 Address Incomplete	Call release due to expiry of T7 within the ISUP/BICC procedures	According to ISUP/BICC procedures.
480 Temporarily Unavailable	Call release due to expiry of T9 within the BICC/ISUP procedures	According to BICC/ISUP procedures.
480 Temporarily Unavailable.	Other BICC/ISUP procedures result in release before answer.	According to BICC/ISUP procedures.
NOTE: MGCF receives unrecognized ISUP or BICC signalling information and determines that the call needs to be released based on the coding of the compatibility indicators, refer to ITU-T Recommendation Q.764 [4] and ITU-T Q.1902.4 [30].		

7.2.3.1.11 Internal through connection of the bearer path

The through connection procedure is described in clause subclauses 9.2.3.1.7 and 9.2.3.2.7.

7.2.3.2 Outgoing Call Interworking from ISUP to SIP at O-MGCF

7.2.3.2.1 Sending of INVITE

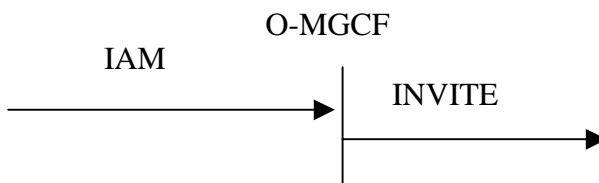

**Figure 12: Receipt of an IAM (En bloc signalling in CS network)**

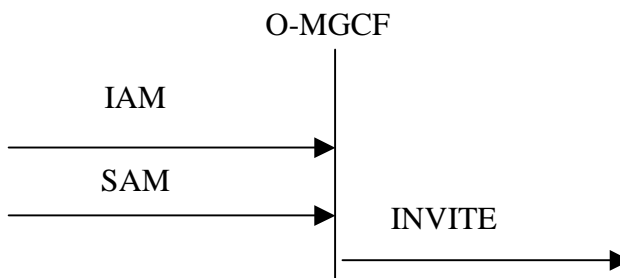

**Figure 13: Receipt of an IAM (Overlap signalling in CS network)**

After initiating the normal incoming BICC/ISUP call establishment procedures, determining the end of address signalling and selecting to route the call to the IMS domain, the O-MGCF shall send the initial INVITE with pre-conditions. Only calls with Transmission Requirements of speech or 3.1 kHz audio will be routed to the IMS domain, all other types of call attempts will be rejected.

The end of address signalling shall be determined by the earlier of the following criteria:

- a) by receipt of an end-of-pulsing (ST) signal; or
- b) by receipt of the maximum number of digits used in the national numbering plan; or
- c) by analysis of the called party number to indicate that a sufficient number of digits has been received to route the call to the called party; or
- d) by observing that timer Ti/w1 has expired after the receipt of the latest address message and the minimum number of digits required for routing the call have been received.

If the end of the address signalling is determined in accordance with criteria a) b) or c), the timer Ti/w2 is started when INVITE is sent.

### 7.2.3.2.2 Coding of the INVITE

#### 7.2.3.2.2.1 REQUEST URI Header

The called party number parameter of the IAM message is used to derive Request URI of the INVITE Request. The Request URI is a tel URL and shall contain an International public telecommunication number prefixed by a "+" sign (e.g. tel:+4911231234567).

#### 7.2.3.2.2.2 SDP Media Description

Depending on the coding of the continuity indicators different precondition information (RFC 3312 [37]) is included. If the continuity indicator indicates "continuity performed on a previous circuit" or "continuity required on this circuit", then the O-MGCF shall indicate that the precondition is not met. Otherwise the MGCF shall indicate whether the precondition is met, dependent on the possibly applied resource reservation within the IMS.

The SDP media description will contain precondition information as per RFC 3312 [37].

The O-MGCF shall include the AMR codec transported according to RFC 3267 [23] with the options listed in clause 5.1.1 of 3GPP TS 26.236 [32] in the SDP offer. Within the SDP offer, the O-MGCF should also provide SDP RR and RS bandwidth modifiers specified in IETF RFC 3556 [59] to disable RTCP, as detailed in Clause 7.4 of 3GPP TS 26.236 [32].

Table 11 provides a summary of how the header fields within the outgoing INVITE message are populated.

**Table 11 – Interworked contents of the INVITE message**

IAM→	INVITE→
Called Party Number	Request-URI
Calling Party Number	P-Asserted-Identity
	Privacy
	From
Generic Number (" <i>additional calling party number</i> ")	From
Hop Counter	Max-Forwards
TMR/USI	Message Body (application/SDP)



7.2.3.2.2.3 P-Asserted-Identity, From and Privacy header fields

**Table 12: Mapping BICC/ISUP CLI parameters to SIP header fields**

Has a Calling Party Number parameter with complete E.164 number, with Screening Indicator = UPVP or NP (See note 1), and with APRI = "presentation allowed" or "presentation restricted" been received?	Has a Generic Number (additional calling party number) with a complete E.164 number, with Screening Indicator = UPNV, and with APRI = "presentation allowed" been received?	P-Asserted-Identity header field	From header field:	Privacy header field
N	N	Header field not included	SIP or SIPS URI with addr spec "unavailable@anonymous.invalid" (note 2)	Header field not included
N (Note 3)	Y	Header field not included	addr-spec derived from Generic Number (ACgPN) address signals if available or network provided value	Header field not included
Y (note 1)	N	Derived from Calling Party Number parameter address signals (See table 14)	if APRI = "allowed", Tel URL derived from Calling Party Number parameter address signals (See table 14) if APRI = 'restricted', SIP or SIPS URI with addr spec 'anonymous@anonymous.invalid' (note 2)	If Calling Party Number parameter APRI = 'restricted' then priv-value =: 'id'. For other APRI settings Privacy header is not included or if included, 'id' is not included (See table 16)
Y	Y	Derived from Calling Party Number parameter address signals (See table 14)	Derived from Generic Number (ACgPN) address signals (See table 13)	If Calling Party Number parameter APRI = 'restricted' then priv-value =: 'id'. For other APRI settings Privacy header is not included or if included, 'id' is not included (See table 16)
<p>NOTE 1: A Network Provided CLI in the CgPN parameter may occur on a call to IMS. Therefore in order to allow the 'display' of this Network Provided CLI at a SIP UAS it shall be mapped into the SIP From header. It is also considered suitable to map into the P-Asserted-Identity header since in this context it is a fully authenticated CLI related exclusively to the calling line, and therefore as valid as a User Provided Verified and Passed CLI for this purpose.</p> <p>NOTE 2: The 'From' header may contain an 'Anonymous URI'. An 'Anonymous URI' includes information that does not point to the calling party. RFC 3261 [19] recommends that the display-name component contains "Anonymous". The Anonymous URI itself should have the value "anonymous@anonymous.invalid".</p> <p>NOTE 3: This combination of CgPN and ACgPN is an error case and this is shown here to ensure consistent mapping across different implementations.</p>				

**Table 13: Mapping of generic number (additional calling party number) to SIP from header fields**

BICC/ISUP parameter / field	Value	SIP component	Value
Generic Number Number Qualifier Indicator	'additional calling party number'	From header field	display-name (optional) and addr-spec
Nature of Address Indicator	'national (significant) number'	Tel URL	Add CC (of the country where the MGCF is located) to GN address signals to construct E.164 number in URI. Prefix number with '+'. Map complete GN address signals to E.164 number in URI. Prefix number with '+'.
	'international number'		
Address signal	if NOA is 'national (significant) number' then the format of the address signals is: NDC+ SN If NOA is 'international number' then the format of the address signals is: CC + NDC + SN		
		Tel URL	CC+NDC+SN as E.164 number in URI. Prefix number with '+'.

**Table 14: Mapping of calling party number parameter to SIP P-Asserted-Identity header fields**

BICC/ISUP Parameter / field	Value	SIP component	Value
Calling Party Number		P-Asserted-Identity header field	
Nature of Address Indicator	'national (significant) number'	Tel URL	Add CC (of the country where the MGCF is located) to CgPN address signals to construct E.164 number in URI. Prefix number with '+'. Map complete CgPN address signals to E.164 number in URI. Prefix number with '+'.
	'international number'		
Address signal	If NOA is 'national (significant) number' then the format of the address signals is: NDC + SN If NOA is 'international number' then the format of the address signals is: CC + NDC + SN		

**Table 15: Mapping of BICC/ISUP Calling Party Number parameter to SIP From header fields**

BICC/ISUP parameter / field	Value	SIP component	Value
Calling Party Number		From header field	
Nature of Address Indicator	<i>'national (significant) number'</i>	Tel URL	Add CC (of the country where the MGCF is located) to CgPN address signals then map to construct E.164 number in URI. Prefix number with '+'. Map complete CgPN address signals to construct E.164 number in URI. Prefix number with '+'.
	<i>'international number'</i>		
Address signal	If NOA is <i>'national (significant) number'</i> then the format of the address signals is: NDC + SN If NOA is <i>'international number'</i> then the format of the address signals is: CC + NDC + SN	Tel URL	CC+NDC+SN as E.164 number in URI. Prefix number with '+'. Map complete CgPN address signals to construct E.164 number in URI. Prefix number with '+'.

**Table 16: Mapping of BICC/ISUP APRI into SIP privacy header fields**

BICC/ISUP parameter / field	Value	SIP component	Value
Calling Party Number		Privacy header field	priv-value
APRI (See to determine which APRI to use for this mapping)	<i>'presentation restricted'</i>	Priv-value	'id' ( <i>'id'</i> included only if the P-Asserted-Identity header is included in the SIP INVITE)
	<i>'presentation allowed'</i>	Priv-value	omit Privacy header or Privacy header without <i>'id'</i> if other privacy service is needed
NOTE: When Calling Party Number parameter exists, P-Asserted-Identity header is always derived from it as in table 14.			

#### 7.2.3.2.2.4 Max Forwards header

If the Hop Counter procedure is supported in the CS network, the O-MGCF shall use the Hop Counter parameter to derive the Max-Forwards SIP header. Due to the different default values (that are based on network demands/provisions) of the SIP Max-Forwards header and the Hop Counter, an adaptation mechanism shall be used to adopt the Hop Counter to the Max Forwards at the O-MGCF. For example, the following guidelines could be applied.

- Max-Forwards for a given message should be monotone decreasing with each successive visit to a SIP entity, regardless of intervening interworking, and similarly for Hop Counter.
- The initial and successively mapped values of Max-Forwards should be large enough to accommodate the maximum number of hops that may be expected of a validly routed call.

The table 17 shows the principle of the mapping:

**Table 17: Hop counter-Max forwards**

Hop Counter	= Y	Max-Forwards	= X
NOTE: The Mapping of value X to Y should be done with the used (implemented) adaptation mechanism.			

The Principle of adaptation could be implemented on a basis of the network provision, trust domain rules and bilateral agreement.

7.2.3.2.3 Receipt of CONTINUITY

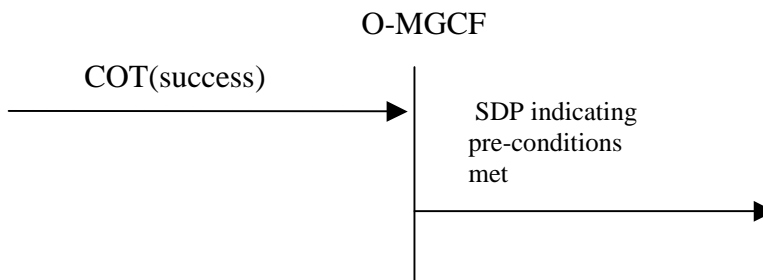

**Figure 14: Receipt of COT (success).**

When the requested preconditions in the IMS (if any) have been met and if possible outstanding continuity procedures have successfully been completed (COT with the Continuity Indicators parameter set to 'continuity check successful' is received), a SDP offer (e.g. a SIP UPDATE request) shall be sent for each early SIP dialogue confirming that all the required preconditions have been met.

7.2.3.2.4 Sending of ACM and awaiting answer indication

If the Address Complete Message (ACM) has not yet been sent, the following cases are possible trigger conditions that shall lead to the sending the address complete message (ACM).

- the detection of end of address signalling by the expiry of Timer T i/w<sub>1</sub> or,

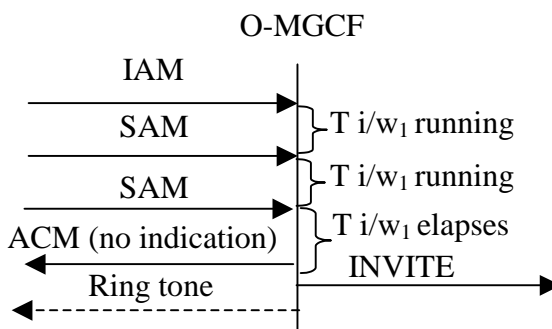

**Figure 15: Sending of ACM T i/w<sub>1</sub> elapses**

- the reception of the first 180 Ringing or,

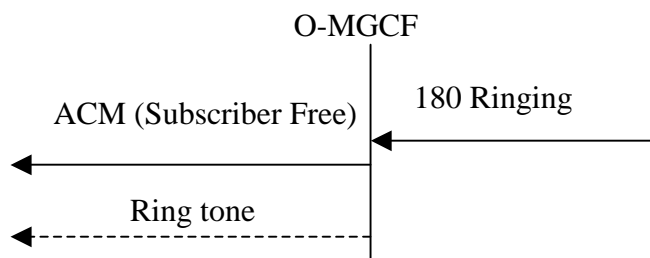

**Figure 16: Sending of ACM (Receipt of first 180 ringing)**

- $T_{i/w 2}$  expires after the initial INVITE is sent.

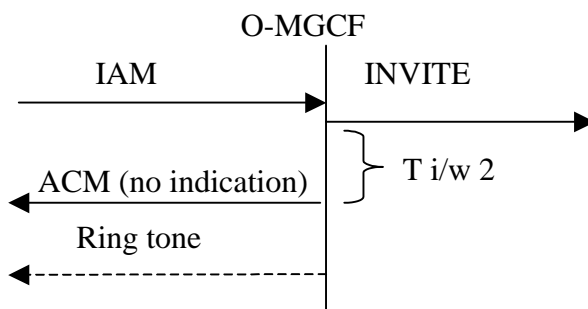

**Figure 17: Sending of ACM ( $T_{i/w 2}$  elapses)**

The sending of an awaiting answer indication is described in clause 9.2.3.3

### 7.2.3.2.5 Coding of the ACM

The description of the following ISDN user part parameters can be found in ITU-T Recommendation Q.763 [4].

#### 7.2.3.2.5.1 Backward call indicators

bits	AB	Charge indicator Contributors
	1 0	<i>charge</i>
bits	DC	Called party's status indicator
	0 1	<i>subscriber free</i> if the 180 Ringing has been received.
	0 0	<i>no indication</i> otherwise
bits	FE	Called party's category indicator
	0 0	<i>no indication</i>
bits	HG	End-to-end method indicator
	00	<i>no end-to-end method available</i>
bit	I	Interworking indicator
	1	<i>interworking encountered</i>
bit	J	End-to-end information indicator
	0	<i>no end-to-end information available</i>
bit	K	ISDN user part/BICC indicator

- 0 ISDN user part not used all the way
- bit L Holding indicator (national use)
  - 0 holding not requested
- bit M ISDN access indicator
  - 0 terminating access non-ISDN
- bit N Echo control device indicator
  - 1 Incoming echo control device included

### 7.2.3.2.6 Sending of the Call Progress message (CPG)

If the Address Complete Message (ACM) has already been sent, the O-MGCF shall send the Call Progress message (CPG) when receiving the following message:

- the first SIP 180 Ringing provisional response.

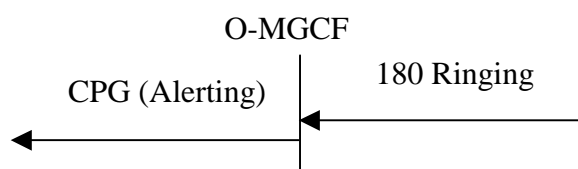

**Figure 18: Sending of CPG(Alerting)**

### 7.2.3.2.7 Coding of the CPG

The description of the following ISDN user part parameters can be found in ITU-T Recommendation Q.763 [4].

#### 7.2.3.2.7.1 Event information

- bits G-A Event indicator
- 0 0 0 0 0 0 1 *alerting*

#### 7.2.3.2.7a Receipt of 200 OK(INVITE)

Upon receipt of the first 200 OK (INVITE), the O-MGCF shall send an Answer Message (ANM) or Connect message (CON) as described in clauses 7.2.3.2.8 to 7.2.3.2.11.

The O-MGCF shall not progress any further early dialogues to established dialogues. Therefore, upon the reception of a subsequent final 200 (OK) response for any further dialogue for an INVITE request (e.g., due to forking), the O-MGCF shall:

- 1) acknowledge the response with an ACK request; and
- 2) send a BYE request to this dialog in order to terminate it.

### 7.2.3.2.8 Sending of the Answer Message (ANM)

Upon receipt of the first 200 OK (INVITE), if the Address Complete Message (ACM) has already been sent, the O-MGCF shall send the Answer Message (ANM) to the preceding exchange.

Note: Through connection and the stop of awaiting answer indication are described in clause 9.2.3.3

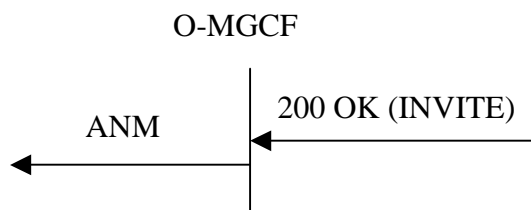

**Figure 19: Sending of ANM**

### 7.2.3.2.9 Coding of the ANM

#### 7.2.3.2.9.1 Backwards Call Indicators

If Backwards Call Indicators are included in the ANM, then the coding of these parameters shall be as described in clause 7.2.3.2.5.1.

### 7.2.3.2.10 Sending of the Connect message (CON)

Upon receipt of the first 200 OK (INVITE), if the Address Complete Message (ACM) has not yet been sent, the O-MGCF shall send the Connect message (CON) to the preceding exchange.

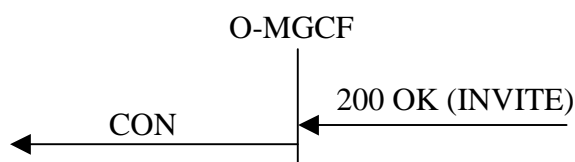

**Figure 20: Sending of CON**

### 7.2.3.2.11 Coding of the CON

The description of the following ISDN user part parameters can be found in ITU-T Recommendation Q.763 [4].

#### 7.2.3.2.11.1 Backward call indicators

The Called Party's status indicator (Bit DC) of BCI parameter is set to "no indication". The other BCI indicators shall be set as described in clause 7.2.3.2.5.1

### 7.2.3.2.12 Receipt of Status Codes 4xx, 5xx or 6xx

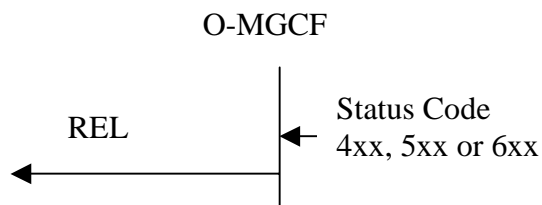

**Figure 21: Receipt of Status codes 4xx, 5xx or 6xx**

When receiving SIP response with status codes 4xx, 5xx or 6xx, the O-MGCF shall send a REL message. The coding of the Cause parameter value in the REL message is derived from the SIP Status code received according to table 18. The Cause Parameter Values are defined in ITU-T Recommendation Q.850 [38].

In all cases where SIP itself specify additional SIP side behaviour related to the receipt of a particular INVITE response these procedures should be followed in preference to the immediate sending of a REL message to BICC/ISUP.

If there are no SIP side procedures associated with this response, the REL shall be sent immediately.

NOTE: Depending upon the SIP side procedures applied at the O-MGCF it is possible that receipt of certain 4xx/5xx/6xx responses to an INVITE may in some cases not result in any REL message being sent to the BICC/ISUP network. For example, if a 401 Unauthorized response is received and the O-MGCF successfully initiates a new INVITE containing the correct credentials, the call will proceed.

**Table 18: 4xx/5xx/6xx Received on SIP side of O-MGCF**

←REL (cause code)	←4xx/5xx/6xx SIP Message
127 (interworking unspecified)	400 Bad Request
127 (interworking unspecified)	401 Unauthorized
127 (interworking unspecified)	402 Payment Required
127 (interworking unspecified)	403 Forbidden
1 (Unallocated number)	404 Not Found
127 (interworking unspecified)	405 Method Not Allowed
127 (interworking unspecified)	406 Not Acceptable
127 (interworking unspecified)	407 Proxy authentication required
127 (interworking unspecified)	408 Request Timeout
22 (Number changed)	410 Gone
127 (interworking unspecified)	413 Request Entity too long
127 (interworking unspecified)	414 Request-URI too long
127 (interworking unspecified)	415 Unsupported Media type
127 (interworking unspecified)	416 Unsupported URI scheme
127 (interworking unspecified)	420 Bad Extension
127 (interworking unspecified)	421 Extension required
127 (interworking unspecified)	423 Interval Too Brief
20 Subscriber absent	480 Temporarily Unavailable
127 (interworking unspecified)	481 Call/Transaction does not exist
127 (interworking unspecified)	482 Loop detected
127 (interworking unspecified)	483 Too many hops
28 (Invalid Number format)	484 Address Incomplete
127 (interworking unspecified)	485 Ambiguous
17 (User busy)	486 Busy Here
127 (Interworking unspecified) or not interworked. (Note 1)	487 Request terminated
127 (interworking unspecified)	488 Not acceptable here
127 (interworking unspecified)	493 Undecipherable
127 (interworking unspecified)	500 Server Internal error
127 (interworking unspecified)	501 Not implemented
127 (interworking unspecified)	502 Bad Gateway
127 (interworking unspecified)	503 Service Unavailable



←REL (cause code)	←4xx/5xx/6xx SIP Message
127 (interworking unspecified)	504 Server timeout
127 (interworking unspecified)	505 Version not supported
127 (interworking unspecified)	513 Message too large
127 (interworking unspecified)	580 Precondition failure
17 (User busy)	600 Busy Everywhere
21 (Call rejected)	603 Decline
1 (unallocated number)	604 Does not exist anywhere
127 (interworking unspecified)	606 Not acceptable
Note 1 – No interworking if the O-MGCF previously issued a CANCEL request for the INVITE.	
Note 2 – The 4xx/5xx/6xx SIP Messages that are not covered in this table are not interworked.	

### 7.2.3.2.13 Receipt of a BYE

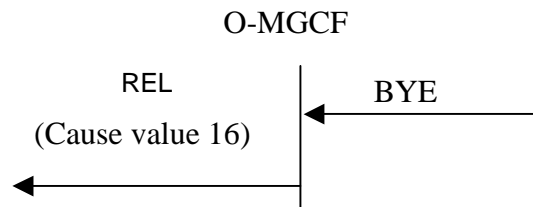

**Figure 22: Receipt of BYE method**

**NOTE:** If an optional Reason header field is included in the BYE, then the Cause Value can be mapped to the ISUP Cause Value field in the ISUP REL. The mapping of the Reason header to the Cause Indicators parameter is out of the scope of the present specification.

On receipt of a BYE method, the O-MGCF sends a REL message with Cause Code value 16 (Normal Call Clearing).

### 7.2.3.2.14 Receipt of the Release Message

In the case that the REL message is received and a final response (i.e. 200 OK (INVITE)) has already been received the O-MGCF shall send a BYE method. If the final response (i.e. 200 OK (INVITE)) has not already been received the O-MGCF shall send a CANCEL method.

### 7.2.3.2.15 Receipt of RSC, GRS or CGB (H/W oriented)

If a RSC, GRS or CGB (H/W oriented) message is received and a final response (i.e. 200 OK (INVITE)) has already been received the O-MGCF shall send a BYE method. If a final response (i.e. 200 OK (INVITE)) has not already been received the O-MGCF shall send a CANCEL method.

### 7.2.3.2.16 Autonomous Release at O-MGCF

If the O-MGCF determines due to internal procedures that the call shall be released then the MGCF shall send

- A BYE method if the ACK has been sent.
- A CANCEL method before 200 OK (INVITE) has been received.

**NOTE:** The MGCF shall send the ACK method before it sends the BYE, if 200 OK (INVITE) is received.

**Table 18a: Autonomous Release at O-MGCF**

REL ← Cause parameter	Trigger event	→ SIP
As determined by BICC/ISUP procedure.	COT received with the Continuity Indicators parameter set to ' <i>continuity check failed</i> ' (ISUP only) or the BICC/ISUP timer T8 expires.	CANCEL or BYE according to the rules described in this subclause.
<b>REL with cause value 47 (resource unavailable, unspecified).</b>	Internal resource reservation unsuccessful	As determined by SIP procedure
As determined by BICC/ISUP procedure.	BICC/ISUP procedures result in generation of autonomous REL on BICC/ISUP side.	CANCEL or BYE according to the rules described in this subclause.
Depending on the SIP release reason.	SIP procedures result in a decision to release the call.	As determined by SIP procedure.

**7.2.3.2.17 Special handling of 580 precondition failure received in response to either an INVITE or UPDATE**

A 580 Precondition failure response may be received as a response either to an INVITE or to an UPDATE request.

**7.2.3.2.17.1 580 Precondition failure response to an INVITE**

Release with cause code as indicated in table 17 is sent immediately to the BICC/ISUP network.

**7.2.3.2.17.2 580 Precondition failure response to an UPDATE within an early dialog**

Release with Cause Code '127 Interworking' is sent immediately to the BICC/ISUP network. A BYE request is sent for the INVITE transaction within which the UPDATE was sent.

**7.2.3.2.18 Sending of CANCEL**

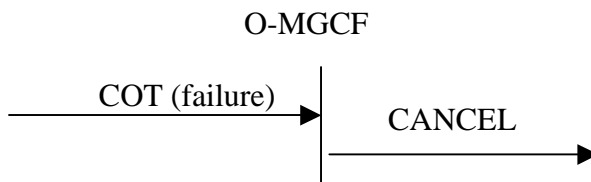

**Figure 23: Receipt of COT (failure).**

CANCEL shall be sent if the Continuity message is received with the Continuity Indicators parameter set to '*continuity check failed*' or the ISUP (or BICC) timer T8 expires.

7.2.3.2.19 Receipt of SIP redirect (3xx) response

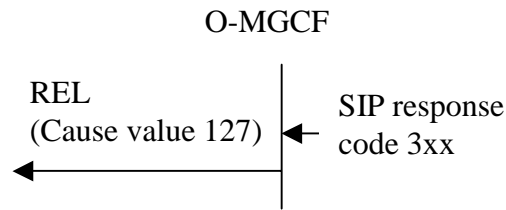

Figure 24: Receipt of SIP response code 3xx

When receiving a SIP response with a response code 3xx, the default behaviour of the O-MGCF is to release the call with a cause code value 127 (Interworking unspecified).

NOTE: The O-MGCF may also decide for example to redirect the call towards the URIs in the Contact header field of the response as an operator option, but such handling is outside of the scope of the present document.

7.2.3.3 Timers

Table 19: Timers for interworking

Symbol	Time-out value	Cause for initiation	Normal termination	At expiry	Reference
Ti/w1	4 s to 6 s (default of 4 s)	When last address message is received and the minimum number of digits required for routing the call have been received.	At the receipt of fresh address information.	Send INVITE, send the address complete message and insert ring tone	7.2.3.2.1 7.2.3.2.4 (Note 1)
Ti/w2	4 s to 14 s (default of 4 s)	When INVITE is sent.	On reception of 180 Ringing ,or 200 OK INVITE.	Send ACM (no indication) and send the awaiting answer indication (e.g. ring tone) or appropriate progress announcement to the calling party.	7.2.3.2.4 7.2.3.2.1

NOTE 1: This timer is used when overlap signalling is received from BICC/ISUP network.

### 7.3 Interworking between CS networks supporting BICC and the IM CN subsystem

The control plane between CS networks supporting BICC and the IM CN subsystem supporting SIP, where the underlying network is SS7 and IP respectively is as shown in figures 25, 26 and 27.

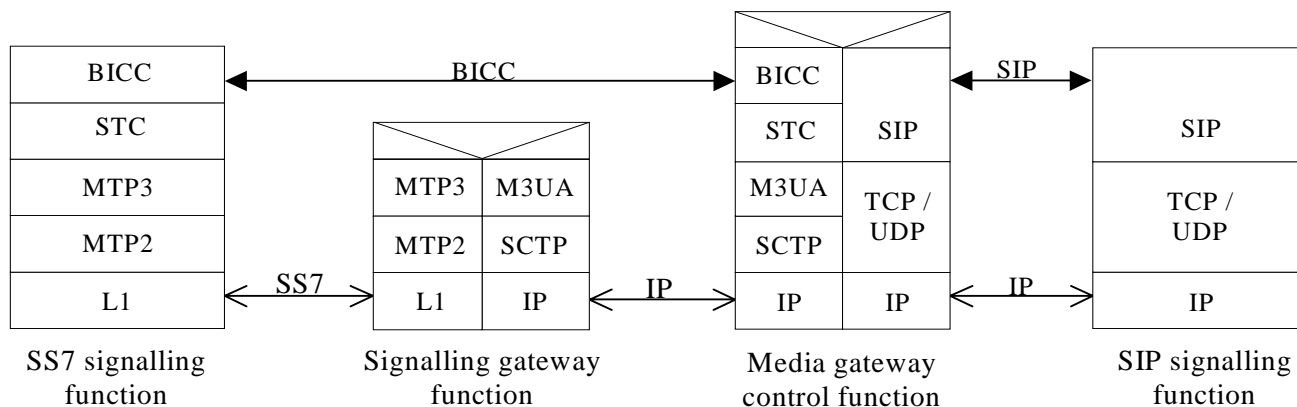

Figure 25: Control Plane interworking between CS networks supporting BICC over MTP3 and the IM CN subsystem

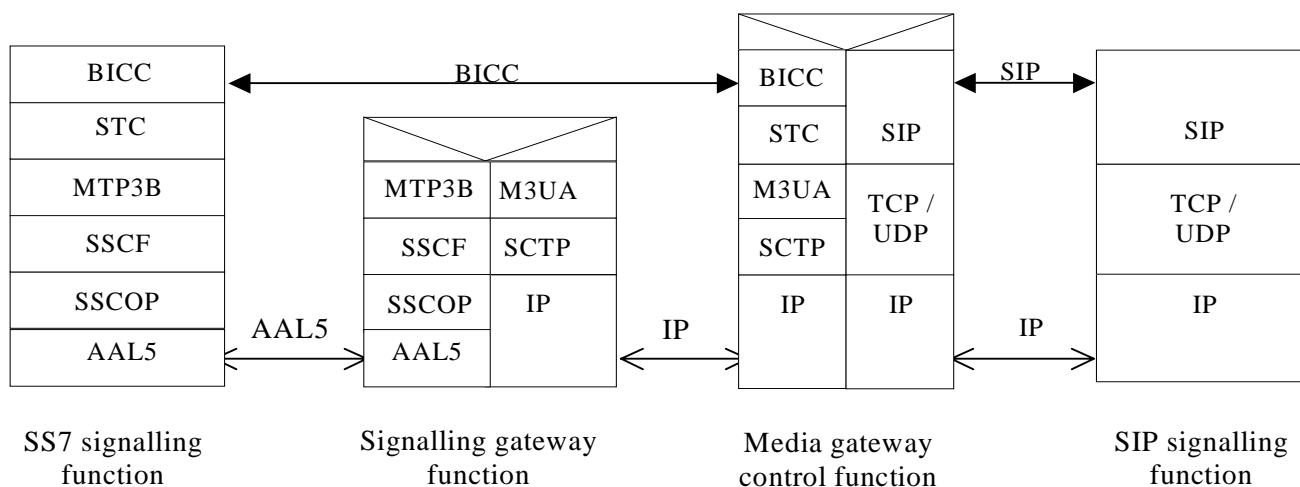

Figure 26: Control Plane interworking between CS networks supporting BICC over MTP3B over AAL5 and the IM CN subsystem

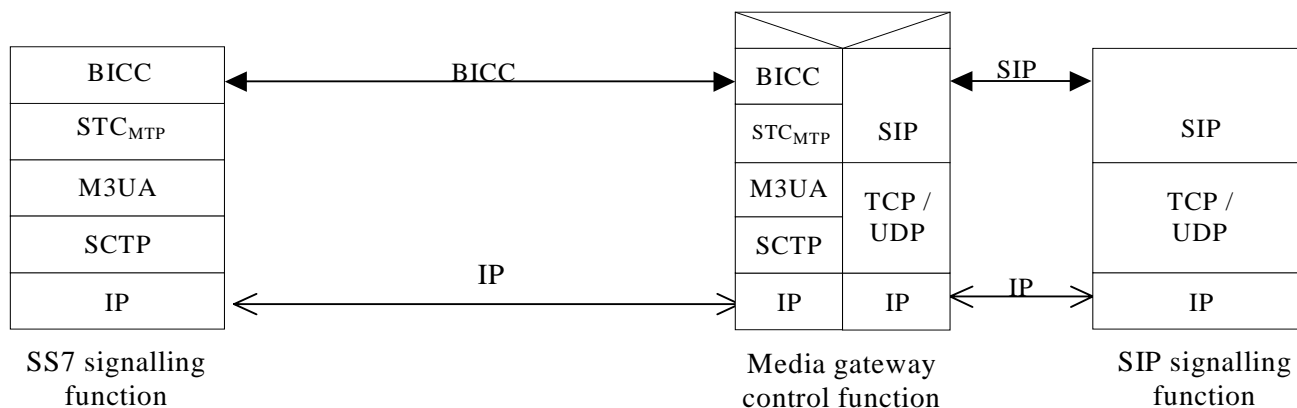

Figure 27: Control Plane interworking between CS networks supporting BICC over STC and M3UA and the IM CN subsystem

## 7.3.1 Services performed by network entities in the control plane

Services offered by the network entities in the control plane are as detailed in clause 7.2.1.

If ATM transport is applied between the SS7 Signalling function and the Signalling Gateway Function, they shall apply MTP3B (ITU-T Recommendation Q.2210 [46]) over SSCF (ITU-T Recommendation Q.2140 [45]) over SSCOP (ITU-T Recommendation Q.2110 [44]) over AAL5 (ITU-T Recommendation I.363.6 [43]) as depicted in figure 26.

If IP transport is applied between the SS7 Signalling function and the MGCF, they shall support and apply M3UA, SCTP and IP (either IPv4, see RFC 791 [16], or IPv6, see RFC 2460 [39]), as depicted in figure 27.

## 7.3.2 Signalling interactions between network entities in the control plane

### 7.3.2.1 Signalling between the SS7 signalling function and MGCF

See clause 7.2.2.1.

#### 7.3.2.1.1 Signalling from MGCF to SS7 signalling function

See clause 7.2.2.1.1.

#### 7.3.2.1.2 Signalling from SS7 signalling function to MGCF

See clause 7.2.2.1.2.

#### 7.3.2.1.3 Services offered by STC, SCTP and M3UA

See clause 7.2.2.1.3.

##### 7.3.2.1.3.1 Services offer by SCTP

See clause 7.2.2.1.3.1.

##### 7.3.2.1.3.2 Services offered by M3UA

See clause 7.2.2.1.3.2.

##### 7.3.2.1.3.3 Services offered by STC

STC provides the services for the transparent transfer of STC user information, e.g. BICC, between STC users, i.e. the SS7 signalling function and the MGCF (see 3GPP TS 29.205 [14]).

STC performs the functions of data transfer service availability reporting and congestion reporting to the STC user and User part availability control. See ITU-T Recommendation Q.2150.1 [29].

### 7.3.2.2 Signalling between the MGCF and SIP signalling function

See clause 7.2.2.2.

## 7.3.3 SIP-BICC protocol interworking

### 7.3.3.1 Incoming call interworking from SIP to ISUP at I-MGCF

#### 7.3.3.1.1 Sending of IAM

On reception of a SIP INVITE requesting an audio session, the I-MGCF shall send an IAM message.

The I-MGCF shall interwork forked INVITE requests with different request URIs.

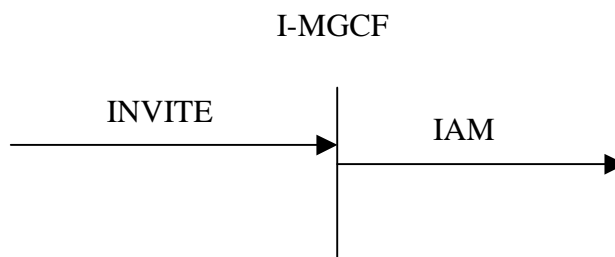

**Figure 28: receipt of Invite**

The I-MGCF shall reject an INVITE request for a non-audio session by sending a status code 488 "Not Acceptable Here". If audio media streams and non-audio media streams are contained in a single INVITE request, the non-audio media streams shall be rejected in the SDP answer, as detailed in RFC 3264 [36].

The I-MGCF shall include a To tag in the first backward non-100 provisional response, in order to establish an early dialog as described in RFC 3261 [19].

### 7.3.3.1.2 Coding of IAM

The description of the following ISDN user part parameters can be found in ITU-T Recommendation Q.763 [4].

#### 7.3.3.1.2.1 Called party number

See clause 7.2.3.1.2.1.

#### 7.3.3.1.2.2 Nature of connection indicators

bits	<u>BA</u>	Satellite indicator
	0 1	one satellite circuit in the connection
bits	<u>DC</u>	Continuity indicator (BICC)
	1 0	COT to be expected
bit	<u>E</u>	Echo control device indicator
	1	outgoing echo control device included

#### 7.3.3.1.2.3 Forward call indicators

See clause 7.2.3.1.2.3.

#### 7.3.3.1.2.4 Calling party's category

See clause 7.2.3.1.2.4.

#### 7.3.3.1.2.5 Transmission medium requirement

See clause 7.2.3.1.2.5.

#### 7.3.3.1.2.6 Calling party number

See clause 7.2.3.1.2.6.

7.3.3.1.2.7 Generic number

See clause 7.2.3.1.2.7.

7.3.3.1.2.8 User service information

See clause 7.2.3.1.2.8.

7.3.3.1.2.9 Hop counter (National option)

See clause 7.2.3.1.2.9.

7.3.3.1.3 Sending of COT

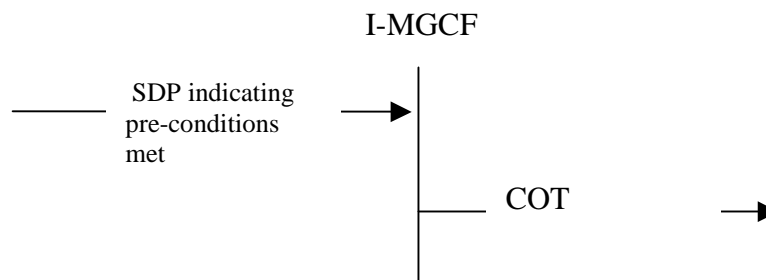

**Figure 29: Sending of COT**

When the requested preconditions in the IMS have been met, the IAM has already been sent, then the Continuity message shall be sent indicating "continuity check successful".

7.3.3.1.4 Sending of 180 Ringing

See clause 7.2.3.1.4

7.3.3.1.5 Sending of the 200 OK (INVITE)

See clause 7.2.3.1.5.

7.3.3.1.6 Sending of the Release message (REL)

See clause 7.2.3.1.6.

7.3.3.1.7 Coding of the REL

See clause 7.2.3.1.7.

7.3.3.1.8 Receipt of the Release Message

See clause 7.2.3.1.8.

7.3.3.1.9 Receipt of RSC, GRS or CGB (H/W oriented)

See clause 7.2.3.1.9.

7.3.3.1.10 Internal through connection of the bearer path

The through connection procedure is described in subclauses 9.2.3.1.7 and 9.2.3.2.7.

### 7.3.3.1.11 Out of Band DTMF

If a SIP UA sends DTMF tones to the IM-MGW, the IM-MGW may send this information via the Mn interface to the MGCF. The MGCF shall send to the BICC network the APM message with the following values for the different parameters:

- Action indicator in accordance with the requested DTMF transport function
- Signal in accordance with which DTMF digit to send
- Duration in accordance with the required duration of the DTMF digit.

If the BICC network sends an APM message with DTMF signal, duration and action indicator to the MGCF, the MGCF may send this information to the IM-MGW via the Mn interface. The IM-MGW shall send the corresponding DTMF signal and duration information on the user plane of the IM CN subsystem according to RFC 2833 [34].

The interactions with the IM-MGW are shown in clause 9.2.8.

### 7.3.3.2 Outgoing Call Interworking from BICC to SIP at O-MGCF

#### 7.3.3.2.1 Sending of INVITE

The following particularities applies for a BICC IAM received case, with regard to the already specified in clause 7.2.3.2.1.

An INVITE with precondition not yet satisfied on receipt of BICC IAM is sent.

#### 7.3.3.2.2 Coding of the INVITE

##### 7.3.3.2.2.1 REQUEST URI Header

See clause 7.2.3.2.2.1

##### 7.3.3.2.2.2 SDP Media Description

The O-MGCF shall indicate that precondition is not met.

The SDP media description will contain precondition information as per RFC 3312 [37].

The O-MGCF shall include the AMR codec transported according to RFC 3267 [23] with the options listed in clause 5.1.1 of 3GPP TS 26.236 [32] in the SDP offer. Within the SDP offer, the O-MGCF should also provide SDP RR and RS bandwidth modifiers specified in IETF RFC 3556 [59] to disable RTCP, as detailed in Clause 7.4 of 3GPP TS 26.236 [32].

##### 7.3.3.2.2.3 P-Asserted-Identity and privacy header fields

See clause 7.2.3.2.2.3

##### 7.3.3.2.2.4 Max Forwards header

See clause 7.2.3.2.2.4



## 7.3.3.2.3 Sending of UPDATE

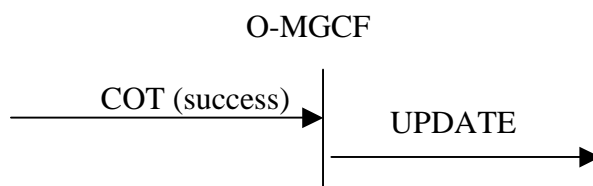

**Figure 30: Receipt of COT (success).**

The UPDATE shall be sent for each early SIP dialogue confirming that all the required preconditions have been met when all the following conditions are met.

1. A Continuity message, with the Continuity Indicators parameter set to "continuity" shall be received.
2. The requested preconditions in the IMS (if any) are met.

In addition, depending on which bearer set-up procedure used for the call one of the following condition shall be met

- The event Bearer Set-up indication – for the forward bearer set-up case where the incoming Connect Type is "notification not required", which indicate successful completion of bearer set-up, shall also be received by the Incoming bearer set-up procedure, (ITU-T Recommendation Q.1902.4 [30] clause 7.5)
- Bearer Set-up Connect indication for the backward call set-up case, which indicate successful completion of bearer set-up, shall also be received by the Incoming bearer set-up procedure, (ITU-T Recommendation Q.1902.4 [30] clause 7.5)
- BNC set-up success indication for cases using bearer control tunnelling which indicate successful completion of bearer set-up, shall also be received by the Incoming bearer set-up procedure, (ITU-T Recommendation Q.1902.4 [30] clause 7.5)

## 7.3.3.2.4 Sending of ACM and Awaiting Answer indication

See clause 7.2.3.2.4

The sending of an awaiting answer indication is described in clause 9.2.3.1. and clause 9.2.3.2.

## 7.3.3.2.5 Coding of the ACM

## 7.3.3.2.5.1 Backward call indicators

See clause 7.2.3.2.5.1

## 7.3.3.2.6 Sending of the Call Progress message (CPG)

See clause 7.2.3.2.6.

## 7.3.3.2.7 Coding of the CPG

## 7.3.3.2.7.1 Event information

See clause 7.2.3.2.7.1.

## 7.3.3.2.7a Receipt of 200 OK (INVITE)

See clause 7.2.3.2.7a.

### 7.3.3.2.8 Sending of the Answer Message (ANM)

See clause 7.2.3.2.8.

### 7.3.3.2.9 Coding of the ANM

See clause 7.2.3.2.9.

### 7.3.3.2.10 Sending of the Connect message (CON)

See clause 7.2.3.2.10.

### 7.3.3.2.11 Coding of the CON

See clause 7.2.3.2.11.

#### 7.3.3.2.11.1 Backward call indicators

See clause 7.2.3.2.11.1.

### 7.3.3.2.12 Receipt of Status Codes 4xx, 5xx or 6xx

See clause 7.2.3.2.12.

### 7.3.3.2.13 Receipt of a BYE

See clause 7.2.3.2.13.

### 7.3.3.2.14 Receipt of the Release Message

See clause 7.2.3.2.14.

### 7.3.3.2.15 Receipt of RSC, GRS or CGB (H/W oriented)

See clause 7.2.3.2.15.

### 7.3.3.2.16 Out of Band DTMF

If a SIP UA sends DTMF tones to the IM-MGW, the IM-MGW may send this information via the Mn interface to the MGCF. The MGCF shall send to the BICC network the APM message with the following values for the different parameters:

- Action indicator in accordance with the requested DTMF transport function
- Signal in accordance with which DTMF digit to send
- Duration in accordance with the required duration of the DTMF digit.

If the BICC network sends an APM message with DTMF signal, duration and action indicator to the MGCF, the MGCF may send this information to the IM-MGW via the Mn interface. The IM-MGW shall send the corresponding DTMF signal and duration information on the user plane of the IM CN subsystem according to RFC 2833 [34].

The interaction with the IM-MGW is shown in clause 9.2.8.

### 7.3.3.2.17 Sending of CANCEL

See clause 7.2.3.2.18.

### 7.3.3.2.18 Autonomous Release at O-MGCF

See clause 7.2.3.2.16.

#### 7.3.3.2.19 Special handling of 580 precondition failure received in response to either an INVITE or UPDATE

See clause 7.2.3.2.17.

#### 7.3.3.2.20 Receipt of SIP redirect (3xx) response

See clause 7.2.3.2.19.

#### 7.3.3.3 Timers

See clause 7.2.3.3.

### 7.4 Supplementary services

The following sub-clauses describe the MGCF behaviour related to supplementary services as defined in ITU-T Recommendations Q.730 to ITU-T Q.737. [42].

#### 7.4.1 Calling line identification presentation/restriction (CLIP/CLIR)

The inter working between the Calling Party Number parameter and the P-Asserted-ID header and vice versa used for the CLIP-CLIR service is defined in the clauses 7.2.3.1.2.6 and 7.2.3.2.2.6. This inter working is essentially the same as for basic call and differs only in that if the CLIR service is invoked the "Address Presentation Restriction Indicator (APRI)" (in the case of ISUP to SIP calls) or the "priv value" of the "calling" Privacy header field (in the case of SIP to ISUP calls) is set to the appropriate "restriction/privacy" value.

In the specific case of ISUP originated calls, use of the CLIP service additionally requires the ability to determine whether the number was network provided or provided by the access signalling system. Due to the possible SIP indication of the P-Asserted-Identity the Screening indicator is set to network provided as default. For the CLIP-CLIR service the mapping of the APRI from privacy header at the O-MGCF is described within table 16 in Clause 7.2.3.2.2.6.

At the O-MGCF the presentation restricted indication shall be mapped to the privacy header = "id" and "header". This is described in table 5 in clause 7.2.3.1.2.6.

#### 7.4.2 Connected line presentation and restriction (COLP/COLR)

The COLP/COLR services are only to be interworked between trusted nodes - that is before passing any COLP/COLR information over the SIP-BICC/ISUP boundary the MGCF shall satisfy itself that the nodes on the BICC/ISUP side to which the information is to be passed are trusted.

##### 7.4.2.1 Incoming Call Interworking From SIP to BICC/ISUP At The I-MGCF

###### 7.4.2.1.1 INVITE to IAM interworking (SIP to ISUP/BICC calls)

In the case of SIP to ISUP/BICC calls the I-MGCF may invoke the COLP service as an operator option by setting the "Connected Line Identity Request indicator" parameter of the "Optional forward call indicator" of the IAM to "requested".

NOTE: This implies that all outgoing calls will invoke the COLP/COLR service.

###### 7.4.2.1.2 ANM/CON to 200 OK (INVITE)

Tables 20 and 21 specify the interworking required in the case when the COLP has been automatically requested on behalf of the originating SIP node. The table also indicates the inter workings required if the COLP service has been invoked and the called party has or has not invoked the COLR service.

**Table 20 – Mapping to P-Asserted-Identity and Privacy Header Fields**

SIP Component	Setting
P-Asserted-Identity	See table 21
Privacy	See table 22

**Table 21 - Mapping of connected number parameter to SIP P-Asserted-Identity header fields**

BICC/ISUP parameter / field	Value	SIP component	Value
Connected Number		P-Asserted-Identity header field	
Nature of Address Indicator	"national (significant) number"	Tel URL	Add CC (of the country where the MGCF is located) to Connected PN address signals to construct E.164 number in URI. Prefix number with '+'. .
	"international number"		Map complete Connected address signals to construct E.164 number in URI. Prefix number with "+".
Address signal	If NOA is "national (significant) number" then the format of the address signals is: NDC + SN If NOA is "international number" then the format of the address signals is: CC + NDC + SN		
		Tel URL	CC+NDC+SN as E.164 number in URI. Prefix number with "+".

**Table 22: Mapping of BICC/ISUP APRIs into SIP privacy header fields**

BICC/ISUP parameter / field	Value	SIP component	Value
Connected Number		Privacy header field	priv-value
APRI (See to determine which APRI to use for this mapping)	"presentation restricted"	Priv-value	"id" ("id" included only if the P-Asserted-Identity header is included in the SIP INVITE)
	"presentation allowed"	Priv-value	omit Privacy header or Privacy header without "id" if other privacy service is needed

## 7.4.2.2 Outgoing Call Interworking from BICC/ISUP to SIP at O-MGCF

### 7.4.2.2.1 IAM to INVITE interworking (ISUP to SIP calls)

The O-MGCF determines that the COLP service has been requested by the calling party by parsing the "Optional Forward Call Indicators" field of the incoming IAM. If the "Connected Line Identity Request indicator" is set to "requested" then the BICC/ISUP to SIP interworking node shall ensure that any backwards "connected party" information is interworked to the appropriate parameters of the ISUP ANM or CON message sent backwards to the calling party as detailed within this clause.

The O-MGCF has to store the status of the "Connected Line Identity Request indicator".

### 7.4.2.2.2 1XX to ANM or CON interworking

If the P-Asserted-Identity header field is included within a 1XX SIP response, the identity shall be stored within the O-MGCF together with information about the SIP dialogue of the 1XX SIP response and be included within the ANM or CON message. In accordance with ISUP procedures a connected number shall not be included within the ACM message. The mapping of the of the P-Asserted-Identity and Privacy header fields is shown in tables 23 and 24.

### 7.4.2.2.3 200 OK (INVITE) to ANM/CON interworking

Tables 23 and 24 specify the interworking required in the case when the calling party has invoked the COLP service. The tables also indicate the interworking procedures required if the calling party has invoked the COLP service and the called party has or has not invoked the COLR service.

If no P-Asserted-Identity header field is provided within the 200 OK (INVITE) message, the stored information previously received in last provisional 1XX response of the same SIP dialogue shall be used.

NOTE: Due to forking, other P-Asserted-Identities may have been received in different SIP dialogues.

If the Calling Party has requested the COLP service (as indicated by the stored request status) but the 200 OK (INVITE) and previous 1XX provisional responses do not include a P-Asserted-Identity header field, the O-MGCF shall set up a network provided Connected Number with an Address not Available indication.

If the P-Asserted-Identity is available then the Connected number has to be setup with the screening indication network provided. The mapping of the P-Asserted-Identity and Privacy (if available) is shown in table 24.

Table 23 – Connected number parameter mapping

← ANM/CON	← 200 OK INVITE
Connected Number (Network Provided)	P-Asserted-ID
Address Presentation Restriction Indication	Privacy Value Field

Table 24: Mapping of P-Asserted-Identity and privacy headers to the ISUP/BICC connected number parameter

SIP component	Value	BICC/ISUP parameter / field	Value
P-Asserted-Identity header field (note 1)	E.164 number	Connected Number	
		Number incomplete indicator	"Complete"
		Numbering Plan Indicator	"ISDN/Telephony (E.164)"
		Nature of Address Indicator	If CC encoded in the URI is equal to the CC of the country where MGCF is located AND the next BICC/ISUP node is located in the same country then set to "national (significant) number" else set to "international number"
		Address Presentation Restricted Indicator (APRI)	Depends on priv-value in Privacy header.
		Screening indicator	Network Provided
Addr-spec	"CC" 'NDC' 'SN' from the URI	Address signal	if NOA is 'national (significant) number' then set to 'NDC' + 'SN' If NOA is 'international number' Then set to 'CC'+ 'NDC'+ 'SN'
Privacy header field is not present		APRI	Presentation allowed
Privacy header field	priv-value	APRI	"Address Presentation Restricted Indicator"
priv-value	"header"	APRI	Presentation restricted
	"user"	APRI	Presentation restricted
	"none"	APRI	Presentation allowed
	"id"	APRI	Presentation restricted
NOTE 1: It is possible that a P-Asserted –Identity header field includes both a TEL URI and a SIP or SIPS URI. In this case, the TEL URL is used.			

### 7.4.3 Direct Dialling In (DDI)

A direct dialling in call is a basic call and no additional treatment is required by the MGCF.

### 7.4.4 Malicious call identification

The actions of the MGCF at the ISUP/BICC side are described in ITU-T Recommendation Q.731.7 [42] under the clause "Interactions with other networks".

### 7.4.5 Sub-addressing (SUB)

The actions of the MGCF at the ISUP/BICC side are described in ITU-T Recommendation Q.731.8 [42] under the clause "Interactions with other networks".

### 7.4.6 Call Forwarding Busy (CFB)/ Call Forwarding No Reply (CFNR) / Call Forwarding Unconditional (CFU)

The actions of the MGCF at the ISUP/BICC side are described in ITU-T Recommendation Q.732.2-4 [42] under the clause "Interactions with networks not providing any call diversion information".

### 7.4.7 Call Deflection (CD)

The actions of the MGCF at the ISUP/BICC side are described in ITU-T Recommendation Q.732.5 [42] under the clause "Interactions with other networks".

### 7.4.8 Explicit Call Transfer (ECT)

The actions of the MGCF at the ISUP/BICC side are described in ITU-T Recommendation Q.732.7 [42] under the clause "Interactions with other networks".

### 7.4.9 Call Waiting

The actions of the MGCF at the ISUP/BICC side are described in ITU-T Q.733.1 [42] under the clause "Interactions with other networks".

### 7.4.10 Call Hold

The service is interworked as indicated in 3GPP TS 23.228 [12].

#### 7.4.10.1 Session hold initiated from the IM CN subsystem side

The IMS network makes a hold request by sending an UPDATE or re-INVITE message with an "inactive" or a "sendonly" SDP attribute (refer to RFC 3264 [36]), depending on the current state of the session. Upon receipt of the hold request from the IMS side, the MGCF shall send a CPG message to the CS side with a "*remote hold*" *Generic notification indicator*. To resume the session, the IMS side sends an UPDATE or re-INVITE message with a 'recvonly' or 'sendrecv' SDP attribute, depending on the current state of the session. Upon receipt of the resume request from the IMS side, the MGCF shall send a CPG message to the CS side with a "*remove retrieval*" *Generic notification indicator*. The user plane interworking of the hold/resume request is described in the clause 9.2.9.

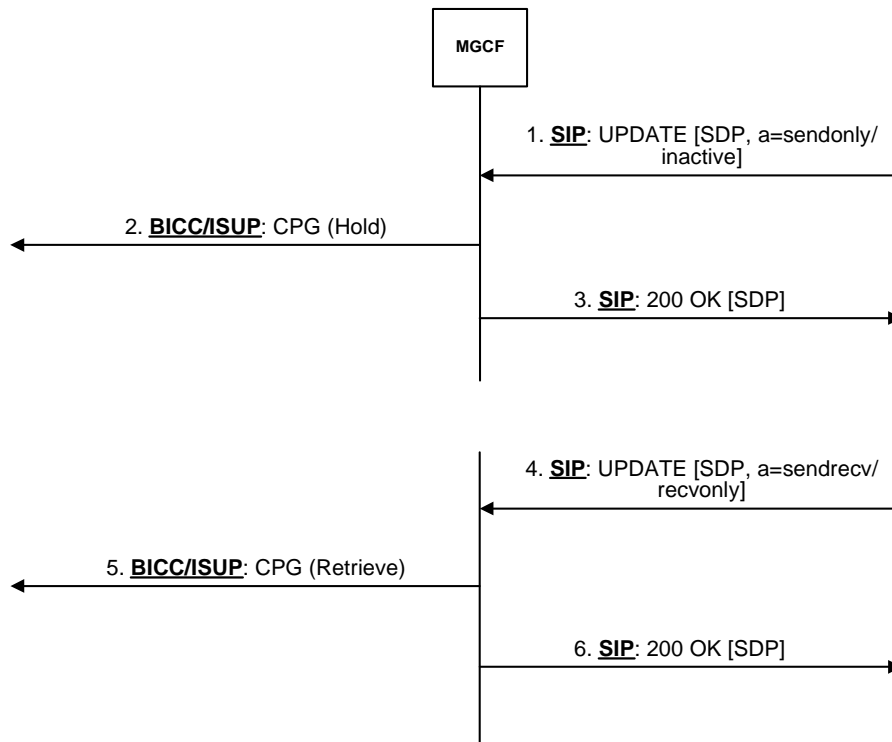

**Figure 30a Session hold/resume initiated from the IM CN subsystem side**

#### 7.4.10.2 Session hold initiated from the CS network side

When an MGCF receives a CPG message with a "*remote hold*" Generic notification indicator, the MGCF shall forward the hold request by sending an UPDATE or re-INVITE message containing SDP with '*sendonly*' or '*inactive*' media.

When an MGCF receives a CPG message with a "*remote retrieval*" Generic notification indicator, the MGCF shall forward the resume request by sending an UPDATE or re-INVITE message containing SDP with '*sendrecv*' or '*recvonly*' media.

If the MGCF receives a CPG with "*remote hold*" or "*remote retrieval*" before answer, it shall forward the request using an UPDATE message. If the MGCF receives a CPG with "*remote hold*" or "*remote retrieval*" after answer, it should forward the request using re-INVITE but may use UPDATE.

If link aliveness information is required at the IM-MGW while the media are on hold, the O-MGCF should provide modified SDP RR and RS bandwidth modifiers specified in IETF RFC 3556 [59] within the UPDATE or re-INVITE messages holding and retrieving the media to temporarily enable RTCP while the media are on hold, as detailed in Clause 7.4 of 3GPP TS 26.236 [32]. If no link aliveness information is required at the IM-MGW, the O-MGCF should provide the SDP RR and RS bandwidth modifiers previously used.

The interworking does not impact the user plane, unless the MGCF provides modified SDP RR and RS bandwidth modifiers within the UPDATE or re-INVITE messages. If the MGCF provides modified SDP RR and RS bandwidth modifiers to the IMS side, the MGCF shall also provide modified SDP RR and RS bandwidths to the IM-MGW, as described in the clause 9.2.10.



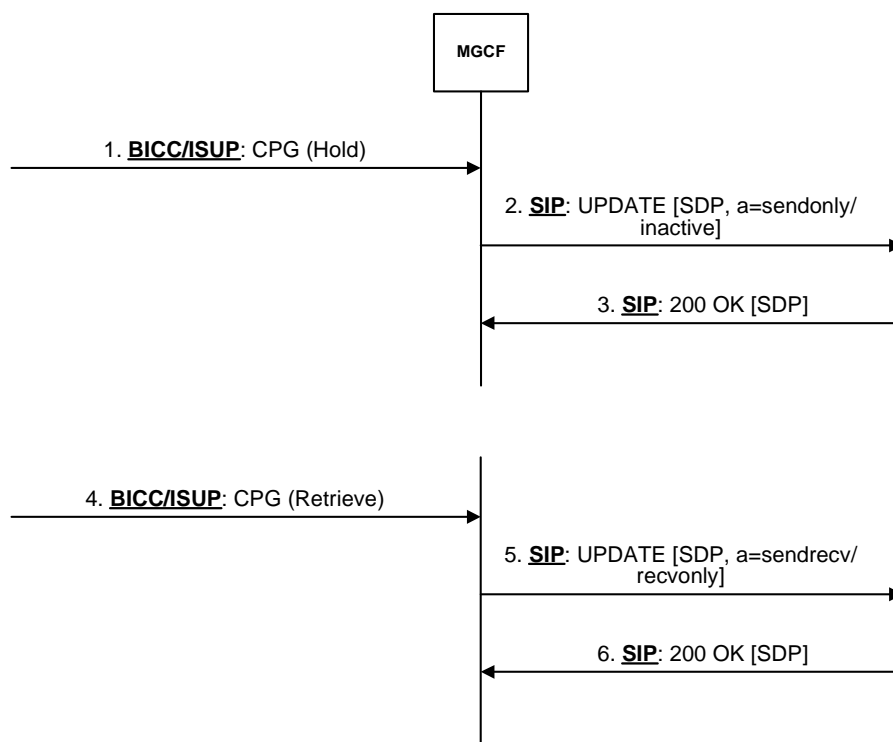

**Figure 30b Session hold/resume initiated from the CS network side**

### 7.4.11 Call Completion on busy subscriber

The actions of the MGCF at the ISUP/BICC side are described in ITU-T Recommendation Q.733.3 [42] under the clause "Interactions with other networks".

### 7.4.12 Completion of Calls on No Reply (CCNR)

The actions of the MGCF at the ISUP/BICC side are described in ITU-T Recommendation Q.733.5 [42] under the clause "Interactions with other networks".

### 7.4.13 Terminal Portability (TP)

The actions of the MGCF at the ISUP/BICC side are described in ITU-T Recommendation Q.733.4 [42] under the clause "Interactions with other networks".

### 7.4.14 Conference calling (CONF)

The actions of the MGCF at the ISUP/BICC side are described in ITU-T Recommendation Q.734.1 [42] under the clause "Interactions with other networks".

### 7.4.15 Three-Party Service (3PTY)

The actions of the MGCF at the ISUP/BICC side are described in ITU-T Recommendation Q.734.2 [42] under the clause "Interactions with other networks".

### 7.4.16 Closed User Group (CUG)

The actions of the MGCF at the ISUP/BICC side are described in ITU-T Recommendation Q.735.1[42] under the Clause 1.5.2.4.2 "Exceptional procedures".

### 7.4.17 Multi-Level Precedence and Pre-emption (MLPP)

The actions of the MGCF at the ISUP/BICC side are described in ITU-T Recommendation Q.735.3 [42] under the clause "Interactions with other networks".

### 7.4.18 Global Virtual Network Service (GVNS)

The actions of the MGCF at the ISUP/BICC side are described in ITU-T Recommendation Q.735.6 [42] under the clause "Interactions with other networks".

### 7.4.19 International telecommunication charge card (ITCC)

An International Telecommunication charge card call is a basic call and no additional treatment is required by the MGCF.

### 7.4.20 Reverse charging (REV)

The actions of the MGCF at the ISUP/BICC side are described in ITU-T Recommendation Q.736.3 [42] under the clause "Interactions with other networks".

### 7.4.21 User-to-User Signalling (UUS)

The actions of the MGCF at the ISUP/BICC side are described in ITU-T Recommendation Q.737.1[42] under the clause "Interactions with other networks".

### 7.4.22 Multiple Subscriber Number (MSN)

A MSN call is a basic call and no additional treatment is required by the MGCF.

---

## 8 User plane interworking

### 8.1 Interworking between IM CN subsystem and bearer independent CS network

When the IM CN subsystem interworks with the bearer independent CS networks (e.g. CS domain of a PLMN, 3GPP TS 29.414 [25], 3GPP TS 29.415 [26], 3GPP TS 23.205 [27]), the Transport Network Layer (TNL) of the bearer independent CS network can be based e.g. on IP/UDP/RTP, or IP/UDP/RTP/IuFP, or ATM/AAL2/ framing protocol (e.g. Iu framing) transport techniques. Figure 31 shows the user plane protocol stacks for the IM CS subsystem and bearer independent CS network interworking. If the same AMR configuration is used on the CS network side as on the IMS side, transcoding is not required. However, there is still a need to interwork between RTP/UDP/IP/L2/LI to TNL/LI.

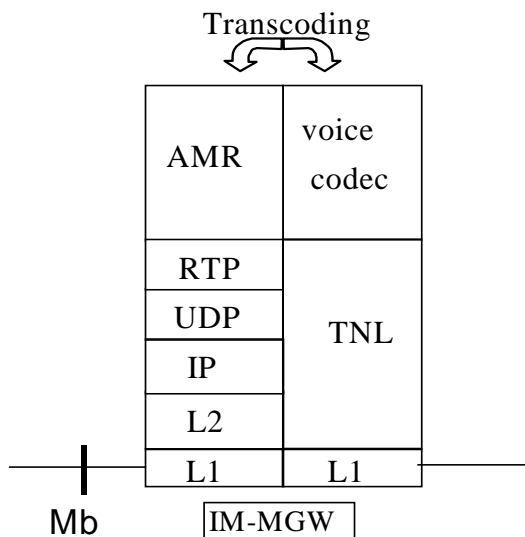

Figure 31/1: IM CN subsystem to bearer independent CS network user plane protocol stack

### 8.1.1 Transcoder-less Mb to Nb Interworking

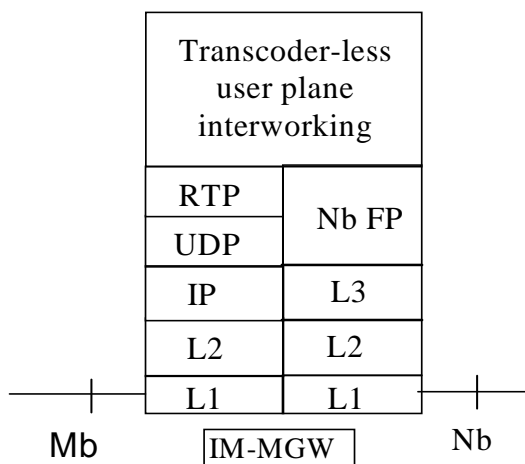

Figure 31/2: IM CN subsystem to bearer independent CS network user plane protocol stack (optional in the event the codecs on both sides are the same)

If no transcoder is inserted, the IM-MGW shall interwork the following procedures between the Nb and Mb interfaces.

#### 8.1.1.1 Initialisation

. There is no need to interwork initialisation procedures between Nb and Mb interfaces see 3GPP TS 29.415 [26].

#### 8.1.1.2 Time alignment

The purpose of the time alignment procedure on the Nb interface is to minimise the buffer delay in the RNC for downlink transmissions by adjusting the vocoder time reference within the network. No such procedure exists on the Mb interface, so the IM-MGW shall return NACK indication time alignment not supported according to 3GPP TS 25.415 [26].

### 8.1.1.3 Rate control

The rate control procedure signals to the peer entity the maximum rate among the currently allowed rates at which it can receive codec frames. Rate control only applies to AMR family codec configurations with multiple active modes. On the Nb interface, IuFP provides for rate control via the exchange of RATE CONTROL and RATE CONTROL ACK PDUs. On the Mb interface, RFC 3267 [23] provides for in-band rate control via the Codec Mode Request (CMR) field of every codec frame.

Interworking of rate control procedures at an IM-MGW between an Mb interface and a corresponding Nb interface only applies when the IM-MGW bridges compatible codec configurations between the interfaces without applying a transcoding function. An IM-MGW receiving a CMR from an Mb interface shall initiate the IuFP rate control procedure on the corresponding Nb interface. An IM-MGW receiving a rate control request on an Nb interface shall adjust the CMR field of outgoing speech frames on the corresponding Mb interface.

### 8.1.1.4 Frame quality indication

The Nb interface signals frame quality with the Frame Quality Classification (FQC) field of each speech frame PDU. See 3GPP TS 26.102 [50] and 3GPP TS 25.415 [26] for details. The FQC may have possible values: 0=frame\_good; 1=frame\_bad; 2=frame\_bad\_due\_to\_radio; and 3=spare. The Mb interface signals frame quality with the Q bit (frame quality indicator) field of each speech frame, as defined in RFC 3267 [23]. The Q bit may have values: 1=speech\_good; and 0=speech\_bad or sid\_bad.

Tables 24a and 24b provide the mapping between Mb and Nb interfaces.

**Table 24a: Mapping of Mb (Q bit) onto Nb (FQC)**

Mb - Qbit	Mb - FT	Nb - FQC
1	x	0
0	x	1

**Table 24b: Mapping Nb onto Mb**

Nb - FQC	Mb - Qbit	Mb - FT
0	1	NC
1	0	NO_DATA
2	0	NC

### 8.1.1.5 Framing

Even when the IM-MGW bridges compatible codec configurations between the Nb and Mb interfaces, the IM-MGW shall perform translation between the frame formats defined for the two interfaces, since all codec configurations have different framing procedures for the two interfaces. The framing details for Nb are defined in 3GPP TS 26.102 [50] and 3GPP TS 25.415 [26], although they do not describe the framing for ITU-T codecs other than G.711. The framing details for Mb are defined in RFC 3267 [23], RFC 3550 [51], RFC 3551 [52] and RFC 3555 [53].

### 8.1.1.6 Transcoding

Transcoding at the IM-MGW is avoided when the IM-MGW bridges compatible codec configurations between the Nb and Mb interfaces. Otherwise transcoding is necessary, which eliminates the need to interwork other user plane procedures between the interfaces.

### 8.1.1.7 Discontinuous transmission

When the IM-MGW bridges compatible codec configurations between the Nb and Mb interfaces, the DTX procedures are normally interworked transparently by translating between the framing formats on the interfaces. All the ITU-T and AMR family codecs have configurations that are compatible between the Mb and Nb interfaces.

### 8.1.1.8 Timing and sequence information

The IM-MGW shall always correct out-of-sequence delivery between Nb and Mb interfaces, either by re-ordering frames, or by dropping frames that are out of sequence.

When the IuFP frame numbers are based on time and if the IM-MGW bridges compatible codec configurations between the Nb and Mb interfaces, it shall either correct jitter before forwarding PDUs or interwork the RTP timestamp (see RFC 3550 [51]) with the IuFP Frame Number (see 3GPP TS 25.415 [26]) so that both the RTP timestamp and IuFP frame number similarly reflect the nominal sampling instant of the user data in the packet.

NOTE: Correcting jitter may cause additional delay.

The RTP sequence number (see RFC 3550 [51]) is handled independently on Mb, i.e. it is not interworked with the IuFP Frame Number (see 3GPP TS 25.415 [26]).

## 8.2 Interworking between IM CN subsystem and TDM-based CS network

It shall be possible for the IM CN subsystem to interwork with the TDM based CS networks (e.g. PSTN, ISDN or CS domain of a PLMN). Figure 32 describes the user plane protocol stack to provide the particular interworking.

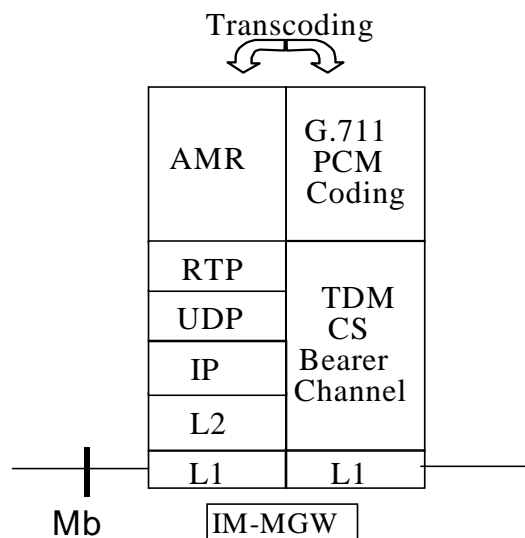

Figure 32: IM CN subsystem to TDM-based CS network user plane protocol stack

### 8.3 Transcoding requirements

The IM CN subsystem supports the AMR codec as the native codec for basic voice services. For IM CN subsystem terminations, the IM MGW shall support the transport of AMR over RTP according to RFC 3267 [23]. The MGCF shall support the options of RFC 3267 listed within clause 5.1.1 of 3GPP TS 26.236 [32].

It shall be possible for the IM CN subsystem to interwork with the CS networks (e.g. PSTN, ISDN or a CS domain of a PLMN) by supporting AMR to G.711 transcoding (see ITU-T Recommendation G.711 [1]) in the IM-MGW. The IM-MGW may also perform transcoding between AMR and other codec types supported by CS networks.

### 8.4 Diffserv code point requirements

The IM-MGW shall perform DiffServ Code Point (DSCP) markings (see RFC 2474 [21]) on the IP packets sent towards the IM CN subsystem entity like UE or MRFP across the Mb interface to allow DiffServ compliant routers and GGSNs to schedule the traffic accordingly.

The IETF Differentiated Services architecture ( see RFC 2475 [22]) shall be used to provide QoS for the external bearer service.

The DSCP shall be operator configurable.

## 9 MGCF – IM-MGW Interaction

### 9.1 Overview

The MGCF shall control the functions of the IM-MGW, which are used to provide the connection between media streams of an IP based transport network and bearer channels from a CS network.

The MGCF shall interact with the IM-MGW across the Mn reference point. The MGCF shall terminate the signalling across the Mn interface towards the IM-MGW and the IM-MGW shall terminate the signalling from the MGCF.

The signalling interface across the Mn reference point shall be defined in accordance with ITU-T Recommendation H.248.1 [2] and shall conform to 3GPP specific extensions as detailed in 3GPP TS 29.332 [15].

The present specification describes Mn signalling procedures and their interaction with BICC/ISUP and SIP signalling in the control plane, and with user plane procedures. 3GPP TS 29.332 [15] maps these signalling procedures to H.248 messages and defines the required packages and parameters.

### 9.2 Mn signalling interactions

The following paragraphs describe the Mn interface procedures triggered by SIP and BICC signalling relayed in MGCF.

The SIP signalling occurring at the MGCF is described in 3GPP TS 24.229 [9].

All message sequence charts in this clause are examples.

#### 9.2.1 Network model

Figure 33 shows the network model, applicable to BICC and ISUP cases. The broken line represents the call control signalling. The dotted line represents the bearer control signalling (if applicable) and the user plane. The MGCF uses one context with two terminations in the IM-MGW. The termination T1 is used towards the IM CN subsystem entity and the bearer termination T2 is used for the bearer towards the succeeding CS network element.

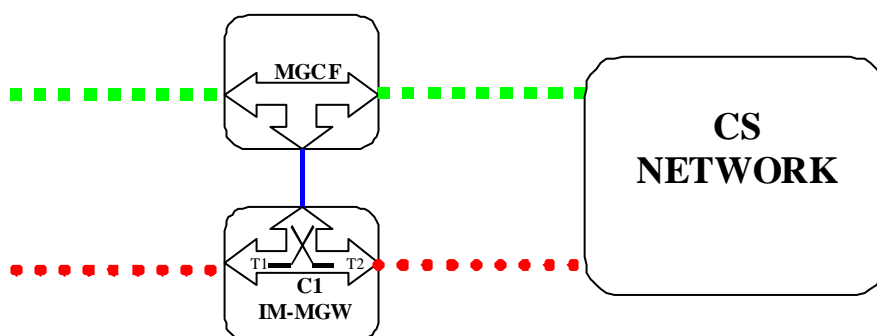

Figure 33: Network model

## 9.2.2 Basic IM CN subsystem originated session

### 9.2.2.1 BICC forward bearer establishment

#### 9.2.2.1.1 IM-MGW selection

The MGCF shall select an IM-MGW for the bearer connection before it performs the CS network side bearer establishment. This may happen either before sending the IAM or after receiving the APM message (signal 5 or signal 6 in figure 34). In the latter case, the IM-MGW selection may be based on a possibly received MGW-id from the succeeding node.

#### 9.2.2.1.2 CS network side bearer establishment

The MGCF shall either select bearer characteristics or request the IM-MGW to select and provide the bearer characteristics for the CS network side bearer connection before sending the IAM. In the latter case the MGCF shall use the Prepare Bearer procedure, not shown in figure 34, to request the IM-MGW to select the bearer characteristics. After the succeeding node has provided a bearer address and a binding reference in the APM, the MGCF shall use the Establish Bearer procedure to request the IM-MGW to establish a bearer towards the destination CS-MGW. The MGCF shall provide the IM-MGW with the bearer address, the binding reference and the bearer characteristics (signal 7 in figure 34).

#### 9.2.2.1.3 IM CN subsystem side termination reservation

On receipt of an initial INVITE (signal 1 in figure 34) the MGCF shall initiate the Reserve IMS Connection Point and Configure Remote Resources procedure (signal 3 and 4 in figure 34). From the received SDP and local configuration data the MGCF:

- Shall send the appropriate remote codec(s), the remote UDP port and the remote IP address to the IM-MGW. The remote UDP port and IP address refer to the destination of user plane data sent towards the IM CN subsystem. The remote codec(s) are the codec(s) the IM-MGW may select for user plane data sent towards the IM CN subsystem.
- Shall indicate to the IM-MGW the appropriate local codec(s) and request a local IP address and UDP port. The local IP address and UDP port are used by the IM-MGW to receive user plane data from the IM CN subsystem. The local codec(s) are the codec(s) the IM-MGW may select to receive user plane data from the IM CN subsystem.
- If DTMF support together with speech support is required, the reserve value indicator shall be set to "true".

The IM-MGW

- Shall reply to the MGCF with the selected local codec(s) and the selected remote codec(s) and the selected local UDP port and IP address.
- Shall reserve resources for those codec(s).

The MCGF shall send the local codec(s), UDP port and IP address to the IMS in the Session Progress (signal 9 in figure 34).

#### 9.2.2.1.4 IM CN subsystem side session establishment

Dependent on what the MGCF receives in the PRACK message (signal 10 in figure 34), the MGCF may initiate the Configure IMS Resources procedure. If no SDP is received, or if the received SDP does not contain relevant changes compared to the previous SDP sent to the IMS in signal 9 in figure 34, the procedure is not invoked. Otherwise the MGCF shall use the Configure IMS Resources procedure to provide to the IM-MGW

- The appropriate remote codec(s), the remote UDP port and the remote IP address.
- Optionally the appropriate local codec(s), UDP port and IP address.
- If DTMF support together with speech support is required, the reserve value indicator shall be set to "true".

The IM-MGW shall:

- Reply to the MGCF with the selected remote codec(s),
- Reply to the MGCF with the selected local codec(s) if the MGCF supplied local codec(s),
- Update the codec reservation and remote IP address and remote UDP port in accordance with the received information.

The MGCF shall include the selected codec(s) and UDP port and IP address in an 200 OK (PRACK) (signal 11 in figure 34) sent back to the IMS.

#### 9.2.2.1.5 Through-connection

During the Prepare Bearer and Establish Bearer procedures, the MGCF shall either use the Change Through-Connection procedure to request the IM-MGW to backward through-connect the BICC terminations, or the MGCF shall use this procedure to both-way through-connect the BICC termination already on this stage (signal 7 in figure 34). During the Reserve IMS Connection Point procedure, the MGCF shall use the Change IMS Through-Connection procedure to request the IM-MGW to backward through-connect the IMS termination (signal 3 in figure 34).

When the MGCF receives the BICC:ANM answer indication, it shall request the IM-MGW to both-way through-connect the termination using the Change Through-Connection or Change IMS Through-Connection procedures (signal 22 in figure 34), unless those terminations are already both-way through-connected.

#### 9.2.2.1.6 Codec handling

The IM-MGW may include a speech transcoder based upon the speech coding information provided to each termination.

#### 9.2.2.1.7 Failure handling in MGCF

If any procedure between the MGCF and the IM-MGW is not completed successfully the default action by the MGCF is to release the session, as described in clause 9.2.6. If the MGCF receives a Bearer Released procedure from the IM-MGW the default action by the MGCF is to release the session as described in clause 9.2.7.

**NOTE:** As an implementation option the MGCF may also decide for example to only release the resources in the IM-MGW that caused the failure, possibly select a new IM-MGW for the connection and continue the call establishment using new resources in the selected IM-MGW but such handling is outside of the scope of the present document.

#### 9.2.2.1.8 Message sequence chart

Figure 34 shows the message sequence chart for the IM CN subsystem originating session with BICC forward bearer establishment where the selection of IM-MGW is done before the sending of the IAM. In the chart the MGCF requests the seizure of an IM CN subsystem side termination. When the APM is received from the succeeding node, the MGCF requests the seizure of a CS network side bearer termination and the establishment of the bearer. When the MGCF receives an answer indication, it requests the IM-MGW to both-way through-connect the terminations.



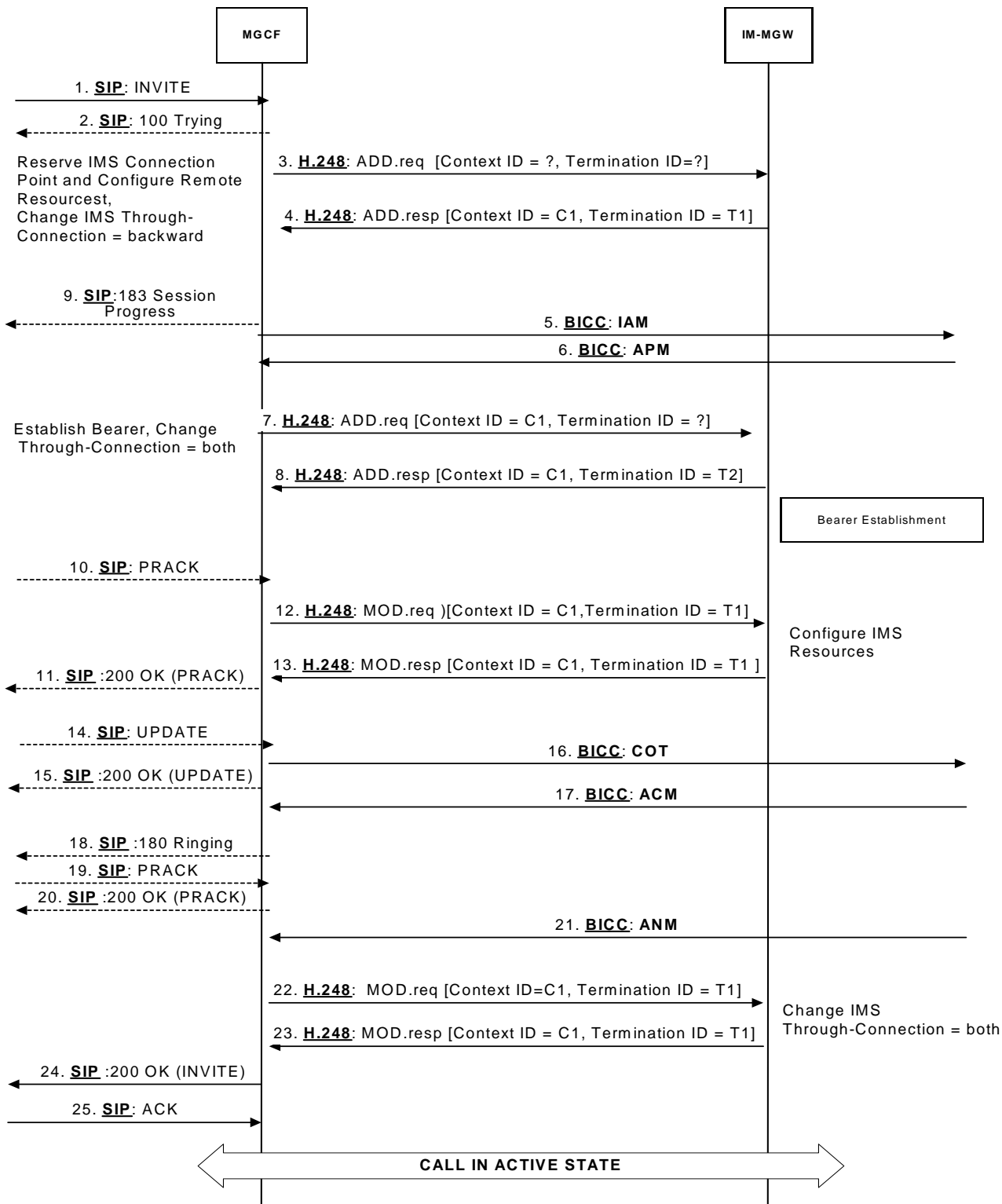

Figure 34: Basic IM CN Subsystem originating session, BICC forward bearer establishment (message sequence chart)

## 9.2.2.2 BICC backward bearer establishment

### 9.2.2.2.1 IM-MGW selection

The MGCF shall select an IM-MGW for the bearer connection before it performs the IM CN subsystem session establishment or the CS network side bearer establishment, and before it sends the IAM (signal 8 in figure 35).

### 9.2.2.2.2 IM CN subsystem side termination reservation

On receipt of an initial INVITE (signal 1 in figure 35) the MGCF shall initiate the Reserve IMS Connection Point and Configure Remote Resources procedure (signal 3 and 4 in figure 35). From the received SDP and local configuration data the MGCF:

- Shall send the appropriate remote codec(s), the remote UDP port and the remote IP address to the IM-MGW. The remote UDP port and IP address refer to the destination of user plane data sent towards the IM CN subsystem. The remote codec(s) are the codec(s) the IM-MGW may select for user plane data sent towards the IM CN subsystem.
- Shall indicate to the IM-MGW the appropriate local codec(s) and request a local IP address and UDP port. The local UDP port and IP address are used by the IM-MGW to receive user plane data from the IM CN subsystem. The local codec(s) are the codec(s) the IM-MGW may select to receive user plane data from the IM CN subsystem.
- If DTMF support together with speech support is required, the reserve value indicator shall be set to "true".

The IM-MGW shall

- Reply to the MGCF with the selected local codec(s) and the selected remote codec(s) and the selected local UDP port and IP address.
- Reserve resources for those codec(s).

The MGCF shall send the local codec(s), UDP port and IP address to the IMS in the Session Progress (signal 5 in figure 35).

### 9.2.2.2.3 IM CN subsystem side session establishment

Dependent on what the MGCF receives in the PRACK message (signal 9 in figure 35) the MGCF may initiate the Select Configure IMS Resources procedure (signals 10 and 11 in figure 35). If no SDP is received, or if the received SDP does not contain relevant changes compared to the previous SDP the procedure is not invoked. Otherwise the MGCF shall use the Configure IMS Resources procedure to provide to the IM-MGW.

- the appropriate remote codec(s), the remote UDP port and the remote IP address.
- optionally if DTMF support together with speech support is required, the reserve value indicator shall be set to "true".

The IM-MGW shall:

- Reply to the MGCF with the selected remote codec(s).
- Reply to the MGCF with the selected local codec(s), if the MGCF supplied local codec(s).
- Update the codec reservation and remote IP address and remote UDP port in accordance with the received information.

The MGCF shall include the selected codec(s), IP address and UDP port in an 200 OK (PRACK) (signal 12 in figure 35) sent back to the IMS

#### 9.2.2.2.4 CS network side bearer establishment

The MGCF shall request the IM-MGW to prepare for the CS network side bearer establishment using the Prepare Bearer procedure before sending the IAM to the succeeding node. Within this procedure, the MGCF shall request the IM-MGW to provide a bearer address and a binding reference, and the MGCF shall either provide the IM-MGW with the preferred bearer characteristics or it shall request the IM-MGW to select and provide the bearer characteristics (signal 6 in figure 35). After the IM-MGW has replied with the bearer address, the binding reference and the bearer characteristics (if requested), the MGCF sends the IAM to the succeeding node (signal 8 in figure 35).

#### 9.2.2.2.5 Through-connection

During the Prepare Bearer procedure, the MGCF shall either use the Change Through-Connection procedure to request the IM-MGW to backward through-connect the BICC termination, or the MGCF shall use this procedure to both-way through-connect the BICC termination already on this stage (signal 6 in figure 35). During the Reserve IMS Connection Point procedure, the MGCF shall use the Change IMS Through-Connection procedure to request the IM-MGW to backward through-connect the IMS termination (signal 3 in figure 35).

When the MGCF receives the BICC:ANM answer indication, it shall request the IM-MGW to both-way through-connect the terminations using the Change Through-Connection or Change IMS Through-Connection procedures (signal 21 in figure 35), unless those terminations are already both-way through-connected.

#### 9.2.2.2.6 Codec handling

The IM-MGW may include a speech transcoder based upon the speech coding information provided to each termination.

#### 9.2.2.2.7 Failure handling in MGCF

If any procedure between the MGCF and the IM-MGW is not completed successfully the default action by the MGCF is to release the session as described in clause 9.2.6. If the MGCF receives a Bearer Released procedure from the IM-MGW the default action by the MGCF is to release the session, as described in clause 9.2.7.

**NOTE:** As an implementation option the MGCF may also decide for example to only release the resources in the IM-MGW that caused the failure, possibly select a new IM-MGW for the connection and continue the call establishment using new resources in the selected IM-MGW but such handling is outside of the scope of the present document.

#### 9.2.2.2.8 Message sequence chart

Figure 35 shows the message sequence chart for the IM CN subsystem originating session with BICC backward bearer establishment. In the chart the MGCF requests the seizure of an IM CN subsystem side termination and a CS network side bearer termination. When the MGCF receives an answer indication, it requests the IM-MGW to both-way through-connect the terminations.

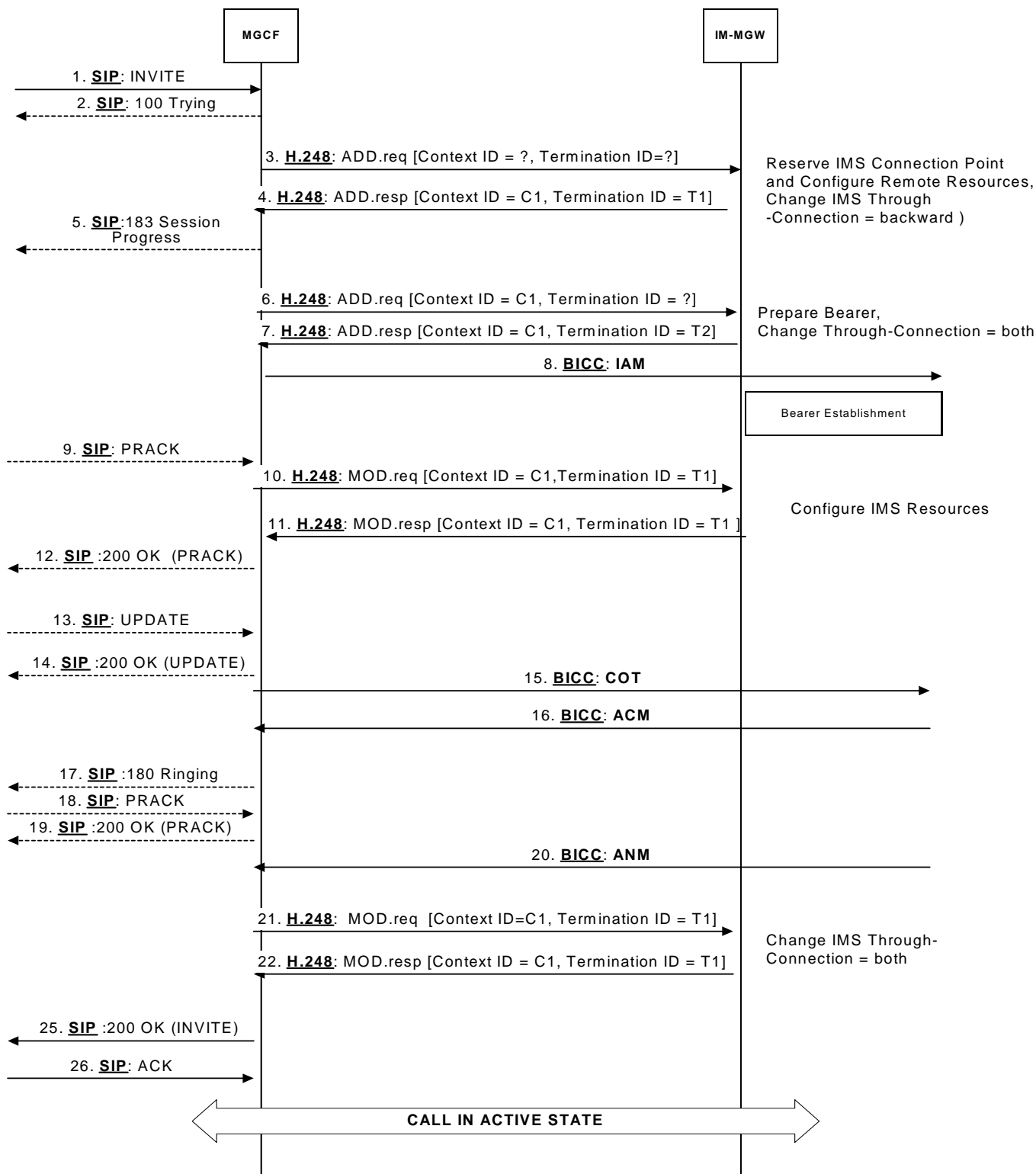

Figure 35: Basic IM CN Subsystem originating session, BICC backward bearer establishment (message sequence chart)

### 9.2.2.3 ISUP

#### 9.2.2.3.1 IM-MGW selection

The MGCF shall select an IM-MGW with circuits to the given destination in the CS domain before it performs the IM CN subsystem session establishment and before it sends the IAM (signal 8 in figure 36).

#### 9.2.2.3.2 IM CN subsystem side termination reservation

On receipt of an initial INVITE (signal 1 in figure 36) the MGCF shall initiate the Reserve IMS Connection Point and Configure Remote Resources procedure (signal 3 and 4 in figure 36). From the received SDP and local configuration data the MGCF

- shall send the appropriate remote codec(s), the remote UDP port and the remote IP address to the IM-MGW. The remote UDP port and IP address refer to the destination of user plane data sent towards the IM CN subsystem. The remote codec(s) are the codec(s) the IM-MGW may select for user plane data sent towards the IM CN subsystem.
- shall indicate to the IM-MGW the appropriate local codec(s) and request a local IP address and UDP port. The local IP address and UDP port are used by the IM-MGW to receive user plane data from the IM CN subsystem. The local codec(s) are the codec(s) the IM-MGW may select to receive user plane data from the IM CN subsystem.
- If DTMF support together with speech support is required, the reserve value indicator shall be set to "true".

The IM-MGW shall

- reply to the MGCF with the selected local codec(s) and the selected remote codec(s) and the selected local UDP port and IP address.
- reserve resources for those codec(s).

The MCGF shall send selected local codec(s) and the selected remote codec and the selected local UDP port and IP address to the IMS in the Session Progress (signal 5 in figure 36)

#### 9.2.2.3.3 IM CN subsystem side session establishment

Dependent on what the MGCF receives in the PRACK message (signal 9 in figure 35) the MGCF may initiate the Configure IMS Resources procedure. If no SDP is received, or if the received SDP does not contain relevant changes compared to the previous SDP, the procedure is not invoked. Otherwise the MGCF shall use the Configure IMS Resources procedure to provide to the IM-MGW

- the appropriate remote codec(s), the remote UDP port and the remote IP address.
- optionally the appropriate local codec(s), UDP port and IP address.
- -If DTMF support together with speech support is required, the reserve value indicator shall be set to "true".

The IM-MGW shall:

- reply to the MGCF with the selected remote codec.
- reply to the MGCF with the selected local codec(s), if the MGCF supplied local codec(s).
- update the codec reservation and remote IP address and UDP port in accordance with the received information.

The MGCF shall include the selected codec(s) UDP port and IP address in 200 OK (PRACK) (signal 12 in figure 36) sent back to the IMS.

#### 9.2.2.3.4 CS network side circuit reservation

The MGCF shall request the IM-MGW to reserve a circuit using the Reserve TDM Circuit procedure. The MGCF sends the IAM to the succeeding node including the reserved circuit identity.

#### 9.2.2.3.5 Through-connection

During the Reserve TDM Circuit and Reserve IMS Connection Point procedures, the MGCF shall either use the Change TDM Through-Connection procedure to request the IM-MGW to backward through-connect the termination, or the MGCF shall use this procedure to both-way through-connect the TDM termination already on this stage (signal 6 in figure 36). During the Reserve IMS connection Point procedure, the MGCF shall use the Change IMS through-connection procedure to request the IM-MGW to backward through-connect the IMS termination (signal 3 in figure 36).

When the MGCF receives the ISUP:ANM answer indication, it shall request the IM-MGW to both-way through-connect the terminations using the Change IMS Through-Connection or Change TDM Through-Connection procedures (signal 21 in figure 36), unless those terminations are already both-way through-connected.

#### 9.2.2.3.6 Continuity check

The MGCF may request a continuity check on the connection towards the CS network within the IAM message. In this case, the MGCF shall use the Continuity Check procedure towards the IM-MGW to request the generation of a continuity check tone on the TDM termination. The IM-MGW shall then use the Continuity Check Verify procedure to notify the MGCF of an incoming continuity check tone on the corresponding circuit. In addition to other conditions detailed in Section 7, the MGCF shall wait until receiving this notification before sending the COT. (Not depicted in figure 36)

#### 9.2.2.3.7 Codec handling

The IM-MGW may include a speech transcoder based upon the speech coding information provided to each termination.

#### 9.2.2.3.8 Voice processing function

A voice processing function located on the IM-MGW may be used to achieve desired acoustic quality on the terminations. If the voice processing function is used, the MGCF shall request the activation of it in the termination towards the CS network using the Activate TDM Voice Processing Function procedure (signal 23 in figure 36).

#### 9.2.2.3.9 Failure handling in MGCF

If any procedure between the MGCF and the IM-MGW is not completed successfully session shall be released as described in clause 9.2.6. If the MGCF receives a Bearer Released procedure from the IM-MGW the default action by the MGCF is to release the session as described in clause 9.2.7.

#### 9.2.2.3.10 Message sequence chart

Figure 36 shows the message sequence chart for the IM CN subsystem originating session. In the chart the MGCF requests the seizure of an IM CN subsystem side termination and a CS network side bearer termination. When the MGCF receives an answer indication, it requests the IM-MGW to both-way through-connect the terminations. The MGCF requests the possible activation of the voice processing functions for the bearer terminations.

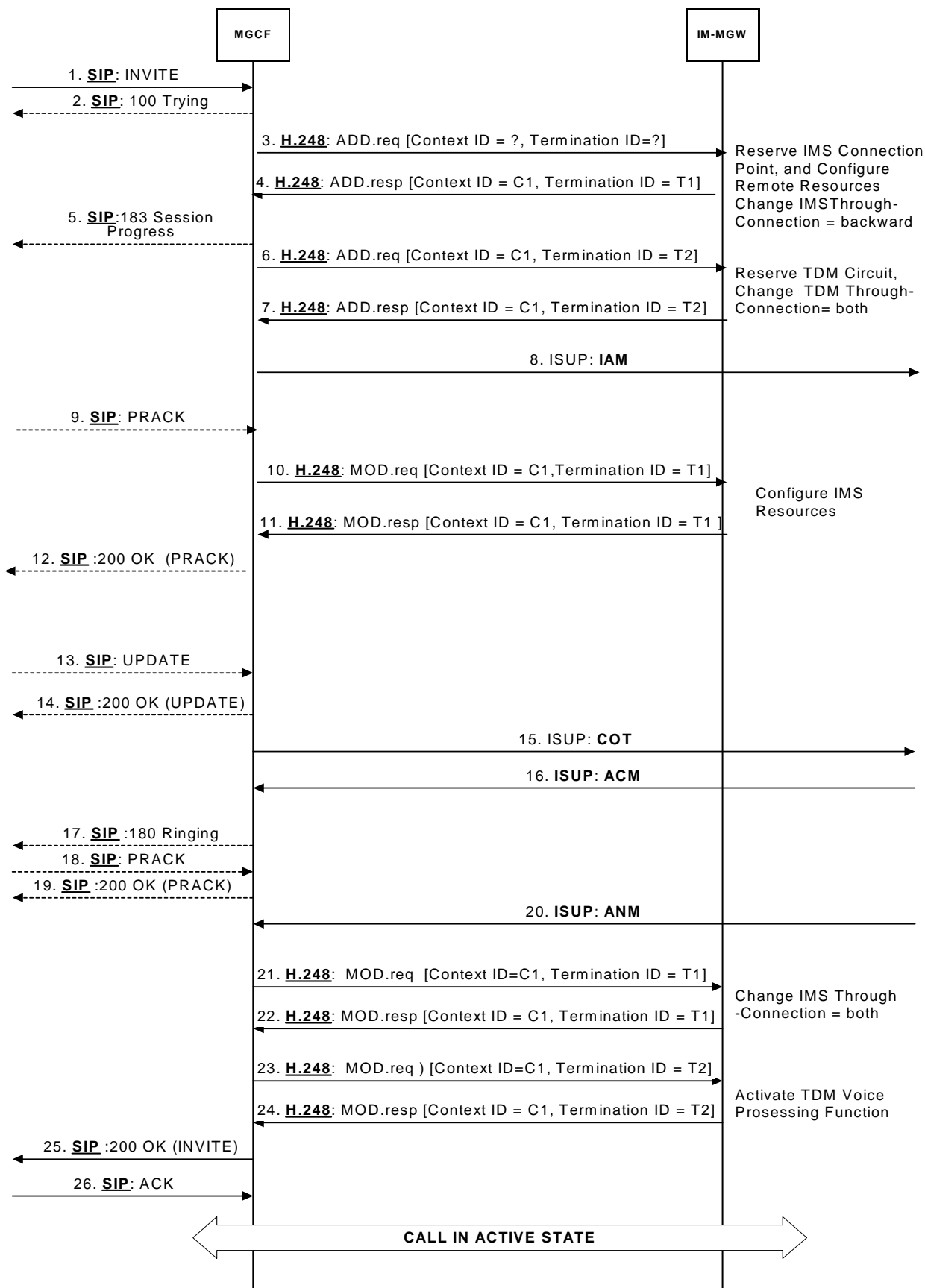

Figure 36: Basic IM CN Subsystem originating session, ISUP (message sequence chart)

## 9.2.3 Basic CS network originated session

### 9.2.3.1 BICC forward bearer establishment

#### 9.2.3.1.1 IM-MGW selection

The MGCF shall select an IM-MGW for the bearer connection before it performs the IM CN subsystem session establishment or the CS network side bearer establishment.

#### 9.2.3.1.2 IM CN subsystem side termination reservation

The MGCF shall derive from configuration data one or several appropriate local codec(s) the IM-MGW may use to receive user plane data from the IM CN subsystem. The MGCF shall use the Reserve IMS Connection Point procedure (signals 2 and 3 in figure 37). Within this procedure, the MGCF shall indicate the local codec(s) and request a local IP address and UDP port from the IM-MGW. The local IP address and UDP port are used by the IM-MGW to receive user plane data from the IM CN subsystem. If DTMF support together with speech support is required, or if the resources for multiple speech codecs shall be reserved at this stage, the reserve value indicator shall be set to "true".

The IM-MGW shall reply to the MGCF with the selected local codec(s) and the selected local IP address and UDP port.

The MGCF shall send this information in the INVITE (signal 4 in figure 37) to the IM CN subsystem.

#### 9.2.3.1.3 IM CN subsystem side session establishment

The MGCF shall use the Configure IMS Resources procedure (signals 7 and 8 in figure 37) to provide configuration data (derived from SDP received in signal 6 in figure 37 and local configuration data) to the IM-MGW as detailed below:

- The MGCF shall indicate the remote IP address and UDP port, i.e. the destination IP address and UDP port for data sent in the user plane towards the IM CN subsystem,
- The MGCF shall indicate the remote codec(s), i.e. the speech codec(s) for data sent in the user plane towards the IM CN subsystem.
- The MGCF may indicate the local codec(s) and the local IP address and UDP port. The MGCF shall indicate the local codec(s) if a change is required.
- IF DTMF support together with speech support is required, the reserve value indicator shall be set to "true".

The IM-MGW shall reply with the selected remote codec(s) and reserve resources for these codec(s). If local codec(s) were received, the IM-MGW shall also reply with the selected local codec(s) and reserve the corresponding resources.

If the selected local codec(s) differ from the codec(s) received in the SDP of signal 6 in figure 37, the MGCF shall send the local reserved codec(s), and the local IP address and UDP port in the PRACK (signal 9 in figure 37) to the IMS.

#### 9.2.3.1.4 CS network side bearer establishment

The MGCF shall request the IM-MGW to prepare for the CS network side bearer establishment using the Prepare Bearer procedure (signals 11 and 12 in figure 37). Within this procedure, the MGCF shall request the IM-MGW to provide a bearer address, a binding reference and optionally notify when the bearer is established. The MGCF shall also provide the IM-MGW with the bearer characteristics that was received from the preceding node in the IAM. After the IM-MGW has replied with the bearer address and the binding reference, the MGCF provides the APM message (signals 13 in figure 37) to the preceding node. The MGCF may also provide the IM-MGW-id in the APM message.

#### 9.2.3.1.5 Called party alerting

The MGCF shall request the IM-MGW to provide an awaiting answer indication (ringing tone) to the calling party using the Send Tone procedure (signals 20 and 21 in figure 37) , when the first of the following conditions is satisfied:

- the MGCF receives the first 180 Ringing message



- Timer T i/w<sub>1</sub> expires
- Timer T i/w<sub>2</sub> expires

#### 9.2.3.1.6 Called party answer

When the MGCF receives a 200 OK message (signal 23 in figure 34), it shall request the IM-MGW to stop providing the ringing tone to the calling party using the Stop Tone procedure (signals 26 and 27 in figure 37).

#### 9.2.3.1.7 Through-Connection

During the Prepare Bearer procedure, the MGCF shall either use the Change Through-Connection procedure to request the IM-MGW to backward through-connect the BICC termination, or the MGCF shall use this procedure to both-way through-connect the BICC termination already on this stage (signals 11 and 12 in figure 37). During the Reserve IMS Connection Point procedure, the MGCF shall use the Change IMS Through-Connection procedure to request the IM-MGW to backward through-connect the IMS termination (signals 2 and 3 in figure 37).

When the MGCF receives the SIP 200 OK(INVITE) (signal 23 in figure 37), it requests the IM-MGW to both-way through-connect the terminations using the Change IMS Through-Connection or Change Through-Connection procedures (signals 28 and 29 in figure 37), unless those terminations are already both-way through-connected.

#### 9.2.3.1.8 Codec handling

The IM-MGW may include a speech transcoder based upon the speech coding information provided to each termination.

#### 9.2.3.1.9 Failure handling in MGCF

If any procedure between the MGCF and the IM-MGW is not completed successfully, the default action by the MGCF is to release the session as described in clause 9.2.6. If the MGCF receives a Bearer Released procedure from the IM-MGW the default action by the MGCF is to release the session, as described in clause 9.2.7.

**NOTE:** As an implementation option the MGCF may also decide for example to only release the resources in the IM-MGW that caused the failure, possibly select a new IM-MGW for the connection and continue the call establishment using new resources in the selected IM-MGW but such handling is outside of the scope of the present document.

#### 9.2.3.1.10 Message sequence chart

Figure 37 shows the message sequence chart for the CS network originating session with BICC forward bearer establishment. In the chart the MGCF requests the seizure of the IM CN subsystem side termination and CS network side bearer termination. When the MGCF receives an answer indication, it requests the IM-MGW to both-way through-connect the terminations

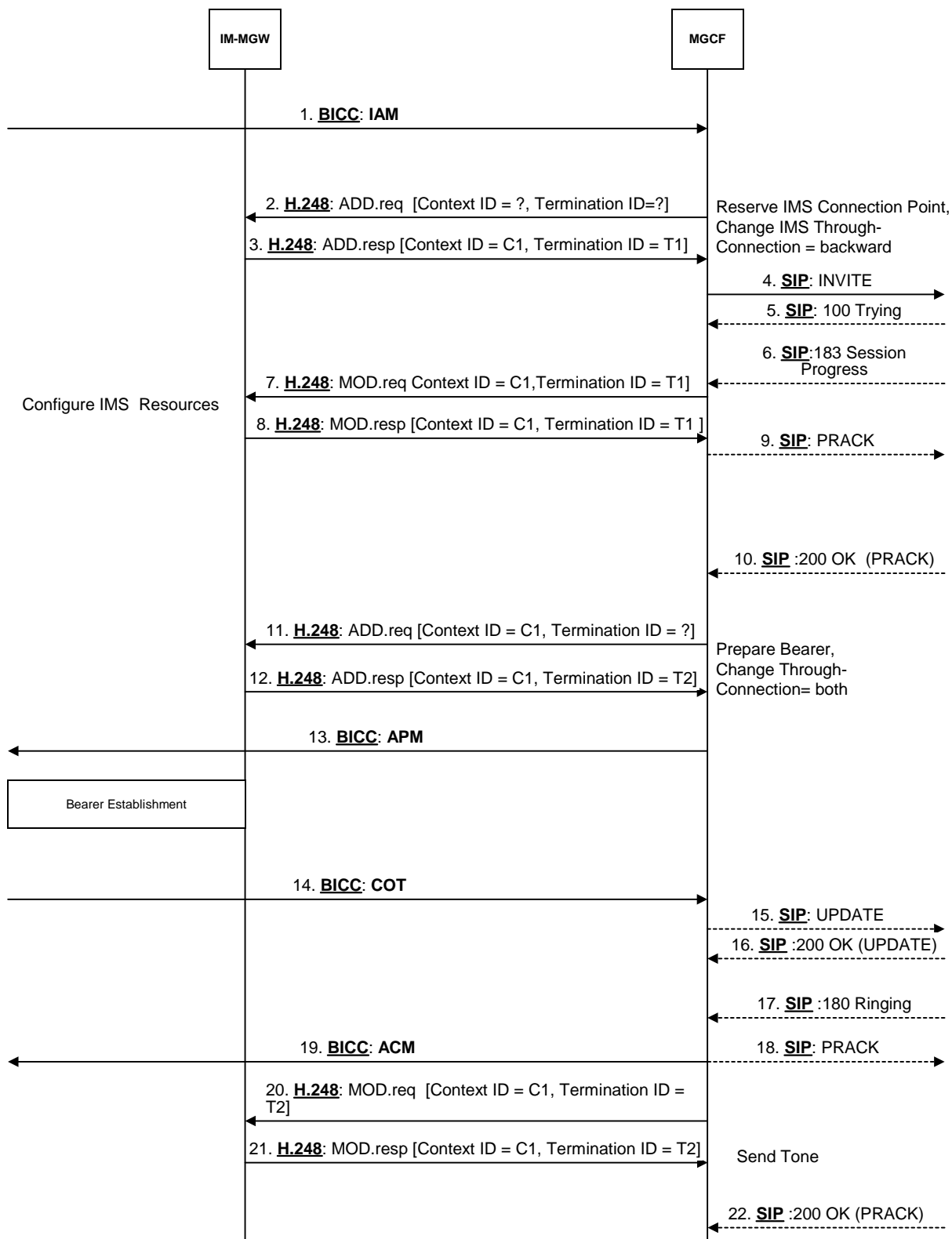
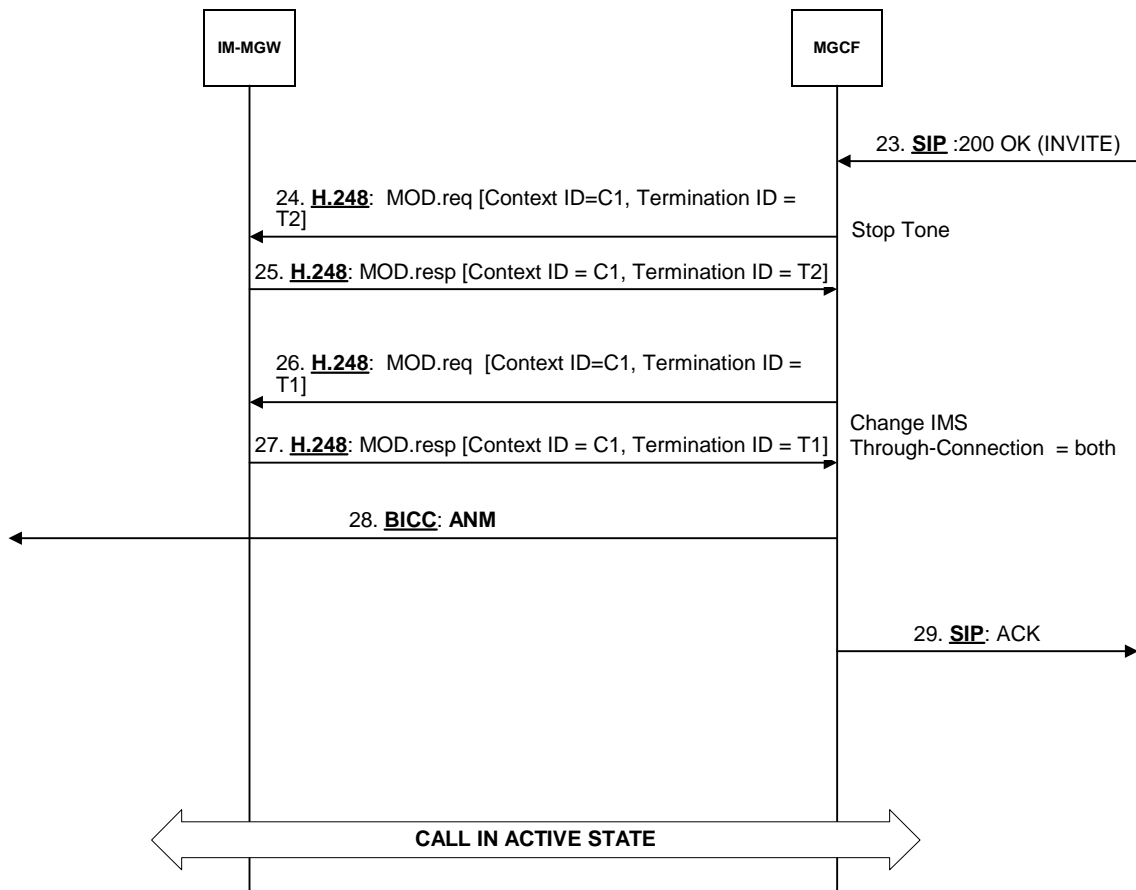

Figure 37/1: Basic CS Network Originating Session, Forward Bearer Establishment (message sequence chart)



**Figure 37/2: Basic CS Network Originating Session, Forward Bearer Establishment (message sequence chart continue)**

9.2.3.2 BICC Backward bearer establishment

9.2.3.2.1 IM-MGW selection

The MGCF shall select an IM-MGW for the bearer connection before it performs the IM CN subsystem session establishment or the CS network side bearer establishment.

9.2.3.2.2 CS network side bearer establishment

The MGCF shall request the IM-MGW to establish a bearer using the Establish Bearer procedure (signals 2 and 3 in figure 38). The MGCF provides the IM-MGW with the bearer address, the binding reference and the bearer characteristics that were received from the preceding node in the IAM (signal 1 in figure 38).

9.2.3.2.3 IM CN subsystem side termination reservation

The MGCF shall derive from configuration data one or several appropriate local codec(s) the IM-MGW may use to receive user plane data from the IM CN subsystem. The MGCF shall use the Reserve IMS Connection Point procedure (signals 2 and 3 in figure 38). Within this procedure, the MGCF shall indicate the local codec(s) and request a local IP address and UDP port from the IM-MGW. The local IP address and UDP port are used by the IM-MGW to receive user plane data from the IM CN subsystem. If DTMF support together with speech support is required, or if the resources for multiple speech codecs shall be reserved at this stage, the reserve value indicator shall be set to "true".

The IM-MGW shall reply to the MGCF with the selected local codec(s) and the selected local IP address and UDP port.

The MGCF shall send this information in the INVITE (signal 6 in figure 38) to the IM CN subsystem.

#### 9.2.3.2.4 IM CN subsystem side session establishment

The MGCF shall use the Configure IMS Resources procedure (signals 9 and 10 in figure 38) to provide configuration data (derived from SDP received in signal 8 in figure 38 and local configuration data) to the IM-MGW as detailed below:

- The MGCF shall indicate the remote IP address and UDP port, i.e. the destination IP address and UDP port for data sent in the user plane towards the IM CN subsystem
- The MGCF shall indicate the remote codec(s), i.e. the speech codec(s) for data sent in the user plane towards the IM CN subsystem.
- The MGCF may indicate the local codec(s) and the local IP address and UDP port. The MGCF shall indicate the local codec(s) if a change is required.
- If DTMF support together with speech support is required, the reserve value indicator shall be set to "true".

The IM-MGW shall reply with the selected remote codec(s) and reserve resources for this codec. If local codec(s) were received, the IM-MGW shall also reply with the selected local codec(s) and reserve the corresponding resources.

If the selected local codec(s) differ from the codec(s) received in the SDP of signal 8 in figure 38, the MGCF shall send the reserved speech codec(s), and the local IP address and UDP port in the PRACK (signal 11 in figure 38) to the IMS.

#### 9.2.3.2.5 Called party alerting

The MGCF shall request the IM-MGW to provide an awaiting answer indication (ringing tone) to the calling party using the Send Tone procedure (signals 19 and 20 in figure 38) , when the first of the following conditions is satisfied:

- the MGCF receives the first 180 Ringing message,
- Timer T<sub>i/w<sub>1</sub></sub> expires,
- Timer T<sub>i/w<sub>2</sub></sub> expires.

#### 9.2.3.2.6 Called party answer

When the MGCF receives a 200 OK message (signal 22 in figure 38), it shall request the IM-MGW to stop providing the ringing tone to the calling party using the Stop Tone procedure (signals 23 and 24 in figure 38).

#### 9.2.3.2.7 Through-Connection

During the Establish Bearer procedure, the MGCF shall either use the Change Through-Connection procedure to request the IM-MGW to backward through-connect the BICC termination, or the MGCF shall use this procedure to both-way through-connect the BICC termination already on this stage (signals 2 and 3 in figure 38). During the Reserve IMS Connection Point procedure, the MGCF shall use the Change IMS Through-Connection procedure to request the IM-MGW to backward through-connect the IMS termination (signals 4 and 5 in figure 38).

When the MGCF receives the SIP 200 OK(INVITE) (signal 22 in figure 38), it shall request the IM-MGW to both-way through-connect the bearer using the Change IMS Through-Connection or Change Through-Connection procedure (signals 25 and 26 in figure 38), unless those terminations are already both-way through-connected.

#### 9.2.3.2.8 Codec handling

The IM-MGW may include a speech transcoder based upon the speech coding information provided to each termination.

### 9.2.3.2.9 Failure handling in MGCF

If any procedure between the MGCF and the IM-MGW is not completed successfully, the default action by the MGCF is to release the session as described in clause 9.2.6. If the MGCF receives a Bearer Released procedure from the IM-MGW the default action by the MGCF is to release the session as described in clause 9.2.7.

Note: As an implementation option the MGCF may also decide for example to only release the resources in the IM-MGW that caused the failure, possibly select a new IM-MGW for the connection and continue the call establishment using new resources in the selected IM-MGW but such handling is outside of the scope of the present document.

### 9.2.3.2.10 Message sequence chart

Figure 38 shows the message sequence chart for the CS network originating session with BICC backward bearer establishment. In the chart the MGCF requests seizure of the IM CN subsystem side termination and CS network side bearer termination. When the MGCF receives an answer indication, it requests the IM-MGW to both-way through-connect the terminations.

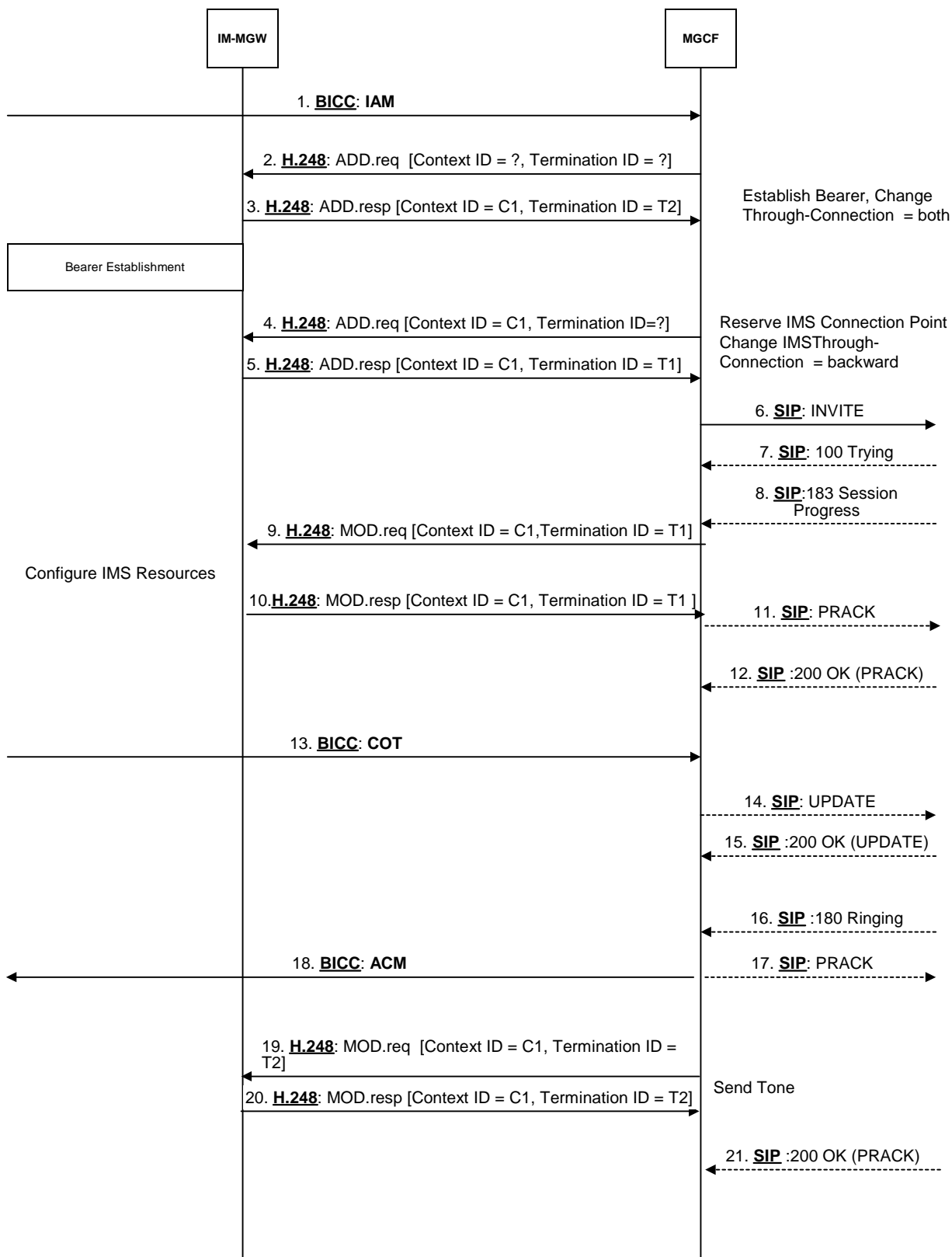
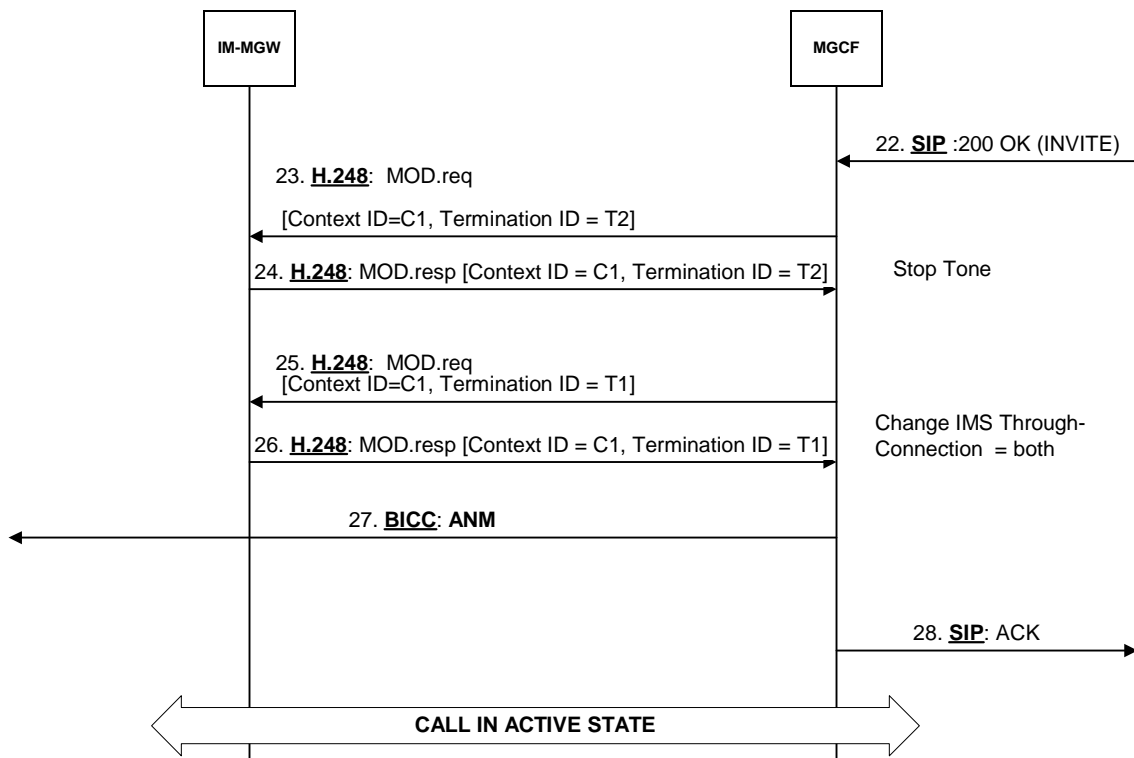

Figure 38/1: Basic CS Network Originating Session, BICC Backward Bearer Establishment (message sequence chart)



**Figure 38/2: Basic CS Network Originating Session, BICC Backward Bearer Establishment (message sequence chart continue)**

### 9.2.3.3 ISUP

#### 9.2.3.3.1 IM-MGW selection

The MGCF selects the IM-MGW based on the received circuit identity in the IAM.

#### 9.2.3.3.2 CS network side circuit reservation

The MGCF shall request the IM-MGW to reserve a circuit using the Reserve TDM Circuit procedure.

#### 9.2.3.3.3 IM CN subsystem side termination reservation

The MGCF shall derive from configuration data one or several appropriate local codec(s) the IM-MGW may use to receive user plane data from the IM CN subsystem. The MGCF shall use the Reserve IMS Connection Point procedure (signals 2 and 3 in figure 39). Within this procedure, the MGCF shall indicate the local codec(s) and request a local IP address and UDP port from the IM-MGW. The local IP address and UDP port are used by the IM-MGW to receive user plane data from the IM CN subsystem. If DTMF support together with speech support is required, or if the resources for multiple speech codecs shall be reserved at this stage, the reserve value indicator shall be set to "true".

The IM-MGW shall reply to the MGCF with the selected local codec(s) and the selected local IP address and UDP port.

The MGCF shall send this information in the INVITE (signal 6 in figure 39) to the IM CN subsystem.

#### 9.2.3.3.4 IM CN subsystem side session establishment

The MGCF shall use the Configure IMS Resources procedure (signals 9 and 10 in figure 39) to provide configuration data (derived from SDP received in signal 8 in figure 39 and local configuration data) as detailed below:

- The MGCF shall indicate the remote IP address and UDP port, i.e. the destination IP address and UDP port for data sent in the user plane towards the IM CN subsystem.

- The MGCF shall indicate the remote codec(s), i.e. the speech codec(s) for data sent in the user plane towards the IM CN subsystem.
  - The MGCF may indicate the local codec(s) and the local IP address and UDP port. The MGCF shall indicate the local codec(s) if a change is required.
  - If DTMF support together with speech support is required, the reserve value indicator shall be set to "true".

The IM-MGW shall reply with the selected remote codec(s) and reserve resources for these codec(s). If local codec(s) were received, the IM-MGW shall also reply with the selected local codec(s) and reserve the corresponding resources.

If the selected local codec(s) differ from the codec(s) received in the SDP of signal 8 in figure 39, the MGCF shall send the reserved speech codec(s), and the local IP address and UDP port in the PRACK (signal 11 in figure 39) to the IMS.

#### 9.2.3.3.5 Called party alerting

The MGCF shall request the IM-MGW to provide an awaiting answer indication (ringing tone) to the calling party using the Send TDM Tone procedure (signals 19 and 20 in figure 39), when the first of the following conditions is satisfied:

- the MGCF receives the first 180 Ringing message
- Timer T<sub>i/w<sub>1</sub></sub> expires
- Timer T<sub>i/w<sub>2</sub></sub> expires

#### 9.2.3.3.6 Called party answer

When the MGCF receives a 200 OK message (signal 22 in figure 39), it shall request the IM-MGW to stop providing the ringing tone to the calling party using the Stop TDM Tone procedure (signals 23 and 24 in figure 39).

#### 9.2.3.3.7 Through-Connection

Within the Reserve TDM Circuit procedure, the MGCF shall either use the Change TDM Through-Connection procedure to request the IM-MGW to backward through-connect the TDM termination, or the MGCF shall use this procedure to both-way through-connect the TDM termination already on this stage (signals 2 and 3 in figure 39). During the Reserve IMS Connection Point procedure, the MGCF shall use the Change IMS Through-Connection procedure to request the IM-MGW to backward through-connect the IMS termination (signals 4 and 5 in figure 39).

When the MGCF receives the SIP 200 OK(INVITE) message, it shall request the IM-MGW to both-way through-connect the terminations using the Change IMS Through-Connection or Change TDM Through-Connection procedure (signals 25 and 26 in figure 39), unless those terminations are already both-way through-connected.

#### 9.2.3.3.8 Continuity Check

If a continuity check on the connection towards the CS network is requested in the IAM message, the MGCF shall use the Continuity Check Response procedure towards the IM-MGW to request loop-back of a received continuity check tone on the TDM circuit. Upon reception of the COT message, the MGCF shall use the Continuity Check Response procedure towards the IM-MGW to request the removal of the loop-back. (Not depicted in figure 39)

#### 9.2.3.3.9 Codec handling

The IM-MGW may include a speech transcoder based upon the speech coding information provided to each termination.

#### 9.2.3.3.10 Voice Processing function

A voice processing function located on the IM-MGW may be used to achieve desired acoustic quality on the terminations. If the voice processing function is used, the MGCF shall request the activation of it in the termination towards the CS network using the Activate TDM Voice Processing Function procedure (signal 23 in figure 39).



#### 9.2.3.3.11 Failure handling in MGCF

If any procedure between the MGCF and the IM-MGW is not completed successfully, the session shall be released as described in clause 9.2.6. If the MGCF receives a Bearer Released procedure from the IM-MGW the default action by the MGCF is to release the session as described in clause 9.2.7.

#### 9.2.3.3.12 Message sequence chart

Figure 39 shows the message sequence chart for the CS network originating Session with ISUP. In the chart the MGCF requests seizure of the IM CN subsystem side termination and CS network side bearer termination. When the MGCF receives an answer indication, it requests the IM-MGW to both-way through-connect the terminations. The MGCF may request the possible activation of the voice processing functions for the terminations.

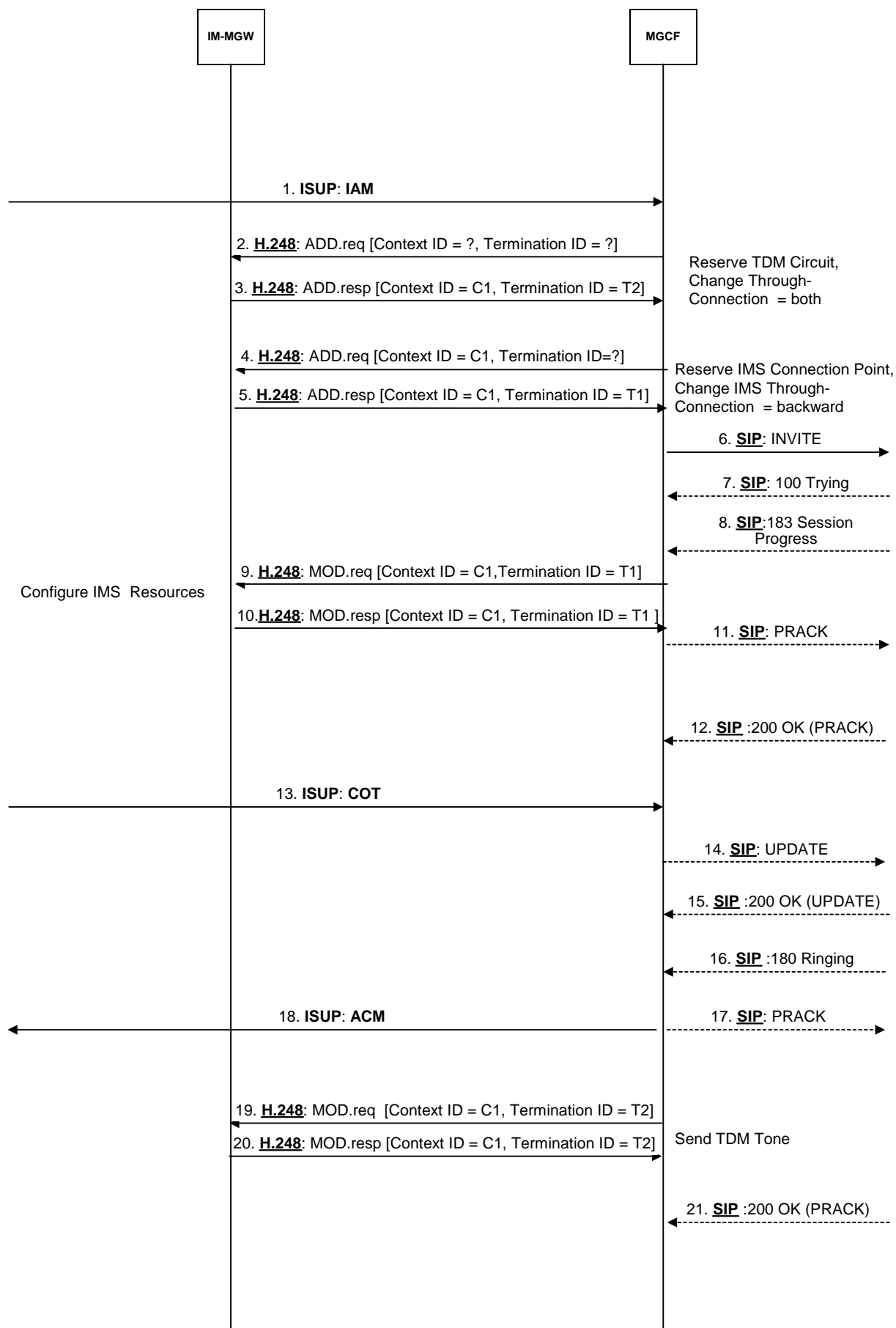

Figure 39/1: Basic CS Network Originating Session, ISUP (message sequence chart)

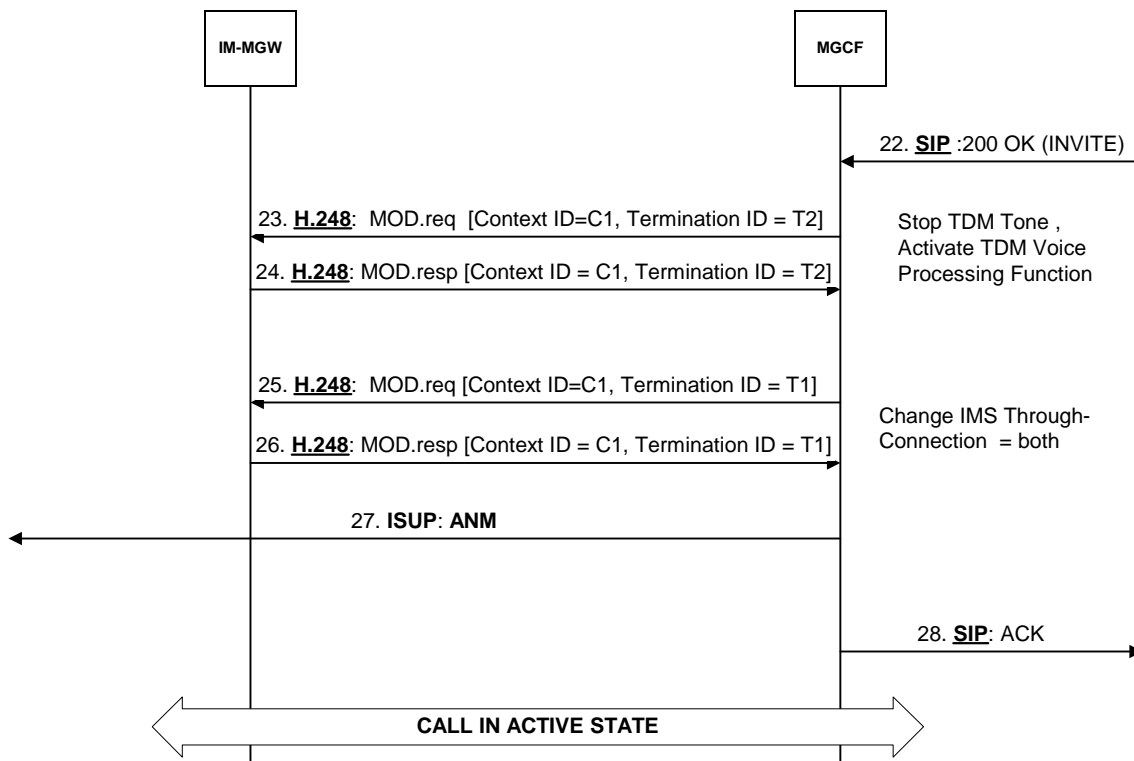

Figure 39/2: Basic CS Network Originating Session, ISUP (message sequence chart continue)

#### 9.2.3.4 Handling of Forking

The procedures described in clauses 9.2.3.1 to 9.2.3.3 shall be applied with the following additions.

##### 9.2.3.4.1 Detection of Forking

According to SIP procedures, the O-MGCF inspects the tags in the 'to' SIP header fields of provisional and final responses to identify the SIP dialogue the response belongs to. If responses belonging to different dialogues are received (signals 8 and 13 in figure 39a), the INVITE request (signal 6 in figure 39a) has been forked.

##### 9.2.3.4.2 IM CN subsystem side session establishment

If SDP is received in a provisional response and more than one SIP dialogue exists (signal 13 in figure 39a), the MGCF may either refrain from reconfiguring the IM-MGW, or it may use the Configure IMS Resources procedure (signals 14 and 15 in figure 39a) as detailed below:

- The MGCF may compare the selected local codecs of the different dialogues (which the MGCF selects due to the received SDP answer and local configuration data). If different local codecs are selected for the different dialogues, the MGCF may include all these codecs in the 'local IMS resources', and set the 'reserve value' to indicate that resources for all these codecs shall be reserved. Alternatively, the MGCF may only include the codecs received in the last SDP in the 'local IMS resources'.
- The MGCF may update the 'remote IMS resources' with the information received in the latest SDP. The MGCF should provide the remote IP address and UDP port, and the remote codec selected from the received SDP and local configuration data.

NOTE: The behaviour in the second bullet is beneficial if forking is applied in a sequential manner.

#### 9.2.3.4.3 IM CN subsystem side session establishment completion

Upon reception of the first final 2xx response (signal 32 in figure 39a), the MGCF shall use the Configure IMS Resources procedure (signals 35 and 36 in figure 39a) as detailed below unless the IM-MGW is already configured accordingly:

- If the remote IMS resources configured at the IM-MGW do not match the remote resources selected for the established dialogue of the final response, the MGCF shall provide the remote IP address and UDP port from the latest received SDP of this established dialogue, and the remote codec selected from the latest received SDP of this established dialogue and local configuration data within the 'remote IMS resources'.
- If the local IMS resources configured at the IM-MGW contain more codecs than selected for the established dialogue of the final response, the MGCF should update the 'local IMS resources' with the selected local codec derived from the latest SDP of this established dialogue and local configuration data. The 'reserve value' may be cleared unless it is required for DTMF.

#### 9.2.3.4.4 Message sequence chart

Figure 39a shows an example message sequence chart for an CS network originating Session Setup with ISUP, where forking occurs.

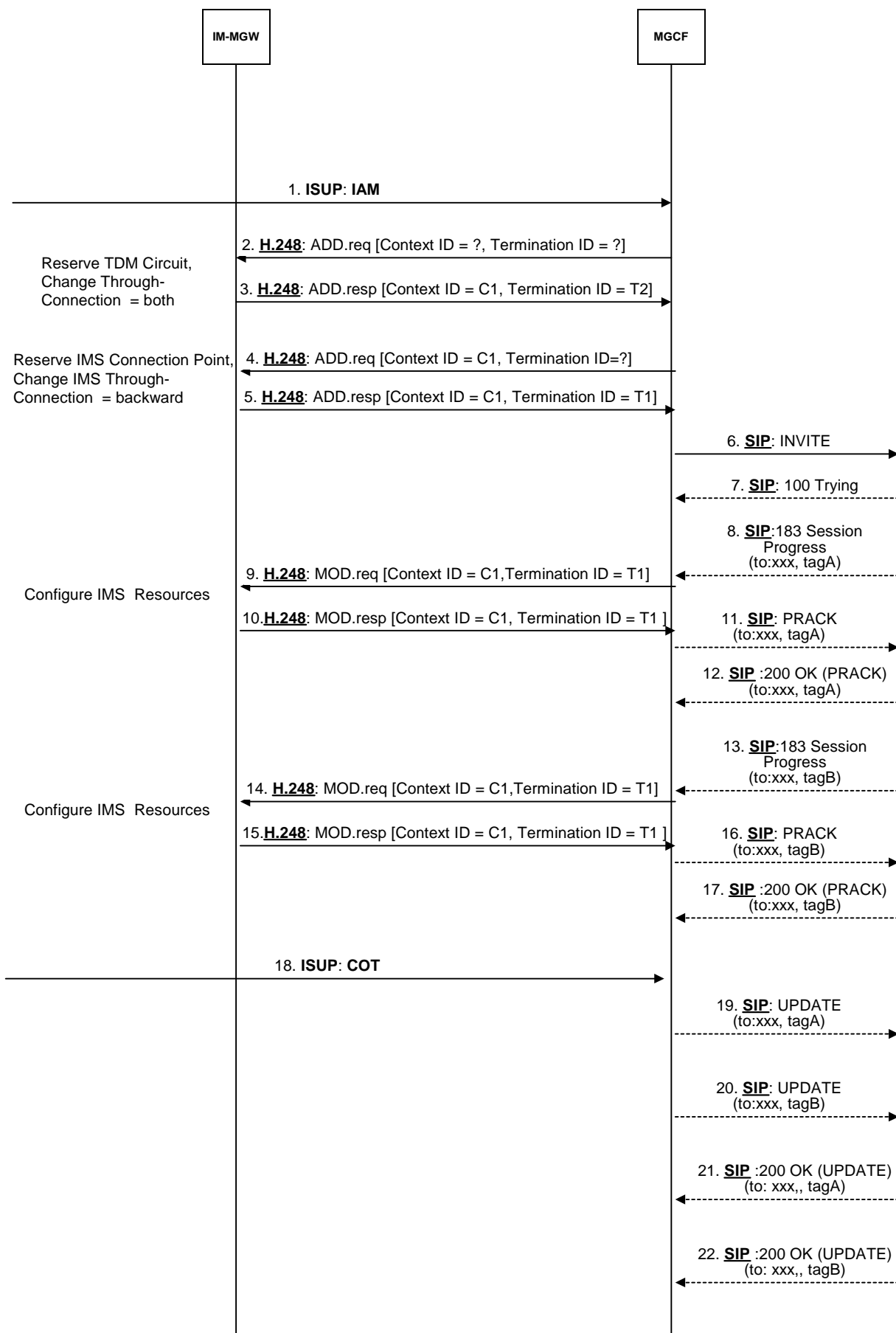

Figure 39a/1: CS Network Originating Session with forking, ISUP (message sequence chart)

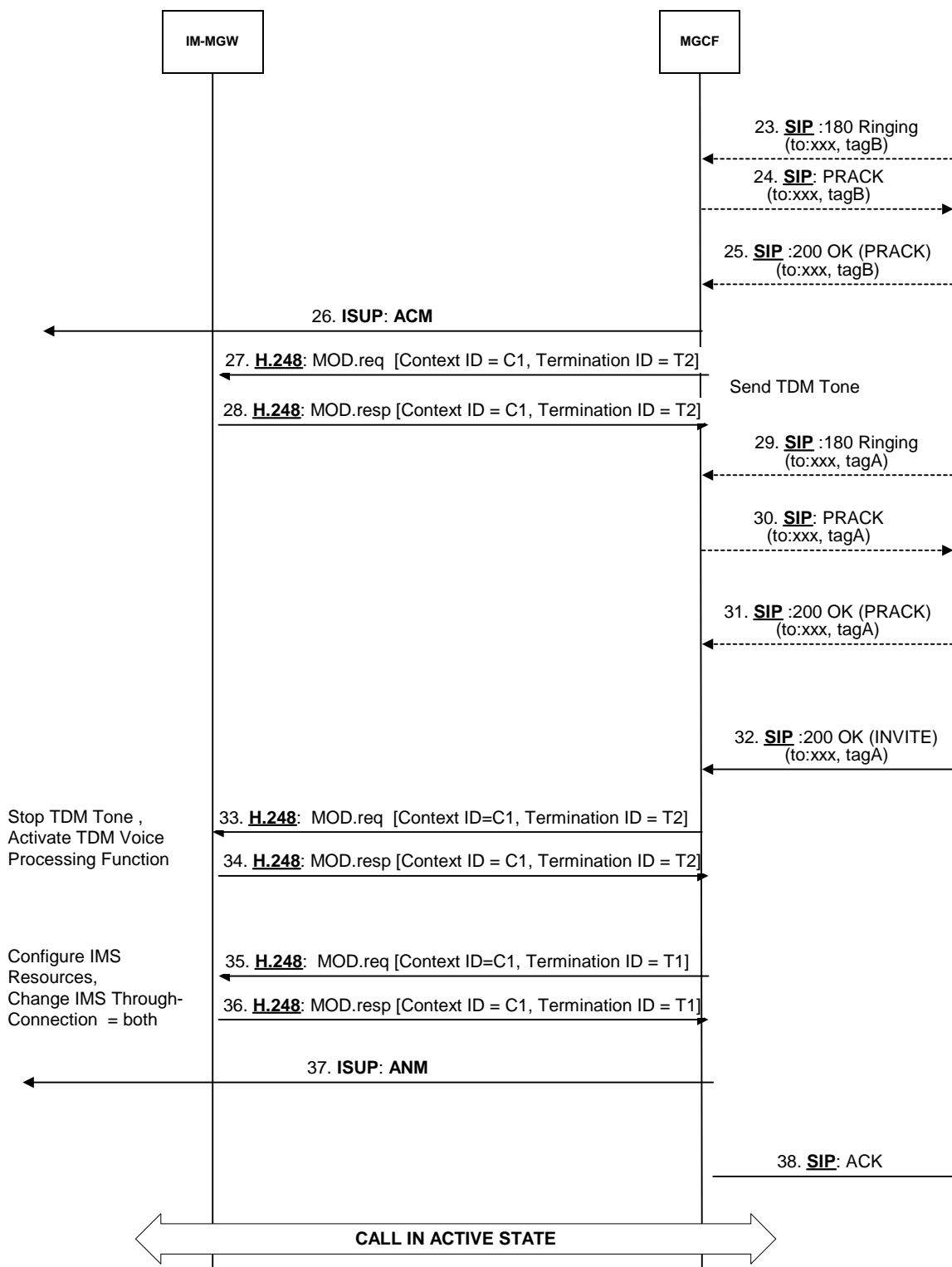

Figure 39a/2: CS Network Originating Session with forking, ISUP (message sequence chart continue)

## 9.2.4 Session release initiated from IM CN subsystem side

### 9.2.4.1 BICC

#### 9.2.4.1.1 Session release in the IM CN subsystem side

When the MGCF has received a BYE message from the IM CN subsystem side, the MGCF shall release resources in the IM-MGW serving the relevant Mb interface connection by using the "Release IMS Termination" procedure (signals 5 and 6 in figure 40). After receiving the BYE message, the MGCF shall also send a 200 OK [BYE] message towards the IM CN subsystem (signal 2 in Figure 40).

#### 9.2.4.1.2 Session release in the CS network side

When the MGCF has received a BYE message from the IM CN subsystem side, the MGCF shall send a REL message to the succeeding node (signal 3 in figure 40). Once the succeeding node has responded with the RLC message (signal 6 in figure 40), the MGCF shall release the resources for the CS network side in the IM-MGW. If any resources were seized in the IM-MGW, the MGCF shall use the "Release Bearer", "Change Through-Connection" and "Release Termination" procedures (signals 7 to 10 in figure 40) to indicate to the IM-MGW that the CS network side bearer termination shall be removed and the bearer shall be released towards the succeeding MGW.

#### 9.2.4.1.3 Message sequence chart

Figure 40 shows the message sequence chart for the session release initiated from the IM CN subsystem side.

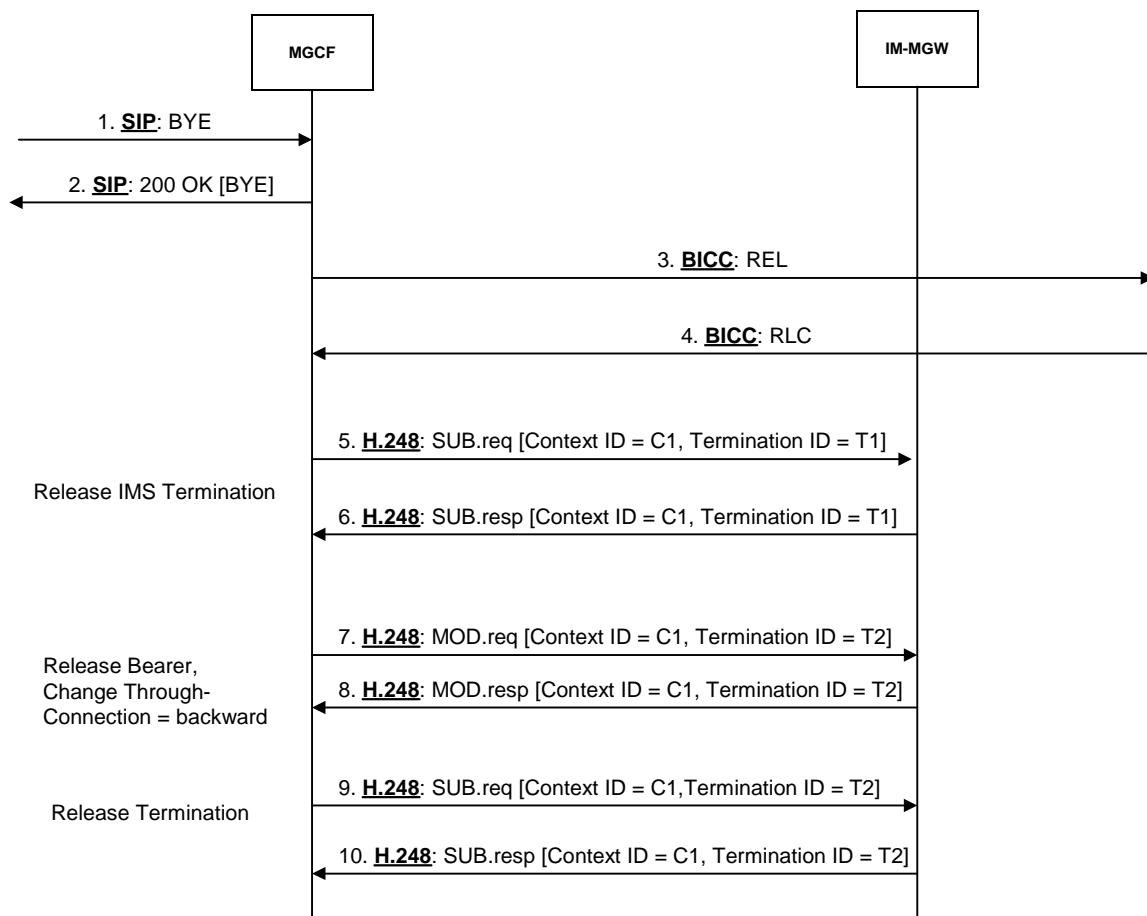

Figure 40: Session release from IM CN subsystem side for BICC (message sequence chart)

## 9.2.4.2 ISUP

### 9.2.4.2.1 Session release in the IM CN subsystem side

When the MGCF has received a BYE message from the IM CN subsystem side, the MGCF shall release resources in the IM-MGW serving the relevant Mb interface connection by using the "Release IMS Termination" procedure (signals 4 and 5 in figure 41). After receiving the BYE message, the MGCF shall also send a 200 OK [BYE] message towards the IM CN subsystem (signal 2 in figure 41).

### 9.2.4.2.2 Session release in the CS network side

When the MGCF has received a BYE message from the IM CN subsystem side, the MGCF shall send a REL message to the succeeding node (signal 3 in figure 41). After sending the REL message, the MGCF shall expect a RLC message (signal 8 in figure 41) from the succeeding node. The MGCF shall also release the resources for the CS network side in the IM-MGW. If any resources were seized in the IM-MGW, the MGCF shall use the "Release TDM Termination" procedure (signals 6 to 7 in figure 41) to indicate to the IM-MGW that the CS network side bearer termination can be released.

### 9.2.4.2.3 Message sequence chart

Figure 41 shows the message sequence chart for the session release initiated from the IM CN subsystem side.

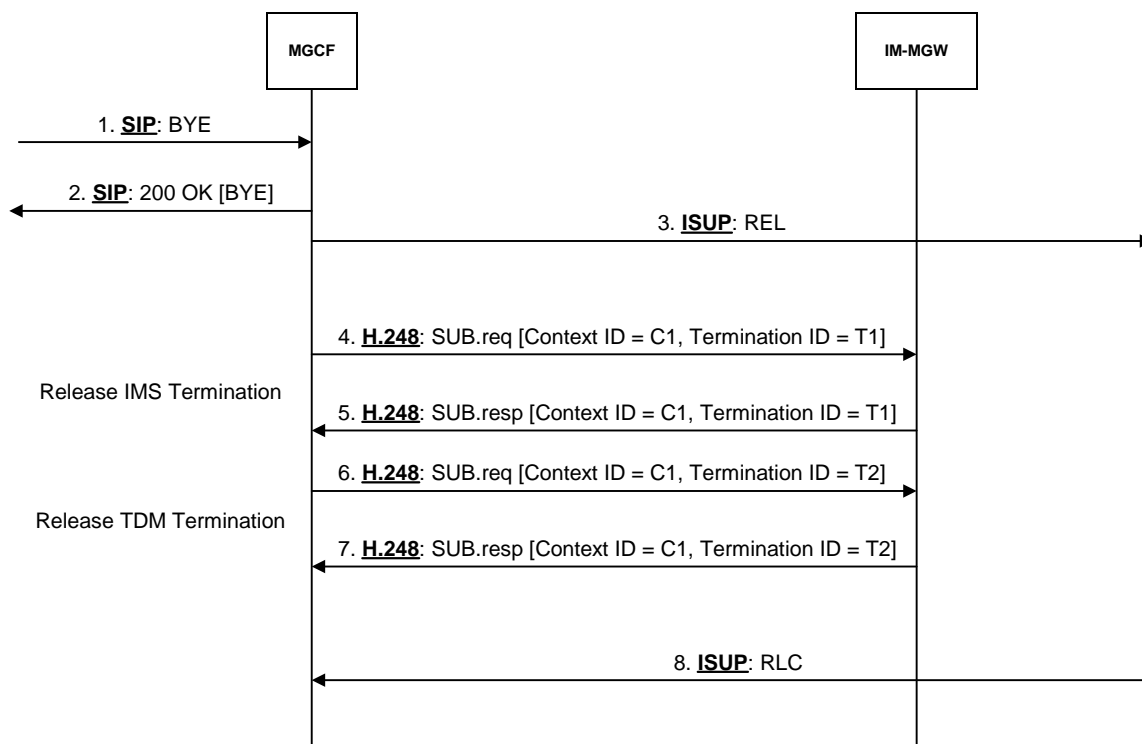

Figure 41: Session release from IM CN subsystem side for ISUP (message sequence chart)

## 9.2.5 Session release initiated from CS network side

### 9.2.5.1 BICC

#### 9.2.5.1.1 Session release in the CS network side

When the MGCF receives a REL message from the preceding node (signal 1 in figure 42), the MGCF shall release resources for the CS network side in the IM-MGW. If any resources were seized in the IM-MGW, the MGCF shall use the "Release Bearer", "Change Through-Connection" and "Release Termination" procedures to indicate to the IM-MGW that the CS network side bearer termination shall be removed and the bearer shall be released towards the



preceding MGW (signal 3 to 6 in figure 42). After completion of resource release, the MGCF shall send a RLC message towards the preceding node.

### 9.2.5.1.2 Session release in the IM CN subsystem side

When the MGCF receives a REL message from the preceding node (signal 1 in figure 42), the MGCF shall send a BYE message to the IM CN subsystem (signal 2 in figure 42) and the MGCF shall release the resources in the IM-MGW serving the relevant Mb interface connection by using the "Release IMS Termination" procedure (signals 7 and 8 in figure 42). The MGCF shall also expect to receive a 200 OK [BYE] message from the IM CN subsystem side (signal 10 in figure 42).

### 9.2.5.1.3 Message sequence chart

Figure 42 shows the message sequence chart for the session release initiated from the CS network side.

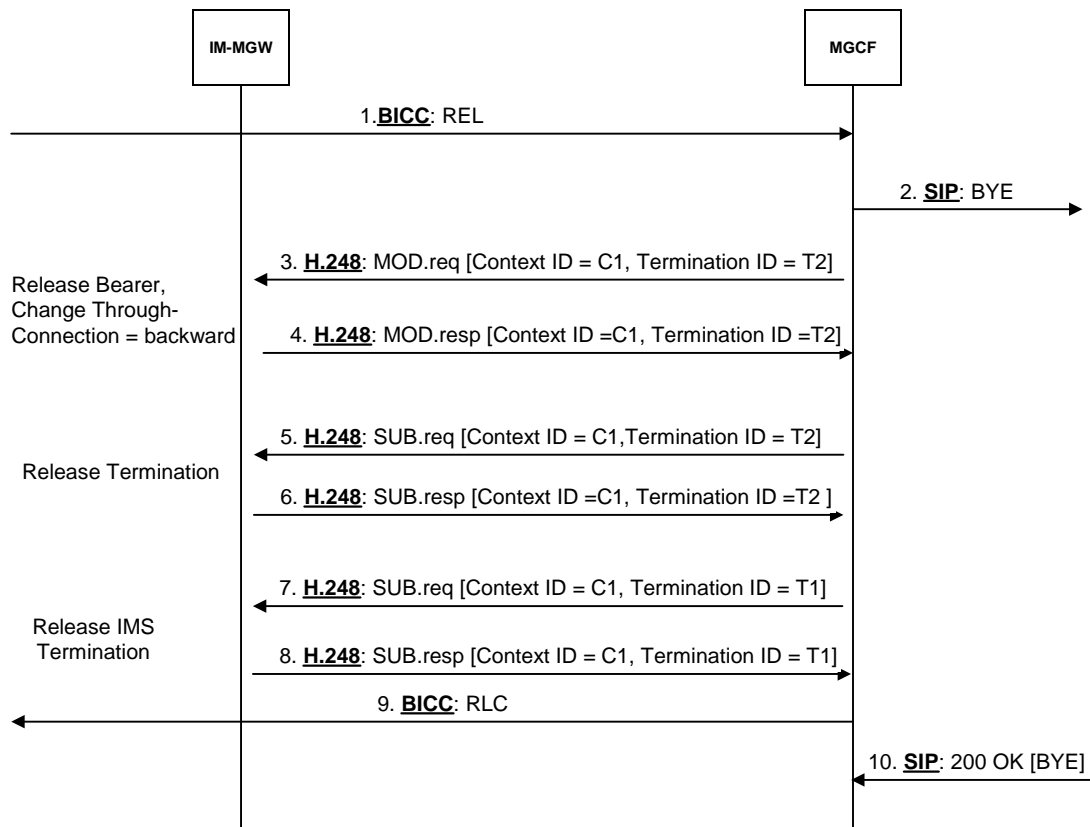

Figure 42: Session release from CS network side for BICC (message sequence chart)

## 9.2.5.2 ISUP

### 9.2.5.2.1 Session release in the CS network side

When the MGCF receives a REL message from the preceding node (signal 1 in figure 43), the MGCF shall release resources for the CS network side in the IM-MGW. If any resources were seized in the IM-MGW, the MGCF shall use the "Release TDM Termination procedures" to indicate to the IM-MGW that the CS network side bearer termination can be released (signal 3 to 4 in figure 43). After completion of resource release, the MGCF shall send a RLC message towards the preceding node.

### 9.2.5.2.2 Session release in the IM CN subsystem side

When the MGCF receives a REL message from the preceding node (signal 1 in figure 43), the MGCF shall send a BYE message to the IM CN subsystem (signal 2 in figure 43) and the MGCF shall release the resources in the IM-MGW serving the relevant Mb interface connection by using the "Release IMS Termination" procedure (signal 5 to 6 in figure

43). The MGCF shall also expect to receive a 200 OK [BYE] message from the IM CN subsystem side (signal 8 in figure 43).

### 9.2.5.2.3 Message sequence chart

Figure 43 shows the message sequence chart for the session release initiated from the CS network side.

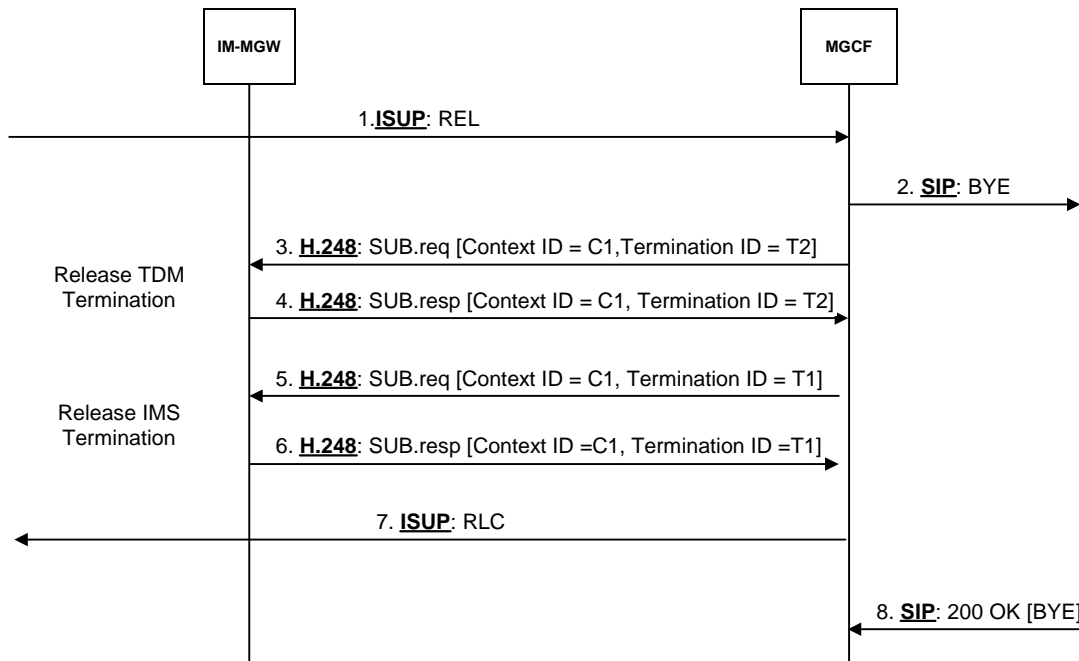

Figure 43: Session release from CS network side for ISUP (message sequence chart)

## 9.2.6 Session release initiated by MGCF

### 9.2.6.1 BICC

#### 9.2.6.1.1 Session release in the CS network side

The MGCF shall send a REL message to the succeeding node on the CS network side (signal 1 in figure 44) Once the succeeding node has responded with the RLC message (signal 3 in figure 44), the MGCF shall release the resources for the CS network side in the IM-MGW. If any resources were seized in the IM-MGW, the MGCF shall use the "Release Bearer", "Change Through-Connection" and "Release Termination" procedures to indicate to the IM-MGW that the CS network side bearer termination shall be removed and the bearer shall be released towards the succeeding MGW (signal 4 to 7 in figure 44).

#### 9.2.6.1.2 Session release in the IM CN subsystem side

The MGCF shall sends a BYE message to the IM CN subsystem side (signal 2 in figure 44) and the MGCF shall release the resources in the IM-MGW serving the relevant Mb interface connection by using the "Release IMS Termination" procedure (signals 8 and 9 in figure 44). The MGCF shall also expect to receive a 200 OK [BYE] message is received from the IM CN subsystem side (signal 10 in figure 44).

### 9.2.6.1.3 Message sequence chart

Figure 44 shows the message sequence chart for the session release initiated by the MGCF.

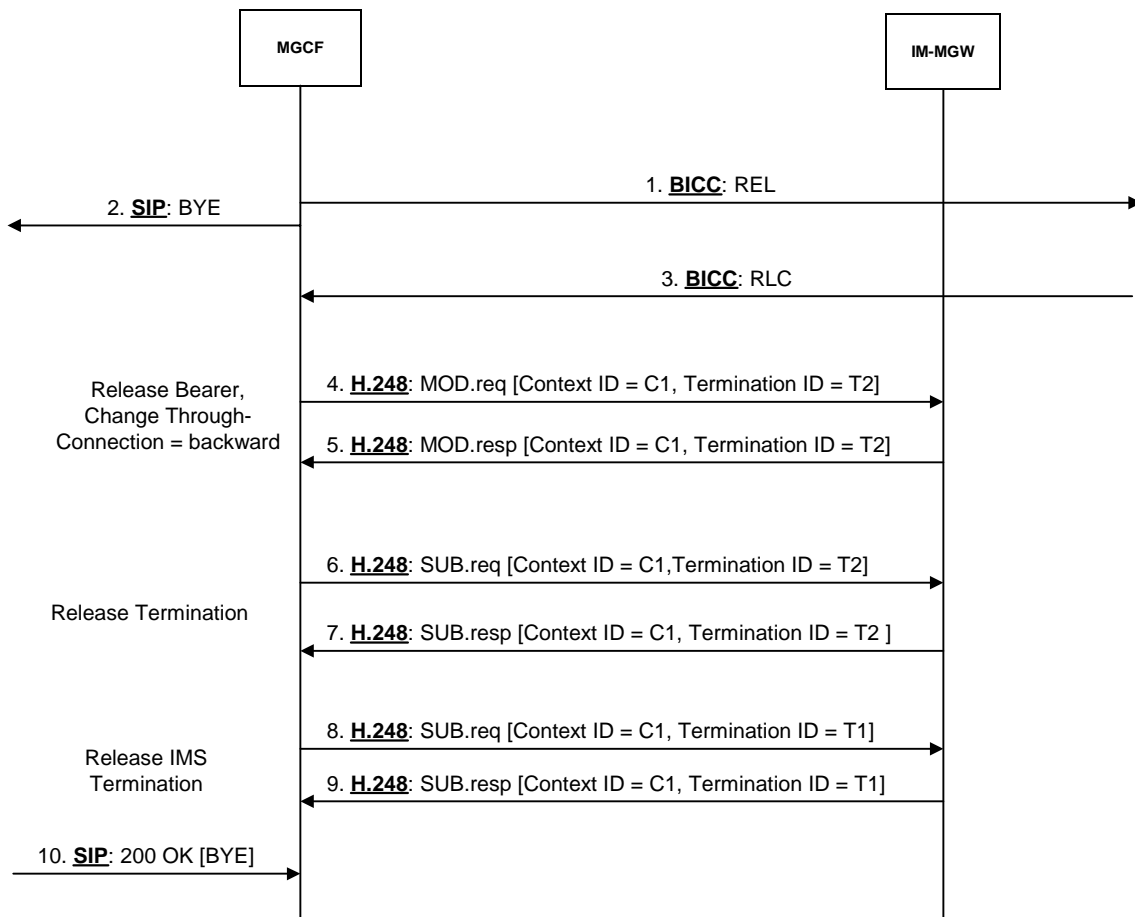

Figure 44: Session release initiated by MGCF for BICC (message sequence chart)

9.2.6.2 ISUP

9.2.6.2.1 Session release in the CS network side

The MGCF shall send a REL message to the succeeding node on the CS network side (signal 2 in figure 45) and the MGCF shall release the resources for the CS network side in the IM-MGW. If any resources were seized in the IM-MGW, the MGCF shall use the "Release TDM Termination" procedure to indicate to the IM-MGW that the CS network side termination shall be released (signal 5 to 6 in figure 45). The MGCF shall also expect to receive a RLC message from the succeeding node on the CS network side (signal 7 in figure 45).

9.2.6.2.2 Session release in the IM CN subsystem side

The MGCF shall send a BYE message to the IM CN subsystem side (signal 1 in figure 45) and the MGCF shall release the resources in the IM-MGW serving the relevant Mb interface connection by using the "Release IMS Termination" procedure (signal 5 to 6 in figure 45). The MGCF shall also expect to receive a 200 OK [BYE] message from the IM CN subsystem side (signal 8 in figure 45).

9.2.6.2.3 Message sequence chart

Figure 45 shows the message sequence chart for the session release initiated by the MGCF.

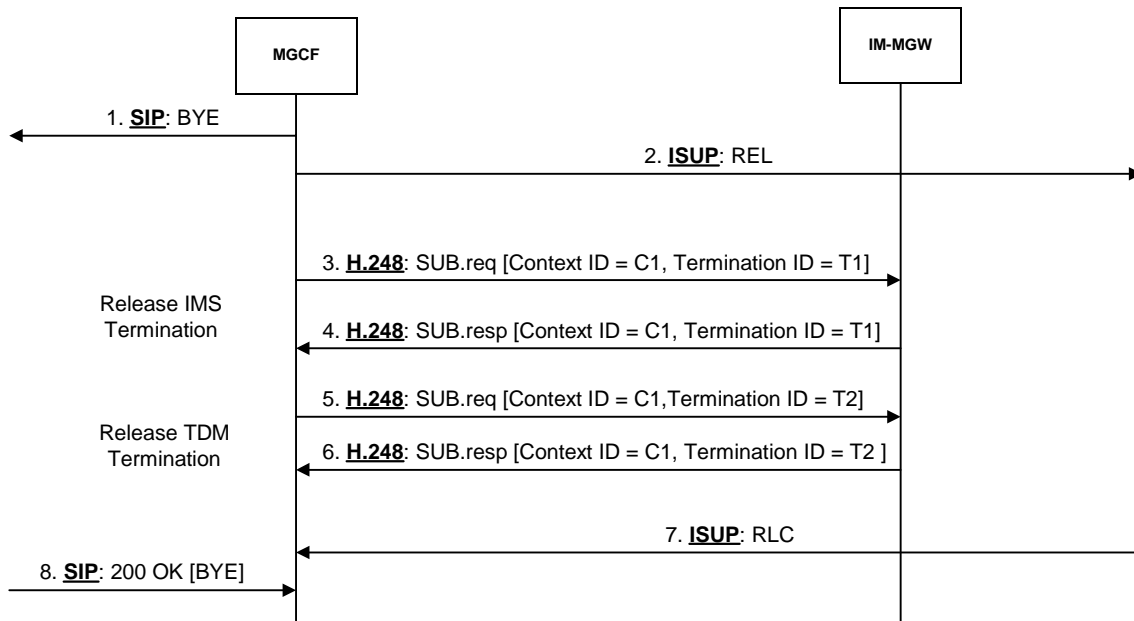

Figure 45: Session release initiated by MGCF for ISUP (message sequence chart)

## 9.2.7 Session release initiated by IM-MGW

### 9.2.7.1 BICC

#### 9.2.7.1.1 Session release in the CS network side

Upon receiving from the IM-MGW a "Bearer Released" procedure (signal 1a and 2a in figure 46) or 'IMS Bearer Released' procedure (signal 1b and 2b in figure 46) or a "MGW Out-of-Service" procedure indicating an immediate release (H248 ServiceChangeMethod="Forced") (not depicted in figure 46), the MGCF shall send a REL message to the succeeding node on the CS network side (signal 3 in figure 46). Once the succeeding node has responded with the RLC message (signal 5 in figure 46), the MGCF shall release the resources for the CS network side in the IM-MGW, unless the "MGW Out-of-Service" procedure was received.. If any resources were seized in the IM-MGW, the MGCF shall use the "Release Termination" procedure to indicate to the IM-MGW that the CS network side bearer termination shall be removed (signals 6 and 7 in figure 46).

Note: Other actions related to MGW Out-Of-Service procedure is defined in 3GPP TS 23.205 [27].

#### 9.2.7.1.2 Session release in the IM CN subsystem side

Upon receiving from the IM-MGW a "Bearer Released" procedure (signals 1a and 2a in figure 46) or 'IMS Bearer Released' procedure (signal 1b and 2b in figure 46) or a "MGW Out-of-Service" procedure indicating an immediate release (H248 ServiceChangeMethod="Forced") (not depicted in figure 46), the MGCF shall send a BYE/CANCEL message to the IM CN subsystem side (signal 4 in figure 46) Upon receiving from the IM-MGW a "Bearer Released" procedure or 'IMS Bearer Released' procedure, the MGCF shall also release the resources in the IM-MGW serving the relevant Mb interface connection by using the "Release IMS Termination" procedure (signals 8 and 9 in figure 46). The MGCF shall also expect to receive a 200 OK [BYE] message from the IM CN subsystem side (signal 10 in figure 46).

NOTE: Other actions related to MGW-Out-Of-Service procedure is defined in 3GPP TS 23.205 [27]

#### 9.2.7.1.3 Message sequence chart

Figure 46 shows the message sequence chart for the session release initiated by the IM-MGW.

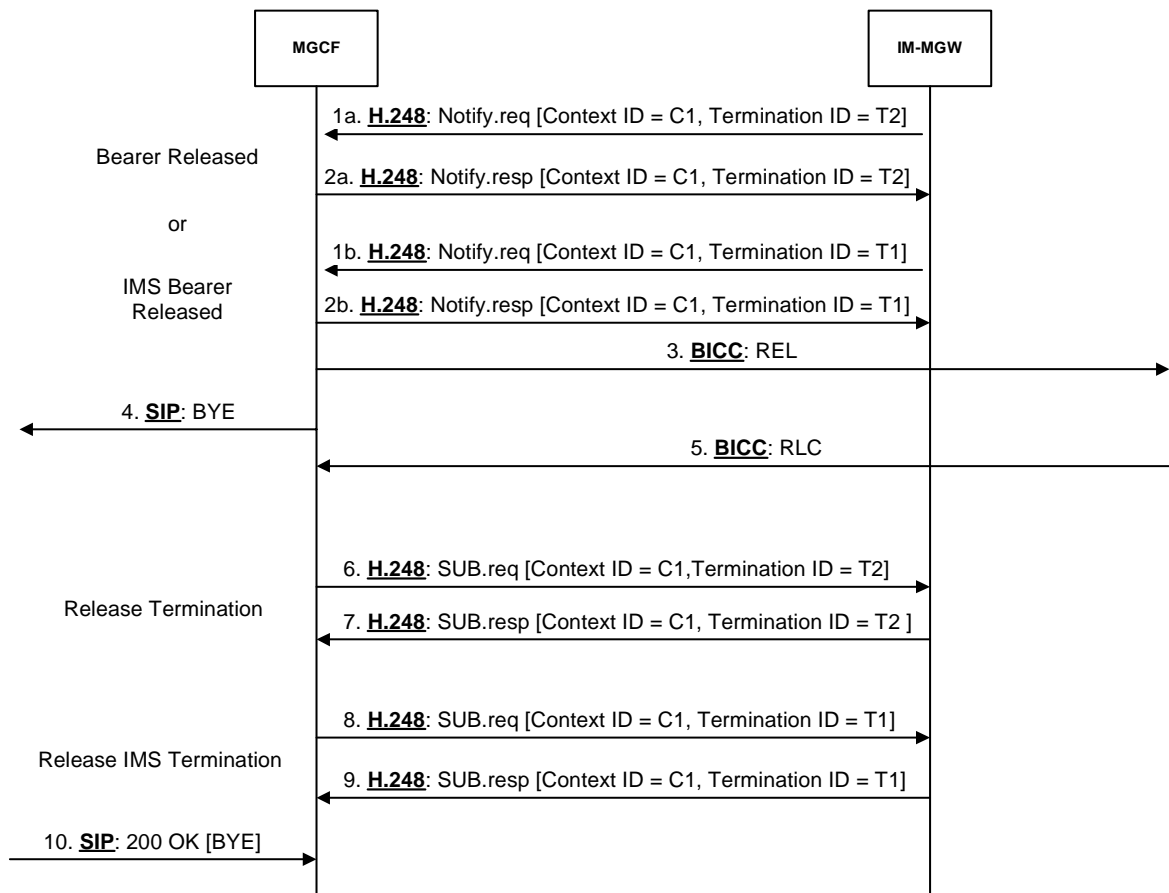

Figure 46: Session release initiated by the IM-MGW for BICC (message sequence chart)

## 9.2.7.2 ISUP

### 9.2.7.2.1 Session release in the CS network side

Upon receiving from the IM-MGW a "Termination Out-of-Service" procedure indicating an immediate release (signals 1a and 2a in figure 47), a "Bearer Released" procedure (signal 1b and 2b in figure 47), a "IMS Bearer Released" procedure (signal 1c and 2c in figure 47) or a "MGW Out-of-Service procedure" (not depicted in figure 47) indicating an immediate release (H248 ServiceChangeMethod="Forced") the MGCF shall send a REL message to the succeeding node (signal 3 in figure 47). Upon receiving from the IM-MGW a "Termination Out-of-Service" message procedure indicating an immediate release or a "Bearer Released" procedure, the MGCF shall also release the resources for the corresponding CS network side termination(s) in the IM-MGW. If any resources were seized in the IM-MGW, the MGCF shall use the "Release TDM Termination" procedure to indicate to the IM-MGW that the CS network side bearer termination can be removed (signals 7 and 8 in figure 47). The MGCF also expects to receive a RLC message on the CS network side (signal 9 in figure 47) before the circuit is reselectable.

Note: Other actions related to "MGW-Out-Of-Service" procedure is defined in 3GPP TS 23.205 [27].

### 9.2.7.2.2 Session release in the IM CN subsystem side

Upon receiving from the IM-MGW a "Termination Out-of-Service" procedure indicating an immediate release (signal 1a and 2a in figure 47) on the CS termination in the context, a "Bearer Released" procedure (signal 1b and 2b in figure 47), an 'IMS Bearer Released' procedure (signal 1c and 2c in figure 47) or a "MGW Out-of-Service procedure" (not depicted in figure 47) indicating an immediate release, (H248 ServiceChangeMethod="Forced") the MGCF shall send a BYE/CANCEL message to the IM CN subsystem side (signal 4 in figure 47). Upon receiving from the IM-MGW a "Termination Out-of-Service" procedure indicating an immediate release on the CS termination in the context, a "Bearer Released" procedure or an 'IMS Bearer Released' procedure, the MGCF shall also release the resources in the IM-MGW for the corresponding terminations towards the IM CN subsystem using the "Release IMS Termination"

procedure (signals 5 and 6 in figure 47). The MGCF also expects to receive a 200 OK [BYE] message from the IM CN subsystem side (signal 10 in figure 47).

NOTE: Other actions related to 'MGW-Out-Of-Service' procedure is defined in 3GPP TS 23.205 [27].

### 9.2.7.2.3 Message sequence chart

Figure 47 shows the message sequence chart for the session release initiated by the IM-MGW.

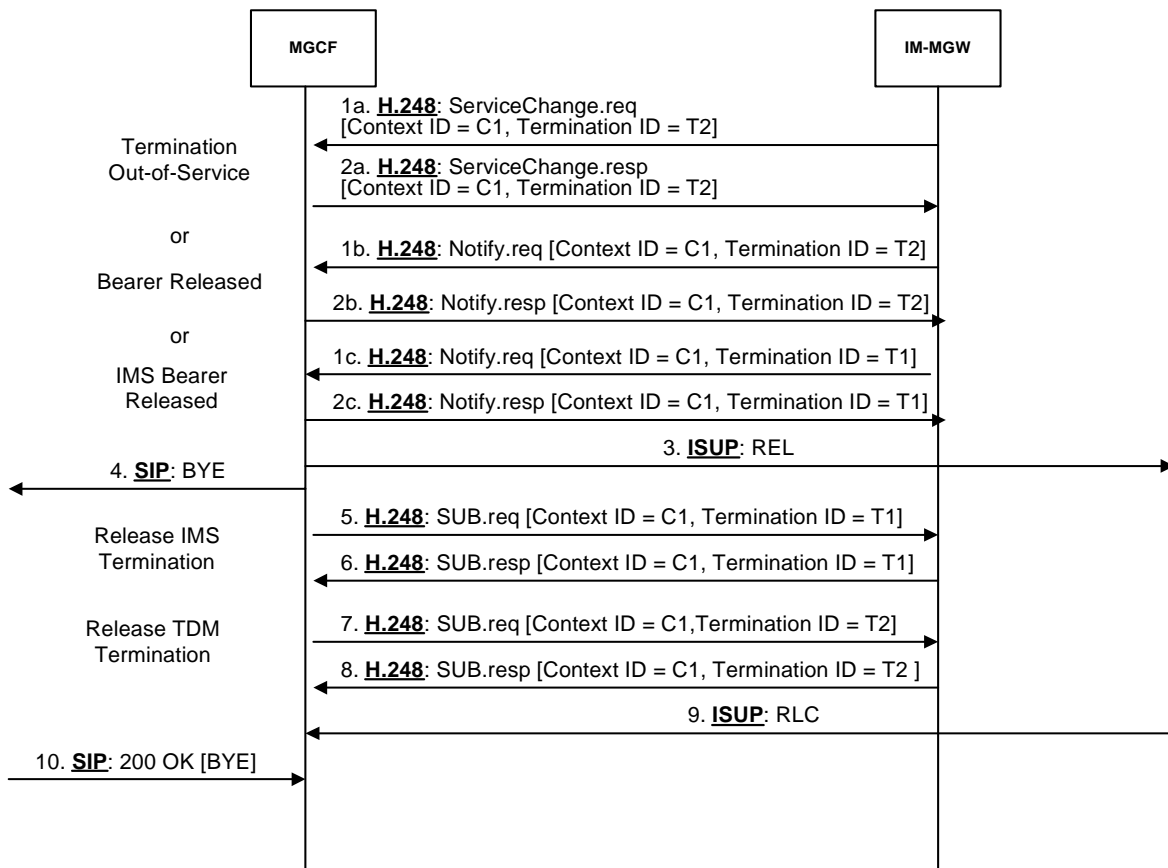

Figure 47: Session release initiated by the IM-MGW for ISUP (message sequence chart)

## 9.2.8 Handling of RTP telephone events

DTMF digits, telephony tones and signals (telephone events) can be transferred using different mechanisms. For the IM CN Subsystem, 3GPP TS 24.229 [9] defines the usage of the RTP payload format defined for DTMF Digits, Telephony Tones and Telephony Signals in RFC 2833 [34]. When BICC signalling is used in the CS network, telephony signals may be sent either inband or out-of-band as defined in ITU-T Recommendation Q.1902.4 [30] and in ITU-T Recommendation Q.765.5 [35]. If ISUP signalling is used the DTMF tones are sent inband. The following paragraphs describe the Mn interface procedures to transfer DTMF between RTP format defined in RFC 2833 [34] and the CS CN.

Before the actual usage of the telephony signals can occur the sending/receiving of telephone events need to be agreed with the SDP offer-answer mechanism defined in RFC 3264 [36]. The outcome of the negotiation can be e.g. that no telephone events are sent in RTP payload, telephone events are sent only in one direction or in both directions. If the outcome of the negotiation is that RTP payload telephone-events are sent in both directions, the IM-MGW may nevertheless be configured to interwork only mobile originated telephone-events.

When the offer-answer mechanism based session parameters negotiation results in an agreement that telephone events are sent in the RTP payload and the needed preconditions are fulfilled, telephone events can be sent in RTP payload. This negotiation can be done at call control signalling phase or during an ongoing call.

If the MGCF and IM-MGW support the reception and/or transmission of the RTP MIME type "telephone event" (as defined in RFC 2833 [34]) with the IMS, the following applies:

- For CS Network Originating Sessions, the MGCF shall include the MIME type "telephone events" with default events in the first SDP offer. After the usage of telephone events is agreed in the subsequent offer-answer parameter exchanges and the needed preconditions defined in RFC 3312 [37] are fulfilled, telephone events can be sent as RTP payload.
- In case of IM CN Subsystem Originating Sessions, the MGCF shall accept the MIME type "telephone events" with default events in any SDP answer when it received such an offer.

### 9.2.8.1 Sending DTMF digits out-of-band to CS CN (BICC)

For the IM CN subsystem terminated session, the MGCF shall use the "Configure IMS Resources" procedure as described in Clause 9.2.3. For the IM CN subsystem originating session, the MGCF shall use the "Reserve IMS Connection Point and Configure Remote Resources" procedure as described in Clause 9.2.2. If DTMF is supported, the MGCF shall include "telephone event" along with the selected speech codecs within the "local IMS resources" Parameter of these procedures. The same termination shall be used to receive and transmit DTMF and speech of the same call.

Furthermore, the MGCF shall use the "Detect IMS RTP Tel Signal" procedure to request the MGW to detect incoming telephone events from the IMS and notify the MGCF about the detected events. The MGW shall use the "Notify IMS RTP Tel Event" procedure for this notification. The termination used to receive DTMF shall be placed in the same context used for the speech of the same call. If the IM-MGW received a "Detect IMS RTP Tel Event" procedure for a termination, the IM-MGW shall not forward inband to the CS network any DTMF received at this termination.

Figure 48 shows the message sequence chart when DTMF digits are received from the IM CN subsystem in the RTP payload. For the first digit, the received RTP message contains all information including the duration and only a single notification is received. For the second digit, the start and the end of the DTMF digit are notified separately.

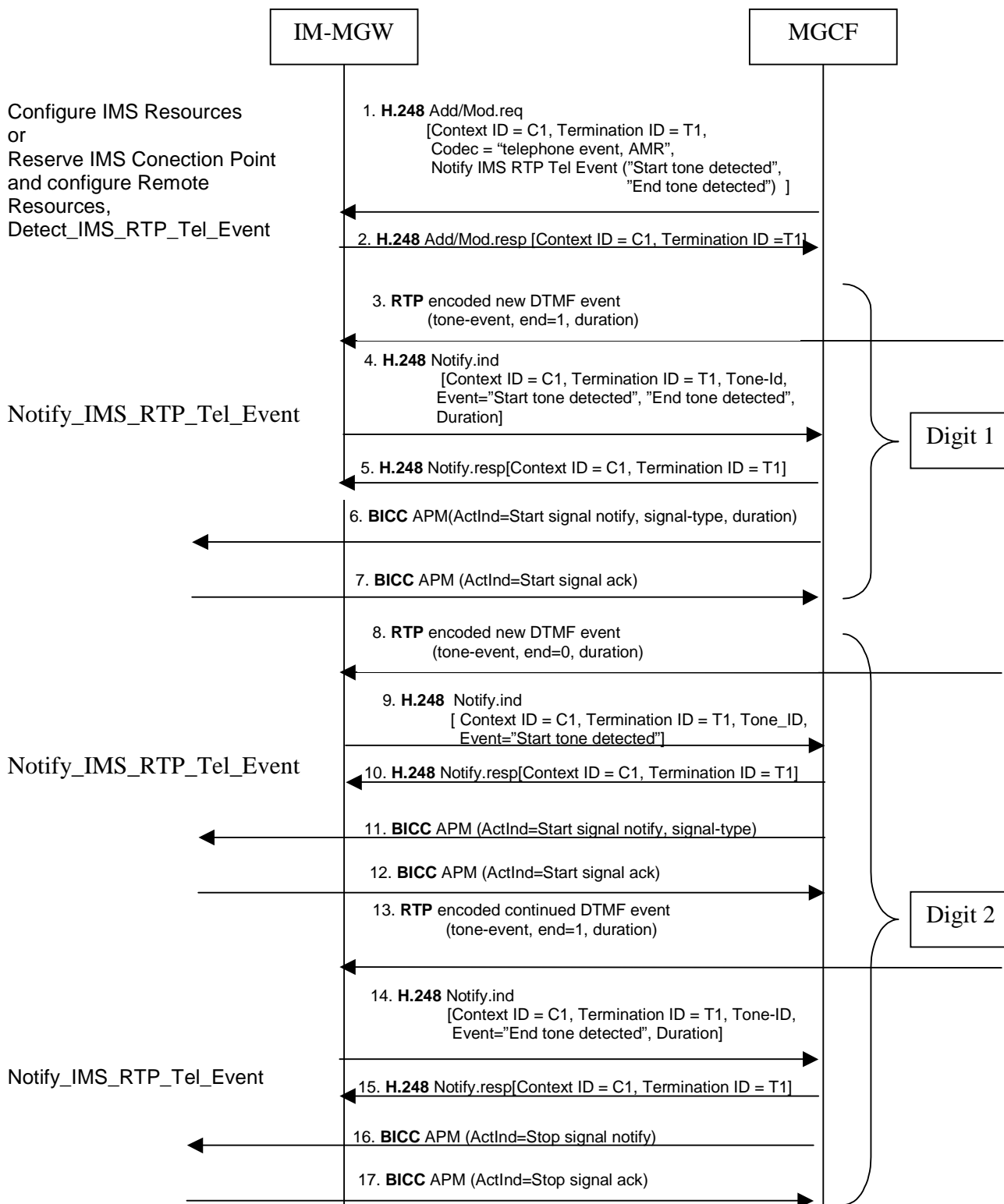

Figure 48: Activation of notification of DTMF digits received in RTP and examples of sending the digits out-of-band to CS CN (message sequence chart)

9.2.8.2 Sending and receiving DTMF digits inband to/from CS CN (ISUP or BICC)

For the IM CN subsystem terminated session, the MGCF shall use the "Configure IMS Resources" procedure as described in Clause 9.2.3. For the IM CN subsystem originating session, the MGCF shall use the "Reserve IMS Connection Point and Configure Remote Resources" procedure as described in Clause 9.2.2. If DTMF is supported, the MGCF shall include "telephone event" along with the selected speech codecs within the "local IMS resources" parameter of these procedures to request the MGW to detect incoming telephone events and transform them into speech



signals on the CS side. When receiving this configuration, the MGW may in addition optionally detect incoming telephone events received inband from the CS CN network and transform them into telephone events on the IMS side. The same termination shall be used to receive and transmit DTMF and speech of the same call.

Figure 49 shows the message sequence chart to configure the IM-MGW to receive DTMF detection on the IMS side and transfer the DTMF inband on the CS side. When receiving this configuration, the IM-MGW may in addition optionally detect DTMF inband on the CS side and transmit DTMF on the IMS side.

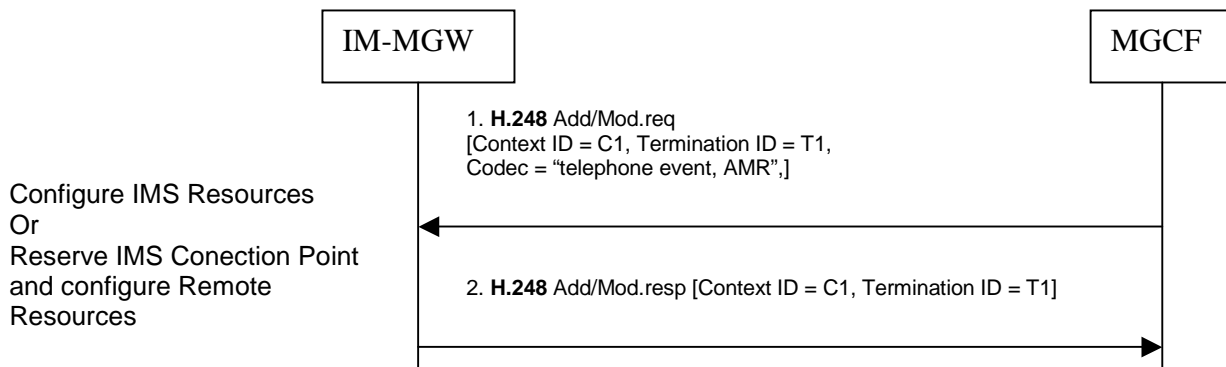

**Figure 49: Activation of processing of DTMF digits received in RTP for sending the digits inband to CS CN (message sequence chart)**

### 9.2.8.3 Receiving DTMF digits out-of-band from CS CN (BICC)

For the IM CN subsystem terminated session , the MGCF shall use the "Configure IMS Resources" procedure as described in Clause 9.2.3. For the IM CN subsystem originating session , the MGCF shall use the "Reserve IMS Connection Point and Configure Remote Resources" procedure as described in Clause 9.2.2. If DTMF is supported, the MGCF shall include "telephone event" along with the selected speech codecs within the "local IMS resources" Parameter of these procedures. The same termination shall be used to receive and transmit DTMF and speech of the same call.

Furthermore, the MGCF shall use the 'Send IMS RTP Tel Event' and 'Stop IMS RTP Tel Event' procedures to request the MGW to play out DTMF to the IM CN subsystem whenever it receives out-of-band DTMF indications from the BICC network.

Figure 49a shows the message sequence chart when DTMF digits are transmitted to the IM CN subsystem in the RTP payload. For the first digit, the received APM message contains all information including the duration and only a single notification is received. For the second digit, the start and the end of the DTMF digit are notified separately.

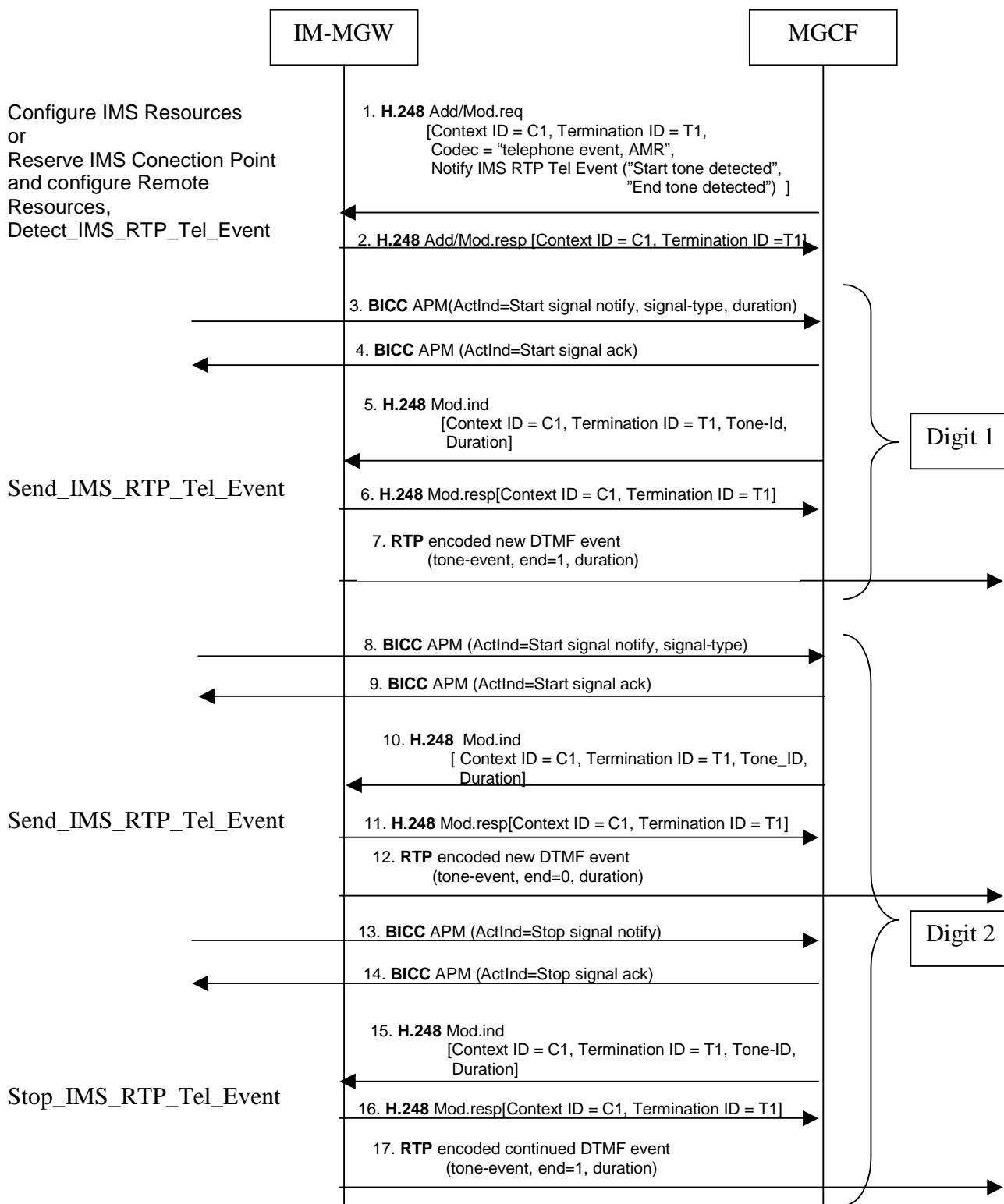

Figure 49a: Examples of receiving DTMF digits out-of-band from the CS CN and transmitting them in RTP (message sequence chart)

### 9.2.9 Session hold initiated from IM CN subsystem

The network model in the clause 9.2.1 shall apply here.

Hold request

When the IMS network makes a hold request by sending an UPDATE or re-INVITE message (signal 1 of figure 50), the MGCF shall request the IM-MGW to suspend sending media towards the IMS side by changing the through-connection of the IM CN subsystem side termination to 'not through-connected' (signal 2 of figure 50). If the IMS side provides modified SDP RR or RS bandwidth modifiers, as specified in IETF RFC 3556 [59], within the hold request, the MGCF shall use the Configure IMS Resources Mn procedure to forward this information to the IM-MGW (not depicted in figure 50, but may be combined with signal 2). The MGCF shall send a CPG (Hold) message to the succeeding CS network node to indicate that the session is on hold (signal 4 of figure 50). Simultaneously a SIP message acknowledging the Hold request is sent to the IMS side (signal 7 of figure 50, acknowledged by signal 7.a if the INVITE method is used). Announcements may be applied to the party on hold, depending on the held party's status, using the Play Announcement procedure (for BICC) or the Play TDM Announcement procedure (for ISUP, signal 5 in figure 50). The hold operation shall not block RTCP flows.

#### Resume request

When the IMS network makes a request to retrieve the session on hold by sending an UPDATE or re-INVITE message (signal 8 of figure 50), the MGCF shall request the IM-MGW to re-establish communication towards the IMS network by changing the through-connection of the IM CN subsystem side termination to both-way through-connected (signal 11 of figure 50). If the IMS side provides modified SDP RR or RS bandwidth modifiers, as specified in IETF RFC 3556 [59], within the retrieve request, the MGCF shall use the Configure IMS Resources Mn procedure to forward this information to the IM-MGW (not depicted in figure 50, but may be combined with signal 11). Possible announcements to the party on hold shall be stopped using the Stop Announcement procedure (for BICC) or the Stop TDM Announcement procedure (for ISUP, signal 9 in figure 50). The MGCF shall send a CPG (Retrieve) message to the succeeding CS network node to indicate that the session is retrieved (signal 13 of figure 50).

#### Message sequence chart

Figure 50 shows the message sequence chart for the call hold and retrieval procedures.

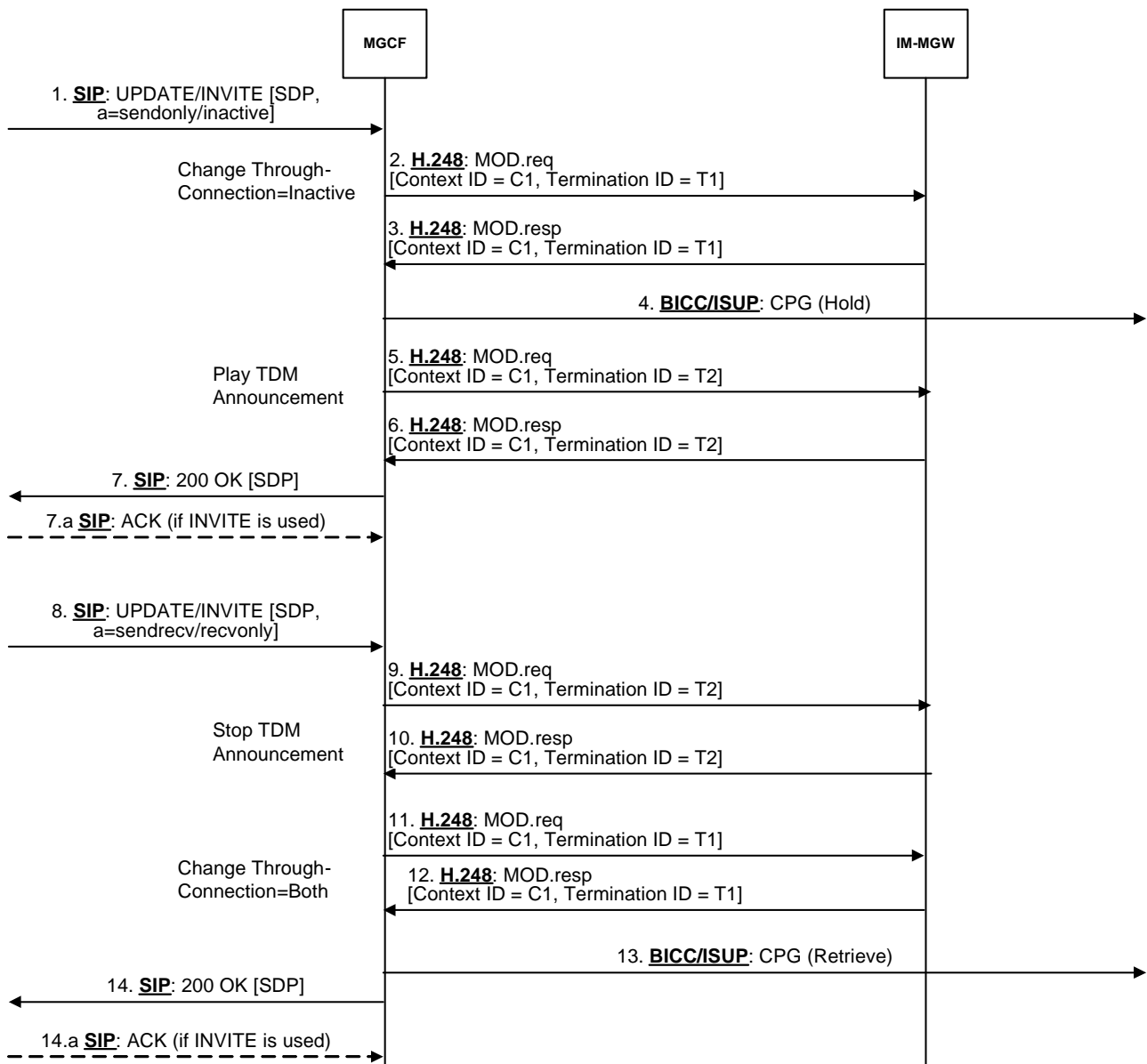

Figure 50 Session hold from IM CN subsystem

### 9.2.10 Session hold initiated from CS network

When an MGCF receives a CPG message with a "remote hold" Generic notification indicator (signal 1 of figure 51), the MGCF forwards the hold request by sending an UPDATE or re-INVITE message containing SDP with 'sendonly' or 'inactive' media (signal 4 of figure 51).

When an MGCF receives a CPG message with a "remote retrieval" Generic notification indicator (signal 6 of figure 51), the MGCF forwards the resume request by sending an UPDATE or re-INVITE message containing SDP with 'sendrecv' or 'recvonly' media (signal 9 of figure 51).

If the MGCF receives a CPG with "remote hold" or "remote retrieval" before answer, it shall forward the request using an UPDATE message. If the MGCF receives a CPG with "remote hold" or "remote retrieval" after answer, it should forward the request using re-INVITE but may use UPDATE.

If link aliveness information is required at the IM-MGW while the media are on hold, the MGCF should provide to the modified SDP RR and RS bandwidth modifiers specified in IETF RFC 3556 [59] within the SDP offers in the UPDATE

or re-INVITE messages holding and retrieving the media to temporarily enable RTCP while the media are on hold, as detailed in Clause 7.4 of 3GPP TS 26.236 [32]. If no link aliveness information is required at the IM-MGW, the MGCF should provide the SDP RR and RS bandwidth modifiers previously used.

The interworking does not impact the user plane, unless the MGCF provides modified SDP RR and RS bandwidth modifiers in the UPDATE or re-INVITE messages. If the MGCF provides modified SDP RR and RS bandwidth modifiers in the UPDATE or re-INVITE messages, the MGCF shall also provide modified SDP RR and RS bandwidths to the IM-MGW using the Configure IMS Resources procedures (signals 2-3 and 7-8 of figure 51).

### Message sequence chart

Figure 51 shows the message sequence chart for the call hold and retrieval procedures.

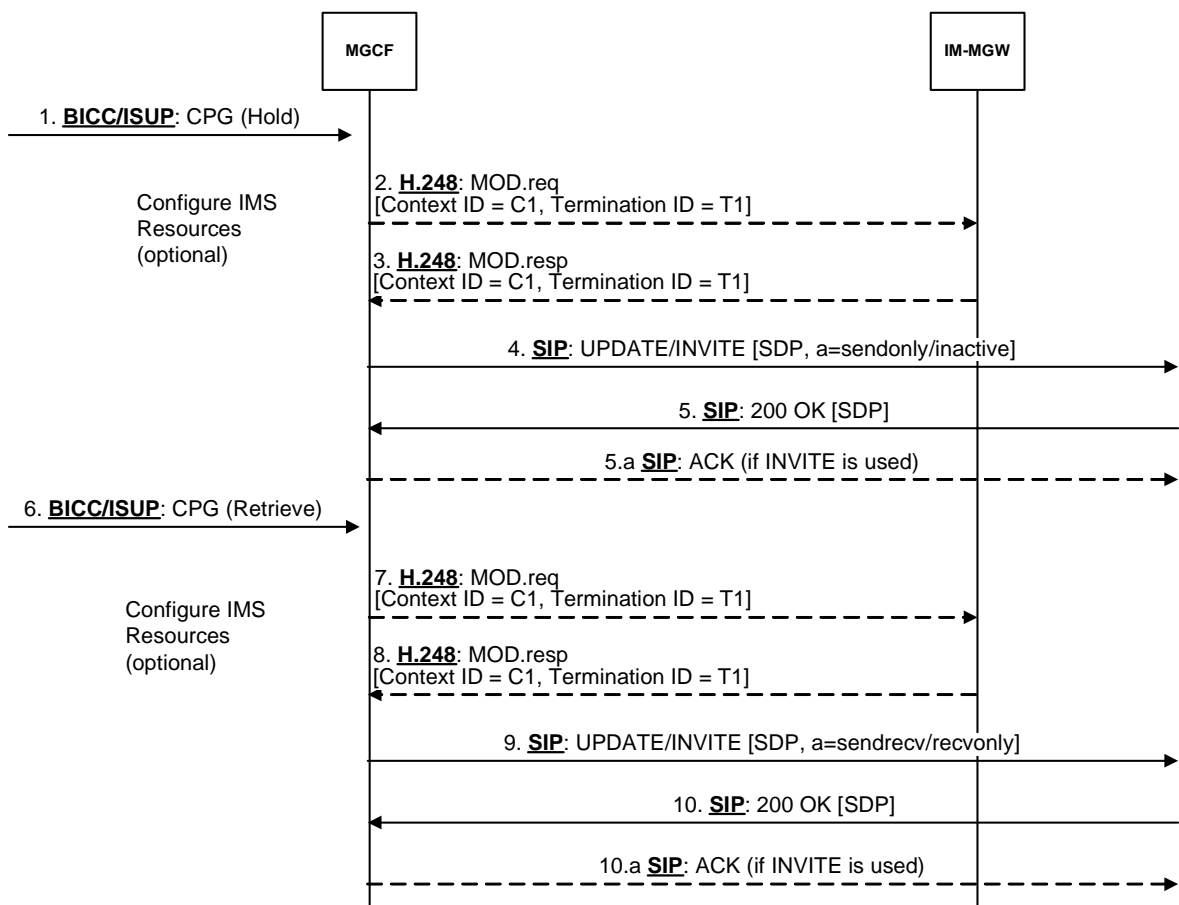

Figure 51 Session hold from CS network

## 9.3 Mn Signalling procedures

This clause describes of logical signalling procedures (i.e. message identifiers are not part of the protocol) between the MGCF and IM-MGW. The procedures within this clause are intended to be implemented using the standard H.248 procedure as defined in] ITU recommendation H.248.1 [2]with appropriate parameter combinations.

### 9.3.1 Procedures related to terminations towards the IM CN Subsystem

A mapping of the procedures defined here to H.248 procedures and parameters is provided in 3GPP TS 29.332 [15].

### 9.3.1.1 Reserve IMS connection point

This procedure is used to reserve local connection addresses and local resources.

**Table 25: Procedures toward the IM Subsystem: Reserve IMS connection point**

Procedure	Initiated	Information element name	Information element required	Information element description
Reserve IMS Connection Point	MGCF	Context/Context Request	M	This information element indicates the existing context or requests a new context for the bearer termination.
		IMS Termination Request	M	This information element requests a new IMS termination for the bearer to be established.
		Local IMS Resources/	M	This information element indicates the resource(s) (i.e. codecs) for which the IM-MGW shall be prepared to receive user data.
		ReserveValue	O	This information element indicates if multiple local IMS resources are to be reserved.
		Local Connection Addresses Request	M	This information element requests an IP address and port number on the IM-MGW that the remote end can send user plane data to.
		Notify Released Bearer	O	This information element requests a notification of a released bearer.
Reserve IMS Connection Point Ack	IM-MGW	Context	M	This information element indicates the context where the command was executed.
		IMS Termination	M	This information element indicates the IMS termination where the command was executed.
		Local IMS Resources	M	This information element indicates the resources that the IM-MGW has reserved to receive the user plane data from the IMS.
		Local Connection Addresses	M	This information element indicates the IP address and port on the IM-MGW that shall receive user plane data from IMS.

### 9.3.1.2 Configure IMS resources

This procedure is used to select multimedia-processing resources for a Mb interface connection.

**Table 26: Procedures toward the IM Subsystem: Select Local, Select Remote IMS Processing Resource**

Procedure	Initiated	Information element name	Information element required	Information element description
Configure IMS Resources	MGCF	Context	M	This information element indicates the existing context.
		IMS Termination	M	This information element indicates the existing bearer termination.
		Local IMS Resources	O	This information element indicates the resources (i.e. codec) that the IM-MGW may use on the reception of user plane data.
		Remote IMS Resources	M	This information element indicates the resources (i.e. codec) that the IM-MGW may send user plane data to.
		Local Connection Addresses	O	This information element indicates the IP address and port on the IM-MGW that the IMS user can send user plane data to.

		Remote Connection Addresses	M	This information element indicates the IP address and port that the IM-MGW can send user plane data to.
		Reserve Value	O	This information element indicates if multiple IMS resources are to be reserved.
Configure IMS Resources Ack	IM-MGW	Context	M	This information element indicates the context where the command was executed.
		IMS Termination	M	This information element indicates the IMS termination where the command was executed.
		Local IMS Resource	O	This information element indicates the resources that the IM-MGW has reserved to receive the user plane data from the far end.
		Remote IMS Resource	M	This information element indicates the resource (i.e. codec) that the IM-MGW shall use to send user data to.
		Local Connection Address	O	This information element indicates the IP address and port on the IM-MGW that the remote end can send user plane data to.
		Remote Connection Address	M	This information element indicates the IP address and port that the IM-MGW can send user plane data to.

### 9.3.1.3 Reserve IMS Connection point and configure remote resources

This procedure is used to reserve multimedia-processing resources for an Mb interface connection.

**Table 27: Procedures toward the IM Subsystem: reserve local, reserve remote IMS connection point**

Procedure	Initiated	Information element name	Information element required	Information element description
Reserve IMS Connection Point and Configure Remote Resources	MGCF	Context/Context Request	M	This information element indicates the existing context or requests a new context for the bearer termination.
		IMS Termination/IMS Termination Request	M	This information element indicates the existing bearer termination or requests a new IMS termination for the bearer to be established.
		Local IMS Resources	M	This information element indicates the resource(s) (i.e. codecs) for which the IM-MGW shall be prepared to receive user data,
		Remote IMS Resources	M	This information element indicates the resources (i.e. codec) that the IM-MGW shall use to send user data in the IMS.
		Reserve Value	O	This information element indicates if multiple IMS resources are to be reserved.
		Local Connection Address request	M	This information element requests an IP address and a port number on the IM-MGW that the remote end can send user plane data to.
		Remote Connection Addresses	M	This information element indicates the IP address and ports at an IMS user that the IM-MGW can send user plane data to.
		Notify Released Bearer	O	This information element requests a notification of a released bearer.
Reserve IMS Connection Point and Configure Remote Resources Ack	IM-MGW	Context	M	This information element indicates the context where the command was executed.
		IMS Termination	M	This information element indicates the IMS termination where the command was executed.

		Local IMS Resources	M	This information element indicates the resources that the IM-MGW has reserved to receive the user plane data from IMS.
		Remote IMS Resources	M	This information element indicates the resource (i.e. codec) that the IM-MGW shall use to send user data.
		Local Connection Addresses	M	This information element indicates the IP address on the IM-MGW that shall receive user plane data from the IMS.

#### 9.3.1.4 Release IMS termination

This procedure is used by the MGCF to release a termination towards the IMS and free all related resources.

**Table 28: Release IMS termination**

Procedure	Initiated	Information element name	Information element required	Information element description
Release IMS Termination	MGCF	Context	M	This information element indicates the context for the bearer termination.
		Bearer Termination	M	This information element indicates the bearer termination to be released.
Release IMS Termination Ack	IM-MGW	Context	M	This information element indicates the context where the command was executed.
		Bearer Termination	M	This information element indicates the bearer termination where the command was executed.

#### 9.3.1.5 Detect IMS RTP Tel event

This procedure is used by the MGCF to request from the MGW the detection of telephony events signalled within RTP according to RFC 2833 [34] and the notification of received telephony events. This procedure is the same as that is defined in the subclause "Detect DTMF" in 3GPP TS 23.205 [27].

**Table 29: VOID**

#### 9.3.1.6 Notify IMS RTP Tel event

This procedure is used by the MGW to notify the MGCF about the detection of telephony events signalled within RTP according to RFC 2833 [34]. This procedure is the same as that defined in the subclause "Report DTMF" in 3GPP TS 23.205 [27].

**Table 30: VOID**



### 9.3.1.7 Void

### 9.3.1.8 Send IMS RTP Tel event

This procedure is used by the MGCF to request from the MGW to signal a telephone event within RTP according to RFC 2833 [34]. This procedure is the same as that defined in the subclause "Send DTMF" in 3GPP TS 23.205 [27].

### 9.3.1.9 Stop IMS RTP Tel event

This procedure is used by the MGW to request from the MGW to stop signalling a telephone event within RTP according to RFC 2833 [34]. This procedure is the same as that defined in the subclause "Stop DTMF" in 3GPP TS 23.205 [27].

### 9.3.1.10 IMS Bearer Released

This procedure is used by the IM-MGW to indicate towards the MGCF that an error occurred on an IMS termination which requires the release of the termination. This procedure is the same as that defined in the subclause 'Bearer Released' in 3GPP TS 23.205 [27].

### 9.3.1.11 End IMS RTP Tel event

This procedure is used by the MGCF to indicate to the IM-MGW to stop detection of telephony events signalled within RTP according to IETF RFC 2833 [34]. This procedure is the same as that is defined in the subclause "Stop Detect DTMF" in 3GPP TS 23.205 [27].

### 9.3.1.12 IMS Send Tone

This procedure is used by the MGCF to order the IM-MGW to generate a tone at termination towards IMS. This procedure is the same as that defined in the subclause 'Send Tone' in 3GPP TS 23.205 [27].

### 9.3.1.13 IMS Stop Tone

This procedure is used by the the MGCF to order the IM-MGW to stop generating a tone at a termination towards IMS This procedure is the same as that defined in the subclause 'Stop Tone' in 3GPP TS 23.205 [27].

### 9.3.1.14 IMS Tone Completed

This procedure is used by the IM-MGW to indicate to the MGCF that a tone has finished being generated at a termination. This procedure is the same as that defined in the subclause 'Tone Completed' in 3GPP TS 23.205 [27].

## 9.3.2 Procedures related to a termination towards an ISUP network

A mapping of the procedures defined here to H.248 procedures and parameters is provided in 3GPP TS 29.332 [15].

### 9.3.2.1 Reserve TDM circuit

This procedure is used by the MGCF to reserve a TDM circuit in the IM-MGW towards the preceding/succeeding CS network element.

**Table 31: Reserve TDM circuit procedure**

Procedure	Initiated	Information element name	Information element required	Information element description
Reserve TDM Circuit	MGCF	Context/Context Request	M	This information element indicates the existing context or requests a new context for the bearer termination.
		Bearer Termination	M	This information element indicates the physical bearer termination for the TDM circuit.
		Bearer Service Characteristics	M	This information element indicates the bearer service requested by the user.
		Notify Released Bearer	O	This information element requests a notification of a released bearer
Reserve Circuit Ack	IM-MGW	Context	M	This information element indicates the context where the command was executed.
		Bearer Termination	M	This information element indicates the bearer termination where the command was executed.

### 9.3.2.2 Change TDM through-connection

This procedure is used by the MGCF to modify the through-connection (forward, backward, both-way, inactive) of a TDM termination at the IM-MGW towards the PSTN.

This procedure is the same as Change Through Connection in TS 23.205 [27].

### 9.3.2.3 Activate TDM voice-processing function

This procedure is used by the MGCF to activate or de-activate a voice processing function of a TDM termination at the IM-MGW towards the PSTN. This voice processing function may include a cancellation for electronic echoes.

This procedure is the same as Activate Voice Processing Function in 3GPP TS 23.205 [27].

### 9.3.2.4 Send TDM tone

This procedure is used by the MGCF to order the IM-MGW to generate a tone at a TDM termination towards the PSTN.

This procedure is the same as Send Tone in 3GPP TS 23.205 [27].

### 9.3.2.5 Stop TDM tone

This procedure is used by the MGCF to order the IM-MGW to stop generating a tone at a TDM termination towards the PSTN.

This procedure is the same as Stop tone in 3GPP TS 23.205 [27].

### 9.3.2.6 Play TDM announcement

This procedure is used by the MGCF to order the IM-MGW to generate an announcement at a TDM termination towards the PSTN. The MGCF may request a notification that the announcement is completed. This procedure is the same as Play Announcement in 3GPP TS 23.205 [27]. This procedure is optional.

### 9.3.2.7 TDM announcement completed

This procedure is used by the IM-MGW to notify the MGCF that an announcement at a TDM termination towards the PSTN is completed. This procedure is the same as Announcement Completed in 3GPP TS 23.205 [27]. This procedure is optional.

### 9.3.2.8 Stop TDM announcement

This procedure is the same as Stop Announcement 3GPP TS 23.205 [27]. This procedure is used by the MGCF to order the IM-MGW to stop generating an announcement at a TDM termination towards the PSTN. This procedure is optional.

### 9.3.2.9 Continuity check

This procedure is used by the MGCF to order the IM-MGW to generate a continuity check tone at a TDM termination towards the PSTN and to inform the MGCF about the result of the continuity check as soon as the continuity check tone is received or a time-out occurs. This procedure is optional.

**Table 32: Continuity check procedure**

Procedure	Initiated	Information element name	Information element required	Information element description
Continuity check	MGCF	Context/Context Request	M	This information element indicates the existing context or requests a new context for the bearer termination.
		TDM Termination	M	This information element indicates the existing bearer termination
		Request for continuity tone sending	M	This information request the IM-MGW to apply the continuity check procedure on the indicated TDM termination
		Request for continuity check tone detection	M	This information request the IM-MGW to inform e continuity check procedure on the indicated TDM termination
Continuity Check Ack	IM-MGW	Context	M	This information element indicates the context where the command was executed.

### 9.3.2.10 Continuity check verify

This procedure is used by the IM-MGW to indicate towards the MGCF that the continuity check at a TDM termination towards the PSTN has been completed and to return the result of the check: success or failure. This procedure is optional.

**Table 33: Continuity check verify procedure**

Procedure	Initiated	Information element name	Information element required	Information element description
Continuity check Verify	IM-MGW	Context/t	M	This information element indicates the context where the command was executed.
		TDM Termination	M	This information element indicates the TDM termination involved in the procedure
		Outcome of the continuity check	M	This information element indicates the outcome of the continuity check (successful/unsuccessful)
Continuity Check Verify Ack	MGCF	Context	M	This information element indicates the context where the command was executed.

### 9.3.2.11 Continuity check response

This procedure is used by the MGCF to order the IM-MGW to loop back an incoming continuity check tone at a TDM termination towards the PSTN. This procedure is optional.

**Table 34: Continuity check response procedure**

Procedure	Initiated	Information element name	Information element required	Information element description
Continuity check response	MGCF	Context/Context Request	M	This information element indicates the existing context or requests a new context for the bearer termination.
		TDM Termination	M	This information element indicates the existing bearer termination
		Request for loop back of the continuity tone	M	This information request the IM-MGW to loop back the continuity check tone on the indicated TDM termination
Continuity Check Response Ack	IM-MGW	Context	M	This information element indicates the context where the command was executed.

### 9.3.2.12 Release TDM termination

This procedure is used by the MGCF to release a TDM termination at the IM-MGW towards the PSTN and free all related resources.

**Table 35: Release TDM termination procedure**

Procedure	Initiated	Information element name	Information element required	Information element description
Release TDM Termination	MGCF	Context	M	This information element indicates the context for the bearer termination.
		Bearer Termination	M	This information element indicates the bearer termination to be released.
Release TDM Termination Ack	IM-MGW	Context	M	This information element indicates the context where the command was executed.
		Bearer Termination	M	This information element indicates the bearer termination where the command was executed.

### 9.3.2.13 Termination Out-of-Service

This procedure is used by the IM-MGW to indicate towards the MGCF that one or several physical termination(s) will go out of service. This procedure is the same as Termination Out-of-Service in 3GPP TS 23.205 [27].

### 9.3.2.14 Bearer Released

This procedure is used by the IM-MGW to indicate towards the MGCF that an error occurred on a physical termination which requires the release of the termination. This procedure is the same as Bearer Released in 3GPP TS 23.205 [27].

### 9.3.2.15 TDM tone completed

This procedure is used by the IM-MGW to MGCF to indicate that a tone has finished being generated at a TDM termination.

This procedure is the same as Tone Completed in 3GPP TS 23.205 [27].

## 9.3.3 Procedures related to a termination towards a BICC network

The procedures detailed in ITU.T Recommendation Q.1950 [31] and 3GPP TS 29.232 [33] shall be applied. As those procedures are already defined in those specifications, they are not re-described here.

The call related procedures listed in table 36 shall be supported. For terminations connecting the MGCF with a 3GPP CS domain on a direct link, the procedures may be applied as described in 3GPP TS 29.232 [33]. For other terminations, the corresponding Q.1950 procedures shall be applied without the additions and modifications defined in TS 29.232.

NOTE: In clause 9.3.2, the terminology of 3GPP TS 29.232 [33] is applied. This does not preclude the use of the corresponding ITU-T Recommendation Q.1950 [31] procedures

**Table 36: Correspondence between applied Q.1950 call-related procedures and 3GPP TS 29.232 procedures**

Procedures defined in Q.1950	Procedure defined in 3GPP TS 29.232	Remarks
Establish_BNC_Notify+(tunnel)	Establish Bearer	
Prepare_BNC_Notify+(tunnel)	Prepare Bearer	
Cut_Through	Change Through-Connection	
Cut_BNC (MOD H.248 Command).	Release Bearer	
Cut_BNC (SUB H.248 Command).	Release Termination	
BNC Established	Bearer Established	
BNC Release	Bearer Released	
Insert_Tone	Send Tone	
Insert Tone	Stop Tone	
Insert_Announcement	Play Announcement	Optional
Insert Announcement	Stop Announcement	Optional
Signal Completion	Announcement Completed	Optional
Confirm_Char	Confirm Char	Optional
Modify Char	Modify Bearer Characteristics	Optional
Reserve_Char_Notify	Reserve Char	Optional
BNC Modified	Bearer Modified	Optional
Echo Canceller	Activate Voice Processing Function	Optional
Tunnel (MGC-MGW)	Tunnel Information Down	Conditional: For IP Transport at BICC termination
Tunnel (MGW-MGC)	Tunnel Information Up	Conditional: For IP Transport at BICC termination
BIWF Service Cancellation Indication	Termination Out-of-Service	

### 9.3.4 Non-call related procedures

The procedures from 3GPP TS 23.205 [27] detailed in table 37 shall be applied for the IM-MGW handling component of the Mn interface.

Table 37: Non-call related procedures

Procedure defined in 3GPP TS 29.332 [15]	Corresponding Procedure defined in 3GPP TS 23.205 [27]]	Remarks
IM-MGW Out of service	MGW Out of Service	
IM-MGW Communication Up	MGW Communication Up	
IM-MGW Restoration	MGW Restoration	
IM-MGW Register	MGW Register	
IM-MGW Re-register	MGW Re-register	
MGCF Ordered Re-register	(G)MSC Server Ordered Re-register	
MGCF Restoration	(G)MSC Server Restoration	
MGCF Out of Service	(G)MSC Server Out of Service	
Termination Out-of-Service	Termination Out-of-Service	The 'Termination Out-of-Service procedure' is used as call-related H248 command as well
Termination Restoration	Termination Restoration	
Audit Value	Audit Value	
Audit Capability	Audit Capability	
Command Rejected	Command Rejected	The 'Command Rejected' procedure may be used in response both to call-related and non-call-related H.248 Commands.
IM-MGW Capability Change	Capability Update	
IM-MGW Resource Congestion Handling - Activate	MGW Resource Congestion Handling - Activate	
IM-MGW Resource Congestion Handling - Indication	MGW Resource Congestion Handling - Indication	

---

## Annex A (informative): Summary of differences items between 3GPP TS 29.163 and ITU-T Q.1912.5

The present document specifies the principles of interworking between the 3GPP IM CN subsystem and BICC/ISUP based legacy CS networks, in order to support IMS basic voice calls. A specification exists in the ITU-T that covers similar work: Interworking between Session Initiation Protocol (SIP) and Bearer Independent Call Control Protocol or ISDN User Part. (ITU-T Q.1912.5 [49]) in order to support services that can be commonly supported by BICC or ISUP and SIP based network domains. Three profiles are described in the ITU-T specification: A, B, and C. Profile B and C are out of the scope of the present specification.

3GPP intends to strive for alignment with ITU-T Q.1912.5 [49], however some differences exist. This annex contains a list of these differences. Future revisions of this document will seek to incorporate text to address these differences.

This Annex is intended as an informative tool for the designer community and operators to understand the main differences between 3GPP and ITU recommendations for the SIP-BICC/ISUP interworking.

The list of differences between TS 29.163 and ITU-T Q.1912.5 [49] is referred to profile A of the latter.

### A.1 List of differences

1. Table10 (TS 29.163) vs. Table 22/Q.1912.5 (ITU-T Q.1912.5 [49])

Extra entry comprising the case when SIP procedures result in release after answer.

2. Table11 (TS 29.163) vs. Table 25/Q.1912.5 (ITU-T Q.1912.5 [49])

Hostportion was removed in 3GPP table.

3. Table 12 (TS 29.163) vs. Table 27/Q.1912.5 (ITU-T Q.1912.5 [49])

Use of Tel URL instead of Addr-spec.

4. Table 13 (TS 29.163) vs. Table 28/Q.1912.5 (ITU-T Q.1912.5 [49])

Address signal is not mapped.

5. Table 14 (TS 29.163) vs. Table 29/Q.1912.5 (ITU-T Q.1912.5 [49])

Tel URL used instead of Addr-spec.

6. Satellite indicator

It is set to '01 one satellite circuit in the connection'. While in ITU-T Q.1912.5 [49] is set to '00 No satellite circuit in the connection'

7. The mapping of the Reason Header and the Location Field mapping is missing in the 3GPP specification, whereas in ITU is specified.

The reason for this is that the Reason Header was included in IMS only as optional. As the reason header is optional, it can be proprietary interworked and in that case ITU-T mapping recommendation can be used.

8. COLP/COLR Service interworked is included in 29.163, and left FFS in ITU-T Q.1912.5 [49]

---

## Annex B (normative): Codec Negotiation between a BICC CS network and the IM CN subsystem

### B.1 Introduction

This annex describes optional procedures for interworking of codec negotiation between a BICC CS network and the IM CN subsystem.

### B.2 Control plane interworking

The following optional procedures apply in addition to the procedures of clause 7.3 when both the BICC CS network and the IM CN subsystem support codec negotiation. All five variations of the bearer set-up procedures defined in clauses 7.4 and 7.5 of ITU-T Q.1902.4 [30] are supported. The codec negotiation procedures are also independent of the procedures for interworking between continuity procedures and SDP preconditions.

#### B.2.1 Incoming call interworking from SIP to BICC at I-MGCF

##### B.2.1.1 Sending of IAM

When the I-MGCF receives an INVITE with SDP offer, the I-MGCF shall follow the procedures of clause B.2.5 to convert the list of codecs in the SDP offer into a Supported Codec List for transmission in the outgoing IAM, according to clause 8.3.1 of ITU-T Q.1902.4 [30], and deleting those codecs not supported at the IM-MGW. When generating the Supported Codec List, the I-MGCF should add to the SDP offer all codec configurations for which it can provide transcoding. The I-MGCF shall allocate any IM-MGW resources as necessary to support the chosen bearer set-up procedures towards the BICC CS network.

When the I-MGCF receives an INVITE without SDP offer, the I-MGCF shall continue call establishment without interworking of codec negotiation procedures. The mid-call interworking procedures of clause B.2.3 and clause B.2.4 may still apply.

##### B.2.1.2 Sending of SDP answer

The I-MGCF shall suspend the SDP answer procedure until it receives backward codec information from the BICC serving node terminating codec negotiation. When the I-MGCF receives the backward codec information, it shall select a codec configuration for use on the bearer interface to the IM CN subsystem from the codecs in the SDP offer, format an SDP answer based on this selected codec, send the SDP answer to the offerer in the appropriate SIP message (e.g., a reliable 18x response), and complete bearer establishment procedures. To avoid allocating a transcoder at the IM-MGW, the I-MGCF should preferably select a codec for the IM CN subsystem by converting the Selected Codec from the BICC CS network into an SDP answer according to the procedures of clause B.2.5, if allowed by the SDP offer/answer rules. Otherwise the I-MGCF should select the highest priority codec from the codecs in the received SDP offer supported by the IM-MGW for insertion in the SDP answer. Note that the I-MGCF stores the Available Codec List and does not send it to the offerer in the SDP answer. Codec negotiation is complete so it is not necessary for the offerer to begin a second phase offer/answer exchange using the PRACK request.

#### B.2.2 Outgoing call interworking from BICC to SIP at O-MGCF

##### B.2.2.1 Sending of INVITE

When the O-MGCF receives an IAM, the O-MGCF shall follow the procedures of clause B.2.5 to convert the Supported Codec List from the IAM into an SDP offer for transmission in the outgoing INVITE request, according to RFC 3264, deleting those codecs not supported at the IM-MGW. When generating the SDP offer, the O-MGCF should include all codec configurations for which it can provide transcoding in addition to those converted from the Supported Codec List. The O-MGCF shall include at least one AMR codec configuration in the SDP offer. The O-MGCF shall



allocate any IM-MGW resources as necessary to support the inclusion of session address information in the SDP offer towards the IM CN subsystem.

### B.2.2.2 Responding to serving node initiating codec negotiation

The O-MGCF shall suspend the incoming bearer set-up procedure while waiting for receipt of the SDP answer from the IM CN subsystem. When the O-MGCF receives the SDP answer while suspending the incoming bearer set-up procedure, it shall select a codec configuration for use on the bearer interface to the IM CN subsystem from the codecs in the SDP answer, construct the Available Codec List for the BICC CS network from the list of codecs received in the Supported Codec List by removing codecs not supported at the IM-MGW, choose the Selected Codec for the BICC CS network from the codecs in the Available Codec List, initiate the second SDP offer/answer exchange with the IM CN subsystem using the codec selected for the IM CN subsystem, if necessary, and resume the incoming bearer set-up procedure in the BICC CS network. The O-MGCF should select codecs for the bearer interfaces to the BICC CS network and IM CN subsystem in such a way as to avoid transcoding at the IM-MGW and minimize speech degradation, if possible, according to clause B.2.5. Otherwise the O-MGCF should choose the highest priority codec from the Available Codec List as the Selected Codec for the BICC CS network, and the highest priority codec from the codecs in the SDP answer as the codec for the IM CN subsystem. If the SDP answer only included a single voice codec, then there is no need for a second SDP offer/answer exchange, and the codec selected for the IM CN subsystem is the codec in the SDP answer.

Certain BICC timers or events can force completion of the incoming bearer set-up procedure before the O-MGCF receives the SDP answer from the IM CN subsystem. In this case, the O-MGCF shall perform the terminating codec negotiation procedure according to clause 8.3.3 of ITU-T Q.1902.4 [30], including all supported codecs in the Available Codec List, and shall resume the incoming bearer set-up procedure without waiting any longer for the SDP answer.

When an SDP answer arrives from the IM CN subsystem in response to the SDP offer in an INVITE request after the BICC incoming bearer set-up procedure has started, the O-MGCF shall select a codec configuration for use on the bearer interface to the IM CN subsystem from the codecs in the SDP answer, choose a new Selected Codec for the BICC CS network from the codecs in the Available Codec List constructed during incoming bearer set-up, and initiate the second SDP offer/answer exchange with the IM CN subsystem using the codec selected for the IM CN subsystem, if necessary. The O-MGCF should select codecs for the bearer interfaces to the BICC CS network and IM CN subsystem in such a way as to avoid transcoding at the IM-MGW and minimize speech degradation, if possible, according to clause B.2.5. Otherwise the O-MGCF should select the highest priority codecs from the available options for the two bearer interfaces. If the SDP answer only included a single voice codec, then there is no need for a second SDP offer/answer exchange, and the codec selected for the IM CN subsystem is the codec in the SDP answer. When the call in the BICC CS network enters a state capable of supporting codec modification, if the new Selected Codec is different from the Selected Codec chosen during the incoming bearer set-up procedure for the BICC CS network, the O-MGCF should initiate the codec modification procedure towards the BICC CS network using the new Selected Codec, according to clause 10.4.1 of ITU-T Q.1902.4 [30].

## B.2.3 Mid-call interworking from SIP to BICC at I-MGCF or O-MGCF

### B.2.3.1 Receipt of SDP offer

When the MGCF receives a SIP message (e.g. UPDATE request or re-INVITE request) with an SDP offer that is not associated with incoming call bearer establishment or preconditions, if the call is in a state capable of supporting BICC codec negotiation, the MGCF shall follow the procedures of clause B.2.5 to convert the list of codecs in the SDP offer into a Supported Codec List, delete those codecs in the Supported Codec List not supported at the IM-MGW, and initiate the mid-call codec negotiation procedure according to clause 10.4.4 of ITU-T Q.1902.4 [30], by sending an APM with the Supported Codec List and an Action indicator set to 'mid-call codec negotiation'. When generating the Supported Codec List, the MGCF should add to the SDP offer all codec configurations for which it can provide transcoding.

When the MGCF receives a SIP message with an SDP offer that is not associated with incoming call bearer establishment or preconditions, if the call is not in a state capable of supporting BICC codec negotiation, the MGCF shall respond to the SDP offer with existing procedures for the IM CN subsystem. When the call is in a state capable of supporting BICC codec negotiation, the MGCF may send a re-INVITE request without SDP towards the IM CN subsystem, soliciting a response with an SDP offer, thereby restarting the codec negotiation interworking procedure.

### B.2.3.2 Generating SDP answer

After initiating a BICC codec negotiation procedure towards the BICC CS network in response to receipt of a SIP message with an SDP offer from the IM CN subsystem, the MGCF shall suspend the SDP answer procedure until it receives codec information from the succeeding BICC serving node. If the succeeding serving node returns a successful response, the MGCF shall select a codec configuration for use on the bearer interface to the IM CN subsystem from the codecs in the SDP offer, format an SDP answer based on this selected codec, send the SDP answer to the offerer in the appropriate SIP message (e.g. 200 OK (UPDATE) or 200 OK (INVITE)), send an APM to the succeeding serving node with an Action indicator set to 'successful codec modification', and complete bearer establishment procedures. To avoid allocating a transcoder at the IM-MGW, the MGCF should preferably select a codec for the IM CN subsystem by converting the Selected Codec from the BICC CS network into an SDP answer according to the procedures of clause B.2.5, if allowed by the SDP offer/answer rules. Otherwise the MGCF should select the highest priority codec from the codecs in the received SDP offer supported by the IM-MGW for insertion in the SDP answer. Note that the MGCF stores the Available Codec List and does not send it to the offerer in the SDP answer.

If the succeeding serving node returns an Action indicator set to 'mid-call codec negotiation failure', the MGCF either should send a 488 response to the SDP offerer indicating rejection of the initial SDP offer, or should select the highest priority codec from the codecs in the received SDP offer supported by the IM-MGW, format an SDP answer based on this selected codec, and send the SDP answer to the offerer in the appropriate SIP message. If the MGCF sends a 488 response to the SDP offerer, it should continue the call with the bearer configuration in place before initiating this codec negotiation procedure.

## B.2.4 Mid-call interworking from BICC to SIP at I-MGCF or O-MGCF

### B.2.4.1 Receipt of mid-call codec negotiation request

When the MGCF receives an APM with an Action indicator set to 'mid-call codec negotiation', the MGCF shall follow the procedures of clause B.2.5 to convert the Supported Codec List from the APM into an SDP offer for transmission in an appropriate SIP message (e.g. re-INVITE request) towards the IM CN subsystem, according to RFC 3264 [36], deleting those codecs not supported at the IM-MGW. When generating the SDP offer, the MGCF should include all codec configurations for which it can provide transcoding in addition to those converted from the Supported Codec List. The MGCF shall include at least one AMR codec configuration in the SDP offer.

### B.2.4.2 Responding to serving node initiating mid-call codec negotiation

The MGCF shall delay responding to the mid-call codec negotiation from the BICC CS network until it receives a response to the SDP offer from the IM CN subsystem. If the MGCF receives an SDP answer, it shall construct the Available Codec List for the BICC CS network from the list of codecs received in the Supported Codec List by removing codecs not supported at the IM-MGW, choose the Selected Codec for the BICC CS network from the codecs in the Available Codec List, and complete the mid-call codec negotiation procedure towards the preceding serving node according to clause 10.4.5 of ITU-T Q.1902.4 [30]. The MGCF should choose the Selected Codec for the BICC CS network in such a way as to avoid transcoding at the IM-MGW and minimize speech degradation, if possible, according to clause B.2.5. Otherwise the MGCF should choose the highest priority codec from the Available Codec List for the Selected Codec for the BICC CS network. If the MGCF receives an APM from the preceding serving node with an Action indicator set to 'codec modification failure', then the MGCF may initiate a new SDP offer/answer exchange towards the IM CN subsystem in an attempt to recreate the bearer configuration in place before this codec negotiation procedure began.

If the MGCF receives a 488 response or other failure response (e.g. 3xx-6xx) to the SDP offer, either it should reject the mid-call codec negotiation from the BICC CS network by sending an APM with an Action indicator set to 'mid-call codec negotiation failure' towards the preceding serving node, or it should continue as if it received an SDP answer with no change in codec selected for the IM CN subsystem. If the MGCF sends an APM with an Action indicator set to 'mid-call codec negotiation failure', it should continue the call with the bearer configuration in place before initiating this codec negotiation procedure.

### B.2.4.3 Receipt of codec modification request

If the MGCF receives an APM from a BICC CS network that includes an Action indicator set to 'modify codec' with no change in the selected codec, it shall act as a serving node terminating codec modification, according to clause 10.4.2 of ITU-T Q.1902.4 [30], without interworking the procedure with the IM CN subsystem.

If the MGCF receives an APM from a BICC CS network that includes an Action indicator set to 'modify codec' and the new selected codec in the message is different from the Selected Codec at the IM-MGW bearer interface to the BICC CS network, the MGCF either may act as a serving node terminating codec modification, according to clause 10.4.2 of ITU-T Q.1902.4 [30], without interworking the procedure with the IM CN subsystem, or may follow the procedures of clause B.2.5 to convert the new Available Codec List (with new priority order) from the APM into an SDP offer for transmission in an appropriate SIP message (e.g. re-INVITE request) towards the IM CN subsystem, according to RFC 3264 [36], deleting those codecs not supported at the IM-MGW. When generating the SDP offer, the MGCF should include all codec configurations for which it can provide transcoding in addition to those converted from the new Available Codec List. The MGCF shall include at least one AMR codec configuration in the SDP offer.

If the MGCF sends a SIP message with an SDP offer towards the IM CN subsystem in response to receipt of a BICC codec modification request, then it shall delay responding to the BICC codec modification request until it receives a response to the SDP offer from the IM CN subsystem. When the MGCF receives either an SDP answer or a rejection of the SDP offer within the appropriate SIP message (e.g. 200 OK (INVITE)) from the IM CN subsystem, it shall decide whether to accept or reject the BICC codec modification procedure and complete the procedure for a BICC serving node terminating codec modification, according to clause 10.4.2 of ITU-T Q.1902.4 [30].

If the MGCF sends an APM with an Action indicator set to 'codec modification failure' in response to receipt of a codec modification request, the preceding BICC serving node may retry the request with a mid-call codec negotiation using an APM including an Action indicator set to 'mid-call negotiation' and a Supported Codec List with a new priority order encouraging selection of a new codec.

## B.2.5 Codec parameter translation between BICC CS network and the IM CN subsystem

The IM CN subsystem uses the Session Description Protocol (SDP, defined in RFC 2327 [56]) to select and potentially re-negotiate the codec type and configuration and associated bearer format attributes to be used in the user plane. RFC 3550 [51] defines the Real Time Protocol (RTP) for framing of all codecs in the user plane, RFC 3551 [52] and RFC 3555 [53] define the framing details for many of the ITU-T codecs, and RFC 3267 [23] defines framing details for the AMR family of codecs. This clause will focus only on codec-specific SDP parameters not already constrained by clause 5.1.1 of TS 26.236 [32]. The signalling plane of the IM CN subsystem uses SDP offer/answer procedures defined in RFC 3264 [36] to select the desired codec type and configuration for the user plane from a prioritized list of codec types and configurations and to re-negotiate the user plane attributes as necessary.

The bearer independent CS network uses the Single Codec and Codec List information elements of the Application Transport Mechanism (APM) defined in ITU-T Q.765.5 [35] to negotiate (offer and select) and potentially re-negotiate the codec type and configuration and associated bearer format attributes to be used in the user plane. TS 29.414 [25] and TS 25.415 [26] define the IuFP framing protocol for all codecs in the user plane for both ATM and IP transport, and TS 26.102 [50] provides the framing details for AMR and PCM family codecs. The Codec List information element of the APM comprises multiple instances of the Single Codec information element in priority order, as shown in Figure 13 of ITU-T Q.765.5 [35]. Figure 14 of ITU-T Q.765.5 [35] defines the Single Codec information element. Clause 11.1.7.2 of ITU-T Q.765.5 [35] defines the encoding of the Single Codec information element for the ITU-T codecs. TS 26.103 [57] defines the encoding of the Single Codec information element for the 3GPP codecs, and Table 7.11.3.1.3-2 of TS 28.062 [58] defines the preferred configurations of the narrowband AMR codecs (Config-NB-Code) for interoperation with TFO. The signalling plane of the bearer independent CS network uses the APM to negotiate the desired codec type and configuration for the user plane from the prioritized list of codec types and to re-negotiate the user plane attributes as necessary.

The following subclauses define the translations between the SDP payload format parameters of the IM CN subsystem and the corresponding subfields of the Single Codec information element of the bearer independent CS network for certain 3GPP and ITU-T codecs. Following these translation rules will in many cases allow the IM-MGW to perform interworking between the framing protocols on the bearer interfaces to the BICC CS network and the IM CN subsystem without transcoding. Implementations may signal other codec types not listed herein or other codec configurations of codec types listed herein. Implementations may also choose to perform transcoding between codec configurations signalled separately for the bearer interfaces to the networks, if necessary, but voice quality may suffer.

### B.2.5.1 Codec parameters for 3GPP AMR-NB codecs

Table B.1 shows the correspondence between the codec format parameters in the Single Codec information element (TS 26.103 [57]) and the SDP for the 3GPP narrowband AMR codecs (RFC 3267 [23]).

**Table B.1: Mapping between Single Codec subfields and SDP parameters for 3GPP AMR-NB codecs**

Single Codec information element		SDP payload format parameters		
Codec Identification	ACS, SCS, OM, MACS	Payload Type number	Encoding name	Other Parameters (NOTE1) (NOTE2)
FR_AMR or OHR_AMR or HR_AMR	OM=0 or Selected Codec Type	dynamic	AMR	mode-set=values corresponding to ACS (NOTE 3)
FR_AMR or OHR_AMR or HR_AMR	(OM=1 or OM not present) and (Supported Codec List or Available Codec List)	dynamic	AMR	mode-set=select from values corresponding to ACS, SCS and MACS (NOTE 3)
UMTS_AMR	OM=0 or Selected Codec Type	dynamic	AMR	mode-set=values corresponding to ACS
UMTS_AMR	(OM=1 or OM not present) and (Supported Codec List or Available Codec List)	dynamic	AMR	mode-set=select from values corresponding to ACS, SCS and MACS (NOTE 4)
UMTS_AMR_2	OM=0 or Selected Codec Type	dynamic	AMR	mode-set=values corresponding to ACS (NOTE 5)
UMTS_AMR_2	(OM=1 or OM not present) and (Supported Codec List or Available Codec List)	dynamic	AMR	mode-set=select from values corresponding to ACS, SCS and MACS (NOTE 3) (NOTE 5)
<p><b>NOTE 1:</b> Table 1 of RFC 3267 [23] provides the correspondence between codec rates and AMR modes for use when generating the 'mode-set' parameter. When all modes are selected for use, the 'mode-set' parameter shall not be included in SDP.</p> <p><b>NOTE 2:</b> SDP payload format configurations in this table with only one value in the 'mode-set' parameter shall not include the 'mode-change-period' and 'mode-change-neighbor' parameters.</p> <p><b>NOTE 3:</b> Payload types for FR_AMR, OHR_AMR and HR_AMR with more than one value in the 'mode-set' parameter shall include the 'mode-change-period=2' parameter and should include the 'mode-change-neighbor=1' parameter.</p> <p><b>NOTE 4:</b> RFC 3267 [23] does not currently provide a mechanism to signal the SCS, MACS or OM parameters in SDP, nor does it distinguish between the different AMR-NB codec types. Each AMR-NB codec type in the Supported Codec List or the Available Codec List with OM=1 should be translated into a list of SDP payload formats in priority order, where each includes a 'mode-set' parameter with a unique value derived from the ACS, SCS and MACS. Each 'mode-set' should correspond to a codec configuration that is compatible with the given codec type according to the compatibility rules defined in clauses 11 and 12 of TS 28.062 [58].</p> <p><b>NOTE 5:</b> Payload types for UMTS_AMR_2 should include the 'mode-change-period=2' and 'mode-change-neighbor=1' parameters, normally used for signalling GSM AMR codecs, to assure end-to-end interoperability with OoBCT and TFO. Its actual capabilities would otherwise be signalled without these two parameters.</p>				

**Definitions:**

**Supported Codec List:** contains the offered Codec Types and Configuration-possibilities of the node initiating codec negotiation in BICC (see also TS 23.153). The Supported Codec List is sent from the initiating node forward to the terminating node. The Supported Codec List corresponds to an SDP offer during codec negotiation..

**Available Codec List:** contains the offered Codec Types and Configuration-possibilities of the contiguous portion of the connection between initiating and terminating BICC nodes, including all intermediate nodes through the BICC network(s). The Available Codec List is sent from the BICC node terminating codec negotiation backward to the initiating node. The Available Codec List corresponds to information sometimes available in a first-round SDP answer. The Available Codec List might not represent an end-to-end view of the available Codec Types and Configuration-possibilities when traversing both BICC and SIP networks.

**Selected Codec Type:** is determined by the node terminating codec negotiation. It specifies exactly the Codec Type and one unique Codec Configuration for the call. The Selected Codec Type corresponds to the final SDP answer.

When translating from a Single Codec information element to the equivalent SDP payload format parameters, where either OM=0 (in the Supported or Available Codec List) or the information element is the Selected Codec Type, the SDP shall include a single payload type and any associated parameters from the corresponding row in Table B.1. When translating from a Single Codec information element to the equivalent SDP payload format parameters, where OM=1 in the Supported or Available Codec List, the SDP shall only include payload formats corresponding to Codec

Configurations compatible with the offered ACS, SCS and MACS, according to Table B.1. Since the number of compatible payload formats can be large, implementations should select a reasonable subset of the higher-priority payload formats for inclusion in the SDP. When translating a list of Single Codec information elements into SDP, duplicate payload types (matching on all parameters) shall be removed.

The following guidelines shall apply when translating from an SDP payload format specification to a Single Codec information element:

- If there is no 'mode-set' parameter for a payload format in the SDP and the SDP is to be translated into a Supported or Available Codec List, then the corresponding Single Codec subfields shall be OM=1, MACS=8, all SCS modes offered, and ACS modes offered. Alternatively it is sufficient to specify only the Codec Type (see below) and omit the other parameters.
- If there is no 'mode-set' parameter for a payload format in an SDP answer that is to be translated into a Selected Codec Type, then the corresponding Single Codec subfields shall be derived from the payload type in the SDP offer (to which the SDP answer was sent in response).
- If there is a 'mode-set' parameter for a payload format in the SDP, then the corresponding Single Codec subfields shall be OM=0 and ACS modes selected according to the value of 'mode-set'. The SCS shall be set identical to the ACS and MACS shall be set to the number of modes in the ACS. If this 'mode-set' does not represent a valid configuration for the Codec Type (determined by OoBTC procedures), then the payload format shall not be translated.
- If a payload format in an SDP offer that is to be translated into a Supported Codec List includes 'mode-change-period=2', then the Codec IDentification value for the corresponding Single Codec shall be FR\_AMR.
- If a payload format in an SDP answer that is to be translated into a Selected Codec Type or Available Codec List includes 'mode-change-period=2', then the Codec IDentification value for the corresponding Single Codec shall be one of FR\_AMR, HR\_AMR, OHR\_AMR or UMTS\_AMR\_2, if offered in the Supported Codec List.
- If a payload format in an SDP offer that is to be translated into a Supported Codec List does not include 'mode-change-period=2', then the Codec IDentification value for the corresponding Single Codec shall be UMTS\_AMR.
- If a payload format in an SDP answer that is to be translated into a Selected Codec Type or Available Codec List does not include 'mode-change-period=2', then the Codec IDentification value for the corresponding Single Codec shall be one of UMTS\_AMR\_2, FR\_AMR, HR\_AMR, OHR\_AMR or UMTS\_AMR, if offered in the Supported Codec List.

### B.2.5.2 Codec parameters for 3GPP AMR-WB codecs

Table B.2 shows the correspondence between the codec format parameters in the Single Codec information element (TS 26.103 [57]) and the SDP for the 3GPP wideband AMR codecs (RFC 3267 [23]).

**Table B.2: Mapping between Single Codec subfields and SDP parameters for 3GPP AMR-WB codecs**

Single Codec information element		SDP payload format parameters		
Codec IDentification	Config-WB-Code	Payload Type number	Encoding name	Other Parameters (NOTE 1)
FR_AMR-WB or OHR_AMR-WB	0	dynamic	AMR-WB	mode-set=0,1,2
OFR_AMR-WB or UMTS_AMR-WB	0	dynamic	AMR-WB	mode-set=0,1,2 (NOTE 2)
OFR_AMR-WB or UMTS_AMR-WB	1	dynamic dynamic dynamic	AMR-WB AMR-WB AMR-WB	mode-set=0,1,2 mode-set=0,1,2,8 mode-set=0,1,2,4 (NOTE 2)
OFR_AMR-WB or UMTS_AMR-WB	2	dynamic	AMR-WB	mode-set=0,1,2,4 (NOTE 2)
OFR_AMR-WB or UMTS_AMR-WB	3	dynamic dynamic dynamic	AMR-WB AMR-WB AMR-WB	mode-set=0,1,2,4 mode-set=0,1,2,8 mode-set=0,1,2 (NOTE 2)
OFR_AMR-WB or UMTS_AMR-WB	4	dynamic	AMR-WB	mode-set=0,1,2,8 (NOTE 2)
OFR_AMR-WB or UMTS_AMR-WB	5	dynamic dynamic dynamic	AMR-WB AMR-WB AMR-WB	mode-set=0,1,2,8 mode-set=0,1,2,4 mode-set=0,1,2 (NOTE 2)
<p><b>NOTE 1:</b> Payload types for FR_AMR-WB, OHR_AMR-WB and OFR_AMR-WB shall include the 'mode-change-period=2' parameter and should include the 'mode-change-neighbor=1' parameter.</p> <p><b>NOTE 2:</b> Payload types for UMTS_AMR-WB should include the 'mode-change-period=2' and 'mode-change-neighbor=1' parameters, normally used for signalling GSM AMR-WB codecs, to assure end-to-end interoperability with OoBTC and TFO. Its actual capabilities would otherwise be signalled without these two parameters.</p>				

When translating from a Single Codec information element to the equivalent SDP payload format parameters, the SDP shall include a distinct payload type and any associated parameters for each row in the table that matches the Config-WB-Code parameter. For example, OFR\_AMR-WB with Config-WB-Code=3 can generate three SDP payload types for AMR-WB, each including the "mode-change-period=2" parameter, the 'mode-change-neighbor=1' parameter, and the "mode-set" parameter with value sets "0,1,2,4", "0,1,2,8", and "0,1,2", respectively. When translating a list of Single Codec information elements into SDP, duplicate payload types (matching on all parameters) shall be removed.

The following guidelines shall apply when translating from one or more SDP payload format specifications to a Single Codec information element:

- Payload formats that match except for different values of 'mode-set' shall be represented with the fewest values of Config-WB-Code, while retaining the priority represented by the order of the payload formats in the SDP. For example, three SDP payload types for AMR-WB, each including the "mode-change-period=2" parameter, the 'mode-change-neighbor=1' parameter, and the "mode-set" parameter with value sets "0,1,2,4", "0,1,2,8", and "0,1,2", respectively, will generate Config-WB-Code=3.
- If there is no 'mode-set' parameter for a payload format in the SDP and the SDP is to be translated into a Supported or Available Codec List, then the corresponding Single Codec shall have a Config-WB-Code value of 1.
- If there is no 'mode-set' parameter for a payload format in an SDP answer that is to be translated into a Selected Codec Type, then the corresponding Config-WB-Code value shall be derived from the payload type in the SDP offer (to which the SDP answer was sent in response).
- If a payload format in an SDP offer that is to be translated into a Supported Codec List includes 'mode-change-period=2', then the Codec IDentification value for the corresponding Single Codec shall be OFR\_AMR-WB.
- If a payload format in an SDP answer is to be translated into a Selected Codec Type or Available Codec List, then the Codec IDentification value for the corresponding Single Codec shall be one of OFR\_AMR-WB, FR\_AMR-WB, OHR\_AMR-WB or UMTS\_AMR-WB, if offered in the Supported Codec List.

- If a payload format in an SDP offer that is to be translated into a Supported Codec List does not include 'mode-change-period=2', then the payload format shall not be translated.

### B.2.5.3 Codec parameters for 3GPP non-AMR codecs

Table B.3 shows the correspondence between the codec format parameters in the Single Codec information element (TS 26.103 [57]) and the SDP for the 3GPP non-AMR codecs (RFC 3267 [23], RFC 3551 [52], and RFC 3555 [53]).

**Table B.3: Mapping between Single Codec subfields and SDP parameters for 3GPP non-AMR codecs**

Single Codec information element Codec Identification	SDP payload format parameters		
	Payload Type number	Encoding name	Other Parameters
GSM FR	3	GSM	
GSM HR	N/A	N/A	
GSM EFR (NOTE 1)	dynamic	GSM-EFR	
GSM EFR (NOTE 2)	dynamic	AMR	mode-set=7
TDMA EFR (NOTE 2)	dynamic	AMR	mode-set=4
PDC EFR (NOTE 2)	dynamic	AMR	mode-set=3
<b>NOTE 1:</b> This translation for GSM EFR (GSM-EFR) is preferred to the alternative (AMR mode-set=7) if it is supported by the IM-MGW.			
<b>NOTE 2:</b> AMR DTX is not compatible with the DTX schemes for any of the codecs in this list. The IM-MGW may support these configurations without transcoding by providing interworking between the DTX procedures and frame encodings on the bearer interfaces to the BICC CS network and the IM CN subsystem.			

### B.2.5.4 Codec parameters for ITU-T codecs

Table B.4 shows the correspondence between the codec format parameters in the Single Codec information element (Clause 11.1.7 of ITU-T Q.765.5 [35]) and the SDP for the ITU-T codecs (Table 4 of RFC 3551 [52], and RFC 3555 [53]).

**Table B.4: Mapping between Single Codec subfields and SDP parameters for ITU-T codecs**

Single Codec information element			SDP payload format parameters		
Codec Type subfield	Codec Name	Codec Configuration subfield (dcba)	Payload Type number	Encoding name	Other Parameters
00000001	G.711 64 kbit/s A-law	N/A	8	PCMA	
00000010	G.711 64 kbit/s $\mu$ -law	N/A	0	PCMU	
00000011	G.711 56 kbit/s A-law	N/A	N/A	N/A	
00000100	G.711 56 kbit/s $\mu$ -law	N/A	N/A	N/A	
00000101	G.722 (SB-ADPCM)	N/A	9	G722	
00000110	G.723.1	N/A	4	G723	annexa=no
00000111	G.723.1 Annex A (silence suppression)	N/A	4	G723	
00001000	G.726 (ADPCM)	xxx1 xx1x x1xx 1xxx	dynamic dynamic dynamic dynamic	G726-16 G726-24 G726-32 G726-40	
00001001	G.727 (Embedded ADPCM)	xxxx	N/A	N/A	
00001010	G.728	111 (subsets of defined rates not supported)	15	G728	
00001011	G.729 (CS-ACELP)	xx1 x1x 1xx	dynamic 18 dynamic	G729D G729 G729E	annexb=no annexb=no annexb=no
00001100	G.729 Annex B (silence suppression)	xx1 x1x 1xx	dynamic 18 dynamic	G729D G729 G729E	
<b>NOTE:</b> An "x" in a bit position of the Codec Configuration subfield indicates a "don't care" value. The SDP payload description for each listed codec includes a clock rate of 8000 Hz. TS 26.102 [50] only describes the BICC CS network framing for the PCM codecs.					

When translating from a Single Codec information element to the equivalent SDP payload format parameters, the SDP shall include a distinct payload type and any associated parameters for each matching instance of the Codec Configuration subfield. For example, G.726 (ADPCM) with Codec Configuration subfield "0101" shall generate SDP payload types for G726-32 and G726-16.

When translating from an SDP payload format specification to the Single Codec information element, each SDP payload type should be represented by one matching Single Codec information element. For example, SDP payload types for G729 and G729E may generate one Single Codec information element for "G.729 Annex B" with Codec Configuration subfield "110". The G729 and G729E codecs may alternately be represented by two Single Codec information elements for "G.729 Annex B" with Codec Configuration subfields "100" and "010", respectively, if it is necessary to indicate preference between them.

## B.3 MGCF – IM-MGW interaction during interworking of codec negotiation

### B.3.1 Basic IM CN subsystem originated session

This clause shows an example of the interworking of codec negotiation between an IM CN subsystem and a BICC CS network during session establishment for an IM CN subsystem originated session. The example applies to BICC forward bearer establishment. Similar procedures apply to the other four versions of bearer establishment procedure applicable to the BICC CS network. The exchange of codec information is identical in all five cases, but there are differences in the sequence of operations associated with bearer establishment within the BICC CS network.

#### B.3.1.1 BICC forward bearer establishment

##### B.3.1.1.1 IM-MGW selection

The MGCF shall select an IM-MGW for the bearer connection before it performs the CS network side bearer establishment. This may happen either before sending the IAM or after receiving the APM message (signal 3 or signal 4 in figure B.1). In the latter case, the IM-MGW selection may be based on a possibly received MGW-id from the succeeding node.

##### B.3.1.1.2 CS network side bearer establishment

The MGCF shall either select bearer characteristics or request the IM-MGW to select and provide the bearer characteristics for the CS network side bearer connection before sending the IAM. In the latter case the MGCF shall use the Prepare Bearer procedure, not shown in figure B.1, to request the IM-MGW to select the bearer characteristics. After the succeeding node has provided a bearer address and a binding reference in the APM, the MGCF shall use the Establish Bearer procedure to request the IM-MGW to establish a bearer towards the destination CS-MGW. The MGCF shall provide the IM-MGW with the bearer address, the binding reference and the bearer characteristics (signal 5 in figure B.1).

##### B.3.1.1.3 IM CN subsystem side session establishment

When the MGCF receives the Selected Codec from the succeeding serving node in the CS network (signal 4 in figure B.1) and selects a codec for use in the IM CN subsystem, the MGCF shall initiate the Reserve IMS Connection Point and Configure Remote Resources procedure (signal 7 and 8 in figure B.1). From the received SDP and selected configuration data the MGCF:

- Shall send the appropriate remote codec(s), the remote UDP port and the remote IP address to the IM-MGW. The remote UDP port and IP address refer to the destination of user plane data sent towards the IM CN subsystem. The remote codec(s) are the codec(s) the IM-MGW may select for user plane data sent towards the IM CN subsystem.
- Shall indicate to the IM-MGW the appropriate local codec(s) and request a local IP address and UDP port. The local IP address and UDP port are used by the IM-MGW to receive user plane data from the IM CN subsystem. The local codec(s) are the codec(s) the IM-MGW may select to receive user plane data from the IM CN subsystem.



- If DTMF support together with speech support is required, the reserve value indicator shall be set to "true".

The IM-MGW

- Shall reply to the MGCF with the selected local codec(s) and the selected remote codec(s) and the selected local UDP port and IP address.
- Shall reserve resources for those codec(s).

The MGCF shall send the local codec(s), UDP port and IP address to the IMS in the Session Progress (signal 9 in figure B.1).

#### B.3.1.1.4 Through-connection

During the Prepare Bearer and Establish Bearer procedures, the MGCF shall either use the Change Through-Connection procedure to request the IM-MGW to backward through-connect the BICC terminations, or the MGCF shall use this procedure to both-way through-connect the BICC termination already on this stage (signal 5 in figure B.1). During the Reserve IMS Connection Point procedure, the MGCF shall use the Change IMS Through-Connection procedure to request the IM-MGW to backward through-connect the IMS termination (signal 7 in figure B.1).

When the MGCF receives the BICC:ANM answer indication, it shall request the IM-MGW to both-way through-connect the termination using the Change Through-Connection or Change IMS Through-Connection procedures (signal 20 in figure B.1), unless those terminations are already both-way through-connected.

#### B.3.1.1.5 Codec handling

The IM-MGW may include a speech transcoder based upon the speech coding information provided to each termination.

#### B.3.1.1.6 Failure handling in MGCF

If any procedure between the MGCF and the IM-MGW is not completed successfully the default action by the MGCF is to release the session, as described in clause 9.2.6. If the MGCF receives a Bearer Released procedure from the IM-MGW the default action by the MGCF is to release the session as described in clause 9.2.7.

**NOTE:** As an implementation option the MGCF may also decide for example to only release the resources in the IM-MGW that caused the failure, possibly select a new IM-MGW for the connection and continue the call establishment using new resources in the selected IM-MGW but such handling is outside of the scope of the present document.

#### B.3.1.1.7 Message sequence chart

Figure B.1 shows the message sequence chart for the IM CN subsystem originating session with BICC forward bearer establishment where the selection of IM-MGW is done after receipt of the APM. The MGCF then requests the seizure of a CS network side bearer termination and the establishment of the bearer. When the MGCF receives an answer indication, it requests the IM-MGW to both-way through-connect the terminations.

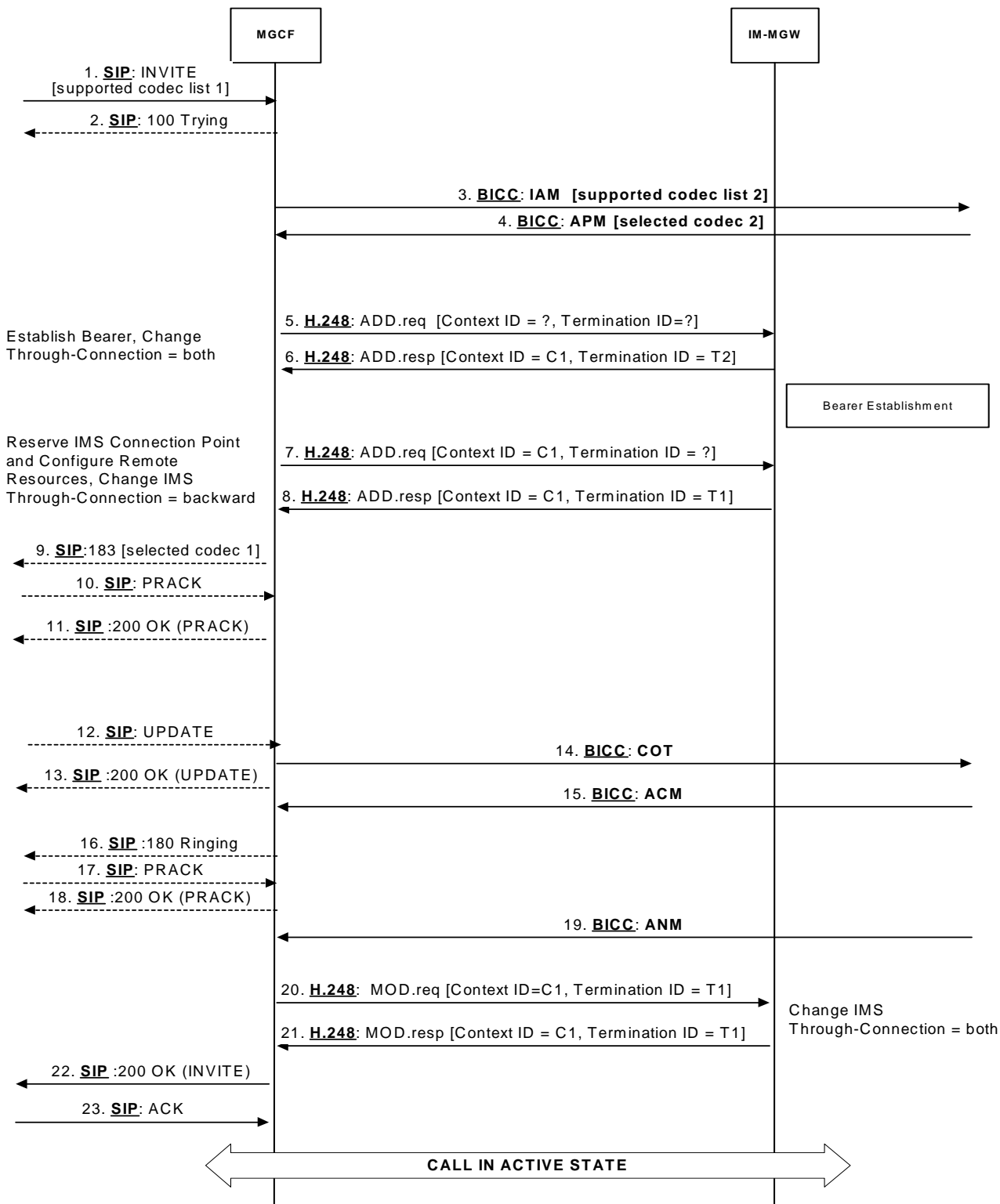

Figure B.1: Basic IM CN Subsystem originating session, BICC forward bearer establishment (message sequence chart)

## B.3.2 Basic CS network originated session

This clause shows an example of the interworking of codec negotiation between a BICC CS network and an IM CN subsystem during session establishment for a BICC CS network originated session. The example applies to BICC forward bearer establishment. Similar procedures apply to the other four versions of bearer establishment procedure applicable to the BICC CS network. The exchange of codec information is identical in all five cases, but there are differences in the sequence of operations associated with bearer establishment within the BICC CS network.

### B.3.2.1 BICC forward bearer establishment

#### B.3.2.1.1 IM-MGW selection

The MGCF shall select an IM-MGW for the bearer connection before it performs the IM CN subsystem session establishment or the CS network side bearer establishment.

#### B.3.2.1.2 IM CN subsystem side termination reservation

The MGCF shall derive from the codec negotiation procedure one or several appropriate local codec(s) the IM-MGW may use to receive user plane data from the IM CN subsystem. The MGCF shall use the Reserve IMS Connection Point procedure (signals 2 and 3 in figure B.2/1). Within this procedure, the MGCF shall indicate the local codec(s) and request a local IP address and UDP port from the IM-MGW. The local IP address and UDP port are used by the IM-MGW to receive user plane data from the IM CN subsystem. If DTMF support together with speech support is required, or if the resources for multiple speech codecs shall be reserved at this stage, the reserve value indicator shall be set to "true".

The IM-MGW shall reply to the MGCF with the selected local codec(s) and the selected local IP address and UDP port.

The MGCF shall send this information in the INVITE (signal 4 in figure B.2/1) to the IM CN subsystem.

#### B.3.2.1.3 IM CN subsystem side session establishment

The MGCF shall use the Configure IMS Resources procedure (signals 7 and 8 in figure B.2/1) to provide configuration data (derived from SDP received in signal 6 in figure B.2/1 and the codec negotiation procedure) to the IM-MGW as detailed below:

- The MGCF shall indicate the remote IP address and UDP port, i.e. the destination IP address and UDP port for data sent in the user plane towards the IM CN subsystem,
- The MGCF shall indicate the remote codec(s), i.e. the speech codec(s) for data sent in the user plane towards the IM CN subsystem.
- The MGCF may indicate the local codec(s) and the local IP address and UDP port. The MGCF shall indicate the local codec(s) if a change is required.
- IF DTMF support together with speech support is required, the reserve value indicator shall be set to "true".

The IM-MGW shall reply with the selected remote codec(s) and reserve resources for these codec(s). If local codec(s) were received, the IM-MGW shall also reply with the selected local codec(s) and reserve the corresponding resources.

If the selected local codec(s) differ from the codec(s) received in the SDP of signal 6 in figure B.2/1, the MGCF shall send the local reserved codec(s), and the local IP address and UDP port in the PRACK (signal 9 in figure B.2/1) to the IMS.

#### B.3.2.1.4 CS network side bearer establishment

The MGCF shall request the IM-MGW to prepare for the CS network side bearer establishment using the Prepare Bearer procedure (signals 11 and 12 in figure B.2/1). Within this procedure, the MGCF shall request the IM-MGW to provide a bearer address, a binding reference and optionally notify when the bearer is established. The MGCF shall also provide the IM-MGW with the bearer characteristics determined by the codec negotiation procedure. After the IM-

MGW has replied with the bearer address and the binding reference, the MGCF provides the APM message (signal 13 in figure B.2/1) to the preceding node. The MGCF may also provide the IM-MGW-id in the APM message.

#### B.3.2.1.5 Called party alerting

The MGCF shall request the IM-MGW to provide an awaiting answer indication (ringing tone) to the calling party using the Send Tone procedure (signals 21 and 22 in figure B.2/1) , when the first of the following conditions is satisfied:

- the MGCF receives the first 180 Ringing message
- Timer T i/w<sub>1</sub> expires
- Timer T i/w<sub>2</sub> expires

#### B.3.2.1.6 Called party answer

When the MGCF receives a 200 OK message (signal 23 in figure B.2/2), it shall request the IM-MGW to stop providing the ringing tone to the calling party using the Stop Tone procedure (signals 26 and 27 in figure B.2/2).

#### B.3.2.1.7 Through-Connection

During the Prepare Bearer procedure, the MGCF shall either use the Change Through-Connection procedure to request the IM-MGW to backward through-connect the BICC termination, or the MGCF shall use this procedure to both-way through-connect the BICC termination already on this stage (signals 11 and 12 in figure B.2/1). During the Reserve IMS Connection Point procedure, the MGCF shall use the Change IMS Through-Connection procedure to request the IM-MGW to backward through-connect the IMS termination (signals 2 and 3 in figure B.2/1).

When the MGCF receives the SIP 200 OK(INVITE) (signal 23 in figure B.2/2), it requests the IM-MGW to both-way through-connect the terminations using the Change IMS Through-Connection or Change Through-Connection procedures (signals 28 and 29 in figure B.2/2), unless those terminations are already both-way through-connected.

#### B.3.2.1.8 Codec handling

The IM-MGW may include a speech transcoder based upon the speech coding information provided to each termination.

#### B.3.2.1.9 Failure handling in MGCF

If any procedure between the MGCF and the IM-MGW is not completed successfully, the default action by the MGCF is to release the session as described in clause 9.2.6. If the MGCF receives a Bearer Released procedure from the IM-MGW the default action by the MGCF is to release the session, as described in clause 9.2.7.

NOTE: As an implementation option the MGCF may also decide for example to only release the resources in the IM-MGW that caused the failure, possibly select a new IM-MGW for the connection and continue the call establishment using new resources in the selected IM-MGW but such handling is outside of the scope of the present document.

#### B.3.2.1.10 Message sequence chart

Figures B.2/1 and B.2/2 show the message sequence chart for the CS network originating session with BICC forward bearer establishment.

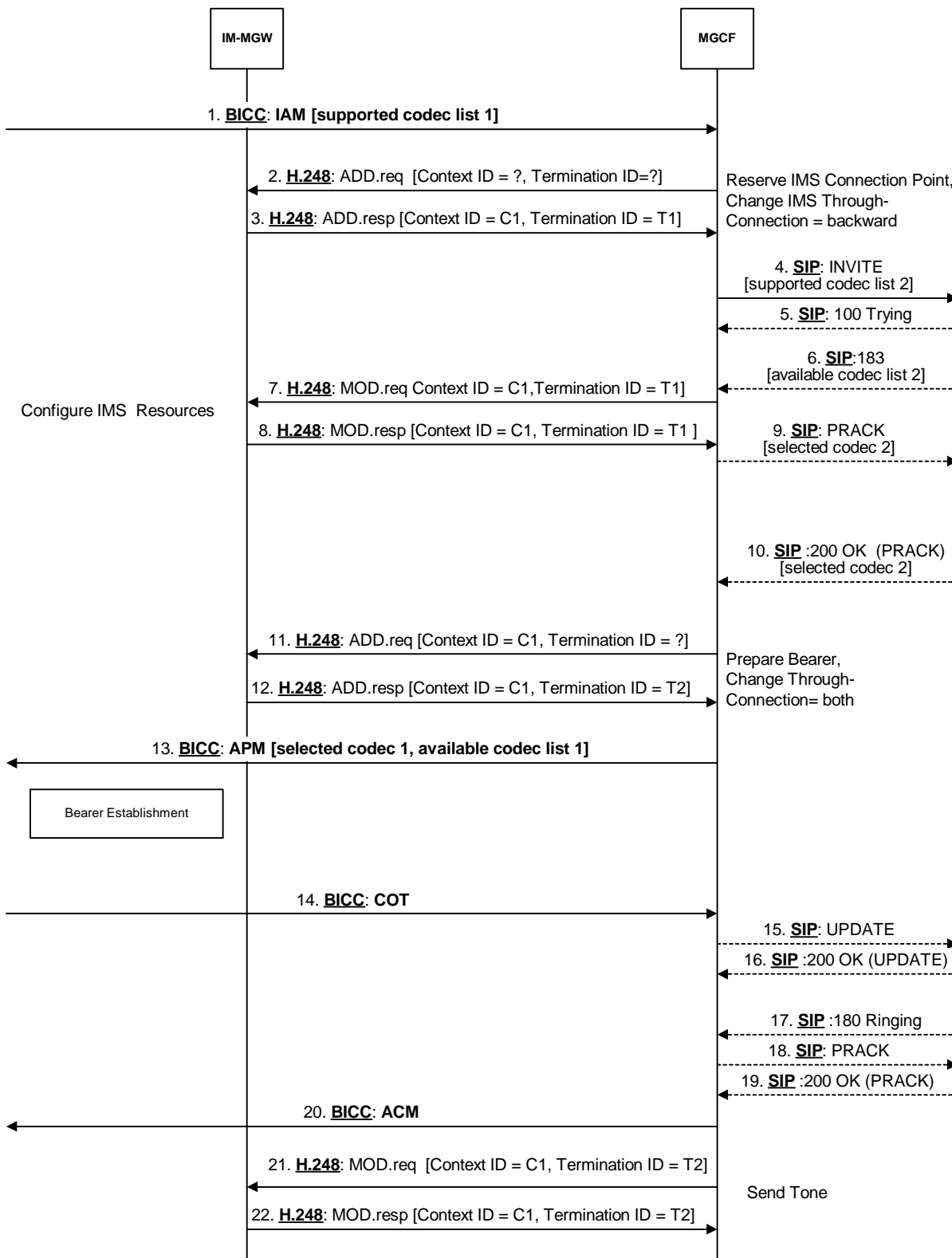

Figure B.2/1: Basic CS Network Originating Session, BICC forward bearer establishment (message sequence chart)

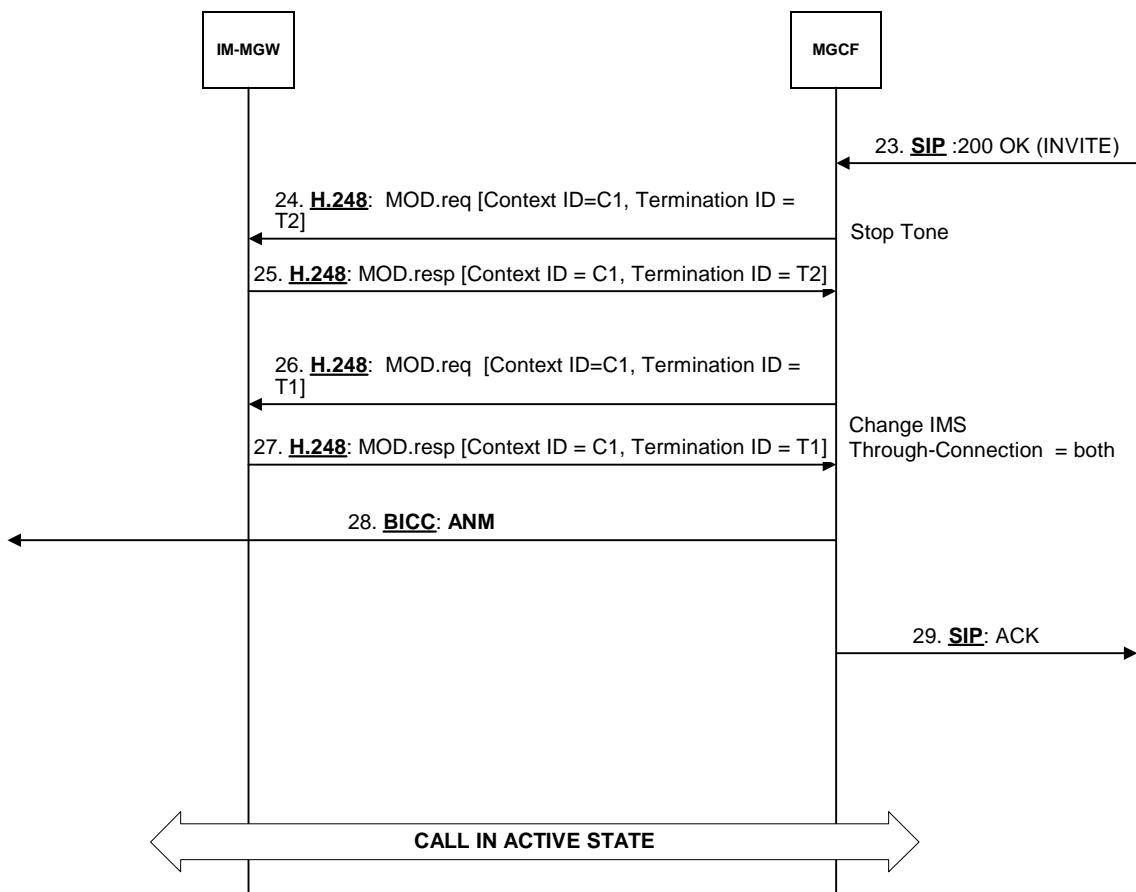

Figure B.2/2: Basic CS Network Originating Session, BICC forward bearer establishment (message sequence chart continued)

### B.3.3 CS network initiated mid-call codec negotiation

Figure B.3 shows the CS network initiated mid-call codec negotiation procedure interworking with the IM CN subsystem. When the MGCF selects the codecs for the CS network and the IM CN subsystem (after signal 3 in figure B.3), the MGCF shall modify the CS network termination and the IM CN subsystem termination on the IM-MGW to conform to the newly selected configuration data on the two interfaces. The MGCF may perform bearer operations (not shown) at the IM-MGW before interworking the initial codec modification request (signal 2 in figure B.3) to determine new connection information, if necessary, or to verify resource availability.

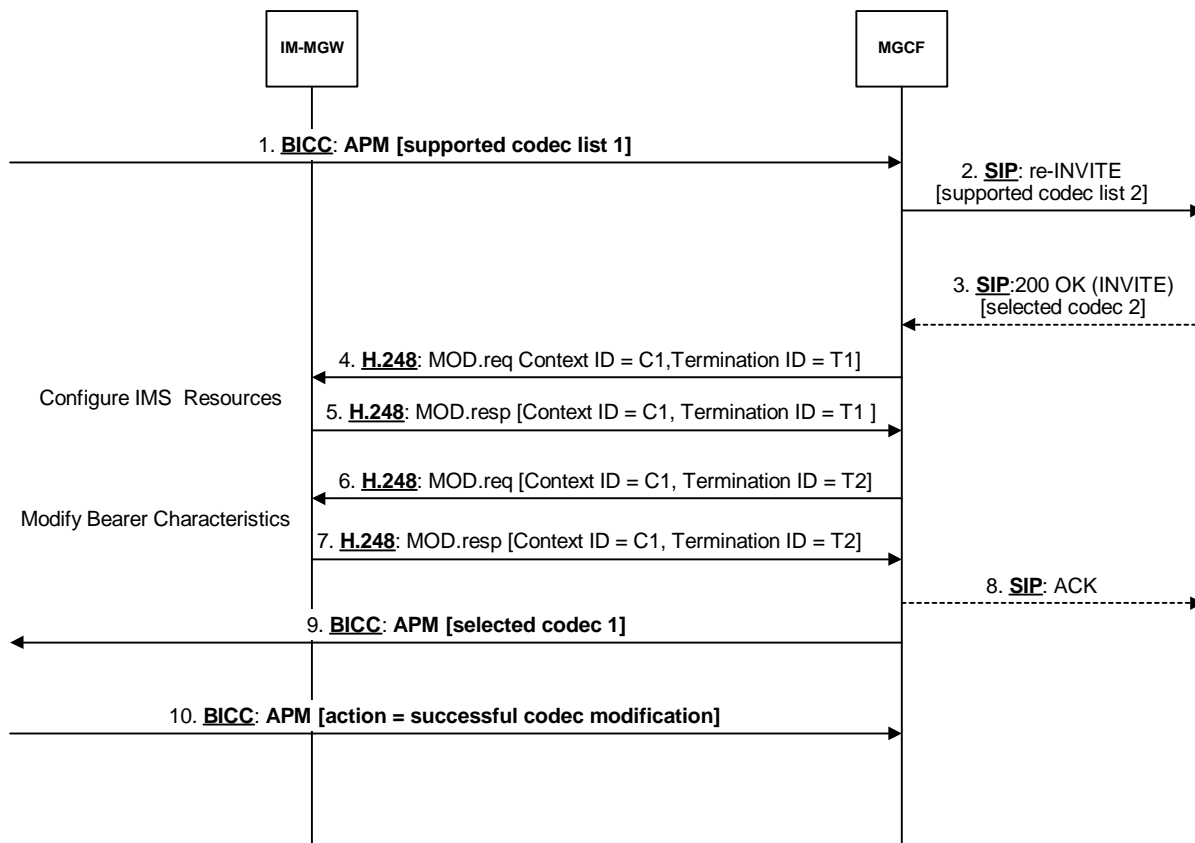

Figure B.3: CS network initiated mid-call codec negotiation (message sequence chart)

### B.3.4 IM CN subsystem initiated mid-call codec negotiation

Figure B.4 shows the IM CN subsystem initiated mid-call codec negotiation procedure interworking with a BICC CS network. When the MGCF selects the codecs for the CS network and the IM CN subsystem (after signal 3 in figure B.4), the MGCF shall modify the CS network termination and the IM CN subsystem termination on the IM-MGW to conform to the newly selected configuration data on the two interfaces. The MGCF may perform bearer operations (not shown) at the IM-MGW before interworking the initial codec modification request (signal 2 in figure B.3) to determine new connection information, if necessary, or to verify resource availability. The MGCF may also perform bearer operations (not shown) at the IM-MGW after sending the final APM (signal 8 in figure B.4) to modify transport bandwidth, if necessary.

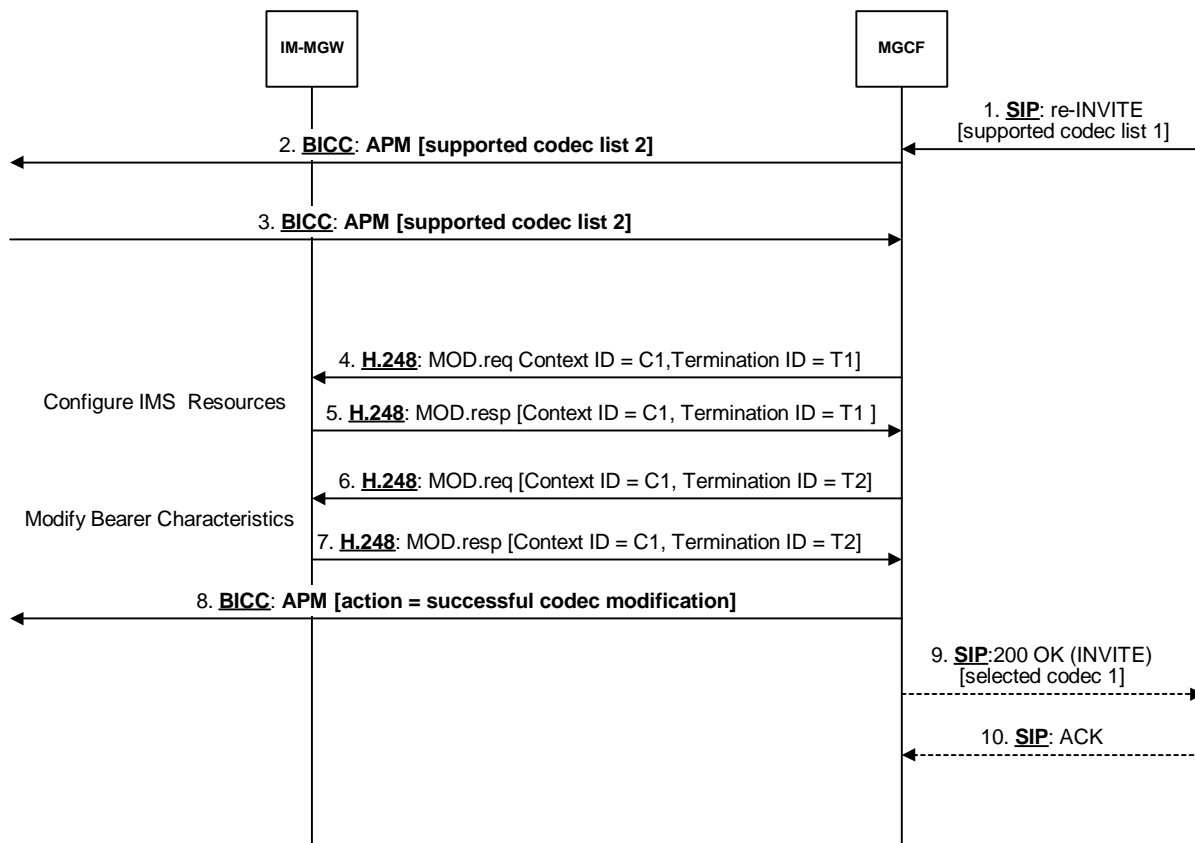

Figure B.4: IM CN subsystem initiated mid-call codec negotiation (message sequence chart)



## Annex C (informative): Change history

Change history							
Date	TSG #	TSG Doc.	CR	Rev	Subject/Comment	Old	New
2003-09	NP#21	NP-030326			Approved at NP#21 and placed under change control	2.0.0	6.0.0
2003-12	NP#22	NP-030569	001	1	Use of response code 500 instead of 503	6.0.0	6.1.0
2003-12	NP#22	NP-030569	002	1	Autonomous Release at I MGCF on T7 expiry	6.0.0	6.1.0
2003-12	NP#22	NP-030569	003	1	Clarification of 487 mapping to 127	6.0.0	6.1.0
2003-12	NP#22	NP-030569	004	2	Table 12 modifications	6.0.0	6.1.0
2003-12	NP#22	NP-030569	008		Correction of clause titles	6.0.0	6.1.0
2003-12	NP#22	NP-030570	009	1	Failure handling in MGCF	6.0.0	6.1.0
2003-12	NP#22	NP-030569	010	1	Interworking of user plane	6.0.0	6.1.0
2003-12	NP#22	NP-030569	011	2	Alignment between subclause 7.2.3 and 7.3.3 in TS 29.163	6.0.0	6.1.0
2003-12	NP#22	NP-030570	012	5	Corrections to clause 9 of TS 29.163	6.0.0	6.1.0
2003-12	NP#22	NP-030569	013	1	Interworking (overlap to en-bloc conversion) timer corrections	6.0.0	6.1.0
2003-12	NP#22	NP-030570	014	2	IM-MGW initiated release	6.0.0	6.1.0
2003-12	NP#22	NP-030569	015	1	Alignment of TS 29.163 with the ITU-T Q.1912.5 recommendation	6.0.0	6.1.0
2003-12	NP#22	NP-030570	016	1	Corrections to table 29 and 30 of TS 29.163	6.0.0	6.1.0
2003-12	NP#22	NP-030569	018	1	Mapping of unknown cause code values	6.0.0	6.1.0
2003-12	NP#22	NP-030569	021	2	Addition of References	6.0.0	6.1.0
2003-12	NP#22	NP-030569	022	3	Handling of closed used group supplementary service	6.0.0	6.1.0
2003-12	NP#22	NP-030570	023	2	Corrections on Clause 9.2.8 Handling of RTP telephony events	6.0.0	6.1.0
2003-12	NP#22	NP-030570	024		Wrong Mn Procedure in Figure 36	6.0.0	6.1.0
2003-12	NP#22	NP-030569	025	1	Interworking of Hold/Resume from the CS Network	6.0.0	6.1.0
2004-03	NP#23	NP-040083	030	2	Reason Headers	6.1.0	6.2.0
2004-03	NP#23	NP-040083	031	2	Informative annex for missalignments with Q.1912.5	6.1.0	6.2.0
2004-03	NP#23	NP-040083	032	2	Criteria for sending UPDATE in BICC	6.1.0	6.2.0
2004-03	NP#23	NP-040084	033	2	Impact of Forking on Mn procedures	6.1.0	6.2.0
2004-03	NP#23	NP-040083	034	1	Impact of Forking on Incoming call interworking	6.1.0	6.2.0
2004-03	NP#23	NP-040083	035	2	Impact of Forking on Outgoing call interworking	6.1.0	6.2.0
2004-03	NP#23	NP-040083	036	1	Impact of Forking on COLP supplementary service	6.1.0	6.2.0
2004-06	NP#24	NP-040241	037	1	Message sequence implies that CS side "ACM" message is sent only after 200 OK to PRACK is received	6.2.0	6.3.0
2004-06	NP#24	NP-040241	038	1	Originated/terminated correction	6.2.0	6.3.0
2004-06	NP#24	NP-040242	039	1	Interworking with Nb user plane procedures	6.2.0	6.3.0
2004-06	NP#24	NP-040242	040	1	Codec Negotiation between BICC CS networks and the IM CN subsystem	6.2.0	6.3.0
2004-06	NP#24	NP-040242	041	1	Codec negotiation incoming call interworking	6.2.0	6.3.0
2004-06	NP#24	NP-040242	042	2	Codec negotiation – Mid call interworking	6.2.0	6.3.0
2004-06	NP#24	NP-040242	043	1	Codec parameter translation – IM CN subsystem to BICN	6.2.0	6.3.0
2004-06	NP#24	NP-040242	044	2	MGCF IM-MGW interactions	6.2.0	6.3.0
2004-06	NP#24	NP-040241	045		Notify IMS RTP Tel Event (same as "Report DTMF") message sequence shows IEs that are not used with this procedure	6.2.0	6.3.0
2004-06	NP#24	NP-040241	046		Correction of sub-clause 7.2.3.2.5.1 Backward call indicators	6.2.0	6.3.0
2004-09	NP#25	NP-040334	050	3	Corrections to AMR codec parameter translations	6.3.0	6.4.0
2004-09	NP#25	NP-040346	048	2	Non call-related Mc procedures	6.3.0	6.4.0
2004-12	NP#26	NP-040582	059		Editorial mistake in Table 12	6.4.0	6.5.0
2004-12	NP#26	NP-040582	056	1	Corrections to EFR codec parameters	6.4.0	6.5.0
2004-12	NP#26	NP-040582	057	2	DTMF towards IM CN subsystem	6.4.0	6.5.0
2004-12	NP#26	NP-040582	054	3	Mapping of continuity signal	6.4.0	6.5.0
2004-12	NP#26	NP-040583	058	2	Clarifications for Mn procedures for call hold	6.4.0	6.5.0
2005-03	NP#27	NP-050105	060	1	Corrections to AMR codec parameters	6.5.0	6.6.0
2005-06	CP#28	CP-050038	064	1	Call Hold corrections	6.6.0	6.7.0
2006-03	CP#31	CP-060046	099		Bearer Released use with TDM Circuit	6.7.0	6.8.0
2006-03	CP#31	CP-060048	102	1	Removal of reason header from responses	6.7.0	6.8.0
2006-03	CP#31	CP-060046	104		488 status code	6.7.0	6.8.0

2006-03	CP#31	CP-060047	108	3	Interworking RTP timestamps and luFP frame numbers	6.7.0	6.8.0
2006-06	CP#32	CP-060220	115	1	Bearer Released use with IMS terminations	6.8.0	6.9.0
2006-06	CP#33	CP-060424	124		Echo Control Device indication in ACM/CPG	6.9.0	6.10.0
2006-06	CP#33	CP-060425	127	2	Missing procedures toward IMS Terminations	6.9.0	6.10.0

---

## History

<b>Document history</b>		
V6.1.0	December 2003	Publication
V6.2.0	March 2004	Publication
V6.3.0	June 2004	Publication
V6.4.0	September 2004	Publication
V6.5.0	December 2004	Publication
V6.6.0	March 2005	Publication
V6.7.0	June 2005	Publication
V6.8.0	March 2006	Publication
V6.9.0	June 2006	Publication
V6.10.0	September 2006	Publication