

ETSI TS 129 468 V12.2.0 (2015-04)



**Universal Mobile Telecommunications System (UMTS);
LTE;
Group Communication System Enablers for LTE (GCSE_LTE);
MB2 reference point;
Stage 3
(3GPP TS 29.468 version 12.2.0 Release 12)**



Reference

RTS/TSGC-0329468vc20

Keywords

LTE,UMTS

ETSI

650 Route des Lucioles
F-06921 Sophia Antipolis Cedex - FRANCE

Tel.: +33 4 92 94 42 00 Fax: +33 4 93 65 47 16

Siret N° 348 623 562 00017 - NAF 742 C
Association à but non lucratif enregistrée à la
Sous-Préfecture de Grasse (06) N° 7803/88

Important notice

The present document can be downloaded from:
<http://www.etsi.org/standards-search>

The present document may be made available in electronic versions and/or in print. The content of any electronic and/or print versions of the present document shall not be modified without the prior written authorization of ETSI. In case of any existing or perceived difference in contents between such versions and/or in print, the only prevailing document is the print of the Portable Document Format (PDF) version kept on a specific network drive within ETSI Secretariat.

Users of the present document should be aware that the document may be subject to revision or change of status. Information on the current status of this and other ETSI documents is available at
<http://portal.etsi.org/tb/status/status.asp>

If you find errors in the present document, please send your comment to one of the following services:
<https://portal.etsi.org/People/CommiteeSupportStaff.aspx>

Copyright Notification

No part may be reproduced or utilized in any form or by any means, electronic or mechanical, including photocopying and microfilm except as authorized by written permission of ETSI.

The content of the PDF version shall not be modified without the written authorization of ETSI.
The copyright and the foregoing restriction extend to reproduction in all media.

© European Telecommunications Standards Institute 2015.
All rights reserved.

DECT™, **PLUGTESTS™**, **UMTS™** and the ETSI logo are Trade Marks of ETSI registered for the benefit of its Members.
3GPP™ and **LTE™** are Trade Marks of ETSI registered for the benefit of its Members and of the 3GPP Organizational Partners.
GSM® and the GSM logo are Trade Marks registered and owned by the GSM Association.

Intellectual Property Rights

IPRs essential or potentially essential to the present document may have been declared to ETSI. The information pertaining to these essential IPRs, if any, is publicly available for **ETSI members and non-members**, and can be found in ETSI SR 000 314: *"Intellectual Property Rights (IPRs); Essential, or potentially Essential, IPRs notified to ETSI in respect of ETSI standards"*, which is available from the ETSI Secretariat. Latest updates are available on the ETSI Web server (<http://ipr.etsi.org>).

Pursuant to the ETSI IPR Policy, no investigation, including IPR searches, has been carried out by ETSI. No guarantee can be given as to the existence of other IPRs not referenced in ETSI SR 000 314 (or the updates on the ETSI Web server) which are, or may be, or may become, essential to the present document.

Foreword

This Technical Specification (TS) has been produced by ETSI 3rd Generation Partnership Project (3GPP).

The present document may refer to technical specifications or reports using their 3GPP identities, UMTS identities or GSM identities. These should be interpreted as being references to the corresponding ETSI deliverables.

The cross reference between GSM, UMTS, 3GPP and ETSI identities can be found under <http://webapp.etsi.org/key/queryform.asp>.

Modal verbs terminology

In the present document "**shall**", "**shall not**", "**should**", "**should not**", "**may**", "**need not**", "**will**", "**will not**", "**can**" and "**cannot**" are to be interpreted as described in clause 3.2 of the [ETSI Drafting Rules](#) (Verbal forms for the expression of provisions).

"**must**" and "**must not**" are **NOT** allowed in ETSI deliverables except when used in direct citation.

Contents

| | |
|---|----|
| Intellectual Property Rights | 2 |
| Foreword..... | 2 |
| Modal verbs terminology..... | 2 |
| Foreword..... | 5 |
| 1 Scope | 6 |
| 2 References | 6 |
| 3 Definitions, symbols and abbreviations | 7 |
| 3.1 Definitions | 7 |
| 3.2 Abbreviations | 7 |
| 4 Architectural Overview | 7 |
| 4.1 Reference Model | 7 |
| 4.2 Functional Elements | 8 |
| 4.2.1 Group Communication Service Application Server (GCS AS) | 8 |
| 4.2.2 Broadcast-Multicast Service Centre (BM-SC)..... | 8 |
| 5 Procedures over the MB2 Reference Point | 9 |
| 5.1 TMGI and Flow ID handling..... | 9 |
| 5.2 TMGI Management | 9 |
| 5.2.1 TMGI Allocation Procedure | 9 |
| 5.2.2 TMGI Deallocation Procedure..... | 10 |
| 5.2.3 TMGI Expiry Notification Procedure | 10 |
| 5.3 MBMS Bearer Control Procedures | 10 |
| 5.3.1 General..... | 10 |
| 5.3.2 Activate MBMS Bearer Procedure | 10 |
| 5.3.3 Deactivate MBMS Bearer Procedure..... | 11 |
| 5.3.4 Modify MBMS Bearer Procedure..... | 11 |
| 5.3.5 MBMS Bearer Status Indication Procedure..... | 12 |
| 5.4 BM-SC selection | 12 |
| 5.5 BM-SC overload control | 12 |
| 5.6 Restoration Procedures | 12 |
| 5.6.1 General..... | 12 |
| 5.6.2 Restart Counter | 12 |
| 5.6.3 GCS AS initiated Heartbeat Procedure | 13 |
| 5.6.4 BM-SC initiated Heartbeat Procedure | 13 |
| 5.6.5 GCS AS procedures after detection of BM-SC Restart | 13 |
| 5.6.6 BM-SC procedures after detection of GCS AS Restart | 13 |
| 5.6.7 GCS AS procedures upon detection of MB2-C path failure..... | 13 |
| 5.6.8 BM-SC procedures upon detection of MB2-C path failure | 13 |
| 6 MB2-C Protocol | 14 |
| 6.1 Protocol support | 14 |
| 6.1.1 Use of Diameter base protocol..... | 14 |
| 6.1.2 Transport protocol | 14 |
| 6.1.3 Advertising Application Support | 14 |
| 6.2 Initialization and maintenance of connection and session..... | 14 |
| 6.3 Security on the MB2-C interface..... | 15 |
| 6.4 MB2-C specific AVPs..... | 15 |
| 6.4.1 General..... | 15 |
| 6.4.2 BMSC-Address AVP..... | 15 |
| 6.4.3 BMSC-Port AVP | 15 |
| 6.4.4 MBMS- Bearer-Event AVP..... | 15 |
| 6.4.5 MBMS-Bearer-Event-Notification AVP | 16 |
| 6.4.6 MBMS-Bearer-Request AVP | 16 |

| | | |
|--|--|-----------|
| 6.4.7 | MBMS-Bearer-Response AVP | 16 |
| 6.4.8 | MBMS-Bearer-Result AVP | 17 |
| 6.4.9 | MBMS-Start-Time AVP | 17 |
| 6.4.10 | Radio-Frequency AVP | 17 |
| 6.4.11 | TMGI-Allocation-Request AVP | 18 |
| 6.4.12 | TMGI-Allocation-Response AVP | 18 |
| 6.4.13 | TMGI-Allocation-Result AVP | 18 |
| 6.4.14 | TMGI-Deallocation-Request AVP | 19 |
| 6.4.15 | TMGI-Deallocation-Response AVP | 19 |
| 6.4.16 | TMGI-Deallocation-Result AVP | 19 |
| 6.4.17 | TMGI-Expiry AVP | 19 |
| 6.4.18 | TMGI-Number AVP | 19 |
| 6.4.19 | MB2U-Security AVP | 20 |
| 6.5 | MB2-C re-used AVPs | 20 |
| 6.5.1 | General | 20 |
| 6.5.2 | Supported-Feature-List AVP | 21 |
| 6.5.2.1 | Use of the Supported-Features AVP | 21 |
| 6.5.2.2 | Supported-Feature-List AVP for the MB2-C application | 22 |
| 6.6 | MB2-C Messages | 22 |
| 6.6.1 | Command-Code Values | 22 |
| 6.6.2 | GCS-Action-Request (GAR) command | 22 |
| 6.6.3 | GCS-Action-Answer (GAA) command | 23 |
| 6.6.4 | GCS-Notification-Request (GNR) command | 23 |
| 6.6.5 | GCS-Notification-Answer (GNA) command | 24 |
| 7 | MB2-U Protocol | 24 |
| 7.1 | Protocol Stack | 24 |
| 7.2 | Procedures | 26 |
| Annex A (informative): Call Flows | | 27 |
| A.1 | TMGI Management | 27 |
| A.1.1 | TMGI Allocation Procedure | 27 |
| A.1.2 | TMGI Deallocation Procedure | 27 |
| A.1.3 | TMGI Expiry Notification | 28 |
| A.2 | MBMS Bearer Control Procedures | 29 |
| A.2.1 | Activate MBMS Bearer Procedure | 29 |
| A.2.2 | Deactivate MBMS Bearer Procedure | 29 |
| A.2.3 | Modify MBMS Bearer Procedure | 30 |
| A.2.4 | MBMS Bearer Status Indication Procedure | 31 |
| A.3 | Restoration Procedures | 32 |
| A.3.1 | GCS AS initiated Heartbeat Procedure | 32 |
| A.3.2 | BM-SC initiated Heartbeat Procedure | 32 |
| Annex B (informative): Change history | | 33 |
| History | | 34 |

Foreword

This Technical Specification has been produced by the 3rd Generation Partnership Project (3GPP).

The contents of the present document are subject to continuing work within the TSG and may change following formal TSG approval. Should the TSG modify the contents of the present document, it will be re-released by the TSG with an identifying change of release date and an increase in version number as follows:

Version x.y.z

where:

- x the first digit:
 - 1 presented to TSG for information;
 - 2 presented to TSG for approval;
 - 3 or greater indicates TSG approved document under change control.
- Y the second digit is incremented for all changes of substance, i.e. technical enhancements, corrections, updates, etc.
- z the third digit is incremented when editorial only changes have been incorporated in the document.

1 Scope

This document defines the protocol for the MB2 reference point between the Group Communication Service Application Server (GCS AS) and the Broadcast-Multicast Service Centre (BM-SC).

The MB2 reference point and related stage 2 procedures are defined in 3GPP TS 23.468 [4] as part of the Group Communication System Enablers for LTE. The stage 1 requirements for Group Communication System Enablers for LTE are specified in 3GPP TS 22.468 [2].

2 References

The following documents contain provisions which, through reference in this text, constitute provisions of the present document.

- References are either specific (identified by date of publication, edition number, version number, etc.) or non-specific.
- For a specific reference, subsequent revisions do not apply.
- For a non-specific reference, the latest version applies. In the case of a reference to a 3GPP document (including a GSM document), a non-specific reference implicitly refers to the latest version of that document *in the same Release as the present document*.

- [1] 3GPP TR 21.905: "Vocabulary for 3GPP Specifications".
- [2] 3GPP TS 22.468: "Group Communication System Enablers for LTE (GCSE_LTE)".
- [3] 3GPP TS 23.246: "Multimedia Broadcast/Multicast Service (MBMS); Architecture and functional description".
- [4] 3GPP TS 23.468: "Group Communication System Enablers for LTE (GCSE_LTE); stage 2".
- [5] 3GPP TS 26.346: "Multimedia Broadcast/Multicast Service (MBMS); Protocols and codecs".
- [6] 3GPP TS 29.061: "Interworking between the Public Land Mobile Network (PLMN) supporting packet based services and Packet Data Networks (PDN)".
- [7] 3GPP TS 29.212: "Policy and Charging Control (PCC); Reference points".
- [8] 3GPP TS 29.274: "3GPP Evolved Packet System (EPS); Evolved General Packet Radio Service (GPRS) Tunnelling Protocol for Control plane (GTPv2-C); Stage 3".
- [9] 3GPP TS 29.281: "General Packet Radio System (GPRS) Tunnelling Protocol User Plane (GTPv1-U)".
- [10] 3GPP TS 33.246: "Security of Multimedia Broadcast/Multicast Service (MBMS)".
- [11] IETF RFC 791: "Transmission Control Protocol".
- [12] IETF RFC 768: "User Datagram Protocol".
- [13] IETF RFC 2234: "Augmented BNF for syntax specifications".
- [14] IETF RFC 3588: "Diameter Base Protocol".
- [15] IETF RFC 4960: "Stream Control Transmission Protocol".
- [16] IETF RFC 5719: "Updated IANA Considerations for Diameter Command Code Allocations".
- [17] IETF RFC 5996: "The Internet Key Exchange (IKE)".
- [18] IETF RFC 3947: "Negotiation of NAT-Traversal in the IKE".
- [19] IETF RFC 3948: "UDP Encapsulation of IPsec ESP Packets".

- [20] IETF RFC 4303: "IP Encapsulating Security Payload (ESP)".
- [21] IETF RFC 6347: "Datagram Transport Layer Security Version 1.2".#
- [22] 3GPP TS 23.007: "Restoration procedures".
- [23] 3GPP TS 29.229: "Cx and Dx interfaces based on the Diameter protocol".

3 Definitions, symbols and abbreviations

3.1 Definitions

For the purposes of the present document, the terms and definitions given in TR 21.905 [1] and the following apply:

MBMS bearer: The service provided by the EPS to deliver the same IP datagrams to multiple receivers in a designated location.

3.2 Abbreviations

For the purposes of the present document, the abbreviations given in TR 21.905 [1] and the following apply. An abbreviation defined in the present document takes precedence over the definition of the same abbreviation, if any, in TR 21.905 [1].

| | |
|---------|--|
| ARP | Allocation and Retention Priority |
| AVP | Attribute-Value Pair |
| BM-SC | Broadcast-Multicast Service Centre |
| DTLS | Datagram Transport Layer Security |
| ESP | Encapsulating Security Payload |
| GAA | GCS-Action-Answer |
| GAR | GCS-Action-Request |
| GCS | Group Communication Service |
| GCSE | Group Communication System Enablers |
| GCS AS | Group Communication Service Application Server |
| GNA | GCS-Notification-Answer |
| GNR | GCS-Notification-Request |
| MBMS-GW | MBMS Gateway |
| PCRF | Policy and Charging Rules Function |
| P-GW | PDN Gateway |
| TMGI | Temporary Mobile Group Identity |
| UDP | User Datagram Protocol |

4 Architectural Overview

4.1 Reference Model

Figure 4.1-1 shows a high level reference model of the architectural elements relevant to understand the MB2 reference point. More complete reference models for GCSE are contained in 3GPP TS 23.468 [4].

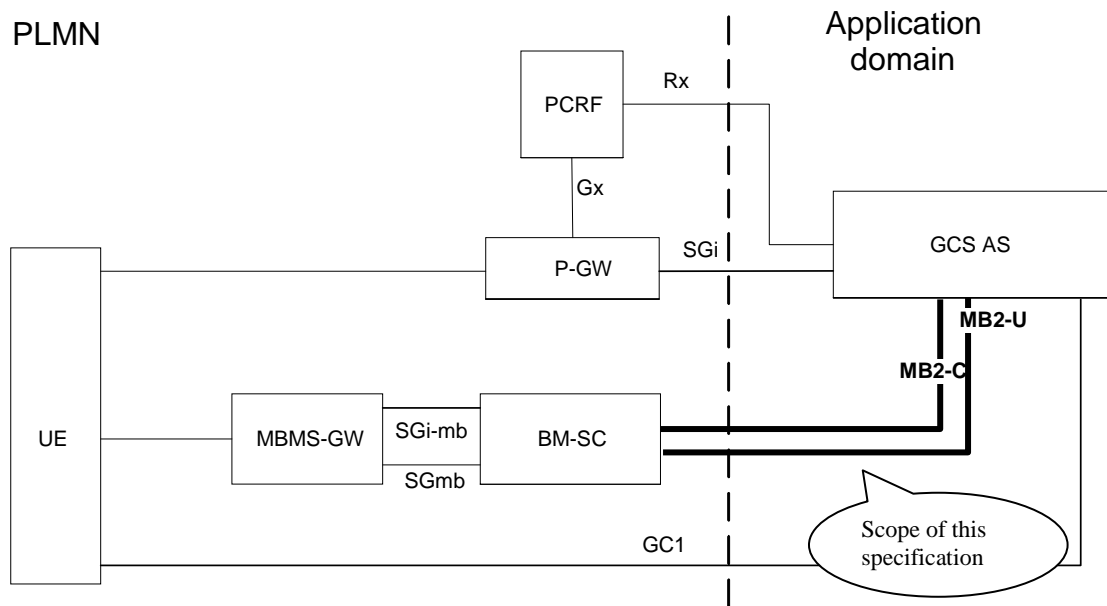

Figure 4.1-1: Reference Model

NOTE: The GC1 reference point between the UE and the GCS AS is unspecified in the present release. Data related to the GC1 reference point are transported via the Sgi reference point between GCS AS and P-GW.

4.2 Functional Elements

4.2.1 Group Communication Service Application Server (GCS AS)

The GCS AS is defined in 3GPP TS 23.468 [4] and supports the following functionality:

- Exchanging GC1 signalling with the UE.
- Receiving unicast uplink data from the UE via the Sgi reference point.
- Delivery of data to all the Ues belonging to a group using unicast delivery over the Sgi reference point and/or MBMS delivery over the MB2 reference point.
- Support for service continuity procedures for a UE to switch between unicast delivery and MBMS delivery.
- For MBMS delivery:
 - o MB2-C procedures defined in 3GPP TS 23.468 [4], for requesting the BM-SC to activate, deactivate, modify an MBMS bearer, allocate/deallocate TMGI.
 - o Forwarding of data to be delivered via an MBMS bearer to the BM-SC via the MB2-U reference point.

4.2.2 Broadcast-Multicast Service Centre (BM-SC)

The BM-SC is defined in 3GPP TS 23.246 [3], with additions related to the MB2 reference point in 3GPP TS 23.468 [4], and supports the following functionality:

- MBMS Broadcast Mode procedures defined in 3GPP TS 23.246 [3] (stage 2) and in 3GPP TS 29.061 [6] (stage 3).
- MB2-C procedures defined in 3GPP TS 23.468 [4], for activating, deactivating, modifying an MBMS bearer, allocating/deallocating TMGI and notifying the TMGI expiry or the MBMS Bearer condition to GCS AS.
- SGmb procedures for controlling MBMS broadcast bearers defined in 3GPP TS 29.061 [6].

- Reception of user data from the GCS AS via the MB2-U reference point and forwarding those data via the Sgi-mb reference point as described in 3GPP TS 29.061 [6].

5 Procedures over the MB2 Reference Point

5.1 TMGI and Flow ID handling

The combination of TMGI and Flow Identifier shall uniquely identify an MBMS bearer. TMGI and Flow Identifier are defined in 3GPP TS 23.246 [3].

A TMGI shall be assigned by the BM-SC upon request of the GCS AS. The BM-SC shall provide an expiration time for each assigned TMGI or group of TMGIs to the GCS AS. The BM-SC shall assign a TMGI, which is different from any other TMGI, which the BM-SC has previously assigned and for which the timer has not yet expired and there is no active MBMS broadcast bearer. The GCS AS may request the BM-SC to refresh the expiration timer for a TMGI. The BM-SC and GCS AS shall store the TMGI until the timer expires.

NOTE: As defined in 3GPP TS 23.246 [3], TMGIs need to be globally unique. It is assumed that the BM-SC uses a configured range of TMGI values.

The BM-SC shall assign Flow Identifier values, which shall be unique for the corresponding TMGI. For each assigned TMGI, both BM-SC and GCS AS shall store all assigned Flow Identifiers until the expiry of the timer of the TMGI, or until GCS AS requests the deallocation of the TMGI.

5.2 TMGI Management

5.2.1 TMGI Allocation Procedure

The TMGI Allocation procedure may be used by the GCS AS to request a set of TMGIs, or to request the renewal of the expiration time for already allocated TMGIs.

To apply this procedure, the GCS AS shall send a GCS-Action-Request (GAR) command including the TMGI-Allocation-Request AVP. Within the TMGI-Allocation-Request AVP, the GCS AS shall indicate the number of requested new TMGIs, excluding any TMGIs for which only an expiration timer renewal is requested, in the TMGI-Number AVP, and may include within TMGI AVPs TMGIs that are already allocated to the GCS AS, and for which the GCS AS wishes to obtain a later expiration time. The number of TMGIs requested may be zero, if this procedure is used only to renew the expiration time for already allocated TMGIs.

Upon reception of a GCS-Action-Request (GAR) command including the TMGI-Allocation-Request AVP, the BM-SC shall determine whether the GCS AS is authorized to receive the requested TMGIs. If the renewal of TMGIs has been requested, the BM-SC shall also determine whether the TMGIs are allocated to the requesting GCS AS and if yes, whether the renewal of TMGI expiration times is possible. The BM-SC shall also determine an expiration time, which shall be applicable for all new TMGIs and all TMGIs for which the timer was renewed.

NOTE 1: During the TMGI Allocation Procedure, the BM-SC does not activate MBMS. However TMGIs, for which the expiration time is renewed, may already have active MBMS bearers.

The BM-SC shall then send the GCS-Action-Answer (GAA) command including the TMGI-Allocation-Response AVP. For a successful TMGI allocation, the TMGI-Allocation-Response AVP shall include TMGI AVPs and the MBMS-Session-Duration AVP. The TMGI AVPs shall contain all successfully allocated or refreshed TMGIs and the MBMS-Session-Duration AVP shall indicate their common new expiration time. For an unsuccessful TMGI allocation request, the TMGI-Allocation-Response AVP shall include the TMGI-Allocation-Result AVP. For a partial success (i.e. if some, but not all of the requested TMGIs are allocated or timers refreshed), the TMGI-Allocation-Response AVP shall include the TMGI AVPs, the MBMS-Session-Duration AVP and the TMGI-Allocation-Result AVP. The TMGI AVPs shall contain all successfully allocated or refreshed TMGIs and the MBMS-Session-Duration AVP shall indicate their common new expiration time. The TMGI-Allocation-Result AVP shall indicate both success and the reason(s) why the allocation or refresh failed for some TMGIs.

5.2.2 TMGI Deallocation Procedure

The TMGI Deallocation procedure may be used by the GCS AS to immediately release a set of TMGIs, irrespective of their expiration times.

To apply this procedure, the GCS AS shall send a GCS-Action-Request (GAR) command including the TMGI-Deallocation-Request AVP. If the GCS AS desires to deallocate some, but not all currently allocated TMGIs, it shall include TMGI AVPs for all TMGIs that are to be deallocated within the TMGI-Deallocation-Request AVP. If the GCS AS desires to deallocate all currently allocated TMGIs, it shall not include TMGI AVPs within the TMGI-Deallocation-Request AVP.

Upon reception of a GCS-Action-Request (GAR) command including the TMGI-Deallocation-Request AVP, the BM-SC shall determine whether the GCS AS is authorized to deallocate the TMGIs.

The BM-SC shall then send the GCS-Action-Answer (GAA) command and shall include a TMGI-Deallocation-Response AVP for each TMGI contained in the TMGI-Deallocation-Request AVP. Each TMGI-Deallocation-Response AVP shall include the affected TMGI in the TMGI AVP. For an unsuccessful TMGI deallocation, the TMGI-Deallocation-Response AVP shall also include the TMGI-Deallocation-Result AVP.

When the GCS AS requests the deallocation of a TMGI with some related active MBMS bearers, the BM-SC shall terminate those bearer(s).

5.2.3 TMGI Expiry Notification Procedure

At timer expiry for a TMGI, the BM-SC shall notify the GCS AS by sending a GCS-Notification-Request (GNR) command including one TMGI-Expiry AVP.

If there are active MBMS bearer(s) related to an expiring TMGI, the BM-SC shall terminate those bearer(s) and shall notify the GCS AS about the bearer termination by including MBMS-Bearer-Event-Notification AVP(s) in the GNR in accordance with the MBMS Bearer Status Indication Procedure in subclause 5.3.5.

5.3 MBMS Bearer Control Procedures

5.3.1 General

The GAR command described in subclauses 5.3.2, 5.3.3 and 5.3.4 may contain more than one MBMS-Bearer-Request AVPs requesting the activation, modification or deactivation of different MBMS bearers.

5.3.2 Activate MBMS Bearer Procedure

The Activate MBMS Bearer procedure may be used by the GCS AS to cause allocation of resources for MBMS bearer(s).

To apply this procedure, the GCS AS shall send a GCS-Action-Request (GAR) command including one MBMS-Bearer-Request AVP for each bearer that is to be activated. Within the MBMS-Bearer-Request AVP, the GCS AS shall include the MBMS-StartStop-Indication AVP set to "START", the MBMS-Service-Area AVP and the QoS-Information AVP, and the GCS AS may include the TMGI AVP, the MBMS-Start-Time AVP and the MB2U-Security AVP.

Upon reception of a GCS-Action-Request (GAR) command including the MBMS-Bearer-Request AVP with the MBMS-StartStop-Indication AVP set to "START", the BM-SC shall determine whether the GCS AS is authorized to use the TMGI. If so, the BM-SC shall allocate MBMS resources to support content delivery of the MBMS bearer to the requested MBMS service area using the Session Start procedure defined in TS 23.246 [3]. If no TMGI AVP is included in the MBMS-Bearer-Request AVP, the BM-SC shall allocate a new TMGI. The BM-SC shall allocate a new Flow Identifier. The BM-SC shall decide whether to use MB2-U Security, and shall take into account related requests of the GCS AS, as received within the MB2U-Security AVP in the MBMS-Bearer-Request AVP.

If the new MBMS service area overlaps with the service area of any active bearer with the same TMGI, the BM-SC should reject the activation request with the result code "Overlapping-MBMS-Service-Area".

The BM-SC shall then send GCS-Action-Answer (GAA) command including an MBMS-Bearer-Response AVP. The BM-SC shall include an MBMS-Bearer-Response AVP for each MBMS-Bearer-Request AVP that was included in the GAR. The MBMS-Bearer-Response AVP shall be included in the same position in the GAA that the corresponding MBMS-Bearer-Request AVP had in the GAR.

For a successful MBMS bearer activation, the MBMS-Bearer-Response AVP shall include the TMGI AVP, the MBMS-Flow-Identifier AVP, the MBMS-Session-Duration AVP, the BMSC-Address AVP and BMSC-Port AVP, and may include Radio-Frequency AVP(s) as MBMS bearer related service description. If MB2-U Security is applied, the MBMS-Bearer-Response AVP shall also include the MB2U-Security AVP.

5.3.3 Deactivate MBMS Bearer Procedure

The Deactivate MBMS Bearer procedure may be used by the GCS AS to cause deallocation of resources for MBMS bearer(s).

To apply this procedure, the GCS AS shall send a GCS-Action-Request (GAR) command including one MBMS-Bearer-Request AVP for each bearer that is to be deactivated. Within the MBMS-Bearer-Request AVP, the GCS AS shall include the MBMS-StartStop-Indication AVP set to "STOP", the TMGI AVP and the MBMS-Flow-Identifier AVP to designate the bearer to be deactivated.

Upon reception of a GCS-Action-Request (GAR) command including the MBMS-Bearer-Request AVP with MBMS-StartStop-Indication AVP set to "STOP", the BM-SC shall determine whether the GCS AS is authorized to use the TMGI. If so, the BM-SC shall stop the broadcast to the MBMS bearer identified by the TMGI AVP and the MBMS-Flow-Identifier AVP and shall deallocate MBMS resources used for the MBMS bearer using the Session Stop procedure defined in TS 23.246 [3].

The BM-SC shall then send GCS-Action-Answer (GAA) command including an MBMS-Bearer-Response AVP. The BM-SC shall include an MBMS-Bearer-Response AVP for each MBMS-Bearer-Request AVP that was included in the GAR. The MBMS-Bearer-Response AVP shall be included in the same position in the GAA that the corresponding MBMS-Bearer-Request AVP had in the GAR. For a successful MBMS bearer deactivation, the MBMS-Bearer-Response AVP shall include the TMGI AVP and the MBMS-Flow-Identifier AVP.

5.3.4 Modify MBMS Bearer Procedure

The Modify MBMS Bearer procedure may be used by the GCS AS to cause modification of the priority and pre-emption values for an MBMS bearer, the MBMS broadcast area, or both.

To apply this procedure, the GCS AS shall send a GCS-Action-Request (GAR) command including one MBMS-Bearer-Request AVP for each bearer that is to be modified. Within the MBMS-Bearer-Request AVP, the GCS AS shall include The MBMS-StartStop-Indication AVP set to "UPDATE", the TMGI AVP and the MBMS-Flow-Identifier AVP to designate the bearer to be modified. The GCS AS may include the MBMS-Service-Area AVP and the QoS-Information AVP. However, at least one of the MBMS-Service-Area AVP and the QoS-Information AVP shall be included. The QoS-Information AVP shall only be used to modify the Allocation and Retention Priority (ARP), and shall otherwise indicate the same values that were supplied when the activation of the MBMS bearer was requested.

Upon reception of a GCS-Action-Request (GAR) command including the MBMS-Bearer-Request AVP with MBMS-StartStop-Indication AVP set to "UPDATE", the BM-SC shall determine whether the GCS AS is authorized to use the TMGI. If so, the BM-SC shall modify the characteristics of the MBMS bearer using the Session Update procedure defined in TS 23.246 [3].

If the MBMS broadcast area is being modified, the BM-SC shall ensure that the new MBMS broadcast area is not overlapping with the MBMS broadcast area of any other existing MBMS bearer(s) with the same TMGI, in accordance with 3GPP TS 23.246 [3]. Otherwise, the BM-SC should reject the modification request with the result code Overlapping-MBMS-Service-Area.

The BM-SC shall then send the GCS-Action-Answer (GAA) command including an MBMS-Bearer-Response AVP. The BM-SC shall include an MBMS-Bearer-Response AVP for each MBMS-Bearer-Request AVP that was included in the GAR. The MBMS-Bearer-Response AVP shall be included in the same position in the GAA that the corresponding MBMS-Bearer-Request AVP had in the GAR. For a successful MBMS bearer modification, the MBMS-Bearer-Response AVP shall include the TMGI AVP and the MBMS-Flow-Identifier AVP.

5.3.5 MBMS Bearer Status Indication Procedure

The BM-SC may use the MBMS Bearer Status Indication Procedure to notify the GCS AS of conditions affecting the delivery of services that use MBMS Delivery, for instance the termination of an MBMS bearer.

To apply this procedure, the BM-SC shall send a GCS-Notification-Request (GNR) command including one MBMS-Bearer-Event-Notification AVP for each bearer with an event to be notified. Within the MBMS-Bearer-Event-Notification AVP, the BM-SC shall indicate the bearer event using the MBMS-Bearer-Event AVP and shall include the TMGI AVP and the MBMS-Flow-Identifier AVP to designate the affected bearer.

Upon reception of a GCS-Notification-Request (GNR), the GCS AS shall reply with a GCS-Notification-Answer (GNA) command.

5.4 BM-SC selection

To discover the BM-SC with which to establish the MB2-C session, the GCS AS may use:

- a pre-configured BM-SC identity
- Diameter routing

5.5 BM-SC overload control

Upon receiving a request from the GCS AS, if the BM-SC is in an overload condition, the BM-SC may respond to the GCS AS with a GCS-Action-Answer command containing the Result-Code AVP with the value set to DIAMETER_TOO_BUSY, see IETF RFC 3588 [14].

The GCS AS may implement a back off timer. When this timer is running, the GCS AS does not initiate MB2-C requests. Once the timer expires, the GCS AS may re-attempt to use the BM-SC. The algorithm the BM-SC uses for the back off timer is out of scope of this 3GPP specification.

5.6 Restoration Procedures

5.6.1 General

The restoration procedures enable the BM-SC and GCS AS to detect an MB2-C path failure or the restart of the peer node, as specified in 3GPP TS 23.007 [22].

The BM-SC and GCS AS shall detect an MB2-C path failure or the restart of the peer node as specified in 3GPP TS 23.007 [22], i.e. either making use of mechanisms of the Diameter base protocol, or of the Heartbeat procedures and procedures related to the Restart-Counter AVP defined in subclause 5.6. 2, 5.6.3 and 5.6.4. The Heartbeat procedure and the procedures related to the Restart-Counter AVP are optional to support for both BM-SC and GCS AS.

NOTE: In deployments with a Diameter Agent between the GCS AS and the BM-SC, the restoration mechanisms of the Diameter base protocol cannot be used.

The use of the Heartbeat procedure and the Restart-Counter AVP shall be negotiated between the BM-SC and GCS AS using the Supported-Features AVP upon contacting the peer node for the first time.

5.6.2 Restart Counter

The BM-SC shall maintain a local restart counter which shall be incremented monotonically whenever the BM-SC restarts with loss of previous states. After the BM-SC starts (or restarts with loss of previous states), it shall include the Restart-Counter AVP indicating the local value of its restart counter in the first message it sends to any peer GCS AS.

The GCS AS shall store the received restart counter value for each peer BM-SC it communicates with. If the new received restart counter value for a peer BM-SC is incremented, the BM-SC has restarted.

The GCS AS shall also maintain a local restart counter which shall be incremented monotonically whenever the GCS AS restarts with loss of previous states. After the GCS AS starts (or restarts with loss of previous states), it shall include the Restart-Counter AVP indicating the local value of its restart counter in the first message it sends to any peer BM-SC.

The BM-SC shall store the received restart counter value for each peer GCS AS it communicates with. If the new received restart counter value for a peer GCS AS is incremented, the GCS AS has restarted

5.6.3 GCS AS initiated Heartbeat Procedure

To detect an MB2-C path failure or the outage or restart of a peer BM-SC, the GCS AS shall send GARs including the Restart-Counter AVP indicating the local value of its restart counter periodically to each peer BM-SC when no other signalling is exchanged between those two nodes. The GCS AS shall repeat sending the GAR one or more times if no GAA is received. The GCS AS shall consider the MB2-C path to be down if it does not receive a GAA to a configured number of consecutive GARs

If the BM-SC receives a GAR including the Restart-Counter AVP, it shall reply with a GAA including the Restart-Counter AVP indicating the local value of its restart counter.

5.6.4 BM-SC initiated Heartbeat Procedure

To detect an MB2-C path failure or the outage or restart of a peer GCS AS, the BM-SC shall send GNRs including the Restart-Counter AVP indicating the local value of its restart counter periodically to each peer GCS AS when no other signalling is exchanged between those two nodes. The BM-SC shall repeat sending the GNR one or more times if no GNA is received. The BM-SC shall consider the MB2-C path to be down if it does not receive a GNA to a configured number of consecutive GNRs .

If the GCS AS receives a GNR including the Restart-Counter AVP, it shall reply with a GNA including the Restart-Counter AVP indicating the local value of its restart counter.

5.6.5 GCS AS procedures after detection of BM-SC Restart

When the GCS AS detects that the the BM-SC has restarted, the GCS AS:

- shall assume that all the TMGIs that had been assigned by the restarted BM-SC have been de-allocated and that all the related MBMS bearers have been deactivated; and
- may restore the MBMS delivery.

5.6.6 BM-SC procedures after detection of GCS AS Restart

When the BM-SC detects that the GCS AS has restarted, the BM-SC:

- shall deallocate (locally) all the TMGIs that had been assigned to the GCS AS; and
- shall stop all the related MBMS bearers.

5.6.7 GCS AS procedures upon detection of MB2-C path failure

Upon detecting a non-transient MB2-C path failure, the GCS AS:

- shall assume that all the TMGIs that had been assigned by the BM-SC have been de-allocated and that all the related MBMS bearers have been deactivated; and
- may restore the MBMS delivery.

5.6.8 BM-SC procedures upon detection of MB2-C path failure

Upon detecting a non-transient MB2-C path failure, the BM-SC shall:

- deallocate (locally) all the TMGIs that had been assigned to the GCS AS; and

- stop all the related MBMS bearers.

6 MB2-C Protocol

6.1 Protocol support

6.1.1 Use of Diameter base protocol

The Diameter Base Protocol as specified in IETF RFC 3588 [14] shall apply except as modified by the defined support of the methods and the defined support of the commands and AVPs, result and error codes as specified in this specification. Unless otherwise specified, the procedures specified in IETF RFC 3588 [14] (including error handling and unrecognised information handling) shall be used unmodified. Only commands related to peer-to-peer connection are re-used from the Diameter Base Protocol, i.e. Capabilities-Exchange-Request (CER), Capabilities-Exchange-Answer (CEA), Disconnect-Peer-Request (DPR), Disconnect-Peer-Answer (DPA), Device-Watchdog-Request (DWR) and Device-Watchdog-Answer (DWA).

With regards to the Diameter protocol defined over the MB2-C interface, the BM-SC shall act as the Diameter server, in the sense that it is the network element that handles action requests and sends notifications. The GCS AS shall act as the Diameter client, in the sense that it is the network element requesting actions and handles notification from the BM-SC.

A Diameter routing table entry can have a different destination based on the application identifier of the command. The application identifier stored in the command header must match the value of any application identifier AVPs in the command body. Diameter agents (relay, proxy, redirection, translation agents) should use the application identifier in the command header to route to a suitable destination.

6.1.2 Transport protocol

Diameter messages over the MB2-C interface shall make use of SCTP (see IETF RFC 4960 [15]) or TCP (see IETF RFC 791 [11]).

6.1.3 Advertising Application Support

The Diameter application identifier assigned to the MB2-C interface application is 16777335.

The GCS AS and BM-SC shall advertise support of the Diameter MB2-C application by including the value of the MB2-C application identifier in the Auth-Application-Id AVP within the Vendor-Specific-Application-Id grouped AVP of the CER and CEA commands.

The vendor identifier value of 3GPP (10415) shall be included in the Supported-Vendor-Id AVP of the CER and CEA commands, and in the Vendor-Id AVP within the Vendor-Specific-Application-Id grouped AVP of the CER and CEA commands.

The Vendor-Id AVP included in CER and CEA commands that is not included in the Vendor-Specific-Application-Id AVPs as described above shall indicate the manufacturer of the Diameter node as per IETF RFC 3588 [14].

6.2 Initialization and maintenance of connection and session

A peer-to-peer connection is a connection between GCS AS and BM-SC. It has no associated meaning beyond this link. A MB2-C peer-to-peer connection may carry commands associated with multiple TMGIs and/or MBMS bearers.

A MB2-C Diameter session shall consist of a single request and answer pair. The MB2-C Diameter session is terminated after each request and answer pair interaction. In order to indicate that the session state is not to be maintained, the Diameter client and server shall include the Auth-Session-State AVP with the value set to NO_STATE_MAINTAINED (1), in the request and in the answer messages (see IETF RFC 3588 [14]).

6.3 Security on the MB2-C interface

The security mechanism in Annex N of 3GPP TS 33.246 [10] shall apply.

6.4 MB2-C specific AVPs

6.4.1 General

Table 6.4.1-1 describes the Diameter AVPs defined for the MB2-C reference point, their AVP Code values, types and possible flag values. The Vendor-Id header of all AVPs defined in the present document shall be set to 3GPP (10415).

Table 6.4.1-1: MB2-C specific Diameter AVPs

| Attribute Name | AVP Code | Clause defined | Value Type | AVP Flag rules (Note 1) | | | | Applicability (Note 2) |
|--------------------------------|----------|----------------|------------|-------------------------|-----|------------|----------|------------------------|
| | | | | Must | May | Should not | Must not | |
| BMSC-Address | 3500 | 6.4.2 | Address | M,V | P | | | |
| BMSC-Port | 3501 | 6.4.3 | Unsigned32 | M,V | P | | | |
| MB2U-Security | 3517 | 6.4.19 | Unsigned32 | M,V | P | | | |
| MBMS-Bearer-Event | 3502 | 6.4.4 | Unsigned32 | M,V | P | | | |
| MBMS-Bearer-Event-Notification | 3503 | 6.4.5 | Grouped | M,V | P | | | |
| MBMS-Bearer-Request | 3504 | 6.4.6 | Grouped | M,V | P | | | |
| MBMS-Bearer-Response | 3505 | 6.4.7 | Grouped | M,V | P | | | |
| MBMS-Bearer-Result | 3506 | 6.4.8 | Unsigned32 | M,V | P | | | |
| MBMS-Start-Time | 3507 | 6.4.9 | Time | M,V | P | | | |
| Radio-Frequency | 3508 | 6.4.10 | Unsigned32 | M,V | P | | | |
| TMGI-Allocation-Request | 3509 | 6.4.11 | Grouped | M,V | P | | | |
| TMGI-Allocation-Response | 3510 | 6.4.12 | Grouped | M,V | P | | | |
| TMGI-Allocation-Result | 3511 | 6.4.13 | Unsigned32 | M,V | P | | | |
| TMGI-Deallocation-Request | 3512 | 6.4.14 | Grouped | M,V | P | | | |
| TMGI-Deallocation-Response | 3513 | 6.4.15 | Grouped | M,V | P | | | |
| TMGI-Deallocation-Result | 3514 | 6.4.16 | Unsigned32 | M,V | P | | | |
| TMGI-Expiry | 3515 | 6.4.17 | Grouped | M,V | P | | | |
| TMGI-Number | 3516 | 6.4.18 | Unsigned32 | M,V | P | | | |

NOTE 1: The AVP header bit denoted as 'M', indicates whether support of the AVP is required. The AVP header bit denoted as 'V', indicates whether the optional Vendor-ID field is present in the AVP header. For further details, see IETF RFC 3588 [14].

NOTE 2: AVPs marked with a supported feature are applicable as described in subclause 6.5.2.

For all AVPs which contain bit masks and are of the type Unsigned32 or Unsigned64, bit 0 shall be the least significant bit. For example, to get the value of bit 0, a bit mask of 0x0001 should be used.

Every AVP of type Grouped is defined by means of the ABNF syntax in IETF RFC 2234 [13] and according to the rules in IETF RFC 3588 [14].

6.4.2 BMSC-Address AVP

The BMSC-Address AVP (AVP code 3500) is of type Address and indicates the IP address where the BM-SC wants to receive user data via the MB2-U interface.

6.4.3 BMSC-Port AVP

The BMSC-Port AVP (AVP code 3501) is of type Unsigned32 and indicates the port where the BM-SC wants to receive user data via the MB2-U interface.

6.4.4 MBMS- Bearer-Event AVP

The MBMS-BearerEvent AVP (AVP code 3502) is of type Unsigned32 and it shall contain a bit mask with values as defined table 6.4.4-1. Several bits may be set in combination.

Table 6.4.4-1: MBMS-Bearer-Event AVP

| Bit | Name | Description |
|-----|-------------------|---------------------------------|
| 0 | Bearer Terminated | The MBMS bearer was terminated. |

6.4.5 MBMS-Bearer-Event-Notification AVP

The MBMS-Bearer-Response AVP (AVP code 3503) is of type Grouped. It is used by the BM-SC to notify the GCS AS about an MBMS bearer event.

AVP Format:

```

MBMS-Bearer-Event-Notification ::=
    < AVP Header: 3503 >
    {
        TMGI
        MBMS-Flow-Identifier
        MBMS-Bearer-Event
    }
    *[ AVP ]

```

6.4.6 MBMS-Bearer-Request AVP

The MBMS-Bearer-Request AVP (AVP code 3504) is of type Grouped. It is used by the GCS AS to request the activation, modification, or deactivation of an MBMS bearer.

The MBMS-StartStop-Indication AVP shall indicate if an activation, modification, or deactivation of an MBMS bearer is requested.

For the activation of an MBMS bearer, the TMGI AVP, the MBMS-Flow-Identifier AVP, and the MBMS-Start-Time AVP may be included, and the MBMS-Service-Area AVP and the QoS-Information AVP shall be included, and the MB2U-Security AVP may be included.

For the modification of an MBMS bearer, the TMGI AVP, and the MBMS-Flow-Identifier AVP shall be included and the MBMS-Service-Area AVP and the QoS-Information AVP may be included. However, at least one of the MBMS-Service-Area AVP and the QoS-Information AVP shall be included. The QoS-Information AVP shall only be used to modify the priority and pre-emption characteristics, and shall otherwise indicate the same values that were supplied when the activation of the MBMS bearer was requested.

For the deactivation of an MBMS bearer, the TMGI AVP and the MBMS-Flow-Identifier AVP shall be included.

AVP Format:

```

MBMS-Bearer-Request ::=
    < AVP Header: 3504 >
    {
        MBMS-StartStop-Indication
    }
    [ TMGI ]
    [ MBMS-Flow-Identifier ]
    [ QoS-Information ]
    [ MBMS-Service-Area ]
    [ MBMS-Start-Time ]
    [ MB2U-Security ]
    *[ AVP ]

```

6.4.7 MBMS-Bearer-Response AVP

The MBMS-Bearer-Response AVP (AVP code 3505) is of type Grouped. It is used by the BM-SC to inform the GCS AS about the result of a MBMS bearer request.

For a successful MBMS bearer activation, the TMGI AVP, the MBMS-Flow-Identifier AVP, the MBMS-Session-Duration AVP, the BMSC-Address AVP and the BMSC-Port AVP shall be included, and Radio-Frequency AVP(s) and the MB2U-Security AVP may be included.

For a successful MBMS bearer modification or deactivation, the TMGI AVP and the MBMS-Flow-Identifier AVP shall be included.

For an unsuccessful MBMS bearer request, the MBMS-Bearer-Result AVP shall be included.

AVP Format:

```

MBMS-Bearer-Response ::= < AVP Header: 3505 >
    [ TMGI ]
    [ MBMS-Flow-Identifier ]
    [ MBMS-Session-Duration ]
    [ MBMS-Bearer-Result ]
    [ BMSC-Address ]
    [ BMSC-Port ]
    [ MB2U-Security ]
    * [ Radio-Frequency ]
    * [ AVP ]

```

6.4.8 MBMS-Bearer-Result AVP

The MBMS-Bearer-Result AVP (AVP code 3506) is of type Unsigned32 and it shall contain a bit mask with values as defined table 6.4.8-1. Several bits may be set in combination.

Table 6.4.8-1: MBMS- Bearer-Result AVP

| Bit | Name | Description |
|-----|--|---|
| 0 | Success | The requested bearer activation, modification or deactivation was successful. |
| 1 | Authorization rejected | The requested bearer activation, modification or deactivation failed because the BM-SC did not authorize it. |
| 2 | Resources exceeded | The requested bearer activation, modification or deactivation failed because the BM-SC could not provide sufficient resources. |
| 3 | Unknown TMGI | The requested bearer activation, modification or deactivation failed because the BM-SC did not know the requested TMGI or the TMGI expired. |
| 4 | TMGI not in use | The requested bearer modification or deactivation failed because the requested TMGI was not related to an active MBMS bearer. |
| 5 | Overlapping MBMS-Service-Area | The requested bearer modification failed because the requested Service area was overlapping with a service area already in use for the requested TMGI. |
| 6 | Unknown Flow Identifier | The requested bearer modification or deactivation failed because the BM-SC did not know the requested Flow Identifier. |
| 7 | QoS Authorization Rejected | The requested bearer activation or modification failed because the BM-SC did not authorize the requested QoS. |
| 8 | Unknown MBMS-Service-Area | The requested bearer activation or modification failed because the BM-SC did not know the requested MBMS-Service-Area |
| 9 | MBMS-Service-Area Authorization Rejected | The requested bearer activation or modification failed because the BM-SC did not authorize the requested MBMS-Service-Area |
| 10 | MBMS-Start-Time | The requested bearer activation failed because the MBMS-Start-Time contained an inappropriate value. |
| 11 | Invalid AVP combination | The requested bearer activation, modification or deactivation failed because the provided AVP combination within the corresponding MBMS-Bearer-Request AVP was not allowed (e.g. because some mandatory AVPs for a given MBMS-StartStop-Indication value were missing). |

6.4.9 MBMS-Start-Time AVP

The MBMS-Start-Time AVP (AVP code 3507) is of type Time and indicates the requested time when an MBMS bearer shall be allocated.

6.4.10 Radio-Frequency AVP

The Radio-Frequency AVP (AVP code 3508) is of type Unsigned32. It is used by the BM-SC to indicate radio frequencies, as defined in 3GPP TS 26.346 [5], as MBMS bearer related configuration information to the GCS AS. The coding of this AVP shall be the same as defined for the *radiofrequency* child element of the *infoBinding* in 3GPP TS 26.346 [5].

6.4.11 TMGI-Allocation-Request AVP

The TMGI-Allocation-Request AVP (AVP code 3509) is of type Grouped. It is used by the GCS AS to request the allocation, or timer refresh of TMGIs.

The TMGI-Number shall indicate the number of newly requested TMGI, excluding any TMGI where a timer refresh is requested. Any TMGIs where a timer refresh is requested shall be included in TMGI AVPs.

AVP Format:

```
TMGI-Allocation-Request ::= < AVP Header: 3509 >
                             { TMGI-Number }
                             * [ TMGI ]
                             * [ AVP ]
```

6.4.12 TMGI-Allocation-Response AVP

The TMGI-Allocation-Response AVP (AVP code 3510) is of type Grouped. It is used by the BM-SC to inform the GCS AS about the result of a TMGI allocation request.

For a successful TMGI allocation, TMGI AVPs and the MBMS-Session-Duration AVP shall be included. The TMGI AVPs shall contain all successfully allocated or refreshed TMGIs and the MBMS-Session-Duration AVP shall indicate their common new expiration time.

For an unsuccessful TMGI allocation request, the TMGI-Allocation-Result AVP shall be included.

For a partial success, if some, but not all of the requested TMGIs are allocated or timers refreshed, TMGI AVPs, the MBMS-Session-Duration AVP and the TMGI-Allocation-Result AVP shall be included. The TMGI AVPs shall contain all successfully allocated or refreshed TMGIs and the MBMS-Session-Duration AVP shall indicate their common new expiration time. The TMGI-Allocation-Result AVP shall indicate both success and the reason(s) why the allocation or refresh failed for some TMGIs.

AVP Format:

```
TMGI-Allocation-Response ::= < AVP Header: 3510 >
                             * [ TMGI ]
                             [ MBMS-Session-Duration ]
                             [ TMGI-Allocation-Result ]
                             * [ AVP ]
```

6.4.13 TMGI-Allocation-Result AVP

The TMGI-Allocation-Result AVP (AVP code 3511) is of type Unsigned32 and it shall contain a bit mask with values as defined table 6.4.13-1. Several bits may be set in combination.

Table 6.4.13-1: TMGI-Allocation-Result AVP

| Bit | Name | Description |
|-----|--------------------------|---|
| 0 | Success | The requested TMGI allocation was successful. |
| 1 | Authorization rejected | The requested TMGI allocation failed because the BM-SC did not authorize it. |
| 2 | Resources exceeded | The requested TMGI allocation failed because the BM-SC could not provide sufficient resources. |
| 3 | Unknown TMGI | The requested TMGI timer refresh failed because the BM-SC did not know the requested TMGI, e.g. because the TMGI already expired. |
| 4 | Too many TMGIs requested | The requested TMGI allocation or timer refresh failed because the maximum number of allowed TMGIs for the GCS AS was exceeded. |

6.4.14 TMGI-Deallocation-Request AVP

The TMGI-Deallocation-Request AVP (AVP code 3512) is of type Grouped. It is used by the GCS AS to request the deallocation of TMGIs.

AVP Format:

```
TMGI-Deallocation-Request ::= < AVP Header: 3512 >
                               *{ TMGI }
                               *[ AVP ]
```

6.4.15 TMGI-Deallocation-Response AVP

The TMGI-Deallocation-Response AVP (AVP code 3513) is of type Grouped. It is used by the BM-SC to inform the GCS AS about the results of a TMGI deallocation request for a given TMGI.

The TMGI AVP shall indicate the TMGI.

For an unsuccessful TMGI deallocation request, the TMGI-Deallocation-Result AVP shall be included.

AVP Format:

```
TMGI-Deallocation-Response ::= < AVP Header: 3513 >
                               { TMGI }
                               [ TMGI-Deallocation-Result ]
                               *[ AVP ]
```

6.4.16 TMGI-Deallocation-Result AVP

The TMGI-Deallocation-Result AVP (AVP code 3514) is of type Unsigned32 and it shall contain a bit mask with values as defined table 6.4.16-1. Several bits may be set in combination.

Table 6.4.16-1: TMGI-Deallocation-Result AVP

| Bit | Name | Description |
|-----|------------------------|--|
| 0 | Success | The requested TMGI allocation was successful. |
| 1 | Authorization rejected | The requested TMGI deallocation failed because the BM-SC did not authorize it. |
| 2 | Unknown TMGI | The requested TMGI deallocation failed because the BM-SC did not know the requested TMGI, e.g. because the TMGI already expired. |

6.4.17 TMGI-Expiry AVP

The TMGI-Expiry AVP (AVP code 3515) is of type Grouped. It is used by the BM-SC to notify the GCS AS about the expiry of TMGIs.

The TMGI AVPs shall include all TMGIs that have expired.

AVP Format:

```
TMGI-Expiry ::= < AVP Header: 3515 >
                *{ TMGI }
                *[ AVP ]
```

6.4.18 TMGI-Number AVP

The TMGI-Number AVP (AVP code 3516) is of type Unsigned32 and it indicates a number of requested TMGIs.

6.4.19 MB2U-Security AVP

The MB2U-Security AVP (AVP code 3517) is of type Unsigned32. It is used to indicate whether the usage of a security protocol for the MB2-U interface is requested (when send by the GCS AS) or decided (when send by the BM-SC).

The following values are defined in this specification:

0 (No security):

This value shall be used to indicate that the usage of no security protocol for the MB2-U interface is requested or decided. "0" is the default value that shall be used if the AVP is omitted.

1 (Security):

This value shall be used to indicate that the usage of a security protocol for the MB2 U interface is requested or decided.

6.5 MB2-C re-used AVPs

6.5.1 General

Table 6.5.1-1 lists the Diameter AVPs re-used by the MB2-C reference point from existing Diameter Applications, reference to their respective specifications and a short description of their usage within the MB2-C reference point. Other AVPs from existing Diameter Applications, except for the AVPs from Diameter base protocol, do not need to be supported. The AVPs from Diameter base protocol are not included in table 6.5.1-1, but they are re-used for the MB2-C reference point. Unless otherwise stated, re-used AVPs shall maintain their 'M', 'P' and 'V' flag settings.

Table 6.5.1-1: MB2-C re-used Diameter AVPs

| Attribute Name | Reference | Description | Applicability (Note 2) |
|--|---------------------|--|------------------------|
| MBMS-Flow-Identifier | 3GPP TS 29.061 [6] | Represents a location dependent subflow of an MBMS bearer service. | |
| MBMS-Session-Duration | 3GPP TS 29.061 [6] | Indicates the duration of the TMGI expiration time. (NOTE 1) | |
| TMGI | 3GPP TS 29.061 [6] | Contains the Temporary Mobile Group Identity allocated to a particular MBMS bearer service | |
| MBMS-Service-Area | 3GPP TS 29.061 [6] | Indicates the area over which the MBMS bearer service has to be distributed. | |
| MBMS-StartStop-Indication | 3GPP TS 29.061 [6] | Indicates if the allocation, deallocation or modification of an MBMS bearer is requested. | |
| QoS-Information | 3GPP TS 29.212 [7] | Contains the QoS that is required for the MBMS bearer. Only the QoS-Class-Identifier AVP, Max-Requested-Bandwidth-DL, Guaranteed-Bitrate-DL AVP and Allocation-Retention-Priority AVP within the QoS-Information AVP are applicable. | |
| Supported-Features | 3GPP TS 29.229 [23] | If present, this AVP informs the destination host about the features that the origin host requires to successfully complete this command exchange. | |
| Restart-Counter | 3GPP TS 29.061 [6] | This AVP contains a monotonically increasing value that is advanced whenever the sending entity restarts with loss of previous state, for example upon restart. The Restart-Counter AVP may be included in any Diameter message over the MB2-C reference point, including CER/CEA defined in IETF RFC 3588 [14]. | Heartbeat |
| NOTE 1: This re-used AVP has a different meaning as compared to the meaning in SGmb interface. | | | |
| NOTE 2: AVPs marked with a supported feature are applicable as described in subclause 6.5.2. | | | |

6.5.2 Supported-Feature-List AVP

6.5.2.1 Use of the Supported-Features AVP

When new functionality is introduced on the MB2-C reference point, it should be defined as optional. If backwards incompatible changes cannot be avoided, the new functionality shall be introduced as a new feature and support advertised with the Supported-Features AVP. Unless otherwise stated, the use of the Supported-Features AVP on the MB2-C reference point shall be compliant with the usage of the Supported-Features AVP on the Cx reference point i.e. with the procedures for the dynamic discovery of supported features as defined in clause 7.2 of 3GPP TS 29.229 [23].

When extending the application by adding new AVPs for a feature, the new AVPs shall have the M bit cleared and the AVP shall not be defined mandatory in the command ABNF.

As defined in 3GPP TS 29.229 [23], the Supported-Features AVP is of type grouped and contains the Vendor-Id, Feature-List-ID and Feature-List AVPs. On the all reference points as specified in this specification, the Supported-Features AVP is used to identify features that have been defined by 3GPP and hence, for features defined in this document, the Vendor-Id AVP shall contain the vendor ID of 3GPP (10415). If there are multiple feature lists defined for the reference point, the Feature-List-ID AVP shall differentiate those lists from one another. One instance of Supported-Features AVP is needed per Feature-List-ID.

Every GAR shall include the features supported by the GCS AS within Supported-Features AVP(s) with the 'M' bit cleared. Every GAA shall include the features supported by the BM-SC within Supported-Features AVP(s) with the 'M' bit cleared.

The Table 6.5.2.2-1 defines the features applicable to the MB2-C reference point for the feature list with a Feature-List-ID of 1.

6.5.2.2 Supported-Feature-List AVP for the MB2-C application

The syntax of this AVP is defined in 3GPP TS 29.229 [23].

For the MB2-C application, the meaning of the bits shall be as defined in table 6.5.2.2-1 for the Supported-Feature-List-ID of 1.

Table 6.5.2.2-1: Features of Feature-List-ID 1 used for MB2-C application

| Feature bit (NOTE 1) | Feature (NOTE 2) | M/O (NOTE 3) | Description (NOTE 4) |
|---|---------------------|-----------------|--|
| 0 | Heartbeat | O | This feature indicates the support of the Restoration functionality related Heartbeat procedures and procedures for the Restart-Counter AVP defined in subclause 5.6.2, 5.6.3 and 5.6.4. |
| NOTE 1: Feature bit: The order number of the bit within the Supported-Features AVP, e.g. "0". | | | |
| NOTE 2: Feature: A short name that can be used to refer to the bit and to the feature, e.g. "". | | | |
| NOTE 3: M/O: Defines if the implementation of the feature is mandatory ("M") or optional ("O"). | | | |
| NOTE 4: Description: A clear textual description of the feature. | | | |

6.6 MB2-C Messages

6.6.1 Command-Code Values

This section defines the Command-Code values for the MB2-C interface application as allocated by IANA from the vendor-specific namespace defined in IETF RFC 5719 [16]. Every command is defined by means of the ABNF syntax in IETF RFC 2234 [13], and according to the rules in IETF RFC 3588 [14].

The following Command Codes are defined in this specification:

Table 6.6.1-1: Command-Code values for MB2-C

| Command-Name | Abbreviation | Code | Section |
|--------------------------|--------------|---------|---------|
| GCS-Action-Request | GAR | 8388662 | 6.6.2 |
| GCS-Action-Answer | GAA | 8388662 | 6.6.3 |
| GCS-Notification-Request | GNR | 8388663 | 6.6.4 |
| GCS-Notification-Answer | GNA | 8388663 | 6.6.5 |

For the commands defined in this specification and reused commands, the Application-ID field shall be set to 16777335.

6.6.2 GCS-Action-Request (GAR) command

The GAR command, indicated by the Command-Code field set to xxx and the 'R' bit set in the Command Flags field, is sent by the GCS AS to the BM-SC as part of the MBMS bearer activation, modification, or deactivation procedure, or as part of the TMGI allocation or deallocation procedure.

Message Format:

```

<GA-Request> ::= <Diameter Header: 8388662, REQ, PXY >
  < Session-Id >
  { Auth-Application-Id }
  { Auth-Session-State }
  { Origin-Host }
  { Origin-Realm }
  { Destination-Realm }
  [ Destination-Host ]
  [ Origin-State-Id ]
  * [ Proxy-Info ]
  * [ Route-Record ]
  * { Supported-Features }
  [ TMGI-Allocation-Request ]
  [ TMGI-Deallocation-Request ]
  * [ MBMS-Bearer-Request ]
  [ Restart-Counter ]
  * [ AVP ]

```

6.6.3 GCS-Action-Answer (GAA) command

The GAA command, indicated by the Command-Code field set to xxx and the 'R' bit cleared in the Command Flags field, is sent by the BM-SC to the GCS AS as part of the MBMS bearer activation, modification, or deactivation procedure, or as part of the TMGI allocation or deallocation procedure.

Message Format:

```

<GA-Answer> ::= < Diameter Header: 8388662, PXY >
  < Session-Id >
  { Auth-Application-Id }
  { Auth-Session-State }
  { Origin-Host }
  { Origin-Realm }
  [ Result-Code ]
  [ Experimental-Result ]
  [ Error-Message ]
  [ Error-Reporting-Host ]
  * [ Failed-AVP ]
  [ Origin-State-Id ]
  * [ Redirect-Host ]
  [ Redirect-Host-Usage ]
  [ Redirect-Max-Cache-Time ]
  * [ Proxy-Info ]
  * { Supported-Features }
  [ TMGI-Allocation-Response ]
  * [ TMGI-Deallocation-Response ]
  * [ MBMS-Bearer-Response ]
  [ Restart-Counter ]
  * [ AVP ]

```

6.6.4 GCS-Notification-Request (GNR) command

The GNR command, indicated by the Command-Code field set to xxx and the 'R' bit set in the Command Flags field, is sent by the BM-SC to the GCS AS as part of the MBMS Bearer Status Indication procedure.

Message Format:

```

<GN-Request> ::= < Diameter Header: 8388663, REQ, PXY >
  < Session-Id >
    { Auth-Application-Id }
    { Auth-Session-State }
    { Origin-Host }
    { Origin-Realm }
    { Destination-Realm }
    { Destination-Host }
    [ Origin-State-Id ]
  * [ Proxy-Info ]
  * [ Route-Record ]
  [ TMGI-Expiry ]
  * [ MBMS-Bearer-Event-Notification ]
  [ Restart-Counter ]
  * [ AVP ]

```

6.6.5 GCS-Notification-Answer (GNA) command

The GNA command, indicated by the Command-Code field set to xxx and the 'R' bit cleared in the Command Flags field, is sent by the GCS AS to the BM-SC as part of the MBMS Bearer Status Indication procedure.

Message Format:

```

<GN-Answer> ::= < Diameter Header: 8388663, PXY >
  < Session-Id >
    { Auth-Application-Id }
    { Auth-Session-State }
    { Origin-Host }
    { Origin-Realm }
    [ Result-Code ]
    [ Experimental-Result ]
    [ Origin-State-Id ]
    [ Error-Message ]
    [ Error-Reporting-Host ]
  * [ Redirect-Host ]
    [ Redirect-Host-Usage ]
    [ Redirect-Max-Cache-Time ]
  * [ Failed-AVP ]
  * [ Proxy-Info ]
    [ Restart-Counter ]
  * [ AVP ]

```

7 MB2-U Protocol

7.1 Protocol Stack.

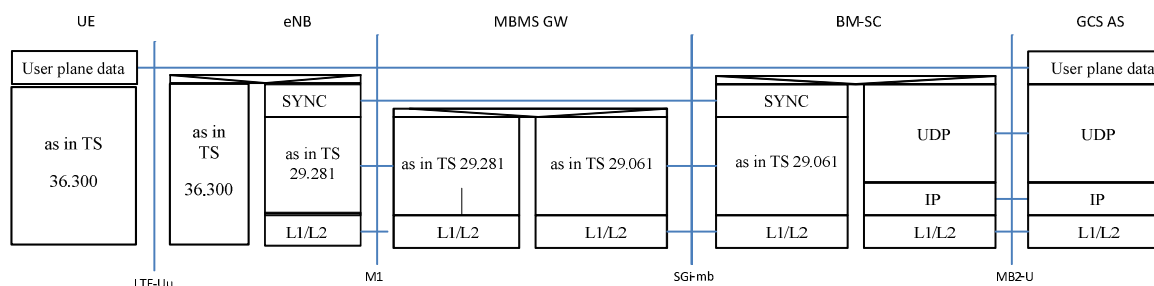

Figure 7.1-1: The user plane protocol stack without security protocols on the MB2-U reference point and in the EPC

Figure 7.1-1 depicts the MB2-U protocol stack without security protocols. The stack shall include:

- User plane data, for instance an IP layer and UDP layer. The user plane data are transparently transported between the GCS AS and the UE. The BM-SC shall forward these protocol layers transparently.

NOTE: The user plane data can contain data related to several services, which are transported in the same MBMS bearer. The multiplexing protocol is transparent to the BM-SC.

- UDP according to IETF RFC 768 [12]. UDP shall be terminated at the GCS AS and BM-SC.
- IP transported by lower layers L1 and L2. These layers shall be terminated at the GCS AS and BM-SC.

Figure 7.1-1 also depicts the Sgi-mb protocol stack defined in 3GPP TS 29.061 [6] and the M1 protocol stack as defined in 3GPP TS 29.274 [8] and 3GPP TS 29.281 [9] for informational purposes.

The security solutions for the MB2-U reference point in Annex N.3 of 3GPP TS 33.246 [10] shall apply. The MB2-U protocol stack is augmented depending on the selected security protocol:

- If DTLS (IETF RFC 6347 [21]) is used, it resides in the MB2-U protocol stack between UDP and the user plane data as shown on Figure 7.1-2.
- If IPsec is used without UDP encapsulation for NAT traversal, IKE (IETF RFC 5996 [17]), is transported on top of UDP during the security association establishment, and ESP (IETF RFC 4303 [20]), resides in the MB2-U protocol stack between IP and UDP, as shown on Figure 7.1-3.
- If IPsec is used with possible UDP encapsulation for NAT traversal, IKE (IETF RFC 5996 [17]), is transported on top of UDP during the security association establishment. IKE is used according to IETF RFC 3947 [18] to negotiate if UDP encapsulating of ESP is used for NAT-Traversal. If UDP encapsulating of ESP (IETF RFC 3948 [19]), is used, a lower IP layer, a lower UDP layer and ESP reside in the MB2-U protocol stack between L1/L2 and the IP layer shown in Figure 7.1-1; see Figure 7.1-4. Otherwise, ESP (IETF RFC 4303 [20]), resides in the MB2-U protocol stack between IP and UDP.

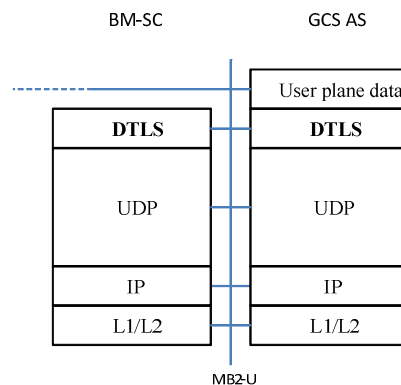

Figure 7.1-2: MB2-U Protocol stack with DTLS Security

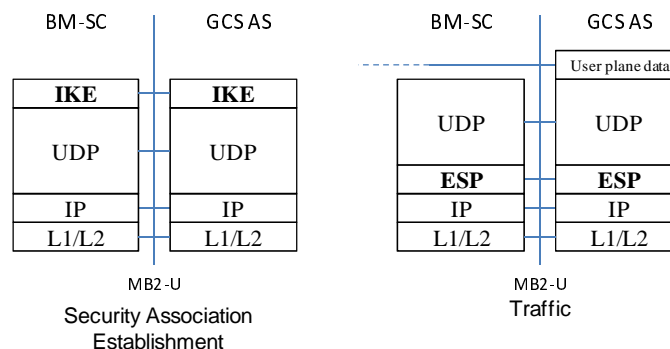

Figure 7.1-3: MB2-U Protocol stack with IPsec Security without UDP encapsulation

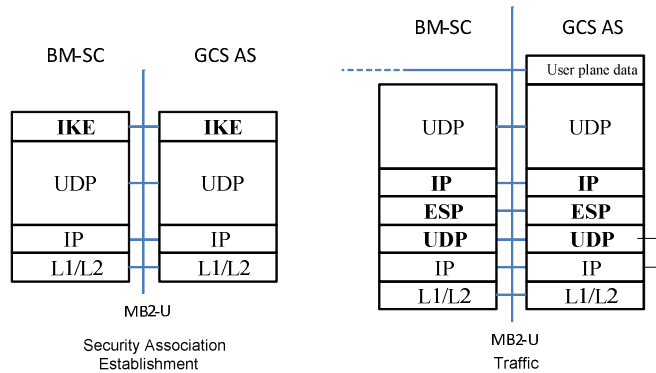

Figure 7.1-4: MB2-U Protocol stack with IPsec Security with UDP encapsulation

7.2 Procedures

When receiving an MBMS bearer allocation request via the MB2-C reference point, the BM-SC shall select an own IP address to receive user plane data from the GCS AS sending the request. The BM-SC shall also allocate a value for the UDP port that is unique on the selected IP address for the MBMS bearer to be activated. The BM-SC shall decide whether to use MB2-U Security. The BM-SC shall send the IP address (within the BMSC-Address AVP), the UDP port value (within the BMSC-Port AVP), and, if MB2-U Security is applied, a request to use user plane security (within the MB2U-Security AVP), in the response to the MBMS bearer allocation request via the MB2-C reference point to the GCS AS.

If security was requested by the BM-SC, the GCS AS shall either establish a new security association or reuse an existing security association towards the BM-SC. The security protocol (DTLS or IKE/Ipsec) to be used over MB2-U needs to be configured in the GCS AS, possibly dependent on BM-SC and/or target network.

For IPsec, the IP address shall also apply to the transport of IKE.

NOTE 1: Well-known UDP ports are used for IKE.

For UDP encapsulation of ESP, IETF RFC 3948 [19], the IP address shall apply both to the lower IP layer and the upper IP layer layer shown in Figure 7.1-4. The UDP port shall apply to the upper IP layer layer shown in Figure 7.1-4.

NOTE 2: A well-known UDP port for ESP is used in the lower layer.

The BM-SC shall then transparently forward any user plane data within UDP packets, which are received over the MB2-U reference point at the allocated UDP port on the selected IP address, to the corresponding MBMS bearer at the Sgi-mb interface. The BM-SC shall continue forwarding received payload until the corresponding MBMS Bearer is deallocated.

When receiving an MBMS bearer allocation response via the MB2-C reference point, the GCS AS shall store the contained IP address and UDP port and may send user plane data for the corresponding MBMS bearer until the MBMS Bearer is deallocated.

NOTE 3: The GCS AS will be informed about the MBMS bearer deallocation by MB2-C procedures defined in clause 6.

To send user plane data towards the MBMS bearer, the GCS AS shall encapsulate them in UDP; it shall use the UDP port signalled by the BM-SC as destination UDP port, and it shall send the resulting packets towards the IP address signalled by the BM-SC.

Annex A (informative): Call Flows

A.1 TMGI Management

A.1.1 TMGI Allocation Procedure

The TMGI allocation procedure is used by the GCS AS to request TMGI(s). This procedure may also be used to renew the expiration time for already allocated TMGI(s).

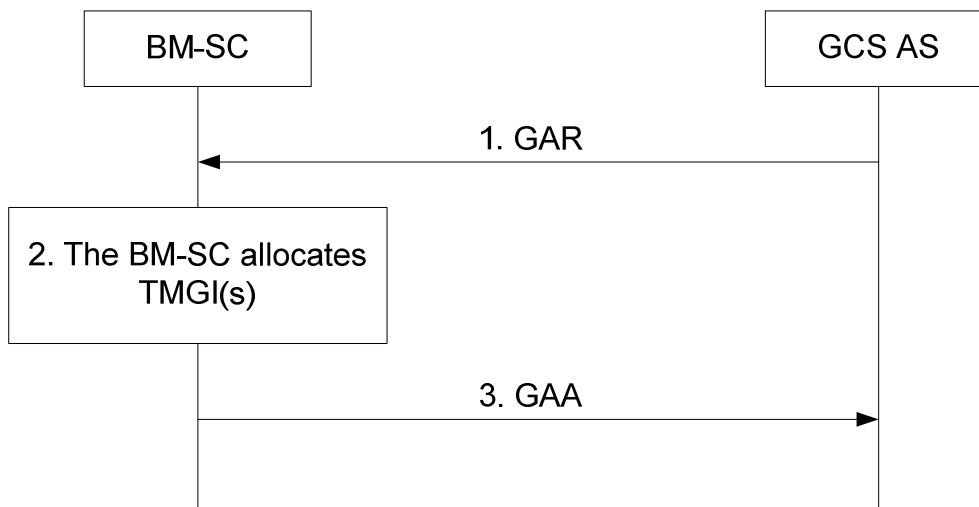

Figure A.1.1-1: TMGI Allocation Procedure

1. If the GCS AS needs to request from the BM-SC the allocation of one or more TMGIs, the GCS AS shall send a Diameter GAR command including the parameters as defined in subclause 5.2.1.
2. The BM-SC determines whether the GCS AS is authorized to receive the TMGIs and allocates a set of TMGIs. The BM-SC determines an expiration time for the TMGIs. If a list of TMGIs has been received in the previous Diameter GAR command, the BM-SC also determines whether the TMGIs are allocated to the requesting GCS AS and if yes, whether the expiration time for those TMGIs can be set to the new expiration time.
3. The BM-SC send a Diameter GAA command including the parameters as defined in subclause 5.2.1.

A.1.2 TMGI Deallocation Procedure

The TMGI Deallocation procedure is used by the GCS AS to request the BM-SC to immediately release TMGI(s), irrespective of their expiration time(s).

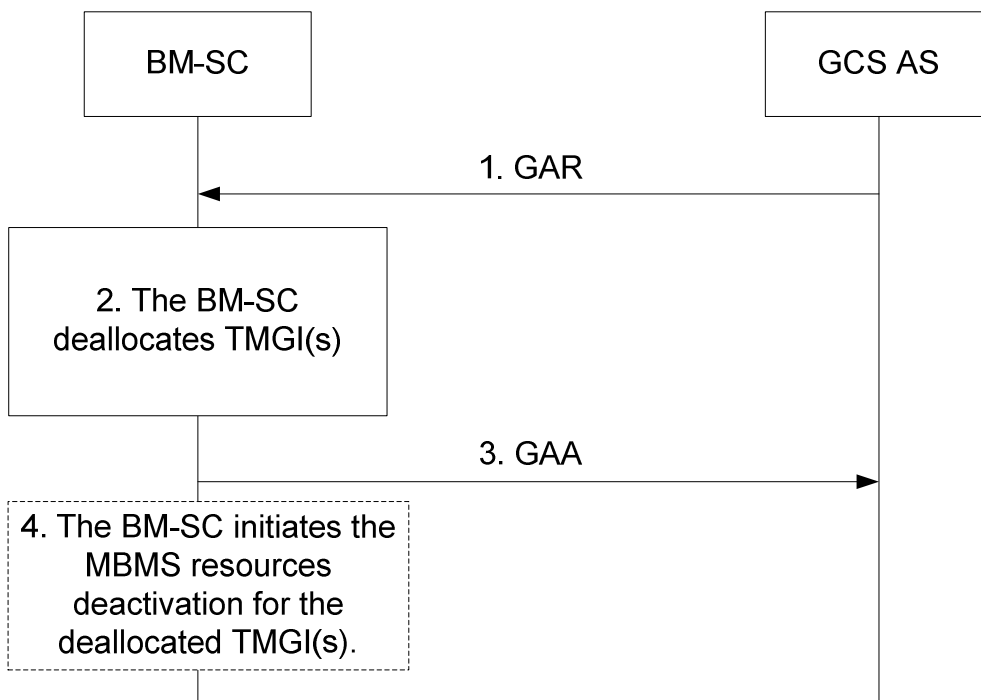

Figure A.1.2-1: TMGI Deallocation Procedure

1. If the GCS AS decides that one or more allocated TMGIs are no longer needed, the GCS AS sends a Diameter GAR command including the parameters as defined in subclause 5.2.2.
2. The BM-SC determines if the GCS AS is authorized to deallocate the indicated TMGIs, and then deallocates those TMGIs. If MBMS resources are in use for any of the deallocated TMGIs, those resources are released using the Session Stop procedure defined in TS 23.246 [3].
3. The BM-SC sends a Diameter GAA command including the parameters as defined in subclause 5.2.2.
4. If MBMS resources are in use for any of the deallocated TMGIs, the BM-SC initiates the Session Stop procedure defined in sub-clause 20.3.3 of TS 29.061 [6] to release those resources.

A.1.3 TMGI Expiry Notification

The TMGI expiry notification procedure is used by the BM-SC to notify the GCS AS when a timer expires for a TMGI.

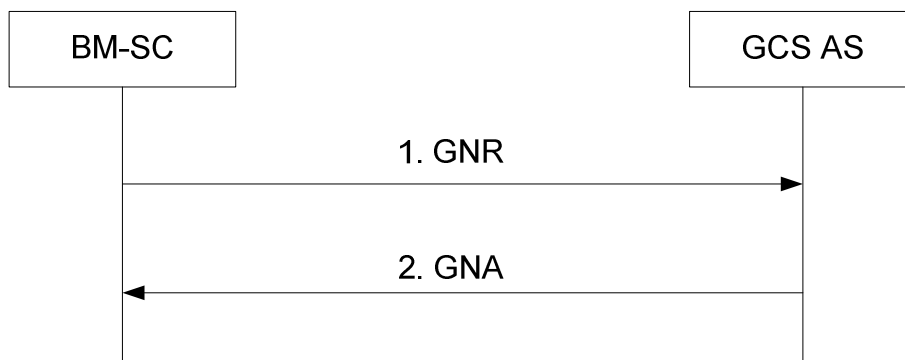

Figure A.1.3-1: TMGI Expiry Notification Procedure

1. If the BM-SC detects a timer expiry for a TMGI, the BM-SC sends a Diameter GNR command to indicate the TMGI expiry to GCS AS including TMGI-Expiry AVP. If there is (are) active MBMS bearer(s) related to this

expiring TMGI, the BM-SC terminates this (these) bearer(s) by applying the Session Stop procedure as defined in subclause 20.3.3 of 3GPP TS 29.061 [6].

2. The GCS AS responds to the BM-SC with a Diameter GNA command. The Diameter session ends after the GNA command.

A.2 MBMS Bearer Control Procedures

A.2.1 Activate MBMS Bearer Procedure

The Activate MBMS Bearer procedure is used by the GCS AS to cause the allocation of resources for an MBMS bearer.

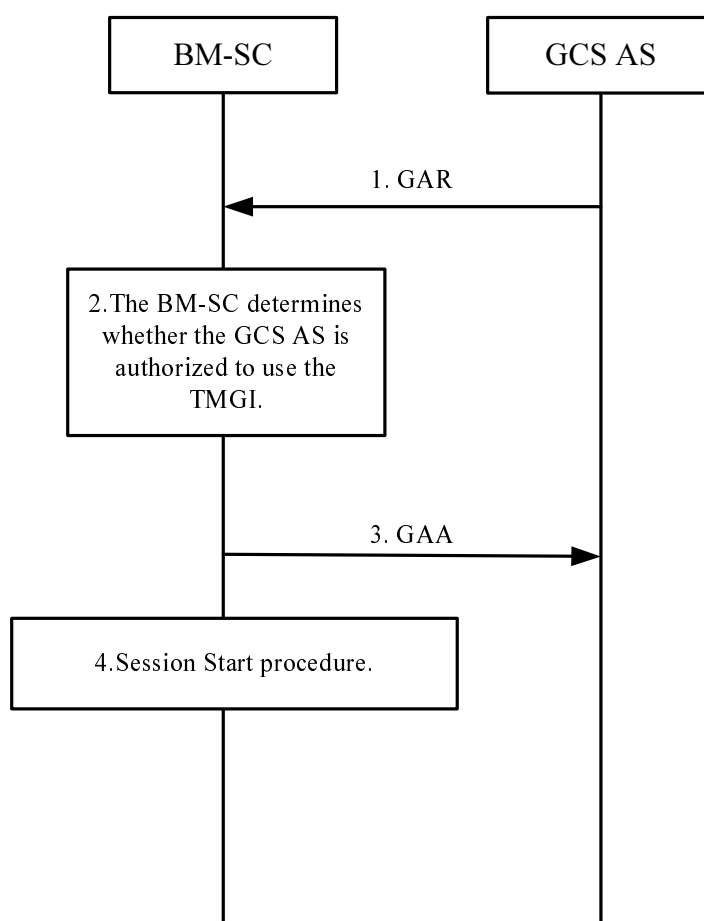

Figure A.2.1.1: Activate MBMS bearer Procedure

1. When the GCS AS wishes to activate an MBMS bearer, the GCS AS sends a GAR command to the BM-SC, including the parameters as defined in subclause 5.3.2.
2. The BM-SC determines whether the GCS AS is authorized to use the TMGI.
3. The BM-SC sends a GAA command to the GCS AS including the parameters as defined in subclause 5.3.2.
4. If the authorization is successful, the BM-SC applies the Session Start procedure as defined in subclause 20.3.1 of 3GPP 29.061 [6].

A.2.2 Deactivate MBMS Bearer Procedure

The Deactivate MBMS Bearer procedure is used by the GCS AS to cause the deallocation of resources for an MBMS bearer.

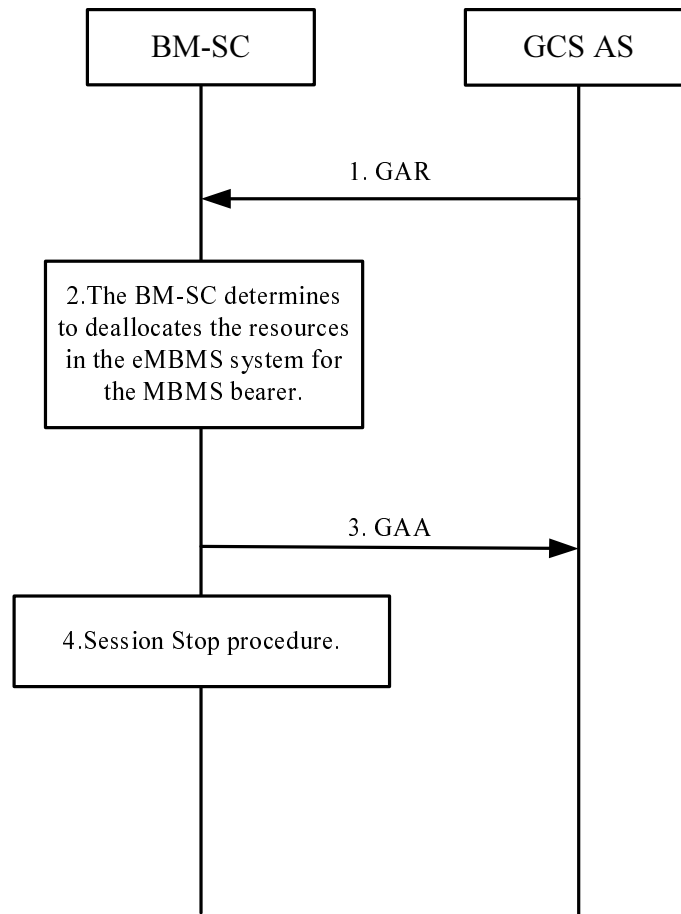

Figure A.2.2.1: Deactivate MBMS bearer Procedure

1. When the GCS AS determines that the MBMS bearer is no longer needed, it sends a GAR command to the BM-SC, including the parameters as defined in subclause 5.3.3.
2. The BM-SC determines whether the GCS AS is authorized to use the TMGI and determines to deallocate the resources in the eMBMS system for the MBMS bearer.
3. The BM-SC sends a GAA command to the GCS AS including the parameters as defined in subclause 5.3.3.
4. The BM-SC applies the Session Stop procedure as defined in subclause 20.3.3 of 3GPP TS 29.061 [6].

A.2.3 Modify MBMS Bearer Procedure

The Modify MBMS Bearer procedure is used by the GCS AS to cause modification of the priority and pre-emption values for an MBMS bearer, the MBMS broadcast area, or both.

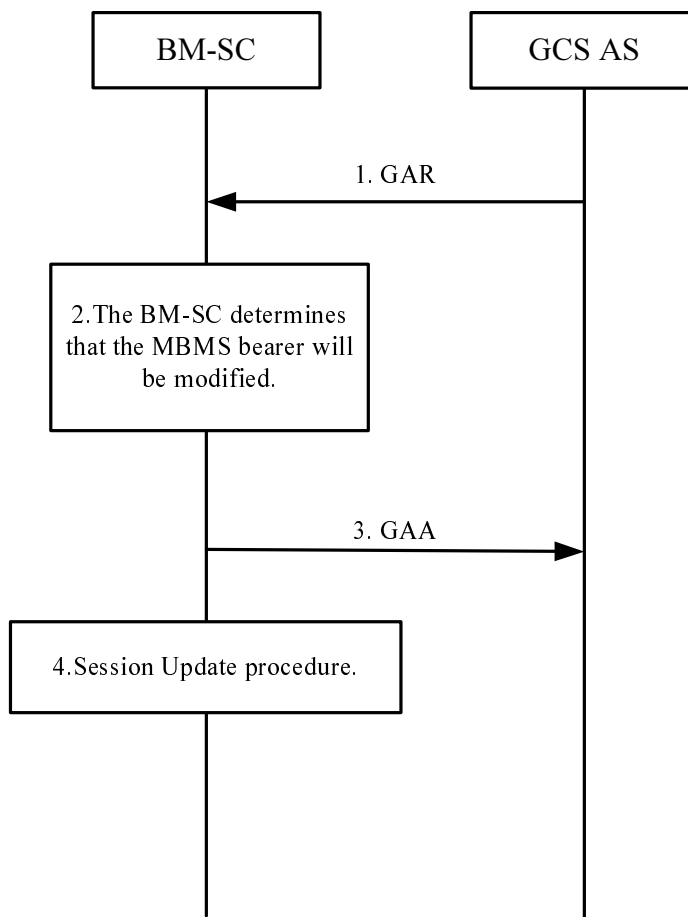

Figure A.2.3.1: Modify MBMS bearer Procedure

1. When the GCS AS determines that an activated MBMS bearer needs to be modified, it sends a GAR command to the BM-SC, including the parameters as defined in subclause 5.3.4.
2. The BM-SC determines that the MBMS bearer can be modified.
3. The BM-SC sends a GAA command to the GCS AS including the parameters as defined in subclause 5.3.4.
4. The BM-SC applies the Session Update procedure as defined in subclause 20.3.2 of 3GPP TS 29.061 [6].

A.2.4 MBMS Bearer Status Indication Procedure

Figure A.2.4-1 provides the procedure used between the GCS AS and the BM-SC to indicate the change of the MBMS bearer status, e.g. a release of the MBMS bearer.

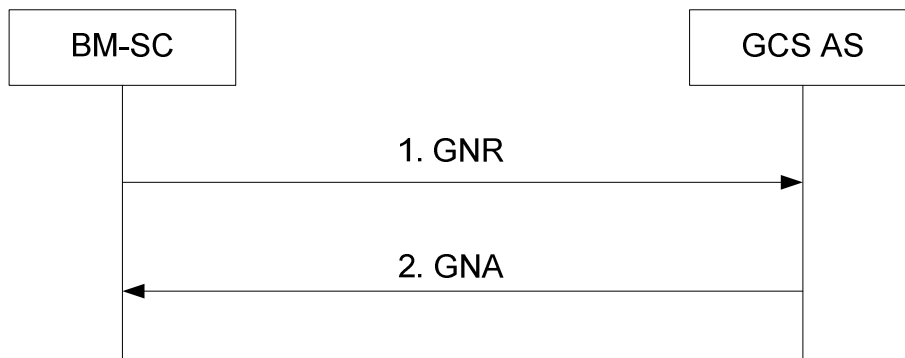

Figure A.2.4-1: MBMS Bearer Status Indication Procedure

1. If the BM-SC receives a MBMS session termination request initiated by MBMS GW, the BM-SC sends a Diameter GNR command to indicate the bearer status to the GCS AS including the parameters as defined in subclause 5.3.5. Other actions which will trigger the MBMS bearer status indication procedure are not included in this specification.
2. The GCS AS responds to the BM-SC with a Diameter GNA command. The Diameter session ends after the GNA command.

A.3 Restoration Procedures

A.3.1 GCS AS initiated Heartbeat Procedure

The Heartbeat Procedure is used by the GCS AS to detect an MB2-C path failure or the outage or restart of a peer BM-SC.

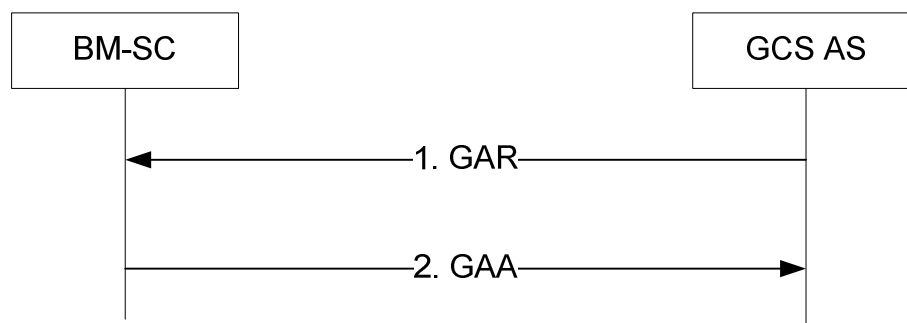

Figure A.3.1-1: GCS AS initiated Heartbeat Procedure

1. The GCS AS periodically sends a GAR including the Restart-Counter AVP to a peer BM-SC when no other signalling is exchanged between those two nodes, as defined in subclause 5.6.3.
2. The BM-SC replies with a GAR including the Restart-Counter AVP.

A.3.2 BM-SC initiated Heartbeat Procedure

The Heartbeat Procedure is used by the BM-SC to detect an MB2-C path failure or the outage or restart of a peer GCS AS.

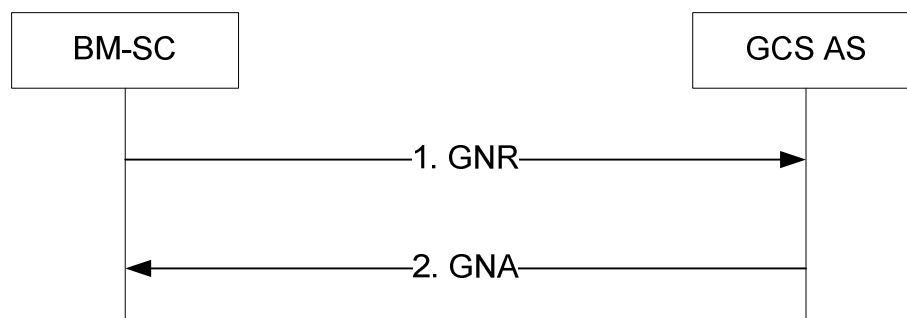

Figure A.3.2-1: BM-SC initiated Heartbeat Procedure

1. The BM-SC periodically sends a GNR including the Restart-Counter AVP to a peer GCS AS when no other signalling is exchanged between those two nodes, as defined in subclause 5.6.4.
2. The GCS AS replies with a GNR including the Restart-Counter AVP.

Annex B (informative): Change history

| Change history | | | | | | | |
|----------------|-------|-----------|-----|-----|---|--------|--------|
| Date | TSG # | TSG Doc. | CR | Rev | Subject/Comment | Old | New |
| 09/2014 | CT#65 | CP-140562 | | | MCC clean-up for presentation for approval to CT#65 | 1.1.0 | 2.0.0 |
| 09/2014 | CT#65 | CP-140562 | | | Raised to v.12.0.0 following CT#65 approval | 2.0.0 | 12.0.0 |
| 10/2014 | - | - | - | - | "Foreword" section added | 12.0.0 | 12.0.1 |
| 12/2014 | CT#66 | CP-140910 | 001 | 1 | "Foreword" section added | 12.0.1 | 12.1.0 |
| 12/2014 | CT#66 | CP-140910 | 002 | | TMGI allocation and deallocation by BM-SC | 12.0.1 | 12.1.0 |
| 12/2014 | CT#66 | CP-140910 | 003 | | MBMS bearers termination based on TMGI deallocation request from GCS AS | 12.0.1 | 12.1.0 |
| 12/2014 | CT#66 | CP-140910 | 004 | | Protocol Numbers | 12.0.1 | 12.1.0 |
| 12/2014 | CT#66 | CP-140910 | 005 | 3 | MB2-U Security | 12.0.1 | 12.1.0 |
| 12/2014 | CT#66 | CP-140910 | 006 | 1 | MB2-U User Plane terminated in the UE | 12.0.1 | 12.1.0 |
| 12/2014 | CT#66 | CP-140910 | 007 | 3 | Heartbeat procedure | 12.0.1 | 12.1.0 |
| 12/2014 | CT#66 | CP-140910 | 008 | 1 | Correction of the MB2 mandatory function | 12.0.1 | 12.1.0 |
| 12/2014 | CT#66 | CP-140910 | 009 | 2 | Correction of the TMGI allocation and deallocation procedures | 12.0.1 | 12.1.0 |
| 12/2014 | CT#66 | CP-140910 | 010 | 1 | Correction of the TMGI handling | 12.0.1 | 12.1.0 |
| 03/2015 | CT#67 | CP-150119 | 012 | 1 | TMGI and Flow ID Handling | 12.1.0 | 12.2.0 |
| 03/2015 | CT#67 | CP-150119 | 013 | 3 | Activation of an additional MBMS Bearer for a TMGI with already an active MBMS Bearer | 12.1.0 | 12.2.0 |

History

| Document history | | |
|-------------------------|--------------|-------------|
| V12.0.1 | October 2014 | Publication |
| V12.1.0 | January 2015 | Publication |
| V12.2.0 | April 2015 | Publication |
| | | |
| | | |