

ETSI TS 131 111 V4.4.0 (2001-09)

Technical Specification

**Digital cellular telecommunications system (Phase 2+) (GSM);
Universal Mobile Telecommunications System (UMTS);
USIM Application Toolkit (USAT)
(3GPP TS 31.111 version 4.4.0 Release 4)**



Reference

RTS/TSGT-0331111Uv4R2

Keywords

GSM, UMTS

ETSI

650 Route des Lucioles
F-06921 Sophia Antipolis Cedex - FRANCE

Tel.: +33 4 92 94 42 00 Fax: +33 4 93 65 47 16

Siret N° 348 623 562 00017 - NAF 742 C
Association à but non lucratif enregistrée à la
Sous-Préfecture de Grasse (06) N° 7803/88

Important notice

Individual copies of the present document can be downloaded from:

<http://www.etsi.org>

The present document may be made available in more than one electronic version or in print. In any case of existing or perceived difference in contents between such versions, the reference version is the Portable Document Format (PDF). In case of dispute, the reference shall be the printing on ETSI printers of the PDF version kept on a specific network drive within ETSI Secretariat.

Users of the present document should be aware that the document may be subject to revision or change of status. Information on the current status of this and other ETSI documents is available at

<http://portal.etsi.org/tb/status/status.asp>

If you find errors in the present document, send your comment to:

editor@etsi.fr

Copyright Notification

No part may be reproduced except as authorized by written permission.
The copyright and the foregoing restriction extend to reproduction in all media.

© European Telecommunications Standards Institute 2001.
All rights reserved.

Intellectual Property Rights

IPRs essential or potentially essential to the present document may have been declared to ETSI. The information pertaining to these essential IPRs, if any, is publicly available for **ETSI members and non-members**, and can be found in ETSI SR 000 314: "*Intellectual Property Rights (IPRs); Essential, or potentially Essential, IPRs notified to ETSI in respect of ETSI standards*", which is available from the ETSI Secretariat. Latest updates are available on the ETSI Web server (<http://www.etsi.org/legal/home.htm>).

Pursuant to the ETSI IPR Policy, no investigation, including IPR searches, has been carried out by ETSI. No guarantee can be given as to the existence of other IPRs not referenced in ETSI SR 000 314 (or the updates on the ETSI Web server) which are, or may be, or may become, essential to the present document.

Foreword

This Technical Specification (TS) has been produced by ETSI 3rd Generation Partnership Project (3GPP).

The present document may refer to technical specifications or reports using their 3GPP identities, UMTS identities or GSM identities. These should be interpreted as being references to the corresponding ETSI deliverables.

The cross reference between GSM, UMTS, 3GPP and ETSI identities can be found under www.etsi.org/key.

Contents

Intellectual Property Rights	2
Foreword.....	2
Foreword.....	9
1 Scope	10
2 References	10
3 Definitions, abbreviations and symbols	11
3.1 Definitions	11
3.2 Abbreviations	12
3.3 Symbols.....	13
4 Overview of USAT	13
4.1 Profile Download	14
4.2 Proactive UICC	14
4.3 Data download to UICC	14
4.4 Menu selection	14
4.5 Call control by USIM.....	15
4.6 MO Short Message control by USIM.....	15
4.7 Event download.....	15
4.8 Security	15
4.9 Multiple card	15
4.10 Timer Expiration	15
4.11 Bearer Independent Protocol	15
5 Profile download	16
5.1 Procedure.....	16
5.2 Structure and coding of TERMINAL PROFILE.....	16
5.3 Definition of display parameters in Profile download.....	20
5.3.1 Number of characters supported down the ME display	20
5.3.2 Number of characters supported across the ME display	20
5.3.3 Display can be resized	20
5.3.4 Text Wrapping	20
5.3.5 Text Scrolling	20
5.3.6 Width reduction when in a menu	21
6 Proactive UICC	21
6.1 Introduction	21
6.2 Identification of ME support	23
6.3 General procedure	23
6.4 Proactive UICC commands and procedures.....	24
6.4.1 DISPLAY TEXT	24
6.4.2 GET INKEY	25
6.4.3 GET INPUT.....	26
6.4.4 MORE TIME.....	28
6.4.5 PLAY TONE	28
6.4.6 POLL INTERVAL	28
6.4.7 REFRESH.....	29
6.4.7.1 EF _{IMSI} changing procedure	30
6.4.8 SET UP MENU	30
6.4.9 SELECT ITEM.....	31
6.4.10 SEND SHORT MESSAGE	32
6.4.11 SEND SS	33
6.4.12 SEND USSD.....	34
6.4.13 SET UP CALL.....	35
6.4.14 POLLING OFF	36
6.4.15 PROVIDE LOCAL INFORMATION	36

6.4.16	SET UP EVENT LIST	37
6.4.17	PERFORM CARD APDU	37
6.4.18	POWER OFF CARD	38
6.4.19	POWER ON CARD	39
6.4.20	GET READER STATUS	39
6.4.21	TIMER MANAGEMENT	39
6.4.22	SET UP IDLE MODE TEXT	40
6.4.23	RUN AT COMMAND	40
6.4.24	SEND DTMF	41
6.4.25	LANGUAGE NOTIFICATION	42
6.4.26	LAUNCH BROWSER	42
6.4.27	OPEN CHANNEL	43
6.4.27.1	OPEN CHANNEL related to CS bearer	43
6.4.27.2	OPEN CHANNEL related to GPRS	44
6.4.27.3	OPEN CHANNEL related to local bearer	45
6.4.28	CLOSE CHANNEL	47
6.4.29	RECEIVE DATA	48
6.4.30	SEND DATA	48
6.4.31	GET CHANNEL STATUS	49
6.4.32	DECLARE SERVICE	49
6.4.33	SERVICE SEARCH	50
6.4.34	GET SERVICE INFORMATION	51
6.5	Common elements in proactive UICC commands	51
6.5.1	Command number	51
6.5.2	Device identities	51
6.5.3	Alpha identifier	51
6.5.4	Icon identifiers	52
6.6	Structure of proactive UICC commands	52
6.6.1	DISPLAY TEXT	52
6.6.2	GET INKEY	52
6.6.3	GET INPUT	53
6.6.4	MORE TIME	53
6.6.5	PLAY TONE	53
6.6.6	POLL INTERVAL	54
6.6.7	SET-UP MENU	54
6.6.8	SELECT ITEM	55
6.6.9	SEND SHORT MESSAGE	55
6.6.10	SEND SS	55
6.6.11	SEND USSD	56
6.6.12	SET UP CALL	56
6.6.13	REFRESH	56
6.6.14	POLLING OFF	56
6.6.15	PROVIDE LOCAL INFORMATION	57
6.6.16	SET UP EVENT LIST	57
6.6.17	PERFORM CARD APDU	57
6.6.18	POWER OFF CARD	57
6.6.19	POWER ON CARD	57
6.6.20	GET READER STATUS	57
6.6.21	TIMER MANAGEMENT	58
6.6.22	SET UP IDLE MODE TEXT	58
6.6.23	RUN AT COMMAND	58
6.6.24	SEND DTMF COMMAND	58
6.6.25	LANGUAGE NOTIFICATION	59
6.6.26	LAUNCH BROWSER	59
6.6.27	OPEN CHANNEL	60
6.6.27.1	OPEN CHANNEL related to CS bearer	60
6.6.27.2	OPEN CHANNEL related to GPRS	61
6.6.27.3	OPEN CHANNEL for local links	61
6.6.28	CLOSE CHANNEL	62
6.6.29	RECEIVE DATA	62
6.6.30	SEND DATA	62
6.6.31	GET CHANNEL STATUS	63

6.6.32	SERVICE SEARCH	63
6.6.33	GET SERVICE INFORMATION	63
6.6.34	DECLARE SERVICE	63
6.7	Command results	63
6.8	Structure of TERMINAL RESPONSE	65
6.8.1	Command details	67
6.8.2	Device identities	67
6.8.3	Result	67
6.8.4	Duration	67
6.8.5	Text string	67
6.8.6	Item identifier	68
6.8.7	Local information	68
6.8.8	Call control requested action	68
6.8.9	Result data object 2	68
6.8.10	Card reader status	68
6.8.11	Card ATR	68
6.8.12	R-APDU	69
6.8.13	Timer identifier	69
6.8.14	Timer value	69
6.8.15	AT Response	69
6.8.16	Text string 2	69
6.8.17	Channel data	69
6.8.18	Channel status	69
6.8.19	Channel data length	69
6.8.20	Bearer description	70
6.8.21	Buffer size	70
6.8.22	Total Display Duration	70
6.8.23	Service Availability	70
6.8.24	Service Record	70
6.9	Proactive UICC session and ME display interaction	70
6.10	Handling of unknown, unforeseen and erroneous messages	71
6.10.1	General	71
6.10.2	Message too short	71
6.10.3	Missing minimum information	71
6.10.4	Unknown Tag value	71
6.10.5	Unexpected Tag value	71
6.10.6	Length errors	72
6.10.7	Contents not understood	72
6.10.8	Extended length data objects	72
6.11	Proactive commands versus possible Terminal response	72
7	ENVELOPE Commands	75
7.1	Data download to UICC	75
7.1.1	SMS-PP data download	75
7.1.1.1	Procedure	75
7.1.1.2	Structure of ENVELOPE (SMS-PP DOWNLOAD)	75
7.1.2	Cell Broadcast data download	76
7.1.2.1	Procedure	76
7.1.2.2	Structure of ENVELOPE (CELL BROADCAST DOWNLOAD)	76
7.2	Menu Selection	77
7.2.1	Procedure	77
7.2.2	Structure of ENVELOPE (MENU SELECTION)	77
7.3	Call Control and MO SMS control by USIM	78
7.3.1	Call Control by USIM	78
7.3.1.1	Procedure for mobile originated calls	78
7.3.1.2	Procedure for Supplementary Services and USSD	79
7.3.1.3	Indication to be given to the user	80
7.3.1.4	Interaction with Fixed Dialling Number	80
7.3.1.5	Support of Barred Dialling Number (BDN) service	81
7.3.1.6	Structure of ENVELOPE (CALL CONTROL)	81
7.3.2	MO Short Message Control by USIM	84
7.3.2.1	Description	84

7.3.2.2	Structure of ENVELOPE (MO SHORT MESSAGE CONTROL)	84
7.3.2.3	Indication to be given to the user	85
7.3.2.4	Interaction with Fixed Dialling Number	85
7.4	Timer Expiration	85
7.4.1	Description	85
7.4.2	Structure of ENVELOPE (TIMER EXPIRATION)	85
7.5	Event download	86
7.5.1	MT call event	86
7.5.1.1	Procedure	86
7.5.1.2	Structure of ENVELOPE (EVENT DOWNLOAD - MT call)	86
7.5.2	Call connected event	87
7.5.2.1	Procedure	87
7.5.2.2	Structure of ENVELOPE (EVENT DOWNLOAD - call connected)	87
7.5.3	Call disconnected event	88
7.5.3.1	Procedure	88
7.5.3.2	Structure of ENVELOPE (EVENT DOWNLOAD - Call disconnected)	88
7.5.4	Location status event	89
7.5.4.1	Procedure	89
7.5.4.2	Structure of ENVELOPE (EVENT DOWNLOAD - Location status)	89
7.5.5	User activity event	90
7.5.5.1	Procedure	90
7.5.5.2	Structure of ENVELOPE (EVENT DOWNLOAD - User activity)	90
7.5.6	Idle screen available event	91
7.5.6.1	Procedure	91
7.5.6.2	Structure of ENVELOPE (EVENT DOWNLOAD - Idle screen available)	91
7.5.7	Card reader status event	91
7.5.7.1	Procedure	92
7.5.7.2	Structure of ENVELOPE (EVENT DOWNLOAD - card reader status)	92
7.5.8	Language selection event	92
7.5.8.1	Procedure	92
7.5.8.2	Structure of ENVELOPE (language selection)	92
7.5.9	Browser Termination event	93
7.5.9.1	Procedure	93
7.5.9.2	Structure of ENVELOPE (browser termination)	93
7.5.10	Data available event	94
7.5.10.1	Procedure	94
7.5.10.2	Structure of ENVELOPE (EVENT DOWNLOAD – Data available)	94
7.5.11	Channel status event	94
7.5.11.1	Procedure	94
7.5.11.2	Structure of ENVELOPE (EVENT DOWNLOAD – Channel status)	95
7.5.12	Access Technology Change Event	95
7.5.12.1	Procedure	95
7.5.12.2	Structure of ENVELOPE (EVENT DOWNLOAD – Access Technology Change)	95
7.5.13	Display parameters changed event	96
7.5.13.1	Procedure	96
7.5.13.2	Structure of ENVELOPE (EVENT DOWNLOAD – Display parameters changed)	96
7.5.14	Local Connection event	96
7.5.14.1	Procedure	96
7.5.14.2	Structure of ENVELOPE (EVENT DOWNLOAD – Local Connection)	96
8	SIMPLE-TLV data objects	97
8.1	Address	97
8.2	Alpha identifier	98
8.3	Subaddress	98
8.4	Capability configuration parameters	98
8.5	Cell Broadcast Page	98
8.6	Command details	99
8.7	Device identities	103
8.8	Duration	104
8.9	Item	105
8.10	Item identifier	105
8.11	Response length	105

8.12	Result.....	105
8.12.1	Additional information for SEND SS	107
8.12.2	Additional information for ME problem.....	107
8.12.3	Additional information for network problem.....	107
8.12.4	Additional information for SS problem	108
8.12.5	Additional information for SMS problem.....	108
8.12.6	Not used	108
8.12.7	Additional information for USSD problem	108
8.12.8	Additional information for interaction with call control or MO SM control	108
8.12.9	Additional information for MultipleCard commands	108
8.12.10	Additional information for Launch Browser problem	109
8.12.11	Additional information for Bearer Independent Protocol	109
8.13	SMS TPDU	110
8.14	SS string	110
8.15	Text string	110
8.15.1	Coding of text in unpacked format	110
8.15.2	Coding of text in packed format	110
8.15.3	Coding of text in 16 bits UCS2 alphabet format.....	111
8.16	Tone.....	111
8.17	USSD string.....	112
8.18	File List	112
8.19	Location Information.....	112
8.20	IMEI	113
8.21	Help Request	113
8.22	Network Measurement Results.....	113
8.23	Default Text.....	113
8.24	Items Next Action Indicator	113
8.25	Event list.....	114
8.26	Cause	114
8.27	Location status.....	115
8.28	Transaction identifier	115
8.29	BCCCH channel list.....	115
8.30	Call control requested action	116
8.31	Icon Identifier	116
8.32	Item Icon Identifier list.....	117
8.33	Card reader status	117
8.34	Card ATR	118
8.35	C-APDU	119
8.36	R-APDU	119
8.37	Timer identifier	119
8.38	Timer value	120
8.39	Date-Time and Time zone	120
8.40	AT Command.....	120
8.41	AT Response	121
8.42	BC Repeat indicator	121
8.43	Immediate response	121
8.44	DTMF string.....	121
8.45	Language	122
8.46	Timing Advance	122
8.47	Browser Identity	122
8.48	URL.....	122
8.49	Bearer	123
8.50	Provisioning File Reference	123
8.51	Browser Termination Cause	123
8.52	Bearer description.....	123
8.52.1	Bearer parameters for CSD	124
8.52.2	Bearer parameters for GPRS/Packet Service	124
8.52.3	Default bearer	125
8.52.4	Bearer parameters for local links (Bluetooth, IrDA, RS232, USB)	125
8.53	Channel data.....	125
8.54	Channel data length	125
8.55	Buffer size	125

8.56	Channel status	126
8.57	Card reader identifier.....	126
8.58	Other Address.....	127
8.59	SIM/ME interface transport level.....	127
8.60	AID.....	127
8.61	Network Access Name	127
8.62	Access Technology.....	128
8.63	Display parameters	128
8.64	Service Record	129
8.65	Device Filter.....	130
8.66	Service Search	131
8.67	Attribute Information	131
8.68	Service Availability.....	132
8.69	Remote Entity Address.....	132
9	Tag values	133
9.1	BER-TLV tags in ME to UICC direction	133
9.2	BER-TLV tags in UICC TO ME direction.....	133
9.3	SIMPLE-TLV tags in both directions	134
9.4	Type of Command and Next Action Indicator	136
10	Allowed Type of command and Device identity combinations	137
11	Security requirements.....	138
Annex A (normative): Support of USAT by Mobile Equipment.....		139
Annex B (informative): Example of DISPLAY TEXT Proactive UICC Command		140
Annex C (normative): Structure of USAT communications		141
C.1	SIMPLE-TLV tag format	141
C.1.1	Single byte format	142
C.1.2	Three-byte format.....	142
Annex D (informative): ME display in proactive UICC session		143
Annex E (informative): Help information feature processing.....		144
Annex F (informative): Monitoring of events		145
Annex G (normative): Support of Multiple Card Operation		146
Annex H (informative): Multiple Card proactive command examples		147
Annex I (informative): Bearer independent protocol proactive command examples		148
Annex J (informative): WAP References		151
Annex K (informative): Use of USAT Bearer independent protocol for local links Bluetooth case		152
K.1	Service Search command	152
K.2	Get Service Information command.....	152
K.3	OPEN CHANNEL command.....	152
Annex L (informative): Bluetooth Service Discovery protocol		154
L.1	Service Attribute:	154
Annex M (informative): Use of USAT Bearer independent protocol for local links, server case		156
Annex N (informative): Change history		157
History		158

Foreword

This Technical Specification (TS) has been produced by the 3rd Generation Partnership Project (3GPP).

The contents of the present document are subject to continuing work within the TSG and may change following formal TSG approval. Should the TSG modify the contents of the present document, it will be re-released by the TSG with an identifying change of release date and an increase in version number as follows:

Version x.y.z

where:

- x the first digit:
 - 1 presented to TSG for information;
 - 2 presented to TSG for approval;
 - 3 or greater indicates TSG approved document under change control.
- y the second digit is incremented for all changes of substance, i.e. technical enhancements, corrections, updates, etc.
- z the third digit is incremented when editorial only changes have been incorporated in the document.

1 Scope

The present document defines the interface between the Universal ICC (UICC) and the Mobile Equipment (ME), and mandatory ME procedures, specifically for "USIM Application Toolkit".

USAT is a set of commands and procedures for use during the network operation phase of 3G, in addition to those defined in TS 31.101 [13].

Specifying the interface is to ensure interoperability between a UICC and an ME independently of the respective manufacturers and operators.

The present document defines:

- the commands;
- the application protocol;
- the mandatory requirements on the UICC and ME for each procedure.

The present document does not specify any aspects related to the administrative management phase. Any internal technical realization of either the UICC or the ME are only specified where these reflect over the interface. The present document does not specify any of the security algorithms which may be used.

2 References

The following documents contain provisions which, through reference in this text, constitute provisions of the present document.

- References are either specific (identified by date of publication, edition number, version number, etc.) or non-specific.
- For a specific reference, subsequent revisions do not apply.
- For a non-specific reference, the latest version applies. In the case of a reference to a 3GPP document (including a GSM document), a non-specific reference implicitly refers to the latest version of that document in the same Release as the present document.

- [1] 3GPP TS 22.002: "Circuit Bearer Services (BS) supported by a Public Land Mobile Network (PLMN)".
- [2] 3GPP TS 22.030: "Man-Machine Interface (MMI) of the User Equipment (UE)".
- [3] 3GPP TS 22.042: "Network identity and timezone (NITZ); Service description; Stage 1".
- [4] 3GPP TS 23.038: "Alphabets and language-specific information".
- [5] 3GPP TS 23.040: "Technical realization of the Short Message Service (SMS)".
- [6] 3GPP TS 23.041: "Technical realization of Cell Broadcast Service (CBS)".
- [7] 3GPP TS 23.122: "Non Access Stratum functions related to Mobile Station (MS) in idle mode".
- [8] 3GPP TS 24.007: "Mobile radio interface signalling layer 3; General aspects".
- [9] 3GPP TS 24.008: "Mobile radio interface layer 3 specification; Core Network Protocols; Stage 3".
- [10] 3GPP TS 24.011: "Point-to-Point (PP) Short Message Service (SMS) support on mobile radio interface".
- [11] 3GPP TS 24.080: "Mobile radio interface layer 3 supplementary services specification; Formats and coding".

- [12] 3GPP TS 27.007: "AT command set for 3GPP User Equipment (UE)".
- [13] 3GPP TS 31.101: "UICC-Terminal Interface; Physical and Logical Characteristics".
- [14] 3GPP TS 31.102: "Characteristics of the USIM application".
- [15] 3GPP TS 31.110: "Numbering system for telecommunication IC card applications".
- [16] ISO/IEC 7816-3 (1997): "Information technology; Identification cards - Integrated circuit(s) cards with contacts, Part 3: Electronic signals and transmission protocols".
- [17] ISO/IEC 7816-4 (1995): "Identification cards - Integrated circuit(s) cards with contacts, Part 4: Inter-industry commands for interchange".
- [18] ISO/IEC 7816-6 (1995): "Identification cards - Integrated circuit(s) cards with contacts, Part 6 Inter-industry data elements".
- [19] ISO 639 (1988): "Code for the representation of names of languages".
- [20] GSM 02.07: "Mobile Stations (MS) features".
- [21] 3GPP TS 42.017: "Subscriber Identity Modules; Functional characteristics".
- [22] 3GPP TS 22.001: "Principles of circuit telecommunication services supported by a Public Land Mobile Network (PLMN) ".
- [23] 3GPP TS 23.048: "Security Mechanisms for the SIM application toolkit Stage 2".
- [24] IETF RFC 1738: "Uniform Resource Locators (URL)"
- [25] IETF RFC 768 "User Datagram Protocol (UDP)"
- [26] IETF RFC 793 "Transmission Control Protocol (TCP)"
- [27] 3GPP TS 44.018: "Mobile Radio Interface Layer 3 Specification; Radio Resource Control Protocol"
- [28] "Specification of the Bluetooth system; Profiles part"
<http://www.virelex.com/bluetooth/specification.asp>;
- [29] TIA/EIA-136-123: "Third Generation Wireless – Digital Control Channel Layer 3, April 23, 2001"
- [30] 3GPP TS 23.003: "Numbering, addressing and identification"

3 Definitions, abbreviations and symbols

3.1 Definitions

For the purposes of the present document, the following terms and definitions given in 3G TS 21.905 and the following apply:

application: set of security mechanisms, files, data and protocols (excluding transmission protocols)

application protocol: set of procedures required by the application

bearer independent protocol: mechanism by which the ME provides the UICC with access to the data bearers supported by the ME and the network

card session: link between the card and the external world starting with the ATR and ending with a subsequent reset or a deactivation of the card

card x: additional card

card reader x: electrical interface to support additional card

data channel: channel which allows the UICC and the network to exchange data using a selected bearer

data object: information seen at the interface for which are defined a tag (identifier), a length and a value

NOTE 1: Data objects can be either BER-TLV (objects that conform to the Basic Encoding Rules of ASN.1) or SIMPLE-TLV. In the present document, all BER-TLV data objects are "primitive": the value part consists only of SIMPLE-TLV data objects.

link: radio resource

padding: one or more bits appended to a message in order to cause the message to contain the required number of bits or bytes

proactive UICC: UICC which is capable of issuing commands to the ME

proactive UICC session: sequence of related USAT commands and responses

NOTE 2: A proactive UICC session starts with the status response '91 xx' (proactive command pending) and ends with a status response of '90 00' (normal ending of command) after Terminal Response.

Rx buffer: dedicated memory used to temporarily store data to be retrieved

Service data unit (SDU): in layered systems, [set](#) of [data](#) that is sent by a [user](#) of the services of a given [layer](#), and is transmitted to a peer service user semantically unchanged

NOTE 3 A Protocol Control Information (PCI) header is attached to the Service Data Unit (SDU) by the layer to form a Protocol Data Unit (PDU).

Tx buffer: dedicated memory used to temporarily store data to be sent

UICC application session: execution of a sequence of commands internal to the UICC that can result in the performance of one or several proactive UICC sessions

NOTE 4: The UICC application session can be started by any event in the card session, and can execute for the duration of the card session. Processing of the UICC application session will not interfere with normal 3G operation.

USAT: set of applications and related procedures that may be used during a 3G session

3.2 Abbreviations

For the purpose of the present document, the following abbreviations apply:

ADN	Abbreviated Dialling Number
APDU	Application Protocol Data Unit
ATR	Answer To Reset
BCD	Binary Coded Decimal
BD_ADDR	Bluetooth Device address
BDN	Barred Dialling Number
BER	Basic Encoding Rules of ASN.1
C-APDU	Command Application Protocol Data Unit
CB	Cell Broadcast
CBMI	Cell Broadcast Message Identifier
CCP	Capability/Configuration Parameter
CoD	Class Of Device (Bluetooth related)
CSD	Circuit Switched Data
DTMF	Dual Tone Multiple Frequency
EF	Elementary File
EGPRS	EDGE General Packet Radio Service
EIA	Electronics Industries Association
ETSI	European Telecommunications Standards Institute
etu	elementary time unit
FDN	Fixed Dialling Number
GGSN	Gateway GPRS Support Node

GPRS	General Packet Radio Service
GSM	Global System for Mobile communications
ID	IDentifier
IEC	International Electrotechnical Commission
IMEI	International Mobile Equipment Identity
IMSI	International Mobile Subscriber Identity
ISO	International Organization for Standardization
lgth	The (specific) length of a data unit
LND	Last Number Dialed
ME	Mobile Equipment
MMI	Man Machine Interface
NMR	Network Measurement Results (see also 3G 24.008 [9])
NPI	Numbering Plan Identifier
PDN	Packet Data Network
PDP	Packet Data Protocol, e.g., Ip or X25 or PPP
PDU	Protocol Data Unit
RAND	A RANDom challenge issued by the network
R-APDU	Response Application Protocol Data Unit
RFU	Reserved for Future Use
SDP	Service Discovery Protocol (Bluetooth related)
SDU	Service Data Unit
SMS	Short Message Service
SRES	Signed RESponse calculated by a UICC
SS	Supplementary Service
SSC	Supplementary Service Control string
SW1/SW2	Status Word 1/Status Word 2
TCP	Transmission Control Protocol
TE	Terminal Equipment (e.g. an attached personal computer)
TIA	Telecommunications Industries Association
TLV	Tag, length, value
TON	Type Of Number
TP	Transfer layer Protocol
TS	Technical Specification
UCS2	Universal two byte coded Character Set
UDP	User Datagram Protocol
UE	User Equipment
UICC	USIM Integrated Circuit Card
UMTS	Universal Mobile Telecommunication System
URL	Uniform Resource Location
USAT	USIM Application Toolkit
USIM	Universal Subscriber Identity Module
USSD	Unstructured Supplementary Service Data

3.3 Symbols

For the purposes of the present document, the following symbols apply:

'0' to '9' and 'A' to 'F' The sixteen hexadecimal digits

4 Overview of USAT

The USAT provides mechanisms which allow applications, existing in the UICC, to interact and operate with any ME which supports the specific mechanism(s) required by the application.

If class "a" is supported, a UICC supporting USAT shall be able to communicate with the additional card(s) and get information about the additional reader(s) via the ME.

The following mechanisms have been defined. These mechanisms are dependent upon the commands and protocols relevant to USAT in TS 31.101 [13].

4.1 Profile Download

Profile downloading provides a mechanism for the ME to tell the UICC what it is capable of.

4.2 Proactive UICC

Proactive UICC gives a mechanism whereby the UICC can initiate actions to be taken by the ME. These actions include:

- displaying text from the UICC to the ME;
- sending a short message;
- setting up a voice call to a number held by the UICC;
- setting up a data call to a number and bearer capabilities held by the UICC;
- sending a SS control or USSD string;
- playing tone in earpiece;
- initiating a dialogue with the user;
- USIM initialization request and notification of changes to EF(s);
- providing local information from the ME to the UICC;
- communicating with the additional card(s) (if class "a" is supported);
- providing information about the additional card reader(s) (if class "a" is supported);
- managing timers running physically in the ME;
- running an AT command received from the UICC, and returning the result to the UICC (if class "b" is supported);
- sending DTMF;
- requesting the ME to launch the browser corresponding to a URL. (if class "c" is supported);
- establishing and managing a bearer independent protocol (if class "e" is supported).

For each command involved in the dialog with the user, a help information may be available, either for each item of a list of items proposed to the user, or with each command requesting a response from the user. If a proactive command involved in the dialog with the user indicates the availability of the help feature, the support of this feature is optional for the ME.

4.3 Data download to UICC

Data downloading to the UICC uses either dedicated commands (the transport mechanisms of SMS point-to-point and Cell Broadcast) or the Bearer independent protocol. Transferral of information over the UICC-ME interface uses the ENVELOPE command.

4.4 Menu selection

A set of possible menu entries is supplied by the UICC in a proactive UICC command. The menu selection mechanism is used to transfer the UICC application menu item which has been selected by the user to the UICC. The menu selection mechanism may also be used for requesting help information on the items of the UICC application menu.

4.5 Call control by USIM

When this service is activated by the USIM, all dialled digit strings, supplementary service control strings and USSD strings are first passed to a USIM application before the ME sets up the call, the supplementary service operation or the USSD operation. The ME shall also pass to the USIM application at the same time its current serving cell. The USIM application has the ability to allow, bar or modify the call, the supplementary service operation or the USSD operation. The USIM application also has the ability to replace a call request, a supplementary service operation or a USSD operation by another call request or supplementary service operation or USSD operation. For example, a call request can be replaced by a supplementary service operation or a USSD operation, and vice-versa.

4.6 MO Short Message control by USIM

When this service is activated by the USIM, all MO short messages are first passed to the USIM application before the ME sends the short message. The ME shall also pass to the USIM application at the same time its current serving cell. The USIM application shall have the ability to allow the sending, bar the sending or modify the destination address of the short message before sending it.

4.7 Event download

A set of events to monitor for is supplied by the UICC in a proactive UICC command. The event download mechanism is used to transfer details of the event to the UICC, when it occurs. Events that the ME can report to the UICC include incoming calls, location status, access technology, display parameters changed, and availability of the screen for applications.

4.8 Security

Applications designed using the features in the present document may require methods to ensure data confidentiality, data integrity, and data sender validation, or any subset of these. Requirements for these mechanisms are defined in clause 11.

4.9 Multiple card

This clause applies only if class "a" is supported.

One event and a set of proactive commands are supplied to monitor and control Card x behaviour.

4.10 Timer Expiration

The UICC is able to manage timers running physically in the ME with a proactive command. The Timer Expiration mechanism is used to inform the UICC when a timer expires.

4.11 Bearer Independent Protocol

The following paragraph applies if class "e" is supported.

The set of proactive commands (OPEN CHANNEL, CLOSE CHANNEL, SEND DATA, RECEIVE DATA and GET CHANNEL STATUS) and events (Data available, Channel status) allows the UICC to establish a data channel with the ME, and through the ME either to a remote Server in the Network or to a remote device in the Personal Area Network. The UICC provides information for the ME to select an available bearer at the time of channel establishment. The ME then allows the UICC and the Server to exchange data on this channel, transparently. The SIM uses service of ME lower layer to send data by providing Service Data Unit to ME. The default lower layer is the higher layer of selected bearer.

The following paragraphs apply if class "f" is supported.

The proactive command SERVICE SEARCH allows the UICC to look for services available on remote devices. The proactive command GET SERVICE INFORMATION allows the UICC to get detailed information regarding one service.

The proactive command DECLARE SERVICE allows the UICC to add or delete a service to the ME service database. The event Local Connection allows to inform the UICC of a connection request on a local bearer.

5 Profile download

5.1 Procedure

The profile download instruction is sent by the ME to the UICC as part of the UICC initialization procedure. This procedure is specified in TS 31.101 [13]. The profile sent by the ME shall state the facilities relevant to USAT that are supported by the ME.

This procedure is important, as it is by this that the UICC knows what the ME is capable of, and the UICC can then limit its instruction range accordingly. If no command is sent by the ME, the UICC shall assume that the ME does not support USAT.

5.2 Structure and coding of TERMINAL PROFILE

Direction: ME to UICC.

The command header is specified in TS 31.101 [13].

Command parameters/data:

Description	Clause	M/O/C	Length
Profile	-	M	lgth

- Profile:

Contents: The list of USAT facilities that are supported by the ME.

Coding:

1 bit is used to code each facility:

bit = 1: facility supported by ME

bit = 0: facility not supported by ME

First byte (Download):

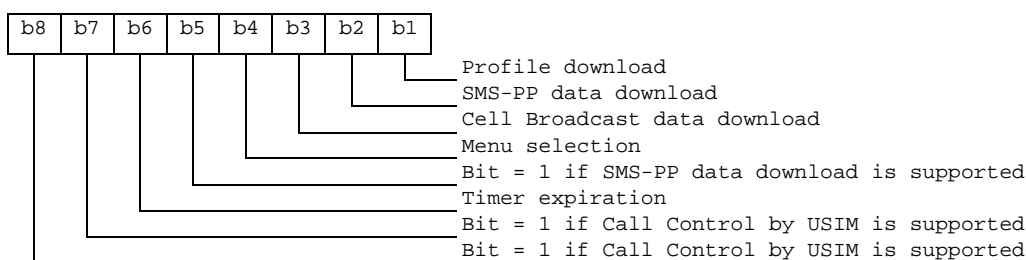

Second byte (Other):

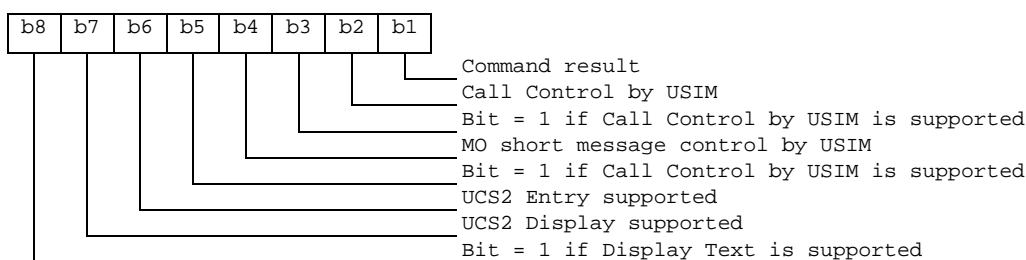

Third byte (Proactive UICC):

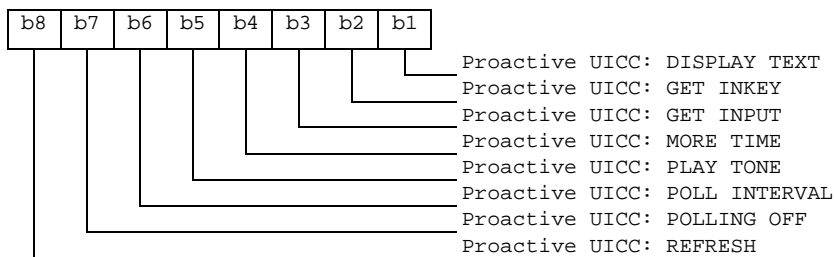

Fourth byte (Proactive UICC):

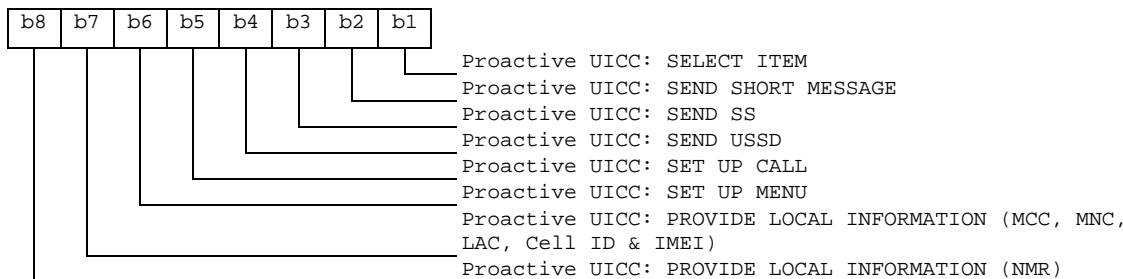

Fifth byte (Event driven information):

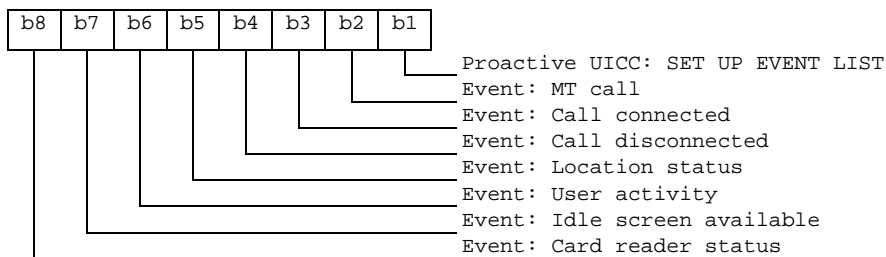

Sixth byte (Event driven information extensions):

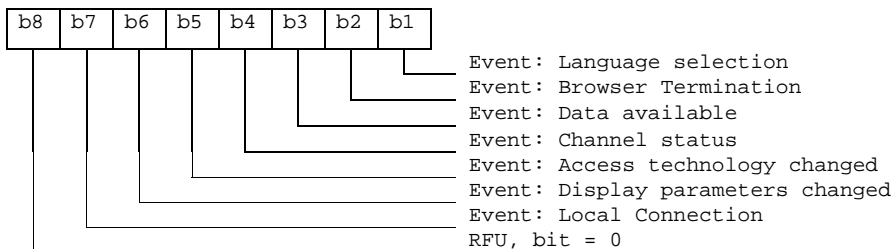

Seventh byte (Multiple card proactive commands) for class "a"

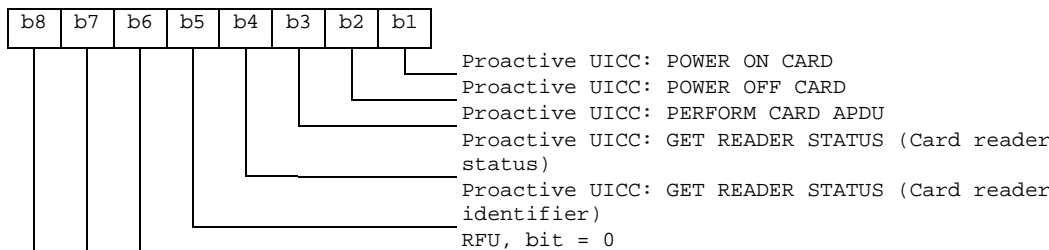

Eighth byte (Proactive UICC):

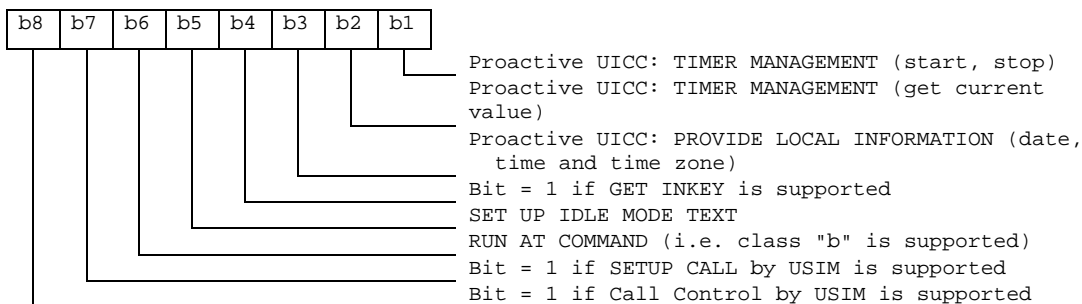

Ninth byte:

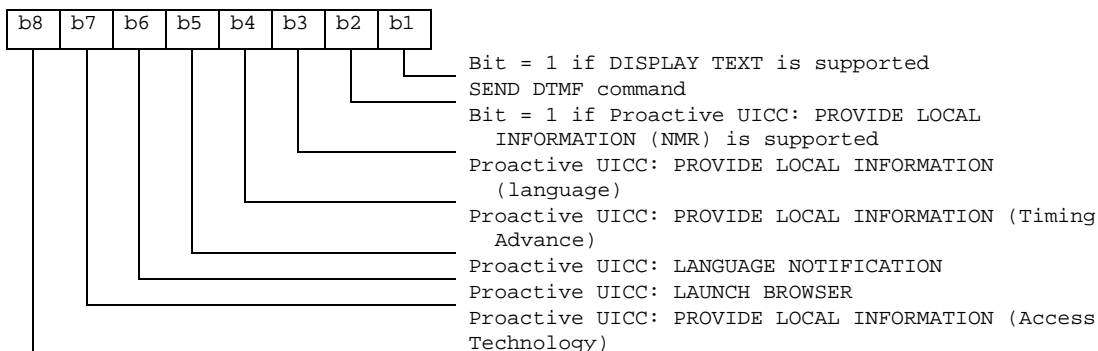

Tenth byte (Soft keys support) for class "d":

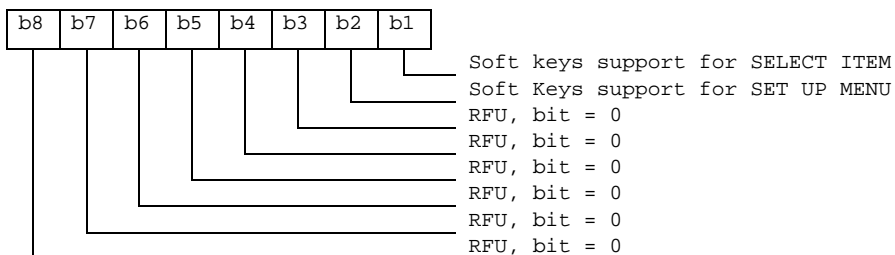

Eleventh byte: (Soft keys information)

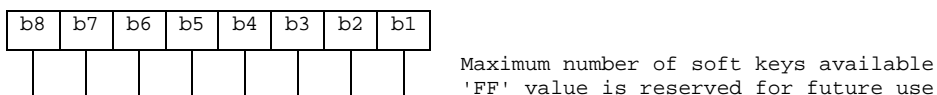

Twelfth byte:

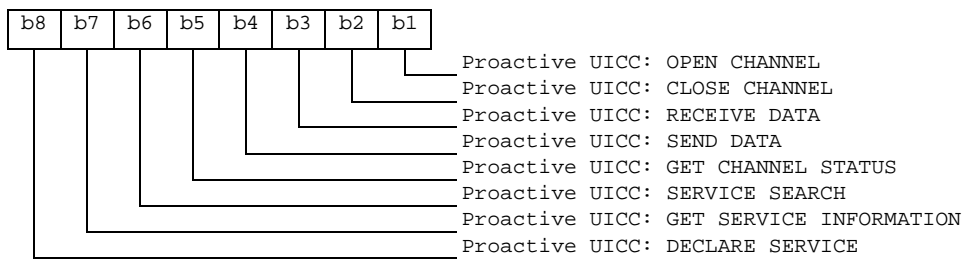

Thirteenth byte:

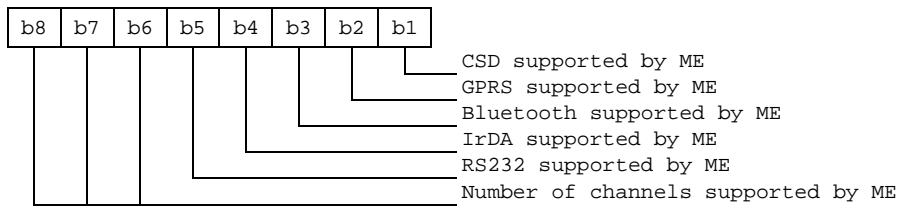

Fourteenth byte: (Screen height)

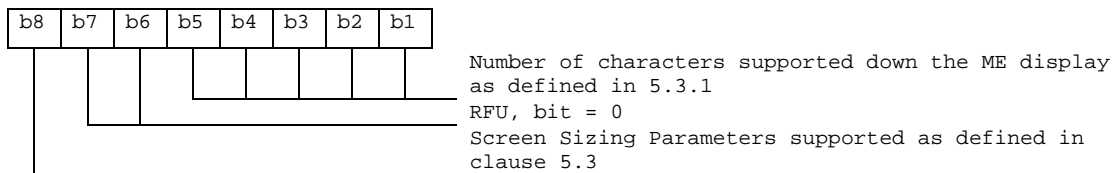

Fifteenth byte: (Screen width)

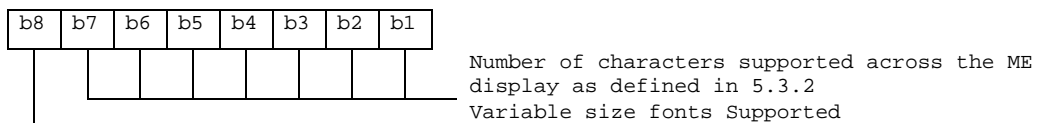

Sixteenth byte: (Screen effects)

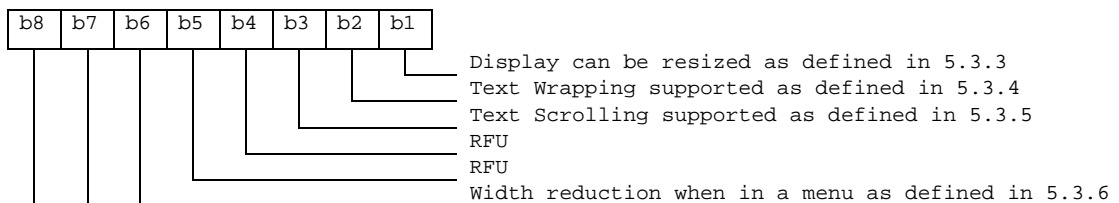

Seventeenth byte:

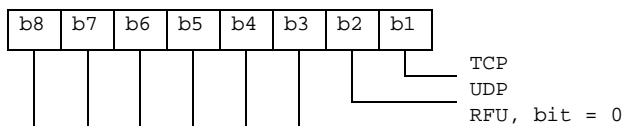

Eighteenth byte:

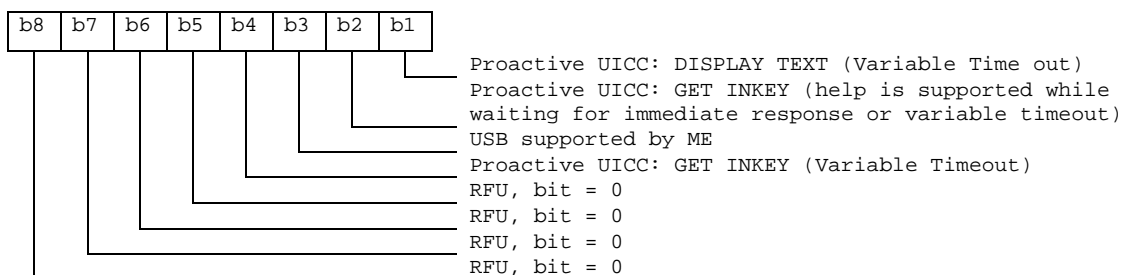

Nineteenth byte: (reserved for TIA/EIA-136 facilities):

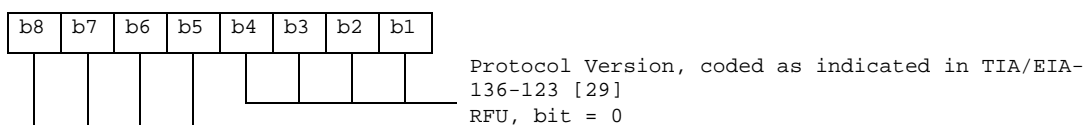

Subsequent bytes:

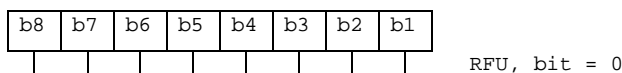

RFU bits, and all bits of subsequent bytes, are reserved to indicate future facilities. A SIM supporting only the features of SIM Application Toolkit defined here shall not check the value of RFU bits.

Response parameters/data: None.

5.3 Definition of display parameters in Profile download

This clause defines the terms used for defining the passing of the ME's screen parameters from the ME to the SIM.

5.3.1 Number of characters supported down the ME display

This is the guaranteed number of characters supported down the ME display without scrolling (using the default character set specified in 3G TS 23.038 [4]) as a result of a Display Text Proactive command.

If the screen resized as defined in clause 5.3.3 then this value shall be the initial number of characters supported before the display can be resized.

5.3.2 Number of characters supported across the ME display

This is the guaranteed number of characters supported across the ME display without scrolling (using the default character set specified in 3G TS 23.038 [4]) as a result of a Display Text Proactive command that can be viewed in one instance.

If the screen resized as defined in clause 5.3.3 then this value shall be the initial number of characters supported before the display can be resized.

5.3.3 Display can be resized

Display can be resized is supported if either:

- the user can change the number of characters supported across the display, down the display or both;
- the ME can dynamically change the number of characters supported across the display, down the display or both.

5.3.4 Text Wrapping

Text wrapping is supported if the ME puts words that would be split across two lines, due to the display size, at the beginning of the next line down.

5.3.5 Text Scrolling

Text scrolling is supported if the ME scrolls, on one line, words that would be split across two lines, due to the display size.

5.3.6 Width reduction when in a menu

This value is the number of characters available across the display due to a DISPLAY TEXT proactive command without scrolling (using the default character set specified in 3G TS 23.038 [4]) minus the number of characters available across the display due to a SELECT ITEM proactive command without scrolling (using the default character set specified in 3G TS 23.038 [4]).

If the screen resized as defined in clause 5.3.3 then this value shall be calculated using the initial number of characters supported before the display can be resized.

6 Proactive UICC

6.1 Introduction

TS 31.101 [13] defines that the ME communicates to the UICC using the T=0 or T=1 protocols, which are specified in ISO/IEC 7816-3 [16]. The ME is always the "master" and initiates commands to the UICC, and therefore there is no mechanism for the UICC to initiate a communication with the ME. This limits the possibility of introducing new UICC features requiring the support of the ME, as the ME needs to know in advance what actions it should take.

The UICC shall execute all USAT Proactive commands or procedures in such a way as not to jeopardise, or cause suspension, of service provisioning to the user. This could occur if, for example, execution of INTERNAL AUTHENTICATE is delayed by internal USAT activity, which would result in the network denying or suspending service to the user. Specifically, the MORE TIME command shall be used, whenever possible, to allow the ME access to the 3G functionality of the UICC if a USAT application is taking an unreasonable amount of time to complete execution.

NOTE: The maximum work waiting time without sending a MORE TIME command depends on several factors (e.g. the permissible duration of a network-UICC authentication); in some cases as little as 2 seconds could be required. During this period the UICC should respect the work waiting time procedure, defined in TS 31.101 [13].

The proactive UICC service provides a mechanism which stays within the T=0 and T=1 protocols, but adds a new status response word SW1. This status response has the same meaning as the normal ending ('90 00'), and can be used with most of the commands that allow the normal ending, but it also allows the UICC to say to the ME "I have some information to send to you". The ME then uses the FETCH function to find out what this information is.

To avoid cross-phase compatibility problems, these functions shall only be used between a proactive UICC and an ME that supports proactive UICC commands (see clause 6.2).

The UICC can issue a variety of commands through this mechanism, given in alphabetical order:

- **CLOSE CHANNEL:** which requests the ME to close the specified data channel (if class "e" is supported);
- **DECLARE SERVICE:** which requests the ME to add or remove a service from its service database (the list of the resources available through a local bearer). (if class "f" is supported);
- **DISPLAY TEXT:** which displays text or an icon on screen. A high priority is available, to replace anything else on screen;
- **GET CHANNEL STATUS:** which requests the ME to return the current status of all available data channels (if class "e" is supported);
- **GET INKEY:** which sends text or an icon to the display and requests a single character response in return. It is intended to allow a dialogue between the UICC and the user, particularly for selecting an option from a menu;
- **GET INPUT:** which sends text or an icon to the display and requests a response in return. It is intended to allow a dialogue between the UICC and the user;
- **GET READER STATUS:** which gives information about the additional reader(s) and inserted card(s) (Card x state, e.g. powered on or not, Card x Presence), if class "a" is supported;

- **GET SERVICE INFORMATION:** which requests the ME to look for detailed information on a given service on a given device (if class "f" is supported);
- **LANGUAGE NOTIFICATION:** which allows the UICC to notify the ME about the currently used language in text strings issued by the USAT application;
- **LAUNCH BROWSER:** which requests a browser inside a browser enabled ME to interpret the content corresponding to an URL;
- **MORE TIME:** which does not request any action from the ME. The ME is required to respond with TERMINAL RESPONSE (OK) as normal - see below. The purpose of the MORE TIME command is to provide a mechanism for the USAT task in the UICC to request more processing time;
- **OPEN CHANNEL:** which requests the ME to open a data channel with parameters indicated in the command (if class "e" is supported);
- **PERFORM CARD APDU:** which requests the ME to send an APDU command to the additional card, if class "a" is supported. This command is compatible with any protocol between the ME and the additional card;
- **PLAY TONE:** which requests the ME to play a tone in its earpiece, ringer, or other appropriate loudspeaker;
- **POLL INTERVAL:** which negotiates how often the ME sends STATUS commands to the UICC during idle mode. Polling is disabled with POLLING OFF. Use of STATUS for the proactive UICC is described in TS 31.101 [13];
- **POWER OFF CARD:** which closes the session with the additional card, if class "a" is supported;
- **POWER ON CARD:** which initiates a session with the additional card and returns all the ATR bytes, if class "a" is supported;
- **PROVIDE LOCAL INFORMATION:** which requests the ME to pass local information to the UICC, for example the mobile country and network codes (MCC + MNC) of the network on which the user is registered;
- **RECEIVE DATA:** which requests the ME to return to the UICC data received on the specified channel (if class "e" is supported);
- **REFRESH:** which requests the ME to carry out an initialization, and/or advises the ME that the contents or structure of EFs on the UICC have been changed. The command also makes it possible to restart a card session by resetting the UICC;
- **RUN AT COMMAND:** which will convey an AT Command to the ME, and cause the response to the AT Command to be returned to the UICC;
- **SELECT ITEM:** where the UICC supplies a list of items, and the user is expected to choose one. The ME presents the list in an implementation-dependent way;
- **SEND DATA:** which requests the ME to send on the specified channel data provided by the UICC (if class "e" is supported);
- **SEND DTMF:** which requests the ME to send DTMF tone(s) during an established call;
- **SEND SHORT MESSAGE:** which sends a short message or SMS-COMMAND to the network;
- **SEND SS:** which sends an SS request to the network;
- **SEND USSD:** which sends a USSD string to the network;
- **SERVICE SEARCH:** which requests the ME to look for services available in the ME environment (if class "f" is supported);
- **SET UP CALL:** of which there are three types:
 - set up a call, but only if not currently busy on another call;
 - set up a call, putting all other calls (if any) on hold;
 - set up a call, disconnecting all other calls (if any);

- **SET UP EVENT LIST:** where the UICC supplies a list of events which it wants the ME to provide details of when these events happen;
- **SET UP IDLE MODE TEXT:** which supplies a text string to be used by the ME as stand-by mode text;
- **SET UP MENU:** where the UICC supplies a list of items to be incorporated into the ME's menu structure;
- **TIMER MANAGEMENT:** which requests the ME to manage a timer in a way described in the command (start, deactivate and get the current value) and, in the case of starting a timer, for a duration indicated in the command.

The ME tells the UICC if the command was successful or not using the command result procedure defined in clause 6.7. Responsibility for what happens after that (whether to repeat the command, try another one immediately, try again sometime later, or not to try again at all) lies with the USAT. However, the USAT needs to know why the command failed, so the ME provides the UICC with the result of the command.

Results are grouped into three main types:

- OK;
- temporary problem. These results are further broken down into types of temporary problems, and specific causes. Generally, they indicate to the UICC that it may be worth trying again;
- permanent problem. These results are again further broken down into types of permanent problems, and specific causes. Generally, they indicate to the UICC that it is not worth trying again during this 3G session.

If the UICC issues an instruction to the ME to initiate a Mobile Originated transaction (e.g. SEND SMS, SEND USSD or SEND DTMF), then unless explicitly stated elsewhere in the present document or in TS 31.101 [13], the content supplied by the UICC for onward transmission by the ME shall not be altered by the ME.

6.2 Identification of ME support

An ME that supports proactive UICCs shall be identified as such when it sends a **TERMINAL PROFILE** command during UICC initialization. A proactive UICC shall not send any command requests (status bytes SW1 SW2 = '91 XX') to a mobile that does not support the proactive UICC feature.

6.3 General procedure

For all of the procedures that can end in '90 00' (indicating normal ending to the command) a proactive UICC operating with an ME that supports proactive UICCs may instead use the status response '91 XX'.

The response code '91 XX' shall indicate to the ME that the previous command has been successfully executed by the UICC in the same way as '90 00' (i.e. "OK"), but additionally it shall indicate response data which contains a command from the UICC for a particular ME procedure (defined in clause 6.4).

The value 'XX' indicates the length of the response data. The ME shall use the **FETCH** command to obtain this data.

It is the responsibility of the UICC to remind the ME of a pending proactive command by applying the '91 XX' returncode until it is fetched by the ME.

NOTE 1: The last value of 'XX' received in a '91 XX' return code from the UICC should be used by the ME in a following **FETCH** command.

NOTE 2: It is recommended that the ME interprets a '90 00' following a '91 XX' without a corresponding **FETCH** as if no proactive command is available in the UICC and regard the proactive UICC session as being terminated. However, the UICC should be able to handle a **FETCH** command being sent in this case, e.g. by applying the appropriate error handling (cf. "Handling of unknown, unforeseen and erroneous messages").

TS 31.101 [13] shows how the UICC can initiate a proactive command.

When the ME has received a command from the UICC, it shall attempt to process the command immediately.

- If the command has been successfully executed, the ME shall inform the UICC as soon as possible, using TERMINAL RESPONSE.
- If the command was not successfully executed, the ME shall inform the UICC as soon as possible using TERMINAL RESPONSE with an error condition.

Responsibility for re-trying lies with the UICC application. The USAT can make a judgement whether to send the same command again, to send a different one, or not to try again, from the information given by the ME in TERMINAL RESPONSE. If the UICC application wishes the ME to try again, it shall issue a new (identical) command.

Only one proactive command can be ongoing at any one time.

6.4 Proactive UICC commands and procedures

6.4.1 DISPLAY TEXT

This command instructs the ME to display a text message, and/or an icon (see clause 6.5.4). It allows the UICC to define the priority of that message, and the text string format.

Two types of priority are defined:

- display normal priority text and/or icon on screen;
- display high priority text and/or icon on screen.

The text string can be in one of three formats:

- packed format in SMS default alphabet - (see clause 8.15.2);
- unpacked format in SMS default alphabet - (see clause 8.15.2);
- UCS2 alphabet format - (see clause 8.15.3).

NOTE 1: The text string may contain up to 240 bytes.

A flag (see command qualifier, clause 8.6) shall be set to inform the ME whether the availability of the screen for subsequent information display after its use for 'Display Text' should be either after a short delay (the duration of the delay being at the discretion of the ME manufacturer unless an exact duration is indicated by a duration object), or following a user MMI action.

An immediate response object may be included by the UICC, to indicate if the ME should sustain the display beyond sending the TERMINAL RESPONSE. ME support of this feature is indicated in the PROFILE DOWNLOAD. The behaviour of non-supporting MEs is dependent on the Comprehension Required flag.

A duration object that represents the variable display timeout may be included by the UICC. The duration informs the ME about the required duration of the display (Precision and resolution are in accordance with clause 6.4.21 Timer Management). The requested timeout value replaces the timeout set by the ME manufacturer. ME support of this feature is indicated in the PROFILE DOWNLOAD. The behaviour of MEs that do not support this feature is dependent on the Comprehension Required flag.

- If the user has indicated the need to end the proactive UICC application session, the ME shall send a TERMINAL RESPONSE with "Proactive UICC application session terminated by the user" result value.
- If the user has indicated the need to go backwards in the proactive UICC application session, the ME shall send a TERMINAL RESPONSE with "Backward move in the proactive UICC session requested by the user" result value.
- If a flag of the command qualifier (see clause 8.6) indicates that the ME shall wait for the user to clear message and if the ME decides that no user response has been received, the ME shall send a TERMINAL RESPONSE with "No response from user" result value.
- If the UICC includes a duration object, the ME shall limit the display time of the message for a period that does not exceed the requested duration. The timer starts when the text is displayed on the screen and stops when the TERMINAL RESPONSE is sent except if the text is to be sustained beyond an immediate response. The timeout

may be used with other options of this command. The variable timeout does not affect TERMINAL RESPONSE values that are deriving from other chosen options of this command.

- If the UICC includes an immediate response object, the ME shall immediately send TERMINAL RESPONSE (Command performed successfully). The ME shall continue to display the text until one of the following events occurs:
 - a subsequent proactive command is received containing display data;
 - the expiration of the variable display timeout, if so indicated by the duration object;
 - the expiration of the short delay, if so indicated by the command qualifier;
 - following a user MMI action;
 - when a higher priority event occurs, e.g. an incoming mobile terminated call.
- No further TERMINAL RESPONSE shall be sent when the ME removes the text from the display, regardless of the cause.
- Otherwise, the ME shall send TERMINAL RESPONSE (Command performed successfully) at the expiration of either the short delay or the variable display timeout, or following a user MMI action not described above.

In each case the availability of the screen for the subsequent information display is defined in clause 6.9.

NOTE 2: For the case where the text is cleared after a short delay, the ME may also allow the user to clear the display via the MMI prior to this.

The ME shall reject normal priority text commands if the screen is currently being used for more than its normal stand-by display. If the command is rejected, the ME informs the UICC using TERMINAL RESPONSE (ME currently unable to process command - screen busy).

High priority text shall be displayed on the screen immediately, except if there is a conflict of priority level of alerting such as incoming calls or a low battery warning. In that situation, the resolution is left to the ME. If the command is rejected in spite of the high priority, the ME shall inform the UICC using TERMINAL RESPONSE (ME currently unable to process command - screen is busy).

If help information is requested by the user, this command may be used to display help information on the screen. The help information should be sent as high priority text and with the option that it should be cleared after a short delay.

6.4.2 GET INKEY

This command instructs the ME to display text and/or an icon (see clause 6.5.4) and to expect the user to enter a single character. Any response entered by the user shall be passed transparently by the ME to the UICC.

The text can be in one of three formats:

- packed format in SMS default alphabet - (see clause 8.15.2);
- unpacked format in SMS default alphabet - (see clause 8.15.2);
- UCS2 alphabet format - (see clause 8.15.3).

The response can be from one of three character sets. This is specified by the UICC:

- digits only (0-9, *, #, and +);
- characters from the SMS default alphabet;
- characters from the UCS2 alphabet.

Upon receiving the command, the ME shall display the text. The ME shall allow the user to enter a single character in response.

- If the user has indicated the need to go backwards in the proactive UICC session, the ME shall send a TERMINAL RESPONSE with "Backward move in the proactive UICC session requested by the user" result value.

- If the user has indicated the need to end the proactive UICC session, the ME shall send a TERMINAL RESPONSE with "Proactive UICC session terminated by the user" result value.
- If the ME decides that no user response has been received, the ME shall send a TERMINAL RESPONSE with "No response from user" result value.
- If the UICC requests an immediate digit response, the ME shall only allow the user to enter a character that can be entered by a single key press (that means for MEs providing only the keypad as defined in 3G TS 22.030 [2], from the digits 0-9, * and # (but not +)). When the user has entered a digit, the ME shall pass the entered digit transparently to the UICC, using TERMINAL RESPONSE. The ME shall not display the entered digit in any way. The ME shall not allow the user to change the entered digit. The ME shall not request the user to confirm the response.

NOTE 1: A larger portion of the screen may be used for display purposes, since the ME shall not display the entered digit in any way.

- If the UICC requests a digit only, the ME shall only allow the user to enter a character from the digits 0-9, *, # and +. When the user has entered a digit, the ME shall pass the entered digit transparently to the UICC, using TERMINAL RESPONSE.
- If help information is available for the command and if the user has indicated the need to get help information, the ME shall send a TERMINAL RESPONSE with "help information required by the user" result value. Depending of ME implementation, combination with the option "immediate response" and/or the option "variable timeout" may result that the user is unable to request the help.
- The ME support of help information combined with immediate response and/or timeout is indicated in the TERMINAL PROFILE.
- If the UICC requests a character from the SMS default alphabet, the ME shall allow the user to enter a character using characters from this alphabet. When the user has entered a character, the ME shall pass the entered character transparently to the UICC, using TERMINAL RESPONSE.
- If the UICC requests a "Yes/No" response, the ME shall allow the user to enter either a positive or a negative decision using MMI means left to ME manufacturer's choice (keypad, touch screen, softkey,...). The ME may use SEND, ACCEPT or END functions in relation to GET INKEY "Yes/No" response. If used, the SEND and ACCEPT functions as defined in 3G 22.030 [2] shall mean positive decision and the END function as defined in 3G 22.030 [2] shall mean a negative one. Depending on the user's choice, the ME shall pass the positive or a negative value to the UICC, using TERMINAL RESPONSE.
- If the UICC requests a "Yes/No" response together with immediate digit response, the ME shall combine the behaviour of "Yes/No" UICC request with the behaviour of an immediate digit response UICC request.
- If the UICC requests a variable timeout, the ME shall wait until either the user enters a single character or the timeout expires. The timer starts when the text is displayed on the screen and stops when the TERMINAL RESPONSE is sent. The ME shall pass the total display text duration (command execution duration) to the UICC using the TERMINAL RESPONSE. The time unit of the response is identical to the time unit of the requested variable timeout. The timeout may be used with other options of this command. The variable timeout does not affect TERMINAL RESPONSE values that are deriving from other chosen options of this command. ME support of this feature is indicated in the PROFILE DOWNLOAD. The behaviour of MEs that do not support this feature is dependent on the Comprehension Required flag.

NOTE2: If the MMI of the ME requires more than one keypress in order to select a character, it is an implementation decision for the ME manufacturer how to indicate completion (e.g. timeout, pressing SEND, OK). It may be useful to echo the input character on the display.

For digits only (0-9,*,# and +) and SMS default alphabet characters sets, the response shall be coded using the SMS default alphabet in unpacked format.

6.4.3 GET INPUT

This command instructs the ME to display text and/or an icon (see 6.5.4) and that any response string entered by the user shall be passed transparently by the ME to the UICC. If the UICC provides a default text, the ME shall display this default text, which the user may accept, reject or edit as the response string.

The text can be in one of three formats:

- packed format in SMS default alphabet (see clause 8.15.2);
- unpacked format in SMS default alphabet (see clause 8.15.2);
- UCS2 alphabet format (see clause 8.15.3).

The UICC indicates how many characters are expected for the response string, by giving a minimum and a maximum acceptable length.

The UICC specifies the following variables for the response string it is expecting from the user:

- the response contains either digits only (0-9, *, # and +) or characters from one of the possible alphabets;
- the response contains either characters coded in SMS default alphabet or characters coded in UCS2 alphabet;
- the response for digits only (0-9,*,# and +) or characters from SMS default alphabet is either in an unpacked format or in a packed format;
- the ME may display the text string being entered by the user (the response), or the ME shall hide the actual text string.

The combination of characters from either the SMS default alphabet or the UCS2 alphabet and hidden entry mode is not allowed. In hidden entry mode, only digits from the set "0-9", "*" and "#" are allowed for the user input. "+" is not allowed for user input in this mode.

If the UICC requests that the user input (text string) is to be hidden, the ME shall prevent the text string from being identified by any means. For example, the text string shall not be displayed and no DTMF tones shall be emitted. Nevertheless, it is permissible for the ME to indicate the entry of characters, so long as the characters themselves are not revealed.

Upon receiving the command, the ME shall display the text. The ME shall allow the user to enter characters in response.

- The ME MMI is responsible for managing the entry of the correct number of characters.
- If the user has indicated the need to go backwards in the proactive UICC session, the ME shall send a TERMINAL RESPONSE with "Backward move in the proactive UICC session requested by the user" result value.
- If the user has indicated the need to end the proactive UICC session, the ME shall send a TERMINAL RESPONSE with "Proactive UICC session terminated by the user" result value.
- If the ME decides that no user response has been received, the ME shall send a TERMINAL RESPONSE with "No response from user" result value.
- If the UICC requests digits only, the ME shall only allow the user to enter the digits 0-9, *, # and +. When the user has indicated completion, the ME shall pass the entered digit string transparently to the UICC, using TERMINAL RESPONSE.
- If the UICC requests characters from the UCS2 alphabet or SMS default alphabet, the ME shall allow the user to enter a character string using characters from one of these alphabets. When the user has indicated completion, the ME shall pass the entered text string transparently to the UICC, using TERMINAL RESPONSE.
- If help information is available for the command and if the user has indicated the need to get help information, the ME shall send a TERMINAL RESPONSE with 'help information required by the user' result value.

If the UICC requests the user input to be in packed format, then the ME shall pack the text according to TS 23.038 [4] before submitting it to the UICC.

6.4.4 MORE TIME

This procedure is provided to allow the USAT task in the UICC more time for processing, where the processing is so long that it is in danger of affecting normal 3G operation, and clock stop prevents processing to take place in the background.

The ME shall take no extraordinary action when it receives this command, and all other operations shall be unaffected. The ME shall conclude the command by sending TERMINAL RESPONSE (OK) to the UICC, as soon as possible after receiving the MORE TIME command.

6.4.5 PLAY TONE

This command instructs the ME to play an audio tone.

Upon receiving this command, the ME shall check if it is currently in, or in the process of setting up (SET-UP message sent to the network, see 3G 24.008 [9]), a speech call.

- If the ME is in, or is setting up a speech call, it shall superimpose the tone on top of the downlink audio (if any), for the duration given in the command. The progress or current state of the call shall not be affected in any way. The ME shall send the TERMINAL RESPONSE (Command performed successfully) as soon as possible after the tone has been completed and, if an alpha identifier was included and displayed, the screen is available for subsequent information display.
- If the ME is not in or setting up a speech call, it shall route the audio to the external ringer, or other appropriate audio device, and play the tone for the duration given in the command. The ME shall send the TERMINAL RESPONSE (Command performed successfully) as soon as possible after the tone has been completed and, if an alpha identifier was included and displayed, the screen is available for subsequent information display.
- If the user has indicated the need to end the proactive UICC application session while the ME plays the tone, the ME shall stop playing the tone and shall send a TERMINAL RESPONSE with "Proactive UICC application session terminated by the user" result value.
- If ME support for the specific tone requested is optional, and the ME does not support this particular tone, the ME shall inform the UICC using TERMINAL RESPONSE (Command beyond ME's capabilities).

This proactive command contains no information on how a call is progressing; therefore the ME shall not generate any verbal indication or display any text or graphical indication about the normal meaning of this tone (e.g. display "called subscriber busy"). If the UICC wishes to convey a meaning in text to the user, it shall do this through the alpha identifier data object and/or an icon (see clause 6.5.4).

The use of this alpha identifier by the ME is described below:

- If the alpha identifier is provided by the SIM and is not a null data object, the ME shall use it to inform the user. If an icon is provided by the SIM, the icon indicated in the command may be used by the ME to inform the user, in addition to, or instead of the alpha identifier, as indicated with the icon qualifier (see clause 6.5.4).
- If the alpha identifier is provided by the SIM and is a null data object (i.e. length = '00' and no value part), the ME should not give any information to the user.
- If the alpha identifier is not provided by the SIM, the ME may give information to the user concerning what is happening

If the ME is required to generate a supervisory tone due to the progress of the current call (e.g. the network sends the ME call control cause information) as defined in TS 22.001 [22], then the call supervisory tone shall take precedence over the tone requested by the UICC.

6.4.6 POLL INTERVAL

This procedure negotiates how often the ME shall send STATUS commands related to Proactive Polling (defined in 3G TS 31.101 [13]). The UICC indicates the poll interval it requests from then onwards, and the ME responds through TERMINAL RESPONSE with the maximum interval that it will use. If the ME does not support the poll interval requested by the UICC, then the ME shall respond with the closest interval to the one requested by the UICC,

or, if the intervals the ME can offer are equidistant (higher and lower) from the UICC's request, the ME shall respond with the lower interval of the two.

Applications on the UICC should not request short time intervals for an extended period, as this will have an adverse effect on battery life, and should not use this command for time management purposes.

6.4.7 REFRESH

The purpose of this command is to enable the ME to be notified of the changes to the UICC configuration that have occurred as the result of a USIM application activity. It is up to the USIM application to ensure that this is done correctly.

The UICC may indicate the AID of the USIM application it wants to REFRESH.

- If the indicated USIM is active, the ME shall perform the REFRESH.
- If indicated USIM is not active, the ME shall send a TERMINAL RESPONSE. The ME shall not select the indicated USIM.
- If no AID is indicated, then the ME shall assume the REFRESH applies to the current USIM application.

The command supports seven different modes:

- USIM Initialization. This mode tells the ME to carry out USIM initialization as it is defined in TS 31.102 [14] only, starting after the PIN verification procedure.
- USIM File Change Notification. This mode advises the ME of the identity of the EFs that have been changed (in structure and/or contents) in the indicated USIM and files under DF_{TELECOM}. This information can be used by the ME if there is an image of USIM EFs in the ME's memory, to determine whether it needs to update this image.
- USIM Initialization and File Change Notification. This is a combination of the first two modes above.
- USIM Initialization and Full File Change Notification. This mode causes the ME to perform the USIM initialization procedure of the first mode above and advises the ME that several EFs have been changed (in structure or contents) in the indicated USIM. If there is an image of USIM EFs in the ME's memory, the ME shall completely update this image.
- UICC Reset. This mode causes the ME to run the UICC session termination procedure in accordance with TS 31.101 [13]. Subsequently, the ME performs a reset (warm reset preferred) on the UICC and starts a new application session. The ME shall not send the TERMINAL RESPONSE; this is an exception from the normal procedure, where TERMINAL RESPONSE is sent after completion of the command. The UICC shall interpret the reset as an implicit TERMINAL RESPONSE. The UICC Reset mode is used when a USAT requires ATR or complete UICC initialization procedures to be performed.
- USIM Application Reset. This mode causes the ME to run the 3G session termination and the USIM application closure procedures in accordance with TS 31.102 [14]. Subsequently, the ME performs USIM initialization procedure.
- 3G Session Reset. This mode is equivalent to "USIM Initialization and File Change Notification" mode and in addition requires the ME to perform the MM Restart procedure defined in 3G 23.122 [7].

If the ME performs the REFRESH command successfully for only those EFs indicated in the mode, the ME shall inform the UICC using TERMINAL RESPONSE (OK), after it has completed its refreshing (i.e. taking into account the new value of the EFs).

For REFRESH commands with mode other than "UICC Reset" or "USIM Application Reset", it is permissible for the ME, as part of its execution of the REFRESH command, to read EFs in addition to those notified by the UICC, or to perform a USIM initialisation, provided that the procedure executed wholly encompasses the mode requested by the UICC and does not involve re-entering the PIN. The ME shall not electrically reset the UICC. If the ME does the refreshing successfully, it shall inform the UICC using TERMINAL RESPONSE (Refresh performed with additional EFs read), after the ME has completed its refreshing. It should be noted that reading additional EFs will lengthen the refresh procedure.

If the ME receives a REFRESH command while in a state where execution of the command would be unacceptable, upsetting the current user operation (e.g. notification during a call that the IMSI has changed), the ME shall inform the

UICC using TERMINAL RESPONSE (ME currently unable to process command - currently busy on call) or TERMINAL RESPONSE (ME currently unable to process command - screen is busy) as appropriate.

NOTE: Many MEs copy an image of the USIM application files to the ME at initialization to speed up access to these fields during a 3G session. One of the purposes of this coding of the REFRESH command is to enable MEs to change such an image efficiently.

If, on receipt of the REFRESH command, the ME replies that it is busy (e.g. in call or navigating menus), the toolkit application may retry it later.

It is recommended for the ME to minimise the use of sending temporary problem TERMINAL RESPONSE, as during the period between the UICC issuing a REFRESH command and the ME performing the refresh procedure, there may be inconsistencies between data held in the ME and in the UICC. However, responsibility for retrying of all pro-active commands lies with the UICC.

6.4.7.1 EF_{IMSI} changing procedure

When an EF_{IMSI} is changed via Data Download or a USAT application and a REFRESH command is issued by the UICC the following rules apply to the UICC and ME:

- USIM Initialization. This command shall not be used if an EF_{IMSI} is changed, as the behaviour of the UE is unpredictable;
- File Change Notification. This command shall not be used if an EF_{IMSI} is changed, as the behaviour of the UE is unpredictable;
- USIM Initialization and File Change Notification. This command shall not be used if an EF_{IMSI} is changed, as the behaviour of the UE is unpredictable;
- USIM Initialization and Full File Change Notification. This command shall not be used if an EF_{IMSI} is changed, as the behaviour of the UE is unpredictable;
- UICC Reset. Normal UICC Reset procedure is carried out;
- USIM Application Reset. Normal USIM Application Reset procedure is carried out;
- 3G Session Reset. Normal 3G Session Reset procedure is carried out.

If an EF_{IMSI} is to be updated, neither EF_{IMSI} nor EF_{LOC1} shall be updated in the UICC before the 3G session termination procedure has been completed by the ME.

6.4.8 SET UP MENU

The UICC shall supply a set of menu items, which shall be integrated with the menu system (or other MMI facility) in order to give the user the opportunity to choose one of these menu items at his own discretion. Each item comprises a short identifier (used to indicate the selection), a text string and optionally an icon identifier, contained in an item icon identifier list data object located at the end of the list of items.

The UICC shall include an alpha identifier, and optionally an icon identifier, which acts as a title for the list of menu items. This icon may be used by the ME to provide an entry into the list of toolkit menu items for the user.

If an icon is provided by the UICC, the icon(s) indicated in the command may be used by the ME in addition to, or instead of the alpha identifier or text string, as indicated with the icon qualifier (see clause 6.5.4). Additionally if soft key preferred is indicated in the command details and soft key for SET UP MENU is supported by the ME and the number of icons items does not exceed the number of soft keys available then the ME shall display those icons as soft key.

The UICC may include an items next action indicator data object located at the end of the list of items. The inclusion of the items next action indicator is to allow the ME to indicate to the user the consequences of performing the selection of an item.

NOTE: The maximum amount of data sent in one proactive UICC command is 256 bytes. It is therefore unavoidable that there is trade-off between the number of items and the length of the descriptive text (the alpha identifier of the SET-UP MENU command and the text strings of the items), e.g. for an average length of 10 bytes per text string the maximum amount of items is 18.

The list of menu items shall then be part of the menu system of the ME and the user is allowed to select an item from this list. The presentation style is left as an implementation decision to the ME manufacturer. However, the ME shall present the menu items in the order given by the UICC, unless instructed otherwise by the user, or when this would be inappropriate for the presentation style of the ME. The menu provided by the UICC in the last SET UP MENU command shall no longer be part of the menu system of the ME if the ME is powered off or the UICC is removed or electrically reset.

Any subsequent SET-UP MENU command replaces the current list of menu items supplied in the previous SET-UP MENU command. The SET-UP MENU command can also be used to remove a menu from the menu system in the ME; see clause 6.6.7.

When the ME has successfully integrated or removed the list of menu items, it shall send TERMINAL RESPONSE (OK) to the UICC.

When the ME is not able to successfully integrate or remove the list of menu items, it shall send TERMINAL RESPONSE (Command beyond ME's capabilities).

When the user has selected one of the menu items of this menu item list, then the ME shall use the Menu Selection mechanism to transfer the identifier of the selected menu item to the UICC.

If help is available for the command and if the user has indicated the need to get help information on one of the menu items, the ME shall use the Menu Selection mechanism to inform the UICC about this help request.

6.4.9 SELECT ITEM

The UICC shall supply a set of items from which the user may choose one. Each item comprises a short identifier (used to indicate the selection), a text string and optionally an icon identifier, contained in an item icon identifier list data object located at the end of the list of items.

Optionally the UICC may include an alpha identifier, and an icon identifier. These are intended to act as a title for the list of items. The UICC may include an items next action indicator data object located at the end of the list of items. The inclusion of the items next action indicator is to allow the ME to indicate to the user the consequences of performing the selection of an item.

The alpha identifier included by the UICC shall be used by the ME as the title for the list of items.

If an icon is provided by the UICC, the icon(s) indicated in the command may be used by the ME in addition to, or instead of the alpha identifier, as indicated with the icon qualifier (see clause 6.5.4). Additionally, if "selection using soft key preferred" is indicated in the command details and "soft key for SELECT ITEM" is supported by the ME and the number of icons items does not exceed the number of soft keys available, then the ME shall display those icons as soft keys.

NOTE: The maximum amount of data sent in one proactive UICC command is 256 bytes. It is therefore unavoidable that there is trade-off between the number of items and the length of the descriptive text (the alpha identifier of the SELECT ITEM command and the text strings of the items), e.g. for an average length of 10 bytes per text string the maximum amount of items is 18.

The ME shall present the list of text strings to the user, and allow the user to select an item from this list. A flag of the command qualifier (see clause 8.6) indicates whether the list is a choice of navigation options, or a choice of data values. The presentation style is left as an implementation decision to the ME manufacturer. However, the ME shall present the menu items in the order given by the UICC, unless instructed otherwise by the user, or when this would be inappropriate for the presentation style of the ME. The menu provided by the UICC in the last SET UP MENU command shall no longer be part of the menu system of the ME if the ME is powered off or the UICC is removed or electrically reset.

The UICC may supply with the list, if applicable, indication of the default item, e.g. the previously selected item.

When the user has selected an item, the ME shall send TERMINAL RESPONSE (OK) to the UICC with the identifier of the item chosen.

- If the user has indicated the need to end the proactive UICC session, the ME shall send a TERMINAL RESPONSE with "Proactive UICC session terminated by the user" result value.
- If the user has indicated the need to go backwards in the proactive UICC session, the ME shall send a TERMINAL RESPONSE with "Backward move in the proactive UICC session requested by the user" result value.
- If the ME decides that no user response has been received, the ME shall send a TERMINAL RESPONSE with "No response from user" result value.
- If help information is available for the command and if the user has indicated the need to get help information, the ME shall send a TERMINAL RESPONSE with "help information required by the user" result value to the UICC with the identifier of the item for which the user is requiring help information.

6.4.10 SEND SHORT MESSAGE

Two types are defined:

- a short message to be sent to the network in an SMS-SUBMIT message, or an SMS-COMMAND message, where the user data can be passed transparently;
- a short message to be sent to the network in an SMS-SUBMIT message where the text needs to be packed by the ME.

Where the text has been packed, the text string provided by the UICC shall not be longer than 160 characters. It shall use the SMS default 7-bit coded alphabet, packed into 8-bit octets, in accordance with TS 23.038 [4]. The data coding indication contained in the Data Coding Scheme byte shall be "default alphabet". The text length (which is part of the SMS TPDU) given by the UICC shall state the number of 7-bit characters in the text string. The command details shall indicate "packing not required".

8-bit data Short Messages may be sent by the UICC. The command shall indicate packing not required. The data coding indication contained in the Data Coding Scheme byte shall be "8 bit". The string shall not be longer than 140 bytes, and the length (in SMS TPDU) shall state the number of bytes in the string.

If UCS2 is supported by the ME, 16-bit data Short Messages may be sent by the UICC. The text string provided by the UICC shall not be longer than 70 characters. It shall use the 16-bit UCS2 alphabet format, in accordance with TS 23.038 [4]. The text length (which is part of the SMS TPDU) given by the UICC shall state the number of 16-bit characters in the text string. The command details shall indicate "packing not required".

SMS commands may be sent by the UICC. These shall count as packed text message. The SMS TPDU from the UICC shall indicate SMS-COMMAND. The command details shall indicate "packing not required".

Where packing by the ME is required, the text string provided by the UICC shall not be longer than 160 characters. It shall use the SMS default 7-bit coded alphabet as defined in TS 23.038 [4] with bit 8 set to 0. The text length given by the UICC shall state the number of characters in the text string. The ME shall pack the text string and modify the Data Coding Scheme byte to "default alphabet" in accordance with TS 23.038 [4] before submitting the message to the network.

Optionally, the UICC may include in this command an alpha identifier. The use of this alpha identifier by the ME is described below.

- If the alpha identifier is provided by the UICC and is not a null data object, the ME shall use it to inform the user. This is also an indication that the ME should not give any other information to the user on the fact that the ME is sending a short message. If an icon is provided by the UICC, the icon indicated in the command may be used by the ME to inform the user, in addition to, or instead of the alpha identifier, as indicated with the icon qualifier (see clause 6.5.4).

- If the alpha identifier is provided by the UICC and is a null data object (i.e. length = '00' and no value part), this is an indication that the ME should not give any information to the user on the fact that the ME is sending a short message.
- If the alpha identifier is not provided by the UICC, the ME may give information to the user concerning what is happening.

If the ME is capable of SMS-MO, then it shall send the data as a Short Message TPDU to the destination address. The ME shall give the result to the UICC using TERMINAL RESPONSE (indicating successful or unsuccessful transmission of the Short Message) after receiving an SMS RP-ACK or RP-Error from the network. If an alpha identifier was provided by the UICC, the ME should not give any information to the user at the reception of SMS RP-ACK or RP-Error.

If the Short Message TPDU is unsuccessfully received by the network (e.g. the reception of a CP-ERROR), the ME shall inform the UICC using TERMINAL RESPONSE (network currently unable to process command). If a null alpha identifier was provided by the UICC, the ME should not give any information to the user at the unsuccessful network reception.

The destination address and the SMSC address included in the SEND SHORT MESSAGE proactive command shall not be checked against those of the FDN list, even if the Fixed Dialling Number service is enabled.

6.4.11 SEND SS

Upon receiving this command, the ME shall decide if it is able to execute the command. Examples are given below, but the list is not exhaustive:

- if the command is rejected because the ME is busy on an SS transaction, the ME informs the UICC using TERMINAL RESPONSE (ME unable to process command - currently busy on SS transaction);
- if the command is rejected because the ME is busy on a USSD transaction, the ME shall inform the UICC using TERMINAL RESPONSE (ME unable to process command - currently busy on USSD transaction);
- if the command is rejected because the ME does not support that Supplementary Service, the ME informs the UICC using TERMINAL RESPONSE (Command beyond ME's capabilities).

If the ME is able to send the SS request, the ME shall:

- send the SS request immediately, without need to alert the user first;
- optionally, the UICC may include in this command an alpha-identifier. The use of this alpha-identifier by the ME is described below:
 - if the alpha identifier is provided by the UICC and is not a null data object, the ME shall use it to inform the user. This is also an indication that the ME should not give any other information to the user on the fact that the ME is sending a SS request. If an icon is provided by the UICC, the icon indicated in the command may be used by the ME to inform the user, in addition to, or instead of the alpha identifier, as indicated with the icon qualifier (see clause 6.5.4);
 - if the alpha identifier is provided by the UICC and is a null data object (i.e. length = '00' and no value part), this is an indication that the ME should not give any information to the user on the fact that the ME is sending an SS request;
 - if the alpha identifier is not provided by the UICC, the ME may give information to the user concerning what is happening.
- once an SS Return Result message not containing an error has been received from the network, the ME shall inform the UICC that the command has been successfully executed, using TERMINAL RESPONSE. This command shall include the contents of SS Return Result as additional data. If a null alpha identifier was provided by the UICC, the ME should not give any information to the user at the reception of an SS Return Result message;
- if the command is rejected because the network cannot support or is not allowing the Supplementary Service request, the ME informs the UICC using TERMINAL RESPONSE (SS Return Result error code).

If a null alpha identifier was provided by the UICC, the ME should not give any information to the user at the reception of a SS Return Result message;

- if the SS request is unsuccessfully received by the network, the ME shall inform the UICC using **TERMINAL RESPONSE** (network currently unable to process command), and not retry to send the request.
If a null alpha identifier was provided by the UICC, the ME should not give any information to the user at the reception of a SS Return Result message.

If the ME supports the Last Number Dialed service, the ME shall not store in EF_{LND} the supplementary service control string sent by the UICC in this command.

The supplementary service control string included in the **SEND SS** proactive command shall not be checked against those of the FDN list, even if the Fixed Dialling Number service is enabled.

6.4.12 SEND USSD

Upon receiving this command, the ME shall decide if it is able to execute the command. Examples are given below, but the list is not exhaustive:

- if the command is rejected because the ME is busy on a USSD transaction, the ME informs the UICC using **TERMINAL RESPONSE** (ME unable to process command - currently busy on USSD transaction);
- if the command is rejected because the ME is busy on a SS transaction, the ME informs the UICC using **TERMINAL RESPONSE** (ME unable to process command - currently busy on SS transaction).

If the ME is able to send the USSD request, the ME shall:

- send the USSD immediately, without need to alert the user first;
- optionally, the UICC may include in this command an alpha-identifier. The use of this alpha-identifier by the ME is described below:
 - if the alpha identifier is provided by the UICC and is not a null data object, the ME shall use it to inform the user. This is also an indication that the ME should not give any other information to the user on the fact that the ME is sending a USSD request. If an icon is provided by the UICC, the icon indicated in the command may be used by the ME to inform the user, in addition to, or instead of the alpha identifier, as indicated with the icon qualifier (see clause 6.5.4);
 - if the alpha identifier is provided by the UICC and is a null data object (i.e. length = '00' and no value part), this is an indication that the ME should not give any information to the user on the fact that the ME is sending a USSD request;
 - if the alpha identifier is not provided by the UICC, the ME may give information to the user concerning what is happening.
- once the USSD transaction is initiated, a dialogue between the network and the user may occur which involves the MMI of the ME. If an alpha identifier was initially provided by the UICC, this alpha identifier may be discarded during this dialogue;
- once a **RELEASE COMPLETE** message containing the USSD Return Result message not containing an error has been received from the network, the ME shall inform the UICC that the command has been successfully executed, using **TERMINAL RESPONSE**. This command shall include the text contained in the USSD Return Result in a Text String data object. If a null alpha identifier was provided by the UICC, the ME should not give any information to the user at the reception of a USSD Return Result message;
- if the UE clears the transaction by sending a **RELEASE COMPLETE** upon request of the user, the ME shall inform the UICC using **TERMINAL RESPONSE** (USSD transaction terminated by user);
- if the USSD operation is rejected because the network cannot support or is not allowing mobile initiated USSD, the ME informs the UICC using **TERMINAL RESPONSE** (USSD Return Result error code). If a null alpha identifier was provided by the UICC, the ME should not give any information to the user at the reception of a USSD Return Result message;
- if the USSD request is unsuccessfully received by the network, the ME shall inform the UICC using **TERMINAL RESPONSE** (network currently unable to process command), and not retry to send the request. If a

null alpha identifier was provided by the UICC, the ME should not give any information to the user at the reception of a USSD Return Result message.

6.4.13 SET UP CALL

Three types are defined:

- set up a call, but only if not currently busy on another call;
- set up a call, putting all other calls (if any) on hold;
- set up a call, disconnecting all other calls (if any) first.

For each of these types, the UICC may request the use of an automatic redial mechanism according to GSM 02.07 [20]. The UICC may also request an optional maximum duration for the redial mechanism. The ME shall attempt at least one call set-up.

In addition to the called party number, the command may contain capability configuration parameters (giving the bearer capability to request for the call) and the called party subaddress. The ME shall use these in its call set-up request to the network. The command may also include DTMF digits, which the ME shall send to the network after the call has connected. The ME shall not locally generate audible DTMF tones and play them to the user.

NOTE: On the downlink audio, DTMF tones reflected by the network may be heard.

It is possible for the UICC to request the ME to set up an emergency call by supplying the number "112" as called party number. If the UICC supplies a number stored in EF_{ECC}, this shall not result in an emergency call.

The number included in the SET UP CALL proactive command shall not be checked against those of the FDN list, even if the Fixed Dialling Number service is enabled.

Upon receiving this command, the ME shall decide if it is able to execute the command. Examples are given below, but the list is not exhaustive:

- if the command is rejected because the ME is busy on another call, the ME informs the UICC using TERMINAL RESPONSE (ME unable to process command - currently busy on call);
- if the command is rejected because the ME is busy on a SS transaction, the ME informs the UICC using TERMINAL RESPONSE (ME unable to process command - currently busy on SS transaction);
- if the command is rejected because the ME cannot support Call Hold, or because the ME does not support the capability configuration parameters requested by the UICC, the ME informs the UICC using TERMINAL RESPONSE (Command beyond ME's capabilities);
- if the command is rejected because the network cannot support or is not allowing Call Hold of a multi party call, the ME informs the UICC using TERMINAL RESPONSE (SS Return Result error code);
- if the command is rejected because the network cannot support or is not allowing Call Hold of a single call, the ME informs the UICC using TERMINAL RESPONSE (Network currently unable to process command).

If the ME is able to set up the call on the serving network, the ME shall:

- alert the user (as for an incoming call). This is the confirmation phase;
- optionally, the UICC may include in this command one or two alpha-identifiers. The use of these alpha-identifiers by the ME is described below:
 - if the first alpha identifier is provided by the UICC and is not a null data object, the ME shall use it during the user confirmation phase. This is also an indication that the ME should not give any other information to the user during the user confirmation phase. If an icon is provided by the UICC, the icon indicated in the command may be used by the ME to inform the user, in addition to, or instead of the alpha identifier, as indicated with the icon qualifier (see clause 6.5.4);
 - if the first alpha identifier is not provided by the UICC or is a null data object (i.e. length = '00' and no value part), the ME may give information to the user;

- if the second alpha identifier (i.e the one after the mandatory address object) is provided by the UICC and is not a null data object, the ME shall use it during the call set-up phase and during the call. If an icon is provided by the UICC, the icon indicated in the command may be used by the ME to inform the user, in addition to, or instead of the alpha identifier, as indicated with the icon qualifier (see clause 6.5.4);
- if the second alpha identifier is not provided by the UICC or is a null data object (i.e. length = '00' and no value part), the ME may give information to the user.
- if the user accepts the call, the ME shall then set up a call to the destination address given in the response data, with the relevant capability configuration parameters and called party subaddress (if provided by the UICC);
- if the user does not accept the call, or rejects the call, then the ME informs the UICC using TERMINAL RESPONSE (user did not accept the proactive command). The operation is aborted;
- if the user has indicated the need to end the proactive UICC session, the ME shall send a TERMINAL RESPONSE with "Proactive UICC session terminated by the user" result value;
- optionally, during call set-up, the ME can give some audible or display indication concerning what is happening;
- once a CONNECT message has been received from the network (defined in 3G 24.008), the ME shall inform the UICC that the command has been successfully executed, using TERMINAL RESPONSE. Operation of the call then proceeds as normal.

If the first call set-up attempt is unsuccessful:

- if the UICC did not request redial then the ME shall inform the UICC using TERMINAL RESPONSE (network currently unable to process command), and not redial to set-up the call;
- if the UICC requested redial, then the ME may automatically redial the call (depending on its capability/configuration). In this case, the ME shall not send a command result to the UICC concerning the first or any subsequent failed set-up attempts. If the call set-up has not been successful, and the ME is not going to perform any more redials, or the time elapsed since the first call set-up attempt has exceeded the duration requested by the UICC, then the ME shall inform the UICC using TERMINAL RESPONSE (network currently unable to process command), and the redial mechanism shall be terminated;
- if the user stops the call set-up attempt or the redial mechanism before a result is received from the network, the ME informs the UICC using TERMINAL RESPONSE (user cleared down call before connection or network release).

If the ME supports the Last Number Dialed service, the ME shall not store in EF_{LND} the call set-up details (called party number and associated parameters) sent by the UICC in this command.

6.4.14 POLLING OFF

This command disables the Proactive Polling (defined in 3G TS 31.101 [13]). UICC Presence Detection (defined in 3G TS 31.101 [13]) is not affected by this command.

6.4.15 PROVIDE LOCAL INFORMATION

This command requests the ME to send current local information to the UICC. At present, this information is restricted to:

- location information: the mobile country code (MCC), mobile network code (MNC), location area code (LAC) and cell ID of the current serving cell;
- the IMEI of the ME;
- the Network Measurement Results and the BCCH channel list, suitable only for GSM access network;
- the current date, time and time zone;
- the current ME language setting;
- the Timing Advance, suitable only for GSM access network;

- the current access technology.

The ME shall return the requested local information within a TERMINAL RESPONSE. Where location information or Network Measurement Results has been requested and no service is currently available, then the ME shall return TERMINAL RESPONSE (ME currently unable to process command - no service). Where location information or Network Measurement Results has been requested and the ME is on limited service (e.g. emergency calls only), the ME shall return the data requested in the TERMINAL RESPONSE with the general result (Limited Service).

NMR are only available if the ME is connected to a GSM access network. If the NMR are requested and a call is in progress, the value of all the returned parameters provided by the ME in the response to the command will be valid. The NMR returned when a call is in progress from MEs supporting multiband operation, shall be according to the value of the multiband reporting parameter as defined in TS 44.018 [27]. If a call is not in progress (i.e. ME is in idle mode) some of the returned parameters (e.g. RXQUAL) may be invalid. In idle mode, MEs supporting multiband operation shall ignore the value of the multiband reporting parameter and the NMR returned shall be as defined in TS 44.018 [27] when the multiband reporting parameter equals zero.

NOTE 2: When in idle mode, the only information element on which it is possible to rely on is the RXLEV-FULL-SERVING-CELL, which contains the value of the received signal strength on the BCCH of the current serving cell.

NOTE 3: Network Measurement Results are defined in TS 44.018 [27] as Measurement Results.

The BCCH channel list is only available if the ME is connected to a GSM access network.

The ME shall return the current date and time as set by the user. If available, the ME shall also return the time zone known from the network with the NITZ feature (see 3G 22.042 [3]). If the time zone information is not available, the ME shall return 'FF' for this element.

If language setting is requested, the ME shall return the currently used language.

Timing advance is only available if the ME is connected to a GSM access network. If the Timing Advance is requested, the ME shall return the timing advance value that was received from the BTS during the last active dedicated connection (e.g. for call or SMS). Timing advance is defined in TS 44.018 [27]. An ME supporting the Timing Advance feature shall be able to store the last value of timing advance. In addition to the timing advance value, the ME shall return its current status (i.e. ME is in idle mode or not) in order for the application to be aware of potential misinterpretation of the timing advance value. Caution should be taken if using the Timing Advance value for distance measurement as reflections from the external environment (buildings etc.) may affect the accuracy.

If the access technology is requested, the ME shall return the current access technology that the ME is using.

6.4.16 SET UP EVENT LIST

The UICC shall use this command to supply a set of events. This set of events shall become the current list of events for which the ME is to monitor.

Any subsequent SET UP EVENT LIST command replaces the current list of events supplied in the previous SET UP EVENT LIST command. The SET UP EVENT LIST command can also be used to remove the entire list of events current in the ME; see clause 6.6.16. The list of events provided by the UICC in the last SET UP EVENT LIST command shall be removed if the ME is powered off or the UICC is removed or electrically reset.

When the ME has successfully accepted or removed the list of events, it shall send TERMINAL RESPONSE (OK) to the UICC.

When the ME is not able to successfully accept or remove the list of events, it shall send TERMINAL RESPONSE (Command beyond ME's capabilities).

When one of the events in the current list occurs, then the ME shall use the Event Download mechanism to transfer details of the event to the UICC; see clause 7.5.

6.4.17 PERFORM CARD APDU

This clause applies only if class "a" is supported.

This command requests the ME to send an APDU command to the additional card (Card x).

The command includes:

- the additional card reader identifier, which is part of the Device Identities object;
- the APDU command to be performed.

Upon receiving this command, the ME shall decide if it is able to execute the command:

- if the command is rejected because the card reader identity is not valid, the ME informs the UICC using TERMINAL RESPONSE (MultipleCard command error – Card reader not valid);
- if the command is rejected because the card reader is not present or has been removed, the ME informs the UICC using TERMINAL RESPONSE (MultipleCard command error – Card reader removed or not present);
- if the command is rejected because the card is not present or has been removed, the ME informs the UICC using TERMINAL RESPONSE (MultipleCard command error – Card removed or not present);
- if the command is rejected because the card reader is busy, the ME informs the UICC using TERMINAL RESPONSE (MultipleCard command error – Card reader busy);
- if the command is rejected because the card is not powered on, the ME informs the UICC using TERMINAL RESPONSE (MultipleCard command error – Card powered off);
- if the command is rejected because the received C-APDU format is not valid, the ME informs the UICC using TERMINAL RESPONSE (MultipleCard command error – C-APDU format error).

If the ME is able to transfer the C-APDU to the addressed card, the ME shall:

- transfer the C-APDU to the addressed card, through the selected ME- Card x protocol;
- extract the R-APDU data from the addressed card if so requested by the UICC;
- if the command fails because no response is received from Card x, the ME informs the UICC using TERMINAL RESPONSE (MultipleCard command error – Card mute);
- if the command fails because of any form of transmission error, the ME informs the UICC using TERMINAL RESPONSE (MultipleCard command error – Transmission error);
- if the command fails because the ME does not support the protocol used by Card x, the ME informs the UICC using TERMINAL RESPONSE (MultipleCard command error – Protocol not supported).

If the command is performed successfully from a protocol point of view, the ME shall include the R-APDU within the TERMINAL RESPONSE command.

6.4.18 POWER OFF CARD

This clause applies only if class "a" is supported.

This command requests the ME to close a session with the additional card (Card x).

The command includes the additional card reader identifier, which is part of the Device Identities object.

Upon receiving this command, the ME shall decide if it is able to execute the command:

- if the command is rejected because the card reader identity is not valid, the ME informs the UICC using TERMINAL RESPONSE (MultipleCard command error – Card reader not valid);
- if the command is rejected because the card reader is not present or has been removed, the ME informs the UICC using TERMINAL RESPONSE (MultipleCard command error – Card reader removed or not present);
- if the command is rejected because the card is not present or has been removed, the ME informs the UICC using TERMINAL RESPONSE (MultipleCard command error – Card removed or not present);
- if the command is rejected because the card reader is busy, the ME informs the UICC using TERMINAL RESPONSE (MultipleCard command error – Card reader busy).

If the ME is able to execute the command, the addressed Card x shall be deactivated according to ISO/IEC 7816-3 [16].

6.4.19 POWER ON CARD

This clause applies only if class "a" is supported.

This command requests the ME to start a session with the additional card (Card x).

The command includes the additional card reader identifier, which is part of the Device Identities object.

Upon receiving this command, the ME shall decide if it is able to execute the command:

- if the command is rejected because the card reader identity is not valid, the ME informs the UICC using TERMINAL RESPONSE (MultipleCard command error – Card reader not valid);
- if the command is rejected because the card reader is not present or has been removed, the ME informs the UICC using TERMINAL RESPONSE (MultipleCard command error – Card reader removed or not present);
- if the command is rejected because the card is not present or has been removed, the ME informs the UICC using TERMINAL RESPONSE (MultipleCard command error – Card removed or not present);
- if the command is rejected because the card reader is busy, the ME informs the UICC using TERMINAL RESPONSE (MultipleCard command error – Card reader busy).

If the ME is able to execute the command, and the addressed Card x is powered off, the ME shall activate the addressed Card x according to ISO/IEC 7816-3 [16]. If the addressed Card x is already powered on, the ME shall treat the POWER ON CARD command as a warm reset, as defined in ISO/IEC 7816-3 [16].

The ME shall return the Answer To Reset within the TERMINAL RESPONSE command. If no ATR is received, the ME shall inform the UICC using TERMINAL RESPONSE (MultipleCard command error – Card mute).

Application writers are advised that the Card x should not be powered up for longer than necessary due to battery life considerations.

6.4.20 GET READER STATUS

This clause applies only if class "a" is supported.

This command requests the ME to get information about all interfaces or the indicated interface to additional card reader(s). This information is restricted to:

- card reader status;
- card reader identifier.

The ME shall return the requested information from the interfaces to additional card reader(s) within a TERMINAL RESPONSE command.

6.4.21 TIMER MANAGEMENT

This command requests the ME to manage timers running physically in the ME. The possible actions on timers are defined below:

- start a timer;
- deactivate a timer;
- get the current value of a timer.

The UICC and the ME are able to manage 8 different timers running in parallel. The possible duration of a timer is between 1 second and 24 hours. The resolution of a timer is 1 second. The precision of the returned value can not be relied upon in all cases due to potential ME activities. When the ME is switched off or the UICC is reset, all timers are deactivated in the ME.

For a given timer:

- when the UICC requests the ME to start the timer with a duration, then:
 - the ME shall start the timer with the duration given by the UICC, even if this timer is already running. When a timer is started, it takes the value given by the UICC, and is then decremented. The ME shall inform the UICC that the command has been successfully executed, using TERMINAL RESPONSE (OK).
- when the UICC requests the ME to deactivate the timer, then:
 - if the timer is running, the ME shall deactivate the timer. This prevents the UICC from receiving unnecessary information at the expiration of a timer. The ME shall pass the current value of the timer (i.e. the duration that remains before the timer elapses) to the UICC, using TERMINAL RESPONSE;
 - if the timer is already deactivated, the ME shall inform the UICC using TERMINAL RESPONSE ('action in contradiction with the current timer state').
- when the UICC requests the ME to get the current value of the timer, then:
 - if the timer is running, the ME shall pass the current value of the timer (i.e. the duration that remains before the timer elapses) to the UICC, using TERMINAL RESPONSE;
 - if the timer is deactivated, the ME shall inform the UICC using TERMINAL RESPONSE ('action in contradiction with the current timer state').

When a timer expires (i.e. reaches zero), the ME shall use the Timer Expiration mechanism to transfer the identifier of the timer that has expired and the difference between the time when this transfer occurs and the time when the timer was initially started. The ME shall then deactivate the timer.

6.4.22 SET UP IDLE MODE TEXT

The UICC shall supply a text string, which shall be displayed by the ME as an idle mode text if the ME is able to do it. The presentation style is left as an implementation decision to the ME manufacturer. The idle mode text shall be displayed in a manner that ensures that neither the network name nor the service providers name are affected.

If idle mode text is competing with other information to be displayed on the same area, for instance a CB message, the idle mode text shall be replaced by the other information. It is up to the ME to restore the idle mode text when the other information has no longer to be displayed.

The text shall be removed from the ME's memory and display if either:

- the ME is powered off; or
- the UICC is removed or electrically reset; or
- a REFRESH command occurs with "initialisation" or "reset".

Any subsequent SET UP IDLE MODE TEXT command replaces the current idle mode text of the previous SET UP IDLE MODE TEXT. The SET UP IDLE MODE TEXT command can also be used to remove an idle mode text from the ME; see clause 6.6.22.

When the ME has successfully integrated or removed an idle mode text, it shall send TERMINAL RESPONSE (OK) to the UICC.

When the ME is not able to successfully integrate or remove the idle mode text, it shall send TERMINAL RESPONSE "Command beyond ME's capabilities" to the UICC.

6.4.23 RUN AT COMMAND

This clause applies only if class "b" is supported by the ME and enabled by the subscriber through the ME.

The UICC uses this command to send an AT Command to the ME as though initiated by an attached TE. The ME shall then return an AT Response within a TERMINAL RESPONSE to the UICC.

If this feature is enabled, the UICC uses this command to send an AT Command to the ME as though initiated by an attached TE. The ME shall then return an AT Response within a TERMINAL RESPONSE to the UICC.

If this feature is disabled or the mobile does not support the RUN AT COMMAND, then if the USAT receives an instruction from the network to issue the command, the USAT should return an error indication in accordance with the AT Response set (e.g. as indicated in 3G 27.007 [12]) to the network.

Optionally, the UICC may include in this command an alpha identifier. The use of this alpha identifier by the ME is described below:

- if the alpha identifier is provided by the UICC and is not a null data object, the ME shall use it to inform the user. This is also an indication that the ME should not give any other information to the user on the fact that the ME is performing an AT command. If an icon is provided by the UICC, the icon indicated in the command may be used by the ME to inform the user, in addition to, or instead of the alpha identifier, as indicated with the icon qualifier (see clause 6.5.4);
- if the alpha identifier is provided by the UICC and is a null data object (i.e. length = '00' and no value part), this is an indication that the ME should not give any information to the user on the fact that the ME is performing an AT command;
- if the alpha identifier is not provided by the UICC, the ME may give information to the user concerning what is happening.

6.4.24 SEND DTMF

This command requests the ME to send a DTMF string after a call has been successfully established either by the proactive command SET UP CALL or the user. This command is independent of sending DTMF within the call set up (as defined in the SET UP CALL command) and therefore, can be used at any time during a call.

The ME shall not locally generate audible DTMF tones and play them to the user.

NOTE: On the downlink audio, DTMF tones reflected by the network may be heard.

It shall be possible for the user to deactivate this command.

The sending of a DTMF string applies only to the currently active call.

The TERMINAL RESPONSE indicating that the command has been performed successfully shall be sent after the complete DTMF string has been sent to the network by the ME.

If the command is sent in idle mode, or a call is terminated or put on hold before the complete DTMF string has been sent to the network, the ME shall inform the UICC using TERMINAL RESPONSE '20' with the additional information "Not in speech call".

If the user indicates the need to end the proactive UICC application session whilst the ME is sending the DTMF string, the ME shall stop sending the DTMF string and shall send a TERMINAL RESPONSE with "Proactive UICC application session terminated by the user" result value.

Optionally, the UICC may include in this command an alpha identifier. The use of this alpha identifier by the ME is described below:

- if the alpha identifier is provided by the UICC and is not a null data object, the ME shall use it to inform the user. This is also an indication that the ME should not give any other information to the user on the fact that the ME is performing a SEND DTMF command. If an icon is provided by the UICC, the icon indicated in the command may be used by the ME to inform the user, in addition to, or instead of the alpha identifier, as indicated with the icon qualifier (see clause 6.5.4);
- if the alpha identifier is provided by the UICC and is a null data object (i.e. length = '00' and no value part), this is an indication that the ME should not give any information to the user on the fact that the ME is performing a SEND DTMF command.

If the alpha identifier is not provided by the UICC, the ME may give information to the user concerning what is happening.

6.4.25 LANGUAGE NOTIFICATION

The UICC shall use this command to notify the ME about the language currently used for any text string within proactive commands or envelope command responses.

The notified language stays valid within the ME until the end of the card session or upon executing another LANGUAGE NOTIFICATION command.

When the USAT application is not aware of the current USAT application language, no specific language is in use or several languages are in use, the UICC may notify non-specific language. This has the effect of cancelling a previous specific LANGUAGE NOTIFICATION.

Two types of language notification are defined:

- specific, where an additional Language object shall be included by the UICC;
- non-specific, where no Language object shall be included by the UICC.

Regardless of whether the ME recognises the notified language or not, the ME shall send TERMINAL RESPONSE (OK) to the UICC.

The ME may use the language included in LANGUAGE NOTIFICATION as appropriate. For instance, this could be done to avoid a mix of languages in screen displays combining ME MMI and USAT originating text strings.

6.4.26 LAUNCH BROWSER

This command is used to request a browser inside a browser-enabled ME to interpret the content corresponding to a URL.

Upon receiving this command, the ME shall decide if it is able to execute the command. Examples are given below, but the list is not exhaustive:

- if the command is rejected because the browser on the ME is busy or not available, the ME informs the UICC using TERMINAL RESPONSE (ME unable to process command – browser unavailable);
- if the command is rejected because the ME is busy on a SS transaction, the ME informs the UICC using TERMINAL RESPONSE (ME unable to process command – ME currently unable to process command);
- if the command is rejected because the bearer provided in the command is not available, the ME informs the UICC using TERMINAL RESPONSE (ME unable to process command – bearer unavailable).

If the ME is able to execute the command:

- the ME shall inform the UICC that the command has been successfully taken into account, using TERMINAL RESPONSE;
- the UICC shall end the proactive session;
- then the ME shall request content using the URL.

If the gateway addresses and/or the bearer objects are present in the command and are non null data objects, then the browser shall use these data to request content using the URL. If the gateway addresses, bearer objects, Provisioning File Reference, Browser Identity or URL are null objects or missing, then the ME shall use default values (for an example, see Annex J reference [2]).

The ME shall ask the user for confirmation using the Alpha Identifier/Icon Identifier (user confirmation phase) if present, when it receives a LAUNCH BROWSER command which requests the existing browser session connected to a new URL or to terminate a browser session.

The way the ME requests content using the URL is outside the scope of the present document (for an example, see annex J reference [1]).

NOTE: That there is a maximum size for the URL that can be given in argument of this proactive command.

6.4.27 OPEN CHANNEL

6.4.27.1 OPEN CHANNEL related to CS bearer

This clause applies only if class "e" is supported.

Upon receiving this command, the ME shall decide if it is able to execute the command. The UICC shall indicate whether the ME should establish the link immediately or upon receiving the first transmitted data (on demand).

The UICC provides to the ME a list of parameters necessary to establish a link.

The UICC may request the use of an automatic reconnection mechanism according to GSM 02.07 [20]. The UICC may also request an optional maximum duration for the reconnection mechanism. The ME shall attempt at least one link establishment set-up.

The UICC may also request an optional maximum duration for the ME to automatically release the link if no data is exchanged.

If the Fixed Dialling Number service is enabled, the address included in the OPEN CHANNEL proactive command shall not be checked against those of the FDN list.

Upon receiving this command, the ME shall decide if it is able to execute the command. Examples are given below, but the list is not exhaustive:

- if immediate link establishment is requested and the ME is unable to set-up a channel using the exact parameters provided by the UICC, the ME sets up the channel using the best parameters it can support and informs the UICC of the channel identifier and the modified parameters using TERMINAL RESPONSE (Command performed with modification);
- if immediate link establishment is requested and the ME is unable to set-up the link with the network using the exact parameters provided by the UICC, the ME informs the UICC using TERMINAL RESPONSE (Network currently unable to process command). The operation is aborted;
- if on demand link establishment is requested and the ME is unable to set-up a channel using the exact parameters provided by the UICC, the ME sets up the channel using the best parameters it can support and informs the UICC of the channel identifier and the modified parameters using TERMINAL RESPONSE (Command performed with modification);
- if the command is rejected because the ME has no channel left with the requested bearer capabilities, the ME informs the UICC using TERMINAL RESPONSE (Bearer independent protocol error). The operation is aborted;
- if the user does not accept the channel set-up, the ME informs the UICC using TERMINAL RESPONSE (User did not accept the proactive command). The operation is aborted;
- if the user has indicated the need to end the proactive UICC session, the ME informs the UICC using TERMINAL RESPONSE (Proactive UICC session terminated by the user). The operation is aborted;
- if the command is rejected because the ME is busy on another call, the ME informs the UICC using TERMINAL RESPONSE (ME unable to process command - currently busy on call). The operation is aborted;
- if the command is rejected because the ME is busy on a SS transaction, the ME informs the UICC using TERMINAL RESPONSE (ME unable to process command - currently busy on SS transaction). The operation is aborted.

The ME shall inform the UICC that the command has been successfully executed using TERMINAL RESPONSE:

- if immediate link establishment is requested, the ME allocates buffers, sets up the link and informs the UICC and reports the channel identifier using TERMINAL RESPONSE (Command performed successfully);
- if on demand link establishment is requested, the ME allocates buffers, informs the UICC and reports the channel identifier using TERMINAL RESPONSE (Command performed successfully).

If the ME is able to set up the channel on the serving network, the ME shall:

- alert the user (as for an incoming call). This is the confirmation phase;

- optionally, the UICC may include in this command an alpha-identifier. The use of this alpha-identifier by the ME is described below:
 - if the alpha identifier is provided by the UICC and is not a null data object, the ME shall use it during the user confirmation phase. This is also an indication that the ME should not give any other information to the user during the user confirmation phase. If an icon is provided by the UICC, the icon indicated in the command may be used by the ME to inform the user, in addition to, or instead of the alpha identifier, as indicated with the icon qualifier (see clause 6.5.4);
 - if the alpha identifier is not provided by the UICC or is a null data object (i.e. length = '00' and no value part), the ME may give information to the user.
- if the user accepts the channel, the ME shall then set up a channel;
- if the user does not accept the channel or rejects the channel, then the ME informs the UICC using TERMINAL RESPONSE (user did not accept the proactive command). The operation is aborted;
- if the user has indicated the need to end the proactive UICC session, the ME shall send a TERMINAL RESPONSE with (Proactive UICC session terminated by the user) result value;
- optionally, during call set-up, the ME can give some audible or display indication concerning what is happening;
- if the first link set-up attempt is unsuccessful:
 - if the UICC did not request link re-connection then the ME shall inform the UICC using TERMINAL RESPONSE (network currently unable to process command), and not retry to set-up the link:
 - if the UICC requested link re-connection, then the ME may automatically retry to set-up the link (depending on its configuration capabilities). In this case, the ME shall not send a command result to the UICC concerning the first or any subsequent failed set-up attempts. If the link set-up has not been successful, and the ME is not going to perform any more re-tries, or the time elapsed since the first link set-up attempt has exceeded the duration requested by the UICC, then the ME shall inform the UICC using TERMINAL RESPONSE (network currently unable to process command), and the re-try mechanism shall be terminated;
 - if the user stops the link set-up attempt or the re-try mechanism before a result is received from the network, the ME informs the UICC using TERMINAL RESPONSE (user cleared down call before connection or network release).

If the ME supports the Last Number Dialed service, the ME shall not store in EF_{LND} the channel set-up details (called party number and associated parameters) sent by the UICC in this command.

6.4.27.2 OPEN CHANNEL related to GPRS

This clause applies only if class "e" is supported.

Upon receiving this command, the ME shall decide if it is able to execute the command. The UICC shall indicate whether the ME should establish the link immediately or upon receiving the first transmitted data (on demand).

The UICC provides to the ME a list of parameters necessary to activate a PDP context.

The ME shall attempt at least one PDP context activation.

Upon receiving this command, the ME shall decide if it is able to execute the command. Examples are given below, but the list is not exhaustive:

- if immediate PDP context activation is requested and the ME is unable to set-up a channel using the exact parameters provided by the UICC, the ME sets up the channel using the best parameters it can support and informs the UICC of the channel identifier and the modified parameters using TERMINAL RESPONSE (Command performed with modification);
- if immediate PDP context activation is requested and the ME is unable to activate the PDP context with the network using the exact parameters provided by the UICC, the ME informs the UICC using TERMINAL RESPONSE (Network currently unable to process command). The operation is aborted;

- if on demand link establishment is requested and the ME is unable to set-up a channel using the exact parameters provided by the UICC, the ME sets up the channel using the best parameters it can support and informs the UICC of the channel identifier and the modified parameters using TERMINAL RESPONSE (Command performed with modification);
- if the command is rejected because the ME has no channel left with the requested bearer capabilities, the ME informs the UICC using TERMINAL RESPONSE (Bearer independent protocol error). The operation is aborted;
- if the user does not accept the channel set-up, the ME informs the UICC using TERMINAL RESPONSE (User did not accept the proactive command). The operation is aborted;
- if the user has indicated the need to end the proactive UICC session, the ME informs the UICC using TERMINAL RESPONSE(Proactive UICC session terminated by the user). The operation is aborted;
- if the command is rejected because the class B ME is busy on a call, the ME informs the UICC using TERMINAL RESPONSE (ME unable to process command - currently busy on call). The operation is aborted;
- if the command is rejected because the class B ME is busy on a SS transaction, the ME informs the UICC using TERMINAL RESPONSE (ME unable to process command - currently busy on SS transaction). The operation is aborted.

The ME shall inform the UICC that the command has been successfully executed using TERMINAL RESPONSE:

- if immediate PDP context activation is requested, the ME allocates buffers, activates the PDP context and informs the UICC and reports the channel identifier using TERMINAL RESPONSE (Command performed successfully);
- if on demand PDP context activation is requested, the ME allocates buffers, informs the UICC and reports the channel identifier using TERMINAL RESPONSE (Command performed successfully).

If the ME is able to set up the channel on the serving network, the ME shall:

- alert the user (as for an incoming call). This is the confirmation phase;
- optionally, the UICC may include in this command an alpha-identifier. The use of this alpha-identifier by the ME is described below:
 - if the alpha identifier is provided by the UICC and is not a null data object, the ME shall use it during the user confirmation phase. This is also an indication that the ME should not give any other information to the user during the user confirmation phase. If an icon is provided by the UICC, the icon indicated in the command may be used by the ME to inform the user, in addition to, or instead of the alpha identifier, as indicated with the icon qualifier (see clause 6.5.4);
 - if the alpha identifier is not provided by the UICC or is a null data object (i.e. length = '00' and no value part), the ME may give information to the user.
- if the user accepts the channel, the ME shall then set up a channel;
- if the user does not accept the channel or rejects the channel, then the ME informs the UICC using TERMINAL RESPONSE (user did not accept the proactive command). The operation is aborted;
- if the user has indicated the need to end the proactive UICC session, the ME shall send a TERMINAL RESPONSE with (Proactive UICC session terminated by the user) result value;
- optionally, during PDP context activation, the ME can give some audible or display indication concerning what is happening;
- if the user stops the PDP context activation attempt before a result is received from the network, the ME informs the UICC using TERMINAL RESPONSE (user cleared down call before connection or network release).

6.4.27.3 OPEN CHANNEL related to local bearer

This clause applies if classes "e" and "f" are supported.

This command is used to establish a connection using a local bearer (Bluetooth, IrDA, RS232, USB). The UICC can act as a server or a client. In the server use case, the UICC performs an OPEN CHANNEL only after having received a Local Connection event from the ME.

Upon receiving this command, the ME shall decide if it is able to execute the command. The UICC shall indicate whether the ME should establish the link immediately or upon receiving the first transmitted data (on demand).

The UICC provides to the ME a list of parameters necessary to establish a link.

The UICC may request the use of an automatic reconnection mechanism. The UICC may also request an optional maximum duration for the reconnection mechanism. The ME shall attempt at least one link establishment set-up.

The UICC may also request an optional maximum duration for the ME to automatically release the link if no data is exchanged.

Upon receiving this command, the ME shall decide if it is able to execute the command. Examples are given below, but the list is not exhaustive:

- if immediate link establishment is requested and the ME is unable to set-up a channel using the exact parameters provided by the UICC, the ME sets up the channel using the best parameters it can support and informs the UICC of the channel identifier and the modified parameters using TERMINAL RESPONSE (Command performed with modification);
- if immediate link establishment is requested and the ME is unable to set-up the link with the network using the exact parameters provided by the UICC, the ME informs the UICC using TERMINAL RESPONSE (Network currently unable to process command). The operation is aborted;
- if on demand link establishment is requested and the ME is unable to set-up a channel using the exact parameters provided by the UICC, the ME sets up the channel using the best parameters it can support and informs the UICC of the channel identifier and the modified parameters using TERMINAL RESPONSE (Command performed with modification);
- if the command is rejected because the ME has no channel left with the requested bearer capabilities, the ME informs the UICC using TERMINAL RESPONSE (Bearer independent protocol error). The operation is aborted;
- if the user does not accept the channel set-up, the ME informs the UICC using TERMINAL RESPONSE (User did not accept the proactive command). The operation is aborted;
- if the user has indicated the need to end the proactive UICC session, the ME informs the UICC using TERMINAL RESPONSE (Proactive UICC session terminated by the user). The operation is aborted;
- if the command is rejected because the ME is busy on another call, the ME informs the UICC using TERMINAL RESPONSE (ME unable to process command - currently busy on call). The operation is aborted;
- if the command is rejected because the ME is busy on a SS transaction, the ME informs the UICC using TERMINAL RESPONSE (ME unable to process command - currently busy on SS transaction). The operation is aborted.

The ME shall inform the UICC that the command has been successfully executed using TERMINAL RESPONSE:

- if immediate link establishment is requested, the ME allocates buffers, sets up the link and informs the UICC and reports the channel identifier using TERMINAL RESPONSE (Command performed successfully);
- if on demand link establishment is requested, the ME allocates buffers, informs the UICC and reports the channel identifier using TERMINAL RESPONSE (Command performed successfully).

If the ME is able to set up the channel on the requested local bearer, the ME shall:

- alert the user (as for an incoming call). This is the confirmation phase;
- optionally, the UICC may include in this command an alpha-identifier. The use of this alpha-identifier by the ME is described below:
 - if the alpha identifier is provided by the UICC and is not a null data object, the ME shall use it during the user confirmation phase. This is also an indication that the ME should not give any other information to the user during the user confirmation phase. If an icon is provided by the UICC, the icon indicated in the

command may be used by the ME to inform the user, in addition to, or instead of the alpha identifier, as indicated with the icon qualifier (see clause 6.5.4);

- if the alpha identifier is not provided by the UICC or is a null data object (i.e. length = '00' and no value part), the ME may give information to the user.
- if the user accepts the channel, the ME shall then set up a channel;
- if the user does not accept the channel or rejects the channel, then the ME informs the UICC using TERMINAL RESPONSE (user did not accept the proactive command). The operation is aborted;
- if the user has indicated the need to end the proactive UICC session, the ME shall send a TERMINAL RESPONSE with (Proactive UICC session terminated by the user) result value;
- optionally, during call set-up, the ME can give some audible or display indication concerning what is happening;
- if the first link set-up attempt is unsuccessful:
- if the UICC did not request link re-connection then the ME shall inform the UICC using TERMINAL RESPONSE (network currently unable to process command), and not retry to set-up the link:
 - if the UICC requested link re-connection, then the ME may automatically retry to set-up the link (depending on its configuration capabilities). In this case, the ME shall not send a command result to the UICC concerning the first or any subsequent failed set-up attempts. If the link set-up has not been successful, and the ME is not going to perform any more re-tries, or the time elapsed since the first link set-up attempt has exceeded the duration requested by the UICC, then the ME shall inform the UICC using TERMINAL RESPONSE (network currently unable to process command), and the re-try mechanism shall be terminated;
 - if the user stops the link set-up attempt or the re-try mechanism before a result is received from the network, the ME informs the UICC using TERMINAL RESPONSE (user cleared down call before connection or network release).

6.4.28 CLOSE CHANNEL

This clause applies only if class "e" is supported.

This command requests the ME to close the channel corresponding to the Channel identifier.

Upon receiving this command, the ME shall decide if it is able to execute the command:

- if the command is rejected because the channel identifier is not valid, the ME informs the UICC using TERMINAL RESPONSE (Bearer independent protocol error);
- if the command is rejected because the requested channel is in error, the ME informs the UICC using TERMINAL RESPONSE (Bearer independent protocol error).

If the ME is able to process the command:

- the ME shall release the data transfer, discard the remaining data and inform the UICC that the command has been successfully executed, using TERMINAL RESPONSE;
- optionally, during CLOSE CHANNEL, the ME can give some audible or display indication concerning what is happening. In this intention, the UICC may include in this command an alpha-identifier. The use of this alpha-identifier by the ME is described below:
 - if the alpha identifier is provided by the UICC and is not a null data object, the ME shall use it to indicate the link closing phase. If an icon is provided by the UICC, the icon indicated in the command may be used by the ME to inform the user, in addition to, or instead of the alpha identifier, as indicated with the icon qualifier (see clause 6.5.4);
 - if the alpha identifier is not provided by the UICC or is a null data object (i.e. length = '00' and no value part), the ME may give information to the user.

6.4.29 RECEIVE DATA

This clause applies only if class "e" is supported.

This command requests the ME to return data from a dedicated Channel identifier according to the number of bytes specified by the UICC.

Upon receiving this command, the ME shall return the data available in the Rx buffer corresponding to the Channel identifier. Examples are given below, but the list is not exhaustive.

If the ME is unable to process the command:

- if the command is rejected because the requested channel is already closed the ME informs the UICC using TERMINAL RESPONSE (Bearer independent protocol error);
- if the user has indicated the need to end the proactive UICC session, the ME informs the UICC using TERMINAL RESPONSE (Proactive UICC session terminated by the user).

If the ME is able to process the command:

- if the requested number of bytes is available in the buffer, the ME shall inform the UICC that the command has been successfully executed, using TERMINAL RESPONSE and return the requested data and the number of bytes remaining in the channel buffer (or FF if more than the maximum bytes remains);
- if the requested number of bytes is not yet available in the buffer, the ME shall NOT wait for the requested number of bytes to arrive. The ME shall inform the UICC, using TERMINAL RESPONSE (Command performed with missing information) and returns the data currently available in the channel buffer;
- in the case of packet/datagram transmission, the ME shall put in the Rx buffer a complete packet SDU and only one at one time. For example, if UDP datagrams are received by the ME, the latter shall insert only the SDU of each UDP packet received in the Rx buffer. After one SDU has been downloaded by the UICC (using one or several RECEIVE DATA commands), the ME shall insert the next SDU of UDP datagram, and so on;
- if the alpha identifier is provided by the UICC, the ME shall use it to inform the user. The ME may also use it to inform the user during data transfer. If an icon is provided by the UICC, the icon indicated in the command may be used by the ME to inform the user, in addition to, or instead of the alpha identifier, as indicated with the icon qualifier (see clause 6.5.4).

6.4.30 SEND DATA

This clause applies only if class "e" is supported.

This command requests the ME to send data through a previously set up data channel corresponding to a dedicated Channel identifier. The UICC informs the ME if the data is:

- to be sent immediately;

- or to be stored in a Tx buffer. Then it is up to the ME to manage the data sending in order to use the bearer in an optimised way. To send the data stored in a Tx buffer, the ME shall be notified by a "send data immediately" and it shall consider the data presently and previously concatenated in its Tx buffer as one SDU, and send it in only one PDU. The Tx buffer shall then be emptied before returning the TERMINAL RESPONSE to the UICC and allowing new UICC sending.

Upon receiving this command, the ME shall either immediately send data or store provided data into the Tx buffer corresponding to the Channel identifier. Examples are given below, but the list is not exhaustive.

If the ME is unable to process the command:

- if the command is rejected because the requested channel is already closed the ME informs the UICC using TERMINAL RESPONSE (Bearer Independent Protocol error – channel identifier not valid);
- if the command is rejected because the ME could not establish the link (after OPEN CHANNEL (on demand)) or the link was dropped, the ME informs the UICC using TERMINAL RESPONSE (Bearer Independent Protocol error – channel closed);
- if the command is rejected because the channel is temporarily unavailable the ME informs the UICC using TERMINAL RESPONSE (ME currently unable to process command);
- if the requested number of bytes of empty space is not yet available in the buffer the ME informs the UICC using TERMINAL RESPONSE (Bearer Independent Protocol error);
- if the user has indicated the need to end the proactive UICC session, the ME informs the UICC using TERMINAL RESPONSE (Proactive UICC session terminated by the user).

If the ME is able to process the command:

- if the requested number of bytes of empty space is available in the buffer the ME shall inform the UICC that the command has been successfully executed, using TERMINAL RESPONSE and return the number of bytes of empty space available in the Tx buffer (or FF if more than 255 bytes are available);
- in the case of packet/datagram transmission, the structure of the SDU sent by the UICC to the ME shall be fully respected while sending to the ME external interface. The size of the SDU is therefore limited by the size of the packet PDU sent over the ME external interface. In order to send one complete SDU, the USAT application may fill the Tx buffer with several SEND DATA commands, if necessary. Then the ME shall send the complete SDU in one packet PDU;
- if the alpha identifier is provided by the UICC, the ME shall use it to inform the user. The ME may also use it to inform the user during data transfer. If an icon is provided by the UICC, the icon indicated in the command may be used by the ME to inform the user, in addition to, or instead of the alpha identifier, as indicated with the icon qualifier (see clause 6.5.4).

6.4.31 GET CHANNEL STATUS

This clause applies only if class "e" is supported.

This command requests the ME to return a Channel status data object for each dedicated Channel identifier.

The ME shall return the requested information concerning the channel(s) within a TERMINAL RESPONSE command.

6.4.32 DECLARE SERVICE

This clause applies only if class "f" is supported.

This command allows the UICC to download into the ME service database the services that the card provides as a server. The declaration is to be made on a service by service basis, at the set up (e.g. after the profile download). The UICC shall indicate whether the ME is required to add a new service in the ME service database or to remove a service from the ME service database.

When adding a new service, the UICC shall provide a Service Record that the ME is required to register into its local service database.

When removing a service, the UICC shall provide the Service Identifier which uniquely identifies the service to be deleted from the database.

Upon receiving this command, the ME shall decide if it is able to execute the command. Examples are given below, but the list is not exhaustive:

- If the command is rejected because the ME is busy on a call, the ME informs the UICC using TERMINAL RESPONSE (ME unable to process command – ME currently busy on call).
- If the command is rejected because the ME has not enough memory available to store the service record, the ME informs the UICC using TERMINAL RESPONSE(Bearer Independent Protocol Error – Requested buffer size not available).
- If the command for deletion is rejected because the service identifier is not valid, the ME informs the UICC using TERMINAL RESPONSE(Bearer Independent Protocol Error- Service identifier unknown).
- If the command is performed with modification of certain parameters of the Service Record (of which value is dynamically assigned by the ME), the ME informs the UICC using TERMINAL RESPONSE (command performed with modification).

If the ME is able to execute the command:

- The ME shall inform the UICC that the command has been successfully performed using TERMINAL RESPONSE (command performed successfully).
- When performing a DECLARE SERVICE for deletion, if the UICC provides a Service Identifier parameter different from 'FF', the ME shall ignore the parameter and proceed with the command.

NOTE: a service can be coded using a coding type issued from a specific local bearer technology (e.g. Bluetooth or IrDA); however this service shall be considered by the ME as available for any bearer.

6.4.33 SERVICE SEARCH

This clause applies if class "f" is supported.

This command is used to search for the availability of a service in the environment of the ME.

The UICC may provide a Device Filter. The devices responding to the service search shall then be part of the set given by Device Filter. If the Device Filter parameter is not present, no filter on the type of equipment is done by the ME.

The UICC provides a Service Search parameter. The devices responding to the service search shall then support the requested service.

Upon receiving this command, the ME shall decide if it is able to execute the command. Examples are given below, but the list is not exhaustive:

- If the command is rejected because the ME is busy on a call, the ME informs the UICC using TERMINAL RESPONSE (ME unable to process command – ME currently busy on call).
- If the command is rejected because the bearer provided in the command is not available, the ME informs the UICC using TERMINAL RESPONSE(ME unable to process command – bearer unavailable).

If the ME is able to execute the command:

- the ME performs the service search, gathers all received responses and informs the UICC using TERMINAL RESPONSE(command performed successfully, Service Availability).
- If the command fails because no device in the radio range supported the requested service, the ME informs the UICC using TERMINAL RESPONSE (Bearer independent protocol error – Service error).
- If the command fails because there is no device reachable, the ME informs the UICC using TERMINAL RESPONSE (Bearer independent protocol error – Remote device is not reachable).

6.4.34 GET SERVICE INFORMATION

This clause applies if class "f" is supported.

This proactive command is used to look for the complete service record related to a service. By service record, it is meant all information that allows the UICC to define precisely the service (e.g. protocol stacks).

The UICC provides the Attribute Information parameter which indicates which detailed information is required.

Upon receiving this command, the ME shall decide if it is able to execute the command. Examples are given below, but the list is not exhaustive:

- If the command is rejected because the ME is busy on a call, the ME informs the UICC using TERMINAL RESPONSE (ME unable to process command – ME currently busy on call).
- If the command is rejected because the bearer provided in the command is not available, the ME informs the UICC using TERMINAL RESPONSE (ME unable to process command – bearer unavailable).

If the ME is able to execute the command:

- the ME performs the search for the service details and informs the UICC using TERMINAL RESPONSE (command performed successfully, Service Record). The Service Record shall then be used as argument of an Open Channel proactive command.
- If the command fails because there is no device reachable, the ME informs the UICC using TERMINAL RESPONSE (Bearer independent protocol error – Remote device is not reachable).

If the USAT application already has all information concerning the service, it may directly try to connect the service performing an OPEN CHANNEL, and bypass the GET SERVICE INFORMATION step.

6.5 Common elements in proactive UICC commands

6.5.1 Command number

The command number is to cater for the future possibility of multiple ongoing commands (i.e. when the UICC issues further commands before receiving the response to the ongoing command). The implications of such multiple ongoing commands have not been elaborated at this stage of the toolkit specification.

Each command issued by a proactive UICC during a 3G session shall have its own command number. Command numbers may take any hexadecimal value between '01' and 'FE'. The command number is held in the command details data object.

The UICC is responsible for assigning the command number.

The ME shall keep a record of the status of each command and its command number, until the ME gives the result of the command to the UICC, using TERMINAL RESPONSE. After this, the ME may erase all internal records concerning this command. The command number is then free for allocation by the UICC to a new command.

When the UE is powered off and on, the details of any ongoing command shall be reset. The ME shall not be expected to know the status of commands issued in a previous 3G session.

6.5.2 Device identities

This data object gives the devices which are the source and destination for the instruction. Only certain combinations of source and destination devices are allowed for each proactive command. These are given in clause 10 of the present document.

6.5.3 Alpha identifier

Many of the commands include an alpha identifier data object. The text it contains shall be displayed on screen by the ME at the same time as the UICC command is performed.

6.5.4 Icon identifiers

Some commands may provide an icon identifier. Icons are intended to enhance the MMI by providing graphical information to the user. The display of icons is optional for the ME. If icons are provided by the UICC, the related alpha identifier or text string shall be present and not a null string.

The UICC indicates to the ME whether the icon replaces an alpha identifier or text string, or whether it accompanies it (see clause 8.32).

If both an alpha identifier or text string, and an icon are provided with a proactive command, and both are requested to be displayed, but the ME is not able to display both together on the screen, then the alpha identifier or text string takes precedence over the icon.

If the UICC provides an icon identifier with a proactive command, then the ME shall inform the UICC if the icon could not be displayed by sending the general result "Command performed successfully, but requested icon could not be displayed".

If the ME receives an icon qualifier with bit 1 set to 0, meaning "an alpha identifier or text string related to the icon may be displayed together with the icon by the ME" (see clause 8.32), and no alpha identifier/text string is given by the UICC, then the ME shall reject the command with general result "Command data not understood by ME".

NOTE: Application designers should be aware that icons provided by the application may not be displayed by the ME.

6.6 Structure of proactive UICC commands

The general structure of proactive UICC commands using TLV objects is described in annex C.

6.6.1 DISPLAY TEXT

Description	Clause	M/O/C	Min	Length
Proactive UICC command Tag	9.2	M	Y	1
Length (A+B+C+D+E+F)	-	M	Y	1 or 2
Command details	8.6	M	Y	A
Device identities	8.7	M	Y	B
Text string	8.15	M	Y	C
Icon identifier	8.31	O	N	D
Immediate response	8.43	O	N	E
Duration	8.8	O	N	F

- Duration:
 - Contents: the required duration for execution of the command before the timeout expires. Resolution and the precision of the time value are in accordance with clause 6.4.21 Timer Management.

6.6.2 GET INKEY

Description	Clause	M/O/C	Min	Length
Proactive UICC command Tag	9.2	M	Y	1
Length (A+B+C+D+E)	-	M	Y	1 or 2
Command details	8.6	M	Y	A
Device identities	8.7	M	Y	B
Text string	8.15	M	Y	C
Icon identifier	8.31	O	N	D
Duration	8.8	O	N	E

- Text string:
 - Contents: text for the ME to display in conjunction with asking the user to respond.

- Duration:
 - Contents: the duration for execution of the command before the timeout expires. Resolution and the precision of the time value are in accordance with clause 6.4.21 Timer Management.

6.6.3 GET INPUT

Description	Clause	M/O/C	Min	Length
Proactive UICC command Tag	9.2	M	Y	1
Length (A+B+C+D+E+F)	-	M	Y	1 or 2
Command details	8.6	M	Y	A
Device identities	8.7	M	Y	B
Text string	8.15	M	Y	C
Response length	8.11	M	Y	D
Default Text	8.23	O	N	E
Icon identifier	8.31	O	N	F

- Text string:
 - Contents: text for the ME to display in conjunction with asking the user to respond.
- Response length:
 - Contents: the minimum and maximum acceptable lengths in characters (see clause 6.4.3) for the response from the user.
- Default Text:
 - Contents: text for the ME to display, corresponds to a default text string offered by the UICC.

6.6.4 MORE TIME

Description	Clause	M/O/C	Min	Length
Proactive UICC command Tag	9.2	M	Y	1
Length (A+B)	-	M	Y	1 or 2
Command details	8.6	M	Y	A
Device identities	8.7	M	Y	B

6.6.5 PLAY TONE

Description	Clause	M/O/C	Min	Length
Proactive UICC command Tag	9.2	M	Y	1
Length (A+B+C+D+E+F)	-	M	Y	1 or 2
Command details	8.6	M	Y	A
Device identities	8.7	M	Y	B
Alpha identifier	8.2	O	N	C
Tone	8.16	O	N	D
Duration	8.8	O	N	E
Icon identifier	8.31	O	N	F

- Tone:
 - Contents: the standard supervisory tone or proprietary ME tone that the ME shall generate, either on its own or on top of the downlink audio path. If no tone is specified, then the ME shall default to "general beep".

NOTE: Some supervisory tones are optional for mobile equipment (see TS 22.001 [22]).

- Duration:

- Contents: the length of time for which the ME shall generate the tone, if the tone is continuous or repeatable. For single tones, the value of this data object shall be ignored by the ME. If no duration is specified, the ME shall default to a duration determined by the ME manufacturer.

6.6.6 POLL INTERVAL

Description	Clause	M/O/C	Min	Length
Proactive UICC command Tag	9.2	M	Y	1
Length (A+B+C)	-	M	Y	1 or 2
Command details	8.6	M	Y	A
Device identities	8.7	M	Y	B
Duration	8.8	M	Y	C

- Duration:
 - Contents: the maximum interval between two STATUS commands related to Proactive Polling.

6.6.7 SET-UP MENU

Description	Clause	M/O/C	Min	Length
Proactive UICC command Tag	9.2	M	Y	1
Length (A+B+C+D1+D2+...Dn+E+F+G)	-	M	Y	1 or 2
Command details	8.6	M	Y	A
Device identities	8.7	M	Y	B
Alpha identifier	8.2	M	Y	C
Item data object for item 1	8.9	M	Y	D1
Item data object for item 2	8.9	O	N	D2
.....	8.9	O	N	Dx
Item data object for last item in list	8.9	O	N	Dn
Items Next Action Indicator	8.24	O	N	E
Icon identifier	8.31	O	N	F
Item Icon identifier list	8.32	O	N	G

The SET-UP MENU command BER-TLV data object shall contain Item SIMPLE-TLV data objects. Each Item data object contains an item in the list, for the user to choose. The length of each Item data object may be different. Within a list, each Item shall have a unique item identifier.

If the "Item data object for item 1" is a null data object (i.e. length = '00' and no value part), this is an indication to the ME to remove the existing menu from the menu system in the ME.

If the UICC provides an Items Next Action Indicator data object, the comprehension required flag shall be set to '0'.

The UICC may provide a title icon identifier data object and/or an item icon identifier list data object. The item icon identifier data object contains an icon identifier for each item.

6.6.8 SELECT ITEM

Description	Clause	M/O/C	Min	Length
Proactive UICC command Tag	9.2	M	Y	1
Length (A+B+C+D1+D2+...Dn+E+F+G+H)	-	M	Y	1 or 2
Command details	8.6	M	Y	A
Device identities	8.7	M	Y	B
Alpha identifier	8.2	O	N	C
Item data object for item 1	8.9	M	Y	D1
Item data object for item 2	8.9	O	N	D2
.....	8.9	O	N	Dx
Item data object for last item in list	8.9	O	N	Dn
Items Next Action Indicator	8.24	O	N	E
Item Identifier	8.10	O	N	F
Icon identifier	8.31	O	N	G
Item Icon identifier list	8.32	O	N	H

The SELECT ITEM command BER-TLV data object shall contain Item SIMPLE-TLV data objects. Each Item data object contains an item in the list, for the user to choose. The length of each Item data object may be different. Within a list, each Item shall have a unique item identifier. The SELECT ITEM command BER-TLV data object may contain a single Item Identifier data object as an indication of the default item. The Comprehension Required flag in the Item Identifier data object shall be set to 0, indicating that it is not mandatory for the ME to support indication of the default item.

If the UICC provides an Items Next Action Indicator data object, the comprehension required flag shall be set to '0'.

The UICC may provide a title icon identifier data object and/or an item icon identifier list data object. The item icon identifier data object contains an icon identifier for each item.

6.6.9 SEND SHORT MESSAGE

Description	Clause	M/O/C	Min	Length
Proactive UICC command Tag	9.2	M	Y	1
Length (A+B+C+D+E+F)	-	M	Y	1 or 2
Command details	8.6	M	Y	A
Device identities	8.7	M	Y	B
Alpha identifier	8.2	O	N	C
Address	8.1	O	N	D
SMS TPDU (SMS-SUBMIT or SMS-COMMAND)	8.13	M	Y	E
Icon identifier	8.31	O	N	F

The address data object holds the RP_Destination_Address of the Service Centre. If no RP_Destination_Address is transferred, then the ME shall insert the default Service Centre address.

6.6.10 SEND SS

Description	Clause	M/O/C	Min	Length
Proactive UICC command Tag	9.2	M	Y	1
Length (A+B+C+D+E)	-	M	Y	1 or 2
Command details	8.6	M	Y	A
Device identities	8.7	M	Y	B
Alpha identifier	8.2	O	N	C
SS string	8.14	M	Y	D
Icon identifier	8.31	O	N	E

6.6.11 SEND USSD

Description	Clause	M/O/C	Min	Length
Proactive UICC command Tag	9.2	M	Y	1
Length (A+B+C+D+E)	-	M	Y	1 or 2
Command details	8.6	M	Y	A
Device identities	8.7	M	Y	B
Alpha identifier	8.2	O	N	C
USSD String	8.17	M	Y	D
Icon identifier	8.31	O	N	E

6.6.12 SET UP CALL

Description	Clause	M/O/C	Min	Length
Proactive UICC command Tag	9.2	M	Y	1
Length (A+B+C+D+E+F+G+H+I+J)	-	M	Y	1 or 2
Command details	8.6	M	Y	A
Device identities	8.7	M	Y	B
Alpha identifier (user confirmation phase)	8.2	O	N	C
Address	8.1	M	Y	D
Capability configuration parameters	8.4	O	N	E
Subaddress	8.3	O	N	F
Duration	8.8	O	N	G
Icon identifier (user confirmation phase)	8.31	O	N	H
Alpha identifier (call set up phase)	8.2	O	N	I
Icon identifier (call set up phase)	8.31	O	N	J

If the capability configuration parameters are not present, the ME shall assume the call is a speech call.

If the subaddress is not present, the ME shall not provide a called party subaddress to the network.

If the duration is not present, the UICC imposes no restrictions on the ME of the maximum duration of redials.

6.6.13 REFRESH

Description	Clause	M/O/C	Min	Length
Proactive UICC command Tag	9.2	M	Y	1
Length (A+B+C+D)	-	M	Y	1 or 2
Command details	8.6	M	Y	A
Device identities	8.7	M	Y	B
File List	8.18	C	N	C
AID	8.60	O	N	D

For the refresh modes "File Change Notification", "USIM Initialization and File Change Notification" and "3G Session Reset", the UICC shall supply a File List data object, indicating which EFs need to be refreshed. For other modes, inclusion of a File List is optional, and the ME shall ignore it.

If an AID TLV is present, it indicates the USIM application which needs to be refreshed. If it is not present, the ME shall assume the current USIM application needs to be refreshed.

6.6.14 POLLING OFF

Description	Clause	M/O/C	Min	Length
Proactive UICC command Tag	9.2	M	Y	1
Length (A+B)	-	M	Y	1 or 2
Command details	8.6	M	Y	A
Device identities	8.7	M	Y	B

6.6.15 PROVIDE LOCAL INFORMATION

Description	Clause	M/O/C	Min	Length
Proactive UICC command Tag	9.2	M	Y	1
Length (A+B)	-	M	Y	1 or 2
Command details	8.6	M	Y	A
Device Identities	8.7	M	Y	B

6.6.16 SET UP EVENT LIST

Description	Clause	M/O/C	Min	Length
Proactive UICC command Tag	9.2	M	Y	1
Length (A+B+C)	-	M	Y	1 or 2
Command details	8.6	M	Y	A
Device Identities	8.7	M	Y	B
Event list	8.25	M	Y	C

If the Event list is a null data object (i.e. length = '00' and no value part), this is an indication to the ME to remove the existing list of events in the ME.

6.6.17 PERFORM CARD APDU

Description	Clause	M/O/C	Min	Length
Proactive UICC command Tag	9.2	M	Y	1
Length (A+B+C)	-	M	Y	1 or 2
Command details	8.6	M	Y	A
Device Identities	8.7	M	Y	B
C-APDU	8.35	M	Y	C

6.6.18 POWER OFF CARD

Description	Clause	M/O/C	Min	Length
Proactive UICC command Tag	9.2	M	Y	1
Length (A+B)	-	M	Y	1 or 2
Command details	8.6	M	Y	A
Device Identities	8.7	M	Y	B

6.6.19 POWER ON CARD

Description	Clause	M/O/C	Min	Length
Proactive UICC command Tag	9.2	M	Y	1
Length (A+B)	-	M	Y	1 or 2
Command details	8.6	M	Y	A
Device Identities	8.7	M	Y	B

6.6.20 GET READER STATUS

Description	Clause	M/O/C	Min	Length
Proactive UICC command Tag	9.2	M	Y	1
Length (A+B)	-	M	Y	1 or 2
Command details	8.6	M	Y	A
Device Identities	8.7	M	Y	B

6.6.21 TIMER MANAGEMENT

Description	Clause	M/O/C	Min	Length
Proactive UICC command Tag	9.2	M	Y	1
Length (A+B+C+D)	-	M	Y	1 or 2
Command details	8.6	M	Y	A
Device Identities	8.7	M	Y	B
Timer Identifier	8.37	M	Y	C
Timer value	8.38	C	N	D

- Timer Identifier:
 - Contents: identifier of the timer to which the command applies.
- Timer value:
 - Contents: length of time during which the timer has to run. The UICC shall supply this data object only when a timer has to be started.

6.6.22 SET UP IDLE MODE TEXT

Description	Clause	M/O/C	Min	Length
Proactive UICC command Tag	8.2	M	Y	1
Length (A+B+C+D)	-	M	Y	1 or 2
Command details	7.5.6	M	Y	A
Device identities	7.5.7	M	Y	B
Text string	7.5.15	M	Y	C
Icon identifier	8.31	O	N	D

If the "Text string" is a null data object (i.e. length = '00' and no value part), the ME shall remove the existing idle mode text in the ME.

6.6.23 RUN AT COMMAND

Description	Clause	M/O/C	Min	Length
Proactive UICC command Tag	9.2	M	Y	1
Length (A+B+C+D+E)	-	M	Y	1 or 2
Command details	8.6	M	Y	A
Device Identities	8.7	M	Y	B
Alpha Identifier	8.2	O	N	C
AT Command	8.40	M	Y	D
Icon identifier	8.31	O	N	E

6.6.24 SEND DTMF COMMAND

Description	Clause	M/O/C	Min	Length
Proactive UICC command Tag	9.2	M	Y	1
Length (A+B+C+D+E)	-	M	Y	1 or 2
Command details	8.6	M	Y	A
Device Identities	8.7	M	Y	B
Alpha Identifier	8.2	O	N	C
DTMF String	8.44	M	Y	D
Icon identifier	8.31	O	N	E

6.6.25 LANGUAGE NOTIFICATION

Description	Clause	M/O/C	Min	Length
Proactive UICC command Tag	9.2	M	Y	1
Length (A+B+C)	-	M	Y	1
Command details	8.6	M	Y	A
Device identities	8.7	M	Y	B
Language	8.45	C	Y/N	C

- Language:
 - Contents: Currently used language. The UICC shall include a Language object, when a specific language is being notified.

6.6.26 LAUNCH BROWSER

Description	Clause	M/O	Min	Length
Proactive UICC command Tag	9.2	M	Y	1
Length (A+B+C+D+E+F1+F2+...+FN+G+H+I)	-	M	Y	1 or 2
Command details	8.6	M	Y	A
Device Identities	8.7	M	Y	B
Browser Identity	8.47	O	N	C
URL	8.48	M	Y	D
Bearer	8.49	O	N	E
Provisioning File Reference 1	8.50	O	N	F1
Provisioning File Reference 2	8.50	O	N	F2
.....	8.50	O	N	Fx
Provisioning File Reference N	8.50	O	N	FN
Text String (Gateway/Proxy Identity)	8.15	O	N	G
Alpha identifier (user confirmation phase)	8.2	O	N	H
Icon identifier (user confirmation phase)	8.31	O	N	I

If the URL data object is provisioned the URL value shall take precedence over any other URL value.

If Provisioning File Reference data object is present in the command then it shall take precedence over Bearer and Proxy Identity. If several Provisioning File References are present in the same command the information in the first reference shall take precedence.

Gateway/Proxy Identity is a text string which gives to the mobile the name/identity of the Gateway/Proxy to be used for connecting to the URL. This Gateway/Proxy Identity is required when the bearer data object is present.

6.6.27 OPEN CHANNEL

6.6.27.1 OPEN CHANNEL related to CS bearer

Description	Clause	M/O/C	Min	Length
Proactive UICC command Tag	9.2	M	Y	1
Length (A+B+C+D+E+F+G+H+I+J+K+L+M+N+O)	-	M	Y	1 or 2
Command details	8.6	M	Y	A
Device identities	8.7	M	Y	B
Alpha identifier	8.2	O	N	C
Icon identifier	8.31	O	N	D
Address	8.1	M	Y	E
Subaddress	8.3	O	N	F
Duration 1	8.8	C	N	G
Duration 2	8.8	O	N	H
Bearer description	8.52	M	Y	I
Buffer size	8.55	M	Y	J
Other address (local address)	8.58	O	N	K
Text String (User login)	8.15	O	N	L
Text String (User password)	8.15	O	N	M
SIM/ME interface transport level	8.59	O	N	N
Data destination address	8.58	C	Y	O

The subaddress may be requested. If the subaddress is not present, the ME shall not provide a called party subaddress to the network.

Duration 1 indicates the duration of reconnection tries. If Duration 1 is not present or is null, the UICC imposes no restrictions on the ME. Duration 1 shall be present if Duration 2 is present.

Duration 2 indicates the timeout value before the ME releases the link if there is no data exchanged on the link. If duration 2 is not present the link is never released automatically by the ME.

The local address parameter (see 8.58) provides information to the ME necessary to identify the local device (i.e. it provides an IP address). If local address length is null, dynamic local address is required. If parameter is not present, the mobile may use the mobile default local address configuration.

The ME may support a remote access login feature (e.g. PPP login). If supported by the ME, the UICC may provide "User login" and "User password" parameters which allow the ME to answer an access authentication challenge. If only one parameter is present, it is considered as the User Login and the ME shall use default Password configuration if any. If the parameters are not present, the ME shall use default Login/Password configuration if any. If no authentication challenge is requested, the user login and password parameters shall be ignored.

If the SIM/ME interface transport level is present in the command, then the ME shall provide the requested transport layer protocols under the channel and shall use this object containing a set of parameters required to make the transport connection. The data that is exchanged at the SIM/ME interface in the RECEIVE DATA/SEND DATA commands are SDUs. When the USAT application sends an SDU, the transport layer within the ME is in charge to add the transport header to the SDU in order to build the Transport-PDU. When the USAT application requests to receive an SDU, the transport layer within the ME is in charge to remove the transport header of the Transport-PDU, and to forward the SDU to the USAT. If the parameter is not present, the SIM/ME interface is the bearer level (serial link or packet link as defined in TS 27.007 [12]) and the USAT application is in charge of the network and transport layer.

The Data destination address is the end point destination address of sent data. This data destination address is requested when a SIM/ME interface transport is present, otherwise it is ignored. The data destination address is a data network address.

6.6.27.2 OPEN CHANNEL related to GPRS

Description	Clause	M/O/C	Min	Length
Proactive UICC command Tag	9.2	M	Y	1
Length (A+B+C+D+E+F+G+H+I+J)	-	M	Y	1 or 2
Command details	8.6	M	Y	A
Device identities	8.7	M	Y	B
Alpha identifier	8.2	O	N	C
Icon identifier	8.31	O	N	D
Bearer description	8.52	M	Y	E
Buffer size	8.55	M	Y	F
Network Access Name	8.61	O	N	G
Other address (local address)	8.58	O	N	H
SIM/ME interface transport level	8.59	O	N	I
Data destination address	8.58	C	Y	J

The Network Access Name parameter may be requested. The Network Access Name parameter contains an Access Point Name (APN) identifying the Gateway GSN (GGSN) which provides interworking with an external packet data network. If the parameter is not present, the mobile may use the default Access Point Name in the mobile configuration or the default subscription value.

The local address parameter (see 8.58) provides information to the ME necessary to identify the local device. If the parameter is present and length is not null, it provides an IP address that identifies the USAT application in the address area applicable to the PDN. If local address length is null, dynamic local address allocation is required for the SAT application. If parameter is not present, the mobile may use the mobile default local address configuration.

If the SIM/ME interface transport level is present in the command, then the ME shall provide the requested transport layer protocols under the channel and shall use this object containing a set of parameters required to make the transport connection. The data that is exchanged at the SIM/ME interface in the RECEIVE DATA/SEND DATA commands are SDUs. When the USAT application sends an SDU, the transport layer within the ME is in charge to add the transport header to the SDU in order to build the Transport-PDU. When the SAT application requests to receive an SDU, the transport layer within the ME is in charge to remove the transport header of the Transport-PDU, and to forward the SDU to the USAT. If the parameter is not present, the SIM/ME interface is the bearer level (serial link or packet link as defined in TS 27.007 [12]), and the USAT application is in charge of the network and transport layer.

The Data destination address is the end point destination address of sent data. This data destination address is requested when a SIM/ME interface transport is present, otherwise it is ignored. The data destination address is a data network address (e.g. IP address).

6.6.27.3 OPEN CHANNEL for local links

Description	Clause	M/O/C	Min	Length
Proactive UICC command Tag	9.2	M	Y	1
Length (A+B+C+D+E+F+G+H+I+J+K+L)	-	M	Y	1 or 2
Command details	8.6	M	Y	A
Device identities	8.7	M	Y	B
Alpha identifier	8.2	O	N	C
Icon identifier	8.31	O	N	D
Duration 1	8.8	C	N	E
Duration 2	8.8	O	N	F
Bearer description	8.52	M	Y	G
Buffer size	8.55	M	N	H
Text String (User password)	8.15	O	N	I
SIM/ME interface transport level	8.59	O	N	J
Data destination address	8.58	C	Y	K
Remote Entity Address	8.69	O	N	L

Duration 1 indicates the duration of reconnection tries. If Duration 1 is not present or is null, the UICC imposes no restrictions on the ME. Duration 1 shall be present if Duration 2 is present.

Duration 2 indicates the timeout value before the ME releases the link if there is no data exchanged on the link. If duration 2 is not present the link is never released automatically by the ME.

Bearer Description gives detailed information characterising the bearer. When the UICC acts as a server, local information (local service record data) is included in Bearer Description; in addition, if the UICC provides a Service Record field (which is part of the Bearer Description TLV) different from '00', the ME shall ignore it and proceed with the command. When the UICC acts as a client, remote information (remote service record data) is included in Bearer Description; in addition, if the UICC provides a Service Identifier field (which is part of the Bearer Description TLV) different from 'FF', the ME shall ignore it and proceed with the command.

The UICC may optionally provide a user password that should be used by the ME for authentication. For the Bluetooth local bearer, the user password corresponds to the passkey/PIN as defined in [28].

If the SIM/ME interface transport level is present in the command, then the ME shall provide the requested transport layer protocols under the channel and shall use this object containing a set of parameters required to make the transport connection. If the parameter is not present, the SIM/ME interface is the bearer level. The data that will be received/sent from the SAT to the transport layer is a SDU that will be received/transmitted in the Transport-PDU.

The Data destination address is the end point destination address of sent data. This data destination address is requested when a SIM/ME interface transport is present, otherwise it is ignored. The data destination address is a data network address (e.g. IP address).

The Remote Entity Address parameter provides information to the ME necessary to identify the entity which provides access to the requested resource. Depending on the local technology, this parameter is necessary or not. For Bluetooth, it shall be the BD_ADDR of the remote device.

6.6.28 CLOSE CHANNEL

Description	Clause	M/O	Min	Length
Proactive UICC command Tag	9.2	M	Y	1
Length (A+B+C+D)	-	M	Y	1 or 2
Command details	8.6	M	Y	A
Device Identities	8.7	M	Y	B
Alpha identifier	8.2	O	N	C
Icon identifier	8.31	O	N	D

6.6.29 RECEIVE DATA

Description	Clause	M/O	Min	Length
Proactive UICC command Tag	9.2	M	Y	1
Length (A+B+C+D+E)	-	M	Y	1 or 2
Command details	8.6	M	Y	A
Device Identities	8.7	M	Y	B
Alpha identifier	8.2	O	N	C
Icon identifier	8.31	O	N	D
Channel data length	8.54	M	Y	E

6.6.30 SEND DATA

Description	Clause	M/O	Min	Length
Proactive UICC command Tag	9.2	M	Y	1
Length (A+B+C+D+E)	-	M	Y	1 or 2
Command details	8.6	M	Y	A
Device identities	8.7	M	Y	B
Alpha identifier	8.2	O	N	C
Icon identifier	8.31	O	N	D
Channel data	8.53	M	Y	E

6.6.31 GET CHANNEL STATUS

Description	Clause	M/O	Min	Length
Proactive UICC command Tag	9.2	M	Y	1
Length (A+B)	-	M	Y	1 or 2
Command details	8.6	M	Y	A
Device identities	8.7	M	Y	B

6.6.32 SERVICE SEARCH

Description	Section	M/O	Min	Length
Proactive SIM command Tag	9.3	M	Y	1
Length (A+B+C+D+E+F)	-	M	Y	1 or 2
Command details	8.6	M	Y	A
Device Identities	8.7	M	Y	B
Alpha identifier	8.2	O	N	C
Icon identifier	8.31	O	N	D
Service search	8.66	M	Y	E
Device filter	8.65	O	N	F

6.6.33 GET SERVICE INFORMATION

Description	Clause	M/O	Min	Length
Proactive SIM command Tag	9.3	M	Y	1
Length (A+B+C+D+E)	-	M	Y	1 or 2
Command details	8.6	M	Y	A
Device Identities	8.7	M	Y	B
Alpha identifier	8.2	O	N	C
Icon identifier	8.31	O	N	D
Attribute information	8.67	M	Y	E

6.6.34 DECLARE SERVICE

Description	Clause	M/O	Min	Length
Proactive SIM command Tag	9.3	M	Y	1
Length (A+B+C+D)	-	M	Y	1 or 2
Command details	8.6	M	Y	A
Device Identities	8.7	M	Y	B
Service Record	8.64	M	Y	C
SIM/ME interface	8.59	O	N	D

For Device identities field, Destination Device Identity is required to be the ME.

The SIM/ME interface parameter specifies the protocol stack the UICC will be connected to on the ME. If the SIM/ME interface data object is not present, the SIM/ME interface is the bearer level as defined in the OPEN CHANNEL command.

6.7 Command results

Once the ME has made its attempt to execute a proactive command from the UICC, the ME shall inform the UICC of the success or otherwise of that command, by using TERMINAL RESPONSE. This message gives the command details, including the number of the command (see clause 6.5.1), a general result, and sometimes more specific information.

Three overall categories of results are defined:

- command performed successfully. This is returned by the ME for every successful command;

- temporary problem with executing command. This is further defined below, but generally these indicate to the UICC that it is worth trying again later;
- permanent problem with executing command. These are further defined below, but generally indicate that the same command will end in the same result if repeated during the same 3G session.

Successful commands are further defined as:

- command performed successfully. There were no problems;
- command performed with partial comprehension. Here the ME receives a command with one or more SIMPLE-TLV data objects that are unrecognized or unexpected, all of which do not have their "comprehension required" flag set (clause 9.3), but the parent BER-TLV data object still has the minimum set of SIMPLE-TLV data objects required to perform the command;
- command performed, with missing information. The ME received at least the minimum set of component parts, but did not receive all of the parts that it believed mandatory for the UICC to send;
- REFRESH performed with additional EFs read (see clause 6.4.7);
- command performed successfully but requested icon could not be displayed;
- command performed, but modified by call control. This is sent by the ME to indicate that call control modified the type of request indicated in the proactive command, and that the action requested by call control was performed successfully;
- command performed with modification. This is sent by the ME to indicate that it is unable to process the command using the exact parameters provided by the UICC. The command is processed with the best possible parameters;
- command performed successfully, limited service;
- REFRESH performed but indicated USIM was not active.

Temporary problems are further defined as:

- ME is currently unable to process the command. Specific causes for this are:
 - the screen is busy;
 - ME currently busy on a call;
 - ME currently busy on SEND DTMF operation;
 - ME currently busy on SS transaction;
 - ME currently busy on USSD operation;
 - no service is currently available;
 - access control class barred on serving network;
 - no radio resource currently available;
 - not in speech call;
 - no USIM active.
- if none of these can be made to apply, a "no cause can be given" value can be used;
- network is currently unable to process the command. Specific cause values are the cause values given by the network, as defined in 3G 24.008 [9];

- in some proactive commands, the ME is required to solicit and receive approval of the user before executing the proactive command. In the case that the user does not give approval for the execution of the proactive command, it shall not be executed by the ME and the terminal response "user did not accept the proactive command" shall be returned by the ME to the UICC;
- the user cleared down the call, before the call connected (CONNECT received from network, as defined in 3G 24.008 [9]) or before the network released the call;
- action in contradiction with the current timer state. This is where the UICC requests an action for a timer to be taken by the ME and the state of the timer does not allow that action;
- interaction with call control by UICC, temporary problem. This is sent by the ME to indicate that call control modified the type of request indicated in the proactive command, and that the action requested by call control encounters a temporary problem.

Permanent problems are further defined as:

- command is beyond ME's capabilities. This is sent by the ME when it understands what the UICC is asking it to do, but does not have the capability to do it, e.g. ME which only supports SMS asked to set up a call;
- command type not understood by ME. This is sent by the ME when the UICC sends a command with the Type of Command byte set to a value the ME does not know. This is to allow future expansion of commands;
- command data not understood by ME. This is sent by the ME when the command type is understood by the ME, but the related data object(s) are not, e.g. reserved values have been included in a data object, or one or more unknown SIMPLE-TLV data objects have a "comprehension required" tag;
- SS Return Error. This is given to the UICC when the network returns a SS error in response to a previous SS command. Specific cause values are the same as given by the network in the Return Error message;
- USSD Return Error. This is given to the UICC when the network returns a USSD error in response to a previous USSD command. Specific cause values are the same as given by the network in a Return Error message;
- SMS RP-ERROR. This is given to the UICC when the network returns an error in response to the ME trying to send a short message. Specific cause values are the same as the cause value of RP-Cause in an RP-ERROR message;
- error, required values are missing. This is given when the command type is understood by the ME, but it does not receive the minimum set of SIMPLE-TLV data objects that it requires to perform the command. These components are shown by the "Min" column in the command structure definitions;
- interaction with call control by USIM or MO short message control by USIM, permanent problem. This is sent by the ME to indicate that:
 - call control by USIM does not allow the action corresponding to the proactive command; or
 - call control by USIM has modified the type of request indicated in the proactive command and that the action requested by call control encounters a permanent problem.
- specific cause values for this are:
 - action not allowed;
 - the type of request has changed.
- Current Access Technology unable to process command. This is given to the USIM when ME is unable to process the requested command due to the current access technology in use.
- if none of these can be made to apply, a "no cause can be given" value can be used.

6.8 Structure of TERMINAL RESPONSE

Direction: ME to UICC.

The command header is specified in TS 31.101 [13]. Length (A+B+ ... +Y) is indicated by P3 of the header.

Command parameters/data.

Description	Clause	M/O/C	Min	Length
Command details	8.6	M	Y	A
Device identities	8.7	M	N	B
Result	8.12	M	Y	C
Duration (only required in response to a POLL INTERVAL proactive command)	8.8	C	N	D
Text string (only required in response to a GET INKEY or GET INPUT or SEND USSD proactive command)	8.15	C	N	E
Item identifier (only required in response to SELECT ITEM proactive command)	8.10	C	N	F
Local information (only required in response to PROVIDE LOCAL INFORMATION proactive command)	8.19, 8.20, 8.22, 8.29, 8.39, 8.45, 8.46, 8.62	C	N	G
Call control requested action (only required if call control by USIM has modified a proactive command SET UP CALL, SEND SS or SEND USSD in another type of request).	8.30	C	N	H
Result data object 2 (only required if call control by USIM has modified a proactive command SET UP CALL, SEND SS or SEND USSD in another type of request).	8.12	C	N	I
Card reader status (only required in response to GET READER STATUS command). According to the requested information, one Card reader status object for each card interface reported, or one Card reader identifier object is required..	8.33, 8.57	C	N	$J_0 + \dots + J_n$ or J
Card ATR (only required in response to POWER ON CARD).	8.33	C	N	K
R-APDU (only required in response to PERFORM CARD APDU).	8.36	C	N	L
Timer identifier (only required in response to a TIMER MANAGEMENT proactive command)	8.37	C	N	M
Timer value (only required in response to a TIMER MANAGEMENT proactive command)	8.38	C	N	N
AT Response (only required in response to RUN AT COMMAND proactive command)	8.41	C	N	P
Text string2 (only required if call control by USIM has modified the proactive command SET UP CALL or SEND SS into a USSD request)	8.15	C	N	Q
Channel data (only required in response to RECEIVE DATA)	8.54	C	N	R
Channel status (only required in response to GET CHANNEL STATUS or OPEN CHANNEL proactive command)	8.56	C	N	$S_0 + \dots + S_n$
Channel data length (only required in response to RECEIVE DATA or SEND DATA proactive command)	8.54	C	N	T
Bearer description (only required in response to OPEN CHANNEL proactive command)	8.52	C	N	U
Buffer size (only required in response to OPEN CHANNEL proactive command)	8.55	C	N	V
Total display duration (only required in response to a GET INKEY proactive command)	8.8	C	N	W
Service availability (only required in response to SERVICE SEARCH proactive command)	8.68	C	N	X
Service record (only required in response to GET SERVICE INFORMATION proactive command)	8.64	C	N	Y

Under no circumstances shall the UICC wait indefinitely for a TERMINAL RESPONSE.

For all the Conditional (C) SIMPLE-TLV objects, the ME should not include them in the response to non-applicable situations. However, if one is present, the UICC shall ignore it.

For all SIMPLE-TLV objects with Min=N, the ME should set the CR flag to comprehension not required. Any future additional SIMPLE-TLV objects will be included as Min = N and comprehension not required. This will ensure that any proactive command will end in a predictable way.

Response parameters/data: None.

6.8.1 Command details

This data object shall be identical to the command details data object (including the comprehension required flag) given by the UICC in the proactive command to which the ME is giving the result.

- if the ME has not received a valid Command number, all Command Details object values shall be set to '00' and the Result shall indicate an error;
- if the failure is caused by a problem on the transmission layer, the ME shall respond with "temporary problem" ("ME currently not able to process command"). If not, the ME shall respond with "permanent problem" (either "command not understood by ME" or "Error required values are missing");
- the UICC shall interpret a Terminal Response with a command number '00' as belonging to the last proactive command having been sent to the ME.

6.8.2 Device identities

The ME shall set the device identities to:

- source: ME;
- destination: UICC.

6.8.3 Result

This data object holds the result of the proactive UICC command.

6.8.4 Duration

When the ME issues a successful TERMINAL RESPONSE for a POLL INTERVAL command, it shall state the polling interval it will be using in the Duration data object.

6.8.5 Text string

When the ME issues a successful TERMINAL RESPONSE ('0X' result value - refer to clause 8.12) for a GET INKEY or GET INPUT or SEND USSD command, it shall supply the single character or the character string entered by the user in the Text string data object, or the text returned within the Return Result message from the network for the USSD command, no matter what type of string was entered. When the ME issues a successful TERMINAL RESPONSE ('0X' result value - refer to clause 8.12) for a GET INKEY ("Yes/No") command with command qualifier set to "Yes/No", it shall supply the value '01' when the answer is "positive" and the value '00' when the answer is "negative" in the Text string data object.

When the ME issues a successful TERMINAL RESPONSE ('0X' result value - refer to clause 8.12) for a GET INPUT command to which the user has made an empty input (i.e. if the user does not enter any character), the ME shall indicate this by means of either a null text string (see clause 8.15 for the coding of this object), or by means of a Text string object with Length = '01', and a Value part consisting of a data coding scheme only.

NOTE: The notion of empty input is different from the general result 'no response from user' (see clause 8.12). The latter event is typically caused by a timeout in the MMI, whereas an empty input requires an acknowledgement from the user.

6.8.6 Item identifier

When the ME issues a successful TERMINAL RESPONSE ('0X' result value - refer to clause 8.12) for a SELECT ITEM command, it shall supply the identifier of the item selected by the user in the Item identifier data object. If the ME issues a TERMINAL RESPONSE with result "Help information required by the user" for a SELECT ITEM command, it shall supply the identifier of the item for which the user is requiring help information.

6.8.7 Local information

When the ME issues a successful TERMINAL RESPONSE for a PROVIDE LOCAL INFORMATION command, it shall supply the requested local information.

- Where the UICC has requested location information, TERMINAL RESPONSE shall contain the location information data object.
- Where the UICC has requested the IMEI, TERMINAL RESPONSE shall contain the IMEI data object.
- Where the UICC has requested the Network Measurement Results the TERMINAL RESPONSE shall contain the NMR data object and the BCCH channel list data object.
- Where the UICC has requested the date, time and time zone the TERMINAL RESPONSE shall contain the Date-Time and Time zone data object.
- Where the UICC has requested the currently used language, the TERMINAL RESPONSE shall contain the Language data object.
- Where the UICC has requested the Timing Advance, the TERMINAL RESPONSE shall contain the Timing Advance data object.
- Where the UICC has requested the Access Technology, the TERMINAL RESPONSE shall contain the Access Technology data object.

6.8.8 Call control requested action

When the ME issues a TERMINAL RESPONSE for a proactive command SET UP CALL, SEND SS or SEND USSD which has been modified by call control by UICC in another type of request, it shall supply the response data given in response to the ENVELOPE (CALL CONTROL).

6.8.9 Result data object 2

When the ME issues a TERMINAL RESPONSE for a proactive command SET UP CALL, SEND SS or SEND USSD which has been modified by call control by UICC in another type of request, it shall supply the Result data object it would have supplied for the proactive command equivalent to the action requested by call control, and given in the Call control request data element.

6.8.10 Card reader status

This clause applies if class "a" is supported.

When the ME issues a successful TERMINAL RESPONSE for a GET READER STATUS command, it shall supply the requested readers' information:

- Where the UICC has requested the card reader status, TERMINAL RESPONSE shall supply the status of each card reader in n consecutive Card reader status data objects, where n is the card reader count.
- Where the UICC has requested the card reader identifier, TERMINAL RESPONSE shall supply the identifier of the requested card reader identifier.

6.8.11 Card ATR

This clause applies if class "a" is supported.

When the ME issues a successful TERMINAL RESPONSE for a POWER ON CARD command, it shall supply the ATR returned by the addressed card in the Card ATR data object.

6.8.12 R-APDU

This clause applies if class "a" is supported.

When the ME issues a successful TERMINAL RESPONSE for a PERFORM CARD APDU command, it shall supply the response data and status words in the R-APDU data object.

6.8.13 Timer identifier

When the ME issues a successful TERMINAL RESPONSE for a TIMER MANAGEMENT, it shall state in the timer identifier data object the identifier of the timer to which this command applies.

6.8.14 Timer value

When the ME issues a successful TERMINAL RESPONSE for a TIMER MANAGEMENT command with command qualifier indicating 'deactivate' or 'get the current value of the timer', it shall state in the timer value data object the current value of the timer.

6.8.15 AT Response

This clause applies if class "b" is supported.

When the ME issues a successful TERMINAL RESPONSE for a RUN AT COMMAND command, the TERMINAL RESPONSE shall contain the AT Response (as defined in clause 8.40).

6.8.16 Text string 2

When the ME issues a successful TERMINAL RESPONSE for a proactive command SET UP CALL or SEND SS which has been modified by "call control" by USIM into a USSD request ('05' result value), it shall supply the Text string 2. The Text string 2 shall contain the text returned within the Return Result message from the network for the USSD response. Text string 2 is equivalent to the Text string in the Terminal Response to a SEND USSD command.

6.8.17 Channel data

This clause applies only if class "e" is supported.

When the ME issues a successful TERMINAL RESPONSE for a RECEIVE DATA command, the TERMINAL RESPONSE shall contain the Channel Data data object.

6.8.18 Channel status

This clause applies only if class "e" is supported.

When the ME issues a successful TERMINAL RESPONSE for a GET CHANNEL STATUS proactive command, the TERMINAL RESPONSE shall contain as many Channel Status data objects as there are available channels.

When the ME issues a successful TERMINAL RESPONSE for an OPEN CHANNEL command, the TERMINAL RESPONSE shall contain a Channel status data object for the opened channel.

6.8.19 Channel data length

This clause applies only if class "e" is supported.

When the ME issues a successful TERMINAL RESPONSE for a RECEIVE DATA command or a SEND DATA, the TERMINAL RESPONSE shall contain the Channel Data Length data object.

6.8.20 Bearer description

This clause applies only if class "e" is supported.

When the ME issues a successful or an unsuccessful TERMINAL RESPONSE for an OPEN CHANNEL command, the TERMINAL RESPONSE shall contain the Bearer description data object.

6.8.21 Buffer size

This clause applies only if class "e" is supported.

When the ME issues a successful or an unsuccessful TERMINAL RESPONSE for a OPEN CHANNEL command, the TERMINAL RESPONSE shall contain the Buffer size data object.

6.8.22 Total Display Duration

When the ME issues a TERMINAL RESPONSE for a GET INKEY proactive command with variable timeout, it shall supply the total display text duration (command execution duration). The time unit of the response is identical to the time unit of the requested variable timeout.

Resolution and the precision of the time value are in accordance with clause 6.4.21 Timer Management.

6.8.23 Service Availability

This clause applies if class "f" is supported.

When the ME issues a successful TERMINAL RESPONSE for a SERVICE SEARCH command, the TERMINAL RESPONSE shall contain the Service Availability data object.

6.8.24 Service Record

This clause applies if class "f" is supported.

When the ME issues a successful TERMINAL RESPONSE for a GET SERVICE INFORMATION command, the TERMINAL RESPONSE shall contain the Service Record data object.

6.9 Proactive UICC session and ME display interaction

During a proactive session the ME display shall be refreshed by any display data contained in the first and each subsequent proactive command. The refresh shall occur once the ME has retrieved the proactive command using the Fetch instruction, following the proactive command pending status response.

If no proactive command is pending (status response of '90 00' following the Terminal Response), then the session releases the display back into ME control. If this session was terminated in a backwards move, and the session was initiated from an Envelope command containing a Menu Selection, it is recommended that the display returns to the Setup Menu.

If the text is to be sustained, the ME shall display the text of applicable DISPLAY TEXT commands beyond the sending of the TERMINAL RESPONSE and possibly beyond the end of the proactive session.

If a variable display timeout was indicated for a DISPLAY TEXT command, then the session releases the display back into ME control no later than the period stated by the duration. If the text is to be sustained beyond an immediate response, the ME shall display the text for a period that does not exceed the duration.

6.10 Handling of unknown, unforeseen and erroneous messages

6.10.1 General

The procedures described in this clause apply to the BER-TLV and SIMPLE-TLV data objects described in the present document. The purpose of this clause is to allow greater flexibility in future versions of the present document, and a greater predictability across different versions of the present document.

The procedures described here specify how the ME and UICC shall behave when they receive a proactive command or response that is not fully compliant with the standards by which it was designed. A response will be made to the UICC by means of the "general result" field of the "result".

If the ME sends a FETCH or TERMINAL RESPONSE to the UICC that contains values that the UICC does not understand, then the UICC shall issue the appropriate SW1/SW2 error response. The current proactive transaction shall be considered complete and neither the ME or the UICC shall take no further action with regard to it. In this case, unless the "General result" is "command performed..." then the UICC shall assume that the command was not carried out and that a permanent error exists with regard to that particular proactive command. If the command was performed, but the "additional information on result" field was not understood, then the UICC may attempt the command again at a later stage in the current 3G session.

If the UICC has enough information to proceed (i.e. it has received all the data objects of the Minimum set) then it shall do so.

6.10.2 Message too short

Any information received that is not a complete tag and length shall be ignored.

6.10.3 Missing minimum information

If a message is received that does not have all the mandatory elements in it, then if all of the minimum set elements are present then the receiver shall complete the command and report "command performed, with missing information".

If the minimum set of elements is not complete, then the ME shall respond with "Error, required values are missing".

6.10.4 Unknown Tag value

If a BER-TLV object is received that has a tag that is understood, but contains SIMPLE-TLV components that have unknown tags, then provided the minimum set condition is fulfilled, the "comprehension required" bit of the tag shall determine how the receiving entity behaves.

If the comprehension required flag in an unknown tag is set to '1', and the ME either does not recognize or is not expecting one or more of the SIMPLE-TLV objects in the message, then it shall respond with "Command data not understood by ME".

If the comprehension required flag is set to '0', then the ME shall read the length field that follows and ignore that object. In this case the ME will be able to carry out the command without the SIMPLE-TLV components that it cannot understand. It shall respond with "command performed with partial comprehension".

6.10.5 Unexpected Tag value

If a BER-TLV object is received that contains elements that have recognisable tags, but which were not expected in the context of this message (for example, the ME sees SMS TDPU tag as part of DISPLAY TEXT), then it shall discard that element. It shall then proceed as described for Unknown Tag values.

If a received object has a tag that has already been received, then the first instance shall be used and any subsequent instances shall be discarded.

6.10.6 Length errors

If the total lengths of the SIMPLE-TLV data objects are not consistent with the length given in the BER-TLV data object, then the whole BER-TLV data object shall be rejected. The result field in the TERMINAL RESPONSE shall have the error condition "Command data not understood by ME".

If the length of the BER-TLV data object is shorter than the length of the response data, the ME shall ignore response data following the complete BER-TLV data object. If the length of the BER-TLV data object is longer than the length of the response data, then clauses 6.10.2. and 6.10.3 apply.

6.10.7 Contents not understood

If the contents of a SIMPLE-TLV data object contains a field with a value that is defined as reserved, then the whole SIMPLE-TLV data object shall be considered as invalid. It will then depend on the "comprehension required" bit of the relevant tag as to whether the whole BER-TLV data object shall be rejected, or whether that particular SIMPLE-TLV data object shall be ignored.

If the contents of a BER-TLV object contains RFU bits or bytes, then these shall be ignored.

6.10.8 Extended length data objects

If a SIMPLE-TLV data object has a length longer than expected (i.e. more information has been added), then the receiver shall ignore this extra information to the end of the object. The end of the object shall be found by looking at the "length" field of that object.

NOTE: If comprehension of the extra bytes is required, this can be achieved by the use of a reserved coding in an earlier field.

6.11 Proactive commands versus possible Terminal response

Table 6.1 shows for each proactive command the possible terminal response returned (marked by a "•" character).

Table 6.1: Proactive commands versus possible Terminal response (continued overleaf...)

		PROACTIVE COMMAND																			
		RE-FRESH	MORE TIME	POLL INTER-VAL	POLL-ING OFF	SETUP EVENT LIST	SET UP CALL	SEND SS	SEND USSD	SEND SMS	SEND DTMF	LAUNCH BROWSER	PLAY TONE	DIS-PLAY TEXT	GET INKEY	GET INPUT	SELECT ITEM	SET UP MENU	PRO-VIDE LOCAL INFO	TIMER MAN-AGE-MENT	SETU P IDLE MODE TEXT
TERMINAL RESPONSE		'01'	'02'	'03'	'04'	'05'	'10'	'11'	'12'	'13'	'14'	'15'	'20'	'21'	'22'	'23'	'24'	'25'	'26'	'27'	'28'
00	Command performed successfully	•	•	•	•	•	•	•	•	•	•	•	•	•	•	•	•	•	•	•	•
01	Command performed with partial comprehension	•	•	•	•	•	•	•	•	•	•	•	•	•	•	•	•	•	•	•	•
02	Command performed, with missing information	•	•	•	•	•	•	•	•	•	•	•	•	•	•	•	•	•	•	•	•
03	REFRESH performed with additional EFs read	•																			
04	Command performed successfully, but requested icon could not be displayed						•		•	•			•		•		•				
05	Command performed, but modified by call control by USIM						•		•	•											
06	Command performed successfully, limited service																		•		
07	Command performed with modification																				
08	REFRESH performed but indicated USIM was not active	•																			
10	Proactive UICC session terminated by the user						•				•				•	•					
11	Backward move in the proactive UICC session requested by the user														•	•		•	•		
12	No response from user														•	•		•	•		
13	Help information required by the user															•		•	•		
14	USSD or SS Transaction terminated by user							•		•	•										
20	ME currently unable to process command	•	•	•	•	•	•	•	•	•	•	•	•	•	•	•	•	•	•	•	•
21	Network currently unable to process command							•		•	•										
22	User did not accept the proactive command						•					•									
23	User cleared down call before connection or network release						•														
24	Action in contradiction with the current timer state																				•
25	Interaction with call control by USIM, temporary problem						•		•	•											
26	Launch browser generic error											•									
30	Command beyond MEs capabilities	•	•	•	•	•	•	•	•	•	•	•	•	•	•	•	•	•	•	•	•
31	Command type not understood by ME	•	•	•	•	•	•	•	•	•	•	•	•	•	•	•	•	•	•	•	•
32	Command data not understood by ME	•	•	•	•	•	•	•	•	•	•	•	•	•	•	•	•	•	•	•	•
33	Command number not known by ME	•	•	•	•	•	•	•	•	•	•	•	•	•	•	•	•	•	•	•	•
34	SS Return Error						•		•												
35	SMS RPERROR											•									
36	Error, required values are missing	•	•	•	•	•	•	•	•	•	•	•	•	•	•	•	•	•	•	•	•
37	USSD return error											•									
38	Multiple Card command error																				
39	Interaction with call/SM control by USIM, permanent problem						•		•	•	•										
3A	Bearer Independent Protocol error																				
3B	Access Technology unable to process command								•	•											

Table 6.1: Proactive commands versus possible Terminal response

TERMINAL RESPONSE		PROACTIVE COMMAND													
		CARD APDU	POWER ON CARD	POWER OFF CARD	GET READER STATUS	RUN AT COMMAND	LANG NOTIFICATION	OPEN CHANNEL	CLOSE CHANNEL	RECEIVE DATA	SEND DATA	GET CHANNEL STATUS	SERVICE SEARCH	GET SERVICE INFORMATION	DECLARE SERVICE
		'30'	'31'	'32'	'33'	'34'	'35'	'40'	'41'	'42'	'43'	'44'	'45'	'46'	'47'
00	Command performed successfully
01	Command performed with partial comprehension
02	Command performed, with missing information
03	REFRESH performed with additional EFs read
04	Command performed successfully, but requested icon could not be displayed							
05	Command performed, but modified by call control by USIM														
06	Command performed successfully, limited service														
07	Command performed with modification							.						.	
08	REFRESH performed but indicated USIM was not active							.							
10	Proactive UICC session terminated by the user							
11	Backward move in the proactive UICC session requested by the user														
12	No response from user														
13	Help information required by the user														
14	USSD or SS Transaction terminated by user														
20	ME currently unable to process command
21	Network currently unable to process command
22	User did not accept the proactive command							.							
23	User cleared down call before connection or network release							.							
24	Action in contradiction with the current timer state														
25	Interaction with call control by USIM, temporary problem							.							
26	Launch browser generic error														
30	Command beyond MEs capabilities
31	Command type not understood by ME
32	Command data not understood by ME
33	Command number not known by ME
34	SS Return Error														
35	SMS RPERROR														
36	Error, required values are missing
37	USSD return error														
38	Multiple Card command error										
39	Interaction with call/SM control by USIM, permanent problem														
3A	Bearer Independent Protocol error						
3B	Access Technology unable to process command							

7 ENVELOPE Commands

7.1 Data download to UICC

7.1.1 SMS-PP data download

7.1.1.1 Procedure

If the service "data download via SMS Point-to-point" is allocated and activated in the UICC Service Table (see 3G TS 31.101 [13]), then the ME shall follow the procedure below:

- when the ME receives a Short Message with:
 - protocol identifier = SIM data download; and
 - data coding scheme = class 2 message; or
- when the ME receives a Short Message with:
 - protocol identifier=ANSI-136 R-DATA (see 3G TS 23.040 [7]); and
 - data coding scheme = class 2 message, and the ME chooses not to handle the message (e.g. MEs not supporting EGPRS over TIA/EIA-136 do not need to handle the message).
- then the ME shall pass the message transparently to the UICC using the ENVELOPE (SMS-PP DOWNLOAD) command as defined below;
- the ME shall not display the message, or alert the user of a short message waiting;
- the ME shall wait for an acknowledgement from the UICC;
- if the UICC responds with '90 00', the ME shall acknowledge the receipt of the short message to the network using an RP-ACK message. The response data from the UICC will be supplied by the ME in the TP-User-Data element of the RP-ACK message it will send back to the network (see 3G 23.040 [5] and 3G 24.011 [10]). The values of protocol identifier and data coding scheme in RP-ACK shall be as in the original message;
- if the UICC responds with '93 00', the ME shall either retry the command or send back an RP-ERROR message to the network with the TP-FCS value indicating 'SIM Application Toolkit Busy' (see 3G 23.040 [5]).
- If the UICC responds with '6F XX', the ME shall send back an RP-ERROR message to the network with the TP-FCS value indicating "UICC data download error". The values of protocol identifier and data coding scheme in RP-ERROR shall be as in the original message;

NOTE: The preferred way for a USAT application to indicate a Data Download error is by using the specific code '62 XX' or '63 XX' as described in the following bullet point.

- if the UICC responds with '62 XX' or '63 XX', the ME shall acknowledge the receipt of the short message to the network using an RP-ERROR message. The response data from the UICC will be supplied by the ME in the TP-User-Data element of the RP-ERROR message it will send back to the network (see 3G 23.040 [5] and 3G 24.011 [10]). The values of protocol identifier and data coding scheme in RP-ERROR shall be as in the original message. The value of the TP-FCS element of the RP-ERROR shall be "SIM data download error".

If the service "data download via SMS-PP" is not available in the UICC Service Table, and the ME receives a Short Message with the protocol identifier = SIM data download and data coding scheme = class 2 message, then the ME shall store the message in EF_{SMS} in accordance with 3G TS 31.102 [14].

7.1.1.2 Structure of ENVELOPE (SMS-PP DOWNLOAD)

Direction: ME to UICC.

The command header is specified in TS 31.101 [13].

Command parameters/data.

Description	Clause	M/O/C	Min	Length
SMS-PP download tag	9.1	M	Y	1
Length (A+B+C)	-	M	Y	1 or 2
Device identities	8.7	M	Y	A
Address	8.1	O	N	B
SMS TPDU (SMS-DELIVER)	8.13	M	Y	C

- Device identities: the ME shall set the device identities to:
 - source: Network;
 - destination: UICC.
- Address: The address data object holds the RP_Originating_Address of the Service Centre (TS-Service-Centre-Address), as defined in 3G 24.011 [10].

Response parameters/data.

It is permissible for the UICC not to provide response data. If the UICC provides response data, the following data is returned.

Byte(s)	Description	Length
1-X (X≤128)	UICC Acknowledgement	X

7.1.2 Cell Broadcast data download

7.1.2.1 Procedure

If the service "data download via SMS-CB" is available in the UICC Service Table or USIM Service Table (see TS 31.102 [14]), then the ME shall follow the procedure below:

- when the ME receives a new Cell Broadcast message, the ME shall compare the message identifier of the Cell Broadcast message with the message identifiers contained in EF_{CBMID};
- if the message identifier is found in EF_{CBMID}, the cell broadcast page is passed to the UICC using the ENVELOPE (CELL BROADCAST DOWNLOAD) command, defined below. The ME shall not display the message;
- if the message identifier of the incoming cell broadcast message is not found in EF_{CBMID}, then the ME shall determine if the message should be displayed, by following the procedures in 3G 23.041 [6] and 3G TS 31.102 [14].

The ME shall identify new cell broadcast pages by their message identifier, serial number and page values.

7.1.2.2 Structure of ENVELOPE (CELL BROADCAST DOWNLOAD)

Direction: ME to UICC.

The command header is specified in TS 31.101 [13].

Command parameters/data.

Description	Clause	M/O/C	Min	Length
Cell Broadcast Download tag	9.1	M	Y	1
Length (A+B)	-	M	Y	1 or 2
Device identities	8.7	M	Y	A
Cell Broadcast page	8.5	M	Y	B

- Device identities: the ME shall set the device identities to:
 - source: Network;
 - Destination: UICC.

Response parameters/data: None for this type of ENVELOPE command.

7.2 Menu Selection

A set of possible menu options can be supplied by the UICC using the proactive command SET UP MENU. If the UICC has sent this command, and the user subsequently chooses an option or, the user requests help on it, the ME informs the UICC using this procedure.

7.2.1 Procedure

The ME shall follow the procedure below.

- When the ME receives a menu selection from one of the menu items defined by a "SET-UP MENU" command issued previously by the UICC, or the user has indicated the need to get help information on one of these menu items, then it shall pass the identifier of the selected menu item to the UICC using the ENVELOPE (MENU SELECTION) command, as defined below.

7.2.2 Structure of ENVELOPE (MENU SELECTION)

Direction: ME to UICC.

The command header is specified in TS 31.101 [13].

Command parameters/data.

Description	Clause	M/O/C	Min	Length
Menu Selection tag	9.1	M	Y	1
Length (A+B+C)	-	M	Y	1 or 2
Device identities	8.7	M	Y	A
Item identifier	8.10	M	Y	B
Help request	8.21	O	N	C

- Device identities: the ME shall set the device identities to:
 - source: Keypad;
 - destination: UICC.
- Help request: inclusion of this data object depends upon whether the user actually selected the named menu item or just requested help information on it. If the user actually selected the menu item, this data object shall not be included. If the user indicated the need to get help information on the menu item, this data object shall be included.

Response parameters/data: None for this type of ENVELOPE command.

7.3 Call Control and MO SMS control by USIM

7.3.1 Call Control by USIM

7.3.1.1 Procedure for mobile originated calls

If the service "call control" is available in the USIM Service Table (see TS 31.102 [14]), then the ME shall follow the procedure below:

- for all call set-up attempts (even those resulting from a SET UP CALL proactive UICC command, from the Bearer Independent Protocol proactive UICC commands where CSD is selected, or those occurring when another call is already in progress, and those resulting from automatic redial attempts), the ME shall first pass the call set-up details (dialled digits and associated parameters) to the UICC, using the ENVELOPE (CALL CONTROL) command defined below. The "Location Information" shall be the current information, even for automatic redial attempts. USAT applications should take into account the following exception;
- when the user is dialling "112" or an emergency call code stored in EF_{ECC}, for which the ME sets up an emergency call instead of passing the call set-up details to the UICC;
- if the UICC responds with '90 00', the ME shall set up the call with the dialled digits and other parameters as sent to the UICC;
- if the UICC responds with '93 00', the ME shall not set up the call and may retry the command;
- if the UICC provides response data, then the response data from the UICC shall indicate to the ME whether to set up the call as proposed, not set up the call, set up a call using the data supplied by the UICC, or instead send a supplementary service or USSD operation using the data supplied by the UICC. It is mandatory for the ME to perform the call set-up request and the supplementary service or USSD operation in accordance with the data from the UICC, if it is within the ME's capabilities to do so. If the UICC requires a call set-up or supplementary service or USSD operation that is beyond the ME's capabilities (e.g. the UICC maps a speech call to a data call, and the ME does not support data calls), then the ME shall not perform the call set-up request or supplementary service or USSD operation at all. It is possible for the UICC to request the ME to set up an emergency call by supplying the number "112" as the response data. If the UICC supplies a number stored in EF_{ECC}, this shall not result in an emergency call.

In the case where the initial call set-up request results from a proactive command SET UP CALL:

- if the call control result is "not allowed", the ME shall inform the UICC using TERMINAL RESPONSE "interaction with call control by UICC or MO short message control by UICC, action not allowed";
- if the call set-up request is changed by call control in a supplementary service or USSD operation, and if the supplementary service or USSD operation is within the ME's capabilities, then the ME shall send this request to the network. The ME shall then send back a TERMINAL RESPONSE to the SET UP CALL command at the same time it would have done for the proactive command equivalent to the action requested by call control (i.e. SEND SS or SEND USSD). However, in that case, the TERMINAL RESPONSE shall contain the response data given in the response to ENVELOPE (CALL CONTROL) and a second Result TLV identical to the one given in response to the proactive command equivalent to the action requested by call control (i.e. SEND SS or SEND USSD). The mapping between the general result in the first Result TLV and the general result in the second Result TLV is given below:
 - the general result "command performed, but modified by call control by USIM" shall be given in the first Result TLV if the general result of the second Result TLV is '0X' or '1X';
 - the general result "interaction with call control by USIM, temporary problem" shall be given in the first Result TLV if the general result of the second Result TLV is '2X';
 - the general result "interaction with call control by USIM or MO short message control by USIM, permanent problem" shall be given in the first Result TLV if the general result of the second Result TLV is '3X';

- if the call set-up request is changed by call control into a supplementary service or USSD operation, and if the supplementary service or USSD operation is beyond the ME's capabilities, then the ME shall send back a TERMINAL RESPONSE to the SET UP CALL command, without performing the supplementary service or USSD operation at all. In that case, the TERMINAL RESPONSE shall contain the response data given in the response to ENVELOPE (CALL CONTROL) and a second Result TLV identical to the one given in response to the proactive command equivalent to the action requested by call control (i.e. SEND SS or SEND USSD). The mapping between the general result in the first Result TLV and the general result in the second Result TLV is given below:
 - the general result "interaction with call control by USIM or MO short message control by USIM, permanent problem" shall be given in the first Result TLV, and the general result "command beyond ME's capabilities" shall be given in the second Result TLV.

If the ME supports the Last Number Dialed service, the ME shall update EF_{LND} with the call set-up details (digits string and associated parameters) corresponding to the initial user request.

The ME shall then follow the call set-up procedure defined in 3G 24.008 [9] or the supplementary service or USSD operation procedure defined in 3G 24.080 [11].

7.3.1.2 Procedure for Supplementary Services and USSD

If the service "call control" is available in the USIM Service Table (see TS 31.102 [14]), then for all supplementary service and USSD operations (including those resulting from a SEND SS or SEND USSD proactive UICC command), the ME shall first pass the supplementary service or USSD control string (corresponding to the supplementary service or USSD operation and coded as defined in 3G 22.030 [2], even if this SS or USSD operation has been performed via a specific menu of the ME) to the UICC, using the ENVELOPE (CALL CONTROL) command defined below. The ME shall also pass to the UICC in the ENVELOPE (CALL CONTROL) command the current serving cell.

The UICC shall respond in the same way as for mobile originated calls. The ME shall interpret the response as follows:

- if the UICC responds with '90 00', the ME shall send the supplementary service or USSD operation with the information as sent to the UICC;
- if the UICC responds with '93 00', the ME shall not send the supplementary service or USSD operation and may retry the command;
- if the UICC provides response data, then the response data from the UICC shall indicate to the ME whether to send the supplementary service or USSD operation as proposed, not send the SS or USSD operation, send the SS or USSD operation using the data supplied by the UICC, or instead set up a call using the data supplied by the UICC. It is mandatory for the ME to perform the supplementary service or USSD operation or the call set-up request in accordance with the data from the UICC, if it is within the ME's capabilities to do so. If the UICC requires a call set-up or supplementary service or USSD operation that is beyond the ME's capabilities (e.g. the UICC maps a USSD operation to a data call, and the ME does not support data calls), then the ME shall not perform the call set-up request or supplementary service or USSD operation at all.

In the case where the initial SS or USSD request results from a proactive command SEND SS or SEND USSD:

- if the call control result is "not allowed", the ME shall inform the UICC using TERMINAL RESPONSE ("interaction with call control by UICC or MO short message control by UICC, action not allowed");
- if the SS or USSD request is changed by call control in a call set-up request, then the ME shall set up the call using the data given by the UICC, if it is within the ME's capabilities to do so. If the UICC requires a call set-up that is beyond the ME's capabilities (e.g. the UICC maps a USSD operation to a data call, and the ME does not support data calls), then the ME shall not set up the call at all. The ME shall send back a TERMINAL RESPONSE to the initial proactive command at the same time it would have done for the proactive command equivalent to the action requested by call control (i.e. SET UP CALL). However, in that case, the TERMINAL RESPONSE shall contain the response data given in the response to ENVELOPE (CALL CONTROL) and a second Result TLV identical to the one given in response to the proactive command equivalent to the action requested by call control (i.e. SET UP CALL). The mapping between the general result in the first Result TLV and the general result in the second Result TLV is the same as the one described in clause 7.3.1.1.

If the ME supports the Last Number Dialed service, the ME shall update EF_{LND} with the supplementary service or USSD control string corresponding to the initial user request.

The ME shall then follow the supplementary service or USSD operation procedure defined in 3G 24.080 [11] or the call set-up procedure defined in 3G 24.008 [9].

7.3.1.3 Indication to be given to the user

The UICC may optionally include an alpha-identifier in the response data to the ENVELOPE (CALL CONTROL) message, in order to inform the user at the time the response is received by the ME. The use of this alpha identifier by the ME is described below:

- if the UICC responds with "allowed, no modification", then:
 - if the alpha identifier is provided by the UICC and is not a null data object, the ME shall use it to inform the user during the call set-up;
 - if the alpha identifier is provided by the UICC and is a null data object (i.e. length = '00' and no value part), this is an indication that the ME should not modify the display corresponding to the initial user request;
 - if the alpha identifier is not provided by the UICC, the ME may give information to the user concerning what is happening;
- if the UICC responds with "not allowed", then:
 - if the alpha identifier is provided by the UICC and is not a null data object, the ME shall use it to inform the user. This is also an indication that the ME should not give any other information to the user on the reason of the barring;
 - if the alpha identifier is provided by the UICC and is a null data object (i.e. length = '00' and no value part), the ME may give information to the user concerning what is happening;
 - if the alpha identifier is not provided by the UICC, the ME may give information to the user concerning what is happening.
- if the UICC responds with "allowed, with modifications", and the modified request is within the ME's capabilities, then:
 - if the alpha identifier is provided by the UICC and is not a null data object, the ME shall use it to inform the user. The ME shall then not display the destination address or SS string given by the UICC. This is also an indication that the ME should not give any other information to the user on the changes made by the UICC to the initial user request;
 - if the alpha identifier is provided by the UICC and is a null data object (i.e. length = '00' and no value part), this is an indication that the ME should not give any information to the user on the changes made by the UICC to the initial user request. The ME shall not display the destination address or SS string given by the UICC. The ME should not modify the display corresponding to the initial user request;
 - if the alpha identifier is not provided by the UICC, the ME may indicate to the user that the initial user request has been changed.
- if the UICC responds with "allowed, with modifications" to a user-initiated request (i.e. a request not initiated by a proactive command), and the modified user request is beyond the ME's capabilities, then the ME may give information to the user on the modified request and the fact that the modified request is beyond the ME's capabilities, optionally using the alpha identifier, if one is provided by the UICC;
- if the UICC responds with "allowed, with modifications" to a request by a proactive command SET UP CALL, SEND SS or SEND USSD, and the modified request is beyond the ME's capabilities, then the ME shall not give any information to the user on the fact that the modified request is beyond the ME's capabilities, and shall give a TERMINAL RESPONSE to the proactive command (i.e. SET UP CALL, SEND SS or SEND USSD) as detailed in clauses 7.3.1.1 and 7.3.1.2. The responsibility to inform the user in this case lies with the UICC application which sent the proactive command.

7.3.1.4 Interaction with Fixed Dialling Number

It is permissible for the Fixed Dialling Number service to be enabled (see TS 31.102 [14]) at the same time as Call Control is available in the USIM Service Table.

If FDN is enabled and Call Control is activated, the ME shall follow this procedure:

- the ME shall check that the number (or the supplementary service control string) entered through the MMI is on the FDN list, in accordance with GSM 02.07 [20];
- if the MMI input does not pass the FDN check, the call (or the supplementary service operation) shall not be set-up;
- if the MMI input does pass the FDN check, the ME shall pass the dialled digits (or the supplementary service control string) and other parameters to the UICC, using the ENVELOPE (CALL CONTROL) command;
- if the UICC responds with "allowed, no modification", the ME shall set up the call (or the supplementary service operation) as proposed;
- if the UICC responds with "not allowed", the ME shall not set up the call (or the supplementary service operation);
- if the UICC responds with "allowed with modifications", the ME shall set up the call (or supplementary service operation) in accordance with the response from the UICC. If the modifications involve changing the dialled digits (or the supplementary service control string), the ME shall not re-check this modified number (or string) against the FDN list.

If the user wishes to enable or disable Fixed Dialling Number, the ME shall follow the procedure in TS 31.102 [14]. The state of the Call Control service shall have no effect on this procedure.

7.3.1.5 Support of Barred Dialling Number (BDN) service

The BDN service shall be allocated and activated in the USIM Service Table only if Call Control is also available in the USIM Service Table.

If Barred Dialling Number service is enabled (see TS 31.102 [14]), when receiving the dialled number (or supplementary service control string) and other parameters from the ME, the USIM may check this information against those stored in EF_{BDN} (examples of comparison methods are given in GSM 02.07 [20]).

- If the UICC responds with "not allowed" (e.g., a match is made against a BDN), the ME shall not set up the call (or the supplementary service operation).
- If the UICC responds with "allowed, no modification", the ME shall set up the call (or the supplementary service operation) as proposed.
- If the UICC responds with "allowed with modifications", the ME shall set up the call (or the supplementary service operation) in accordance with the response from the UICC. If the modifications involve changing the dialled number (or the supplementary service control string), the ME shall not re-check this modified number (or string) against the FDN list when FDN is enabled.

If the user wishes to enable or disable Barred Dialling Number, the ME shall follow the procedure in TS 31.102 [14].

7.3.1.6 Structure of ENVELOPE (CALL CONTROL)

Direction: ME to UICC.

The command header is specified in TS 31.101 [13].

Command parameters/data.

Description	Clause	M/O/C	Min	Length
Call control tag	9.1	M	Y	1
Length (A+B+C+D+E+F)	-	M	Y	1 or 2
Device identities	8.7	M	Y	A
Address or SS string or USSD string	8.1, 8.14 or 8.17	M	Y	B
Capability configuration parameters 1	8.4	O	N	C
Subaddress	8.3	O	N	D
Location information	8.19	M	N	E
Capability configuration parameters 2	8.4	O	N	F

- Device identities: the ME shall set the device identities to:
 - source: ME;
 - destination: UICC.
- Address or SS string or USSD string: only one data object shall be sent to the UICC:
 - for a call set-up, the address data object is used and holds the Called Party Number, as defined in 3G 24.008 [9], to which the ME is proposing setting up the call;
 - for a supplementary service, the SS string data object is used and holds the corresponding supplementary service;
 - for a USSD operation, the USSD string data object is used and holds the corresponding USSD control string;
 - USIM Applications and MEs should take into account that early implementations of USAT use the SS string data object for coding of USSD control strings (instead of the USSD string data object). This behaviour is only possible for USSD control strings consisting of digits (0-9,*,#). The UICC can identify MEs having this early implementation by evaluating the indication "USSD string data object supported in Call Control" in the TERMINAL PROFILE. The ME can identify SIMs having this early implementation by evaluating the indication "USSD string data object supported in Call Control" in the UICC Service Table.
- Capability configuration parameters: Only used for a call set-up, this contains the Bearer capabilities that the ME is proposing to send to the network. The first capability configuration parameters corresponds to the bearer capability 1 information element of a mobile originating SETUP message, as defined in 3G 24.008 [9]. The second capability configuration parameters correspond to the bearer capability 2 information element of a mobile originating SETUP message, as defined in 3G 24.008 [9]. If no capability configuration parameters are present, this shall indicate a speech call.
- Subaddress: Only used for a call set-up, this contains the called party subaddress that the ME is proposing to send to the network. If one is not present, this shall indicate that the ME is proposing not to send this information element to the network.
- Location information: This data object contains the identification (MCC, MNC, LAC, Cell Identity) of the current serving cell of the UE. The comprehension required flag of this data object in this command shall be set to '0'.

Response parameters/data.

It is permissible for the UICC to provide no response data, by responding with SW1/SW2 = '90 00'. If the UICC does not provide any response data, then this shall have the same meaning as "allowed, no modification".

Description	Clause	M/O/C	Min	Length
Call control result	-	M	Y	1
Length (A+B+C+D+E+F)	-	M	Y	1 or 2
Address or SS string or USSD string	8.1, 8.14 or 8.17	O	N	A
Capability configuration parameters 1	8.4	O	N	B
Subaddress	8.3	O	N	C
Alpha identifier	8.2	O	N	D
BC repeat indicator	8.42	C	N	E
Capability configuration parameters 2	8.4	O	N	F

- Call control result:
 - contents: the command that the UICC gives to the ME concerning whether to allow, bar or modify the proposed call (or supplementary service operation);
 - Coding:
 - '00' = Allowed, no modification;
 - '01' = Not allowed;
 - '02' = Allowed with modifications.
- Address or SS string or USSD string: Only one data object may be included if the UICC requests the call (or supplementary service or USSD operation) details to be modified:
 - for a call set-up, if the address data object is not present, then the ME shall assume the Dialling number is not to be modified;
 - for a supplementary service, if the SS string data object is not present, then the ME shall assume that SS is not to be modified;
 - for a USSD operation, if the USSD string data object is not present, then the ME shall assume that the USSD operation is not to be modified.
- Capability configuration parameters: Only used for a call set-up, this data object is only required if the USIM application requests the call details to be modified. The first capability configuration parameters corresponds to the bearer capability 1 information element of a mobile originating SETUP message, as defined in 3G 24.008 [9]. The second capability configuration parameters corresponds to the bearer capability 2 information element of a mobile originating SETUP message, as defined in 3G 24.008 [9]. If the capability configuration parameters are not present, then the ME shall assume the parameters are not to be modified.
- Subaddress: Only used for a call set-up, this data object is only required if the USIM application requests the call details to be modified. If the subaddress is not present, then the ME shall assume the called party subaddress is not to be modified. If the subaddress supplied by the USIM application is a null data object, then the ME shall not provide a called party subaddress to the network. A null data object shall have length = '00' and no value part.
- Alpha identifier: this data object is only required if the UICC requests a particular indication to be given to the user. The handling of this data object by the ME is described in clause 7.3.1.3. The comprehension required flag of this data object shall be set to '0'.
- BC repeat indicator: indicates how the 2 associated bearers shall be interpreted. The two modes to manage the bearers are the "alternate way" or "sequential way". The change of bearer occurs on a network event. This BC repeat indicator is conditioned to the presence of the second capability configuration parameters and is coded as defined in 3G 24.008 [9].

It is mandatory for the UICC to provide at least one of the optional data objects if it has set the Call control result to "allowed with modifications".

7.3.2 MO Short Message Control by USIM

7.3.2.1 Description

If the service "MO Short Message Control" is available in the USIM Service Table (see 31.102 [14]), then the ME shall follow the procedure below:

- for all MO short message attempts (even those resulting from a SEND SM proactive UICC command), the ME shall first pass the RP_destination_address of the service center and the TP_Destination_Address to the UICC, using the ENVELOPE (MO SHORT MESSAGE CONTROL) command defined below. The ME shall also pass to the UICC in the ENVELOPE (MO SHORT MESSAGE CONTROL) command the current serving cell;
- if the UICC responds with '90 00', the ME shall send the short message with the addresses unchanged;
- if the UICC responds with '93 00', the ME shall not send the short message and may retry the command;
- if the UICC provides response data, then the response data from the UICC shall indicate to the ME whether to send the short message as proposed, not send the short message or send a short message using the data supplied by the UICC. It is mandatory for the ME to perform the MO short message request in accordance with the data from the UICC.

The ME shall then follow the MO Short Message procedure defined in 3G 24.011 [10].

In the case where the initial MO short message request results from a proactive command SEND SHORT MESSAGE, if the MO short message control result is "not allowed", the ME shall inform the UICC using TERMINAL RESPONSE, "interaction with call control by UICC or MO short message control by UICC, action not allowed".

7.3.2.2 Structure of ENVELOPE (MO SHORT MESSAGE CONTROL)

Direction: ME to UICC.

The command header is specified in TS 31.101 [13].

Command parameters/data.

Description	Clause	M/O/C	Min	Length
MO Short Message control tag	9.1	M	Y	1
Length (A+B+C+D)	-	M	Y	1 or 2
Device identities	8.7	M	Y	A
Address data object 1	8.1	M	Y	B
Address data object 2	8.1	M	Y	C
Location information	8.19	M	Y	D

- Device identities: the ME shall set the device identities to:
 - source: ME;
 - destination: UICC.
- Address data object 1: this address data object 1 contains the RP_Destination_Address of the Service Center to which the ME is proposing to send the short message.
- Address data object 2: this address data object 2 contains the TP_Destination_Address to which the ME is proposing to send the short message.
- Location information: this data object contains the identification (MCC, MNC, LAC, Cell Identity) of the current serving cell of the UE.

Response parameters/data.

It is permissible for the UICC to provide no response data, by responding with SW1/SW2 = '90 00'. If the UICC does not provide any response data, then this shall have the same meaning as "allowed, no modification".

Description	Clause	M/O/C	Min	Length
MO short message control result	-	M	Y	1
Length (A+B+C)	-	M	Y	1 or 2
Address data object 1	8.1	O	N	A
Address data object 2	8.1	O	N	B
Alpha identifier	8.2	O	N	C

- MO Short Message control result:
 - contents: the command that the UICC gives to the ME concerning whether to allow, bar or modify the proposed short message;
 - coding:
 - '00' = Allowed, no modification;
 - '01' = Not allowed;
 - '02' = Allowed with modifications.
 - Address data object 1: if the address data object 1 is not present, then the ME shall assume the RP_Destination_Address of the Service Center is not to be modified.
 - Address data object 2: if the address data object 2 is not present, then the ME shall assume the TP_Destination_Address is not to be modified.
 - Alpha identifier: this data object is only required if the UICC requests a particular indication to be given to the user. The handling of this data object by the ME is described in clause 7.3.2.3.

The UICC shall provide the two optional address data objects if it has set the MO Short Message control result to "allowed with modifications".

7.3.2.3 Indication to be given to the user

The UICC may optionally include an alpha-identifier in the response data to the ENVELOPE (MO SHORT MESSAGE CONTROL) message, in order to inform the user at the time the response is received by the ME. The use of this alpha identifier by the ME is identical to the one described in clause 7.3.1.3 relative to call control by UICC.

7.3.2.4 Interaction with Fixed Dialling Number

It is permissible for the Fixed Dialling Number service to be enabled (see TS 31.102 [14]) at the same time as MO Short Message Control is available (in the USIM Service Table). If FDN is enabled, the ME shall follow the procedure for Call Control (see clause 7.3.1.4), where the number in the procedure refers to both the SMS destination address and the SMSC address.

7.4 Timer Expiration

7.4.1 Description

When a timer previously started by a TIMER MANAGEMENT proactive command expires, the ME shall pass the identifier of the timer that has expired and its value using the ENVELOPE (TIMER EXPIRATION) command, as defined below.

If the UICC is busy and returns status '93 00', the ME shall retry until the command is accepted.

NOTE: In order to avoid retrying periodically, the ME could retry after a TERMINAL RESPONSE processed by the UICC with status '90 00'.

7.4.2 Structure of ENVELOPE (TIMER EXPIRATION)

Direction: ME to UICC.

The command header is specified in TS 31.101 [13].

Command parameters/data.

Description	Clause	M/O/C	Min	Length
Timer Expiration tag	9.1	M	Y	1
Length (A+B+C)	-	M	Y	1 or 2
Device identities	8.7	M	Y	A
Timer identifier	8.37	M	Y	B
Timer value	8.38	M	Y	C

- Device identities: the ME shall set the device identities to:
 - Source: ME;
 - Destination: UICC.
- Timer identifier: identifier of the timer that has expired.
- Timer value: difference between the time when this command is issued and the time when the timer was initially started. This should be as close as possible to the value of the timer given in the initial TIMER MANAGEMENT command.

Response parameters/data:

- none.

7.5 Event download

A set of events for the ME to monitor can be supplied by the UICC using the proactive command SET UP EVENT LIST. If the UICC has sent this command, and an event which is part of the list subsequently occurs, the ME informs the UICC using the procedure below, relevant for that event.

Processing within the ME resulting from this event shall proceed as normal, independent of sending the ENVELOPE command to the UICC.

Where events occur while the UICC-ME interface is already busy, the ME shall queue events and send event download messages to the UICC in the order in which they occurred.

7.5.1 MT call event

7.5.1.1 Procedure

If the MT call event is part of the current event list (as set up by the last SET UP EVENT LIST command, see clause 6.4.16), then when the ME receives an incoming SETUP message, the ME shall inform the UICC that this has occurred, by using the ENVELOPE (EVENT DOWNLOAD - MT call) command as defined below.

7.5.1.2 Structure of ENVELOPE (EVENT DOWNLOAD - MT call)

Direction: ME to UICC.

The command header is specified in TS 31.101 [13].

Command parameters/data.

Description	Clause	M/O/C	Min	Length
Event download tag	9.1	M	Y	1
Length (A+B+C+D+E)	-	M	Y	1 or 2
Event list	8.25	M	Y	A
Device identities	8.7	M	Y	B
Transaction identifier	8.28	M	Y	C
Address	8.1	C	N	D
Subaddress	8.3	C	N	E

- Event list: the event list object shall contain only one event (value part of length 1 byte), and ME shall set the event to:
 - MT call.
- Device identities: the ME shall set the device identities to:
 - source: Network;
 - destination: UICC.
- Transaction identifier: the transaction identifier data object shall contain one transaction identifier, and this shall be the Transaction Identifier in the SETUP message from the network.
- Address: The address data object holds the Calling Party BCD number as received by the ME in the SETUP message. If the Calling Party BCD number is included in the SETUP message, the ME shall include the Address object, otherwise the ME shall not include the Address object.
- Subaddress: The Subaddress data object holds the Calling Party Subaddress as received by the ME in the SETUP message. If the Calling Party Subaddress is included in the SETUP message, the ME shall include the Subaddress object, otherwise the ME shall not include the Subaddress object.

Response parameters/data:

- none.

7.5.2 Call connected event

7.5.2.1 Procedure

If the call connected event is part of the current event list (as set up by the last SET UP EVENT LIST command, see clause 6.4.16), then when the ME receives an incoming CONNECT message (in the case of an MO call), or when the ME sends an outgoing CONNECT message (in the case of an MT call), the ME shall inform the UICC that this has occurred, by using the ENVELOPE (EVENT DOWNLOAD - call connected) command as defined below.

In the case of a call initiated through a SET UP CALL proactive command while the call connected event is part of the current event list, the ME shall send both the TERMINAL RESPONSE related to the proactive command, and the EVENT DOWNLOAD command, in the order TERMINAL RESPONSE first, ENVELOPE(EVENT DOWNLOAD - call connected) second.

7.5.2.2 Structure of ENVELOPE (EVENT DOWNLOAD - call connected)

Direction: ME to UICC.

The command header is specified in TS 31.101 [13].

Command parameters/data.

Description	Clause	M/O/C	Min	Length
Event download tag	9.1	M	Y	1
Length (A+B+C)	-	M	Y	1 or 2
Event list	8.25	M	Y	A
Device identities	8.7	M	Y	B
Transaction identifier	8.28	M	Y	C

- Event list: the event list object shall contain only one event (value part of length 1 byte), and ME shall set the event to:
 - call connected.
- Device identities:
 - in the case of connecting at the near end (an MT call), the ME shall set the device identities to:
 - source: ME;
 - destination: UICC.
 - in the case of connecting at the far end (an MO call), the ME shall set the device identities to:
 - source: Network;
 - destination: UICC.
- Transaction identifier: the transaction identifier data object shall contain one transaction identifier, and this shall be the Transaction Identifier in the CONNECT message.

Response parameters/data:

- none.

7.5.3 Call disconnected event

7.5.3.1 Procedure

If the call disconnected event is part of the current event list (as set up by the last SET UP EVENT LIST command, see clause 6.4.16), then if the ME is not in the CC U0 (NULL) state (i.e. has sent or received a SETUP message, see 3G TS 24.008 [9]), and in this state disconnects a call, the ME shall inform the UICC that this has occurred, by using the ENVELOPE (EVENT DOWNLOAD - call disconnected) command as defined below. This can happen as the result of the ME sending or receiving a DISCONNECT, RELEASE, or RELEASE COMPLETE message, or as the result of a radio link failure; if more than one of these occur within the same call, the ENVELOPE command shall be sent on the first occurrence.

If the ME initiates the disconnection, or in the case of radio link failure, this is considered a "near end" disconnection, whereas a "far end" disconnection is defined as when the network initiates the disconnection. The ME shall set the Device Identities accordingly.

7.5.3.2 Structure of ENVELOPE (EVENT DOWNLOAD - Call disconnected)

Direction: ME to UICC.

The command header is specified in TS 31.101 [13].

Command parameters/data.

Description	Clause	M/O/C	Min	Length
Event download tag	9.1	M	Y	1
Length (A+B+C+D)	-	M	Y	1 or 2
Event list	8.25	M	Y	A
Device identities	8.7	M	Y	B
Transaction identifier	8.28	M	Y	C
Cause	8.26	O	N	D

- Event list: the event list object shall contain only one event (value part of length 1 byte), and ME shall set the event to:
 - call disconnected.
- Device identities:
 - in the case of "near end" disconnection, the ME shall set the device identities to:
 - source: ME;
 - destination: UICC.
 - in the case of "far end" disconnection, the ME shall set the device identities to:
 - source: Network;
 - destination: UICC.
- Transaction identifier: the transaction identifier data object shall contain a list of the transaction identifiers for each of the calls being disconnected.
- Cause: the cause shall reflect the CC-Cause information element sent or received in the DISCONNECT, RELEASE or RELEASE COMPLETE message (see TS 3G 24.008 [9]) triggering the ENVELOPE command. If the Cause information element was not present in the message, or the Cause data object shall not be included. In the case of a radio link timeout, the Cause data object shall be included, with a value part of zero length.

Response parameters/data:

- none.

7.5.4 Location status event

7.5.4.1 Procedure

If the location status event is part of the current event list (as set up by the last SET UP EVENT LIST command, see clause 6.4.16), then when the ME enters the MM-IDLE state (see TS 3G 24.008 [9]) with the result that either the Location status or Location information has been changed or updated, the ME shall inform the UICC that this has occurred, by using the ENVELOPE (EVENT DOWNLOAD - location status) command as defined below.

7.5.4.2 Structure of ENVELOPE (EVENT DOWNLOAD - Location status)

Direction: ME to UICC.

The command header is specified in TS 31.101 [13].

Command parameters/data.

Description	Clause	M/O/C	Min	Length
Event download tag	9.1	M	Y	1
Length (A+B+C+D)	-	M	Y	1 or 2
Event list	8.25	M	Y	A
Device identities	8.7	M	Y	B
Location status	8.27	M	Y	C
Location information	8.19	C	N	D

- Event list: the event list object shall contain only one event (value part of length 1 byte), and ME shall set the event to:
 - location status.
- Device identities: the ME shall set the device identities to:
 - source: ME;
 - destination: UICC.
- Location status: this object shall contain the current service state of the UE.
- Location information: this object shall only be included if the Location status object indicates Normal Service. This object shall contain the details of the network, location area and cell that have been selected.

Response parameters/data:

- none.

7.5.5 User activity event

7.5.5.1 Procedure

If the user activity event is part of the current event list (as set up by the last SET UP EVENT LIST command, see clause 6.4.16), then the ME shall follow the procedure below:

- when the ME next detects some user activity (e.g. a key-press, removal of key-lock), the ME shall inform the UICC that this has occurred, by using the ENVELOPE (EVENT DOWNLOAD - user activity) command as defined below;
- as a result of sending this command to the UICC, the ME shall remove the user activity event from its current event list. This is in order for the ME to report this event only once after the event has been requested by the UICC.

7.5.5.2 Structure of ENVELOPE (EVENT DOWNLOAD - User activity)

Direction: ME to UICC.

The command header is specified in 3G TS 31.101 [13].

Command parameters/data.

Description	Clause	M/O/C	Min	Length
Event download tag	9.1	M	Y	1
Length (A+B)	-	M	Y	1 or 2
Event list	8.25	M	Y	A
Device identities	8.7	M	Y	B

- Event list: the event list object shall contain only one event (value part of length 1 byte), and ME shall set the event to:
 - user activity.
- Device identities: the ME shall set the device identities to:
 - source: ME;
 - destination: UICC.

Response parameters/data:

- none.

7.5.6 Idle screen available event

7.5.6.1 Procedure

If the idle screen available event is part of the current event list (as set up by the last SET UP EVENT LIST command, see clause 6.4.16), then the ME shall follow the procedure below:

- when the ME next enters a state where it would accept rather than reject a DISPLAY TEXT command of normal priority, the ME shall inform the UICC that this has occurred, by using the ENVELOPE (EVENT DOWNLOAD - idle screen available) command as defined below;
- as a result of sending this command to the UICC, the ME shall remove the idle screen available event from its current event list. This is in order for the ME to report this event only once after the event has been requested by the UICC.

7.5.6.2 Structure of ENVELOPE (EVENT DOWNLOAD - Idle screen available)

Direction: ME to UICC.

The command header is specified in TS 31.101 [13].

Command parameters/data.

Description	Clause	M/O/C	Min	Length
Event download tag	9.1	M	Y	1
Length (A+B)	-	M	Y	1 or 2
Event list	8.25	M	Y	A
Device identities	8.7	M	Y	B

- Event list: the event list object shall contain only one event (value part of length 1 byte), and ME shall set the event to:
 - idle screen available.
- Device identities: the ME shall set the device identities to:
 - source: Display;
 - destination: UICC.

Response parameters/data:

- none.

7.5.7 Card reader status event

The following clauses under 7.5.7 apply only if class "a" is supported.

7.5.7.1 Procedure

If the card reader status event is part of the current event list (as set up by the last SET UP EVENT LIST command, see clause 6.4.16), then when the ME detects one of the following changes:

- a card reader becomes available or unavailable (e.g. a removable card reader is attached); or
- a card is inserted or removed.

The ME shall inform the UICC that this has occurred, by using the ENVELOPE (EVENT DOWNLOAD – card reader status) command as defined below.

7.5.7.2 Structure of ENVELOPE (EVENT DOWNLOAD - card reader status)

Direction: ME to UICC.

The command header is specified in TS 31.101 [13].

Command parameters/data.

Description	Clause	M/O/C	Min	Length
Event download tag	9.1	M	Y	1
Length (A+B+C)	-	M	Y	1 or 2
Event list	8.25	M	Y	A
Device identities	8.7	M	Y	B
Card reader status	8.33	M	Y	C

- Event list: the event list object shall contain only one event (value part of length 1 byte), and ME shall set the event to:
 - card reader status.
- Device identities: the ME shall set the device identities to:
 - source: ME;
 - destination: UICC.
- Card reader status: the card reader status data object shall contain the identifier and status flags for the card reader that has generated the event.

Response parameters/data: None for this type of ENVELOPE command.

7.5.8 Language selection event

7.5.8.1 Procedure

If the language selection event is part of the event list (as set up by the last SET UP EVENT LIST command, see clause 6.4.16), then when the ME changes the currently used language, the ME shall inform the UICC that this has occurred, by using the ENVELOPE (EVENT DOWNLOAD – language selection) command as defined below.

7.5.8.2 Structure of ENVELOPE (language selection)

Direction: ME to UICC.

The command header is specified in TS 31.101 [13].

Command parameters/data.

Description	Clause	M/O/C	Min	Length
Event download tag	9.1	M	Y	1
Length (A+B+C)	-	M	Y	1 or 2
Event list	8.25	M	Y	A
Device identities	8.7	M	Y	B
Language	8.45	M	Y	C

- Event list: the event list object shall contain only one event (value part of length 1 byte), and ME shall set the event to:
 - language selection.
- Device identities: the ME shall set the device identities to:
 - source: ME;
 - destination: UICC.
- Language: This object shall contain the currently used language of the ME.

Response parameters/data: None for this type of ENVELOPE command.

7.5.9 Browser Termination event

7.5.9.1 Procedure

If the browser termination event is part of the event list (as set up by the last SET UP EVENT LIST command, see clause 6.4.16), then when the browser is terminated either by the user action or by an error, the ME shall inform the UICC that this has occurred, by using the ENVELOPE (EVENT DOWNLOAD – browser termination) command as defined below.

7.5.9.2 Structure of ENVELOPE (browser termination)

Direction: ME to UICC.

The command header is specified in TS 31.101 [13].

Command parameters/data.

Description	Clause	M/O	Min	Length
Event download tag	9.1	M	Y	1
Length (A+B+C)	-	M	Y	1 or 2
Event list	8.25	M	Y	A
Device identities	8.7	M	Y	B
Browser termination cause	8.51	M	Y	C

- Event list: the event list object shall contain only one event (value part of length 1 byte), and ME shall set the event to:
 - browser termination.
- Device identities: the ME shall set the device identities to:
 - source: ME;
 - destination: UICC.
- Browser termination cause: This object shall contain the browser termination cause.

Response parameters/data: None for this type of ENVELOPE command.

7.5.10 Data available event

The following clauses apply only if class "e" is supported.

7.5.10.1 Procedure

If the Data available event is part of the current event list (as set up by the last SET UP EVENT LIST command, see clause 6.4.16), then, only if the targeted channel buffer is empty when new data arrives in it, the ME shall inform the UICC that this has occurred, by using the ENVELOPE (EVENT DOWNLOAD – Data available) command as defined below.

7.5.10.2 Structure of ENVELOPE (EVENT DOWNLOAD – Data available)

Direction: ME to UICC.

The command header is specified in TS 31.101 [13].

Command parameters/data.

Description	Clause	M/O	Min	Length
Event download tag	9.1	M	Y	1
Length (A+B+C+D)	-	M	Y	1 or 2
Event list	8.25	M	Y	A
Device identities	8.7	M	Y	B
Channel status	8.56	M	Y	C
Channel data length	8.54	M	Y	D

- Event list: the Event list data object shall contain only one event (value part of length 1 byte), and ME shall set the event to:
 - data available.
- Device identities: the ME shall set the device identities to:
 - source: ME;
 - destination: UICC.
- Channel status: this data object shall contain the status and identifier of the channel on which the event occurred.
- Channel data length: this data object shall contain the number of bytes received, eg available in the channel buffer. If more than 255 bytes are available, 'FF' is used.

Response parameters/data: None for this type of ENVELOPE command.

7.5.11 Channel status event

The following clauses apply only if class "e" is supported.

7.5.11.1 Procedure

If the Channel status event is part of the current event list (as set up by the last SET UP EVENT LIST command, see clause 6.4.16), then, when the ME detects one of the following changes:

- a link is error; or
- any other error,

which is not resulting from the execution of a proactive command, the ME shall inform the UICC that this has occurred, by using the ENVELOPE (EVENT DOWNLOAD – Channel status) command as defined below.

7.5.11.2 Structure of ENVELOPE (EVENT DOWNLOAD – Channel status)

Direction: ME to UICC.

The command header is specified in TS 31.101 [13].

Command parameters/data.

Description	Clause	M/O	Min	Length
Event download tag	9.1	M	Y	1
Length (A+B+C)	-	M	Y	1 or 2
Event list	8.25	M	Y	A
Device identities	8.7	M	Y	B
Channel status	8.56	M	Y	C

- Event list: the Event list data object shall contain only one event (value part of length 1 byte), and ME shall set the event to:
 - channel status.
- Device identities: the ME shall set the device identities to:
 - source: ME;
 - destination: UICC.
- Channel status: this data object shall contain the status and identifier of the channel on which the event occurred.

Response parameters/data: None for this type of ENVELOPE command.

7.5.12 Access Technology Change Event

7.5.12.1 Procedure

If the Access Tehnology Change event is part of the current event list (as set up by the last SET UP EVENT LIST command, see clause 6.4.16), then, when the ME detects a change in its current access technology the ME shall inform the UICC that this has occurred, by using the ENVELOPE (EVENT DOWNLOAD – Access Technology Change) command as defined below.

7.5.12.2 Structure of ENVELOPE (EVENT DOWNLOAD – Access Technology Change)

Direction: ME to UICC.

The command header is specified in TS 31.101 [13].

Command parameters/data.

Description	Clause	M/O	Min	Length
Event download tag	9.1	M	Y	1
Length (A+B+C)	-	M	Y	1 or 2
Event list	8.25	M	Y	A
Device identities	8.7	M	Y	B
Access Technology	8.62	M	Y	C

- Event list: the Event list data object shall contain only one event (value part of length 1 byte), and ME shall set the event to:
 - Access Technology Change.
- Device identities: the ME shall set the device identities to:

- source: ME;
- destination: UICC.
- Access Technology: this data object shall contain the current access technology that the ME is using.

Response parameters/data: None for this type of ENVELOPE command.

7.5.13 Display parameters changed event

7.5.13.1 Procedure

If the display parameters changed event is part of the current event list (as set up by the last SET UP EVENT LIST command, see clause 6.4.16), then when the screen of the ME is resized, the ME shall inform the UICC that this has occurred, by using the ENVELOPE (EVENT DOWNLOAD – Display parameters changed) command as defined below.

7.5.13.2 Structure of ENVELOPE (EVENT DOWNLOAD – Display parameters changed)

Direction: ME to UICC.

The command header is specified in TS 31.101 [13].

Command parameters/data.

Description	Clause	M/O	Min	Length
Event download tag	9.1	M	Y	1
Length (A+B+C)	-	M	Y	1 or 2
Event list	8.25	M	Y	A
Device identities	8.7	M	Y	B
Display Parameters	8.63	M	Y	C

- Event list: the Event list data object shall contain only one event (value part of length 1 byte), and ME shall set the event to:
 - Display parameters changed
- Device identities: the ME shall set the device identities to:
 - source: ME;
 - destination: UICC.
- Display parameters changed: this data object shall contain the current ME's screen parameters

Response parameters/data: None for this type of ENVELOPE command.

7.5.14 Local Connection event

7.5.14.1 Procedure

If the Local Connection event is part of the current event list (as set up by the last SET UP EVENT LIST command, see clause 6.4.16), then when the ME receives an incoming connection request on a local bearer using a service previously declared by the UICC, the ME shall inform the UICC that it has occurred, by using the ENVELOPE (EVENT DOWNLOAD – Local Connection) command as defined below. The ME shall then wait for an OPEN CHANNEL with the parameters given in the event before proceeding with the local connection establishment.

7.5.14.2 Structure of ENVELOPE (EVENT DOWNLOAD – Local Connection)

Direction: ME to UICC.

The command header is specified in TS 31.101 [13].

Command parameters/data.

Description	Clause	M/O/C	Min	Length
Event download tag	9.1	M	Y	1
Length (A+B+C+D)	-	M	Y	1 or 2
Event list	8.25	M	Y	A
Device identities	8.7	M	Y	B
Service Record	8.64	M	Y	D
Remote Entity Address	8.X	O	N	C

- Event list: the event list object shall contain only one event (value part of length 1 byte), and ME shall set the event to:
 - Local connection.
- Device identities: the ME shall set the device identities to:
 - source: Network;
 - destination: UICC.
- Service Record: this data object shall contain the service record of the service being connected by a remote device. If the ME provides a Service Record different from '00', the UICC shall ignore it.

Response parameters/data:

- none.

8 SIMPLE-TLV data objects

This clause specifies the coding of the SIMPLE-TLV data objects, which are contained in a BER-TLV data object. SIMPLE-TLV data objects may be transferred across the interface in either direction. A SIMPLE-TLV data object consists of a tag of length one byte, a length indicator, which gives the number of bytes in the value field, and a value part of variable length, whose contents, meaning and coding are given below.

Tag codings are given in clause 9.3 for all SIMPLE-TLV data objects.

'00' and 'FF' are never used as tag values for SIMPLE-TLVs. This is in alignment with ISO/IEC 7816-6 [18]. Padding characters are not allowed.

For some of the SIMPLE-TLV data objects described, the length field shall be coded on 1 or 2 bytes (Y value) according to annex C, depending on the value of byte 1.

All bits and bytes indicated as RFU within all SIMPLE-TLV data objects shall be respectively set to 0 and '00' by the sending entity.

The handling of reserved values and RFU bits or bytes within all SIMPLE-TLV data objects at the receiving entity is described in clause 6.10.

8.1 Address

Byte(s)	Description	Length
1	Address tag	1
2 to (Y-1)+2	Length (X)	Y
(Y-1)+3	TON and NPI	1
(Y-1)+4 to (Y-1)+X+2	Dialling number string	X-1

TON/NPI is coded as for EF_{ADN}.

Dialling number string is coded as for EF_{ADN} , and may include DTMF separators and DTMF digits, which the ME shall send in the same way as for EF_{ADN} but without locally generating audible DTMF tones to the user.

See TS 31.102 [14] for the coding of all EFs.

8.2 Alpha identifier

Byte(s)	Description	Length
1	Alpha identifier tag	1
2 to (Y-1)+2	Length (X)	Y1
(Y-1)+3 to (Y-1)+X+2	Alpha identifier	X

The alpha identifier is coded as for EF_{ADN} .

See TS 31.102 [14] for the coding of all EFs.

8.3 Subaddress

Byte(s)	Description	Length
1	Subaddress tag	1
2 to (Y-1)+2	Length (X)	Y
(Y-1)+3 to (Y-1)+X+2	Subaddress	X

Subaddress contains information as defined for this purpose in 3G 24.008 [9] (calling party subaddress or called party subaddress). All information defined in 3G 24.008 shall be given in the value part of the data object, except the information element identifier and the length of subaddress contents (which is given by the length part of the data object).

8.4 Capability configuration parameters

Byte(s)	Description	Length
1	Capability configuration parameters tag	1
2 to (Y-1)+2	Length (X)	Y
(Y-1)+3 to (Y-1)+X+2	Capability configuration parameters	X

Capability configuration parameters are coded as for EF_{CCP} . If it is being provided by the UICC, the UICC shall supply all information required to complete the Bearer Capability Information Element in the Call Set-up message (see 3G 24.008 [9]). Any unused bytes at the end of the value part shall be coded 'FF'.

See TS 31.102 [14] for the coding of all EFs.

NOTE: The second byte of this TLV contains the Length of the TLV and the third byte contains the Length of the bearer capability contents, followed by the actual contents.

8.5 Cell Broadcast Page

Byte(s)	Description	Length
1	Cell Broadcast page tag	1
2	Length = '58' (88 decimal)	1
3 - 90	Cell Broadcast page	88

The Cell Broadcast page is formatted in the same way as described in 3G 23.041 [6].

8.6 Command details

Byte(s)	Description	Length
1	Command details tag	1
2	Length = '03'	1
3	Command number	1
4	Type of command	1
5	Command Qualifier	1

- Command number
 - for contents and coding, see clause 6.5.1.
- Type of command:
 - contents: The Type of Command specifies the required interpretation of the data objects which follow, and the required ME procedure;
 - coding:
 - see clause 9.4;
 - the ME shall respond to reserved values (i.e. values not listed) with the result "Command type not understood".
- Command Qualifier:
 - contents: Qualifiers specific to the command;
 - coding:
 - REFRESH:
 - '00' = USIM Initialization and Full File Change Notification;
 - '01' = File Change Notification;
 - '02' = USIM Initialization and File Change Notification;
 - '03' = USIM Initialization;
 - '04' = UICC Reset;
 - '05' = USIM Application Reset;
 - '06' = 3G Session Reset;
 - '07' to 'FF' = reserved values.
 - MORE TIME:
 - this byte is RFU.
 - POLL INTERVAL:
 - this byte is RFU.
 - POLLING OFF:
 - this byte is RFU.
 - SET UP CALL:
 - '00' = set up call, but only if not currently busy on another call;
 - '01' = set up call, but only if not currently busy on another call, with redial;

- '02' = set up call, putting all other calls (if any) on hold;
- '03' = set up call, putting all other calls (if any) on hold, with redial;
- '04' = set up call, disconnecting all other calls (if any);
- '05' = set up call, disconnecting all other calls (if any), with redial;
- '06' to 'FF' = reserved values.
- SEND DTMF:
 - this byte is RFU.
- SET UP EVENT LIST:
 - this byte is RFU.
- SEND SS:
 - this byte is RFU.
- SEND USSD:
 - this byte is RFU.
- SEND SHORT MESSAGE:
 - bit 1: 0 = packing not required;
 1 = SMS packing by the ME required.
 - bits 2-8: = 0 RFU.
- PLAY TONE:
 - this byte is RFU.
- DISPLAY TEXT:
 - bit 1: 0 = normal priority;
 1 = high priority.
 - bits 2-7: = RFU.
 - bit 8: 0 = clear message after a delay;
 1 = wait for user to clear message.
- GET INKEY:
 - bit 1: 0 = digits (0-9, *, # and +) only;
 1 = alphabet set.
 - bit 2: 0 = SMS default alphabet;
 1 = UCS2 alphabet.
 - bit 3: 0 = character sets defined by bit 1 and bit 2 are enabled;
 1 = character sets defined by bit 1 and bit 2 are disabled and the "Yes/No" response is requested.
 - bit 4: 0 = user response shall be displayed. The ME may allow alteration and/or confirmation;
 1 = an immediate digit response (0-9, * and #) is requested.

- bits 5-7: = RFU.
- bit 8: 0 = no help information available;
1 = help information available.
- GET INPUT:
 - bit 1: 0 = digits (0-9, *, #, and +) only;
1 = alphabet set.
 - bit 2: 0 = SMS default alphabet;
1 = UCS2 alphabet.
 - bit 3: 0 = ME may echo user input on the display;
1 = user input shall not be revealed in any way (see note).
 - bit 4: 0 = user input to be in unpacked format;
1 = user input to be in SMS packed format.
 - bits 5 to 7: = RFU.
 - bit 8: 0 = no help information available;
1 = help information available.

NOTE: Where user input is not to be revealed, the ME may provide an indication of key entries, such as by displaying "*"s. See clause 6.4.3 for more information on the character set available in this mode.

- SELECT ITEM:
 - bit 1: 0 = presentation type is not specified;
1 = presentation type is specified in bit 2.
 - bit 2: 0 = presentation as a choice of data values if bit 1 = '1';
1 = presentation as a choice of navigation options if bit 1 is '1'.
 - bit 3: 0 = no selection preference;
1 = selection using soft key preferred.
 - bits 4 to 7: = RFU.
 - bit 8: 0 = no help information available;
1 = help information available.
- SET UP MENU:
 - bit 1: 0 = no selection preference;
1 = selection using soft key preferred.
 - bits 2 to 7: = RFU.
 - bit 8: 0 = no help information available;
1 = help information available.
- PROVIDE LOCAL INFORMATION:
 - '00' = Location Information (MCC, MNC, LAC and Cell Identity);

- '01' = IMEI of the ME;
- '02' = Network Measurement results;
- '03' = Date, time and time zone;
- '04' = Language setting;
- '05' = Timing Advance;
- '06' = Access Technology;
- '07' to 'FF' = Reserved.
- SET UP IDLE MODE TEXT:
 - this byte is RFU.
- PERFORM CARD APDU:
 - this byte is RFU.
- POWER OFF CARD:
 - this byte is RFU.
- POWER ON CARD:
 - this byte is RFU.
- GET READER STATUS:
 - '00' = Card reader status;
 - '01' = Card reader identifier;
 - '02' to 'FF' = Reserved.
- TIMER MANAGEMENT:
 - bits 1 to 2: 00 = start;
01 = deactivate;
10 = get current value;
11 = RFU.
 - bits 3 to 8: RFU.
- RUN AT COMMAND:
 - this byte is RFU.
- LANGUAGE NOTIFICATION:
 - bit 1: 0 = non-specific language notification;
1 = specific language notification.
 - bits 2 to 8: = RFU.
- LAUNCH BROWSER:
 - '00' = launch browser if not already launched;
 - '01' = not used;
 - '02' = use the existing browser (the browser shall not use the active existing secured session);

- '03' = close the existing browser session and launch new browser session;
- '04' = not used;
- '05' to 'FF' = RFU.
- OPEN CHANNEL:
 - bit 1: 0 = On demand link establishment;
 1 = Immediate link establishment.
 - bit 2: 0 = no automatic reconnection;
 1 = automatic reconnection.
 - bits 3 to 8: = RFU.
- CLOSE CHANNEL:
 - this byte is RFU.
- RECEIVE DATA:
 - this byte is RFU.
- SEND DATA:
 - bit 1: 0 = store data in Tx buffer;
 1 = Send data immediately.
 - bits 2 to 8: = RFU.
- GET CHANNEL STATUS:
 - this byte is RFU.
- SERVICE SEARCH (if class "f" is supported):
 - this byte is RFU.
- GET SERVICE INFORMATION (if class "f" is supported)
 - this byte is RFU.
- DECLARE SERVICE (if class "f" is supported):
 - bit1: 0 = add a new service to the ME service database;
 1 = delete a service from the ME service database;
 - bit 2 to 8 RFU.

The ME shall respond to reserved values with the result "Command type not understood".

8.7 Device identities

Byte(s)	Description	Length
1	Device identities tag	1
2	Length = '02'	1
3	Source device identity	1
4	Destination device identity	1

- Source device identity:
 - contents: the source device for information held in the data objects which follow.

- Destination device identity:
 - contents: the destination device for information held in the data objects which follow;

NOTE: Only some combinations of Type of Command, Data Download type and Device identities are allowed. These are defined in clause 10.

- coding: both Source and Destination device identities are coded as follows:
 - '01' = Keypad;
 - '02' = Display;
 - '03' = Earpiece;
 - '10' to '17' = Additional Card Reader x (0 to 7). Value assigned by ME;
 - '21' to '27' = Channel x (1 to 7). Value assigned by ME;
 - '81' = UICC;
 - '82' = ME;
 - '83' = Network;
 - All other values are reserved.

8.8 Duration

Byte(s)	Description	Length
1	Duration tag	1
2	Length = '02'	1
3	Time unit	1
4	Time interval	1

- Time unit:
 - contents: time unit used; minutes, seconds or tenths of seconds;
 - coding:
 - '00' Minutes;
 - '01' Seconds;
 - '02' Tenths of seconds;
 - All other values are reserved.
- Time interval:
 - contents: the length of time required, expressed in units;
 - coding: The time interval is coded in integer multiples of the time unit used. The range is from 1 unit to 255 units. The encoding is:
 - '00': reserved;
 - '01': 1 unit;
 - '02': 2 units;
 - : :
 - 'FF': 255 units.

8.9 Item

Byte(s)	Description	Length
1	Item tag	1
2 to (Y-1)+2	Length (X)	Y
(Y-1)+3	Identifier of item	1
(Y-1)+4 to (Y-1)+X+2	Text string of item	X - 1

The identifier is a single byte between '01' and 'FF'. Each item shall have a unique identifier within an Item list.

The text string is coded in the same way as the alpha identifier for EF_{ADN}. Any unused bytes at the end of the value part shall be coded 'FF'.

8.10 Item identifier

Byte(s)	Description	Length
1	Item identifier tag	1
2	Length = '01'	1
3	Identifier of item chosen	1

The identifier is a single byte between '01' and 'FF', exactly the same as for the Item data object. A null item identifier is coded '00'.

8.11 Response length

Byte(s)	Description	Length
1	Response length tag	1
2	Length = '02'	1
3	Minimum length of response	1
4	Maximum length of response	1

The range of length is between '00' and 'FF'. A minimum length coding of '00' indicates that there is no minimum length requirement; a maximum length coding of 'FF' indicates that there is no maximum length requirement. If a fixed length is required the minimum and maximum values are identical.

8.12 Result

Byte(s)	Description	Length
1	Result tag	1
2 to (Y-1)+2	Length (X)	Y
(Y-1)+3	General result	1
(Y-1)+4 to (Y-1)+X+2	Additional information on result	X-1

- General result:
 - contents: General result specifies the result and indicates appropriate UICC action;
 - coding:
 - '00' = Command performed successfully;
 - '01' = Command performed with partial comprehension;
 - '02' = Command performed, with missing information;

- '03' = REFRESH performed with additional EFs read;
- '04' = Command performed successfully, but requested icon could not be displayed;
- '05' = Command performed, but modified by call control by USIM;
- '06' = Command performed successfully, limited service;
- '07' = Command performed with modification;
- '08' = REFRESH performed but indicated USIM was not active;
- '10' = Proactive UICC session terminated by the user;
- '11' = Backward move in the proactive UICC session requested by the user;
- '12' = No response from user;
- '13' = Help information required by the user;
- '14' = USSD or SS transaction terminated by the user.
- results '0X' and '1X' indicate that the command has been performed:
 - '20' = ME currently unable to process command;
 - '21' = Network currently unable to process command;
 - '22' = User did not accept the proactive command;
 - '23' = User cleared down call before connection or network release;
 - '24' = Action in contradiction with the current timer state;
 - '25' = Interaction with call control by USIM, temporary problem;
 - '26' = Launch browser generic error code.
- results '2X' indicate to the UICC that it may be worth re-trying the command at a later opportunity:
 - '30' = Command beyond ME's capabilities;
 - '31' = Command type not understood by ME;
 - '32' = Command data not understood by ME;
 - '33' = Command number not known by ME;
 - '34' = SS Return Error;
 - '35' = SMS RP-ERROR;
 - '36' = Error, required values are missing;
 - '37' = USSD Return Error;
 - '38' = MultipleCard commands error;
 - '39' = Interaction with call control by USIM or MO short message control by USIM, permanent problem;
 - '3A' = Bearer Independent Protocol error;
 - '3B' = Access Technology unable to process command.

Results '3X' indicate that it is not worth the UICC re-trying with an identical command, as it will only get the same response. However, the decision to retry lies with the application.

The application should avoid a rapid sequence of repeated retried commands as this may be detrimental to ME performance.

All other values are reserved:

- Additional information.
- Contents: For the general result "Command performed successfully", some proactive commands require additional information in the command result. This is defined in the clauses below. For the general results '20', '21', '26', '34', '35', '37', '38', '39' and '3A', it is mandatory for the ME to provide a specific cause value as additional information, as defined in the clauses below. For the other general results, the ME may optionally supply additional information. If additional information is not supplied, then the length of the value part of the data object need only contain the general result.

8.12.1 Additional information for SEND SS

When the ME issues a successful COMMAND RESULT for a SEND SS proactive command, it shall also include the Operation Code and Parameters included in the Return Result component from the network, as additional information.

The first byte of the additional information shall be the SS Return Result Operation code, as defined in 3G 24.080 [11].

The rest of the additional information shall be the SS Return Result Parameters, as defined in 3G 24.080 [11].

8.12.2 Additional information for ME problem

For the general result "ME currently unable to process command", it is mandatory for the ME to provide additional information, the first byte of which to be as defined below:

- '00' = No specific cause can be given;
- '01' = Screen is busy;
- '02' = ME currently busy on call;
- '03' = ME currently busy on SS transaction;
- '04' = No service;
- '05' = Access control class bar;
- '06' = Radio resource not granted;
- '07' = Not in speech call;
- '08' = ME currently busy on USSD transaction;
- '09' = ME currently busy on SEND DTMF command;
- '0A' = No USIM active.

All other values shall be interpreted by the UICC as '00'. The coding '00' shall only be used by the ME if no others apply.

8.12.3 Additional information for network problem

For the general result "network currently unable to process command", it is mandatory for the ME to provide additional information. The first byte shall be the cause value of the Cause information element returned by the network (as defined in 3G 24.008 [9]). Bit 8 shall be set to '1'. One further value is defined:

- '00' = No specific cause can be given.

All other values shall be interpreted by the UICC as '00'. The coding '00' shall only be used by the ME if no others apply.

8.12.4 Additional information for SS problem

For the general result "SS Return Error", it is mandatory for the ME to provide additional information. The first byte shall be the error value given in the Facility (Return result) information element returned by the network (as defined in 3G 24.080 [11]). One further value is defined:

- '00' = No specific cause can be given.

All other values shall be interpreted by the UICC as '00'. The coding '00' shall only be used by the ME if no others apply.

8.12.5 Additional information for SMS problem

For the general result "SMS RP-ERROR", it is mandatory for the ME to provide additional information. The first byte shall be the cause value given in the RP-Cause element of the RP-ERROR message returned by the network (as defined in 3G 24.011 [10]), with bit 8 = 0. One further value is defined:

- '00' = No specific cause can be given.

All other values shall be interpreted by the UICC as '00'. Specific cause '00' shall only be used by the ME if no others apply.

8.12.6 Not used

8.12.7 Additional information for USSD problem

For the general result "USSD Return Error", the ME shall provide additional information. The first byte shall be the error value given in the Facility (Return result) information element returned by the network (as defined in 3G 24.080 [11]). One further value is defined:

- '00' = No specific cause can be given.

All other values shall be interpreted by the UICC as '00'.

The coding '00' shall only be used by the ME if no others apply.

8.12.8 Additional information for interaction with call control or MO SM control

For the general result "interaction with call control by USIM or MO short message control by USIM, permanent problem", it is mandatory for the ME to provide additional information, the first byte of which to be as defined below:

- '00' = No specific cause can be given;
- '01' = Action not allowed;
- '02' = The type of request has changed.

All other values shall be interpreted by the UICC as '00'. The coding '00' shall only be used by the ME if no others apply.

8.12.9 Additional information for MultipleCard commands

This clause applies only if class "a" is supported.

For the general result "MultipleCard commands error", it is mandatory for the ME to provide additional information, the first byte of which is defined below:

- '00' = No specific cause can be given;
- '01' = Card reader removed or not present;

- '02' = Card removed or not present;
- '03' = Card reader busy;
- '04' = Card powered off;
- '05' = C-APDU format error;
- '06' = Mute card;
- '07' = Transmission error;
- '08' = Protocol not supported;
- '09' = Specified reader not valid.

All other values shall be interpreted by the UICC as '00'.

The coding '00' shall only be used by the ME if no others apply.

8.12.10 Additional information for Launch Browser problem

For the general result "launch browser generic error code", it is mandatory for the ME to provide additional information, the first byte of which to be as defined below:

- '00' = No specific cause can be given;
- '01' = Bearer unavailable;
- '02' = Browser unavailable;
- '03' = ME unable to read the provisioning data.

All other values shall be interpreted by the UICC as '00'. The coding '00' shall only be used by the ME if no others apply.

8.12.11 Additional information for Bearer Independent Protocol

This clause applies only if class "e" or "f" is supported.

For the general result "Bearer Independent Protocol error", it is mandatory for the ME to provide additional information, the first byte of which is defined below:

- '00' = No specific cause can be given;
- '01' = No channel available;
- '02' = Channel closed;
- '03' = Channel identifier not valid;
- '04' = Requested buffer size not available;
- '05' = Security error (unsuccessful authentication);
- '06' = Requested SIM/ME interface transport level not available;
- '07' = remote device is not reachable (not present, not physically connected, switched off...);
- '08' = Service error (service not available on remote device);
- '09' = Service identifier unknown.

All other values shall be interpreted by the UICC as '00'.

The coding '00' shall only be used by the ME if no others apply.

8.13 SMS TPDU

Byte(s)	Description	Length
1	SMS TPDU tag	1
2 to (Y-1)+2	Length (X)	Y
(Y-1)+3 to (Y-1)+X+2	SMS TPDU	X

The TPDU is formatted as described in 3G 23.040 [5].

Where the TPDU is being sent from the UICC to the ME (to be forwarded to the network), and where it includes a TP-Message-Reference which is to be incremented by the ME for every outgoing message, the TP-Message-Reference as provided by the UICC need not be the valid value. TP-Message-Reference shall be checked and corrected by the ME to the value described in 3G 23.040 [5].

8.14 SS string

Byte(s)	Description	Length
1	SS string tag	1
2 to (Y-1)+2	Length (X)	Y
(Y-1)+3	TON and NPI	1
(Y-1)+4 to (Y-1)+X+2	SS or USSD string	X - 1

TON/NPI and SS or USSD control string are coded as for EF_{ADN} , where the ADN record relates to a Supplementary Service Control string. See TS 31.102 [14] for the coding of EF_{ADN} .

8.15 Text string

Byte(s)	Description	Length
1	Text string tag	1
2 to (Y-1)+2	Length (X)	Y
(Y-1)+3	Data coding scheme	1
(Y-1)+4 to (Y-1)+X+2	Text string	X-1

A null text string shall be coded with Length = '00', and no Value part.

Data coding scheme is coded as for SMS Data coding scheme defined in TS 23.038 [4].

8.15.1 Coding of text in unpacked format

This is indicated by the data coding scheme having a value of 8 bit data. Other parts of the data coding scheme shall be ignored.

This string use the SMS default 7-bit coded alphabet as defined in TS 23.038 [4] with bit 8 set to 0. It may or may not include formatting characters, but all such formatting characters shall be taken from the set given in the SMS alphabet.

NOTE: This is exactly the same format as is used for EF_{ADN} alpha-identifiers. It is also the same as SMS messages that have been "unpacked".

8.15.2 Coding of text in packed format

This is indicated by the data coding scheme having a value of 7 bit SMS default alphabet. Other parts of the data coding scheme shall be ignored.

This string shall use the SMS default 7-bit coded alphabet, packed into 8-bit octets, as defined in TS 23.038 [4]. It may or may not include formatting characters, but all such formatting characters shall be taken from the set given in the SMS alphabet.

If the total number of characters in the text string equals $(8n-1)$ where $n=1,2,3$ etc. then there are 7 spare bits at the end of the message. To avoid the situation where the receiving entity confuses 7 binary zero pad bits as the @ character, the carriage return (i.e. <CR>) character shall be used for padding in this situation, as defined in TS 23.038 [4].

NOTE: This is the same format as is used in SMS messages to and from the network.

8.15.3 Coding of text in 16 bits UCS2 alphabet format

This is indicated by the data coding scheme having a value of 16 bit UCS2 alphabet. Other parts of the data coding scheme shall be ignored.

This string shall use the UCS2 alphabet if the UCS2 is supported, as defined in TS 23.038 [4]. It may or may not include formatting characters, but all such formatting characters shall be taken from the set given in the UCS2 alphabet.

NOTE: This is the same format as is used in SMS messages to and from the network.

8.16 Tone

Byte(s)	Description	Length
1	Tone tag	1
2	Length = '01'	1
3	Tone	1

- Tone:

- contents: Tones can be either the standard supervisory tone, as defined in TS 22.001 [22], or proprietary tones defined by the ME manufacturer. The code values for proprietary tones shall be supported by the ME. If proprietary tones are not supported the ME shall map these codings to tones that it can generate. The tones to be used are left as an implementation decision by the manufacturer;
- coding:
 - standard supervisory tones:
 - '01' Dial tone;
 - '02' Called subscriber busy;
 - '03' Congestion;
 - '04' Radio path acknowledge;
 - '05' Radio path not available/Call dropped;
 - '06' Error/Special information;
 - '07' Call waiting tone;
 - '08' Ringing tone.
 - ME proprietary tones:
 - '10' General beep;
 - '11' Positive acknowledgement tone;
 - '12' Negative acknowledgement or error tone;
 - '13' Ringing tone as selected by the user for incoming speech call;

- '14' Alert tone as selected by the user for incoming SMS.

All other values are reserved.

8.17 USSD string

Byte(s)	Description	Length
1	USSD string tag	1
2 to (Y-1)+2	Length (X)	Y
(Y-1)+3	Data coding scheme	1
(Y-1)+4 to (Y-1)+X+2	USSD string	X-1

The Data coding scheme is coded as for Cell Broadcast defined in TS 23.038 [4]. The coding of the USSD string is defined in 3G 22.030 [2].

8.18 File List

Byte(s)	Description	Length
1	File List tag	1
2 to (Y-1)+2	Length (X) of bytes following	Y
(Y-1)+3	Number of files (n)	1
(Y-1)+4 to (Y-1)+X+2	Files	X-1

- Number of files:
 - this is the number of files that will be described in the following list.

Files:

- full paths are given to files. Each of these shall be at least 4 octets in length (e.g. '3F002FE2' or '3F007F206FAD'). Each entry in the file description is composed of two bytes, where the first byte identifies the type of file (see 3G TS 31.101 [13]).

The path '3F007FFF' indicates the relevant USIM Application dedicated file.

An entry in the file description shall therefore always begin with '3FXX'. There can be any number of Dedicated File entries between the Master File and Elementary File. There shall be no delimiters between files, as this is implied by the fact that the full path to any EF starts with '3FXX' and ends with an Elementary type file.

8.19 Location Information

Byte(s)	Description	Length
1	Location Information tag	1
2	Length = '07'	1
3 - 5	Mobile Country & Network Codes (MCC & MNC)	3
6 - 7	Location Area Code (LAC)	2
8 - 9	Cell Identity Value (Cell ID)	2

The mobile country code (MCC), the mobile network code (MNC), the location area code (LAC) and the cell ID are coded as in 3G 24.008 [9].

8.20 IMEI

Byte(s)	Description	Length
1	IMEI tag	1
2	Length = '08'	1
3 - 10	IMEI of the ME	8

The IMEI is coded as in 3G 24.008 [9].

8.21 Help Request

Byte(s)	Description	Length
1	Help Request tag	1
2	Length = '00'	1

8.22 Network Measurement Results

This information is only available when the ME is connected to a GSM access network.

Byte(s)	Description	Length
1	Network Measurement Results tag	1
2	Length = '10'	1
3 - 18	Network Measurement Results	16

The Network Measurement Results are coded as for the Measurement Results information element in TS 44.018 [27], starting at octet 2 (the IEI is removed, as this information is duplicated by the data object tag).

8.23 Default Text

The coding of this data object is the same as for the Text String data object (see clause 8.15) with the exception that the Default Text tag has a specific value (see clause 9.3).

8.24 Items Next Action Indicator

Byte(s)	Description	Length
1	Items Next Action Indicator tag	1
2	Length (X)	1
3 to 3+X-1	Items Next Action Indicator list	X

- Contents: Each item of a list of items has a next action indicator coded on one byte. The length of the Items Next Action Indicator list shall be the number of items of the list of items (X shall be the number of items in the list). The order of each item next action indicator, shall reflect the order of the items in the list of items.

The Item Next action indicator gives the possible actions that will be initiated by the UICC in case of selection by the user.

- Coding: If the value is equal to '00' or if the value is reserved (that is, value not listed), the ME shall ignore the next action indicator type.

See clause 9.4 for further information.

EXAMPLE: For the following list of items:

- item #1;
- item #2;
- item #3;
-;
- item #n.

The Items Next Action Indicator (NAI) shall be as follows:

Tag	Length	NAI#1	NAI#2	NAI#3	...	NAI#n
-----	--------	-------	-------	-------	-----	-------

8.25 Event list

Byte(s)	Description	Length
1	Event list tag	1
2 to Y+1	Length (X) of bytes following	Y
Y+2 to X+Y+1	Event list	X

- Event list:
 - contents: A list of events, of variable length. Each byte in the list defines an event. Each event type shall not appear more than once within the list;
 - coding: Each byte in the event list shall be coded with one of the values below:
 - '00' = MT call;
 - '01' = Call connected;
 - '02' = Call disconnected;
 - '03' = Location status;
 - '04' = User activity;
 - '05' = Idle screen available;
 - '06' = Card reader status;
 - '07' = Language selection;
 - '08' = Browser termination;
 - '09' = Data available;
 - '0A' = Channel status;
 - '0B' = Access technology changed;
 - '0C' = Display parameters changed;
 - '0D' = Local connection.

8.26 Cause

Byte(s)	Description	Length
1	Cause tag	1
2	Length (X) of bytes following. $X=0$, or $2 \leq X \leq 30$.	1
3 to X+2	Cause	X

The Cause data object is coded as for the Cause call control information element in 3G 24.008 [9], starting at octet 3 (the IEI and Length information are removed, as this information is duplicated by the data object tag and length).

Radio Link Timeout is indicated by the Cause data object having a value part of zero length (only the Tag and Length components are sent).

8.27 Location status

Byte(s)	Description	Length
1	Location status tag	1
2	Length (X) of bytes following	1
3	Location status	1

- Location status:
 - contents: this data object indicates the current service state of the UE:
 - "normal service" shall indicate that the UE is in a state where all requests for services are treated normally;
 - "limited service" shall indicate that the UE is in a state where only emergency call services are offered;
 - "no service" shall indicate that the UE is in a state where no services are offered.
 - coding: Each byte in the event list shall be coded with one of the values below:
 - '00' = Normal service;
 - '01' = Limited service;
 - '02' = No service.

8.28 Transaction identifier

Byte(s)	Description	Length
1	Transaction identifier tag	1
2	Length (X) of bytes following	1
3 to X+2	Transaction identifier list	X

- Transaction identifier list:
 - contents: A list of transaction identifiers, of variable length. Each byte in the list defines a transaction identifier. Each transaction identifier shall not appear more than once within the list;
 - coding: Each byte in the transaction identifier list shall be coded as defined below:
 - bits 1 to 4 = RFU;
 - bits 5 to 7 = TI value;
 - bit 8 = TI flag.

TI value and TI flag are coded as defined in 3G 24.007 [8].

8.29 BCCH channel list

This information is only available when the ME is connected to a GSM access network.

Byte(s)	Description	Length
1	BCCH channel list tag	1
2	Length (X) of bytes following	1
3 to X+2	BCCH channel list	X

- BCCH channel list:
 - contents: the list of absolute RF channels for BCCH carriers, as known by the ME from the SYSTEM INFORMATION messages. The BCCH channel list is composed of one to three BCCH channel sub lists, each sub list is derived from the set of frequencies defined by reference neighbour cells description information element or elements. In the latter case the set is the union of the different subsets defined by the neighbour cells description information elements (see TS 44.018 [27]). The length of the BCCH channel list field depends on the length of the received BCCH channel list derived from the different SYSTEM INFORMATION messages to be considered.
 - coding: Each ARFCN is represented by 10 bits. Spare bit(s) are to be filled with 0.

	Bit 8	Bit 7	Bit 6	Bit 5	Bit 4	Bit 3	Bit 2	Bit 1
Byte 1	ARFCN#1 (high part)							
Byte 2	ARFCN#1 (low part)				ARFCN#2 (high part)			
Byte 3	ARFCN#2 (low part)				ARFCN#3 (high part)			
...	...							
Byte X-1	ARFCN#m-1 (low part)				ARFCN#m (high part)			
Byte X	ARFCN#m (low part)						Spare bit (0)	Spare bit (0)

8.30 Call control requested action

Byte(s)	Description	Length
1	Call control requested action tag	1
2 to (Y-1)+2	Length (X)	Y
(Y-1)+3 to (Y-1)+X+2	Call control requested action	X

- Call control requested action:
 - contents: The action given in response to the ENVELOPE (CALL CONTROL). It may contain, in the same order as given by the UICC, the address or SS string, the capability configuration parameters, the called party sub-address and the alpha identifier;
 - coding: as described in clause 7.3.1.6, starting with the first optional element given in the response data to the ENVELOPE (CALL CONTROL).

8.31 Icon Identifier

Byte(s)	Description	Length
1	Icon identifier tag	1
2	Length = '02'	1
3	Icon qualifier	1
4	Icon identifier	1

- Icon qualifier:
 - contents: The icon qualifier indicates to the ME how the icon is to be used;
 - coding:
 - bit 1: 0 = icon is self-explanatory, i.e. if displayed, it replaces the alpha identifier or text string;
1 = icon is not self-explanatory, i.e. if displayed, it shall be displayed together with the alpha identifier or text string.
 - bits 2-8 = 0 RFU.

- Icon identifier:
 - contents: The icon identifier addresses a record in EF_{IMG} as defined in TS 31.102 [14];
 - coding: Binary.

8.32 Item Icon Identifier list

Byte(s)	Description	Length
1	Items Icon identifier tag	1
2	Length (X) of bytes following	1
3	Icon list qualifier	1
4 to 4+X-2	Icon identifier list	X-1

- Icon list qualifier:
 - contents: The icon list qualifier indicates to the ME how the icons are to be used;
 - coding:
 - bit 1: 0 = icon is self-explanatory, i.e. if displayed, it replaces the item text;
1 = icon is not self-explanatory, i.e. if displayed, it shall be displayed together with the item text.
 - bits 2-8 = 0 RFU.

All icons in the list shall be treated in the same manner by the ME, i.e. either none of the icons in this list are displayed, or for each item its related icon is displayed.

- Icon identifier list:
 - contents:
 - each item of a list of items has an icon identifier coded on one byte. The length of the Items icon identifier list shall be the number of items of the list of items (X-1 shall be the number of items in the list). The order of each item icon identifier, shall reflect the order of the items in the list of items;
 - each icon identifier addresses a record in EF_{IMG} as defined in 3G TS 31.102 [14].
 - coding: Binary.

EXAMPLE: For the following list of items:

- item #1;
- item #2;
- item #3;
-;
- item #n.

The Items icon identifier list shall be as follows.

Tag	Length	icon identifier#1	icon identifier#2	icon identifier#3	...	icon identifier#n

8.33 Card reader status

Byte(s)	Description	Length
1	Card reader status tag	1
2	Length	1
3	Card reader status	1

- Card reader status:
 - contents:
 - this contains the identity of the card reader, and flags to indicate the status of the reader with respect to:
 - whether the card reader is removable or permanently connected;
 - whether the card reader is present (this can only be false if the card reader is removable);
 - whether the card reader present accepts ID-1 size cards (this can only be true if the card reader is present);
 - whether there is a card present in the card reader (this can only be true if the card reader is present);
 - whether power is being applied to the card (this can only be true if a card is present).
 - coding:
 - the value of this byte indicates the identity and status of a card reader:
 - bits 1-3 = identity of card reader x.
 - bit 4 0 = Card reader is not removable;
 1 = Card reader is removable.
 - bit 5 0 = Card reader is not present;
 1 = Card reader is present.
 - bit 6 0 = Card reader present is not ID-1 size;
 1 = Card reader present is ID-1 size.
 - bit 7 0 = No card present;
 1 = Card is present in reader.
 - bit 8 0 = No card powered;
 1 = Card in reader is powered.

8.34 Card ATR

Byte(s)	Description	Length
1	Card ATR tag	1
2	Length (X) of bytes following	1
3 to (X+2)	ATR	X

- ATR:
 - contents:
 - this is the Answer To Reset returned by the card.
 - coding:
 - the coding of the Answer To Reset is defined in ISO/IEC 7816-3 [16].

8.35 C-APDU

Byte(s)	Description	Length
1	C-APDU tag	1
2 to (Y+1)	Length (X) of bytes following (Y = 1 or 2)	Y
Y+2	Command class CLA	1
Y+3	Command instruction code INS	1
Y+4	P1 parameter	1
Y+5	P2 parameter	1
Y+6	Lc (optional)	0 or 1
(Y+7) to (Y+X)	Data (optional)	Lc
Y+X+1	Le (optional)	0 or 1

This object contains the command APDU for Card x in the format defined in ISO/IEC 7816-4 [17]. Command class CLA, instruction code INS, P1 and P2 parameters, Lc, Data and Le are coded as defined in ISO/IEC 7816-4 [17]. Extended lengths are not supported.

Note: The maximum size of the value part of this Simple TLV (value of X) is limited to 241 bytes, so the maximum length for the Data (value of Lc) in a Case 3 type of APDU is 236 bytes.

8.36 R-APDU

Byte(s)	Description	Length
1	R-APDU tag	1
2 to Y+1	Length (X) of bytes following (Y = 1 or 2)	Y
Y+2 to Y+X-1	R-APDU data (optional)	X-2
Y+X	Status word SW1	1
Y+X+1	Status word SW2	1

This object contains the response APDU from Card x in the format defined in ISO/IEC 7816-4 [17]. The R-APDU data and status words SW1 and SW2 are coded as defined in ISO/IEC 7816-4 [17]. It is possible for no R-APDU data to be present; this is indicated by the length of the data object.

NOTE: The maximum size of the value part of this Simple TLV (value of X) is limited to 239 bytes, so the maximum length of the R-APDU data is 237 bytes.

8.37 Timer identifier

Byte(s)	Description	Length
1	Timer identifier tag	1
2	Length='01'	1
3	Timer identifier	1

- Timer identifier:
 - contents: identifier of a timer;
 - coding:
 - '01' Timer 1;
 - '02' Timer 2;
 - '03' Timer 3;
 - '04' Timer 4;
 - '05' Timer 5;

- '06' Timer 6;
- '07' Timer 7;
- '08' Timer 8.

All other values are reserved.

8.38 Timer value

Byte(s)	Description	Length
1	Timer value tag	1
2	Length='03'	1
3 - 5	Timer value	3

- Timer value:
 - contents: value of a timer, expressed using the format hour, minute, second;
 - coding:
 - byte 3: hour; this byte is coded exactly in the same way as the hour field of the TP-Service-Centre-Time-Stamp in 3G 23.040 [5];
 - byte 4: minute; this byte is coded exactly in the same way as the minute field of the TP-Service-Centre-Time-Stamp in 3G 23.040 [5];
 - byte 5: second; this byte is coded exactly in the same way as the second field of the TP-Service-Centre-Time-Stamp in 3G 23.040 [5].

8.39 Date-Time and Time zone

Byte(s)	Description	Length
1	Date-Time and Time zone tag	1
2	Length = '07'	1
3 to 9	Date-Time and Time zone	7

The Date-Time and Time zone is coded as for the Time Zone and Time information element in 3G 24.008 [9], starting at octet 2 (i.e. 1 byte for year, month, day, hour, minute, second and time zone). Each byte is encoded in exactly the same way as the corresponding field of the TP-Service-Centre-Time-Stamp in 3G 23.040 [5]. For the time zone field, 'FF' indicates an unknown value.

8.40 AT Command

Byte(s)	Description	Length
1	AT Command tag	1
2 to (Y-1)+2	Length (X)	Y
(Y-1)+3 to (Y-1)+3+X-1	AT Command string	X

- Contents: The AT Command string is structured exactly as the AT Command line as defined in 3G 27.007 [12], which may contain single or concatenated AT commands.

8.41 AT Response

Byte(s)	Description	Length
1	AT Response tag	1
2 to (Y-1)+2	Length (X)	Y
(Y-1)+3 to (Y-1)+3+X-1	AT Response string	X

- Contents: The AT Response string is structured exactly as the response to a command line as defined in 3G 27.007 [12], which may contain single or concatenated responses appropriate to the issued AT command.
- If the AT Response string is longer than the maximum length capable of being transmitted to the UICC then the AT Response string shall be truncated to this length by the ME.

8.42 BC Repeat indicator

Byte(s)	Description	Length
1	BC repeat indicator tag	1
2	Length	1
3	BC repeat indicator values	1

- Contents: The BC repeat indicator is structured exactly as defined in 3G 24.008 [08], which may be alternate mode or sequential mode.
- Coding:
 - '01' = Alternate mode;
 - '03' = Sequential mode.

8.43 Immediate response

This TLV object is used in the sustained DISPLAY TEXT command.

Byte(s)	Description	Length
1	Immediate response tag	1
2	Length='00'	1

8.44 DTMF string

Byte(s)	Description	Length
1	DTMF String tag	1
2 to (Y-1)+2	Length (X)	Y
(Y-1)+3 to (Y-1)+3+X-1	DTMF string	X

- Contents:
 - the DTMF string which can be single or multiple characters is coded in BCD, in the same way as the Dialling number string defined for EF_{ADN} in TS 31.102 [14]. It may include extended BCD coding. There is no need for a DTMF control digit separator at the beginning of the string, but if present it shall be interpreted as PAUSE.

8.45 Language

Byte(s)	Description	Length
1	Language tag	1
2	Length = '02'	1
3-4	Language	2

- Coding:
 - each language code is a pair of alpha-numeric characters, defined in ISO 639 [19]. Each alpha-numeric character shall be coded on one byte using the SMS default 7-bit coded alphabet as defined in TS 23.038 [4] with bit 8 set to 0.

8.46 Timing Advance

This information is only available when the ME is connected to a GSM access network.

Byte(s)	Description	Length
1	Timing Advance tag	1
2	Length = '02'	1
3	ME Status	1
4	Timing Advance	1

- Coding of ME status:
 - '00' = ME is in the idle state;
 - '01' = ME is not in idle state;
 - '02' to 'FF' = reserved values.

The Timing Advance is coded as for the Timing Advance information element in TS 44.018 [27], starting at octet 2 (the IEI is removed, as this information is duplicated by the data object tag).

8.47 Browser Identity

Byte(s)	Description	Length
1	Browser identity tag	1
2	Length (1)	1
3	Browser Identity	1

- Coding:
 - 00 = Default Browser shall be used;
 - Other values are RFU.

8.48 URL

Byte(s)	Description	Length
1	URL tag	1
2 to (Y+1)	Length (X)	Y
(Y+2) to (Y+1 + X)	URL	X

A null URL shall be coded with Length = '00', and no Value part. In that case, the ME shall use the default URL.

- Coding:

- the data used for the URL shall be coded as defined in RFC 1738 [24] on using the "SMS 7bit default alphabet" with bit 8 set to 0.

8.49 Bearer

Byte(s)	Description	Length
1	Bearer tag	1
2 to (Y + 1)	Length (X)	Y
(Y+2) to (Y + X + 1)	List of bearers in order of priority requested	X

The ME shall use this list to choose which bearers are allowed in order of priority.

- Coding of the bearers:
 - '00' = SMS;
 - '01' = CSD;
 - '02' = USSD;
 - '03' = GPRS;
 - '04' to 'FF' = RFU.

8.50 Provisioning File Reference

Byte(s)	Description	Length
1	Provisioning file reference tag	1
2 to (Y + 1)	Length (X)	Y
(Y+2) to (Y + X + 1)	Path to the provisioning file	X

NOTE: The path is the concatenation of file identifiers starting from the Master File, e.g.: 3F007F206FXY...

The file shall contain a single unambiguous set of parameters required to make the connection. The content of the file shall be consistent with the format defined for provisioning information for the requested type of browser.

8.51 Browser Termination Cause

Byte(s)	Description	Length
1	Browser Termination Cause tag	1
2	Length (1)	1
3	Browser Termination Cause	1

- Coding:
 - 00 = User Termination;
 - 01 = Error Termination.

8.52 Bearer description

Byte(s)	Description	Length
1	Bearer description tag	1
2	Length (X+1)	1
3	Bearer type	1
4 to (3+X)	Bearer parameters	X

- Bearer Type coding:
 - '01' = CSD;
 - '02' = GPRS;
 - '03' = default bearer for requested transport layer;
 - '04' = local link technology independent;
 - '05' = Bluetooth;
 - '06' = IrDA;
 - '07' = RS232;
 - '10' = USB

All other values are reserved.

8.52.1 Bearer parameters for CSD

Contents: parameters specific to the bearer.

In this case X=3.

- NOTE: The default values of the subparameters are manufacturer specific since they depend on the purpose of the device and data services provided by it. Not all combinations and values of these subparameters are supported by GSM (refer TS 22.002 [1]).
- Coding: The following values are as defined in the TS 27.007 [12] for the select service bearer type "+CBST" extended command. They are coded in hexadecimal.
 - Coding of Byte 4 - Data rate: same as the "speed" subparameter defined in [12].
 - Coding of byte 5 - bearer service: same as the "name" subparameter defined in [12].
 - Coding of Byte 6 - connection element: same as the "ce" subparameter defined in [12].

8.52.2 Bearer parameters for GPRS/Packet Service

Contents: parameters describing the Quality of Service (QoS) and the type of PDP. This is an element of the PDP context.

In this case X=8.

Coding: The following values are as defined in the TS 27.007 [12], for the "+CGQREQ" extended command. They are coded in hexadecimal.

- Coding of Byte 4 - Precedence class: same as the "precedence" subparameter, defined in [12].
- Coding of Byte 5 - Delay class: same as the "delay" subparameter, defined in [12].
- Coding of Byte 6 - Reliability class: same as the "reliability" subparameter, defined in [12].
- Coding of Byte 7 - Peak throughput class: same as the "peak" subparameter, defined in [12].
- Coding of Byte 8 - Mean throughput class: same as the "mean" subparameter, defined in [12].
- Coding of Byte 9 - Packet data protocol type:
 - '02' = IP (Internet Protocol, IETF STD 5);
 - all other values are reserved.

8.52.3 Default bearer

Contents: parameters specific to the bearer.

When the default bearer is present, the ME shall provide its default available bearer parameter configuration.

X (length of parameters) = 0.

8.52.4 Bearer parameters for local links (Bluetooth, IrDA, RS232, USB)

In this case, X= variable.

Contents: "Service Identifier" and "Service Record" fields as defined in 8.64 and according to the Bearer Type coding.

8.53 Channel data

Byte(s)	Description	Length
1	Channel data tag	1
2	Length (X)	1
3 to (3+X)-1	Channel data string	X

- Contents:
 - the Channel data object contains application data read from or written to a specific channel buffer in the ME.
- Coding:
 - the Channel data string must be considered by the ME as binary coded on 8 bits.

8.54 Channel data length

Byte(s)	Description	Length
1	Channel data length tag	1
2	Length (1)	1
3	Channel data length	1

The Channel data length codes:

- either the number of bytes that are available in a channel buffer (Tx or Rx buffers negotiated during OPEN CHANNEL) using TERMINAL RESPONSE. Since the Tx or Rx buffer size can be larger than 255 bytes, 'FF' means "more than 255 bytes are available".
- or the number of bytes that are requested in a RECEIVE DATA command.

8.55 Buffer size

Byte(s)	Description	Length
1	Buffer size tag	1
2 to (Y+1)	Length (2)	Y
(Y+2) to (Y+X+1)	Buffer size	2

The Buffer size codes the number of bytes requested by the UICC in an OPEN CHANNEL command or what the ME can offer the UICC (placed in TERMINAL RESPONSE).

8.56 Channel status

Byte(s)	Description	Length
1	Data tag	1
2	Length (2)	1
3 to 4	Channel status	2

- Contents:
 - the Channel status is a string of binary coded characters.
- Coding of byte 3:
 - bit 1 to 3: Channel identifier: 1..7;
Channel identifier 0 means "No channel available".
 - bit 4 to 7: RFU.
 - bit 8: 0 = Link not established or PDP context not activated;
1 = Link established or PDP context not activated.
- Coding of byte 4:
 - '00' = No further info can be given;
 - '01' = Not used;
 - '02' = Not used;
 - '03' = Not used;
 - '04' = Not used;
 - '05' = Link dropped;
 - all other values are reserved.

8.57 Card reader identifier

Byte(s)	Description	Length
1	Card reader identifier tag	1
2	Length (X)	1
3 to (X+2)	Identifier of card reader	X

- Identifier of card reader:
 - contents:
 - this contains manufacturer-specific information to identify the type of card reader being used.
- coding:
 - the identifier of card reader is coded in hexadecimal.

8.58 Other Address

Byte(s)	Description	Length
1	Other address tag	1
2	Length (X)	1
3	Type of address	1
4 to (4 + X-1)	Address	X

A null Local address shall be coded with Length = '00', and no Value part. In that case, the ME shall request a dynamic address.

Coding of Type of address: according to packet data protocol address in 24.008 [9]:

'21' = IPv4 address;

'97' = IPv6 address;

'others' = reserved.

Coding of address: according to packet data protocol address in 24.008 [9]:

If type of address indicates IPv4, the Address information in octet 4 to octet 7 contains the IPv4 address. Bit 8 of octet 4 represents the most significant bit of the IP address and bit 1 of octet 7 the least significant bit.

If type of address indicates IPv6, the Address information in octet 4 to octet 19 contains the IPv6 address. Bit 8 of octet 4 represents the most significant bit of the IP address and bit 1 of octet 19 the least significant bit.

8.59 SIM/ME interface transport level

This clause applies only if class "e" is supported.

Byte(s)	Description	Length
1	SIM/ME interface transport level tag	1
2	Length (X+1)	1
3	Transport protocol type	1
4 to 5	Port number	2

- Transport protocol type coding:
 - '01': UDP (as defined in RFC 768 [25]);
 - '02': TCP (as defined in RFC 793 [26]);
 - all other value are reserved.
- Port number coding: integer.

8.60 AID

Byte(s)	Description	Length
1	AID tag	1
2	Length (X)	1
3 to (X+2)	AID	X

- Contents:
 - application identifier as defined in TS 31.110 [15].

8.61 Network Access Name

Byte(s)	Description	Length
1	Network Access Name tag	1
2	Length (X)	1
3 to 3+X-1	Network Access Name	X

- Content: The Network Access Name is used to identify the Gateway entity, which provides interworking with an external packet data network. For GPRS, the Network Access Name is an APN.
- Coding: As defined in TS 23.003 [30].

8.62 Access Technology

Byte(s)	Description	Length
1	Access Technology tag	1
2	Length = '01'	1
3	Technology	1

- Technology:
Contents: The ME shall use this information as a mechanism to indicate to the UICC the current access technology that it is using.

Coding:

- '00' GSM;
- '01' EIA/TIA-553;
- '02' TIA/EIA-136;
- '03' UTRAN;
- '04' TETRA;
- '05' TIA/EIA-95;
- '06' TIA/EIA/IS-2000;
- All other values are reserved for future use.

8.63 Display parameters

Byte(s)	Description	Length
1	Display parameters tag	1
2	Length (3)	1
3 to 5	Parameters list	3

- Parameters list:
Contents: A list of different information regarding the ME's screen.

Coding:

- 1 bit is used to code parameters supported or not:
bit = 1: parameters supported by ME;
bit = 0: parameters not supported by ME.

First byte: (Screen height)

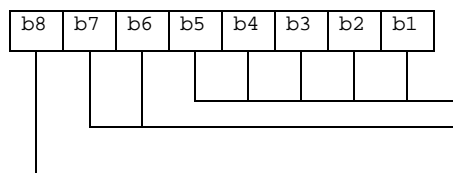

Number of characters supported down the ME display as defined in 5.3.1
RFU, bit = 0
Screen Sizing Parameters supported as defined in clause 5.3

Second byte: (Screen width)

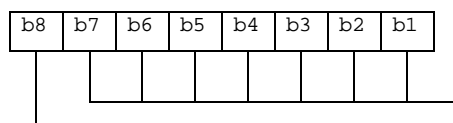

Number of characters supported across the ME display as defined in 5.3.2
Variable size fonts Supported

Third byte: (Screen effects)

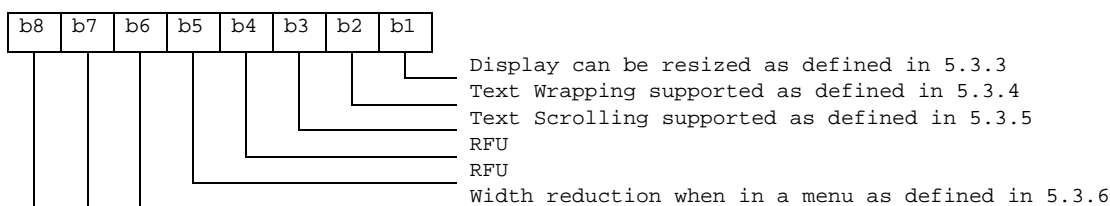

8.64 Service Record

This service record can have different formats that are dependent on the technology they are associated with.

This object can be used in both directions (ME to UICC or UICC to ME), when a USAT application needs to declare a service that it supports (DECLARE SERVICE command) and when USAT application searches for a service (GET SERVICE INFORMATION).

Byte(s)	Description	Length
1	Item tag	1
2 to Y+1	Length (X+2)	Y
Y+2	Local Bearer technology identifier	1
Y+3	Service Identifier	1
Y+4 to Y+X+3	Service Record	X

Local Bearer Technology identifier:

- '00' = Technology independent: '00';
- '01' = Bluetooth;
- '02' = IrDA;
- '03' = RS232;
- '04' = USB;
- '05' to 'FF' = RFU.

Service identifier:

When declaring a service, the UICC associates a Service Identifier to the Service Record. When the Service Record TLV is returned in response to GET SERVICE INFORMATION, Service Identifier shall be set to 'FF'.

- '00' to '07' Service x (0 to 7). Value assigned by USIM.
- 'FF' = Service Record related to the service provided by a remote device.
- Other value reserved for future use.

Service Record:

When the Service Record field is not meaningful, it shall be assigned the value = '00':

- Technology Independent: RFU;
- Bluetooth:

In Bluetooth a Service record gives all needed information that must be used by a device to connect and use this service.

The full description of the coding of these records is given in the Bluetooth Specification [28] in the SDP section. When Service Record is returned in response to GET SERVICE INFORMATION, it corresponds to the AttributeList parameter contained in the SDP_ServiceAttributeResponse PDU [28].

Strings should be limited to 20 bytes because of the T=0 protocol limitation (255 bytes) and because the service record may include several text strings with length possibly higher than 255 bytes.

- IrDA: RFU;
- RS232: RFU;
- USB: RFU.

Depending on the proactive command, the parameters of this TLV could be either meaningful or optional. The following table indicates in which case the parameters are required.

Proactive command	Service Identifier required	Service Record field required
DECLARE SERVICE (add)	Yes	Yes
DECLARE SERVICE (delete)	Yes	No (value '00' assigned)
Terminal response of a GET SERVICE INFORMATION	No (value 'FF' assigned)	Yes
OPEN CHANNEL (client)	No (value 'FF' assigned)	Yes
OPEN CHANNEL (server)	Yes	No (value '00' assigned)
Local Connection event	Yes	No (value '00' assigned)

8.65 Device Filter

Byte(s)	Description	Length
1	Item tag	1
2 to Y+1	Length (1+X1+X2+...+Xn)	Y
Y+2	Local Bearer technology identifier	1
Y+3 to Y+2+X	Device Filter	X

Local Bearer Technology identifier: see clause 8.64.

Device filter:

If the Local Bearer Technology Identifier is different from '00', the device filter coding is technology dependent:

- Technology Independent: RFU;
- Bluetooth:

The Device Filter parameter is used to filter the responses to a service search. For Bluetooth, it is a list of Class_Of_Device and Class_Of_Device_Mask.

Device Filter =

Class_Of_Device_1 [3 bytes], Class_Of_Device_Mask_1 [3 bytes],

Class_Of_Device_2 [3 bytes], Class_Of_Device_Mask_2 [3 bytes],

....

Class_Of_Device_n [3 bytes], Class_Of_Device_Mask_n [3 bytes].

- IrDA: RFU;
- RS232: RFU;
- USB: RFU.

8.66 Service Search

Byte(s)	Description	Length
1	Item tag	1
2 to Y+1	Length (X+1)	Y
Y+2	Local Bearer technology identifier	1
Y+3 to Y+X+1	Service Search	X

Local Bearer Technology identifier: see clause 8.64.

Service search:

If the Local Bearer Technology Identifier is different from '00', the Service search coding is technology dependent.

- Technology Independent: RFU;
- Bluetooth:

The Service Search field is the *ServiceSearchPattern* parameter of the *SDP_ServiceSearchRequest* command as defined in [28].

- IrDA: RFU;
- RS232: RFU;
- USB: RFU.

8.67 Attribute Information

Byte(s)	Description	Length
1	Item tag	1
2 to Y+1	Length (X+1)	Y
Y+2	Local Bearer technology identifier	1
Y+3 to Y+X+2	Attribute Information	X

Local Bearer Technology identifier: see 8.64.

Attribute Information:

If the Local Bearer Technology Identifier is different from '00', the Attribute Information coding is technology dependent:

- Technology Independent: RFU;
- Bluetooth:

The Attribute Information field consists of a *BD_ADDR*, followed by the *ServiceRecordHandle* and the *AttributeIDList* parameters of the *SDP_ServiceAttributeRequest* command as defined in [28].

The *BD_ADDR* is the Bluetooth device address of the device the ME shall connect to. The ME shall use the *ServiceRecordHandle* and the *AttributeIDList* parameters to perform the *SDP_ServiceAttributeRequest*. The *ServiceRecordHandle* has been previously retrieved with the *SERVICE SEARCH* command.

- IrDA: RFU;
- RS232: RFU;
- USB: RFU.

8.68 Service Availability

The Service Availability parameter contains a list of available services that the SERVICE SEARCH command returns. This object is formatted according to the local bearer technology identifier byte set in the SERVICE SEARCH command arguments.

Byte(s)	Description	Length
1	Service General Information tag	1
2 to Y+1	Length='X1'+ 'X2'+ 'X3'+... 'Xn' (n maxi = 7)	Y
Y+2 to Y+X1+1	Service_1	X1
Y+X1+2 to Y+X1+X2+1	Service_2	X2
...
Y+X1+...+X(n-1)+2 to Y+X1+...+Xn+1	Service_n	Xn

- Technology Independent: RFU;
- Bluetooth:

For Bluetooth, Service_i = BD_ADDR_i[6 bytes] + ServiceRecordHandle_i[4 bytes] + CoD_i[3 bytes] + Device_Name_i[20 bytes], those parameters being defined in [28]. Device Name parameter should be truncated to 20 bytes because of the T=0 protocol limitation (255 bytes) and because device name parameter length can be higher than 255 bytes.

Byte(s)	Description	Length
1	Service General Information tag	1
2 to Y+1	Length='X1'+ 'X2'+ 'X3'+... 'Xn' (n maxi = 7)	Y
Y+2 to Y+X1+1	BD_ADDR + ServiceRecordHandle + CoD + Device_Name	X1
Y+X1+2 to Y+X1+X2+1	BD_ADDR + ServiceRecordHandle + CoD + Device_Name	X2
...
Y+X1+...+X(n-1)+2 to Y+X1+...+Xn+1	BD_ADDR + ServiceRecordHandle + CoD + Device_Name	Xn

- IrDA: RFU;
- RS232: RFU;
- USB: RFU.

8.69 Remote Entity Address

Byte(s)	Description	Length
1	Item tag	1
2 to Y+1	Length (X+1)	Y
Y+2	Coding Type	1
Y+3 to Y+X+2	Remote Entity address	X

Coding Type:

- '00': IEEE-802 48-bit address;
- '01' to 'FF' are reserved values.

Remote Entity Address:

according to Coding Type.

9 Tag values

This clause specifies the tag values used to identify the BER-TLV and SIMPLE-TLV data objects used in the present document.

9.1 BER-TLV tags in ME to UICC direction

Description	Length of tag	Value
SMS-PP download tag	1	'D1'
Cell Broadcast download tag	1	'D2'
Menu Selection tag	1	'D3'
Call control tag	1	'D4'
MO Short message control tag	1	'D5'
Event download tag	1	'D6'
Timer expiration	1	'D7'
Reserved for TIA/EIA-136	1	'DF'

9.2 BER-TLV tags in UICC TO ME direction

Description	Length of tag	Value
Proactive UICC command tag	1	'D0'

9.3 SIMPLE-TLV tags in both directions

Description	Length of tag	Tag value, bits 1-7 (Range: '01' - '7E')	Tag (CR and Tag value)
Command details tag	1	'01'	'01' or '81'
Device identity tag	1	'02'	'02' or '82'
Result tag	1	'03'	'03' or '83'
Duration tag	1	'04'	'04' or '84'
Alpha identifier tag	1	'05'	'05' or '85'
Address tag	1	'06'	'06' or '86'
Capability configuration parameters tag	1	'07'	'07' or '87'
Subaddress tag	1	'08'	'08' or '88'
SS string tag	1	'09'	'09' or '89'
USSD string tag	1	'0A'	'0A' or '8A'
SMS TPDU tag	1	'0B'	'0B' or '8B'
Cell Broadcast page tag	1	'0C'	'0C' or '8C'
Text string tag	1	'0D'	'0D' or '8D'
Tone tag	1	'0E'	'0E' or '8E'
Item tag	1	'0F'	'0F' or '8F'
Item identifier tag	1	'10'	'10' or '90'
Response length tag	1	'11'	'11' or '91'
File List tag	1	'12'	'12' or '92'
Location Information tag	1	'13'	'13' or '93'
IMEI tag	1	'14'	'14' or '94'
Help request tag	1	'15'	'15' or '95'
Network Measurement Results tag	1	'16'	'16' or '96'
Default Text	1	'17'	'17' or '97'
Items Next Action Indicator tag	1	'18'	'18' only
Event list tag	1	'19'	'19' or '99'
Cause tag	1	'1A'	'1A' or '9A'
Location status tag	1	'1B'	'1B' or '9B'
Transaction identifier tag	1	'1C'	'1C' or '9C'
BCCH channel list tag	1	'1D'	'1D' or '9D'
Icon identifier	1	'1E'	'1E' or '9E'
Item Icon identifier list	1	'1F'	'1F' or '9F'
Card reader status tag	1	'20'	'20' or 'A0'
Card ATR tag	1	'21'	'21' or 'A1'
C-APDU tag	1	'22'	'22' or 'A2'
R-APDU tag	1	'23'	'23' or 'A3'
Timer identifier tag	1	'24'	'24' or 'A4'
Timer value tag	1	'25'	'25' or 'A5'
Date-Time and Time zone tag	1	'26'	'26' or 'A6'
Call control requested action tag	1	'27'	'27' or 'A7'
AT Command tag	1	'28'	'28' or 'A8'
AT Response tag	1	'29'	'29' or 'A9'
BC Repeat Indicator tag	1	'2A'	'2A' or 'AA'
Immediate response tag	1	'2B'	'2B' or 'AB'
DTMF string tag	1	'2C'	'2C' or 'AC'
Language tag	1	'2D'	'2D' or 'AD'
Timing Advance tag	1	'2E'	'2E' or 'AE'
AID tag	1	'2F'	'2F' or 'AF'
Browser Identity tag	1	'30'	'30' or 'B0'
URL tag	1	'31'	'31' or 'B1'
Bearer tag	1	'32'	'32' or 'B2'
Provisioning Reference File tag	1	'33'	'33' or 'B3'
Browser Termination Cause tag	1	'34'	'34' or 'B4'
Bearer description tag	1	'35'	'35' or 'B5'
Channel data tag	1	'36'	'36' or 'B6'
Channel data length tag	1	'37'	'37' or 'B7'
Channel status tag	1	'38'	'38' or 'B8'
Buffer size tag	1	'39'	'39' or 'B9'
Continued.....			

Description	Length of tag	Tag value, bits 1-7 (Range: '01' - '7E')	Tag (CR and Tag value)
Card reader identifier tag	1	'3A'	'3A' or 'BA'
not used	-	'3B'	-
USIM/ME interface transport level	1	'3C'	'3C' or 'BC'
not used	-	'3D'	-
Other address (data destination address)	1	'3E'	'3E' or 'BE'
Access Technology tag	1	'3F'	'3F' or 'BF'
Display parameters tag	1	'40'	'40' or 'C0'
Service Record	1	'41'	'41' or 'C1'
Device Filter	1	'42'	'42' or 'C2'
Service Search	1	'43'	'43' or 'C3'
Attribute information	1	'44'	'44' or 'C4'
Service Availability	1	'45'	'45' or 'C5'
Reserved for ETSI SCP	1	'46'	
Network Access Name	1	'47'	'47' or 'C7'
Reserved for TIA/EIA-136	1	'60'	'60' or 'E0'
Reserved for TIA/EIA-136	1	'61'	'61' or 'E1'

9.4 Type of Command and Next Action Indicator

The table below shows the values which shall be used for Type of Command coding (see clause 8.6) and Next Action Indicator coding (see clause 8.24).

Value	Name	used for Type of Command coding	used for Next Action Indicator coding
'00'		-	-
'01'	REFRESH	X	
'02'	MORE TIME	X	
'03'	POLL INTERVAL	X	
'04'	POLLING OFF	X	
'05'	SET UP EVENT LIST	X	
'10'	SET UP CALL	X	X
'11'	SEND SS	X	X
'12'	SEND USSD	X	X
'13'	SEND SHORT MESSAGE	X	X
'14'	SEND DTMF	X	
'15'	LAUNCH BROWSER	X	X
'20'	PLAY TONE	X	X
'21'	DISPLAY TEXT	X	X
'22'	GET INKEY	X	X
'23'	GET INPUT	X	X
'24'	SELECT ITEM	X	X
'25'	SET UP MENU	X	X
'26'	PROVIDE LOCAL INFORMATION	X	
'27'	TIMER MANAGEMENT	X	
'28'	SET UP IDLE MODEL TEXT	X	X
'30'	PERFORM CARD APDU	X	X
'31'	POWER ON CARD	X	X
'32'	POWER OFF CARD	X	X
'33'	GET READER STATUS	X	X
'34'	RUN AT COMMAND	X	
'35'	LANGUAGE NOTIFICATION	X	
'40'	OPEN CHANNEL	X	X
'41'	CLOSE CHANNEL	X	X
'42'	RECEIVE DATA	X	X
'43'	SEND DATA	X	X
'44'	GET CHANNEL STATUS	X	X
'45'	SERVICE SEARCH	X	X
'46'	GET SERVICE INFORMATION	X	X
'47'	DECLARE SERVICE	X	
'60'	Reserved for TIA/EIA-136	X	X
'81'	End of the proactive session	not applicable	X

10 Allowed Type of command and Device identity combinations

Only certain types of commands can be issued with certain device identities. These are defined below.

Command description	Source	Destination
CALL CONTROL	ME	UICC
CELL BROADCAST DOWNLOAD	Network	UICC
COMMAND RESULT	ME	UICC
DISPLAY TEXT	UICC	Display
EVENT DOWNLOAD		
- MT call	Network	UICC
- Call connected at near end (MT call)	ME	UICC
- Call connected at far end (MO call)	Network	UICC
- Call disconnected at near end	ME	UICC
- Call disconnected at far end	Network	UICC
- Location status	ME	UICC
- User activity	ME	UICC
- Idle screen available	Display	UICC
- Card reader status	ME	UICC
- language selection	ME	UICC
- data available	ME	UICC
- channel status	ME	UICC
- access technology changed	ME	UICC
- display parameters changed	ME	UICC
- local connection	Network	UICC
GET INKEY	UICC	ME
GET INPUT	UICC	ME
GET READER STATUS		
- if card reader status requested	UICC	ME
- if card reader identifier requested	UICC	card reader x
LANGUAGE NOTIFICATION	UICC	ME
LAUNCH BROWSER	UICC	ME
MENU SELECTION	Keypad	UICC
MO SHORT MESSAGE CONTROL	ME	UICC
MORE TIME	UICC	ME
PERFORM CARD APDU	UICC	Card reader x
PLAY TONE	UICC	Earpiece (see note)
POLLING OFF	UICC	ME
POLL INTERVAL	UICC	ME
POWER ON CARD	UICC	Card reader x
POWER OFF CARD	UICC	Card reader x
PROFILE DOWNLOAD	ME	UICC
PROVIDE LOCAL INFORMATION	UICC	ME
REFRESH	UICC	ME
RUN AT COMMAND	UICC	ME
SELECT ITEM	UICC	ME
SEND DTMF	UICC	Network
SEND SHORT MESSAGE	UICC	Network
SEND SS	UICC	Network
SEND USSD	UICC	Network
SET UP CALL	UICC	Network
SET UP EVENT LIST	UICC	ME
SET UP IDLE MODE TEXT	UICC	ME
SET UP MENU	UICC	ME
SMS-PP DOWNLOAD	Network	UICC
TIMER MANAGEMENT	UICC	ME
TIMER EXPIRATION	ME	UICC

Continued...

Command description	Source	Destination
OPEN CHANNEL	UICC	ME
CLOSE CHANNEL	UICC	Channel x
RECEIVE DATA	UICC	Channel x
SEND DATA	UICC	Channel x
GET CHANNEL STATUS	UICC	ME
SERVICE SEARCH	UICC	ME
GET SERVICE INFORMATION	UICC	ME
DECLARE SERVICE	UICC	ME
NOTE: The ME may route the tone to other loudspeakers (external ringer, car kit) if more appropriate.		

11 Security requirements

GSM 03.48 [22] specifies standardised methods of securing the content of application messages. If it is necessary to secure application messaging to Toolkit applications, then GSM 03.48 may be used.

Annex A (normative): Support of USAT by Mobile Equipment

Support of USAT is optional for Mobile Equipment. However, if an ME states conformance with a specific 3G release, it is mandatory for the ME to support all functions of that release.

The support of letter classes, which specify mainly ME hardware dependent features, is optional for the ME and may supplement the USAT functionality described in the present document. If an ME states conformance to a letter class, it is mandatory to support all functions within the respective letter class.

The table below indicates the commands and functions of the optional letter classes.

Letter classes	Command/function description
a	Proactive command: GET READER STATUS Proactive command: PERFORM CARD APDU Proactive command: POWER ON CARD Proactive command: POWER OFF CARD Event download: Card reader status
b	Proactive command: RUN AT COMMAND
c	Proactive command: LAUNCH BROWSER Event download: Browser termination
d	Soft key support
e	Proactive command: OPEN CHANNEL Proactive command: CLOSE CHANNEL Proactive command: RECEIVE DATA Proactive command: SEND DATA Proactive command: GET CHANNEL STATUS Event download: Data available Event download: Channel status
f	Proactive command: SERVICE SEARCH Proactive command: GET SERVICE INFORMATION Proactive command: DECLARE SERVICE Event download: Local connection

Annex B (informative): Example of DISPLAY TEXT Proactive UICC Command

Example of DISPLAY TEXT Proactive UICC Command (BER-TLV Data Object).

Byte#	Value (Hex)	Description
1	D0	Proactive UICC command tag
2	10	length
3	81	command details tag
4	03	length
5	01	command number
6 - 7	21 00	Display text (normal priority, clear message after a delay)
8	82	Device identities tag
9	02	length
10	81	source: UICC
11	02	destination: Display
12	8D	Text string tag
13	05	length
14	04	Data coding scheme ('04'=8-bit default SMS)
15 - 18	55,53,41,54	text string ("USAT")

Annex C (normative): Structure of USAT communications

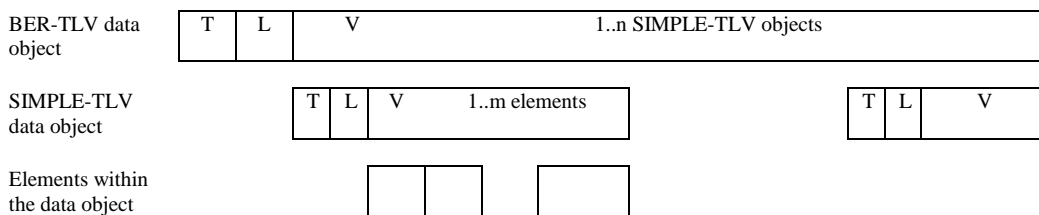

USAT commands and responses are sent across the interface as BER-TLV data objects. Each APDU shall only contain one BER-TLV object. See ISO/IEC 7816-6 [18] for more information on data objects.

The tag of a BER-TLV is a constant value, length one byte, indicating it is a USAT command.

The length is coded onto 1, or 2 bytes according to ISO/IEC 7816-6 [18]. The table C.1 details this coding.

Table C.1

Length	Byte 1	Byte 2
0-127	length ('00' to '7F')	not present
128-255	'81'	length ('80' to 'FF')

Any length within the APDU limits (up to 255 bytes) can thus be encoded on two bytes. This coding is chosen to remain compatible with ISO/IEC 7816-6 [18].

Any values for byte 1 or byte 2 that are not shown above shall be treated as an error and the whole message shall be rejected.

The value part of the BER-TLV data object consists of SIMPLE-TLV data objects, as shown in the description of the SIMPLE-TLV data objects on individual commands. It is mandatory for SIMPLE-TLV data objects to be provided in the order given in the description of each command. New SIMPLE-TLV data objects can be added to the end of a command.

The structure of SIMPLE-TLV tags is defined in the clause below.

The M/O/C columns specify whether it is mandatory, optional or conditional for the sender to send that particular SIMPLE-TLV data object for compliance with the current version of the present document. The Min (Minimum Set) column describes whether it is necessary for the receiver to have received that particular SIMPLE-TLV data object to be able to attempt at least the most basic form of this command. The procedure for dealing with incomplete messages is described in clause 6.10.

'00' and 'FF' are never used as tag values. This is in accordance with ISO/IEC 7816-6 [18]. Padding characters are not allowed.

C.1 SIMPLE-TLV tag format

SIMPLE-TLV tags can be in one of two formats: single byte and three-byte format.

The value of the first byte identifies the format used.

First byte value	Format
'00'	Not used, in accordance with ISO/IEC 7816-6 [18]
'01' - '7E'	Single byte
'7F'	Three-byte
'80'	Reserved for future use
'81' - 'FE'	Single byte
'FF'	Not used, in accordance with ISO/IEC 7816-6 [18]

The same value in the two formats represent the same data object.

C.1.1 Single byte format

The tag is coded over one byte.

8	7	6	5	4	3	2	1
CR		Tag value					

CR: Comprehension required for this object.

Unless otherwise stated, for SIMPLE-TLV data objects it is the responsibility of the UICC application and the ME to decide the value of the CR flag for each data object in a given command.

Handling of the CR flag at the receiving entity is described in clause 6.10.

CR	Value
Comprehension required	1
Comprehension not required	0

C.1.2 Three-byte format

The tag is coded over three bytes.

Byte 1	Byte 2							Byte 3
	8	7	6	5	4	3	2	
Tag value format = '7F'	CR	Tag value						

Tag value format: Byte 1 equal to '7F' indicates that the tag is in the three-byte format.

CR: Comprehension required for this object. Use and coding is the same as in single byte format.

Tag value: Coded over 15 bits, with bit 7 of byte 2 as the most significant bit. Range is from '00 01' to '7F FF'.

Annex D (informative): ME display in proactive UICC session

Example of the ME display whilst the ME is in a proactive UICC session.

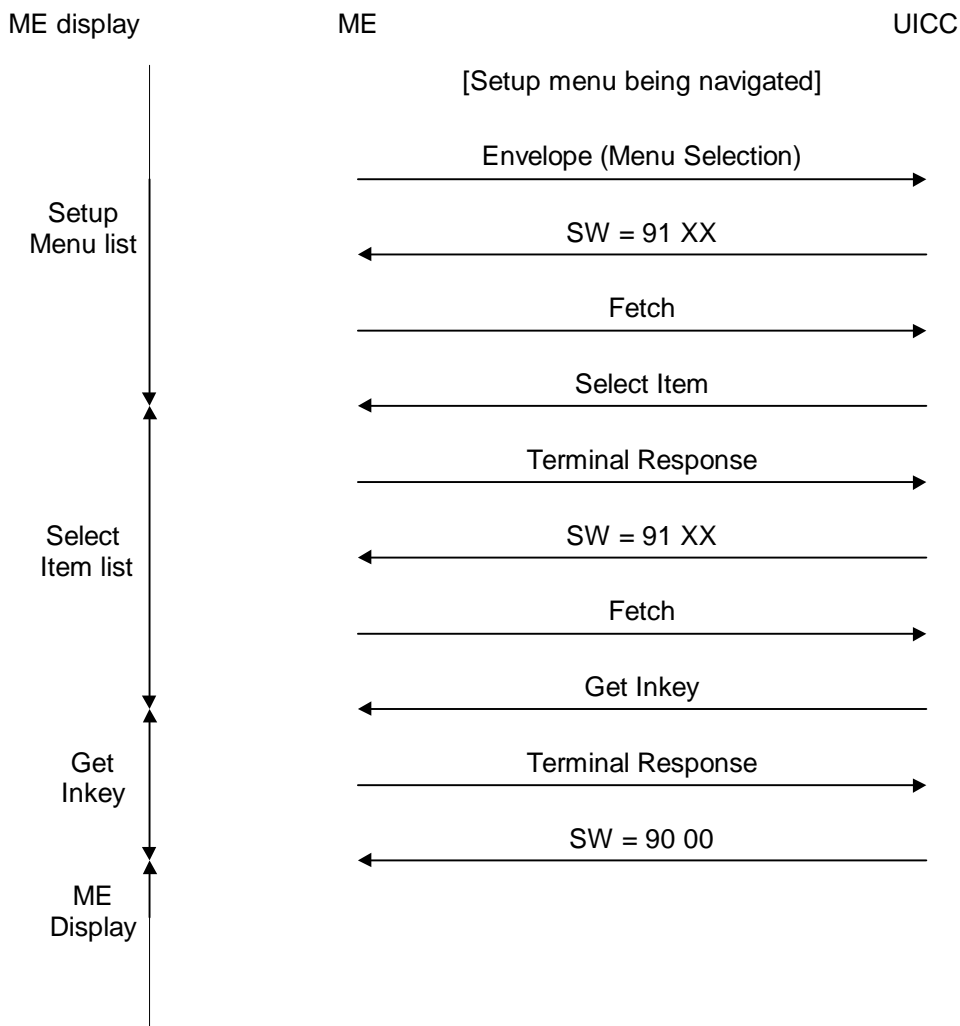

Figure D.1

Annex E (informative): Help information feature processing

The following example shows the use of the commands Menu Selection/Select Item and Get Input in conjunction with the help information feature.

ME		UICC
TERMINAL PROFILE	----->	
		<----- 91xx
FETCH	----->	
		<----- SET UP MENU (Help available)
TERMINAL RESPONSE (OK)	----->	
		<----- 90 00
...		
ENVELOPE (MENU SELECTION, help on menu item m)	----->	
		<----- 91 xx
FETCH	----->	
		<----- DISPLAY TEXT (Help info to item m)
TERMINAL RESPONSE (OK)	----->	
		<----- 90 00
(ME offers menu again and user selects item m)		
ENVELOPE (MENU SELECTION, select item m)	----->	
		<----- 91 xx
FETCH	----->	
		<----- SELECT ITEM (Item list under item m, help available)
TERMINAL RESPONSE (Help on item mn in item list under item m)	----->	
		<----- 91 xx
FETCH	----->	
	<-----	DISPLAY TEXT (Help info to item mn)
TERMINAL RESPONSE (OK)	----->	
		<----- 91 xx
FETCH	----->	
		<----- Repetition of SELECT ITEM (Item list under item m, help available)
...		
		<----- 91xx
FETCH	----->	
		<----- GET INPUT
TERMINAL RESPONSE (Help info required)	----->	
		<----- 91 xx
FETCH	----->	
		<----- DISPLAY TEXT (Help info)
TERMINAL RESPONSE (OK)	----->	
		<----- 91 xx
FETCH	----->	
		<----- Repetition of GET INPUT
TERMINAL RESPONSE (OK)	----->	
		...
...		

Annex F (informative): Monitoring of events

Some of the events monitored through the event download mechanism are reported by the mobile each time the event occurs, while other events are reported only once (the ME removes the event type from the current event list once the event occurs). This is summarised in the table below.

Event	Continuously reported	Reported once
MT call	X	
Call connected	X	
Call disconnected	X	
Location status	X	
User activity		X
Idle screen available		X
Card reader status	X	
Language selection	X	
Data available	X	
Channel status	X	
Browser termination	X	
Access technology changed	X	
Display parameters changed	X	
Local connection	X	

Annex G (normative): Support of Multiple Card Operation

This annex applies only if class "a" is supported.

It is intended that MultipleCard commands are an optional extension to the basic USAT functionality in the present document.

The ME is responsible for appropriate protocol management, as defined in ISO/IEC 7816-4 [17]. This includes APDU mapping and procedure byte handling.

If the ME is already powered on and a UICC is active, then, when Card x is inserted, the ME powers on Card x. The ME shall identify if Card x contains the UICC application. If it does, GSM 02.17 [21] applies. If it does not contain the UICC application, or it is not selected by the user for 3G operation, then the ME powers off Card x. If applicable, the ME shall send an event download (card reader status) message to the current UICC. When required, the USAT application of the current UICC card shall power on Card x and control communications, through the relevant proactive commands.

When the ME is powered on, the ME locates and selects the preferred UICC card defined in GSM 02.17 [21]. If applicable, the ME sends a Terminal Profile command to the UICC. When required, the USAT application issues a Get Reader Status proactive command, which gets information on all readers and cards available to the USAT application. This procedure also applies if the ME is already powered on with no UICC present, and a card is then inserted.

When the UICC issues a POWER ON CARD, and the ME successfully receives an Answer To Reset from Card x, the ME shall return a successful Terminal Response containing the ATR, even if it does not understand the contents of the ATR, or support any of the protocols indicated.

The ME shall ensure that Card x is deactivated according to ISO/IEC 7816-3 [16]. Where deactivation is not due to a POWER OFF CARD proactive command (e.g. card removed, card reader removed, or low battery), the event download (card reader status) procedure may also be applicable.

Annex H (informative): Multiple Card proactive command examples

This annex applies only if class "a" is supported.

UICC	ME	Card-x
PERFORM CARD APDU		
<p>PERFORM CARD APDU →</p> <p>← Terminal Response (R-APDU)</p>		<p>C-APDU →</p> <p>← R-APDU</p>
POWER OFF CARD		
<p>POWER OFF CARD →</p> <p>← Terminal Response()</p>		<p>Deactivate Card x →</p>
POWER ON CARD		
<p>POWER ON CARD →</p> <p>← Terminal Response (ATR)</p> <p>POWER ON CARD →</p> <p>← Terminal Response (ATR)</p>		<p>Activate and Reset Card x →</p> <p>← Answer to Reset</p> <p>Reset Card x →</p> <p>← Answer to Reset</p>
GET READER STATUS		
<p>GET READER STATUS →</p> <p>← Terminal Response (Status of card reader(s))</p>	<p>ME scans all possible card reader interfaces</p>	

Annex I (informative): Bearer independent protocol proactive command examples

This annex applies only if class "e" is supported.

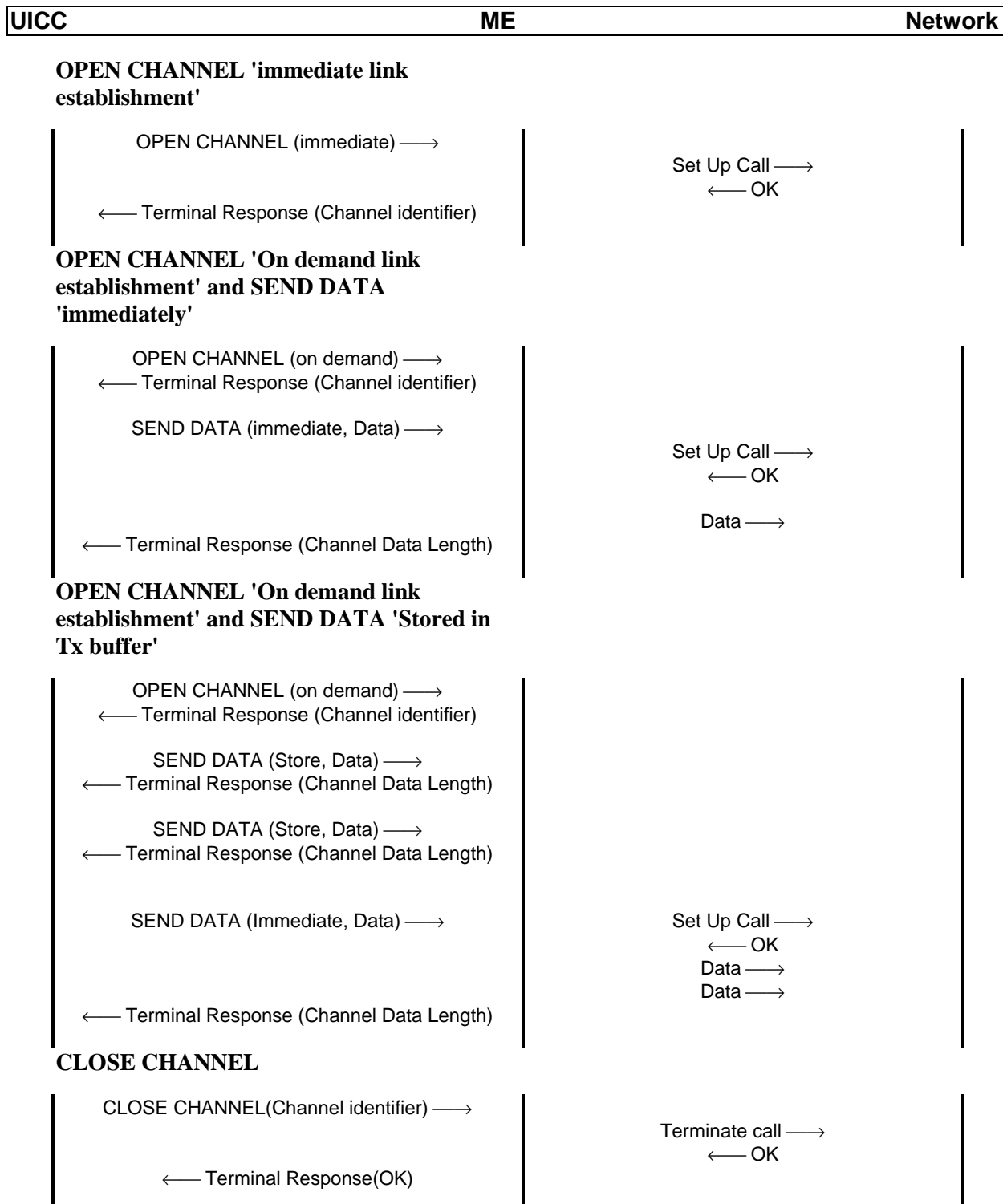

RECEIVE DATA

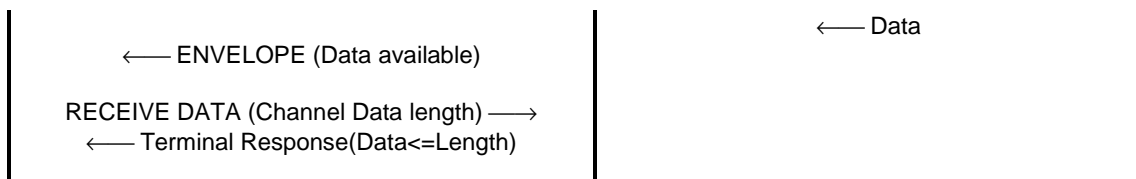

SEND DATA 'immediately'

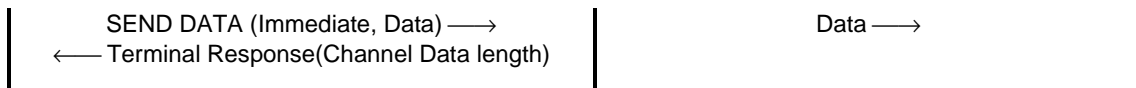

SEND DATA 'Stored in Tx Buffer'

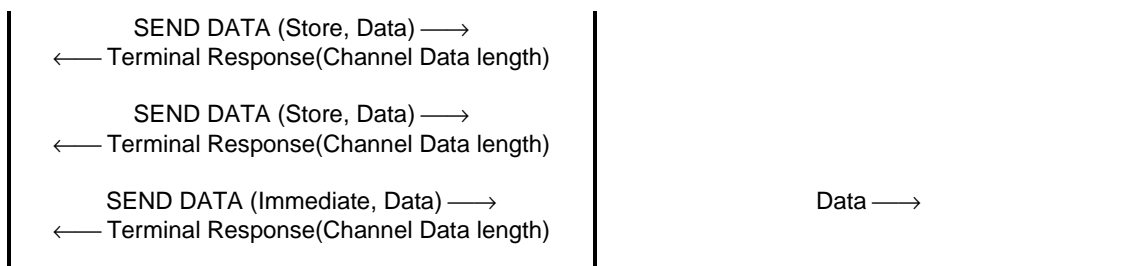

GET CHANNEL STATUS



Example for GPRS bearer:

ICC	ME	SGSN
------------	-----------	-------------

OPEN CHANNEL

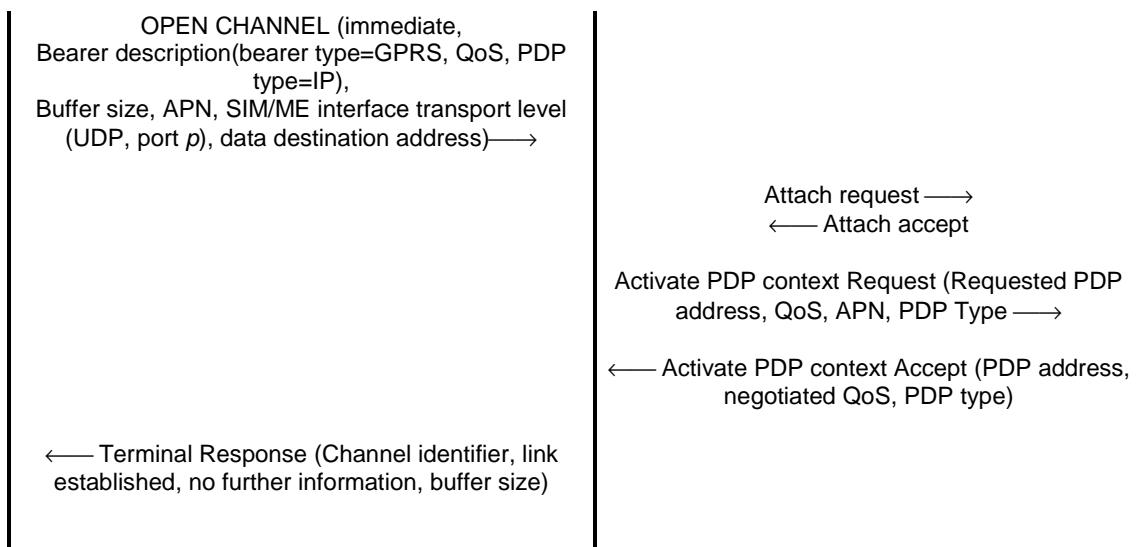

CLOSE CHANNEL

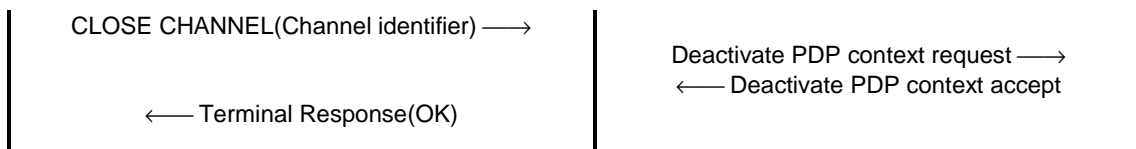

RECEIVE DATA

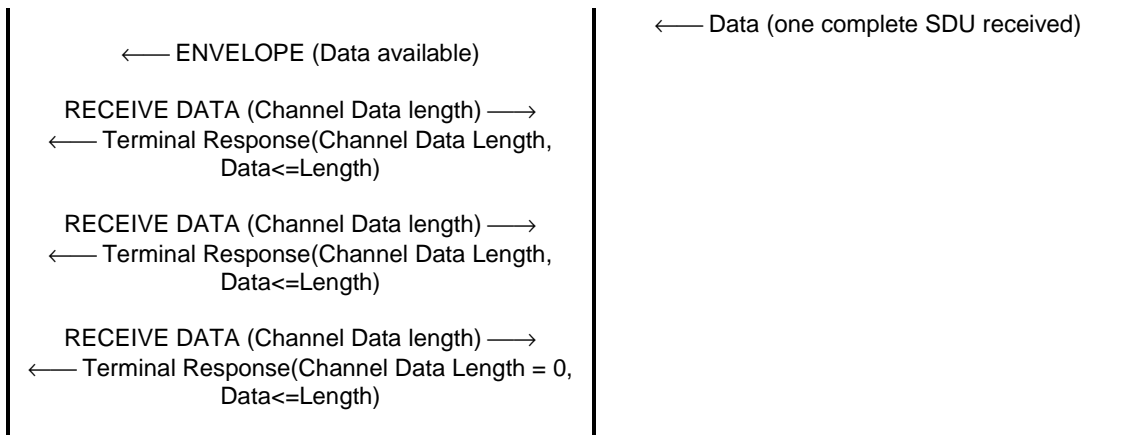

SEND DATA 'Stored in Tx Buffer'

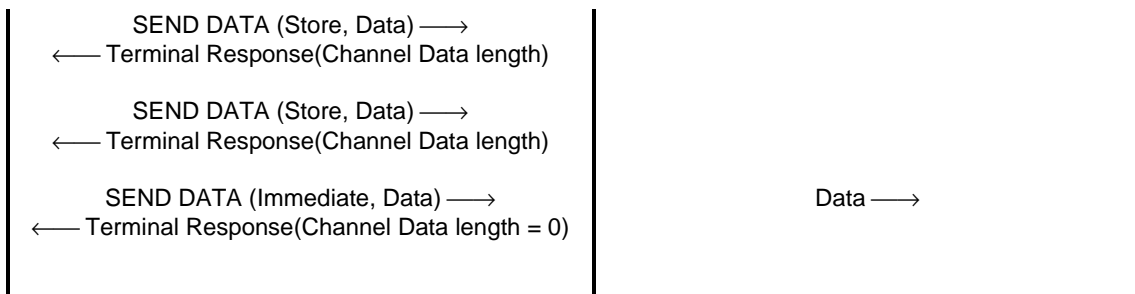

GET CHANNEL STATUS



Annex J (informative): WAP References

- [1] WAP specifications: [URL: http://www.wapforum.org/](http://www.wapforum.org/).
- [2] WAP Smart card provisioning specification: [URL: http://www.wapforum.org/](http://www.wapforum.org/).

Definitions:

WAE User Agent: any software or device that interprets WML, WMLScript.

WMLScript: a scripting language used to run a program in the mobile device.

Abbreviations:

WAE	Wireless Application Environment
WAP	Wireless Application Protocol
WML	Wireless Markup Language

Annex K (informative): Use of USAT Bearer independent protocol for local links Bluetooth case

Bluetooth services to be run by the USIM should be developed so that the access to their service record is open and does not necessitate any security mechanism (no authentication or encryption).

K.1 Service Search command

The Local Bearer Technology Identifier is Bluetooth. Service Search consists for the ME in first performing a device discovery of the devices that conform to the Device Filter (inquiry responses are filtered according to the list of Class of Device given in the Device Filter); then performing an SDP_ServiceSearchRequest, as defined in [28], on each device to check the support of the given service. The ME shall then return the Service Availability data object which is a list of BD_ADDR, ServiceRecordHandle, CoD and Device Name.

Note for Handset Manufacturers:

As the mobile is not always connected to other devices present in the remote environment (e.g. Bluetooth), when performing a service search, it is up to the ME to set a procedure that allows:

- A "scan" of the environment to discover new devices;
- A connection to Service Discovery Servers of discovered devices;
- A match with the requested service to set up the response to the USAT application.

K.2 Get Service Information command

The Local Bearer Technology Identifier is Bluetooth, GET SERVICE INFORMATION consists for the ME in connecting to a specific device and performing a SDP_ServiceAttributeRequest PDU as defined in [28]. The ME shall then return the Service Record data object.

When performing a GET SERVICE INFORMATION, it is up to the ME to set up a connection with the requested device and perform the SDP exchange.

K.3 OPEN CHANNEL command

If the SIM/ME interface parameter is not present, the SIM/ME interface is the bearer level which is the RFCOMM level.

The Remote Entity Address shall be present and shall be the BD_ADDR of the remote device.

Example: Interaction - USAT client case:

UICC	ME	Remote entity
------	----	---------------

SERVICE RETRIEVAL

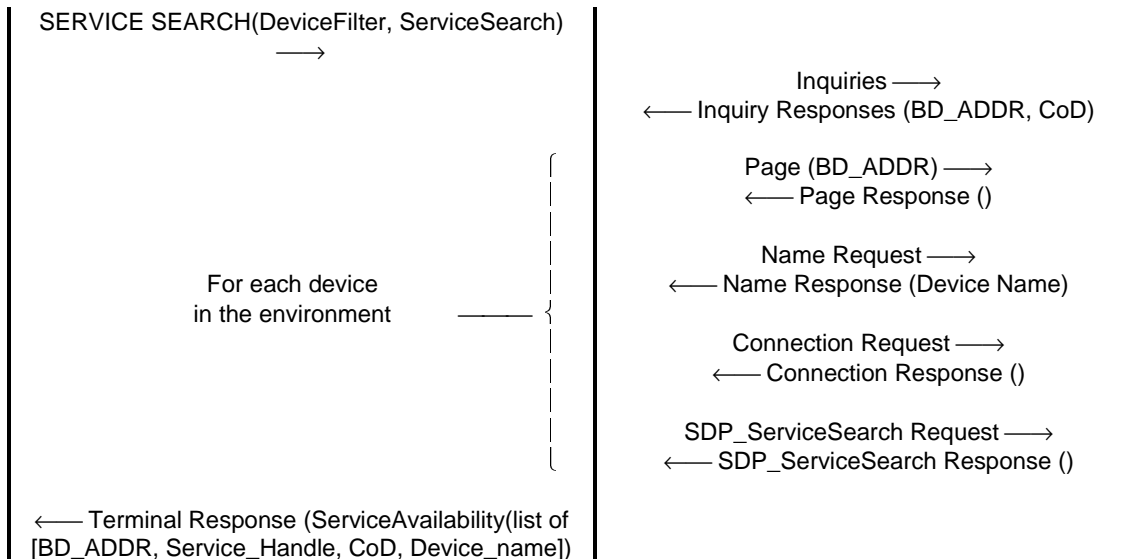

DETAILED INFORMATION ON SERVICE

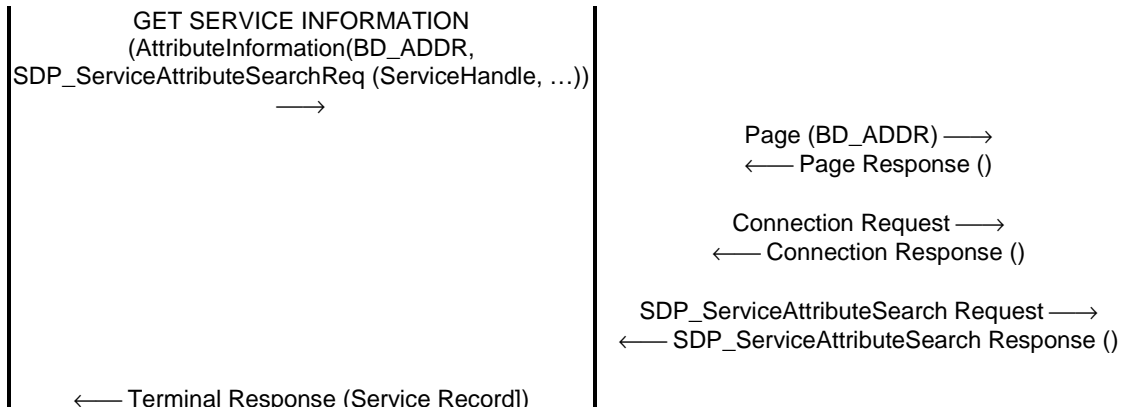

OPEN CHANNEL 'active link establishment'



RECEIVE DATA

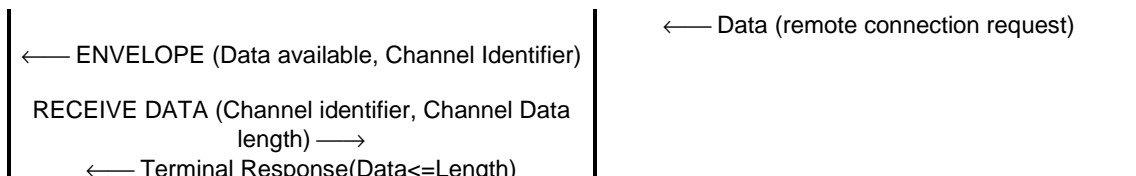

Annex L (informative): Bluetooth Service Discovery protocol

The service Bluetooth protocol is used to provide a way to get information of services offered by device present in a same Bluetooth environment. Each device providing a service must have a SDP Server software that can be connected by any other device. This connection is set-up by a SDP Client software and is performed in a one to one process.

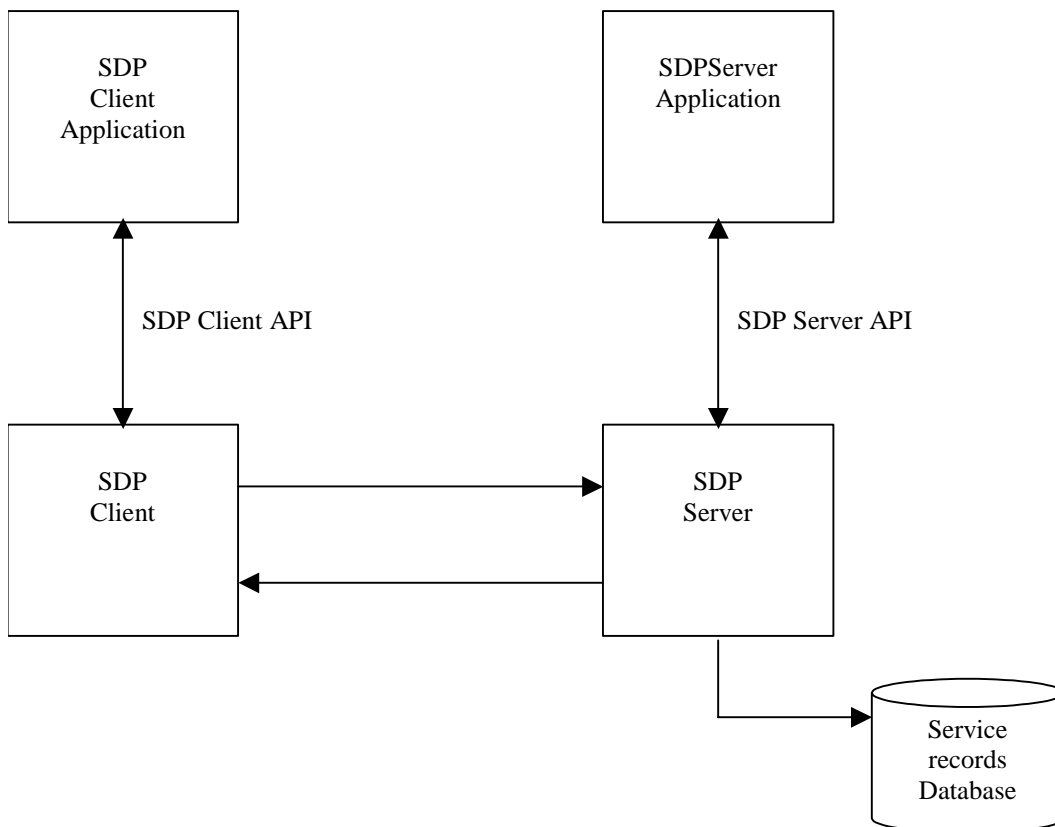

Figure L.1

The server maintains a Service Record Database that describe the characteristics of services associated with the server. Each service record contains information about a single service. A client may retrieve information from a service record maintained by the SDP Server by issuing an SDP request.

The notion of Service Record need to be presented here for a better understanding of function set introduced. We have seen that the SDP server must maintain a list of record describing services present on the device.

The service record consists entirely of a list of service attributes.

A service record handle is a 32-bit number that uniquely identifies each service record within an SDP server.

L.1 Service Attribute:

Each service attribute describes a single characteristic of a service. Each service attribute consists of two components: an attribute ID and an attribute value. The set of attributes characterising one service are gathered in a service record. The table below introduces examples of attributes that can be used in a service record.

Attribute	Description
ServiceClassIdList	Identifies the type of service represented by a service record. In other words, the list of classes of which the service is an instance
ServiceID	Uniquely identifies a specific instance of a service
ProtocolDescriptorList	Specifies the protocol stack(s) that may be used to utilise a service
ProviderName	The textual name of the individual or organisation that provides a service
ServiceName	A text string containing a human readable name for the service
ServiceDescription	A text string describing the service

The USAT application shall provide such record to the SDP server in order to become reachable by any other device. Information shall be presented to the SDP server in the good format (see Bluetooth specification [28]) to be easily integrated in its own Service record Database.

Following is a brief description of the way by which a USAT application could retrieve a service residing on another device.

A Bluetooth device can perform a search by Patterns (Service UUID or Attributes) or by browsing. A service browsing must interact with the user. We here prefer that the USAT application simply sends a search that the SDP Client ME software will perform. The USAT application will perform a Service Search with a service search pattern. A service search pattern is a list of UUIDs used to locate matching service records. The USAT application will prepare PDU(s) that the SDP client software will just have to push to L2CAP layer and to SDP Server software residing on another device. Once the USAT gets the list of services available, it can get further information on the services and then select one to perform an OPEN CHANNEL.

Annex M (informative): Use of USAT Bearer independent protocol for local links, server case

This annex applies if classes "e" and "f" are supported.

UICC	ME	Remote entity
------	----	---------------

SERVICE DECLARATION

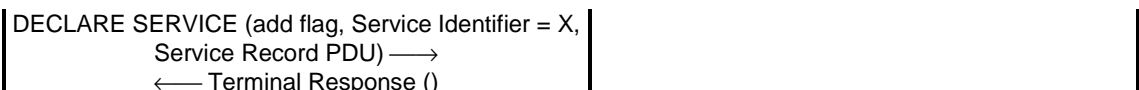

OPEN CHANNEL as server

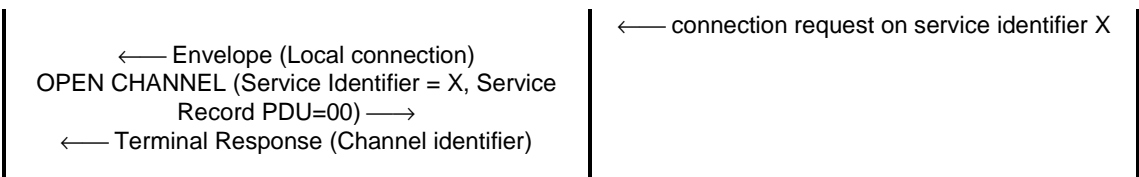

RECEIVE DATA

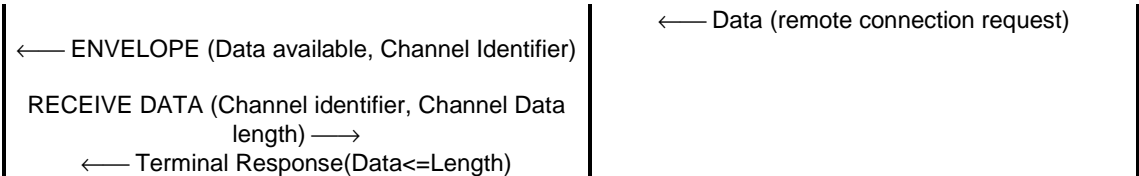

SERVICE REMOVAL

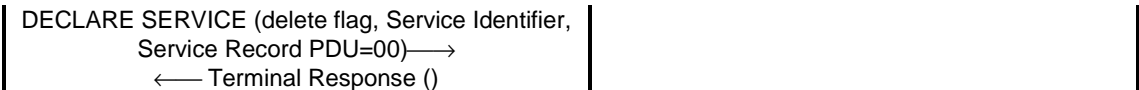

Annex N (informative): Change history

The table below indicates all change requests that have been incorporated into the present document since it was initially approved by 3GPP TSG-T.

Change history								
Date	TSG #	TSG Doc	CR	Rev	Cat	Subject/Comment	Old	New
2000-04	TP-07	TP-000055				Version 2.1.0 was approved at TSG-T #07	2.1.0	3.0.0
2000-07	TP-08	TP-000096	001		F	Release 99 alignment of 31.111 with GSM 11.14	3.0.0	3.1.0
			003		F	Correction of SAT commands for using GPRS in bearer independent protocol feature		
			004		F	Clarification of ME/SIM interface for bearer independent protocol feature		
2000-10	TP-09	TP-000154	005		F	Correction of Profile Download regarding USAT service table	3.1.0	4.0.0
			006		C	Modification of GET INKEY		
			007		C	DTMF issues		
			008		F	correction to GET INPUT regarding number of response string variables		
			009		F	Clarification for Alpha Identifier in PLAY TONE		
			010		F	EVENT DOWNLOAD-MT call: correction of the sub-address description		
011		B	Addition of a Technology Indicator Tag in a Terminal Response message					
2000-12	TP-10	TP-000202	013		A	Get Reader Status - correction to card identifier tag	4.0.0	4.1.0
			014		B	New event for display parameters		
			016		A	General Clarification and Correction		
			018		A	Clarification of command qualifier related to LAUNCH BROWSER		
			020		A	Modification of general result for proactive command with user confirmation		
			022		A	Clarification of bearer independent related to GPRS		
024		A	Correction to device identity coding					
2001-03	TP-11	TP-010039	026		A	Correction of TERMINAL PROFILE	4.1.0	4.2.0
			027		F	Addition of UTRAN to the technology indicator		
			028		C	Introduction of additional Access Technology Indicator values"		
			032		A	Correction of reference from GSM 02.40 to TS 22.001		
			033		B	Addition of variable timeout to the Display Text command		
			034		F	Correction to display parameters tag		
			035		B	Use of USAT Bearer independent protocol for local links. Client use case.		
			036		B	Use of USAT Bearer independent protocol for local links. server use case.		
			037		A	Correction of Annex A: Support of USAT by Mobile Equipment		
			038		F	Alignment with GSM 11.14 for reserved TIA/EIA-136 tags"		
			039		B	Addition of variable timeout to GetInkey command		
040		C	Precisions on the PlayTone command					
						Implementation of CRs 035 & 036 was corrected	4.2.0	4.2.1
2001-06	TP-12	TP-010151	042		A	Correction to NMR functionality (and BCCH list & TA)	4.2.1	4.3.0
			044		A	General corrections		
			046		A	Clarification of min and max length for GET INPUT		
			048		A	Limitation of data field in the C-APDU and R-APDU data object		
050		A	Correction of Annex I (Bearer independant protocol examples)					
2001-09	TP-13	TP-010202	052		B	Reservation of TIA/EIA 136 byte to terminal profile	4.3.0	4.4.0
			054		A	Corrections to OPEN CHANNEL commands		
			056		A	TLV object for the APN in the OPEN CHANNEL command		
			058		A	Corrections to SEND DATA commands and Channel Status Event		

History

Document history		
V4.2.1	March 2001	Publication
V4.3.0	June 2001	Publication
V4.4.0	September 2001	Publication