

# ETSI TS 131 111 V7.15.0 (2010-10)

---

*Technical Specification*

**Digital cellular telecommunications system (Phase 2+);  
Universal Mobile Telecommunications System (UMTS);  
LTE;  
Universal Subscriber Identity Module (USIM)  
Application Toolkit (USAT)  
(3GPP TS 31.111 version 7.15.0 Release 7)**

---



---

Reference

RTS/TSGC-063111v7f0

---

Keywords

GSM, UMTS

**ETSI**

650 Route des Lucioles  
F-06921 Sophia Antipolis Cedex - FRANCE

Tel.: +33 4 92 94 42 00 Fax: +33 4 93 65 47 16

Siret N° 348 623 562 00017 - NAF 742 C  
Association à but non lucratif enregistrée à la  
Sous-Préfecture de Grasse (06) N° 7803/88

---

**Important notice**

Individual copies of the present document can be downloaded from:

<http://www.etsi.org>

The present document may be made available in more than one electronic version or in print. In any case of existing or perceived difference in contents between such versions, the reference version is the Portable Document Format (PDF). In case of dispute, the reference shall be the printing on ETSI printers of the PDF version kept on a specific network drive within ETSI Secretariat.

Users of the present document should be aware that the document may be subject to revision or change of status. Information on the current status of this and other ETSI documents is available at

<http://portal.etsi.org/tb/status/status.asp>

If you find errors in the present document, please send your comment to one of the following services:

[http://portal.etsi.org/chaicor/ETSI\\_support.asp](http://portal.etsi.org/chaicor/ETSI_support.asp)

---

**Copyright Notification**

No part may be reproduced except as authorized by written permission.  
The copyright and the foregoing restriction extend to reproduction in all media.

© European Telecommunications Standards Institute 2010.  
All rights reserved.

**DECT**<sup>TM</sup>, **PLUGTESTS**<sup>TM</sup>, **UMTS**<sup>TM</sup>, **TIPHON**<sup>TM</sup>, the TIPHON logo and the ETSI logo are Trade Marks of ETSI registered for the benefit of its Members.

**3GPP**<sup>TM</sup> is a Trade Mark of ETSI registered for the benefit of its Members and of the 3GPP Organizational Partners.

**LTE**<sup>TM</sup> is a Trade Mark of ETSI currently being registered

for the benefit of its Members and of the 3GPP Organizational Partners.

**GSM**<sup>®</sup> and the GSM logo are Trade Marks registered and owned by the GSM Association.

---

## Intellectual Property Rights

IPRs essential or potentially essential to the present document may have been declared to ETSI. The information pertaining to these essential IPRs, if any, is publicly available for **ETSI members and non-members**, and can be found in ETSI SR 000 314: "*Intellectual Property Rights (IPRs); Essential, or potentially Essential, IPRs notified to ETSI in respect of ETSI standards*", which is available from the ETSI Secretariat. Latest updates are available on the ETSI Web server (<http://webapp.etsi.org/IPR/home.asp>).

Pursuant to the ETSI IPR Policy, no investigation, including IPR searches, has been carried out by ETSI. No guarantee can be given as to the existence of other IPRs not referenced in ETSI SR 000 314 (or the updates on the ETSI Web server) which are, or may be, or may become, essential to the present document.

---

## Foreword

This Technical Specification (TS) has been produced by ETSI 3rd Generation Partnership Project (3GPP).

The present document may refer to technical specifications or reports using their 3GPP identities, UMTS identities or GSM identities. These should be interpreted as being references to the corresponding ETSI deliverables.

The cross reference between GSM, UMTS, 3GPP and ETSI identities can be found under <http://webapp.etsi.org/key/queryform.asp>.

# Contents

|   |    |
|---|----|
| Intellectual Property Rights .....                                  | 2  |
| Foreword.....   | 2  |
| Foreword.....   | 10 |
| 1 Scope .....   | 11 |
| 2 References .....  | 11 |
| 3 Definitions, abbreviations and symbols .....                      | 13 |
| 3.1 Definitions .....   | 13 |
| 3.2 Abbreviations .....   | 13 |
| 3.3 Symbols.....  | 13 |
| 4 Overview of USAT .....  | 14 |
| 4.1 Profile Download .....  | 14 |
| 4.2 Proactive UICC .....  | 14 |
| 4.3 Data download to UICC .....                                     | 14 |
| 4.4 Menu selection .....  | 14 |
| 4.5 Call control by USIM.....                                       | 14 |
| 4.6 MO Short Message control by USIM.....                           | 14 |
| 4.7 Event download.....   | 14 |
| 4.8 Security .....  | 15 |
| 4.9 Multiple card .....   | 15 |
| 4.10 Timer Expiration .....   | 15 |
| 4.11 Bearer Independent Protocol .....                              | 15 |
| 4.12 Description of the access technology indicator mechanism ..... | 15 |
| 4.13 Description of the network search mode mechanism .....         | 15 |
| 4.14 Tag allocation guidelines.....                                 | 15 |
| 5 Profile download .....  | 15 |
| 5.1 Procedure.....  | 15 |
| 5.2 Structure and coding of TERMINAL PROFILE.....                   | 16 |
| 5.3 Definition of display parameters in Profile download.....       | 19 |
| 6 Proactive UICC .....  | 19 |
| 6.1 Introduction .....  | 19 |
| 6.2 Identification of ME support .....                              | 19 |
| 6.3 General procedure .....   | 19 |
| 6.4 Proactive UICC commands and procedures.....                     | 20 |
| 6.4.1 DISPLAY TEXT .....  | 20 |
| 6.4.2 GET INKEY .....   | 20 |
| 6.4.3 GET INPUT.....  | 20 |
| 6.4.4 MORE TIME .....   | 20 |
| 6.4.5 PLAY TONE .....   | 20 |
| 6.4.6 POLL INTERVAL .....   | 20 |
| 6.4.7 REFRESH.....  | 20 |
| 6.4.7.1 EF <sub>MSI</sub> changing procedure .....                  | 20 |
| 6.4.7.2 Generic Bootstrapping Procedure Request.....                | 21 |
| 6.4.8 SET UP MENU .....   | 21 |
| 6.4.9 SELECT ITEM.....  | 21 |
| 6.4.10 SEND SHORT MESSAGE .....                                     | 21 |
| 6.4.11 SEND SS .....  | 22 |
| 6.4.12 SEND USSD.....   | 23 |
| 6.4.12.1 MMI Mode.....  | 23 |
| 6.4.12.2 Application Mode .....                                     | 23 |
| 6.4.13 SET UP CALL.....   | 24 |
| 6.4.14 POLLING OFF .....  | 25 |
| 6.4.15 PROVIDE LOCAL INFORMATION .....                              | 25 |

|          |  |    |
|----------|--|----|
| 6.4.16   | SET UP EVENT LIST .....                                | 26 |
| 6.4.17   | PERFORM CARD APDU .....                                | 26 |
| 6.4.18   | POWER OFF CARD .....                                   | 26 |
| 6.4.19   | POWER ON CARD .....                                    | 27 |
| 6.4.20   | GET READER STATUS .....                                | 27 |
| 6.4.21   | TIMER MANAGEMENT .....                                 | 27 |
| 6.4.22   | SET UP IDLE MODE TEXT .....                            | 27 |
| 6.4.23   | RUN AT COMMAND .....                                   | 27 |
| 6.4.24   | SEND DTMF .....  | 27 |
| 6.4.25   | LANGUAGE NOTIFICATION .....                            | 27 |
| 6.4.26   | LAUNCH BROWSER .....                                   | 27 |
| 6.4.27   | OPEN CHANNEL .....                                     | 27 |
| 6.4.27.1 | OPEN CHANNEL related to CS bearer .....                | 27 |
| 6.4.27.2 | OPEN CHANNEL related to GPRS/3G packet service .....   | 28 |
| 6.4.27.3 | OPEN CHANNEL related to local bearer .....             | 28 |
| 6.4.27.4 | OPEN CHANNEL related to Default (network) Bearer ..... | 28 |
| 6.4.27.5 | OPEN CHANNEL related to I-WLAN bearer .....            | 28 |
| 6.4.27.6 | OPEN CHANNEL related to Terminal Server Mode .....     | 29 |
| 6.4.27.7 | OPEN CHANNEL related to UICC Server Mode .....         | 29 |
| 6.4.28   | CLOSE CHANNEL .....                                    | 29 |
| 6.4.29   | RECEIVE DATA .....                                     | 30 |
| 6.4.30   | SEND DATA .....  | 30 |
| 6.4.31   | GET CHANNEL STATUS .....                               | 30 |
| 6.4.32   | SERVICE SEARCH .....                                   | 30 |
| 6.4.33   | GET SERVICE INFORMATION .....                          | 30 |
| 6.4.34   | DECLARE SERVICE .....                                  | 30 |
| 6.4.35   | RETRIEVE MULTIMEDIA MESSAGE .....                      | 30 |
| 6.4.36   | SUBMIT MULTIMEDIA MESSAGE .....                        | 30 |
| 6.4.37   | DISPLAY MULTIMEDIA MESSAGE .....                       | 30 |
| 6.4.38   | SET FRAMES .....                                       | 30 |
| 6.4.39   | GET FRAME STATUS .....                                 | 30 |
| 6.4.40   | ACTIVATE .....   | 30 |
| 6.5      | Common elements in proactive UICC commands .....       | 30 |
| 6.5.1    | Command number .....                                   | 30 |
| 6.5.2    | Device identities .....                                | 31 |
| 6.5.3    | Alpha identifier .....                                 | 31 |
| 6.5.4    | Icon identifiers .....                                 | 31 |
| 6.5.5    | Text attribute .....                                   | 31 |
| 6.5.6    | Frame identifier .....                                 | 31 |
| 6.6      | Structure of proactive UICC commands .....             | 31 |
| 6.6.1    | DISPLAY TEXT .....                                     | 31 |
| 6.6.2    | GET INKEY .....  | 31 |
| 6.6.3    | GET INPUT .....  | 31 |
| 6.6.4    | MORE TIME .....  | 31 |
| 6.6.5    | PLAY TONE .....  | 31 |
| 6.6.6    | POLL INTERVAL .....                                    | 31 |
| 6.6.7    | SET-UP MENU .....                                      | 31 |
| 6.6.8    | SELECT ITEM .....                                      | 31 |
| 6.6.9    | SEND SHORT MESSAGE .....                               | 32 |
| 6.6.10   | SEND SS .....  | 32 |
| 6.6.11   | SEND USSD .....  | 32 |
| 6.6.12   | SET UP CALL .....                                      | 32 |
| 6.6.13   | REFRESH .....  | 32 |
| 6.6.14   | POLLING OFF .....                                      | 33 |
| 6.6.15   | PROVIDE LOCAL INFORMATION .....                        | 33 |
| 6.6.16   | SET UP EVENT LIST .....                                | 33 |
| 6.6.17   | PERFORM CARD APDU .....                                | 33 |
| 6.6.18   | POWER OFF CARD .....                                   | 33 |
| 6.6.19   | POWER ON CARD .....                                    | 33 |
| 6.6.20   | GET READER STATUS .....                                | 33 |
| 6.6.21   | TIMER MANAGEMENT .....                                 | 33 |
| 6.6.22   | SET UP IDLE MODE TEXT .....                            | 34 |

|          |  |    |
|----------|--|----|
| 6.6.23   | RUN AT COMMAND .....   | 34 |
| 6.6.24   | SEND DTMF COMMAND.....                                       | 34 |
| 6.6.25   | LANGUAGE NOTIFICATION .....                                  | 34 |
| 6.6.26   | LAUNCH BROWSER .....   | 34 |
| 6.6.27   | OPEN CHANNEL.....  | 34 |
| 6.6.27.1 | OPEN CHANNEL related to I-WLAN Bearer .....                  | 34 |
| 6.6.28   | CLOSE CHANNEL.....   | 35 |
| 6.6.29   | RECEIVE DATA .....   | 35 |
| 6.6.30   | SEND DATA.....   | 35 |
| 6.6.31   | GET CHANNEL STATUS .....                                     | 35 |
| 6.6.32   | SERVICE SEARCH.....  | 35 |
| 6.6.33   | GET SERVICE INFORMATION .....                                | 35 |
| 6.6.34   | DECLARE SERVICE .....  | 35 |
| 6.6.35   | RETRIEVE MULTIMEDIA MESSAGE.....                             | 35 |
| 6.6.36   | SUBMIT MULTIMEDIA MESSAGE .....                              | 35 |
| 6.6.37   | DISPLAY MULTIMEDIA MESSAGE .....                             | 35 |
| 6.6.38   | SET FRAMES .....   | 35 |
| 6.6.39   | GET FRAMES STATUS.....                                       | 35 |
| 6.6.40   | ACTIVATE .....   | 36 |
| 6.7      | Command results.....   | 36 |
| 6.8      | Structure of TERMINAL RESPONSE.....                          | 37 |
| 6.8.1    | Command details .....  | 38 |
| 6.8.2    | Device identities .....                                      | 38 |
| 6.8.3    | Result .....   | 38 |
| 6.8.4    | Duration .....   | 38 |
| 6.8.5    | Text string.....   | 38 |
| 6.8.6    | Item identifier .....  | 38 |
| 6.8.7    | Local information .....                                      | 38 |
| 6.8.8    | Call control requested action .....                          | 39 |
| 6.8.9    | Result data object 2.....                                    | 39 |
| 6.8.10   | Card reader status .....                                     | 39 |
| 6.8.11   | Card ATR .....   | 39 |
| 6.8.12   | R-APDU .....   | 39 |
| 6.8.13   | Timer identifier.....  | 39 |
| 6.8.14   | Timer value.....   | 39 |
| 6.8.15   | AT Response.....   | 39 |
| 6.8.16   | Text string 2.....   | 39 |
| 6.8.17   | Channel data .....   | 39 |
| 6.8.18   | Channel status.....  | 40 |
| 6.8.19   | Channel data length .....                                    | 40 |
| 6.8.20   | Bearer description.....                                      | 40 |
| 6.8.21   | Buffer size.....   | 40 |
| 6.8.22   | Total Display Duration .....                                 | 40 |
| 6.8.23   | Service Availability .....                                   | 40 |
| 6.8.24   | Service Record.....  | 40 |
| 6.8.25   | Other address (local address).....                           | 40 |
| 6.8.26   | Frames Information.....                                      | 40 |
| 6.9      | Proactive UICC session and ME display interaction.....       | 40 |
| 6.10     | Handling of unknown, unforeseen and erroneous messages ..... | 40 |
| 6.11     | Proactive commands versus possible Terminal response .....   | 40 |
| 7        | ENVELOPE Commands .....                                      | 42 |
| 7.1      | Data download to UICC .....                                  | 42 |
| 7.1.1    | SMS-PP data download .....                                   | 42 |
| 7.1.1.1  | Procedure .....  | 42 |
| 7.1.1.2  | Structure of ENVELOPE (SMS-PP DOWNLOAD) .....                | 43 |
| 7.1.2    | Cell Broadcast data download .....                           | 43 |
| 7.1.2.1  | Procedure .....  | 43 |
| 7.1.2.2  | Structure of ENVELOPE (CELL BROADCAST DOWNLOAD) .....        | 44 |
| 7.2      | Menu Selection.....  | 45 |
| 7.3      | Call Control and MO SMS control by USIM.....                 | 45 |
| 7.3.1    | Call Control by USIM.....                                    | 45 |

|         |  |    |
|---------|--|----|
| 7.3.1.1 | Procedure for mobile originated calls .....                        | 45 |
| 7.3.1.2 | Procedure for Supplementary Services and USSD .....                | 46 |
| 7.3.1.3 | Indication to be given to the user .....                           | 47 |
| 7.3.1.4 | Interaction with Fixed Dialling Number .....                       | 48 |
| 7.3.1.5 | Support of Barred Dialling Number (BDN) service.....               | 48 |
| 7.3.1.6 | Structure of ENVELOPE (CALL CONTROL) .....                         | 48 |
| 7.3.1.7 | Procedure for PDP Context Activation .....                         | 50 |
| 7.3.2   | MO Short Message Control by USIM .....                             | 51 |
| 7.3.2.1 | Description .....  | 51 |
| 7.3.2.2 | Structure of ENVELOPE (MO SHORT MESSAGE CONTROL).....              | 51 |
| 7.3.2.3 | Indication to be given to the user .....                           | 52 |
| 7.3.2.4 | Interaction with Fixed Dialling Number .....                       | 52 |
| 7.4     | Timer Expiration .....   | 52 |
| 7.5     | Event download.....  | 52 |
| 7.5.1   | I-WLAN Access status event.....                                    | 53 |
| 7.5.1.1 | Procedure .....  | 53 |
| 7.5.1.2 | Structure of ENVELOPE (EVENT DOWNLOAD – I-WLAN Access Status)..... | 53 |
| 7.5.1A  | MT Call event .....  | 53 |
| 7.5.2   | Call connected event .....   | 54 |
| 7.5.3   | Call disconnected event .....                                      | 54 |
| 7.5.4   | Location status event .....  | 54 |
| 7.5.5   | User activity event .....  | 54 |
| 7.5.6   | Idle screen available event.....                                   | 54 |
| 7.5.7   | Card reader status event .....                                     | 54 |
| 7.5.8   | Language selection event.....                                      | 54 |
| 7.5.9   | Browser termination event.....                                     | 54 |
| 7.5.10  | Data available event.....  | 54 |
| 7.5.11  | Channel status event .....   | 54 |
| 7.5.12  | Access Technology Change Event.....                                | 54 |
| 7.5.13  | Display parameters changed event.....                              | 54 |
| 7.5.14  | Local Connection event .....                                       | 54 |
| 7.5.15  | Network Search Mode Change Event.....                              | 54 |
| 7.5.16  | Browsing status event .....  | 55 |
| 7.5.17  | Frames Information changed event.....                              | 55 |
| 7.5.18  | HCI connectivity event .....                                       | 55 |
| 7.6     | USSD Data Download.....  | 55 |
| 7.6.1   | Procedure .....  | 55 |
| 7.6.2   | Structure of ENVELOPE (USSD Data Download) .....                   | 55 |
| 7.7     | MMS Transfer Status.....   | 56 |
| 7.8     | MMS notification download .....                                    | 56 |
| 7.9     | Terminal Applications .....  | 56 |
| 8       | COMPREHENSION-TLV data objects .....                               | 56 |
| 8.1     | Address.....   | 56 |
| 8.2     | Alpha identifier .....   | 56 |
| 8.3     | Subaddress.....  | 56 |
| 8.4     | Capability configuration parameters .....                          | 57 |
| 8.5     | Cell Broadcast Page.....   | 57 |
| 8.6     | Command details.....   | 57 |
| 8.7     | Device identities .....  | 58 |
| 8.8     | Duration.....  | 58 |
| 8.9     | Item .....   | 58 |
| 8.10    | Item identifier.....   | 58 |
| 8.11    | Response length.....   | 58 |
| 8.12    | Result.....  | 58 |
| 8.12.1  | Additional information for SEND SS .....                           | 58 |
| 8.12.2  | Additional information for ME problem.....                         | 58 |
| 8.12.3  | Additional information for network problem.....                    | 59 |
| 8.12.4  | Additional information for SS problem .....                        | 59 |
| 8.12.5  | Additional information for SMS problem.....                        | 59 |
| 8.12.6  | Not used .....   | 59 |
| 8.12.7  | Additional information for USSD problem .....                      | 59 |

|         |  |    |
|---------|--|----|
| 8.12.8  | Additional information for interaction with call control or MO SM control .....  | 59 |
| 8.12.9  | Additional information for MultipleCard commands .....                           | 60 |
| 8.12.10 | Additional information for launch browser problem .....                          | 60 |
| 8.12.11 | Additional information for Bearer Independent Protocol .....                     | 60 |
| 8.12.12 | Additional information for Frames commands .....                                 | 60 |
| 8.12.13 | Additional information for SUBMIT and RETRIEVE MULTIMEDIA MESSAGE .....          | 60 |
| 8.13    | SMS TPDU .....   | 60 |
| 8.14    | SS string .....  | 60 |
| 8.15    | Text string .....  | 61 |
| 8.16    | Tone.....  | 61 |
| 8.17    | USSD string.....   | 61 |
| 8.18    | File List .....  | 61 |
| 8.19    | Location Information.....  | 61 |
| 8.20    | IMEI .....   | 62 |
| 8.21    | Help Request .....   | 62 |
| 8.22    | Network Measurement Results.....   | 62 |
| 8.23    | Default Text.....  | 62 |
| 8.24    | Items Next Action Indicator .....  | 62 |
| 8.25    | Event list.....  | 62 |
| 8.26    | Cause .....  | 63 |
| 8.27    | Location status.....   | 63 |
| 8.28    | Transaction identifier .....   | 63 |
| 8.29    | BCCH channel list.....   | 63 |
| 8.30    | Call control requested action .....  | 64 |
| 8.31    | Icon Identifier .....  | 64 |
| 8.32    | Item Icon Identifier list.....   | 64 |
| 8.33    | Card reader status .....   | 64 |
| 8.34    | Card ATR .....   | 64 |
| 8.35    | C-APDU .....   | 65 |
| 8.36    | R-APDU .....   | 65 |
| 8.37    | Timer identifier .....   | 65 |
| 8.38    | Timer value .....  | 65 |
| 8.39    | Date-Time and Time zone .....  | 65 |
| 8.40    | AT Command .....   | 65 |
| 8.41    | AT Response .....  | 65 |
| 8.42    | BC Repeat indicator .....  | 66 |
| 8.43    | Immediate response .....   | 66 |
| 8.44    | DTMF string.....   | 66 |
| 8.45    | Language .....   | 66 |
| 8.46    | Timing Advance .....   | 66 |
| 8.47    | Browser Identity .....   | 66 |
| 8.48    | URL.....   | 66 |
| 8.49    | Bearer .....   | 67 |
| 8.50    | Provisioning File Reference .....  | 67 |
| 8.51    | Browser Termination Cause .....  | 67 |
| 8.52    | Bearer description.....  | 67 |
| 8.52.1  | Bearer parameters for CSD .....  | 67 |
| 8.52.2  | Bearer parameters for GPRS/3G Packet Service .....                               | 68 |
| 8.52.3  | Bearer parameters for UTRAN Packet Service with extended parameters / HSDPA..... | 68 |
| 8.52.4  | Bearer parameters for I-WLAN .....   | 69 |
| 8.53    | Channel data.....  | 70 |
| 8.54    | Channel data length .....  | 70 |
| 8.55    | Buffer size .....  | 70 |
| 8.56    | Channel status .....   | 70 |
| 8.57    | Card reader identifier.....  | 70 |
| 8.58    | Other Address.....   | 70 |
| 8.59    | UICC/ME interface transport level .....  | 70 |
| 8.60    | AID.....   | 70 |
| 8.61    | Network Access Name .....  | 70 |
| 8.62    | Access Technology.....   | 70 |
| 8.63    | Display parameters .....   | 71 |
| 8.64    | Service Record .....   | 71 |



|                               |   |           |
|-------------------------------|---|-----------|
| 8.65                          | Device Filter .....   | 71        |
| 8.66                          | Service Search .....  | 71        |
| 8.67                          | Attribute Information .....   | 71        |
| 8.68                          | Service Availability .....  | 71        |
| 8.69                          | Remote Entity Address.....  | 71        |
| 8.70                          | Text Attribute .....  | 71        |
| 8.71                          | Item Text Attribute List.....   | 71        |
| 8.72                          | PDP context Activation parameters.....  | 71        |
| 8.73                          | UTRAN Measurement Qualifier .....   | 71        |
| 8.74                          | Multimedia Message Reference .....  | 72        |
| 8.75                          | Multimedia Message Identifier.....  | 72        |
| 8.76                          | Multimedia Message Transfer status.....   | 72        |
| 8.77                          | MM Content Identifier .....   | 72        |
| 8.78                          | Multimedia Message Notification .....   | 72        |
| 8.79                          | Last Envelope.....  | 72        |
| 8.80                          | Frames Layout .....   | 72        |
| 8.81                          | Frames Information .....  | 72        |
| 8.82                          | Frames identifier .....   | 72        |
| 8.83                          | I-WLAN Identifier .....   | 73        |
| 8.84                          | I-WLAN Access Status .....  | 73        |
| 8.85                          | IMEISV .....  | 73        |
| 8.86                          | Network search mode.....  | 73        |
| 8.87                          | Battery State .....   | 73        |
| 8.88                          | Browsing status .....   | 73        |
| 8.89                          | Registry application data .....   | 73        |
| 8.90                          | PLMNwAcT List.....  | 74        |
| 9                             | Tag values .....  | 74        |
| 9.1                           | BER-TLV tags in ME to UICC direction.....   | 74        |
| 9.2                           | BER-TLV tags in UICC TO ME direction.....   | 74        |
| 9.3                           | COMPREHENSION-TLV tags in both directions.....                                      | 74        |
| 9.4                           | Type of Command and Next Action Indicator .....                                     | 75        |
| 10                            | Allowed Type of command and Device identity combinations .....                      | 75        |
| 11                            | Security requirements.....  | 75        |
| <b>Annex A (normative):</b>   | <b>Support of USAT by Mobile Equipment .....</b>                                    | <b>76</b> |
| <b>Annex B (informative):</b> | <b>Example of DISPLAY TEXT Proactive UICC Command .....</b>                         | <b>77</b> |
| <b>Annex C (normative):</b>   | <b>Structure of USAT communications .....</b>                                       | <b>78</b> |
| <b>Annex D (informative):</b> | <b>ME display in proactive UICC session.....</b>                                    | <b>79</b> |
| <b>Annex E (informative):</b> | <b>Help information feature processing.....</b>                                     | <b>80</b> |
| <b>Annex F (informative):</b> | <b>Monitoring of events.....</b>  | <b>81</b> |
| <b>Annex G (normative):</b>   | <b>Support of Multiple Card Operation .....</b>                                     | <b>82</b> |
| <b>Annex H (informative):</b> | <b>Multiple Card proactive command examples .....</b>                               | <b>83</b> |
| <b>Annex I (informative):</b> | <b>Bearer independent protocol proactive command examples.....</b>                  | <b>84</b> |
| <b>Annex J (informative):</b> | <b>WAP References .....</b>   | <b>85</b> |
| <b>Annex K (informative):</b> | <b>Use of USAT Bearer independent protocol for local links Bluetooth case .....</b> | <b>86</b> |
| <b>Annex L (informative):</b> | <b>Bluetooth Service Discovery protocol .....</b>                                   | <b>87</b> |
| <b>Annex M (informative):</b> | <b>Use of USAT Bearer independent protocol for local links, server case ....</b>    | <b>88</b> |

|                               |  |           |
|-------------------------------|--|-----------|
| <b>Annex N (informative):</b> | <b>USSD information flow between the Network, the ME and the UICC.....</b> | <b>89</b> |
| N.1                           | MMI Mode .....   | 89        |
| N.2                           | Application Mode.....  | 91        |
| N.3                           | USSD Data Download.....  | 93        |
| <b>Annex O (informative):</b> | <b>Change History .....</b>  | <b>94</b> |
| History .....                 |  | 95        |

---

## Foreword

This Technical Specification (TS) has been produced by the 3<sup>rd</sup> Generation Partnership Project (3GPP).

The contents of the present document are subject to continuing work within the TSG and may change following formal TSG approval. Should the TSG modify the contents of the present document, it will be re-released by the TSG with an identifying change of release date and an increase in version number as follows:

Version x.y.z

where:

- x the first digit:
  - 1 presented to TSG for information;
  - 2 presented to TSG for approval;
  - 3 or greater indicates TSG approved document under change control.
- y the second digit is incremented for all changes of substance, i.e. technical enhancements, corrections, updates, etc.
- z the third digit is incremented when editorial only changes have been incorporated in the document.

---

# 1 Scope

The present document defines the interface between the UICC and the Mobile Equipment (ME), and mandatory ME procedures, specifically for "USIM Application Toolkit".

The present document refers in its majority to the ETSI TS 102 223 [32], which describes the generic aspects of application toolkits within the UICC.

USAT is a set of commands and procedures for use during the network operation phase of 3G, in addition to those defined in TS 31.101 [13].

Specifying the interface is to ensure interoperability between a UICC and an ME independently of the respective manufacturers and operators.

The present document defines for 3G technology:

- the commands;
- the application protocol;
- the mandatory requirements on the UICC and ME for each procedure.

The present document does not specify any aspects related to the administrative management phase. Any internal technical realization of either the UICC or the ME are only specified where these reflect over the interface. The present document does not specify any of the security algorithms which may be used.

For the avoidance of doubt, references to clauses of ETSI TS 102 223 [32] include all the subclauses of that clause, unless specifically mentioned.

The target specification ETSI TS 102 223 [32] contains material that is outside of the scope of 3GPP requirements and the present document indicates which parts are in the scope and which are not.

A 3GPP ME may support functionality that is not required by 3GPP, but the requirements to do so are outside of the scope of 3GPP.

---

# 2 References

The following documents contain provisions which, through reference in this text, constitute provisions of the present document.

- References are either specific (identified by date of publication, edition number, version number, etc.) or non-specific.
- For a specific reference, subsequent revisions do not apply.
- For a non-specific reference, the latest version applies. In the case of a reference to a 3GPP document (including a GSM document), a non-specific reference implicitly refers to the latest version of that document in the same Release as the present document.

- [1] 3GPP TS 22.002: "Circuit Bearer Services (BS) supported by a Public Land Mobile Network (PLMN)".
- [2] 3GPP TS 22.030: "Man-Machine Interface (MMI) of the User Equipment (UE)".
- [3] 3GPP TS 22.042: "Network Identity and Time Zone (NITZ); Service description; Stage 1".
- [4] 3GPP TS 23.038: "Alphabets and language-specific information".
- [5] 3GPP TS 23.040: "Technical realization of the Short Message Service (SMS)".
- [6] 3GPP TS 23.041: "Technical realization of Cell Broadcast Service (CBS)".

- [7] 3GPP TS 23.122: "Non-Access Stratum functions related to Mobile Station (MS) in idle mode".
- [8] 3GPP TS 24.007: "Mobile radio interface signalling layer 3; General aspects".
- [9] 3GPP TS 24.008: "Mobile radio interface layer 3 specification; Core network protocols; Stage 3".
- [10] 3GPP TS 24.011: "Point-to-Point (PP) Short Message Service (SMS) support on mobile radio interface".
- [11] 3GPP TS 24.080: "Mobile radio layer 3 supplementary services specification; Formats and coding".
- [12] 3GPP TS 27.007: "AT command set for 3G User Equipment (UE)".
- [13] 3GPP TS 31.101: "UICC-terminal interface; Physical and logical characteristics".
- [14] 3GPP TS 31.102: "Characteristics of the USIM application".
- [15] Void.
- [16] Void.
- [17] Void.
- [18] Void.
- [19] Void.
- [20] Void.
- [21] Void.
- [22] 3GPP TS 22.001: "Principles of circuit telecommunication services supported by a Public Land Mobile Network (PLMN)".
- [23] Void.
- [24] Void.
- [25] Void.
- [26] Void.
- [27] 3GPP TS 44.018: "Mobile radio interface Layer 3 specification; Radio Resource Control Protocol".
- [28] Void.
- [29] Void.
- [30] 3GPP TS 23.003: "Numbering, addressing and identification".
- [31] Void.
- [32] ETSI TS 102 223 V7.15.0: "Smart Cards; Card Application Toolkit".
- [33] 3GPP TR 21.905: "Vocabulary for 3GPP specifications".
- [34] 3GPP TS 22.101: "Service aspects; Service principles".
- [35] 3GPP TS 25.401: "UTRAN overall description".
- [36] 3GPP TS 25.413: "UTRAN Iu interface RANAP signalling".
- [37] 3GPP TS 24.090: "Unstructured Supplementary Service Data (USSD) - Stage 3".
- [38] 3GPP TS 25.331: "Radio Resource Control (RRC) Protocol Specification".
- [39] 3GPP TS 25.133: "Requirements for support of radio resource management".

- [40] Void.
- [41] 3GPP TS 31.115: "Secured packet structure for the (U)SIM Toolkit applications".
- [42] 3GPP TS 24.234: "3GPP System to WLAN Interworking; UE to Network protocols; Stage 3".
- [43] ETSI TS 101 220: "Smart Cards; ETSI numbering system for telecommunication application providers".
- [44] 3GPP TS 31.116: "Remote APDU Structure for (U)SIM Toolkit applications"

---

## 3 Definitions, abbreviations and symbols

### 3.1 Definitions

For the purposes of the present document, the terms and definitions given in ETSI TS 102 223 [32] and TR 21.905 [33] apply.

Within the context of the present document, the term "terminal" used in ETSI TS 102 223 [32] refers to the Mobile Equipment (ME).

Within the context of the present document, the term "NAA" used in ETSI TS 102 223 [32] refers to the USIM.

Within the context of the present document, the term "CAT" used in ETSI TS 102 223 [32] refers to the USAT.

### 3.2 Abbreviations

For the purpose of the present document, the abbreviations given in ETSI TS 102 223 [32] and TR 21.905 [33] and the following apply:

|       |  |
|-------|--|
| ADN   | Abbreviated Dialling Number                  |
| CB    | Cell Broadcast                               |
| CBMID | Cell Broadcast Message IDentifier            |
| EGPRS | EDGE General Packet Radio Service            |
| FDN   | Fixed Dialling Number                        |
| GGSN  | Gateway GPRS Support Node                    |
| GPRS  | General Packet Radio Service                 |
| GSM   | Global System for Mobile communications      |
| HSDPA | High Speed Downlink Packet Access            |
| MM    | Multimedia Message                           |
| MMS   | Multimedia Messaging Service                 |
| MMI   | Man Machine Interface                        |
| PDP   | Packet Data Protocol, e.g., Ip or X25 or PPP |
| RFU   | Reserved for Future Use                      |
| SS    | Supplementary Service                        |
| SSC   | Supplementary Service Control string         |
| USAT  | USIM Application Toolkit                     |
| USIM  | Universal Subscriber Identity Module         |
| USSD  | Unstructured Supplementary Service Data      |
| WSID  | WLAN Specific IDentifier                     |

### 3.3 Symbols

For the purposes of the present document, the following symbols apply:

'0' to '9' and 'A' to 'F' The sixteen hexadecimal digits.

---

## 4 Overview of USAT

The USAT provides mechanisms which allow applications, existing in the UICC, to interact and operate with any ME which supports the specific mechanism(s) required by the application.

The following mechanisms have been defined. These mechanisms are dependent upon the commands and protocols relevant to USAT in TS 31.101 [13].

### 4.1 Profile Download

Profile downloading provides a mechanism for the ME to tell the UICC what it is capable of.

### 4.2 Proactive UICC

Proactive UICC gives a mechanism whereby the UICC can initiate actions to be taken by the ME. The supported functions are specified in clause 6.4.

For each command involved in the dialog with the user, a help information may be available, either for each item of a list of items proposed to the user, or with each command requesting a response from the user. If a proactive command involved in the dialog with the user indicates the availability of the help feature, the support of this feature is optional for the terminal.

### 4.3 Data download to UICC

Data downloading to the UICC uses either dedicated commands (the transport mechanisms of SMS point-to-point and Cell Broadcast) or the Bearer independent protocol. Transferral of information over the UICC-ME interface uses the ENVELOPE command.

### 4.4 Menu selection

See ETSI TS 102 223 [32] clause 4.4.

### 4.5 Call control by USIM

When this service is activated by the USIM, all dialled digit strings, supplementary service control strings and USSD strings or PDP context parameters are first passed to a USIM application before the ME sets up the call, the supplementary service operation or the USSD operation or establishes the PDP context. The ME shall also pass to the USIM application at the same time its current serving cell. The USIM application has the ability to allow, bar or modify the call, the supplementary service operation or, the USSD operation or PDP context activation by another context activation. The USIM application also has the ability to replace a call request, a supplementary service operation or a USSD operation by another call request or supplementary service operation or USSD operation.

**EXAMPLE:** A call request can be replaced by a supplementary service operation or a USSD operation, and vice-versa.

### 4.6 MO Short Message control by USIM

When this service is activated by the USIM, all MO short messages are first passed to the USIM application before the ME sends the short message. The ME shall also pass to the USIM application at the same time its current serving cell. The USIM application shall have the ability to allow the sending, bar the sending or modify the destination address of the short message before sending it.

### 4.7 Event download

See ETSI TS 102 223 [32] clause 4.7.

## 4.8 Security

See ETSI TS 102 223 [32] clause 4.8.

## 4.9 Multiple card

See ETSI TS 102 223 [32] clause 4.9.

## 4.10 Timer Expiration

See ETSI TS 102 223 [32] clause 4.10.

## 4.11 Bearer Independent Protocol

See ETSI TS 102 223 [32] clause 4.11.

## 4.12 Description of the access technology indicator mechanism

See ETSI TS 102 223 [32] clause 4.12.

## 4.13 Description of the network search mode mechanism

See ETSI TS 102 223 [32] clause 4.14.

## 4.14 Tag allocation guidelines

See ETSI TS 102 223 [32] clause 4.13.

---

# 5 Profile download

## 5.1 Procedure

The profile download instruction is sent by the ME to the UICC as part of the UICC initialization procedure. The UICC initialization procedure is specified in TS 31.101 [13].

If the UICC indicates the support of "Additional TERMINAL PROFILE after UICC activation" in its USIM Service Table, the ME shall handle the profile download procedure as specified in ETSI TS 102 223 [32] clause 5.1.

If the UICC does not indicate the support of "Additional TERMINAL PROFILE after UICC activation" in its USIM Service Table, the profile download instruction shall only be sent by the ME to the UICC as part of the UICC initialization procedure. However, if a USIM initialisation procedure is performed due to a refresh proactive command, the USIM initialisation procedure may also include a profile download.

The profile(s) sent by the ME shall state the facilities relevant to USAT that are supported by the ME.



## 5.2 Structure and coding of TERMINAL PROFILE

Direction: ME to UICC.

The command header is specified in TS 31.101 [13].

Command parameters/data:

| Description | Clause | M/O/C | Length |
|-------------|--------|-------|--------|
| Profile     | -      | M     | lgth   |

- Profile:

Contents:

- The list of USAT facilities that are supported by the ME.

Coding:

- 1 bit is used to code each facility:
  - bit = 1: facility supported by ME.
  - bit = 0: facility not supported by ME.

NOTE: several bits may need to be set to 1 for the support of the same facility. This is because of backward compatibility with SAT: several options existed in SAT for a given facility, and they are mandatory in USAT when this facility is supported.

First byte (Download):

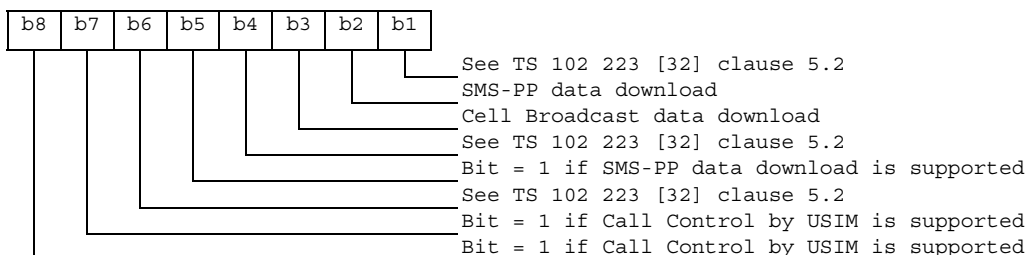

Second byte (Other):

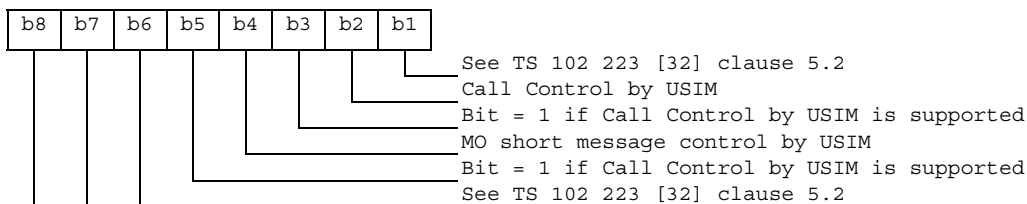

Third byte (Proactive UICC):

- See ETSI TS 102 223 [32] clause 5.2.

Fourth byte (Proactive UICC):

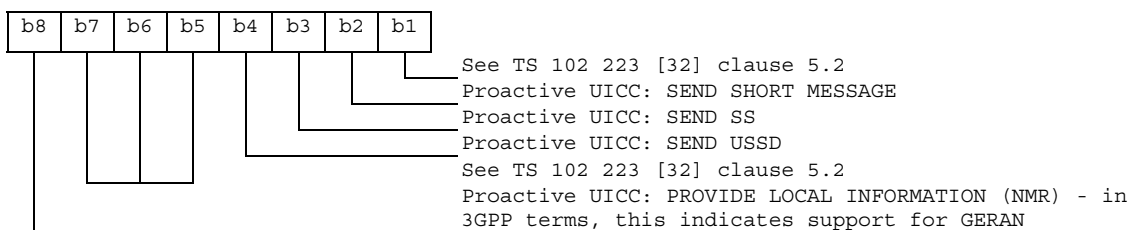

Fifth byte (Event driven information):

- See ETSI TS 102 223 [32] clause 5.2.

Sixth byte (Event driven information extensions):

- See ETSI TS 102 223 [32] clause 5.2.

Seventh byte (Multiple card proactive commands) for class "a":

- See ETSI TS 102 223 [32] clause 5.2.

Eighth byte (Proactive UICC):

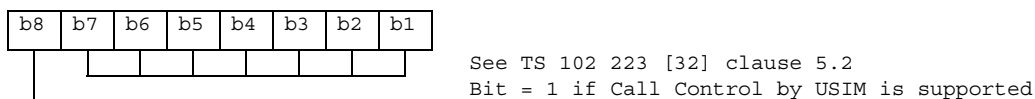

Ninth byte:

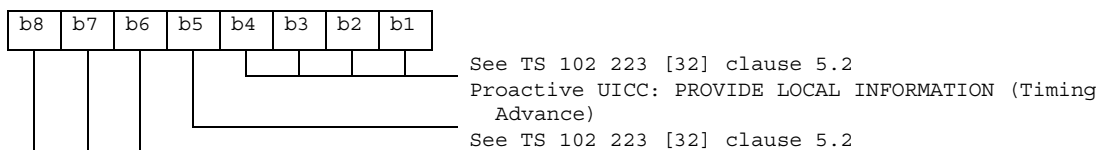

Tenth byte (Soft keys support) for class "d":

- See ETSI TS 102 223 [32] clause 5.2.

Eleventh byte: (Soft keys information):

- See ETSI TS 102 223 [32] clause 5.2.

Twelfth byte (Bearer Independent protocol proactive commands) for class "e":

- See ETSI TS 102 223 [32] clause 5.2.

Thirteenth byte (Bearer Independent protocol supported bearers) for class "e":

- See ETSI TS 102 223 [32] clause 5.2.

Fourteenth byte: (Screen height):

- See ETSI TS 102 223 [32] clause 5.2.

Fifteenth byte: (Screen width):

- See ETSI TS 102 223 [32] clause 5.2.

Sixteenth byte: (Screen effects):

- See ETSI TS 102 223 [32] clause 5.2.

Seventeenth byte (Bearer independent protocol supported transport interface/bearers) for class "e":

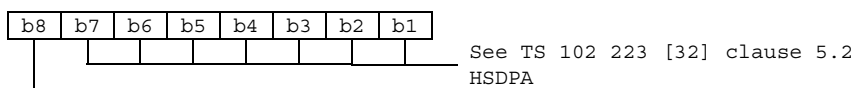

Eighteenth byte:

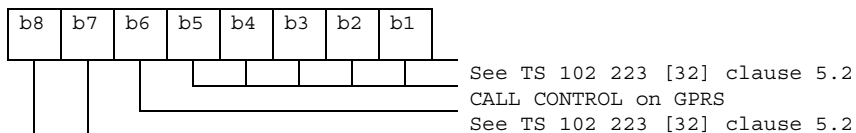

Nineteenth byte: (reserved for TIA/EIA-136 facilities):

- See ETSI TS 102 223 [32] clause 5.2.

Twentieth byte: (reserved for TIA/EIA/IS-820 facilities):

- See ETSI TS 102 223 [32] clause 5.2.

Twenty-first byte (Extended Launch Browser Capability) for class "c":

- See ETSI TS 102 223 [32] clause 5.2.

Twenty second byte:

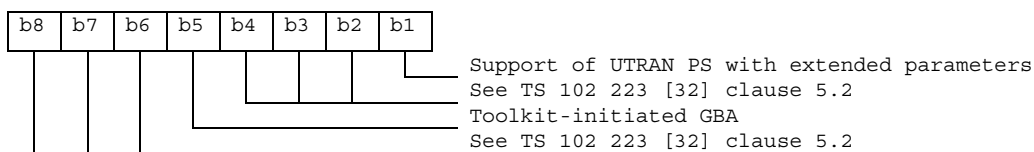

Twenty third byte:

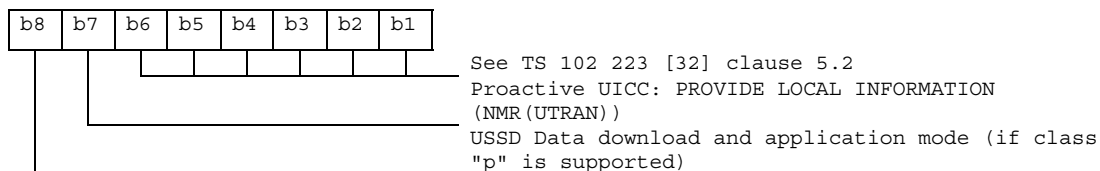

Twenty fourth byte for class "i":

- See ETSI TS 102 223 [32] clause 5.2.

Twenty-fifth byte (Event driven information extensions):

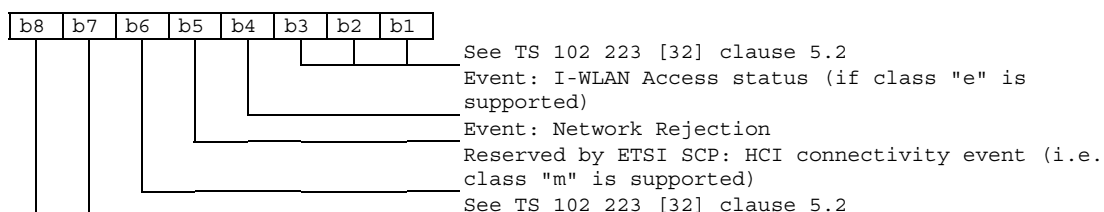

Twenty-sixth byte (Event driven information extensions):

- See ETSI TS 102 223 [32] clause 5.2.

Twenty-seventh byte (Event driven information extensions):

- See ETSI TS 102 223 [32] clause 5.2.

Twenty-eighth byte (Text attributes):

- See ETSI TS 102 223 [32] clause 5.2.

Twenty-ninth byte (Text attributes):

- See ETSI TS 102 223 [32] clause 5.2.

Thirtieth byte:

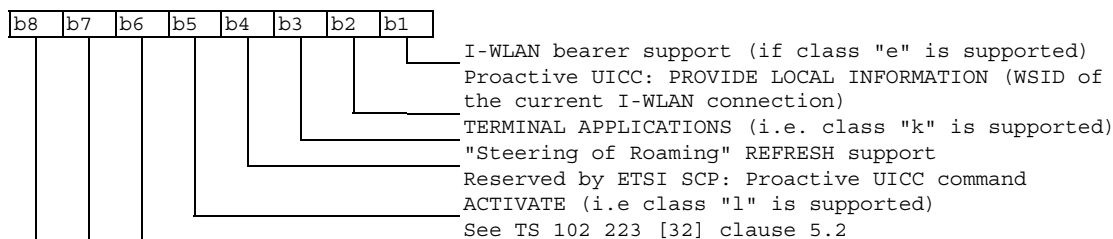

Subsequent bytes:

- See ETSI TS 102 223 [32] clause 5.2.

Response parameters/data:

- None.

## 5.3 Definition of display parameters in Profile download

See ETSI TS 102 223 [32] clause 5.3.

# 6 Proactive UICC

## 6.1 Introduction

TS 31.101 [13] defines the communication protocols between the ME and the UICC, and defines a mechanism to transport "proactive" commands using these protocols. Details about how this mechanism is used for USAT are defined in TS 102 223 [32] clause 6.1. The supported proactive commands are specified in clause 6.4. of the present document.

If the UICC issues an instruction to the ME to initiate a Mobile Originated transaction (e.g. SEND SMS, SEND SS, SEND USSD or SEND DTMF), then unless explicitly stated elsewhere in the present document or in TS 31.101 [13], the content supplied by the UICC for onward transmission by the ME shall not be altered by the ME.

## 6.2 Identification of ME support

See ETSI TS 102 223 [32] clause 6.2.

## 6.3 General procedure

See ETSI TS 102 223 [32] clause 6.3.

## 6.4 Proactive UICC commands and procedures

### 6.4.1 DISPLAY TEXT

See ETSI TS 102 223 [32] clause 6.4.1.

### 6.4.2 GET INKEY

See ETSI TS 102 223 [32] clause 6.4.2.

### 6.4.3 GET INPUT

See ETSI TS 102 223 [32] clause 6.4.3.

### 6.4.4 MORE TIME

See ETSI TS 102 223 [32] clause 6.4.4.

### 6.4.5 PLAY TONE

See ETSI TS 102 223 [32] clause 6.4.5.

NOTE: Some supervisory tones are optional for mobile equipment (see TS 22.001 [22]).

### 6.4.6 POLL INTERVAL

See ETSI TS 102 223 [32] clause 6.4.6.

### 6.4.7 REFRESH

See ETSI TS 102 223 [32] clause 6.4.7 except for "3G Session Reset" and "Steering of Roaming" which are defined as follows.

3G Session Reset. This mode causes the ME to reset the 3G session, in accordance with the 3G session reset procedure defined in TS 31.102 [14]. Subsequently, the ME performs the "USIM Initialization and File Change Notification" procedure and the MM Restart procedure as defined in TS 23.122 [7].

Steering of Roaming. This mode triggers a steering of roaming procedure as defined in TS 23.122 [7].

#### 6.4.7.1 EF<sub>IMSI</sub> changing procedure

When an EF<sub>IMSI</sub> is changed via Data Download or a USAT application and a REFRESH command is issued by the UICC the following rules apply to the UICC and ME:

- USIM Initialization. This command shall not be used if an EF<sub>IMSI</sub> is changed, as the behaviour of the UE is unpredictable;
- File Change Notification. This command shall not be used if an EF<sub>IMSI</sub> is changed, as the behaviour of the UE is unpredictable;
- USIM Initialization and File Change Notification. This command shall not be used if an EF<sub>IMSI</sub> is changed, as the behaviour of the UE is unpredictable;
- USIM Initialization and Full File Change Notification. This command shall not be used if an EF<sub>IMSI</sub> is changed, as the behaviour of the UE is unpredictable;
- UICC Reset. Normal UICC Reset procedure is carried out;
- USIM Application Reset. Normal USIM Application Reset procedure is carried out;

- 3G Session Reset. Normal 3G Session Reset procedure is carried out.

If an  $EF_{IMSI}$  is to be updated, neither  $EF_{IMSI}$  nor  $EF_{LOCI}$  shall be updated in the UICC before the 3G session termination procedure has been completed by the ME.

#### 6.4.7.2 Generic Bootstrapping Procedure Request

If Toolkit-initiated GBA is supported by the ME, as indicated in the TERMINAL PROFILE, then the following applies:

When the UICC issues a REFRESH command implying a File Change Notification on  $EF_{GBABP}$  under ADF USIM (GBA Bootstrapping parameters) the ME shall perform a GBA bootstrapping procedure (as defined in TS 31.102 [14]).

This procedure applies to REFRESH command only in the following modes: USIM File Change Notification; USIM Initialization and File Change Notification; and 3G Session Reset.

#### 6.4.8 SET UP MENU

See ETSI TS 102 223 [32] clause 6.4.8.

#### 6.4.9 SELECT ITEM

See ETSI TS 102 223 [32] clause 6.4.9.

#### 6.4.10 SEND SHORT MESSAGE

This command requests the ME to send a short message.

Two types are defined in ETSI TS 102 223 [32] clause 6.4.10 and apply as follows within the context of the present document:

- a short message to be sent to the network in an SMS-SUBMIT message, or an SMS-COMMAND message, where the user data can be passed transparently;
- a short message to be sent to the network in an SMS-SUBMIT message where the text needs to be packed by the ME.

Where the text has been packed, the text string provided by the UICC shall not be longer than 160 characters. It shall use the SMS default 7-bit coded alphabet, packed into 8-bit octets, in accordance with TS 23.038 [4]. The data coding indication contained in the Data Coding Scheme byte shall be "default alphabet". The text length (which is part of the SMS TPDU) given by the UICC shall state the number of 7-bit characters in the text string. The command details shall indicate "packing not required".

8-bit data Short Messages may be sent by the UICC. The command shall indicate packing not required. The data coding indication contained in the Data Coding Scheme byte shall be "8 bit". The string shall not be longer than 140 bytes, and the length (in SMS TPDU) shall state the number of bytes in the string.

If UCS2 is supported by the ME, 16-bit data Short Messages may be sent by the UICC. The text string provided by the UICC shall not be longer than 70 characters. It shall use the 16-bit UCS2 alphabet format, in accordance with TS 23.038 [4]. The text length (which is part of the SMS TPDU) given by the UICC shall state the number of 16-bit characters in the text string. The command details shall indicate "packing not required".

SMS commands may be sent by the UICC. These shall count as packed text message. The SMS TPDU from the UICC shall indicate SMS-COMMAND. The command details shall indicate "packing not required".

Where packing by the ME is required, the text string provided by the UICC shall not be longer than 160 characters. It shall use the SMS default 7-bit coded alphabet as defined in TS 23.038 [4] with bit 8 set to 0. The text length given by the UICC shall state the number of characters in the text string. The ME shall pack the text string and modify the Data Coding Scheme byte to "default alphabet" in accordance with TS 23.038 [4] before submitting the message to the network.

Optionally, the UICC may include in this command an alpha identifier. See ETSI TS 102 223 [32] clause 6.4.10 for the use of this alpha identifier.

If the ME is capable of SMS-MO, then it shall send the data as a Short Message TPDU to the destination address. The ME shall give the result to the UICC using TERMINAL RESPONSE (indicating successful or unsuccessful transmission of the Short Message) after receiving an SMS RP-ACK or RP-Error from the network. If an alpha identifier was provided by the UICC, the ME should not give any information to the user at the reception of SMS RP-ACK or RP-Error.

If the Short Message TPDU is unsuccessfully received by the network (e.g. the reception of a CP-ERROR), the ME shall inform the UICC using TERMINAL RESPONSE (network currently unable to process command). If a null alpha identifier was provided by the UICC, the ME should not give any information to the user at the unsuccessful network reception.

## 6.4.11 SEND SS

Upon receiving this command, the ME shall decide if it is able to execute the command. Examples are given below, but the list is not exhaustive:

- if the command is rejected because the ME is busy on an SS transaction, the ME informs the UICC using TERMINAL RESPONSE (ME unable to process command - currently busy on SS transaction);
- if the command is rejected because the ME is busy on a USSD transaction, the ME shall inform the UICC using TERMINAL RESPONSE (ME unable to process command - currently busy on USSD transaction);
- if the command is rejected because the ME does not support that Supplementary Service, the ME informs the UICC using TERMINAL RESPONSE (Command beyond ME's capabilities).

If the ME is able to send the SS request, the ME shall:

- send the SS request immediately, without need to alert the user first;
- optionally, the UICC may include in this command an alpha-identifier. The use of this alpha-identifier by the ME is described below:
  - if the alpha identifier is provided by the UICC and is not a null data object, the ME shall use it to inform the user. This is also an indication that the ME should not give any other information to the user on the fact that the ME is sending a SS request. If an icon is provided by the UICC, the icon indicated in the command may be used by the ME to inform the user, in addition to, or instead of the alpha identifier, as indicated with the icon qualifier (see clause 6.5.4);
  - if the alpha identifier is provided by the UICC and is a null data object (i.e. length = '00' and no value part), this is an indication that the ME should not give any information to the user on the fact that the ME is sending an SS request;
  - if the alpha identifier is not provided by the UICC, the ME may give information to the user concerning what is happening.
- once an SS Return Result message not containing an error has been received from the network, the ME shall inform the UICC that the command has been successfully executed, using TERMINAL RESPONSE. This command shall include the contents of SS Return Result as additional data. If a null alpha identifier was provided by the UICC, the ME should not give any information to the user at the reception of an SS Return Result message;
- if the command is rejected because the network cannot support or is not allowing the Supplementary Service request, the ME informs the UICC using TERMINAL RESPONSE (SS Return Result error code). If a null alpha identifier was provided by the UICC, the ME should not give any information to the user at the reception of a SS Return Result message;
- if the SS request is unsuccessfully received by the network, the ME shall inform the UICC using TERMINAL RESPONSE (network currently unable to process command), and not retry to send the request. If a null alpha identifier was provided by the UICC, the ME should not give any information to the user at the reception of a SS Return Result message.

If the ME supports the Last Number Dialed service, the ME shall not store in EF<sub>LND</sub> the supplementary service control string sent by the UICC in this command.

The supplementary service control string included in the SEND SS proactive command shall not be checked against those of the FDN list, even if the Fixed Dialling Number service is enabled.

## 6.4.12 SEND USSD

### 6.4.12.1 MMI Mode

Upon receiving this command, the ME shall decide if it is able to execute the command. Examples are given below, but the list is not exhaustive:

- if the command is rejected because the ME is busy on a USSD transaction, the ME informs the UICC using TERMINAL RESPONSE (ME unable to process command - currently busy on USSD transaction);
- if the command is rejected because the ME is busy on a SS transaction, the ME informs the UICC using TERMINAL RESPONSE (ME unable to process command - currently busy on SS transaction).

If the ME is able to send the USSD request, the ME shall:

- send the USSD immediately, without need to alert the user first;
- optionally, the UICC may include in this command an alpha-identifier. The use of this alpha-identifier by the ME is described below:
  - if the alpha identifier is provided by the UICC and is not a null data object, the ME shall use it to inform the user. This is also an indication that the ME should not give any other information to the user on the fact that the ME is sending a USSD request. If an icon is provided by the UICC, the icon indicated in the command may be used by the ME to inform the user, in addition to, or instead of the alpha identifier, as indicated with the icon qualifier (see clause 6.5.4);
  - if the alpha identifier is provided by the UICC and is a null data object (i.e. length = '00' and no value part), this is an indication that the ME should not give any information to the user on the fact that the ME is sending a USSD request;
  - if the alpha identifier is not provided by the UICC, the ME may give information to the user concerning what is happening.
- once the USSD transaction is initiated, a dialogue between the network and the user may occur which involves the MMI of the ME. If an alpha identifier was initially provided by the UICC, this alpha identifier may be discarded during this dialogue;
- once a RELEASE COMPLETE message containing the USSD Return Result message not containing an error has been received from the network, the ME shall inform the UICC that the command has been successfully executed, using TERMINAL RESPONSE. This command shall include the text contained in the USSD Return Result in a Text String data object. If a null alpha identifier was provided by the UICC, the ME should not give any information to the user at the reception of a USSD Return Result message;
- if the UE clears the transaction by sending a RELEASE COMPLETE upon request of the user, the ME shall inform the UICC using TERMINAL RESPONSE (USSD transaction terminated by user);
- if the USSD operation is rejected because the network cannot support or is not allowing mobile initiated USSD, the ME informs the UICC using TERMINAL RESPONSE (USSD Return Result error code). If a null alpha identifier was provided by the UICC, the ME should not give any information to the user at the reception of a USSD Return Result message;
- if the USSD request is unsuccessfully received by the network, the ME shall inform the UICC using TERMINAL RESPONSE (network currently unable to process command), and not retry to send the request. If a null alpha identifier was provided by the UICC, the ME should not give any information to the user at the reception of a USSD Return Result message.

### 6.4.12.2 Application Mode

This clause applies if class "p" is supported.



A USSD is considered as Application Mode (Send USSD used for the transport of Data to the network) if the service "data download via USSD and USSD application mode" is allocated and activated in the USIM Service Table (see TS 31.102 [14]) and the DCS coding within the USSD string TLV is set to 8 bit data.

Upon receiving this command, the ME shall decide if it is able to execute the command. Examples are given below, but the list is not exhaustive:

- if the command is rejected because the ME is busy on a USSD transaction, the ME informs the UICC using TERMINAL RESPONSE (ME unable to process command - currently busy on USSD transaction);
- if the command is rejected because the ME is busy on a SS transaction, the ME informs the UICC using TERMINAL RESPONSE (ME unable to process command - currently busy on SS transaction).

If the ME is able to send the USSD request then the ME shall:

- send the USSD immediately, without need to alert the user first;
- optionally, the UICC may include in this command an alpha-identifier. The use of this alpha-identifier by the ME is described below:
  - if the alpha identifier is provided by the UICC and is not a null data object, the ME shall use it to inform the user. This is also an indication that the ME should not give any other information to the user on the fact that the ME is sending a USSD request. If an icon is provided by the UICC, the icon indicated in the command may be used by the ME to inform the user, in addition to, or instead of the alpha identifier, as indicated with the icon qualifier (see clause 6.5.4);
  - if the alpha identifier is provided by the UICC and is a null data object (i.e. length = '00' and no value part), this is an indication that the ME should not give any information to the user on the fact that the ME is sending a USSD request;
  - if the alpha identifier is not provided by the UICC, the ME may give information to the user concerning what is happening.
- once a FACILITY (including RELEASE COMPLETE) message containing a USSD Request message has been received from the network, the ME shall inform the UICC that the network requests more information, using the command ENVELOPE (USSD Data Download). This command shall include the text contained in the USSD Request in a Text String data object. If a null alpha identifier was provided by the UICC, the ME should not give any information to the user at the reception of a USSD Request message

### 6.4.13 SET UP CALL

This command is issued by the UICC to request a call set up. The procedure is defined in ETSI TS 102 223 [32] clause 6.4.13, except when stated otherwise in the present document.

The UICC may request the use of an automatic redial mechanism according to TS 22.001 [22]

In addition to the rules given in ETSI TS 102 223 [32] clause 6.4.13 the following applies:

- If the UICC supplies a number stored in EF<sub>ECC</sub>, this shall not result in an emergency call.

Upon receiving this command, the ME shall decide if it is able to execute the command. Examples are given below, but the list is not exhaustive:

- if the command is rejected because the ME is busy on another call, the ME informs the UICC using TERMINAL RESPONSE (ME unable to process command - currently busy on call);
- if the command is rejected because the ME is busy on a SS transaction, the ME informs the UICC using TERMINAL RESPONSE (ME unable to process command - currently busy on SS transaction);
- if the command is rejected because the ME cannot support Call Hold, or because the ME does not support the capability configuration parameters requested by the UICC, the ME informs the UICC using TERMINAL RESPONSE (Command beyond ME's capabilities);
- if the command is rejected because the network cannot support or is not allowing Call Hold of a multi party call, the ME informs the UICC using TERMINAL RESPONSE (SS Return Result error code);

- if the command is rejected because the network cannot support or is not allowing Call Hold of a single call, the ME informs the UICC using TERMINAL RESPONSE (Network currently unable to process command).

If the ME supports the Outgoing Call Information service, the ME shall not store in EF<sub>OCT</sub> and in EF<sub>OCT</sub> the call set-up details (called party number and associated parameters) sent by the UICC in this command.

#### 6.4.14 POLLING OFF

See ETSI TS 102 223 [32] clause 6.4.14.

#### 6.4.15 PROVIDE LOCAL INFORMATION

This command requests the ME to send current local information to the UICC. At present, this information is restricted to:

- location information: the mobile country code (MCC), mobile network code (MNC), location area code (LAC) and cell ID of the current serving cell;

NOTE: For UTRAN the cell ID returned in terminal response is the last known cell ID which may not be the current serving cell, when the ME is on a dedicated channel.

- the IMEI or IMEISV of the ME;
- the Network Measurement Results (and the BCCH channel list if connected to GERAN);
- the current date, time and time zone;
- the current ME language setting;
- the Timing Advance, suitable only for GERAN;
- the current access technology;
- the current network search mode;
- the charge state of the battery (if class "g" is supported);
- the WSID of the current I-WLAN connection.

The above information can be requested only if supported by the ME as indicated in the TERMINAL PROFILE.

The ME shall return the requested local information within a TERMINAL RESPONSE.

Where location information or Network Measurement Results has been requested and no service is currently available, then the ME shall return TERMINAL RESPONSE (ME currently unable to process command - no service).

Where location information or Network Measurement Results has been requested and the ME is on limited service (e.g. emergency calls only), the ME shall return the data requested in the TERMINAL RESPONSE with the general result (Limited Service).

Where Network Measurement Results has been requested and the ME is connected to a different access technology to the one requested (e.g. UTRAN Measurement Qualifier included when ME is connected to a GERAN), then the ME shall return TERMINAL RESPONSE (ME currently unable to process command - no service).

Network Measurement Results are available on a per access technology basis and indicated as such in the Terminal Profile.

Network Measurement Results for a GERAN:

If the NMR are requested and a call is in progress, the value of all the returned parameters provided by the ME in the response to the command will be valid. The NMR returned when a call is in progress from MEs supporting multiband operation, shall be according to the value of the multiband reporting parameter as defined in TS 44.018 [27]. If a call is not in progress (i.e. ME is in idle mode) some of the returned parameters (e.g. RXQUAL) may be invalid. In idle mode, MEs supporting multiband operation shall ignore the value of the multiband reporting parameter and the NMR returned shall be as defined in TS 44.018 [27] when the multiband reporting parameter equals zero.

NOTE 1: When in idle mode, the only information element on which it is possible to rely on is the RXLEV-FULL-SERVING-CELL, which contains the value of the received signal strength on the BCCH of the current serving cell.

NOTE 2: Network Measurement Results are defined in TS 44.018 [27] as Measurement Results.

The BCCH channel list is only available if the ME is connected to a GERAN.

- Network Measurement Results for a UTRAN:

The USIM request for measurement information shall not trigger any measurement activities in ME in addition to those requested by UTRAN.

The ME shall only report measurement results that are valid according to the current RRC state or the UTRAN configuration requested.

NOTE 3: The returned parameters provided by the ME, in the response to the command, are subject to the ME capability, currently used radio configuration, current RRC state and the UTRAN configuration requested as defined in the TS 25.331 [38].

NOTE 4: Network Measurement Results are defined in TS 25.331 [38] as the MEASUREMENT REPORT message.

The ME shall return the current date and time as set by the user. If available, the ME shall also return the time zone known from the network with the NITZ feature (see TS 22.042 [3]). If the time zone information is not available, the ME shall return 'FF' for this element.

If language setting is requested, the ME shall return the currently used language.

Timing advance is only available if the ME is connected to a GERAN. If the Timing Advance is requested, the ME shall return the timing advance value that was received from the BTS during the last active dedicated connection (e.g. for call or SMS). Timing advance is defined in TS 44.018 [27]. An ME supporting the Timing Advance feature shall be able to store the last value of timing advance. In addition to the timing advance value, the ME shall return its current status (i.e. ME is in idle mode or not) in order for the application to be aware of potential misinterpretation of the timing advance value. Caution should be taken if using the Timing Advance value for distance measurement as reflections from the external environment (buildings etc.) may affect the accuracy.

If the access technology is requested, the ME shall return the current access technology that the ME is using.

The WSID is only available if the ME is connected to a I-WLAN. If the WSID is requested, the ME shall return the WSID of the currently connected I-WLAN. Where a WSID has been requested and no I-WLAN is currently connected, then the ME shall return TERMINAL RESPONSE (ME currently unable to process command - no service).

## 6.4.16 SET UP EVENT LIST

See ETSI TS 102 223 [32] clause 6.4.16.

## 6.4.17 PERFORM CARD APDU

See ETSI TS 102 223 [32] clause 6.4.17.

## 6.4.18 POWER OFF CARD

See ETSI TS 102 223 [32] clause 6.4.18.

## 6.4.19 POWER ON CARD

See ETSI TS 102 223 [32] clause 6.4.19.

## 6.4.20 GET READER STATUS

See ETSI TS 102 223 [32] clause 6.4.20.

## 6.4.21 TIMER MANAGEMENT

See ETSI TS 102 223 [32] clause 6.4.21.

## 6.4.22 SET UP IDLE MODE TEXT

See ETSI TS 102 223 [32] clause 6.4.22.

## 6.4.23 RUN AT COMMAND

See ETSI TS 102 223 [32] clause 6.4.23.

## 6.4.24 SEND DTMF

See ETSI TS 102 223 [32] clause 6.4.24.

## 6.4.25 LANGUAGE NOTIFICATION

See ETSI TS 102 223 [32] clause 6.4.25.

## 6.4.26 LAUNCH BROWSER

This command is used to request a browser inside a browser-enabled ME to interpret the content corresponding to a URL. See ETSI TS 102 223 [32] clause 6.4.26.

Upon receiving this command, the ME shall decide if it is able to execute the command. In addition to the examples given in ETSI TS 102 223 [32] clause 6.4.26 the following example applies:

- if the command is rejected because the ME is busy on a SS transaction, the ME informs the UICC using TERMINAL RESPONSE (ME unable to process command - ME currently unable to process command);

## 6.4.27 OPEN CHANNEL

### 6.4.27.1 OPEN CHANNEL related to CS bearer

This command is issued by the UICC to request a channel opening. The procedure is defined in ETSI TS 102 223 [32] clause 6.4.27.1, except when stated otherwise in the present document.

The UICC may request the use of an automatic reconnection mechanism according to TS 22.001 [22].

Upon receiving this command, the ME shall decide if it is able to execute the command. In addition to the examples given in ETSI TS 102 223 [32] clause 6.4.27.1 the following example applies:

- if the command is rejected because the ME is busy on a SS transaction, the ME informs the UICC using TERMINAL RESPONSE (ME unable to process command - currently busy on SS transaction). The operation is aborted.

The "Bearer description" provided in the command gives recommended values for parameters that the ME should use to establish the data link. However if the ME or network does not support these values, the ME selects the most appropriate values.

#### 6.4.27.2 OPEN CHANNEL related to GPRS/3G packet service

The procedures defined in ETSI TS 102 223 [32] clause 6.4.27.2 apply, understanding that:

- "packet data service" means GPRS or 3G packet service,
- "activation of packet data service" means activation of a PDP context.

The UICC provides to the terminal a list of parameters necessary to activate a packet data service. The UICC has two ways to indicate to the ME the QoS it requires:

- either use a Bearer Description called "Bearer description for GPRS/3G Packet Service", which is valid for 2G and 3G packet service
- or use a Bearer Description called "Bearer description for UTRAN Packet Service with extended parameters and HSDPA" which is valid for a UTRAN packet service and HSDPA.

Upon receiving this command, the ME shall decide if it is able to execute the command. In addition to the examples given in ETSI TS 102 223 [32] clause 6.4.27.2 the following example applies:

- if the command is rejected because the ME is busy on a SS transaction and unable to activate a PDP context in parallel with this SS transaction, the ME informs the UICC using TERMINAL RESPONSE (ME unable to process command - currently busy on SS transaction). The operation is aborted.

The "Bearer description" provided in the command gives recommended values for parameters that the ME should use to establish the data link. However if the ME or network does not support these values, the ME selects the most appropriate values.

#### 6.4.27.3 OPEN CHANNEL related to local bearer

See ETSI TS 102 223 [32] clause 6.4.27.3.

#### 6.4.27.4 OPEN CHANNEL related to Default (network) Bearer

See ETSI TS 102 223 [32] clause 6.4.27.4.

#### 6.4.27.5 OPEN CHANNEL related to I-WLAN bearer

This clause applies if class "e" is supported.

Upon receiving this command, the ME shall decide if it is able to execute the command. The UICC shall indicate whether the ME should establish the link immediately, in background mode or upon receiving the first transmitted data (on demand).

The UICC provides to the ME a list of parameters necessary to activate a I-WLAN service.

The ME shall attempt at least one I-WLAN service activation.

Upon receiving this command, the ME shall decide if it is able to execute the command. Examples are given below, but the list is not exhaustive:

- if immediate or background I-WLAN service activation is requested and the ME is unable to set-up a channel using the exact parameters provided by the UICC, the ME sets up the channel according to TS 24.234 [42] and informs the UICC of the I-WLAN identifier and the modified parameters using TERMINAL RESPONSE (Command performed with modification);
- if immediate I-WLAN service activation is requested and the ME is unable to activate the I-WLAN service with the network using the exact parameters provided by the UICC, the ME informs the UICC using TERMINAL RESPONSE (Network currently unable to process command). The operation is aborted;
- if background mode I-WLAN service activation is requested and the ME is unable to activate the I-WLAN service with the network using the exact parameters provided by the UICC, the ME informs the UICC using a channel status event (link not established - no further info). The operation is aborted;

- if the command is rejected because the ME has no channel left with the requested bearer capabilities, the ME informs the UICC using TERMINAL RESPONSE (Bearer independent protocol error). The operation is aborted;
- if the user does not accept the channel set-up, the ME informs the UICC using TERMINAL RESPONSE (User did not accept the proactive command). The operation is aborted;
- if the user has indicated the need to end the proactive UICC session, the ME informs the UICC using TERMINAL RESPONSE (Proactive UICC session terminated by the user). The operation is aborted;
- if background mode I-WLAN service activation is requested, the ME allocates buffers, starts activation of I-WLAN service, informs the UICC and reports the channel identifier immediately using TERMINAL RESPONSE (Command performed successfully). At the end of activation, the ME shall send a channel status event (link established or link not established - no further info).

The ME shall inform the UICC that the command has been successfully executed using TERMINAL RESPONSE:

- if immediate I-WLAN service activation is requested, the ME allocates buffers, activates the I-WLAN service and informs the UICC and reports the channel identifier using TERMINAL RESPONSE (Command performed successfully);
- if on demand I-WLAN service activation is requested, the ME allocates buffers, informs the UICC and reports the channel identifier using TERMINAL RESPONSE (Command performed successfully).

If the ME is able to set up the channel on the serving network, the ME shall then enter the confirmation phase described hereafter; optionally, the UICC may include in this command an alpha-identifier. The use of this alpha-identifier by the ME is described below:

- if the alpha identifier is provided by the UICC and is not a null data object, the ME shall use it during the user confirmation phase. This is also an indication that the ME should not give any other information to the user during the user confirmation phase. If an icon is provided by the UICC, the icon indicated in the command may be used by the terminal to inform the user, in addition to, or instead of the alpha identifier, as indicated with the icon qualifier (see clause 6.5.4);
- if the alpha identifier is provided by the UICC and is a null data object (i.e. length = '00' and no value part), this is an indication that the ME should not give any information to the user or ask for user confirmation;
- if the alpha identifier is not provided by the UICC, the ME may give information to the user;
- if the user doesn't reject the channel, the ME shall then set up a channel;
- if the user does not accept the channel or rejects the channel, then the ME informs the UICC using TERMINAL RESPONSE (user did not accept the proactive command). The operation is aborted;
- if the user has indicated the need to end the proactive UICC session, the ME shall send a TERMINAL RESPONSE with (Proactive UICC session terminated by the user) result value;
- optionally, during packet data service activation, the ME can give some audible or display indication concerning what is happening;
- if the user stops the I-WLAN service activation attempt before a result is received from the network, the ME informs the UICC using TERMINAL RESPONSE (user cleared down call before connection or network release).

#### 6.4.27.6 OPEN CHANNEL related to Terminal Server Mode

See ETSI TS 102 223 [32] clause 6.4.27.6.

#### 6.4.27.7 OPEN CHANNEL related to UICC Server Mode

See ETSI TS 102 223 [32] clause 6.4.27.5.

#### 6.4.28 CLOSE CHANNEL

See ETSI TS 102 223 [32] clause 6.4.28.

### 6.4.29 RECEIVE DATA

See ETSI TS 102 223 [32] clause 6.4.29.

### 6.4.30 SEND DATA

See ETSI TS 102 223 [32] clause 6.4.30.

### 6.4.31 GET CHANNEL STATUS

See ETSI TS 102 223 [32] clause 6.4.31.

### 6.4.32 SERVICE SEARCH

See ETSI TS 102 223 [32] clause 6.4.32.

### 6.4.33 GET SERVICE INFORMATION

See ETSI TS 102 223 [32] clause 6.4.33.

### 6.4.34 DECLARE SERVICE

See ETSI TS 102 223 [32] clause 6.4.34.

### 6.4.35 RETRIEVE MULTIMEDIA MESSAGE

See ETSI TS 102 223 [32] clause 6.4.37.

### 6.4.36 SUBMIT MULTIMEDIA MESSAGE

See ETSI TS 102 223 [32] clause 6.4.38.

### 6.4.37 DISPLAY MULTIMEDIA MESSAGE

See ETSI TS 102 223 [32] clause 6.4.39.

### 6.4.38 SET FRAMES

See ETSI TS 102 223 [32] clause 6.4.35.

### 6.4.39 GET FRAME STATUS

See ETSI TS 102 223 [32] clause 6.4.36.

### 6.4.40 ACTIVATE

Not required by 3GPP.

## 6.5 Common elements in proactive UICC commands

See ETSI TS 102 223 [32] clause 6.5.

### 6.5.1 Command number

See ETSI TS 102 223 [32] clause 6.5.1.

## 6.5.2 Device identities

See ETSI TS 102 223 [32] clause 6.5.2.

## 6.5.3 Alpha identifier

See ETSI TS 102 223 [32] clause 6.5.3.

## 6.5.4 Icon identifiers

The display of icons is optional for the terminal on a per command basis, see ETSI TS 102 223 [32] clause 6.5.4.

## 6.5.5 Text attribute

See ETSI TS 102 223 [32] clause 6.5.5.

## 6.5.6 Frame identifier

See ETSI TS 102 223 [32] clause 6.5.6.

# 6.6 Structure of proactive UICC commands

The general structure of proactive UICC commands using TLV objects is described in annex C.

## 6.6.1 DISPLAY TEXT

See ETSI TS 102 223 [32] clause 6.6.1.

## 6.6.2 GET INKEY

See ETSI TS 102 223 [32] clause 6.6.2.

## 6.6.3 GET INPUT

See ETSI TS 102 223 [32] clause 6.6.3.

## 6.6.4 MORE TIME

See ETSI TS 102 223 [32] clause 6.6.4.

## 6.6.5 PLAY TONE

See ETSI TS 102 223 [32] clause 6.6.5.

## 6.6.6 POLL INTERVAL

See ETSI TS 102 223 [32] clause 6.6.6.

## 6.6.7 SET-UP MENU

See ETSI TS 102 223 [32] clause 6.6.7.

## 6.6.8 SELECT ITEM

See ETSI TS 102 223 [32] clause 6.6.8.



## 6.6.9 SEND SHORT MESSAGE

| Description                          | Clause | M/O/C | Min | Length |
|--------------------------------------|--------|-------|-----|--------|
| Proactive UICC command Tag           | 9.2    | M     | Y   | 1      |
| Length (A+B+C+D+E+F+G+H)             | -      | M     | Y   | 1 or 2 |
| Command details                      | 8.6    | M     | Y   | A      |
| Device identities                    | 8.7    | M     | Y   | B      |
| Alpha identifier                     | 8.2    | O     | N   | C      |
| Address                              | 8.1    | O     | N   | D      |
| SMS TPDU (SMS-SUBMIT or SMS-COMMAND) | 8.13   | M     | Y   | E      |
| Icon identifier                      | 8.31   | O     | N   | F      |
| Text attribute                       | 8.70   | C     | N   | G      |
| Frame Identifier                     | 8.82   | O     | N   | H      |

The address data object holds the RP\_Destination\_Address of the Service Centre. If no RP\_Destination\_Address is transferred, then the ME shall insert the default Service Centre address.

The Text attribute applies to the Alpha Identifier. It may be present only if the Alpha Identifier is present.

## 6.6.10 SEND SS

| Description                | Clause | M/O/C | Min | Length |
|----------------------------|--------|-------|-----|--------|
| Proactive UICC command Tag | 9.2    | M     | Y   | 1      |
| Length (A+B+C+D+E+F+G)     | -      | M     | Y   | 1 or 2 |
| Command details            | 8.6    | M     | Y   | A      |
| Device identities          | 8.7    | M     | Y   | B      |
| Alpha identifier           | 8.2    | O     | N   | C      |
| SS string                  | 8.14   | M     | Y   | D      |
| Icon identifier            | 8.31   | O     | N   | E      |
| Text attribute             | 8.70   | C     | N   | F      |
| Frame Identifier           | 8.82   | O     | N   | G      |

The Text attribute applies to the Alpha Identifier. It may be present only if the Alpha Identifier is present.

## 6.6.11 SEND USSD

| Description                | Clause | M/O/C | Min | Length |
|----------------------------|--------|-------|-----|--------|
| Proactive UICC command Tag | 9.2    | M     | Y   | 1      |
| Length (A+B+C+D+E+F+G)     | -      | M     | Y   | 1 or 2 |
| Command details            | 8.6    | M     | Y   | A      |
| Device identities          | 8.7    | M     | Y   | B      |
| Alpha identifier           | 8.2    | O     | N   | C      |
| USSD String                | 8.17   | M     | Y   | D      |
| Icon identifier            | 8.31   | O     | N   | E      |
| Text attribute             | 8.70   | C     | N   | F      |
| Frame Identifier           | 8.82   | O     | N   | G      |

The Text attribute applies to the Alpha Identifier. It may be present only if the Alpha Identifier is present.

## 6.6.12 SET UP CALL

See ETSI TS 102 223 [32] clause 6.6.12.

## 6.6.13 REFRESH

For all REFRESH modes except "Steering of Roaming", see ETSI TS 102 223 [32] clause 6.6.13.

For "Steering of Roaming":

| Description                | Clause | M/O/C | Min | Length |
|----------------------------|--------|-------|-----|--------|
| Proactive UICC command Tag | 9.2    | M     | Y   | 1      |
| Length (A+B+C+D+E+F+G)     | -      | M     | Y   | 1 or 2 |
| Command details            | 8.6    | M     | Y   | A      |
| Device identities          | 8.7    | M     | Y   | B      |
| Alpha identifier           | 8.2    | O     | N   | C      |
| Icon identifier            | 8.31   | O     | N   | D      |
| Text Attribute             | 8.70   | C     | N   | E      |
| Frame Identifier           | 8.82   | O     | N   | F      |
| PLMNwAcT List              | 8.90   | M     | N   | G      |

The Text attribute applies to the Alpha Identifier. It may be present only if the Alpha Identifier is present.

## 6.6.14 POLLING OFF

See ETSI TS 102 223 [32] clause 6.6.14.

## 6.6.15 PROVIDE LOCAL INFORMATION

| Description                 | Clause | M/O/C | Min | Length |
|-----------------------------|--------|-------|-----|--------|
| Proactive UICC command Tag  | 9.2    | M     | Y   | 1      |
| Length (A+B+C)              | -      | M     | Y   | 1 or 2 |
| Command details             | 8.6    | M     | Y   | A      |
| Device Identities           | 8.7    | M     | Y   | B      |
| UTRAN Measurement Qualifier | 8.73   | C     | N   | C      |

UTRAN Measurement Qualifier: This data object applies when the Command Qualifier in Command details is set to indicate "Network Measurement results". It shall be included to indicate to the ME that "Network Measurement Results for a UTRAN" is required. It shall be excluded to indicate to the ME that "Network Measurement Results for a GERAN" is required. It shall only be included/excluded if the ME has indicated that it supports the implied access technology via the respective Terminal Profile setting.

## 6.6.16 SET UP EVENT LIST

See ETSI TS 102 223 [32] clause 6.6.16.

## 6.6.17 PERFORM CARD APDU

See ETSI TS 102 223 [32] clause 6.6.17.

## 6.6.18 POWER OFF CARD

See ETSI TS 102 223 [32] clause 6.6.18.

## 6.6.19 POWER ON CARD

See ETSI TS 102 223 [32] clause 6.6.19.

## 6.6.20 GET READER STATUS

See ETSI TS 102 223 [32] clause 6.6.20.

## 6.6.21 TIMER MANAGEMENT

See ETSI TS 102 223 [32] clause 6.6.21.

## 6.6.22 SET UP IDLE MODE TEXT

See ETSI TS 102 223 [32] clause 6.6.22.

## 6.6.23 RUN AT COMMAND

See ETSI TS 102 223 [32] clause 6.6.23.

## 6.6.24 SEND DTMF COMMAND

See ETSI TS 102 223 [32] clause 6.6.24.

## 6.6.25 LANGUAGE NOTIFICATION

See ETSI TS 102 223 [32] clause 6.6.25.

## 6.6.26 LAUNCH BROWSER

See ETSI TS 102 223 [32] clause 6.6.26.

## 6.6.27 OPEN CHANNEL

The structure of the OPEN CHANNEL command is defined in ETSI TS 102 223 [32] clause 6.6.27. , with the addition of the following:

### 6.6.27.1 OPEN CHANNEL related to I-WLAN Bearer

| Description                             | Clause | M/O/C | Min | Length |
|---|--------|-------|-----|--------|
| Proactive UICC command Tag              | 9.2    | M     | Y   | 1      |
| Length (A+B+C+D+E+F+G+H+I+J+K+L)        | -      | M     | Y   | 1 or 2 |
| Command details                         | 8.6    | M     | Y   | A      |
| Device identities                       | 8.7    | M     | Y   | B      |
| Alpha identifier                        | 8.2    | O     | N   | C      |
| Icon identifier                         | 8.31   | O     | N   | D      |
| Bearer description                      | 8.52   | M     | Y   | E      |
| Buffer size                             | 8.55   | M     | Y   | F      |
| I-WLAN Identifier                       | 8.83   | O     | N   | G      |
| Other address (local address)           | 8.58   | O     | N   | H      |
| UICC/terminal interface transport level | 8.59   | O     | N   | I      |
| Data destination address                | 8.58   | C     | Y   | J      |
| Text Attribute                          | 8.70   | C     | N   | K      |
| Frame Identifier                        | 8.82   | O     | N   | L      |

The I-WLAN Identifier may be requested. If the parameter is not present, the ME shall select the I-WLAN according to TS 24.234 [42] using the Automatic PLMN Selection Mode Procedure.

The local address parameter provides information to the ME necessary to identify the local device. If the parameter is present and length is not null, it provides an IP address that identifies the USAT application in the address area applicable to the PDN. If local address length is null, dynamic local address allocation is required for the USAT application. If parameter is not present, the ME may use the ME default local address configuration.

If the UICC/ME interface transport level is present in the command, then the ME shall provide the requested transport layer protocols under the channel and shall use this object containing a set of parameters required to make the transport connection. The data that is exchanged at the UICC/ME interface in the RECEIVE DATA/SEND DATA commands are SDUs. When the USAT application sends an SDU, the transport layer within the ME is in charge to add the transport header to the SDU in order to build the Transport-PDU. When the USAT application requests to receive an SDU, the transport layer within the ME is in charge to remove the transport header of the Transport-PDU, and to forward the

SDU to the USAT. If the parameter is not present, the UICC/ME interface is the bearer level (serial link or packet link), and the USAT application is in charge of the network and transport layer.

The Data destination address is the end point destination address of sent data. This data destination address is requested when a UICC/ME interface transport is present, otherwise it is ignored. The data destination address is a data network address (e.g. IP address).

Text Attribute applies to the Alpha Identifier. It may be present only if the Alpha Identifier is present.

## 6.6.28 CLOSE CHANNEL

See ETSI TS 102 223 [32] clause 6.6.28.

## 6.6.29 RECEIVE DATA

See ETSI TS 102 223 [32] clause 6.6.29.

## 6.6.30 SEND DATA

See ETSI TS 102 223 [32] clause 6.6.30.

## 6.6.31 GET CHANNEL STATUS

See ETSI TS 102 223 [32] clause 6.6.31.

## 6.6.32 SERVICE SEARCH

See ETSI TS 102 223 [32] clause 6.6.32.

## 6.6.33 GET SERVICE INFORMATION

See ETSI TS 102 223 [32] clause 6.6.33.

## 6.6.34 DECLARE SERVICE

See ETSI TS 102 223 [32] clause 6.6.34.

## 6.6.35 RETRIEVE MULTIMEDIA MESSAGE

See ETSI TS 102 223 [32] clause 6.6.37.

## 6.6.36 SUBMIT MULTIMEDIA MESSAGE

See ETSI TS 102 223 [32] clause 6.6.38.

## 6.6.37 DISPLAY MULTIMEDIA MESSAGE

See ETSI TS 102 223 [32] clause 6.6.39.

## 6.6.38 SET FRAMES

See ETSI TS 102 223 [32] clause 6.6.35.

## 6.6.39 GET FRAMES STATUS

See ETSI TS 102 223 [32] clause 6.6.36.

## 6.6.40 ACTIVATE

Not required by 3GPP.

## 6.7 Command results

Once the ME has made its attempt to execute a proactive command from the UICC, the ME shall inform the UICC of the success or otherwise of that command, by using TERMINAL RESPONSE.

This procedure is defined in ETSI TS 102 223 [32] clause 6.7, and applies here except for the following statements.

Temporary problems are defined as:

- ME is currently unable to process the command. Specific causes for this are listed in ETSI TS 102 223 [32] clause 6.7; in addition to these, the following causes may be returned within the USAT context:
  - ME currently busy on SS transaction;
  - ME currently busy on USSD operation;
  - access control class barred on serving network;
- if none of these can be made to apply, a "no cause can be given" value can be used;
- network is currently unable to process the command. Within the USAT context, specific cause values are the cause values given by the network, as defined in TS 24.008 [9];
- in some proactive commands, the ME is required to solicit and receive approval of the user before executing the proactive command. In the case that the user does not give approval for the execution of the proactive command, it shall not be executed by the ME and the terminal response 'user did not accept the proactive command' shall be returned by the ME to the UICC;
- the user cleared down the call, before the call connected (CONNECT received from network, as defined in TS 24.008 [9]) or before the network released the call;
- action in contradiction with the current timer state. This is where the UICC requests an action for a timer to be taken by the ME and the state of the timer does not allow that action;
- interaction with call control by UICC, temporary problem. This is sent by the ME to indicate that call control modified the type of request indicated in the proactive command, and that the action requested by call control encounters a temporary problem.

Permanent problems are defined as in ETSI TS 102 223 [32] clause 6.7, with the addition of:

- SS Return Error. This is given to the UICC when the network returns a SS error in response to a previous SS command. Specific cause values are the same as given by the network in the Return Error message;
- USSD Return Error. This is given to the UICC when the network returns a USSD error in response to a previous USSD command. Specific cause values are the same as given by the network in a Return Error message;
- SMS RP-ERROR. This is given to the UICC when the network returns an error in response to the ME trying to send a short message. Specific cause values are the same as the cause value of RP-Cause in an RP-ERROR message;
- interaction with MO short message control by USIM, permanent problem. This is sent by the ME to indicate that:
  - MO short message control by USIM does not allow the action corresponding to the proactive command; or
  - MO short message control by USIM has modified the type of request indicated in the proactive command and that the action requested by call control encounters a permanent problem.

## 6.8 Structure of TERMINAL RESPONSE

Direction: ME to UICC.

The command header is specified in TS 31.101 [13]. Length (A+B+ ... +AA) is indicated by P3 of the header.

Command parameters/data.

| Description   | Clause   | M/O/C | Min | Length  |
|---|--|-------|-----|---|
| Command details   | 8.6  | M     | Y   | A   |
| Device identities   | 8.7  | M     | N   | B   |
| Result  | 8.12   | M     | Y   | C   |
| Duration (only required in response to a POLL INTERVAL proactive command)   | 8.8  | C     | N   | D   |
| Text string (only required in response to a GET INKEY or GET INPUT or SEND USSD proactive command)  | 8.15   | C     | N   | E   |
| Item identifier (only required in response to SELECT ITEM proactive command)  | 8.10   | C     | N   | F   |
| Local information (only required in response to PROVIDE LOCAL INFORMATION proactive command)  | 8.19, 8.20, 8.22, 8.29, 8.39, 8.45, 8.46, 8.62, 8.83, 8.85, 8.86, 8.87 | C     | N   | G   |
| Call control requested action (only required if call control by USIM has modified a proactive command SET UP CALL, SEND SS or SEND USSD in another type of request).  | 8.30   | C     | N   | H   |
| Result data object 2 (only required if call control by USIM has modified a proactive command SET UP CALL, SEND SS or SEND USSD in another type of request).   | 8.12   | C     | N   | I   |
| Card reader status (only required in response to GET READER STATUS command). According to the requested information, one Card reader status object for each card interface reported, or one Card reader identifier object is required.. | 8.33, 8.57   | C     | N   | J <sub>0</sub> + ... + J <sub>n</sub><br>or J |
| Card ATR (only required in response to POWER ON CARD).  | 8.34   | C     | N   | K   |
| R-APDU (only required in response to PERFORM CARD APDU).  | 8.36   | C     | N   | L   |
| Timer identifier (only required in response to a TIMER MANAGEMENT proactive command)  | 8.37   | C     | N   | M   |
| Timer value (only required in response to a TIMER MANAGEMENT proactive command)   | 8.38   | C     | N   | N   |
| AT Response (only required in response to RUN AT COMMAND proactive command)   | 8.41   | C     | N   | P   |
| Text string2 (only required if call control by USIM has modified the proactive command SET UP CALL or SEND SS into a USSD request)  | 8.15   | C     | N   | Q   |
| Channel data (only required in response to RECEIVE DATA)  | 8.53   | C     | N   | R   |
| Channel status (only required in response to GET CHANNEL STATUS or OPEN CHANNEL proactive command)  | 8.56   | C     | N   | S <sub>0</sub> + ... + S <sub>n</sub>         |
| Channel data length (only required in response to RECEIVE DATA or SEND DATA proactive command)  | 8.54   | C     | N   | T   |

| Description  | Clause | M/O/C | Min | Length |
|--|--------|-------|-----|--------|
| Bearer description (only required in response to OPEN CHANNEL proactive command)   | 8.52   | C     | N   | U      |
| Buffer size (only required in response to OPEN CHANNEL proactive command)  | 8.55   | C     | N   | V      |
| Total display duration (only required in response to a GET INKEY proactive command)  | 8.8    | C     | N   | W      |
| Service availability (only required in response to SERVICE SEARCH proactive command)   | 8.68   | C     | N   | X      |
| Service record (only required in response to GET SERVICE INFORMATION proactive command)  | 8.64   | C     | N   | Y      |
| Other address (local address) (only required in response to OPEN CHANNEL proactive command with dynamic local address request) | 8.58   | C     | N   | Z      |
| Frames Information (only required in response to SET FRAMES or GET FRAMES STATUS proactive commands)                           | 8.81   | C     | N   | AA     |

Specific rules apply for the coding of the TERMINAL RESPONSE, see ETSI TS 102 223 [32] clause 6.8.

Response parameters/data: None.

### 6.8.1 Command details

See ETSI TS 102 223 [32] clause 6.8.1.

### 6.8.2 Device identities

See ETSI TS 102 223 [32] clause 6.8.2.

### 6.8.3 Result

See ETSI TS 102 223 [32] clause 6.8.3.

### 6.8.4 Duration

See ETSI TS 102 223 [32] clause 6.8.4.

### 6.8.5 Text string

ETSI TS 102 223 [32] clause 6.8.5 applies, with the addition of the following procedure.

When the ME issues a successful TERMINAL RESPONSE for a SEND USSD command, it shall supply the text returned within the Return Result message from the network, no matter what type of string was returned.

### 6.8.6 Item identifier

See ETSI TS 102 223 [32] clause 6.8.6.

### 6.8.7 Local information

For Local Information values defined in clause 8.6 then ETSI TS 102 223 [32] clause 6.8.7 applies, with the addition of the following procedures:

- Where the UICC has requested the Network Measurement Results, the TERMINAL RESPONSE shall contain
- for GERAN: The NMR data object and the BCCH channel list data object

- for UTRAN: The Network Measurement Results are coded as the MEASUREMENT REPORT message as defined in TS 25.331 [38].
- Where the UICC has requested the WLAN Specific Identifier, the TERMINAL RESPONSE shall contain the WSID of the current I-WLAN connection.

### 6.8.8 Call control requested action

When the ME issues a TERMINAL RESPONSE for a proactive command SET UP CALL, SEND SS or SEND USSD which has been modified by call control by UICC in another type of request, it shall supply the response data given in response to the ENVELOPE (CALL CONTROL).

### 6.8.9 Result data object 2

When the ME issues a TERMINAL RESPONSE for a proactive command SET UP CALL, SEND SS or SEND USSD which has been modified by call control by UICC in another type of request, it shall supply the Result data object it would have supplied for the proactive command equivalent to the action requested by call control, and given in the Call control request data element.

### 6.8.10 Card reader status

See ETSI TS 102 223 [32] clause 6.8.10.

### 6.8.11 Card ATR

See ETSI TS 102 223 [32] clause 6.8.11.

### 6.8.12 R-APDU

See ETSI TS 102 223 [32] clause 6.8.12.

### 6.8.13 Timer identifier

See ETSI TS 102 223 [32] clause 6.8.13.

### 6.8.14 Timer value

See ETSI TS 102 223 [32] clause 6.8.14.

### 6.8.15 AT Response

See ETSI TS 102 223 [32] clause 6.8.15.

### 6.8.16 Text string 2

When the ME issues a successful TERMINAL RESPONSE for a proactive command SET UP CALL or SEND SS which has been modified by "call control" by USIM into a USSD request ('05' result value), it shall supply the Text string 2. The Text string 2 shall contain the text returned within the Return Result message from the network for the USSD response. Text string 2 is equivalent to the Text string in the Terminal Response to a SEND USSD command.

### 6.8.17 Channel data

See ETSI TS 102 223 [32] clause 6.8.17.



### 6.8.18 Channel status

See ETSI TS 102 223 [32] clause 6.8.18.

### 6.8.19 Channel data length

See ETSI TS 102 223 [32] clause 6.8.19.

### 6.8.20 Bearer description

See ETSI TS 102 223 [32] clause 6.8.20.

### 6.8.21 Buffer size

See ETSI TS 102 223 [32] clause 6.8.21.

### 6.8.22 Total Display Duration

See ETSI TS 102 223 [32] clause 6.8.22.

### 6.8.23 Service Availability

See ETSI TS 102 223 [32] clause 6.8.23.

### 6.8.24 Service Record

See ETSI TS 102 223 [32] clause 6.8.24.

### 6.8.25 Other address (local address)

See ETSI TS 102 223 [32] clause 6.8.25.

### 6.8.26 Frames Information

See ETSI TS 102 223 [32] clause 6.8.26.

## 6.9 Proactive UICC session and ME display interaction

See ETSI TS 102 223 [32] ] clause 6.9.

## 6.10 Handling of unknown, unforeseen and erroneous messages

See ETSI TS 102 223 [32] ] clause 6.10.

## 6.11 Proactive commands versus possible Terminal response

Table 6.1 shows for each proactive command the possible terminal response returned (marked by a "•" character), in addition to those defined in ETSI TS 102 223 [32] ] clause 6.11.

**Table 6.1: Proactive commands versus possible terminal response**

| TERMINAL RESPONSE |   | PROACTIVE COMMAND |         |           |          |  |  |  |  |
|-------------------|---|-------------------|---------|-----------|----------|--|--|--|--|
|                   |   | SET UP CALL       | SEND SS | SEND USSD | SEND SMS |  |  |  |  |
|                   |   | '10'              | '11'    | '12'      | '13'     |  |  |  |  |
| 00                | Command performed successfully  | •                 | •       | •         | •        |  |  |  |  |
| 01                | Command performed with partial comprehension                              | •                 | •       | •         | •        |  |  |  |  |
| 02                | Command performed, with missing information                               | •                 | •       | •         | •        |  |  |  |  |
| 03                | REFRESH performed with additional EFs read                                |                   |         |           |          |  |  |  |  |
| 04                | Command performed successfully, but requested icon could not be displayed | •                 | •       | •         | •        |  |  |  |  |
| 05                | Command performed, but modified by call control by USIM                   | •                 |         | •         |          |  |  |  |  |
| 06                | Command performed successfully, limited service                           |                   |         |           |          |  |  |  |  |
| 07                | Command performed with modification                                       |                   |         |           |          |  |  |  |  |
| 08                | REFRESH performed but indicated USIM was not active                       |                   |         |           |          |  |  |  |  |
| 09                | Command performed successfully, tone not played                           |                   |         |           |          |  |  |  |  |
| 10                | Proactive UICC session terminated by the user                             | •                 |         |           |          |  |  |  |  |
| 11                | Backward move in the proactive UICC session requested by the user         |                   |         |           |          |  |  |  |  |
| 12                | No response from user   |                   |         |           |          |  |  |  |  |
| 13                | Help information required by the user                                     |                   |         |           |          |  |  |  |  |
| 14                | USSD or SS Transaction terminated by user                                 | •                 | •       | •         |          |  |  |  |  |
| 20                | ME currently unable to process command                                    | •                 | •       | •         | •        |  |  |  |  |
| 21                | Network currently unable to process command                               | •                 | •       | •         | •        |  |  |  |  |
| 22                | User did not accept the proactive command                                 | •                 |         |           |          |  |  |  |  |
| 23                | User cleared down call before connection or network release               | •                 |         |           |          |  |  |  |  |
| 24                | Action in contradiction with the current timer state                      |                   |         |           |          |  |  |  |  |
| 25                | Interaction with call control by USIM, temporary problem                  | •                 | •       | •         |          |  |  |  |  |
| 26                | Launch browser generic error  |                   |         |           |          |  |  |  |  |
| 27                | MMS Temporary Problem   |                   |         |           |          |  |  |  |  |
| 30                | Command beyond MEs capabilities   | •                 | •       | •         | •        |  |  |  |  |
| 31                | Command type not understood by ME   | •                 | •       | •         | •        |  |  |  |  |
| 32                | Command data not understood by ME   | •                 | •       | •         | •        |  |  |  |  |
| 33                | Command number not known by ME  | •                 | •       | •         | •        |  |  |  |  |
| 34                | SS Return Error   | •                 | •       |           |          |  |  |  |  |
| 35                | SMS RPERROR   |                   |         |           | •        |  |  |  |  |
| 36                | Error, required values are missing  | •                 | •       | •         | •        |  |  |  |  |
| 37                | USSD return error   |                   |         | •         |          |  |  |  |  |
| 38                | Multiple Card command error   |                   |         |           |          |  |  |  |  |
| 39                | Interaction with call/SM control by USIM, permanent problem               | •                 | •       | •         | •        |  |  |  |  |
| 3A                | Bearer Independent Protocol error   |                   |         |           |          |  |  |  |  |
| 3B                | Access Technology unable to process command                               |                   |         |           |          |  |  |  |  |
| 3C                | Frames error  | •                 |         |           |          |  |  |  |  |
| 3D                | MMS Error   |                   |         |           |          |  |  |  |  |

---

## 7 ENVELOPE Commands

### 7.1 Data download to UICC

#### 7.1.1 SMS-PP data download

##### 7.1.1.1 Procedure

If the service "data download via SMS Point-to-point" is allocated and activated in the USIM Service Table (see TS 31.102 [14]), then the ME shall follow the procedure below:

- when the ME receives a Short Message with:
  - protocol identifier = SIM data download; and
  - data coding scheme = class 2 message; or
- when the ME receives a Short Message with:
  - protocol identifier=ANSI-136 R-DATA (see TS 23.040 [7]); and
  - data coding scheme = class 2 message, and the ME chooses not to handle the message (e.g. MEs not supporting EGPRS over TIA/EIA-136 do not need to handle the message).
- then the ME shall pass the message transparently to the UICC using the ENVELOPE (SMS-PP DOWNLOAD) command as defined below;
- the ME shall not display the message, or alert the user of a short message waiting;
- the ME shall wait for an acknowledgement from the UICC;
- if the UICC responds with '90 00', the ME shall acknowledge the receipt of the short message to the network using an RP-ACK message. The response data from the UICC will be supplied by the ME in the TP-User-Data element of the RP-ACK message it will send back to the network (see TS 23.040 [5] and TS 24.011 [10]). The values of protocol identifier and data coding scheme in RP-ACK shall be as in the original message;
- if the UICC responds with '93 00', the ME shall either retry the command or send back an RP-ERROR message to the network with the TP-FCS value indicating 'SIM Application Toolkit Busy' (see TS 23.040 [5]).
- If the UICC responds with '6F XX', the ME shall send back an RP-ERROR message to the network with the TP-FCS value indicating "UICC data download error". The values of protocol identifier and data coding scheme in RP-ERROR shall be as in the original message;

NOTE: The preferred way for a USAT application to indicate a Data Download error is by using the specific code '62 XX' or '63 XX' as described in the following bullet point.

- if the UICC responds with '62 XX' or '63 XX', the ME shall acknowledge the receipt of the short message to the network using an RP-ERROR message. The response data from the UICC will be supplied by the ME in the TP-User-Data element of the RP-ERROR message it will send back to the network (see TS 23.040 [5] and TS 24.011 [10]). The values of protocol identifier and data coding scheme in RP-ERROR shall be as in the original message. The value of the TP-FCS element of the RP-ERROR shall be "SIM data download error".

If the service "data download via SMS-PP" is not available in the USIM Service Table, and the ME receives a Short Message with the protocol identifier = SIM data download and data coding scheme = class 2 message, then the ME shall store the message in EF<sub>SMS</sub> in accordance with TS 31.102 [14].

### 7.1.1.2 Structure of ENVELOPE (SMS-PP DOWNLOAD)

Direction: ME to UICC.

The command header is specified in TS 31.101 [13].

Command parameters/data.

| Description  | Clause | M/O/C | Min         | Length |
|--|--------|-------|-------------|--------|
| SMS-PP download tag  | 9.1    | M     | Y           | 1      |
| Length (A+B+C)   | -      | M     | Y           | 1 or 2 |
| Device identities  | 8.7    | M     | Y           | A      |
| Address  | 8.1    | M     | N(see note) | B      |
| SMS TPDU (SMS-DELIVER)   | 8.13   | M     | Y           | C      |
| Note: The UICC shall be able to manage the situation when the address field is not present, in order to ensure backwards compatibility with previous releases of this specification. |        |       |             |        |

- Device identities: the ME shall set the device identities to:
  - source: Network;
  - destination: UICC.
- Address: The address data object holds the RP\_Originating\_Address of the Service Centre (TS-Service-Centre-Address), as defined in TS 24.011 [10].

Response parameters/data.

It is permissible for the UICC not to provide response data. If the UICC provides response data, the following data is returned.

| Byte(s)     | Description          | Length |
|-------------|----------------------|--------|
| 1-X (X≤128) | UICC Acknowledgement | X      |

## 7.1.2 Cell Broadcast data download

### 7.1.2.1 Procedure

If the service "data download via SMS-CB" is available in the USIM Service Table (see TS 31.102 [14]), then the ME shall follow the procedure below:

- when the ME receives a new Cell Broadcast message, the ME shall compare the message identifier of the Cell Broadcast message with the message identifiers contained in EF<sub>CBMID</sub>;
- In the case of a GSM Cell Broadcast message, if the message identifier is found in EFCBMID, the cell broadcast page is passed to the UICC using the ENVELOPE (CELL BROADCAST DOWNLOAD) command, defined below. The ME shall not display the message;
- In the case of a UMTS Cell Broadcast message, if the message identifier is found in EFCBMID, the ME shall deconstruct the UMTS Cell Broadcast message Parameter into its Cell Broadcast pages, and reconstruct each page in the format of the GSM Cell Broadcast Message Parameter, as described below, and according to the definition of the Cell Broadcast message structure in TS 23.041[6]:
  - 1) From the Number-of-Pages byte of the UMTS message, the ME shall obtain the number of Cell Broadcast pages to be constructed.
  - 2) For each page the ME shall reconstruct GSM Cell Broadcast Page header as follows:

- The 2-byte Serial Number of the UMTS message shall be mapped to the reconstructed GSM message Serial Number.
- The 2-byte Message ID of the UMTS message shall be mapped to the reconstructed GSM message Message ID.
- The 1-byte Data Coding Scheme of the UMTS message shall be mapped to the reconstructed GSM message Data Coding Scheme.
- The 1-byte Number-Of-Pages of the UMTS message in combination with the current page"s sequence number (based on the order of the pages in the UMTS message) shall be formatted into the reconstructed GSM message Page Parameter byte, as described in TS 23.041[6].
- The respective 82 byte CBS-Message-Information-Page shall be mapped to the reconstructed GSM message content.

**Table: Cell Broadcast Message Parameter Element mapping**

| Network – ME (UMTS Cell Broadcast Message) | ME-USAT interface (GSM Cell Broadcast Message Format) |
|--|---|
| Message ID                                 | Message ID  |
| Serial Number                              | Serial Number   |
| Data Coding Scheme                         | Data Coding Scheme                                    |
| Number-Of –Pages                           | Page Parameter (Note)                                 |
| CBS-Message-Information-Page               | Content of Message                                    |

NOTE: The Page Parameter byte is constructed from the total number of pages as indicated in the UMTS CB message, in combination with the current page"s sequence number (based on the order of the pages in the UMTS message).

- Each of the resulting pages shall then be passed to the UICC using the ENVELOPE (CELL BROADCAST DOWNLOAD) command, defined below. The ME shall not display the message;
- if the message identifier of the incoming cell broadcast message is not found in EFCBMID, then the ME shall determine if the message should be displayed, by following the procedures in TS 23.041 [6] and TS 31.102 [14].
- if the UICC responds with '93 00', the ME shall consider that the Cell Broadcast page has not been delivered successfully. The ME may retry to deliver the same Cell Broadcast page.

The ME shall identify new cell broadcast pages by their message identifier, serial number and page values.

### 7.1.2.2 Structure of ENVELOPE (CELL BROADCAST DOWNLOAD)

Direction: ME to UICC.

The command header is specified in TS 31.101 [13].

Command parameters/data.

| Description                 | Clause | M/O/C | Min | Length |
|-----------------------------|--------|-------|-----|--------|
| Cell Broadcast Download tag | 9.1    | M     | Y   | 1      |
| Length (A+B)                | -      | M     | Y   | 1 or 2 |
| Device identities           | 8.7    | M     | Y   | A      |
| Cell Broadcast page         | 8.5    | M     | Y   | B      |

- Device identities: the ME shall set the device identities to:
  - source: Network;
  - destination: UICC.

Response parameters/data: None for this type of ENVELOPE command.

## 7.2 Menu Selection

See ETSI TS 102 223 [32] ] clause 7.2.

If the UICC responds with '93 00', the ME shall not re-issue this particular envelope.

## 7.3 Call Control and MO SMS control by USIM

### 7.3.1 Call Control by USIM

#### 7.3.1.1 Procedure for mobile originated calls

If the service "call control" is available in the USIM Service Table (see TS 31.102 [14]), then the ME shall follow the procedure described in ETSI TS 102 223 [32] with the additional rules listed here:

- when the user is dialling "112" or an emergency call code stored in EF<sub>ECC</sub>, the ME shall set up an emergency call instead of passing the call set-up details to the UICC;
- if the UICC provides response data, then in addition to the response data listed by ETSI TS 102 223 [32] clause 7.3.1.6, the response data from the UICC may indicate to the ME to send instead a supplementary service or USSD operation using the data supplied by the UICC. It is then mandatory for the ME to perform the supplementary service or USSD operation in accordance with the data from the UICC, if it is within the ME's capabilities to do so. If the UICC requires a supplementary service or USSD operation that is beyond the ME's capabilities, then the ME shall not perform the supplementary service or USSD operation at all.
- If, as a result of the procedure, the UICC supplies a number stored in EF<sub>ECC</sub>, this shall not result in an emergency call.

In the case where the initial call set-up request results from a proactive command SET UP CALL:

- if the call control result is "not allowed", the ME shall inform the UICC using TERMINAL RESPONSE "interaction with call control by UICC or MO short message control by USIM, permanent problem; action not allowed";
- if the call set-up request is changed by call control in a supplementary service or USSD operation, and if the supplementary service or USSD operation is within the ME's capabilities, then the ME shall send this request to the network. The ME shall then send back a TERMINAL RESPONSE to the SET UP CALL command at the same time it would have done for the proactive command equivalent to the action requested by call control (i.e. SEND SS or SEND USSD). However, in that case, the TERMINAL RESPONSE shall contain the response data given in the response to ENVELOPE (CALL CONTROL) and a second Result TLV identical to the one given in response to the proactive command equivalent to the action requested by call control (i.e. SEND SS or SEND USSD). The mapping between the general result in the first Result TLV and the general result in the second Result TLV is given below:

the general result "command performed, but modified by call control by USIM" shall be given in the first Result TLV if the general result of the second Result TLV is '0X' or '1X';

the general result "interaction with call control by USIM, temporary problem" shall be given in the first Result TLV if the general result of the second Result TLV is '2X';

the general result "interaction with call control by USIM or MO short message control by USIM, permanent problem" shall be given in the first Result TLV if the general result of the second Result TLV is '3X';

- if the call set-up request is changed by call control into a supplementary service or USSD operation, and if the supplementary service or USSD operation is beyond the ME's capabilities, then the ME shall send back a TERMINAL RESPONSE to the SET UP CALL command, without performing the supplementary service or USSD operation at all. In that case, the TERMINAL RESPONSE shall contain the response data given in the response to ENVELOPE (CALL CONTROL) and a second Result TLV identical to the one given in response to the proactive command equivalent to the action requested by call control (i.e. SEND SS or SEND USSD). The mapping between the general result in the first Result TLV and the general result in the second Result TLV is given below:

the general result "interaction with call control by USIM or MO short message control by USIM, permanent problem" shall be given in the first Result TLV, and the general result "command beyond ME's capabilities" shall be given in the second Result TLV.

The ME shall then follow the call set-up procedure defined in TS 24.008 [9] or the supplementary service or USSD operation procedure defined in TS 24.080 [11].

### 7.3.1.2 Procedure for Supplementary Services and USSD

If the service "call control" is available in the USIM Service Table (see TS 31.102 [14]), then for all supplementary service and USSD operations (including those resulting from a SEND SS or SEND USSD proactive UICC command), the ME shall first pass the supplementary service or USSD control string (corresponding to the supplementary service or USSD operation and coded as defined in TS 22.030 [2], even if this SS or USSD operation has been performed via a specific menu of the ME) to the UICC, using the ENVELOPE (CALL CONTROL) command defined below. The ME shall also pass to the UICC in the ENVELOPE (CALL CONTROL) command the current serving cell.

The UICC shall respond in the same way as for mobile originated calls. The ME shall interpret the response as follows:

- if the UICC responds with '90 00', the ME shall send the supplementary service or USSD operation with the information as sent to the UICC;
- if the UICC responds with any status code indicating an error, the ME shall not send the supplementary service or USSD;
- if the UICC responds with '93 00', the ME shall not send the supplementary service or USSD operation and may retry the command;
- if the UICC provides response data, then the response data from the UICC shall indicate to the ME whether to send the supplementary service or USSD operation as proposed, not send the SS or USSD operation, send the SS or USSD operation using the data supplied by the UICC, or instead set up a call using the data supplied by the UICC. It is mandatory for the ME to perform the supplementary service or USSD operation or the call set-up request in accordance with the data from the UICC, if it is within the ME's capabilities to do so. If the UICC requires a call set-up or supplementary service or USSD operation that is beyond the ME's capabilities (e.g. the UICC maps a USSD operation to a data call, and the ME does not support data calls), then the ME shall not perform the call set-up request or supplementary service or USSD operation at all.

In the case where the initial SS or USSD request results from a proactive command SEND SS or SEND USSD:

- if the call control result is "not allowed", the ME shall inform the UICC using TERMINAL RESPONSE ("interaction with call control by UICC or MO short message control by UICC, action not allowed");
- if the SS or USSD request is changed by call control in a call set-up request, then the ME shall set up the call using the data given by the UICC, if it is within the ME's capabilities to do so. If the UICC requires a call set-up that is beyond the ME's capabilities (e.g. the UICC maps a USSD operation to a data call, and the ME does not support data calls), then the ME shall not set up the call at all. The ME shall send back a TERMINAL RESPONSE to the initial proactive command at the same time it would have done for the proactive command equivalent to the action requested by call control (i.e. SET UP CALL). However, in that case, the TERMINAL RESPONSE shall contain the response data given in the response to ENVELOPE (CALL CONTROL) and a second Result TLV identical to the one given in response to the proactive command equivalent to the action requested by call control (i.e. SET UP CALL). The mapping between the general result in the first Result TLV and the general result in the second Result TLV is the same as the one described in clause 7.3.1.1.

If the ME supports the Last Number Dialed service, the ME shall update EF<sub>LND</sub> with the supplementary service or USSD control string corresponding to the initial user request.

The ME shall then follow the supplementary service or USSD operation procedure defined in TS 24.080 [11] or the call set-up procedure defined in TS 24.008 [9].

### 7.3.1.3 Indication to be given to the user

The UICC may optionally include an alpha-identifier in the response data to the ENVELOPE (CALL CONTROL) message, in order to inform the user at the time the response is received by the ME. The use of this alpha identifier by the ME is described below:

- if the UICC responds with "allowed, no modification", then:
  - if the alpha identifier is provided by the UICC and is not a null data object, the ME shall use it to inform the user during the PDP context activation or call set-up;
  - if the alpha identifier is provided by the UICC and is a null data object (i.e. length = '00' and no value part), this is an indication that the ME should not modify the display corresponding to the initial user request;
  - if the alpha identifier is not provided by the UICC, the ME may give information to the user concerning what is happening;
- if the UICC responds with "not allowed", then:
  - if the alpha identifier is provided by the UICC and is not a null data object, the ME shall use it to inform the user. This is also an indication that the ME should not give any other information to the user on the reason of the barring;
  - if the alpha identifier is provided by the UICC and is a null data object (i.e. length = '00' and no value part), the ME may give information to the user concerning what is happening;
  - if the alpha identifier is not provided by the UICC, the ME may give information to the user concerning what is happening.
- if the UICC responds with "allowed, with modifications", and the modified request is within the ME's capabilities, then:
  - if the alpha identifier is provided by the UICC and is not a null data object, the ME shall use it to inform the user. The ME shall then not display the destination address or SS string given by the UICC. This is also an indication that the ME should not give any other information to the user on the changes made by the UICC to the initial user request;
  - if the alpha identifier is provided by the UICC and is a null data object (i.e. length = '00' and no value part), this is an indication that the ME should not give any information to the user on the changes made by the UICC to the initial user request. The ME shall not display the destination address or SS string given by the UICC. The ME should not modify the display corresponding to the initial user request;
  - if the alpha identifier is not provided by the UICC, the ME may indicate to the user that the initial user request has been changed.
- if the UICC responds with "allowed, with modifications" to a user-initiated request (i.e. a request not initiated by a proactive command), and the modified user request is beyond the ME's capabilities, then the ME may give information to the user on the modified request and the fact that the modified request is beyond the ME's capabilities, optionally using the alpha identifier, if one is provided by the UICC;
- if the UICC responds with "allowed, with modifications" to a request by a proactive command SET UP CALL, SEND SS, SEND USSD or OPEN CHANNEL where GPRS is selected, and the modified request is beyond the ME's capabilities, then the ME shall not give any information to the user on the fact that the modified request is beyond the ME's capabilities, and shall give a TERMINAL RESPONSE to the proactive command (i.e. SET UP CALL, SEND SS, SEND USSD or OPEN CHANNEL) as detailed in clauses 7.3.1.1, 7.3.1.2 and 7.3.1.3. The responsibility to inform the user in this case lies with the UICC application which sent the proactive command.



### 7.3.1.4 Interaction with Fixed Dialling Number

The procedure defined in ETSI TS 102 223 [32] clause 7.3.1.4 for calls applies. In addition, it shall apply in the same way for supplementary service operations, the supplementary service control string being checked as if it was a called number.

The ME shall check the number (or the supplementary service control string) in accordance with TS 22.101 [34].

### 7.3.1.5 Support of Barred Dialling Number (BDN) service

The procedure defined in ETSI TS 102 223 [32] clause 7.3.1.5 for calls applies. In addition, it shall apply in the same way for supplementary service operations, the supplementary service control string being checked as if it was a called number.

The ME shall check the number (or the supplementary service control string) in accordance with TS 22.101 [34].

### 7.3.1.6 Structure of ENVELOPE (CALL CONTROL)

Direction: ME to UICC.

The command header is specified in TS 31.101 [13].

Command parameters/data.

| Description  | Clause                    | M/O/C | Min | Length |
|--|---------------------------|-------|-----|--------|
| Call control tag   | 9.1                       | M     | Y   | 1      |
| Length (A+B+C+D+E+F)   | -                         | M     | Y   | 1 or 2 |
| Device identities  | 8.7                       | M     | Y   | A      |
| Address or SS string or USSD string or PDP context activation parameters | 8.1, 8.14 or 8.17 or 8.72 | M     | Y   | B      |
| Capability configuration parameters 1                                    | 8.4                       | O     | N   | C      |
| Subaddress   | 8.3                       | O     | N   | D      |
| Location information   | 8.19                      | M     | N   | E      |
| Capability configuration parameters 2                                    | 8.4                       | O     | N   | F      |

- Device identities: the ME shall set the device identities to:

source: ME;

destination: UICC.

- Address or SS string or USSD string or PDP context activation parameters: only one data object shall be sent to the UICC:

for a call set-up, the address data object is used and holds the Called Party Number, as defined in TS 24.008 [9], to which the ME is proposing setting up the call;

for a supplementary service, the SS string data object is used and holds the corresponding supplementary service;

for a USSD operation, the USSD string data object is used and holds the corresponding USSD control string;

USIM Applications and MEs should take into account that early implementations of USAT use the SS string data object for coding of USSD control strings (instead of the USSD string data object). This behaviour is only possible for USSD control strings consisting of digits (0-9,\*,#). The UICC can identify MEs having this early implementation by evaluating the indication "USSD string data object supported in Call Control" in the TERMINAL PROFILE. The ME can identify USIMs having this early implementation by evaluating the indication "USSD string data object supported in Call Control" in the USIM Service Table.

for a PDP context activation, the Activate PDP context request parameters are used, as defined in TS 24.008 [9].

- Capability configuration parameters: Only used for a call set-up, this contains the Bearer capabilities that the ME is proposing to send to the network. The first capability configuration parameters corresponds to the bearer capability 1 information element of a mobile originating SETUP message, as defined in TS 24.008 [9]. The second capability configuration parameters correspond to the bearer capability 2 information element of a mobile originating SETUP message, as defined in TS 24.008 [9]. If no capability configuration parameters are present, this shall indicate a speech call.
- Subaddress: Only used for a call set-up, this contains the called party subaddress that the ME is proposing to send to the network. If one is not present, this shall indicate that the ME is proposing not to send this information element to the network.
- Location information: This data object contains the identification (MCC, MNC, LAC, Cell Identity) of the current serving cell of the UE. The comprehension required flag of this data object in this command shall be set to '0'.

Response parameters/data.

It is permissible for the UICC to provide no response data, by responding with SW1/SW2 = '90 00'. If the UICC does not provide any response data, then this shall have the same meaning as "allowed, no modification".

| Description  | Clause                    | M/O/C | Min | Length |
|--|---------------------------|-------|-----|--------|
| Call control result  | -                         | M     | Y   | 1      |
| Length (A+B+C+D+E+F)   | -                         | M     | Y   | 1 or 2 |
| Address or SS string or USSD string or PDP context activation parameters | 8.1, 8.14 or 8.17 or 8.72 | O     | N   | A      |
| Capability configuration parameters 1                                    | 8.4                       | O     | N   | B      |
| Subaddress   | 8.3                       | O     | N   | C      |
| Alpha identifier   | 8.2                       | O     | N   | D      |
| BC repeat indicator  | 8.42                      | C     | N   | E      |
| Capability configuration parameters 2                                    | 8.4                       | O     | N   | F      |

- Call control result:

Contents:

- The command that the UICC gives to the ME concerning whether to allow, bar or modify the proposed call (or supplementary service operation);

Coding:

- '00' = Allowed, no modification;
  - '01' = Not allowed;
  - '02' = Allowed with modifications.
- Address or SS string or USSD string or PDP context activation parameters: Only one data object may be included if the UICC requests the call (or supplementary service or USSD operation or PDP context activation) details to be modified:

for a call set-up, if the address data object is not present, then the ME shall assume the Dialling number is not to be modified;

if the SS string data object or address data object is present and the ME receives wild values according to TS 31.102 [14], then the ME shall not process the command.

for a supplementary service, if the SS string data object is not present, then the ME shall assume that SS is not to be modified;

for a USSD operation, if the USSD string data object is not present, then the ME shall assume that the USSD operation is not to be modified.

for a PDP context activation, if the PDP context activation parameters object is not present, then the ME shall assume that the PDP context activation is not to be modified.

- Capability configuration parameters: Only used for a call set-up, this data object is only required if the USIM application requests the call details to be modified. The first capability configuration parameters corresponds to the bearer capability 1 information element of a mobile originating SETUP message, as defined in TS 24.008 [9]. The second capability configuration parameters corresponds to the bearer capability 2 information element of a mobile originating SETUP message, as defined in TS 24.008 [9]. If the capability configuration parameters are not present, then the ME shall assume the parameters are not to be modified.
- Subaddress: Only used for a call set-up, this data object is only required if the USIM application requests the call details to be modified. If the subaddress is not present, then the ME shall assume the called party subaddress is not to be modified. If the subaddress supplied by the USIM application is a null data object, then the ME shall not provide a called party subaddress to the network. A null data object shall have length = '00' and no value part.
- Alpha identifier: this data object is only required if the UICC requests a particular indication to be given to the user. The handling of this data object by the ME is described in clause 7.3.1.3. The comprehension required flag of this data object shall be set to '0'.
- BC repeat indicator: indicates how the associated bearers shall be interpreted. The change of bearer occurs on a network event. This BC repeat indicator is conditioned to the presence of the second capability configuration parameters and is coded as defined in TS 24.008 [9].

It is mandatory for the UICC to provide at least one of the optional data objects if it has set the Call control result to "allowed with modifications".

### 7.3.1.7 Procedure for PDP Context Activation

If the service "call control on GPRS by USIM" is available in the USIM Service Table (see TS 31.102 [14]), then for all PDP Context activation (including those resulting from a OPEN CHANNEL proactive UICC command where GPRS is selected), the ME shall first pass the corresponding Activate PDP Context message (see TS 24.008 [9]) to the UICC, using the ENVELOPE (CALL CONTROL) command defined below. The ME shall also pass to the UICC in the ENVELOPE (CALL CONTROL) command the current serving cell.

The UICC shall respond in the same way as for mobile originated calls. The ME shall interpret the response as follows:

- if the UICC responds with '90 00', the ME shall send the Activate PDP Context message with the information as sent to the UICC;
- if the UICC responds with '93 00', the ME shall not the Activate PDP Context message and may retry the command;
- if the UICC provides response data, then the response data from the UICC shall indicate to the ME whether to send the Activate PDP Context message as proposed, not send the Activate PDP Context message or send the Activate PDP Context message using the data supplied by the UICC. It is mandatory for the ME to perform the PDP Context Activation in accordance with the data from the UICC, if it is within the ME's capabilities to do so. If the UICC requires PDP Context Activation that is beyond the ME's capabilities, then the ME shall not perform PDP Context Activation at all.

In the case where the initial PDP Context Activation request results from a proactive command OPEN CHANNEL where GPRS is selected:

- if the call control result is "not allowed", the ME shall inform the UICC using TERMINAL RESPONSE ("interaction with call control by UICC or MO short message control by UICC, action not allowed");
- if the PDP Context Activation data is changed by call control, then the ME shall activate the PDP context using the data given by the UICC, if it is within the ME's capabilities to do so. If the UICC requires a PDP Context Activation that is beyond the ME's capabilities (e.g. the UICC requests a QoS that the ME cannot handle ), then the ME shall not activate the PDP context at all.

## 7.3.2 MO Short Message Control by USIM

### 7.3.2.1 Description

If the service "MO Short Message Control" is available in the USIM Service Table (see TS 31.102 [14]), then the ME shall follow the procedure below:

- for all MO short message attempts (even those resulting from a SEND SM proactive UICC command), the ME shall first pass the RP\_destination\_address of the service centre and the TP\_Destination\_Address to the UICC, using the ENVELOPE (MO SHORT MESSAGE CONTROL) command defined below. The ME shall also pass to the UICC in the ENVELOPE (MO SHORT MESSAGE CONTROL) command the current serving cell;
- if the UICC responds with '90 00', the ME shall send the short message with the addresses unchanged;
- if the UICC responds with any other status code indicating an error, the ME shall not send the short message;
- if the UICC responds with '93 00', the ME shall not send the short message and may retry the command;
- if the UICC provides response data, then the response data from the UICC shall indicate to the ME whether to send the short message as proposed, not send the short message or send a short message using the data supplied by the UICC. It is mandatory for the ME to perform the MO short message request in accordance with the data from the UICC.

The ME shall then follow the MO Short Message procedure defined in TS 24.011 [10].

In the case where the initial MO short message request results from a proactive command SEND SHORT MESSAGE, if the MO short message control result is "not allowed", the ME shall inform the UICC using TERMINAL RESPONSE, "interaction with call control by UICC or MO short message control by UICC, action not allowed".

### 7.3.2.2 Structure of ENVELOPE (MO SHORT MESSAGE CONTROL)

Direction: ME to UICC.

The command header is specified in TS 31.101 [13].

Command parameters/data.

| Description                  | Clause | M/O/C | Min | Length |
|------------------------------|--------|-------|-----|--------|
| MO Short Message control tag | 9.1    | M     | Y   | 1      |
| Length (A+B+C+D)             | -      | M     | Y   | 1 or 2 |
| Device identities            | 8.7    | M     | Y   | A      |
| Address data object 1        | 8.1    | M     | Y   | B      |
| Address data object 2        | 8.1    | M     | Y   | C      |
| Location information         | 8.19   | M     | Y   | D      |

- Device identities: the ME shall set the device identities to:  
source: ME;  
destination: UICC.
- Address data object 1: this address data object 1 contains the RP\_Destination\_Address of the Service Centre to which the ME is proposing to send the short message.
- Address data object 2: this address data object 2 contains the TP\_Destination\_Address to which the ME is proposing to send the short message.
- Location information: this data object contains the identification (MCC, MNC, LAC, Cell Identity) of the current serving cell of the UE.

Response parameters/data.

It is permissible for the UICC to provide no response data, by responding with SW1/SW2 = '90 00'. If the UICC does not provide any response data, then this shall have the same meaning as "allowed, no modification".

| Description                     | Clause | M/O/C | Min | Length |
|---------------------------------|--------|-------|-----|--------|
| MO short message control result | -      | M     | Y   | 1      |
| Length (A+B+C)                  | -      | M     | Y   | 1 or 2 |
| Address data object 1           | 8.1    | O     | N   | A      |
| Address data object 2           | 8.1    | O     | N   | B      |
| Alpha identifier                | 8.2    | O     | N   | C      |

- MO Short Message control result:

Contents:

- The command that the UICC gives to the ME concerning whether to allow, bar or modify the proposed short message;

Coding:

- '00' = Allowed, no modification;
- '01' = Not allowed;
- '02' = Allowed with modifications.
- Address data object 1: if the address data object 1 is not present, then the ME shall assume the RP\_Destination\_Address of the Service Centre is not to be modified.
- if the address data object 1 or address data object 2 is present and the ME receives wild values according to TS 31.102 [14], then the ME shall not process the command.
- Address data object 2: if the address data object 2 is not present, then the ME shall assume the TP\_Destination\_Address is not to be modified.
- Alpha identifier: this data object is only required if the UICC requests a particular indication to be given to the user. The handling of this data object by the ME is described in clause 7.3.2.3.

The UICC shall provide the two optional address data objects if it has set the MO Short Message control result to "allowed with modifications".

### 7.3.2.3 Indication to be given to the user

The UICC may optionally include an alpha-identifier in the response data to the ENVELOPE (MO SHORT MESSAGE CONTROL) message, in order to inform the user at the time the response is received by the ME. The use of this alpha identifier by the ME is identical to the one described in clause 7.3.1.3 relative to call control by UICC.

### 7.3.2.4 Interaction with Fixed Dialling Number

It is permissible for the Fixed Dialling Number service to be enabled (see TS 31.102 [14]) at the same time as MO Short Message Control is available (in the USIM Service Table). If FDN is enabled, the ME shall follow the procedure for Call Control (see clause 7.3.1.4), where the number in the procedure refers to both the SMS destination address and the SMSC address.

## 7.4 Timer Expiration

See ETSI TS 102 223 [32] clause 7.4.

## 7.5 Event download

See ETSI TS 102 223 [32] clause 7.5.

Regarding all the call events, the following equivalences shall apply :

- the "call setup message" is the SETUP message as defined in TS 24.008 [09];
- the "call connect message" is the CONNECT message as defined in TS 24.008 [09];
- the "disconnect messages" are the DISCONNECT, RELEASE, RELEASE COMPLETE messages as defined in TS 24.008 [09];
- the "NULL state" is the CC-U0 state as defined in TS 24.008 [09].

Regarding the location status event, the following equivalence shall apply:

- the "idle" state is the MM-IDLE state as defined in TS 24.008 [09].

Where events occur and the UICC responds with '93 00', the ME shall retry to deliver the event download messages to the UICC.

## 7.5.1 I-WLAN Access status event

### 7.5.1.1 Procedure

If the I-WLAN Access Status event is part of the current event list (as set up by the last SET UP EVENT LIST command, see clause 6.4.16), then, when the terminal detects a change in its current I-WLAN access the terminal shall inform the UICC that this has occurred, by using the ENVELOPE (EVENT DOWNLOAD – I-WLAN Access Status) command as defined in clause 7.5.1.2.

### 7.5.1.2 Structure of ENVELOPE (EVENT DOWNLOAD – I-WLAN Access Status)

Direction: terminal to UICC.

The command header is specified in TS 31.101 [13].

Command parameters/data.

| Description          | Clause | M/O | Min | Length |
|----------------------|--------|-----|-----|--------|
| Event download tag   | 9.1    | M   | Y   | 1      |
| Length (A+B+C)       | -      | M   | Y   | 1 or 2 |
| Event list           | 8.25   | M   | Y   | A      |
| Device identities    | 8.7    | M   | Y   | B      |
| I-WLAN Access Status | 8.84   | M   | Y   | C      |

Event list: the Event list data object shall contain only one event (value part of length 1 byte), and terminal shall set the event to:

I-WLAN Access Status.

Device identities: the terminal shall set the device identities to:

source: terminal;

destination: UICC.

I-WLAN Access Status: this data object shall contain the I-WLAN Access status of the terminal.

Response parameters/data: None for this type of ENVELOPE command.

### 7.5.1A MT Call event

See ETSI TS 102 223 [32] clause 7.5.1.

## 7.5.2 Call connected event

See ETSI TS 102 223 [32] clause 7.5.2.

## 7.5.3 Call disconnected event

See ETSI TS 102 223 [32] clause 7.5.3.

## 7.5.4 Location status event

See ETSI TS 102 223 [32] clause 7.5.4.

## 7.5.5 User activity event

See ETSI TS 102 223 [32] clause 7.5.5.

## 7.5.6 Idle screen available event

See ETSI TS 102 223 [32] clause 7.5.6.

## 7.5.7 Card reader status event

See ETSI TS 102 223 [32] clause 7.5.7.

## 7.5.8 Language selection event

See ETSI TS 102 223 [32] clause 7.5.8.

## 7.5.9 Browser termination event

See ETSI TS 102 223 [32] clause 7.5.9.

## 7.5.10 Data available event

See ETSI TS 102 223 [32] clause 7.5.10.

## 7.5.11 Channel status event

See ETSI TS 102 223 [32] clause 7.5.11.

## 7.5.12 Access Technology Change Event

See ETSI TS 102 223 [32] clause 7.5.12.

## 7.5.13 Display parameters changed event

See ETSI TS 102 223 [32] clause 7.5.13.

## 7.5.14 Local Connection event

See ETSI TS 102 223 [32] clause 7.5.14.

## 7.5.15 Network Search Mode Change Event

See ETSI TS 102 223 [32] clause 7.5.15.

## 7.5.16 Browsing status event

See ETSI TS 102 223 [32] clause 7.5.16.

## 7.5.17 Frames Information changed event

See ETSI TS 102 223 [32] clause 7.5.17.

## 7.5.18 HCI connectivity event

Not required by 3GPP.

# 7.6 USSD Data Download

This clause applies if class "p" is supported.

## 7.6.1 Procedure

If the service "data download via USSD and USSD application mode" is allocated and activated in the USIM Service Table (see TS 31.102 [14]), then the ME shall follow the procedure below:

- When the ME receives a USSD packet it shall pass the message transparently to the USIM using the ENVELOPE (USSD DOWNLOAD) if the Data Coding Scheme of the USSD message (as defined for the CBS Data Coding Scheme in TS 23.038 [4]) indicate the USIM as the target (Bit 0 set to 0 and Bit 1 set to 1):
  - The ME shall wait for an acknowledgement from the USIM:
    - if the UICC responds with '90 00', the ME shall acknowledge the receipt of USSD message to the network using a FACILITY message. The ME will supply the response data from the UICC in the USSD String of the return result component of the FACILITY message it will send back to the network (see TS 24.090 [37]). The alphabet and language indicators shall be those used in the original message.
    - if the USIM responds with '93 00', the ME shall either retry the command or send back a FACILITY message to the network. The ME will supply the status word followed by the response data from the UICC in the USSD String of the return result component of the FACILITY message it will send back to the network (see TS 24.090 [37]). The alphabet and language indicators shall be those used in the original message.
    - if the UICC responds with '62 XX' or '63 XX', the ME shall acknowledge the receipt of the USSD message to the network using a FACILITY message. The ME will supply the status word followed by the response data from the UICC in the USSD String of the return result component of the FACILITY message it will send back to the network (see TS 24.090 [37]). The alphabet and language indicators shall be those used in the original message.

If the service "data download via USSD and USSD application mode" is not allocated and activated in the USIM Service Table, and the ME receives a USSD message with a Data Coding Scheme indicating that the destination is the card (as defined above), the ME shall return a FACILITY message to the network. The ME will supply the status word '6D 00' (i.e. Instruction code not supported or invalid) in the USSD String of the return result component of the FACILITY message it will send back to the network (see TS 24.090 [37]). The alphabet and language indicators shall be those used in the original message.

## 7.6.2 Structure of ENVELOPE (USSD Data Download)

Direction: ME to UICC

The command header is specified in TS 31.101 [13].

Command parameters/data:



| Description       | Section | M/O | Min | Length |
|-------------------|---------|-----|-----|--------|
| USSD Download tag | 9.1     | M   | Y   | 1      |
| Length (A+B)      | -       | M   | Y   | 1 or 2 |
| Device identities | 8.7     | M   | Y   | A      |
| USSD string       | 8.17    | M   | Y   | B      |

- Device identities: the ME shall set the device identities to:

Source: Network

Destination: UICC

Response parameters/data:

It is permissible for the UICC not to provide response data. If the UICC provides response data, the following data is returned.

| Byte(s)              | Description   | Length |
|----------------------|---------------|--------|
| 1-X ( $X \leq 182$ ) | UICC response | X      |

## 7.7 MMS Transfer Status

See ETSI TS 102 223 [32] clause 7.6.

## 7.8 MMS notification download

See ETSI TS 102 223 [32] clause 7.7.

Considering the addressing mechanism to the UICC indicated in ETSI TS 102 223 [32] clause 7.7, the UICC shall be targeted using the following application identifier: "uicc.3gpp.org".

## 7.9 Terminal Applications

See ETSI TS 102 223 [32] clause 7.8.

---

# 8 COMPREHENSION-TLV data objects

The coding of the TLV objects is as described in ETSI TS 102 223 [32] clause 8, except when stated otherwise in the present document.

## 8.1 Address

See ETSI TS 102 223 [32] clause 8.1.

## 8.2 Alpha identifier

See ETSI TS 102 223 [32] clause 8.2.

## 8.3 Subaddress

See ETSI TS 102 223 [32] clause 8.3.

## 8.4 Capability configuration parameters

| Byte(s)              | Description                             | Length |
|----------------------|---|--------|
| 1                    | Capability configuration parameters tag | 1      |
| 2 to (Y-1)+2         | Length (X)                              | Y      |
| (Y-1)+3 to (Y-1)+X+2 | Capability configuration parameters     | X      |

Capability configuration parameters are coded as for EF<sub>CCP</sub>. If it is being provided by the UICC, the UICC shall supply all information required to complete the Bearer Capability Information Element in the Call Set-up message (see TS 24.008 [9]). Any unused bytes at the end of the value part shall be coded 'FF'.

See TS 31.102 [14] for the coding of all EFs.

NOTE: The second byte of this TLV contains the Length of the TLV and the third byte contains the Length of the bearer capability contents, followed by the actual contents.

## 8.5 Cell Broadcast Page

| Byte(s) | Description                | Length |
|---------|----------------------------|--------|
| 1       | Cell Broadcast page tag    | 1      |
| 2       | Length = '58' (88 decimal) | 1      |
| 3 – 90  | Cell Broadcast page        | 88     |

The Cell Broadcast page is formatted in the same way as the GSM Cell Broadcast Message Parameter, as described in TS 23.041 [6].

## 8.6 Command details

The content and the coding of the Command Details TLV object is defined in ETSI TS 102 223 [32] clause 8.6, except for the following.

The coding of the Command Qualifier is defined for the following commands:

- SEND SS:  
this byte is RFU.
- SEND USSD:  
this byte is RFU.
- PROVIDE LOCAL INFORMATION. The following additional values are defined:
  - '00' = Location Information (MCC, MNC, LAC, Cell Identity and Extended Cell Identity)
  - '02' = Network Measurement results.
  - '05' = Timing Advance.
  - '0C' = current WSID.

The following values do not apply

- '07' = Reserved by ETSI (ESN)
- '0B' = Reserved by ETSI (MEID)
- REFRESH. The following additional values are defined:
  - '07' = Steering of Roaming.

## 8.7 Device identities

See ETSI TS 102 223 [32] clause 8.7.

## 8.8 Duration

See ETSI TS 102 223 [32] clause 8.8.

## 8.9 Item

See ETSI TS 102 223 [32] clause 8.9.

## 8.10 Item identifier

See ETSI TS 102 223 [32] clause 8.10.

## 8.11 Response length

See ETSI TS 102 223 [32] clause 8.11.

## 8.12 Result

For the general result byte coding the following values are defined in addition to or replacement of those in ETSI TS 102 223 [32] clause 8.12:

- '14' = USSD or SS transaction terminated by the user
- '34' = SS Return Error;
- '35' = SMS RP-ERROR;
- '37' = USSD Return Error;
- '39' = Interaction with call control by USIM or MO short message control by USIM, permanent problem;
- Additional information:

Contents:

- For the general result "Command performed successfully", some proactive commands require additional information in the command result. This is defined in the clauses below. For the general result values '20', '21', '34', '35', '37', and '39', it is mandatory for the ME to provide a specific cause value as additional information, as defined in the clauses below. For other values, see ETSI TS 102 223 [32] clause 8.12.

### 8.12.1 Additional information for SEND SS

When the ME issues a successful general result for a SEND SS proactive command, it shall also include the Operation Code and Parameters included in the Return Result component from the network, as additional information.

The first byte of the additional information shall be the SS Return Result Operation code, as defined in TS 24.080 [11].

The rest of the additional information shall be the SS Return Result Parameters, as defined in TS 24.080 [11].

### 8.12.2 Additional information for ME problem

For the general result "ME currently unable to process command", it is mandatory for the ME to provide additional information, the first byte of which to be as defined in ETSI TS 102 223 [32] clause 8.12.2, with the addition of the following value:

- '03' = ME currently busy on SS transaction;
- '08' = ME currently busy on USSD transaction.

### 8.12.3 Additional information for network problem

For the general result "network currently unable to process command", it is mandatory for the ME to provide additional information. The first byte shall be the cause value of the Cause information element returned by the network (as defined in TS 24.008 [9]). Bit 8 shall be set to '1'. One further value is defined:

- '00' = No specific cause can be given.

All other values shall be interpreted by the UICC as '00'. The coding '00' shall only be used by the ME if no others apply.

### 8.12.4 Additional information for SS problem

For the general result "SS Return Error", it is mandatory for the ME to provide additional information. The first byte shall be the error value given in the Facility (Return Error) information element returned by the network (as defined in TS 24.080 [11]). One further value is defined:

- '00' = No specific cause can be given.

All other values shall be interpreted by the UICC as '00'. The coding '00' shall only be used by the ME if no others apply.

### 8.12.5 Additional information for SMS problem

For the general result "SMS RP-ERROR", it is mandatory for the ME to provide additional information. The first byte shall be the cause value given in the RP-Cause element of the RP-ERROR message returned by the network (as defined in TS 24.011 [10]), with bit 8 = 0. One further value is defined:

- '00' = No specific cause can be given.

All other values shall be interpreted by the UICC as '00'. Specific cause '00' shall only be used by the ME if no others apply.

### 8.12.6 Not used

### 8.12.7 Additional information for USSD problem

For the general result "USSD Return Error", the ME shall provide additional information. The first byte shall be the error value given in the Facility (Return Error) information element returned by the network (as defined in TS 24.080 [11]). One further value is defined:

- '00' = No specific cause can be given.

All other values shall be interpreted by the UICC as '00'.

The coding '00' shall only be used by the ME if no others apply.

### 8.12.8 Additional information for interaction with call control or MO SM control

For the general result "interaction with call control by USIM or MO short message control by USIM, permanent problem", it is mandatory for the ME to provide additional information, the first byte of which to be as defined below:

- '00' = No specific cause can be given;

- '01' = Action not allowed;
- '02' = The type of request has changed.

All other values shall be interpreted by the UICC as '00'. The coding '00' shall only be used by the ME if no others apply.

### 8.12.9 Additional information for MultipleCard commands

See ETSI TS 102 223 [32] clause 8.12.9

### 8.12.10 Additional information for launch browser problem

See ETSI TS 102 223 [32] clause 8.12.10

### 8.12.11 Additional information for Bearer Independent Protocol

See ETSI TS 102 223 [32] clause 8.12.11

### 8.12.12 Additional information for Frames commands

See ETSI TS 102 223 [32] clause 8.12.12

### 8.12.13 Additional information for SUBMIT and RETRIEVE MULTIMEDIA MESSAGE

See ETSI TS 102 223 [32] clause 8.12.13

## 8.13 SMS TPDU

| Byte(s)              | Description  | Length |
|----------------------|--------------|--------|
| 1                    | SMS TPDU tag | 1      |
| 2 to (Y-1)+2         | Length (X)   | Y      |
| (Y-1)+3 to (Y-1)+X+2 | SMS TPDU     | X      |

The TPDU is formatted as described in TS 23.040 [5].

Where the TPDU is being sent from the UICC to the ME (to be forwarded to the network), and where it includes a TP-Message-Reference which is to be incremented by the ME for every outgoing message, the TP-Message-Reference as provided by the UICC need not be the valid value. TP-Message-Reference shall be checked and corrected by the ME to the value described in TS 23.040 [5].

## 8.14 SS string

| Byte(s)              | Description       | Length |
|----------------------|-------------------|--------|
| 1                    | SS string tag     | 1      |
| 2 to (Y-1)+2         | Length (X)        | Y      |
| (Y-1)+3              | TON and NPI       | 1      |
| (Y-1)+4 to (Y-1)+X+2 | SS or USSD string | X - 1  |

TON/NPI and SS or USSD control string are coded as for EF<sub>ADN</sub>, where the ADN record relates to a Supplementary Service Control string. See TS 31.102 [14] for the coding of EF<sub>ADN</sub>.

## 8.15 Text string

Content and coding is defined ETSI TS 102 223 [32] clause 8.15, with the following requirement:

Data coding scheme is coded as for SMS Data coding scheme defined in TS 23.038 [4]. Parts of the data coding scheme other than the character set indication shall be ignored.

## 8.16 Tone

See ETSI TS 102 223 [32] clause 8.16.

NOTE: Standard supervisory tones for 3G are specified in TS 22.001 [22].

## 8.17 USSD string

| Byte(s)              | Description        | Length |
|----------------------|--------------------|--------|
| 1                    | USSD string tag    | 1      |
| 2 to (Y-1)+2         | Length (X)         | Y      |
| (Y-1)+3              | Data coding scheme | 1      |
| (Y-1)+4 to (Y-1)+X+2 | USSD string        | X-1    |

The Data coding scheme is coded as for Cell Broadcast defined in TS 23.038 [4]. The coding of the USSD string is defined in TS 22.030 [2].

NOTE 1: The MMI mode uses a 7 bit character set, the Application mode uses a 8 bit character set.

NOTE2: The DCS is set to 0x96 to indicate that the USSD string is formatted according to TS 31.115 [41].

## 8.18 File List

See ETSI TS 102 223 [32] clause 8.18.

## 8.19 Location Information

| Byte(s)   | Description                                | Length |
|---|--|--------|
| 1   | Location Information tag                   | 1      |
| 2   | Length = '09' or '07' (see Note)           | 1      |
| 3 - 5   | Mobile Country & Network Codes (MCC & MNC) | 3      |
| 6 - 7   | Location Area Code (LAC)                   | 2      |
| 8 - 9   | Cell Identity Value (Cell ID)              | 2      |
| 10 - 11   | Extended Cell identity Value (see Note)    | 2      |
| NOTE: The Extended Cell Identity Value is not available in GERAN. When in GERAN, this field shall not be present and the length field shall be set to "07". |  |        |

The Mobile Country Code (MCC), the Mobile Network Code (MNC) and the Location Area Code (LAC) are coded as in TS 24.008 [9].

For GERAN, the Cell Identity Value is coded as in TS 24.008 [9].

For UTRAN, only the C-id part of the UC-id is returned in the Cell Identity Value (i.e. the 16 least significant bits of the UC-id), as defined in TS 25.401 [35] and TS 25.413 [36].

The Extended Cell identity Value is coded as the RNC-id part of the UC-id, as defined in TS 25.401 [35] and TS 25.413 [36]. It is left padded with zeros (this means that byte 10 contains the 4 most significant bits of the RNC-id value, and byte 11 contains the 8 least significant bits of the RNC-id value).

## 8.20 IMEI

See ETSI TS 102 223 [32] clause 8.20.

## 8.21 Help Request

See ETSI TS 102 223 [32] clause 8.21.

## 8.22 Network Measurement Results

| Byte(s)    | Description                     | Length |
|------------|---------------------------------|--------|
| 1          | Network Measurement Results tag | 1      |
| 2          | Length (X) of bytes following   | 1      |
| 3 – to X+2 | Network Measurement Results     | X      |

For GERAN: The Network Measurement Results are coded as for the Measurement Results information element in TS 44.018 [27], starting at octet 2 (the IEI is removed, as this information is duplicated by the data object tag). The Length shall be set to '10' (16 decimal).

For UTRAN: The Network Measurement Results are coded as for the "MeasurementReport" information element as defined in the ASN.1 description of TS 25.331 [38], according to the following:

- The "Measurement identity" field in the MEASUREMENT REPORT shall be set to the value '1'.
- If "intra-frequency measurements" are requested by USIM, the ME shall, in the MEASUREMENT REPORT, include IE "Intra-frequency measured results list" in IE "Measured Results". The ME shall report CPICH Ec/No, CPICH RSCP and pathloss for the up to 6 strongest (highest Ec/No value) intra-frequency cells, if available in the ME according to TS 25.331 [38] and TS 25.133 [39].
- If "inter-frequency measurements" are requested by USIM, the ME shall, in the MEASUREMENT REPORT, include IE "inter-frequency measured results list" in IE "Measured Results". The ME shall report CPICH Ec/No, CPICH RSCP and pathloss for the up to 6 strongest (highest Ec/No value) inter-frequency cells per monitored frequency, if available in the ME according to TS 25.331 [38] and TS 25.133 [39].
- If "inter-RAT (GSM) measurements" are requested by USIM, the ME shall, in the MEASUREMENT REPORT, include IE "inter-RAT measured results list" in IE "Measured Results". The ME shall report GSM carrier RSSI for the up to 6 strongest (highest RSSI value) inter-RAT GSM cells (identified by the BCCH ARFCN), if available in the ME according to TS 25.331 [38] and TS 25.133 [39].
- All other optional fields in the MEASUREMENT REPORT shall be set to be absent.

## 8.23 Default Text

See ETSI TS 102 223 [32] clause 8.23.

## 8.24 Items Next Action Indicator

See ETSI TS 102 223 [32] clause 8.24.

## 8.25 Event list

For the event list byte coding, the following value is defined in addition to those in ETSI TS 102 223 [32]:

- '11' = I-WLAN Access Status.

## 8.26 Cause

| Byte(s)  | Description  | Length |
|----------|--|--------|
| 1        | Cause tag  | 1      |
| 2        | Length (X) of bytes following. $X=0$ , or $2 \leq X \leq 30$ . | 1      |
| 3 to X+2 | Cause  | X      |

The Cause data object is coded as for the Cause call control information element in TS 24.008 [9], starting at octet 3 (the IEI and Length information are removed, as this information is duplicated by the data object tag and length).

Radio Link Timeout is indicated by the Cause data object having a value part of zero length (only the Tag and Length components are sent).

## 8.27 Location status

See ETSI TS 102 223 [32] clause 8.27.

## 8.28 Transaction identifier

| Byte(s)  | Description                   | Length |
|----------|-------------------------------|--------|
| 1        | Transaction identifier tag    | 1      |
| 2        | Length (X) of bytes following | 1      |
| 3 to X+2 | Transaction identifier list   | X      |

- Transaction identifier list:

Contents:

- A list of transaction identifiers, of variable length. Each byte in the list defines a transaction identifier. Each transaction identifier shall not appear more than once within the list;

Coding:

- Each byte in the transaction identifier list shall be coded as defined below:

bits 1 to 4 = RFU;

bits 5 to 7 = TI value;

bit 8 = TI flag.

TI value and TI flag are coded as defined in TS 24.007 [8].

## 8.29 BCCH channel list

This information is only available when the ME is connected to a GSM access network.

| Byte(s)  | Description                   | Length |
|----------|-------------------------------|--------|
| 1        | BCCH channel list tag         | 1      |
| 2        | Length (X) of bytes following | 1      |
| 3 to X+2 | BCCH channel list             | X      |

- BCCH channel list:

Contents:

- The list of absolute RF channels for BCCH carriers, as known by the ME from the SYSTEM INFORMATION messages. The BCCH channel list is composed of one to three BCCH channel sub lists,



each sub list is derived from the set of frequencies defined by reference neighbour cells description information element or elements. In the latter case the set is the union of the different subsets defined by the neighbour cells description information elements (see TS 44.018 [27]). The length of the BCCH channel list field depends on the length of the received BCCH channel list derived from the different SYSTEM INFORMATION messages to be considered.

Coding:

- Each ARFCN is represented by 10 bits. Spare bit(s) are to be filled with 0.

|          | Bit 8                | Bit 7 | Bit 6 | Bit 5               | Bit 4               | Bit 3         | Bit 2 | Bit 1         |
|----------|----------------------|-------|-------|---------------------|---------------------|---------------|-------|---------------|
| Byte 1   | ARFCN#1 (high part)  |       |       |                     |                     |               |       |               |
| Byte 2   | ARFCN#1 (low part)   |       |       | ARFCN#2 (high part) |                     |               |       |               |
| Byte 3   | ARFCN#2 (low part)   |       |       |                     | ARFCN#3 (high part) |               |       |               |
| ...      | ...                  |       |       |                     |                     |               |       |               |
| Byte X-1 | ARFCN#m-1 (low part) |       |       |                     | ARFCN#m (high part) |               |       |               |
| Byte X   | ARFCN#m (low part)   |       |       |                     |                     | Spare bit (0) |       | Spare bit (0) |

## 8.30 Call control requested action

| Byte(s)              | Description                       | Length |
|----------------------|-----------------------------------|--------|
| 1                    | Call control requested action tag | 1      |
| 2 to (Y-1)+2         | Length (X)                        | Y      |
| (Y-1)+3 to (Y-1)+X+2 | Call control requested action     | X      |

- Call control requested action:

Contents:

- The action given in response to the ENVELOPE (CALL CONTROL). It may contain, in the same order as given by the UICC, the address or SS string, the capability configuration parameters, the called party sub-address and the alpha identifier;

Coding:

- As described in clause 7.3.1.6, starting with the first optional element given in the response data to the ENVELOPE (CALL CONTROL).

## 8.31 Icon Identifier

See ETSI TS 102 223 [32] clause 8.31.

## 8.32 Item Icon Identifier list

See ETSI TS 102 223 [32] clause 8.32.

## 8.33 Card reader status

See ETSI TS 102 223 [32] clause 8.33.

## 8.34 Card ATR

See ETSI TS 102 223 [32] clause 8.34.

## 8.35 C-APDU

See ETSI TS 102 223 [32] clause 8.35.

## 8.36 R-APDU

See ETSI TS 102 223 [32] clause 8.36.

## 8.37 Timer identifier

See ETSI TS 102 223 [32] clause 8.37.

## 8.38 Timer value

See ETSI TS 102 223 [32] clause 8.38.

## 8.39 Date-Time and Time zone

See ETSI TS 102 223 [32] clause 8.39.

NOTE: coding is as for the Time Zone and Time information element in TS 24.008 [9], starting at octet 2.

## 8.40 AT Command

| Byte(s)                | Description       | Length |
|------------------------|-------------------|--------|
| 1                      | AT Command tag    | 1      |
| 2 to (Y-1)+2           | Length (X)        | Y      |
| (Y-1)+3 to (Y-1)+3+X-1 | AT Command string | X      |

Contents:

- The AT Command string is structured exactly as the AT Command line as defined in TS 27.007 [12], which may contain single or concatenated AT commands.

## 8.41 AT Response

| Byte(s)                | Description        | Length |
|------------------------|--------------------|--------|
| 1                      | AT Response tag    | 1      |
| 2 to (Y-1)+2           | Length (X)         | Y      |
| (Y-1)+3 to (Y-1)+3+X-1 | AT Response string | X      |

Contents:

- The AT Response string is structured exactly as the response to a command line as defined in TS 27.007 [12], which may contain single or concatenated responses appropriate to the issued AT command.
- If the AT Response string is longer than the maximum length capable of being transmitted to the UICC then the AT Response string shall be truncated to this length by the ME.

## 8.42 BC Repeat indicator

| Byte(s) | Description                | Length |
|---------|----------------------------|--------|
| 1       | BC repeat indicator tag    | 1      |
| 2       | Length                     | 1      |
| 3       | BC repeat indicator values | 1      |

Contents & coding:

- The BC repeat indicator is structured exactly as defined in TS 24.008 [08].

## 8.43 Immediate response

See ETSI TS 102 223 [32] clause 8.43.

## 8.44 DTMF string

See ETSI TS 102 223 [32] clause 8.44.

## 8.45 Language

See ETSI TS 102 223 [32] clause 8.45.

## 8.46 Timing Advance

This information is only available when the ME is connected to a GSM access network.

| Byte(s) | Description        | Length |
|---------|--------------------|--------|
| 1       | Timing Advance tag | 1      |
| 2       | Length = '02'      | 1      |
| 3       | ME Status          | 1      |
| 4       | Timing Advance     | 1      |

Coding of ME status:

- '00' = ME is in the idle state;
- '01' = ME is not in idle state;
- '02' to 'FF' = reserved values.

The Timing Advance is coded as for the Timing Advance information element in TS 44.018 [27], starting at octet 2 (the IEI is removed, as this information is duplicated by the data object tag).

## 8.47 Browser Identity

See ETSI TS 102 223 [32] clause 8.47.

## 8.48 URL

See ETSI TS 102 223 [32] clause 8.48.

## 8.49 Bearer

| Byte(s)              | Description                                    | Length |
|----------------------|--|--------|
| 1                    | Bearer tag                                     | 1      |
| 2 to (Y + 1)         | Length (X)                                     | Y      |
| (Y+2) to (Y + X + 1) | List of bearers in order of priority requested | X      |

The ME shall use this list to choose which bearers are allowed in order of priority.

Coding of the bearers:

- '00' = SMS;
- '01' = CSD;
- '02' = USSD;
- '03' = GPRS;
- '04' to 'FF' = RFU.

## 8.50 Provisioning File Reference

See ETSI TS 102 223 [32] clause 8.50.

## 8.51 Browser Termination Cause

See ETSI TS 102 223 [32] clause 8.51.

## 8.52 Bearer description

| Byte(s)    | Description            | Length |
|------------|------------------------|--------|
| 1          | Bearer description tag | 1      |
| 2          | Length (X+1)           | 1      |
| 3          | Bearer type            | 1      |
| 4 to (3+X) | Bearer parameters      | X      |

- Bearer Type coding: in addition to the values defined in ETSI TS 102 223 [32] clause 8.52, the following are defined:

'01' = CSD;

'02' = GPRS / 3G packet service.

'09' = UTRAN packet service with extended parameters / HSDPA.

'0A' = I-WLAN.

- Bearer parameters coding: see the following clauses.

### 8.52.1 Bearer parameters for CSD

Contents: parameters specific to the bearer.

In this case X=3.

NOTE: The default values of the subparameters are manufacturer specific since they depend on the purpose of the device and data services provided by it. Not all combinations and values of these subparameters are supported by GSM (see TS 22.002 [1]).

Coding:

- The following values are as defined in the TS 27.007 [12] for the select service bearer type "+CBST" extended command. They are coded in hexadecimal.

Coding of Byte 4:

- Data rate: same as the "speed" subparameter defined in TS 27.007 [12].

Coding of byte 5:

- Bearer service: same as the "name" subparameter defined in TS 27.007 [12].

Coding of Byte 6:

- Connection element: same as the "ce" subparameter defined in TS 27.007 [12].

## 8.52.2 Bearer parameters for GPRS/3G Packet Service

Contents: parameters describing the Quality of Service (QoS) and the type of PDP. This is an element of the PDP context. These parameters can be used for 2G or 3G packet service.

In this case X=6.

Coding:

- The following values are as defined in the TS 27.007 [12], for the "+CGQREQ" extended command. They are coded in hexadecimal.

Coding of Byte 4:

- Precedence class: same as the "precedence" subparameter, defined in TS 27.007 [12].

Coding of Byte 5:

- Delay class: same as the "delay" subparameter, defined in TS 27.007 [12].

Coding of Byte 6:

- Reliability class: same as the "reliability" subparameter, defined in TS 27.007 [12].

Coding of Byte 7:

- Peak throughput class: same as the "peak" subparameter, defined in TS 27.007 [12].

Coding of Byte 8:

- Mean throughput class: same as the "mean" subparameter, defined in TS 27.007 [12].

Coding of Byte 9:

- Packet data protocol type:

'02' = IP (Internet Protocol, IETF STD 5);

all other values are reserved.

## 8.52.3 Bearer parameters for UTRAN Packet Service with extended parameters / HSDPA

Contents: parameters describing the Quality of Service (QoS) and the type of PDP. This is an element of the PDP context.

In this case X=17.

Coding:

- The following values are as defined in the TS 27.007 [12], for the "+CGEQREQ" extended command. They are coded in hexadecimal.

Coding of Byte 4:

- Traffic class: same as the "Traffic class" subparameter, defined in TS 27.007 [12].

Coding of Byte 5 and 6:

- Maximum bitrate UL: same as the "Maximum bitrate UL" subparameter, defined in TS 27.007 [12].

Coding of Byte 7 and 8:

- Maximum bitrate DL: same as the "Maximum bitrate DL" subparameter, defined in TS 27.007 [12].

Coding of Byte 9 and 10:

- Guaranteed bitrate UL: same as the "Guaranteed bitrate UL" subparameter, defined in TS 27.007 [12].

Coding of Byte 11 and 12:

- Guaranteed bitrate DL: same as the "Guaranteed bitrate DL" subparameter, defined in TS 27.007 [12].

Coding of Byte 13:

- Delivery order: same as the "Delivery order" subparameter, defined in TS 27.007 [12].

Coding of Byte 14:

- Maximum SDU size: same as the "Maximum SDU size" subparameter, defined in TS 27.007 [12].

Coding of Byte 15:

- SDU error ratio: same as the "SDU error ratio" subparameter, defined in TS 27.007 [12].

Coding of Byte 16:

- Residual bit error ratio: same as the "Residual bit error ratio" subparameter, defined in TS 27.007 [12].

Coding of Byte 17:

- Delivery of erroneous SDUs: same as the "Delivery of erroneous SDUs" subparameter, defined in TS 27.007 [12].

Coding of Byte 18:

- Transfer delay: same as the "Transfer delay" subparameter, defined in TS 27.007 [12].

Coding of Byte 19:

- Traffic handling priority: same as the "Traffic handling priority" subparameter, defined in TS 27.007 [12].

Coding of Byte 20:

- PDP\_type: same as the "PDP\_type" subparameter, defined in TS 27.007 [12].

Note: HSDPA parameters and UTRAN Packet Service parameters are the same except for the maximum bitrate DL and the guaranteed bitrate DL, which can be higher for HSDPA (see TS 24.008 [9]).

## 8.52.4 Bearer parameters for I-WLAN

Content: parameters specific to the bearer. RFU.

In this case X=0

## 8.53 Channel data

See ETSI TS 102 223 [32] clause 8.53.

## 8.54 Channel data length

See ETSI TS 102 223 [32] clause 8.54.

## 8.55 Buffer size

See ETSI TS 102 223 [32] clause 8.55.

## 8.56 Channel status

See ETSI TS 102 223 [32] clause 8.56.

## 8.57 Card reader identifier

See ETSI TS 102 223 [32] clause 8.57.

## 8.58 Other Address

See ETSI TS 102 223 [32] clause 8.58.

## 8.59 UICC/ME interface transport level

See ETSI TS 102 223 [32] clause 8.59.

## 8.60 AID

See ETSI TS 102 223 [32] clause 8.60.

## 8.61 Network Access Name

| Byte(s)    | Description             | Length |
|------------|-------------------------|--------|
| 1          | Network Access Name tag | 1      |
| 2          | Length (X)              | 1      |
| 3 to 3+X-1 | Network Access Name     | X      |

Content:

- The Network Access Name is used to identify the Gateway entity (GGSN), which provides interworking with an external packet data network. For GPRS, the Network Access Name is an APN.

Coding:

- As defined in TS 23.003 [30].

## 8.62 Access Technology

See ETSI TS 102 223 [32] clause 8.61.

## 8.63 Display parameters

See ETSI TS 102 223 [32] clause 8.62.

## 8.64 Service Record

See ETSI TS 102 223 [32] clause 8.63.

## 8.65 Device Filter

See ETSI TS 102 223 [32] clause 8.64.

## 8.66 Service Search

See ETSI TS 102 223 [32] clause 8.65.

## 8.67 Attribute Information

See ETSI TS 102 223 [32] clause 8.66.

## 8.68 Service Availability

See ETSI TS 102 223 [32] clause 8.67.

## 8.69 Remote Entity Address

See ETSI TS 102 223 [32] clause 8.68.

## 8.70 Text Attribute

See ETSI TS 102 223 [32] clause 8.72.

## 8.71 Item Text Attribute List

See ETSI TS 102 223 [32] clause 8.73.

## 8.72 PDP context Activation parameters

| Byte(s)  | Description                           | Length |
|----------|---------------------------------------|--------|
| 1        | PDP context Activation parameters tag | 1      |
| 2        | Length (X)                            | 1      |
| 3 to X+2 | PDP context Activation parameters     | X      |

The PDP context Activation parameters are coded as the ACTIVATE PDP CONTEXT REQUEST message, refer to TS 24.008 [9].

## 8.73 UTRAN Measurement Qualifier

This information is only available when the ME is connected to a UTRAN.



| Byte(s) | Description                     | Length |
|---------|---------------------------------|--------|
| 1       | UTRAN Measurement Qualifier tag | 1      |
| 2       | Length (1)                      | 1      |
| 3       | UTRAN Measurement Qualifier     | 1      |

#### UTRAN Measurement Qualifier

Contents: Qualifier specific to the UTRAN NMR

##### Coding

'01'            Intra-frequency measurements  
 '02'            Inter-frequency measurements  
 '03'            Inter-RAT (GSM) measurements  
 All other values are reserved

## 8.74      Multimedia Message Reference

See ETSI TS 102 223 [32] clause 8.82.

## 8.75      Multimedia Message Identifier

See ETSI TS 102 223 [32] clause 8.83.

## 8.76      Multimedia Message Transfer status

See ETSI TS 102 223 [32] clause 8.84.

## 8.77      MM Content Identifier

In addition to ETSI TS 102 223 [32] clause 8.85, the codinf of the MM Content Data Object tag is done according to TS 31.102[14].

## 8.78      Multimedia Message Notification

See ETSI TS 102 223 [32] clause 8.86.

## 8.79      Last Envelope

See ETSI TS 102 223 [32] clause 8.87.

## 8.80      Frames Layout

See ETSI TS 102 223 [32] clause 8.78.

## 8.81      Frames Information

See ETSI TS 102 223 [32] clause 8.79.

## 8.82      Frames identifier

See ETSI TS 102 223 [32] clause 8.80.

## 8.83 I-WLAN Identifier

| Byte(s)    | Description           | Length |
|------------|-----------------------|--------|
| 1          | I-WLAN Identifier tag | 1      |
| 2          | Length (X)            | 1      |
| 3 to (2+X) | WSID value            | X      |

The WSID Value is coded as the WLAN Specific Identifier (WSID) defined in TS 24.234 [42].

## 8.84 I-WLAN Access Status

| Byte(s) | Description              | Length |
|---------|--------------------------|--------|
| 1       | I-WLAN Access Status tag | 1      |
| 2       | Length (1)               | 1      |
| 3       | Access status            | 1      |

Coding of Access status:

- '00' = No current I-WLAN coverage;
- '01' = I-WLAN coverage available, no current connection;
- '02' = I-WLAN coverage available, connection on-going;
- '03' to 'FF' = reserved values.

## 8.85 IMEISV

See ETSI TS 102 223 [32] clause 8.74.

## 8.86 Network search mode

See ETSI TS 102 223 [32] clause 8.75.

## 8.87 Battery State

See ETSI TS 102 223 [32] clause 8.76.

## 8.88 Browsing status

See ETSI TS 102 223 [32] clause 8.77.

## 8.89 Registry application data

See ETSI TS 102 223 [32] clause 8.88.

## 8.90 PLMNwAcT List

| Byte(s)          | Description                                       | Length |
|------------------|---|--------|
| 1                | PLMNwAcT List tag                                 | 1      |
| 2                | Length (5n)                                       | 1      |
| 3 to 5           | 1 <sup>st</sup> PLMN Identifier(highest priority) | 3      |
| 6 to 7           | 1 <sup>st</sup> PLMN Access Technology Identifier | 2      |
| :                | :   |        |
| (5n-2) to (5n)   | nth PLMN Identifier (lowest priority)             | 3      |
| (5n+1) to (5n+2) | nth PLMN Access Technology Identifier             | 2      |

Coding of PLMN Identifier:

As for PLMN within  $EF_{\text{PLMNwAcT}}$  in TS 31.102 [14].

Coding of PLMN Access Technology Identifier:

As for Access Technology Identifier within  $EF_{\text{PLMNwAcT}}$  in TS 31.102 [14].

---

## 9 Tag values

This clause specifies the tag values used to identify the BER-TLV and COMPREHENSION-TLV data objects used in the present document, in addition to those defined in ETSI TS 101 220 [43].

### 9.1 BER-TLV tags in ME to UICC direction

| Description                  | Length of tag | Value |
|------------------------------|---------------|-------|
| SMS-PP download tag          | 1             | 'D1'  |
| Cell Broadcast download tag  | 1             | 'D2'  |
| MO Short message control tag | 1             | 'D5'  |
| USSD download tag            | 1             | 'D9'  |

### 9.2 BER-TLV tags in UICC TO ME direction

See ETSI TS 102 223 [32] clause 9.2. No additional tag is defined for 3G.

### 9.3 COMPREHENSION-TLV tags in both directions

| Description                           | Length of tag | Tag value, bits 1-7<br>(Range: '01' - '7E') | Tag<br>(CR and Tag value) |
|---------------------------------------|---------------|---|---------------------------|
| SS string tag                         | 1             | '09'  | '09' or '89'              |
| USSD string tag                       | 1             | '0A'  | '0A' or '8A'              |
| SMS TPDU tag                          | 1             | '0B'  | '0B' or '8B'              |
| Cell Broadcast page tag               | 1             | '0C'  | '0C' or '8C'              |
| Cause tag                             | 1             | '1A'  | '1A' or '9A'              |
| Transaction identifier tag            | 1             | '1C'  | '1C' or '9C'              |
| BCCH channel list tag                 | 1             | '1D'  | '1D' or '9D'              |
| BC Repeat Indicator tag               | 1             | '2A'  | '2A' or 'AA'              |
| Timing Advance tag                    | 1             | '2E'  | '2E' or 'AE'              |
| PDP context Activation parameters tag | 1             | "52"  | "52" or "D2"              |
| UTRAN Measurement Qualifier tag       | 1             | '69'  | '69' or 'E9'              |
| I-WLAN Identifier tag                 | 1             | '4A'  | '4A' or 'CA'              |
| I-WLAN Access Status tag              | 1             | '4B'  | '4B' or 'CB'              |
| PLMNwAcT List tag                     | 1             | '72'  | '72' or 'F2'              |

## 9.4 Type of Command and Next Action Indicator

The table below shows the values which shall be used for Type of Command coding (see clause 8.6) and Next Action Indicator coding (see clause 8.24) in addition to those defined in ETSI TS 102 223 [32] clause 9.4.

| Value | Name      | used for Type of Command coding | used for Next Action Indicator coding |
|-------|-----------|---------------------------------|---------------------------------------|
| '11'  | SEND SS   | X                               | X                                     |
| '12'  | SEND USSD | X                               | X                                     |

---

## 10 Allowed Type of command and Device identity combinations

Only certain types of commands can be issued with certain device identities. These combinations are defined below, in addition to ETSI TS 102 223 [32] clause 10.

| Command description      | Source  | Destination |
|--------------------------|---------|-------------|
| CELL BROADCAST DOWNLOAD  | Network | UICC        |
| MO SHORT MESSAGE CONTROL | ME      | UICC        |
| SEND SS                  | UICC    | Network     |
| SEND USSD                | UICC    | Network     |
| I-WLAN Access Status     | ME      | UICC        |

---

## 11 Security requirements

TS 31.115 [41] and TS 31.116 [44] specify standardized methods of securing the content of application messages. If it is necessary to secure application messaging to Toolkit applications, then TS 31.115 [41] and TS 31.116 [44] may be used.

## Annex A (normative): Support of USAT by Mobile Equipment

Support of USAT is optional for Mobile Equipment. However, if an ME states conformance with a specific 3G release, it is mandatory for the ME to support all functions of that release.

The support of USAT implies the support of CAT (ETSI TS 102 223 [32]).

The support of letter classes, which specify mainly ME hardware dependent features, is optional for the ME and may supplement the USAT functionality described in the present document. If an ME states conformance to a letter class, it is mandatory to support all functions within the respective letter class.

The table below indicates the commands and functions of the optional letter classes.

| Letter classes | Command/function description                                  |
|----------------|---|
| a              | See TS 102 223 [32]   |
| b              | See TS 102 223 [32]   |
| c              | See TS 102 223 [32]   |
| d              | See TS 102 223 [32]   |
| e              | See TS 102 223 [32]   |
| f              | See TS 102 223 [32]   |
| g              | See TS 102 223 [32]   |
| h              | See TS 102 223 [32]   |
| i              | See TS 102 223 [32]   |
| j              | See TS 102 223 [32]   |
| k              | See TS 102 223 [32]   |
| l              | reserved by ETSI SCP (Proactive command: ACTIVATE)            |
| m              | reserved by ETSI SCP (Event download: HCI connectivity event) |
| p              | USSD Data download in application mode                        |
| p              | See TS 102 223 [32]   |

## Annex B (informative): Example of DISPLAY TEXT Proactive UICC Command

See ETSI TS 102 223 [32] Annex B.

## Annex C (normative): Structure of USAT communications

See ETSI TS 102 223 [32] Annex C.

## Annex D (informative): ME display in proactive UICC session

See ETSI TS 102 223 [32] Annex D.



## Annex E (informative): Help information feature processing

See ETSI TS 102 223 [32] Annex E.

---

## Annex F (informative): Monitoring of events

In addition to ETSI TS 102 223 [32] Annex F. , the following is defined:

| <b>Event</b>         | <b>Continuously reported</b> | <b>Reported once</b> |
|----------------------|------------------------------|----------------------|
| I-WLAN Access Status | X                            |                      |

## Annex G (normative): Support of Multiple Card Operation

See ETSI TS 102 223 [32] Annex G.

## Annex H (informative): Multiple Card proactive command examples

See ETSI TS 102 223 [32] Annex H.

## Annex I (informative): Bearer independent protocol proactive command examples

See ETSI TS 102 223 [32] Annex I.

## Annex J (informative): WAP References

See ETSI TS 102 223 [32] Annex J.

---

## Annex K (informative): Use of USAT Bearer independent protocol for local links Bluetooth case

See ETSI TS 102 223 [32] Annex K.

## Annex L (informative): Bluetooth Service Discovery protocol

See ETSI TS 102 223 [32] Annex L.



---

## Annex M (informative): Use of USAT Bearer independent protocol for local links, server case

See ETSI TS 102 223 [32] Annex M.

# Annex N (informative): USSD information flow between the Network, the ME and the UICC

## N.1 MMI Mode

Mobile initiated USSD operation, Nentwork does not request further information

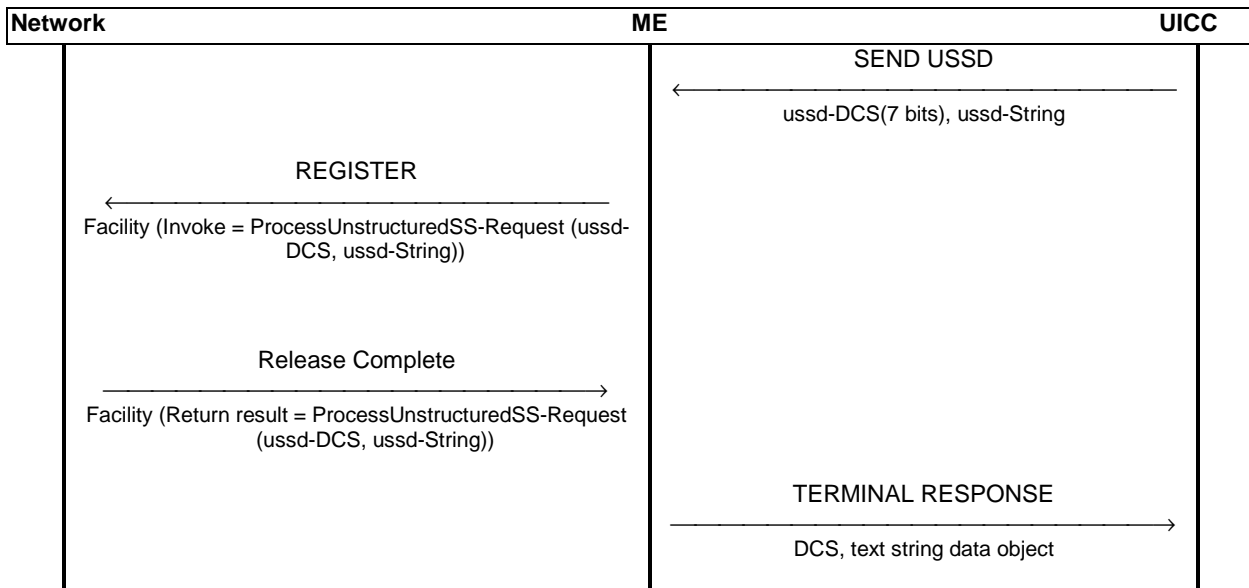

Figure N.1

Mobile initiated USSD operation, Network requests further information

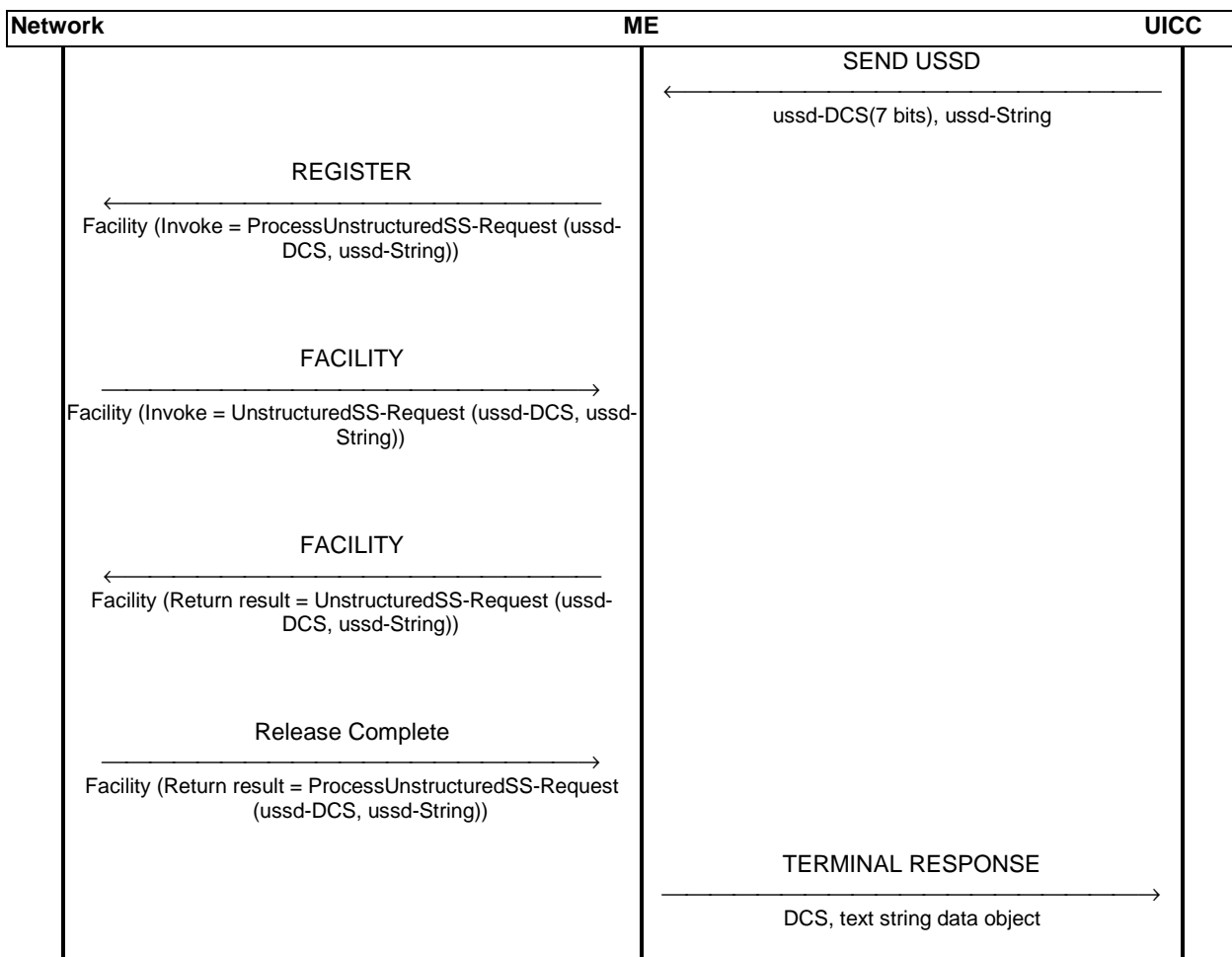

Figure N.2

## N.2 Application Mode

Mobile initiated USSD operation, Network does not request further information

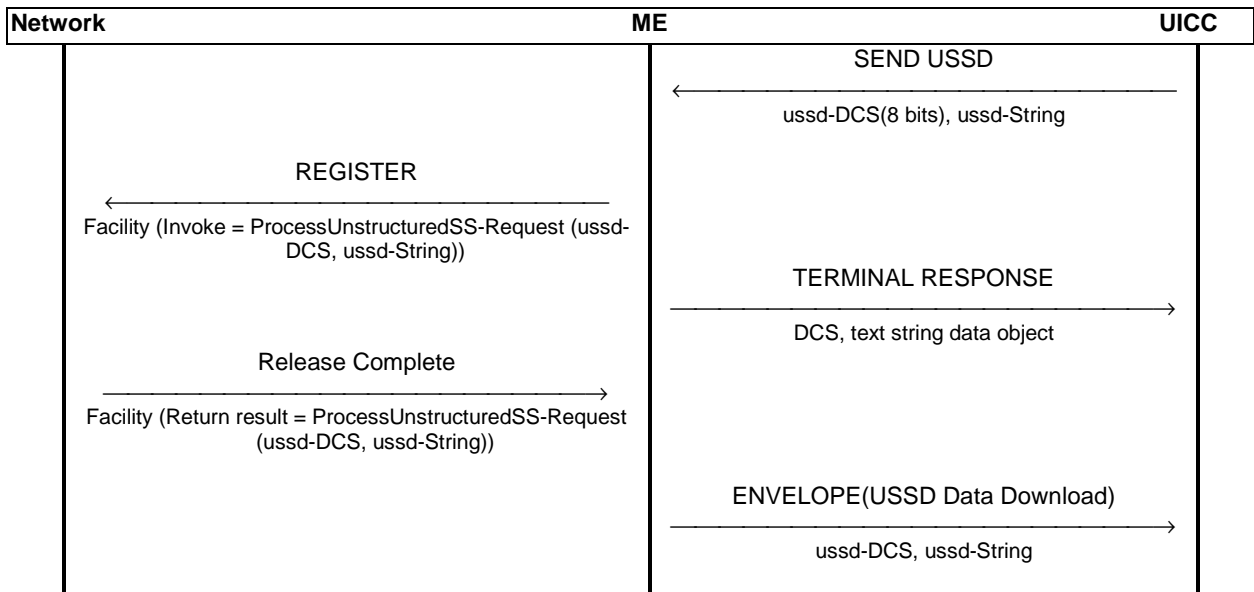

Figure N.3

Mobile initiated USSD operation, Network requests further information

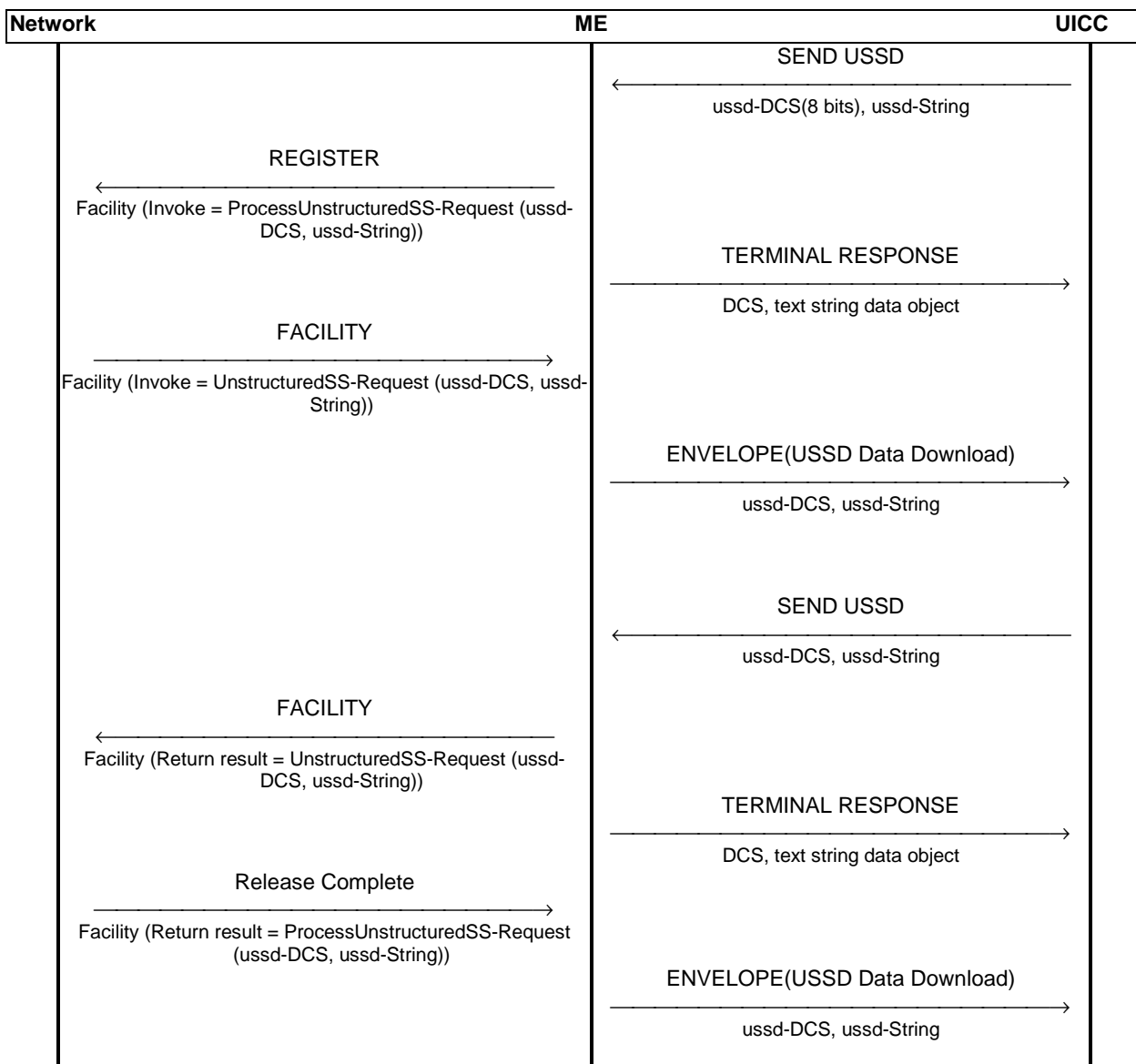

Figure N.4

# N.3 USSD Data Download

Network initiated USSD operation

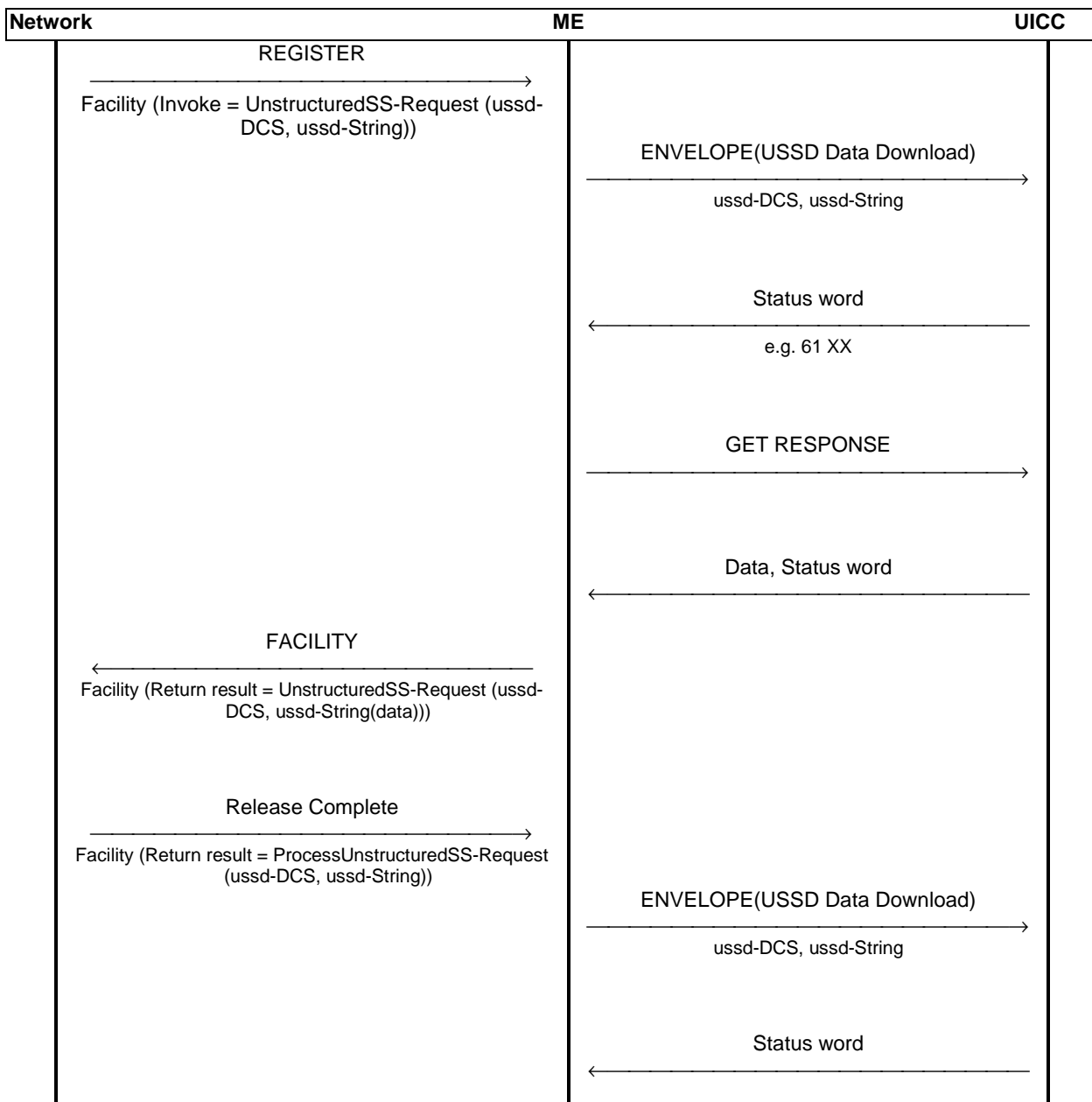

Figure N.5

## Annex O (informative): Change History

| TSG # | TSG TD#   | WG TD#                     | CR   | Rev | Cat | Subject/Comment  | New    |
|-------|-----------|----------------------------|------|-----|-----|--|--------|
| CT-28 | CP-050141 | C6-050419                  | 144  | -   | F   | Clarification on the coding of the DCS field for USSD data download                | 7.0.0  |
| CT-29 | CP-050341 | C6-050717                  | 149  | -   | F   | Transfer MMS commands to SCP   | 7.1.0  |
| CT-30 | CP-050500 | C6-050880                  | 152  | -   | A   | Missing data objects concerning Frames   | 7.2.0  |
| CT-30 | CP-050500 | C6-050887                  | 150  | -   | A   | Correction of the length of Bearer parameters for UTRAN Packet Service             | 7.2.0  |
| CT-30 | CP-050497 | C6-050896                  | 153  | -   | B   | Extension of BIP bearers with I-WLAN   | 7.2.0  |
| CT-31 | CP-060019 | C6-060124                  | 155  | -   | A   | Corrections to align TS 31.111 with ETSI TS 102 223 and ETSI TS 101 220            | 7.3.0  |
| CT-31 | CP-060019 | C6-060127                  | 157  | -   | A   | Introduction of HSDPA in BIP   | 7.3.0  |
| CT-31 | CP-060024 | C6-060185                  | 158  | -   | D   | Editorial corrections  | 7.3.0  |
| CT-31 | CP-060024 | C6-060186                  | 159  | -   | F   | Alignment with SCP specifications  | 7.3.0  |
| CT-31 | CP-060157 | C6-060195                  | 161  | -   | A   | Correction on 'USIM Service table' in data SMS-PP download                         | 7.3.0  |
| CT-32 | CP-060244 | C6-060320                  | 0162 | -   | F   | Incorrect Service Table referenced   | 7.4.0  |
| CT-33 | CP-060476 | C6-060603                  | 0167 | -   | A   | UTRAN NMR encoding and Local Information clarifications                            | 7.5.0  |
| CT-35 | CP-070060 | C6-070092                  | 0169 | 1   | A   | Removal of re-introduced text for Call Control User indication                     | 7.6.0  |
| CT-36 | CP-070300 | C6-070334                  | 0176 | 2   | F   | Correction of possible Terminal Responses to the Send SMS command                  | 7.7.0  |
| CT-36 | CP-070300 | C6-070320                  | 0181 | 2   | F   | Addition of missing Frame Identifiers to proactive commands                        | 7.7.0  |
| CT-36 | CP-070300 | C6-070294                  | 0184 | -   | F   | Correction for the general results "SS Return Error" and "USSD Return Error"       | 7.7.0  |
| CT-37 | CP-070616 | C6-070419                  | 0185 | 1   | F   | Incomplete Launch Application command definition                                   | 7.8.0  |
| CT-37 | CP-070612 | C6-070384                  | 0187 | -   | A   | Correction to UTRAN Network Measurement Results                                    | 7.8.0  |
| CT-37 | CP-070661 | Rev2 of C6-070435          | 0188 | 5   | B   | Steering of Roaming Refresh Command  | 7.8.0  |
| CT-40 | CP-080386 | C6-080148                  | 0192 | 2   | F   | Explicit definition of Provide Local Information values                            | 7.9.0  |
| CT-42 | CP-090190 | C6-090020                  | 0205 | -   | A   | Downgrade of Data download via USSD and USSD application mode                      | 7.10.0 |
| CT-42 | CP-090455 | C6-090168                  | 0208 | 1   | F   | Correction to OPEN CHANNEL   | 7.11.0 |
| CT-45 | CP-090716 | C6-090337                  | 0224 | 1   | F   | Correction of an open reference and clarification of display icon                  | 7.12.0 |
| CT-47 | CP-100181 | C6-100066                  | 0233 | 1   | F   | ETSI SCP references correction   | 7.13.0 |
| CT-48 | CP-100392 | C6-100269                  | 0241 | 1   | F   | Update of the specification and of references to SCP specifications                | 7.14.0 |
| CP-48 | CP-100393 | <a href="#">C6-100287</a>  | 0238 | 1   | F   | Correction to security requirement references                                      | 7.14.0 |
| CP-48 | CP-100393 | <a href="#">C6-1002934</a> | 0244 | 1   | F   | Correction of TERMINAL RESPONSE  | 7.14.0 |
| CP-49 | CP-100594 | C6-100380                  | 0234 | 2   | F   | Reference update and restoration of the Terminal Profile's bytes with letter class | 7.15.0 |

---

## History

| <b>Document history</b> |                |             |
|-------------------------|----------------|-------------|
| V7.2.0                  | December 2005  | Publication |
| V7.3.0                  | March 2006     | Publication |
| V7.4.0                  | May 2006       | Publication |
| V7.5.0                  | September 2006 | Publication |
| V7.6.0                  | March 2007     | Publication |
| V7.7.0                  | June 2007      | Publication |
| V7.8.0                  | October 2007   | Publication |
| V7.9.0                  | July 2008      | Publication |
| V7.10.0                 | April 2009     | Publication |
| V7.11.0                 | July 2009      | Publication |
| V7.12.0                 | October 2009   | Publication |
| V7.13.0                 | April 2010     | Publication |
| V7.14.0                 | July 2010      | Publication |
| V7.15.0                 | October 2010   | Publication |