

ETSI TS 132 005 V3.2.0 (2000-09)

Technical Specification

**Digital cellular telecommunications system (Phase 2+) (GSM);
Universal Mobile Telecommunications System (UMTS);
Telecommunication Management; Charging and billing;
3G call and event data for the Circuit Switched (CS) domain
(3GPP TS 32.005 version 3.2.0 Release 1999)**



Reference

RTS/TSGS-0532005UR3

Keywords

GSM,UMTS

ETSI

650 Route des Lucioles
F-06921 Sophia Antipolis Cedex - FRANCE

Tel.: +33 4 92 94 42 00 Fax: +33 4 93 65 47 16

Siret N° 348 623 562 00017 - NAF 742 C
Association à but non lucratif enregistrée à la
Sous-Préfecture de Grasse (06) N° 7803/88

Important notice

Individual copies of the present document can be downloaded from:

<http://www.etsi.org>

The present document may be made available in more than one electronic version or in print. In any case of existing or perceived difference in contents between such versions, the reference version is the Portable Document Format (PDF). In case of dispute, the reference shall be the printing on ETSI printers of the PDF version kept on a specific network drive within ETSI Secretariat.

Users of the present document should be aware that the document may be subject to revision or change of status. Information on the current status of this and other ETSI documents is available at <http://www.etsi.org/tb/status/>

If you find errors in the present document, send your comment to:
editor@etsi.fr

Copyright Notification

No part may be reproduced except as authorized by written permission.
The copyright and the foregoing restriction extend to reproduction in all media.

© European Telecommunications Standards Institute 2000.

All rights reserved.

Intellectual Property Rights

IPRs essential or potentially essential to the present document may have been declared to ETSI. The information pertaining to these essential IPRs, if any, is publicly available for **ETSI members and non-members**, and can be found in ETSI SR 000 314: "*Intellectual Property Rights (IPRs); Essential, or potentially Essential, IPRs notified to ETSI in respect of ETSI standards*", which is available from the ETSI Secretariat. Latest updates are available on the ETSI Web server (<http://www.etsi.org/ipr>).

Pursuant to the ETSI IPR Policy, no investigation, including IPR searches, has been carried out by ETSI. No guarantee can be given as to the existence of other IPRs not referenced in ETSI SR 000 314 (or the updates on the ETSI Web server) which are, or may be, or may become, essential to the present document.

Foreword

This Technical Specification (TS) has been produced by the ETSI 3rd Generation Partnership Project (3GPP).

The present document may refer to technical specifications or reports using their 3GPP identities, UMTS identities or GSM identities. These should be interpreted as being references to the corresponding ETSI deliverables.

The cross reference between GSM, UMTS, 3GPP and ETSI identities can be found under www.etsi.org/key .

Contents

Foreword.....	9
1 Scope.....	10
2 References.....	10
3 Definitions.....	11
4 Abbreviations.....	12
5 General.....	13
6 TMN management services.....	14
6.1 Tariff and charging administration.....	14
6.1.1 Subscriber billing.....	15
6.1.2 Accounting.....	15
6.1.2.1 Inter-PLMN accounting.....	15
6.1.2.1.1 'Visitors' from other PLMNs.....	15
6.1.2.1.2 'Home' subscribers roaming in other PLMNs.....	15
6.1.2.2 Fixed network operators and other service providers.....	15
6.1.3 Service provision.....	16
6.1.4 Customer administration.....	16
6.2 Management of mobile equipment.....	16
7 TMN management service components.....	17
7.1 Tariff and charging administration.....	17
7.1.1 Tariff administration.....	17
7.1.2 Data collection.....	17
7.1.2.1 Data generation control.....	17
7.1.2.2 Data transfer control.....	17
7.2 Management of mobile equipment.....	18
8 TMN management functions.....	18
8.1 Tariff administration.....	19
8.1.1 Tariff class management.....	19
8.1.1.1 Charging origin functions.....	19
8.1.1.2 Charging destination functions.....	19
8.1.1.3 Charging zone functions.....	19
8.1.1.4 AoC service functions.....	20
8.1.1.5 Tariff class functions.....	20
8.1.2 Tariff period management.....	20
8.1.3 Day class management.....	21
8.1.4 Tariff management.....	21
8.1.5 Tariff system management (change control).....	21
8.2 Data collection.....	22
8.2.1 Data generation control.....	23
8.2.1.1 Record generation control.....	23
8.2.1.1.1 Record type generation control.....	23
8.2.1.1.2 Partial record generation control.....	24
8.2.1.1.3 Supplementary service recording control.....	24
8.2.1.2 Emergency call notification control.....	24
8.2.1.3 Observed IMEI ticket control.....	25
8.2.1.4 Log control.....	25
8.2.2 Data transfer control.....	25
8.2.2.1 Event reporting.....	25
8.2.2.1.1 Event forwarding discriminators.....	25
8.2.2.1.2 Call event record reporting.....	25
8.2.2.1.3 Emergency call reporting.....	26
8.2.2.1.4 Observed IMEI ticket reporting.....	26
8.2.2.2 Bulk record transfer.....	26

8.2.2.3	Log access	26
Annex A (normative):	Information model	27
A.1	Overview	27
A.1.1	Tariff administration, the service and distance view	27
A.1.2	Tariff administration, the date and time view	28
A.1.3	The call recording View	30
A.2	Naming hierarchy	32
A.3	Inheritance	33
A.4	Managed object classes	34
A.4.1	AoC service	34
A.4.2	Call and event log entry	35
A.4.3	Log (ITU-T X.721)	36
A.4.4	Call recording function	36
A.4.5	Charging calendar	36
A.4.6	Charging destination	37
A.4.7	Charging origin	37
A.4.8	Charging zone	37
A.4.9	Day class	38
A.4.10	Event forwarding discriminator	38
A.4.11	Roamer tariff	38
A.4.12	Record class	38
A.4.13	Record type control	39
A.4.14	Supplementary service action control	39
A.4.15	Supplementary service control	39
A.4.16	Tarif (AoC)	40
A.4.17	Tariff administration	40
A.4.18	Tariff class	41
A.4.19	Tariff switch pattern	41
A.4.20	Tariff System	41
A.4.21	Emergency call indication log entry	43
A.4.22	Observed IMEI ticket report log entry	43
A.5	Attributes	44
A.5.1	AoC Service Identity	44
A.5.2	AoC Service Name	44
A.5.3	Basic service	44
A.5.4	Basic Services	44
A.5.5	Calendar year	45
A.5.6	Call duration	45
A.5.7	Caller ID	45
A.5.8	Call event record content	45
A.5.9	Call event record type	45
A.5.10	Call recording function Identity	46
A.5.11	Call reference	46
A.5.12	Call types	46
A.5.13	Cause for termination	46
A.5.14	Cell identity	46
A.5.15	Date definitions	47
A.5.16	Day classes	47
A.5.17	Day class identity	47
A.5.18	Day class name	47
A.5.19	Day definitions	48
A.5.20	Destination identity	48
A.5.21	Destination name	48
A.5.22	Emergency call indication destination	48
A.5.23	Emergency call indication enable	49
A.5.24	E1: Units per time interval	49
A.5.25	E2: Seconds per time interval	49
A.5.26	E3: Scaling factor	49

A.5.27	E4: Unit increment	50
A.5.28	E5: Units per data interval	50
A.5.29	E6: Segments per data interval	50
A.5.30	E7: Initial seconds per time interval	50
A.5.31	Home PLMN identity	51
A.5.32	Location	51
A.5.33	Mobile station classmark	51
A.5.34	MSC incoming trunk group	51
A.5.35	MSC outgoing trunk group	51
A.5.36	MS power classes	52
A.5.37	Network-specific services	52
A.5.38	Observed IMEI ticket destination	52
A.5.39	Observed IMEI ticket generation enable	52
A.5.40	Origin identity	53
A.5.41	Origin destination combinations	53
A.5.42	Origin name	53
A.5.43	Partial record timer	53
A.5.44	Partial record generation	53
A.5.45	Radio channels requested	54
A.5.46	Radio channel used	54
A.5.47	Record class destination	54
A.5.48	Record class identity	54
A.5.49	Record class name	55
A.5.50	Recording method	55
A.5.51	Record type	55
A.5.52	Served IMSI	55
A.5.53	Served MSISDN	55
A.5.54	Service centre address (SMS)	55
A.5.55	Service distance dependencies	56
A.5.56	Supplementary service action type	56
A.5.57	Supplementary service code	56
A.5.58	Supplementary Services	56
A.5.59	Tariff administration id.	56
A.5.60	Tariff class Id.	57
A.5.61	Tariff id.	57
A.5.62	Tariff name	57
A.5.63	Tariff periods	57
A.5.64	Tariff switching pattern id.	58
A.5.65	Tariff system id.	58
A.5.66	Tariff system status	58
A.5.67	Transparency indicator	58
A.5.68	TS active	59
A.5.69	TS next change	59
A.5.70	TS standby	59
A.5.71	Type of subscribers	59
A.5.72	Type of transaction	60
A.5.73	Zone id.	60
A.5.74	Zone name	60
A.5.75	Observed IEMI ticket content	60
A.5.76	HSCSD channels requested	60
A.5.77	HSCSD channels allocated	61
A.5.78	AIUR	61
A.5.79	FNUR	61
A.5.80	Channel Codings Acceptable	61
A.5.81	Channel Coding Used	61
A.5.82	Speech version supported	62
A.5.83	Speech version used	62
A.5.84	Destination routing address	62
A.5.85	CAMEL call leg information	62
A.5.86	Number of DP encountered	62
A.5.87	Level of CAMEL service	63
A.5.88	Free format data	63

A.6	Actions	63
A.6.1	TS Cancel change-over	63
A.6.2	TS Change-over.....	63
A.6.3	TS Check.....	64
A.6.4	TS Copy tariff system.....	64
A.6.5	TS Unfreeze.....	64
A.7	Notifications	65
A.7.1	Call event record report.....	65
A.7.2	Emergency call indication.....	65
A.7.3	Observed IMEI ticket report.....	65
A.8	Name bindings.....	66
A.9	Abstract syntax.....	68
A.10	Application context	85
Annex B (normative):	Call and event records.....	86
B.1	General	86
B.1.1	Use of supplementary services	86
B.1.1.1	Use of call forwarding	86
B.1.1.2	Use of call hold and multi-party services.....	87
B.1.2	Partial records.....	87
B.1.3	Use of packet data services.....	88
B.1.4	Inter-msc handover.....	88
B.1.5	Call re-establishment.....	88
B.1.6	Restricted directory numbers.....	89
B.1.7	CAMEL services	89
B.2	Record contents	89
B.2.1	Mobile originated call attempt.....	90
B.2.2	Mobile originated emergency call attempt.....	92
B.2.3	Mobile originated call forwarding attempt.....	93
B.2.4	Mobile terminated call attempt.....	95
B.2.5	Roaming call attempt.....	96
B.2.6	Incoming gateway call attempt.....	97
B.2.7	Outgoing gateway call attempt.....	97
B.2.8	Transit call attempt.....	98
B.2.9	Supplementary service actions	98
B.2.10	HLR interrogation	99
B.2.11	Location update (VLR)	100
B.2.12	Location update (HLR)	100
B.2.13	Short message service, mobile originated	101
B.2.14	Short message service, mobile terminated	101
B.2.15	SMS-MO interworking record	102
B.2.16	SMS-MT gateway record.....	102
B.2.17	Common equipment usage record.....	102
B.2.18	Reduced partial records	103
B.2.19	Terminating CAMEL interrogation call attempt.....	104
B.3	Description of record fields.....	104
B.3.1	Additional Charging Information.....	104
B.3.2	AoC parameters / change of AoC parameters	105
B.3.3	Basic Service / change of service / ISDN Basic Service	105
B.3.4	Call duration.....	105
B.3.5	Call reference	106
B.3.5.1	Network call reference.....	106
B.3.6	Calling / called / connected / translated number.....	106
B.3.7	CAMEL call leg information.....	107
B.3.7.1	CAMEL information.....	107
B.3.8	CAMEL initiated CF indicator.....	107
B.3.9	CAMEL SMS Information.....	107

B.3.10	Cause for termination	108
B.3.11	Data volume	108
B.3.12	Default call handling	108
B.3.13	Destination Number	108
B.3.14	Diagnostics	108
B.3.15	Entity number	108
B.3.16	Equipment id	109
B.3.17	Equipment type	109
B.3.18	Event time stamps	109
B.3.19	Free format data	110
B.3.20	Free format data append indicator	110
B.3.21	GsmSCF address	110
B.3.22	HSCSD parameters / Change of HSCSD parameters	111
B.3.23	Incoming/ outgoing trunk group	111
B.3.24	Interrogation result	111
B.3.25	Level of CAMEL service	111
B.3.26	Location / change of location	111
B.3.27	Message reference	112
B.3.28	Mobile station classmark / change of classmark	112
B.3.29	Number of DP encountered	112
B.3.30	Number of forwarding	112
B.3.31	Old /new location	112
B.3.32	Radio channel requested / rad. channel used / change of rad. channel / speech version supported / speech version used	112
B.3.33	Record extensions	113
B.3.34	Record type	113
B.3.35	Routing number / roaming number	113
B.3.36	Sequence number	113
B.3.37	Served IMEI	113
B.3.38	Served IMSI	113
B.3.39	Served MSISDN	113
B.3.40	Service centre address	113
B.3.41	Service key	113
B.3.42	Short message service result	114
B.3.43	Supplementary service action	114
B.3.44	Supplementary service action result	114
B.3.45	Supplementary service parameters	114
B.3.46	Supplementary service(s)	114
B.3.47	Transparency indicator	114
B.3.48	Update result	114
B.4	Example scenarios	114
B.4.1	Mobile to land (outgoing) call	115
B.4.2	Land to mobile (incoming) call	116
B.4.3	Mobile to mobile call within the same network	117
B.4.4	Incoming call to a roaming subscriber	118
B.4.5	Incoming call to a PLMN service centre	119
B.4.6	Call forwarding unconditional	120
B.4.7	Call forwarding conditional (on busy)	121
B.4.8	Delivery of a mobile terminated short message	122
B.4.9	Call hold and multi-party service	123
B.4.10	Outgoing call handled by CAMEL	124
B.4.11	Incoming call handled by CAMEL without redirection	125
B.4.12	Incoming call to a roaming subscriber handled by CAMEL	127
B.4.13	Incoming call handled by CAMEL with redirection decided and forwarding leg handled by CAMEL	128
B.4.14	Incoming call handled by CAMEL without redirection and forwarded early using GSM SS but controlled by CAMEL	131
B.4.15	Incoming call handled by CAMEL without redirection and forwarded late using GSM SS but controlled by CAMEL	132
B.4.16	Early forwarded call controlled by CAMEL	134
B.4.17	Late forwarded call controlled by CAMEL	136
B.4.18	Incoming call handled by CAMEL with redirection initiated by CAMEL feature	137

Annex C (normative): Observed IMEI tickets139

C.1 General139

C.2 Observed IMEI tickets139

C.3 Description of record fields.....139

C.3.1 IMEI Check Event.....140

C.3.2 IMEI Status140

Annex D (informative): Change history141

Foreword

This Technical Specification has been produced by the 3GPP.

The contents of the present document are subject to continuing work within the TSG and may change following formal TSG approval. Should the TSG modify the contents of this TS, it will be re-released by the TSG with an identifying change of release date and an increase in version number as follows:

Version x.y.z

where:

- x the first digit:
 - 1 presented to TSG for information;
 - 2 presented to TSG for approval;
 - 3 Indicates TSG approved document under change control.
- y the second digit is incremented for all changes of substance, i.e. technical enhancements, corrections, updates, etc.
- z the third digit is incremented when editorial only changes have been incorporated in the document.

1 Scope

The present document is concerned with the administration of subscriber related event and call data. This includes both the collection of call data from, and the distribution of tariff data to, the network elements.

The subscriber (IMSI) and mobile equipment (IMEI) related call and event data collected is employed by a number of management activities including billing & accounting, statistical analysis and customer care.

The tariff data in the network elements is required to support the supplementary service "Advice of Charge".

The aim of the present document is to describe both the network management functions required and the data involved.

2 References

The following documents contain provisions which through reference in this text, constitute provisions of the present document.

- References are either specific (identified by date of publication, edition number, version number, etc.) or non-specific.
- For a specific reference, subsequent revisions do not apply.
- For a non-specific reference, the latest version applies.
- A non-specific reference to an ETS shall also be taken to refer to later versions published as an EN with the same number.

- [1] ITU-T D.93 (1988): " Charging & Accounting in the international land mobile telephone service provided via cellular radio systems".
- [2] ITU-T E.164 (1988): " Numbering Plan for the ISDN Era".
- [3] ITU-T M.3010: " Principles for a telecommunications management network".
- [4] ITU-T M.3200: " TMN Management Services: Overview".
- [5] ITU-T X.721 (ISO/IEC 10165-2) (1992): " Information technology - Open Systems Interconnection - Structure of management information: Definition of management information".
- [6] ITU-T X.722 (ISO/IEC 10165-4) (1992): " Information technology - Open Systems Interconnection - Structure of Management Information: Guidelines for the definition of managed objects".
- [7] ITU-T X.730 (ISO/IEC 10164-1): "Information technology - Open Systems Interconnection - Systems Management: Object Management Function".
- [8] ITU-T X.731 (ISO/IEC 10164-2): "Information technology - Open Systems Interconnection - Systems Management: State Management Function".
- [9] ITU-T X.733: "Information technology - Open Systems Interconnection - Systems Management: Alarm reporting function".
- [10] ITU-T X.734 (ISO/IEC 10164-5): "Information technology - Open Systems Interconnection - Systems Management: Event Report Management Function".
- [11] ITU-T X.735 (ISO/IEC 10164-6): "Information technology - Open Systems Interconnection - Systems Management: Log Control Function".
- [12] 3GPP TS 22.024: "Description of Charge Advice Information (CAI)".
- [13] 3GPP TS 22.086: "Advice of charge (AoC) supplementary services - Stage 1".

- [14] 3GPP TS 23.003: "Numbering, addressing and identification".
- [15] 3GPP TS 23.040: "Technical realization of the Short Message Service (SMS) Point to Point (PP)".
- [16] 3GPP TS 24.008: "Mobile radio interface layer 3 specification".
- [17] 3GPP TS 29.002: "Mobile Application Part (MAP) specification".
- [18] GSM 12.00: "Digital cellular telecommunication system (Phase 2); Objectives and structure of Network Management (NM)".
- [19] GSM 12.01: "Digital cellular telecommunication system (Phase 2); Common aspects of GSM Network Management (NM)".
- [20] GSM 12.02: "Digital cellular telecommunication system (Phase 2+); Subscriber, Mobile Equipment (ME) and services data administration".
- [21] 3GPP TS 32.015: "3G call and event data for the Packet Switched (PS) domain".
- [22] ETS 300 196-1: "Integrated Services Digital Network (ISDN); Generic functional protocol for the support of supplementary services; Digital Subscriber Signalling System No. one (DSS1) protocol; Part 1: Protocol specification".
- [23] 3GPP TS 23.078: "Customised Application for Mobile network Enhanced Logic (CAMEL) - Phase 2; Stage 2".
- [24] 3GPP TS 29.078: "Customised Application for Mobile network Enhanced Logic (CAMEL); CAMEL Application Part (CAP) specification - Phase 2".
- [25] ITU-T Rec. Q.763 (09/97) Signalling System No. 7 - ISDN user part formats and codes
- [26] ITU-T Rec. Q.767 (02/91) Application of the ISDN user part of ITU-T Signalling System No. 7 for international ISDN interconnections

3 Definitions

For the purposes of the present document, the following terms and definitions apply.

accounting meter record: A record containing one or more counters employed to register the usage of resources en masse. Includes simple event counters and/ or cumulative call second counters.

advice of charge: The real-time display of the network utilisation charges incurred by the Mobile Station. The charges are displayed in the form of charging units. If a unit price is stored by the MS then the display may also include the equivalent charge in the home currency.

aoc service: A combination of one or more services, both basic and supplementary, together with a number of other charging relevant parameters to define a customised service for the purpose of advice of charge.

call data: One or more call records.

call record: A set of parameters related to one call attempt.

CAMEL: A network feature that provides the mechanisms to support operator specific services even when roaming outside HPLMN.

CAMEL subscription information: Identifies a subscriber as having CAMEL services.

charging calendar: One or more date definitions each of which assigns a day class to a particular day.

charging destination: Also referred to as a destination for charging, this is a nominal reference defining the point of termination of a connection for charging purposes.

charging origin: A nominal reference defining the point of origin of a connection for charging purposes.

charging zone: A distance class (e.g. "local" and "long distance") defined by one or more combinations of charging origins and charging destinations.

day class: A group of days for which the same tariff switch-over pattern applies e.g. public holidays

event data: One or more event records.

event record: A set of parameters related to a single telecommunications event.

observed IMEI ticket: A record used to describe an EIR relevant event e.g. a blacklisted IMEI

service distance dependency: The relationship between an AoC service, a charging zone and the relevant tariff class.

successful call: A connection that reaches the communication or data transfer phase e.g. the "answered" state for speech connections. All other connection attempts are regarded as unsuccessful.

tariff: A set of parameters defining the network utilisation charges for the use of a particular service.

tariff class: A grouping of one or more service distance dependencies for the purpose of defining the corresponding tariff switching patterns.

tariff period: A part of one (calendar) day during which a particular tariff is applied. Defined by the time at which the period commences (the switch-over time) and the tariff to be applied after switch-over.

tariff switch-over pattern: A set of tariff periods defining the tariffs to be applied over one complete 24 hour period (calendar day).

4 Abbreviations

For the purposes of the present document, the following abbreviations apply:

ADC	Administration Centre
AoC	Advice of Charge
BSS	Base Station System
CAI	Charge Advice Information
CAMEL	Customised Applications for Mobile network Enhanced Logic
CMIP	Common Management Information Protocol
CMIS	Common Management Information Service
CUG	Closed User Group
EFD	Event forwarding discriminator
EIR	Equipment Identity Register
ETSI	European Telecommunications Standard Institute
DP	Detection Point
EDP	Event Detection Point
FTAM	File Transfer, Access and Management
GMSC	Gateway MSC
gsmSCF	GSM Service Control Function
gsmSSF	GSM Service Switching Function
HLR	Home Location Register
HPLMN	Home PLMN
HSCSD	High Speed Circuit Switched Data
ICS	Implementation Conformance Statements
IMEI	International Mobile Equipment Identity
IMSI	International Mobile Subscriber Identity
ISDN	Integrated Services Digital Network
ISP	Internal Standardized Profiles
MCS	Management Conformance Summary
MMI	Man Machine Interface
MOC	Mobile Originated Call (attempt)
MOCS	Managed Object Conformance Statements
MS	Mobile Station
MSC	Mobile Services Switching Centre
MSRN	Mobile Station Roaming Number
MTC	Mobile Terminated Call (attempt)
NE	Network Element
NEF	Network Element Function block
NM	Network Management
OACSU	Off air call set-up
O-CSI	Originating CAMEL Subscription Information

OMC	Operations and Maintenance Centre
OS	Operations System
OSF	Operations System Function
OSS	Operator Specific Service
PICS	Protocol Implementation Conformance Statements
PLMN	Public Land Mobile Network
PSPDN	Packet Switched Public Data Network
SCI	Subscriber Controlled (MMI) Input
SCS	System Conformance Statement
SDR	Special Drawing Right
SMF	System Management Function
SMS	Short Message Service
T-CSI	Terminating CAMEL Subscription Information
TAP	Transferred Account Procedure
TDP	Trigger Detection Point
TMN	Telecommunications Management Network
TMN-MF	TMN Management Function
TMN-MS	TMN Management Service
TMN-MSC	TMN Management Service Component
USSD	Unstructured Supplementary Service Data
VAS	Value Added Service
VLR	Visitor Location Register
VMSC	Visited MSC
VPLMN	Visited PLMN

5 General

Call and event data from the Mobile Services Switching Centres (MSCs), Base Station Systems (BSSs) and location registers (HLR/VLR) is required for a number of network management activities including, but not limited to, the following:

- the billing of home subscribers, either directly or via service providers, for network utilisation charges;
- the settlement of accounts for traffic carried or services performed by fixed network and other operators;
- the settlement of accounts with other PLMNs for roaming traffic via the transferred account procedure;
- statistical analysis of service usage;
- as historical evidence in dealing with customer service and billing complaints;

In addition to the information collected from these network elements, network management functions are required for the administration of on-line charging data stored in the MSCs. This data is employed to drive the charge display in the Mobile Station (MS) as required by the advice of charge (AoC) service and defined by 3GPP TS 22.086 [13] and 3GPP TS 22.024 [12].

The present document describes the network management interfaces and functions required in terms of the Telecommunications Management Network (TMN) information model defined by the ITU-T (see ITU-T M.3010 [3] and GSM 12.00 [18]).

For the purpose of the present document, the call and event data is considered to be collected, in real-time, by network element function (NEF) blocks located within the MSCs, BSSs and location registers.

The data collected by the NEFs is sent to, or collected by, the appropriate Operations System Function (OSF) blocks for storage and further processing.

Similarly, the tariff data required by the NEFs to provide on-line charging information is distributed by the appropriate OSF.

The location of the OSF is implementation specific and may, for example, be provided either by an Administration Centre (ADC) or integrated within the network elements themselves.

6 TMN management services

6.1 Tariff and charging administration

The TMN Management Service "Tariff and Charging Administration", as defined in ITU-T M.3200 [4], covers those management activities related to the charging of service usage including both the data collection process and the administration of charging data within the network elements. The relationship between this and other management services and activities is illustrated in figure 1 and described in the following subclauses.

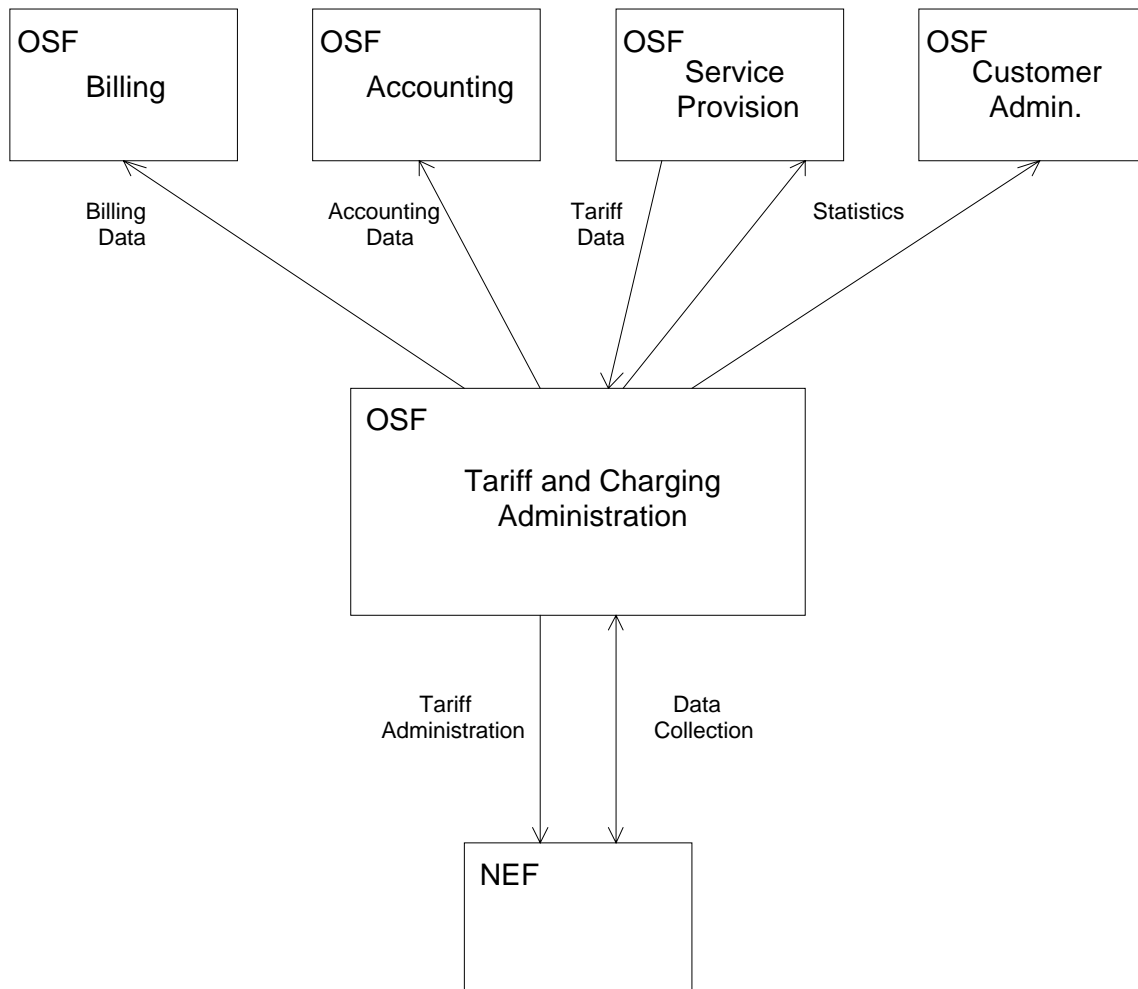

Figure 1: Tariff and charging administration

6.1.1 Subscriber billing

The call and event data collected from the network elements is employed to determine the network utilisation charges for the basic and supplementary services utilised by the home subscribers of the PLMN. The charges calculated are then combined with the network access (subscription) charges and billed to those customers directly serviced by the PLMN.

For those subscribers handled by Service Providers, the billing information is employed for both wholesale (Network Operator to Service Provider) and retail (Service Provider to Subscriber) billing. Consequently, having been processed by the PLMN Billing Centre, the call and event data collected from the network elements may also be sent to the Service Provider for further processing.

6.1.2 Accounting

6.1.2.1 Inter-PLMN accounting

Inter-PLMN accounts for roaming traffic are determined in accordance with ITU-T principles (see ITU-T D.93 [1]) and are settled by means of the Transferred Account Procedure (TAP).

6.1.2.1.1 'Visitors' from other PLMNs

The call and event data collected from the network also includes details of the services employed by visiting (roaming) subscribers. The charges for mobile originated calls (MOCs) and for supplementary services used are calculated as for home subscribers, converted to an agreed accounting currency (e.g. SDRs) and included in the call detail records for the TAP. Even if mobile terminated calls (MTCs) are zero-priced in the visited network (VPLMN), in the absence of 'optimised routing' the MTC TAP records are still required by the home network (HPLMN) in order to determine the re-routing charges from the HPLMN to the VPLMN.

The TAP records generated are exchanged with each HPLMN on a regular basis. These TAP records form the basis of the invoice submitted by the VPLMN for the traffic carried.

6.1.2.1.2 'Home' subscribers roaming in other PLMNs

The HPLMN receives TAP records from each VPLMN for services employed by home subscribers whilst roaming. These records are employed to verify the invoices from the VPLMN and to bill the home subscribers for the services used. The charges contained in the TAP records are converted from the accounting currency to the local currency and a handling surcharge (mark-up) is added if required. The TAP records are subsequently passed to the subscriber billing process described in subclause 6.1.1.

6.1.2.2 Fixed network operators and other service providers

The settlement of accounts with the operators of fixed networks for traffic carried, is generally performed on a bulk basis according to the principles outlined in the ITU-T D-series of recommendations.

The traffic accounted for in this manner may include:

- outgoing (Mobile to Land) traffic;
- incoming (Land to Mobile) traffic;
- transit traffic, carried by intermediate networks;
- signalling (MAP/SCCP, CAP/SCCP) traffic e.g. location updates.

Accounting information may also be required for the use of services provided by other operators such as short message service centres and other value added service (VAS) providers.

The charges for the various traffic shares may be determined on the basis of the call records generated by the network elements or on the basis of bulk counters (accounting meter records) in the gateway MSCs (GMSCs). For the purpose of the present document, the management information required is assumed to be derived from call and event records. The management of accounting meters is outside the scope of the present document.

6.1.3 Service provision

The call and event data collected from the network elements may be used to provide statistical information concerning the use of services, by both home and visiting subscribers, within the network. In addition, the introduction of new services and/or modifications to the tariffs of existing services may also require the distribution of the appropriate tariff information to the network elements for Advice of Charge purposes.

6.1.4 Customer administration

The call data collected from the NEs provides a historic record of subscriber activity and may be used for the handling of customer care enquiries and, in particular, billing complaints. For further details of customer administration services see GSM 12.02 [20].

6.2 Management of mobile equipment

The TMN Management Service "Management of Mobile Equipment" covers those management activities related to the International Mobile Station Equipment Identity (IMEI) of the mobile station (MS). The main objective of this management service is to administer the data of the Equipment Identity Register (EIR) thereby preventing the access by unauthorised or faulty equipment to the network.

Figure 2 illustrates the exchange of information between the OSF and the appropriate NEFs. The EIR Management Data exchanged takes the form of a number of lists (white, grey and black) which determine whether or not access to the network is permitted for a particular range of IMEIs. For further details concerning the content and use of the white, grey and black lists see GSM 22.016. For full details of the management of these lists see GSM 12.02 [20].

The Observed IMEI Ticket Data collected from the network elements may be used to identify unknown IMEIs, to gather statistics concerning the use of the network by unauthorised mobile stations and to detect the presence of cloned equipment. The present document is concerned with the control of the generation of IMEI tickets together with the collection of those tickets from the NEFs.

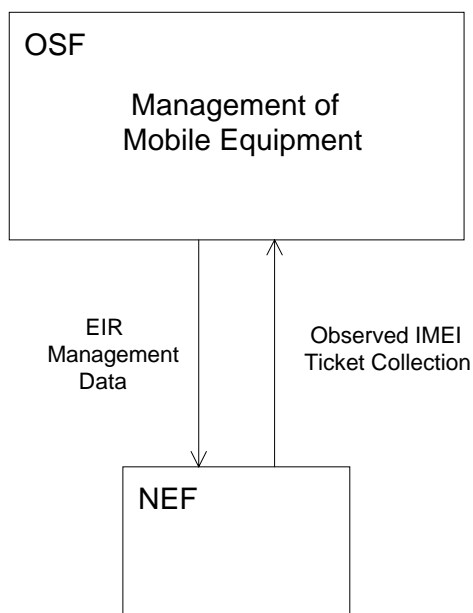

Figure 2: Management of mobile equipment

7 TMN management service components

7.1 Tariff and charging administration

The following TMN Management Service Components (TMN-MSCs) are relevant for mobile applications:

- Tariff Administration (real-time tariffing i.e. advice of charge);
- Data Collection Management (detailed billing, statistics etc.).

These components are illustrated in figure 3 (see also ITU-T M.3400 for comparison).

7.1.1 Tariff administration

This service component is concerned with the administration of tariff information in the network elements (NEFs). This information is required by the MSC for the on-line transmission of tariff information to the mobile station in order to support the Advice of Charge (AoC) service as described in 3GPP TS 22.086 [13] and 3GPP TS 22.024 [12].

The tariff to be applied to a particular service may depend on a number of factors including:

- the service itself;
- the origin and destination of the connection (charging zone);
- the date of the year, day of the week and the time of day;
- the type of resource being used e.g. full/ half rate radio traffic channel;
- the mode of operation of the basic service employed (transparent/ non-transparent);
- the call/ connection type e.g. MOC/ MTC;
- additional network-specific criteria.

The tariff administration service component provides the OS with the management functions required to administer both the tariffs themselves and the parameters required for the application of those tariffs.

7.1.2 Data collection

This service component is concerned with the collection of data from the NEs. It includes the specification of the data to be collected as well as the mechanisms required for the transfer of that data to the OS.

7.1.2.1 Data generation control

The generation, intermediate storage and transmission of call and event data consume considerable amounts of network and TMN resources. This service component permits the OS to configure and optimise both the generation of records within the NEs and the contents of those records according to the needs of the network operator.

7.1.2.2 Data transfer control

The call and event records produced by the NEF of the appropriate NEs shall be transmitted to, or collected by, the appropriate OSF for subsequent (off-line) processing.

This service component provides mechanisms for the transfer of call and event records, both individually (real-time event reporting) and in bulk (file transfer), between the NEFs and OSFs.

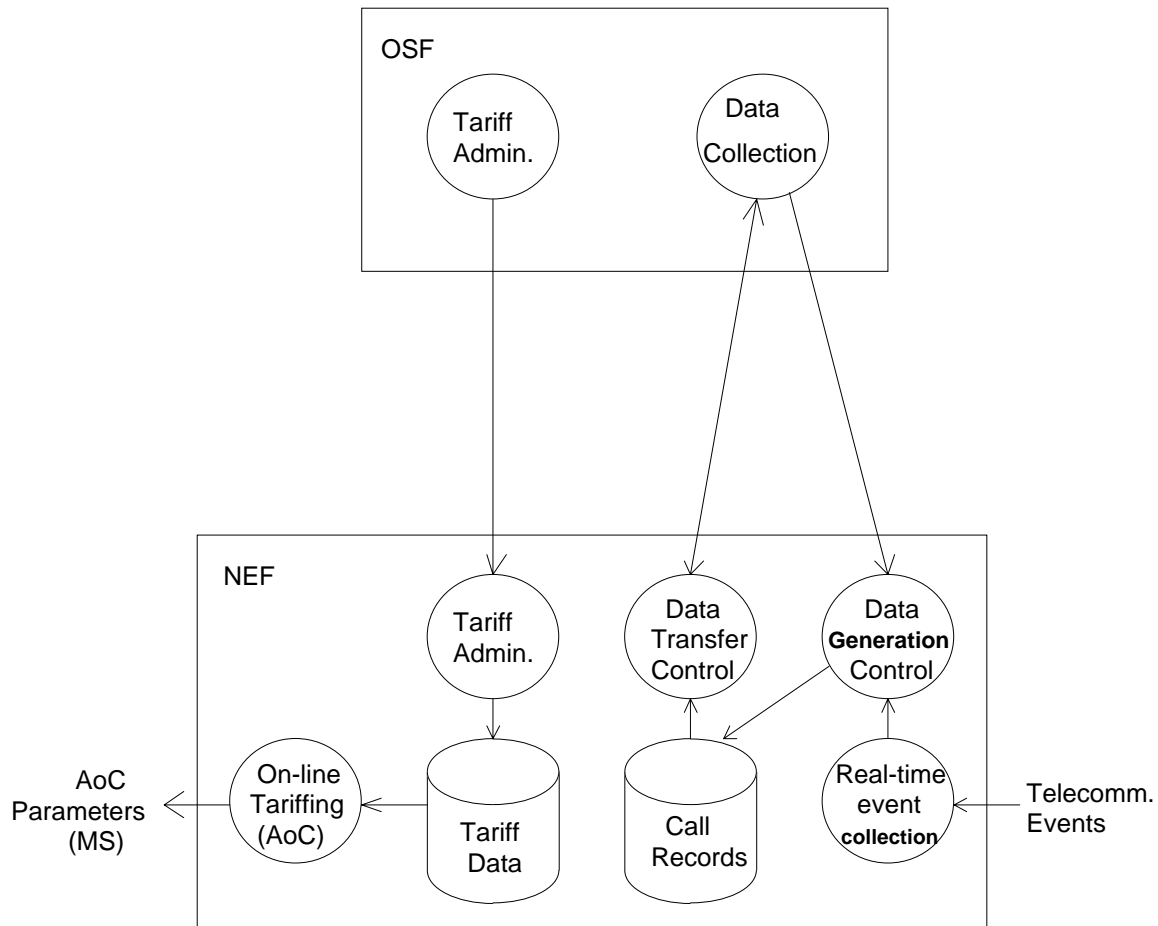

Figure 3: Management Service Components

7.2 Management of mobile equipment

The present document is concerned solely with the management of the EIR data collection process. This service component permits the OS to enable and disable the generation of observed IMEI tickets within the NEs. It also controls the transfer of the IMEI tickets from the NEs to the OS.

8 TMN management functions

This clause describes the individual TMN management functions (TMN-MFs) required. As described in ITU-T M.3400, each of these TMN-MFs shall be mapped onto one or more OSI System Management Functions (SMFs) defined in the following recommendations:

- Object Management Function (ITU-T X.730 [7]);
- State Management Function (ITU-T X.731 [8]);
- Alarm Reporting Function (ITU-T X.733 [9]);
- Event Reporting Management Function (ITU-T X.734 [10]);
- Log Control Function (ITU-T X.735 [11]).

In the following subclauses, each group of TMN functions is described in terms of the SMFs required. The terms create/ set/ get/ delete/ action/ and notification each refer to the appropriate pass-through service defined in ITU-T X.730 [7]. The object classes on which these operations are performed are described in detail in annex A.

It should be noted that each of the network management operations described may be performed on a particular network element (NEF) or "broadcast" to all relevant network elements. Both the handling of such "broadcast" operations and the mechanisms required to ensure the consistency of the information distributed are considered to be outside the scope of the present document.

8.1 Tariff administration

The following management functions are provided:

- Tariff class management;
- Tariff period management;
- Day class management;
- Tariff management;
- Tariff system management (change control).

8.1.1 Tariff class management

The purpose of the tariff class management functions is to permit the OS to assign a tariff class to a set of service and distance dependent charging parameters. Distance dependencies are defined in terms of charging origins, charging destinations and charging zones. Service dependencies are defined in terms of customised AoC services. For further details see subclause A.1.1. The table 1 includes some examples of possible tariff classes.

Table 1: Tariff class examples

Tariff class description	Service and distance dependencies
Telephony, class 2 mobiles, calls made within a particular metropolitan area	Service, origin, destination, MS classmark
Telephony, half rate codec, international calls	Service, destination, radio channel used
Short message service, mobile originated	Service only

8.1.1.1 Charging origin functions

This group of functions shall be used to create, set, get, and delete one or more charging origins. A charging origin represents a nominal reference point for the origination of a connection or transaction. Charging origins may be derived from a number of network configuration parameters including originating cell-id., incoming trunk group, MSC id. etc. The derivation of charging origins is a network specific matter and outside the scope of the present document. For the purpose of the present document it is sufficient to know the names and identities of the origins available.

The following system management functions are required:

Create/Set/Get/Delete chargingOrigin

8.1.1.2 Charging destination functions

This group of functions shall be used to create, set, get, and delete one or more charging destinations. A charging destination represents a nominal reference point for the termination of a connection or transaction. Charging destinations may be derived from a number of parameters including the called number, roaming number etc. The derivation of charging destinations is a network specific matter and outside the scope of the present document. For the purpose of the present document, it is sufficient to know the names and identities of the destinations available.

The following system management functions are required:

Create/Set/Get/Delete chargingDestination

8.1.1.3 Charging zone functions

This group of functions shall be used to create, set, get, and delete one or more charging zones. A charging zone provides a nominal measurement of the distance between the point of origination and termination of a connection.

Each charging zone shall consist of one or more origin and destination combinations. Each origin and destination combination shall contain a charging origin and/ or a charging destination. Only those origins and destinations previously created by means of the TMN-MFs functions described above may be referenced by a charging zone.

The following system management functions are required:

Create/Set/Get/Delete chargingZone

8.1.1.4 AoC service functions

This group of functions shall be used to create, set, get, and delete one or more AoC service definitions. An AoC service definition is a grouping of services together with additional charging parameters to provide a customised definition of a service for the purpose of Advice of Charge.

An AoC service definition shall consist of a combination of the following:

- one or more basic services; and/or
- one or more supplementary services; and/or
- one or more network specific services; and/or
- one or more power capability classes (MS classmark); and/or
- the type of radio traffic channel used/ requested;
- the transparency mode of the basic service employed (transparent/non-transparent);
- the type of call or connection (e.g. MOC/ MTC).

This list may also be extended to include additional network specific parameters.

The following system management functions are required:

Create/Set/Get/Delete aocService

8.1.1.5 Tariff class functions

This group of functions shall be used to create, set, get, and delete one or more tariff classes. A tariff class is a grouping of service and distance dependent charging parameters for the purpose of defining the corresponding tariff switching patterns.

Each tariff class shall contain one or more service distance dependencies. Each service distance dependency shall contain a reference to an AoC service definition and may include a reference to a charging zone.

The following system management functions are required:

Create/Set/Get/Delete tariffClass

8.1.2 Tariff period management

These functions permit the OS to create, set, get, and delete the tariff switching patterns and tariff periods defined in the NEs i.e. to manage the time-based tariff dependencies.

Each tariff class shall contain one or more tariff switching patterns, each of which assigns a tariff switching pattern to a particular day class. Each tariff switching pattern in turn shall contain one or more tariff periods.

A tariff period is a period of the day during which a particular tariff is applied e.g. a "peak rate" tariff period from 08:00 to 20:00. A tariff period shall contain a tariff switch-over time and a reference to the tariff to be applied after the switch-over. If the tariff to be applied does not change during the day then a single tariff period shall be defined with a default switching time of "00:00" i.e. Midnight. For further details see subclause A.1.2. The following table includes an example switching pattern for a particular tariff class.

Table 2: Tariff switching patterns for one tariff class

Day Class	Tariff	Switching	Pattern
	Tariff Period 1	Tariff Period 2	Tariff Period 3
Working day	00:00 "off-peak"	08:00 "peak"	18:00 "off-peak"
Holiday	00:00 "off-peak"	-	-

The following system management functions are required:

Create/Set/Get/Delete tariffSwitchPattern

8.1.3 Day class management

These functions permit the OS to create, set, get, and delete the day classes employed by the charging calendar table in the NEs. A day class groups together a number of days of the year for which the same tariff switch-over pattern applies e.g. Work days, Weekends and Holidays etc.

Each day of the week (Monday, Tuesday, etc.) shall be assigned by the charging calendar to a particular day class. Each day of the year (date) may also be assigned to a day class. The day class defined for a particular date takes priority over the class defined for the day of the week i.e. each day of the year belongs to one and only one day class.

A day class shall first be explicitly created before it can be referenced by a charging calendar. A separate charging calendar shall be created for each year.

The following system management functions are required:

Create/Set/Get/Delete chargingCalendar
Create/Set/Get/Delete dayClass

8.1.4 Tariff management

These functions permit the OS to create, set, get, and delete the tariffs defined in the NEs. In a GSM environment the tariff information takes the form of charge advice information (CAI) parameters as defined in 3GPP TS 22.024 [12].

In addition to the tariffs of the home PLMN, an invariant tariff set shall also be held for each foreign PLMN in order to provide AoC for MTCs to roaming subscribers as defined in 3GPP TS 22.024 [12]. This set also includes the e3 scaling factor required to convert the VPLMN units incurred into the units of the roaming subscribers home PLMN as displayed by the MS.

The following system management functions are required:

Create/Set/Get/Delete tariff
Create/Set/Get/Delete roamerTariff

8.1.5 Tariff system management (change control)

This group of functions controls the changes made to a tariff system as a whole rather than to individual entities. A tariff system is defined as a complete and consistent set of the following: tariffs (including roamer tariffs), tariff periods, tariff switching patterns and tariff classes.

Only one tariff system may be "active" at any given time and the entities contained within the active tariff system shall not be modified.

In addition to the active tariff system, there may be a number of additional tariff systems under development. On creation a tariff system shall assume the "available" state and may be extended or modified by employing any of the tariff class, tariff period or tariff administration functions as required.

In order to minimise the amount of effort required to modify an existing tariff system the "tsCopyTariffSystem" action may be used to create a complete copy of the current tariff system. The new (copied) system may then be modified or extended as required.

On completion of the modifications to a tariff system a check may be performed within the NEF in order to ensure that the set of tariffing parameters is consistent. If required, the check shall be invoked by means of the "tsCheck" action. If the check is successful then the tariff system shall assume the "checked" state.

The activation of a tariff system may either be immediate, or scheduled to take place at some future date and time e.g. Midnight on the 1 January. The activation of a tariff system involves a changeover between the current and the new tariff system. A changeover between tariff systems shall be invoked by means of the "tsChangeover" action. On changeover, the old tariff system shall assume the "standby" state. If, for any reason, the new tariff system causes problems then a second changeover may be performed swapping the current and standby tariff systems and thereby restoring the old configuration.

The change-over function may also include authentication parameters to ensure that the OS user is permitted to carry out the desired changes to the tariff system.

If, for any reason, a scheduled changeover is to be prevented, then the "tsCancelChangeover" action shall be employed to remove the scheduled changeover request. Both the currently active tariff system and the next scheduled changeover may be retrieved at any time by means of a "get" on the appropriate attributes.

Modifications and extensions to a tariff system (or the entities contained in it) are only permitted in the "available" state. If, for any reason, a tariff system in the "checked" or "standby" state requires modification then it shall first be explicitly released via the "tsUnfreeze" action.

Any modification in the state of a tariff system shall be reported to the OS by means of the "stateChange" notification.

The following system management functions are required:

Get	tariffAdmin
Action	tsChangeover, tsCancelChangeover, tsCopyTariffSystem
Notification	stateChange
Create/Set/Get/Delete	tariffSystem
Action	tsCheck, tsUnfreeze
Notification	stateChange

8.2 Data collection

The data collection management service component employs both the event report function (ITU-T X.734 [10]) and log control function (ITU-T X.735 [11]). The conceptual model is illustrated in figure 4. The call recording function collects internal telecommunication events within the NEF and formats them into potential call and event records. The record generation control functions determine which of these potential records are actually stored in the local NEF record filestore. The records within the filestore are collected by the OSF via file transfer (FTAM). The record classes of the record generation control function also determine which of the records produced are transmitted to the OSF in the form of event reports.

Similarly, the log control function determines which of the potential records are stored locally as log records. Once stored the log records may be individually accessed by the OSF via the appropriate object management functions. Care should be taken in the selection of filter criteria for the call and event record logs to avoid unnecessary overheads.

Finally, the potential call and event records are also passed to the event forwarding discriminators of the event reporting function. The EFDs determine which of the potential records are transmitted to the OSF in the form of event reports. Whereas the record classes are intended to produce event reports on a semi-permanent basis for day to day operation, the EFDs are intended for short term event reporting and with more complex filter constructs.

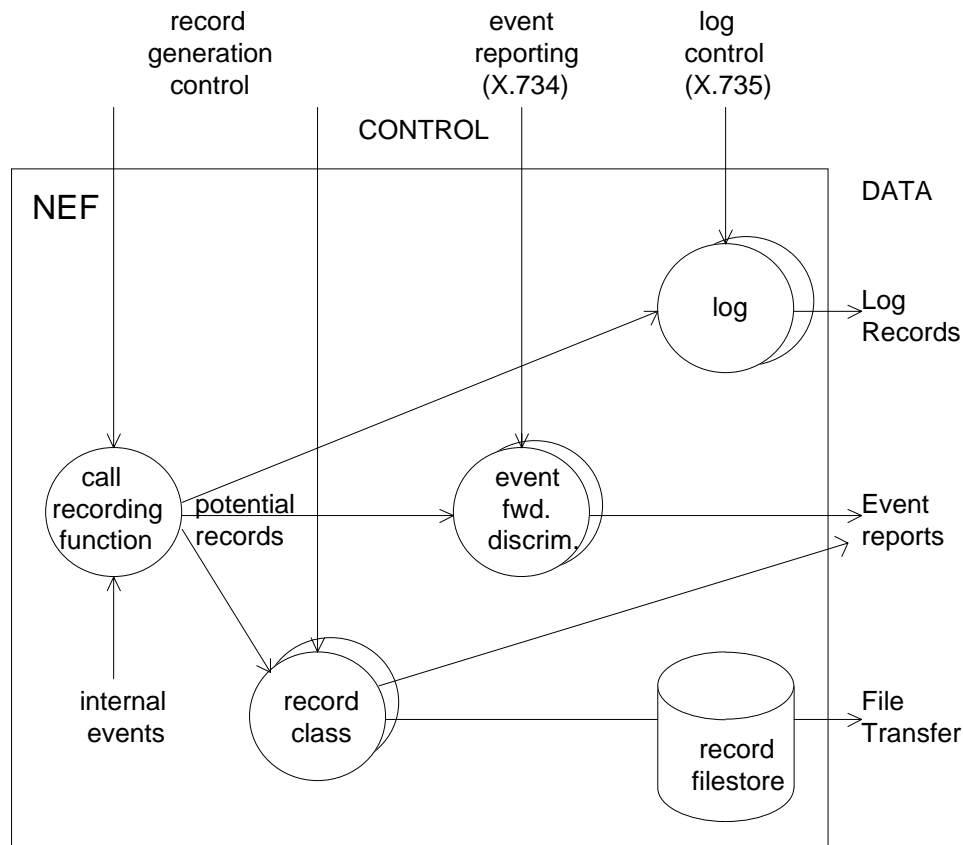

Figure 4: Data collection model

8.2.1 Data generation control

The following groups of TMN management functions are provided:

- Record generation control;
- Emergency call notification control;
- Observed IMEI ticket control;
- Log control.

8.2.1.1 Record generation control

These TMN management functions control the generation of call and event records within the record filestore of the NEF. The following groups of functions are provided:

- Record type generation control;
- Supplementary service recording control;
- Partial record generation control.

8.2.1.1.1 Record type generation control

This group of functions permit the network operator to enable/disable the generation of each call/event record type and to specify the conditions under which such records will be generated.

Each type of record to be stored locally within the record filestore shall be contained within one or more record classes. The record class shall define the destination(s) to which the records are to be sent. Each destination may be either a particular type of file within the filestore, or another management application to which the record shall be sent in the form of an event report.

Each record class shall contain one or more record type controls. Each record type control shall include the conditions under which the records of this type are to be generated. The records may be created for home subscriber and/ or visiting subscribers. The records may also be created for unsuccessful and/ or successful transactions.

The following system management functions are required:

Create/Set/Get/Delete recordClass
Create/Set/Get/Delete recordTypeControl

See also supplementary service recording control.

8.2.1.1.2 Partial record generation control

This function controls the generation of partial records. Partial records may be generated for any one of the following reasons:

- expiry of the partial record timer;
- change of basic service during a connection;
- change of location (LAC or Cell Id.) during a connection;
- change of MS classmark during a connection;
- change of AoC parameters during a call;
- change of radio channel (full/ half rate) during a call;
- change of HSCSD parameters during call;
- change of destination during a call (CAMEL).

This functions permits both the selection of the above options and the specification of the partial record interval timer for long hold calls. The timer may take any value within the range 0 to 24 hours, where 0 means no partial records will be generated.

The following system management functions are required:

Set/Get callRecordingFunction

8.2.1.1.3 Supplementary service recording control

These functions control the recording of supplementary service actions. There are two basic kinds of supplementary service action, call-related and non-call related.

Non-call related SS-actions may be recorded in SS-action records as defined in Annex B. Call-related SS-actions (usually "invocation") may either be included in the appropriate call record (MOC/ MTC) or recorded in separate SS-action records.

Functions are provided to enable the OS to define the supplementary services to be recorded via the creation of "supplServiceControl" objects. These objects may be defined for both individual services and for groups of services. A separate set of these objects may be contained within each record class object.

Each "supplServiceControl" object shall contain one or more "ssActionControl" objects which define the supplementary service action (registration, erasure, etc.) to be recorded; how the action is to be recorded (in MOC/ MTC records or in SS-action records); and for which class of subscribers the actions are to be recorded (own/ visiting/ all subscribers).

The following system management functions are required:

Create/Set/Get/Delete supplServiceControl
Create/Set/Get/Delete ssActionControl

8.2.1.2 Emergency call notification control

This function permits the OS to enable/ disable the generation of the emergency call notification. It also permits the OS to define the destinations (management application entities) to which the notification is to be sent.

The following system management functions are required:

Set/Get callRecordingFunction

8.2.1.3 Observed IMEI ticket control

This function permits the OS to enable/ disable the generation of observed IMEI tickets. If the generation of these tickets is enabled then they shall be stored in the appropriate file type ("observed IMEI ticket") within the local record filestore.

This function also permits the definition of one or more destinations (management application entities) to which the tickets may be sent in the form of event reports.

The following system management functions are required:

Set/Get callRecordingFunction

8.2.1.4 Log control

This function permits the record notifications described above to be stored and retrieved from logs within the NEF. The logging of these records is performed in accordance with the log control function specified in ITU-T X.735 [11] and no additional management functions are required.

8.2.2 Data transfer control

This service component contains the following groups of TMN management functions:

- Event reporting;
- Bulk record transfer;
- Log access.

8.2.2.1 Event reporting

These TMN functions control the generation and transmission of notifications from the NEF to the OSF.

8.2.2.1.1 Event forwarding discriminators

In addition to the notification control functions outlined in subclause 8.2.1, for short-term recording of specific events and for more complicated filter conditions the event forwarding discriminator construct defined in ITU-T X.734 [10] and ITU-T X.721 [5] shall be employed.

The event forwarding discriminator construct is extremely flexible permitting the combination of a number of fields and logical operations with a wide variety of scheduling options. The EFD also controls the destinations to which the event reports are sent. Several such filters may be defined and scheduled for operation at different times and for different time periods.

The following system management functions are required:

Create/Set/Get/Delete eventForwardingDiscriminator

8.2.2.1.2 Call event record reporting

This function permits the NEF to transmit a call or event record for a particular call attempt or event to the OSF. In general the record shall be sent on completion of the call or event. This function is controlled by means of the management functions described in subclause 8.2.1.1.

The following system management functions are required:

Notification callEventRecordReport

8.2.2.1.3 Emergency call reporting

This function permits the NEF to send a notification to an application entity within the OS whenever an emergency call is made within the network. The notification includes the IMEI (if available), the IMSI (if available) and the identity of the cell from which the call is made. This notification shall be sent during the emergency call set-up. The generation of this notification is controlled by means of the functions described in subclause 8.2.1.2.

The following system management functions are required:

Notification	emergencyCallIndication
--------------	-------------------------

8.2.2.1.4 Observed IMEI ticket reporting

This function permits the NEF to send a notification to an application entity within the OS whenever an observed IMEI ticket is generated. The generation of this notification is controlled by means of the functions described in subclause 8.2.1.3.

The following system management functions are required:

Notification	observedIMEITicketReport
--------------	--------------------------

8.2.2.2 Bulk record transfer

This group of TMN functions is concerned with the bulk transfer of call and event records from the NEF record filestore to the NEF.

The call and event records shall be transferred from the NEF to the OSF by the use of FTAM services. For further details of the use of FTAM see GSM 12.01 [19].

In addition to the simple file transfer services provided by FTAM, peer-to-peer application process communication may also be supported. The use of CMIS services for the uploading of files from the NEF to the OSF is specified in GSM 12.00 [18].

8.2.2.3 Log access

This TMN function control the access to the log described in subclause 8.2.1.4. Each log defined may contain one or more log entries. Each log entry contains a single call/ event record, emergency call indication report or observed IMEI ticket report.

NOTE: The term log entry has been used instead of the term log record to avoid confusion between the records contained within the local filestore and the records stored within logs.

For further details concerning the use of logs see ITU-T X.735 [11].

The following system management functions are required:

Get/Delete	callEventLogEntry
Get/Delete	emergencyCallIndicationLogRecord
Get/Delete	observedIEMITicketReportLogEntry

Annex A (normative): Information model

A.1 Overview

This annex contains the formal description of the information model for the present document. It consists of a simplified Entity-Relationship (ER) model by way of introduction, together with an object model specified in terms of the templates defined in ITU-T X.722 [6] "Guidelines for the Definition of Managed Objects".

The ER model consists of the following diagrams:

- tariff administration, the service and distance view;
- tariff administration, the date and time view;
- the call recording view.

These diagrams are intended to be an aid to understanding and, as a result, only the most important entities and relationships are shown. Some of the entities are present to resolve "many-to-many" relationships and are modelled via attributes rather than object classes. Such entities are explicitly marked.

A.1.1 Tariff administration, the service and distance view

Figure A.1 illustrates the most important service and distance relationships.

The "AoC Service" entity represents one or more services combined with a number of additional charging relevant parameters to form a customised service definition for the purpose of advice of charge. If a number of services are charged in the same way then they may be combined into a single "AoC Service" definition.

Each network contains a finite number of charging origins, nominal reference points defining the point of origin of a connection. The allocation of charging origins to cell identities, MSC areas, incoming trunk groups etc. is a network-specific matter and outside the scope of the present document. For the purpose of tariff administration it is sufficient to know the identities of the origins available.

Similarly, the derivation of charging destinations from, for example, the called address or number dialled is outside the scope of the present document. For the purpose of tariff administration it is sufficient to have a definitive list of the destinations available.

The combination of a charging origin with a charging destination provides a nominal measure of the distance factor involved in a connection. It should be noted that both the origin and destination within the "origin/ destination combination" are optional and that either of them may be omitted e.g. international connections may be purely destination dependent.

The combination of one or more such origin/ destination pairs defines a charging zone. The charging zone groups together those pairs belonging to the same distance class, typical examples include "local" and "long distance" zones.

The "Service Distance Dependency" combines an AoC service with a charging zone in order to apply a particular tariff class. Again, the charging zone is optional, if the charging of the service is not distance dependent then the zone is omitted.

Finally, a tariff class groups together those service distance dependencies to which the same tariff switching pattern is applied. The tariff switching pattern (see subclause A.1.2) determines the tariff to be applied at any particular point in time.

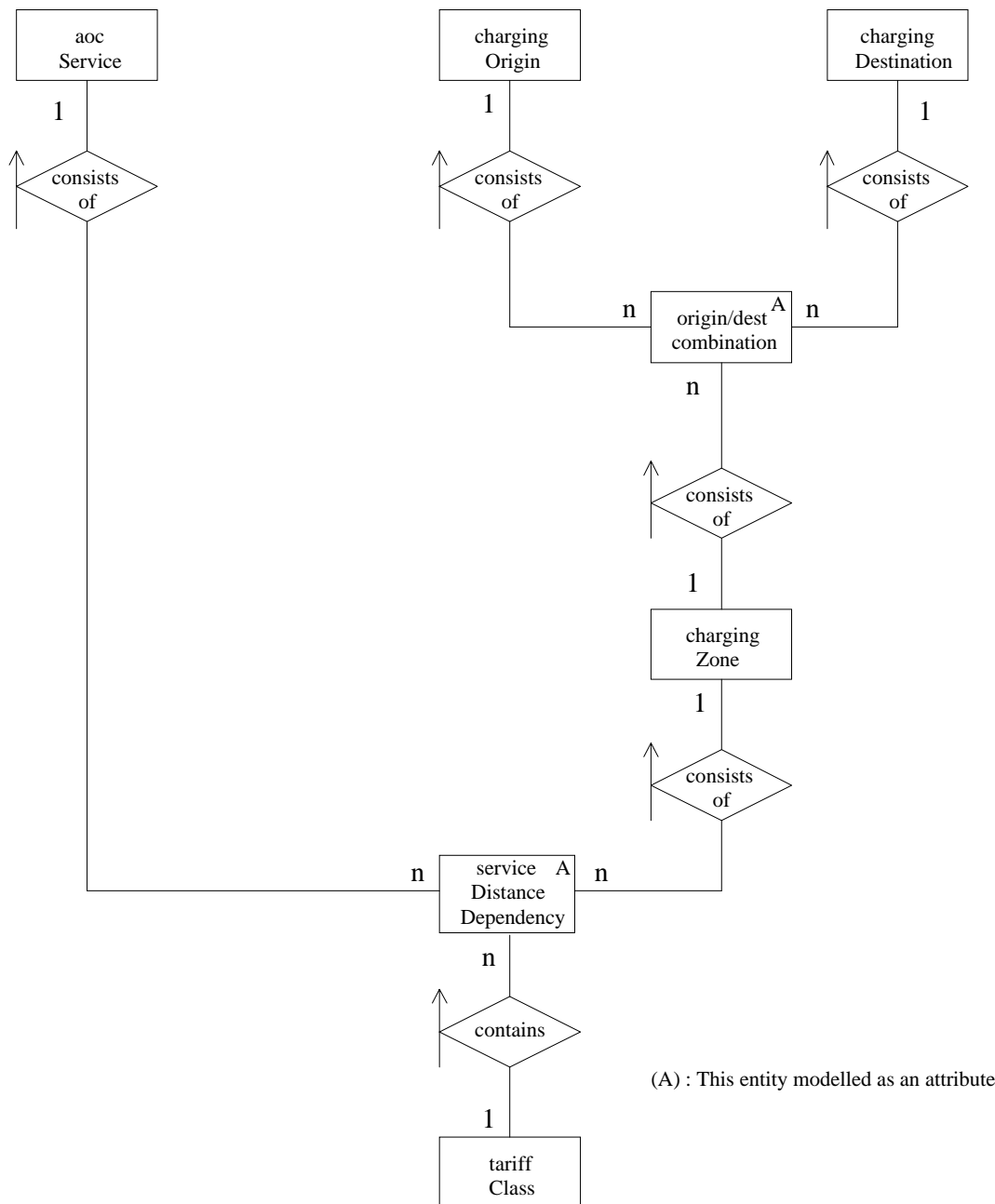

Figure A.1: Tariff administration, the service and distance view

A.1.2 Tariff administration, the date and time view

In general, the tariffs to be applied are dependent on a number of time-based factors including day, date and time of day. Figure A.2 illustrates the major entities involved and the relationships between them.

Each tariff class contains a number of tariff switching patterns defining the tariff to be applied over a complete 24 hour period (calendar day). The tariff switching pattern to be applied on a particular day depends on the day class of the day in question. Typical day classes include "weekday", "weekend" and "holiday". Each tariff class contains one, and only one, tariff switching pattern for each day class defined. However, the tariff switching pattern applied to a number of day classes may be the same.

A charging calendar contains a number of both "day" and "date" definitions assigning a day class to days of the week and days of the year respectively. Whereas a day class shall be defined for each day of the week, only those dates explicitly requiring a day class (e.g. holidays) are included in the charging calendar. It should be noted that the "date" definitions take precedence over the "day" definitions. For the avoidance of doubt, each day of the year belongs to one, and only one, day class.

Each tariff switching pattern contains one or more tariff periods. A tariff period is a continuous period of time during which the same tariff is applied. A tariff period is characterised by a tariff switch-over time and a reference to the tariff to be applied after that time. If the tariff does not vary over the 24 hour period covered by the switching pattern then a single tariff period shall be created with a switch-over time of midnight (00:00).

A tariff system (not shown) is defined as a complete and consistent set of tariff classes, tariff switching patterns and tariffs. There can be only one "active" tariff system at any one point in time and this system may not be altered. Alterations to tariff classes, tariff switch-over patterns and tariffs are prepared in advance by either copying the active tariff system or creating a new one. When the modifications are complete, a changeover between tariff systems may occur.

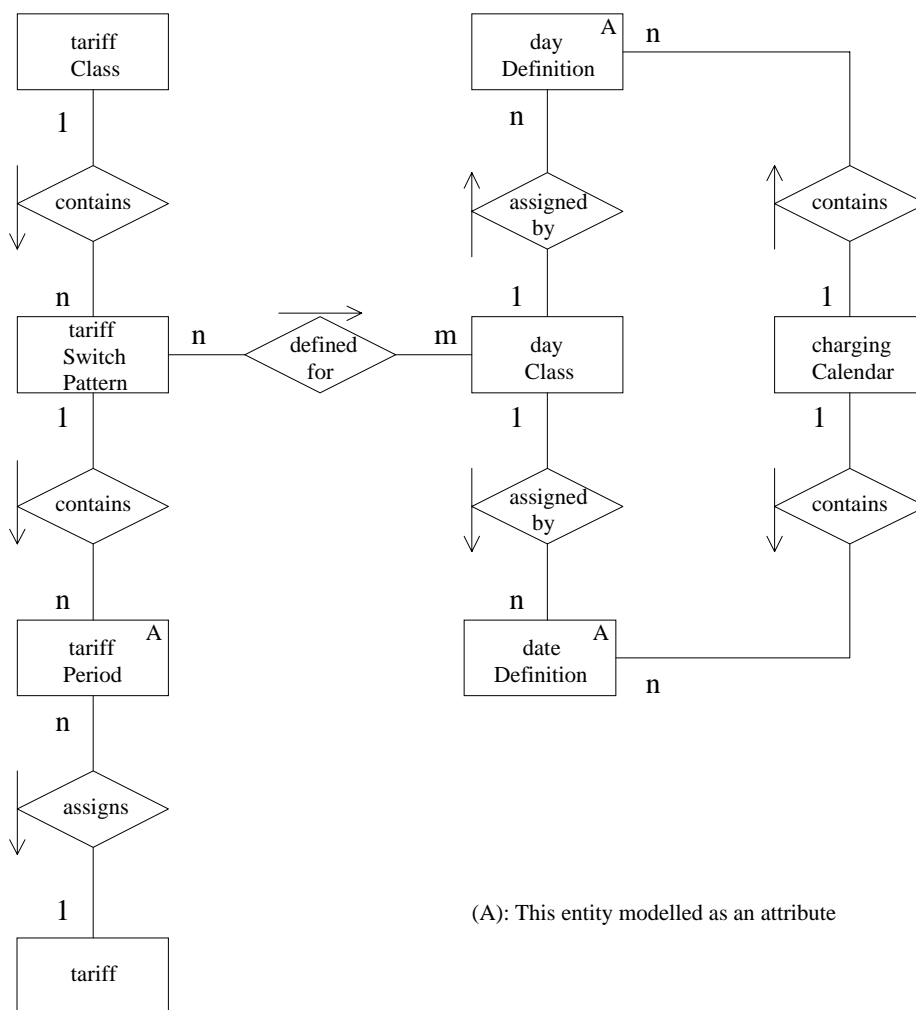

Figure A.2: Tariff administration, the date and time view

A.1.3 The call recording View

The call recording entities illustrated in figure A.3 control the generation and transfer of call and event records within a particular NE. The network element itself is represented by the managed element object. Each managed element may contain a call recording function. The call recording function represents the management view of the record generation process within the NE.

The generation of call records is controlled by the record class object. A record class defines the records to be produced for a particular purpose and the conditions under which those records are produced. A record class contains one or more record type control objects each of which controls the generation of records of a particular record type.

The record class also contains a number of supplementary service control objects. These objects determine which supplementary services (or groups thereof) are recorded. Each supplementary service control object contains one or more supplementary service action control objects each of which in turn determines whether or not a particular action (registration, invocation, etc.) is recorded.

The record class objects, together with the objects contained within them, define the call record generation control algorithm for normal usage. This includes both the records to be stored in the local NE filestore as well as those that are sent to the OS in the form of event reports. Additional call and event record event report filters may also be defined by employing the standard event forwarding discriminator object class. These filters are more suitable for temporary recording requirements as well as those containing more complicated filter constructs.

The notifications generated by the call recording function and presented to both the record classes and EFDs, may also be logged locally within the NE. Each managed element may contain one or more instances of the log managed object class.

Each log may contain one or more log entries each of which in turn contains a call and event record notification, an emergency call indication report or an observed IMEI ticket report.

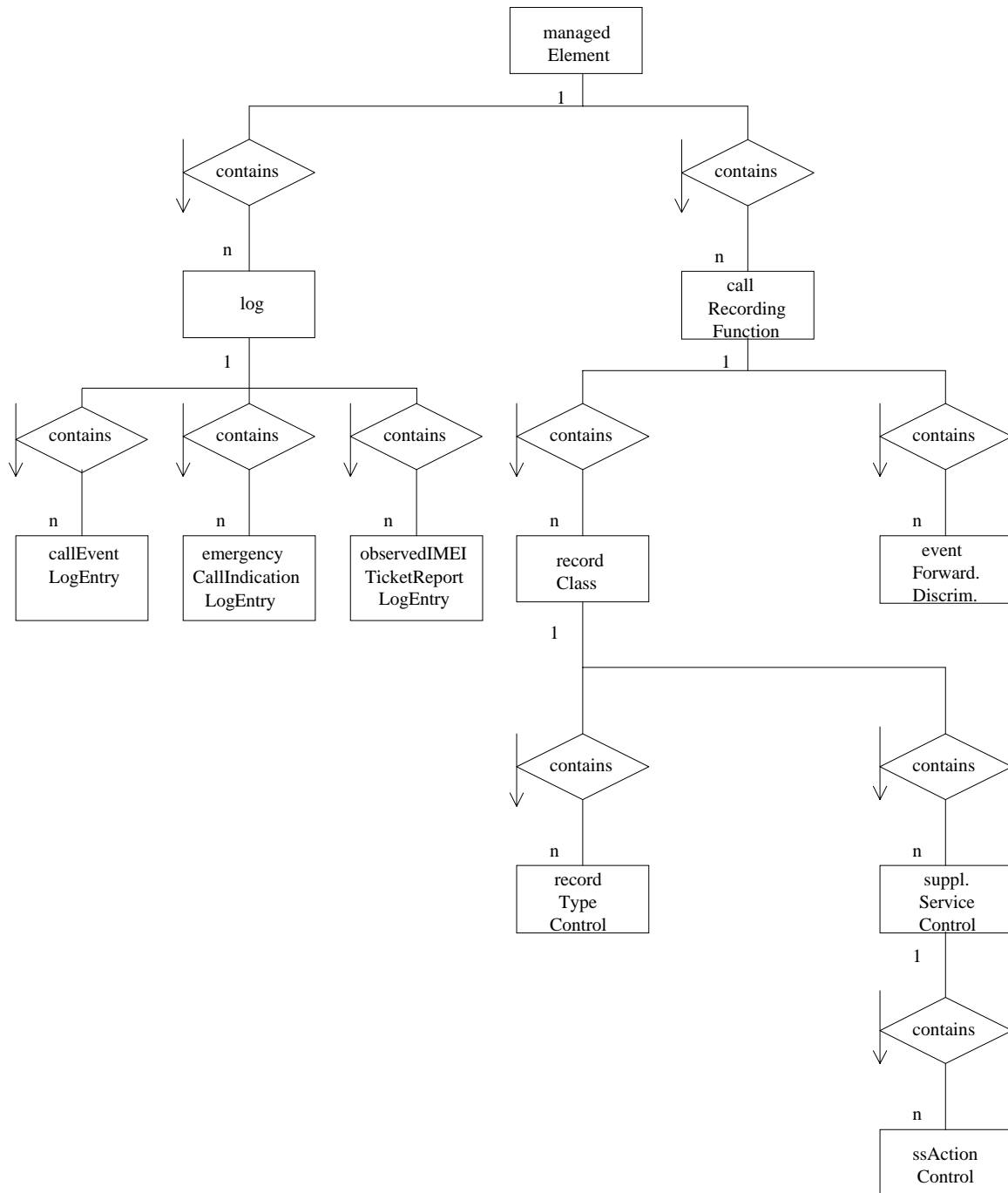

Figure A.3: The call recording view

A.2 Naming hierarchy

The naming (containment) tree for the objects defined within the present document is illustrated in Figure A.4 below. It should be noted that all of the object classes in the present document are shown relative to the "managedElement". For further details of the upper layers of the containment tree, including the object classes "managedElement" and "mscFunction" see GSM 12.00 [18]. For further details concerning the log class see ITU-T X.721 [5].

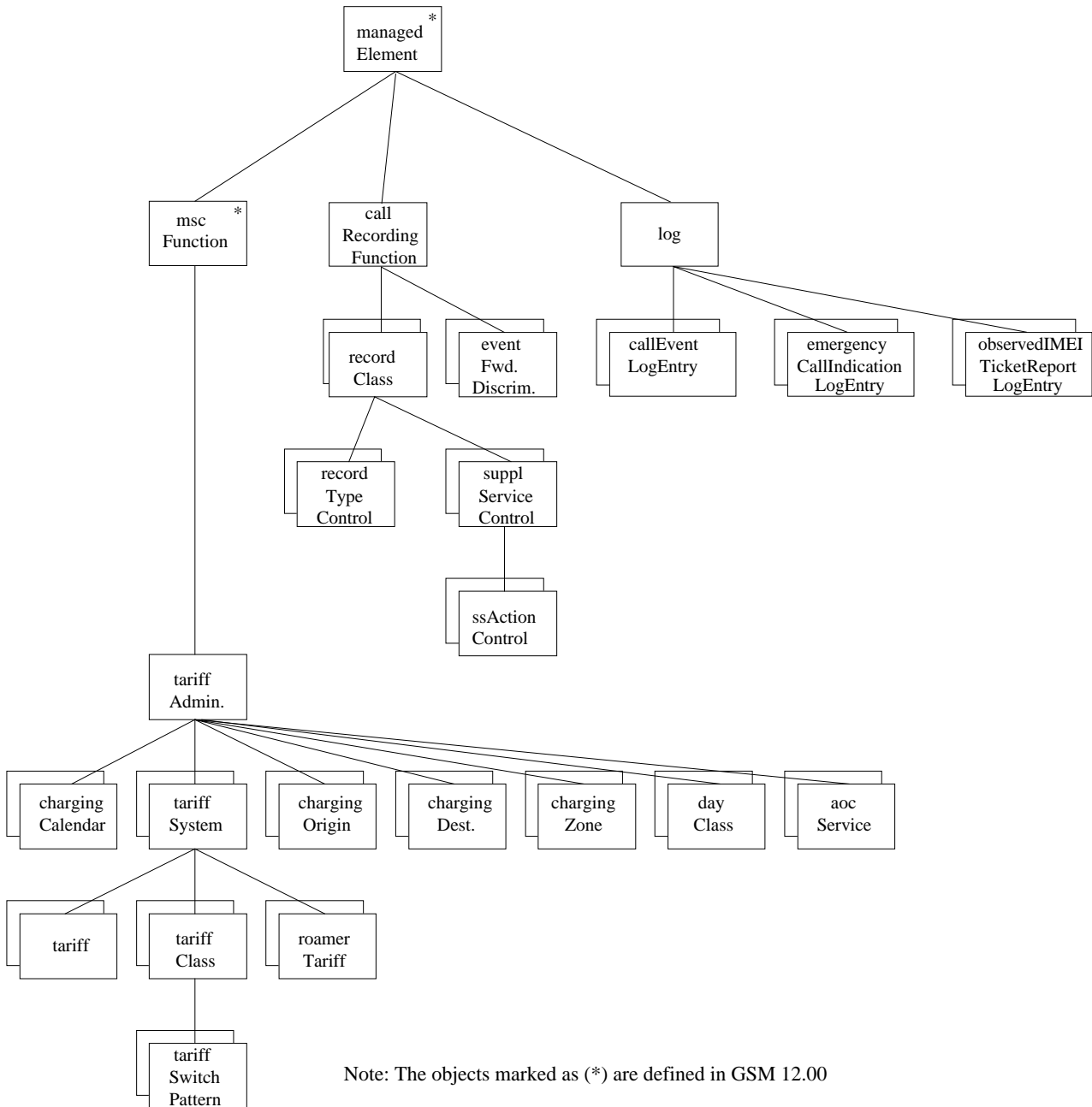

Figure A.4: The Naming Tree

A.3 Inheritance

The inheritance tree for the present document is illustrated in Figure A.5 below. Details of the object classes "mscFunction", and "managedElement" are included in GSM 12.00 [18] and therefore not included here.

Similarly, the object classes "log", "logRecord", "eventLogRecord", and "eventForwardingDiscriminator" (not shown here) are defined in ITU-T X.721 [5].

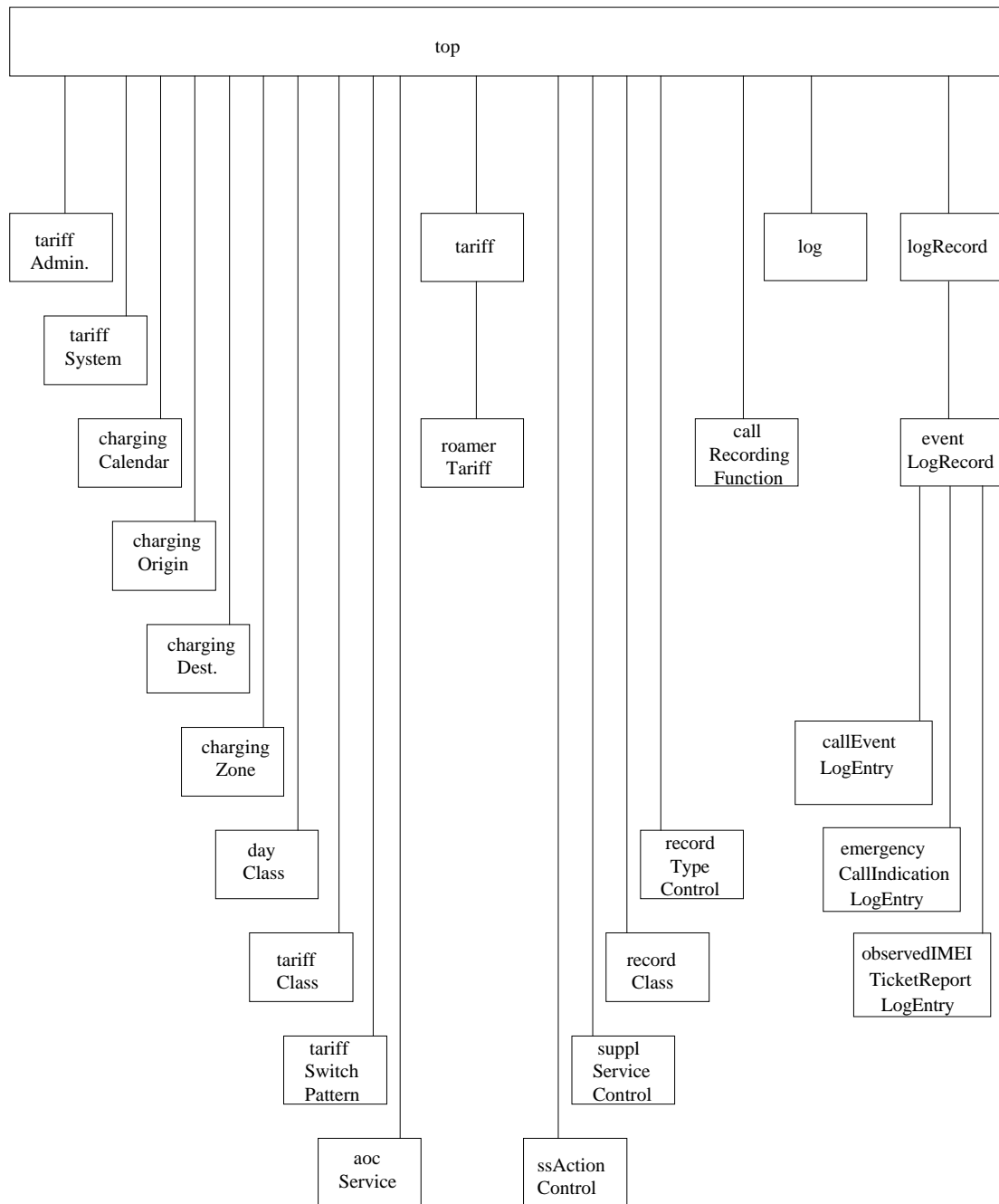

Figure A.5: The Inheritance Tree

A.4 Managed object classes

A.4.1 AoC service

This managed object class enables a number of services and additional charging parameters to be grouped together to define a "customised" network service for the purpose of AoC.

The presence of a conditional package within an instance of this object class shall be interpreted as a logical "AND" relationship i.e. if both basic and supplementary services are specified then the service definition only applies if both basic and supplementary services are used.

The SET of values within the attributes of the various packages shall be interpreted as a logical "OR" relationship i.e. the service definition applies if any one of the listed members is used.

Example: If, for the purpose of AoC, the same tariff switching pattern is to be applied to the use of call forwarding in conjunction with all teleservices except for Short Message Services then a single "aocService" object instance may be created with both the "basicServices" and "supplServices" packages instantiated. The list of basic services including all teleservice group codes except for SMS and the list of supplementary services including a single group code for "all call forwarding".

Network specific charging parameters, if required, may be included by defining a sub-class of the "aocService" object and specifying additional conditional packages.

```
aocService MANAGED OBJECT CLASS
  DERIVED FROM "Recommendation X.721 : 1992":top;
  CHARACTERIZED BY
  aocServiceDefinition PACKAGE
  ATTRIBUTES
    aocServiceId          GET,
    aocServiceName        GET-REPLACE;
  REGISTERED AS { gsm1205Package 1 };;

CONDITIONAL PACKAGES

  basicServicesPackage PACKAGE
  ATTRIBUTES
    basicServices          GET-REPLACE ADD-REMOVE;
  REGISTERED AS {gsm1205Package 2};
  PRESENT IF "the aoc service definition applies to basic services",

  supplServicesPackage PACKAGE
  ATTRIBUTES
    supplServices          GET-REPLACE ADD-REMOVE;
  REGISTERED AS {gsm1205Package 3};
  PRESENT IF "the aoc service definition applies to suppl. services",

  networkSpecificServicesPackage PACKAGE
  ATTRIBUTES
    networkSpecificServices GET-REPLACE ADD-REMOVE;
  REGISTERED AS {gsm1205Package 4};
  PRESENT IF "the aoc service definition applies to non-GSM services",

  radioChannelsRequestedPackage PACKAGE
  ATTRIBUTES
    radioChannelsRequested GET-REPLACE ADD-REMOVE;
  REGISTERED AS {gsm1205Package 5};
  PRESENT IF "the aoc service definition applies to the type of radio
  channel requested e.g. dual mode half rate preferred",
```

```

radioChannelUsedPackage PACKAGE
  ATTRIBUTES
    radioChannelUsed          GET-REPLACE;
REGISTERED AS {gsm1205Package 6};
PRESENT IF "the aoc service definition applies to the type of radio
channel actually employed i.e. full/ half rate",

msPowerClassesPackage PACKAGE
  ATTRIBUTES
    msPowerClasses          GET-REPLACE ADD-REMOVE;
REGISTERED AS {gsm1205Package 7};
PRESENT IF "the aoc service definition applies for certain MS classmark
(RF power capability) values",

transparencyPackage PACKAGE
  ATTRIBUTES
    transparencyInd          GET-REPLACE;
REGISTERED AS {gsm1205Package 8};
PRESENT IF "the aoc service definition applies to the mode of the basic
service employed i.e. transparent/ non-transparent",

callTypesPackage PACKAGE
  ATTRIBUTES
    callTypes          GET-REPLACE ADD-REMOVE;
REGISTERED AS {gsm1205Package 9};
PRESENT IF "the aoc service definition applies for certain types of call
e.g. MOC/ MTC";

HSCSDChannelsRequestedPackage PACKAGE
  ATTRIBUTES
    HSCSDChannelsRequested GET-REPLACE ADD-REMOVE;
REGISTERED AS {gsm1205Package 10};
PRESENT IF "the aoc service definition applies to the number of HSCSD
channels requested e.g. max 4 HSCSD channels",

HSCSDChannelsAllocatedPackage PACKAGE
  ATTRIBUTES
    HSCSDChannelsAllocated GET-REPLACE ADD-REMOVE;
REGISTERED AS {gsm1205Package 11};
PRESENT IF "the aoc service definition applies to the number of HSCSD
channels actually allocated for the connection e.g. 2 HSCSD channels
allocated";

REGISTERED AS {gsm1205ManagedObjectClass 1 };

```

A.4.2 Call and event log entry

This managed object class is a subclass of the "eventLogRecord" class described in ITU-T X.735 [11] and defined in ITU-T X.721 [5] and therefore inherits all of the properties of both the "logRecord" and eventLogRecord" classes. This includes the name binding "logRecord-log" defined in X.721.

```

callEventLogEntry MANAGED OBJECT CLASS
  DERIVED FROM "Recommendation X.721 : 1992":eventLogRecord;
  CHARACTERIZED BY
  callEventLogEntryPackage PACKAGE
    BEHAVIOUR
      callEventLogEntryBehaviour BEHAVIOUR
      DEFINED AS "This managed object is used to store a single call and
      event record.";;
    ATTRIBUTES
      callEventRecordType          GET,
      callEventRecordContent       GET;;;

```

```
REGISTERED AS {gsm1205ManagedObjectClass 2 };
```

A.4.3 Log (ITU-T X.721)

This managed object class is described in ITU-T X.735 [11] and defined in ITU-T X.721 [5].

A.4.4 Call recording function

This managed object class is employed to control the generation of call and event records within a particular Network Element. Only one instance of this object may be created within any one NE. This class contains notifications that permit the NE to transmit call and event records; emergency call indications; and observed IMEI tickets to the OS. It also controls the generation of partial records.

```
callRecordingFunction MANAGED OBJECT CLASS
  DERIVED FROM "Recommendation X.721 : 1992":top;
  CHARACTERIZED BY
  callRecordingFunctionPackage PACKAGE
  ATTRIBUTES
    callRecordingFunctionId          GET,
    partialRecordTimer              GET-REPLACE,
    partialRecordGeneration         GET-REPLACE ADD-REMOVE;
  NOTIFICATIONS
    callEventRecordReport;
  REGISTERED AS { gsm1205Package 12 };;
```

CONDITIONAL PACKAGES

```
emergencyCallNotificationPackage PACKAGE
  ATTRIBUTES
    emergencyCallIndEnable GET-REPLACE,
    emergencyCallIndDestGET-REPLACE ADD-REMOVE;
  NOTIFICATIONS
    emergencyCallIndication;
  REGISTERED AS { gsm1205Package 13 };
  PRESENT IF "the emergency notification is supported",
```

```
observedIMEITicketPackage PACKAGE
  ATTRIBUTES
    observedIMEITicketGenerationEnable GET-REPLACE,
    observedIMEITicketDest             GET-REPLACE;
  NOTIFICATIONS
    observedIMEITicketReport;
  REGISTERED AS { gsm1205Package 14 };
  PRESENT IF "observed IMEI tickets are supported";
```

```
REGISTERED AS {gsm1205ManagedObjectClass 4 };
```

A.4.5 Charging calendar

This managed object represents a charging calendar for a particular year. The calendar contains a set of day definitions each of which allocates a day class to a particular day of the week together with a set of date definitions which allocate a day class to a particular day of the year. The date definitions take precedence over the day definitions.

```

chargingCalendar MANAGED OBJECT CLASS
  DERIVED FROM "Recommendation X.721 : 1992":top;
  CHARACTERIZED BY
  chargingCalendarPackage PACKAGE
    ATTRIBUTES
      calendarYear          GET,
      dayDefinitions        GET-REPLACE ADD-REMOVE,
      dateDefinitions       GET-REPLACE ADD-REMOVE;;;
REGISTERED AS {gsm1205ManagedObjectClass 5 };

```

A.4.6 Charging destination

This managed object class defines a logical destination for distance sensitive charging purposes. A charging destination may be associated with one or more address strings (e.g. country codes) but may also be derived from other quantities such as routes, trunk groups etc. As a result, this object may be allocated to/ referenced by a number of configuration management objects. It should however be noted that the administration of such configuration management objects is outside the scope of the present document.

```

chargingDestination MANAGED OBJECT CLASS
  DERIVED FROM "Recommendation X.721 : 1992":top;
  CHARACTERIZED BY
  chargingDestinationPackage PACKAGE
    ATTRIBUTES
      destinationId         GET,
      destinationName      GET-REPLACE;;;
REGISTERED AS {gsm1205ManagedObjectClass 6 };

```

A.4.7 Charging origin

This managed object class defines a logical origin for distance sensitive charging purposes. A charging origin may be associated with one or more of the following: cell-ids, incoming trunk groups etc. As a result, this object may be allocated to/ referenced by a number of configuration management objects such as cell-ids, trunk groups etc. It should however be noted that the administration of such configuration management objects is outside the scope of the present document.

```

chargingOrigin MANAGED OBJECT CLASS
  DERIVED FROM "Recommendation X.721 : 1992":top;
  CHARACTERIZED BY
  chargingOriginPackage PACKAGE
    ATTRIBUTES
      originId              GET,
      originName           GET-REPLACE;;;
REGISTERED AS {gsm1205ManagedObjectClass 7 };

```

A.4.8 Charging zone

This managed object class defines a distance class for charging purposes. A charging zone contains a set of origin and destination combinations. Each origin/ destination combination shall appear in one, and only one, charging zone.

```

chargingZone MANAGED OBJECT CLASS
  DERIVED FROM "Recommendation X.721 : 1992":top;
  CHARACTERIZED BY
  chargingZonePackage PACKAGE
    ATTRIBUTES
      zoneId                GET,
      zoneName              GET-REPLACE,
      originDestCombinations GET-REPLACE ADD-REMOVE;;;
REGISTERED AS {gsm1205ManagedObjectClass 8 };

```

A.4.9 Day class

This managed object class defines a day class to be used in the charging calendar. A day class is used to group together days on which the same tariff switch pattern is applied.

```

dayClass MANAGED OBJECT CLASS
  DERIVED FROM "Recommendation X.721 : 1992":top;
  CHARACTERIZED BY
    dayClassPackage PACKAGE
      ATTRIBUTES
        dayClassId                               GET,
        dayClassName                             GET-REPLACE;;;
REGISTERED AS {gsm1205ManagedObjectClass 9 };

```

A.4.10 Event forwarding discriminator

The use of event forwarding discriminators (EFDs) is described in detail in ITU-T X.734 [10]. The object class itself is a subclass of the "discriminator" object class. Both discriminator and event forwarding discriminator classes are defined in ITU-T X.721 [5].

A.4.11 Roamer tariff

The "roamerTariff" object class is a subclass of "tariff" and therefore inherits all of its properties. This object class also contains additional information required for tariffs applied to roaming subscribers e.g. the scaling factor (e3) required to convert VPLMN units to HPLMN units.

NOTE: At present there is only one such tariff per HPLMN. This tariff, depending solely on the HPLMN, is independent of time, service etc. This invariant tariff is defined by the HPLMN but stored in the VPLMN in order to drive the AOC display for MTCs to roaming subscribers. This tariff covers the charges for the re-routing of the call from the HPLMN to the VPLMN. For further details see 3GPP TS 22.024 [12].

```

roamerTariff MANAGED OBJECT CLASS
  DERIVED FROM tariff;
  CHARACTERIZED BY
    roamerTariffPackage PACKAGE
      ATTRIBUTES
        hplmnId                               GET,
        e3-Scaling-Factor                     GET-REPLACE;;;
REGISTERED AS {gsm1205ManagedObjectClass 10 };

```

A.4.12 Record class

This managed object class defines a record class. A record class groups together a number of record types recorded for a particular purpose. Examples of possible record classes might include:

- the billing relevant records both stored locally and sent to the OS in the form of event reports;
- customised record classes defined by the network operator.

The managed object instance includes the name of the record class and a list of destinations to which the records are sent and contains one or more objects of the classes "recordTypeControl", "supplServiceControl", and "ssActionControl".

```

recordClass MANAGED OBJECT CLASS
  DERIVED FROM "Recommendation X.721 : 1992":top;
  CHARACTERIZED BY
  recordClassPackage PACKAGE
    ATTRIBUTES
      recordClassId                GET,
      recordClassName              GET-REPLACE,
      recordClassDestination       GET-REPLACE ADD-REMOVE;;;
REGISTERED AS {gsm1205ManagedObjectClass 11 };

```

A.4.13 Record type control

This managed object class controls the type of call and event records generated. A managed object instance of this class is created for each type of record to be produced. The object instance defines both the type of transaction recorded (successful, unsuccessful, all) and the type of subscribers for whom the records are to be created e.g. home / visiting / all subscribers.

```

recordTypeControl MANAGED OBJECT CLASS
  DERIVED FROM "Recommendation X.721 : 1992":top;
  CHARACTERIZED BY
  recordTypeControlPackage PACKAGE
    ATTRIBUTES
      recordType                    GET,
      typeOfTransaction             GET-REPLACE,
      typeOfSubscribers             GET-REPLACE;;;
REGISTERED AS {gsm1205ManagedObjectClass 12 };

```

A.4.14 Supplementary service action control

This managed object class controls the recording of individual supplementary service actions. A managed object instance of this class is created for each supplementary service action to be recorded. The object instance defines how the action is to be recorded (in MOC / MTC records or in SS-Action records); and for whom the records are to be created e.g. home / visiting / all subscribers.

```

ssActionControl MANAGED OBJECT CLASS
  DERIVED FROM "Recommendation X.721 : 1992":top;
  CHARACTERIZED BY
  ssActionControlPackage PACKAGE
    ATTRIBUTES
      ssActionType                  GET,
      recordingMethod               GET-REPLACE,
      typeOfSubscribers             GET-REPLACE;;;
REGISTERED AS {gsm1205ManagedObjectClass 13 };

```

A.4.15 Supplementary service control

This managed object class controls the recording of the use of supplementary services. A managed object instance of this class shall be created for each supplementary service, or group of supplementary services, to be recorded. Each instance of this object class shall contain one or more objects of the class "ssActionControl" defining which of the possible supplementary service actions are to be recorded.

```

supplServiceControl MANAGED OBJECT CLASS
  DERIVED FROM "Recommendation X.721 : 1992":top;
  CHARACTERIZED BY
  supplServiceControlPackage PACKAGE
  ATTRIBUTES
    supplServiceCode GET;;;
REGISTERED AS {gsm1205ManagedObjectClass 14 };

```

A.4.16 Tarif (AoC)

This object represents an on-line GSM (AoC) tariff and contains the so-called "e-parameters" defined in 3GPP TS 22.024 [12]. The parameters e1, e2, and e7 determine the time (duration) based charges to be applied; the parameters e5 and e6 determine the data volume based charges and the parameter e4 represents a simple unit increment.

```

tariff MANAGED OBJECT CLASS
  DERIVED FROM "Recommendation X.721 : 1992":top;
  CHARACTERIZED BY
  tariffPackage PACKAGE
  ATTRIBUTES
    tariffId GET,
    tariffName GET-REPLACE,
    e1-Units-per-Time-Interval GET-REPLACE,
    e2-Secs-per-Time-Interval GET-REPLACE,
    e4-Unit-Increment GET-REPLACE,
    e5-Units-per-Data-Interval GET-REPLACE,
    e6-Segments-per-Data-Interval GET-REPLACE,
    e7-Initial-Secs-per-Time-Interval GET-REPLACE;;;
REGISTERED AS {gsm1205ManagedObjectClass 15 };

```

A.4.17 Tariff administration

This managed object class contains all of the managed objects required by the tariff administration function. There shall be one, and only one managed object instance of this class in any network element. The "tsActive" attribute points to the currently active "tariffSystem" and the attribute "tsStandby" points to a back-up "tariffSystem" to permit a roll-back to a previous state. Both "tsActive" and "tsStandby" are read-only and may only be changed via the action "tsChangeover".

The action "tsChangeover" updates the attribute "tsActive" with a new tariff system Id. and replaces the value of "tsStandby" with the currently active tariff system Id. The state of the tariff system objects involved is also updated accordingly. This action may be performed immediately or scheduled for later execution.

Once scheduled, the attribute "tsNextChange" contains details of both the change-over time and the change that will take place. A scheduled change-over may be cancelled at any time by means of the action "tsCancelChangeover".

Any change to the contents of the attributes "tsActive"/"tsStandby" shall result in the generation of a "stateChange" notification.

No changes are permitted to the currently active tariff system or the objects contained within it. The action "tsCopyTariffSystem" may be employed to copy the entire contents of the active tariff system, including all of the contained objects, to a new tariff system. The new system may then be modified as required.

```

tariffAdministration MANAGED OBJECT CLASS
  DERIVED FROM "Recommendation X.721 : 1992":top;
  CHARACTERIZED BY
  tariffAdminPackage PACKAGE

```

```

ATTRIBUTES
    tariffAdminId          GET,
    tsActive                GET,
    tsStandby              GET,
    tsNextChange           GET;
ACTIONS
    tsChangeover,
    tsCancelChangeover,
    tsCopyTariffSystem;
NOTIFICATIONS
    "Recommendation X.721:1992":stateChange;;;
REGISTERED AS {gsm1205ManagedObjectClass 16 };

```

A.4.18 Tariff class

This managed object class represents a tariff class. The tariff class defines a set of service and distance dependencies for which the same tariff switch-over patterns apply.

Each instance of a tariff class shall contain one or more tariff switching pattern objects.

```

tariffClass MANAGED OBJECT CLASS
    DERIVED FROM "Recommendation X.721 : 1992":top;
    CHARACTERIZED BY
    tariffClassPackage PACKAGE
    ATTRIBUTES
        tariffClassId          GET,
        serviceDistanceDependencies GET-REPLACE ADD-REMOVE;;;
REGISTERED AS {gsm1205ManagedObjectClass 17 };

```

A.4.19 Tariff switch pattern

This managed object class defines the tariff switching pattern for a 24 hour period i.e. one calendar day. This pattern is applied to all of the days belonging to particular day classes. The day classes attribute contains the list of day classes to which the tariff pattern is applied.

The tariff periods attribute contains one or more tariff periods defined by their switch-over times and a reference to the tariff to be applied after the switch-over. Each tariff switching pattern contains a minimum of one tariff period with a switch-over time of midnight ("00:00:00"). If the tariff does not change within the 24 hour period covered by the tariff switching pattern then no other tariff period is required.

```

tariffSwitchPattern MANAGED OBJECT CLASS
    DERIVED FROM "Recommendation X.721 : 1992":top;
    CHARACTERIZED BY
    tariffSwitchPatternPackage PACKAGE
    ATTRIBUTES
        tariffSwitchPatternId  GET,
        dayClasses              GET-REPLACE ADD-REMOVE,
        tariffPeriods           GET-REPLACE ADD-REMOVE;;;
REGISTERED AS {gsm1205ManagedObjectClass 18 };

```

A.4.20 Tariff System

This managed object class defines a consistent set of tariff entities (tariff classes, tariffs etc.). It also provides the mechanisms required to control the modification of such entities in order to guarantee that the set remains consistent after modification.

The tariff system object class contains a complete set of tariffs, roamer tariffs, and tariff classes. The tariff classes in turn contain the switch-over patterns.

The state of the tariff system is contained within the attribute "tariffSystemStatus". A simplified state transition diagram is illustrated in figure A.6. There shall be one, and only one, "active" tariff system at any one point in time and the objects contained within this tariff system may not be modified whilst it is in the "active" state. There may be a number of tariff systems currently in preparation.

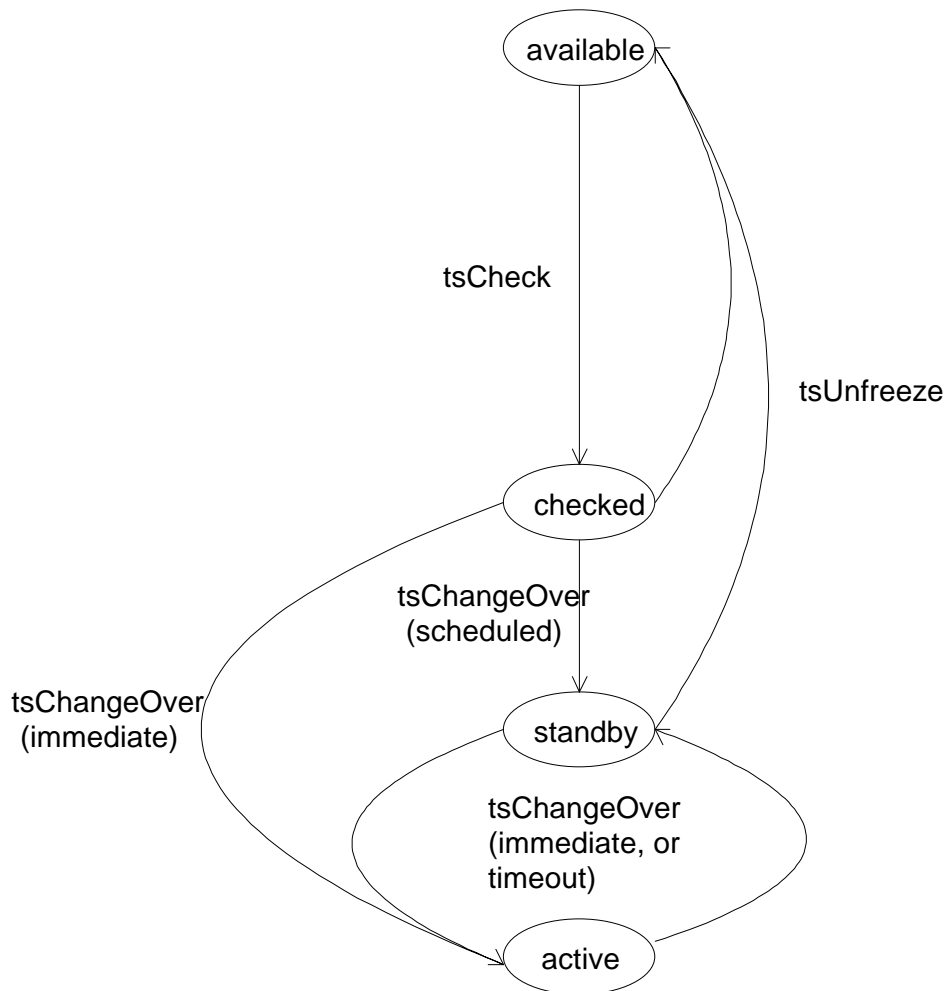

Figure A.6: Tariff system state transition diagram

If supported by the network element, a completed tariff system and its contained objects may be checked for consistency. On receipt of the "tsCheck" action the NEF shall perform a set of standard checks to ensure that the tariff system is both complete and consistent.

Once complete, a tariff system may be activated by means of the "tsChangeover" action (see managed object class "tariffAdmin"). Depending on the activation date and time specified in the action, the tariff system may become active immediately or be placed in the standby state and scheduled for later activation. The "tsChangeover" action may also include a signature (passwords, encryption keys etc.) to authorise the changes to be made. The definition of such security features is outside the scope of the present document.

On activation, a changeover takes place between the currently active tariff system and the new tariff system specified in the "tsChangeover" action. The new tariff system becomes active and the old is placed into the "standby" state. This action also results in the updating of the "tariffAdmin" attributes as described in subclause A.2.3.16. In the event of any problems with the new tariff system a second "tsChangeover" may be issued causing a roll-back to the standby system.

If, for any reason, a "tariffSystem" that has been checked or is awaiting activation requires further modification, then it may be returned to the "available" state by means of the "tsUnfreeze" action.

Any change to the "tariffSystemStatus" shall result in the generation of a "stateChange" notification.

tariffSystem MANAGED OBJECT CLASS

```

DERIVED FROM "Recommendation X.721 : 1992":top;
CHARACTERIZED BY
tariffSystemPackage PACKAGE
  ATTRIBUTES
    tariffSystemId          GET,
    tariffSystemStatus      GET;
  ACTIONS
    tsUnfreeze;
  NOTIFICATIONS
    "Recommendation X.721:1992":stateChange;
REGISTERED AS { gsm1205Package 10 };

```

CONDITIONAL PACKAGES

```

tariffSystemCheckPackage PACKAGE
  ACTIONS
    tsCheck;
REGISTERED AS {gsm1205Package 11 };
PRESENT IF "the checking of a tariff system is supported by the NEF";

```

```
REGISTERED AS {gsm1205ManagedObjectClass 19 };
```

A.4.21 Emergency call indication log entry

This managed object class is used to store the emergency call indication notifications as log records. It is a subclass of the “eventLogRecord” class described in ITU-T X.735 [11] and defined in ITU-T X.721 [5] and therefore inherits a; of the properties of both the “logRecord” and “eventLogRecord” classes. This includes the name binding “logRecord-log” defined in X.721.

```

emergencyCallIndicationLogEntry MANAGED OBJECT CLASS
  DERIVED FROM "Recommendation X.721 : 1992":eventLogRecord;
  CHARACTERIZED BY
  emergencyCallIndicationLogEntryPackage PACKAGE
    BEHAVIOUR
      emergencyCallIndicationLogEntryBehaviour BEHAVIOUR
      DEFINED AS "This managed object is used to store a single emergency
      call indication record.";;
    ATTRIBUTES
      cellId          GET,
      callerId        GET;;;
REGISTERED AS {gsm1205ManagedObjectClass 20 };

```

A.4.22 Observed IMEI ticket report log entry

This managed object class is used to store the observed IMEI ticket report notifications as log records. It is a subclass of the “eventLogRecord” class described in ITU-T X.735 [11] and defined in ITU-T X.721 [5] and therefore inherits all of the properties of both the “logRecord” and “eventLogRecord” classes. This includes the name binding “logRecord-log” defined in X.721.

```

observedIMEITicketReportLogEntry MANAGED OBJECT CLASS
  DERIVED FROM "Recommendation X.721 : 1992":eventLogRecord;
  CHARACTERIZED BY
  observedIMEITicketReportLogEntryPackage PACKAGE
    BEHAVIOR
      observedIMEITicketReportLogEntryBehaviour BEHAVIOUR
      DEFINED AS "This managed object is used to store a single observed
      IMEI ticket report record.";;
    ATTRIBUTES
      observedIMEITicketContent          GET;;;
REGISTERED AS {gsm1205ManagedObjectClass 21 };

```

A.5 Attributes

A.5.1 AoC Service Identity

```
aocServiceId ATTRIBUTE
  WITH ATTRIBUTE SYNTAX GSM1205-DataTypes.SimpleIntegerName;
  MATCHES FOR EQUALITY;
  BEHAVIOUR
  aocServiceIdBehaviour BEHAVIOUR
  DEFINED AS
  "This attribute uniquely identifies an AoC service definition";
REGISTERED AS {gsm1205Attribute 1 };
```

A.5.2 AoC Service Name

```
aocServiceName ATTRIBUTE
  WITH ATTRIBUTE SYNTAX GSM1205-DataTypes.SimpleStringName;
  MATCHES FOR EQUALITY;
  BEHAVIOUR
  aocServiceNameBehaviour BEHAVIOUR
  DEFINED AS
  "This attribute contains the descriptive name of an AoC service
  definition.";;
REGISTERED AS {gsm1205Attribute 2 };
```

A.5.3 Basic service

This attribute may be used to define the filter of an event forwarding discriminator.

```
basicService ATTRIBUTE
  WITH ATTRIBUTE SYNTAX MAP-CommonDataTypes.BasicServiceCode;
  MATCHES FOR EQUALITY;
REGISTERED AS {gsm1205Attribute 3 };
```

A.5.4 Basic Services

```
basicServices ATTRIBUTE
  WITH ATTRIBUTE SYNTAX GSM1205-DataTypes.BasicServices;
  MATCHES FOR EQUALITY, SET-COMPARISON, SET-INTERSECTION;
  BEHAVIOUR
  basicServicesBehaviour BEHAVIOUR
  DEFINED AS
  "This attribute contains a list of GSM basic services.";;
REGISTERED AS {gsm1205Attribute 4 };
```

A.5.5 Calendar year

```
calendarYear ATTRIBUTE
    WITH ATTRIBUTE SYNTAX GSM1205-DataTypes.SimpleIntegerName;
    MATCHES FOR EQUALITY, ORDERING;
    BEHAVIOUR
    calendarYearBehaviour BEHAVIOUR
    DEFINED AS
    "This attribute contains a calendar year expressed as a four figure
    decimal integer e.g. 1993. This value uniquely identifies a charging
    calendar";
REGISTERED AS {gsm1205Attribute 5 };
```

A.5.6 Call duration

This attribute may be used to define the filter of an event forwarding discriminator.

```
callDuration ATTRIBUTE
    WITH ATTRIBUTE SYNTAX GSM1205-DataTypes.CallDuration;
    MATCHES FOR EQUALITY, ORDERING;
REGISTERED AS {gsm1205Attribute 6 };
```

A.5.7 Caller ID

This attribute may be used to define the filter of an event forwarding discriminator.

```
callerId ATTRIBUTE
    WITH ATTRIBUTE SYNTAX GSM1205-DataTypes.IMSIorIMEI;
    MATCHES FOR EQUALITY, ORDERING;
REGISTERED AS {gsm1205Attribute 7 };
```

A.5.8 Call event record content

```
callEventRecordContent ATTRIBUTE
    WITH ATTRIBUTE SYNTAX GSM1205-DataTypes.CallEventRecord;
    MATCHES FOR EQUALITY, ORDERING;
    BEHAVIOUR
    callEventRecordContentBehaviour BEHAVIOUR
    DEFINED AS
    "This attribute contains the contents of a call or event record.";;
REGISTERED AS {gsm1205Attribute 8 };
```

A.5.9 Call event record type

```
callEventRecordType ATTRIBUTE
    WITH ATTRIBUTE SYNTAX GSM1205-DataTypes.CallEventRecordType;
    MATCHES FOR EQUALITY, ORDERING;
    BEHAVIOUR
    callEventRecordTypeBehaviour BEHAVIOUR
    DEFINED AS
    "This attribute contains the type of a call or event record.";;
REGISTERED AS {gsm1205Attribute 9 };
```

A.5.10 Call recording function Identity

```
callRecordingFunctionId ATTRIBUTE
    WITH ATTRIBUTE SYNTAX GSM1205-DataTypes.SimpleIntegerName;
    MATCHES FOR EQUALITY;
    BEHAVIOUR
    callRecordingFunctionIdBehaviour BEHAVIOUR
    DEFINED AS
    "This attribute uniquely identifies the call recording function.";;
REGISTERED AS {gsm1205Attribute 10 };
```

A.5.11 Call reference

This attribute may be used to define the filter of an event forwarding discriminator.

```
callReference ATTRIBUTE
    WITH ATTRIBUTE SYNTAX GSM1205-DataTypes.CallReference;
    MATCHES FOR EQUALITY, ORDERING;
REGISTERED AS {gsm1205Attribute 11 };
```

A.5.12 Call types

```
callTypes ATTRIBUTE
    WITH ATTRIBUTE SYNTAX GSM1205-DataTypes.CallTypes;
    MATCHES FOR EQUALITY, ORDERING;
    BEHAVIOUR
    callTypesBehaviour BEHAVIOUR
    DEFINED AS
    "This set-valued attribute contains a list of call types.";;
REGISTERED AS {gsm1205Attribute 12 };
```

A.5.13 Cause for termination

This attribute may be used to define the filter of an event forwarding discriminator.

```
causeForTermination ATTRIBUTE
    WITH ATTRIBUTE SYNTAX GSM1205-DataTypes.CauseForTerm;
    MATCHES FOR EQUALITY;
REGISTERED AS {gsm1205Attribute 13 };
```

A.5.14 Cell identity

This attribute may be used to define the filter of an event forwarding discriminator.

```
cellId ATTRIBUTE
    WITH ATTRIBUTE SYNTAX GSM1205-DataTypes.CellId;
    MATCHES FOR EQUALITY;
REGISTERED AS {gsm1205Attribute 14 };
```

A.5.15 Date definitions

```
dateDefinitions ATTRIBUTE
  WITH ATTRIBUTE SYNTAX GSM1205-DataTypes.DateDefinitions;
  MATCHES FOR EQUALITY, SET-COMPARISON, SET-INTERSECTION;
  BEHAVIOUR
  dateDefinitionsBehaviour BEHAVIOUR
  DEFINED AS
  "This set-valued attribute contains a list of date definitions each of
  which assigns a day of the year to a particular day class. This day class
  takes precedence over the day class defined for the day of the week. If no
  day class is specified for a particular date then the day class for the
  appropriate day of the week is used (see dayDefinitions). Any attempt to
  reference a non-existent day class shall result in an 'invalid attribute
  value' error.";;
REGISTERED AS {gsm1205Attribute 15 };
```

A.5.16 Day classes

```
dayClasses ATTRIBUTE
  WITH ATTRIBUTE SYNTAX GSM1205-DataTypes.DayClasses;
  MATCHES FOR EQUALITY, SET-COMPARISON, SET-INTERSECTION;
  BEHAVIOUR
  dayClassesBehaviour BEHAVIOUR
  DEFINED AS
  "This set-valued attribute contains a list of day classes. Any attempt to
  include a reference to a non-existent day class shall result in an
  'invalid attribute value' error";;
REGISTERED AS {gsm1205Attribute 16 };
```

A.5.17 Day class identity

```
dayClassId ATTRIBUTE
  WITH ATTRIBUTE SYNTAX GSM1205-DataTypes.SimpleIntegerName;
  MATCHES FOR EQUALITY, ORDERING;
  BEHAVIOUR
  dayClassIdBehaviour BEHAVIOUR
  DEFINED AS
  "This attribute contains the integer identifier of a day class.";;
REGISTERED AS {gsm1205Attribute 17 };
```

A.5.18 Day class name

```
dayClassName ATTRIBUTE
  WITH ATTRIBUTE SYNTAX GSM1205-DataTypes.SimpleStringName;
  MATCHES FOR EQUALITY;
  BEHAVIOUR
  dayClassNameBehaviour BEHAVIOUR
  DEFINED AS
  "This attribute contains the descriptive name of a day class.";;
REGISTERED AS {gsm1205Attribute 18 };
```

A.5.19 Day definitions

```
dayDefinitions ATTRIBUTE
  WITH ATTRIBUTE SYNTAX GSM1205-DataTypes.DayDefinitions;
  MATCHES FOR EQUALITY, SET-COMPARISON, SET-INTERSECTION;
  BEHAVIOUR
  dayDefinitionsBehaviour BEHAVIOUR
  DEFINED AS
  "This set-valued attribute contains a list of day definitions each of
  which assigns a day of the week to a particular day class. This attribute
  must contain seven values (see also dateDefinitions). Any attempt to
  reference a non-existent day class shall result in an 'invalid attribute
  value' error.";;
REGISTERED AS {gsm1205Attribute 19 };
```

A.5.20 Destination identity

```
destinationId ATTRIBUTE
  WITH ATTRIBUTE SYNTAX GSM1205-DataTypes.SimpleIntegerName;
  MATCHES FOR EQUALITY, ORDERING;
  BEHAVIOUR
  destinationIdBehaviour BEHAVIOUR
  DEFINED AS
  "This attribute contains the integer identifier of a particular charging
  destination.";;
REGISTERED AS {gsm1205Attribute 20 };
```

A.5.21 Destination name

```
destinationName ATTRIBUTE
  WITH ATTRIBUTE SYNTAX GSM1205-DataTypes.SimpleStringName;
  MATCHES FOR EQUALITY;
  BEHAVIOUR
  destinationNameBehaviour BEHAVIOUR
  DEFINED AS
  "This attribute contains the descriptive name of a particular charging
  destination.";;
REGISTERED AS {gsm1205Attribute 21 };
```

A.5.22 Emergency call indication destination

```
emergencyCallIndDest ATTRIBUTE
  WITH ATTRIBUTE SYNTAX GSM1205-DataTypes.Destinations;
  MATCHES FOR EQUALITY, SET-COMPARISON, SET-INTERSECTION;
  BEHAVIOUR
  emergencyCallIndDestBehaviour BEHAVIOUR
  DEFINED AS
  "This set-valued attribute contains a list of destinations (application
  entities) to which the emergency call notification is to be sent.";;
REGISTERED AS {gsm1205Attribute 22 };
```

A.5.23 Emergency call indication enable

```
emergencyCallIndEnable ATTRIBUTE
  WITH ATTRIBUTE SYNTAX GSM1205-DataTypes.EmergencyCallIndEnable;
  MATCHES FOR EQUALITY;
  BEHAVIOUR
    emergencyCallIndEnableBehaviour BEHAVIOUR
  DEFINED AS
    "This attribute controls the generation of the emergency call
    notification.";;
REGISTERED AS {gsm1205Attribute 23 };
```

A.5.24 E1: Units per time interval

```
e1-Units-per-Time-Interval ATTRIBUTE
  WITH ATTRIBUTE SYNTAX GSM1205-DataTypes.EParameter;
  MATCHES FOR EQUALITY, ORDERING;
  BEHAVIOUR
    e1-Units-per-Time-IntervalBehaviour BEHAVIOUR
  DEFINED AS
    "This attribute contains the number of charging units to be added at the
    end of a charging interval (see also e2 / e7) as defined in TS 22.024.
    This value is expressed as an integer in the range 0..8191 and represents
    the logical range 0 to 819.1";;
REGISTERED AS {gsm1205Attribute 24 };
```

A.5.25 E2: Seconds per time interval

```
e2-Secs-per-Time-Interval ATTRIBUTE
  WITH ATTRIBUTE SYNTAX GSM1205-DataTypes.EParameter;
  MATCHES FOR EQUALITY, ORDERING;
  BEHAVIOUR
    e2-Secs-per-Time-IntervalBehaviour BEHAVIOUR
  DEFINED AS
    "This attribute contains the length of a charging interval in seconds as
    defined in TS 22.024. This value is expressed as an integer in the range
    0..8191 and represents the logical range 0 to 819.1";;
REGISTERED AS {gsm1205Attribute 25 };
```

A.5.26 E3: Scaling factor

```
e3-Scaling-Factor ATTRIBUTE
  WITH ATTRIBUTE SYNTAX GSM1205-DataTypes.EParameter;
  MATCHES FOR EQUALITY, ORDERING;
  BEHAVIOUR
    e3-Scaling-FactorBehaviour BEHAVIOUR
  DEFINED AS
    "This attribute contains the scaling factor required to convert VPLMN
    charging units to HPLMN units as defined in TS 22.024. This value is
    expressed as an integer in the range 0..8191 representing the logical
    range 0 to 81.91";;
REGISTERED AS {gsm1205Attribute 26 };
```

A.5.27 E4: Unit increment

```
e4-Unit-Increment ATTRIBUTE
  WITH ATTRIBUTE SYNTAX GSM1205-DataTypes.EParameter;
  MATCHES FOR EQUALITY, ORDERING;
  BEHAVIOUR
  e4-Unit-IncrementBehaviour BEHAVIOUR
  DEFINED AS
    "This attribute contains the number of charging units to be added
    independent of time and data volume as defined in TS 22.024. This value is
    expressed as an integer in the range 0..8191 and represents the logical
    range 0 to 819.1";
REGISTERED AS {gsm1205Attribute 27 };
```

A.5.28 E5: Units per data interval

```
e5-Units-per-Data-Interval ATTRIBUTE
  WITH ATTRIBUTE SYNTAX GSM1205-DataTypes.EParameter;
  MATCHES FOR EQUALITY, ORDERING;
  BEHAVIOUR
  e5-Units-per-Data-IntervalBehaviour BEHAVIOUR
  DEFINED AS
    "This attribute contains the number of charging units to be added for each
    data interval (see also e6) as defined in TS 22.024. This value is
    expressed as an integer in the range 0..8191 and represents the logical
    range 0 to 819.1";
REGISTERED AS {gsm1205Attribute 28 };
```

A.5.29 E6: Segments per data interval

```
e6-Segments-per-Data-Interval ATTRIBUTE
  WITH ATTRIBUTE SYNTAX GSM1205-DataTypes.EParameter;
  MATCHES FOR EQUALITY, ORDERING;
  BEHAVIOUR
  e6-Segments-per-Data-IntervalBehaviour BEHAVIOUR
  DEFINED AS
    "This attribute contains the number of 64 byte segments per data interval
    as defined in TS 22.024. This value is expressed as an integer in the
    range 0..8191 and represents the logical range 0 to 8191";
REGISTERED AS {gsm1205Attribute 29 };
```

A.5.30 E7: Initial seconds per time interval

```
e7-Initial-Secs-per-Time-Interval ATTRIBUTE
  WITH ATTRIBUTE SYNTAX GSM1205-DataTypes.EParameter;
  MATCHES FOR EQUALITY, ORDERING;
  BEHAVIOUR
  e7-Initial-Secs-per-Time-IntervalBehaviour BEHAVIOUR
  DEFINED AS
    "This attribute contains the length of the first charging interval in
    seconds as defined in TS 22.024. This value is expressed as an integer in
    the range 0..8191 and represents the logical range 0 to 819.1";
REGISTERED AS {gsm1205Attribute 30 };
```

A.5.31 Home PLMN identity

```
hplmnId ATTRIBUTE
    WITH ATTRIBUTE SYNTAX GSM1205-DataTypes.MCCMNC;
    MATCHES FOR EQUALITY;
    BEHAVIOUR
    hplmnIdBehaviour BEHAVIOUR
    DEFINED AS
    "This attribute contains the mobile country code and mobile network code
    of a particular PLMN expressed as a 5 digit numerical character string.
    ";
REGISTERED AS {gsm1205Attribute 31 };
```

A.5.32 Location

This attribute may be used to define the filter of an event forwarding discriminator.

```
location ATTRIBUTE
    WITH ATTRIBUTE SYNTAX GSM1205-DataTypes.LocationAreaAndCell;
    MATCHES FOR EQUALITY;
REGISTERED AS {gsm1205Attribute 32 };
```

A.5.33 Mobile station classmark

This attribute may be used to define the filter of an event forwarding discriminator.

```
msClassmark ATTRIBUTE
    WITH ATTRIBUTE SYNTAX GSM1205-DataTypes.Classmark;
    MATCHES FOR EQUALITY;
REGISTERED AS {gsm1205Attribute 33 };
```

A.5.34 MSC incoming trunk group

This attribute may be used to define the filter of an event forwarding discriminator.

```
mscIncomingTKGP ATTRIBUTE
    WITH ATTRIBUTE SYNTAX GSM1205-DataTypes.TrunkGroup;
    MATCHES FOR EQUALITY;
REGISTERED AS {gsm1205Attribute 34 };
```

A.5.35 MSC outgoing trunk group

This attribute may be used to define the filter of an event forwarding discriminator.

```
mscOutgoingTKGP ATTRIBUTE
    WITH ATTRIBUTE SYNTAX GSM1205-DataTypes.TrunkGroup;
    MATCHES FOR EQUALITY;
REGISTERED AS {gsm1205Attribute 35 };
```

A.5.36 MS power classes

```
msPowerClasses ATTRIBUTE
  WITH ATTRIBUTE SYNTAX GSM1205-DataTypes.MSPowerClasses;
  MATCHES FOR EQUALITY, SET-COMPARISON, SET-INTERSECTION;
  BEHAVIOUR
  msPowerClassesBehaviour BEHAVIOUR
  DEFINED AS
  "This attribute contains a list of MS power classes (RF power
  capabilities).";
REGISTERED AS {gsm1205Attribute 36 };
```

A.5.37 Network-specific services

```
networkSpecificServices ATTRIBUTE
  WITH ATTRIBUTE SYNTAX GSM1205-DataTypes.NetworkSpecificServices;
  MATCHES FOR EQUALITY, SET-COMPARISON, SET-INTERSECTION;
  BEHAVIOUR
  networkSpecificServicesBehaviour BEHAVIOUR
  DEFINED AS
  "This attribute contains a list of network-specific (non-GSM) services.";
REGISTERED AS {gsm1205Attribute 37 };
```

A.5.38 Observed IMEI ticket destination

```
observedIMEITicketDest ATTRIBUTE
  WITH ATTRIBUTE SYNTAX GSM1205-DataTypes.Destinations;
  MATCHES FOR EQUALITY, SET-COMPARISON, SET-INTERSECTION;
  BEHAVIOUR
  observedIMEITicketDestBehaviour BEHAVIOUR
  DEFINED AS
  "This set-valued attribute contains a list of destinations (application
  entities) to which the observed IMEI ticket notification is to be sent.
  This set may be empty.";
REGISTERED AS {gsm1205Attribute 38 };
```

A.5.39 Observed IMEI ticket generation enable

```
observedIMEITicketGenerationEnable ATTRIBUTE
  WITH ATTRIBUTE SYNTAX GSM1205-DataTypes.ObservedIMEITicketEnable;
  MATCHES FOR EQUALITY;
  BEHAVIOUR
  observedIMEITicketGenerationEnableBehaviour BEHAVIOUR
  DEFINED AS
  "This attribute may be used to enable/disable the generation of observed
  IMEI tickets within an MSC. The setting of this attribute will have no
  effect for any other type of NEF.";
REGISTERED AS {gsm1205Attribute 39 };
```

A.5.40 Origin identity

```
originId ATTRIBUTE
  WITH ATTRIBUTE SYNTAX GSM1205-DataTypes.SimpleIntegerName;
  MATCHES FOR EQUALITY, ORDERING;
  BEHAVIOUR
  originIdBehaviour BEHAVIOUR
  DEFINED AS
  "This attribute contains the integer identifier of a particular charging
  origin.";;
REGISTERED AS {gsm1205Attribute 40 };
```

A.5.41 Origin destination combinations

```
originDestCombinations ATTRIBUTE
  WITH ATTRIBUTE SYNTAX GSM1205-DataTypes.OriginDestCombinations;
  MATCHES FOR EQUALITY, ORDERING;
  BEHAVIOUR
  originDestCombinationsBehaviour BEHAVIOUR
  DEFINED AS
  "This set-valued attribute contains one or more combinations of a charging
  origin with a charging destination.";;
REGISTERED AS {gsm1205Attribute 41 };
```

A.5.42 Origin name

```
originName ATTRIBUTE
  WITH ATTRIBUTE SYNTAX GSM1205-DataTypes.SimpleStringName;
  MATCHES FOR EQUALITY;
  BEHAVIOUR
  originNameBehaviour BEHAVIOUR
  DEFINED AS
  "This attribute contains the descriptive name of a charging origin.";;
REGISTERED AS {gsm1205Attribute 42 };
```

A.5.43 Partial record timer

```
partialRecordTimer ATTRIBUTE
  WITH ATTRIBUTE SYNTAX GSM1205-DataTypes.PartialRecordTimer;
  MATCHES FOR EQUALITY, ORDERING;
  BEHAVIOUR
  partialRecordTimerBehaviour BEHAVIOUR
  DEFINED AS
  "This attribute contains the value of the partial record generation timer
  expressed in seconds. If partial records are not to be produced at regular
  intervals then the default value of zero seconds shall be used.";;
REGISTERED AS {gsm1205Attribute 43 };
```

A.5.44 Partial record generation

```
partialRecordGeneration ATTRIBUTE
  WITH ATTRIBUTE SYNTAX GSM1205-DataTypes.PartialRecordTypes;
  MATCHES FOR EQUALITY, SET-COMPARISON, SET-INTERSECTION;
  BEHAVIOUR
  partialRecordGenerationBehaviour BEHAVIOUR
  DEFINED AS
```

"This set-valued attribute contains a list of values that define the conditions under which partial records are to be generated. If partial records are not produced then the set is empty.";;
REGISTERED AS {gsm1205Attribute 44 };

A.5.45 Radio channels requested

radioChannelsRequested ATTRIBUTE
WITH ATTRIBUTE SYNTAX GSM1205-DataTypes.RadioChannelsRequested;
MATCHES FOR EQUALITY;
BEHAVIOUR
radioChannelsRequestedBehaviour BEHAVIOUR
DEFINED AS
"This attribute contains a list of the type of radio channel requested by the mobile station (e.g. dual rate half rate preferred).";;
REGISTERED AS {gsm1205Attribute 45 };

A.5.46 Radio channel used

radioChannelUsed ATTRIBUTE
WITH ATTRIBUTE SYNTAX GSM1205-DataTypes.TrafficChannel;
MATCHES FOR EQUALITY;
BEHAVIOUR
radioChannelUsedBehaviour BEHAVIOUR
DEFINED AS
"This attribute contains the type of radio (traffic) channel used by the mobile station (i.e. full or half rate).";;
REGISTERED AS {gsm1205Attribute 46 };

A.5.47 Record class destination

recordClassDestination ATTRIBUTE
WITH ATTRIBUTE SYNTAX GSM1205-DataTypes.RecordClassDestinations;
MATCHES FOR EQUALITY;
BEHAVIOUR
recordClassDestinationBehaviour BEHAVIOUR
DEFINED AS
"This set-valued attribute contains one or more destinations to which the records defined for this class are sent. Each destination is either an application entity or a type of file within a local filestore.";;
REGISTERED AS {gsm1205Attribute 47 };

A.5.48 Record class identity

recordClassId ATTRIBUTE
WITH ATTRIBUTE SYNTAX GSM1205-DataTypes.SimpleIntegerName;
MATCHES FOR EQUALITY, ORDERING;
BEHAVIOUR
recordClassIdBehaviour BEHAVIOUR
DEFINED AS
"This attribute contains the integer identifier of a particular record class.";;
REGISTERED AS {gsm1205Attribute 48 };

A.5.49 Record class name

```
recordClassName ATTRIBUTE
    WITH ATTRIBUTE SYNTAX GSM1205-DataTypes.SimpleStringName;
    MATCHES FOR EQUALITY;
    BEHAVIOUR
    recordClassNameBehaviour BEHAVIOUR
    DEFINED AS
    "This attribute contains the descriptive name of a particular record
    class.";;
REGISTERED AS {gsm1205Attribute 49 };
```

A.5.50 Recording method

```
recordingMethod ATTRIBUTE
    WITH ATTRIBUTE SYNTAX GSM1205-DataTypes.RecordingMethod;
    MATCHES FOR EQUALITY;
REGISTERED AS {gsm1205Attribute 50 };
```

A.5.51 Record type

```
recordType ATTRIBUTE
    WITH ATTRIBUTE SYNTAX GSM1205-DataTypes.CallEventRecordType;
    MATCHES FOR EQUALITY, ORDERING;
    BEHAVIOUR
    recordTypeBehaviour BEHAVIOUR
    DEFINED AS
    "This attribute contains the integer identifier of a particular type of
    call detail record.";;
REGISTERED AS {gsm1205Attribute 51 };
```

A.5.52 Served IMSI

This attribute may be used to define the filter of an event forwarding discriminator.

```
servedIMSI ATTRIBUTE
    WITH ATTRIBUTE SYNTAX MAP-CommonDataTypes.IMSI;
    MATCHES FOR EQUALITY, SUBSTRINGS;
REGISTERED AS {gsm1205Attribute 52 };
```

A.5.53 Served MSISDN

This attribute may be used to define the filter of an event forwarding discriminator.

```
servedMSISDN ATTRIBUTE
    WITH ATTRIBUTE SYNTAX GSM1205-DataTypes.MSISDN;
    MATCHES FOR EQUALITY, SUBSTRINGS;
REGISTERED AS {gsm1205Attribute 53 };
```

A.5.54 Service centre address (SMS)

This attribute may be used to define the filter of an event forwarding discriminator.

```
serviceCentre ATTRIBUTE
    WITH ATTRIBUTE SYNTAX MAP-CommonDataTypes.AddressString;
    MATCHES FOR EQUALITY;
REGISTERED AS {gsm1205Attribute 54 };
```

A.5.55 Service distance dependencies

```

serviceDistanceDependencies ATTRIBUTE
  WITH ATTRIBUTE SYNTAX GSM1205-DataTypes.ServiceDistanceDependencies;
  MATCHES FOR EQUALITY, ORDERING;
  BEHAVIOUR
  serviceDistanceDependenciesBehaviour BEHAVIOUR
  DEFINED AS
  "This set-valued attribute contains one or more combinations of an aoc
  service with a charging zone.>";
REGISTERED AS {gsm1205Attribute 55 };

```

A.5.56 Supplementary service action type

```

ssActionType ATTRIBUTE
  WITH ATTRIBUTE SYNTAX GSM1205-DataTypes.SSActionType;
  MATCHES FOR EQUALITY;
REGISTERED AS {gsm1205Attribute 56 };

```

A.5.57 Supplementary service code

```

suppServiceCode ATTRIBUTE
  WITH ATTRIBUTE SYNTAX MAP-SS-Code.SS-Code;
  MATCHES FOR EQUALITY;
  BEHAVIOUR
  suppServiceCodeBehaviour BEHAVIOUR
  DEFINED AS
  "This attribute contains the code of a particular type of supplementary
  service or supplementary service group.>";
REGISTERED AS {gsm1205Attribute 57 };

```

A.5.58 Supplementary Services

```

supplServices ATTRIBUTE
  WITH ATTRIBUTE SYNTAX GSM1205-DataTypes.SupplServices;
  MATCHES FOR EQUALITY, SET-COMPARISON, SET-INTERSECTION;
  BEHAVIOUR
  supplServicesBehaviour BEHAVIOUR
  DEFINED AS
  "This attribute contains a list of GSM supplementary services.>";
REGISTERED AS {gsm1205Attribute 58 };

```

A.5.59 Tariff administration id.

```

tariffAdminId ATTRIBUTE
  WITH ATTRIBUTE SYNTAX GSM1205-DataTypes.SimpleIntegerName;
  MATCHES FOR EQUALITY;
  BEHAVIOUR
  tariffAdminIdBehaviour BEHAVIOUR
  DEFINED AS
  "This attribute contains the integer identifier of the tariff
  administration function.>";
REGISTERED AS {gsm1205Attribute 59 };

```

A.5.60 Tariff class Id.

```
tariffClassId ATTRIBUTE
    WITH ATTRIBUTE SYNTAX GSM1205-DataTypes.SimpleIntegerName;
    MATCHES FOR EQUALITY, ORDERING;
    BEHAVIOUR
    tariffClassIdBehaviour BEHAVIOUR
    DEFINED AS
    "This attribute contains the integer identifier of a particular tariff
    class";
REGISTERED AS {gsm1205Attribute 60 };
```

A.5.61 Tariff id.

```
tariffId ATTRIBUTE
    WITH ATTRIBUTE SYNTAX GSM1205-DataTypes.SimpleIntegerName;
    MATCHES FOR EQUALITY, ORDERING;
    BEHAVIOUR
    tariffIdBehaviour BEHAVIOUR
    DEFINED AS
    "This attribute contains the integer identifier of a particular tariff.";;
REGISTERED AS {gsm1205Attribute 61 };
```

A.5.62 Tariff name

```
tariffName ATTRIBUTE
    WITH ATTRIBUTE SYNTAX GSM1205-DataTypes.SimpleStringName;
    MATCHES FOR EQUALITY;
    BEHAVIOUR
    tariffNameBehaviour BEHAVIOUR
    DEFINED AS
    "This attribute contains the descriptive name of a particular tariff.";;
REGISTERED AS {gsm1205Attribute 62 };
```

A.5.63 Tariff periods

```
tariffPeriods ATTRIBUTE
    WITH ATTRIBUTE SYNTAX GSM1205-DataTypes.TariffPeriods;
    MATCHES FOR EQUALITY;
    BEHAVIOUR
    tariffPeriodsBehaviour BEHAVIOUR
    DEFINED AS
    "This set-valued attribute contains one or more tariff periods for a
    particular tariff switching pattern. There must be at least one tariff
    period with a switch-over time of midnight (00:00:00).";
REGISTERED AS {gsm1205Attribute 63 };
```

A.5.64 Tariff switching pattern id.

```
tariffSwitchPatternId ATTRIBUTE
  WITH ATTRIBUTE SYNTAX GSM1205-DataTypes.SimpleIntegerName;
  MATCHES FOR EQUALITY;
  BEHAVIOUR
  tariffSwitchPatternIdBehaviour BEHAVIOUR
  DEFINED AS
  "This attribute contains the integer identifier of a particular tariff
  switching pattern.";;
REGISTERED AS {gsm1205Attribute 64 };
```

A.5.65 Tariff system id.

```
tariffSystemId ATTRIBUTE
  WITH ATTRIBUTE SYNTAX GSM1205-DataTypes.SimpleIntegerName;
  MATCHES FOR EQUALITY;
  BEHAVIOUR
  tariffSystemIdBehaviour BEHAVIOUR
  DEFINED AS
  "This attribute contains the unique integer identifier of a particular
  tariff system.";;
REGISTERED AS {gsm1205Attribute 65 };
```

A.5.66 Tariff system status

```
tariffSystemStatus ATTRIBUTE
  WITH ATTRIBUTE SYNTAX GSM1205-DataTypes.TariffSystemStatus;
  MATCHES FOR EQUALITY;
  BEHAVIOUR
  tariffSystemStatusBehaviour BEHAVIOUR
  DEFINED AS
  "This attribute contains the state of a particular tariff system.";;
REGISTERED AS {gsm1205Attribute 66 };
```

A.5.67 Transparency indicator

```
transparencyInd ATTRIBUTE
  WITH ATTRIBUTE SYNTAX GSM1205-DataTypes.TransparencyInd;
  MATCHES FOR EQUALITY;
  BEHAVIOUR
  transparencyIndBehaviour BEHAVIOUR
  DEFINED AS
  "This attribute contains a basic service transparency mode indicator i.e.
  transparent/ non-transparent.";;
REGISTERED AS {gsm1205Attribute 67 };
```

A.5.68 TS active

```
tsActive ATTRIBUTE
  WITH ATTRIBUTE SYNTAX GSM1205-DataTypes.SimpleIntegerName;
  MATCHES FOR EQUALITY;
  BEHAVIOUR
  tsActiveBehaviour BEHAVIOUR
  DEFINED AS
  "This integer valued attribute uniquely identifies the tariff system that
  is currently active. This integer value corresponds to the
  'tariffSystemId' attribute of the tariff system.>";
REGISTERED AS {gsm1205Attribute 68 };
```

A.5.69 TS next change

```
tsNextChange ATTRIBUTE
  WITH ATTRIBUTE SYNTAX GSM1205-DataTypes.TSNextChange;
  MATCHES FOR EQUALITY;
  BEHAVIOUR
  tsNextChangeBehaviour BEHAVIOUR
  DEFINED AS
  "This attribute contains details of the next scheduled change-over between
  tariff systems.>";
REGISTERED AS {gsm1205Attribute 69 };
```

A.5.70 TS standby

```
tsStandby ATTRIBUTE
  WITH ATTRIBUTE SYNTAX GSM1205-DataTypes.SimpleIntegerName;
  MATCHES FOR EQUALITY;
  BEHAVIOUR
  tsStandbyBehaviour BEHAVIOUR
  DEFINED AS
  "This integer valued attribute uniquely identifies the tariff system that
  is currently in the standby state. This integer value corresponds to the
  'tariffSystemId' attribute of the tariff system.>";
REGISTERED AS {gsm1205Attribute 70 };
```

A.5.71 Type of subscribers

```
typeOfSubscribers ATTRIBUTE
  WITH ATTRIBUTE SYNTAX GSM1205-DataTypes.TypeOfSubscribers;
  MATCHES FOR EQUALITY, ORDERING;
  BEHAVIOUR
  typeOfSubscribersBehaviour BEHAVIOUR
  DEFINED AS
  "This attribute contains an integer value indicating the type of
  subscribers (e.g. home and/ or visiting) for which a particular type of
  call detail record is to be generated.>";
REGISTERED AS {gsm1205Attribute 71 };
```

A.5.72 Type of transaction

```
typeOfTransaction ATTRIBUTE
  WITH ATTRIBUTE SYNTAX GSM1205-DataTypes.TypeOfTransaction;
  MATCHES FOR EQUALITY;
  BEHAVIOUR
  typeOfTransactionBehaviour BEHAVIOUR
  DEFINED AS
  "This attribute contains an integer value indicating the type of
  transactions (successful and/ or unsuccessful) to be recorded for a
  particular type of call detail record.";;
REGISTERED AS {gsm1205Attribute 72 };
```

A.5.73 Zone id.

```
zoneId ATTRIBUTE
  WITH ATTRIBUTE SYNTAX GSM1205-DataTypes.SimpleIntegerName;
  MATCHES FOR EQUALITY;
  BEHAVIOUR
  zoneIdBehaviour BEHAVIOUR
  DEFINED AS
  "This attribute contains the unique integer identifier of a particular
  charging zone.";;
REGISTERED AS {gsm1205Attribute 73 };
```

A.5.74 Zone name

```
zoneName ATTRIBUTE
  WITH ATTRIBUTE SYNTAX GSM1205-DataTypes.SimpleStringName;
  MATCHES FOR EQUALITY;
  BEHAVIOUR
  zoneNameBehaviour BEHAVIOUR
  DEFINED AS
  "This attribute contains the descriptive name of a particular charging
  zone.";;
REGISTERED AS {gsm1205Attribute 74 };
```

A.5.75 Observed IMEI ticket content

```
observedIMEITicketContent ATTRIBUTE
  WITH ATTRIBUTE SYNTAX GSM1205-DataTypes.ObservedIMEITicket;
  MATCHES FOR EQUALITY;
  BEHAVIOUR
  observedIMEITicketContentBehaviour BEHAVIOUR
  DEFINED AS
  "This attribute contains the information of a single observed IMEI
  ticket.";;
REGISTERED AS {gsm1205Attribute 75 };
```

A.5.76 HSCSD channels requested

```
HSCSDChannelsRequested ATTRIBUTE
  WITH ATTRIBUTE SYNTAX GSM1205-DataTypes.HSCSDChannelsRequested;
  MATCHES FOR EQUALITY;
  BEHAVIOUR
  hSCSDChannelsRequestedBehaviour BEHAVIOUR
  DEFINED AS
```

"This attribute contains the maximum number of HSCSD channels requested by the mobile station that can be assigned for a connection.";;
REGISTERED AS {gsm1205Attribute 76 };

A.5.77 HSCSD channels allocated

HSCSDChannelsAllocated ATTRIBUTE
WITH ATTRIBUTE SYNTAX GSM1205-DataTypes.HSCSDChannelsAllocated;
MATCHES FOR EQUALITY;
BEHAVIOUR
hSCSDChannelsAllocatedBehaviour BEHAVIOUR
DEFINED AS
"This attribute contains the number of HSCSD channels actually allocated for a connection.";;
REGISTERED AS {gsm1205Attribute 77 };

A.5.78 AIUR

aiur ATTRIBUTE
WITH ATTRIBUTE SYNTAX GSM1205-DataTypes.Aiur;
MATCHES FOR EQUALITY;
BEHAVIOUR
aiurBehaviour BEHAVIOUR
DEFINED AS
"This attribute contains the air interface user rate requested by the MS for an HSCSD connection at call setup time or later during the call.";;
REGISTERED AS {gsm1205Attribute 78 };

A.5.79 FNUR

fnur ATTRIBUTE
WITH ATTRIBUTE SYNTAX GSM1205-DataTypes.Fnur;
MATCHES FOR EQUALITY;
BEHAVIOUR
fnurBehaviour BEHAVIOUR
DEFINED AS
"This attribute contains the fixed network user rate for an HSCSD connection.";;
REGISTERED AS {gsm1205Attribute 79 };

A.5.80 Channel Codings Acceptable

chanCodingsAcceptable ATTRIBUTE
WITH ATTRIBUTE SYNTAX GSM1205-DataTypes.ChannelCoding;
MATCHES FOR EQUALITY;
BEHAVIOUR
chanCodingsAcceptable BEHAVIOUR
DEFINED AS
"This attribute contains a list of the channel codings accepted by the MS for an HSCSD connection.";;
REGISTERED AS {gsm1205Attribute 80 };

A.5.81 Channel Coding Used

chanCodingUsed ATTRIBUTE
WITH ATTRIBUTE SYNTAX GSM1205-DataTypes.ChannelCoding;
MATCHES FOR EQUALITY;
BEHAVIOUR
chanCodingUsed BEHAVIOUR
DEFINED AS

"This attribute contains the traffic channel coding allocated for an HSCSD connection at call setup time or later during the call.";;
REGISTERED AS {gsm1205Attribute 81 };

A.5.82 Speech version supported

speechVersionSupported ATTRIBUTE
WITH ATTRIBUTE SYNTAX GSM1205-DataTypes.SpeechVersionIdentifier;
MATCHES FOR EQUALITY;
BEHAVIOUR
speechVersionSupported BEHAVIOUR
DEFINED AS
"This attribute defines the highest priority supported speech codec by MS";;
REGISTERED AS {gsm1205Attribute 82 };

A.5.83 Speech version used

speechVersionUsed ATTRIBUTE
WITH ATTRIBUTE SYNTAX GSM1205-DataTypes.SpeechVersionIdentifier;
MATCHES FOR EQUALITY;
BEHAVIOUR
speechVersionUsed BEHAVIOUR
DEFINED AS
"This attribute defines the speech codec used for that call";;
REGISTERED AS {gsm1205Attribute 83 };

A.5.84 Destination routing address

DestinationRoutingAddress ATTRIBUTE
WITH ATTRIBUTE SYNTAX GSM1205-DataTypes.DestinationRoutingAddress;
MATCHES FOR EQUALITY;
BEHAVIOUR
DestinationRoutingAddressBehaviour BEHAVIOUR
DEFINED AS
"This attribute contains the destination number modified due to a terminating CAMEL dialogue.";;
REGISTERED AS {gsm1205Attribute 84 };

A.5.85 CAMEL call leg information

SubsequentCAMELCallLegInformation ATTRIBUTE
WITH ATTRIBUTE SYNTAX GSM1205-DataTypes.SubsequentCAMELCallLegInformation;
MATCHES FOR EQUALITY;
BEHAVIOUR
SubsequentCAMELCallLegInformationBehaviour BEHAVIOUR
DEFINED AS
"This attribute contains information with parameters modified due to a CAMEL dialogue, if subsequent call legs are initiated.";;
REGISTERED AS {gsm1205Attribute 85 };

A.5.86 Number of DP encountered

NumberOfDPEncountered ATTRIBUTE
WITH ATTRIBUTE SYNTAX GSM1205-DataTypes.NumberOfDPEncountered;
MATCHES FOR EQUALITY;
BEHAVIOUR
NumberOfDPEncountered BEHAVIOUR
DEFINED AS
"This attribute contains information how often armed detection points (TDP and EDP) are encountered.";;

REGISTERED AS {gsm1205Attribute 86 };

A.5.87 Level of CAMEL service

```
LevelOfCAMELService ATTRIBUTE
  WITH ATTRIBUTE SYNTAX GSM1205-DataTypes.levelOfCAMELService;
  MATCHES FOR EQUALITY;
  BEHAVIOUR
    LevelOfCAMELService BEHAVIOUR
  DEFINED AS
    "This attribute describes briefly the complexity of the CAMEL feature
    invocation.";;
REGISTERED AS {gsm1205Attribute 87 };
```

A.5.88 Free format data

```
FreeFormatData ATTRIBUTE
  WITH ATTRIBUTE SYNTAX GSM1205-DataTypes.freeFormatData;
  MATCHES FOR EQUALITY;
  BEHAVIOUR
    FreeFormatData BEHAVIOUR
  DEFINED AS
    "This attribute contains transparent charging data received from the
    gsmSCF.";;
REGISTERED AS {gsm1205Attribute 88 };
```

A.6 Actions

A.6.1 TS Cancel change-over

```
tsCancelChangeover ACTION
  BEHAVIOUR tsCancelChangeoverBehaviour
  BEHAVIOUR DEFINED AS
    "This action is employed to cancel a previously scheduled tariff system
    change-over.";;
  MODE CONFIRMED;
  WITH INFORMATION SYNTAX GSM1205-DataTypes.TSChangeover;
REGISTERED AS { gsm1205Action 1 };
```

A.6.2 TS Change-over

```
tsChangeover ACTION
  BEHAVIOUR tsChangeoverBehaviour
  BEHAVIOUR DEFINED AS
    "This action is employed to swap the currently active tariff system with a
    second tariff system. ";;
  MODE CONFIRMED;
  WITH INFORMATION SYNTAX GSM1205-DataTypes.TSChangeover;
REGISTERED AS { gsm1205Action 2 };
```

A.6.3 TS Check

```
tsCheck ACTION
  BEHAVIOUR tsCheckBehaviour
  BEHAVIOUR DEFINED AS
    "This action is employed to verify the contents of a tariff system object
    and all objects contained in it. If successful the tariff system is
    placed in the 'checked' state";;
  MODE CONFIRMED;
  WITH REPLY SYNTAX GSM1205-DataTypes.TSCheckResult;
REGISTERED AS { gsm1205Action 3 };
```

A.6.4 TS Copy tariff system

```
tsCopyTariffSystem ACTION
  BEHAVIOUR tsCopyTariffSystemBehaviour
  BEHAVIOUR DEFINED AS
    "This action is employed to copy an existing (active) tariff system,
    including the objects it contains, to a second tariff system. Note that
    both the tariff system to be copied and the new tariff system to be
    created are referenced relative to the tariffAdmin object i.e. only the
    tariffSystemId is provided and not the full distinguished name.";;
  MODE CONFIRMED;
  WITH INFORMATION SYNTAX GSM1205-DataTypes.TSCopyTariffSystem;
REGISTERED AS { gsm1205Action 4 };
```

A.6.5 TS Unfreeze

```
tsUnfreeze ACTION
  BEHAVIOUR tsUnfreezeBehaviour
  BEHAVIOUR DEFINED AS
    "This action is employed to reset a tariff system to the 'available' state
    for further modification";;
  MODE CONFIRMED;
REGISTERED AS { gsm1205Action 5 };
```

A.7 Notifications

Unless otherwise stated, all notifications shall be sent via the M-EVENT-REPORT operation in CONFIRMED mode.

A.7.1 Call event record report

```
callEventRecordReport      NOTIFICATION
  BEHAVIOUR callEventRecordReportBhv
  BEHAVIOUR DEFINED AS
    "This notification is issued by the call recording function to transmit a
    call or event record to the OS. The attribute IDs listed below may be
    used by Event Forwarding Discriminators to specify additional filtering
    constraints.";;
  WITH INFORMATION SYNTAX GSM1205-DataTypes.CallEventRecord
    AND ATTRIBUTE IDS
      basicService                basicService,
      callDuration                callDuration,
      causeForTerm                causeForTermination,
      callReference               callReference,
      location                    location,
      msClassmark                 msClassmark,
      mscIncomingTKGP            mscIncomingTKGP,
      mscOutgoingTKGP            mscOutgoingTKGP,
      recordType                  recordType,
      servedIMSI                  servedIMSI,
      servedMSISDN                servedMSISDN,
      serviceCentre               serviceCentre,
      ssAction                     ssActionType;
REGISTERED AS {gsm1205Notification 1 };
```

NOTE: For the avoidance of doubt, the ASN.1 type references in the AND ATTRIBUTE IDS clause refers to **all** of the records that include this name.

A.7.2 Emergency call indication

```
emergencyCallIndication NOTIFICATION
  BEHAVIOUR emergencyCallIndicationBehaviour
  BEHAVIOUR DEFINED AS
    "This notification is issued to inform the OS that an emergency call set-
    up is in progress. The attribute IDs listed below may be used by Event
    Forwarding Discriminators to specify filtering constraints.";;
  WITH INFORMATION SYNTAX GSM1205-DataTypes.EmergencyCallIndication
    AND ATTRIBUTE IDS
      cellId                      cellId,
      callerId                    callerId;
REGISTERED AS {gsm1205Notification 2 };
```

A.7.3 Observed IMEI ticket report

```
observedIMEITicketReport NOTIFICATION
  BEHAVIOUR observedIMEITicketReportBhv
  BEHAVIOUR DEFINED AS
    "This notification is issued by the call recording function to transmit an
    observed IMEI ticket to the OS.";;
  WITH INFORMATION SYNTAX GSM1205-DataTypes.ObservedIMEITicket;
REGISTERED AS {gsm1205Notification 3 };
```

A.8 Name bindings

```
aocService-tariffAdministration NAME BINDING
  SUBORDINATE OBJECT CLASS aocService;
  NAMED BY SUPERIOR OBJECT CLASS tariffAdministration;
  WITH ATTRIBUTE aocServiceId;
  CREATE;
  DELETE;
REGISTERED AS {gsm1205NameBinding 1 };
```

```
callRecordingFunction-managedElement NAME BINDING
  SUBORDINATE OBJECT CLASS callRecordingFunction;
  NAMED BY SUPERIOR OBJECT CLASS
  "Recommendation M.3100 : 1992":managedElement;
  WITH ATTRIBUTE callRecordingFunctionId;
  CREATE;
  DELETE DELETES-CONTAINED-OBJECTS;
REGISTERED AS {gsm1205NameBinding 4 };
```

```
chargingCalendar-tariffAdministration NAME BINDING
  SUBORDINATE OBJECT CLASS chargingCalendar;
  NAMED BY SUPERIOR OBJECT CLASS tariffAdministration;
  WITH ATTRIBUTE calendarYear;
  CREATE;
  DELETE;
REGISTERED AS {gsm1205NameBinding 5 };
```

```
chargingOrigin-tariffAdministration NAME BINDING
  SUBORDINATE OBJECT CLASS chargingOrigin;
  NAMED BY SUPERIOR OBJECT CLASS tariffAdministration;
  WITH ATTRIBUTE originId;
  CREATE;
  DELETE;
REGISTERED AS {gsm1205NameBinding 6 };
```

```
chargingDestination-tariffAdministration NAME BINDING
  SUBORDINATE OBJECT CLASS chargingDestination;
  NAMED BY SUPERIOR OBJECT CLASS tariffAdministration;
  WITH ATTRIBUTE destinationId;
  CREATE;
  DELETE;
REGISTERED AS {gsm1205NameBinding 7 };
```

```
chargingZone-tariffAdministration NAME BINDING
  SUBORDINATE OBJECT CLASS chargingZone;
  NAMED BY SUPERIOR OBJECT CLASS tariffAdministration;
  WITH ATTRIBUTE zoneId;
  CREATE;
  DELETE;
REGISTERED AS {gsm1205NameBinding 8 };
```

```
dayClass-tariffAdministration NAME BINDING
  SUBORDINATE OBJECT CLASS dayClass;
  NAMED BY SUPERIOR OBJECT CLASS tariffAdministration;
  WITH ATTRIBUTE dayClassId;
  CREATE;
  DELETE;
REGISTERED AS {gsm1205NameBinding 9 };
```

```
eventForwardingDiscriminator-callRecordingFunction NAME BINDING
  SUBORDINATE OBJECT CLASS
  "Recommendation X.721 : 1992":eventForwardingDiscriminator;
  NAMED BY SUPERIOR OBJECT CLASS "GSM 12.00 : 1994":callRecordingFunction;
  WITH ATTRIBUTE "Recommendation X.721 : 1992":discriminatorId;
  CREATE;
  DELETE;
REGISTERED AS {gsm1205NameBinding 10 };

recordClass-callRecordingFunction NAME BINDING
  SUBORDINATE OBJECT CLASS recordClass;
  NAMED BY SUPERIOR OBJECT CLASS "GSM 12.00 : 1994":callRecordingFunction;
  WITH ATTRIBUTE recordClassId;
  CREATE;
  DELETE DELETES-CONTAINED-OBJECTS;
REGISTERED AS {gsm1205NameBinding 11 };

recordTypeControl-recordClass NAME BINDING
  SUBORDINATE OBJECT CLASS recordTypeControl;
  NAMED BY SUPERIOR OBJECT CLASS recordClass;
  WITH ATTRIBUTE recordType;
  CREATE;
  DELETE;
REGISTERED AS {gsm1205NameBinding 12 };

roamerTariff-tariffSystem NAME BINDING
  SUBORDINATE OBJECT CLASS roamerTariff;
  NAMED BY SUPERIOR OBJECT CLASS tariffSystem;
  WITH ATTRIBUTE tariffId;
  CREATE;
  DELETE;
REGISTERED AS {gsm1205NameBinding 13 };

ssActionControl-supplServiceControl NAME BINDING
  SUBORDINATE OBJECT CLASS ssActionControl;
  NAMED BY SUPERIOR OBJECT CLASS supplServiceControl;
  WITH ATTRIBUTE ssActionType;
  CREATE;
  DELETE;
REGISTERED AS {gsm1205NameBinding 14 };

supplServiceControl-recordClass NAME BINDING
  SUBORDINATE OBJECT CLASS supplServiceControl;
  NAMED BY SUPERIOR OBJECT CLASS recordClass;
  WITH ATTRIBUTE suppServiceCode;
  CREATE;
  DELETE DELETES-CONTAINED-OBJECTS;
REGISTERED AS {gsm1205NameBinding 15 };

tariff-tariffSystem NAME BINDING
  SUBORDINATE OBJECT CLASS tariff;
  NAMED BY SUPERIOR OBJECT CLASS tariffSystem;
  WITH ATTRIBUTE tariffId;
  CREATE;
  DELETE;
REGISTERED AS {gsm1205NameBinding 16 };
```

```

tariffAdministration-mscFunction NAME BINDING
  SUBORDINATE OBJECT CLASS tariffAdministration;
  NAMED BY SUPERIOR OBJECT CLASS "GSM 12.00 : 1994":mscFunction;
  WITH ATTRIBUTE tariffAdminId;
  CREATE;
  DELETE;
REGISTERED AS {gsm1205NameBinding 17 };

tariffClass-tariffSystem NAME BINDING
  SUBORDINATE OBJECT CLASS tariffClass;
  NAMED BY SUPERIOR OBJECT CLASS tariffSystem;
  WITH ATTRIBUTE tariffClassId;
  CREATE;
  DELETE DELETES-CONTAINED-OBJECTS;
REGISTERED AS {gsm1205NameBinding 18 };

tariffSwitchPattern-tariffClass NAME BINDING
  SUBORDINATE OBJECT CLASS tariffSwitchPattern;
  NAMED BY SUPERIOR OBJECT CLASS tariffClass;
  WITH ATTRIBUTE tariffSwitchPatternId;
  CREATE;
  DELETE;
REGISTERED AS {gsm1205NameBinding 19 };

tariffSystem-tariffAdministration NAME BINDING
  SUBORDINATE OBJECT CLASS tariffSystem;
  NAMED BY SUPERIOR OBJECT CLASS tariffAdministration;
  WITH ATTRIBUTE tariffSystemId;
  CREATE;
  DELETE DELETES-CONTAINED-OBJECTS;
REGISTERED AS {gsm1205NameBinding 20 };

```

A.9 Abstract syntax

```
GSM1205-DataTypes { ccitt (0) identified-organization (4) etsi (0) mobileDomain (0) gsm-Operation-
Maintenance (3) gsm-12-05 (5) informationModel (0) asnlModule (2) 1 }
```

```
DEFINITIONS IMPLICIT TAGS ::=
```

```
BEGIN
```

```
-- EXPORTS everything
```

```
IMPORTS
```

```
NumberOfForwarding, CallReferenceNumber
FROM MAP-CH-DataTypes { ccitt identified-organization (4) etsi(0) mobileDomain (0) gsmNetworkId (1)
moduleId (3) map-CH-DataTypes (13) version2 (2) }
```

```
AddressString, ISDN-AddressString, BasicServiceCode, IMSI, IMEI
FROM MAP-CommonDataTypes { ccitt identified-organization (4) etsi(0) mobileDomain (0) gsmNetworkId
(1) moduleId (3) map-CommonDataTypes (18) version2 (2) }
```

```
DestinationRoutingAddress,
FROM CAP-DataTypes { ccitt identified-organization (4) etsi(0) mobileDomain (0)
gsm-Network(1) modules(3) cap-datatypes (52) version1 (0) }
```

```
ServiceKey, DefaultCallHandling, DefaultSMS-Handling
FROM MAP-MS-DataTypes { ccitt identified-organization (4) etsi(0) mobileDomain (0)
gsm-Network(1) modules(3) map-MS-DataTypes (11) version6 (6) }
```

```
BearerServiceCode
FROM MAP-BS-Code { ccitt identified-organization (4) etsi(0) mobileDomain(0) gsmNetworkId (1)
moduleId (3) map-BS-Code (20) version2 (2) }
```

```
TeleserviceCode
```

```
FROM MAP-TS-Code { ccitt identified-organization (4) etsi(0) mobileDomain(0) gsmNetworkId (1)
moduleId (3) map-TS-Code (19) version2 (2) }
```

SS-Code

```
FROM MAP-SS-Code { ccitt identified-organization (4) etsi(0) mobileDomain(0) gsmNetworkId (1)
moduleId (3) map-SS-Code (15) version2 (2) }
```

BasicService

```
FROM Basic-Service-Elements { ccitt identified-organization (4) etsi (0)
196 basic-service-elements (8) }
```

--

-- See "Digital Subscriber Signalling System No. one (DSS1) protocol"

-- ETS 300 196

--

ObjectInstance

```
FROM CMIP-1 {joint-iso-ccitt ms(9) cmip(1) version1 (1) protocol (3)}
```

ManagementExtension

```
FROM Attribute-ASN1Module {joint-iso-ccitt ms(9) smi(3) part2 (2) asn1Module(2) 1}
```

AE-title

```
FROM ACSE-1 {joint-iso-ccitt association-control(2) abstract-syntax(1) apdus(0) version(1) };
```

--

-- Note that the syntax of AE-title to be used is from

-- ITU-T Rec. X.227 / ISO 8650 corrigendum and not "ANY"

--

-- CALL AND EVENT RECORDS

--

CallEventRecord ::= CHOICE

```
{
  moCallRecord      [0] MOCallRecord,
  mtCallRecord      [1] MTCallRecord,
  roamingRecord     [2] RoamingRecord,
  incGatewayRecord  [3] IncGatewayRecord,
  outGatewayRecord  [4] OutGatewayRecord,
  transitRecord     [5] TransitCallRecord,
  moSMSRecord       [6] MOSMSRecord,
  mtSMSRecord       [7] MTSMSRecord,
  moSMSIWRecord     [8] MOSMSIWRecord,
  mtSMSGWRecord     [9] MTSMSGWRecord,
  ssActionRecord    [10] SSActionRecord,
  hlrIntRecord      [11] HLRIntRecord,
  locUpdateHLRRecord [12] LocUpdateHLRRecord,
  locUpdateVLRRecord [13] LocUpdateVLRRecord,
  commonEquipRecord [14] CommonEquipRecord,
  recTypeExtensions [15] ManagementExtensions,
  termCAMELIntRecord [16] TermCAMELIntRecord
}
```

MOCallRecord ::= SET

```
{
  recordType      [0] CallEventRecordType,
  servedIMSI      [1] IMSI OPTIONAL,
  servedIMEI      [2] IMEI OPTIONAL,
  servedMSISDN    [3] MSISDN OPTIONAL,
  callingNumber   [4] CallingNumber OPTIONAL,
  calledNumber    [5] CalledNumber OPTIONAL,
  translatedNumber [6] TranslatedNumber OPTIONAL,
  connectedNumber [7] ConnectedNumber OPTIONAL,
  roamingNumber   [8] RoamingNumber OPTIONAL,
  recordingEntity [9] RecordingEntity,
  mscIncomingTKGP [10] TrunkGroup OPTIONAL,
  mscOutgoingTKGP [11] TrunkGroup OPTIONAL,
  location        [12] LocationAreaAndCell OPTIONAL,
  changeOfLocation [13] SEQUENCE OF LocationChange OPTIONAL,
  basicService    [14] BasicServiceCode OPTIONAL,
  transparencyIndicator [15] TransparencyInd OPTIONAL,
  changeOfService [16] SEQUENCE OF ChangeOfService OPTIONAL,
  supplServicesUsed [17] SEQUENCE OF SuppServiceUsed OPTIONAL,
  aocParameters  [18] AOCParameters OPTIONAL,
  changeOfAOCParms [19] SEQUENCE OF AOCParmChange OPTIONAL,
  msClassmark    [20] Classmark OPTIONAL,
  changeOfClassmark [21] ChangeOfClassmark OPTIONAL,
  seizureTime    [22] TimeStamp OPTIONAL,
}
```

```

answerTime          [23] TimeStamp OPTIONAL,
releaseTime         [24] TimeStamp OPTIONAL,
callDuration        [25] CallDuration,
dataVolume          [26] DataVolume OPTIONAL,
radioChanRequested [27] RadioChanRequested OPTIONAL,
radioChanUsed       [28] TrafficChannel OPTIONAL,
changeOfRadioChan   [29] ChangeOfRadioChannel OPTIONAL,
causeForTerm        [30] CauseForTerm,
diagnostics         [31] Diagnostics OPTIONAL,
callReference       [32] CallReference,
sequenceNumber      [33] INTEGER OPTIONAL,
additionalChgInfo   [34] AdditionalChgInfo OPTIONAL,
recordExtensions    [35] ManagementExtensions OPTIONAL,
gsm-SCFAddress      [36] Gsm-SCFAddress OPTIONAL,
serviceKey          [37] ServiceKey OPTIONAL,
networkCallReference [38] NetworkCallReference OPTIONAL,
mSCAddress          [39] MSCAddress OPTIONAL,
cAMELInitCFIndicator [40] CAMELInitCFIndicator OPTIONAL,
defaultCallHandling [41] DefaultCallHandling OPTIONAL,
hSCSDChanRequested [42] NumOfHSCSDChanRequested OPTIONAL,
hSCSDChanAllocated [43] NumOfHSCSDChanAllocated OPTIONAL,
changeOfHSCSDParms [44] SEQUENCE OF HSCSDParmsChange OPTIONAL,
fnur                [45] Fnur OPTIONAL,
aiurRequested       [46] AiurRequested OPTIONAL,
chanCodingsAcceptable [47] SEQUENCE OF ChannelCoding OPTIONAL,
chanCodingUsed      [48] ChannelCoding OPTIONAL,
speechVersionSupported [49] SpeechVersionIdentifier OPTIONAL,
speechVersionUsed   [50] SpeechVersionIdentifier OPTIONAL,
numberOfDPENcountered [51] INTEGER OPTIONAL,
levelOfCAMELService [52] LevelOfCAMELService OPTIONAL,
freeFormatData      [53] FreeFormatData OPTIONAL,
cAMELCallLegInformation [54] SEQUENCE OF CAMELInformation OPTIONAL,
freeFormatDataAppend [55] BOOLEAN OPTIONAL,
defaultCallHandling_2 [56] DefaultCallHandling OPTIONAL,
gsm-SCFAddress_2    [57] Gsm-SCFAddress OPTIONAL,
serviceKey_2        [58] ServiceKey OPTIONAL,
freeFormatData_2    [59] FreeFormatData OPTIONAL,
freeFormatDataAppend_2 [60] BOOLEAN OPTIONAL
}

```

```

MTCallRecord ::= SET
{
  recordType          [0] CallEventRecordType,
  servedIMSI         [1] IMSI,
  servedIMEI         [2] IMEI OPTIONAL,
  servedMSISDN       [3] CalledNumber OPTIONAL,
  callingNumber      [4] CallingNumber OPTIONAL,
  connectedNumber    [5] ConnectedNumber OPTIONAL,
  recordingEntity     [6] RecordingEntity,
  mscIncomingTKGP    [7] TrunkGroup OPTIONAL,
  mscOutgoingTKGP    [8] TrunkGroup OPTIONAL,
  location           [9] LocationAreaAndCell OPTIONAL,
  changeOfLocation   [10] SEQUENCE OF LocationChange OPTIONAL,
  basicService       [11] BasicServiceCode OPTIONAL,
  transparencyIndicator [12] TransparencyInd OPTIONAL,
  changeOfService    [13] SEQUENCE OF ChangeOfService OPTIONAL,
  supplServicesUsed  [14] SEQUENCE OF SuppServiceUsed OPTIONAL,
  aocParameters      [15] AOCParameters OPTIONAL,
  changeOfAOCParms   [16] SEQUENCE OF AOCParmChange OPTIONAL,
  msClassmark        [17] Classmark OPTIONAL,
  changeOfClassmark  [18] ChangeOfClassmark OPTIONAL,
  seizureTime        [19] TimeStamp OPTIONAL,
  answerTime         [20] TimeStamp OPTIONAL,
  releaseTime        [21] TimeStamp OPTIONAL,
  callDuration       [22] CallDuration,
  dataVolume         [23] DataVolume OPTIONAL,
  radioChanRequested [24] RadioChanRequested OPTIONAL,
  radioChanUsed      [25] TrafficChannel OPTIONAL,
  changeOfRadioChan  [26] ChangeOfRadioChannel OPTIONAL,
  causeForTerm       [27] CauseForTerm,
  diagnostics        [28] Diagnostics OPTIONAL,
  callReference      [29] CallReference,
  sequenceNumber     [30] INTEGER OPTIONAL,
  additionalChgInfo  [31] AdditionalChgInfo OPTIONAL,
  recordExtensions   [32] ManagementExtensions OPTIONAL,
  networkCallReference [33] NetworkCallReference OPTIONAL,
  mSCAddress         [34] MSCAddress OPTIONAL,

```

```

hSCSDChanRequested      [35] NumOfHSCSDChanRequested OPTIONAL,
hSCSDChanAllocated     [36] NumOfHSCSDChanAllocated OPTIONAL,
changeOfHSCSDParams    [37] SEQUENCE OF HSCSDParamsChange OPTIONAL,
fnur                   [38] Fnur OPTIONAL,
aiurRequested          [39] AiurRequested OPTIONAL,
chanCodingsAcceptable [40] SEQUENCE OF ChannelCoding OPTIONAL,
chanCodingUsed         [41] ChannelCoding OPTIONAL,
speechVersionSupported [42] SpeechVersionIdentifier OPTIONAL,
speechVersionUsed      [43] SpeechVersionIdentifier OPTIONAL,
gsm-SCFAddress         [44] Gsm-SCFAddress OPTIONAL,
serviceKey             [45] ServiceKey OPTIONAL,
networkCallReference   [46] NetworkCallReference OPTIONAL,
mSCAddress             [47] MSCAddress OPTIONAL,
defaultCallHandling    [48] DefaultCallHandling OPTIONAL,
freeFormatData         [49] FreeFormatData OPTIONAL,
freeFormatDataAppend   [50] BOOLEAN OPTIONAL
}

RoamingRecord ::= SET
{
  recordType          [0] CallEventRecordType,
  servedIMSI         [1] IMSI,
  servedMSISDN       [2] MSISDN OPTIONAL,
  callingNumber      [3] CallingNumber OPTIONAL,
  roamingNumber      [4] RoamingNumber OPTIONAL,
  recordingEntity    [5] RecordingEntity,
  mscIncomingTKGP    [6] TrunkGroup OPTIONAL,
  mscOutgoingTKGP    [7] TrunkGroup OPTIONAL,
  basicService       [8] BasicServiceCode OPTIONAL,
  transparencyIndicator [9] TransparencyInd OPTIONAL,
  changeOfService    [10] SEQUENCE OF ChangeOfService OPTIONAL,
  supplServicesUsed  [11] SEQUENCE OF SuppServiceUsed OPTIONAL,
  seizureTime        [12] TimeStamp OPTIONAL,
  answerTime         [13] TimeStamp OPTIONAL,
  releaseTime        [14] TimeStamp OPTIONAL,
  callDuration       [15] CallDuration,
  dataVolume         [16] DataVolume OPTIONAL,
  causeForTerm       [17] CauseForTerm,
  diagnostics        [18] Diagnostics OPTIONAL,
  callReference      [19] CallReference,
  sequenceNumber     [20] INTEGER OPTIONAL,
  recordExtensions   [21] ManagementExtensions OPTIONAL,
  networkCallReference [22] NetworkCallReference OPTIONAL,
  mSCAddress         [23] MSCAddress OPTIONAL
}

TermCAMELIntRecord ::= SET
{
  recordtype          [0] CallEventRecordType,
  servedIMSI         [1] IMSI,
  servedMSISDN       [2] MSISDN OPTIONAL,
  recordingEntity    [3] RecordingEntity,
  interrogationTime   [4] TimeStamp,
  destinationRoutingAddress [5] DestinationRoutingAddress,
  gsm-SCFAddress     [6] Gsm-SCFAddress,
  serviceKey         [7] ServiceKey,
  networkCallReference [8] NetworkCallReference OPTIONAL,
  mSCAddress         [9] MSCAddress OPTIONAL,
  defaultCallHandling [10] DefaultCallHandling OPTIONAL,
  recordExtensions   [11] ManagementExtensions OPTIONAL,
  calledNumber       [12] CalledNumber,
  callingNumber      [13] CallingNumber OPTIONAL,
  mscIncomingTKGP    [14] TrunkGroup OPTIONAL,
  mscOutgoingTKGP    [15] TrunkGroup OPTIONAL,
  seizureTime        [16] TimeStamp OPTIONAL,
  answerTime         [17] TimeStamp OPTIONAL,
  releaseTime        [18] TimeStamp OPTIONAL,
  callDuration       [19] CallDuration,
  dataVolume         [20] DataVolume OPTIONAL,
  causeForTerm       [21] CauseForTerm,
  diagnostics        [22] Diagnostics OPTIONAL,
  callReference      [23] CallReference,
  sequenceNumber     [24] INTEGER OPTIONAL,
  numberOfDPEncountered [25] INTEGER OPTIONAL,
  levelOfCAMELService [26] LevelOfCAMELService OPTIONAL,
  freeFormatData     [27] FreeFormatData OPTIONAL,
  cAMELCallLegInformation [28] SEQUENCE OF CAMELInformation OPTIONAL,
  freeFormatDataAppend [29] BOOLEAN OPTIONAL
}

```



```

IncGatewayRecord ::= SET
{
  recordType           [0] CallEventRecordType,
  callingNumber        [1] CallingNumber OPTIONAL,
  calledNumber         [2] CalledNumber,
  recordingEntity      [3] RecordingEntity,
  mscIncomingTKGP     [4] TrunkGroup OPTIONAL,
  mscOutgoingTKGP     [5] TrunkGroup OPTIONAL,
  seizureTime         [6] TimeStamp OPTIONAL,
  answerTime          [7] TimeStamp OPTIONAL,
  releaseTime          [8] TimeStamp OPTIONAL,
  callDuration         [9] CallDuration,
  dataVolume          [10] DataVolume OPTIONAL,
  causeForTerm        [11] CauseForTerm,
  diagnostics          [12] Diagnostics OPTIONAL,
  callReference        [13] CallReference,
  sequenceNumber       [14] INTEGER OPTIONAL,
  recordExtensions    [15] ManagementExtensions OPTIONAL
}

OutGatewayRecord ::= SET
{
  recordType           [0] CallEventRecordType,
  callingNumber        [1] CallingNumber OPTIONAL,
  calledNumber         [2] CalledNumber,
  recordingEntity      [3] RecordingEntity,
  mscIncomingTKGP     [4] TrunkGroup OPTIONAL,
  mscOutgoingTKGP     [5] TrunkGroup OPTIONAL,
  seizureTime         [6] TimeStamp OPTIONAL,
  answerTime          [7] TimeStamp OPTIONAL,
  releaseTime          [8] TimeStamp OPTIONAL,
  callDuration         [9] CallDuration,
  dataVolume          [10] DataVolume OPTIONAL,
  causeForTerm        [11] CauseForTerm,
  diagnostics          [12] Diagnostics OPTIONAL,
  callReference        [13] CallReference,
  sequenceNumber       [14] INTEGER OPTIONAL,
  recordExtensions    [15] ManagementExtensions OPTIONAL
}

TransitCallRecord ::= SET
{
  recordType           [0] CallEventRecordType,
  recordingEntity      [1] RecordingEntity,
  mscIncomingTKGP     [2] TrunkGroup OPTIONAL,
  mscOutgoingTKGP     [3] TrunkGroup OPTIONAL,
  callingNumber        [4] CallingNumber OPTIONAL,
  calledNumber         [5] CalledNumber,
  isdnBasicService    [6] BasicService OPTIONAL,
  seizureTimestamp     [7] TimeStamp OPTIONAL,
  answerTimestamp      [8] TimeStamp OPTIONAL,
  releaseTimestamp     [9] TimeStamp OPTIONAL,
  callDuration         [10] CallDuration,
  dataVolume          [11] DataVolume OPTIONAL,
  causeForTerm        [12] CauseForTerm,
  diagnostics          [13] Diagnostics OPTIONAL,
  callReference        [14] CallReference,
  sequenceNumber       [15] INTEGER OPTIONAL,
  recordExtensions    [16] ManagementExtensions OPTIONAL
}

MOSMSRecord ::= SET
{
  recordType           [0] CallEventRecordType,
  servedIMSI          [1] IMSI,
  servedIMEI          [2] IMEI OPTIONAL,
  servedMSISDN        [3] MSISDN OPTIONAL,
  msClassmark         [4] Classmark,
  serviceCentre        [5] AddressString,
  recordingEntity      [6] RecordingEntity,
  location             [7] LocationAreaAndCell OPTIONAL,
  messageReference     [8] MessageReference,
  originationTime      [9] TimeStamp,
  smsResult           [10] SMSResult OPTIONAL,
  recordExtensions    [11] ManagementExtensions OPTIONAL,
  destinationNumber   [12] CalledNumber OPTIONAL,
  CAMELSMSInformation [13] CAMELSMSInformation OPTIONAL
}

```

```

}

MTSMSRecord ::= SET
{
    recordType           [0] CallEventRecordType,
    serviceCentre       [1] AddressString,
    servedIMSI          [2] IMSI,
    servedIMEI          [3] IMEI OPTIONAL,
    servedMSISDN        [4] MSISDN OPTIONAL,
    msClassmark         [5] Classmark,
    recordingEntity      [6] RecordingEntity,
    location             [7] LocationAreaAndCell OPTIONAL,
    deliveryTime        [8] TimeStamp,
    smsResult            [9] SMSResult OPTIONAL,
    recordExtensions     [10] ManagementExtensions OPTIONAL
}

MOSMSIWRecord ::= SET
{
    recordType           [0] CallEventRecordType,
    serviceCentre       [1] AddressString,
    servedIMSI          [2] IMSI,
    recordingEntity      [3] RecordingEntity,
    eventTime           [4] TimeStamp,
    smsResult            [5] SMSResult OPTIONAL,
    recordExtensions     [6] ManagementExtensions OPTIONAL
}

MTSMMSGWRecord ::= SET
{
    recordType           [0] CallEventRecordType,
    serviceCentre       [1] AddressString,
    servedIMSI          [2] IMSI,
    servedMSISDN        [3] MSISDN OPTIONAL,
    recordingEntity      [4] RecordingEntity,
    eventTime           [5] TimeStamp,
    smsResult            [6] SMSResult OPTIONAL,
    recordExtensions     [7] ManagementExtensions OPTIONAL
}

SSActionRecord ::= SET
{
    recordType           [0] CallEventRecordType,
    servedIMSI          [1] IMSI,
    servedIMEI          [2] IMEI OPTIONAL,
    servedMSISDN        [3] MSISDN OPTIONAL,
    msClassmark         [4] Classmark,
    recordingEntity      [5] RecordingEntity,
    location             [6] LocationAreaAndCell OPTIONAL,
    basicServices        [7] BasicServices OPTIONAL,
    supplService         [8] SS-Code OPTIONAL,
    ssAction             [9] SSActionType OPTIONAL,
    ssActionTime         [10] TimeStamp,
    ssParameters         [11] SSParameters OPTIONAL,
    ssActionResult       [12] SSActionResult OPTIONAL,
    callReference        [13] CallReference,
    recordExtensions     [14] ManagementExtensions OPTIONAL
}

HLRIntRecord ::= SET
{
    recordType           [0] CallEventRecordType,
    servedIMSI          [1] IMSI,
    servedMSISDN        [2] MSISDN,
    recordingEntity      [3] RecordingEntity,
    basicService         [4] BasicServiceCode OPTIONAL,
    routingNumber        [5] RoutingNumber,
    interrogationTime     [6] TimeStamp,
    numberOfForwarding   [7] NumberOfForwarding OPTIONAL,
    interrogationResult   [8] HLRIntResult OPTIONAL,
    recordExtensions     [9] ManagementExtensions OPTIONAL
}

LocUpdateHLRRecord ::= SET
{
    recordType           [0] CallEventRecordType,
    servedIMSI          [1] IMSI,
    recordingEntity      [2] RecordingEntity,

```

```

    oldLocation      [3] Location-info OPTIONAL,
    newLocation      [4] Location-info,
    updateTime       [5] TimeStamp,
    updateResult     [6] LocUpdResult OPTIONAL,
    recordExtensions [7] ManagementExtensions OPTIONAL
}

LocUpdateVLRRecord ::= SET
{
    recordType      [0] CallEventRecordType,
    servedIMSI     [1] IMSI,
    servedMSISDN   [2] MSISDN OPTIONAL,
    recordingEntity [3] RecordingEntity,
    oldLocation    [4] Location-info OPTIONAL,
    newLocation    [5] Location-info,
    msClassmark    [6] Classmark,
    updateTime     [7] TimeStamp,
    updateResult   [8] LocUpdResult OPTIONAL,
    recordExtensions [9] ManagementExtensions OPTIONAL
}

CommonEquipRecord ::= SET
{
    recordType      [0] CallEventRecordType,
    equipmentType   [1] EquipmentType,
    equipmentId     [2] EquipmentId,
    servedIMSI     [3] IMSI,
    servedMSISDN   [4] MSISDN OPTIONAL,
    recordingEntity [5] RecordingEntity,
    basicService   [6] BasicServiceCode OPTIONAL,
    changeOfService [7] SEQUENCE OF ChangeOfService OPTIONAL,
    supplServicesUsed [8] SEQUENCE OF SuppServiceUsed OPTIONAL,
    seizureTime    [9] TimeStamp,
    releaseTime    [10] TimeStamp OPTIONAL,
    callDuration   [11] CallDuration,
    callReference  [12] CallReference,
    sequenceNumber [13] INTEGER OPTIONAL,
    recordExtensions [14] ManagementExtensions OPTIONAL
}

-----
--
-- OBSERVED IMEI TICKETS
--
-----

ObservedIMEITicket ::= SET
{
    servedIMEI      [0] IMEI,
    imeiStatus     [1] IMEIStatus,
    servedIMSI     [2] IMSI,
    servedMSISDN   [3] MSISDN OPTIONAL,
    recordingEntity [4] RecordingEntity,
    eventTime      [5] TimeStamp,
    location       [6] LocationAreaAndCell ,
    imeiCheckEvent [7] IMEICheckEvent OPTIONAL,
    callReference  [8] CallReference OPTIONAL,
    recordExtensions [9] ManagementExtensions OPTIONAL
}

-----
--
-- FTAM FILE CONTENTS
--
-----

CallEventDataFile ::= SEQUENCE
{
    headerRecord      [0] HeaderRecord,
    callEventRecords [1] SEQUENCE OF CallEventRecord,
    trailerRecord     [2] TrailerRecord,
    extensions       [3] ManagementExtensions
}

ObservedIMEITicketFile ::= SEQUENCE
{

```

```

    productionDateTime [0] TimeStamp,
    observedIMEITickets [1] SEQUENCE OF ObservedIMEITicket,
    noOfRecords [2] INTEGER,
    extensions [3] ManagementExtensions
}

HeaderRecord ::= SEQUENCE
{
    productionDateTime [0] TimeStamp,
    recordingEntity [1] RecordingEntity,
    extensions [2] ManagementExtensions
}

TrailerRecord ::= SEQUENCE
{
    productionDateTime [0] TimeStamp,
    recordingEntity [1] RecordingEntity,
    firstCallDateTime [2] TimeStamp,
    lastCallDateTime [3] TimeStamp,
    noOfRecords [4] INTEGER,
    extensions [5] ManagementExtensions
}

-----
--
-- OBJECT IDENTIFIERS
--
-----

gsm1205InformationModel OBJECT IDENTIFIER ::=
{ ccitt (0) identified-organization (4) etsi (0) mobileDomain (0)
  gsm-Operation-Maintenance (3) gsm-12-05 (5) informationModel (0) }

gsm1205ASN1Module OBJECT IDENTIFIER ::=
{ gsm1205InformationModel asn1Module(2) }

gsm1205ManagedObjectClass OBJECT IDENTIFIER ::=
{ gsm1205InformationModel managedObjectClass(3) }

gsm1205Package OBJECT IDENTIFIER ::=
{ gsm1205InformationModel package(4) }

gsm1205NameBinding OBJECT IDENTIFIER ::=
{ gsm1205InformationModel nameBinding(6) }

gsm1205Attribute OBJECT IDENTIFIER ::=
{ gsm1205InformationModel attribute(7) }

gsm1205Action OBJECT IDENTIFIER ::=
{ gsm1205InformationModel action(9) }

gsm1205Notification OBJECT IDENTIFIER ::=
{ gsm1205InformationModel notification(10) }

-----
--
-- COMMON DATA TYPES
--
-----

AdditionalChgInfo ::= SEQUENCE
{
    chargeIndicator [0] ChargeIndicator OPTIONAL,
    chargeParameters [1] OCTET STRING OPTIONAL
}

AiurRequested ::= ENUMERATED
{
    --
    -- See Bearer Capability TS 24.008
    -- (note that value "4" is intentionally missing
    -- because it is not used in TS 24.008)
    --
    aiur09600BitsPerSecond (1),
    aiur14400BitsPerSecond (2),
    aiur19200BitsPerSecond (3),
    aiur28800BitsPerSecond (5),

```

```

    aiur38400BitsPerSecond      (6),
    aiur43200BitsPerSecond      (7),
    aiur57600BitsPerSecond      (8),
    aiur38400BitsPerSecond1     (9),
    aiur38400BitsPerSecond2     (10),
    aiur38400BitsPerSecond3     (11),
    aiur38400BitsPerSecond4     (12)
}

AOCParameters ::= SEQUENCE
{
    --
    -- See TS 22.024.
    --
    e1      [1] EParameter OPTIONAL,
    e2      [2] EParameter OPTIONAL,
    e3      [3] EParameter OPTIONAL,
    e4      [4] EParameter OPTIONAL,
    e5      [5] EParameter OPTIONAL,
    e6      [6] EParameter OPTIONAL,
    e7      [7] EParameter OPTIONAL
}

AOCParamChange ::= SEQUENCE
{
    changeTime      [0] TimeStamp,
    newParameters   [1] AOCParameters
}

BasicServices ::= SET OF BasicServiceCode

BCDDirectoryNumber ::= OCTET STRING
-- This type contains the binary coded decimal representation of
-- a directory number e.g. calling/called/connected/translated number.
-- The encoding of the octet string is in accordance with the
-- the elements "Calling party BCD number", "Called party BCD number"
-- and "Connected number" defined in TS 24.008.
-- This encoding includes type of number and number plan information
-- together with a BCD encoded digit string.
-- It may also contain both a presentation and screening indicator
-- (octet 3a).
-- For the avoidance of doubt, this field does not include
-- octets 1 and 2, the element name and length, as this would be
-- redundant.

CallDuration ::= INTEGER
--
-- The call duration in seconds.
-- For successful calls this is the chargeable duration.
-- For call attempts this is the call holding time.
--

CallEventRecordType ::= INTEGER
{
    moCallRecord      (0),
    mtCallRecord      (1),
    roamingRecord     (2),
    incGatewayRecord  (3),
    outGatewayRecord  (4),
    transitCallRecord (5),
    moSMSRecord       (6),
    mtSMSRecord       (7),
    moSMSIWRecord     (8),
    mtSMSGWRecord     (9),
    ssActionRecord    (10),
    hlrIntRecord      (11),
    locUpdateHLRRecord (12),
    locUpdateVLRRecord (13),
    commonEquipRecord (14),
    moTraceRecord     (15),
    mtTraceRecord     (16),
    termCAMELIntRecord (17),
    --
    -- Record values 18..22 are GPRS specific.
    -- The contents are defined in TS 32.015
    --
    sgsnPDPRecord     (18),
    ggsnPDPRecord     (19),

```

```

sgsnMMRecord      (20),
sgsnSMORecord    (21),
sgsnSMTRecord    (22)
}

CalledNumber      ::= BCDDirectoryNumber

CallingNumber     ::= BCDDirectoryNumber

CallingPartyCategory ::= Category

CallReference     ::= INTEGER

CallType          ::= INTEGER
{
  mobileOriginated (0),
  mobileTerminated (1)
}

CallTypes        ::= SET OF CallType

CAMELDestinationNumber ::= DestinationRoutingAddress

CAMELInformation   ::= SET
{
  CAMELDestinationNumber [1] CAMELDestinationNumber OPTIONAL,
  connectedNumber        [2] ConnectedNumber OPTIONAL,
  roamingNumber          [3] RoamingNumber OPTIONAL,
  mscOutgoingTKGP       [4] TrunkGroup OPTIONAL,
  seizureTime           [5] TimeStamp OPTIONAL,
  answerTime            [6] TimeStamp OPTIONAL,
  releaseTime           [7] TimeStamp OPTIONAL,
  callDuration          [8] CallDuration OPTIONAL,
  dataVolume            [9] DataVolume OPTIONAL,
  CAMELInitCFIndicator  [10] CAMELInitCFIndicator OPTIONAL,
  causeForTerm          [11] CauseForTerm OPTIONAL,
  CAMELModification     [12] ChangedParameters OPTIONAL,
  freeFormatData        [13] FreeFormatData OPTIONAL,
  diagnostics           [14] Diagnostics OPTIONAL,
  freeFormatDataAppend  [15] BOOLEAN OPTIONAL,
  freeFormatData_2     [16] FreeFormatData OPTIONAL,
  freeFormatDataAppend_2 [17] BOOLEAN OPTIONAL
}

CAMELSMSInformation ::= SET
{
  gsm-SCFAddress [1] Gsm-SCFAddress OPTIONAL,
  serviceKey     [2] ServiceKey OPTIONAL,
  defaultSMSHandling [3] DefaultSMS-Handling OPTIONAL,
  freeFormatData  [4] FreeFormatData OPTIONAL,
  CallingPartyNumber [5] CallingNumber OPTIONAL,
  DestinationSubscriberNumber [6] CalledNumber OPTIONAL,
  CAMELSMSCAddress [7] AddressString OPTIONAL
}

CAMELInitCFIndicator ::= ENUMERATED
{
  noCAMELCallForwarding (0),
  CAMELCallForwarding (1)
}

CAMELModificationParameters ::= SET
--
-- The list contains only parameters changed due to CAMEL call
-- handling.
--
{
  callingPartyNumber [0] CallingNumber OPTIONAL,
  callingPartyCategory [1] CallingPartyCategory OPTIONAL,
  originalCalledPartyNumber [2] OriginalCalledNumber OPTIONAL,
  genericNumbers [3] GenericNumbers OPTINAL,
  redirectingPartyNumber [4] RedirectingNumber OPTIONAL,
  redirectionCounter [5] NumberOfForwarding OPTIONAL
}

Category ::= OCTET STRING (SIZE(1))
--

```

```

-- The internal structure is defined in ITU-T Rec Q.763.
--

CauseForTerm ::= INTEGER
--
-- Cause codes from 16 up to 31 are defined in TS 32.015 as 'CauseForRecClosing'
-- (cause for record closing).
-- There is no direct correlation between these two types.
--
{
  normalRelease          (0),
  partialRecord          (1),
  partialRecordCallReestablishment (2),
  unsuccessfulCallAttempt (3),
  stableCallAbnormalTermination (4),
  CAMELInitCallRelease   (5)
}

CellId ::= OCTET STRING (SIZE(2))
--
-- Coded according to TS 24.008
--

ChangedParameters ::= SET
{
  changeFlags [0] ChangeFlags,
  changeList  [1] CAMELModificationParameters OPTIONAL
}

ChangeFlags ::= BIT STRING
{
  callingPartyNumberModified      (0),
  callingPartyCategoryModified    (1),
  originalCalledPartyNumberModified (2),
  genericNumbersModified          (3),
  redirectingPartyNumberModified   (4),
  redirectionCounterModified       (5)
}

ChangeOfClassmark ::= SEQUENCE
{
  classmark [0] Classmark,
  changeTime [1] TimeStamp
}

ChangeOfRadioChannel ::= SEQUENCE
{
  radioChannel [0] TrafficChannel,
  changeTime [1] TimeStamp,
  speechVersionUsed [2] SpeechVersionIdentifier OPTIONAL
}

ChangeOfService ::= SEQUENCE
{
  basicService [0] BasicServiceCode,
  transparencyInd [1] TransparencyInd OPTIONAL,
  changeTime [2] TimeStamp
}

ChannelCoding ::= ENUMERATED
{
  tchF4800 (1),
  tchF9600 (2),
  tchF14400 (3)
}

ChargeIndicator ::= INTEGER
{
  noCharge (0),
  charge (1)
}

Classmark ::= OCTET STRING
--
-- See Mobile station classmark 2, TS 24.008
--

ConnectedNumber ::= BCDDirectoryNumber

```

```

DataVolume          ::= INTEGER
--
-- The volume of data transferred in segments of 64 octets.
--

Day                 ::= INTEGER (1..31)

DayClass            ::= ObjectInstance

DayClasses          ::= SET OF DayClass

DayDefinition       ::= SEQUENCE
{
    day              [0] DayOfTheWeek,
    dayClass         [1] ObjectInstance
}

DayDefinitions      ::= SET OF DayDefinition

DateDefinition      ::= SEQUENCE
{
    month            [0] Month,
    day              [1] Day,
    dayClass         [2] ObjectInstance
}

DateDefinitions    ::= SET OF DateDefinition

DayOfTheWeek        ::= ENUMERATED
{
    allDays          (0),
    sunday           (1),
    monday           (2),
    tuesday          (3),
    Wednesday        (4),
    thursday         (5),
    friday           (6),
    Saturday         (7)
}

Diagnostics         ::= CHOICE
{
    gsm0408Cause     [0] INTEGER,
    -- See TS 24.008
    gsm0902MapErrorValue [1] INTEGER,
    -- Note: The value to be stored here corresponds to
    -- the local values defined in the MAP-Errors and
    -- MAP-DialogueInformation modules, for full details
    -- see TS 29.002.
    ccittQ767Cause   [2] INTEGER,
    -- See ITU-T Q.767
    networkSpecificCause [3] ManagementExtension,
    -- To be defined by network operator
    manufacturerSpecificCause [4] ManagementExtension
    -- To be defined by manufacturer
}

Destinations        ::= SET OF AE-title

EmergencyCallIndEnable ::= BOOLEAN

EmergencyCallIndication ::= SEQUENCE
{
    cellId           [0] CellId,
    callerId         [1] IMSIorIMEI
}

EParameter          ::= INTEGER (0..1023)
--
-- Coded according to TS 22.024 and TS 24.080
--

EquipmentId         ::= INTEGER

EquipmentType       ::= INTEGER
{
    conferenceBridge (0)
}

```



```

}

FileType ::= INTEGER
{
  callRecords (1),
  traceRecords (9),
  observedIMEITicket (14)
}

Fnur ::= ENUMERATED
{
  --
  -- See Bearer Capability TS 24.008
  --
  Fnur9600-BitsPerSecond (1),
  Fnur14400BitsPerSecond (2),
  Fnur19200BitsPerSecond (3),
  Fnur28800BitsPerSecond (4),
  Fnur38400BitsPerSecond (5),
  Fnur48000BitsPerSecond (6),
  Fnur56000BitsPerSecond (7),
  Fnur64000BitsPerSecond (8)
}

ForwardToNumber ::= AddressString

FreeFormatData ::= OCTET STRING (SIZE(1..160))
--
-- Free formatted data as sent in the FCI message
-- See TS 29.078
--

GenericNumber ::= BCDDirectoryNumber

GenericNumbers ::= SET OF GenericNumber

Gsm-SCFAddress ::= ISDNAddressString
--
-- See TS 29.002
--

HLRIntResult ::= Diagnostics

HSCSDParmsChange ::= SEQUENCE
{
  changeTime [0] TimeStamp,
  hSCSDChanAllocated [1] NumOfHSCSDChanAllocated,
  initiatingParty [2] InitiatingParty OPTIONAL,
  aiurRequested [3] AiurRequested OPTIONAL,
  chanCodingUsed [4] ChannelCoding,
  hSCSDChanRequested [5] NumOfHSCSDChanRequested OPTIONAL,
}

IMEICheckEvent ::= INTEGER
{
  mobileOriginatedCall (0),
  mobileTerminatedCall (1),
  smsMobileOriginating (2),
  smsMobileTerminating (3),
  ssAction (4),
  locationUpdate (5)
}

IMEIStatus ::= ENUMERATED
{
  greyListedMobileEquipment (0),
  blackListedMobileEquipment (1),
  nonWhiteListedMobileEquipment (2)
}

IMSIorIMEI ::= CHOICE
{
  imsi [0] IMSI,
  imei [1] IMEI
}

InitiatingParty ::= ENUMERATED
{

```

```

    network          (0),
    subscriber       (1)
}

LevelOfCAMELService ::= BIT STRING
{
    basic              (0),
    callDurationSupervision (1),
    onlineCharging     (2)
}

LocationAreaAndCell ::= SEQUENCE
{
    locationAreaCode [0] LocationAreaCode,
    cellId           [1] CellId
}

LocationAreaCode ::= OCTET STRING (SIZE(2))
--
-- See TS 24.008
--

LocationChange ::= SEQUENCE
{
    location          [0] LocationAreaAndCell,
    changeTime       [1] TimeStamp
}

Location-info ::= SEQUENCE
{
    mscNumber         [1] MscNo OPTIONAL,
    location-area     [2] LocationAreaCode,
    cell-identification [3] CellId OPTIONAL
}

LocUpdResult ::= Diagnostics

ManagementExtensions ::= SET OF ManagementExtension

MCCMNC ::= GraphicString (SIZE(5))
--
-- This type contains the mobile country code (MCC) and the mobile -- network code (MNC) of
a PLMN.
--

MessageReference ::= OCTET STRING

Month ::= INTEGER (1..12)

MSCAddress ::= AddressString

MscNo ::= ISDN-AddressString
--
-- See TS 23.003
--

MSISDN ::= ISDN-AddressString
--
-- See TS 23.003
--

MSPowerClasses ::= SET OF RFPowerCapability

NetworkCallReference ::= CallReferenceNumber --
-- See TS 29.002
--

NetworkSpecificCode ::= INTEGER
--
-- To be defined by network operator
--

NetworkSpecificServices ::= SET OF NetworkSpecificCode

NumOfHSCSDChanRequested ::= INTEGER

NumOfHSCSDChanAllocated ::= INTEGER

```

```

ObservedIMEITicketEnable ::= BOOLEAN

OriginalCalledNumber ::= BCDDirectoryNumber

OriginDestCombinations ::= SET OF OriginDestCombination

OriginDestCombination ::= SEQUENCE
{
    origin [0] INTEGER OPTIONAL,
    destination [1] INTEGER OPTIONAL
    --
    -- Note that these values correspond to the contents
    -- of the attributes originId and destinationId
    -- respectively. At least one of the two must be present.
    --
}

PartialRecordTimer ::= INTEGER

PartialRecordType ::= ENUMERATED
{
    timeLimit (0),
    serviceChange (1),
    locationChange (2),
    classmarkChange (3),
    aocParmChange (4),
    radioChannelChange (5),
    hSCSDParmChange (6),
    changeOfCAMELDestination (7)
}

PartialRecordTypes ::= SET OF PartialRecordType

RadioChannelsRequested ::= SET OF RadioChanRequested

RadioChanRequested ::= ENUMERATED
{
    --
    -- See Bearer Capability TS 24.008
    --
    halfRateChannel (0),
    fullRateChannel (1),
    dualHalfRatePreferred (2),
    dualFullRatePreferred (3)
}

RecordClassDestination ::= CHOICE
{
    osApplication [0] AE-title,
    fileType [1] FileType
}

RecordClassDestinations ::= SET OF RecordClassDestination

RecordingEntity ::= AddressString

RecordingMethod ::= ENUMERATED
{
    inCallRecord (0),
    inSSRecord (1)
}

RedirectingNumber ::= BCDDirectoryNumber

RFPowerCapability ::= INTEGER
--
-- This field contains the RF power capability of the Mobile station
-- classmark 1 and 2 of TS 24.008 expressed as an integer.
--

RoamingNumber ::= ISDN-AddressString
--
-- See TS 23.003
--

RoutingNumber ::= CHOICE
{
    roaming [1] RoamingNumber,

```

```

    forwarded          [2] ForwardToNumber
  }

Service                ::= CHOICE
{
    teleservice         [1] TeleserviceCode,
    bearerService      [2] BearerServiceCode,
    supplementaryService [3] SS-Code,
    networkSpecificService [4] NetworkSpecificCode
}

ServiceDistanceDependencies ::= SET OF ServiceDistanceDependency

ServiceDistanceDependency ::= SEQUENCE
{
    aocService          [0] INTEGER,
    chargingZone       [1] INTEGER OPTIONAL
    --
    -- Note that these values correspond to the contents
    -- of the attributes aocServiceId and zoneId
    -- respectively.
    --
}

SimpleIntegerName      ::= INTEGER

SimpleStringName       ::= GraphicString

SMSResult              ::= Diagnostics

SpeechVersionIdentifier ::= OCTET STRING (SIZE(1))

-- see GSM 08.08

-- 000 0001    GSM speech full rate version 1
-- 001 0001    GSM speech full rate version 2    used for enhanced full rate
-- 010 0001    GSM speech full rate version 3    for future use
-- 000 0101    GSM speech half rate version 1
-- 001 0101    GSM speech half rate version 2    for future use
-- 010 0101    GSM speech half rate version 3    for future use

SSActionResult        ::= Diagnostics

SSActionType          ::= ENUMERATED
{
    registration        (0),
    erasure              (1),
    activation           (2),
    deactivation         (3),
    interrogation        (4),
    invocation           (5),
    passwordRegistration (6)
}

SSParameters          ::= CHOICE
{
    forwardedToNumber    [0] ForwardToNumber,
    unstructuredData     [1] OCTET STRING
}

SupplServices         ::= SET OF SS-Code

SuppServiceUsed       ::= SEQUENCE
{
    ssCode               [0] SS-Code,
    ssTime               [1] TimeStamp OPTIONAL
}

SwitchoverTime        ::= SEQUENCE
{
    hour                 INTEGER (0..23),
    minute               INTEGER (0..59),
    second               INTEGER (0..59)
}

TariffId              ::= INTEGER

TariffPeriod          ::= SEQUENCE

```

```

{
  switchoverTime      [0] SwitchoverTime,
  tariffId           [1] INTEGER
  -- Note that the value of tariffId corresponds
  -- to the attribute tariffId.
}

TariffPeriods        ::= SET OF TariffPeriod

TariffSystemStatus   ::= ENUMERATED
{
  available          (0),    -- available for modification
  checked            (1),    -- "frozen" and checked
  standby            (2),    -- "frozen" awaiting activation
  active             (3) -- "frozen" and active
}

TimeStamp             ::= OCTET STRING (SIZE(9))
--
-- The contents of this field are a compact form of the UTCTime format
-- containing local time plus an offset to universal time. Binary coded
-- decimal encoding is employed for the digits to reduce the storage and
-- transmission overhead
-- e.g. YYMMDDhhmmssShhmm
-- where
-- YY   =   Year 00 to 99       BCD encoded
-- MM   =   Month 01 to 12     BCD encoded
-- DD   =   Day 01 to 31       BCD encoded
-- hh   =   hour 00 to 23      BCD encoded
-- mm   =   minute 00 to 59    BCD encoded
-- ss   =   second 00 to 59    BCD encoded
-- S    =   Sign 0 = "+", "-"  ASCII encoded
-- hh   =   hour 00 to 23      BCD encoded
-- mm   =   minute 00 to 59    BCD encoded
--
TrafficChannel        ::= ENUMERATED
{
  fullRate           (0),
  halfRate           (1)
}

TranslatedNumber      ::= BCDDirectoryNumber

TransparencyInd       ::= ENUMERATED
{
  transparent        (0),
  nonTransparent     (1)
}

TrunkGroup           ::= CHOICE
{
  tkgpNumber         [0] INTEGER,
  tkgpName           [1] GraphicString
}

TSChangeover         ::= SEQUENCE
{
  newActiveTS        [0] INTEGER,
  newStandbyTS       [1] INTEGER,
  changeoverTime     [2] GeneralizedTime OPTIONAL,
  authkey            [3] OCTET STRING OPTIONAL,
  checksum            [4] OCTET STRING OPTIONAL,
  versionNumber      [5] OCTET STRING OPTIONAL
  -- Note that if the changeover time is not
  -- specified then the change is immediate.
}

TSCheckError         ::= SEQUENCE
{
  errorId            [0] TSCheckErrorId,
  fail               [1] ANY DEFINED BY errorId OPTIONAL
}

TSCheckErrorId       ::= CHOICE
{
  globalForm         [0] OBJECT IDENTIFIER,
  localForm          [1] INTEGER
}

```

```
}
TSCheckResult ::= CHOICE
{
    success      [0] NULL,
    fail         [1] SET OF TSCheckError
}

TSCopyTariffSystem ::= SEQUENCE
{
    oldTS        [0] INTEGER,
    newTS        [1] INTEGER
}

TSNextChange ::= CHOICE
{
    noChangeover [0] NULL,
    tsChangeover [1] TSChangeover
}

TypeOfSubscribers ::= ENUMERATED
{
    home          (0),    -- HPLMN subscribers
    visiting      (1),    -- roaming subscribers
    all (2)
}

TypeOfTransaction ::= ENUMERATED
{
    successful    (0),
    unsuccessful  (1),
    all           (2)
}

END
```

A.10 Application context

The application context name to be used in connection with the management functions described in this document shall take the following object identifier value:

```
{gsm-OM-DomainId gsm-12-05 (5) protocolSupport(1) applicationContext (0)    gsm-Management (0)}
```

and the following object description value:

```
"gsm 12.05 management application context".
```

Annex B (normative): Call and event records

B.1 General

In order to provide the data required for the management activities outlined in the previous chapters (billing, accounting, statistics etc.), the NEF of the MSC and/or Location Registers shall be able to produce an event or call record for each of the following:

- Mobile originated call attempt;
- Mobile originated emergency call attempt;
- Mobile originated, call forwarding attempt;
- Mobile terminated call attempt;
- Roaming call attempt in a gateway MSC;
- Incoming call attempt in a gateway MSC;
- Outgoing call attempt from a gateway MSC;
- Transit call attempt;
- Terminating CAMEL interrogation call attempt;
- Supplementary service actions;
- HLR interrogation;
- Location updating (HLR & VLR);
- Short message service (point-to-point), mobile originated;
- Short message service (point-to-point), mobile terminated;
- Short message service (point-to-point), mobile originated interworking MSC;
- Short message service (point-to-point), mobile terminated gateway MSC;
- Common equipment usage.

The contents and purpose of each of these records are described in the following subclauses. A detailed formal description of the data defined in the present document is to be found in Annex A.

As not all of these records may be required for any given network, each record type shall be enabled/ disabled by means of the network management functions outlined in 8.2.1.1.

B.1.1 Use of supplementary services

The recording of supplementary service usage is controlled via the procedures outlined in subclause 8.2.1.1.3. These procedures permit the OS to specify the supplementary service actions (invocation, registration etc.) to be recorded.

In addition to specifying the actions to be recorded, the OS may also determine how these events are to be recorded. Non-call related events, such as the administration of supplementary services by the subscriber via the MMI of the MS, shall result in the production of supplementary service action records. Call related events (e.g. invocation of supplementary services) shall be recorded "in-line" in the appropriate call record and/ or in a separate SS-action record depending on the configuration specified by the OS.

Where the use of a supplementary service results in the production of further connections (e.g. call forwarding, multi-party service etc.) additional call records shall be produced to describe the relevant connections. The use of such services is described in more detail both in this subclause and in the example scenarios.

B.1.1.1 Use of call forwarding

When one of the call forwarding services is used, the NEF of the MSC that forwards the call, shall produce the call record for the forwarded part of the call. The call record produced is an MOC record as described in subclause B.2.3.

For further information concerning the recording of call forwarding services see the example scenarios in subclause B.4.6 and B.4.7.

B.1.1.2 Use of call hold and multi-party services

The use of the call hold service shall be recorded either in-line in the appropriate call record or in a separate supplementary service "invocation" record as described above. For the avoidance of doubt, the duration for which the call is held, i.e. is inactive, is not recorded.

The use of the multi-party service requires a minimum of 3 subscribers and the use of a conference circuit. For the purpose of the following description the subscriber invoking the service is referred to as the conference originator ("A") and the conference call is regarded as consisting of a number of individual "legs" between the organiser and the other parties ("B", "C", etc.) in the call.

Normal MOC and MTC call records shall be generated for each party and each leg of the call. In addition, if common equipment records are enabled, a common equipment record shall be produced for the conference originator in order to record the use of a conference bridge and to record the total duration of the conference connection.

Example: Subscriber "C" calls subscriber "A". Subscriber "A" places the call from "C" on hold and makes a second call to subscriber "B". Subscriber "A" then invokes the multi-party service in order to set-up a conference call with "B" and "C".

Assuming that the appropriate types of record are enabled, the following call records shall be produced:

- An MOC record for subscriber "C" and the "C"->"A" leg of the call;
- An MTC record for subscriber "A" and the "C"->"A" leg of the call;
- An MOC record for subscriber "A" and the "A"->"B" leg of the call;
- An SS-Action record for the invocation of the call hold service by subscriber "A";
- An MTC record for subscriber "B" and the "A"->"B" leg of the call;
- An SS-Action record for the invocation of the multi-party service by subscriber "A";
- A common equipment record for the use of the conference bridge by subscriber "A";

Each of the MOC/MTC records for the conference originator ("A") shall include the supplementary service code for the multi-party service.

Any subsequent action affecting only one leg of the connection shall be recorded either in a separate supplementary service action record or in-line in the appropriate call record. Any action affecting the conference as a whole e.g. the originator holding the conference shall be recorded either in a separate supplementary service action record or in the common equipment usage record.

For further information concerning the recording of multi-party services see the example scenario in subclause B.4.9.

B.1.2 Partial records

In order to increase the security of the recording process and to simplify post-processing, it may be desirable to generate a sequence of call records to describe a single connection or transaction.

In case of connections of extended duration, the loss of a single call record may result in an unacceptable loss of revenue. If the connection is, for example, recorded in a number of consecutive partial records generated at say hourly intervals, then the maximum loss of revenue is the equivalent of a one hour continuous connection.

Most modern billing systems employ some form of cumulative credit-limit checking based on the stream of input call records. If however, a call record is only produced at the end of the connection then a subscriber may avoid such credit checking by employing a connection for days, weeks or even months without a single call record being produced.

All of the records defined in the present document are of variable length and some at least are potentially unlimited in size (SET OF, SEQUENCE OF etc.). However, the storage capacity of the internal records within the NEF is normally subject to strict size limitations. Under such conditions a partial record may be required in order to circumvent internal resource limitations. For example, if an internal MOC record can only support the use of four supplementary service invocations then the use of a fifth may result in the generation of a partial record.

Alternatively, for those manufacturers whose systems are based on fixed length records, partial records may be employed instead of the various lists contained within the present document definitions. In such cases a partial record will be produced each time one of the key fields alters during the connection.

Finally, in case of radio link failure and subsequent call re-establishment partial records shall be generated to record the duration of the call prior to the radio link failure and the subsequent duration of the call once the call has been re-established. For further details see subclause B.1.5.

To summarise, the following events may result in the generation of a partial record:

- expiry of the partial record timer;
- change of basic service during a connection;
- change of location (LAC or Cell Id.) during a connection;
- change of MS classmark during a connection;
- change of AoC Parameters during a call;
- change of Radio Channel Type (full/half rate) during a call;
- radio link failure and subsequent call re-establishment;
- change of HSCSD Parameters during a call;
- change of CAMEL destination (CAMEL controlled/initiated) during a call.

All partial records for the same connection shall contain the same call reference and shall be ordered via a running sequence number. The time stamps involved shall apply to the individual partial records rather than the connection as a whole i.e. the "end" time stamp (duration) of one record shall, in general, coincide with the "start" time stamp (answer time) of the next. Each time a new partial record is created the cause for termination of the previous field shall contain the value "partial record ". The cause for termination of the final partial record shall contain the true cause for termination of the connection.

It should be noted that the records produced in case of call re-establishment are not contiguous and that the value of the cause for term field in the record that is closed on radio link failure contains the value "partial record call re-establishment". For further details of these records see subclause B.2.18.

The partial records generated may repeat each of the non-varying fields contained in the original record. Alternatively, a form of reduced partial record may be generated which includes only those fields required to identify the original record together with the field(s) that actually change. An example of a reduced partial record for MOCs is provided in subclause B.2.18.

B.1.3 Use of packet data services

If packet data services are employed in conjunction with a Packet Switched Public Data Network (PSPDN) then an MOC/MTC call record may be produced in the originating/terminating MSC and a gateway record in the gateway/interworking MSC. If the packet volume is not available within the PLMN then this information may also be provided in the form of a call record from the PSPDN. In such cases the OS is responsible for the correlation of the various records describing the connection. The definition of such PSPDN call records is outside the scope of the present document.

B.1.4 Inter-msc handover

In the case of an inter-MSM handover the controlling MSC, as defined by GSM 23.009, remains in control of the connection and shall therefore, produce the call record. For the avoidance of doubt, it is not necessary to produce call or event records in the subsequent MSC(s).

B.1.5 Call re-establishment

In case of radio link failure as described in 3GPP TS 24.008 [16], the MS may attempt to re-establish the call using the procedures described in 3GPP TS 24.008 [16].

For the time period between the detection of the radio link failure by the mobile station and the successful re-establishment of the call, the advice of charge function in the MS is suspended as described in 3GPP TS 24.086. In order to minimise the difference in charges between the on-line calculations performed by the MS and the off-line processing on the basis of the call records, it is necessary to exclude the time taken for the re-establishment phase from the chargeable duration stored in the call records.

If the re-establishment attempt fails then an ordinary call record (MOC/MTC) shall be produced with the cause for termination value "stable call abnormal termination". The chargeable duration stored in this record covers the time period from "Answer" to the detection of the radio link failure by the MSC.

If, the attempt to re-establish the call succeeds then the current call record shall be closed with the cause for termination value "partial record call re-establishment" and a new partial record shall be opened for the re-established call. The chargeable duration stored in the original record is once again the time period from "answer" to detection of the radio link failure by the MSC. Both the "seizure" and "answer" times of the subsequent partial record correspond to the time at which the new traffic channel is allocated for the re-established call (see subclause B.3.16 for further details).

Further radio link failures during the re-established call may result in the generation of additional partial records as described above. All of the partial records belonging to the same connection are identified by the same call reference and a running sequence number as described in subclause

NOTE: As the MS and MSC may detect the radio link failure at different points in time, it is not possible to guarantee that the duration used for the AOC display corresponds to that recorded in the call records. The purpose of the above procedure is merely to minimise any discrepancies that may occur.

B.1.6 Restricted directory numbers

In addition to the information pertaining to the served mobile subscriber (IMSI, MSISDN, etc.), the call records defined in the present document also contain the directory numbers of other parties involved in the recorded connections or transactions. In order to comply with data protection legislation, it is necessary to distinguish between those numbers that may be passed on to third parties and those that needs to be handled confidentially. As a result, each of the number fields (e.g. calling/connected number) contains the presentation and screening information defined in both 3GPP TS 24.008 [16] and ISUP signalling. If this information is supported by the network, then even restricted numbers may be included in the appropriate records and suppressed off-line by the administration or billing centre. If this information is not supported then the entire directory number shall be suppressed by the MSC/VLR.

B.1.7 CAMEL services

CAMEL service can be activated for originating, forwarded and terminated calls and originating SMS. Several fields describing CAMEL subscription and free format data are recorded to appropriate CDR. For originating and forwarded calls two different CAMEL services can be active and part of stored information is different Originating service and Dialed service defined in O-CSI and D-CSI). If two services are active, the Originating CAMEL service information is stored in fields without '_2' suffix and Dialed CAMEL service information in corresponding fields with '_2' suffix. If only one CAMEL service is active, either Originating or Dialed service, then fields without '_2' suffix are used. CAMEL fields describing usage level of service, CAMEL modified parameters and CAMEL initiated call forwarding include information for one call leg including impacts on all CAMEL services. For more information about CAMEL service and interworking see 3GPP TS 23.078[23] and TS 29.078[24].

CAMEL Terminating service in the VPLMN defined in VT_CSI affect the corresponding incoming CAMEL call leg part of the relevant record.

B.2 Record contents

The following tables describe the contents of each of the call and event records defined in the present document. Each table contains the name of the field, a key indicating whether or not the field is mandatory, and a description of the contents.

The key field has the following meaning:

- M** This field is mandatory and always present. Any exceptions to this rule are explicitly described.
- C** This field is only available under certain conditions. If available the field is present. The conditions under which the field is available are individually described.
- O** This field is optional and configurable either via additional TMN management functions or manufacturer specific means. For the avoidance of doubt, optional does not mean that the parameter is not supported by the

network element. Equipment manufacturers shall be capable of providing all of these fields in order to claim conformance with the present document.

B.2.1 Mobile originated call attempt

If the generation of these records is enabled then an MOC record shall be created for each outgoing call attempt made by a mobile station. These MOC records shall be produced in the originating MSC.

Table B.1: MOC record

Field		Description
Record Type	M	Mobile originated.
Served IMSI	M	IMSI of the calling party.
Served IMEI	C	IMEI of the calling ME, if available.
Served MSISDN	O	The primary MSISDN of the calling party.
Called Number	M	The address of the called party e.g. the number dialled by the calling sub.
Translated Number	O	The called number after digit translation within the MSC (if applicable)
Connected Number	O	The number of the connected party if different to the Called Number
Roaming Number	O	The Mobile Station Roaming Number employed to route this connection, if applicable.
Recording Entity	M	The E.164 number of the visited MSC producing the record.
Incoming TKGP	O	The MSC trunk group on which the call originated , usually from the BSS
Outgoing TKGP	O	The trunk group on which the call left the MSC
Location	M	The identity of the cell in which the call originated including the location area code.
Change of Location	O	A list of changes in Location Area Code / Cell Id. each time-stamped.
Basic service	M	Bearer or teleservice employed.
Transparency Indicator	C	Only provided for those teleservices which may be employed in both transparent and non-transparent mode.
ChangeOfService	O	A list of changes of basic service during a connection each time-stamped.
Supp. Services	C	Supplementary services invoked as a result of this connection.
AOC Parameters	O	The charge advice parameters sent to the MS on call set-up
Change of AOC Parms	O	New AOC parameters sent to the MS e.g. as a result of a tariff switch over, including the time at which the new set was applied.
MS Classmark	M	The mobile station classmark employed on call set-up.
Change of Classmark	O	A list of changes to the classmark during the connection each time-stamped
Event time stamps:	C	Seizure of incoming traffic channel (for unsuccessful call attempts)
	C	Answer (for successful calls)
	O	Release of traffic channel
Call duration	M	The chargeable duration of the connection for successful calls, the holding time for call attempts.
Radio Chan. Requested	O	The type of radio traffic channel (full / half etc.) requested by the MS.
Radio Chan. Used	M	The type of radio channel actually used (full or half rate).
Change of Rad. Chan.	O	A list of changes each time stamped
Cause for termination	M	The reason for the release of the connection.
Diagnostics	O	A more detailed reason for the release of the connection.
Data volume	C	The number of data segments transmitted if available at the MSC
Sequence no.	C	Partial record sequence number, only present in case of partial records.
Call reference	M	A local identifier distinguishing between transactions on the same MS
Additional Chg. Info	O	Charge/no charge indicator and additional charging parameters
Record extensions	O	A set of network/ manufacturer specific extensions to the record.
gsmSCF address	C	Identifies the CAMEL server serving the subscriber.
Service key	C	The CAMEL service logic to be applied.
Network call reference	C	An identifier to correlate transactions on the same call taking place in different network nodes, shall be present if CAMEL is applied.
MSC Address	C	This field contains the E.164 number assigned to the MSC that generated the network call reference.
Default call handling	O	Indicates whether or not a CAMEL call encountered default call handling. This field shall be present only if default call handling has been applied.
Number of HSCSD Channels Requested	C	The maximum number of HSCSD channels requested as received from the MS at call set-up
Number of HSCSD Channels Allocated	C	The number of HSCSD channels allocated to the MS at call set-up
Change of HSCSD Parameters	C	A list of network or user initiated changes of number of HSCSD channels during a connection each timestamped. Shall only be present in case of an HSCSD call, if the basic HSCSD parameters are modified due the user or network initiated modification procedure.
Fixed Network User Rate	O	May be present for HSCSD connections.
Air Interface User Rate Requested	C	The total Air Interface User Rate Requested by the MS at call setup. Shall only be present for non-transparent HSCSD connections.
Channel Coding Accepted	C	A list of the traffic channels codings accepted by the MS. Shall only be present for HSCSD connections.

Channel Coding Used	C	The traffic channels codings negotiated between the MS and the network at call setup. Shall only be present for HSCSD connections.
Speech Version Used	O	Speech version used for that call
Speech Version Supported	O	Speech version supported by the MS with highest priority indicated by MS
Number of DP encountered	O	Number that counts how often armed detection points (TDP and EDP) were encountered.
Level of CAMEL service	O	Indicator for the complexity of the CAMEL feature used.
Free format Data	C	This field contains data sent by the gsmSCF in the FCI message(s). The data can be sent either in one FCI message or several FCI messages with append indicator.
CAMEL call leg information	C	Set of CAMEL information IEs. Each of these IEs contains information related to one outgoing CAMEL call leg.
Free format data append indicator	C	Indicator if free format data from this CDR is to be appended to free format data in previous partial CDR.
Free format Data	C	This field contains data sent by the gsmSCF in the FCI messages. The data can be sent either in one FCI message or several FCI messages with append indicator.
CAMEL call leg information	C	Set of CAMEL information IEs. Each of these IEs contains information related to one outgoing CAMEL call leg.
Free format data append indicator	C	Indicator if free format data from this CDR is to be appended to free format data in previous partial CDR.
Default call handling 2	O	Indicates whether or not a CAMEL call encountered default call handling for 2 nd service such as dialled service. This field shall be present only if default call handling has been applied.
GsmSCF address 2	C	Identifies the CAMEL server serving the subscriber for 2 nd service such as dialled service.
Service key 2	C	The CAMEL service logic to be applied for 2 nd service such as dialled service.
Free format Data 2	C	This field contains data sent by the gsmSCF in the FCI message(s) for 2 nd service such as dialled service. The data can be sent either in one FCI message or several FCI messages with append indicator.
Free format data append indicator 2	C	Indicator if free format data for 2 nd service from this CDR is to be appended to free format data in previous partial CDR.

B.2.2 Mobile originated emergency call attempt

If the generation of MOC records is enabled then an MOC emergency record shall be created for each outgoing emergency call attempt made by a mobile station. These records shall be produced in the originating MSC.

Table B.2: MOC emergency record

Field		Description
Record Type	M	Mobile originated.
Served IMSI	C	IMSI of the calling party in case of an emergency call with a SIM card.
Served IMEI	C	IMEI of the calling mobile equipment if available.
Served MSISDN	O	The primary MSISDN of the calling party.
Translated Number	O	The called number after digit translation within the MSC (if applicable)
Recording Entity	M	The E.164 number of the visited MSC producing the record.
Incoming TKGP	O	The MSC trunk group on which the call originated, usually from the BSS
Outgoing TKGP	O	The trunk group on which the call left the MSC
Location	M	The identity of the cell in which the call originated including the location area code.
Change of Location	O	A list of changes in Location Area Code / Cell Id. each time-stamped.
Basic service	M	Teleservice 'emergency call'.
AOC Parameters	O	The charge advice parameters sent to the MS on call set-up
Change of AOC Parms	O	New AOC parameters sent to the MS e.g. as a result of a tariff switch over, including the time at which the new set was applied.
MS Classmark	M	The mobile station classmark employed on call set-up.
Change of classmark	O	A list of changes to the classmark during the connection each time-stamped
Event time stamps:	C C O	Seizure of incoming traffic channel (for unsuccessful call attempts) Answer (for successful calls) Release of traffic channel
Call duration	M	The chargeable duration of the connection for successful calls, the holding time for call attempts.
Radio Chan. Requested	O	The type of radio traffic channel (full / half etc.) requested by the MS.
Radio Chan. Used	M	The type of radio channel used (full or half rate).
Change of Rad. Chan.	O	A list of changes each time stamped
Cause for termination	M	The reason for the release of the connection.
Diagnostics	O	A more detailed reason for the release of the connection.
Sequence no.	C	Partial record sequence number, only present in case of partial records.
Call reference	M	A local identifier distinguishing between transactions on the same MS
Record extensions	O	A set of network/ manufacturer specific extensions to the record.

B.2.3 Mobile originated call forwarding attempt

If the generation of MOC records is enabled then, In case of call forwarding, the forwarded-leg of the call shall also result in the production of an MOC record in the MSC that forwards the call (see the example scenarios in subclause B.4.6 and B.4.7).

Table B.3: MOC, call forwarding record

Field		Description
Record Type	M	Mobile originated.
Served IMSI	M	IMSI of the calling party.
Served MSISDN	O	The MSISDN of the forwarding party.
Calling Number	O	The address of the calling party.
Called Number	M	The address of the "forwarded-to" party.
Translated Number	O	The called number after digit translation within the MSC (if applicable)
Connected Number	O	The number of the connected party if different to the Called Number
Roaming Number	O	The Mobile Station Roaming Number employed to route this connection, if applicable.
Recording Entity	M	The E.164 number of the forwarding MSC
Incoming TKGP	O	The MSC trunk group on which the call originated at the forwarding MSC.
Outgoing TKGP	O	The trunk group on which the call left the forwarding MSC
Basic service	C	Bearer or teleservice employed, not always available e.g. in case of call forwarding unconditional.
Transparency Indicator	C	Only provided for those teleservices which may be employed in both transparent and non-transparent mode.
ChangeOfService	O	A list of changes of basic service during a connection each time-stamped.
Supp. Services	C	Supplementary services invoked as a result of this connection.
Event time stamps:	C	Seizure of incoming traffic channel (for unsuccessful call attempts)
	C	Answer (for successful calls)
	O	Release of traffic channel
Call duration	M	The chargeable duration of the connection for successful calls, the holding time of call attempts.
Cause for termination	M	The reason for the release of the connection.
Diagnostics	O	A more detailed reason for the release of the connection.
Data volume	C	The number of data segments transmitted if available at the MSC
Sequence no.	C	Partial record sequence number, only present in case of partial records.
Call reference	M	A local identifier distinguishing between transactions on the same MS
Additional Chg. Info	O	Charge/no charge indicator and additional charging parameters
Record extensions	O	A set of network/ manufacturer specific extensions to the record.
gsmSCF address	C	Identifies the CAMEL server serving the subscriber.
Service key	C	The CAMEL service logic to be applied.
Network call reference	C	An identifier to correlate transactions on the same call taking place in different network nodes, shall be present if CAMEL is applied.
MSC Address	C	This field contains the E.164 number assigned to the MSC that generated the network call reference.
CAMEL initiated CF indicator	C	Indicates that the CAMEL server initiated call forwarding.
Default call handling	O	Indicates whether or not a CAMEL call encountered default call handling. This field shall be present only if default call handling has been applied.
Number of DP encountered	O	Number that counts how often armed detection points (TDP and EDP) were encountered.
Level of CAMEL service	O	Indicator of the complexity of the CAMEL feature used.
Free format Data	C	This field contains data sent by the gsmSCF in the FCI messages. The data can be sent either in one FCI message or several FCI messages with append indicator.
CAMEL call leg information	C	Set of CAMEL information IEs. Each of these IEs contains information related to one outgoing CAMEL call leg.
Free format data append indicator	C	Indicator if free format data from this CDR is to be appended to free format data in previous partial CDR.
Default call handling 2	O	Indicates whether or not a CAMEL call encountered default call handling for 2 nd service such as dialled service. This field shall be present only if default call handling has been applied.
GsmSCF address 2	C	Identifies the CAMEL server serving the subscriber for 2 nd service such as dialled service.
Service key 2	C	The CAMEL service logic to be applied for 2 nd service such as dialled service.
Free format Data 2	C	This field contains data sent by the gsmSCF in the FCI message(s) for 2 nd service such as dialled service. The data can be sent either in one FCI message or several FCI messages with append indicator.
Free format data append indicator 2	C	Indicator if free format data for 2 nd service from this CDR is to be appended to free format data in previous partial CDR.

B.2.4 Mobile terminated call attempt

If the generation of these records is enabled, then an MTC record shall be created for each incoming call attempt made for a mobile station. The MTC records shall be produced in the terminating MSC.

Table B.4: MTC record

Field		Description
Record Type	M	Mobile Terminated.
Served IMSI	M	IMSI of the called party.
Served IMEI	O	IMEI of the called ME.
Served MSISDN	O	The MSISDN of the called party.
Calling Number	C	The number of the calling party if available.
Connected Number	O	Only relevant in case of call forwarding where the "forwarded-to" number is recorded.
Recording Entity	M	The E.164 number of the visited (terminating) MSC
Incoming TKGP	O	The MSC trunk group on which the call originated.
Outgoing TKGP	O	The trunk group on which the call left the MSC, usually to the BSS
Location	C	The identity of the cell occupied by the called party when the call was set up including the location area code.
Change of Location	O	A list of changes in Location Area Code / Cell Id. each time-stamped.
Basic Service	M	Bearer or teleservice employed
Transparency Indicator	C	Only provided for those teleservices which may be employed in both transparent and non-transparent mode.
Change of Service	O	A list of changes of basic service during a connection each time-stamped.
Supp. services	C	Supplementary services invoked as a result of this connection.
AOC Parameters	O	The charge advice parameters sent to the MS on call set-up
Change of AOC Parm.s.	O	New AOC parameters sent to the MS e.g. as a result of a tariff switch-over, including the time at which the new set was applied.
MS Classmark	M	The mobile station class mark
Change of Classmark	O	A list of changes to the classmark during the connection each time-stamped
Event time stamps:	C C O	Seizure of traffic channel for unsuccessful call attempts Answer time for successful calls Release of traffic channel
Call duration	M	The chargeable duration of the connection if successful, the holding time of the call if unsuccessful.
Radio Chan. Requested	O	The type of radio traffic channel (full / half etc.) requested by the MS.
Radio Chan. Used	M	The type of radio channel used (full or half rate).
Change of Rad. Chan	O	A list of changes each time stamped
Cause for term.	M	The reason for the release of the call.
Diagnostics	O	A more detailed reason for the release of the connection.
Data volume	C	The number of data segments transmitted, if available at the MSC
Sequence no.	C	Partial record sequence number, only present in case of partial records.
Call reference	M	A local identifier distinguishing between transactions at the same MS
Additional Chg. Info	O	Charge/no charge indicator and additional charging parameters
Record extensions	O	A set of network/ manufacturer specific extensions to the record.
Network call reference	C	An identifier to correlate transactions on the same call taking place in different network nodes, shall be present if CAMEL is applied.
MSC Address	C	This field contains the E.164 number assigned to the MSC that generated the network call reference.
Number of HSCSD Channels Requested	O	The maximum number of HSCSD channels requested as received from the MS at call set-up
Number of HSCSD Channels Allocated	O	The number of HSCSD channels allocated to the MS at call set-up
Change of HSCSD Parameters	O	A list of network or user initiated changes of number of HSCSD channels during a connection each timestamped. Shall only be present in case of an HSCSD call, if the basic HSCSD parameters are modified due the user or network initiated modification procedure.
Fixed Network User Rate	O	May be present for HSCSD connections.
Air Interface User Rate Requested	C	The total Air Interface User Rate Requested by the MS at call setup. Shall only be present for non-transparent HSCSD connections.
Channel Coding Accepted	C	A list of the traffic channels codings accepted by the MS. Shall only be present for HSCSD connections.

Channel Coding Used	C	The traffic channels codings negotiated between the MS and the network at call setup. Shall only be present for HSCSD connections.
Speech Version Used	O	Speech version used for that call
Speech Version Supported	O	Speech version supported by the MS with highest priority indicated by MS
GsmSCF address	C	Identifies the CAMEL server serving the subscriber.
Service Key	C	The CAMEL service logic to be applied.
Default Call handling	O	Indicates whether or not a CAMEL call encountered default call handling. This field shall be present only if default call handling has been applied.
Free format Data	C	Indicator if free format data from this CDR is to be appended to free format data in previous partial CDR.
Free format data append indicator	C	Indicator if free format data from this CDR is to be appended to free format data in previous partial CDR.

B.2.5 Roaming call attempt

If the generation of these records is enabled then, a roaming record shall be created for each call redirected to a mobile subscriber roaming outside the HPLMN. These roaming records shall be produced in the GMSC.

Table B.5: Roaming record

Field		Description
Record Type	M	Roaming record.
Served IMSI	M	IMSI of the called (roaming) party.
Served MSISDN	O	The MSISDN of the called (roaming) party.
Calling Number	C	The address of the calling party, if available.
Roaming Number	M	The Mobile Station Roaming Number employed to route this connection.
Recording Entity	M	The E.164 number of the GMSC
Incoming TKGP	O	The GMSC trunk group on which the call originated.
Outgoing TKGP	O	The trunk group on which the call left the GMSC
Basic service	M	Bearer or teleservice employed.
Transparency Indicator	C	Only provided for those teleservices which may be employed in both transparent and non-transparent mode.
ChangeOfService	O	A list of changes of basic service during a connection each time-stamped.
Supp. Services	C	Supplementary services invoked as a result of this connection.
Event time stamps:	C C O	Seizure of incoming traffic channel (for unsuccessful call attempts) Answer (for successful calls) Release of traffic channel
Call duration	M	The chargeable duration of the connection for successful calls, the holding time of call attempts.
Cause for termination	M	The reason for the release of the connection.
Diagnostics	O	A more detailed reason for the release of the connection.
Data volume	C	The number of data segments transmitted if available at the GMSC
Sequence no.	C	Partial record sequence number, only present in case of partial records.
Call reference	M	A local identifier distinguishing between transactions on the same MS
Record extensions	O	A set of network/ manufacturer specific extensions to the record.
Network call reference	C	An identifier to correlate transactions on the same call taking place in different network nodes, shall be present if CAMEL is applied.
MSC Address	C	This field contains the E.164 number assigned to the MSC that generated the network call reference.

B.2.6 Incoming gateway call attempt

If generation of these records is enabled, an incoming gateway record shall be created for each incoming call attempt received by a gateway MSC from another network. These records, produced in the gateway MSC, may be used to settle accounts with other networks. The generation of gateway records shall not be influenced by the production of MTC records i.e. even if the GMSC and terminating MSC are co-located a gateway record shall still be produced.

Table B.6: Incoming gateway record

Field		Description
Record Type	M	Incoming gateway record
Calling Number	C	The number of the calling party if available at this node.
Called Number	M	The address of the called party as seen by the GMSC. This is the number employed by the GMSC for routing.
Recording Entity	M	The E.164 number of the GMSC
Incoming TKGP	M	The incoming GMSC trunk group on which the call originated.
Outgoing TKGP	O	The trunk group on which the call left the GMSC.
Event time stamps:	M C O	Seizure of incoming trunk Answer (successful calls only) Release of incoming trunk
Call duration	M	The accountable duration (answer -> release of incoming trunk) of the connection if successful, the call holding time of the incoming trunk for call attempts.
Data Volume	C	If applicable and known at the GMSC
Cause for term.	M	The reason for the release of the connection.
Diagnostics	O	A more detailed reason for the release of the connection.
Sequence no.	C	Partial record sequence number, if applicable.
Call Reference	M	A local identifier distinguishing between transactions.
Record extensions	O	A set of network/ manufacturer specific extensions to the record.

B.2.7 Outgoing gateway call attempt

If generation of these records is enabled, an outgoing gateway record shall be created for each outgoing call attempt from a gateway MSC to another network. These records, produced in the gateway MSC, may be used to settle accounts with other networks. The generation of gateway records shall not be influenced by the production of MOC records i.e. even if the GMSC and originating MSC are co-located a gateway record shall still be produced.

Table B.7: Outgoing gateway record

Field		Description
Record Type	M	Outgoing gateway record
Calling Number	C	The number of the calling party if available at this node.
Called Number	M	The address of the called party as seen by the GMSC. This is the number employed by the GMSC for routing.
Recording Entity	M	The E.164 number of the GMSC
Incoming TKGP	O	The incoming GMSC trunk group on which the call originated.
Outgoing TKGP	M	The trunk group on which the call left the GMSC.
Event time stamps:	M C O	Seizure of outgoing trunk Answer (successful calls only) Release of outgoing trunk
Call duration	M	The accountable duration (answer -> release of outgoing trunk) of the connection if successful, the call holding time of the outgoing trunk for call attempts.
Data Volume	C	If applicable and known at the GMSC
Cause for term.	M	The reason for the release of the connection.
Diagnostics	O	A more detailed reason for the release of the connection.
Sequence no.	C	Partial record sequence number, if applicable.
Call Reference	M	A local identifier distinguishing between transactions.
Record extensions	O	A set of network/ manufacturer specific extensions to the record.

B.2.8 Transit call attempt

If generation of these records is enabled then a transit record may be generated for each incoming call attempt received by a Transit MSC i.e. neither originating nor terminating. For the avoidance of doubt, a transit record shall only be produced if no MOC or MTC record is produced for this call attempt. The transit records, produced in the TMSC, may be used to record traffic from particular origins or to particular destinations (see also the example scenario in subclause B.4.5).

Table B.8: Transit record

Field		Description
Record Type	M	Transit.
Calling Number	C	The number of the calling party if available at this node.
Called Number	M	The address of the called party as seen by the TMSC.
ISDN Basic Service	O	The ISDN basic service employed
Recording Entity	M	The E.164 number of the transit MSC
Incoming TKGP	M	The TMSC trunk group on which the call originated.
Outgoing TKGP	M	The trunk group on which the call left the TMSC.
Event time stamps:	C	Seizure of incoming trunk for unsuccessful call attempts
	C	Answer (successful calls only)
	O	Release of traffic channel
Call duration	M	The chargeable duration of the connection if successful, the call holding time for call attempts.
Data Volume	C	If applicable and known at the transit MSC
Cause for term.	M	The reason for the release of the connection.
Diagnostics	O	A more detailed reason for the release of the connection.
Sequence no.	C	Partial record sequence number, if applicable.
Call Reference	M	A local identifier distinguishing between transactions.
Record extensions	O	A set of network/ manufacturer specific extensions to the record.

B.2.9 Supplementary service actions

A supplementary service record may be produced in the NEF of the appropriate MSC or HLR for each supplementary service action (activation, deactivation, invocation etc.) performed or initiated by the subscriber.

There are two basic types of SS-actions:

- Call related i.e. as a result of a connection e.g. Invocation of CLIP / CLIR / AOC etc.
- Non-call related i.e. as a result of subscriber controlled input (SCI) e.g. Registration of call forwarding

Each supplementary service action shall be performed on one or more basic service groups. If the action applies to all tele and all bearer services (i.e. to all basic services) then the basic services field shall be omitted.

SCI actions may be recorded in individual SS-action records. Call related actions may be recorded in either the appropriate call record (MOC/MTC) or in separate SS-action records. For further details concerning the generation of supplementary service records see subclause 8.2.1.1.3.

Additional non-standard supplementary service actions may be made available within some networks in the form of Unstructured Supplementary Service Data (USSD). These actions may also be recorded in SS-action records. However, as these actions are non-standard they may not include an appropriate action type, supplementary service code or basic service code.

Table B.9: SS-action record

Field		Description
Record Type	M	Supplementary service action.
Served IMSI	M	The IMSI of the MS performing the action.
Served IMEI	O	The IMEI of the ME performing the action.
Served MSISDN	O	The primary MSISDN of the party performing the action.
MS Classmark	M	The mobile station classmark.
Recording Entity	M	The E.164 number of the visited MSC / HLR.
Location	O	The Location Area Code and Cell Identity from which the request originated.
Supp. Service	C	The supplementary service or group of supplementary services for which the request was made. May not be available in case of USSD.
Basic Services	C	The basic service group(s) to which the supplementary service applies. This field is not provided if the action applies to all basic services.
SS Action	C	Activation, deactivation, interrogation etc. May not be available in case of USSD.
SS Action time stamp	M	The time at which the action was requested.
SS Parameters	C	Service dependent parameters or unstructured suppl. service data.
SS Action Result	C	Result of the requested transaction if unsuccessful.
Call Reference	M	A local identifier distinguishing between transactions at the same MS.
Record extensions	O	A set of network/ manufacturer specific extensions to the record.

B.2.10 HLR interrogation

If enabled, a HLR interrogation record shall be created for each interrogation performed for a mobile subscriber. These records may be produced in either the HLR itself or the interrogating MSC.

Table B.10: HLR-int. record

Field		Description
Record Type	M	HLR interrogation.
Served IMSI	C	The IMSI of the party being interrogated, if successful
Served MSISDN	M	The MSISDN of the subscriber being interrogated.
Recording Entity	M	The E.164 Number of the HLR / MSC.
Routing Number	C	Routing number (MSRN, forwarding no.) provided by the HLR if the interrogation was successful.
Basic Service	O	Only for teleservice 21 (SMS-MT).
Int. time stamp	M	Time at which the interrogation was invoked.
Number of Forwarding	C	The number of times the call has been forwarded if provided by ISUP.
Interrogation Result	C	The result of the interrogation request if unsuccessful.
Record extensions	O	A set of network/ manufacturer specific extensions to the record.

B.2.11 Location update (VLR)

If enabled, a VLR location update record shall be produced in the (new) VLR for each location registration or location update received by the VLR for a mobile subscriber.

Table B.11: Loc.-upd. (VLR) record

Field		Description
Record Type	M	Location update.
Served IMSI	M	IMSI of the served MS.
Served MSISDN	O	The primary MSISDN of the party performing the location update
Recording Entity	M	The E.164 number of the entity (VLR or MSC/VLR) generating the record.
Old location		Not present for registration:
	C	VMSC Number
New location	C	Location Area Code
	M	VMSC Number
	M	Location Area Code
MS Classmark	O	Cell Identification
	M	The mobile station classmark
Update time stamp	M	Time at which the update was invoked.
Update Result	C	The result of the location update if unsuccessful.
Record extensions	O	A set of network/ manufacturer specific extensions to the record.

B.2.12 Location update (HLR)

If enabled, an HLR location update record shall be produced in the HLR for each location registration or location update received by the HLR for a mobile subscriber including location updates received from subscribers roaming in foreign PLMNs.

Table B.12: Loc.-Upd. (HLR) record

Field		Description
Record Type	M	Location update.
Served IMSI	M	IMSI of the served MS.
Recording Entity	M	The E.164 Number of the HLR.
Old location	O	VMSC Number
		VLR Number
New location	M	VMSC Number
		VLR Number
Update time stamp	M	Time at which the update was invoked.
Update Result	C	The result of the location update if unsuccessful.
Record extensions	O	A set of network/ manufacturer specific extensions to the record.

B.2.13 Short message service, mobile originated

If enabled, an SMS-MO record shall be produced, within the originating MSC, for each short message sent by a mobile subscriber.

Table B.13: SMS-MO record

Field		Description
Record Type	M	SMS-Mobile originated.
Served IMSI	M	The IMSI of the subscriber sending the short message.
Served IMEI	O	The IMEI of the ME sending the message, if available.
Served MSISDN	O	The primary MSISDN of the subscriber sending the message.
MS Classmark	M	The mobile station classmark.
Service Centre	M	The address (E.164) of the SMS-service centre.
Recording Entity	M	The E.164 number of the visited MSC
Location	O	The Location Area Code and Cell Identity from which the message originated.
Event Time stamp	M	The time at which the message was received by the MSC from the subscriber.
Message Reference	M	A reference, provided by the MS uniquely identifying this message.
SMS Result	C	The result of the attempted delivery if unsuccessful.
Record extensions	O	A set of network/ manufacturer specific extensions to the record.
Destination number	O	The destination short message subscriber number.
CAMELSMSInformation	C	Set of CAMEL information IEs. Each of these IEs contains information related to CAMEL call leg related for the SMS.

B.2.14 Short message service, mobile terminated

If enabled, an SMS-MT record shall be produced, within the terminating MSC, for each short message received by a mobile subscriber.

Table B.14: SMS-MT record

Field		Description
Record Type	M	SMS-Mobile Terminated.
Service Centre	M	The E.164 address of the SMS service centre.
Served IMSI	M	The IMSI of the receiving party.
Served IMEI	O	The IMEI of the receiving party, if available.
Served MSISDN	O	The MSISDN of the receiving party.
MS Classmark	M	The mobile station classmark.
Recording Entity	M	The E.164 number of the visited MSC.
Location	O	The Location Area Code and Cell Identity to which the message was delivered.
Event time stamp	M	Delivery time stamp, time at which message was sent to the MS by the MSC.
SMS Result	C	The result of the attempted delivery if unsuccessful.
Record extensions	O	A set of network/ manufacturer specific extensions to the record.

B.2.15 SMS-MO interworking record

If enabled, an SMS-MO interworking record shall be produced, within the interworking MSC, for each short message generated by a mobile subscriber. These records may be used to settle accounts between PLMNs and SMS service centres.

Table B.15: SMS-MO interworking record

Field		Description
Record Type	M	SMS-MO interworking record.
Service Centre	M	The E.164 address of the SMS service centre.
Served IMSI	M	The IMSI of the sending party.
Recording Entity	M	The E.164 number of the visited MSC.
Time stamp	M	The time at which the message was received by the interworking function.
SMS Result	C	The result of the attempted delivery if unsuccessful.
Record extensions	O	A set of network/ manufacturer specific extensions to the record.

B.2.16 SMS-MT gateway record

If enabled, an SMS-MT gateway record shall be produced, within the gateway MSC, for each short message sent to a mobile subscriber.

Table B.16: SMS-MT gateway record

Field		Description
Record Type	M	SMS-MT gateway record.
Service Centre	M	The E.164 address of the SMS service centre.
Served IMSI	M	The IMSI of the receiving party.
Served MSISDN	O	The MSISDN of the receiving party.
Recording Entity	M	The E.164 number of the visited MSC.
Time stamp	M	The time at which the message was received by the gateway.
SMS Result	C	The result of the attempted delivery if unsuccessful.
Record extensions	O	A set of network/ manufacturer specific extensions to the record.

B.2.17 Common equipment usage record

If enabled, a common equipment usage record shall be created in the VMSC to record the usage (duration) of common equipment, e.g. conference circuits, employed by a mobile subscriber. For further details see the example scenario in subclause B.4.9.

Table B.17: Common equipment usage record

Field		Description
Record Type	M	Common equipment usage record.
Equipment type	M	e.g. Conference circuit.
Equipment Id.	C	The local id. of the equipment employed.
Served IMSI	M	The IMSI of the party responsible for the seizure of the equipment..
Served MSISDN	O	The primary MSISDN of the served party..
Recording Entity	M	The E.164 number of the MSC in which the equipment is located.
Basic service	C	Bearer or teleservice employed, if appropriate.
ChangeOfService	O	A list of changes of basic service during a connection each time-stamped.
Supp. Services	C	Supplementary services invoked in connection with this equipment.
Event Time Stamp	M	Seizure time: the time at which the equipment was seized.
	O	Release time: the time at which the equipment was released.
Call Duration	M	The total duration of the usage of the equipment.
Call Reference	M	A local identifier distinguishing between transactions.
Sequence no.	C	Partial record sequence number if applicable.
Record extensions	O	A set of network/ manufacturer specific extensions to the record.

B.2.18 Reduced partial records

In order to minimise the amount of data transferred, the contents of partial record may be reduced to those fields required to uniquely identify the connection and those fields that actually change. Table B.18 contains an example of such a record for a mobile originated call attempt. Reduced partial records may be generated for any of the relevant call records.

Table B.18: Reduced partial (MOC) record

Field		Description
Record Type	M	Mobile originated.
Served IMSI	C	IMSI of the calling party, if available
Called Number	C	If available.
Recording Entity	M	The E.164 number of the visited MSC producing the record.
Change of Location	C	A list of changes in Location Area Code / Cell Id. each time-stamped.
ChangeOfService	C	A list of changes of basic service during a connection each time-stamped.
Change of AOC Parm	C	New AOC parameters sent to the MS e.g. as a result of a tariff switch over, including the time at which the new set was applied.
Change of Classmark	C	A list of changes to the classmark during the connection each time-stamped
Event time stamps:	M	Answer time, start of this partial record.
Call duration	M	The chargeable duration of this partial record.
Change of Rad. Chan.	C	A list of changes each time stamped
Cause for termination	M	The reason for the release of the connection.
Diagnostics	O	Only relevant for the last record in the sequence.
Data volume	C	The number of data segments transmitted during this partial output
Sequence no.	M	Partial record sequence number, only present in case of partial records.
Call reference	M	A local identifier distinguishing between transactions on the same MS
Record extensions	O	A set of network/ manufacturer specific extensions to the record.

B.2.19 Terminating CAMEL interrogation call attempt

If the generation of these records is enabled, a terminating CAMEL interrogation call attempt record shall be generated for each call toward a subscriber with a T-CSI and if the terminating trigger criterias are met. The record is generated in the GMSC/gsmSSF carrying out the terminating CAMEL call handling.

Table B.19: Terminating CAMEL interrogation record

Field		Description
Record Type	M	Terminating CAMEL interrogation.
Served IMSI	M	IMSI of the called party
Served MSISDN	O	The MSISDN of the called party.
Recording Entity	M	The E.164 number of the GMSC.
Int. time stamp	M	Time at which the interrogation was invoked.
CAMEL Destination Number	M	The number available for routing after the CAMEL server enquiry.
gsmSCF Address	M	The CAMEL server serving the subscriber.
Service key	M	The CAMEL service logic to be applied.
Network call reference	M	An identifier to correlate transactions on the same call taking place in different network nodes, shall be present if CAMEL is applied.
MSC Address	M	This field contains the E.164 number assigned to the MSC that generated the network call reference.
Default call handling	O	Indicates whether or not a CAMEL call encountered default call handling. This field shall be present only if default call handling has been applied.
Record extensions	O	A set of network/ manufacturer specific extensions to the record.
Called Number	M	The address of the called party as received by the GMSC/gsmSSF.
Calling Number	C	The address of the calling party, if available.
Incoming TKGP	O	The GMSC trunk group on which the call originated.
Outgoing TKGP	O	The trunk group on which the call left the GMSC
Event time stamps:	C C O	Seizure of incoming traffic channel (for unsuccessful call attempts) Answer (for successful calls) Release of traffic channel
Call duration	M	The chargeable duration of the connection for successful calls, the holding time of call attempts.
Data volume	C	The number of data segments transmitted if available at the GMSC
Cause for termination	M	The reason for the release of the connection.
Diagnostics	O	A more detailed reason for the release of the connection.
Call reference	M	A local identifier distinguishing between transactions on the same MS
Sequence no.	C	Partial record sequence number, only present in case of partial records.
Number of DP encountered	O	Number that counts how often armed detection points (TDP and EDP) were encountered.
Level of CAMEL service	O	Indicator of the complexity of the CAMEL feature used.
Free format Data	C	This field contains data sent by the gsmSCF in the FCI message(s). The data can be sent either in one FCI message or several FCI messages with append indicator.
CAMEL call leg information	C	Set of CAMEL information IEs. Each of these IEs contains information related to one outgoing CAMEL call leg.
Free format data append indicator	C	Indicator if free format data from this CDR is to be appended to free format data in previous partial CDR.

B.3 Description of record fields

This subclause contains a brief description of each field of the call and event records described in the previous subclause.

B.3.1 Additional Charging Information

This field consists of two parts, a charge indicator and additional charging parameters. The charge indicator is derived from the information contained within the ISUP "backward call indicator" and may be used to store a charge indicator (charge/no charge) received from another network node. The additional charging parameters are non-standard and

intended to permit the inclusion of further charging information received from Intelligent Network and/or Value Added Service nodes.

B.3.2 AoC parameters / change of AoC parameters

The AoC parameter field contains the set of charge advice (AoC) parameters sent to the MS on call set-up. If further sets of parameters are sent during the call, as a result of a tariff switch-over for example, then this may be recorded in the Change of AoC Parameter field including the time at which the change occurred.

It should be noted that the Change of AoC Parms. field is optional and not required if partial records are generated on tariff switch-over.

The AoC parameters are defined in 3GPP TS 22.024 [12].

B.3.3 Basic Service / change of service / ISDN Basic Service

The basic service field contains the code of the basic service employed on call set-up. Any alteration to the basic service during the connection may be recorded in the change of service field including the time at which the change took place.

The change of service field is optional and may be omitted if partial records are created whenever the basic service is changed.

The coding of basic services is defined in detail in 3GPP TS 29.002 [17].

In the case of the transit record the GSM basic service employed is generally not available. However, if the device on which the call originates/terminates is connected via ISDN digital subscriber signalling then the appropriate ISDN basic service code may be recorded in the record. One possible example includes the direct connection of an ISDN PABX to an MSC/VLR.

B.3.4 Call duration

This field contains the relevant call duration in seconds. For incomplete calls (call attempts) the relevant duration is the call holding time from the seizure to the release of the traffic channel. For complete (answered) calls this is the chargeable duration from answer to release of the traffic channel. For partial records this is the duration of the individual partial record and not the cumulative duration of the call.

It should be noted that the time stamps may be expressed in terms of tenths of seconds or even milliseconds and, as a result, the calculation of the call duration may result in the rounding or truncation of the measured duration to a whole number of seconds.

Whether or not rounding or truncation is to be used is considered to be outside the scope of the present document subject to the following restrictions:

- 1) A call duration of zero seconds shall not be accepted.
- 2) The same method of truncation/rounding shall be applied to both single and partial records.

If CAMEL is invoked for the call and a control relationship is existing, the call might continue after a RELEASE or a DISCONNECT from the called party side received by the gsmSSF. The call duration of the incoming leg is stored in the main body of the call record. For each outgoing leg the call duration is stored in the respective 'CAMELInformation' module. If a call leg does not reach answer status and attempt charging is enabled a 'CAMELInformation' module containing the holding time is generated.

An example of how to use the call duration and the timestamps is given in Figure B.0. It shows a CAMEL controlled mobile originated follow-on scenario. The uppermost arrow ① marks the over all duration of the call that is to be measured and stored in the main body of the respective MOC record. The duration before t_5 (incoming leg) or t_4 (outgoing leg) needs not to be stored since the call is answered later on. The call duration in the first outgoing leg module contains the time interval from t_4 to t_6 (period ②). The call duration measurement of the second outleg is started with t_9 and ended with t_{10} (interval ③).

Since the last outgoing leg is not answered, the respective module contains the holding time starting with t_{11} and ending with t_{13} (period ④).

(The timestamps t_1 , t_2 , t_3 , t_7 , t_8 and t_{12} are mentioned for completion reasons only.)

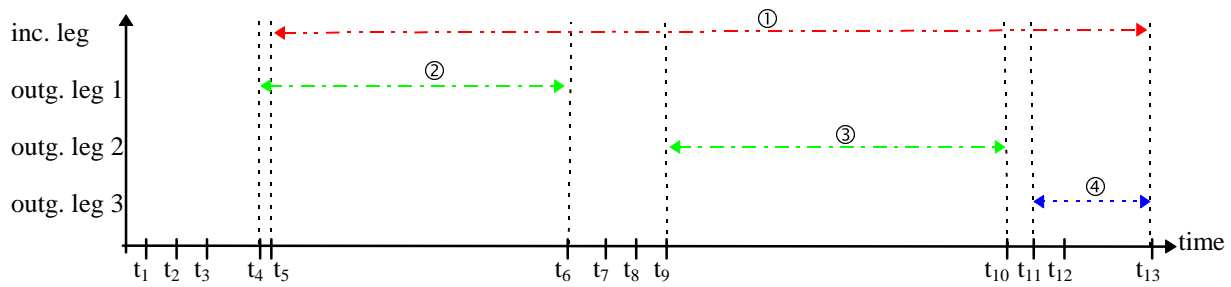

call duration of incoming leg = ←- - - - ->

call duration of outgoing leg = ←- - - - ->

holding time of outgoing leg = ←- - - - ->

Point in time	Signalling message sent/received trigger detection point encountered	Duration logging
t_1	SETUP; TDP(control)	
t_2	IAM	seizure of outg. leg 1
t_3	ACM	
t_4	ANSWER	start of call duration (outg. leg 1)
t_5	CONNECT	start of call duration (inc. leg)
t_6	RELEASE; EDP(control)	stop of call duration (outg. leg 1)
t_7	IAM	seizure of outg. leg 2
t_8	ACM	
t_9	ANSWER	start of call duration (outg. leg 2)
t_{10}	RELEASE; EDP(control)	stop of call duration (outg. leg 2)
t_{11}	IAM	seizure of outg. leg 3
		start of holding time (outg. leg 3)
t_{12}	ACM	
t_{13}	RELEASE; EDP(control)	stop of holding time (outg. leg 3)

Figure B.0: Call duration measurement in follow-on scenarios

B.3.5 Call reference

This field uniquely identifies a call or transaction on one side of the interface (i.e. 'A' or 'B' side) and is derived from the transaction identifier of 3GPP TS 24.008 [16]. It is also used to identify all partial records and transactions belonging to the same connection.

For the avoidance of doubt, there is **no** global call reference defined within GSM and the call reference field **cannot** be used to combine, for example, the MOC and MTC records of a mobile-to-mobile connection.

B.3.5.1 Network call reference

Whenever CAMEL is applied, this field is used for correlation of call records outputted from the originating MSC (when applicable), the GMSC and the terminating MSC, and a network optional call record from the gsmSCF.

B.3.6 Calling / called / connected / translated number

In general a ITU-T E.164 [2] number but may also include other numbering plans e.g. X.121. Each of these fields includes the type of number and number plan as specified in detail in 3GPP TS 24.008 [16]. Where appropriate, these fields may also contain the presentation and screening information also specified in 3GPP TS 24.008 [16].

The called number is the number received from the mobile station on mobile originated call set-up as defined in 3GPP TS 24.008 [16]. Similarly, the calling number is the number received from the network on mobile terminated call set-up. In case of CAMEL initiated CF, the called (forwarded-to) number is returned by CAMEL.

The translated number is the result of any digit translation performed by the MSC on the called number received from the mobile station on mobile originated call set-up.

The connected number is the number of the actual party reached as defined in 3GPP TS 24.008 [16]. Although this is normally identical to the called number it may differ.

The following examples are intended to explain the use of these fields:

- Example 1: Called Number = Connected Number
Normal call from a mobile subscriber to a mobile subscriber or to a PSTN subscriber.
- Example 2: Called Number != Connected Number
In case of routing to a PABX with Automatic Call Distribution or to an ISDN Basic Access with several devices attached. The connected number is that of the party actually reached. N.B. The recording of the actual number connected may be limited by the capability of intermediate signalling connections.
- Example 3: MTC record for Call Forwarding ("A" -> "B" -> "C")
In case of call forwarding, the connected number recorded in the MTC record of the "B" subscriber is that of the forwarded-to party or "C" subscriber. The calling party field contains the number of the "A" subscriber.
- Example 4: Translated Number
This field is only present if digit translation is applied by the MSC to the called number received from the mobile station. Examples include abbreviated dialling codes and service numbers.

B.3.7 CAMEL call leg information

This field contains a set of CAMEL information IEs according to the number of outgoing CAMEL call legs.

B.3.7.1 CAMEL information

This field contains a list of parameters with information related to one CAMEL outgoing call leg.

As a network option, parameters that are identical to the corresponding values in the top level structure of the record are not recorded again. That means whenever a value is not mentioned in this set the value provided in the basic record is valid instead. This might lead to an empty or even absent structure, if no parameter was modified.

B.3.8 CAMEL initiated CF indicator

The purpose of this field is to distinguish CAMEL call forwarding service scenarios from standard GSM call forwarding scenarios.

From the BCSM's point of view this field is set to 'CF' whenever the O_CSI was applied after terminating CAMEL call processing had been taken place changing the call destination. For the avoidance of doubt: this flag does not depend on other modified call parameter(s) (e.g.: redirection information, e.t.c.) received in the CAP_CONNECT message of the T_CSI service.

This flag also indicates that another record might be generated, one containing the charging information related to the terminating CAMEL service and one containing the charging information related to the originating CAMEL service.

B.3.9 CAMEL SMS Information

This field contains following CAMEL information for mobile originated SMS:

- Default SMS handling

This field indicates whether or not a CAMEL encounters default SMS handling. This field shall be present only if default SMS handling has been applied.

- Free format data

See subclause B.3.13.

- Calling Party Number

This field contains Calling Party Number modified by CAMEL service.

- CAMEL modified Service Centre

This field contains SMS-C address modified by CAMEL service.

- Destination Subscriber Number

This field contains short message Destination Number modified by CAMEL service.

B.3.10 Cause for termination

This field contains a generalised reason for the release of the connection including the following:

- normal release;
- CAMEL initiated call release;
- partial record generation;
- partial record call re-establishment;
- unsuccessful call attempt;
- abnormal termination during the stable phase.

A more detailed reason may be found in the diagnostics field.

B.3.11 Data volume

This field includes the number of 64 octet segments transmitted during the use of data services if known (see B.1.3 Packet Data Services).

B.3.12 Default call handling

This field indicates whether or not a CAMEL encountered default call handling. This field shall be present only if default call handling has been applied. Parameter is defined in HLR as part of CAMEL subscription information.

B.3.13 Destination Number

This field contains short message Destination Number requested by the user.

B.3.14 Diagnostics

This field includes a more detailed technical reason for the release of the connection and may contain one of the following:

- a MAP error from 3GPP TS 29.002 [17];
- a Cause from 3GPP TS 24.008 [16];
- a Cause from 3GPP TS 29.078 [23];
- a Cause from ISUP Q.767[26].

The diagnostics may also be extended to include manufacturer and network specific information.

B.3.15 Entity number

This field contains the ITU-T E.164 [2] number assigned to the entity (MSC, VLR, HLR etc.) that produced the record. For further details concerning the structure of MSC and location register numbers see 3GPP TS 23.003 [14].

B.3.16 Equipment id

This field contains a local identifier used to distinguish between equipment of the same equipment type e.g. the number of the conference circuit employed if more than one is available.

B.3.17 Equipment type

This field contains the type of common equipment employed e.g. conference circuit for multi-party service.

B.3.18 Event time stamps

These fields contain the event time stamps relevant for each of the individual record types.

The call records may contain three significant call handling time stamps:

- The time at which the resource in question was seized (Seizure time)
- The time at which the call was answered or at which charging commences. (Answer time)
- The time at which the resource was released (Release time)

For both Mobile Originated and Mobile Terminated calls, the Seizure time is the time at which the traffic channel is allocated i.e. the time at which the ASSIGN COMMAND message is sent to the MS.

For Mobile Originated calls the Answer time is the time at which the CONNECT message is sent to the calling party. For Mobile Terminated calls the time at which the CONNECT message is received from the called party. However, if the subscriber has subscribed to the advice of charge charging level service, then the answer time shall be derived from the time at which the FACILITY message is received from the MS containing the acknowledgement of receipt of the AOC parameters. Similarly, if the AOC parameters are changed during the call then the change time recorded for a subscriber with AOC charging level is the receipt of the FACILITY message from the MS. For a subscriber with AOC information level the change time recorded is the time at which the FACILITY is sent to the MS. Finally, in case of call re-establishment (see subclause B.1.5) the answer time is the time at which the new traffic channel is allocated by the MSC i.e. when the ASSIGN COMMAND is sent to the MS.

The Release time is the time at which the connection is released by either party i.e. a DISCONNECT or RELEASE is sent by the network or a DISCONNECT is received from the MS. In the case of a radio link failure, the release time is the time at which the failure was detected by the MSC.

For unsuccessful call attempts the Seizure time is mandatory. The Release time is optional and the call duration recorded is the call holding time i.e. the difference between the two.

For successful calls the Answer time is mandatory and both the Seizure and Release times are optional. The call duration recorded is the chargeable duration i.e. the difference between the Answer and Release time stamps.

The event records include the following time stamps:

- HLR-int time: The receipt of a MAP_SEND_ROUTING_INFO request by the HLR.
- Loc.Upd. time: The receipt of a MAP_UPDATE_LOCATION_AREA request by the VLR or the receipt of a MAP_UPDATE_LOCATION request by the HLR.
- SS-Action: The receipt of a supplementary service request by the VLR.
e.g. MAP_REGISTER_SS, MAP_INVOKE_SS
- SMS-MO: The receipt of an RP_DATA message from the MS containing an SMS_SUBMIT PDU.
- SMS-MT: The transmission of an RP_DATA message to the MS containing an SMS_DELIVER PDU.

It should be noted that the events listed above are only examples in order to demonstrate the principles and that the list is by no means exhaustive.

All time-stamps include a minimum of date, hour, minute and second.

B.3.19 Free format data

This field contains charging information sent by the gsmSCF in the FCI messages as defined in 3GPP TS 29.078. The data can be sent either in one FCI message or several FCI messages with append indicator. This data is transferred transparently in the CAMEL sections of the relevant call records. 'Free format data' sent to the legID=1 is always stored in the top level of the respective record. 'Free format data' sent to the legID >1 is stored in the appropriate CAMEL call leg information field.

If the FCI is received more than once during one continuing incoming/outgoing CAMEL call leg, the append indicator defines whether the FCI information is appended to previous FCI and stored in the relevant record or the information of the last FCI received is stored in the relevant record (the previous FCI information shall be overwritten).

In the event of partial output the currently valid 'Free format data' is stored in the partial record.

B.3.20 Free format data append indicator

This field contains an indicator whether free format data is to be appended to free format data stored in previous partial CDR. This field is needed in CDR postprocessing to sort out valid free format data for that call leg from sequence of partial records. Creation of partial records is independent on received FCIs and thus valid free format data may be divided to different partial records.

If field is missing then free format data in this CDR replaces all received free format data in previous CDRs. Append indicator is not needed in the first partial record. In following partial records indicator shall get value true if all FCIs received during that partial record have append indicator. If one or more of the received FCIs for that call leg during the partial record do not have append indicator then this field shall be missing.

B.3.21 GsmSCF address

This field identifies the CAMEL server serving the subscriber. Address is defined in HLR as part of CAMEL subscription information.

B.3.22 HSCSD parameters / Change of HSCSD parameters

The basic HSCSD parameters are negotiated between the MS and the network at call setup time. They comprise of the following parameters:

- the FNUR (Fixed Network User Rate) (optionally)
- the total AIUR (Air Interface User Rate) requested by the MS (for non-transparent HSCSD connections only)
- a list of the channel codings accepted by the MS
- the maximum number of traffic channels accepted by the MS (this is noted in the channels requested field)
- the channel coding and the number of traffic channels actually used for the call.

In case the network or user initiated modification procedure takes place during the call, the AIUR requested, the channel coding used and the number of traffic channel requested/used might be recorded in the Change of HSCSD parameters field including the time at which the change occurred and which entity requested the change.

It should be noted that the Change of HSCSD Parameters field is optional and not required if partial records are generated when a Change of HSCSD Parameters takes place.

B.3.23 Incoming/ outgoing trunk group

The incoming trunk group describes the trunk on which the call originates as seen from the MSC. For mobile originated calls this will generally be a BSS trunk. Similarly, the outgoing trunk group describes the trunk on which the call leaves the MSC.

B.3.24 Interrogation result

This field contains the result of the HLR interrogation attempt as defined in the MAP (3GPP TS 29.002 [17]).

NOTE: This field is only provided if the attempted interrogation was unsuccessful.

B.3.25 Level of CAMEL service

This field describes briefly the complexity of CAMEL invocation.

- 'Basic' means that CAMEL feature is invoked during the setup phase (e.g.: to modify the destination) of the call only.
- 'Online charging' means that CAMEL supported AoC parameter were sent to the mobile station (SCI is received from the gsmSCF).
- The flag 'call duration supervision' is set whenever the call duration supervision is applied in the gsmSSF of the VPLMN (apply charging message is received from the gsmSCF).

B.3.26 Location / change of location

The location field contains a combination of the Location Area Code (LAC) and Cell Identity (CI) of the cell in which the served party is currently located. Any change of location may be recorded in the change of location field including the time at which the change took place.

The change of location field is optional and not required if partial records are generated when the location changes.

The LAC and CI are both 2 octet quantities and coded according to 3GPP TS 24.008 [16].

B.3.27 Message reference

This field contains a unique message reference number allocated by the mobile station when transmitting a short message to the service centre. This field corresponds to the TP-Message-Reference element of the SMS_SUBMIT PDU defined in 3GPP TS 23.040 [15].

B.3.28 Mobile station classmark / change of classmark

This MS classmark field contains the mobile station classmark employed by the served MS on call set-up as defined in 3GPP TS 24.008 [16] (see mobile station classmark 2). Any alteration in the classmark during the connection may be recorded in the change of classmark field and will include the time at which the change took place.

It should be noted that the change of classmark field is optional and not required if partial records are created when the classmark is altered.

B.3.29 Number of DP encountered

This field indicates how often CAMEL armed detection points (TDP and EDP) were encountered and is a measure of signalling between serving network and CAMEL service and complements 'Level of CAMEL service' field. Detection points from all applied CAMEL services for a single call leg and processed in the same gsmSSF shall be counted together.

B.3.30 Number of forwarding

This field, if provided via ISUP signalling, contains the number of times a call has been forwarded prior to the interrogation of the HLR and is defined in 3GPP TS 29.002 [17].

B.3.31 Old /new location

These fields contain the location of a mobile subscriber before and after a location update. In case of VLR location update the location information consists of a VMSC number and location area code. In case of HLR location update the field contains the VMSC number and the VLR number.

B.3.32 Radio channel requested / rad. channel used / change of rad. channel / speech version supported / speech version used

The radio channel requested field contains the type of channel requested by the user. The following values are permitted:

- full rate;
- half rate;
- dual mode half rate preferred;
- dual mode full rate preferred.

The radio channel used field indicates the type of traffic channel actually employed for the connection i.e. either full rate (Bm) or half rate (Lm) as described in GSM 05.01. Any change in the type of channel used may be recorded in the change of radio channel used field including the time at which the change occurred and the speech version used after the change of radio channel.

The speech version supported field contains the speech version supported by the MS with the highest priority. The speech version used field contains the speech codec version assigned for that call. The coding is according GSM 08.08 speech version identifier with the extension bit 8 set to 0.

It should be noted that the change of radio channel field is optional and not required if partial records are generated.

B.3.33 Record extensions

The field enables network operators and/ or manufacturers to add their own extensions to the standard record definitions. This field contains a set of "management extensions" as defined in ITU-T X.721 [5].

B.3.34 Record type

The field identifies the type of the record e.g. mobile originated, mobile terminated etc.

B.3.35 Routing number / roaming number

The routing number field of the HLR interrogation record contains either a mobile station roaming number or, in case of call forwarding, a forwarded-to number.

The roaming number field of the MOC record contains the mobile subscriber roaming number as defined in 3GPP TS 23.003 [14] and coded according to 3GPP TS 29.002 [17].

B.3.36 Sequence number

This field contains a running sequence number employed to link the partial records generated for a particular connection (see A.1.2 Partial records).

B.3.37 Served IMEI

This field contains the international mobile equipment identity (IMEI) of the equipment served. The term "served" equipment is used to describe the ME involved in the transaction recorded e.g. the called ME in case of an MTC record.

The structure of the IMEI is defined in 3GPP TS 23.003 [14].

B.3.38 Served IMSI

This field contains the international mobile subscriber identity (IMSI) of the served party. The term "served" party is used to describe the mobile subscriber involved in the transaction recorded e.g. the calling subscriber in case of an MOC record.

The structure of the IMSI is defined in 3GPP TS 23.003 [14].

B.3.39 Served MSISDN

This field contains the mobile station ISDN number (MSISDN) of the served party. The term "served" party is used to describe the mobile subscriber involved in the transaction recorded e.g. the called subscriber in case of an MTC record. In case of multi-numbering the MSISDN stored in a MOC record will be the primary MSISDN of the calling party.

The structure of the MSISDN is defined in 3GPP TS 23.003 [14].

B.3.40 Service centre address

This field contains a ITU-T E.164 [2] number identifying a particular service centre e.g. short message service centre (see 3GPP TS 23.040 [15]).

B.3.41 Service key

This field identifies the CAMEL service logic applied. Service key is defined in HLR as part of CAMEL subscription information.

B.3.42 Short message service result

This field contains the result of an attempt to deliver a short message either to a service centre or to a mobile subscriber (see 3GPP TS 29.002 [17]). Note that this field is only provided if the attempted delivery was unsuccessful.

B.3.43 Supplementary service action

This field contains the type of supplementary service action requested by the subscriber or performed by the network. Possible values include:

- registration;
- erasure;
- activation;
- deactivation;
- interrogation;
- invocation.

For further details see 3GPP TS 22.004.

B.3.44 Supplementary service action result

This field contains the result of an attempted supplementary service action (see 3GPP TS 29.002 [17]). Note that this field is only provided if the SS-action was at least partially unsuccessful.

B.3.45 Supplementary service parameters

This field contains the parameters associated with a supplementary service action requested by the subscriber. For further details of the parameters involved see the GSM 02.8n series of documents.

B.3.46 Supplementary service(s)

The supplementary service field in the Supplementary Service record type contains the code of the supplementary service on which the action was performed.

The supplementary services field in the MOC / MTC records contains the codes of the supplementary services invoked as a result of, or during, a connection.

The coding of supplementary service is described in detail in 3GPP TS 29.002 [17].

B.3.47 Transparency indicator

This field indicates whether the basic service was employed in transparent or non-transparent mode. It should also be noted that this field is only relevant for those services which may be operated in both transparent and non-transparent modes.

B.3.48 Update result

This field contains the result of the location update request as defined in the MAP (3GPP TS 29.002 [17]). Note that this field is only provided if the attempted update was unsuccessful.

B.4 Example scenarios

This clause contains a number of example scenarios illustrating the purpose and practical usage of the various types of records defined in the previous subclauses. These examples are by no means exhaustive.

For the purpose of these examples the following assumptions have been made:

- that the MSC and VLR are co-located;
- that the records are sent to an OS "Administration/ Billing Center (ADC/BC)" for post-processing;
- that the generation of all of the record types described in this annex has been enabled;
- that the HLR interrogation records are produced in the HLR and not the interrogating MSC;
- that supplementary service actions are recorded in separate event records.

The following conventions have been used for the figures contained within this subclause:

- 1) Network connections and signalling transactions are illustrated by means of solid lines and referenced by number e.g. (1).
- 2) Operation & Maintenance actions, such as the transfer of call records, are represented by means of dotted lines and referenced by letter e.g. (A).
- 3) The ADC/BC has been included in some, but not all, of the examples. The only reason for this decision is to simplify the resulting figures. For the avoidance of doubt, the presence of an ADC/BC is assumed even if not explicitly included.

The following examples are included:-

- 1) Mobile to Land (outgoing) call;
- 2) Land to Mobile (incoming) call;
- 3) Mobile to Mobile call within the same network;
- 4) Incoming call to a roaming subscriber;
- 5) Incoming call to a PLMN Service Centre;
- 6) Call Forwarding Unconditional;
- 7) Call Forwarding conditional (on Busy);
- 8) Delivery of a Mobile Terminated Short Message;
- 9) Call Hold and Multi-party services;
- 10) Outgoing call handled by CAMEL;
- 11) Incoming call handled by CAMEL without redirection;
- 12) Incoming call to a roaming subscriber handled by CAMEL;
- 13) Incoming call handled by CAMEL with redirection decided and forwarding leg handled by CAMEL;
- 14) Incoming call handled by CAMEL without redirection and forwarded early using GSM SS but controlled by CAMEL;
- 15) Incoming call handled by CAMEL without redirection and forwarded late using GSM SS but controlled by CAMEL;
- 16) Early forwarded call controlled by CAMEL;
- 17) Late forwarded call controlled by CAMEL;
- 18) Incoming call handled by CAMEL with redirection initiated by CAMEL feature.

B.4.1 Mobile to land (outgoing) call

Figure B.1 illustrates a simple outgoing call from a PLMN subscriber "A" to a fixed network subscriber "B" (1).

The originating MSC (MSC-A) shall generate an MOC record for subscriber "A".

The GMSC shall create an outgoing gateway record for accounting with the fixed network including details of the point at which the call left the PLMN i.e. the GMSC id. and outgoing trunk group. This record also includes time stamps to determine both the holding time of the outgoing trunk and the duration of the conversation.

For the avoidance of doubt, even if the MSC and GMSC are co-located both records shall be produced.

The records generated are subsequently transferred to the OS (A) either as event reports following the release of the connection or when collected by the OS.

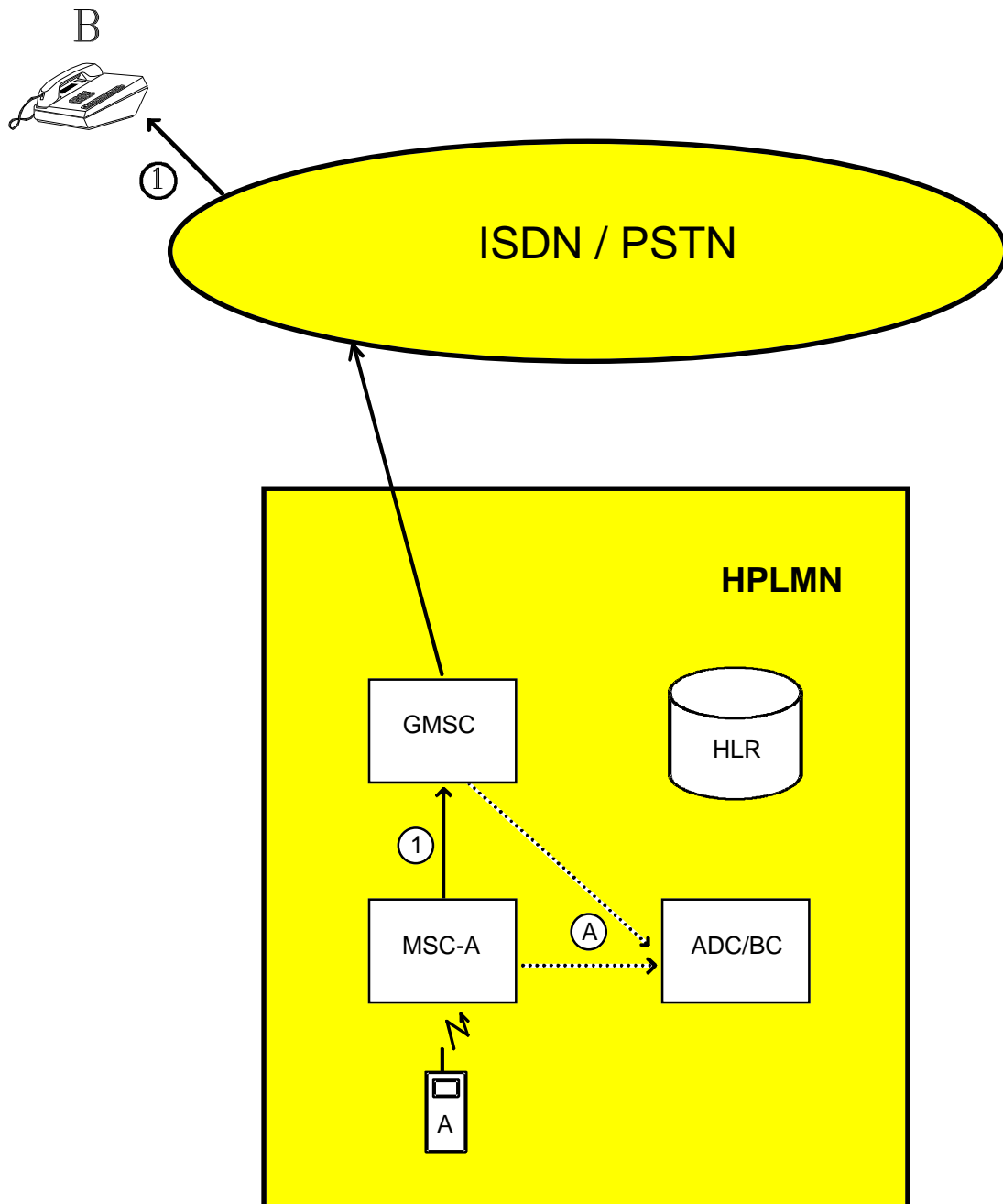

Figure B.1: Mobile to land (outgoing) call

B.4.2 Land to mobile (incoming) call

Figure B.2 illustrates a simple incoming call from a fixed network subscriber "A" to a PLMN subscriber "B".

The incoming call is first routed to a GMSC (1). The GMSC shall create an incoming gateway record for fixed network accounting purposes to record the point at which the call entered the network together with the time stamps required to calculate the holding time of the incoming trunk and the conversation duration. This gateway record shall contain the IMSI of the called subscriber.

The GMSC interrogates the HLR of the called subscriber in order to determine his current location (2). The HLR shall create an HLR interrogation event record.

The GMSC routes the call to the MSC at which the subscriber is currently registered (3). This terminating MSC (MSC-B) shall create an MTC record for subscriber "B".

For the avoidance of doubt, even if the MSC and GMSC are co-located both the MTC and gateway records shall be produced.

The records generated are subsequently transferred to the OS either on release of the connection or when collected by the OS (A).

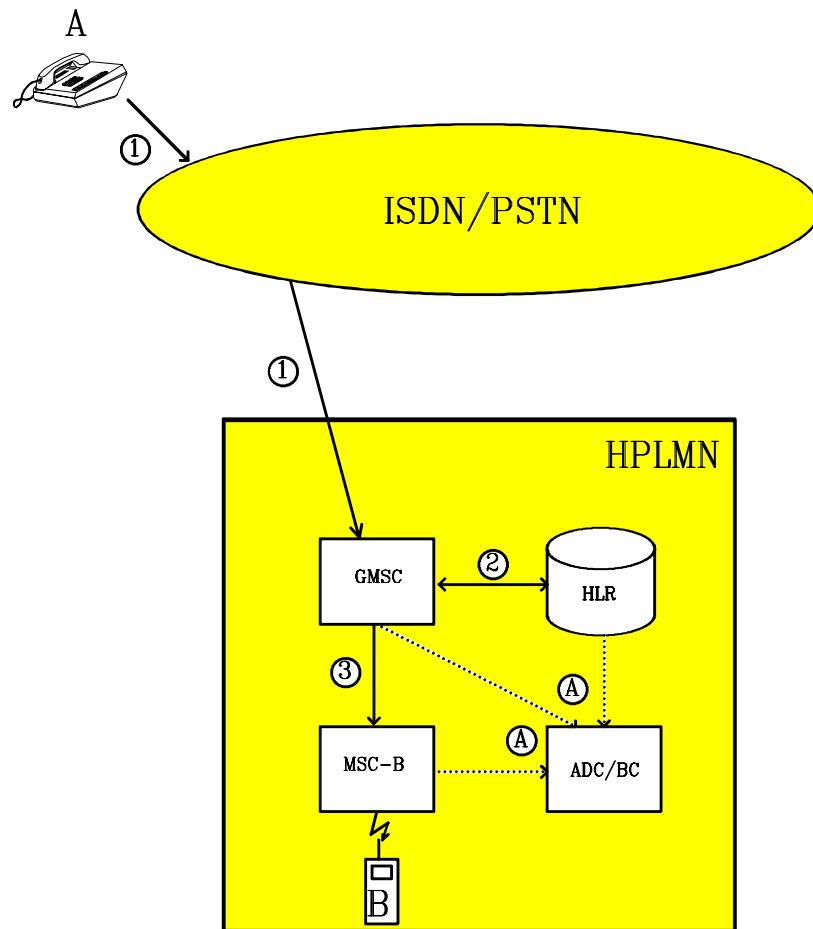

Figure B.2: Land to mobile (incoming) call

B.4.3 Mobile to mobile call within the same network

Figure B.3 illustrates a simple mobile to mobile call from subscriber "A" to subscriber "B" both within the same PLMN.

The originating MSC (MSC-A) shall produce an MOC record for the call to subscriber "B".

Having received a setup request from subscriber "A" (1), MSC-A interrogates the HLR of the called subscriber in order to determine his current location (2). The HLR shall create an HLR interrogation event record.

MSC-A routes the call to the MSC at which subscriber is currently registered (3). This terminating MSC (MSC-B) shall create an MTC record for subscriber "B". If MSC-A and MSC-B are co-located then two records, one MOC and one MTC, shall be produced for this call.

The records generated are subsequently transferred to the OS either immediately following the release of the connection or when collected by the OS.

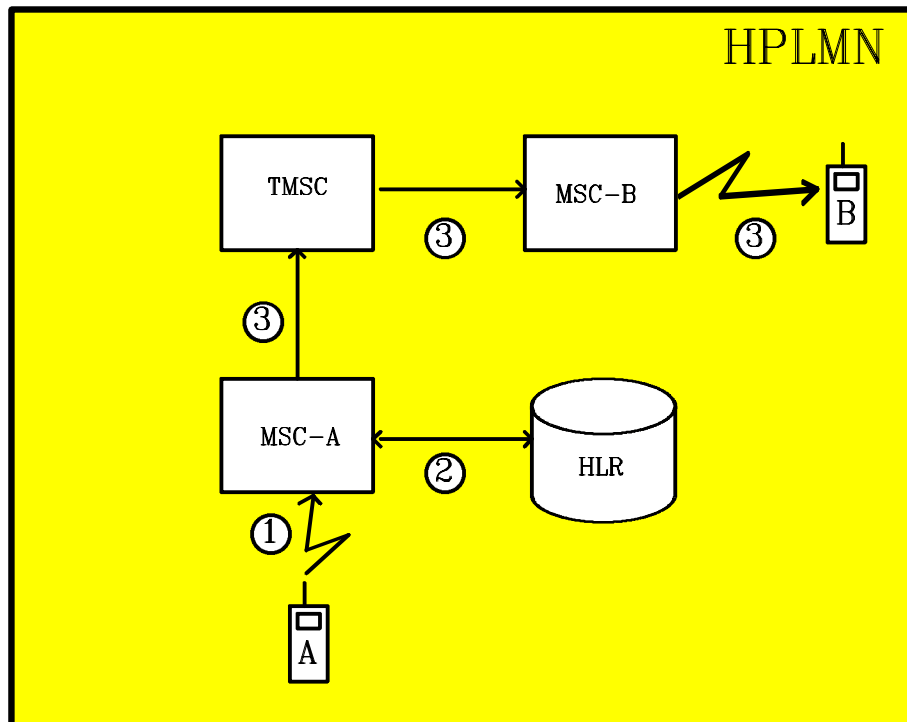

Figure B.3: Mobile to mobile call

B.4.4 Incoming call to a roaming subscriber

Figure B.4 illustrates an incoming call from a fixed network subscriber "A" to a PLMN subscriber "B" who is currently roaming in another PLMN.

The call is first routed to a GMSC (1) and the GMSC shall create an incoming gateway record for accounting purposes as described in subclause B.4.2. The GMSC interrogates the HLR of the called subscriber in order to determine his current location (2). The HLR shall create an Interrogation event record.

The GMSC routes the call to the VPLMN in which subscriber "B" is currently located (3). The GMSC shall create an outgoing gateway record for accounting purposes. The GMSC shall also create a roaming record. This record includes the IMSI of the "B" subscriber and may be used as a cross-check for the TAP information received from the VPLMN.

The call is then routed by the VPLMN to the MSC at which the subscriber is currently located (4). The GMSC of the VPLMN shall produce an incoming gateway record and the terminating MSC shall create an MTC record for the call to "B".

The records generated are subsequently transferred to the OS of the appropriate PLMN (A). The MTC record generated by the terminating MSC shall be employed to create the appropriate MTC TAP record. The TAP records shall be included in a TAP file and transmitted to the HPLMN (B).

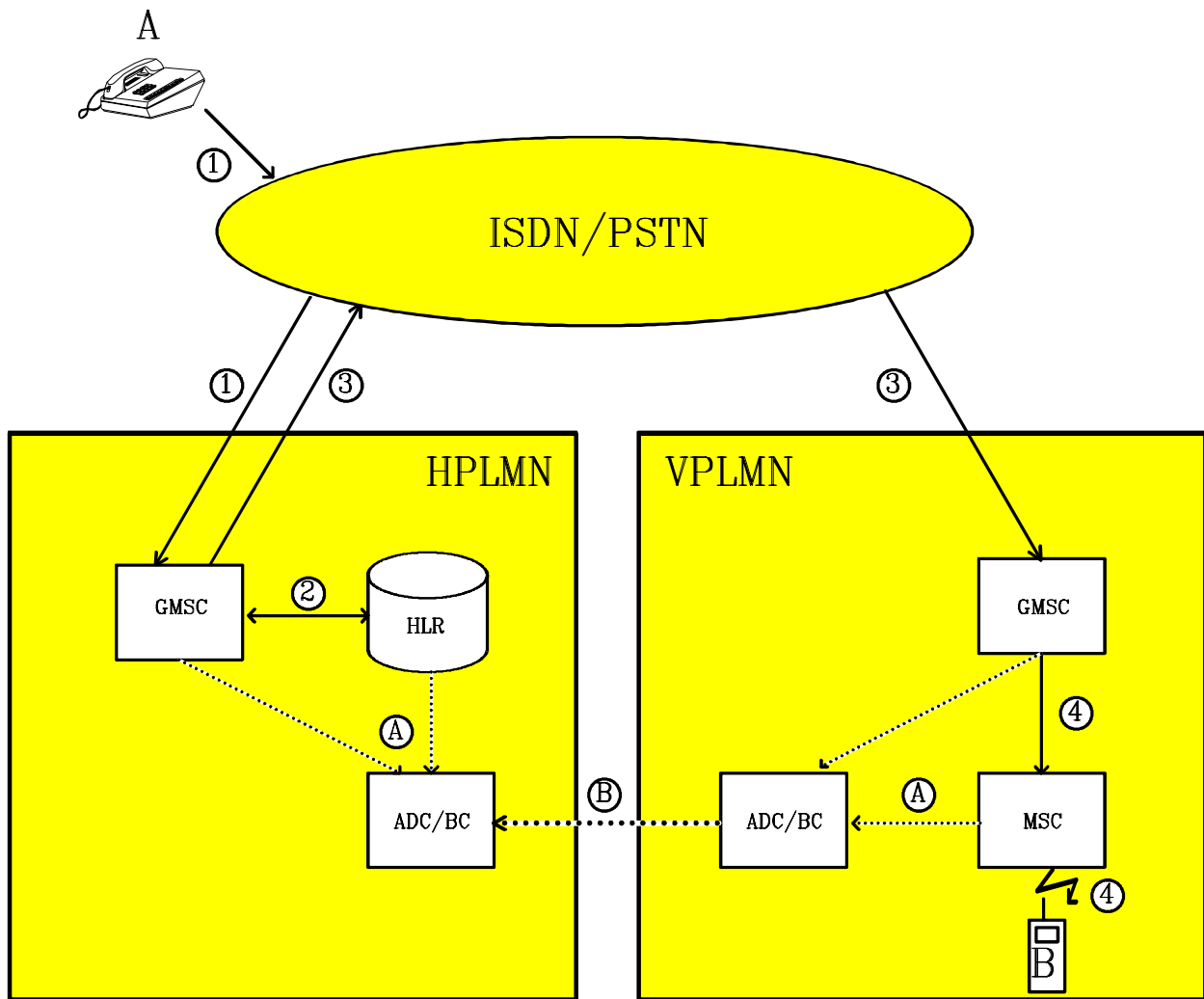

Figure B.4: Incoming call to a roaming subscriber

B.4.5 Incoming call to a PLMN service centre

Figure B.5 illustrates an incoming call from a fixed network subscriber "A" to a Service Centre directly connected to an MSC within a PLMN network. Examples for services provided by such a Service Centre include Voice Mail services, Operator services etc.

The call is routed to a GMSC within the PLMN (1). The GMSC analyses the dialled digits and routes the call directly to the MSC to which the Service Centre is connected (2).

As HLR interrogation is not required, there will be no HLR Interrogation record. The GMSC shall however, create an incoming gateway record based on the point at which the call entered the network and the destination (Service Centre) of the call.

The MSC then connects the calling subscriber to the service centre. As no mobile subscriber is involved, the MSC will not create an MTC record, however, the MSC shall create a transit Record describing the destination of the call.

The records generated are subsequently transferred to the OS of the PLMN (A).

It should be noted that without the transit record, the MSC would not generate a record for this connection.

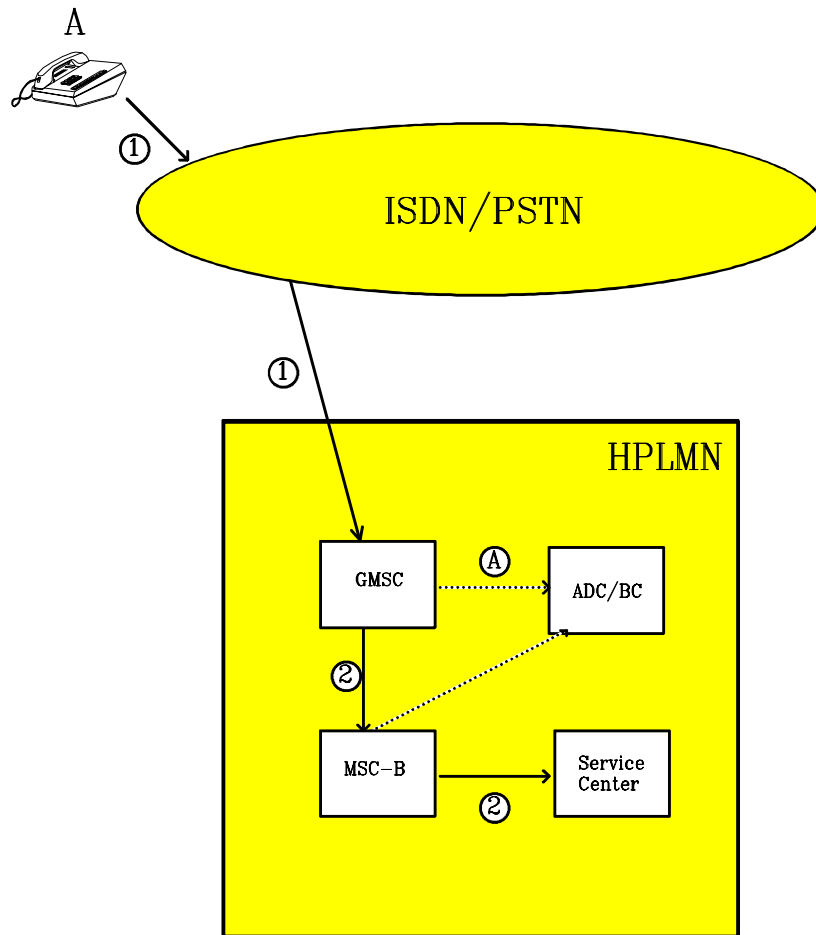

Figure B.5: Incoming call to a PLMN service centre

B.4.6 Call forwarding unconditional

Figure B.6 illustrates an incoming call from a fixed network subscriber "A" to a mobile subscriber "B" who has registered and activated Call Forwarding Unconditional (CFU) for the appropriate service. The call is subsequently forwarded to a second fixed network subscriber "C".

For simplicity the registration and activation of CFU have not been included in the diagram. These actions shall of course be recorded in the appropriate supplementary service records.

The incoming call is routed to a GMSC (1). This part of the connection is identical to the scenario outlined in subclause B.4.2.

The GMSC interrogates the HLR of the called subscriber in order to determine his current location (2). The HLR shall create an HLR interrogation event record. The HLR informs the GMSC that "B" has activated CFU to subscriber "C".

The GMSC forwards the call to the fixed network subscriber "C" (3). The GMSC shall create an MTC record for the "B" subscriber for the call from "A" and an MOC (call forwarding) record for the "B" subscriber for the call to "C". Both records shall contain the supplementary service employed (CFU). The GMSC shall also produce an outgoing gateway record as described in subclause B.4.1.

The records generated are subsequently transferred to the OS of the HPLMN (A).

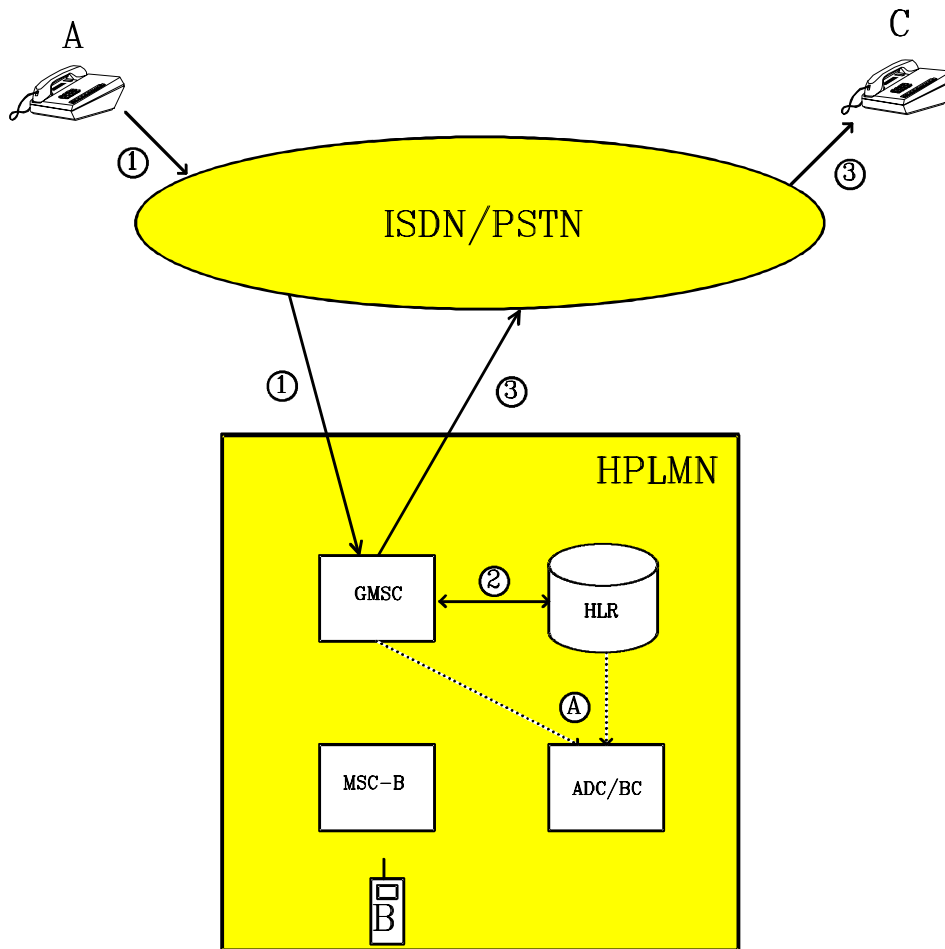

Figure B.6: Call forwarding unconditional

B.4.7 Call forwarding conditional (on busy)

Figure B.7 illustrates a mobile originated call from subscriber "A" to a second mobile subscriber "B" who has registered and activated Call Forwarding on Busy (CFB) for the appropriate service. The call is subsequently forwarded to a third mobile subscriber "C". In this example, all three subscribers are currently located within the same (the home) network.

For simplicity the registration and activation of CFB have not been included in the diagram.

Having received a setup request from subscriber "A" (1), the originating MSC (MSC-A) interrogates the HLR of subscriber "B" in order to determine his current location (1a). The call is then routed to MSC-B (2).

MSC-A shall create an MOC record for subscriber "A" containing details of the call to "B". The HLR shall produce an HLR interrogation record.

On determining that subscriber "B" is busy and that CFB is active, the forwarding MSC/VLR (MSC-B) interrogates the HLR of subscriber "C" to determine his current location (2a) and forwards the call accordingly (3).

MSC-B shall produce an MTC record for the "B" subscriber for the call from "A" and an MOC record for the "B" subscriber for the call to "C". Both records shall include the supplementary service employed (CFB). The HLR shall produce an Interrogation record.

The terminating MSC (MSC-C) shall create a normal MTC record for subscriber "C".

The records generated are subsequently transferred to the OS of the PLMN.

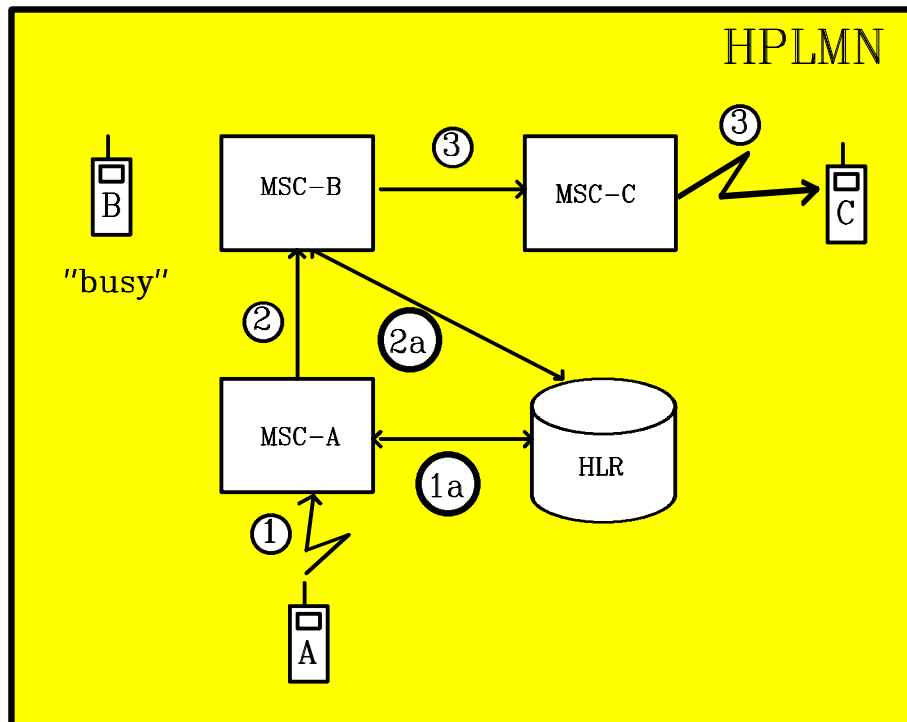

Figure B.7: Call forwarding conditional (busy)

B.4.8 Delivery of a mobile terminated short message

Figure B.8 illustrates the delivery of a short message to a mobile subscriber.

The short message service center delivers the message to a GMSC or gateway function (1). The GMSC shall create an SMS gateway MT record.

The GMSC then interrogates the HLR of the subscriber to determine his current location (2). The HLR shall create an HLR interrogation record.

The message is subsequently transmitted to the MSC serving the mobile subscriber and finally to the mobile station of that subscriber (3). The MSC shall create an SMS MT record.

The records generated are subsequently transferred to the OS of the HPLMN (A).

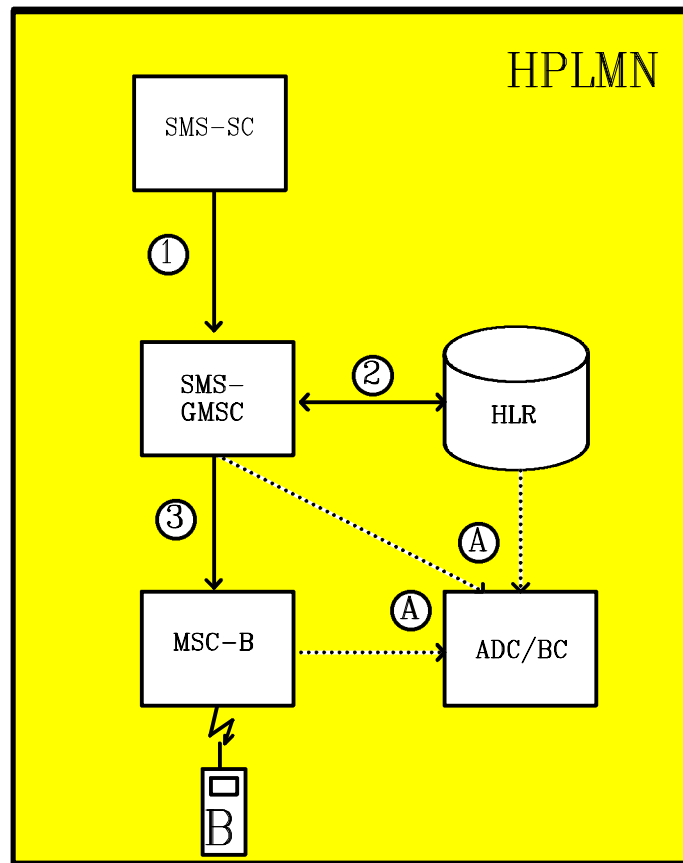

Figure B.8: Delivery of a short message to a mobile subscriber

B.4.9 Call hold and multi-party service

Figure B.9 illustrates the use of the call hold and multi-party services.

A mobile subscriber ("A") sets up an outgoing call (1) to an ISDN subscriber ("B"). This call is recorded as outlined in subclause B.4.1.

Subscriber "A" then invokes the call hold service. MSC-A shall produce a supplementary service action record for the invocation.

Subscriber "A" then sets up a side-call (2) to a second mobile subscriber ("C") within the same network. This call is recorded as outlined in subclause B.4.3.

Subscriber "A" subsequently invokes the multi-party service in order to set up a three-party conference with "B" and "C". MSC-A shall produce a common equipment record for the use of a conference circuit by subscriber "A". This record shall record the duration of the whole conference irrespective of the number of parties subsequently added to, or removed from the conference connection.

Note that the MOC records produced by MSC-A for both the A -> B and A -> C legs of the conference shall contain the supplementary service code for multi-party.

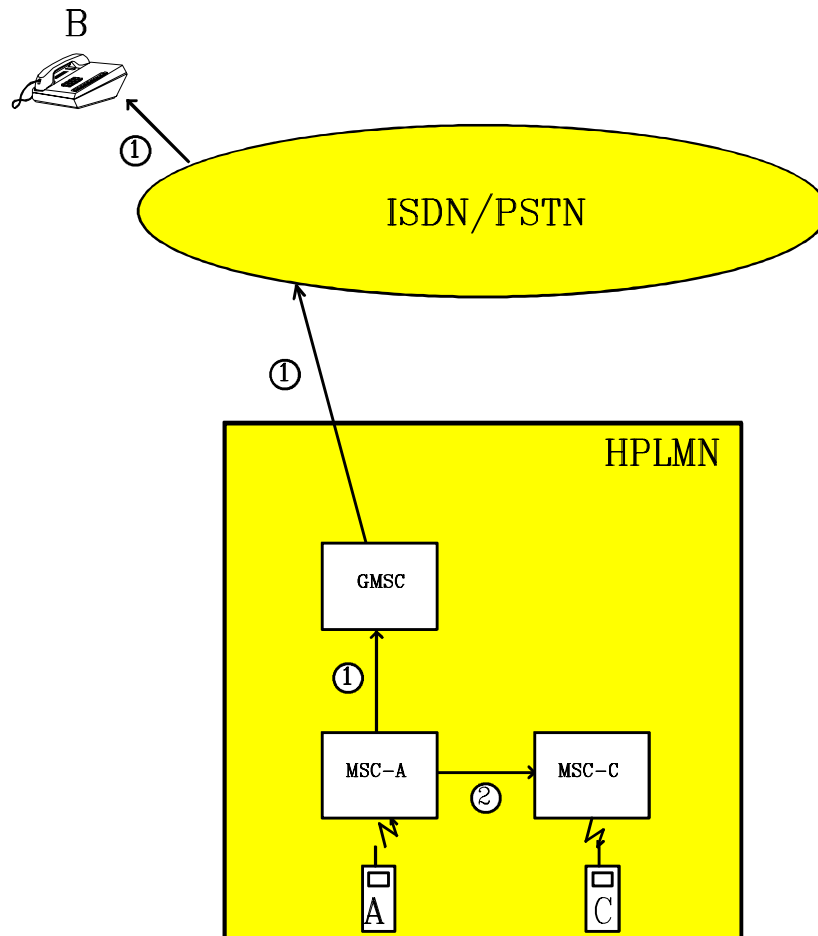

Figure B.9: Call hold and multi-party service

B.4.10 Outgoing call handled by CAMEL

Figure B.10 illustrates an outgoing CAMEL call from a mobile CAMEL subscriber "A" to a fixed network subscriber "B" (1).

The "A" subscriber has an active O-CSI (stored in the VLR). Therefore MSC-A requests instructions from the gsmSSF which passes the CAMEL service key to the gsmSCF to indicate which service logic it should apply (2).

The gsmSCF may interrogate the HLR for subscriber information. As a network option, the operator may refuse to provide the requested information.

When gsmSCF processing is complete the call control is returned to MSC-A.

MSC-A generates an MOC record for the "A" subscriber. This record may be linked to an optional SCF-record. The record includes O-CSI data.

The GMSC routes the call to the "B" subscriber (3). The GMSC shall create an outgoing gateway record as described in subclause B.4.1.

The generated records are subsequently transferred to the OS (A) either as event reports following the release of the connection or when collected by the OS.

The following records are generated in HPLMN in this call scenario:

GMSC	MSC	HLR
Outgoing gateway record	MOC record	-

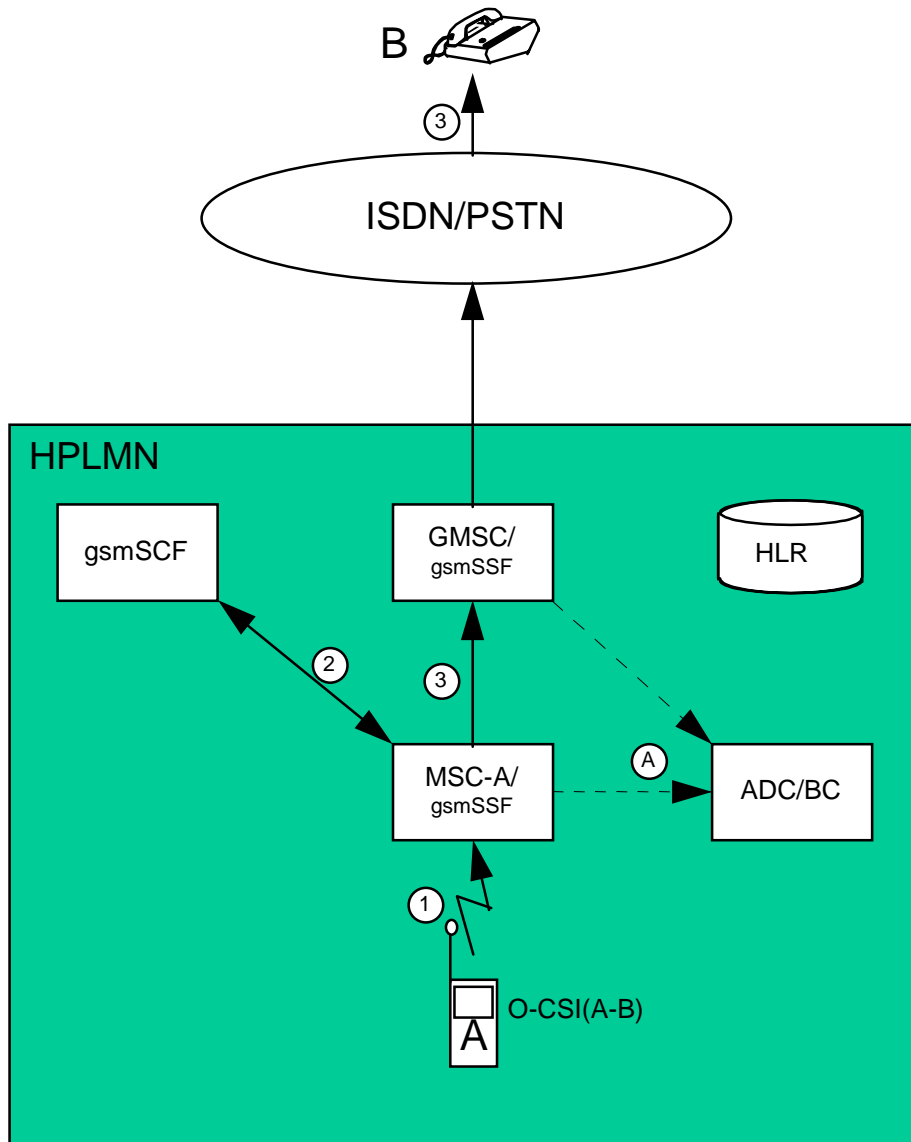

Figure B.10: Outgoing call handled by CAMEL

B.4.11 Incoming call handled by CAMEL without redirection

Figure B.11 illustrates an incoming call from a fixed network subscriber "A" to a mobile CAMEL subscriber "B".

The incoming call is first routed to the GMSC (1). The GMSC shall create an incoming gateway record for fixed network accounting purposes.

The GMSC interrogates the HLR of the called subscriber in order to fetch the T-CSI (2). The HLR shall create an HLR interrogation record.

The "B" subscriber has an active T-CSI. Therefore the GMSC requests instructions from the gsmSSF which passes the CAMEL service key to a gsmSCF to indicate which service logic it should apply (3).

The gsmSCF may interrogate the HLR for subscriber information. As a network option, the operator may refuse to provide the requested information.

When gsmSCF processing is complete the call control is returned to the GMSC. The GMSC shall generate a terminating CAMEL interrogation record which contains T-CSI data.

The GMSC interrogates the HLR in order to determine his current location (4). The HLR shall create an HLR interrogation record.

The call is routed to MSC-B (5). An MTC record shall be generated.

For avoidance of doubt, even if the MSC and GMSC are co-located both the MTC and gateway records shall be produced.

The generated records are subsequently transferred to the OS (A) either as event reports following the release of the connection or when collected by the OS.

The following records are generated in HPLMN in this call scenario:

GMSC	MSC	HLR
Incoming gateway record	MTC record	HLR interrogation record
Terminating CAMEL int. record		

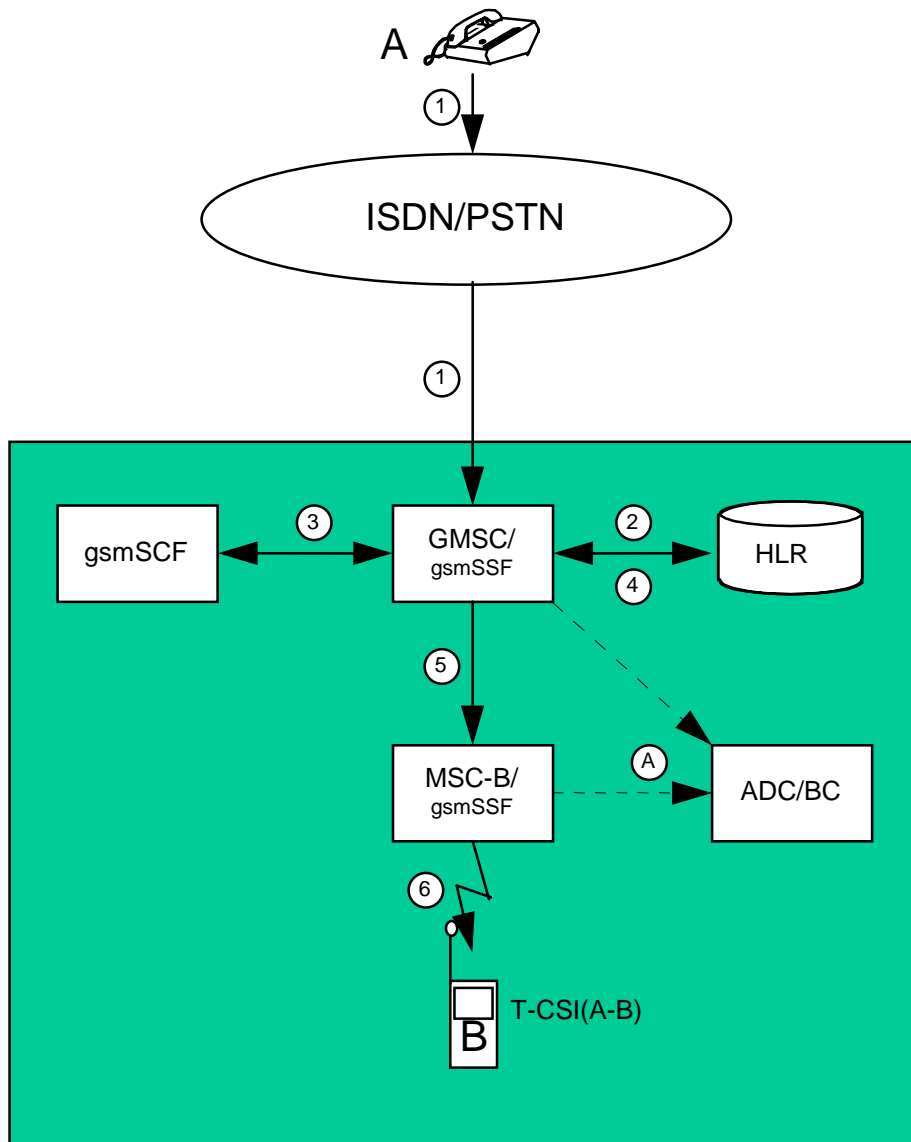

Figure B.11: Incoming call handled by CAMEL without redirection

B.4.12 Incoming call to a roaming subscriber handled by CAMEL

Figure B.12 illustrates an incoming call from a fixed network subscriber "A" to a mobile CAMEL subscriber "B" who is currently roaming in another PLMN.

The call is first routed to a GMSC (1) and the GMSC shall create an incoming gateway record for fixed network accounting purposes.

The GMSC interrogates the HLR of the called subscriber in order to fetch the T-CSI (2). The HLR shall create an HLR interrogation record.

The "B" subscriber has an active T-CSI. Therefore the GMSC requests instructions from the gsmSSF which passes the CAMEL service key to a gsmSCF to indicate which service logic it should apply (3).

The gsmSCF may interrogate the HLR for subscriber information. As a network option, the operator may refuse to provide the requested information.

When gsmSCF processing is complete the call control is returned to the GMSC. The GMSC shall generate a terminating CAMEL interrogation record which contains T-CSI data.

The GMSC interrogates the HLR in order to determine his current location (4). The HLR shall create an HLR interrogation record.

The GMSC routes the call to the VPLMN in which subscriber "B" is currently located (5). The GMSC shall create an outgoing gateway record for accounting purposes. The GMSC shall also create a roaming record. This record includes the IMSI of the "B" subscriber and may be used as a cross-check for the TAP information received from the VPLMN.

The call is then routed by the VPLMN to the MSC at which the subscriber is currently located (6). The GMSC of the VPLMN shall produce an incoming gateway record and the terminating MSC shall create an MTC record for the call to "B".

The records generated are subsequently transferred to the OS of the appropriate PLMN (A). The MTC record generated by the terminating MSC shall be employed to create the appropriate MTC TAP record. The TAP records shall be included in a TAP file and transmitted to the HPLMN (B).

The following records are generated in HPLMN in this call scenario:

GMSC	MSC	HLR
Incoming gateway record	-	HLR interrogation record
Terminating CAMEL int. record		
Roaming record		
Outgoing gateway record		

The following records are generated in VPLMN in this call scenario:

GMSC	MSC	HLR
Incoming gateway record	MTC record	-

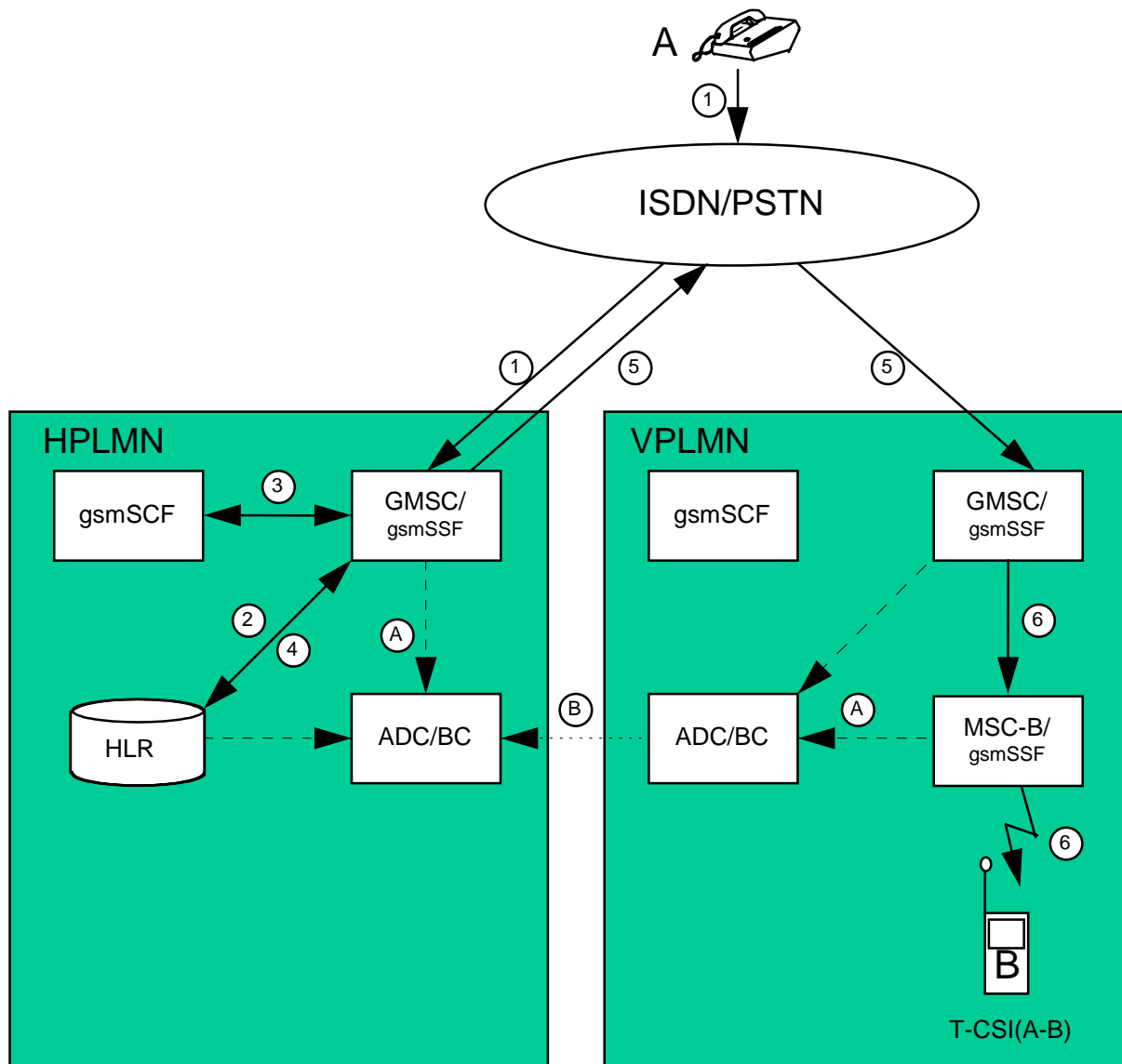

Figure B.12: Incoming call to a roaming subscriber handled by CAMEL

B.4.13 Incoming call handled by CAMEL with redirection decided and forwarding leg handled by CAMEL

Figure B.13 illustrates an incoming call from a fixed network subscriber "A" to a mobile CAMEL subscriber "B". The call is subsequently forwarded to a second fixed network subscriber "C" by CAMEL initiated Call Forwarding.

The incoming call is routed to the GMSC (1). The GMSC shall create an incoming gateway record for fixed network accounting purposes.

The GMSC interrogates the HLR of the called subscriber in order to fetch the T-CSI and O-CSI (2).

The "B" subscriber has an active T-CSI. Therefore the GMSC requests instructions from the gmSSF which passes the CAMEL service key to a gsmSCF to indicate which service logic it should apply (3).

The gsmSCF may interrogate the HLR for subscriber information. As a network option, the operator may refuse to provide the requested information.

The gsmSCF modifies the Called Party number and sets the CAP parameter 'Apply O-CSI'. When gsmSCF processing is complete the call control is returned to the GMSC. The GMSC shall generate a terminating CAMEL interrogation record which contains T-CSI data.

The "B" subscriber has an active O-CSI. Therefore the GMSC requests instructions from the gsmSSF which passes the CAMEL service key to a gsmSCF to indicate which service logic it should apply (4).

The gsmSCF may interrogate the HLR for subscriber information. As a network option, the operator may refuse to provide the requested information.

When gsmSCF processing is complete the call control is returned to the GMSC

The GMSC redirects the call to the fixed network subscriber "C" (5). The GMSC shall generate an MTC record for the "B" subscriber for the call from "A" and an MOC (call forwarding) record for the "B" subscriber for the call to "C". The MOC record includes O-CSI data and the parameter 'CAMEL initiated CF indicator'. The GMSC shall also produce an outgoing gateway record as described in subclause B.4.1.

The generated records are subsequently transferred to the OS (A) either as event reports following the release of the connection or when collected by the OS.

The following records are generated in HPLMN in this call scenario:

GMSC	MSC	HLR
Incoming gateway record	-	HLR interrogation record
Terminating CAMEL int. record		
MTC record		
MOC (CF) record		
Outgoing gateway record		

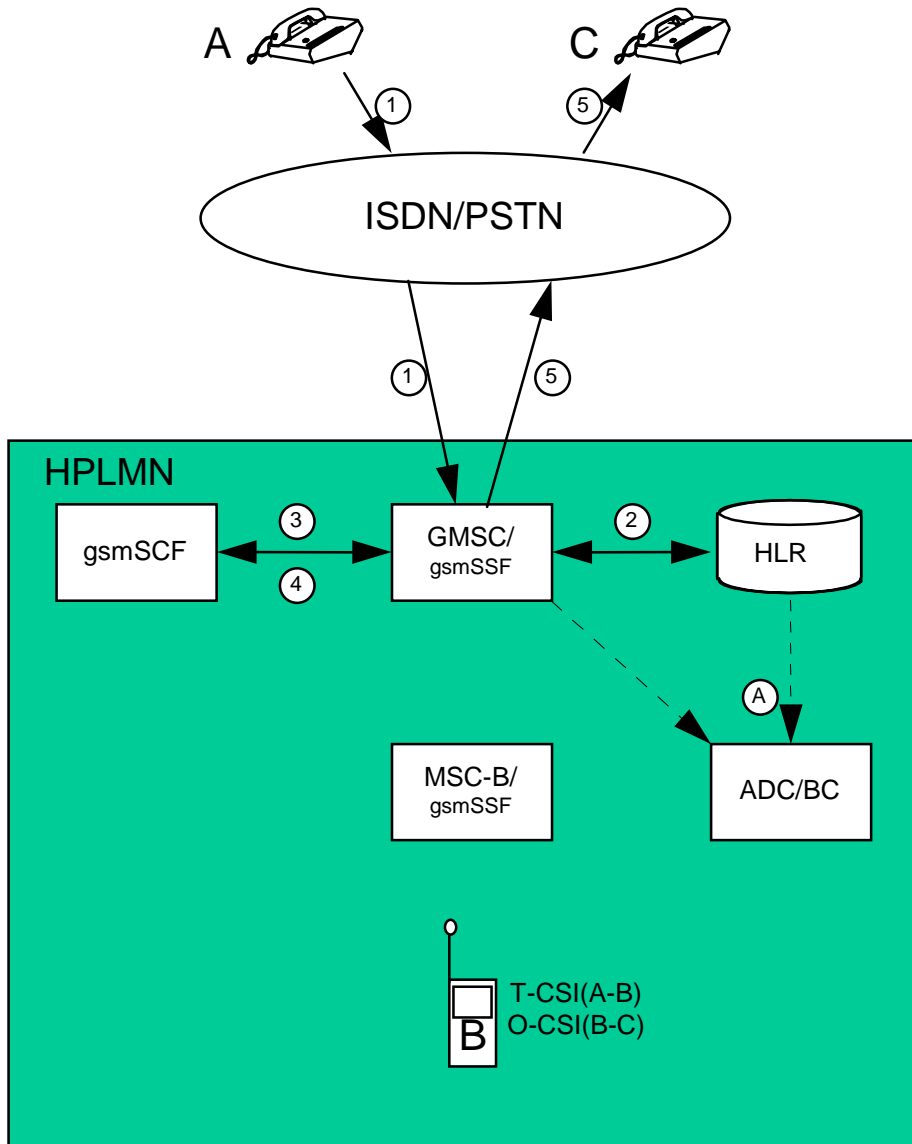

Figure B.13: Incoming call handled by CAMEL with redirection decided and forwarding leg handled by CAMEL

B.4.14 Incoming call handled by CAMEL without redirection and forwarded early using GSM SS but controlled by CAMEL

Figure B.14 illustrates an incoming call from a fixed network subscriber "A" to a mobile CAMEL subscriber "B". The call is subsequently forwarded to a second fixed network subscriber "C" by GSM SS Call Forwarding Unconditional (CFU) but controlled by CAMEL.

For simplicity the activation and registration of CFU have not been included in the diagram. These actions shall of course be registered in the appropriate supplementary service records.

The incoming call is routed to the GMSC (1). The GMSC shall create an incoming gateway record for fixed network accounting purposes.

The GMSC interrogates the HLR of the called subscriber in order to fetch the T-CSI and O-CSI (2). The HLR shall create an HLR interrogation record. The HLR informs the GMSC that "B" has activated CFU.

The "B" subscriber has an active T-CSI. Therefore the GMSC requests instructions from the gsmSSF which passes the CAMEL service key to a gsmSCF to indicate which service logic it should apply (3).

The gsmSCF may interrogate the HLR for subscriber information. As a network option, the operator may refuse to provide the requested information.

When gsmSCF processing is complete the call control is returned to the GMSC. The GMSC shall generate a terminating CAMEL interrogation record which contains T-CSI data.

The "B" subscriber has an active O-CSI. Because the "B" subscriber has activated CFU he acts as the originating party for the forwarded leg. Therefore the GMSC requests instructions from the gsmSSF which passes the CAMEL service key to a gsmSCF to indicate which service logic it should apply (5).

The gsmSCF may interrogate the HLR for subscriber information. As a network option, the operator may refuse to provide the requested information.

When gsmSCF processing is complete the call control is returned to the GMSC

The GMSC redirects the call to the fixed network subscriber "C" (6). The GMSC shall generate an MTC record for the "B" subscriber for the call from "A" and an MOC (call forwarding) record for the "B" subscriber for the call to "C". The MOC record includes O-CSI data. The GMSC shall also produce an outgoing gateway record as described in subclause B.4.1.

If the B-subscriber do not have an active O-CSI the call is forwarded to the "C" subscriber after the first gsmSCF invocation.

The generated records are subsequently transferred to the OS (A) either as event reports following the release of the connection or when collected by the OS.

The following records are generated in HPLMN in this call scenario:

GMSC	MSC	HLR
Incoming gateway record	-	HLR interrogation record
Terminating CAMEL int. record		
MTC record		
MOC (CF) record		
Outgoing gateway record		

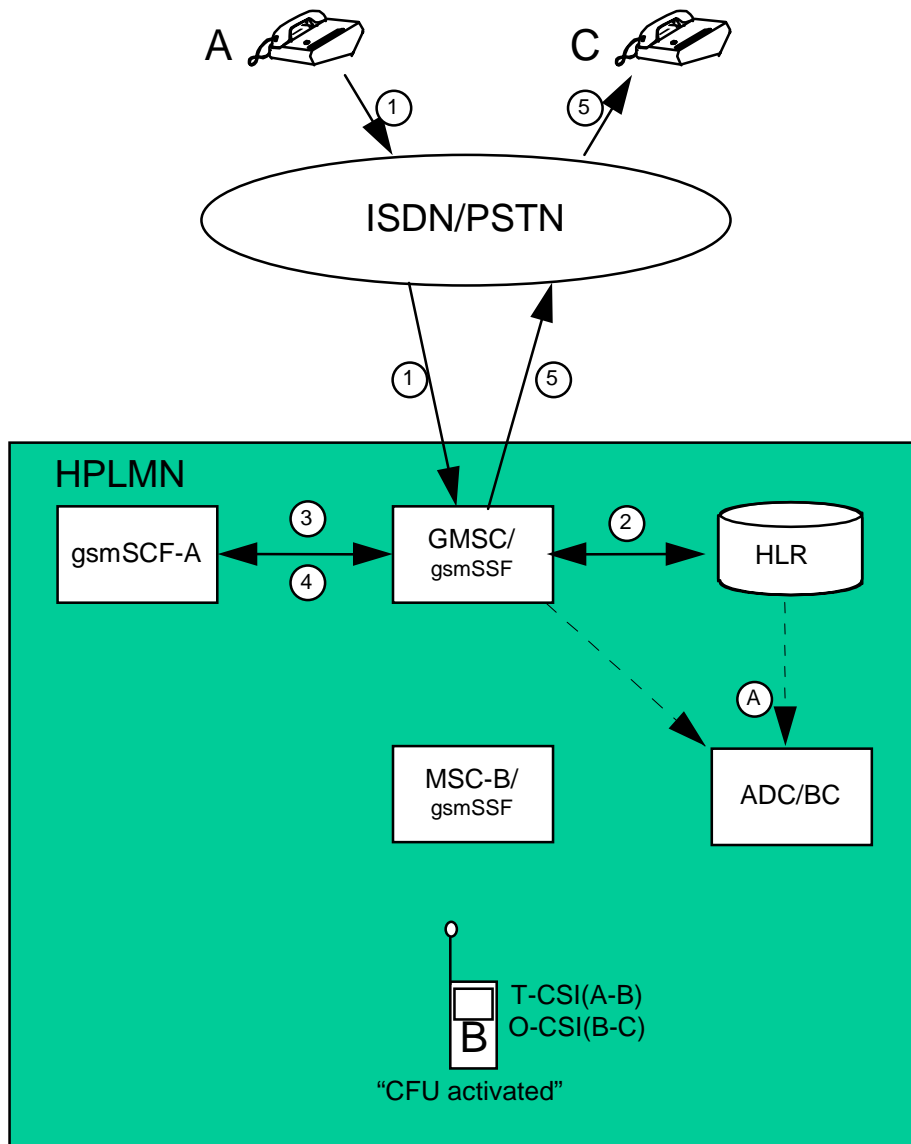

Figure B.14: Incoming call handled by CAMEL without redirection and forwarded early using GSM SS but controlled by CAMEL

B.4.15 Incoming call handled by CAMEL without redirection and forwarded late using GSM SS but controlled by CAMEL

Figure B.15 illustrates an incoming call from a fixed network subscriber "A" to a mobile CAMEL subscriber "B" who has registered and activated Call Forwarding on No Reply (CFNRY) for the appropriate service. The call is subsequently forwarded to a second fixed network subscriber "C".

For simplicity the registration and activation of CFNRY have not been included in this diagram. These actions shall be recorded in the appropriate supplementary service records.

The incoming call is routed to the GMSC (1). The GMSC shall create an incoming gateway record for fixed network accounting purposes.

The GMSC interrogates the HLR of the called subscriber in order to fetch the T-CSI and O-CSI (2). The HLR shall create an HLR interrogation record.

The "B" subscriber has an active T-CSI. Therefore the GMSC requests instructions from the gsmSSF which passes the CAMEL service key to the gsmSCF to indicate which service logic it should apply (3).

The gsmSCF may interrogate the HLR for subscriber information. As a network option, the operator may refuse to provide the requested information.

When gsmSCF processing is complete the call control is returned to the GMSC. The GMSC shall generate a terminating CAMEL interrogation record which contains T-CSI data.

The GMSC interrogates the HLR in order to determine his current location (4). The HLR shall create an HLR interrogation record.

The call is routed to MSC-B (5). The "B" subscriber do not answer the call. MSC-B shall produce an MTC record for the "B" subscriber for the call from "A".

The "B" subscriber has an active O-CSI. Because the "B" subscriber has activated CFNRY he acts as the originating party for the forwarded leg. Therefore MSC-B requests instructions from the gsmSSF which passes the CAMEL service key to the gsmSCF to indicate which service logic it should apply (6).

The gsmSCF may interrogate the HLR for subscriber information. As a network option, the operator may refuse to provide the requested information.

When gsmSCF processing is complete the call control is returned to MSC-B.

MSC-B forwards the call via the GMSC to the "C" subscriber (7). MSC-B shall produce an MOC (call forwarding) for the "B" subscriber for the call to "C". The record includes O-CSI data. The GMSC shall also produce an outgoing gateway record as described in subclause B.4.1.

If the B-subscriber do not have an active O-CSI the call is forwarded to the "C" subscriber after detecting the call forwarding condition.

The generated records are subsequently transferred to the OS (A) either as event reports following the release of the connection or when collected by the OS.

The following records are generated in HPLMN in this call scenario:

GMSC	MSC	HLR
Incoming gateway record	MTC record	-
Terminating CAMEL int. record	MOC (CF) record	
Outgoing gateway record		

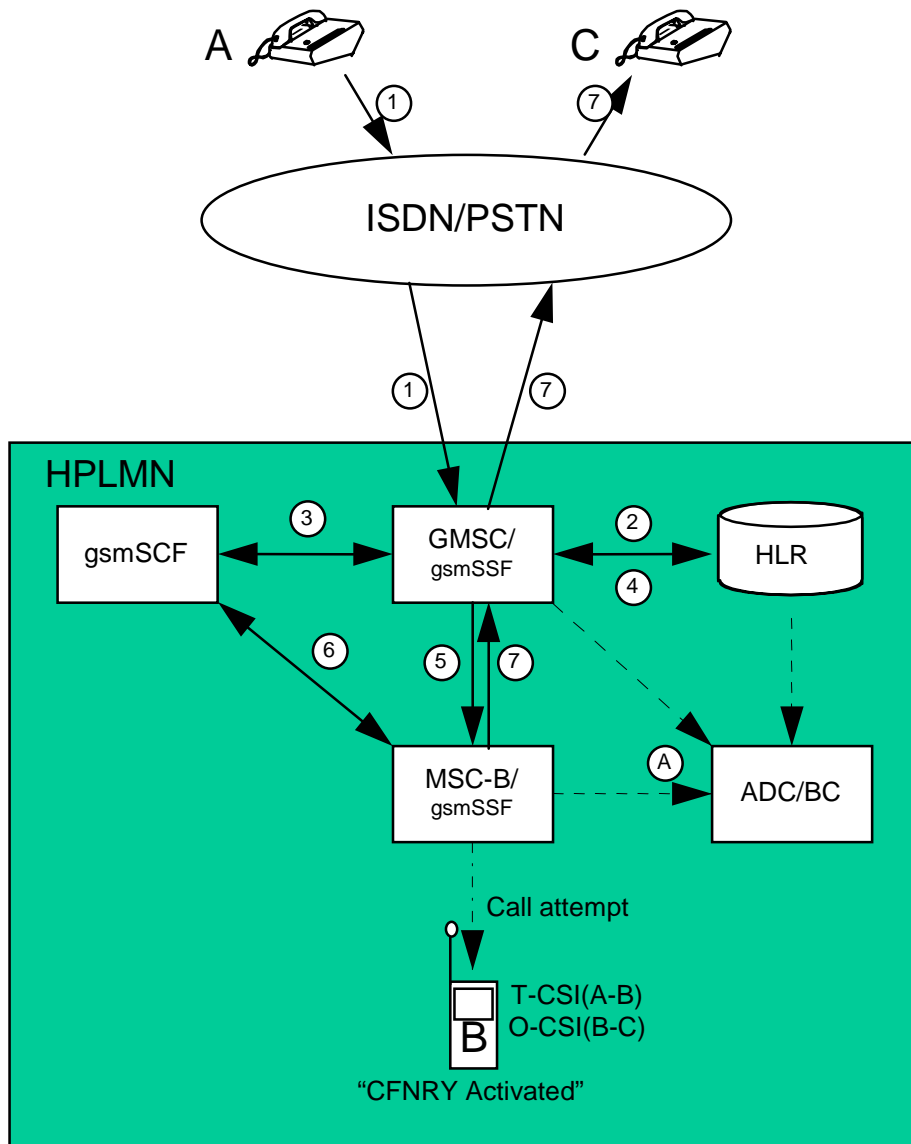

Figure B.15: Incoming call handled by CAMEL without redirection and forwarded late using GSM SS but controlled by CAMEL

B.4.16 Early forwarded call controlled by CAMEL

Figure B.16 illustrates an incoming call from a fixed network subscriber "A" to a mobile CAMEL subscriber "B". The call is subsequently forwarded to a second fixed network subscriber "C" by GSM SS Call Forwarding Unconditional (CFU) but controlled by CAMEL.

For simplicity the activation and registration of CFU have not been included in the diagram. These actions shall of course be registered in the appropriate supplementary service records.

The incoming call is routed to the GMSC (1). The GMSC shall create an incoming gateway record for fixed network accounting purposes.

The GMSC interrogates the HLR of the called subscriber in order to fetch the O-CSI (2). The HLR shall create an HLR interrogation record. The HLR informs the GMSC that "B" has activated CFU.

The "B" subscriber has an active O-CSI. Because the "B" subscriber has activated CFU he acts as the originating party for the forwarded leg. Therefore the GMSC requests instructions from the gsmSSF which passes the CAMEL service key to a gsmSCF to indicate which service logic it should apply (3).

The gsmSCF may interrogate the HLR for subscriber information. As a network option, the operator may refuse to provide the requested information.

When gsmSCF processing is complete the call control is returned to the GMSC

The GMSC redirects the call to the fixed network subscriber "C" (5). The GMSC shall generate an MTC record for the "B" subscriber for the call from "A" and an MOC (call forwarding) record for the "B" subscriber for the call to "C". The MOC record includes O-CSI data. The GMSC shall also produce an outgoing gateway record as described in subclause B.4.1.

The generated records are subsequently transferred to the OS (A) either as event reports following the release of the connection or when collected by the OS.

The following records are generated in HPLMN in this call scenario:

GMSC	MSC	HLR
Incoming gateway record	-	HLR interrogation record
MTC record		
MOC (CF) record		
Outgoing gateway record		

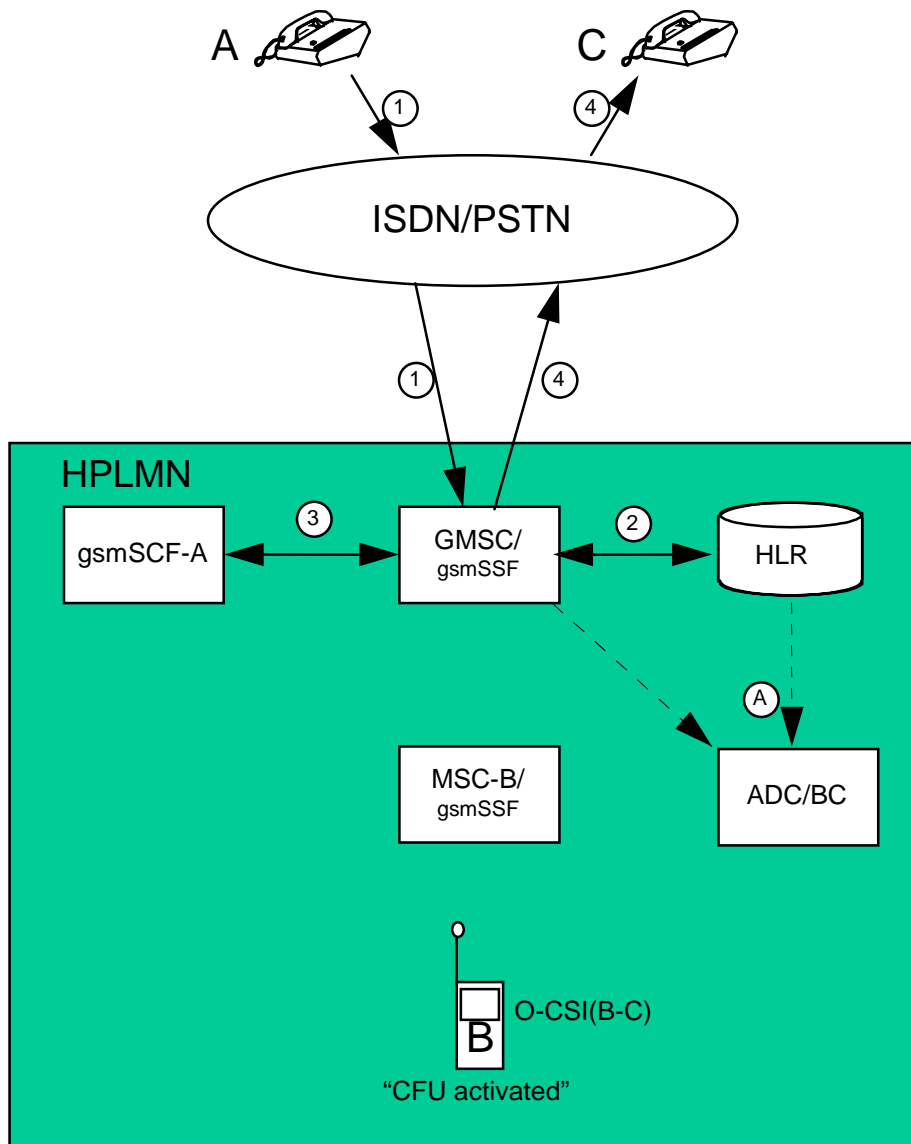

Figure B.16: Early forwarded call controlled by CAMEL

B.4.17 Late forwarded call controlled by CAMEL

Figure B.17 illustrates an incoming call from a fixed network subscriber "A" to a mobile CAMEL subscriber "B" who has registered and activated Call Forwarding on No Reply (CFNRY) for the appropriate service. The call is subsequently forwarded to a second fixed network subscriber "C".

For simplicity the registration and activation of CFNRY have not been included in this diagram. These actions shall be recorded in the appropriate supplementary service records.

The incoming call is routed to the GMSC (1). The GMSC shall create an incoming gateway record for fixed network accounting purposes.

The GMSC interrogates the HLR of the called subscriber in order to determine the current location (2). The HLR shall create an HLR interrogation record.

The call is routed to MSC-B (3). The "B" subscriber do not answer the call. MSC-B shall produce an MTC record for the "B" subscriber for the call from "A".

The "B" subscriber has an active O-CSI. Because the "B" subscriber has activated CFNRY he acts as the originating party for the forwarded leg. Therefore MSC-B requests instructions from the gsmSSF which passes the CAMEL service key to gsmSCF-B to indicate which service logic it should apply (4).

The gsmSCF may interrogate the HLR for subscriber information. As a network option, the operator may refuse to provide the requested information.

When gsmSCF processing is complete the call control is returned to MSC-B.

MSC-B forwards the call via the GMSC to the "C" subscriber (5). MSC-B shall produce an MOC (call forwarding) for the "B" subscriber for the call to "C". The record includes O-CSI data. The GMSC shall also produce an outgoing gateway record as described in subclause B.4.1.

The generated records are subsequently transferred to the OS (A) either as event reports following the release of the connection or when collected by the OS.

The following records are generated in HPLMN in this call scenario:

GMSC	MSC	HLR
Incoming gateway record	MTC record	HLR interrogation record
Outgoing gateway record	MOC (CF) record	

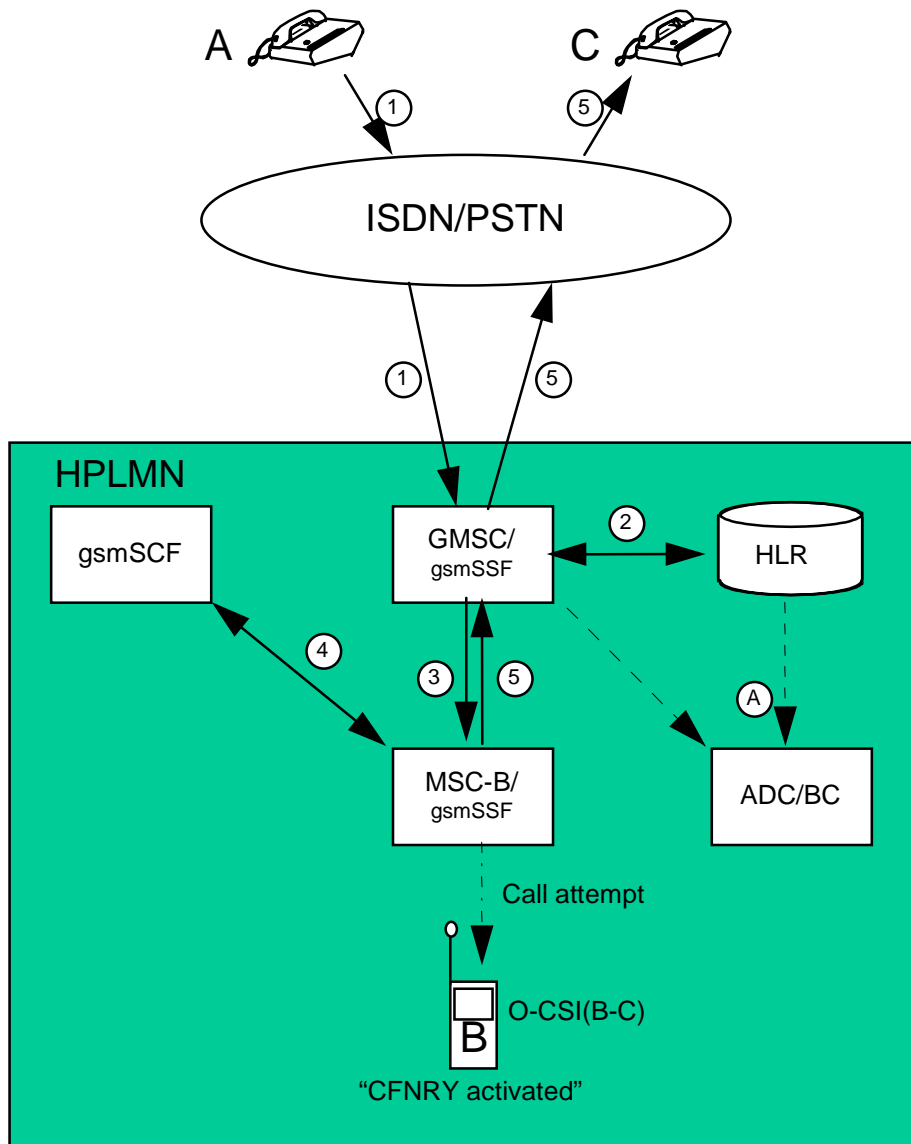

Figure B.17: Late forwarded call controlled by CAMEL

B.4.18 Incoming call handled by CAMEL with redirection initiated by CAMEL feature

Figure B.4.18 illustrates an incoming call from a fixed network subscriber "A" to a mobile CAMEL subscriber "B". The call is subsequently redirected to a second fixed network subscriber "C" by CAMEL initiated redirection.

The incoming call is routed to the GMSC (1). The GMSC shall create an incoming gateway record for fixed network accounting purposes.

The GMSC interrogates the HLR of the called subscriber in order to fetch the T-CSI (2) and the O-CSI (2). The HLR shall create an HLR interrogation record.

Since subscriber "B" has an active T-CSI and the trigger criterias are met the GMSC requests instructions from the gsmSSF which passes the CAMEL service key to a gsmSCF to indicate which service logic it should apply (3). A terminating CAMEL interrogation record is generated in the GMSC for invoking the terminating CAMEL call handling.

The gsmSCF may interrogate the HLR for subscriber information. As a network option, the operator may refuse to provide the requested information.

The gsmSCF returns a modified destination routing address to the GMSC (without the option "apply O-CSI"). Therefore for the redirection leg (B-C) the CAMEL feature is not invoked.

The GMSC redirects the call to the fixed network subscriber "C" (4). For fixed network accounting purposes the GMSC shall generate an outgoing gateway record as described in subclause B.4.1.

The generated records are subsequently transferred to the OS (A) either as event reports following the release of the connection or when collected by the OS.

The following records are generated in HPLMN in this call scenario:

GMSC	MSC	HLR
Incoming gateway record		HLR interrogation record
Terminating CAMEL interrogation record		
Outgoing gateway record		

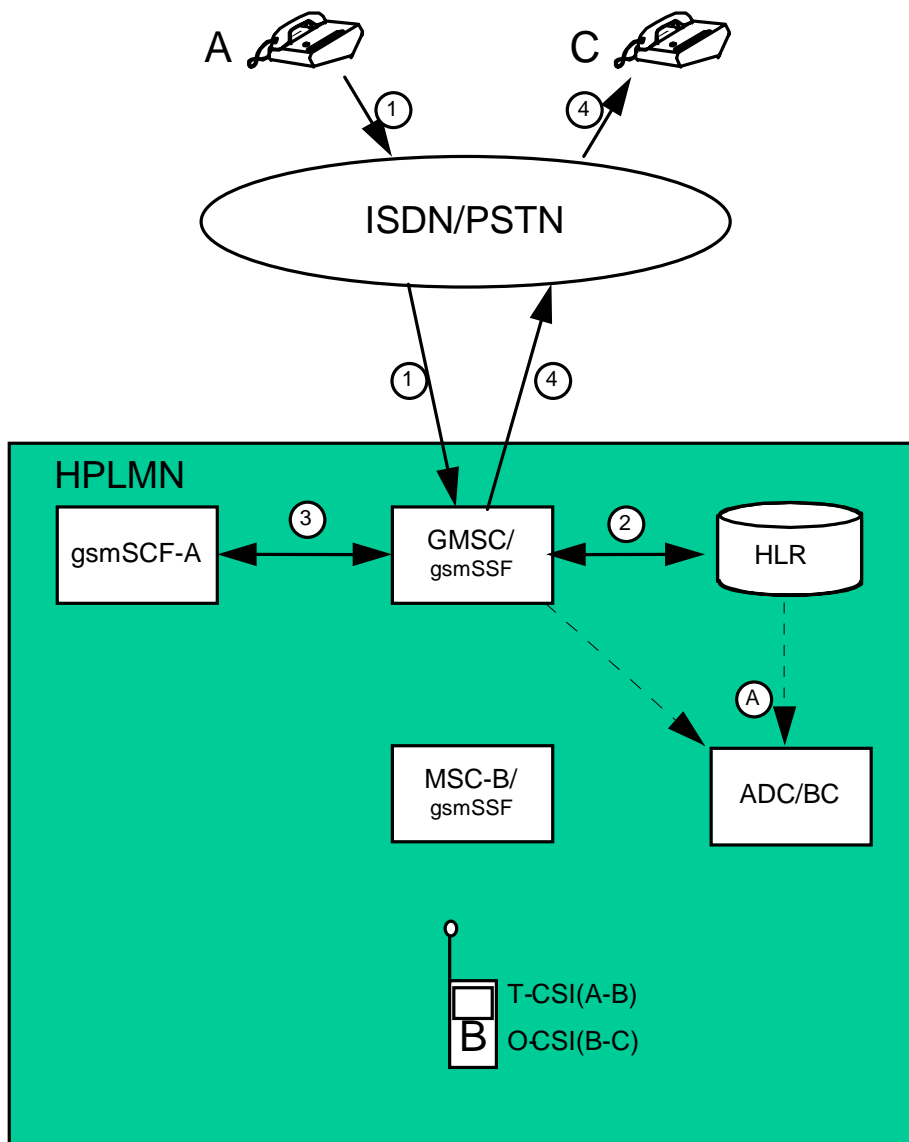

Figure B.18: Incoming call handled by CAMEL with redirection initiated and by CAMEL feature

Annex C (normative): Observed IMEI tickets

C.1 General

In order to provide the data required by the mobile equipment management activities outlined in the previous chapters, the NEF of the MSC shall be capable of producing IMEI tickets for each of the following events:

- usage of a blacklisted IMEI;
- usage of a greylisted IMEI;
- usage of an IMEI not found on the white list.

The production of these records shall be enabled/disabled under network management control by the use of the procedure outlined in subclause 8.2.1.3.

C.2 Observed IMEI tickets

An observed IMEI ticket is generated whenever greylisted, blacklisted or non-whitelisted mobile equipment is detected during an IMEI check. The purpose of the ticket is to link the mobile equipment under observation with its current user (IMSI). The ticket also includes information describing when and where the equipment was used to enable the tracking of such equipment. Finally, if the ticket was triggered by a call attempt, a call reference is provided in order to locate the corresponding call record.

The IMEI tickets are generated by the NEF of the MSC performing the IMEI check.

Table C.1: IMEI ticket

Field		Description
Served IMEI	M	IMEI of the observed mobile equipment
IMEI Status	M	The result of the IMEI check e.g. blacklisted, greylisted, unknown.
Served IMSI	M	The IMSI of the subscriber currently using the mobile equipment.
Served MSISDN	C	The MSISDN of the subscriber currently using the observed mobile equipment, only available if the event that triggered the IMEI check was an MOC, MTC, SMS-MO or SMS-MT
Recording Entity	M	The E.164 number of the recording MSC.
Event Time Stamp	M	The time at which the IMEI check was performed.
Location	M	The location area code and cell identity of the cell from which the mobile equipment was used.
IMEI Check Event	O	The event that caused IMEI checking to take place
Call Reference	O	Only available if the IMEI check was related to an MOC or MTC
Record extensions	O	A set of network/ manufacturer specific extensions to the record.

C.3 Description of record fields

For the definition of Served IMEI, Served MSISDN, Recording Entity, Event Time Stamp, Location and Call Reference see clause B.2.

C.3.1 IMEI Check Event

This field identifies the type of event that caused the IMEI check to take place:

- Mobile originating call attempt;
- Mobile terminating call attempt;
- Mobile originating SMS;
- Mobile terminating SMS;
- Supplementary service actions performed by the subscriber;
- Location update.

C.3.2 IMEI Status

This field contains the result of the IMEI checking procedure:

- Greylisted;
- Blacklisted;
- Non-whitelisted.

Annex D (informative): Change history

This annex lists all change requests approved for this document since the specification was first approved by 3GPP TSG-SA.

Change history					
TSG SA#	Version	CR	Tdoc SA	New Version	Subject/Comment
S_06	-	-		3.0.0	Transferred from GSM 12.05 v7.0.1
S_08	3.0.0	001	SP-000240	3.1.0	Circuit domain charging enhancements on CAMEL phase 3
	3.1.0	001	SP-000240	3.2.0	Circuit domain charging enhancements on CAMEL phase 3 (complete implementation of CR001 in SP-000240; clause B.3 re-numbered in alphabetical order)
	3.1.0			3.2.0	Title Changed: "GSM call ... into "3G call ...

History

Document history		
V3.0.0	January 2000	Publication
V3.1.0	July 2000	Publication
V3.2.0	September 2000	Publication