

ETSI TS 132 015 V3.9.0 (2002-03)

Technical Specification

**Universal Mobile Telecommunications System (UMTS);
Telecommunication Management;
Charging and billing;
3G call and event data for the Packet Switched (PS) domain
(3GPP TS 32.015 version 3.9.0 Release 1999)**



Reference

RTS/TSGS-0532015UR9

Keywords

UMTS

ETSI

650 Route des Lucioles
F-06921 Sophia Antipolis Cedex - FRANCE

Tel.: +33 4 92 94 42 00 Fax: +33 4 93 65 47 16

Siret N° 348 623 562 00017 - NAF 742 C
Association à but non lucratif enregistrée à la
Sous-Préfecture de Grasse (06) N° 7803/88

Important notice

Individual copies of the present document can be downloaded from:

<http://www.etsi.org>

The present document may be made available in more than one electronic version or in print. In any case of existing or perceived difference in contents between such versions, the reference version is the Portable Document Format (PDF). In case of dispute, the reference shall be the printing on ETSI printers of the PDF version kept on a specific network drive within ETSI Secretariat.

Users of the present document should be aware that the document may be subject to revision or change of status. Information on the current status of this and other ETSI documents is available at

<http://portal.etsi.org/tb/status/status.asp>

If you find errors in the present document, send your comment to:

editor@etsi.fr

Copyright Notification

No part may be reproduced except as authorized by written permission.
The copyright and the foregoing restriction extend to reproduction in all media.

© European Telecommunications Standards Institute 2002.
All rights reserved.

DECTTM, **PLUGTESTS**TM and **UMTS**TM are Trade Marks of ETSI registered for the benefit of its Members.
TIPHONTM and the **TIPHON logo** are Trade Marks currently being registered by ETSI for the benefit of its Members.
3GPPTM is a Trade Mark of ETSI registered for the benefit of its Members and of the 3GPP Organizational Partners.

Intellectual Property Rights

IPRs essential or potentially essential to the present document may have been declared to ETSI. The information pertaining to these essential IPRs, if any, is publicly available for **ETSI members and non-members**, and can be found in ETSI SR 000 314: *"Intellectual Property Rights (IPRs); Essential, or potentially Essential, IPRs notified to ETSI in respect of ETSI standards"*, which is available from the ETSI Secretariat. Latest updates are available on the ETSI Web server (<http://webapp.etsi.org/IPR/home.asp>).

Pursuant to the ETSI IPR Policy, no investigation, including IPR searches, has been carried out by ETSI. No guarantee can be given as to the existence of other IPRs not referenced in ETSI SR 000 314 (or the updates on the ETSI Web server) which are, or may be, or may become, essential to the present document.

Foreword

This Technical Specification (TS) has been produced by ETSI 3rd Generation Partnership Project (3GPP).

The present document may refer to technical specifications or reports using their 3GPP identities, UMTS identities or GSM identities. These should be interpreted as being references to the corresponding ETSI deliverables.

The cross reference between GSM, UMTS, 3GPP and ETSI identities can be found under www.etsi.org/key.

Contents

Intellectual Property Rights	2
Foreword.....	2
Foreword.....	6
1 Scope	7
2 References	7
3 Definitions, abbreviations and symbols	8
3.1 Definitions	8
3.2 Abbreviations	9
3.3 Symbols.....	10
4 Architecture.....	11
4.1 Charging Gateway Functionality.....	12
5 Charging Principles	14
5.1 Requirements.....	14
5.2 Charging Information	14
5.3 Charging Data Collection Principles	15
5.3a Volume counting in RNC.....	15
5.4 Generation of Charging ID.....	16
5.5 Charging for SMS in GPRS	16
5.6 Charging Triggers – CDR Generation.....	16
5.6.1 Triggers for S-CDR Charging Information Collection	17
5.6.1.1 Triggers for S-CDR Charging Information Addition.....	17
5.6.1.2 Triggers for S-CDR Closure	17
5.6.2 Triggers for M-CDR Charging Information Collection.....	18
5.6.2.1 Triggers for M-CDR Charging Information Addition.....	18
5.6.2.2 Triggers for M-CDR Closure	18
5.6.3 Triggers for G-CDR Charging Information Collection.....	19
5.7 Examples of charging scenarios	19
5.7.1 GPRS Mobile to PDN Context	20
5.7.2 GPRS Mobile to Mobile Context.....	20
5.7.3 PDN to GPRS Mobile Context	21
5.7.4 GPRS Mobile to PDN Context while roaming, GGSN in HPLMN	22
5.8 Charging support for CAMEL.....	22
6 Charging Data Collection	23
6.1 Record contents	23
6.1.1 GPRS charging data in SGSN (S-CDR)	24
6.1.2 GPRS charging data in GGSN (G-CDR).....	25
6.1.3 GPRS mobile station mobility management data in SGSN (M-CDR)	26
6.1.4 GPRS MO SMS data in SGSN (S-SMO-CDR).....	27
6.1.5 GPRS MT SMS data in SGSN (S-SMT-CDR).....	27
6.1.6 Description of Record Fields	28
6.1.6.1 Access Point Name (APN) Network/Operator Identifier	28
6.1.6.2 APN Selection Mode.....	28
6.1.6.3 CAMEL Information.....	28
6.1.6.4 Cause for Record Closing	29
6.1.6.5 Charging Characteristics	29
6.1.6.6 Charging ID.....	30
6.1.6.7 Destination Number	30
6.1.6.8 Diagnostics.....	30
6.1.6.9 Duration	30
6.1.6.10 Dynamic Address Flag.....	31
6.1.6.11 Event Time Stamps	31
6.1.6.12 GGSN Address/GGSN Address Used.....	31

6.1.6.13	List of Traffic Data Volumes	31
6.1.6.14	Local Record Sequence Number	32
6.1.6.15	Message reference	32
6.1.6.16	MS Network Capability	32
6.1.6.17	Network Initiated PDP Context	32
6.1.6.18	Node ID	33
6.1.6.19	PDP Type	33
6.1.6.20	QoS Requested/QoS Negotiated	33
6.1.6.21	Record Extensions	33
6.1.6.22	Record Opening Time	33
6.1.6.23	Record Sequence Number	33
6.1.6.24	Record Type	33
6.1.6.25	Recording Entity Number	33
6.1.6.26	RNC Unsent Downlink Volume	33
6.1.6.27	Routing Area Code/Cell Identifier/Change of location	34
6.1.6.28	Served IMEI	34
6.1.6.29	Served IMSI	34
6.1.6.30	Served MSISDN	34
6.1.6.31	Served PDP Address	34
6.1.6.32	Service Centre Address	34
6.1.6.33	SGSN Address	34
6.1.6.34	SGSN Change	35
6.1.6.35	Short Message Service (SMS) Result	35
6.1.6.36	System Type	35
7	Charging Protocols	35
7.1	GPRS CDR Collection by GTP' Protocol	35
7.1.1	SGSN - CGF communication	35
7.1.2	GGSN - CGF communication	36
7.1.3	CGF - CGF communication	36
7.1.4	Port usage	37
7.1.4.1	UDP as the Path Protocol	37
7.1.4.2	TCP as Path Protocol	37
7.1.4.3	Network layer and lower layers	37
7.1.5	Charging related requirements for GPRS nodes	37
7.2	The GTP' charging protocol	38
7.2.1	Usage of GTP Header in charging	38
7.2.2	Information elements	39
7.3	GTP' Message Types	39
7.3.1	List of all GTP' message types	39
7.3.2	Reused GTP message types	40
7.3.3	GTP message type modifications implied by GTP'	41
7.3.4	GTP' message types	41
7.3.4.1	Node Alive Request	41
7.3.4.2	Node Alive Response	42
7.3.4.3	Redirection Request	42
7.3.4.4	Redirection Response	43
7.3.4.5	Data Record Transfer Request	43
7.3.4.5.1	General logic	43
7.3.4.5.2	Information Elements in Data Record Transfer Request	46
7.3.4.5.3	Packet Transfer Command IE	46
7.3.4.5.4	Data Record Packet IE	47
7.3.4.5.5	Sequence Numbers of Released Packets IE	48
7.3.4.5.6	Sequence Numbers of Cancelled Packets IE	48
7.3.4.5.7	Private Extension IE	49
7.3.4.6	Data Record Transfer Response	49
7.3.4.7	Examples of GTP' messaging cases	50
7.3.4.7.1	Case 1: The normal CDR packet transfer	51
7.3.4.7.2	Case 2: The GSN-CGF1 connection breaks before a successful CDR reception	51
7.3.4.7.3	Case 3: The GSN-CGF1 connection breaks after a successful CDR reception	54
7.4	Data Record Format in GTP	55
7.4.1	Standard Data Record Format	55

7.4.2	Private Data Record Formats	56
7.5	Data Record Format Version for CDRs	56
7.6	CGF - BS Protocol Interface	56
7.6.1	The transfer protocols at CGF - BS interface	56
7.6.2	The format of the CDRs at CGF - BS interface	57
8	Charging Data Record Structure	57
8.1	ASN.1 definitions for CDR information	57
Annex A (informative):	Change history	65
History		66

Foreword

This Technical Specification (TS) has been produced by the 3rd Generation Partnership Project (3GPP).

The contents of the present document are subject to continuing work within the TSG and may change following formal TSG approval. Should the TSG modify the contents of the present document, it will be re-released by the TSG with an identifying change of release date and an increase in version number as follows:

Version x.y.z

where:

- x the first digit:
 - 1 presented to TSG for information;
 - 2 presented to TSG for approval;
 - 3 or greater indicates TSG approved document under change control.
- y the second digit is incremented for all changes of substance, i.e. technical enhancements, corrections, updates, etc.
- z the third digit is incremented when editorial only changes have been incorporated in the document.

1 Scope

The GSM and UMTS PLMN support a range of packet based services in the same network. In order to enable operators the ability to provide a commercially viable service there is a need to provide charging functions. The present document describes the functionality of charging, which includes the General Packet Radio Service (GPRS) in GSM and UMTS, as defined in 3GPP TS 22.060 [3] and 3GPP TS 23.060 [8] (packet based services).

2 References

The following documents contain provisions which, through reference in this text, constitute provisions of the present document.

- References are either specific (identified by date of publication, edition number, version number, etc.) or non-specific.
- For a specific reference, subsequent revisions do not apply.
- For a non-specific reference, the latest version applies. In the case of a reference to a 3GPP document (including a GSM document), a non-specific reference implicitly refers to the latest version of that document *in the same Release as the present document*.

- [1] 3GPP TS 21.905: "3G vocabulary".
- [2] Void
- [3] 3GPP TS 22.060: "General Packet Radio Service (GPRS); Service description; Stage 1".
- [4] 3GPP TS 23.003: "Numbering, addressing and identification".
- [5] Void
- [6] Void
- [7] 3GPP TS 23.040: "Technical realisation of the Short Message Service (SMS); Point-to-Point (PP)".
- [8] 3GPP TS 23.060: "General Packet Radio Service (GPRS); Service description; Stage 2".
- [9] 3GPP TS 23.078: "Customised Applications for Mobile network Enhanced Logic (CAMEL) Phase 3 - Stage 2".
- [10] Void
- [11] Void
- [12] Void
- [13] 3GPP TS 24.008: "Digital cellular telecommunications system (Phase 2+); Mobile radio interface layer 3 specification".
- [14] 3GPP TS 25.401: "UTRAN Overall Description".
- [15] 3GPP TS 25.413: "UTRAN Iu Interface RANAP Signalling".
- [16] Void
- [17] Void
- [18] Void
- [19] Void

- [20] 3GPP TS 29.078: "Digital cellular telecommunications system (Phase 2+); CAMEL Application Part (CAP) specification - Phase 3".
- [21] 3GPP TS 29.002: "Mobile Application Part (MAP) specification".
- [22] 3GPP TS 29.060: "General Packet Radio Service (GPRS); GPRS Tunnelling Protocol (GTP) across the Gn and Gp Interface".
- [23] 3GPP TS 32.005: " 3G call and event data for the Circuit Switched (CS) domain".
- [24] Void
- [25] ITU-T Rec. E.164: "Numbering plan for the ISDN era".
- [26] Void
- [27] Void
- [28] Void
- [29] ITU-T Rec. V.42 bis (01/90) Data compression procedures for data circuit-terminating equipment (DCE) using error correcting procedures
- [30] ITU-T Rec. X.721 (02/92) Information technology – Open Systems Interconnection - Structure of management information: definition of management information
- [31] Void
- [32] Void
- [33] Void
- [34] Void
- [35] Void
- [36] IETF RFC 768 (1980): "User Datagram Protocol" (STD 6).
- [37] IETF RFC 791 (1981): "Internet Protocol" (STD 5).
- [38] IETF RFC 792 (1981): "Internet Control Message Protocol" (STD 5).
- [39] IETF RFC 793 (1981): "Transmission Control Protocol" (STD 7).
- [40] ISO8824 (90) / X.208 (88): "Information technology - open System Interconnection - Specification of Abstract Syntax Notation One (ASN.1)".
- [41] ISO8824-1 (94) / X.680 (94): "Information technology - Abstract Syntax Notation One (ASN.1) - Specification of Basic Notation".

3 Definitions, abbreviations and symbols

3.1 Definitions

For the purposes of the present document the following definitions apply. Additional applicable definitions can be found in 3GPP TS 22.060 [3] and 3GPP TS 25.401 [14].

GPRS: Packet Services for GSM and UMTS systems.

(GSM only): indicates that this clause or paragraph applies only to a GSM system. For multi-system cases this is determined by the current serving radio access network.

(UMTS only): indicates that this clause or paragraph applies only to a UMTS system. For multi-system cases this is determined by the current serving radio access network.

In GSM,...: indicates that this paragraph applies only to GSM System. For multi system cases this is determined by the current serving radio access network.

In UMTS,...: indicates that this paragraph applies only to UMTS System. For multi system cases this is determined by the current serving radio access network.

inter-system change: a change of radio access between different radio access technologies such as GSM and UMTS.

MS: the present document makes no distinction between MS and UE.

2G- / 3G- : The prefixes 2G- and 3G- refer to functionality that supports only GSM or UMTS, respectively, e.g. 2G-SGSN refers only to the GSM functionality of an SGSN. When the prefix is omitted, reference is made independently from the GSM or UMTS functionality.

3.2 Abbreviations

For the purposes of the present document the following abbreviations apply. Additional applicable abbreviations can be found in 3GPP TS 21.905 [1].

APN	Access Point Name
BG	Border Gateway
BS	Billing System
BSS	Base Station Subsystem
CAMEL	Customised Applications for Mobile network Enhanced Logic
CAP	CAMEL Application Part
CDR	Call Detail Record
CG	Charging Gateway
CGF	Charging Gateway Functionality
C-ID	Charging ID
CMIP	Common Management Information Protocol
EDP	Event Detection Point
F/W	Firewall
FCI	Furnish Charging Information
FTAM	
G-CDR	Gateway GPRS Support Node – Call Detail Record
GGSN	Gateway GPRS Support Node
GPRS	General Packet Radio Service
GTP	GPRS Tunnelling Protocol
IHOSS:OSP	Internet Hosted Octet Stream Service: Octet Stream Protocol
IMEI	International Mobile Equipment Identity
IMSI	International Mobile Subscriber Identity
IP	Internet Protocol
IPv4	Internet Protocol version 4
IPv6	Internet Protocol version 6
M-CDR	Mobility Management - Call Detail Record
MS	Mobile Station
NE	Network Element
NMG	Network Management Gateway
NMN	Network Management Node
NSS	Network and Switching Subsystem
OMC	Operations and Maintenance Centre
OSF	Operations System Function
OSP	Octet Stream Protocol
PDN	Packet Data Network
PDP	Packet Data Protocol, e.g. IP
PLMN	Public Land Mobile Network
PPP	Point-to-Point Protocol
PSPDN	Packet Switched Public Data Network
RAB	Radio Access Bearer
RAC	Routing Area Code
RNC	Radio Network Controller
S-CDR	Serving GPRS Support Node – Call Detail Record

SAC	Service Area Code
SCF	Service Control Function
SCI	Send Charging Information
SGSN	Serving GPRS Support Node
SNDCP	Sub-Network Dependent Convergence Protocol
SNMP	Simple Network Management Protocol
SS7	Signalling System No. 7
SSF	Service Switching Function
S-SMO-CDR	SGSN delivered Short message Mobile Originated – Call Detail Record
S-SMT-CDR	SGSN delivered Short message Mobile Terminated – Call Detail Record
TDP	Trigger Detection Point
TID	Tunnel Identifier
UMTS	Universal Mobile Telecommunications System
URA	UTRAN Registration Area
USIM	Universal Subscriber Identity Module
UTRAN	UMTS Terrestrial Radio Access Network

3.3 Symbols

For the purposes of the present document the following symbols apply:

A	Interface between an MSC and a BSC.
Ga	Charging data collection interface between a CDR transmitting unit (e.g. GGSN or SGSN) and a CDR receiving functionality (CGF).
Gb	Interface between an SGSN and a BSC.
Gc	Interface between an GGSN and an HLR.
Gd	Interface between an SMS-GMSC and an SGSN, and between a SMS-IW MSC and an SGSN.
Gf	Interface between an SGSN and an EIR.
Gi	Reference point between GPRS and an external packet data network.
Gn	Interface between two GSNs within the same PLMN.
Gp	Interface between two GSNs in different PLMNs. The Gp interface allows support of GPRS network services across areas served by the co-operating GPRS PLMNs.
Gr	Interface between an SGSN and an HLR.
Gs	Interface between an SGSN and an MSC/VLR.
Iu	Interface between the RNS and the core network. It is also considered as a reference point.
kbit/s	Kilobits per second.
Mbit/s	Megabits per second. 1 Mbit/s = 1 million bits per second.
R	Reference point between a non-ISDN compatible TE and MT. Typically this reference point supports a standard serial interface.
Reporting Area	The service area for which an MS's location shall be reported.
Service Area	The location accuracy level needed for service management purposes in the 3G-SGSN, e.g. a routing area or a cell. The 3G-SGSN can request the SRNC to report: i) the MS's current service area; ii) when the MS moves into a given service area; or iii) when the MS moves out of a given service area.
Um	Interface between the Mobile Station (MS) and the GSM fixed network part. The Um interface is the GSM network interface for providing GPRS services over the radio to the MS. The MT part of the MS is used to access the GPRS services in GSM through this interface.

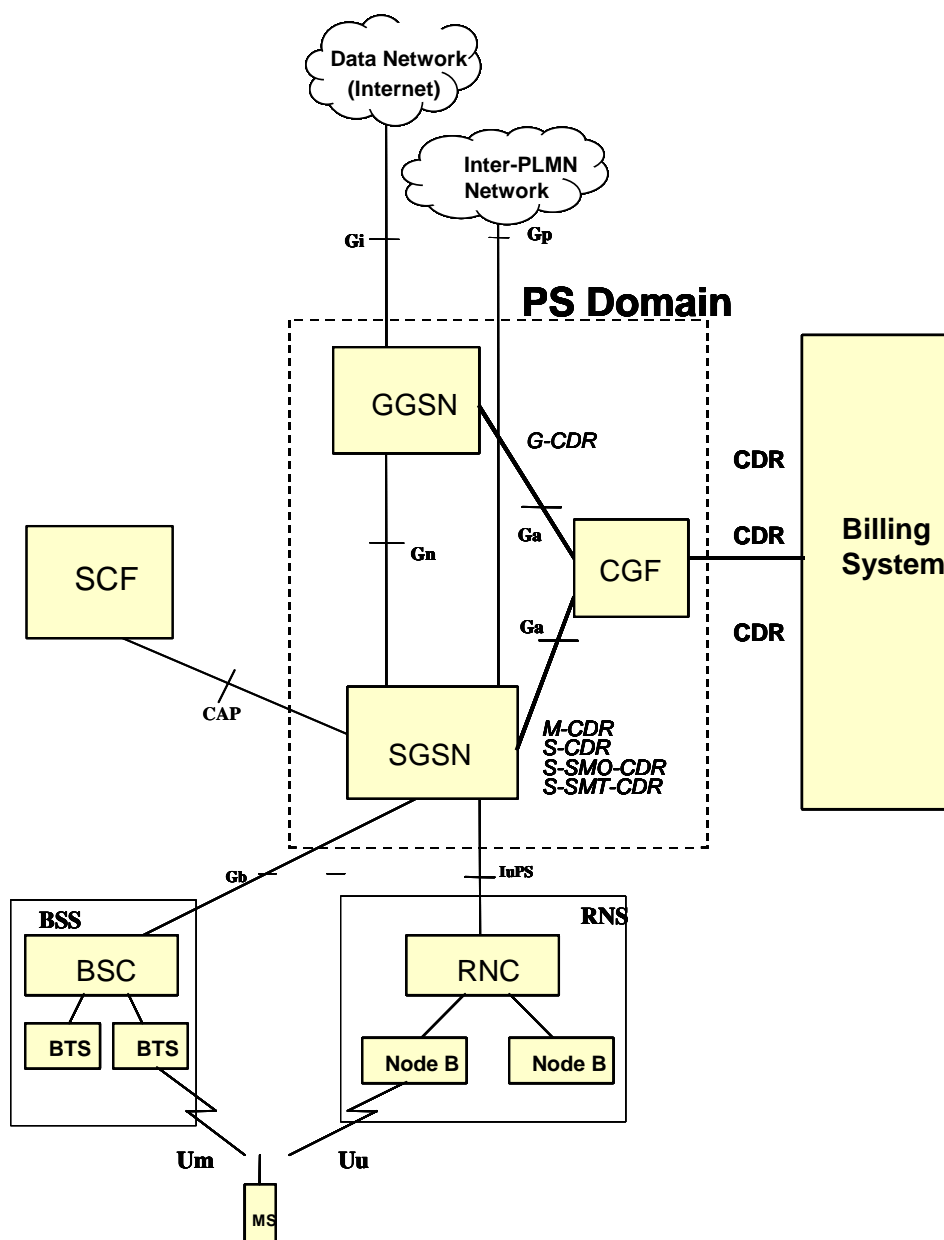

Figure 2: Packet Domain (PD) Charging logical architecture

4.1 Charging Gateway Functionality

The Charging Gateway Functionality (CGF) provides a mechanism to transfer charging information from the SGSN and GGSN nodes to the network operator's chosen Billing Systems (BS). The Charging Gateway concept enables an operator to have just one logical interface between the CGF and the BS. The CGF may be supported in one of the following ways:

- as a centralised separate Network Element – NE (Charging Gateway);
- as a distributed functionality resident in the SGSNs and GGSNs.

Support of the centralised or distributed CGF in a network is implementation dependent, and subject to vendor/matrix agreement. Regardless of the way in which the CGF is supported in the network, the functionality of the CGF is similar. Figure 3 gives an overview of the two basic configurations: In scenario 1, the GSNs support an external interface to the charging gateways they are connected to. In scenario 2, the GSNs support the charging gateway functionality internally.

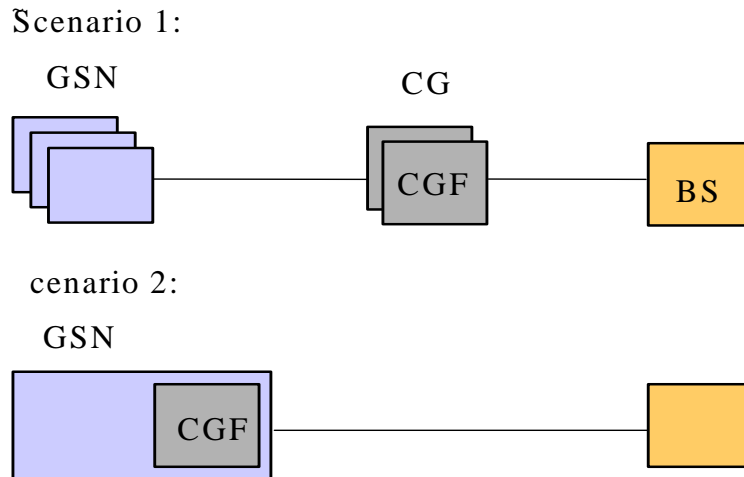

Figure 3: Basic architectural scenarios for the CGF location

If the GSNs with internal charging gateway functionality also support the external interface, additional configurations as shown in Figure 4 are possible. In scenario 3, the GSN with integrated charging gateway function also acts as CGF for other GSNs. In scenario 4, the GSN with integrated charging gateway function also supports the transmission of CDRs to external CGFs.

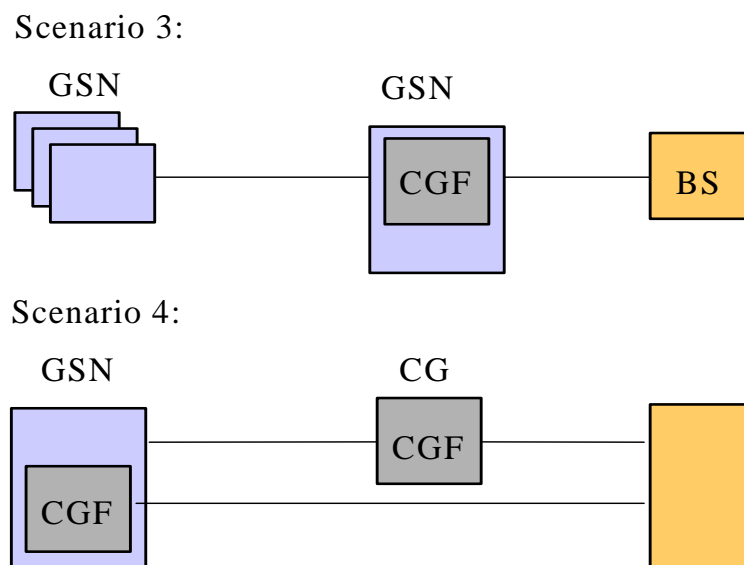

Figure 4: Optional scenarios for the CGF configuration

The four scenarios in Figure 4 and Figure 5 are not exhaustive.

The CGF provides the mechanism to transfer charging information from the SGSN and GGSN nodes to the network operator's chosen Billing Systems(s) (BSs). The main functions of the CGF are:

- the collection of GPRS CDRs from the GPRS nodes generating CDRs;
- intermediate CDR storage buffering;
- the transfer of the CDR data to the billing systems.

The CGF acts as storage buffer for real-time CDR collection. It provides the CDR data to the billing system. The present document identifies the external interfaces of the CGF, but does not specify the internal functionality of the CGF. However, in order to assist in the understanding of the CGF, it may perform specific activities, such as consolidation of CDRs, pre-processing of CDR fields, filtering of un-required CDR fields, and adding of Operator defined fields for specific billing systems. These specific activities may be performed to optimise the charging information that is to be forwarded to the Billing System, which should reduce the load in the Billing System.

In addition to the centralised CGF it is possible to have the CGF distributed to the SGSNs and/or GGSNs.

The CGF can reside in a separate Network Element (Charging Gateway) or be integrated in the GSNs. It can receive CDR fields from the GSNs in real-time mode. It should have enough storage to enable it to transmit the collected charging data to the Billing System (BS) in file mode.

The CGF may have to support several transmission protocols towards the Billing System, depending on the Billing System(s) used. One of the main purposes of the CG (or even just a CGF) is to reduce the number of different interfaces between the Billing System (BS) and the GGSNs and SGSNs sending charging data. If a new BS is introduced it shall be interfaced to the CGF, i.e. the protocol stacks and configurations of the GSNs do not need to be updated. The usage and load of mass memory media can be more evenly distributed. The portion of the CGF embedded into a single physical device is called the Charging Gateway entity. The CGF may be distributed to several physical Charging Gateways or GSNs, to facilitate redundancy. If that Charging Gateway entity that is the Primary Charging Gateway entity, does not respond to communication originating from the GSNs, the GSNs will try to send the CDR data to a Secondary Charging Gateway entity. Here each GSN will have several IP addresses (of different priority) for the Charging Gateway entities, thus avoiding downtime of the CGF.

5 Charging Principles

5.1 Requirements

Based on the requirements in 3GPP TS 22.115 here are the specific details relating to the packet domain.

- 1) Every PDP context shall be assigned a unique identity number for billing purposes. (i.e. the charging id).
- 2) Data volumes on both the uplink and downlink direction shall be counted separately. The data volumes shall reflect the data as delivered to and from the user.
- 3) The charging mechanisms shall provide the duration of the PDP context with date and time information.
- 4) The GPRS operator may define a subset of the charging information specified by GPRS charging standards. This means that it shall be possible to configure the SGSN and GGSN for the CDR information generated.
- 5) The GSNs shall be capable of handling specific charging characteristics provided through either HLR subscription data or default values. This is to improve charging record generation efficiency determined by the operator, based on the configuration of CDR trigger parameters at the GSNs.
- 6) SGSN shall support charging of CAMEL services.

5.2 Charging Information

Charging information in the GPRS network is collected for each MS by the SGSNs and GGSNs, which are serving that MS. The information that the operator uses to generate an invoice to the subscriber is operator-specific. Billing aspects, e.g. a regular fee for a fixed period, are outside the scope of the present document.

The SGSN collects charging information for each MS related with the radio network usage, while the GGSN collects charging information for each MS related with the external data network usage. Both GSNs also collect charging information on usage of the GPRS network resources.

The GSNs shall collect the following charging information:

1. usage of the radio interface: the charging information shall describe the amount of data transmitted in MO and MT directions categorised with QoS and user protocols;
2. usage duration: Duration of PDP context is counted as the time interval from PDP Context activation to PDP Context Deactivation.
3. usage of the general GPRS resources: the charging information shall describe the usage of other GPRS-related resources and the MSs GPRS network activity (e.g. mobility management).
4. destination and source: the charging information shall provide the actual source addresses used by the subscriber for the PDP context.. The charging information shall describe the destination addresses with a level of accuracy as determined by the Access Point Name (APN).

- usage of the external data networks: the charging information shall describe the amount of data sent and received to and from the external data network.

External networks can be identified by the Access Point Name (APN).

- location of MS: HPLMN, VPLMN, plus optional higher-accuracy location information.

The highest accuracy location information available in GGSN is SGSN address.

5.3 Charging Data Collection Principles

Call data record generation and contents should be flexible and unnecessary redundancy in data should be avoided.

- Each PDP context generates its own record types (the S-CDR for the SGSN and the G-CDR for the GGSN related to PDP contexts).
- The SGSN can optionally provide a record for mobility management of the attached MS in the M-CDR.
- The SGSN shall provide two SMS related records, in case of GPRS delivered MO short message S-SMO-CDR and MT short message S-SMT-CDR.
- MS Location information shall be included in the SGSN PDP context records.
- Records shall only include relevant information, i.e. traffic activity since last record.

The criteria for record generation is based on real-time needs, information safety (backup) and some specific events, such as expiry of the partial record timer(s), transferred data volume limit(s), inter SGSN routing area update, inter/intra system handover.

- Change of tariff period (if used) should not cause new CDRs to be sent to avoid peaks in data transfer. Instead such events should close the existing volume counters and open new ones when appropriate traffic is detected. This can be done by having a new record in the same message. It is up to the operator how often the CDRs are transferred from a GSN.
- Both SGSN and GGSN nodes shall collect information from same chargeable sessions (PDP contexts). A unique reference (Charging ID in combination with GGSN address) is needed to enable correlation between information from several records produced from same PDP context.
- The RNC shall collect the amount of not transferred downlink data, i.e., data that the RNC has either discarded or forwarded to a 2G-SGSN, for an MS's RABs when instructed by the 3G-SGSN.

5.3a Volume counting in RNC

The 3G-SGSN counts all downlink data sent to the RNC over Iu interface. Any discarded data between MS and RNC causes inaccurate charging, as the 3G-SGSN cannot account for this and subsequently causing overcharging. Additionally any buffered data in the RNC at RAB release or forwarded to another SGSN during handover is possible counted again i.e. twice, which causes overcharging.

To avoid inaccurate charging at the 3G-SGSN, the 3G-SGSN will always instruct the RNC at RAB set-up to count the unsent downlink data towards the MS.

The reporting of unsent data by the RNC to the 3G-SGSN will only occur at RAB release. Examples when this occurs are at termination of the PDP context, handover or PDP Context Preservation (see 3GPP TS 23.060 [8]).

The reporting of unsent data by the RNC to the 3G-SGSN will only occur at RAB release. This occurs at either the termination of the PDP context or handover.

The 3G-SGSN shall not use the optional 'Data Volume Request' message to RNC in any situation, as this shall cause a significant performance impact to both the RNC and 3G-SGSN.

When 3G-SGSN receives a report of unsent data volume from the RNC at RAB release. The 3G-SGSN shall report this value to the 'RNC Unsent Downlink Volume' field in the S-CDR.

5.4 Generation of Charging ID

The concept of serving connections is different in the GSM switching network to that for the GPRS network. Therefore different mechanisms are needed to supply the Billing System (BS) centres with charging information.

Circuit switched calls can be charged in one MSC (the anchor MSC) where all relevant data is available. That is guaranteed by routing all signalling information through the anchor MSC even if the traffic channel of a call is routed through another MSC due to handover.

In a GPRS network the complete PDP context handling can be switched over from an old SGSN to a new SGSN due to routing area updates with the consequence that charging records will be generated in more than one SGSN. Furthermore different data has to be collected in the SGSNs and GGSNs. So for one PDP context, charging records are needed from both the SGSN and GGSN.

The Billing System (BS) shall be provided with all relevant information from the network to charge for that one activated PDP context.

During the active PDP context all records, which belong to this context could normally be identified by the TID. However:

- an MS can activate and deactivate PDP contexts in a very short time interval, and these PDP contexts can have the same TID (only parallel established PDP contexts have different TIDs);
- different SGSNs can be involved in the same PDP context as described above;
- the timing clocks of the GSN elements may not be fully synchronised.

Therefore it is nearly impossible for a billing post-processing system to gather the records of one PDP context only by using the IMSI, NSAPI (TID) and time.

This is solved by assigning a unique Charging ID number (C-ID) to all records generated for that one PDP context.

The unique C-ID is generated in the GGSN when the PDP context is activated. A C-ID is generated for each activated context, so that each has a unique C-ID. The C-ID shall be transferred from the GGSN to the new SGSN in the routing area update response message. All CDRs for each activated PDP context generated by each SGSNs and GGSNs shall therefore contain the same unique combination of the C-ID and GGSN address, to permit subsequent Charging Gateway / Billing System (BS) correlation of the generated CDRs.

This combination of GGSN address together with the C-ID should be a unique identification over a long period of time in all GPRS networks.

5.5 Charging for SMS in GPRS

SMS transmission (MO or MT) can be provided over GPRS via the SGSN. The SGSN shall provide an S-SMO-CDR when short message is mobile originated and an S-SMT-CDR when it is mobile terminated. In addition, also SMS-IW MSC (MO-SMS) and SMS-GMSC (MT-SMS) may provide SMS related CDRs as described in 3GPP TS 32.005 [23].

No active PDP context is required when sending or receiving short messages. If the subscriber has an active PDP context, volume counters of S-CDR are not updated due to short message delivery.

The contents of S-SMO and S-SMT CDRs are presented in Table 8 and Table 9.

5.6 Charging Triggers – CDR Generation

The S-CDR, M-CDR, G-CDR, S-SMO-CDR and S-SMT-CDR are generated by the SGSN and GGSN to collect charging information such that they may be subsequently transferred to the Charging Gateway Function.

Charging Characteristics may be specified for a PDP context. It is determined as described in subclause 5.7.1.2 and 5.7.3. If set, it will determine the S-CDRs and G-CDRs generation and trigger values. If no Charging Characteristics are set for a PDP context, a default set of trigger values shall be applied.

In the GSNs it shall be possible to activate and deactivate CDR generation for each Charging Characteristics. If CDR generation is activated, it shall be possible to define separate trigger conditions values per Charging Characteristics for the following triggers:

- data volume limit;
- time (duration limit);
- maximum number of charging conditions changes (QoS change, Tariff Time change).

The following subclauses describe the trigger conditions for collection of charging information and CDR generation by the SGSN/GGSN.

5.6.1 Triggers for S-CDR Charging Information Collection

An S-CDR is used to collect charging information related to the PDP context data information for a GPRS mobile in the SGSN.

If according to the Charging Characteristics of a PDP context, CDR generation is activated an S-CDR shall be opened at PDP context activation, and record includes details such as Record Type, Served IMSI, Sequence Number etc. Not all of the charging information to be collected is static, and other charging information is directly dependent on dynamic GPRS usage.

The subsequent subclauses identify the conditions for adding information to, and closing of the S-CDR for generation towards the CGF.

5.6.1.1 Triggers for S-CDR Charging Information Addition

The "List of Traffic Volumes" attribute of the S-CDR consists of a set of containers, which are added when specific trigger conditions are met, and identify the volume count separated for uplink and downlink traffic on encountering that trigger condition.

Table 1: Triggers for S-CDR charging information addition

Trigger Conditions	Description/Behaviour
QoS Change	A change in the QoS shall result in a "List of Traffic Data Volumes" container being added to the CDR.
Tariff Time Change	On reaching the Tariff Time Change a "List of Traffic Data Volumes " container shall be added to the CDR.
CDR Closure	A list of "List of Traffic Data Volumes" container shall be added to the S-CDR.

5.6.1.2 Triggers for S-CDR Closure

The S-CDR shall be closed on encountering some trigger conditions. Table 2 identifies which conditions are supported to permit closure of the S-CDR.

Table 2: Triggers for S-CDR closure

Closure Conditions	Description/Behaviour
End of PDP Context within the SGSN	Deactivation of the PDP context in the SGSN shall result in the CDR being closed. The trigger condition covers:- <ul style="list-style-type: none"> - termination of PDP context, - SGSN change (inter-SGSN routing area update including system handover), - any abnormal release.
Partial Record Reason	O&M reasons permit the closure of the CDR for internal reasons. The trigger condition covers:- <ul style="list-style-type: none"> - data volume limit,

	<ul style="list-style-type: none"> - time (duration) limit, - maximum number of charging condition changes, - management intervention.
--	---

The Partial Record generation trigger thresholds are those associated to the Charging Characteristics of the related PDP context. The Charging Characteristics of the PDP context are determined as follows:

- If a "PDP context Charging Characteristics" is present in the subscriber's data for this PDP context, than it shall be used;
- If there is no "PDP context Charging Characteristics" but a "Subscribed Charging Characteristics" is present in the subscriber's data, the "Subscribed Charging Characteristics" shall be used;
- If neither a "PDP context Charging Characteristics" nor a "Subscribed Charging Characteristics" is present, a default charging profile shall be applied.

The Partial Record generation trigger thresholds are GSN configuration parameters defined by the operator through O&M means.

In the event that the S-CDR is closed and the PDP context remains active, a further S-CDR shall be opened with an incremented Sequence Number in the SGSN.

5.6.2 Triggers for M-CDR Charging Information Collection

An M-CDR is used to collect charging information related to the mobility management of a GPRS mobile in the SGSN.

An M-CDR shall be opened for each GPRS mobile upon GPRS Attach, and record details such as Record Type, Served IMSI, Sequence Number etc. Not all of the charging information to be collected is static, and other charging information is directly dependent on the mobility of the MS as provided by the Radio Access Network (RAN). Subsequent partial records may be opened if the M-CDR is closed and the MS is still attached to the network.

The subsequent subclauses identify the conditions for adding information to, and closing of the M-CDR for generation towards the CGF.

5.6.2.1 Triggers for M-CDR Charging Information Addition

The "Change of Location" attribute of the M-CDR consists of a set of containers, which are added when specific trigger conditions are met, and identify the time stamped routing area on encountering that trigger condition.

Table 3: Triggers for M-CDR Charging Information Addition

Trigger Conditions	Description/Behaviour
Mobility Change	A change in the Routing Area shall result in a "Change of Location" container being added to the M-CDR.

5.6.2.2 Triggers for M-CDR Closure

The M-CDR shall be closed on encountering some trigger conditions. Table 4 identifies which conditions are supported to permit closures of the M-CDR.

Table 4: Triggers for M-CDR closure

Closure Conditions	Description/Behaviour
End of MM Context within SGSN	Deactivation of the MM context in the SGSN shall result in the CDR being closed. The trigger condition covers:- <ul style="list-style-type: none"> - SGSN change (inter-SGSN routing area update including system handover), - GPRS detach, - any abnormal release.

Partial Record Reason	<p>O&M reasons permit the closure of the CDR for internal reasons. The trigger condition covers:-</p> <ul style="list-style-type: none"> - time (duration) limit, - maximum number of mobility changes, and - Management intervention, - Intra system handover (change of radio interface from GSM to 3G or visa versa).
-----------------------	--

In the event that the M-CDR is closed and the GPRS mobile is still known to the SGSN, a further logical M-CDR shall be opened with an incremented Sequence Number in the SGSN.

5.6.3 Triggers for G-CDR Charging Information Collection

A G-CDR is used to collect charging information related to the packet data information for a GPRS mobile in the GGSN.

If, according to the Charging Characteristics of a PDP context, CDR generation is activated a G-CDR shall be opened at PDP context activation, and record includes details such as Record Type, Served IMSI, Sequence Number etc. Not all of the charging information to be collected is static, and other charging information is directly dependent on dynamic GPRS usage.

A G-CDR shall be opened for each activated PDP context, and record details such as Record Type, Served IMSI, Sequence Number etc. Not all of the charging information to be collected is static, and other charging information is directly dependent on dynamic GPRS usage.

The "List of Traffic Data Volumes" attribute of the G-CDR consists of a set of containers, which are added following specific trigger conditions, and identify the volume count on encountering that trigger condition. The trigger conditions are as for the S-CDR (see subclause 5.6.1 on "Triggers for S-CDR Charging Information Collection") with exception that an SGSN change will not close the G-CDR. Subsequent partial records may be opened if the G-CDR is closed and the PDP context is still active.

The Partial Record generation trigger thresholds are those associated to the Charging Characteristics of the related PDP context determined as follows:

- If a "PDP context Charging Characteristics" is present in the PDP context data, it shall be used;
- Otherwise a default charging profile shall be applied.

The Partial Record generation trigger thresholds are GSN configuration parameters defined by the operator through O&M means.

In the event that the G-CDR is closed and the PDP context remains active, a further G-CDR is opened with an incremented Sequence Number in the GGSN.

5.7 Examples of charging scenarios

This subclause contains a number of example scenarios illustrating the purpose and practical usage of the various types of records defined in the previous subclauses. These examples are by no means exhaustive.

For the purpose of these examples the following assumptions have been made:

- the CDR records are sent to a CGF;
- the generation of all of the CDR record types has been enabled.

The following conventions have been used for the Figures 5, 6, 7 and 8, contained within this subclause:

- 1) Network connections and signalling transactions are illustrated by means of solid lines and referenced by number e.g. (1).
- 2) Operation & Maintenance actions, such as the transfer of call records, are represented by means of dotted lines and referenced by letter e.g. (A).

5.7.1 GPRS Mobile to PDN Context

Figure 5 illustrates a simple outgoing GPRS context from a PLMN GPRS subscriber "A" to a mainframe "B" via a PDN (1).

The respective PDP context is activated in the SGSN and GGSN and PDP PDUs are routed in MO and MT direction. The SGSN shall create an S-CDR and the GGSN shall create a G-CDR for subscriber "A".

The records generated are subsequently transferred to the CGF (A). The CGF transfers the CDRs to the BS.

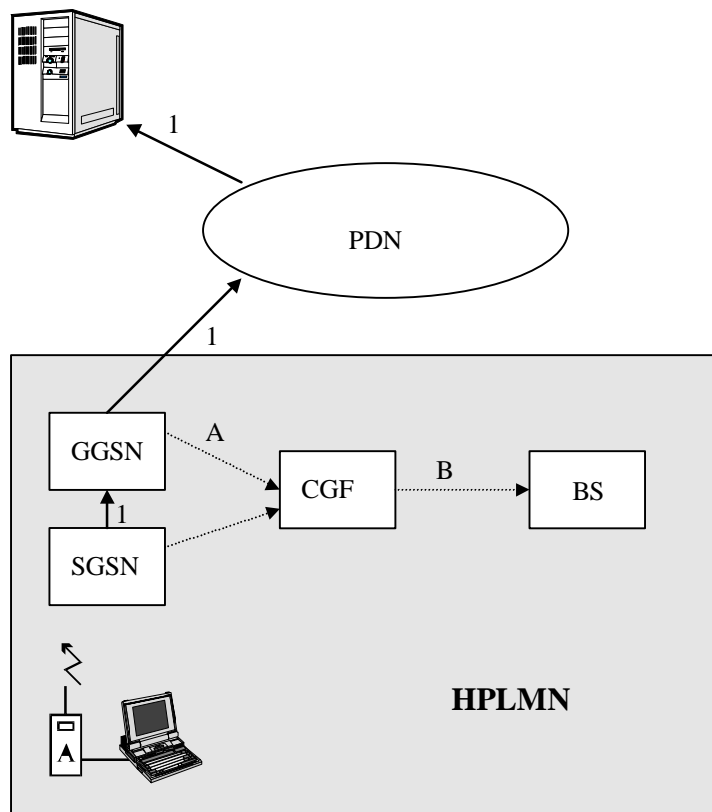

Figure 5: GPRS Mobile to PDN Context

5.7.2 GPRS Mobile to Mobile Context

Figure 6 illustrates a simple GPRS mobile to mobile context within the same HPLMN.

The respective A-party related PDP context is activated in the SGSN-A and the GGSN (1).

After the location of subscriber "B" is determined, the B party related PDP context is activated (2) in the SGSN-B and the GGSN and PDP PDUs are routed in MO and MT direction. The SGSN-A shall create an S-CDR and the GGSN shall create a G-CDR for subscriber A, the SGSN-B shall create an S-CDR and the GGSN shall create a G-CDR for subscriber "B".

If subscriber "A" and subscriber "B" use the same GGSN, both G-CDRs are produced at that GGSN.

If session leg (2) requires a PDP context activation the respective PDP records will contain a network initiated PDP context activation-flag.

The records generated are subsequently transferred to the CGF (A). The CGF transfers the CDRs to the BS.

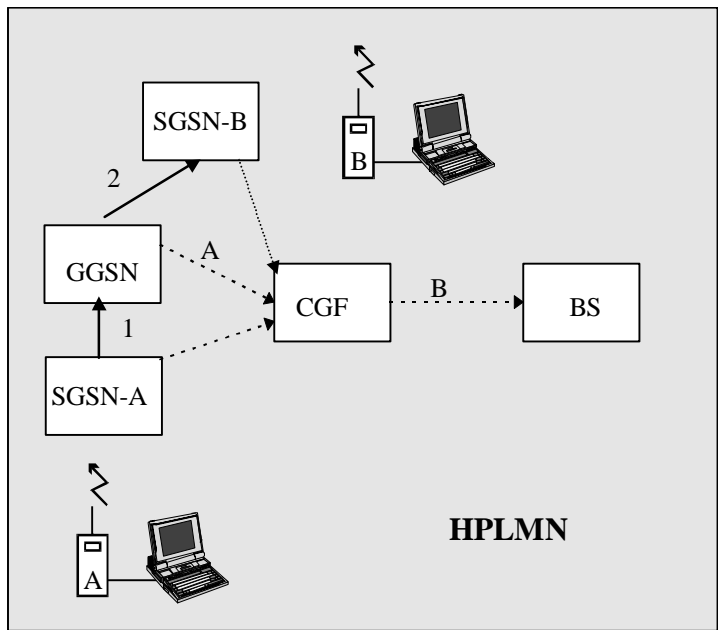

Figure 6: GPRS Mobile to Mobile Context

5.7.3 PDN to GPRS Mobile Context

Figure 7 illustrates a simple incoming GPRS context from a mainframe "A" to GPRS mobile subscriber "B" via a PDN (1). After the location of subscriber "B" is determined, the PDP context is activated (2).

The GGSN receiving the PDUs shall generate a G-CDR whereas the SGSN currently serving subscriber "B" creates an S-CDR. These records contain a flag that the PDP context is activated due to network request.

The records generated are subsequently transferred to the CGF (A). The CGF transfers the CDRs to the BS.

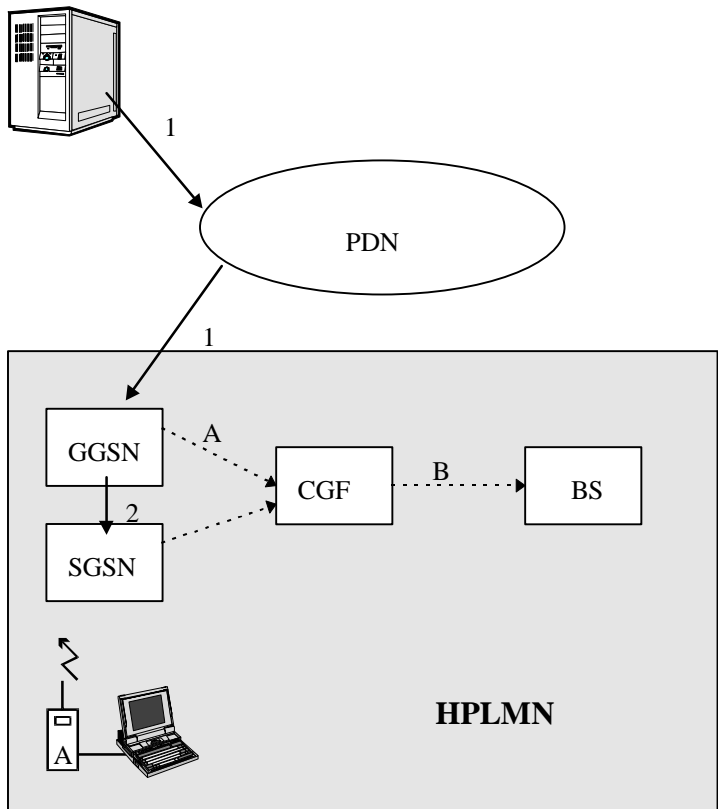

Figure 7: PDN to GPRS Mobile Context

5.7.4 GPRS Mobile to PDN Context while roaming, GGSN in HPLMN

Figure 8 illustrates an outgoing GPRS context from a roaming GPRS mobile subscriber "A" to mainframe "B" via Border Gateway, inter PLMN backbone and GGSN of the HPLMN (1).

The respective a-party related PDP context is activated in the SGSN and GGSN and PDUs are routed in MO and MT direction. The SGSN shall create an S-CDR (VPLMN) and a G-CDR is generated at the used GGSN (HPLMN) for subscriber "A". From the GGSN the packets are sent via the PDN to the mainframe "B".

The records generated in the HPLMN and the VPLMN are subsequently transferred to the CGFs (A). The CGFs transfer the CDRs to the BS. (B)

Later on the records created in the VPLMN are transferred from the BS to the BS of the HPLMN via TAP procedure (C).

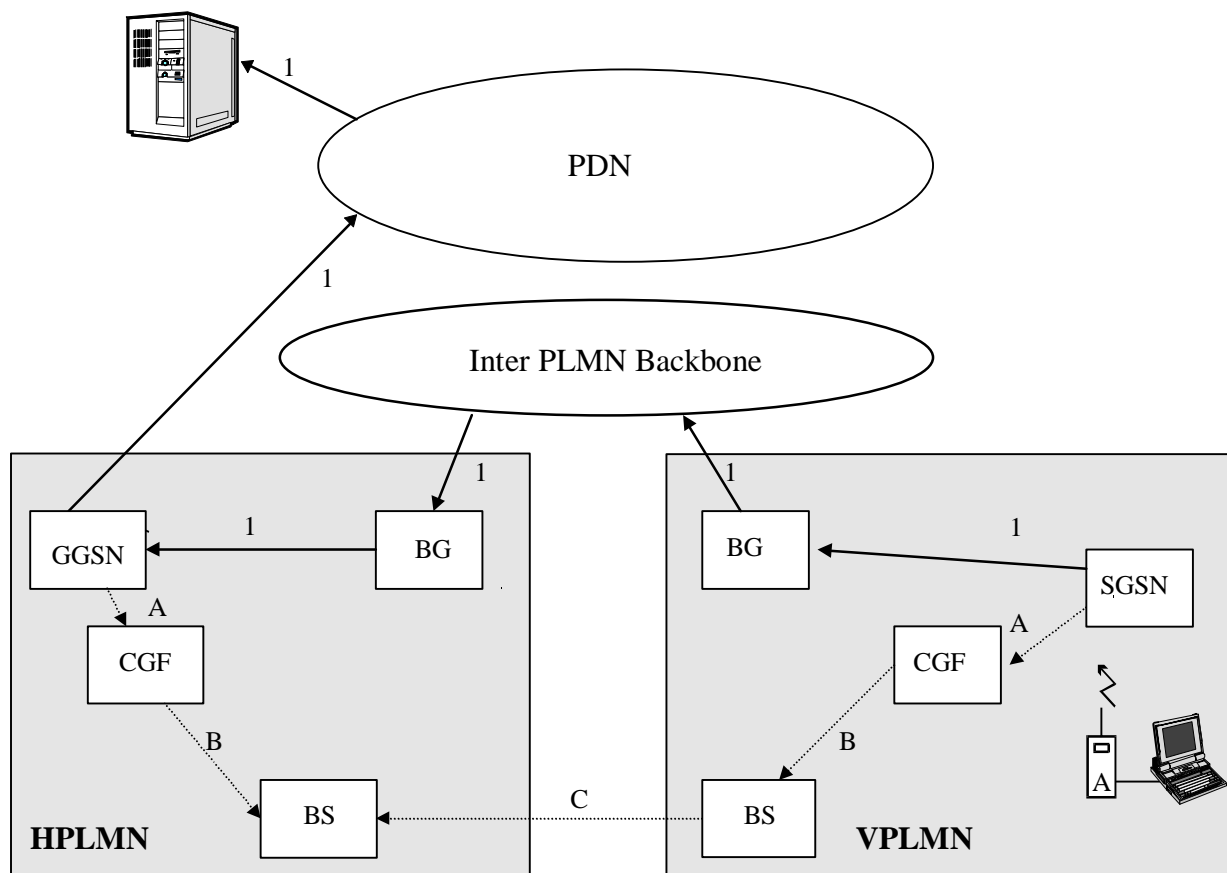

Figure 8: GPRS Mobile to PDN Context whilst roaming via BG

5.8 Charging support for CAMEL

CAMEL GPRS interworking can be activated for GPRS session, SGSN PDP context and mobile originated SMS based on subscription information stored in HLR. Control point for all CAMEL interactions in GPRS network domain reside at gprsSSF typically co-located with SGSN. GGSN is not aware of CAMEL service at all. For more information about CAMEL interworking (see 3GPP TS 23.078 [9]).

An M-CDR, S-CDR and S-SMO-CDR include basic information about CAMEL service information, such as service key and SCF address, and service usage, such as CAMEL modification information and amount of signalling. CAMEL service may also send transparent free format data in one or several messages to be stored in the CDR. Each received free format data indicates whether it is overwritten or appended to previously received free format data.

CAMEL service may deny the GPRS attach, PDP context activation or sending of short message. CAMEL service may also change the APN determined by SGSN before activating PDP context or it may change the destination information of short message.

CAMEL feature to download advice of charge parameters does not need to be supported because sending of these parameters down to MS and usage in the MS is not standardised for GPRS terminals. The message itself shall however be supported and in case of a relative tariff switch is received, then at that tariff switch time volume counts shall be reported to CAMEL service.

Tariff switch times configured in GSN and those received from CAMEL service are independent. Tariff time switches reported in CDRs must not be influenced by tariff time switches provided via CAMEL. In the context of CDRs only tariff time switches defined on GSN level are valid.

6 Charging Data Collection

6.1 Record contents

Tables 5, 6, 7, 8 and 9 describe the contents of each of the call and event records generated by the GSNs. Each table contains the name of the field, a key indicating whether or not the field is Mandatory (M), and a description of the contents.

The key field has the following meaning:

M This field is Mandatory and always present. Any exceptions to this rule are explicitly described.

C This field is only available under certain Conditions. If available the field is present.

The Conditions under which the field is available are individually described.

O This field is Optional and configurable either via additional TMN management functions or manufacturer specific means. For the avoidance of doubt, Optional does not mean that the parameter is not supported by the Network Element (NE). Equipment manufacturers shall be capable of providing all of these fields in order to claim conformance with the present document.

The Mandatory (M), Conditional (C) and Optional (O) designations are described at the GSN / CGF interface (see exceptions below) and may be available at the CGF / BS interface to meet the Billing System (BS) requirement.

All the Mandatory or Conditional fields are not required in all CDRs at the GSN / CGF interface in the following cases:

- Each information element is included at least in one record. This applies for situations where partial records are produced between the GSN and CGF, and the information has not changed, e.g. "Network Initiated PDP Context". The following primary identifier fields are however needed in all records: Record Type, Served IMSI, and if the CDR is related to a PDP context (G-CDR and S-CDR), GGSN Address, then also the Charging ID.
- GSNs are configured to produce only part of the described information. This applies for situations where record types are not produced or some functional component is excluded from the records such as whole M-CDR or time based charging in G-CDR.

In the case of a distributed CGF the following charging data records are not applicable at the GSN / CGF interface and proprietary solutions or variations to the present document are allowed. However, the described information content needs to be supported to be able to conform to the requirements towards the BS.

6.1.1 GPRS charging data in SGSN (S-CDR)

If the collection of CDR data is enabled then the following GSM or 3G SGSN data shall be available for each PDP context.

Table 5: GPRS SGSN PDP context data

Field		Description
Record Type	M	GPRS SGSN PDP context record.
Network Initiated PDP Context	C	Present if this is a network initiated PDP context.
System Type	C	Indicates the type of air interface used, e.g. UTRAN. This field is present when either the UTRAN or GERAN air-interface is used. It is omitted when the service is provided by a GSM air interface.
Served IMSI	M	IMSI of the served party (if Anonymous Access Indicator is FALSE or not supplied).
Served IMEI	C	The IMEI of the ME, if available.
Served MSISDN	O	The primary MSISDN of the subscriber.
SGSN Address	M	The IP address of the current SGSN.
MS Network Capability	O	The mobile station Network Capability.
Routing Area	O	Routing Area at the time of the record creation.
Local Area Code	O	Location area code at the time of the record creation.
Cell Identifier	O	Cell identity or Service Area Code (SAC) at the time of the record creation.
Charging ID	M	PDP context identifier used to identify this PDP context in different records created by GSNs
GGSN Address Used	M	The IP address of the GGSN currently used. The GGSN address is always the same for an activated PDP.
Access Point Name Network Identifier	M	The logical name of the connected access point to the external packet data network (network identifier part of APN).
APN Selection Mode	O	An index indicating how the APN was selected.
PDP Type	M	PDP type, i.e. IP, PPP, IHOSS:OSP
Served PDP Address	C	PDP address of the served IMSI, i.e. IPv4 or IPv6
List of Traffic Data Volumes	M	A list of changes in charging conditions for this PDP context, each time stamped. Charging conditions are used to categorise traffic volumes, such as per QoS/tariff period. Initial and subsequently changed QoS and corresponding data values are listed. In GSM, data volumes are in Octets above the SNDCP layer and are separated for uplink and downlink traffic. In 3G, data volumes are in octets above the GTP-U layer and are separated for uplink and downlink traffic.
Record Opening Time	M	Time stamp when PDP context activation is created in this SGSN or record opening time on following partial records
Duration	M	Duration of this record in the SGSN.
SGSN Change	C	Present if this is first record after SGSN change.
Cause for Record Closing	M	The reason for the release of record from this SGSN.
Diagnostics	O	A more detailed reason for the release of the connection.
Record Sequence Number	C	Partial record sequence number in this SGSN. Only present in case of partial records.
Node ID	O	Name of the recording entity
Record Extensions	O	A set of network/ manufacturer specific extensions to the record.
Local Record Sequence Number	O	Consecutive record number created by this node. The number is allocated sequentially including all CDR types.
Access Point Name Operator Identifier	M	The Operator Identifier part of the APN.
RNC Unsent Downlink Volume	C	The downlink data volume which the RNC has not sent to MS.
CAMEL Information	C	Set of CAMEL information related to PDP context. For more information see Description of Record Fields.
Charging Characteristics	C	The Charging Characteristics flag retrieved from subscriber's data as described in subclause 6.1.6.5.

6.1.2 GPRS charging data in GGSN (G-CDR)

If the collection of CDR data is enabled then the following GSM or 3G GGSN data shall be available for each PDP context.

Table 6: GPRS GGSN PDP context data

Field		Description
Record Type	M	GPRS GGSN PDP context record.
Network initiated PDP context	C	Present if this is a network initiated PDP context.
Served IMSI	M	IMSI of the served party (if Anonymous Access Indicator is FALSE or not supplied).
Served MSISDN	O	The primary MSISDN of the subscriber.
GGSN Address	M	The IP address of the GGSN used.
Charging ID	M	PDP context identifier used to identify this PDP context in different records created by GSNs
SGSN Address	M	List of SGSN addresses used during this record.
Access Point Name Network Identifier	M	The logical name of the connected access point to the external packet data network (network identifier part of APN).
APN Selection Mode	O	An index indicating how the APN was selected.
PDP Type	M	PDP type, i.e. IP, PPP, or IHQSS:OSP
Served PDP Address	C	PDP address, i.e. IPv4 or IPv6
Dynamic Address Flag	C	Indicates whether served PDP address is dynamic, which is allocated during PDP context activation.
List of Traffic Data Volumes	M	A list of changes in charging conditions for this PDP context, each time stamped. Charging conditions are used to categorise traffic volumes, such as per tariff period. Initial and subsequently changed QoS and corresponding data values are listed. In GSM, data volumes are in octets above the GTP layer and are separated for uplink and downlink traffic. In 3G, data volumes are in octets above the GTP-U layer and are separated for uplink and downlink traffic.
Record Opening Time	M	Time stamp when this record was opened.
Duration	M	Duration of this record in the GGSN.
Cause for Record Closing	M	The reason for the release of record from this GGSN.
Diagnostics	O	A more detailed reason for the release of the connection.
Record Sequence Number	C	Partial record sequence number, only present in case of partial records.
Node ID	O	Name of the recording entity.
Record Extensions	O	A set of network/ manufacturer specific extensions to the record.
Local Record Sequence Number	O	Consecutive record number created by this node. The number is allocated sequentially including all CDR types.
Charging Characteristics	C	The Charging Characteristics flag retrieved from subscriber's data as described in subclause 6.1.6.5.

6.1.3 GPRS mobile station mobility management data in SGSN (M-CDR)

If the collection of MS mobility management data is enabled then GSM or 3G SGSN shall start collecting information each time the mobile is attached to the SGSN.

Table 7: GPRS SGSN Mobile Station mobility management data

Field		Description
Record Type	M	GPRS SGSN mobility management record.
Served IMSI	M	IMSI of the MS.
Served IMEI	C	The IMEI of the ME, if available.
Served MSISDN	O	The primary MSISDN of the subscriber.
SGSN Address	M	The IP address of the current SGSN.
MS Network Capability	O	The mobile station network capability.
Routing Area	O	Routing Area at the time of the record creation..
Local Area Code	O	Location Area Code at the time of record creation.
Cell Identifier	O	The Cell Identity or Service Area Code (SAC) at the time of the record creation.
Change of Location	O	A list of changes in Routing Area Identity, each time stamped.
Record Opening Time	M	Timestamp when this record was opened.
Duration	O	Duration of this record.
SGSN Change	C	Present if this is first record after SGSN change.
Cause for Record Closing	M	The reason for the release of the record in this SGSN.
Diagnostics	O	A more detailed reason for the release of the connection.
Record Sequence Number	C	Partial record sequence number in this SGSN; only present in case of partial records.
Node ID	O	Name of the recording entity.
Record Extensions	O	A set of network/ manufacturer specific extensions to the record.
Local Record Sequence Number	O	Consecutive record number created by this node. The number is allocated sequentially including all CDR types.
Charging Characteristics	C	The Charging Characteristics flag set used by the SGSN.
System Type	C	Indicates the type of air interface used, e.g. UTRAN. This field is present when either the UTRAN or GERAN air-interface is used. It is omitted when the service is provided by a GSM air interface.
CAMEL Information	C	Set of CAMEL related to Attach/Detach session. For more information see Description of Record Fields.

6.1.4 GPRS MO SMS data in SGSN (S-SMO-CDR)

If enabled, an S-SMO-CDR SGSN Mobile originated SMS record shall be produced for each short message sent by a mobile subscriber via the SGSN.

Table 8: SGSN Mobile originated SMS record

Field		Description
Record Type	M	SGSN Mobile Originated SMS.
Served IMSI	M	The IMSI of the subscriber.
Served IMEI	O	The IMEI of the ME, if available.
Served MSISDN	O	The primary MSISDN of the subscriber.
MS Network Capability	M	The mobile station network capability.
Service Centre	M	The address (E.164) of the SMS-service centre.
Recording Entity	M	The E.164 number of the SGSN.
Location Area Code	O	The Location Area Code from which the message originated.
Routing Area Code	O	The Routing Area Code from which the message originated.
Cell Identifier	O	The Cell Identity or Service Area Code (SAC) from which the message originated.
Event Time Stamp	M	The time at which the message was received by the SGSN from the subscriber.
Message Reference	M	A reference provided by the MS uniquely identifying this message.
SMS Result	C	The result of the attempted delivery if unsuccessful.
Record Extensions	O	A set of network/ manufacturer specific extensions to the record.
Node ID	O	Name of the recording entity.
Local Record Sequence Number	O	Consecutive record number created by this node. The number is allocated sequentially including all CDR types.
Charging Characteristics	C	The Charging Characteristics flag set used by the SGSN.
System Type	C	Indicates the type of air interface used, e.g. UTRAN. This field is present when either the UTRAN or GERAN air-interface is used. It is omitted when the service is provided by a GSM air interface.
Destination Number	O	The destination short message subscriber number.
CAMEL Information	C	Set of CAMEL information related to SMS session. For more information see Description of Record Fields.

6.1.5 GPRS MT SMS data in SGSN (S-SMT-CDR)

If enabled, an SGSN Mobile terminated SMS record shall be produced for each short message received by a mobile subscriber via the SGSN.

Table 9: SGSN Mobile terminated SMS record

Field		Description
Record Type	M	SGSN Mobile terminated SMS.
Served IMSI	M	The IMSI of the subscriber.
Served IMEI	O	The IMEI of the ME, if available.
Served MSISDN	O	The primary MSISDN of the subscriber.
MS Network Capability	M	The mobile station network capability
Service Centre	M	The address (E.164) of the SMS-service centre.
Recording Entity	M	The E.164 number of the SGSN.
Location Area Code	O	The Location Area Code to which the message was delivered.
Routing Area Code	O	The Routing Area Code to which the message was delivered.
Cell Identifier	O	The Cell Identity or Service Area Code (SAC) to which the message was delivered.
Event Time Stamp	M	Delivery time stamp, time at which message was sent to the MS by the SGSN.
SMS Result	C	The result of the attempted delivery if unsuccessful.
Record Extensions	O	A set of network/ manufacturer specific extensions to the record.
Node ID	O	Name of the recording entity.
Local Record Sequence Number	O	Consecutive record number created by this node. The number is allocated sequentially including all CDR types.
Charging Characteristics	C	The Charging Characteristics flag set used by the SGSN.
System Type	C	Indicates the type of air interface used, e.g. UTRAN. This field is present when either the UTRAN or GERAN air-interface is used. It is omitted when the service is provided by a GSM air interface.

6.1.6 Description of Record Fields

This subclause contains a brief description of each field of the CDRs described in the previous subclause.

6.1.6.1 Access Point Name (APN) Network/Operator Identifier

These fields contain the actual connected Access Point Name Network/Operator Identifier determined either by MS, SGSN or modified by CAMEL service. An APN can also be a wildcard, in which case the SGSN selects the access point address.

The APN Network Identifier containing more than one label corresponds to an Internet domain name. The APN Operator Identifier is composed of three labels. The first and second labels together shall uniquely identify the GPRS PLMN (e.g. "operator name>.<operator group>.gprs").

See 3GPP TS 23.003 [4] and 3GPP TS 23.060 [8] for more information about APN format and access point decision rules.

6.1.6.2 APN Selection Mode

This field indicates how the SGSN selected the APN to be used. The values and their meaning are as specified in 3GPP TS 29.060 [22] subclause 7.9 'Information elements'.

6.1.6.3 CAMEL Information

This field includes following CAMEL information elements for PDP context (S-CDR), Attach/Detach session (M-CDR) and Mobile originated SMS (S-SMO-CDR) if corresponding CAMEL service is activated.

- CAMEL Access Point Name NI (S-CDR)

This field contains the network identifier part of APN before modification by the SCF.
- CAMEL Access Point Name OI (S-CDR)

This field contains the operator identifier part of APN before modification by the SCF.
- CAMEL Calling Party Number (S-SMO-CDR)

This field contains the Calling Party Number modified by the CAMEL service.
- CAMEL Destination Subscriber Number (S-SMO-CDR)

This field contains the short message Destination Number modified by the CAMEL service.
- CAMEL SMSC Address (S-SMO-CDR)

This field contains the SMSC address modified by the CAMEL service.
- SCF address (S-CDR, M-CDR, S-SMO-CDR)

This field identifies the CAMEL server serving the subscriber. Address is defined in HLR as part of CAMEL subscription information
- Service key (S-CDR, M-CDR, S-SMO-CDR)

This field identifies the CAMEL service logic applied. Service key is defined in HLR as part of CAMEL subscription information.
- Default Transaction/SMS Handling (S-CDR, M-CDR, S-SMO-CDR)

This field indicates whether or not a CAMEL encountered default GPRS- or SMS-handling. This field shall be present only if default call handling has been applied. Parameter is defined in HLR as part of CAMEL subscription information.
- Free Format Data (S-CDR, M-CDR, S-SMO-CDR)

This field contains charging information sent by the gsmSCF in the Furnish Charging Information GPRS messages as defined in 3GPP TS 29.078 [20]. The data can be sent either in one FCI message or several FCI messages with append indicator. This data is transferred transparently in the CAMEL sections of the relevant call records.

If the FCI is received more than once during one CAMEL call, the append indicator defines whether the FCI information is appended to previous FCI and stored in the relevant record or the information of the last FCI received is stored in the relevant record (the previous FCI information shall be overwritten).

In the event of partial output the currently valid 'Free format data' is stored in the partial record.

- FFD Append Indicator (S-CDR, M-CDR)

This field contains an indicator whether CAMEL free format data is to be appended to free format data stored in previous partial CDR. This field is needed in CDR post processing to sort out valid free format data for that call leg from sequence of partial records. Creation of partial records is independent on received FCIs and thus valid free format data may be divided to different partial records.

If field is missing then free format data in this CDR replaces all received free format data in previous CDRs. Append indicator is not needed in the first partial record. In following partial records indicator shall get value true if all FCIs received during that partial record have append indicator. If one or more of the received FCIs for that call leg during the partial record do not have append indicator then this field shall be missing.

- Level of CAMEL services (S-CDR, M-CDR)

This field describes briefly the complexity of CAMEL invocation. Categories are same than in circuit switched services and measure of resource usage in VPLMN requested by HPLMN.

- 'Basic' means that CAMEL feature is invoked during the PDP context activation phase only (e.g. to modify APN_NI / APN_OI).

- 'Call duration supervision' means that PDP context duration or volume supervision is applied in the gprsSSF of the VPLMN (Apply Charging message is received from the gsmSCF)

- Number of DP encountered (S-CDR, M-CDR)

This field indicates how often armed CAMEL detection points (TDP and EDP) were encountered and is a measure of signalling between VPLMN and CAMEL service and complements 'Level of CAMEL service' field.

- SMSReferenceNumber (S-SMO-CDR)

This parameter contains the SMS Reference Number assigned to the Short Message by the SGSN.

6.1.6.4 Cause for Record Closing

This field contains a reason for the release of the CDR including the following:

- normal release: PDP context release or GPRS detach;
- partial record generation: data volume limit, time (duration) limit, SGSN change or maximum number of changes in charging conditions;
- abnormal termination (PDP or MM context);
management intervention (request due to O&M reasons).

A more detailed reason may be found in the diagnostics field.

6.1.6.5 Charging Characteristics

The Charging Characteristics field as defined in Figure 8a allows the operator to apply different kind of charging methods for the CDRs. The N flag in the Charging Characteristics indicates normal charging, the P flag indicates prepaid charging, the F flag indicates flat rate charging and the H flag indicates charging by hot billing. The 2nd octet is reserved for future use. One or more of the flags shall be set according to the charging characteristics received from the HLR and transmitted by the CDR generating node over the Ga interface.

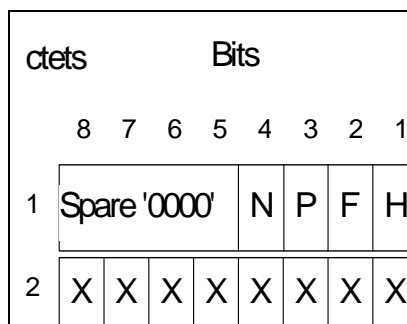

Figure 8a: Charging Characteristics flags

Charging Characteristics in S-CDR is determined by the SGSN as follows:

- If a "PDP context Charging Characteristics" is present in the subscriber's data for this PDP context, than it shall be used,
- If there is no "PDP context Charging Characteristics" but a "Subscribed Charging Characteristics" is present in the subscriber's data, the "Subscribed Charging Characteristics" shall be used.

Charging Characteristics in G-CDR corresponds to the "Charging characteristics" information of the PDP context data in the GGSN.

6.1.6.6 Charging ID

This field is a charging identifier, which can be used together with GGSN address to identify all records produced in SGSN(s) and GGSN involved in a single PDP context. Charging ID is generated by GGSN at PDP context activation and transferred to context requesting SGSN. At inter-SGSN routing area update charging ID is transferred to the new SGSN as part of each active PDP context.

Different GGSNs allocate the charging ID independently of each other and may allocate the same numbers. The CGF and/or BS may check the uniqueness of each charging ID together with the GGSN address and optionally (if still unambiguous) with the record opening time stamp.

6.1.6.7 Destination Number

This field contains short message Destination Number requested by the user.

6.1.6.8 Diagnostics

This field includes a more detailed technical reason for the release of the connection and may contain one of the following:

- a MAP error from 3GPP TS 29.002 [21];
- a Cause from 3GPP TS 24.008 [13].

The diagnostics may also be extended to include manufacturer and network specific information.

6.1.6.9 Duration

This field contains the relevant duration in seconds for PDP contexts (S-CDR, G-CDR, and attachment (M-CDR)). For partial records this is the duration of the individual partial record and not the cumulative duration.

It should be noted that the internal time measurements may be expressed in terms of tenths of seconds or even milliseconds and, as a result, the calculation of the duration may result in the rounding or truncation of the measured duration to a whole number of seconds.

Whether or not rounding or truncation is to be used is considered to be outside the scope of the present document subject to the following restrictions:

- 1) A duration of zero seconds shall be accepted providing that the transferred data volume is greater than zero.

- 2) The same method of truncation/rounding shall be applied to both single and partial records.

6.1.6.10 Dynamic Address Flag

This field indicates that PDP address has been dynamically allocated for that particular PDP context. This field is missing if address is static i.e. part of PDP context subscription. Dynamic address allocation might be relevant for charging e.g. the duration of PDP context as one resource offered and possible owned by network operator.

6.1.6.11 Event Time Stamps

These fields contain the event time stamps relevant for each of the individual record types.

All time-stamps include a minimum of date, hour, minute and second.

6.1.6.12 GGSN Address/GGSN Address Used

These fields are the current serving GGSN IP address for the control plane.

6.1.6.13 List of Traffic Data Volumes

This list includes one or more containers, which each include the following fields:

Data Volume Uplink, Data Volume Downlink, Change Condition and Time Stamp.

Data Volume includes the number of octets transmitted during the use of packet data services.

Change condition defines the reason for closing the container (see 5.7.1 and 5.7.3), such as tariff time change, QoS change or closing the CDR. Change time is a time stamp, which defines the moment when the new volume counts are started or CDR is closed. All the active PDP contexts do not need to have exactly the same time stamp e.g. due to same tariff time change (variance of the time stamps is implementation and traffic load dependent, and is out of the scope of standardisation).

First container includes following optional fields: QoS Requested (not in G-CDR) and QoS Negotiated. In following containers QoS Negotiated is present if previous change condition is "QoS change". In addition to the QoS Negotiated parameter the QoS Requested parameter is present in following containers if the change condition is "QoS change" and the QoS change was initiated by the MS via a PDP context modification procedure.

Following is an example of a list, which has three containers (sets of volume counts) caused by one QoS change and one tariff time change.

Table 10: Example list of traffic data volumes

QoS Requested = QoS1	QoS Requested = QoS2 (if requested by the MS)	
QoS Negotiated = QoS1	QoS Negotiated = QoS2	
Data Volume Uplink = 1	Data Volume Uplink = 5	Data Volume Uplink = 3
Data Volume Downlink = 2	Data Volume Downlink = 6	Data Volume Downlink = 4
Change Condition = QoS change	Change Condition = Tariff change	Change Condition = Record closed
Time Stamp = TIME1	Time Stamp = TIME2	Time Stamp = TIME3

First container includes initial QoS values and corresponding volume counts. Second container includes new QoS values and corresponding volume counts before tariff time change. Last container includes volume counts after the tariff time change. Following total volume counts can be itemised (tariff1 is used before and tariff2 after the tariff time change):

		Container
QoS1+Tariff1	uplink = 1, downlink = 2	1
QoS2+Tariff1	uplink = 5, downlink = 6	2
QoS2+Tariff2	uplink = 3, downlink = 4	3
QoS1	uplink = 1, downlink = 2	1
QoS2	uplink = 8, downlink = 10	2+3
Tariff1	uplink = 6, downlink = 8	1+2
Tariff2	uplink = 3, downlink = 4	1

The amount of data counted in the GGSN shall be the data volume sent over the GTP layer. Therefore the data counted already includes the IP PDP bearer protocols i.e. IP, TCP or UDP Headers.

The data volume counted in the SGSN covers the amount of data transferred in the SNDCP PDUs. Therefore the data counted already includes the overheads of any PDP bearer protocols.

The amount of data counted in the 3G-GGSN shall be the data volume sent over the GTP-U layer. Therefore the data counted already includes the overheads of any PDP bearer protocols.

The data volume counted in the 3G-SGSN covers the amount of data transferred in the GTP-U PDUs. Therefore the data counted already includes the overheads of any PDP bearer protocols.

In GSM, in order to avoid that downstream packets transmitted from the old SGSN to the new SGSN at inter SGSN RA update induce the increase of the PDP CDR downstream volume counters in both SGSN the following rule is followed:

- For PDP contexts using LLC in unacknowledged mode: an SGSN shall update the PDP CDR when the packet has been sent by the SGSN towards the MS;
- In GSM, for PDP contexts using LLC in acknowledged mode a 2G-SGSN shall only update the PDP CDR at the reception of the acknowledgement by the MS of the correct reception of a downstream packet. This implies that for downstream packets under transmission at inter SGSN RA update a packet sent by the old SGSN actually received by the MS and acknowledged by the MS towards the new SGSN through the RA update complete message induces the update of the PDP CDR record by the new SGSN. In UMTS, the not transferred downlink data 'RNC Unsent Downlink Volume' can be accounted for in the S-CDR, i.e. data that the RNC has either discarded or forwarded during handover.
- In UMTS, The not transferred downlink data 'RNC Unsent Downlink Volume' can be accounted for in the S-CDR, i.e. data that the RNC has either discarded or forwarded during handover.

Data volumes retransmitted (by RLC or LLC) due to poor radio link conditions shall not be counted.

6.1.6.14 Local Record Sequence Number

This field includes a unique record number created by this node. The number is allocated sequentially including all CDR types. The number is unique within one node, which is identified either by field Node ID or by record-dependent node address (SGSN address, GGSN address, Recording Entity).

The field can be used e.g. to identify missing records in post processing system.

6.1.6.15 Message reference

This field contains a unique message reference number allocated by the Mobile Station (MS) when transmitting a short message to the service centre. This field corresponds to the TP-Message-Reference element of the SMS_SUBMIT PDU defined in 3GPP TS 23.040 [7].

6.1.6.16 MS Network Capability

This MS Network Capability field contains the MS network capability value of the MS network capability information element of the served MS on PDP context activation or on GPRS attachment as defined in 3GPP TS 24.008 [13].

6.1.6.17 Network Initiated PDP Context

This field indicates that PDP context is network initiated. The field is missing in case of mobile activated PDP context.

6.1.6.18 Node ID

This field contains an optional operator configurable identifier string for the node, which generated the CDR.

6.1.6.19 PDP Type

This field defines the PDP type, e.g. IP, PPP, or IHQSS:OSP (see 3GPP TS 29.060 [22] for exact format).

6.1.6.20 QoS Requested/QoS Negotiated

Quality of Service Requested contains the QoS wanted by MS at PDP context activation. QoS Negotiated indicates the applied QoS accepted by the network.

If a pre-Release '99 only capable terminal is served, the QoS profile consists of five (5) attributes as follows: reliability, delay, precedence, peak throughput and mean throughput. The encoding of this QoS profile shall be in accordance with GSM 12.15.

In Release 99, the QoS profile consists of the above 2G parameters plus the following UMTS attributes: Traffic class ('conversational', 'streaming', 'interactive', 'background'), Maximum bit-rate (kbps), Delivery order (y/n), Maximum SDU size (octets), SDU error ratio, Residual bit error ratio, Delivery of erroneous SDUs (y/n/-), Transfer delay (ms), Traffic handling priority, Allocation/Retention Priority. This QoS profile shall be encoded according to the "Quality of Service (QoS) Profile" parameter specified in 3GPP TS 29.060 [22].

6.1.6.21 Record Extensions

This field enables network operators and/or manufacturers to add their own Recommendation extensions to the standard record definitions. This field contains a set of "management extensions" as defined in ITU-T X.721 [30].

6.1.6.22 Record Opening Time

This field contains the time stamp when the record is opened (see 3GPP TS 32.005 [23] for exact format).

Record opening reason does not have a separate field. For G-CDR and M-CDR it can be derived from the field "Sequence number"; i.e. missing field or value one means activation of PDP context and GPRS attachment. For S-CDR also field "SGSN change" need to be taken into account.

6.1.6.23 Record Sequence Number

This field contains a running sequence number employed to link the partial records generated in the SGSN/GGSN for a particular PDP context (characterised with same the Charging ID and GGSN address pair). In the S-CDR the sequence number is always started from one after inter-SGSN routing area update, see field "SGSN change". The Record Sequence Number is missing if the record is the only one produced in the SGSN/GGSN for the PDP context (e.g. inter-SGSN routing area update can result to two S-CDRs without sequence number and field "SGSN update" present in the second record).

6.1.6.24 Record Type

The field identifies the type of the record e.g. S-CDR, G-CDR, M-CDR, S-SMO-CDR and S-SMT-CDR.

6.1.6.25 Recording Entity Number

This field contains the ITU-T E.164 number assigned to the entity that produced the record. For further details see 3GPP TS 23.003 [4].

6.1.6.26 RNC Unsent Downlink Volume

This field contains the unsent downlink volume that the RNC has either discarded or forwarded to 2G-SGSN and already included in S-CDR. This field is present when RNC has provided unsent downlink volume count at RAB release and can be used by a downstream system to apply proper charging for this PDP context.

6.1.6.27 Routing Area Code/Cell Identifier/Change of location

The location information contains a combination of the Routing Area Code (RAC) and an optional Cell Identifier of the routing area and cell in which the served party is currently located. In 2G domain the Cell Identifier is defined by the Cell Identity (CI) and in 3G domain by the Service Area Code (SAC). Any change of location (i.e. Routing Area change) may be recorded in the change of location field including the time at which the change took place.

The change of location field is optional and not required if partial records are generated when the location changes.

The RAC and (optionally) CI are coded according to 3G TS 24.008 [13] and the SAC according 3GPP TS 25.413 [15].

6.1.6.28 Served IMEI

This field contains the International Mobile Equipment Identity (IMEI) of the equipment served. The term "served" equipment is used to describe the ME involved in the transaction recorded e.g. the called ME in the case of a network initiated PDP context.

The structure of the IMEI is defined in 3GPP TS 23.003 [4].

6.1.6.29 Served IMSI

This field contains the International Mobile Subscriber Identity (IMSI) of the served party. The term "served" party is used to describe the mobile subscriber involved in the transaction recorded e.g. the calling subscriber in case of a mobile initiated PDP context.

The structure of the IMSI is defined in 3GPP TS 23.003 [4].

6.1.6.30 Served MSISDN

This field contains the Mobile Station (MS) ISDN number (MSISDN) of the served party. The term "served" party is used to describe the mobile subscriber involved in the transaction recorded e.g. the called subscriber in case of an MTC record. In case of multi-numbering the MSISDN stored in an MOC record will be the primary MSISDN of the calling party.

The structure of the MSISDN is defined in 3GPP TS 23.003 [4].

6.1.6.31 Served PDP Address

This field contains the PDP address of the served IMSI. This is a network layer address i.e. of type IP version 4, IP version 6. The address for each PDP type is allocated either temporarily or permanently (see "Dynamic Address Flag" field in subclause 6.1.6.10). This parameter shall be present except when both the PDP type is PPP and dynamic PDP address assignment is used.

6.1.6.32 Service Centre Address

This field contains a ITU-T E.164 number identifying a particular service centre e.g. Short Message Service (SMS) centre (see 3GPP TS 23.040 [7]).

6.1.6.33 SGSN Address

These fields contain one or several IP addresses of SGSN.

The S-CDR fields contain single address of current SGSN and GGSN used.

The G-CDR fields contains the address of the current GGSN and a list of SGSNs, which have been connected during the record (SGSN change due to inter SGSN Routing Area update).

The M-CDR only contains the address of the current SGSN. The M-CDR does not identify any information related to active PDP context(s) and thus does not know connected (used) GGSN(s).

6.1.6.34 SGSN Change

This field is present only in the S-CDR to indicate that this is the first record after an inter-SGSN routing area update.

6.1.6.35 Short Message Service (SMS) Result

This field contains the result of an attempt to deliver a short message either to a service centre or to a mobile subscriber (see 3GPP TS 29.002). Note that this field is only provided if the attempted delivery was unsuccessful.

6.1.6.36 System Type

This field is present conditionally, indicating the use of the UTRAN or GERAN air-interface for the provision of service recorded by this CDR. In the case of service provided by a GSM air interface, this field is not present.

NOTE: The ASN.1 contains a value of "unknown" which may be used in other domains but not in the PS domain.

7 Charging Protocols

The GTP' charging protocol is optional. GPRS nodes generate CDRs. These CDRs are to be collected by the CGF. The protocol GTP' has been designed to provide this CDR collection.

The CGF-BS interface is also described in this subclause.

7.1 GPRS CDR Collection by GTP' Protocol

The GTP' protocol has been designed to deliver GPRS CDR's to the CGF(s) from those Network Elements (NEs) or functional entities generating charging records. The GTP' protocol is required when the CGF resides in alternate nodes to those CDR generating nodes (e.g. the SGSN and GGSN). The GTP' protocol designed for GPRS charging data collection has been derived from the GTP protocol (defined in 3GPP TS 29.060 [22]) which is used for packet data tunnelling in the GPRS backbone network.

GTP' is based on GTP with enhancements and additional message types. GTP' operates on the Ga interface. GTP' however does not imply the use of the GPRS backbone network, and may be implemented on alternate bearers.

The GTP' contains the following functions:

- CDR transfer mechanism between GPRS nodes generating CDRs and the Charging Gateway Functionality.
- Redirection of CDR transfer to another CGF.
- Ability to detect communication failures between the CDR handling GPRS Network Elements by echo messaging.
- Ability of a CDR handling node to advertise the peer CDR handling GPRS Network Elements about its CDR transfer capability (e.g. after a period of service downtime).
- Ability to prevent duplicate CDRs that might arise during redundancy operations. If so configured, the CDR duplication prevention function may also be carried out by marking potentially duplicated CDR packets and delegating the final duplicate deletion task to CGF or Billing System - BS (instead of handling the possible duplicates solely by GTP' messaging).
- The aim of the duplication prevention support of GTP' is to reduce the number of duplicated CDRs sent towards the BS and to support the BS in keeping the efforts for duplicate CDR checking as small as possible.

7.1.1 SGSN - CGF communication

SGSN - CGF: GTP' over UDP/TCP and IP

When a new PDP context is activated or after an inter SGSN handover the GGSN will inform the related SGSN which CGF it should send its CDRs to. All other non-PDP context related CDRs are sent to the current default CGF for that CDR generating node. Each CDR generating node will have an O&M configurable CGF address list to which it can send its CDRs. The list will be organized in CGF address priority order. If the Primary CGF is e.g. out of service, then the CDR generating node shall send the CDRs to the Secondary CGF and so on.

Each GPRS CDR generating node will only send the records to the CGF(s) of the same GPRS PLMN, not to CGF(s) located in other PLMNs.

Each CGF in the GPRS PLMN shall know of all other CGFs network addresses. This is achieved by O&M configuration facilities that will enable each CGF to have a configurable list of peer CGF addresses.

7.2 The GTP' charging protocol

This subclause describes the features of the GTP' protocol. For the message types mentioned in subclause 7.3.2 ("Reused GTP message types") of the present document, see also the related subchapters in 3GPP TS 29.060 [22]. GTP' is used for GPRS and 3G charging data collection.

7.2.1 Usage of GTP Header in charging

The start of the GTP header defined in 3GPP TS 29.060 [22] is reused. In GTP' messaging only the signalling plane of GTP is partly reused.

Bit 5 of octet 1 of the GTP header is the Protocol Type flag and is '0' if the message is GTP'.

The Version bits indicate the GTP' protocol version when the Protocol Type flag is '0'.

Bit 1 of octet 1 is not used in GTP' (except in v0), and it is '0' in the GTP' header.

The Length indicates the length of payload (number of octets after the GTP' header).

The Sequence Number of the packet is part of the GTP' header.

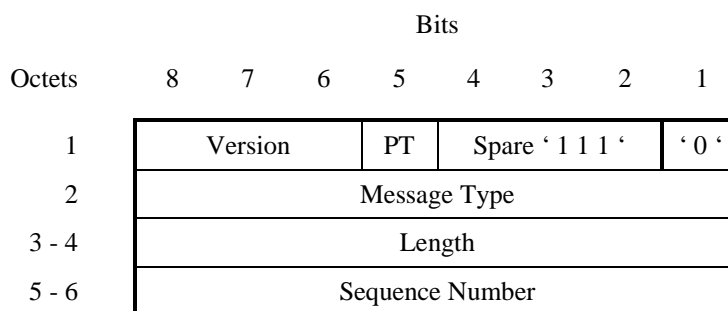

Figure 12: GTP' header

7.2.2 Information elements

The messages may contain several information elements. The TLV (Type, Length, Value) or TV (Type, Value) encoding formats shall be used for the GTP' information elements. The GTP' messages shall have the information elements sorted with the Type fields in ascending order. The Length field shall contain the information element length excluding the Type and Length fields.

Within the Type field the most significant bit will be set to 0 when the TV format is used and set to 1 when the TLV format is used.

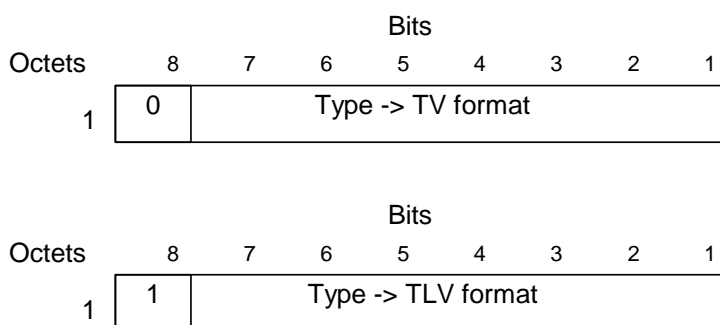

Figure 12a: Type field for TV and TLV format

7.3 GTP' Message Types

7.3.1 List of all GTP' message types

GTP' defines a set of messages between two associated nodes. The GTP' messages defined are shown in table 11. The messages introduced by GTP' are printed in this table in **boldface**. The other messages are inherited from the GTP protocol.

Of the GTP' introduced signalling message types, Node Alive Request, Node Alive Response, Redirection Request and Redirection Response belong to the "Path Management messages". The Data Record Transfer Request and Data Record Transfer Response form the message type group "Record Transmission messages".

The reserved fields in the signalling messages shall be filled with ones, and are intended for future use.

GTP' reuses the GTP Cause values. The message type numbers required for the newly introduced GTP' messages have been derived from the unallocated message type number space specified in the GTP message table defined in 3GPP TS 29.060 [22].

The number ranges allocated for GTP' are as follows:

For Information Elements: 117-127 (TV type fields) and 239-254 (for TLV type fields).

TLV Information Element types introduced in the present document:

- 254 Address of Recommended Node
- 253 Requests Responded
- 252 Data Record Packet
- 251 Charging Gateway Address (this IE is also used in 3GPP TS 29.060 [22])
- 250 Sequence Numbers of Cancelled Packets
- 249 Sequence Numbers of Released Packets

TV Information Element types introduced in the present document:

- 127 Charging ID
- 126 Packet Transfer Command

For Cause Codes: Cause values used in requests: 49 to 63, Cause values used in responses indicating acceptance: 177 to 191, Cause values used in responses indicating rejection: 241 to 255.

Charging related Cause values introduced for the present document:

In requests:

- 63 This node is about to go down
- 62 Another node is about to go down
- 61 The receive buffers are becoming full
- 60 The transmit buffers are becoming full
- 59 System failure

In responses indicating acceptance:

- 177 CDR decoding error

In responses indicating rejection:

- 255 Request not fulfilled
- 254 Sequence numbers of released/cancelled packets IE incorrect
- 253 Request already fulfilled
- 252 Request related to possibly duplicated packets already fulfilled

The charging related message types are listed in table 11. Those GTP' messages that are listed in **boldface** in table 11, are defined in the present document, the other GTP' messages listed in table 11 are inherited from the GTP protocol. For a description about the GTP messages reused in GTP', see the subclause 7.3.2 ("Reused GTP message types") of the present document, and for further details about those messages see 3GPP TS 29.060 [22], the GTP specification.

Table 11: GTP' messages

Message Type value (Decimal)	GTP' message (see NOTE)
1	Echo Request
2	Echo Response
3	Version Not Supported
4	Node Alive Request
5	Node Alive Response
6	Redirection Request
7	Redirection Response
240	Data Record Transfer Request
241	Data Record Transfer Response
others	reserved for future use

7.3.2 Reused GTP message types

The existing **Echo Request** and **Echo Response** messages defined in 3GPP TS 29.060 [22] are also used in GPRS charging. They may be used by the CDR generating nodes SGSN or GGSN, or by the CGF for checking if another GSN or CGF is alive. If the present document and 3GPP TS 29.060 [22] differ in their description then the 3GPP TS 29.060

[22] is to be taken as the latest specification status of the related Information Elements. If the path protocol is TCP, Echo Request and Echo Response messages are not required.

The **Version Not Supported** message in the GTP' resembles much the corresponding GTP message. It indicates the latest GTP' version that the GTP' entity can support. If a receiving node receives a GTP' message of an unsupported version, that node shall return a GTP' Version Not Supported message indicating in the Version field of the GTP' header the latest GTP' version that that node supports. The received payload data of the GTP' packet shall then be discarded.

The Version bits in the GTP' header have currently the following possible values:

GTP' version 0 (binary '000') is the GSM 12.15 v7.0.0 (October 1998) level, with the following Message Type values: 3 = Version Not Supported, 4 = Node Alive Request, 5 = Node Alive Response, 6 = Redirection Request, 7 = Redirection Response. In clause 7.3.4.6 the Requests Responded information element has Length field in place of the Number of Requests Responded field, to make that TLV IE to be handled like normal TLV IEs. If the GTP' v0 is used in parallel to GTP' v2 or a newer version, then a 6 octet header length (with no trailing dummy octets) is used also with v0 (like in GTP' v2). The mark of the usage of GTP' v0 with 6 octet header (instead of the original 20 octet long header) is then the version bits being 0 and the bit 1 of octet 1 being '1' (instead of '0').

GTP' version 1 (binary '001') is the same as version 0, but with the duplicate CDR prevention mechanism, introduced in GSM 12.15 version 7.2.1 (1999-07) of the GPRS charging specification.

GTP' version 2 (binary '010') is the same as version 1, but the header is just 6 octets long (no unused trailing octets). IPv6 address type is also supported (for Address of Recommended Node information element of the Redirection Request).

7.3.3 GTP message type modifications implied by GTP'

The GPRS charging related features in GTP are in the Create PDP Context Response: the Charging ID Information Element (IE) and the Charging Gateway Address IE, in the Update PDP Context Response the Charging ID Information Element (IE) and the Charging Gateway Address IE, in the Create AA PDP Context Response: the Charging ID IE and the Charging Gateway Address IE. Refer to 3GPP TS 29.060 [22] for details.

The general principle is that the CDRs are always sent to a CGF residing in the same network as the CDR generating node. In the case of roaming it is conceivable that some CDRs relating to the same PDP context will be sent to different networks' CGFs. The cost balancing of the roaming traffic is to be agreed between the GPRS Operators.

7.3.4 GTP' message types

7.3.4.1 Node Alive Request

The Node Alive Request message may be used to inform that a node in the network has started its service (e.g. after a service break due to software or hardware maintenance or data service interruption after an error condition). A node may send a different Node Address than its own in the Information Element, e.g. informing the "next node in the chain" that the "previous node in the chain" (which is located on the other side of the sender of this message) is now ready for service. This message type is optional if the Path Protocol is TCP.

The Node Alive Request message allows a quicker reconnect capability than the Echo Request message based polling can provide, and its usage will have a reduced load effect on the network, particularly when the number of network nodes using GTP' is high. It may also be used to inform when a new network node has become available for service. If the Echo Request message is also used then the usage of the Node Alive Request message allows the interval of Echo Requests to be longer than would be otherwise required, thus reducing network loading with many Echo Requests.

Table 12: Information Elements in a Node Alive Request

Information Element	Presence requirement
Node Address	Mandatory
Private Extension	Optional

The Node Address format and type number are the same as for the Charging Gateway Address format and type described in 3GPP TS 29.060 [22]).

The optional Private Extension IE contains vendor- or operator-specific information.

7.3.4.2 Node Alive Response

The Node Alive Response message shall be sent as a response to a received Node Alive Request.

Table 13: Information Elements in a Node Alive Response

Information Element	Presence requirement
Private Extension	Optional

The optional Private Extension IE contains vendor- or operator-specific information.

7.3.4.3 Redirection Request

There are two kinds of usage for the Redirection Request message. One is to advise that received CDR traffic is to be redirected to another CGF due to that CGF node is about to stop service (due to an outage for maintenance or an error condition). The second purpose is to inform a CDR generating node (e.g. SGSN) that is currently sending data to this node (e.g. CGF), that the next node in the chain (e.g. a mediator device or Billing Computer) has lost connection to this node (e.g. CGF).

An Address of Recommended Node may be given if for example a CGF maintenance outage is handled by first introducing another CGF ready to take incoming CDRs. In this way the network performance can be maintained. The Address of Recommended Node shall only describe an intra-PLMN node containing a CGF, and not to a node in any other PLMN.

Table 14: Information Elements in a Redirection Request

Information Element	Presence requirement
Cause	Mandatory
Address of Recommended Node	Optional
Private Extension	Optional

Possible Cause values are:

- "This node is about to go down";
- "Another node is about to go down";
- "System failure";
- "Receive buffers becoming full";
- "Send buffers becoming full".

The Address of Recommended Node information element defines the IPv4 or IPv6 format address that the node is identified by in the GPRS network.

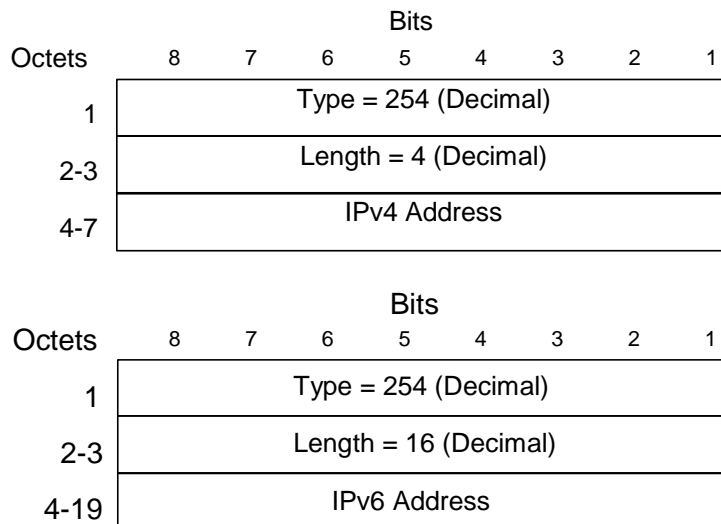

Figure 13: Address of Recommended Node information elements

The optional Private Extension contains vendor- or operator- specific information.

7.3.4.4 Redirection Response

The message shall be sent as a response of a received Redirection Request.

Table 15: Information Elements in a Redirection Response

Information Element	Presence requirement
Cause	Mandatory
Private Extension	Optional

Possible Cause values are:

- "Request Accepted";
- "No resources available";
- "Service not supported";
- "System failure";
- "Mandatory IE incorrect";
- "Mandatory IE missing";
- "Optional IE incorrect";
- "Invalid message format";
- "Version not supported".

The optional Private Extension contains vendor- or operator-specific information.

7.3.4.5 Data Record Transfer Request

This message is used in GPRS charging to transmit the CDR information. The CDR information is placed in the Data Record information element.

7.3.4.5.1 General logic

This subclause is intended to be read together with subclause 7.3.4.7 "Examples of GTP' messaging cases". The normal communication would be GSN sending Data Record Packets to a CGF, which answers with "Request Accepted" responses. Under normal condition the CDR transmission uses a Request-Response messaging sequence in the GSN to CGF GTP' protocol communication.

Sometimes a non-PDP context related CDR (e.g. M-CDRs) is transmitted, and thus the GGSN does not pass the CGF address information to the SGSN. The SGSN will in this case direct the CDRs to the current default CGF for the SGSN. This is the configured Primary CGF address, or if that CGF is out of service, then the secondary CGF address etc.

Summary of the CGF redundancy mechanism that prevents duplicated CDR packets to enter the BS:

The general logic of the duplicate CDR packet prevention in CGF redundancy cases is shown in Figure 14, where the message numbers are numbered in the order of time sequence. Alternative messages are indicated by an index character ('a' or 'b') that follows the arrow sequence number.

The main mechanism of the messaging in CGF redundancy cases (when a GSN-CGF link is down or a CGF is not working) is based on (1) first trying to send a CDR packet to CGF1. Then if no successful response is received (2) because the request does not reach CGF1 even when retried (or the responses from CGF1 to GSN are lost after CGF1 either stored it securely or sent it towards post-processing (2b)), the unacknowledged CDR packets are redirected to CGF2. The GSN may first test the GSN-CGF2 link by an Echo Request message that the CGF2 would respond by Echo Response. The CDR packets not successfully received by the primary CGF (=CGF1) are sent to another CGF2 (3), marked as potential duplicates, and CGF2 responds the request(s) (4). Those CDRs will wait there for further commands from GSN. When the GSN detects (5) and (6) that CGF1 is again able to communicate with it by receiving Node Alive Request (or getting a Echo Response from CGF2 to a Echo Request sent by the GSN) it answers by Node Alive Respond. Then the GSN tests with an empty packet (7), retrying continuously if no response, using e.g. increasing timeouts (using the old unacknowledged packet's Sequence Number, if the CGF1 would consider the packet to be a new one (8a) or an already received one (8b)). According to the response of the CGF1, the GSN gives the CGF2 a command to either release (9a) or cancel (9b) the corresponding CDR packet from CGF2. CGF2 then confirms the decision (10), and is able to send the CDRs towards the BS (11a).

Error handling: As a default, retransmissions after configurable timeouts are used. If after CGF1 communication failure the CDR packet sending from GSN to CGF2 does not succeed, the GSN tries to use CGF3 as the intermediate CDR packet storage entity, etc. If the acknowledgement (10) is not got by the GSN for its message (9a) or (9b), the GSN will retransmit the message (9a) or (9b) continuously and persistently, using e.g. increasing time intervals. An alarm should be sent to the O&M system if a communication link goes down. It shall be possible to release/cancel CDR packets from CGFs and unacknowledged sequence numbers from GSNs by O&M operations if permanent GSN-CGF link failures would occur. The buffers containing Sequence Numbers of potentially duplicated packets and the buffers containing the numbers of unacknowledged CDR packets shall be kept up to date (with CDR packet transfers) using atomic transaction mechanisms. If the GSN-CGF1 communication link is down, any new CDRs generated by the GSN are sent to a properly working CGF2, instead of the CGF1.

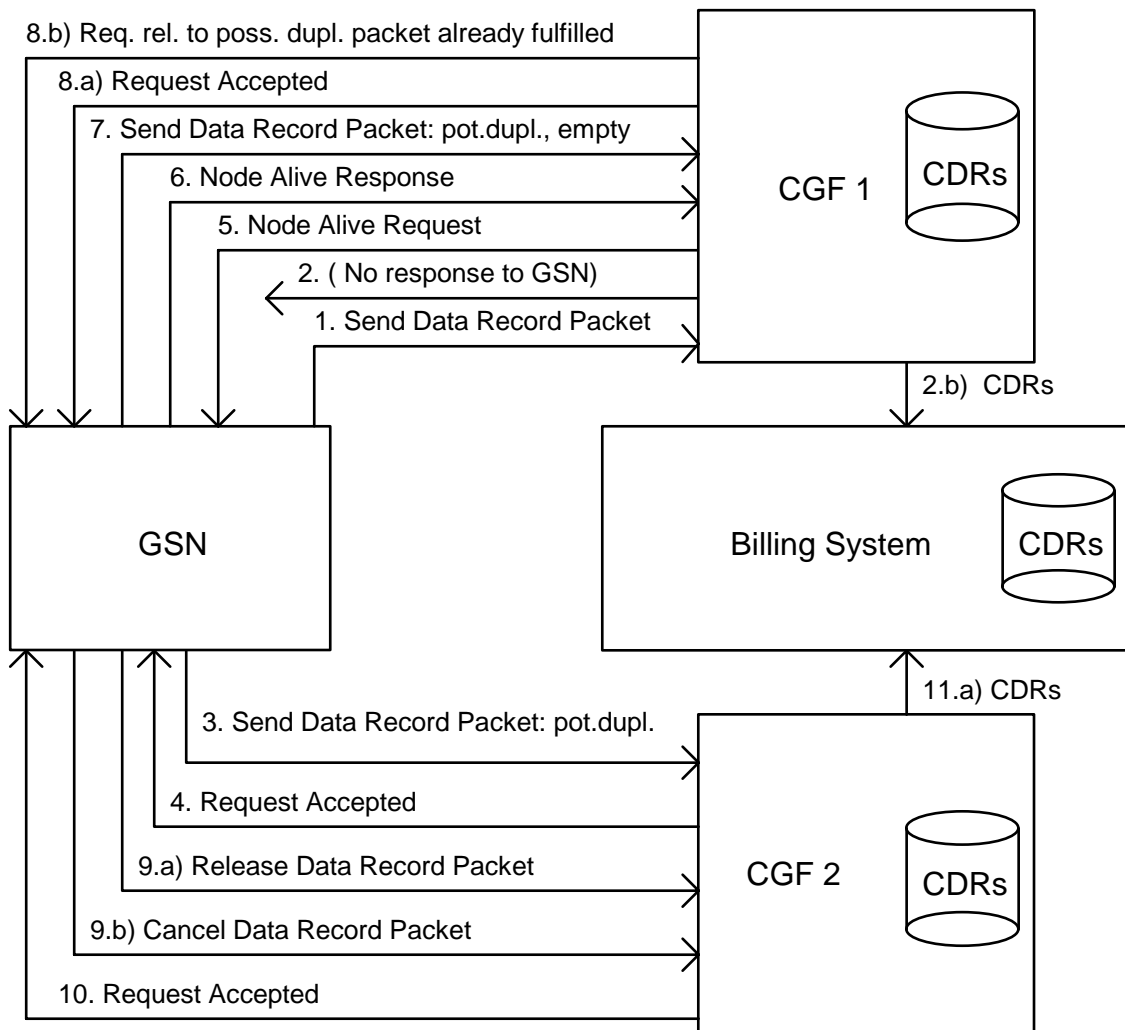

Figure 14: General CGF redundancy messaging scheme

A more detailed description of the CGF redundancy mechanism:

Due to a network failure or node failure, a CGF might not send a response within the configured timeout period to a request it got from a GSN. As a first attempt, retries of requests are to be used as defined in 3GPP TS 29.060 [22], if the response is not received in the configured time.

If a CDR generating node loses its connection to the CGF unexpectedly, it may send the CDRs to the next CGF in the priority list. If the CGF changes, the GSN can continue sending CDRs to different CGF nodes, depending on which CGF has been configured as the receiver of CDRs for a particular PDP context.

Sequence number buffers: The GSN might lose its connection to its primary CGF due to a link failure or CGF going down. In this kind of redundancy condition the GSN attempts to redirect the CDR traffic to a secondary CGF (after possible retries have failed). The GSN maintains an internal buffer for Sequence Numbers of requests not yet successfully responded by the primary CGF, for the case that it may become capable of communicating to the primary CGF at a later date. The GSN will send the not responded Data Record Packets (DRPs) to the secondary CGF, and the GSN maintains also a buffer for the Sequence Numbers related to those DRPs that have been temporarily stored to this secondary CGF. (If the communication towards the secondary CGF would not work, the transfer of possibly duplicated DRPs and Sequence Number bookkeeping would be done for a tertiary CGF etc.) Also the CGFs maintain Sequence Number buffers for each of their GSN links. The Sequence Numbers may in future be needed in relation to the possibly duplicated CDRs that the CGFs have got from the GSN(s). The Sequence Numbers are stored to wait for a final decision to release them towards the BS (if the primary CGF had not received successfully the packets originally sent by a GSN) or to cancel them (if the primary CGF had received and processed successfully the originally by GSN sent packets).

The GSN is able to cancel (or release for transfer towards the BS) CDR packets sent to a secondary CGF if the primary CGF becomes available for service. To make the right decision the GSN first sends an empty test packet with the 'Send possibly duplicated Data Record Packet' Packet Transfer Command to the primary CGF, using a previously not responded Sequence Number.

In case that the empty test packet to the primary CGF which was temporarily down (or to which the link was down) is responded with the Cause value "Request Accepted", the GSN will release the corresponding CDRs waiting for final decision in the secondary CGF, towards the Billing System (BS) with the Packet Transfer Command 'Release Data Record Packet'.

If the primary CGF responses this test message with the Cause value "Request related to possibly duplicated packets already fulfilled", the GSN will cancel the corresponding CDRs waiting for final decision in the secondary CGF, using the Packet Transfer Command 'Cancel Data Record Packet'.

To enable that a GSN failure (destroying its Sequence Number buffers per each CGF link for non-responded requests or possibly duplicated packets) would not cause CDR packets to stay forever in the temporary decision waiting buffers of CGFs, there should also be O&M means of emptying those CGF buffers.

There shall be a also configurable parameter in the CGF for making the final decision as to whether or not it is able to send the CDRs to the Billing System (BS) for the case where the backup buffering mechanism in the GSN could not be used until the end of the messaging sequence related to a certain CDR packet has completed. This way the operator can:

- A) Select that the GSNs and CGFs take care of duplicate prevention and the BS is not required to do duplicate checking due to possible duplicates caused by GPRS node redundancy.
- B) Select that BS performs the duplicate prevention. To do this in the most effective way, the CGF may include an additional flag linked to possibly duplicated CDRs sent to Billing System, that they have not been released by a GSN for BS use (or use special kind of file name if a file protocol is used between CGF and BS). This means that the BS has somewhat more processing work to do, but the BS would anyway get a duplicate free end result. CGF is in this case always authorised to forward CDRs towards the BS, also when they contain possibly duplicated data. For this case the CGFs may also have a configurable flag that Data Record Packet Cancel/Release operations are not needed.

7.3.4.5.2 Information Elements in Data Record Transfer Request

Table 16: Information Elements in a Data Record Transfer Request

Information Element	Presence requirement
Packet Transfer Command	Mandatory
Data Record Packet	Conditional
Sequence Numbers of Released Packets	Conditional
Sequence Numbers of Cancelled Packets	Conditional
Private Extension	Optional

7.3.4.5.3 Packet Transfer Command IE

The value of the Packet Transfer Command in its Information Element tells the nature of the message:

- 1 = 'Send Data Record Packet';
- 2 = 'Send possibly duplicated Data Record Packet';
- 3 = 'Cancel Data Record Packet';
- 4 = 'Release Data Record Packet'.

The following describes the usage of each Packet Transfer Command.

- 1) Send Data Record Packet. This is used for the normal CDR sending, and it is the usual Packet Transfer Command, other commands being used only in error recovery cases. Of the conditional IEs, the "Data Record Packet" is present in the message.
- 2) Send possibly duplicated Data Record Packet. When the CDR packet is directed to a secondary CGF (by a CDR generating node) because the currently used CGF not working or the CDR transfer is not working properly, then this

Packet Transfer Command is used instead of the normal 'Send Data Record Packet'. Of the conditional IEs, the Data Record Packet" is present in the message, when sending the message to a CGF acting as temporary storage, when the original primary CGF could not be contacted. This Packet Transfer Command is used also when sending "empty" test packets with older (but not yet acknowledged) sequence numbers after a peer node or link recovery, to check if the CGF had received some Data Record Packets (whose acknowledgement did not come to the Data Record Packet sending node) before the link to the recipient node became inoperable.

3) Cancel Data Record Packet. Of the conditional IEs, the "Sequence Numbers of Cancelled Packets" is present in the message.

4) Release Data Record Packet. Of the conditional IEs, the "Sequence Numbers of Released Packets" is present in the message.

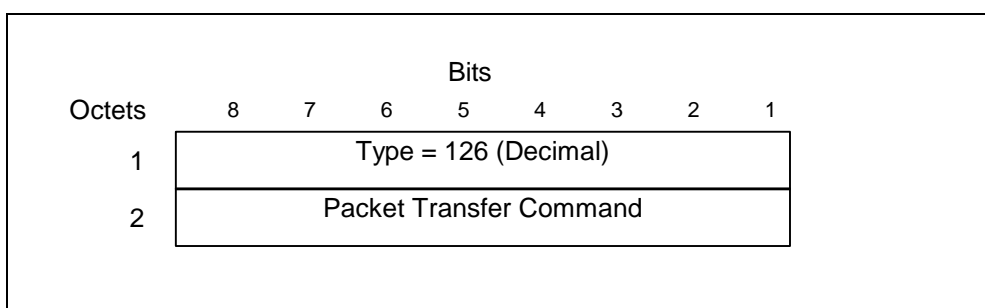

Figure 15: Packet Transfer Command information element

After the CGF has received the Packet Transfer Command 'Release Data Record Packet' with the Sequence Number(s) for earlier sent 'Send possibly duplicated Data Record Packet' command(s), it can consider itself authorised to send the Data Record Packets previously marked as possibly duplicated towards the Billing System (BS) as normal (not duplicated) CDRs.

7.3.4.5.4 Data Record Packet IE

The Data Record Packet element, which is present conditionally if the Packet Transfer Command is 'Send Data Record Packet' or 'Send possibly duplicated Data Record Packet', may contain one or more data records. This IE is illustrated in Figure 16. If an "empty packet" is to be sent, then the *Data Record Packet* IE contains only the *Type* (with value 252 in decimal) and the *Length* (with value 0) fields.

As shown in Figure 16, there are two fields identifying the CDR format: *Data Record Format* and *Data Record Format Version*. The format of the records is ASN.1 or some other format, as identified by the *Data Record Format*. The *Data Record Format Version* identifies the TS release and version numbers that were used for the CDR encoding. The formats of these two fields are described in detail in section 7.4 and 7.5, respectively.

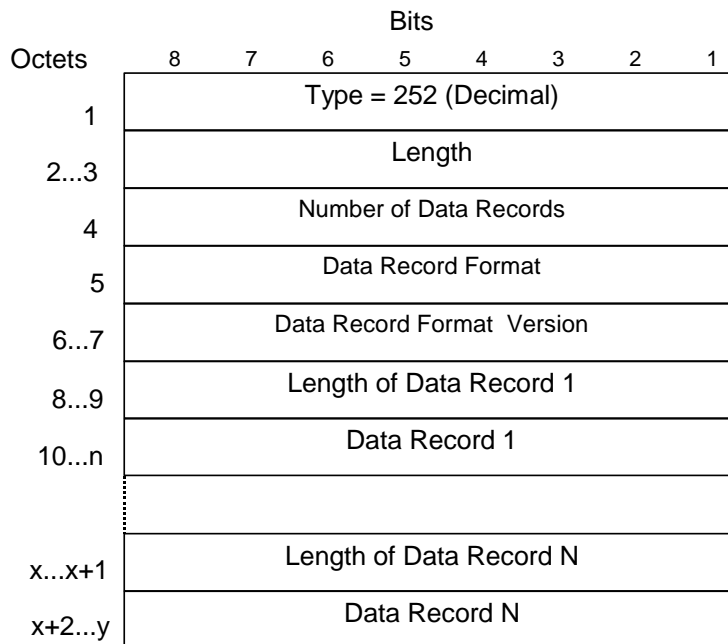

Figure 16: Data Record Packet information element

7.3.4.5.5 Sequence Numbers of Released Packets IE

The Sequence Numbers of Released Packets is present if the Packet Transfer Command is ‘Cancel Data Record Packet’. The format of the Information Element is described below:

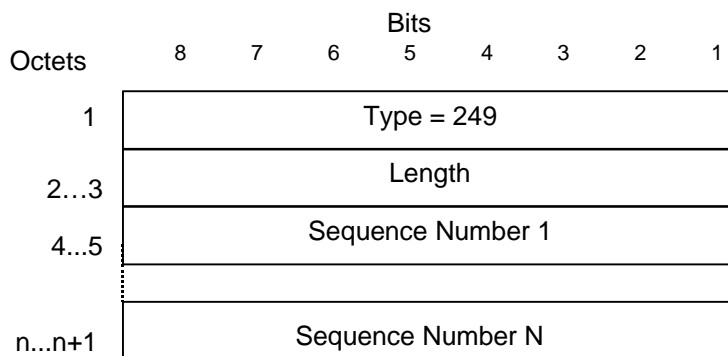

Figure 17: Sequence Numbers of Released Packets information element

7.3.4.5.6 Sequence Numbers of Cancelled Packets IE

The Sequence Numbers of Cancelled Packets information element contains the IE Type, Length and the Sequence Number(s) (each 2 octets) of the cancelled Data Record Transfer Request(s). It is present if the Packet Transfer Command is ‘Cancel Data Record Packet’.

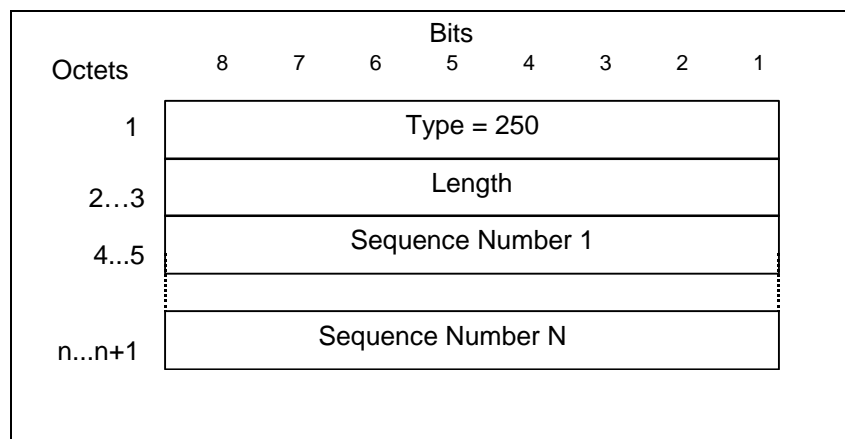

Figure 18: Sequence Numbers of Cancelled Packets information element

7.3.4.5.7 Private Extension IE

The optional Private Extension contains vendor or operator specific information.

7.3.4.6 Data Record Transfer Response

The message shall be sent as a response of a received Data Record Transfer Request. Also, several Data Record Transfer Requests can be responded by a single Data Record Transfer Response.

Table 17: Information Elements in a Data Record Transfer Response

Information Element	Presence requirement
Cause	Mandatory
Requests Responded	Mandatory
Private Extension	Optional

The Cause value is the same (whatever the value) for all those messages responded by that particular Response.

Possible Cause values are:

- "Request Accepted";
- "No resources available";
- "Service not supported";
- "System failure";
- "Mandatory IE incorrect";
- "Mandatory IE missing";
- "Optional IE incorrect";
- "Invalid message format";
- "Version not supported";
- "Request not fulfilled";
- "CDR decoding error";
- "Request already fulfilled";
- "Request related to possibly duplicated packet already fulfilled".

The cause value "CDR decoding error" is optional, primarily intended to inform the CDR generating node that the receiving node can not decode the CDR. Thus, special features in the receiving node that are based on information within the CDR would not be operable. This message could alert the operator of a remote generating node of incompatible CDR encoding. It is Optional and no action or response is required.

The Requests Responded information element contains the IE Type, Length and the Sequence Numbers (each 2 octets) of the Data Record Transfer Requests.

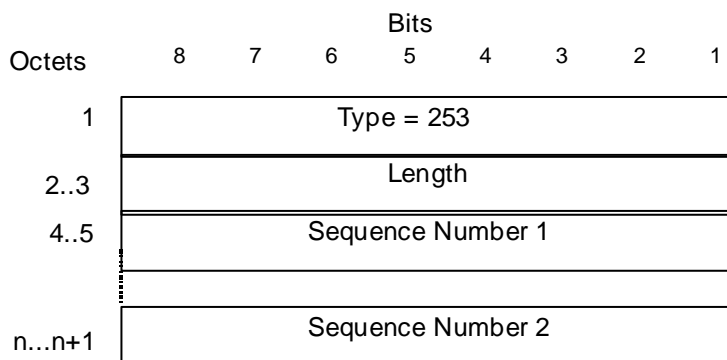

Figure 19: Requests Responded information element

The optional Private Extension contains vendor or operator specific information.

Depending on the Cause value severity and general occurrence frequency, the node that sent the corresponding Data Record Transfer Request, may start to direct its CDRs to another CGF.

7.3.4.7 Examples of GTP' messaging cases

The following example cases represent the three different key Data Record Transfer Request/Response messaging related CDR packet handling schemes:

Case 1): The normal CDR packet transfer:

GSN sends successfully a CDR packet to the CGF, and since the GSN gets a response (Request Accepted) for the Data Record Transfer Request, there is no need to revert to the CGF redundancy mechanism and redirect the CDR packet traffic flow to an other CGF.

Case 2): The GSN-CGF1 connection breaks before a successful CDR reception:

In this example case the CDR packet sent by the GSN is lost before it is received by the CGF1. (The loss might be caused by a link failure or e.g. a major CGF1 failure.)

Case 3): The GSN-CGF1 connection breaks after a successful CDR reception:

In this example case the CDR packet sent by the GSN is received correctly by the CGF1 and moved to its non-volatile memory (or even to the next NE in the communication chain). Anyhow, the GSN-CGF1 communication stops in this example case working before the GSN gets the positive response (Data Record Transfer Response: Request Accepted) that would acknowledge that the CDR packet was successfully received by CGF1.

The next three subclauses describe in more detail each of the key Data Record Transfer Request/Response messaging schemes.

7.3.4.7.1 Case 1: The normal CDR packet transfer

Figure 20 represents the default mode of CDR transfer from the CDR generating entities (GSNs) to the CDR packet collecting entities (CGFs).

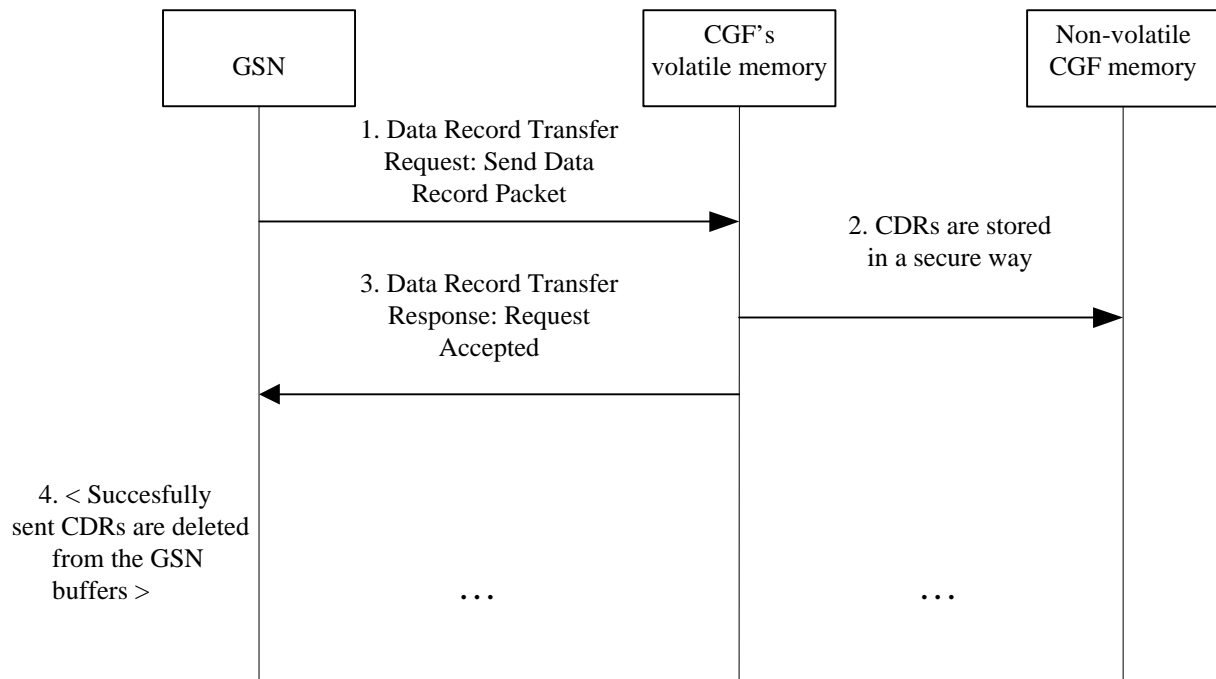

Figure 20: A normal CDR transfer process between a GSN and CGF

- 1) The CDR generating entity (here the GSN symbolises either SGSN or GGSN) sends CDR(s) in a packet to CGF (that is the current primary Charging Gateway Functionality for the specific CDR generating node, "CGF1"). The sending is performed by using the Data Record Transfer Request message, with the Packet Transfer Command IE having the value 'Send Data Record Packet'.
- 2) The CGF opens the received message and stores the packet contents in a safe way (to e.g. a redundant RAM memory unit or a mirrored non-volatile memory or even to another node).
- 3) The CDR receiving entity (CGF) sends confirmation of the successful packet reception to the CDR generating node (GSN). The confirmation is performed by using the Data Record Transfer Response message, with the Cause value being 'Request Accepted'.
- 4) After the positive response 'Request Accepted' is received by the GSN, it may delete the successfully sent CDRs from its send buffer.

The general principle of GTP' to retransmit the request if the response has not been received within a configurable time-out limit, is also followed here in point 1). The maximum amount of retries is a configurable value.

7.3.4.7.2 Case 2: The GSN-CGF1 connection breaks before a successful CDR reception

Figure 21 describes the exceptional case when the CDR transfer from a CDR generating entity (GSN) to the primary CDR packet collecting entity (CGF1) fails in a way that the CGF1 is not able to store the CDR packet sent by the GSN. (The reason for the failure in packet transfer may be e.g. a link failure between the GSN and CGF1, or a capacity exhausting error in the storage device of CGF1, or a general CGF1 system failure or CGF1 maintenance break.)

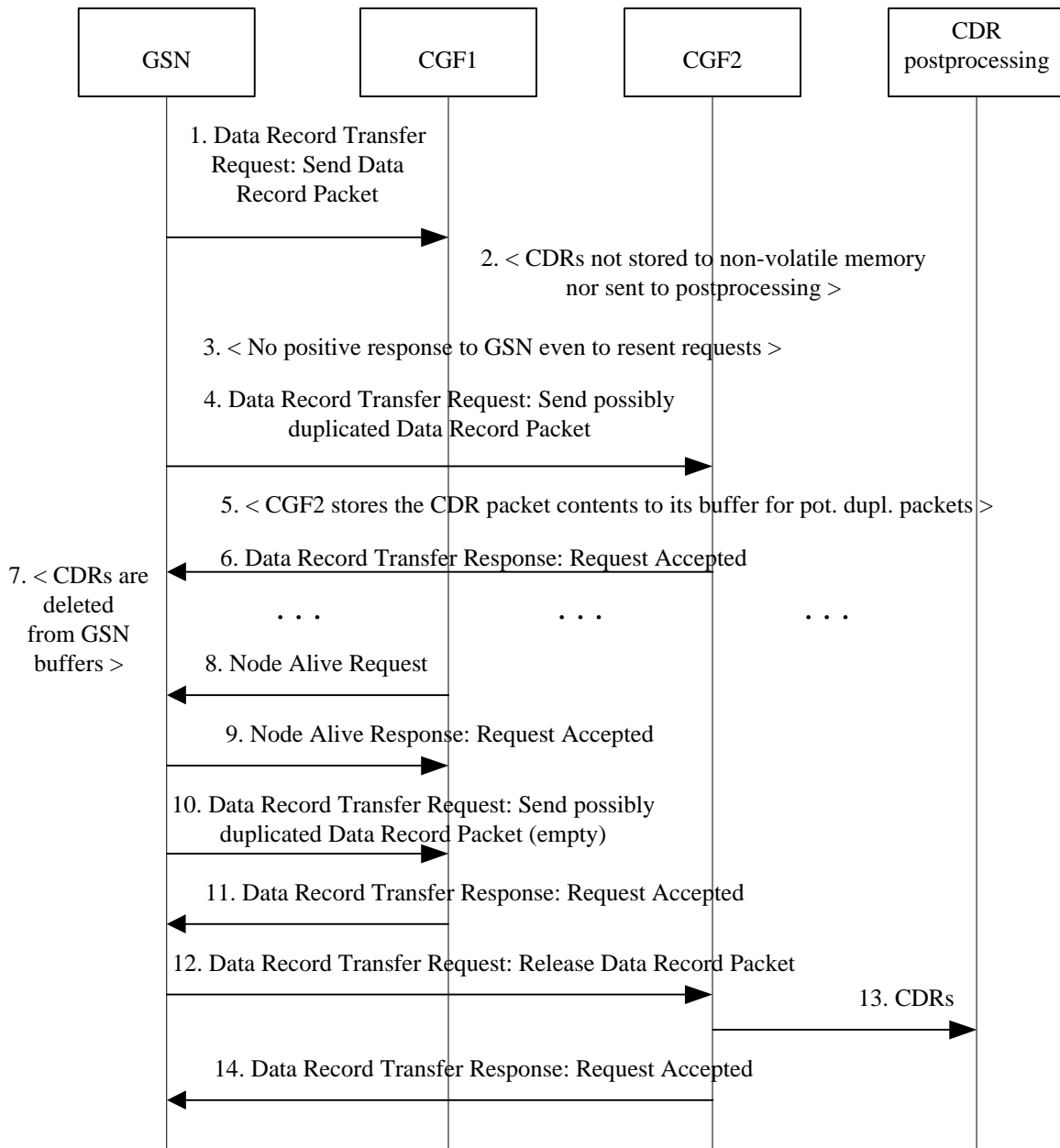

Figure 21: Duplicate prevention case: CDR sending via CGF1 had not succeeded

- 1) The CDR generating entity (GSN) sends CDR(s) in a packet to CGF (that is the current primary Charging Gateway Functionality for the specific CDR generating node, "CGF1"). The sending is performed by using the Data Record Transfer Request message, with the Packet Transfer Command IE having the value 'Send Data Record Packet'.
- 2) Due to a failure in the GSN-CGF1 communication link of CGF1, the CGF1 is not able to store the packet sent by the GSN in a safe way (to e.g. a redundant RAM memory unit or a mirrored non-volatile memory or to another node).

- 3) Therefore the GSN is not able to get a response (or it could alternatively get a negative response like "No resources available" as the Cause value in the Data Record Transfer Response message).
- 4) (The GSN may now first test the GSN-CGF2 link by an Echo Request message that the CGF2 would respond by the Echo Response.) Then the GSN sends the same CDR packet that could not be sent to CGF1 to the next CGF in its CGF preference list (here CGF2) using the Data Record Transfer Request message, with the Packet Transfer Command IE having the value 'Send possible duplicated Data Record Packet'.
- 5) As the connection to the CGF2 is working, the CGF2 is able to process the CDR packet. Since the packet was marked by the sending GSN to be potentially duplicated, it is stored into the CGF2, but not yet sent forward towards the Billing System.
- 6) The CGF2 sends confirmation of the successful packet reception to the GSN. The confirmation is performed by using the Data Record Transfer Response message, with the Cause value being 'Request Accepted'.
- 7) The GSN can now delete the now successfully sent (potentially duplicated) CDRs from its CDR buffer (but it keeps the sequence number(s) of the sent potentially duplicated packet(s) in a buffer dedicated for that).
- 8) When CGF1 is recovering after a system reboot, it sends a Node Alive Request message to the configured peer GSN(s), and so the GSN notices that it can again successfully communicate with the CGF1. (The GSN may also detect this by using the Echo Request messages, which would be answered by CGF1 by the Echo Response message.)
- 9) GSN acknowledges the CGF1 by Node Alive Response message.
- 10) For the earlier unacknowledged Data Record Transfer Request message(s), the GSN sends CGF1 empty test packet(s) (with no CDR payload in the Data Record Packet IE but just the other parts of the message frame).
- 11) CGF1 responds with Data Record Transfer Response message, with the Cause value being 'Request Accepted', because in this example case CGF1 had lost the communication capability towards GSN before storing the previously received (and by CGF1 unacknowledged) CDR packet.
- 12) Now GSN knows that the CGF1 had not originally been able to process and forward the original version of the CDR packet from the GSN, and it indicates CGF2 that CGF2 can send the CDR packet(s) related to the previously unacknowledged GTP' Sequence Number(s) to post-processing. Those packets' Sequence Numbers are indicated in the Sequence Numbers of the Released Packets IE.
- 13) CGF2 shall now be able to send the released packets towards post-processing.
- 14) CGF2 responds with Data Record Transfer Response message, with the Cause value being 'Request Accepted'.

After all the potentially duplicated packets are cleared from CGF(s), the GSN can continue in normal way the transfer of CDRs.

7.3.4.7.3 Case 3: The GSN-CGF1 connection breaks after a successful CDR reception

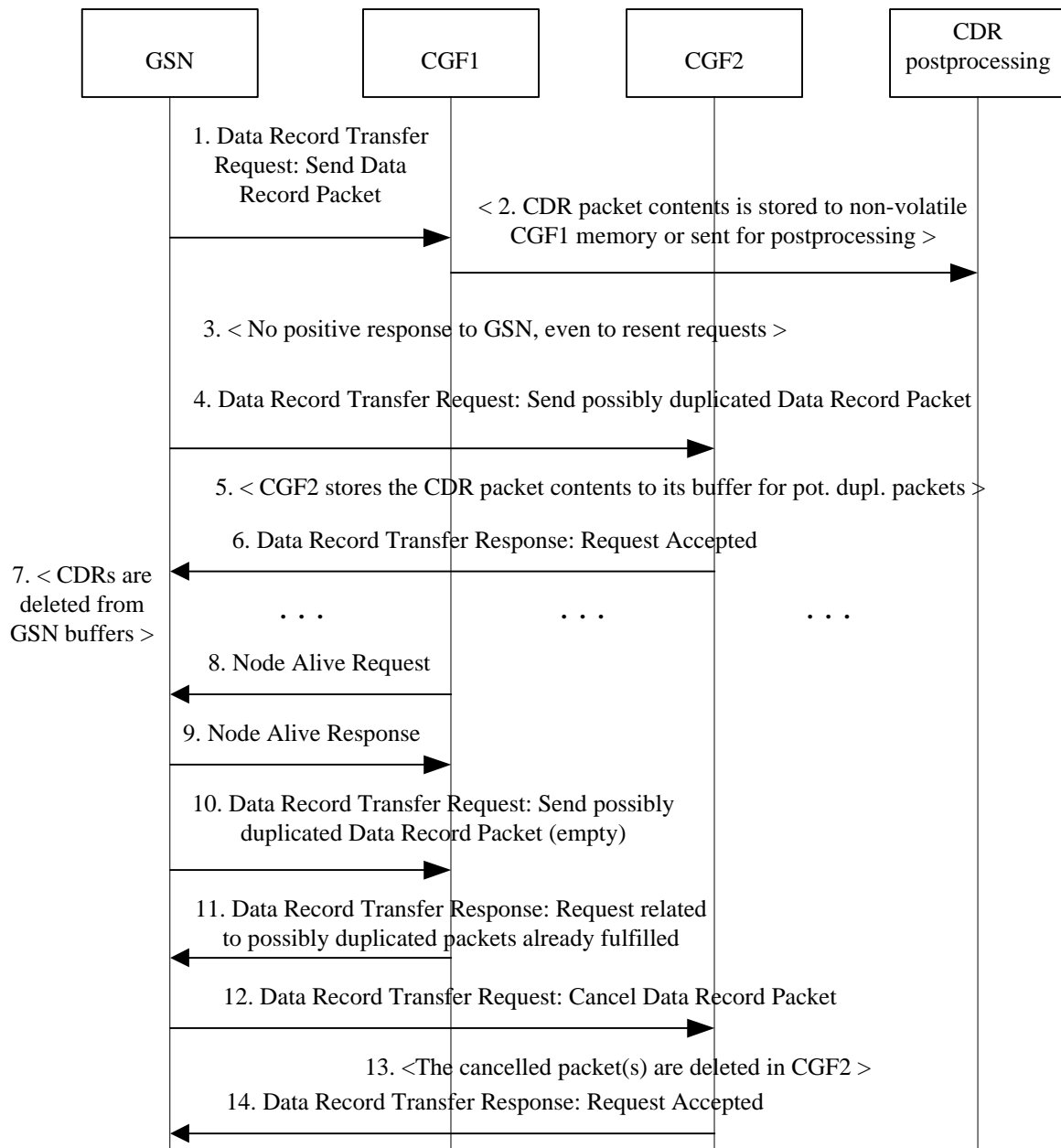

Figure 22: Duplicate prevention case: CDR sending via CGF1 had succeeded

- 1) The CDR generating entity (GSN) sends CDR(s) in a packet to CGF (that is the current primary Charging Gateway Functionality for the specific CDR generating node, "CGF1"). The sending is performed by using the Data Record Transfer Request message, with the Packet Transfer Command IE having the value 'Send Data Record Packet'.
- 2) The CGF1 is able to store the packet sent by the GSN in a safe way (to e.g. a redundant RAM memory unit or a mirrored non-volatile memory or to another node).

- 3) Since the GSN-CGF1 communication connection is now broken, the GSN is not able to get the response "Request Accepted" as the Cause value in the Data Record Transfer Response message.
- 4) Then the GSN sends the same CDR packet that could not be sent to CGF1 to the next CGF in its CGF preference list (here CGF2) a Data Record Transfer Request message, with the Packet Transfer Command IE having the value 'Send possible duplicated Data Record Packet'. (That sending may be preceded by the testing of the GSN-CGF2 link by an Echo Request message, that the CGF2 would respond by the Echo Response.)
- 5) As the connection to CGF2 is working, CGF2 is able to process the CDR packet. Since the packet was marked by the sending GSN to be potentially duplicated, it is stored in CGF2, but not yet sent forward towards the post processing or Billing System.
- 6) The CGF2 sends confirmation of the successful packet reception to the GSN. The confirmation is performed by using the Data Record Transfer Response message, with the Cause value being 'Request Accepted'
- 7) The GSN can now delete the now successfully sent (potentially duplicated) CDRs from its CDR buffer (but it keeps the sequence number(s) of the sent potentially duplicated packet(s) in a buffer dedicated for that.
- 8) When CGF1 is recovering after a system reboot, it sends a Node Alive Request message to the configured peer GSN(s), and so the GSN notices that it can again successfully communicate with the CGF1. (The GSN may also detect this by using the Echo Request messages, which would be answered by CGF1 by the Echo Response message.)
- 9) GSN acknowledges the CGF1 by Node Alive Response message.
- 10) For the earlier unacknowledged Data Record Transfer Request message(s), the GSN sends CGF1 empty test packet(s) (with no CDR payload in the Data Record Packet IE but just the other parts of the message frame).
- 11) CGF1 responds with Data Record Transfer Response message, with the Cause value being 'Request related to possibly duplicated packets already fulfilled', because in this example case CGF1 had lost the communication capability towards GSN after storing the previously received (and by CGF1 unacknowledged) CDR packet.
- 12) Now GSN knows that the CGF1 had originally been able to process and forward the original version of the CDR packet from the GSN, and it indicates CGF2 that CGF2 can cancel the CDR packet(s) related to the previously unacknowledged GTP' GSN-CGF1 Sequence Number(s). Those packets' Sequence Numbers are indicated in the Sequence Numbers of the Cancelled Packets IE.
- 13) CGF2 shall now delete the cancelled packet(s) from its buffer for potentially duplicated packets.
- 14) CGF2 responds with Data Record Transfer Response message, with the Cause value being 'Request Accepted'.

After all the potentially duplicated packets are cleared from CGF(s), the GSN can continue in normal way the transfer of CDRs.

7.4 Data Record Format in GTP

The format of the CDRs sent between the Network Elements that generate the PS domain CDRs and the CGF are defined by the *Data Record Format*, which is the 5th octet of *Data Record Packet* information element, shown in Figure 16.

The following rules govern the *Data Record Format*:

- This field consists of one octet (#5).
- The value range is 1-255 in decimal. The value '0' should not be used.
- Only the values 1-10 and 51-255 can be used for standards purposes.
- Values in the range of 11-50 are to be configured only by operators, and are not subject to standardization.
- The value '1' identifies ASN.1 format (in PS domain charging). If needed other values are specified in subclause 7.4.1.

7.4.1 Standard Data Record Format

For the PS Domain CDR transfer, defined by this TS, only an ASN.1 format is used. For this format the *Data Record Format* value is '1'. See clause 6 and the ASN.1 language descriptions for the definitions. Basic Encoding Rules (BER) provides the transfer syntax for abstract syntax defined in ASN.1.

7.4.2 Private Data Record Formats

The *Data Record Format identifiers* 11...50 (decimal) are reserved for private (implementation specific) format use.

7.5 Data Record Format Version for CDRs

The CDR release and versions numbers are defined by the '*Data Record Format Version*', in octet 6 and 7 of the *Data Record Packet IE*, shown in Figure 13. The format of this field is depicted in Figure 23.

The first octet (#6 in *Data Record Packet IE*) is divided into two fields each with 4 bits. The first field (octet 6, bits 8-5 in Fig 23) identifies the application. The second field (bits 4-1 of octet 6) identifies the release. For charging purposes, the Application Identifier has a value of '1' (decimal). Other possible applications of GTP' may use different numbers. The Release Identifier indicates the TS release used to encode the CDR. The following values are used to identify the CDR release:

- '2' (decimal) for R98, and
- '3' (decimal) for R99.

The second octet (#7) identifies the version of the TS used to encode the CDR. For R98, the version number is 1. For R99 the decimal value of the Version identifier is provided in Table 18. Note that the value must be '1' or larger.

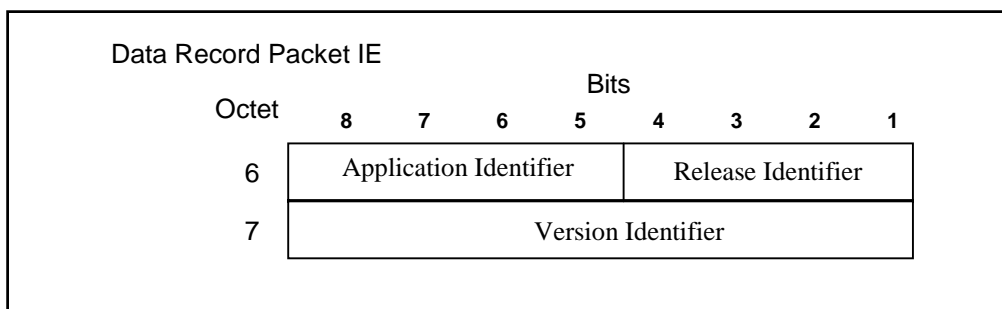

Figure 23: The Format of the *Data Record Format Version* Field

Table 18: The decimal value of the Version Identifier used in R99 CDRs

Value	R99
1	TS 32.015 v3.0.0
2	TS 32.015 v3.1.0
3	TS 32.015 v3.1.1
4	TS 32.015 v3.2.0
5	TS 32.015 v3.3.0
6	TS 32.015 v3.4.0
7	TS 32.015 v3.5.0
8	TS 32.015 v3.6.0
9	TS 32.015 v3.7.0

7.6 CGF - BS Protocol Interface

7.6.1 The transfer protocols at CGF - BS interface

The present document gives several recommendations for the main protocol layers for the Charging Gateway Functionality - Billing System (BS) interface protocol stack. These recommendations are not strictly specified features, since there are a lot of variations among the existing Billing Systems. The recommendations are FTAM protocol on X.25 or TCP/IP, and FTP over TCP/IP.

7.6.2 The format of the CDRs at CGF - BS interface

The contents of the CDRs sent between the CGF and the Billing System (BS) are defined by the ASN.1 language clause 8, Charging Data Record Structure. Other CDR contents or formats are possible if the CGF provides processing functionality for the CDRs.

8 Charging Data Record Structure

8.1 ASN.1 definitions for CDR information

Within the current GSM 12-series of specifications the ASN.1 definitions are based on ISO8824 (90) / X.208 (88) [40], which has been superseded by ISO8824-1 (94) / X.680 (94). This newer version not only includes new features but also removes some that were present in ISO8824 (90) / X.208 (88) [40].

Where possible, the GPRS work would be based on those ASN.1 features to both. However, where necessary, the new features in ISO8824-1 (94) / X.680 (94) [41] be used in some places.

ISO8824 (90) / X.208 (88) [40] features that are no longer in ISO8824-1 (94) / X.680 (94) [41] will not be used.

Changes (enhancements) in GSM1205-DataTypes:

```

CallEventRecordType ::= INTEGER
{
    moCallRecord      (0),
    mtCallRecord      (1),
    roamingRecord     (2),
    incGatewayRecord  (3),
    outGatewayRecord  (4),
    transitCallRecord (5),
    moSMSRecord       (6),
    mtSMSRecord       (7),
    moSMSIWRecord     (8),
    mtSMSGWRecord     (9),
    ssActionRecord    (10),
    hlrIntRecord      (11),
    locUpdateHLRRecord (12),
    locUpdateVLRRecord (13),
    commonEquipRecord (14),
    moTraceRecord     (15),
    mtTraceRecord     (16),
    termCAMELRecord   (17),
    sgsnPDPRecord     (18),
    ggsnPDPRecord     (19),
    sgsnMMRecord      (20),
    sgsnSMORRecord    (21),
    sgsnSMTRRecord    (22)
}
GPRS-Charging-DataTypes {ccitt (0) identified-organization (4) etsi (0) mobileDomain (0) umts-
Operation-Maintenance (3) ts-32-015 (15) informationModel (0) asn1Module (2) version1 (1)}

DEFINITIONS IMPLICIT TAGS ::=

BEGIN

EXPORTS everything

IMPORTS

CellId, Diagnostics, CallDuration, ManagementExtensions, TimeStamp, MSISDN, LocationAreaCode,
MessageReference, RecordingEntity, SMSResult, LevelOfCAMELService, CalledNumber, CallingNumber
FROM GSM1205-DataTypes{ ccitt (0) identified-organization (4) etsi(0) mobileDomain (0) gsm-
Operation-Maintenance (3) moduleId (3) gsm-12-05 (5) informationModel (0) asn1Module (2) 1 }

AddressString, ISDN-AddressString, IMSI, IMEI
FROM MAP-CommonDataTypes { ccitt identified-organization (4) etsi(0) mobileDomain (0) gsm-Network
(1) modules (3) map-CommonDataTypes (18) version6 (6) }

CallReferenceNumber
FROM MAP-CH-DataTypes {ccitt(0) identified-organization(4) etsi(0) mobileDomain(0)
gsm-network(1) modules(3) map-CH-DataTypes(13) version6(6)}

```

```

DefaultGPRS-Handling, DefaultSMS-Handling, ServiceKey
FROM MAP-MS-DataTypes { ccitt identified-organization (4) etsi (0) mobileDomain (0)
gsm-Network (1) modules (3) map-MS-DataTypes (11) version6 (6) }

```

```

ManagementExtension
FROM Attribute-ASN1Module {joint-iso-ccitt ms(9) smi(3) part2 (2) asn1Module(2) 1}
;
--

```

```

-- Note that the syntax of AE-title to be used is from
-- CCITT Rec. X.227 / ISO 8650 corrigendum and not "ANY"
--

```

```

-----
-- CALL AND EVENT RECORDS
--
-----

```

```

CallEventRecord ::= CHOICE
{
-- Record values 0..16 are 3G curcuit switch specific
--
moCallRecord          [0] MOCallRecord,
mtCallRecord          [1] MTCallRecord,
roamingRecord        [2] RoamingRecord,
incGatewayRecord     [3] IncGatewayRecord,
outGatewayRecord     [4] OutGatewayRecord,
transitRecord        [5] TransitCallRecord,
moSMSRecord          [6] MOSMSRecord,
mtSMSRecord          [7] MTSMSRecord,
moSMSIWRecord        [8] MOSMSIWRecord,
mtSMSGWRecord        [9] MTSMSGWRecord,
ssActionRecord       [10] SSActionRecord,
hlrIntRecord         [11] HLRIntRecord,
locUpdateHLRRecord  [12] LocUpdateHLRRecord,
locUpdateVLRRecord  [13] LocUpdateVLRRecord,
commonEquipRecord   [14] CommonEquipRecord,
recTypeExtensions   [15] ManagementExtensions,
termCAMELRecord      [16] TermCAMELRecord,
--
sgsnPDPRecord        [20] SGSNPDPRecord,
ggsnPDPRecord        [21] GGSNPDPRecord,
sgsnMMRecord         [22] SGSNMMRecord,
sgsnSMORRecord       [23] SGSNSMORRecord,
sgsnSMTRRecord       [24] SGSNSMTRRecord
}

```

```

GGSNPDPRecord ::= SET
{
recordType           [0] CallEventRecordType,
networkInitiation    [1] NetworkInitiatedPDPContext OPTIONAL,
servedIMSI           [3] IMSI,
ggsnAddress          [4] GSNAddress,
chargingID           [5] ChargingID,
sgsnAddress          [6] SEQUENCE OF GSNAddress,
accessPointNameNI    [7] AccessPointNameNI,
pdpType              [8] PDPType,
servedPDPAddress     [9] PDPAddress OPTIONAL,
dynamicAddressFlag   [11] DynamicAddressFlag OPTIONAL,
listOfTrafficVolumes [12] SEQUENCE OF ChangeOfCharCondition,
recordOpeningTime    [13] TimeStamp,
duration              [14] CallDuration,
causeForRecClosing   [15] CauseForRecClosing,
diagnostics          [16] Diagnostics OPTIONAL,
recordSequenceNumber [17] INTEGER OPTIONAL,
nodeID               [18] NodeID OPTIONAL,
recordExtensions     [19] ManagementExtensions OPTIONAL,
localSequenceNumber  [20] LocalSequenceNumber OPTIONAL,
apnSelectionMode     [21] APNSelectionMode OPTIONAL,
servedMSISDN         [22] MSISDN OPTIONAL,
chargingCharacteristics [23] ChargingCharacteristics OPTIONAL
}

```

```

SGSNMMRecord ::= SET
{
recordType           [0] CallEventRecordType,
servedIMSI           [1] IMSI,
servedIMEI           [2] IMEI OPTIONAL,
ggsnAddress          [3] GSNAddress,

```

```

msNetworkCapability [4] MSNetworkCapability OPTIONAL,
routingArea [5] RoutingAreaCode OPTIONAL,
locationAreaCode [6] LocationAreaCode OPTIONAL,
cellIdentifier [7] CellId OPTIONAL,
changeLocation [8] SEQUENCE OF ChangeLocation OPTIONAL,
recordOpeningTime [9] TimeStamp,
duration [10] CallDuration OPTIONAL,
sgsnChange [11] SGSNChange OPTIONAL,
causeForRecClosing [12] CauseForRecClosing,
diagnostics [13] Diagnostics OPTIONAL,
recordSequenceNumber [14] INTEGER OPTIONAL,
nodeID [15] NodeID OPTIONAL,
recordExtensions [16] ManagementExtensions OPTIONAL,
localSequenceNumber [17] LocalSequenceNumber OPTIONAL,
servedMSISDN [18] MSISDN OPTIONAL,
chargingCharacteristics [19] ChargingCharacteristics OPTIONAL,
cAMELInformationMM [20] CAMELInformationMM OPTIONAL,
systemType [21] SystemType OPTIONAL

```

```

}

```

```

SGSNPDPRecord ::= SET

```

```

{
  recordType [0] CallEventRecordType,
  networkInitiation [1] NetworkInitiatedPDPContext OPTIONAL,
  servedIMSI [3] IMSI,
  servedIMEI [4] IMEI OPTIONAL,
  sgsnAddress [5] GSNAddress,
  msNetworkCapability [6] MSNetworkCapability OPTIONAL,
  routingArea [7] RoutingAreaCode OPTIONAL,
  locationAreaCode [8] LocationAreaCode OPTIONAL,
  cellIdentifier [9] CellId OPTIONAL,
  chargingID [10] ChargingID,
  ggsnAddressUsed [11] GSNAddress,
  accessPointNameNI [12] AccessPointNameNI,
  pdpType [13] PDPTType,
  servedPDPAddress [14] PDPAddress OPTIONAL,
  listOfTrafficVolumes [15] SEQUENCE OF ChangeOfCharCondition,
  recordOpeningTime [16] TimeStamp,
  duration [17] CallDuration,
  sgsnChange [18] SGSNChange OPTIONAL,
  causeForRecClosing [19] CauseForRecClosing,
  diagnostics [20] Diagnostics OPTIONAL,
  recordSequenceNumber [21] INTEGER OPTIONAL,
  nodeID [22] NodeID OPTIONAL,
  recordExtensions [23] ManagementExtensions OPTIONAL,
  localSequenceNumber [24] LocalSequenceNumber OPTIONAL,
  apnSelectionMode [25] APNSelectionMode OPTIONAL,
  accessPointNameOI [26] AccessPointNameOI,
  servedMSISDN [27] MSISDN OPTIONAL,
  chargingCharacteristics [28] ChargingCharacteristics OPTIONAL,
  systemType [29] SystemType OPTIONAL,
  cAMELInformationPDP [30] CAMELInformationPDP OPTIONAL,
  rNCUnsentDownlinkVolume [31] DataVolumeGPRS OPTIONAL
}

```

```

SGSNSMORRecord ::= SET

```

```

{
  recordType [0] CallEventRecordType,
  servedIMSI [1] IMSI,
  servedIMEI [2] IMEI OPTIONAL,
  servedMSISDN [3] MSISDN OPTIONAL,
  msNetworkCapability [4] MSNetworkCapability,
  serviceCentre [5] AddressString,
  recordingEntity [6] RecordingEntity,
  locationArea [7] LocationAreaCode OPTIONAL,
  routingArea [8] RoutingAreaCode OPTIONAL,
  cellIdentifier [9] CellId OPTIONAL,
  messageReference [10] MessageReference,
  originationTime [11] TimeStamp,
  smsResult [12] SMSResult OPTIONAL,
  recordExtensions [13] ManagementExtensions OPTIONAL,
  nodeID [14] NodeID OPTIONAL,
  localSequenceNumber [15] LocalSequenceNumber OPTIONAL,
  chargingCharacteristics [16] ChargingCharacteristics OPTIONAL,
  systemType [17] SystemType OPTIONAL,
  destinationNumber [18] CalledNumber OPTIONAL,
  cAMELInformationSMS [19] CAMELInformationSMS OPTIONAL
}

```

```

}

SGSNSMTRRecord ::= SET
{
    recordType           [0] CallEventRecordType,
    servedIMSI          [1] IMSI,
    servedIMEI          [2] IMEI OPTIONAL,
    servedMSISDN        [3] MSISDN OPTIONAL,
    msNetworkCapability [4] MSNetworkCapability,
    serviceCentre       [5] AddressString,
    recordingEntity     [6] RecordingEntity,
    locationArea        [7] LocationAreaCode OPTIONAL,
    routingArea         [8] RoutingAreaCode OPTIONAL,
    cellIdentifier      [9] CellId OPTIONAL,
    originationTime     [10] TimeStamp,
    smsResult           [11] SMSResult OPTIONAL,
    recordExtensions    [12] ManagementExtensions OPTIONAL,
    nodeID              [13] NodeID OPTIONAL,
    localSequenceNumber [14] LocalSequenceNumber OPTIONAL,
    chargingCharacteristics [15] ChargingCharacteristics OPTIONAL,
    systemType          [16] SystemType OPTIONAL
}

```

```

-----
--
-- OBJECT IDENTIFIERS
--
-----

```

```

gsm1205InformationModel OBJECT IDENTIFIER ::=
{ ccitt (0) identified-organization (4) etsi (0) mobileDomain (0)
  gsm-Operation-Maintenance (3) gsm-12-05 (5) informationModel (0) }

```

```

gsm1205ASN1Module OBJECT IDENTIFIER ::=
{ gsm1205InformationModel asn1Module(2) }

```

```

-----
--
-- COMMON DATA TYPES
--
-----

```

```

AccessPointNameNI ::= IA5String (SIZE(1..63))
--
-- Network Identifier part of APN in "dot" representation
-- For example, if the complete APN is 'apnla.apnlb.apnlc.mnc022.mcc111.gprs'
-- NI is 'apnla.apnlb.apnlc' and is presented in this form in the CDR.

```

```

AccessPointNameOI ::= IA5String (SIZE(1..37))
--
-- Operator Identifier part of APN in "dot" representation
-- In the 'apnla.apnlb.apnlc.mnc022.mcc111.gprs' example, the OI portion is 'mnc022.mcc111.gprs'
-- and is presented in this form in the CDR.

```

```

APNSelectionMode ::= ENUMERATED
{
    --
    -- See Information Elements TS 29.060
    --
    mSorNetworkProvidedSubscriptionVerified (0),
    mSProvidedSubscriptionNotVerified (1),
    networkProvidedSubscriptionNotVerified (2)
}

```

```

CAMELAccessPointNameNI ::= AccessPointNameNI

```

```

CAMELAccessPointNameOI ::= AccessPointNameOI

```

```

CAMELInformationMM ::= SET
{
    sCFAddress           [1] SCFAddress OPTIONAL,
    serviceKey           [2] ServiceKey OPTIONAL,
    defaultTransactionHandling [3] DefaultGPRS-Handling OPTIONAL,
    numberOfDPENcountered [4] NumberOfDPENcountered OPTIONAL,
    levelOfCAMELService   [5] LevelOfCAMELService OPTIONAL,
    freeFormatData       [6] FreeFormatData OPTIONAL,
    fFDAppendIndicator    [7] FFDAppendIndicator OPTIONAL
}

```

```

}

CAMELInformationPDP ::= SET
{
    sCFAddress          [1] SCFAddress OPTIONAL,
    serviceKey          [2] ServiceKey OPTIONAL,
    defaultTransactionHandling [3] DefaultGPRS-Handling OPTIONAL,
    cAMELAccessPointNameNI [4] CAMELAccessPointNameNI OPTIONAL,
    cAMELAccessPointNameOI [5] CAMELAccessPointNameOI OPTIONAL,
    numberOfDPEncountered [6] NumberOfDPEncountered OPTIONAL,
    levelOfCAMELService    [7] LevelOfCAMELService OPTIONAL,
    freeFormatData        [8] FreeFormatData OPTIONAL,
    fFDAppendIndicator    [9] FFDAAppendIndicator OPTIONAL
}

CAMELInformationSMS ::= SET
{
    sCFAddress          [1] SCFAddress OPTIONAL,
    serviceKey          [2] ServiceKey OPTIONAL,
    defaultSMShandling  [3] DefaultSMS-Handling OPTIONAL,
    cAMELCallingPartyNumber [4] CallingNumber OPTIONAL,
    cAMELDestinationSubscriberNumber [5] CalledNumber OPTIONAL,
    cAMELMSCAAddress     [6] AddressString OPTIONAL,
    freeFormatData      [7] FreeFormatData OPTIONAL,
    SMSReferenceNumber   [8] CallReferenceNumber OPTIONAL
}

CauseForRecClosing ::= INTEGER
{
    --
    -- in GGSN the value sGSNChange should be used for partial record
    -- generation due to SGSN Address List Overflow
    --
    -- cause codes 0 to 15 are defined in TS 32.005 as 'CauseForTerm' (cause for termination)
    --
    normalRelease          (0),
    abnormalRelease       (4),
    cAMELInitCallRelease  (5),
    volumeLimit           (16),
    timeLimit             (17),
    sGSNChange            (18),
    maxChangeCond         (19),
    managementIntervention (20)
}

ChangeCondition ::= ENUMERATED
{
    qosChange          (0),
    tariffTime        (1),
    recordClosure      (2)
}

ChangeOfCharCondition ::= SEQUENCE
{
    --
    -- used in PDP context record only
    --
    qosRequested          [1] QoSInformation OPTIONAL,
    qosNegotiated         [2] QoSInformation OPTIONAL,
    dataVolumeGPRSUplink [3] DataVolumeGPRS,
    dataVolumeGPRSDownlink [4] DataVolumeGPRS,
    changeCondition      [5] ChangeCondition,
    changeTime           [6] TimeStamp
}

ChangeLocation ::= SEQUENCE
{
    --
    -- used in SGSNMMRecord only
    --
    locationAreaCode [0] LocationAreaCode,
    routingAreaCode  [1] RoutingAreaCode,
    cellId           [2] CellId OPTIONAL,
    changeTime       [3] TimeStamp
}

```

```

ChargingCharacteristics ::= OCTET STRING (SIZE(2))
--
-- Descriptions for the bits of the flag set:
--
-- Bit 1: H (Hot billing)           := '00000001'B
-- Bit 2: F (Flat rate)            := '00000010'B
-- Bit 3: P (Prepaid service)       := '00000100'B
-- Bit 4: N (Normal billing)       := '00001000'B
-- Bit 5: - (Reserved, set to 0)   := '00010000'B
-- Bit 6: - (Reserved, set to 0)   := '00100000'B
-- Bit 7: - (Reserved, set to 0)   := '01000000'B
-- Bit 8: - (Reserved, set to 0)   := '10000000'B
--

ChargingID ::= INTEGER (0..4294967295)
--
-- generated in GGSN, part of PDP context, see TS 23.060
-- 0..4294967295 is equivalent to 0..2**32-1

DataVolumeGPRS ::= INTEGER
--
-- The volume of data transferred in octets.
--

DynamicAddressFlag ::= BOOLEAN

ETSIAddress ::= AddressString
--
--first octet for nature of address, and numbering plan indicator (3 for X.121)
--other octets TBCD
-- See TS 29.002
--

FFDAppendIndicator ::= BOOLEAN

FreeFormatData ::= OCTET STRING (SIZE(1..160))
--
-- Free formatted data as sent in the FurnishChargingInformationGPRS
-- see TS 29.078
--

GSNAddress ::= IPAddress

GSMQoSInformation ::= SEQUENCE
{
    reliability    [0] QoSReliability,
    delay          [1] QoSDelay,
    precedence     [2] QoSPrecedence,
    peakThroughput [3] QoSPeakThroughput,
    meanThroughput [4] QoSMeanThroughput
}

IPAddress ::= CHOICE
{
    iPBinaryAddress      IPBinaryAddress,
    iPTextRepresentedAddress  IPTextRepresentedAddress
}

IPBinaryAddress ::= CHOICE
{
    iPBinV4Address    [0] OCTET STRING (SIZE(4)),
    iPBinV6Address    [1] OCTET STRING (SIZE(16))
}

IPTextRepresentedAddress ::= CHOICE
{
    --
    -- IP address in the familiar "dot" notation
    --
    iPTextV4Address    [2] IA5String (SIZE(7..15)),
    iPTextV6Address    [3] IA5String (SIZE(15..45))
}

LocalSequenceNumber ::= INTEGER (0..4294967295)
--
-- Sequence number of the record in this node
-- 0.. 4294967295 is equivalent to 0..2**32-1, unsigned integer in four octets

MSNetworkCapability ::= OCTET STRING (SIZE(1..8))

```

```

NetworkInitiatedPDPContext ::= BOOLEAN
--
-- Set to true if PDP context was initiated from network side
--

NodeID ::= IA5String (SIZE(1..20))

PDPAddress ::= CHOICE
{
  ipAddress      [0] IPaddress,
  eTsiAddress     [1] ETSIAddress
}

PDPTType ::= OCTET STRING (SIZE(2))
--
--OCTET 1: PDP Type Organization
--OCTET 2: PDP Type Number
-- See TS 29.060
--

QoSDelay ::= ENUMERATED
{
  --
  -- See Quality of service TS 24.008
  --
  delayClass1    (1),
  delayClass2    (2),
  delayClass3    (3),
  delayClass4    (4)
}

QoSInformation ::= CHOICE
{
  gsmQoSInformation [0] GSMQoSInformation,
  umtsQoSInformation [1] OCTET STRING (SIZE (4..12))
}
-- When dealing with a pre R99 QoS profile the GSN may either choose the "GSMQoSInformation" or the
-- "umtsQoSInformation" encoding. Dealing with R99 QoS profiles the GSN shall apply the
-- "umtsQoSInformation" encoding. The umtsQoSInformation octet string is a 1:1 copy of the contents
-- (starting with octet 4) of the "Quality of service Profile" information element specified in
-- 3GPP TS 29.060 [22] for R99 and GSM TS 09.60 for pre R99 cases.
}

QoSMeanThroughput ::= ENUMERATED
{
  --
  -- See Quality of service TS 24.008
  --
  subscribedMeanThroughput (0), -- MS to network direction
  -- Network to MS direction needs not to be covered since value (0) = "reserved"
  mean100octetPh (1),
  mean200octetPh (2),
  mean500octetPh (3),
  mean1000octetPh (4),
  mean2000octetPh (5),
  mean5000octetPh (6),
  mean10000octetPh (7),
  mean20000octetPh (8),
  mean50000octetPh (9),
  mean100000octetPh (10),
  mean200000octetPh (11),
  mean500000octetPh (12),
  mean1000000octetPh (13),
  mean2000000octetPh (14),
  mean5000000octetPh (15),
  mean10000000octetPh (16),
  mean20000000octetPh (17),
  mean50000000octetPh (18),
  reserved (30),
  bestEffort (31)
}

QoSPeakThroughput ::= ENUMERATED
{
  --
  -- See Quality of service TS 24.008
  --

```



```
    unspecified          (0),
    upTo1000octetPs     (1),
    upTo2000octetPs     (2),
    upTo4000octetPs     (3),
    upTo8000octetPs     (4),
    upTo16000octetPs    (5),
    upTo32000octetPs    (6),
    upTo64000octetPs    (7),
    upTo128000octetPs   (8),
    upTo256000octetPs   (9)
}

QoSPrecedence ::= ENUMERATED
{
    --
    -- See Quality of service TS 24.008
    --
    unspecified          (0),
    highPriority         (1),
    normalPriority       (2),
    lowPriority          (3)
}

QoSReliability ::= ENUMERATED
{
    --
    -- See Quality of service TS 24.008
    --
    unspecifiedReliability (0),
    acknowledgedGTP       (1),
    unackGTPAcknowLLC     (2),
    unackGTPLLCAcknowRLC  (3),
    unackGTPLLCRLC       (4),
    unacknowUnprotectedData (5)
}

RoutingAreaCode ::= OCTET STRING (SIZE(1))
--
-- See TS 24.008
--

SCFAddress ::= AddressString
--
-- See TS 29.002
--

NumberOfDPEncountered ::= INTEGER

SGSNChange ::= BOOLEAN
--
-- present if first record after inter SGSN routing area update
-- in new SGSN
--

SystemType ::= ENUMERATED
{
    unknown          (0),
    iuUTRAN          (1),
    gGERAN           (2)
}

END
```

Annex A (informative): Change history

Change history							
Date	TSG #	TSG Doc.	CR	Rev	Subject/Comment	Old	New
Dec 1999	S_06	SP-99577	-	--	Transferred from GSM 12.15 v7.4.0	-	3.0.0
Mar 2000	S_07	SP-000017	001	--	IP v6 support to GTP'	3.0.0	3.1.0
Mar 2000	S_07	SP-000017	002	--	GTP' header length fix	3.0.0	3.1.0
Mar 2000	S_07	SP-000017	003	--	Charging Characteristics to CDRs	3.0.0	3.1.0
Mar 2000	S_07	SP-000017	004	--	include MSISDN in S,G,M-CDR	3.0.0	3.1.0
Mar 2000				--	Cosmetic	3.1.0	3.1.1
Jun 2000	S_08	SP-000236	005	--	Correction of ASN.1 for QoS 'Delay Class'	3.1.1	3.2.0
Jun 2000	S_08	SP-000237	006	--	Draft update of document for 3G Publication	3.1.1	3.2.0
Jun 2000	S_08	SP-000238	007	--	Principles for accurate volume counting	3.1.1	3.2.0
Jun 2000	S_08	SP-000239	008	--	Packet domain charging enhancements on CAMEL phase 3	3.1.1	3.2.0
Jun 2000	S_08	SP-000246	009	--	GPRS charging enhancement, Addition of charging characteristics per PDP context	3.1.1	3.2.0
Sep 2000	S_09	SP-000433	010	--	Clarifications to chapter 7	3.2.0	3.3.0
Sep 2000	S_09	SP-000433	011	--	Clarifications and corrections	3.2.0	3.3.0
Sep 2000	S_09	SP-000433	012	--	Clarification for QoS parameter	3.2.0	3.3.0
Oct 2000				--	Title Changed: "GSM call ... into "3G call ...	3.2.0	3.3.0
Dec 2000	S_10	SP-000516	013	--	Alignment of Triggers for S-CDR closure	3.3.0	3.4.0
Dec 2000	S_10	SP-000516	014	--	Ambiguities in Packet Transfer Command IE & Data Record Packet IE	3.3.0	3.4.0
Dec 2000	S_10	SP-000516	015	--	Inconsistency of Charging Characteristic size	3.3.0	3.4.0
Dec 2000	S_10	SP-000516	016	--	Alignment of ASN.1 for QoS attributes	3.3.0	3.4.0
Dec 2000	S_10	SP-000516	017	--	Correction of parameter CallEventRecord	3.3.0	3.4.0
Dec 2000	S_10	SP-000516	018	--	Correction of parameter Location Area and Cell	3.3.0	3.4.0
Dec 2000	S_10	SP-000516	019	--	Correction of ASN.1 errors	3.3.0	3.4.0
Mar 2001	S_11	SP-010024	020	--	Correct ASN.1 errors	3.4.0	3.5.0
Mar 2001	S_11	SP-010024	021	--	Correction of Requests Responded IE Type Value	3.4.0	3.5.0
Mar 2001	S_11	SP-010024	022	--	Correction/completion of ASN.1 module	3.4.0	3.5.0
Mar 2001	S_11	SP-010024	023	--	Correct ASN.1 errors	3.4.0	3.5.0
Mar 2001	S_11	SP-010024	024	--	Trigger for RNC volume report	3.4.0	3.5.0
Mar 2001	S_11	SP-010024	025	--	Correction of parameter 'Served PDP Address'	3.4.0	3.5.0
Jun 2001	S_12	SP-010235	026	--	Correct the Node Address IE	3.5.0	3.6.0
Jun 2001	S_12	SP-010235	027	--	Correct GGSN address in G-CDR and S-CDR	3.5.0	3.6.0
Sep 2001	S_13	SP-010463	028	--	Decoupling of Tariff time switches on GSN- and CAMEL-level from a CDR's perspective	3.6.0	3.7.0
Sep 2001	S_13	SP-010463	029	--	Data type definition for MSNetworkCapability corrected and aligned with TS 24.008	3.6.0	3.7.0
Sep 2001	S_13	SP-010463	030	--	Modification of "System Type"	3.6.0	3.7.0
Sep 2001	S_13	SP-010463	031	--	Correction of G-CDR trigger conditions	3.6.0	3.7.0
Dec 2001	S_14	SP-010633	032	--	Specification of the "Data Record Format" and "Data Record Format Version"	3.7.0	3.8.0
Dec 2001	S_14	SP-010632	033	--	Precision of encoding rule for CDR item "Access Point Name"	3.7.0	3.8.0
Dec 2001	S_14	SP-010633	034	--	Correction of ASN.1 data items QoSMeanThroughput/QoSInformation	3.7.0	3.8.0
Mar 2002	S_15	SP-020022	035	--	Addition of CAMEL phase 3 extensions in SMS-MO CDR	3.8.0	3.9.0
Mar 2002	S_15	SP-020024	036	--	Addition of "QoSRequested" parameter into "traffic volume containers"	3.8.0	3.9.0

History

Document history		
V3.0.0	January 2000	Publication
V3.1.1	March 2000	Publication
V3.2.0	July 2000	Publication
V3.3.0	September 2000	Publication
V3.4.0	December 2000	Publication
V3.5.0	March 2001	Publication
V3.6.0	June 2001	Publication
V3.7.0	September 2001	Publication
V3.8.0	December 2001	Publication
V3.9.0	March 2002	Publication