

# ETSI TS 132 251 V7.7.0 (2010-04)

---

*Technical Specification*

**Digital cellular telecommunications system (Phase 2+);  
Universal Mobile Telecommunications System (UMTS);  
LTE;  
Telecommunication management;  
Charging management;  
Packet Switched (PS) domain charging  
(3GPP TS 32.251 version 7.7.0 Release 7)**

---



---

Reference

RTS/TSGS-0532251v770

---

Keywords

GSM, UMTS

**ETSI**

650 Route des Lucioles  
F-06921 Sophia Antipolis Cedex - FRANCE

Tel.: +33 4 92 94 42 00 Fax: +33 4 93 65 47 16

Siret N° 348 623 562 00017 - NAF 742 C  
Association à but non lucratif enregistrée à la  
Sous-Préfecture de Grasse (06) N° 7803/88

---

**Important notice**

Individual copies of the present document can be downloaded from:

<http://www.etsi.org>

The present document may be made available in more than one electronic version or in print. In any case of existing or perceived difference in contents between such versions, the reference version is the Portable Document Format (PDF). In case of dispute, the reference shall be the printing on ETSI printers of the PDF version kept on a specific network drive within ETSI Secretariat.

Users of the present document should be aware that the document may be subject to revision or change of status. Information on the current status of this and other ETSI documents is available at

<http://portal.etsi.org/tb/status/status.asp>

If you find errors in the present document, please send your comment to one of the following services:

[http://portal.etsi.org/chaicor/ETSI\\_support.asp](http://portal.etsi.org/chaicor/ETSI_support.asp)

---

**Copyright Notification**

No part may be reproduced except as authorized by written permission.  
The copyright and the foregoing restriction extend to reproduction in all media.

© European Telecommunications Standards Institute 2010.  
All rights reserved.

**DECT**<sup>™</sup>, **PLUGTESTS**<sup>™</sup>, **UMTS**<sup>™</sup>, **TIPHON**<sup>™</sup>, the TIPHON logo and the ETSI logo are Trade Marks of ETSI registered for the benefit of its Members.

**3GPP**<sup>™</sup> is a Trade Mark of ETSI registered for the benefit of its Members and of the 3GPP Organizational Partners.

**LTE**<sup>™</sup> is a Trade Mark of ETSI currently being registered

for the benefit of its Members and of the 3GPP Organizational Partners.

**GSM**<sup>®</sup> and the GSM logo are Trade Marks registered and owned by the GSM Association.

---

## Intellectual Property Rights

IPRs essential or potentially essential to the present document may have been declared to ETSI. The information pertaining to these essential IPRs, if any, is publicly available for **ETSI members and non-members**, and can be found in ETSI SR 000 314: "*Intellectual Property Rights (IPRs); Essential, or potentially Essential, IPRs notified to ETSI in respect of ETSI standards*", which is available from the ETSI Secretariat. Latest updates are available on the ETSI Web server (<http://webapp.etsi.org/IPR/home.asp>).

Pursuant to the ETSI IPR Policy, no investigation, including IPR searches, has been carried out by ETSI. No guarantee can be given as to the existence of other IPRs not referenced in ETSI SR 000 314 (or the updates on the ETSI Web server) which are, or may be, or may become, essential to the present document.

---

## Foreword

This Technical Specification (TS) has been produced by ETSI 3rd Generation Partnership Project (3GPP).

The present document may refer to technical specifications or reports using their 3GPP identities, UMTS identities or GSM identities. These should be interpreted as being references to the corresponding ETSI deliverables.

The cross reference between GSM, UMTS, 3GPP and ETSI identities can be found under <http://webapp.etsi.org/key/queryform.asp>.

# Contents

Intellectual Property Rights .....	2
Foreword.....	2
Foreword.....	5
1 Scope .....	6
2 References .....	7
3 Definitions, symbols and abbreviations .....	8
3.1 Definitions .....	8
3.2 Symbols.....	10
3.3 Abbreviations .....	11
4 Architecture considerations .....	13
4.1 High level GPRS architecture .....	13
4.2 PS domain offline charging architecture .....	15
4.3 PS domain online charging architecture.....	16
5 PS domain charging principles and scenarios .....	17
5.1 PS charging principles.....	17
5.1.1 Requirements .....	17
5.1.2 Charging information.....	18
5.2 PS domain offline charging scenarios .....	19
5.2.1 Basic principles.....	19
5.2.1.1 PDP context charging.....	19
5.2.1.2 MM context charging .....	20
5.2.1.3 Flow Based bearer Charging (FBC).....	20
5.2.1.4 SMS charging.....	22
5.2.1.5 LCS charging .....	22
5.2.1.6 MBMS context charging .....	23
5.2.2 Rf message flows.....	23
5.2.3 CDR generation .....	23
5.2.3.1 Triggers for S-CDR charging information collection .....	24
5.2.3.1.1 Triggers for S-CDR Charging Information Addition .....	24
5.2.3.1.2 Triggers for S-CDR closure.....	25
5.2.3.2 Triggers for M-CDR charging information collection .....	25
5.2.3.2.1 Triggers for M-CDR charging information addition .....	26
5.2.3.2.2 Triggers for M-CDR closure .....	26
5.2.3.3 Triggers for G-CDR charging information collection.....	26
5.2.3.3.1 Triggers for G-CDR Charging Information Addition.....	27
5.2.3.3.2 Triggers for G-CDR closure .....	27
5.2.3.4 Triggers for eG-CDR charging information collection .....	27
5.2.3.4.1 Triggers for eG-CDR Charging Information Addition.....	28
5.2.3.4.2 Triggers for eG-CDR closure .....	29
5.2.3.5 Triggers for SMS-CDR charging information collection.....	29
5.2.3.6 Triggers for LCS-CDR charging information collection .....	30
5.2.3.7 Triggers for S-MB-CDR and G-MB-CDR charging information collection .....	30
5.2.3.7.1 Triggers for S-MB-CDR and G-MB-CDR Charging Information Creation.....	30
5.2.3.7.2 Triggers for S-MB-CDR and G-MB-CDR Charging Information Addition .....	30
5.2.3.7.3 Triggers for S-MB-CDR and G-MB-CDR closure.....	31
5.2.4 Usage scenarios .....	32
5.2.4.1 Mobile to PDN Context .....	32
5.2.4.2 Mobile to mobile context .....	33
5.2.4.3 PDN to mobile context.....	34
5.2.4.4 Mobile to PDN context while roaming, GGSN in HPLMN.....	34
5.2.5 Ga record transfer flows .....	35
5.2.6 Bp CDR file transfer .....	35
5.3 PS domain online charging scenarios.....	36

5.3.1	Basic principles.....	36
5.3.1.1	PDP context charging.....	36
5.3.1.2	Flow Based Bearer Charging .....	36
5.3.1.3	PS Furnish Charging Information procedure .....	37
5.3.1.4	Support of Failure Situations.....	37
5.3.2	Ro message flows .....	38
5.3.2.1	Triggers for PDP context Online Charging.....	38
5.3.2.1.1	Void.....	38
5.3.2.1.2	Void.....	38
5.3.2.2	Triggers for FBC Online Charging .....	38
5.3.2.2.1	Triggers for starting and stopping an FBC Credit Control session.....	39
5.3.2.2.2	Triggers for providing interim information for an FBC Credit Control session.....	39
5.3.2.3	PS Furnish Charging Information procedure .....	40
5.3.2.4	Support of Failure Situations.....	40
6	Definition of charging information .....	41
6.1	Data description for PS offline charging .....	41
6.1.1	PDP context charging data in SGSN (S-CDR) .....	42
6.1.2	PDP context charging data in GGSN (G-CDR).....	43
6.1.3	FBC enhanced PDP context charging data in GGSN (eG-CDR).....	44
6.1.4	Mobile Station mobility management data in SGSN (M-CDR) .....	46
6.1.5	SMS-MO data in SGSN (S-SMO-CDR) .....	47
6.1.6	SMS-MT data in SGSN (S-SMT-CDR) .....	48
6.1.7	Mobile terminated location request (LCS-MT-CDR).....	49
6.1.8	Mobile originated Location request (LCS-MO-CDR).....	50
6.1.9	Network induced Location request (LCS-NI-CDR) .....	51
6.1.10	MBMS bearer context charging data in SGSN (S-MB-CDR) .....	52
6.1.11	MBMS bearer context charging data in GGSN (G-MB-CDR).....	53
6.2	Data description for PS Online Charging .....	53
6.2.1	Diameter message contents.....	53
6.2.1.1	Summary of Online Charging Message Formats .....	53
6.2.1.2	Structure for the Credit Control Message Formats.....	54
6.2.1.2.1	Credit-Control-Request Message .....	54
6.2.1.2.2	Credit-Control-Answer Message.....	55
6.2.2	Void .....	55
6.3	PS Online Charging Specific Parameters .....	56
6.3.1	Definition of PS charging information.....	56
6.3.1.1	PS charging information assignment for Service Information .....	56
6.3.1.2	Definition of the PS Information.....	57
<b>Annex A (normative):</b>	<b>Charging characteristics .....</b>	<b>58</b>
<b>Annex B (normative):</b>	<b>Tx expiration; Failure Handling procedure and session failover mechanism description .....</b>	<b>62</b>
<b>Annex C (informative):</b>	<b>Bibliography .....</b>	<b>64</b>
<b>Annex D (informative):</b>	<b>Change history .....</b>	<b>65</b>
History .....		66

---

# Foreword

This Technical Specification has been produced by the 3<sup>rd</sup> Generation Partnership Project (3GPP).

The contents of the present document are subject to continuing work within the TSG and may change following formal TSG approval. Should the TSG modify the contents of the present document, it will be re-released by the TSG with an identifying change of release date and an increase in version number as follows:

Version x.y.z

where:

- x the first digit:
  - 1 presented to TSG for information;
  - 2 presented to TSG for approval;
  - 3 or greater indicates TSG approved document under change control.
- y the second digit is incremented for all changes of substance, i.e. technical enhancements, corrections, updates, etc.
- z the third digit is incremented when editorial only changes have been incorporated in the document.

---

# 1 Scope

The present document is part of a series of documents specifying charging functionality and charging management in GSM/UMTS networks. The GSM/UMTS core network charging architecture and principles are specified in 3GPP TS 32.240 [1], which provides an umbrella for other charging management documents that specify:

- the content of the CDRs per domain / subsystem / service (offline charging);
- the content of real-time charging messages per domain / subsystem /service (online charging);
- the functionality of online and offline charging for those domains / subsystems / services;
- the interfaces that are used in the charging framework to transfer the charging information (i.e. CDRs or charging events).

The complete document structure for these TSs is defined in 3GPP TS 32.240 [1].

The present document specifies the Offline and Online Charging description for the Packet Switched (PS) domain (i.e. GPRS), based on the functional stage 2 description of GPRS in 3GPP TS 23.060 [201]. This charging description includes the offline and online charging architecture and scenarios specific to the PS domain, as well as the mapping of the common 3GPP charging architecture specified in TS 32.240 [1] onto the PS domain. It further specifies the structure and content of the CDRs for offline charging, and the charging events for online charging. The present document is related to other 3GPP charging TSs as follows:

- The common 3GPP charging architecture is specified in TS 32.240 [1];
- The parameters, abstract syntax and encoding rules for the CDRs are specified in TS 32.298 [51];
- A transaction based mechanism for the transfer of CDRs within the network is specified in TS 32.295 [54];
- The file based mechanism used to transfer the CDRs from the network to the operator's billing domain (e.g. the billing system or a mediation device) is specified in TS 32.297 [52];
- The 3GPP Diameter application that is used for PS domain offline and online charging is specified in TS 32.299 [50].

Note that a CAMEL based prepaid function and protocol is also specified for the PS domain (3GPP TS 23.078 [206] and 3GPP TS 29.078 [202]). CAMEL entities and functions are outside the scope of the present document.

All terms, definitions and abbreviations used in the present document, which are common across 3GPP TSs, are defined in 3GPP TR 21.905 [100]. Those that are common across charging management in GSM/UMTS domains, services or subsystems are provided in the umbrella document 3GPP TS 32.240 [1] and are copied into clause 3 of the present document for ease of reading. Finally, those items that are specific to the present document are defined exclusively in the present document.

Furthermore, requirements that govern the charging work are specified in 3GPP TS 22.115 [102].

---

## 2 References

The following documents contain provisions which, through reference in this text, constitute provisions of the present document.

- References are either specific (identified by date of publication, edition number, version number, etc.) or non-specific.
- For a specific reference, subsequent revisions do not apply.
- For a non-specific reference, the latest version applies. In the case of a reference to a 3GPP document (including a GSM document), a non-specific reference implicitly refers to the latest version of that document *in the same Release as the present document*.

- [1] 3GPP TS 32.240: "Telecommunication management; Charging management; Charging architecture and principles".
- [2]- [9] Void.
- [10] 3GPP TS 32.250: "Telecommunication management; Charging management; Circuit Switched (CS) domain charging".
- [11-19] Void.
- [20] 3GPP TS 32.260: "Telecommunication management; Charging management; IP Multimedia Subsystem (IMS) charging".
- [21]- [29] Void.
- [30] 3GPP TS 32.270: "Telecommunication management; Charging management; Multimedia Messaging Service (MMS) charging".
- [31] 3GPP TS 32.271: "Telecommunication management; Charging management; Location Services (LCS) charging".
- [32] 3GPP TS 32.273: "Telecommunication management; Charging management; Multimedia Broadcast and Multicast Service (MBMS) charging".
- [33]- [49] Void.
- [50] 3GPP TS 32.299: "Telecommunication management; Charging management; Diameter charging application".
- [51] 3GPP TS 32.298: "Telecommunication management; Charging management; Charging Data Record (CDR) encoding rules description".
- [52] 3GPP TS 32.297: "Telecommunication management; Charging management; Charging Data Records (CDR) file format and transfer".
- [53] 3GPP TS 32.296: "Telecommunication management; Charging management; Online Charging System (OCS) applications and interfaces".
- [54] 3GPP TS 32.295: "Telecommunication management; Charging management; Charging Data Record (CDR) transfer".
- [55]- [69] Void.
- [70] Void.
- [71] 3GPP TS 29.212: "Policy and Charging Control over Gx reference point".
- [72] 3GPP TS 23.203: "Policy and Charging Control Architecture".
- [73]- [99] Void.
- [100] 3GPP TR 21.905: "Vocabulary for 3GPP Specifications".



[101]	Void.
[102]	3GPP TS 22.115 "Service aspects; Charging and billing".
[103]- [199]	Void.
[200]	3GPP TS 22.060: "General Packet Radio Service (GPRS); Service description; Stage 1".
[201]	3GPP TS 23.060: "General Packet Radio Service (GPRS); Service description; Stage 2".
[202]	3GPP TS 29.078: "Customized Applications for Mobile network Enhanced Logic (CAMEL); CAMEL Application Part (CAP) specification".
[203]	3GPP TS 29.060: "General Packet Radio Service (GPRS); GPRS Tunnelling Protocol (GTP) across the Gn and Gp interface".
[204]	Void.
[205]	3GPP TS 29.061: "Interworking between the Public Land Mobile Network (PLMN) supporting packet based services and Packet Data Networks (PDN)".
[206]	3GPP TS 23.078: "Customized Applications for Mobile network Enhanced Logic (CAMEL); Stage 2".
[207]	3GPP TS 23.246: "Multimedia Broadcast/Multicast Service (MBMS); Architecture and functional description".
[208]- [299]	Void.
[301]- [399]	Void.
[400]	Void.
[401]	IETF RFC 3588 (2003): 'Diameter Base Protocol'
[402]	IETF RFC 4006: 'Diameter Credit Control' Application
[403]	Void.

---

## 3 Definitions, symbols and abbreviations

### 3.1 Definitions

For the purposes of the present document, the terms and definitions defined in 3GPP TR 21.905 [100], 3GPP TS 32.240 [1] and 3GPP TS 22.060 [200], and the following apply:

**2G-/3G-:** prefixes 2G- and 3G- refer to functionality that supports only GSM or UMTS, respectively, e.g. 2G-SGSN refers only to the GSM functionality of an SGSN

When the term/prefix is omitted, reference is made independently from the GSM or UMTS functionality.

**accounting:** process of apportioning charges between the Home Environment, Serving Network and Subscriber.

**billing:** function whereby CDRs generated by the charging function(s) are transformed into bills requiring payment.

**Billing Domain:** Part of the operator network, which is outside the core network that receives and processes CDR files from the core network charging functions. It includes functions that can provide billing mediation and billing or other (e.g. statistical) end applications. It is only applicable to offline charging (see 'Online Charging System' for equivalent functionality in online charging).

**CAMEL:** network feature that provides the mechanisms to support operator specific services even when roaming outside HPLMN.

**CAMEL subscription information:** identifies a subscriber as having CAMEL services.

**CDR field Categories:** the CDR fields are defined in the present document. They are divided into the following categories:

- **Mandatory (M):** field that shall always be present in the CDR.
- **Conditional (C):** field that shall be present in a CDR if certain conditions are met.
- **Operator Provisionable: Mandatory (O<sub>M</sub>):** A field that operators have provisioned to always be included in the CDR.
- **Operator Provisionable: Conditional (O<sub>C</sub>):** A field that operators have provisioned to be included in the CDR if certain conditions are met.

**chargeable event:** activity utilizing telecommunications network resources and related services for:

- user to user communication (e.g. a single call, a data communication session or a short message); or
- user to network communication (e.g. service profile administration); or
- inter-network communication (e.g. transferring calls, signalling, or short messages); or
- mobility (e.g. roaming or inter-system handover); and
- that the network operator may want to charge for.

As a minimum, a chargeable event characterises the resource / service usage and indicates the identity of the involved end user(s).

**charged party:** user involved in a chargeable event that has to pay parts or the whole charges of the chargeable event, or a third party paying the charges caused by one or all users involved in the chargeable event, or a network operator.

**charging:** a function within the telecommunications network and the associated OCS/BD components whereby information related to a chargeable event is collected, formatted and transferred in order to make it possible to determine usage for which the charged party may be billed.

**Charging Data Record (CDR):** A formatted collection of information about a chargeable event (e.g. time of call set-up, duration of the call, amount of data transferred, etc) for use in billing and accounting. For each party to be charged for parts of or all charges of a chargeable event a separate CDR shall be generated, i.e. more than one CDR may be generated for a single chargeable event, e.g. because of its long duration, or because more than one charged party is to be charged.

**Charging event:** a set of charging information forwarded by the CTF towards the CDF (offline charging) or towards the OCS (online charging). Each charging event matches exactly one chargeable event.

**charging function:** entity inside the core network domain, subsystem or service that is involved in charging for that domain, subsystem or service.

**credit control:** mechanism which directly interacts in real-time with an account and controls or monitors the charges, related to the service usage. Credit control is a process of: checking if credit is available, credit reservation, deduction of credit from the end user account when service is completed and refunding of reserved credit not used.

**domain:** part of a communication network that provides network resources using a certain bearer technology.

**Fully qualified Partial CDR (FQPC):** partial CDR that contains a complete set of the fields specified in the present document. This includes all the mandatory and conditional fields as well as those fields that the PLMN operator has provisioned to be included in the CDR. The first Partial CDR shall be a Fully qualified Partial CDR.

**GPRS:** packet switched bearer and radio services for GSM and UMTS systems.

**GSM only:** qualifier indicating that this clause or paragraph applies only to a GSM system. For multi-system cases this is determined by the current serving radio access network.

**in GSM,....:** qualifier indicating that this paragraph applies only to GSM System.

**in UMTS,....:** qualifier indicating that this paragraph applies only to UMTS System.

**inter-system change:** change of radio access between different radio access technologies such as GSM and UMTS.

**middle tier (charging) TS:** used for the 3GPP charging TSs that specify the domain / subsystem / service specific, online and offline, charging functionality. These are all the TSs in the numbering range from 3GPP TS 32.250 [10] to 3GPP TS 32.271 [31], e.g. 3GPP TS 32.250 [10] for the CS domain, or 3GPP TS 32.270 [30] for the MMS service. Currently, there is only one "tier 1" TS in 3GPP, which is TS 32.240 [1] that specifies the charging architecture and principles. Finally, there are a number of top tier TSs in the 32.29x numbering range ([50] ff) that specify common charging aspects such as parameter definitions, encoding rules, the common billing domain interface or common charging applications.

**near real-time:** near real-time charging and billing information is to be generated, processed, and transported to a desired conclusion in less than 1 minute.

**offline charging:** charging mechanism where charging information **does not** affect, in real-time, the service rendered.

**online charging:** charging mechanism where charging information can affect, in real-time, the service rendered and therefore a direct interaction of the charging mechanism with bearer/session/service control is required.

**Online Charging System:** the entity that performs real-time credit control. Its functionality includes transaction handling, rating, online correlation and management of subscriber account balances.

**packet switched domain:** domain within GSM / UMTS in which data is transferred in packet switched mode. Corresponds to the term "GPRS".

**partial CDR:** CDR that provides information on part of a subscriber session. A long session may be covered by several partial CDRs. Two formats are considered for Partial CDRs. One that contains all of the necessary fields (FQPC); the second has a reduced format (RPC).

**Real-time:** real-time charging and billing information is to be generated, processed, and transported to a desired conclusion in less than 1 second.

**Reduced Partial CDR (RPC):** partial CDRs that only provide mandatory fields and information regarding changes in the session parameters relative to the previous partial CDR. For example, location information is not repeated in these CDRs if the subscriber did not change its location.

**settlement:** payment of amounts resulting from the accounting process.

**subscriber:** A subscriber is an entity (associated with one or more users) that is engaged in a Subscription with a service provider. The subscriber is allowed to subscribe and unsubscribe services, to register a user or a list of users authorised to enjoy these services, and also to set the limits relative to the use that associated users make of these services.

**tariff period:** part of one (calendar) day during which a particular tariff is applied. Defined by the time at which the period commences (the switch-over time) and the tariff to be applied after switch-over.

**tariff:** set of parameters defining the network utilisation charges for the use of a particular bearer / session / service.

**UMTS only:** qualifier indicating that this clause or paragraph applies only to a UMTS system. For multi-system cases this is determined by the current serving radio access network.

**user:** An entity, not part of the 3GPP System that uses network resources by means of a subscription. The user may or may not be identical to the subscriber holding that subscription.

**User Equipment (UE):** A device allowing a user access to network services. For the purpose of 3GPP specifications the interface between the UE and the network is the radio interface. A User Equipment can be subdivided into a number of domains, the domains being separated by reference points. Currently defined domains are the USIM and ME Domains. The ME Domain can further be subdivided into several components showing the connectivity between multiple functional groups. These groups can be implemented in one or more hardware devices. An example of such connectivity is the TE – MT interface. Further, an occurrence of a User Equipment is an MS for GSM as defined in GSM TS 04.02.

## 3.2 Symbols

For the purposes of the present document the following symbols apply:

A	Interface between an MSC and a BSC.
Bp	Reference point for the CDR file transfer from the GPRS CGF to the BD.

C	Interface between a HLR and a SMSC.
D	Interface between a MSC and a HLR.
E	Interface between a MSC and a SMSC.
Ga	Reference point between a CDF and the CGF for CDR transfer.
Gb	Interface between an SGSN and a BSC.
Gc	Interface between an GGSN and an HLR.
Gd	Interface between an SMS-GMSC and an SGSN, and between a SMS-IWMSC and an SGSN.
Ge	Interface between a SGSN and a CAMEL GSM SCF
Gf	Interface between an SGSN and an EIR.
Gi	Interface between the Packet-Switched domain and an external packet data network.
Gn	Interface between two GSNs within the same PLMN.
Gp	Interface between two GSNs in different PLMNs.
Gr	Interface between an SGSN and an HLR.
Gs	Interface between an SGSN and an MSC/VLR.Iu Interface between the 3G SGSN and the UTRAN
Gy	Online charging reference point between a PCEF and an OCS.
Gz	Offline charging reference point between a PCEF and a CGF.
kbit/s	Kilobits per second. 1 kbit/s = 2 <sup>10</sup> bits per second.
Mbit/s	Megabits per second. 1 Mbit/s = 2 <sup>20</sup> bits per second.
R	Reference point between a non-ISDN compatible TE and MT. Typically this reference point supports a standard serial interface.
Ro	Online Charging Reference Point between a 3G network element and the OCS.
Um	Interface between the Mobile Station (MS) and the GSM fixed network part.
Uu	Interface between the Mobile Station (MS) and the UMTS fixed network part.

### 3.3 Abbreviations

For the purposes of the present document, the abbreviations defined in 3GPP TR 21.905 [50] and the following apply:

3G	3 <sup>rd</sup> Generation
AoC	Advice of Charge
APN	Access Point Name
BD	Billing Domain
CAMEL	Customized Applications for Mobile network Enhanced Logic
CCA	Credit Control Answer
CCR	Credit Control Request
CDF	Charging Data Function
CDR	Charging Data Record
CG	Charging Gateway
CGF	Charging Gateway Function
CI	Cell Identity
CS	Circuit Switched
CSE	CAMEL Service Environment
DCCA	Diameter Credit Control Application
ECUR	Event Charging with Unit Reservation
eG-CDR	enhanced G-CDR (enhanced by FBC)
FBC	Flow Based bearer Charging
FQPC	Fully Qualified Partial CDR
G-CDR	GGSN generated - CDR
GGSN	Gateway GPRS Support Node
GPRS	General Packet Radio Service
GSM	Global System for Mobile communication
GSN	GPRS Support Node (either SGSN or GGSN)
GTP	GPRS Tunnelling Protocol
GTP'	The GPRS protocol used for CDR transport. It is derived from GTP with enhancements to improve transport reliability necessary for CDRs.
HLR	Home Location Register
HPLMN	Home PLMN
IEC	Immediate Event Charging
IETF	Internet Engineering Task Force
IHOSS:OSP	Internet Hosted Octet Stream Service: Octet Stream Protocol
IMEI	International Mobile Equipment Identity

IMSI	International Mobile Subscriber Identity
IP	Internet Protocol
IPv4	Internet Protocol version 4
IPv6	Internet Protocol version 6
ISDN	Integrated Services Digital Network
ITU-T	International Telecommunication Union - Telecommunications standardization sector
LAC	Location Area Code
LR	Location Request
M-CDR	Mobility management generated - Charging Data Record
MCC	Mobile Country Code (part of IMSI)
ME	Mobile Equipment
MLC	Mobile Location Center
MMS	Multimedia Messaging Service
MNC	Mobile Network Code (part of IMSI)
MO	Mobile Originated
MO-LR	Mobile Originated - Location Request
MS	Mobile Station
MSISDN	Mobile Station ISDN number
MT	Mobile Terminated
MT-LR	Mobile Terminated - Location Request
NE	Network Element
NI	Network Identifier (part of the APN)
NI-LR	Network Induced - Location Request
OCF	Online Charging Function
OCS	Online Charging System
OI	Operator Identifier (part of the APN)
PCEF	Policy and Charging Enforcement Function
PDN	Packet Data Network
PDP	Packet Data Protocol (e.g. IP)
PDU	Packet Data Unit
PLMN	Public Land Mobile Network
PPP	Point-to-Point Protocol
PS	Packet Switched
QoS	Quality of Service
RAB	Radio Access Bearer
RAC	Routing Area Code
RANAP	Radio Access Network Application Part
RNC	Radio Network Controller
RPC	Reduced Partial CDR
SAC	Service Area Code
S-CDR	SGSN (PDP context) generated - CDR
SCUR	Session Charging with Unit Reservation
SGSN	Serving GPRS Support Node
SMS	Short Message Service
S-SMO-CDR	SGSN delivered Short message Mobile Originated - CDR
S-SMT-CDR	SGSN delivered Short message Mobile Terminated - CDR
TR	Technical Report
TS	Technical Specification
UMTS	Universal Mobile Telecommunications System
USIM	Universal Subscriber Identity Module
UTRAN	UMTS Terrestrial Radio Access Network

## 4 Architecture considerations

This clause describes the functional entities involved in the PS domain charging architecture. It also presents the mappings of the ubiquitous offline and online charging architecture specified in TS 32.240 [1] onto physical implementations that are standardised for the 3GPP PS domain.

### 4.1 High level GPRS architecture

Figure 4.1 shows a high level overview of the GPRS system architecture. Each PLMN has two access points to GPRS services, the radio interface (labelled Um in A/Gb mode and Uu in Iu mode) used for mobile access and the R reference point used for origination or reception of messages. There is an inter PLMN interface labelled Gp that connects two independent GPRS packet domain networks for message exchange.

There is also a PLMN to packet data network reference point called Gi. Gi is defined in 3GPP TS 29.061 [205].

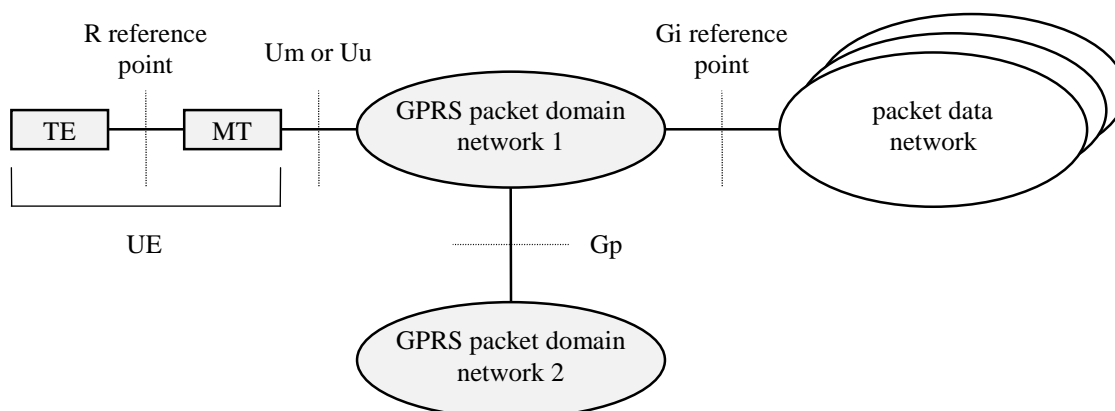
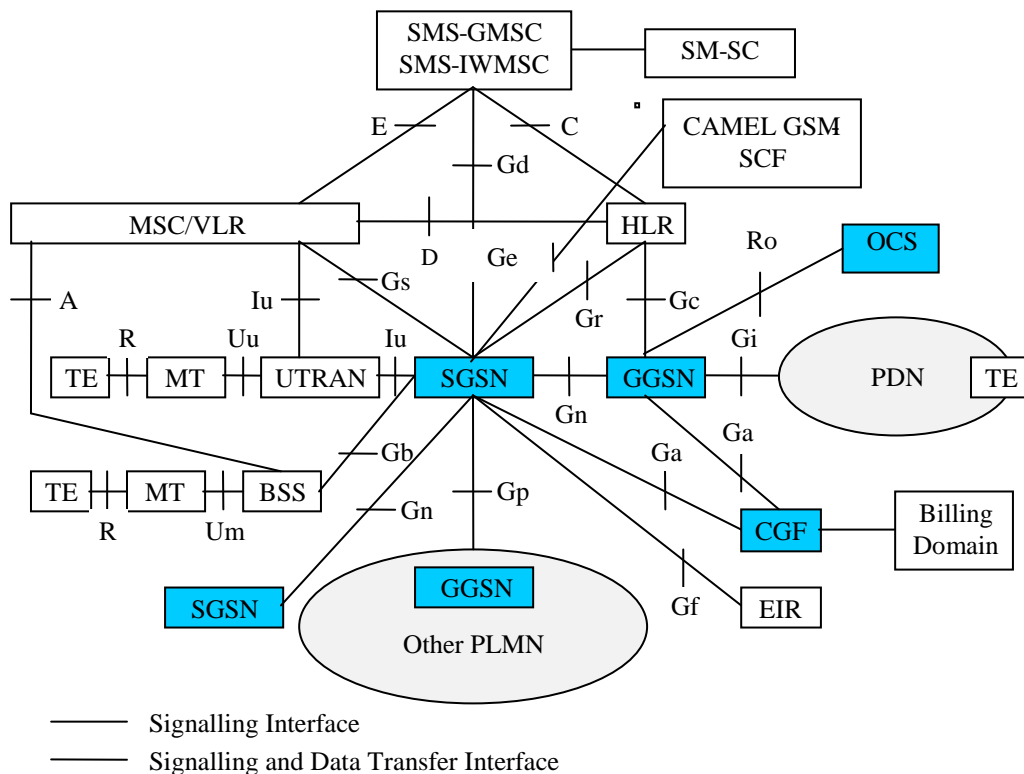

**Figure 4.1: GPRS Access Interfaces and Reference Points**

There may be more than a single network interface to several different packet data networks. These networks may both differ in ownership as well as in communications protocol (e.g. TCP/IP etc.). The network operator defines and negotiates interconnection with each interconnected packet data network.

Figure 4.2 depicts the logical GPRS architecture in more detail. The GPRS Core Network functionality is logically implemented on two network elements, the Serving GPRS Support Node (SGSN) and the Gateway GPRS Support Node (GGSN), connected by a number of new interfaces between each others and the rest of the network. No inference should be drawn about the physical configuration of any network element or interface from Figure 4.2.

Note that a visited GMLC may be connected to the SGSN via the Lg reference point, this is not shown in figure 4.2. Refer to TS 32.271 [31] for further information.



**Figure 4.2: Overview of the GPRS Logical Architecture**

For offline charging the elements that are involved in PS domain charging are specially colored in figure 4.2. The following nodes may generate accounting metrics sets for PS domain CDRs:

- the SGSN, to record a user's access to PLMN resources, mobility management activities, SMS and LCS usage;
- the GGSN, to record a user's access to external networks.

The GSNs send the CDRs to the CGF in near real-time. The responsibility of the CGF is to provide non-volatile CDR storage and the Bp interface towards the Billing Domain. Further details on the CGF can be found in TS 32.240 [1] and TS 32.297 [52].

For more information about online charging in PS domains see clause 4.3

## 4.2 PS domain offline charging architecture

As described in TS 32.240 [1], the CTF (an integrated component in each charging relevant NE) generates charging events and forwards them to the CDF. The CDF, in turn, generates CDRs which are then transferred to the CGF. Finally, the CGF creates CDR files and forwards them to the Billing Domain.

In GPRS, each GSN has an integrated CDF, hence a physical GSN can produce CDRs. The CGF may also be integrated in the GSN, or it may exist as a physically separate entity. If the CGF is external to the GSN, then the CDF forwards the CDRs to the CGF across the Ga interface. In this case, the relationship between GSN/CDF and CGF is m:1. If the CGF is integrated in the GSN, then there is only an internal interface between the CDF and the CGF. In this case, the relationship between GSN/CDF and CGF is 1:1. An integrated CGF may support the Ga interface from other GSN/CDFs.

When an external CGF is used, this CGF may also be used by other, i.e. non-GPRS, network elements, according to network design and operator decision. It should be noted that the CGF may also be an integrated component of the BD – in this case, the Bp interface does not exist and is replaced by a proprietary solution internal to the BD.

Figure 4.3. depicts the architectural options described above.

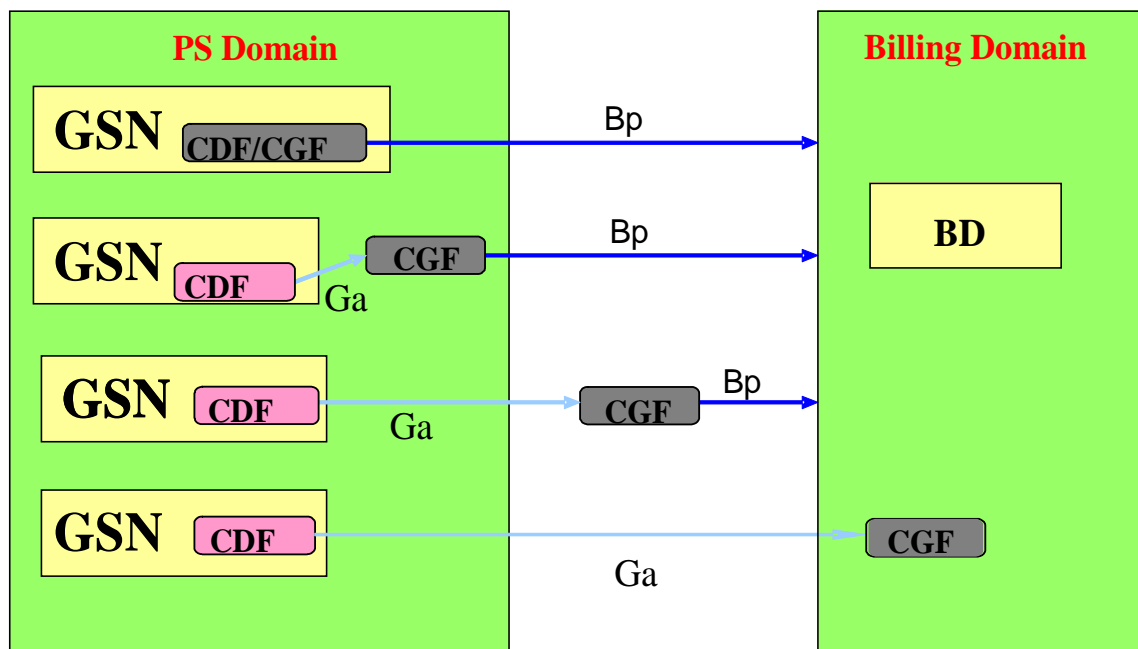

**Figure 4.3: PS domain offline charging architecture**

The GGSN may include a Policy and Charging Enforcement Function (PCEF) to support Flow Based Bearer Charging (FBC) functionality; this is not depicted in figure 4.3. The Ga and Bp reference points include the required functionality, e.g. defined for the Gz reference point in TS 23.203 [72]. Refer to clause 5.2.1.3, TS 32.240 [1] and TS 23.203 [72] for further details on FBC.

The GSNs may provide inter-operator charging functionality for Multimedia Broadcast/Multicast Services (MBMS) defined in TS 23.246 [207] and TS 32.273 [32], not for subscriber charging.

In addition to the standardised approaches depicted in figure 4.3, vendors may implement the CDF separately from the GSN for the PS domain. In that case, the interface between the GSN (CTF) and the CDF should comply with the definition of the Rf interface specified in 3GPP TS 32.299 [50].



### 4.3 PS domain online charging architecture

PS domain online charging based on SGSN functions is implemented by CAMEL techniques as described in 3GPP TS 23.078 [206] and 3GPP TS 29.078 [202], i.e. outside the scope of the 32 series of charging TSs. Note, however, that the CDRs described in the present document do contain CAMEL information. This is because some of that information is relevant to offline charging in case of CAMEL control of (part of) the session, and thus needs to be captured in the offline charging information. However, this is not related to the online charging functions for the PS domain.

PS domain online charging based on GGSN functions with included PCEF is specified in the present document, utilising the Ro interface and application as specified in TS 32.299 [50]. The reason for this alternative solution is that operators may enforce the use of HPLMN GGSNs in the case of roaming, hence GGSN service control and charging can be executed in the HPLMN in all circumstances. The GGSN based PS domain online charging architecture is depicted in figure 4.4.

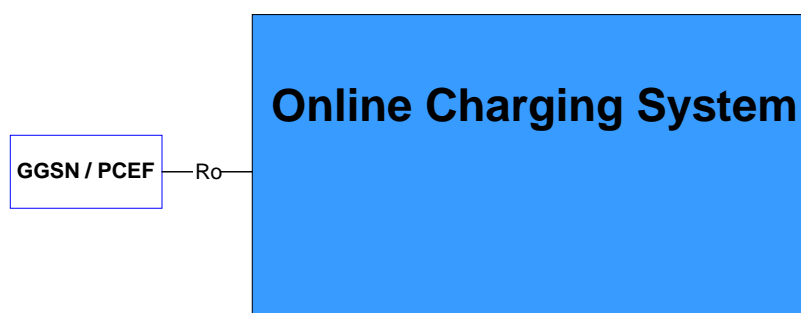

**Figure 4.4: PS domain GGSN based online charging architecture**

The Ro reference point includes the functionality defined for the Gy reference point (required for the PCEF) in TS 23.203 [72]. Refer to clause 5.2.1.3, TS 32.240 [1] and TS 23.203 [72] for further details on FBC.

Details on the interfaces and functions can be found in TS 32.240 [1] for the general architecture components, TS 32.296 [53] for the OCS, and TS 32.299 [50] for the Ro application.

---

## 5 PS domain charging principles and scenarios

### 5.1 PS charging principles

The charging functions specified for the PS domain relate to

- mobility management, refer to TS 23.060 [201];
- SMS transmissions / receptions, refer to TS 23.060 [201];
- PDP contexts, refer to TS 23.060 [201];
- LCS events, refer to TS 32.271 [31];
- individual service data flows within a PDP context, refer to TS 23.203 [72].
- MBMS bearer contexts, refer to TS 23.246 [207] and TS 32.273 [32].

#### 5.1.1 Requirements

The following are high-level charging requirements specific to the packet domain, derived from the requirements in 3GPP TS 22.115 [102], 23.060 [201] and TS 23.203 [72].

- 1) Every PDP context shall be assigned a unique identity number for billing purposes. (i.e. the charging id).
- 2) Data volumes on both the uplink and downlink direction shall be counted separately. The data volumes shall reflect the data as delivered to and from the user.
- 3) The charging mechanisms shall provide the duration of the PDP context with date and time information.
- 4) The network operator may define a subset of the charging information specified by Packet-Switched domain charging standards. This means that it shall be possible to configure the SGSN and GGSN for the CDR information generated.
- 5) The GSNs shall be capable of handling the charging characteristics. Charging characteristics can be specific for a subscription or for subscribed PDP contexts (i.e. per APN), see annex A for details.
- 6) The SGSN shall support charging of CAMEL services.
- 7) The SGSN shall support charging for location requests.
- 8) The SGSN may support online charging using CAMEL techniques.
- 9) The GGSN may support online charging using IETF based techniques.
- 10) The GGSN may be capable of identifying data volumes, elapsed time or events for individual service data flows (flow based bearer charging). One PCC rule identifies one service data flow.
- 11) When online charging is used in the GGSN, the credit control shall be per rating group.
- 12) When FBC is used, the GGSN shall allow reporting of the service usage per rating group or per combination of the rating group and service id. This reporting level can be activated per PCC rule.

These requirements apply equally to PS domain online charging and offline charging.

## 5.1.2 Charging information

Charging information in the PS domain network is collected for each MS/UE by the SGSNs and GGSNs, which are serving that MS/UE. The SGSN collects charging information for each MS/UE related with the radio network usage, while the GGSN collects charging information for each MS related with the external data network usage. Both GSNs also collect charging information on usage of the PS domain network resources. For MBMS, charging information in the PS domain network is collected for each MBMS bearer context. The following paragraphs list the charging information to be collected by the GSNs for both online and offline charging.

For PDP contexts, the GSNs shall collect the following charging information:

1. usage of the radio interface: the charging information shall describe the amount of data transmitted in MO and MT directions categorized with QoS and user protocols;
2. usage duration: duration of PDP context is counted as the time interval from PDP Context activation to PDP Context Deactivation;
3. usage of the general PS domain resources: the charging information shall describe the usage of other PS domain-related resources and the MSs PS domain network activity (e.g. mobility management);
4. destination and source: the charging information shall provide the actual source addresses used by the subscriber for the PDP context. The charging information shall describe the destination addresses with a level of accuracy as determined by the Access Point Name (APN);
5. usage of the external data networks: the charging information shall describe the amount of data sent and received to and from the external data network. External networks can be identified by the Access Point Name (APN).
6. location of MS/UE: HPLMN, VPLMN, plus optional higher-accuracy location information.

For service data flows defined for FBC, the GGSN shall collect the following charging information:

1. the information described above for PDP context charging;
2. the amount of data transmitted in MO and MT directions categorized by rating group or combination of the rating group and service id when volume based charging applies;
3. the duration of service data flows is counted and categorized by rating group or combination of the rating group and service id when time based charging applies;
4. the amount of events and corresponding timestamps categorized by rating group or combination of the rating group and service id when event based charging applies.

For non-PDP context related activities, the SGSN shall collect the following charging information:

1. mobility management actions for GPRS attached UEs/MSs;
2. short messages passing through the SGSN in MO and MT directions;
3. location requests passing through the SGSN, triggered by the UE/MS, by an external source, or by the network.

For MBMS bearer contexts, the GSNs shall collect the following charging information:

1. usage of the radio interface: the charging information shall describe the amount of data transmitted categorized with QoS and MBMS specific information defined in TS 32.273 [72];
2. usage duration: duration of MBMS bearer context is counted as the time interval from the local creation of the MBMS bearer context to the local deletion of the MBMS bearer context;
3. source: the charging information shall provide the source address used by the MBMS bearer service for the MBMS bearer context. The charging information may describe the destination addresses with a level of accuracy as determined by the Access Point Name (APN);
4. location information: the charging information shall describe a list of the downstream nodes being sent the MBMS bearer service.

## 5.2 PS domain offline charging scenarios

### 5.2.1 Basic principles

In order to provide the data required for the management activities outlined in TS 32.240 [1] (billing, accounting, statistics etc.), the SGSN and GGSN shall be able to produce CDRs for each of the following:

- Charging Data related to PDP contexts in the SGSN (S-CDR) and the GGSN (G-CDR);
- Charging Data related to service data flows in the GGSN (eG-CDR);
- Charging Data related to MM contexts (Mobile Station Mobility Management Data) in SGSN (M-CDR);
- SMS Mobile Originated Data (S-SMO-CDR) and SMS Mobile Terminated Data (SMS-SMT-CDR) in the SGSN;
- Charging Data related to mobile originated location requests (LCS-MO-CDR), mobile terminated location request (LCS-MT-CDR), and network induced location request (LCS-NI-CDR) passing through the SGSN;
- Charging Data related to MBMS bearer contexts (S-MB-CDR and G-MB-CDR).

The contents and purpose of each of these CDRs, as well as the chargeable events that trigger CDR creation, information addition, or closure are described in the following clauses. A detailed formal description of the CDR parameters defined in the present document is to be found in 3GPP TS 32.298 [51].

#### 5.2.1.1 PDP context charging

SGSN and GGSN collect charging information per user per PDP context. PDP context charging allows the GSNs to collect charging information related to data volumes sent to and received by the UE/MS, categorised by the QoS applied to the PDP context. The user can be identified by MSISDN and/or IMSI, while the PDP context can be determined by a unique identifier generated by the GGSN when creating a PDP context. This identifier is also forwarded to the SGSN so as to allow correlation of SGSN PDP context CDRs with the matching GGSN CDRs in the BD.

The main collected information items are duration of the PDP context and data volume transferred during the lifetime of the PDP context. The following chargeable events are defined for PDP context charging:

- Start of PDP context. Upon encountering this event, a new CDR for this PDP context is created and the data volume is captured for the PDP context.
- End of PDP context in the SGSN/GGSN. For the SGSN only, this trigger includes inter-SGSN routing area update (e.g. PDP context being moved from a 2G SGSN to a 3G SGSN, a new SGSN address is added to PDP context CDR for GGSN). The PDP context CDR is closed for SGSN upon encountering this trigger.
- Intra-SGSN intersystem change (change of radio interface from GSM to UMTS or vice versa). This event applies to the SGSN only and closes the PDP context CDR in the SGSN. A new one is opened if the PDP context is still active.
- Intersystem change (e.g. change of radio interface from GSM to UMTS or vice versa) visible in the GGSN. This event closes the PDP context CDR. A new one is opened if the PDP context is still active.
- PLMN change visible in the GGSN. This event closes the PDP context CDR. A new one is opened if the PDP context is still active.
- MS Timezone change visible in the GGSN. This event closes the PDP context CDR. A new one is opened if the PDP context is still active.
- Expiry of an operator configured time limit per PDP context. This event closes the PDP context CDR, and a new one is opened if the PDP context is still active.
- Expiry of an operator configured data volume limit per PDP context. This event closes the PDP context CDR, and a new one is opened if the PDP context is still active.

- Change of charging condition in the SGSN: QoS change, tariff time change or direct tunnel establishment/removal. When this event is encountered, the current volume count is captured and a new volume count is started.
- Change of charging condition in the GGSN: QoS change, tariff time change, CGI/SAI change and RAI change. When this event is encountered, the current volume count is captured and a new volume count is started.
- Expiry of an operator configured change of charging condition limit per PDP context. This event closes the PDP context CDR, and a new one is opened if the PDP context is still active.
- Management intervention may also force trigger a chargeable event.

### 5.2.1.2 MM context charging

The SGSN collects charging information for mobility management actions per attached UE/MS, i.e. per user. The user can be identified by MSISDN and/or IMSI. There can be only one MM context per UE/MS at a time, and only the SGSN is involved. Therefore there is no need for special MM context identifiers. The main information items collected are changes of location pertaining to the UE/MS. The following chargeable events are defined for MM context charging:

- Start of MM context (UE/MS attaches to a SGSN). A new M-CDR is created upon encountering this event.
- End of MM context: explicit or implicit GPRS detach, including SGSN change (inter-SGSN routing area update including intersystem change). This event triggers the closure of the M-CDR.
- Mobility Change, i.e. a change in the Routing Area. The new location information is captured for the M-CDR.
- Expiry of an operator configured time limit. This event triggers the closure of the M-CDR.
- Expiry of an operator configured mobility change limit. This event triggers the closure of the M-CDR.
- Intra-SGSN intersystem change (change of radio interface from GSM to UMTS or vice versa). This event triggers the closure of the M-CDR.

Management intervention may also force trigger a chargeable event.

### 5.2.1.3 Flow Based bearer Charging (FBC)

PDP context charging allows the GGSN to collect charging information related to data volumes sent to and received by the UE/MS, categorised by the QoS applied to the PDP context. FBC may be supported by the GGSN by the integration of a PCEF. When the PCEF is present, the normal PDP context charging is enhanced by the capability to categorise the service data flows within PDP context data traffic by rating group or combination of the rating group and service id. I.e., while there is only one uplink and one downlink data volume count per PDP context in PDP context charging, FBC may provide one count per each rating group or combination of the rating group and service id. The level of the reporting is defined per PCC rule. The default PCC rule is the wildcard, i.e. all traffic for all IP addresses, all TCP ports, etc.; when no other, specific PCC rules are configured, the behaviour of FBC is identical to the normal PDP context charging on the GGSN. When further PCC rules are specified, traffic is categorised, and counted, according to the PCC rule specification, and the wildcard PCC rule may apply to all traffic that does not match any of the specific PCC rules depending on the precedence of the PCC rules. Details of this functionality are specified in TS 23.203 [72] and TS 32.240 [1].

PDP context offline charging may also be achieved with PDP context specific rating group/service identifier defined in clause 5.3.1.1.

According to TS 23.203 [72], FBC shall support different charging models per PCC rule. These charging models may be based on volume and/or time and on number of events matching a specific service data flow template in PCC rule. In general the charging of a service data flow shall be linked to the PDP Context under which the service data flow has been activated.

**Editor's note: Operators may be interested in defining chargeable events not linked to the charging of a PDP Context. Charging mechanisms defined for event based charging not linked to a PDP Context are FFS.**

The following chargeable events are defined for FBC:

- Start of PDP context. Upon encountering this event, a new eG-CDR for this context is created.
- Start of service data flow. If service identifier level reporting is required by the PCC rule new counts and time stamps for this combination of the rating group and service id are started. If rating group level reporting is required by the PCC rule needed new counts and time stamps for this rating group are started. The type of counters shall depend on the measurement method configured for the PCC rule. When event based charging applies, the first occurrence of an event matching a service data flow template in PCC rule shall imply that a new count is started. When new events occur, the counter shall be increased. Each event shall be time stamped.
- Termination of service data flow. If service identifier level reporting is required by the PCC rule and this was the last active service data flow for this combination of the rating group and service id or if rating group level reporting is required by the PCC rule and this was the last active service data flow for this rating group, the counters and time stamps are closed and added to the eG-CDR. For information on how the termination of service data flows is detected, refer to TS 23.203 [72].
- End of PDP context in the GGSN. The eG-CDR is closed upon encountering this trigger.
- Expiry of an operator configured time limit per PDP context. This event closes the eG-CDR, and a new one is opened if the PDP context is still active.
- Expiry of an operator configured time limit per rating group. The counters and time stamps are closed and added to the eG-CDR. A new service data flow container is opened if any matching service data flow is still active.
- Expiry of an operator configured data volume limit per PDP context. This event closes the eG-CDR, and a new one is opened if the PDP context is still active.
- Expiry of an operator configured data volume limit per rating group. The counters and time stamps are closed and added to the eG-CDR. A new service data flow container is opened if any matching service data flow is still active.
- Expiry of an operator configured data event limit per rating group. The counters and time stamps are closed and added to the eG-CDR. A new service data flow container is opened if any matching service data flow is still active.
- Change of charging condition: GTP modification (e.g. QoS change, SGSN change, PLMN Id change, RAT change, CGI/SAI change, RAI change), tariff time change or failure handling procedure triggering. When this event is encountered, all current configured counts and time stamps are captured and new counts and time stamps for all active service data flows are started.
- Change of charging condition: GTP modification (QoS change, CGI/SAI change, RAI change), tariff time change or failure handling procedure triggering. When this event is encountered, the current volume count for list of traffic data volume container is captured and a new volume count is started.
- Intersystem change (e.g. change of radio interface from GSM to UMTS) visible in the GGSN. This event closes the eG-CDR, and a new one is opened if the PDP context is still active.
- PLMN change visible in the GGSN. This event closes the eG-CDR. A new one is opened if the PDP context is still active.
- MS Timezone change visible in the GGSN. This event closes the eG-CDR. A new one is opened if the PDP context is still active.
- Inter SGSN routing area update in the GGSN. New SGSN address is added to eG-CDR.
- Expiry of an operator configured report of service flow data limit per PDP context. This event closes the eG-CDR, and a new one is opened if the PDP context is still active.
- Completion of a time envelope as defined in 3GPP TS 32.299 [50]. This event closes a service data flow container. Further details are described in "Triggers for eG-CDR Charging Information Addition" (clause 5.2.3.4.1). The need for reporting time envelopes may be statically configured for each rating group or dynamically controlled by online charging.

NOTE: The specific chargeable events may be configured per charging key and may be different from those used for the G-CDR.

Management intervention may also force trigger a chargeable event.

Relevant service data flows for a certain PDP context are determined when FBC is applied. PCC rules are used for this determination. One PCC rule identifies service data flow to be measured but it can also include certain characteristics related to that service data flow.

PCC rules can be activated, deactivated and modified any time during the PDP context lifetime. PCC rule activation, deactivation and modification are not chargeable events. However these PCC rule changes may lead to "start of service data flow" and "termination of service data flow" chargeable events.

Policy and Charging Control rule can contain e.g.:

- service data flow template (filters) to identify packets belonging to certain service data flow,
- charging method to identify whether online/offline/both/neither charging interface is used,
- measurement method for offline charging to identify whether time/volume/events are measured for this service data flow,
- rating group for that service data flow,
- service id for that service data flow,
- application function record information to correlate the measurement with application level reports,
- reporting level for the service data flow (rating group or combination of the rating group and service id),
- precedence to the situations where two or more PCC rules are overlapping.

And Policy and Charging Control rules can be:

- pre-defined in GGSN (can be activated either by the PCRF or PCEF) or,
- dynamically provisioned and activated by the Policy and Charging Rules Function over Gx interface.

This is specified in TS 23.203 [72] and TS 29.212 [71].

#### 5.2.1.4 SMS charging

The SGSN collects charging information for each Short Message sent to, or received by, a MS/UE. There are two chargeable events for SMS charging in the SGSN:

- the transfer of a SM through the SGSN in MO direction;
- the transfer of a SM through the SGSN in MT direction.

Management intervention may also force trigger a chargeable event.

#### 5.2.1.5 LCS charging

The SGSN collects charging information for each Location Request for a MS/UE. The following chargeable events are specified for LCS.

- A location request for a MS/UE triggered by that MS/UE (LCS-MO);
- A location request for a MS/UE triggered by an external entity (LCS-MT);
- A location request for a MS/UE triggered by the network (LCS-NI).

Management intervention may also force trigger a chargeable event.

### 5.2.1.6 MBMS context charging

The SGSN and GGSN collect charging information for each MBMS bearer service activated. The following chargeable events are specified for MBMS.

- Start of MBMS bearer context. Upon encountering this event, a new CDR for this MBMS bearer context is created and the data volume is captured for the MBMS bearer context.
- End of MBMS bearer context in the SGSN/GGSN. For the SGSN only, this trigger includes inter-SGSN routing area update (e.g. the last UE using the MBMS bearer context leaves the routing area). The MBMS bearer context CDR is closed upon encountering this trigger.
- Expiry of an operator configured time limit per MBMS bearer context. This event closes the MBMS bearer context CDR, and a new one is opened if the MBMS bearer context is still active.
- Expiry of an operator configured data volume limit per MBMS bearer context. This event closes the MBMS bearer context CDR, and a new one is opened if the MBMS bearer context is still active.
- Change of charging condition: tariff time change. When this event is encountered, the current volume count is captured and a new volume count is started.
- Expiry of an operator configured change of charging condition limit per MBMS bearer context. This event closes the MBMS bearer context CDR, and a new one is opened if the MBMS bearer context is still active.

Management intervention may also force trigger a chargeable event.

### 5.2.2 Rf message flows

Not applicable, as the separation of the CTF and CDF is not in the scope of the 3GPP PS domain charging standards. Refer to clause 4.2 for further information.

Vendors may nevertheless implement a separate CTF and CDF for PS domain charging. In this case, the approach chosen shall conform to the principles and protocol applications specified in TS 32.299 [50].

### 5.2.3 CDR generation

The S-CDR, M-CDR, S-SMO-CDR, S-SMT-CDR, LCS-MO-CDR, LCS-MT-CDR, LCS-NI-CDR and S-MB-CDR are generated by the SGSN and the G-CDR, eG-CDR and G-MB-CDR by the GGSN to collect charging information that they subsequently transfer to the Charging Gateway Function (CGF).

The GSNs shall use the Charging Characteristics to determine whether to activate or deactivate CDR generation. The Charging Characteristics are also used to set the coherent chargeable event conditions (e.g. time/volume limits that trigger CDR generation or information addition). Multiple Charging Characteristics 'profiles' may be configured on the GSNs to allow different sets of trigger values. Further details of this functionality, including the mechanism of conveying the charging characteristics data item (HLR -> SGSN -> GGSN), are specified in annex A. Charging Characteristics are not applicable to MBMS CDR generation.

If CDR generation is activated, it shall be possible to define separate trigger conditions values per Charging Characteristics profile for the following triggers:

- data volume limit;
- time (duration limit);
- maximum number of charging conditions changes (QoS change, Tariff Time change).

The following clauses describe the trigger conditions for the chargeable events described in clause 5.2.1.1 – 5.2.1.5. In GPRS offline charging, these chargeable events correspond to the triggers for collection of charging information and CDR generation by the SGSN/GGSN.



### 5.2.3.1 Triggers for S-CDR charging information collection

An S-CDR is used to collect charging information related to the PDP context data information for a MS/UE in the SGSN.

If according to the Charging Characteristics, CDR generation is activated an S-CDR shall be opened at PDP context activation, and the volume for the context is counted separately in uplink and downlink direction. When a change of charging condition occurs, the volume count is added to the S-CDR and a new count is started. The S-CDR includes details such as Record Type, Served IMSI, Sequence Number etc. Not all of the charging information to be collected is static, and other charging information is directly depending on dynamic Packet-Switched service usage.

The subsequent clauses identify in detail the conditions for adding information to, and closing the S-CDR for generation towards the CGF.

#### 5.2.3.1.1 Triggers for S-CDR Charging Information Addition

The "List of Traffic Volumes" attribute of the S-CDR consists of a set of containers, which are added when specific trigger conditions are met, and identify the volume count per PDP context, separated for uplink and downlink traffic, on encountering that trigger condition. Table 5.1 identifies which conditions are supported to trigger S-CDR charging information addition.

**Table 5.1: Triggers for S-CDR charging information addition**

Trigger Conditions	Description/Behaviour
QoS Change	A change in the QoS shall result in a "List of Traffic Data Volumes" container being added to the CDR.
Tariff Time Change	On reaching the Tariff Time Change a "List of Traffic Data Volumes" container shall be added to the CDR.
Direct Tunnel establishment/removal	When the SGSN establishes or removes a Direct Tunnel between the RNC and the GGSN a "List of Traffic Data Volumes " container shall be added to the CDR. See NOTE.
CDR Closure	A list of "List of Traffic Data Volumes" container shall be added to the S-CDR.
NOTE:	When a direct tunnel is established, the SGSN will no longer be able to count data volumes associated with the PDP context for which the direct tunnel is established

The first volume container of a PDP context identifies the uplink/downlink volume since the PDP context was opened. Subsequent volume containers store the volume count accrued since the closure of the last container.

### 5.2.3.1.2 Triggers for S-CDR closure

The S-CDR shall be closed on encountering some trigger conditions. Table 5.2 identifies which conditions are supported to permit closure of the S-CDR.

**Table 5.2: Triggers for S-CDR closure**

Closure Conditions	Description/Behaviour
End of PDP Context within the SGSN	Deactivation of the PDP context in the SGSN shall result in the CDR being closed. The trigger condition covers: <ul style="list-style-type: none"> <li>- termination of PDP context;</li> <li>- SGSN change (inter-SGSN routing area update including intersystem change);</li> <li>- any abnormal release.</li> </ul>
Partial Record Reason	O&M reasons permit the closure of the CDR for internal reasons. The trigger condition covers: <ul style="list-style-type: none"> <li>- data volume limit;</li> <li>- time (duration) limit;</li> <li>- maximum number of charging condition changes (QoS/tariff time change);</li> <li>- management intervention;</li> <li>- Intra-SGSN intersystem change (change of radio interface from GSM to UMTS or vice versa).</li> </ul>

The Partial Record generation trigger thresholds are those associated with the Charging Characteristics. The Partial Record generation trigger thresholds are GSN configuration parameters defined per charging characteristics profile by the operator through O&M means, as specified in annex A.

In the event that the S-CDR is closed and the PDP context remains active, a further S-CDR shall be opened with an incremented Sequence Number in the SGSN.

### 5.2.3.2 Triggers for M-CDR charging information collection

An M-CDR is used to collect charging information related to the mobility management of a mobile in the SGSN.

An M-CDR shall be opened for each mobile upon GPRS Attach, indicating the current location information for that MS/UE. When a location change occurs for the attached MS/UE, the new location information is added to the M-CDR. The M-CDR records details such as Record Type, Served IMSI, Sequence Number etc. Not all of the charging information to be collected is static, and other charging information is directly dependent on the mobility of the MS as provided by the Radio Access Network (RAN). Subsequent partial records may be opened if the M-CDR is closed and the MS is still attached to the network.

The subsequent clauses identify in detail the conditions for adding information to, and closing of the M-CDR for generation towards the CGF.

### 5.2.3.2.1 Triggers for M-CDR charging information addition

The "Change of Location" attribute of the M-CDR consists of a set of containers, which are added when specific trigger conditions are met, and identify the time stamped routing area on encountering that trigger condition. Table 5.3 identifies which conditions are supported to trigger M-CDR charging information addition.

**Table 5.3: Triggers for M-CDR charging information addition**

Trigger Conditions	Description/Behaviour
Mobility Change	The first 'Change of Location' container shall be captured when the MM context is created. Subsequent changes in the Routing Area shall result in a "Change of Location" container being added to the M-CDR.

### 5.2.3.2.2 Triggers for M-CDR closure

The M-CDR shall be closed on encountering some trigger conditions. Table 5.4 identifies which conditions are supported to permit closures of the M-CDR.

**Table 5.4: Triggers for M-CDR closure**

Closure Conditions	Description/Behaviour
End of MM Context within SGSN	Deactivation of the MM context in the SGSN shall result in the CDR being closed. The trigger condition covers: <ul style="list-style-type: none"> <li>- SGSN change (inter-SGSN routing area update including intersystem change);</li> <li>- GPRS detach;</li> <li>- any abnormal release.</li> </ul>
Partial Record Reason	O&M reasons permit the closure of the CDR for internal reasons. The trigger condition covers: <ul style="list-style-type: none"> <li>- time (duration) limit;</li> <li>- maximum number of mobility changes; and</li> <li>- Management intervention;</li> <li>- Intra-SGSN intersystem change (change of radio interface from GSM to UMTS or vice versa).</li> </ul>

The Partial Record generation trigger thresholds are those associated with the Charging Characteristics. The Partial Record generation trigger thresholds are GSN configuration parameters defined per charging characteristics profile by the operator through O&M means, as specified in annex A.

In the event that the M-CDR is closed and the mobile is still known to the SGSN, a further M-CDR shall be opened with an incremented Sequence Number in the SGSN.

### 5.2.3.3 Triggers for G-CDR charging information collection

A G-CDR is used to collect charging information related to the PDP context data information for a UE/MS in the GGSN.

If, according to the Charging Characteristics, CDR generation is activated a G-CDR shall be opened at PDP context activation, and the volume for the context is counted separately in uplink and downlink direction. When a change of charging condition occurs, the volume count is added to the G-CDR and a new count is started. The G-CDR includes details such as Record Type, Served IMSI, Sequence Number etc. Not all of the charging information to be collected is static, and other charging information is directly dependent on dynamic Packet-Switched service usage.

The subsequent clauses identify in detail the conditions for adding information to, and closing the G-CDR for generation towards the CGF.

### 5.2.3.3.1 Triggers for G-CDR Charging Information Addition

The "List of Traffic Volumes" attribute of the G-CDR consists of a set of containers, which are added when specific trigger conditions are met, and identify the volume count per PDP context, separated for uplink and downlink traffic, on encountering that trigger condition. Table 5.5 identifies which conditions are supported to trigger G-CDR charging information addition.

**Table 5.5: Triggers for G-CDR charging information addition**

Trigger Conditions	Description/Behaviour
QoS Change	A change in the QoS shall result in a "List of Traffic Data Volumes" container being added to the CDR.
Tariff Time Change	On reaching the Tariff Time Change a "List of Traffic Data Volumes" container shall be added to the CDR.
CGI/SAI Change	A change in the CGI/SAI shall result in a "List of Traffic Data Volumes" container being added to the CDR, if location reporting is required and a report of CGI/SAI change is received.
RAI Change	A change in the RAI shall result in a "List of Traffic Data Volumes" container being added to the CDR, if location reporting is required and a report of RAI change is received.
CDR Closure	A list of "List of Traffic Data Volumes" container shall be added to the G-CDR.

The first volume container of a PDP context identifies the uplink/downlink volume since the PDP context was opened. Subsequent volume containers store the volume count accrued since the closure of the last container.

The "SGSN Address" attribute of the G-CDR consists of a list of SGSN addresses. New SGSN address is added to the list when SGSN changes.

### 5.2.3.3.2 Triggers for G-CDR closure

The G-CDR shall be closed on encountering some trigger conditions. Table 5.6 identifies which conditions are supported to permit closure of the G-CDR.

**Table 5.6: Triggers for G-CDR closure**

Closure Conditions	Description/Behaviour
End of PDP Context within the GGSN	Deactivation of the PDP context in the GGSN shall result in the CDR being closed. The trigger condition covers: <ul style="list-style-type: none"> <li>- termination of PDP context;</li> <li>- any abnormal release.</li> </ul>
Partial Record Reason	O&M reasons permit the closure of the CDR for internal reasons. The trigger condition covers: <ul style="list-style-type: none"> <li>- data volume limit;</li> <li>- time (duration) limit;</li> <li>- maximum number of charging condition changes (QoS/tariff time change);</li> <li>- management intervention;</li> <li>- MS time zone change;</li> <li>- inter-PLMN SGSN change;</li> <li>- radio access technology change (RAT Type).</li> </ul>

The Partial Record generation trigger thresholds are those associated with the Charging Characteristics. The Partial Record generation trigger thresholds are GSN configuration parameters defined per charging characteristics profile by the operator through O&M means, as specified in annex A.

In the event that the G-CDR is closed and the PDP context remains active, a further G-CDR is opened with an incremented Sequence Number in the GGSN.

### 5.2.3.4 Triggers for eG-CDR charging information collection

An eG-CDR is used to collect charging information related to the PDP context data information for a UE/MS in the GGSN, where the data volumes, elapsed time or number of events within each eG-CDR are separately counted per rating group or per combination of the rating group and service id.

The eG-CDR is produced instead of a G-CDR if PCEF is active in the GGSN. I.e. the GGSN either creates G-CDRs or eG-CDRs, depending on whether PCEF is enabled (eG-CDR) or disabled (G-CDR). In contrast to the G-CDR, where

only one volume container (uplink/downlink) can be active per PDP context, many service data flow containers per PDP context can be active simultaneously when FBC is enabled. A service data flow container is activated when traffic is detected and no matching active service data flow container exist; a service data flow container is closed when the termination of the last service data flow matching to the service data flow container is detected by the GGSN. When event based charging applies, the first occurrence of an event matching a service data flow template shall imply service data flow start. Details on FBC can be found in TS 23.203 [72] and TS 32.240 [1].

If, according to the Charging Characteristics profile, CDR generation is activated an eG-CDR shall be opened at PDP context activation, and the volume (separately in uplink and downlink direction), elapsed time and/or number of events are counted. When a change of charging condition occurs, all containers are added to the eG-CDR. The eG-CDR includes details such as Record Type, Served IMSI, Sequence Number etc. as defined in the G-CDR and the FBC specific charging data. Not all of the charging information to be collected is static, and other charging information is directly dependent on dynamic Packet-Switched service usage.

It shall be possible to activate both online and offline charging interfaces for same PDP context. The default online and offline charging shall work independently of each other. Optionally it may be possible to operate in a tight interworking between online and offline charging mechanism i.e. only the specified quota re-authorisation triggers armed by OCS (including e.g. tariff time change, returned quotas, etc.) are used to close the service data flow containers for the eG-CDR charging information addition.

The subsequent clauses identify in detail the conditions for adding information to, and closing the eG-CDR for generation towards the CGF.

#### 5.2.3.4.1 Triggers for eG-CDR Charging Information Addition

The "List of Traffic Volumes" attribute of the eG-CDR are as defined for the G-CDR. The additional triggers for adding new containers to the "List of Traffic Volumes" are defined as follows:

**Table 5.7: Additional Triggers for eG-CDR charging information addition "List of Traffic Volumes"**

Trigger Conditions	Description/Behaviour
CGI/SAI Change	A change in the CGI/SAI shall result in a "List of Traffic Data Volumes" container being added to the CDR, if location reporting is required and a report of CGI/SAI change is received.
RAI Change	A change in the RAI shall result in a "List of Traffic Data Volumes" container being added to the CDR, if location reporting is required and a report of RAI change is received.
DCCA Failure-Handling procedure triggering	When the Diameter Credit-Control-Failure-Handling mechanism is triggered a 'List of Traffic Data Volumes' container shall be added to the CDR. The causes are only relevant in case of simultaneously usage of an active DCCA session.

The "List of Service Data" attribute of the eG-CDR consists of a set of containers, which are added when specific trigger conditions are met. Each container identifies the configured counts (volume separated for uplink and downlink, elapsed time or number of events) per rating group or combination of the rating group and service id within the same PDP context, on encountering that trigger condition. For envelope reporting, the containers represent complete and closed time envelopes determined by mechanisms defined in 3GPP TS 32.299 [50]. Table 5.8 identifies conditions that may be supported as recording triggers under consideration of additional DCCA triggers.

Some of the triggers are non-exclusive (e.g. PDP context modification with a couple of reasons, PDP context modification reasons that cause eG-CDR closure).

**Table 5.8: Triggers for eG-CDR charging information addition "List of Service Data"**

Trigger Conditions	Description/Behaviour
PDP context modification	A change of PDP context conditions (e.g. QoS change, SGSN change, PLMN Id change, RAT change, CGI/SAI change, RAI change) shall result in a set of "List of Service Data" containers, i.e. all active service data flow containers, being added to the CDR as described in clause 5.2.1.3. In a tight interworking between online and offline charging the specified quota re-authorization triggers armed by OCS are supported.
Tariff Time Change	On reaching the Tariff Time Change a set of "List of Service Data" containers, i.e. all active service data flow containers, shall be added to the CDR. In a tight interworking between online and offline charging the DCCA tariff time change from OCS is supported.
DCCA Failure-Handling procedure triggering	When the Diameter Credit-Control-Failure-Handling mechanism is triggered a "List of Service Data", i.e. all active service data flow containers shall be added to the CDR. The causes are only relevant in case of simultaneously usage of an active DCCA session.
Service data flow report	In case of independent online and offline charging a "List of Service Data" container for the service data flow shall be added when: <ul style="list-style-type: none"> <li>- expiry of time limit;</li> <li>- expiry of volume limit;</li> <li>- expiry of unit limit;</li> <li>- termination of service data flow.</li> </ul> In case of tight interworking online and offline charging a "List of Service Data" container for the service data flow shall be added when: <ul style="list-style-type: none"> <li>- time threshold reached;</li> <li>- volume threshold reached;</li> <li>- unit threshold reached;</li> <li>- time quota exhausted;</li> <li>- volume quota exhausted;</li> <li>- unit quota exhausted;</li> <li>- expiry of quota validity time;</li> <li>- termination of service data flow;</li> <li>- re-authorization request by OCS.</li> </ul>
CDR Closure	All active "List of Service Data" containers shall be added to the eG-CDR Note: The trigger condition is a common value that has to be used for CDR closure together with detailed reason.

The first traffic container identifies the data traffic since the PDP context was opened. Subsequent data traffic containers store the configured counts accrued since the closure of the last container.

The triggers for adding new containers to the "List of Traffic Data Volumes" and "List of Service Data" may be independent. Therefore there may be a different number of containers being added when a trigger condition is met.

For envelope reporting, each envelope contains information about the data volume transferred in both uplink and downlink and / or the number of events that occurred for the duration that envelope is open. Only completed time envelopes shall be added to the eG-CDR. The determination of completed envelopes are defined in 3GPP TS 32.299 [50]. The triggers listed in the previous table shall not apply to envelope reporting. Envelopes that are not complete when a partial eG-CDR is closed shall be added to the next eG-CDR.

The "SGSN Address" attribute of the eG-CDR consists of a list of SGSN addresses. New SGSN address is added to the list when SGSN changes.

#### 5.2.3.4.2 Triggers for eG-CDR closure

The eG-CDR shall be closed on encountering same trigger conditions as specified for the G-CDR.

#### 5.2.3.5 Triggers for SMS-CDR charging information collection

The generation of the SMS related CDRs is based on the observation and capture of simple events, i.e. the transfer of Short Messages through the SGSN in MO or MT direction.

A S-SMO-CDR is used to collect charging information related to the transmission of a SM in MO direction via the SGSN. If, according to the Charging Characteristics, CDR generation is activated a S-SMO-CDR shall be created when the SGSN has successfully forwarded a SM to the SMSC on behalf of the UE/MS. The S-SMO-CDR includes details such as Record Type, Served IMSI, Sequence Number etc.

A S-SMT-CDR is used to collect charging information related to the transmission of a SM in MT direction via the SGSN. If, according to the Charging Characteristics, CDR generation is activated a S-SMT-CDR shall be created when the SGSN has successfully forwarded a SM to the UE/MS. The S-SMT-CDR includes details such as Record Type, Served IMSI, Sequence Number etc.

Note that the above CDR types only capture the SMS events when transferred through the SGSN. Equivalent charging functionality for the CS domain is specified in TS 32.250 [10]. 3GPP standards do not define service specific charging functionality for SMS.

### 5.2.3.6 Triggers for LCS-CDR charging information collection

The generation of the LCS related CDRs is based on the observation and capture of simple events, i.e. the invocation of location requests from the UE/MS (LCS-MO-CDR), an external entity (LCS-MT-CDR) or the network (LCS-NI-CDR).

A LCS-MO-CDR is used to collect charging information related to the transmission of a location request, originating from the UE/MS to be located, via the SGSN. If, according to the Charging Characteristics, CDR generation is activated a LCS-MO-CDR shall be created when the SGSN has received the RANAP "Location report" message from the RNC. The LCS-MO-CDR includes details such as Record Type, Served IMSI, Sequence Number etc.

A LCS-MT-CDR is used to collect charging information related to the transmission of a location request for a UE via the SGSN where the location request originates from an external entity. If, according to the Charging Characteristics, CDR generation is activated a LCS-MT-CDR shall be created when the SGSN has received the RANAP "Location report" message from the RNC. The LCS-MT-CDR includes details such as Record Type, Served IMSI, Sequence Number etc.

A LCS-NI-CDR is used to collect charging information related to the transmission of a network induced location request via the SGSN. If, according to the Charging Characteristics, CDR generation is activated a LCS-NI-CDR shall be created when the SGSN has received the RANAP "Location report" message from the RNC. The LCS-MO-CDR includes details such as Record Type, Served IMSI, Sequence Number etc.

Note that the above CDR types only capture the LCS events when transferred through the SGSN. Equivalent charging functionality for the CS domain is specified in TS 32.250 [10]. Service specific charging functionality for LCS is specified in TS 32.271 [31].

### 5.2.3.7 Triggers for S-MB-CDR and G-MB-CDR charging information collection

#### 5.2.3.7.1 Triggers for S-MB-CDR and G-MB-CDR Charging Information Creation

S-MB-CDR and G-MB-CDR are used to collect charging information related to the MBMS bearer context data information for a MBMS bearer service in the GSN. The triggers for both S-MB-CDR and G-MB-CDR to start collecting charging information are the same.

S-MB-CDR and G-MB-CDR shall be opened at MBMS bearer context creation. Not all of the charging information to be collected is static, and other charging information is directly dependent on dynamic Packet-Switched service usage.

The subsequent clauses identify in detail the conditions for adding information to, and closing the S-MB-CDR and G-MB-CDR for generation towards the CGF.

#### 5.2.3.7.2 Triggers for S-MB-CDR and G-MB-CDR Charging Information Addition

The "List of Traffic Volumes" attribute consists of a set of containers, which are added when specific trigger conditions are met, and identify the volume count per MBMS bearer context, for downlink traffic, on encountering that trigger condition. Table 5.9 identifies which conditions are supported to trigger S-MB-CDR and G-MB-CDR charging information addition.

**Table 5.9: Triggers for S-MB-CDR and G-MB-CDR charging information addition**

Trigger Conditions	Description/Behaviour
Tariff Time Change	On reaching the Tariff Time Change a "List of Traffic Data Volumes " container shall be added to the CDR.
CDR Closure	A list of "List of Traffic Data Volumes" container shall be added to the relevant CDR.

The first volume container of a MBMS bearer context identifies the volume since the record was opened. Subsequent volume containers store the volume count accrued since the closure of the last container.

### 5.2.3.7.3 Triggers for S-MB-CDR and G-MB-CDR closure

The S-MB-CDR and G-MB-CDR shall be closed on encountering the trigger conditions identified in Table 5.10.

**Table 5.10: Triggers for S-MB-CDR and G-MB-CDR closure**

Closure Conditions	Description/Behaviour
End of MBMS Bearer Context within the GSN	Deactivation of the MBMS bearer context in the GSN shall result in the CDR being closed. The trigger condition covers: <ul style="list-style-type: none"> <li>- termination of MBMS bearer context;</li> <li>- any abnormal release.</li> </ul>
Partial Record Reason	O&M reasons permit the closure of the CDR for internal reasons. The trigger condition covers: <ul style="list-style-type: none"> <li>- data volume limit;</li> <li>- time (duration) limit;</li> <li>- change in list of downstream nodes;</li> <li>- management intervention.</li> </ul>

The Partial Record generation trigger thresholds are those associated with GSN configured information. In the event that the CDR is closed and the MBMS bearer context remains active, a further CDR is opened with an incremented Sequence Number in the GSN.



## 5.2.4 Usage scenarios

This clause contains a number of example scenarios illustrating the purpose and practical usage of the various CDR types defined in the previous clauses. These examples are by no means exhaustive.

For the purpose of these examples the following assumptions have been made:

- the CDRs are sent to a CGF;
- the generation of all of the CDR types has been enabled.

The following conventions have been used for the figures 5.9 to 5.12 below:

- 1) Network connections and signalling transactions are illustrated by means of solid lines and referenced by number e.g. (1).
- 2) Operation & Maintenance actions, such as the transfer of CDRs, are represented by means of dotted lines and referenced by letter e.g. (A).

NOTE: Visiting scenarios are excluded.

### 5.2.4.1 Mobile to PDN Context

Figure 5.9 illustrates a simple outgoing Packet-Switched context from a PLMN Packet-Switched service subscriber "A" to a mainframe "B" via a PDN (1).

The respective PDP context is activated in the SGSN and GGSN and PDP PDUs are routed in MO and MT direction. The SGSN shall create an S-CDR and the GGSN shall create a G-CDR or eG-CDR for subscriber "A".

The records generated are subsequently transferred to the CGF (A). The CGF transfers the CDRs to the BS.

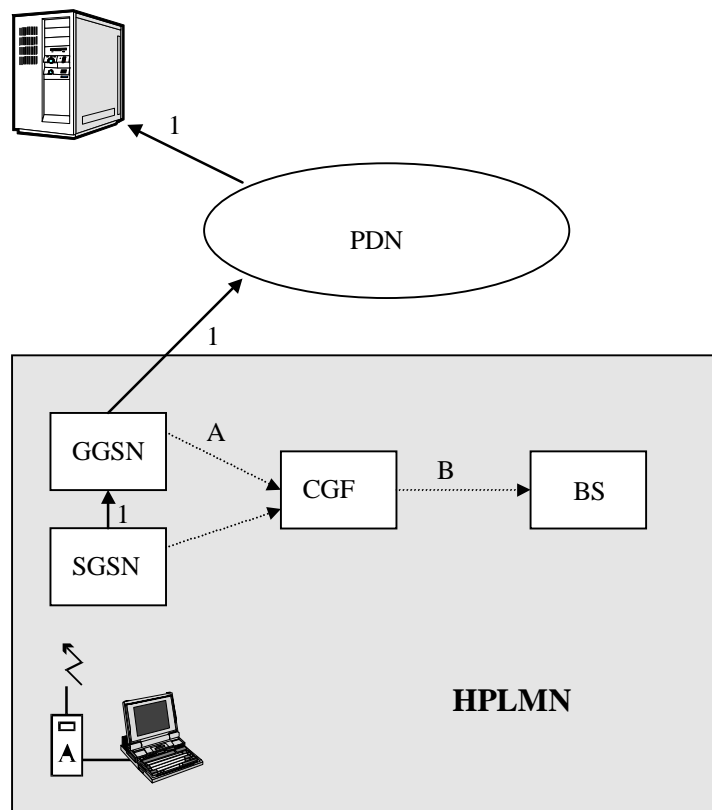

Figure 5.9: Mobile to PDN context

### 5.2.4.2 Mobile to mobile context

Figure 5.10 illustrates a simple Packet-Switched mobile-to-mobile context within the same HPLMN.

The respective A-party related PDP context is activated in the SGSN-A and the GGSN (1).

After the location of subscriber "B" is determined, the B party related PDP context is activated (2) in the SGSN-B and the GGSN and PDP PDUs are routed in MO and MT direction. The SGSN-A shall create an S-CDR and the GGSN shall create a G-CDR or eG-CDR for subscriber A, the SGSN-B shall create an S-CDR and the GGSN shall create a G-CDR or eG-CDR for subscriber "B".

If subscriber "A" and subscriber "B" use the same GGSN, both G-CDRs or eG-CDRs are produced at that GGSN.

If session leg (2) requires a PDP context activation the respective PDP records will contain a network initiated PDP context activation-flag.

The records generated are subsequently transferred to the CGF (A). The CGF transfers the CDRs to the BS.

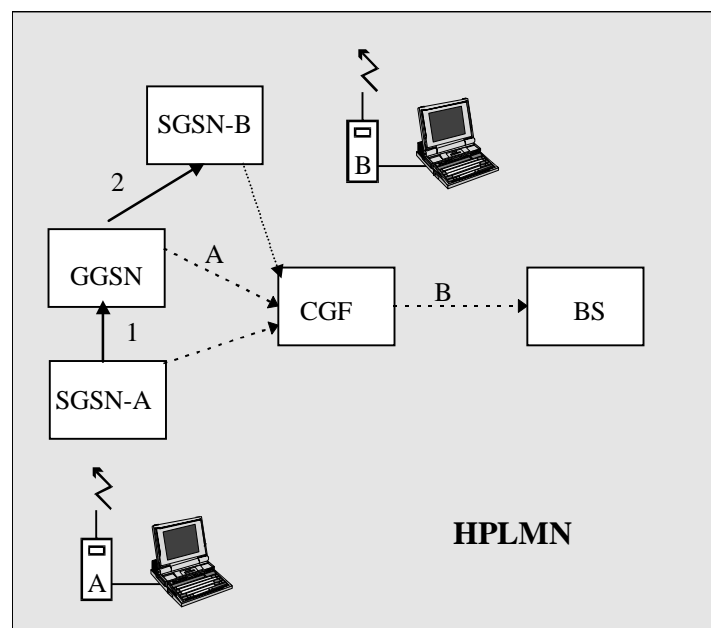

Figure 5.10: Packet-switched mobile to mobile context

### 5.2.4.3 PDN to mobile context

Figure 5.11 illustrates a simple incoming Packet-Switched domain context from a mainframe "A" to mobile subscriber "B" via a PDN (1). After the location of subscriber "B" is determined, the PDP context is activated (2).

The GGSN receiving the PDUs shall generate a G-CDR or eG-CDR whereas the SGSN currently serving subscriber "B" creates an S-CDR. These records contain a flag that the PDP context is activated due to network request.

The records generated are subsequently transferred to the CGF (A). The CGF transfers the CDRs to the BS.

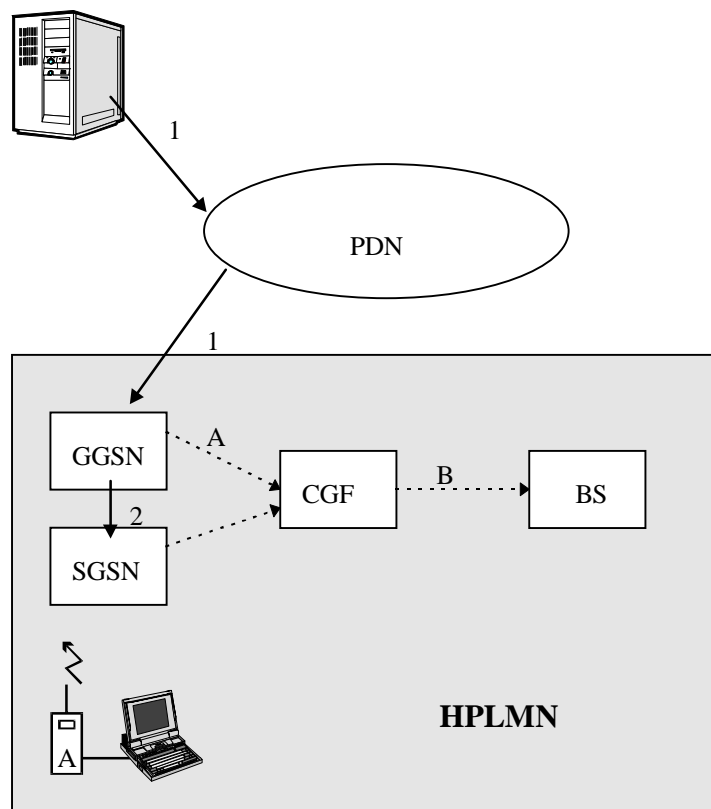

Figure 5.11: PDN to mobile context

### 5.2.4.4 Mobile to PDN context while roaming, GGSN in HPLMN

Figure 5.12 illustrates an outgoing Packet-Switched context from a roaming mobile subscriber "A" to mainframe "B" via Boarder Gateway, inter PLMN backbone and GGSN of the HPLMN (1).

The respective a-party related PDP context is activated in the SGSN and GGSN and PDUs are routed in MO and MT direction. The SGSN shall create an S-CDR (VPLMN) and a G-CDR or eG-CDR is generated at the used GGSN (HPLMN) for subscriber "A". From the GGSN the packets are sent via the PDN to the mainframe "B".

The records generated in the HPLMN and the VPLMN are subsequently transferred to the CGFs (A). The CGFs transfer the CDRs to the BS. (B)

Later on the records created in the VPLMN are transferred from the BS to the BS of the HPLMN via TAP procedure (C).

Note that this scenario is an example, representing only one case of roaming CDR generation.

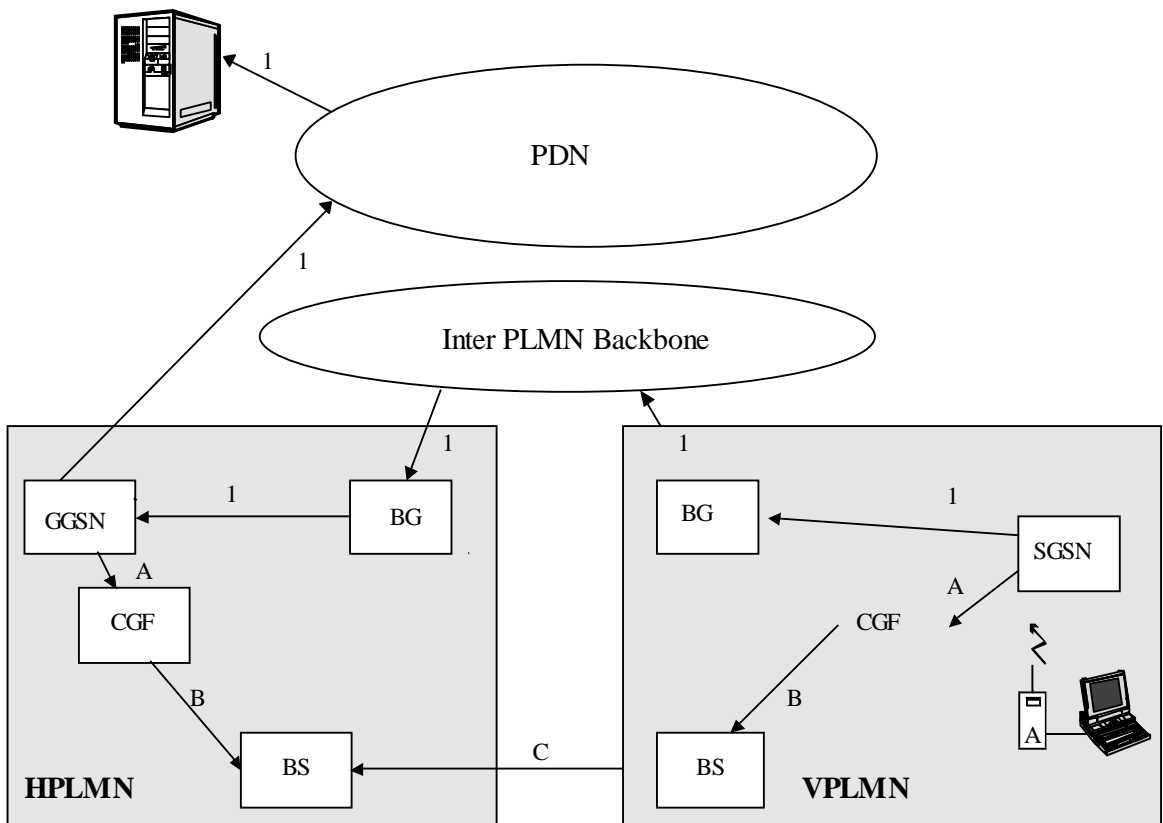

Figure 5.4: Mobile to PDN Context whilst roaming via BG

### 5.2.5 Ga record transfer flows

In GPRS, both fully qualified partial CDRs (FQPC) and reduced partial CDRs (RPC), as specified in TS 32.240 [1] may be supported on the Ga interface. In line with TS 32.240 [13], the support of FQPCs is mandatory, the support of RPCs is optional. For further details on the Ga protocol application refer to TS 32.295 [54].

### 5.2.6 Bp CDR file transfer

In GPRS, both fully qualified partial CDRs (FQPC) and reduced partial CDRs (RPC), as specified in TS 32.240 [1] may be supported on the Bp interface. In line with TS 32.240 [13], the support of FQPCs is mandatory, the support of RPCs is optional. For further details on the Bp protocol application refer to TS 32.297 [52].

## 5.3 PS domain online charging scenarios

### 5.3.1 Basic principles

PS domain online charging may be performed in the SGSN using CAMEL techniques. This functionality is specified in TS 23.078 [206] and TS 29.078 [202] and is outside the scope of the present document.

PS domain online charging may be performed by the PCEF in the GGSN using the common Ro based credit control application specified in TS 32.299 [50]. In order to provide the data required for the management activities outlined in TS 32.240 [1] (credit control, accounting, statistics etc.), the PCEF shall be able to perform online charging for each of the following:

- Charging Data related to PDP contexts;
- Charging Data related to service data flows.

The above items both pertain to sessions (PDP contexts), hence session based online charging (SCUR) is required in the PCEF. The Credit Control Requests (CCR) and Credit Control Answers (CCA) specified for SCUR in TS 32.299 [50] (initial/update/termination) are issued towards the OCS / received from the OCS when certain conditions (chargeable events) are met. The PS domain specific contents and purpose of each of these messages, as well as the chargeable events that trigger them, are described in the following subclauses. A detailed formal description of the online charging parameters defined in the present document is to be found in 3GPP TS 32.299 [50]. Further information on the general principles of the common 3GPP online charging application can also be found in TS 32.299 [50] and TS 32.240 [1].

The credit control is always per rating group but the reporting level can be either per rating group or per combination of the rating group and service id. Reporting level is defined per PCC rule.

**Editor's note: Operators may be interested in defining chargeable events not linked to the charging of a PDP Context. Charging mechanisms defined for event based charging not linked to a PDP Context are FFS.**

#### 5.3.1.1 PDP context charging

PDP context online charging is achieved by FBC online charging, see clause 5.3.1.2. When the PDP Context is online charged by means of FBC, the quota handling shall also be based on the use of a Rating Group/Service Identifier. The value of this PDP Context specific Rating Group/Service Identifier shall be vendor specific.

The amount of data counted with PDP context specific Rating Group/Service Identifier shall be the GTP-U protocol payload at the Gn interface. Time metering is started when PDP context is activated.

#### 5.3.1.2 Flow Based Bearer Charging

PDP context charging allows the GGSN to collect charging information related to data volumes sent to and received by the UE/MS, categorised by the QoS applied to the PDP context. FBC is supported by the GGSN by the integrated PCEF. When the PCEF is present, the normal PDP context charging is enhanced by the capability to categorise the service data flows within PDP context data traffic by rating group or combination of the rating group and service id. I.e., while there is only one uplink and one downlink data volume count per PDP context in PDP context charging, FBC may provide one count per each rating group or combination of the rating group and service id. The level of the reporting is defined per PCC rule. The default PCC rule is the wildcard, i.e. all traffic for all IP addresses, all TCP ports, etc.; when no other, specific PCC rules are configured, the behaviour of FBC is identical to the normal PDP context charging on the GGSN. When further PCC rules are specified, traffic is categorised, and counted, according to the PCC rule specification, and the wildcard PCC rule may apply to all traffic that does not match any of the specific PCC rules depending on the precedence of the PCC rules. Details of this functionality are specified in TS 23.203 [72] and TS 32.240 [1].

According to TS 23.203 [72], FBC shall support different charging models per PCC rule. These charging models may be based on volume and/or time and on number of events matching a specific service data flow template in PCC rule. In general the charging of a service data flow shall be linked to the PDP Context under which the service data flow has been activated. In online charging the PCEF shall request the reservation of units prior to service delivery.

The following chargeable events are defined for FBC when online charging is activated:

- Network request for PDP context activation before the Initiate PDP Context Activation message is sent. Associated with the network requested secondary PDP context activation procedure, as defined in TS 23.203 [72] and 23.060 [201], upon encountering this event, a CCR initial, indicating the request for activation of secondary PDP context is sent toward the OCS.
- Start of PDP context. Upon encountering this event, a CCR initial, indicating the start of the PDP context, is sent towards the OCS to authorize the PDP context. For network requested secondary PDP context activation, this event triggers a CCR update, when the PCEF receives an Update PDP Context Request message with the RAN Procedures Ready flag. PCEF may request quota later when service usage is started.
- Start of service data flow. In case valid quota does not exist a CCR update is generated to request quota. When event based charging applies, the first occurrence of an event matching a service data flow template in PCC rule shall be considered as the start of a service.
- Termination of service data flow. If reporting is per rating group and this is the last service data flow utilizing that specific rating group or if reporting is per combination of the rating group and service id and this is the last service data flow utilizing that specific rating group and service id, the required counters are updated. Termination of the service data flow itself does not trigger CCR update.
- End of PDP context. Upon encountering this event, a CCR termination, indicating the end of the PDP context, is sent towards the OCS together with the final counts.
- Ro specific chargeable events (e.g. threshold reached, QHT expires, quota exhaustion, validity time reached, forced re-authorization). Corresponding counts for the rating group(s) are closed and CCR update is triggered according the rules defined in TS 32.299 [50].
- Change of charging condition: QoS change, location change (CGI/SAI or RAI). When this event is encountered and the corresponding re-authorization trigger is armed, all current counts are captured and sent towards the OCS with a CCR update.
- Tariff time change. When this event is encountered, all current counts are captured and a new counts are started. The counts are sent to the OCS in next CCR.

Management intervention may also force trigger a chargeable event.

PCC rules can be activated, deactivated and modified any time during the PDP context lifetime. PCC rule activation, deactivation and modification are not chargeable events. However these PCC rule changes may lead to "start of service data flow" and "termination of service data flow" chargeable events.

### 5.3.1.3 PS Furnish Charging Information procedure

The OCS online charging function may use this procedure to add online charging session specific information to the eG-CDR. The information can be sent per online session and in case FBC is enabled for a specific APN, the OCS online charging function may also send specific information per each online charged service by means this procedure.

### 5.3.1.4 Support of Failure Situations

In case the OCS fails, the GGSN shall support the Failure Handling procedure and Failover mechanism described in [50]. These mechanisms give flexibility to have different failure handling scenarios when the OCS fails.

Three different actions are described in [402]. In PS domain GGSN shall support the following actions when the failure handling mechanism is executed:

- Terminate: The online session is finished. The associated PDP Context is released (ongoing sessions) or not established (new sessions). Failover for ongoing sessions is not supported. Failover for new sessions is always supported.
- Retry&Terminate: The online session is finished. The associated PDP Context is released (ongoing sessions) or not established (new sessions). Failover for ongoing sessions is supported. Failover for new sessions is always supported.
- Continue: The online session is finished. The associated PDP Context is established (new sessions) or not released (ongoing sessions). Failover for ongoing sessions is supported. Failover for new sessions is always supported.

In both cases, if the user is simultaneously online and offline charged, the failure situation shall be registered in the eG-CDR. When the user is only online charged, the execution of the Failure Handling mechanism with value equal to Continue shall imply that a new eG-CDR is opened.

### 5.3.2 Ro message flows

CCR initial, update and termination, as defined in TS 32.299 [50], are used by the GGSN to transfer the collected charging information towards the OCS. CCA is used by the OCS to assign quotas for the rating groups, and to instruct the GGSN whether to continue or terminate a service data flow(s) or PDP context.

CCA is also used to communicate to the PCEF the Termination Action, i.e. the GGSN behaviour when the user has consumed the final granted units. The Termination Action is specified in TS 32.299 [50].

The GGSN uses charging characteristics profile to determine whether to activate or deactivate online charging. Further details of this functionality, including the mechanism of conveying the charging characteristics data item (HLR -> SGSN -> GGSN), are specified in annex A.

The following clauses describe the trigger conditions for the chargeable events described in clause 5.3.1.1 and 5.3.1.2. In FBC online charging, these chargeable events correspond to the triggers for collection of charging information and CCR emission towards the OCS. The responses from the OCS and the detailed behaviour of the PCEF upon receiving those responses are also specified in the subclauses below.

#### 5.3.2.1 Triggers for PDP context Online Charging

PDP context online charging is achieved by FBC online charging, see clause 5.3.2.2 below.

5.3.2.1.1 Void

5.3.2.1.2 Void

#### 5.3.2.2 Triggers for FBC Online Charging

CCR initial / update / termination is used to convey charging information related to the PDP context and service data flows collected in the PCEF. CCA is used by the OCS to return quotas for rating groups or to instruct the PCEF on the further handling of the PDP context (terminate, continue, reroute, etc.). The CCR includes details such as CCR Type, Served IMSI, Sequence Number etc. The CCA includes details such as credit control quotas and session management instructions (continue, terminate, interim interval, etc). Not all of the charging information to be collected is static, and other charging information is directly dependent on dynamic Packet-Switched service usage.

FBC online charging is employed if it is activated for the PDP context. The charging method in the PCC rule defines whether service data flow requires the online charging. The PCEF shall request the quota prior to service delivery. If only certain quotas are authorised by the OCS (e.g. due to insufficient credit), the rating groups for which no quota was authorised are handled according the received Result-Code AVP value. The quota supervision mechanism is further described in TS 32.299 [50]. Details on FBC can be found in TS 23.203 [72] and TS 29.212 [71].

CCR initial is sent to the OCS during the PDP context activation. The OCS supplies a PDP context authorisation and may supply volume, time or events quotas for the rating groups, based on the information provided by the PCEF, e.g. QoS, APN.

When start of the service data flow is detected and no valid quota exist a CCR update is sent to request quota for the rating group unless the rating group is e.g. blacklisted. See TS 32.299 [50] for further information.

When a change of charging condition occurs and corresponding re-authorization trigger is armed, all MSCC instances are reported to the OCS with a CCR update with Reporting-Reason AVP value set to RATING\_CONDITION\_CHANGE together with Trigger-Type AVP indicating the accurate reason for the change.

When Ro specific chargeable event (e.g. threshold reached, QHT expires, quota exhaustion, validity time reached, forced re-authorization) occurs required MSCC instances are reported to OCS with a CCR update with corresponding Reporting-Reason AVP value. See TS 32.299 [50] for further information.

When tariff time change is encountered, the Tariff-Change-Usage AVP is used within the Used-Service-Units AVP to distinguish usage before and after the tariff time change. The MSCC instances are sent to the OCS in next CCR.

The OCS may specify the behaviour on consumption of the final granted units known as termination action. The required termination action is indicated with Final-Unit-Action AVP and possible values are TERMINATE and REDIRECT. See TS 32.299 [50] for further information.

TS 23.203 [72] specifies that it shall be possible to request online charging quotas for each charging key. Each quota allocated to a Diameter CC session has a unique Rating-Group AVP value. TS 23.203 [72] also specifies that PCEF shall report charging information for each combination of the charging key and service identifier when service identifier level reporting is present. As defined in TS 23.203 [72] the service identifier is a piece of information which provides the most detailed identification, specified for flow based charging, of a service data flow. The charging key is a piece of information used for rating purposes as defined in TS 23.203 [72]. The charging key and Service Identifier are mapped into the Rating-Group AVP and the Service-Identifier AVP respectively as defined in DCCA [402].

The subsequent clauses identify in detail the conditions for reporting online charging information, management of user and credit control sessions and PS domain quota supervision.

#### 5.3.2.2.1 Triggers for starting and stopping an FBC Credit Control session

CCR initial is sent to OCS when PDP context is activated. For network requested secondary PDP context activation, the CCR initial is sent to the OCS when the PCEF determines a need for the PDP context and before any GPRS signalling is initiated.

CCR terminate is sent to OCS when:

- PDP context is deactivated
- Session termination is indicated by the OCS (e.g. Credit Limit Reached)
- Abort-Session-Request is received from the OCS, this also results in network initiated PDP context deactivation.

#### 5.3.2.2.2 Triggers for providing interim information for an FBC Credit Control session

CCR update is sent to OCS when:

- User starts to use certain service
- Active service is removed from the allowed services (e.g. charging rule is removed)
- Granted quota runs out
- Validity time for granted quota expires
- Update is requested by the OCS
- Change of charging conditions occur and according re-authorisation trigger re-authorisation is needed
- Management intervention
- Quota Holding Timer is expired
- For network requested secondary PDP context activation, reception of an Update PDP Context Request message with the RAN Procedures Ready flag.



### 5.3.2.3 PS Furnish Charging Information procedure

The OCS online charging function may use this procedure to add online charging session specific information to the eG-CDR by means of the Diameter Credit Control Application in the Ro interface. The data can be sent either in one Diameter Credit Control *Credit-Control-Answer* message or several Diameter Credit Control *Credit-Control-Answer* messages with append indicator.

The OCS online charging function can send multiple concatenated PS Furnish Charging Information elements per online charging session in the Ro interface. The OCS online charging function can also send multiple concatenated PS Furnish Information Element per each quota (i.e. per rating group).

The total maximum of free format data is 160 octets per service so the total maximum of free format data per online session is  $n \times 160$  octets, where  $n$  indicates the number of rating groups activated per online session.

In the OCS online charging function a PS online charging session shall be identified by the GGSN-C address and the ChargingId. In the GGSN, the PS online charging session and the PS offline charging session shall be identified by the same ChargingId. Therefore the ChargingId shall allow the GGSN to correlate an online charging session with an offline charging session.

This procedure can only apply when online and offline charging is performed simultaneously for the same session (PDP Context) or rating group. In any other case, the GGSN shall discard the additional charging information sent by the OCS in the Diameter Credit Control *Credit-Control-Answer* messages.

When the OCS sends session specific charging information, it must send the 'PS-Furnish-Charging-Information' AVP at command level in the *Credit-Control-Answer* message. In this case, the information is added to the main body of the eG-CDR. When the OCS sends service specific charging information, it must send the 'PS-Furnish-Charging-Information' AVP at MSCC level in the *Credit-Control-Answer* message. In this case, the information is added to the specific service container in the eG-CDR.

The PS Furnish Charging Information AVP is described in TS 32.299 [50].

### 5.3.2.4 Support of Failure Situations

In case the OCS fails the GGSN must support the Failure Handling procedure and Failover mechanism described in 3GPP TS 32.299 [50].

The Failure Handling Procedure affects the whole online session so in case FBC is enabled, the procedure shall affect all services activated during the PDP Context triggering the online charging session.

According to 3GPP TS 32.299 [50], timer  $T_x$  determines the maximum interval the GGSN shall wait for an answer to each credit control request sent to the OCS. In case FBC is enabled, it is possible that several concurrent Credit Control Request messages are triggered for the same online charging session. In this case, each Credit Control Request message shall reset the  $T_x$  timer. When  $T_x$  expires, GGSN shall execute the Failover and Failure Handling mechanisms according to the behaviour described in Annex B.

Three different actions are described in [402]. In PS domain GGSN shall support the following actions when the failure handling mechanism is executed:

- **Terminate:** The online session is finished. The associated PDP Context is released (ongoing sessions) or not established (new sessions). Failover for ongoing sessions is not supported. Failover for new sessions is always supported.
- **Retry&Terminate:** The online session is finished. The associated PDP Context is released (ongoing sessions) or not established (new sessions). Failover for ongoing sessions is supported. Failover for new sessions is always supported.
- **Continue:** The online session is finished. The associated PDP Context is established (new sessions) or not released (ongoing sessions). Failover for ongoing sessions is supported. Failover for new sessions is always supported. It shall be operator configurable to limit the maximum duration of the PDP Context in this situation.

In case the user is simultaneously online and offline charged, the failure situation must be registered in the eG-CDR. When the user is only online charged, the execution of the Failure Handling mechanism with value equal to Continue shall imply that a new eG-CDR is opened.

---

## 6 Definition of charging information

### 6.1 Data description for PS offline charging

The tables in the subsequent parts of clause x specify the Mandatory (M), Conditional (C) and Operator optional ( $O_M$  or  $O_C$ ) designations. The category of a CDR parameter can have one of two primary values:

- M** This parameter is **Mandatory** and shall always be present in the CDR.
- C** This parameter shall be present in the CDR only when certain Conditions are met. These Conditions are specified as part of the parameter definition.

All other parameters are designated as Operator (**O**) provisionable, which replaced the "Optional" category, specified in earlier releases. Using network management functions or specific tools provided by an equipment vendor, operators may choose if they wish to include or omit the parameter from the CDR. Once omitted, this parameter is not generated in a CDR. To avoid any potential ambiguity, a CDR generating element **MUST** be able to provide all these parameters. Only an operator can choose whether or not these parameters should be generated in their system.

Those parameters that the operator wishes to be present are further divided into a mandatory and conditional categories:

- $O_M$**  This is a parameter that, if provisioned by the operator to be present, shall always be included in the CDRs. In other words, an  $O_M$  parameter that is provisioned to be present is a mandatory parameter.
- $O_C$**  This is a parameter that, if provisioned by the operator to be present, shall be included in the CDRs when the required conditions are met. In other words, an  $O_C$  parameter that is configured to be present is a conditional parameter.

The following tables provide a brief description of each CDR parameter. Full definitions of the parameters, sorted by the parameter name in alphabetical order, are provided in 3GPP TS 32.298 [51].

## 6.1.1 PDP context charging data in SGSN (S-CDR)

If the collection of CDR data is enabled then the SGSN data specified in the following table shall be available for each PDP context.

**Table 6.1.1 : SGSN PDP context data (S-CDR)**

Field	Category	Description
Record Type	M	SGSN PDP context record.
Network Initiated PDP Context	O <sub>C</sub>	A flag that is present if this is a network initiated PDP context.
Served IMSI	M	IMSI of the served party.
Served IMEI	O <sub>C</sub>	The IMEI of the ME, if available.
SGSN Address	O <sub>M</sub>	The IP address of the current SGSN.
MS Network Capability	O <sub>M</sub>	The mobile station Network Capability.
Routing Area Code (RAC)	O <sub>M</sub>	RAC at the time of "Record Opening Time".
Location Area Code (LAC)	O <sub>M</sub>	LAC at the time of "Record Opening Time".
Cell Identifier	O <sub>M</sub>	Cell identity for GSM or Service Area Code (SAC) for UMTS at the time of "Record Opening Time".
Charging ID	M	PDP context identifier used to identify this PDP context in different records created by GSNs.
GGSN Address Used	M	The control plane IP address of the GGSN currently used. The GGSN address is always the same for an activated PDP context.
Access Point Name Network Identifier	O <sub>M</sub>	The logical name of the connected access point to the external packet data network (network identifier part of APN).
PDP Type	O <sub>M</sub>	PDP type, i.e. IP, PPP, IHOSS:OSP.
Served PDP Address	O <sub>C</sub>	PDP address of the served IMSI, i.e. IPv4 or IPv6. This parameter shall be present except when both the PDP type is PPP and dynamic PDP address assignment is used.
List of Traffic Data Volumes	O <sub>M</sub>	A list of changes in charging conditions for this PDP context, each change is time stamped. Charging conditions are used to categorize traffic volumes, such as per tariff period. Initial and subsequently changed QoS and corresponding data volumes are also listed.
Record Opening Time	M	Time stamp when PDP context is activated in this SGSN or record opening time on subsequent partial records.
Duration	M	Duration of this record in the SGSN.
SGSN Change	C	Present if this is first record after SGSN change.
Cause for Record Closing	M	The reason for closure of the record from this SGSN.
Diagnostics	O <sub>M</sub>	A more detailed reason for the release of the connection.
Record Sequence Number	C	Partial record sequence number in this SGSN. Only present in case of partial records.
Node ID	O <sub>M</sub>	Name of the recording entity.
Record Extensions	O <sub>C</sub>	A set of network operator/manufacturer specific extensions to the record. Conditioned upon the existence of an extension.
Local Record Sequence Number	O <sub>M</sub>	Consecutive record number created by this node. The number is allocated sequentially including all CDR types.
APN Selection Mode	O <sub>M</sub>	An index indicating how the APN was selected.
Access Point Name Operator Identifier	O <sub>M</sub>	The Operator Identifier part of the APN.
Served MSISDN	O <sub>M</sub>	The primary MSISDN of the subscriber.
Charging Characteristics	M	The Charging Characteristics applied to the PDP context.
RAT Type	O <sub>C</sub>	This field indicates the Radio Access Technology (RAT) type, e.g. UTRAN or GERAN, currently used by the Mobile Station as defined in TS 29.060 [204].
CAMEL Information	O <sub>C</sub>	Set of CAMEL information related to PDP context. For more information see Description of Record Fields. This field is present if CAMEL service is activated.
RNC Unsent Downlink Volume	O <sub>C</sub>	The downlink data volume, which the RNC has not sent to MS. This field is present when the RNC has provided unsent downlink volume count at RAB release.
Charging Characteristics Selection Mode	O <sub>M</sub>	Holds information about how Charging Characteristics were selected.
Dynamic Address Flag	O <sub>C</sub>	Indicates whether served PDP address is dynamic, which is allocated during PDP context activation. This field is missing if address is static.

## 6.1.2 PDP context charging data in GGSN (G-CDR)

If FBC is disabled and the collection of CDR data is enabled then the GGSN data specified in the following table shall be available for each PDP context.

**Table 6.1.2: GGSN PDP context data (G-CDR)**

Field	Category	Description
Record Type	M	GGSN PDP context record.
Network initiated PDP context	O <sub>C</sub>	A flag that is present if this is a network initiated PDP context.
Served IMSI	M	IMSI of the served party.
Served IMEISV	O <sub>C</sub>	IMEISV of the ME, if available.
GGSN Address used	M	The control plane IP address of the GGSN used.
Charging ID	M	PDP context identifier used to identify this PDP context in different records created by GSNs
SGSN Address	M	List of SGSN addresses used during this record.
Access Point Name Network Identifier	O <sub>M</sub>	The logical name of the connected access point to the external packet data network (network identifier part of APN).
PDP Type	O <sub>M</sub>	PDP type, i.e. IP, PPP, or IHQSS:OSP.
Served PDP Address	O <sub>C</sub>	PDP address, i.e. IPv4 or IPv6. This parameter shall be present except when both the PDP type is PPP and dynamic PDP address assignment is used.
Dynamic Address Flag	O <sub>C</sub>	Indicates whether served PDP address is dynamic, which is allocated during PDP context activation. This field is missing if address is static.
List of Traffic Data Volumes	O <sub>M</sub>	A list of changes in charging conditions for this PDP context, each change is time stamped. Charging conditions are used to categorize traffic volumes, such as per tariff period. Initial and subsequently changed QoS and corresponding data values are also listed.
Record Opening Time	M	Time stamp when PDP context is activated in this GGSN or record opening time on subsequent partial records.
MS Time Zone	O <sub>C</sub>	This field contains the MS Time Zone the MS is currently located as defined in TS 29.060 [203], if provided by SGSN.
Duration	M	Duration of this record in the GGSN.
Cause for Record Closing	M	The reason for the release of record from this GGSN.
Diagnostics	O <sub>M</sub>	A more detailed reason for the release of the connection.
Record Sequence Number	C	Partial record sequence number, only present in case of partial records.
Node ID	O <sub>M</sub>	Name of the recording entity.
Record Extensions	O <sub>C</sub>	A set of network operator/manufacture specific extensions to the record. Conditioned upon the existence of an extension.
Local Record Sequence Number	O <sub>M</sub>	Consecutive record number created by this node. The number is allocated sequentially including all CDR types.
APN Selection Mode	O <sub>M</sub>	An index indicating how the APN was selected.
Served MSISDN	O <sub>M</sub>	The primary MSISDN of the subscriber.
User Location Information	O <sub>C</sub>	This field contains the User Location Information of the MS as defined in TS 29.060 [203], if provided by SGSN.
Charging Characteristics	M	The Charging Characteristics applied to the PDP context.
Charging Characteristics Selection Mode	O <sub>M</sub>	Holds information about how Charging Characteristics were selected.
IMS Signalling Context	O <sub>C</sub>	Included if the IM-CN Subsystem Signalling Flag is set, see [201]PDP context is used for IMS signalling.
External Charging Identifier	O <sub>C</sub>	Holds a Charging Identifier and is present only if it is received from a non-GPRS, external network entity
SGSN PLMN Identifier	O <sub>M</sub>	SGSN PLMN Identifier (MCC and MNC) used during this record.
CAMEL Information	O <sub>C</sub>	Set of CAMEL information related to PDP context. This field is present if CAMEL Charging Information is received by the GGSN in the GTP Create PDP context request.
RAT Type	O <sub>C</sub>	This field indicates the Radio Access Technology (RAT) type currently used by the Mobile Station as defined in TS 29.060 [204]. The field is present in the G-CDR if provided by SGSN.

### 6.1.3 FBC enhanced PDP context charging data in GGSN (eG-CDR)

If FBC is enabled and the collection of CDR data is enabled then the GGSN data specified in the following table shall be available for each PDP context.

**Table 6.1.3: GGSN FBC enhanced PDP context data (eG-CDR)**

Field	Category	Description
Record Type	M	Enhanced GGSN PDP context record.
Network initiated PDP context	O <sub>C</sub>	A flag that is present if this is a network initiated PDP context.
Served IMSI	M	IMSI of the served party.
Served IMEISV	O <sub>C</sub>	IMEISV of the ME, if available.
GGSN Address used	M	The control plane IP address of the GGSN used.
Charging ID	M	PDP context identifier used to identify this PDP context in different records created by GSNs
SGSN Address	M	List of SGSN addresses used during this record.
Access Point Name Network Identifier	O <sub>M</sub>	The logical name of the connected access point to the external packet data network (network identifier part of APN).
PDP Type	O <sub>M</sub>	PDP type, i.e. IP, PPP, or IHOSS:OSP.
Served PDP Address	O <sub>C</sub>	PDP address, i.e. IPv4 or IPv6. This parameter shall be present except when both the PDP type is PPP and dynamic PDP address assignment is used.
Dynamic Address Flag	O <sub>C</sub>	Indicates whether served PDP address is dynamic, which is allocated during PDP context activation. This field is missing if address is static.
List of Traffic Data Volumes	O <sub>M</sub>	A list of changes in charging conditions for this PDP context, each change is time stamped. Charging conditions are used to categorize traffic volumes, such as per tariff period. Initial and subsequently changed QoS and corresponding data values are also listed. Failure-Handling: This field shall be present in case GGSN triggers the Failure-Handling procedure. It shall indicate the Failure Handling scenario and the instant the Failure Action is triggered (see annex B). Scenarios: Continue/New Session; Continue/Ongoing Session; Retry&Terminate/Ongoing Session; Terminate/Ongoing Session.
List of Service Data	O <sub>M</sub>	A list of changes in charging conditions for all service data flows within this PDP context categorized per rating group or per combination of the rating group and service id. Each change is time stamped. Charging conditions are used to categorize traffic volumes, elapsed time and number of events, such as per tariff period. Initial and subsequently changed QoS and corresponding data values are also listed. Online charging information (PS Furnish Charging Information) may be added per each service data flow container in case it is sent by the OCS. Failure-Handling: This field shall be present in case GGSN triggers the Failure-Handling procedure. It shall indicate the Failure Handling scenario and the instant the Failure Action is triggered (see annex B). Scenarios: Continue/New Session; Continue/Ongoing Session; Retry&Terminate/Ongoing Session; Terminate/Ongoing Session.
Record Opening Time	M	Time stamp when PDP context is activated in this GGSN or record opening time on subsequent partial records.
MS Time Zone	O <sub>C</sub>	This field contains the MS Time Zone the MS is currently located as defined in TS 29.060 [203], if provided by SGSN.
Duration	M	Duration of this record in the GGSN.
Cause for Record Closing	M	The reason for the release of record from this GGSN.
Diagnostics	O <sub>M</sub>	A more detailed reason for the release of the connection.
Record Sequence Number	C	Partial record sequence number, only present in case of partial records.
Node ID	O <sub>M</sub>	Name of the recording entity.
Record Extensions	O <sub>C</sub>	A set of network operator/manufacturer specific extensions to the record. Conditioned upon the existence of an extension.
Local Record Sequence Number	O <sub>M</sub>	Consecutive record number created by this node. The number is allocated sequentially including all CDR types.
APN Selection Mode	O <sub>M</sub>	An index indicating how the APN was selected.
Served MSISDN	O <sub>M</sub>	The primary MSISDN of the subscriber.
User Location Information	O <sub>C</sub>	This field contains the User Location Information of the MS as defined in TS 29.060 [203], if provided by SGSN.
Charging Characteristics	M	The Charging Characteristics applied to the PDP context.

Field	Category	Description
Charging Characteristics Selection Mode	O <sub>M</sub>	Holds information about how Charging Characteristics were selected.
IMS Signalling Context	O <sub>C</sub>	Included if the PDP context IM-CN Subsystem Signalling Flag is set, see [201] is used for IMS signalling.
External Charging Identifier	O <sub>C</sub>	A Charging Identifier received from a non-GPRS, external network entity.
SGSN PLMN Identifier	O <sub>M</sub>	SGSN PLMN Identifier (MCC and MNC) used during this record.
PS Furnish Charging Information	O <sub>C</sub>	Online charging session specific information
CAMEL Information	O <sub>C</sub>	Set of CAMEL information related to PDP context. This field is present if CAMEL Charging Information is received by the GGSN in the GTP Create PDP context request.
RAT Type	O <sub>C</sub>	This field indicates the Radio Access Technology (RAT) type currently used by the Mobile Station as defined in TS 29.060 [204]. The field is present in the eG-CDR if provided by SGSN.

## 6.1.4 Mobile Station mobility management data in SGSN (M-CDR)

If the collection of MS mobility management data is enabled then the SGSN shall start collecting the information specified in the following table each time the mobile is attached to the SGSN.

**Table 6.1.4: SGSN Mobile Station mobility management data (M-CDR)**

Field	Category	Description
Record Type	M	SGSN mobility management record.
Served IMSI	M	IMSI of the MS.
Served IMEI	O <sub>C</sub>	The IMEI of the ME, if available.
SGSN Address	O <sub>M</sub>	The IP address of the current SGSN.
MS Network Capability	O <sub>M</sub>	The mobile station network capability.
Routing Area Code	O <sub>M</sub>	Routing Area at the time of the Record Opening Time.
Local Area Code	O <sub>M</sub>	Location Area Code at the time of Record Opening Time.
Cell Identifier	O <sub>M</sub>	The Cell Identity for GSM or Service Area Code (SAC) for UMTS at the time of the Record Opening Time.
Cell PLMN Id	O <sub>M</sub>	The MCC and MNC of the Cell at the time of Record Opening Time.
Change of Location	O <sub>C</sub>	A list of changes in Routing Area Code including MCC and MNC, each with a time stamp. This field is not required if partial records are generated when the location changes.
Record Opening Time	M	Timestamp when MS is attached to this SGSN or record opening time on following partial record.
Duration	O <sub>M</sub>	Duration of this record.
SGSN Change	C	Present if this is first record after SGSN change.
Cause for Record Closing	M	The reason for the closure of the record in this SGSN.
Diagnostics	O <sub>M</sub>	A more detailed reason for the release of the connection.
Record Sequence Number	C	Partial record sequence number in this SGSN; only present in case of partial records.
Node ID	O <sub>M</sub>	Name of the recording entity.
Record Extensions	O <sub>C</sub>	A set of network operator/manufacture specific extensions to the record. Conditioned upon the existence of an extension.
Local Record Sequence Number	O <sub>M</sub>	Consecutive record number created by this node. The number is allocated sequentially including all CDR types.
Served MSISDN	O <sub>M</sub>	The primary MSISDN of the subscriber.
Charging Characteristics	M	The Charging Characteristics used by the SGSN.
CAMEL Information	O <sub>C</sub>	Set of CAMEL information related to Attach/Detach session. For more information see Description of Record Fields. This field is present if CAMEL service is activated.
RAT Type	O <sub>C</sub>	This field indicates the Radio Access Technology (RAT) type, e.g. UTRAN or GERAN, currently used by the Mobile Station as defined in TS 29.060 [204].
Charging Characteristics Selection Mode	O <sub>M</sub>	Holds information about how Charging Characteristics were selected.

## 6.1.5 SMS-MO data in SGSN (S-SMO-CDR)

If enabled, an S-SMO-CDR SGSN Mobile originated SMS record shall be produced for each short message sent by a mobile subscriber via the SGSN. The fields in the record are specified in the following table.

**Table 6.1.5: SGSN Mobile originated SMS record (S-SMO-CDR)**

Field	Category	Description
Record Type	M	SGSN Mobile Originated SMS.
Served IMSI	M	The IMSI of the subscriber.
Served IMEI	O <sub>C</sub>	The IMEI of the ME, if available.
Served MSISDN	O <sub>M</sub>	The primary MSISDN of the subscriber.
MS Network Capability	O <sub>M</sub>	The mobile station network capability.
Service Centre	O <sub>M</sub>	The address (E.164) of the SMS-service centre.
Recording Entity	O <sub>M</sub>	The E.164 number of the SGSN.
Location Area Code	O <sub>M</sub>	The Location Area Code from which the message originated.
Routing Area Code	O <sub>M</sub>	The Routing Area Code from which the message originated.
Cell Identifier	O <sub>M</sub>	The Cell Identity for GSM or Service Area Code (SAC) for UMTS from which the message originated.
Message Reference	M	A reference provided by the MS uniquely identifying this message.
Event Time Stamp	M	The time at which the message was received by the SGSN from the subscriber.
SMS Result	C	The result of the attempted delivery if unsuccessful.
Record Extensions	O <sub>C</sub>	A set of network operator/ manufacturer specific extensions to the record. Conditioned upon the existence of an extension.
Node ID	O <sub>M</sub>	Name of the recording entity.
Local Record Sequence Number	O <sub>M</sub>	Consecutive record number created by this node. The number is allocated sequentially including all CDR types.
Charging Characteristics	M	The Charging Characteristics flag set used by the SGSN.
RAT Type	O <sub>C</sub>	This field indicates the Radio Access Technology (RAT) type, e.g. UTRAN or GERAN, currently used by the Mobile Station as defined in TS 29.060 [204].
Destination Number	O <sub>M</sub>	The destination short message subscriber number.
CAMEL Information	O <sub>C</sub>	Set of CAMEL information related to SMS session. For more information see Description of Record Fields. This field is present if CAMEL service is activated.
Charging Characteristics Selection Mode	O <sub>M</sub>	Holds information about how Charging Characteristics were selected.



## 6.1.6 SMS-MT data in SGSN (S-SMT-CDR)

If enabled, an SGSN Mobile terminated SMS record shall be produced for each short message received by a mobile subscriber via the SGSN. The fields in the record are specified in the following table.

**Table 6.1.6: SGSN Mobile terminated SMS record (S-SMT-CDR)**

Field	Category	Description
Record Type	M	SGSN Mobile Terminated SMS.
Served IMSI	M	The IMSI of the subscriber.
Served IMEI	O <sub>C</sub>	The IMEI of the ME, if available.
Served MSISDN	O <sub>M</sub>	The primary MSISDN of the subscriber.
MS Network Capability	O <sub>M</sub>	The mobile station network capability.
Service Centre	O <sub>M</sub>	The address (E.164) of the SMS-service centre.
Recording Entity	O <sub>M</sub>	The E.164 number of the SGSN.
Location Area Code	O <sub>M</sub>	The Location Area Code to which the message was delivered.
Routing Area Code	O <sub>M</sub>	The Routing Area Code to which the message was delivered.
Cell Identifier	O <sub>M</sub>	The Cell Identity for GSM or Service Area Code (SAC) for UMTS to which the message was delivered.
Event Time Stamp	M	Delivery time stamp, time at which message was sent to the MS by the SGSN.
SMS Result	C	The result of the attempted delivery if unsuccessful.
Record Extensions	O <sub>C</sub>	A set of network operator/manufacturer specific extensions to the record. Conditioned upon the existence of an extension.
Node ID	O <sub>M</sub>	Name of the recording entity.
Local Record Sequence Number	O <sub>M</sub>	Consecutive record number created by this node. The number is allocated sequentially including all CDR types.
Charging Characteristics	M	The Charging Characteristics flag set used by the SGSN.
RAT Type	O <sub>C</sub>	This field indicates the Radio Access Technology (RAT) type, e.g. UTRAN or GERAN, currently used by the Mobile Station as defined in TS 29.060 [204].
Charging Characteristics Selection Mode	O <sub>M</sub>	Holds information about how Charging Characteristics were selected.
CAMEL Information	O <sub>C</sub>	Set of CAMEL information related to SMS session. For more information see Description of Record Fields. This field is present if CAMEL service is activated.

## 6.1.7 Mobile terminated location request (LCS-MT-CDR)

If enabled, an SGSN Mobile terminated LCS record shall be produced for each mobile terminated location request that is performed via the SGSN. The fields in the record are specified in the following table.

**Table 6.1.7: SGSN Mobile terminated LCS record (SGSN-LCS-MT)**

Field	Category	Description
Record Type	M	SGSN Mobile Terminated LCS.
Recording Entity	M	The E.164 number of the SGSN.
LCS Client Type	M	The type of the LCS client that invoked the LR.
LCS Client Identity	M	Further identification of the LCS client.
Served IMSI	M	The IMSI of the subscriber.
Served MSISDN	O <sub>M</sub>	The primary MSISDN of the subscriber.
SGSN Address	O <sub>M</sub>	The IP address of the current SGSN.
Location Type	M	The type of the estimated location.
LCS QoS	C	QoS of the LR, if available.
LCS Priority	C	Priority of the LR, if available.
MLC Number	M	The E.164 address of the requesting GMLC.
Event Time stamp	M	The time at which the Perform_Location_Request is sent by the SGSN.
Measurement Duration	O <sub>M</sub>	The duration of proceeding the location request.
Notification To MS User	C	The privacy notification to MS user that was applicable when the LR was invoked, if available.
Privacy Override	C	This parameter indicates the override MS privacy by the LCS client, if available.
Location	O <sub>M</sub>	The LAC and CI when the LR is received.
Routing Area Code	O <sub>M</sub>	The Routing Area Code to which the LCS terminated.
Location Estimate	O <sub>C</sub>	The location estimate for the subscriber if contained in geographic position and the LR was successful.
Positioning Data	C	The positioning method used or attempted, if available.
LCS Cause	O <sub>C</sub>	The result of the LR if any failure or partial success happened as known at radio interface.
Cause for Record Closing	M	The reason for closure of the record from this SGSN.
Diagnostics	C	A more detailed information about the Cause for Record Closing if any failure or partial success happened.
Node ID	O <sub>M</sub>	Name of the recording entity.
Local Record Sequence Number	O <sub>M</sub>	Consecutive record number created by this node. The number is allocated sequentially including all CDR types.
Charging Characteristics	M	The Charging Characteristics used by the SGSN. (always use the subscribed CC).
Charging Characteristics Selection Mode	O <sub>M</sub>	Holds information about how Charging Characteristics were selected. (only subscribed/home default/visited default).
RAT Type	O <sub>C</sub>	This field indicates the Radio Access Technology (RAT) type, e.g. UTRAN or GERAN, currently used by the Mobile Station as defined in TS 29.060 [204].
Record Extensions	O <sub>C</sub>	A set of network operator/manufacture specific extensions to the record. Conditioned upon the existence of an extension.

## 6.1.8 Mobile originated Location request (LCS-MO-CDR)

If enabled, an SGSN Mobile originated LCS record shall be produced for each mobile originated location request that is performed via the SGSN. The fields in the record are specified in the following table.

**Table 6.1.8: SGSN Mobile originated LCS record (SGSN-LCS-MO)**

Field	Category	Description
Record Type	M	SGSN Mobile Originated LCS.
Recording Entity	M	The E.164 number of the SGSN.
LCS Client Type	C	The type of the LCS client that invoked the LR, if available.
LCS Client Identity	C	Further identification of the LCS client, if available.
Served IMSI	M	The IMSI of the subscriber.
Served MSISDN	O <sub>M</sub>	The primary MSISDN of the subscriber.
SGSN Address	O <sub>M</sub>	The IP address of the current SGSN.
Location Method	M	The type of the location request.
LCS QoS	C	QoS of the LR, if available.
LCS Priority	O <sub>C</sub>	Priority of the LR, if available.
MLC Number	C	The E.164 address of the involved GMLC, if applicable.
Event Time stamp	M	The time at which the Perform_Location_Request is sent by the SGSN.
Measurement Duration	O <sub>M</sub>	The duration of proceeding the location request.
Location	O <sub>M</sub>	The LAC and CI when the LR is received.
Routing Area Code	O <sub>M</sub>	The Routing Area Code from which the LCS originated.
Location Estimate	O <sub>C</sub>	The location estimate for the subscriber if contained in geographic position and the LR was successful.
Positioning Data	C	The positioning method used or attempted, if available.
LCS Cause	O <sub>C</sub>	The result of the LR if any failure or partial success happened as known at radio interface.
Cause for Record Closing	M	The reason for closure of the record from this SGSN.
Diagnostics	C	A more detailed information about the Cause for Record Closing if any failure or partial success happened.
Node ID	O <sub>M</sub>	Name of the recording entity.
Local Record Sequence Number	O <sub>M</sub>	Consecutive record number created by this node. The number is allocated sequentially including all CDR types.
Charging Characteristics	M	The Charging Characteristics flag set used by the SGSN.
Charging Characteristics Selection Mode	O <sub>M</sub>	Holds information about how Charging Characteristics were selected.
RAT Type	O <sub>C</sub>	This field indicates the Radio Access Technology (RAT) type, e.g. UTRAN or GERAN, currently used by the Mobile Station as defined in TS 29.060 [204].
Record Extensions	O <sub>C</sub>	A set of network operator/manufacture specific extensions to the record. Conditioned upon the existence of an extension.

## 6.1.9 Network induced Location request (LCS-NI-CDR)

If enabled, an SGSN Network induced LCS record shall be produced for each network induced location request that is performed via the SGSN. The fields in the record are specified in the following table.

**Table 6.1.9: SGSN Network induced LCS record (SGSN-LCS-NI)**

Field	Category	Description
Record Type	M	SGSN Network Induced LCS.
Recording Entity	M	The E.164 number of the SGSN.
LCS Client Type	C	The type of the LCS client that invoked the LR, if available.
LCS Client Identity	C	Further identification of the LCS client, if available.
Served IMSI	C	The IMSI of the subscriber if supplied.
Served MSISDN	C	The primary MSISDN of the subscriber if supplied.
SGSN Address	O <sub>M</sub>	The IP address of the current SGSN.
Served IMEI	O <sub>C</sub>	The IMEI of the ME, if available.
LCS QoS	C	QoS of the LR, if available.
LCS Priority	C	Priority of the LR, if available.
MLC Number	C	The E.164 address of the involved GMLC, if applicable.
Event Time stamp	M	The time at which the Perform_Location_Request is sent by the SGSN.
Measurement Duration	O <sub>M</sub>	The duration of proceeding the location request.
Location	O <sub>M</sub>	The LAC and CI when the LR is received.
Routing Area Code	O <sub>M</sub>	The Routing Area Code from which the LCS originated.
Location Estimate	O <sub>C</sub>	The location estimate for the subscriber if contained in geographic position and the LR was successful.
Positioning Data	C	The positioning method used or attempted, if available.
LCS Cause	O <sub>C</sub>	The result of the LR if any failure or partial success happened as known at radio interface.
Cause for Record Closing	M	The reason for closure of the record from this SGSN.
Diagnostics	C	A more detailed information about the Cause for Record Closing if any failure or partial success happened.
Node ID	O <sub>M</sub>	Name of the recording entity.
Local Record Sequence Number	O <sub>M</sub>	Consecutive record number created by this node. The number is allocated sequentially including all CDR types.
Charging Characteristics	M	The Charging Characteristics flag set used by the SGSN.
Charging Characteristics Selection Mode	O <sub>M</sub>	Holds information about how Charging Characteristics were selected.
RAT Type	O <sub>C</sub>	This field indicates the Radio Access Technology (RAT) type, e.g. UTRAN or GERAN, currently used by the Mobile Station as defined in TS 29.060 [204].
Record Extensions	O <sub>C</sub>	A set of network operator/manufacture specific extensions to the record. Conditioned upon the existence of an extension.

## 6.1.10 MBMS bearer context charging data in SGSN (S-MB-CDR)

If the collection of CDR data is enabled then the SGSN data specified in the following table shall be available for each MBMS bearer context.

**Table 6.1.10: SGSN MBMS bearer context data (S-MB-CDR)**

Field	Category	Description
Record Type	M	SGSN MBMS bearer context record.
GGSN Address used	M	The control plane IP address of the GGSN used.
Charging ID	M	Bearer context identifier used to identify this MBMS bearer context in different records created by GSNs
List of RAs	O <sub>C</sub>	List of routing areas receiving data used during this record. equivalent to the list of RAs defined in TS 23.246 [207].
Access Point Name Network Identifier	O <sub>M</sub>	The logical name of the connected access point to the BM-SC (network identifier part of APN).
Served PDP Address	O <sub>C</sub>	Indicates the IP Multicast address used for the MBMS bearer context..
List of Traffic Data Volumes	O <sub>M</sub>	A list of changes in charging conditions for this MBMS bearer context, each change is time stamped. Charging conditions are used to categorize traffic volumes, such as per tariff period. It shall include the required bearer capabilities (QoS Negotiated)
Record Opening Time	M	Time stamp when MBMS bearer context is activated in this SGSN or record opening time on subsequent partial records.
Duration	M	Duration of this record in the SGSN.
Cause for Record Closing	M	The reason for the release of record from this SGSN.
Diagnostics	O <sub>M</sub>	A more detailed reason for the release of the connection.
Record Sequence Number	C	Partial record sequence number, only present in case of partial records.
Node ID	O <sub>M</sub>	Name of the recording entity.
Record Extensions	O <sub>C</sub>	A set of network operator/manufacturer specific extensions to the record. Conditioned upon the existence of an extension.
Local Record Sequence Number	O <sub>M</sub>	Consecutive record number created by this node. The number is allocated sequentially including all CDR types.
Number of receiving UEs	O <sub>C</sub>	Indicates the number of UEs receiving the MBMS bearer service
MBMS Information	O <sub>M</sub>	MBMS related information related to MBMS bearer context being charged, defined in TS 32.273 [32].

## 6.1.11 MBMS bearer context charging data in GGSN (G-MB-CDR)

If the collection of CDR data is enabled then the GGSN data specified in the following table shall be available for each MBMS bearer context.

**Table 6.1.11: GGSN MBMS bearer context data (G-MB-CDR)**

Field	Category	Description
Record Type	M	GGSN MBMS bearer context record.
GGSN Address used	M	The control plane IP address of the GGSN used.
Charging ID	M	Bearer context identifier used to identify this MBMS bearer context in different records created by GSNs
List of Downstream Nodes	M	List of SGSN addresses used during this record. equivalent to the list of downstream nodes defined in TS 23.246 [207].
Access Point Name Network Identifier	O <sub>M</sub>	The logical name of the connected access point to the BM-SC (network identifier part of APN).
Served PDP Address	O <sub>C</sub>	Indicates the IP Multicast address used for the MBMS bearer context.
List of Traffic Data Volumes	O <sub>M</sub>	A list of changes in charging conditions for this MBMS bearer context, each change is time stamped. Charging conditions are used to categorize traffic volumes, such as per tariff period. It shall include the required bearer capabilities (QoS Negotiated).
Record Opening Time	M	Time stamp when MBMS bearer context is activated in this GGSN or record opening time on subsequent partial records.
Duration	M	Duration of this record in the GGSN.
Cause for Record Closing	M	The reason for the release of record from this GGSN.
Diagnostics	O <sub>M</sub>	A more detailed reason for the release of the connection.
Record Sequence Number	C	Partial record sequence number, only present in case of partial records.
Node ID	O <sub>M</sub>	Name of the recording entity.
Record Extensions	O <sub>C</sub>	A set of network operator/manufacture specific extensions to the record. Conditioned upon the existence of an extension.
Local Record Sequence Number	O <sub>M</sub>	Consecutive record number created by this node. The number is allocated sequentially including all CDR types.
MBMS Information	O <sub>M</sub>	MBMS related information related to MBMS bearer context being charged, defined in TS 32.273 [32].

## 6.2 Data description for PS Online Charging

### 6.2.1 Diameter message contents

#### 6.2.1.1 Summary of Online Charging Message Formats

The PS Online Charging uses the Credit-Control-Request (CCR) and Credit-Control-Answer (CCA) messages defined in TS 32.299 [50].

The following table describes the use of these messages for PDP context based online charging.

**Table 6.2.1.1.1 : Online Charging Messages Reference Table for PDP context**

Command-Name	Source	Destination	Abbreviation
Credit-Control-Request	GGSN	OCS	CCR
Credit-Control-Answer	OCS	GGSN	CCA

The following table describes the use of these messages for Flow based online charging.

**Table 6.2.1.1.2 : Online Charging Messages Reference Table for FBC**

Command-Name	Source	Destination	Abbreviation
Credit-Control-Request	PCEF	OCS	CCR
Credit-Control-Answer	OCS	PCEF	CCA

## 6.2.1.2 Structure for the Credit Control Message Formats

This clause describes the AVPs used in the credit control messages.

### 6.2.1.2.1 Credit-Control-Request Message

Table 6.2.1.2.1 illustrates the basic structure of a Diameter CCR message from the PCEF as used for PS online charging.

**Table 6.2.1.2.1 : Credit-Control-Request (CCR) Message Contents**

AVP	Category	Description
Session-Id	M	Described in TS 32.299 [50]
Origin-Host	M	Described in TS 32.299 [50]
Origin-Realm	M	Described in TS 32.299 [50]
Destination-Realm	M	Described in TS 32.299 [50]
Auth-Application-Id	M	Described in TS 32.299 [50]
Service-Context-Id	M	Described in TS 32.299 [50]
CC-Request-Type	M	Described in TS 32.299 [50]
CC-Request-Number	M	Described in TS 32.299 [50]
Destination-Host	O <sub>M</sub>	Described in TS 32.299 [50]
User-Name	O <sub>M</sub>	The content of the field corresponds to the Protocol Configuration Options (PCO) field of the Create PDP Context Request message.
Origin-State-Id	O <sub>C</sub>	Described in TS 32.299 [50]
Event-Timestamp	O <sub>C</sub>	Described in TS 32.299 [50]
Subscription-Id	O <sub>M</sub>	Described in TS 32.299 [50]. As a minimum the IMSI and the MSISDN have to be included.
User-Equipment-Info	O <sub>C</sub>	Described in TS 32.299 [50]. Contains the IMEISV.
Termination-Cause	O <sub>C</sub>	Described in TS 32.299 [50]
Multiple-Services-Indicator	O <sub>M</sub>	Described in TS 32.299 [50]
Multiple-Services-Credit Control	O <sub>C</sub>	Described in TS 32.299 [50]
Route-Record	O <sub>C</sub>	Described in TS 32.299 [50]
AVP	O <sub>M</sub>	Described in TS 32.299 [50]
Service-Information	O <sub>C</sub>	Described in TS 32.299 [50]
PS-Information	O <sub>C</sub>	Described in clause 6.2.2.1
IMS-Information	O <sub>C</sub>	Described in clause 6.2.2.2
NOTE: The PS-Information and IMS-Information AVPs are inside the Service-Information AVP and not directly at CCR command level.		

The full description of the AVPs is specified in TS 32.299 [50].

### 6.2.1.2.2 Credit-Control-Answer Message

The following table illustrates the basic structure of a DCCA message as used for the PCEF. This message is always used by the OCS as specified below, independent of the receiving PCEF and the CCR request type that is being replied to.

**Table 6.2.1.2.2 : Credit-Control-Answer (CCA) Message Contents**

AVP	Category	Description
Session-Id	M	Described in 32.299 [50]
Result-Code	M	Described in 32.299 [50]
Origin-Host	M	Described in 32.299 [50]
Origin-Realm	M	Described in 32.299 [50]
Auth-Application-Id	M	Described in 32.299 [50]
CC-Request-Type	M	Described in 32.299 [50]
CC-Request-Number	M	Described in 32.299 [50]
Multiple-Services-Credit-Control	O <sub>c</sub>	Described in 32.299 [50]
CC-Session-Failover	O <sub>c</sub>	Described in 32.299 [50]
Credit-Control-Failure-Handling	O <sub>c</sub>	Described in 32.299 [50]
Redirect-Host	O <sub>c</sub>	Described in 32.299 [50]
Redirect-Host-Usage	O <sub>c</sub>	Described in 32.299 [50]
Redirect-Max-Cache-Time	O <sub>c</sub>	Described in 32.299 [50]
Failed-AVP	O <sub>c</sub>	Described in 32.299 [50]
Route-Record	O <sub>c</sub>	Described in 32.299 [50]
Service-Information	O <sub>c</sub>	Described in 32.299 [50]
AVP	O <sub>M</sub>	Described in 32.299 [50]

### 6.2.2 Void



## 6.3 PS Online Charging Specific Parameters

### 6.3.1 Definition of PS charging information

The PS Information parameter used for PS online charging is provided in the Service Information parameter.

#### 6.3.1.1 PS charging information assignment for Service Information

The components in the Service Information that are use for PS charging can be found in Table 6.3.1.1.

**Table 6.3.1.1 : Service Information used for PS Charging**

Field	Category	Description
Service Information	O <sub>M</sub>	This is a structured field and holds the 3GPP specific parameter as defined in TS 32.299 [50].
PS Information	O <sub>M</sub>	This is a structured field and holds the PS specific parameters. The details are defined in subclause 6.3.1.2.
IMS Information	O <sub>C</sub>	This is a structured field and holds IMS specific parameters. The complete structure is defined in TS 32.260 [20].
IMS Charging Identifier	O <sub>C</sub>	This field holds the IMS Charging Identifier (ICID) as generated by an IMS node for a SIP session.

### 6.3.1.2 Definition of the PS Information

PS specific charging information is provided within the PS Information.

The detailed structure of the PS Information can be found in the table 6.3.1.2.

**Table 6.3.1.2 : Structure of the PS Information**

Field	Category	Description
Charging Id	O <sub>C</sub>	This field holds the Charging Id for this PDP context (this together with the GGSN-Address constitutes a unique identifier for the PDP context).
PDP Type	O <sub>C</sub>	This field holds the type of PDP context, e.g. IP or PPP.
PDP Address	O <sub>C</sub>	This field holds the PDP address of the served IMSI, i.e. IPv4 or IPv6. This parameter shall be present except when both the PDP type is PPP and dynamic PDP address assignment is used.
Negotiated QoS Profile	O <sub>C</sub>	This field holds the QoS profile applied by GGSN. See NOTE.
SGSN Address	O <sub>C</sub>	This field holds the SGSN IP address that is used by the GTP control plane for the handling of control messages. It may be used to identify the PLMN to which the user is attached.
GGSN Address	O <sub>C</sub>	This field holds the IP-address of the GGSN that generated the Charging Id.
CG Address	O <sub>C</sub>	This field holds the Charging Gateway IP address.
IMSI MCC MNC	O <sub>C</sub>	This field holds the MCC and MNC extracted from the user's IMSI (first 5 or 6 digits, as applicable from the presented IMSI).
GGSN MCC MNC	O <sub>C</sub>	This field holds the MCC-MNC of the network the GGSN belongs to.
NSAPI	O <sub>C</sub>	This field Identifies a particular PDP context for the associated PDN and MSISDN/IMSI from creation to deletion. See NOTE.
Called Station Id	O <sub>C</sub>	This field contains the identifier of the access point (APN) the user is connected to.
Session Stop Indicator	O <sub>C</sub>	This field indicates to the OCS that the last PDP context of a session is released and that the PDP session has been terminated.
Selection Mode	O <sub>C</sub>	This field contains the Selection mode for this PDP Context received in the Create PDP Context Request Message.
Charging Characteristics	O <sub>C</sub>	This field contains the charging characteristics for this PDP Context received in the Create PDP Context Request Message (only available in R99 and later releases).
SGSN MCC MNC	O <sub>C</sub>	This field holds the MCC and MNC extracted from the RAI within the Create PDP Context Request or Update PDP Context Request message.
MS Time Zone	O <sub>C</sub>	This field indicates the offset between universal time and local time in steps of 15 minutes of where the MS currently resides.
Charging Rule Base Name	O <sub>C</sub>	This field indicates the name of a pre-defined group of PCC rules residing at the PCEF. It may occur several times within the PS Information field.
User Location Info	O <sub>C</sub>	This field indicates details of where the UE is currently located (e.g. SAI or CGI).
RAT Type	O <sub>C</sub>	This field indicates which Radio Access Technology is currently serving the UE.
Furnish Charging Information	O <sub>C</sub>	This field contains the PS Furnish Information Elements.
Offline Charging	O <sub>C</sub>	This field contains the Offline Charging parameters to control offline charging.
PDP Context Type	O <sub>C</sub>	This field indicates the type of a PDP context (i.e. Primary or Secondary)
NOTE:		For Network Requested Secondary PDP Context Activation, the CCR Initial does not contain a value of NSAPI, whilst the Negotiated QoS profile reflects the requested QoS profile used in the activation request.

---

## Annex A (normative): Charging characteristics

Charging Characteristics can be supplied by the HLR to the SGSN as part of the subscription information. A subscriber may have charging characteristics assigned to his subscription and/or his subscribed APNs. The SGSN applies a pre-configured default if no charging characteristics are supplied by the HLR. The SGSN shall support three different charging characteristics default configurations:

- the home default profile for subscribers of the SGSN's PLMN;
- the visiting default profile for visitors using a GGSN belonging to the same PLMN as the SGSN;
- the roaming default profile for visitors using a GGSN belonging to their home PLMN.

The SGSN can determine the GGSN PLMN from the operator identifier part of the APN. Optionally the SGSN may support several visiting and roaming default profiles based on the MNC/MCC combination of the subscriber.

In the case of a home subscriber, the charging characteristics are selected by the SGSN according to the following procedures. For PDP context specific charging characteristics (i.e. those used for the S-CDRs that are generated for this PDP context):

- If the MS requests a particular APN then:
  - \* If the SGSN accepts this request (i.e. it has been verified against the subscription) then:
    - If it has been matched against the wildcard APN then:
      - If charging characteristics for the wildcard APN are present in the subscription information then they shall be used;
      - If no charging characteristics are present for the wildcard APN but subscription related charging characteristics are present, then they shall be chosen;
      - If neither of the two are present then the SGSN home default shall be applied.
    - If it has been matched against a specific subscribed APN then:
      - If charging characteristics for this APN are present in the subscription information then they shall be used;
      - If no charging characteristics are present for the APN but subscription related charging characteristics are present, then they shall be chosen;
      - If neither of the two are present then the SGSN home default shall be applied.
  - \* If the SGSN rejects the request then charging characteristics selection does not apply.
- If the MS does not request an APN then:
  - \* If the SGSN chooses a subscribed APN then:
    - If charging characteristics for this APN are present in the subscription information then they shall be used;
    - If no charging characteristics are present for the APN but subscription related charging characteristics are present, then they shall be chosen;
    - If neither of the two are present then the SGSN home default shall be applied.

- \* If only the wildcard APN is present in the subscription, i.e. the SGSN applies its configured default APN then:
  - If charging characteristics for the wildcard APN are present in the subscription information then they shall be used;
  - If no charging characteristics are present for the wildcard APN but subscription related charging characteristics are present, then they shall be chosen;
  - If neither of the two are present then the SGSN home default shall be applied.

For the non-PDP context specific CDR types, i.e. the M-CDRs and the SMS CDRs, the SGSN applies the subscription specific charging characteristics, or, if not supplied, it shall choose the home default profile as defined above.

In case of subscribers from other PLMNs, the SGSN may be configured to either apply the "home subscriber case" charging characteristics selection procedure defined above, or to ignore charging characteristics provided by the subscriber's HLR, and apply a default configuration instead. If default charging characteristics are selected for the foreign subscriber, then the SGSN shall choose either the visiting or roaming default profile for the PDP context specific charging characteristics, according to the roaming or visiting scenario, as described above. For M-CDRs and SMS CDRs, the operator can configure if the roaming or the visiting profile shall be applied, since no GGSN is involved.

Upon activation of a PDP context, the SGSN forwards the charging characteristics to the GGSN according to the following rules:

- if charging characteristics were received from the HLR, then they shall be sent as provided by the HLR, regardless of the home, visiting, or roaming case, and regardless of whether the SGSN applies the HLR supplied charging characteristics or chooses to ignore them;
- if no charging characteristics were received from the HLR, then the SGSN does not forward any charging characteristics to the GGSN.

The above procedure implies that no explicit transfer of the Charging Characteristics Selection Mode (see 3GPP TS 23.060 [201]) to the GGSN is necessary, because it is implicitly given as "subscribed" when the GGSN receives charging characteristics from the SGSN, and "non-subscribed" otherwise.

The GGSN shall also apply charging characteristics to its PDP contexts. It shall either apply the SGSN supplied parameters, or it may be configured to ignore the SGSN supplied charging characteristics in any combination of the following cases:

- visiting case, i.e. the subscriber belongs to a different PLMN;
- roaming case, i.e. the SGSN belongs to a different PLMN;
- home case, i.e. the subscriber belongs to the same PLMN as the GGSN; or
- unconditionally, i.e. it always ignores the SGSN supplied parameters.

If the GGSN ignores the parameters supplied by the SGSN, it shall nevertheless accept the PDP context request. It shall then apply its own pre-configured charging characteristics as appropriate, i.e. the home, visiting or roaming profile. The GGSN shall support the configuration of one set of default charging characteristics (i.e. home, visiting, roaming) for each of its supported APNs.

Charging Characteristics consists of a string of 16 bits designated as Profile (P) and Behaviour (B), shown in 3GPP TS 32.298 [41]. The first four bits (P) shall be used to select different charging trigger profiles, where each profile consists of the following trigger sets, e.g.:

- **S-CDR:** activate/deactivate CDRs, time limit, volume limit, maximum number of charging conditions, tariff times;
- **G-CDR:** same as SGSN, plus maximum number of SGSN changes;
- **eG-CDR:** same as G-CDR;
- **M-CDR:** activate/deactivate CDRs, time limit, and maximum number of mobility changes;

- **SMS-MO-CDR:** activate/deactivate CDRs;
- **SMS-MT-CDR:** active/deactivate CDRs.
- **LCS-MO-CDR.**
- **LCS-MT-CDR.**
- **LCS-NI-CDR.**

In addition to these trigger sets, the profile may also specify an optional charging gateway address. If this CGF address is configured in the GGSN's selected trigger profile, the GGSN shall apply it for the G-CDRs and send this charging gateway address in its GTP message exchange with the SGSN (overriding any other GGSN configured CGF address). In the home or visiting case, the SGSN shall apply the received CGF address to the S-CDRs pertaining to this PDP context. In the roaming case, or if no address is received from the GGSN, then the SGSN shall use the CGF address from its own selected charging characteristics trigger profile, or, if it does not exist, use the default CGF address. For M-CDRs and SMS CDRs, the SGSN shall use the CGF address configured in the charging characteristics that it applies to the respective CDRs, or if no such address is configured then the default CGF shall be used.

Table A.1 and A.2 are informative examples intended for clarification.

**Table A.1: Example of charging characteristics profiles for SGSN**

Profile Index bits 0 - 3	CGF Address	S-CDR					M-CDR	
		Active	Time limit	Volume limit	Change cond	Tariff times	Active	...
0	-	Yes	30 min	100 K	2	0-7, 7-12, ...	Yes	..
1	100.128.35.20	No	-	-	-	-	No	..
2	-	Yes	10 min	50 K	1	0-24	Yes	..
..	..	..	..	..	..	..	..	..

Charging characteristics profile in GGSN is used for G-CDR generation when FBC is not activated. When FBC is activated the charging characteristics profile is used for eG-CDR generation/online charging.

PCRF may provide default charging method to PCEF (GGSN) per PDP session. If received by the PCEF, it supersedes the "Default charging method" in charging characteristics profile, see TS 23.203 [72] for more information about default charging method. PCRF may also provide CGF/OCS addresses to PCEF (GGSN) per PDP session. If received by the PCEF it supersedes the "Primary CGF/OCS address" and "Secondary CGF/OCS address" in charging characteristics profile, see TS 23.203 [72] for more information.

**Table A.2: Example of charging characteristics profiles for GGSN**

Profile Index Bits 0-3	Default charging method	Offline charging (G-CDR or eG-CDR)							Online charging		
		Primary and Secondary CGF addresses	Active	Time Limit	Vol Limit	Change Cond.	Tariff times	...	Primary and Secondary OCS addresses	Active	...
0	Online	100.128.35.20 100.128.35.21	Yes	30 min	100K	2	0-7, 7-12	...	100.128.35.30 100.128.35.31	Yes	...
1	Offline	100.128.35.21 100.128.35.20	No	-	-	-	-	...	-	No	...
2	Online /Offline	100.128.35.21 100.128.35.20	Yes	10 min	50K	1	0-24	...	100.128.35.31 100.128.35.30	Yes	...
...	...	...	...	...	...	...	...	...	...	...	...

NOTE: "Default charging method" and "Online charging" part in charging characteristics profile are applicable only if FBC is activated.

The remaining 12 (B) bits can be freely assigned to particular charging behaviours that the GSNs support. Examples of those behaviours are:

- Selection of the applicable idle context purge timer, i.e. use global value or use special value. This feature could be used to distinguish between customers and/or APNs whose PDP contexts should be purged after short (e.g. 30 minutes) or long (e.g. 12 hours) periods of inactivity.
- Use specific charging gateway address (override all other configured/selected CG addresses).
- Deactivate SMS-MO-CDRs for customers of the own PLMN using pre-configured SMSC addresses.
- Disable G-CDRs or eG-CDRs for roamers that use the HPLMN GGSN.
- Allow or inhibit the use of own GGSNs by visitors.
- Allow or inhibit network triggered QoS change (upgrade and/or downgrade).

The SGSN selects the charging characteristics for M-CDR generation upon the creation of a MM context. Both SGSN and GGSN select the charging characteristics for PDP context CDR generation (i.e. S-CDR, M-CDR and G-CDR or eG-CDR, respectively) upon creation of a PDP context or secondary PDP context. Once selected, the charging characteristics shall be maintained throughout the lifetime of the MM or PDP contexts. If the SGSN receives modified subscriber information from the HLR (e.g. execution of a stand-alone Insert Subscriber Data procedure) which includes changes to the charging characteristics, they shall be applied only to new MM, PDP and secondary PDP contexts, this implies that the SGSN shall not send PDP context modifications for the existing PDP contexts to the GGSN.

## Annex B (normative): Tx expiration; Failure Handling procedure and session failover mechanism description

DIAMETER CREDIT-CONTROL FAILURE HANDLING	Initial CCR, Tx expiration	Initial CCR, Tx expiration	Update CCR, Tx expiration	Update CCR, Tx expiration	Initial CCR, Tx expiration for second OCS	Update CCR, Tx expiration for second OCS
	Session failover enabled	Session failover disabled	Session failover enabled	Session failover disabled		
<b>Failure Action = TERMINATE</b>	PDP Context is not established.	PDP Context is not established.	PDP Context is terminated. The eG-CDR is marked.	PDP Context is terminated. The eG-CDR is marked.	N/A	N/A
<b>Failure Action= RETRY &amp; TERMINATE</b>	<p>After Tx expiration, the GGSN sends the Initial CCR to the secondary OCS. The next considerations also apply:</p> <ul style="list-style-type: none"> <li>- Tx is restarted.</li> <li>- Service is not granted yet, i.e. PDP context is not accepted yet.</li> <li>- If an answer from the first OCS is received after the first Tx expiration, it is ignored.</li> </ul> <p>In case the secondary OCS is not available, the behaviour is described in the column: "Initial CCR, Tx expiration for second OCS".</p>	PDP Context is not established.	<p>After Tx expiration, the GGSN will move all pending update CCRs for the online session to the secondary OCS. The next considerations also apply:</p> <ul style="list-style-type: none"> <li>- Tx is restarted</li> <li>- Service is only granted until the quota is exhausted.</li> <li>- If an answer from the first OCS is received after first Tx expiration, it is ignored.</li> </ul> <p>In case the secondary OCS is not available, the behaviour is described in the column: "Update CCR, Tx expiration for second OCS".</p>	PDP Context is terminated. The eG-CDR is marked.	PDP Context is not established.	PDP Context is terminated. The eG-CDR is marked.

DIAMETER CREDIT-CONTROL FAILURE HANDLING	Initial CCR, Tx expiration	Initial CCR, Tx expiration	Update CCR, Tx expiration	Update CCR, Tx expiration	Initial CCR, Tx expiration for second OCS	Update CCR, Tx expiration for second OCS
	Session failover enabled	Session failover disabled	Session failover enabled	Session failover disabled		
<b>Failure Action= CONTINUE</b>	<p>After Tx expiration, the GGSN sends the Initial CCR to the secondary OCS. The next considerations also apply:</p> <ul style="list-style-type: none"> <li>- Tx is restarted</li> <li>- Service is only granted until the quota is exhausted</li> <li>- If an answer from the first OCS is received after the first Tx expiration, it is ignored.</li> </ul> <p>In case the secondary OCS is not available, the behaviour is described in the column: "Initial CCR, Tx expiration for second OCS".</p>	<p>The PDP context is accepted and the credit-control session is considered closed for the GGSN. The operator can limit the duration of the PDP Context.</p> <p>The eG-CDR is marked.</p>	<p>After Tx expiration, the GGSN will move all pending update CCRs for the online session to the secondary OCS. The next considerations also apply:</p> <ul style="list-style-type: none"> <li>- Tx is restarted</li> <li>- Service is only granted until the quota is exhausted</li> <li>- If an answer from the first OCS is received after the first Tx expiration, it is ignored.</li> </ul> <p>In case the secondary OCS is not available, the behaviour is described in the column: "Update CCR, Tx expiration for second OCS".</p>	<p>After the Tx expiration, the failure handling mechanism is immediately triggered: The credit-control session is considered closed for the GGSN and access to all services is granted for an operator configurable period of time.</p> <p>The eG-CDR is marked. All active service data flow containers shall be added to the CDR.</p>	<p>After the Tx expiration for the secondary OCS, the failure handling mechanism is immediately triggered: The PDP context is accepted and the credit-control session is considered closed for the GGSN. The operator can limit the duration of the PDP Context. The eG-CDR is marked.</p>	<p>After Tx expiration for the secondary OCS, the failure handling mechanism is immediately triggered: The credit-control session is considered closed for the GGSN and access to all services is granted for an operator configurable period of time. The eG-CDR is marked. All active service data flow containers shall be added to the CDR</p>



---

## Annex C (informative): Bibliography

### a) **The 3GPP charging specifications**

- 3GPP TS 32.252: "Telecommunication management; Charging management; Wireless Local Area Network (WLAN) charging".

### b) **Common 3GPP specifications**

- 3GPP TS 22.101: "Service aspects; Service principles".
- 3GPP TS 23.002: "Network Architecture".
- 3GPP TS 23.003: "Numbering, addressing and identification".
- 3GPP TS 27.001: "General on Terminal Adaptation Functions (TAF) for Mobile Stations (MS)".

### c) **other Domain and Service specific 3GPP / ETSI specifications**

- 3GPP TS 49.031: "Location Services (LCS); Base Station System Application Part LCS extension (BSSAP-LE)".
- 3GPP TS 24.008: "Mobile radio interface layer 3 specification; Core network protocols; Stage 3".
- 3GPP TS 23.040: "Technical realization of the Short Message Service (SMS)".
- 3GPP TS 32.215: "Telecommunication management; Charging management; Charging data description for the Packet Switched (PS) domain (Release 5)". Not propagated beyond Release 5.

### d) **Relevant ITU Recommendations**

- ITU-T Recommendation D.93: "Charging and accounting in the international land mobile telephone service (provided via cellular radio systems)".
- ITU-T Recommendation E.164: "The international public telecommunication numbering plan".
- ITU-T Recommendation Q.767: "Application of the ISDN user part of CCITT signalling System No.7 for international ISDN interconnections".
- ITU-T Recommendation X.25: "Interface between Data Terminal Equipment (DTE) and Data Circuit-terminating Equipment (DCE) for terminals operating in the packet mode and connected to public data networks by dedicated circuit".
- ITU-T Recommendation X.121: "International numbering plan for public data networks".

### e) **Relevant IETF RFCs**

- IETF RFC 959 (1985): "File Transfer Protocol".
- IETF RFC 1350: "The TFTP Protocol (Revision 2)"

## Annex D (informative): Change history

Change history								
Date	TSG #	TSG Doc.	CR	Rev	Subject/Comment	Cat	Old	New
Jun 2006	SA_32	SP-060247	0035	1	Correction on PS charging information	C	6.7.0	7.0.0
Jun 2006	--	--	--	--	Deleted sections duplicate sections 6.3 to Annex D	--	7.0.0	7.0.1
Sep 2006	SA_33	SP-060541	0036	--	Add support for location based charging models - Align with SA1's 22.101 Service principles	B	7.0.1	7.1.0
Sep 2006	SA_33	SP-060525	0038	--	Correction on Flow Based Charging - Align with 23.125	A	7.0.1	7.1.0
Dec 2006	SA_34	SP-060715	0039	--	Align PDP context level online charging information with PCC charging	F	7.1.0	7.2.0
Dec 2006	SA_34	SP-060714	0040	--	Update of Flow Based Charging for PCC - Align with 23.203	F	7.1.0	7.2.0
Dec 2006	SA_34	SP-060714	0041	--	Introduce support of event based charging for PCC - Align with 23.203	B	7.1.0	7.2.0
Mar 2007	SA_35	SP-070043	0043	--	Add charging support for Direct Tunnel	B	7.2.0	7.3.0
Mar 2007	SA_35	SP-070043	0044	--	Add MCC and MNC in M-CDR	B	7.2.0	7.3.0
Mar 2007	SA_35	SP-070036	0045	--	Introduce support for Network Requested Secondary PDP Context Activation for online charging	B	7.2.0	7.3.0
Mar 2007	SA_35	SP-070034	0046	--	Correction of online charging errors	A	7.2.0	7.3.0
Jun 2007	SA_36	SP-070268	0049	--	Correction on offline charging trigger conditions	A	7.3.0	7.4.0
Jun 2007	SA_36	SP-070268	0051	--	Correction on FBC basic requirements - Align with TS 23.203	A	7.3.0	7.4.0
Jun 2007	SA_36	SP-070270	0052	--	Correction to eG-CDR Charging triggers	F	7.3.0	7.4.0
Jun 2007	SA_36	SP-070270	0053	--	Perform envelope reporting in offline CDRs based on requirements from online charging	B	7.3.0	7.4.0
Jun 2007	SA_36	SP-070270	0054	--	Several corrections and alignments on Charging and PCC	F	7.3.0	7.4.0
Jun 2007	SA_36	SP-070270	0055	--	Correction on Charging characteristics profile when FBC is used - Align with 23.203	F	7.3.0	7.4.0
Jun 2007	SA_36	SP-070270	0056	--	Correct the category of the MSCC AVP - Align with TS 23.203	F	7.3.0	7.4.0
Jun 2007	SA_36	SP-070270	0057	--	Correct the Rule-Base-Name AVP definition - Align with TS 29.212	F	7.3.0	7.4.0
Jun 2007	SA_36	SP-070273	0058	--	Clarification on PCC charging principles - Align with TS 23.203	F	7.3.0	7.4.0
Sep 2007	SA_37	SP-070608	0059	--	Align Flow Based Charging for PDP context charging	F	7.4.0	7.5.0
Sep 2007	SA_37	SP-070608	0060	--	Correction on PCC rule changes - Align with 23.203 and 29.212	F	7.4.0	7.5.0
Oct 2007					Removal of erroneous line in history table		7.5.0	7.5.1
Dec 2008	SA_42	SP-080841	0068	--	Correction on Multiple Service Indicator category	F	7.5.1	7.6.0
Mar 2010	SA_47	SP-100039	0129	--	Correction to PS Online Charging service context- Alignment with TS 32.299	F	7.6.0	7.7.0

---

## History

<b>Document history</b>		
V7.4.0	June 2007	Publication
V7.5.1	October 2007	Publication
V7.6.0	January 2009	Publication
V7.7.0	April 2010	Publication