

ETSI TS 132 260 V6.3.0 (2005-09)

Technical Specification

**Universal Mobile Telecommunications System (UMTS);
Telecommunication management;
Charging management;
IP Multimedia Subsystem (IMS) charging
(3GPP TS 32.260 version 6.3.0 Release 6)**



Reference

RTS/TSGS-0532260v630

Keywords

UMTS

ETSI

650 Route des Lucioles
F-06921 Sophia Antipolis Cedex - FRANCE

Tel.: +33 4 92 94 42 00 Fax: +33 4 93 65 47 16

Siret N° 348 623 562 00017 - NAF 742 C
Association à but non lucratif enregistrée à la
Sous-Préfecture de Grasse (06) N° 7803/88

Important notice

Individual copies of the present document can be downloaded from:

<http://www.etsi.org>

The present document may be made available in more than one electronic version or in print. In any case of existing or perceived difference in contents between such versions, the reference version is the Portable Document Format (PDF). In case of dispute, the reference shall be the printing on ETSI printers of the PDF version kept on a specific network drive within ETSI Secretariat.

Users of the present document should be aware that the document may be subject to revision or change of status. Information on the current status of this and other ETSI documents is available at

<http://portal.etsi.org/tb/status/status.asp>

If you find errors in the present document, please send your comment to one of the following services:

http://portal.etsi.org/chaicor/ETSI_support.asp

Copyright Notification

No part may be reproduced except as authorized by written permission.
The copyright and the foregoing restriction extend to reproduction in all media.

© European Telecommunications Standards Institute 2005.
All rights reserved.

DECTTM, **PLUGTESTS**TM and **UMTS**TM are Trade Marks of ETSI registered for the benefit of its Members.
TIPHONTM and the **TIPHON logo** are Trade Marks currently being registered by ETSI for the benefit of its Members.
3GPPTM is a Trade Mark of ETSI registered for the benefit of its Members and of the 3GPP Organizational Partners.

Intellectual Property Rights

IPRs essential or potentially essential to the present document may have been declared to ETSI. The information pertaining to these essential IPRs, if any, is publicly available for **ETSI members and non-members**, and can be found in ETSI SR 000 314: "*Intellectual Property Rights (IPRs); Essential, or potentially Essential, IPRs notified to ETSI in respect of ETSI standards*", which is available from the ETSI Secretariat. Latest updates are available on the ETSI Web server (<http://webapp.etsi.org/IPR/home.asp>).

Pursuant to the ETSI IPR Policy, no investigation, including IPR searches, has been carried out by ETSI. No guarantee can be given as to the existence of other IPRs not referenced in ETSI SR 000 314 (or the updates on the ETSI Web server) which are, or may be, or may become, essential to the present document.

Foreword

This Technical Specification (TS) has been produced by ETSI 3rd Generation Partnership Project (3GPP).

The present document may refer to technical specifications or reports using their 3GPP identities, UMTS identities or GSM identities. These should be interpreted as being references to the corresponding ETSI deliverables.

The cross reference between GSM, UMTS, 3GPP and ETSI identities can be found under <http://webapp.etsi.org/key/queryform.asp>.

Contents

Intellectual Property Rights	2
Foreword.....	2
Foreword.....	5
1 Scope	6
2 References	6
3 Definitions, symbols and abbreviations	7
3.1 Definitions	7
3.2 Abbreviations	8
3.3 Symbols.....	9
4 Architecture Considerations	10
4.1 High level IP Multimedia Subsystem (IMS) architecture	10
4.2 IMS offline charging architecture.....	11
4.3 IMS online charging architecture	11
5 Charging Principles	12
5.1 IMS Charging Principles	12
5.1.2 IMS Charging Correlation	12
5.1.2.1 Basic Principles for IMS Domain Correlation	12
5.1.2.2 IMS Charging Identifier (ICID)	12
5.1.2.3 Access network charging identifier.....	13
5.1.2.4 Inter Operator Identifier (IOI).....	13
5.1.2.5 Application Charging Identifier (ACID).....	13
5.2 IMS Offline Charging Principles.....	13
5.2.1 Basic Principles	13
5.2.2 Diameter Message Flows and Types	15
5.2.2.1 Message Flows - Successful Cases and Scenarios	15
5.2.2.1.1 Session Establishment - Mobile Origination	15
5.2.2.1.2 Session Establishment - Mobile Termination.....	16
5.2.2.1.3 Mid-Session Procedures	17
5.2.2.1.4 Session Release - Mobile Initiated	18
5.2.2.1.5 Session-Unrelated Procedures	19
5.2.2.1.7 Session Establishment - IMS Initiated.....	21
5.2.2.1.8 Session Release - PSTN Initiated	22
5.2.2.1.9 Session Release - IMS Initiated.....	23
5.2.2.1.10 Multi-Party Call.....	23
5.2.2.1.11 AS Related Procedures - AS Acting as a Redirect Server	26
5.2.2.1.12 AS Related Procedures - AS Acting as a Voice Mail Server.....	27
5.2.2.2 Message Flows - Error Cases and Scenarios.....	28
5.2.2.2.1 Session Related SIP Procedures- Reception of SIP error messages	28
5.2.2.2.2 Session Related SIP Procedures - SIP session failure	28
5.2.2.2.3 Session Unrelated SIP procedures	28
5.2.2.2.4 CDF Connection Failure.....	28
5.2.2.2.5 No Reply from CDF	28
5.2.2.2.6 Duplicate Detection	28
5.2.2.2.7 CDF Detected Failure.....	29
5.2.3 CDR generation	29
5.2.4 GTP" record transfer flows	29
5.2.5 Bi CDR file transfer	29
5.3 IMS Online Charging Scenarios.....	29
5.3.1 Basic Principles	29
5.3.2 Diameter Message Flows and Types	30
5.3.2.1 Immediate Event Charging (IEC).....	30
5.3.2.1.1 Message Flows - Successful Cases and Scenarios.....	30
5.3.2.1.2 Message Flows - Error Cases and Scenarios	30
5.3.2.2 Event Charging with Unit Reservation (ECUR) and Session Charging with Unit Reservation (SCUR)	30

5.3.2.2.1	Message Flows - Successful Cases and Scenarios.....	31
5.3.2.2.1.2	Expiration of Reservation Validity	31
5.3.2.2.2	Message Flows - Error Cases and Scenarios	31
6	Definition of charging information	32
6.1	Data description for IMS offline charging	32
6.1.1	Diameter Message contents	32
6.1.1.1	Summary of Offline Charging Message Formats.....	32
6.1.1.2	Structure for the Accounting Message Formats	32
6.1.1.2.1	Accounting-Request Message	33
6.1.1.2.2	Accounting-Answer Message.....	34
6.1.1.2.3	Detailed Message Formats.....	34
6.1.2	GTP" message contents	35
6.1.3	CDR Description on the Bi Interface.....	36
6.1.3.1	CDR Field Types	36
6.1.3.2	CDR Triggers.....	36
6.1.3.2.1	Session Related CDRs	36
6.1.3.2.2	Session Unrelated CDRs	36
6.1.3.3	S-CSCF CDR Content.....	38
6.1.3.4	P-CSCF CDR Content.....	40
6.1.3.5	I-CSCF CDR Content	42
6.1.3.6	MRFC CDR Content.....	43
6.1.3.7	MGCF CDR Content.....	45
6.1.3.8	BGCF CDR Content	47
6.1.3.9	SIP AS CDR Content.....	49
6.2	Data description for IMS online charging	50
6.2.1	Diameter message contents.....	50
6.2.1.1	Summary of Online Charging Message Formats	50
6.2.1.2	Structure for the Credit Control Message Formats.....	51
6.2.1.2.1	MRFC Credit-Control-Request Message	51
6.2.1.2.2	AS Credit-Control-Request Message	52
6.2.1.2.3	IMS Gateway Credit-Control Message	53
6.2.1.2.4	Credit-Control-Answer Message.....	54
6.2.2	AVPs for IMS Online Charging on the Ro interface	54
6.2.2.1	Definition of the IMS-Information AVP.....	55
Annex A (informative): Application Charging ID.....		56
A.1	Charging correlation procedures for presence.....	56
A.1.1	Subscription for presence event notification	56
A.1.2	Subscription for his own resource list	56
A.1.3	RLS subscription to presentities	56
A.1.4	Updating of presence information by UE.....	56
A.1.5	PS notifying watcher of updates to presence information	57
A.1.6	PS notifying resource list server and watcher of updates to presence information	57
A.1.7	Generation of ICID for non SIP request.....	57
A.2	Charging correlation procedures for Conference	57
A.2.1	Joining a conference using the conference URI - dial in.....	57
A.2.2	Adding a participant by the Focus - dial out	57
A.2.3	Manually creating a conference by dialling into conferencing application	57
A.2.4	Creating a Conference by conference-unaware UA	58
A.2.5	Creating a Conference using Ad-Hoc SIP methods	58
A.2.6	Requesting the Focus to add a new resource to a conference.....	58
A.2.7	Adding a 3 rd party using conference URI.....	58
A.2.8	Adding a 3 rd party using dialog identifier.....	58
A.2.9	Changing user agents within a conference	58
A.2.10	Bringing a point to point dialog into a conference	58
A.2.11	Generation of ICID for non SIP request.....	58
Annex B (informative): Bibliography		59
Annex C (informative): Change history		60
History		61

Foreword

This Technical Specification has been produced by the 3rd Generation Partnership Project (3GPP).

The contents of the present document are subject to continuing work within the TSG and may change following formal TSG approval. Should the TSG modify the contents of the present document, it will be re-released by the TSG with an identifying change of release date and an increase in version number as follows:

Version x.y.z

where:

- x the first digit:
 - 1 presented to TSG for information;
 - 2 presented to TSG for approval;
 - 3 or greater indicates TSG approved document under change control.
- y the second digit is incremented for all changes of substance, i.e. technical enhancements, corrections, updates, etc.
- z the third digit is incremented when editorial only changes have been incorporated in the document.

1 Scope

The present document is part of a series of documents that specify charging functionality and charging management in GSM/UMTS networks. The GSM/UMTS core network charging architecture and principles are specified in document TS 32.240 [1], which provides an umbrella for other charging management documents that specify

- the content of the CDRs per domain and subsystem (offline charging),
- the content of real-time charging events per domain / subsystem (online charging);
- the functionality of online and offline charging for those domains and subsystems;
- the interfaces that are used in the charging framework to transfer the charging information (i.e. CDRs or charging events)

The complete document structure for these TSs is defined in TS 32.240 [1].

The present document specifies the Offline and Online Charging description for the IP Multimedia Subsystem (IMS), based on the functional descriptions of the IMS in 3GPP TS 23.228 [200]. This charging description includes the offline and online charging architecture and scenarios specific to IMS, as well as the mapping of common 3GPP charging architecture specified in TS 32.240 [1] onto IMS. It further specifies the structure and content of the CDRs for offline charging, and the charging events for online charging. The present document is related to other 3GPP charging TSs as follows:

- The common 3GPP charging architecture is specified in TS 32.240 [1];
- The parameters, abstract syntax and encoding rules for these CDR types are specified in TS 32.298 [51].
- A transaction based mechanism for the transfer of CDRs within the network is specified in TS 32.295 [54].
- The file based mechanism used to transfer the CDRs from the network to the operator's billing domain (e.g. the billing system or a mediation device) is specified in TS 32.297 [52].
- The 3GPP Diameter application that is used for IMS offline and online charging is specified in TS 32.299 [50].

All terms, definitions and abbreviations used in the present document, that are common across 3GPP TSs, are defined in the 3GPP Vocabulary, TR 21.905 [100]. Those that are common across charging management in GSM/UMTS domains, services or subsystems are provided in the umbrella document TS 32.240 [1] and are copied into clause 3 of the present document for ease of reading. Finally, those items that are specific to the present document are defined exclusively in the present document.

Furthermore, requirements that govern the charging work are specified in 3GPP TS 22.115 [102].

2 References

The following documents contain provisions, which, through reference in this text, constitute provisions of the present document.

- References are either specific (identified by date of publication, edition number, version number, etc.) or non-specific.
- For a specific reference, subsequent revisions do not apply.
- For a non-specific reference, the latest version applies. In the case of a reference to a 3GPP document (including a GSM document), a non-specific reference implicitly refers to the latest version of that document *in the same Release as the present document*.

[1] 3GPP TS 32.240: "Telecommunication management; Charging management; Charging architecture and principles".

[2]-[49] Void.

- [50] 3GPP TS 32.299: "Telecommunication management; Charging management; Diameter charging application
- [51] 3GPP TS 32.298: "Telecommunication management; Charging management; Charging Data Record (CDR) parameter description
- [52] 3GPP TS 32.297: "Telecommunication management; Charging management; Charging Data Records (CDR) file format and transfer
- [53] Void.
- [54] 3GPP TS 32.295: "Telecommunication management; Charging management; Charging Data Record (CDR) transfer".
- [55]-[99] Void.
- [100] 3GPP TR 21.905: "Vocabulary for 3GPP Specifications".
- [101]-[102] Void.
- [103] 3GPP TS 23.002: "Network Architecture".
- [104]-[199] Void.
- [200] 3GPP TS 22.228: "IMS Stage 1".
- [201] 3GPP TS 23.228: " Functional stage 2 description of IMS".
- [202] 3GPP TS 24.228: "Signalling flows for the IP multimedia call control based on SIP and SDP, Stage 3'
- [203] 3GPP TS 23.218: "IP Multimedia (IM) session handling; IM call model; Stage 2".
- [204] 3GPP TS 24.229: "Internet Protocol (IP) multimedia call control protocol based on Session Initiation Protocol (SIP) and Session Description Protocol (SDP); Stage 3".
- [205]-[299] Void.
- [300]-[399] Void.
- [400] Void.
- [401] IETF RFC 3588 (2003): 'diameter base protocol".
- [402] IETF RFC 4006: 'Diameter Credit Control Application".
- [403] IETF RFC 2806: "URLs for Telephone Calls".
- [404] IETF RFC 3261: "SIP: Session Initiation Protocol".
- [405] IETF RFC 2486: "The Network Access Identifier".
- [406] RFC 3455 (January 2003): "Private Header (P-Header) Extensions to the Session Initiation Protocol (SIP) for the 3rd-Generation Partnership Project (3GPP)".

3 Definitions, symbols and abbreviations

3.1 Definitions

For the purposes of the present document, the following terms and definitions given in 3GPP TR 21.905 [50], 3GPP TS 32.240 [1], and the following apply:

billing: function whereby CDRs generated by the charging function are transformed into bills requiring payment.

Billing Domain: Part of the operator network, which is outside the core network, that receives and processes charging information from the core network charging functions. It includes functions that can provide billing mediation and billing end applications.

CDR field Categories: the CDR fields are defined in the present document. They are divided into the following categories:

- **Mandatory:** field that shall be present in the CDR.
- **Conditional:** field that shall be present in a CDR if certain conditions are met.
- **Operator Provisionable: Mandatory:** A field that operators have provisioned to be included in the CDR for all conditions.
- **Operator Provisionable: Conditional:** A field that operators have provisioned to be included in the CDR if certain conditions are met.

chargeable event: activity utilizing telecommunications network infrastructure and related services for:

- user to user communication (e.g. a single call, a data communication session or a short message); or
- user to network communication (e.g. service profile administration); or
- inter-network communication (e.g. transferring calls, signalling, or short messages); or
- mobility (e.g. roaming or inter-system handover); and
- that the network operator wants to charge for.

charged party: user involved in a chargeable event who has to pay parts or the whole charges of the chargeable event, or a third party paying the charges caused by one or all users involved in the chargeable event, or a network operator.

charging: function whereby information related to a chargeable event is formatted and transferred in order to make it possible to determine usage for which the charged party may be billed.

Charging Data Record (CDR): record generated by a network element for the purpose of billing a subscriber for the provided service. It includes fields identifying the user, the session and the network elements as well as information on the network resources and services used to support a subscriber session. In the traditional circuit domain, CDR has been used to denote "Call Detail Record", which is subsumed by "Charging Data Record" hereafter.

charging function: entity inside the core network domain, subsystem or service that is involved in charging for that domain, subsystem or service.

offline charging: charging mechanism where charging information **does not** affect, in real-time, the service rendered

online charging: charging mechanism where charging information can affect, in real-time, the service rendered and therefore a direct interaction of the charging mechanism with session/service control is required

partial CDR: CDR that provides information on part of a subscriber session. A long session may be covered by several partial CDRs. Two formats are considered for Partial CDRs. One that contains all of the necessary fields; the second has a reduced format.

3.2 Abbreviations

For the purposes of the present document, the following abbreviations apply:

ABNF	Augmented Backus-Naur Form
ACA	Accounting Answer
ACR	Accounting Request
AS	Application Server
AVP	Attribute Value Pair
B2BUA	Back-to-Back User Agent
BGCF	Breakout Gateway Control Function
BS	Billing System

CCA	Credit Control Answer
CCF	Charging Collection Function
CCR	Credit Control Request
CDF	Charging Data Function
CDR	Charging Data Record
CGF	Charging Gateway Function
CPCF	Content Provider Charging Function
ECF	Event Charging Function
ECUR	Event Charging with Unit Reservation
CSCF	Call Session Control Function (I-Interrogating; P-Proxy; and S-Serving)
IEC	Immediate Event Charging
IMS	IP Multimedia Subsystem
IMS-GWF	IMS Gateway Function
ISC	IMS Service Control
MGCF	Media Gateway Control Function
MRFC	Media Resource Function Controller
MRFP	Multimedia Resource Function Processor
OCS	Online Charging System
SCCF	Subscriber Content Charging Function
SCUR	Session Charging with Unit Reservation
SDP	Session Description Protocol
SIP	Session Initiation Protocol
UA	User Agent
UE	User Equipment

3.3 Symbols

For the purposes of the present document, the following symbols apply:

Bi	Reference point for the CDR file transfer from the IMS CGF to the BD.
Ga	Reference point for CDR transfer between a CDF and CGF.
Rf	Offline Charging Reference Point between an IMS Network Entity or an AS and CDF
Ro	Online Charging Reference Point between an AS or MRFC and IMS-GWF and the OCS

4 Architecture Considerations

4.1 High level IP Multimedia Subsystem (IMS) architecture

Figure 4.1 depicts the logical IMS architecture, as described in 3GPP TS 23.002 [103]

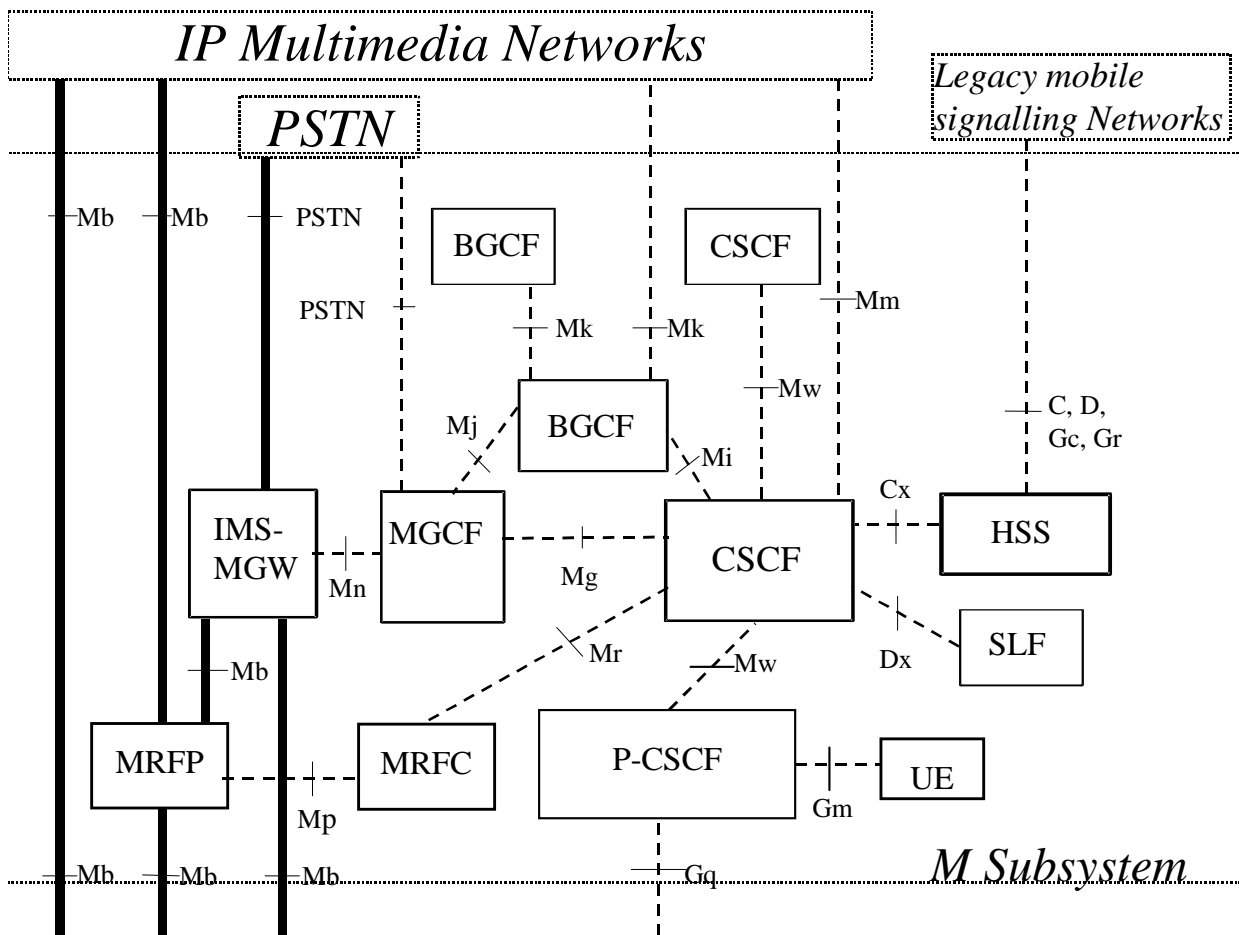

Figure 4.1: IMS logical architecture

4.2 IMS offline charging architecture

The architecture for IMS offline charging is described in the following figure. The Rf interface is described in clause 6.1.1 and Bi in clause 6.1.2.

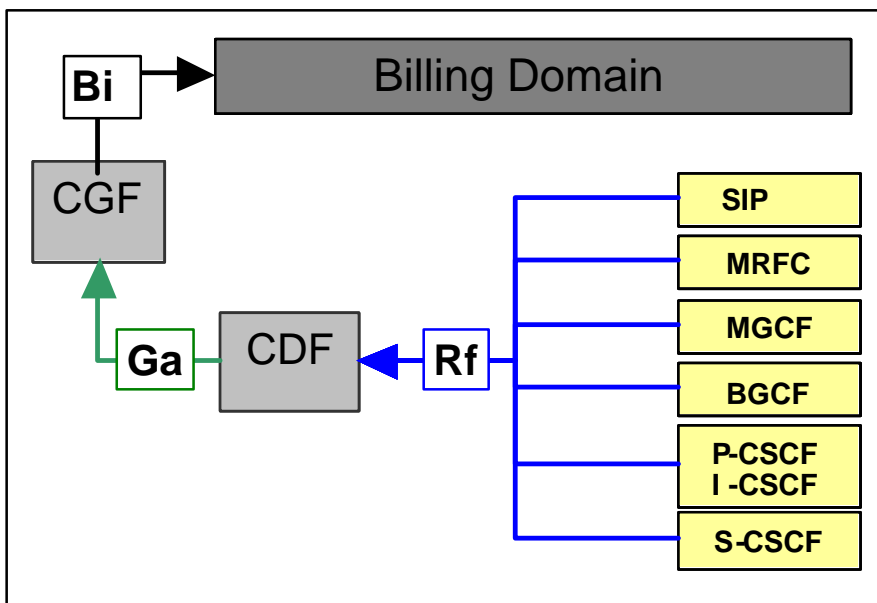

Figure 4.2: IMS offline charging architecture

NOTE: The combination of the CDF/CGF corresponds to the 3GPP Rel-5 CCF.

4.3 IMS online charging architecture

The architecture for IMS online charging is described in the following figure. The Ro interface is described in clause 6.2 and ISC in TS 23.228 [201].

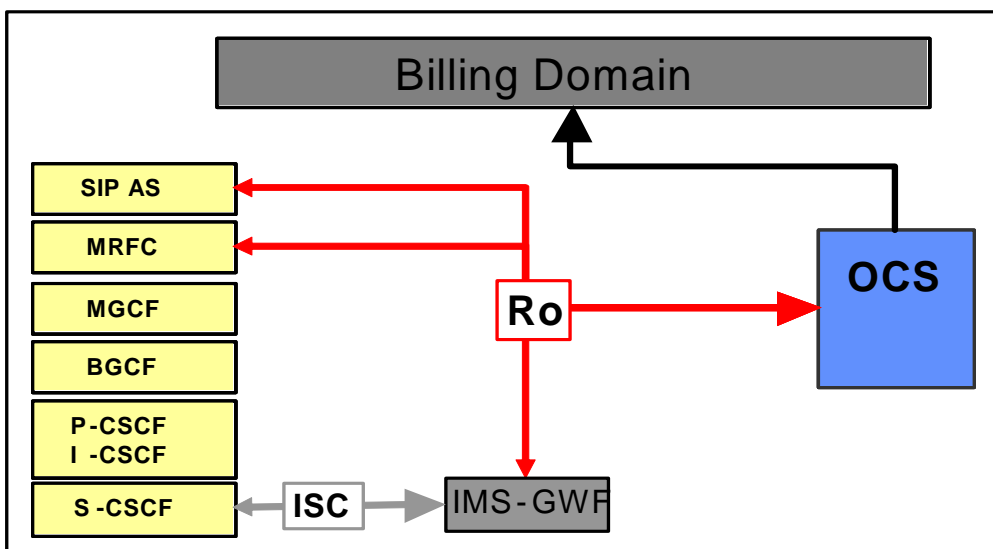

Figure 4.3: IMS online charging Architecture

5 Charging Principles

5.1 IMS Charging Principles

The AS and MRFC are able to distinguish whether to apply offline or online charging, i.e. whether to send charging information over the Rf interface to the CDF or over the Ro interface to the OCS, which includes ECF and SCF as described in chapter 4.3 (or to use both). The decision of which interface to use is based on the information (CDF and/or OCS address) the AS/MRFC receive in the SIP signalling and the system configuration as provisioned by the operator. If the AS/MRFC only receive the CDF address and do not receive an OCS address then they use only the Rf interface. If only the OCS address was provided then they use only the Ro interface. In cases where both CDF and OCS addresses are provided it is possible to use both interfaces simultaneously.

However, operators may overrule the addresses received via the SIP signalling and use their own configured rules instead. Operators may configure locally on the AS/MRFC an OCS and/or CDF address. The choice of whether the IMS network elements use locally configured addresses or the addresses received by SIP signalling, and the decision on which interface(s) to use, is left for operator configuration.

All other IMS network elements (S-CSCF, P-CSCF, I-CSCF, BGCF and MGCF) apply offline charging via the Rf interface using the CDF address as received via SIP signalling or the locally configured CDF address in the IMS network element. The S-CSCF supports online charging using:

- the ISC interface, i.e. if the application server addressed over ISC is the IMS Gateway Function, or
- the Ro interface directly instead of the ISC, if the IMS Gateway Function is integrated within the S-CSCF.

The offline and online charging function addresses transferred in SIP signalling are encoded in the P-Charging-Function-Addresses as defined in TS 24.229 [204] and RFC 3455 [406]. The P-Charging-Function-Addresses header contains the following parameters: CCF (i.e. CDF) and ECF (i.e. OCS).

5.1.2 IMS Charging Correlation

5.1.2.1 Basic Principles for IMS Domain Correlation

The IMS charging correlation information is encoded in the SIP P-Charging-Vector header as defined in the following sub clauses. The P-Charging-Vector header contains the following parameters: ICID, access network charging identifier and IOI.

General correlation mechanisms are defined in TS 32.240 [1], and further details about the usage of P-Charging-Vector are defined in TS 24.229 [204] and RFC 3455 [406].

5.1.2.2 IMS Charging Identifier (ICID)

The IMS domain correlation is based on IMS Charging Identifier (ICID) shared between IMS network elements involved with the same session/transaction. With ICID it is possible to correlate session/transaction related charging data generated in different IMS elements (i.e. x-CSCFs, ASs"). The ICID is included in all SIP methods, if the P-Charging-Vector header is present, and transferred through originating and terminating side nodes, except to UE.

The value of the ICID parameter is identical with the 'icid-value' parameter defined in TS 24.229 [204]. The 'icid-value' is a mandatory part of the P-Charging-Vector and coded as a text-based UTF-8 charset (as are all SIP messages). For further information regarding the composition and usage of the P-Charging-Vector refer to [204] and RFC 3455 [406].

The ICID value is globally unique across all 3GPP IMS networks for a time period of at least one month, implying that neither the node that generated this ICID nor any other IMS network element reuse this value before the uniqueness period expires. The one month minimum uniqueness period counts from the time of release of the ICID, i.e. the ICID value no longer being used. This can be achieved by using node specific information, e.g. high-granularity time information and / or topology / location information. The exact method how to achieve the uniqueness requirement is an implementation issue.

At each SIP session unrelated method, both initial and subsequent (e.g., REGISTER, NOTIFY, MESSAGE etc.), a new, session unrelated ICID is generated at the first IMS network element that processes the method. This ICID value is contained in the SIP request and response of that SIP transaction and must be valid for the duration of the transaction.

At each SIP session establishment a new, session specific ICID is generated at the first IMS network element that processes the session-initiating SIP INVITE message. This ICID is then used in all subsequent SIP messages for that session (e.g., 200 OK, (re-)INVITE, BYE etc.) until the session is terminated.

5.1.2.3 Access network charging identifier

The access network charging identifier is the media flow level data shared among the IMS network elements for one side of the session (either the originating or terminating side). This information is used to correlate the access network charging data with the IMS charging data. GPRS charging information (GGSN identifier and PDP context information) is an example of access network charging identifier. The access network charging identifier is populated in the P-Charging-Vector using the access-network-charging-info parameter. For further information regarding the composition and usage of the access-network-charging-info parameter refer to TS 24.229[204] and RFC 3455 [406].

5.1.2.4 Inter Operator Identifier (IOI)

The IOI identifies both originating and terminating networks involved in a session/transaction. The IOI may be generated from each side of session/transaction to identify the home networks associated with each side. The orig-ioi and term-ioi parameters of P-Charging-Vector represent the originating and terminating operator identifiers. For further information regarding the composition and usage of the orig-ioi and term-ioi parameters refer to TS 24.229[204] and RFC 3455 [406].

5.1.2.5 Application Charging Identifier (ACID)

< If ACID will be accepted, the same kind of description than for ICID should be included here, i.e. more general than in Annex B >

5.2 IMS Offline Charging Principles

5.2.1 Basic Principles

The offline charging functionality is based on the IMS network nodes reporting accounting information upon reception of various SIP methods or ISUP messages, as most of the accounting relevant information is contained in these messages. This reporting is achieved by sending Diameter *Accounting Requests* (ACR) [Start, Interim, Stop and Event] from the IMS network elements to the CDF.

The Diameter client uses ACR Start, Interim and Stop in procedures related to successful SIP sessions. It uses ACR Events for unsuccessful SIP sessions and for session unrelated procedures. Further details are specified in the tables below and in clause 5.2.2.

It is operator configurable in the nodes for which SIP method or ISUP messages an *Accounting Request* is sent, with the exception that if accounting information is collected for sessions the ACR [Start] and ACR [Stop] messages are mandatory according to the tables below. The table below describes all possible ACRs that might be sent from a P-CSCF, I-CSCF, S-CSCF, MGCF or BGCF. A list of node specific ACRs, along with the AVPs to be included are detailed in TS 32.299 [50].

The ACRs to be sent from a MRFC are described in table 5.2.1.2.

In the tables below, the terms "configurable" implies that operators may enable or disable the generation of an ACR message by the IMS node in response to a particular "Triggering SIP Method /ISUP Message". However, for those table entries marked with *, the operator can enable or disable the ACR message based on whether or not the SIP (Re) Invite message that is replied to by the "Triggering SIP Method /ISUP Message" carried piggybacked user data.

Table 5.2.1.1: Accounting Request Messages Triggered by SIP Methods or ISUP Messages for all IMS nodes except for MRFC and AS

Diameter Message	Triggering SIP Method /ISUP Message	Mandatory/Configurable
ACR [Start]	SIP 200 OK acknowledging an initial SIP INVITE	Mandatory
	ISUP:ANM (applicable for the MGCF)	Mandatory
ACR [Interim]	SIP 200 OK acknowledging a SIP RE-INVITE or SIP UPDATE [e.g. change in media components]	Configurable
	Expiration of AVP [Acct-Interim-Interval]	Configurable
ACR [Stop]	SIP BYE message (both normal and abnormal session termination cases)	Mandatory
	ISUP:REL (applicable for the MGCF)	Mandatory
ACR [Event]	SIP 200 OK acknowledging non-session related SIP messages, which are:	
	SIP NOTIFY	Configurable
	SIP MESSAGE	Configurable
	SIP REGISTER	Configurable
	SIP SUBSCRIBE	Configurable
	SIP REFER	Configurable
	SIP PUBLISH	Configurable
	SIP Final Response 2xx (except SIP 200 OK)	Configurable
	SIP Final/Redirection Response 3xx	Configurable *
	SIP Final Response (4xx, 5xx or 6xx), indicating an unsuccessful SIP session set-up	Configurable *
SIP Final Response (4xx, 5xx or 6xx), indicating an unsuccessful session-unrelated procedure	Configurable *	
SIP CANCEL, indicating abortion of a SIP session set-up	Configurable *	
I-CSCF completing a Cx Query that was issued in response to a SIP INVITE	Configurable	
NOTE:	SIP SUBSCRIBE with the field "Expires" set to 0 means unsubscribe. SIP REGISTER with its "Expires" header field or "Expires" parameter equal to 0 means Deregistration (see 3GPP TS 24.229 [204]).	

Table 5.2.1.2: Accounting Request Messages Triggered by SIP Methods for the MRFC

Diameter Message	Trigger	Mandatory/Configurable
ACR [Start]	SIP 200 OK acknowledging an SIP INVITE for initiating a multimedia ad hoc conferencing session	Mandatory
ACR [Interim]	SIP ACK acknowledging a SIP INVITE to connect an UE to the conferencing session	Configurable
	Expiration of AVP [Acct-Interim-Interval]	Configurable
ACR [Stop]	SIP BYE message	Mandatory
	SIP Final Response with error codes 4xx, 5xx or 6xx indicating termination of an ongoing session	Mandatory

ASs support all four ACR types (Start/Interim/Stop/Event). The use of ACR Start, Interim and Stop (Session Charging) versus ACR Event (Event Charging) depends on the services provided by the application server. Example flows for an AS employing Event Charging and an AS using Session Charging are shown in clause 5.2.2.1.

The ability of SIP methods not listed in table 5.2.1.1 and table 5.2.1.2 to trigger ACRs is for further study.

5.2.2 Diameter Message Flows and Types

The flows described in the present document specify the charging communications between IMS entities and the charging functions for different charging scenarios. The SIP messages associated with these charging scenarios are shown primarily for general information and to illustrate the charging triggers. They are not intended to be exhaustive of all the SIP message flows discussed in TS 24.228 [200].

5.2.2.1 Message Flows - Successful Cases and Scenarios

5.2.2.1.1 Session Establishment - Mobile Origination

The following figure shows the Diameter transactions that are required between CSCF and CDF during session establishment originated by a UE.

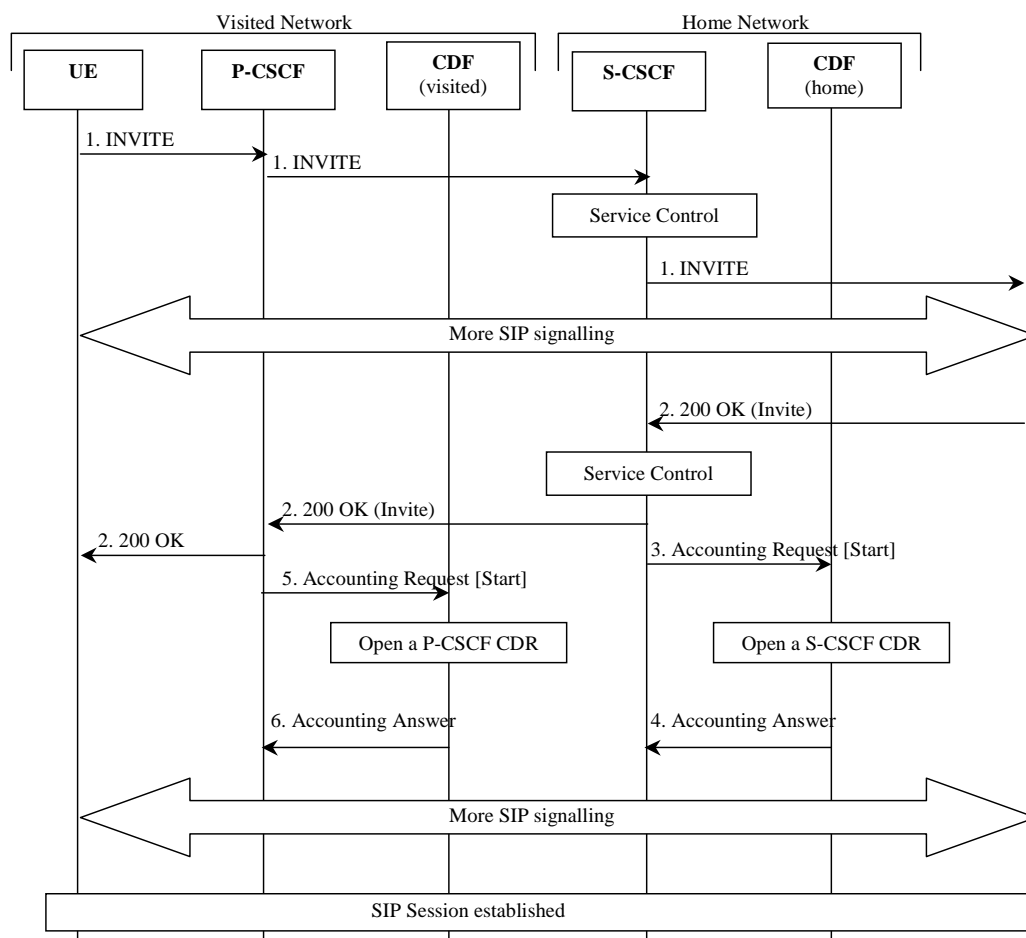

Figure : Message Sequence Chart for Session Establishment (Mobile Origination)

1. The session is initiated.
2. The destination party answers and a final response is received.
3. Upon reception of the final response, the S-CSCF sends an *Accounting-Request* with *Accounting-Record-Type* indicating *START_RECORD* to record start of a user session and start of a media component in the S-CSCF CDR.
4. The CDF acknowledges the reception of the data and opens a S-CSCF CDR.
5. Same as 3, but for P-CSCF.
6. Same as 4, but creating a P-CSCF CDR.

5.2.2.1.2 Session Establishment - Mobile Termination

The following figure shows the Diameter transactions that are required between CSCF and CDF during a session establishment that is terminated to a mobile. The I-CSCF is only involved in the INVITE transaction.

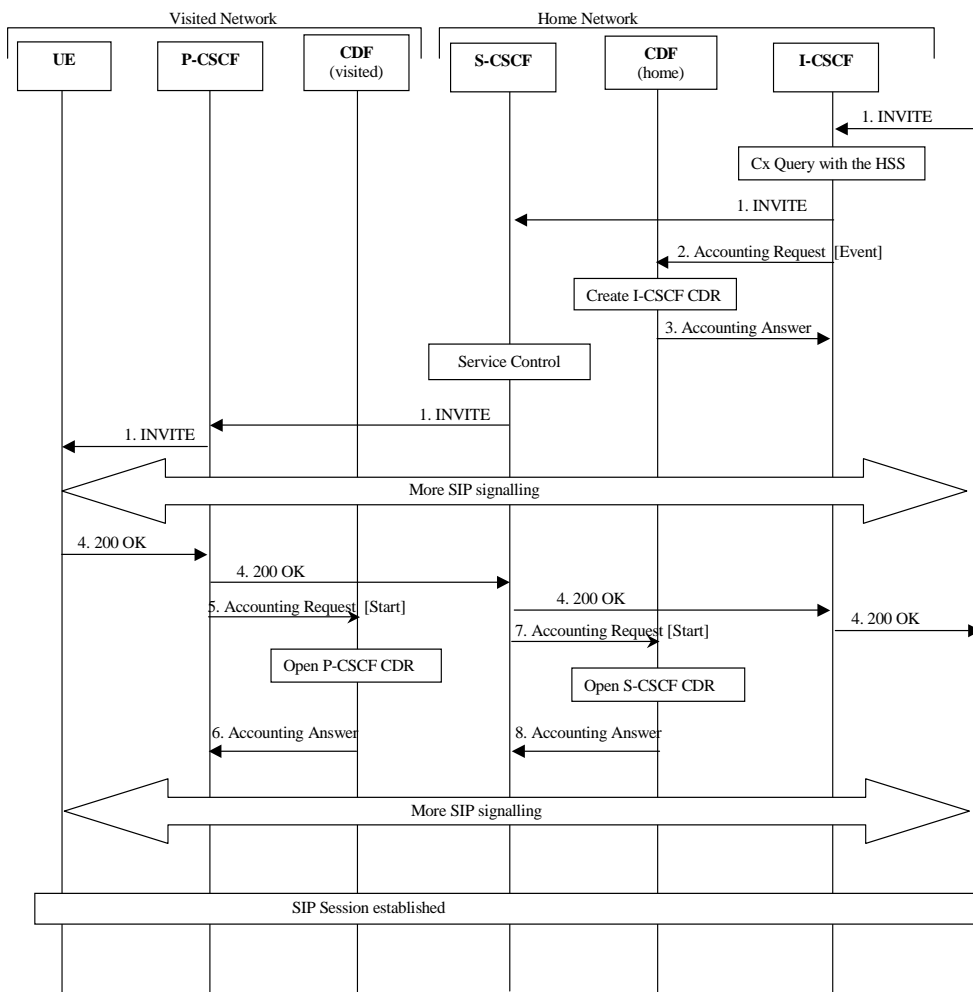

Figure : Message Sequence Chart for Session Establishment (Mobile Termination)

1. The session is initiated.
2. Upon completing a Cx query the I-CSCF sends an *Accounting Request* with the *Accounting-Record-Type* set to EVENT.
3. The CDF acknowledges the data received and creates an I-CSCF CDR.
4. The destination party answers and a final response is sent.
5. - 8. These steps are identical to the corresponding steps described in clause 5.2.2.1.1.

5.2.2.1.3 Mid-Session Procedures

The following figure shows the Diameter transactions that are required between CSCF and CDF when a UE generates a SIP (Re-)INVITE or SIP UPDATE in mid-session, e.g. in order to modify media component(s), or when the hold and resume procedure is executed.

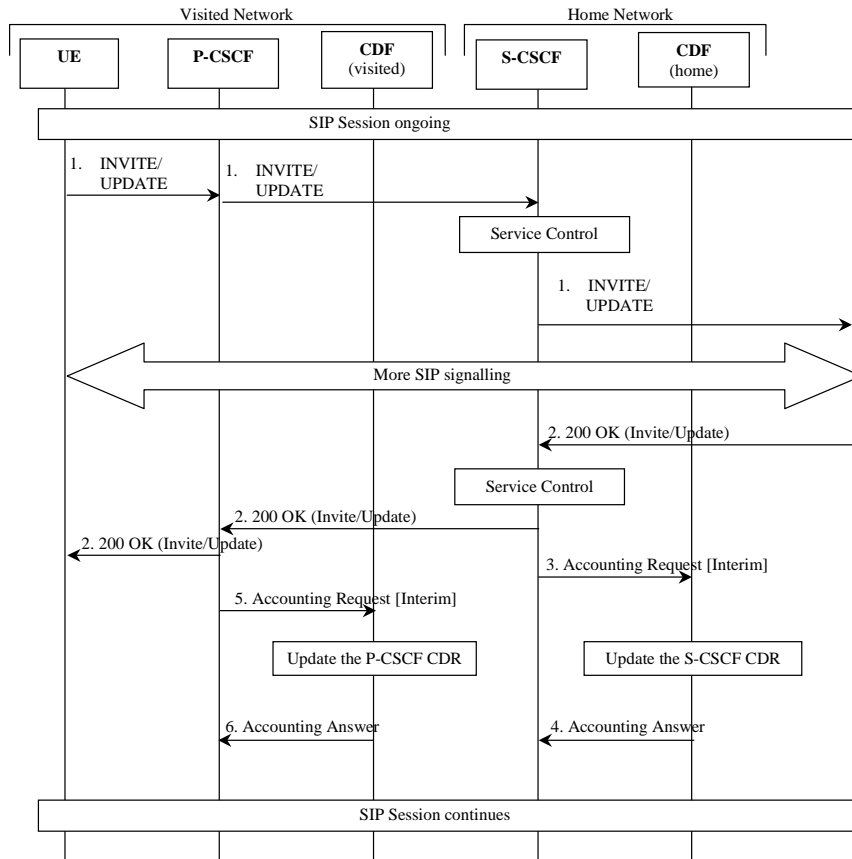

Figure : Message Sequence Chart for Media Modification

1. Modified media information is received from the subscriber.
2. The destination party acknowledges the media modification.
3. At modification of a media, the S-CSCF sends *Accounting-Request* with *Accounting-Record-Type* indicating INTERIM_RECORD to record modification of a media component in the S-CSCF CDR.
4. The CDF acknowledges the reception of the data and updates the S-CSCF CDR.
5. Same as 3, but for P-CSCF.
6. Same as 4, updating the P-CSCF CDR.

5.2.2.1.4 Session Release - Mobile Initiated

The following figure shows the Diameter transactions that are required between CSCF and CDF for a session release that is initiated by the UE.

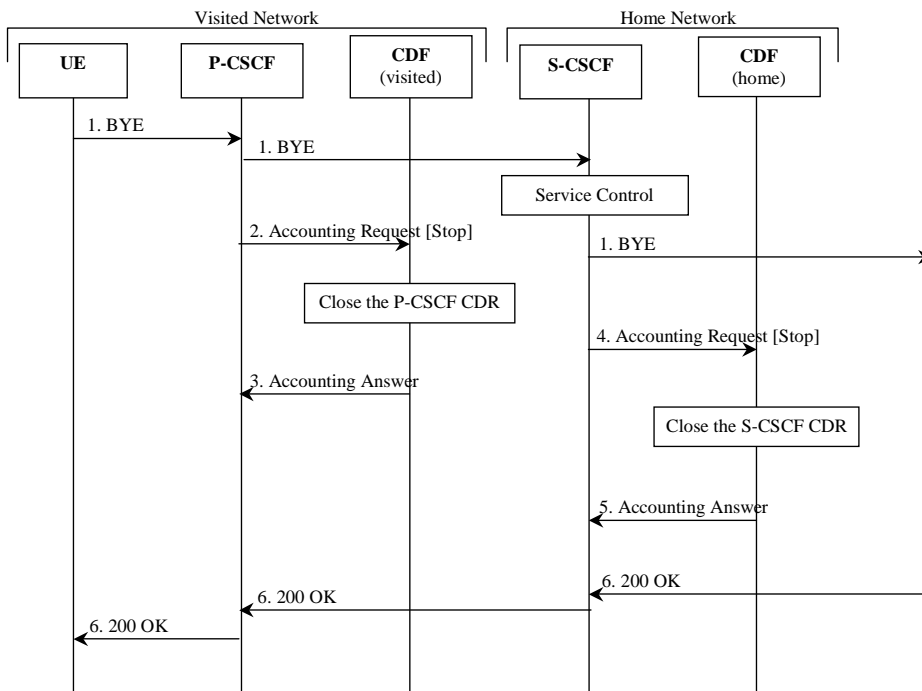

Figure : Message Sequence Chart for Session Release

1. The session is released.
2. At session termination the P-CSCF sends *Accounting-Request* with *Accounting-Record-Type* indicating STOP_RECORD to record stop of a session and stop of a media component in the P-CSCF CDR.
3. The CDF acknowledges the reception of the data and closes the P-CSCF CDR.
4. Same as 2, but for S-CSCF.
5. Same as 3, closing the S-CSCF CDR.
6. The release is acknowledged.

5.2.2.1.5 Session-Unrelated Procedures

The following figure shows the Diameter transactions that are required between CSCF and CDF for session-unrelated IMS procedures, i.e. those that relate to the Diameter ACR [Event], as listed in Table 5.2.1.1.

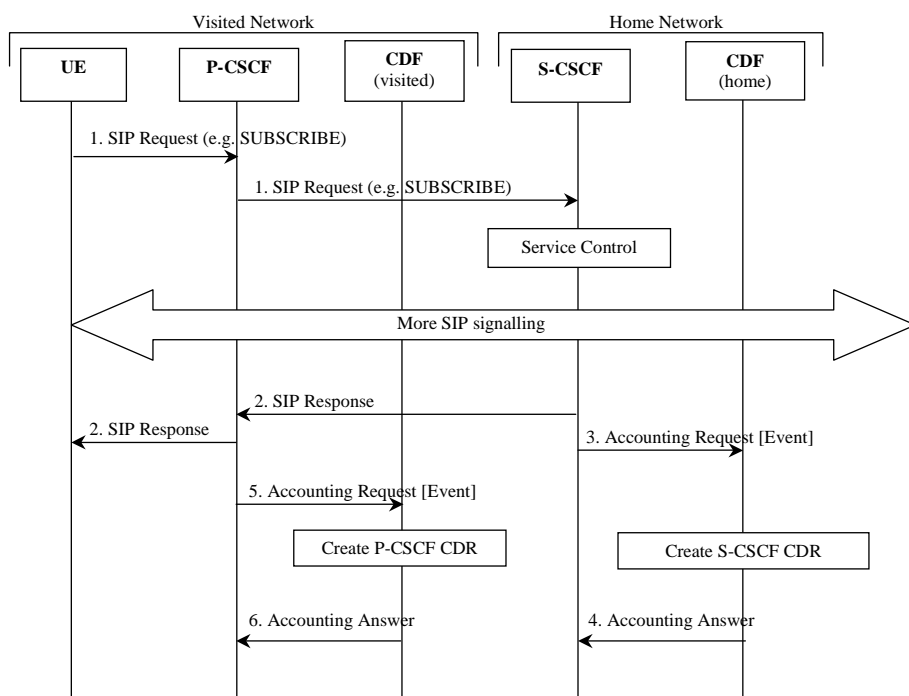

Figure : Message Sequence Chart for Session-Unrelated Procedure

1. The P-CSCF receives a "SIP Request" (e.g. SUBSCRIBE) from the subscriber.
2. The "SIP Request" is acknowledged by the "SIP Response" as follows:
 - in the successful case, a 200 OK message is returned;
 - in case of failure an appropriate SIP error message is returned.

Depending on the used SIP method, there might be additional signalling between steps 1 and 2.

3. After the completion of the procedure, the S-CSCF sends *Accounting-Request* with *Accounting-Record-Type* indicating *EVENT_RECORD* to record transaction specific information in the S-CSCF CDR.
4. The CDF acknowledges the reception of the data and produces an S-CSCF CDR.
5. Same as 3, but for P-CSCF.
6. Same as 4, creating a P-CSCF CDR.

5.2.2.1.6 Session Establishment - PSTN Initiated

The following figure shows the Diameter transactions that are required between MGCF and CDF during session establishment initiated from the PSTN side.

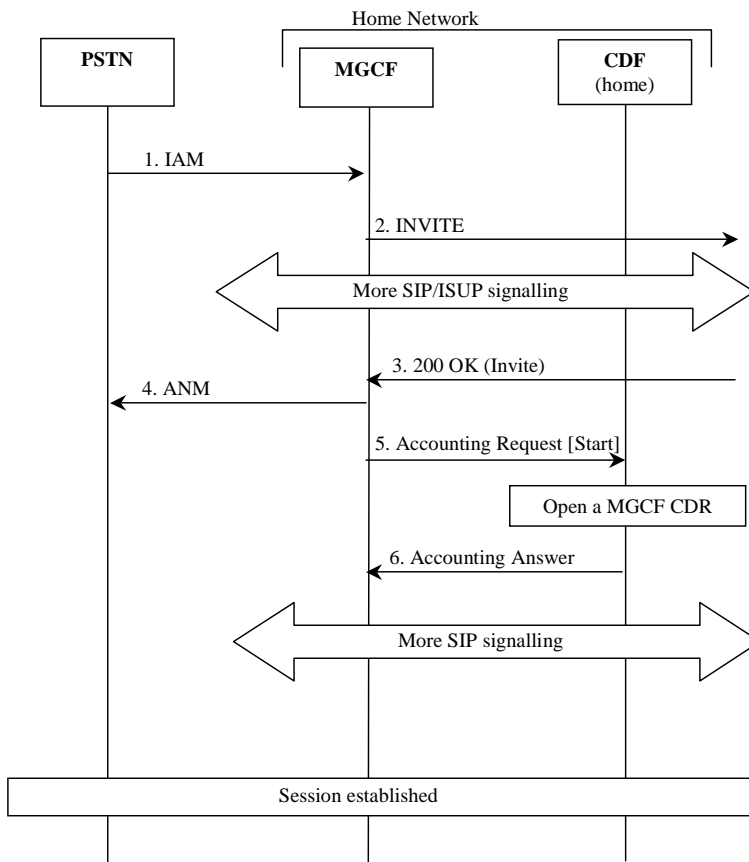

Figure : Message Sequence Chart for Session Establishment (PSTN Initiated)

1. The session is originated from the PSTN.
2. The session setup is triggered in the IMS.
3. The destination party answers and a final response is received.
4. MGCF forwards an answer message to the PSTN.
5. Upon reception of the final response, the MGCF sends an *Accounting-Request* with *Accounting-Record-Type* indicating *START_RECORD* to record start of a user session and start of a media component in the MGCF CDR.
6. The CDF acknowledges the reception of the data and opens a MGCF CDR.

5.2.2.1.7 Session Establishment - IMS Initiated

The following figure shows the Diameter transactions that are required between BGCF, MGCF and CDF during session establishment initiated from the IMS side.

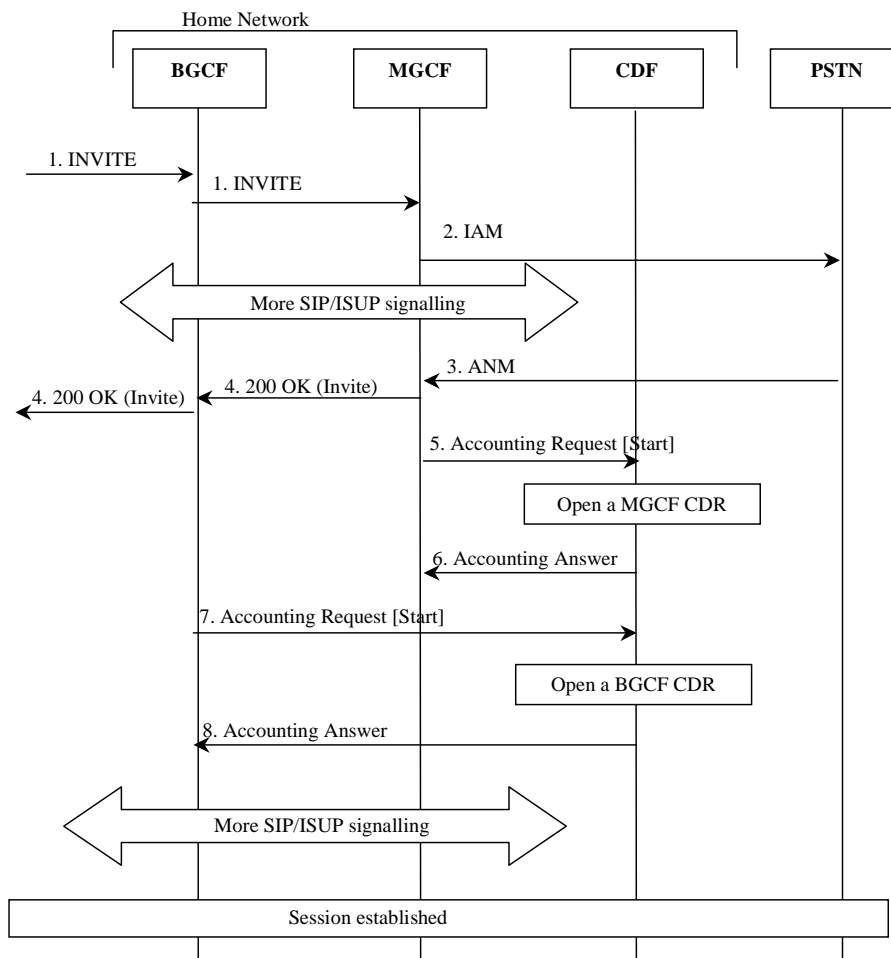

Figure : Message Sequence Chart for Session Establishment (IMS Initiated)

1. The session is originated from the IMS.
2. A session towards PSTN is established.
3. The destination party answers and an answer message is received.
4. A final response message is sent to the session originator.
5. Upon reception of the answer message, the MGCF sends an *Accounting-Request* with *Accounting-Record-Type* indicating START_RECORD to record start of a user session and start of a media component in the MGCF CDR.
6. The CDF acknowledges the reception of the data and opens a MGCF CDR.
7. Upon reception of the 200 OK message, the BGCF sends an *Accounting-Request* with *Accounting-Record-Type* indicating START_RECORD to record start of a user session and start of a media component in the BGCF CDR.
8. The CDF acknowledges the reception of the data and opens a BGCF CDR.

5.2.2.1.8 Session Release - PSTN Initiated

The following figure shows the Diameter transactions that are required between BGCF, MGCF and CDF during a PSTN initiated session release. The BGCF is only involved if the session had been initiated from the IMS side.

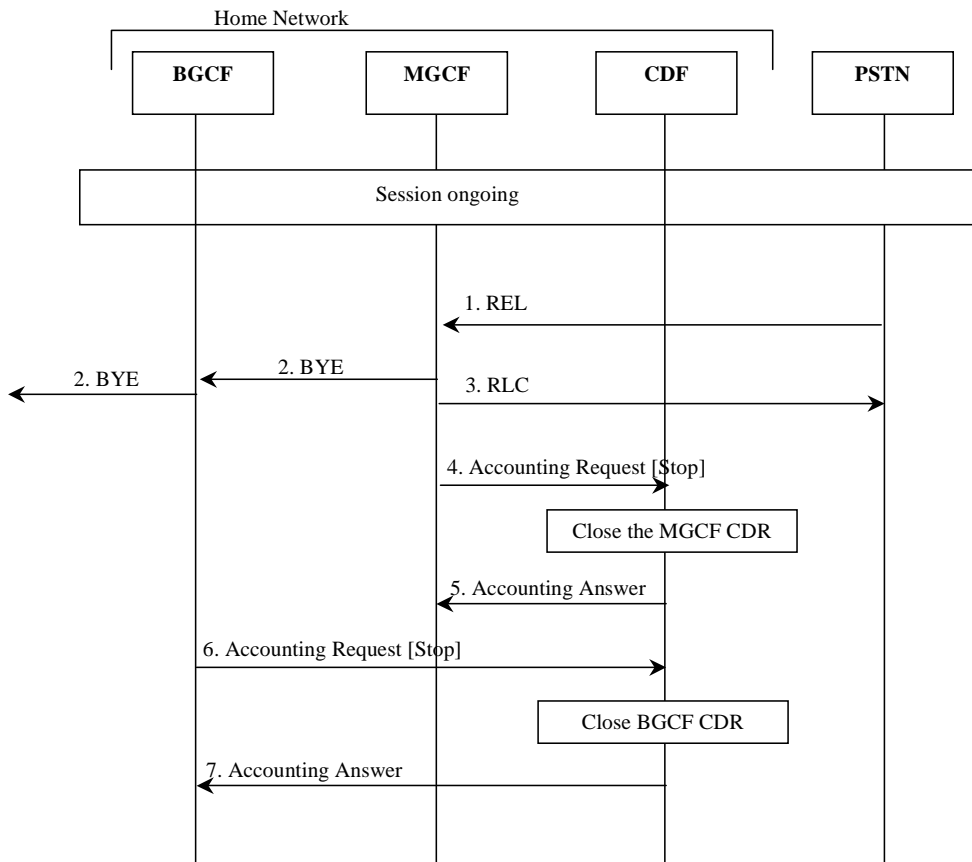

Figure : Message Sequence Chart for Session Release (PSTN initiated)

1. The session release is initiated from PSTN.
2. Session release continues within IMS.
3. The reception of the release message is acknowledged.
4. Upon reception of the release message, the MGCF sends an *Accounting-Request* with *Accounting-Record-Type* indicating STOP_RECORD to record stop of a session in the MGCF CDR.
5. The CDF acknowledges the reception of the data and closes the MGCF CDR.
6. Same as 4, but for BGCF.
7. Same as 5, but for BGCF.

5.2.2.1.9 Session Release - IMS Initiated

The following figure shows the Diameter transactions that are required between BGCF, MGCF and CDF during a IMS initiated session release.

The BGCF is only involved if the session had been initiated from the IMS side.

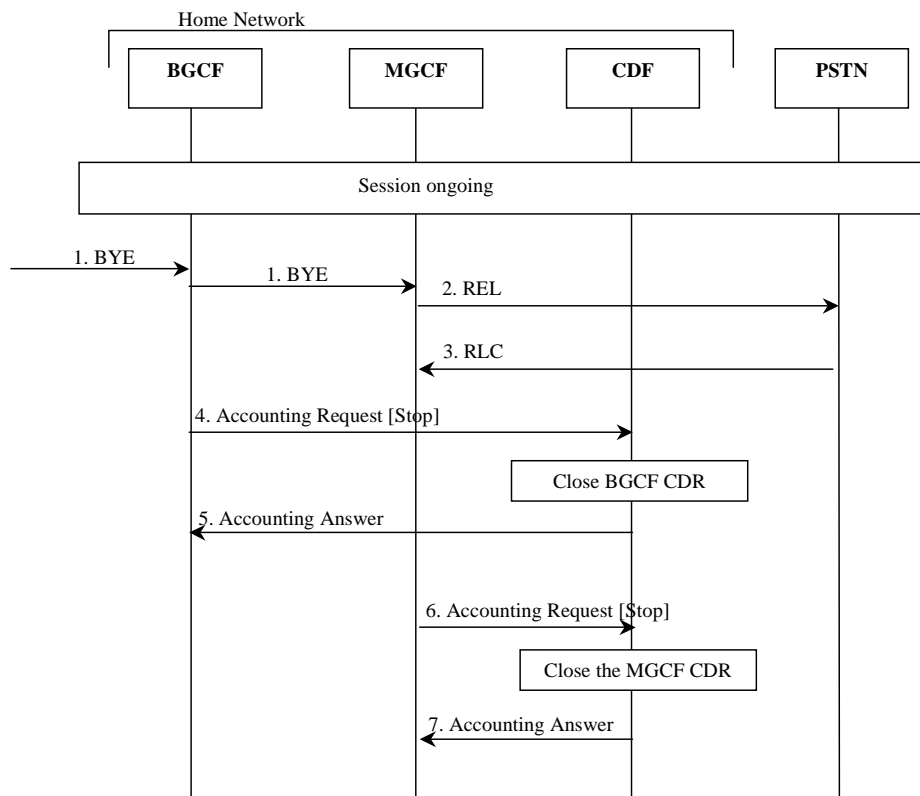

Figure : Message Sequence Chart for Session Release (IMS initiated)

1. The session release is initiated from the IMS side.
2. A release message is sent towards PSTN.
3. The acknowledgement of the release message is received from PSTN.
4. Upon reception of the BYE message, the BGCF sends an *Accounting-Request* with *Accounting-Record-Type* indicating STOP_RECORD to record stop of a session in the BGCF CDR.
5. The CDF acknowledges the reception of the data and closes the BGCF CDR.
6. Same as 4, but for MGCF.
7. Same as 5, but for MGCF.

5.2.2.1.10 Multi-Party Call

The following figure shows the establishment of an ad hoc conference (multiparty call). An AS (acting as B2BUA) performs third party call control with the MRFC, where the S-CSCF is in the signalling path. The Application Server that is in control of the ad hoc conference is aware of the MRFC capabilities.

NOTE: Only accounting information sent from the MRFC is shown in detail in the figure. The SIP messages are for illustrative purpose only.

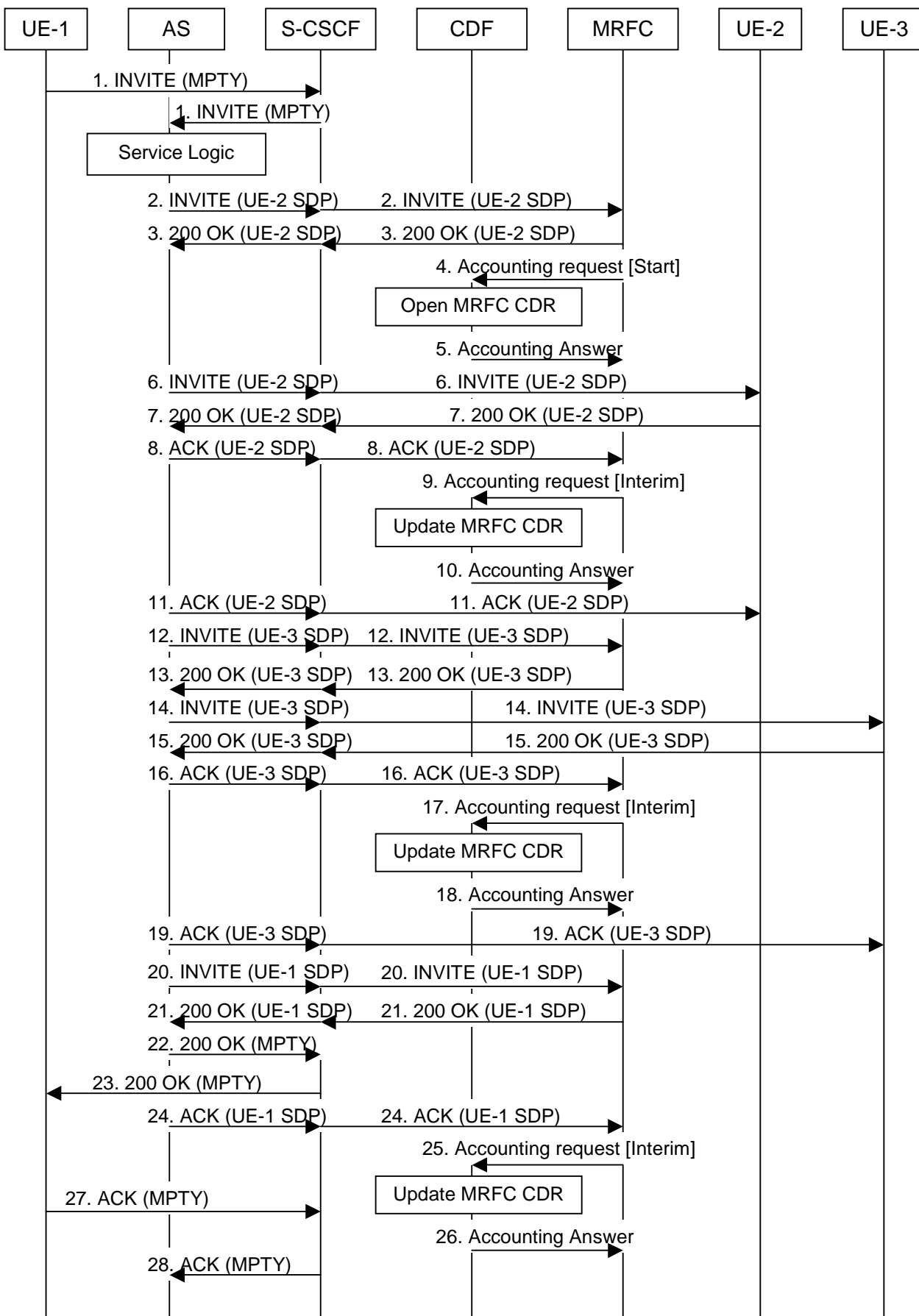

Figure : Message Sequence Chart for Multi-Party Call Establishment in MRFC

1. Sessions exist between UE-1 and UE-2, and between UE-1 and UE-3. A request is received from UE-1 for putting all parties together to a multi-party call.
2. - 3. Request and acknowledgement to initiate multi-party call. MRFC assigns a conference-ID that is used by the AS in subsequent interactions with the MRFC in INVITE messages connecting other endpoints (see TS 23.228 [201]). Path establishment between AS and MRFC for UE-2.
4. At start of session establishment the MRFC sends an *Accounting-Request* with *Accounting-Record-Type* indicating START_RECORD to record start of multi-party call in the MRFC CDR.
5. The CDF acknowledges the reception of the data and creates the MRFC CDR. 'Calling Party Address', 'Service Request Time Stamp', 'Service ID' (holding the conference-ID) etc. are included in the MRFC CDR.
- 6 - 7. Path establishment between UE-2 and AS. Same ICID is used as for the path between AS and MRFC for UE-2 (step 2. - 3.).
8. Acknowledgement of path between AS and MRFC for UE-2.
9. The MRFC may send an *Accounting-Request* with *Accounting-Record-Type* indicating INTERIM_RECORD to report that UE-2 has been connected to the multi-party call.
10. The CDF acknowledges the reception of the data and includes UE-2 in the field 'Application Provided Called Parties' of the MRFC CDR.
11. Acknowledgement of path between AS and UE-2. Now a path between UE-2 and MRFP via AS is established.
- 12 -13.. Request and acknowledgement to establish path between AS and MRFC for UE-3.
14. -15. Path establishment between UE-3 and AS. Same ICID is used as for the path between AS and MRFC for UE-3 (step 12. - 13.).
16. Acknowledgement of path between AS and MRFC for UE-3.
17. The MRFC may send an *Accounting-Request* with *Accounting-Record-Type* indicating INTERIM_RECORD to report that UE-3 has been connected to the multi-party call.
18. The CDF acknowledges the reception of the data and includes UE-3 in a new field 'Application Provided Called Parties' of the MRFC CDR.
19. Acknowledgement of path between AS and UE-3.
- 20 - 21. Request and acknowledgement to establish path between AS and MRFC for UE-1. Same ICID is used as for the path between UE-1 and AS (step 1.).
- 22 - 23. Request for multi-party conference with UE-2 and UE-3 is acknowledged to UE 1. Implicit acknowledgement of path UE-1 to AS.
24. Acknowledgement of path between AS and MRFC for UE-1.
25. The MRFC may send an *Accounting-Request* with *Accounting-Record-Type* indicating INTERIM_RECORD to report that UE-1 has been connected to the multi-party call.
26. The CDF acknowledges the reception of the data and includes the field 'Service Delivery Start Time Stamp' into the MRFC CDR.
- 27 -28. UE-1 acknowledges the multi-party call session establishment.

NOTE: It is in the responsibility of the AS to terminate the sessions existing at the beginning of the multi-party call establishment between UE-1 and UE-2 and between UE-1 and UE-3 (see step 1.) in case of successful multi-party call establishment. This is not shown in the diagram above.

5.2.2.1.11 AS Related Procedures - AS Acting as a Redirect Server

Application servers may support a multitude of services which are not specified in 3GPP standards. Therefore it is not possible to standardise charging flows and procedures for those services. However, for all such services, the AS may apply either Event Charging, where ACR [Event] messages are generated, or Session Charging, using ACR [Start, Stop and Interim]. The following clauses depict one example for each of the two scenarios. The first procedure, AS acting as a Redirect Server, depicts the "event" case, while the second procedure, AS acting as a Voice Mail Server, depicts the "session" case.

The following figure shows the case where an Application Server acts as a Redirect Server. In the figure below, UE-1 sets up a session towards UE-2 but due to Call Forwarding functionality located in the AS, a new number (to UE-3) is returned to UE-1. Finally UE-1 sets up the session towards UE-3.

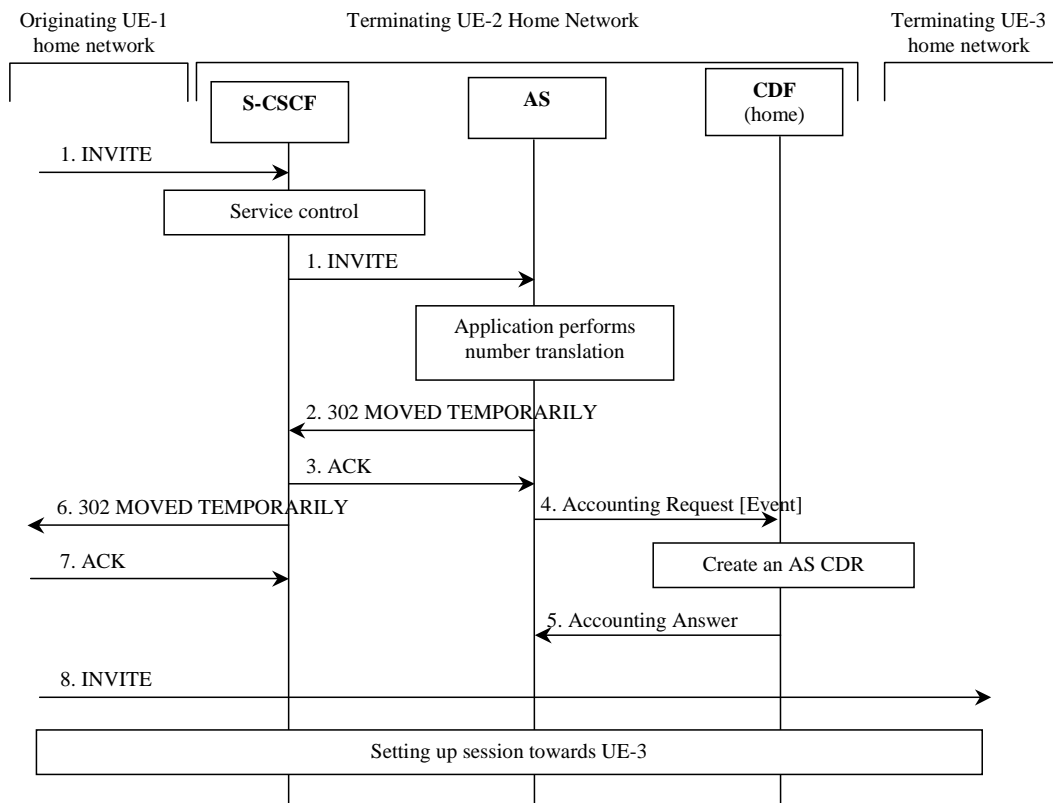

Figure : Message Sequence Chart for AS Acting as a Redirect Server

- 1. Sessions initiated by UE-1 towards UE-2.
- 2. - 3. Response indicating that session should be redirected towards another number (UE-3).
- 4. After successful service execution, the AS sends *Accounting-Request* with *Accounting-Record-Type* indicating *EVENT_RECORD* to record service specific information in the AS CDR.
- 5. The CDF acknowledges the reception of the data and creates the AS CDR.
- 6-7. Response indicating that session should be redirected towards another number (UE-3).
- 8. Session is initiated by UE-1 towards UE-3.

5.2.2.1.12 AS Related Procedures - AS Acting as a Voice Mail Server

The following figure shows the case where an Application Server acts as a Voice Mail Server. S-CSCF invokes the AS acting as Voice Mail Server according to procedure as defined in TS 23.218 [203].

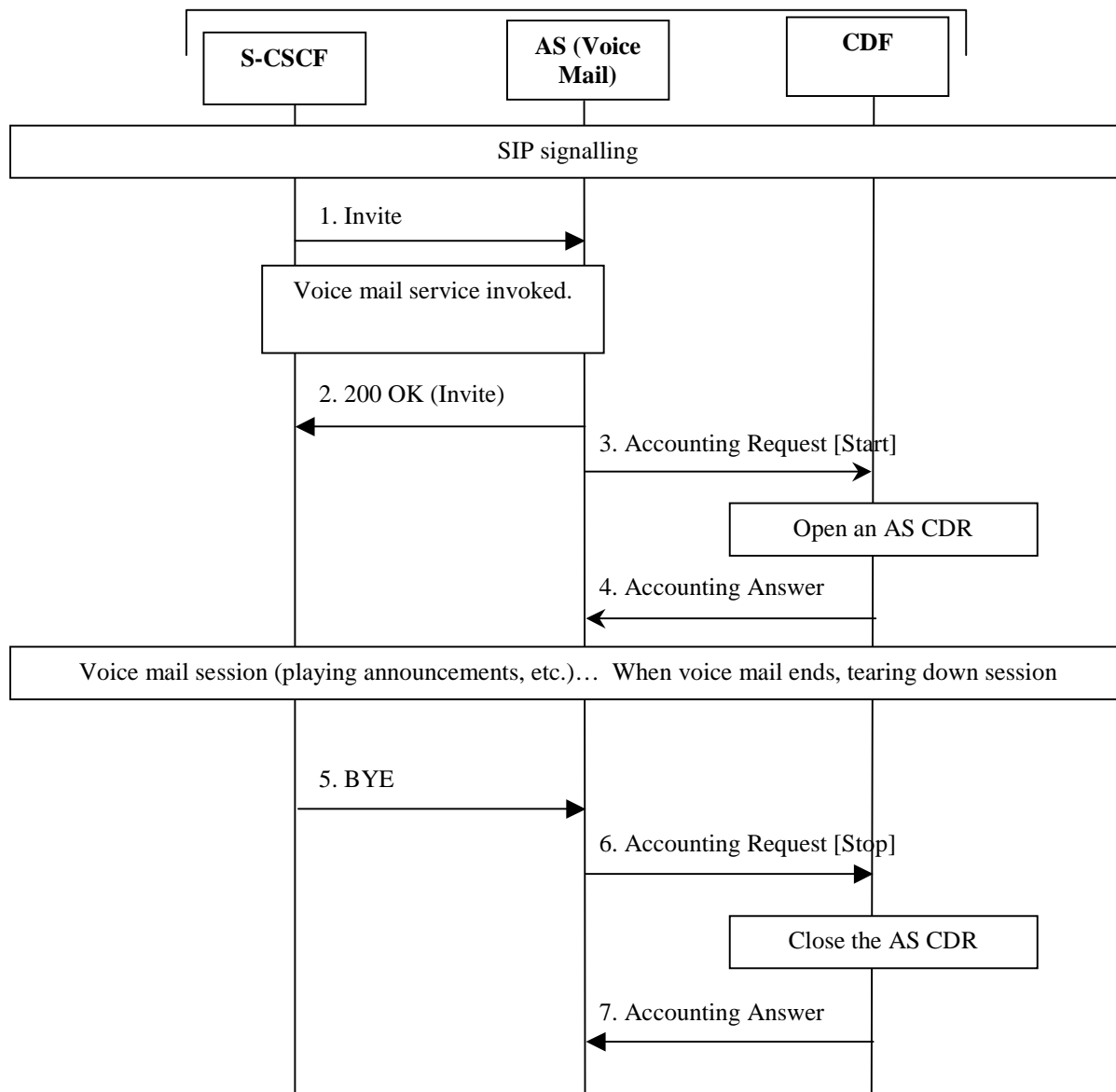

Figure : Message Sequence Chart for AS Acting as a Mail Server

1. AS receives the INVITE from the S-CSCF.
2. AS acknowledges the initiated Voice Mail session by issuing a 200 OK in response to the INVITE.
3. AS sends *Accounting-Request* with *Accounting-Record-Type* indicating START_RECORD to record start of a voice mail session.
4. The CDF acknowledges the reception of the *Accounting-Request* with *Accounting-Record-Type* indicating START_RECORD and opens a AS CDR.
5. Voice mail session release is initiated.
6. Upon reception of release message AS sends an *Accounting-Request* with *Accounting-Record-Type* indicating STOP_RECORD to record stop of a session in the AS CDR.
7. The CDF acknowledges the reception of the data and closes the AS CDR.

5.2.2.2 Message Flows - Error Cases and Scenarios

This clause describes various error cases and how these should be handled. The error cases are grouped into the following categories:

- Failure in SIP Related Procedures:
 - Session Related Error Scenarios;
 - Session Unrelated Error Scenarios.
- Errors in Diameter (Accounting) Related Procedures.

5.2.2.2.1 Session Related SIP Procedures- Reception of SIP error messages

A SIP session is closed abnormally by the reception of a BYE message indicating the reason for such termination.

In this case, an ACR [Stop] message that includes an appropriate error indication is sent.

5.2.2.2.2 Session Related SIP Procedures - SIP session failure

All nodes involved in the SIP session are expected to exercise some kind of session supervision. In case a node detects an error in the SIP session, such as a timeout or the occurrence of an invalid SIP message that results in the inability to maintain the session, this IMS node will generate a BYE message towards both ends of the connection.

The node that sent the BYE to trigger session termination identifies the cause of the failure in the ACR [Stop] towards the CDF. All other nodes, i.e. those that receive the BYE, are not aware of an error, and therefore they treat this situation as any normal SIP session termination.

5.2.2.2.3 Session Unrelated SIP procedures

As described in clause 5.1.2.1.2, a session unrelated SIP procedure may either be completed with the reception of a 200OK, or a SIP error message. If the latter occurs, i.e. there is a failure in the procedure, the ACR [Event] sent towards the CDF includes an appropriate error indication.

5.2.2.2.4 CDF Connection Failure

When the connection towards the primary CDF is broken, the process of sending accounting information should continue towards a secondary CDF (if such a CDF is configured). For further CDF connection failure functionality, see clause "*Transport Failure Detection*" in IETF RFC 3588 [401].

If no CDF is reachable the network element may buffer the generated accounting data in non-volatile memory. Once the CDF connection is working again, all accounting messages stored in the buffer is sent to the CDF, in the order they were stored in the buffer.

5.2.2.2.5 No Reply from CDF

In case an IMS node does not receive an ACA in reply to an ACR, it may repeat the ACR message. The waiting time until a repetition is sent, and the maximum number of repetitions are both configurable by the operator. When the maximum number of repetitions is reached and still no ACA reply has been received, the IMS node executes the CDF connection failure procedure as specified above.

If retransmitted ACRs are sent, they are marked with the T-flag as described in IETF RFC 3588 [401] , in order to allow duplicate detection in the CDF, as specified in the next clause.

5.2.2.2.6 Duplicate Detection

A Diameter client marks possible duplicate request messages (e.g. retransmission due to the link failover process) with the T-flag as described in IETF RFC 3588 [401].

If the CDF receives a message that is marked as retransmitted and this message was already received, then it discards the duplicate message. However, if the original of the re-transmitted message was not yet received, it is the information

in the marked message that is taken into account when generating the CDR. The CDRs are marked if information from duplicated message(s) is used.

5.2.2.2.7 CDF Detected Failure

The CDF closes a CDR when it detects that expected Diameter ACRs for a particular SIP session have not been received for a period of time. The exact behaviour of the CDF is operator configurable.

5.2.3 CDR generation

Editor's Note: ffs

5.2.4 GTP" record transfer flows

GTP" is not used between CDF and CGF in IP Multimedia subsystem, because CDF and CGF are combined into CCF (see clause 4).

Text should be copied from the middle tear template section.

5.2.5 Bi CDR file transfer

Editor's Note: ffs

5.3 IMS Online Charging Scenarios

5.3.1 Basic Principles

IMS online charging uses the Credit Control application that is specified in 3GPP Rel-6 TS 32.299 [50].

Three cases for online charging are distinguished:

- Immediate Event Charging (IEC); and
- Event Charging with Unit Reservation (ECUR), and
- Session Charging with Unit Reservation (SCUR)

Both stage 2 and stage 3 mechanisms for the three cases for online charging are detailed in TS 32.299 [50].

In the case of Immediate Event Charging (IEC), granting units to the IMS network element is performed in a single operation that also includes the deduction of the corresponding monetary units from the subscriber's account. The charging process is controlled by the corresponding credit control request which is sent for a given credit control event.

In contrast, Event Charging with Unit Reservation (ECUR) also includes the process of requesting, reserving, releasing and returning unused units for events. The deduction of the corresponding monetary units then occurs upon conclusion of the ECUR transaction. In this case, the credit control request is used to control the credit control session.

Session Charging with Unit Reservation (SCUR) is used for credit control of sessions. SCUR also includes the process of requesting, reserving, releasing and returning unused units for sessions, and the deduction of the corresponding monetary units. During a SIP session there can be repeated execution of unit reservation and debit operations as specified in TS 32.299 [50].

The IMS network element may apply IEC, where CCR Event messages are generated, or ECUR, using CCR Initial, and Termination or SCUR. The decision whether to apply IEC, ECUR or SCUR is based on the service and/or operator's policy.

NOTE: To the extent possible alignment with the IETF RFC 4006 [402] is planned.

5.3.2 Diameter Message Flows and Types

This clause describes the message flows for the event charging procedures on the Ro interface.

5.3.2.1 Immediate Event Charging (IEC)

This clause provides the details of the "Debit Units" operation specified in TS 32.299 [50].

5.3.2.1.1 Message Flows - Successful Cases and Scenarios

5.3.2.1.1.1 IEC – Debit Units Operation

The transactions that are required on the Ro interface in order to perform IEC with Debit Units operations are carried out as described in TS 32.299 [50] where 'CTF' refers to IMS network element. The Debit Units operation may alternatively be carried out prior to, concurrently with or after service/content delivery. The IMS network element must ensure that the requested service execution is successful, when this scenario is used.

Editor's Note: Must be aligned with TS 32.299 [50].

5.3.2.1.2 Message Flows - Error Cases and Scenarios

This clause describes various error cases and how these should be handled.

The failure handling behaviour is locally configurable in the IMS network element. If the *Direct-Debiting-Failure-Handling* AVP is not used, the locally configured values are used instead.

5.3.2.1.2.1 Reception of SIP Error Messages

If SIP errors in SIP response (4xx, 5xx or 6xx) occur during service delivery, as defined in TS 24.228 [202] and TS 23.218 [203], it is up to the IMS network element to determine to what extent the service was delivered before the error occurred and act appropriately with respect to charging. This may imply that no units at all (or no more units) are debited.

5.3.2.1.2.2 Debit Units Operation Failure

This case comprises situations where either no, or an erroneous response, is received from the ECF. The 'no response' case is detected by the IMS network element when the connection supervision timer Tx expires (IETF RFC 4006 [402]) before a response *Credit-Control-Answer* (CCA) is received. The case of receiving an erroneous response implies that the IMS network element receives a *Credit-Control-Answer* (CCA), which it is unable to process, while Tx is running. The failure handling complies with the failure procedures for "Direct Debiting" scenario described in IETF RFC 4006 [402].

5.3.2.1.2.3 Duplicate Detection

The detection of duplicate request is needed and must be enabled. To speed up and simplify as much as possible the duplicate detection, the all-against-all record checking should be avoided and just those records marked as potential duplicates need to be checked against other received requests (within a reasonable time window) by the receiver entity.

The IMS network element marks the request messages that are retransmitted after a link failover as possible duplicates with the T-flag as described in [201]. For optimized performance, uniqueness checking against other received requests is only necessary for those records marked with the T-flag received within a reasonable time window. This focused check is based on the inspection of the *Session-Id* and *CC-Request-Number* AVP pairs.

5.3.2.2 Event Charging with Unit Reservation (ECUR) and Session Charging with Unit Reservation (SCUR)

This clause provides the details of the "Reserve Units" and "Debit Units" operation specified in TS 32.299 [50].

5.3.2.2.1 Message Flows - Successful Cases and Scenarios

5.3.2.2.1.1 ECUR and SCUR - Reserve Units and Debit Units Operations

The transactions that are required on the Ro interface in order to perform ECUR/SCUR with Reserve Units and Debit Units operations is carried out as described in TS 32.299 [50] where 'CTF' refers to an IMS network element. Multiple replications of both of these operations are possible.

5.3.2.2.1.2 Expiration of Reservation Validity

This clause defines how reserved units are returned, if not used, within a reasonable time. It should be possible that both the reservation and SIP sessions are cancelled or only the reservation is cancelled without removing the SIP session.

5.3.2.2.2 Message Flows - Error Cases and Scenarios

This clause describes various error cases and how these should be handled.

The failure handling behaviour is locally configurable in the IMS network element. If *Credit-Control-Failure-Handling* AVP is not used, the locally configured values are used instead.

5.3.2.2.2.1 Reception of SIP Error Messages

If SIP errors occur during service delivery, as defined in [202] and [203], it is up to the IMS network element to determine to what extent the service was delivered before the error occurred and act appropriately with respect to charging. This may imply that no units at all (or no more units) are reserved or debited.

5.3.2.2.2.2 Reserve Units and Debit Units Operation Failure

This case comprises of OCS connection failure, and/or receiving error responses from the OCS.

The IMS network element detects an OCS connection failure when the timer Tx expires (IETF RFC 4006 [402]) or a transport failure is detected as defined in IETF RFC 3588 [401]. The OCS also has the capability to detect failures when the timer Ts (IETF RFC 3588 [401]) expires. The OCS should indicate the cause of failure by setting the appropriate result code as defined in IETF RFC 3588 [401] and IETF RFC 4006 [402]. In any case, the failure handling of IMS network element and OCS complies with the failure procedures for session based credit control scenario described in IETF RFC 4006 [402].

5.3.2.2.2.3 Duplicate Detection

For credit control duplicate detection is performed only for possible duplicate event requests related to IEC as mentioned in clause 5.3.2.1.2.3, as retransmission of ECUR/SCUR related credit control requests is not allowed.

6 Definition of charging information

Charging Data Record Format Specifications (provide some introductory statement here)

Equipment vendors shall be able to provide all of the parameters listed in the Diameter messages/CDR content table in order to claim compliance with the present document. However, since Diameter messages/CDR processing and transport consume network resources, operators may opt to eliminate some of the parameters that are not essential for their operation. This operator provisionable reduction is specified by the parameter category.

A parameter category can have one of two primary values:

- M** This parameter is **Mandatory** and shall always be present in the Diameter messages/CDR.
- C** This parameter shall be present in the Diameter message/CDR only when certain **Conditions** are met. These **Conditions** are specified as part of the parameter definition.

Some of these parameters are designated as **Operator provisionable (O)**. Using TMN management functions or specific tools provided by an equipment vendor, operators may choose to include or omit the parameter from the charging event/CDR. Once omitted, this parameter is not generated in a CDR of the particular type.. To avoid any potential ambiguity, the CTF/CDF/CGF **MUST** be able to provide all these parameters. Only an operator can choose whether or not these parameters should be generated in its system, i.e. included in the charging Diameter message/CDR.

Those parameters that the operator configures to be present or absent are further qualified with the "Operator provisionable" indicator as follows:

- O_M** This is a parameter that, if provisioned by the operator to be present, shall always be included in the Diameter messages/CDRs. In other words, an **O_M** parameter that is provisioned to be present is a mandatory parameter.
- O_C** This is a parameter that, if provisioned by the operator to be present, shall be included in the Diameter messages/CDRs when the specified conditions are met. In other words, an **O_C** parameter that is configured to be present is a conditional parameter.

6.1 Data description for IMS offline charging

6.1.1 Diameter Message contents

6.1.1.1 Summary of Offline Charging Message Formats

The IMS nodes generate accounting information that can be transferred from the nodes to the CDF. For this purpose, the IMS Charging application employs the *Accounting-Request* and *Accounting-Answer* messages from the base Diameter protocol.

Table 6.1.1.1 describes the use of these messages for offline charging.

Table 6.1.1.1: Offline Charging Messages Reference Table

Command-Name	Source	Destination	Abbreviation
Accounting-Request	S-CSCF, I-CSCF, P-CSCF, MRFC, MGCF, BGCF, AS	CDF	ACR
Accounting-Answer	CDF	S-CSCF, I-CSCF, P-CSCF, MRFC, MGCF, BGCF, AS	ACA

6.1.1.2 Structure for the Accounting Message Formats

IMS offline charging used the diameter accounting application with the two messages *Accounting-Request* and *Accounting-Answer*. The request can be of type start, stop, interim and event. The accounting request message includes all charging information and the answer is just an acknowledgement of the request message. Detailed information about the diameter offline charging application is described in TS 32.299 [50].

This sub clause describes the different AVPs used in the accounting messages.

6.1.1.2.1 Accounting-Request Message

Table 6.1.1.2.1 illustrates the basic structure of a Diameter *Accounting-Request* message as used for IMS offline charging.

Table 6.1.1.2.1: Accounting-Request (ACR) Message Contents for Offline Charging

AVP	Category	Description	Provided by IMS NE
Session-Id	M	Described in 32.299 [50]	All
Origin-Host	M	Described in 32.299 [50]	All
Origin-Realm	M	Described in 32.299 [50]	All
Destination-Realm	M	Described in 32.299 [50]	All
Accounting-Record-Type	M	Described in 32.299 [50]	All
Accounting-Record-Number	M	Described in 32.299 [50]	All
Acct-Application-Id	Oc	Described in 32.299 [50]	All
User-Name	Oc	Described in 32.299 [50]	All
Acct-Interim-Interval	Co	Described in 32.299 [50]	All
Origin-State-Id	Oc	Described in 32.299 [50]	All
Event-Timestamp	Oc	Described in 32.299 [50]	All
Event-Type	Oc	This AVP holds the content of the "Event" header used in SUBSCRIBE and NOTIFY messages.	All
Role-of-node	Oc	This AVP specifies the role of the AS/CSCF	All
User-Session-ID	Oc	This AVP holds the session identifier. For a SIP session the <i>Session-ID</i> contains the SIP Call ID.	All
Calling-Party-Address	Oc	This AVP holds the address (Public User ID: SIP URL, E.164, etc.) of the party initiating a session.	All
Called-Party-Address	Oc	This AVP holds the address (Public User ID: SIP URL, E.164, etc.) of the party to whom a session is established.	All
Time-stamp	Oc	This AVP holds the time of the initial SIP request and the time of the response to the initial SIP Request.	All
Application-Server-Information	Oc	This AVP holds the SIP URL(s) of the AS(s) addressed during the session and the called party number (SIP URL, E.164), if an application server determines it..	Only from S-CSCF/MRFC
Inter-Operator-Identifier	Oc	This AVP holds the identification of the network neighbours (originating and terminating) as exchanged via SIP signalling.	All
IMS-Charging-Identifier	Oc	This AVP holds the IMS Charging Identifier (ICID) as generated by a IMS node for a SIP session and described in clause 5.1.2.2.	All
SDP-Session-Description	Oc	This AVP holds the content of an "attribute-line" (i=, c=, b=, k=, a=, etc.) related to a session.	All
SDP-Media-Components	Oc	This AVP contains information about media used for a IMS session.	All
GGSN-Address	Oc	This AVP holds the IP-address of the GGSN that generated the GPRS Charging ID, as described in [1].	All
Served-Party-IP-Address	Oc	This AVP holds the IP address of either the calling or called party, depending on whether the P-CSCF is in touch with the calling or the called party.	Only from P-CSCF
Authorised-QoS	Oc	This AVP holds the Authorised QoS as defined in TS 23.207 / TS 29.207 and applied via the Go interface.	Only from P-CSCF
Server-Capabilities	Oc	This AVP is described in 3GPP TS 29.229: "Cx and Dx Interfaces based on the Diameter protocol; Protocol Details".	Only from I-CSCF
Trunk-Group-ID	Oc	This AVP identifies the incoming and outgoing PSTN legs.	Only from MRFC
Bearer-Service	Oc	This AVP holds the used bearer service for the PSTN leg.	Only from MRFC
Service-Id	Oc	This AVP identifies the service the MRFC is hosting. For conferences the conference ID is used as the value of this parameter.	Only from MGCF
UUS-Data	Oc	This AVP holds information about the sent User-To-User data.	All

AVP	Category	Description	Provided by IMS NE
Cause	Oc	This AVP contains the cause value and the Node-Functionality AVP that contains the function of the node where the cause code was generated.	All
Service-Specific-Data	Oc	This AVP contains service specific data if and as provided by an Application Server	Only from AS

NOTE: For AVP of type "Grouped" only the group AVP is listed in table 6.1.1.2.1. Detailed descriptions of the AVPs are provided in TS 32.299 [50].

6.1.1.2.2 Accounting-Answer Message

Table 6.1.1.2.2 illustrates the basic structure of a Diameter *Accounting-Answer* message as used for IMS charging. This message is always used by the CDF as specified below, regardless of the IMS node it is received from and the ACR record type that is being replied to.

Table 6.1.1.2.2: Accounting-Answer (ACA) Message Contents for Offline Charging

AVP	Category	Description
Session-Id	M	Described in 32.299 [50]
Result-Code	M	Described in 32.299 [50]
Origin-Host	M	Described in 32.299 [50]
Origin-Realm	M	Described in 32.299 [50]
Accounting-Record-Type	M	Described in 32.299 [50]
Accounting-Record-Number	M	Described in 32.299 [50]
Acct-Application-Id	Oc	Described in 32.299 [50]
User-Name	Oc	Described in 32.299 [50]
Acct-Interim-Interval	Oc	Described in 32.299 [50]
Origin-State-Id	Oc	Described in 32.299 [50]
Event-Timestamp	Oc	Described in 32.299 [50]

Category in table 6.1.1.2.1 and table 6.1.1.2.2 shall use the categories according to clause 5.4 in 32.240.

6.1.1.2.3 Detailed Message Formats

Table 6.1.1.2.3 specifies per ACR type the accounting data that are sent by each of the IMS network elements:

- S-CSCF
- P-CSCF
- I-CSCF
- MRFC
- MGCF
- BGCF
- AS

The ACR types in table 6.1.1.2.3 are listed in the following order: S (start)/I (interim)/S (stop)/E (event). Therefore, when all ACR types are possible it is marked as SISE. If only some ACR types are allowed for a node, only the appropriate letters are used (i.e. SIS or E) as indicated in the table heading. The omission of an ACR type for a particular AVP is marked with "-" (i.e. SI-E). Also, when an entire AVP is not allowed in a node the entire cell is marked as "-".

Note that not for all Grouped AVPs the individual AVP members are listed in the table. Detailed descriptions of the AVPs are provided in TS 32.299 [50].

Table 6.1.1.2.3: Detailed Diameter ACR Message Contents for Offline Charging

AVP name	Node Type	S-CSCF	P-CSCF	I-CSCF	MRFC	MGCF	BGCF	AS
	Supported ACRs	S/I/S/E	S/I/S/E	E	S/I/S	S/I/S/E	S/I/S/E	S/I/S/E
AVPs from the Diameter base protocol								
<Session-Id>		SISE	SISE	E	SIS	SISE	SISE	SISE
{Origin-Host}		SISE	SISE	E	SIS	SISE	SISE	SISE
{Origin-Realm}		SISE	SISE	E	SIS	SISE	SISE	SISE
{Destination-Realm}		SISE	SISE	E	SIS	SISE	SISE	SISE
{Accounting-Record-Type}		SISE	SISE	E	SIS	SISE	SISE	SISE
{Accounting-Record-Number}		SISE	SISE	E	SIS	SISE	SISE	SISE
[Vendor-Specific-Application-Id]		SISE	SISE	E	SIS	SISE	SISE	SISE
[Acct-Application-Id]		SISE	SISE	E	SIS	SISE	SISE	SISE
[User-Name] (see note 1)		SISE	SISE	E	SIS	SISE	SISE	SISE
[Accounting-Sub-Session-Id]		-	-	-	-	-	-	-
[Accounting-RADIUS-Session-Id]		-	-	-	-	-	-	-
[Acct-Multi-Session-Id]		-	-	-	-	-	-	-
[Acct-Interim-Interval]		SIS-	SIS-	-	SIS-	SIS-	SIS-	SIS-
[Accounting-Realtime-Required]		-	-	-	-	-	-	-
[Origin-State-Id]		SISE	SISE	E	SIS	SISE	SISE	SISE
[Event-Timestamp]		SISE	SISE	E	SIS	SISE	SISE	SISE
*[Proxy-Info]		-	-	-	-	-	-	-
*[Route-Record]		-	-	-	-	-	-	-
*[AVP]		-	-	-	-	-	-	-
3GPP Diameter AVPs								
[Event-Type]		SISE	SISE	E	SIS	SISE	SISE	SISE
[Role-of-Node]		SISE	SISE	E	SIS	SISE	SISE	SISE
[User-Session-Id]		SISE	SISE	E	SIS	SISE	SISE	SISE
[Calling-Party-Address]		SISE	SISE	E	SIS	SISE	SISE	SISE
[Called-Party-Address]		SISE	SISE	E	SIS	SISE	SISE	SISE
[Time-stamps]		SISE	SISE	E	SIS	SISE	SISE	SISE
*[Application-server-Information] (see note 1)		SISE	-	-	SIS	-	-	-
[Inter-Operator-Identifiers] (see note 1)		SISE	SISE	E	SIS	SISE	SISE	SISE
[IMS-Charging-Identifier]		SISE	SISE	E	SIS	SISE	SISE	SISE
*[SDP-Session-Description]		SI--	SI--	-	SI--	SI--	SI--	SI--
*[SDP-Media-component]		SI--	SI--		SI--	SI--	SI--	SI--
[GGSN-Address]		SI--	SI--		SI--	SI--	SI--	SI--
[Served-Party-IP-Address] (see note 1)		-	SISE	-	-	-	-	-
[Authorized-QoS] (see note 1)		-	SI--	-	-	-	-	-
[Server-Capabilities]		-	-	E	-	-	-	-
[Trunk-Group-ID]		-	-	-	-	SISE	-	-
[Bearer-Service]		-	-	-	-	SISE	-	-
[Service-Id]		-	-	-	SIS	-	-	-
[Service-Specific-Data]		-	-	-	-	-	-	SISE
[UUS-Data] (see note 2)		SISE	SISE					SISE
[Cause]		--SE	--SE	E	--S	--SE	--SE	--SE
NOTE 1: Only present if available in the IMS node.								
NOTE 2: Present only if user-to-user data is included in the SIP message that triggered the ACR.								

6.1.2 GTP" message contents

GTP" is not used between CDF and CGF in IP Multimedia subsystem, because CDF and CGF are combined into CCF (see clause 4).

Use text from middle tear template

6.1.3 CDR Description on the Bi Interface

6.1.3.1 CDR Field Types

The following Standard CDR content and format are considered:

S-CSCF-CDR generated based on information from the S-CSCF.

I-CSCF-CDR generated based on information from the I-CSCF.

P-CSCF-CDR generated based on information from the P-CSCF.

BGCF-CDR generated based on information from the BGCF.

MGCF-CDR generated based on information from the MGCF.

MRFC-CDR generated based on information from the MRFC.

AS-CDR generated based on information from the AS.

The content of each CDR type is defined in the tables in clauses 6.1.3.3 to 6.1.3.9. For each CDR type the field definition includes the field name, category and description. The detailed field descriptions are provided in TS 32.298 [51].

Editor's Note: Equipment vendors shall be able to provide all of the fields listed in the CDR content table in order to claim compliance with the present document. However, since CDR processing and transport consume network resources, operators may opt to eliminate some of the fields that are not essential for their operation.

Editors note: Rephrase the above paragraph and ref. to 32.240

The CDF provides the CDRs at the Bi interface in the format and encoding described in TS 32.298 [51]. Additional CDR formats and contents may be available at the interface to the billing system to meet the requirements of the billing system, these are outside of the scope of 3GPP standardisation.

6.1.3.2 CDR Triggers

6.1.3.2.1 Session Related CDRs

Reflecting the usage of multimedia sessions IMS CDRs are generated by the CDF on a per session level. In the scope of the present document the term "session" refers always to a SIP session. The coherent media components are reflected inside the session CDRs with a media component container comprising of all the information necessary for the description of a media component.

Accounting information for SIP sessions is transferred from the IMS nodes involved in the session to the CDF using Diameter ACR Start, Interim and Stop messages. A session CDR is opened in the CDF upon reception of a Diameter ACR [Start] message. Partial CDRs may be generated upon reception of a Diameter ACR [Interim] message, which is sent by the network entity towards the CDF due to a session modification procedure (i.e. change in media). Session CDRs are updated, or partial CDRs are generated upon reception of a diameter ACR [Interim] message, which is sent by the network entity due to expiration of the Accounting-Interim-Interval AVP. The CDF closes the final session CDR upon reception of a Diameter ACR [Stop] message, which indicates that the SIP session is terminated. Further details on triggers for the generation of IMS CDRs are specified in [1].

Accounting information for unsuccessful session set-up attempts may be sent by the IMS node to the CDF employing the Diameter ACR [Event] message. The behaviour of the CDF upon receiving ACR [Event] messages is specified in clause 6.1.3.2.2.

6.1.3.2.2 Session Unrelated CDRs

To reflect chargeable events not directly related to a session the CDF may generate CDRs upon the occurrence of session unrelated SIP procedures, such as registration respectively de-registration events. Accounting information for SIP session-unrelated procedures is transferred from the IMS nodes involved in the procedure to the CDF using Diameter ACR [Event] messages. Session unrelated CDRs are created in the CDF in a "one-off" action based on the

information contained in the Diameter ACR [Event] message. One session unrelated CDR is created in the CDF for each Diameter ACR [Event] message received, whereas the creation of partial CDRs is not applicable for session unrelated CDRs. The cases for which the IMS nodes send ACR [Event] messages are listed per SIP procedure in table 5.2.1.1 and table 5.2.1.2.

Further details on triggers for the generation of IMS CDRs are specified in clause 5.2.2.

6.1.3.3 S-CSCF CDR Content

The detailed description of the field is provided in TS 32.298 [51].

Table 6.1.3.3: Charging Data of S-CSCF CDR

Field	Category	Description
Record Type	M	Identifies the type of record. The parameter is derived from the <i>Origin-Host</i> AVP
Retransmission	O _c	This parameter, when present, indicates that information from retransmitted Diameter ACRs has been used in this CDR
SIP Method	O _c	Specifies the SIP-method for which the CDR is generated. Only available in session unrelated cases. This parameter corresponds to SIP-Event-Type AVP
Role of Node	O _M	This field indicates the role of the AS/CSCF. This parameter corresponds to Role-of-Node AVP
Node Address	O _M	This item holds the address of the node providing the information for the CDR. This may either be the IP address or the FQDN of the IMS node generating the accounting data. This parameter corresponds to the <i>Origin-Host</i> AVP
Session ID	O _M	The Session identification. For a SIP session the Session-ID contains the SIP Call ID as defined in the Session Initiation Protocol RFC 3261 [404]. This parameter corresponds to User-Session-ID AVP
Calling Party Address	O _M	The address (Public User ID) of the party requesting a service or initiating a session. This field holds either the SIP URL (according to IETF RFC 3261 [404]) or the TEL URL (according to RFC 2806 [403]) of the calling party. This parameter corresponds to Calling-Party-Address AVP
Called Party Address	O _M	In the context of an end-to-end SIP transaction this field holds the address of the party (Public User ID) to whom the SIP transaction is posted. This parameter corresponds to Called-Party-Address AVP
Private User ID	O _M	Holds the used Network Access Identifier of the served party according to RFC2486 [405]. This parameter corresponds to the <i>User-Name</i> AVP
Service Request Time Stamp	O _M	This field contains the time stamp, which indicates the time at which the service was requested. This parameter corresponds to SIP-Request-Timestamp AVP. Present with ACR [Start] and ACR [Event].
Service Delivery Start Time Stamp	O _M	This field holds the time stamp reflecting either: successful session set-up, a delivery unrelated service, an unsuccessful session set-up and an unsuccessful session unrelated request. This parameter corresponds to SIP-Response-Timestamp AVP. Present with ACR [Start] and ACR [Event].
Service Delivery End Time Stamp	O _c	This field records the time at which the service delivery was terminated. It is Present only in SIP session related case. This parameter corresponds to SIP-Request-Timestamp AVP. Present with ACR [Stop].
Record Opening Time	O _c	A time stamp reflecting the time the CCF opened this record. Present only in SIP session related case
Record Closure Time	O _M	A Time stamp reflecting the time the CCF closed the record
Application Servers Information	O _c	This a grouped CDR field containing the fields: 'Application Server Involved' and 'Application Provided Called Parties'
Application Servers Involved	O _c	Holds the ASs (if any) identified by the SIP URLs. This parameter corresponds to Application-Server AVP
Application Provided Called Parties	O _c	Holds a list of the Called Party Address(es), if the address(es) are determined by an AS (SIP URL, E.164...). This parameter corresponds to Application-Provided-Called-Party-Address AVP
Inter Operator Identifiers	O _c	Holds the identification of the home network (originating and terminating) if exchanged via SIP signalling, as recorded in the <i>Inter-Operator-Identifier</i> AVP
Originating IOI	O _c	This parameter corresponds to Originating-IOI AVP
Terminating IOI	O _c	This parameter corresponds to Terminating-IOI AVP
Local Record Sequence Number	O _M	This field includes a unique record number created by this node. The number is allocated sequentially for each partial CDR (or whole CDR) including all CDR types. The number is unique within the CCF
Record Sequence Number	O _c	This field contains a running sequence number employed to link the partial records generated by the CCF for a particular session
Cause For Record Closing	O _M	This field contains a reason for the release of the CDR
Incomplete CDR Indication	O _c	This field provides additional diagnostics when the CCF detects missing ACRs
IMS Charging Identifier	O _M	This parameter holds the IMS charging identifier (ICID) as generated by the IMS node for the SIP session. This parameter corresponds to IMS-Charging-Identifier (ICID) AVP

Field	Category	Description
SDP Session Description	O _c	Holds the Session portion of the SDP data exchanged between the User Agents if available in the SIP transaction. This parameter corresponds to SDP-Session-Description AVP
List of SDP Media Components	O _c	This is a grouped field comprising several sub-fields associated with one media component. It may occur several times in one CDR. The field is present only in a SIP session related case
SIP Request Timestamp	O _M	This parameter contains the time of the SIP Request (usually a (Re)Invite). This parameter corresponds to SIP-Request-Timestamp AVP in ACR [Interim] .
SIP Response Timestamp	O _M	This parameter contains the time of the response to the SIP Request (usually a 200 OK). This parameter corresponds to SIP-Response-Timestamp AVP in ACR [Interim] .
SDP Media Components	O _M	This is a grouped field comprising several sub-fields associated with one media component. Since several media components may exist for a session in parallel these sub-fields may occur several times. This parameter corresponds to SDP-Media-Component AVP
SDP Media Name	O _M	This field holds the name of the media as available in the SDP data. This parameter corresponds to SDP-Media-Name
SDP Media Description	O _M	This field holds the attributes of the media as available in the SDP data. This parameter corresponds to SDP-Media-Description
GPRS Charging ID	O _M	This parameter holds the GPRS charging ID (GCID) which is generated by the GGSN for a GPRS PDP context. This parameter corresponds to GPRS-Charging-Id
Media Initiator Flag	O _c	This field indicates if the called party has requested the session modification and it is present only if the initiator was the called party
GGSN Address	O _c	This parameter holds the control plane IP address of the GGSN that handles one or more media component(s) of a IMS session. This parameter corresponds to GGSN-Address AVP
Service Delivery Failure Reason	O _c	Holds the reason for why a requested service could not be successfully provided (i.e. SIP error codes taken from <i>SIP-Method</i> AVP). This field is not present in case of a successful service delivery
List of Message Bodies	O _c	This grouped field comprising several sub-fields describing the data that may be conveyed end-to-end in the body of a SIP message. Since several message bodies may be exchanged via SIP-signalling, this grouped field may occur several times. This parameter corresponds to UUS-Data AVP
Content-Type	O _c	This sub-field of Message Bodies holds the MIME type of the message body, Examples are: application/zip, image/gif, audio/mpeg, etc. This parameter corresponds to UUS-Data AVP/Mime-Type AVP or Event-Type AVP/ Content-Type AVP
Content-Disposition	O _c	This sub-field of Message Bodies holds the content disposition of the message body inside the SIP signalling, Content-disposition header field equal to 'render', indicates that 'the body part should be displayed or otherwise rendered to the user'. Content disposition values are: session, render, inline, icon, alert, attachment, etc. This parameter corresponds to Even-Type AVP / Content-Disposition AVP
Content-Length	O _c	This sub-field of Message Bodies holds the size of the data of a message body in bytes. This parameter corresponds to UUS-Data AVP/ Amount-of-UUS-data AVP or Event-Type AVP / Content-Length AVP
Originator	O _c	This sub-field of the "List of Message Bodies" indicates the originating party of the message body. This parameter corresponds to UUS-Data AVP/ Direction AVP
Record Extensions	O _c	A set of operator/manufacture specific extensions to the record, conditioned upon existence of an extension

6.1.3.4 P-CSCF CDR Content

The detailed description of the field is provided in TS 32.298 [51].

Table 6.1.3.4: Charging Data of P-CSCF CDR

Field	Category	Description
Record Type	M	Identifies the type of record. The parameter is derived from the <i>Origin-Host</i> AVP
Retransmission	O _c	This parameter, when present, indicates that information from retransmitted Diameter ACRs has been used in this CDR
SIP Method	O _c	Specifies the SIP-method for which the CDR is generated. Only available in session unrelated cases. This parameter corresponds to <i>SIP-Event-Type</i> AVP
Role of Node	O _M	This field indicates the role of the AS/CSCF. This parameter corresponds to <i>Role-of-Node</i> AVP
Node Address	O _M	This item holds the address of the node providing the information for the CDR. This may either be the IP address or the FQDN of the IMS node generating the accounting data. This parameter corresponds to the <i>Origin-Host</i> AVP
Session ID	O _M	The Session identification. For a SIP session the Session-ID contains the SIP Call ID as defined in the Session Initiation Protocol RFC 3261 [404]. This parameter corresponds to <i>User-Session-ID</i> AVP
Calling Party Address	O _M	The address (Public User ID) of the party requesting a service or initiating a session. This field holds either the SIP URL (according to IETF RFC 3261 [404]) or the TEL URL (according to RFC 2806 [403]) of the calling party. This parameter corresponds to <i>Calling-Party-Address</i> AVP
Called Party Address	O _M	In the context of an end-to-end SIP transaction this field holds the address of the party (Public User ID) to whom the SIP transaction is posted. This parameter corresponds to <i>Called-Party-Address</i> AVP
Served Party IP Address	O _M	This field contains the IP address of either the calling or called party, depending on whether the P-CSCF is in touch with the calling or called network. This parameter corresponds to <i>Served-Party-IP-Address</i> AVP
Service Request Time Stamp	O _M	This field contains the time stamp, which indicates the time at which the service was requested. This parameter corresponds to <i>SIP-Request-Timestamp</i> AVP. Present with <i>ACR [Start]</i> and <i>ACR [Event]</i> .
Service Delivery Start Time Stamp	O _M	This field holds the time stamp reflecting either: successful session set-up, a delivery unrelated service, an unsuccessful session set-up and an unsuccessful session unrelated request. This parameter corresponds to <i>SIP-Response-Timestamp</i> AVP. Present with <i>ACR [Start]</i> and <i>ACR [Event]</i> .
Service Delivery End Time Stamp	O _c	This field records the time at which the service delivery was terminated. It is Present only in SIP session related case. This parameter corresponds to <i>SIP-Request-Timestamp</i> AVP. Present with <i>ACR [Stop]</i> .
Record Opening Time	O _c	A time stamp reflecting the time the CCF opened this record. Present only in SIP session related case
Record Closure Time	O _M	A Time stamp reflecting the time the CCF closed the record
Inter Operator Identifiers	O _c	Holds the identification of the home network (originating and terminating) if exchanged via SIP signalling, as recorded in the <i>Inter-Operator-Identifier</i> AVP
Originating IOI	O _c	This parameter corresponds to <i>Originating-IOI</i> AVP
Terminating IOI	O _c	This parameter corresponds to <i>Terminating-IOI</i> AVP
Local Record Sequence Number	O _M	This field includes a unique record number created by this node. The number is allocated sequentially for each partial CDR (or whole CDR) including all CDR types. The number is unique within the CCF
Record Sequence Number	O _c	This field contains a running sequence number employed to link the partial records generated by the CCF for a particular session
Cause For Record Closing	O _M	This field contains a reason for the release of the CDR
Incomplete CDR Indication	O _c	This field provides additional diagnostics when the CCF detects missing ACRs
IMS Charging Identifier	O _M	This parameter holds the IMS charging identifier (ICID) as generated by the IMS node for the SIP session. This parameter corresponds to <i>IMS-Charging-Identifier (ICID)</i> AVP
SDP Session Description	O _c	Holds the Session portion of the SDP data exchanged between the User Agents if available in the SIP transaction. This parameter corresponds to <i>SDP-Session-Description</i> AVP
List of SDP Media Components	O _c	This is a grouped field comprising several sub-fields associated with one media component. It may occur several times in one CDR. The field is present only in a SIP session related case

Field	Category	Description
SIP Request Timestamp	O _M	This parameter contains the time of the SIP Request (usually a (Re)Invite). This parameter corresponds to SIP-Request-Timestamp AVP. in ACR [Interim].
SIP Response Timestamp	O _M	This parameter contains the time of the response to the SIP Request (usually a 200 OK). This parameter corresponds to SIP-Response-Timestamp AVP in ACR [Interim].
SDP Media Components	O _M	This is a grouped field comprising several sub-fields associated with one media component. Since several media components may exist for a session in parallel these sub-fields may occur several times. This parameter corresponds to SDP-Media-Component AVP
SDP Media Name	O _M	This field holds the name of the media as available in the SDP data. This parameter corresponds to SDP-Media-Name
SDP Media Description	O _M	This field holds the attributes of the media as available in the SDP data. This parameter corresponds to SDP-Media-Description
GPRS Charging ID	O _M	This parameter holds the GPRS charging ID (GCID) which is generated by the GGSN for a GPRS PDP context. This parameter corresponds to GPRS-Charging-Id AVP
Media Initiator Flag	O _c	This field indicates if the called party has requested the session modification and it is present only if the initiator was the called party
Authorised QoS	O _c	Authorised QoS as defined in TS 23.207 [7] / TS 29.207 [8] and applied via the Go interface. This parameter corresponds to Authorised-QoS AVP
GGSN Address	O _c	This parameter holds the control plane IP address of the GGSN that handles one or more media component(s) of a IMS session. This parameter corresponds to GGSN-Address AVP
Service Delivery Failure Reason	O _c	Holds the reason for why a requested service could not be successfully provided (i.e. SIP error codes taken from <i>SIP-Method</i> AVP). This field is not present in case of a successful service delivery
List of Message Bodies	O _c	This grouped field comprising several sub-fields describing the data that may be conveyed end-to-end in the body of a SIP message. Since several message bodies may be exchanged via SIP-signalling, this grouped field may occur several times. This parameter corresponds to UUS-Data AVP
Content-Type	O _c	This sub-field of Message Bodies holds the MIME type of the message body, Examples are: application/zip, image/gif, audio/mpeg, etc. This parameter corresponds to UUS-Data AVP/Mime-Type AVP or Event-Type AVP/ Content-Type AVP
Content-Disposition	O _c	This sub-field of Message Bodies holds the content disposition of the message body inside the SIP signalling, Content-disposition header field equal to 'render', indicates that 'the body part should be displayed or otherwise rendered to the user'. Content disposition values are: session, render, inline, icon, alert, attachment, etc. This parameter corresponds to Even-Type AVP / Content-Disposition AVP
Content-Length	O _c	This sub-field of Message Bodies holds the size of the data of a message body in bytes. This parameter corresponds to UUS-Data AVP/ Amount-of-UUS-data AVP or Event-Type AVP / Content-Length AVP
Originator	O _c	This sub-field of the "List of Message Bodies" indicates the originating party of the message body. This parameter corresponds to UUS-Data AVP/ Direction AVP
Record Extensions	O _c	A set of operator/manufacture specific extensions to the record, conditioned upon existence of an extension

6.1.3.5 I-CSCF CDR Content

The detailed description of the field is provided in TS 32.298 [51].

Table 6.1.3.5: Charging Data of I-CSCF CDR

Field	Category	Description
Record Type	M	Identifies the type of record. The parameter is derived from the <i>Origin-Host</i> AVP
Retransmission	O _c	This parameter, when present, indicates that information from retransmitted Diameter ACRs has been used in this CDR
SIP Method	O _c	Specifies the SIP-method for which the CDR is generated. Only available in session unrelated cases. This parameter corresponds to <i>SIP-Event-Type</i> AVP
Role of Node	O _M	This field indicates the role of the AS/CSCF. This parameter corresponds to <i>Role-of-Node</i> AVP
Node Address	O _M	This item holds the address of the node providing the information for the CDR. This may either be the IP address or the FQDN of the IMS node generating the accounting data. This parameter corresponds to the <i>Origin-Host</i> AVP
Session ID	O _M	The Session identification. For a SIP session the Session-ID contains the SIP Call ID as defined in the Session Initiation Protocol RFC 3261 [404]. This parameter corresponds to <i>User-Session-ID</i> AVP
Calling Party Address	O _M	The address (Public User ID) of the party requesting a service or initiating a session. This field holds either the SIP URL (according to IETF RFC 3261 [404]) or the TEL URL (according to RFC 2806 [403]) of the calling party. This parameter corresponds to <i>Calling-Party-Address</i> AVP
Called Party Address	O _M	In the context of an end-to-end SIP transaction this field holds the address of the party (Public User ID) to whom the SIP transaction is posted. This parameter corresponds to <i>Called-Party-Address</i> AVP
Service Request Time Stamp	O _M	This field contains the time stamp, which indicates the time at which the service was requested. This parameter corresponds to <i>SIP-Request-Timestamp</i> AVP. Present with ACR [Event].
Inter Operator Identifiers	O _c	Holds the identification of the home network (originating and terminating) if exchanged via SIP signalling, as recorded in the <i>Inter-Operator-Identifier</i> AVP
Originating IOI	O _c	This parameter corresponds to <i>Originating-IOI</i> AVP
Terminating IOI	O _c	This parameter corresponds to <i>Terminating-IOI</i> AVP
Local Record Sequence Number	O _M	This field includes a unique record number created by this node. The number is allocated sequentially for each partial CDR (or whole CDR) including all CDR types. The number is unique within the CCF
Cause For Record Closing	O _M	This field contains a reason for the release of the CDR
Incomplete CDR Indication	O _c	This field provides additional diagnostics when the CCF detects missing ACRs
S-CSCF Information	O _c	This field contains Information related to the serving CSCF, e.g. the S-CSCF capabilities upon registration event or the S-CSCF address upon the session establishment event
IMS Charging Identifier	M _o	This parameter holds the IMS charging identifier (ICID) as generated by the IMS node for the SIP session. This parameter corresponds to <i>IMS-Charging-Identifier</i> (ICID) AVP
Service Delivery Failure Reason	O _c	Holds the reason for why a requested service could not be successfully provided (i.e. SIP error codes taken from <i>SIP-Method</i> AVP). This field is not present in case of a successful service delivery
Record Extensions	O _c	A set of operator/manufacture specific extensions to the record, conditioned upon existence of an extension

6.1.3.6 MRFC CDR Content

The detailed description of the field is provided in TS 32.298 [51].

Table 6.1.3.6: Charging Data of MRFC CDR

Field	Category	Description
Record Type	M	Identifies the type of record. The parameter is derived from the <i>Origin-Host</i> AVP
Retransmission	O _c	This parameter, when present, indicates that information from retransmitted Diameter ACRs has been used in this CDR
SIP Method	O _c	Specifies the SIP-method for which the CDR is generated. Only available in session unrelated cases. This parameter corresponds to SIP-Event-Type AVP
Role of Node	O _M	This field indicates the role of the AS/CSCF. This parameter corresponds to Role-of-Node AVP
Node Address	O _M	This item holds the address of the node providing the information for the CDR. This may either be the IP address or the FQDN of the IMS node generating the accounting data. This parameter corresponds to the <i>Origin-Host</i> AVP
Session ID	O _M	The Session identification. For a SIP session the Session-ID contains the SIP Call ID as defined in the Session Initiation Protocol RFC 3261 [404]. This parameter corresponds to User-Session-ID AVP
Service ID	O _M	This field identifies the service the MRFC is hosting. For conferences the conference ID is used here. This parameter corresponds to Service-Id AVP
Calling Party Address	O _M	The address (Public User ID) of the party requesting a service or initiating a session. This field holds either the SIP URL (according to IETF RFC 3261 [404]) or the TEL URL (according to RFC 2806 [403]) of the calling party. This parameter corresponds to Calling-Party-Address AVP
Called Party Address	O _c	In the context of an end-to-end SIP transaction this field holds the address of the party (Public User ID) to whom the SIP transaction is posted. This parameter corresponds to Called-Party-Address AVP
Service Request Time Stamp	O _M	This field contains the time stamp which indicates the time at which the service was requested. This parameter corresponds to SIP-Request-Timestamp AVP. Present with ACR [Start] and ACR [Event].
Service Delivery Start Time Stamp	O _M	This field holds the time stamp reflecting either: successful session set-up, a delivery unrelated service, an unsuccessful session set-up and an unsuccessful session unrelated request. This parameter corresponds to SIP-Response-Timestamp AVP. Present with ACR [Start] and ACR [EVENT].
Service Delivery End Time Stamp	O _c	This field records the time at which the service delivery was terminated. It is Present only in SIP session related case. This parameter corresponds to SIP-Request-Timestamp AVP. Present with ACR [Stop].
Record Opening Time	O _c	A time stamp reflecting the time the CCF opened this record. Present only in SIP session related case
Record Closure Time	O _M	A Time stamp reflecting the time the CCF closed the record
Application Servers Information	O _c	This a grouped CDR field containing the fields: 'Application Server Involved' and 'Application Provided Called Parties'
Application Servers Involved	O _c	Holds the ASs (if any) identified by the SIP URLs. This parameter corresponds to Application-Server AVP
Application Provided Called Parties	O _c	Holds a list of the Called Party Address(es), if the address(es) are determined by an AS (SIP URL, E.164...). This parameter corresponds to Application-Provided-Called-Party-Address AVP
Inter Operator Identifiers	O _c	Holds the identification of the home network (originating and terminating) if exchanged via SIP signalling, as recorded in the <i>Inter-Operator-Identifier</i> AVP
Originating IOI	O _c	This parameter corresponds to Originating-IOI AVP
Terminating IOI	O _c	This parameter corresponds to Terminating-IOI AVP
Local Record Sequence Number	O _M	This field includes a unique record number created by this node. The number is allocated sequentially for each partial CDR (or whole CDR) including all CDR types. The number is unique within the CCF
Record Sequence Number	O _c	This field contains a running sequence number employed to link the partial records generated by the CCF for a particular session
Cause For Record Closing	O _M	This field contains a reason for the release of the CDR
Incomplete CDR Indication	O _c	This field provides additional diagnostics when the CCF detects missing ACRs
IMS Charging Identifier	O _M	This parameter holds the IMS charging identifier (ICID) as generated by the IMS node for the SIP session. This parameter corresponds to IMS-Charging-Identifier (ICID AVP

Field	Category	Description
SDP Session Description	O _c	Holds the Session portion of the SDP data exchanged between the User Agents if available in the SIP transaction. This parameter corresponds to SDP-Session-Description AVP
List of SDP Media Components	O _c	This is a grouped field comprising several sub-fields associated with one media component. It may occur several times in one CDR. The field is present only in a SIP session related case
SIP Request Timestamp	O _M	This parameter contains the time of the SIP Request (usually a (Re)Invite). This parameter corresponds to SIP-Request-Timestamp AVP. in ACR [Interim] .
SIP Response Timestamp	O _M	This parameter contains the time of the response to the SIP Request (usually a 200 OK). This parameter corresponds to SIP-Response-Timestamp AVP. in ACR [Interim].
SDP Media Components	O _M	This is a grouped field comprising several sub-fields associated with one media component. Since several media components may exist for a session in parallel these sub-fields may occur several times. This parameter corresponds to SDP-Media-Component AVP
SDP Media Name	O _M	This field holds the name of the media as available in the SDP data. This parameter corresponds to SDP-Media-Name
SDP Media Description	O _M	This field holds the attributes of the media as available in the SDP data. This parameter corresponds to SDP-Media-Description
GPRS Charging ID	O _M	This parameter holds the GPRS charging ID (GCID) which is generated by the GGSN for a GPRS PDP context. This parameter corresponds to GPRS-Charging-Id AVP
Media Initiator Flag	O _c	This field indicates if the called party has requested the session modification and it is present only if the initiator was the called party
GGSN Address	O _c	This parameter holds the control plane IP address of the GGSN that handles one or more media component(s) of a IMS session. This parameter corresponds to GGSN-Address AVP
Service Delivery Failure Reason	O _c	Holds the reason for why a requested service could not be successfully provided (i.e. SIP error codes taken from <i>SIP-Method</i> AVP). This field is not present in case of a successful service delivery
Record Extensions	O _c	A set of operator/manufacture specific extensions to the record, conditioned upon existence of an extension

6.1.3.7 MGCF CDR Content

The detailed description of the field is provided in TS 32.298 [51].

Table 6.1.3.7: Charging Data of MGCF CDR

Field	Category	Description
Record Type	M	Identifies the type of record. The parameter is derived from the <i>Origin-Host</i> AVP
Retransmission	O _c	This parameter, when present, indicates that information from retransmitted Diameter ACRs has been used in this CDR
SIP Method	O _c	Specifies the SIP-method for which the CDR is generated. Only available in session unrelated cases. This parameter corresponds to SIP-Event-Type AVP
Role of Node	O _M	This fields indicates the role of the AS/CSCF. This parameter corresponds to Role-of-Node AVP
Node Address	O _M	This item holds the address of the node providing the information for the CDR. This may either be the IP address or the FQDN of the IMS node generating the accounting data. This parameter corresponds to the <i>Origin-Host</i> AVP
Session ID	O _M	The Session identification. For a SIP session the Session-ID contains the SIP Call ID as defined in the Session Initiation Protocol RFC 3261 [404]. This parameter corresponds to User-Session-ID AVP
Calling Party Address	O _M	The address (Public User ID) of the party requesting a service or initiating a session. This field holds either the SIP URL (according to IETF RFC 3261 [404]) or the TEL URL (according to RFC 2806 [403]) of the calling party. This parameter corresponds to Calling-Party-Address AVP
Called Party Address	O _M	In the context of an end-to-end SIP transaction this field holds the address of the party (Public User ID) to whom the SIP transaction is posted. This parameter to corresponds Called-Party-Address AVP
Service Request Time Stamp	O _M	This field contains the time stamp which indicates the time at which the service was requested. This parameter corresponds to SIP-Request-Timestamp AVP. Present with ACR [Start] and ACR [Event].
Service Delivery Start Time Stamp	O _M	This field holds the time stamp reflecting either: successful session set-up, a delivery unrelated service, an unsuccessful session set-up and an unsuccessful session unrelated request. This parameter corresponds to SIP-Response-Timestamp AVP. Present with ACR [Start] and ACR [Event].
Service Delivery End Time Stamp	O _c	This field records the time at which the service delivery was terminated. It is Present only in SIP session related case. This parameter corresponds to SIP-Request-Timestamp AVP. Present with ACR [Stop].
Record Opening Time	O _c	A time stamp reflecting the time the CCF opened this record. Present only in SIP session related case
Record Closure Time	O _M	A Time stamp reflecting the time the CCF closed the record
Inter Operator Identifiers	O _c	Holds the identification of the home network (originating and terminating) if exchanged via SIP signalling, as recorded in the <i>Inter-Operator-Identifier</i> AVP
Originating IOI	O _c	This parameter corresponds to Originating-IOI AVP
Terminating IOI	O _c	This parameter corresponds to Terminating-IOI AVP
Local Record Sequence Number	O _M	This field includes a unique record number created by this node. The number is allocated sequentially for each partial CDR (or whole CDR) including all CDR types. The number is unique within the CCF
Record Sequence Number	O _c	This field contains a running sequence number employed to link the partial records generated by the CCF for a particular session
Cause For Record Closing	O _M	This field contains a reason for the release of the CDR
Incomplete CDR Indication	O _c	This field provides additional diagnostics when the CCF detects missing ACRs
IMS Charging Identifier	O _M	This parameter holds the IMS charging identifier (ICID) as generated by the IMS node for the SIP session. This parameter corresponds to IMS-Charging-Identifier (ICID) AVP
SDP Session Description	O _c	Holds the Session portion of the SDP data exchanged between the User Agents if available in the SIP transaction. This parameter corresponds to SDP-Session-Description AVP
List of SDP Media Components	O _c	This is a grouped field comprising several sub-fields associated with one media component. It may occur several times in one CDR. The field is present only in a SIP session related case
SIP Request Timestamp	O _M	This parameter contains the time of the SIP Request (usually a (Re)Invite). This parameter corresponds to SIP-Request-Timestamp AVP in ACR [Interim].
SIP Response Timestamp	O _M	This parameter contains the time of the response to the SIP Request (usually a 200 OK). This parameter corresponds to SIP-Response-Timestamp AVP in ACR [Interim].

Field	Category	Description
SDP Media Components	O _M	This is a grouped field comprising several sub-fields associated with one media component. Since several media components may exist for a session in parallel these sub-fields may occur several times. This parameter corresponds to SDP-Media-Component AVP
SDP Media Name	O _M	This field holds the name of the media as available in the SDP data. This parameter corresponds to SDP-Media-Name
SDP Media Description	O _M	This field holds the attributes of the media as available in the SDP data. This parameter corresponds to SDP-Media-Description
GPRS Charging ID	O _M	This parameter holds the GPRS charging ID (GCID) which is generated by the GGSN for a GPRS PDP context. This parameter corresponds to GPRS-Charging-Id AVP
Media Initiator Flag	O _C	This field indicates if the called party has requested the session modification and it is present only if the initiator was the called party
GGSN Address	O _C	This parameter holds the control plane IP address of the GGSN that handles one or more media component(s) of a IMS session. This parameter corresponds to GGSN-Address AVP
Service Delivery Failure Reason	O _C	Holds the reason for why a requested service could not be successfully provided (i.e. SIP error codes taken from <i>SIP-Method</i> AVP). This field is not present in case of a successful service delivery
Trunk Group ID Incoming/Outgoing	O _M	Contains the outgoing trunk group ID for an outgoing session/call or the incoming trunk group ID for an incoming session/call. This parameter corresponds to Trunk-Group-ID AVP
Bearer Service	O _M	Holds the used bearer service for the PSTN leg. This parameter corresponds to Bearer-Service AVP
Record Extensions	O _C	A set of operator/manufacture specific extensions to the record, conditioned upon existence of an extension

6.1.3.8 BGCF CDR Content

The detailed description of the field is provided in TS 32.298 [51].

Table 6.1.3.8: Charging Data of BGCF CDR

Field	Category	Description
Record Type	M	Identifies the type of record. The parameter is derived from the <i>Origin-Host</i> AVP
Retransmission	O _c	This parameter, when present, indicates that information from retransmitted Diameter ACRs has been used in this CDR
SIP Method	O _c	Specifies the SIP-method for which the CDR is generated. Only available in session unrelated cases. This parameter corresponds to SIP-Event-Type AVP
Role of Node	O _M	This field indicates the role of the AS/CSCF. This parameter corresponds to Role-of-Node AVP
Node Address	O _M	This item holds the address of the node providing the information for the CDR. This may either be the IP address or the FQDN of the IMS node generating the accounting data. This parameter corresponds to the <i>Origin-Host</i> AVP
Session ID	O _M	The Session identification. For a SIP session the Session-ID contains the SIP Call ID as defined in the Session Initiation Protocol RFC 3261 [404]. This parameter corresponds to User-Session-ID AVP
Calling Party Address	O _M	The address (Public User ID) of the party requesting a service or initiating a session. This field holds either the SIP URL (according to IETF RFC 3261 [404]) or the TEL URL (according to RFC 2806 [403]) of the calling party. This parameter corresponds to Calling-Party-Address AVP
Called Party Address	O _M	In the context of an end-to-end SIP transaction this field holds the address of the party (Public User ID) to whom the SIP transaction is posted. This parameter corresponds to Called-Party-Address AVP
Service Request Time Stamp	O _M	This field contains the time stamp which indicates the time at which the service was requested. This parameter corresponds to SIP-Request-Timestamp AVP. Present with ACR [Start] and ACR [Event].
Service Delivery Start Time Stamp	O _M	This field holds the time stamp reflecting either: successful session set-up, a delivery unrelated service, an unsuccessful session set-up and an unsuccessful session unrelated request. This parameter corresponds to SIP-Response-Timestamp AVP. Present with ACR [Start] and ACR [Event].
Service Delivery End Time Stamp	O _c	This field records the time at which the service delivery was terminated. It is Present only in SIP session related case. This parameter corresponds to SIP-Request-Timestamp AVP. Present with ACR [Stop].
Record Opening Time	O _c	A time stamp reflecting the time the CCF opened this record. Present only in SIP session related case
Record Closure Time	O _M	A Time stamp reflecting the time the CCF closed the record
Inter Operator Identifiers	O _c	Holds the identification of the home network (originating and terminating) if exchanged via SIP signalling, as recorded in the <i>Inter-Operator-Identifier</i> AVP
Originating IOI	O _c	This parameter corresponds to Originating-IOI AVP
Terminating IOI	O _c	This parameter corresponds to Terminating-IOI AVP
Local Record Sequence Number	O _M	This field includes a unique record number created by this node. The number is allocated sequentially for each partial CDR (or whole CDR) including all CDR types. The number is unique within the CCF
Record Sequence Number	O _c	This field contains a running sequence number employed to link the partial records generated by the CCF for a particular session
Cause For Record Closing	O _M	This field contains a reason for the release of the CDR
Incomplete CDR Indication	O _c	This field provides additional diagnostics when the CCF detects missing ACRs
IMS Charging Identifier	O _M	This parameter holds the IMS charging identifier (ICID) as generated by the IMS node for the SIP session. This parameter corresponds to IMS-Charging-Identifier (ICID) AVP
SDP Session Description	O _c	Holds the Session portion of the SDP data exchanged between the User Agents if available in the SIP transaction. This parameter corresponds to SDP-Session-Description AVP
List of SDP Media Components	O _c	This is a grouped field comprising several sub-fields associated with one media component. It may occur several times in one CDR. The field is present only in a SIP session related case
SIP Request Timestamp	O _M	This parameter contains the time of the SIP Request (usually a (Re)Invite). This parameter corresponds to SIP-Request-Timestamp AVP in ACR [Interim] .
SIP Response Timestamp	O _M	This parameter contains the time of the response to the SIP Request (usually a 200 OK). This parameter corresponds to SIP-Response-Timestamp AVP in ACR [Interim].

Field	Category	Description
SDP Media Components	O _M	This is a grouped field comprising several sub-fields associated with one media component. Since several media components may exist for a session in parallel these sub-fields may occur several times. This parameter corresponds to SDP-Media-Component AVP
SDP Media Name	O _M	This field holds the name of the media as available in the SDP data. This parameter corresponds to SDP-Media-Name
SDP Media Description	O _M	This field holds the attributes of the media as available in the SDP data. This parameter corresponds to SDP-Media-Description
GPRS Charging ID	O _M	This parameter holds the GPRS charging ID (GCID) which is generated by the GGSN for a GPRS PDP context. This parameter corresponds to GPRS-Charging-Id AVP
Media Initiator Flag	O _C	This field indicates if the called party has requested the session modification and it is present only if the initiator was the called party
GGSN Address	O _C	This parameter holds the control plane IP address of the GGSN that handles one or more media component(s) of a IMS session. This parameter corresponds to GGSN-Address AVP
Service Delivery Failure Reason	O _C	Holds the reason for why a requested service could not be successfully provided (i.e. SIP error codes taken from <i>SIP-Method</i> AVP). This field is not present in case of a successful service delivery
Record Extensions	O _C	A set of operator/manufacturer specific extensions to the record, conditioned upon existence of an extension

6.1.3.9 SIP AS CDR Content

The detailed description of the field is provided in TS 32.298 [51].

Table 6.1.3.9: Charging Data of AS CDR

Field	Category	Description
Record Type	M	Identifies the type of record. The parameter is derived from the <i>Origin-Host</i> AVP
Retransmission	O _c	This parameter, when present, indicates that information from retransmitted Diameter ACRs has been used in this CDR
SIP Method	O _c	Specifies the SIP-method for which the CDR is generated. Only available in session unrelated cases. This parameter corresponds to SIP-Event-Type AVP
Role of Node	O _M	This field indicates the role of the AS/CSCF. This parameter corresponds to Role-of-Node AVP
Node Address	O _M	This item holds the address of the node providing the information for the CDR. This may either be the IP address or the FQDN of the IMS node generating the accounting data. This parameter corresponds to the <i>Origin-Host</i> AVP
Session ID	O _M	The Session identification. For a SIP session the Session-ID contains the SIP Call ID as defined in the Session Initiation Protocol RFC 3261 [404]. This parameter corresponds to User-Session-ID AVP
Calling Party Address	O _M	The address (Public User ID) of the party requesting a service or initiating a session. This field holds either the SIP URL (according to IETF RFC 3261 [404]) or the TEL URL (according to RFC 2806 [403]) of the calling party. This parameter corresponds to Calling-Party-Address AVP
Called Party Address	O _M	In the context of an end-to-end SIP transaction this field holds the address of the party (Public User ID) to whom the SIP transaction is posted. This parameter corresponds to Called-Party-Address AVP
Service Request Time Stamp	O _M	This field contains the time stamp which indicates the time at which the service was requested. This parameter corresponds to SIP-Request-Timestamp AVP. Present with ACR [Start] and ACR [Event].
Service Delivery Start Time Stamp	O _M	This field holds the time stamp reflecting either: successful session set-up, a delivery unrelated service, an unsuccessful session set-up and an unsuccessful session unrelated request. This parameter corresponds to SIP-Response-Timestamp AVP. Present with ACR [Start] and ACR [Event].
Service Delivery End Time Stamp	O _c	This field records the time at which the service delivery was terminated. It is Present only in SIP session related case. This parameter corresponds to SIP-Request-Timestamp AVP. Present with ACR [Stop].
Record Opening Time	O _c	A time stamp reflecting the time the CCF opened this record. Present only in SIP session related case
Record Closure Time	O _M	A Time stamp reflecting the time the CCF closed the record
Inter Operator Identifiers	O _c	Holds the identification of the home network (originating and terminating) if exchanged via SIP signalling, as recorded in the <i>Inter-Operator-Identifier</i> AVP
Originating IOI	O _c	This parameter corresponds to Originating-IOI AVP
Terminating IOI	O _c	This parameter corresponds to Terminating-IOI AVP
Local Record Sequence Number	O _M	This field includes a unique record number created by this node. The number is allocated sequentially for each partial CDR (or whole CDR) including all CDR types. The number is unique within the CCF
Record Sequence Number	O _c	This field contains a running sequence number employed to link the partial records generated by the CCF for a particular session
Cause For Record Closing	O _M	This field contains a reason for the release of the CDR
Incomplete CDR Indication	O _c	This field provides additional diagnostics when the CCF detects missing ACRs
IMS Charging Identifier	O _M	This parameter holds the IMS charging identifier (ICID) as generated by the IMS node for the SIP session. This parameter corresponds to IMS-Charging-Identifier (ICID) AVP
SDP Session Description	O _c	Holds the Session portion of the SDP data exchanged between the User Agents if available in the SIP transaction. This parameter corresponds to SDP-Session-Description AVP
List of SDP Media Components	O _c	This is a grouped field comprising several sub-fields associated with one media component. It may occur several times in one CDR. The field is present only in a SIP session related case
SIP Request Timestamp	O _M	This parameter contains the time of the SIP Request (usually a (Re)Invite). This parameter corresponds to SIP-Request-Timestamp AVP in ACR [Interim] .

Field	Category	Description
SIP Response Timestamp	O _M	This parameter contains the time of the response to the SIP Request (usually a 200 OK). This parameter corresponds to SIP-Response-Timestamp AVP in ACR [Interim].
SDP Media Components	O _M	This is a grouped field comprising several sub-fields associated with one media component. Since several media components may exist for a session in parallel these sub-fields may occur several times. This parameter corresponds to SDP-Media-Component AVP
SDP Media Name	O _M	This field holds the name of the media as available in the SDP data. This parameter corresponds to SDP-Media-Name
SDP Media Description	O _M	This field holds the attributes of the media as available in the SDP data. This parameter corresponds to SDP-Media-Description
GPRS Charging ID	O _M	This parameter holds the GPRS charging ID (GCID) which is generated by the GGSN for a GPRS PDP context. This parameter corresponds to GPRS-Charging-Id AVP
Media Initiator Flag	O _c	This field indicates if the called party has requested the session modification and it is present only if the initiator was the called party
GGSN Address	O _c	This parameter holds the control plane IP address of the GGSN that handles one or more media component(s) of a IMS session. This parameter corresponds to GGSN-Address AVP
Service Delivery Failure Reason	O _c	Holds the reason for why a requested service could not be successfully provided (i.e. SIP error codes taken from <i>SIP-Method</i> AVP). This field is not present in case of a successful service delivery
Service Specific Data	O _c	This field contains service specific data
List of Message Bodies	O _c	This grouped field comprising several sub-fields describing the data that may be conveyed end-to-end in the body of a SIP message. Since several message bodies may be exchanged via SIP-signalling, this grouped field may occur several times
Content-Type	O _c	This sub-field of Message Bodies holds the MIME type of the message body, Examples are: application/zip, image/gif, audio/mpeg, etc. This parameter corresponds to UUS-Data AVP/Mime-Type AVP or Event-Type AVP/ Content-Type
Content-Disposition	O _c	This sub-field of Message Bodies holds the content disposition of the message body inside the SIP signalling, Content-disposition header field equal to 'render', indicates that 'the body part should be displayed or otherwise rendered to the user'. Content disposition values are: session, render, inline, icon, alert, attachment, etc. This parameter corresponds to Even-Type AVP / Content-Disposition AVP
Content-Length	O _c	This sub-field of Message Bodies holds the size of the data of a message body in bytes. This parameter corresponds to UUS-Data AVP/ Amount-of-UUS-data AVP or Event-Type AVP / Content-Length AVP
Originator	O _c	This sub-field of the "List of Message Bodies" indicates the originating party of the message body. This parameter corresponds to UUS-Data AVP/ Direction AVP
Record Extensions	O _c	A set of operator/manufacturer specific extensions to the record, conditioned upon existence of an extension

6.2 Data description for IMS online charging

6.2.1 Diameter message contents

6.2.1.1 Summary of Online Charging Message Formats

IMS Online Charging uses the Credit-Control-Request (CCR) and Credit-Control-Answer (CCA) messages defined in TS 32.299 [50].

Table 6.2.1.1 describes the use of these messages for online charging.

Table 6.2.1.1: Online Charging Messages Reference Table

Command-Name	Source	Destination	Abbreviation
Credit-Control-Request	MRFC, AS, IMS-GWF	OCS	CCR
Credit-Control-Answer	OCS	MRFC, AS, IMS-GWF	CCA

6.2.1.2 Structure for the Credit Control Message Formats

IMS online charging uses the diameter credit control application with the two messages Credit-Control-Request (CCR) and Credit-Control-Answer (CCA). The request performs rating of the IMS service and reserves units on the users account. The answer replies back with amount of reserved units or an error code if the user is out of credit. Detailed information about the diameter online charging application is described in TS 32.299 [50].

This sub clause describes the different AVPs used in the credit control messages.

Editors Note: The IMS specific AVPs should be put in the Service Information AVP

The CCR types in the table are listed in the following order: I (initial)/ U (update)/ T (terminate)/E (event). Therefore, when all CCR types are possible it is marked as IUTE. If only some CCR types are allowed for a node, only the appropriate letters are used (i.e. IUT or E) as indicated in the table heading. The omission of a CCR type for a particular AVP is marked with "-" (i.e. IU-E). Also, when an entire AVP is not allowed in a node the entire cell is marked as "-".

Note that not for all Grouped AVPs the individual AVP members are listed in the table. Detailed descriptions of the AVPs are provided in TS 32.299 [50].

6.2.1.2.1 MRFC Credit-Control-Request Message

Table 6.2.1.2.1 illustrates the basic structure of a Diameter credit control request message from MRFC as used for IMS online charging.

Table 6.2.1.2.1: Credit-Control-Request (CCR) Message Contents for MRFC

AVP	Category	Description	Type
Session-Id	M	Described in 32.299 [50]	IUTE
Origin-Host	M	Described in 32.299 [50]	IUTE
Origin-Realm	M	Described in 32.299 [50]	IUTE
Destination-Realm	M	Described in 32.299 [50]	IUTE
Auth-Application-Id	M	Described in 32.299 [50]	IUTE
Destination-Host	O _C	Described in 32.299 [50]	IUTE
User-Name	O _C	Described in 32.299 [50]	IUTE
Origin-State-Id	O _C	Described in 32.299 [50]	IUTE
Event-Timestamp	O _C	Described in 32.299 [50]	IUTE
CC-Request-Type	M	Described in 32.299 [50]	IUTE
CC-Request-Number	M	Described in 32.299 [50]	IUTE
CC-Subsession-Id	?	Described in 32.299 [50]	-
Subscription-Id	O _C	Described in 32.299 [50]	IUTE
Requested-Action	O _C	Described in 32.299 [50]	---E
Requested-Service-Unit	O _C	Described in 32.299 [50]	IU-E
Used-Service-Unit	O _C	Described in 32.299 [50]	-UT-
Service-Parameter-Info	O _C	Described in 32.299 [50]	IUTE
CC-Correlation-Id	O _C	Described in 32.299 [50]	IUTE
Service-Identifier	?	Described in 32.299 [50]	????
Service-Context	?	Described in 32.299 [50]	????
Multiple-Services-Indicator	?	Described in 32.299 [50]	-
Multiple-Services-Credit Control	?	Described in 32.299 [50]	-
Route-Record	C	Described in 32.299 [50]	IUTE
AVP	O _C	Described in 32.299 [50]	IUTE
IMS-Information	O _C	Described in clause 6.2.2	IUTE

The full description of the AVPs is specified in TS 32.299 [50].

6.2.1.2.2 AS Credit-Control-Request Message

Table 6.2.1.2.2 illustrates the basic structure of a Diameter credit control request message from Application Server as used for IMS online charging.

Table 6.2.1.2.2: Credit-Control-Request (CCR) Message Contents for AS

AVP	Category	Description	Type
Session-Id	M	Described in 32.299 [50]	IUTE
Origin-Host	M	Described in 32.299 [50]	IUTE
Origin-Realm	M	Described in 32.299 [50]	IUTE
Destination-Realm	M	Described in 32.299 [50]	IUTE
Auth-Application-Id	M	Described in 32.299 [50]	IUTE
Destination-Host	O _c	Described in 32.299 [50]	IUTE
User-Name	O _c	Described in 32.299 [50]	IUTE
Origin-State-Id	O _c	Described in 32.299 [50]	IUTE
Event-Timestamp	O _c	Described in 32.299 [50]	IUTE
CC-Request-Type	M	Described in 32.299 [50]	IUTE
CC-Request-Number	M	Described in 32.299 [50]	IUTE
CC-Subsession-Id	?	Described in 32.299 [50]	-
Subscription-Id	O _c	Described in 32.299 [50]	IUTE
Requested-Action	O _c	Described in 32.299 [50]	---E
Requested-Service-Unit	O _c	Described in 32.299 [50]	IU-E
Used-Service-Unit	O _c	Described in 32.299 [50]	-UT-
Service-Parameter-Info	O _c	Described in 32.299 [50]	IUTE
CC-Correlation-Id	O _c	Described in 32.299 [50]	IUTE
Service-Identifier	?	Described in 32.299 [50]	????
Multiple-Services-Indicator	?	Described in 32.299 [50]	-
Multiple-Services-Credit Control	?	Described in 32.299 [50]	-
Route-Record	C	Described in 32.299 [50]	IUTE
AVP	O _c	Described in 32.299 [50]	IUTE
IMS-Information	O _c	Described in clause 6.2.2	IUTE

The full description of the AVPs for IMS is specified in TS 32.299 [50].

6.2.1.2.3 IMS Gateway Credit-Control Message

Table 6.2.1.2.3 illustrates the basic structure of a Diameter credit control request message from IMS Gateway as used for IMS online charging.

Table 6.2.1.2.3: Credit-Control-Request (CCR) Message Contents for IMS-GWF

AVP	Category	Description	Type
Session-Id	M	Described in 32.299 [50]	IUTE
Origin-Host	M	Described in 32.299 [50]	IUTE
Origin-Realm	M	Described in 32.299 [50]	IUTE
Destination-Realm	M	Described in 32.299 [50]	IUTE
Auth-Application-Id	M	Described in 32.299 [50]	IUTE
Destination-Host	O _C	Described in 32.299 [50]	IUTE
User-Name	O _C	Described in 32.299 [50]	IUTE
Origin-State-Id	O _C	Described in 32.299 [50]	IUTE
Termination-Cause	O _C	Described in 32.299 [50]	IUTE
Event-Timestamp	O _C	Described in 32.299 [50]	IUTE
CC-Request-Type	M	Described in 32.299 [50]	IUTE
CC-Request-Number	M	Described in 32.299 [50]	-
CC-Subsession-Id	O _C	Described in 32.299 [50]	IUTE
Subscription-Id	O _C	Described in 32.299 [50]	---E
Requested-Action	O _C	Described in 32.299 [50]	IU-E
Requested-Service-Unit	O _C	Described in 32.299 [50]	-UT-
Used-Service-Unit	O _C	Described in 32.299 [50]	IUTE
Service-Parameter-Info	O _C	Described in 32.299 [50]	IUTE
CC-Correlation-Id	O _C	Described in 32.299 [50]	IUTE
Service-Identifier	?	Described in 32.299 [50]	-
Multiple-Services-Indicator	?	Described in 32.299 [50]	-
Multiple-Services-Credit Control	?	Described in 32.299 [50]	-
Route-Record	C	Described in 32.299 [50]	IUTE
AVP	O _C	Described in 32.299 [50]	IUTE
IMS-Information	O _C	Described in clause 6.2.2	IUTE

The full description of the AVPs for IMS is specified in TS 32.299 [50].

6.2.1.2.4 Credit-Control-Answer Message

Table 6.2.1.2.4 illustrates the basic structure of a Diameter credit control answer message as used for IMS charging. This message is always used by the OCS as specified below, independent of the receiving IMS node and the CCR request type that is being replied to.

Editors Note: rework the table to include which network elements use which parameters.

Table 6.2.1.2.4: Credit-Control-Answer (CCA) Message Contents for MRFC, AS and IMS-GWF

AVP	Category	Description	Type
Session-Id	M	Described in 32.299 [50]	IUTE
Result-Code	M	Described in 32.299 [50]	IUTE
Origin-Host	M	Described in 32.299 [50]	IUTE
Origin-Realm	M	Described in 32.299 [50]	IUTE
Auth-Application-Id	M	Described in 32.299 [50]	IUTE
User-Name	O _c	Described in 32.299 [50]	IUTE
Origin-State-Id	O _c	Described in 32.299 [50]	IUTE
Event-Timestamp	O _c	Described in 32.299 [50]	IUTE
CC-Request-Type	M	Described in 32.299 [50]	IUTE
CC-Request-Number	M	Described in 32.299 [50]	IUTE
CC-Subsession-Id	?	Described in 32.299 [50]	-
Subscription-Id	O _c	Described in 32.299 [50]	IUTE
Tariff-Switch-Definition	?	Described in 32.299 [50]	-
Cost-Information	O _c	Described in 32.299 [50]	IUTE
Final-Unit-Indication	O _c	Described in 32.299 [50]	IUTE
Check-Balance-Result	O _c	Described in 32.299 [50]	IUTE
Credit-Control-Failure-Handling	O _c	Described in 32.299 [50]	IU--
Validity-Time	O _c	Described in 32.299 [50]	IU--
Direct-Debiting-Failure-Handling	?	Described in 32.299 [50]	-
Multiple-Services-Credit Control	?	Described in 32.299 [50]	-

6.2.2 AVPs for IMS Online Charging on the Ro interface

The IMS Information AVP used for IMS online charging is provided in the Service-Information AVP.

The use of the Attribute Value Pairs (AVPs) that are defined is available in the Diameter application specification TS 32.299 [50].

6.2.2.1 Definition of the IMS-Information AVP

The detailed structure of the IMS-Information AVP can be found in table 6.2.2.1.

The AVP header bit denoted as 'M', indicates whether support of the AVP is required. The AVP header bit denoted as 'V', indicates whether the optional Vendor-ID field is present in the AVP header.

Table 6.2.2.1: Structure of the IMS-Information AVP

AVP Name	AVP Code	Defined	Value Type	AVP Flag rules			
				Must	May	Should not	Must not
[Event-Type]	823	[50]	Grouped				
[SIP-Method]	824	[50]	UTF8String				
[Event]	825	[50]	UTF8String				
[Content-Type]	826	[50]	UTF8String				
[Content-Length]	827	[50]	UTF8String				
[Content-Disposition]	828	[50]	UTF8String				
[Role-of-Node]	829	[50]	Enumerated				
[User Session Id]	830	[50]	UTF8String				
[Calling-Party-Address]	831	[50]	UTF8String				
[Called-Party-Address]	832	[50]	UTF8String				
[Time-stamps]	833	[50]	Grouped				
[SIP-Request-Timestamp]	834	[50]	UTF8String				
[SIP-Response-Timestamp]	835	[50]	UTF8String				
[Application-server-Information]	863	[50]	Grouped				
[Application-server]	836	[50]	UTF8String				
*[Application-provided-called-party-address]	837	[50]	UTF8String				
*[Inter-Operator-Identifier]	838	[50]	Grouped				
[Originating-IOI]	839	[50]	UTF8String				
[Terminating-IOI]	840	[50]	UTF8String				
[IMS-Charging-Identifier]	841	[50]	UTF8String				
*[SDP-Session-Description]	842	[50]	UTF8String				
*[SDP-Media-component]	843	[50]	Grouped				
[SDP-Media-Name]	844	[50]	UTF8String				
*[SDP-Media-Description]	845	[50]	UTF8String				
[GPRS-Charging-Id]	846	[50]	UTF8String				
[GGSN-Address]	847	[50]	IPAddress				
[Served-Party-IP-Address]	848	[50]	IPAddress				
[Authorized-QoS]	849	[50]	UTF8String				
[Server-Capabilities]	[19]	[50]					
[Trunk-Group-Id]	851	[50]	Grouped				
[Incoming-Trunk-Group-Id]	852	[50]	UTF8String				
[Outgoing-Trunk-Group-Id]	853	[50]	UTF8String				
[Bearer-Service]	854	[50]	OctetString				
[Service-Id]	855	[50]	UTF8String				
[UUS-Data]	856	[50]	Grouped				
[Amount-of-UUS-data]	857	[50]	UTF8String				
[Mime-type]	858	[50]	UTF8String				
[Direction]	859	[50]	Enumerated				
[Cause]	860	[50]	Grouped				
{Cause-Code}	861	[50]	Enumerated				
{Node-Functionality}	862	[50]	Enumerated				
[Service-Specific-Data]	xxx	[50]	UTF8String				

Annex A (informative): Application Charging ID

Editors note: Subject for further review.

A.1 Charging correlation procedures for presence

For presence service, ICID is not sufficient for correlation information for presence charging because ICID is used only to correlate IMS session level with bearer level for IMS basic PS services. In Release 6, non SIP protocol such as XCAP for Ut interface shall also trigger to generate the ICID for charging purposes. Besides that in rel6, new services such as presence, conference, etc is coming up where ICID is not enough correlation information any more.

Since presence service is involved with the other SIP requests triggered by Presence server or Resource list server, new ACID (Application Charging ID) shall be generated apart from ICID during presence related SIP/non SIP requests.

The ACID is used for correlation between the multiple session related or session unrelated dialog for watcher and the session related or session unrelated dialog for the presentities. Because these multiple set of dialogs shares the related charging data records so that these shall be treaded as one package for charging purposes.

The ACID is generated at the first entity which decides the SIP/non SIP request as presence service or conference service. Note that in case when the combined presence and conference services are occurred, for example, first initiated ACID triggered by either of service is used entirely until all involved dialogs are terminated.

A.1.1 Subscription for presence event notification

When S-CSCF receives SUBSCRIBE from the watcher, S-CSCF shall check event header in SUBSCRIBE and shall generate ACID if event header is set to "presence". S-CSCF shall insert the ACID to P-Application Charging-Vector header of SUBSCRIBE when S-CSCF sends SUBSCRIBE to presence server. The presence server shall insert ACID to 200 OK when the presence server sends 200 OK to the watcher.

A.1.2 Subscription for his own resource list

When S-CSCF receives SUBSCRIBE from the watcher, S-CSCF shall check event header in SUBSCRIBE and shall generate ACID if event header is set to "presence". S-CSCF shall insert the ACID to P-Service Charging-Vector header of SUBSCRIBE when S-CSCF sends SUBSCRIBE to resource list server. The resource list server shall insert ACID to 200 OK when the resource list server sends 200 OK to the watcher.

A.1.3 RLS subscription to presentities

When RLS sends SUBSCRIBE to presence server belonging to presentities, RLS shall insert ACID into P-Application Charging-Vector header of SUBSCRIBE saved locally when SUBSCRIBE is received from the watcher. In case when RLS has to send multiple SUBSCRIBE to presentities, the same SCID shall be inserted into SUBSCRIBE to each presentity.

A.1.4 Updating of presence information by UE

When S-CSCF receives PUBLISH from the presentity, S-CSCF shall check ACID saved locally for the presentity S-CSCF shall insert the ACID to P-Service Charging-Vector header of PUBLISH when S-CSCF sends PUBLISH to presence server. The presence server shall insert the SCID to 200 OK when the presence server sends 200 OK to the presentity.

A.1.5 PS notifying watcher of updates to presence information

When PS sends NOTIFY to watcher, PS shall insert ACID into NOTIFY saved locally when SUBSCRIBE is received from the watcher.

A.1.6 PS notifying resource list server and watcher of updates to presence information

When PS sends NOTIFY to RLS, PS shall insert ACID into P-Service Charging-Vector header of NOTIFY saved locally when SUBSCRIBE is received from the watcher. In case when RLS has to send multiple NOTIFY to watchers, the same ACID shall be inserted into NOTIFY to each watcher.

A.1.7 Generation of ICID for non SIP request

For the presence service, on receiving the non SIP request (ex. XCAP for Ut interface) at P-CSCF or on initiating the non SIP request at AS, ICID shall be generated and inserted into the relevant xml parameter of message and sent to the next entities.

A.2 Charging correlation procedures for Conference

Since conference service is involved with multi-party sessions triggered by Focus or other participants, ACID shall be also generated apart from ICID during conference related SIP/non SIP requests. ACID is used for correlation between the session related or session unrelated dialog for participants. Because these set of dialogs share the related charging data records so that these shall be treated as one package for charging purposes in later use. The ACID is generated at the first entity which decides the SIP/non SIP requests as conference service. The ACID is also used for presence or other service.

Note that in case when the combined presence and conference services are occurred, for example, first initiated ACID triggered by either of service is used entirely until all involved dialogs are terminated.

A.2.1 Joining a conference using the conference URI - dial in

When S-CSCF receives INVITE from participant, S-CSCF shall check conference URI in INVITE and shall generate ACID if present. S-CSCF shall insert the ACID to P-Service-Charging ID-Vector of INVITE when S-CSCF sends INVITE to Focus. Focus shall insert ACID to 200 OK when Focus sends 200 OK to the participant.

A.2.2 Adding a participant by the Focus - dial out

When Focus initiates INVITE to participant, the Focus shall generate ACID and shall insert the ACID to P-Service-Charging ID-Vector of INVITE when the Focus sends INVITE to the participant.

A.2.3 Manually creating a conference by dialling into conferencing application

When a conference server application receives INVITE from participant, the application requests additional input from participant before it is able to create a conference. After focus is created, when the focus initiates INVITE to participant, the Focus shall generate ACID and shall insert the generated ACID to P-Service-Charging ID-Vector of INVITE when the Focus sends INVITE to the participant.

A.2.4 Creating a Conference by conference-unaware UA

In this case, participant creates the conference URI (using some convention agreed to with the focus domain) and sends an INVITE to that URI which creates the focus. When S-CSCF receives INVITE from participant, S-CSCF shall check conference URI in INVITE and shall generate ACID if present. S-CSCF shall insert the generated ACID to P-Service-Charging ID-Vector of INVITE when S-CSCF sends INVITE to Focus. Focus shall insert ACID to 200 OK when Focus sends 200 OK to participant.

A.2.5 Creating a Conference using Ad-Hoc SIP methods

In this case, the conference factory URI is used to automatically create the conference. The SIP URI of the conference factory is provided with preconfigured data in UA. Initial INVITE from participant is sent to conference factory for creating the focus. The conference factory applications send back a 302 Moved temporarily response with the conference URI generated at conference factory. After receiving 302 Moved temporarily, participant sends INVITE to the focus. When S-CSCF receives INVITE from participant, S-CSCF shall check conference URI in INVITE and shall generate ACID if present. S-CSCF shall insert the ACID to P-Service-Charging ID-Vector of INVITE when S-CSCF sends INVITE to the focus.

A.2.6 Requesting the Focus to add a new resource to a conference

When the S-CSCF receives REFER from participants, S-CSCF shall insert the ACID saved locally for this session, and send REFER to S-CSCF and Focus. When the Focus initiates INVITE to new participant, the Focus shall insert the said ACID which is received from S-CSCF to INVITE when the Focus sends INVITE to new participant.

A.2.7 Adding a 3rd party using conference URI

When the S-CSCF receives REFER from participants, S-CSCF shall insert the ACID saved locally for this session, and send REFER to new participant. When the new participant initiates INVITE to the Focus, the Focus shall insert the said ACID received from S-CSCF to INVITE when the Focus sends INVITE to new participant.

A.2.8 Adding a 3rd party using dialog identifier

When the Focus receives JOIN with dialogue identifier from new participants, the Focus shall insert the ACID saved locally for the session related to this dialog identifier, and send 200 OK to new participant.

A.2.9 Changing user agents within a conference

When the Focus receives REPLACE with dialogue identifier from new UA, but the same participants, the Focus shall insert the ACID saved locally for the session related to this dialog identifier, and send 200 OK to new participant.

A.2.10 Bringing a point to point dialog into a conference

Focus shall send re-INVITE with a different conference URI and the ACID saved locally for the session related to this dialog identifier to the requesting participant.

A.2.11 Generation of ICID for non SIP request

For the conference service, on receiving the non SIP request (ex. XCAP for Ut interface) at P-CSCF or on initiating the non SIP request at AS, ICID shall be generated and inserted into the relevant XML parameter of message and sent to the next entities.

Annex B (informative): Bibliography

a) **The 3GPP charging specifications**

- 3GPP TS 32.250: "Telecommunication management; Charging management; Circuit Switched (CS) domain charging".
- 3GPP TS 32.251: "Telecommunication management; Charging management; Packet Switched (PS) domain charging".
- 3GPP TS 32.252: "Telecommunication management; Charging management; Wireless Local Area Network (WLAN) charging".
- 3GPP TS 32.270: "Telecommunication management; Charging management; Multimedia Messaging Service (MMS) charging".
- 3GPP TS 32.271: "Telecommunication management; Charging management; Location Services (LCS) charging".
- 3GPP TS 32.296: "Telecommunication management; Charging management; Online Charging System (OCS) applications and interfaces".

b) **Common 3GPP specifications**

- 3GPP TS 22.101: "Service aspects; Service Principles".
- 3GPP TS 22.115 "Service aspects; Charging and Billing".
- 3GPP TS 23.003: "Numbering, addressing and identification".
- 3GPP TS 27.001: "General on Terminal Adaptation Functions (TAF) for Mobile Stations (MS)".

c) **other Domain and Service specific 3GPP / ETSI specifications**

-

d) **Relevant ITU Recommendations**

- ITU-T Recommendation D.93: "Charging and accounting in the international land mobile telephone service (provided via cellular radio systems)".
- ITU-T Recommendation E.164: "The international public telecommunication numbering plan".
- ITU-T Recommendation Q.767: "Application of the ISDN user part of CCITT signalling System No.7 for international ISDN interconnections".
- ITU-T Recommendation X.25: "Interface between Data Terminal Equipment (DTE) and Data Circuit-terminating Equipment (DCE) for terminals operating in the packet mode and connected to public data networks by dedicated circuit".
- ITU-T Recommendation X.121: "International numbering plan for public data networks".

e) **Relevant IETF RFCs**

- IETF RFC 959 (1985): "File Transfer Protocol".

Annex C (informative): Change history

Change history								
Date	TSG #	TSG Doc.	CR	Rev	Subject/Comment	Cat	Old	New
Mar 2004	SA_23	SP-040144	--	--	Submitted to TSG SA#23 for Information		1.0.0	
Dec 2004	SA_26	SP-040777	--	--	Submitted to TSG SA#26 for Approval		2.0.0	6.0.0
Mar 2005	SA_27	SP-050030	0001	--	Correction of missing Service Specific Data AVP (Attribute Value Pair)	A	6.0.0	6.1.0
Mar 2005	SA_27	SP-050030	0002	--	Correction of criteria for the presence of the GPRS charging ID in the IMS CDRs - Align with SA2's TS 23.228	A	6.0.0	6.1.0
Mar 2005	SA_27	SP-050030	0003	--	Correction of Table 5.2.1.1: 'addition of reporting of 2xx/3xx events'	F	6.0.0	6.1.0
Jun 2005	SA_28	SP-050276	0004	--	Correction to scope	F	6.1.0	6.2.0
Jun 2005	SA_28	SP-050276	0005	--	Correction to references	F	6.1.0	6.2.0
Jun 2005	SA_28	SP-050276	0005	-	Correction to references	F	6.1.0	6.2.0
Sep 2005	SA_29	SP-050437	0006	-	Remove GGSN Address from the I-CSCF CDR	F	6.2.0	6.3.0
Sep 2005	SA_29	SP-050437	0007	-	Correct service delivery "Start" and "End" time stamps	F	6.2.0	6.3.0
Sep 2005	SA_29	SP-050437	0009	-	Correct handling of 3xx response	F	6.2.0	6.3.0

History

Document history		
V6.0.0	December 2004	Publication
V6.1.0	March 2005	Publication
V6.2.0	June 2005	Publication
V6.3.0	September 2005	Publication