

ETSI TS 132 260 V7.6.0 (2009-01)

Technical Specification

**Digital cellular telecommunications system (Phase 2+);
Universal Mobile Telecommunications System (UMTS);
LTE;
Telecommunication management;
Charging management;
IP Multimedia Subsystem (IMS) charging
(3GPP TS 32.260 version 7.6.0 Release 7)**



Reference

RTS/TSGS-0532260v760

Keywords

GSM, UMTS

ETSI

650 Route des Lucioles
F-06921 Sophia Antipolis Cedex - FRANCE

Tel.: +33 4 92 94 42 00 Fax: +33 4 93 65 47 16

Siret N° 348 623 562 00017 - NAF 742 C
Association à but non lucratif enregistrée à la
Sous-Préfecture de Grasse (06) N° 7803/88

Important notice

Individual copies of the present document can be downloaded from:

<http://www.etsi.org>

The present document may be made available in more than one electronic version or in print. In any case of existing or perceived difference in contents between such versions, the reference version is the Portable Document Format (PDF). In case of dispute, the reference shall be the printing on ETSI printers of the PDF version kept on a specific network drive within ETSI Secretariat.

Users of the present document should be aware that the document may be subject to revision or change of status.

Information on the current status of this and other ETSI documents is available at

<http://portal.etsi.org/tb/status/status.asp>

If you find errors in the present document, please send your comment to one of the following services:

http://portal.etsi.org/chaicor/ETSI_support.asp

Copyright Notification

No part may be reproduced except as authorized by written permission.
The copyright and the foregoing restriction extend to reproduction in all media.

© European Telecommunications Standards Institute 2009.
All rights reserved.

DECTTM, **PLUGTESTS**TM, **UMTS**TM, **TIPHON**TM, the TIPHON logo and the ETSI logo are Trade Marks of ETSI registered for the benefit of its Members.

3GPPTM is a Trade Mark of ETSI registered for the benefit of its Members and of the 3GPP Organizational Partners.

LTETM is a Trade Mark of ETSI currently being registered

for the benefit of its Members and of the 3GPP Organizational Partners.

GSM[®] and the GSM logo are Trade Marks registered and owned by the GSM Association.

Intellectual Property Rights

IPRs essential or potentially essential to the present document may have been declared to ETSI. The information pertaining to these essential IPRs, if any, is publicly available for **ETSI members and non-members**, and can be found in ETSI SR 000 314: *"Intellectual Property Rights (IPRs); Essential, or potentially Essential, IPRs notified to ETSI in respect of ETSI standards"*, which is available from the ETSI Secretariat. Latest updates are available on the ETSI Web server (<http://webapp.etsi.org/IPR/home.asp>).

Pursuant to the ETSI IPR Policy, no investigation, including IPR searches, has been carried out by ETSI. No guarantee can be given as to the existence of other IPRs not referenced in ETSI SR 000 314 (or the updates on the ETSI Web server) which are, or may be, or may become, essential to the present document.

Foreword

This Technical Specification (TS) has been produced by ETSI 3rd Generation Partnership Project (3GPP).

The present document may refer to technical specifications or reports using their 3GPP identities, UMTS identities or GSM identities. These should be interpreted as being references to the corresponding ETSI deliverables.

The cross reference between GSM, UMTS, 3GPP and ETSI identities can be found under <http://webapp.etsi.org/key/queryform.asp>.

Contents

| | |
|---|----|
| Intellectual Property Rights | 2 |
| Foreword..... | 2 |
| Foreword..... | 5 |
| 1 Scope | 6 |
| 2 References | 6 |
| 3 Definitions, symbols and abbreviations | 8 |
| 3.1 Definitions | 8 |
| 3.2 Symbols..... | 9 |
| 3.3 Abbreviations | 9 |
| 4 Architecture Considerations | 10 |
| 4.1 High level IP Multimedia Subsystem (IMS) architecture | 10 |
| 4.2 IMS offline charging architecture..... | 11 |
| 4.3 IMS online charging architecture | 11 |
| 5 Charging Principles | 12 |
| 5.1 IMS Charging Principles | 12 |
| 5.1.2 IMS Charging Correlation | 12 |
| 5.1.2.1 Basic Principles for IMS Domain Correlation | 12 |
| 5.1.2.2 IMS Charging Identifier (ICID)..... | 12 |
| 5.1.2.3 Access network charging identifier..... | 13 |
| 5.1.2.4 Inter Operator Identifier (IOI)..... | 13 |
| 5.1.2.5 Void..... | 13 |
| 5.2 IMS Offline Charging Principles..... | 13 |
| 5.2.1 Basic Principles | 13 |
| 5.2.2 Diameter Message Flows and Types | 15 |
| 5.2.2.1 Message Flows - Successful Cases and Scenarios | 15 |
| 5.2.2.1.1 Session Establishment - Mobile Origination | 15 |
| 5.2.2.1.2 Session Establishment - Mobile Termination..... | 16 |
| 5.2.2.1.3 Mid-Session Procedures | 17 |
| 5.2.2.1.4 Session Release - Mobile Initiated | 18 |
| 5.2.2.1.5 Session-Unrelated Procedures | 19 |
| 5.2.2.1.6 Session Establishment - PSTN Initiated | 20 |
| 5.2.2.1.7 Session Establishment - IMS Initiated..... | 21 |
| 5.2.2.1.8 Session Release - PSTN Initiated | 22 |
| 5.2.2.1.9 Session Release - IMS Initiated..... | 23 |
| 5.2.2.1.10 Multi-Party Call..... | 24 |
| 5.2.2.1.11 AS Related Procedures - AS Acting as a Redirect Server | 26 |
| 5.2.2.1.12 AS Related Procedures - AS Acting as a Voice Mail Server..... | 27 |
| 5.2.2.1.13 AS Related Procedures - AS Acting as a VCC AS..... | 28 |
| 5.2.2.1.14 Initiating Alternate Charged Party Call | 36 |
| 5.2.2.2 Message Flows - Error Cases and Scenarios..... | 37 |
| 5.2.2.2.1 Session Related SIP Procedures- Reception of SIP error messages | 37 |
| 5.2.2.2.2 Session Related SIP Procedures - SIP session failure | 37 |
| 5.2.2.2.3 Session Unrelated SIP procedures | 37 |
| 5.2.2.2.4 CDF Connection Failure..... | 37 |
| 5.2.2.2.5 No Reply from CDF | 37 |
| 5.2.2.2.6 Duplicate Detection | 37 |
| 5.2.2.2.7 CDF Detected Failure..... | 38 |
| 5.2.3 CDR generation | 38 |
| 5.2.4 GTP" record transfer flows | 38 |
| 5.2.5 Bi CDR file transfer | 38 |
| 5.3 IMS Online Charging Scenarios..... | 38 |
| 5.3.1 Basic Principles | 38 |
| 5.3.2 Diameter Message Flows and Types | 41 |
| 5.3.2.1 Immediate Event Charging (IEC)..... | 41 |

| | | |
|-------------------------------|---|-----------|
| 5.3.2.1.1 | Message Flows - Successful Cases and Scenarios..... | 41 |
| 5.3.2.1.2 | Message Flows - Error Cases and Scenarios | 42 |
| 5.3.2.2 | Event Charging with Unit Reservation (ECUR) and Session Charging with Unit Reservation (SCUR) | 43 |
| 5.3.2.2.1 | Message Flows - Successful Cases and Scenarios..... | 43 |
| 5.3.2.2.1.2 | Expiration of Reservation Validity | 43 |
| 5.3.2.2.2 | Message Flows - Error Cases and Scenarios | 49 |
| 5.3.2.3 | IMS Service Termination by OCS | 49 |
| 5.3.2.3.1 | Triggers on Ro interface which imply the termination of the IMS service | 49 |
| 5.3.2.3.2 | Indication to the UE of the reason for IMS service release | 50 |
| 6 | Definition of charging information | 51 |
| 6.1 | Data description for IMS offline charging | 51 |
| 6.1.1 | Rf Message contents | 51 |
| 6.1.1.1 | Charging Data-Request Message..... | 51 |
| 6.1.1.2 | Charging Data Response Message..... | 52 |
| 6.1.2 | GTP" message contents | 52 |
| 6.1.3 | CDR Description on the Bi Interface..... | 52 |
| 6.1.3.1 | CDR Field Types | 52 |
| 6.1.3.2 | CDR Triggers..... | 53 |
| 6.1.3.2.1 | Session Related CDRs..... | 53 |
| 6.1.3.2.2 | Session Unrelated CDRs | 53 |
| 6.1.3.3 | S-CSCF CDR Content..... | 54 |
| 6.1.3.4 | P-CSCF CDR Content..... | 57 |
| 6.1.3.5 | I-CSCF CDR Content | 60 |
| 6.1.3.6 | MRFC CDR Content..... | 61 |
| 6.1.3.7 | MGCF CDR Content..... | 64 |
| 6.1.3.8 | BGCF CDR Content | 66 |
| 6.1.3.9 | SIP AS CDR Content..... | 68 |
| 6.2 | Data description for IMS online charging | 70 |
| 6.2.1 | Ro message contents..... | 70 |
| 6.2.1.1 | Debit and Reserve Units Request Message | 71 |
| 6.2.1.2 | Debit and Reserve Units Response Message..... | 72 |
| 6.3 | IMS Charging Specific Parameters | 73 |
| 6.3.1 | Definition of IMS charging information..... | 73 |
| 6.3.1.1 | IMS charging information assignment for Service Information | 73 |
| 6.3.1.2 | Definition of the IMS Information..... | 73 |
| 6.3.2 | Detailed Message Format for offline charging | 75 |
| 6.3.3 | Detailed Message Format for online charging..... | 77 |
| 6.3.4 | Formal IMS charging parameter description | 79 |
| 6.3.4.1 | IMS charging information for CDRs | 79 |
| 6.3.4.2 | IMS charging information for charging events | 79 |
| Annex A (informative): | Bibliography..... | 80 |
| Annex B (informative): | Message Flows for Service Termination by OCS..... | 81 |
| B.1 | Scenario 1 - Session Related (SCUR): Service Termination on reception of an initial SIP INVITE Request..... | 81 |
| B.2 | Scenario 2 - Session Related (SCUR): Service Termination triggered after an early SIP Dialog is established..... | 82 |
| B.3 | Scenario 3 - Session Related (SCUR): Service Termination triggered after a confirmed SIP Dialog is established..... | 85 |
| B.4 | Scenario 4 - Session Unrelated (ECUR): Service Termination on reception of an initial SIP non-INVITE Request..... | 88 |
| B.5 | Scenario 5 - Session Unrelated (IEC): Service Termination on reception of an initial SIP non-INVITE Request..... | 89 |
| Annex C (informative): | Change history | 90 |
| History | | 91 |

Foreword

This Technical Specification has been produced by the 3rd Generation Partnership Project (3GPP).

The contents of the present document are subject to continuing work within the TSG and may change following formal TSG approval. Should the TSG modify the contents of the present document, it will be re-released by the TSG with an identifying change of release date and an increase in version number as follows:

Version x.y.z

where:

- x the first digit:
 - 1 presented to TSG for information;
 - 2 presented to TSG for approval;
 - 3 or greater indicates TSG approved document under change control.
- y the second digit is incremented for all changes of substance, i.e. technical enhancements, corrections, updates, etc.
- z the third digit is incremented when editorial only changes have been incorporated in the document.

1 Scope

The present document is part of a series of documents that specify charging functionality and charging management in GSM/UMTS networks. The GSM/UMTS core network charging architecture and principles are specified in document TS 32.240 [1], which provides an umbrella for other charging management documents that specify:

- the content of the CDRs per domain and subsystem (offline charging),
- the content of real-time charging events per domain / subsystem (online charging);
- the functionality of online and offline charging for those domains and subsystems;
- the interfaces that are used in the charging framework to transfer the charging information (i.e. CDRs or charging events)

The complete document structure for these TSs is defined in TS 32.240 [1].

The present document specifies the Offline and Online Charging description for the IP Multimedia Subsystem (IMS), based on the functional descriptions of the IMS in 3GPP TS 23.228 [200]. This charging description includes the offline and online charging architecture and scenarios specific to IMS, as well as the mapping of common 3GPP charging architecture specified in TS 32.240 [1] onto IMS. It further specifies the structure and content of the CDRs for offline charging, and the charging events for online charging. The present document is related to other 3GPP charging TSs as follows:

- The common 3GPP charging architecture is specified in TS 32.240 [1];
- The parameters, abstract syntax and encoding rules for these CDR types are specified in TS 32.298 [51].
- A transaction based mechanism for the transfer of CDRs within the network is specified in TS 32.295 [54].
- The file based mechanism used to transfer the CDRs from the network to the operator's billing domain (e.g. the billing system or a mediation device) is specified in TS 32.297 [52].
- The 3GPP Diameter application that is used for IMS offline and online charging is specified in TS 32.299 [50].

All terms, definitions and abbreviations used in the present document, that are common across 3GPP TSs, are defined in the 3GPP Vocabulary, TR 21.905 [100]. Those that are common across charging management in GSM/UMTS domains, services or subsystems are provided in the umbrella document TS 32.240 [1] and are copied into clause 3 of the present document for ease of reading. Finally, those items that are specific to the present document are defined exclusively in the present document.

Furthermore, requirements that govern the charging work are specified in 3GPP TS 22.115 [102].

2 References

The following documents contain provisions, which, through reference in this text, constitute provisions of the present document.

- References are either specific (identified by date of publication, edition number, version number, etc.) or non-specific.
- For a specific reference, subsequent revisions do not apply.
- For a non-specific reference, the latest version applies. In the case of a reference to a 3GPP document (including a GSM document), a non-specific reference implicitly refers to the latest version of that document *in the same Release as the present document*.

[1] 3GPP TS 32.240: "Telecommunication management; Charging management; Charging architecture and principles".

[2] 3GPP TS 32.250: "Telecommunication management; Charging management; Circuit Switched (CS) domain charging".

- [3] - [10] Void.
- [11] 3GPP TS 32.251: "Telecommunication management; Charging management; Packet Switched (PS) domain charging".
- [12]- [49] Void.
- [50] 3GPP TS 32.299: "Telecommunication management; Charging management; Diameter charging application
- [51] 3GPP TS 32.298: "Telecommunication management; Charging management; Charging Data Record (CDR) parameter description
- [52] 3GPP TS 32.297: "Telecommunication management; Charging management; Charging Data Records (CDR) file format and transfer
- [53] Void.
- [54] 3GPP TS 32.295: "Telecommunication management; Charging management; Charging Data Record (CDR) transfer".
- [55]- [99] Void.
- [100] 3GPP TR 21.905: "Vocabulary for 3GPP Specifications".
- [101]- [102] Void.
- [103] 3GPP TS 23.002: "Network Architecture".
- [104]- [199] Void.
- [200] 3GPP TS 22.228: "IMS Stage 1".
- [201] 3GPP TS 23.228: "Functional stage 2 description of IMS".
- [202] 3GPP TS 24.228: "Signalling flows for the IP multimedia call control based on SIP and SDP, Stage 3'
- [203] 3GPP TS 23.218: "IP Multimedia (IM) session handling; IM call model; Stage 2".
- [204] 3GPP TS 24.229: "Internet Protocol (IP) multimedia call control protocol based on Session Initiation Protocol (SIP) and Session Description Protocol (SDP); Stage 3".
- [205] 3GPP TS 29.229: "Cx and Dx Interfaces based on the Diameter protocol; Protocol Details".
- [206]- [299] Void.
- [300]- [399] Void.
- [400] Void.
- [401] IETF RFC 3588 (2003): 'diameter base protocol".
- [402] IETF RFC 4006: 'Diameter Credit Control Application".
- [403] IETF RFC 2806: "URLs for Telephone Calls".
- [404] IETF RFC 3261: "SIP: Session Initiation Protocol".
- [405] IETF RFC 2486: "The Network Access Identifier".
- [406] RFC 3455 (January 2003): "Private Header (P-Header) Extensions to the Session Initiation Protocol (SIP) for the 3rd-Generation Partnership Project (3GPP)".

3 Definitions, symbols and abbreviations

3.1 Definitions

For the purposes of the present document, the following terms and definitions given in 3GPP TR 21.905 [50], 3GPP TS 32.240 [1], and the following apply:

billing: function whereby CDRs generated by the charging function are transformed into bills requiring payment.

Billing Domain: Part of the operator network, which is outside the core network that receives and processes charging information from the core network charging functions. It includes functions that can provide billing mediation and billing end applications.

CDR field Categories: the CDR fields are defined in the present document. They are divided into the following categories:

- **Mandatory:** field that shall be present in the CDR.
- **Conditional:** field that shall be present in a CDR if certain conditions are met.
- **Operator Provisionable: Mandatory:** A field that operators have provisioned to be included in the CDR for all conditions.
- **Operator Provisionable: Conditional:** A field that operators have provisioned to be included in the CDR if certain conditions are met.

chargeable event: activity utilizing telecommunications network infrastructure and related services for:

- user to user communication (e.g. a single call, a data communication session or a short message); or
- user to network communication (e.g. service profile administration); or
- inter-network communication (e.g. transferring calls, signalling, or short messages); or
- mobility (e.g. roaming or inter-system handover); and
- that the network operator wants to charge for.

charged party: user involved in a chargeable event that has to pay parts or the whole charges of the chargeable event, or a third party paying the charges caused by one or all users involved in the chargeable event, or a network operator.

charging: function whereby information related to a chargeable event is formatted and transferred in order to make it possible to determine usage for which the charged party may be billed.

Charging Data Record (CDR): record generated by a network element for the purpose of billing a subscriber for the provided service. It includes fields identifying the user, the session and the network elements as well as information on the network resources and services used to support a subscriber session. In the traditional circuit domain, CDR has been used to denote "Call Detail Record", which is subsumed by "Charging Data Record" hereafter.

charging function: entity inside the core network domain, subsystem or service that is involved in charging for that domain, subsystem or service.

offline charging: charging mechanism where charging information **does not** affect, in real-time, the service rendered

online charging: charging mechanism where charging information can affect, in real-time, the service rendered and therefore a direct interaction of the charging mechanism with session/service control is required

partial CDR: CDR that provides information on part of a subscriber session. A long session may be covered by several partial CDRs. Two formats are considered for Partial CDRs. One that contains all of the necessary fields; the second has a reduced format.

3.2 Symbols

For the purposes of the present document, the following symbols apply:

| | |
|----|---|
| Bi | Reference point for the CDR file transfer from the IMS CGF to the BD. |
| Ga | Reference point for CDR transfer between a CDF and CGF. |
| Rf | Offline Charging Reference Point between an IMS Network Entity or an AS and CDF |
| Ro | Online Charging Reference Point between an AS or MRFC and IMS-GWF and the OCS |

3.3 Abbreviations

For the purposes of the present document, the following abbreviations apply:

| | |
|---------|---|
| ABNF | Augmented Backus-Naur Form |
| ACA | Accounting Answer |
| ACR | Accounting Request |
| AS | Application Server |
| AVP | Attribute Value Pair |
| B2BUA | Back-to-Back User Agent |
| BGCF | Breakout Gateway Control Function |
| BS | Billing System |
| CCA | Credit Control Answer |
| CCF | Charging Collection Function |
| CCR | Credit Control Request |
| CDF | Charging Data Function |
| CDR | Charging Data Record |
| CGF | Charging Gateway Function |
| CPCF | Content Provider Charging Function |
| ECF | Event Charging Function |
| ECUR | Event Charging with Unit Reservation |
| CSCF | Call Session Control Function (I-Interrogating; P-Proxy; and S-Serving) |
| IEC | Immediate Event Charging |
| IMS | IP Multimedia Subsystem |
| IMS-GWF | IMS Gateway Function |
| ISC | IMS Service Control |
| MGCF | Media Gateway Control Function |
| MRFC | Media Resource Function Controller |
| MRFP | Multimedia Resource Function Processor |
| OCS | Online Charging System |
| SCCF | Subscriber Content Charging Function |
| SCUR | Session Charging with Unit Reservation |
| SDP | Session Description Protocol |
| SIP | Session Initiation Protocol |
| UA | User Agent |
| UE | User Equipment |
| VCC | Voice Call Continuity |
| VDN | VCC Domain transfer Number |

4 Architecture Considerations

4.1 High level IP Multimedia Subsystem (IMS) architecture

Figure 4.1 depicts the logical IMS architecture, as described in 3GPP TS 23.002 [103]

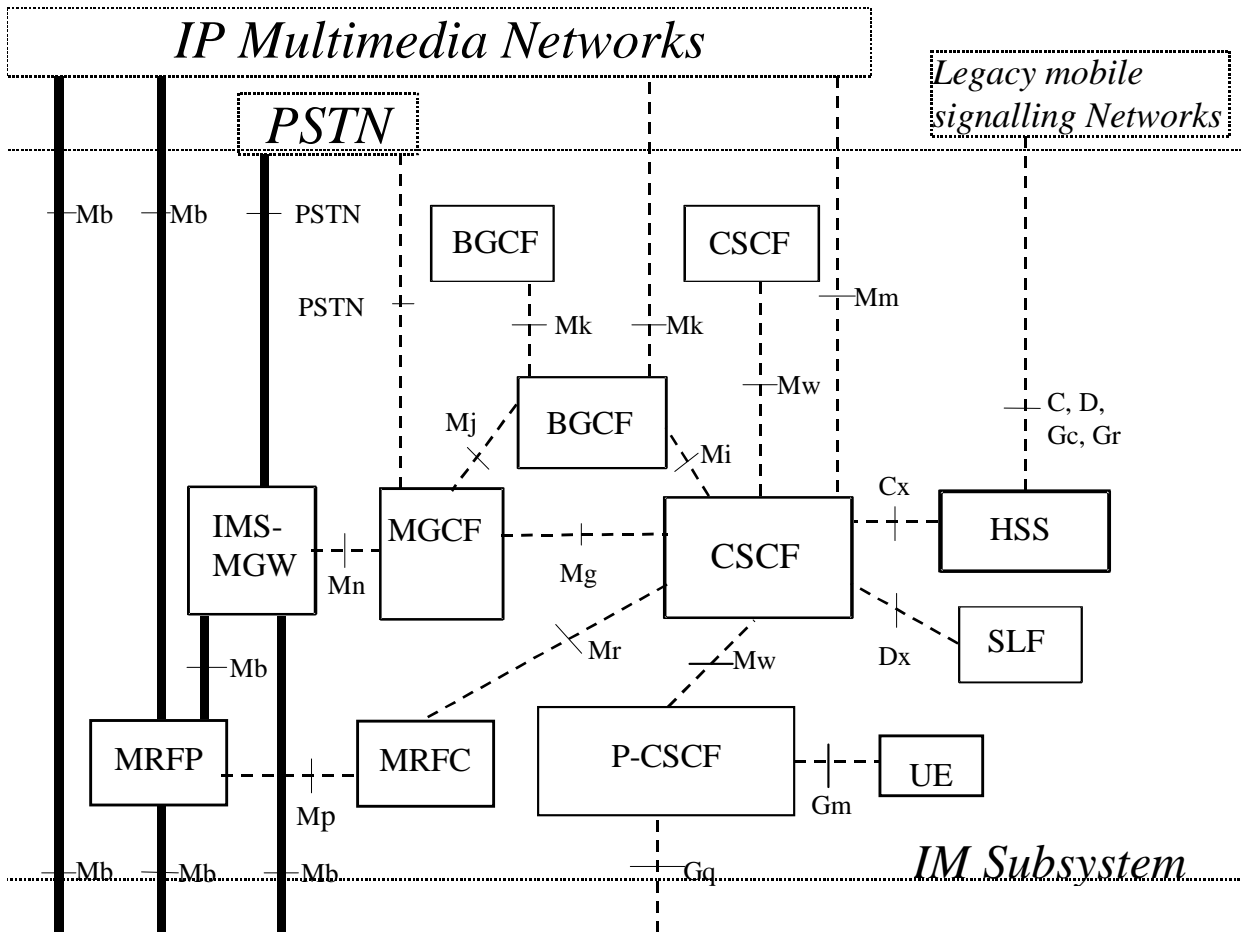

Figure 4.1: IMS logical architecture

4.2 IMS offline charging architecture

The architecture for IMS offline charging is described in the following figure. The Rf interface is described in clause 6.1.1 and Bi in clause 6.1.2.

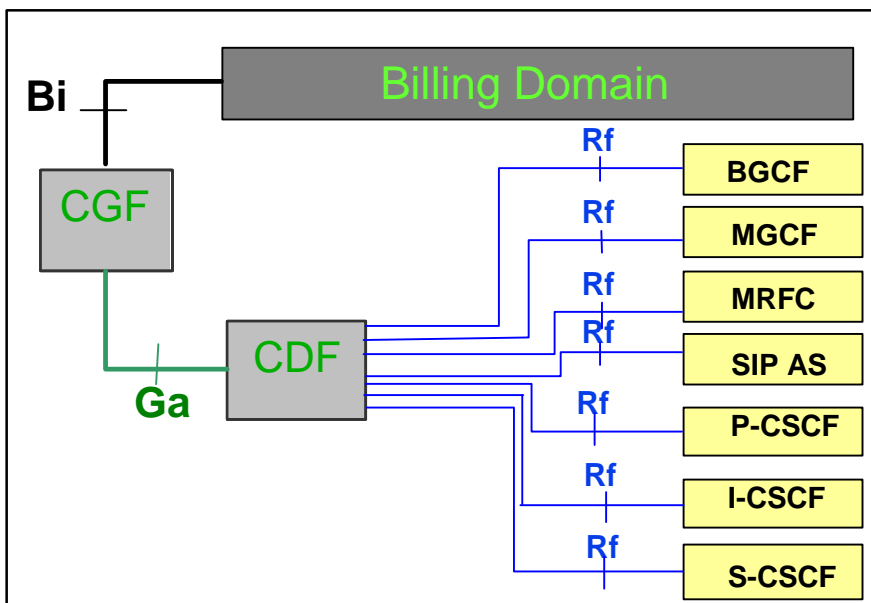

Figure 4.2: IMS offline charging architecture

NOTE: The combination of the CDF/CGF corresponds to the 3GPP Rel-5 CCF.

4.3 IMS online charging architecture

The architecture for IMS online charging is described in the following figure. The Ro interface is described in clause 6.2 and ISC in TS 23.228 [201].

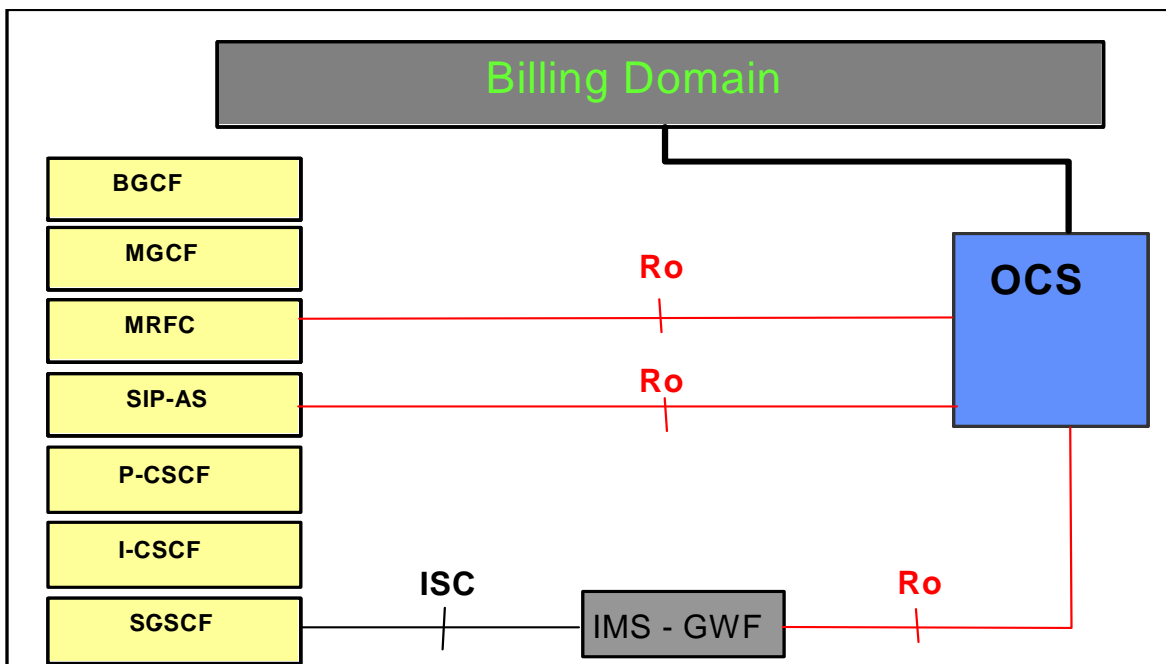

Figure 4.3: IMS online charging Architecture

5 Charging Principles

5.1 IMS Charging Principles

The AS and MRFC are able to distinguish whether to apply offline or online charging, i.e. whether to send charging information over the Rf interface to the CDF or over the Ro interface to the OCS, which includes ECF and SCF as described in chapter 4.3 (or to use both). The decision of which interface to use is based on the information (CDF and/or OCS address) the AS/MRFC receives in the SIP signalling and the system configuration as provisioned by the operator. If the AS/MRFC only receive the CDF address and do not receive an OCS address then they use only the Rf interface. If only the OCS address was provided then they use only the Ro interface. In cases where both CDF and OCS addresses are provided it is possible to use both interfaces simultaneously.

However, operators may overrule the addresses received via the SIP signalling and use their own configured rules instead. Operators may configure locally on the AS/MRFC an OCS and/or CDF address. The choice of whether the IMS network elements use locally configured addresses or the addresses received by SIP signalling, and the decision on which interface(s) to use, is left for operator configuration.

All other IMS network elements (S-CSCF, P-CSCF, I-CSCF, BGCF and MGCF) apply offline charging via the Rf interface using the CDF address as received via SIP signalling or the locally configured CDF address in the IMS network element. The S-CSCF supports online charging using:

- the ISC interface, i.e. if the application server addressed over ISC is the IMS Gateway Function, or
- the Ro interface directly instead of the ISC, if the IMS Gateway Function is integrated within the S-CSCF.

The offline and online charging function addresses transferred in SIP signalling are encoded in the P-Charging-Function-Addresses as defined in TS 24.229 [204] and RFC 3455 [406]. The P-Charging-Function-Addresses header contains the following parameters: CCF (i.e. CDF) and ECF (i.e. OCS).

5.1.2 IMS Charging Correlation

5.1.2.1 Basic Principles for IMS Domain Correlation

The IMS charging correlation information is encoded in the SIP P-Charging-Vector header as defined in the following sub clauses. The P-Charging-Vector header contains the following parameters: ICID, access network charging identifier and IOI.

General correlation mechanisms are defined in TS 32.240 [1], and further details about the usage of P-Charging-Vector are defined in TS 24.229 [204] and RFC 3455 [406].

5.1.2.2 IMS Charging Identifier (ICID)

The IMS domain correlation is based on IMS Charging Identifier (ICID) shared between IMS network elements involved with the same session/transaction. With ICID it is possible to correlate session/transaction related charging data generated in different IMS elements (i.e. x-CSCFs, ASs"). The ICID is included in all SIP methods, if the P-Charging-Vector header is present, and transferred through originating and terminating side nodes, except to UE.

The value of the ICID parameter is identical with the 'icid-value' parameter defined in TS 24.229 [204]. The 'icid-value' is a mandatory part of the P-Charging-Vector and coded as a text-based UTF-8 charset (as are all SIP messages). For further information regarding the composition and usage of the P-Charging-Vector refer to [204] and RFC 3455 [406].

The ICID value is globally unique across all 3GPP IMS networks for a time period of at least one month, implying that neither the node that generated this ICID nor any other IMS network element reuse this value before the uniqueness period expires. The one month minimum uniqueness period counts from the time of release of the ICID, i.e. the ICID value no longer being used. This can be achieved by using node specific information, e.g. high-granularity time information and / or topology / location information. The exact method how to achieve the uniqueness requirement is an implementation issue.

At each SIP session unrelated method, both initial and subsequent (e.g., REGISTER, NOTIFY, MESSAGE etc.), a new, session unrelated ICID is generated at the first IMS network element that processes the method. This ICID value is contained in the SIP request and response of that SIP transaction and must be valid for the duration of the transaction.

At each SIP session establishment a new, session specific ICID is generated at the first IMS network element that processes the session-initiating SIP INVITE message. This ICID is then used in all subsequent SIP messages for that session (e.g., 200 OK, (re-)INVITE, BYE etc.) until the session is terminated.

5.1.2.3 Access network charging identifier

The access network charging identifier is the media flow level data shared among the IMS network elements for one side of the session (either the originating or terminating side). This information is used to correlate the access network charging data with the IMS charging data. The access network is identified by bearer specific correlation identifier, e.g. for Packet Switched Access (GGSN address and PDP context Identifier) or Fixed Broadband Access (Multimedia Charging Identifier). The access network charging identifier is populated in the P-Charging-Vector using the access-network-charging-info parameter. For further information regarding the composition and usage of the access-network-charging-info parameter refer to TS 24.229[204] and RFC 3455 [406].

5.1.2.4 Inter Operator Identifier (IOI)

The IOI identifies both originating and terminating networks involved in a session/transaction. The IOI may be generated from each side of session/transaction to identify the home networks associated with each side. The orig-ioi and term-ioi parameters of P-Charging-Vector represent the originating and terminating operator identifiers. For further information regarding the composition and usage of the orig-ioi and term-ioi parameters refer to TS 24.229[204] and RFC 3455 [406].

5.1.2.5 Void

5.2 IMS Offline Charging Principles

5.2.1 Basic Principles

The offline charging functionality is based on the IMS network nodes reporting accounting information upon reception of various SIP methods or ISUP messages, as most of the accounting relevant information is contained in these messages. This reporting is achieved by sending Diameter *Accounting Requests* (ACR) [Start, Interim, Stop and Event] from the IMS network elements to the CDF.

The Diameter client uses ACR Start, Interim and Stop in procedures related to successful SIP sessions. It uses ACR Events for unsuccessful SIP sessions and for session unrelated procedures. Further details are specified in the tables below and in clause 5.2.2.

It is operator configurable in the nodes for which SIP method or ISUP messages an *Accounting Request* is sent. Table 5.2.1.1 describes all possible ACRs that might be sent from a P-CSCF, I-CSCF, S-CSCF, MGCF or BGCF. A list of node specific ACRs, along with the AVPs to be included are detailed in TS 32.299 [50].

The ACRs to be sent from a MRFC are described in table 5.2.1.2.

It is configurable for the operators to enable or disable the generation of an ACR message by the IMS node in response to a particular "Triggering SIP Method /ISUP Message". However, for those table entries marked with *, the operator can enable or disable the ACR message based on whether or not the SIP (Re) Invite message that is replied to by the "Triggering SIP Method /ISUP Message" carried piggybacked user data.

Table 5.2.1.1: Accounting Request Messages Triggered by SIP Methods or ISUP Messages for all IMS nodes except for MRFC and AS

| Diameter Message | Triggering SIP Method /ISUP Message |
|---|---|
| ACR [Start] | SIP 200 OK acknowledging an initial SIP INVITE (see note 2) (not applicable for BGCF) ISUP:ANM (applicable for the MGCF) |
| ACR [Interim] | SIP 200 OK acknowledging a SIP RE-INVITE or SIP UPDATE [e.g. change in media components] (see note 2) Expiration of AVP [Acct-Interim-Interval] (see note 2) |
| ACR [Stop] | SIP BYE message (both normal and abnormal session termination cases) (see note 2) (not applicable for BGCF) ISUP:REL (applicable for the MGCF) |
| ACR [Event] | SIP 200 OK acknowledging non-session related SIP messages, which are: SIP NOTIFY (see note 1 and note 2) SIP MESSAGE SIP REGISTER (see note 1) SIP SUBSCRIBE (see note 3) SIP PUBLISH SIP 200 OK acknowledging an initial SIP INVITE (only for BGCF) SIP 202 Accepted acknowledging a SIP REFER or any other method SIP Final Response 2xx (except SIP 200 OK) SIP Final/Redirection Response 3xx SIP Final Response (4xx, 5xx or 6xx), indicating an unsuccessful SIP session set-up SIP Final Response (4xx, 5xx or 6xx), indicating an unsuccessful session-unrelated procedure SIP CANCEL, indicating abortion of a SIP session set-up (see note 2) I-CSCF completing a Cx Query that was issued in response to a SIP INVITE |
| NOTE 1: SIP REGISTER with its "Expires" header field or "Expires" parameter equal to 0 or local deregistration due to expiry means Deregistration (see 3GPP TS 24.229 [204]). | |
| NOTE 2: (only for I-CSCF): This trigger may only occur if I-CSCF is acting in THIG mode. | |
| NOTE 3: SIP SUBSCRIBE with the field "Expires" set to 0 means unsubscribe. | |

Table 5.2.1.2: Accounting Request Messages Triggered by SIP Methods for the MRFC

| Diameter Message | Triggering SIP Method |
|--|---|
| ACR [Start] | SIP 200 OK acknowledging a SIP INVITE for initiating a multimedia ad hoc conferencing session |
| ACR [Interim] | SIP ACK acknowledging a SIP INVITE to connect an UE to the conferencing session SIP REINVITE (see Note 1) SIP BYE (see Note 2) Expiration of AVP [Acct-Interim-Interval] |
| ACR [Stop] | SIP BYE message (see Note 3) SIP CANCEL (see Note 3) SIP Final Response with error codes 4xx, 5xx or 6xx indicating termination of an ongoing session (see Note 3) |
| ACR [Event] | SIP Final/Redirection Response 3xx SIP Final Response with error codes 4xx, 5xx or 6xx indicating termination of an ongoing session SIP CANCEL, indicating abortion of a SIP session set-up SIP REFER SIP SUBSCRIBE |
| NOTE 1: This trigger only applies to a user joining an ongoing conferencing session | |
| NOTE 2: This trigger only applies to a user leaving an ongoing conferencing session | |
| NOTE 3: This trigger only applies if this causes the ongoing conferencing session to terminate | |

5.2.2 Diameter Message Flows and Types

The flows described in the present document specify the charging communications between IMS entities and the charging functions for different charging scenarios. The SIP messages and Diameter transactions associated with these charging scenarios are shown primarily for general information and to illustrate the charging triggers. They are not intended to be exhaustive of all the SIP message flows discussed in TS 24.228 [200] and they depend on the Diameter Accounting Requests triggers configured by the operator.

5.2.2.1 Message Flows - Successful Cases and Scenarios

5.2.2.1.1 Session Establishment - Mobile Origination

The following figure shows the Diameter transactions that are required between CSCF and CDF during session establishment originated by a UE.

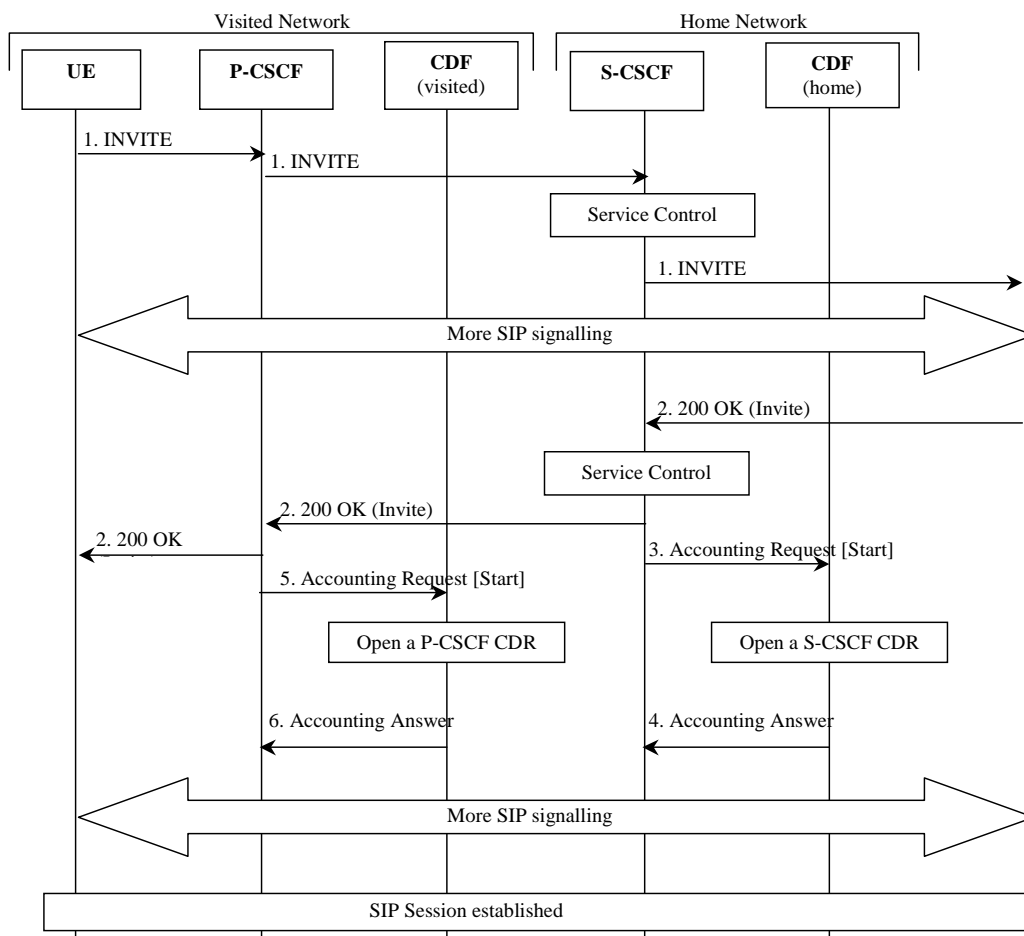

Figure : Message Sequence Chart for Session Establishment (Mobile Origination)

1. The session is initiated.
2. The destination party answers and a final response are received.
3. Upon reception of the final response, the S-CSCF sends an *Accounting-Request* with *Accounting-Record-Type* indicating START_RECORD to record start of a user session and start of a media component in the S-CSCF CDR.
4. The CDF acknowledges the reception of the data and opens an S-CSCF CDR.
5. Same as 3, but for P-CSCF.
6. Same as 4, but creating a P-CSCF CDR.

5.2.2.1.2 Session Establishment - Mobile Termination

The following figure shows the Diameter transactions that are required between CSCF and CDF during a session establishment that is terminated to a mobile. The I-CSCF is only involved in the INVITE transaction.

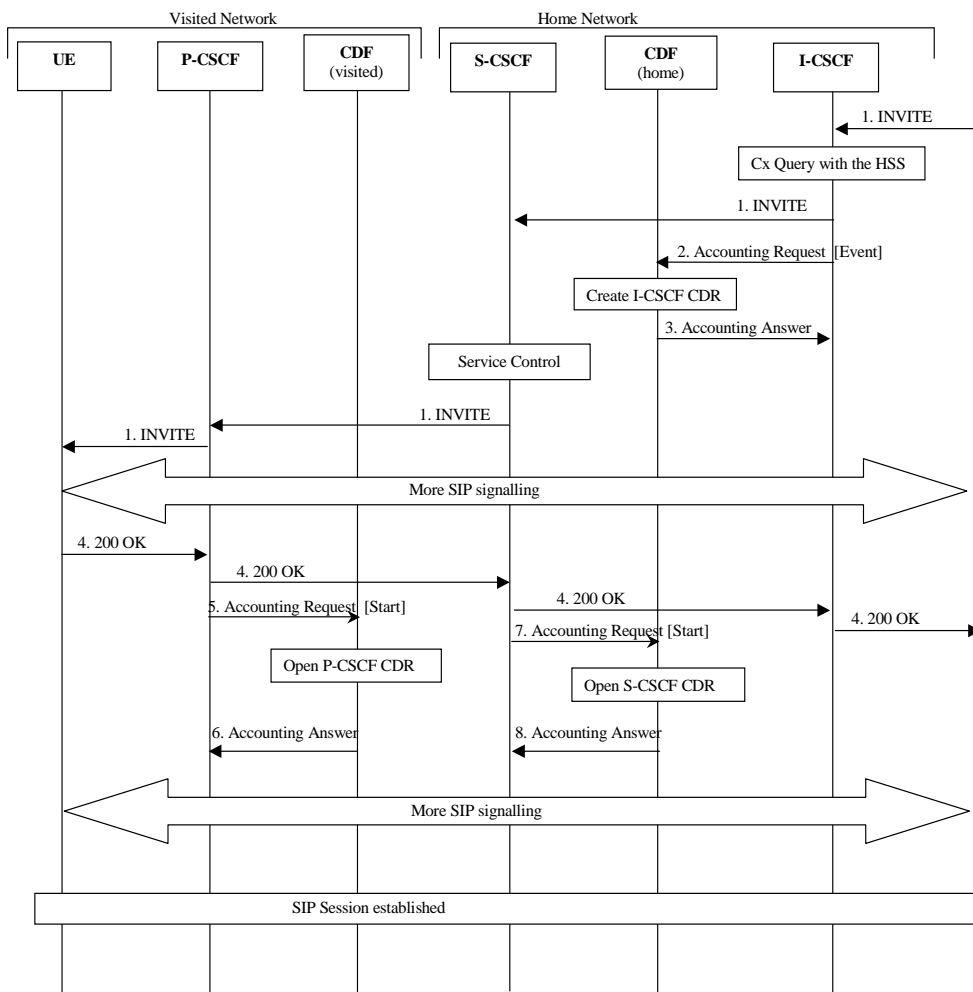

Figure : Message Sequence Chart for Session Establishment (Mobile Termination)

- 1. The session is initiated.
- 2. Upon completing a Cx query the I-CSCF sends an *Accounting Request* with the *Accounting-Record-Type* set to EVENT.
- 3. The CDF acknowledges the data received and creates an I-CSCF CDR.
- 4. The destination party answers and a final response are sent.
- 5. - 8. These steps are identical to the corresponding steps described in clause 5.2.2.1.1.

5.2.2.1.3 Mid-Session Procedures

The following figure shows the Diameter transactions that are required between CSCF and CDF when a UE generates a SIP (Re-)INVITE or SIP UPDATE in mid-session, e.g. in order to modify media component(s), or when the hold and resume procedure is executed.

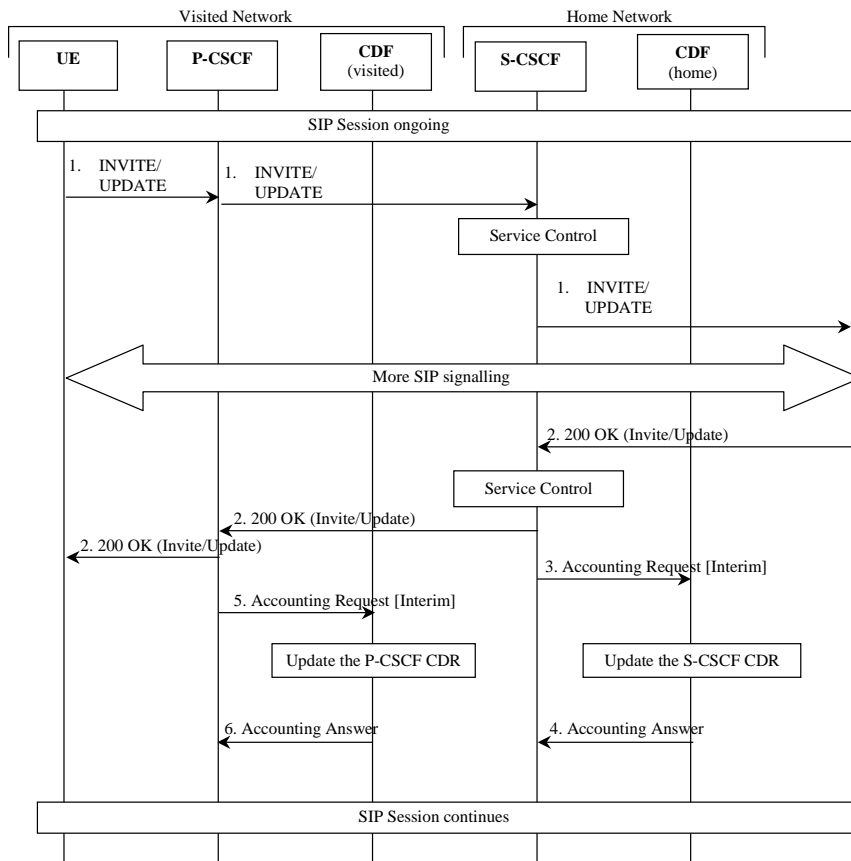

Figure : Message Sequence Chart for Media Modification

1. Modified media information is received from the subscriber.
2. The destination party acknowledges the media modification.
3. At modification of a media, the S-CSCF sends *Accounting-Request* with *Accounting-Record-Type* indicating INTERIM_RECORD to record modification of a media component in the S-CSCF CDR.
4. The CDF acknowledges the reception of the data and updates the S-CSCF CDR.
5. Same as 3, but for P-CSCF.
6. Same as 4, updating the P-CSCF CDR.

5.2.2.1.4 Session Release - Mobile Initiated

The following figure shows the Diameter transactions that are required between CSCF and CDF for a session release that is initiated by the UE.

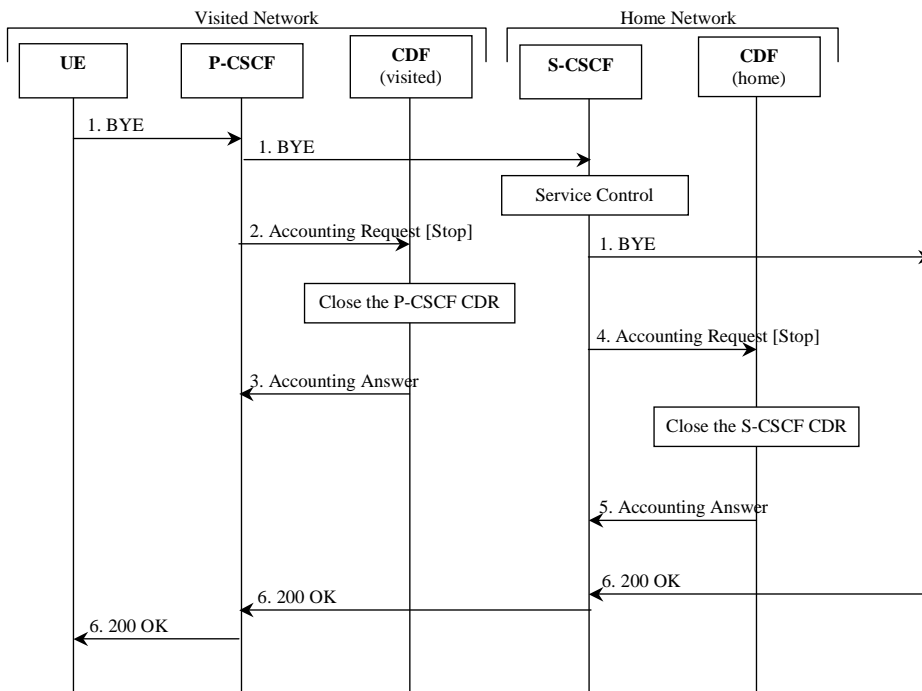

Figure : Message Sequence Chart for Session Release

1. The session is released.
2. At session termination the P-CSCF sends *Accounting-Request* with *Accounting-Record-Type* indicating STOP_RECORD to record stop of a session and stop of a media component in the P-CSCF CDR.
3. The CDF acknowledges the reception of the data and closes the P-CSCF CDR.
4. Same as 2, but for S-CSCF.
5. Same as 3, closing the S-CSCF CDR.
6. The release is acknowledged.

5.2.2.1.5 Session-Unrelated Procedures

The following figure shows the Diameter transactions that are required between CSCF and CDF for session-unrelated IMS procedures, i.e. those that relate to the Diameter ACR [Event], as listed in Table 5.2.1.1.

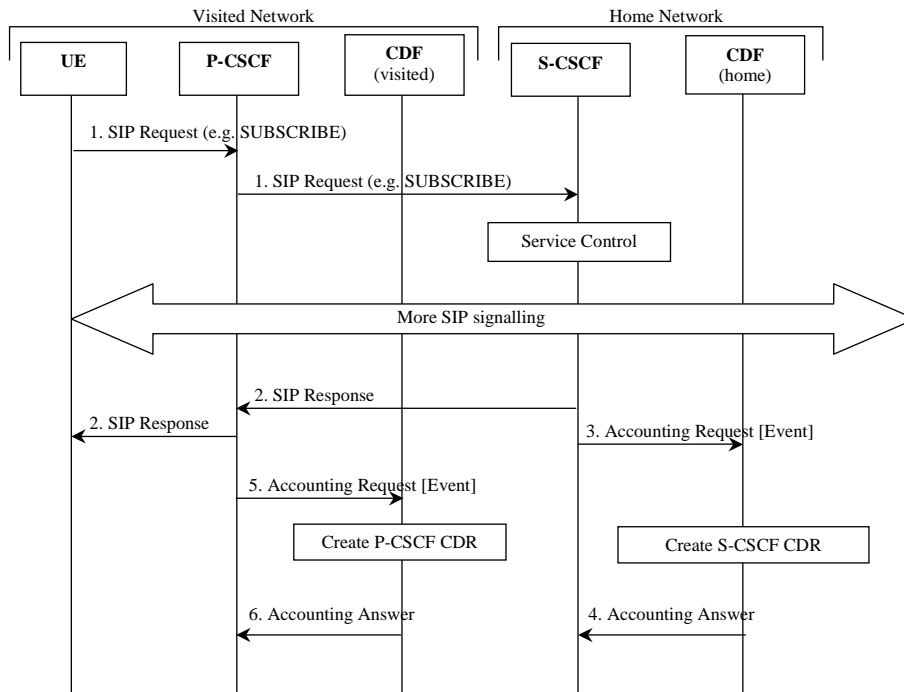

Figure : Message Sequence Chart for Session-Unrelated Procedure

1. The P-CSCF receives a "SIP Request" (e.g. SUBSCRIBE) from the subscriber.
2. The "SIP Request" is acknowledged by the "SIP Response" as follows:
 - in the successful case, a 200 OK message is returned;
 - in case of failure an appropriate SIP error message is returned.

Depending on the used SIP method, there might be additional signalling between steps 1 and 2.

3. After the completion of the procedure, the S-CSCF sends *Accounting-Request* with *Accounting-Record-Type* indicating *EVENT_RECORD* to record transaction specific information in the S-CSCF CDR.
4. The CDF acknowledges the reception of the data and produces an S-CSCF CDR.
5. Same as 3, but for P-CSCF.
6. Same as 4, creating a P-CSCF CDR.

5.2.2.1.6 Session Establishment - PSTN Initiated

The following figure shows the Diameter transactions that are required between MGCF and CDF during session establishment initiated from the PSTN side.

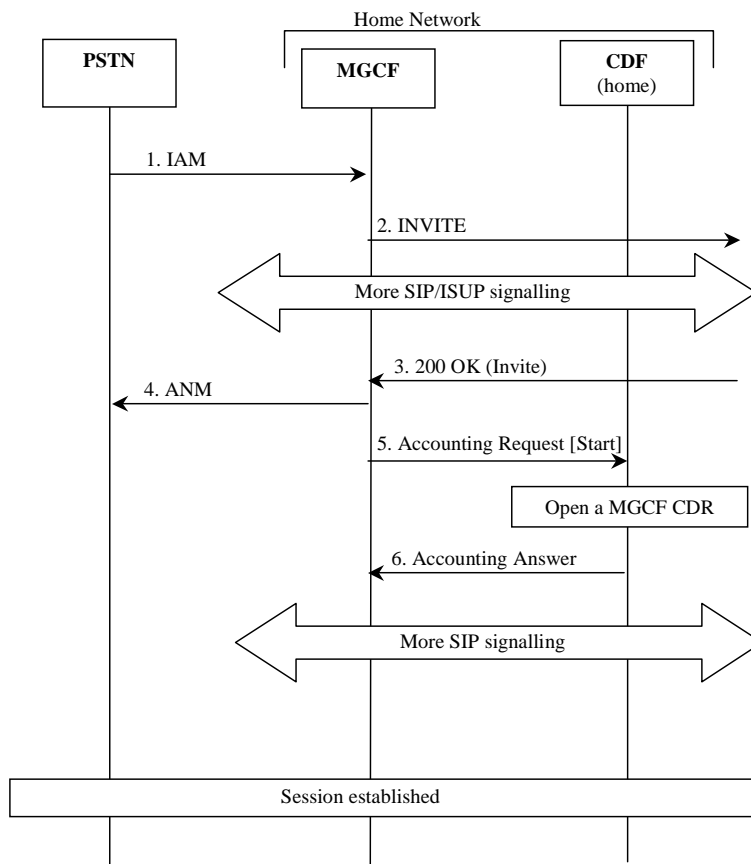

Figure : Message Sequence Chart for Session Establishment (PSTN Initiated)

1. The session is originated from the PSTN.
2. The session setup is triggered in the IMS.
3. The destination party answers and a final response are received.
4. MGCF forwards an answer message to the PSTN.
5. Upon reception of the final response, the MGCF sends an *Accounting-Request* with *Accounting-Record-Type* indicating *START_RECORD* to record start of a user session and start of a media component in the MGCF CDR.
6. The CDF acknowledges the reception of the data and opens a MGCF CDR.

5.2.2.1.7 Session Establishment - IMS Initiated

The following figure shows the Diameter transactions that are required between BGCF, MGCF and CDF during session establishment initiated from the IMS side.

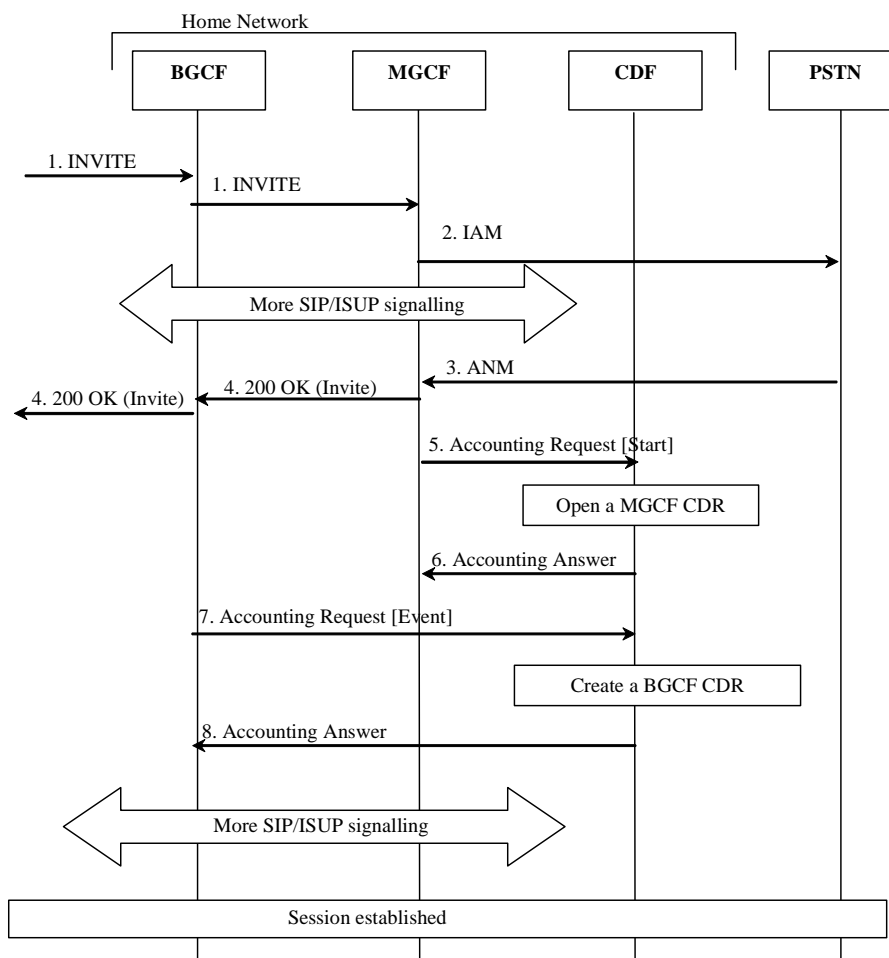

Figure : Message Sequence Chart for Session Establishment (IMS Initiated)

1. The session is originated from the IMS.
2. A session towards PSTN is established.
3. The destination party answers and an answer message are received.
4. A final response message is sent to the session originator.
5. Upon reception of the answer message, the MGCF sends an *Accounting-Request* with *Accounting-Record-Type* indicating START_RECORD to record start of a user session and start of a media component in the MGCF CDR.
6. The CDF acknowledges the reception of the data and opens a MGCF CDR.
7. Upon reception of the 200 OK message, the BGCF sends an *Accounting-Request* with *Accounting-Record-Type* indicating EVENT_RECORD to record start of a user session and start of a media component in the BGCF CDR.
8. The CDF acknowledges the reception of the data and creates a BGCF CDR.

5.2.2.1.8 Session Release - PSTN Initiated

The following figure shows the Diameter transactions that are required between MGCF and CDF during a PSTN initiated session release.

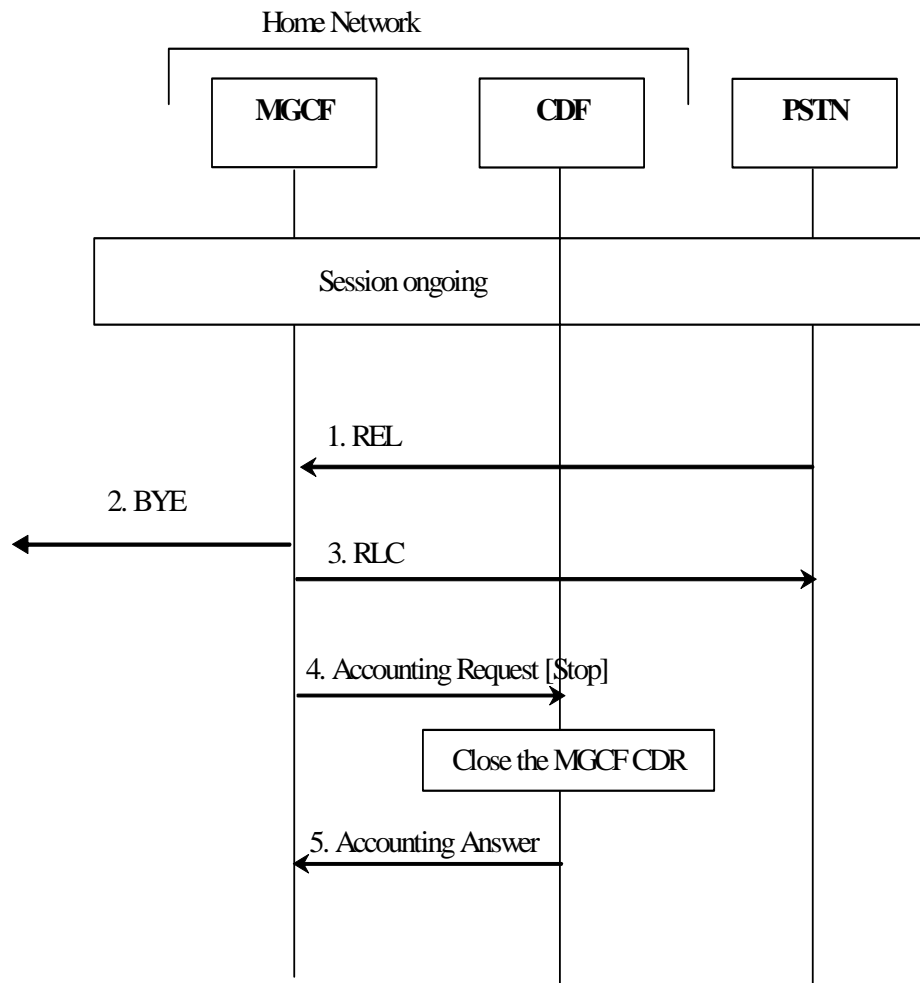

Figure : Message Sequence Chart for Session Release (PSTN initiated)

1. The session release is initiated from PSTN.
2. Session release continues within IMS.
3. The reception of the release message is acknowledged.
4. Upon reception of the release message, the MGCF sends an *Accounting-Request* with *Accounting-Record-Type* indicating STOP_RECORD to record stop of a session in the MGCF CDR.
5. The CDF acknowledges the reception of the data and closes the MGCF CDR.

5.2.2.1.9 Session Release - IMS Initiated

The following figure shows the Diameter transactions that are required between MGCF and CDF during a IMS initiated session release.

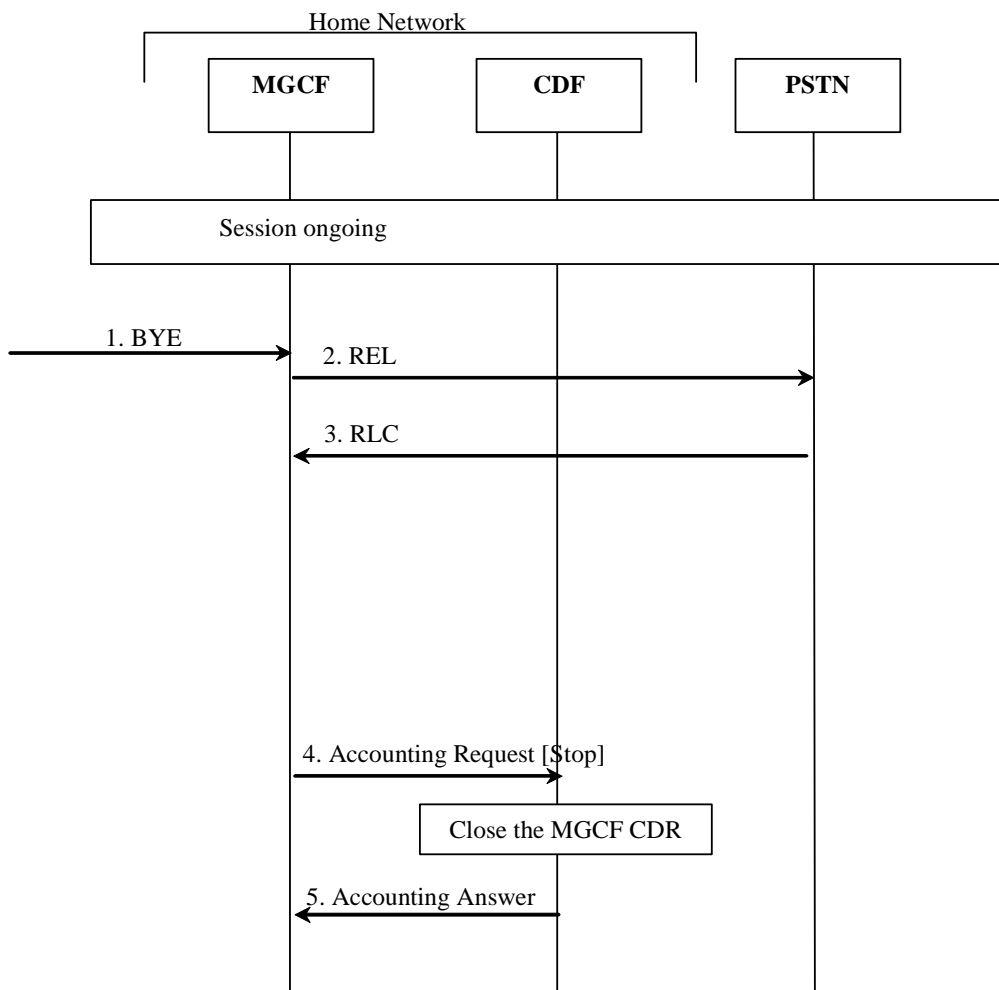

Figure : Message Sequence Chart for Session Release (IMS initiated)

1. The session release is initiated from the IMS side.
2. A release message is sent towards PSTN.
3. The acknowledgement of the release message is received from PSTN.
4. Upon reception of the BYE message the MGCF sends an *Accounting Request* with *Accounting Record Type* indicating STOP_RECORD to record stop of a session in the MGCF CDR.
5. The CDF acknowledges the reception of the data and closes the MGCF CDR.

5.2.2.1.10 Multi-Party Call

The following figure shows the establishment of an ad hoc conference (multiparty call). An AS (acting as B2BUA) performs third party call control with the MRFC, where the S-CSCF is in the signalling path. The Application Server that is in control of the ad hoc conference is aware of the MRFC capabilities. Note that only accounting information sent from the MRFC is shown in detail in the figure. The SIP messages are for illustrative purpose only.

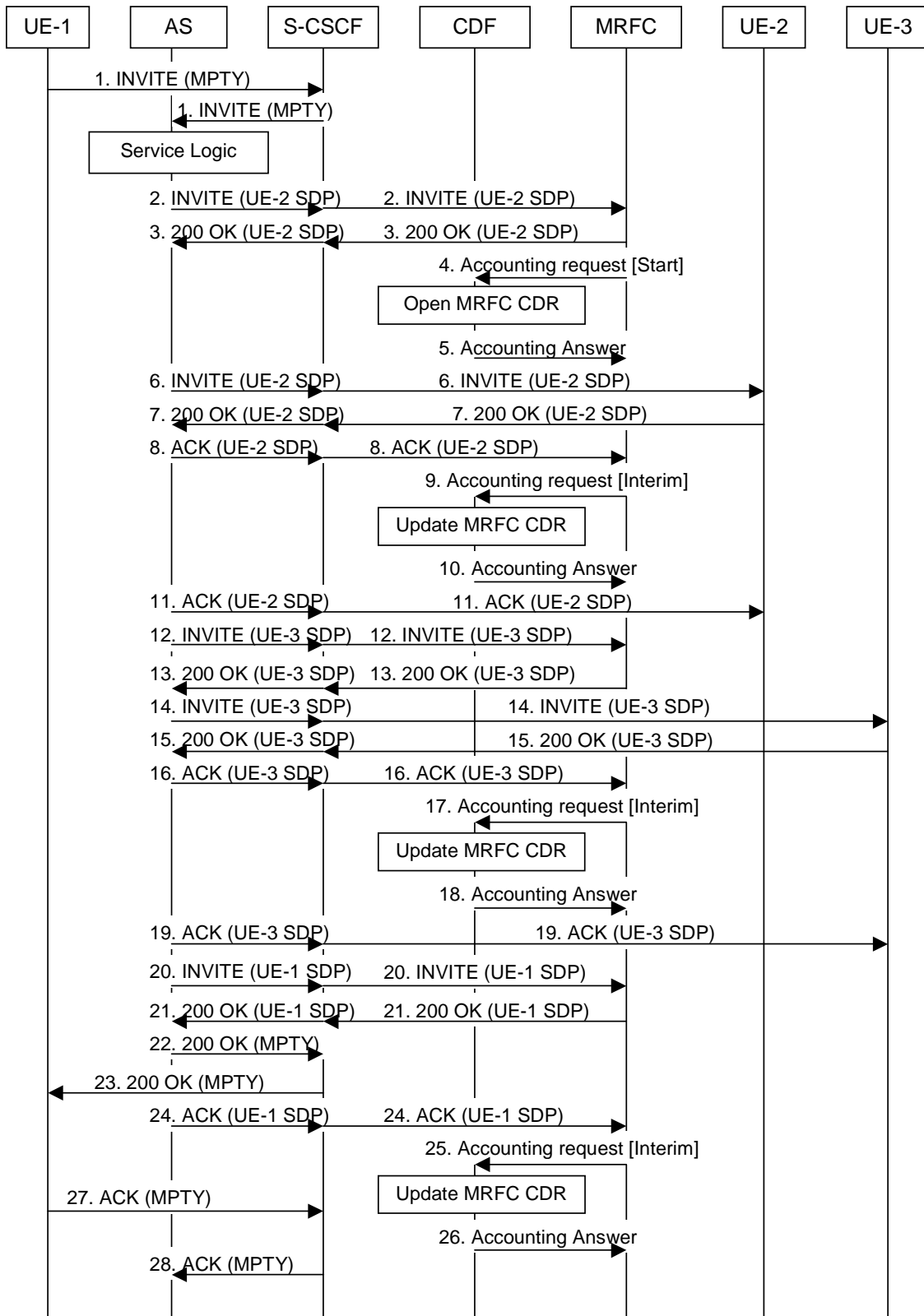

Figure : Message Sequence Chart for Multi-Party Call Establishment in MRFC

1. Sessions exist between UE-1 and UE-2, and between UE-1 and UE-3. A request is received from UE-1 for putting all parties together to a multi-party call.
- 2 - 3. Request and acknowledgement to initiate multi-party call. MRFC assigns a conference-ID that is used by the AS in subsequent interactions with the MRFC in INVITE messages connecting other endpoints (see TS 23.228 [201]). Path establishment between AS and MRFC for UE-2.
4. At start of session establishment the MRFC sends an *Accounting-Request* with *Accounting-Record-Type* indicating START_RECORD to record start of multi-party call in the MRFC CDR
5. The CDF acknowledges the reception of the data and creates the MRFC CDR. 'Calling Party Address', 'Service Request Time Stamp', 'Service ID' (holding the conference-ID) etc. are included in the MRFC CDR
- 6 - 7. Path establishment between UE-2 and AS. Same ICID is used as for the path between AS and MRFC for UE-2 (step 2. - 3.).
8. Acknowledgement of path between AS and MRFC for UE-2.
9. The MRFC may send an *Accounting-Request* with *Accounting-Record-Type* indicating INTERIM_RECORD to report that UE-2 has been connected to the multi-party call.
10. The CDF acknowledges the reception of the data and includes UE-2 in the field 'Application Provided Called Parties' of the MRFC CDR.
11. Acknowledgement of path between AS and UE-2. Now a path between UE-2 and MRFC via AS is established.
- 12 -13.. Request and acknowledgement to establish path between AS and MRFC for UE-3.
14. -15. Path establishment between UE-3 and AS. Same ICID is used as for the path between AS and MRFC for UE-3 (step 12. - 13.).
16. Acknowledgement of path between AS and MRFC for UE-3.
17. The MRFC may send an *Accounting-Request* with *Accounting-Record-Type* indicating INTERIM_RECORD to report that UE-3 has been connected to the multi-party call.
18. The CDF acknowledges the reception of the data and includes UE-3 in a new field 'Application Provided Called Parties' of the MRFC CDR.
19. Acknowledgement of path between AS and UE-3.
- 20 - 21. Request and acknowledgement to establish path between AS and MRFC for UE-1. Same ICID is used as for the path between UE-1 and AS (step 1.).
- 22 - 23. Request for multi-party conference with UE-2 and UE-3 is acknowledged to UE 1. Implicit acknowledgement of path UE-1 to AS.
24. Acknowledgement of path between AS and MRFC for UE-1.
25. The MRFC may send an *Accounting-Request* with *Accounting-Record-Type* indicating INTERIM_RECORD to report that UE-1 has been connected to the multi-party call.
26. The CDF acknowledges the reception of the data and includes the field 'Service Delivery Start Time Stamp' into the MRFC CDR.
- 27 -28. UE-1 acknowledges the multi-party call session establishment.

NOTE: It is in the responsibility of the AS to terminate the sessions existing at the beginning of the multi-party call establishment between UE-1 and UE-2 and between UE-1 and UE-3 (see step 1.) in case of successful multi-party call establishment. This is not shown in the diagram above.

5.2.2.1.11 AS Related Procedures - AS Acting as a Redirect Server

Application servers may support a multitude of services which are not specified in 3GPP standards. Therefore it is not possible to standardise charging flows and procedures for those services. However, for all such services, the AS may apply either Event Charging, where ACR [Event] messages are generated, or Session Charging, using ACR [Start, Stop and Interim]. The following clauses depict one example for each of the two scenarios. The first procedure, AS acting as a Redirect Server, depicts the "event" case, while the second procedure, AS acting as a Voice Mail Server, depicts the "session" case.

The following figure shows the case where an Application Server acts as a Redirect Server. In the figure below, UE-1 sets up a session towards UE-2 but due to Call Forwarding functionality located in the AS, a new number (to UE-3) is returned to UE-1. Finally UE-1 sets up the session towards UE-3.

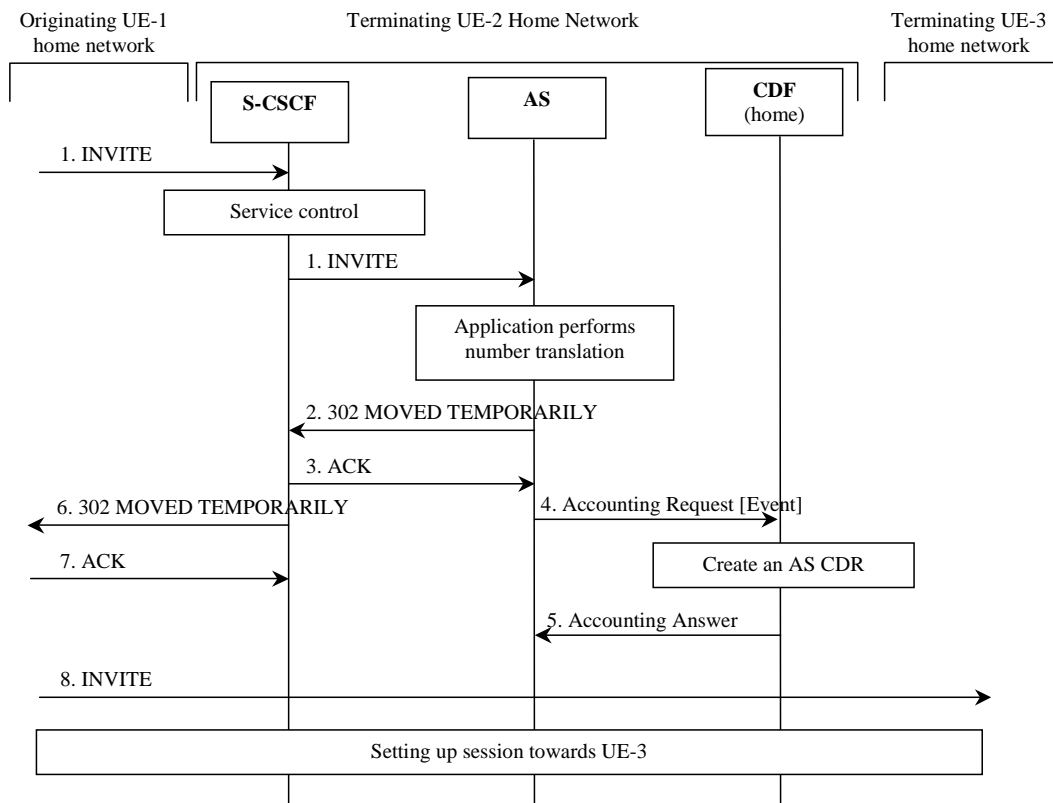

Figure : Message Sequence Chart for AS Acting as a Redirect Server

- 1. Sessions initiated by UE-1 towards UE-2.
- 2. - 3. Response indicating that session should be redirected towards another number (UE-3).
- 4. After successful service execution, the AS sends *Accounting-Request* with *Accounting-Record-Type* indicating *EVENT_RECORD* to record service specific information in the AS CDR.
- 5. The CDF acknowledges the reception of the data and creates the AS CDR.
- 6-7. Response indicating that session should be redirected towards another number (UE-3).
- 8. Session is initiated by UE-1 towards UE-3.

5.2.2.1.12 AS Related Procedures - AS Acting as a Voice Mail Server

The following figure shows the case where an Application Server acts as a Voice Mail Server. S-CSCF invokes the AS acting as Voice Mail Server according to procedure as defined in TS 23.218 [203].

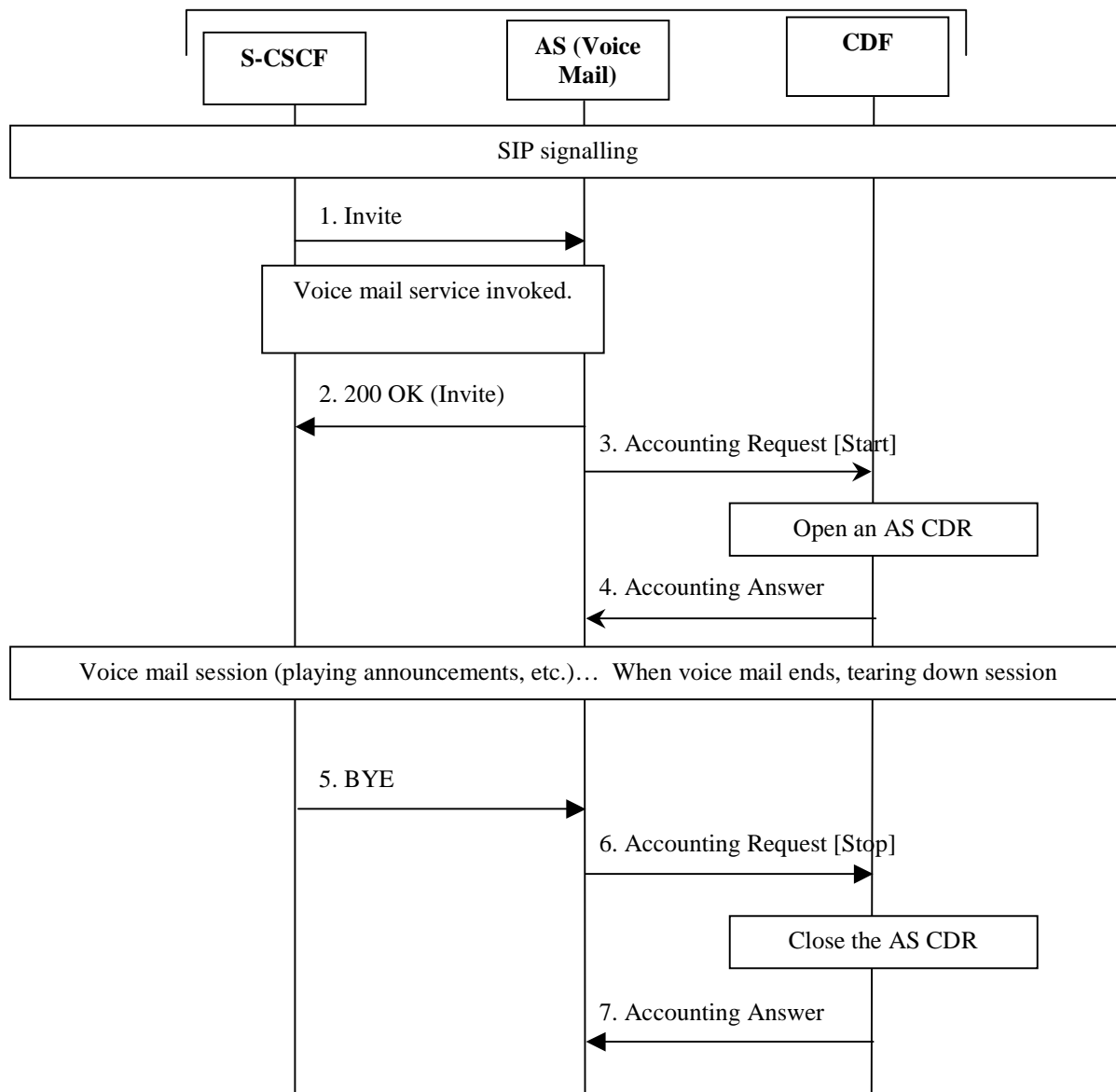

Figure : Message Sequence Chart for AS Acting as a Mail Server

1. AS receives the INVITE from the S-CSCF.
2. AS acknowledges the initiated Voice Mail session by issuing a 200 OK in response to the INVITE.
3. AS sends *Accounting-Request* with *Accounting-Record-Type* indicating START_RECORD to record start of a voice mail session.
4. The CDF acknowledges the reception of the *Accounting-Request* with *Accounting-Record-Type* indicating START_RECORD and opens a AS CDR.
5. Voice mail session release is initiated.
6. Upon reception of release message AS sends an *Accounting-Request* with *Accounting-Record-Type* indicating STOP_RECORD to record stop of a session in the AS CDR.
7. The CDF acknowledges the reception of the data and closes the AS CDR.

5.2.2.1.13 AS Related Procedures - AS Acting as a VCC AS

5.2.2.1.13.1 VCC UE originating call from IMS and Domain Transfer IMS to CS

The following figure shows the case where an Application Server acts as a Voice Call Continuity AS (VCC AS). It illustrates the Diameter transactions that are required for VCC UE originating call from IMS (A.) followed by a Domain Transfer from IMS to CS (B.)

A. VCC UE Originating call from IMS and routed to IMS

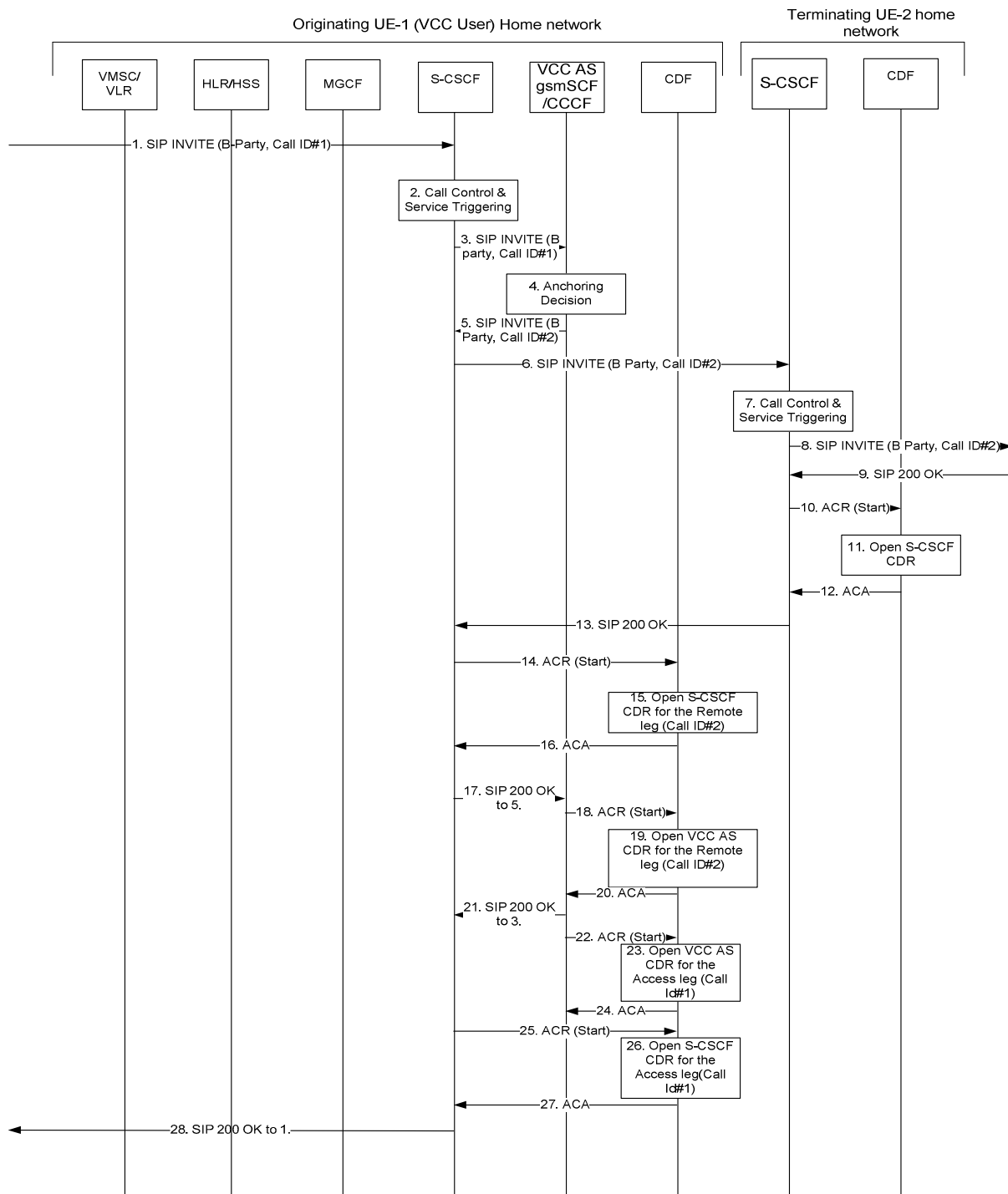

Figure: Message Sequence Chart VCC UE originating call from IMS and Domain Transfer IMS to CS

1. The VCC session is initiated

2. The S-CSCF validates the service profile, and invokes any appropriate service logic required for this user.
3. The S-CSCF forwards the INVITE request message to the VCC AS, according to the service origination logic defined by initial Filter Criteria (iFC) in the subscriber profile of the HSS.
4. The VCC call is anchored at the VCC AS in the home IMS Domain upon reception of the SIP Invite (Call Id#1)
- 5 and 6. The S-CSCF forwards the INVITE request message to the terminating network (Call Id#2)
7. The S-CSCF in the terminating network performs call control and service triggering for the incoming call

The session is conveyed to the UE-2 in the terminating network

The destination party answers and a final response 200 OK is received.

10. Upon reception of the final response, the S-CSCF in the terminating network sends an *Accounting-Request* with *Accounting-Record-Type* indicating START_RECORD to record start of a user session and start of a media component in the S-CSCF CDR.
11. and 12. The CDF from the terminating network opens an S-CSCF CDR and acknowledges the reception of the data
13. The final response 200 OK is transmitted to the S-CSCF in the Originating network
14. Upon reception of the final response, the S-CSCF in the originating network sends an *Accounting-Request* with *Accounting-Record-Type* indicating START_RECORD to record VCC call routing and start of a user session/media component in the S-CSCF CDR.
15. and 16. The CDF from the Originating network opens an S-CSCF CDR related to the Remote leg and acknowledges the reception of the data.
17. Same as 13. but for VCC AS (Remote leg)
18. Same as 14. but for the VCC AS (Remote leg)
19. and 20. Same as 15. and 16. but opening a VCC AS CDR related to the Remote leg
21. Same as 13. but for VCC AS (Access leg)
22. Same as 14. but for the VCC AS (Access leg)
23. and 24. Same as 15. and 16. but opening a VCC AS (Access leg)
25. Same as 14. but for the S-CSCF (Access leg)
26. and 27. Same as 15. and 16. but opening a VCC AS (Access leg)
28. The final response to SIP Invite (Call Id#1) is received by the UE-1

B. Domain Transfer from IMS to CS

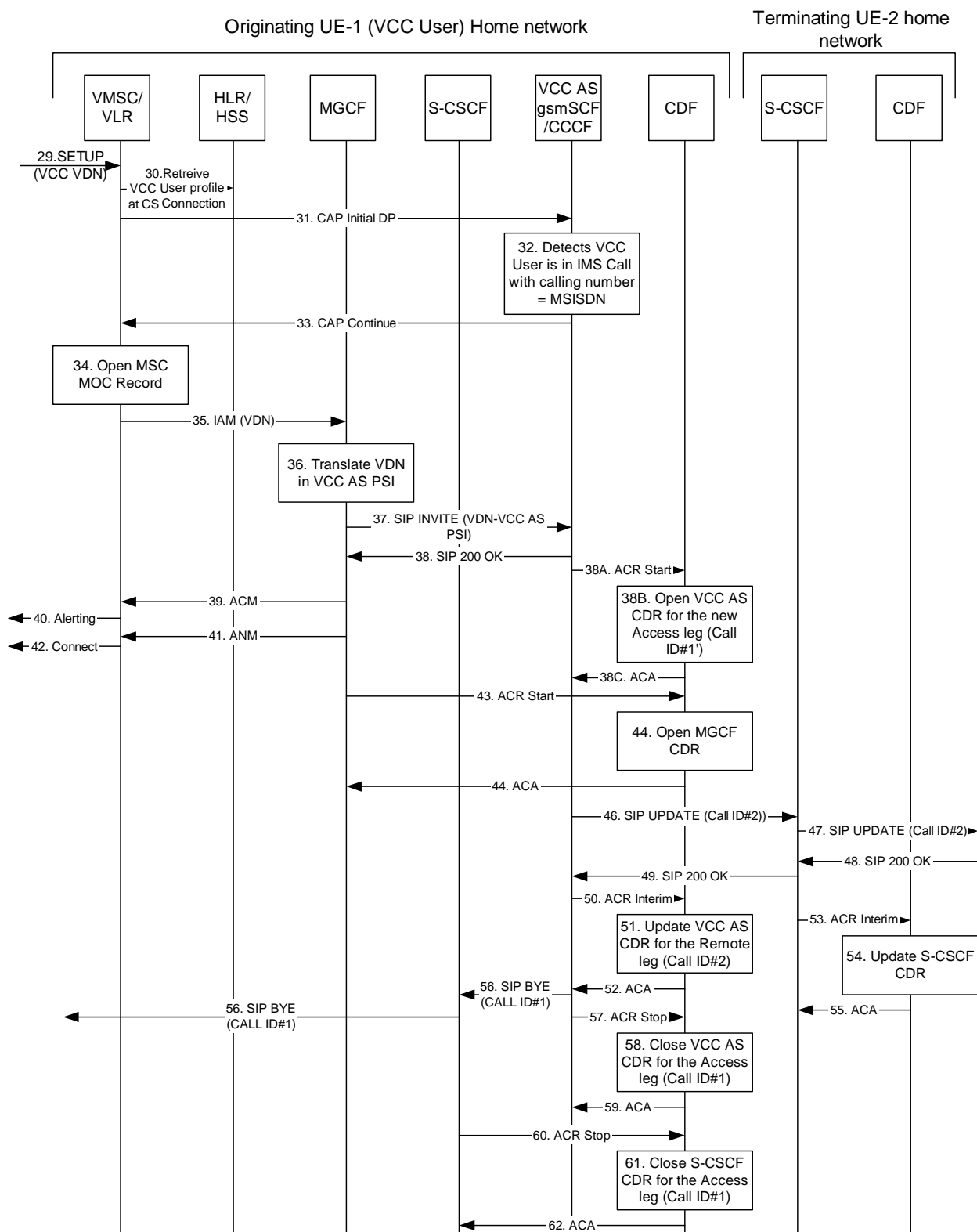

Figure: Message Sequence Chart VCC UE originating call from IMS and Domain Transfer IMS to CS (Continued)

29. The VCC User (UE-1) originates a voice call in the CS domain using the VCC Domain Transfer Number (VDN) of the VCC function to establish an Access Leg via the CS domain and request Domain Transfer of the active IMS session to CS Domain.
30. The originating call is processed in the CS network according to CS origination procedures. The user profile is retrieved from the HLR with the CAMEL Detection points for VCC.
31. A CAP Initial DP message is sent to the VCC AS to get instructions on how to process the call
32. The VCC application detects that the user is in IMS call
33. It responds with a CAP continue
34. The MSC opens a MOC Record as defined in 3GPP TS 32.250 [2]
35. The VMSC routes the call towards the user's home IMS network via an MGCF in the home network
36. The VCC AS PSI DN is resolved using the VDN at the CS network
37. The MGCF initiates an INVITE towards the VCC AS in the home IMS of the originating VCC user. This message is routed based on one of the standard procedures specified for PSI based Application Server Termination.
- 38, 39, 40, 41 and 42. The VCC AS completes the establishment of the Access Leg using normal CS to IMS procedures.
- 38A. Upon generation of the final response, the VCC AS in the home IMS of the originating VCC user sends an *Accounting-Request* with Accounting-Record-Type indicating START_RECORD to record start of a user session in the VCC AS-CDR.
- 38B and 38C. The CDF from the originating network opens an AS CDR and acknowledges the reception of the data.
43. Upon reception of the final response, the MGCF sends an *Accounting-Request* with Accounting-Record-Type indicating START_RECORD to record start of a user session in the MGCF CDR.
- 44 and 45. The CDF from the originating network opens an MGCF CDR and acknowledges the reception of the data
46. and 47. The VCC AS performs the Domain Transfer by updating the Remote Leg with the connection information of the newly established Access Leg using the Access Leg Update procedure toward remote end. It sends an UPDATE message. The new SDP in the UPDATE message indicates that the IP address towards the VCC UE is changed: the IP address that was previously the IP address of the VCC UE is changed into the IP address of the MGW. The new bearer path goes now from the VCC UE to the MSC, the IM-MGW and then to the other end-point network.
- 48 and 49. The 200 OK responses to the SIP Update are received.
50. At Access Leg update the VCC AS sends Accounting-Request with Accounting-Record-Type indicating INTERIM_RECORD to record update of a session in the VCC AS CDR.
51. and 52. The CDF closes the AS CDR in the originating network and acknowledges the reception of the data
53. Same as 50, but for S-CSCF in the terminating network.
- 54 and 55. Same as 51 and 52 updating the S-CSCF CDR in the terminating network.
56. The source Access Leg which is the Access leg previously established over IMS is subsequently released
57. At session termination the VCC AS sends *Accounting-Request* with Accounting-Record-Type indicating STOP_RECORD to record stop of a session and stop of a media component in the VCC AS CDR. This CDR may be generated with special handling. One example of special handling is to zero rate the IMS resource usage for the Access leg establishment. This can be performed using the "Service Specific Data" parameter in the VCC AS CDR indicating the anchoring of a VCC call.
58. and 59. The CDF closes the AS CDR for initial Access leg and acknowledges the reception of the data
60. Same as 57, but for S-CSCF.
- 61 and 62. Same as 58 and 59 closing the S-CSCF CDR related to the initial Access leg. This CDR may be generated with special handling. One example of special handling is to zero rate the IMS resource usage for Access leg establishment. This can be performed using the correlation mechanism with the VCC AS CDR for Access leg.

5.2.2.1.13.2 VCC UE originating call from CS and Domain Transfer CS to IMS

The following figure shows the case where an Application Server acts as a Voice Call Continuity AS (VCC AS). It illustrates the Diameter transactions that are required for VCC UE originating call from CS (C.) followed by a Domain Transfer from CS to IMS (D.)

C. VCC UE Originating call from CS and routed to IMS

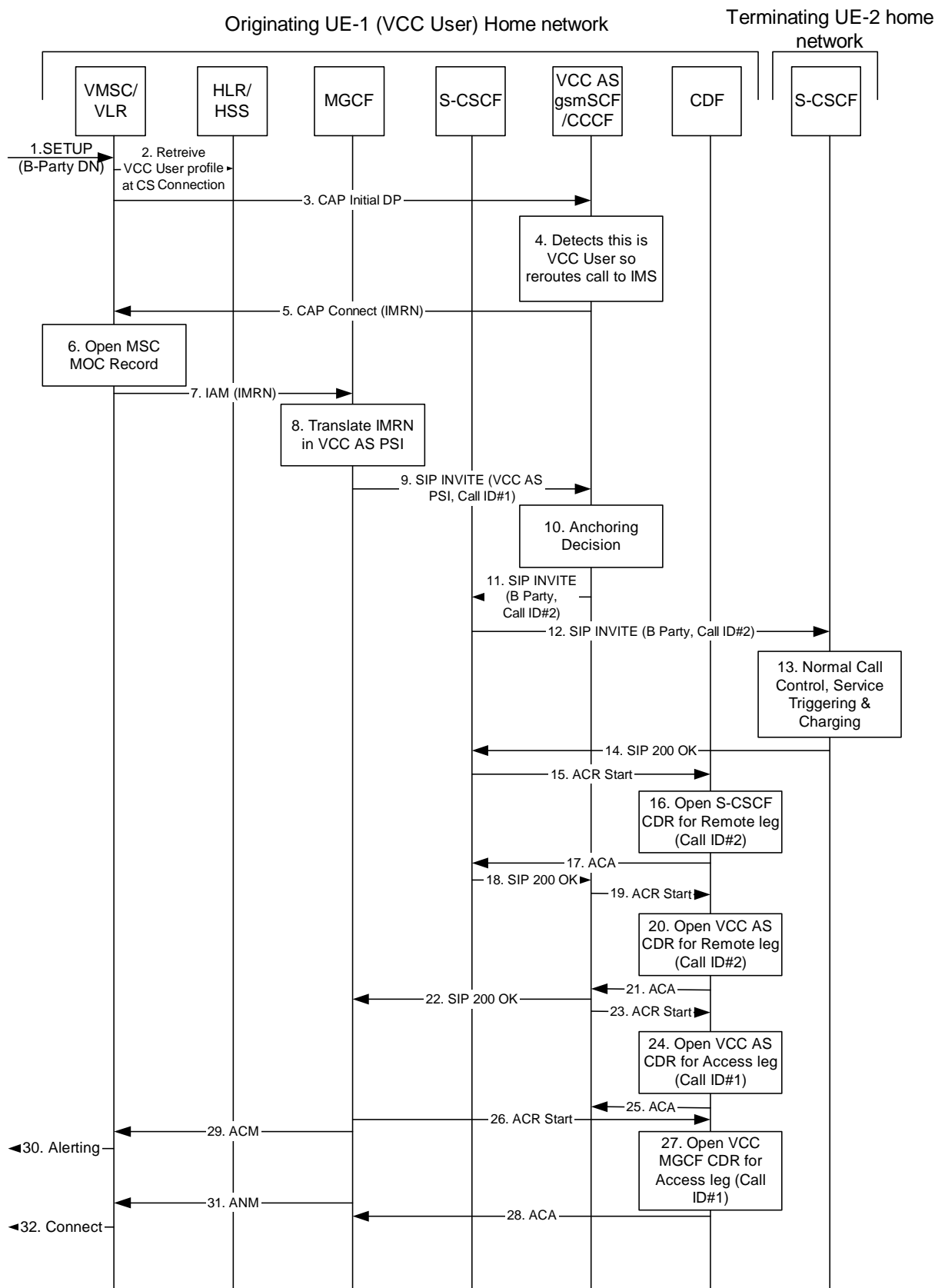

Figure 5.2.2.1.13.2-C: Message Sequence Chart VCC UE originating call from CS and Domain Transfer CS to IMS

1. The VCC User (UE-1) originates a voice call in the CS domain.
2. The originating call is processed in the CS network according to CS origination procedures. The user profile is retrieved from the HLR with the CAMEL Detection points for VCC.
3. A CAP Initial DP message is sent to the VCC AS to get instructions on how to process the call.
4. The VCC application detects that the user is an IMS user in the CS-domain, so reroutes the call to IMS for anchoring.
5. It responds with a CAP connect containing the IMS Routing Number (IMRN).
6. The MSC opens a MOC Record as defined in 3GPP TS 32.250 [2].
7. The VMSC routes the call towards the user's home IMS network via an MGCF in the home network.
8. The VCC AS PSI DN is resolved using the IMRN.
9. The MGCF initiates an INVITE towards the VCC AS in the home IMS of the originating VCC user. This message is routed based on one of the standard procedures specified for PSI based Application Server Termination.
10. The VCC call is anchored at the VCC AS in the home IMS Domain upon reception of the SIP Invite (Call Id#1)
11. and 12. The AS forwards the INVITE request message to the terminating network (Call Id#2) via the S-CSCF in the originating network.
13. The terminating network performs call control, service triggering for the incoming call as usual. (This is shown in more detail in the first figure in section 15.2.2.1.13.1.)
14. The final response 200 OK is transmitted to the S-CSCF in the Originating network.
15. Upon reception of the final response, the S-CSCF in the originating network sends an *Accounting-Request* with *Accounting-Record-Type* indicating START_RECORD to record VCC call routing and start of a user session/media component in the S-CSCF CDR.
16. and 17. The CDR from the Originating network opens an S-CSCF CDR related to the Remote leg and acknowledges the reception of the data.
18. The final response 200 OK is transmitted to the VCC AS.
19. Same as 15 but for VCC AS (Remote leg)
20. and 21. Same as 16 and 17 but opening a VCC AS CDR related to the Remote leg.
22. The final response 200 OK is transmitted from the VCC AS to the MGCF for the Access leg.
23. Same as 19. but for VCC AS (Access leg).
24. and 25. Same as 20 and 21 but for the VCC AS CDR (Access leg).
26. Same as 19. but for the MGCF (Access leg)
27. and 28. Same as 20. and 21. but opening a MGCF CDR (Access leg)
28. The final response to SIP Invite (Call Id#1) is received by the UE-1
- 29, 30, 31. & 32. The MGCF completes the establishment of the Access Leg using normal ISUP & CS procedures.

D. Domain Transfer from CS to IMS

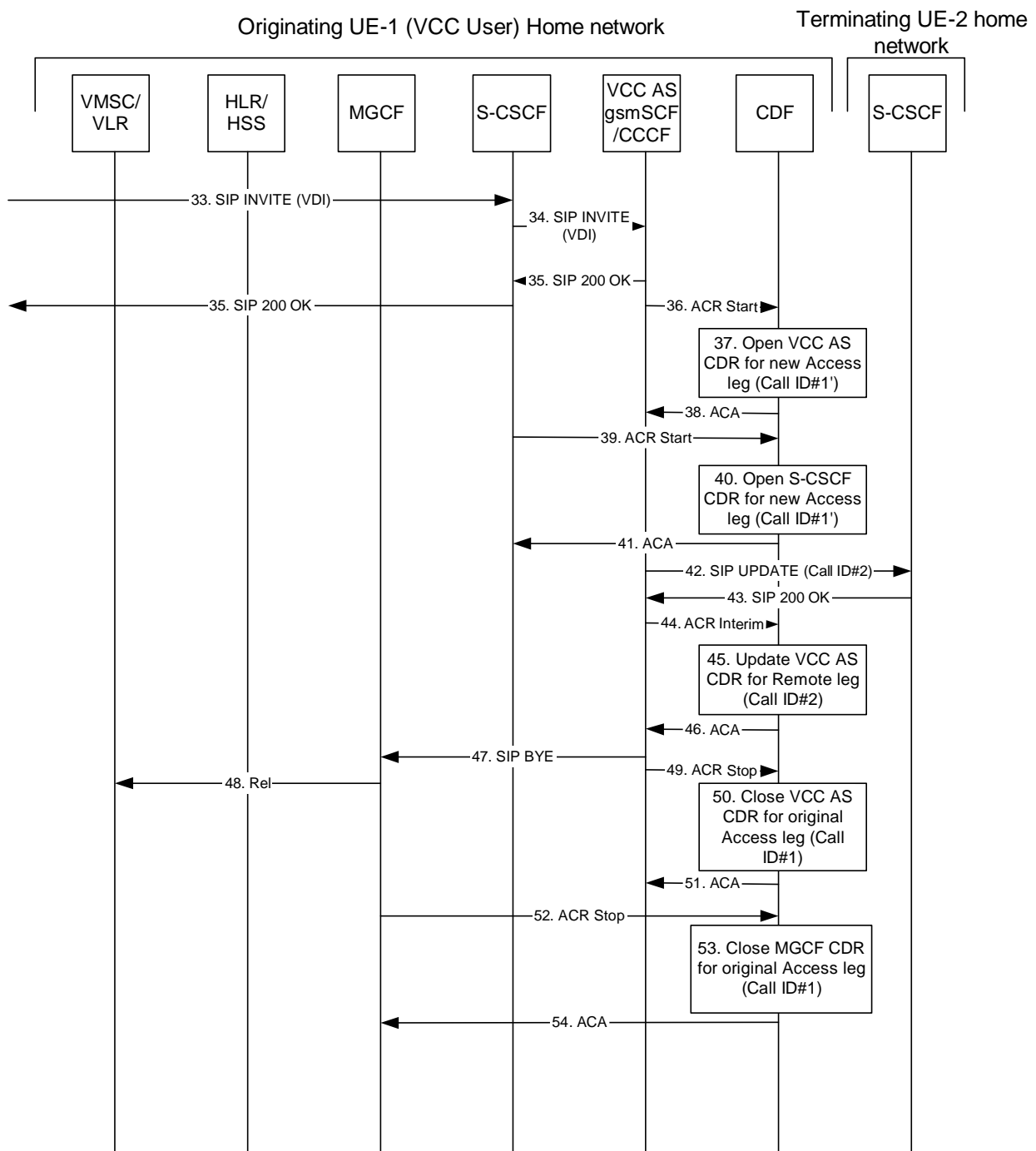

Figure 5.2.2.1.13.2-D: Message Sequence Chart VCC UE originating call from CS and Domain Transfer CS to IMS (Continued)

- 33. The VCC User (UE-1) originates a voice call in the IMS domain using the VCC Domain Transfer URI (VDI) to establish an Access Leg via the IMS domain and request Domain Transfer of the active CS session to IMS.
- 34. The home S-CSCF routes the call to the VCC AS.
- 35. The VCC AS responds with a final response which is sent back to the UE.
- 36. Upon generation of the final response, the VCC AS in the home IMS of the originating VCC user sends an Accounting-Request with Accounting-Record-Type indicating START_RECORD to record start of a user session in the VCC AS CDR.
- 37. and 38. The CDF opens an VCC AS CDR and acknowledges the reception of the data.

39. Same as 36, but for S-CSCF in the originating network.
40. and 41. Same as 37 and 38 open the S-CSCF CDR in the originating network.
42. and 43. The VCC AS performs the Domain Transfer by updating the Remote Leg with the connection information of the newly established Access Leg using the Access Leg Update procedure toward remote end. It sends an UPDATE message. The new SDP in the UPDATE message indicates that the IP address towards the VCC UE is changed: the IP address that was previously the IP address of the VCC UE is changed into the IP address of the MGW. The new bearer path goes now from the VCC UE to the IM-MGW and then to the other end-point network.
44. At Access Leg update the VCC AS sends Accounting-Request with Accounting-Record-Type indicating INTERIM_RECORD to record update of a session in the VCC AS CDR.
45. and 46. The CDF updates the VCC AS CDR and acknowledges the reception of the data.
47. and 48. The original access leg, previously established over CS is released.
49. At session termination the VCC AS sends Accounting-Request with Accounting-Record-Type indicating STOP_RECORD to record stop of a session and stop of a media component in the VCC AS CDR. This CDR may be generated with special handling. One example of special handling is to zero rate the IMS resource usage for the Access leg establishment. This can be performed using the "Service Specific Data" parameter in the VCC AS CDR indicating the anchoring of a VCC call.
50. and 51. The CDF closes the AS CDR for the initial Access leg and acknowledges the reception of the data
52. Same as 49, but for MGCF.
53. and 54. Same as 50. and 51. closing the MGCF CDR related to the initial Access leg. This CDR may be generated with special handling. One example of special handling is to zero rate the IMS resource usage for Access leg establishment. This can be performed using the correlation mechanism with the VCC AS CDR for Access leg.

5.2.2.1.14 Initiating Alternate Charged Party Call

The following figure shows the case where a call with an alternate charged party is successfully initiated.

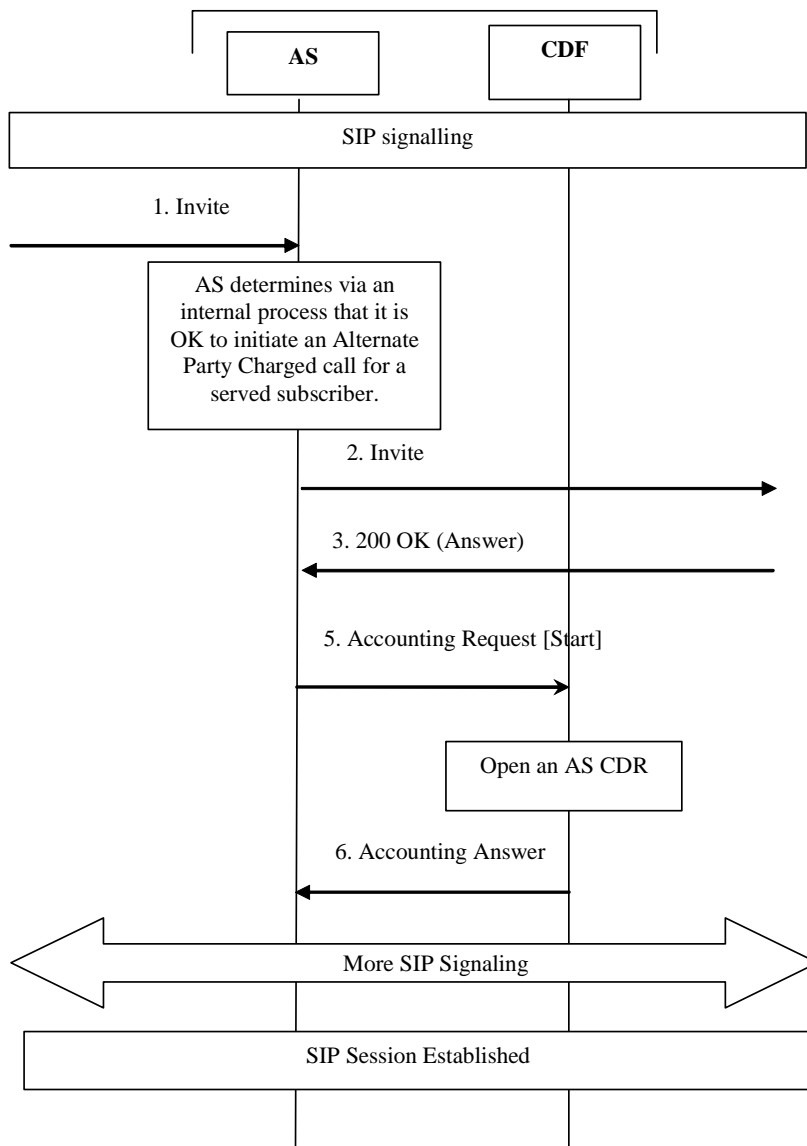

Figure: Successful Initiation of Alternate Party Charging

1. The AS receives a SIP Invite.
2. After determining that Alternate Charged Party is supported, the AS initiates an Invite with an "Alternate Party Identity" for charging. The method for determination of the alternate charged party includes accessing subscriber data and doing a security assessment.
3. The terminating side issues a 200 OK (Answer), to AS.
4. The AS sends a 200 OK.
5. The AS sends an accounting request to the CDF.
6. The CDF opens a CDR with the Subscription-ID for the Alternate Charged Party and sends an accounting answer to the AS.
7. The session is established.

5.2.2.2 Message Flows - Error Cases and Scenarios

This clause describes various error cases and how these should be handled. The error cases are grouped into the following categories:

- Failure in SIP Related Procedures:
 - Session Related Error Scenarios;
 - Session Unrelated Error Scenarios.
- Errors in Diameter (Accounting) Related Procedures.

5.2.2.2.1 Session Related SIP Procedures- Reception of SIP error messages

A SIP session is closed abnormally by the reception of a BYE message indicating the reason for such termination.

In this case, an ACR [Stop] message that includes an appropriate error indication is sent.

5.2.2.2.2 Session Related SIP Procedures - SIP session failure

All nodes involved in the SIP session are expected to exercise some kind of session supervision. In case a node detects an error in the SIP session, such as a timeout or the occurrence of an invalid SIP message that results in the inability to maintain the session, this IMS node will generate a BYE message towards both ends of the connection.

The node that sent the BYE to trigger session termination identifies the cause of the failure in the ACR [Stop] towards the CDF. All other nodes, i.e. those that receive the BYE, are not aware of an error, and therefore they treat this situation as any normal SIP session termination.

5.2.2.2.3 Session Unrelated SIP procedures

As described in clause 5.1.2.1.2, a session unrelated SIP procedure may either be completed with the reception of a 200OK, or a SIP error message. If the latter occurs, i.e. there is a failure in the procedure, the ACR [Event] sent towards the CDF includes an appropriate error indication.

5.2.2.2.4 CDF Connection Failure

When the connection towards the primary CDF is broken, the process of sending accounting information should continue towards a secondary CDF (if such a CDF is configured). For further CDF connection failure functionality, see clause "*Transport Failure Detection*" in IETF RFC 3588 [401].

If no CDF is reachable the network element may buffer the generated accounting data in non-volatile memory. Once the CDF connection is working again, all accounting messages stored in the buffer is sent to the CDF, in the order they were stored in the buffer.

5.2.2.2.5 No Reply from CDF

In case an IMS node does not receive an ACA in reply to an ACR, it may repeat the ACR message. The waiting time until a repetition is sent, and the maximum number of repetitions are both configurable by the operator. When the maximum number of repetitions is reached and still no ACA reply has been received, the IMS node executes the CDF connection failure procedure as specified above.

If retransmitted ACRs are sent, they are marked with the T-flag as described in IETF RFC 3588 [401] , in order to allow duplicate detection in the CDF, as specified in the next clause.

5.2.2.2.6 Duplicate Detection

A Diameter client marks possible duplicate request messages (e.g. retransmission due to the link failover process) with the T-flag as described in IETF RFC 3588 [401].

If the CDF receives a message that is marked as retransmitted and this message was already received, then it discards the duplicate message. However, if the original of the re-transmitted message was not yet received, it is the information

in the marked message that is taken into account when generating the CDR. The CDRs are marked if information from duplicated message(s) is used.

5.2.2.2.7 CDF Detected Failure

The CDF closes a CDR when it detects that expected Diameter ACRs for a particular SIP session have not been received for a period of time. The exact behaviour of the CDF is operator configurable.

5.2.3 CDR generation

Editor's Note: FFS

5.2.4 GTP" record transfer flows

GTP" is not used between CDF and CGF in IP Multimedia subsystem, because CDF and CGF are combined into CCF (see clause 4).

Text should be copied from the middle tear template section.

5.2.5 Bi CDR file transfer

Editor's Note: FFS

5.3 IMS Online Charging Scenarios

5.3.1 Basic Principles

IMS online charging uses the Credit Control application that is specified in 3GPP Rel-6 TS 32.299 [50].

Three cases for online charging are distinguished:

- Immediate Event Charging (IEC); and
- Event Charging with Unit Reservation (ECUR), and
- Session Charging with Unit Reservation (SCUR)

Both stage 2 and stage 3 mechanisms for the three cases for online charging are detailed in TS 32.299 [50].

In the case of Immediate Event Charging (IEC), granting units to the IMS network element is performed in a single operation that also includes the deduction of the corresponding monetary units from the subscriber's account. The charging process is controlled by the corresponding credit control request which is sent for a given credit control event.

In contrast, Event Charging with Unit Reservation (ECUR) also includes the process of requesting, reserving, releasing and returning unused units for events. The deduction of the corresponding monetary units then occurs upon conclusion of the ECUR transaction. In this case, the credit control request is used to control the credit control session.

Session Charging with Unit Reservation (SCUR) is used for credit control of sessions. SCUR also includes the process of requesting, reserving, releasing and returning unused units for sessions, and the deduction of the corresponding monetary units. During a SIP session there can be repeated execution of unit reservation and debit operations as specified in TS 32.299 [50].

The IMS network element may apply IEC, where CCR Event messages are generated, or ECUR, using CCR Initial, and Termination or SCUR. The decision whether to apply IEC, ECUR or SCUR is based on the service and/or operator's policy.

The CTF uses CCR Initial, Update, Terminate in procedures related to successful SIP sessions. It uses CCR Events for unsuccessful SIP sessions and for session unrelated procedures. Further details are specified in the tables below.

It is operator configurable in the nodes for which SIP method a *Credit Control Request* is sent. The table below describes all possible CCRs that might be sent from a S-CSCF.

It is configurable for the operators to enable or disable the generation of a CCR message by the IMS node in response to a particular "Triggering SIP Method".

Table 5.3.1.1: Credit Control Request Messages Triggered by SIP Methods for IMS-GWF

| Diameter Message | Triggering SIP Method |
|------------------|--|
| CCR [Initial] | SIP INVITE (SCUR) |
| | SIP NOTIFY (ECUR) |
| | SIP MESSAGE (ECUR) |
| | SIP REGISTER (ECUR) |
| | SIP SUBSCRIBE (ECUR) |
| | SIP REFER (ECUR) |
| | SIP PUBLISH (ECUR) |
| CCR [Update] | SIP 200 OK acknowledging a SIP INVITE, RE-INVITE or SIP UPDATE [e.g. change in media components] (SCUR) |
| | RE-INVITE or SIP UPDATE [e.g. change in media components] (SCUR) |
| | Expiration of quota, Validity time expiry or other authorization triggers (quota threshold reached, ...). (SCUR) |
| | Any SIP message (except those triggering a CCR INITIAL or those not covered by the above triggers for CCR UPDATE) conveying a SDP offer or its associated SDP answer before SIP session establishment (SCUR) |
| CCR [Terminate] | SIP BYE message (both normal and abnormal session termination cases) (SCUR) |
| | SIP 200 OK acknowledging non-session related SIP messages (ECUR) |
| | Aborting a SIP session set-up procedure, using an internal trigger, or a SIP CANCEL.(SCUR/ECUR) |
| | Deregistration (see NOTE) (SCUR/ECUR) |
| | SIP Final Response 2xx (including 202 response to REFER, except SIP 200 OK) (ECUR) |
| | SIP Final/Redirection Response 3xx (SCUR/ECUR) |
| | SIP Final Response (4xx, 5xx or 6xx), indicating an unsuccessful SIP session set-up procedure (SCUR) |
| CCR [Event] | SIP NOTIFY (IEC) |
| | SIP MESSAGE (IEC) |
| | SIP REGISTER (IEC) |
| | SIP SUBSCRIBE (IEC) |
| | SIP REFER (IEC) |
| | SIP PUBLISH (IEC) |
| | SIP Final Response (4xx, 5xx or 6xx), indicating an unsuccessful session-unrelated procedure (IEC) |
| NOTE : | SIP SUBSCRIBE with the field "Expires" set to 0 means unsubscribe. SIP REGISTER with its "Expires" header field or "Expires" parameter equal to 0 or local deregistration due to expiry means Deregistration (see 3GPP TS 24.229 [204]). |

Table 5.3.1.2: Credit Control Request messages triggered by SIP Methods for MRFC

| Diameter Message | Triggering SIP Method |
|------------------|--|
| CCR [Initial] | SIP INVITE(SCUR) for initiating a multimedia ad hoc conferencing session |
| CCR [Update] | SIP RE-INVITE or SIP UPDATE[e.g. change in media components](SCUR) |
| | SIP BYE message |
| | Expiration of AVP[Acct-Interim-Interval](SCUR) |
| CCR [Terminate] | SIP BYE message(both normal and abnormal session termination cases)(SCUR) |
| | SIP Final Response with error codes 4xx, 5xx or 6xx indicating termination of an ongoing session(SCUR) |
| | SIP CANCEL(SCUR) |
| CCR [Event] | SIP Final/Redirection Response 3xx |
| | SIP Final Response with error codes 4xx, 5xx or 6xx indicating termination of an ongoing session(IEC) |
| | SIP CANCEL, indicating abortion of a SIP session set-up |
| | SIP REFER(IEC) |
| | SIP SUBSCRIBE(IEC) |

Editors Note: Triggers for AS are FFS.

NOTE: To the extent possible alignment with the IETF RFC 4006 [402] is planned.

5.3.2 Diameter Message Flows and Types

This clause describes the message flows for the event charging procedures on the Ro interface.

5.3.2.1 Immediate Event Charging (IEC)

This clause provides the details of the "Debit Units" operation specified in TS 32.299 [50].

5.3.2.1.1 Message Flows - Successful Cases and Scenarios

5.3.2.1.1.1 IEC – Debit Units Operation

The transactions that are required on the Ro interface in order to perform IEC with Debit Units operations are carried out as described in TS 32.299 [50] where 'CTF' refers to IMS network element. The Debit Units operation may alternatively be carried out prior to, concurrently with or after service/content delivery. The IMS network element must ensure that the requested service execution is successful, when this scenario is used.

Editor's Note: Must be aligned with TS 32.299 [50].

5.3.2.1.1.2 Scenarios

The following figure shows the Diameter credit control transactions that are required between the IMS-GWF and the OCS for session-unrelated IMS procedures, i.e. those that relate to the CCR [Event], as listed in Table 5.3.1.

SIP messages and Diameter transactions associated with these charging scenarios are shown primarily for general information and to illustrate the charging triggers. They are not intended to be exhaustive and depend on the Diameter Credit Control Requests triggers configured by the operator.

Scenario 1: Successful session unrelated case

NOTE: The Debit Units operation is carried out prior to service/content delivery.

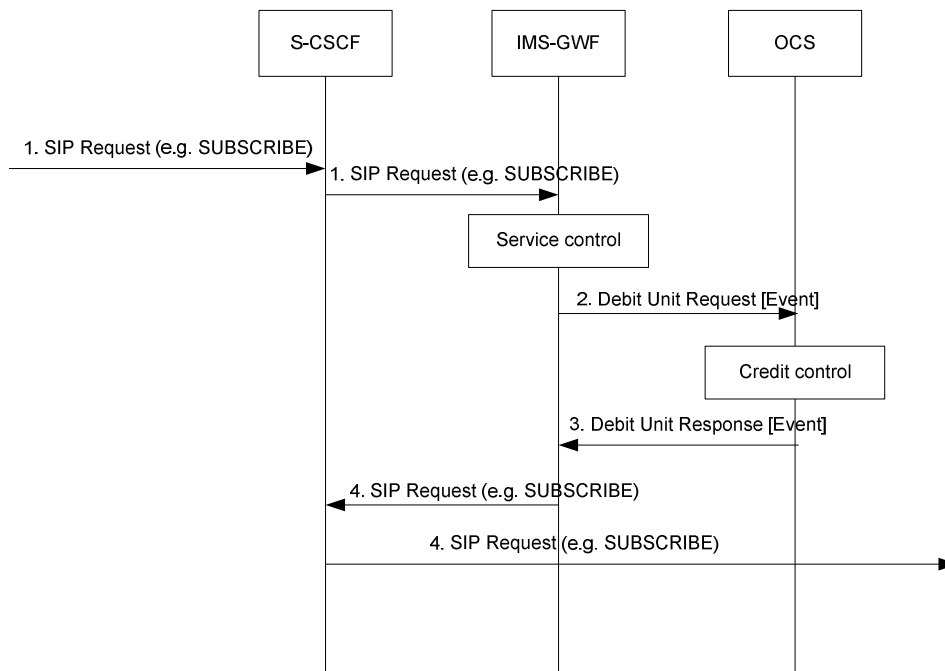

- 1) A session unrelated SIP Request (e.g. SUBSCRIBE) is received in the S-CSCF. The S-CSCF forwards this request to the IMS-GWF.
- 2) The IMS-GWF sends a Debit Unit Request (CC-Request-Type=EVENT_REQUEST) to the OCS, requesting units in order to provide the service.
- 3) The OCS sends the Debit Unit Response to acknowledge the Debit Unit Request, granting the requested units.
- 4) The IMS-GWF and the S-CSCF forward the SIP Request.

Figure Scenario 1 : Message Sequence Chart for Session-Unrelated Procedure

5.3.2.1.2 Message Flows - Error Cases and Scenarios

This clause describes various error cases and how these should be handled.

The failure handling behaviour is locally configurable in the IMS network element. If the *Direct-Debiting-Failure-Handling* AVP is not used, the locally configured values are used instead.

5.3.2.1.2.1 Reception of SIP Error Messages

If SIP errors in SIP response (4xx, 5xx or 6xx) occur during service delivery, as defined in TS 24.228 [202] and TS 23.218 [203], it is up to the IMS network element to determine to what extent the service was delivered before the error

occurred and act appropriately with respect to charging. This may imply that no units at all (or no more units) are debited.

5.3.2.1.2.2 Debit Units Operation Failure

This case comprises situations where either no, or an erroneous response, is received from the OCS. The 'no response' case is detected by the IMS network element when the connection supervision timer Tx expires (IETF RFC 4006 [402]) before a response *Credit-Control-Answer* (CCA) is received. The case of receiving an erroneous response implies that the IMS network element receives a *Credit-Control-Answer* (CCA), which it is unable to process, while Tx is running. The failure handling complies with the failure procedures for "Direct Debiting" scenario described in IETF RFC 4006 [402].

5.3.2.1.2.3 Duplicate Detection

The detection of duplicate request is needed and must be enabled. To speed up and simplify as much as possible the duplicate detection, the all-against-all record checking should be avoided and just those records marked as potential duplicates need to be checked against other received requests (within a reasonable time window) by the receiver entity.

The IMS network element marks the request messages that are retransmitted after a link failover as possible duplicates with the T-flag as described in [201]. For optimized performance, uniqueness checking against other received requests is only necessary for those records marked with the T-flag received within a reasonable time window. This focused check is based on the inspection of the *Session-Id* and *CC-Request-Number* AVP pairs.

5.3.2.2 Event Charging with Unit Reservation (ECUR) and Session Charging with Unit Reservation (SCUR)

This clause provides the details of the "Reserve Units" and "Debit Units" operation specified in TS 32.299 [50].

5.3.2.2.1 Message Flows - Successful Cases and Scenarios

5.3.2.2.1.1 ECUR and SCUR - Reserve Units and Debit Units Operations

The transactions that are required on the Ro interface in order to perform ECUR/SCUR with Reserve Units and Debit Units operations is carried out as described in TS 32.299 [50] where 'CTF' refers to an IMS network element. Multiple replications of both of these operations are possible.

5.3.2.2.1.2 Expiration of Reservation Validity

This clause defines how reserved units are returned, if not used, within a reasonable time. It should be possible that both, reservation and SIP sessions are cancelled or only the reservation is cancelled without removing the SIP session.

5.3.2.2.1.3 Scenarios

The following figure shows the Diameter credit control transactions that are required between the IMS-GWF and the OCS for session-related and session-unrelated IMS procedures.

The SIP messages and Diameter transactions associated with these charging scenarios are shown primarily for general information and to illustrate the charging triggers. They are not intended to be exhaustive and they depend on the Diameter Credit Control Requests triggers configured by the operator.

5.3.2.2.1.3.1 Session Related Procedures (SCUR).

Scenario 1: Successful Session Establishment

The following figure shows the Diameter credit control transactions that are required in the IMS-GWF during a SIP session establishment.

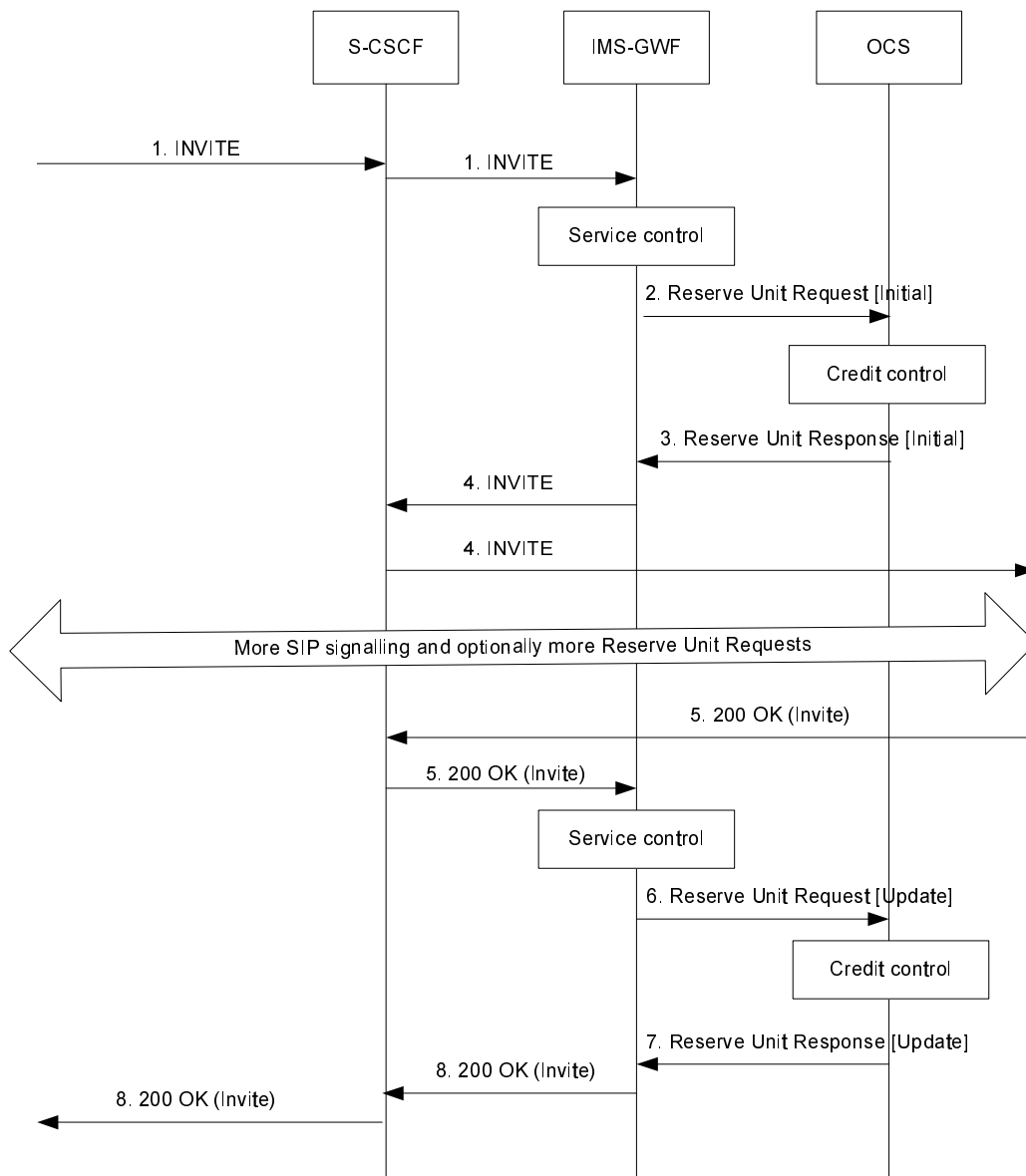

- 1) An initial SIP Invite Request is received in the S-CSCF. This request is forwarded to the IMS-GWF.
- 2) The IMS-GWF sends a Reserve Unit Request (CC-Request-Type =INITIAL_REQUEST) to the OCS requesting service units. The online credit control session is initiated.
- 3) The OCS grants units in the Reserve Unit Response.
- 4) The IMS-GWF and S-CSCF forward the initial INVITE.
- 5) A final response is received in the IMS-GWF.
- 6) If the trigger is active, the 200 OK answer triggers a Reserve Unit Request (CC-Request-Type =UPDATE_REQUEST) in the IMS-GWF in order to update the credit control session. New service units are requested. Also the used service units (if any) are reported.
- 7) The OCS sends the Reserve Unit Response to acknowledge the Reserve Unit Request. New service units are granted.
- 8) The final answer is forwarded.

Figure Scenario 1 : Message Sequence Chart for Successful Session Establishment

Scenario 2 : Successful Session Establishment with Early Media Negotiation

The following figure shows the Diameter transactions that are required in the IMS-GWF during a SIP session establishment in which SDP negotiation is completed before a final response to the initial INVITE is exchanged.

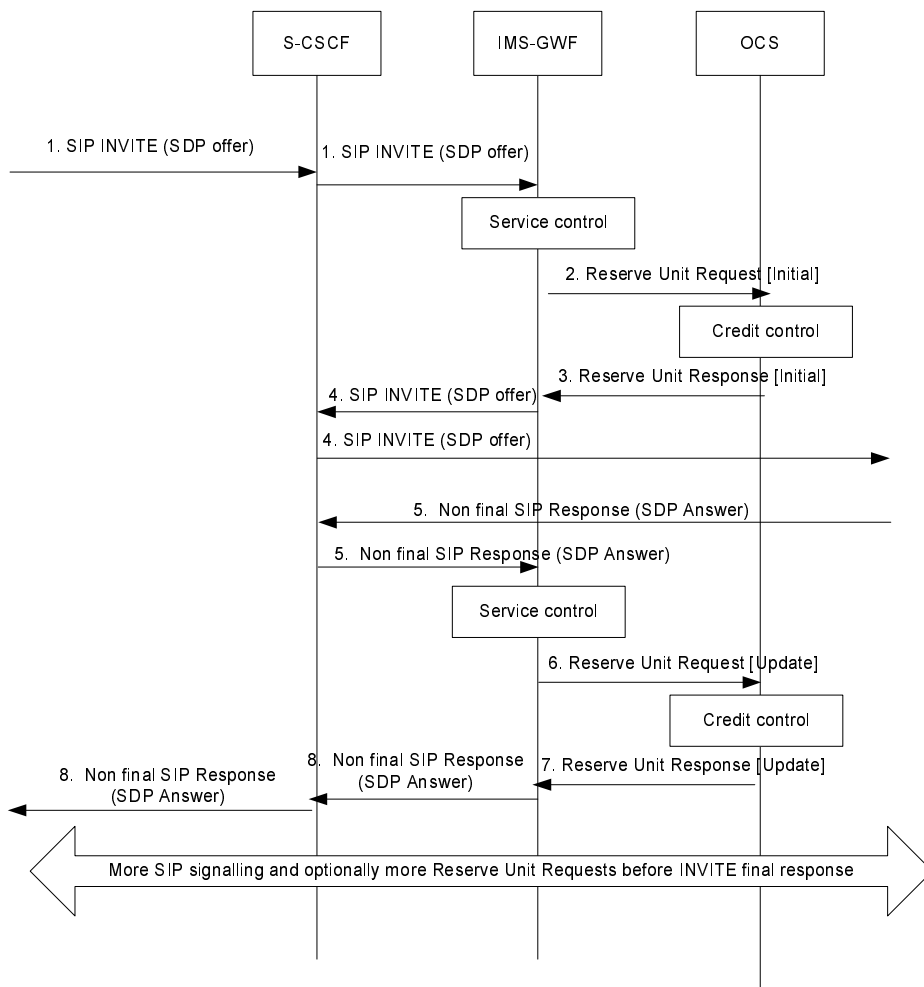

- 1) An initial SDP offer is conveyed in a SIP INVITE message. The SIP INVITE message received in the S-CSCF is forwarded to the IMS-GWF.
- 2) In this example, the SDP offer is conveyed in a SIP request which implies the start of the online session towards the OCS. The IMS-GWF sends a Reserve Unit Request (CC-Request-Type =INITIAL_REQUEST) to the OCS requesting service units. The online credit control session is initiated.
- 3) The OCS grants units in the Reserve Unit Response.
- 4) The IMS-GWF and S-CSCF forward the SIP Request conveying the SDP offer.
- 5) A non-final SIP message (e.g. a provisional reliable response) conveying an SDP answer is received in the IMS-GWF.
- 6) The received SDP answer triggers a Reserve Unit Request (CC-Request-Type =UPDATE_REQUEST) in order to update the credit control session. New service units are requested. Also the used service units (if any) are reported.
- 7) The OCS sends the Reserve Unit Response to acknowledge the Reserve Unit Request. New service units are granted.
- 8) The SDP answer is forwarded.

Figure Scenario 2 : Message Sequence Chart for Session Establishment with Early Media Negotiation

Scenario 3 : Mid-Session Procedures

The figure shows the Diameter transactions that are required in the IMS-GWF when receiving a SIP Re-INVITE in mid-session, e.g. in order to modify media component(s), or when the hold and resume procedure is executed.

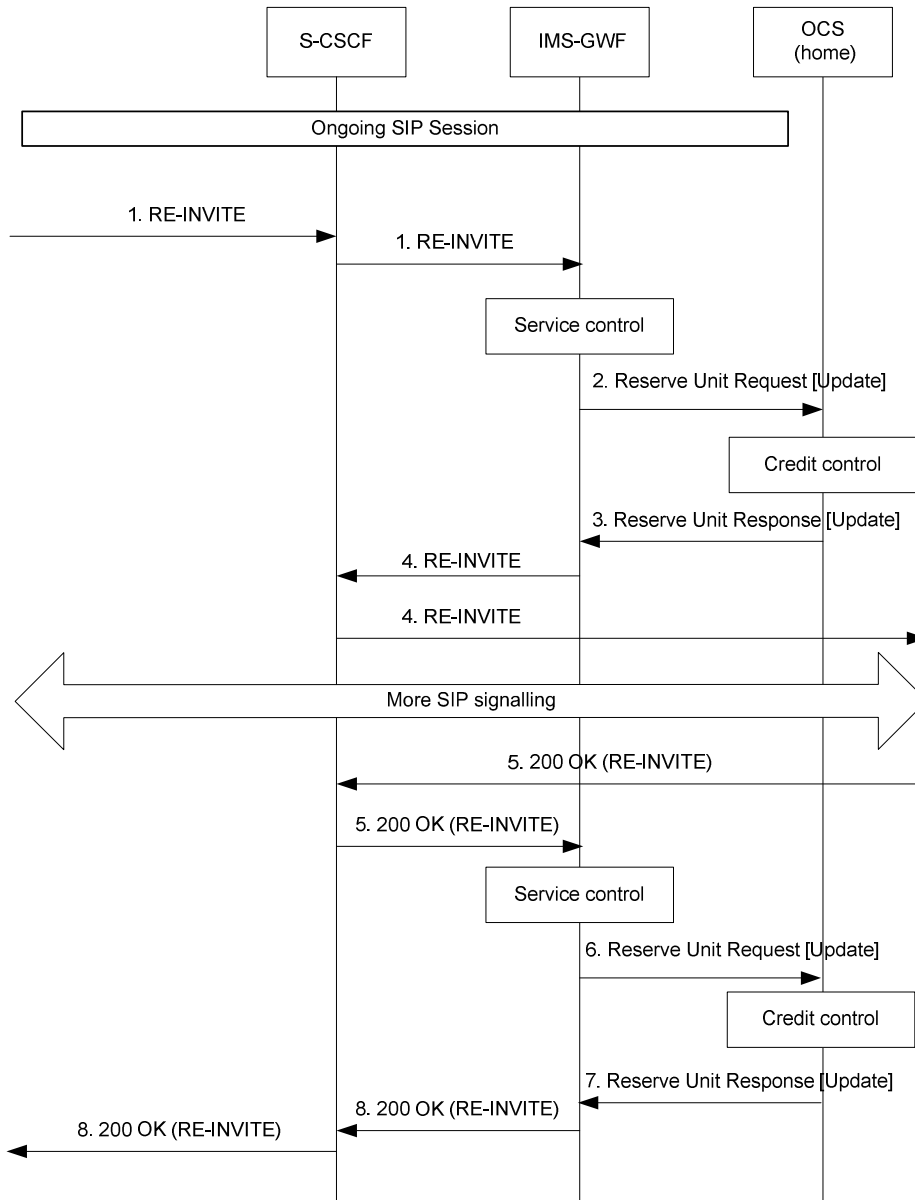

- 1) A SIP RE-INVITE request is received in the S-CSCF. This request is forwarded to the IMS-GWF.
- 2) Upon receiving the SIP RE-INVITE request, the IMS-GWF sends a Reserve Unit Request (CC-Request-Type = UPDATE_REQUEST) to update the previously initiated credit control session. New service units are requested. The used service units (if any) are also reported.
- 3) The OCS grants new service units in the Reserve Unit Response.
- 4) The RE-INVITE request is forwarded.
- 5) The RE-INVITE request is acknowledged with a 200 OK.
- 6) If the trigger is active, the IMS-GWF sends a Reserve Unit Request (CC-Request-Type =UPDATE_REQUEST) to the OCS to update the credit control session. New service units are requested. The used service units (if any) are also reported.
- 7) The OCS grants new service units in the Reserve Unit Response.
- 8) The 200 OK message is forwarded.

Figure Scenario 3 : Message Sequence Chart for Mid-Session Procedures

Scenario 4: Session Release

The following figure shows the Diameter transactions that are required in the IMS-GWF for a session release scenario.

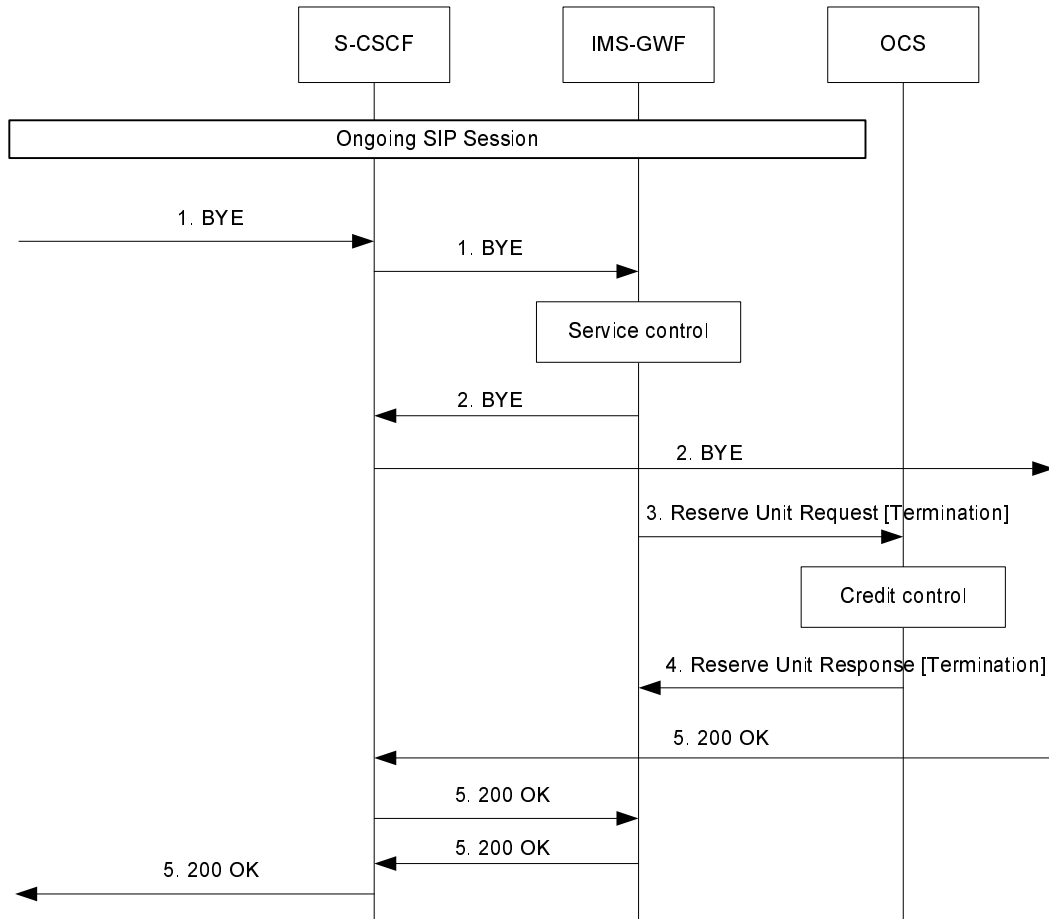

- 1) A SIP session is released by sending a SIP BYE message. The S-CSCF forwards this message to the IMS-GWF.
- 2) Upon receiving the BYE message, the IMS-GWF forwards the SIP BYE request to the UE.
- 3) In case there is an ongoing online control session, the IMS-GWF sends a Reserve Unit Request (CC-Request-Type =TERMINATION_REQUEST) reporting the used granted units.
- 4) The OCS sends a Reserve Unit Response. The online credit control session is terminated.
- 5) The final answer to the Bye message is forwarded.

Figure Scenario 4 : Message Sequence Chart for Session Release.

5.3.2.2.1.3.2 Session Unrelated Procedures (ECUR).

Scenario 1: Successful session unrelated procedure

The following figure shows the Diameter transactions that are required in the IMS-GWF for a session unrelated procedure.

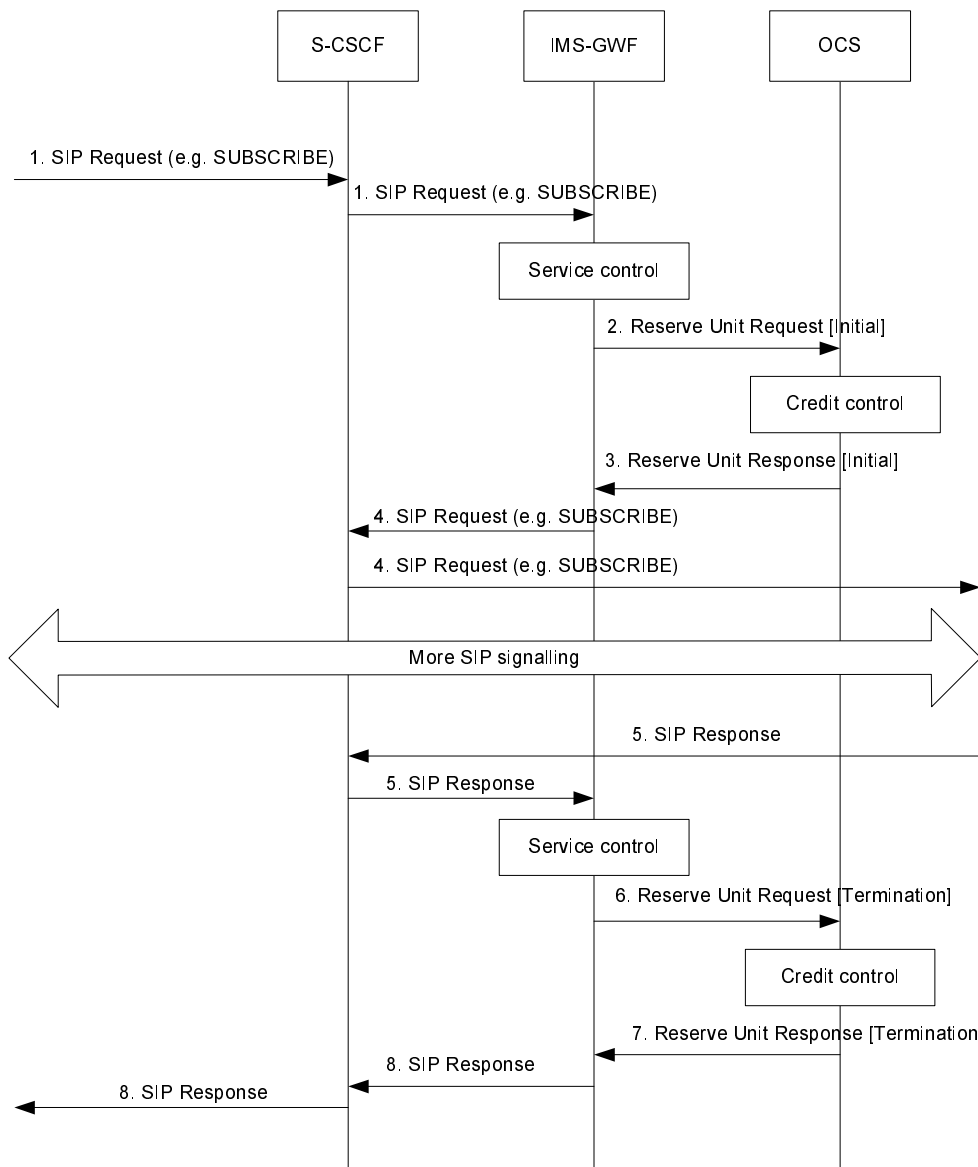

- 1) A session unrelated SIP Request (e.g. SUBSCRIBE) is received in the S-CSCF. The S-CSCF forwards this to the IMS-GWF.
- 2) The IMS-GWF sends a Reserve Unit Request (CC-Request-Type = INITIAL_REQUEST) to initiate a credit control session. Service units are requested to the OCS.
- 3) The OCS grants service units in the Reserve Unit Response.
- 4) The IMS-GWF and the S-CSCF forward the SIP Request
- 5) Depending on the used SIP method, there might be additional signalling between steps 4 and 5.
- 6) The SIP Request is acknowledged by a SIP Response.
- 7) The IMS-GWF sends a Reserve Unit Request (CC-Request-Type=TERMINATION_REQUEST) to the OCS. It also reports the used granted units.
- 8) The OCS sends a Reserve Unit Response to acknowledge the Reserve Unit Request. The online credit control session is terminated.
- 9) The IMS-GWF and S-CSCF forward the SIP Response.

Figure Scenario 1 : Message Sequence Chart for Session-Unrelated Procedures

5.3.2.2.2 Message Flows - Error Cases and Scenarios

This clause describes various error cases and how these should be handled.

The failure handling behaviour is locally configurable in the IMS network element. If *Credit-Control-Failure-Handling* AVP is not used, the locally configured values are used instead.

5.3.2.2.2.1 Reception of SIP Error Messages

If SIP errors occur during service delivery, as defined in [202] and [203], it is up to the IMS network element to determine to what extent the service was delivered before the error occurred and act appropriately with respect to charging. This may imply that no units at all (or no more units) are reserved or debited.

5.3.2.2.2.2 Reserve Units and Debit Units Operation Failure

This case comprises of OCS connection failure, and/or receiving error responses from the OCS.

The IMS network element detects an OCS connection failure when the timer Tx expires (IETF RFC 4006 [402]) or a transport failure is detected as defined in IETF RFC 3588 [401]. The OCS also has the capability to detect failures when the timer Ts (IETF RFC 3588 [401]) expires. The OCS should indicate the cause of failure by setting the appropriate result code as defined in IETF RFC 3588 [401] and IETF RFC 4006 [402]. In any case, the failure handling of IMS network element and OCS complies with the failure procedures for session based credit control scenario described in IETF RFC 4006 [402].

5.3.2.2.2.3 Duplicate Detection

For credit control duplicate detection is performed only for possible duplicate event requests related to IEC as mentioned in clause 5.3.2.1.2.3, as retransmission of ECUR/SCUR related credit control requests is not allowed.

5.3.2.2.2.4 Aborted Session Setup

If a trigger occurs during session establishment to release a session during the establishment procedure, the IMS Network Element shall initiate procedures to cancel the session establishment as defined in TS 24.229 [204]. On completion of the cancellation procedure, the IMS Network Element shall close the credit-control session (for SCUR and ECUR) indicating an appropriate cause code.

5.3.2.3 IMS Service Termination by OCS

Annex C describes several scenarios related to IMS service termination.

For IMS session related scenarios charged by means of SCUR in the IMS-GWF, Service Termination shall imply the rejection of a request for IMS session establishment or the release of an established session that is possibly associated to an online Diameter Charging Session.

For IMS session unrelated scenarios charged by means of ECUR in the IMS-GWF, Service Termination shall imply the rejection of the SIP method triggering the Reserve Unit Request as defined in TS 32.299 [50].

For IMS session unrelated scenarios charged by means of IEC prior to service/content delivery in the IMS-GWF, Service Termination shall imply the rejection of the SIP method triggering the Debit Unit Request as defined in TS 32.299 [50].

5.3.2.3.1 Triggers on Ro interface which imply the termination of the IMS service

The procedures in Ro interface which may trigger the IMS Service termination are the following:

- Reception of an unsuccessful Operation Result different from DIAMETER_CREDIT_CONTROL_NOT_APPLICABLE (TS32.299 [50]) in the Debit and Reserve Unit Response message.
- Reception of an unsuccessful Result Code different from DIAMETER_CREDIT_CONTROL_NOT_APPLICABLE (TS32.299 [50]) within the Multiple Unit

Operation in the Debit and Reserve Unit Response message when only one instance of the Multiple Unit Operation field is used.

- Execution of the Termination Action procedure as defined in TS32.299 [50] when only one instance of the Multiple Unit Operation field is used.
- Execution of the Failure Handling Procedures when the Failure Action is set to "Terminate" or "Retry & Terminate".
- Reception in the IMS-GWF of an Abort-Session-Request Message from OCS.

In case either a Final-Unit-Indication or an erroneous Result-Code at Multiple Unit Operation level trigger the IMS service termination and the charging is based on ECUR or SCUR, the IMS-GWF shall close the Diameter online session by sending a Debit Units and Reserve Units operation of Type "Termination".

Refer to TS 32.299 [50] for a detailed description of these procedures.

5.3.2.3.2 Indication to the UE of the reason for IMS service release

As a result of Service Termination triggering in IMS-GWF, the IMS service shall be denied to end-users. The network should provide an indication to UEs of the reason the service has been released or rejected. The procedure shall depend on:

- The charged party.

The network should provide UEs with an indication of the reason the service has been released or rejected. However, this reason shall depend on whether the UE is the charged party or not. The premise is that only the charged party should know that the IMS service is being rejected / released because of OCS interaction.

- IMS specific protocol issues as defined in TS 24.229 [204].

- A) The IMS-GWF generates a non-2xx final SIP response as a result of the IMS Service Termination procedure:

In this scenario, the Response Code of the SIP response shall indicate the server understood the request but is refusing to fulfil it and that this request should not be repeated. The SIP response may include additional information about the cause to reject/release the IMS service. The presence of this additional error information in the response shall be operator configurable.

The additional information included in the SIP response may contain a SIP URI. The UE may treat the SIP URI as if it were a Contact in a redirect and generate a new INVITE, resulting, for example, in a recorded announcement session being established.

- B) The IMS-GWF generates a SIP request (e.g. SIP BYE or SIP CANCEL) as a result of the IMS Service Termination procedure:

In this scenario, the IMS-GWF may include a "Reason" field in the request which provides additional information about the cause to reject/release the IMS service. The presence of this additional information in the request shall be operator configurable.

In both scenarios, it shall also be operator configurable both per SIP Method and per Originating/Terminating side, the content of the additional error information sent to the UEs. This error information shall also be configurable based on the procedure in Ro interface which has triggered the release/rejection of the IMS service according to clause 5.3.2.3.1. In particular when the Service Termination is triggered by the reception of an unsuccessful Operation Result (different from DIAMETER_CREDIT_CONTROL_NOT_APPLICABLE as defined in TS 32.299 [50]) in the Debit and Reserve Unit Response message or the reception of an unsuccessful Result Code (different from DIAMETER_CREDIT_CONTROL_NOT_APPLICABLE as defined in TS 32.299 [50]) within the Multiple Unit Operation in the Debit and Reserve Unit Response message, the additional error information/reason shall also be configurable based on the Result Code received through Ro interface.

6 Definition of charging information

6.1 Data description for IMS offline charging

6.1.1 Rf Message contents

The IMS nodes generate accounting information that can be transferred from the CTF to the CDF. For this purpose, IMS offline charging utilises the *Charging Data Transfer* that is specified in the 3GPP accounting application described in TS 32.299 [50].

The *Charging Data Transfer* operation employs the *Charging Data Request* and *Charging Data Response* messages. The following table describes the use of these messages for offline charging.

Table 6.1.1: Offline Charging Messages Reference Table

| Command-Name | Source | Destination |
|-------------------------------|--|--|
| <i>Charging Data Request</i> | S-CSCF, I-CSCF, P-CSCF, MRFC, MGCF, BGCF, AS | CDF |
| <i>Charging Data Response</i> | CDF | S-CSCF, I-CSCF, P-CSCF, MRFC, MGCF, BGCF, AS |

6.1.1.1 Charging Data-Request Message

The following table illustrates the basic structure of a Diameter *Charging Data-Request* message as used for IMS offline charging.

Table 6.1.1.1: Charging Data Request Message Contents

| Field | Category | Description |
|-----------------------|----------------|--|
| Session Identifier | M | Described in 32.299 [50] |
| Originator Host | M | Described in 32.299 [50] |
| Originator Domain | M | Described in 32.299 [50] |
| Destination Domain | M | Described in 32.299 [50] |
| Operation Type | M | Described in 32.299 [50] |
| Operation Number | M | Described in 32.299 [50] |
| Operation Identifier | O _M | The field corresponds to the unique operation identification. |
| User Name | O _C | Described in 32.299 [50] |
| Operation Interval | O _C | TBD |
| Origination State | O _C | TBD |
| Origination Timestamp | O _C | This field contains the time when the operation is requested. |
| Proxy Information | O _C | This field contains the parameter of the proxy. |
| Route Information | O _C | This field contains the parameter of the route. |
| Operation Token | O _M | This field identifies the domain, subsystem, or service and release. |
| Service Information | O _M | This field holds the 3GPP specific IMS parameter, described in 6.3. |

6.1.1.2 Charging Data Response Message

The following table illustrates the basic structure of a Diameter *Charging Data Response* message as used for IMS offline charging.

Table 6.1.1.2: Charging Data Response Message Contents

| Field | Category | Description |
|-----------------------|----------------|---|
| Session Identifier | M | This field identifies the operation session. |
| Operation Result | M | This field identifies the result of the operation. |
| Originator Host | M | This field contains the identification of the source point of the operation and the realm of the operation originator. |
| Originator Domain | M | This field contains the realm of the operation originator. |
| Operation Type | M | This field defines the transfer type: event for event based charging and start, interim, stop for session based charging. |
| Operation Number | M | This field contains the sequence number of the transferred messages. |
| Operation Identifier | O _M | The field corresponds to the unique operation identification. |
| User Name | O _C | The field contains the Private User Identity [201]. |
| Operation Interval | O _C | TBD |
| Origination State | O _C | TBD |
| Origination Timestamp | O _C | This field contains the time when the operation is requested. |
| Proxy Information | O _C | This field contains the parameter of the proxy. |

6.1.2 GTP" message contents

GTP" is used between CDF and CGF in IP Multimedia subsystem.

Use text from middle tear template

6.1.3 CDR Description on the Bi Interface

6.1.3.1 CDR Field Types

The following Standard CDR content and format are considered:

S-CSCF-CDR generated based on information from the S-CSCF.

I-CSCF-CDR generated based on information from the I-CSCF.

P-CSCF-CDR generated based on information from the P-CSCF.

BGCF-CDR generated based on information from the BGCF.

MGCF-CDR generated based on information from the MGCF.

MRFC-CDR generated based on information from the MRFC.

AS-CDR generated based on information from the AS.

The content of each CDR type is defined in the tables in clauses 6.1.3.3 to 6.1.3.9. For each CDR type the field definition includes the field name, category and description. The detailed field descriptions are provided in TS 32.298 [51].

Editor's Note: Equipment vendors shall be able to provide all of the fields listed in the CDR content table in order to claim compliance with the present document. However, since CDR processing and transport consume network resources, operators may opt to eliminate some of the fields that are not essential for their operation.

Editors note: Rephrase the above paragraph and ref. to 32.240

The CDF provides the CDRs at the Bi interface in the format and encoding described in TS 32.298 [51]. Additional CDR formats and contents may be available at the interface to the billing system to meet the requirements of the billing system, these are outside of the scope of 3GPP standardisation.

6.1.3.2 CDR Triggers

6.1.3.2.1 Session Related CDRs

Reflecting the usage of multimedia sessions IMS CDRs are generated by the CDF on a per session level. In the scope of the present document the term "session" refers always to a SIP session. The coherent media components are reflected inside the session CDRs with a media component container comprising of all the information necessary for the description of a media component.

Accounting information for SIP sessions is transferred from the CTF involved in the session to the CDF using Charging Data Request Start, Interim and Stop messages. A session CDR is opened in the CDF upon reception of a Charging Data Request [Start] message. Partial CDRs may be generated upon reception of a Charging Data Request [Interim] message, which is sent by the network entity towards the CDF due to a session modification procedure (i.e. change in media). Session CDRs are updated, or partial CDRs are generated upon reception of a Charging Data Request [Interim] message, which is sent by the network entity due to expiration of the Charging Data Interim Interval. The CDF closes the final session CDR upon reception of a Charging Data Request [Stop] message, which indicates that the SIP session is terminated. Further details on triggers for the generation of IMS CDRs are specified in [1].

Accounting information for unsuccessful session set-up attempts may be sent by the CTF to the CDF employing the Charging Data Request [Event] message. The behaviour of the CDF upon receiving Charging Data Request [Event] messages is specified in clause 6.1.3.2.2.

6.1.3.2.2 Session Unrelated CDRs

To reflect chargeable events not directly related to a session the CDF may generate CDRs upon the occurrence of session unrelated SIP procedures, such as registration respectively de-registration events. Accounting information for SIP session-unrelated procedures is transferred from the IMS nodes involved in the procedure to the CDF using Charging Data Request [Event] messages. Session unrelated CDRs are created in the CDF in a "one-off" action based on the information contained in the Charging Data Request [Event] message. One session unrelated CDR is created in the CDF for each Charging Data Request [Event] message received, whereas the creation of partial CDRs is not applicable for session unrelated CDRs. The cases for which the IMS nodes send Charging Data Request [Event] messages are listed per SIP procedure in table 5.2.1.1 and table 5.2.1.2.

Further details on triggers for the generation of IMS CDRs are specified in clause 5.2.2.

6.1.3.3 S-CSCF CDR Content

The detailed description of the field is provided in TS 32.298 [51].

Table 6.1.3.3: Charging Data of S-CSCF CDR

| Field | Category | Description |
|-------------------------------------|----------------|--|
| Record Type | M | Identifies the type of record. The parameter is derived from the Node functionality parameter. |
| Retransmission | O _C | This parameter, when present, indicates that information from retransmitted Charging Data Requests has been used in this CDR |
| SIP Method | O _C | Specifies the SIP-method for which the CDR is generated. Only available in session unrelated cases. |
| Event | O _C | This field identifies the SIP event package to which the SIP request is referred. |
| Expires Information | O _C | This field indicates the validity time of either the SIP message or its content, depending on the SIP method. |
| Role of Node | O _M | This field indicates the role of the S-CSCF. |
| Node Address | O _M | This item holds the address of the node providing the information for the CDR. This may either be the IP address or the FQDN of the IMS node generating the accounting data. |
| Session ID | O _M | The Session identification. For a SIP session the Session-ID contains the SIP Call ID as defined in the Session Initiation Protocol RFC 3261 [404]. |
| List Of Calling Party Address | O _M | The address or addresses (Public User ID or Public Service ID) of the party requesting a service or initiating a session. |
| List of Associated URI | O _C | The list of non-barred public user identities (SIP URIs and/or TEL URIs) associated to the public user identity under registration. |
| Called Party Address | O _M | For SIP transactions, except for registration, this field holds the address of the party (Public User ID or Public Service ID) to whom the SIP transaction is posted. For registration transactions, this field holds the Public User ID under registration. |
| Requested Party Address | O _C | For SIP transactions this field holds the address of the party (Public User ID or Public Service ID) to whom the SIP transaction was originally posted. This field is only present if different from the Called Party Address parameter. |
| List of Called Asserted Identity | O _C | The address or addresses of the final asserted identities. Present if the final asserted identities are available in the SIP 2xx response. |
| Private User ID | O _M | Holds the used private user identity of the served party according to RFC2486 [405]. |
| List of Subscription Id | O _M | Holds the public user identities of the served user |
| Service Request Time Stamp | O _M | This field contains the time stamp, which indicates the time at which the service was requested. |
| Service Delivery Start Time Stamp | O _M | This field holds the time stamp reflecting either: successful session set-up, a delivery unrelated service, an unsuccessful session set-up and an unsuccessful session unrelated request. |
| Service Delivery End Time Stamp | O _C | This field records the time at which the service delivery was terminated. It is Present only in SIP session related case. |
| Record Opening Time | O _C | A time stamp reflecting the time the CDF opened this record. Present only in SIP session related case. |
| Record Closure Time | O _M | A Time stamp reflecting the time the CDF closed the record. |
| Application Servers Information | O _C | This a grouped CDR field containing the fields: 'Application Server Involved' and 'Application Provided Called Parties'. |
| Application Servers Involved | O _C | Holds the ASs (if any) identified by the SIP URIs. |
| Application Provided Called Parties | O _C | Holds a list of the Called Party Address(es), if the address(es) are determined by an AS (SIP URI, E.164...). |
| List of Inter Operator Identifiers | O _C | Holds the identification of the home network (originating and terminating) if exchanged via SIP signalling, as recorded in the P-Charging-Vector header. This grouped field may occur several times in one CDR. |
| Originating IOI | O _C | This parameter corresponds to Orig-IOI header of the P-Charging-Vector defined in TS 24.229 [204]. |
| Terminating IOI | O _C | This parameter corresponds to Term-IOI header of the P-Charging-Vector defined in TS 24.229 [204]. |
| Local Record Sequence Number | O _M | This field includes a unique record number created by S-CSCF. The number is allocated sequentially for each partial CDR (or whole CDR) including all CDR types. The number is unique within the CDF. |
| Record Sequence Number | O _C | This field contains a running sequence number employed to link the partial records generated by the CDF for a particular session. |

| Field | Category | Description |
|------------------------------------|----------------|--|
| Cause For Record Closing | O _M | This field contains a reason for the close of the CDR. |
| Incomplete CDR Indication | O _C | This field provides additional diagnostics when the CDF detects missing Charging Data Requests. |
| IMS Charging Identifier | O _M | This parameter holds the IMS charging identifier (ICID) as generated by the IMS node for the SIP session. |
| List of Early SDP Media Components | O _C | This is a grouped field which may occur several times in one CDR. Each occurrence shall describe a change in the state (inactive/active or vice versa) of the media components negotiated during the SIP session establishment previously to the reception of a SIP final response to the initial SIP Invite. This field shall not be present if no media components are set to active before the final SIP session answer to the initial SIP Invite is received. This field can be present in either session or event CDRs. |
| SDP Session Description | O _C | Holds the Session portion of SDP data exchanged in the above mentioned scenario, if available. |
| SDP Offer Timestamp | O _M | This parameter contains the time of the SIP Request which conveys the SDP offer. |
| SDP Answer Timestamp | O _M | This parameter contains the time of the response to the SIP Request which conveys the SDP answer. |
| SDP Media Components | O _M | This is a grouped field comprising several sub-fields associated with one media component. Since several media components may exist for a session in parallel these sub-fields may occur several times. |
| SDP Media Name | O _M | This field holds the name of the media as available in the SDP data. |
| SDP Media Description | O _M | This field holds the attributes of the media as available in the SDP data. |
| Access Correlation ID | O _C | This parameter holds the charging identifier from the access network, consisting of either GPRS charging ID (GCID) which is generated by the GGSN for a GPRS PDP context or the Access Network Charging Identifier Value which is generated by another type of access network. It is present only if received from the access network when PCC architecture is implemented. |
| Media Initiator Flag | O _C | This field indicates if the called party has requested the session modification and it is present only if the initiator was the called party. |
| List of SDP Media Components | O _C | This is a grouped field which may occur several times in one CDR. The first occurrence describes the initial SIP session negotiation whilst the other would stem from session re-negotiations. The field is present only in a SIP session related case. |
| SDP Session Description | O _C | Holds the Session portion of the SDP data exchanged between the User Agents if available in the SIP transaction. |
| SIP Request Timestamp | O _M | This parameter contains the time of the SIP Request (usually a (Re)Invite). |
| SIP Response Timestamp | O _M | This parameter contains the time of the response to the SIP Request (usually a 200 OK). |
| SDP Media Components | O _M | This is a grouped field comprising several sub-fields associated with one media component. Since several media components may exist for a session in parallel these sub-fields may occur several times. |
| SDP Media Name | O _M | This field holds the name of the media as available in the SDP data. |
| SDP Media Description | O _M | This field holds the attributes of the media as available in the SDP data. |
| Access Correlation ID | O _C | This parameter holds the charging identifier from the access network, consisting of either GPRS charging ID (GCID) which is generated by the GGSN for a GPRS PDP context or the Access Network Charging Identifier Value which is generated by another type of access network. It is present only if received from the access network when PCC architecture is implemented. |
| Media Initiator Flag | O _C | This field indicates if the called party has requested the session modification and it is present only if the initiator was the called party. |
| GGSN Address | O _C | This parameter holds the control plane IP address of the GGSN that handles one or more media component(s) of an IMS session. |
| Service Reason Return Code | O _M | This parameter provides the returned SIP status code for the service request for the successful and failure case, |

| Field | Category | Description |
|------------------------------|----------------|--|
| List of Message Bodies | O _C | This grouped field comprising several sub-fields describing the data that may be conveyed end-to-end in the body of a SIP message. Since several message bodies may be exchanged via SIP-signalling, this grouped field may occur several times. |
| Content-Type | O _M | This sub-field of Message Bodies holds the MIME type of the message body, Examples are: application/zip, image/gif, audio/mpeg, etc. |
| Content-Disposition | O _C | This sub-field of Message Bodies holds the content disposition of the message body inside the SIP signalling, Content-disposition header field equal to 'render', indicates that 'the body part should be displayed or otherwise rendered to the user'. Content disposition values are: session, render, inline, icon, alert, attachment, etc. |
| Content-Length | O _M | This sub-field of Message Bodies holds the size of the data of a message body in bytes. |
| Originator | O _C | This sub-field of the "List of Message Bodies" indicates the originating party of the message body. |
| Access Network Information | O _C | This field contains the content of the SIP P-header 'P-Access-Network-Info' if available. |
| Service Context Id | O _M | Holds the context information to which the CDR belongs. The information is obtained from the Operation Token of the Charging Data Request message. |
| IMS Communication Service ID | O _C | This field contains the IMS communication service identifier if received in the P-Asserted-Service header in the SIP request. |
| Record Extensions | O _C | A set of operator/manufacture specific extensions to the record, conditioned upon existence of an extension. |

6.1.3.4 P-CSCF CDR Content

The detailed description of the field is provided in TS 32.298 [51].

Table 6.1.3.4: Charging Data of P-CSCF CDR

| Field | Category | Description |
|-----------------------------------|----------------|---|
| Record Type | M | Identifies the type of record. The parameter is derived from the Node functionality parameter. |
| Retransmission | O _C | This parameter, when present, indicates that information from retransmitted Charging Data Requests has been used in this CDR. |
| SIP Method | O _C | Specifies the SIP-method for which the CDR is generated. Only available in session unrelated cases. |
| Event | O _C | This field identifies the SIP event package to which the SIP request is referred. |
| Expires Information | O _C | This field indicates the validity time of either the SIP message or its content, depending on the SIP method. |
| Role of Node | O _M | This fields indicates the role of the P-CSCF. |
| Node Address | O _M | This item holds the address of the node providing the information for the CDR. This may either be the IP address or the FQDN of the IMS node generating the accounting data. |
| Session ID | O _M | The Session identification. For a SIP session the Session-ID contains the SIP Call ID as defined in the Session Initiation Protocol RFC 3261 [404]. |
| List Of Calling Party Address | O _M | The address (Public User ID or Public Service ID) of the party requesting a service or initiating a session. Note: For P-CSCF, only one address is present |
| List of Associated URI | O _C | The list of non-barred public user identities (SIP URIs and/or TEL URIs) associated to the public user identity under registration. |
| Called Party Address | O _M | In the context of an end-to-end SIP transaction this field holds the address of the party (Public User ID) to whom the SIP transaction is posted. |
| Served Party IP Address | O _M | This field contains the IP address of either the calling or called party, depending on whether the P-CSCF is in touch with the calling or called network. |
| List of Subscription Id | O _M | Holds the public user identities of the served user. |
| Service Request Time Stamp | O _M | This field contains the time stamp, which indicates the time at which the service was requested. |
| Service Delivery Start Time Stamp | O _M | This field holds the time stamp reflecting either: successful session set-up, a delivery unrelated service, an unsuccessful session set-up and an unsuccessful session unrelated request. |
| Service Delivery End Time Stamp | O _C | This field records the time at which the service delivery was terminated. It is Present only in SIP session related case. Present with Charging Data Request [Stop]. |
| Record Opening Time | O _C | A time stamp reflecting the time the CDF opened this record. Present only in SIP session related case. |
| Record Closure Time | O _M | A Time stamp reflecting the time the CDF closed the record. |
| Inter Operator Identifiers | O _C | Holds the identification of the home network (originating and terminating) if exchanged via SIP signalling, as recorded in the <i>P-Charging-Vector header</i> . |
| Originating IOI | O _C | This parameter corresponds to Orig-IOI header of the P-Charging-Vector defined in TS 24.229 [204]. |
| Terminating IOI | O _C | This parameter corresponds to Term-IOI header of the P-Charging-Vector defined in TS 24.229 [204]. |
| Local Record Sequence Number | O _M | This field includes a unique record number created by this node. The number is allocated sequentially for each partial CDR (or whole CDR) including all CDR types. The number is unique within the CDF. |
| Record Sequence Number | O _C | This field contains a running sequence number employed to link the partial records generated by the CDF for a particular session. |
| Cause For Record Closing | O _M | This field contains a reason for the close of the CDR. |
| Incomplete CDR Indication | O _C | This field provides additional diagnostics when the CDF detects missing Charging Data Requests. |
| IMS Charging Identifier | O _M | This parameter holds the IMS charging identifier (ICID) as generated by the IMS node for the SIP session. |

| Field | Category | Description |
|------------------------------------|----------------|--|
| List of Early SDP Media Components | O _C | This is a grouped field which may occur several times in one CDR. Each occurrence shall describe a change in the state (inactive/active or vice versa) of the media components negotiated during the SIP session establishment previously to the reception of a SIP final response to the initial SIP Invite. This field shall not be present if no media components are set to active before the final SIP session answer to the initial SIP Invite is received. This field can be present in either session or event CDRs. |
| SDP Session Description | O _C | Holds the Session portion of SDP data exchanged in the above mentioned scenario, if available. |
| SDP Offer Timestamp | O _M | This parameter contains the time of the SIP Request which conveys the SDP offer. |
| SDP Answer Timestamp | O _M | This parameter contains the time of the response to the SIP Request which conveys the SDP answer. |
| SDP Media Components | O _M | This is a grouped field comprising several sub-fields associated with one media component. Since several media components may exist for a session in parallel these sub-fields may occur several times. |
| SDP Media Name | O _M | This field holds the name of the media as available in the SDP data. |
| SDP Media Description | O _M | This field holds the attributes of the media as available in the SDP data. |
| Access Correlation ID | O _C | This parameter holds the charging identifier from the access network, consisting of either GPRS charging ID (GCID) which is generated by the GGSN for a GPRS PDP context or the Access Network Charging Identifier Value which is generated by another type of access network. It is present only if received from the access network when PCC architecture is implemented. |
| Media Initiator Flag | O _C | This field indicates if the called party has requested the session modification and it is present only if the initiator was the called party. |
| List of SDP Media Components | O _C | This is a grouped field which may occur several times in one CDR. The first occurrence describes the initial session negotiation whilst the other would stem from session re-negotiations. The field is present only in a SIP session related case. |
| SDP Session Description | O _C | Holds the Session portion of the SDP data exchanged between the User Agents if available in the SIP transaction. |
| SIP Request Timestamp | O _M | This parameter contains the time of the SIP Request (usually a (Re)Invite). This parameter corresponds to SIP Request Timestamp in Charging Data Request [Interim]. |
| SIP Response Timestamp | O _M | This parameter contains the time of the response to the SIP Request (usually a 200 OK). This parameter corresponds to SIP Response Timestamp in Charging Data Request [Interim]. |
| SDP Media Components | O _M | This is a grouped field comprising several sub-fields associated with one media component. Since several media components may exist for a session in parallel these sub-fields may occur several times. |
| SDP Media Name | O _M | This field holds the name of the media as available in the SDP data. This parameter corresponds to SDP-Media-Name. |
| SDP Media Description | O _M | This field holds the attributes of the media as available in the SDP data. This parameter corresponds to SDP-Media-Description. |
| Access Correlation ID | O _C | This parameter holds the charging identifier from the access network, consisting of either GPRS charging ID (GCID) which is generated by the GGSN for a GPRS PDP context or the Access Network Charging Identifier Value which is generated by another type of access network. It is present only if received from the access network when PCC architecture is implemented. |
| Authorised QoS | O _C | Authorised QoS as defined in TS 23.207 [7] / TS 29.207 [8] and applied via the Go interface. |
| Media Initiator Flag | O _C | This field indicates if the called party has requested the session modification and it is present only if the initiator was the called party. |
| GGSN Address | O _C | This parameter holds the control plane IP address of the GGSN that handles one or more media component(s) of a IMS session. |
| Service Reason Return Code | O _M | This parameter provides the returned SIP status code for the service request for the successful and failure case. |
| List of Message Bodies | O _C | This grouped field comprising several sub-fields describing the data that may be conveyed end-to-end in the body of a SIP message. Since several message bodies may be exchanged via SIP-signalling, this grouped field may occur several times. |
| Content-Type | O _M | This sub-field of Message Bodies holds the MIME type of the message body, Examples are: application/zip, image/gif, audio/mpeg, etc. |

| Field | Category | Description |
|----------------------------|----------------|--|
| Content-Disposition | O _C | This sub-field of Message Bodies holds the content disposition of the message body inside the SIP signalling, Content-disposition header field equal to 'render', indicates that 'the body part should be displayed or otherwise rendered to the user'. Content disposition values are: session, render, inline, icon, alert, attachment, etc. |
| Content-Length | O _M | This sub-field of Message Bodies holds the size of the data of a message body in bytes. |
| Originator | O _C | This sub-field of the "List of Message Bodies" indicates the originating party of the message body. |
| Access Network Information | O _C | This field contains the content of the SIP P-header 'P-Access-Network-Info' if available. |
| Service Context Id | O _M | Holds the context information to which the CDR belongs. The information is obtained from the Operation Token of the Charging Data Request message. |
| Record Extensions | O _C | A set of operator/manufacture specific extensions to the record, conditioned upon existence of an extension. |

6.1.3.5 I-CSCF CDR Content

The detailed description of the field is provided in TS 32.298 [51].

Table 6.1.3.5: Charging Data of I-CSCF CDR

| Field | Category | Description |
|-------------------------------|----------------|---|
| Record Type | M | Identifies the type of record. The parameter is derived from the Node functionality parameter. |
| Retransmission | O _C | This parameter, when present, indicates that information from retransmitted Charging Data Requests has been used in this CDR |
| SIP Method | O _C | Specifies the SIP-method for which the CDR is generated. Only available in session unrelated cases. |
| Event | O _C | This field identifies the SIP event package to which the SIP request is referred. |
| Expires Information | O _C | This field indicates the validity time of either the SIP message or its content, depending on the SIP method. |
| Role of Node | O _M | This fields indicates the role of the I-CSCF. |
| Node Address | O _M | This item holds the address of the node providing the information for the CDR. This may either be the IP address or the FQDN of the IMS node generating the accounting data. |
| Session ID | O _M | The Session identification. For a SIP session the Session-ID contains the SIP Call ID as defined in the Session Initiation Protocol RFC 3261 [404]. |
| List Of Calling Party Address | O _M | The address or addresses (Public User ID or Public Service ID) of the party requesting a service or initiating a session. |
| List of Associated URI | O _C | The list of non-barred public user identities (SIP URIs and/or TEL URIs) associated to the public user identity under registration. |
| Called Party Address | O _M | In the context of an end-to-end SIP transaction this field holds the address of the party (Public User ID) to whom the SIP transaction is posted. |
| Service Request Time Stamp | O _M | This field contains the time stamp, which indicates the time at which the service was requested. This parameter corresponds to SIP Request Timestamp. Present with Charging Data Request [Event]. |
| Inter Operator Identifiers | O _C | Holds the identification of the home network (originating and terminating) if exchanged via SIP signalling, as recorded in the <i>P-Charging-Vector header</i> . |
| Originating IOI | O _C | This parameter corresponds to Orig-IOI header of the P-Charging-Vector defined in TS 24.229 [204]. |
| Terminating IOI | O _C | This parameter corresponds to Term-IOI header of the P-Charging-Vector defined in TS 24.229 [204]. |
| Local Record Sequence Number | O _M | This field includes a unique record number created by this node. The number is allocated sequentially for each partial CDR (or whole CDR) including all CDR types. The number is unique within the CDF. |
| Cause For Record Closing | O _M | This field contains a reason for the close of the CDR. |
| Incomplete CDR Indication | O _C | This field provides additional diagnostics when the CDF detects missing Charging Data Requests. |
| S-CSCF Information | O _C | This field contains Information related to the serving CSCF, e.g. the S-CSCF capabilities upon registration event or the S-CSCF address upon the session establishment event. |
| IMS Charging Identifier | O _M | This parameter holds the IMS charging identifier (ICID) as generated by the IMS node for the SIP session. |
| Service Reason Return Code | O _M | This parameter provides the returned SIP status code for the service request for the successful and failure case, |
| Access Network Information | O _C | This field contains the content of the SIP P-header 'P-Access-Network-Info' if available. |
| Service Context Id | O _M | Holds the context information to which the CDR belongs. The information is obtained from the Operation Token of the Charging Data Request message. |
| Record Extensions | O _C | A set of operator/manufacture specific extensions to the record, conditioned upon existence of an extension. |

6.1.3.6 MRFC CDR Content

The detailed description of the field is provided in TS 32.298 [51].

Table 6.1.3.6: Charging Data of MRFC CDR

| Field | Category | Description |
|-------------------------------------|----------------|---|
| Record Type | M | Identifies the type of record. The parameter is derived from the Node functionality parameter. |
| Retransmission | O _C | This parameter, when present, indicates that information from retransmitted Charging Data Requests has been used in this CDR. |
| SIP Method | O _C | Specifies the SIP-method for which the CDR is generated. Only available in session unrelated cases. |
| Event | O _C | This field identifies the SIP event package to which the SIP request is referred. |
| Expires Information | O _C | This field indicates the validity time of either the SIP message or its content, depending on the SIP method. |
| Role of Node | O _M | This field indicates the role of the MRFC. |
| Node Address | O _M | This item holds the address of the node providing the information for the CDR. This may either be the IP address or the FQDN of the IMS node generating the accounting data. |
| Session ID | O _M | The Session identification. For a SIP session the Session-ID contains the SIP Call ID as defined in the Session Initiation Protocol RFC 3261 [404]. |
| Service ID | O _M | This field identifies the service the MRFC is hosting. For conferences the conference ID is used here. |
| List Of Calling Party Address | O _M | The address or addresses (Public User ID or Public Service ID) of the party requesting a service or initiating a session. |
| Called Party Address | O _C | For SIP transactions, except for registration, this field holds the address of the party (Public User ID or Public Service ID) to whom the SIP transaction is posted. For registration transactions, this field holds the Public User ID under registration. |
| Requested Party Address | O _C | For SIP transactions this field holds the address of the party (Public User ID or Public Service ID) to whom the SIP transaction was originally posted. This field is only present if different from the Called Party Address parameter. |
| List of Called Asserted Identity | O _C | The address or addresses of the final asserted identities. Present if the final asserted identities are available in the SIP 2xx response. |
| List of Subscription Id | O _M | Holds the public user identities of the served user |
| Service Request Time Stamp | O _M | This field contains the time stamp which indicates the time at which the service was requested. This parameter corresponds to SIP Request Timestamp. Present with Charging Data Request [Start] and Charging Data Request [Event]. |
| Service Delivery Start Time Stamp | O _M | This field holds the time stamp reflecting either: successful session set-up, a delivery unrelated service, an unsuccessful session set-up and an unsuccessful session unrelated request. This parameter corresponds to SIP Response Timestamp. Present with Charging Data Request [Start] and Charging Data Request [EVENT]. |
| Service Delivery End Time Stamp | O _C | This field records the time at which the service delivery was terminated. It is Present only in SIP session related case. This parameter corresponds to SIP Request Timestamp. Present with Charging Data Request [Stop]. |
| Record Opening Time | O _C | A time stamp reflecting the time the CDF opened this record. Present only in SIP session related case. |
| Record Closure Time | O _M | A Time stamp reflecting the time the CDF closed the record. |
| Application Servers Information | O _C | This is a grouped CDR field containing the fields: 'Application Server Involved' and 'Application Provided Called Parties'. |
| Application Servers Involved | O _C | Holds the ASs (if any) identified by the SIP URIs. |
| Application Provided Called Parties | O _C | Holds a list of the Called Party Address(es), if the address(es) are determined by an AS (SIP URI, E.164...). |
| Inter Operator Identifiers | O _C | Holds the identification of the home network (originating and terminating) if exchanged via SIP signalling, as recorded in the <i>P-Charging-Vector header</i> . |
| Originating IOI | O _C | This parameter corresponds to Orig-IOI header of the P-Charging-Vector defined in TS 24.229 [204]. |
| Terminating IOI | O _C | This parameter corresponds to Term-IOI header of the P-Charging-Vector defined in TS 24.229 [204]. |
| Local Record Sequence Number | O _M | This field includes a unique record number created by this node. The number is allocated sequentially for each partial CDR (or whole CDR) including all CDR types. The number is unique within the CDF. |
| Record Sequence Number | O _C | This field contains a running sequence number employed to link the partial records generated by the CDF for a particular session. |

| Field | Category | Description |
|------------------------------------|----------------|--|
| Cause For Record Closing | O _M | This field contains a reason for the close of the CDR. |
| Incomplete CDR Indication | O _C | This field provides additional diagnostics when the CDF detects missing Charging Data Requests. |
| IMS Charging Identifier | O _M | This parameter holds the IMS charging identifier (ICID) as generated by the IMS node for the SIP session. |
| List of SDP Media Components | O _C | This is a grouped field which may occur several times in one CDR. The first occurrence describes the initial session negotiation whilst the other would stem from session re-negotiations. The field is present only in a SIP session related case |
| List of Early SDP Media Components | O _C | This is a grouped field which may occur several times in one CDR. Each occurrence shall describe a change in the state (inactive/active or vice versa) of the media components negotiated during the SIP session establishment previously to the reception of a SIP final response to the initial SIP Invite. This field shall not be present if no media components are set to active before the final SIP session answer to the initial SIP Invite is received. This field can be present in either session or event CDRs. |
| SDP Session Description | O _C | Holds the Session portion of SDP data exchanged in the above mentioned scenario, if available. |
| SDP Offer Timestamp | O _M | This parameter contains the time of the SIP Request which conveys the SDP offer. |
| SDP Answer Timestamp | O _M | This parameter contains the time of the response to the SIP Request which conveys the SDP answer. |
| SDP Media Components | O _M | This is a grouped field comprising several sub-fields associated with one media component. Since several media components may exist for a session in parallel these sub-fields may occur several times. |
| SDP Media Name | O _M | This field holds the name of the media as available in the SDP data. |
| SDP Media Description | O _M | This field holds the attributes of the media as available in the SDP data. |
| Access Correlation ID | O _C | This parameter holds the charging identifier from the access network, consisting of either GPRS charging ID (GCID) which is generated by the GGSN for a GPRS PDP context or the Access Network Charging Identifier Value which is generated by another type of access network. It is present only if received from the access network when PCC architecture is implemented. |
| Media Initiator Flag | O _C | This field indicates if the called party has requested the session modification and it is present only if the initiator was the called party. |
| SDP Session Description | O _C | Holds the Session portion of the SDP data exchanged between the User Agents if available in the SIP transaction. |
| SIP Request Timestamp | O _M | This parameter contains the time of the SIP Request (usually a (Re)Invite). This parameter corresponds to SIP Request Timestamp in the Charging Data Request [Interim]. |
| SIP Response Timestamp | O _M | This parameter contains the time of the response to the SIP Request (usually a 200 OK). This parameter corresponds to SIP Response Timestamp In the Charging Data Request [Interim]. |
| SDP Media Components | O _M | This is a grouped field comprising several sub-fields associated with one media component. Since several media components may exist for a session in parallel these sub-fields may occur several times. |
| SDP Media Name | O _M | This field holds the name of the media as available in the SDP data. This parameter corresponds to SDP-Media-Name. |
| SDP Media Description | O _M | This field holds the attributes of the media as available in the SDP data. |
| Access Correlation ID | O _C | This parameter holds the charging identifier from the access network, consisting of either GPRS charging ID (GCID) which is generated by the GGSN for a GPRS PDP context or the Access Network Charging Identifier Value which is generated by another type of access network. It is present only if received from the access network when PCC architecture is implemented. |
| Media Initiator Flag | O _C | This field indicates if the called party has requested the session modification and it is present only if the initiator was the called party. |
| GGSN Address | O _C | This parameter holds the control plane IP address of the GGSN that handles one or more media component(s) of a IMS session. |
| Service Reason Return Code | O _M | This parameter provides the returned SIP status code for the service request for the successful and failure case, |

| Field | Category | Description |
|----------------------------|-----------------|--|
| Access Network Information | O _C | This field contains the content of the SIP P-header 'P-Access-Network-Info' if available. |
| Service Context Id | O _M | Holds the context information to which the CDR belongs. The information is obtained from the Operation Token of the Charging Data Request message. |
| Record Extensions | O _C | A set of operator/manufacture specific extensions to the record, conditioned upon existence of an extension. |

6.1.3.7 MGCF CDR Content

The detailed description of the field is provided in TS 32.298 [51].

Table 6.1.3.7: Charging Data of MGCF CDR

| Field | Category | Description |
|------------------------------------|----------------|--|
| Record Type | M | Identifies the type of record. The parameter is derived from the Node functionality parameter. |
| Retransmission | O _C | This parameter, when present, indicates that information from retransmitted Charging Data Requests has been used in this CDR |
| SIP Method | O _C | Specifies the SIP-method for which the CDR is generated. Only available in session unrelated cases. |
| Event | O _C | This field identifies the SIP event package to which the SIP request is referred. |
| Expires Information | O _C | This field indicates the validity time of either the SIP message or its content, depending on the SIP method. |
| Role of Node | O _M | This field indicates the role of the MGCF. |
| Node Address | O _M | This item holds the address of the node providing the information for the CDR. This may either be the IP address or the FQDN of the IMS node generating the accounting data. |
| Session ID | O _M | The Session identification. For a SIP session the Session-ID contains the SIP Call ID as defined in the Session Initiation Protocol RFC 3261 [404]. |
| List Of Calling Party Address | O _M | The address or addresses (Public User ID or Public Service ID) of the party requesting a service or initiating a session. |
| Called Party Address | O _M | In the context of an end-to-end SIP transaction this field holds the address of the party (Public User ID) to whom the SIP transaction is posted. |
| Service Request Time Stamp | O _M | This field contains the time stamp which indicates the time at which the service was requested. This parameter corresponds to SIP Request Timestamp. Present with Charging Data Request [Start] and Charging Data Request [Event]. |
| Service Delivery Start Time Stamp | O _M | This field holds the time stamp reflecting either: successful session set-up, a delivery unrelated service, an unsuccessful session set-up and an unsuccessful session unrelated request. This parameter corresponds to SIP Response Timestamp. Present with Charging Data Request [Start] and Charging Data Request [Event]. |
| Service Delivery End Time Stamp | O _C | This field records the time at which the service delivery was terminated. It is Present only in SIP session related case. This parameter corresponds to SIP Request Timestamp. Present with Charging Data Request [Stop]. |
| Record Opening Time | O _C | A time stamp reflecting the time the CDF opened this record. Present only in SIP session related case. |
| Record Closure Time | O _M | A Time stamp reflecting the time the CDF closed the record. |
| Inter Operator Identifiers | O _C | Holds the identification of the home network (originating and terminating) if exchanged via SIP signalling, as recorded in the <i>P-Charging-Vector header</i> . |
| Originating IOI | O _C | This parameter corresponds to Orig-IOI header of the P-Charging-Vector defined in TS 24.229 [204]. |
| Terminating IOI | O _C | This parameter corresponds to Term-IOI header of the P-Charging-Vector defined in TS 24.229 [204]. |
| Local Record Sequence Number | O _M | This field includes a unique record number created by this node. The number is allocated sequentially for each partial CDR (or whole CDR) including all CDR types. The number is unique within the CDF. |
| Record Sequence Number | O _C | This field contains a running sequence number employed to link the partial records generated by the CDF for a particular session. |
| Cause For Record Closing | O _M | This field contains a reason for the close of the CDR. |
| Incomplete CDR Indication | O _C | This field provides additional diagnostics when the CDF detects missing Charging Data Requests. |
| IMS Charging Identifier | O _M | This parameter holds the IMS charging identifier (ICID) as generated by the IMS node for the SIP session. |
| List of Early SDP Media Components | O _C | This is a grouped field which may occur several times in one CDR. Each occurrence shall describe a change in the state (inactive/active or vice versa) of the media components negotiated during the SIP session establishment previously to the reception of a SIP final response to the initial SIP Invite. This field shall not be present if no media components are set to active before the final SIP session answer to the initial SIP Invite is received. This field can be present in either session or event CDRs. |

| Field | Category | Description |
|----------------------------------|----------------|--|
| SDP Session Description | O _C | Holds the Session portion of SDP data exchanged in the above mentioned scenario, if available. |
| SDP Offer Timestamp | O _M | This parameter contains the time of the SIP Request which conveys the SDP offer. |
| SDP Answer Timestamp | O _M | This parameter contains the time of the response to the SIP Request which conveys the SDP answer. |
| SDP Media Components | O _M | This is a grouped field comprising several sub-fields associated with one media component. Since several media components may exist for a session in parallel these sub-fields may occur several times. |
| SDP Media Name | O _M | This field holds the name of the media as available in the SDP data. |
| SDP Media Description | O _M | This field holds the attributes of the media as available in the SDP data. |
| Media Initiator Flag | O _C | This field indicates if the called party has requested the session modification and it is present only if the initiator was the called party. |
| List of SDP Media Components | O _C | This is a grouped field which may occur several times in one CDR. The first occurrence describes the initial session negotiation whilst the other would stem from session re-negotiations. The field is present only in a SIP session related case. |
| SDP Session Description | O _C | Holds the Session portion of the SDP data exchanged between the User Agents if available in the SIP transaction. |
| SIP Request Timestamp | O _M | This parameter contains the time of the SIP Request (usually a (Re)Invite). This parameter corresponds to SIP Request Timestamp in Charging Data Request [Interim]. |
| SIP Response Timestamp | O _M | This parameter contains the time of the response to the SIP Request (usually a 200 OK). This parameter corresponds to SIP Response Timestamp in Charging Data Request [Interim]. |
| SDP Media Components | O _M | This is a grouped field comprising several sub-fields associated with one media component. Since several media components may exist for a session in parallel these sub-fields may occur several times. |
| SDP Media Name | O _M | This field holds the name of the media as available in the SDP data. This parameter corresponds to SDP-Media-Name. |
| SDP Media Description | O _M | This field holds the attributes of the media as available in the SDP data. |
| Media Initiator Flag | O _C | This field indicates if the called party has requested the session modification and it is present only if the initiator was the called party. |
| Service Reason Return Code | O _M | This parameter provides the returned SIP status code for the service request for the successful and failure case. |
| Trunk Group ID Incoming/Outgoing | O _M | Contains the outgoing trunk group ID for an outgoing session/call or the incoming trunk group ID for an incoming session/call. |
| Bearer Service | O _M | Holds the used bearer service for the PSTN leg. |
| Access Network Information | O _C | This field contains the content of the SIP P-header 'P-Access-Network-Info' if available. |
| Service Context Id | O _M | Holds the context information to which the CDR belongs. The information is obtained from the Operation Token of the Charging Data Request message. |
| Record Extensions | O _C | A set of operator/manufacture specific extensions to the record, conditioned upon existence of an extension. |

6.1.3.8 BGCF CDR Content

The detailed description of the field is provided in TS 32.298 [51].

Table 6.1.3.8: Charging Data of BGCF CDR

| Field | Category | Description |
|------------------------------------|----------------|--|
| Record Type | M | Identifies the type of record. The parameter is derived from the Node functionality parameter. |
| Retransmission | O _C | This parameter, when present, indicates that information from retransmitted Charging Data Requests has been used in this CDR. |
| SIP Method | O _C | Specifies the SIP-method for which the CDR is generated. Only available in session unrelated cases. |
| Event | O _C | This field identifies the SIP event package to which the SIP request is referred. |
| Expires Information | O _C | This field indicates the validity time of either the SIP message or its content, depending on the SIP method. |
| Role of Node | O _M | This field indicates the role of the BGCF. |
| Node Address | O _M | This item holds the address of the node providing the information for the CDR. This may either be the IP address or the FQDN of the IMS node generating the accounting data. |
| Session ID | O _M | The Session identification. For a SIP session the Session-ID contains the SIP Call ID as defined in the Session Initiation Protocol RFC 3261 [404]. |
| List Of Calling Party Address | O _M | The address or addresses (Public User ID or Public Service ID) of the party requesting a service or initiating a session. |
| Called Party Address | O _M | In the context of an end-to-end SIP transaction this field holds the address of the party (Public User ID) to whom the SIP transaction is posted. |
| Service Request Time Stamp | O _M | This field contains the time stamp which indicates the time at which the service was requested. This parameter corresponds to SIP Request Timestamp. Present with Charging Data Request [Start] and Charging Data Request [Event]. |
| Service Delivery Start Time Stamp | O _M | This field holds the time stamp reflecting either: successful session set-up, a delivery unrelated service, an unsuccessful session set-up and an unsuccessful session unrelated request. This parameter corresponds to SIP Response Timestamp. Present with Charging Data Request [Start] and Charging Data Request [Event]. |
| Service Delivery End Time Stamp | O _C | This field records the time at which the service delivery was terminated. It is Present only in SIP session related case. This parameter corresponds to SIP Request Timestamp. Present with Charging Data Request [Stop]. |
| Record Opening Time | O _C | A time stamp reflecting the time the CDF opened this record. Present only in SIP session related case. |
| Record Closure Time | O _M | A Time stamp reflecting the time the CDF closed the record |
| Inter Operator Identifiers | O _C | Holds the identification of the home network (originating and terminating) if exchanged via SIP signalling, as recorded in the <i>P-Charging-Vector header</i> . |
| Originating IOI | O _C | This parameter corresponds to Orig-IOI header of the P-Charging-Vector defined in TS 24.229 [204]. |
| Terminating IOI | O _C | This parameter corresponds to Term-IOI header of the P-Charging-Vector defined in TS 24.229 [204]. |
| Local Record Sequence Number | O _M | This field includes a unique record number created by this node. The number is allocated sequentially for each partial CDR (or whole CDR) including all CDR types. The number is unique within the CDF. |
| Record Sequence Number | O _C | This field contains a running sequence number employed to link the partial records generated by the CDF for a particular session. |
| Cause For Record Closing | O _M | This field contains a reason for the close of the CDR. |
| Incomplete CDR Indication | O _C | This field provides additional diagnostics when the CDF detects missing Charging Data Requests. |
| IMS Charging Identifier | O _M | This parameter holds the IMS charging identifier (ICID) as generated by the IMS node for the SIP session. |
| List of Early SDP Media Components | O _C | This is a grouped field which may occur several times in one CDR. Each occurrence shall describe a change in the state (inactive/active or vice versa) of the media components negotiated during the SIP session establishment previously to the reception of a SIP final response to the initial SIP Invite. This field shall not be present if no media components are set to active before the final SIP session answer to the initial SIP Invite is received. This field can be present in either session or event CDRs. |
| SDP Session Description | O _C | Holds the Session portion of SDP data exchanged in the above mentioned scenario, if available. |

| Field | Category | Description |
|------------------------------|----------------|--|
| SDP Offer Timestamp | O _M | This parameter contains the time of the SIP Request which conveys the SDP offer. |
| SDP Answer Timestamp | O _M | This parameter contains the time of the response to the SIP Request which conveys the SDP answer. |
| SDP Media Components | O _M | This is a grouped field comprising several sub-fields associated with one media component. Since several media components may exist for a session in parallel these sub-fields may occur several times. |
| SDP Media Name | O _M | This field holds the name of the media as available in the SDP data. |
| SDP Media Description | O _M | This field holds the attributes of the media as available in the SDP data. |
| Media Initiator Flag | O _C | This field indicates if the called party has requested the session modification and it is present only if the initiator was the called party. |
| List of SDP Media Components | O _C | This is a grouped field which may occur several times in one CDR. The first occurrence describes the initial session negotiation whilst the other would stem from session re-negotiations. The field is present only in a SIP session related case. |
| SDP Session Description | O _C | Holds the Session portion of the SDP data exchanged between the User Agents if available in the SIP transaction. |
| SIP Request Timestamp | O _M | This parameter contains the time of the SIP Request (usually a (Re)Invite). This parameter corresponds to SIP Request Timestamp in Charging Data Request [Interim]. |
| SIP Response Timestamp | O _M | This parameter contains the time of the response to the SIP Request (usually a 200 OK). This parameter corresponds to SIP Response Timestamp in Charging Data Request [Interim]. |
| SDP Media Components | O _M | This is a grouped field comprising several sub-fields associated with one media component. Since several media components may exist for a session in parallel these sub-fields may occur several times. |
| SDP Media Name | O _M | This field holds the name of the media as available in the SDP data. |
| SDP Media Description | O _M | This field holds the attributes of the media as available in the SDP data. |
| Media Initiator Flag | O _C | This field indicates if the called party has requested the session modification and it is present only if the initiator was the called party. |
| Service Reason Return Code | O _M | This parameter provides the returned SIP status code for the service request for the successful and failure case, |
| Access Network Information | O _C | This field contains the content of the SIP P-header 'P-Access-Network-Info' if available. |
| Service Context Id | O _M | Holds the context information to which the CDR belongs. The information is obtained from the Operation Token of the Charging Data Request message. |
| Record Extensions | O _C | A set of operator/manufacture specific extensions to the record, conditioned upon existence of an extension. |

6.1.3.9 SIP AS CDR Content

The detailed description of the field is provided in TS 32.298 [51].

Table 6.1.3.9: Charging Data of AS CDR

| Field | Category | Description |
|-----------------------------------|----------------|---|
| Record Type | M | Identifies the type of record. The parameter is derived from the Node functionality parameter. |
| Retransmission | O _C | This parameter, when present, indicates that information from retransmitted Charging Data Requests has been used in this CDR. |
| SIP Method | O _C | Specifies the SIP-method for which the CDR is generated. Only available in session unrelated cases. |
| Event | O _C | This field identifies the SIP event package to which the SIP request is referred. |
| Expires Information | O _C | This field indicates the validity time of either the SIP message or its content, depending on the SIP method. |
| Role of Node | O _M | This field indicates the role of the AS. |
| Node Address | O _M | This item holds the address of the node providing the information for the CDR. This may either be the IP address or the FQDN of the IMS node generating the accounting data. |
| Session ID | O _M | The Session identification. For a SIP session the Session-ID contains the SIP Call ID as defined in the Session Initiation Protocol RFC 3261 [404]. |
| List Of Calling Party Address | O _M | The address or addresses (Public User ID or Public Service ID) of the party requesting a service or initiating a session. |
| Called Party Address | O _M | For SIP transactions, except for registration, this field holds the address of the party (Public User ID or Public Service ID) to whom the SIP transaction is posted. For registration transactions, this field holds the Public User ID under registration. |
| Alternate Charged Party Address | O _C | The address of an alternate party that is identified by the AS at session initiation, and is charged in place of the calling party. |
| Requested Party Address | O _C | For SIP transactions this field holds the address of the party (Public User ID or Public Service ID) to whom the SIP transaction was originally posted. This field is only present if different from the Called Party Address parameter. |
| List of Subscription Id | O _M | Holds the public user identities of the served user |
| List of Called Asserted Identity | O _C | The address or addresses of the final asserted identities. Present if the final asserted identities are available in the SIP 2xx response. |
| Service Request Time Stamp | O _M | This field contains the time stamp which indicates the time at which the service was requested. This parameter corresponds to SIP Request Timestamp. Present with Charging Data Request [Start] and Charging Data Request [Event]. |
| Service Delivery Start Time Stamp | O _M | This field holds the time stamp reflecting either: successful session set-up, a delivery unrelated service, an unsuccessful session set-up and an unsuccessful session unrelated request. This parameter corresponds to SIP Response Timestamp. Present with Charging Data Request [Start] and Charging Data Request [Event]. |
| Service Delivery End Time Stamp | O _C | This field records the time at which the service delivery was terminated. It is Present only in SIP session related case. This parameter corresponds to SIP Request Timestamp. Present with Charging Data Request [Stop]. |
| Record Opening Time | O _C | A time stamp reflecting the time the CDF opened this record. Present only in SIP session related case. |
| Record Closure Time | O _M | A Time stamp reflecting the time the CDF closed the record. |
| Inter Operator Identifiers | O _C | Holds the identification of the home network (originating and terminating) if exchanged via SIP signalling, as recorded in the <i>P-Charging-Vector header</i> . |
| Originating IOI | O _C | This parameter corresponds to Orig-IOI header of the P-Charging-Vector defined in TS 24.229 [204]. |
| Terminating IOI | O _C | This parameter corresponds to Term-IOI header of the P-Charging-Vector defined in TS 24.229 [204]. |

| Field | Category | Description |
|------------------------------------|----------------|--|
| Local Record Sequence Number | O _M | This field includes a unique record number created by this node. The number is allocated sequentially for each partial CDR (or whole CDR) including all CDR types. The number is unique within the CDF. |
| Record Sequence Number | O _C | This field contains a running sequence number employed to link the partial records generated by the CDF for a particular session. |
| Cause For Record Closing | O _M | This field contains a reason for the close of the CDR. |
| Incomplete CDR Indication | O _C | This field provides additional diagnostics when the CDF detects missing Charging Data Requests. |
| IMS Charging Identifier | O _M | This parameter holds the IMS charging identifier (ICID) as generated by the IMS node for the SIP session. |
| List of Early SDP Media Components | O _C | This is a grouped field which may occur several times in one CDR. Each occurrence shall describe a change in the state (inactive/active or vice versa) of the media components negotiated during the SIP session establishment previously to the reception of a SIP final response to the initial SIP Invite. This field shall not be present if no media components are set to active before the final SIP session answer to the initial SIP Invite is received. This field can be present in either session or event CDRs. |
| SDP Session Description | O _C | Holds the Session portion of SDP data exchanged in the above mentioned scenario, if available. |
| SDP Offer Timestamp | O _M | This parameter contains the time of the SIP Request which conveys the SDP offer. |
| SDP Answer Timestamp | O _M | This parameter contains the time of the response to the SIP Request which conveys the SDP answer. |
| SDP Media Components | O _M | This is a grouped field comprising several sub-fields associated with one media component. Since several media components may exist for a session in parallel these sub-fields may occur several times. |
| SDP Media Name | O _M | This field holds the name of the media as available in the SDP data. |
| SDP Media Description | O _M | This field holds the attributes of the media as available in the SDP data. |
| Access Correlation ID | O _C | This parameter holds the charging identifier from the access network, consisting of either GPRS charging ID (GCID) which is generated by the GGSN for a GPRS PDP context or the Access Network Charging Identifier Value which is generated by another type of access network. It is present only if received from the access network when PCC architecture is implemented. |
| Media Initiator Flag | O _C | This field indicates if the called party has requested the session modification and it is present only if the initiator was the called party. |
| List of SDP Media Components | O _C | This is a grouped field which may occur several times in one CDR. The first occurrence describes the initial session negotiation whilst the other would stem from session re-negotiations. The field is present only in a SIP session related case. |
| SDP Session Description | O _C | Holds the Session portion of the SDP data exchanged between the User Agents if available in the SIP transaction. |
| SIP Request Timestamp | O _M | This parameter contains the time of the SIP Request (usually a (Re)Invite). This parameter corresponds to SIP Request Timestamp in Charging Data Request [Interim]. |
| SIP Response Timestamp | O _M | This parameter contains the time of the response to the SIP Request (usually a 200 OK). This parameter corresponds to SIP Response Timestamp in Charging Data Request [Interim]. |
| SDP Media Components | O _M | This is a grouped field comprising several sub-fields associated with one media component. Since several media components may exist for a session in parallel these sub-fields may occur several times. |
| SDP Media Name | O _M | This field holds the name of the media as available in the SDP data. |
| SDP Media Description | O _M | This field holds the attributes of the media as available in the SDP data. |
| Access Correlation ID | O _C | This parameter holds the charging identifier from the access network, consisting of either GPRS charging ID (GCID) which is generated by the GGSN for a GPRS PDP context or the Access Network Charging Identifier Value which is generated by another type of access network. It is present only if received from the access network when PCC architecture is implemented. |

| Field | Category | Description |
|------------------------------|----------------|---|
| Media Initiator Flag | O _C | This field indicates if the called party has requested the session modification and it is present only if the initiator was the called party. |
| GGSN Address | O _C | This parameter holds the control plane IP address of the GGSN that handles one or more media component(s) of a IMS session. |
| Service Reason Return Code | O _M | This parameter provides the returned SIP status code for the service request for the successful and failure case, |
| Service Specific Info | O _C | This is a grouped field that contains service specific data if and as provided by an Application Server. It may occur several times in one CDR. |
| Service Specific Data | O _M | This sub-field of Service Specific Data holds the value of the Service Specific Data. |
| Service Specific Type | O _M | This sub-field of Service Specific Data holds the type of the Service Specific Data. |
| List of Message Bodies | O _C | This grouped field comprising several sub-fields describing the data that may be conveyed end-to-end in the body of a SIP message. Since several message bodies may be exchanged via SIP-signalling, this grouped field may occur several times. |
| Content-Type | O _M | This sub-field of Message Bodies holds the MIME type of the message body, Examples are: application/zip, image/gif, audio/mpeg, etc. |
| Content-Disposition | O _C | This sub-field of Message Bodies holds the content disposition of the message body inside the SIP signalling, Content-disposition header field equal to 'render', indicates that 'the body part should be displayed or otherwise rendered to the user'. Content disposition values are : session, render, inline, icon, alert, attachment, etc. |
| Content-Length | O _M | This sub-field of Message Bodies holds the size of the data of a message body in bytes. |
| Originator | O _C | This sub-field of the "List of Message Bodies" indicates the originating party of the message body. |
| Access Network Information | O _C | This field contains the content of the SIP P-header 'P-Access-Network-Info' if available. |
| Service Context Id | O _M | Holds the context information to which the CDR belongs. The information is obtained from the Operation Token of the Charging Data Request message. |
| IMS Communication Service ID | O _C | This field contains the IMS communication service identifier if received in the P-Asserted-Service header in the SIP request. |
| Record Extensions | O _C | A set of operator/manufacturer specific extensions to the record, conditioned upon existence of an extension. |

6.2 Data description for IMS online charging

6.2.1 Ro message contents

The IMS nodes generate debit and reserve units information that can be transferred from the CTF to the OCF. For this purpose, IMS online charging utilises the *Debit Units and Reserve Units* procedure that is specified in the 3GPP debit unit operation in TS 32.299 [50].

The *Debit and reserve units* procedure employs the *Debit and Reserve Units Request* and *Debit and Reserve Units Response* messages. Table 6.2.1 describes the use of these messages in IMS online charging.

Table 6.2.1: Online Charging Messages Reference Table

| Command-Name | Source | Destination |
|----------------------------------|-------------------|-------------------|
| Debit and Reserve Units Request | MRFC, AS, IMS-GWF | OCS |
| Debit and Reserve Units Response | OCS | MRFC, AS, IMS-GWF |

6.2.1.1 Debit and Reserve Units Request Message

Table 6.2.1.1 illustrates the basic structure of a *Debit and Reserve Units Request* message from the CTF in MRFC and AS and the IMS-GWF as used for IMS online charging.

Table 6.2.1.1: Debit and reserve units Request Message Contents

| Field | Category | Description |
|-----------------------------|----------------|---|
| Session Identifier | M | Described in 32.299 [50] |
| Originator Host | M | Described in 32.299 [50] |
| Originator Domain | M | Described in 32.299 [50] |
| Destination Domain | M | Described in 32.299 [50] |
| Operation Identifier | M | Described in 32.299 [50] |
| Operation Token | M | Described in 32.299 [50] |
| Operation Type | M | Described in 32.299 [50] |
| Operation Number | M | Described in 32.299 [50] |
| Destination Host | O _C | Described in 32.299 [50] |
| User Name | O _C | The field contains the Private User Identity [201] |
| Origination State | O _C | Described in 32.299 [50] |
| Origination Timestamp | O _C | Described in 32.299 [50] |
| Subscriber Identifier | O _M | This field contains the identification of the mobile subscriber (i.e. MSISDN or SIP-URI) that uses the requested service. |
| Termination Cause | O _C | Described in 32.299 [50] |
| Requested Action | O _C | Described in 32.299 [50] |
| Multiple Operation | O _M | Described in 32.299 [50] |
| Multiple Unit Operation | O _C | Described in 32.299 [50] |
| Subscriber Equipment Number | O _C | Described in 32.299 [50] |
| Proxy Information | O _C | Described in 32.299 [50] |
| Route Information | O _C | Described in 32.299 [50] |
| Service Information | O _M | This field holds additional 3GPP service specific parameter: - IMS Information, - PS Information |
| Extended Information | O _C | This field holds the network/manufacture specific extensions. |

6.2.1.2 Debit and Reserve Units Response Message

Table 6.2.1.2 illustrates the basic structure of a Debit and Reserve Units Response message as used for IMS charging. This message is always used by the OCS as specified below, independent of the receiving IMS node and the operation type that is being replied to.

Table 6.2.1.2: Debit and Reserve Units Response Message Contents for MRFC, AS and IMS-GWF

| Field | Category | Description |
|--------------------------------|----------------|--|
| Session Identifier | M | Described in 32.299 [50] |
| Operation Result | M | Described in 32.299 [50] |
| Originator Host | M | Described in 32.299 [50] |
| Originator Domain | M | Described in 32.299 [50] |
| Operation Identifier | M | Described in 32.299 [50] |
| Operation Type | M | Described in 32.299 [50] |
| Operation Number | M | Described in 32.299 [50] |
| Operation Failover | O _C | Described in 32.299 [50] |
| Multiple Unit Operation | O _C | Described in 32.299 [50] |
| Operation Failure Action | O _C | Described in 32.299 [50]. This field defines the operation if a failure has occurred at the OCS for SCUR and ECUR. |
| Operation Event Failure Action | O _C | Described in 32.299 [50]. This field defines the operation if a failure has occurred at the OCS for IEC. |
| Redirection Host | O _C | Described in 32.299 [50] |
| Redirection Host Usage | O _C | Described in 32.299 [50] |
| Redirection Cache Time | O _C | Described in 32.299 [50] |
| Proxy Information | O _C | Described in 32.299 [50] |
| Route Information | O _C | Described in 32.299 [50] |
| Failed parameter | O _C | Described in 32.299 [50] |
| Service Information | O _C | This field holds additional 3GPP service specific parameter: - IMS Information, - PS Information |
| Extended Information | O _C | This field holds the network/manufacturer specific extensions. |

6.3 IMS Charging Specific Parameters

6.3.1 Definition of IMS charging information

The IMS Information parameter used for IMS charging is provided in the Service Information parameter.

6.3.1.1 IMS charging information assignment for Service Information

The components in the Service Information that are use for IMS charging can be found in Table 6.3.1.1.

Table 6.3.1.1: Service Information used for IMS Charging

| Field | Category | Description | Provided by IMS NE |
|---------------------|----------------|--|---------------------------|
| Service Information | O _M | This is a structured field and holds the 3GPP specific parameter as defined in TS 32.299 [50]. For IMS Charging the IMS Information is used. | All |
| Subscription-Id | O _M | Described in TS 32.299 [50] and contains the Private User Identity and / or Public User Identity/Identities | All |
| IMS Information | O _M | This is a structured field and holds the IMS specific parameters. The details are defined in clause 6.3.1.2. | All |
| PS Information | O _C | This is a structured field and holds PS specific parameters. The complete structure is defined in TS 32.251 [11]. | Not in I-CSCF |
| GGSN Address | O _C | This field holds the IP-address of the GGSN that generated the GPRS Charging ID, as described in [1]. | Not in I-CSCF, MGCF, BGCF |

6.3.1.2 Definition of the IMS Information

IMS specific charging information is provided within the IMS Information. The fields of the IMS Information which are different covered in several IMS network nodes are indicated by the node specific type.

The detailed structure of the IMS Information can be found in table 6.3.1.2.

Table 6.3.1.2: Structure of the IMS Information

| Field | Category | Description | Provided by IMS NE |
|---------------------------------|----------------|---|--------------------|
| Event Type | O _C | This field holds the SIP Method, the content of the SIP 'Event' header and the content of the SIP 'expires' header when present in the SIP request. | All |
| Node Functionality | M | This field contains the function of the node. | All |
| Role of Node | O _M | This field specifies the role of the AS/CSCF. | All |
| User Session ID | O _M | This field holds the session identifier. For a SIP session the <i>Session-ID</i> contains the SIP Call ID. | All |
| Calling Party Address | O _M | This field holds the address (SIP URI or TEL URI)URI of the party (Public User Identity or Public Service Identity) initiating a session or requesting a service. | All |
| Called Party Address | O _M | For SIP transactions, except for registration, this field holds the address of the party (Public User ID or Public Service ID) to whom the SIP transaction is posted. For registration transactions, this field holds the Public User ID under registration. | All |
| Alternate Charged Party Address | O _C | The address of an alternate party that is identified by the AS at session initiation, and is charged in place of the calling party. | AS only |

| Field | Category | Description | Provided by IMS NE |
|--------------------------------|----------------|---|-----------------------------|
| Requested Party Address | O _C | For SIP transactions this field holds the address of the party (Public User ID or Public Service ID) to whom the SIP transaction was originally posted. This field is only present if different from the Called Party Address parameter. | S-CSCF and AS/MRFC |
| Called Asserted Identity | O _C | The address of the final asserted identity. Present if the final asserted identity is available in the SIP 2xx response. | S-CSCF and AS/MRFC |
| Associated URI | O _C | This field holds a non-barred public user identity (SIP URI or TEL URI) associated to the public user identity under registration. | S-CSCF, P-CSCF, I-CSCF |
| Time Stamps | O _M | This field holds the time of the SIP REQUEST and the time of the response to the SIP REQUEST. | All |
| Application Server Information | O _C | This field holds the SIP URI(s) of the AS(s) addressed during the session and the called party number (SIP URI, E.164), if an application server determines it. | S-CSCF and MRFC |
| Inter Operator Identifier | O _C | This field holds the identification of the network neighbours (originating and terminating) as exchanged via SIP signalling if available. | All |
| IMS Charging Identifier | O _M | This field holds the IMS Charging Identifier (ICID) as generated by a IMS node for a SIP session. | All |
| Early Media Description | O _C | This field holds session and media parameters related to media components set to active during the SIP session establishment and before a final successful or unsuccessful SIP answer to the initial SIP INVITE request is received. Once a media component is set to active, subsequent status changes shall be registered. Since several SDP negotiations may occur during the SIP session establishment, this field may occur several times. | Not in I-CSCF |
| SDP Session Description | O _C | This field holds the content of an "attribute-line" (i=, c=, b=, k=, a=, etc.) related to a session. | Not in I-CSCF |
| SDP Media Component | O _C | This is a grouped field comprising several sub-fields associated with one media component. Since several media components may exist for a session in parallel these sub-fields may occur several times. | Not in I-CSCF |
| Served Party IP Address | O _C | This field holds the IP address of either the calling or called party, depending on whether the P-CSCF is in touch with the calling or the called party. | P-CSCF |
| Server Capabilities | O _C | This field contains the server capabilities as described in 3GPP TS 29.229 [205]. | I-CSCF |
| Trunk Group ID | O _C | This field identifies the incoming and outgoing PSTN legs. | MGCF |
| Bearer Service | O _C | This field holds the used bearer service for the PSTN leg. | MGCF |
| Service Id | O _C | This field identifies the service the MRFC is hosting. For conferences the conference ID is used as the value of this parameter. | MRFC |
| Service Specific Info | O _C | This field contains service specific data if and as provided by an Application Server. | AS |
| Message Bodies | O _C | This field holds information about the Message body, Content-Type, Content-Length, Content-Disposition and Originator if available. | P-CSCF, S-CSCF, MGCF and AS |
| Access Network Information | O _C | This field contains the content of the P-header P-Access-Network-Info. | All |
| IMS Communication Service ID | O _C | This field contains the IMS communication service identifier if received in the P-Asserted-Service header in the SIP request. | S-CSCF and AS |
| Cause Code | O _C | This field contains the cause value. | All |

6.3.2 Detailed Message Format for offline charging

The following chapter specifies per Operation Type the charging data that are sent by each of the IMS network elements for:

- IMS session and IMS event (S/I/S/E)
 - S-CSCF, P-CSCF, MGFC, AS, IBCF
- IMS session only (S/I/S)
 - MRFC
- IMS event only (E)
 - I-CSCF, BGCF

The Operation Types are listed in the following order: S (start)/I (interim)/S (stop)/E (event). Therefore, when all Operation Types are possible it is marked as SISE. If only some Operation Types are allowed for a node, only the appropriate letters are used (i.e. SIS or E) as indicated in the table heading. The omission of an Operation Type for a particular field is marked with "-" (i.e. SI-E). Also, when an entire field is not allowed in a node the entire cell is marked as "-".

Table 6.3.2.1 illustrates the basic structure of the supported fields in the Charging Data Request message for IMS offline charging.

Table 6.3.2.1 : Supported fields in Charging Data Request Message

| Field | Node Type | S-CSCF | P-CSCF | I-CSCF | MRFC | MGCF | BGCF | AS |
|--|---------------------------|---------|---------|--------|-------|---------|---------|---------|
| | Supported Operation Types | S/I/S/E | S/I/S/E | E | S/I/S | S/I/S/E | S/I/S/E | S/I/S/E |
| Session Identifier | | SISE | SISE | E | SIS | SISE | E | SISE |
| Originator Node | | SISE | SISE | E | SIS | SISE | E | SISE |
| Originator Domain | | SISE | SISE | E | SIS | SISE | E | SISE |
| Destination Domain | | SISE | SISE | E | SIS | SISE | E | SISE |
| Operation Type | | SISE | SISE | E | SIS | SISE | E | SISE |
| Operation Number | | SISE | SISE | E | SIS | SISE | E | SISE |
| Operation Identifier | | SISE | SISE | E | SIS | SISE | E | SISE |
| User Name | | SISE | SISE | E | SIS | SISE | E | SISE |
| Operation Interval | | SISE | SISE | E | SIS | SISE | E | SISE |
| Origination State | | SISE | SISE | E | SIS | SISE | E | SISE |
| Origination Timestamp | | SISE | SISE | E | SIS | SISE | E | SISE |
| Proxy Information | | SISE | SISE | E | SIS | SISE | E | SISE |
| Route Information | | SISE | SISE | E | SIS | SISE | E | SISE |
| Operation Token | | SISE | SISE | E | SIS | SISE | E | SISE |
| Subscriber Identifier | | SISE | SISE | - | SIS | - | - | SISE |
| Service Information with PS and IMS Information | | | | | | | | |
| Event Type | | SISE | SISE | E | SIS | SISE | E | SISE |
| Role of Node | | SISE | SISE | E | SIS | SISE | E | SISE |
| Node Functionality | | SISE | SISE | E | SIS | SISE | E | SISE |
| User Session Id | | SISE | SISE | E | SIS | SISE | E | SISE |
| Calling Party Address | | SISE | SISE | E | SIS | SISE | E | SISE |
| Called Party Address | | SISE | SISE | E | SIS | SISE | E | SISE |
| Alternate Charged Party Address | | - | - | - | - | - | - | S--- |
| Requested Party Address | | S--E | - | - | S-- | - | - | S--E |
| Called Asserted Identity | | S--E | - | - | S-- | - | - | S--E |
| Associated URI | | ---E | ---E | E | - | - | - | - |
| Time stamps (see note 3) | | SISE | SISE | E | SIS | SISE | E | SISE |
| Application server Information (see note 1) | | SISE | - | - | SIS | - | - | - |
| Inter Operator Identifiers (see note 1) | | SISE | SISE | E | SIS | SISE | E | SISE |
| IMS Charging Identifier | | SISE | SISE | E | SIS | SISE | E | SISE |
| Early Media Description | | S--E | S--E | - | S-- | S--E | E | S--E |
| SDP Session Description | | SI-- | SI-- | - | SI-- | SI-- | - | SI-- |
| SDP Media Component | | SI-- | SI-- | - | SI-- | SI-- | - | SI-- |
| GGSN Address | | SI-- | SI-- | - | SI-- | SI-- | - | SI-- |
| Served Party (see note 1) | | - | SISE | - | - | - | - | - |
| Authorized QoS (see note 1) | | - | SI-- | - | - | - | - | - |
| Server Capabilities (see note 1) | | - | - | E | - | - | - | - |
| Trunk Group ID (see note 1) | | - | - | - | - | SISE | - | - |
| Bearer Service (see note 1) | | - | - | - | - | SISE | - | - |
| Service Id (see note 1) | | - | - | - | SIS | - | - | - |
| Service Specific Info (see note 1) | | - | - | - | - | - | - | SISE |
| Message Bodies (see note 2) | | SISE | SISE | - | - | SISE | - | SISE |
| Cause Code | | --SE | --SE | E | --S | --SE | E | --SE |
| Access Network Information | | SISE | SISE | E | SIS | SISE | E | SISE |
| IMS Communication Service ID | | S--E | - | - | - | - | - | S--E |
| NOTE 1: Only present if available in the CTF of the IMS node. | | | | | | | | |
| NOTE 2: Present only if Messages Bodies is included in the SIP message that triggered the Charging Data Request. | | | | | | | | |
| NOTE 3: Only present if ACR is triggered on a SIP message (e.g. SIP INVITE, SIP UPDATE). | | | | | | | | |

Table 6.3.2.2 illustrates the basic structure of the supported fields in the Charging Data Response message for IMS offline charging.

Table 6.3.2.2 : Supported fields in Charging Data Response Message

| Field | Node Type | S-CSCF | P-CSCF | I-CSCF | MRFC | MGCF | BGCF | AS |
|-----------------------|---------------------------|---------|---------|--------|-------|---------|------|---------|
| | Supported Operation Types | S/I/S/E | S/I/S/E | E | S/I/S | S/I/S/E | E | S/I/S/E |
| Session Identifier | | SISE | SISE | E | SIS | SISE | E | SISE |
| Originator Node | | SISE | SISE | E | SIS | SISE | E | SISE |
| Originator Domain | | SISE | SISE | E | SIS | SISE | E | SISE |
| Destination Domain | | SISE | SISE | E | SIS | SISE | E | SISE |
| Operation Type | | SISE | SISE | E | SIS | SISE | E | SISE |
| Operation Number | | SISE | SISE | E | SIS | SISE | E | SISE |
| Operation Identifier | | SISE | SISE | E | SIS | SISE | E | SISE |
| User Name | | SISE | SISE | E | SIS | SISE | E | SISE |
| Operation Interval | | SISE | SISE | E | SIS | SISE | E | SISE |
| Origination State | | SISE | SISE | E | SIS | SISE | E | SISE |
| Origination Timestamp | | SISE | SISE | E | SIS | SISE | E | SISE |
| Proxy Information | | SISE | SISE | E | SIS | SISE | E | SISE |
| Route Information | | SISE | SISE | E | SIS | SISE | E | SISE |

6.3.3 Detailed Message Format for online charging

The following table specifies per Operation type the charging data that are sent by each of the IMS network elements for:

- IMS session and IMS event (I/U/T/E)
 - IMS-GWF, AS
- IMS session only (I/U/T)
 - MRFC

The Operation types are listed in the following order: I (initial)/U (update)/T (terminate)/E (event). Therefore, when all Operation types are possible it is marked as IUTE. If only some Operation types are allowed for a node, only the appropriate letters are used (i.e. IUT or E) as indicated in the table heading. The omission of an Operation type for a particular field is marked with "-" (i.e. IU-E). Also, when an entire field is not allowed in a node the entire cell is marked as "-".

Note that not for all structured fields the individual field members are listed in the table. Detailed descriptions of the fields are provided in TS 32.299 [50].

Table 6.3.3.1 illustrates the basic structure of the supported fields in the Debit and Reserve Units Request for IMS online charging.

Table 6.3.3.1: Supported fields in *Debit and Reserve Units Request* Message

| Field | Node Type | IMS-GWF | MRFC | AS |
|--|---------------------------|---------|-------|---------|
| | Supported Operation Types | I/U/T/E | I/U/T | I/U/T/E |
| Session Identifier | | IUTE | IUT | IUTE |
| Originator Host | | IUTE | IUT | IUTE |
| Originator Domain | | IUTE | IUT | IUTE |
| Destination Domain | | IUTE | IUT | IUTE |
| Operation Identifier | | IUTE | IUT | IUTE |
| Operation Token | | IUTE | IUT | IUTE |
| Operation Type | | IUTE | IUT | IUTE |
| Operation Number | | IUTE | IUT | IUTE |
| Destination Host | | IUTE | IUT | IUTE |
| User Name | | IUTE | IUT | IUTE |
| Origination State | | IUTE | IUT | IUTE |
| Origination Timestamp | | IUTE | IUT | IUTE |
| Subscriber Identifier | | IUTE | IUT | IUTE |
| Termination Cause | | -T- | -T | -T- |
| Requested Action | | IUTE | IUT | IUTE |
| Multiple Operation | | IU-E | IU- | IU-E |
| Multiple Unit Operation | | IU-E | IU- | IU-E |
| Service Units Requested | | IU-E | IU- | IU-E |
| Action Requested | | ---E | --- | ---E |
| Service Units Used | | -UT- | -UT | -UT- |
| Subscriber Equipment Number | | IUTE | IUT | IUTE |
| Proxy Information | | IUTE | IUT | IUTE |
| Route Information | | IUTE | IUT | IUTE |
| Extended Information | | IUTE | IUT | IUTE |
| Service Information with PS and IMS Information | | | | |
| Event Type | | IUTE | IUT | IUTE |
| Role Of Node | | IUTE | IUT | IUTE |
| Node Functionality | | IUTE | IUT | IUTE |
| User Session Id | | IUTE | IUT | IUTE |
| Calling Party Address | | IUTE | IUT | IUTE |
| Called Party Address | | IUTE | IUT | IUTE |
| Requested Party Address | | I-E | I-E | I-E |
| Called Asserted Identity | | -UTE | -UT | -UTE |
| Associated URI | | --TE | - | - |
| Application Server Information | | IUTE | IUT | - |
| Inter Operator Identifier | | IUTE | IUT | IUTE |
| IMS Charging Identifier | | IUTE | IUTE | IUTE |
| SDP Session Description | | IU-- | IU- | IU-- |
| SDP Media Component | | IU-- | IU- | IU-- |
| GGSN Address | | IU-- | IU- | IU-- |
| Served Party | | - | - | - |
| Server Capabilities | | - | - | - |
| Trunk Group ID | | - | - | - |
| Bearer Service | | - | - | - |
| Service Id | | - | IUT | - |
| Service Specific Info | | - | - | - |
| Messages Bodies | | IUTE | - | IUTE |
| Cause Code | | --TE | --T | --TE |
| Access Network Information | | IUTE | IUT | IUTE |
| IMS Communication Service ID | | I-E | - | I-E |

Table 6.3.3.2 illustrates the basic structure of the supported fields in the Debit and Reserve Units Response for IMS online charging.

Table 6.3.3.2: Supported fields in *Debit and Reserve Units Response* Message

| Field | Node Type | IMS-GWF | MRFC | AS |
|--------------------------|---------------------------|---------|-------|---------|
| | Supported Operation Types | I/U/T/E | I/U/T | I/U/T/E |
| Session Identifier | | IUTE | IUT | IUTE |
| Operation Result | | IUTE | IUT | IUTE |
| Originator Host | | IUTE | IUT | IUTE |
| Originator Domain | | IUTE | IUT | IUTE |
| Operation Identifier | | IUTE | IUT | IUTE |
| Operation Type | | IUTE | IUT | IUTE |
| Operation Number | | IUTE | IUT | IUTE |
| Operation Failover | | IUTE | IUT | IUTE |
| Multiple Unit Operation | | IUTE | IUT | IUTE |
| Operation Failure Action | | - | - | - |
| Redirection Host | | - | - | - |
| Redirection Host Usage | | - | - | - |
| Redirection Cache Time | | - | - | - |
| Proxy Information | | - | - | - |
| Route Information | | - | - | - |
| Failed parameter | | - | - | - |
| Extended Information | | IUTE | IUT | IUTE |

6.3.4 Formal IMS charging parameter description

6.3.4.1 IMS charging information for CDRs

The detailed definitions, abstract syntax and encoding of the IMS CDR parameters are specified in TS 32.298 [51].

6.3.4.2 IMS charging information for charging events

The detailed charging event parameter definitions are specified in 3GPP TS 32.299 [50].

Annex A (informative): Bibliography

a) **The 3GPP charging specifications**

- 3GPP TS 32.252: "Telecommunication management; Charging management; Wireless Local Area Network (WLAN) charging".
- 3GPP TS 32.270: "Telecommunication management; Charging management; Multimedia Messaging Service (MMS) charging".
- 3GPP TS 32.271: "Telecommunication management; Charging management; Location Services (LCS) charging".
- 3GPP TS 32.296: "Telecommunication management; Charging management; Online Charging System (OCS) applications and interfaces".

b) **Common 3GPP specifications**

- 3GPP TS 22.101: "Service aspects; Service Principles".
- 3GPP TS 22.115 "Service aspects; Charging and Billing".
- 3GPP TS 23.003: "Numbering, addressing and identification".
- 3GPP TS 27.001: "General on Terminal Adaptation Functions (TAF) for Mobile Stations (MS)".

c) **other Domain and Service specific 3GPP / ETSI specifications**

-

d) **Relevant ITU Recommendations**

- ITU-T Recommendation D.93: "Charging and accounting in the international land mobile telephone service (provided via cellular radio systems)".
- ITU-T Recommendation E.164: "The international public telecommunication numbering plan".
- ITU-T Recommendation Q.767: "Application of the ISDN user part of CCITT signalling System No.7 for international ISDN interconnections".
- ITU-T Recommendation X.25: "Interface between Data Terminal Equipment (DTE) and Data Circuit-terminating Equipment (DCE) for terminals operating in the packet mode and connected to public data networks by dedicated circuit".
- ITU-T Recommendation X.121: "International numbering plan for public data networks".

e) **Relevant IETF RFCs**

- IETF RFC 959 (1985): "File Transfer Protocol".

Annex B (informative): Message Flows for Service Termination by OCS

This annex describes several scenarios related to IMS service termination in IMS-GWF.

SIP messages and Diameter transactions associated with these charging scenarios are shown primarily to illustrate the service termination procedures. They are not intended to be exhaustive and depend on the Diameter Credit Control Requests triggers configured by the operator. The triggers for sending Debit and Reserve Unit Requests from the IMS-GWF to the OCS are defined according to table 5.3.1.

B.1 Scenario 1 - Session Related (SCUR): Service Termination on reception of an initial SIP INVITE Request

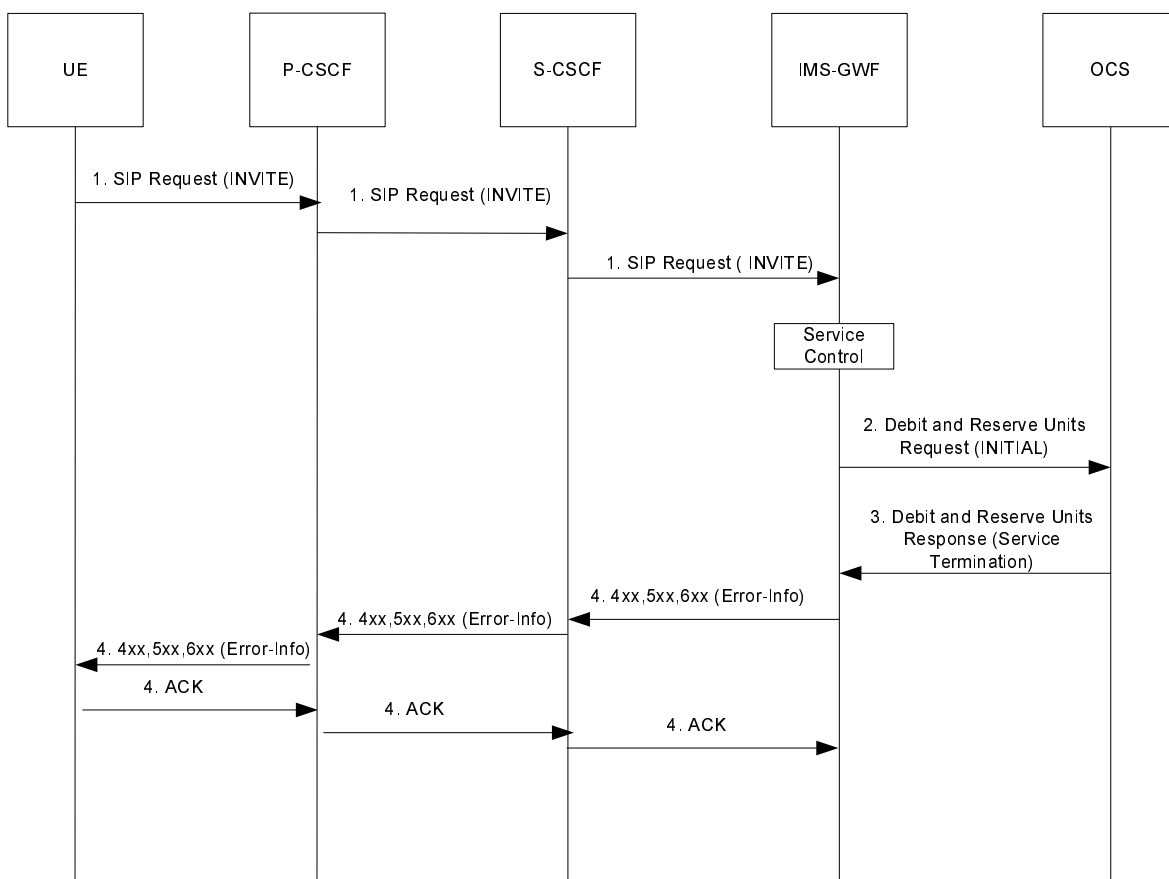

Figure B.1.1 : Service Termination triggered by an initial SIP Request

B.2 Scenario 2 - Session Related (SCUR): Service Termination triggered after an early SIP Dialog is established

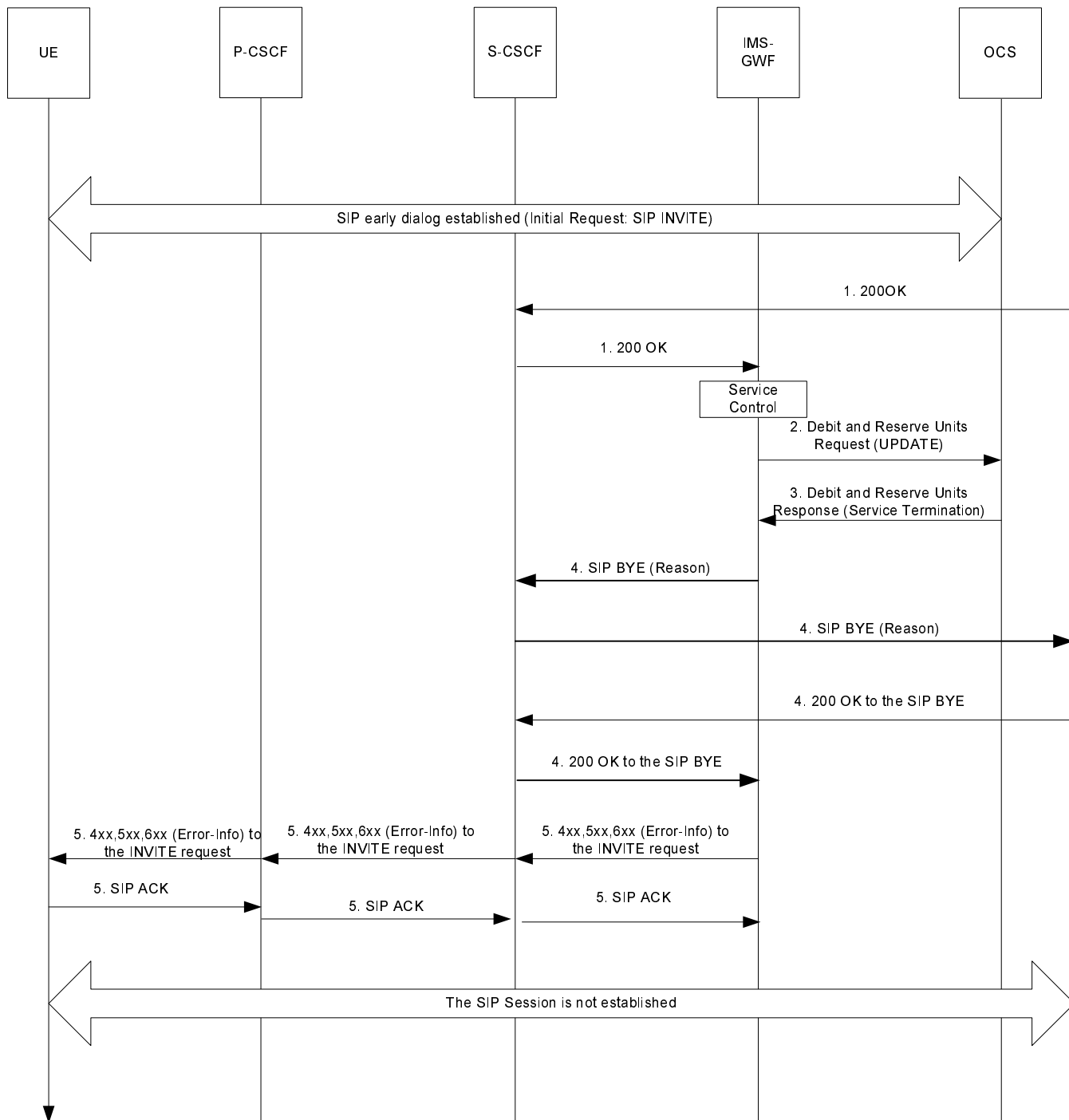

Figure B.2.1: Service Termination triggered by the 200OK response to the initial INVITE

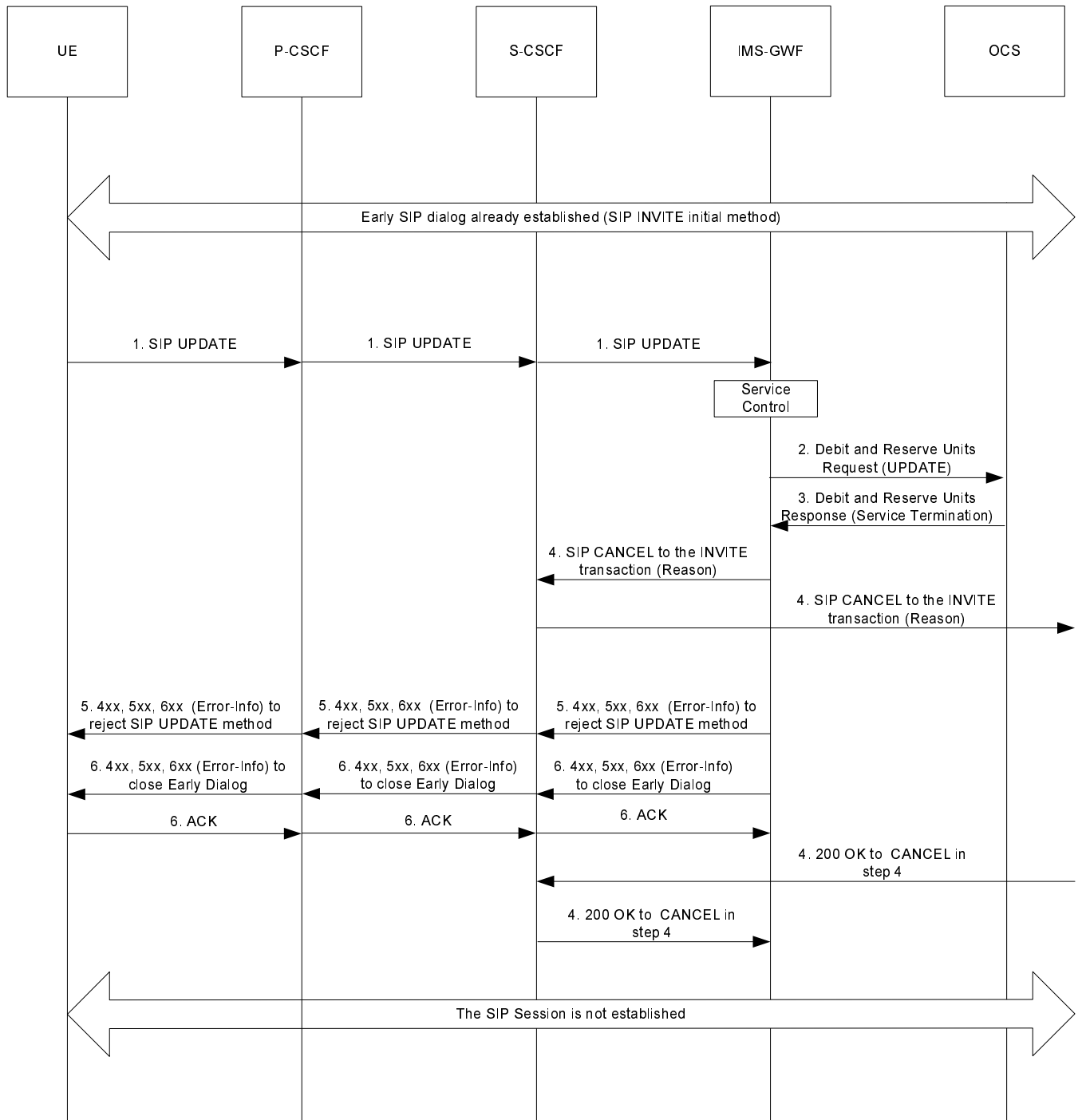

Figure B.2.2 : Service Termination triggered by an UPDATE request within an early SIP dialog

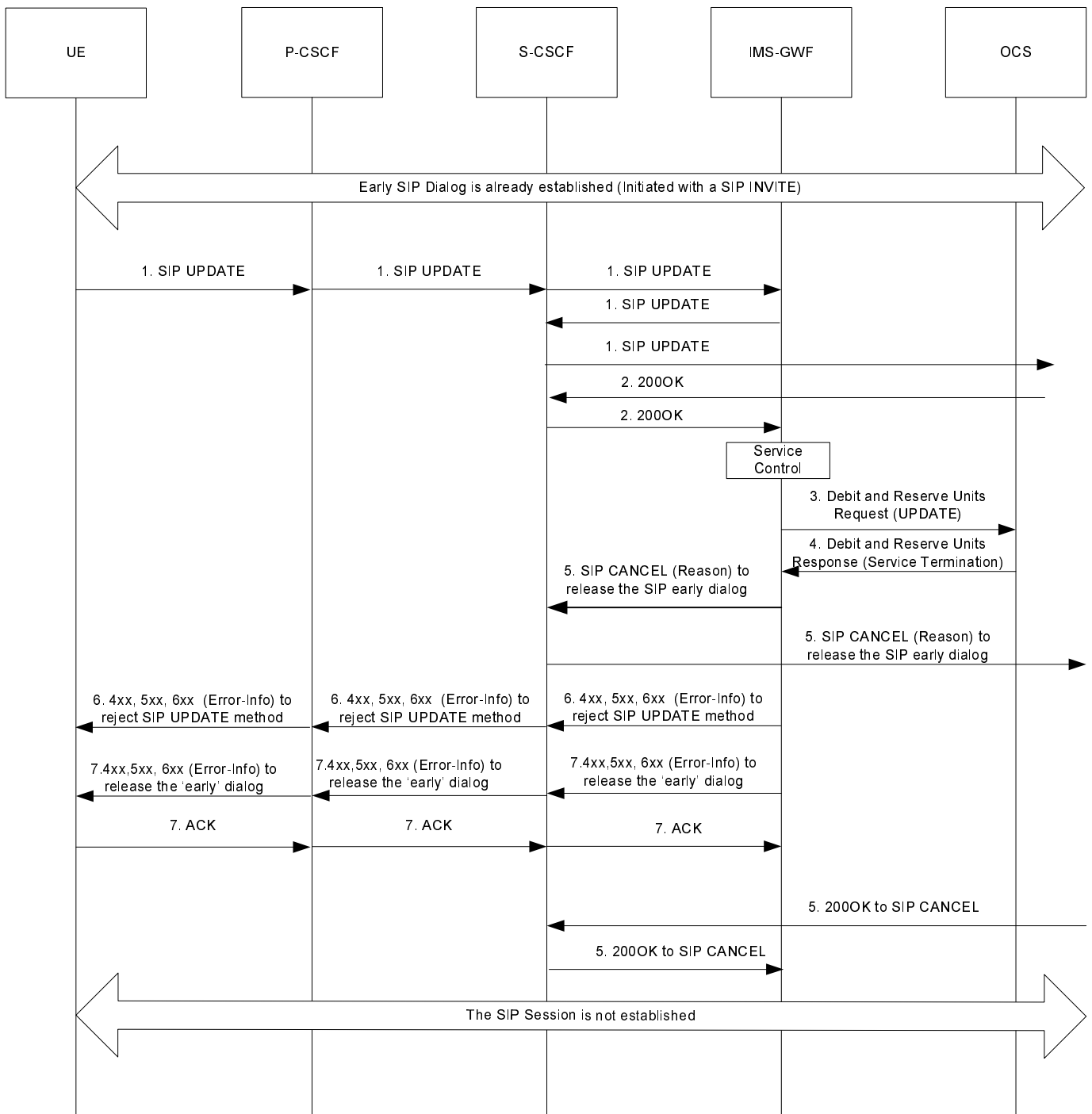

Figure B.2.3 : Service Termination triggered by the 200OK to an UPDATE request within an early SIP dialog

B.3 Scenario 3 - Session Related (SCUR): Service Termination triggered after a confirmed SIP Dialog is established

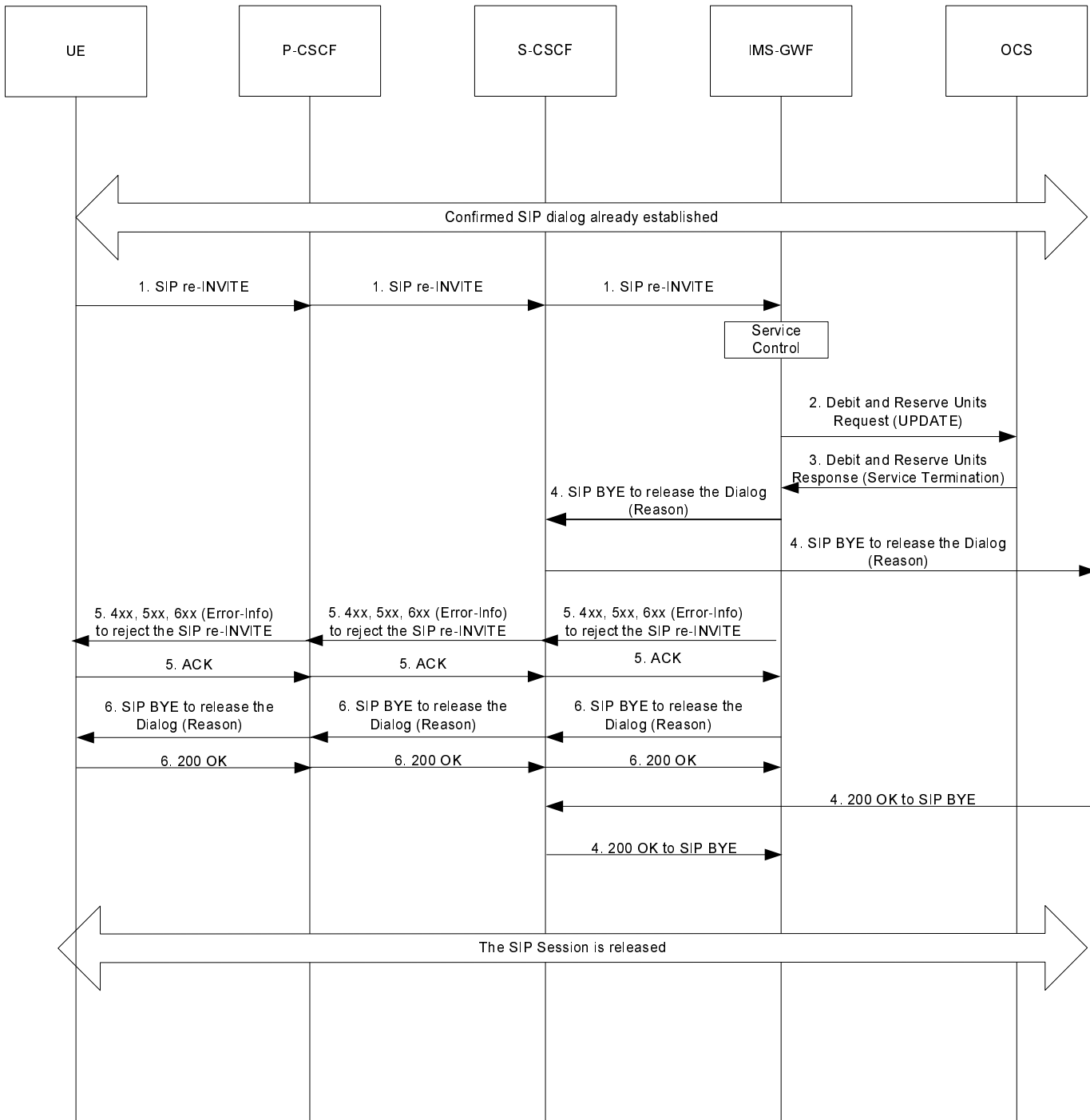

Figure B.3.1 : Service Termination triggered by a re-INVITE request within a confirmed SIP dialog

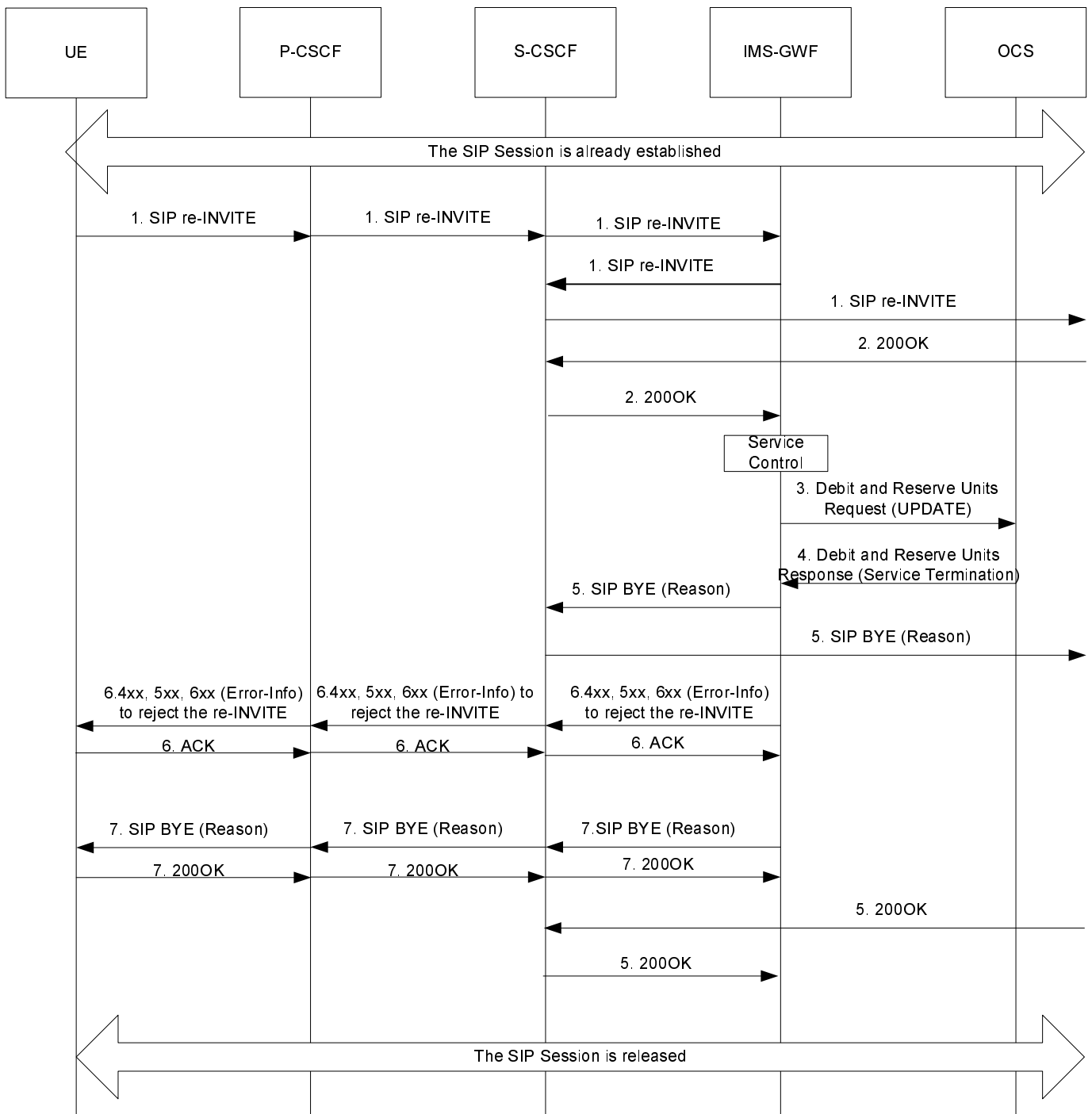

Figure B.3.2: Service Termination triggered by the 200OK response to a re-INVITE request within a confirmed SIP dialog

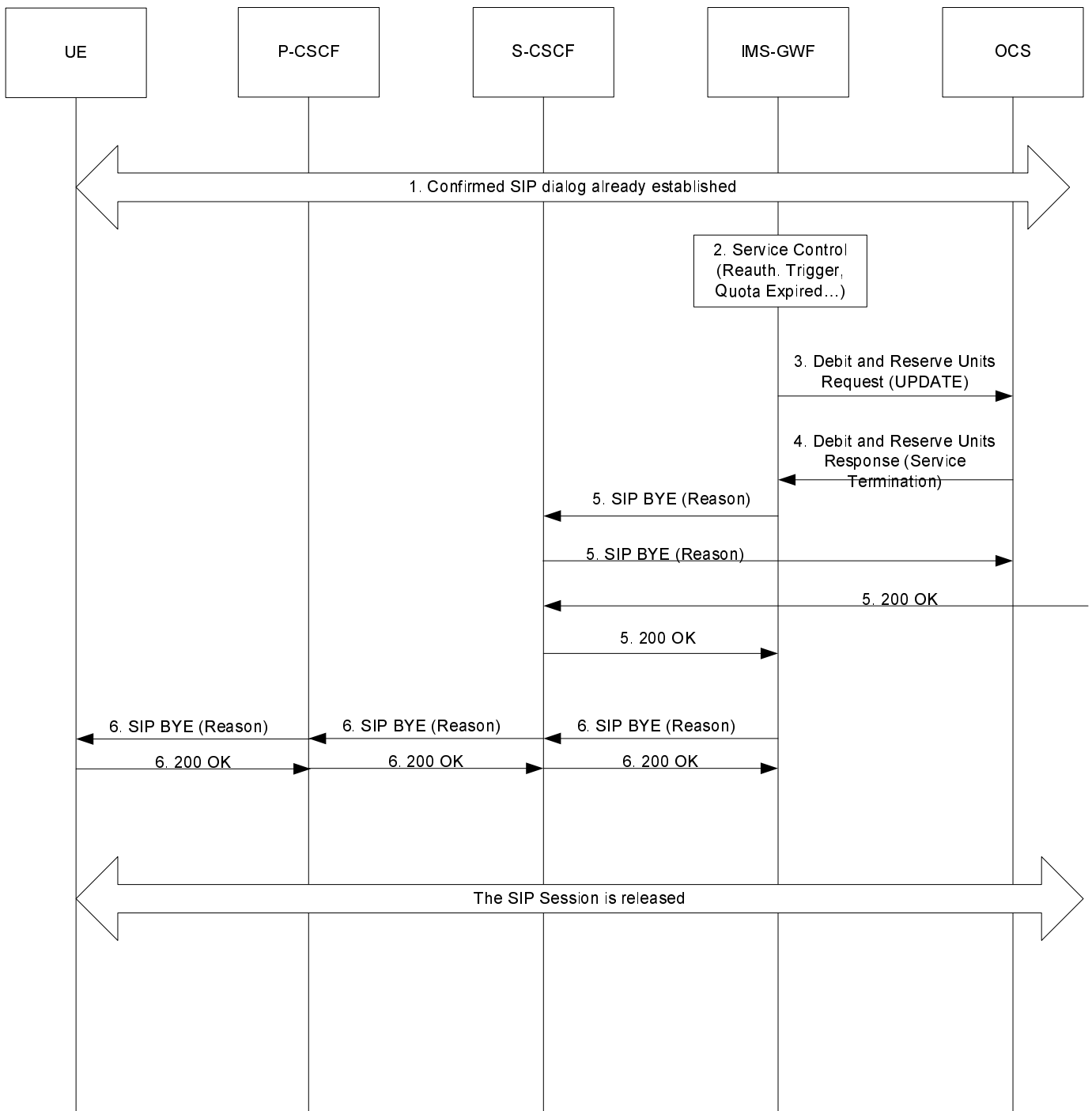

Figure B.3.3 : Service Termination triggered by the Charging Application procedures as defined in TS 32.299 [50] within a confirmed SIP dialog

B.4 Scenario 4 - Session Unrelated (ECUR): Service Termination on reception of an initial SIP non-INVITE Request

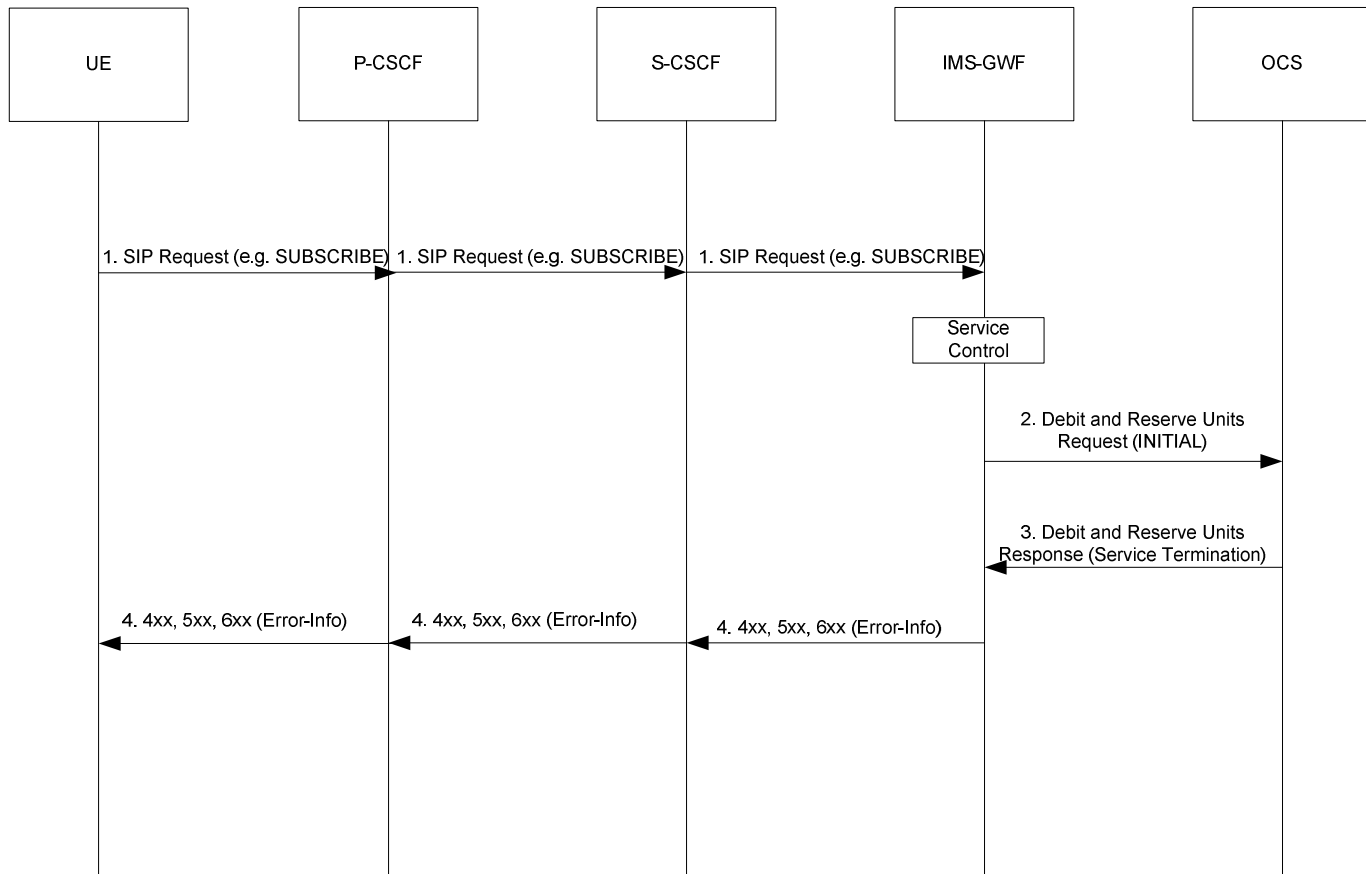

Figure B.4.1 : Service Termination triggered by the reception of a non-INVITE SIP request

B.5 Scenario 5 - Session Unrelated (IEC): Service Termination on reception of an initial SIP non-INVITE Request

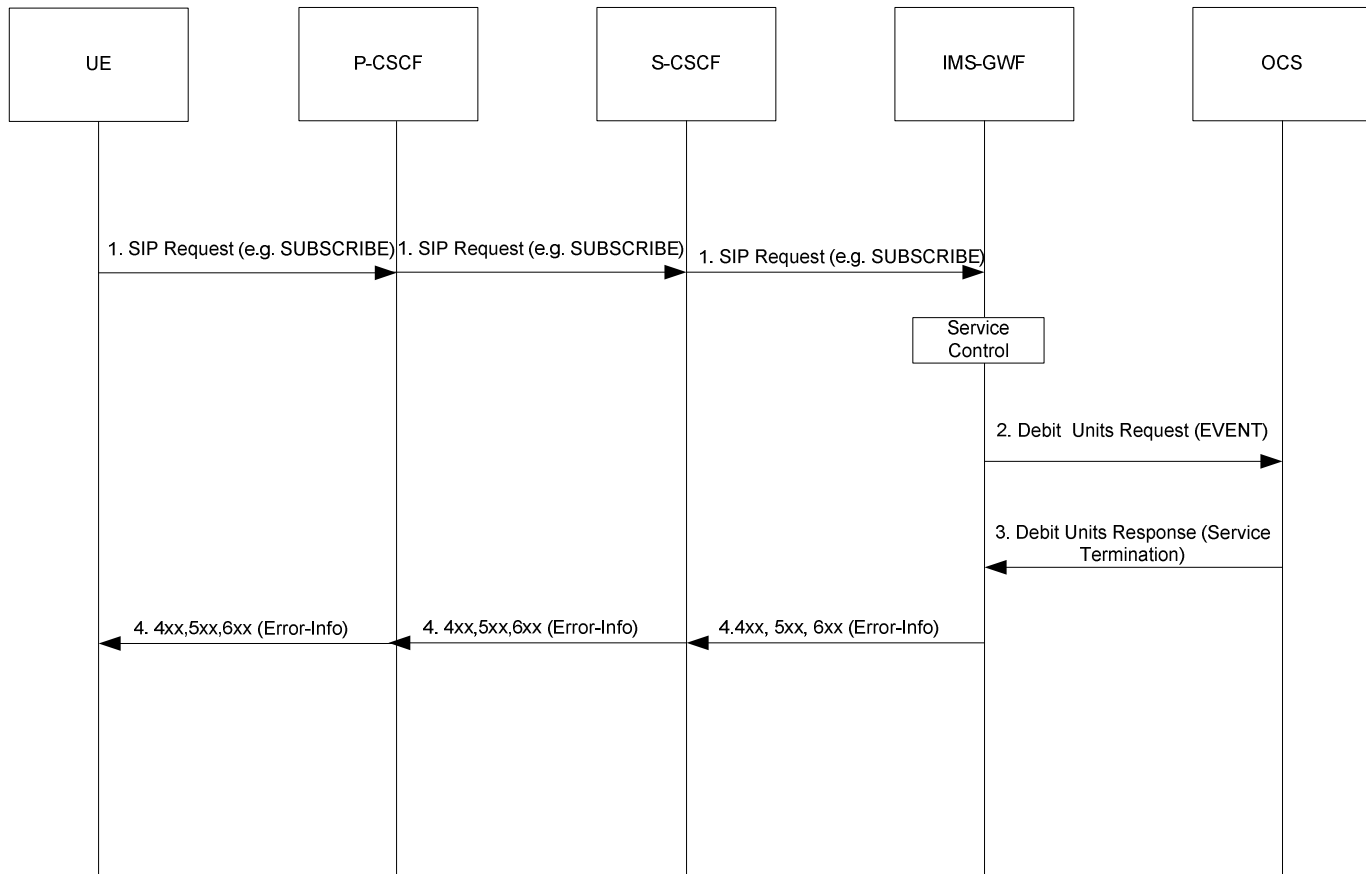

Figure B.5.1 : Service Termination triggered by the reception of a non-INVITE SIP request

Annex C (informative): Change history

| Change history | | | | | | | | |
|----------------|-------|-----------|------|-----|--|-----|-------|-------|
| Date | TSG # | TSG Doc. | CR | Rev | Subject/Comment | Cat | Old | New |
| Sep 2006 | SA_33 | SP-060542 | 0028 | -- | Add P-Access-Network-Info to IMS-Information and CDRs | C | 6.7.0 | 7.0.0 |
| Sep 2006 | SA_33 | SP-060540 | 0029 | -- | Extend the IMS correlation description for the access network to cover the fixed broadband access for multimedia data services (FBI-PCBL-CH) | C | 6.7.0 | 7.0.0 |
| Sep 2006 | SA_33 | SP-060542 | 0032 | -- | Add Flow Diagrams for IMS online charging | C | 6.7.0 | 7.0.0 |
| Sep 2006 | SA_33 | SP-060542 | 0033 | -- | Inclusion of Event and Expires Information parameters into IMS CDRs - Align with 32.299 | C | 6.7.0 | 7.0.0 |
| Sep 2006 | SA_33 | SP-060542 | 0034 | -- | Enhance Service Specific Data field definition | C | 6.7.0 | 7.0.0 |
| Dec 2006 | SA_34 | SP-060713 | 0035 | - | Add Access Network Charging Identifier in IMS CDRs | C | 7.0.0 | 7.1.0 |
| Dec 2006 | SA_34 | SP-060717 | 0036 | - | Add an identifier for the service initiating offline Diameter Accounting | B | 7.0.0 | 7.1.0 |
| Dec 2006 | SA_34 | SP-060717 | 0037 | - | Add an identifier for the served user in offline Diameter Accounting | B | 7.0.0 | 7.1.0 |
| Dec 2006 | SA_34 | SP-060717 | 0038 | - | Correction on Service Specific Data | F | 7.0.0 | 7.1.0 |
| Mar 2007 | SA_35 | SP-070043 | 0040 | -- | Introduce Charging Support for IMS Early Media | B | 7.1.0 | 7.2.0 |
| Mar 2007 | SA_35 | SP-070039 | 0041 | -- | Introduce IMS charging implications of VCC | B | 7.1.0 | 7.2.0 |
| Mar 2007 | SA_35 | SP-070043 | 0042 | -- | Removal of ACID | F | 7.1.0 | 7.2.0 |
| Mar 2007 | SA_35 | SP-070043 | 0043 | -- | Corrections to Online and Offline charging message trigger conditions for MRFC | F | 7.1.0 | 7.2.0 |
| Mar 2007 | SA_35 | SP-070044 | 0044 | -- | Add flow description for Alternate Charged Party | B | 7.1.0 | 7.2.0 |
| Mar 2007 | SA_35 | SP-070043 | 0045 | -- | Corrections to BGCF state during PSTN and IMS initiated session establishment and releases | F | 7.1.0 | 7.2.0 |
| Mar 2007 | SA_35 | SP-070033 | 0046 | -- | Correction on SDP Media Info - Align with 24.229 | A | 7.1.0 | 7.2.0 |
| Jun 2007 | SA_36 | SP-070273 | 0047 | -- | Correction to failure handling procedures for online charging | F | 7.2.0 | 7.3.0 |
| Jun 2007 | SA_36 | SP-070272 | 0048 | -- | Correction to call flow for VCC charging for IMS-CS transfer | F | 7.2.0 | 7.3.0 |
| Jun 2007 | SA_36 | SP-070272 | 0049 | -- | Add call flows for VCC charging for CS-domain initiation and transfer to IMS | B | 7.2.0 | 7.3.0 |
| Jun 2007 | SA_36 | SP-070274 | 0050 | -- | Add Alternate Charged Party Address to AS CDR content. | B | 7.2.0 | 7.3.0 |
| Sep 2007 | SA_37 | SP-070674 | 0052 | -- | Add IMS Communication Service Identification (ICSI) in Charging information | B | 7.3.0 | 7.4.0 |
| Jun 2008 | SA_40 | SP-080271 | 0057 | -- | Correction on supported fields in the Charging Operations | F | 7.4.0 | 7.5.0 |
| Dec 2008 | SA_42 | SP-080841 | 0061 | -- | Correction on Multiple Unit Operation category | F | 7.5.0 | 7.6.0 |

History

| Document history | | |
|-------------------------|--------------|-------------|
| V7.2.0 | March 2007 | Publication |
| V7.3.0 | June 2007 | Publication |
| V7.4.0 | October 2007 | Publication |
| V7.5.0 | July 2008 | Publication |
| V7.6.0 | January 2009 | Publication |