

ETSI TS 132 275 V12.1.0 (2014-10)



**Universal Mobile Telecommunications System (UMTS);
LTE;
Telecommunication management;
Charging management;
MultiMedia Telephony (MMTel) charging
(3GPP TS 32.275 version 12.1.0 Release 12)**



Reference

RTS/TSGS-0532275vc10

Keywords

LTE,UMTS

ETSI

650 Route des Lucioles
F-06921 Sophia Antipolis Cedex - FRANCE

Tel.: +33 4 92 94 42 00 Fax: +33 4 93 65 47 16

Siret N° 348 623 562 00017 - NAF 742 C
Association à but non lucratif enregistrée à la
Sous-Préfecture de Grasse (06) N° 7803/88

Important notice

The present document can be downloaded from:

<http://www.etsi.org>

The present document may be made available in electronic versions and/or in print. The content of any electronic and/or print versions of the present document shall not be modified without the prior written authorization of ETSI. In case of any existing or perceived difference in contents between such versions and/or in print, the only prevailing document is the print of the Portable Document Format (PDF) version kept on a specific network drive within ETSI Secretariat.

Users of the present document should be aware that the document may be subject to revision or change of status. Information on the current status of this and other ETSI documents is available at

<http://portal.etsi.org/tb/status/status.asp>

If you find errors in the present document, please send your comment to one of the following services:

http://portal.etsi.org/chaicor/ETSI_support.asp

Copyright Notification

No part may be reproduced or utilized in any form or by any means, electronic or mechanical, including photocopying and microfilm except as authorized by written permission of ETSI.

The content of the PDF version shall not be modified without the written authorization of ETSI.

The copyright and the foregoing restriction extend to reproduction in all media.

© European Telecommunications Standards Institute 2014.

All rights reserved.

DECT™, **PLUGTESTS™**, **UMTS™** and the ETSI logo are Trade Marks of ETSI registered for the benefit of its Members. **3GPP™** and **LTE™** are Trade Marks of ETSI registered for the benefit of its Members and of the 3GPP Organizational Partners.

GSM® and the GSM logo are Trade Marks registered and owned by the GSM Association.

Intellectual Property Rights

IPRs essential or potentially essential to the present document may have been declared to ETSI. The information pertaining to these essential IPRs, if any, is publicly available for **ETSI members and non-members**, and can be found in ETSI SR 000 314: *"Intellectual Property Rights (IPRs); Essential, or potentially Essential, IPRs notified to ETSI in respect of ETSI standards"*, which is available from the ETSI Secretariat. Latest updates are available on the ETSI Web server (<http://ipr.etsi.org>).

Pursuant to the ETSI IPR Policy, no investigation, including IPR searches, has been carried out by ETSI. No guarantee can be given as to the existence of other IPRs not referenced in ETSI SR 000 314 (or the updates on the ETSI Web server) which are, or may be, or may become, essential to the present document.

Foreword

This Technical Specification (TS) has been produced by ETSI 3rd Generation Partnership Project (3GPP).

The present document may refer to technical specifications or reports using their 3GPP identities, UMTS identities or GSM identities. These should be interpreted as being references to the corresponding ETSI deliverables.

The cross reference between GSM, UMTS, 3GPP and ETSI identities can be found under <http://webapp.etsi.org/key/queryform.asp>.

Modal verbs terminology

In the present document "**shall**", "**shall not**", "**should**", "**should not**", "**may**", "**may not**", "**need**", "**need not**", "**will**", "**will not**", "**can**" and "**cannot**" are to be interpreted as described in clause 3.2 of the [ETSI Drafting Rules](#) (Verbal forms for the expression of provisions).

"**must**" and "**must not**" are **NOT** allowed in ETSI deliverables except when used in direct citation.

Contents

Intellectual Property Rights	2
Foreword.....	2
Modal verbs terminology.....	2
Foreword.....	6
1 Scope	7
2 References	9
3 Definitions and abbreviations.....	11
3.1 Definitions	11
3.2 Symbols.....	11
3.3 Abbreviations	11
4 Architecture considerations	12
4.1 High level MMTel architecture	12
4.2 MMTel offline charging architecture	13
4.3 MMTel online charging architecture	14
5 MMTel charging principles and scenarios	15
5.0 Introduction	15
5.1 MMTel charging principles.....	15
5.1.1 Supplementary services invocation.....	16
5.1.1.1 OIP charging	16
5.1.1.2 OIR charging.....	16
5.1.1.3 TIP charging.....	16
5.1.1.4 TIR charging	16
5.1.1.5 HOLD charging.....	16
5.1.1.6 CB charging	16
5.1.1.7 CDIV charging.....	17
5.1.1.8 CW charging	17
5.1.1.9 ECT charging.....	17
5.1.1.10 MWI charging.....	17
5.1.1.11 CONF charging	18
5.1.1.12 CCBS charging	18
5.1.1.13 CCNR charging.....	18
5.1.1.14 FA charging.....	19
5.1.1.15 MCID charging	19
5.1.1.16 CAT charging.....	19
5.1.1.17 CUG charging	19
5.1.1.18 PNM charging	20
5.1.1.19 CRS charging.....	20
5.1.1.20 Reverse charging.....	20
5.1.1.21 AoC charging.....	20
5.1.2 Supplementary services management by the user.....	20
5.2 MMTel offline charging scenarios	21
5.2.2 Diameter message flows	21
5.2.2.0 Introduction.....	21
5.2.2.1 Message flows - Successful cases and scenarios.....	21
5.2.2.1.0 Introduction	21
5.2.2.1.1 Originating Identification Presentation (OIP) charging.....	22
5.2.2.1.2 Originating Identification Restriction (OIR) charging	23
5.2.2.1.3 Terminating Identification Presentation (TIP) charging.....	24
5.2.2.1.4 Terminating Identification Restriction (TIR) charging.....	25
5.2.2.1.5 Communication Hold (HOLD) charging.....	26
5.2.2.1.6 Communication Barring – CB (ICB/ACB) charging.....	27
5.2.2.1.6.1 Communication Barring (CB) – ICB and Charging Data Request	27

5.2.2.1.6.2	Communication Barring (CB) – OCB	28
5.2.2.1.7	Communications Diversion (CDIV) charging	29
5.2.2.1.7.1	Communications Diversion (CDIV) – successful establishment	29
5.2.2.1.7.2	Communications Diversion (CDIV) – release	31
5.2.2.1.8	Communication Waiting (CW) charging	32
5.2.2.1.9	Explicit Communication Transfer (ECT) charging	33
5.2.2.1.9.1	Explicit Communication Transfer (ECT): Blind Transfer	33
5.2.2.1.9.2	Explicit Communication Transfer (ECT): Release	37
5.2.2.1.10	Message Waiting Indication (MWI) charging	38
5.2.2.1.11	Conferencing (CONF) Charging	39
5.2.2.1.11.0	Introduction	39
5.2.2.1.11.1	CONF charging – user creating a conference	39
5.2.2.1.11.2	CONF charging – user joining a conference	41
5.2.2.1.11.3	CONF charging – user inviting another user to a conference	42
5.2.2.1.11.4	CONF charging – user leaving a conference	43
5.2.2.1.11.5	Three-Party (3PTY) charging – successful establishment	44
5.2.2.1.11.6	Three-Party (3PTY) charging – release	47
5.2.2.1.12	CCBS charging	48
5.2.2.1.13	CCNR charging	51
5.2.2.1.14	Flexible Alerting (FA)	53
5.2.2.1.14.1	Flexible Alerting (FA) - establishment	53
5.2.2.1.14.2	Flexible Alerting (FA) – call release	54
5.2.2.1.15	Malicious Communication Identification (MCID)	55
5.2.2.1.16	Customized Alerting Tone (CAT)	57
5.2.2.1.17	Closed User Group (CUG)	59
5.2.2.1.17.1	Closed User Group (CUG): Originating	59
5.2.2.1.17.2	Closed User Group (CUG): Terminating	60
5.2.2.1.18	Personal Network Management (PNM)	62
5.2.2.1.19	Customized Ringing Signal (CRS)	64
5.2.2.1.20	Advice of Charge (AoC)	65
5.2.3	GTP' record transfer flows	65
5.2.4	B ₁ CDR file transfer	65
5.3	MMTel online charging scenarios	66
5.3.1	Basic principles	66
5.3.2	Diameter message flows	66
5.3.2.1	Message flows - Successful cases and scenarios	67
5.3.2.1.0	Interaction with IMS-GWF	67
5.3.2.1.1	Communications Diversion (CDIV)	68
5.3.2.1.1.1	Communications Diversion (CDIV) – successful establishment	68
5.3.2.1.1.2	Communications Diversion (CDIV) – release	69
5.3.2.1.2	Flexible Alerting (FA)	70
5.3.2.1.3	Closed User Group (CUG)	72
5.3.2.1.3.1	Closed User Group (CUG): Originating	72
5.3.2.1.3.2	Closed User Group (CUG): Terminating	74
5.3.2.1.4	Conference (CONF)	76
5.3.2.1.4.0	Introduction	76
5.3.2.1.4.1	CONF – user creating a conference - ECUR mode	76
5.3.2.1.4.2	CONF – user creating a conference - SCUR mode	78
5.3.2.1.4.3	CONF – user joining a conference (SCUR mode)	79
5.3.2.1.4.4	CONF – user inviting another user to a conference (SCUR mode)	80
5.3.2.1.4.5	CONF – user leaving a conference (SCUR mode)	81
5.3.2.1.4.6	CONF (3PTY) – successful establishment	82
5.3.2.1.5	Explicit Communication Transfer (ECT)	83
5.3.2.1.5.0	Introduction	83
5.3.2.1.5.1	Explicit Communication Transfer (ECT): Blind Transfer with sending SIP REFER	84
5.3.2.1.5.2	Explicit Communication Transfer (ECT): Blind Transfer with 3PCC	87
5.3.2.1.5.3	Explicit Communication Transfer (ECT): Release	89
5.3.2.2	Message flows - error cases and scenarios	89
6	Definition of charging information	90
6.1	Data description for MMTel offline charging	90
6.1.1	Rf message contents	90

6.1.1.0	Introduction	90
6.1.1.1	Charging Data Request message description	90
6.1.1.2	Charging Data Response message description	90
6.1.2	GTP' message contents	90
6.1.3	CDR description on the Bi interface	90
6.1.3.1	CDR field type	90
6.1.3.2	CDR triggers	91
6.1.3.3	MMTel-AS CDR content	91
6.2	Data description for MMTel online charging	91
6.2.1	Ro message contents	91
6.2.1.0	Introduction	91
6.2.1.1	Debit / Reserve Units Request message	91
6.2.1.2	Debit / Reserve Units Response message	91
6.3	MMTel charging specific parameters	92
6.3.1	Definition of MMTel charging information	92
6.3.1.0	Introduction	92
6.3.1.1	MMTel charging information assignment for Service Information	92
6.3.1.2	Definition of the MMTel Information	92
6.3.1.3	Support of MMTel Information in MMTel offline charging	93
6.3.1.4	Support of MMTel Information in MMTel online charging	94
Annex A (informative): Bibliography		95
Annex B (informative): Change history		97
History		99

Foreword

This Technical Specification has been produced by the 3rd Generation Partnership Project (3GPP).

The contents of the present document are subject to continuing work within the TSG and may change following formal TSG approval. Should the TSG modify the contents of the present document, it will be re-released by the TSG with an identifying change of release date and an increase in version number as follows:

Version x.y.z

where:

- x the first digit:
 - 1 presented to TSG for information;
 - 2 presented to TSG for approval;
 - 3 or greater indicates TSG approved document under change control.
- y the second digit is incremented for all changes of substance, i.e. technical enhancements, corrections, updates, etc.
- z the third digit is incremented when editorial only changes have been incorporated in the document.

1 Scope

The present document is part of a series of Technical Specifications (TSs) that specify charging functionality and charging management in GSM/UMTS networks. The GSM/UMTS core network charging architecture and principles are specified in TS 32.240 [1], which provides an umbrella for other charging management TSs that specify:

- the content of the CDRs per domain and subsystem (offline charging);
- the content of real-time charging messages per domain / subsystem (online charging);
- the functionality of online and offline charging for those domains and subsystems;
- the interfaces that are used in the charging framework to transfer the charging information (i.e. CDRs or charging events)

The complete document structure for these TSs is defined in TS 32.240 [1].

The present document specifies the Offline and Online Charging for MultiMedia Telephony (MMTel) service and supplementary services, based on the functional description of MMTel in TS 22.173 [200]. Charging for the following supplementary services is specified:

- Communications Diversion (CDIV);
- Communication Hold (HOLD);
- CONference (CONF);
- Message Waiting Indication (MWI);
- Originating Identity Presentation (OIP) / Originating Identity Restriction (OIR);
- Terminating Identity Presentation (TIP) / Terminating Identity Restriction (TIR);
- Call Barring (CB);
- Explicit Call Transfer (ECT);
- Communication Wait (CW);
- Completion of Communications to Busy Subscriber (CCBS);
- Completion of Communications by No Reply (CCNR);
- Malicious Communication Identification (MCID);
- Customized Alerting Tone (CAT);
- Closed User Group (CUG);
- Personal Network Management (PNM);
- Customized Ringing Signal (CRS);
- Reverse Charging;
- Advice of Charge (AoC).

Charging of these supplementary services is performed at the respective MMTel AS. The MMTel charging aspects are an extension of the basic IMS charging capabilities as specified in the TS 32.260 [20].

This charging description includes the offline and online charging architecture and scenarios specific to the MMTel, as well as the mapping of the common 3GPP charging architecture specified in TS 32.240 [1] onto the MMTel. It further specifies the structure and content of the CDRs for offline charging, and the charging events for online charging.

The present document is related to other 3GPP charging TSs as follows:

- The common 3GPP charging architecture is specified in TS 32.240 [1];
- The common IMS charging principles are specified in the TS 32.260 [20].
- The parameters, abstract syntax and encoding rules for these CDR types are specified in TS 32.298 [51].
- A transaction based mechanism for the transfer of CDRs within the network is specified in TS 32.295 [54].
- The file based mechanism used to transfer the CDRs from the network to the operator's Billing Domain (e.g. the billing system or a mediation device) is specified in TS 32.297 [52].
- The 3GPP Diameter application that is used for MMTel offline and online charging is specified in TS 32.299 [50].

All references, abbreviations, definitions, descriptions, principles and requirements, used in the present document, that are common across 3GPP TSs, are defined in the 3GPP Vocabulary, TR 21.905 [100]. Those that are common across charging management in GSM/UMTS domains or subsystems are provided in the umbrella document TS 32.240 [1]. Finally, those items that are specific to the present document are defined exclusively in the present document.

2 References

The following documents contain provisions which, through reference in this text, constitute provisions of the present document.

- References are either specific (identified by date of publication, edition number, version number, etc.) or non-specific.
- For a specific reference, subsequent revisions do not apply.
- For a non-specific reference, the latest version applies. In the case of a reference to a 3GPP document (including a GSM document), a non-specific reference implicitly refers to the latest version of that document *in the same Release as the present document*.

- [1] 3GPP TS 32.240: "Telecommunication management; charging management; charging architecture and principles".
- [2] - [19] Void
- [20] 3GPP TS 32.260: "Telecommunication management; Charging management; IP Multimedia Subsystem (IMS) charging".
- [21] - [49] Void.
- [50] 3GPP TS 32.299: "Telecommunication management; Charging management; Diameter charging application".
- [51] 3GPP TS 32.298: "Telecommunication management; Charging management; Charging Data Record (CDR) parameter description".
- [52] 3GPP TS 32.297: "Telecommunication management; Charging management; Charging Data Record (CDR) file format and transfer".
- [53] 3GPP TS 32.296: "Telecommunication management; Charging management; Online Charging System (OCS) applications and interfaces".
- [54] 3GPP TS 32.295: "Telecommunication management; Charging management; Charging Data Record (CDR) transfer".
- [55] - [68] void
- [69] 3GPP TS 32.280: "Telecommunication management; Charging management; Advice of Charge (AoC) service".
- [70] - [99] Void.
- [100] 3GPP TR 21.905: "Vocabulary for 3GPP Specifications".
- [101] 3GPP TS 22.101: "Service aspects; Service principles".
- [102] 3GPP TS 22.115: "Service aspects; Charging and billing".
- [103] 3GPP TS 23.002: "Network architecture".
- [104] - [199] Void.
- [200] 3GPP TS 22.173: "IP Multimedia Core Network Subsystem (IMS) Multimedia Telephony Service and supplementary services; Stage 1".
- [201] 3GPP TS 24.173: "IMS Multimedia telephony communication service and supplementary services; Stage 3".
- [202] 3GPP TS 24.604: "Communication Diversion (CDIV) using IP Multimedia (IM) Core Network (CN) subsystem; Protocol specification".

- [203] 3GPP TS 24.605: "Conference (CONF) using IP Multimedia (IM) Core Network (CN) subsystem; Protocol specification".
- [204] 3GPP TS 24.606: "Message Waiting Indication (MWI) using IP Multimedia (IM) Core Network (CN) subsystem; Protocol specification".
- [205] 3GPP TS 24.607: "Originating Identification Presentation (OIP) and Originating Identification Restriction (OIR) using IP Multimedia (IM) Core Network (CN) subsystem; Protocol specification".
- [206] 3GPP TS 24.608: "Terminating Identification Presentation (TIP) and Terminating Identification Restriction (TIR) using IP Multimedia (IM) Core Network (CN) subsystem; Protocol specification".
- [207] 3GPP TS 24.610: "Communication HOLD (HOLD) using IP Multimedia (IM) Core Network (CN) subsystem; Protocol specification".
- [208] 3GPP TS 24.611: "Anonymous Communication Rejection (ACR) and Communication Barring (CB) using IP Multimedia (IM) Core Network (CN) subsystem; Protocol specification".
- [209] 3GPP TS 24.615: "Communication Waiting (CW) using IP Multimedia (IM) Core Network (CN) subsystem; Protocol specification".
- [210] 3GPP TS 24.616: "Malicious Communication Identification (MCID) using IP Multimedia (IM) Core Network (CN) subsystem; Protocol specification".
- [211] 3GPP TS 24.623: "Extensible Markup Language (XML) Configuration Access Protocol (XCAP) over the Ut interface for Manipulating Simulation Services".
- [212] 3GPP TS 24.629: "Explicit Communication Transfer (ECT) using IP Multimedia (IM) Core Network (CN) subsystem; Protocol specification".
- [213] 3GPP TS 24.642: "Completion of Communications to Busy Subscriber (CCBS) and Completion of Communications by No Reply (CCNR) using IP Multimedia (IM) Core Network (CN) subsystem; Protocol specification".
- [214] 3GPP TS 24.647: "Advice Of Charge (AOC) using IP Multimedia (IM) Core Network (CN) subsystem; Protocol specification".
- [215] 3GPP TS 24.654: "Closed User Group (CUG) using IP Multimedia (IM) Core Network (CN) subsystem; Protocol specification".
- [216] 3GPP TS 24.239: "Flexible Alerting (FA) using IP Multimedia (IM) Core Network (CN) subsystem, Protocol specification".
- [217] 3GPP TS 24.182: "IP Multimedia Subsystem (IMS) Customized Alerting Tones (CAT); Protocol specification".
- [218] 3GPP TS 23.259: "Personal Network Management (PNM); Procedures and information flows; Stage 2".
- [219] 3GPP TS 24.183: "IP Multimedia Subsystem (IMS) Customized Ringing Signal (CRS); Protocol specification".
- [220] 3GPP TS 24.147: "Conferencing using the IP Multimedia (IM) Core Network (CN) subsystem; Stage 3".
- [221] 3GPP TS 24.228: "Signalling flows for the IP multimedia call control based on Session Initiation Protocol (SIP) and Session Description Protocol (SDP); Stage 3". [222] - [400] Void.
- [401] IETF RFC 3588 (2003): "Diameter Base Protocol".
- [402] IETF RFC 4006 (2005): "Diameter Credit-Control Application".
- [403] - [499] Void.

3 Definitions and abbreviations

3.1 Definitions

For the purposes of the present document, the terms and definitions given in TR 21.905 [100], TS 32.240 [1] apply.

3.2 Symbols

For the purposes of the present document, the following symbols applies:

Bi	Reference point for the CDR file transfer from the IMS CGF to the BD.
Ga	Reference point for CDR transfer between a CDF and CGF.
Rf	Offline Charging Reference Point between an IMS Network Entity or an AS and CDF
Ro	Online Charging Reference Point between an AS or MRFC and IMS-GWF and the OCS

3.3 Abbreviations

For the purposes of the present document, the abbreviations defined in TR 21.905 [100], TS 32.240 [1] and the following apply:

3PCC	Third Party Call Control
3PTY	Three-Party
AoC	Advice of Charge
CAT	Customized Alerting Tone
CB	Communication session Barring
CCBS	Completion of Communication sessions to Busy Subscriber
CCNR	Completion of Communications on No Reply
CD	Communication Deflection
CDIV	Communication DIVersion
CFB	Communication Forwarding Busy
CFU	Communication Forwarding Unconditional
CFNL	Communication Forwarding on Not Logged-in
CFNR	Communication Forwarding No Reply
CFNRc	Communication Forwarding on Subscriber Not Reachable
CFUDB	Communication Forwarding User Determined Busy
CONF	CONFerence
CUG	Closed User Group
CW	Communication Waiting
ECT	Explicit Communication Transfer
FA	Flexible Alerting
HOLD	Communication HOLD
ICB	Incoming Communication Barring
MCID	Malicious Communication Identification
MMTel	MultiMedia Telephony
MWI	Message Waiting Indication
NDUB	Network Determined User Busy
OCB	Outgoing Communication Barring
OIP	Originating Identity Presentation
OIR	Originating Identity Restriction
PNM	Personal Network Management
CRS	Customized Ringing Signal
TIP	Terminating Identity Presentation
TIR	Terminating Identity Restriction
URN	Uniform Resource Name

4 Architecture considerations

4.1 High level MMTel architecture

Figure 4.1.1 depicts the IMS reference architecture, as described in TS 23.002 [103], with "colorized" AS as entity involved in MMTel service and supplementary services charging described in the present document.

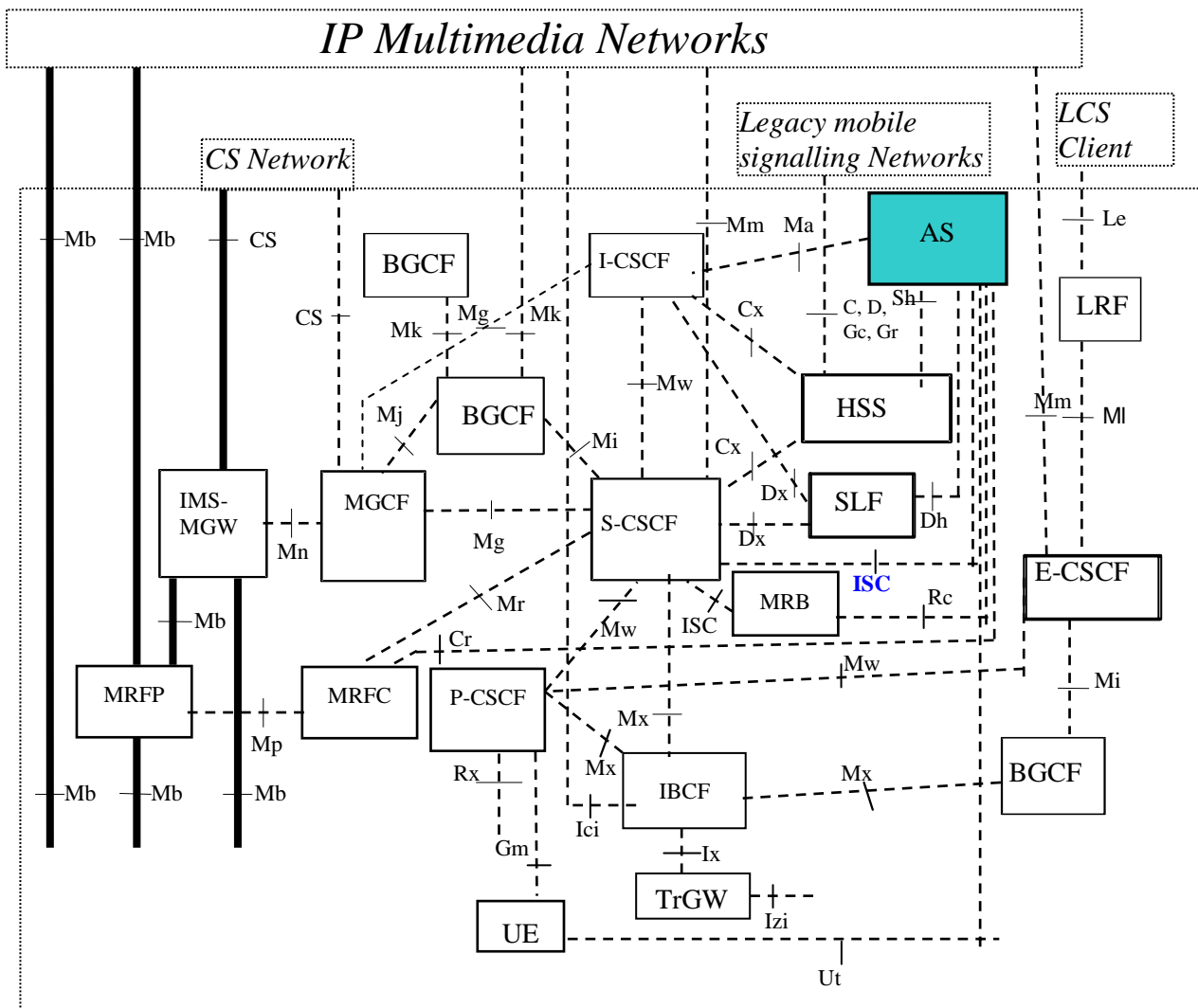

Figure 4.1.1: Entities involved in MMTel service charging in IMS logical architecture

The AS provides the application level network functionality for MMTel service and supplementary services, whereas the overall IMS Network provides the basic IMS capabilities supporting MMTel service.

4.2 MMTel offline charging architecture

Figure 4.2.1 depicts the MMTel offline charging architecture.

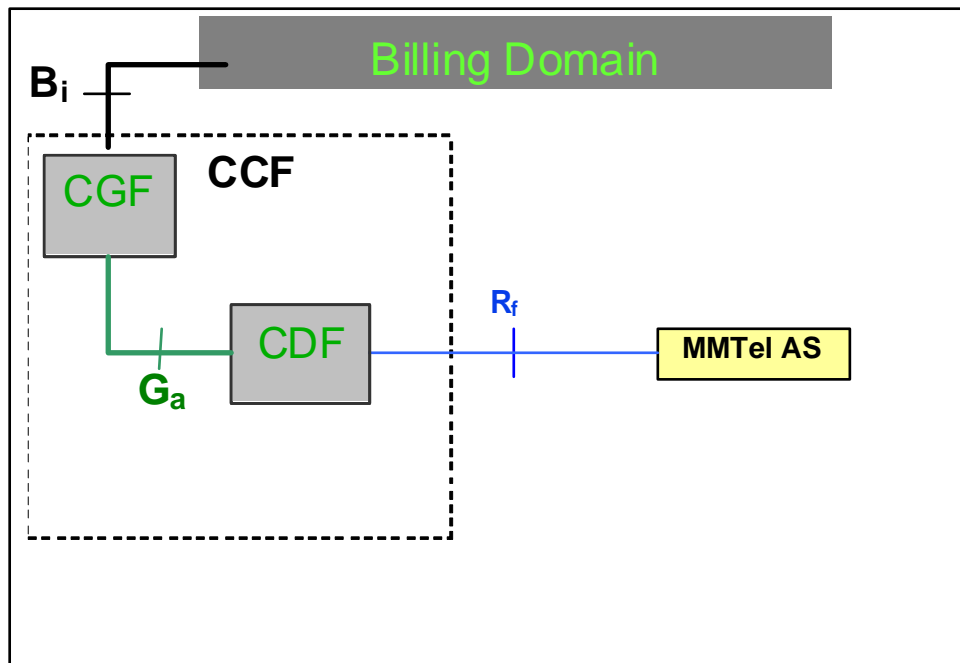

Figure 4.2.1: MMTel offline charging architecture

This MMTel offline charging architecture is based on the IMS offline charging architecture described in TS 32.260 [20], with service CTFs supporting MMTel specific service charging, interfacing the CDF through the R_f reference point.

The CTFs considered in the MMTel offline charging architecture reside in the Application level network functionality providing MMTel service and supplementary services.

The CTFs related to charging for the IMS basic capabilities supporting MMTel service, are described in TS 32.260 [20], and reside in the set of IMS Nodes (S-CSCF, MRFC...) reflected in IMS offline architecture.

4.3 MMTel online charging architecture

The architecture for MMTel online charging is described in figure 4.3.1..

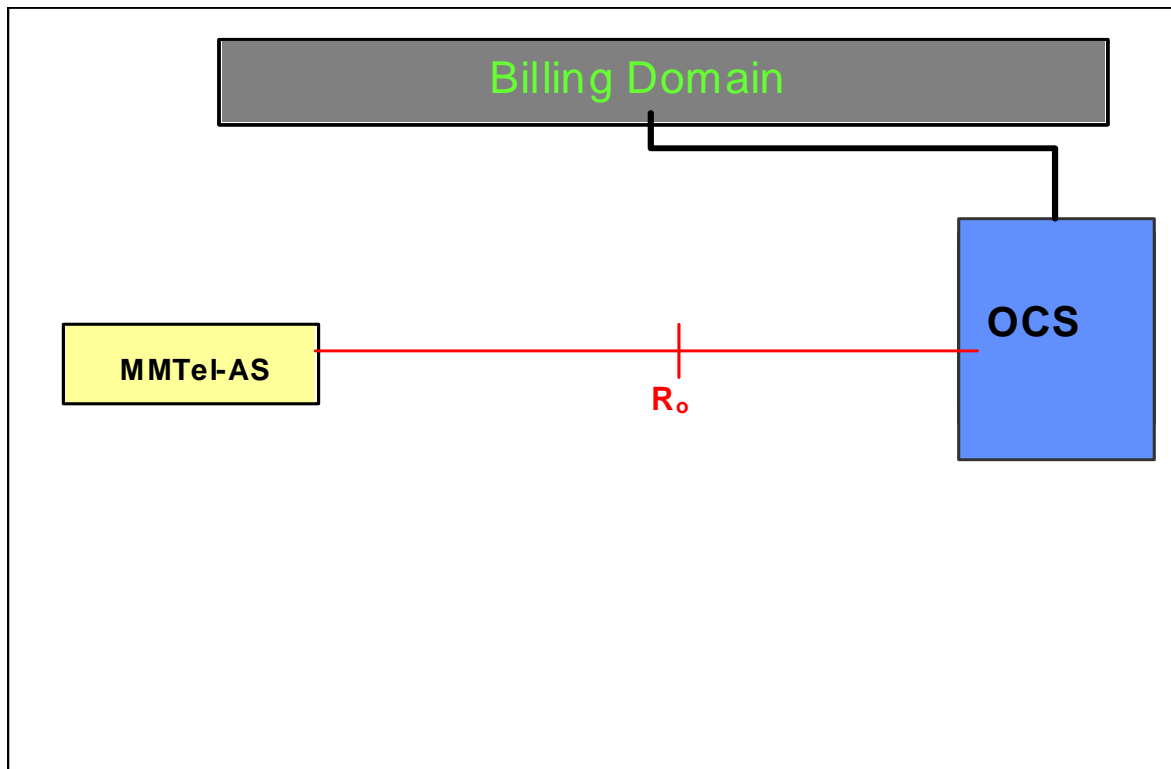

Figure 4.3.1: MMTel online charging architecture

This MMTel online charging architecture is based on the IMS online charging architecture described in TS 32.260 [20], with service CTFs supporting MMTel specific service charging, interfacing the OCS through the Ro reference point.

The CTFs considered in the MMTel online charging architecture reside in the Application level network functionality providing MMTel service and supplementary services.

The CTFs related to charging for the IMS basic capabilities supporting MMTel service, are described in TS 32.260 [20], and reside in the set of IMS Nodes (S-CSCF, MRFC...) reflected in IMS online architecture.

5 MMTel charging principles and scenarios

5.0 Introduction

There are a variety of multimedia telephony supplementary services implemented at different IMS nodes. All the services should support subscription based charging, and some also consumption based charging. The subscription based charging is out of the scope of the present document.

Table 5.0.1 summarizes which of the services are applicable for offline and online charging.

Table 5.0.1: Relevance of the services for offline and online charging

Supplementary services	Offline Charging	Online Charging
OIP	X	-
OIR	X	-
TIP	X	-
TIR	X	-
CW	X	-
HOLD	X	-
CB	X	-
MWI	X	-
CONF	X	X
CCBS	X	-
CCNR	X	-
CDIV	X	X
ECT	X	X
FA	X	X
MCID	X	-
CAT	X	-
CUG	X	X
PNM	X	-
CRS	X	-
AoC	X	-

5.1 MMTel charging principles

The MMTel charging encompasses the Multimedia telephony service (e.g. multimedia conversational communications between two or more users, with speech as a typical usage, and also others combinations of media) together with the associated supplementary services charging aspects.

Every Supplementary services described in TS 22.173 [200] are subject to be involved in MMTel charging function description.

MMTel service and supplementary services charging function focuses on charging information provided by the CTFs supporting MMTel specific service charging: calling user identification, called user identification, media component characteristics and usage (speech only, speech with other component, add/retrieve components..), supplementary services applied. It enables to apply different flexible charging based on supplementary service type and options.

All the CTFs supporting MMTel specific service charging (AS) pertain to IMS domain, and as explained in TS 32.260 [20], it is possible to correlate session/transaction related charging data generated from these different Nodes (AS), and others IMS Nodes involved in the session used for MMTel service handling, based on IMS Charging Identifier (ICID).

For AS(s) providing MMTel specific service and supplementary services, the "OneChargingSession" option, as described in TS 32.260 [20] can be applied, when acting as a B2BUA with IMS Charging Identifier (ICID) preserved between dialogs.

5.1.1 Supplementary services invocation

5.1.1.1 OIP charging

The Originating Identification Presentation (OIP) service provides the terminating user with the possibility of receiving trusted (i.e. network-provided) identity information in order to identify the originating user.

The charging of the OIP subscribers is measured by the MMTel AS handling OIP in offline charging only.

5.1.1.2 OIR charging

The Originating Identification Restriction (OIR) service is a service offered to the originating user. It restricts presentation of the originating user's identity information to the terminating user.

The charging of the OIR subscribers is measured by the MMTel AS handling OIR in offline charging only.

5.1.1.3 TIP charging

The Terminating Identification Presentation (TIP) service provides the originating party with the possibility of receiving trusted information in order to identify the terminating party.

The charging of the TIP subscribers is measured by the MMTel AS handling TIP in offline charging only.

5.1.1.4 TIR charging

The Terminating Identification Restriction (TIR) is a service offered to the terminating party which enables the terminating party to prevent presentation of the terminating identity information to originating party.

The charging of the TIP subscribers is measured by the MMTel AS handling TIR in offline charging only.

5.1.1.5 HOLD charging

The Communication Hold supplementary service enables a user to suspend the media stream(s) of an established IP multimedia session, and resume the media stream(s) at a later time.

The charged parties may be any of the Hold parties. These roles are:

- Calling Party;
- Called Party;

Editor's note: When one of the parties originates a new call to a third party and the new call overbooks the bearer resource reserved by the held call, overbooking may be taken into account in charging. The solution for that is FFS.

5.1.1.6 CB charging

The Communication Barring (CB) service offers the following services:

- The Incoming Communications Barring (ICB) is a service that rejects incoming communications that fulfil certain provisioned or configured conditions on behalf of the terminating user.
- The Anonymous Communication Rejection (ACR) is a particular case of the ICB service, that allows barring of incoming communications from an anonymous originator on behalf of the terminating user.
- The Outgoing Communication Barring (OCB) is a service that rejects outgoing communications that fulfil certain provisioned or configured conditions on behalf of the originating user.

The charging of the CB subscribers is measured by the MMTel AS handling CB in offline charging only.

5.1.1.7 CDIV charging

The Communications Diversion (CDIV) services enables the diverting user, to divert the communications addressed to the diverting user to another destination.

There are three actors active in a CDIV service of one diversion with the following roles:

- Diverting user; the party that initiates the diversion of an incoming communication;
- Originating user; the party which has initiated the communication and that stays in the communication which is diverted;
- Diverted to user;

In case there is another diversion, the user that was first the diverting user (user B), is the originating user in the second diversion. The diverted to user of the first diversion (user C) is the diverting user of the second diversion.

The charging of the diverting user for the B-C leg is measured by the MMTel AS handling the CDIV service, i.e. by the MMTel AS of the diverting user (user B). For the diverting user a separate charging dialog (online and/or offline charging) is needed. Charging of the originating and the terminating user (user C) is done in alignment with the TS 32.260 [20].

Typically the diverting user is charged for the forwarded leg (B-C leg), however, normal roaming charging principles apply for the diverted to user also in case of communication diversion. If there is another diversion, the user that performs the second diversion (user C) is charged (typically) for the new forwarded leg (C-D leg).

Charging at the S-CSCF is done in alignment with the TS 32.260 [20] but the S-CSCF has no knowledge of the CDIV service.

5.1.1.8 CW charging

The Communication Waiting (CW) service enables the application server to indicate to the subscriber, that there is at least one new communication is requested, and that no resources are available for that incoming communication. The user has then the choice of accepting, rejecting or ignoring the incoming communication. The maximum number of communications that may be waiting is a service provider option. If the current number of communications waiting is equal to the maximum, then any new attempted incoming communication request shall be rejected with a busy cause.

The charging of the CW subscribers is measured by the MMTel AS handling CW in offline charging only.

5.1.1.9 ECT charging

The Explicit Communication Transfer (ECT) service provides a party involved in a communication to transfer that communication to a third party.

There are three actors active in a transfer, they are acting in the following roles:

- Transferor: the party that initiates the transfer of the active communication that it has with the Transferee;
- Transferee: the party which stays in the communication which is transferred;
- transfer target: the party which the communication is transferred to and which replaces the Transferor in the communication.

The charging of the Transferor is measured by the MMTel AS handling the ECT service for the Transferor.

The charging of the Transferee is measured by the MMTel AS handling the ECT service for the Transferee.

5.1.1.10 MWI charging

The Message Waiting Indication (MWI) service enables the application server to indicate to the subscriber, that there is at least one message waiting. The indication is delivered to the subscriber's UE after successful subscription to the MWI service as described in the present document.

The charging of the MWI subscribers is measured by the MMTel AS handling MWI in offline charging only.

5.1.1.11 CONF charging

The Conference (CONF) service enables a user to participate in and control a simultaneous communication involving a number of users.

CONF Charging for the conference owner could be based on:

- establishment of the conference;
- number of participants;
- duration.

CONF Charging for the conference participants could be based on:

- duration.

The charging of the conference owners and participants is measured by the SIP AS and MRFC handling conference service. For each participant (call leg) a separate charging dialog (online and/or offline charging) at the SIP AS is needed.

5.1.1.12 CCBS charging

The Completion of Communication to Busy Subscriber (CCBS) service enables user A, encountering a busy destination B, to have the communication completed without the user having to manually initiate a new communication attempt when the destination B becomes not busy.

When user A requests the CCBS supplementary service, the network monitors for destination B becoming free again.

When destination B becomes free again, the network waits a short time in order to allow the resources to be re-used for originating a communication. If the resources are not re-used by destination B within this time, the network automatically recalls user A.

When user A accepts the CCBS recall, the network automatically generates a CCBS call to destination B.

The charging of the CCBS subscribers is measured by the MMTel AS handling CCBS in offline charging only.

5.1.1.13 CCNR charging

The Completion of Communications on No Reply (CCNR) service enables user A, encountering a destination B which does not answer the communication (No Reply), to have the communication completed without the user having to manually initiate a new communication attempt when the destination becomes not busy after having initiated and completed a new communication.

When user A encounters a destination B which does not answer the communication (No Reply), user A can request the CCNR supplementary service.

When user A requests the CCNR supplementary service, the network monitors for destination B becoming not busy after having initiated and completed a new communication.

When destination B becomes not busy after having initiated and completed a new communication, the network waits a short time (as defined by the destination B idle guard timer) in order to allow the resources to be reused for originating a communication. If the resources are not reused by destination B within this time, the network automatically recalls user A.

When user A accepts the CCNR recall, then the network automatically generates a CCNR call to destination B.

The charging of the CCNR subscribers is measured by the MMTel AS handling CCNR in offline charging only.

5.1.1.14 FA charging

Flexible Alerting (FA) causes a call to a "Pilot Identity" to branch the call into several legs to alert several termination addresses (FA group members) simultaneously.

Additional calls may be delivered to the FA Pilot Identity at any time.

The first leg to be answered is connected to the calling party. The other call legs are abandoned.

The FA group, identified by the "Pilot Identity" consists of a list of FA group members alerted through their the public addressable identity.

The charging of the "Pilot Identity" is measured by the MMTel AS handling Flexible Alerting for the "Pilot Identity".

5.1.1.15 MCID charging

The Malicious Communication Identification (MCID) service enables an incoming communication to be identified as malicious and registered.

The Network shall register the communication related information (such as Terminating Identity Information, Originator Identity Information, Local Time and Date...), which shall be kept under Network Operator's control (i.e not available to the terminating entity nor the originating entity).

This service has two modes: permanent mode and temporary mode. The permanent mode is active for all incoming communications, and the temporary mode is active only for the incoming communications declared by the served user.

The MCID service can be invoked during the active phase of the communication, or after the active phase for a limited period (but never after communication termination) by the served user, or, automatically invoked during the alerting phase.

The charging of the MCID subscriber is measured by the MMTel AS handling MCID service for the called subscriber in offline charging only.

5.1.1.16 CAT charging

The Customized Alerting Tone Service (CAT) service is an operator specific service by which an operator enables the subscriber to customize the alerting tone which is played to the calling party.

The charging of the CAT subscriber is measured by the MMTel AS handling CAT service for the called subscriber, in offline charging only.

5.1.1.17 CUG charging

The Closed User Group (CUG) service enables users to form groups of members, whose communication profile is restricted for incoming and outgoing communications. Members of a specific CUG can communicate among themselves but not, in general, with users outside the group.

Specific CUG members can have additional capabilities that allow them to initiate outgoing communications to users outside the group, and/or to accept incoming communications from users outside the group. Specific CUG members can have additional restrictions that prevent outgoing communications to other members of the CUG, or prevent incoming communications from other members of the CUG.

A specific user may be a member of one or more CUGs.

The charging of the CUG subscribers is measured by the MMTel AS handling CUG service for offline and online charging.

5.1.1.18 PNM charging

The Personal Network Management (PNM) service allows a user to manage his UEs in regard to terminating services according to preferences set by the user, capabilities and availabilities of devices. Charging for the "PN UE redirection" functionality of the defined PNM service, is considered in the scope of MMTel supplementary service charging, and applies to the active UE the terminating services are delivered to.

The charging of the PNM subscribers is measured by the MMTel AS handling PNM in offline charging only.

5.1.1.19 CRS charging

The Customized Ringing Signal (CRS) service is an operator specific service by which an operator enables the subscriber to customize the ringing signal which is played to the called party.

The charging of the CRS subscriber is measured by the MMTel AS handling CRS service for the called or the calling subscriber, in offline charging only.

5.1.1.20 Reverse charging

The Reverse charging at communication set up time service allows the terminating party to be charged for the entire communication. The service, requested by the originating party at communication set up time, is explicitly indicated to the terminating party so he can accept or deny the reverse charge communication request.

Editor's Note: There is no stage 3 description for Reverse Charging in this Release: FFS.

5.1.1.21 AoC charging

The Advice of Charge (AoC) service allows the served user to be provided with MMTel service charging information related to:

- AoC at communication set-up time (AoC-S);
- AoC during the communication (AoC-D);
- AoC at the end of the communication (AoC-E).

The AoC related charging information provided by the MMTel AS is applicable in offline charging only.

5.1.2 Supplementary services management by the user

When an IMS supplementary service control can be provided to the UE as a subscription option, every action performed by the user for this service (Provision/Withdrawal, Registration/Erasure, Activation/Deactivation, interrogation) may be subject to produce charging information, but this aspect is out of the scope of the present document.

5.2 MMTel offline charging scenarios

5.2.1 Basic principles

The MMTel offline charging functionality is based on the CTFs reporting accounting information, by sending Diameter *Charging Data Requests* Charging Data Request [Start, Interim, Stop and Event] to the CDF.

The circumstances on which the Diameter client uses Charging Data Request[Start, Interim and Stop], or Charging Data Request[Event] depend on the supplementary service type and is determined for each of them. Further details are specified in clause 5.2.2.

These Diameter Charging Data Request triggers may be configured in such a way several MMTel supplementary services can be regrouped. Providing this flexibility allows to improve situations where several MMTel supplementary services are handled within the same AS for complying with interactions requirements associated to these MMTel supplementary services.

5.2.2 Diameter message flows

5.2.2.0 Introduction

The flows described in the present document specify the charging communications between the different CTF entities and the charging functions for different charging scenarios. The SIP messages and Diameter transactions associated with these charging scenarios are shown primarily for general information and to illustrate the charging triggers. They are not intended to be exhaustive of all the SIP message flows discussed in TS 24.228 [221] and they depend on the Diameter Charging Data Requests triggers configured by the operator.

Although each MMTel supplementary service is described by separated flows illustrating the dedicated trigger(s) for this MMTel supplementary service, the Diameter Charging Data Request triggers (as stated in 5.2.1), may be configured with several MMTel supplementary services information.

5.2.2.1 Message flows - Successful cases and scenarios

5.2.2.1.0 Introduction

Following message flows are defined in TS 32.260 [20], and can be re-used for charging the basic multimedia telephony capabilities:

- Session Establishment - IMS Origination;
- Session Establishment- IMS Termination;
- Mid-Session Procedures;
- Session Release - Mobile Initiated.

5.2.2.1.1 Originating Identification Presentation (OIP) charging

Figure 5.2.2.1.1.1 shows the Diameter transactions that are required between AS and CDF, which implements the OIP service, and CDF after service execution.

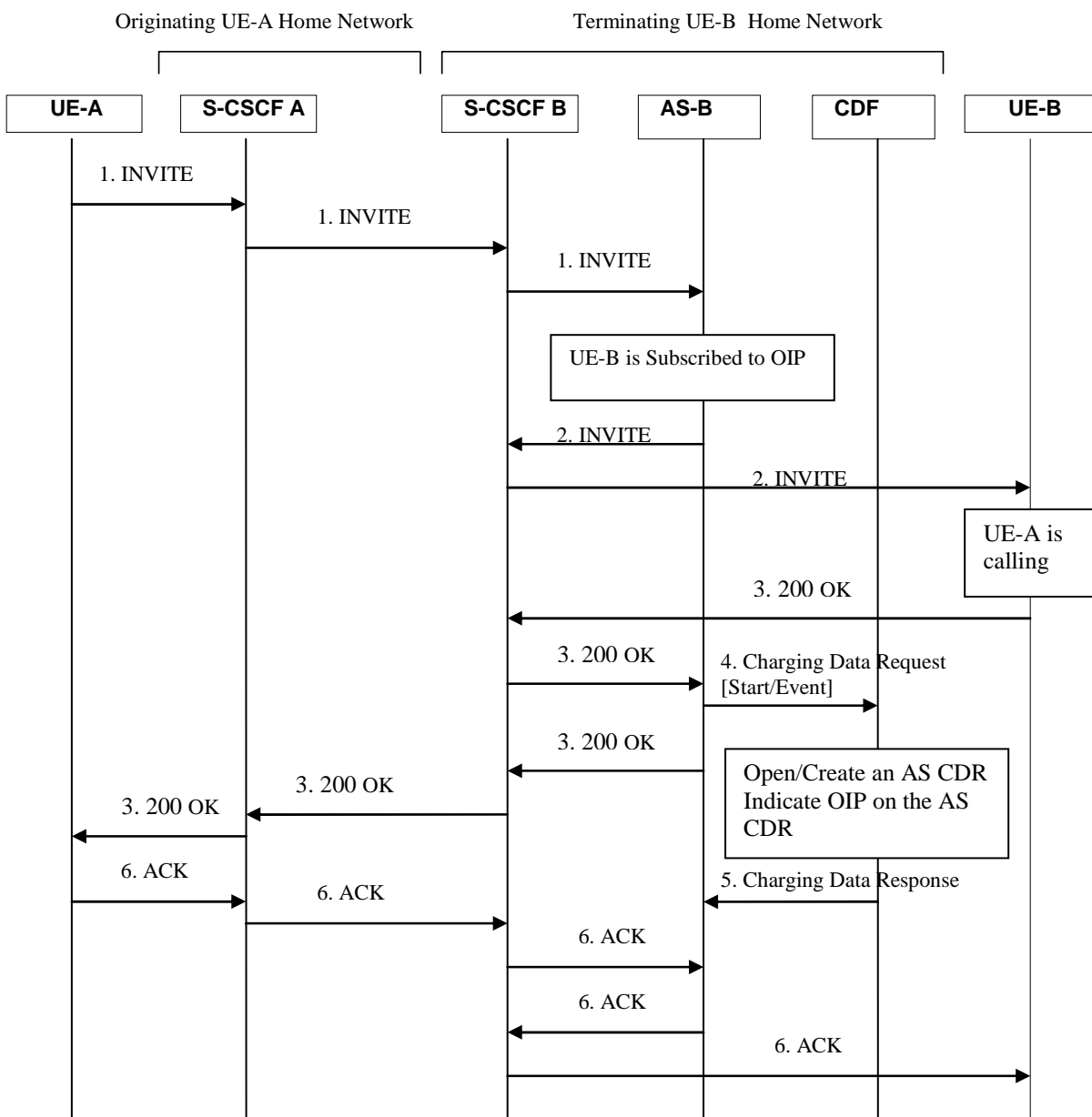

Figure 5.2.2.1.1.1: Message sequence chart for offline charging of OIP service

5.2.2.1.2 Originating Identification Restriction (OIR) charging

Figure 5.2.2.1.2.1 shows the Diameter transactions that are required between AS and CDF, which implements the OIR service, and CDF after service execution.

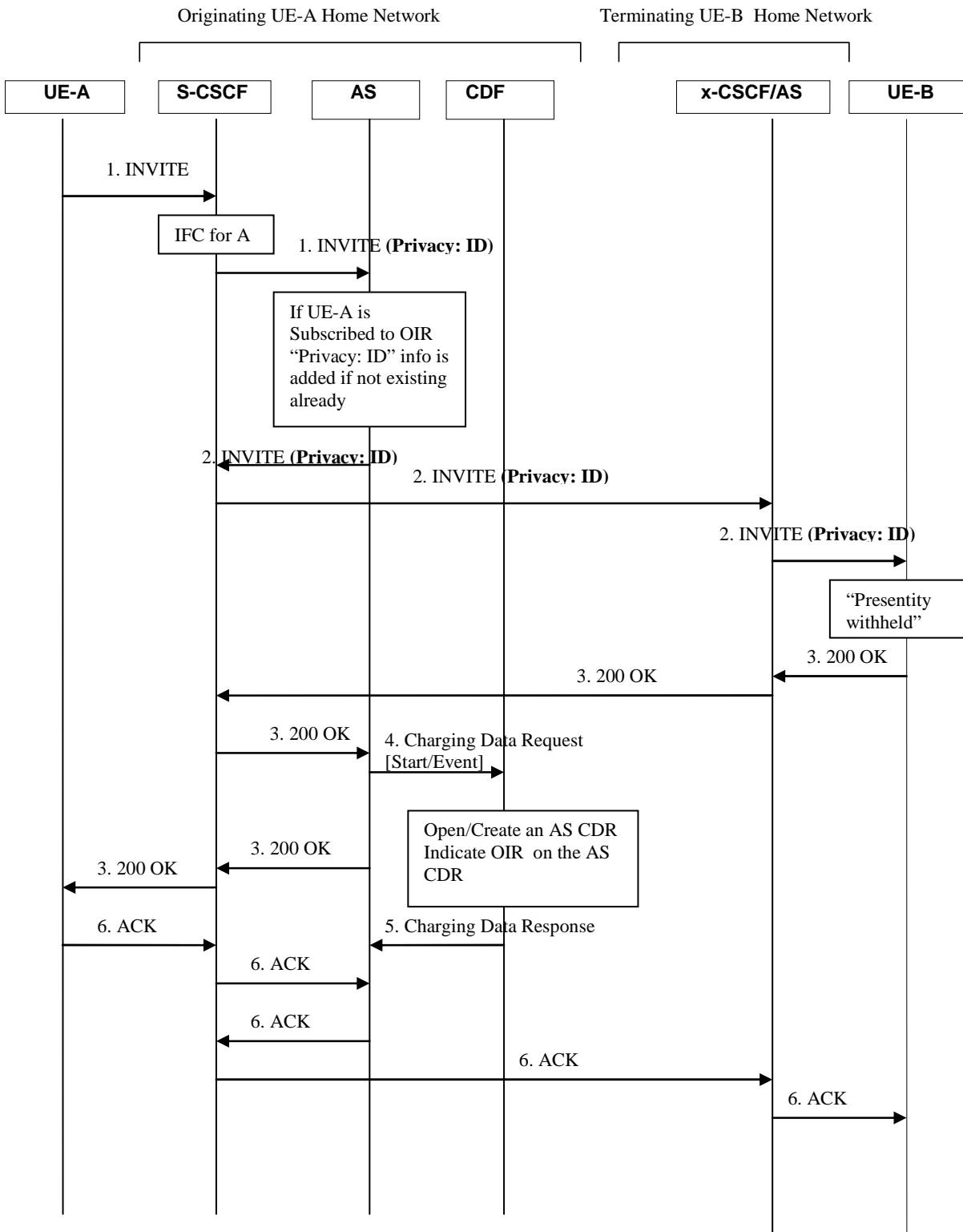

Figure 5.2.2.1.2.1: Message sequence chart for offline charging of OIR service

5.2.2.1.3 Terminating Identification Presentation (TIP) charging

Figure 5.2.2.1.3.1 shows the Diameter transactions that are required between AS and CDF, which implements the TIP service, and CDF after service execution.

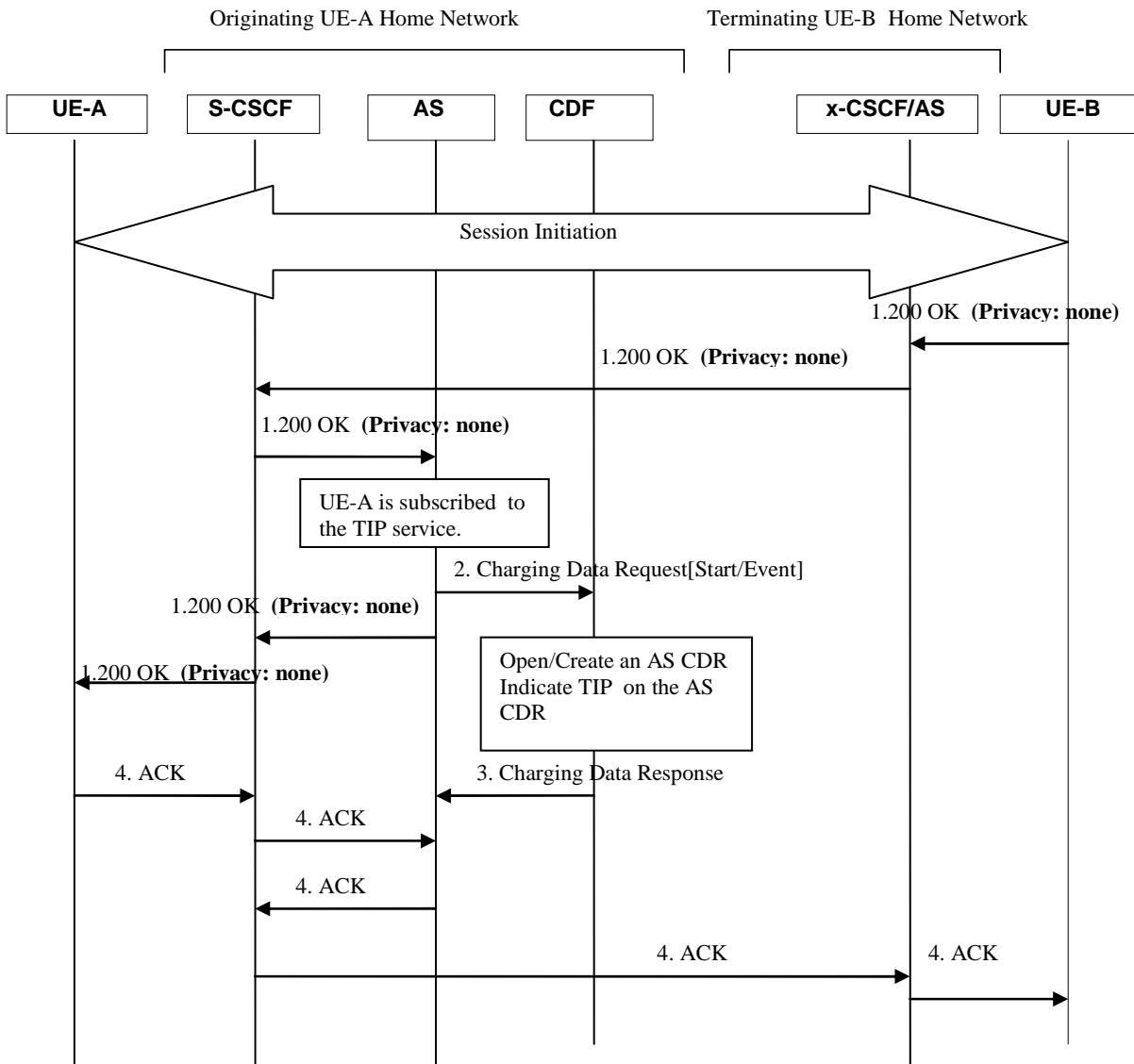

Figure 5.2.2.1.3.1: Message sequence chart for offline charging of TIP service

5.2.2.1.4 Terminating Identification Restriction (TIR) charging

Figure 5.2.2.1.4.1 shows the Diameter transactions that are required between AS and CDF, which implements the TIR service, and CDF after service execution.

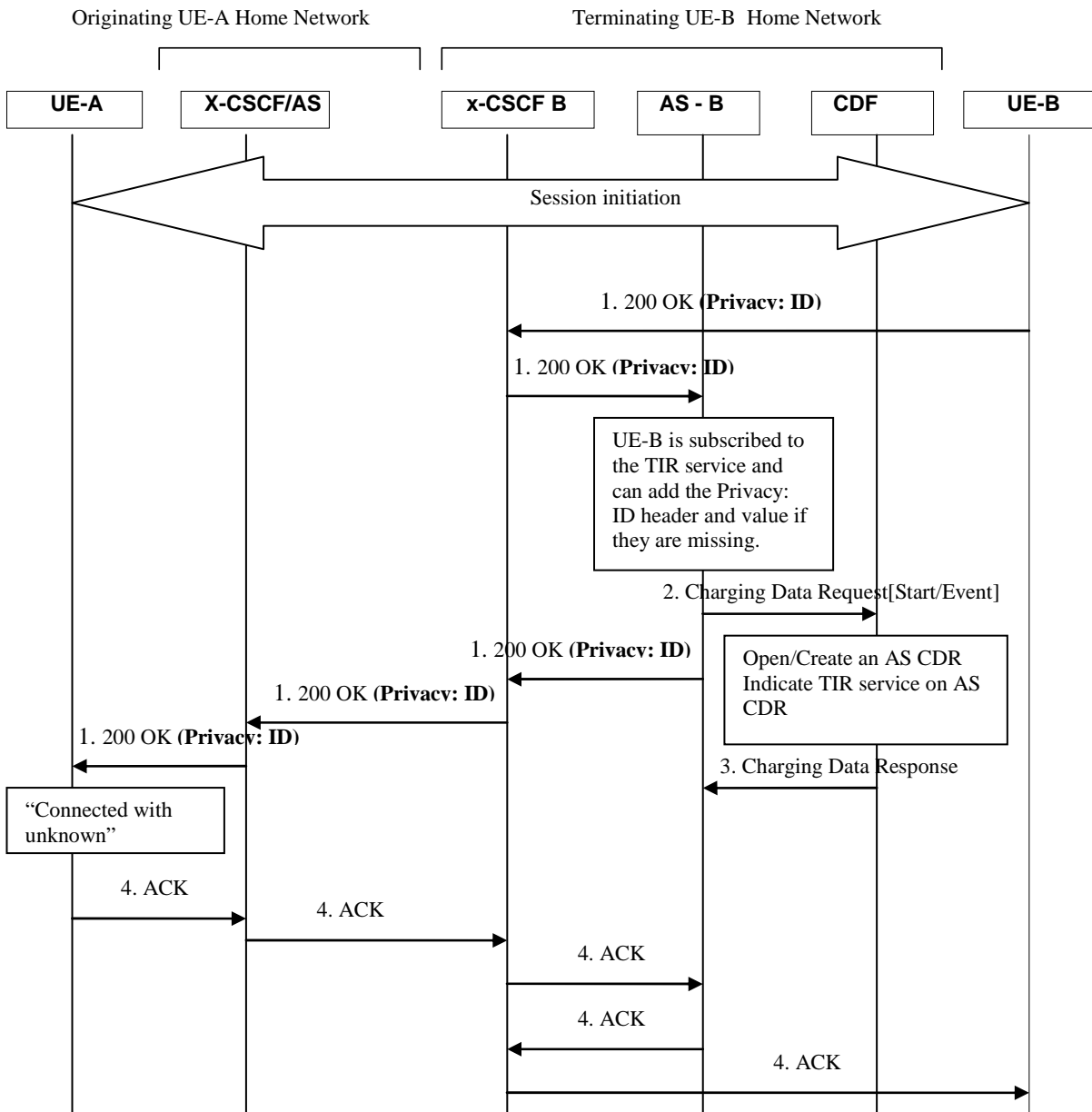

Figure 5.2.2.1.4.1: Message sequence chart for offline charging of TIR service

5.2.2.1.5 Communication Hold (HOLD) charging

Figure 5.2.2.1.5.1 shows the Diameter transactions that are required between AS which implements the HOLD service, and CDF after service execution. The involvement of the AS is optional as it is involved to the HOLD service provision only for announcement purposes.

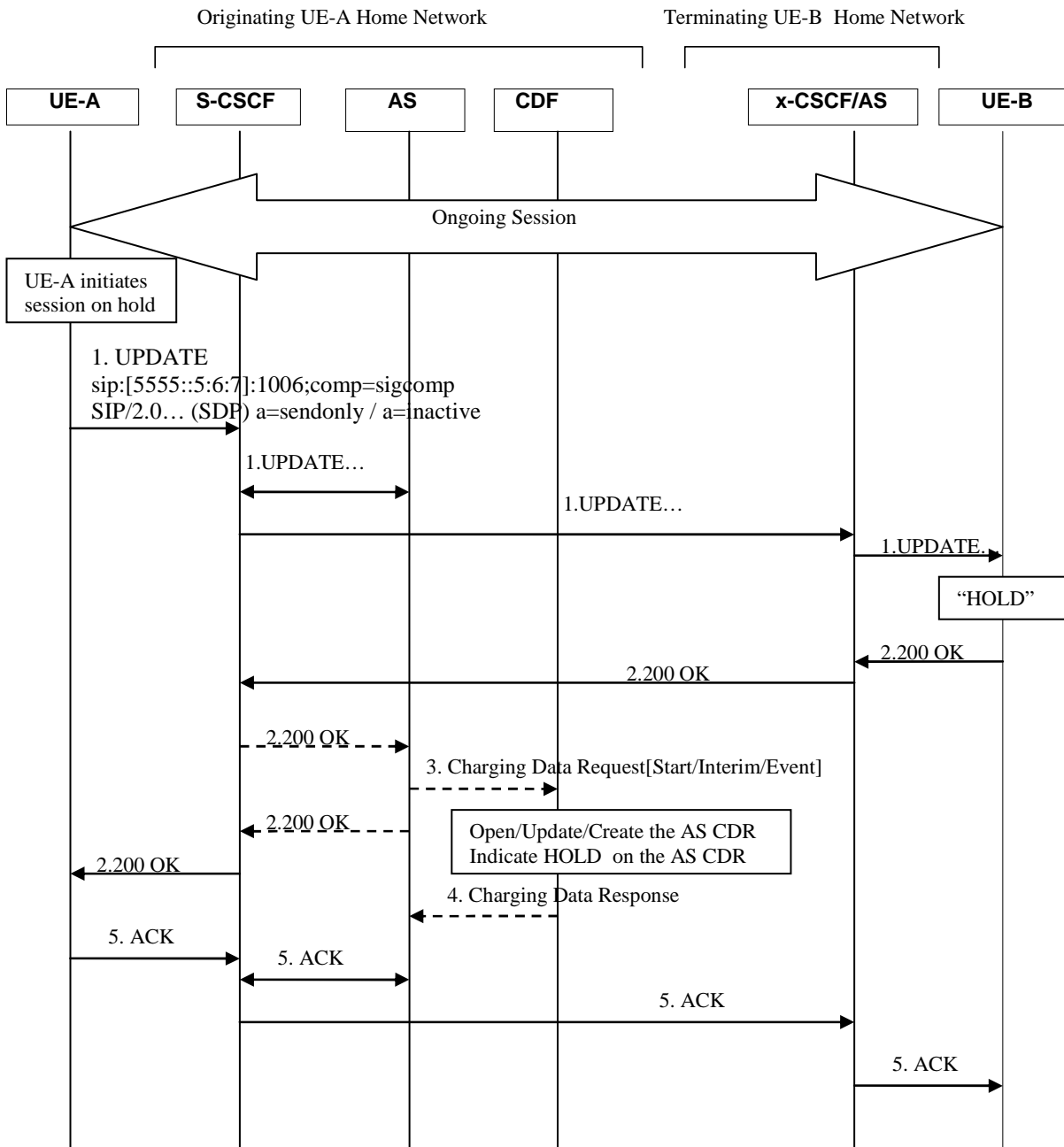

Figure 5.2.2.1.5.1: Message sequence chart for offline charging of HOLD service

NOTE: Based on TS 24.610 [207] a scenarion triggered by Re-Invite is also possible.

5.2.2.1.6 Communication Barring – CB (ICB/ACB) charging

5.2.2.1.6.1 Communication Barring (CB) – ICB and Charging Data Request

Figure 5.2.2.1.6.1.1 shows the Diameter transactions that are required between AS and CDF, which implements the CB service, and CDF after service execution.

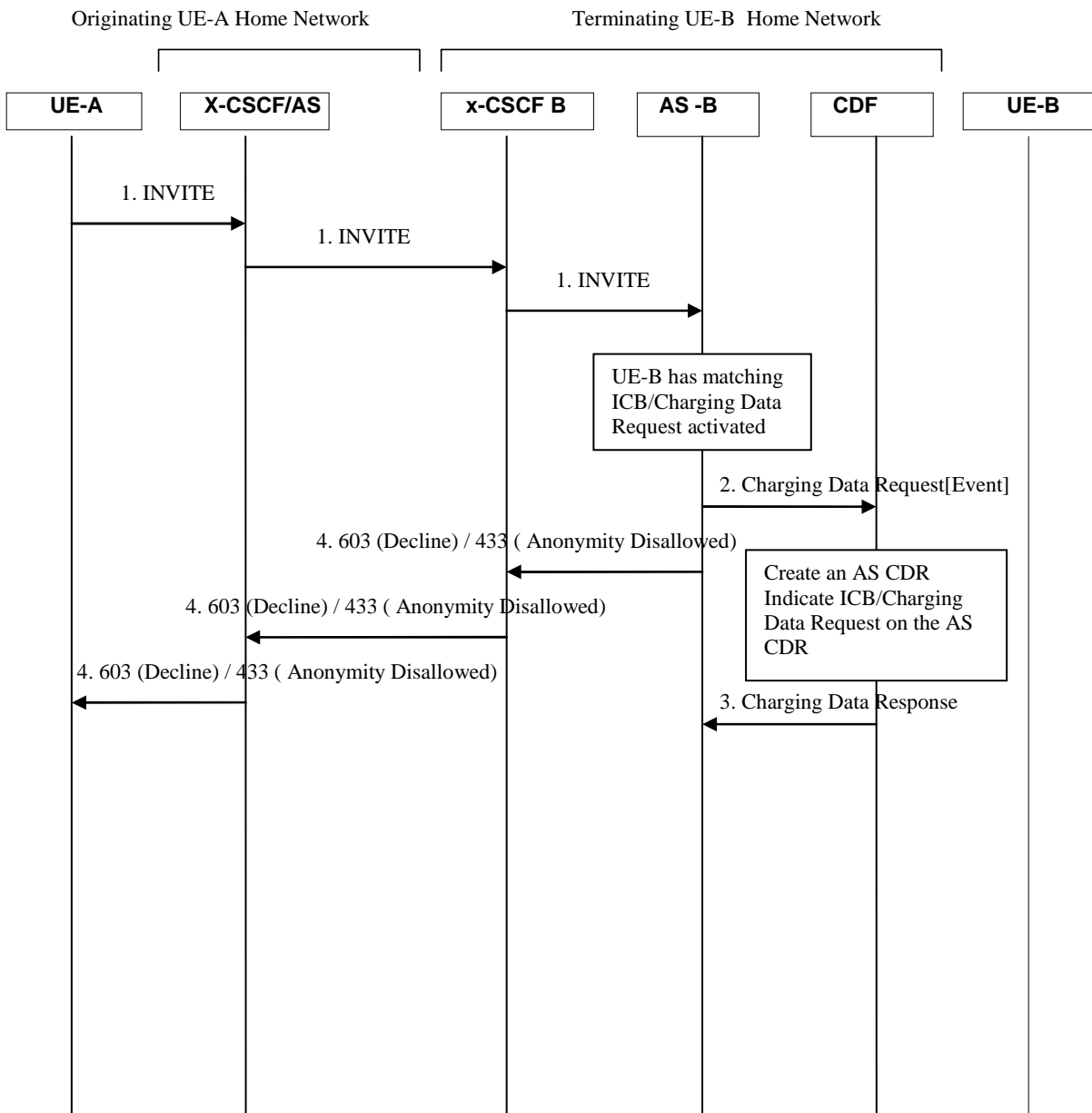

Figure 5.2.2.1.6.1.1: Message sequence chart for offline charging of CB service

5.2.2.1.6.2 Communication Barring (CB) – OCB

Figure 5.2.2.1.6.2.1 shows the Diameter transactions that are required between AS and CDF, which implements the CB service, and CDF after service execution.

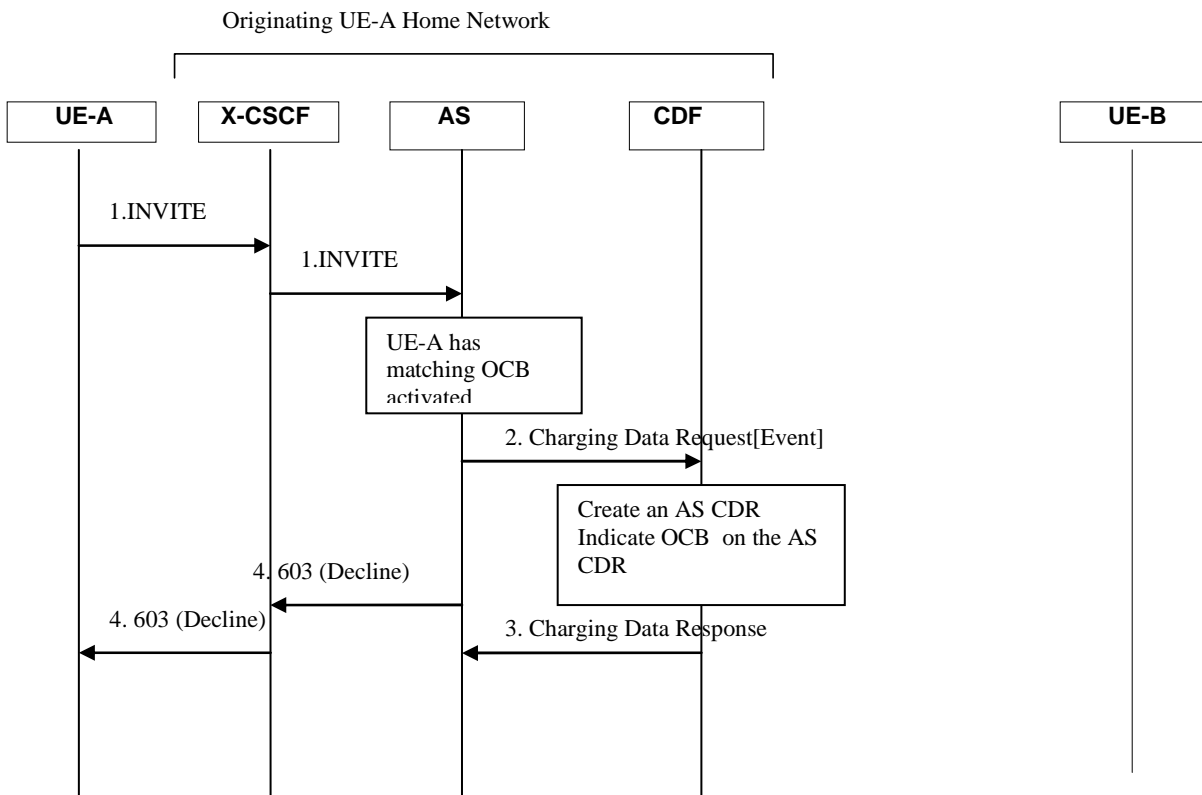

Figure 5.2.2.1.6.2.1: Message sequence chart for offline charging of CB service

5.2.2.1.7 Communications Diversion (CDIV) charging

5.2.2.1.7.1 Communications Diversion (CDIV) – successful establishment

Figure 5.2.2.1.7.1.1 shows the Diameter transactions that are required between AS, implementing the CDIV service and CDF for a successful communication forwarding on no reply.

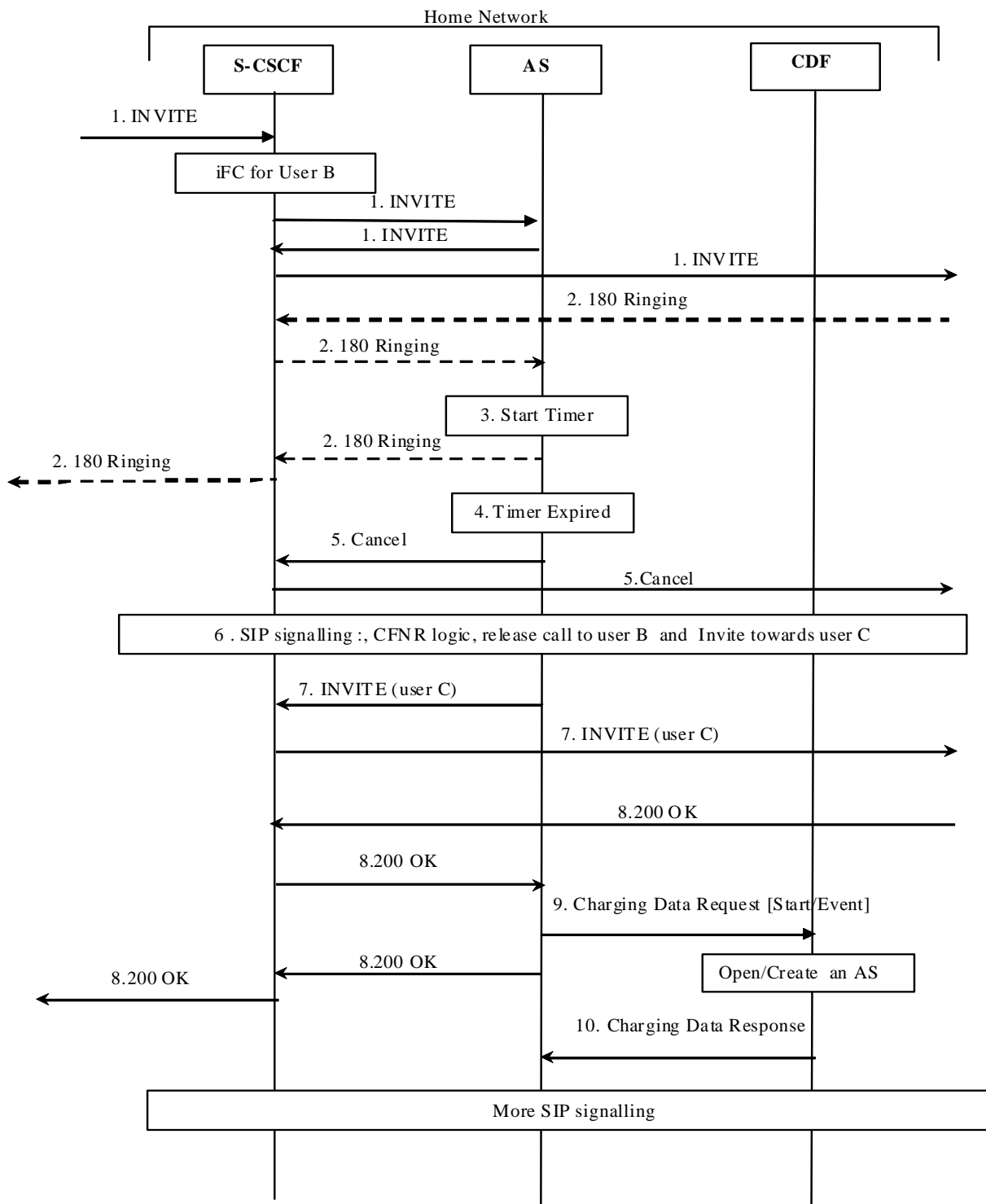

Figure 5.2.2.1.7.1.1 : Message sequence chart for offline charging of CDIV service - establishment

A communication is requested towards User B, user B has activated the CFNR

1. SIP INVITE request incoming for User B. Based on the Initial Filter Criteria (IFC) rules, indicating that User B is subscribed to the CDIV supplementary services, the communication is forwarded to an AS implementing AS implementing CDIV. Then SIP INVITE is forwarded to User B.
2. 180 ringing is sent back from User B.
3. The non-reply timer in the AS is started .
4. The timer expires.
- 5 to 7. The AS implementing the CDIV service performs the Call Forwarding No Reply logic: release the communication to User B, and forward the call towards user C (SIP INVITE request including URI-C as destination).
8. The destination User C party answers and a final response is received.
9. Upon reception of the final response, the AS implementing the CDIV service sends a Charging Data Request [Start/Event] to record call forwarding execution (start of the forwarded leg from User B to User C): basic communication information are transferred with specific call forwarding information (service mode= "CFNR", associated number = " user B" as the user who invoked the call forwarding).
10. The CDF acknowledges the reception of the data and opens/creates an AS CDR to record the forwarded leg from User B to User C.

NOTE : Although only the "call forwarding on no reply" case is depicted here , it serves as a basis for all other call forwarding modes description (Call Forwarding Unconditional, Call Deflection, Call Forwarding on Busy, Call Forwarding Not Logged-in) for Charging Data Request generation : In all these cases, the AS AS implementing the CDIV service sends a Charging Data Request [Start] to record call forwarding execution (whatever the mode), when the final response is received from user-C.

5.2.2.1.7.2 Communications Diversion (CDIV) – release

Figure 5.2.2.1.7.2.1 shows the Diameter transactions occurring on release of the previous established communication, initiated by user C.

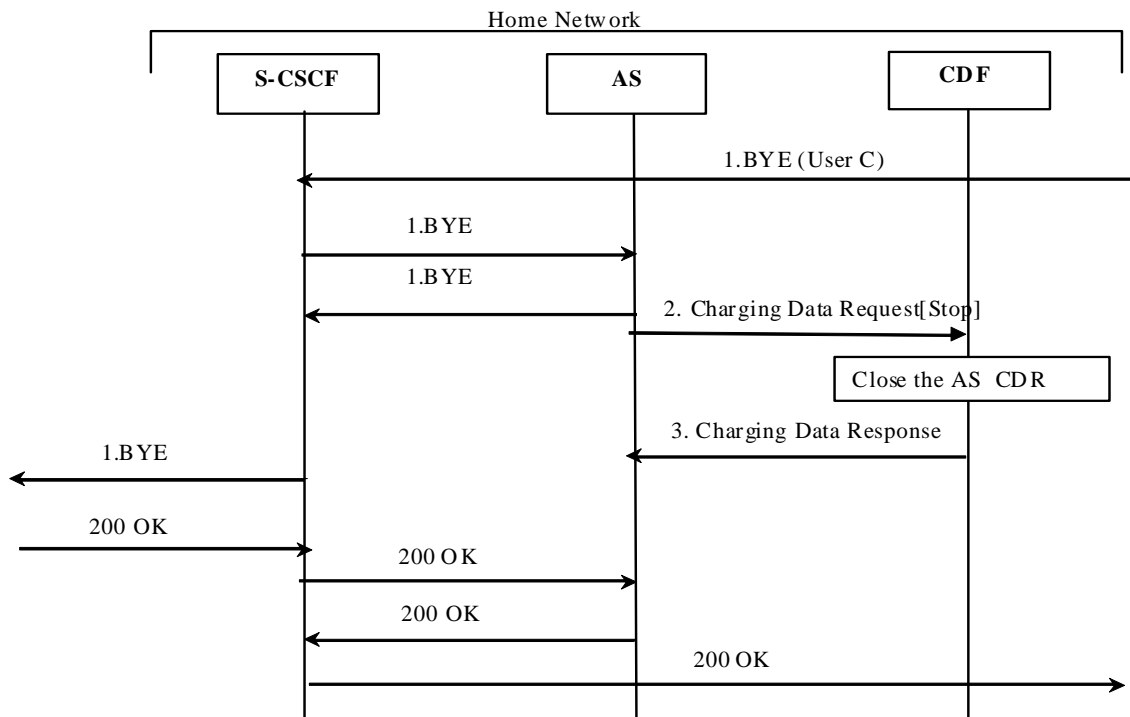

Figure 5.2.2.1.7.2.1: Message sequence chart for offline charging of CDIV service -release

1. User C initiates release of the communication.
2. At session termination the AS implementing the CDIV service, sends a Charging Data Request [Stop] to record stop the call for which User B has been forwarded. The AS CDR is closed.

5.2.2.1.8 Communication Waiting (CW) charging

Figure 5.2.2.1.8.1 shows the Diameter transactions that are required between AS, which implements the CW service and CDF for the callee (subscriber of CW).

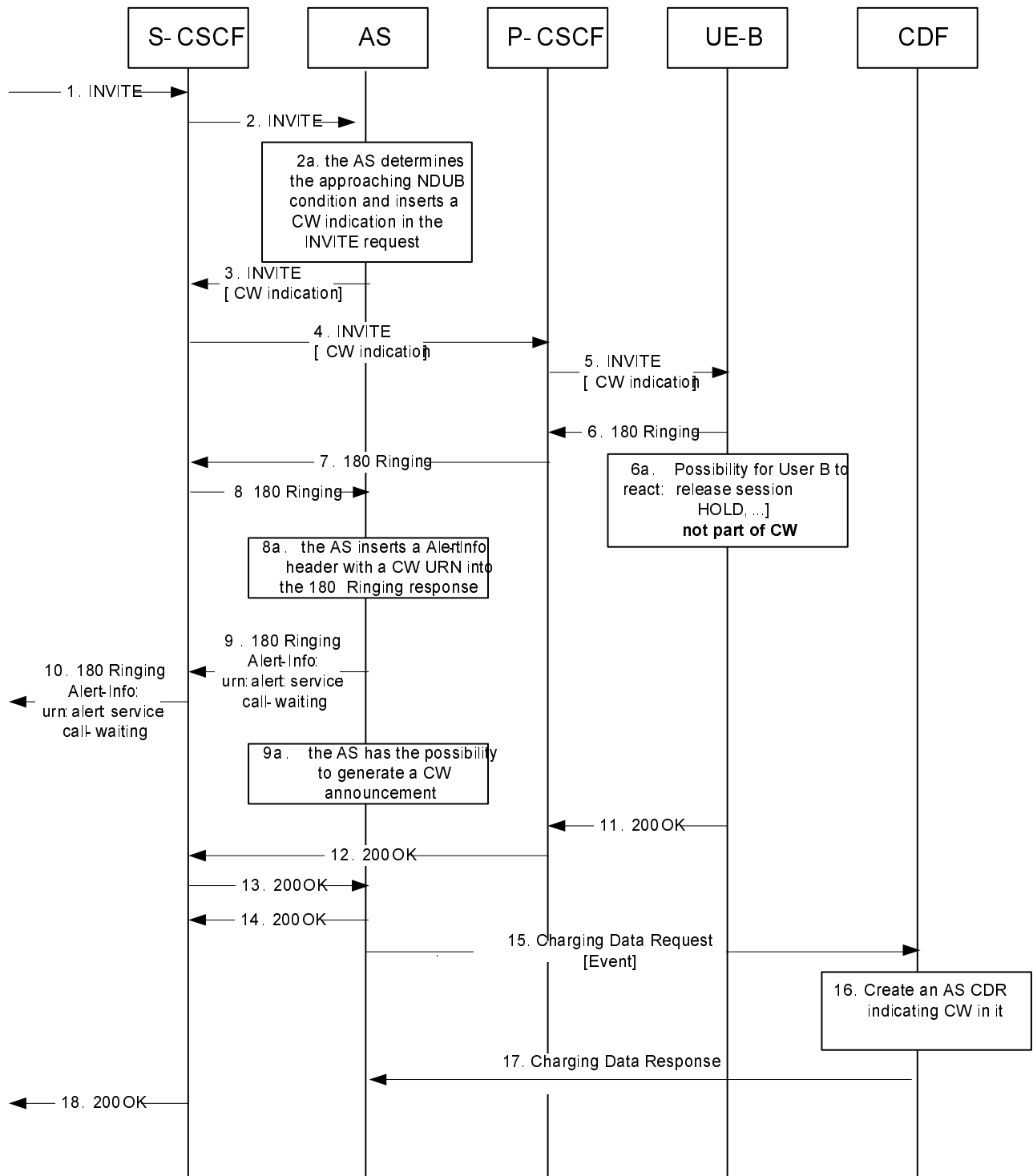

Figure 5.2.2.1.8.1: Message sequence chart for offline charging of CW service

- 1-2. The communication is initiated by UE-A by sending an SIP INVITE request. The Request URI includes the URI of UE-B. After IFC evaluation in the S-CSCF the SIP INVITE request is routed to the CW AS.
- 2a. The AS detects the CW condition and inserts a CW indication into the SIP INVITE request per procedures.
- 3-4. The SIP INVITE is routed to UE-B.

5. UE-B recognizes the CW indication per procedures.
6. UE-B sends back a 180 (Ringing) response.
 - 6a. Out of scope: user B uses the HOLD service or releases a session in order to free resources.
- 7-8. The SIP 180 (Ringing) response is routed back to the AS.
- 8a. The AS optionally inserts a Alert-Info with a 'CW' URN into the 180 (Ringing) response.
- 9-10. The SIP 180 (Ringing) response is routed back to the communication origin.
- 9a. The AS may initiate an announcement to the calling user that the communication is a waiting communication, in accordance with TS 24.628 [4].]
- 11-14. UE-B sends back a SIP 200 (OK) response to the CW AS and CW AS sends it to the S-CSCF.
- 15-17. The CW AS sends a Charging Data Request [Start]/ Charging Data Request [Event] to CDF, then the CDF opens/creates an AS CDR for the Communication Waiting with CW indication on the AS CDR and returns Charging Data Response to the CW AS.
18. S-CSCF sends back a SIP 200(OK) response to UE-A.

5.2.2.1.9 Explicit Communication Transfer (ECT) charging

5.2.2.1.9.1 Explicit Communication Transfer (ECT): Blind Transfer

Figure 5.2.2.1.9.1.1 and figure 5.2.2.1.9.1.2 show the Diameter transactions that are required between ASs implementing the ECT service (for the transferor and for the transferee) and CDF: a successful Blind Transfer from User A to User C, initiated by User B.

For diagram simplification, only one CDF is shown.

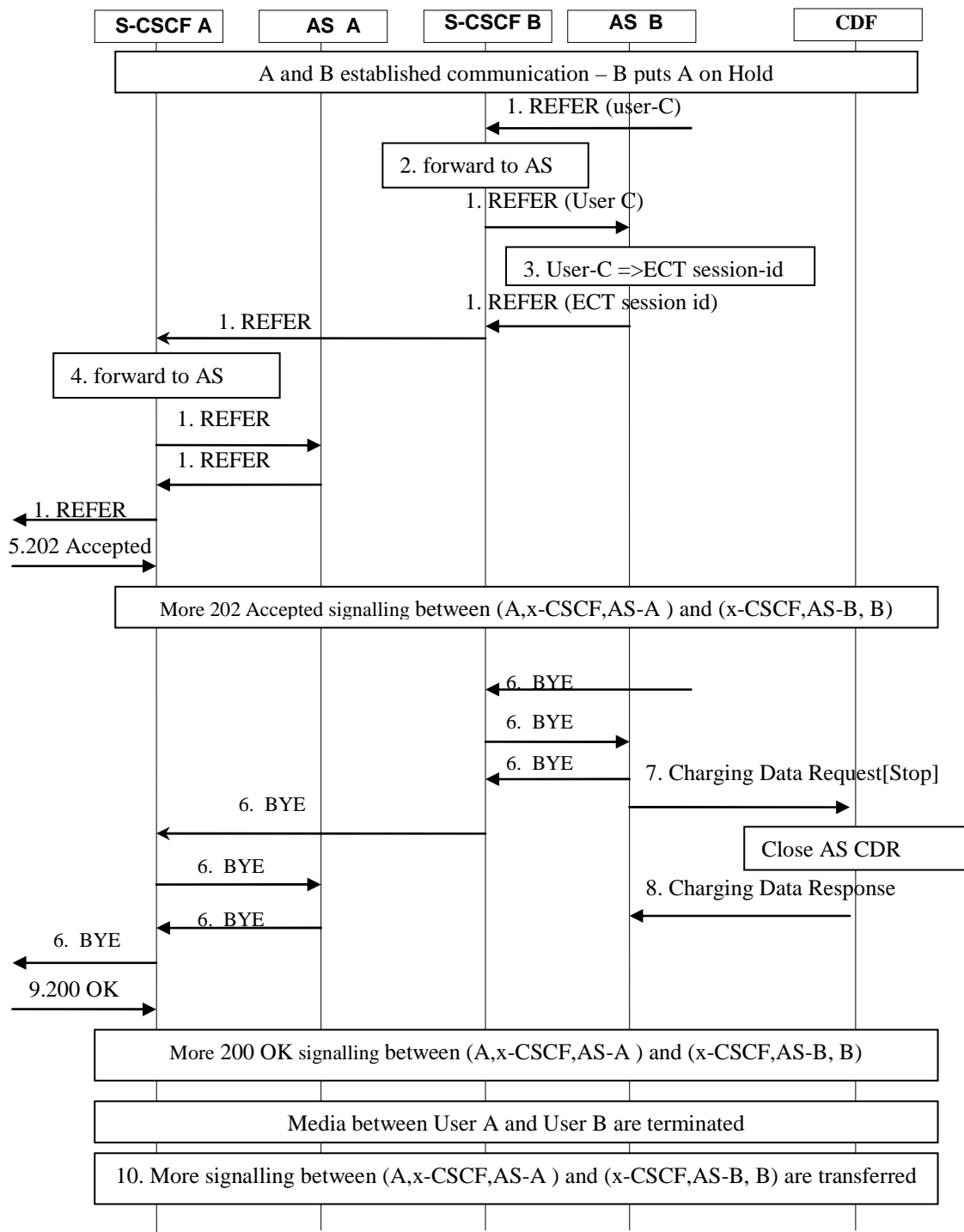

Figure 5.2.2.1.9.1.1: Message sequence chart for offline charging of ECT service – Blind Transfer (part1)

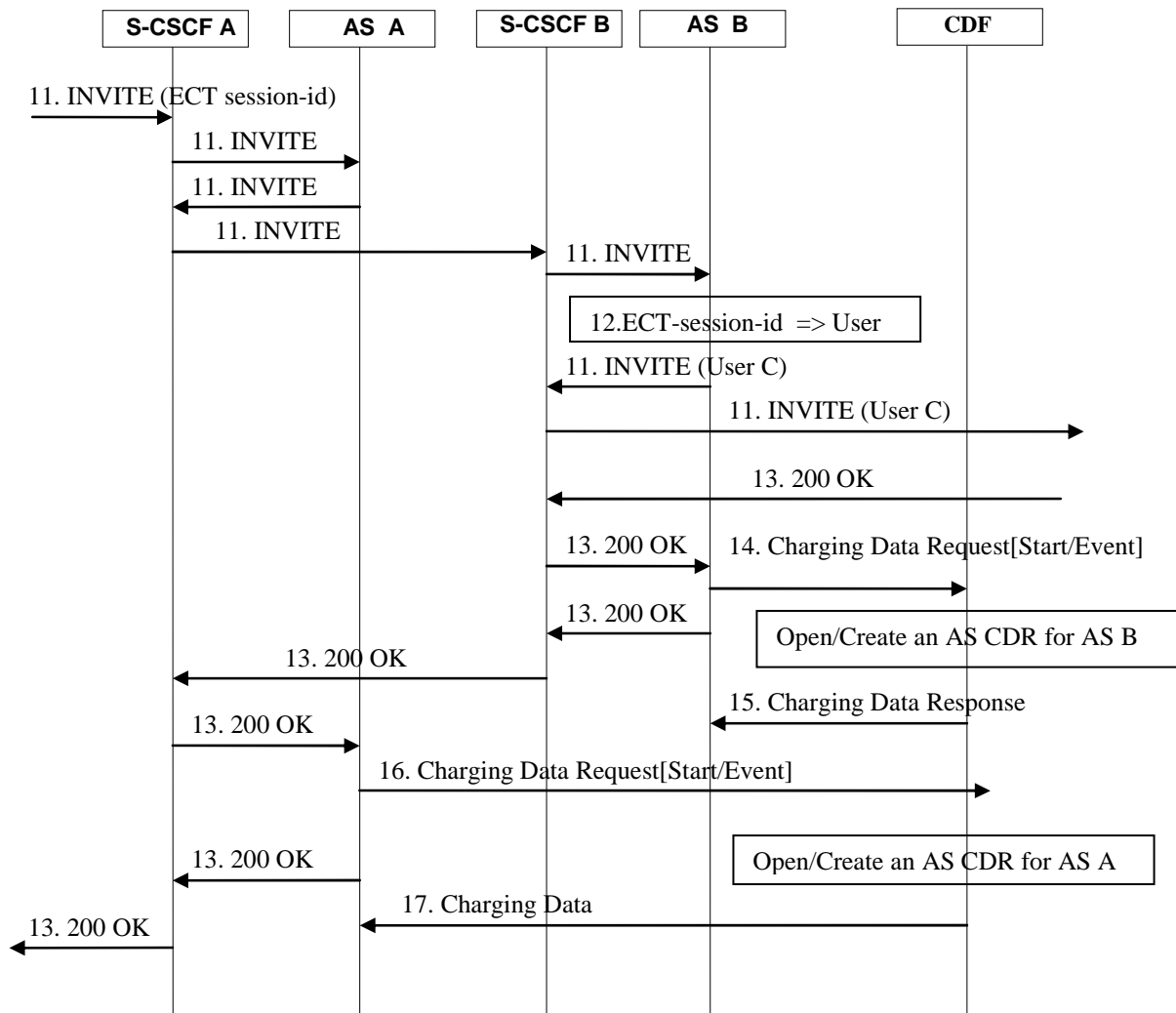

Figure 5.2.2.1.9.1.2: Message sequence chart for offline charging of ECT service – Blind Transfer (part 2)

In this scenario User A is the transferee, User B is the transferor, and User C is the transfer target.

User A and User B are in an established communication for which, based on the Initial Filter Criteria (IFC) rules indicating that User B is subscribed to the ECT supplementary service, the SIP INVITE was forwarded to an AS implementing ECT (for User A and User B).

User B puts User A on Hold.

1. User B sends SIP REFER request in the existing A-B dialog, to initiate transfer User A to User C.
2. this subsequent request is forwarded to the AS implementing ECT.
3. AS generates an "ECT Session Identifier" replacing User C as the new destination information, for remaining in the loop, for transferor's role.
4. On SIP REFER receipt, this request is forwarded the AS implementing ECT.
5. The SIP REFER is accepted by User A, and 202 Accepted is transferred from User A to User B.
- 6-9. User B sends SIP BYE for terminating original SIP INVITE with User A, acknowledged by SIP 200 OK from User A.

AS B releases the media between User A and User B which are on hold, then sends a Charging Data Request [Stop] to record termination of the dialogue between User A and User B.

10. More signalling between (User A,x-CSCF,AS-A) and (x-CSCF,AS-B,User B) : User A sends SIP NOTIFY(100 Trying) associated to the received REFER, and User B acknowledges by SIP 200 OK..
11. User A initiates a new session by sending an SIP INVITE request with "ECT Session Identifier".
12. AS implementing the ECT service correlates this SIP INVITE to the initial session to be transferred and replaces "ECT Session Identifier" with User C for creating an SIP INVITE towards UE-C.
- 13 The destination User C party answers and a final response is received.
14. Upon reception of the final response, the AS implementing the ECT service for the transferor, sends a Charging Data Request [Start] to record Transfer execution.
15. The CDF acknowledges the reception of the data and opens/creates an AS CDR.
16. Upon reception of the final response, the AS implementing the ECT service for the transferee, sends a Charging Data Request [Start] to record User A is transferred, with specific indicator on the transferee's "subscriber role" (whether the transferee was engaged in an originating call or in a terminating call) before the transfer execution.
17. The CDF acknowledges the reception of the data and opens/creates an AS CDR.

NOTE 1: The "Consultative transfer" scenario mainly differs from the "Blind transfer" on the transfer establishment phase : when User B has put User A on Hold, User B establishes a communication towards User C and puts User C on Hold, then User B initiates the SIP REFER for the transfer triggering. The Charging Data Request [Start] for recording Transfer execution occurs at the same steps for both scenarios: on the final response associated to SIP INVITE towards User C for the transferor and for the transferee.

NOTE 2: The "Assured transfer" scenario mainly differs from the "Blind transfer" on the transfer establishment phase: User B may include an Expires header field in the Refer-To URI of the SIP REFER request when initiating transfer. If User B has not received a SIP NOTIFY request indicating the end of the transfer operation within the duration of the Expires header allow or received a SIP NOTIFY indicating that the Assured transfer attempt failed, User B may request to terminate the transfer attempt by sending a SIP REFER request in the original communications dialog. Then User B may decide to retrieve the original communication by sending a SIP re-INVITE message in the original SIP dialog.
A Charging Data Request [Event] when the termination SIP NOTIFY is send out.
A Charging Data Request [Interim] when the retrieving SIP re-INVITE is sent out.

5.2.2.1.9.2 Explicit Communication Transfer (ECT): Release

Figure 5.2.2.1.9.2.1 shows the Diameter transactions that are required between ASs implementing the ECT service (for the transferor and for the transferee) and CDF: release from User A, after a successful Blind Transfer from User A to User C, initiated by User B.

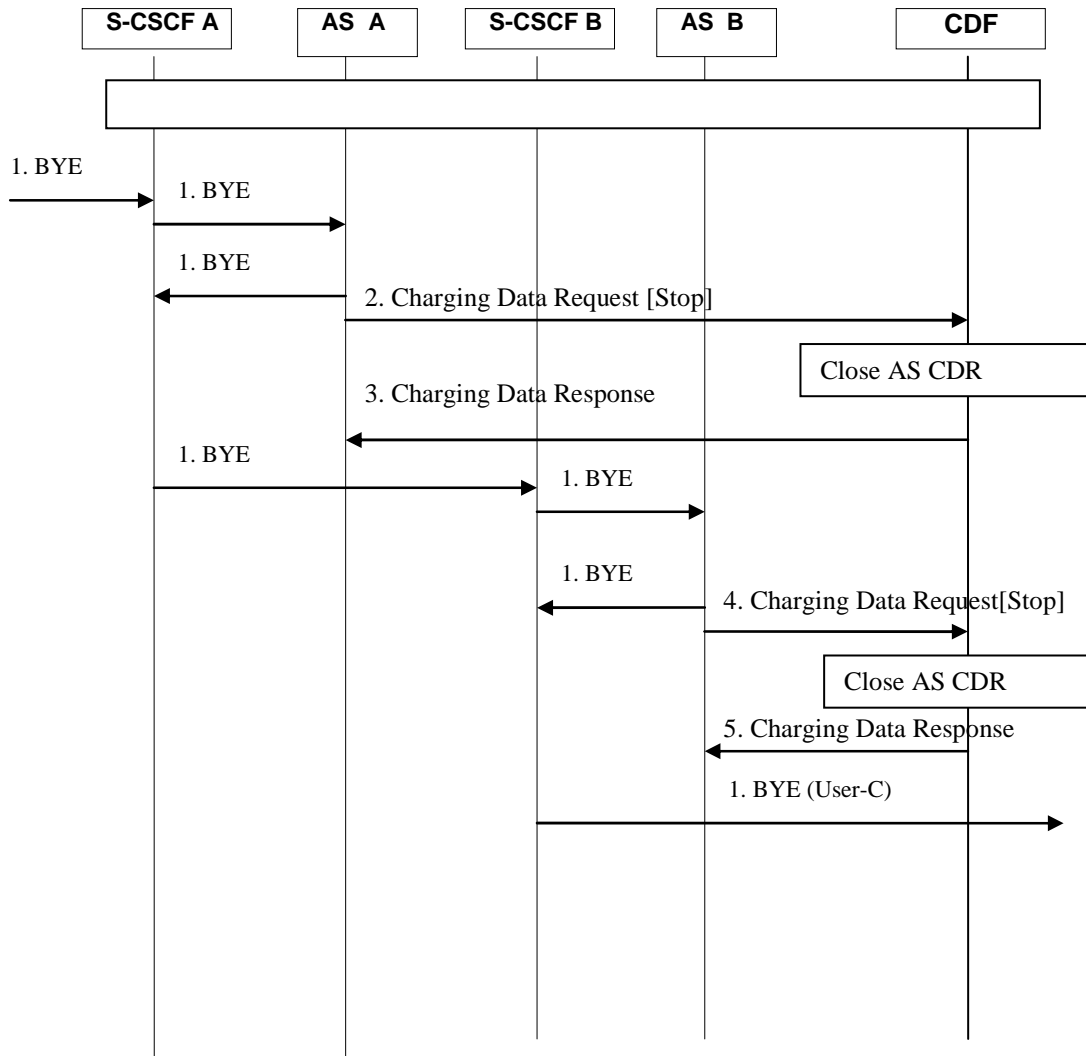

Figure 5.2.2.1.9.2.1: Message sequence chart for offline charging of ECT service – Release

1. User A initiates release of the communication.
- 2-3. At session termination the AS implementing the ECT service for the transferee, sends a Charging Data Request [Stop] to record stop the call for which User A has been transferred.
- 4-5. At session termination the AS implementing the ECT service for the transferor, sends a Charging Data Request [Stop] to record stop the call transferred by User B. The AS CDR is closed.

5.2.2.1.10 Message Waiting Indication (MWI) charging

Figure 5.2.2.1.10.1 shows the Diameter transactions that are required between AS (MWI), which implements the MWI service and CDF.

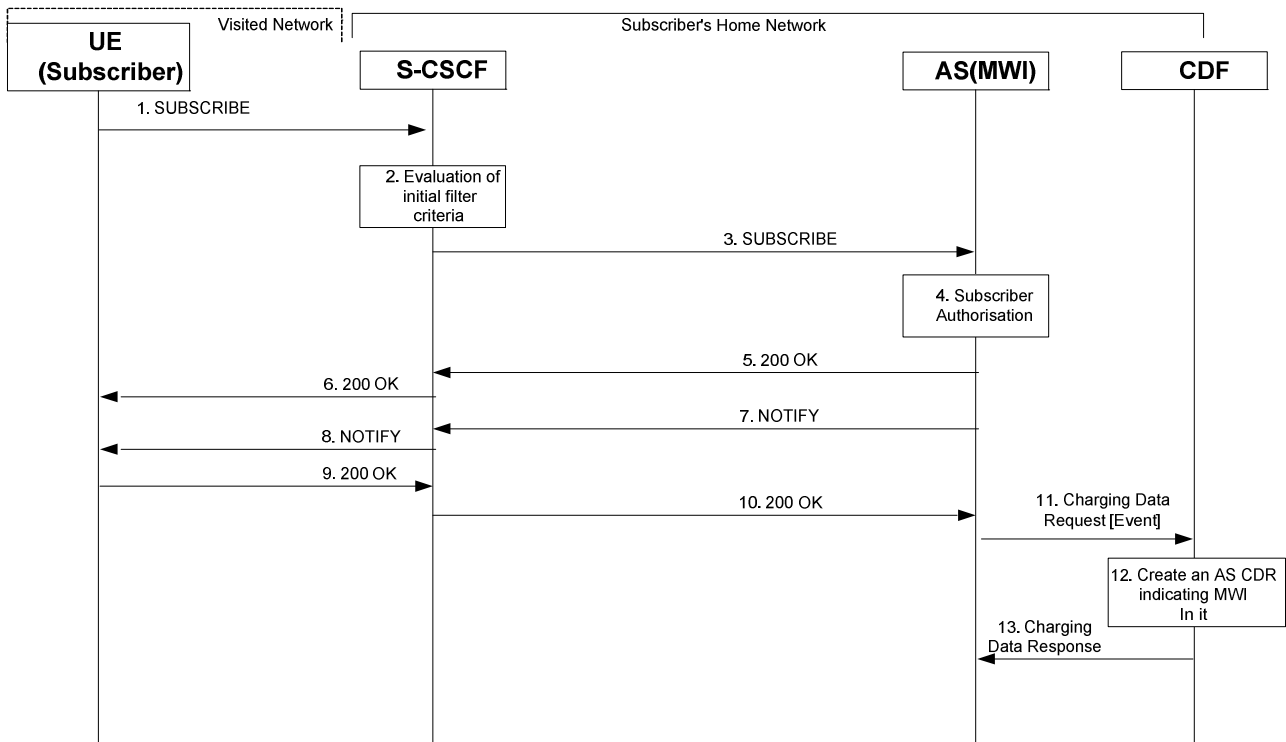

Figure 5.2.2.1.10.1: Message sequence chart for offline charging of MWI service

- 1-6. UE subscribes to AS (MWI) and the AS (MWI) returns SIP 200 OK.
- 7-10. The AS (MWI) sends SIP NOTIFY request to S-CSCF and the subscriber UE acknowledges the SIP NOTIFY request.
- 11-13. The AS (MWI) sends Charging Data Request [Event] message to CDF, CDF creates an AS CDR and returns Charging Data Response to the AS (MWI).

5.2.2.1.11 Conderence (CONF) Charging

5.2.2.1.11.0 Introduction

During a conference, the user could create the conference, join a conference, invite another user to the conference and leave the conference, according to TS 24.605 [203]. The following subclauses respectively show the Diameter transactions that are required between AS, which implements the CONF service and CDF corresponding different conference scenarios.

5.2.2.1.11.1 CONF charging – user creating a conference

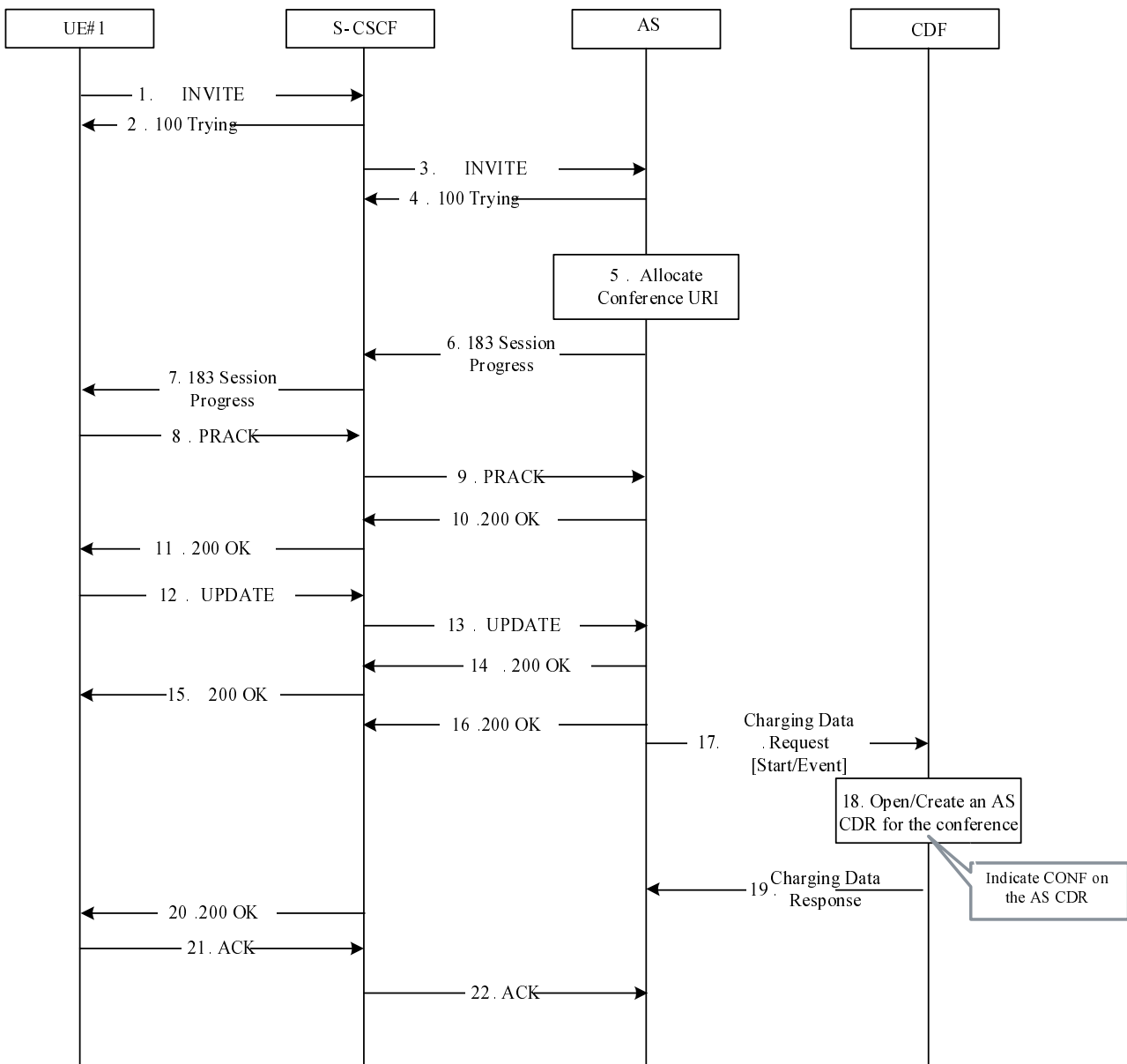

Figure 5.2.2.1.11.1.1 : Message sequence chart for offline charging of CONF service - User creating a conference

- 1-2. The communication is initiated by UE#1 by sending an SIP INVITE request to S-CSCF. And S-CSCF sends back 100 Trying reponse to inform UE#1 to wait for a while because the request is being treated.
- 3-4. S-CSCF transfers SIP INVITE request from UE#1 to CONF AS and the CONF AS sends back 100 Trying response to inform S-CSCF to wait for a while because the request is being treated.
- 5. The CONF AS allocates the conference URI.

6-16. After the media resource negotiation process, the CONF AS sends back SIP 200 OK response.

17-19. The CONF AS sends Charging Data Request [Start]/Charging Data Request [Event] to CDF, then the CDF opens/creates an AS CDR for the conference with CONF indication on the AS CDR and returns Charging Data Response to the CONF AS.

5.2.2.1.11.2 CONF charging – user joining a conference

5.2.2.1.11.2.1 shows the Diameter transactions that are required between AS, which implements the CONF service and CDF corresponding to the conference scenario: user joining a conference.

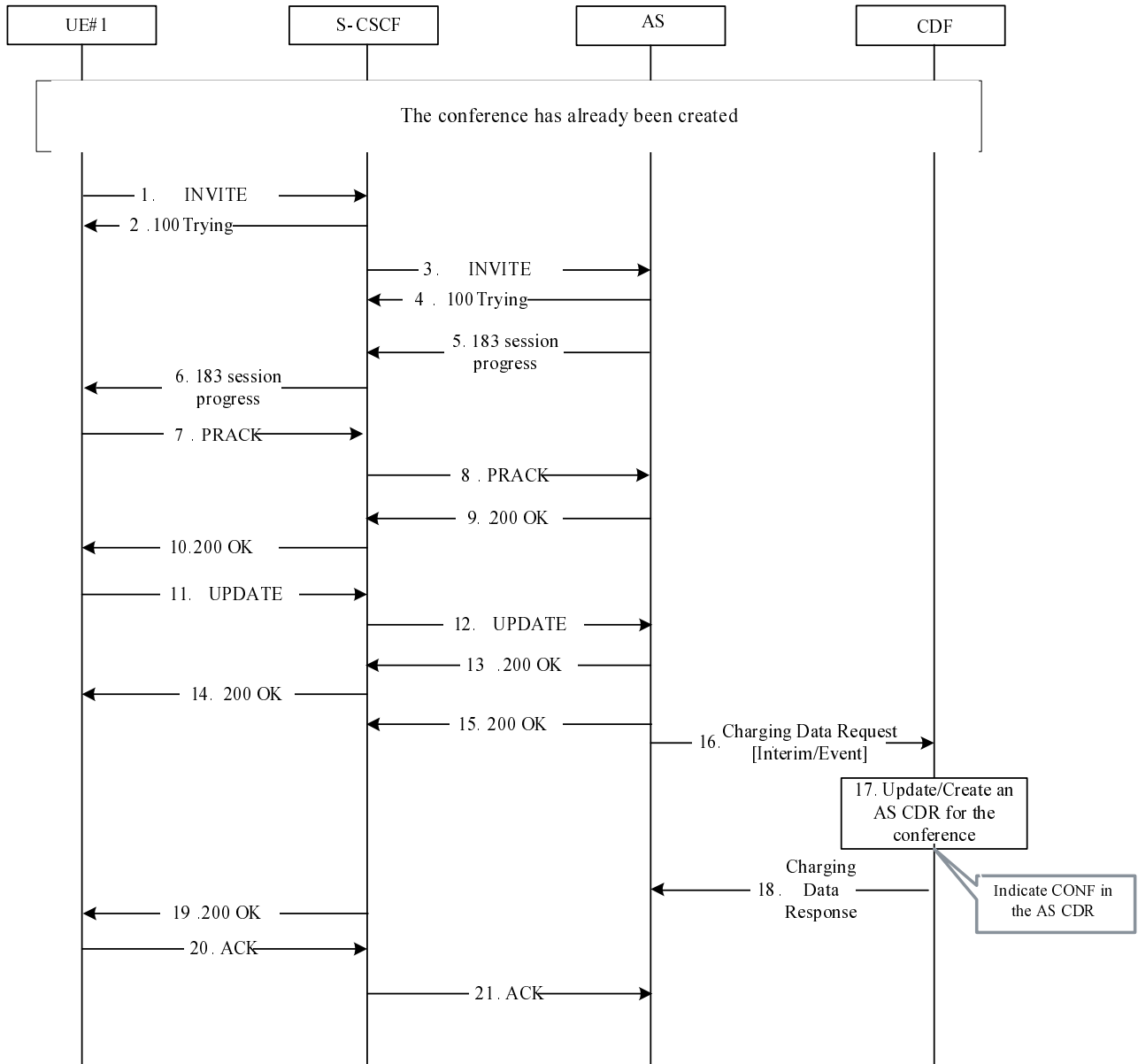

Figure 5.2.2.1.11.2.1: CONF charging – user joining a conference

- 1-2. The conference has already been created. UE#1 sends an SIP INVITE request to S-CSCF in order to join in the conference. And S-CSCF sends back SIP 100 Trying reponse to inform UE#1 to wait for a while because the request is being treated.
- 3-4. S-CSCF transfers SIP INVITE request from UE#1 to CONF AS and the CONF AS sends back SIP 100 Trying response to inform S-CSCF to wait for a while because the request is being treated.
- 5-15. After the media resource negotiation process, the CONF AS sends back SIP 200 OK response.
- 16-18. The CONF AS sends Charging Data Request [Interim/Event] to CDF, CDF updates or creates an AS CDR for the conference and returns Charging Data Response to the CONF AS.

5.2.2.1.11.3 CONF charging – user inviting another user to a conference

Figure: 5.2.2.1.11.3.1 shows the Diameter transactions that are required between AS, which implements the CONF service and CDF corresponding to the conference scenario: user being invited into a conference.

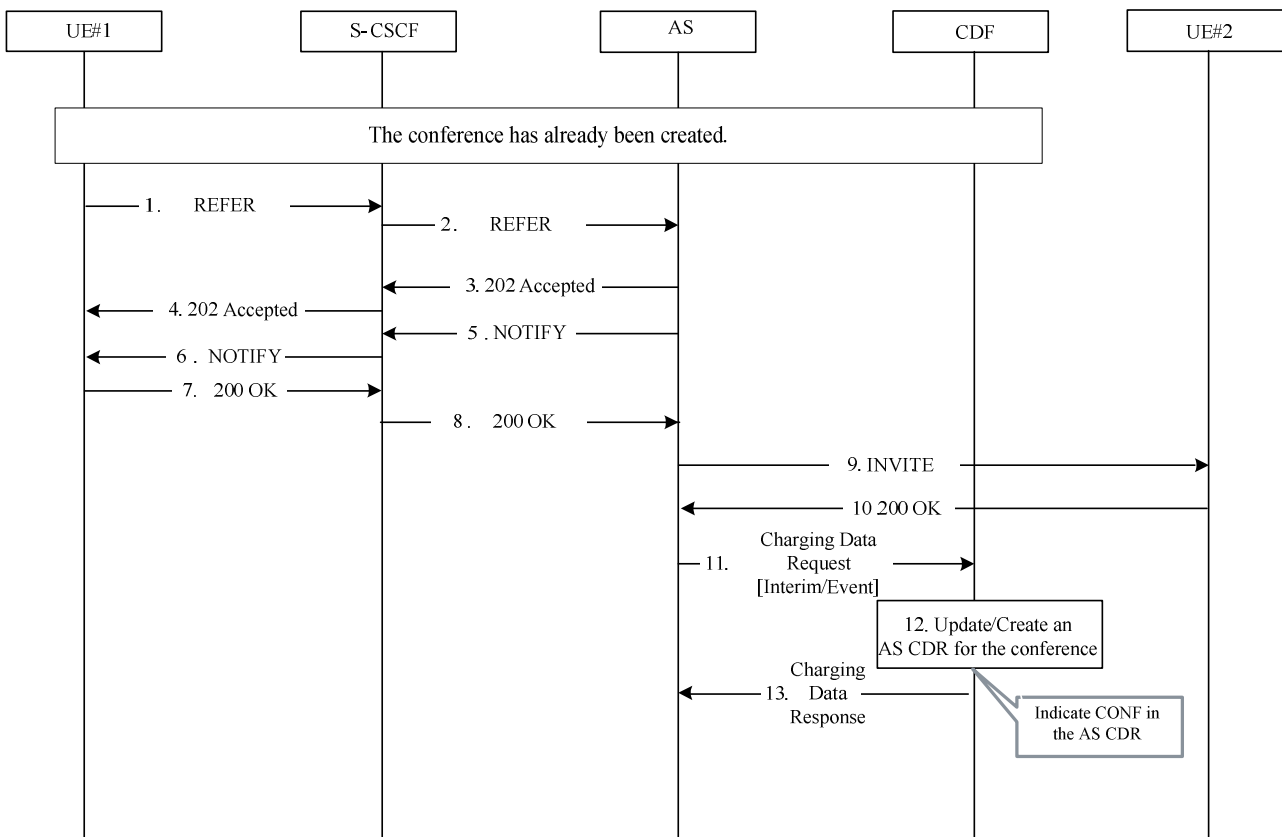

Figure 5.2.2.1.11.3.1: CONF charging – user inviting another user to a conference

- 1-2. The conference has already been created. UE#1 sends a SIP REFER request to S-CSCF in order to invite UE#2 into the conference.
- 3-4. The CONF AS sends back 202 Accepted response to UE#1 via some related NEs like S-CSCF to indicate that he has received the SIP REFER request successfully.
- 5-6. The CONF AS sends a SIP NOTIFY request corresponding the SIP REFER request to UE#1.
- 7-8. UE#1 sends back SIP 200 OK response to the CONF AS.
- 9-10. The CONF AS sends an SIP INVITE request to UE#2 in order to invite him into the conference. And UE#2 sends back SIP 200 OK response to the CONF AS.
- 11-13. The CONF AS sends Charging Data Request [Interim/Event] to CDF, CDF updates or creates an AS CDR for the conference and returns Charging Data Response to the CONF AS.

5.2.2.1.11.4 CONF charging – user leaving a conference

Figure: 5.2.2.1.11.4.1 shows the Diameter transactions that are required between AS, which implements the CONF service and CDF corresponding to the conference scenario: user leaving a conference.

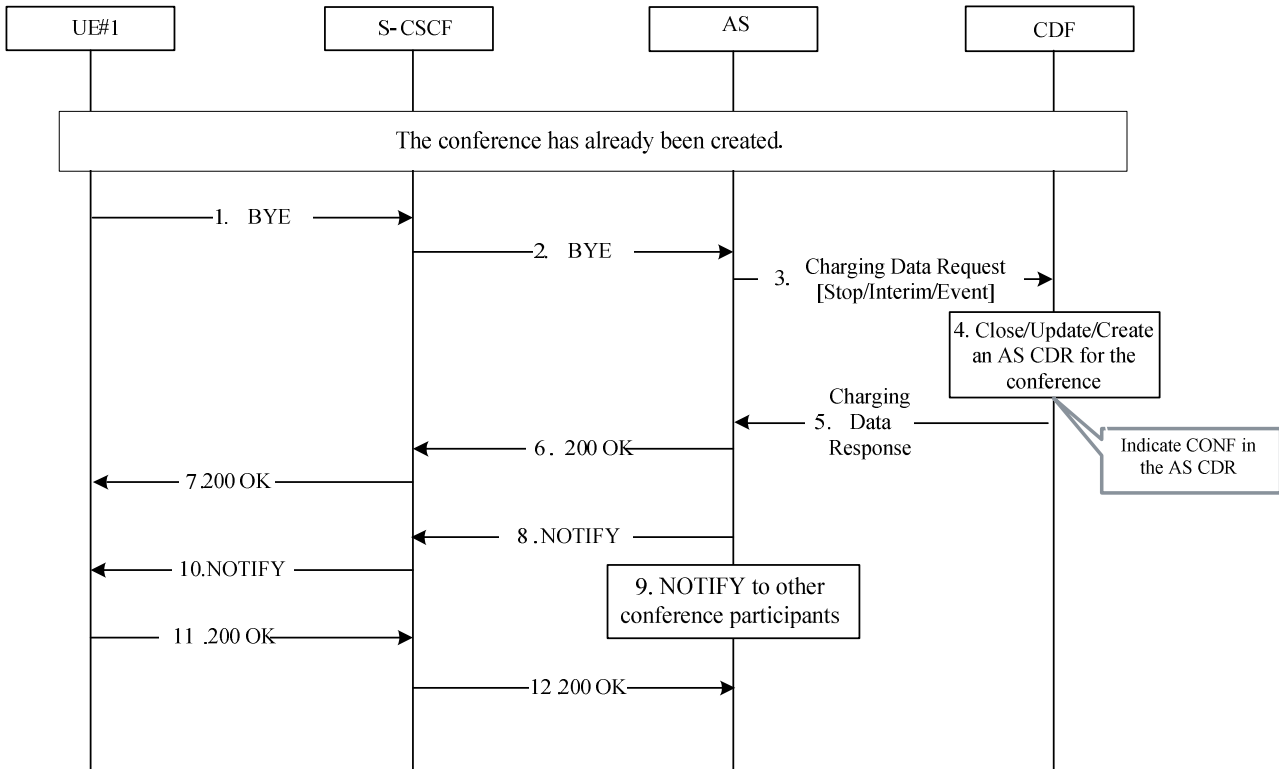

Figure: 5.2.2.1.11.4.1: CONF charging – user leaving a conference

- 1-2. The conference has already been created. UE#1 sends a SIP BYE request to the CONF AS in order to quit the conference.
- 3-5. The CONF AS sends Charging Data Request [Interim/Event] to CDF, CDF updates or creates an AS CDR for the conference and returns Charging Data Response to the CONF AS. Conference termination should refer to the description of clause 5.3.2.7 in TS 24.147 [220], e.g. if there is not any conference policy and the last online conference user quits the conference could be considered as the conference termination, when the last online conference user quits the conference (sends a SIP BYE request to the CONF AS), the CONF AS sends Charging Data Request [Stop/Event] to CDF, CDF stops or creates an AS CDR for the conference and returns Charging Data Response to the CONF AS.
- 6-7. The CONF AS sends back SIP 200 OK response to UE#1.
- 8-10. The CONF AS sends a SIP NOTIFY request to other conference participants that UE#1 has quitted the conference.
- 11-12. Other conference participants send back SIP 200 OK response to the CONF AS.

5.2.2.1.11.5 Three-Party (3PTY) charging – successful establishment

Figure 5.2.2.1.11.5.1 shows the Diameter transactions that are required between AS, which implements the 3PTY service and CDF corresponding to the 3PTY scenario: 3PTY service successful establishment.

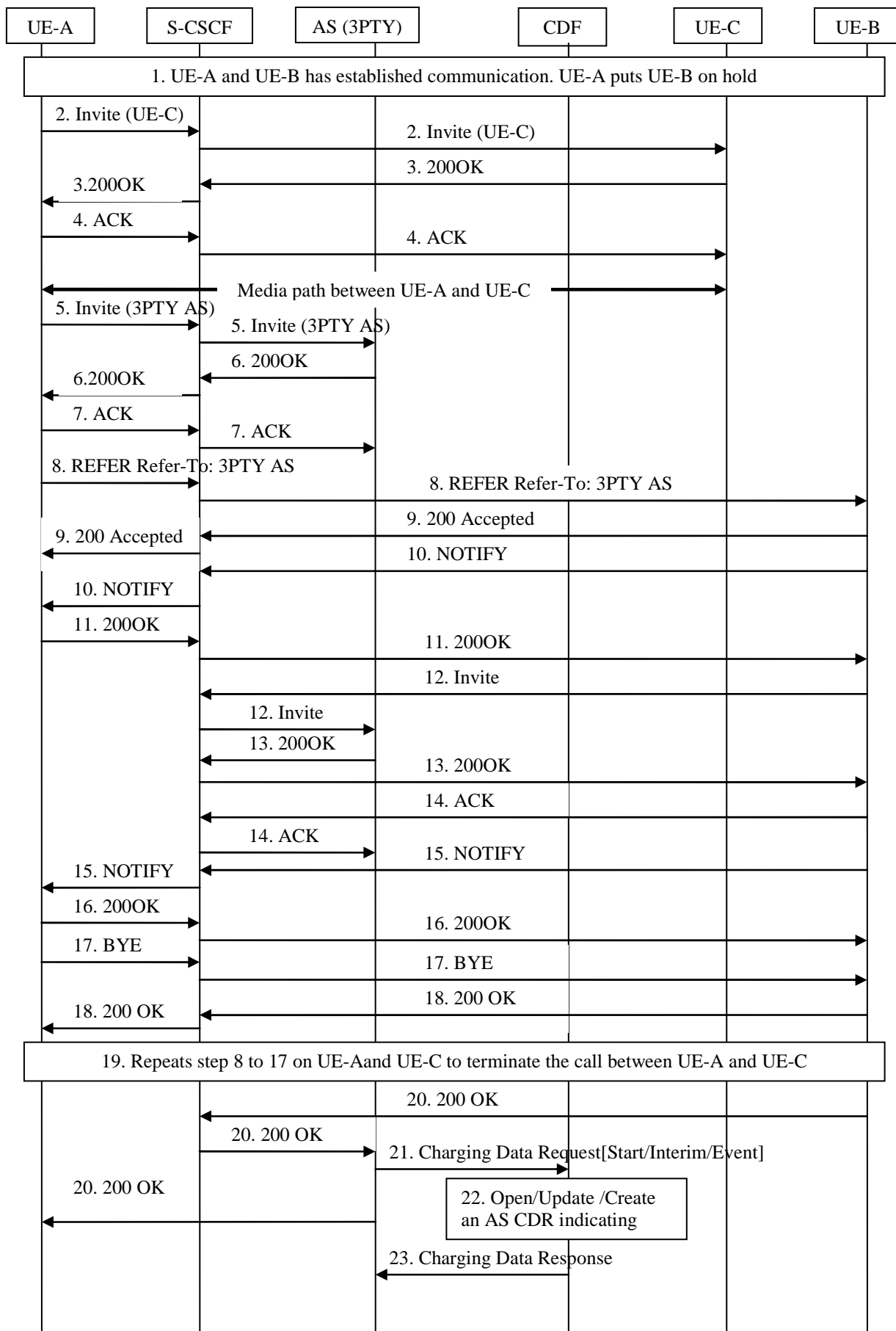

Figure 5.2.2.1.11.5.1: Three-Party (3PTY) charging – successful establishment

1. UE-A and UE-B has established communication. UE-A puts UE-B on hold before invoking the 3-Way Calling with UE-C.
- 2-4. UE-A establishes a call with UE-C following normal call setup procedure and gets UE-C's permission to start the 3-Way Calling.
5. UE-A sends an SIP INVITE request to the 3PTY AS to establish a 3PTY session.
- 6-7. The 3PTY AS sends a SIP 200 OK response and receives an ACK request from UE-A.
- 8-9. UE-A sends a SIP REFER request to UE-B with the Refer-To header set to the address of the 3PTY AS; UE-B accepts the SIP REFER request.
- 10-11. UE-B sends a SIP NOTIFY request to UE-A to indicate that UE-B is acting on the SIP REFER request.
12. UE-B sends an SIP INVITE request to the 3PTY AS to join the 3PTY session.
- 13-14. The 3PTY AS sends a SIP 200 OK response to UE-B and receives an ACK request.
- 15-16. UE-B sends a SIP NOTIFY request to UE-A to indicate that it has finished action required by the SIP REFER request.
- 17-18. UE-A sends a SIP BYE request to terminate the call between UE-A and UE-B.
- 19-20. Repeats step 8 to 18 on UE-A and UE-C to terminate the call between UE-A and UE-C.
- 21-23. 3PTY AS sends an Charging Data Request [Start/Interim/Event] to CDF, CDF opens or updates or create an 3PTY AS CDR for the 3PTY service and returns Charging Data Response to the 3PTY AS.

5.2.2.1.11.6 Three-Party (3PTY) charging – release

Figure 5.2.2.1.11.6.1 shows the Diameter transactions that are required between AS, which implements the 3PTY service and CDF corresponding to the 3PTY scenario: release the 3PTY service.

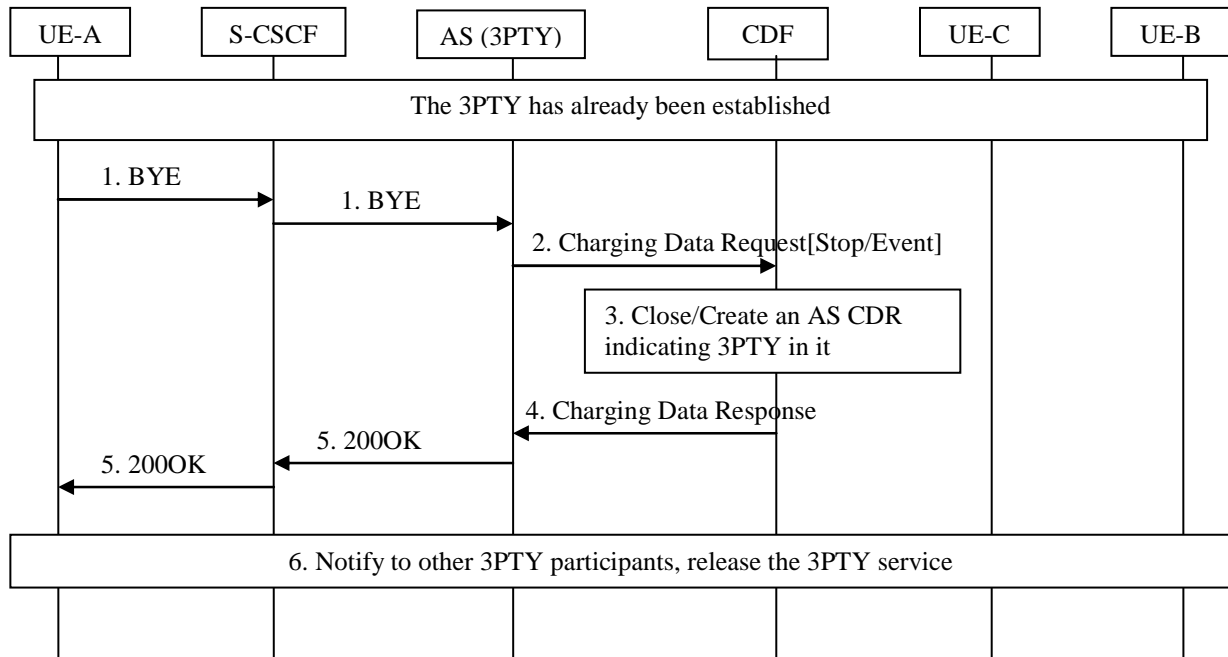

Figure 5.2.2.1.11.6.1: Three-Party (3PTY) charging – release

1. The 3PTY has already been established. UE-A sends a SIP BYE request to the 3PTY AS in order to release from the 3PTY service.
- 2-4. At session termination 3PTY AS, sends an *Accounting-Request [Stop/Event]* to CDF, CDF stops or creates an AS CDR for the 3PTY service and returns *Accounting Answer* to the 3PTY AS.
5. The 3PTY AS sends back SIP 200 OK response to UE-A.
6. The 3PTY AS sends a SIP NOTIFY request to other participants that 3PTY service has released.

5.2.2.1.12 CCBS charging

Figure 5.2.2.1.12.1 shows the Diameter transactions that are required between AS and CDF, which implements the CCBS service, and CDF after service execution.

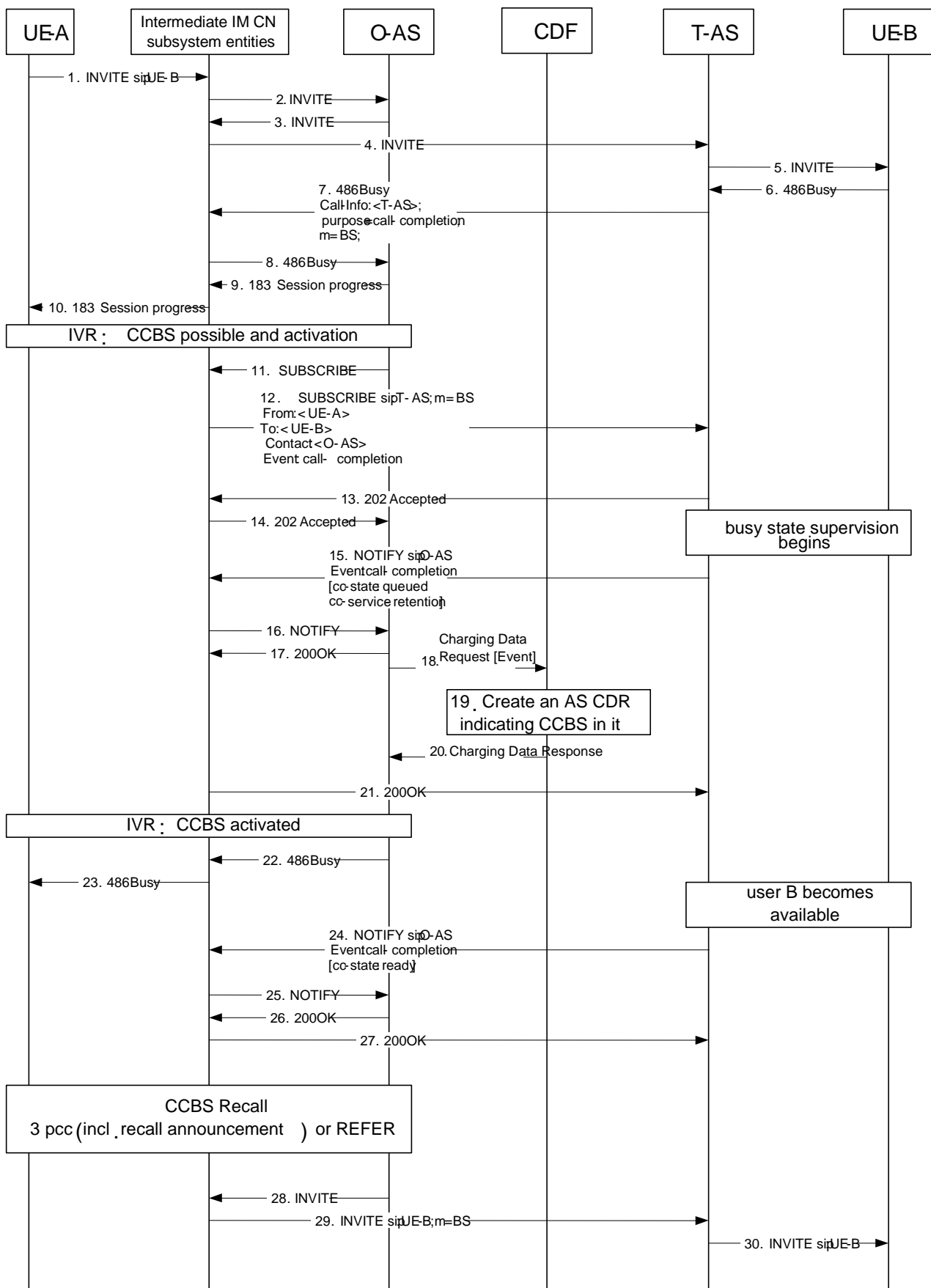

Figure 5.2.2.1.12.1 : Message sequence chart for offline charging of CCBS service

- 1-5) The communication is initiated by UE-A by sending an SIP INVITE request.
- 6) UE-B answers with a SIP 486 (Busy Here) response. The SIP 486 (Busy Here) response is routed back to the terminating AS.
- 7-8) The terminating AS inserts a Call-Info header field in the SIP 486 (Busy Here) response. The Call-Info header field contains the URI of the terminating AS with an "m" header field parameter set to "BS" (busy subscriber). It further includes a "purpose" header field parameters set to "call-completion". The SIP 486 (Busy Here) response is routed back to the originating AS.
- 9-10) The originating AS sends back a SIP 183 (Session Progress) response to UE-A and initiates IVR procedures. User A is informed that CCBS is possible. User A activates CCBS.
- 11-14) The originating AS subscribes for the call-completion event package. The terminating AS accepts the subscription and starts busy state supervision procedures on the callee.
- 15-17) The terminating AS sends a notification to the originating AS.
- 18-20) The originating AS sends Charging Data Request [Event] to CDF, then the CDF creates an AS CDR for the CCBS service subscriber with CCBS indication on the AS CDR and returns Charging Data Response to the originating AS.
- 21) After confirmation of the notification the originating AS starts announcements procedures informing about the activation of CCBS.
- 22-23) The originating AS forwards the SIP 486 (Busy Here) response to UE-A.
- 24-27) When UE-B becomes available, the terminating AS sends a SIP NOTIFY request to the originating AS,
- 28-29) The originating AS starts the CCBS recall by sending an SIP INVITE request to UE-B. In order to mark the SIP INVITE request as a prioritized request for call-completion, the originating AS adds the "m" SIP URI parameter with the value 'BS' to the Request-URI.

5.2.2.1.13 CCNR charging

Figure 5.2.2.1.13.1 shows the Diameter transactions that are required between AS and CDF, which implements the CCNR service, and CDF after service execution.

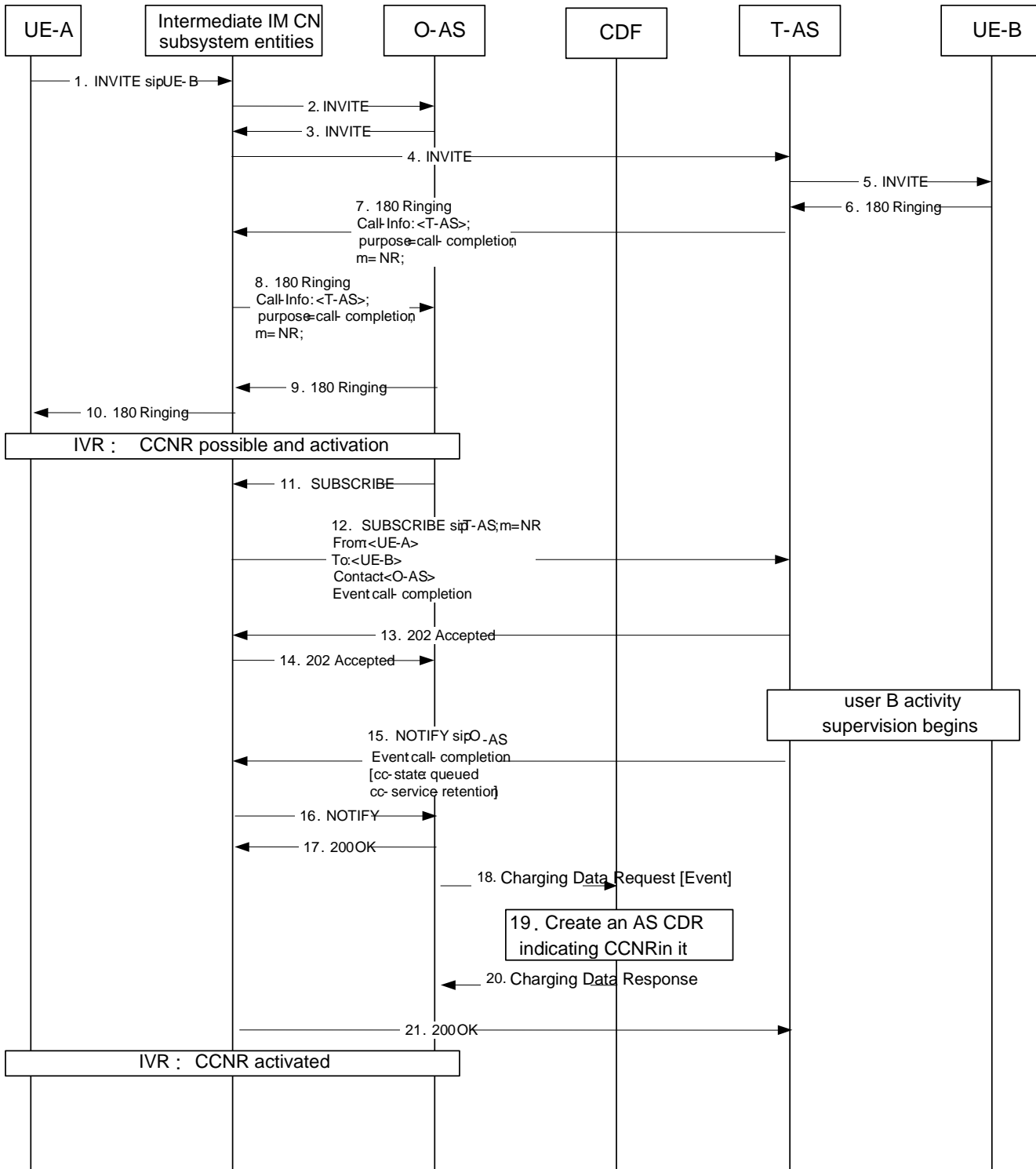

Figure 5.2.2.1.13.1: Message sequence chart for offline charging of CCNR service

- 1-5. The communication is initiated by UE-A by sending an SIP INVITE request.
6. UE-B answers with a 180 (Ringing) response. The 180 (Ringing) response is routed back to the terminating AS.
- 7-8. The terminating AS inserts a Call-Info header field in the 180 (Ringing) response. The Call-Info header field will contain the URI of the terminating AS with a "m" header field parameter set to "NR" (no reply). It further includes a "purpose" header field parameter set to "call-completion". The 180 (Ringing) response is routed back to the originating AS.
- 9-10. The originating AS removes the Call-Info header field, forwards the 180 (Ringing) response to UE-A and initiates IVR procedures. User A is informed that CCNR is possible. User A activates CCNR.
- 11-14. The originating AS subscribes for the call-completion event package. The terminating AS accepts the subscription and starts activity supervision procedures on the callee.
- 15-17. The terminating AS sends a notification to the originating AS,.
- 18-20. The originating AS sends Charging Data Request [Event] to CDF, then the CDF creates an AS CDR for the CCNR service subscriber with CCNR indication on the AS CDR and returns Charging Data Response to the originating AS.
21. After confirmation of the notification the originating AS starts announcements procedures informing about the activation of CCNR.

5.2.2.1.14 Flexible Alerting (FA)

5.2.2.1.14.1 Flexible Alerting (FA) - establishment

Figure 5.2.2.1.14.1.1 shows the Diameter transactions that are required between AS, implementing the FA service and CDF, with answer from one of FA group members.

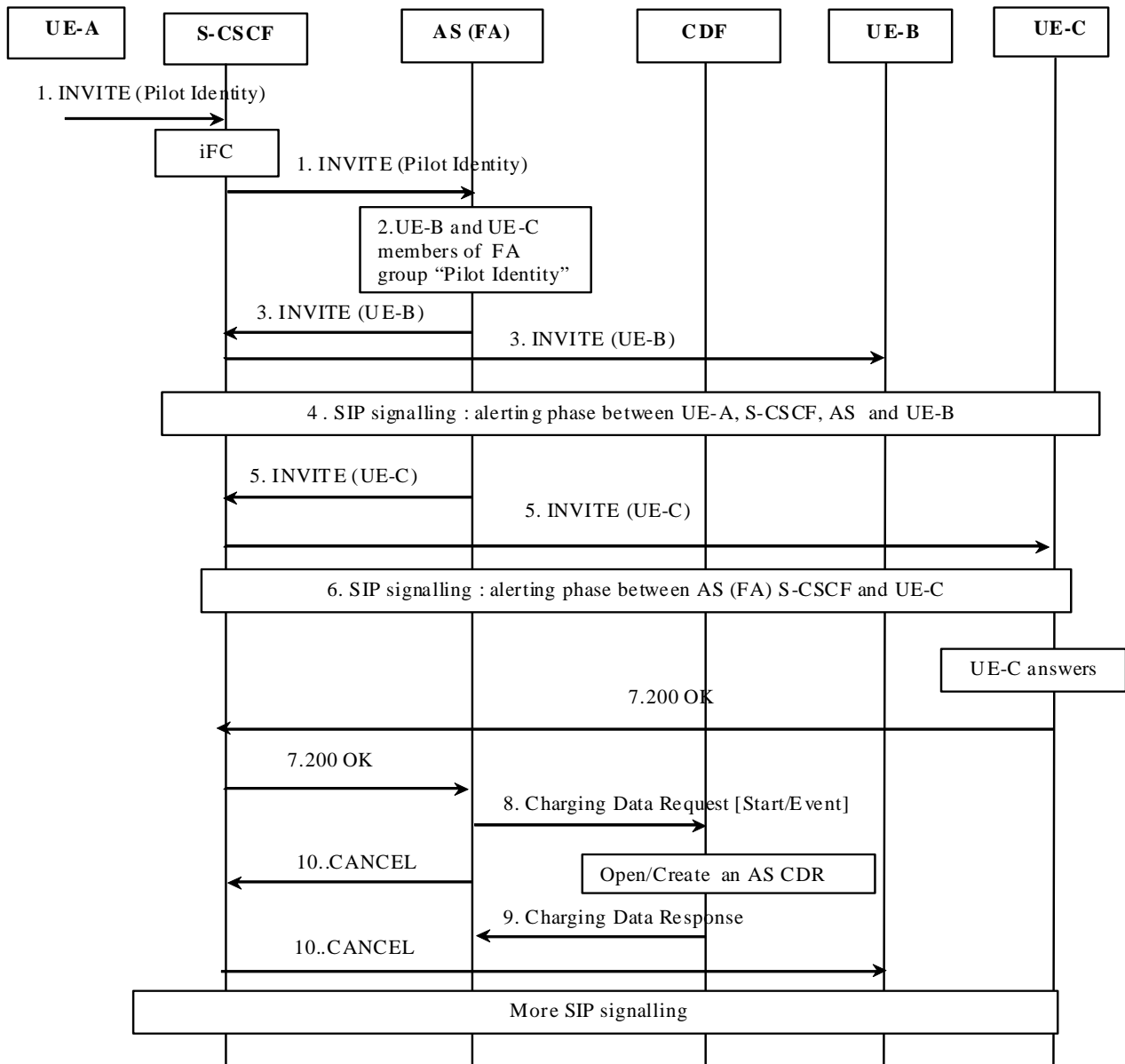

Figure 5.2.2.1.14.1.1: Message sequence chart for offline charging of FA service - Answered

UE-B and UE-C are FA group members of the FA group identified by the "Pilot Identity".

A communication is requested from UE-A towards the "Pilot Identity".

1. SIP INVITE request incoming for "Pilot Identity". Based on the Initial Filter Criteria (IFC), indicating the request must be forwarded to an AS implementing FA for this "Pilot Identity".
2. The AS implementing FA maps the Pilot Identity to the list of FA group members: UE-B and UE-C, and forwards SIP INVITE to all FA members.
- 3 to 4. SIP INVITE forwarded towards UE-B and alerting phase signalling occurs with UE-A.

5 to 6. SIP INVITE forwarded towards UE-C and alerting phase signalling occurs with UE-A.

7. UE-C answers.

8 to 10. Upon reception of the SIP 200 OK answer from UE-C, AS implementing the FA service:

- Sends Charging Data Request [Start] with FA MMTel supplementary service indication. The CDF creates an AS CDR and returns Charging Data Response to the AS.
- Sends SIP CANCEL to other FA group member being alerted, UE-B.

5.2.2.1.14.2 Flexible Alerting (FA) – call release

Figure 5.2.2.1.14.2.1 shows the Diameter transactions that are required between AS, implementing the FA service and CDF, when previous successfully established call is released.

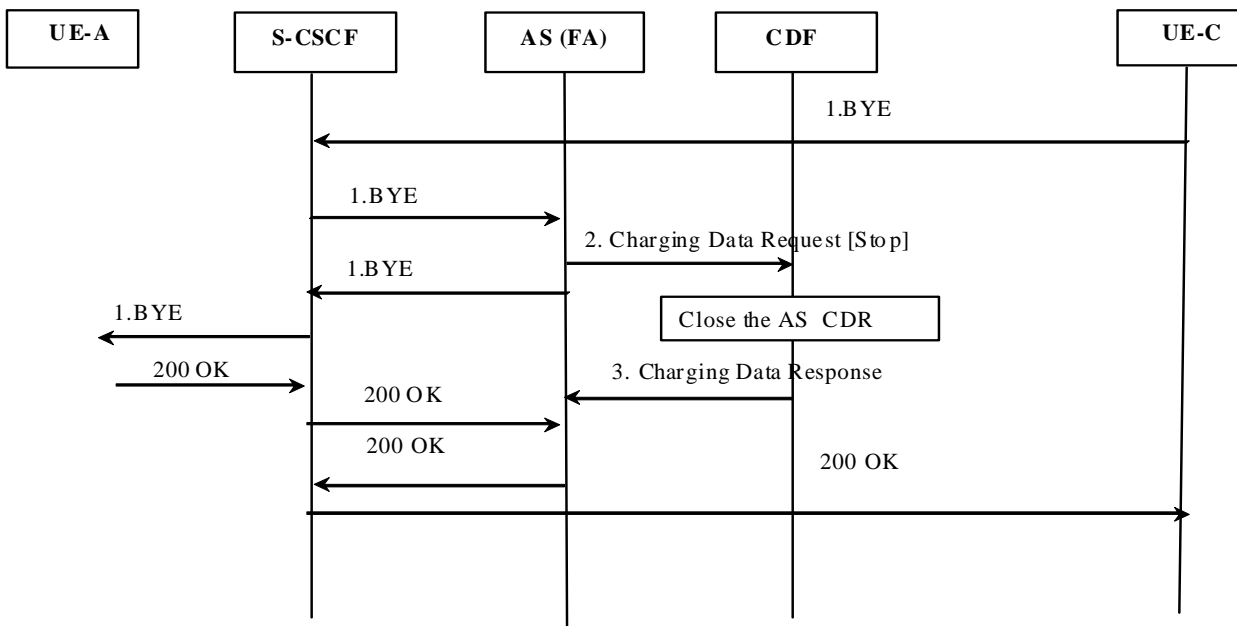

Figure 5.2.2.1.14.2.1: Message sequence chart for offline charging of FA service - Release

1. UEC initiates release of the communication.

2 to 3. At session termination the AS implementing the FA service, sends Charging Data Request [Stop] and the AS CDR is closed.

5.2.2.1.15 Malicious Communication Identification (MCID)

Figure 5.2.2.1.15.1 shows the Diameter transactions that are required between AS implementing the MCID service and CDF for a successful MCID delivery for permanent mode or temporary mode.

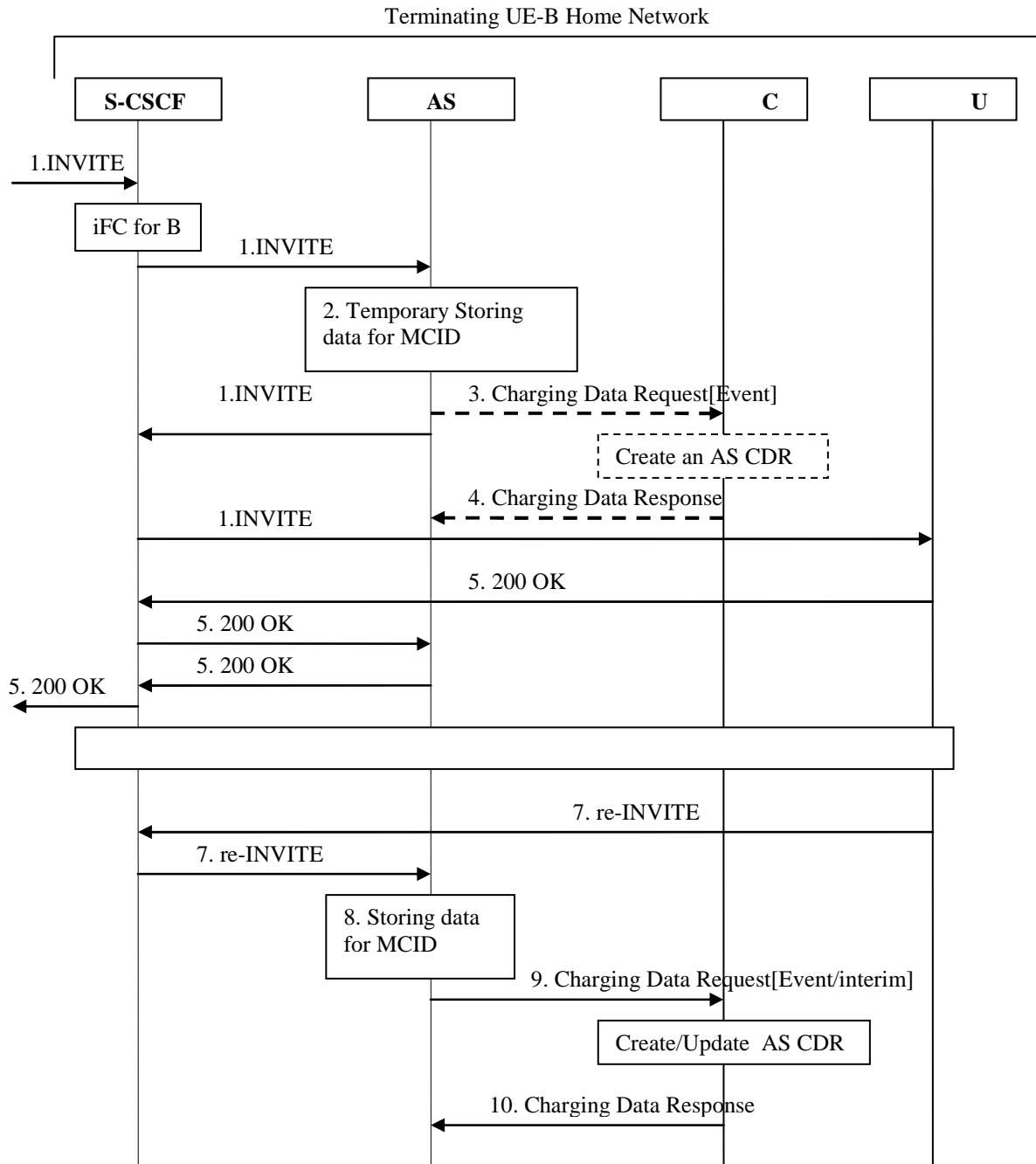

Figure 5.2.2.1.15.1: Message sequence chart for offline charging of MCID service

A communication is requested towards User B, and User B is subscribed to MCID service.

1. SIP INVITE request incoming for User B. Based on the Initial Filter Criteria (IFC) rules, indicating that User B is subscribed to the MCID supplementary services, the communication is forwarded to an AS implementing MCID.

- 2-4. In case of MCID temporary mode, AS stores relevant data temporarily, in case permanent mode AS registers the data and sends Accounting-Request [Event] to record invocation of MCID, acknowledged by the CDF when AS CDR is created. Then SIP INVITE is forwarded to User B.
5. SIP 200 OK answer received from User B.
6. Further SIP signalling for communication establishment, or mid-communication take place, before SIP BYE from User-B.
- 7-10. Upon reception of SIP re-INVITE from User-B, indicating temporary MCID request, AS registers the data previously stored and sends Charging Data Request[Event/interim] message to CDF to record invocation of MCID, the CDF creates/updates AS CDR and returns Charging Data Response.

5.2.2.1.16 Customized Alerting Tone (CAT)

Although CAT Supplementary services may be delivered according to different models (CAT forking, CAT early session, CAT Gateway) as described in TS 24.182 [217], only one scenario is depicted here, and serves as a basis for CAT charging description, as the same principle applies.

Figure 5.2.2.1.16.1 shows the Diameter transactions that are required between AS implementing the CAT service and CDF for a successful communication establishment with CAT delivery.

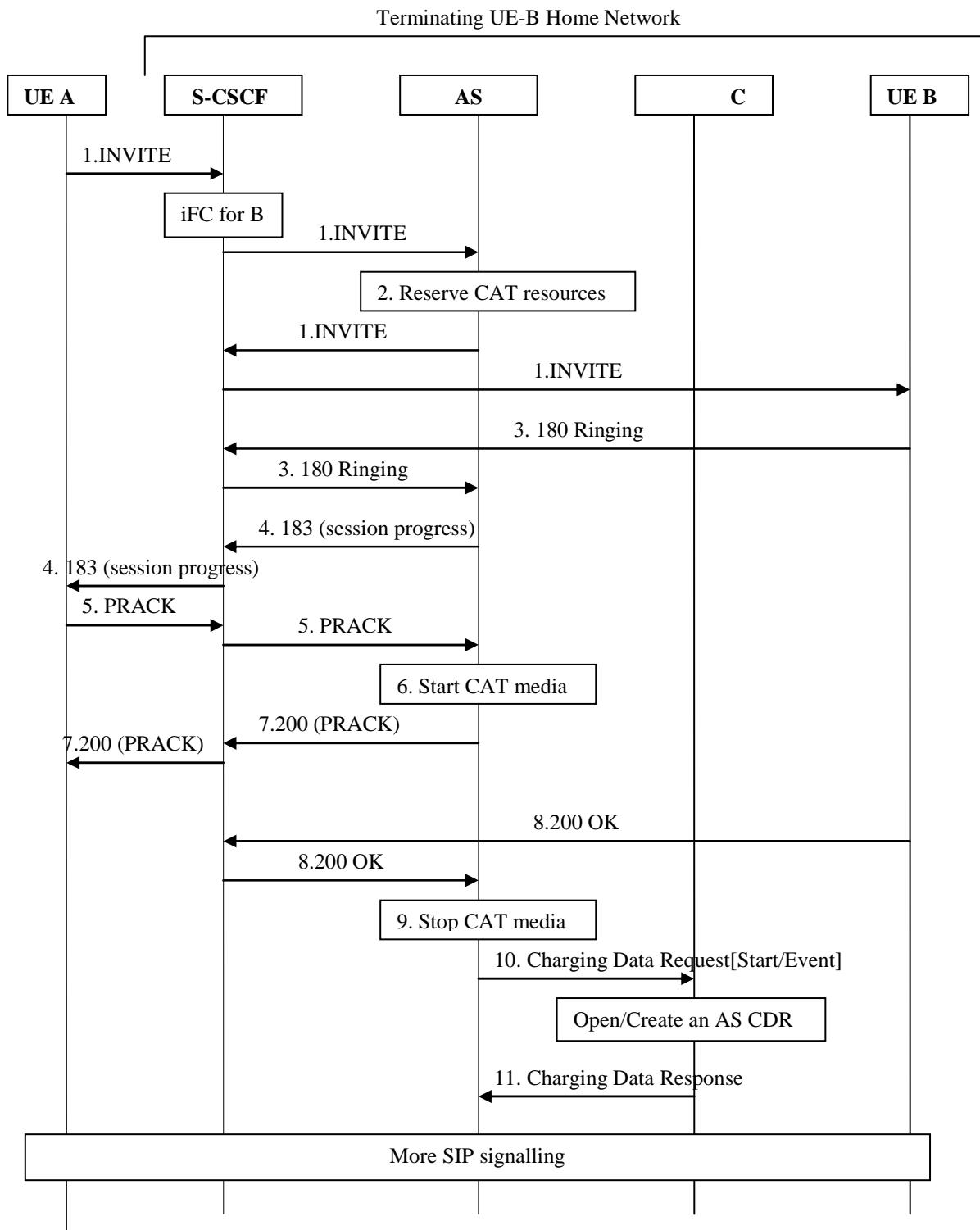

Figure 5.2.2.1.16.1: Message sequence chart for offline charging of CAT service delivery

A communication is requested towards User B, user B has subscribed to CAT service.

1. SIP INVITE request incoming for User B. Based on the Initial Filter Criteria (IFC) rules, indicating that User B is subscribed to the CAT supplementary service, the communication is forwarded to an AS implementing CAT.
2. The AS proceeds to CAT resources reservation and forwards SIP INVITE towards User B..
3. 180 ringing is sent back from User B.
4. The AS sends a reliable 183 (session progress) response to User A with codecs to be used for CAT., acknowledged by PRACK from User A.
- 5 to 7. Upon acknowledgment from User A (SIP PRACK), the AS starts CAT media playing (alerting tone), and sends SIP 200 OK response to SIP PRACK towards User A.
- 8 to 11. Upon SIP 200 OK answer received from User B, AS stops CAT media playing (alerting tone), and sends a Charging Data Request [Start/Event] message to CDF, CDF opens/creates an AS CDR and returns Charging Data Response.

NOTE: The same following principle applies for all others CAT delivery scenarii:
a Charging Data Request [Start] is sent from AS to record beginning of alerting tone playing, and
Charging Data Request[Stop] is sent to record end of alerting tone playing.

5.2.2.1.17 Closed User Group (CUG)

5.2.2.1.17.1 Closed User Group (CUG): Originating

Figure 5.2.2.1.17.1.1 shows the Diameter transactions that are required between AS implementing the CUG service and CDF for a successful originating communication from User-A CUG member.

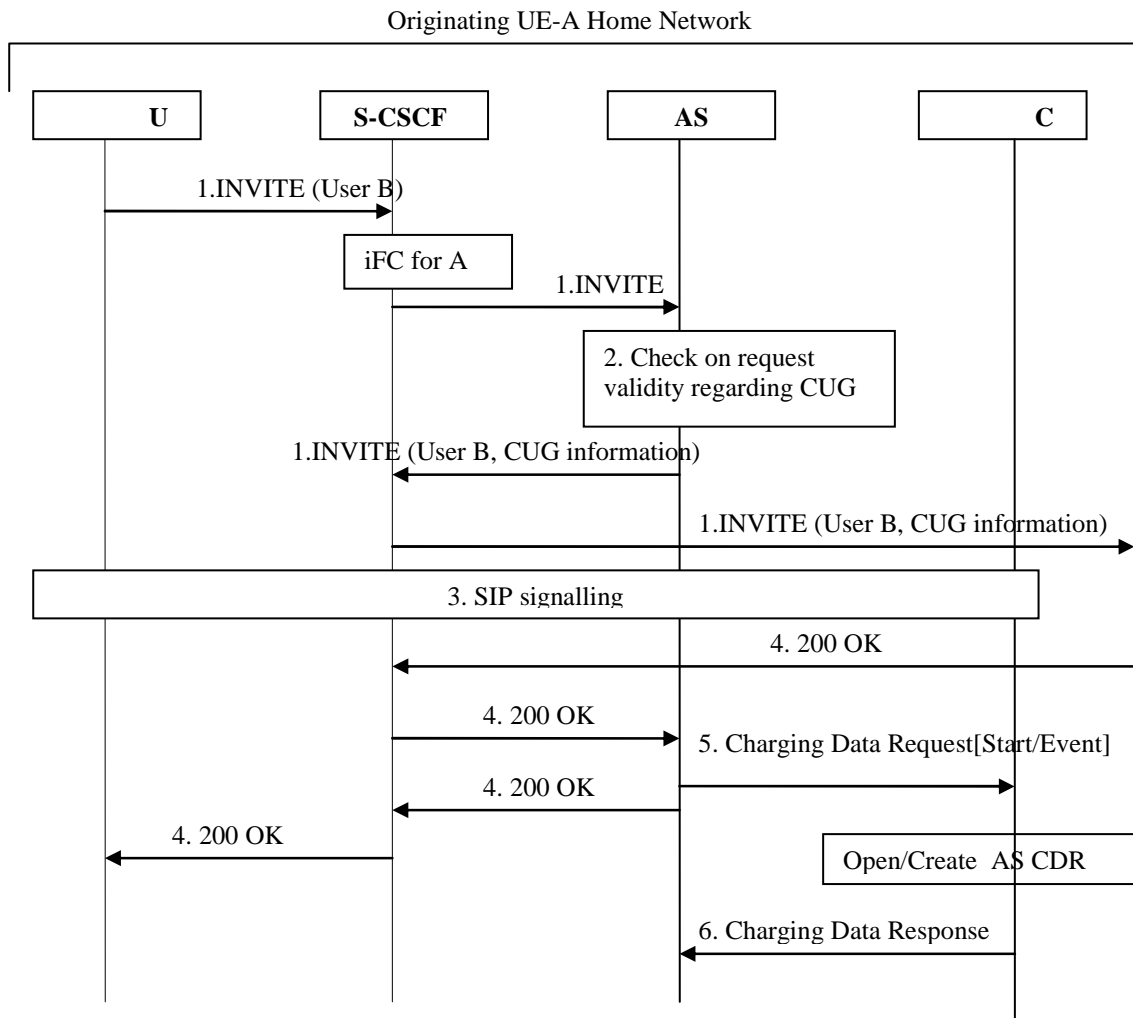

Figure 5.2.2.1.17.1.1: Message sequence chart for offline charging of CUG service - originating call

User-A is subscribed to CUG service, and initiates a communication towards User B.

1. User-A initiates a communication towards User B sending SIP INVITE request. Based on the Initial Filter Criteria (IFC) rules, indicating that User A is subscribed to the CUG supplementary service, the communication is forwarded to an AS implementing CUG.
2. AS performs checks from the request received regarding User A CUG subscription profile, and determines the CUG-communication is allowed for CUG member User-A towards User-B : AS forwards SIP INVITE towards User-B with CUG information included.

NOTE: In case the result from AS checks indicates non-CUG communication behaviour (for CUG communication with outgoing access...), CUG information is not included, and non-CUG communication charging applies.

3. SIP signalling for communication establishment.

4-6. SIP 200 OK answer received from User B, and AS sends Charging Data Request [Start/Event] message to CDF to record start of the CUG-communication for User A CUG member. The CDF opens/creates an AS CDR and returns Charging Data Response

5.2.2.1.17.2 Closed User Group (CUG): Terminating

Figure 5.2.2.1.17.2.1 shows the Diameter transactions that are required between AS implementing the CUG service and CDF for a successful terminating communication towards User-B CUG member.

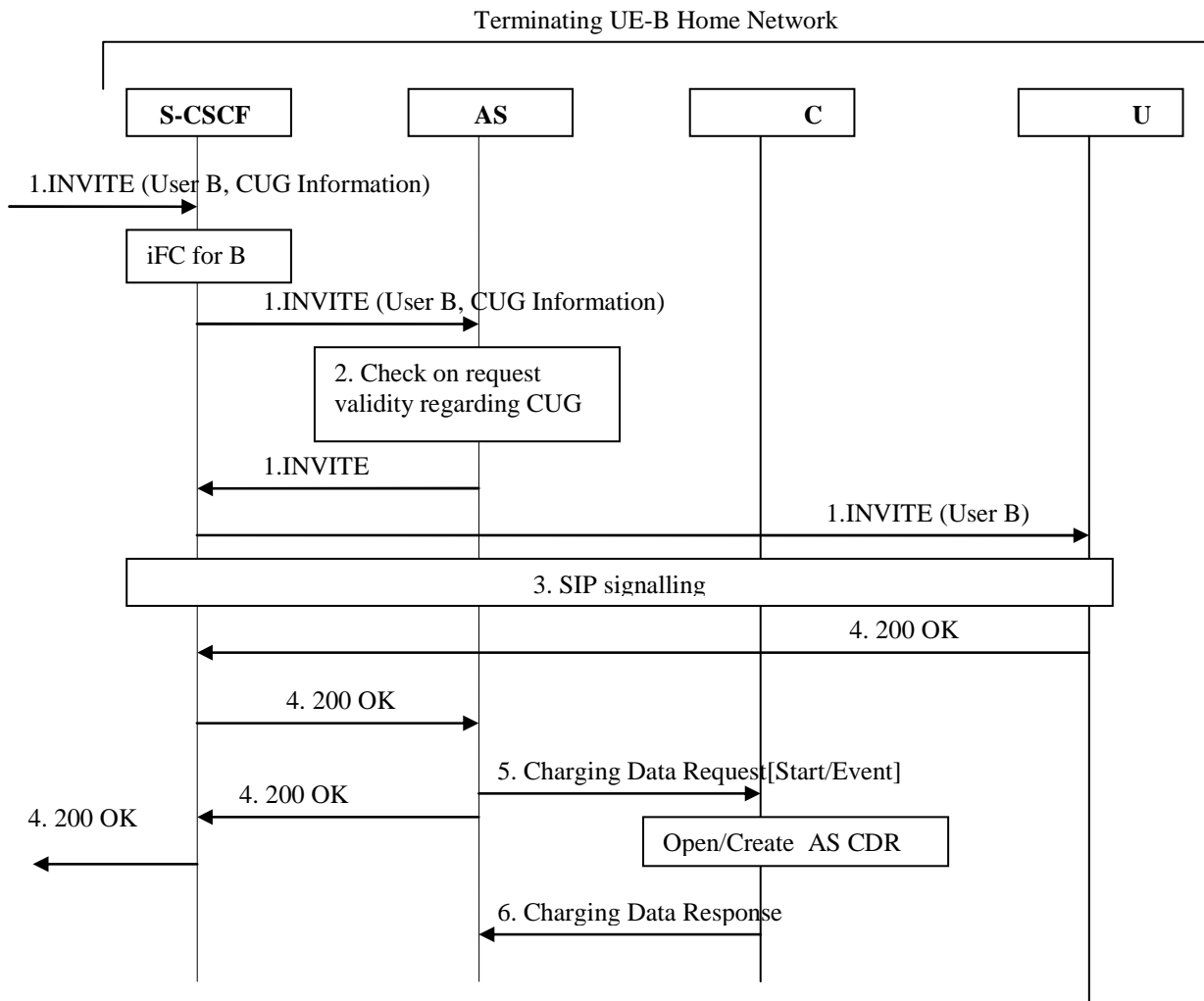

Figure 5.2.2.1.17.2.1: Message sequence chart for offline charging of CUG service - terminating call

User-B is subscribed to CUG service.

1. incoming SIP INVITE request towards User-B. Based on the Initial Filter Criteria (IFC) rules, indicating that User B is subscribed to the CUG supplementary services, the communication is forwarded to an AS implementing CUG.
2. AS performs checks from the request received regarding User B CUG subscription profile, and determines the CUG-communication is allowed for CUG member User-B from User A: AS forwards SIP INVITE towards User-B.

NOTE: In case the result from AS checks indicates non-CUG communication behaviour (incoming access from non-CUG member...), non-CUG communication charging applies.

3. SIP signalling for communication establishment.
- 4-6. SIP 200 OK answer received from User B, and AS sends Charging Data Request [Start/Event] message to CDF to record start of the CUG-communication for User B CUG member. The CDF opens/creates an AS CDR and returns Charging Data Response.

5.2.2.1.18 Personal Network Management (PNM)

Figure 5.2.2.1.18.1 shows the Diameter transactions that are required between AS implementing the PNM service and CDF for a successful "PN UE redirection" for a terminating communication, as described in TS 23.259 [218].

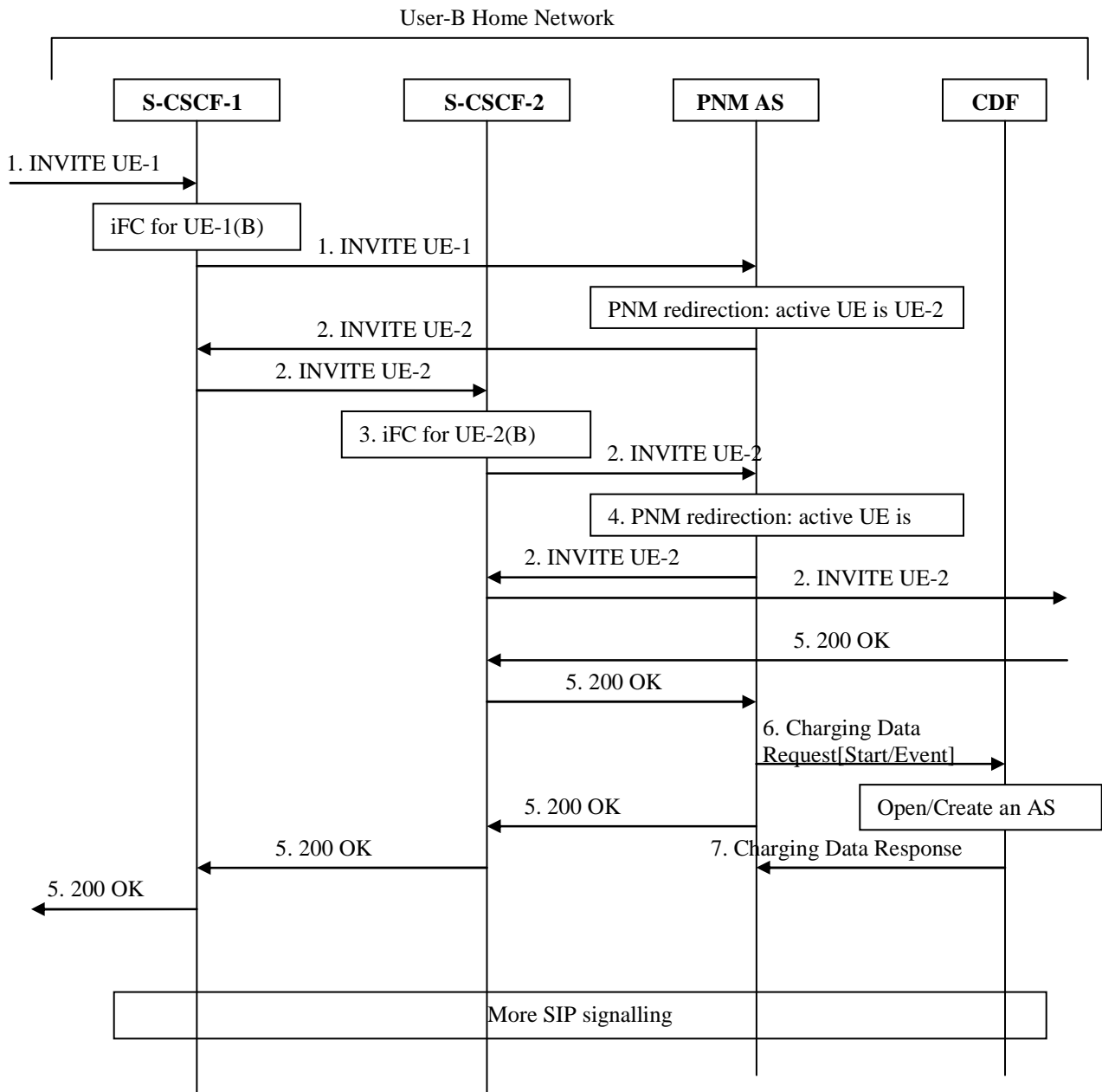

Figure 5.2.2.1.18.1: Message sequence chart for offline charging of "PNM-redirection" service

1. Incoming SIP INVITE request for UE-1 of User B. Based on the Initial Filter Criteria (IFC) rules, for UE-1, the communication is forwarded to the AS implementing PNM. From PN-user's PN configuration, the PNM AS determines the initial request is to be redirected to the default UE of the PN, i.e. to the UE-2.
2. SIP INVITE is forwarded towards UE-2.
3. Based on the Initial Filter Criteria (IFC) rules, for UE-2, the communication is forwarded to the AS implementing PNM.

4. From PN-user's PN configuration, the PNM AS determines the initial request is to be sent to the default UE of the PN, i.e. to the UE-2. SIP INVITE is forwarded towards UE-2.
5. The destination UE-2 party answers and a final response is received.
6. Upon reception of the final response, the AS implementing the PNM service sends Charging Data Request [Start] to record "PN UE redirection" execution to CDF.
7. The CDF acknowledges the reception of the data and opens/creates an AS CDR.

5.2.2.1.19 Customized Ringing Signal (CRS)

Although CRS Supplementary services may be delivered according to different models (download and play model, DTMF...) as described in TS 24.183 [219], only one scenario is depicted here, and serves as a basis for CRS charging description, as the same principle applies.

Figure 5.2.2.1.19.1 shows the Diameter transactions that are required between AS implementing the CRS service and CDF for a successful communication establishment with CRS delivery.

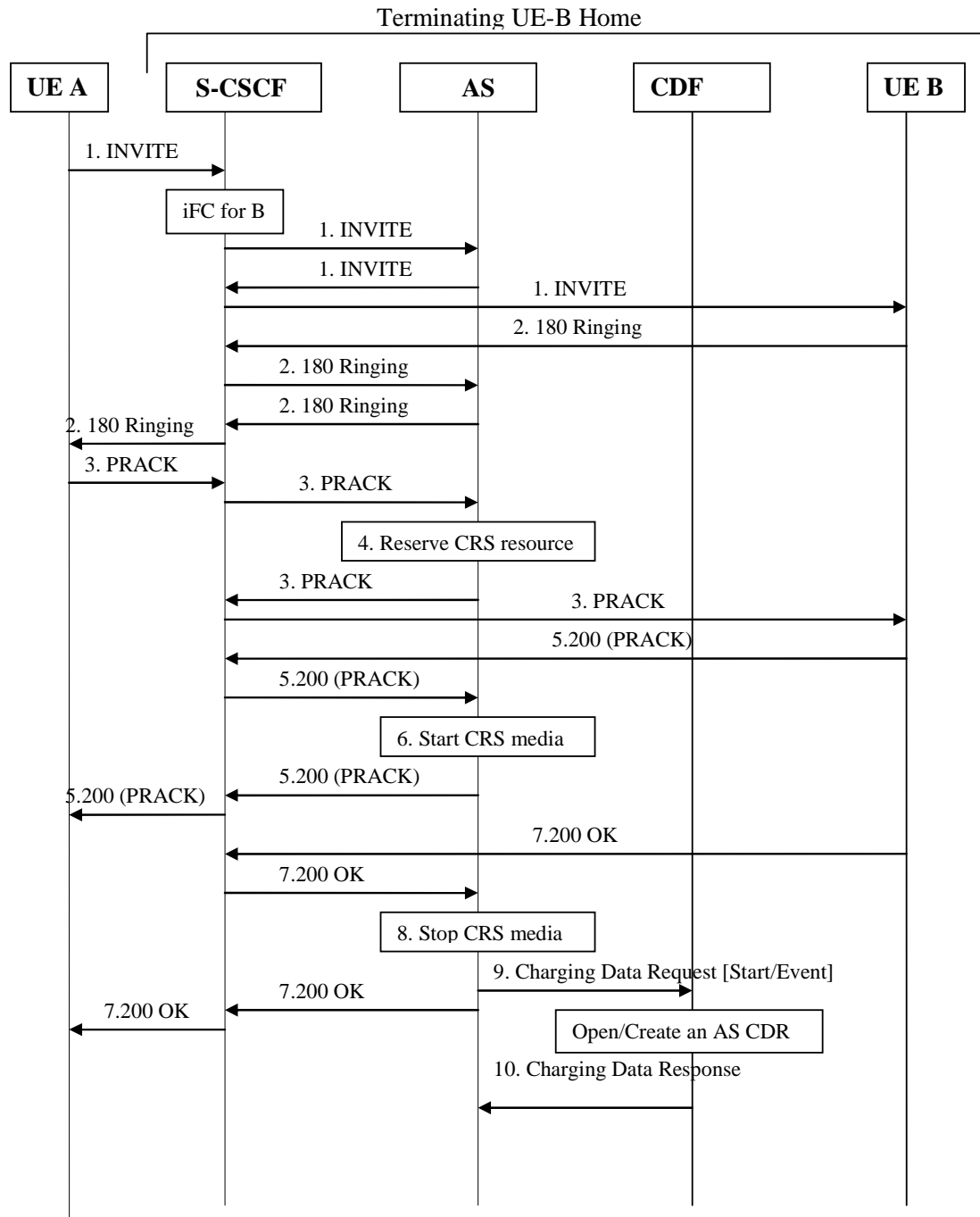

Figure 5.2.2.1.19.1: Message sequence chart for offline charging of "CRS" service delivery

A communication is requested towards User B, user B has subscribed to CRS service.

1. SIP INVITE request incoming for User B. Based on the Initial Filter Criteria (IFC) rules, indicating that User B is subscribed to the CRS supplementary service, the communication is forwarded to an AS implementing CRS. The INVITE is forwarded towards User B.
2. SIP 180 ringing is sent back from User B.
- 3 to 4. Upon acknowledgment from User A (SIP PRACK), the AS reserves CRS media, and forwards PRACK towards User B.
- 5-6. Upon SIP 200 OK(SIP PRACK acknowledgment) from User B, the AS starts CRS media playing, and forwards SIP 200 OK towards User A.
- 7-10. Upon SIP 200 OK answer received from User B, the AS stops CRS media playing, and sends Charging Data Request [Start/Event] message to CDF, CDF opens/creates an AS CDR and returns Charging Data Response. The AS forwards SIP 200 OK towards User A.

NOTE: The same following principle applies for all others CRS delivery scenarii:
a Charging Data Request [Start/Event] is sent from AS to record CRS service delivery.

5.2.2.1.20 Advice of Charge (AoC)

The information flows showing the transactions between AS implementing the AoC service and CDF for AoC-S, AoC-D and AoC-E are described in TS 32.280 [69].

5.2.3 GTP' record transfer flows

As in IMS offline charging, GTP' is not used between CDF and CGF for MMTel offline charging, because CDF and CGF are combined into CCF (see clause 4.2).

NOTE: Vendors may nevertheless implement a separate CDF and CGF for MMTel offline charging. In this case, it is recommended that the approach chosen conforms to the principles and protocol applications specified in TS 32.295 [54].

5.2.4 B₁ CDR file transfer

For further details on the B₁ protocol application refer to TS 32.297 [52].

5.3 MMTel online charging scenarios

5.3.1 Basic principles

Online charging of MMTel services is done according to the general principles of Diameter Credit-Control Applications (Debit / Reserve Units Response) as specified in TS 32.299 [50].

The CTFs implementing the MMTel online charging functionality may apply:

- Immediate Event Charging (IEC) with Debit Units Request [Event] generated, or
- Event Charging with Unit Reservation (ECUR), or Session Charging with Unit Reservation (SCUR), both with Reserve Units Request [Initial or Termination] generated.

The circumstances on which IEC, ECUR or SCUR are applied, depend on the MMTel supplementary service and/or operator's policy. Further details are specified in clause 5.3.2.

5.3.2 Diameter message flows

The flows described in the present document specify the charging communications between the different CTF entities and the charging functions for different online charging scenarios. The SIP messages and Diameter transactions associated with these online charging scenarios are shown primarily for general information and to illustrate the charging triggers. They are not intended to be exhaustive of all the SIP message flows discussed in TS 24.228 [221] and they depend on the Diameter Debit / Reserve Units Request triggers configured by the operator.

Each MMTel supplementary service is described by specific flows illustrating the dedicated trigger(s) for this MMTel supplementary service.

Following message flows are defined in TS 32.260 [20], and can be re-used for charging the basic multimedia telephony capabilities:

- Successful Session Establishment;
- Successful Session Establishment with Early Media Negotiation;
- Mid-Session Procedures;
- Session Release.

5.3.2.1 Message flows - Successful cases and scenarios

5.3.2.1.0 Interaction with IMS-GWF

As an MMTel principle, when online charging has to be applied for an MMTel supplementary service, and the trigger list includes IMS-GWF together with MMTel AS (implementing the MMTel supplementary service), filter criteria should be configured to have the MMTel AS triggered before IMS-GWF, in order to prevent improper charging.

Figure 5.3.2.1.0.1 shows the Diameter transactions that are required between MMTel AS, IMS-GWF and OCS, when online charging is applied for MMTel supplementary service.

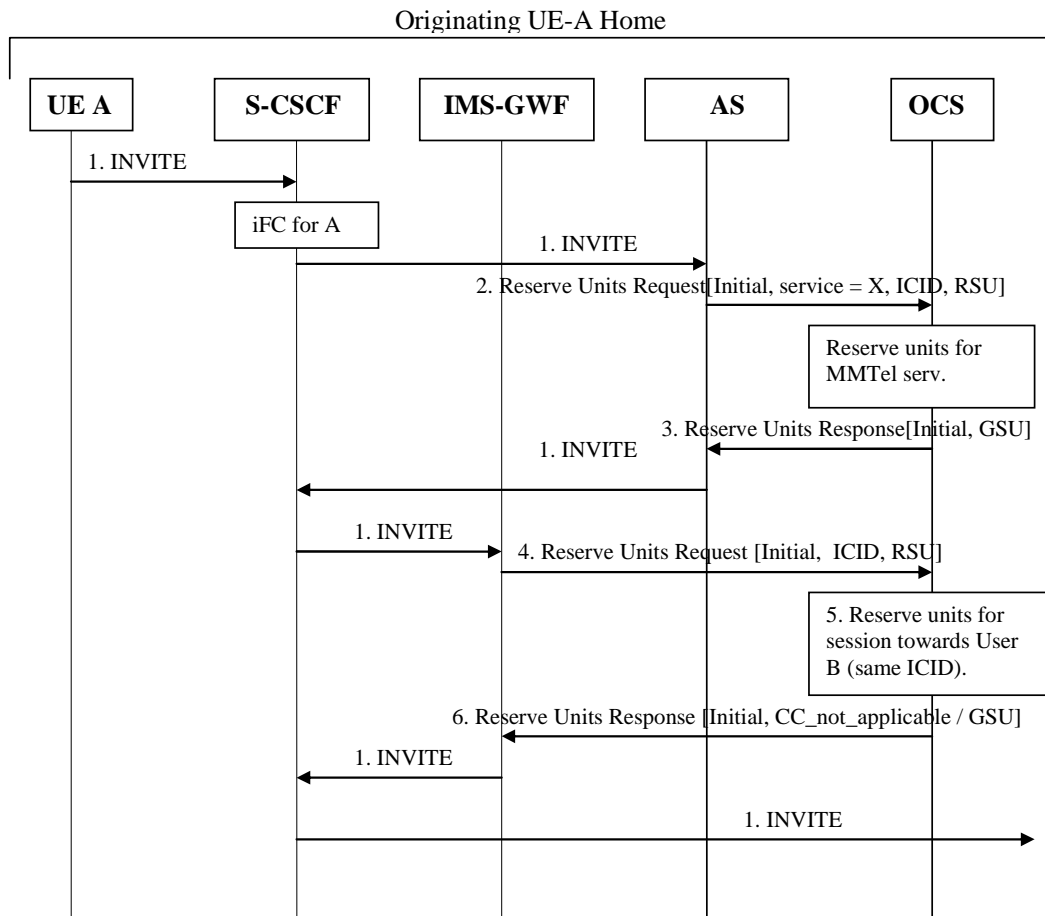

Figure 5.3.2.1.0.1: Message sequence chart for online charging – IMS-GWF, MMTel AS and OCS

1. User-A initiates a session by sending SIP INVITE request. Based on the Initial Filter Criteria (IFC) rules, indicating that User A is subscribed to the MMTel supplementary service X, the communication is forwarded to an AS implementing this service.
- 2-3. As "online charging" is activated for User A, the AS sends a Reserve Units Request [Initial, service X, ICID] to the OCS for requesting units for the X supplementary service. The OCS grants units in the Reserve Units Response response for this request. The AS forwards SIP INVITE via the S-CSCF.
4. As "online charging" is activated for User A, IMS-GWF is triggered by the S-CSCF, and IMS-GWF sends a Reserve Units Request [Initial, ICID] to the OCS for requesting units for the session identified by ICID.
- 5-6. The OCS detects this request is within a session for which there is already an ongoing online Credit-Control Diameter session (same ICID). Based on operator policy the OCS can use either Credit_Control_not_applicable to supersede online charging in S-CSCF or grant appropriate service units (GSU).

5.3.2.1.1 Communications Diversion (CDIV)

5.3.2.1.1.1 Communications Diversion (CDIV) – successful establishment

Figure 5.3.2.1.1.1.1 shows the Diameter transactions that are required between AS implementing the CDIV service and OCS, when online charging is applied to a successful CFU communication.

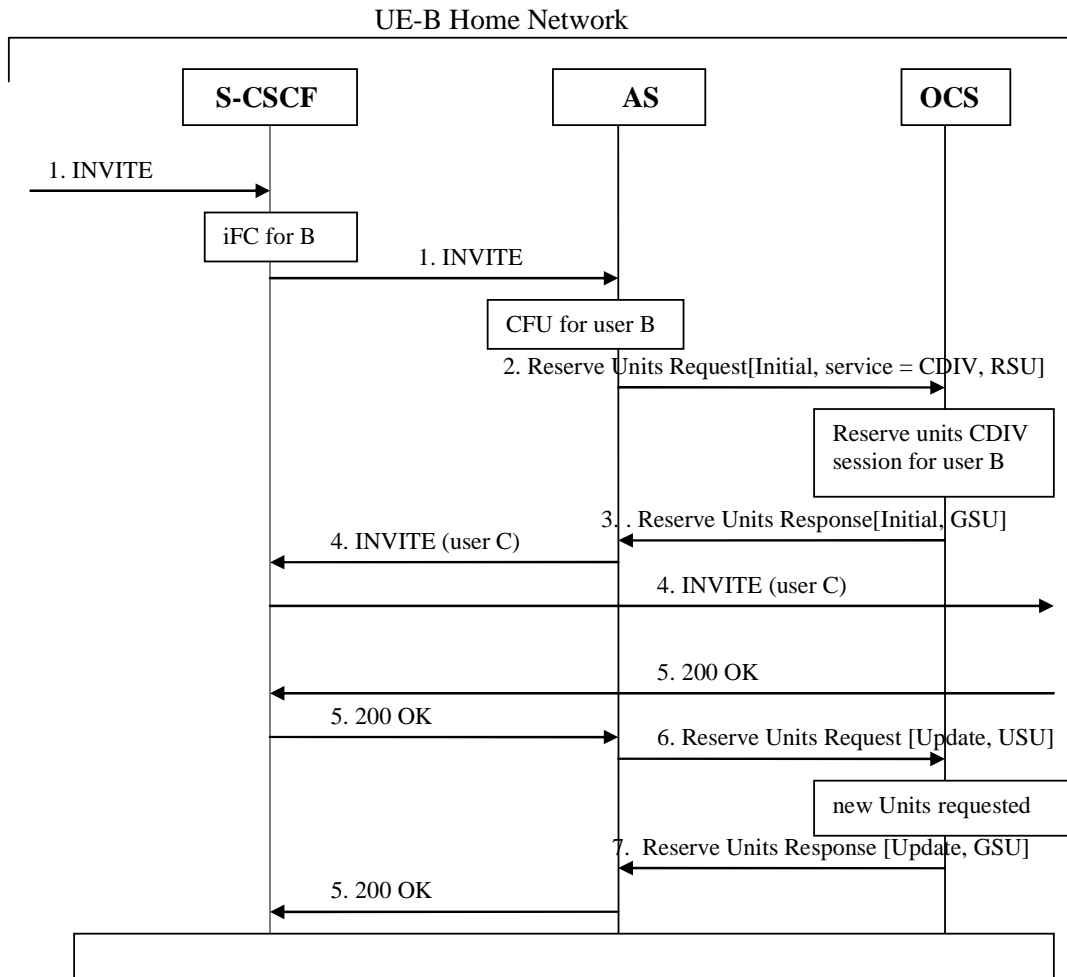

Figure 5.3.2.1.1.1.1 : Message sequence chart for online charging of CDIV service - establishment

A communication is requested towards User B: CFU and online-based charging activated for user B.

1. SIP INVITE request incoming for User B. Based on the iFC, indicating that User B is subscribed to the CDIV supplementary service, the communication is forwarded to AS implementing CDIV, where CFU is detected.
2. As the subscriber is "online charging", the AS sends a Reserve Units Request [Initial, service CDIV, ICID..] to the OCS for requesting units for the CDIV (CFU) supplementary service.
3. The OCS grants units in the Reserve Units Response response for this request.
4. The CDIV (CFU) can now be delivered: an Invite is sent towards user C via the S-CSCF.
- 5-6. On answer from User-C (SIP 200 OK), the AS sends a Reserve Units Request [Update, USU] with possible already used units and requests new units to continue.
7. New units are granted via Reserve Units Response and the SIP 200 OK is propagated.

5.3.2.1.1.2 Communications Diversion (CDIV) – release

Figure 5.3.2.1.1.2.1 shows the Diameter transactions occurring on release of the previous established communication, initiated by user C:

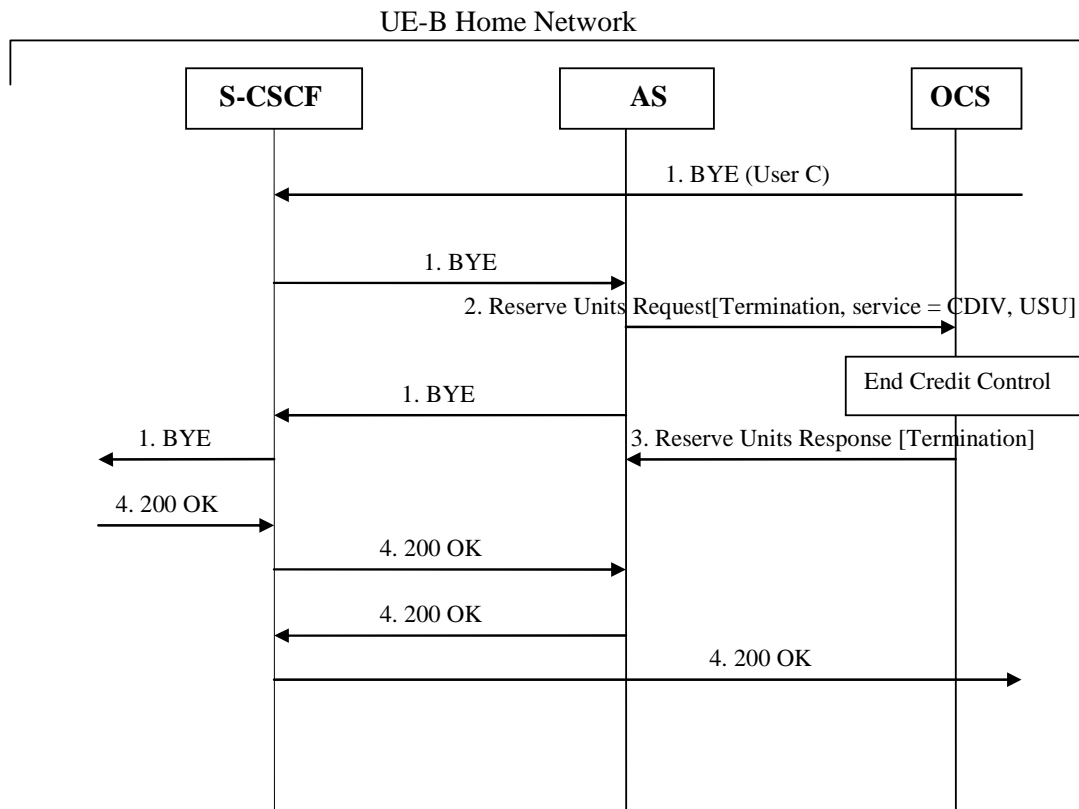

Figure 5.3.2.1.1.2.1: Message sequence chart for offline charging of CDIV service -release

1. User C initiates release of the communication.
2. At session termination the AS implementing the CDIV service, sends a Debit Units Request [Terminate, used service units] for ending Credit-Control.

5.3.2.1.2 Flexible Alerting (FA)

Figure 5.3.2.1.2.1 shows the Diameter transactions that are required between AS implementing the FA service and OCS, when online charging is applied to a successful FA communication.

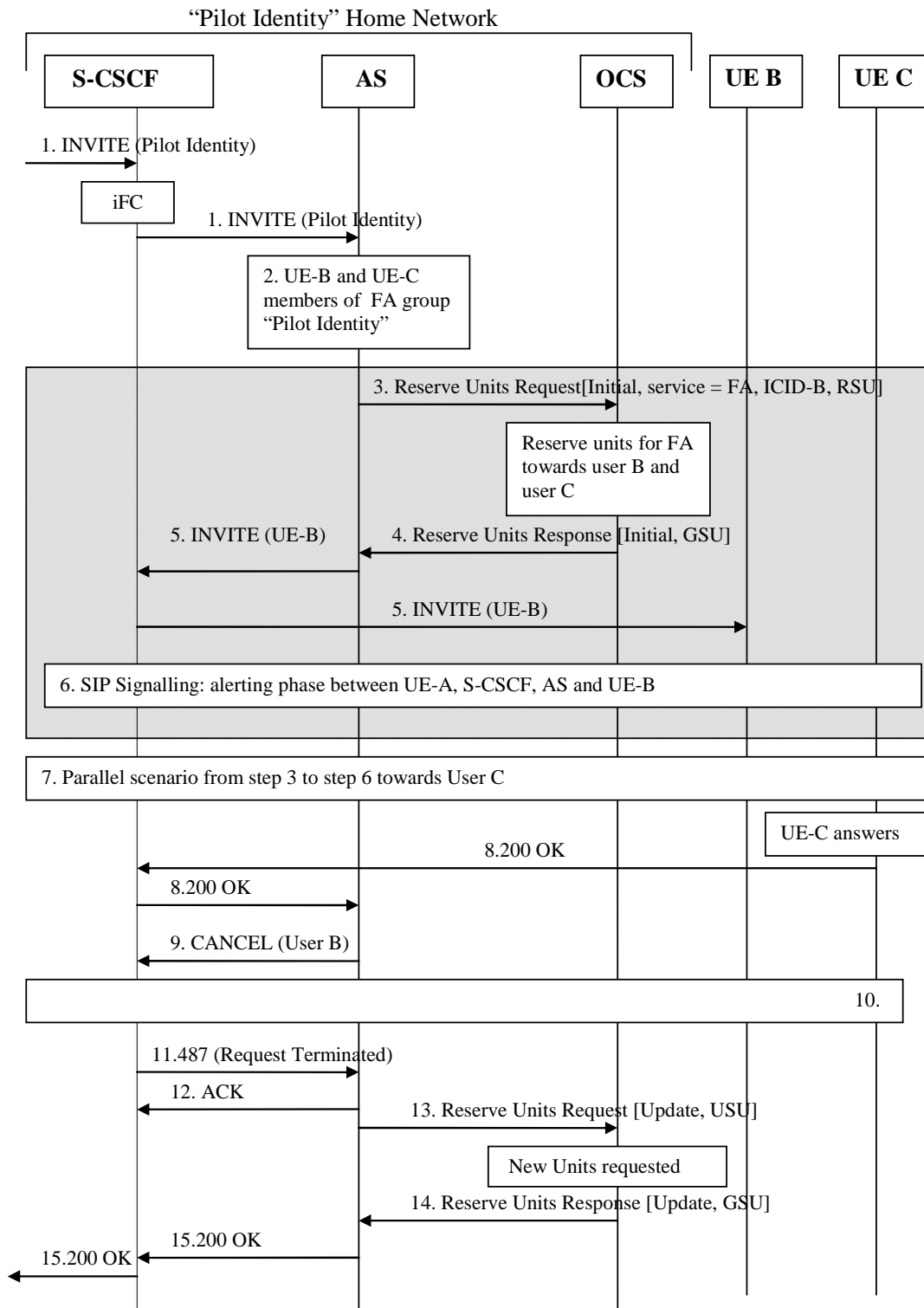

Figure 5.3.2.1.2.1: Message sequence chart for online charging of FA service

UE-B and UE-C are FA group members of the FA group identified by the "Pilot Identity".

A communication is requested from UE-A towards the "Pilot Identity".

1. SIP INVITE request incoming for "Pilot Identity". Based on the Initial Filter Criteria (IFC), indicating the request must be forwarded to an AS implementing FA for this "Pilot Identity".
2. As "online charging" is activated for the "Pilot Identity", the AS implementing FA has to initiate parallel Invite towards each of FA group members.
3. For FA member User B, the AS sends a Reserve Units Request [Initial, service FA, ICID-B] to the OCS for requesting units for the FA supplementary service.
4. The OCS grants units in the Reserve Units Response response for this request.
5. SIP INVITE is sent towards User B via the S-CSCF.
6. Alerting phase signalling occurs with UE-A.
7. A parallel (from step 3 to step 6) scenario occurs towards User-C with session identified by ICID-C.
- 8-9. Upon reception of the SIP 200 OK answer from UE-C, AS sends SIP CANCEL to other FA group member being alerted (UE-B).
10. More signalling for SIP CANCEL transactions.
- 11-13. When the last SIP CANCEL transaction is terminated, AS sends a Reserve Units Request [Update, USU] with possible already used units, and requests new units to continue the communication between User A and User C.
14. New units are granted via Reserve Units Response.
15. SIP 200 OK is propagated towards User A.

5.3.2.1.3 Closed User Group (CUG)

5.3.2.1.3.1 Closed User Group (CUG): Originating

Figure 5.3.2.1.3.1.1 shows the Diameter transactions that are required between AS implementing the CUG service and OCS, when online charging is applied to a successful originating communication from User-A CUG member.

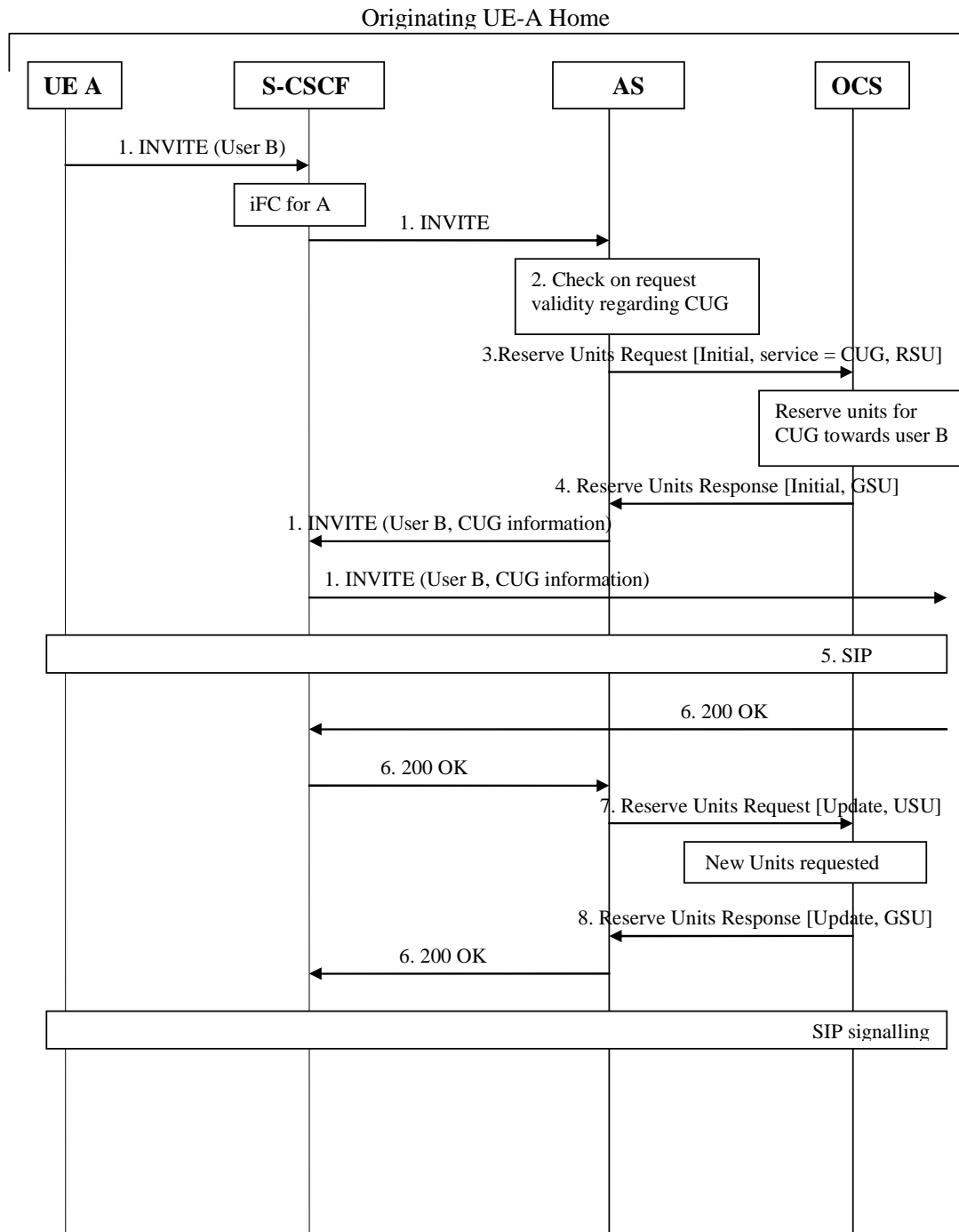

Figure 5.3.2.1.3.1.1: Message sequence chart for online charging of CUG service - originating call

User-A is subscribed to CUG service, and initiates a communication towards User B.

1. User-A initiates a communication towards User B sending SIP INVITE request. Based on the Initial Filter Criteria (IFC) rules, indicating that User A is subscribed to the CUG supplementary service, the communication is forwarded to an AS implementing CUG.

2. AS performs checks from the request received regarding User A CUG subscription profile, and determines the CUG-communication is allowed for CUG member User-A towards User-B.
 - 3-4. As "online charging" is activated for User A, the AS sends a Reserve Units Request [Initial, service CUG, ICID] to the OCS for requesting units for the CUG supplementary service. The OCS grants units in the Reserve Units Response response for this request.
The AS forwards SIP INVITE via the S-CSCF towards User-B with CUG information included.
- NOTE: In case the result from AS checks indicates non-CUG communication behaviour (for CUG communication with outgoing access...), non-CUG communication charging applies, and CUG information is not included in the forwarded Invite.
5. SIP signalling for communication establishment.
 - 6-8. SIP 200 OK answer received from User B, and AS sends a Reserve Units Request [Update, USU] with possible already used units, and requests new units to continue the CUG communication between User A and User B. New units are granted via Reserve Units Response, and SIP 200 OK is propagated towards User A.

5.3.2.1.3.2 Closed User Group (CUG): Terminating

Figure 5.3.2.1.3.2.1 shows the Diameter transactions that are required between AS implementing the CUG service and OCS, when online charging is applied to a successful terminating communication towards User-B CUG member.

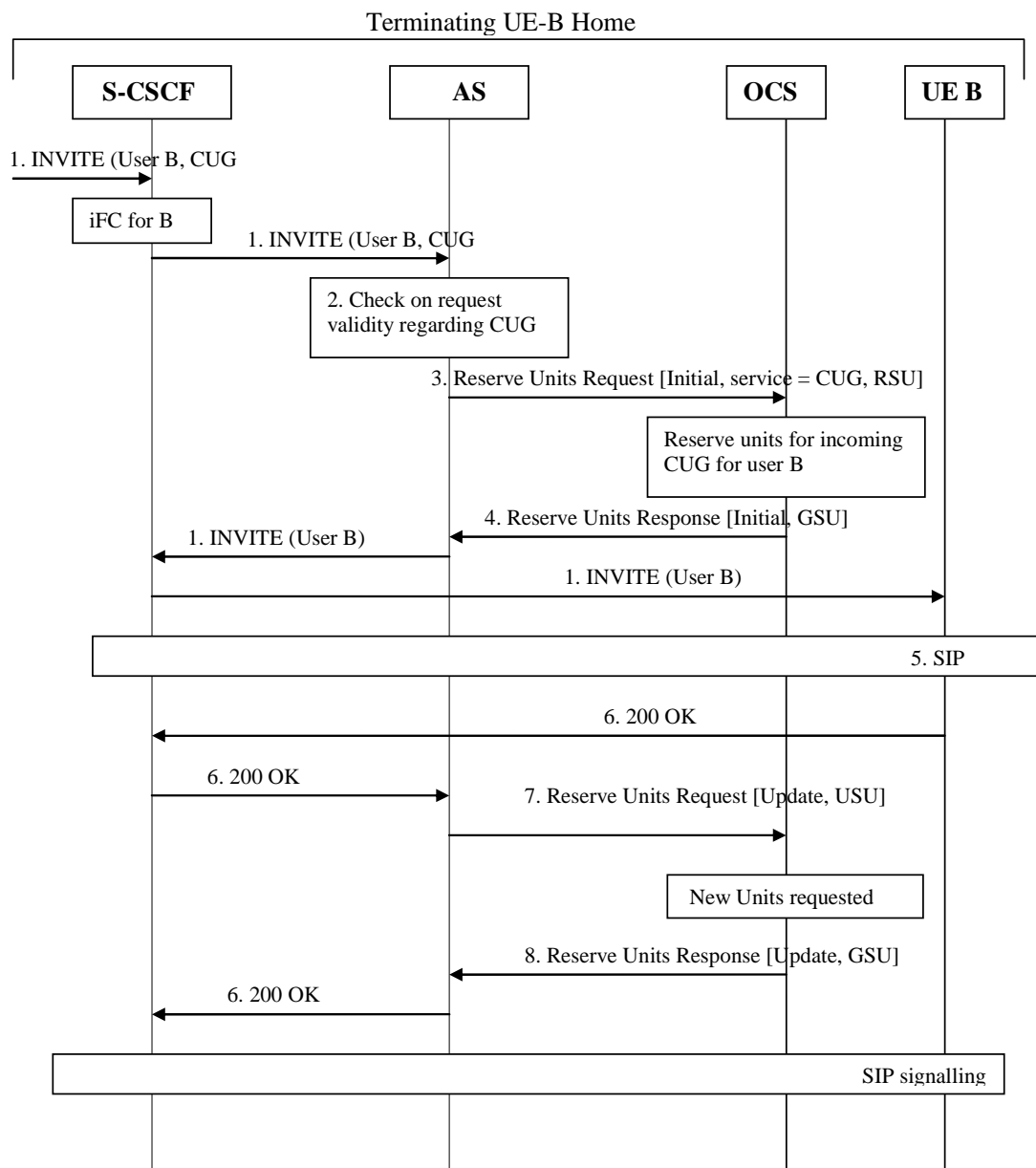

Figure 5.3.2.1.3.2.1: Message sequence chart for online charging of CUG service - terminating call

User-B is subscribed to CUG service.

1. Incoming SIP INVITE request with CUG information towards User-B. Based on the Initial Filter Criteria (IFC) rules, indicating that User B is subscribed to the CUG supplementary services, the communication is forwarded to an AS implementing CUG.
2. AS performs checks from the request received regarding User B CUG subscription profile, and determines the CUG-communication is allowed for CUG member User-B from User A.
- 3-4. As "online charging" is activated for User B, the AS sends a Reserve Units Request [Initial, service CUG, ICID] to the OCS for requesting units for the CUG supplementary service. The OCS grants units in the Reserve Units Response response for this request. The AS forwards SIP INVITE via the S-CSCF towards User-B.

NOTE: In case the result from AS checks indicates non-CUG communication behaviour (incoming access from non-CUG member...), non-CUG communication charging applies.

5. SIP signalling for communication establishment.

6-8. SIP 200 OK answer received from User B, and AS sends a Reserve Units Request [Update, USU] with possible already used units, and requests new units to continue the CUG communication between User B and User A. New units are granted via Reserve Units Response, and SIP 200 OK is propagated towards User A.

5.3.2.1.4 Conference (CONF)

5.3.2.1.4.0 Introduction

Figure 5.3.2.1.4.1.1 to figure 5.3.2.1.4.5.1 show the Diameter transactions that are required between AS implementing the CONF service and OCS, when online charging is applied to different conference scenarios.

For CONF service, two different set of scenarios are provided for illustrating the situation where ECUR or SCUR apply, depending on operator's policy.

5.3.2.1.4.1 CONF – user creating a conference - ECUR mode

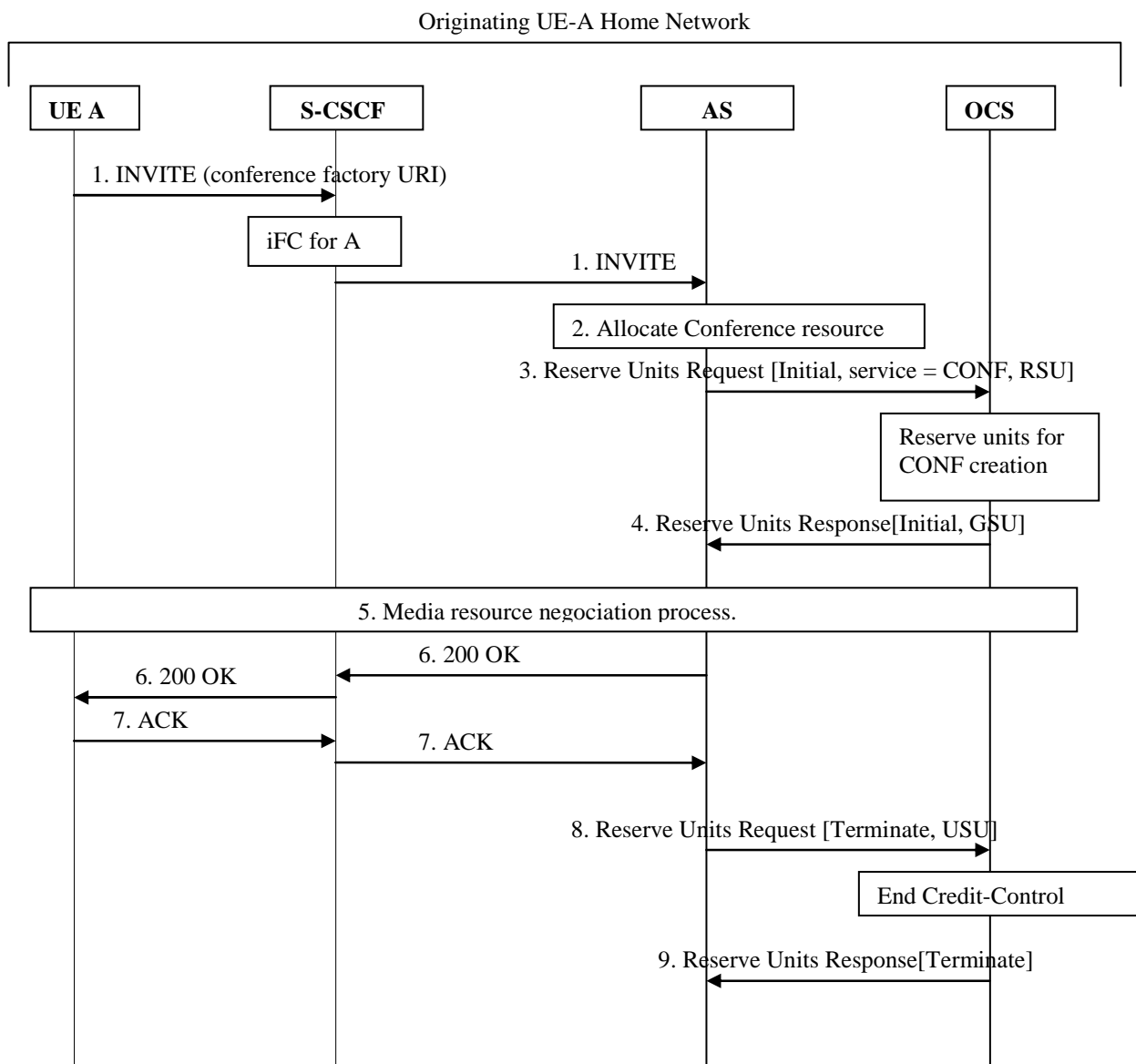

Figure 5.3.2.1.4.1.1: Message sequence chart for online charging of CONF service- User creating a conference - ECUR mode

1. User-A initiates a conference by sending an SIP INVITE request to S-CSCF. Based on the Initial Filter Criteria (IFC) rules, indicating that User A is subscribed to the CONF supplementary service, the communication is forwarded to an AS implementing CONF.

2. The CONF AS allocates the conference resource.
- 3-4. As "online charging" is activated, the AS sends a Reserve Units Request [Initial, service CONF, creation] to the OCS for requesting units for the CONF supplementary service creation.
The OCS grants units in the Reserve Units Response response for this request.
5. Media resource negotiation process.
- 6-7. The AS (CONF) sends a SIP 200 OK response replied by SIP ACK from UE-A.
- 8-9. On successful service delivery, AS (CONF) sends Reserve Units Request [Terminate, USU] for ending Credit-Control, with granted units used for CONF creation.

5.3.2.1.4.2 CONF – user creating a conference - SCUR mode

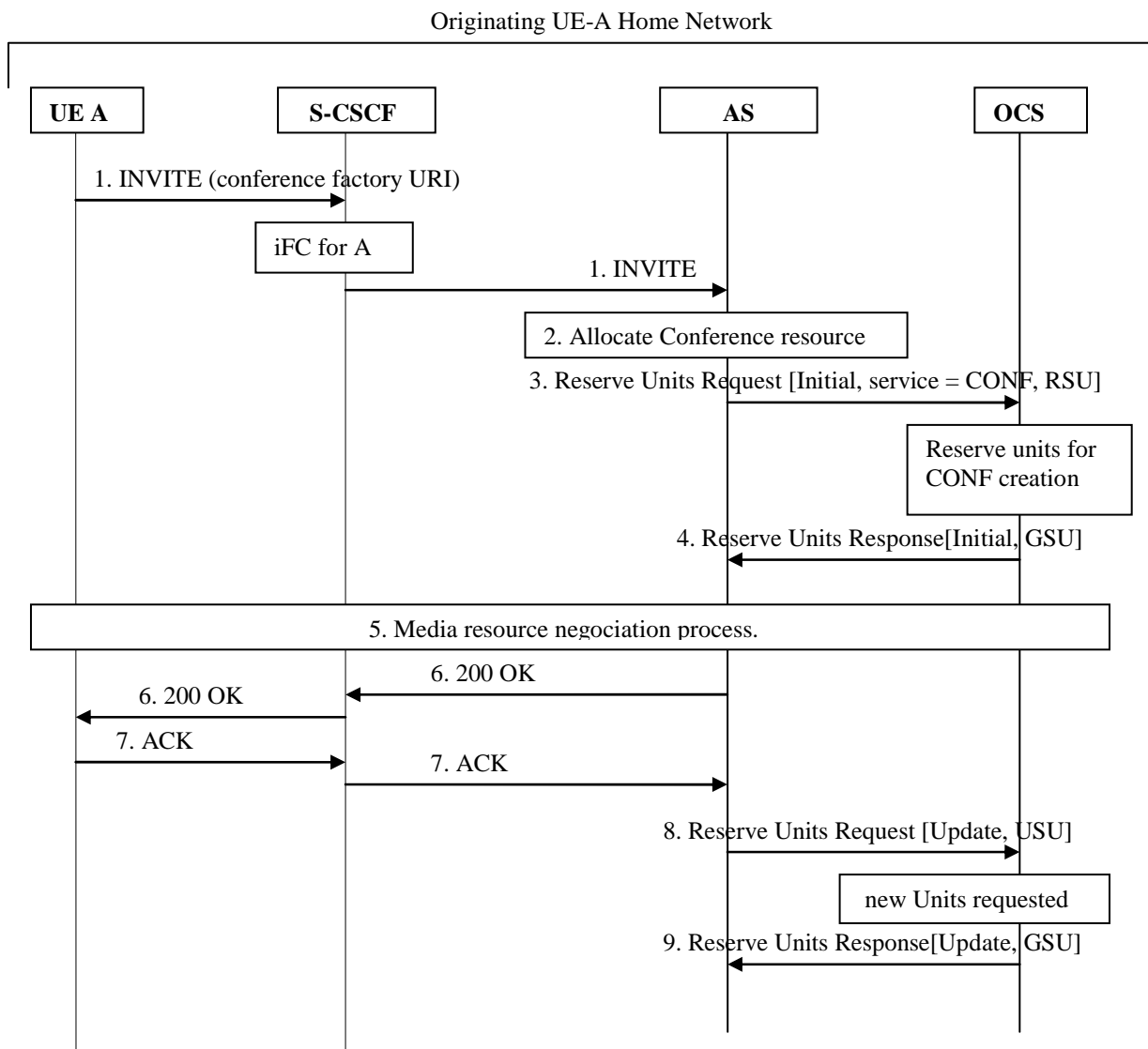

Figure 5.3.2.1.4.2.1: Message sequence chart for online charging of CONF service- User creating a conference - SCUR mode

1. User-A initiates a conference by sending an SIP INVITE request to S-CSCF. Based on the Initial Filter Criteria (IFC) rules, indicating that User A is subscribed to the CONF supplementary service, the communication is forwarded to an AS implementing CONF.
2. The CONF AS allocates the conference resource.
- 3-4. As "online charging" is activated, the AS sends a Reserve Units Request [Initial, service CONF, creation] to the OCS for requesting units for the CONF supplementary service creation. The OCS grants units in the Reserve Units Response response for this request.
5. Media resource negotiation process.
- 6-7. The AS (CONF) sends a SIP 200 OK response replied by ACK from UE-A.

8-9. As CONF charging is based on duration or other CONF parameters, from start of the service on step 7), new units are subsequently requested by sending Reserve Units Request [Update, USU] with already used units, for continuing the service when new CONF parameters or values are provided.

5.3.2.1.4.3 CONF – user joining a conference (SCUR mode)

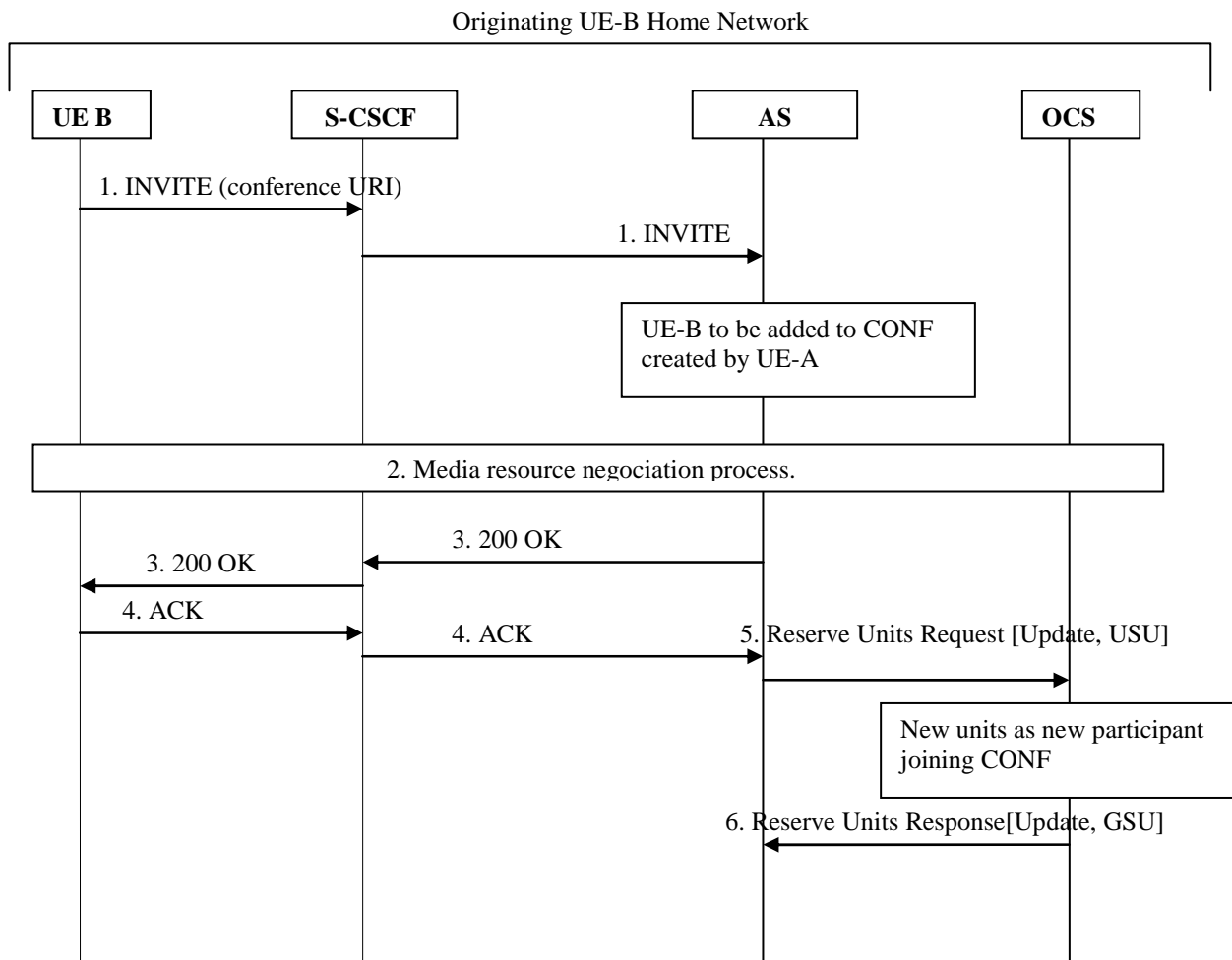

Figure 5.3.2.1.4.3.1: Message sequence chart for online charging of CONF service- User joining a conference - SCUR mode

1. The conference has already been created by User A. User-B sends an SIP INVITE request to S-CSCF in order to join in the conference identified by the conference URI. The communication is forwarded to AS addressed by conference URI.
2. Media resource negotiation process for adding UE-B to the conference.
- 3-4. The AS (CONF) sends a SIP 200 OK response replied by SIP ACK from UE-B.
- 5-6. This step applies for SCUR mode, when "Nb of participants" is needed for the "online charging" running for this conference: the AS(CONF) sends a Reserve Units Request [Update, USU] with possible already used units, for requesting new units with new number of participants. The OCS grants units in the Reserve Units Response response for this request.

5.3.2.1.4.4 CONF – user inviting another user to a conference (SCUR mode)

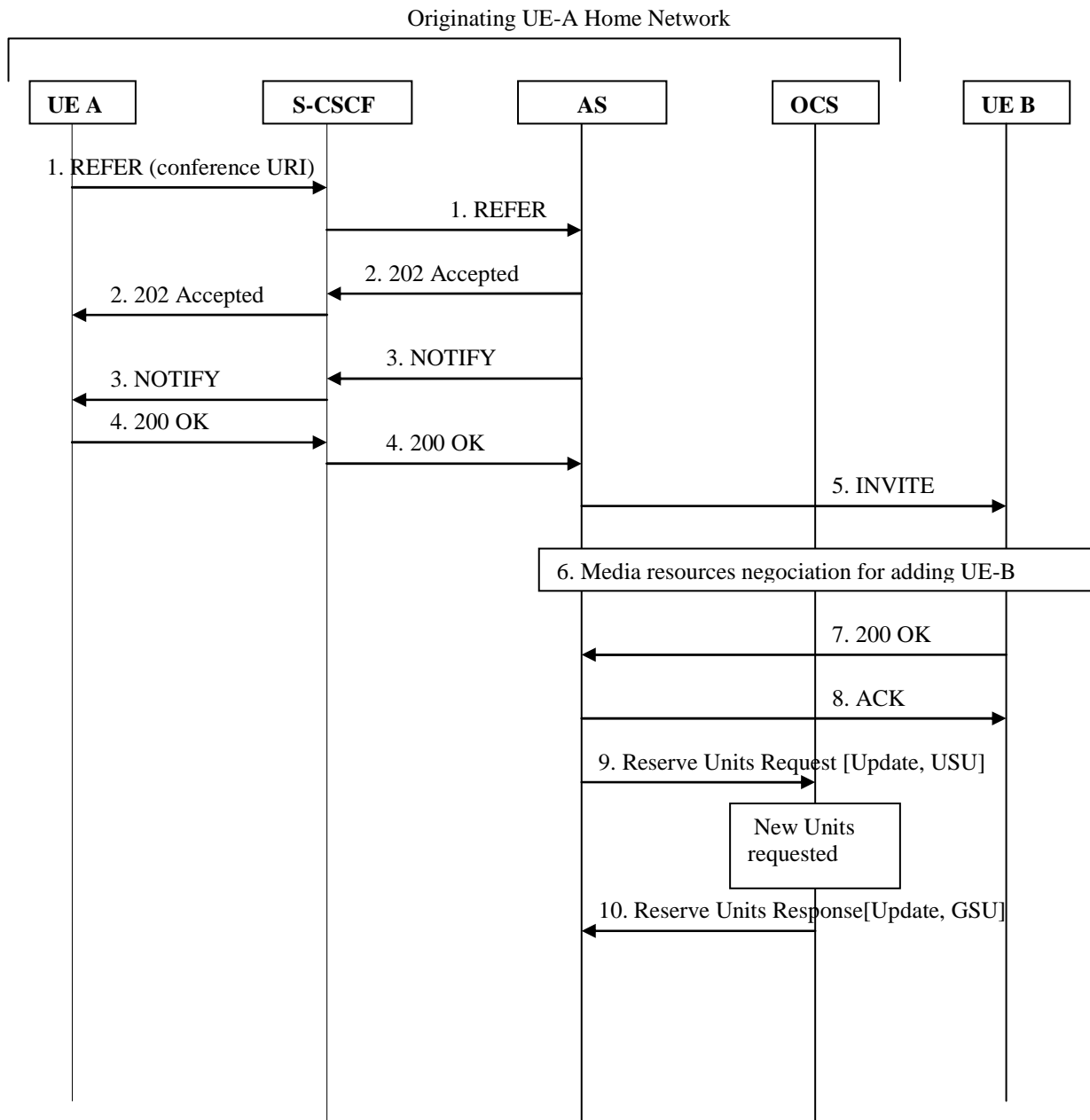

Figure 5.3.2.1.4.4.1: Message sequence chart for online charging of CONF service - user inviting another user to a conference – SCUR mode

1. The conference has already been created by User A. User A sends aSIP REFER request to S-CSCF with the conference URI in order to invite User B into the conference. The communication is forwarded to the AS addressed by conference URI.
- 2-4. Sequence between UE-A and AS (CONF) to proceed the SIP REFER (accept, SIP NOTIFY...).
5. User B is invited to the Conference by SIP INVITE from AS (CONF).
6. Media resource negotiation process for adding UE-B to the conference.

7-8. UE-B sends SIP 200 OK response when he joins the conf, replied by ACK from AS (CONF).

9-10. This step applies for SCUR mode, when "Nb of participants" is needed for the "online charging" running for this conference: the AS(CONF) sends a Reserve Units Request [Update, USU] with possible already used units, for requesting new units with new number of participants. The OCS grants units in the Reserve Units Response response for this request.

5.3.2.1.4.5 CONF – user leaving a conference (SCUR mode)

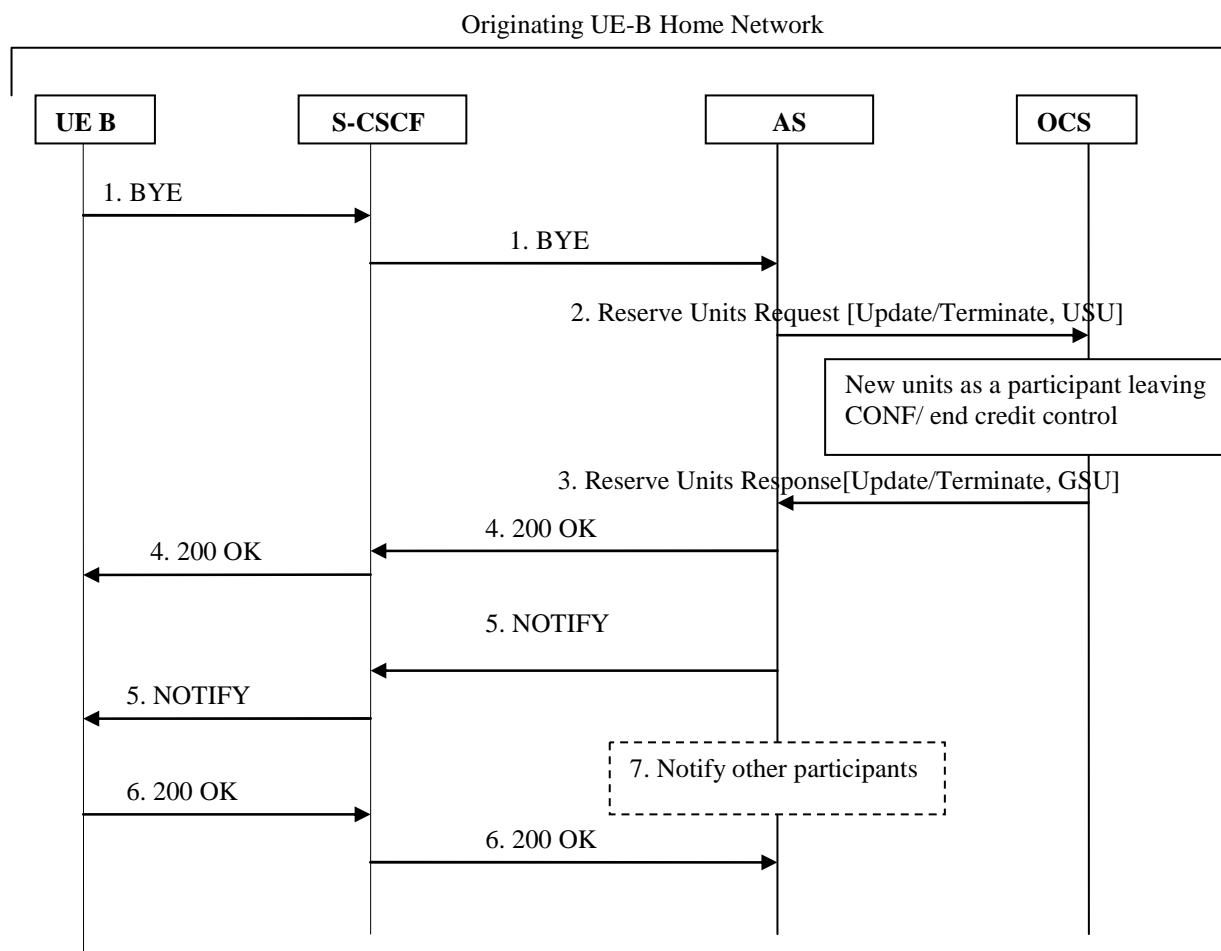

Figure 5.3.2.1.4.5.1: Message sequence chart for online charging of CONF service - user leaving a conference SCUR mode

1. The conference has already been created. User B sends a SIP BYE request request to the AS (CONF) in order to quit the conference. The communication is forwarded to the AS addressed by conference URI.

2-3. This step applies for SCUR mode:

- In case "Nb of participants" is needed for the "online charging" running for this conference, and UE-B leaving does not cause conference termination: the AS(CONF) sends a Reserve Units Request [Update, USU] with possible already used units, for requesting new units with new number of participants. The OCS grants units in the Reserve Units Response response for this request.
- In case UE-B leaving does cause conference termination, the AS(CONF) sends a Reserve Units Request [Terminate, USU] with used units, for ending Credit-Control.

4. The AS (CONF) sends back SIP 200 OK response to UE-B.

5-6. The AS (CONF) sends a SIP NOTIFY request to UE-B for unsubscribe UE-B to conf event package, replied by SIP 200 OK from UE-B.

7. This step does not apply if conference has terminated:
Other conference participants are Notified UE-B has quit the conference.

5.3.2.1.4.6 CONF (3PTY) – successful establishment

Figure 5.3.2.1.4.6.1 shows the Diameter transactions that are required between AS implementing the CONF (3PTY) service and OCS, when online charging is applied to a successful 3PTY conference scenario.

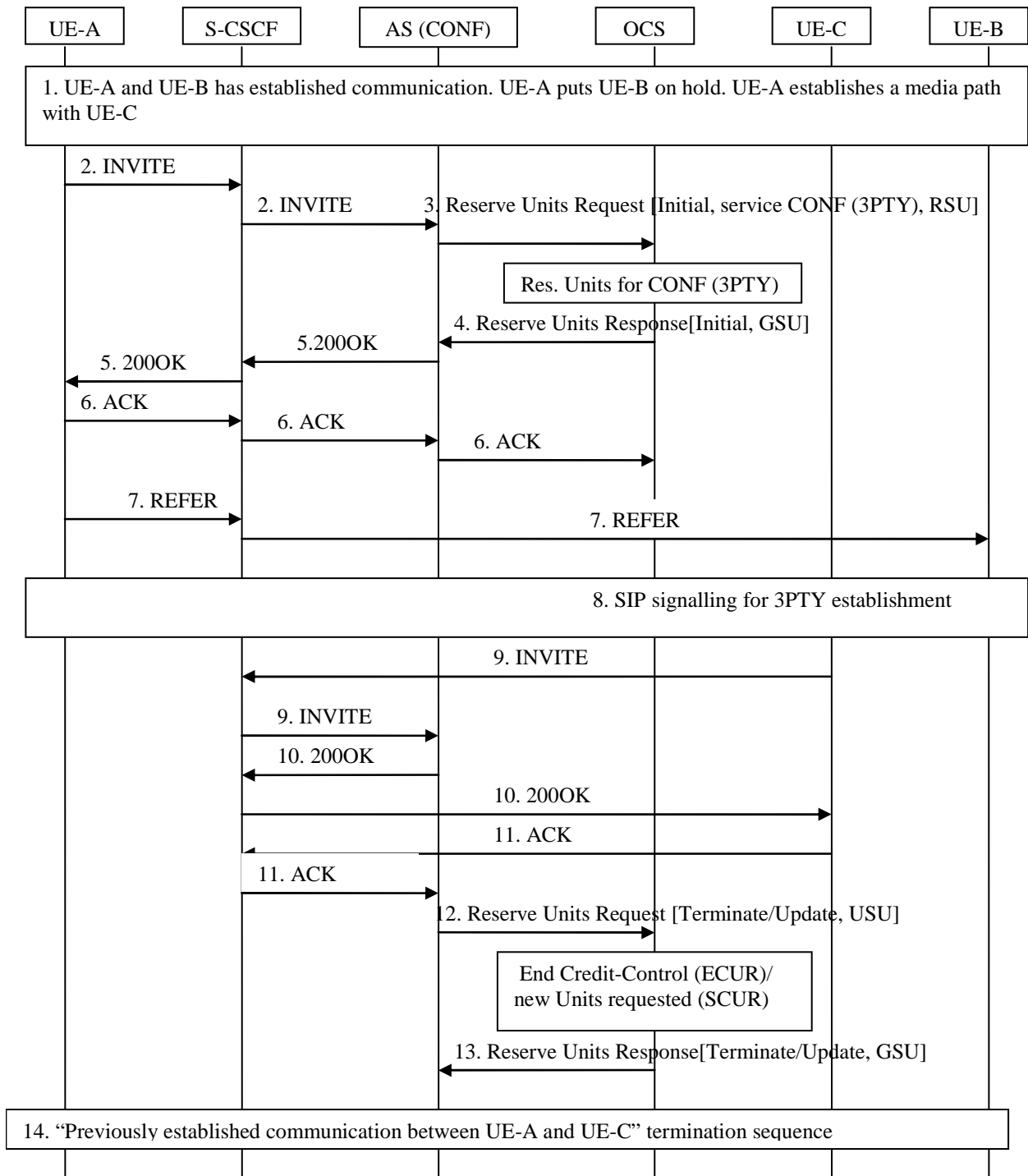

Figure 5.3.2.1.4.6.1: Message sequence chart for online charging of CONF (3PTY) service - establishment

1. UE-A and UE-B have established communication. UE-A puts UE-B on hold. Before invoking the 3-Way Calling UE-A establishes a communication with UE-C.
2. UE-A sends an SIP INVITE request to the AS (CONF) to establish a 3PTY session.
- 3-4. As "online charging" is activated, the AS (CONF) sends a Reserve Units Request [Initial, service CONF (3PTY)] to the OCS for requesting units for the service. The OCS grants units in the Reserve Units Response response for this request.
- 5-6. The AS (CONF) sends a SIP 200 OK response replied by SIP ACK from UE-A.
7. UE-A sends a SIP REFER request to UE-B with the Refer-To header set to the address of the AS (CONF).
8. Sequence for 3PTY establishment:
 - SIP REFER sequence (accept, SIP NOTIFY...) between UE-B and UE-A.
 - SIP INVITE from UE-B sequence for joining
 - Original communication UE-A UE-B sequence termination
 - SIP REFER sequence (accept, SIP NOTIFY...) between UE-A and UE-C.
- 9-11. SIP INVITE from UE-C sequence for joining the CONF (3PTY)
- 12-13. In case ECUR mode applies to CONF (3PTY) Charging, on SIP ACK receipt, AS (CONF) sends Reserve Units Request [Terminate, USU] for ending Credit-Control, with granted units used for 3PTY creation.

In case SCUR mode applies to CONF (3PTY) charging (charging to be based on duration or other parameters), from ACK receipt, new units are subsequently requested by sending Reserve Units Request [Update, USU] with already used units, for continuing the service when new CONF parameters or values have are provided.
14. Original communication UE-A UE-C sequence termination, occurring at any time from step 11.

5.3.2.1.5 Explicit Communication Transfer (ECT)

5.3.2.1.5.0 Introduction

Figure 5.3.2.1.5.1.1 and figure 5.3.2.1.5.1.2 show the Diameter transactions that are required between AS implementing the ECT service and OCS, when online charging is applied to a successful Blind Transfer from User A to User C, initiated by User B.

For diagram simplification, only one OCS is shown.

5.3.2.1.5.1 Explicit Communication Transfer (ECT): Blind Transfer with sending SIP REFER

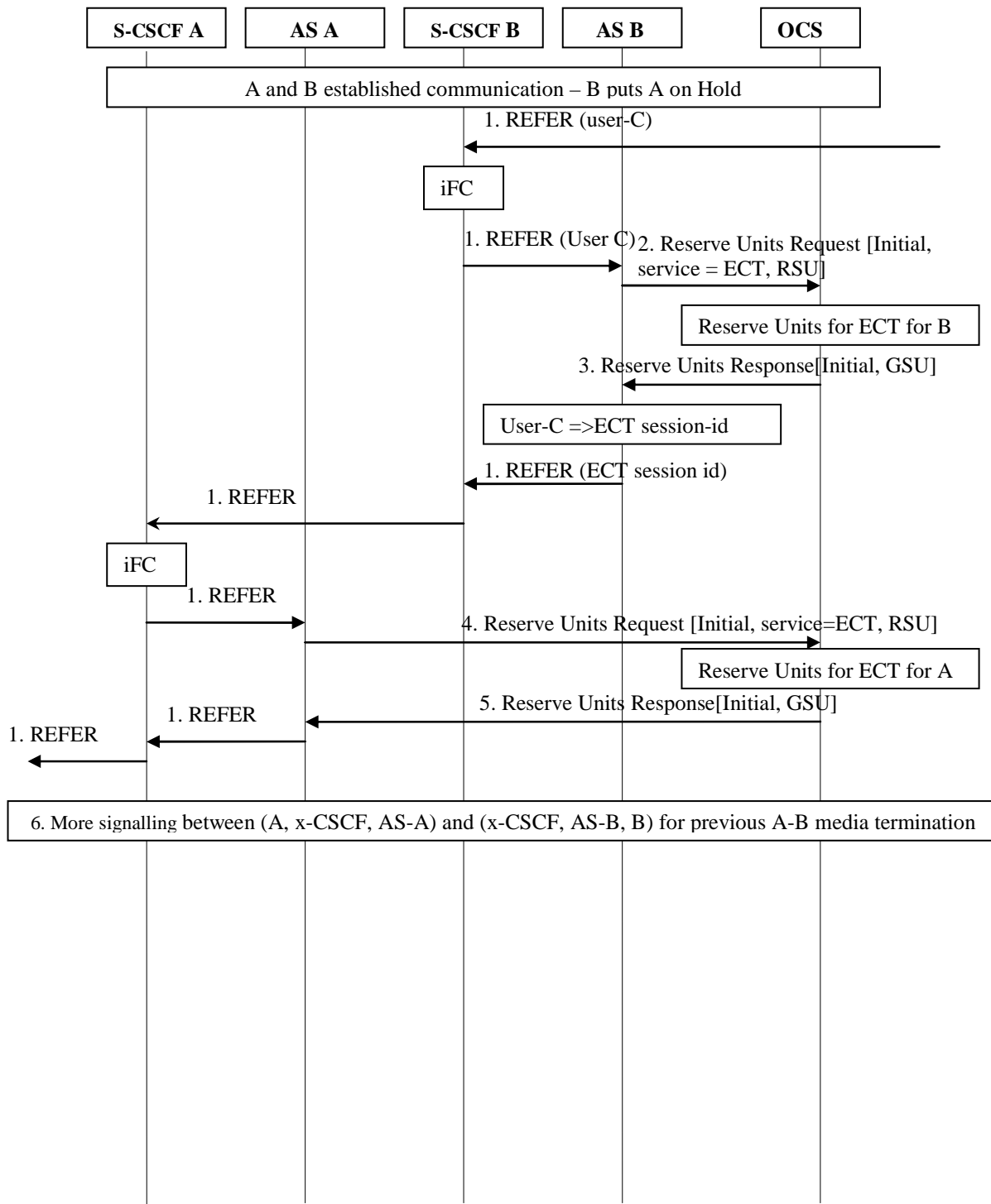

Figure 5.3.2.1.5.1.1: Message sequence chart for online charging of ECT service establishment – Blind Transfer (part 1)

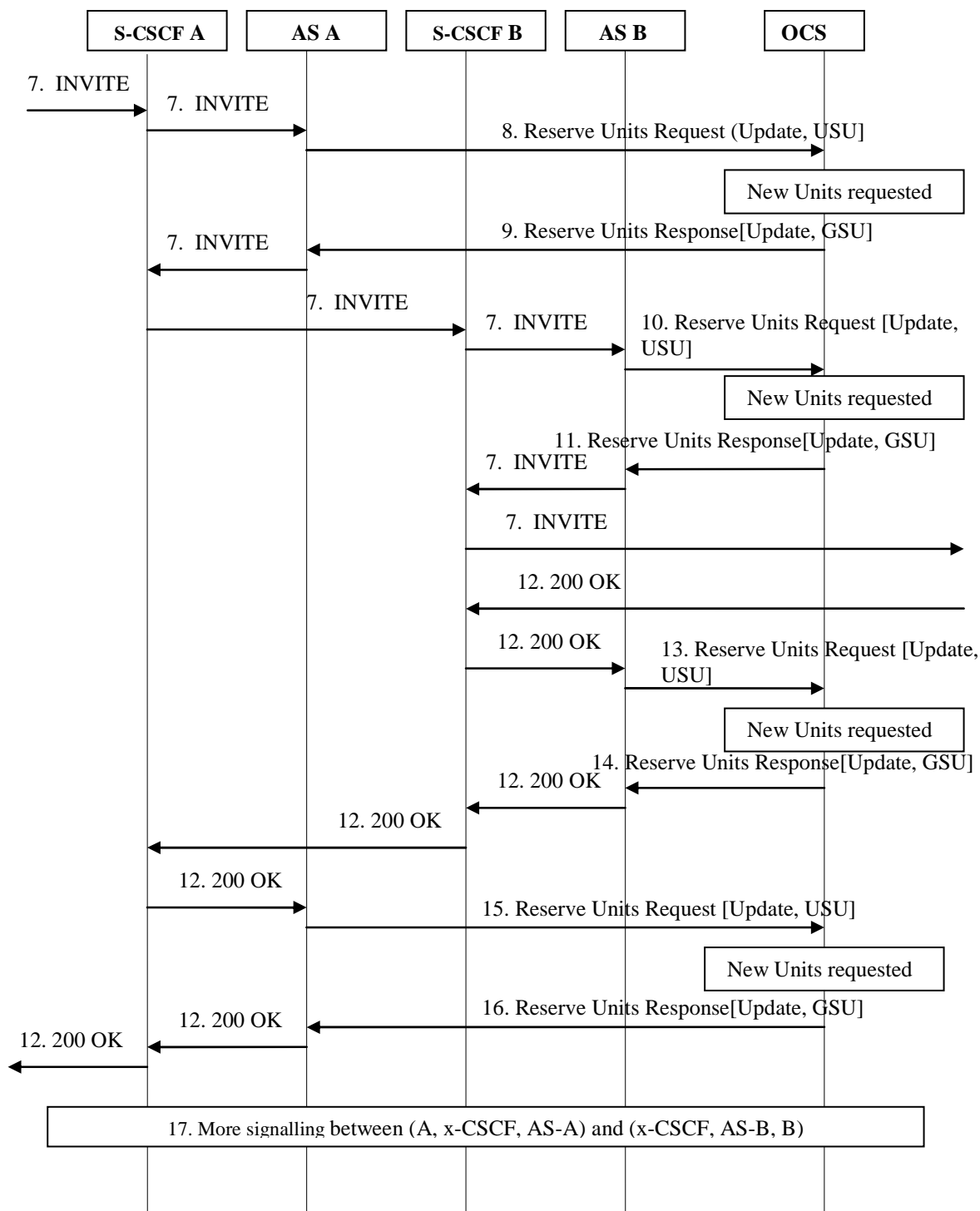

Figure 5.3.2.1.5.1.2: Message sequence chart for online charging of ECT service establishment – Blind Transfer (part 2)

In this scenario User A is the transferee, User B is the transferor, and User C is the transfer target.

User A and User B are in an established communication, User B puts User A on Hold.

1. User B sends SIP REFER request in the existing A-B dialog, to initiate transfer User A to User C. Based on the iFC, indicating that User B is subscribed to the ECT supplementary service, the communication is forwarded to AS implementing ECT.
 - 2-3. As "online charging" is activated, the AS sends a Reserve Units Request [Initial, service ECT] to the OCS for requesting units for the ECT supplementary service. The OCS grants units in the Reserve Units Response response for this request. The AS generates an "ECT Session Identifier" replacing User C as the new destination information and forwards SIP REFER towards User A.
 - 4-5. As "online charging" is activated for User A, the AS sends a Reserve Units Request [Initial, service ECT] to the OCS for requesting units for the ECT supplementary service for the transferee. The OCS grants units in the Reserve Units Response response for this request. The AS forwards SIP REFER towards User-A.
 6. More signalling between (User A, x-CSCF, AS-A) and (x-CSCF, AS-B, User B) for SIP REFER acceptance sequence and terminating previous media between User A and User B.
 7. User A initiates a new session by sending an SIP INVITE request with "ECT Session Identifier".
 - 8-9. AS implementing the ECT service for the transferee correlates this SIP INVITE to the transfer being processed, and new units are requested by sending Reserve Units Request [Update, USU] with already used units, for continuing the service. The AS forwards SIP INVITE request.
 - 10-11. AS implementing the ECT service for the transferor correlates this SIP INVITE to the initial session to be transferred and new units are requested by sending Reserve Units Request [Update, USU] with already used units, for continuing the service, prior to forwarding SIP INVITE towards UE-C.
 12. The destination User C party answers, and a final response is received.
 - 13-14. On transfer execution, the AS sends a Reserve Units Request [Update, USU] with possible already used units and requests new units for transferor to continue.
 - 15-16. On transfer execution, the AS sends a Reserve Units Request [Update, USU] with possible already used units and requests new units for transferee to continue.
- NOTE 1: For "Consultative Transfer" scenario, the same steps apply for interactions with OCS for transferee and transferor: Reserve Units Request [Initial] on SIP REFER initiating, intermediate Reserve Units Request [Update] for more units on SIP INVITE for new session, and Reserve Units Request [Update] for more units on transfer execution when User C answers.
- NOTE 2: For "Assured Transfer" scenario, the same steps apply for interactions with OCS for transferee and transferor: Reserve Units Request [Initial] on SIP REFER initiating, intermediate Reserve Units Request [Update] for more units on SIP INVITE for new session, and Reserve Units Request [Update] for more units on transfer execution when User C answers. Besides, Reserve Units Request [Terminate] on transferring timeout or failure, and Reserve Units Request [Update] for more units on original dialog retrieval.

5.3.2.1.5.2 Explicit Communication Transfer (ECT): Blind Transfer with 3PCC

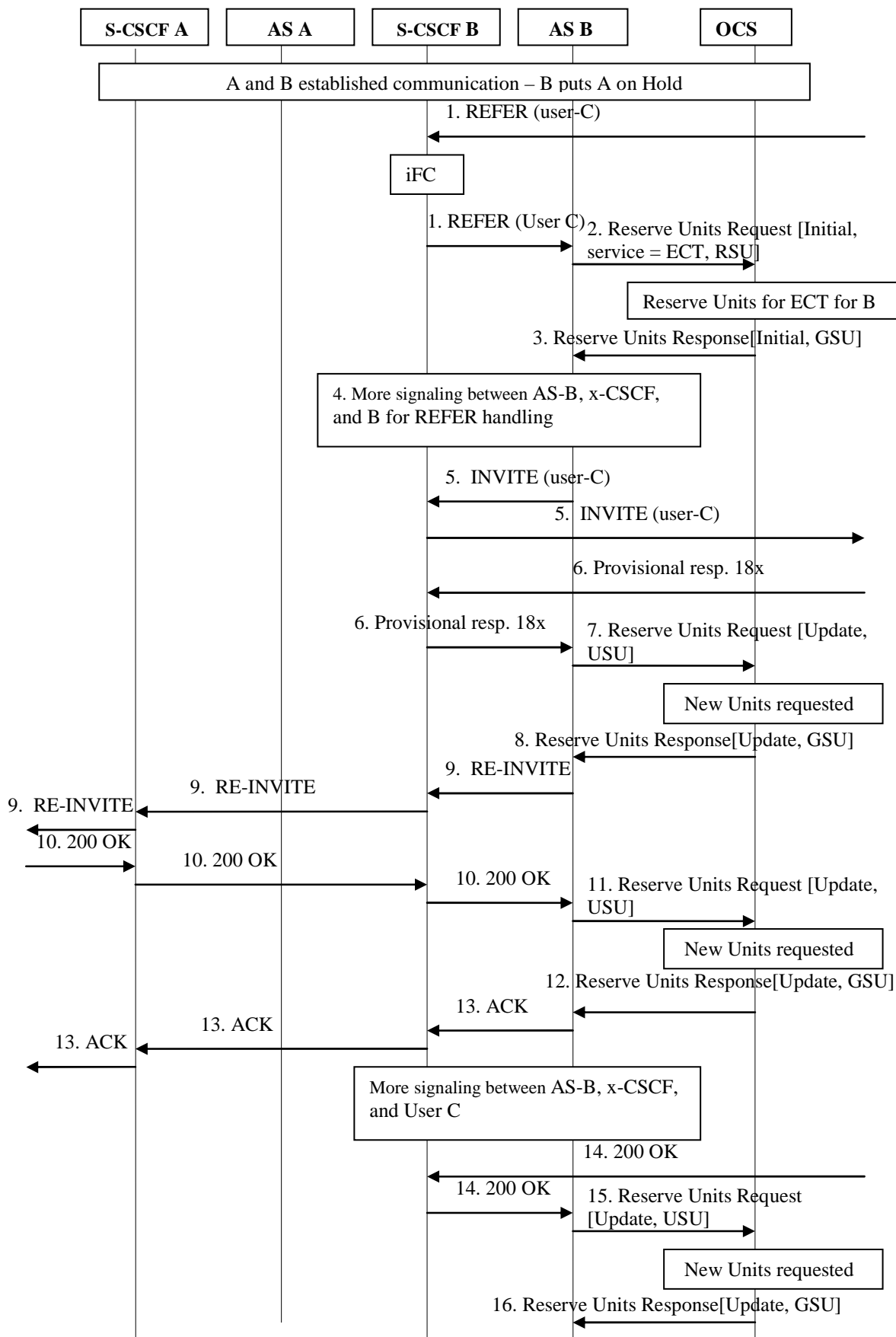

Figure 5.3.2.1.5.2.1: Message sequence chart for online charging of ECT service establishment – Blind Transfer with 3PCC

In this scenario User A is the transferee, User B is the transferor, and User C is the transfer target, and the User B's AS acts as a 3PCC (Third Party Call Control) initiating B2BUA:

User A and User B are in an established communication, User B puts User A on Hold.

1. User B sends SIP REFER request in the existing A-B dialog, to initiate transfer User A to User C. Based on the iFC, indicating that User B is subscribed to the ECT supplementary service, the communication is forwarded to AS implementing ECT in a 3PCC mode.
- 2-3. As "online charging" is activated, the AS sends a Reserve Units Request [Initial, service ECT] to the OCS for requesting units for the ECT supplementary service. The OCS grants units in the Reserve Units Response response for this request.
- 4-5. AS B performs the SIP REFER procedure with User B, and sends SIP INVITE towards User C.
- 6-8. On Provisionnal response from User C, the AS sends a Reserve Units Request [Update, USU] with possible already used units and requests new units for transferor to continue.
9. AS B sends SIP Re-INVITE towards User A on existing dialog. From User A side, the basic SIP RE-INVITE procedure applies (ECT service not invoked).
- 10-13. On SIP 200 OK response from User A, the AS sends a Reserve Units Request [Update, USU] with possible already used units and requests new units for transferor to continue, and sends ACK back to User A.
- 14-16. On SIP 200 OK response from User C, the AS sends a Reserve Units Request [Update, USU] with possible already used units and requests new units for transferred communication to continue.

5.3.2.1.5.3 Explicit Communication Transfer (ECT): Release

Figure 5.3.2.1.5.3.1 shows the Diameter transactions that are required between ASs implementing the ECT service for the transferor and for the transferee, and OCS: release from User A, after a successful Blind Transfer from User A to User C, initiated by User B.

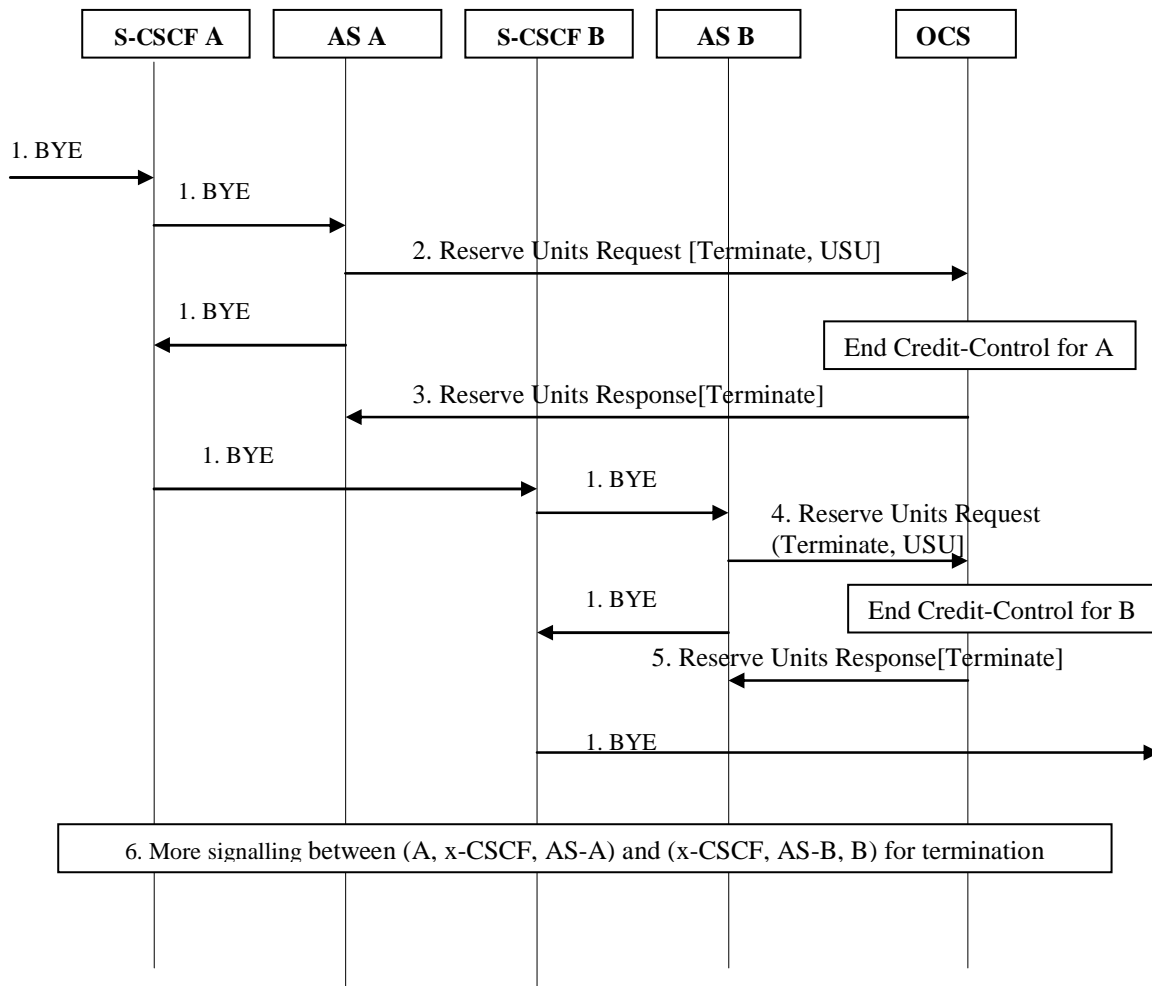

Figure 5.3.2.1.5.3.1: Message sequence chart for offline charging of ECT service – release

1. User A initiates release of the communication.
- 2-3. At session termination the AS implementing the ECT service for the transferee, sends a Reserve Units Request [Terminate, USU] with used units, for ending Credit-Control.
- 4-5. At session termination the AS implementing the ECT service for the transferor, sends a Reserve Units Request [Terminate, USU] with used units, for ending Credit-Control.

NOTE: For "Blind Transfer with 3PCC" release scenario, only interactions between AS-B and OCS apply for ECT service.

5.3.2.2 Message flows - error cases and scenarios

Error cases and scenarios for SIP related procedures and Diameter related procedures used for MMTel service and Supplementary services charging are defined in TS 32.260 [20].

6 Definition of charging information

6.1 Data description for MMTel offline charging

6.1.1 Rf message contents

6.1.1.0 Introduction

For offline charging, the different service CTFs supporting MMTel specific service charging generate accounting information transferred to the CDF using the Diameter accounting application, as described in TS 32.299 [50].

The *Charging Data Request* and *Charging Data Response* are used for this MMTel service offline charging, as described in TS 32.260 [20].

6.1.1.1 Charging Data Request message description

The generic *Charging Data Request* message described in TS 32.260 [20] used for MMTel offline charging is enhanced with specific MMTel service information.

Table 6.1.1.1.1 illustrates the overall *Charging Data Request* message as used for MMTel offline charging.

Table 6.1.1.1.1: Charging Data Request message contents

Information Element	Category	Description
See <i>Charging Data-Request</i> message fields described in TS 32.260 [20]		
Service Information	O _M	This field holds the MMTel specific parameter and is described in clause 6.3.

NOTE: Detailed descriptions of the fields are provided in TS 32.299 [50].

6.1.1.2 Charging Data Response message description

The generic *Charging Data Response* message described in TS 32.260 [20] is used for MMTel offline charging.

6.1.2 GTP' message contents

Not applicable. Refer to sclause 5.2.3 for further information.

6.1.3 CDR description on the Bi interface

6.1.3.1 CDR field type

The MMTel CDR content and format description is based on TS 32.260 [20] AS-CDR description, enhanced with specific MMTel service information.

The content of MMTel CDR type is defined in the table in clause 6.1.3.3. The field definition includes the field name, category and description. The detailed field descriptions are provided in TS 32.298 [51].

The CDF provides the CDRs at the Bi interface in the format and encoding described in TS 32.298 [51]. Additional CDR formats and contents may be available at the interface to the billing system to meet the requirements of the billing system, these are outside of the scope of standardization.

6.1.3.2 CDR triggers

Accounting information for MMTel services charging is transferred from the CTFs supporting MMTel service charging to the CDF, using Charging Data Request Start, Interim Stop or Event messages, depending on MMTel service behaviour (detailed in clause 5.2.2). Within the CDF, the CDRs triggering follows the same principle as described for SIP sessions in TS 32.260 [20]: MMTel CDR is opened upon reception of a Charging Data Request [Start] message, closed upon reception of a Charging Data Request [Stop] message, updated upon reception of a Charging Data Request [Interim], and created upon reception of a Charging Data Request [Event].

6.1.3.3 MMTel-AS CDR content

The MMTel CDR content and format description is based on TS 32.260 [20] AS-CDR description, enhanced with specific MMTel information.

The detailed description of the field is provided in TS 32.298 [51].

Table 6.1.3.3.1 : Charging data of MMTel CDR

Field	Category	Description
See Charging Data of AS CDR described in TS 32.260 [20].		
MMTel information	O _C	This field includes a list of MMTel supplementary services which may occur within the same AS. The MMTel supplementary services related informations are described in clause 6.3.1.2.

6.2 Data description for MMTel online charging

6.2.1 Ro message contents

6.2.1.0 Introduction

For online charging, the different service CTFs supporting MMTel specific service charging, generate debit and reserve units information transferred to the OCF. For this purpose, MMTel online charging utilises the *Debit Units* and *Reserve Units* procedure specified in the Debit / Reserve Units operation in TS 32.299 [50].

The *Debit / Reserve Units Request* and *Debit / Reserve Units Response* messages are used for this MMTel service online charging, as described in TS 32.260 [20].

6.2.1.1 Debit / Reserve Units Request message

The generic *Debit / Reserve Units Request* message described in TS 32.260 [20], used for MMTel online charging is enhanced with specific MMTel service information.

Table 6.2.1.1.1 illustrates the overall *Debit / Reserve Units Request* message as used for MMTel online charging.

Table 6.2.1.1.1: Debit / Reserve Units Request message contents

Information Element	Category	Description
See <i>Debit / Reserve Units Request</i> message fields described in TS 32.260 [20].		
Service Information	O _M	This field holds the MMTel specific parameter and is described in clause 6.3.

NOTE: Detailed descriptions of the fields are provided in TS 32.299 [50].

6.2.1.2 Debit / Reserve Units Response message

The generic *Debit / Reserve Units Response* message described in TS 32.260 [20] is used for MMTel online charging.

6.3 MMTel charging specific parameters

6.3.1 Definition of MMTel charging information

6.3.1.0 Introduction

The MMTel Information parameter used for MMTel charging is provided in the Service Information parameter.

6.3.1.1 MMTel charging information assignment for Service Information

The components in the Service Information that are use for MMTel charging can be found in table 6.3.1.1.1.

Table 6.3.1.1.1: Service Information used for MMTel charging

Information Element	Category	Description
Service Information	O _M	A set of fields hold the 3GPP specific parameter as defined in TS 32.299 [50].
Subscription Id	O _M	Used as defined in TS 32.260 [20].
IMS Information	O _C	The details are defined in TS 32.260 [20].
PS Information	O _C	The details are defined in TS 32.260 [20].
MMTel Information	O _M	This field holds a set of MMTel services with theirs specific parameters. The details are defined in clause 6.3.1.2.

6.3.1.2 Definition of the MMTel Information

MMTel specific charging information is provided within the MMTel Information, and the detailed structure of the MMTel Information can be found in table 6.3.1.2.1

Table 6.3.1.2.1 : Structure of the MMTel Information

Information Element	Category	Description
Supplementary Service	O _M	This is a grouped field comprising several sub-fields associated with one supplementary service. It can be present multiple times as necessary to present the parallel activity of the different supplementary services.
Service Type	O _M	This field holds the type of the Supplementary Service, i.e. OIP, OIR, TIP, TIR, CW, HOLD, CB, MWI, CONF, CDIV, ECT, FA, MCID, CAT, CUG, PNM, CRS, AoC.
Service Mode	O _C	This field holds the mode of specific Service Type, i.e. for CB: ACR, ICB, OC, Bfor CDIV: CFU, CFB, CFNR, CFNRC, CFNL, CFUDB and for CONF: 3PTY, AoC-S, AoC-D, AoC-E.
Number of diversions	O _C	This field holds the number of diversions for CDIV.
Associated party address	O _C	This field holds additional party identification needed for the service charging, i.e. for CDIV the "forwarding party", for ECT the "transferor", for FA the "Pilot Identity", for 3PTY the "Initiator party".
Service id	O _C	This field holds the conference ID for CONF supplementary service
Change Time	O _C	This field holds the time of the requested action indicated in the "Participant Action Type" during the CONF supplementary service. It provides the time stamps for the CONF supplementary service parameters reporting. When the action is set to "CREATE", this field indicates the start time of the CONF supplementary service. When the action is set to "QUIT" and Number Of Participants holds the value "0", this field indicates the end time of the CONF supplementary service.
Number Of Participants	O _C	This field holds the number of parties who are currently attached to the Conference at the time stamped indicated in the "Change Time", for the CONF supplementary service.
Participant Action Type	O _C	This field holds the participant action type for CONF supplementary service (CREATE_CONF, JOIN_CONF, INVITE_CONF, QUIT_CONF) at the time stamped indicated in the "Change Time".
CUG Information	O _C	This field holds the CUG information conveyed by the Network and identifies the CUG-communication : it is the "CUG Interlock Code" .
AoC information	O _C	This field holds the AoC related Charging information conveyed to CDF, as defined in TS 32.280 [69] Since AoC information may be sent more than once (e.g for AoC-S), this field may be multiple.

6.3.1.3 Support of MMTel Information in MMTel offline charging

In table 6.3.1.3.1, the supported Operation Types for Service Type field within the MMTel Information on the Rf interface are presented. The other MMTel Information fields are not detailed.

The supported Operation Types for Service Information fields, used in the Charging Data Request and Charging Data Response messages for MMTel charging, other than MMTel Information fields, are described in TS 32.260 [20].

Operation Types for Service Type, encompasses the various situations, where the basic MMTel service Charging Data Request messages are sent from:

- a separate entity (another AS or S-CSCF), than the AS implementing the supplementary service;
- the same AS.

Each service may be reported through a dedicated Charging Data Request Message or combined Charging Data Request Messages (regrouped supplementary services or with basic MMTel service).

Table 6.3.1.3.1: Supported values for Service Type in MMTel Information

Information Element	Node Type	AS
	Supported Operation Types	S//S/E
Service Type		
OIP (see note 1)		SISE
OIR		SISE
TIP		SISE
TIR (see note 2)		SISE
CW		SISE
HOLD (see note 3)		SISE
CB (see note 2)		---E
MWI		---E
CAT		SISE
CCBS		SISE
CCNR		SISE
CONF		SISE
CDIV		SISE
ECT		SISE
FA		SISE
MCID		SISE
CUG		SISE
PNM		SISE
CRS		SISE
AoC		SISE
NOTE 1: Only present at terminating side.		
NOTE 2: Terminating side service.		
NOTE 3: AS may be involved for announcement purposes.		

6.3.1.4 Support of MMTel Information in MMTel online charging

In table 6.3.1.4.1 the basic structure of the supported fields within the MMTel Information in the Debit and Reserve Units Request for IMS online charging on the Ro interface are presented. The Operation types are listed in the following order: I (initial)/U (update)/T (terminate)/E (event). Therefore, when all Operation types are possible it is marked as IUTE. If only some Operation types are allowed for a node, only the appropriate letters are used (i.e. IUT or E) as indicated in the table heading. The omission of an Operation type for a particular field is marked with "-" (i.e. IU-E). Also, when an entire field is not allowed in a node the entire cell is marked as "-".

Table 6.3.1.4.1: Supported values in Debit / Reserve Units Request message MMTel Information

Information Element	
Node Type	AS
Supported Operation Types	I/U/T/E
Service Type	
OIP (see note)	-
OIR (see note)	-
TIP (see note)	-
TIR (see note)	-
CW (see note)	-
HOLD (see note)	-
CB (see note)	-
MWI (see note)	-
CAT (see note)	-
CCBS (see note)	-
CCNR (see note)	-
CONF	IUTE
CDIV	IUT-
ECT	IUT-
MCID (see note)	-
PNM (see note)	-
FA	IUT-
CUG	IUT-
CRS (see note)	-
AoC (see note)	-
NOTE: Only reported in offline charging.	

Annex A (informative): Bibliography

a) **The 3GPP charging specifications**

- 3GPP TS 32.250: "Telecommunication management; Charging management; Circuit Switched (CS) domain charging".
- 3GPP TS 32.251: "Telecommunication management; Charging management; Packet Switched (PS) domain charging".
- 3GPP TS 32.252: "Telecommunication management; Charging management; Wireless Local Area Network (WLAN) charging".
- 3GPP TS 32.270: "Telecommunication management; Charging management; Multimedia Messaging Service (MMS) charging".
- 3GPP TS 32.271: "Telecommunication management; Charging management; Location Services (LCS) charging".
- 3GPP TS 32.272: "Telecommunication management; Charging management; Push-to-talk over Cellular (PoC) charging".
- 3GPP TS 32.273: "Telecommunication management; Charging management; Multimedia Broadcast and Multicast Service (MBMS) charging".
- 3GPP TS 32.274: "Telecommunication management; Charging management; Short Message Service (SMS) charging".
- 3GPP TS 32.276: "Telecommunication management; Charging management; Voice Call Service Charging".
- 3GPP TS 32.293: "Telecommunication management; Charging management; Proxy Function".

b) **Common 3GPP specifications**

- 3GPP TS 23.003: "Numbering, addressing and identification".
- 3GPP TS 27.001: "General on Terminal Adaptation Functions (TAF) for Mobile Stations (MS)".

c) **other Domain and Service specific 3GPP / ETSI specifications**

- 3GPP TS 22.002: "Circuit Bearer Services (BS) supported by a Public Land Mobile Network
- 3GPP TS 22.003: "Circuit Teleservices Supported by a Public Land Mobile Network (PLMN)".
- 3GPP TS 22.004: "General on Supplementary Services".
- 3GPP TS 23.009: "Handover procedures"
- 3GPP TS 23.040: "Technical realization of the Short Message Service (SMS)".
- 3GPP TS 23.140: "Multimedia Messaging Service (MMS); Functional description; Stage 2".
- 3GPP TS 23.271: "Location Services (LCS); Functional description; Stage 2".

d) **Relevant ITU Recommendations**

- ITU-T Recommendation E.164: "The international public telecommunication numbering plan".
- ITU-T Recommendation Q.767: "Application of the ISDN user part of CCITT signalling System No.7 for international ISDN interconnections".

- ITU-T Recommendation X.25: "Interface between Data Terminal Equipment (DTE) and Data Circuit-terminating Equipment (DCE) for terminals operating in the packet mode and connected to public data networks by dedicated circuit".
- ITU-T Recommendation X.121: "International numbering plan for public data networks".

e) **Relevant IETF RFCs**

- IETF RFC 959 (1985): "File Transfer Protocol".
- IETF RFC 1350 (1992): "The TFTP Protocol (Revision 2)".

Annex B (informative): Change history

Change history								
Date	TSG #	TSG Doc.	CR	Rev	Subject/Comment	Cat	Old	New
Sep 2008	--	--	--	--	Presentation to SA Plenary		0.2.0	1.0.0
Mar 2009	SA-43	SP-090058	--	--	Presentation to SA for approval		2.0.0	8.0.0
Jun 2009	SA-44	SP-090432	005	--	Correction of offline charging message flow of Communications Diversion (CDIV) service	F	8.0.0	8.1.0
Jun 2009	SA-44	SP-090432	007	--	Correction of offline charging message flow of Explicit Communication Transfer (ECT) service	F	8.0.0	8.1.0
Jun 2009	SA-44	SP-090432	012	--	Clarification on MMTel charging architecture	F	8.0.0	8.1.0
Jun 2009	SA-44	SP-090294	1	-	Add "Flexible Alerting" MMTel supplementary service Charging description			
Jun 2009	SA-44	SP-090294	2	-	Basic principles description for MMTel online charging	B	8.1.0	9.0.0
Jun 2009	SA-44	SP-090294	3	-	R9 CR Add CCNR in MMTel Charging	B	8.1.0	9.0.0
Jun 2009	SA-44	SP-090294	4	-	R9 CR Add CCNR in MMTel Charging	B	8.1.0	9.0.0
Jun 2009	SA-44	SP-090294	6	-	Add MMTel CDIV online charging scenario	B	8.1.0	9.0.0
Jun 2009	SA-44	SP-090294	8	-	Add CCBS and CCNR MMTel supplementary services in Scope chapter. Small cleanups	B	8.1.0	9.0.0
Jun 2009	SA-44	SP-090294	9	-	Add "Malicious Communication Identification (MCID)" MMTel supplementary service Charging description	B	8.1.0	9.0.0
Jun 2009	SA-44	SP-090294	10	-	Add "Customized Alerting Tone (CAT)" MMTel supplementary service Charging description	B	8.1.0	9.0.0
Jun 2009	SA-44	SP-090294	11	-	Add "Closed User Group (CUG)" MMTel supplementary service Charging description	B	8.1.0	9.0.0
Jun 2009	SA-44	SP-090294	13	-	Add "Flexible Alerting" MMTel supplementary service Online Charging scenario	B	8.1.0	9.0.0
Jun 2009	SA-44	SP-090294	14	-	Add "Closed User Group (CUG)" MMTel supplementary service Online Charging scenario	B	8.1.0	9.0.0
Sep-2009	SA-45	SP-090538	16	-	Aligning MMTel Charging error cases with TS 32.260 IMS Charging	A	9.0.0	9.1.0
Sep-2009	SA-45	SP-090538	17	-	Refinement on CUG information in MMTel information	F	9.0.0	9.1.0
Sep-2009	SA-45	SP-090538	19	-	Setting for Operation Types related to "service type" values in ACR for MMTel charging	A	9.0.0	9.1.0
Sep-2009	SA-45	SP-090538	20	-	Add 3PTY MMTel supplementary service charging	B	9.0.0	9.1.0
Sep-2009	SA-45	SP-090538	21	-	Clarification on generic behaviour for Supplementary services Online Charging description	C	9.0.0	9.1.0
Dec 2009	SA-46	SP-090722	22	-	Add "Conference (CONF)" MMTel supplementary service Online Charging scenario	B	9.1.0	9.2.0
Dec 2009	SA-46	SP-090722	23	-	MMTel Online charging scenarios simplification – IMS-GWF interaction removal	C	9.1.0	9.2.0
Dec 2009	SA-46	SP-090722	24	-	Add "CONF (3PTY)" MMTel supplementary service Online Charging scenario	B	9.1.0	9.2.0
Dec 2009	SA-46	SP-090722	25	-	Add Messages description for MMTel Online Charging	B	9.1.0	9.2.0
Mar 2010	SA-47	SP-100044	26	-	Add "Explicit Communication Transfer (ECT)" MMTel supplementary service Online Charging scenario	B	9.2.0	9.3.0
Mar 2010	SA-47	SP-100040	28	-	Correction on MMTel CDR description for Ealy SDP - Alignment with TS 32.260	A	9.2.0	9.3.0
Mar 2010	SA-47	SP-100040	30	-	Correction in MMTel Charging for session priority - Alignment with TS 32.260	A	9.2.0	9.3.0
Mar 2010	SA-47	SP-100044	31	-	Add "Personal Network management" MMTel supplementary service charging description.	B	9.2.0	9.3.0
Mar 2010	SA-47	SP-100044	32	-	Add "Customized Ringing Signal (CRS)" MMTel supplementary service charging description	B	9.2.0	9.3.0
Mar 2010	SA-47	SP-100044	33	-	Add "Reverse Charging" MMTel supplementary service Charging not supported	B	9.2.0	9.3.0
Mar 2010	SA-47	SP-100044	34	-	Completion for Supported values setting for MMTel Information - Online Charging	B	9.2.0	9.3.0
Sep 2010	SA-49	SP-100496	036	--	Correction to Message Sequence Chart for Offline Charging of CW Service	A	9.3.0	9.4.0
Sep 2010	SA-49	SP-100497	037	--	Correction to Support of MMTel Information in MMTel Online Charging	F	9.3.0	9.4.0
Dec 2010	SA-50	SP-100758	038	2	Correction of Communication session Barring (CB) to support MMTel Information in MMTel Offline Charging	F	9.4.0	9.5.0
Dec 2010	SA-50	SP-100758	039	2	Correction of Communication Waiting (CW) Charging Flow	F	9.4.0	9.5.0
Mar 2011	SA-51	SP-110109	42	1	MMTel Charging enhancement for alignment with generic AS Charging description in TS 32.260	C	9.5.0	10.0.0
Mar 2011	SA-51	SP-110112	40	1	Add 'Advice Of Charge (AoC)' MMTel supplementary service Charging description - Align with 22.173	B	9.5.0	10.0.0
Mar 2011	SA-51	SP-110109	41	1	Correction on Subscriber role	F	9.5.0	10.0.0

2012-09	-	-	-	-	Update to Rel-11 version (MCC)	-	10.0.0	11.0.0
2012-12	SA-58	SP-120793	42	1	Single charging session applicability to MMTel	B	11.0.0	11.1.0
2013-03	SA-59				Changes from SA-59 implemented		11.1.0	11.2.0
2013-04					History table correction by MCC		11.2.0	11.2.1
2013-09	SA-61	SP-130464	44	1	Correct use of PS information elements	F	11.2.1	11.3.0
		SP-130437	47	-	Correction on MMTel Online Charging	A	11.2.1	11.3.0
2014-06	SA-64	SP-140336	52	1	assured transfer charging discription	B	11.3.0	12.0.0
2014-07	-	-	-	-	Rapporteur/MCC: General editorial changes and clean-up.	-	12.0.0	12.0.1
2014-09	SA-65	SP-140564	57	1	Corrections for alignment between charging specifications	F	12.0.1	12.1.0
		SP-140561	58	1	Removal of CDIVN service	A		

History

Document history		
V12.1.0	October 2014	Publication